

MOOG®

CATMO1901

2019-2020

STEERING & SUSPENSION COMMERCIAL VEHICLES

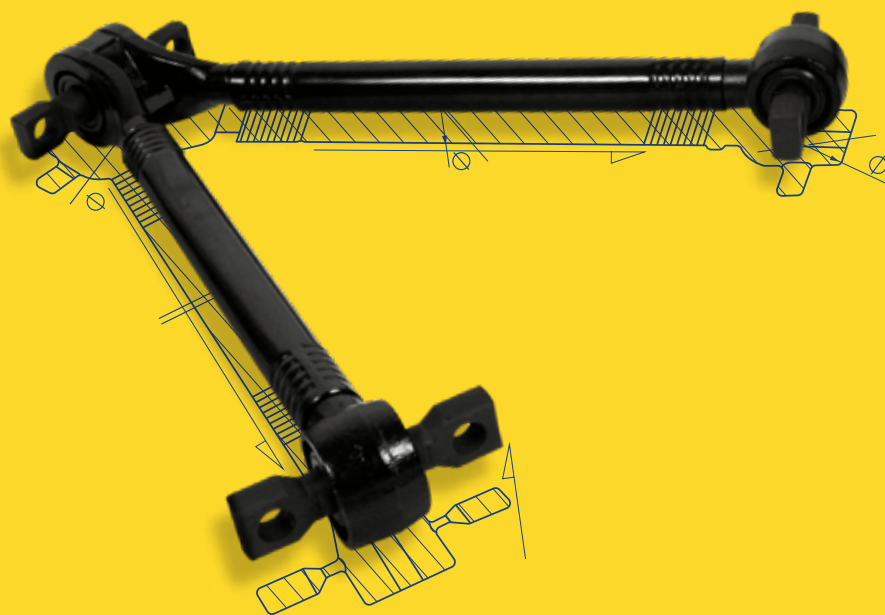

Pièces de Direction et Suspension pour Poids Lourds ■ Lenkungs- und Fahrwerksteile für Nutzfahrzeuge ■ Dirección y suspensión para vehículos industriales ■ Soluzioni sterzo e sospensioni per veicoli commerciali ■ Stuur- en ophangingsonderdelen voor bedrijfswagens ■ Układy kierownicze i zawieszenia do samochodów ciężarowych ■ Детали рулевой системы и подвески для коммерческих автомобилей ■ Σύστημα Διεύθυνσης και Ανάρτηση Επαγγελματικών Οχημάτων ■ Direção e Suspensão para Veículos Comerciais ■ Řízení a zavěšení pro užitková vozidla ■ Componente de direcție și suspensie pentru vehicule comerciale ■ Kormánymű- és felfüggesztési alkatrészek a haszon-gépjárművek számára ■ Управление и окачивание за товарни автомобили ■ Krmiljenje in vzmetenje za gospodarska vozila

QUALITY AND SAFETY FIRST AT MOOG®

Chassis components play a vital role in keeping vehicles stable, ensuring predictable handling and safe operation throughout a vehicle's lifetime. Today, the majority of commercial vehicles in Europe weigh over 16 tonnes (and some as much as 30 tonnes), so the loads and stresses that a truck's chassis must cope with are huge. Because we understand this, all MOOG® parts meet or exceed OE quality standards and undergo rigorous testing to ensure that they offer the highest quality and reliability.

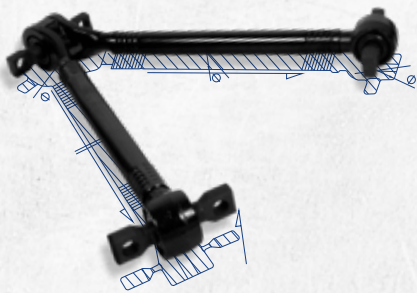

PRODUCT IS KEY

MOOG parts are designed, produced and tested to withstand extreme situations. Our engineers use the original equipment as the master to develop all MOOG products. The metallurgy and geometry of every original part is identified, measured and improved whenever possible. Next, every product is subjected to extensive testing to ensure optimal performance and maximum durability.



EASY TO INSTALL

With over 1.000 references, MOOG offers an extensive range of Steering & Suspension parts for trucks and busses. We keep in touch with market needs through continuous new product introductions. Every single MOOG part comes with all the necessary hardware and accessories. In addition, repair kits and pre-assembled parts are also available to ensure a perfect and hassle-free installation.

MOOG®

WE'RE PROBLEM SOLVERS

We know that your time is precious, so at MOOG, we offer you a wide range of tools to make your life easier and save you time. We have industry-leading online and offline catalogues, an online training centre and training videos. We back these up with our solution and technical bulletins, newsletter and e-mail alerts. Not to mention the MOOG quality check and much more...

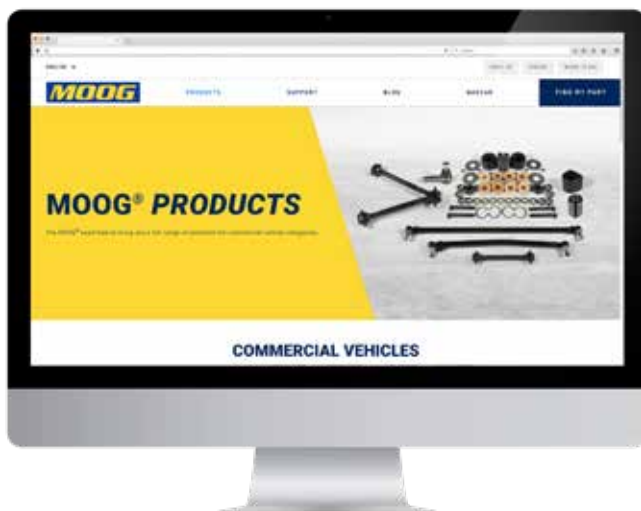

INDEX

**1 > 3279**

DAF.....	2
ERF.....	310
IRISBUS.....	312
IRIZAR.....	312
IVECO.....	314
MAN.....	464

MERCEDES-BENZ.....	1584
NEOPLAN.....	2642
RENAULT TRUCKS.....	2644
SCANIA.....	2872
SETRA.....	3116
VOLVO.....	3120

**3280 > 3292****OE****MOOG****3293 > 3305****??****MOOG****3306 > 3311**

21



MERCEDES-BENZ ...

ACTROS MP2 / MP3 ...

1846 LS, LLS ...	04/03 →	Tie Rod	DB-DL-8389		
	04/03 →	Tie Rod	DB-DL-8640		Guide Rod
	04/03 →	Tie Rod	DB-DL-12310		
	04/03 →	Tie Rod	DB-ES-5227		Guide Rod
	04/03 →	Tie Rod End	CV-ES-0543		for Push Rod
	04/03 →	Tie Rod End	CV-ES-0888		for Push Rod
	04/03 →	Tie Rod End	CV-ES-14162		for Steering Rod
	04/03 →	Tie Rod End	CV-ES-14163		for Steering Rod
	04/03 →	Tie Rod End	DB-ES-5234		for Steering Rod
	04/03 →	Tie Rod End	DB-ES-8164		for Push Rod
	04/03 →	Tie Rod End	DB-ES-8530		for Push Rod
	04/03 →	Track Control Arm		DB-TC-12410	Control Arm
	04/03 →	Track Control Arm		DB-VB-7798	Wishbone (CV), Air Suspension Axle, * K 864074 * →
	04/03 →	Track Control Arm		DB-VB-10425	Wishbone (CV)
	04/03 →	Track Control Arm	DB-DL-5224		Control Arm, 1st FA; Air Suspension Axle
	04/03 →	Track Control Arm	DB-DL-9218	DB-DL-9218	Trailing Arm, 1st FA; Air Suspension Axle
1846, L, LL	04/03 →	Ball Head, gearshift linkage	DB-ES-8510		
	04/03 →	Bush, driver cab suspension	DB-SB-10384		
	04/03 →	Centre Rod	DB-DL-2144		Push Rod
	04/03 →	Centre Rod	DB-DL-5230		Suspension Rod
	04/03 →	Centre Rod	DB-DL-5241		Push Rod
	04/03 →	Centre Rod	DB-DL-5405		Push Rod
	04/03 →	Centre Rod	DB-DL-5405		Push Rod, Leaf Spring Axle
	04/03 →	Centre Rod	DB-DL-7270		Push Rod
	04/03 →	Centre Rod	DB-DL-8167		Push Rod



CV-ES-0543

Length: 125
 Cone Ø: d1 Ø 32 / d2 Ø 29
 Thread: M30 x 1,5 RHT
 0004605748, 0004606048, 0004606848,
 0004607048, 0014600448, 0014601148,
 0014601748, 0014602448, 0014607648,
 0014608648



CV-ES-0888

Length: 125
 Cone Ø: d1 Ø 32 / d2 Ø 29
 Thread: M30 x 1,5 LHT
 0004605848, 0004606148, 0004606948,
 0004607148, 0004608048, 0014600548,
 0014601348, 0014602548, 0014607948,
 0024600448



CV-ES-14162

Length: 125
 Cone Ø: d1 Ø 30 / d2 Ø 27
 Thread: M30 x 1,5 LHT
 4600648, 4601248, 4603448,
 0004603548, 4603548, 14600348,
 14601448, 14602348, 0014603748,
 14607848, 0014607848, 0024600348



CV-ES-14163

Length: 125
 Cone Ø: d1 Ø 30 / d2 Ø 27
 Thread: M30 x 1,5 RHT
 0003305248, 0003387310, 0004600348,
 0004600948, 0004602848, 0004602948,
 0004606948, 0014600248, 0014600648,
 0014601248, 0014602248, 0014607748,
 0024600148, 0003387310, 0004600348,
 0004602848, 0004602948, 0014600848,

DB-DL-7270

Length: 875 Ø: 40
 Cone Ø: d1 Ø 28,6 / d2 Ø 23,9
 01208300A, 0024604705, 0024604805,
 0034604905, A0024604705



DB-DL-8167

Length: 866 Ø: 38
 Cone Ø: d1 Ø 30 / d2 Ø 27
 0014608805, 0014609905, 0024606305,
 0024606405



DB-DL-8168

Length: 904 Ø: 52
 Cone Ø: d1 Ø 32 / d2 Ø 29
 0004608405, 0004608505, 0014607105



DB-DL-8184

Length: 1095 Ø: 42
 Cone Ø: d1 Ø 32 / d2 Ø 28,8
 01217700A, 0014601305, 0014601405,
 0024600505, 0034603205, 3754601505,
 A0014601305, A0014601405, A0024600505



DB-DL-8185

Length: 711 Ø: 42
 Cone Ø: d1 Ø 32 / d2 Ø 28,8
 01213600A, 0014601105, 0024600405,
 0034605105, A0014601105, A0024600405



DB-DL-8307

Length: 885 Ø: 38

DB-DL-8641

Length: 905 Ø: 42
 Cone Ø: d1 Ø 30 / d2 Ø 27
 0014605105, 0014608105



DB-DL-8642

Length: 954 Ø: 42
 Cone Ø: d1 Ø 30 / d2 Ø 27
 0014608605, 0014608705



DB-DL-9218

Length: 754 Ø: 40
 Hole Distance: 100
 000360098524, 000390098524,
 3753300111, 9413300011,
 A3753300111, SA50831601



DB-DL-9254

Length: 1815 Ø: 58
 0003220823, 0003220823, 3753220423



DB-DL-12300

Length: 733 Ø: 36
 Cone Ø: d1 Ø 32 / d2 Ø 29
 0014601505, 0014607305, 0034603305,
 3754601605, A0014601505,
 A0034603305, A3754601605



DB-DL-12310

Length: 1532 Ø: 50
 Cone Ø: d1 Ø 32 / d2 Ø 29
 Thread: M32 x 1,5 LHT

DB-RK-8391

Ø: 85 Hole Distance: 152
 Thick/Height: 24
 01336800A, 0003502705



DB-RK-8550

Ø: 75 Hole Distance: 152
 Thick/Height: 24
 0003502105, 0003504605



DB-RK-8626

Ø: 75 Hole Distance: 130
 Thick/Height: 24
 0003502205, 0003502505, 0003503405,
 0003504505, GL11319



DB-RK-8638

Length: 100 Ø: 67
 Hole Distance: 100
 Thick/Height: 20
 0003301411



DB-RK-9294

Ø: 85 Hole Distance: 152
 Thick/Height: 24
 0003503105



DB-RK-9296

Ø: 88 Hole Distance: 130
 Thick/Height: 24
 9423260050

DB-VB-3707

Length: 622 Ø: 46
 Hole Ø 25 / 25 / 25
 Hole Distance: 152 / 130 / 130
 01337100A, 9423501005, 9423501505,
 9443500005, 9473500105, 9473501005,
 A3753500005, A9423501005, A9423501505,
 A9443500005, A9473500105, A9473501005



DB-VB-7798

Length: 622 Ø: 48
 Hole Ø 25 / 23 / 23
 Hole Distance: 152 / 130 / 130
 9423500505, 9423500805, 9423501205,
 A9423501205



DB-VB-10425

Length: 622 Ø: 46
 Hole Ø 25 / 23 / 23
 Hole Distance: 152 / 130 / 130
 9423500905, 9423501305



MOOG: YOUR ONE-STOP-SHOP, COVERING ALL MAJOR COMMERCIAL VEHICLE BRANDS AND PART TYPES

- DAF
- Iveco
- MAN
- Mercedes-Benz
- Renault
- Scania
- Volvo

The actual MOOG CV range offers more than 1000 parts, one of the widest in Steering & Suspension.



Tie Rod Ends / Ball Joints /
Ball Sockets / Gearshift Links /
Joint Shift Rods



Track Control Arms
Rods / Strut Stabilisers



V-Bars



Tie Rod Assemblies /
Tie Rods Steering



Bushings / Silent Blocks / Repair Kits /
Stabilisers Bushes /
Rubber Metal-bearings



Drag Links / Centre Rods /
Rod Assemblies

PART NUMBER STRUCTURE



MOOG	UK	F	D	ES	I	NL	PL	RU
1	TIE ROD ENDS	ROTULES DE DIRECTION	SPURSTANGEN-KÖPFE	RÓTULAS DE DIRECCIÓN	TESTE TIRANTE	STUURKOGELS	KOŃCÓWKI DRAŻKA KIEROWNICZEGO	РУЛЕВЫЕ НАКОНЕЧНИКИ
XX-BJ-1234 	Ball Joint	Rotule de suspension	Traggelenk	Rótula de suspensión	Snodo sferico	Kogelgewricht	Sworzeń kulowy	Шаровой шарнир
XX-ES-1234 	Tie Rod End, Threaded Sleeve, Gearshift link, Tie Rod Steering	Rotule de direction extérieure, Manchon fileté, Tringlerie de commande, Barre d'accouplement	Spurstangenkopf, Gewindebuchse, Schaltverbindung, Lenkstange	Rótula de dirección, camisa roscada, varilla de la transmisión, barra transversal	Teste tirante, Canotto filettato, Tirante cambio, Tirante sterzo	Stuurkogel, schroefdraadhuls, schakelstang, spoorstang stuurinrichting	Końcówka drążka kierowniczego, Tuleja gwintowana, Połączenie dźwigni zmiany biegów, Drążek kierowniczy	Рулевой наконечник, резьбовая муфта, тяга рычага переключения передач, рулевая тяга
2	TIE RODS, DRAG LINKS	BIELLETES, BARRES DE DIRECTION	SPURSTANGEN, LENKSCHUBSTANGEN	BARRAS TRANSVERSALES, BARRAS DE ACOPLAMIENTO	TIRANTI, TIRANTI LONGITUDINALI STERZO	SPOORSTANGEN, KOPPELINGSSTANGEN	DRAŻKI KIEROWNICZE	ПОПЕРЕЧНЫЕ РУЛЕВЫЕ ТЯГИ, ПРОДОЛЬНЫЕ РУЛЕВЫЕ ТЯГИ
XX-DL-1234 XX-DS-1234 	Tie Rod Assembly, Drag Link, Tie Rod Tube, Centre Rod, Rod-Strut Stabiliser	Biellette de direction, Barre de direction, Manchon de barre de direction, Bielle-Jambe, Stabilisateur	Spurstangen, Lenkschubstange, Spurstangenrohr, Zwischenstange, Stange/Strebe-Stabilisator	Conjunto de barra transversal, barra de acoplamiento, tubo de barra transversal, varilla central, estabilizador de barra transversal	Gruppi tirante, Tirante longitudinale sterzo, Tubo del tirante, Tirante centrale, Tirante barra stabilizzatrice	Spoorstang-eenheid, koppelingsstang, spoorstangbuis, middenstang, stabilisatorstang	Komplet drążka kierowniczego, Drążek środkowy, Tuleja drążka kierowniczego, Drążek-podpora stabilizatora	Поперечная рулевая тяга в сборе, продольная рулевая тяга, трубка поперечной рулевой тяги, центральная рулевая тяга, тяга стабилизатора
3	AXLE RODS, TORQUE RODS	BARRES D'ESSIEU, BARRES DE TORSION	ACHSSTANGEN, SCHUBSTREBEN	BARRAS DE EJE, BARRAS DE TORSIÓN	TIRANTI ASSIALI, TIRANTI DI REAZIONE	AXIAAL GEWRICHTEN, REACTIE-STANGEN	DRAŻKI OSIOWE, DRAŻKI PROWADZĄCE	ОСЕВЫЕ ШАРНИРЫ, РЕАКТИВНЫЕ ТЯГИ
XX-DL-1234 	Axial Rod, Torque Rod, Track Control Arm	Rotule de direction intérieure, barre de torsion, bras de suspension	Axialgelenk, Schubstrebe, Lenker	Varilla axial, barra de torsión, brazo estabilizador de suspensión	Tirante assiale, Braccio di reazione, Braccetto	Axiaal gewricht, reactiestang, ophangingsstang	Drążek osiowy, Drążek prowadzący, Wahacz drążkowy	Осевые шарнир, реактивная тяга, рычаг подвески



MOOG	GR	PT	CZ	RO	HU	BG	SL	AR
1	ΑΚΡΟΜΠΑΡΑ	RÓTULA DA BARRA DE DIRECÇÃO	KONCOVÉ ČEPY ŘÍZENÍ	CAPETE DE BARĂ	KORMÁN-YÖSSZEKÖTŐ GÖMBFEJEK	КОРМИЛЕН НАКРАЙК ВЪНШЕН	KONČNIK VOLANA	أطراف قضيب الربط
XX-BJ-1234 	Σφαιρικός σύνδεσμος	Articulação de suspensão/guia	Kulový kloub	Pivot	Gömbcsukló	Шарнир	Krogelni zgib	وصلة كروية
XX-ES-1234 	Ακρόμπαρο, Σπειροειδές περίβλημα, Σύνδεσμος συστήματος επιλογής ταχυτήτων, Ακρόμπαρο τιμονιού	Rótula da barra de direcção, Manga roscada, Tirante de mudanças, Direcção da barra de direcção	Koncový čep řízení, závitová objímka, táhlo řízení	Cap de bară, cămașă filetată, conexiune cutie de viteze, bară de direcție	Kormányösszekötő gömbfej, csavarmenetes persely, váltórudazat, kormányösszekötő rúd	Кормилен крайник, резбована втулка, щанга на механизма за превключване на скоростите, вътрешна кормилна щанга на рейката	Zglob jarmovega droga, navojna puša, končnik menjalnika, krmiljenje jarmovega droga	طرف قضيب الربط، جلبة مسننة، وصلة مغنير التروس، موجه قضيب الربط
2	ΑΚΡΟΜΠΑΡΑ, ΡΑΒΔΟΙ ΖΕΥΞΗΣ	BARRAS DE DIRECÇÃO, TIRANTES DA DIRECÇÃO	TÁHLA, TÁHLA ŘÍZENÍ	BARE DE DIRECȚIE, BARE DE COMANDĂ DIRECȚIE	KORMÁNYÖSSZEKÖTŐ RUDAK, KORMÁNYTOLÓRUDAK	КОРМИЛНИ НАКРАЙНИ, КОРМИЛНИ ЩАНГИ	JARMOVI DROGI, VLEČNI KONČNIK	قضبان الربط، وصلات السحب
XX-DL-1234 XX-DS-1234 	Συναρμογή Ακρόμπαρου, Ράβδος Ζεύξης, Σωλήνας Ακρόμπαρου, Κεντρική Ράβδος, Βραχίονας Σταθεροποίησης Μπάρας Τιμονιού	Conjunto da barra de direcção, Tirante da direcção, Tubo da barra de direcção-barra estabilizadora	Sestava táhla, táhlo řízení, trubka táhla, středová tyč, vzpěra stabilizátoru	Bieletă de direcție, bară de comandă direcție, țevă bară de direcție, stabilizator tijă-lonjeron	Összekötőrúd-szerelvény, kormánytolórúd, összekötőrúd-cső, középső rúd, rúd-rugóstag stabilizátor	Комплект външни кормилна щанга, кормилна щанга, тръба на кормилния крайник, централна щанга, биелетка	Sestav jarmovega droga, vlečni končnik, cev jarmovega droga, centralni drog, stabilizator drog-nosilec	مجموعة قضيب الربط، وصلة السحب، أنبوب قضيب الربط، القضيب المركزي، مثبت قائم القضيب
3	ΑΞΟΝΙΚΟΙ ΣΥΝΔΕΣΜΟΙ (ΗΜΙΜΠΑΡΑ), ΡΑΒΔΟΙ ΣΤΡΕΨΗΣ	HASTES DO EIXO, HASTES DE BINÁRIO	RAMENA NÁPRAVY, TORZNÍ TYČE	BARE DE OSIE, TENDOANE	TENGYELYRUDAK, TOLÓRUDAK	НАПРЕЧНИ И НАДЛЪЖНИ ЩАНГИ, НОСАЧИ	OSNI DROGI, VZVOJNE PALICE	القضبان المحورية قضبان عزم الدوران
XX-DL-1234 	Αξονικός Σύνδεσμος, Ράβδος Στρέψης, Βραχίονας Ελέγχου	Haste axial, Haste de binário, Braço oscilante, suspensão da roda	Axiální rameno, torzní tyč, příčné rameno nápravy	Bară axială, tendon, braț de suspensie	Tengelyrúd, tolórúd, kereszt-lengőkar	напречна щанга, надлъжна щанги, носач	Osni drog, vzvojna palica, prečno vodilo	قضيب محوري، قضيب عزم الدوران، ذراع التحكم في المسار

PART NUMBER STRUCTURE





MOOG	UK	F	D	ES	I	NL	PL	RU
4	V-TORQUE RODS	BARRES DE TORSION EN V	V-SCHUBSTREBEN	BARRAS DE TORSIÓN EN V	BRACCI DI REAZIONE A V	V-REACTIE-STANGEN	DRAŻKI PROWADZĄCE TYPU V	V-ОБРАЗНЫЕ РЕАКТИВНЫЕ ТЯГИ
XX- VB -1234 	V-Torque Rod, V-Bar, Triangular Torque Rod	Barre de torsion en V, Barre en V, Barre de torsion triangulaire	V-Schubstrebe, Dreieckslenker, Dreieck-schubstrebe	Barra de torsión en V, varilla en V, barra de torsión triangular	Braccio di reazione a V, V-bar, Braccio di reazione triangolare	V-reactiestang, V-stang, triangel-reactiestang	Drażki prowadzące typu V, Drażki typu V, Trójkątny drążek prowadzący	V-образная реактивная тяга, V-образная штанга, треугольная реактивная тяга
5	BUSHES, REPAIR KITS	SILENTBLOCS, KITS DE RÉPARATION	BUCHSEN, REPARATURSÄTZE	SILENTBLOCKS, KITS DE REPARACIÓN	BOCCOLE, KIT RIPARAZIONE	BUSSEN, REPARATIESETS	TULEJE, ZESTAWY NAPRAWCZE	ВТУЛКИ, РЕМОНТНЫЕ КОМПЛЕКТЫ
XX- SB -1234 	Silent Block, Bush (Spring Bracket), Engine/Rubber/Spring Mounting, Stabiliser Bearing-Bush, Trailing Arm Bush	Silentbloc, Douille (Main de ressort), Suspension moteur / caoutchouc/ressort, Bague-roulement de stabilisateur, Silentbloc de bras de suspension	Silentblock, Buchse (Federhalterung), Motor-/Gummi-/Federlagerung, Stabilisator-lagerbuchse, Längslenkerbuchse	Silentblock, casquillo (soporte de resorte), / de goma / del motor, conjunto de cojinete estabilizador, silentblock de la barra de torsión	Silent Block, Boccola (Staffa elastica), Montaggio Motore/ Gommino/ Molla, Boccola supporto stabilizzatore, Boccola braccio oscillante longitudinale	Silent block, bus (veersteun), motor/rubber/veer-bevestiging, stabilisator-lagerbus, langs draagarmbus	Silent-block, Tuleja (wspornik sprężysty) Silnik/Guma/ Sprężyna mocująca, Tuleja łożyskowa stabilizatora, Tuleja końcowa wahacza	Сайлент-блок, втулка (кронштейн рессоры), кронштейн двигателя/ резиновой опоры/ пружины, втулка подшипника стабилизатора, втулка продольного рычага подвески
XX- RK -1234 	Repair Kit, Repair Kit link, Ball Pin	Kit de réparation, Kit de réparation de barre, Queue à rotule	Reparatursatz, Reparatursatz-verbinding, Kugelzapfen	Kit de reparaciones, varilla del kit de reparaciones, perno esférico	Kit riparazione, Kit riparazione tirante, Perno sferico	Reparatiekit, reparatiekit draagarm, kogelpen	Zestaw naprawczy, Zestaw naprawczy łącznika, Sworzeń kulowy	Ремонтный комплект, ссылка на ремонтный комплект, шаровой палец



MOOG	GR	PT	CZ	RO	HU	BG	SL	AR
4	ΡΑΒΔΟΙ ΣΤΡΕΨΗΣ V	HASTES DE BINÁRIO EM V	TORZNÍ TYČE TVARU V	TENDOANE V	V TOLÓRUDAK	V-ОБРАЗНИ НОСАЧИ	V-VZVOJNE PALICE	V قضبان عزم الدوران
XX- VB -1234 	Ράβδος Στρέψης V, Μπάρα V, Τριγωνική Ράβδος Στρέψης	Haste de binário em V, Barra em V, Haste de binário triangular	Torzni tyč tvaru V, V-tyč, trojúhelníková torzní tyč	Tendon V, bară V, Tendon triunghiular	V tolórúd, V rúd, háromszögű tolórúd	V-образен торсиалиен носач, V-образен носач, Триъгален носач	V-vzvojna palica, V-palica, trikotna vzvojna palica	قضيب عزم الدوران على شكل حرف V, قضيب عزم الدوران مثلثي
5	ΕΛΑΣΤΙΚΟΙ ΤΡΙΒΕΙΣ, ΚΙΤ ΕΠΙΣΚΕΥΩΝ	CASQUILHOS, KITS DE REPARAÇÃO	POUZDRA, OPRAVÁRENSKÉ SADY	BUCȘI, SETURI DE REPARAȚIE	PERSELYEK, JAVÍTÓKÉSZLETEK	ВТУЛКИ, РЕМОНТНИ КОМПЛЕКТИ ЗА ОКАЧВАНЕТО	PUŠE, KOMPLET ZA POPRAVILO	الجب ومعدات الإصلاح
XX- SB -1234 	Ελαστικός τριβέας (Σινεμπλόκ), Ελαστική Βάση Σταθεροποίησης (Βάση Συγκράτησης Ελατηρίου), Βάσεις Κινητήρα / Αποσβεστήρα / Ελατηρίου, Ελαστικός Τριβέας Σταθεροποίησης, Ελαστικός Τριβέας Βραχίονα Ρυμούλκας.	Sinobloco, Casquilho (Suporte de mola), Montagem da mola/borracha/motor, Casquilho do rolamento estabilizador, Casquilho do braço oscilante	Silentblok, pouzdro, motor/silentblok/ pružné uložení, ložiskové pouzdro stabilizátoru, pouzdro vlečného ramene	Silentbloc, bucsă (suport cu arc), prindere motor/din cauciuc/cu arc, rulment-bucșă stabilizator, bucsă braț longitudinal	Szilentblokk, csapágy (rugóbak), motor-/gumis/rugós rögzítés, stabilizátor csapágyper-selye, hosszszel-gőkar perselye	гумено-метална втулка, гумени втулки, Тампони на двигател / Тампони за пружини, втулките за стабилизиращата щанга, втулка за носач	Silent blok, puša (nosilec vzmeti), nosilec motorja/gumijasti/vzmeti, puša ležaja stabilizatorja, puša prečnega vodila	كتلة صامتة، جلبة (نايض)، محرك/مطاط/ مثبت زنيكري/جلبة تحميل / مثبت، جلبة الذراع الحلفي
XX- RK -1234 	Κιτ Επίσκευής, Σύνδεσμος Κιτ Επίσκευής, Σφαιρικός Πείρος	Kit de reparação, União do kit de reparação, Cavilha de esfera	Oprávérenská sada, táhlo ze sady pro opravu, kulový čep	Set reparație, braț set reparație, bolt cu cap sferic	Javítőkészlet, összekötőrúd javítőkészlete, gömbcsap	Ремонтни комплекти, Ремонтни комплекти за накрайници на кормилната рейка, ремонтен шарнирен болт	Komplet za popravilo, komplet za popravilo končnika, kroglasti sornik	معدات إصلاح / وصلة معدات الإصلاح، مسمار كروي

GLOSSARY

MOOG	UK	F	D	ES	I	NL	PL	RU
GLOSSARY	GLOSSARY	GLOSSAIRE	GLOSSAR	GLOSARIO	GLOSSARIO	WOORDEN-LIJST	SŁOWNIK	ГЛОССАРИЙ
Cones	Cones	Cônes	Konus	Conos	Coni	Conussen	Stożki	Конусы
	Diameter	Diamètre	Durchmesser	Diámetro	Diametro	Diameter	Średnica	Диаметр
	Cone Diameter	Diamètre du cône	Konusdurchmesser	Diámetro del cono	Diametro cono	Conus-diameter	Stożek Średnica	Диаметр конуса
d 1	Diameter 1	Diamètre 1	Durchmesser 1	Diámetro 1	Diametro 1	Diameter 1	Średnica 1	Диаметр 1
d 2	Diameter 2	Diamètre 2	Durchmesser 2	Diámetro 2	Diametro 2	Diameter 2	Średnica 2	Диаметр 2
Bore	Bore	Alésage	Bohrung	Agujero	Alesaggio	Boring	Średnica	Внутренний диаметр
Hole	Hole	Trou	Loch	Orificio	Foro	Gat	Otwór	Отверстие
Hole distance	Hole distance	Distance du trou	Lochabstand	Distancia del orificio	Interasse fori	Gatafstand	Otwór odległość	Расстояние между отверстиями
Left	Left	Gauche	Links	Izquierda	Sinistra	Links	Lewy	Левый
Left hand drive	Left hand drive	Conduite à gauche	Linkslenker	Conducción a la izquierda	Guida a sinistra	Linksgestuurd voertuig	Kierownica po lewej stronie	Автомобиль с левосторонним управлением
LHT	Left hand thread	Filetage à gauche	Linksgewinde	Roscado a izquierdas	Filetto sinistrorso	Linkse schroefdraad	Gwint lewy	Левая резьба
Length	Length	Longueur	Länge	Longitud	Lunghezza	Lengte	Długość	Длина
	Length	Longueur	Länge	Longitud	Lunghezza	Lengte	Długość	Длина
Pipe	Pipe	Tuyau	Rohr	Conducto	Tubo	Leiding	Przewód	Труба
Position	Position	Position	Position	Posición	Posizione	Positie	Położenie	Положение
Right	Right	Droite	Rechts	Derecha	Destra	Rechts	Prawy	Правый
Right hand drive	Right hand drive	Conduite à droite	Rechtslenker	Conducción a derecha	Guida a destra	Rechts-gestuurd voertuig	Kierownica po prawej stronie	Автомобиль с правосторонним управлением
RHT	Right hand thread	Filetage à droite	Rechts-gewinde	Roscado a derechas	Filetto destrorso	Rechtse schroefdraad	Gwint prawy	Правая резьба
Taper	Taper	Cône	Konizität	Conicidad	Conicità	Taps	Stożkowy	Конус
Thickness	Thickness	Épaisseur	Stärke	Grosor	Spessore	Dikte	Grubość	Толщина
Thread	Thread	Filetage	Gewinde	Rosca	Filetto	Schroefdraad	Gwint	Резьба
Various trucks	Various trucks	Camions divers	Verschiedene Lkw	Diferentes camiones	Autocarri vari	Verschillende vrachtwagens	Różne ciężarówki	Различные грузовые автомобили

MOOG	GR	PT	CZ	RO	HU	BG	SL	AR
GLOSSARY	ΓΛΩΣΣΑΡΙ	GLOSSÁRIO	SLOVNÍK	GLOSAR	SZÓJEGYZÉK	КРАТЪК РЕЧНИК	SLOVAR	
Cones	Κώνοι	Cones	Kužele	Conuri	Kúpok	Конуси	Stožci	مخاريط
\varnothing	Διάμετρος	Diâmetro	Průměr	Diametru	Átmérő	Диаметър	Premer	قطر
	Διάμετρος κώνου	Diâmetro do cone	Průměr kužele	Diametru con	Kúp átmérője	Диаметър на конуса	Premer stožca	قطر المخاريط
d 1	Διάμετρος 1	Diâmetro 1	Průměr 1	Diametru 1	1. átmérő	Диаметър 1	Premer 1	القطر 1.
d 2	Διάμετρος 2	Diâmetro 2	Průměr 2	Diametru 2	2. átmérő	Диаметър 2	Premer 2	القطر 2.
Bore	Διαμέτρηση	Furo	Vrtání	Alezaj	Furat	Диаметър на отвора	Vrtina	قطر داخلي
Hole	Οπή	Furo	Otvor	Gaură	Lyuk	Отвор	Luknja	تجويف
Hole distance	Απόσταση οπών	Distância do furo	Vzdálenost otvorů	Distanță gaură	Lyuktávolság	Отстояние на отвора	Razdalja luknje	مساحة التجويف
Left	Αριστερά	Esquerda	Vlevo	Stânga	Bal	Ляво	Levo	أيسر
Left hand drive	Αριστεροτίμονο	Volante à esquerda	Levostranné řízení	Volan pe stânga	Balkormányos jármű	Ляв волан	Volan na levi	عجلة القيادة جهة اليسار
LHT	Αριστερόστροφο σπείρωμα	Rosca esquerda	Levotočivý závit	Filet pe stânga	Balmenet	лява резба	Levi navoj	سن أيسر اللولب
Length	Μήκος	Comprimento	Délka	Lungime	Hossz	Дължина	Dolžina	الطول
	Μήκος	Comprimento	Délka	Lungime	Hossz	Дължина	Dolžina	الطول
Pipe	Αγωγός	Tubo	Trubka	Conductă	Cső	Тръба	Cev	أنبوب
Position	Θέση	Posição	Pozice	Poziție	Helyzet	Положение	Položaj	وضع
Right	Δεξιά	Direita	Vpravo	Dreapta	Jobb	Дясно	Desno	أيمن
Right hand drive	Δεξιότιμονο	Volante à direita	Pravostranné řízení	Volan pe dreapta	Jobbkormányos jármű	Десен волан	Volan na desni	عجلة القيادة جهة اليمين
RHT	Δεξιόστροφο σπείρωμα	Rosca direita	Pravotočivý závit	Filet pe dreapta	Jobbmenet	дясна резба	Desni navoj	سن أيمن اللولب
Taper	Σφηνοειδής	Conicidade	Kužel	Conic	Kúpos	Конусност	Stožec	نوع
Thickness	Πάχος	Espessura	Tloušťka	Grosime	Vastagság	Дебелина	Debelina	السماك
Thread	Σπείρωμα	Rosca	Závit	Filet	Menet	Резба	Navoj	سن
Various trucks	Διάφορα φορτηγά	Diversos veículos pesados	Různé nákladní automobily	Diverse camioane	Több teherautó	Различни камиони	Različni tovornjaki	شاحنات متعددة

TERMS OF BUSINESS

EN - TERMS OF BUSINESS

Orders are accepted subject to our Terms and Conditions which are available from Federal-Mogul Aftermarket and Tenneco Motorparts. Part numbers, vehicle model and engine details change from time to time and although the information contained in the catalogues was, to the best of our knowledge, accurate at the time of compilation and publication, Federal-Mogul cannot accept responsibility for any inaccuracies and subsequent changes to the information provided.

FR - CLAUSES COMMERCIALES

Les commandes sont soumises à nos conditions générales de ventes, lesquelles sont disponibles auprès de Federal-Mogul Aftermarket France et Tenneco Motorparts. Les références des pièces ou les renseignements concernant les modèles ou les moteurs sont susceptibles de subir des modifications de temps en temps. Et bien que toutes les informations figurant dans ce catalogue proviennent de sources authentiques, et étaient exactes, à notre connaissance, au moment de la publication, Federal-Mogul n'acceptera aucune responsabilité dans le cas où ces indications se révéleraient inexactes.

DE - GESCHÄFTSBEDINGUNGEN

Aufträge werden auf der Grundlage der allgemeinen Geschäftsbedingungen entgegengenommen. Diese erhalten Sie von: Federal-Mogul Aftermarket und der Tenneco Motorparts. Teilenummern, Angaben zum Fahrzeugmodell und Motor ändern sich laufend. Die Informationen in diesem Katalog waren zum Zeitpunkt der Zusammenstellung und Veröffentlichung korrekt. Federal-Mogul ist jedoch nicht verantwortlich für fehlerhafte Angaben und die daraus resultierenden veränderten Informationen.

ES - CONDICIONES COMERCIALES

Todos los pedidos están sujetos a las condiciones generales de venta disponibles de Federal-Mogul Aftermarket y Tenneco Motorparts. Las referencias, modelo de vehículo y detalles del motor están sujetos a cambios y modificaciones sin previo aviso del constructor, aunque la información contenida en este catálogo es, según nuestro leal saber y entender correcta a la hora de su recopilación y publicación, Federal-Mogul no acepta responsabilidad alguna por cualquier inexactitud o cambios subsiguientes a la información provista.

I - CONDIZIONI GENERALI DI VENDITA

Ogni ordine è soggetto alle condizioni generali di vendita di Federal-Mogul Aftermarket e Tenneco Motorparts. Sebbene le informazioni contenute in questo catalogo siano state verificate, Federal-Mogul non si assume responsabilità per eventuali errori o modifiche successive relativamente alle informazioni fornite.

NL - HANDELSVOORWAARDEN

Bestellingen worden aanvaard volgens onze standaard verkoopvoorwaarden die kunnen worden verkregen bij Federal-Mogul Aftermarket en Tenneco Motorparts. Artikelnummers, voertuigmodellen en motorgegevens wijzigen soms. De informatie in de catalogi werd naar best vermogen opgenomen en was accuraat op het ogenblik van de samenstelling en publicatie van deze catalogi. Federal-Mogul kan niet verantwoordelijk worden gesteld voor eventuele onnauwkeurigheden van en latere wijzigingen aan de verstrekte informatie.

PL - WARUNKI SPRZEDAŻY

Zamówienia są przyjmowane zgodnie ze standardowymi Warunkami Sprzedaży oferowanymi przez Federal-Mogul Aftermarket i Tenneco Motorparts. Dane dotyczące modeli pojazdów i silników oraz numery części mogą się zmieniać w czasie i choć informacje zawarte w naszych katalogach zostały umieszczone zgodnie z naszą najlepszą wiedzą i dokładnością w czasie ich zbierania i publikowania, to Federal-Mogul nie może zaakceptować jakiegokolwiek odpowiedzialności wynikającej z nieścisłości czy późniejszych zmian w stosunku do dostarczonych informacji.

RU - УСЛОВИЯ СЛОВИАСОТРУДНИЧЕСТВА

Заказы на продукцию принимаются согласно стандартным условиям продаж Federal-Mogul Aftermarket и Tenneco Motorparts. Время от времени наименования деталей, рекомендации и данные по моделям автомобилей и двигателям могут меняться и несмотря на то, что информация содержащаяся в каталогах на момент публикации была наиболее правильной, Federal-Mogul не может нести ответственности за любые погрешности и последующие изменения предоставленной информации.

GR - ΟΡΟΙ ΣΥΝΕΡΓΑΣΙΑΣ

Οι παραγγελίες γίνονται αποδεκτές σύμφωνα με τους Επίσημους Όρους Πώλησης οι οποίοι είναι διαθέσιμοι από την Federal-Mogul Aftermarket και την Tenneco Motorparts. Οι κωδικοί αριθμοί των εξαρτημάτων, τα μοντέλα των οχημάτων και τα στοιχεία των κινητήρων αλλάζουν κατά διαστήματα. Αν και οι πληροφορίες οι οποίες περιλαμβάνονται στους καταλόγους, ήταν σύμφωνα με τις γνώσεις μας κατά το καλύτερο δυνατό ακριβείς κατά την διάρκεια της σύνταξης και της δημοσίευσης, η Federal-Mogul δεν μπορεί να δεχτεί την ευθύνη για οποιεσδήποτε ανακρίβειες και επόμενες αλλαγές στις παρεχόμενες πληροφορίες.

PT - TERMOS DE NEGÓCIO

As encomendas são aceites sujeitas às Condições de Venda padrão que se encontram disponíveis no Aftermarket da Federal-Mogul e na Tenneco Motorparts. As referências de peças, modelos de veículos e detalhes do motor são alterados periodicamente e apesar das informações contidas nos catálogos serem, de acordo com o nosso melhor conhecimento, precisas na altura da compilação e publicação, a Federal-Mogul não aceita responsabilidade por quaisquer imprecisões e subsequentes alterações às informações fornecidas.

CZ - OBCHODNÍ PODMÍNKY

Objednávky jsou přijímány v souladu se standardními Prodejními podmínkami, které jsou dostupné u společností Federal-Mogul Aftermarket a Tenneco Motorparts. Čísla dílů, informace o modelech vozidel a motorech se čas od času mění, a přestože byly informace obsaženy v katalozích podle našich nejlepších znalostí v okamžiku sestavení a uveřejnění přesné, společnost Federal-Mogul nepřijímá odpovědnost za žádné nepřesnosti a následné změny poskytnutých informací.

RO - CONDIȚII DE AFACERI

Comenzile sunt acceptate sub rezerva Condițiilor de vânzare standard, puse la dispoziție de Federal-Mogul Aftermarket și Tenneco Motorparts. Codurile pieselor, modelele de vehicule și detaliile motoarelor se modifică periodic și, deși informațiile conținute în cataloage erau, după cunoștințele noastre, exacte în momentul colectării și publicării, Federal-Mogul nu poate accepta responsabilitatea pentru nicio inadvertență și nici pentru modificările ulterioare aduse informațiilor furnizate.

HU - ÜZLETI FELTÉTELEK

AA rendeléseket a Federal-Mogul Aftermarket és Tenneco Motorparts normál értékesítési feltételei alapján fogadjuk. A cikkszámok, a járművek típusjelzései és a motorok adatai időről időre változnak. Éppen ezért, habár a katalógusainkban foglalt információk a legjobb tudomásunk szerint a kiadás napján helyesek voltak, a Federal-Mogul nem vállalhat felelősséget a pontatlanságokért és az ezekből eredő változásokért.

BG - УСЛОВИЯ НА РАБОТА

Поръчки се приемат при спазване на Стандартните условия на продажба, които са на разположение във "Federal-Mogul Aftermarket" и "Tenneco Motorparts". Номерата на частите, моделът на превозното средство и данните за двигателя се променят през определено време и въпреки, че информацията, съдържаща се в каталозите е била, доколкото ни е известно, вярна по време на изготвянето и публикуването, "Federal-Mogul" не носи отговорност за неточности и последващите промени в предоставената информация.

SL - POSLOVNI POGOJI

Naročila so sprejeta v skladu s standardnimi prodajnimi pogoji, ki so na voljo pri podjetju Federal-Mogul Aftermarket in korporaciji Tenneco Motorparts. Številke delov, model vozila in podrobnosti o motorju se od časa do časa spremenijo. Čeprav so bili podatki v katalogu, po naši najboljši vednosti, v času sestavljanja in objave točni, podjetje Federal-Mogul ne more prevzeti odgovornosti za kakršnekoli netočnosti in naknadne spremembe priskrbljenih podatkov.

AR - شروط العمل التجاري

.Federal-Mogul Corporation وشركة Tenneco Motorparts وضعتها شركة تمت الموافقة عليها لشروط البيع القياسية التي وضعها Tenneco Motorparts وشركة Federal-Mogul Corporation. يتم تغيير أرقام القطع وطرزات السيارات وتفاصيل المحرك من وقت لآخر، وعلى الرغم من أن هذه المعلومات الواردة بالكتالوجات دقيقة على حد علمنا أثناء جمعها ونشرها، فإن شركة Federal-Mogul لا تتحمل مسؤولية أي أخطاء وتغييرات لاحقة تطرأ على المعلومات الواردة بها.

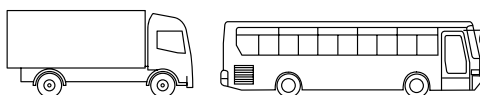
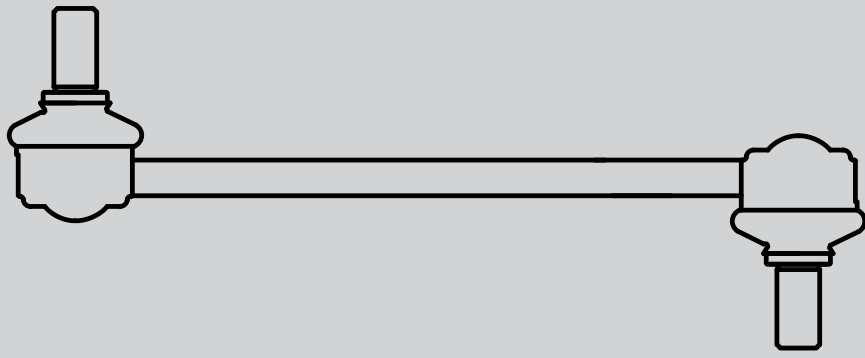

CV-ES-2119

Length: 55

Cone Ø: d1 Ø 10 / d2 Ø 10

Thread: M12 x 1,75 LHT

592106, 1249088



CV-ES-2182

Length: 55

Cone Ø: d1 Ø 10 / d2 Ø 10

Thread: M12 x 1,75 RHT

589333, 1249129



CV-ES-2534

Length: 101

Cone Ø: d1 Ø 22 / d2 Ø 20

Thread: M28 x 1,5 LHT

607452



DF-ES-8524

Length: 178

Cone Ø: d1 Ø 22 / d2 Ø 20

Thread: M30 x 1,5 RHT

AFRA888



LF-ES-3809

Length: 178

Cone Ø: d1 Ø 22 / d2 Ø 20

Thread: M28 x 1,5 LHT

ACU9239



LF-ES-3810

Length: 178

Cone Ø: d1 Ø 22 / d2 Ø 20

Thread: M28 x 1,5 RHT

ACU9240





45 ...

FA 45.160 C09	05/91→12/00	Ball Head, gearshift linkage	CV-ES-2119		
	05/91→12/00	Ball Head, gearshift linkage	CV-ES-2182		
	05/91→12/00	Tie Rod End	CV-ES-2534		
	05/91→12/00	Tie Rod End	DF-ES-8524		
	05/91→12/00	Tie Rod End	LF-ES-3809		
	05/91→12/00	Tie Rod End	LF-ES-3810		
FA 45.160 C11	05/91→12/00	Ball Head, gearshift linkage	CV-ES-2119		
	05/91→12/00	Ball Head, gearshift linkage	CV-ES-2182		
	05/91→12/00	Tie Rod End	CV-ES-2534		
	05/91→12/00	Tie Rod End	DF-ES-8524		
	05/91→12/00	Tie Rod End	LF-ES-3809		
	05/91→12/00	Tie Rod End	LF-ES-3810		
FA 45.180 B08	05/95→12/00	Ball Head, gearshift linkage	CV-ES-2119		
	05/95→12/00	Ball Head, gearshift linkage	CV-ES-2182		
	05/95→12/00	Tie Rod End	CV-ES-2534		
	05/95→12/00	Tie Rod End	DF-ES-8524		
	05/95→12/00	Tie Rod End	LF-ES-3809		
	05/95→12/00	Tie Rod End	LF-ES-3810		
FA 45.180 B10	05/95→12/00	Ball Head, gearshift linkage	CV-ES-2119		
	05/95→12/00	Ball Head, gearshift linkage	CV-ES-2182		
	05/95→12/00	Tie Rod End	CV-ES-2534		
	05/95→12/00	Tie Rod End	DF-ES-8524		
	05/95→12/00	Tie Rod End	LF-ES-3809		
	05/95→12/00	Tie Rod End	LF-ES-3810		
FA 45.180 B11	05/95→12/00	Ball Head, gearshift linkage	CV-ES-2119		
	05/95→12/00	Ball Head, gearshift linkage	CV-ES-2182		
	05/95→12/00	Tie Rod End	CV-ES-2534		
	05/95→12/00	Tie Rod End	DF-ES-8524		
	05/95→12/00	Tie Rod End	LF-ES-3809		
	05/95→12/00	Tie Rod End	LF-ES-3810		
FA 45.210 B11	05/95→12/00	Ball Head, gearshift linkage	CV-ES-2119		
	05/95→12/00	Ball Head, gearshift linkage	CV-ES-2182		
	05/95→12/00	Tie Rod End	CV-ES-2534		
	05/95→12/00	Tie Rod End	DF-ES-8524		
	05/95→12/00	Tie Rod End	LF-ES-3809		
	05/95→12/00	Tie Rod End	LF-ES-3810		

65

FA 65.180	03/93→02/98	Ball Head, gearshift linkage	CV-ES-2119		
	03/93→02/98	Ball Head, gearshift linkage	CV-ES-2182		
	03/93→02/98	Suspension Arm Repair Kit		IV-RK-8998	for Wishbone (CV)
	03/93→02/98	Tie Rod End	CV-ES-12461		for Steering Rod
	03/93→02/98	Tie Rod End	CV-ES-12462		for Steering Rod
	03/93→02/98	Tie Rod End	CV-ES-14163		for Steering Rod
	03/93→02/98	Tie Rod End	DF-ES-3804		
	03/93→02/98	Tie Rod End	DF-ES-3805		
FA 65.210	03/93→02/98	Ball Head, gearshift linkage	CV-ES-2119		
	03/93→02/98	Ball Head, gearshift linkage	CV-ES-2182		
	03/93→02/98	Suspension Arm Repair Kit		IV-RK-8998	for Wishbone (CV)
	03/93→02/98	Tie Rod End	CV-ES-12461		for Steering Rod
	03/93→02/98	Tie Rod End	CV-ES-12462		for Steering Rod
	03/93→02/98	Tie Rod End	CV-ES-14163		for Steering Rod
	03/93→02/98	Tie Rod End	DF-ES-3804		
	03/93→02/98	Tie Rod End	DF-ES-3805		
FA 65.240	05/96→02/98	Ball Head, gearshift linkage	CV-ES-2119		
	05/96→02/98	Ball Head, gearshift linkage	CV-ES-2182		
	05/96→02/98	Suspension Arm Repair Kit		IV-RK-8998	for Wishbone (CV)
	05/96→02/98	Tie Rod End	CV-ES-12461		for Steering Rod
	05/96→02/98	Tie Rod End	CV-ES-12462		for Steering Rod
	05/96→02/98	Tie Rod End	CV-ES-14163		for Steering Rod
	05/96→02/98	Tie Rod End	DF-ES-3804		
	05/96→02/98	Tie Rod End	DF-ES-3805		

CV-ES-2119

Length: 55
Cone Ø: d1 Ø 10 / d2 Ø 10
Thread: M12 x 1,75 LHT
592106, 1249088



CV-ES-14163

Length: 125
Cone Ø: d1 Ø 30 / d2 Ø 27
Thread: M30 x 1,5 RHT
0607981, 0698450, 1149907, 1152350,
1257890, 1603789, 1618048, ACHF060



LF-ES-3810

Length: 178
Cone Ø: d1 Ø 22 / d2 Ø 20
Thread: M28 x 1,5 RHT
ACU9240



CV-ES-2182

Length: 55
Cone Ø: d1 Ø 10 / d2 Ø 10
Thread: M12 x 1,75 RHT
589333, 1249129



DF-ES-3804

Length: 140
Cone Ø: d1 Ø 30 / d2 Ø 27
Thread: M48 x 1,5 LHT
0067303



CV-ES-2534

Length: 101
Cone Ø: d1 Ø 22 / d2 Ø 20
Thread: M28 x 1,5 LHT
607452



DF-ES-3805

Length: 140
Cone Ø: d1 Ø 30 / d2 Ø 27
Thread: M48 x 1,5 RHT
0067389



CV-ES-12461

Length: 120
Cone Ø: d1 Ø 26 / d2 Ø 23,5
Thread: M30 x 1,5 LHT
69513, 0069513, 0311300, 311300,
0607998, 607998, 1190653, 1315447,
1319838, 1332123, 1338714, 1401934,
1407394, ACHB063, ACHF241, MAK1295



DF-ES-8524

Length: 178
Cone Ø: d1 Ø 22 / d2 Ø 20
Thread: M30 x 1,5 RHT
AFRA888



CV-ES-12462

Length: 120
Cone Ø: d1 Ø 26 / d2 Ø 23,5
Thread: M30 x 1,5 RHT
0069514, 0586753, 0607999, 0694298,
0694360, 0698609, 1137230, 1229944,
1326862, 1326896, 1331925, ACHB064,
ACHF242, MAK1296



IV-RK-8998

Ø: 85
Hole Distance: 130
Thick/Height: 30
0513757, 0531757, 0691709, 691709



LF-ES-3809

Length: 178
Cone Ø: d1 Ø 22 / d2 Ø 20
Thread: M28 x 1,5 LHT
ACU9239



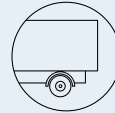

65 ...

FAV 65.180	03/93→02/98	Ball Head, gearshift linkage	CV-ES-2119		
	03/93→02/98	Ball Head, gearshift linkage	CV-ES-2182		
	03/93→02/98	Suspension Arm Repair Kit		IV-RK-8998	for Wishbone (CV)
	03/93→02/98	Tie Rod End	CV-ES-12461		for Steering Rod
	03/93→02/98	Tie Rod End	CV-ES-12462		for Steering Rod
	03/93→02/98	Tie Rod End	CV-ES-14163		for Steering Rod
	03/93→02/98	Tie Rod End	DF-ES-3804		
	03/93→02/98	Tie Rod End	DF-ES-3805		
FAV 65.210	03/93→02/98	Ball Head, gearshift linkage	CV-ES-2119		
	03/93→02/98	Ball Head, gearshift linkage	CV-ES-2182		
	03/93→02/98	Suspension Arm Repair Kit		IV-RK-8998	for Wishbone (CV)
	03/93→02/98	Tie Rod End	CV-ES-12461		for Steering Rod
	03/93→02/98	Tie Rod End	CV-ES-12462		for Steering Rod
	03/93→02/98	Tie Rod End	CV-ES-14163		for Steering Rod
	03/93→02/98	Tie Rod End	DF-ES-3804		
	03/93→02/98	Tie Rod End	DF-ES-3805		

65 CF

FA 65 CF 180	02/98→12/00	Ball Head, gearshift linkage	CV-ES-2119		
	02/98→12/00	Ball Head, gearshift linkage	CV-ES-2182		
	02/98→12/00	Centre Rod	DF-DL-5226		Push Rod
	02/98→12/00	Centre Rod	DF-DL-5237		Push Rod
	02/98→12/00	Centre Rod	DF-DL-8196		Push Rod
	02/98→12/00	Stabiliser Mounting	DF-SB-5253	DF-SB-5253	
	02/98→12/00	Suspension Arm Repair Kit		DF-RK-9336	
	02/98→12/00	Suspension Arm Repair Kit		IV-RK-8998	for Wishbone (CV)
	02/98→12/00	Suspension Arm Repair Kit		SC-RK-8575	for Wishbone (CV)
	02/98→12/00	Suspension Strut Repair Kit		DF-RK-8637	
	02/98→12/00	Suspension Strut Repair Kit		MN-RK-8537	
	02/98→12/00	Tie Rod	DF-DL-5403		1st FA
	02/98→12/00	Tie Rod	DF-DL-7780		1st FA
	02/98→12/00	Tie Rod End	CV-ES-12461		for Steering Rod
	02/98→12/00	Tie Rod End	CV-ES-12462		for Steering Rod
	02/98→12/00	Tie Rod End	CV-ES-14163		for Steering Rod
	02/98→12/00	Tie Rod End	DF-ES-3804		
	02/98→12/00	Tie Rod End	DF-ES-3805		
	02/98→12/00	Track Control Arm		DF-DL-8158	Trailing Arm, 1st RA; Air Suspension Axle
	02/98→12/00	Track Control Arm		DF-VB-8561	Wishbone (CV), Air Suspension Axle
FA 65 CF 210	02/98→12/00	Ball Head, gearshift linkage	CV-ES-2119		
	02/98→12/00	Ball Head, gearshift linkage	CV-ES-2182		
	02/98→12/00	Centre Rod	DF-DL-5226		Push Rod
	02/98→12/00	Centre Rod	DF-DL-5237		Push Rod
	02/98→12/00	Centre Rod	DF-DL-8196		Push Rod
	02/98→12/00	Stabiliser Mounting	DF-SB-5253	DF-SB-5253	
	02/98→12/00	Suspension Arm Repair Kit		DF-RK-9336	
	02/98→12/00	Suspension Arm Repair Kit		IV-RK-8998	for Wishbone (CV)
	02/98→12/00	Suspension Arm Repair Kit		SC-RK-8575	for Wishbone (CV)
	02/98→12/00	Suspension Strut Repair Kit		DF-RK-8637	
	02/98→12/00	Suspension Strut Repair Kit		MN-RK-8537	
	02/98→12/00	Tie Rod	DF-DL-5403		1st FA
	02/98→12/00	Tie Rod	DF-DL-7780		1st FA
	02/98→12/00	Tie Rod End	CV-ES-12461		for Steering Rod
	02/98→12/00	Tie Rod End	CV-ES-12462		for Steering Rod
	02/98→12/00	Tie Rod End	CV-ES-14163		for Steering Rod
	02/98→12/00	Tie Rod End	DF-ES-3804		
	02/98→12/00	Tie Rod End	DF-ES-3805		
	02/98→12/00	Track Control Arm		DF-DL-8158	Trailing Arm, 1st RA; Air Suspension Axle
	02/98→12/00	Track Control Arm		DF-VB-8561	Wishbone (CV), Air Suspension Axle

CV-ES-2119

Length: 55
Cone Ø: d1 Ø 10 / d2 Ø 10
Thread: M12 x 1,75 LHT
592106, 1249088



CV-ES-2182

Length: 55
Cone Ø: d1 Ø 10 / d2 Ø 10
Thread: M12 x 1,75 RHT
589333, 1249129



CV-ES-12461

Length: 120
Cone Ø: d1 Ø 26 / d2 Ø 23,5
Thread: M30 x 1,5 LHT
0069513, 69513, 0311300, 311300,
0607998, 607998, 1190653, 1315447,
1319838, 1332123, 1338714, 1401934,
1407394, ACHB063, ACHF241, MAK1295



CV-ES-12462

Length: 120
Cone Ø: d1 Ø 26 / d2 Ø 23,5
Thread: M30 x 1,5 RHT
0069514, 0586753, 0607999, 0694298,
0694360, 0698609, 1137230, 1229944,
1326862, 1326896, 1331925, ACHB064,
ACHF242, MAK1296



CV-ES-14163

Length: 125
Cone Ø: d1 Ø 30 / d2 Ø 27
Thread: M30 x 1,5 RHT
0607981, 0698450, 1149907, 1152350,
1257890, 1603789, 1618048, ACHF060



DF-DL-5226

Length: 850
Ø: 52
Cone Ø: d1 Ø 26 / d2 Ø 23,5
1247957, 1283212, 1351715, 1385492,
10200900A



DF-DL-5237

Length: 880
Ø: 52
Cone Ø: d1 Ø 26 / d2 Ø 23,5
1283211, 1351714, 1385497, 10201000A



DF-DL-5403

Length: 1742
Ø: 40
Cone Ø: d1 Ø 26 / d2 Ø 23,5
0288281, 1270854, 1337644



DF-DL-7780

Length: 1690
Ø: 40
Cone Ø: d1 Ø 26 / d2 Ø 23,5
1270853, 1353391, 10212000A



DF-DL-8158

Length: 611
Ø: 48
Hole Distance: 130 / 130
0267743, 1361649, 1361650, 1656428



DF-DL-8196

Length: 867
Ø: 50
Cone Ø: d1 Ø 30 / d2 Ø 27
1363859, 1448063, 1602821



DF-ES-3804

Length: 140
Cone Ø: d1 Ø 30 / d2 Ø 27
Thread: M48 x 1,5 LHT
0067303



DF-ES-3805

Length: 140
Cone Ø: d1 Ø 30 / d2 Ø 27
Thread: M48 x 1,5 RHT
0067389



DF-RK-8637

Ø: 72
1376730



DF-RK-9336

Ø: 108
1445656



DF-SB-5253

Ø: 86
Thick/Height: 60,5
0371586, 0558864, 10306500A



DF-VB-8561

Length: 609
Ø: 48
Hole Distance: 152 / 152
0080521, 080521, 1361651, 1368270,
1390932, 1617096, 1793875, 1817808,
1892492



IV-RK-8998

Ø: 85
Hole Distance: 130
Thick/Height: 30
0513757, 0531757, 0691709, 691709



MN-RK-8537

Ø: 95
Hole Distance: 152
Thick/Height: 24
696321, 81432706099



SC-RK-8575

Ø: 95
Hole Distance: 152
Thick/Height: 35
0696321





65 CF ...

FA 65 CF 240	02/98 → 12/00	Ball Head, gearshift linkage	CV-ES-2119			
	02/98 → 12/00	Ball Head, gearshift linkage	CV-ES-2182			
	02/98 → 12/00	Centre Rod	DF-DL-5226		Push Rod	
	02/98 → 12/00	Centre Rod	DF-DL-5237		Push Rod	
	02/98 → 12/00	Centre Rod	DF-DL-8196		Push Rod	
	02/98 → 12/00	Stabiliser Mounting	DF-SB-5253	DF-SB-5253		
	02/98 → 12/00	Suspension Arm Repair Kit		DF-RK-9336		
	02/98 → 12/00	Suspension Arm Repair Kit		IV-RK-8998	for Wishbone (CV)	
	02/98 → 12/00	Suspension Arm Repair Kit		SC-RK-8575	for Wishbone (CV)	
	02/98 → 12/00	Suspension Strut Repair Kit		DF-RK-8637		
	02/98 → 12/00	Suspension Strut Repair Kit		MN-RK-8537		
	02/98 → 12/00	Tie Rod	DF-DL-5403		1st FA	
	02/98 → 12/00	Tie Rod	DF-DL-7780		1st FA	
	02/98 → 12/00	Tie Rod End	CV-ES-12461		for Steering Rod	
	02/98 → 12/00	Tie Rod End	CV-ES-12462		for Steering Rod	
	02/98 → 12/00	Tie Rod End	CV-ES-14163		for Steering Rod	
	02/98 → 12/00	Tie Rod End	DF-ES-3804			
	02/98 → 12/00	Tie Rod End	DF-ES-3805			
	02/98 → 12/00	Track Control Arm		DF-DL-8158	Trailing Arm, 1st RA; Air Suspension Axle	
	02/98 → 12/00	Track Control Arm		DF-VB-8561	Wishbone (CV), Air Suspension Axle	
	FAV 65 CF 180	02/98 → 12/00	Ball Head, gearshift linkage	CV-ES-2119		
		02/98 → 12/00	Ball Head, gearshift linkage	CV-ES-2182		
		02/98 → 12/00	Centre Rod	DF-DL-5226		Push Rod
02/98 → 12/00		Centre Rod	DF-DL-5237		Suspension Rod	
02/98 → 12/00		Centre Rod	DF-DL-8196		Push Rod	
02/98 → 12/00		Stabiliser Mounting	DF-SB-5253	DF-SB-5253		
02/98 → 12/00		Suspension Arm Repair Kit		DF-RK-9336		
02/98 → 12/00		Suspension Arm Repair Kit		IV-RK-8998	for Wishbone (CV)	
02/98 → 12/00		Suspension Arm Repair Kit		SC-RK-8575	for Wishbone (CV)	
02/98 → 12/00		Suspension Strut Repair Kit		DF-RK-8637		
02/98 → 12/00		Suspension Strut Repair Kit		MN-RK-8537		
02/98 → 12/00		Tie Rod	DF-DL-7780			
02/98 → 12/00		Tie Rod End	CV-ES-12461		for Steering Rod	
02/98 → 12/00		Tie Rod End	CV-ES-12462		for Steering Rod	
02/98 → 12/00		Tie Rod End	CV-ES-14163		for Steering Rod	
02/98 → 12/00		Tie Rod End	DF-ES-3804			
02/98 → 12/00		Tie Rod End	DF-ES-3805			
02/98 → 12/00		Track Control Arm		DF-DL-8158	Trailing Arm	
02/98 → 12/00		Track Control Arm		DF-VB-8561	Wishbone (CV)	
FAV 65 CF 210		02/98 → 12/00	Ball Head, gearshift linkage	CV-ES-2119		
		02/98 → 12/00	Ball Head, gearshift linkage	CV-ES-2182		
		02/98 → 12/00	Centre Rod	DF-DL-5226		Push Rod
		02/98 → 12/00	Centre Rod	DF-DL-5237		Suspension Rod
	02/98 → 12/00	Centre Rod	DF-DL-8196		Push Rod	
	02/98 → 12/00	Stabiliser Mounting	DF-SB-5253	DF-SB-5253		
	02/98 → 12/00	Suspension Arm Repair Kit		DF-RK-9336		
	02/98 → 12/00	Suspension Arm Repair Kit		IV-RK-8998	for Wishbone (CV)	
	02/98 → 12/00	Suspension Arm Repair Kit		SC-RK-8575	for Wishbone (CV)	
	02/98 → 12/00	Suspension Strut Repair Kit		DF-RK-8637		
	02/98 → 12/00	Suspension Strut Repair Kit		MN-RK-8537		
	02/98 → 12/00	Tie Rod	DF-DL-7780			
	02/98 → 12/00	Tie Rod End	CV-ES-12461		for Steering Rod	
	02/98 → 12/00	Tie Rod End	CV-ES-12462		for Steering Rod	
	02/98 → 12/00	Tie Rod End	CV-ES-14163		for Steering Rod	
	02/98 → 12/00	Tie Rod End	DF-ES-3804			
	02/98 → 12/00	Tie Rod End	DF-ES-3805			
	02/98 → 12/00	Track Control Arm		DF-DL-8158	Trailing Arm	
	02/98 → 12/00	Track Control Arm		DF-VB-8561	Wishbone (CV)	

CV-ES-2119

Length: 55
Cone Ø: d1 Ø 10 / d2 Ø 10
Thread: M12 x 1,75 LHT
592106, 1249088



DF-DL-5226

Length: 850
Ø: 52
Cone Ø: d1 Ø 26 / d2 Ø 23,5
1247957, 1283212, 1351715, 1385492,
10200900A



DF-ES-3804

Length: 140
Cone Ø: d1 Ø 30 / d2 Ø 27
Thread: M48 x 1,5 LHT
0067303



IV-RK-8998

Ø: 85
Hole Distance: 130
Thick/Height: 30
0513757, 0531757, 0691709, 691709



CV-ES-2182

Length: 55
Cone Ø: d1 Ø 10 / d2 Ø 10
Thread: M12 x 1,75 RHT
589333, 1249129



DF-DL-5237

Length: 880
Ø: 52
Cone Ø: d1 Ø 26 / d2 Ø 23,5
1283211, 1351714, 1385497, 10201000A



DF-ES-3805

Length: 140
Cone Ø: d1 Ø 30 / d2 Ø 27
Thread: M48 x 1,5 RHT
0067389



MN-RK-8537

Ø: 95
Hole Distance: 152
Thick/Height: 24
696321, 81432706099



CV-ES-12461

Length: 120
Cone Ø: d1 Ø 26 / d2 Ø 23,5
Thread: M30 x 1,5 LHT
0069513, 69513, 0311300, 311300,
0607998, 607998, 1190653, 1315447,
1319838, 1332123, 1338714, 1401934,
1407394, ACHB063, ACHF241, MAK1295



DF-DL-5403

Length: 1742
Ø: 40
Cone Ø: d1 Ø 26 / d2 Ø 23,5
0288281, 1270854, 1337644



DF-RK-8637

Ø: 72
1376730



SC-RK-8575

Ø: 95
Hole Distance: 152
Thick/Height: 35
0696321



CV-ES-12462

Length: 120
Cone Ø: d1 Ø 26 / d2 Ø 23,5
Thread: M30 x 1,5 RHT
0069514, 0586753, 0607999, 0694298,
0694360, 0698609, 1137230, 1229944,
1326862, 1326896, 1331925, ACHB064,
ACHF242, MAK1296



DF-DL-7780

Length: 1690
Ø: 40
Cone Ø: d1 Ø 26 / d2 Ø 23,5
1270853, 1353391, 10212000A



DF-RK-9336

Ø: 108
1445656



CV-ES-14163

Length: 125
Cone Ø: d1 Ø 30 / d2 Ø 27
Thread: M30 x 1,5 RHT
0607981, 0698450, 1149907, 1152350,
1257890, 1603789, 1618048, ACHF060



DF-DL-8158

Length: 611
Ø: 48
Hole Distance: 130 / 130
0267743, 1361649, 1361650, 1656428



DF-SB-5253

Ø: 86
Thick/Height: 60,5
0371586, 0558864, 10306500A



DF-DL-8196

Length: 867
Ø: 50
Cone Ø: d1 Ø 30 / d2 Ø 27
1363859, 1448063, 1602821



DF-VB-8561

Length: 609
Ø: 48
Hole Distance: 152 / 152
0080521, 080521, 1361651, 1368270,
1390932, 1617096, 1793875, 1817808,
1892492





75

FA 75.240	07/92→02/98	Ball Head, gearshift linkage	CV-ES-2119		
	07/92→02/98	Ball Head, gearshift linkage	CV-ES-2182		
	07/92→02/98	Stabiliser Mounting		DF-SB-9342	
	07/92→02/98	Suspension Arm Repair Kit		CV-RK-5322	for Wishbone (CV)
	07/92→02/98	Suspension Arm Repair Kit		IV-RK-8998	for Wishbone (CV)
	07/92→02/98	Suspension Arm Repair Kit		MN-RK-7280	for Drag Link
	07/92→02/98	Suspension Arm Repair Kit		SC-RK-8575	for Wishbone (CV)
	07/92→02/98	Suspension Strut Repair Kit		MN-RK-8537	
	07/92→02/98	Tie Rod	DF-DL-7836		
	07/92→02/98	Tie Rod End	CV-ES-12461		for Steering Rod
	07/92→02/98	Tie Rod End	CV-ES-12462		for Steering Rod
	07/92→02/98	Tie Rod End	CV-ES-14163		for Steering Rod
	07/92→02/98	Tie Rod End	DF-ES-3804		
	07/92→02/98	Tie Rod End	DF-ES-3805		
	FA 75.270	07/92→02/98	Ball Head, gearshift linkage	CV-ES-2119	
07/92→02/98		Ball Head, gearshift linkage	CV-ES-2182		
07/92→02/98		Stabiliser Mounting		DF-SB-9342	
07/92→02/98		Suspension Arm Repair Kit		CV-RK-5322	for Wishbone (CV)
07/92→02/98		Suspension Arm Repair Kit		IV-RK-8998	for Wishbone (CV)
07/92→02/98		Suspension Arm Repair Kit		MN-RK-7280	for Drag Link
07/92→02/98		Suspension Arm Repair Kit		SC-RK-8575	for Wishbone (CV)
07/92→02/98		Suspension Strut Repair Kit		MN-RK-8537	
07/92→02/98		Tie Rod	DF-DL-7836		
07/92→02/98		Tie Rod End	CV-ES-12461		for Steering Rod
07/92→02/98		Tie Rod End	CV-ES-12462		for Steering Rod
07/92→02/98		Tie Rod End	CV-ES-14163		for Steering Rod
07/92→02/98		Tie Rod End	DF-ES-3804		
07/92→02/98		Tie Rod End	DF-ES-3805		
FA 75.300		07/92→02/98	Ball Head, gearshift linkage	CV-ES-2119	
	07/92→02/98	Ball Head, gearshift linkage	CV-ES-2182		
	07/92→02/98	Stabiliser Mounting		DF-SB-9342	
	07/92→02/98	Suspension Arm Repair Kit		CV-RK-5322	for Wishbone (CV)
	07/92→02/98	Suspension Arm Repair Kit		IV-RK-8998	for Wishbone (CV)
	07/92→02/98	Suspension Arm Repair Kit		MN-RK-7280	for Drag Link
	07/92→02/98	Suspension Arm Repair Kit		SC-RK-8575	for Wishbone (CV)
	07/92→02/98	Suspension Strut Repair Kit		MN-RK-8537	
	07/92→02/98	Tie Rod	DF-DL-7836		
	07/92→02/98	Tie Rod End	CV-ES-12461		for Steering Rod
	07/92→02/98	Tie Rod End	CV-ES-12462		for Steering Rod
	07/92→02/98	Tie Rod End	CV-ES-14163		for Steering Rod
	07/92→02/98	Tie Rod End	DF-ES-3804		
	07/92→02/98	Tie Rod End	DF-ES-3805		
	FAG 75.240,FAN 75.240	07/92→02/98	Ball Head, gearshift linkage	CV-ES-2119	
07/92→02/98		Ball Head, gearshift linkage	CV-ES-2182		
07/92→02/98		Stabiliser Mounting		DF-SB-9342	
07/92→02/98		Suspension Arm Repair Kit		CV-RK-5322	for Wishbone (CV)
07/92→02/98		Suspension Arm Repair Kit		IV-RK-8998	for Wishbone (CV)
07/92→02/98		Suspension Arm Repair Kit		MN-RK-7280	for Drag Link
07/92→02/98		Suspension Arm Repair Kit		SC-RK-8575	for Wishbone (CV)
07/92→02/98		Suspension Strut Repair Kit		MN-RK-8537	
07/92→02/98		Tie Rod	DF-DL-7836		
07/92→02/98		Tie Rod End	CV-ES-12461		for Steering Rod
07/92→02/98		Tie Rod End	CV-ES-12462		for Steering Rod
07/92→02/98		Tie Rod End	CV-ES-14163		for Steering Rod
07/92→02/98		Tie Rod End	DF-ES-3804		
07/92→02/98		Tie Rod End	DF-ES-3805		
FAG 75.270,FAN 75.270		07/92→02/98	Ball Head, gearshift linkage	CV-ES-2119	
	07/92→02/98	Ball Head, gearshift linkage	CV-ES-2182		
	07/92→02/98	Stabiliser Mounting		DF-SB-9342	
	07/92→02/98	Suspension Arm Repair Kit		CV-RK-5322	for Wishbone (CV)
	07/92→02/98	Suspension Arm Repair Kit		IV-RK-8998	for Wishbone (CV)
	07/92→02/98	Suspension Arm Repair Kit		SC-RK-8575	for Wishbone (CV)

CV-ES-2119

Length: 55
Cone Ø: d1 Ø 10 / d2 Ø 10
Thread: M12 x 1,75 LHT
5892106, 1249088



DF-DL-7836

Length: 1698
Ø: 52
Cone Ø: d1 Ø 26 / d2 Ø 23,5
0754922, 1286343, 1353396



MN-RK-8537

Ø: 95
Hole Distance: 152
Thick/Height: 24
696321, 81432706099



CV-ES-2182

Length: 55
Cone Ø: d1 Ø 10 / d2 Ø 10
Thread: M12 x 1,75 RHT
589333, 1249129



DF-ES-3804

Length: 140
Cone Ø: d1 Ø 30 / d2 Ø 27
Thread: M48 x 1,5 LHT
0067303



SC-RK-8575

Ø: 95
Hole Distance: 152
Thick/Height: 35
00696321



CV-ES-12461

Length: 120
Cone Ø: d1 Ø 26 / d2 Ø 23,5
Thread: M30 x 1,5 LHT
0069513, 69513, 0311300, 311300,
0607998, 607998, 1190653, 1315447,
1319838, 1332123, 1338714, 1401934,
1407394, ACHB063, ACHF241, MAK1295



DF-ES-3805

Length: 140
Cone Ø: d1 Ø 30 / d2 Ø 27
Thread: M48 x 1,5 RHT
0067389



CV-ES-12462

Length: 120
Cone Ø: d1 Ø 26 / d2 Ø 23,5
Thread: M30 x 1,5 RHT
0069514, 0586753, 0607999, 0694298,
0694360, 0698609, 1137230, 1229944,
1326862, 1326896, 1331925, ACHB064,
ACHF242, MAK1296



DF-SB-9342

Ø: 94
Thick/Height: 80 / 70
0281007, 0298498, 008169892, 8169892,
041270883, 41270883



CV-ES-14163

Length: 125
Cone Ø: d1 Ø 30 / d2 Ø 27
Thread: M30 x 1,5 RHT
0607981, 0698450, 1149907, 1152350,
1257890, 1603789, 1618048, ACHF060



IV-RK-8998

Ø: 85
Hole Distance: 130
Thick/Height: 30
0513757, 0531757, 0691709, 691709



CV-RK-5322

Ø: 72
Thick/Height: 50
0691704



MN-RK-7280

Ø: 75
Hole Distance: 115
Thick/Height: 24
0689748, 689748





75 ...

FAG 75.270,FAN 75.270 ...	07/92→02/98	Suspension Strut Repair Kit		MN-RK-8537	
	07/92→02/98	Tie Rod	DF-DL-7836		
	07/92→02/98	Tie Rod End	CV-ES-12461		for Steering Rod
	07/92→02/98	Tie Rod End	CV-ES-12462		for Steering Rod
	07/92→02/98	Tie Rod End	CV-ES-14163		for Steering Rod
	07/92→02/98	Tie Rod End	DF-ES-3804		
	07/92→02/98	Tie Rod End	DF-ES-3805		
FAG 75.300,FAN 75.300	07/92→02/98	Ball Head, gearshift linkage	CV-ES-2119		
	07/92→02/98	Ball Head, gearshift linkage	CV-ES-2182		
	07/92→02/98	Stabiliser Mounting		DF-SB-9342	
	07/92→02/98	Suspension Arm Repair Kit		CV-RK-5322	for Wishbone (CV)
	07/92→02/98	Suspension Arm Repair Kit		IV-RK-8998	for Wishbone (CV)
	07/92→02/98	Suspension Arm Repair Kit		MN-RK-7280	for Drag Link
	07/92→02/98	Suspension Arm Repair Kit		SC-RK-8575	for Wishbone (CV)
	07/92→02/98	Suspension Strut Repair Kit		MN-RK-8537	
	07/92→02/98	Tie Rod	DF-DL-7836		
	07/92→02/98	Tie Rod End	CV-ES-12461		for Steering Rod
	07/92→02/98	Tie Rod End	CV-ES-12462		for Steering Rod
	07/92→02/98	Tie Rod End	CV-ES-14163		for Steering Rod
	07/92→02/98	Tie Rod End	DF-ES-3804		
	07/92→02/98	Tie Rod End	DF-ES-3805		
FAR 75.240,FAS 75.240	07/92→02/98	Ball Head, gearshift linkage	CV-ES-2119		
	07/92→02/98	Ball Head, gearshift linkage	CV-ES-2182		
	07/92→02/98	Stabiliser Mounting		DF-SB-9342	
	07/92→02/98	Suspension Arm Repair Kit		CV-RK-5322	for Wishbone (CV)
	07/92→02/98	Suspension Arm Repair Kit		IV-RK-8998	for Wishbone (CV)
	07/92→02/98	Suspension Arm Repair Kit		MN-RK-7280	for Drag Link
	07/92→02/98	Suspension Arm Repair Kit		SC-RK-8575	for Wishbone (CV)
	07/92→02/98	Suspension Strut Repair Kit		MN-RK-8537	
	07/92→02/98	Tie Rod	DF-DL-7836		
	07/92→02/98	Tie Rod End	CV-ES-12461		for Steering Rod
	07/92→02/98	Tie Rod End	CV-ES-12462		for Steering Rod
	07/92→02/98	Tie Rod End	CV-ES-14163		for Steering Rod
	07/92→02/98	Tie Rod End	DF-ES-3804		
	07/92→02/98	Tie Rod End	DF-ES-3805		
FAR 75.270,FAS 75.270	07/92→02/98	Ball Head, gearshift linkage	CV-ES-2119		
	07/92→02/98	Ball Head, gearshift linkage	CV-ES-2182		
	07/92→02/98	Stabiliser Mounting		DF-SB-9342	
	07/92→02/98	Suspension Arm Repair Kit		CV-RK-5322	for Wishbone (CV)
	07/92→02/98	Suspension Arm Repair Kit		IV-RK-8998	for Wishbone (CV)
	07/92→02/98	Suspension Arm Repair Kit		MN-RK-7280	for Drag Link
	07/92→02/98	Suspension Arm Repair Kit		SC-RK-8575	for Wishbone (CV)
	07/92→02/98	Suspension Strut Repair Kit		MN-RK-8537	
	07/92→02/98	Tie Rod	DF-DL-7836		
	07/92→02/98	Tie Rod End	CV-ES-12461		for Steering Rod
	07/92→02/98	Tie Rod End	CV-ES-12462		for Steering Rod
	07/92→02/98	Tie Rod End	CV-ES-14163		for Steering Rod
	07/92→02/98	Tie Rod End	DF-ES-3804		
	07/92→02/98	Tie Rod End	DF-ES-3805		
FAR 75.300,FAS 75.300	07/92→02/98	Ball Head, gearshift linkage	CV-ES-2119		
	07/92→02/98	Ball Head, gearshift linkage	CV-ES-2182		
	07/92→02/98	Stabiliser Mounting		DF-SB-9342	
	07/92→02/98	Suspension Arm Repair Kit		CV-RK-5322	for Wishbone (CV)
	07/92→02/98	Suspension Arm Repair Kit		IV-RK-8998	for Wishbone (CV)
	07/92→02/98	Suspension Arm Repair Kit		MN-RK-7280	for Drag Link
	07/92→02/98	Suspension Arm Repair Kit		SC-RK-8575	for Wishbone (CV)
	07/92→02/98	Suspension Strut Repair Kit		MN-RK-8537	
	07/92→02/98	Tie Rod	DF-DL-7836		
	07/92→02/98	Tie Rod End	CV-ES-12461		for Steering Rod
	07/92→02/98	Tie Rod End	CV-ES-12462		for Steering Rod
	07/92→02/98	Tie Rod End	CV-ES-14163		for Steering Rod
	07/92→02/98	Tie Rod End	DF-ES-3804		
	07/92→02/98	Tie Rod End	DF-ES-3805		

CV-ES-2119

Length: 55
Cone Ø: d1 Ø 10 / d2 Ø 10
Thread: M12 x 1,75 LHT
5892106, 1249088



DF-DL-7836

Length: 1698
Ø: 52
Cone Ø: d1 Ø 26 / d2 Ø 23,5
0754922, 1286343, 1353396



MN-RK-8537

Ø: 95
Hole Distance: 152
Thick/Height: 24
696321, 81432706099



CV-ES-2182

Length: 55
Cone Ø: d1 Ø 10 / d2 Ø 10
Thread: M12 x 1,75 RHT
589333, 1249129



DF-ES-3804

Length: 140
Cone Ø: d1 Ø 30 / d2 Ø 27
Thread: M48 x 1,5 LHT
0067303



SC-RK-8575

Ø: 95
Hole Distance: 152
Thick/Height: 35
0696321



CV-ES-12461

Length: 120
Cone Ø: d1 Ø 26 / d2 Ø 23,5
Thread: M30 x 1,5 LHT
0069513, 69513, 0311300, 311300, 607998,
0607998, 1190653, 1315447, 1319838,
1332123, 1338714, 1401934, 1407394,
ACHB063, ACHF241, MAK1295



DF-ES-3805

Length: 140
Cone Ø: d1 Ø 30 / d2 Ø 27
Thread: M48 x 1,5 RHT
0067389



CV-ES-12462

Length: 120
Cone Ø: d1 Ø 26 / d2 Ø 23,5
Thread: M30 x 1,5 RHT
0069514, 0586753, 0607999, 0694298,
0694360, 0698609, 1137230, 1229944,
1326862, 1326896, 1331925, ACHB064,
ACHF242, MAK1296



DF-SB-9342

Ø: 94
Thick/Height: 80 / 70
0281007, 0298498, 008169892, 8169892,
041270883, 41270883



CV-ES-14163

Length: 125
Cone Ø: d1 Ø 30 / d2 Ø 27
Thread: M30 x 1,5 RHT
0607981, 0698450, 1149907, 1152350,
1257890, 1603789, 1618048, ACHF060



IV-RK-8998

Ø: 85
Hole Distance: 130
Thick/Height: 30
0513757, 0531757, 0691709, 691709



CV-RK-5322

Ø: 72
Thick/Height: 50
0691704



MN-RK-7280

Ø: 75
Hole Distance: 115
Thick/Height: 24
0689748, 689748





75 ...

FAT 75.270	07/92→02/98	Ball Head, gearshift linkage	CV-ES-2119		
	07/92→02/98	Ball Head, gearshift linkage	CV-ES-2182		
	07/92→02/98	Stabiliser Mounting		DF-SB-9342	
	07/92→02/98	Suspension Arm Repair Kit		CV-RK-5322	for Wishbone (CV)
	07/92→02/98	Suspension Arm Repair Kit		IV-RK-8998	for Wishbone (CV)
	07/92→02/98	Suspension Arm Repair Kit		MN-RK-7280	for Drag Link
	07/92→02/98	Suspension Arm Repair Kit		SC-RK-8575	for Wishbone (CV)
	07/92→02/98	Suspension Strut Repair Kit		MN-RK-8537	
	07/92→02/98	Tie Rod	DF-DL-7836		
	07/92→02/98	Tie Rod End	CV-ES-12461		for Steering Rod
	07/92→02/98	Tie Rod End	CV-ES-12462		for Steering Rod
	07/92→02/98	Tie Rod End	CV-ES-14163		for Steering Rod
	07/92→02/98	Tie Rod End	DF-ES-3804		
	07/92→02/98	Tie Rod End	DF-ES-3805		
FAV 75.240	07/92→02/98	Ball Head, gearshift linkage	CV-ES-2119		
	07/92→02/98	Ball Head, gearshift linkage	CV-ES-2182		
	07/92→02/98	Stabiliser Mounting		DF-SB-9342	
	07/92→02/98	Suspension Arm Repair Kit		CV-RK-5322	for Wishbone (CV)
	07/92→02/98	Suspension Arm Repair Kit		IV-RK-8998	for Wishbone (CV)
	07/92→02/98	Suspension Arm Repair Kit		MN-RK-7280	for Drag Link
	07/92→02/98	Suspension Arm Repair Kit		SC-RK-8575	for Wishbone (CV)
	07/92→02/98	Suspension Strut Repair Kit		MN-RK-8537	
	07/92→02/98	Tie Rod	DF-DL-7836		
	07/92→02/98	Tie Rod End	CV-ES-12461		for Steering Rod
	07/92→02/98	Tie Rod End	CV-ES-12462		for Steering Rod
	07/92→02/98	Tie Rod End	CV-ES-14163		for Steering Rod
	07/92→02/98	Tie Rod End	DF-ES-3804		
	07/92→02/98	Tie Rod End	DF-ES-3805		
FAV 75.270	07/92→02/98	Ball Head, gearshift linkage	CV-ES-2119		
	07/92→02/98	Ball Head, gearshift linkage	CV-ES-2182		
	07/92→02/98	Stabiliser Mounting		DF-SB-9342	
	07/92→02/98	Suspension Arm Repair Kit		CV-RK-5322	for Wishbone (CV)
	07/92→02/98	Suspension Arm Repair Kit		IV-RK-8998	for Wishbone (CV)
	07/92→02/98	Suspension Arm Repair Kit		MN-RK-7280	for Drag Link
	07/92→02/98	Suspension Arm Repair Kit		SC-RK-8575	for Wishbone (CV)
	07/92→02/98	Suspension Strut Repair Kit		MN-RK-8537	
	07/92→02/98	Tie Rod	DF-DL-7836		
	07/92→02/98	Tie Rod End	CV-ES-12461		for Steering Rod
	07/92→02/98	Tie Rod End	CV-ES-12462		for Steering Rod
	07/92→02/98	Tie Rod End	CV-ES-14163		for Steering Rod
	07/92→02/98	Tie Rod End	DF-ES-3804		
	07/92→02/98	Tie Rod End	DF-ES-3805		
FT 75.240	07/92→02/98	Ball Head, gearshift linkage	CV-ES-2119		
	07/92→02/98	Ball Head, gearshift linkage	CV-ES-2182		
	07/92→02/98	Stabiliser Mounting		DF-SB-9342	
	07/92→02/98	Suspension Arm Repair Kit		CV-RK-5322	for Wishbone (CV)
	07/92→02/98	Suspension Arm Repair Kit		IV-RK-8998	for Wishbone (CV)
	07/92→02/98	Suspension Arm Repair Kit		MN-RK-7280	for Drag Link
	07/92→02/98	Suspension Arm Repair Kit		SC-RK-8575	for Wishbone (CV)
	07/92→02/98	Suspension Strut Repair Kit		MN-RK-8537	
	07/92→02/98	Tie Rod	DF-DL-7836		
	07/92→02/98	Tie Rod End	CV-ES-12461		for Steering Rod
	07/92→02/98	Tie Rod End	CV-ES-12462		for Steering Rod
	07/92→02/98	Tie Rod End	CV-ES-14163		for Steering Rod
	07/92→02/98	Tie Rod End	DF-ES-3804		
	07/92→02/98	Tie Rod End	DF-ES-3805		
FT 75.270	07/92→02/98	Ball Head, gearshift linkage	CV-ES-2119		
	07/92→02/98	Ball Head, gearshift linkage	CV-ES-2182		
	07/92→02/98	Stabiliser Mounting		DF-SB-9342	
	07/92→02/98	Suspension Arm Repair Kit		CV-RK-5322	for Wishbone (CV)
	07/92→02/98	Suspension Arm Repair Kit		IV-RK-8998	for Wishbone (CV)
	07/92→02/98	Suspension Arm Repair Kit		MN-RK-7280	for Drag Link
07/92→02/98	Suspension Arm Repair Kit		SC-RK-8575	for Wishbone (CV)	

CV-ES-2119

Length: 55
Cone Ø: d1 Ø 10 / d2 Ø 10
Thread: M12 x 1,75 LHT
5892106, 1249088



DF-DL-7836

Length: 1698
Ø: 52
Cone Ø: d1 Ø 26 / d2 Ø 23,5
0754922, 1286343, 1353396



MN-RK-8537

Ø: 95
Hole Distance: 152
Thick/Height: 24
696321, 81432706099



CV-ES-2182

Length: 55
Cone Ø: d1 Ø 10 / d2 Ø 10
Thread: M12 x 1,75 RHT
589333, 1249129



DF-ES-3804

Length: 140
Cone Ø: d1 Ø 30 / d2 Ø 27
Thread: M48 x 1,5 LHT
0067303



SC-RK-8575

Ø: 95
Hole Distance: 152
Thick/Height: 35
0696321



CV-ES-12461

Length: 120
Cone Ø: d1 Ø 26 / d2 Ø 23,5
Thread: M30 x 1,5 LHT
0069513, 69513, 0311300, 311300,
0607998, 607998, 1190653, 1315447,
1319838, 1332123, 1338714, 1401934,
1407394, ACHB063, ACHF241, MAK1295



DF-ES-3805

Length: 140
Cone Ø: d1 Ø 30 / d2 Ø 27
Thread: M48 x 1,5 RHT
0067389



CV-ES-12462

Length: 120
Cone Ø: d1 Ø 26 / d2 Ø 23,5
Thread: M30 x 1,5 RHT
0069514, 0586753, 0607999, 0694298,
0694360, 0698609, 1137230, 1229944,
1326862, 1326896, 1331925, ACHB064,
ACHF242, MAK1296



DF-SB-9342

Ø: 94
Thick/Height: 80 / 70
0281007, 0298498, 008169892, 8169892,
041270883, 41270883



CV-ES-14163

Length: 125
Cone Ø: d1 Ø 30 / d2 Ø 27
Thread: M30 x 1,5 RHT
0607981, 0698450, 1149907, 1152350,
1257890, 1603789, 1618048, ACHF060



IV-RK-8998

Ø: 85
Hole Distance: 130
Thick/Height: 30
0513757, 0531757, 691709, 0691709



CV-RK-5322

Ø: 72
Thick/Height: 50
0691704



MN-RK-7280

Ø: 75
Hole Distance: 115
Thick/Height: 24
689748, 0689748





75 ...

FT 75.270 ...	07/92→02/98	Suspension Strut Repair Kit		MN-RK-8537	
	07/92→02/98	Tie Rod	DF-DL-7836		
	07/92→02/98	Tie Rod End	CV-ES-12461		for Steering Rod
	07/92→02/98	Tie Rod End	CV-ES-12462		for Steering Rod
	07/92→02/98	Tie Rod End	CV-ES-14163		for Steering Rod
	07/92→02/98	Tie Rod End	DF-ES-3804		
	07/92→02/98	Tie Rod End	DF-ES-3805		
FT 75.300	07/92→02/98	Ball Head, gearshift linkage	CV-ES-2119		
	07/92→02/98	Ball Head, gearshift linkage	CV-ES-2182		
	07/92→02/98	Stabiliser Mounting		DF-SB-9342	
	07/92→02/98	Suspension Arm Repair Kit		CV-RK-5322	for Wishbone (CV)
	07/92→02/98	Suspension Arm Repair Kit		IV-RK-8998	for Wishbone (CV)
	07/92→02/98	Suspension Arm Repair Kit		MN-RK-7280	for Drag Link
	07/92→02/98	Suspension Arm Repair Kit		SC-RK-8575	for Wishbone (CV)
	07/92→02/98	Suspension Strut Repair Kit		MN-RK-8537	
	07/92→02/98	Tie Rod	DF-DL-7836		
	07/92→02/98	Tie Rod End	CV-ES-12461		for Steering Rod
	07/92→02/98	Tie Rod End	CV-ES-12462		for Steering Rod
	07/92→02/98	Tie Rod End	CV-ES-14163		for Steering Rod
	07/92→02/98	Tie Rod End	DF-ES-3804		
	07/92→02/98	Tie Rod End	DF-ES-3805		

75 CF

FA 75 CF 250	02/98→12/00	Centre Rod	DF-DL-5226		Push Rod
	02/98→12/00	Centre Rod	DF-DL-5237		Push Rod
	02/98→12/00	Centre Rod	DF-DL-8196		Push Rod
	02/98→12/00	Stabiliser Mounting		DF-SB-9342	
	02/98→12/00	Stabiliser Mounting	DF-SB-5253	DF-SB-5253	
	02/98→12/00	Stabiliser Mounting	DF-SB-10402		
	02/98→12/00	Suspension Arm Repair Kit		CV-RK-5322	for Wishbone (CV)
	02/98→12/00	Suspension Arm Repair Kit		DF-RK-9336	
	02/98→12/00	Suspension Arm Repair Kit		IV-RK-8998	for Wishbone (CV)
	02/98→12/00	Suspension Arm Repair Kit		MN-RK-7280	for Drag Link
	02/98→12/00	Suspension Arm Repair Kit		SC-RK-8575	for Wishbone (CV)
	02/98→12/00	Suspension Strut Repair Kit		DF-RK-8637	
	02/98→12/00	Suspension Strut Repair Kit		DF-RK-8685	
	02/98→12/00	Suspension Strut Repair Kit		MN-RK-8537	
	02/98→12/00	Tie Rod	DF-DL-5403		1st FA
	02/98→12/00	Tie Rod	DF-DL-7780		1st FA
	02/98→12/00	Tie Rod	DF-DL-7836		1st FA
	02/98→12/00	Tie Rod End	CV-ES-12461		for Steering Rod
	02/98→12/00	Tie Rod End	CV-ES-12462		for Steering Rod
	02/98→12/00	Tie Rod End	CV-ES-14163		for Steering Rod
	02/98→12/00	Tie Rod End	DF-ES-3804		
	02/98→12/00	Tie Rod End	DF-ES-3805		
	02/98→12/00	Track Control Arm		DF-DL-8158	Trailing Arm, Air Suspension Axle
	02/98→12/00	Track Control Arm		DF-DL-9331	Wishbone (CV), 1st RA
	02/98→12/00	Track Control Arm		DF-VB-8561	Wishbone (CV), Air Suspension Axle
02/98→12/00	Track Control Arm		DF-VB-9343	Wishbone (CV)	
FA 75 CF 290	02/98→12/00	Centre Rod	DF-DL-5226		Push Rod
	02/98→12/00	Centre Rod	DF-DL-5237		Push Rod
	02/98→12/00	Centre Rod	DF-DL-8196		Push Rod
	02/98→12/00	Stabiliser Mounting		DF-SB-9342	
	02/98→12/00	Stabiliser Mounting	DF-SB-5253	DF-SB-5253	
	02/98→12/00	Stabiliser Mounting	DF-SB-10402		
	02/98→12/00	Suspension Arm Repair Kit		CV-RK-5322	for Wishbone (CV)
	02/98→12/00	Suspension Arm Repair Kit		DF-RK-9336	
	02/98→12/00	Suspension Arm Repair Kit		IV-RK-8998	for Wishbone (CV)
	02/98→12/00	Suspension Arm Repair Kit		MN-RK-7280	for Drag Link
	02/98→12/00	Suspension Arm Repair Kit		SC-RK-8575	for Wishbone (CV)
	02/98→12/00	Suspension Strut Repair Kit		DF-RK-8637	
	02/98→12/00	Suspension Strut Repair Kit		DF-RK-8685	
	02/98→12/00	Suspension Strut Repair Kit		MN-RK-8537	

CV-ES-2119

Length: 55
 Cone Ø: d1 Ø 10 / d2 Ø 10
 Thread: M12 x 1,75 LHT
 592106, 1249088

**CV-ES-2182**

Length: 55
 Cone Ø: d1 Ø 10 / d2 Ø 10
 Thread: M12 x 1,75 RHT
 589333, 1249129

**CV-ES-12461**

Length: 120
 Cone Ø: d1 Ø 26 / d2 Ø 23,5
 Thread: M30 x 1,5 LHT
 0069513, 69513, 0311300, 311300, 607998, 0607998, 1190653, 1315447, 1319838, 1332123, 1338714, 1401934, 1407394, ACHB063, ACHF241, MAK1295

**CV-ES-12462**

Length: 120
 Cone Ø: d1 Ø 26 / d2 Ø 23,5
 Thread: M30 x 1,5 RHT
 0069514, 0586753, 0607999, 0694298, 0694360, 0698609, 1137230, 1229944, 1326862, 1326896, 1331925, ACHB064, ACHF242, MAK1296

**CV-ES-14163**

Length: 125
 Cone Ø: d1 Ø 30 / d2 Ø 27
 Thread: M30 x 1,5 RHT
 0607981, 0698450, 1149907, 1152350, 1257890, 1603789, 1618048, ACHF060

**CV-RK-5322**

Ø: 72
 Thick/Height: 50
 0691704

**DF-DL-5226**

Length: 850
 Ø: 52
 Cone Ø: d1 Ø 26 / d2 Ø 23,5
 1247957, 1283212, 1351715, 1385492, 10200900A

**DF-DL-5237**

Length: 880
 Ø: 52
 Cone Ø: d1 Ø 26 / d2 Ø 23,5
 1283211, 1351714, 1385497, 10201000A

**DF-DL-5403**

Length: 1742
 Ø: 40
 Cone Ø: d1 Ø 26 / d2 Ø 23,5
 0288281, 1270854, 1337644

**DF-DL-7780**

Length: 1690
 Ø: 40
 Cone Ø: d1 Ø 26 / d2 Ø 23,5
 1270853, 1353391, 10212000A

**DF-DL-7836**

Length: 1698
 Ø: 52
 Cone Ø: d1 Ø 26 / d2 Ø 23,5
 0754922, 1286343, 1353396

**DF-DL-8158**

Length: 611
 Ø: 48
 Hole Distance: 130 / 130
 0267743, 1361649, 1361650, 1656428

**DF-DL-8196**

Length: 867
 Ø: 50
 Cone Ø: d1 Ø 30 / d2 Ø 27
 1363859, 1448063, 1602821

**DF-DL-9331**

Length: 390
 Ø: 50
 Hole Distance: 130 / 152
 1261101

**DF-ES-3804**

Length: 140
 Cone Ø: d1 Ø 30 / d2 Ø 27
 Thread: M48 x 1,5 LHT
 0067303

**DF-ES-3805**

Length: 140
 Cone Ø: d1 Ø 30 / d2 Ø 27
 Thread: M48 x 1,5 RHT
 0067389

**DF-RK-8637**

Ø: 72
 1376730

**DF-RK-8685**

Ø: 67
 Hole Distance: 130
 Thick/Height: 24
 1321936

**DF-RK-9336**

Ø: 108
 1445656

**DF-SB-5253**

Ø: 86
 Thick/Height: 60,5
 0371586, 0558864, 10306500A

**DF-SB-9342**

Ø: 94
 Thick/Height: 80 / 70
 0281007, 0298498, 8169892, 008169892, 041270883, 41270883

**DF-SB-10402**

Ø: 62
 Thick/Height: 60
 1291233, 1732887

**DF-VB-8561**

Length: 609
 Ø: 48
 Hole Distance: 152 / 152
 0080521, 080521, 1361651, 1368270, 1390932, 1617096, 1793875, 1817808, 1892492

**DF-VB-9343**

Length: 608,2
 Ø: 48
 Hole Distance: 152 / 152
 1361652, 1620436, 1793876, 10309600A

**IV-RK-8998**

Ø: 85
 Hole Distance: 130
 Thick/Height: 30
 0513757, 0531757, 0691709, 691709

**MN-RK-7280**

Ø: 75
 Hole Distance: 115
 Thick/Height: 24
 0689748, 689748

**MN-RK-8537**

Ø: 95
 Hole Distance: 152
 Thick/Height: 24
 696321, 81432706099

**SC-RK-8575**

Ø: 95
 Hole Distance: 152
 Thick/Height: 35
 0696321



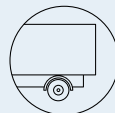

DAF ...

75 CF ...

FA 75 CF 290 ...	02/98→12/00	Tie Rod	DF-DL-5403		1st FA	
	02/98→12/00	Tie Rod	DF-DL-7780		1st FA	
	02/98→12/00	Tie Rod	DF-DL-7836			
	02/98→12/00	Tie Rod End	CV-ES-12461		for Steering Rod	
	02/98→12/00	Tie Rod End	CV-ES-12462		for Steering Rod	
	02/98→12/00	Tie Rod End	CV-ES-14163		for Steering Rod	
	02/98→12/00	Tie Rod End	DF-ES-3804			
	02/98→12/00	Tie Rod End	DF-ES-3805			
	02/98→12/00	Track Control Arm		DF-DL-8158	Trailing Arm, Air Suspension Axle	
	02/98→12/00	Track Control Arm		DF-VB-8561	Wishbone (CV), Air Suspension Axle	
	02/98→12/00	Track Control Arm		DF-VB-9343	Wishbone (CV)	
	FA 75 CF 320	02/98→12/00	Centre Rod	DF-DL-5226		Push Rod
		02/98→12/00	Centre Rod	DF-DL-5237		Push Rod
02/98→12/00		Centre Rod	DF-DL-8196		Push Rod	
02/98→12/00		Stabiliser Mounting		DF-SB-9342		
02/98→12/00		Stabiliser Mounting	DF-SB-5253	DF-SB-5253		
02/98→12/00		Stabiliser Mounting	DF-SB-10402			
02/98→12/00		Suspension Arm Repair Kit		CV-RK-5322	for Wishbone (CV)	
02/98→12/00		Suspension Arm Repair Kit		DF-RK-9336		
02/98→12/00		Suspension Arm Repair Kit		IV-RK-8998	for Wishbone (CV)	
02/98→12/00		Suspension Arm Repair Kit		MN-RK-7280	for Drag Link	
02/98→12/00		Suspension Arm Repair Kit		SC-RK-8575	for Wishbone (CV)	
02/98→12/00		Suspension Strut Repair Kit		DF-RK-8637		
02/98→12/00		Suspension Strut Repair Kit		DF-RK-8685		
02/98→12/00		Suspension Strut Repair Kit		MN-RK-8537		
02/98→12/00		Tie Rod	DF-DL-5403		1st FA	
02/98→12/00		Tie Rod	DF-DL-7780		1st FA	
02/98→12/00		Tie Rod	DF-DL-7836			
02/98→12/00		Tie Rod End	CV-ES-12461		for Steering Rod	
02/98→12/00		Tie Rod End	CV-ES-12462		for Steering Rod	
02/98→12/00		Tie Rod End	CV-ES-14163		for Steering Rod	
02/98→12/00		Tie Rod End	DF-ES-3804			
02/98→12/00		Tie Rod End	DF-ES-3805			
02/98→12/00		Track Control Arm		DF-DL-8158	Trailing Arm, Air Suspension Axle	
02/98→12/00		Track Control Arm		DF-VB-8561	Wishbone (CV), Air Suspension Axle	
02/98→12/00		Track Control Arm		DF-VB-9343	Wishbone (CV)	
FAG 75 CF 250,FAN 75 CF 250		02/98→12/00	Centre Rod	DF-DL-5226	DF-DL-5226	Push Rod, for vehicles with Hinged Trailing Axle
		02/98→12/00	Centre Rod	DF-DL-5237	DF-DL-5237	Push Rod, for vehicles with Hinged Trailing Axle
		02/98→12/00	Centre Rod	DF-DL-8196		Push Rod
		02/98→12/00	Centre Rod	DF-DL-8658	DF-DL-8658	Push Rod, Leading Axle
		02/98→12/00	Stabiliser Mounting		DF-SB-9342	
		02/98→12/00	Stabiliser Mounting	DF-SB-5253	DF-SB-5253	
		02/98→12/00	Stabiliser Mounting	DF-SB-10402		
		02/98→12/00	Suspension Arm Repair Kit		CV-RK-5322	for Wishbone (CV)
	02/98→12/00	Suspension Arm Repair Kit		DF-RK-9336		
	02/98→12/00	Suspension Arm Repair Kit		IV-RK-8998	for Wishbone (CV)	
	02/98→12/00	Suspension Arm Repair Kit		MN-RK-7280	for Drag Link	
	02/98→12/00	Suspension Arm Repair Kit		SC-RK-8575	for Wishbone (CV)	
	02/98→12/00	Suspension Strut Repair Kit		DF-RK-8637		
	02/98→12/00	Suspension Strut Repair Kit		DF-RK-8685		
	02/98→12/00	Suspension Strut Repair Kit		MN-RK-8537		
	02/98→12/00	Tie Rod	DF-DL-5403		1st FA	
	02/98→12/00	Tie Rod	DF-DL-7780		for vehicles with Hinged Leading Axle	
	02/98→12/00	Tie Rod	DF-DL-7780	DF-DL-7780	for vehicles with Hinged Trailing Axle	
	02/98→12/00	Tie Rod	DF-DL-7836			
	02/98→12/00	Tie Rod End	CV-ES-12461		for Steering Rod	
	02/98→12/00	Tie Rod End	CV-ES-12462		for Steering Rod	
	02/98→12/00	Tie Rod End	CV-ES-14163		for Steering Rod	
	02/98→12/00	Tie Rod End	DF-ES-3804			
	02/98→12/00	Tie Rod End	DF-ES-3805			
	02/98→12/00	Tie Rod End	DF-ES-12429		for Steering Rod	
	02/98→12/00	Track Control Arm		DF-DL-8158	Trailing Arm, Air Suspension Axle; Drive Axle;Leading Axle;Trailing Axle	

CV-ES-12461

Length: 120
Cone Ø: d1 Ø 26 / d2 Ø 23,5
Thread: M30 x 1,5 LHT
0069513, 69513, 0311300, 311300,
0607998, 607998, 1190653, 1315447,
1319838, 1332123, 1338714, 1401934,
1407394, ACHB063, ACHF241, MAK1295



CV-ES-12462

Length: 120
Cone Ø: d1 Ø 26 / d2 Ø 23,5
Thread: M30 x 1,5 RHT
0069514, 0586753, 0607999, 0694298,
0694360, 0698609, 1137230, 1229944,
1326862, 1326896, 1331925, ACHB064,
ACHF242, MAK1296



CV-ES-14163

Length: 125
Cone Ø: d1 Ø 30 / d2 Ø 27
Thread: M30 x 1,5 RHT
0607981, 0698450, 1149907, 1152350,
1257890, 1603789, 1618048, ACHF060



CV-RK-5322

Ø: 72
Thick/Height: 50
0691704



DF-DL-5226

Length: 850
Ø: 52
Cone Ø: d1 Ø 26 / d2 Ø 23,5
1247957, 1283212, 1351715, 1385492,
10200900A



DF-DL-5237

Length: 880
Ø: 52
Cone Ø: d1 Ø 26 / d2 Ø 23,5
1283211, 1351714, 1385497, 10201000A



DF-DL-5403

Length: 1742
Ø: 40
Cone Ø: d1 Ø 26 / d2 Ø 23,5
0288281, 1270854, 1337644



DF-DL-7780

Length: 1690
Ø: 40
Cone Ø: d1 Ø 26 / d2 Ø 23,5
1270853, 1353391, 10212000A



DF-DL-7836

Length: 1698
Ø: 52
Cone Ø: d1 Ø 26 / d2 Ø 23,5
0754922, 1286343, 1353396



DF-DL-8158

Length: 611
Ø: 48
Hole Distance: 130 / 130
0267743, 1361649, 1361650, 1656428



DF-DL-8196

Length: 867
Ø: 50
Cone Ø: d1 Ø 30 / d2 Ø 27
1363859, 1448063, 1602821



DF-DL-8658

Length: 622
Ø: 42
Cone Ø: d1 Ø 26 / d2 Ø 23,5
0593883, 1351730, 1351745, 1385488



DF-ES-3804

Length: 140
Cone Ø: d1 Ø 30 / d2 Ø 27
Thread: M48 x 1,5 LHT
0067303



DF-ES-3805

Length: 140
Cone Ø: d1 Ø 30 / d2 Ø 27
Thread: M48 x 1,5 RHT
0067389



DF-ES-12429

Length: 90
Cone Ø: d1 Ø 26 / d2 Ø 23,5
1299555, 4125657, 0004632329,
0004632629, 120110404, 1605300141



DF-RK-8637

Ø: 72
1376730



DF-RK-8685

Ø: 67
Hole Distance: 130
Thick/Height: 24
1321936



DF-RK-9336

Ø: 108
1445656



DF-SB-5253

Ø: 86
Thick/Height: 60,5
0371586, 0558864, 10306500A



DF-SB-9342

Ø: 94
Thick/Height: 80 / 70
0281007, 0298498, 008169892, 8169892,
041270883, 41270883



DF-SB-10402

Ø: 62
Thick/Height: 60
1291233, 1732887



DF-VB-8561

Length: 609
Ø: 48
Hole Distance: 152 / 152
0080521, 080521, 1361651, 1368270,
1390932, 1617096, 1793875, 1817808,
1892492



DF-VB-9343

Length: 608,2
Ø: 48
Hole Distance: 152 / 152
1361652, 1620436, 1793876, 10309600A



IV-RK-8998

Ø: 85
Hole Distance: 130
Thick/Height: 30
0513757, 0531757, 0691709, 691709



MN-RK-7280

Ø: 75
Hole Distance: 115
Thick/Height: 24
0689748, 689748



MN-RK-8537

Ø: 95
Hole Distance: 152
Thick/Height: 24
696321, 81432706099



SC-RK-8575

Ø: 95
Hole Distance: 152
Thick/Height: 35
0696321



CV-ES-12461

Length: 120
Cone Ø: d1 Ø 26 / d2 Ø 23,5
Thread: M30 x 1,5 LHT
0069513, 69513, 0311300, 311300,
0607998, 607998, 1190653, 1315447,
1319838, 1332123, 1338714, 1401934,
1407394, ACHB063, ACHF241, MAK1295





75 CF ...

FAG 75 CF 250,FAN 75 CF 250 ...	02/98→12/00	Track Control Arm		DF-VB-8561	Wishbone (CV), Air Suspension Axle; Drive Axle;Trailing Axle
	02/98→12/00	Track Control Arm		DF-VB-9343	Wishbone (CV)
FAG 75 CF 290,FAN 75 CF 290	02/98→12/00	Centre Rod	DF-DL-5226	DF-DL-5226	Push Rod, for vehicles with Hinged Trailing Axle
	02/98→12/00	Centre Rod	DF-DL-5237	DF-DL-5237	Push Rod, for vehicles with Hinged Trailing Axle
	02/98→12/00	Centre Rod	DF-DL-8196		Push Rod
	02/98→12/00	Centre Rod	DF-DL-8658	DF-DL-8658	Push Rod, Leading Axle
	02/98→12/00	Stabiliser Mounting		DF-SB-9342	
	02/98→12/00	Stabiliser Mounting	DF-SB-5253	DF-SB-5253	
	02/98→12/00	Stabiliser Mounting	DF-SB-10402		
	02/98→12/00	Suspension Arm Repair Kit		CV-RK-5322	for Wishbone (CV)
	02/98→12/00	Suspension Arm Repair Kit		DF-RK-9336	
	02/98→12/00	Suspension Arm Repair Kit		IV-RK-8998	for Wishbone (CV)
	02/98→12/00	Suspension Arm Repair Kit		MN-RK-7280	for Drag Link
	02/98→12/00	Suspension Arm Repair Kit		SC-RK-8575	for Wishbone (CV)
	02/98→12/00	Suspension Strut Repair Kit		DF-RK-8637	
	02/98→12/00	Suspension Strut Repair Kit		DF-RK-8685	
	02/98→12/00	Suspension Strut Repair Kit		MN-RK-8537	
	02/98→12/00	Tie Rod	DF-DL-5403		1st FA
	02/98→12/00	Tie Rod	DF-DL-7780		for vehicles with Hinged Leading Axle
	02/98→12/00	Tie Rod	DF-DL-7780	DF-DL-7780	for vehicles with Hinged Trailing Axle
	02/98→12/00	Tie Rod	DF-DL-7836		
	02/98→12/00	Tie Rod End	CV-ES-12461		for Steering Rod
02/98→12/00	Tie Rod End	CV-ES-12462		for Steering Rod	
02/98→12/00	Tie Rod End	CV-ES-14163		for Steering Rod	
02/98→12/00	Tie Rod End	DF-ES-3804			
02/98→12/00	Tie Rod End	DF-ES-3805			
02/98→12/00	Tie Rod End	DF-ES-12429		for Steering Rod	
02/98→12/00	Track Control Arm			DF-DL-8158	Trailing Arm, Air Suspension Axle; Drive Axle;Leading Axle;Trailing Axle
	Track Control Arm			DF-VB-8561	Wishbone (CV), Air Suspension Axle; Drive Axle;Trailing Axle
02/98→12/00	Track Control Arm			DF-VB-9343	Wishbone (CV)
FAG 75 CF 320,FAN 75 CF 320	02/98→12/00	Centre Rod	DF-DL-5226	DF-DL-5226	Push Rod, for vehicles with Hinged Trailing Axle
	02/98→12/00	Centre Rod	DF-DL-5237	DF-DL-5237	Push Rod, for vehicles with Hinged Trailing Axle
	02/98→12/00	Centre Rod	DF-DL-8196		Push Rod
	02/98→12/00	Centre Rod	DF-DL-8658	DF-DL-8658	Push Rod, Leading Axle
	02/98→12/00	Stabiliser Mounting		DF-SB-9342	
	02/98→12/00	Stabiliser Mounting	DF-SB-5253	DF-SB-5253	
	02/98→12/00	Stabiliser Mounting	DF-SB-10402		
	02/98→12/00	Suspension Arm Repair Kit		CV-RK-5322	for Wishbone (CV)
	02/98→12/00	Suspension Arm Repair Kit		DF-RK-9336	
	02/98→12/00	Suspension Arm Repair Kit		IV-RK-8998	for Wishbone (CV)
	02/98→12/00	Suspension Arm Repair Kit		MN-RK-7280	for Drag Link
	02/98→12/00	Suspension Arm Repair Kit		SC-RK-8575	for Wishbone (CV)
	02/98→12/00	Suspension Strut Repair Kit		DF-RK-8637	
	02/98→12/00	Suspension Strut Repair Kit		DF-RK-8685	
	02/98→12/00	Suspension Strut Repair Kit		MN-RK-8537	
	02/98→12/00	Tie Rod	DF-DL-5403		1st FA
	02/98→12/00	Tie Rod	DF-DL-7780		for vehicles with Hinged Leading Axle
	02/98→12/00	Tie Rod	DF-DL-7780	DF-DL-7780	for vehicles with Hinged Trailing Axle
	02/98→12/00	Tie Rod	DF-DL-7836		
	02/98→12/00	Tie Rod End	CV-ES-12461		for Steering Rod
02/98→12/00	Tie Rod End	CV-ES-12462		for Steering Rod	
02/98→12/00	Tie Rod End	CV-ES-14163		for Steering Rod	
02/98→12/00	Tie Rod End	DF-ES-3804			
02/98→12/00	Tie Rod End	DF-ES-3805			
02/98→12/00	Tie Rod End	DF-ES-12429		for Steering Rod	
02/98→12/00	Track Control Arm			DF-DL-8158	Trailing Arm, Air Suspension Axle; Drive Axle;Leading Axle;Trailing Axle
	Track Control Arm			DF-VB-8561	Wishbone (CV), Air Suspension Axle; Drive Axle;Trailing Axle
02/98→12/00	Track Control Arm			DF-VB-9343	Wishbone (CV)

CV-ES-12462

Length: 120
Cone Ø: d1 Ø 26 / d2 Ø 23,5
Thread: M30 x 1,5 RHT
0069514, 0586753, 0607999, 0694298, 0694360, 0698609, 1137230, 1229944, 1326862, 1326896, 1331925, ACHB064, ACHF242, MAK1296



CV-ES-14163

Length: 125
Cone Ø: d1 Ø 30 / d2 Ø 27
Thread: M30 x 1,5 RHT
0607981, 0698450, 1149907, 1152350, 1257890, 1603789, 1618048, ACHF060



CV-RK-5322

Ø: 72
Thick/Height: 50
0691704



DF-DL-5226

Length: 850
Ø: 52
Cone Ø: d1 Ø 26 / d2 Ø 23,5
1247957, 1283212, 1351715, 1385492, 10200900A



DF-DL-5237

Length: 880
Ø: 52
Cone Ø: d1 Ø 26 / d2 Ø 23,5
1283211, 1351714, 1385497, 10201000A



DF-DL-5403

Length: 1742
Ø: 40
Cone Ø: d1 Ø 26 / d2 Ø 23,5
0288281, 1270854, 1337644



DF-DL-7780

Length: 1690
Ø: 40
Cone Ø: d1 Ø 26 / d2 Ø 23,5
1270853, 1353391, 10212000A



DF-DL-7836

Length: 1698
Ø: 52
Cone Ø: d1 Ø 26 / d2 Ø 23,5
0754922, 1286343, 1353396



DF-DL-8158

Length: 611
Ø: 48
Hole Distance: 130 / 130
0267743, 1361649, 1361650, 1656428



DF-DL-8196

Length: 867
Ø: 50
Cone Ø: d1 Ø 30 / d2 Ø 27
1363859, 1448063, 1602821



DF-DL-8658

Length: 622
Ø: 42
Cone Ø: d1 Ø 26 / d2 Ø 23,5
0593883, 1351730, 1351745, 1385488



DF-ES-3804

Length: 140
Cone Ø: d1 Ø 30 / d2 Ø 27
Thread: M48 x 1,5 LHT
0067303



DF-ES-3805

Length: 140
Cone Ø: d1 Ø 30 / d2 Ø 27
Thread: M48 x 1,5 RHT
0067389



DF-ES-12429

Length: 90
Cone Ø: d1 Ø 26 / d2 Ø 23,5
1299555, 4125657, 0004632329, 0004632629, 120110404, 1605300141



DF-RK-8637

Ø: 72
1376730



DF-RK-8685

Ø: 67
Hole Distance: 130
Thick/Height: 24
1321936



DF-RK-9336

Ø: 108
1445656



DF-SB-5253

Ø: 86
Thick/Height: 60,5
0371586, 0558864, 10306500A



DF-SB-9342

Ø: 94
Thick/Height: 80 / 70
0281007, 0298498, 008169892, 8169892, 041270883, 41270883



DF-SB-10402

Ø: 62
Thick/Height: 60
1291233, 1732887



DF-VB-8561

Length: 609
Ø: 48
Hole Distance: 152 / 152
0080521, 080521, 1361651, 1368270, 1390932, 1617096, 1793875, 1817808, 1892492



DF-VB-9343

Length: 608,2
Ø: 48
Hole Distance: 152 / 152
1361652, 1620436, 1793876, 10309600A



IV-RK-8998

Ø: 85
Hole Distance: 130
Thick/Height: 30
0513757, 0531757, 0691709, 691709



MN-RK-7280

Ø: 75
Hole Distance: 115
Thick/Height: 24
689748, 0689748



MN-RK-8537

Ø: 95
Hole Distance: 152
Thick/Height: 24
696321, 81432706099



SC-RK-8575

Ø: 95
Hole Distance: 152
Thick/Height: 35
0696321





75 CF ...

FAR 75 CF 250, FAS 75 CF 250	02/98→12/00	Centre Rod	DF-DL-5226		Push Rod	
	02/98→12/00	Centre Rod	DF-DL-5237		Push Rod	
	02/98→12/00	Centre Rod	DF-DL-8196		Push Rod	
	02/98→12/00	Stabiliser Mounting		DF-SB-9342		
	02/98→12/00	Stabiliser Mounting	DF-SB-5253	DF-SB-5253		
	02/98→12/00	Stabiliser Mounting	DF-SB-10402			
	02/98→12/00	Suspension Arm Repair Kit		CV-RK-5322	for Wishbone (CV)	
	02/98→12/00	Suspension Arm Repair Kit		DF-RK-9336		
	02/98→12/00	Suspension Arm Repair Kit		IV-RK-8998	for Wishbone (CV)	
	02/98→12/00	Suspension Arm Repair Kit		MN-RK-7280	for Drag Link	
	02/98→12/00	Suspension Arm Repair Kit		SC-RK-8575	for Wishbone (CV)	
	02/98→12/00	Suspension Strut Repair Kit		DF-RK-8637		
	02/98→12/00	Suspension Strut Repair Kit		DF-RK-8685		
	02/98→12/00	Suspension Strut Repair Kit		MN-RK-8537		
	02/98→12/00	Tie Rod	DF-DL-5403		1st FA	
	02/98→12/00	Tie Rod	DF-DL-7780		1st FA	
	02/98→12/00	Tie Rod	DF-DL-7836			
	02/98→12/00	Tie Rod End	CV-ES-12461		for Steering Rod	
	02/98→12/00	Tie Rod End	CV-ES-12462		for Steering Rod	
	02/98→12/00	Tie Rod End	CV-ES-14163		for Steering Rod	
	02/98→12/00	Tie Rod End	DF-ES-3804			
	02/98→12/00	Tie Rod End	DF-ES-3805			
	02/98→12/00	Track Control Arm		DF-DL-8158	Trailing Arm, Air Suspension Axle; Drive Axle;Trailing Axle	
	02/98→12/00	Track Control Arm		DF-VB-8561	Wishbone (CV), Air Suspension Axle; Drive Axle;Trailing Axle	
	02/98→12/00	Track Control Arm		DF-VB-9343	Wishbone (CV)	
	FAR 75 CF 290, FAS 75 CF 290	02/98→12/00	Centre Rod	DF-DL-5226		Push Rod
		02/98→12/00	Centre Rod	DF-DL-5237		Push Rod
		02/98→12/00	Centre Rod	DF-DL-8196		Push Rod
		02/98→12/00	Stabiliser Mounting		DF-SB-9342	
		02/98→12/00	Stabiliser Mounting	DF-SB-5253	DF-SB-5253	
02/98→12/00		Stabiliser Mounting	DF-SB-10402			
02/98→12/00		Suspension Arm Repair Kit		CV-RK-5322	for Wishbone (CV)	
02/98→12/00		Suspension Arm Repair Kit		DF-RK-9336		
02/98→12/00		Suspension Arm Repair Kit		IV-RK-8998	for Wishbone (CV)	
02/98→12/00		Suspension Arm Repair Kit		MN-RK-7280	for Drag Link	
02/98→12/00		Suspension Arm Repair Kit		SC-RK-8575	for Wishbone (CV)	
02/98→12/00		Suspension Strut Repair Kit		DF-RK-8637		
02/98→12/00		Suspension Strut Repair Kit		DF-RK-8685		
02/98→12/00		Suspension Strut Repair Kit		MN-RK-8537		
02/98→12/00		Tie Rod	DF-DL-5403		1st FA	
02/98→12/00		Tie Rod	DF-DL-7780		1st FA	
02/98→12/00		Tie Rod	DF-DL-7836			
02/98→12/00		Tie Rod End	CV-ES-12461		for Steering Rod	
02/98→12/00		Tie Rod End	CV-ES-12462		for Steering Rod	
02/98→12/00		Tie Rod End	CV-ES-14163		for Steering Rod	
02/98→12/00		Tie Rod End	DF-ES-3804			
02/98→12/00		Tie Rod End	DF-ES-3805			
02/98→12/00		Track Control Arm		DF-DL-8158	Trailing Arm, Air Suspension Axle; Drive Axle;Trailing Axle	
02/98→12/00		Track Control Arm		DF-VB-8561	Wishbone (CV), Air Suspension Axle; Drive Axle;Trailing Axle	
02/98→12/00		Track Control Arm		DF-VB-9343	Wishbone (CV)	
FAR 75 CF 320, FAS 75 CF 320		02/98→12/00	Centre Rod	DF-DL-5226		Push Rod
		02/98→12/00	Centre Rod	DF-DL-5237		Push Rod
		02/98→12/00	Centre Rod	DF-DL-8196		Push Rod
		02/98→12/00	Stabiliser Mounting		DF-SB-9342	
		02/98→12/00	Stabiliser Mounting	DF-SB-5253	DF-SB-5253	
	02/98→12/00	Stabiliser Mounting	DF-SB-10402			
	02/98→12/00	Suspension Arm Repair Kit		CV-RK-5322	for Wishbone (CV)	
	02/98→12/00	Suspension Arm Repair Kit		DF-RK-9336		
	02/98→12/00	Suspension Arm Repair Kit		IV-RK-8998	for Wishbone (CV)	

CV-ES-12461

Length: 120
Cone Ø: d1 Ø 26 / d2 Ø 23,5
Thread: M30 x 1,5 LHT
0069513, 69513, 0311300, 311300,
0607998, 607998, 1190653, 1315447,
1319838, 1332123, 1338714, 1401934,
1407394, ACHB063, ACHF241, MAK1295



CV-ES-12462

Length: 120
Cone Ø: d1 Ø 26 / d2 Ø 23,5
Thread: M30 x 1,5 RHT
0069514, 0586753, 0607999, 0694298,
0694360, 0698609, 1137230, 1229944,
1326862, 1326896, 1331925, ACHB064,
ACHF242, MAK1296



CV-ES-14163

Length: 125
Cone Ø: d1 Ø 30 / d2 Ø 27
Thread: M30 x 1,5 RHT
0607981, 0698450, 1149907, 1152350,
1257890, 1603789, 1618048, ACHF060



CV-RK-5322

Ø: 72
Thick/Height: 50
0691704



DF-DL-5226

Length: 850
Ø: 52
Cone Ø: d1 Ø 26 / d2 Ø 23,5
1247957, 1283212, 1351715, 1385492,
10200900A



DF-DL-5237

Length: 880
Ø: 52
Cone Ø: d1 Ø 26 / d2 Ø 23,5
1283211, 1351714, 1385497, 10201000A



DF-DL-5403

Length: 1742
Ø: 40
Cone Ø: d1 Ø 26 / d2 Ø 23,5
0288281, 1270854, 1337644



DF-DL-7780

Length: 1690
Ø: 40
Cone Ø: d1 Ø 26 / d2 Ø 23,5
1270853, 1353391, 10212000A



DF-DL-7836

Length: 1698
Ø: 52
Cone Ø: d1 Ø 26 / d2 Ø 23,5
0754922, 1286343, 1353396



DF-DL-8158

Length: 611
Ø: 48
Hole Distance: 130 / 130
0267743, 1361649, 1361650, 1656428



DF-DL-8196

Length: 867
Ø: 50
Cone Ø: d1 Ø 30 / d2 Ø 27
1363859, 1448063, 1602821



DF-ES-3804

Length: 140
Cone Ø: d1 Ø 30 / d2 Ø 27
Thread: M48 x 1,5 LHT
0067303



DF-ES-3805

Length: 140
Cone Ø: d1 Ø 30 / d2 Ø 27
Thread: M48 x 1,5 RHT
0067389



DF-RK-8637

Ø: 72
1376730



DF-RK-8685

Ø: 67
Hole Distance: 130
Thick/Height: 24
1321936



DF-RK-9336

Ø: 108
1445656



DF-SB-5253

Ø: 86
Thick/Height: 60,5
0371586, 0558864, 10306500A



DF-SB-9342

Ø: 94
Thick/Height: 80 / 70
0281007, 0298498, 008169892, 8169892,
041270883, 41270883



DF-SB-10402

Ø: 62
Thick/Height: 60
1291233, 1732887



DF-VB-8561

Length: 609
Ø: 48
Hole Distance: 152 / 152
0080521, 080521, 1361651, 1368270,
1390932, 1617096, 1793875, 1817808,
1892492



DF-VB-9343

Length: 608,2
Ø: 48
Hole Distance: 152 / 152
1361652, 1620436, 1793876, 10309600A



IV-RK-8998

Ø: 85
Hole Distance: 130
Thick/Height: 30
0513757, 0531757, 0691709, 691709



MN-RK-7280

Ø: 75
Hole Distance: 115
Thick/Height: 24
689748, 0689748



MN-RK-8537

Ø: 95
Hole Distance: 152
Thick/Height: 24
696321, 81432706099



SC-RK-8575

Ø: 95
Hole Distance: 152
Thick/Height: 35
0696321





75 CF ...

FAR 75 CF 320,FAS 75 CF 320 ...	02/98→12/00	Suspension Arm Repair Kit		MN-RK-7280	for Drag Link	
	02/98→12/00	Suspension Arm Repair Kit		SC-RK-8575	for Wishbone (CV)	
	02/98→12/00	Suspension Strut Repair Kit		DF-RK-8637		
	02/98→12/00	Suspension Strut Repair Kit		DF-RK-8685		
	02/98→12/00	Suspension Strut Repair Kit		MN-RK-8537		
	02/98→12/00	Tie Rod	DF-DL-5403		1st FA	
	02/98→12/00	Tie Rod	DF-DL-7780		1st FA	
	02/98→12/00	Tie Rod	DF-DL-7836			
	02/98→12/00	Tie Rod End	CV-ES-12461		for Steering Rod	
	02/98→12/00	Tie Rod End	CV-ES-12462		for Steering Rod	
	02/98→12/00	Tie Rod End	CV-ES-14163		for Steering Rod	
	02/98→12/00	Tie Rod End	DF-ES-3804			
	02/98→12/00	Tie Rod End	DF-ES-3805			
	02/98→12/00	Track Control Arm		DF-DL-8158	Trailing Arm, Air Suspension Axle; Drive Axle;Trailing Axle	
	02/98→12/00	Track Control Arm		DF-VB-8561	Wishbone (CV), Air Suspension Axle; Drive Axle;Trailing Axle	
	02/98→12/00	Track Control Arm		DF-VB-9343	Wishbone (CV)	
	FAT 75 CF 250	02/98→12/00	Centre Rod	DF-DL-5226		Push Rod
		02/98→12/00	Centre Rod	DF-DL-5237		Push Rod
		02/98→12/00	Centre Rod	DF-DL-8196		Push Rod
		02/98→12/00	Stabiliser Mounting		DF-SB-9342	
02/98→12/00		Stabiliser Mounting	DF-SB-5253	DF-SB-5253		
02/98→12/00		Stabiliser Mounting	DF-SB-10402			
02/98→12/00		Suspension Arm Repair Kit		CV-RK-5322	for Wishbone (CV)	
02/98→12/00		Suspension Arm Repair Kit		DF-RK-9336		
02/98→12/00		Suspension Arm Repair Kit		IV-RK-8998	for Wishbone (CV)	
02/98→12/00		Suspension Arm Repair Kit		MN-RK-7280	for Drag Link	
02/98→12/00		Suspension Arm Repair Kit		SC-RK-8575	for Wishbone (CV)	
02/98→12/00		Suspension Strut Repair Kit		DF-RK-8637		
02/98→12/00		Suspension Strut Repair Kit		DF-RK-8685		
02/98→12/00		Suspension Strut Repair Kit		MN-RK-8537		
02/98→12/00		Tie Rod	DF-DL-5403		1st FA	
02/98→12/00		Tie Rod	DF-DL-7780		1st FA	
02/98→12/00		Tie Rod	DF-DL-7836			
02/98→12/00		Tie Rod End	CV-ES-12461		for Steering Rod	
02/98→12/00		Tie Rod End	CV-ES-12462		for Steering Rod	
02/98→12/00		Tie Rod End	CV-ES-14163		for Steering Rod	
02/98→12/00	Tie Rod End	DF-ES-3804				
02/98→12/00	Tie Rod End	DF-ES-3805				
02/98→12/00	Track Control Arm		DF-DL-8158	Trailing Arm		
02/98→12/00	Track Control Arm		DF-DL-9318	Trailing Arm		
02/98→12/00	Track Control Arm		DF-TC-12262	Control Arm		
02/98→12/00	Track Control Arm		DF-VB-8561	Wishbone (CV)		
02/98→12/00	Track Control Arm		DF-VB-9343	Wishbone (CV)		
FAT 75 CF 290	02/98→12/00	Centre Rod	DF-DL-5226		Push Rod	
	02/98→12/00	Centre Rod	DF-DL-5237		Push Rod	
	02/98→12/00	Centre Rod	DF-DL-8196		Push Rod	
	02/98→12/00	Stabiliser Mounting		DF-SB-9342		
	02/98→12/00	Stabiliser Mounting	DF-SB-5253	DF-SB-5253		
	02/98→12/00	Stabiliser Mounting	DF-SB-10402			
	02/98→12/00	Suspension Arm Repair Kit		CV-RK-5322	for Wishbone (CV)	
	02/98→12/00	Suspension Arm Repair Kit		DF-RK-9336		
	02/98→12/00	Suspension Arm Repair Kit		IV-RK-8998	for Wishbone (CV)	
	02/98→12/00	Suspension Arm Repair Kit		MN-RK-7280	for Drag Link	
	02/98→12/00	Suspension Arm Repair Kit		SC-RK-8575	for Wishbone (CV)	
	02/98→12/00	Suspension Strut Repair Kit		DF-RK-8637		
	02/98→12/00	Suspension Strut Repair Kit		DF-RK-8685		
	02/98→12/00	Suspension Strut Repair Kit		MN-RK-8537		
	02/98→12/00	Tie Rod	DF-DL-5403		1st FA	
	02/98→12/00	Tie Rod	DF-DL-7780		1st FA	
	02/98→12/00	Tie Rod	DF-DL-7836			
	02/98→12/00	Tie Rod End	CV-ES-12461		for Steering Rod	

CV-ES-12461

Length: 120
Cone Ø: d1 Ø 26 / d2 Ø 23,5
Thread: M30 x 1,5 LHT
0069513, 69513, 0311300, 311300, 607998, 0607998, 1190653, 1315447, 1319838, 1332123, 1338714, 1401934, 1407394, ACHB063, ACHF241, MAK1295



CV-ES-12462

Length: 120
Cone Ø: d1 Ø 26 / d2 Ø 23,5
Thread: M30 x 1,5 RHT
0069514, 0586753, 0607999, 0694298, 0694360, 0698609, 1137230, 1229944, 1326862, 1326896, 1331925, ACHB064, ACHF242, MAK1296



CV-ES-14163

Length: 125
Cone Ø: d1 Ø 30 / d2 Ø 27
Thread: M30 x 1,5 RHT
0607981, 0698450, 1149907, 1152350, 1257890, 1603789, 1618048, ACHF060



CV-RK-5322

Ø: 72
Thick/Height: 50
0691704



DF-DL-5226

Length: 850
Ø: 52
Cone Ø: d1 Ø 26 / d2 Ø 23,5
1247957, 1283212, 1351715, 1385492, 10200900A



DF-DL-5237

Length: 880
Ø: 52
Cone Ø: d1 Ø 26 / d2 Ø 23,5
1283211, 1351714, 1385497, 10201000A



DF-DL-5403

Length: 1742
Ø: 40
Cone Ø: d1 Ø 26 / d2 Ø 23,5
0288281, 1270854, 1337644



DF-DL-7780

Length: 1690
Ø: 40
Cone Ø: d1 Ø 26 / d2 Ø 23,5
1270853, 1353391, 10212000A



DF-DL-7836

Length: 1698
Ø: 52
Cone Ø: d1 Ø 26 / d2 Ø 23,5
0754922, 1286343, 1353396



DF-DL-8158

Length: 611
Ø: 48
Hole Distance: 130 / 130
0267743, 1361649, 1361650, 1656428



DF-DL-8196

Length: 867
Ø: 50
Cone Ø: d1 Ø 30 / d2 Ø 27
1363859, 1448063, 1602821



DF-DL-9318

Length: 600
Ø: 50
Hole Distance: 130 / 130
0646373, 0655695, 0655697, 1284860, 1620438



DF-ES-3804

Length: 140
Cone Ø: d1 Ø 30 / d2 Ø 27
Thread: M48 x 1,5 LHT
0067303



DF-ES-3805

Length: 140
Cone Ø: d1 Ø 30 / d2 Ø 27
Thread: M48 x 1,5 RHT
0067389



DF-RK-8637

Ø: 72
1376730



DF-RK-8685

Ø: 67
Hole Distance: 130
Thick/Height: 24
1321936



DF-RK-9336

Ø: 108
1445656



DF-SB-5253

Ø: 86
Thick/Height: 60,5
0371586, 0558864, 10306500A



DF-SB-9342

Ø: 94
Thick/Height: 80 / 70
0281007, 0298498, 008169892, 8169892, 041270883, 41270883



DF-SB-10402

Ø: 62
Thick/Height: 60
1291233, 1732887



DF-TC-12262

Length: 595
Ø: 50
Hole Distance: 130 / 130
0661406, 661406, 0661407, 661407, 1620439



DF-VB-8561

Length: 609
Ø: 48
Hole Distance: 152 / 152
080521, 0080521, 1361651, 1368270, 1390932, 1617096, 1793875, 1817808, 1892492



DF-VB-9343

Length: 608,2
Ø: 48
Hole Distance: 152 / 152
1361652, 1620436, 1793876, 10309600A



IV-RK-8998

Ø: 85
Hole Distance: 130
Thick/Height: 30
0513757, 0531757, 691709, 0691709



MN-RK-7280

Ø: 75
Hole Distance: 115
Thick/Height: 24
0689748, 689748



MN-RK-8537

Ø: 95
Hole Distance: 152
Thick/Height: 24
696321, 81432706099



SC-RK-8575

Ø: 95
Hole Distance: 152
Thick/Height: 35
0696321





75 CF ...

FAT 75 CF 290 ...	02/98→12/00	Tie Rod End	CV-ES-12462		for Steering Rod
	02/98→12/00	Tie Rod End	CV-ES-14163		for Steering Rod
	02/98→12/00	Tie Rod End	DF-ES-3804		
	02/98→12/00	Tie Rod End	DF-ES-3805		
	02/98→12/00	Track Control Arm		DF-DL-8158	Trailing Arm
	02/98→12/00	Track Control Arm		DF-DL-9318	Trailing Arm
	02/98→12/00	Track Control Arm		DF-TC-12262	Control Arm
	02/98→12/00	Track Control Arm		DF-VB-8561	Wishbone (CV)
FAT 75 CF 320	02/98→12/00	Track Control Arm		DF-VB-9343	Wishbone (CV)
	02/98→12/00	Centre Rod	DF-DL-5226		Push Rod
	02/98→12/00	Centre Rod	DF-DL-5237		Push Rod
	02/98→12/00	Centre Rod	DF-DL-8196		Push Rod
	02/98→12/00	Stabiliser Mounting		DF-SB-9342	
	02/98→12/00	Stabiliser Mounting	DF-SB-5253	DF-SB-5253	
	02/98→12/00	Stabiliser Mounting	DF-SB-10402		
	02/98→12/00	Suspension Arm Repair Kit		CV-RK-5322	for Wishbone (CV)
	02/98→12/00	Suspension Arm Repair Kit		DF-RK-9336	
	02/98→12/00	Suspension Arm Repair Kit		IV-RK-8998	for Wishbone (CV)
	02/98→12/00	Suspension Arm Repair Kit		MN-RK-7280	for Drag Link
	02/98→12/00	Suspension Arm Repair Kit		SC-RK-8575	for Wishbone (CV)
	02/98→12/00	Suspension Strut Repair Kit		DF-RK-8637	
	02/98→12/00	Suspension Strut Repair Kit		DF-RK-8685	
	02/98→12/00	Suspension Strut Repair Kit		MN-RK-8537	
	02/98→12/00	Tie Rod	DF-DL-5403		1st FA
	02/98→12/00	Tie Rod	DF-DL-7780		1st FA
	02/98→12/00	Tie Rod	DF-DL-7836		
	02/98→12/00	Tie Rod End	CV-ES-12461		for Steering Rod
	02/98→12/00	Tie Rod End	CV-ES-12462		for Steering Rod
	02/98→12/00	Tie Rod End	CV-ES-14163		for Steering Rod
	02/98→12/00	Tie Rod End	DF-ES-3804		
	02/98→12/00	Tie Rod End	DF-ES-3805		
	02/98→12/00	Track Control Arm		DF-DL-8158	Trailing Arm
	02/98→12/00	Track Control Arm		DF-DL-9318	Trailing Arm
	02/98→12/00	Track Control Arm		DF-TC-12262	Control Arm
	02/98→12/00	Track Control Arm		DF-VB-8561	Wishbone (CV)
	02/98→12/00	Track Control Arm		DF-VB-9343	Wishbone (CV)
FT 75 CF 250	02/98→12/00	Centre Rod	DF-DL-5226		Push Rod
	02/98→12/00	Centre Rod	DF-DL-5237		Suspension Rod
	02/98→12/00	Centre Rod	DF-DL-8196		Push Rod
	02/98→12/00	Stabiliser Mounting		DF-SB-9342	
	02/98→12/00	Stabiliser Mounting	DF-SB-5253	DF-SB-5253	
	02/98→12/00	Stabiliser Mounting	DF-SB-10402		
	02/98→12/00	Suspension Arm Repair Kit		CV-RK-5322	for Wishbone (CV)
	02/98→12/00	Suspension Arm Repair Kit		DF-RK-9336	
	02/98→12/00	Suspension Arm Repair Kit		IV-RK-8998	for Wishbone (CV)
	02/98→12/00	Suspension Arm Repair Kit		MN-RK-7280	for Drag Link
	02/98→12/00	Suspension Arm Repair Kit		SC-RK-8575	for Wishbone (CV)
	02/98→12/00	Suspension Strut Repair Kit		DF-RK-8637	
	02/98→12/00	Suspension Strut Repair Kit		DF-RK-8685	
	02/98→12/00	Suspension Strut Repair Kit		MN-RK-8537	
	02/98→12/00	Tie Rod	DF-DL-7780		1st FA
	02/98→12/00	Tie Rod	DF-DL-7836		
	02/98→12/00	Tie Rod End	CV-ES-12461		for Steering Rod
	02/98→12/00	Tie Rod End	CV-ES-12462		for Steering Rod
	02/98→12/00	Tie Rod End	CV-ES-14163		for Steering Rod
	02/98→12/00	Tie Rod End	DF-ES-3804		
	02/98→12/00	Tie Rod End	DF-ES-3805		
	02/98→12/00	Track Control Arm		DF-DL-8158	Trailing Arm
	02/98→12/00	Track Control Arm		DF-VB-8561	Wishbone (CV)
	02/98→12/00	Track Control Arm		DF-VB-9343	Wishbone (CV)

CV-ES-12461

Length: 120
Cone Ø: d1 Ø 26 / d2 Ø 23,5
Thread: M30 x 1,5 LHT
0069513, 69513, 0311300, 311300,
0607998, 607998, 1190653, 1315447,
1319838, 1332123, 1338714, 1401934,
1407394, ACHB063, ACHF241, MAK1295



CV-ES-12462

Length: 120
Cone Ø: d1 Ø 26 / d2 Ø 23,5
Thread: M30 x 1,5 RHT
0069514, 0586753, 0607999, 0694298,
0694360, 0698609, 1137230, 1229944,
1326862, 1326896, 1331925, ACHB064,
ACHF242, MAK1296



CV-ES-14163

Length: 125
Cone Ø: d1 Ø 30 / d2 Ø 27
Thread: M30 x 1,5 RHT
0607981, 0698450, 1149907, 1152350,
1257890, 1603789, 1618048, ACHF060



CV-RK-5322

Ø: 72
Thick/Height: 50
0691704



DF-DL-5226

Length: 850
Ø: 52
Cone Ø: d1 Ø 26 / d2 Ø 23,5
1247957, 1283212, 1351715, 1385492,
10200900A



DF-DL-5237

Length: 880
Ø: 52
Cone Ø: d1 Ø 26 / d2 Ø 23,5
1283211, 1351714, 1385497, 10201000A



DF-DL-5403

Length: 1742
Ø: 40
Cone Ø: d1 Ø 26 / d2 Ø 23,5
0288281, 1270854, 1337644



DF-DL-7780

Length: 1690
Ø: 40
Cone Ø: d1 Ø 26 / d2 Ø 23,5
1270853, 1353391, 10212000A



DF-DL-7836

Length: 1698
Ø: 52
Cone Ø: d1 Ø 26 / d2 Ø 23,5
0754922, 1286343, 1353396



DF-DL-8158

Length: 611
Ø: 48
Hole Distance: 130 / 130
0267743, 1361649, 1361650, 1656428



DF-DL-8196

Length: 867
Ø: 50
Cone Ø: d1 Ø 30 / d2 Ø 27
1363859, 1448063, 1602821



DF-DL-9318

Length: 600
Ø: 50
Hole Distance: 130 / 130
0646373, 0655695, 0655697, 1284860,
1620438



DF-ES-3804

Length: 140
Cone Ø: d1 Ø 30 / d2 Ø 27
Thread: M48 x 1,5 LHT
0067303



DF-ES-3805

Length: 140
Cone Ø: d1 Ø 30 / d2 Ø 27
Thread: M48 x 1,5 RHT
0067389



DF-RK-8637

Ø: 72
1376730



DF-RK-8685

Ø: 67
Hole Distance: 130
Thick/Height: 24
1321936



DF-RK-9336

Ø: 108
1445656



DF-SB-5253

Ø: 86
Thick/Height: 60,5
0371586, 0558864, 10306500A



DF-SB-9342

Ø: 94
Thick/Height: 80 / 70
0281007, 0298498, 008169892, 8169892,
041270883, 41270883



DF-SB-10402

Ø: 62
Thick/Height: 60
1291233, 1732887



DF-TC-12262

Length: 595
Ø: 50
Hole Distance: 130 / 130
0661406, 661406, 0661407, 661407,
1620439



DF-VB-8561

Length: 609
Ø: 48
Hole Distance: 152 / 152
080521, 0080521, 1361651, 1368270,
1390932, 1617096, 1793875, 1817808,
1892492



DF-VB-9343

Length: 608,2
Ø: 48
Hole Distance: 152 / 152
1361652, 1620436, 1793876, 10309600A



IV-RK-8998

Ø: 85
Hole Distance: 130
Thick/Height: 30
0513757, 0531757, 691709, 0691709



MN-RK-7280

Ø: 75
Hole Distance: 115
Thick/Height: 24
0689748, 689748



MN-RK-8537

Ø: 95
Hole Distance: 152
Thick/Height: 24
696321, 81432706099



SC-RK-8575

Ø: 95
Hole Distance: 152
Thick/Height: 35
0696321



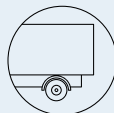

DAF ...

75 CF ...

FT 75 CF 290	02/98→12/00	Centre Rod	DF-DL-5226		Push Rod	
	02/98→12/00	Centre Rod	DF-DL-5237		Suspension Rod	
	02/98→12/00	Centre Rod	DF-DL-8196		Push Rod	
	02/98→12/00	Stabiliser Mounting		DF-SB-9342		
	02/98→12/00	Stabiliser Mounting	DF-SB-5253	DF-SB-5253		
	02/98→12/00	Stabiliser Mounting	DF-SB-10402			
	02/98→12/00	Suspension Arm Repair Kit		CV-RK-5322	for Wishbone (CV)	
	02/98→12/00	Suspension Arm Repair Kit		DF-RK-9336		
	02/98→12/00	Suspension Arm Repair Kit		IV-RK-8998	for Wishbone (CV)	
	02/98→12/00	Suspension Arm Repair Kit		MN-RK-7280	for Drag Link	
	02/98→12/00	Suspension Arm Repair Kit		SC-RK-8575	for Wishbone (CV)	
	02/98→12/00	Suspension Strut Repair Kit		DF-RK-8637		
	02/98→12/00	Suspension Strut Repair Kit		DF-RK-8685		
	02/98→12/00	Suspension Strut Repair Kit		MN-RK-8537		
	02/98→12/00	Tie Rod	DF-DL-7780		1st FA	
	02/98→12/00	Tie Rod	DF-DL-7836			
	02/98→12/00	Tie Rod End	CV-ES-12461		for Steering Rod	
	02/98→12/00	Tie Rod End	CV-ES-12462		for Steering Rod	
	02/98→12/00	Tie Rod End	CV-ES-14163		for Steering Rod	
	02/98→12/00	Tie Rod End	DF-ES-3804			
	02/98→12/00	Tie Rod End	DF-ES-3805			
	02/98→12/00	Track Control Arm		DF-DL-8158	Trailing Arm	
	02/98→12/00	Track Control Arm		DF-VB-8561	Wishbone (CV)	
	02/98→12/00	Track Control Arm		DF-VB-9343	Wishbone (CV)	
	FT 75 CF 320	02/98→12/00	Centre Rod	DF-DL-5226		Push Rod
		02/98→12/00	Centre Rod	DF-DL-5237		Suspension Rod
		02/98→12/00	Centre Rod	DF-DL-8196		Push Rod
		02/98→12/00	Stabiliser Mounting		DF-SB-9342	
		02/98→12/00	Stabiliser Mounting	DF-SB-5253	DF-SB-5253	
		02/98→12/00	Stabiliser Mounting	DF-SB-10402		
02/98→12/00		Suspension Arm Repair Kit		CV-RK-5322	for Wishbone (CV)	
02/98→12/00		Suspension Arm Repair Kit		DF-RK-9336		
02/98→12/00		Suspension Arm Repair Kit		IV-RK-8998	for Wishbone (CV)	
02/98→12/00		Suspension Arm Repair Kit		MN-RK-7280	for Drag Link	
02/98→12/00		Suspension Arm Repair Kit		SC-RK-8575	for Wishbone (CV)	
02/98→12/00		Suspension Strut Repair Kit		DF-RK-8637		
02/98→12/00		Suspension Strut Repair Kit		DF-RK-8685		
02/98→12/00		Suspension Strut Repair Kit		MN-RK-8537		
02/98→12/00		Tie Rod	DF-DL-7780		1st FA	
02/98→12/00		Tie Rod	DF-DL-7836			
02/98→12/00		Tie Rod End	CV-ES-12461		for Steering Rod	
02/98→12/00		Tie Rod End	CV-ES-12462		for Steering Rod	
02/98→12/00		Tie Rod End	CV-ES-14163		for Steering Rod	
02/98→12/00		Tie Rod End	DF-ES-3804			
02/98→12/00		Tie Rod End	DF-ES-3805			
02/98→12/00		Track Control Arm		DF-DL-8158	Trailing Arm	
02/98→12/00		Track Control Arm		DF-VB-8561	Wishbone (CV)	
02/98→12/00		Track Control Arm		DF-VB-9343	Wishbone (CV)	

85

FA 85.330	07/92→02/98	Centre Rod	DF-DL-3798		Push Rod
	07/92→02/98	Stabiliser Mounting		DF-SB-9342	
	07/92→02/98	Suspension Arm Repair Kit		CV-RK-5322	for Wishbone (CV)
	07/92→02/98	Suspension Arm Repair Kit		IV-RK-8998	for Wishbone (CV)
	07/92→02/98	Suspension Arm Repair Kit		MN-RK-7280	for Drag Link
	07/92→02/98	Suspension Arm Repair Kit		SC-RK-8575	for Wishbone (CV)
	07/92→02/98	Suspension Strut Repair Kit		MN-RK-8537	
	07/92→02/98	Tie Rod	DF-DL-7836		
	07/92→02/98	Tie Rod End	CV-ES-12461		for Steering Rod
	07/92→02/98	Tie Rod End	CV-ES-12462		for Steering Rod
	07/92→02/98	Tie Rod End	CV-ES-14163		for Steering Rod
	07/92→02/98	Tie Rod End	DF-ES-3804		
	07/92→02/98	Tie Rod End	DF-ES-3805		

CV-ES-12461

Length: 120
Cone Ø: d1 Ø 26 / d2 Ø 23,5
Thread: M30 x 1,5 LHT
0069513, 69513, 0311300, 311300,
0607998, 607998, 1190653, 1315447,
1319838, 1332123, 1338714, 1401934,
1407394, ACHB063, ACHF241, MAK1295



CV-ES-12462

Length: 120
Cone Ø: d1 Ø 26 / d2 Ø 23,5
Thread: M30 x 1,5 RHT
0069514, 0586753, 0607999, 0694298,
0694360, 0698609, 1137230, 1229944,
1326862, 1326896, 1331925, ACHB064,
ACHF242, MAK1296



CV-ES-14163

Length: 125
Cone Ø: d1 Ø 30 / d2 Ø 27
Thread: M30 x 1,5 RHT
0607981, 0698450, 1149907, 1152350,
1257890, 1603789, 1618048, ACHF060



CV-RK-5322

Ø: 72
Thick/Height: 50
0691704



DF-DL-3798

Length: 1015
Ø: 50
Cone Ø: d1 Ø 30 / d2 Ø 27
0094038, 0525433

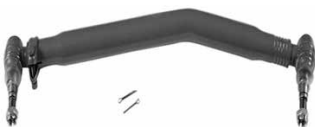

DF-DL-5226

Length: 850
Ø: 52
Cone Ø: d1 Ø 26 / d2 Ø 23,5
1247957, 1283212, 1351715, 1385492,
10200900A



DF-DL-5237

Length: 880
Ø: 52
Cone Ø: d1 Ø 26 / d2 Ø 23,5
1283211, 1351714, 1385497, 10201000A



DF-DL-7780

Length: 1690
Ø: 40
Cone Ø: d1 Ø 26 / d2 Ø 23,5
1270853, 1353391, 10212000A



DF-DL-7836

Length: 1698
Ø: 52
Cone Ø: d1 Ø 26 / d2 Ø 23,5
0754922, 1286343, 1353396



DF-DL-8158

Length: 611
Ø: 48
Hole Distance: 130 / 130
0267743, 1361649, 1361650, 1656428



DF-DL-8196

Length: 867
Ø: 50
Cone Ø: d1 Ø 30 / d2 Ø 27
1363859, 1448063, 1602821



DF-ES-3804

Length: 140
Cone Ø: d1 Ø 30 / d2 Ø 27
Thread: M48 x 1,5 LHT
0067303



DF-ES-3805

Length: 140
Cone Ø: d1 Ø 30 / d2 Ø 27
Thread: M48 x 1,5 RHT
0067389



DF-RK-8637

Ø: 72
1376730



DF-RK-8685

Ø: 67
Hole Distance: 130
Thick/Height: 24
1321936



DF-RK-9336

Ø: 108
1445656



DF-SB-5253

Ø: 86
Thick/Height: 60,5
0371586, 0558864, 10306500A



DF-SB-9342

Ø: 94
Thick/Height: 80 / 70
0281007, 0298498, 008169892, 8169892,
041270883, 41270883



DF-SB-10402

Ø: 62
Thick/Height: 60
1291233, 1732887



DF-VB-8561

Length: 609
Ø: 48
Hole Distance: 152 / 152
080521, 0080521, 1361651, 1368270,
1390932, 1617096, 1793875, 1817808,
1892492



DF-VB-9343

Length: 608,2
Ø: 48
Hole Distance: 152 / 152
1361652, 1620436, 1793876, 10309600A



IV-RK-8998

Ø: 85
Hole Distance: 130
Thick/Height: 30
0513757, 0531757, 0691709, 691709



MN-RK-7280

Ø: 75
Hole Distance: 115
Thick/Height: 24
0689748, 689748



MN-RK-8537

Ø: 95
Hole Distance: 152
Thick/Height: 24
696321, 81432706099



SC-RK-8575

Ø: 95
Hole Distance: 152
Thick/Height: 35
0696321





85 ...

FA 85.360	07/92→02/98	Centre Rod	DF-DL-3798		Push Rod
	07/92→02/98	Stabiliser Mounting		DF-SB-9342	
	07/92→02/98	Suspension Arm Repair Kit		CV-RK-5322	for Wishbone (CV)
	07/92→02/98	Suspension Arm Repair Kit		IV-RK-8998	for Wishbone (CV)
	07/92→02/98	Suspension Arm Repair Kit		MN-RK-7280	for Drag Link
	07/92→02/98	Suspension Arm Repair Kit		SC-RK-8575	for Wishbone (CV)
	07/92→02/98	Suspension Strut Repair Kit		MN-RK-8537	
	07/92→02/98	Tie Rod	DF-DL-7836		
	07/92→02/98	Tie Rod End	CV-ES-12461		for Steering Rod
	07/92→02/98	Tie Rod End	CV-ES-12462		for Steering Rod
	07/92→02/98	Tie Rod End	CV-ES-14163		for Steering Rod
	07/92→02/98	Tie Rod End	DF-ES-3804		
	07/92→02/98	Tie Rod End	DF-ES-3805		
	FA 85.400	03/95→02/98	Centre Rod	DF-DL-3798	
03/95→02/98		Stabiliser Mounting		DF-SB-9342	
03/95→02/98		Suspension Arm Repair Kit		CV-RK-5322	for Wishbone (CV)
03/95→02/98		Suspension Arm Repair Kit		IV-RK-8998	for Wishbone (CV)
03/95→02/98		Suspension Arm Repair Kit		MN-RK-7280	for Drag Link
03/95→02/98		Suspension Arm Repair Kit		SC-RK-8575	for Wishbone (CV)
03/95→02/98		Suspension Strut Repair Kit		MN-RK-8537	
03/95→02/98		Tie Rod	DF-DL-7836		
03/95→02/98		Tie Rod End	CV-ES-12461		for Steering Rod
03/95→02/98		Tie Rod End	CV-ES-12462		for Steering Rod
03/95→02/98		Tie Rod End	CV-ES-14163		for Steering Rod
03/95→02/98		Tie Rod End	DF-ES-3804		
03/95→02/98		Tie Rod End	DF-ES-3805		
FAD 85.330		07/92→02/98	Stabiliser Mounting		DF-SB-9342
	07/92→02/98	Suspension Arm Repair Kit		CV-RK-5322	for Wishbone (CV)
	07/92→02/98	Suspension Arm Repair Kit		IV-RK-8998	for Wishbone (CV)
	07/92→02/98	Suspension Arm Repair Kit		MN-RK-7280	for Drag Link
	07/92→02/98	Suspension Arm Repair Kit		SC-RK-8575	for Wishbone (CV)
	07/92→02/98	Suspension Strut Repair Kit		MN-RK-8537	
	07/92→02/98	Tie Rod	DF-DL-7836		
	07/92→02/98	Tie Rod End	CV-ES-12461		for Steering Rod
	07/92→02/98	Tie Rod End	CV-ES-12462		for Steering Rod
	07/92→02/98	Tie Rod End	CV-ES-14163		for Steering Rod
FAD 85.360	07/92→02/98	Stabiliser Mounting		DF-SB-9342	
	07/92→02/98	Suspension Arm Repair Kit		CV-RK-5322	for Wishbone (CV)
	07/92→02/98	Suspension Arm Repair Kit		IV-RK-8998	for Wishbone (CV)
	07/92→02/98	Suspension Arm Repair Kit		MN-RK-7280	for Drag Link
	07/92→02/98	Suspension Arm Repair Kit		SC-RK-8575	for Wishbone (CV)
	07/92→02/98	Suspension Strut Repair Kit		MN-RK-8537	
	07/92→02/98	Tie Rod	DF-DL-7836		
	07/92→02/98	Tie Rod End	CV-ES-12461		for Steering Rod
	07/92→02/98	Tie Rod End	CV-ES-12462		for Steering Rod
	07/92→02/98	Tie Rod End	CV-ES-14163		for Steering Rod
FAD 85.400	03/95→02/98	Stabiliser Mounting		DF-SB-9342	
	03/95→02/98	Suspension Arm Repair Kit		CV-RK-5322	for Wishbone (CV)
	03/95→02/98	Suspension Arm Repair Kit		IV-RK-8998	for Wishbone (CV)
	03/95→02/98	Suspension Arm Repair Kit		MN-RK-7280	for Drag Link
	03/95→02/98	Suspension Arm Repair Kit		SC-RK-8575	for Wishbone (CV)
	03/95→02/98	Suspension Strut Repair Kit		MN-RK-8537	
	03/95→02/98	Tie Rod	DF-DL-7836		
	03/95→02/98	Tie Rod End	CV-ES-12461		for Steering Rod
	03/95→02/98	Tie Rod End	CV-ES-12462		for Steering Rod
	03/95→02/98	Tie Rod End	CV-ES-14163		for Steering Rod
FAR 85.330,FAS 85.330	07/92→02/98	Centre Rod	DF-DL-3798		Push Rod
	07/92→02/98	Stabiliser Mounting		DF-SB-9342	
	07/92→02/98	Suspension Arm Repair Kit		CV-RK-5322	for Wishbone (CV)
	07/92→02/98	Suspension Arm Repair Kit		IV-RK-8998	for Wishbone (CV)
	07/92→02/98	Suspension Arm Repair Kit		MN-RK-7280	for Drag Link
	07/92→02/98	Suspension Arm Repair Kit		SC-RK-8575	for Wishbone (CV)
	07/92→02/98	Suspension Strut Repair Kit		MN-RK-8537	

CV-ES-12461

Length: 120
Cone Ø: d1 Ø 26 / d2 Ø 23,5
Thread: M30 x 1,5 LHT
0069513, 69513, 0311300, 311300,
0607998, 607998, 1190653, 1315447,
1319838, 1332123, 1338714, 1401934,
1407394, ACHB063, ACHF241, MAK1295



CV-ES-12462

Length: 120
Cone Ø: d1 Ø 26 / d2 Ø 23,5
Thread: M30 x 1,5 RHT
0069514, 0586753, 0607999, 0694298,
0694360, 0698609, 1137230, 1229944,
1326862, 1326896, 1331925, ACHB064,
ACHF242, MAK1296



CV-ES-14163

Length: 125
Cone Ø: d1 Ø 30 / d2 Ø 27
Thread: M30 x 1,5 RHT
0607981, 0698450, 1149907, 1152350,
1257890, 1603789, 1618048, ACHF060



CV-RK-5322

Ø: 72
Thick/Height: 50
0691704



DF-DL-3798

Length: 1015
Ø: 50
Cone Ø: d1 Ø 30 / d2 Ø 27
0094038, 0525433

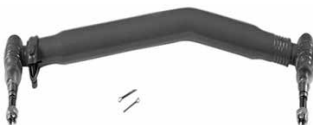

DF-DL-7836

Length: 1698
Ø: 52
Cone Ø: d1 Ø 26 / d2 Ø 23,5
0754922, 1286343, 1353396



DF-ES-3804

Length: 140
Cone Ø: d1 Ø 30 / d2 Ø 27
Thread: M48 x 1,5 LHT
0067303



DF-ES-3805

Length: 140
Cone Ø: d1 Ø 30 / d2 Ø 27
Thread: M48 x 1,5 RHT
0067389



DF-SB-9342

Ø: 94
Thick/Height: 80 / 70
0281007, 0298498, 008169892, 8169892,
41270883, 041270883



IV-RK-8998

Ø: 85
Hole Distance: 130
Thick/Height: 30
0513757, 0531757, 0691709, 691709



MN-RK-7280

Ø: 75
Hole Distance: 115
Thick/Height: 24
0689748, 689748



MN-RK-8537

Ø: 95
Hole Distance: 152
Thick/Height: 24
696321, 81432706099



SC-RK-8575

Ø: 95
Hole Distance: 152
Thick/Height: 35
0696321





85 ...

FAR 85.330,FAS 85.330 ...	07/92→02/98	Tie Rod	DF-DL-7836		
	07/92→02/98	Tie Rod End	CV-ES-12461		for Steering Rod
	07/92→02/98	Tie Rod End	CV-ES-12462		for Steering Rod
	07/92→02/98	Tie Rod End	CV-ES-14163		for Steering Rod
	07/92→02/98	Tie Rod End	DF-ES-3804		
	07/92→02/98	Tie Rod End	DF-ES-3805		
FAR 85.360,FAS 85.360	07/92→02/98	Centre Rod	DF-DL-3798		Push Rod
	07/92→02/98	Stabiliser Mounting		DF-SB-9342	
	07/92→02/98	Suspension Arm Repair Kit		CV-RK-5322	for Wishbone (CV)
	07/92→02/98	Suspension Arm Repair Kit		IV-RK-8998	for Wishbone (CV)
	07/92→02/98	Suspension Arm Repair Kit		MN-RK-7280	for Drag Link
	07/92→02/98	Suspension Arm Repair Kit		SC-RK-8575	for Wishbone (CV)
	07/92→02/98	Suspension Strut Repair Kit		MN-RK-8537	
	07/92→02/98	Tie Rod	DF-DL-7836		
	07/92→02/98	Tie Rod End	CV-ES-12461		for Steering Rod
	07/92→02/98	Tie Rod End	CV-ES-12462		for Steering Rod
	07/92→02/98	Tie Rod End	CV-ES-14163		for Steering Rod
	07/92→02/98	Tie Rod End	DF-ES-3804		
	07/92→02/98	Tie Rod End	DF-ES-3805		
	FAR 85.400,FAS 85.400	03/95→02/98	Centre Rod	DF-DL-3798	
03/95→02/98		Stabiliser Mounting		DF-SB-9342	
03/95→02/98		Suspension Arm Repair Kit		CV-RK-5322	for Wishbone (CV)
03/95→02/98		Suspension Arm Repair Kit		IV-RK-8998	for Wishbone (CV)
03/95→02/98		Suspension Arm Repair Kit		MN-RK-7280	for Drag Link
03/95→02/98		Suspension Arm Repair Kit		SC-RK-8575	for Wishbone (CV)
03/95→02/98		Suspension Strut Repair Kit		MN-RK-8537	
03/95→02/98		Tie Rod	DF-DL-7836		
03/95→02/98		Tie Rod End	CV-ES-12461		for Steering Rod
03/95→02/98		Tie Rod End	CV-ES-12462		for Steering Rod
03/95→02/98		Tie Rod End	CV-ES-14163		for Steering Rod
03/95→02/98		Tie Rod End	DF-ES-3804		
03/95→02/98		Tie Rod End	DF-ES-3805		
FAT 85.330		07/92→02/98	Centre Rod	DF-DL-3798	
	07/92→02/98	Stabiliser Mounting		DF-SB-9342	
	07/92→02/98	Suspension Arm Repair Kit		CV-RK-5322	for Wishbone (CV)
	07/92→02/98	Suspension Arm Repair Kit		IV-RK-8998	for Wishbone (CV)
	07/92→02/98	Suspension Arm Repair Kit		MN-RK-7280	for Drag Link
	07/92→02/98	Suspension Arm Repair Kit		SC-RK-8575	for Wishbone (CV)
	07/92→02/98	Suspension Strut Repair Kit		MN-RK-8537	
	07/92→02/98	Tie Rod	DF-DL-7836		
	07/92→02/98	Tie Rod End	CV-ES-12461		for Steering Rod
	07/92→02/98	Tie Rod End	CV-ES-12462		for Steering Rod
	07/92→02/98	Tie Rod End	CV-ES-14163		for Steering Rod
	07/92→02/98	Tie Rod End	DF-ES-3804		
	07/92→02/98	Tie Rod End	DF-ES-3805		
	FAT 85.360	07/92→02/98	Centre Rod	DF-DL-3798	
07/92→02/98		Stabiliser Mounting		DF-SB-9342	
07/92→02/98		Suspension Arm Repair Kit		CV-RK-5322	for Wishbone (CV)
07/92→02/98		Suspension Arm Repair Kit		IV-RK-8998	for Wishbone (CV)
07/92→02/98		Suspension Arm Repair Kit		MN-RK-7280	for Drag Link
07/92→02/98		Suspension Arm Repair Kit		SC-RK-8575	for Wishbone (CV)
07/92→02/98		Suspension Strut Repair Kit		MN-RK-8537	
07/92→02/98		Tie Rod	DF-DL-7836		
07/92→02/98		Tie Rod End	CV-ES-12461		for Steering Rod
07/92→02/98		Tie Rod End	CV-ES-12462		for Steering Rod
07/92→02/98		Tie Rod End	CV-ES-14163		for Steering Rod
07/92→02/98		Tie Rod End	DF-ES-3804		
07/92→02/98		Tie Rod End	DF-ES-3805		

CV-ES-12461

Length: 120
Cone Ø: d1 Ø 26 / d2 Ø 23,5
Thread: M30 x 1,5 LHT
0069513, 69513, 0311300, 311300, 607998,
0607998, 1190653, 1315447, 1319838,
1332123, 1338714, 1401934, 1407394,
ACHB063, ACHF241, MAK1295



CV-ES-12462

Length: 120
Cone Ø: d1 Ø 26 / d2 Ø 23,5
Thread: M30 x 1,5 RHT
0069514, 0586753, 0607999, 0694298,
0694360, 0698609, 1137230, 1229944,
1326862, 1326896, 1331925, ACHB064,
ACHF242, MAK1296



CV-ES-14163

Length: 125
Cone Ø: d1 Ø 30 / d2 Ø 27
Thread: M30 x 1,5 RHT
0607981, 0698450, 1149907, 1152350,
1257890, 1603789, 1618048, ACHF060



CV-RK-5322

Ø: 72
Thick/Height: 50
0691704



DF-DL-3798

Length: 1015
Ø: 50
Cone Ø: d1 Ø 30 / d2 Ø 27
0094038, 0525433

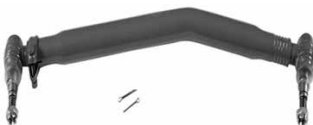

DF-DL-7836

Length: 1698
Ø: 52
Cone Ø: d1 Ø 26 / d2 Ø 23,5
0754922, 1286343, 1353396



DF-ES-3804

Length: 140
Cone Ø: d1 Ø 30 / d2 Ø 27
Thread: M48 x 1,5 LHT
0067303



DF-ES-3805

Length: 140
Cone Ø: d1 Ø 30 / d2 Ø 27
Thread: M48 x 1,5 RHT
0067389



DF-SB-9342

Ø: 94
Thick/Height: 80 / 70
0281007, 0298498, 008169892, 8169892,
41270883, 041270883



IV-RK-8998

Ø: 85
Hole Distance: 130
Thick/Height: 30
0513757, 0531757, 0691709, 691709



MN-RK-7280

Ø: 75
Hole Distance: 115
Thick/Height: 24
0689748, 689748



MN-RK-8537

Ø: 95
Hole Distance: 152
Thick/Height: 24
696321, 81432706099



SC-RK-8575

Ø: 95
Hole Distance: 152
Thick/Height: 35
0696321





85 ...

FAT 85.400	03/95→02/98	Centre Rod	DF-DL-3798		Push Rod
	03/95→02/98	Stabiliser Mounting		DF-SB-9342	
	03/95→02/98	Suspension Arm Repair Kit		CV-RK-5322	for Wishbone (CV)
	03/95→02/98	Suspension Arm Repair Kit		IV-RK-8998	for Wishbone (CV)
	03/95→02/98	Suspension Arm Repair Kit		MN-RK-7280	for Drag Link
	03/95→02/98	Suspension Arm Repair Kit		SC-RK-8575	for Wishbone (CV)
	03/95→02/98	Suspension Strut Repair Kit		MN-RK-8537	
	03/95→02/98	Tie Rod	DF-DL-7836		
	03/95→02/98	Tie Rod End	CV-ES-12461		for Steering Rod
	03/95→02/98	Tie Rod End	CV-ES-12462		for Steering Rod
	03/95→02/98	Tie Rod End	CV-ES-14163		for Steering Rod
	03/95→02/98	Tie Rod End	DF-ES-3804		
	03/95→02/98	Tie Rod End	DF-ES-3805		
	FT 85.330	07/92→02/98	Centre Rod	DF-DL-3798	
07/92→02/98		Stabiliser Mounting		DF-SB-9342	
07/92→02/98		Suspension Arm Repair Kit		CV-RK-5322	for Wishbone (CV)
07/92→02/98		Suspension Arm Repair Kit		IV-RK-8998	for Wishbone (CV)
07/92→02/98		Suspension Arm Repair Kit		MN-RK-7280	for Drag Link
07/92→02/98		Suspension Arm Repair Kit		SC-RK-8575	for Wishbone (CV)
07/92→02/98		Suspension Strut Repair Kit		MN-RK-8537	
07/92→02/98		Tie Rod	DF-DL-7836		
07/92→02/98		Tie Rod End	CV-ES-12461		for Steering Rod
07/92→02/98		Tie Rod End	CV-ES-12462		for Steering Rod
07/92→02/98		Tie Rod End	CV-ES-14163		for Steering Rod
07/92→02/98		Tie Rod End	DF-ES-3804		
07/92→02/98		Tie Rod End	DF-ES-3805		
FT 85.360		07/92→02/98	Centre Rod	DF-DL-3798	
	07/92→02/98	Stabiliser Mounting		DF-SB-9342	
	07/92→02/98	Suspension Arm Repair Kit		CV-RK-5322	for Wishbone (CV)
	07/92→02/98	Suspension Arm Repair Kit		IV-RK-8998	for Wishbone (CV)
	07/92→02/98	Suspension Arm Repair Kit		MN-RK-7280	for Drag Link
	07/92→02/98	Suspension Arm Repair Kit		SC-RK-8575	for Wishbone (CV)
	07/92→02/98	Suspension Strut Repair Kit		MN-RK-8537	
	07/92→02/98	Tie Rod	DF-DL-7836		
	07/92→02/98	Tie Rod End	CV-ES-12461		for Steering Rod
	07/92→02/98	Tie Rod End	CV-ES-12462		for Steering Rod
	07/92→02/98	Tie Rod End	CV-ES-14163		for Steering Rod
	07/92→02/98	Tie Rod End	DF-ES-3804		
	07/92→02/98	Tie Rod End	DF-ES-3805		
	07/92→02/98	Track Control Arm		DF-VB-8561	Wishbone (CV)
FT 85.400	03/95→02/98	Centre Rod	DF-DL-3798		Push Rod
	03/95→02/98	Stabiliser Mounting		DF-SB-9342	
	03/95→02/98	Suspension Arm Repair Kit		CV-RK-5322	for Wishbone (CV)
	03/95→02/98	Suspension Arm Repair Kit		IV-RK-8998	for Wishbone (CV)
	03/95→02/98	Suspension Arm Repair Kit		MN-RK-7280	for Drag Link
	03/95→02/98	Suspension Arm Repair Kit		SC-RK-8575	for Wishbone (CV)
	03/95→02/98	Suspension Strut Repair Kit		MN-RK-8537	
	03/95→02/98	Tie Rod	DF-DL-7836		
	03/95→02/98	Tie Rod End	CV-ES-12461		for Steering Rod
	03/95→02/98	Tie Rod End	CV-ES-12462		for Steering Rod
	03/95→02/98	Tie Rod End	CV-ES-14163		for Steering Rod
	03/95→02/98	Tie Rod End	DF-ES-3804		
	03/95→02/98	Tie Rod End	DF-ES-3805		
	03/95→02/98	Track Control Arm		DF-VB-8561	Wishbone (CV)

CV-ES-12461

Length: 120
Cone Ø: d1 Ø 26 / d2 Ø 23,5
Thread: M30 x 1,5 LHT
0069513, 69513, 0311300, 311300,
0607998, 607998, 1190653, 1315447,
1319838, 1332123, 1338714, 1401934,
1407394, ACHB063, ACHF241, MAK1295



CV-ES-12462

Length: 120
Cone Ø: d1 Ø 26 / d2 Ø 23,5
Thread: M30 x 1,5 RHT
0069514, 0586753, 0607999, 0694298,
0694360, 0698609, 1137230, 1229944,
1326862, 1326896, 1331925, ACHB064,
ACHF242, MAK1296



CV-ES-14163

Length: 125
Cone Ø: d1 Ø 30 / d2 Ø 27
Thread: M30 x 1,5 RHT
0607981, 0698450, 1149907, 1152350,
1257890, 1603789, 1618048, ACHF060



CV-RK-5322

Ø: 72
Thick/Height: 50
0691704



DF-DL-3798

Length: 1015
Ø: 50
Cone Ø: d1 Ø 30 / d2 Ø 27
0094038, 0525433

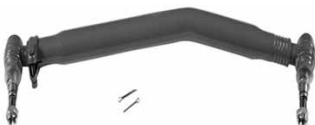

DF-DL-7836

Length: 1698
Ø: 52
Cone Ø: d1 Ø 26 / d2 Ø 23,5
0754922, 1286343, 1353396



DF-ES-3804

Length: 140
Cone Ø: d1 Ø 30 / d2 Ø 27
Thread: M48 x 1,5 LHT
0067303



DF-ES-3805

Length: 140
Cone Ø: d1 Ø 30 / d2 Ø 27
Thread: M48 x 1,5 RHT
0067389



DF-SB-9342

Ø: 94
Thick/Height: 80 / 70
0281007, 0298498, 008169892, 8169892,
041270883, 41270883



DF-VB-8561

Length: 609
Ø: 48
Hole Distance: 152 / 152
0080521, 080521, 1361651, 1368270,
1390932, 1617096, 1793875, 1817808,
1892492



IV-RK-8998

Ø: 85
Hole Distance: 130
Thick/Height: 30
0513757, 0531757, 691709, 0691709



MN-RK-7280

Ø: 75
Hole Distance: 115
Thick/Height: 24
0689748, 689748



MN-RK-8537

Ø: 95
Hole Distance: 152
Thick/Height: 24
696321, 81432706099



SC-RK-8575

Ø: 95
Hole Distance: 152
Thick/Height: 35
0696321





85 ...

FTG 85.330	07/92→02/98	Centre Rod	DF-DL-3798		Push Rod	
	07/92→02/98	Stabiliser Mounting		DF-SB-9342		
	07/92→02/98	Suspension Arm Repair Kit		CV-RK-5322	for Wishbone (CV)	
	07/92→02/98	Suspension Arm Repair Kit		IV-RK-8998	for Wishbone (CV)	
	07/92→02/98	Suspension Arm Repair Kit		MN-RK-7280	for Drag Link	
	07/92→02/98	Suspension Arm Repair Kit		SC-RK-8575	for Wishbone (CV)	
	07/92→02/98	Suspension Strut Repair Kit		MN-RK-8537		
	07/92→02/98	Tie Rod	DF-DL-7836			
	07/92→02/98	Tie Rod End	CV-ES-12461		for Steering Rod	
	07/92→02/98	Tie Rod End	CV-ES-12462		for Steering Rod	
	07/92→02/98	Tie Rod End	CV-ES-14163		for Steering Rod	
	07/92→02/98	Tie Rod End	DF-ES-3804			
	07/92→02/98	Tie Rod End	DF-ES-3805			
	07/92→02/98	Track Control Arm		DF-VB-8561	Wishbone (CV)	
	FTG 85.360	07/92→02/98	Centre Rod	DF-DL-3798		Push Rod
		07/92→02/98	Centre Rod	DF-DL-8703		Push Rod
07/92→02/98		Centre Rod	DF-DL-10186		Push Rod	
07/92→02/98		Centre Rod	DF-DL-10188		Push Rod	
07/92→02/98		Stabiliser Mounting		DF-SB-9342		
07/92→02/98		Suspension Arm Repair Kit		CV-RK-5322	for Wishbone (CV)	
07/92→02/98		Suspension Arm Repair Kit		IV-RK-8998	for Wishbone (CV)	
07/92→02/98		Suspension Arm Repair Kit		MN-RK-7280	for Drag Link	
07/92→02/98		Suspension Arm Repair Kit		SC-RK-8575	for Wishbone (CV)	
07/92→02/98		Suspension Strut Repair Kit		MN-RK-8537		
07/92→02/98		Tie Rod		DF-DL-5403	Tag Axle	
07/92→02/98		Tie Rod		DF-DL-7780	Tag Axle	
07/92→02/98		Tie Rod	DF-DL-5403		1st FA	
07/92→02/98		Tie Rod	DF-DL-7780		2nd FA	
07/92→02/98		Tie Rod	DF-DL-7836			
07/92→02/98		Tie Rod End	CV-ES-12461		for Steering Rod	
07/92→02/98		Tie Rod End	CV-ES-12462		for Steering Rod	
07/92→02/98		Tie Rod End	CV-ES-14163		for Steering Rod	
07/92→02/98		Tie Rod End	DF-ES-3804			
07/92→02/98		Tie Rod End	DF-ES-3805			
07/92→02/98		Tie Rod End	DF-ES-8602			
07/92→02/98		Track Control Arm		DF-DL-8158	Trailing Arm, 1st RA; Tag Axle; Air Suspension Axle	
07/92→02/98		Track Control Arm		DF-DL-9318	Trailing Arm, 1st RA; Tag Axle; Leaf Spring Axle	
07/92→02/98		Track Control Arm		DF-VB-8561	Wishbone (CV), 1st RA; Tag Axle; Air Suspension Axle	
07/92→02/98		Track Control Arm		DF-VB-9343	Wishbone (CV), Tag Axle; 1st RA; Leaf Spring Axle	
FTG 85.400		03/95→02/98	Centre Rod	DF-DL-3798		Push Rod
	03/95→02/98	Stabiliser Mounting		DF-SB-9342		
	03/95→02/98	Suspension Arm Repair Kit		CV-RK-5322	for Wishbone (CV)	
	03/95→02/98	Suspension Arm Repair Kit		IV-RK-8998	for Wishbone (CV)	
	03/95→02/98	Suspension Arm Repair Kit		MN-RK-7280	for Drag Link	
	03/95→02/98	Suspension Arm Repair Kit		SC-RK-8575	for Wishbone (CV)	
	03/95→02/98	Suspension Strut Repair Kit		MN-RK-8537		
	03/95→02/98	Tie Rod	DF-DL-7836			
	03/95→02/98	Tie Rod End	CV-ES-12461		for Steering Rod	
	03/95→02/98	Tie Rod End	CV-ES-12462		for Steering Rod	
	03/95→02/98	Tie Rod End	CV-ES-14163		for Steering Rod	
	03/95→02/98	Tie Rod End	DF-ES-3804			
	03/95→02/98	Tie Rod End	DF-ES-3805			
	03/95→02/98	Track Control Arm		DF-DL-8158	Trailing Arm	
03/95→02/98	Track Control Arm		DF-VB-8561	Wishbone (CV)		

CV-ES-12461

Length: 120
Cone Ø: d1 Ø 26 / d2 Ø 23,5
Thread: M30 x 1,5 LHT
0069513, 69513, 0311300, 311300,
0607998, 607998, 1190653, 1315447,
1319838, 1332123, 1338714, 1401934,
1407394, ACHB063, ACHF241, MAK1295



CV-ES-12462

Length: 120
Cone Ø: d1 Ø 26 / d2 Ø 23,5
Thread: M30 x 1,5 RHT
0069514, 0586753, 0607999, 0694298,
0694360, 0698609, 1137230, 1229944,
1326862, 1326896, 1331925, ACHB064,
ACHF242, MAK1296



CV-ES-14163

Length: 125
Cone Ø: d1 Ø 30 / d2 Ø 27
Thread: M30 x 1,5 RHT
0607981, 0698450, 1149907, 1152350,
1257890, 1603789, 1618048, ACHF060



CV-RK-5322

Ø: 72
Thick/Height: 50
0691704



DF-DL-3798

Length: 1015
Ø: 50
Cone Ø: d1 Ø 30 / d2 Ø 27
0094038, 0525433



DF-DL-5403

Length: 1742
Ø: 40
Cone Ø: d1 Ø 26 / d2 Ø 23,5
0288281, 1270854, 1337644



DF-DL-7780

Length: 1690
Ø: 40
Cone Ø: d1 Ø 26 / d2 Ø 23,5
1270853, 1353391, 10212000A



DF-DL-7836

Length: 1698
Ø: 52
Cone Ø: d1 Ø 26 / d2 Ø 23,5
0754922, 1286343, 1353396



DF-DL-8158

Length: 611
Ø: 48
Hole Distance: 130 / 130
0267743, 1361649, 1361650, 1656428



DF-DL-8703

Length: 1977
Ø: 52
Cone Ø: d1 Ø 30 / d2 Ø 27
1451122



DF-DL-9318

Length: 600
Ø: 50
Hole Distance: 130 / 130
0646373, 0655695, 0655697, 1284860,
1620438



DF-DL-10186

Length: 860
Ø: 38
Cone Ø: d1 Ø 30 / d2 Ø 27
1451118



DF-DL-10188

Length: 860
Ø: 36
Cone Ø: d1 Ø 30 / d2 Ø 27
1380417, 1451129



DF-ES-3804

Length: 140
Cone Ø: d1 Ø 30 / d2 Ø 27
Thread: M48 x 1,5 LHT
0067303



DF-ES-3805

Length: 140
Cone Ø: d1 Ø 30 / d2 Ø 27
Thread: M48 x 1,5 RHT
0067389



DF-ES-8602

Length: 95
Cone Ø: d1 Ø 30 / d2 Ø 27
Thread: M22 x 1,5 RHT
0273203, 1399724



DF-SB-9342

Ø: 94
Thick/Height: 80 / 70
0281007, 0298498, 008169892, 8169892,
041270883, 41270883



DF-VB-8561

Length: 609
Ø: 48
Hole Distance: 152 / 152
0080521, 080521, 1361651, 1368270,
1390932, 1617096, 1793875, 1817808,
1892492



DF-VB-9343

Length: 608,2
Ø: 48
Hole Distance: 152 / 152
1361652, 1620436, 1793876, 10309600A



IV-RK-8998

Ø: 85
Hole Distance: 130
Thick/Height: 30
0513757, 0531757, 0691709, 691709



MN-RK-7280

Ø: 75
Hole Distance: 115
Thick/Height: 24
0689748, 689748



MN-RK-8537

Ø: 95
Hole Distance: 152
Thick/Height: 24
696321, 81432706099



SC-RK-8575

Ø: 95
Hole Distance: 152
Thick/Height: 35
0696321





85 ...

FTT 85.330	07/92→02/98	Centre Rod	DF-DL-3798		Push Rod
	07/92→02/98	Stabiliser Mounting		DF-SB-9342	
	07/92→02/98	Suspension Arm Repair Kit		CV-RK-5322	for Wishbone (CV)
	07/92→02/98	Suspension Arm Repair Kit		IV-RK-8998	for Wishbone (CV)
	07/92→02/98	Suspension Arm Repair Kit		MN-RK-7280	for Drag Link
	07/92→02/98	Suspension Arm Repair Kit		SC-RK-8575	for Wishbone (CV)
	07/92→02/98	Suspension Strut Repair Kit		MN-RK-8537	
	07/92→02/98	Tie Rod	DF-DL-7836		
	07/92→02/98	Tie Rod End	CV-ES-12461		for Steering Rod
	07/92→02/98	Tie Rod End	CV-ES-12462		for Steering Rod
	07/92→02/98	Tie Rod End	CV-ES-14163		for Steering Rod
	07/92→02/98	Tie Rod End	DF-ES-3804		
	07/92→02/98	Tie Rod End	DF-ES-3805		
	07/92→02/98	Track Control Arm		DF-VB-8561	Wishbone (CV)
	FTT 85.360	07/92→02/98	Centre Rod	DF-DL-3798	
07/92→02/98		Stabiliser Mounting		DF-SB-9342	
07/92→02/98		Suspension Arm Repair Kit		CV-RK-5322	for Wishbone (CV)
07/92→02/98		Suspension Arm Repair Kit		IV-RK-8998	for Wishbone (CV)
07/92→02/98		Suspension Arm Repair Kit		MN-RK-7280	for Drag Link
07/92→02/98		Suspension Arm Repair Kit		SC-RK-8575	for Wishbone (CV)
07/92→02/98		Suspension Strut Repair Kit		MN-RK-8537	
07/92→02/98		Tie Rod	DF-DL-7836		
07/92→02/98		Tie Rod End	CV-ES-12461		for Steering Rod
07/92→02/98		Tie Rod End	CV-ES-12462		for Steering Rod
07/92→02/98		Tie Rod End	CV-ES-14163		for Steering Rod
07/92→02/98		Tie Rod End	DF-ES-3804		
07/92→02/98		Tie Rod End	DF-ES-3805		
07/92→02/98		Track Control Arm		DF-VB-8561	Wishbone (CV)
FTT 85.400		03/95→02/98	Centre Rod	DF-DL-3798	
	03/95→02/98	Stabiliser Mounting		DF-SB-9342	
	03/95→02/98	Suspension Arm Repair Kit		CV-RK-5322	for Wishbone (CV)
	03/95→02/98	Suspension Arm Repair Kit		IV-RK-8998	for Wishbone (CV)
	03/95→02/98	Suspension Arm Repair Kit		MN-RK-7280	for Drag Link
	03/95→02/98	Suspension Arm Repair Kit		SC-RK-8575	for Wishbone (CV)
	03/95→02/98	Suspension Strut Repair Kit		MN-RK-8537	
	03/95→02/98	Tie Rod	DF-DL-7836		
	03/95→02/98	Tie Rod End	CV-ES-12461		for Steering Rod
	03/95→02/98	Tie Rod End	CV-ES-12462		for Steering Rod
	03/95→02/98	Tie Rod End	CV-ES-14163		for Steering Rod
	03/95→02/98	Tie Rod End	DF-ES-3804		
	03/95→02/98	Tie Rod End	DF-ES-3805		
	03/95→02/98	Track Control Arm		DF-DL-8158	Trailing Arm
	03/95→02/98	Track Control Arm		DF-VB-8561	Wishbone (CV)

85 CF

FA 85 CF 340	02/98→12/00	Centre Rod	DF-DL-5226		Push Rod
	02/98→12/00	Centre Rod	DF-DL-5237		Push Rod
	02/98→12/00	Centre Rod	DF-DL-8196		Push Rod
	02/98→12/00	Stabiliser Mounting		DF-SB-9342	
	02/98→12/00	Stabiliser Mounting	DF-SB-5253	DF-SB-5253	
	02/98→12/00	Stabiliser Mounting	DF-SB-10402		
	02/98→12/00	Suspension Arm Repair Kit		CV-RK-5322	for Wishbone (CV)
	02/98→12/00	Suspension Arm Repair Kit		DF-RK-8994	for Wishbone (CV)
	02/98→12/00	Suspension Arm Repair Kit		IV-RK-8998	for Wishbone (CV)
	02/98→12/00	Suspension Arm Repair Kit		MN-RK-7280	for Drag Link
	02/98→12/00	Suspension Arm Repair Kit		SC-RK-8575	for Wishbone (CV)
	02/98→12/00	Suspension Strut Repair Kit		DF-RK-8637	
	02/98→12/00	Suspension Strut Repair Kit		DF-RK-8685	
	02/98→12/00	Suspension Strut Repair Kit		MN-RK-8537	
	02/98→12/00	Tie Rod	DF-DL-5403		1st FA
	02/98→12/00	Tie Rod	DF-DL-7780		1st FA
	02/98→12/00	Tie Rod	DF-DL-7836		1st FA
	02/98→12/00	Tie Rod End	CV-ES-12461		for Steering Rod

CV-ES-12461

Length: 120
Cone Ø: d1 Ø 26 / d2 Ø 23,5
Thread: M30 x 1,5 LHT
69513, 0069513, 0311300, 311300,
0607998, 607998, 1190653, 1315447,
1319838, 1332123, 1338714, 1401934,
1407394, ACHB063, ACHF241, MAK1295



CV-ES-12462

Length: 120
Cone Ø: d1 Ø 26 / d2 Ø 23,5
Thread: M30 x 1,5 RHT
0069514, 0586753, 0607999, 0694298,
0694360, 0698609, 1137230, 1229944,
1326862, 1326896, 1331925, ACHB064,
ACHF242, MAK1296



CV-ES-14163

Length: 125
Cone Ø: d1 Ø 30 / d2 Ø 27
Thread: M30 x 1,5 RHT
0607981, 0698450, 1149907, 1152350,
1257890, 1603789, 1618048, ACHF060



CV-RK-5322

Ø: 72
Thick/Height: 50
0691704



DF-DL-3798

Length: 1015
Ø: 50
Cone Ø: d1 Ø 30 / d2 Ø 27
0094038, 0525433

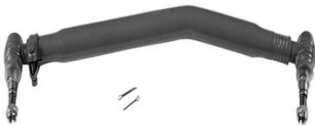

DF-DL-5226

Length: 850
Ø: 52
Cone Ø: d1 Ø 26 / d2 Ø 23,5
1247957, 1283212, 1351715, 1385492,
10200900A



DF-DL-5237

Length: 880
Ø: 52
Cone Ø: d1 Ø 26 / d2 Ø 23,5
1283211, 1351714, 1385497, 10201000A



DF-DL-5403

Length: 1742
Ø: 40
Cone Ø: d1 Ø 26 / d2 Ø 23,5
0288281, 1270854, 1337644



DF-DL-7780

Length: 1690
Ø: 40
Cone Ø: d1 Ø 26 / d2 Ø 23,5
1270853, 1353391, 10212000A



DF-DL-7836

Length: 1698
Ø: 52
Cone Ø: d1 Ø 26 / d2 Ø 23,5
0754922, 1286343, 1353396



DF-DL-8158

Length: 611
Ø: 48
Hole Distance: 130 / 130
0267743, 1361649, 1361650, 1656428



DF-DL-8196

Length: 867
Ø: 50
Cone Ø: d1 Ø 30 / d2 Ø 27
1363859, 1448063, 1602821



DF-ES-3804

Length: 140
Cone Ø: d1 Ø 30 / d2 Ø 27
Thread: M48 x 1,5 LHT
0067303



DF-ES-3805

Length: 140
Cone Ø: d1 Ø 30 / d2 Ø 27
Thread: M48 x 1,5 RHT
0067389



DF-RK-8637

Ø: 72
1376730



DF-RK-8685

Ø: 67
Hole Distance: 130
Thick/Height: 24
1321936



DF-RK-8994

Ø: 75
Hole Distance: 130
Thick/Height: 24
1252284



DF-SB-5253

Ø: 86
Thick/Height: 60,5
0371586, 0558864, 10306500A



DF-SB-9342

Ø: 94
Thick/Height: 80 / 70
0281007, 0298498, 008169892, 8169892,
041270883, 41270883



DF-SB-10402

Ø: 62
Thick/Height: 60
1291233, 1732887



DF-VB-8561

Length: 609
Ø: 48
Hole Distance: 152 / 152
0080521, 080521, 1361651, 1368270,
1390932, 1617096, 1793875, 1817808,
1892492



IV-RK-8998

Ø: 85
Hole Distance: 130
Thick/Height: 30
0513757, 0531757, 0691709, 691709



MN-RK-7280

Ø: 75
Hole Distance: 115
Thick/Height: 24
0689748, 689748



MN-RK-8537

Ø: 95
Hole Distance: 152
Thick/Height: 24
696321, 81432706099



SC-RK-8575

Ø: 95
Hole Distance: 152
Thick/Height: 35
0696321





85 CF ...

FA 85 CF 340 ...	02/98→12/00	Tie Rod End	CV-ES-12462		for Steering Rod
	02/98→12/00	Tie Rod End	CV-ES-14163		for Steering Rod
	02/98→12/00	Track Control Arm		DF-DL-8158	Trailing Arm
	02/98→12/00	Track Control Arm		DF-VB-8561	Wishbone (CV)
	02/98→12/00	Track Control Arm		DF-VB-9343	Wishbone (CV)
FA 85 CF 380	02/98→12/00	Centre Rod	DF-DL-5226		Push Rod
	02/98→12/00	Centre Rod	DF-DL-8196		Push Rod
	02/98→12/00	Stabiliser Mounting		DF-SB-9342	
	02/98→12/00	Stabiliser Mounting	DF-SB-5253	DF-SB-5253	
	02/98→12/00	Stabiliser Mounting	DF-SB-10402		
	02/98→12/00	Suspension Arm Repair Kit		CV-RK-5322	for Wishbone (CV)
	02/98→12/00	Suspension Arm Repair Kit		DF-RK-8994	for Wishbone (CV)
	02/98→12/00	Suspension Arm Repair Kit		IV-RK-8998	for Wishbone (CV)
	02/98→12/00	Suspension Arm Repair Kit		MN-RK-7280	for Drag Link
	02/98→12/00	Suspension Arm Repair Kit		SC-RK-8575	for Wishbone (CV)
	02/98→12/00	Suspension Strut Repair Kit		DF-RK-8637	
	02/98→12/00	Suspension Strut Repair Kit		DF-RK-8685	
	02/98→12/00	Suspension Strut Repair Kit		MN-RK-8537	
	02/98→12/00	Tie Rod	DF-DL-5403		
	02/98→12/00	Tie Rod	DF-DL-7780		
	02/98→12/00	Tie Rod	DF-DL-7836		
	02/98→12/00	Tie Rod End	CV-ES-12461		for Steering Rod
	02/98→12/00	Tie Rod End	CV-ES-12462		for Steering Rod
	02/98→12/00	Tie Rod End	CV-ES-14163		for Steering Rod
	02/98→12/00	Track Control Arm		DF-DL-8158	Trailing Arm
	02/98→12/00	Track Control Arm		DF-VB-8561	Wishbone (CV)
	02/98→12/00	Track Control Arm		DF-VB-9343	Wishbone (CV)
FA 85 CF 430	02/98→12/00	Centre Rod	DF-DL-5226		Push Rod
	02/98→12/00	Centre Rod	DF-DL-8196		Push Rod
	02/98→12/00	Stabiliser Mounting		DF-SB-9342	
	02/98→12/00	Stabiliser Mounting	DF-SB-5253	DF-SB-5253	
	02/98→12/00	Stabiliser Mounting	DF-SB-10402		
	02/98→12/00	Suspension Arm Repair Kit		CV-RK-5322	for Wishbone (CV)
	02/98→12/00	Suspension Arm Repair Kit		DF-RK-8994	for Wishbone (CV)
	02/98→12/00	Suspension Arm Repair Kit		IV-RK-8998	for Wishbone (CV)
	02/98→12/00	Suspension Arm Repair Kit		MN-RK-7280	for Drag Link
	02/98→12/00	Suspension Arm Repair Kit		SC-RK-8575	for Wishbone (CV)
	02/98→12/00	Suspension Strut Repair Kit		DF-RK-8637	
	02/98→12/00	Suspension Strut Repair Kit		DF-RK-8685	
	02/98→12/00	Suspension Strut Repair Kit		MN-RK-8537	
	02/98→12/00	Tie Rod	DF-DL-5403		
	02/98→12/00	Tie Rod	DF-DL-7780		
	02/98→12/00	Tie Rod	DF-DL-7836		
	02/98→12/00	Tie Rod End	CV-ES-12461		for Steering Rod
	02/98→12/00	Tie Rod End	CV-ES-12462		for Steering Rod
	02/98→12/00	Tie Rod End	CV-ES-14163		for Steering Rod
	02/98→12/00	Track Control Arm		DF-DL-8158	Trailing Arm
	02/98→12/00	Track Control Arm		DF-VB-8561	Wishbone (CV)
	02/98→12/00	Track Control Arm		DF-VB-9343	Wishbone (CV)
FAC 85 CF 340	02/98→12/00	Centre Rod	DF-DL-5226		Push Rod
	02/98→12/00	Centre Rod	DF-DL-8196		Push Rod
	02/98→12/00	Stabiliser Mounting		DF-SB-9342	
	02/98→12/00	Stabiliser Mounting	DF-SB-5253	DF-SB-5253	
	02/98→12/00	Stabiliser Mounting	DF-SB-10402		
	02/98→12/00	Suspension Arm Repair Kit		CV-RK-5322	for Wishbone (CV)
	02/98→12/00	Suspension Arm Repair Kit		DF-RK-8994	for Wishbone (CV)
	02/98→12/00	Suspension Arm Repair Kit		IV-RK-8998	for Wishbone (CV)
	02/98→12/00	Suspension Arm Repair Kit		MN-RK-7280	for Drag Link
	02/98→12/00	Suspension Arm Repair Kit		SC-RK-8575	for Wishbone (CV)
	02/98→12/00	Suspension Strut Repair Kit		DF-RK-8637	
	02/98→12/00	Suspension Strut Repair Kit		DF-RK-8685	
	02/98→12/00	Suspension Strut Repair Kit		MN-RK-8537	
	02/98→12/00	Tie Rod	DF-DL-5403		

CV-ES-12461

Length: 120
Cone Ø: d1 Ø 26 / d2 Ø 23,5
Thread: M30 x 1,5 LHT
0069513, 69513, 0311300, 311300,
0607998, 607998, 1190653, 1315447,
1319838, 1332123, 1338714, 1401934,
1407394, ACHB063, ACHF241, MAK1295



CV-ES-12462

Length: 120
Cone Ø: d1 Ø 26 / d2 Ø 23,5
Thread: M30 x 1,5 RHT
0069514, 0586753, 0607999, 0694298,
0694360, 0698609, 1137230, 1229944,
1326862, 1326896, 1331925, ACHB064,
ACHF242, MAK1296



CV-ES-14163

Length: 125
Cone Ø: d1 Ø 30 / d2 Ø 27
Thread: M30 x 1,5 RHT
0607981, 0698450, 1149907, 1152350,
1257890, 1603789, 1618048, ACHF060



CV-RK-5322

Ø: 72
Thick/Height: 50
0691704



DF-DL-5226

Length: 850
Ø: 52
Cone Ø: d1 Ø 26 / d2 Ø 23,5
1247957, 1283212, 1351715, 1385492,
10200900A



DF-DL-5403

Length: 1742
Ø: 40
Cone Ø: d1 Ø 26 / d2 Ø 23,5
0288281, 1270854, 1337644



DF-DL-7780

Length: 1690
Ø: 40
Cone Ø: d1 Ø 26 / d2 Ø 23,5
1270853, 1353391, 10212000A



DF-DL-7836

Length: 1698
Ø: 52
Cone Ø: d1 Ø 26 / d2 Ø 23,5
0754922, 1286343, 1353396



DF-DL-8158

Length: 611
Ø: 48
Hole Distance: 130 / 130
0267743, 1361649, 1361650, 1656428



DF-DL-8196

Length: 867
Ø: 50
Cone Ø: d1 Ø 30 / d2 Ø 27
1363859, 1448063, 1602821



DF-RK-8637

Ø: 72
1376730



DF-RK-8685

Ø: 67
Hole Distance: 130
Thick/Height: 24
1321936



DF-RK-8994

Ø: 75
Hole Distance: 130
Thick/Height: 24
1252284



DF-SB-5253

Ø: 86
Thick/Height: 60,5
0371586, 0558864, 10306500A



DF-SB-9342

Ø: 94
Thick/Height: 80 / 70
0281007, 0298498, 008169892, 8169892,
41270883, 041270883



DF-SB-10402

Ø: 62
Thick/Height: 60
1291233, 1732887



DF-VB-8561

Length: 609
Ø: 48
Hole Distance: 152 / 152
0080521, 080521, 1361651, 1368270,
1390932, 1617096, 1793875, 1817808,
1892492



DF-VB-9343

Length: 608,2
Ø: 48
Hole Distance: 152 / 152
1361652, 1620436, 1793876, 10309600A



IV-RK-8998

Ø: 85
Hole Distance: 130
Thick/Height: 30
0513757, 0531757, 0691709, 691709



MN-RK-7280

Ø: 75
Hole Distance: 115
Thick/Height: 24
0689748, 689748



MN-RK-8537

Ø: 95
Hole Distance: 152
Thick/Height: 24
696321, 81432706099



SC-RK-8575

Ø: 95
Hole Distance: 152
Thick/Height: 35
0696321





85 CF ...

FAC 85 CF 340 ...	02/98→12/00	Tie Rod	DF-DL-7780		
	02/98→12/00	Tie Rod	DF-DL-7836		
	02/98→12/00	Tie Rod End	CV-ES-12461		for Steering Rod
	02/98→12/00	Tie Rod End	CV-ES-12462		for Steering Rod
	02/98→12/00	Tie Rod End	CV-ES-14163		for Steering Rod
	02/98→12/00	Track Control Arm		DF-DL-8158	Trailing Arm
	02/98→12/00	Track Control Arm		DF-VB-8561	Wishbone (CV)
	02/98→12/00	Track Control Arm		DF-VB-9343	Wishbone (CV)
	FAC 85 CF 380	02/98→12/00	Centre Rod	DF-DL-5226	
02/98→12/00		Centre Rod	DF-DL-8196		Push Rod
02/98→12/00		Stabiliser Mounting		DF-SB-9342	
02/98→12/00		Stabiliser Mounting	DF-SB-5253	DF-SB-5253	
02/98→12/00		Stabiliser Mounting	DF-SB-10402		
02/98→12/00		Suspension Arm Repair Kit		CV-RK-5322	for Wishbone (CV)
02/98→12/00		Suspension Arm Repair Kit		DF-RK-8994	for Wishbone (CV)
02/98→12/00		Suspension Arm Repair Kit		IV-RK-8998	for Wishbone (CV)
02/98→12/00		Suspension Arm Repair Kit		MN-RK-7280	for Drag Link
02/98→12/00		Suspension Arm Repair Kit		SC-RK-8575	for Wishbone (CV)
02/98→12/00		Suspension Strut Repair Kit		DF-RK-8637	
02/98→12/00		Suspension Strut Repair Kit		DF-RK-8685	
02/98→12/00		Suspension Strut Repair Kit		MN-RK-8537	
02/98→12/00		Tie Rod	DF-DL-5403		
02/98→12/00		Tie Rod	DF-DL-7780		
02/98→12/00		Tie Rod	DF-DL-7836		
02/98→12/00		Tie Rod End	CV-ES-12461		for Steering Rod
02/98→12/00		Tie Rod End	CV-ES-12462		for Steering Rod
02/98→12/00		Tie Rod End	CV-ES-14163		for Steering Rod
02/98→12/00		Track Control Arm		DF-DL-8158	Trailing Arm
02/98→12/00		Track Control Arm		DF-VB-8561	Wishbone (CV)
02/98→12/00		Track Control Arm		DF-VB-9343	Wishbone (CV)
FAC 85 CF 430		02/98→12/00	Centre Rod	DF-DL-5226	
	02/98→12/00	Centre Rod	DF-DL-8196		Push Rod
	02/98→12/00	Stabiliser Mounting		DF-SB-9342	
	02/98→12/00	Stabiliser Mounting	DF-SB-5253	DF-SB-5253	
	02/98→12/00	Stabiliser Mounting	DF-SB-10402		
	02/98→12/00	Suspension Arm Repair Kit		CV-RK-5322	for Wishbone (CV)
	02/98→12/00	Suspension Arm Repair Kit		DF-RK-8994	for Wishbone (CV)
	02/98→12/00	Suspension Arm Repair Kit		IV-RK-8998	for Wishbone (CV)
	02/98→12/00	Suspension Arm Repair Kit		MN-RK-7280	for Drag Link
	02/98→12/00	Suspension Arm Repair Kit		SC-RK-8575	for Wishbone (CV)
	02/98→12/00	Suspension Strut Repair Kit		DF-RK-8637	
	02/98→12/00	Suspension Strut Repair Kit		DF-RK-8685	
	02/98→12/00	Suspension Strut Repair Kit		MN-RK-8537	
	02/98→12/00	Tie Rod	DF-DL-5403		
	02/98→12/00	Tie Rod	DF-DL-7780		
	02/98→12/00	Tie Rod	DF-DL-7836		
	02/98→12/00	Tie Rod End	CV-ES-12461		for Steering Rod
	02/98→12/00	Tie Rod End	CV-ES-12462		for Steering Rod
	02/98→12/00	Tie Rod End	CV-ES-14163		for Steering Rod
	02/98→12/00	Track Control Arm		DF-DL-8158	Trailing Arm
	02/98→12/00	Track Control Arm		DF-VB-8561	Wishbone (CV)
	02/98→12/00	Track Control Arm		DF-VB-9343	Wishbone (CV)
	FAD 85 CF 340	02/98→12/00	Centre Rod	DF-DL-5226	
02/98→12/00		Centre Rod	DF-DL-8196		Push Rod
02/98→12/00		Stabiliser Mounting		DF-SB-9342	
02/98→12/00		Stabiliser Mounting	DF-SB-5253	DF-SB-5253	
02/98→12/00		Stabiliser Mounting	DF-SB-10402		
02/98→12/00		Suspension Arm Repair Kit		CV-RK-5322	for Wishbone (CV)
02/98→12/00		Suspension Arm Repair Kit		DF-RK-8994	for Wishbone (CV)
02/98→12/00		Suspension Arm Repair Kit		IV-RK-8998	for Wishbone (CV)
02/98→12/00		Suspension Arm Repair Kit		MN-RK-7280	for Drag Link
02/98→12/00		Suspension Arm Repair Kit		SC-RK-8575	for Wishbone (CV)
02/98→12/00		Suspension Strut Repair Kit		DF-RK-8637	
02/98→12/00		Suspension Strut Repair Kit		DF-RK-8685	

CV-ES-12461

Length: 120
Cone Ø: d1 Ø 26 / d2 Ø 23,5
Thread: M30 x 1,5 LHT
0069513, 69513, 0311300, 311300,
0607998, 607998, 1190653, 1315447,
1319838, 1332123, 1338714, 1401934,
1407394, ACHB063, ACHF241, MAK1295



CV-ES-12462

Length: 120
Cone Ø: d1 Ø 26 / d2 Ø 23,5
Thread: M30 x 1,5 RHT
0069514, 0586753, 0607999, 0694298,
0694360, 0698609, 1137230, 1229944,
1326862, 1326896, 1331925, ACHB064,
ACHF242, MAK1296



CV-ES-14163

Length: 125
Cone Ø: d1 Ø 30 / d2 Ø 27
Thread: M30 x 1,5 RHT
0607981, 0698450, 1149907, 1152350,
1257890, 1603789, 1618048, ACHF060



CV-RK-5322

Ø: 72
Thick/Height: 50
0691704



DF-DL-5226

Length: 850
Ø: 52
Cone Ø: d1 Ø 26 / d2 Ø 23,5
1247957, 1283212, 1351715, 1385492,
10200900A



DF-DL-5403

Length: 1742
Ø: 40
Cone Ø: d1 Ø 26 / d2 Ø 23,5
0288281, 1270854, 1337644



DF-DL-7780

Length: 1690
Ø: 40
Cone Ø: d1 Ø 26 / d2 Ø 23,5
1270853, 1353391, 10212000A



DF-DL-7836

Length: 1698
Ø: 52
Cone Ø: d1 Ø 26 / d2 Ø 23,5
0754922, 1286343, 1353396



DF-DL-8158

Length: 611
Ø: 48
Hole Distance: 130 / 130
0267743, 1361649, 1361650, 1656428



DF-DL-8196

Length: 867
Ø: 50
Cone Ø: d1 Ø 30 / d2 Ø 27
1363859, 1448063, 1602821



DF-RK-8637

Ø: 72
1376730



DF-RK-8685

Ø: 67
Hole Distance: 130
Thick/Height: 24
1321936



DF-RK-8994

Ø: 75
Hole Distance: 130
Thick/Height: 24
1252284



DF-SB-5253

Ø: 86
Thick/Height: 60,5
0371586, 0558864, 10306500A



DF-SB-9342

Ø: 94
Thick/Height: 80 / 70
0281007, 0298498, 008169892, 8169892,
041270883, 41270883



DF-SB-10402

Ø: 62
Thick/Height: 60
1291233, 1732887



DF-VB-8561

Length: 609
Ø: 48
Hole Distance: 152 / 152
0080521, 080521, 1361651, 1368270,
1390932, 1617096, 1793875, 1817808,
1892492



DF-VB-9343

Length: 608,2
Ø: 48
Hole Distance: 152 / 152
1361652, 1620436, 1793876, 10309600A



IV-RK-8998

Ø: 85
Hole Distance: 130
Thick/Height: 30
0513757, 0531757, 0691709, 691709



MN-RK-7280

Ø: 75
Hole Distance: 115
Thick/Height: 24
0689748, 689748



MN-RK-8537

Ø: 95
Hole Distance: 152
Thick/Height: 24
696321, 81432706099



SC-RK-8575

Ø: 95
Hole Distance: 152
Thick/Height: 35
0696321



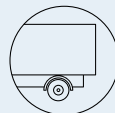

DAF ...

85 CF ...

FAD 85 CF 340 ...	02/98→12/00	Suspension Strut Repair Kit		DF-RK-8685		
	02/98→12/00	Suspension Strut Repair Kit		MN-RK-8537		
	02/98→12/00	Tie Rod	DF-DL-5403			
	02/98→12/00	Tie Rod	DF-DL-7780			
	02/98→12/00	Tie Rod	DF-DL-7836			
	02/98→12/00	Tie Rod End	CV-ES-12461		for Steering Rod	
	02/98→12/00	Tie Rod End	CV-ES-12462		for Steering Rod	
	02/98→12/00	Tie Rod End	CV-ES-14163		for Steering Rod	
	02/98→12/00	Track Control Arm		DF-DL-8158	Trailing Arm	
	02/98→12/00	Track Control Arm		DF-VB-8561	Wishbone (CV)	
	02/98→12/00	Track Control Arm		DF-VB-9343	Wishbone (CV)	
	FAD 85 CF 380	02/98→12/00	Centre Rod	DF-DL-5226		Push Rod
		02/98→12/00	Centre Rod	DF-DL-8196		Push Rod
02/98→12/00		Stabiliser Mounting		DF-SB-9342		
02/98→12/00		Stabiliser Mounting	DF-SB-5253	DF-SB-5253		
02/98→12/00		Stabiliser Mounting	DF-SB-10402			
02/98→12/00		Suspension Arm Repair Kit		CV-RK-5322	for Wishbone (CV)	
02/98→12/00		Suspension Arm Repair Kit		DF-RK-8994	for Wishbone (CV)	
02/98→12/00		Suspension Arm Repair Kit		IV-RK-8998	for Wishbone (CV)	
02/98→12/00		Suspension Arm Repair Kit		MN-RK-7280	for Drag Link	
02/98→12/00		Suspension Arm Repair Kit		SC-RK-8575	for Wishbone (CV)	
02/98→12/00		Suspension Strut Repair Kit		DF-RK-8637		
02/98→12/00		Suspension Strut Repair Kit		DF-RK-8685		
02/98→12/00		Suspension Strut Repair Kit		MN-RK-8537		
02/98→12/00		Tie Rod	DF-DL-5403			
02/98→12/00		Tie Rod	DF-DL-7780			
02/98→12/00		Tie Rod	DF-DL-7836			
02/98→12/00		Tie Rod End	CV-ES-12461		for Steering Rod	
02/98→12/00		Tie Rod End	CV-ES-12462		for Steering Rod	
02/98→12/00		Tie Rod End	CV-ES-14163		for Steering Rod	
02/98→12/00		Track Control Arm		DF-DL-8158	Trailing Arm	
02/98→12/00		Track Control Arm		DF-VB-8561	Wishbone (CV)	
02/98→12/00		Track Control Arm		DF-VB-9343	Wishbone (CV)	
FAD 85 CF 430		02/98→12/00	Centre Rod	DF-DL-5226		Push Rod
		02/98→12/00	Centre Rod	DF-DL-8196		Push Rod
		02/98→12/00	Centre Rod	LF-DL-0288		Push Rod
		02/98→12/00	Stabiliser Mounting		DF-SB-9342	
		02/98→12/00	Stabiliser Mounting	DF-SB-5253	DF-SB-5253	
	02/98→12/00	Stabiliser Mounting	DF-SB-10402			
	02/98→12/00	Suspension Arm Repair Kit		CV-RK-5322	for Wishbone (CV)	
	02/98→12/00	Suspension Arm Repair Kit		DF-RK-8994	for Wishbone (CV)	
	02/98→12/00	Suspension Arm Repair Kit		IV-RK-8998	for Wishbone (CV)	
	02/98→12/00	Suspension Arm Repair Kit		MN-RK-7280	for Drag Link	
	02/98→12/00	Suspension Arm Repair Kit		SC-RK-8575	for Wishbone (CV)	
	02/98→12/00	Suspension Strut Repair Kit		DF-RK-8637		
	02/98→12/00	Suspension Strut Repair Kit		DF-RK-8685		
	02/98→12/00	Suspension Strut Repair Kit		MN-RK-8537		
	02/98→12/00	Tie Rod	DF-DL-5403			
	02/98→12/00	Tie Rod	DF-DL-7780			
	02/98→12/00	Tie Rod	DF-DL-7836			
	02/98→12/00	Tie Rod End	CV-ES-12461		for Steering Rod	
	02/98→12/00	Tie Rod End	CV-ES-12462		for Steering Rod	
	02/98→12/00	Tie Rod End	CV-ES-14163		for Steering Rod	
	02/98→12/00	Track Control Arm		DF-DL-8158	Trailing Arm	
	02/98→12/00	Track Control Arm		DF-VB-8561	Wishbone (CV)	
	02/98→12/00	Track Control Arm		DF-VB-9343	Wishbone (CV)	
	FAG 85 CF 340,FAN 85 CF 340	02/98→12/00	Centre Rod	DF-DL-5226		Push Rod
		02/98→12/00	Centre Rod	DF-DL-8196		Push Rod
		02/98→12/00	Stabiliser Mounting		DF-SB-9342	
		02/98→12/00	Stabiliser Mounting	DF-SB-5253	DF-SB-5253	
		02/98→12/00	Stabiliser Mounting	DF-SB-10402		
		02/98→12/00	Suspension Arm Repair Kit		CV-RK-5322	for Wishbone (CV)
		02/98→12/00	Suspension Arm Repair Kit		DF-RK-8994	for Wishbone (CV)

CV-ES-12461

Length: 120
Cone Ø: d1 Ø 26 / d2 Ø 23,5
Thread: M30 x 1,5 LHT
0069513, 69513, 0311300, 311300, 607998, 0607998, 1190653, 1315447, 1319838, 1332123, 1338714, 1401934, 1407394, ACHB063, ACHF241, MAK1295



CV-ES-12462

Length: 120
Cone Ø: d1 Ø 26 / d2 Ø 23,5
Thread: M30 x 1,5 RHT
0069514, 0586753, 0607999, 0694298, 0694360, 0698609, 1137230, 1229944, 1326862, 1326896, 1331925, ACHB064, ACHF242, MAK1296



CV-ES-14163

Length: 125
Cone Ø: d1 Ø 30 / d2 Ø 27
Thread: M30 x 1,5 RHT
0607981, 0698450, 1149907, 1152350, 1257890, 1603789, 1618048, ACHF060



CV-RK-5322

Ø: 72
Thick/Height: 50
0691704



DF-DL-5226

Length: 850
Ø: 52
Cone Ø: d1 Ø 26 / d2 Ø 23,5
1247957, 1283212, 1351715, 1385492, 10200900A



DF-DL-5403

Length: 1742
Ø: 40
Cone Ø: d1 Ø 26 / d2 Ø 23,5
0288281, 1270854, 1337644



DF-DL-7780

Length: 1690
Ø: 40
Cone Ø: d1 Ø 26 / d2 Ø 23,5
1270853, 1353391, 10212000A



DF-DL-7836

Length: 1698
Ø: 52
Cone Ø: d1 Ø 26 / d2 Ø 23,5
0754922, 1286343, 1353396



DF-DL-8158

Length: 611
Ø: 48
Hole Distance: 130 / 130
0267743, 1361649, 1361650, 1656428



DF-DL-8196

Length: 867
Ø: 50
Cone Ø: d1 Ø 30 / d2 Ø 27
1363859, 1448063, 1602821



DF-RK-8637

Ø: 72
1376730



DF-RK-8685

Ø: 67
Hole Distance: 130
Thick/Height: 24
1321936



DF-RK-8994

Ø: 75
Hole Distance: 130
Thick/Height: 24
1252284



DF-SB-5253

Ø: 86
Thick/Height: 60,5
0371586, 0558864, 10306500A



DF-SB-9342

Ø: 94
Thick/Height: 80 / 70
0281007, 0298498, 008169892, 8169892, 041270883, 41270883



DF-SB-10402

Ø: 62
Thick/Height: 60
1291233, 1732887



DF-VB-8561

Length: 609
Ø: 48
Hole Distance: 152 / 152
0080521, 080521, 1361651, 1368270, 1390932, 1617096, 1793875, 1817808, 1892492



DF-VB-9343

Length: 608,2
Ø: 48
Hole Distance: 152 / 152
1361652, 1620436, 1793876, 10309600A



IV-RK-8998

Ø: 85
Hole Distance: 130
Thick/Height: 30
0513757, 0531757, 0691709, 691709



LF-DL-0288

Length: 860
Ø: 36
Cone Ø: d1 Ø 26 / d2 Ø 23,5
1257991, 1351718, 1385493



MN-RK-7280

Ø: 75
Hole Distance: 115
Thick/Height: 24
0689748, 689748



MN-RK-8537

Ø: 95
Hole Distance: 152
Thick/Height: 24
696321, 81432706099



SC-RK-8575

Ø: 95
Hole Distance: 152
Thick/Height: 35
0696321





85 CF ...

FAG 85 CF 340,FAN 85 CF 340 ...	02/98→12/00	Suspension Arm Repair Kit		IV-RK-8998	for Wishbone (CV)	
	02/98→12/00	Suspension Arm Repair Kit		MN-RK-7280	for Drag Link	
	02/98→12/00	Suspension Arm Repair Kit		SC-RK-8575	for Wishbone (CV)	
	02/98→12/00	Suspension Strut Repair Kit		DF-RK-8637		
	02/98→12/00	Suspension Strut Repair Kit		DF-RK-8685		
	02/98→12/00	Suspension Strut Repair Kit		MN-RK-8537		
	02/98→12/00	Tie Rod	DF-DL-5403			
	02/98→12/00	Tie Rod	DF-DL-7780			
	02/98→12/00	Tie Rod	DF-DL-7836			
	02/98→12/00	Tie Rod End	CV-ES-12461		for Steering Rod	
	02/98→12/00	Tie Rod End	CV-ES-12462		for Steering Rod	
	02/98→12/00	Tie Rod End	CV-ES-14163		for Steering Rod	
	02/98→12/00	Track Control Arm		DF-DL-8158	Trailing Arm	
	02/98→12/00	Track Control Arm		DF-VB-8561	Wishbone (CV)	
	02/98→12/00	Track Control Arm		DF-VB-9343	Wishbone (CV)	
	FAG 85 CF 380,FAN 85 CF 380	02/98→12/00	Centre Rod	DF-DL-5226		Push Rod
		02/98→12/00	Centre Rod	DF-DL-8196		Push Rod
		02/98→12/00	Stabiliser Mounting		DF-SB-9342	
		02/98→12/00	Stabiliser Mounting	DF-SB-5253	DF-SB-5253	
		02/98→12/00	Stabiliser Mounting	DF-SB-10402		
02/98→12/00		Suspension Arm Repair Kit		CV-RK-5322	for Wishbone (CV)	
02/98→12/00		Suspension Arm Repair Kit		DF-RK-8994	for Wishbone (CV)	
02/98→12/00		Suspension Arm Repair Kit		IV-RK-8998	for Wishbone (CV)	
02/98→12/00		Suspension Arm Repair Kit		MN-RK-7280	for Drag Link	
02/98→12/00		Suspension Arm Repair Kit		SC-RK-8575	for Wishbone (CV)	
02/98→12/00		Suspension Strut Repair Kit		DF-RK-8637		
02/98→12/00		Suspension Strut Repair Kit		DF-RK-8685		
02/98→12/00		Suspension Strut Repair Kit		MN-RK-8537		
02/98→12/00		Tie Rod	DF-DL-5403			
02/98→12/00		Tie Rod	DF-DL-7780			
02/98→12/00		Tie Rod	DF-DL-7836			
02/98→12/00		Tie Rod End	CV-ES-12461		for Steering Rod	
02/98→12/00		Tie Rod End	CV-ES-12462		for Steering Rod	
02/98→12/00		Tie Rod End	CV-ES-14163		for Steering Rod	
02/98→12/00		Track Control Arm		DF-DL-8158	Trailing Arm	
02/98→12/00	Track Control Arm		DF-VB-8561	Wishbone (CV)		
02/98→12/00	Track Control Arm		DF-VB-9343	Wishbone (CV)		
FAG 85 CF 430,FAN 85 CF 430	02/98→12/00	Centre Rod	DF-DL-5226		Push Rod	
	02/98→12/00	Centre Rod	DF-DL-8196		Push Rod	
	02/98→12/00	Stabiliser Mounting		DF-SB-9342		
	02/98→12/00	Stabiliser Mounting	DF-SB-5253	DF-SB-5253		
	02/98→12/00	Stabiliser Mounting	DF-SB-10402			
	02/98→12/00	Suspension Arm Repair Kit		CV-RK-5322	for Wishbone (CV)	
	02/98→12/00	Suspension Arm Repair Kit		DF-RK-8994	for Wishbone (CV)	
	02/98→12/00	Suspension Arm Repair Kit		IV-RK-8998	for Wishbone (CV)	
	02/98→12/00	Suspension Arm Repair Kit		MN-RK-7280	for Drag Link	
	02/98→12/00	Suspension Arm Repair Kit		SC-RK-8575	for Wishbone (CV)	
	02/98→12/00	Suspension Strut Repair Kit		DF-RK-8637		
	02/98→12/00	Suspension Strut Repair Kit		DF-RK-8685		
	02/98→12/00	Suspension Strut Repair Kit		MN-RK-8537		
	02/98→12/00	Tie Rod	DF-DL-5403			
	02/98→12/00	Tie Rod	DF-DL-7780			
	02/98→12/00	Tie Rod	DF-DL-7836			
	02/98→12/00	Tie Rod End	CV-ES-12461		for Steering Rod	
	02/98→12/00	Tie Rod End	CV-ES-12462		for Steering Rod	
	02/98→12/00	Tie Rod End	CV-ES-14163		for Steering Rod	
	02/98→12/00	Track Control Arm		DF-DL-8158	Trailing Arm	
02/98→12/00	Track Control Arm		DF-VB-8561	Wishbone (CV)		
02/98→12/00	Track Control Arm		DF-VB-9343	Wishbone (CV)		
FAR 85 CF 340	02/98→12/00	Centre Rod	DF-DL-5226		Push Rod	
	02/98→12/00	Centre Rod	DF-DL-8196		Push Rod	
	02/98→12/00	Stabiliser Mounting		DF-SB-9342		
	02/98→12/00	Stabiliser Mounting	DF-SB-5253	DF-SB-5253		

CV-ES-12461

Length: 120
Cone Ø: d1 Ø 26 / d2 Ø 23,5
Thread: M30 x 1,5 LHT
0069513, 69513, 0311300, 311300, 607998, 0607998, 1190653, 1315447, 1319838, 1332123, 1338714, 1401934, 1407394, ACHB063, ACHF241, MAK1295



CV-ES-12462

Length: 120
Cone Ø: d1 Ø 26 / d2 Ø 23,5
Thread: M30 x 1,5 RHT
0069514, 0586753, 0607999, 0694298, 0694360, 0698609, 1137230, 1229944, 1326862, 1326896, 1331925, ACHB064, ACHF242, MAK1296



CV-ES-14163

Length: 125
Cone Ø: d1 Ø 30 / d2 Ø 27
Thread: M30 x 1,5 RHT
0607981, 0698450, 1149907, 1152350, 1257890, 1603789, 1618048, ACHF060



CV-RK-5322

Ø: 72
Thick/Height: 50
0691704



DF-DL-5226

Length: 850
Ø: 52
Cone Ø: d1 Ø 26 / d2 Ø 23,5
1247957, 1283212, 1351715, 1385492, 10200900A



DF-DL-5403

Length: 1742
Ø: 40
Cone Ø: d1 Ø 26 / d2 Ø 23,5
0288281, 1270854, 1337644



DF-DL-7780

Length: 1690
Ø: 40
Cone Ø: d1 Ø 26 / d2 Ø 23,5
1270853, 1353391, 10212000A



DF-DL-7836

Length: 1698
Ø: 52
Cone Ø: d1 Ø 26 / d2 Ø 23,5
0754922, 1286343, 1353396



DF-DL-8158

Length: 611
Ø: 48
Hole Distance: 130 / 130
0267743, 1361649, 1361650, 1656428



DF-DL-8196

Length: 867
Ø: 50
Cone Ø: d1 Ø 30 / d2 Ø 27
1363859, 1448063, 1602821



DF-RK-8637

Ø: 72
1376730



DF-RK-8685

Ø: 67
Hole Distance: 130
Thick/Height: 24
1321936



DF-RK-8994

Ø: 75
Hole Distance: 130
Thick/Height: 24
1252284



DF-SB-5253

Ø: 86
Thick/Height: 60,5
0371586, 0558864, 10306500A



DF-SB-9342

Ø: 94
Thick/Height: 80 / 70
0281007, 0298498, 008169892, 8169892, 041270883, 41270883



DF-SB-10402

Ø: 62
Thick/Height: 60
1291233, 1732887



DF-VB-8561

Length: 609
Ø: 48
Hole Distance: 152 / 152
0080521, 080521, 1361651, 1368270, 1390932, 1617096, 1793875, 1817808, 1892492



DF-VB-9343

Length: 608,2
Ø: 48
Hole Distance: 152 / 152
1361652, 1620436, 1793876, 10309600A



IV-RK-8998

Ø: 85
Hole Distance: 130
Thick/Height: 30
0513757, 0531757, 0691709, 691709



MN-RK-7280

Ø: 75
Hole Distance: 115
Thick/Height: 24
0689748, 689748



MN-RK-8537

Ø: 95
Hole Distance: 152
Thick/Height: 24
696321, 81432706099



SC-RK-8575

Ø: 95
Hole Distance: 152
Thick/Height: 35
0696321





85 CF ...

FAR 85 CF 340 ...	02/98 → 12/00	Stabiliser Mounting	DF-SB-10402			
	02/98 → 12/00	Suspension Arm Repair Kit		CV-RK-5322	for Wishbone (CV)	
	02/98 → 12/00	Suspension Arm Repair Kit		DF-RK-8994	for Wishbone (CV)	
	02/98 → 12/00	Suspension Arm Repair Kit		IV-RK-8998	for Wishbone (CV)	
	02/98 → 12/00	Suspension Arm Repair Kit		MN-RK-7280	for Drag Link	
	02/98 → 12/00	Suspension Arm Repair Kit		SC-RK-8575	for Wishbone (CV)	
	02/98 → 12/00	Suspension Strut Repair Kit		DF-RK-8637		
	02/98 → 12/00	Suspension Strut Repair Kit		DF-RK-8685		
	02/98 → 12/00	Suspension Strut Repair Kit		MN-RK-8537		
	02/98 → 12/00	Tie Rod	DF-DL-5403			
	02/98 → 12/00	Tie Rod	DF-DL-7780			
	02/98 → 12/00	Tie Rod	DF-DL-7836			
	02/98 → 12/00	Tie Rod End	CV-ES-12461		for Steering Rod	
	02/98 → 12/00	Tie Rod End	CV-ES-12462		for Steering Rod	
	02/98 → 12/00	Tie Rod End	CV-ES-14163		for Steering Rod	
	02/98 → 12/00	Track Control Arm		DF-DL-8158	Trailing Arm	
	02/98 → 12/00	Track Control Arm		DF-VB-8561	Wishbone (CV)	
	02/98 → 12/00	Track Control Arm		DF-VB-9343	Wishbone (CV)	
	FAR 85 CF 380	02/98 → 12/00	Centre Rod	DF-DL-5226		Push Rod
		02/98 → 12/00	Centre Rod	DF-DL-8196		Push Rod
		02/98 → 12/00	Stabiliser Mounting		DF-SB-9342	
		02/98 → 12/00	Stabiliser Mounting	DF-SB-5253	DF-SB-5253	
		02/98 → 12/00	Stabiliser Mounting	DF-SB-10402		
		02/98 → 12/00	Suspension Arm Repair Kit		CV-RK-5322	for Wishbone (CV)
02/98 → 12/00		Suspension Arm Repair Kit		DF-RK-8994	for Wishbone (CV)	
02/98 → 12/00		Suspension Arm Repair Kit		IV-RK-8998	for Wishbone (CV)	
02/98 → 12/00		Suspension Arm Repair Kit		MN-RK-7280	for Drag Link	
02/98 → 12/00		Suspension Arm Repair Kit		SC-RK-8575	for Wishbone (CV)	
02/98 → 12/00		Suspension Strut Repair Kit		DF-RK-8637		
02/98 → 12/00		Suspension Strut Repair Kit		DF-RK-8685		
02/98 → 12/00		Suspension Strut Repair Kit		MN-RK-8537		
02/98 → 12/00		Tie Rod	DF-DL-5403			
02/98 → 12/00		Tie Rod	DF-DL-7780			
02/98 → 12/00		Tie Rod	DF-DL-7836			
02/98 → 12/00		Tie Rod End	CV-ES-12461		for Steering Rod	
02/98 → 12/00		Tie Rod End	CV-ES-12462		for Steering Rod	
02/98 → 12/00		Tie Rod End	CV-ES-14163		for Steering Rod	
02/98 → 12/00		Track Control Arm		DF-DL-8158	Trailing Arm	
02/98 → 12/00		Track Control Arm		DF-VB-8561	Wishbone (CV)	
02/98 → 12/00		Track Control Arm		DF-VB-9343	Wishbone (CV)	
FAR 85 CF 430		02/98 → 12/00	Centre Rod	DF-DL-5226		Push Rod
		02/98 → 12/00	Centre Rod	DF-DL-8196		Push Rod
	02/98 → 12/00	Stabiliser Mounting		DF-SB-9342		
	02/98 → 12/00	Stabiliser Mounting	DF-SB-5253	DF-SB-5253		
	02/98 → 12/00	Stabiliser Mounting	DF-SB-10402			
	02/98 → 12/00	Suspension Arm Repair Kit		CV-RK-5322	for Wishbone (CV)	
	02/98 → 12/00	Suspension Arm Repair Kit		DF-RK-8994	for Wishbone (CV)	
	02/98 → 12/00	Suspension Arm Repair Kit		IV-RK-8998	for Wishbone (CV)	
	02/98 → 12/00	Suspension Arm Repair Kit		MN-RK-7280	for Drag Link	
	02/98 → 12/00	Suspension Arm Repair Kit		SC-RK-8575	for Wishbone (CV)	
	02/98 → 12/00	Suspension Strut Repair Kit		DF-RK-8637		
	02/98 → 12/00	Suspension Strut Repair Kit		DF-RK-8685		
	02/98 → 12/00	Suspension Strut Repair Kit		MN-RK-8537		
	02/98 → 12/00	Tie Rod	DF-DL-5403			
	02/98 → 12/00	Tie Rod	DF-DL-7780			
	02/98 → 12/00	Tie Rod	DF-DL-7836			
	02/98 → 12/00	Tie Rod End	CV-ES-12461		for Steering Rod	
	02/98 → 12/00	Tie Rod End	CV-ES-12462		for Steering Rod	
	02/98 → 12/00	Tie Rod End	CV-ES-14163		for Steering Rod	
	02/98 → 12/00	Track Control Arm		DF-DL-8158	Trailing Arm	
	02/98 → 12/00	Track Control Arm		DF-VB-8561	Wishbone (CV)	
	02/98 → 12/00	Track Control Arm		DF-VB-9343	Wishbone (CV)	

CV-ES-12461

Length: 120
Cone Ø: d1 Ø 26 / d2 Ø 23,5
Thread: M30 x 1,5 LHT
0069513, 69513, 0311300, 311300, 607998, 0607998, 1190653, 1315447, 1319838, 1332123, 1338714, 1401934, 1407394, ACHB063, ACHF241, MAK1295



CV-ES-12462

Length: 120
Cone Ø: d1 Ø 26 / d2 Ø 23,5
Thread: M30 x 1,5 RHT
0069514, 0586753, 0607999, 0694298, 0694360, 0698609, 1137230, 1229944, 1326862, 1326896, 1331925, ACHB064, ACHF242, MAK1296



CV-ES-14163

Length: 125
Cone Ø: d1 Ø 30 / d2 Ø 27
Thread: M30 x 1,5 RHT
0607981, 0698450, 1149907, 1152350, 1257890, 1603789, 1618048, ACHF060



CV-RK-5322

Ø: 72
Thick/Height: 50
0691704



DF-DL-5226

Length: 850
Ø: 52
Cone Ø: d1 Ø 26 / d2 Ø 23,5
1247957, 1283212, 1351715, 1385492, 10200900A



DF-DL-5403

Length: 1742
Ø: 40
Cone Ø: d1 Ø 26 / d2 Ø 23,5
0288281, 1270854, 1337644



DF-DL-7780

Length: 1690
Ø: 40
Cone Ø: d1 Ø 26 / d2 Ø 23,5
1270853, 1353391, 10212000A



DF-DL-7836

Length: 1698
Ø: 52
Cone Ø: d1 Ø 26 / d2 Ø 23,5
0754922, 1286343, 1353396



DF-DL-8158

Length: 611
Ø: 48
Hole Distance: 130 / 130
0267743, 1361649, 1361650, 1656428



DF-DL-8196

Length: 867
Ø: 50
Cone Ø: d1 Ø 30 / d2 Ø 27
1363859, 1448063, 1602821



DF-RK-8637

Ø: 72
1376730



DF-RK-8685

Ø: 67
Hole Distance: 130
Thick/Height: 24
1321936



DF-RK-8994

Ø: 75
Hole Distance: 130
Thick/Height: 24
1252284



DF-SB-5253

Ø: 86
Thick/Height: 60,5
0371586, 0558864, 10306500A



DF-SB-9342

Ø: 94
Thick/Height: 80 / 70
0281007, 0298498, 8169892, 008169892, 041270883, 41270883



DF-SB-10402

Ø: 62
Thick/Height: 60
1291233, 1732887



DF-VB-8561

Length: 609
Ø: 48
Hole Distance: 152 / 152
0080521, 080521, 1361651, 1368270, 1390932, 1617096, 1793875, 1817808, 1892492



DF-VB-9343

Length: 608,2
Ø: 48
Hole Distance: 152 / 152
1361652, 1620436, 1793876, 10309600A



IV-RK-8998

Ø: 85
Hole Distance: 130
Thick/Height: 30
0513757, 0531757, 0691709, 691709



MN-RK-7280

Ø: 75
Hole Distance: 115
Thick/Height: 24
0689748, 689748



MN-RK-8537

Ø: 95
Hole Distance: 152
Thick/Height: 24
696321, 81432706099



SC-RK-8575

Ø: 95
Hole Distance: 152
Thick/Height: 35
0696321



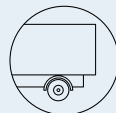

85 CF ...

FAS 85 CF 340	02/98 → 12/00	Centre Rod	DF-DL-5226		Push Rod
	02/98 → 12/00	Centre Rod	DF-DL-8196		Push Rod
	02/98 → 12/00	Stabiliser Mounting		DF-SB-9342	
	02/98 → 12/00	Stabiliser Mounting	DF-SB-5253	DF-SB-5253	
	02/98 → 12/00	Stabiliser Mounting	DF-SB-10402		
	02/98 → 12/00	Suspension Arm Repair Kit		CV-RK-5322	for Wishbone (CV)
	02/98 → 12/00	Suspension Arm Repair Kit		DF-RK-8994	for Wishbone (CV)
	02/98 → 12/00	Suspension Arm Repair Kit		IV-RK-8998	for Wishbone (CV)
	02/98 → 12/00	Suspension Arm Repair Kit		MN-RK-7280	for Drag Link
	02/98 → 12/00	Suspension Arm Repair Kit		SC-RK-8575	for Wishbone (CV)
	02/98 → 12/00	Suspension Strut Repair Kit		DF-RK-8637	
	02/98 → 12/00	Suspension Strut Repair Kit		DF-RK-8685	
	02/98 → 12/00	Suspension Strut Repair Kit		MN-RK-8537	
	02/98 → 12/00	Tie Rod	DF-DL-5403		
	02/98 → 12/00	Tie Rod	DF-DL-7780		
	02/98 → 12/00	Tie Rod	DF-DL-7836		
	02/98 → 12/00	Tie Rod End	CV-ES-12461		for Steering Rod
	02/98 → 12/00	Tie Rod End	CV-ES-12462		for Steering Rod
	02/98 → 12/00	Tie Rod End	CV-ES-14163		for Steering Rod
	02/98 → 12/00	Track Control Arm		DF-DL-8158	Trailing Arm
02/98 → 12/00	Track Control Arm		DF-VB-8561	Wishbone (CV)	
02/98 → 12/00	Track Control Arm		DF-VB-9343	Wishbone (CV)	
FAS 85 CF 380	02/98 → 12/00	Centre Rod	DF-DL-5226		Push Rod
	02/98 → 12/00	Centre Rod	DF-DL-8196		Push Rod
	02/98 → 12/00	Stabiliser Mounting		DF-SB-9342	
	02/98 → 12/00	Stabiliser Mounting	DF-SB-5253	DF-SB-5253	
	02/98 → 12/00	Stabiliser Mounting	DF-SB-10402		
	02/98 → 12/00	Suspension Arm Repair Kit		CV-RK-5322	for Wishbone (CV)
	02/98 → 12/00	Suspension Arm Repair Kit		DF-RK-8994	for Wishbone (CV)
	02/98 → 12/00	Suspension Arm Repair Kit		IV-RK-8998	for Wishbone (CV)
	02/98 → 12/00	Suspension Arm Repair Kit		MN-RK-7280	for Drag Link
	02/98 → 12/00	Suspension Arm Repair Kit		SC-RK-8575	for Wishbone (CV)
	02/98 → 12/00	Suspension Strut Repair Kit		DF-RK-8637	
	02/98 → 12/00	Suspension Strut Repair Kit		DF-RK-8685	
	02/98 → 12/00	Suspension Strut Repair Kit		MN-RK-8537	
	02/98 → 12/00	Tie Rod	DF-DL-5403		
	02/98 → 12/00	Tie Rod	DF-DL-7780		
	02/98 → 12/00	Tie Rod	DF-DL-7836		
	02/98 → 12/00	Tie Rod End	CV-ES-12461		for Steering Rod
	02/98 → 12/00	Tie Rod End	CV-ES-12462		for Steering Rod
	02/98 → 12/00	Tie Rod End	CV-ES-14163		for Steering Rod
	02/98 → 12/00	Track Control Arm		DF-DL-8158	Trailing Arm
02/98 → 12/00	Track Control Arm		DF-VB-8561	Wishbone (CV)	
02/98 → 12/00	Track Control Arm		DF-VB-9343	Wishbone (CV)	
FAS 85 CF 430	02/98 → 12/00	Centre Rod	DF-DL-5226		Push Rod
	02/98 → 12/00	Centre Rod	DF-DL-8196		Push Rod
	02/98 → 12/00	Stabiliser Mounting		DF-SB-9342	
	02/98 → 12/00	Stabiliser Mounting	DF-SB-5253	DF-SB-5253	
	02/98 → 12/00	Stabiliser Mounting	DF-SB-10402		
	02/98 → 12/00	Suspension Arm Repair Kit		CV-RK-5322	for Wishbone (CV)
	02/98 → 12/00	Suspension Arm Repair Kit		DF-RK-8994	for Wishbone (CV)
	02/98 → 12/00	Suspension Arm Repair Kit		IV-RK-8998	for Wishbone (CV)
	02/98 → 12/00	Suspension Arm Repair Kit		MN-RK-7280	for Drag Link
	02/98 → 12/00	Suspension Arm Repair Kit		SC-RK-8575	for Wishbone (CV)
	02/98 → 12/00	Suspension Strut Repair Kit		DF-RK-8637	
	02/98 → 12/00	Suspension Strut Repair Kit		DF-RK-8685	
	02/98 → 12/00	Suspension Strut Repair Kit		MN-RK-8537	
	02/98 → 12/00	Tie Rod	DF-DL-5403		
	02/98 → 12/00	Tie Rod	DF-DL-7780		
	02/98 → 12/00	Tie Rod	DF-DL-7836		
	02/98 → 12/00	Tie Rod End	CV-ES-12461		for Steering Rod
	02/98 → 12/00	Tie Rod End	CV-ES-12462		for Steering Rod
	02/98 → 12/00	Tie Rod End	CV-ES-14163		for Steering Rod

CV-ES-12461

Length: 120
Cone Ø: d1 Ø 26 / d2 Ø 23,5
Thread: M30 x 1,5 LHT
0069513, 69513, 0311300, 311300,
0607998, 607998, 1190653, 1315447,
1319838, 1332123, 1338714, 1401934,
1407394, ACHB063, ACHF241, MAK1295



CV-ES-12462

Length: 120
Cone Ø: d1 Ø 26 / d2 Ø 23,5
Thread: M30 x 1,5 RHT
0069514, 0586753, 0607999, 0694298,
0694360, 0698609, 1137230, 1229944,
1326862, 1326896, 1331925, ACHB064,
ACHF242, MAK1296



CV-ES-14163

Length: 125
Cone Ø: d1 Ø 30 / d2 Ø 27
Thread: M30 x 1,5 RHT
0607981, 0698450, 1149907, 1152350,
1257890, 1603789, 1618048, ACHF060



CV-RK-5322

Ø: 72
Thick/Height: 50
0691704



DF-DL-5226

Length: 850
Ø: 52
Cone Ø: d1 Ø 26 / d2 Ø 23,5
1247957, 1283212, 1351715, 1385492,
10200900A



DF-DL-5403

Length: 1742
Ø: 40
Cone Ø: d1 Ø 26 / d2 Ø 23,5
0288281, 1270854, 1337644



DF-DL-7780

Length: 1690
Ø: 40
Cone Ø: d1 Ø 26 / d2 Ø 23,5
1270853, 1353391, 10212000A



DF-DL-7836

Length: 1698
Ø: 52
Cone Ø: d1 Ø 26 / d2 Ø 23,5
0754922, 1286343, 1353396



DF-DL-8158

Length: 611
Ø: 48
Hole Distance: 130 / 130
0267743, 1361649, 1361650, 1656428



DF-DL-8196

Length: 867
Ø: 50
Cone Ø: d1 Ø 30 / d2 Ø 27
1363859, 1448063, 1602821



DF-RK-8637

Ø: 72
1376730



DF-RK-8685

Ø: 67
Hole Distance: 130
Thick/Height: 24
1321936



DF-RK-8994

Ø: 75
Hole Distance: 130
Thick/Height: 24
1252284



DF-SB-5253

Ø: 86
Thick/Height: 60,5
0371586, 0558864, 10306500A



DF-SB-9342

Ø: 94
Thick/Height: 80 / 70
0281007, 0298498, 8169892, 008169892,
41270883, 041270883



DF-SB-10402

Ø: 62
Thick/Height: 60
1291233, 1732887



DF-VB-8561

Length: 609
Ø: 48
Hole Distance: 152 / 152
0080521, 080521, 1361651, 1368270,
1390932, 1617096, 1793875, 1817808,
1892492



DF-VB-9343

Length: 608,2
Ø: 48
Hole Distance: 152 / 152
1361652, 1620436, 1793876, 10309600A



IV-RK-8998

Ø: 85
Hole Distance: 130
Thick/Height: 30
0513757, 0531757, 0691709, 691709



MN-RK-7280

Ø: 75
Hole Distance: 115
Thick/Height: 24
0689748, 689748



MN-RK-8537

Ø: 95
Hole Distance: 152
Thick/Height: 24
696321, 81432706099



SC-RK-8575

Ø: 95
Hole Distance: 152
Thick/Height: 35
0696321





85 CF ...

FAS 85 CF 430 ...	02/98 → 12/00	Track Control Arm		DF-DL-8158	Trailing Arm
	02/98 → 12/00	Track Control Arm		DF-VB-8561	Wishbone (CV)
	02/98 → 12/00	Track Control Arm		DF-VB-9343	Wishbone (CV)
FAT 85 CF 340	02/98 → 12/00	Centre Rod	DF-DL-5226		Push Rod
	02/98 → 12/00	Centre Rod	DF-DL-8196		Push Rod
	02/98 → 12/00	Stabiliser Mounting		DF-SB-9342	
	02/98 → 12/00	Stabiliser Mounting	DF-SB-5253	DF-SB-5253	
	02/98 → 12/00	Stabiliser Mounting	DF-SB-10402		
	02/98 → 12/00	Suspension Arm Repair Kit		CV-RK-5322	for Wishbone (CV)
	02/98 → 12/00	Suspension Arm Repair Kit		DF-RK-8994	for Wishbone (CV)
	02/98 → 12/00	Suspension Arm Repair Kit		IV-RK-8998	for Wishbone (CV)
	02/98 → 12/00	Suspension Arm Repair Kit		MN-RK-7280	for Drag Link
	02/98 → 12/00	Suspension Arm Repair Kit		SC-RK-8575	for Wishbone (CV)
	02/98 → 12/00	Suspension Strut Repair Kit		DF-RK-8637	
	02/98 → 12/00	Suspension Strut Repair Kit		DF-RK-8685	
	02/98 → 12/00	Suspension Strut Repair Kit		MN-RK-8537	
	02/98 → 12/00	Tie Rod	DF-DL-5403		
	02/98 → 12/00	Tie Rod	DF-DL-7780		
	02/98 → 12/00	Tie Rod	DF-DL-7836		
	02/98 → 12/00	Tie Rod End	CV-ES-12461		for Steering Rod
	02/98 → 12/00	Tie Rod End	CV-ES-12462		for Steering Rod
	02/98 → 12/00	Tie Rod End	CV-ES-14163		for Steering Rod
	02/98 → 12/00	Track Control Arm		DF-DL-8158	Trailing Arm
	02/98 → 12/00	Track Control Arm		DF-VB-8561	Wishbone (CV)
02/98 → 12/00	Track Control Arm		DF-VB-9343	Wishbone (CV)	
FAT 85 CF 380	02/98 → 12/00	Centre Rod	DF-DL-5226		Push Rod
	02/98 → 12/00	Centre Rod	DF-DL-8196		Push Rod
	02/98 → 12/00	Stabiliser Mounting		DF-SB-9342	
	02/98 → 12/00	Stabiliser Mounting	DF-SB-5253	DF-SB-5253	
	02/98 → 12/00	Stabiliser Mounting	DF-SB-10402		
	02/98 → 12/00	Suspension Arm Repair Kit		CV-RK-5322	for Wishbone (CV)
	02/98 → 12/00	Suspension Arm Repair Kit		DF-RK-8994	for Wishbone (CV)
	02/98 → 12/00	Suspension Arm Repair Kit		IV-RK-8998	for Wishbone (CV)
	02/98 → 12/00	Suspension Arm Repair Kit		MN-RK-7280	for Drag Link
	02/98 → 12/00	Suspension Arm Repair Kit		SC-RK-8575	for Wishbone (CV)
	02/98 → 12/00	Suspension Strut Repair Kit		DF-RK-8637	
	02/98 → 12/00	Suspension Strut Repair Kit		DF-RK-8685	
	02/98 → 12/00	Suspension Strut Repair Kit		MN-RK-8537	
	02/98 → 12/00	Tie Rod	DF-DL-5403		
	02/98 → 12/00	Tie Rod	DF-DL-7780		
	02/98 → 12/00	Tie Rod	DF-DL-7836		
	02/98 → 12/00	Tie Rod End	CV-ES-12461		for Steering Rod
	02/98 → 12/00	Tie Rod End	CV-ES-12462		for Steering Rod
	02/98 → 12/00	Tie Rod End	CV-ES-14163		for Steering Rod
	02/98 → 12/00	Track Control Arm		DF-DL-8158	Trailing Arm
	02/98 → 12/00	Track Control Arm		DF-VB-8561	Wishbone (CV)
02/98 → 12/00	Track Control Arm		DF-VB-9343	Wishbone (CV)	
FAT 85 CF 430	02/98 → 12/00	Centre Rod	DF-DL-5226		Push Rod
	02/98 → 12/00	Centre Rod	DF-DL-8196		Push Rod
	02/98 → 12/00	Stabiliser Mounting		DF-SB-9342	
	02/98 → 12/00	Stabiliser Mounting	DF-SB-5253	DF-SB-5253	
	02/98 → 12/00	Stabiliser Mounting	DF-SB-10402		
	02/98 → 12/00	Suspension Arm Repair Kit		CV-RK-5322	for Wishbone (CV)
	02/98 → 12/00	Suspension Arm Repair Kit		DF-RK-8994	for Wishbone (CV)
	02/98 → 12/00	Suspension Arm Repair Kit		IV-RK-8998	for Wishbone (CV)
	02/98 → 12/00	Suspension Arm Repair Kit		MN-RK-7280	for Drag Link
	02/98 → 12/00	Suspension Arm Repair Kit		SC-RK-8575	for Wishbone (CV)
	02/98 → 12/00	Suspension Strut Repair Kit		DF-RK-8637	
	02/98 → 12/00	Suspension Strut Repair Kit		DF-RK-8685	
	02/98 → 12/00	Suspension Strut Repair Kit		MN-RK-8537	
	02/98 → 12/00	Tie Rod	DF-DL-5403		
	02/98 → 12/00	Tie Rod	DF-DL-7780		
	02/98 → 12/00	Tie Rod	DF-DL-7836		

CV-ES-12461

Length: 120
Cone Ø: d1 Ø 26 / d2 Ø 23,5
Thread: M30 x 1,5 LHT
0069513, 69513, 0311300, 311300,
0607998, 607998, 1190653, 1315447,
1319838, 1332123, 1338714, 1401934,
1407394, ACHB063, ACHF241, MAK1295



CV-ES-12462

Length: 120
Cone Ø: d1 Ø 26 / d2 Ø 23,5
Thread: M30 x 1,5 RHT
0069514, 0586753, 0607999, 0694298,
0694360, 0698609, 1137230, 1229944,
1326862, 1326896, 1331925, ACHB064,
ACHF242, MAK1296



CV-ES-14163

Length: 125
Cone Ø: d1 Ø 30 / d2 Ø 27
Thread: M30 x 1,5 RHT
0607981, 0698450, 1149907, 1152350,
1257890, 1603789, 1618048, ACHF060



CV-RK-5322

Ø: 72
Thick/Height: 50
0691704



DF-DL-5226

Length: 850
Ø: 52
Cone Ø: d1 Ø 26 / d2 Ø 23,5
1247957, 1283212, 1351715, 1385492,
10200900A



DF-DL-5403

Length: 1742
Ø: 40
Cone Ø: d1 Ø 26 / d2 Ø 23,5
0288281, 1270854, 1337644



DF-DL-7780

Length: 1690
Ø: 40
Cone Ø: d1 Ø 26 / d2 Ø 23,5
1270853, 1353391, 10212000A



DF-DL-7836

Length: 1698
Ø: 52
Cone Ø: d1 Ø 26 / d2 Ø 23,5
0754922, 1286343, 1353396



DF-DL-8158

Length: 611
Ø: 48
Hole Distance: 130 / 130
0267743, 1361649, 1361650, 1656428



DF-DL-8196

Length: 867
Ø: 50
Cone Ø: d1 Ø 30 / d2 Ø 27
1363859, 1448063, 1602821



DF-RK-8637

Ø: 72
1376730



DF-RK-8685

Ø: 67
Hole Distance: 130
Thick/Height: 24
1321936



DF-RK-8994

Ø: 75
Hole Distance: 130
Thick/Height: 24
1252284



DF-SB-5253

Ø: 86
Thick/Height: 60,5
0371586, 0558864, 10306500A



DF-SB-9342

Ø: 94
Thick/Height: 80 / 70
0281007, 0298498, 008169892, 8169892,
041270883, 41270883



DF-SB-10402

Ø: 62
Thick/Height: 60
1291233, 1732887



DF-VB-8561

Length: 609
Ø: 48
Hole Distance: 152 / 152
0080521, 080521, 1361651, 1368270,
1390932, 1617096, 1793875, 1817808,
1892492



DF-VB-9343

Length: 608,2
Ø: 48
Hole Distance: 152 / 152
1361652, 1620436, 1793876, 10309600A



IV-RK-8998

Ø: 85
Hole Distance: 130
Thick/Height: 30
0513757, 0531757, 0691709, 691709



MN-RK-7280

Ø: 75
Hole Distance: 115
Thick/Height: 24
0689748, 689748



MN-RK-8537

Ø: 95
Hole Distance: 152
Thick/Height: 24
696321, 81432706099



SC-RK-8575

Ø: 95
Hole Distance: 152
Thick/Height: 35
0696321



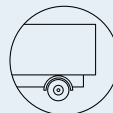

85 CF ...

FAT 85 CF 430 ...	02/98 → 12/00	Tie Rod End	CV-ES-12461		for Steering Rod	
	02/98 → 12/00	Tie Rod End	CV-ES-12462		for Steering Rod	
	02/98 → 12/00	Tie Rod End	CV-ES-14163		for Steering Rod	
	02/98 → 12/00	Track Control Arm		DF-DL-8158	Trailing Arm	
	02/98 → 12/00	Track Control Arm		DF-VB-8561	Wishbone (CV)	
	02/98 → 12/00	Track Control Arm		DF-VB-9343	Wishbone (CV)	
FT 85 CF 340	02/98 → 12/00	Centre Rod	DF-DL-5226		Push Rod	
	02/98 → 12/00	Centre Rod	DF-DL-8196		Push Rod	
	02/98 → 12/00	Stabiliser Mounting		DF-SB-9342		
	02/98 → 12/00	Stabiliser Mounting	DF-SB-5253	DF-SB-5253		
	02/98 → 12/00	Stabiliser Mounting	DF-SB-10402			
	02/98 → 12/00	Suspension Arm Repair Kit		CV-RK-5322	for Wishbone (CV)	
	02/98 → 12/00	Suspension Arm Repair Kit		DF-RK-8994	for Wishbone (CV)	
	02/98 → 12/00	Suspension Arm Repair Kit		IV-RK-8998	for Wishbone (CV)	
	02/98 → 12/00	Suspension Arm Repair Kit		MN-RK-7280	for Drag Link	
	02/98 → 12/00	Suspension Arm Repair Kit		SC-RK-8575	for Wishbone (CV)	
	02/98 → 12/00	Suspension Strut Repair Kit		DF-RK-8637		
	02/98 → 12/00	Suspension Strut Repair Kit		DF-RK-8685		
	02/98 → 12/00	Suspension Strut Repair Kit		MN-RK-8537		
	02/98 → 12/00	Tie Rod	DF-DL-5403			
	02/98 → 12/00	Tie Rod	DF-DL-7780			
	02/98 → 12/00	Tie Rod	DF-DL-7836			
	02/98 → 12/00	Tie Rod End	CV-ES-12461		for Steering Rod	
	02/98 → 12/00	Tie Rod End	CV-ES-12462		for Steering Rod	
	02/98 → 12/00	Tie Rod End	CV-ES-14163		for Steering Rod	
	02/98 → 12/00	Track Control Arm		DF-DL-8158	Trailing Arm	
	02/98 → 12/00	Track Control Arm		DF-VB-8561	Wishbone (CV)	
	02/98 → 12/00	Track Control Arm		DF-VB-9343	Wishbone (CV)	
	FT 85 CF 380	02/98 → 12/00	Centre Rod	DF-DL-5226		Push Rod
		02/98 → 12/00	Centre Rod	DF-DL-8196		Push Rod
02/98 → 12/00		Stabiliser Mounting		DF-SB-9342		
02/98 → 12/00		Stabiliser Mounting	DF-SB-5253	DF-SB-5253		
02/98 → 12/00		Stabiliser Mounting	DF-SB-10402			
02/98 → 12/00		Suspension Arm Repair Kit		CV-RK-5322	for Wishbone (CV)	
02/98 → 12/00		Suspension Arm Repair Kit		DF-RK-8994	for Wishbone (CV)	
02/98 → 12/00		Suspension Arm Repair Kit		IV-RK-8998	for Wishbone (CV)	
02/98 → 12/00		Suspension Arm Repair Kit		MN-RK-7280	for Drag Link	
02/98 → 12/00		Suspension Arm Repair Kit		SC-RK-8575	for Wishbone (CV)	
02/98 → 12/00		Suspension Strut Repair Kit		DF-RK-8637		
02/98 → 12/00		Suspension Strut Repair Kit		DF-RK-8685		
02/98 → 12/00		Suspension Strut Repair Kit		MN-RK-8537		
02/98 → 12/00		Tie Rod	DF-DL-5403			
02/98 → 12/00		Tie Rod	DF-DL-7780			
02/98 → 12/00		Tie Rod	DF-DL-7836			
02/98 → 12/00		Tie Rod End	CV-ES-12461		for Steering Rod	
02/98 → 12/00		Tie Rod End	CV-ES-12462		for Steering Rod	
02/98 → 12/00		Tie Rod End	CV-ES-14163		for Steering Rod	
02/98 → 12/00		Track Control Arm		DF-DL-8158	Trailing Arm	
02/98 → 12/00		Track Control Arm		DF-VB-8561	Wishbone (CV)	
02/98 → 12/00		Track Control Arm		DF-VB-9343	Wishbone (CV)	
FT 85 CF 430		02/98 → 12/00	Centre Rod	DF-DL-5226		Push Rod
		02/98 → 12/00	Centre Rod	DF-DL-8196		Push Rod
	02/98 → 12/00	Stabiliser Mounting		DF-SB-9342		
	02/98 → 12/00	Stabiliser Mounting	DF-SB-5253	DF-SB-5253		
	02/98 → 12/00	Stabiliser Mounting	DF-SB-10402			
	02/98 → 12/00	Suspension Arm Repair Kit		CV-RK-5322	for Wishbone (CV)	
	02/98 → 12/00	Suspension Arm Repair Kit		DF-RK-8994	for Wishbone (CV)	
	02/98 → 12/00	Suspension Arm Repair Kit		IV-RK-8998	for Wishbone (CV)	
	02/98 → 12/00	Suspension Arm Repair Kit		MN-RK-7280	for Drag Link	
	02/98 → 12/00	Suspension Arm Repair Kit		SC-RK-8575	for Wishbone (CV)	
	02/98 → 12/00	Suspension Strut Repair Kit		DF-RK-8637		
	02/98 → 12/00	Suspension Strut Repair Kit		DF-RK-8685		
	02/98 → 12/00	Suspension Strut Repair Kit		MN-RK-8537		

CV-ES-12461

Length: 120
Cone Ø: d1 Ø 26 / d2 Ø 23,5
Thread: M30 x 1,5 LHT
69513, 0069513, 311300, 0311300,
0607998, 607998, 1190653, 1315447,
1319838, 1332123, 1338714, 1401934,
1407394, ACHB063, ACHF241, MAK1295



CV-ES-12462

Length: 120
Cone Ø: d1 Ø 26 / d2 Ø 23,5
Thread: M30 x 1,5 RHT
0069514, 0586753, 0607999, 0694298,
0694360, 0698609, 1137230, 1229944,
1326862, 1326896, 1331925, ACHB064,
ACHF242, MAK1296



CV-ES-14163

Length: 125
Cone Ø: d1 Ø 30 / d2 Ø 27
Thread: M30 x 1,5 RHT
0607981, 0698450, 1149907, 1152350,
1257890, 1603789, 1618048, ACHF060



CV-RK-5322

Ø: 72
Thick/Height: 50
0691704



DF-DL-5226

Length: 850
Ø: 52
Cone Ø: d1 Ø 26 / d2 Ø 23,5
1247957, 1283212, 1351715, 1385492,
10200900A



DF-DL-5403

Length: 1742
Ø: 40
Cone Ø: d1 Ø 26 / d2 Ø 23,5
0288281, 1270854, 1337644



DF-DL-7780

Length: 1690
Ø: 40
Cone Ø: d1 Ø 26 / d2 Ø 23,5
1270853, 1353391, 10212000A



DF-DL-7836

Length: 1698
Ø: 52
Cone Ø: d1 Ø 26 / d2 Ø 23,5
0754922, 1286343, 1353396



DF-DL-8158

Length: 611
Ø: 48
Hole Distance: 130 / 130
0267743, 1361649, 1361650, 1656428



DF-DL-8196

Length: 867
Ø: 50
Cone Ø: d1 Ø 30 / d2 Ø 27
1363859, 1448063, 1602821



DF-RK-8637

Ø: 72
1376730



DF-RK-8685

Ø: 67
Hole Distance: 130
Thick/Height: 24
1321936



DF-RK-8994

Ø: 75
Hole Distance: 130
Thick/Height: 24
1252284



DF-SB-5253

Ø: 86
Thick/Height: 60,5
0371586, 0558864, 10306500A



DF-SB-9342

Ø: 94
Thick/Height: 80 / 70
0281007, 0298498, 008169892, 8169892,
041270883, 41270883



DF-SB-10402

Ø: 62
Thick/Height: 60
1291233, 1732887



DF-VB-8561

Length: 609
Ø: 48
Hole Distance: 152 / 152
080521, 0080521, 1361651, 1368270,
1390932, 1617096, 1793875, 1817808,
1892492



DF-VB-9343

Length: 608,2
Ø: 48
Hole Distance: 152 / 152
1361652, 1620436, 1793876, 10309600A



IV-RK-8998

Ø: 85
Hole Distance: 130
Thick/Height: 30
0513757, 0531757, 691709, 0691709



MN-RK-7280

Ø: 75
Hole Distance: 115
Thick/Height: 24
0689748, 689748



MN-RK-8537

Ø: 95
Hole Distance: 152
Thick/Height: 24
696321, 81432706099



SC-RK-8575

Ø: 95
Hole Distance: 152
Thick/Height: 35
0696321





85 CF ...

FT 85 CF 430 ...	02/98→12/00	Tie Rod	DF-DL-5403		
	02/98→12/00	Tie Rod	DF-DL-7780		
	02/98→12/00	Tie Rod	DF-DL-7836		
	02/98→12/00	Tie Rod End	CV-ES-12461		for Steering Rod
	02/98→12/00	Tie Rod End	CV-ES-12462		for Steering Rod
	02/98→12/00	Tie Rod End	CV-ES-14163		for Steering Rod
	02/98→12/00	Track Control Arm		DF-DL-8158	Trailing Arm
	02/98→12/00	Track Control Arm		DF-VB-8561	Wishbone (CV)
	02/98→12/00	Track Control Arm		DF-VB-9343	Wishbone (CV)
FTG 85 CF 340	02/98→12/00	Centre Rod	DF-DL-5226		Push Rod
	02/98→12/00	Centre Rod	DF-DL-8196		Push Rod
	02/98→12/00	Stabiliser Mounting		DF-SB-9342	
	02/98→12/00	Stabiliser Mounting	DF-SB-5253	DF-SB-5253	
	02/98→12/00	Stabiliser Mounting	DF-SB-10402		
	02/98→12/00	Suspension Arm Repair Kit		CV-RK-5322	for Wishbone (CV)
	02/98→12/00	Suspension Arm Repair Kit		DF-RK-8994	for Wishbone (CV)
	02/98→12/00	Suspension Arm Repair Kit		IV-RK-8998	for Wishbone (CV)
	02/98→12/00	Suspension Arm Repair Kit		MN-RK-7280	for Drag Link
	02/98→12/00	Suspension Arm Repair Kit		SC-RK-8575	for Wishbone (CV)
	02/98→12/00	Suspension Strut Repair Kit		DF-RK-8637	
	02/98→12/00	Suspension Strut Repair Kit		DF-RK-8685	
	02/98→12/00	Suspension Strut Repair Kit		MN-RK-8537	
	02/98→12/00	Tie Rod	DF-DL-5403		
	02/98→12/00	Tie Rod	DF-DL-7780		
	02/98→12/00	Tie Rod	DF-DL-7836		
	02/98→12/00	Tie Rod End	CV-ES-12461		for Steering Rod
	02/98→12/00	Tie Rod End	CV-ES-12462		for Steering Rod
	02/98→12/00	Tie Rod End	CV-ES-14163		for Steering Rod
	02/98→12/00	Track Control Arm		DF-DL-8158	Trailing Arm
	02/98→12/00	Track Control Arm		DF-VB-8561	Wishbone (CV)
02/98→12/00	Track Control Arm		DF-VB-9343	Wishbone (CV)	
FTG 85 CF 380	02/98→12/00	Centre Rod	DF-DL-5226		Push Rod
	02/98→12/00	Centre Rod	DF-DL-8196		Push Rod
	02/98→12/00	Stabiliser Mounting		DF-SB-9342	
	02/98→12/00	Stabiliser Mounting	DF-SB-5253	DF-SB-5253	
	02/98→12/00	Stabiliser Mounting	DF-SB-10402		
	02/98→12/00	Suspension Arm Repair Kit		CV-RK-5322	for Wishbone (CV)
	02/98→12/00	Suspension Arm Repair Kit		DF-RK-8994	for Wishbone (CV)
	02/98→12/00	Suspension Arm Repair Kit		IV-RK-8998	for Wishbone (CV)
	02/98→12/00	Suspension Arm Repair Kit		MN-RK-7280	for Drag Link
	02/98→12/00	Suspension Arm Repair Kit		SC-RK-8575	for Wishbone (CV)
	02/98→12/00	Suspension Strut Repair Kit		DF-RK-8637	
	02/98→12/00	Suspension Strut Repair Kit		DF-RK-8685	
	02/98→12/00	Suspension Strut Repair Kit		MN-RK-8537	
	02/98→12/00	Tie Rod	DF-DL-5403		
	02/98→12/00	Tie Rod	DF-DL-7780		
	02/98→12/00	Tie Rod	DF-DL-7836		
	02/98→12/00	Tie Rod End	CV-ES-12461		for Steering Rod
	02/98→12/00	Tie Rod End	CV-ES-12462		for Steering Rod
	02/98→12/00	Tie Rod End	CV-ES-14163		for Steering Rod
	02/98→12/00	Track Control Arm		DF-DL-8158	Trailing Arm
	02/98→12/00	Track Control Arm		DF-VB-8561	Wishbone (CV)
02/98→12/00	Track Control Arm		DF-VB-9343	Wishbone (CV)	
FTG 85 CF 430	02/98→12/00	Centre Rod	DF-DL-5226		Push Rod
	02/98→12/00	Centre Rod	DF-DL-8196		Push Rod
	02/98→12/00	Stabiliser Mounting		DF-SB-9342	
	02/98→12/00	Stabiliser Mounting	DF-SB-5253	DF-SB-5253	
	02/98→12/00	Stabiliser Mounting	DF-SB-10402		
	02/98→12/00	Suspension Arm Repair Kit		CV-RK-5322	for Wishbone (CV)
	02/98→12/00	Suspension Arm Repair Kit		DF-RK-8994	for Wishbone (CV)
	02/98→12/00	Suspension Arm Repair Kit		IV-RK-8998	for Wishbone (CV)
	02/98→12/00	Suspension Arm Repair Kit		MN-RK-7280	for Drag Link
	02/98→12/00	Suspension Arm Repair Kit		SC-RK-8575	for Wishbone (CV)

CV-ES-12461

Length: 120
Cone Ø: d1 Ø 26 / d2 Ø 23,5
Thread: M30 x 1,5 LHT
0069513, 69513, 0311300, 311300,
0607998, 607998, 1190653, 1315447,
1319838, 1332123, 1338714, 1401934,
1407394, ACHB063, ACHF241, MAK1295



CV-ES-12462

Length: 120
Cone Ø: d1 Ø 26 / d2 Ø 23,5
Thread: M30 x 1,5 RHT
0069514, 0586753, 0607999, 0694298,
0694360, 0698609, 1137230, 1229944,
1326862, 1326896, 1331925, ACHB064,
ACHF242, MAK1296



CV-ES-14163

Length: 125
Cone Ø: d1 Ø 30 / d2 Ø 27
Thread: M30 x 1,5 RHT
0607981, 0698450, 1149907, 1152350,
1257890, 1603789, 1618048, ACHF060



CV-RK-5322

Ø: 72
Thick/Height: 50
0691704



DF-DL-5226

Length: 850
Ø: 52
Cone Ø: d1 Ø 26 / d2 Ø 23,5
1247957, 1283212, 1351715, 1385492,
10200900A



DF-DL-5403

Length: 1742
Ø: 40
Cone Ø: d1 Ø 26 / d2 Ø 23,5
0288281, 1270854, 1337644



DF-DL-7780

Length: 1690
Ø: 40
Cone Ø: d1 Ø 26 / d2 Ø 23,5
1270853, 1353391, 10212000A



DF-DL-7836

Length: 1698
Ø: 52
Cone Ø: d1 Ø 26 / d2 Ø 23,5
0754922, 1286343, 1353396



DF-DL-8158

Length: 611
Ø: 48
Hole Distance: 130 / 130
0267743, 1361649, 1361650, 1656428



DF-DL-8196

Length: 867
Ø: 50
Cone Ø: d1 Ø 30 / d2 Ø 27
1363859, 1448063, 1602821



DF-RK-8637

Ø: 72
1376730



DF-RK-8685

Ø: 67
Hole Distance: 130
Thick/Height: 24
1321936



DF-RK-8994

Ø: 75
Hole Distance: 130
Thick/Height: 24
1252284



DF-SB-5253

Ø: 86
Thick/Height: 60,5
0371586, 0558864, 10306500A



DF-SB-9342

Ø: 94
Thick/Height: 80 / 70
0281007, 0298498, 008169892, 8169892,
041270883, 41270883



DF-SB-10402

Ø: 62
Thick/Height: 60
1291233, 1732887



DF-VB-8561

Length: 609
Ø: 48
Hole Distance: 152 / 152
0080521, 080521, 1361651, 1368270,
1390932, 1617096, 1793875, 1817808,
1892492



DF-VB-9343

Length: 608,2
Ø: 48
Hole Distance: 152 / 152
1361652, 1620436, 1793876, 10309600A



IV-RK-8998

Ø: 85
Hole Distance: 130
Thick/Height: 30
0513757, 0531757, 691709, 0691709



MN-RK-7280

Ø: 75
Hole Distance: 115
Thick/Height: 24
0689748, 689748



MN-RK-8537

Ø: 95
Hole Distance: 152
Thick/Height: 24
696321, 81432706099



SC-RK-8575

Ø: 95
Hole Distance: 152
Thick/Height: 35
0696321



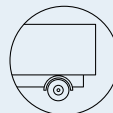

85 CF ...

FTG 85 CF 430 ...	02/98 → 12/00	Suspension Strut Repair Kit		DF-RK-8637		
	02/98 → 12/00	Suspension Strut Repair Kit		DF-RK-8685		
	02/98 → 12/00	Suspension Strut Repair Kit		MN-RK-8537		
	02/98 → 12/00	Tie Rod	DF-DL-5403			
	02/98 → 12/00	Tie Rod	DF-DL-7780			
	02/98 → 12/00	Tie Rod	DF-DL-7836			
	02/98 → 12/00	Tie Rod End	CV-ES-12461		for Steering Rod	
	02/98 → 12/00	Tie Rod End	CV-ES-12462		for Steering Rod	
	02/98 → 12/00	Tie Rod End	CV-ES-14163		for Steering Rod	
	02/98 → 12/00	Track Control Arm		DF-DL-8158	Trailing Arm	
	02/98 → 12/00	Track Control Arm		DF-VB-8561	Wishbone (CV)	
	02/98 → 12/00	Track Control Arm		DF-VB-9343	Wishbone (CV)	
	FTT 85 CF 340	02/98 → 12/00	Centre Rod	DF-DL-5226		Push Rod
		02/98 → 12/00	Centre Rod	DF-DL-8196		Push Rod
02/98 → 12/00		Stabiliser Mounting		DF-SB-9342		
02/98 → 12/00		Stabiliser Mounting	DF-SB-5253	DF-SB-5253		
02/98 → 12/00		Stabiliser Mounting	DF-SB-10402			
02/98 → 12/00		Suspension Arm Repair Kit		CV-RK-5322	for Wishbone (CV)	
02/98 → 12/00		Suspension Arm Repair Kit		DF-RK-8994	for Wishbone (CV)	
02/98 → 12/00		Suspension Arm Repair Kit		IV-RK-8998	for Wishbone (CV)	
02/98 → 12/00		Suspension Arm Repair Kit		MN-RK-7280	for Drag Link	
02/98 → 12/00		Suspension Arm Repair Kit		SC-RK-8575	for Wishbone (CV)	
02/98 → 12/00		Suspension Strut Repair Kit		DF-RK-8637		
02/98 → 12/00		Suspension Strut Repair Kit		DF-RK-8685		
02/98 → 12/00		Suspension Strut Repair Kit		MN-RK-8537		
02/98 → 12/00		Tie Rod	DF-DL-5403			
02/98 → 12/00		Tie Rod	DF-DL-7780			
02/98 → 12/00		Tie Rod	DF-DL-7836			
02/98 → 12/00		Tie Rod End	CV-ES-12461		for Steering Rod	
02/98 → 12/00		Tie Rod End	CV-ES-12462		for Steering Rod	
02/98 → 12/00		Tie Rod End	CV-ES-14163		for Steering Rod	
02/98 → 12/00		Track Control Arm		DF-DL-8158	Trailing Arm	
02/98 → 12/00		Track Control Arm		DF-VB-8561	Wishbone (CV)	
02/98 → 12/00		Track Control Arm		DF-VB-9343	Wishbone (CV)	
FTT 85 CF 380		02/98 → 12/00	Tie Rod	DF-DL-7836		
		02/98 → 12/00	Tie Rod End	CV-ES-12461		for Steering Rod
		02/98 → 12/00	Tie Rod End	CV-ES-12462		for Steering Rod
FTT 85 CF 430		02/98 → 12/00	Centre Rod	DF-DL-5226		Push Rod
	02/98 → 12/00	Centre Rod	DF-DL-8196		Push Rod	
	02/98 → 12/00	Stabiliser Mounting		DF-SB-9342		
	02/98 → 12/00	Stabiliser Mounting	DF-SB-5253	DF-SB-5253		
	02/98 → 12/00	Stabiliser Mounting	DF-SB-10402			
	02/98 → 12/00	Suspension Arm Repair Kit		CV-RK-5322	for Wishbone (CV)	
	02/98 → 12/00	Suspension Arm Repair Kit		DF-RK-8994	for Wishbone (CV)	
	02/98 → 12/00	Suspension Arm Repair Kit		IV-RK-8998	for Wishbone (CV)	
	02/98 → 12/00	Suspension Arm Repair Kit		MN-RK-7280	for Drag Link	
	02/98 → 12/00	Suspension Arm Repair Kit		SC-RK-8575	for Wishbone (CV)	
	02/98 → 12/00	Suspension Strut Repair Kit		DF-RK-8637		
	02/98 → 12/00	Suspension Strut Repair Kit		DF-RK-8685		
	02/98 → 12/00	Suspension Strut Repair Kit		MN-RK-8537		
	02/98 → 12/00	Tie Rod	DF-DL-5403			
	02/98 → 12/00	Tie Rod	DF-DL-7780			
	02/98 → 12/00	Tie Rod	DF-DL-7836			
	02/98 → 12/00	Tie Rod End	CV-ES-12461		for Steering Rod	
	02/98 → 12/00	Tie Rod End	CV-ES-12462		for Steering Rod	
	02/98 → 12/00	Tie Rod End	CV-ES-14163		for Steering Rod	
	02/98 → 12/00	Track Control Arm		DF-DL-8158	Trailing Arm	
	02/98 → 12/00	Track Control Arm		DF-VB-8561	Wishbone (CV)	
	02/98 → 12/00	Track Control Arm		DF-VB-9343	Wishbone (CV)	

CV-ES-12461

Length: 120
Cone Ø: d1 Ø 26 / d2 Ø 23,5
Thread: M30 x 1,5 LHT
0069513, 69513, 0311300, 311300,
0607998, 607998, 1190653, 1315447,
1319838, 1332123, 1338714, 1401934,
1407394, ACHB063, ACHF241, MAK1295



CV-ES-12462

Length: 120
Cone Ø: d1 Ø 26 / d2 Ø 23,5
Thread: M30 x 1,5 RHT
0069514, 0586753, 0607999, 0694298,
0694360, 0698609, 1137230, 1229944,
1326862, 1326896, 1331925, ACHB064,
ACHF242, MAK1296



CV-ES-14163

Length: 125
Cone Ø: d1 Ø 30 / d2 Ø 27
Thread: M30 x 1,5 RHT
0607981, 0698450, 1149907, 1152350,
1257890, 1603789, 1618048, ACHF060



CV-RK-5322

Ø: 72
Thick/Height: 50
0691704



DF-DL-5226

Length: 850
Ø: 52
Cone Ø: d1 Ø 26 / d2 Ø 23,5
1247957, 1283212, 1351715, 1385492,
10200900A



DF-DL-5403

Length: 1742
Ø: 40
Cone Ø: d1 Ø 26 / d2 Ø 23,5
0288281, 1270854, 1337644



DF-DL-7780

Length: 1690
Ø: 40
Cone Ø: d1 Ø 26 / d2 Ø 23,5
1270853, 1353391, 10212000A



DF-DL-7836

Length: 1698
Ø: 52
Cone Ø: d1 Ø 26 / d2 Ø 23,5
0754922, 1286343, 1353396



DF-DL-8158

Length: 611
Ø: 48
Hole Distance: 130 / 130
0267743, 1361649, 1361650, 1656428



DF-DL-8196

Length: 867
Ø: 50
Cone Ø: d1 Ø 30 / d2 Ø 27
1363859, 1448063, 1602821



DF-RK-8637

Ø: 72
1376730



DF-RK-8685

Ø: 67
Hole Distance: 130
Thick/Height: 24
1321936



DF-RK-8994

Ø: 75
Hole Distance: 130
Thick/Height: 24
1252284



DF-SB-5253

Ø: 86
Thick/Height: 60,5
0371586, 0558864, 10306500A



DF-SB-9342

Ø: 94
Thick/Height: 80 / 70
0281007, 0298498, 008169892, 8169892,
041270883, 41270883



DF-SB-10402

Ø: 62
Thick/Height: 60
1291233, 1732887



DF-VB-8561

Length: 609
Ø: 48
Hole Distance: 152 / 152
0080521, 080521, 1361651, 1368270,
1390932, 1617096, 1793875, 1817808,
1892492



DF-VB-9343

Length: 608,2
Ø: 48
Hole Distance: 152 / 152
1361652, 1620436, 1793876, 10309600A



IV-RK-8998

Ø: 85
Hole Distance: 130
Thick/Height: 30
0513757, 0531757, 0691709, 691709



MN-RK-7280

Ø: 75
Hole Distance: 115
Thick/Height: 24
689748, 0689748



MN-RK-8537

Ø: 95
Hole Distance: 152
Thick/Height: 24
696321, 81432706099



SC-RK-8575

Ø: 95
Hole Distance: 152
Thick/Height: 35
0696321





95

FA 95.310	09/87→09/90	Ball Head, gearshift linkage	CV-ES-2119			
	09/87→09/90	Ball Head, gearshift linkage	CV-ES-2182			
	09/87→09/90	Ball Head, gearshift linkage	DF-ES-9335			
	09/87→09/90	Centre Rod	DF-DL-3798		Push Rod	
	09/87→09/90	Centre Rod	DF-DL-12420		Push Rod	
	09/87→09/90	Stabiliser Mounting		DF-SB-5251		
	09/87→09/90	Stabiliser Mounting		DF-SB-9342		
	09/87→09/90	Suspension Arm Repair Kit		CV-RK-5322	for Wishbone (CV)	
	09/87→09/90	Suspension Arm Repair Kit		CV-RK-8118	for Drag Link	
	09/87→09/90	Suspension Arm Repair Kit		IV-RK-8998	for Wishbone (CV)	
	09/87→09/90	Suspension Arm Repair Kit		MN-RK-7280	for Drag Link	
	09/87→09/90	Suspension Arm Repair Kit		MN-RK-7291	for Drag Link	
	09/87→09/90	Suspension Arm Repair Kit		SC-RK-8575	for Wishbone (CV)	
	09/87→09/90	Suspension Strut Repair Kit		DF-RK-8671		
	09/87→09/90	Suspension Strut Repair Kit		MN-RK-8537		
	09/87→09/90	Tie Rod	DF-DL-7836			
	09/87→09/90	Tie Rod End	CV-ES-14163		for Steering Rod	
	09/87→09/90	Tie Rod End	DF-ES-3804			
	09/87→09/90	Tie Rod End	DF-ES-3805			
	FA 95.330	08/90→01/93	Ball Head, gearshift linkage	CV-ES-2119		
08/90→01/93		Ball Head, gearshift linkage	CV-ES-2182			
08/90→01/93		Ball Head, gearshift linkage	DF-ES-9335			
08/90→01/93		Centre Rod	DF-DL-3798		Push Rod	
08/90→01/93		Centre Rod	DF-DL-12420		Push Rod	
08/90→01/93		Stabiliser Mounting		DF-SB-5251		
08/90→01/93		Stabiliser Mounting		DF-SB-9342		
08/90→01/93		Suspension Arm Repair Kit		CV-RK-5322	for Wishbone (CV)	
08/90→01/93		Suspension Arm Repair Kit		CV-RK-8118	for Drag Link	
08/90→01/93		Suspension Arm Repair Kit		IV-RK-8998	for Wishbone (CV)	
08/90→01/93		Suspension Arm Repair Kit		MN-RK-7280	for Drag Link	
08/90→01/93		Suspension Arm Repair Kit		SC-RK-8575	for Wishbone (CV)	
08/90→01/93		Suspension Strut Repair Kit		DF-RK-8671		
08/90→01/93		Tie Rod	DF-DL-7836			
08/90→01/93		Tie Rod End	CV-ES-14163		for Steering Rod	
08/90→01/93		Tie Rod End	DF-ES-3804			
08/90→01/93		Tie Rod End	DF-ES-3805			
FA 95.350		09/87→09/90	Ball Head, gearshift linkage	CV-ES-2119		
		09/87→09/90	Ball Head, gearshift linkage	CV-ES-2182		
		09/87→09/90	Ball Head, gearshift linkage	DF-ES-9335		
	09/87→09/90	Centre Rod	DF-DL-3798		Push Rod	
	09/87→09/90	Centre Rod	DF-DL-12420		Push Rod	
	09/87→09/90	Stabiliser Mounting		DF-SB-5251		
	09/87→09/90	Stabiliser Mounting		DF-SB-9342		
	09/87→09/90	Suspension Arm Repair Kit		CV-RK-5322	for Wishbone (CV)	
	09/87→09/90	Suspension Arm Repair Kit		CV-RK-8118	for Drag Link	
	09/87→09/90	Suspension Arm Repair Kit		IV-RK-8998	for Wishbone (CV)	
	09/87→09/90	Suspension Arm Repair Kit		MN-RK-7280	for Drag Link	
	09/87→09/90	Suspension Arm Repair Kit		SC-RK-8575	for Wishbone (CV)	
	09/87→09/90	Suspension Strut Repair Kit		DF-RK-8671		
	09/87→09/90	Tie Rod	DF-DL-7836			
	09/87→09/90	Tie Rod End	CV-ES-14163		for Steering Rod	
	09/87→09/90	Tie Rod End	DF-ES-3804			
	09/87→09/90	Tie Rod End	DF-ES-3805			
	FA 95.360	08/90→01/98	Ball Head, gearshift linkage	CV-ES-2119		
		08/90→01/98	Ball Head, gearshift linkage	CV-ES-2182		
		08/90→01/98	Ball Head, gearshift linkage	DF-ES-9335		
08/90→01/98		Centre Rod	DF-DL-3798		Push Rod	
08/90→01/98		Centre Rod	DF-DL-12420		Push Rod	
08/90→01/98		Stabiliser Mounting		DF-SB-5251		
08/90→01/98		Stabiliser Mounting		DF-SB-9342		
08/90→01/98		Suspension Arm Repair Kit		CV-RK-5322	for Wishbone (CV)	
08/90→01/98		Suspension Arm Repair Kit		CV-RK-8118	for Drag Link	
08/90→01/98		Suspension Arm Repair Kit		IV-RK-8998	for Wishbone (CV)	

CV-ES-2119

Length: 55
 Cone Ø: d1 Ø 10 / d2 Ø 10
 Thread: M12 x 1,75 LHT
 592106, 1249088

**CV-ES-2182**

Length: 55
 Cone Ø: d1 Ø 10 / d2 Ø 10
 Thread: M12 x 1,75 RHT
 589333, 1249129

**CV-ES-14163**

Length: 125
 Cone Ø: d1 Ø 30 / d2 Ø 27
 Thread: M30 x 1,5 RHT
 0607981, 0698450, 1149907, 1152350,
 1257890, 1603789, 1618048, ACHF060

**CV-RK-5322**

Ø: 72
 Thick/Height: 50
 0691704

**CV-RK-8118**

Ø: 85
 Hole Distance: 130
 Thick/Height: 30
 0689749

**DF-DL-3798**

Length: 1015
 Ø: 50
 Cone Ø: d1 Ø 30 / d2 Ø 27
 0094038, 0525433

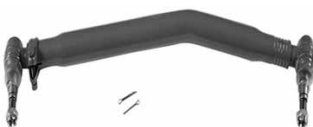
**DF-DL-7836**

Length: 1698
 Ø: 52
 Cone Ø: d1 Ø 26 / d2 Ø 23,5
 0754922, 1286343, 1353396

**DF-DL-12420**

Length: 1004
 Ø: 52
 Cone Ø: d1 Ø 30 / d2 Ø 27
 Thread: M24 x 1,5 / M30 x 1,5
 94613, 0094613, 094613, 0362413, 362413,
 1426101

**DF-ES-3804**

Length: 140
 Cone Ø: d1 Ø 30 / d2 Ø 27
 Thread: M48 x 1,5 LHT
 0067303

**DF-ES-3805**

Length: 140
 Cone Ø: d1 Ø 30 / d2 Ø 27
 Thread: M48 x 1,5 RHT
 0067389

**DF-ES-9335**

Length: 85
 Cone Ø: d1 Ø 12 / d2 Ø 10,75
 Thread: M14 x 1,5 RHT
 0386930, 386930

**DF-RK-8671****DF-SB-5251**

Ø: 85
 Thick/Height: 60
 0366351, 366351, 10305800A

**DF-SB-9342**

Ø: 94
 Thick/Height: 80 / 70
 0281007, 0298498, 008169892, 8169892,
 041270883, 41270883

**IV-RK-8998**

Ø: 85
 Hole Distance: 130
 Thick/Height: 30
 0513757, 0531757, 0691709, 691709

**MN-RK-7280**

Ø: 75
 Hole Distance: 115
 Thick/Height: 24
 0689748, 689748

**MN-RK-7291**

Ø: 72
 Hole Distance: 130
 Thick/Height: 30
 1271124

**MN-RK-8537**

Ø: 95
 Hole Distance: 152
 Thick/Height: 24
 696321, 81432706099

**SC-RK-8575**

Ø: 95
 Hole Distance: 152
 Thick/Height: 35
 0696321





95 ...

FA 95.360 ...	08/90→01/98	Suspension Arm Repair Kit		MN-RK-7280	for Drag Link	
	08/90→01/98	Suspension Arm Repair Kit		SC-RK-8575	for Wishbone (CV)	
	08/90→01/98	Suspension Strut Repair Kit		DF-RK-8671		
	08/90→01/98	Suspension Strut Repair Kit		MN-RK-8537		
	08/90→01/98	Tie Rod	DF-DL-7836			
	08/90→01/98	Tie Rod End	CV-ES-14163		for Steering Rod	
	08/90→01/98	Tie Rod End	DF-ES-3804			
	08/90→01/98	Tie Rod End	DF-ES-3805			
FA 95.380	09/87→09/90	Ball Head, gearshift linkage	CV-ES-2119			
	09/87→09/90	Ball Head, gearshift linkage	CV-ES-2182			
	09/87→09/90	Ball Head, gearshift linkage	DF-ES-9335			
	09/87→09/90	Centre Rod	DF-DL-3798		Push Rod	
	09/87→09/90	Centre Rod	DF-DL-12420		Push Rod	
	09/87→09/90	Stabiliser Mounting		DF-SB-5251		
	09/87→09/90	Stabiliser Mounting		DF-SB-9342		
	09/87→09/90	Suspension Arm Repair Kit		CV-RK-5322	for Wishbone (CV)	
	09/87→09/90	Suspension Arm Repair Kit		CV-RK-8118	for Drag Link	
	09/87→09/90	Suspension Arm Repair Kit		IV-RK-8998	for Wishbone (CV)	
	09/87→09/90	Suspension Arm Repair Kit		MN-RK-7280	for Drag Link	
	09/87→09/90	Suspension Arm Repair Kit		SC-RK-8575	for Wishbone (CV)	
	09/87→09/90	Suspension Strut Repair Kit		DF-RK-8671		
	09/87→09/90	Suspension Strut Repair Kit		MN-RK-8537		
	09/87→09/90	Tie Rod	DF-DL-7836			
	09/87→09/90	Tie Rod End	CV-ES-14163		for Steering Rod	
	09/87→09/90	Tie Rod End	DF-ES-3804			
	09/87→09/90	Tie Rod End	DF-ES-3805			
	FA 95.400	08/90→01/98	Ball Head, gearshift linkage	CV-ES-2119		
		08/90→01/98	Ball Head, gearshift linkage	CV-ES-2182		
08/90→01/98		Ball Head, gearshift linkage	DF-ES-9335			
08/90→01/98		Centre Rod	DF-DL-3798		Push Rod	
08/90→01/98		Centre Rod	DF-DL-12420		Push Rod	
08/90→01/98		Stabiliser Mounting		DF-SB-5251		
08/90→01/98		Stabiliser Mounting		DF-SB-9342		
08/90→01/98		Suspension Arm Repair Kit		CV-RK-5322	for Wishbone (CV)	
08/90→01/98		Suspension Arm Repair Kit		CV-RK-8118	for Drag Link	
08/90→01/98		Suspension Arm Repair Kit		IV-RK-8998	for Wishbone (CV)	
08/90→01/98		Suspension Arm Repair Kit		MN-RK-7280	for Drag Link	
08/90→01/98		Suspension Arm Repair Kit		SC-RK-8575	for Wishbone (CV)	
08/90→01/98		Suspension Strut Repair Kit		DF-RK-8671		
08/90→01/98		Suspension Strut Repair Kit		MN-RK-8537		
08/90→01/98		Tie Rod	DF-DL-7836			
08/90→01/98		Tie Rod End	CV-ES-14163		for Steering Rod	
08/90→01/98		Tie Rod End	DF-ES-3804			
08/90→01/98		Tie Rod End	DF-ES-3805			
FA 95.430		02/92→01/98	Ball Head, gearshift linkage	CV-ES-2119		
		02/92→01/98	Ball Head, gearshift linkage	CV-ES-2182		
	02/92→01/98	Ball Head, gearshift linkage	DF-ES-9335			
	02/92→01/98	Centre Rod	DF-DL-3798		Push Rod	
	02/92→01/98	Centre Rod	DF-DL-12420		Push Rod	
	02/92→01/98	Stabiliser Mounting		DF-SB-5251		
	02/92→01/98	Stabiliser Mounting		DF-SB-9342		
	02/92→01/98	Suspension Arm Repair Kit		CV-RK-5322	for Wishbone (CV)	
	02/92→01/98	Suspension Arm Repair Kit		CV-RK-8118	for Drag Link	
	02/92→01/98	Suspension Arm Repair Kit		IV-RK-8998	for Wishbone (CV)	
	02/92→01/98	Suspension Arm Repair Kit		MN-RK-7280	for Drag Link	
	02/92→01/98	Suspension Arm Repair Kit		SC-RK-8575	for Wishbone (CV)	
	02/92→01/98	Suspension Strut Repair Kit		DF-RK-8671		
	02/92→01/98	Suspension Strut Repair Kit		MN-RK-8537		
	02/92→01/98	Tie Rod	DF-DL-7836			
	02/92→01/98	Tie Rod End	CV-ES-14163		for Steering Rod	
	02/92→01/98	Tie Rod End	DF-ES-3804			
	02/92→01/98	Tie Rod End	DF-ES-3805			

CV-ES-2119

Length: 55
 Cone Ø: d1 Ø 10 / d2 Ø 10
 Thread: M12 x 1,75 LHT
 592106, 1249088

**CV-ES-2182**

Length: 55
 Cone Ø: d1 Ø 10 / d2 Ø 10
 Thread: M12 x 1,75 RHT
 589333, 1249129

**CV-ES-14163**

Length: 125
 Cone Ø: d1 Ø 30 / d2 Ø 27
 Thread: M30 x 1,5 RHT
 0607981, 0698450, 1149907, 1152350,
 1257890, 1603789, 1618048, ACHF060

**CV-RK-5322**

Ø: 72
 Thick/Height: 50
 0691704

**CV-RK-8118**

Ø: 85
 Hole Distance: 130
 Thick/Height: 30
 0689749

**DF-DL-3798**

Length: 1015
 Ø: 50
 Cone Ø: d1 Ø 30 / d2 Ø 27
 0094038, 0525433

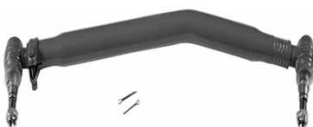
**DF-DL-7836**

Length: 1698
 Ø: 52
 Cone Ø: d1 Ø 26 / d2 Ø 23,5
 0754922, 1286343, 1353396

**DF-DL-12420**

Length: 1004
 Ø: 52
 Cone Ø: d1 Ø 30 / d2 Ø 27
 Thread: M24 x 1,5 / M30 x 1,5
 0094613, 094613, 94613, 0362413, 362413,
 1426101

**DF-ES-3804**

Length: 140
 Cone Ø: d1 Ø 30 / d2 Ø 27
 Thread: M48 x 1,5 LHT
 0067303

**DF-ES-3805**

Length: 140
 Cone Ø: d1 Ø 30 / d2 Ø 27
 Thread: M48 x 1,5 RHT
 0067389

**DF-ES-9335**

Length: 85
 Cone Ø: d1 Ø 12 / d2 Ø 10,75
 Thread: M14 x 1,5 RHT
 0386930, 386930

**DF-RK-8671****DF-SB-5251**

Ø: 85
 Thick/Height: 60
 0366351, 366351, 10305800A

**DF-SB-9342**

Ø: 94
 Thick/Height: 80 / 70
 0281007, 0298498, 8169892, 008169892,
 41270883, 041270883

**IV-RK-8998**

Ø: 85
 Hole Distance: 130
 Thick/Height: 30
 0513757, 0531757, 0691709, 691709

**MN-RK-7280**

Ø: 75
 Hole Distance: 115
 Thick/Height: 24
 0689748, 689748

**MN-RK-8537**

Ø: 95
 Hole Distance: 152
 Thick/Height: 24
 696321, 81432706099

**SC-RK-8575**

Ø: 95
 Hole Distance: 152
 Thick/Height: 35
 0696321





95 ...

FAC 95.310	09/87→01/98	Ball Head, gearshift linkage	DF-ES-9335		
	09/87→01/98	Centre Rod	DF-DL-12420		Push Rod
	09/87→01/98	Stabiliser Mounting		DF-SB-5251	
	09/87→01/98	Stabiliser Mounting		DF-SB-9342	
	09/87→01/98	Suspension Arm Repair Kit		CV-RK-5322	for Wishbone (CV)
	09/87→01/98	Suspension Arm Repair Kit		CV-RK-8118	for Drag Link
	09/87→01/98	Suspension Arm Repair Kit		IV-RK-8998	for Wishbone (CV)
	09/87→01/98	Suspension Arm Repair Kit		MN-RK-7280	for Drag Link
	09/87→01/98	Suspension Arm Repair Kit		SC-RK-8575	for Wishbone (CV)
	09/87→01/98	Suspension Strut Repair Kit		DF-RK-8671	
	09/87→01/98	Suspension Strut Repair Kit		MN-RK-8537	
	09/87→01/98	Tie Rod	DF-DL-7836		
	09/87→01/98	Tie Rod End	CV-ES-14163		for Steering Rod
FAC 95.330	08/90→01/98	Ball Head, gearshift linkage	DF-ES-9335		
	08/90→01/98	Centre Rod	DF-DL-12420		Push Rod
	08/90→01/98	Stabiliser Mounting		DF-SB-5251	
	08/90→01/98	Stabiliser Mounting		DF-SB-9342	
	08/90→01/98	Suspension Arm Repair Kit		CV-RK-5322	for Wishbone (CV)
	08/90→01/98	Suspension Arm Repair Kit		CV-RK-8118	for Drag Link
	08/90→01/98	Suspension Arm Repair Kit		IV-RK-8998	for Wishbone (CV)
	08/90→01/98	Suspension Arm Repair Kit		MN-RK-7280	for Drag Link
	08/90→01/98	Suspension Arm Repair Kit		SC-RK-8575	for Wishbone (CV)
	08/90→01/98	Suspension Strut Repair Kit		DF-RK-8671	
	08/90→01/98	Suspension Strut Repair Kit		MN-RK-8537	
	08/90→01/98	Tie Rod	DF-DL-7836		
	08/90→01/98	Tie Rod End	CV-ES-14163		for Steering Rod
FAC 95.350	09/87→01/98	Ball Head, gearshift linkage	DF-ES-9335		
	09/87→01/98	Centre Rod	DF-DL-12420		Push Rod
	09/87→01/98	Stabiliser Mounting		DF-SB-5251	
	09/87→01/98	Stabiliser Mounting		DF-SB-9342	
	09/87→01/98	Suspension Arm Repair Kit		CV-RK-5322	for Wishbone (CV)
	09/87→01/98	Suspension Arm Repair Kit		CV-RK-8118	for Drag Link
	09/87→01/98	Suspension Arm Repair Kit		IV-RK-8998	for Wishbone (CV)
	09/87→01/98	Suspension Arm Repair Kit		MN-RK-7280	for Drag Link
	09/87→01/98	Suspension Arm Repair Kit		SC-RK-8575	for Wishbone (CV)
	09/87→01/98	Suspension Strut Repair Kit		DF-RK-8671	
	09/87→01/98	Suspension Strut Repair Kit		MN-RK-8537	
	09/87→01/98	Tie Rod	DF-DL-7836		
	09/87→01/98	Tie Rod End	CV-ES-14163		for Steering Rod
FAC 95.360	08/90→01/98	Ball Head, gearshift linkage	DF-ES-9335		
	08/90→01/98	Centre Rod	DF-DL-12420		Push Rod
	08/90→01/98	Stabiliser Mounting		DF-SB-5251	
	08/90→01/98	Stabiliser Mounting		DF-SB-9342	
	08/90→01/98	Suspension Arm Repair Kit		CV-RK-5322	for Wishbone (CV)
	08/90→01/98	Suspension Arm Repair Kit		CV-RK-8118	for Drag Link
	08/90→01/98	Suspension Arm Repair Kit		IV-RK-8998	for Wishbone (CV)
	08/90→01/98	Suspension Arm Repair Kit		MN-RK-7280	for Drag Link
	08/90→01/98	Suspension Arm Repair Kit		SC-RK-8575	for Wishbone (CV)
	08/90→01/98	Suspension Strut Repair Kit		DF-RK-8671	
	08/90→01/98	Suspension Strut Repair Kit		MN-RK-8537	
	08/90→01/98	Tie Rod	DF-DL-7836		
	08/90→01/98	Tie Rod End	CV-ES-14163		for Steering Rod
FAC 95.380	09/87→01/98	Ball Head, gearshift linkage	DF-ES-9335		
	09/87→01/98	Centre Rod	DF-DL-12420		Push Rod
	09/87→01/98	Stabiliser Mounting		DF-SB-5251	
	09/87→01/98	Stabiliser Mounting		DF-SB-9342	
	09/87→01/98	Suspension Arm Repair Kit		CV-RK-5322	for Wishbone (CV)
	09/87→01/98	Suspension Arm Repair Kit		CV-RK-8118	for Drag Link
	09/87→01/98	Suspension Arm Repair Kit		IV-RK-8998	for Wishbone (CV)
	09/87→01/98	Suspension Arm Repair Kit		MN-RK-7280	for Drag Link
	09/87→01/98	Suspension Arm Repair Kit		SC-RK-8575	for Wishbone (CV)
	09/87→01/98	Suspension Strut Repair Kit		DF-RK-8671	
	09/87→01/98	Suspension Strut Repair Kit		MN-RK-8537	

CV-ES-14163

Length: 125
Cone Ø: d1 Ø 30 / d2 Ø 27
Thread: M30 x 1,5 RHT
0607981, 0698450, 1149907, 1152350,
1257890, 1603789, 1618048, ACHF060



CV-RK-5322

Ø: 72
Thick/Height: 50
0691704



CV-RK-8118

Ø: 85
Hole Distance: 130
Thick/Height: 30
0689749



DF-DL-7836

Length: 1698
Ø: 52
Cone Ø: d1 Ø 26 / d2 Ø 23,5
0754922, 1286343, 1353396



DF-DL-12420

Length: 1004
Ø: 52
Cone Ø: d1 Ø 30 / d2 Ø 27
Thread: M24 x 1,5 / M30 x 1,5
0094613, 94613, 094613, 0362413, 362413,
1426101



DF-ES-9335

Length: 85
Cone Ø: d1 Ø 12 / d2 Ø 10,75
Thread: M14 x 1,5 RHT
0386930, 386930



DF-RK-8671



DF-SB-5251

Ø: 85
Thick/Height: 60
0366351, 366351, 10305800A



DF-SB-9342

Ø: 94
Thick/Height: 80 / 70
0281007, 0298498, 008169892, 8169892,
041270883, 41270883



IV-RK-8998

Ø: 85
Hole Distance: 130
Thick/Height: 30

0513757, 0531757, 0691709, 691709



MN-RK-7280

Ø: 75
Hole Distance: 115
Thick/Height: 24
0689748, 689748



MN-RK-8537

Ø: 95
Hole Distance: 152
Thick/Height: 24
696321, 81432706099



SC-RK-8575

Ø: 95
Hole Distance: 152
Thick/Height: 35
0696321





95 ...

FAC 95.380 ...	09/87→01/98	Tie Rod	DF-DL-7836		
	09/87→01/98	Tie Rod End	CV-ES-14163		for Steering Rod
FAC 95.400	08/90→01/98	Ball Head, gearshift linkage	DF-ES-9335		
	08/90→01/98	Centre Rod	DF-DL-12420		Push Rod
	08/90→01/98	Stabiliser Mounting		DF-SB-5251	
	08/90→01/98	Stabiliser Mounting		DF-SB-9342	
	08/90→01/98	Suspension Arm Repair Kit		CV-RK-5322	for Wishbone (CV)
	08/90→01/98	Suspension Arm Repair Kit		CV-RK-8118	for Drag Link
	08/90→01/98	Suspension Arm Repair Kit		IV-RK-8998	for Wishbone (CV)
	08/90→01/98	Suspension Arm Repair Kit		MN-RK-7280	for Drag Link
	08/90→01/98	Suspension Arm Repair Kit		SC-RK-8575	for Wishbone (CV)
	08/90→01/98	Suspension Strut Repair Kit		DF-RK-8671	
	08/90→01/98	Suspension Strut Repair Kit		MN-RK-8537	
	08/90→01/98	Tie Rod	DF-DL-7836		
	08/90→01/98	Tie Rod End	CV-ES-14163		for Steering Rod
FAC 95.430	02/92→01/98	Ball Head, gearshift linkage	DF-ES-9335		
	02/92→01/98	Centre Rod	DF-DL-12420		Push Rod
	02/92→01/98	Stabiliser Mounting		DF-SB-5251	
	02/92→01/98	Stabiliser Mounting		DF-SB-9342	
	02/92→01/98	Suspension Arm Repair Kit		CV-RK-5322	for Wishbone (CV)
	02/92→01/98	Suspension Arm Repair Kit		CV-RK-8118	for Drag Link
	02/92→01/98	Suspension Arm Repair Kit		IV-RK-8998	for Wishbone (CV)
	02/92→01/98	Suspension Arm Repair Kit		MN-RK-7280	for Drag Link
	02/92→01/98	Suspension Arm Repair Kit		SC-RK-8575	for Wishbone (CV)
	02/92→01/98	Suspension Strut Repair Kit		DF-RK-8671	
	02/92→01/98	Suspension Strut Repair Kit		MN-RK-8537	
	02/92→01/98	Tie Rod	DF-DL-7836		
	02/92→01/98	Tie Rod End	CV-ES-14163		for Steering Rod
FAD 95.310	09/87→01/98	Ball Head, gearshift linkage	DF-ES-9335		
	09/87→01/98	Centre Rod	DF-DL-12420		Push Rod
	09/87→01/98	Stabiliser Mounting		DF-SB-5251	
	09/87→01/98	Stabiliser Mounting		DF-SB-9342	
	09/87→01/98	Suspension Arm Repair Kit		CV-RK-5322	for Wishbone (CV)
	09/87→01/98	Suspension Arm Repair Kit		CV-RK-8118	for Drag Link
	09/87→01/98	Suspension Arm Repair Kit		IV-RK-8998	for Wishbone (CV)
	09/87→01/98	Suspension Arm Repair Kit		MN-RK-7280	for Drag Link
	09/87→01/98	Suspension Arm Repair Kit		SC-RK-8575	for Wishbone (CV)
	09/87→01/98	Suspension Strut Repair Kit		DF-RK-8671	
	09/87→01/98	Suspension Strut Repair Kit		MN-RK-8537	
	09/87→01/98	Tie Rod	DF-DL-7836		
	09/87→01/98	Tie Rod End	CV-ES-14163		for Steering Rod
FAD 95.330	08/90→01/98	Ball Head, gearshift linkage	DF-ES-9335		
	08/90→01/98	Centre Rod	DF-DL-12420		Push Rod
	08/90→01/98	Stabiliser Mounting		DF-SB-5251	
	08/90→01/98	Stabiliser Mounting		DF-SB-9342	
	08/90→01/98	Suspension Arm Repair Kit		CV-RK-5322	for Wishbone (CV)
	08/90→01/98	Suspension Arm Repair Kit		CV-RK-8118	for Drag Link
	08/90→01/98	Suspension Arm Repair Kit		IV-RK-8998	for Wishbone (CV)
	08/90→01/98	Suspension Arm Repair Kit		MN-RK-7280	for Drag Link
	08/90→01/98	Suspension Arm Repair Kit		SC-RK-8575	for Wishbone (CV)
	08/90→01/98	Suspension Strut Repair Kit		DF-RK-8671	
	08/90→01/98	Suspension Strut Repair Kit		MN-RK-8537	
	08/90→01/98	Tie Rod	DF-DL-7836		
	08/90→01/98	Tie Rod End	CV-ES-14163		for Steering Rod
FAD 95.350	09/87→09/90	Ball Head, gearshift linkage	CV-ES-2119		
	09/87→09/90	Ball Head, gearshift linkage	CV-ES-2182		
	09/87→09/90	Ball Head, gearshift linkage	DF-ES-9335		
	09/87→09/90	Centre Rod	DF-DL-3798		Push Rod
	09/87→09/90	Centre Rod	DF-DL-12420		Push Rod
	09/87→09/90	Stabiliser Mounting		DF-SB-5251	
	09/87→09/90	Stabiliser Mounting		DF-SB-9342	
	09/87→09/90	Suspension Arm Repair Kit		CV-RK-5322	for Wishbone (CV)
09/87→09/90	Suspension Arm Repair Kit		CV-RK-8118	for Drag Link	

CV-ES-2119

Length: 55
Cone Ø: d1 Ø 10 / d2 Ø 10
Thread: M12 x 1,75 LHT
592106, 1249088



DF-DL-7836

Length: 1698
Ø: 52
Cone Ø: d1 Ø 26 / d2 Ø 23,5
0754922, 1286343, 1353396



IV-RK-8998

Ø: 85
Hole Distance: 130
Thick/Height: 30
0513757, 0531757, 0691709, 691709



CV-ES-2182

Length: 55
Cone Ø: d1 Ø 10 / d2 Ø 10
Thread: M12 x 1,75 RHT
589333, 1249129



DF-DL-12420

Length: 1004
Ø: 52
Cone Ø: d1 Ø 30 / d2 Ø 27
Thread: M24 x 1,5 / M30 x 1,5
0094613, 094613, 94613, 362413, 0362413, 1426101



MN-RK-7280

Ø: 75
Hole Distance: 115
Thick/Height: 24
0689748, 689748



CV-ES-14163

Length: 125
Cone Ø: d1 Ø 30 / d2 Ø 27
Thread: M30 x 1,5 RHT
0607981, 0698450, 1149907, 1152350, 1257890, 1603789, 1618048, ACHF060



DF-ES-9335

Length: 85
Cone Ø: d1 Ø 12 / d2 Ø 10,75
Thread: M14 x 1,5 RHT
0386930, 386930



MN-RK-8537

Ø: 95
Hole Distance: 152
Thick/Height: 24
696321, 81432706099



CV-RK-5322

Ø: 72
Thick/Height: 50
0691704



DF-RK-8671



SC-RK-8575

Ø: 95
Hole Distance: 152
Thick/Height: 35
0696321



CV-RK-8118

Ø: 85
Hole Distance: 130
Thick/Height: 30
0689749



DF-SB-5251

Ø: 85
Thick/Height: 60
0366351, 366351, 10305800A



DF-DL-3798

Length: 1015
Ø: 50
Cone Ø: d1 Ø 30 / d2 Ø 27
0094038, 0525433

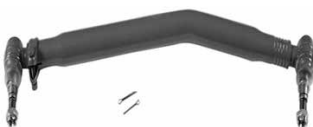

DF-SB-9342

Ø: 94
Thick/Height: 80 / 70
0281007, 0298498, 008169892, 8169892, 41270883, 041270883



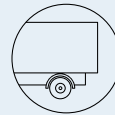

95 ...

FAD 95.350 ...	09/87→09/90	Suspension Arm Repair Kit		IV-RK-8998	for Wishbone (CV)	
	09/87→09/90	Suspension Arm Repair Kit		MN-RK-7280	for Drag Link	
	09/87→09/90	Suspension Arm Repair Kit		SC-RK-8575	for Wishbone (CV)	
	09/87→09/90	Suspension Strut Repair Kit		DF-RK-8671		
	09/87→09/90	Suspension Strut Repair Kit		MN-RK-8537		
	09/87→09/90	Tie Rod	DF-DL-7836			
FAD 95.360	09/87→09/90	Tie Rod End	CV-ES-14163		for Steering Rod	
	08/90→01/98	Ball Head, gearshift linkage	CV-ES-2119			
	08/90→01/98	Ball Head, gearshift linkage	CV-ES-2182			
	08/90→01/98	Ball Head, gearshift linkage	DF-ES-9335			
	08/90→01/98	Centre Rod	DF-DL-3798		Push Rod	
	08/90→01/98	Centre Rod	DF-DL-12420		Push Rod	
	08/90→01/98	Stabiliser Mounting		DF-SB-5251		
	08/90→01/98	Stabiliser Mounting		DF-SB-9342		
	08/90→01/98	Suspension Arm Repair Kit		CV-RK-5322	for Wishbone (CV)	
	08/90→01/98	Suspension Arm Repair Kit		CV-RK-8118	for Drag Link	
	08/90→01/98	Suspension Arm Repair Kit		IV-RK-8998	for Wishbone (CV)	
	08/90→01/98	Suspension Arm Repair Kit		MN-RK-7280	for Drag Link	
	08/90→01/98	Suspension Arm Repair Kit		SC-RK-8575	for Wishbone (CV)	
	08/90→01/98	Suspension Strut Repair Kit		DF-RK-8671		
	08/90→01/98	Suspension Strut Repair Kit		MN-RK-8537		
	08/90→01/98	Tie Rod	DF-DL-7836			
	08/90→01/98	Tie Rod End	CV-ES-14163			for Steering Rod
	FAD 95.380	09/87→09/90	Ball Head, gearshift linkage	CV-ES-2119		
		09/87→09/90	Ball Head, gearshift linkage	CV-ES-2182		
		09/87→09/90	Ball Head, gearshift linkage	DF-ES-9335		
09/87→09/90		Centre Rod	DF-DL-3798		Push Rod	
09/87→09/90		Centre Rod	DF-DL-12420		Push Rod	
09/87→09/90		Stabiliser Mounting		DF-SB-5251		
09/87→09/90		Stabiliser Mounting		DF-SB-9342		
09/87→09/90		Suspension Arm Repair Kit		CV-RK-5322	for Wishbone (CV)	
09/87→09/90		Suspension Arm Repair Kit		CV-RK-8118	for Drag Link	
09/87→09/90		Suspension Arm Repair Kit		IV-RK-8998	for Wishbone (CV)	
09/87→09/90		Suspension Arm Repair Kit		MN-RK-7280	for Drag Link	
09/87→09/90		Suspension Arm Repair Kit		SC-RK-8575	for Wishbone (CV)	
09/87→09/90		Suspension Strut Repair Kit		DF-RK-8671		
09/87→09/90		Suspension Strut Repair Kit		MN-RK-8537		
09/87→09/90		Tie Rod	DF-DL-7836			
09/87→09/90		Tie Rod End	CV-ES-14163			for Steering Rod
FAD 95.400		08/90→01/98	Ball Head, gearshift linkage	CV-ES-2119		
		08/90→01/98	Ball Head, gearshift linkage	CV-ES-2182		
		08/90→01/98	Ball Head, gearshift linkage	DF-ES-9335		
		08/90→01/98	Centre Rod	DF-DL-3798		Push Rod
	08/90→01/98	Centre Rod	DF-DL-12420		Push Rod	
	08/90→01/98	Stabiliser Mounting		DF-SB-5251		
	08/90→01/98	Stabiliser Mounting		DF-SB-9342		
	08/90→01/98	Suspension Arm Repair Kit		CV-RK-5322	for Wishbone (CV)	
	08/90→01/98	Suspension Arm Repair Kit		CV-RK-8118	for Drag Link	
	08/90→01/98	Suspension Arm Repair Kit		IV-RK-8998	for Wishbone (CV)	
	08/90→01/98	Suspension Arm Repair Kit		MN-RK-7280	for Drag Link	
	08/90→01/98	Suspension Arm Repair Kit		SC-RK-8575	for Wishbone (CV)	
	08/90→01/98	Suspension Strut Repair Kit		DF-RK-8671		
	08/90→01/98	Suspension Strut Repair Kit		MN-RK-8537		
	08/90→01/98	Tie Rod	DF-DL-7836			
	08/90→01/98	Tie Rod End	CV-ES-14163			for Steering Rod
	FAD 95.430	02/92→01/98	Ball Head, gearshift linkage	CV-ES-2119		
		02/92→01/98	Ball Head, gearshift linkage	CV-ES-2182		
		02/92→01/98	Ball Head, gearshift linkage	DF-ES-9335		
		02/92→01/98	Centre Rod	DF-DL-3798		Push Rod
02/92→01/98		Centre Rod	DF-DL-12420		Push Rod	
02/92→01/98		Stabiliser Mounting		DF-SB-5251		
02/92→01/98		Stabiliser Mounting		DF-SB-9342		
02/92→01/98		Suspension Arm Repair Kit		CV-RK-5322	for Wishbone (CV)	

CV-ES-2119

Length: 55
Cone Ø: d1 Ø 10 / d2 Ø 10
Thread: M12 x 1,75 LHT
592106, 1249088



DF-DL-7836

Length: 1698
Ø: 52
Cone Ø: d1 Ø 26 / d2 Ø 23,5
0754922, 1286343, 1353396



IV-RK-8998

Ø: 85
Hole Distance: 130
Thick/Height: 30
0513757, 0531757, 0691709, 691709



CV-ES-2182

Length: 55
Cone Ø: d1 Ø 10 / d2 Ø 10
Thread: M12 x 1,75 RHT
589333, 1249129



DF-DL-12420

Length: 1004
Ø: 52
Cone Ø: d1 Ø 30 / d2 Ø 27
Thread: M24 x 1,5 / M30 x 1,5
0094613, 094613, 94613, 0362413, 362413, 1426101



MN-RK-7280

Ø: 75
Hole Distance: 115
Thick/Height: 24
0689748, 689748



CV-ES-14163

Length: 125
Cone Ø: d1 Ø 30 / d2 Ø 27
Thread: M30 x 1,5 RHT
0607981, 0698450, 1149907, 1152350, 1257890, 1603789, 1618048, ACHF060



DF-ES-9335

Length: 85
Cone Ø: d1 Ø 12 / d2 Ø 10,75
Thread: M14 x 1,5 RHT
0386930, 386930



MN-RK-8537

Ø: 95
Hole Distance: 152
Thick/Height: 24
696321, 81432706099



CV-RK-5322

Ø: 72
Thick/Height: 50
0691704



DF-RK-8671



SC-RK-8575

Ø: 95
Hole Distance: 152
Thick/Height: 35
0696321



CV-RK-8118

Ø: 85
Hole Distance: 130
Thick/Height: 30
0689749



DF-SB-5251

Ø: 85
Thick/Height: 60
366351, 0366351, 10305800A



DF-DL-3798

Length: 1015
Ø: 50
Cone Ø: d1 Ø 30 / d2 Ø 27
0094038, 0525433

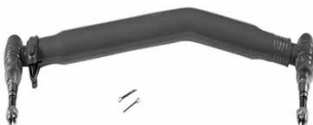

DF-SB-9342

Ø: 94
Thick/Height: 80 / 70
0281007, 0298498, 008169892, 8169892, 041270883, 41270883





95 ...

FAD 95.430 ...	02/92→01/98	Suspension Arm Repair Kit		CV-RK-8118	for Drag Link	
	02/92→01/98	Suspension Arm Repair Kit		IV-RK-8998	for Wishbone (CV)	
	02/92→01/98	Suspension Arm Repair Kit		MN-RK-7280	for Drag Link	
	02/92→01/98	Suspension Arm Repair Kit		SC-RK-8575	for Wishbone (CV)	
	02/92→01/98	Suspension Strut Repair Kit		DF-RK-8671		
	02/92→01/98	Suspension Strut Repair Kit		MN-RK-8537		
	02/92→01/98	Tie Rod	DF-DL-7836			
FAK 95.360	02/92→01/98	Tie Rod End	CV-ES-14163		for Steering Rod	
	08/90→01/98	Ball Head, gearshift linkage	CV-ES-2119			
	08/90→01/98	Ball Head, gearshift linkage	CV-ES-2182			
	08/90→01/98	Ball Head, gearshift linkage	DF-ES-9335			
	08/90→01/98	Centre Rod	DF-DL-3798		Push Rod	
	08/90→01/98	Centre Rod	DF-DL-12420		Push Rod	
	08/90→01/98	Stabiliser Mounting		DF-SB-5251		
	08/90→01/98	Stabiliser Mounting		DF-SB-9342		
	08/90→01/98	Suspension Arm Repair Kit		CV-RK-5322	for Wishbone (CV)	
	08/90→01/98	Suspension Arm Repair Kit		CV-RK-8118	for Drag Link	
	08/90→01/98	Suspension Arm Repair Kit		IV-RK-8998	for Wishbone (CV)	
	08/90→01/98	Suspension Arm Repair Kit		MN-RK-7280	for Drag Link	
	08/90→01/98	Suspension Arm Repair Kit		SC-RK-8575	for Wishbone (CV)	
	08/90→01/98	Suspension Strut Repair Kit		DF-RK-8671		
	08/90→01/98	Suspension Strut Repair Kit		MN-RK-8537		
	08/90→01/98	Tie Rod	DF-DL-7836			
	08/90→01/98	Tie Rod End	CV-ES-14163		for Steering Rod	
	FAK 95.400	08/90→01/98	Ball Head, gearshift linkage	CV-ES-2119		
		08/90→01/98	Ball Head, gearshift linkage	CV-ES-2182		
		08/90→01/98	Ball Head, gearshift linkage	DF-ES-9335		
08/90→01/98		Centre Rod	DF-DL-3798		Push Rod	
08/90→01/98		Centre Rod	DF-DL-12420		Push Rod	
08/90→01/98		Stabiliser Mounting		DF-SB-5251		
08/90→01/98		Stabiliser Mounting		DF-SB-9342		
08/90→01/98		Suspension Arm Repair Kit		CV-RK-5322	for Wishbone (CV)	
08/90→01/98		Suspension Arm Repair Kit		CV-RK-8118	for Drag Link	
08/90→01/98		Suspension Arm Repair Kit		IV-RK-8998	for Wishbone (CV)	
08/90→01/98		Suspension Arm Repair Kit		MN-RK-7280	for Drag Link	
08/90→01/98		Suspension Arm Repair Kit		SC-RK-8575	for Wishbone (CV)	
08/90→01/98		Suspension Strut Repair Kit		DF-RK-8671		
08/90→01/98		Suspension Strut Repair Kit		MN-RK-8537		
08/90→01/98		Tie Rod	DF-DL-7836			
08/90→01/98		Tie Rod End	CV-ES-14163		for Steering Rod	
FAK 95.430		02/92→01/98	Ball Head, gearshift linkage	CV-ES-2119		
		02/92→01/98	Ball Head, gearshift linkage	CV-ES-2182		
		02/92→01/98	Ball Head, gearshift linkage	DF-ES-9335		
		02/92→01/98	Centre Rod	DF-DL-3798		Push Rod
	02/92→01/98	Centre Rod	DF-DL-12420		Push Rod	
	02/92→01/98	Stabiliser Mounting		DF-SB-5251		
	02/92→01/98	Stabiliser Mounting		DF-SB-9342		
	02/92→01/98	Suspension Arm Repair Kit		CV-RK-5322	for Wishbone (CV)	
	02/92→01/98	Suspension Arm Repair Kit		CV-RK-8118	for Drag Link	
	02/92→01/98	Suspension Arm Repair Kit		IV-RK-8998	for Wishbone (CV)	
	02/92→01/98	Suspension Arm Repair Kit		MN-RK-7280	for Drag Link	
	02/92→01/98	Suspension Arm Repair Kit		SC-RK-8575	for Wishbone (CV)	
	02/92→01/98	Suspension Strut Repair Kit		DF-RK-8671		
	02/92→01/98	Suspension Strut Repair Kit		MN-RK-8537		
	02/92→01/98	Tie Rod	DF-DL-7836			
	02/92→01/98	Tie Rod End	CV-ES-14163		for Steering Rod	
	FAR 95.310	09/87→09/90	Ball Head, gearshift linkage	CV-ES-2119		
		09/87→09/90	Ball Head, gearshift linkage	CV-ES-2182		
		09/87→09/90	Ball Head, gearshift linkage	DF-ES-9335		
		09/87→09/90	Centre Rod	DF-DL-3798		Push Rod
09/87→09/90		Centre Rod	DF-DL-12420		Push Rod	
09/87→09/90		Stabiliser Mounting		DF-SB-5251		
09/87→09/90		Stabiliser Mounting		DF-SB-9342		

CV-ES-2119

Length: 55
Cone Ø: d1 Ø 10 / d2 Ø 10
Thread: M12 x 1,75 LHT
592106, 1249088



DF-DL-7836

Length: 1698
Ø: 52
Cone Ø: d1 Ø 26 / d2 Ø 23,5
0754922, 1286343, 1353396



IV-RK-8998

Ø: 85
Hole Distance: 130
Thick/Height: 30
0513757, 0531757, 0691709, 691709



CV-ES-2182

Length: 55
Cone Ø: d1 Ø 10 / d2 Ø 10
Thread: M12 x 1,75 RHT
589333, 1249129



DF-DL-12420

Length: 1004
Ø: 52
Cone Ø: d1 Ø 30 / d2 Ø 27
Thread: M24 x 1,5 / M30 x 1,5
094613, 94613, 0094613, 362413, 0362413, 1426101



MN-RK-7280

Ø: 75
Hole Distance: 115
Thick/Height: 24
0689748, 689748



CV-ES-14163

Length: 125
Cone Ø: d1 Ø 30 / d2 Ø 27
Thread: M30 x 1,5 RHT
0607981, 0698450, 1149907, 1152350, 1257890, 1603789, 1618048, ACHF060



DF-ES-9335

Length: 85
Cone Ø: d1 Ø 12 / d2 Ø 10,75
Thread: M14 x 1,5 RHT
0386930, 386930



MN-RK-8537

Ø: 95
Hole Distance: 152
Thick/Height: 24
696321, 81432706099



CV-RK-5322

Ø: 72
Thick/Height: 50
0691704



DF-RK-8671



SC-RK-8575

Ø: 95
Hole Distance: 152
Thick/Height: 35
0696321



CV-RK-8118

Ø: 85
Hole Distance: 130
Thick/Height: 30
0689749



DF-SB-5251

Ø: 85
Thick/Height: 60
0366351, 366351, 10305800A



DF-DL-3798

Length: 1015
Ø: 50
Cone Ø: d1 Ø 30 / d2 Ø 27
0094038, 0525433

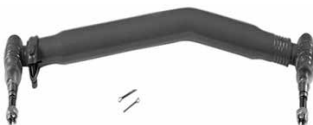

DF-SB-9342

Ø: 94
Thick/Height: 80 / 70
0281007, 0298498, 008169892, 8169892, 041270883, 41270883





95 ...

FAR 95.310 ...	09/87→09/90	Suspension Arm Repair Kit		CV-RK-5322	for Wishbone (CV)	
	09/87→09/90	Suspension Arm Repair Kit		CV-RK-8118	for Drag Link	
	09/87→09/90	Suspension Arm Repair Kit		IV-RK-8998	for Wishbone (CV)	
	09/87→09/90	Suspension Arm Repair Kit		MN-RK-7280	for Drag Link	
	09/87→09/90	Suspension Arm Repair Kit		SC-RK-8575	for Wishbone (CV)	
	09/87→09/90	Suspension Strut Repair Kit		DF-RK-8671		
	09/87→09/90	Suspension Strut Repair Kit		MN-RK-8537		
	09/87→09/90	Tie Rod	DF-DL-7836			
	09/87→09/90	Tie Rod End	CV-ES-14163		for Steering Rod	
	09/87→09/90	Tie Rod End	DF-ES-3804			
	09/87→09/90	Tie Rod End	DF-ES-3805			
	FAR 95.330, FAS 95.330	08/90→01/93	Ball Head, gearshift linkage	CV-ES-2119		
		08/90→01/93	Ball Head, gearshift linkage	CV-ES-2182		
08/90→01/93		Ball Head, gearshift linkage	DF-ES-9335			
08/90→01/93		Centre Rod	DF-DL-3798		Push Rod	
08/90→01/93		Centre Rod	DF-DL-12420		Push Rod	
08/90→01/93		Stabiliser Mounting		DF-SB-5251		
08/90→01/93		Stabiliser Mounting		DF-SB-9342		
08/90→01/93		Suspension Arm Repair Kit		CV-RK-5322	for Wishbone (CV)	
08/90→01/93		Suspension Arm Repair Kit		CV-RK-8118	for Drag Link	
08/90→01/93		Suspension Arm Repair Kit		IV-RK-8998	for Wishbone (CV)	
08/90→01/93		Suspension Arm Repair Kit		MN-RK-7280	for Drag Link	
08/90→01/93		Suspension Arm Repair Kit		SC-RK-8575	for Wishbone (CV)	
08/90→01/93		Suspension Strut Repair Kit		DF-RK-8671		
08/90→01/93		Tie Rod	DF-DL-7836			
08/90→01/93		Tie Rod End	CV-ES-14163		for Steering Rod	
08/90→01/93		Tie Rod End	DF-ES-3804			
08/90→01/93		Tie Rod End	DF-ES-3805			
FAR 95.350, FAS 95.350	09/87→09/90	Ball Head, gearshift linkage	CV-ES-2119			
	09/87→09/90	Ball Head, gearshift linkage	CV-ES-2182			
	09/87→09/90	Ball Head, gearshift linkage	DF-ES-9335			
	09/87→09/90	Centre Rod	DF-DL-3798		Push Rod	
	09/87→09/90	Centre Rod	DF-DL-12420		Push Rod	
	09/87→09/90	Stabiliser Mounting		DF-SB-5251		
	09/87→09/90	Stabiliser Mounting		DF-SB-9342		
	09/87→09/90	Suspension Arm Repair Kit		CV-RK-5322	for Wishbone (CV)	
	09/87→09/90	Suspension Arm Repair Kit		CV-RK-8118	for Drag Link	
	09/87→09/90	Suspension Arm Repair Kit		IV-RK-8998	for Wishbone (CV)	
	09/87→09/90	Suspension Arm Repair Kit		MN-RK-7280	for Drag Link	
	09/87→09/90	Suspension Arm Repair Kit		SC-RK-8575	for Wishbone (CV)	
	09/87→09/90	Suspension Strut Repair Kit		DF-RK-8671		
	09/87→09/90	Tie Rod	DF-DL-7836			
	09/87→09/90	Tie Rod End	CV-ES-14163		for Steering Rod	
	FAR 95.360, FAS 95.360	08/90→01/98	Ball Head, gearshift linkage	CV-ES-2119		
		08/90→01/98	Ball Head, gearshift linkage	CV-ES-2182		
08/90→01/98		Ball Head, gearshift linkage	DF-ES-9335			
08/90→01/98		Centre Rod	DF-DL-3798		Push Rod	
08/90→01/98		Centre Rod	DF-DL-12420		Push Rod	
08/90→01/98		Stabiliser Mounting		DF-SB-5251		
08/90→01/98		Stabiliser Mounting		DF-SB-9342		
08/90→01/98		Suspension Arm Repair Kit		CV-RK-5322	for Wishbone (CV)	
08/90→01/98		Suspension Arm Repair Kit		CV-RK-8118	for Drag Link	
08/90→01/98		Suspension Arm Repair Kit		IV-RK-8998	for Wishbone (CV)	
08/90→01/98		Suspension Arm Repair Kit		MN-RK-7280	for Drag Link	
08/90→01/98		Suspension Arm Repair Kit		SC-RK-8575	for Wishbone (CV)	
08/90→01/98		Suspension Strut Repair Kit		DF-RK-8671		
08/90→01/98		Suspension Strut Repair Kit		MN-RK-8537		
08/90→01/98		Tie Rod	DF-DL-7836			
08/90→01/98		Tie Rod End	CV-ES-14163		for Steering Rod	

CV-ES-2119

Length: 55
Cone Ø: d1 Ø 10 / d2 Ø 10
Thread: M12 x 1,75 LHT
592106, 1249088



CV-ES-2182

Length: 55
Cone Ø: d1 Ø 10 / d2 Ø 10
Thread: M12 x 1,75 RHT
589333, 1249129



CV-ES-14163

Length: 125
Cone Ø: d1 Ø 30 / d2 Ø 27
Thread: M30 x 1,5 RHT
0607981, 0698450, 1149907, 1152350,
1257890, 1603789, 1618048, ACHF060



CV-RK-5322

Ø: 72
Thick/Height: 50
0691704



CV-RK-8118

Ø: 85
Hole Distance: 130
Thick/Height: 30
0689749



DF-DL-3798

Length: 1015
Ø: 50
Cone Ø: d1 Ø 30 / d2 Ø 27
0094038, 0525433

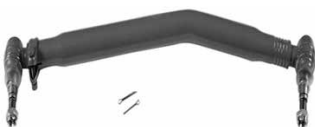

DF-DL-7836

Length: 1698
Ø: 52
Cone Ø: d1 Ø 26 / d2 Ø 23,5
0754922, 1286343, 1353396



DF-DL-12420

Length: 1004
Ø: 52
Cone Ø: d1 Ø 30 / d2 Ø 27
Thread: M24 x 1,5 / M30 x 1,5
0094613, 094613, 94613, 0362413, 362413,
1426101



DF-ES-3804

Length: 140
Cone Ø: d1 Ø 30 / d2 Ø 27
Thread: M48 x 1,5 LHT
0067303



DF-ES-3805

Length: 140
Cone Ø: d1 Ø 30 / d2 Ø 27
Thread: M48 x 1,5 RHT
0067389



DF-ES-9335

Length: 85
Cone Ø: d1 Ø 12 / d2 Ø 10,75
Thread: M14 x 1,5 RHT
0386930, 386930



DF-RK-8671



DF-SB-5251

Ø: 85
Thick/Height: 60
0366351, 366351, 10305800A



DF-SB-9342

Ø: 94
Thick/Height: 80 / 70
0281007, 0298498, 008169892, 8169892,
41270883, 041270883



IV-RK-8998

Ø: 85
Hole Distance: 130
Thick/Height: 30
0513757, 0531757, 0691709, 691709



MN-RK-7280

Ø: 75
Hole Distance: 115
Thick/Height: 24
0689748, 689748



MN-RK-8537

Ø: 95
Hole Distance: 152
Thick/Height: 24
696321, 81432706099



SC-RK-8575

Ø: 95
Hole Distance: 152
Thick/Height: 35
0696321





95 ...

FAR 95.380, FAS 95.380	09/87→09/90	Ball Head, gearshift linkage	CV-ES-2119		
	09/87→09/90	Ball Head, gearshift linkage	CV-ES-2182		
	09/87→09/90	Ball Head, gearshift linkage	DF-ES-9335		
	09/87→09/90	Centre Rod	DF-DL-3798		Push Rod
	09/87→09/90	Centre Rod	DF-DL-12420		Push Rod
	09/87→09/90	Stabiliser Mounting		DF-SB-5251	
	09/87→09/90	Stabiliser Mounting		DF-SB-9342	
	09/87→09/90	Suspension Arm Repair Kit		CV-RK-5322	for Wishbone (CV)
	09/87→09/90	Suspension Arm Repair Kit		CV-RK-8118	for Drag Link
	09/87→09/90	Suspension Arm Repair Kit		IV-RK-8998	for Wishbone (CV)
	09/87→09/90	Suspension Arm Repair Kit		MN-RK-7280	for Drag Link
	09/87→09/90	Suspension Arm Repair Kit		SC-RK-8575	for Wishbone (CV)
	09/87→09/90	Suspension Strut Repair Kit		DF-RK-8671	
	09/87→09/90	Suspension Strut Repair Kit		MN-RK-8537	
	09/87→09/90	Tie Rod	DF-DL-7836		
09/87→09/90	Tie Rod End	CV-ES-14163		for Steering Rod	
FAR 95.400, FAS 95.400	08/90→01/98	Ball Head, gearshift linkage	CV-ES-2119		
	08/90→01/98	Ball Head, gearshift linkage	CV-ES-2182		
	08/90→01/98	Ball Head, gearshift linkage	DF-ES-9335		
	08/90→01/98	Centre Rod	DF-DL-3798		Push Rod
	08/90→01/98	Centre Rod	DF-DL-12420		Push Rod
	08/90→01/98	Stabiliser Mounting		DF-SB-5251	
	08/90→01/98	Stabiliser Mounting		DF-SB-9342	
	08/90→01/98	Suspension Arm Repair Kit		CV-RK-5322	for Wishbone (CV)
	08/90→01/98	Suspension Arm Repair Kit		CV-RK-8118	for Drag Link
	08/90→01/98	Suspension Arm Repair Kit		IV-RK-8998	for Wishbone (CV)
	08/90→01/98	Suspension Arm Repair Kit		MN-RK-7280	for Drag Link
	08/90→01/98	Suspension Arm Repair Kit		SC-RK-8575	for Wishbone (CV)
	08/90→01/98	Suspension Strut Repair Kit		DF-RK-8671	
	08/90→01/98	Suspension Strut Repair Kit		MN-RK-8537	
	08/90→01/98	Tie Rod	DF-DL-7836		
08/90→01/98	Tie Rod End	CV-ES-14163		for Steering Rod	
FAR 95.430, FAS 95.430	02/92→01/98	Ball Head, gearshift linkage	CV-ES-2119		
	02/92→01/98	Ball Head, gearshift linkage	CV-ES-2182		
	02/92→01/98	Ball Head, gearshift linkage	DF-ES-9335		
	02/92→01/98	Centre Rod	DF-DL-3798		Push Rod
	02/92→01/98	Centre Rod	DF-DL-12420		Push Rod
	02/92→01/98	Stabiliser Mounting		DF-SB-5251	
	02/92→01/98	Stabiliser Mounting		DF-SB-9342	
	02/92→01/98	Suspension Arm Repair Kit		CV-RK-5322	for Wishbone (CV)
	02/92→01/98	Suspension Arm Repair Kit		CV-RK-8118	for Drag Link
	02/92→01/98	Suspension Arm Repair Kit		IV-RK-8998	for Wishbone (CV)
	02/92→01/98	Suspension Arm Repair Kit		MN-RK-7280	for Drag Link
	02/92→01/98	Suspension Arm Repair Kit		SC-RK-8575	for Wishbone (CV)
	02/92→01/98	Suspension Strut Repair Kit		DF-RK-8671	
	02/92→01/98	Suspension Strut Repair Kit		MN-RK-8537	
	02/92→01/98	Tie Rod	DF-DL-7836		
02/92→01/98	Tie Rod End	CV-ES-14163		for Steering Rod	
FAT 95.350	09/87→09/90	Ball Head, gearshift linkage	CV-ES-2119		
	09/87→09/90	Ball Head, gearshift linkage	CV-ES-2182		
	09/87→09/90	Ball Head, gearshift linkage	DF-ES-9335		
	09/87→09/90	Centre Rod	DF-DL-3798		Push Rod
	09/87→09/90	Centre Rod	DF-DL-12420		Push Rod
	09/87→09/90	Stabiliser Mounting		DF-SB-5251	
	09/87→09/90	Stabiliser Mounting		DF-SB-9342	
	09/87→09/90	Suspension Arm Repair Kit		CV-RK-5322	for Wishbone (CV)
	09/87→09/90	Suspension Arm Repair Kit		CV-RK-8118	for Drag Link
	09/87→09/90	Suspension Arm Repair Kit		IV-RK-8998	for Wishbone (CV)
	09/87→09/90	Suspension Arm Repair Kit		MN-RK-7280	for Drag Link
	09/87→09/90	Suspension Arm Repair Kit		SC-RK-8575	for Wishbone (CV)
	09/87→09/90	Suspension Strut Repair Kit		DF-RK-8671	
	09/87→09/90	Suspension Strut Repair Kit		MN-RK-8537	
	09/87→09/90	Tie Rod	DF-DL-7836		
09/87→09/90	Tie Rod End	CV-ES-14163		for Steering Rod	

CV-ES-2119

Length: 55
Cone Ø: d1 Ø 10 / d2 Ø 10
Thread: M12 x 1,75 LHT
592106, 1249088



DF-DL-7836

Length: 1698
Ø: 52
Cone Ø: d1 Ø 26 / d2 Ø 23,5
0754922, 1286343, 1353396



IV-RK-8998

Ø: 85
Hole Distance: 130
Thick/Height: 30
0513757, 0531757, 691709, 0691709



CV-ES-2182

Length: 55
Cone Ø: d1 Ø 10 / d2 Ø 10
Thread: M12 x 1,75 RHT
589333, 1249129



DF-DL-12420

Length: 1004
Ø: 52
Cone Ø: d1 Ø 30 / d2 Ø 27
Thread: M24 x 1,5 / M30 x 1,5
0094613, 094613, 94613, 0362413, 362413, 1426101



MN-RK-7280

Ø: 75
Hole Distance: 115
Thick/Height: 24
689748, 0689748



CV-ES-14163

Length: 125
Cone Ø: d1 Ø 30 / d2 Ø 27
Thread: M30 x 1,5 RHT
0607981, 0698450, 1149907, 1152350, 1257890, 1603789, 1618048, ACHF060



DF-ES-9335

Length: 85
Cone Ø: d1 Ø 12 / d2 Ø 10,75
Thread: M14 x 1,5 RHT
0386930, 386930



MN-RK-8537

Ø: 95
Hole Distance: 152
Thick/Height: 24
696321, 81432706099



CV-RK-5322

Ø: 72
Thick/Height: 50
0691704



DF-RK-8671



SC-RK-8575

Ø: 95
Hole Distance: 152
Thick/Height: 35
0696321



CV-RK-8118

Ø: 85
Hole Distance: 130
Thick/Height: 30
0689749



DF-SB-5251

Ø: 85
Thick/Height: 60
0366351, 366351, 10305800A



DF-DL-3798

Length: 1015
Ø: 50
Cone Ø: d1 Ø 30 / d2 Ø 27
0094038, 0525433

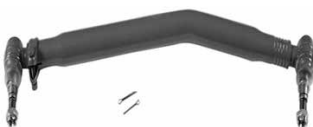

DF-SB-9342

Ø: 94
Thick/Height: 80 / 70
0281007, 0298498, 008169892, 8169892, 041270883, 41270883





95 ...

FAT 95.360	08/90→01/98	Ball Head, gearshift linkage	CV-ES-2119		
	08/90→01/98	Ball Head, gearshift linkage	CV-ES-2182		
	08/90→01/98	Ball Head, gearshift linkage	DF-ES-9335		
	08/90→01/98	Centre Rod	DF-DL-3798		Push Rod
	08/90→01/98	Centre Rod	DF-DL-12420		Push Rod
	08/90→01/98	Stabiliser Mounting		DF-SB-5251	
	08/90→01/98	Stabiliser Mounting		DF-SB-9342	
	08/90→01/98	Suspension Arm Repair Kit		CV-RK-5322	for Wishbone (CV)
	08/90→01/98	Suspension Arm Repair Kit		CV-RK-8118	for Drag Link
	08/90→01/98	Suspension Arm Repair Kit		IV-RK-8998	for Wishbone (CV)
	08/90→01/98	Suspension Arm Repair Kit		MN-RK-7280	for Drag Link
	08/90→01/98	Suspension Arm Repair Kit		SC-RK-8575	for Wishbone (CV)
	08/90→01/98	Suspension Strut Repair Kit		DF-RK-8671	
	08/90→01/98	Suspension Strut Repair Kit		MN-RK-8537	
	08/90→01/98	Tie Rod	DF-DL-7836		
	08/90→01/98	Tie Rod End	CV-ES-14163		for Steering Rod
FAT 95.380	09/87→09/90	Ball Head, gearshift linkage	CV-ES-2119		
	09/87→09/90	Ball Head, gearshift linkage	CV-ES-2182		
	09/87→09/90	Ball Head, gearshift linkage	DF-ES-9335		
	09/87→09/90	Centre Rod	DF-DL-3798		Push Rod
	09/87→09/90	Centre Rod	DF-DL-12420		Push Rod
	09/87→09/90	Stabiliser Mounting		DF-SB-5251	
	09/87→09/90	Stabiliser Mounting		DF-SB-9342	
	09/87→09/90	Suspension Arm Repair Kit		CV-RK-5322	for Wishbone (CV)
	09/87→09/90	Suspension Arm Repair Kit		CV-RK-8118	for Drag Link
	09/87→09/90	Suspension Arm Repair Kit		IV-RK-8998	for Wishbone (CV)
	09/87→09/90	Suspension Arm Repair Kit		MN-RK-7280	for Drag Link
	09/87→09/90	Suspension Arm Repair Kit		SC-RK-8575	for Wishbone (CV)
	09/87→09/90	Suspension Strut Repair Kit		DF-RK-8671	
	09/87→09/90	Suspension Strut Repair Kit		MN-RK-8537	
	09/87→09/90	Tie Rod	DF-DL-7836		
	09/87→09/90	Tie Rod End	CV-ES-14163		for Steering Rod
FAT 95.400	08/90→01/98	Ball Head, gearshift linkage	CV-ES-2119		
	08/90→01/98	Ball Head, gearshift linkage	CV-ES-2182		
	08/90→01/98	Ball Head, gearshift linkage	DF-ES-9335		
	08/90→01/98	Centre Rod	DF-DL-3798		Push Rod
	08/90→01/98	Centre Rod	DF-DL-12420		Push Rod
	08/90→01/98	Stabiliser Mounting		DF-SB-5251	
	08/90→01/98	Stabiliser Mounting		DF-SB-9342	
	08/90→01/98	Suspension Arm Repair Kit		CV-RK-5322	for Wishbone (CV)
	08/90→01/98	Suspension Arm Repair Kit		CV-RK-8118	for Drag Link
	08/90→01/98	Suspension Arm Repair Kit		IV-RK-8998	for Wishbone (CV)
	08/90→01/98	Suspension Arm Repair Kit		MN-RK-7280	for Drag Link
	08/90→01/98	Suspension Arm Repair Kit		SC-RK-8575	for Wishbone (CV)
	08/90→01/98	Suspension Strut Repair Kit		DF-RK-8671	
	08/90→01/98	Suspension Strut Repair Kit		MN-RK-8537	
	08/90→01/98	Tie Rod	DF-DL-7836		
	08/90→01/98	Tie Rod End	CV-ES-14163		for Steering Rod
FAT 95.430	02/92→01/98	Ball Head, gearshift linkage	CV-ES-2119		
	02/92→01/98	Ball Head, gearshift linkage	CV-ES-2182		
	02/92→01/98	Ball Head, gearshift linkage	DF-ES-9335		
	02/92→01/98	Centre Rod	DF-DL-3798		Push Rod
	02/92→01/98	Centre Rod	DF-DL-12420		Push Rod
	02/92→01/98	Stabiliser Mounting		DF-SB-5251	
	02/92→01/98	Stabiliser Mounting		DF-SB-9342	
	02/92→01/98	Suspension Arm Repair Kit		CV-RK-5322	for Wishbone (CV)
	02/92→01/98	Suspension Arm Repair Kit		CV-RK-8118	for Drag Link
	02/92→01/98	Suspension Arm Repair Kit		IV-RK-8998	for Wishbone (CV)
	02/92→01/98	Suspension Arm Repair Kit		MN-RK-7280	for Drag Link
	02/92→01/98	Suspension Arm Repair Kit		SC-RK-8575	for Wishbone (CV)
	02/92→01/98	Suspension Strut Repair Kit		DF-RK-8671	
	02/92→01/98	Suspension Strut Repair Kit		MN-RK-8537	
	02/92→01/98	Tie Rod	DF-DL-7836		
	02/92→01/98	Tie Rod End	CV-ES-14163		for Steering Rod

CV-ES-2119

Length: 55
Cone Ø: d1 Ø 10 / d2 Ø 10
Thread: M12 x 1,75 LHT
592106, 1249088



DF-DL-7836

Length: 1698
Ø: 52
Cone Ø: d1 Ø 26 / d2 Ø 23,5
0754922, 1286343, 1353396



IV-RK-8998

Ø: 85
Hole Distance: 130
Thick/Height: 30
0513757, 0531757, 0691709, 691709



CV-ES-2182

Length: 55
Cone Ø: d1 Ø 10 / d2 Ø 10
Thread: M12 x 1,75 RHT
589333, 1249129



DF-DL-12420

Length: 1004
Ø: 52
Cone Ø: d1 Ø 30 / d2 Ø 27
Thread: M24 x 1,5 / M30 x 1,5
0094613, 94613, 094613, 0362413, 362413, 1426101



MN-RK-7280

Ø: 75
Hole Distance: 115
Thick/Height: 24
0689748, 689748



CV-ES-14163

Length: 125
Cone Ø: d1 Ø 30 / d2 Ø 27
Thread: M30 x 1,5 RHT
0607981, 0698450, 1149907, 1152350, 1257890, 1603789, 1618048, ACHF060



DF-ES-9335

Length: 85
Cone Ø: d1 Ø 12 / d2 Ø 10,75
Thread: M14 x 1,5 RHT
0386930, 386930



MN-RK-8537

Ø: 95
Hole Distance: 152
Thick/Height: 24
696321, 81432706099



CV-RK-5322

Ø: 72
Thick/Height: 50
0691704



DF-RK-8671



SC-RK-8575

Ø: 95
Hole Distance: 152
Thick/Height: 35
0696321



CV-RK-8118

Ø: 85
Hole Distance: 130
Thick/Height: 30
0689749



DF-SB-5251

Ø: 85
Thick/Height: 60
0366351, 366351, 10305800A



DF-DL-3798

Length: 1015
Ø: 50
Cone Ø: d1 Ø 30 / d2 Ø 27
0094038, 0525433

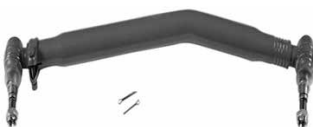

DF-SB-9342

Ø: 94
Thick/Height: 80 / 70
0281007, 0298498, 008169892, 8169892, 041270883, 41270883





95 ...

FT 95.310	09/87→09/90	Ball Head, gearshift linkage	CV-ES-2119		
	09/87→09/90	Ball Head, gearshift linkage	CV-ES-2182		
	09/87→09/90	Ball Head, gearshift linkage	DF-ES-9335		
	09/87→09/90	Centre Rod	DF-DL-3798		Push Rod
	09/87→09/90	Centre Rod	DF-DL-12420		Push Rod
	09/87→09/90	Stabiliser Mounting		DF-SB-5251	
	09/87→09/90	Stabiliser Mounting		DF-SB-9342	
	09/87→09/90	Suspension Arm Repair Kit		CV-RK-5322	for Wishbone (CV)
	09/87→09/90	Suspension Arm Repair Kit		CV-RK-8118	for Drag Link
	09/87→09/90	Suspension Arm Repair Kit		IV-RK-8998	for Wishbone (CV)
	09/87→09/90	Suspension Arm Repair Kit		MN-RK-7280	for Drag Link
	09/87→09/90	Suspension Arm Repair Kit		SC-RK-8575	for Wishbone (CV)
	09/87→09/90	Suspension Strut Repair Kit		DF-RK-8671	
	09/87→09/90	Suspension Strut Repair Kit		MN-RK-8537	
	09/87→09/90	Tie Rod	DF-DL-7836		
	09/87→09/90	Tie Rod End	CV-ES-14163		for Steering Rod
	09/87→09/90	Tie Rod End	DF-ES-3804		
	09/87→09/90	Tie Rod End	DF-ES-3805		
	09/87→09/90	Track Control Arm		DF-DL-9318	Trailing Arm
	09/87→09/90	Track Control Arm		DF-VB-8561	Wishbone (CV)
FT 95.330	08/90→01/93	Ball Head, gearshift linkage	CV-ES-2119		
	08/90→01/93	Ball Head, gearshift linkage	CV-ES-2182		
	08/90→01/93	Ball Head, gearshift linkage	DF-ES-9335		
	08/90→01/93	Centre Rod	DF-DL-3798		Push Rod
	08/90→01/93	Centre Rod	DF-DL-12420		Push Rod
	08/90→01/93	Stabiliser Mounting		DF-SB-5251	
	08/90→01/93	Stabiliser Mounting		DF-SB-9342	
	08/90→01/93	Suspension Arm Repair Kit		CV-RK-5322	for Wishbone (CV)
	08/90→01/93	Suspension Arm Repair Kit		CV-RK-8118	for Drag Link
	08/90→01/93	Suspension Arm Repair Kit		IV-RK-8998	for Wishbone (CV)
	08/90→01/93	Suspension Arm Repair Kit		MN-RK-7280	for Drag Link
	08/90→01/93	Suspension Arm Repair Kit		SC-RK-8575	for Wishbone (CV)
	08/90→01/93	Suspension Strut Repair Kit		DF-RK-8671	
	08/90→01/93	Tie Rod	DF-DL-7836		
	08/90→01/93	Tie Rod End	CV-ES-14163		for Steering Rod
	08/90→01/93	Tie Rod End	DF-ES-3804		
	08/90→01/93	Tie Rod End	DF-ES-3805		
	08/90→01/93	Track Control Arm		DF-DL-9318	Trailing Arm
	08/90→01/93	Track Control Arm		DF-VB-8561	Wishbone (CV)
	FT 95.350	09/87→09/90	Ball Head, gearshift linkage	CV-ES-2119	
09/87→09/90		Ball Head, gearshift linkage	CV-ES-2182		
09/87→09/90		Ball Head, gearshift linkage	DF-ES-9335		
09/87→09/90		Centre Rod	DF-DL-3798		Push Rod
09/87→09/90		Centre Rod	DF-DL-12420		Push Rod
09/87→09/90		Stabiliser Mounting		DF-SB-5251	
09/87→09/90		Stabiliser Mounting		DF-SB-9342	
09/87→09/90		Suspension Arm Repair Kit		CV-RK-5322	for Wishbone (CV)
09/87→09/90		Suspension Arm Repair Kit		CV-RK-8118	for Drag Link
09/87→09/90		Suspension Arm Repair Kit		IV-RK-8998	for Wishbone (CV)
09/87→09/90		Suspension Arm Repair Kit		MN-RK-7280	for Drag Link
09/87→09/90		Suspension Arm Repair Kit		SC-RK-8575	for Wishbone (CV)
09/87→09/90		Suspension Strut Repair Kit		DF-RK-8671	
09/87→09/90		Suspension Strut Repair Kit		MN-RK-8537	
09/87→09/90		Tie Rod	DF-DL-7836		
09/87→09/90		Tie Rod End	CV-ES-14163		for Steering Rod
09/87→09/90		Tie Rod End	DF-ES-3804		
09/87→09/90		Tie Rod End	DF-ES-3805		
09/87→09/90		Track Control Arm		DF-DL-9318	Trailing Arm
09/87→09/90		Track Control Arm		DF-VB-8561	Wishbone (CV)

CV-ES-2119

Length: 55
Cone Ø: d1 Ø 10 / d2 Ø 10
Thread: M12 x 1,75 LHT
592106, 1249088



CV-ES-2182

Length: 55
Cone Ø: d1 Ø 10 / d2 Ø 10
Thread: M12 x 1,75 RHT
589333, 1249129



CV-ES-14163

Length: 125
Cone Ø: d1 Ø 30 / d2 Ø 27
Thread: M30 x 1,5 RHT
0607981, 0698450, 1149907, 1152350,
1257890, 1603789, 1618048, ACHF060



CV-RK-5322

Ø: 72
Thick/Height: 50
0691704



CV-RK-8118

Ø: 85
Hole Distance: 130
Thick/Height: 30
0689749



DF-DL-3798

Length: 1015
Ø: 50
Cone Ø: d1 Ø 30 / d2 Ø 27
0094038, 0525433

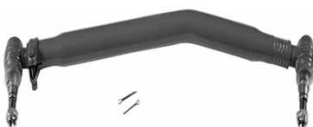

DF-DL-7836

Length: 1698
Ø: 52
Cone Ø: d1 Ø 26 / d2 Ø 23,5
0754922, 1286343, 1353396



DF-DL-9318

Length: 600
Ø: 50
Hole Distance: 130 / 130
0646373, 0655695, 0655697, 1284860,
1620438



DF-DL-12420

Length: 1004
Ø: 52
Cone Ø: d1 Ø 30 / d2 Ø 27
Thread: M24 x 1,5 / M30 x 1,5
94613, 094613, 0094613, 0362413, 362413,
1426101



DF-ES-3804

Length: 140
Cone Ø: d1 Ø 30 / d2 Ø 27
Thread: M48 x 1,5 LHT
0067303



DF-ES-3805

Length: 140
Cone Ø: d1 Ø 30 / d2 Ø 27
Thread: M48 x 1,5 RHT
0067389



DF-ES-9335

Length: 85
Cone Ø: d1 Ø 12 / d2 Ø 10,75
Thread: M14 x 1,5 RHT
0386930, 386930



DF-RK-8671



DF-SB-5251

Ø: 85
Thick/Height: 60
0366351, 366351, 10305800A



DF-SB-9342

Ø: 94
Thick/Height: 80 / 70
0281007, 0298498, 008169892, 8169892,
041270883, 41270883



DF-VB-8561

Length: 609
Ø: 48
Hole Distance: 152 / 152
0080521, 080521, 1361651, 1368270,
1390932, 1617096, 1793875, 1817808,
1892492



IV-RK-8998

Ø: 85
Hole Distance: 130
Thick/Height: 30
0513757, 0531757, 0691709, 691709



MN-RK-7280

Ø: 75
Hole Distance: 115
Thick/Height: 24
0689748, 689748



MN-RK-8537

Ø: 95
Hole Distance: 152
Thick/Height: 24
696321, 81432706099



SC-RK-8575

Ø: 95
Hole Distance: 152
Thick/Height: 35
0696321





95 ...

FT 95.380	08/90→01/98	Ball Head, gearshift linkage	CV-ES-2119		
	08/90→01/98	Ball Head, gearshift linkage	CV-ES-2182		
	08/90→01/98	Ball Head, gearshift linkage	DF-ES-9335		
	08/90→01/98	Centre Rod	DF-DL-3798		Push Rod
	08/90→01/98	Centre Rod	DF-DL-12420		Push Rod
	08/90→01/98	Stabiliser Mounting		DF-SB-5251	
	08/90→01/98	Stabiliser Mounting		DF-SB-9342	
	08/90→01/98	Suspension Arm Repair Kit		CV-RK-5322	for Wishbone (CV)
	08/90→01/98	Suspension Arm Repair Kit		CV-RK-8118	for Drag Link
	08/90→01/98	Suspension Arm Repair Kit		IV-RK-8998	for Wishbone (CV)
	08/90→01/98	Suspension Arm Repair Kit		MN-RK-7280	for Drag Link
	08/90→01/98	Suspension Arm Repair Kit		SC-RK-8575	for Wishbone (CV)
	08/90→01/98	Suspension Strut Repair Kit		DF-RK-8671	
	08/90→01/98	Suspension Strut Repair Kit		MN-RK-8537	
	08/90→01/98	Tie Rod	DF-DL-7836		
	08/90→01/98	Tie Rod End	CV-ES-14163		for Steering Rod
	08/90→01/98	Tie Rod End	DF-ES-3804		
	08/90→01/98	Tie Rod End	DF-ES-3805		
	08/90→01/98	Track Control Arm		DF-DL-8158	Trailing Arm
	08/90→01/98	Track Control Arm		DF-DL-9318	Trailing Arm
08/90→01/98	Track Control Arm		DF-VB-8561	Wishbone (CV)	
FT 95.380	09/87→09/90	Ball Head, gearshift linkage	CV-ES-2119		
	09/87→09/90	Ball Head, gearshift linkage	CV-ES-2182		
	09/87→09/90	Ball Head, gearshift linkage	DF-ES-9335		
	09/87→09/90	Centre Rod	DF-DL-3798		Push Rod
	09/87→09/90	Centre Rod	DF-DL-12420		Push Rod
	09/87→09/90	Stabiliser Mounting		DF-SB-5251	
	09/87→09/90	Stabiliser Mounting		DF-SB-9342	
	09/87→09/90	Suspension Arm Repair Kit		CV-RK-5322	for Wishbone (CV)
	09/87→09/90	Suspension Arm Repair Kit		CV-RK-8118	for Drag Link
	09/87→09/90	Suspension Arm Repair Kit		IV-RK-8998	for Wishbone (CV)
	09/87→09/90	Suspension Arm Repair Kit		MN-RK-7280	for Drag Link
	09/87→09/90	Suspension Arm Repair Kit		SC-RK-8575	for Wishbone (CV)
	09/87→09/90	Suspension Strut Repair Kit		DF-RK-8671	
	09/87→09/90	Suspension Strut Repair Kit		MN-RK-8537	
	09/87→09/90	Tie Rod	DF-DL-7836		
	09/87→09/90	Tie Rod End	CV-ES-14163		for Steering Rod
	09/87→09/90	Tie Rod End	DF-ES-3804		
	09/87→09/90	Tie Rod End	DF-ES-3805		
	09/87→09/90	Track Control Arm		DF-DL-8158	Trailing Arm
	09/87→09/90	Track Control Arm		DF-DL-9318	Trailing Arm
09/87→09/90	Track Control Arm		DF-VB-8561	Wishbone (CV)	
FT 95.400	08/90→01/98	Ball Head, gearshift linkage	CV-ES-2119		
	08/90→01/98	Ball Head, gearshift linkage	CV-ES-2182		
	08/90→01/98	Ball Head, gearshift linkage	DF-ES-9335		
	08/90→01/98	Centre Rod	DF-DL-3798		Push Rod
	08/90→01/98	Centre Rod	DF-DL-12420		Push Rod
	08/90→01/98	Stabiliser Mounting		DF-SB-5251	
	08/90→01/98	Stabiliser Mounting		DF-SB-9342	
	08/90→01/98	Suspension Arm Repair Kit		CV-RK-5322	for Wishbone (CV)
	08/90→01/98	Suspension Arm Repair Kit		CV-RK-8118	for Drag Link
	08/90→01/98	Suspension Arm Repair Kit		IV-RK-8998	for Wishbone (CV)
	08/90→01/98	Suspension Arm Repair Kit		MN-RK-7280	for Drag Link
	08/90→01/98	Suspension Arm Repair Kit		SC-RK-8575	for Wishbone (CV)
	08/90→01/98	Suspension Strut Repair Kit		DF-RK-8671	
	08/90→01/98	Suspension Strut Repair Kit		MN-RK-8537	
	08/90→01/98	Tie Rod	DF-DL-7836		
	08/90→01/98	Tie Rod End	CV-ES-14163		for Steering Rod
	08/90→01/98	Tie Rod End	DF-ES-3804		
	08/90→01/98	Tie Rod End	DF-ES-3805		
	08/90→01/98	Track Control Arm		DF-DL-8158	Trailing Arm
	08/90→01/98	Track Control Arm		DF-DL-9318	Trailing Arm
08/90→01/98	Track Control Arm		DF-VB-8561	Wishbone (CV)	

CV-ES-2119

Length: 55
 Cone Ø: d1 Ø 10 / d2 Ø 10
 Thread: M12 x 1,75 LHT
 5892106, 1249088

**DF-DL-7836**

Length: 1698
 Ø: 52
 Cone Ø: d1 Ø 26 / d2 Ø 23,5
 0754922, 1286343, 1353396

**DF-ES-9335**

Length: 85
 Cone Ø: d1 Ø 12 / d2 Ø 10,75
 Thread: M14 x 1,5 RHT
 0386930, 386930

**MN-RK-7280**

Ø: 75
 Hole Distance: 115
 Thick/Height: 24
 689748, 0689748

**CV-ES-2182**

Length: 55
 Cone Ø: d1 Ø 10 / d2 Ø 10
 Thread: M12 x 1,75 RHT
 589333, 1249129

**DF-DL-8158**

Length: 611
 Ø: 48
 Hole Distance: 130 / 130
 0267743, 1361649, 1361650, 1656428

**DF-RK-8671****MN-RK-8537**

Ø: 95
 Hole Distance: 152
 Thick/Height: 24
 696321, 81432706099

**CV-ES-14163**

Length: 125
 Cone Ø: d1 Ø 30 / d2 Ø 27
 Thread: M30 x 1,5 RHT
 0607981, 0698450, 1149907, 1152350,
 1257890, 1603789, 1618048, ACHF060

**DF-DL-9318**

Length: 600
 Ø: 50
 Hole Distance: 130 / 130
 0646373, 0655695, 0655697, 1284860,
 1620438

**DF-SB-5251**

Ø: 85
 Thick/Height: 60
 0366351, 366351, 10305800A

**SC-RK-8575**

Ø: 95
 Hole Distance: 152
 Thick/Height: 35
 0696321

**CV-RK-5322**

Ø: 72
 Thick/Height: 50
 0691704

**DF-DL-12420**

Length: 1004
 Ø: 52
 Cone Ø: d1 Ø 30 / d2 Ø 27
 Thread: M24 x 1,5 / M30 x 1,5
 0094613, 094613, 94613, 0362413, 362413,
 1426101

**DF-SB-9342**

Ø: 94
 Thick/Height: 80 / 70
 0281007, 0298498, 008169892, 8169892,
 041270883, 41270883

**CV-RK-8118**

Ø: 85
 Hole Distance: 130
 Thick/Height: 30
 0689749

**DF-ES-3804**

Length: 140
 Cone Ø: d1 Ø 30 / d2 Ø 27
 Thread: M48 x 1,5 LHT
 0067303

**DF-VB-8561**

Length: 609
 Ø: 48
 Hole Distance: 152 / 152
 080521, 0080521, 1361651, 1368270,
 1390932, 1617096, 1793875, 1817808,
 1892492

**DF-DL-3798**

Length: 1015
 Ø: 50
 Cone Ø: d1 Ø 30 / d2 Ø 27
 0094038, 0525433

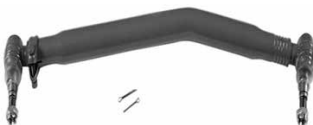
**DF-ES-3805**

Length: 140
 Cone Ø: d1 Ø 30 / d2 Ø 27
 Thread: M48 x 1,5 RHT
 0067389

**IV-RK-8998**

Ø: 85
 Hole Distance: 130
 Thick/Height: 30
 0513757, 0531757, 0691709, 691709





95 ...

FT 95.430	02/92→01/98	Ball Head, gearshift linkage	CV-ES-2119		
	02/92→01/98	Ball Head, gearshift linkage	CV-ES-2182		
	02/92→01/98	Ball Head, gearshift linkage	DF-ES-9335		
	02/92→01/98	Centre Rod	DF-DL-3798		Push Rod
	02/92→01/98	Centre Rod	DF-DL-12420		Push Rod
	02/92→01/98	Stabiliser Mounting		DF-SB-5251	
	02/92→01/98	Stabiliser Mounting		DF-SB-9342	
	02/92→01/98	Suspension Arm Repair Kit		CV-RK-5322	for Wishbone (CV)
	02/92→01/98	Suspension Arm Repair Kit		CV-RK-8118	for Drag Link
	02/92→01/98	Suspension Arm Repair Kit		IV-RK-8998	for Wishbone (CV)
	02/92→01/98	Suspension Arm Repair Kit		MN-RK-7280	for Drag Link
	02/92→01/98	Suspension Arm Repair Kit		SC-RK-8575	for Wishbone (CV)
	02/92→01/98	Suspension Strut Repair Kit		DF-RK-8671	
	02/92→01/98	Suspension Strut Repair Kit		MN-RK-8537	
	02/92→01/98	Tie Rod	DF-DL-7836		
	02/92→01/98	Tie Rod End	CV-ES-14163		for Steering Rod
	02/92→01/98	Tie Rod End	DF-ES-3804		
	02/92→01/98	Tie Rod End	DF-ES-3805		
	02/92→01/98	Track Control Arm		DF-DL-8158	Trailing Arm
02/92→01/98	Track Control Arm		DF-DL-9318	Trailing Arm	
02/92→01/98	Track Control Arm		DF-VB-8561	Wishbone (CV)	
FT 95.500	02/94→01/98	Ball Head, gearshift linkage	CV-ES-2119		
	02/94→01/98	Ball Head, gearshift linkage	CV-ES-2182		
	02/94→01/98	Ball Head, gearshift linkage	DF-ES-9335		
	02/94→01/98	Centre Rod	DF-DL-3798		Push Rod
	02/94→01/98	Centre Rod	DF-DL-12420		Push Rod
	02/94→01/98	Stabiliser Mounting		DF-SB-5251	
	02/94→01/98	Stabiliser Mounting		DF-SB-9342	
	02/94→01/98	Suspension Arm Repair Kit		CV-RK-5322	for Wishbone (CV)
	02/94→01/98	Suspension Arm Repair Kit		CV-RK-8118	for Drag Link
	02/94→01/98	Suspension Arm Repair Kit		IV-RK-8998	for Wishbone (CV)
	02/94→01/98	Suspension Arm Repair Kit		MN-RK-7280	for Drag Link
	02/94→01/98	Suspension Arm Repair Kit		SC-RK-8575	for Wishbone (CV)
	02/94→01/98	Suspension Strut Repair Kit		DF-RK-8671	
	02/94→01/98	Suspension Strut Repair Kit		MN-RK-8537	
	02/94→01/98	Tie Rod	DF-DL-7836		
	02/94→01/98	Tie Rod End	CV-ES-14163		for Steering Rod
	02/94→01/98	Tie Rod End	DF-ES-3804		
	02/94→01/98	Tie Rod End	DF-ES-3805		
	02/94→01/98	Track Control Arm		DF-DL-8158	Trailing Arm
02/94→01/98	Track Control Arm		DF-DL-9318	Trailing Arm	
02/94→01/98	Track Control Arm		DF-VB-8561	Wishbone (CV)	
FTG 95.310	09/87→01/98	Ball Head, gearshift linkage	DF-ES-9335		
	09/87→01/98	Centre Rod	DF-DL-12420		Push Rod
	09/87→01/98	Stabiliser Mounting		DF-SB-5251	
	09/87→01/98	Stabiliser Mounting		DF-SB-9342	
	09/87→01/98	Suspension Arm Repair Kit		CV-RK-5322	for Wishbone (CV)
	09/87→01/98	Suspension Arm Repair Kit		CV-RK-8118	for Drag Link
	09/87→01/98	Suspension Arm Repair Kit		IV-RK-8998	for Wishbone (CV)
	09/87→01/98	Suspension Arm Repair Kit		MN-RK-7280	for Drag Link
	09/87→01/98	Suspension Arm Repair Kit		SC-RK-8575	for Wishbone (CV)
	09/87→01/98	Suspension Strut Repair Kit		DF-RK-8671	
	09/87→01/98	Suspension Strut Repair Kit		MN-RK-8537	
	09/87→01/98	Tie Rod	DF-DL-7836		
	09/87→01/98	Tie Rod End	CV-ES-14163		for Steering Rod
FTG 95.330	08/90→01/98	Ball Head, gearshift linkage	DF-ES-9335		
	08/90→01/98	Centre Rod	DF-DL-12420		Push Rod
	08/90→01/98	Stabiliser Mounting		DF-SB-5251	
	08/90→01/98	Stabiliser Mounting		DF-SB-9342	
	08/90→01/98	Suspension Arm Repair Kit		CV-RK-5322	for Wishbone (CV)
	08/90→01/98	Suspension Arm Repair Kit		CV-RK-8118	for Drag Link
	08/90→01/98	Suspension Arm Repair Kit		IV-RK-8998	for Wishbone (CV)
	08/90→01/98	Suspension Arm Repair Kit		MN-RK-7280	for Drag Link

CV-ES-2119

Length: 55
 Cone Ø: d1 Ø 10 / d2 Ø 10
 Thread: M12 x 1,75 LHT
 5892106, 1249088

**DF-DL-7836**

Length: 1698
 Ø: 52
 Cone Ø: d1 Ø 26 / d2 Ø 23,5
 0754922, 1286343, 1353396

**DF-ES-9335**

Length: 85
 Cone Ø: d1 Ø 12 / d2 Ø 10,75
 Thread: M14 x 1,5 RHT
 0386930, 386930

**MN-RK-7280**

Ø: 75
 Hole Distance: 115
 Thick/Height: 24
 0689748, 689748

**CV-ES-2182**

Length: 55
 Cone Ø: d1 Ø 10 / d2 Ø 10
 Thread: M12 x 1,75 RHT
 589333, 1249129

**DF-DL-8158**

Length: 611
 Ø: 48
 Hole Distance: 130 / 130
 0267743, 1361649, 1361650, 1656428

**DF-RK-8671****MN-RK-8537**

Ø: 95
 Hole Distance: 152
 Thick/Height: 24
 696321, 81432706099

**CV-ES-14163**

Length: 125
 Cone Ø: d1 Ø 30 / d2 Ø 27
 Thread: M30 x 1,5 RHT
 0607981, 0698450, 1149907, 1152350,
 1257890, 1603789, 1618048, ACHF060

**DF-DL-9318**

Length: 600
 Ø: 50
 Hole Distance: 130 / 130
 0646373, 0655695, 0655697, 1284860,
 1620438

**DF-SB-5251**

Ø: 85
 Thick/Height: 60
 0366351, 366351, 10305800A

**SC-RK-8575**

Ø: 95
 Hole Distance: 152
 Thick/Height: 35
 0696321

**CV-RK-5322**

Ø: 72
 Thick/Height: 50
 0691704

**DF-DL-12420**

Length: 1004
 Ø: 52
 Cone Ø: d1 Ø 30 / d2 Ø 27
 Thread: M24 x 1,5 / M30 x 1,5
 0094613, 094613, 94613, 362413, 0362413,
 1426101

**DF-SB-9342**

Ø: 94
 Thick/Height: 80 / 70
 0281007, 0298498, 008169892, 8169892,
 041270883, 41270883

**CV-RK-8118**

Ø: 85
 Hole Distance: 130
 Thick/Height: 30
 0689749

**DF-ES-3804**

Length: 140
 Cone Ø: d1 Ø 30 / d2 Ø 27
 Thread: M48 x 1,5 LHT
 0067303

**DF-VB-8561**

Length: 609
 Ø: 48
 Hole Distance: 152 / 152
 0080521, 080521, 1361651, 1368270,
 1390932, 1617096, 1793875, 1817808,
 1892492

**DF-DL-3798**

Length: 1015
 Ø: 50
 Cone Ø: d1 Ø 30 / d2 Ø 27
 0094038, 0525433

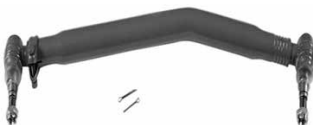
**DF-ES-3805**

Length: 140
 Cone Ø: d1 Ø 30 / d2 Ø 27
 Thread: M48 x 1,5 RHT
 0067389

**IV-RK-8998**

Ø: 85
 Hole Distance: 130
 Thick/Height: 30
 0513757, 0531757, 0691709, 691709





95 ...

FTG 95.330 ...	08/90→01/98	Suspension Arm Repair Kit		SC-RK-8575	for Wishbone (CV)
	08/90→01/98	Suspension Strut Repair Kit		DF-RK-8671	
	08/90→01/98	Suspension Strut Repair Kit		MN-RK-8537	
	08/90→01/98	Tie Rod	DF-DL-7836		
	08/90→01/98	Tie Rod End	CV-ES-14163		for Steering Rod
FTR 95.360, FTS 95.360	08/90→01/98	Ball Head, gearshift linkage	CV-ES-2119		
	08/90→01/98	Ball Head, gearshift linkage	CV-ES-2182		
	08/90→01/98	Ball Head, gearshift linkage	DF-ES-9335		
	08/90→01/98	Centre Rod	DF-DL-3798		Push Rod
	08/90→01/98	Centre Rod	DF-DL-12420		Push Rod
	08/90→01/98	Stabiliser Mounting		DF-SB-5251	
	08/90→01/98	Stabiliser Mounting		DF-SB-9342	
	08/90→01/98	Suspension Arm Repair Kit		CV-RK-5322	for Wishbone (CV)
	08/90→01/98	Suspension Arm Repair Kit		CV-RK-8118	for Drag Link
	08/90→01/98	Suspension Arm Repair Kit		IV-RK-8998	for Wishbone (CV)
	08/90→01/98	Suspension Arm Repair Kit		MN-RK-7280	for Drag Link
	08/90→01/98	Suspension Arm Repair Kit		SC-RK-8575	for Wishbone (CV)
	08/90→01/98	Suspension Strut Repair Kit		DF-RK-8671	
	08/90→01/98	Suspension Strut Repair Kit		MN-RK-8537	
	08/90→01/98	Tie Rod	DF-DL-7836		
	08/90→01/98	Tie Rod End	CV-ES-14163		for Steering Rod
	08/90→01/98	Track Control Arm		DF-DL-8158	Trailing Arm
	08/90→01/98	Track Control Arm		DF-DL-9318	Trailing Arm
	08/90→01/98	Track Control Arm		DF-VB-8561	Wishbone (CV)
	FTR 95.400, FTS 95.400	08/90→01/98	Ball Head, gearshift linkage	CV-ES-2119	
08/90→01/98		Ball Head, gearshift linkage	CV-ES-2182		
08/90→01/98		Ball Head, gearshift linkage	DF-ES-9335		
08/90→01/98		Centre Rod	DF-DL-3798		Push Rod
08/90→01/98		Centre Rod	DF-DL-12420		Push Rod
08/90→01/98		Stabiliser Mounting		DF-SB-5251	
08/90→01/98		Stabiliser Mounting		DF-SB-9342	
08/90→01/98		Suspension Arm Repair Kit		CV-RK-5322	for Wishbone (CV)
08/90→01/98		Suspension Arm Repair Kit		CV-RK-8118	for Drag Link
08/90→01/98		Suspension Arm Repair Kit		IV-RK-8998	for Wishbone (CV)
08/90→01/98		Suspension Arm Repair Kit		MN-RK-7280	for Drag Link
08/90→01/98		Suspension Arm Repair Kit		SC-RK-8575	for Wishbone (CV)
08/90→01/98		Suspension Strut Repair Kit		DF-RK-8671	
08/90→01/98		Suspension Strut Repair Kit		MN-RK-8537	
08/90→01/98		Tie Rod	DF-DL-7836		
08/90→01/98		Tie Rod End	CV-ES-14163		for Steering Rod
08/90→01/98		Track Control Arm		DF-DL-8158	Trailing Arm
08/90→01/98		Track Control Arm		DF-DL-9318	Trailing Arm
08/90→01/98		Track Control Arm		DF-VB-8561	Wishbone (CV)
FTR 95.430, FTS 95.430		02/92→01/98	Ball Head, gearshift linkage	CV-ES-2119	
	02/92→01/98	Ball Head, gearshift linkage	CV-ES-2182		
	02/92→01/98	Ball Head, gearshift linkage	DF-ES-9335		
	02/92→01/98	Centre Rod	DF-DL-3798		Push Rod
	02/92→01/98	Centre Rod	DF-DL-12420		Push Rod
	02/92→01/98	Stabiliser Mounting		DF-SB-5251	
	02/92→01/98	Stabiliser Mounting		DF-SB-9342	
	02/92→01/98	Suspension Arm Repair Kit		CV-RK-5322	for Wishbone (CV)
	02/92→01/98	Suspension Arm Repair Kit		CV-RK-8118	for Drag Link
	02/92→01/98	Suspension Arm Repair Kit		IV-RK-8998	for Wishbone (CV)
	02/92→01/98	Suspension Arm Repair Kit		MN-RK-7280	for Drag Link
	02/92→01/98	Suspension Arm Repair Kit		SC-RK-8575	for Wishbone (CV)
	02/92→01/98	Suspension Strut Repair Kit		DF-RK-8671	
	02/92→01/98	Suspension Strut Repair Kit		MN-RK-8537	
	02/92→01/98	Tie Rod	DF-DL-7836		
	02/92→01/98	Tie Rod End	CV-ES-14163		for Steering Rod
	02/92→01/98	Track Control Arm		DF-DL-8158	Trailing Arm
	02/92→01/98	Track Control Arm		DF-DL-9318	Trailing Arm
02/92→01/98	Track Control Arm		DF-VB-8561	Wishbone (CV)	

CV-ES-2119

Length: 55
 Cone Ø: d1 Ø 10 / d2 Ø 10
 Thread: M12 x 1,75 LHT
 592106, 1249088

**CV-ES-2182**

Length: 55
 Cone Ø: d1 Ø 10 / d2 Ø 10
 Thread: M12 x 1,75 RHT
 589333, 1249129

**CV-ES-14163**

Length: 125
 Cone Ø: d1 Ø 30 / d2 Ø 27
 Thread: M30 x 1,5 RHT
 0607981, 0698450, 1149907, 1152350,
 1257890, 1603789, 1618048, ACHF060

**CV-RK-5322**

Ø: 72
 Thick/Height: 50
 0691704

**CV-RK-8118**

Ø: 85
 Hole Distance: 130
 Thick/Height: 30
 0689749

**DF-DL-3798**

Length: 1015
 Ø: 50
 Cone Ø: d1 Ø 30 / d2 Ø 27
 0094038, 0525433

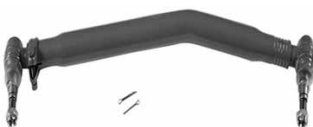
**DF-DL-7836**

Length: 1698
 Ø: 52
 Cone Ø: d1 Ø 26 / d2 Ø 23,5
 0754922, 1286343, 1353396

**DF-DL-8158**

Length: 611
 Ø: 48
 Hole Distance: 130 / 130
 0267743, 1361649, 1361650, 1656428

**DF-DL-9318**

Length: 600
 Ø: 50
 Hole Distance: 130 / 130
 0646373, 0655695, 0655697, 1284860,
 1620438

**DF-DL-12420**

Length: 1004
 Ø: 52
 Cone Ø: d1 Ø 30 / d2 Ø 27
 Thread: M24 x 1,5 / M30 x 1,5
 94613, 0094613, 094613, 362413, 0362413,
 1426101

**DF-ES-9335**

Length: 85
 Cone Ø: d1 Ø 12 / d2 Ø 10,75
 Thread: M14 x 1,5 RHT
 0386930, 386930

**DF-RK-8671****DF-SB-5251**

Ø: 85
 Thick/Height: 60
 0366351, 366351, 10305800A

**DF-SB-9342**

Ø: 94
 Thick/Height: 80 / 70
 0281007, 0298498, 8169892, 008169892,
 041270883, 41270883

**DF-VB-8561**

Length: 609
 Ø: 48
 Hole Distance: 152 / 152
 0080521, 080521, 1361651, 1368270,
 1390932, 1617096, 1793875, 1817808,
 1892492

**IV-RK-8998**

Ø: 85
 Hole Distance: 130
 Thick/Height: 30
 0513757, 0531757, 0691709, 691709

**MN-RK-7280**

Ø: 75
 Hole Distance: 115
 Thick/Height: 24
 0689748, 689748

**MN-RK-8537**

Ø: 95
 Hole Distance: 152
 Thick/Height: 24
 696321, 81432706099

**SC-RK-8575**

Ø: 95
 Hole Distance: 152
 Thick/Height: 35
 0696321





95 ...

FTS 95.350	09/87→09/90	Ball Head, gearshift linkage	CV-ES-2119			
	09/87→09/90	Ball Head, gearshift linkage	CV-ES-2182			
	09/87→09/90	Ball Head, gearshift linkage	DF-ES-9335			
	09/87→09/90	Centre Rod	DF-DL-3798		Push Rod	
	09/87→09/90	Centre Rod	DF-DL-12420		Push Rod	
	09/87→09/90	Stabiliser Mounting		DF-SB-5251		
	09/87→09/90	Stabiliser Mounting		DF-SB-9342		
	09/87→09/90	Suspension Arm Repair Kit		CV-RK-5322	for Wishbone (CV)	
	09/87→09/90	Suspension Arm Repair Kit		CV-RK-8118	for Drag Link	
	09/87→09/90	Suspension Arm Repair Kit		IV-RK-8998	for Wishbone (CV)	
	09/87→09/90	Suspension Arm Repair Kit		MN-RK-7280	for Drag Link	
	09/87→09/90	Suspension Arm Repair Kit		SC-RK-8575	for Wishbone (CV)	
	09/87→09/90	Suspension Strut Repair Kit		DF-RK-8671		
	09/87→09/90	Suspension Strut Repair Kit		MN-RK-8537		
	09/87→09/90	Tie Rod	DF-DL-7836			
	09/87→09/90	Tie Rod End	CV-ES-14163		for Steering Rod	
	09/87→09/90	Track Control Arm		DF-DL-9318	Trailing Arm	
	09/87→09/90	Track Control Arm		DF-VB-8561	Wishbone (CV)	
	FTS 95.380	09/87→09/90	Ball Head, gearshift linkage	CV-ES-2119		
		09/87→09/90	Ball Head, gearshift linkage	CV-ES-2182		
		09/87→09/90	Ball Head, gearshift linkage	DF-ES-9335		
		09/87→09/90	Centre Rod	DF-DL-3798		Push Rod
		09/87→09/90	Centre Rod	DF-DL-12420		Push Rod
09/87→09/90		Stabiliser Mounting		DF-SB-5251		
09/87→09/90		Stabiliser Mounting		DF-SB-9342		
09/87→09/90		Suspension Arm Repair Kit		CV-RK-5322	for Wishbone (CV)	
09/87→09/90		Suspension Arm Repair Kit		CV-RK-8118	for Drag Link	
09/87→09/90		Suspension Arm Repair Kit		IV-RK-8998	for Wishbone (CV)	
09/87→09/90		Suspension Arm Repair Kit		MN-RK-7280	for Drag Link	
09/87→09/90		Suspension Arm Repair Kit		SC-RK-8575	for Wishbone (CV)	
09/87→09/90		Suspension Strut Repair Kit		DF-RK-8671		
09/87→09/90		Suspension Strut Repair Kit		MN-RK-8537		
09/87→09/90		Tie Rod	DF-DL-7836			
09/87→09/90		Tie Rod End	CV-ES-14163		for Steering Rod	
09/87→09/90		Track Control Arm		DF-DL-8158	Trailing Arm	
09/87→09/90		Track Control Arm		DF-DL-9318	Trailing Arm	
09/87→09/90		Track Control Arm		DF-VB-8561	Wishbone (CV)	
FTT 95.310		09/87→01/98	Ball Head, gearshift linkage	DF-ES-9335		
		09/87→01/98	Centre Rod	DF-DL-12420		Push Rod
		09/87→01/98	Stabiliser Mounting		DF-SB-5251	
		09/87→01/98	Stabiliser Mounting		DF-SB-9342	
	09/87→01/98	Suspension Arm Repair Kit		CV-RK-5322	for Wishbone (CV)	
	09/87→01/98	Suspension Arm Repair Kit		CV-RK-8118	for Drag Link	
	09/87→01/98	Suspension Arm Repair Kit		IV-RK-8998	for Wishbone (CV)	
	09/87→01/98	Suspension Arm Repair Kit		MN-RK-7280	for Drag Link	
	09/87→01/98	Suspension Arm Repair Kit		SC-RK-8575	for Wishbone (CV)	
	09/87→01/98	Suspension Strut Repair Kit		DF-RK-8671		
	09/87→01/98	Suspension Strut Repair Kit		MN-RK-8537		
	09/87→01/98	Tie Rod	DF-DL-7836			
	09/87→01/98	Tie Rod End	CV-ES-14163		for Steering Rod	
FTT 95.330	09/87→01/98	Ball Head, gearshift linkage	DF-ES-9335			
	09/87→01/98	Centre Rod	DF-DL-12420		Push Rod	
	09/87→01/98	Stabiliser Mounting		DF-SB-5251		
	09/87→01/98	Stabiliser Mounting		DF-SB-9342		
	09/87→01/98	Suspension Arm Repair Kit		CV-RK-5322	for Wishbone (CV)	
	09/87→01/98	Suspension Arm Repair Kit		CV-RK-8118	for Drag Link	
	09/87→01/98	Suspension Arm Repair Kit		IV-RK-8998	for Wishbone (CV)	
	09/87→01/98	Suspension Arm Repair Kit		MN-RK-7280	for Drag Link	
	09/87→01/98	Suspension Arm Repair Kit		SC-RK-8575	for Wishbone (CV)	
	09/87→01/98	Suspension Strut Repair Kit		DF-RK-8671		
	09/87→01/98	Suspension Strut Repair Kit		MN-RK-8537		
	09/87→01/98	Tie Rod	DF-DL-7836			
	09/87→01/98	Tie Rod End	CV-ES-14163		for Steering Rod	

CV-ES-2119

Length: 55
 Cone Ø: d1 Ø 10 / d2 Ø 10
 Thread: M12 x 1,75 LHT
 592106, 1249088

**CV-ES-2182**

Length: 55
 Cone Ø: d1 Ø 10 / d2 Ø 10
 Thread: M12 x 1,75 RHT
 589333, 1249129

**CV-ES-14163**

Length: 125
 Cone Ø: d1 Ø 30 / d2 Ø 27
 Thread: M30 x 1,5 RHT
 0607981, 0698450, 1149907, 1152350,
 1257890, 1603789, 1618048, ACHF060

**CV-RK-5322**

Ø: 72
 Thick/Height: 50
 0691704

**CV-RK-8118**

Ø: 85
 Hole Distance: 130
 Thick/Height: 30
 0689749

**DF-DL-3798**

Length: 1015
 Ø: 50
 Cone Ø: d1 Ø 30 / d2 Ø 27
 0094038, 0525433

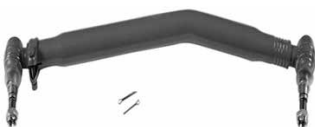
**DF-DL-7836**

Length: 1698
 Ø: 52
 Cone Ø: d1 Ø 26 / d2 Ø 23,5
 0754922, 1286343, 1353396

**DF-DL-8158**

Length: 611
 Ø: 48
 Hole Distance: 130 / 130
 0267743, 1361649, 1361650, 1656428

**DF-DL-9318**

Length: 600
 Ø: 50
 Hole Distance: 130 / 130
 0646373, 0655695, 0655697, 1284860,
 1620438

**DF-DL-12420**

Length: 1004
 Ø: 52
 Cone Ø: d1 Ø 30 / d2 Ø 27
 Thread: M24 x 1,5 / M30 x 1,5
 0094613, 094613, 94613, 0362413, 362413,
 1426101

**DF-ES-9335**

Length: 85
 Cone Ø: d1 Ø 12 / d2 Ø 10,75
 Thread: M14 x 1,5 RHT
 0386930, 386930

**DF-RK-8671****DF-SB-5251**

Ø: 85
 Thick/Height: 60
 0366351, 366351, 10305800A

**DF-SB-9342**

Ø: 94
 Thick/Height: 80 / 70
 0281007, 0298498, 8169892, 008169892,
 041270883, 41270883

**DF-VB-8561**

Length: 609
 Ø: 48
 Hole Distance: 152 / 152
 0080521, 080521, 1361651, 1368270,
 1390932, 1617096, 1793875, 1817808,
 1892492

**IV-RK-8998**

Ø: 85
 Hole Distance: 130
 Thick/Height: 30
 0513757, 0531757, 0691709, 691709

**MN-RK-7280**

Ø: 75
 Hole Distance: 115
 Thick/Height: 24
 0689748, 689748

**MN-RK-8537**

Ø: 95
 Hole Distance: 152
 Thick/Height: 24
 696321, 81432706099

**SC-RK-8575**

Ø: 95
 Hole Distance: 152
 Thick/Height: 35
 0696321





95 ...

FTT 95.350	09/87→09/90	Ball Head, gearshift linkage	CV-ES-2119			
	09/87→09/90	Ball Head, gearshift linkage	CV-ES-2182			
	09/87→09/90	Ball Head, gearshift linkage	DF-ES-9335			
	09/87→09/90	Centre Rod	DF-DL-3798		Push Rod	
	09/87→09/90	Centre Rod	DF-DL-12420		Push Rod	
	09/87→09/90	Stabiliser Mounting		DF-SB-5251		
	09/87→09/90	Stabiliser Mounting		DF-SB-9342		
	09/87→09/90	Suspension Arm Repair Kit		CV-RK-5322	for Wishbone (CV)	
	09/87→09/90	Suspension Arm Repair Kit		CV-RK-8118	for Drag Link	
	09/87→09/90	Suspension Arm Repair Kit		IV-RK-8998	for Wishbone (CV)	
	09/87→09/90	Suspension Arm Repair Kit		MN-RK-7280	for Drag Link	
	09/87→09/90	Suspension Arm Repair Kit		SC-RK-8575	for Wishbone (CV)	
	09/87→09/90	Suspension Strut Repair Kit		DF-RK-8671		
	09/87→09/90	Suspension Strut Repair Kit		MN-RK-8537		
	09/87→09/90	Tie Rod	DF-DL-7836			
	09/87→09/90	Tie Rod End	CV-ES-14163		for Steering Rod	
	09/87→09/90	Track Control Arm		DF-DL-9318	Trailing Arm	
	09/87→09/90	Track Control Arm		DF-VB-8561	Wishbone (CV)	
	FTT 95.360	08/90→01/98	Ball Head, gearshift linkage	CV-ES-2119		
		08/90→01/98	Ball Head, gearshift linkage	CV-ES-2182		
08/90→01/98		Ball Head, gearshift linkage	DF-ES-9335			
08/90→01/98		Centre Rod	DF-DL-3798		Push Rod	
08/90→01/98		Centre Rod	DF-DL-12420		Push Rod	
08/90→01/98		Stabiliser Mounting		DF-SB-5251		
08/90→01/98		Stabiliser Mounting		DF-SB-9342		
08/90→01/98		Suspension Arm Repair Kit		CV-RK-5322	for Wishbone (CV)	
08/90→01/98		Suspension Arm Repair Kit		CV-RK-8118	for Drag Link	
08/90→01/98		Suspension Arm Repair Kit		IV-RK-8998	for Wishbone (CV)	
08/90→01/98		Suspension Arm Repair Kit		MN-RK-7280	for Drag Link	
08/90→01/98		Suspension Arm Repair Kit		SC-RK-8575	for Wishbone (CV)	
08/90→01/98		Suspension Strut Repair Kit		DF-RK-8671		
08/90→01/98		Suspension Strut Repair Kit		MN-RK-8537		
08/90→01/98		Tie Rod	DF-DL-7836			
08/90→01/98		Tie Rod End	CV-ES-14163		for Steering Rod	
08/90→01/98		Track Control Arm		DF-DL-8158	Trailing Arm	
08/90→01/98		Track Control Arm		DF-DL-9318	Trailing Arm	
08/90→01/98		Track Control Arm		DF-VB-8561	Wishbone (CV)	
FTT 95.380		09/87→09/90	Ball Head, gearshift linkage	CV-ES-2119		
	09/87→09/90	Ball Head, gearshift linkage	CV-ES-2182			
	09/87→09/90	Ball Head, gearshift linkage	DF-ES-9335			
	09/87→09/90	Centre Rod	DF-DL-3798		Push Rod	
	09/87→09/90	Centre Rod	DF-DL-12420		Push Rod	
	09/87→09/90	Stabiliser Mounting		DF-SB-5251		
	09/87→09/90	Stabiliser Mounting		DF-SB-9342		
	09/87→09/90	Suspension Arm Repair Kit		CV-RK-5322	for Wishbone (CV)	
	09/87→09/90	Suspension Arm Repair Kit		CV-RK-8118	for Drag Link	
	09/87→09/90	Suspension Arm Repair Kit		IV-RK-8998	for Wishbone (CV)	
	09/87→09/90	Suspension Arm Repair Kit		MN-RK-7280	for Drag Link	
	09/87→09/90	Suspension Arm Repair Kit		SC-RK-8575	for Wishbone (CV)	
	09/87→09/90	Suspension Strut Repair Kit		DF-RK-8671		
	09/87→09/90	Suspension Strut Repair Kit		MN-RK-8537		
	09/87→09/90	Tie Rod	DF-DL-7836			
	09/87→09/90	Tie Rod End	CV-ES-14163		for Steering Rod	
	09/87→09/90	Track Control Arm		DF-DL-8158	Trailing Arm	
	09/87→09/90	Track Control Arm		DF-DL-9318	Trailing Arm	
	09/87→09/90	Track Control Arm		DF-VB-8561	Wishbone (CV)	
	FTT 95.400	08/90→01/98	Ball Head, gearshift linkage	CV-ES-2119		
08/90→01/98		Ball Head, gearshift linkage	CV-ES-2182			
08/90→01/98		Ball Head, gearshift linkage	DF-ES-9335			
08/90→01/98		Centre Rod	DF-DL-3798		Push Rod	
08/90→01/98		Centre Rod	DF-DL-12420		Push Rod	
08/90→01/98		Stabiliser Mounting		DF-SB-5251		
08/90→01/98		Stabiliser Mounting		DF-SB-9342		

CV-ES-2119

Length: 55
 Cone Ø: d1 Ø 10 / d2 Ø 10
 Thread: M12 x 1,75 LHT
 592106, 1249088

**CV-ES-2182**

Length: 55
 Cone Ø: d1 Ø 10 / d2 Ø 10
 Thread: M12 x 1,75 RHT
 589333, 1249129

**CV-ES-14163**

Length: 125
 Cone Ø: d1 Ø 30 / d2 Ø 27
 Thread: M30 x 1,5 RHT
 0607981, 0698450, 1149907, 1152350,
 1257890, 1603789, 1618048, ACHF060

**CV-RK-5322**

Ø: 72
 Thick/Height: 50
 0691704

**CV-RK-8118**

Ø: 85
 Hole Distance: 130
 Thick/Height: 30
 0689749

**DF-DL-3798**

Length: 1015
 Ø: 50
 Cone Ø: d1 Ø 30 / d2 Ø 27
 0094038, 0525433

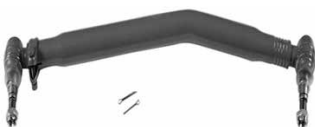
**DF-DL-7836**

Length: 1698
 Ø: 52
 Cone Ø: d1 Ø 26 / d2 Ø 23,5
 0754922, 1286343, 1353396

**DF-DL-8158**

Length: 611
 Ø: 48
 Hole Distance: 130 / 130
 0267743, 1361649, 1361650, 1656428

**DF-DL-9318**

Length: 600
 Ø: 50
 Hole Distance: 130 / 130
 0646373, 0655695, 0655697, 1284860,
 1620438

**DF-DL-12420**

Length: 1004
 Ø: 52
 Cone Ø: d1 Ø 30 / d2 Ø 27
 Thread: M24 x 1,5 / M30 x 1,5
 0094613, 094613, 94613, 0362413, 362413,
 1426101

**DF-ES-9335**

Length: 85
 Cone Ø: d1 Ø 12 / d2 Ø 10,75
 Thread: M14 x 1,5 RHT
 0386930, 386930

**DF-RK-8671****DF-SB-5251**

Ø: 85
 Thick/Height: 60
 0366351, 366351, 10305800A

**DF-SB-9342**

Ø: 94
 Thick/Height: 80 / 70
 0281007, 0298498, 008169892, 8169892,
 041270883, 41270883

**DF-VB-8561**

Length: 609
 Ø: 48
 Hole Distance: 152 / 152
 0080521, 080521, 1361651, 1368270,
 1390932, 1617096, 1793875, 1817808,
 1892492

**IV-RK-8998**

Ø: 85
 Hole Distance: 130
 Thick/Height: 30
 0513757, 0531757, 0691709, 691709

**MN-RK-7280**

Ø: 75
 Hole Distance: 115
 Thick/Height: 24
 0689748, 689748

**MN-RK-8537**

Ø: 95
 Hole Distance: 152
 Thick/Height: 24
 696321, 81432706099

**SC-RK-8575**

Ø: 95
 Hole Distance: 152
 Thick/Height: 35
 0696321





95 ...

FTT 95.400 ...	08/90→01/98	Suspension Arm Repair Kit		CV-RK-5322	for Wishbone (CV)	
	08/90→01/98	Suspension Arm Repair Kit		CV-RK-8118	for Drag Link	
	08/90→01/98	Suspension Arm Repair Kit		IV-RK-8998	for Wishbone (CV)	
	08/90→01/98	Suspension Arm Repair Kit		MN-RK-7280	for Drag Link	
	08/90→01/98	Suspension Arm Repair Kit		SC-RK-8575	for Wishbone (CV)	
	08/90→01/98	Suspension Strut Repair Kit		DF-RK-8671		
	08/90→01/98	Suspension Strut Repair Kit		MN-RK-8537		
	08/90→01/98	Tie Rod	DF-DL-7836			
	08/90→01/98	Tie Rod End	CV-ES-14163		for Steering Rod	
	08/90→01/98	Track Control Arm		DF-DL-8158	Trailing Arm	
	08/90→01/98	Track Control Arm		DF-DL-9318	Trailing Arm	
	08/90→01/98	Track Control Arm		DF-VB-8561	Wishbone (CV)	
	FTT 95.430	02/92→01/98	Ball Head, gearshift linkage	CV-ES-2119		
		02/92→01/98	Ball Head, gearshift linkage	CV-ES-2182		
		02/92→01/98	Ball Head, gearshift linkage	DF-ES-9335		
02/92→01/98		Centre Rod	DF-DL-3798		Push Rod	
02/92→01/98		Centre Rod	DF-DL-12420		Push Rod	
02/92→01/98		Stabiliser Mounting		DF-SB-5251		
02/92→01/98		Stabiliser Mounting		DF-SB-9342		
02/92→01/98		Suspension Arm Repair Kit		CV-RK-5322	for Wishbone (CV)	
02/92→01/98		Suspension Arm Repair Kit		CV-RK-8118	for Drag Link	
02/92→01/98		Suspension Arm Repair Kit		IV-RK-8998	for Wishbone (CV)	
02/92→01/98		Suspension Arm Repair Kit		MN-RK-7280	for Drag Link	
02/92→01/98		Suspension Arm Repair Kit		SC-RK-8575	for Wishbone (CV)	
02/92→01/98		Suspension Strut Repair Kit		DF-RK-8671		
02/92→01/98		Suspension Strut Repair Kit		MN-RK-8537		
02/92→01/98		Tie Rod	DF-DL-7836			
02/92→01/98		Tie Rod End	CV-ES-14163		for Steering Rod	
02/92→01/98		Track Control Arm		DF-DL-8158	Trailing Arm	
02/92→01/98		Track Control Arm		DF-DL-9318	Trailing Arm	
02/92→01/98		Track Control Arm		DF-VB-8561	Wishbone (CV)	

95 XF

FA 95 XF 380	01/97→09/02	Ball Head, gearshift linkage	DF-ES-9335		
	01/97→09/02	Centre Rod	DF-DL-2142		Push Rod
	01/97→09/02	Centre Rod	DF-DL-3798		Push Rod
	01/97→09/02	Centre Rod	DF-DL-12420		Push Rod
	01/97→09/02	Stabiliser Mounting		DF-SB-5251	
	01/97→09/02	Stabiliser Mounting	DF-SB-5253	DF-SB-5253	
	01/97→09/02	Stabiliser Mounting	DF-SB-10402		
	01/97→09/02	Suspension Arm Repair Kit		CV-RK-5322	for Wishbone (CV)
	01/97→09/02	Suspension Arm Repair Kit		CV-RK-8118	for Drag Link
	01/97→09/02	Suspension Arm Repair Kit		IV-RK-8998	for Wishbone (CV)
	01/97→09/02	Suspension Arm Repair Kit		MN-RK-7280	for Drag Link; for Semi-Trailing Arm; for Wishbone (CV)
	01/97→09/02	Suspension Arm Repair Kit		MN-RK-7291	for Drag Link
	01/97→09/02	Suspension Arm Repair Kit		SC-RK-8575	for Wishbone (CV)
	01/97→09/02	Suspension Arm Repair Kit	MN-RK-7280	MN-RK-7280	for Drag Link; for Semi-Trailing Arm; for Wishbone (CV)
	01/97→09/02	Suspension Strut Repair Kit		DF-RK-8637	
	01/97→09/02	Suspension Strut Repair Kit		DF-RK-8671	
	01/97→09/02	Suspension Strut Repair Kit		MN-RK-8537	
	01/97→09/02	Tie Rod	DF-DL-5403		1st FA
	01/97→09/02	Tie Rod	DF-DL-7780		1st FA
	01/97→09/02	Tie Rod	DF-DL-7836		1st FA
	01/97→09/02	Tie Rod	MN-ES-10334		for Push Rod
	01/97→09/02	Tie Rod End	CV-ES-12461		for Steering Rod
	01/97→09/02	Tie Rod End	CV-ES-12462		for Steering Rod
	01/97→09/02	Tie Rod End	CV-ES-14163		for Steering Rod
	01/97→09/02	Tie Rod End	DF-ES-8362		for Steering Rod
	01/97→09/02	Track Control Arm		DF-DL-8158	Trailing Arm
	01/97→09/02	Track Control Arm		DF-VB-8561	Wishbone (CV)
	01/97→09/02	Track Control Arm		DF-VB-9343	Wishbone (CV)

CV-ES-2119

Length: 55
Cone Ø: d1 Ø 10 / d2 Ø 10
Thread: M12 x 1,75 LHT
592106, 1249088



CV-ES-2182

Length: 55
Cone Ø: d1 Ø 10 / d2 Ø 10
Thread: M12 x 1,75 RHT
589333, 1249129



CV-ES-12461

Length: 120
Cone Ø: d1 Ø 26 / d2 Ø 23,5
Thread: M30 x 1,5 LHT
0069513, 69513, 0311300, 311300,
0607998, 607998, 1190653, 1315447,
1319838, 1332123, 1338714, 1401934,
1407394, ACHB063, ACHF241, MAK1295



CV-ES-12462

Length: 120
Cone Ø: d1 Ø 26 / d2 Ø 23,5
Thread: M30 x 1,5 RHT
0069514, 0586753, 0607999, 0694298,
0694360, 0698609, 1137230, 1229944,
1326862, 1326896, 1331925, ACHB064,
ACHF242, MAK1296



CV-ES-14163

Length: 125
Cone Ø: d1 Ø 30 / d2 Ø 27
Thread: M30 x 1,5 RHT
0607981, 0698450, 1149907, 1152350,
1257890, 1603789, 1618048, ACHF060



CV-RK-5322

Ø: 72
Thick/Height: 50
0691704



CV-RK-8118

Ø: 85
Hole Distance: 130
Thick/Height: 30
0689749



DF-DL-2142

Length: 1005 Ø: 52
Cone Ø: d1 Ø 26 / d2 Ø 23,5
1291060, 1351734, 1385499



DF-DL-3798

Length: 1015 Ø: 50
Cone Ø: d1 Ø 30 / d2 Ø 27
0094038, 0525433



DF-DL-5403

Length: 1742 Ø: 40
Cone Ø: d1 Ø 26 / d2 Ø 23,5
0288281, 1270854, 1337644



DF-DL-7780

Length: 1690 Ø: 40
Cone Ø: d1 Ø 26 / d2 Ø 23,5
1270853, 1353391, 10212000A



DF-DL-7836

Length: 1698 Ø: 52
Cone Ø: d1 Ø 26 / d2 Ø 23,5
0754922, 1286343, 1353396



DF-DL-8158

Length: 611 Ø: 48
Hole Distance: 130 / 130
0267743, 1361649, 1361650, 1656428



DF-DL-9318

Length: 600 Ø: 50
Hole Distance: 130 / 130
0646373, 0655695, 0655697, 1284860,
1620438



DF-DL-12420

Length: 1004 Ø: 52
Cone Ø: d1 Ø 30 / d2 Ø 27
Thread: M24 x 1,5 / M30 x 1,5
0094613, 094613, 94613, 0362413, 362413,
1426101



DF-ES-8362

Length: 150
Cone Ø: d1 Ø 26 / d2 Ø 23,5
Thread: M30 x 1,5 RHT
1389190



DF-ES-9335

Length: 85
Cone Ø: d1 Ø 12 / d2 Ø 10,75
Thread: M14 x 1,5 RHT
0386930, 386930



DF-RK-8637

Ø: 72
1376730



DF-RK-8671



DF-SB-5251

Ø: 85
Thick/Height: 60
0366351, 366351, 10305800A



DF-SB-5253

Ø: 86
Thick/Height: 60,5
0371586, 0558864, 10306500A



DF-SB-9342

Ø: 94
Thick/Height: 80 / 70
0281007, 0298498, 8169892, 008169892,
41270883, 041270883



DF-SB-10402

Ø: 62
Thick/Height: 60
1291233, 1732887



DF-VB-8561

Length: 609 Ø: 48
Hole Distance: 152 / 152
0080521, 080521, 1361651, 1368270,
1390932, 1617096, 1793875, 1817808,
1892492



DF-VB-9343

Length: 608,2 Ø: 48
Hole Distance: 152 / 152
1361652, 1620436, 1793876, 10309600A



IV-RK-8998

Ø: 85
Hole Distance: 130
Thick/Height: 30
0513757, 0531757, 0691709, 691709



MN-ES-10334

Length: 140
Cone Ø: d1 Ø 26 / d2 Ø 23,5
Thread: M30 x 1,5 RHT
1320855, 1342026, 3093714, 10220897,
81953016236, 81953016331



MN-RK-7280

Ø: 75
Hole Distance: 115
Thick/Height: 24
0689748, 689748



MN-RK-7291

Ø: 72
Hole Distance: 130
Thick/Height: 30
1271124



MN-RK-8537

Ø: 95
Hole Distance: 152
Thick/Height: 24
696321, 81432706099



SC-RK-8575

Ø: 95
Hole Distance: 152
Thick/Height: 35
0696321





95 XF ...

FA 95 XF 380 ...	06/00→09/02	Centre Rod	DF-DL-5355		Push Rod	
	06/00→09/02	Tie Rod	DF-DL-10193		1st FA	
FA 95 XF 430	01/97→09/02	Ball Head, gearshift linkage	DF-ES-9335			
	01/97→09/02	Centre Rod	DF-DL-2142		Push Rod	
	01/97→09/02	Centre Rod	DF-DL-3798		Push Rod	
	01/97→09/02	Centre Rod	DF-DL-12420		Push Rod	
	01/97→09/02	Stabiliser Mounting		DF-SB-5251		
	01/97→09/02	Stabiliser Mounting	DF-SB-5253	DF-SB-5253		
	01/97→09/02	Stabiliser Mounting	DF-SB-10402			
	01/97→09/02	Suspension Arm Repair Kit		CV-RK-5322	for Wishbone (CV)	
	01/97→09/02	Suspension Arm Repair Kit		CV-RK-8118	for Drag Link	
	01/97→09/02	Suspension Arm Repair Kit		IV-RK-8998	for Wishbone (CV)	
	01/97→09/02	Suspension Arm Repair Kit		MN-RK-7280	for Drag Link;for Semi-Trailing Arm; for Wishbone (CV)	
	01/97→09/02	Suspension Arm Repair Kit		MN-RK-7291	for Drag Link	
	01/97→09/02	Suspension Arm Repair Kit		SC-RK-8575	for Wishbone (CV)	
	01/97→09/02	Suspension Arm Repair Kit	MN-RK-7280	MN-RK-7280	for Drag Link;for Semi-Trailing Arm; for Wishbone (CV)	
	01/97→09/02	Suspension Strut Repair Kit		DF-RK-8637		
	01/97→09/02	Suspension Strut Repair Kit		DF-RK-8671		
	01/97→09/02	Suspension Strut Repair Kit		MN-RK-8537		
	01/97→09/02	Tie Rod	DF-DL-5403		1st FA	
	01/97→09/02	Tie Rod	DF-DL-7780		1st FA	
	01/97→09/02	Tie Rod	DF-DL-7836		1st FA	
	01/97→09/02	Tie Rod	MN-ES-10334		for Push Rod	
	01/97→09/02	Tie Rod End	CV-ES-12461		for Steering Rod	
	01/97→09/02	Tie Rod End	CV-ES-12462		for Steering Rod	
	01/97→09/02	Tie Rod End	CV-ES-14163		for Steering Rod	
	01/97→09/02	Tie Rod End	DF-ES-8362		for Steering Rod	
	01/97→09/02	Track Control Arm		DF-DL-8158	Trailing Arm	
	01/97→09/02	Track Control Arm		DF-VB-8561	Wishbone (CV)	
	01/97→09/02	Track Control Arm		DF-VB-9343	Wishbone (CV)	
	06/00→09/02	Centre Rod	DF-DL-5355		Push Rod	
	FA 95 XF 480	01/97→09/02	Ball Head, gearshift linkage	DF-ES-9335		
		01/97→09/02	Centre Rod	DF-DL-2142		Push Rod
		01/97→09/02	Centre Rod	DF-DL-3798		Push Rod
01/97→09/02		Centre Rod	DF-DL-12420		Push Rod	
01/97→09/02		Stabiliser Mounting		DF-SB-5251		
01/97→09/02		Stabiliser Mounting	DF-SB-5253	DF-SB-5253		
01/97→09/02		Stabiliser Mounting	DF-SB-10402			
01/97→09/02		Suspension Arm Repair Kit		CV-RK-5322	for Wishbone (CV)	
01/97→09/02		Suspension Arm Repair Kit		CV-RK-8118	for Drag Link	
01/97→09/02		Suspension Arm Repair Kit		IV-RK-8998	for Wishbone (CV)	
01/97→09/02		Suspension Arm Repair Kit		MN-RK-7280	for Drag Link;for Semi-Trailing Arm; for Wishbone (CV)	
01/97→09/02		Suspension Arm Repair Kit		MN-RK-7291	for Drag Link	
01/97→09/02		Suspension Arm Repair Kit		SC-RK-8575	for Wishbone (CV)	
01/97→09/02		Suspension Arm Repair Kit	MN-RK-7280	MN-RK-7280	for Drag Link;for Semi-Trailing Arm; for Wishbone (CV)	
01/97→09/02		Suspension Strut Repair Kit		DF-RK-8637		
01/97→09/02		Suspension Strut Repair Kit		DF-RK-8671		
01/97→09/02		Suspension Strut Repair Kit		MN-RK-8537		
01/97→09/02		Tie Rod	DF-DL-5403		1st FA	
01/97→09/02		Tie Rod	DF-DL-7780		1st FA	
01/97→09/02		Tie Rod	DF-DL-7836		1st FA	
01/97→09/02		Tie Rod	MN-ES-10334		for Push Rod	
01/97→09/02		Tie Rod End	CV-ES-12461		for Steering Rod	
01/97→09/02		Tie Rod End	CV-ES-12462		for Steering Rod	
01/97→09/02		Tie Rod End	CV-ES-14163		for Steering Rod	
01/97→09/02		Tie Rod End	DF-ES-8362		for Steering Rod	
01/97→09/02		Track Control Arm		DF-DL-8158	Trailing Arm	
01/97→09/02		Track Control Arm		DF-VB-8561	Wishbone (CV)	
01/97→09/02		Track Control Arm		DF-VB-9343	Wishbone (CV)	

CV-ES-12461

Length: 120
Cone Ø: d1 Ø 26 / d2 Ø 23,5
Thread: M30 x 1,5 LHT
0069513, 69513, 0311300, 311300, 607998, 0607998, 1190653, 1315447, 1319838, 1332123, 1338714, 1401934, 1407394, ACHB063, ACHF241, MAK1295



CV-ES-12462

Length: 120
Cone Ø: d1 Ø 26 / d2 Ø 23,5
Thread: M30 x 1,5 RHT
0069514, 0586753, 0607999, 0694298, 0694360, 0698609, 1137230, 1229944, 1326862, 1326896, 1331925, ACHB064, ACHF242, MAK1296



CV-ES-14163

Length: 125
Cone Ø: d1 Ø 30 / d2 Ø 27
Thread: M30 x 1,5 RHT
0607981, 0698450, 1149907, 1152350, 1257890, 1603789, 1618048, ACHF060



CV-RK-5322

Ø: 72
Thick/Height: 50
0691704



CV-RK-8118

Ø: 85
Hole Distance: 130
Thick/Height: 30
0689749



DF-DL-2142

Length: 1005 Ø: 52
Cone Ø: d1 Ø 26 / d2 Ø 23,5
1291060, 1351734, 1385499



DF-DL-3798

Length: 1015 Ø: 50
Cone Ø: d1 Ø 30 / d2 Ø 27
0094038, 0525433



DF-DL-5355

Length: 995 Ø: 36
Cone Ø: d1 Ø 26 / d2 Ø 23,5
1311048, 1351737, 1385498



DF-DL-5403

Length: 1742 Ø: 40
Cone Ø: d1 Ø 26 / d2 Ø 23,5
0288281, 1270854, 1337644



DF-DL-7780

Length: 1690 Ø: 40
Cone Ø: d1 Ø 26 / d2 Ø 23,5
1270853, 1353391, 10212000A



DF-DL-7836

Length: 1698 Ø: 52
Cone Ø: d1 Ø 26 / d2 Ø 23,5
0754922, 1286343, 1353396



DF-DL-8158

Length: 611 Ø: 48
Hole Distance: 130 / 130
0267743, 1361649, 1361650, 1656428



DF-DL-10193

Length: 1646 Ø: 40
Cone Ø: d1 Ø 26 / d2 Ø 23,5
1351205, 1353395



DF-DL-12420

Length: 1004 Ø: 52
Cone Ø: d1 Ø 30 / d2 Ø 27
Thread: M24 x 1,5 / M30 x 1,5
094613, 94613, 0094613, 0362413, 362413, 1426101



DF-ES-8362

Length: 150
Cone Ø: d1 Ø 26 / d2 Ø 23,5
Thread: M30 x 1,5 RHT
1389190



DF-ES-9335

Length: 85
Cone Ø: d1 Ø 12 / d2 Ø 10,75
Thread: M14 x 1,5 RHT
0386930, 386930



DF-RK-8637

Ø: 72
1376730



DF-RK-8671



DF-SB-5251

Ø: 85
Thick/Height: 60
0366351, 366351, 10305800A



DF-SB-5253

Ø: 86
Thick/Height: 60,5
0371586, 0558864, 10306500A



DF-SB-10402

Ø: 62
Thick/Height: 60
1291233, 1732887



DF-VB-8561

Length: 609
Ø: 48
Hole Distance: 152 / 152
0080521, 080521, 1361651, 1368270, 1390932, 1617096, 1793875, 1817808, 1892492



DF-VB-9343

Length: 608,2
Ø: 48
Hole Distance: 152 / 152
1361652, 1620436, 1793876, 10309600A



IV-RK-8998

Ø: 85
Hole Distance: 130
Thick/Height: 30
0513757, 0531757, 0691709, 691709



MN-ES-10334

Length: 140
Cone Ø: d1 Ø 26 / d2 Ø 23,5
Thread: M30 x 1,5 RHT
1320855, 1342026, 3093714, 10220897, 81953016236, 81953016331



MN-RK-7280

Ø: 75
Hole Distance: 115
Thick/Height: 24
0689748, 689748



MN-RK-7291

Ø: 72
Hole Distance: 130
Thick/Height: 30
1271124



MN-RK-8537

Ø: 95
Hole Distance: 152
Thick/Height: 24
696321, 81432706099



SC-RK-8575

Ø: 95
Hole Distance: 152
Thick/Height: 35
0696321





95 XF ...

FA 95 XF 480 ...	06/00→09/02	Centre Rod	DF-DL-5355		Push Rod	
	06/00→09/02	Tie Rod	DF-DL-10193		1st FA	
FA 95 XF 530	01/97→09/02	Ball Head, gearshift linkage	DF-ES-9335			
	01/97→09/02	Centre Rod	DF-DL-2142		Push Rod	
	01/97→09/02	Centre Rod	DF-DL-3798		Push Rod	
	01/97→09/02	Centre Rod	DF-DL-12420		Push Rod	
	01/97→09/02	Stabiliser Mounting		DF-SB-5251		
	01/97→09/02	Stabiliser Mounting	DF-SB-5253	DF-SB-5253		
	01/97→09/02	Stabiliser Mounting	DF-SB-10402			
	01/97→09/02	Suspension Arm Repair Kit		CV-RK-5322	for Wishbone (CV)	
	01/97→09/02	Suspension Arm Repair Kit		CV-RK-8118	for Drag Link	
	01/97→09/02	Suspension Arm Repair Kit		IV-RK-8998	for Wishbone (CV)	
	01/97→09/02	Suspension Arm Repair Kit		MN-RK-7280	for Drag Link;for Semi-Trailing Arm; for Wishbone (CV)	
	01/97→09/02	Suspension Arm Repair Kit		MN-RK-7291	for Drag Link	
	01/97→09/02	Suspension Arm Repair Kit		SC-RK-8575	for Wishbone (CV)	
	01/97→09/02	Suspension Arm Repair Kit	MN-RK-7280	MN-RK-7280	for Drag Link;for Semi-Trailing Arm; for Wishbone (CV)	
	01/97→09/02	Suspension Strut Repair Kit		DF-RK-8637		
	01/97→09/02	Suspension Strut Repair Kit		DF-RK-8671		
	01/97→09/02	Suspension Strut Repair Kit		MN-RK-8537		
	01/97→09/02	Tie Rod	DF-DL-5403		1st FA	
	01/97→09/02	Tie Rod	DF-DL-7780		1st FA	
	01/97→09/02	Tie Rod	DF-DL-7836			
	01/97→09/02	Tie Rod	MN-ES-10334		for Push Rod	
	01/97→09/02	Tie Rod End	CV-ES-12461		for Steering Rod	
	01/97→09/02	Tie Rod End	CV-ES-12462		for Steering Rod	
	01/97→09/02	Tie Rod End	CV-ES-14163		for Steering Rod	
	01/97→09/02	Tie Rod End	DF-ES-8362		for Steering Rod	
	01/97→09/02	Track Control Arm		DF-DL-8158	Trailing Arm	
	01/97→09/02	Track Control Arm		DF-VB-8561	Wishbone (CV)	
	01/97→09/02	Track Control Arm		DF-VB-9343	Wishbone (CV)	
	06/00→09/02	Tie Rod	DF-DL-7836		1st FA	
	FAC 95 XF 380	01/97→09/02	Ball Head, gearshift linkage	DF-ES-9335		
		01/97→09/02	Centre Rod	DF-DL-2142		Push Rod
01/97→09/02		Centre Rod	DF-DL-3798		Push Rod	
01/97→09/02		Centre Rod	DF-DL-5355		Push Rod	
01/97→09/02		Centre Rod	DF-DL-9312		Push Rod	
01/97→09/02		Centre Rod	DF-DL-12420		Push Rod	
01/97→09/02		Stabiliser Mounting		DF-SB-5251		
01/97→09/02		Stabiliser Mounting	DF-SB-5253	DF-SB-5253		
01/97→09/02		Stabiliser Mounting	DF-SB-10402			
01/97→09/02		Suspension Arm Repair Kit		CV-RK-5322	for Wishbone (CV)	
01/97→09/02		Suspension Arm Repair Kit		CV-RK-8118	for Drag Link	
01/97→09/02		Suspension Arm Repair Kit		IV-RK-8998	for Wishbone (CV)	
01/97→09/02		Suspension Arm Repair Kit		MN-RK-7280	for Drag Link;for Semi-Trailing Arm; for Wishbone (CV)	
01/97→09/02		Suspension Arm Repair Kit		MN-RK-7291	for Drag Link	
01/97→09/02		Suspension Arm Repair Kit		SC-RK-8575	for Wishbone (CV)	
01/97→09/02		Suspension Arm Repair Kit	MN-RK-7280	MN-RK-7280	for Drag Link;for Semi-Trailing Arm; for Wishbone (CV)	
01/97→09/02		Suspension Strut Repair Kit		DF-RK-8637		
01/97→09/02		Suspension Strut Repair Kit		DF-RK-8671		
01/97→09/02		Suspension Strut Repair Kit		MN-RK-8537		
01/97→09/02		Tie Rod	DF-DL-5403		1st FA	
01/97→09/02		Tie Rod	DF-DL-7780			
01/97→09/02		Tie Rod	DF-DL-7836			
01/97→09/02		Tie Rod End	CV-ES-5336		for Steering Rod	
01/97→09/02		Tie Rod End	CV-ES-12461		for Steering Rod	
01/97→09/02		Tie Rod End	CV-ES-12462		for Steering Rod	
01/97→09/02		Tie Rod End	CV-ES-14163		for Steering Rod	
01/97→09/02		Tie Rod End	DF-ES-8362		for Steering Rod	
01/97→09/02		Tie Rod End	DF-ES-9332		for Steering Rod	

CV-ES-5336

Length: 140
Cone Ø: d1 Ø 26 / d2 Ø 23,5
Thread: M30 x 1,5 LHT
1310760, 1603418



CV-ES-12461

Length: 120
Cone Ø: d1 Ø 26 / d2 Ø 23,5
Thread: M30 x 1,5 LHT
69513, 0069513, 311300, 0311300,
0607998, 607998, 1190653, 1315447,
1319838, 1332123, 1338714, 1401934,
1407394, ACHB063, ACHF241, MAK1295



CV-ES-12462

Length: 120
Cone Ø: d1 Ø 26 / d2 Ø 23,5
Thread: M30 x 1,5 RHT
0069514, 0586753, 0607999, 0694298,
0694360, 0698609, 1137230, 1229944,
1326862, 1326896, 1331925, ACHB064,
ACHF242, MAK1296



CV-ES-14163

Length: 125
Cone Ø: d1 Ø 30 / d2 Ø 27
Thread: M30 x 1,5 RHT
0607981, 0698450, 1149907, 1152350,
1257890, 1603789, 1618048, ACHF060



CV-RK-5322

Ø: 72
Thick/Height: 50
0691704



CV-RK-8118

Ø: 85
Hole Distance: 130
Thick/Height: 30
0689749



DF-DL-2142

Length: 1005 Ø: 52
Cone Ø: d1 Ø 26 / d2 Ø 23,5
1291060, 1351734, 1385499



DF-DL-3798

Length: 1015 Ø: 50
Cone Ø: d1 Ø 30 / d2 Ø 27
0094038, 0525433



DF-DL-5355

Length: 995 Ø: 36
Cone Ø: d1 Ø 26 / d2 Ø 23,5
1311048, 1351737, 1385498



DF-DL-5403

Length: 1742 Ø: 40
Cone Ø: d1 Ø 26 / d2 Ø 23,5
0288281, 1270854, 1337644



DF-DL-7780

Length: 1690 Ø: 40
Cone Ø: d1 Ø 26 / d2 Ø 23,5
1270853, 1353391, 10212000A



DF-DL-7836

Length: 1698 Ø: 52
Cone Ø: d1 Ø 26 / d2 Ø 23,5
0754922, 1286343, 1353396



DF-DL-8158

Length: 611 Ø: 48
Hole Distance: 130 / 130
0267743, 1361649, 1361650, 1656428



DF-DL-9312

Length: 820 Ø: 36
Cone Ø: d1 Ø 26 / d2 Ø 23,5
1321170, 1351743, 1385494



DF-DL-10193

Length: 1646 Ø: 40
Cone Ø: d1 Ø 26 / d2 Ø 23,5
1351205, 1353395



DF-DL-12420

Length: 1004 Ø: 52
Cone Ø: d1 Ø 30 / d2 Ø 27
Thread: M24 x 1,5 / M30 x 1,5
0094613, 094613, 94613, 0362413, 362413,
1426101



DF-ES-8362

Length: 150
Cone Ø: d1 Ø 26 / d2 Ø 23,5
Thread: M30 x 1,5 RHT
1389190



DF-ES-9332

Length: 120
Cone Ø: d1 Ø 26 / d2 Ø 23,5
Thread: M30 x 1,5 LHT
1603419



DF-ES-9335

Length: 85
Cone Ø: d1 Ø 12 / d2 Ø 10,75
Thread: M14 x 1,5 RHT
0386930, 386930



DF-RK-8637

Ø: 72
1376730



DF-RK-8671



DF-SB-5251

Ø: 85
Thick/Height: 60
0366351, 366351, 10305800A



DF-SB-5253

Ø: 86
Thick/Height: 60,5
0371586, 0558864, 10306500A



DF-SB-10402

Ø: 62
Thick/Height: 60
1291233, 1732887



DF-VB-8561

Length: 609 Ø: 48
Hole Distance: 152 / 152
080521, 0080521, 1361651, 1368270,
1390932, 1617096, 1793875, 1817808,
1892492



DF-VB-9343

Length: 608,2 Ø: 48
Hole Distance: 152 / 152
1361652, 1620436, 1793876, 10309600A



IV-RK-8998

Ø: 85
Hole Distance: 130
Thick/Height: 30
0513757, 0531757, 691709, 0691709



MN-ES-10334

Length: 140
Cone Ø: d1 Ø 26 / d2 Ø 23,5
Thread: M30 x 1,5 RHT
1320855, 1342026, 3093714, 10220897,
81953016236, 81953016331



MN-RK-7280

Ø: 75
Hole Distance: 115
Thick/Height: 24
0689748, 689748



MN-RK-7291

Ø: 72
Hole Distance: 130
Thick/Height: 30
1271124



MN-RK-8537

Ø: 95
Hole Distance: 152
Thick/Height: 24
696321, 81432706099



SC-RK-8575

Ø: 95
Hole Distance: 152
Thick/Height: 35
0696321





95 XF ...

FAC 95 XF 380 ...	01/97→09/02	Track Control Arm		DF-DL-8158	Trailing Arm
	01/97→09/02	Track Control Arm		DF-TC-12492	Trailing Arm, Leading Axle Steered, for Pneumatic Suspension vehicles
	01/97→09/02	Track Control Arm		DF-VB-8561	Wishbone (CV)
	01/97→09/02	Track Control Arm		DF-VB-9343	Wishbone (CV)
	06/00→09/02	Tie Rod	DF-DL-10193		2nd FA
FAC 95 XF 430	01/97→09/02	Ball Head, gearshift linkage	DF-ES-9335		
	01/97→09/02	Centre Rod	DF-DL-2142		Push Rod
	01/97→09/02	Centre Rod	DF-DL-3798		Push Rod
	01/97→09/02	Centre Rod	DF-DL-5355		Push Rod
	01/97→09/02	Centre Rod	DF-DL-9312		Push Rod
	01/97→09/02	Centre Rod	DF-DL-12420		Push Rod
	01/97→09/02	Stabiliser Mounting		DF-SB-5251	
	01/97→09/02	Stabiliser Mounting	DF-SB-5253	DF-SB-5253	
	01/97→09/02	Stabiliser Mounting	DF-SB-10402		
	01/97→09/02	Suspension Arm Repair Kit		CV-RK-5322	for Wishbone (CV)
	01/97→09/02	Suspension Arm Repair Kit		CV-RK-8118	for Drag Link
	01/97→09/02	Suspension Arm Repair Kit		IV-RK-8998	for Wishbone (CV)
	01/97→09/02	Suspension Arm Repair Kit		MN-RK-7280	for Drag Link;for Semi-Trailing Arm; for Wishbone (CV)
	01/97→09/02	Suspension Arm Repair Kit		MN-RK-7291	for Drag Link
	01/97→09/02	Suspension Arm Repair Kit		SC-RK-8575	for Wishbone (CV)
	01/97→09/02	Suspension Arm Repair Kit	MN-RK-7280	MN-RK-7280	for Drag Link;for Semi-Trailing Arm; for Wishbone (CV)
	01/97→09/02	Suspension Strut Repair Kit		DF-RK-8637	
	01/97→09/02	Suspension Strut Repair Kit		DF-RK-8671	
	01/97→09/02	Suspension Strut Repair Kit		MN-RK-8537	
	01/97→09/02	Tie Rod	DF-DL-5403		1st FA;2nd FA
	01/97→09/02	Tie Rod	DF-DL-7836		
	01/97→09/02	Tie Rod	DF-DL-10193		1st FA;2nd FA
	01/97→09/02	Tie Rod End	CV-ES-5336		for Steering Rod
	01/97→09/02	Tie Rod End	CV-ES-12461		for Steering Rod
	01/97→09/02	Tie Rod End	CV-ES-12462		for Steering Rod
	01/97→09/02	Tie Rod End	CV-ES-14163		for Steering Rod
	01/97→09/02	Tie Rod End	DF-ES-8362		for Steering Rod
	01/97→09/02	Tie Rod End	DF-ES-9332		for Steering Rod
	01/97→09/02	Track Control Arm		DF-DL-8158	Trailing Arm
	01/97→09/02	Track Control Arm		DF-TC-12492	Trailing Arm, Leading Axle Steered, for Pneumatic Suspension vehicles
	01/97→09/02	Track Control Arm		DF-VB-8561	Wishbone (CV)
	01/97→09/02	Track Control Arm		DF-VB-9343	Wishbone (CV)
	06/00→09/02	Tie Rod	DF-DL-7780		1st FA;2nd FA
FAC 95 XF 480	01/97→09/02	Ball Head, gearshift linkage	DF-ES-9335		
	01/97→09/02	Centre Rod	DF-DL-2142		Push Rod
	01/97→09/02	Centre Rod	DF-DL-3798		Push Rod
	01/97→09/02	Centre Rod	DF-DL-5355		Push Rod
	01/97→09/02	Centre Rod	DF-DL-9312		Push Rod
	01/97→09/02	Centre Rod	DF-DL-12420		Push Rod
	01/97→09/02	Stabiliser Mounting		DF-SB-5251	
	01/97→09/02	Stabiliser Mounting	DF-SB-5253	DF-SB-5253	
	01/97→09/02	Stabiliser Mounting	DF-SB-10402		
	01/97→09/02	Suspension Arm Repair Kit		CV-RK-5322	for Wishbone (CV)
	01/97→09/02	Suspension Arm Repair Kit		CV-RK-8118	for Drag Link
	01/97→09/02	Suspension Arm Repair Kit		IV-RK-8998	for Wishbone (CV)
	01/97→09/02	Suspension Arm Repair Kit		MN-RK-7280	for Drag Link;for Semi-Trailing Arm; for Wishbone (CV)
	01/97→09/02	Suspension Arm Repair Kit		MN-RK-7291	for Drag Link
	01/97→09/02	Suspension Arm Repair Kit		SC-RK-8575	for Wishbone (CV)
01/97→09/02	Suspension Arm Repair Kit	MN-RK-7280	MN-RK-7280	for Drag Link;for Semi-Trailing Arm; for Wishbone (CV)	
01/97→09/02	Suspension Strut Repair Kit		DF-RK-8637		
01/97→09/02	Suspension Strut Repair Kit		DF-RK-8671		
01/97→09/02	Suspension Strut Repair Kit		MN-RK-8537		

CV-ES-5336

Length: 140
Cone Ø: d1 Ø 26 / d2 Ø 23,5
Thread: M30 x 1,5 LHT
1310760, 1603418



CV-ES-12461

Length: 120
Cone Ø: d1 Ø 26 / d2 Ø 23,5
Thread: M30 x 1,5 LHT
0069513, 69513, 0311300, 311300,
0607998, 607998, 1190653, 1315447,
1319838, 1332123, 1338714, 1401934,
1407394, ACHB063, ACHF241, MAK1295



CV-ES-12462

Length: 120
Cone Ø: d1 Ø 26 / d2 Ø 23,5
Thread: M30 x 1,5 RHT
0069514, 0586753, 0607999, 0694298,
0694360, 0698609, 1137230, 1229944,
1326862, 1326896, 1331925, ACHB064,
ACHF242, MAK1296



CV-ES-14163

Length: 125
Cone Ø: d1 Ø 30 / d2 Ø 27
Thread: M30 x 1,5 RHT
0607981, 0698450, 1149907, 1152350,
1257890, 1603789, 1618048, ACHF060



CV-RK-5322

Ø: 72
Thick/Height: 50
0691704



CV-RK-8118

Ø: 85
Hole Distance: 130
Thick/Height: 30
0689749



DF-DL-2142

Length: 1005 Ø: 52
Cone Ø: d1 Ø 26 / d2 Ø 23,5
1291060, 1351734, 1385499



DF-DL-3798

Length: 1015 Ø: 50
Cone Ø: d1 Ø 30 / d2 Ø 27
0094038, 0525433



DF-DL-5355

Length: 995 Ø: 36
Cone Ø: d1 Ø 26 / d2 Ø 23,5
1311048, 1351737, 1385498



DF-DL-5403

Length: 1742 Ø: 40
Cone Ø: d1 Ø 26 / d2 Ø 23,5
0288281, 1270854, 1337644



DF-DL-7780

Length: 1690 Ø: 40
Cone Ø: d1 Ø 26 / d2 Ø 23,5
1270853, 1353391, 10212000A



DF-DL-7836

Length: 1698 Ø: 52
Cone Ø: d1 Ø 26 / d2 Ø 23,5
0754922, 1286343, 1353396



DF-DL-8158

Length: 611 Ø: 48
Hole Distance: 130 / 130
0267743, 1361649, 1361650, 1656428



DF-DL-9312

Length: 820 Ø: 36
Cone Ø: d1 Ø 26 / d2 Ø 23,5
1321170, 1351743, 1385494



DF-DL-10193

Length: 1646 Ø: 40
Cone Ø: d1 Ø 26 / d2 Ø 23,5
1351205, 1353395



DF-DL-12420

Length: 1004 Ø: 52
Cone Ø: d1 Ø 30 / d2 Ø 27
Thread: M24 x 1,5 / M30 x 1,5
94613, 0094613, 094613, 0362413, 362413,
1426101



DF-ES-8362

Length: 150
Cone Ø: d1 Ø 26 / d2 Ø 23,5
Thread: M30 x 1,5 RHT
1389190



DF-ES-9332

Length: 120
Cone Ø: d1 Ø 26 / d2 Ø 23,5
Thread: M30 x 1,5 LHT
1603419



DF-ES-9335

Length: 85
Cone Ø: d1 Ø 12 / d2 Ø 10,75
Thread: M14 x 1,5 RHT
0386930, 386930



DF-RK-8637

Ø: 72
1376730



DF-RK-8671



DF-SB-5251

Ø: 85
Thick/Height: 60
0366351, 366351, 10305800A



DF-SB-5253

Ø: 86
Thick/Height: 60,5
0371586, 0558864, 10306500A



DF-SB-10402

Ø: 62
Thick/Height: 60
1291233, 1732887



DF-TC-12492

Length: 600 Ø: 40
Hole Distance: 115 / 115
1274741

No Image

DF-VB-8561

Length: 609 Ø: 48
Hole Distance: 152 / 152
0080521, 080521, 1361651, 1368270,
1390932, 1617096, 1793875, 1817808,
1892492



DF-VB-9343

Length: 608,2 Ø: 48
Hole Distance: 152 / 152
1361652, 1620436, 1793876, 10309600A



IV-RK-8998

Ø: 85
Hole Distance: 130
Thick/Height: 30
0513757, 0531757, 0691709, 691709



MN-RK-7280

Ø: 75
Hole Distance: 115
Thick/Height: 24
0689748, 689748



MN-RK-7291

Ø: 72
Hole Distance: 130
Thick/Height: 30
1271124



MN-RK-8537

Ø: 95
Hole Distance: 152
Thick/Height: 24
696321, 81432706099



SC-RK-8575

Ø: 95
Hole Distance: 152
Thick/Height: 35
0696321





95 XF ...

FAC 95 XF 480 ...	01/97→09/02	Tie Rod	DF-DL-7836			
	01/97→09/02	Tie Rod End	CV-ES-5336		for Steering Rod	
	01/97→09/02	Tie Rod End	CV-ES-12461		for Steering Rod	
	01/97→09/02	Tie Rod End	CV-ES-12462		for Steering Rod	
	01/97→09/02	Tie Rod End	CV-ES-14163		for Steering Rod	
	01/97→09/02	Tie Rod End	DF-ES-8362		for Steering Rod	
	01/97→09/02	Tie Rod End	DF-ES-9332		for Steering Rod	
	01/97→09/02	Track Control Arm		DF-DL-8158	Trailing Arm	
	01/97→09/02	Track Control Arm		DF-TC-12492	Trailing Arm, Leading Axle Steered, for Pneumatic Suspension vehicles	
	01/97→09/02	Track Control Arm		DF-VB-8561	Wishbone (CV)	
	01/97→09/02	Track Control Arm		DF-VB-9343	Wishbone (CV)	
	06/00→09/02	Tie Rod	DF-DL-5403		1st FA;2nd FA	
	06/00→09/02	Tie Rod	DF-DL-7780		1st FA;2nd FA	
	FAC 95 XF 530	01/97→09/02	Suspension Arm Repair Kit	MN-RK-7280	MN-RK-7280	for Drag Link;for Semi-Trailing Arm; for Wishbone (CV)
01/97→09/02		Suspension Strut Repair Kit		DF-RK-8637		
01/97→09/02		Tie Rod End		DF-ES-8362	for Steering Rod	
01/97→09/02		Tie Rod End	CV-ES-5336		for Steering Rod	
01/97→09/02		Tie Rod End	CV-ES-12461		for Steering Rod	
01/97→09/02		Tie Rod End	CV-ES-12462		for Steering Rod	
01/97→09/02		Tie Rod End	CV-ES-14163		for Steering Rod	
01/97→09/02		Tie Rod End	DF-ES-9332		for Steering Rod	
01/97→09/02		Track Control Arm		DF-DL-8158	Trailing Arm	
01/97→09/02		Track Control Arm		DF-TC-12492	Trailing Arm, Leading Axle Steered, for Pneumatic Suspension vehicles	
06/00→09/02		Centre Rod	DF-DL-5355		Push Rod	
06/00→09/02		Centre Rod	DF-DL-9312		Push Rod	
06/00→09/02		Tie Rod	DF-DL-7780		1st FA;2nd FA	
06/00→09/02		Tie Rod	DF-DL-10193		2nd FA	
06/00→09/02		Track Control Arm		DF-VB-8561	Wishbone (CV)	
FAD 95 XF 380		01/97→09/02	Ball Head, gearshift linkage	DF-ES-9335		
		01/97→09/02	Centre Rod	DF-DL-2142		Push Rod
		01/97→09/02	Centre Rod	DF-DL-3798		Push Rod
	01/97→09/02	Centre Rod	DF-DL-5355		Push Rod	
	01/97→09/02	Centre Rod	DF-DL-9312		Push Rod	
	01/97→09/02	Centre Rod	DF-DL-12420		Push Rod	
	01/97→09/02	Stabiliser Mounting		DF-SB-5251		
	01/97→09/02	Stabiliser Mounting	DF-SB-5253	DF-SB-5253		
	01/97→09/02	Stabiliser Mounting	DF-SB-10402			
	01/97→09/02	Suspension Arm Repair Kit		CV-RK-5322	for Wishbone (CV)	
	01/97→09/02	Suspension Arm Repair Kit		CV-RK-8118	for Drag Link	
	01/97→09/02	Suspension Arm Repair Kit		IV-RK-8998	for Wishbone (CV)	
	01/97→09/02	Suspension Arm Repair Kit		MN-RK-7280	for Drag Link;for Semi-Trailing Arm; for Wishbone (CV)	
	01/97→09/02	Suspension Arm Repair Kit		MN-RK-7291	for Drag Link	
	01/97→09/02	Suspension Arm Repair Kit		SC-RK-8575	for Wishbone (CV)	
	01/97→09/02	Suspension Arm Repair Kit	MN-RK-7280	MN-RK-7280	for Drag Link;for Semi-Trailing Arm; for Wishbone (CV)	
	01/97→09/02	Suspension Strut Repair Kit		DF-RK-8637		
	01/97→09/02	Suspension Strut Repair Kit		DF-RK-8671		
	01/97→09/02	Suspension Strut Repair Kit		MN-RK-8537		
	01/97→09/02	Tie Rod	DF-DL-5403			
	01/97→09/02	Tie Rod	DF-DL-7836			
	01/97→09/02	Tie Rod End	CV-ES-5336		for Steering Rod	
	01/97→09/02	Tie Rod End	CV-ES-12461		for Steering Rod	
	01/97→09/02	Tie Rod End	CV-ES-12462		for Steering Rod	
	01/97→09/02	Tie Rod End	CV-ES-14163		for Steering Rod	
	01/97→09/02	Tie Rod End	DF-ES-9332		for Steering Rod	
	01/97→09/02	Track Control Arm		DF-DL-8158	Trailing Arm	
	01/97→09/02	Track Control Arm		DF-TC-12262	Control Arm	
	01/97→09/02	Track Control Arm		DF-VB-8561	Wishbone (CV)	
	01/97→09/02	Track Control Arm		DF-VB-9343	Wishbone (CV)	

CV-ES-5336

Length: 140
Cone Ø: d1 Ø 26 / d2 Ø 23,5
Thread: M30 x 1,5 LHT
1310760, 1603418



CV-ES-12461

Length: 120
Cone Ø: d1 Ø 26 / d2 Ø 23,5
Thread: M30 x 1,5 LHT
0069513, 69513, 0311300, 311300,
0607998, 607998, 1190653, 1315447,
1319838, 1332123, 1338714, 1401934,
1407394, ACHB063, ACHF241, MAK1295



CV-ES-12462

Length: 120
Cone Ø: d1 Ø 26 / d2 Ø 23,5
Thread: M30 x 1,5 RHT
0069514, 0586753, 0607999, 0694298,
0694360, 0698609, 1137230, 1229944,
1326862, 1326896, 1331925, ACHB064,
ACHF242, MAK1296



CV-ES-14163

Length: 125
Cone Ø: d1 Ø 30 / d2 Ø 27
Thread: M30 x 1,5 RHT
0607981, 0698450, 1149907, 1152350,
1257890, 1603789, 1618048, ACHF060



CV-RK-5322

Ø: 72
Thick/Height: 50
0691704



CV-RK-8118

Ø: 85
Hole Distance: 130
Thick/Height: 30
0689749



DF-DL-2142

Length: 1005 Ø: 52
Cone Ø: d1 Ø 26 / d2 Ø 23,5
1291060, 1351734, 1385499



DF-DL-3798

Length: 1015 Ø: 50
Cone Ø: d1 Ø 30 / d2 Ø 27
0094038, 0525433



DF-DL-5355

Length: 995 Ø: 36
Cone Ø: d1 Ø 26 / d2 Ø 23,5
1311048, 1351737, 1385498



DF-DL-5403

Length: 1742 Ø: 40
Cone Ø: d1 Ø 26 / d2 Ø 23,5
0288281, 1270854, 1337644



DF-DL-7780

Length: 1690 Ø: 40
Cone Ø: d1 Ø 26 / d2 Ø 23,5
1270853, 1353391, 10212000A



DF-DL-7836

Length: 1698 Ø: 52
Cone Ø: d1 Ø 26 / d2 Ø 23,5
0754922, 1286343, 1353396



DF-DL-8158

Length: 611 Ø: 48
Hole Distance: 130 / 130
0267743, 1361649, 1361650, 1656428



DF-DL-9312

Length: 820 Ø: 36
Cone Ø: d1 Ø 26 / d2 Ø 23,5
1321170, 1351743, 1385494



DF-DL-10193

Length: 1646 Ø: 40
Cone Ø: d1 Ø 26 / d2 Ø 23,5
1351205, 1353395



DF-DL-12420

Length: 1004 Ø: 52
Cone Ø: d1 Ø 30 / d2 Ø 27
Thread: M24 x 1,5 / M30 x 1,5
94613, 0094613, 094613, 362413, 0362413,
1426101



DF-ES-8362

Length: 150
Cone Ø: d1 Ø 26 / d2 Ø 23,5
Thread: M30 x 1,5 RHT
1389190



DF-ES-9332

Length: 120
Cone Ø: d1 Ø 26 / d2 Ø 23,5
Thread: M30 x 1,5 LHT
1603419



DF-ES-9335

Length: 85
Cone Ø: d1 Ø 12 / d2 Ø 10,75
Thread: M14 x 1,5 RHT
0386930, 386930



DF-RK-8637

Ø: 72
1376730



DF-RK-8671



DF-SB-5251

Ø: 85
Thick/Height: 60
0366351, 366351, 10305800A



DF-SB-5253

Ø: 86
Thick/Height: 60,5
0371586, 0558864, 10306500A



DF-SB-10402

Ø: 62
Thick/Height: 60
1291233, 1732887



DF-TC-12262

Length: 595 Ø: 50
Hole Distance: 130 / 130
0661406, 661406, 0661407, 661407,
1620439



DF-TC-12492

Length: 600 Ø: 40
Hole Distance: 115 / 115
1274741

No Image

DF-VB-8561

Length: 609 Ø: 48
Hole Distance: 152 / 152
080521, 0080521, 1361651, 1368270,
1390932, 1617096, 1793875, 1817808,
1892492



DF-VB-9343

Length: 608,2 Ø: 48
Hole Distance: 152 / 152
1361652, 1620436, 1793876, 10309600A



IV-RK-8998

Ø: 85
Hole Distance: 130
Thick/Height: 30
0513757, 0531757, 691709, 0691709



MN-RK-7280

Ø: 75
Hole Distance: 115
Thick/Height: 24
0689748, 689748



MN-RK-7291

Ø: 72
Hole Distance: 130
Thick/Height: 30
1271124



MN-RK-8537

Ø: 95
Hole Distance: 152
Thick/Height: 24
696321, 81432706099



SC-RK-8575

Ø: 95
Hole Distance: 152
Thick/Height: 35
0696321



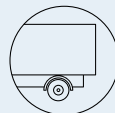

95 XF ...

FAD 95 XF 380 ...	06/00→09/02	Tie Rod	DF-DL-7780		1st FA;2nd FA
	06/00→09/02	Tie Rod	DF-DL-10193		2nd FA
FAD 95 XF 430	01/97→09/02	Ball Head, gearshift linkage	DF-ES-9335		
	01/97→09/02	Centre Rod	DF-DL-2142		Push Rod
	01/97→09/02	Centre Rod	DF-DL-3798		Push Rod
	01/97→09/02	Centre Rod	DF-DL-5355		Push Rod
	01/97→09/02	Centre Rod	DF-DL-9312		Push Rod
	01/97→09/02	Centre Rod	DF-DL-12420		Push Rod
	01/97→09/02	Stabiliser Mounting		DF-SB-5251	
	01/97→09/02	Stabiliser Mounting	DF-SB-5253	DF-SB-5253	
	01/97→09/02	Stabiliser Mounting	DF-SB-10402		
	01/97→09/02	Suspension Arm Repair Kit		CV-RK-5322	for Wishbone (CV)
	01/97→09/02	Suspension Arm Repair Kit		CV-RK-8118	for Drag Link
	01/97→09/02	Suspension Arm Repair Kit		IV-RK-8998	for Wishbone (CV)
	01/97→09/02	Suspension Arm Repair Kit		MN-RK-7280	for Drag Link;for Semi-Trailing Arm; for Wishbone (CV)
	01/97→09/02	Suspension Arm Repair Kit		MN-RK-7291	for Drag Link
	01/97→09/02	Suspension Arm Repair Kit		SC-RK-8575	for Wishbone (CV)
	01/97→09/02	Suspension Arm Repair Kit	MN-RK-7280	MN-RK-7280	for Drag Link;for Semi-Trailing Arm; for Wishbone (CV)
	01/97→09/02	Suspension Strut Repair Kit		DF-RK-8637	
	01/97→09/02	Suspension Strut Repair Kit		DF-RK-8671	
	01/97→09/02	Suspension Strut Repair Kit		MN-RK-8537	
	01/97→09/02	Tie Rod	DF-DL-7836		
	01/97→09/02	Tie Rod End	CV-ES-5336		for Steering Rod
	01/97→09/02	Tie Rod End	CV-ES-12461		for Steering Rod
	01/97→09/02	Tie Rod End	CV-ES-12462		for Steering Rod
	01/97→09/02	Tie Rod End	CV-ES-14163		for Steering Rod
	01/97→09/02	Tie Rod End	DF-ES-9332		for Steering Rod
	01/97→09/02	Track Control Arm		DF-TC-12262	Control Arm
	01/97→09/02	Track Control Arm		DF-VB-8561	Wishbone (CV)
	01/97→09/02	Track Control Arm		DF-VB-9343	Wishbone (CV)
	06/00→09/02	Tie Rod	DF-DL-5403		1st FA;2nd FA
	06/00→09/02	Tie Rod	DF-DL-7780		1st FA;2nd FA
	06/00→09/02	Tie Rod	DF-DL-10193		1st FA;2nd FA
	06/00→09/02	Track Control Arm		DF-DL-8158	Trailing Arm
FAD 95 XF 480	01/97→06/00	Tie Rod	DF-DL-5403		1st FA;2nd FA
	01/97→06/00	Tie Rod	DF-DL-7780		2nd FA
	01/97→09/02	Ball Head, gearshift linkage	DF-ES-9335		
	01/97→09/02	Centre Rod	DF-DL-2142		Push Rod
	01/97→09/02	Centre Rod	DF-DL-3798		Push Rod
	01/97→09/02	Centre Rod	DF-DL-5355		Push Rod
	01/97→09/02	Centre Rod	DF-DL-9312		Push Rod
	01/97→09/02	Centre Rod	DF-DL-12420		Push Rod
	01/97→09/02	Stabiliser Mounting		DF-SB-5251	
	01/97→09/02	Stabiliser Mounting	DF-SB-5253	DF-SB-5253	
	01/97→09/02	Stabiliser Mounting	DF-SB-10402		
	01/97→09/02	Suspension Arm Repair Kit		CV-RK-5322	for Wishbone (CV)
	01/97→09/02	Suspension Arm Repair Kit		CV-RK-8118	for Drag Link
	01/97→09/02	Suspension Arm Repair Kit		IV-RK-8998	for Wishbone (CV)
	01/97→09/02	Suspension Arm Repair Kit		MN-RK-7280	for Drag Link;for Semi-Trailing Arm; for Wishbone (CV)
	01/97→09/02	Suspension Arm Repair Kit		MN-RK-7291	for Drag Link
	01/97→09/02	Suspension Arm Repair Kit		SC-RK-8575	for Wishbone (CV)
	01/97→09/02	Suspension Arm Repair Kit	MN-RK-7280	MN-RK-7280	for Drag Link;for Semi-Trailing Arm; for Wishbone (CV)
	01/97→09/02	Suspension Strut Repair Kit		DF-RK-8637	
	01/97→09/02	Suspension Strut Repair Kit		DF-RK-8671	
	01/97→09/02	Suspension Strut Repair Kit		MN-RK-8537	
	01/97→09/02	Tie Rod	DF-DL-7836		
	01/97→09/02	Tie Rod End	CV-ES-5336		for Steering Rod
	01/97→09/02	Tie Rod End	CV-ES-12461		for Steering Rod
	01/97→09/02	Tie Rod End	CV-ES-12462		for Steering Rod

CV-ES-5336

Length: 140
Cone Ø: d1 Ø 26 / d2 Ø 23,5
Thread: M30 x 1,5 LHT
1310760, 1603418



CV-ES-12461

Length: 120
Cone Ø: d1 Ø 26 / d2 Ø 23,5
Thread: M30 x 1,5 LHT
69513, 0069513, 311300, 0311300,
0607998, 607998, 1190653, 1315447,
1319838, 1332123, 1338714, 1401934,
1407394, ACHB063, ACHF241, MAK1295



CV-ES-12462

Length: 120
Cone Ø: d1 Ø 26 / d2 Ø 23,5
Thread: M30 x 1,5 RHT
0069514, 0586753, 0607999, 0694298,
0694360, 0698609, 1137230, 1229944,
1326862, 1326896, 1331925, ACHB064,
ACHF242, MAK1296



CV-ES-14163

Length: 125
Cone Ø: d1 Ø 30 / d2 Ø 27
Thread: M30 x 1,5 RHT
0607981, 0698450, 1149907, 1152350,
1257890, 1603789, 1618048, ACHF060



CV-RK-5322

Ø: 72
Thick/Height: 50
0691704



CV-RK-8118

Ø: 85
Hole Distance: 130
Thick/Height: 30
0689749



DF-DL-2142

Length: 1005 Ø: 52
Cone Ø: d1 Ø 26 / d2 Ø 23,5
1291060, 1351734, 1385499



DF-DL-3798

Length: 1015 Ø: 50
Cone Ø: d1 Ø 30 / d2 Ø 27
0094038, 0525433



DF-DL-5355

Length: 995 Ø: 36
Cone Ø: d1 Ø 26 / d2 Ø 23,5
1311048, 1351737, 1385498



DF-DL-5403

Length: 1742 Ø: 40
Cone Ø: d1 Ø 26 / d2 Ø 23,5
0288281, 1270854, 1337644



DF-DL-7780

Length: 1690 Ø: 40
Cone Ø: d1 Ø 26 / d2 Ø 23,5
1270853, 1353391, 10212000A



DF-DL-7836

Length: 1698 Ø: 52
Cone Ø: d1 Ø 26 / d2 Ø 23,5
0754922, 1286343, 1353396



DF-DL-8158

Length: 611 Ø: 48
Hole Distance: 130 / 130
0267743, 1361649, 1361650, 1656428



DF-DL-9312

Length: 820 Ø: 36
Cone Ø: d1 Ø 26 / d2 Ø 23,5
1321170, 1351743, 1385494



DF-DL-10193

Length: 1646 Ø: 40
Cone Ø: d1 Ø 26 / d2 Ø 23,5
1351205, 1353395



DF-DL-12420

Length: 1004 Ø: 52
Cone Ø: d1 Ø 30 / d2 Ø 27
Thread: M24 x 1,5 / M30 x 1,5
0094613, 094613, 94613, 0362413, 362413,
1426101



DF-ES-9332

Length: 120
Cone Ø: d1 Ø 26 / d2 Ø 23,5
Thread: M30 x 1,5 LHT
1603419



DF-ES-9335

Length: 85
Cone Ø: d1 Ø 12 / d2 Ø 10,75
Thread: M14 x 1,5 RHT
0386930, 386930



DF-RK-8637

Ø: 72
1376730



DF-RK-8671



DF-SB-5251

Ø: 85
Thick/Height: 60
366351, 0366351, 10305800A



DF-SB-5253

Ø: 86
Thick/Height: 60,5
0371586, 0558864, 10306500A



DF-SB-10402

Ø: 62
Thick/Height: 60
1291233, 1732887



DF-TC-12262

Length: 595 Ø: 50
Hole Distance: 130 / 130
0661406, 661406, 661407, 0661407,
1620439



DF-VB-8561

Length: 609 Ø: 48
Hole Distance: 152 / 152
080521, 0080521, 1361651, 1368270,
1390932, 1617096, 1793875, 1817808,
1892492



DF-VB-9343

Length: 608,2 Ø: 48
Hole Distance: 152 / 152
1361652, 1620436, 1793876, 10309600A



IV-RK-8998

Ø: 85
Hole Distance: 130
Thick/Height: 30
0513757, 0531757, 0691709, 691709



MN-RK-7280

Ø: 75
Hole Distance: 115
Thick/Height: 24
0689748, 689748



MN-RK-7291

Ø: 72
Hole Distance: 130
Thick/Height: 30
1271124



MN-RK-8537

Ø: 95
Hole Distance: 152
Thick/Height: 24
696321, 81432706099



SC-RK-8575

Ø: 95
Hole Distance: 152
Thick/Height: 35
0696321





95 XF ...

FAD 95 XF 480 ...	01/97→09/02	Tie Rod End	CV-ES-14163		for Steering Rod	
	01/97→09/02	Tie Rod End	DF-ES-9332		for Steering Rod	
	01/97→09/02	Track Control Arm		DF-DL-8158	Trailing Arm	
	01/97→09/02	Track Control Arm		DF-VB-8561	Wishbone (CV)	
	01/97→09/02	Track Control Arm		DF-VB-9343	Wishbone (CV)	
	06/00→09/02	Tie Rod	DF-DL-5403		1st FA	
	06/00→09/02	Tie Rod	DF-DL-7780		1st FA;2nd FA	
	06/00→09/02	Tie Rod	DF-DL-10193		2nd FA	
	FAD 95 XF 530	01/97→09/02	Suspension Arm Repair Kit	MN-RK-7280	MN-RK-7280	for Drag Link;for Semi-Trailing Arm; for Wishbone (CV)
01/97→09/02		Tie Rod End	CV-ES-5336		for Steering Rod	
01/97→09/02		Tie Rod End	CV-ES-12461		for Steering Rod	
01/97→09/02		Tie Rod End	CV-ES-12462		for Steering Rod	
01/97→09/02		Tie Rod End	DF-ES-9332		for Steering Rod	
06/00→09/02		Centre Rod	DF-DL-5355		Push Rod	
06/00→09/02		Centre Rod	DF-DL-9312		Push Rod	
06/00→09/02		Tie Rod	DF-DL-5403		1st FA;2nd FA	
06/00→09/02		Tie Rod	DF-DL-7780		1st FA;2nd FA	
06/00→09/02		Tie Rod	DF-DL-10193		1st FA;2nd FA	
06/00→09/02		Track Control Arm		DF-DL-8158	Trailing Arm	
FAR 95 XF 380		01/97→09/02	Ball Head, gearshift linkage	DF-ES-9335		
		01/97→09/02	Centre Rod	DF-DL-2142		Push Rod
		01/97→09/02	Centre Rod	DF-DL-3798		Push Rod
		01/97→09/02	Centre Rod	DF-DL-12420		Push Rod
		01/97→09/02	Stabiliser Mounting		DF-SB-5251	
		01/97→09/02	Stabiliser Mounting	DF-SB-5253	DF-SB-5253	
	01/97→09/02	Stabiliser Mounting	DF-SB-10402			
	01/97→09/02	Suspension Arm Repair Kit		CV-RK-5322	for Wishbone (CV)	
	01/97→09/02	Suspension Arm Repair Kit		CV-RK-8118	for Drag Link	
	01/97→09/02	Suspension Arm Repair Kit		IV-RK-8998	for Wishbone (CV)	
	01/97→09/02	Suspension Arm Repair Kit		MN-RK-7280	for Drag Link;for Semi-Trailing Arm; for Wishbone (CV)	
	01/97→09/02	Suspension Arm Repair Kit		MN-RK-7291	for Drag Link	
	01/97→09/02	Suspension Arm Repair Kit		SC-RK-8575	for Wishbone (CV)	
	01/97→09/02	Suspension Arm Repair Kit	MN-RK-7280	MN-RK-7280	for Drag Link;for Semi-Trailing Arm; for Wishbone (CV)	
	01/97→09/02	Suspension Strut Repair Kit		DF-RK-8637		
	01/97→09/02	Suspension Strut Repair Kit		DF-RK-8671		
	01/97→09/02	Suspension Strut Repair Kit		MN-RK-8537		
	01/97→09/02	Tie Rod	DF-DL-5403		1st FA	
	01/97→09/02	Tie Rod	DF-DL-7836		1st FA	
	01/97→09/02	Tie Rod	MN-ES-10334		for Push Rod	
	01/97→09/02	Tie Rod End	CV-ES-12461		for Steering Rod	
	01/97→09/02	Tie Rod End	CV-ES-12462		for Steering Rod	
	01/97→09/02	Tie Rod End	CV-ES-14163		for Steering Rod	
	01/97→09/02	Tie Rod End	DF-ES-8362		for Steering Rod	
	01/97→09/02	Track Control Arm		DF-DL-8158	Trailing Arm	
	01/97→09/02	Track Control Arm		DF-VB-8561	Wishbone (CV)	
	01/97→09/02	Track Control Arm		DF-VB-9343	Wishbone (CV)	
	06/00→09/02	Centre Rod	DF-DL-5355		Push Rod	
	06/00→09/02	Tie Rod	DF-DL-7780		1st FA	
	FAR 95 XF 430	01/97→09/02	Ball Head, gearshift linkage	DF-ES-9335		
		01/97→09/02	Centre Rod	DF-DL-2142		Push Rod
		01/97→09/02	Centre Rod	DF-DL-3798		Push Rod
		01/97→09/02	Centre Rod	DF-DL-12420		Push Rod
01/97→09/02		Stabiliser Mounting		DF-SB-5251		
01/97→09/02		Stabiliser Mounting	DF-SB-5253	DF-SB-5253		
01/97→09/02		Stabiliser Mounting	DF-SB-10402			
01/97→09/02		Suspension Arm Repair Kit		CV-RK-5322	for Wishbone (CV)	
01/97→09/02		Suspension Arm Repair Kit		CV-RK-8118	for Drag Link	
01/97→09/02		Suspension Arm Repair Kit		IV-RK-8998	for Wishbone (CV)	
01/97→09/02		Suspension Arm Repair Kit		MN-RK-7280	for Drag Link;for Semi-Trailing Arm; for Wishbone (CV)	

CV-ES-5336

Length: 140
Cone Ø: d1 Ø 26 / d2 Ø 23,5
Thread: M30 x 1,5 LHT
1310760, 1603418



CV-ES-12461

Length: 120
Cone Ø: d1 Ø 26 / d2 Ø 23,5
Thread: M30 x 1,5 LHT
69513, 0069513, 0311300, 311300,
0607998, 607998, 1190653, 1315447,
1319838, 1332123, 1338714, 1401934,
1407394, ACHB063, ACHF241, MAK1295



CV-ES-12462

Length: 120
Cone Ø: d1 Ø 26 / d2 Ø 23,5
Thread: M30 x 1,5 RHT
0069514, 0586753, 0607999, 0694298,
0694360, 0698609, 1137230, 1229944,
1326862, 1326896, 1331925, ACHB064,
ACHF242, MAK1296



CV-ES-14163

Length: 125
Cone Ø: d1 Ø 30 / d2 Ø 27
Thread: M30 x 1,5 RHT
0607981, 0698450, 1149907, 1152350,
1257890, 1603789, 1618048, ACHF060



CV-RK-5322

Ø: 72
Thick/Height: 50
0691704



CV-RK-8118

Ø: 85
Hole Distance: 130
Thick/Height: 30
0689749



DF-DL-2142

Length: 1005 Ø: 52
Cone Ø: d1 Ø 26 / d2 Ø 23,5
1291060, 1351734, 1385499



DF-DL-3798

Length: 1015 Ø: 50
Cone Ø: d1 Ø 30 / d2 Ø 27
0094038, 0525433



DF-DL-5355

Length: 995 Ø: 36
Cone Ø: d1 Ø 26 / d2 Ø 23,5
1311048, 1351737, 1385498



DF-DL-5403

Length: 1742 Ø: 40
Cone Ø: d1 Ø 26 / d2 Ø 23,5
0288281, 1270854, 1337644



DF-DL-7780

Length: 1690 Ø: 40
Cone Ø: d1 Ø 26 / d2 Ø 23,5
1270853, 1353391, 10212000A



DF-DL-7836

Length: 1698 Ø: 52
Cone Ø: d1 Ø 26 / d2 Ø 23,5
0754922, 1286343, 1353396



DF-DL-8158

Length: 611 Ø: 48
Hole Distance: 130 / 130
0267743, 1361649, 1361650, 1656428



DF-DL-9312

Length: 820 Ø: 36
Cone Ø: d1 Ø 26 / d2 Ø 23,5
1321170, 1351743, 1385494



DF-DL-10193

Length: 1646 Ø: 40
Cone Ø: d1 Ø 26 / d2 Ø 23,5
1351205, 1353395



DF-DL-12420

Length: 1004 Ø: 52
Cone Ø: d1 Ø 30 / d2 Ø 27
Thread: M24 x 1,5 / M30 x 1,5
0094613, 094613, 94613, 0362413, 362413,
1426101



DF-ES-8362

Length: 150
Cone Ø: d1 Ø 26 / d2 Ø 23,5
Thread: M30 x 1,5 RHT
1389190



DF-ES-9332

Length: 120
Cone Ø: d1 Ø 26 / d2 Ø 23,5
Thread: M30 x 1,5 LHT
1603419



DF-ES-9335

Length: 85
Cone Ø: d1 Ø 12 / d2 Ø 10,75
Thread: M14 x 1,5 RHT
0386930, 386930



DF-RK-8637

Ø: 72
1376730



DF-RK-8671



DF-SB-5251

Ø: 85
Thick/Height: 60
0366351, 366351, 10305800A



DF-SB-5253

Ø: 86
Thick/Height: 60,5
0371586, 0558864, 10306500A



DF-SB-10402

Ø: 62
Thick/Height: 60
1291233, 1732887



DF-VB-8561

Length: 609 Ø: 48
Hole Distance: 152 / 152
080521, 0080521, 1361651, 1368270,
1390932, 1617096, 1793875, 1817808,
1892492



DF-VB-9343

Length: 608,2 Ø: 48
Hole Distance: 152 / 152
1361652, 1620436, 1793876, 10309600A



IV-RK-8998

Ø: 85
Hole Distance: 130
Thick/Height: 30
0513757, 0531757, 0691709, 691709



MN-ES-10334

Length: 140
Cone Ø: d1 Ø 26 / d2 Ø 23,5
Thread: M30 x 1,5 RHT
1320855, 1342026, 3093714, 10220897,
81953016236, 81953016331



MN-RK-7280

Ø: 75
Hole Distance: 115
Thick/Height: 24
0689748, 689748



MN-RK-7291

Ø: 72
Hole Distance: 130
Thick/Height: 30
1271124



MN-RK-8537

Ø: 95
Hole Distance: 152
Thick/Height: 24
696321, 81432706099



SC-RK-8575

Ø: 95
Hole Distance: 152
Thick/Height: 35
0696321



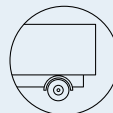

95 XF ...

FAR 95 XF 430 ...	01/97→09/02	Suspension Arm Repair Kit		MN-RK-7291	for Drag Link	
	01/97→09/02	Suspension Arm Repair Kit		SC-RK-8575	for Wishbone (CV)	
	01/97→09/02	Suspension Arm Repair Kit	MN-RK-7280	MN-RK-7280	for Drag Link;for Semi-Trailing Arm; for Wishbone (CV)	
	01/97→09/02	Suspension Strut Repair Kit		DF-RK-8637		
	01/97→09/02	Suspension Strut Repair Kit		DF-RK-8671		
	01/97→09/02	Suspension Strut Repair Kit		MN-RK-8537		
	01/97→09/02	Tie Rod	DF-DL-5403		1st FA	
	01/97→09/02	Tie Rod	DF-DL-7836		1st FA	
	01/97→09/02	Tie Rod	MN-ES-10334		for Push Rod	
	01/97→09/02	Tie Rod End	CV-ES-12461		for Steering Rod	
	01/97→09/02	Tie Rod End	CV-ES-12462		for Steering Rod	
	01/97→09/02	Tie Rod End	CV-ES-14163		for Steering Rod	
	01/97→09/02	Tie Rod End	DF-ES-8362		for Steering Rod	
	01/97→09/02	Track Control Arm		DF-DL-8158	Trailing Arm	
	01/97→09/02	Track Control Arm		DF-VB-8561	Wishbone (CV)	
	01/97→09/02	Track Control Arm		DF-VB-9343	Wishbone (CV)	
	06/00→09/02	Centre Rod	DF-DL-5355		Push Rod	
	06/00→09/02	Tie Rod	DF-DL-7780		1st FA	
	FAR 95 XF 480	01/97→09/02	Ball Head, gearshift linkage	DF-ES-9335		
		01/97→09/02	Centre Rod	DF-DL-2142		Push Rod
01/97→09/02		Centre Rod	DF-DL-3798		Push Rod	
01/97→09/02		Centre Rod	DF-DL-12420		Push Rod	
01/97→09/02		Stabiliser Mounting		DF-SB-5251		
01/97→09/02		Stabiliser Mounting	DF-SB-5253	DF-SB-5253		
01/97→09/02		Stabiliser Mounting	DF-SB-10402			
01/97→09/02		Suspension Arm Repair Kit		CV-RK-5322	for Wishbone (CV)	
01/97→09/02		Suspension Arm Repair Kit		CV-RK-8118	for Drag Link	
01/97→09/02		Suspension Arm Repair Kit		IV-RK-8998	for Wishbone (CV)	
01/97→09/02		Suspension Arm Repair Kit		MN-RK-7280	for Drag Link;for Semi-Trailing Arm; for Wishbone (CV)	
01/97→09/02		Suspension Arm Repair Kit		MN-RK-7291	for Drag Link	
01/97→09/02		Suspension Arm Repair Kit		SC-RK-8575	for Wishbone (CV)	
01/97→09/02		Suspension Arm Repair Kit	MN-RK-7280	MN-RK-7280	for Drag Link;for Semi-Trailing Arm; for Wishbone (CV)	
01/97→09/02		Suspension Strut Repair Kit		DF-RK-8637		
01/97→09/02		Suspension Strut Repair Kit		DF-RK-8671		
01/97→09/02		Suspension Strut Repair Kit		MN-RK-8537		
01/97→09/02		Tie Rod	DF-DL-5403		1st FA	
01/97→09/02		Tie Rod	DF-DL-7836		1st FA	
01/97→09/02		Tie Rod	MN-ES-10334		for Push Rod	
01/97→09/02		Tie Rod End	CV-ES-12461		for Steering Rod	
01/97→09/02		Tie Rod End	CV-ES-12462		for Steering Rod	
01/97→09/02		Tie Rod End	CV-ES-14163		for Steering Rod	
01/97→09/02		Tie Rod End	DF-ES-8362		for Steering Rod	
01/97→09/02		Track Control Arm		DF-DL-8158	Trailing Arm	
01/97→09/02		Track Control Arm		DF-VB-8561	Wishbone (CV)	
01/97→09/02		Track Control Arm		DF-VB-9343	Wishbone (CV)	
06/00→09/02		Centre Rod	DF-DL-5355		Push Rod	
06/00→09/02		Tie Rod	DF-DL-7780		1st FA	
FAR 95 XF 530		01/97→09/02	Ball Head, gearshift linkage	DF-ES-9335		
		01/97→09/02	Centre Rod	DF-DL-2142		Push Rod
		01/97→09/02	Centre Rod	DF-DL-3798		Push Rod
	01/97→09/02	Centre Rod	DF-DL-12420		Push Rod	
	01/97→09/02	Stabiliser Mounting		DF-SB-5251		
	01/97→09/02	Stabiliser Mounting	DF-SB-5253	DF-SB-5253		
	01/97→09/02	Stabiliser Mounting	DF-SB-10402			
	01/97→09/02	Suspension Arm Repair Kit		CV-RK-5322	for Wishbone (CV)	
	01/97→09/02	Suspension Arm Repair Kit		CV-RK-8118	for Drag Link	
	01/97→09/02	Suspension Arm Repair Kit		IV-RK-8998	for Wishbone (CV)	
	01/97→09/02	Suspension Arm Repair Kit		MN-RK-7280	for Drag Link;for Semi-Trailing Arm; for Wishbone (CV)	
	01/97→09/02	Suspension Arm Repair Kit		MN-RK-7291	for Drag Link	

CV-ES-12461

Length: 120
Cone Ø: d1 Ø 26 / d2 Ø 23,5
Thread: M30 x 1,5 LHT
0069513, 69513, 0311300, 311300,
0607998, 607998, 1190653, 1315447,
1319838, 1332123, 1338714, 1401934,
1407394, ACHB063, ACHF241, MAK1295



CV-ES-12462

Length: 120
Cone Ø: d1 Ø 26 / d2 Ø 23,5
Thread: M30 x 1,5 RHT
0069514, 0586753, 0607999, 0694298,
0694360, 0698609, 1137230, 1229944,
1326862, 1326896, 1331925, ACHB064,
ACHF242, MAK1296



CV-ES-14163

Length: 125
Cone Ø: d1 Ø 30 / d2 Ø 27
Thread: M30 x 1,5 RHT
0607981, 0698450, 1149907, 1152350,
1257890, 1603789, 1618048, ACHF060



CV-RK-5322

Ø: 72
Thick/Height: 50
0691704



CV-RK-8118

Ø: 85
Hole Distance: 130
Thick/Height: 30
0689749



DF-DL-2142

Length: 1005 Ø: 52
Cone Ø: d1 Ø 26 / d2 Ø 23,5
1291060, 1351734, 1385499



DF-DL-3798

Length: 1015 Ø: 50
Cone Ø: d1 Ø 30 / d2 Ø 27
0094038, 0525433



DF-DL-5355

Length: 995 Ø: 36
Cone Ø: d1 Ø 26 / d2 Ø 23,5
1311048, 1351737, 1385498



DF-DL-5403

Length: 1742 Ø: 40
Cone Ø: d1 Ø 26 / d2 Ø 23,5
0288281, 1270854, 1337644



DF-DL-7780

Length: 1690 Ø: 40
Cone Ø: d1 Ø 26 / d2 Ø 23,5
1270853, 1353391, 10212000A



DF-DL-7836

Length: 1698 Ø: 52
Cone Ø: d1 Ø 26 / d2 Ø 23,5
0754922, 1286343, 1353396



DF-DL-8158

Length: 611 Ø: 48
Hole Distance: 130 / 130
0267743, 1361649, 1361650, 1656428



DF-DL-12420

Length: 1004 Ø: 52
Cone Ø: d1 Ø 30 / d2 Ø 27
Thread: M24 x 1,5 / M30 x 1,5
0094613, 094613, 94613, 0362413, 362413,
1426101



DF-ES-8362

Length: 150
Cone Ø: d1 Ø 26 / d2 Ø 23,5
Thread: M30 x 1,5 RHT
1389190



DF-ES-9335

Length: 85
Cone Ø: d1 Ø 12 / d2 Ø 10,75
Thread: M14 x 1,5 RHT
0386930, 386930



DF-RK-8637

Ø: 72
1376730



DF-RK-8671



DF-SB-5251

Ø: 85
Thick/Height: 60
0366351, 366351, 10305800A



DF-SB-5253

Ø: 86
Thick/Height: 60,5
0371586, 0558864, 10306500A



DF-SB-10402

Ø: 62
Thick/Height: 60
1291233, 1732887



DF-VB-8561

Length: 609 Ø: 48
Hole Distance: 152 / 152
080521, 0080521, 1361651, 1368270,
1390932, 1617096, 1793875, 1817808,
1892492



DF-VB-9343

Length: 608,2 Ø: 48
Hole Distance: 152 / 152
1361652, 1620436, 1793876, 10309600A



IV-RK-8998

Ø: 85
Hole Distance: 130
Thick/Height: 30
0513757, 0531757, 0691709, 691709



MN-ES-10334

Length: 140
Cone Ø: d1 Ø 26 / d2 Ø 23,5
Thread: M30 x 1,5 RHT
1320855, 1342026, 3093714, 10220897,
81953016236, 81953016331



MN-RK-7280

Ø: 75
Hole Distance: 115
Thick/Height: 24
0689748, 689748



MN-RK-7291

Ø: 72
Hole Distance: 130
Thick/Height: 30
1271124



MN-RK-8537

Ø: 95
Hole Distance: 152
Thick/Height: 24
696321, 81432706099



SC-RK-8575

Ø: 95
Hole Distance: 152
Thick/Height: 35
0696321





95 XF ...

FAR 95 XF 530 ...	01/97→09/02	Suspension Arm Repair Kit		SC-RK-8575	for Wishbone (CV)	
	01/97→09/02	Suspension Arm Repair Kit	MN-RK-7280	MN-RK-7280	for Drag Link;for Semi-Trailing Arm; for Wishbone (CV)	
	01/97→09/02	Suspension Strut Repair Kit		DF-RK-8637		
	01/97→09/02	Suspension Strut Repair Kit		DF-RK-8671		
	01/97→09/02	Suspension Strut Repair Kit		MN-RK-8537		
	01/97→09/02	Tie Rod	DF-DL-5403			
	01/97→09/02	Tie Rod	DF-DL-7780			
	01/97→09/02	Tie Rod	DF-DL-7836			
	01/97→09/02	Tie Rod	MN-ES-10334		for Push Rod	
	01/97→09/02	Tie Rod End	CV-ES-12461		for Steering Rod	
	01/97→09/02	Tie Rod End	CV-ES-12462		for Steering Rod	
	01/97→09/02	Tie Rod End	CV-ES-14163		for Steering Rod	
	01/97→09/02	Tie Rod End	DF-ES-8362		for Steering Rod	
	01/97→09/02	Track Control Arm		DF-DL-8158	Trailing Arm	
	01/97→09/02	Track Control Arm		DF-VB-8561	Wishbone (CV)	
	01/97→09/02	Track Control Arm		DF-VB-9343	Wishbone (CV)	
	06/00→09/02	Tie Rod	DF-DL-5403		1st FA	
	06/00→09/02	Tie Rod	DF-DL-7780		1st FA	
	06/00→09/02	Tie Rod	DF-DL-7836		1st FA	
	FAS 95 XF 380	01/97→09/02	Ball Head, gearshift linkage	DF-ES-9335		
		01/97→09/02	Centre Rod	DF-DL-2142		Push Rod
		01/97→09/02	Centre Rod	DF-DL-3798		Push Rod
		01/97→09/02	Centre Rod	DF-DL-12420		Push Rod
01/97→09/02		Stabiliser Mounting		DF-SB-5251		
01/97→09/02		Stabiliser Mounting	DF-SB-5253	DF-SB-5253		
01/97→09/02		Stabiliser Mounting	DF-SB-10402			
01/97→09/02		Suspension Arm Repair Kit		CV-RK-5322	for Wishbone (CV)	
01/97→09/02		Suspension Arm Repair Kit		CV-RK-8118	for Drag Link	
01/97→09/02		Suspension Arm Repair Kit		IV-RK-8998	for Wishbone (CV)	
01/97→09/02		Suspension Arm Repair Kit		MN-RK-7280	for Drag Link;for Semi-Trailing Arm; for Wishbone (CV)	
01/97→09/02		Suspension Arm Repair Kit		MN-RK-7291	for Drag Link	
01/97→09/02		Suspension Arm Repair Kit		SC-RK-8575	for Wishbone (CV)	
01/97→09/02		Suspension Arm Repair Kit	MN-RK-7280	MN-RK-7280	for Drag Link;for Semi-Trailing Arm; for Wishbone (CV)	
01/97→09/02		Suspension Strut Repair Kit		DF-RK-8637		
01/97→09/02		Suspension Strut Repair Kit		DF-RK-8671		
01/97→09/02		Suspension Strut Repair Kit		MN-RK-8537		
01/97→09/02		Tie Rod	DF-DL-5403		1st FA	
01/97→09/02		Tie Rod	DF-DL-7780		1st FA	
01/97→09/02		Tie Rod	DF-DL-7836		1st FA	
01/97→09/02		Tie Rod	MN-ES-10334		for Push Rod	
01/97→09/02		Tie Rod End	CV-ES-12461		for Steering Rod	
01/97→09/02		Tie Rod End	CV-ES-12462		for Steering Rod	
01/97→09/02		Tie Rod End	CV-ES-14163		for Steering Rod	
01/97→09/02		Tie Rod End	DF-ES-8362		for Steering Rod	
01/97→09/02		Track Control Arm		DF-DL-8158	Trailing Arm	
01/97→09/02		Track Control Arm		DF-VB-8561	Wishbone (CV)	
01/97→09/02		Track Control Arm		DF-VB-9343	Wishbone (CV)	
06/00→09/02		Centre Rod	DF-DL-5355		Push Rod	
FAS 95 XF 430		01/97→09/02	Ball Head, gearshift linkage	DF-ES-9335		
		01/97→09/02	Centre Rod	DF-DL-2142		Push Rod
		01/97→09/02	Centre Rod	DF-DL-3798		Push Rod
		01/97→09/02	Centre Rod	DF-DL-12420		Push Rod
	01/97→09/02	Stabiliser Mounting		DF-SB-5251		
	01/97→09/02	Stabiliser Mounting	DF-SB-5253	DF-SB-5253		
	01/97→09/02	Stabiliser Mounting	DF-SB-10402			
	01/97→09/02	Suspension Arm Repair Kit		CV-RK-5322	for Wishbone (CV)	
	01/97→09/02	Suspension Arm Repair Kit		CV-RK-8118	for Drag Link	
	01/97→09/02	Suspension Arm Repair Kit		IV-RK-8998	for Wishbone (CV)	
	01/97→09/02	Suspension Arm Repair Kit		MN-RK-7280	for Drag Link;for Semi-Trailing Arm; for Wishbone (CV)	

CV-ES-12461

Length: 120
Cone Ø: d1 Ø 26 / d2 Ø 23,5
Thread: M30 x 1,5 LHT
0069513, 69513, 0311300, 311300,
0607998, 607998, 1190653, 1315447,
1319838, 1332123, 1338714, 1401934,
1407394, ACHB063, ACHF241, MAK1295



CV-ES-12462

Length: 120
Cone Ø: d1 Ø 26 / d2 Ø 23,5
Thread: M30 x 1,5 RHT
0069514, 0586753, 0607999, 0694298,
0694360, 0698609, 1137230, 1229944,
1326862, 1326896, 1331925, ACHB064,
ACHF242, MAK1296



CV-ES-14163

Length: 125
Cone Ø: d1 Ø 30 / d2 Ø 27
Thread: M30 x 1,5 RHT
0607981, 0698450, 1149907, 1152350,
1257890, 1603789, 1618048, ACHF060



CV-RK-5322

Ø: 72
Thick/Height: 50
0691704



CV-RK-8118

Ø: 85
Hole Distance: 130
Thick/Height: 30
0689749



DF-DL-2142

Length: 1005 Ø: 52
Cone Ø: d1 Ø 26 / d2 Ø 23,5
1291060, 1351734, 1385499



DF-DL-3798

Length: 1015 Ø: 50
Cone Ø: d1 Ø 30 / d2 Ø 27
0094038, 0525433



DF-DL-5355

Length: 995 Ø: 36
Cone Ø: d1 Ø 26 / d2 Ø 23,5
1311048, 1351737, 1385498



DF-DL-5403

Length: 1742 Ø: 40
Cone Ø: d1 Ø 26 / d2 Ø 23,5
0288281, 1270854, 1337644



DF-DL-7780

Length: 1690 Ø: 40
Cone Ø: d1 Ø 26 / d2 Ø 23,5
1270853, 1353391, 10212000A



DF-DL-7836

Length: 1698 Ø: 52
Cone Ø: d1 Ø 26 / d2 Ø 23,5
0754922, 1286343, 1353396



DF-DL-8158

Length: 611
Ø: 48
Hole Distance: 130 / 130
0267743, 1361649, 1361650, 1656428



DF-DL-12420

Length: 1004
Ø: 52
Cone Ø: d1 Ø 30 / d2 Ø 27
Thread: M24 x 1,5 / M30 x 1,5
0094613, 094613, 94613, 0362413, 362413,
1426101



DF-ES-8362

Length: 150
Cone Ø: d1 Ø 26 / d2 Ø 23,5
Thread: M30 x 1,5 RHT
1389190



DF-ES-9335

Length: 85
Cone Ø: d1 Ø 12 / d2 Ø 10,75
Thread: M14 x 1,5 RHT
0386930, 386930



DF-RK-8637

Ø: 72
1376730



DF-RK-8671



DF-SB-5251

Ø: 85
Thick/Height: 60
0366351, 366351, 10305800A



DF-SB-5253

Ø: 86
Thick/Height: 60,5
0371586, 0558864, 10306500A



DF-SB-10402

Ø: 62
Thick/Height: 60
1291233, 1732887



DF-VB-8561

Length: 609 Ø: 48
Hole Distance: 152 / 152
0080521, 080521, 1361651, 1368270,
1390932, 1617096, 1793875, 1817808,
1892492



DF-VB-9343

Length: 608,2 Ø: 48
Hole Distance: 152 / 152
1361652, 1620436, 1793876, 10309600A



IV-RK-8998

Ø: 85
Hole Distance: 130
Thick/Height: 30
0513757, 0531757, 691709, 0691709



MN-ES-10334

Length: 140
Cone Ø: d1 Ø 26 / d2 Ø 23,5
Thread: M30 x 1,5 RHT
1320855, 1342026, 3093714, 10220897,
81953016236, 81953016331



MN-RK-7280

Ø: 75
Hole Distance: 115
Thick/Height: 24
0689748, 689748



MN-RK-7291

Ø: 72
Hole Distance: 130
Thick/Height: 30
1271124



MN-RK-8537

Ø: 95
Hole Distance: 152
Thick/Height: 24
696321, 81432706099



SC-RK-8575

Ø: 95
Hole Distance: 152
Thick/Height: 35
0696321





95 XF ...

FAS 95 XF 430 ...	01/97→09/02	Suspension Arm Repair Kit		MN-RK-7291	for Drag Link	
	01/97→09/02	Suspension Arm Repair Kit		SC-RK-8575	for Wishbone (CV)	
	01/97→09/02	Suspension Arm Repair Kit	MN-RK-7280	MN-RK-7280	for Drag Link;for Semi-Trailing Arm; for Wishbone (CV)	
	01/97→09/02	Suspension Strut Repair Kit		DF-RK-8637		
	01/97→09/02	Suspension Strut Repair Kit		DF-RK-8671		
	01/97→09/02	Suspension Strut Repair Kit		MN-RK-8537		
	01/97→09/02	Tie Rod	DF-DL-5403		1st FA	
	01/97→09/02	Tie Rod	DF-DL-7836		1st FA	
	01/97→09/02	Tie Rod	MN-ES-10334		for Push Rod	
	01/97→09/02	Tie Rod End	CV-ES-12461		for Steering Rod	
	01/97→09/02	Tie Rod End	CV-ES-12462		for Steering Rod	
	01/97→09/02	Tie Rod End	CV-ES-14163		for Steering Rod	
	01/97→09/02	Tie Rod End	DF-ES-8362		for Steering Rod	
	01/97→09/02	Track Control Arm		DF-DL-8158	Trailing Arm	
	01/97→09/02	Track Control Arm		DF-VB-8561	Wishbone (CV)	
	01/97→09/02	Track Control Arm		DF-VB-9343	Wishbone (CV)	
	06/00→09/02	Centre Rod	DF-DL-5355		Push Rod	
	06/00→09/02	Tie Rod	DF-DL-7780		1st FA	
	FAS 95 XF 480	01/97→09/02	Ball Head, gearshift linkage	DF-ES-9335		
		01/97→09/02	Centre Rod	DF-DL-2142		Push Rod
01/97→09/02		Centre Rod	DF-DL-3798		Push Rod	
01/97→09/02		Centre Rod	DF-DL-12420		Push Rod	
01/97→09/02		Stabiliser Mounting		DF-SB-5251		
01/97→09/02		Stabiliser Mounting	DF-SB-5253	DF-SB-5253		
01/97→09/02		Stabiliser Mounting	DF-SB-10402			
01/97→09/02		Suspension Arm Repair Kit		CV-RK-5322	for Wishbone (CV)	
01/97→09/02		Suspension Arm Repair Kit		CV-RK-8118	for Drag Link	
01/97→09/02		Suspension Arm Repair Kit		IV-RK-8998	for Wishbone (CV)	
01/97→09/02		Suspension Arm Repair Kit		MN-RK-7280	for Drag Link;for Semi-Trailing Arm; for Wishbone (CV)	
01/97→09/02		Suspension Arm Repair Kit		MN-RK-7291	for Drag Link	
01/97→09/02		Suspension Arm Repair Kit		SC-RK-8575	for Wishbone (CV)	
01/97→09/02		Suspension Arm Repair Kit	MN-RK-7280	MN-RK-7280	for Drag Link;for Semi-Trailing Arm; for Wishbone (CV)	
01/97→09/02		Suspension Strut Repair Kit		DF-RK-8637		
01/97→09/02		Suspension Strut Repair Kit		DF-RK-8671		
01/97→09/02		Suspension Strut Repair Kit		MN-RK-8537		
01/97→09/02		Tie Rod	DF-DL-5403		1st FA	
01/97→09/02		Tie Rod	DF-DL-7836		1st FA	
01/97→09/02		Tie Rod	MN-ES-10334		for Push Rod	
01/97→09/02		Tie Rod End	CV-ES-12461		for Steering Rod	
01/97→09/02		Tie Rod End	CV-ES-12462		for Steering Rod	
01/97→09/02		Tie Rod End	CV-ES-14163		for Steering Rod	
01/97→09/02		Tie Rod End	DF-ES-8362		for Steering Rod	
01/97→09/02		Track Control Arm		DF-DL-8158	Trailing Arm	
01/97→09/02		Track Control Arm		DF-VB-8561	Wishbone (CV)	
01/97→09/02		Track Control Arm		DF-VB-9343	Wishbone (CV)	
06/00→09/02		Centre Rod	DF-DL-5355		Push Rod	
06/00→09/02		Tie Rod	DF-DL-7780		1st FA	
FAS 95 XF 530		01/97→09/02	Ball Head, gearshift linkage	DF-ES-9335		
		01/97→09/02	Centre Rod	DF-DL-2142		Push Rod
		01/97→09/02	Centre Rod	DF-DL-3798		Push Rod
	01/97→09/02	Centre Rod	DF-DL-12420		Push Rod	
	01/97→09/02	Stabiliser Mounting		DF-SB-5251		
	01/97→09/02	Stabiliser Mounting	DF-SB-5253	DF-SB-5253		
	01/97→09/02	Stabiliser Mounting	DF-SB-10402			
	01/97→09/02	Suspension Arm Repair Kit		CV-RK-5322	for Wishbone (CV)	
	01/97→09/02	Suspension Arm Repair Kit		CV-RK-8118	for Drag Link	
	01/97→09/02	Suspension Arm Repair Kit		IV-RK-8998	for Wishbone (CV)	
	01/97→09/02	Suspension Arm Repair Kit		MN-RK-7280	for Drag Link;for Semi-Trailing Arm; for Wishbone (CV)	
	01/97→09/02	Suspension Arm Repair Kit		MN-RK-7291	for Drag Link	

CV-ES-12461

Length: 120
Cone Ø: d1 Ø 26 / d2 Ø 23,5
Thread: M30 x 1,5 LHT
0069513, 69513, 0311300, 311300,
0607998, 607998, 1190653, 1315447,
1319838, 1332123, 1338714, 1401934,
1407394, ACHB063, ACHF241, MAK1295



CV-ES-12462

Length: 120
Cone Ø: d1 Ø 26 / d2 Ø 23,5
Thread: M30 x 1,5 RHT
0069514, 0586753, 0607999, 0694298,
0694360, 0698609, 1137230, 1229944,
1326862, 1326896, 1331925, ACHB064,
ACHF242, MAK1296



CV-ES-14163

Length: 125
Cone Ø: d1 Ø 30 / d2 Ø 27
Thread: M30 x 1,5 RHT
0607981, 0698450, 1149907, 1152350,
1257890, 1603789, 1618048, ACHF060



CV-RK-5322

Ø: 72
Thick/Height: 50
0691704



CV-RK-8118

Ø: 85
Hole Distance: 130
Thick/Height: 30
0689749



DF-DL-2142

Length: 1005 Ø: 52
Cone Ø: d1 Ø 26 / d2 Ø 23,5
1291060, 1351734, 1385499



DF-DL-3798

Length: 1015 Ø: 50
Cone Ø: d1 Ø 30 / d2 Ø 27
0094038, 0525433



DF-DL-5355

Length: 995 Ø: 36
Cone Ø: d1 Ø 26 / d2 Ø 23,5
1311048, 1351737, 1385498



DF-DL-5403

Length: 1742 Ø: 40
Cone Ø: d1 Ø 26 / d2 Ø 23,5
0288281, 1270854, 1337644



DF-DL-7780

Length: 1690 Ø: 40
Cone Ø: d1 Ø 26 / d2 Ø 23,5
1270853, 1353391, 10212000A



DF-DL-7836

Length: 1698 Ø: 52
Cone Ø: d1 Ø 26 / d2 Ø 23,5
0754922, 1286343, 1353396



DF-DL-8158

Length: 611 Ø: 48
Hole Distance: 130 / 130
0267743, 1361649, 1361650, 1656428



DF-DL-12420

Length: 1004 Ø: 52
Cone Ø: d1 Ø 30 / d2 Ø 27
Thread: M24 x 1,5 / M30 x 1,5
0094613, 094613, 94613, 0362413, 362413,
1426101



DF-ES-8362

Length: 150
Cone Ø: d1 Ø 26 / d2 Ø 23,5
Thread: M30 x 1,5 RHT
1389190



DF-ES-9335

Length: 85
Cone Ø: d1 Ø 12 / d2 Ø 10,75
Thread: M14 x 1,5 RHT
0386930, 386930



DF-RK-8637

Ø: 72
1376730



DF-RK-8671



DF-SB-5251

Ø: 85
Thick/Height: 60
0366351, 366351, 10305800A



DF-SB-5253

Ø: 86
Thick/Height: 60,5
0371586, 0558864, 10306500A



DF-SB-10402

Ø: 62
Thick/Height: 60
1291233, 1732887



DF-VB-8561

Length: 609 Ø: 48
Hole Distance: 152 / 152
0080521, 080521, 1361651, 1368270,
1390932, 1617096, 1793875, 1817808,
1892492



DF-VB-9343

Length: 608,2 Ø: 48
Hole Distance: 152 / 152
1361652, 1620436, 1793876, 10309600A
1389190



IV-RK-8998

Ø: 85
Hole Distance: 130
Thick/Height: 30
0513757, 0531757, 0691709, 691709



MN-ES-10334

Length: 140
Cone Ø: d1 Ø 26 / d2 Ø 23,5
Thread: M30 x 1,5 RHT
1320855, 1342026, 3093714, 10220897,
81953016236, 81953016331



MN-RK-7280

Ø: 75
Hole Distance: 115
Thick/Height: 24
0689748, 689748



MN-RK-7291

Ø: 72
Hole Distance: 130
Thick/Height: 30
1271124



MN-RK-8537

Ø: 95
Hole Distance: 152
Thick/Height: 24
696321, 81432706099



SC-RK-8575

Ø: 95
Hole Distance: 152
Thick/Height: 35
0696321





95 XF ...

FAS 95 XF 530 ...	01/97→09/02	Suspension Arm Repair Kit		SC-RK-8575	for Wishbone (CV)	
	01/97→09/02	Suspension Arm Repair Kit	MN-RK-7280	MN-RK-7280	for Drag Link;for Semi-Trailing Arm; for Wishbone (CV)	
	01/97→09/02	Suspension Strut Repair Kit		DF-RK-8637		
	01/97→09/02	Suspension Strut Repair Kit		DF-RK-8671		
	01/97→09/02	Suspension Strut Repair Kit		MN-RK-8537		
	01/97→09/02	Tie Rod	DF-DL-5403		1st FA	
	01/97→09/02	Tie Rod	DF-DL-7780			
	01/97→09/02	Tie Rod	DF-DL-7836			
	01/97→09/02	Tie Rod	MN-ES-10334		for Push Rod	
	01/97→09/02	Tie Rod End	CV-ES-12461		for Steering Rod	
	01/97→09/02	Tie Rod End	CV-ES-12462		for Steering Rod	
	01/97→09/02	Tie Rod End	CV-ES-14163		for Steering Rod	
	01/97→09/02	Tie Rod End	DF-ES-8362		for Steering Rod	
	01/97→09/02	Track Control Arm		DF-DL-8158	Trailing Arm	
	01/97→09/02	Track Control Arm		DF-VB-8561	Wishbone (CV)	
	01/97→09/02	Track Control Arm		DF-VB-9343	Wishbone (CV)	
	06/00→09/02	Centre Rod	DF-DL-5355		Push Rod	
	06/00→09/02	Tie Rod	DF-DL-7780		1st FA	
	06/00→09/02	Tie Rod	DF-DL-7836		1st FA	
	FAT 95 XF 380	01/97→06/00	Track Control Arm		DF-DL-9318	Trailing Arm
01/97→09/02		Ball Head, gearshift linkage	DF-ES-9335			
01/97→09/02		Centre Rod	DF-DL-2142		Push Rod	
01/97→09/02		Centre Rod	DF-DL-3798		Push Rod	
01/97→09/02		Centre Rod	DF-DL-12420		Push Rod	
01/97→09/02		Stabiliser Mounting		DF-SB-5251		
01/97→09/02		Stabiliser Mounting	DF-SB-5253	DF-SB-5253		
01/97→09/02		Stabiliser Mounting	DF-SB-10402			
01/97→09/02		Suspension Arm Repair Kit		CV-RK-5322	for Wishbone (CV)	
01/97→09/02		Suspension Arm Repair Kit		CV-RK-8118	for Drag Link	
01/97→09/02		Suspension Arm Repair Kit		IV-RK-8998	for Wishbone (CV)	
01/97→09/02		Suspension Arm Repair Kit		MN-RK-7280	for Drag Link;for Semi-Trailing Arm; for Wishbone (CV)	
01/97→09/02		Suspension Arm Repair Kit		MN-RK-7291	for Drag Link	
01/97→09/02		Suspension Arm Repair Kit		SC-RK-8575	for Wishbone (CV)	
01/97→09/02		Suspension Arm Repair Kit	MN-RK-7280	MN-RK-7280	for Drag Link;for Semi-Trailing Arm; for Wishbone (CV)	
01/97→09/02		Suspension Strut Repair Kit		DF-RK-8637		
01/97→09/02		Suspension Strut Repair Kit		DF-RK-8671		
01/97→09/02		Suspension Strut Repair Kit		MN-RK-8537		
01/97→09/02		Tie Rod	DF-DL-5403		1st FA	
01/97→09/02		Tie Rod	DF-DL-7836			
01/97→09/02		Tie Rod End	CV-ES-12461		for Steering Rod	
01/97→09/02		Tie Rod End	CV-ES-12462		for Steering Rod	
01/97→09/02		Tie Rod End	CV-ES-14163		for Steering Rod	
01/97→09/02		Track Control Arm		DF-TC-12262	Control Arm	
01/97→09/02		Track Control Arm		DF-VB-8561	Wishbone (CV)	
01/97→09/02		Track Control Arm		DF-VB-9343	Wishbone (CV)	
06/00→09/02		Centre Rod	DF-DL-5355		Push Rod	
06/00→09/02		Tie Rod	DF-DL-7780		1st FA	
06/00→09/02		Tie Rod	DF-DL-10193		1st FA	
06/00→09/02		Track Control Arm		DF-DL-8158	Trailing Arm	
FAT 95 XF 430		01/97→09/02	Ball Head, gearshift linkage	DF-ES-9335		
		01/97→09/02	Centre Rod	DF-DL-2142		Push Rod
		01/97→09/02	Centre Rod	DF-DL-3798		Push Rod
	01/97→09/02	Centre Rod	DF-DL-12420		Push Rod	
	01/97→09/02	Stabiliser Mounting		DF-SB-5251		
	01/97→09/02	Stabiliser Mounting	DF-SB-5253	DF-SB-5253		
	01/97→09/02	Stabiliser Mounting	DF-SB-10402			
	01/97→09/02	Suspension Arm Repair Kit		CV-RK-5322	for Wishbone (CV)	
	01/97→09/02	Suspension Arm Repair Kit		CV-RK-8118	for Drag Link	
	01/97→09/02	Suspension Arm Repair Kit		IV-RK-8998	for Wishbone (CV)	

CV-ES-12461

Length: 120
Cone Ø: d1 Ø 26 / d2 Ø 23,5
Thread: M30 x 1,5 RHT
0069513, 69513, 0311300, 311300, 607998, 0607998, 1190653, 1315447, 1319838, 1332123, 1338714, 1401934, 1407394, ACHB063, ACHF241, MAK1295



CV-ES-12462

Length: 120
Cone Ø: d1 Ø 26 / d2 Ø 23,5
Thread: M30 x 1,5 RHT
0069514, 0586753, 0607999, 0694298, 0694360, 0698609, 1137230, 1229944, 1326862, 1326896, 1331925, ACHB064, ACHF242, MAK1296



CV-ES-14163

Length: 125
Cone Ø: d1 Ø 30 / d2 Ø 27
Thread: M30 x 1,5 RHT
0607981, 0698450, 1149907, 1152350, 1257890, 1603789, 1618048, ACHF060



CV-RK-5322

Ø: 72
Thick/Height: 50
0691704



CV-RK-8118

Ø: 85
Hole Distance: 130
Thick/Height: 30
0689749



DF-DL-2142

Length: 1005 Ø: 52
Cone Ø: d1 Ø 26 / d2 Ø 23,5
1291060, 1351734, 1385499



DF-DL-3798

Length: 1015 Ø: 50
Cone Ø: d1 Ø 30 / d2 Ø 27
0094038, 0525433



DF-DL-5355

Length: 995 Ø: 36
Cone Ø: d1 Ø 26 / d2 Ø 23,5
1311048, 1351737, 1385498



DF-DL-5403

Length: 1742 Ø: 40
Cone Ø: d1 Ø 26 / d2 Ø 23,5
0288281, 1270854, 1337644



DF-DL-7780

Length: 1690 Ø: 40
Cone Ø: d1 Ø 26 / d2 Ø 23,5
1270853, 1353391, 10212000A



DF-DL-7836

Length: 1698 Ø: 52
Cone Ø: d1 Ø 26 / d2 Ø 23,5
0754922, 1286343, 1353396



DF-DL-8158

Length: 611 Ø: 48
Hole Distance: 130 / 130
0267743, 1361649, 1361650, 1656428



DF-DL-9318

Length: 600 Ø: 50
Hole Distance: 130 / 130
0646373, 0655695, 0655697, 1284860, 1620438



DF-DL-10193

Length: 1646 Ø: 40
Cone Ø: d1 Ø 26 / d2 Ø 23,5
1351205, 1353395



DF-DL-12420

Length: 1004 Ø: 52
Cone Ø: d1 Ø 30 / d2 Ø 27
Thread: M24 x 1,5 / M30 x 1,5
0094613, 094613, 94613, 0362413, 362413, 1426101



DF-ES-8362

Length: 150
Cone Ø: d1 Ø 26 / d2 Ø 23,5
Thread: M30 x 1,5 RHT
1389190



DF-ES-9335

Length: 85
Cone Ø: d1 Ø 12 / d2 Ø 10,75
Thread: M14 x 1,5 RHT
0386930, 386930



DF-RK-8637

Ø: 72
1376730



DF-RK-8671



DF-SB-5251

Ø: 85
Thick/Height: 60
0366351, 366351, 10305800A



DF-SB-5253

Ø: 86
Thick/Height: 60,5
0371586, 0558864, 10306500A



DF-SB-10402

Ø: 62
Thick/Height: 60
1291233, 1732887



DF-TC-12262

Length: 595 Ø: 50
Hole Distance: 130 / 130
0661406, 661406, 0661407, 661407, 1620439



DF-VB-8561

Length: 609 Ø: 48
Hole Distance: 152 / 152
0080521, 080521, 1361651, 1368270, 1390932, 1617096, 1793875, 1817808, 1892492



DF-VB-9343

Length: 608,2 Ø: 48
Hole Distance: 152 / 152
1361652, 1620436, 1793876, 10309600A



IV-RK-8998

Ø: 85
Hole Distance: 130
Thick/Height: 30
0513757, 0531757, 0691709, 691709



MN-ES-10334

Length: 140
Cone Ø: d1 Ø 26 / d2 Ø 23,5
Thread: M30 x 1,5 RHT
1320855, 1342026, 3093714, 10220897, 81953016236, 81953016331



MN-RK-7280

Ø: 75
Hole Distance: 115
Thick/Height: 24
0689748, 689748



MN-RK-7291

Ø: 72
Hole Distance: 130
Thick/Height: 30
1271124



MN-RK-8537

Ø: 95
Hole Distance: 152
Thick/Height: 24
696321, 81432706099



SC-RK-8575

Ø: 95
Hole Distance: 152
Thick/Height: 35
0696321





95 XF ...

FAT 95 XF 430 ...	01/97→09/02	Suspension Arm Repair Kit		MN-RK-7280	for Drag Link;for Semi-Trailing Arm; for Wishbone (CV)	
	01/97→09/02	Suspension Arm Repair Kit		MN-RK-7291	for Drag Link	
	01/97→09/02	Suspension Arm Repair Kit		SC-RK-8575	for Wishbone (CV)	
	01/97→09/02	Suspension Arm Repair Kit	MN-RK-7280	MN-RK-7280	for Drag Link;for Semi-Trailing Arm; for Wishbone (CV)	
	01/97→09/02	Suspension Strut Repair Kit		DF-RK-8637		
	01/97→09/02	Suspension Strut Repair Kit		DF-RK-8671		
	01/97→09/02	Suspension Strut Repair Kit		MN-RK-8537		
	01/97→09/02	Tie Rod	DF-DL-5403		1st FA	
	01/97→09/02	Tie Rod	DF-DL-7836			
	01/97→09/02	Tie Rod End	CV-ES-12461		for Steering Rod	
	01/97→09/02	Tie Rod End	CV-ES-12462		for Steering Rod	
	01/97→09/02	Tie Rod End	CV-ES-14163		for Steering Rod	
	01/97→09/02	Track Control Arm		DF-DL-9318	Trailing Arm	
	01/97→09/02	Track Control Arm		DF-TC-12262	Control Arm	
	01/97→09/02	Track Control Arm		DF-VB-8561	Wishbone (CV)	
	01/97→09/02	Track Control Arm		DF-VB-9343	Wishbone (CV)	
	06/00→09/02	Centre Rod	DF-DL-5355		Push Rod	
	06/00→09/02	Tie Rod	DF-DL-7780		1st FA	
	06/00→09/02	Tie Rod	DF-DL-10193		1st FA	
	06/00→09/02	Track Control Arm		DF-DL-8158	Trailing Arm	
FAT 95 XF 480	01/97→09/02	Ball Head, gearshift linkage	DF-ES-9335			
	01/97→09/02	Centre Rod	DF-DL-2142		Push Rod	
	01/97→09/02	Centre Rod	DF-DL-3798		Push Rod	
	01/97→09/02	Centre Rod	DF-DL-12420		Push Rod	
	01/97→09/02	Stabiliser Mounting		DF-SB-5251		
	01/97→09/02	Stabiliser Mounting	DF-SB-5253	DF-SB-5253		
	01/97→09/02	Stabiliser Mounting	DF-SB-10402			
	01/97→09/02	Suspension Arm Repair Kit		CV-RK-5322	for Wishbone (CV)	
	01/97→09/02	Suspension Arm Repair Kit		CV-RK-8118	for Drag Link	
	01/97→09/02	Suspension Arm Repair Kit		IV-RK-8998	for Wishbone (CV)	
	01/97→09/02	Suspension Arm Repair Kit		MN-RK-7280	for Drag Link;for Semi-Trailing Arm; for Wishbone (CV)	
	01/97→09/02	Suspension Arm Repair Kit		MN-RK-7291	for Drag Link	
	01/97→09/02	Suspension Arm Repair Kit		SC-RK-8575	for Wishbone (CV)	
	01/97→09/02	Suspension Arm Repair Kit	MN-RK-7280	MN-RK-7280	for Drag Link;for Semi-Trailing Arm; for Wishbone (CV)	
	01/97→09/02	Suspension Strut Repair Kit		DF-RK-8637		
	01/97→09/02	Suspension Strut Repair Kit		DF-RK-8671		
	01/97→09/02	Suspension Strut Repair Kit		MN-RK-8537		
	01/97→09/02	Tie Rod	DF-DL-5403		1st FA	
	01/97→09/02	Tie Rod	DF-DL-7836			
	01/97→09/02	Tie Rod End	CV-ES-12461		for Steering Rod	
	01/97→09/02	Tie Rod End	CV-ES-12462		for Steering Rod	
	01/97→09/02	Tie Rod End	CV-ES-14163		for Steering Rod	
	01/97→09/02	Track Control Arm		DF-VB-8561	Wishbone (CV)	
	01/97→09/02	Track Control Arm		DF-VB-9343	Wishbone (CV)	
	06/00→09/02	Centre Rod	DF-DL-5355		Push Rod	
	06/00→09/02	Tie Rod	DF-DL-7780		1st FA	
	06/00→09/02	Tie Rod	DF-DL-10193		1st FA	
	06/00→09/02	Track Control Arm		DF-DL-8158	Trailing Arm	
	FAT 95 XF 530	01/97→09/02	Suspension Arm Repair Kit		DF-RK-8633	for Wishbone (CV)
		01/97→09/02	Suspension Arm Repair Kit	MN-RK-7280	MN-RK-7280	for Drag Link;for Semi-Trailing Arm; for Wishbone (CV)
01/97→09/02		Tie Rod End	CV-ES-12461		for Steering Rod	
01/97→09/02		Tie Rod End	CV-ES-12462		for Steering Rod	
06/00→09/02		Centre Rod	DF-DL-5355		Push Rod	
06/00→09/02		Tie Rod	DF-DL-5403		1st FA	
06/00→09/02		Tie Rod	DF-DL-7780		1st FA	
06/00→09/02		Tie Rod	DF-DL-10193		1st FA	
06/00→09/02		Track Control Arm		DF-DL-8158	Trailing Arm	



CV-ES-12461

Length: 120
Cone Ø: d1 Ø 26 / d2 Ø 23,5
Thread: M30 x 1,5 LHT
0069513, 69513, 0311300, 311300,
0607998, 607998, 1190653, 1315447,
1319838, 1332123, 1338714, 1401934,
1407394, ACHB063, ACHF241, MAK1295



CV-ES-12462

Length: 120
Cone Ø: d1 Ø 26 / d2 Ø 23,5
Thread: M30 x 1,5 RHT
0069514, 0586753, 0607999, 0694298,
0694360, 0698609, 1137230, 1229944,
1326862, 1326896, 1331925, ACHB064,
ACHF242, MAK1296



CV-ES-14163

Length: 125
Cone Ø: d1 Ø 30 / d2 Ø 27
Thread: M30 x 1,5 RHT
0607981, 0698450, 1149907, 1152350,
1257890, 1603789, 1618048, ACHF060



CV-RK-5322

Ø: 72
Thick/Height: 50
0691704



CV-RK-8118

Ø: 85
Hole Distance: 130
Thick/Height: 30
0689749



DF-DL-2142

Length: 1005 Ø: 52
Cone Ø: d1 Ø 26 / d2 Ø 23,5
1291060, 1351734, 1385499



DF-DL-3798

Length: 1015 Ø: 50
Cone Ø: d1 Ø 30 / d2 Ø 27
0094038, 0525433



DF-DL-5355

Length: 995 Ø: 36
Cone Ø: d1 Ø 26 / d2 Ø 23,5
1311048, 1351737, 1385498



DF-DL-5403

Length: 1742 Ø: 40
Cone Ø: d1 Ø 26 / d2 Ø 23,5
0288281, 1270854, 1337644



DF-DL-7780

Length: 1690 Ø: 40
Cone Ø: d1 Ø 26 / d2 Ø 23,5
1270853, 1353391, 10212000A



DF-DL-7836

Length: 1698 Ø: 52
Cone Ø: d1 Ø 26 / d2 Ø 23,5
0754922, 1286343, 1353396



DF-DL-8158

Length: 611 Ø: 48
Hole Distance: 130 / 130
0267743, 1361649, 1361650, 1656428



DF-DL-9318

Length: 600 Ø: 50
Hole Distance: 130 / 130
0646373, 0655695, 0655697, 1284860,
1620438



DF-DL-10193

Length: 1646 Ø: 40
Cone Ø: d1 Ø 26 / d2 Ø 23,5
1351205, 1353395



DF-DL-12420

Length: 1004 Ø: 52
Cone Ø: d1 Ø 30 / d2 Ø 27
Thread: M24 x 1,5 / M30 x 1,5
0094613, 094613, 94613, 0362413, 362413,
1426101



DF-ES-9335

Length: 85
Cone Ø: d1 Ø 12 / d2 Ø 10,75
Thread: M14 x 1,5 RHT
0386930, 386930



DF-RK-8633

Ø: 90
0696320, 696320



DF-RK-8637

Ø: 72
1376730



DF-RK-8671



DF-SB-5251

Ø: 85
Thick/Height: 60
0366351, 366351, 10305800A



DF-SB-5253

Ø: 86
Thick/Height: 60,5
0371586, 0558864, 10306500A



DF-SB-10402

Ø: 62
Thick/Height: 60
1291233, 1732887



DF-TC-12262

Length: 595 Ø: 50
Hole Distance: 130 / 130
0661406, 661406, 661407, 0661407,
1620439



DF-VB-8561

Length: 609 Ø: 48
Hole Distance: 152 / 152
0080521, 080521, 1361651, 1368270,
1390932, 1617096, 1793875, 1817808,
1892492



DF-VB-9343

Length: 608,2 Ø: 48
Hole Distance: 152 / 152
1361652, 1620436, 1793876, 10309600A



IV-RK-8998

Ø: 85
Hole Distance: 130
Thick/Height: 30
0513757, 0531757, 0691709, 691709



MN-RK-7280

Ø: 75
Hole Distance: 115
Thick/Height: 24
0689748, 689748



MN-RK-7291

Ø: 72
Hole Distance: 130
Thick/Height: 30
1271124



MN-RK-8537

Ø: 95
Hole Distance: 152
Thick/Height: 24
696321, 81432706099



SC-RK-8575

Ø: 95
Hole Distance: 152
Thick/Height: 35
0696321





95 XF ...

FT 95 XF 380

01/97→09/02	Ball Head, gearshift linkage	DF-ES-9335		
01/97→09/02	Centre Rod	DF-DL-2142		Push Rod
01/97→09/02	Centre Rod	DF-DL-3798		Push Rod
01/97→09/02	Centre Rod	DF-DL-12420		Push Rod
01/97→09/02	Stabiliser Mounting		DF-SB-5251	
01/97→09/02	Stabiliser Mounting	DF-SB-5253	DF-SB-5253	
01/97→09/02	Stabiliser Mounting	DF-SB-10402		
01/97→09/02	Suspension Arm Repair Kit		CV-RK-5322	for Wishbone (CV)
01/97→09/02	Suspension Arm Repair Kit		CV-RK-8118	for Drag Link
01/97→09/02	Suspension Arm Repair Kit		IV-RK-8998	for Wishbone (CV)
01/97→09/02	Suspension Arm Repair Kit		MN-RK-7280	for Drag Link;for Semi-Trailing Arm; for Wishbone (CV)
01/97→09/02	Suspension Arm Repair Kit		MN-RK-7291	for Drag Link
01/97→09/02	Suspension Arm Repair Kit		SC-RK-8575	for Wishbone (CV)
01/97→09/02	Suspension Arm Repair Kit	MN-RK-7280	MN-RK-7280	for Drag Link;for Semi-Trailing Arm; for Wishbone (CV)
01/97→09/02	Suspension Strut Repair Kit		DF-RK-8637	
01/97→09/02	Suspension Strut Repair Kit		DF-RK-8671	
01/97→09/02	Suspension Strut Repair Kit		MN-RK-8537	
01/97→09/02	Tie Rod	DF-DL-5403		
01/97→09/02	Tie Rod	DF-DL-7780		1st FA
01/97→09/02	Tie Rod	DF-DL-7836		1st FA
01/97→09/02	Tie Rod	MN-ES-10334		for Push Rod
01/97→09/02	Tie Rod End	CV-ES-12461		for Steering Rod
01/97→09/02	Tie Rod End	CV-ES-12462		for Steering Rod
01/97→09/02	Tie Rod End	CV-ES-14163		for Steering Rod
01/97→09/02	Tie Rod End	DF-ES-8362		for Steering Rod
01/97→09/02	Track Control Arm		DF-DL-8158	Trailing Arm
01/97→09/02	Track Control Arm		DF-DL-9331	Wishbone (CV), 1st RA, for Pneumatic Suspension vehicles
01/97→09/02	Track Control Arm		DF-VB-8561	Wishbone (CV)
01/97→09/02	Track Control Arm		DF-VB-9343	Wishbone (CV)
06/00→09/02	Centre Rod	DF-DL-5355		Push Rod
06/00→09/02	Tie Rod	DF-DL-10193		1st FA

FT 95 XF 430

01/97→09/02	Ball Head, gearshift linkage	DF-ES-9335		
01/97→09/02	Centre Rod	DF-DL-2142		Push Rod
01/97→09/02	Centre Rod	DF-DL-3798		Push Rod
01/97→09/02	Centre Rod	DF-DL-12420		Push Rod
01/97→09/02	Stabiliser Mounting		DF-SB-5251	
01/97→09/02	Stabiliser Mounting	DF-SB-5253	DF-SB-5253	
01/97→09/02	Stabiliser Mounting	DF-SB-10402		
01/97→09/02	Suspension Arm Repair Kit		CV-RK-5322	for Wishbone (CV)
01/97→09/02	Suspension Arm Repair Kit		CV-RK-8118	for Drag Link
01/97→09/02	Suspension Arm Repair Kit		IV-RK-8998	for Wishbone (CV)
01/97→09/02	Suspension Arm Repair Kit		MN-RK-7280	for Drag Link;for Semi-Trailing Arm; for Wishbone (CV)
01/97→09/02	Suspension Arm Repair Kit		MN-RK-7291	for Drag Link
01/97→09/02	Suspension Arm Repair Kit		SC-RK-8575	for Wishbone (CV)
01/97→09/02	Suspension Arm Repair Kit	MN-RK-7280	MN-RK-7280	for Drag Link;for Semi-Trailing Arm; for Wishbone (CV)
01/97→09/02	Suspension Strut Repair Kit		DF-RK-8637	
01/97→09/02	Suspension Strut Repair Kit		DF-RK-8671	
01/97→09/02	Suspension Strut Repair Kit		MN-RK-8537	
01/97→09/02	Tie Rod	DF-DL-5403		
01/97→09/02	Tie Rod	DF-DL-7780		1st FA
01/97→09/02	Tie Rod	DF-DL-7836		1st FA
01/97→09/02	Tie Rod	MN-ES-10334		for Push Rod
01/97→09/02	Tie Rod End	CV-ES-12461		for Steering Rod
01/97→09/02	Tie Rod End	CV-ES-12462		for Steering Rod
01/97→09/02	Tie Rod End	CV-ES-14163		for Steering Rod
01/97→09/02	Tie Rod End	DF-ES-8362		for Steering Rod
01/97→09/02	Track Control Arm		DF-DL-8158	Trailing Arm

CV-ES-12461

Length: 120
Cone Ø: d1 Ø 26 / d2 Ø 23,5
Thread: M30 x 1,5 LHT
0069513, 69513, 0311300, 311300,
0607998, 607998, 1190653, 1315447,
1319838, 1332123, 1338714, 1401934,
1407394, ACHB063, ACHF241, MAK1295



CV-ES-12462

Length: 120
Cone Ø: d1 Ø 26 / d2 Ø 23,5
Thread: M30 x 1,5 RHT
0069514, 0586753, 0607999, 0694298,
0694360, 0698609, 1137230, 1229944,
1326862, 1326896, 1331925, ACHB064,
ACHF242, MAK1296



CV-ES-14163

Length: 125
Cone Ø: d1 Ø 30 / d2 Ø 27
Thread: M30 x 1,5 RHT
0607981, 0698450, 1149907, 1152350,
1257890, 1603789, 1618048, ACHF060



CV-RK-5322

Ø: 72
Thick/Height: 50
0691704



CV-RK-8118

Ø: 85
Hole Distance: 130
Thick/Height: 30
0689749



DF-DL-2142

Length: 1005 Ø: 52
Cone Ø: d1 Ø 26 / d2 Ø 23,5
1291060, 1351734, 1385499



DF-DL-3798

Length: 1015 Ø: 50
Cone Ø: d1 Ø 30 / d2 Ø 27
0094038, 0525433



DF-DL-5355

Length: 995 Ø: 36
Cone Ø: d1 Ø 26 / d2 Ø 23,5
1311048, 1351737, 1385498



DF-DL-5403

Length: 1742 Ø: 40
Cone Ø: d1 Ø 26 / d2 Ø 23,5
0288281, 1270854, 1337644



DF-DL-7780

Length: 1690 Ø: 40
Cone Ø: d1 Ø 26 / d2 Ø 23,5
1270853, 1353391, 10212000A



DF-DL-7836

Length: 1698 Ø: 52
Cone Ø: d1 Ø 26 / d2 Ø 23,5
0754922, 1286343, 1353396



DF-DL-8158

Length: 611 Ø: 48
Hole Distance: 130 / 130
0267743, 1361649, 1361650, 1656428



DF-DL-9331

Length: 390 Ø: 50
Hole Distance: 130 / 152
1261101



DF-DL-10193

Length: 1646 Ø: 40
Cone Ø: d1 Ø 26 / d2 Ø 23,5
1351205, 1353395



DF-DL-12420

Length: 1004 Ø: 52
Cone Ø: d1 Ø 30 / d2 Ø 27
Thread: M24 x 1,5 / M30 x 1,5
094613, 94613, 0094613, 0362413, 362413,
1426101



DF-ES-8362

Length: 150
Cone Ø: d1 Ø 26 / d2 Ø 23,5
Thread: M30 x 1,5 RHT
1389190



DF-ES-9335

Length: 85
Cone Ø: d1 Ø 12 / d2 Ø 10,75
Thread: M14 x 1,5 RHT
0386930, 386930



DF-RK-8637

Ø: 72
1376730



DF-RK-8671



DF-SB-5251

Ø: 85
Thick/Height: 60
0366351, 366351, 10305800A



DF-SB-5253

Ø: 86
Thick/Height: 60,5
0371586, 0558864, 10306500A



DF-SB-10402

Ø: 62
Thick/Height: 60
1291233, 1732887



DF-VB-8561

Length: 609 Ø: 48
Hole Distance: 152 / 152
0080521, 080521, 1361651, 1368270,
1390932, 1617096, 1793875, 1817808,
1892492



DF-VB-9343

Length: 608,2 Ø: 48
Hole Distance: 152 / 152
1361652, 1620436, 1793876, 10309600A



IV-RK-8998

Ø: 85
Hole Distance: 130
Thick/Height: 30
0513757, 0531757, 0691709, 691709



MN-ES-10334

Length: 140
Cone Ø: d1 Ø 26 / d2 Ø 23,5
Thread: M30 x 1,5 RHT
1320855, 1342026, 3093714, 10220897,
81953016236, 81953016331



MN-RK-7280

Ø: 75
Hole Distance: 115
Thick/Height: 24
0689748, 689748



MN-RK-7291

Ø: 72
Hole Distance: 130
Thick/Height: 30
1271124



MN-RK-8537

Ø: 95
Hole Distance: 152
Thick/Height: 24
696321, 81432706099



SC-RK-8575

Ø: 95
Hole Distance: 152
Thick/Height: 35
0696321





95 XF ...

FT 95 XF 430 ...	01/97→09/02	Track Control Arm		DF-DL-9331	Wishbone (CV), 1st RA, for Pneumatic Suspension vehicles	
	01/97→09/02	Track Control Arm		DF-VB-8561	Wishbone (CV)	
	01/97→09/02	Track Control Arm		DF-VB-9343	Wishbone (CV)	
	06/00→09/02	Centre Rod	DF-DL-5355		Push Rod	
	06/00→09/02	Tie Rod	DF-DL-10193		1st FA	
	FT 95 XF 480	01/97→09/02	Ball Head, gearshift linkage	DF-ES-9335		
01/97→09/02		Centre Rod	DF-DL-2142		Push Rod	
01/97→09/02		Centre Rod	DF-DL-3798		Push Rod	
01/97→09/02		Centre Rod	DF-DL-12420		Push Rod	
01/97→09/02		Stabiliser Mounting		DF-SB-5251		
01/97→09/02		Stabiliser Mounting	DF-SB-5253	DF-SB-5253		
01/97→09/02		Stabiliser Mounting	DF-SB-10402			
01/97→09/02		Suspension Arm Repair Kit		CV-RK-5322	for Wishbone (CV)	
01/97→09/02		Suspension Arm Repair Kit		CV-RK-8118	for Drag Link	
01/97→09/02		Suspension Arm Repair Kit		IV-RK-8998	for Wishbone (CV)	
01/97→09/02		Suspension Arm Repair Kit		MN-RK-7280	for Drag Link;for Semi-Trailing Arm; for Wishbone (CV)	
01/97→09/02		Suspension Arm Repair Kit		MN-RK-7291	for Drag Link	
01/97→09/02		Suspension Arm Repair Kit		SC-RK-8575	for Wishbone (CV)	
01/97→09/02		Suspension Arm Repair Kit	MN-RK-7280	MN-RK-7280	for Drag Link;for Semi-Trailing Arm; for Wishbone (CV)	
01/97→09/02		Suspension Strut Repair Kit		DF-RK-8637		
01/97→09/02		Suspension Strut Repair Kit		DF-RK-8671		
01/97→09/02		Suspension Strut Repair Kit		MN-RK-8537		
01/97→09/02		Tie Rod	DF-DL-5403			
01/97→09/02		Tie Rod	DF-DL-7780		1st FA	
01/97→09/02		Tie Rod	DF-DL-7836		1st FA	
01/97→09/02		Tie Rod	MN-ES-10334		for Push Rod	
01/97→09/02		Tie Rod End	CV-ES-12461		for Steering Rod	
01/97→09/02		Tie Rod End	CV-ES-12462		for Steering Rod	
01/97→09/02		Tie Rod End	CV-ES-14163		for Steering Rod	
01/97→09/02		Tie Rod End	DF-ES-8362		for Steering Rod	
01/97→09/02		Track Control Arm		DF-DL-8158	Trailing Arm	
01/97→09/02		Track Control Arm		DF-DL-9331	Wishbone (CV), 1st RA, for Pneumatic Suspension vehicles	
01/97→09/02		Track Control Arm		DF-VB-8561	Wishbone (CV)	
01/97→09/02		Track Control Arm		DF-VB-9343	Wishbone (CV)	
06/00→09/02		Centre Rod	DF-DL-5355		Push Rod	
06/00→09/02		Tie Rod	DF-DL-10193		1st FA	
FT 95 XF 530		01/97→09/02	Ball Head, gearshift linkage	DF-ES-9335		
		01/97→09/02	Centre Rod	DF-DL-2142		Push Rod
		01/97→09/02	Centre Rod	DF-DL-3798		Push Rod
		01/97→09/02	Centre Rod	DF-DL-12420		Push Rod
		01/97→09/02	Stabiliser Mounting		DF-SB-5251	
		01/97→09/02	Stabiliser Mounting	DF-SB-5253	DF-SB-5253	
		01/97→09/02	Stabiliser Mounting	DF-SB-10402		
		01/97→09/02	Suspension Arm Repair Kit		CV-RK-5322	for Wishbone (CV)
		01/97→09/02	Suspension Arm Repair Kit		CV-RK-8118	for Drag Link
		01/97→09/02	Suspension Arm Repair Kit		IV-RK-8998	for Wishbone (CV)
		01/97→09/02	Suspension Arm Repair Kit		MN-RK-7280	for Drag Link;for Semi-Trailing Arm; for Wishbone (CV)
	01/97→09/02	Suspension Arm Repair Kit		MN-RK-7291	for Drag Link	
	01/97→09/02	Suspension Arm Repair Kit		SC-RK-8575	for Wishbone (CV)	
	01/97→09/02	Suspension Arm Repair Kit	MN-RK-7280	MN-RK-7280	for Drag Link;for Semi-Trailing Arm; for Wishbone (CV)	
	01/97→09/02	Suspension Strut Repair Kit		DF-RK-8637		
	01/97→09/02	Suspension Strut Repair Kit		DF-RK-8671		
	01/97→09/02	Suspension Strut Repair Kit		MN-RK-8537		
	01/97→09/02	Tie Rod	DF-DL-5403			
	01/97→09/02	Tie Rod	DF-DL-7780		1st FA	
	01/97→09/02	Tie Rod	MN-ES-10334		for Push Rod	
	01/97→09/02	Tie Rod End	CV-ES-12461		for Steering Rod	

CV-ES-12461

Length: 120
Cone Ø: d1 Ø 26 / d2 Ø 23,5
Thread: M30 x 1,5 LHT
0069513, 69513, 311300, 0311300,
0607998, 607998, 1190653, 1315447,
1319838, 1332123, 1338714, 1401934,
1407394, ACHB063, ACHF241, MAK1254



CV-ES-12462

Length: 120
Cone Ø: d1 Ø 26 / d2 Ø 23,5
Thread: M30 x 1,5 RHT
0069514, 0586753, 0607999, 0694298,
0694360, 0698609, 1137230, 1229944,
1326862, 1326896, 1331925, ACHB064,
ACHF242, MAK1296



CV-ES-14163

Length: 125
Cone Ø: d1 Ø 30 / d2 Ø 27
Thread: M30 x 1,5 RHT
0607981, 0698450, 1149907, 1152350,
1257890, 1603789, 1618048, ACHF060



CV-RK-5322

Ø: 72
Thick/Height: 50
0691704



CV-RK-8118

Ø: 85
Hole Distance: 130
Thick/Height: 30
0689749



DF-DL-2142

Length: 1005 Ø: 52
Cone Ø: d1 Ø 26 / d2 Ø 23,5
1291060, 1351734, 1385499



DF-DL-3798

Length: 1015 Ø: 50
Cone Ø: d1 Ø 30 / d2 Ø 27
0094038, 0525433



DF-DL-5355

Length: 995 Ø: 36
Cone Ø: d1 Ø 26 / d2 Ø 23,5
1311048, 1351737, 1385498



DF-DL-5403

Length: 1742 Ø: 40
Cone Ø: d1 Ø 26 / d2 Ø 23,5
0288281, 1270854, 1337644



DF-DL-7780

Length: 1690 Ø: 40
Cone Ø: d1 Ø 26 / d2 Ø 23,5
1270853, 1353391, 10212000A



DF-DL-7836

Length: 1698 Ø: 52
Cone Ø: d1 Ø 26 / d2 Ø 23,5
0754922, 1286343, 1353396



DF-DL-8158

Length: 611 Ø: 48
Hole Distance: 130 / 130
0267743, 1361649, 1361650, 1656428



DF-DL-9331

Length: 390 Ø: 50
Hole Distance: 130 / 152
1261101



DF-DL-10193

Length: 1646 Ø: 40
Cone Ø: d1 Ø 26 / d2 Ø 23,5
1351205, 1353395



DF-DL-12420

Length: 1004 Ø: 52
Cone Ø: d1 Ø 30 / d2 Ø 27
Thread: M24 x 1,5 / M30 x 1,5
0094613, 094613, 94613, 0362413, 362413,
1426101



DF-ES-8362

Length: 150
Cone Ø: d1 Ø 26 / d2 Ø 23,5
Thread: M30 x 1,5 RHT
1389190



DF-ES-9335

Length: 85
Cone Ø: d1 Ø 12 / d2 Ø 10,75
Thread: M14 x 1,5 RHT
0386930, 386930



DF-RK-8637

Ø: 72
1376730



DF-RK-8671



DF-SB-5251

Ø: 85
Thick/Height: 60
0366351, 366351, 10305800A



DF-SB-5253

Ø: 86
Thick/Height: 60,5
0371586, 0558864, 10306500A



DF-SB-10402

Ø: 62
Thick/Height: 60
1291233, 1732887



DF-VB-8561

Length: 609 Ø: 48
Hole Distance: 152 / 152
0080521, 080521, 1361651, 1368270,
1390932, 1617096, 1793875, 1817808,
1892492



DF-VB-9343

Length: 608,2 Ø: 48
Hole Distance: 152 / 152
1361652, 1620436, 1793876, 10309600A



IV-RK-8998

Ø: 85
Hole Distance: 130
Thick/Height: 30
0513757, 0531757, 691709, 0691709



MN-ES-10334

Length: 140
Cone Ø: d1 Ø 26 / d2 Ø 23,5
Thread: M30 x 1,5 RHT
1320855, 1342026, 3093714, 10220897,
81953016236, 81953016331



MN-RK-7280

Ø: 75
Hole Distance: 115
Thick/Height: 24
0689748, 689748



MN-RK-7291

Ø: 72
Hole Distance: 130
Thick/Height: 30
1271124



MN-RK-8537

Ø: 95
Hole Distance: 152
Thick/Height: 24
696321, 81432706099



SC-RK-8575

Ø: 95
Hole Distance: 152
Thick/Height: 35
0696321





95 XF ...

FT 95 XF 530 ...	01/97→09/02	Tie Rod End	CV-ES-12462		for Steering Rod	
	01/97→09/02	Tie Rod End	CV-ES-14163		for Steering Rod	
	01/97→09/02	Tie Rod End	DF-ES-8362		for Steering Rod	
	01/97→09/02	Track Control Arm		DF-DL-8158	Trailing Arm	
	01/97→09/02	Track Control Arm		DF-DL-9331	Wishbone (CV), 1st RA, for Pneumatic Suspension vehicles	
	01/97→09/02	Track Control Arm		DF-VB-8561	Wishbone (CV)	
	01/97→09/02	Track Control Arm		DF-VB-9343	Wishbone (CV)	
	06/00→09/02	Centre Rod	DF-DL-5355		Push Rod	
	06/00→09/02	Tie Rod	DF-DL-7836		1st FA	
	06/00→09/02	Tie Rod	DF-DL-10193		1st FA	
	02/01→09/02	Tie Rod	DF-DL-7780			
	02/01→09/02	Tie Rod	DF-DL-7836			
	FTG 95 XF 380	01/97→09/02	Ball Head, gearshift linkage	DF-ES-9335		
		01/97→09/02	Centre Rod	DF-DL-2142		Push Rod
01/97→09/02		Centre Rod	DF-DL-3798		Push Rod	
01/97→09/02		Centre Rod	DF-DL-5355		Push Rod	
01/97→09/02		Centre Rod	DF-DL-8359		Push Rod	
01/97→09/02		Centre Rod	DF-DL-10183		Push Rod, for vehicles with Hinged Leading Axle	
01/97→09/02		Centre Rod	DF-DL-12420		Push Rod	
01/97→09/02		Centre Rod	DF-DL-12423		for Steering Rod	
01/97→09/02		Stabiliser Mounting		DF-SB-5251		
01/97→09/02		Stabiliser Mounting	DF-SB-5253	DF-SB-5253		
01/97→09/02		Stabiliser Mounting	DF-SB-10402			
01/97→09/02		Suspension Arm Repair Kit		CV-RK-5322	for Wishbone (CV)	
01/97→09/02		Suspension Arm Repair Kit		CV-RK-8118	for Drag Link	
01/97→09/02		Suspension Arm Repair Kit		IV-RK-8998	for Wishbone (CV)	
01/97→09/02		Suspension Arm Repair Kit		MN-RK-7280	for Drag Link;for Semi-Trailing Arm; for Wishbone (CV)	
01/97→09/02		Suspension Arm Repair Kit		MN-RK-7291	for Drag Link	
01/97→09/02		Suspension Arm Repair Kit		SC-RK-8575	for Wishbone (CV)	
01/97→09/02		Suspension Arm Repair Kit	MN-RK-7280	MN-RK-7280	for Drag Link;for Semi-Trailing Arm; for Wishbone (CV)	
01/97→09/02		Suspension Strut Repair Kit		DF-RK-8637		
01/97→09/02		Suspension Strut Repair Kit		DF-RK-8671		
01/97→09/02		Suspension Strut Repair Kit		MN-RK-8537		
01/97→09/02		Tie Rod		DF-ES-5761	Leading Axle	
01/97→09/02		Tie Rod	DF-DL-5403			
01/97→09/02		Tie Rod	DF-DL-7780		1st FA	
01/97→09/02		Tie Rod	DF-DL-7836			
01/97→09/02		Tie Rod End	CV-ES-12461		for Steering Rod	
01/97→09/02		Tie Rod End	CV-ES-12462		for Steering Rod	
01/97→09/02		Tie Rod End	CV-ES-14163		for Steering Rod	
01/97→09/02		Tie Rod End	DF-ES-8362		for Steering Rod	
01/97→09/02		Tie Rod End	DF-ES-9334		Push Rod	
01/97→09/02		Track Control Arm		DF-DL-8158	Trailing Arm	
01/97→09/02		Track Control Arm		DF-TC-12492	Trailing Arm, Leading Axle, for Pneumatic Suspension vehicles	
01/97→09/02		Track Control Arm		DF-VB-8561	Wishbone (CV)	
01/97→09/02		Track Control Arm		DF-VB-9343	Wishbone (CV)	
FTG 95 XF 430		01/97→09/02	Ball Head, gearshift linkage	DF-ES-9335		
		01/97→09/02	Centre Rod	DF-DL-2142		Push Rod
		01/97→09/02	Centre Rod	DF-DL-3798		Push Rod
		01/97→09/02	Centre Rod	DF-DL-5355		Push Rod
		01/97→09/02	Centre Rod	DF-DL-8359		Push Rod
		01/97→09/02	Centre Rod	DF-DL-10183		Push Rod, for vehicles with Hinged Leading Axle
	01/97→09/02	Centre Rod	DF-DL-12420		Push Rod	
	01/97→09/02	Centre Rod	DF-DL-12423		for Steering Rod	
	01/97→09/02	Stabiliser Mounting		DF-SB-5251		
	01/97→09/02	Stabiliser Mounting	DF-SB-5253	DF-SB-5253		
	01/97→09/02	Stabiliser Mounting	DF-SB-10402			
	01/97→09/02	Suspension Arm Repair Kit		CV-RK-5322	for Wishbone (CV)	
	01/97→09/02	Suspension Arm Repair Kit		CV-RK-8118	for Drag Link	

CV-ES-12461

Length: 120
Cone Ø: d1 Ø 26 / d2 Ø 23,5
Thread: M30 x 1,5 LHT
69513, 0069513, 0311300, 311300,
0607998, 607998, 1190653, 1315447,
1319838, 1332123, 1338714, 1401934,
1407394, ACHB063, ACHF241, MAK1295



CV-ES-12462

Length: 120
Cone Ø: d1 Ø 26 / d2 Ø 23,5
Thread: M30 x 1,5 RHT
0069514, 0586753, 0607999, 0694298,
0694360, 0698609, 1137230, 1229944,
1326862, 1326896, 1331925, ACHB064,
ACHF242, MAK1296



CV-ES-14163

Length: 125
Cone Ø: d1 Ø 30 / d2 Ø 27
Thread: M30 x 1,5 RHT
0607981, 0698450, 1149907, 1152350,
1257890, 1603789, 1618048, ACHF060



CV-RK-5322

Ø: 72 Thick/Height: 50
0691704



CV-RK-8118

Ø: 85
Hole Distance: 130
Thick/Height: 30
0689749



DF-DL-2142

Length: 1005 Ø: 52
Cone Ø: d1 Ø 26 / d2 Ø 23,5
1291060, 1351734, 1385499



DF-DL-3798

Length: 1015 Ø: 50
Cone Ø: d1 Ø 30 / d2 Ø 27
0094038, 0525433

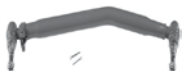

DF-DL-5355

Length: 995 Ø: 36
Cone Ø: d1 Ø 26 / d2 Ø 23,5
1311048, 1351737, 1385498



DF-DL-5403

Length: 1742 Ø: 40
Cone Ø: d1 Ø 26 / d2 Ø 23,5
0288281, 1270854, 1337644



DF-DL-7780

Length: 1690 Ø: 40
Cone Ø: d1 Ø 26 / d2 Ø 23,5
1270853, 1353391, 10212000A



DF-DL-7836

Length: 1698 Ø: 52
Cone Ø: d1 Ø 26 / d2 Ø 23,5
0754922, 1286343, 1353396



DF-DL-8158

Length: 611 Ø: 48
Hole Distance: 130 / 130
0267743, 1361649, 1361650, 1656428



DF-DL-8359

Length: 1018 Ø: 30
Cone Ø: d1 Ø 26 / d2 Ø 23,5
1306332, 1351740, 1385502



DF-DL-9331

Length: 390 Ø: 50
Hole Distance: 130 / 152
1261101



DF-DL-10183

Length: 588 Ø: 36
Cone Ø: d1 Ø 26 / d2 Ø 23,5
1306333, 1351741, 1385487



DF-DL-10193

Length: 1646 Ø: 40
Cone Ø: d1 Ø 26 / d2 Ø 23,5
1351205, 1353395



DF-DL-12420

Length: 1004 Ø: 52
Cone Ø: d1 Ø 30 / d2 Ø 27
Thread: M24 x 1,5 / M30 x 1,5
0094613, 094613, 94613, 0362413, 362413,
1426101



DF-DL-12423

Length: 1955 Ø: 42
Cone Ø: d1 Ø 26 / d2 Ø 23,5
1306336, 1351739, 1385516



DF-ES-5761

Length: 1512 Ø: 52
Cone Ø: d1 Ø 26 / d2 Ø 23,5
1297572, 1361155



DF-ES-8362

Length: 150
Cone Ø: d1 Ø 26 / d2 Ø 23,5
Thread: M30 x 1,5 RHT
1389190



DF-ES-9334

Length: 115
Cone Ø: d1 Ø 26 / d2 Ø 23,5
Thread: M24 x 1,5 RHT
1344684



DF-ES-9335

Length: 85
Cone Ø: d1 Ø 12 / d2 Ø 10,75
Thread: M14 x 1,5 RHT
0386930, 386930



DF-RK-8637

Ø: 72
1376730



DF-RK-8671



DF-SB-5251

Ø: 85 Thick/Height: 60
0366351, 366351, 10305800A



DF-SB-5253

Ø: 86 Thick/Height: 60,5
0371586, 0558864, 10306500A



DF-SB-10402

Ø: 62 Thick/Height: 60
1291233, 1732887



DF-TC-12492

Length: 600 Ø: 40
Hole Distance: 115 / 115
1274741

No Image

DF-VB-8561

Length: 609 Ø: 48
Hole Distance: 152 / 152
0080521, 080521, 1361651, 1368270,
1390932, 1617096, 1793875, 1817808,
1892492



DF-VB-9343

Length: 608,2 Ø: 48
Hole Distance: 152 / 152
1361652, 1620436, 1793876, 10309600A



IV-RK-8998

Ø: 85
Hole Distance: 130
Thick/Height: 30
0513757, 0531757, 0691709, 691709



MN-RK-7280

Ø: 75
Hole Distance: 115
Thick/Height: 24
0689748, 689748



MN-RK-7291

Ø: 72
Hole Distance: 130
Thick/Height: 30
1271124



MN-RK-8537

Ø: 95
Hole Distance: 152
Thick/Height: 24
696321, 81432706099



SC-RK-8575

Ø: 95
Hole Distance: 152
Thick/Height: 35
0696321





95 XF ...

FTG 95 XF 430 ...	01/97→09/02	Suspension Arm Repair Kit		IV-RK-8998	for Wishbone (CV)
	01/97→09/02	Suspension Arm Repair Kit		MN-RK-7280	for Drag Link;for Semi-Trailing Arm; for Wishbone (CV)
	01/97→09/02	Suspension Arm Repair Kit		MN-RK-7291	for Drag Link
	01/97→09/02	Suspension Arm Repair Kit		SC-RK-8575	for Wishbone (CV)
	01/97→09/02	Suspension Arm Repair Kit	MN-RK-7280	MN-RK-7280	for Drag Link;for Semi-Trailing Arm; for Wishbone (CV)
	01/97→09/02	Suspension Strut Repair Kit		DF-RK-8637	
	01/97→09/02	Suspension Strut Repair Kit		DF-RK-8671	
	01/97→09/02	Suspension Strut Repair Kit		MN-RK-8537	
	01/97→09/02	Tie Rod		DF-ES-5761	Leading Axle
	01/97→09/02	Tie Rod	DF-DL-5403		
	01/97→09/02	Tie Rod	DF-DL-7780		1st FA
	01/97→09/02	Tie Rod	DF-DL-7836		
	01/97→09/02	Tie Rod End	CV-ES-12461		for Steering Rod
	01/97→09/02	Tie Rod End	CV-ES-12462		for Steering Rod
	01/97→09/02	Tie Rod End	CV-ES-14163		for Steering Rod
	01/97→09/02	Tie Rod End	DF-ES-8362		for Steering Rod
	01/97→09/02	Tie Rod End	DF-ES-9334		Push Rod
	01/97→09/02	Track Control Arm		DF-DL-8158	Trailing Arm
	01/97→09/02	Track Control Arm		DF-TC-12492	Trailing Arm, Leading Axle, for Pneumatic Suspension vehicles
	01/97→09/02	Track Control Arm		DF-VB-8561	Wishbone (CV)
01/97→09/02	Track Control Arm		DF-VB-9343	Wishbone (CV)	
FTG 95 XF 480	01/97→09/02	Ball Head, gearshift linkage	DF-ES-9335		
	01/97→09/02	Centre Rod	DF-DL-2142		Push Rod
	01/97→09/02	Centre Rod	DF-DL-3798		Push Rod
	01/97→09/02	Centre Rod	DF-DL-5355		Push Rod
	01/97→09/02	Centre Rod	DF-DL-8359		Push Rod
	01/97→09/02	Centre Rod	DF-DL-10183		Push Rod, for vehicles with Hinged Leading Axle
	01/97→09/02	Centre Rod	DF-DL-12420		Push Rod
	01/97→09/02	Centre Rod	DF-DL-12423		for Steering Rod
	01/97→09/02	Stabiliser Mounting		DF-SB-5251	
	01/97→09/02	Stabiliser Mounting	DF-SB-5253	DF-SB-5253	
	01/97→09/02	Stabiliser Mounting	DF-SB-10402		
	01/97→09/02	Suspension Arm Repair Kit		CV-RK-5322	for Wishbone (CV)
	01/97→09/02	Suspension Arm Repair Kit		CV-RK-8118	for Drag Link
	01/97→09/02	Suspension Arm Repair Kit		IV-RK-8998	for Wishbone (CV)
	01/97→09/02	Suspension Arm Repair Kit		MN-RK-7280	for Drag Link;for Semi-Trailing Arm; for Wishbone (CV)
	01/97→09/02	Suspension Arm Repair Kit		MN-RK-7291	for Drag Link
	01/97→09/02	Suspension Arm Repair Kit		SC-RK-8575	for Wishbone (CV)
	01/97→09/02	Suspension Arm Repair Kit	MN-RK-7280	MN-RK-7280	for Drag Link;for Semi-Trailing Arm; for Wishbone (CV)
	01/97→09/02	Suspension Strut Repair Kit		DF-RK-8637	
	01/97→09/02	Suspension Strut Repair Kit		DF-RK-8671	
	01/97→09/02	Suspension Strut Repair Kit		MN-RK-8537	
	01/97→09/02	Tie Rod		DF-ES-5761	Leading Axle
	01/97→09/02	Tie Rod	DF-DL-5403		
	01/97→09/02	Tie Rod	DF-DL-7780		1st FA
	01/97→09/02	Tie Rod	DF-DL-7836		
	01/97→09/02	Tie Rod End	CV-ES-12461		for Steering Rod
	01/97→09/02	Tie Rod End	CV-ES-12462		for Steering Rod
	01/97→09/02	Tie Rod End	CV-ES-14163		for Steering Rod
	01/97→09/02	Tie Rod End	DF-ES-8362		for Steering Rod
	01/97→09/02	Tie Rod End	DF-ES-9334		Push Rod
	01/97→09/02	Track Control Arm		DF-DL-8158	Trailing Arm
	01/97→09/02	Track Control Arm		DF-TC-12492	Trailing Arm, Leading Axle, for Pneumatic Suspension vehicles
01/97→09/02	Track Control Arm		DF-VB-8561	Wishbone (CV)	
01/97→09/02	Track Control Arm		DF-VB-9343	Wishbone (CV)	

CV-ES-12461

Length: 120
Cone Ø: d1 Ø 26 / d2 Ø 23,5
Thread: M30 x 1,5 LHT
0069513, 69513, 0311300, 311300,
0607998, 607998, 1190653, 1315447,
1319838, 1332123, 1338714, 1401934,
1407394, ACHB063, ACHF241, MAK1295



CV-ES-12462

Length: 120
Cone Ø: d1 Ø 26 / d2 Ø 23,5
Thread: M30 x 1,5 RHT
0069514, 0586753, 0607999, 0694298,
0694360, 0698609, 1137230, 1229944,
1326862, 1326896, 1331925, ACHB064,
ACHF242, MAK1296



CV-ES-14163

Length: 125
Cone Ø: d1 Ø 30 / d2 Ø 27
Thread: M30 x 1,5 RHT
0607981, 0698450, 1149907, 1152350,
1257890, 1603789, 1618048, ACHF060



CV-RK-5322

Ø: 72 Thick/Height: 50
0691704



CV-RK-8118

Ø: 85
Hole Distance: 130
Thick/Height: 30
0689749



DF-DL-2142

Length: 1005 Ø: 52
Cone Ø: d1 Ø 26 / d2 Ø 23,5
1291060, 1351734, 1385499



DF-DL-3798

Length: 1015 Ø: 50
Cone Ø: d1 Ø 30 / d2 Ø 27
0094038, 0525433



DF-DL-5355

Length: 995 Ø: 36
Cone Ø: d1 Ø 26 / d2 Ø 23,5
1311048, 1351737, 1385498



DF-DL-5403

Length: 1742 Ø: 40
Cone Ø: d1 Ø 26 / d2 Ø 23,5
0288281, 1270854, 1337644



DF-DL-7780

Length: 1690 Ø: 40
Cone Ø: d1 Ø 26 / d2 Ø 23,5
1270853, 1353391, 10212000A



DF-DL-7836

Length: 1698 Ø: 52
Cone Ø: d1 Ø 26 / d2 Ø 23,5
0754922, 1286343, 1353396



DF-DL-8158

Length: 611 Ø: 48
Hole Distance: 130 / 130
0267743, 1361649, 1361650, 1656428



DF-DL-8359

Length: 1018 Ø: 30
Cone Ø: d1 Ø 26 / d2 Ø 23,5
1306332, 1351740, 1385502



DF-DL-10183

Length: 588 Ø: 36
Cone Ø: d1 Ø 26 / d2 Ø 23,5
1306333, 1351741, 1385487



DF-DL-12420

Length: 1004 Ø: 52
Cone Ø: d1 Ø 30 / d2 Ø 27
Thread: M24 x 1,5 / M30 x 1,5
094613, 94613, 0094613, 0362413, 362413,
1426101



DF-DL-12423

Length: 1955 Ø: 42
Cone Ø: d1 Ø 26 / d2 Ø 23,5
1306336, 1351739, 1385516



DF-ES-5761

Length: 1512 Ø: 52
Cone Ø: d1 Ø 26 / d2 Ø 23,5
1297572, 1361155



DF-ES-8362

Length: 150
Cone Ø: d1 Ø 26 / d2 Ø 23,5
Thread: M30 x 1,5 RHT
1389190



DF-ES-9334

Length: 115
Cone Ø: d1 Ø 26 / d2 Ø 23,5
Thread: M24 x 1,5 RHT
1344684



DF-ES-9335

Length: 85
Cone Ø: d1 Ø 12 / d2 Ø 10,75
Thread: M14 x 1,5 RHT
0386930, 386930



DF-RK-8637

Ø: 72
1376730



DF-RK-8671



DF-SB-5251

Ø: 85 Thick/Height: 60
0366351, 366351, 10305800A



DF-SB-5253

Ø: 86 Thick/Height: 60,5
0371586, 0558864, 10306500A



DF-SB-10402

Ø: 62 Thick/Height: 60
1291233, 1732887



DF-TC-12492

Length: 600 Ø: 40
Hole Distance: 115 / 115
1274741

No Image

DF-VB-8561

Length: 609 Ø: 48
Hole Distance: 152 / 152
080521, 0080521, 1361651, 1368270,
1390932, 1617096, 1793875, 1817808,
1892492



DF-VB-9343

Length: 608,2 Ø: 48
Hole Distance: 152 / 152
1361652, 1620436, 1793876, 10309600A



IV-RK-8998

Ø: 85
Hole Distance: 130
Thick/Height: 30
0513757, 0531757, 0691709, 691709



MN-RK-7280

Ø: 75
Hole Distance: 115
Thick/Height: 24
0689748, 689748



MN-RK-7291

Ø: 72
Hole Distance: 130
Thick/Height: 30
1271124



MN-RK-8537

Ø: 95
Hole Distance: 152
Thick/Height: 24
696321, 81432706099



SC-RK-8575

Ø: 95
Hole Distance: 152
Thick/Height: 35
0696321





95 XF ...

FTG 95 XF 530	01/97→09/02	Centre Rod	DF-DL-12423		for Steering Rod	
	01/97→09/02	Suspension Arm Repair Kit	MN-RK-7280	MN-RK-7280	for Drag Link;for Semi-Trailing Arm; for Wishbone (CV)	
	01/97→09/02	Suspension Strut Repair Kit		DF-RK-8637		
	01/97→09/02	Tie Rod End		DF-ES-8362	for Steering Rod	
	01/97→09/02	Tie Rod End	CV-ES-12461		for Steering Rod	
	01/97→09/02	Tie Rod End	CV-ES-12462		for Steering Rod	
	01/97→09/02	Tie Rod End	DF-ES-9334		Push Rod	
	01/97→09/02	Track Control Arm		DF-TC-12492	Control Arm, Leading Axle, for Pneumatic Suspension vehicles	
	01/97→	Tie Rod	DF-DL-7780		1st FA	
	06/00→09/02	Centre Rod	DF-DL-5355		Push Rod	
	06/00→09/02	Centre Rod	DF-DL-8359		Push Rod	
	06/00→09/02	Centre Rod	DF-DL-10183		Push Rod, for vehicles with Hinged Leading Axle	
	06/00→09/02	Tie Rod		DF-ES-5761	Leading Axle	
	06/00→09/02	Track Control Arm		DF-DL-8158	Trailing Arm	
	06/00→09/02	Track Control Arm		DF-VB-8561	Wishbone (CV)	
	FTP 95 XF 430	01/97→09/02	Centre Rod	DF-DL-2142		Push Rod
01/97→09/02		Centre Rod	DF-DL-5355		Push Rod	
01/97→09/02		Suspension Arm Repair Kit	MN-RK-7280	MN-RK-7280	for Drag Link;for Semi-Trailing Arm; for Wishbone (CV)	
01/97→09/02		Suspension Strut Repair Kit		DF-RK-8637		
01/97→09/02		Tie Rod	DF-DL-7780			
01/97→09/02		Track Control Arm		DF-DL-8158	Trailing Arm	
FTR 95 XF 380	01/97→09/02	Track Control Arm		DF-VB-8561	Wishbone (CV)	
	01/97→09/02	Ball Head, gearshift linkage	DF-ES-9335			
	01/97→09/02	Centre Rod	DF-DL-2142		Push Rod	
	01/97→09/02	Centre Rod	DF-DL-3798		Push Rod	
	01/97→09/02	Centre Rod	DF-DL-12420		Push Rod	
	01/97→09/02	Stabiliser Mounting		DF-SB-5251		
	01/97→09/02	Stabiliser Mounting	DF-SB-5253	DF-SB-5253		
	01/97→09/02	Stabiliser Mounting	DF-SB-10402			
	01/97→09/02	Suspension Arm Repair Kit		CV-RK-5322	for Wishbone (CV)	
	01/97→09/02	Suspension Arm Repair Kit		CV-RK-8118	for Drag Link	
	01/97→09/02	Suspension Arm Repair Kit		IV-RK-8998	for Wishbone (CV)	
	01/97→09/02	Suspension Arm Repair Kit		MN-RK-7280	for Drag Link;for Semi-Trailing Arm; for Wishbone (CV)	
	01/97→09/02	Suspension Arm Repair Kit		MN-RK-7291	for Drag Link	
	01/97→09/02	Suspension Arm Repair Kit		SC-RK-8575	for Wishbone (CV)	
	01/97→09/02	Suspension Arm Repair Kit	MN-RK-7280	MN-RK-7280	for Drag Link;for Semi-Trailing Arm; for Wishbone (CV)	
	01/97→09/02	Suspension Strut Repair Kit		DF-RK-8637		
	01/97→09/02	Suspension Strut Repair Kit		DF-RK-8671		
	01/97→09/02	Suspension Strut Repair Kit		MN-RK-8537		
	01/97→09/02	Tie Rod	DF-DL-5403			
	01/97→09/02	Tie Rod	DF-DL-7780		1st FA	
	01/97→09/02	Tie Rod	DF-DL-7836			
	01/97→09/02	Tie Rod End	CV-ES-12461		for Steering Rod	
	01/97→09/02	Tie Rod End	CV-ES-12462		for Steering Rod	
	01/97→09/02	Tie Rod End	CV-ES-14163		for Steering Rod	
	01/97→09/02	Track Control Arm		DF-DL-8158	Trailing Arm	
	01/97→09/02	Track Control Arm		DF-VB-8561	Wishbone (CV)	
	01/97→09/02	Track Control Arm		DF-VB-9343	Wishbone (CV)	
	FTR 95 XF 430	01/97→09/02	Track Control Arm			
		01/97→09/02	Ball Head, gearshift linkage	DF-ES-9335		
		01/97→09/02	Centre Rod	DF-DL-2142		Push Rod
		01/97→09/02	Centre Rod	DF-DL-3798		Push Rod
		01/97→09/02	Centre Rod	DF-DL-12420		Push Rod
01/97→09/02		Stabiliser Mounting		DF-SB-5251		
01/97→09/02		Stabiliser Mounting	DF-SB-5253	DF-SB-5253		
01/97→09/02		Stabiliser Mounting	DF-SB-10402			
01/97→09/02		Suspension Arm Repair Kit		CV-RK-5322	for Wishbone (CV)	
01/97→09/02		Suspension Arm Repair Kit		CV-RK-8118	for Drag Link	
01/97→09/02		Suspension Arm Repair Kit		IV-RK-8998	for Wishbone (CV)	

CV-ES-12461

Length: 120
Cone Ø: d1 Ø 26 / d2 Ø 23,5
Thread: M30 x 1,5 LHT
0069513, 69513, 311300, 0311300,
0607998, 607998, 1190653, 1315447,
1319838, 1332123, 1338714, 1401934,
1407394, ACHB063, ACHF241, MAK1295



CV-ES-12462

Length: 120
Cone Ø: d1 Ø 26 / d2 Ø 23,5
Thread: M30 x 1,5 RHT
0069514, 0586753, 0607999, 0694298,
0694360, 0698609, 1137230, 1229944,
1326862, 1326896, 1331925, ACHB064,
ACHF242, MAK1296



CV-ES-14163

Length: 125
Cone Ø: d1 Ø 30 / d2 Ø 27
Thread: M30 x 1,5 RHT
0607981, 0698450, 1149907, 1152350,
1257890, 1603789, 1618048, ACHF060



CV-RK-5322

Ø: 72 Thick/Height: 50
0691704



CV-RK-8118

Ø: 85
Hole Distance: 130
Thick/Height: 30
0689749



DF-DL-2142

Length: 1005 Ø: 52
Cone Ø: d1 Ø 26 / d2 Ø 23,5
1291060, 1351734, 1385499



DF-DL-3798

Length: 1015 Ø: 50
Cone Ø: d1 Ø 30 / d2 Ø 27
0094038, 0525433

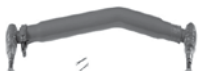

DF-DL-5355

Length: 995 Ø: 36
Cone Ø: d1 Ø 26 / d2 Ø 23,5
1311048, 1351737, 1385498



DF-DL-5403

Length: 1742 Ø: 40
Cone Ø: d1 Ø 26 / d2 Ø 23,5
0288281, 1270854, 1337644



DF-DL-7780

Length: 1690 Ø: 40
Cone Ø: d1 Ø 26 / d2 Ø 23,5
1270853, 1353391, 10212000A



DF-DL-7836

Length: 1698 Ø: 52
Cone Ø: d1 Ø 26 / d2 Ø 23,5
0754922, 1286343, 1353396



DF-DL-8158

Length: 611 Ø: 48
Hole Distance: 130 / 130
0267743, 1361649, 1361650, 1656428



DF-DL-8359

Length: 1018 Ø: 30
Cone Ø: d1 Ø 26 / d2 Ø 23,5
1306332, 1351740, 1385502



DF-DL-10183

Length: 588 Ø: 36
Cone Ø: d1 Ø 26 / d2 Ø 23,5
1306333, 1351741, 1385487



DF-DL-12420

Length: 1004 Ø: 52
Cone Ø: d1 Ø 30 / d2 Ø 27
Thread: M24 x 1,5 / M30 x 1,5
0094613, 094613, 94613, 0362413, 362413,
1426101



DF-DL-12423

Length: 1955 Ø: 42
Cone Ø: d1 Ø 26 / d2 Ø 23,5
1306336, 1351739, 1385516



DF-ES-5761

Length: 1512 Ø: 52
Cone Ø: d1 Ø 26 / d2 Ø 23,5
1297572, 1361155



DF-ES-8362

Length: 150
Cone Ø: d1 Ø 26 / d2 Ø 23,5
Thread: M30 x 1,5 RHT
1389190



DF-ES-9334

Length: 115
Cone Ø: d1 Ø 26 / d2 Ø 23,5
Thread: M24 x 1,5 RHT
1344684



DF-ES-9335

Length: 85
Cone Ø: d1 Ø 12 / d2 Ø 10,75
Thread: M14 x 1,5 RHT
0386930, 386930



DF-RK-8637

Ø: 72
1376730



DF-RK-8671



DF-SB-5251

Ø: 85 Thick/Height: 60
0366351, 366351, 10305800A



DF-SB-5253

Ø: 86 Thick/Height: 60,5
0371586, 0558864, 10306500A



DF-SB-10402

Ø: 62 Thick/Height: 60
1291233, 1732887



DF-TC-12492

Length: 600
Ø: 40
Hole Distance: 115 / 115
1274741

No Image

DF-VB-8561

Length: 609
Ø: 48
Hole Distance: 152 / 152
0080521, 080521, 1361651, 1368270,
1390932, 1617096, 1793875, 1817808,
1892492



DF-VB-9343

Length: 608,2
Ø: 48
Hole Distance: 152 / 152
1361652, 1620436, 1793876, 10309600A



IV-RK-8998

Ø: 85
Hole Distance: 130
Thick/Height: 30
0513757, 0531757, 0691709, 691709



MN-RK-7280

Ø: 75
Hole Distance: 115
Thick/Height: 24
689748, 0689748



MN-RK-7291

Ø: 72
Hole Distance: 130
Thick/Height: 30
1271124



MN-RK-8537

Ø: 95
Hole Distance: 152
Thick/Height: 24
696321, 81432706099



SC-RK-8575

Ø: 95
Hole Distance: 152
Thick/Height: 35
0696321





95 XF ...

FTR 95 XF 430 ...	01/97→09/02	Suspension Arm Repair Kit		MN-RK-7280	for Drag Link;for Semi-Trailing Arm; for Wishbone (CV)	
	01/97→09/02	Suspension Arm Repair Kit		MN-RK-7291	for Drag Link	
	01/97→09/02	Suspension Arm Repair Kit		SC-RK-8575	for Wishbone (CV)	
	01/97→09/02	Suspension Arm Repair Kit	MN-RK-7280	MN-RK-7280	for Drag Link;for Semi-Trailing Arm; for Wishbone (CV)	
	01/97→09/02	Suspension Strut Repair Kit		DF-RK-8637		
	01/97→09/02	Suspension Strut Repair Kit		DF-RK-8671		
	01/97→09/02	Suspension Strut Repair Kit		MN-RK-8537		
	01/97→09/02	Tie Rod	DF-DL-5403			
	01/97→09/02	Tie Rod	DF-DL-7780		1st FA	
	01/97→09/02	Tie Rod	DF-DL-7836			
	01/97→09/02	Tie Rod End	CV-ES-12461		for Steering Rod	
	01/97→09/02	Tie Rod End	CV-ES-12462		for Steering Rod	
	01/97→09/02	Tie Rod End	CV-ES-14163		for Steering Rod	
	01/97→09/02	Track Control Arm		DF-DL-8158	Trailing Arm	
	01/97→09/02	Track Control Arm		DF-VB-8561	Wishbone (CV)	
	01/97→09/02	Track Control Arm		DF-VB-9343	Wishbone (CV)	
	06/00→09/02	Centre Rod	DF-DL-5355		Push Rod	
	06/00→09/02	Tie Rod	DF-DL-10193		1st FA	
	FTR 95 XF 480	01/97→09/02	Ball Head, gearshift linkage	DF-ES-9335		
		01/97→09/02	Centre Rod	DF-DL-2142		Push Rod
		01/97→09/02	Centre Rod	DF-DL-3798		Push Rod
		01/97→09/02	Centre Rod	DF-DL-12420		Push Rod
		01/97→09/02	Stabiliser Mounting		DF-SB-5251	
		01/97→09/02	Stabiliser Mounting	DF-SB-5253	DF-SB-5253	
01/97→09/02		Stabiliser Mounting	DF-SB-10402			
01/97→09/02		Suspension Arm Repair Kit		CV-RK-5322	for Wishbone (CV)	
01/97→09/02		Suspension Arm Repair Kit		CV-RK-8118	for Drag Link	
01/97→09/02		Suspension Arm Repair Kit		IV-RK-8998	for Wishbone (CV)	
01/97→09/02		Suspension Arm Repair Kit		MN-RK-7280	for Drag Link;for Semi-Trailing Arm; for Wishbone (CV)	
01/97→09/02		Suspension Arm Repair Kit		MN-RK-7291	for Drag Link	
01/97→09/02		Suspension Arm Repair Kit		SC-RK-8575	for Wishbone (CV)	
01/97→09/02		Suspension Arm Repair Kit	MN-RK-7280	MN-RK-7280	for Drag Link;for Semi-Trailing Arm; for Wishbone (CV)	
01/97→09/02		Suspension Strut Repair Kit		DF-RK-8637		
01/97→09/02		Suspension Strut Repair Kit		DF-RK-8671		
01/97→09/02		Suspension Strut Repair Kit		MN-RK-8537		
01/97→09/02		Tie Rod	DF-DL-5403			
01/97→09/02		Tie Rod	DF-DL-7780		1st FA	
01/97→09/02		Tie Rod	DF-DL-7836			
01/97→09/02		Tie Rod End	CV-ES-12461		for Steering Rod	
01/97→09/02		Tie Rod End	CV-ES-12462		for Steering Rod	
01/97→09/02		Tie Rod End	CV-ES-14163		for Steering Rod	
01/97→09/02		Track Control Arm		DF-DL-8158	Trailing Arm	
01/97→09/02	Track Control Arm		DF-VB-8561	Wishbone (CV)		
01/97→09/02	Track Control Arm		DF-VB-9343	Wishbone (CV)		
06/00→09/02	Centre Rod	DF-DL-5355		Push Rod		
06/00→09/02	Tie Rod	DF-DL-10193		1st FA		
FTR 95 XF 530	01/97→09/02	Suspension Arm Repair Kit	MN-RK-7280	MN-RK-7280	for Drag Link;for Semi-Trailing Arm; for Wishbone (CV)	
	01/97→09/02	Suspension Strut Repair Kit		DF-RK-8637		
	01/97→09/02	Tie Rod	DF-DL-7780		1st FA	
	01/97→09/02	Tie Rod End	CV-ES-12461		for Steering Rod	
	01/97→09/02	Tie Rod End	CV-ES-12462		for Steering Rod	
	06/00→09/02	Track Control Arm		DF-DL-8158	Trailing Arm	
06/00→09/02	Track Control Arm		DF-VB-8561	Wishbone (CV)		
FTR 95 XF 380	01/97→09/02	Ball Head, gearshift linkage	DF-ES-9335			
	01/97→09/02	Centre Rod	DF-DL-2142		Push Rod	
	01/97→09/02	Centre Rod	DF-DL-3798		Push Rod	
	01/97→09/02	Centre Rod	DF-DL-12420		Push Rod	
	01/97→09/02	Stabiliser Mounting		DF-SB-5251		

CV-ES-12461

Length: 120
Cone Ø: d1 Ø 26 / d2 Ø 23,5
Thread: M30 x 1,5 LHT
0069513, 69513, 0311300, 311300,
0607998, 607998, 1190653, 1315447,
1319838, 1332123, 1338714, 1401934,
1407394, ACHB063, ACHF241, MAK1295



CV-ES-12462

Length: 120
Cone Ø: d1 Ø 26 / d2 Ø 23,5
Thread: M30 x 1,5 RHT
0069514, 0586753, 0607999, 0694298,
0694360, 0698609, 1137230, 1229944,
1326862, 1326896, 1331925, ACHB064,
ACHF242, MAK1296



CV-ES-14163

Length: 125
Cone Ø: d1 Ø 30 / d2 Ø 27
Thread: M30 x 1,5 RHT
0607981, 0698450, 1149907, 1152350,
1257890, 1603789, 1618048, ACHF060



CV-RK-5322

Ø: 72 Thick/Height: 50
0691704



CV-RK-8118

Ø: 85
Hole Distance: 130
Thick/Height: 30
0689749



DF-DL-2142

Length: 1005 Ø: 52
Cone Ø: d1 Ø 26 / d2 Ø 23,5
1291060, 1351734, 1385499



DF-DL-3798

Length: 1015 Ø: 50
Cone Ø: d1 Ø 30 / d2 Ø 27
0094038, 0525433

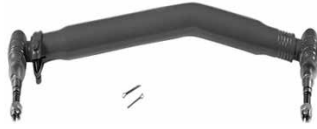

DF-DL-5355

Length: 995 Ø: 36
Cone Ø: d1 Ø 26 / d2 Ø 23,5
1311048, 1351737, 1385498



DF-DL-5403

Length: 1742 Ø: 40
Cone Ø: d1 Ø 26 / d2 Ø 23,5
0288281, 1270854, 1337644



DF-DL-7780

Length: 1690 Ø: 40
Cone Ø: d1 Ø 26 / d2 Ø 23,5
1270853, 1353391, 10212000A



DF-DL-7836

Length: 1698 Ø: 52
Cone Ø: d1 Ø 26 / d2 Ø 23,5
0754922, 1286343, 1353396



DF-DL-8158

Length: 611 Ø: 48
Hole Distance: 130 / 130
0267743, 1361649, 1361650, 1656428



DF-DL-10193

Length: 1646 Ø: 40
Cone Ø: d1 Ø 26 / d2 Ø 23,5
1351205, 1353395



DF-DL-12420

Length: 1004 Ø: 52
Cone Ø: d1 Ø 30 / d2 Ø 27
Thread: M24 x 1,5 / M30 x 1,5
0094613, 094613, 94613, 0362413, 362413,
1426101



DF-ES-9335

Length: 85
Cone Ø: d1 Ø 12 / d2 Ø 10,75
Thread: M14 x 1,5 RHT
0386930, 386930



DF-RK-8637

Ø: 72
1376730



DF-RK-8671



DF-SB-5251

Ø: 85 Thick/Height: 60
0366351, 366351, 10305800A



DF-SB-5253

Ø: 86 Thick/Height: 60,5
0371586, 0558864, 10306500A



DF-SB-10402

Ø: 62 Thick/Height: 60
1291233, 1732887



DF-VB-8561

Length: 609 Ø: 48
Hole Distance: 152 / 152
080521, 0080521, 1361651, 1368270,
1390932, 1617096, 1793875, 1817808,
1892492



DF-VB-9343

Length: 608,2 Ø: 48
Hole Distance: 152 / 152
1361652, 1620436, 1793876, 10309600A



IV-RK-8998

Ø: 85
Hole Distance: 130
Thick/Height: 30
0513757, 0531757, 0691709, 691709



MN-RK-7280

Ø: 75
Hole Distance: 115
Thick/Height: 24
0689748, 689748



MN-RK-7291

Ø: 72
Hole Distance: 130
Thick/Height: 30
1271124



MN-RK-8537

Ø: 95
Hole Distance: 152
Thick/Height: 24
696321, 81432706099



SC-RK-8575

Ø: 95
Hole Distance: 152
Thick/Height: 35
0696321





95 XF ...

FTS 95 XF 380 ...	01/97→09/02	Stabiliser Mounting	DF-SB-5253	DF-SB-5253		
	01/97→09/02	Stabiliser Mounting	DF-SB-10402			
	01/97→09/02	Suspension Arm Repair Kit		CV-RK-5322	for Wishbone (CV)	
	01/97→09/02	Suspension Arm Repair Kit		CV-RK-8118	for Drag Link	
	01/97→09/02	Suspension Arm Repair Kit		IV-RK-8998	for Wishbone (CV)	
	01/97→09/02	Suspension Arm Repair Kit		MN-RK-7280	for Drag Link;for Semi-Trailing Arm; for Wishbone (CV)	
	01/97→09/02	Suspension Arm Repair Kit		MN-RK-7291	for Drag Link	
	01/97→09/02	Suspension Arm Repair Kit		SC-RK-8575	for Wishbone (CV)	
	01/97→09/02	Suspension Arm Repair Kit	MN-RK-7280	MN-RK-7280	for Drag Link;for Semi-Trailing Arm; for Wishbone (CV)	
	01/97→09/02	Suspension Strut Repair Kit		DF-RK-8637		
	01/97→09/02	Suspension Strut Repair Kit		DF-RK-8671		
	01/97→09/02	Suspension Strut Repair Kit		MN-RK-8537		
	01/97→09/02	Tie Rod	DF-DL-5403			
	01/97→09/02	Tie Rod	DF-DL-7780			
	01/97→09/02	Tie Rod	DF-DL-7836			
	01/97→09/02	Tie Rod End	CV-ES-12461		for Steering Rod	
	01/97→09/02	Tie Rod End	CV-ES-12462		for Steering Rod	
	01/97→09/02	Tie Rod End	CV-ES-14163		for Steering Rod	
	01/97→09/02	Track Control Arm		DF-DL-8158	Trailing Arm	
	01/97→09/02	Track Control Arm		DF-VB-8561	Wishbone (CV)	
	01/97→09/02	Track Control Arm		DF-VB-9343	Wishbone (CV)	
FTS 95 XF 430	01/97→09/02	Ball Head, gearshift linkage	DF-ES-9335			
	01/97→09/02	Centre Rod	DF-DL-2142		Push Rod	
	01/97→09/02	Centre Rod	DF-DL-3798		Push Rod	
	01/97→09/02	Centre Rod	DF-DL-12420		Push Rod	
	01/97→09/02	Stabiliser Mounting		DF-SB-5251		
	01/97→09/02	Stabiliser Mounting	DF-SB-5253	DF-SB-5253		
	01/97→09/02	Stabiliser Mounting	DF-SB-10402			
	01/97→09/02	Suspension Arm Repair Kit		CV-RK-5322	for Wishbone (CV)	
	01/97→09/02	Suspension Arm Repair Kit		CV-RK-8118	for Drag Link	
	01/97→09/02	Suspension Arm Repair Kit		IV-RK-8998	for Wishbone (CV)	
	01/97→09/02	Suspension Arm Repair Kit		MN-RK-7280	for Drag Link;for Semi-Trailing Arm; for Wishbone (CV)	
	01/97→09/02	Suspension Arm Repair Kit		MN-RK-7291	for Drag Link	
	01/97→09/02	Suspension Arm Repair Kit		SC-RK-8575	for Wishbone (CV)	
	01/97→09/02	Suspension Arm Repair Kit	MN-RK-7280	MN-RK-7280	for Drag Link;for Semi-Trailing Arm; for Wishbone (CV)	
	01/97→09/02	Suspension Strut Repair Kit		DF-RK-8637		
	01/97→09/02	Suspension Strut Repair Kit		DF-RK-8671		
	01/97→09/02	Suspension Strut Repair Kit		MN-RK-8537		
	01/97→09/02	Tie Rod	DF-DL-5403			
	01/97→09/02	Tie Rod	DF-DL-7780		1st FA	
	01/97→09/02	Tie Rod	DF-DL-7836			
	01/97→09/02	Tie Rod End	CV-ES-12461		for Steering Rod	
	01/97→09/02	Tie Rod End	CV-ES-12462		for Steering Rod	
	01/97→09/02	Tie Rod End	CV-ES-14163		for Steering Rod	
	01/97→09/02	Track Control Arm		DF-DL-8158	Trailing Arm	
	01/97→09/02	Track Control Arm		DF-VB-8561	Wishbone (CV)	
	01/97→09/02	Track Control Arm		DF-VB-9343	Wishbone (CV)	
	06/00→09/02	Centre Rod	DF-DL-5355		Push Rod	
	06/00→09/02	Tie Rod	DF-DL-10193		1st FA	
	FTS 95 XF 480	01/97→09/02	Ball Head, gearshift linkage	DF-ES-9335		
		01/97→09/02	Centre Rod	DF-DL-2142		Push Rod
01/97→09/02		Centre Rod	DF-DL-3798		Push Rod	
01/97→09/02		Centre Rod	DF-DL-12420		Push Rod	
01/97→09/02		Stabiliser Mounting		DF-SB-5251		
01/97→09/02		Stabiliser Mounting	DF-SB-5253	DF-SB-5253		
01/97→09/02		Stabiliser Mounting	DF-SB-10402			
01/97→09/02		Suspension Arm Repair Kit		CV-RK-5322	for Wishbone (CV)	
01/97→09/02	Suspension Arm Repair Kit		CV-RK-8118	for Drag Link		
01/97→09/02	Suspension Arm Repair Kit		IV-RK-8998	for Wishbone (CV)		

CV-ES-12461

Length: 120
Cone Ø: d1 Ø 26 / d2 Ø 23,5
Thread: M30 x 1,5 RHT
0069513, 69513, 0311300, 311300, 607998, 0607998, 1190653, 1315447, 1319838, 1332123, 1338714, 1401934, 1407394, ACHB063, ACHF241, MAK1295



CV-ES-12462

Length: 120
Cone Ø: d1 Ø 26 / d2 Ø 23,5
Thread: M30 x 1,5 RHT
0069514, 0586753, 0607999, 0694298, 0694360, 0698609, 1137230, 1229944, 1326862, 1326896, 1331925, ACHB064, ACHF242, MAK1296



CV-ES-14163

Length: 125
Cone Ø: d1 Ø 30 / d2 Ø 27
Thread: M30 x 1,5 RHT
0607981, 0698450, 1149907, 1152350, 1257890, 1603789, 1618048, ACHF060



CV-RK-5322

Ø: 72 Thick/Height: 50
0691704



CV-RK-8118

Ø: 85
Hole Distance: 130
Thick/Height: 30
0689749



DF-DL-2142

Length: 1005 Ø: 52
Cone Ø: d1 Ø 26 / d2 Ø 23,5
1291060, 1351734, 1385499



DF-DL-3798

Length: 1015 Ø: 50
Cone Ø: d1 Ø 30 / d2 Ø 27
0094038, 0525433



DF-DL-5355

Length: 995 Ø: 36
Cone Ø: d1 Ø 26 / d2 Ø 23,5
1311048, 1351737, 1385498



DF-DL-5403

Length: 1742 Ø: 40
Cone Ø: d1 Ø 26 / d2 Ø 23,5
0288281, 1270854, 1337644



DF-DL-7780

Length: 1690 Ø: 40
Cone Ø: d1 Ø 26 / d2 Ø 23,5
1270853, 1353391, 10212000A



DF-DL-7836

Length: 1698 Ø: 52
Cone Ø: d1 Ø 26 / d2 Ø 23,5
0754922, 1286343, 1353396



DF-DL-8158

Length: 611 Ø: 48
Hole Distance: 130 / 130
0267743, 1361649, 1361650, 1656428



DF-DL-10193

Length: 1646 Ø: 40
Cone Ø: d1 Ø 26 / d2 Ø 23,5
1351205, 1353395



DF-DL-12420

Length: 1004 Ø: 52
Cone Ø: d1 Ø 30 / d2 Ø 27
Thread: M24 x 1,5 / M30 x 1,5
094613, 94613, 0094613, 0362413, 362413, 1426101



DF-ES-9335

Length: 85
Cone Ø: d1 Ø 12 / d2 Ø 10,75
Thread: M14 x 1,5 RHT
0386930, 386930



DF-RK-8637

Ø: 72
1376730



DF-RK-8671



DF-SB-5251

Ø: 85 Thick/Height: 60
0366351, 366351, 10305800A



DF-SB-5253

Ø: 86 Thick/Height: 60,5
0371586, 0558864, 10306500A



DF-SB-10402

Ø: 62 Thick/Height: 60
1291233, 1732887



DF-VB-8561

Length: 609
Ø: 48
Hole Distance: 152 / 152
0080521, 080521, 1361651, 1368270, 1390932, 1617096, 1793875, 1817808, 1892492



DF-VB-9343

Length: 608,2
Ø: 48
Hole Distance: 152 / 152
1361652, 1620436, 1793876, 10309600A



IV-RK-8998

Ø: 85
Hole Distance: 130
Thick/Height: 30
0513757, 0531757, 0691709, 691709



MN-RK-7280

Ø: 75
Hole Distance: 115
Thick/Height: 24
0689748, 689748



MN-RK-7291

Ø: 72
Hole Distance: 130
Thick/Height: 30
1271124



MN-RK-8537

Ø: 95
Hole Distance: 152
Thick/Height: 24
696321, 81432706099



SC-RK-8575

Ø: 95
Hole Distance: 152
Thick/Height: 35
0696321





95 XF ...

FTS 95 XF 480 ...	01/97→09/02	Suspension Arm Repair Kit		MN-RK-7280	for Drag Link;for Semi-Trailing Arm; for Wishbone (CV)
	01/97→09/02	Suspension Arm Repair Kit		MN-RK-7291	for Drag Link
	01/97→09/02	Suspension Arm Repair Kit		SC-RK-8575	for Wishbone (CV)
	01/97→09/02	Suspension Arm Repair Kit	MN-RK-7280	MN-RK-7280	for Drag Link;for Semi-Trailing Arm; for Wishbone (CV)
	01/97→09/02	Suspension Strut Repair Kit		DF-RK-8637	
	01/97→09/02	Suspension Strut Repair Kit		DF-RK-8671	
	01/97→09/02	Suspension Strut Repair Kit		MN-RK-8537	
	01/97→09/02	Tie Rod	DF-DL-5403		
	01/97→09/02	Tie Rod	DF-DL-7780		1st FA
	01/97→09/02	Tie Rod	DF-DL-7836		
	01/97→09/02	Tie Rod End	CV-ES-12461		for Steering Rod
	01/97→09/02	Tie Rod End	CV-ES-12462		for Steering Rod
	01/97→09/02	Tie Rod End	CV-ES-14163		for Steering Rod
	01/97→09/02	Track Control Arm		DF-DL-8158	Trailing Arm
	01/97→09/02	Track Control Arm		DF-VB-8561	Wishbone (CV)
	01/97→09/02	Track Control Arm		DF-VB-9343	Wishbone (CV)
	FTS 95 XF 530	06/00→09/02	Centre Rod	DF-DL-5355	
06/00→09/02		Tie Rod	DF-DL-10193		1st FA
01/97→09/02		Suspension Arm Repair Kit	MN-RK-7280	MN-RK-7280	for Drag Link;for Semi-Trailing Arm; for Wishbone (CV)
01/97→09/02		Suspension Strut Repair Kit		DF-RK-8637	
01/97→09/02		Tie Rod	DF-DL-7780		1st FA
01/97→09/02		Tie Rod End	CV-ES-12461		for Steering Rod
01/97→09/02		Tie Rod End	CV-ES-12462		for Steering Rod
FTT 95 XF 380	06/00→09/02	Centre Rod	DF-DL-5355		Push Rod
	06/00→09/02	Tie Rod	DF-DL-10193		1st FA
	06/00→09/02	Track Control Arm		DF-DL-8158	Trailing Arm
	06/00→09/02	Track Control Arm		DF-VB-8561	Wishbone (CV)
	01/97→09/02	Ball Head, gearshift linkage	DF-ES-9335		
	01/97→09/02	Centre Rod	DF-DL-2142		Push Rod
	01/97→09/02	Centre Rod	DF-DL-3798		Push Rod
	01/97→09/02	Centre Rod	DF-DL-12420		Push Rod
	01/97→09/02	Stabiliser Mounting		DF-SB-5251	
	01/97→09/02	Stabiliser Mounting	DF-SB-5253	DF-SB-5253	
	01/97→09/02	Stabiliser Mounting	DF-SB-10402		
	01/97→09/02	Suspension Arm Repair Kit		CV-RK-5322	for Wishbone (CV)
	01/97→09/02	Suspension Arm Repair Kit		CV-RK-8118	for Drag Link
	01/97→09/02	Suspension Arm Repair Kit		IV-RK-8998	for Wishbone (CV)
	01/97→09/02	Suspension Arm Repair Kit		MN-RK-7280	for Drag Link;for Semi-Trailing Arm; for Wishbone (CV)
	01/97→09/02	Suspension Arm Repair Kit		MN-RK-7291	for Drag Link
	01/97→09/02	Suspension Arm Repair Kit		SC-RK-8575	for Wishbone (CV)
01/97→09/02	Suspension Arm Repair Kit	MN-RK-7280	MN-RK-7280	for Drag Link;for Semi-Trailing Arm; for Wishbone (CV)	
01/97→09/02	Suspension Strut Repair Kit		DF-RK-8637		
01/97→09/02	Suspension Strut Repair Kit		DF-RK-8671		
01/97→09/02	Suspension Strut Repair Kit		MN-RK-8537		
01/97→09/02	Tie Rod	DF-DL-5403			
01/97→09/02	Tie Rod	DF-DL-7780		1st FA	
01/97→09/02	Tie Rod	DF-DL-7836			
01/97→09/02	Tie Rod End	CV-ES-12461		for Steering Rod	
01/97→09/02	Tie Rod End	CV-ES-12462		for Steering Rod	
01/97→09/02	Tie Rod End	CV-ES-14163		for Steering Rod	
01/97→09/02	Track Control Arm		DF-DL-8158	Trailing Arm	
01/97→09/02	Track Control Arm		DF-DL-9318	Trailing Arm	
01/97→09/02	Track Control Arm		DF-VB-9343	Wishbone (CV)	
06/00→09/02	Track Control Arm		DF-VB-8561	Wishbone (CV)	

CV-ES-12461

Length: 120
Cone Ø: d1 Ø 26 / d2 Ø 23,5
Thread: M30 x 1,5 LHT
0069513, 69513, 0311300, 311300,
0607998, 607998, 1190653, 1315447,
1319838, 1332123, 1338714, 1401934,
1407394, ACHB063, ACHF241, MAK1295



CV-ES-12462

Length: 120
Cone Ø: d1 Ø 26 / d2 Ø 23,5
Thread: M30 x 1,5 RHT
0069514, 0586753, 0607999, 0694298,
0694360, 0698609, 1137230, 1229944,
1326862, 1326896, 1331925, ACHB064,
ACHF242, MAK1296



CV-ES-14163

Length: 125
Cone Ø: d1 Ø 30 / d2 Ø 27
Thread: M30 x 1,5 RHT
0607981, 0698450, 1149907, 1152350,
1257890, 1603789, 1618048, ACHF060



CV-RK-5322

Ø: 72 Thick/Height: 50
0691704



CV-RK-8118

Ø: 85
Hole Distance: 130
Thick/Height: 30
0689749



DF-DL-2142

Length: 1005 Ø: 52
Cone Ø: d1 Ø 26 / d2 Ø 23,5
1291060, 1351734, 1385499



DF-DL-3798

Length: 1015 Ø: 50
Cone Ø: d1 Ø 30 / d2 Ø 27
0094038, 0525433



DF-DL-5355

Length: 995 Ø: 36
Cone Ø: d1 Ø 26 / d2 Ø 23,5
1311048, 1351737, 1385498



DF-DL-5403

Length: 1742 Ø: 40
Cone Ø: d1 Ø 26 / d2 Ø 23,5
0288281, 1270854, 1337644



DF-DL-7780

Length: 1690 Ø: 40
Cone Ø: d1 Ø 26 / d2 Ø 23,5
1270853, 1353391, 10212000A



DF-DL-7836

Length: 1698 Ø: 52
Cone Ø: d1 Ø 26 / d2 Ø 23,5
0754922, 1286343, 1353396



DF-DL-8158

Length: 611 Ø: 48
Hole Distance: 130 / 130
0267743, 1361649, 1361650, 1656428



DF-DL-9318

Length: 600 Ø: 50
Hole Distance: 130 / 130
0646373, 0655695, 0655697, 1284860,
1620438



DF-DL-10193

Length: 1646 Ø: 40
Cone Ø: d1 Ø 26 / d2 Ø 23,5
1351205, 1353395



DF-DL-12420

Length: 1004 Ø: 52
Cone Ø: d1 Ø 30 / d2 Ø 27
Thread: M24 x 1,5 / M30 x 1,5
0094613, 094613, 94613, 362413, 0362413,
1426101



DF-ES-9335

Length: 85
Cone Ø: d1 Ø 12 / d2 Ø 10,75
Thread: M14 x 1,5 RHT
386930, 0386930



DF-RK-8637

Ø: 72
1376730



DF-RK-8671



DF-SB-5251

Ø: 85 Thick/Height: 60
0366351, 366351, 10305800A



DF-SB-5253

Ø: 86 Thick/Height: 60,5
0371586, 0558864, 10306500A



DF-SB-10402

Ø: 62
Thick/Height: 60
1291233, 1732887



DF-VB-8561

Length: 609 Ø: 48
Hole Distance: 152 / 152
080521, 0080521, 1361651, 1368270,
1390932, 1617096, 1793875, 1817808,
1892492



DF-VB-9343

Length: 608,2 Ø: 48
Hole Distance: 152 / 152
1361652, 1620436, 1793876, 10309600A



IV-RK-8998

Ø: 85
Hole Distance: 130
Thick/Height: 30
0513757, 0531757, 0691709, 691709



MN-RK-7280

Ø: 75
Hole Distance: 115
Thick/Height: 24
0689748, 689748



MN-RK-7291

Ø: 72
Hole Distance: 130
Thick/Height: 30
1271124



MN-RK-8537

Ø: 95
Hole Distance: 152
Thick/Height: 24
696321, 81432706099



SC-RK-8575

Ø: 95
Hole Distance: 152
Thick/Height: 35
0696321



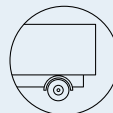

95 XF ...

FTT 95 XF 430	01/97→06/00	Track Control Arm		DF-DL-9318	Trailing Arm	
	01/97→09/02	Ball Head, gearshift linkage	DF-ES-9335			
	01/97→09/02	Centre Rod	DF-DL-2142		Push Rod	
	01/97→09/02	Centre Rod	DF-DL-3798		Push Rod	
	01/97→09/02	Centre Rod	DF-DL-12420		Push Rod	
	01/97→09/02	Stabiliser Mounting		DF-SB-5251		
	01/97→09/02	Stabiliser Mounting	DF-SB-5253	DF-SB-5253		
	01/97→09/02	Stabiliser Mounting	DF-SB-10402			
	01/97→09/02	Suspension Arm Repair Kit		CV-RK-5322	for Wishbone (CV)	
	01/97→09/02	Suspension Arm Repair Kit		CV-RK-8118	for Drag Link	
	01/97→09/02	Suspension Arm Repair Kit		IV-RK-8998	for Wishbone (CV)	
	01/97→09/02	Suspension Arm Repair Kit		MN-RK-7280	for Drag Link;for Semi-Trailing Arm; for Wishbone (CV)	
	01/97→09/02	Suspension Arm Repair Kit		MN-RK-7291	for Drag Link	
	01/97→09/02	Suspension Arm Repair Kit		SC-RK-8575	for Wishbone (CV)	
	01/97→09/02	Suspension Arm Repair Kit	MN-RK-7280	MN-RK-7280	for Drag Link;for Semi-Trailing Arm; for Wishbone (CV)	
	01/97→09/02	Suspension Strut Repair Kit		DF-RK-8637		
	01/97→09/02	Suspension Strut Repair Kit		DF-RK-8671		
	01/97→09/02	Suspension Strut Repair Kit		MN-RK-8537		
	01/97→09/02	Tie Rod	DF-DL-5403		1st FA	
	01/97→09/02	Tie Rod	DF-DL-7780		1st FA	
	01/97→09/02	Tie Rod	DF-DL-7836			
	01/97→09/02	Tie Rod End	CV-ES-12461		for Steering Rod	
	01/97→09/02	Tie Rod End	CV-ES-12462		for Steering Rod	
	01/97→09/02	Tie Rod End	CV-ES-14163		for Steering Rod	
	01/97→09/02	Track Control Arm		DF-TC-12262	Control Arm	
	01/97→09/02	Track Control Arm		DF-VB-9343	Wishbone (CV)	
	06/00→09/02	Centre Rod	DF-DL-5355		Push Rod	
	06/00→09/02	Tie Rod	DF-DL-10193		1st FA	
	06/00→09/02	Track Control Arm		DF-DL-8158	Trailing Arm	
	06/00→09/02	Track Control Arm		DF-VB-8561	Wishbone (CV)	
	FTT 95 XF 480	01/97→09/02	Ball Head, gearshift linkage	DF-ES-9335		
		01/97→09/02	Centre Rod	DF-DL-2142		Push Rod
		01/97→09/02	Centre Rod	DF-DL-3798		Push Rod
01/97→09/02		Centre Rod	DF-DL-12420		Push Rod	
01/97→09/02		Stabiliser Mounting		DF-SB-5251		
01/97→09/02		Stabiliser Mounting	DF-SB-5253	DF-SB-5253		
01/97→09/02		Stabiliser Mounting	DF-SB-10402			
01/97→09/02		Suspension Arm Repair Kit		CV-RK-5322	for Wishbone (CV)	
01/97→09/02		Suspension Arm Repair Kit		CV-RK-8118	for Drag Link	
01/97→09/02		Suspension Arm Repair Kit		IV-RK-8998	for Wishbone (CV)	
01/97→09/02		Suspension Arm Repair Kit		MN-RK-7280	for Drag Link;for Semi-Trailing Arm; for Wishbone (CV)	
01/97→09/02		Suspension Arm Repair Kit		MN-RK-7291	for Drag Link	
01/97→09/02		Suspension Arm Repair Kit		SC-RK-8575	for Wishbone (CV)	
01/97→09/02		Suspension Arm Repair Kit	MN-RK-7280	MN-RK-7280	for Drag Link;for Semi-Trailing Arm; for Wishbone (CV)	
01/97→09/02		Suspension Strut Repair Kit		DF-RK-8637		
01/97→09/02		Suspension Strut Repair Kit		DF-RK-8671		
01/97→09/02		Suspension Strut Repair Kit		MN-RK-8537		
01/97→09/02		Tie Rod	DF-DL-5403		1st FA	
01/97→09/02		Tie Rod	DF-DL-7780		1st FA	
01/97→09/02		Tie Rod	DF-DL-7836			
01/97→09/02		Tie Rod End	CV-ES-12461		for Steering Rod	
01/97→09/02		Tie Rod End	CV-ES-12462		for Steering Rod	
01/97→09/02		Tie Rod End	CV-ES-14163		for Steering Rod	
01/97→09/02		Track Control Arm		DF-DL-9318	Trailing Arm, 1st RA;2nd RA, for Leaf-Spring Suspension vehicles	
01/97→09/02		Track Control Arm		DF-VB-9343	Wishbone (CV)	
06/00→09/02		Centre Rod	DF-DL-5355		Push Rod	
06/00→09/02		Tie Rod	DF-DL-10193		1st FA	
06/00→09/02		Track Control Arm		DF-DL-8158	Trailing Arm	
06/00→09/02		Track Control Arm		DF-VB-8561	Wishbone (CV)	

CV-ES-12461

Length: 120
Cone Ø: d1 Ø 26 / d2 Ø 23,5
Thread: M30 x 1,5 LHT
69513, 0069513, 311300, 0311300,
0607998, 607998, 1190653, 1315447,
1319838, 1332123, 1338714, 1401934,
1407394, ACHB063, ACHF241, MAK1295



CV-ES-12462

Length: 120
Cone Ø: d1 Ø 26 / d2 Ø 23,5
Thread: M30 x 1,5 RHT
0069514, 0586753, 0607999, 0694298,
0694360, 0698609, 1137230, 1229944,
1326862, 1326896, 1331925, ACHB064,
ACHF242, MAK1296



CV-ES-14163

Length: 125
Cone Ø: d1 Ø 30 / d2 Ø 27
Thread: M30 x 1,5 RHT
0607981, 0698450, 1149907, 1152350,
1257890, 1603789, 1618048, ACHF060



CV-RK-5322

Ø: 72 Thick/Height: 50
0691704



CV-RK-8118

Ø: 85
Hole Distance: 130
Thick/Height: 30
0689749



DF-DL-2142

Length: 1005 Ø: 52
Cone Ø: d1 Ø 26 / d2 Ø 23,5
1291060, 1351734, 1385499



DF-DL-3798

Length: 1015 Ø: 50
Cone Ø: d1 Ø 30 / d2 Ø 27
0094038, 0525433



DF-DL-5355

Length: 995 Ø: 36
Cone Ø: d1 Ø 26 / d2 Ø 23,5
1311048, 1351737, 1385498



DF-DL-5403

Length: 1742 Ø: 40
Cone Ø: d1 Ø 26 / d2 Ø 23,5
0288281, 1270854, 1337644



DF-DL-7780

Length: 1690 Ø: 40
Cone Ø: d1 Ø 26 / d2 Ø 23,5
1270853, 1353391, 10212000A



DF-DL-7836

Length: 1698 Ø: 52
Cone Ø: d1 Ø 26 / d2 Ø 23,5
0754922, 1286343, 1353396



DF-DL-8158

Length: 611 Ø: 48
Hole Distance: 130 / 130
0267743, 1361649, 1361650, 1656428



DF-DL-9318

Length: 600 Ø: 50
Hole Distance: 130 / 130
0646373, 0655695, 0655697, 1284860,
1620438



DF-DL-10193

Length: 1646 Ø: 40
Cone Ø: d1 Ø 26 / d2 Ø 23,5
1351205, 1353395



DF-DL-12420

Length: 1004 Ø: 52
Cone Ø: d1 Ø 30 / d2 Ø 27
Thread: M24 x 1,5 / M30 x 1,5
0094613, 094613, 94613, 0362413, 362413,
1426101



DF-ES-9335

Length: 85
Cone Ø: d1 Ø 12 / d2 Ø 10,75
Thread: M14 x 1,5 RHT
0386930, 386930



DF-RK-8637

Ø: 72
1376730



DF-RK-8671



DF-SB-5251

Ø: 85 Thick/Height: 60
0366351, 366351, 10305800A



DF-SB-5253

Ø: 86 Thick/Height: 60,5
0371586, 0558864, 10306500A



DF-SB-10402

Ø: 62 Thick/Height: 60
1291233, 1732887



DF-TC-12262

Length: 595 Ø: 50
Hole Distance: 130 / 130
661406, 0661406, 0661407, 661407,
1620439



DF-VB-8561

Length: 609 Ø: 48
Hole Distance: 152 / 152
0080521, 080521, 1361651, 1368270,
1390932, 1617096, 1793875, 1817808,
1892492



DF-VB-9343

Length: 608,2 Ø: 48
Hole Distance: 152 / 152
1361652, 1620436, 1793876, 10309600A



IV-RK-8998

Ø: 85
Hole Distance: 130
Thick/Height: 30
0513757, 0531757, 0691709, 691709



MN-RK-7280

Ø: 75
Hole Distance: 115
Thick/Height: 24
0689748, 689748



MN-RK-7291

Ø: 72
Hole Distance: 130
Thick/Height: 30
1271124



MN-RK-8537

Ø: 95
Hole Distance: 152
Thick/Height: 24
696321, 81432706099



SC-RK-8575

Ø: 95
Hole Distance: 152
Thick/Height: 35
0696321



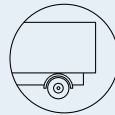

DAF ...

95 XF ...

FTT 95 XF 530	01/97→09/02	Ball Head, gearshift linkage	DF-ES-9335		
	01/97→09/02	Centre Rod	DF-DL-2142		Push Rod
	01/97→09/02	Centre Rod	DF-DL-3798		Push Rod
	01/97→09/02	Centre Rod	DF-DL-5355		Push Rod
	01/97→09/02	Centre Rod	DF-DL-12420		Push Rod
	01/97→09/02	Stabiliser Mounting		DF-SB-5251	
	01/97→09/02	Stabiliser Mounting	DF-SB-5253	DF-SB-5253	
	01/97→09/02	Stabiliser Mounting	DF-SB-10402		
	01/97→09/02	Suspension Arm Repair Kit		CV-RK-5322	for Wishbone (CV)
	01/97→09/02	Suspension Arm Repair Kit		CV-RK-8118	for Drag Link
	01/97→09/02	Suspension Arm Repair Kit		DF-RK-8633	for Wishbone (CV)
	01/97→09/02	Suspension Arm Repair Kit		IV-RK-8998	for Wishbone (CV)
	01/97→09/02	Suspension Arm Repair Kit		MN-RK-7280	for Drag Link;for Semi-Trailing Arm; for Wishbone (CV)
	01/97→09/02	Suspension Arm Repair Kit		MN-RK-7291	for Drag Link
	01/97→09/02	Suspension Arm Repair Kit		SC-RK-8575	for Wishbone (CV)
	01/97→09/02	Suspension Arm Repair Kit	MN-RK-7280	MN-RK-7280	for Drag Link;for Semi-Trailing Arm; for Wishbone (CV)
	01/97→09/02	Suspension Strut Repair Kit		DF-RK-8637	
	01/97→09/02	Suspension Strut Repair Kit		DF-RK-8671	
	01/97→09/02	Suspension Strut Repair Kit		MN-RK-8537	
	01/97→09/02	Tie Rod	DF-DL-5403		
	01/97→09/02	Tie Rod	DF-DL-7780		1st FA
	01/97→09/02	Tie Rod	DF-DL-7836		
	01/97→09/02	Tie Rod End	CV-ES-12461		for Steering Rod
	01/97→09/02	Tie Rod End	CV-ES-12462		for Steering Rod
	01/97→09/02	Tie Rod End	CV-ES-14163		for Steering Rod
	01/97→09/02	Track Control Arm		DF-DL-8158	Trailing Arm
	01/97→09/02	Track Control Arm		DF-DL-9318	Trailing Arm, 1st RA;2nd RA, for Leaf-Spring Suspension vehicles
	01/97→09/02	Track Control Arm		DF-TC-12262	Control Arm
	01/97→09/02	Track Control Arm		DF-VB-8561	Wishbone (CV)
	01/97→09/02	Track Control Arm		DF-VB-9343	Wishbone (CV)
	06/00→09/02	Tie Rod	DF-DL-5403		1st FA
	06/00→09/02	Tie Rod	DF-DL-10193		1st FA

CF 65

FA 65.180	01/01→05/13	Centre Rod	DF-DL-8196		Push Rod	
	01/01→05/13	Centre Rod	DF-DL-8363		Push Rod	
	01/01→05/13	Centre Rod	DF-DL-12424		for Steering Rod	
	01/01→05/13	Suspension Arm Repair Kit		DF-RK-9336		
	01/01→05/13	Tie Rod	DF-DL-5403		1st FA	
	01/01→05/13	Tie Rod	DF-DL-7780		1st FA	
	01/01→05/13	Tie Rod End	CV-ES-12461		for Steering Rod	
	01/01→05/13	Tie Rod End	CV-ES-12462		for Steering Rod	
	01/01→05/13	Tie Rod End	CV-ES-14163		for Steering Rod	
	01/01→05/13	Tie Rod End	DF-ES-8362		for Steering Rod	
	01/01→05/13	Track Control Arm		DF-DL-8158	Trailing Arm	
	01/01→05/13	Track Control Arm		DF-VB-8561	Wishbone (CV)	
	FA 65.220	01/01→05/13	Centre Rod	DF-DL-8196		Push Rod
		01/01→05/13	Centre Rod	DF-DL-8363		Push Rod
01/01→05/13		Centre Rod	DF-DL-12424		for Steering Rod	
01/01→05/13		Suspension Arm Repair Kit		DF-RK-9336		
01/01→05/13		Tie Rod	DF-DL-5403		1st FA	
01/01→05/13		Tie Rod	DF-DL-7780		1st FA	
01/01→05/13		Tie Rod End	CV-ES-12461		for Steering Rod	
01/01→05/13		Tie Rod End	CV-ES-12462		for Steering Rod	
01/01→05/13		Tie Rod End	CV-ES-14163		for Steering Rod	
01/01→05/13		Tie Rod End	DF-ES-8362		for Steering Rod	
01/01→05/13		Track Control Arm		DF-DL-8158	Trailing Arm	
01/01→05/13		Track Control Arm		DF-VB-8561	Wishbone (CV)	
05/06→05/13		Centre Rod	DF-DL-6052		Push Rod	
05/06→05/13	Tie Rod	DF-DL-7780				

CV-ES-12461

Length: 120
Cone Ø: d1 Ø 26 / d2 Ø 23,5
Thread: M30 x 1,5 LHT
69513, 0069513, 0311300, 311300,
0607998, 607998, 1190653, 1315447,
1319838, 1332123, 1338714, 1401934,
1407394, ACHB063, ACHF241, MAK1295



CV-ES-12462

Length: 120
Cone Ø: d1 Ø 26 / d2 Ø 23,5
Thread: M30 x 1,5 RHT
0069514, 0586753, 0607999, 0694298,
0694360, 0698609, 1137230, 1229944,
1326862, 1326896, 1331925, ACHB064,
ACHF242, MAK1296



CV-ES-14163

Length: 125
Cone Ø: d1 Ø 30 / d2 Ø 27
Thread: M30 x 1,5 RHT
0607981, 0698450, 1149907, 1152350,
1257890, 1603789, 1618048, ACHF060



CV-RK-5322

Ø: 72 Thick/Height: 50
0691704



CV-RK-8118

Ø: 85
Hole Distance: 130
Thick/Height: 30
0689749



DF-DL-2142

Length: 1005 Ø: 52
Cone Ø: d1 Ø 26 / d2 Ø 23,5
1291060, 1351734, 1385499



DF-DL-3798

Length: 1015 Ø: 50
Cone Ø: d1 Ø 30 / d2 Ø 27
0094038, 0525433



DF-DL-5355

Length: 995 Ø: 36
Cone Ø: d1 Ø 26 / d2 Ø 23,5
1311048, 1351737, 1385498



DF-DL-5403

Length: 1742 Ø: 40
Cone Ø: d1 Ø 26 / d2 Ø 23,5
0288281, 1270854, 1337644



DF-DL-6052

Length: 926 Ø: 46
Cone Ø: d1 Ø 30 / d2 Ø 27
1405309



DF-DL-7780

Length: 1690 Ø: 40
Cone Ø: d1 Ø 26 / d2 Ø 23,5
1270853, 1353391, 10212000A



DF-DL-7836

Length: 1698 Ø: 52
Cone Ø: d1 Ø 26 / d2 Ø 23,5
0754922, 1286343, 1353396



DF-DL-8158

Length: 611 Ø: 48
Hole Distance: 130 / 130
0267743, 1361649, 1361650, 1656428



DF-DL-8196

Length: 867 Ø: 50
Cone Ø: d1 Ø 30 / d2 Ø 27
1363859, 1448063, 1602821



DF-DL-8363

Length: 855 Ø: 50
Cone Ø: d1 Ø 30 / d2 Ø 27
1363858, 1448062, 1602820



DF-DL-9318

Length: 600 Ø: 50
Hole Distance: 130 / 130
0646373, 0655695, 0655697, 1284860,
1620438



DF-DL-10193

Length: 1646 Ø: 40
Cone Ø: d1 Ø 26 / d2 Ø 23,5
1351205, 1353395



DF-DL-12420

Length: 1004 Ø: 52
Cone Ø: d1 Ø 30 / d2 Ø 27
Thread: M24 x 1,5 / M30 x 1,5
0094613, 094613, 94613, 0362413, 362413,
1426101



DF-DL-12424

Length: 925 Ø: 46
Cone Ø: d1 Ø 30 / d2 Ø 27
1405499



DF-ES-8362

Length: 150
Cone Ø: d1 Ø 26 / d2 Ø 23,5
Thread: M30 x 1,5 RHT
1389190



DF-ES-9335

Length: 85
Cone Ø: d1 Ø 12 / d2 Ø 10,75
Thread: M14 x 1,5 RHT
386930, 0386930



DF-RK-8633

Ø: 90
696320, 0696320



DF-RK-8637

Ø: 72
1376730



DF-RK-8671



DF-RK-9336

Ø: 108
1445656



DF-SB-5251

Ø: 85 Thick/Height: 60
0366351, 366351, 10305800A



DF-SB-5253

Ø: 86 Thick/Height: 60,5
0371586, 0558864, 10306500A



DF-SB-10402

Ø: 62 Thick/Height: 60
1291233, 1732887



DF-TC-12262

Length: 595 Ø: 50
Hole Distance: 130 / 130
0661406, 661406, 0661407, 661407,
1620439



DF-VB-8561

Length: 609 Ø: 48
Hole Distance: 152 / 152
0080521, 080521, 1361651, 1368270,
1390932, 1617096, 1793875, 1817808,
1892492



DF-VB-9343

Length: 608,2 Ø: 48
Hole Distance: 152 / 152
1361652, 1620436, 1793876, 10309600A



IV-RK-8998

Ø: 85
Hole Distance: 130
Thick/Height: 30
0513757, 0531757, 0691709, 691709



MN-RK-7280

Ø: 75
Hole Distance: 115
Thick/Height: 24
689748, 0689748



MN-RK-7291

Ø: 72
Hole Distance: 130
Thick/Height: 30
1271124



MN-RK-8537

Ø: 95
Hole Distance: 152
Thick/Height: 24
696321, 81432706099



SC-RK-8575

Ø: 95
Hole Distance: 152
Thick/Height: 35
0696321



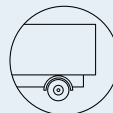

CF 65 ...

FA 65.220 ...	05/06→05/13	Tie Rod	DF-DL-8718		1st FA	
	05/06→05/13	Tie Rod End	CV-ES-14162		for Steering Rod	
FA 65.250	01/01→05/13	Centre Rod	DF-DL-8196		Push Rod	
	01/01→05/13	Centre Rod	DF-DL-8363		Push Rod	
	01/01→05/13	Centre Rod	DF-DL-12424		for Steering Rod	
	01/01→05/13	Suspension Arm Repair Kit		DF-RK-9336		
	01/01→05/13	Tie Rod	DF-DL-5403		1st FA	
	01/01→05/13	Tie Rod	DF-DL-7780		1st FA	
	01/01→05/13	Tie Rod End	CV-ES-12461		for Steering Rod	
	01/01→05/13	Tie Rod End	CV-ES-12462		for Steering Rod	
	01/01→05/13	Tie Rod End	CV-ES-14163		for Steering Rod	
	01/01→05/13	Tie Rod End	DF-ES-8362		for Steering Rod	
	01/01→05/13	Track Control Arm		DF-DL-8158	Trailing Arm	
	01/01→05/13	Track Control Arm		DF-VB-8561	Wishbone (CV)	
	05/06→05/13	Centre Rod	DF-DL-6052		Push Rod	
	05/06→05/13	Tie Rod	DF-DL-8718		1st FA	
05/06→05/13	Tie Rod End	CV-ES-14162		for Steering Rod		
FA 65.280	05/06→05/13	Centre Rod	DF-DL-6052		Push Rod	
	05/06→05/13	Centre Rod	DF-DL-8196		Push Rod	
	05/06→05/13	Centre Rod	DF-DL-12424		for Steering Rod	
	05/06→05/13	Suspension Arm Repair Kit		DF-RK-9336		
	05/06→05/13	Tie Rod	DF-DL-5403		1st FA	
	05/06→05/13	Tie Rod	DF-DL-7780		1st FA	
	05/06→05/13	Tie Rod	DF-DL-8718		1st FA	
	05/06→05/13	Tie Rod End	CV-ES-12461		for Steering Rod	
	05/06→05/13	Tie Rod End	CV-ES-12462		for Steering Rod	
	05/06→05/13	Tie Rod End	CV-ES-14163		for Steering Rod	
	05/06→05/13	Track Control Arm		DF-DL-8158	Trailing Arm	
	05/06→05/13	Track Control Arm		DF-VB-8561	Wishbone (CV)	
	FA 65.300	01/09→05/13	Centre Rod	DF-DL-8196		Push Rod
		01/09→05/13	Centre Rod	DF-DL-12424		for Steering Rod
01/09→05/13		Suspension Arm Repair Kit		DF-RK-9336		
01/09→05/13		Tie Rod	DF-DL-7780			
01/09→05/13		Tie Rod End	CV-ES-12461		for Steering Rod	
01/09→05/13		Tie Rod End	CV-ES-12462		for Steering Rod	
01/09→05/13		Tie Rod End	CV-ES-14162		for Steering Rod	
01/09→05/13		Tie Rod End	CV-ES-14163		for Steering Rod	
01/09→05/13		Tie Rod End	DF-ES-8362		for Steering Rod	
01/09→05/13		Track Control Arm		DF-DL-8158	Trailing Arm	
01/09→05/13		Track Control Arm		DF-VB-8561	Wishbone (CV)	

CF 75

FA 75.250	01/01→04/06	Tie Rod	DF-DL-7836		1st FA
	01/01→04/06	Tie Rod	DF-DL-10193		1st FA
	01/01→05/13	Centre Rod	DF-DL-5237		Push Rod
	01/01→05/13	Centre Rod	DF-DL-8196		Push Rod
	01/01→05/13	Centre Rod	DF-DL-8363		Push Rod
	01/01→05/13	Centre Rod	DF-DL-12425		Push Rod
	01/01→05/13	Stabiliser Mounting	DF-SB-10402		
	01/01→05/13	Suspension Arm Repair Kit		DF-RK-9336	
	01/01→05/13	Tie Rod	DF-DL-5403		1st FA
	01/01→05/13	Tie Rod	DF-DL-7780		1st FA
	01/01→05/13	Tie Rod End	CV-ES-12461		for Steering Rod
	01/01→05/13	Tie Rod End	CV-ES-12462		for Steering Rod
	01/01→05/13	Tie Rod End	CV-ES-14162		for Steering Rod
	01/01→05/13	Tie Rod End	CV-ES-14163		for Steering Rod
	01/01→05/13	Tie Rod End	DF-ES-8362		for Steering Rod
	01/01→05/13	Track Control Arm		DF-DL-8158	Trailing Arm
	01/01→05/13	Track Control Arm		DF-VB-8561	Wishbone (CV)
	04/06→05/13	Tie Rod	DF-DL-8718		1st FA
	10/06→05/13	Suspension Arm Repair Kit	MN-RK-7280	MN-RK-7280	for Drag Link;for Semi-Trailing Arm; for Wishbone (CV)
	10/06→05/13	Tie Rod	DF-DL-5403		

CV-ES-12461

Length: 120
Cone Ø: d1 Ø 26 / d2 Ø 23,5
Thread: M30 x 1,5 LHT
0069513, 69513, 0311300, 311300,
0607998, 607998, 1190653, 1315447,
1319838, 1332123, 1338714, 1401934,
1407394, ACHB063, ACHF241, MAK1295



CV-ES-12462

Length: 120
Cone Ø: d1 Ø 26 / d2 Ø 23,5
Thread: M30 x 1,5 RHT
0069514, 0586753, 0607999, 0694298,
0694360, 0698609, 1137230, 1229944,
1326862, 1326896, 1331925, ACHB064,
ACHF242, MAK1296



CV-ES-14162

Length: 125
Cone Ø: d1 Ø 30 / d2 Ø 27
Thread: M30 x 1,5 LHT
607053, 690225, 696225, 1228115,
1611088



CV-ES-14163

Length: 125
Cone Ø: d1 Ø 30 / d2 Ø 27
Thread: M30 x 1,5 RHT
0607981, 0698450, 1149907, 1152350,
1257890, 1603789, 1618048, ACHF060



DF-DL-5237

Length: 880
Ø: 52
Cone Ø: d1 Ø 26 / d2 Ø 23,5
1283211, 1351714, 1385497, 10201000A



DF-DL-5403

Length: 1742
Ø: 40
Cone Ø: d1 Ø 26 / d2 Ø 23,5
0288281, 1270854, 1337644



DF-DL-6052

Length: 926
Ø: 46
Cone Ø: d1 Ø 30 / d2 Ø 27
1405309



DF-DL-7780

Length: 1690
Ø: 40
Cone Ø: d1 Ø 26 / d2 Ø 23,5
1270853, 1353391, 10212000A



DF-DL-7836

Length: 1698
Ø: 52
Cone Ø: d1 Ø 26 / d2 Ø 23,5
0754922, 1286343, 1353396



DF-DL-8158

Length: 611
Ø: 48
Hole Distance: 130 / 130
0267743, 1361649, 1361650, 1656428



DF-DL-8196

Length: 867
Ø: 50
Cone Ø: d1 Ø 30 / d2 Ø 27
1363859, 1448063, 1602821



DF-DL-8363

Length: 855
Ø: 50
Cone Ø: d1 Ø 30 / d2 Ø 27
1363858, 1448062, 1602820



DF-DL-8718

Length: 1690
Ø: 40
Cone Ø: d1 Ø 30 / d2 Ø 27
1700000



DF-DL-10193

Length: 1646
Ø: 40
Cone Ø: d1 Ø 26 / d2 Ø 23,5
1351205, 1353395



DF-DL-12424

Length: 925
Ø: 46
Cone Ø: d1 Ø 30 / d2 Ø 27
1405499



DF-DL-12425

Length: 865
Ø: 52
Cone Ø: d1 Ø 30 / d2 Ø 27
1373878, 1448064



DF-ES-8362

Length: 150
Cone Ø: d1 Ø 26 / d2 Ø 23,5
Thread: M30 x 1,5 RHT
1389190



DF-RK-9336

Ø: 108
1445656



DF-SB-10402

Ø: 62
Thick/Height: 60
1291233, 1732887



DF-VB-8561

Length: 609
Ø: 48
Hole Distance: 152 / 152
0080521, 080521, 1361651, 1368270,
1390932, 1617096, 1793875, 1817808,
1892492



MN-RK-7280

Ø: 75
Hole Distance: 115
Thick/Height: 24
0689748, 689748





CF 75 ...

FA 75.250 ...	10/06→05/13	Tie Rod	DF-DL-7780			
	10/06→05/13	Tie Rod	DF-DL-7836			
	10/06→05/13	Tie Rod	DF-DL-8718			
FA 75.310	01/01→05/13	Centre Rod	DF-DL-5237		Push Rod	
	01/01→05/13	Centre Rod	DF-DL-8196		Push Rod	
	01/01→05/13	Centre Rod	DF-DL-8363		Push Rod	
	01/01→05/13	Centre Rod	DF-DL-12425		Push Rod	
	01/01→05/13	Stabiliser Mounting	DF-SB-10402			
	01/01→05/13	Suspension Arm Repair Kit		DF-RK-9336		
	01/01→05/13	Tie Rod	DF-DL-5403		1st FA	
	01/01→05/13	Tie Rod	DF-DL-7780		1st FA	
	01/01→05/13	Tie Rod	DF-DL-7836		1st FA	
	01/01→05/13	Tie Rod	DF-DL-10193		1st FA	
	01/01→05/13	Tie Rod End	CV-ES-12461		for Steering Rod	
	01/01→05/13	Tie Rod End	CV-ES-12462		for Steering Rod	
	01/01→05/13	Tie Rod End	CV-ES-14162		for Steering Rod	
	01/01→05/13	Tie Rod End	CV-ES-14163		for Steering Rod	
	01/01→05/13	Tie Rod End	DF-ES-8362		for Steering Rod	
	01/01→05/13	Track Control Arm		DF-DL-8158	Trailing Arm	
	01/01→05/13	Track Control Arm		DF-VB-8561	Wishbone (CV)	
	04/06→05/13	Tie Rod	DF-DL-8718		1st FA	
	10/06→05/13	Suspension Arm Repair Kit	MN-RK-7280	MN-RK-7280	for Drag Link;for Semi-Trailing Arm; for Wishbone (CV)	
	10/06→05/13	Tie Rod	DF-DL-5403			
	10/06→05/13	Tie Rod	DF-DL-7780			
	10/06→05/13	Tie Rod	DF-DL-7836			
	10/06→05/13	Tie Rod	DF-DL-8718			
	FA 75.360	01/01→04/06	Tie Rod	DF-DL-5403		1st FA
		01/01→04/06	Tie Rod	DF-DL-7780		1st FA
		01/01→04/06	Tie Rod	DF-DL-10193		1st FA
		01/01→04/06	Track Control Arm		DF-DL-8158	Trailing Arm
01/01→05/13		Centre Rod	DF-DL-5237		Push Rod	
01/01→05/13		Centre Rod	DF-DL-8196		Push Rod	
01/01→05/13		Centre Rod	DF-DL-8363		Push Rod	
01/01→05/13		Centre Rod	DF-DL-12425		Push Rod	
01/01→05/13		Stabiliser Mounting	DF-SB-10402			
01/01→05/13		Suspension Arm Repair Kit		DF-RK-9336		
01/01→05/13		Tie Rod	DF-DL-7836		1st FA	
01/01→05/13		Tie Rod End	CV-ES-12461		for Steering Rod	
01/01→05/13		Tie Rod End	CV-ES-12462		for Steering Rod	
01/01→05/13		Tie Rod End	CV-ES-14162		for Steering Rod	
01/01→05/13		Tie Rod End	CV-ES-14163		for Steering Rod	
01/01→05/13		Tie Rod End	DF-ES-8362		for Steering Rod	
01/01→05/13		Track Control Arm		DF-VB-8561	Wishbone (CV)	
04/06→05/13		Tie Rod	DF-DL-8718		1st FA	
10/06→05/13		Suspension Arm Repair Kit	MN-RK-7280	MN-RK-7280	for Drag Link;for Semi-Trailing Arm; for Wishbone (CV)	
10/06→05/13		Tie Rod	DF-DL-5403			
10/06→05/13		Tie Rod	DF-DL-7780			
10/06→05/13		Tie Rod	DF-DL-7836			
10/06→05/13		Tie Rod	DF-DL-8718			
FAD 75.250		01/01→01/06	Centre Rod	DF-DL-8703		Push Rod
		01/01→01/06	Centre Rod	DF-DL-10186		Push Rod
		01/01→01/06	Centre Rod	DF-DL-10188		Push Rod
		01/01→01/06	Tie Rod	DF-DL-5403		1st FA
	01/01→01/06	Tie Rod	DF-DL-7780		2nd FA	
	01/01→01/06	Tie Rod End	DF-ES-8602			
	01/01→01/06	Track Control Arm		DF-DL-9318	Trailing Arm	
	01/01→05/13	Centre Rod	DF-DL-5237		Push Rod	
	01/01→05/13	Centre Rod	DF-DL-8196		Push Rod	
	01/01→05/13	Stabiliser Mounting	DF-SB-10402			
	01/01→05/13	Suspension Arm Repair Kit		DF-RK-9336		
	01/01→05/13	Tie Rod End	CV-ES-12461		for Steering Rod	

CV-ES-12461

Length: 120
Cone Ø: d1 Ø 26 / d2 Ø 23,5
Thread: M30 x 1,5 LHT
0069513, 69513, 0311300, 311300,
0607998, 607998, 1190653, 1315447,
1319838, 1332123, 1338714, 1401934,
1407394, ACHB063, ACHF241, MAK1295



CV-ES-12462

Length: 120
Cone Ø: d1 Ø 26 / d2 Ø 23,5
Thread: M30 x 1,5 RHT
0069514, 0586753, 0607999, 0694298,
0694360, 0698609, 1137230, 1229944,
1326862, 1326896, 1331925, ACHB064,
ACHF242, MAK1296



CV-ES-14162

Length: 125
Cone Ø: d1 Ø 30 / d2 Ø 27
Thread: M30 x 1,5 LHT
607053, 690225, 696225, 1228115,
1611088



CV-ES-14163

Length: 125
Cone Ø: d1 Ø 30 / d2 Ø 27
Thread: M30 x 1,5 RHT
0607981, 0698450, 1149907, 1152350,
1257890, 1603789, 1618048, ACHF060



DF-DL-5237

Length: 880
Ø: 52
Cone Ø: d1 Ø 26 / d2 Ø 23,5
1283211, 1351714, 1385497, 10201000A



DF-DL-5403

Length: 1742
Ø: 40
Cone Ø: d1 Ø 26 / d2 Ø 23,5
0288281, 1270854, 1337644



DF-DL-7780

Length: 1690
Ø: 40
Cone Ø: d1 Ø 26 / d2 Ø 23,5
1270853, 1353391, 10212000A



DF-DL-7836

Length: 1698
Ø: 52
Cone Ø: d1 Ø 26 / d2 Ø 23,5
0754922, 1286343, 1353396



DF-DL-8158

Length: 611
Ø: 48
Hole Distance: 130 / 130
0267743, 1361649, 1361650, 1656428



DF-DL-8196

Length: 867
Ø: 50
Cone Ø: d1 Ø 30 / d2 Ø 27
1363859, 1448063, 1602821



DF-DL-8363

Length: 855
Ø: 50
Cone Ø: d1 Ø 30 / d2 Ø 27
1363858, 1448062, 1602820



DF-DL-8703

Length: 1977
Ø: 52
Cone Ø: d1 Ø 30 / d2 Ø 27
1451122



DF-DL-8718

Length: 1690
Ø: 40
Cone Ø: d1 Ø 30 / d2 Ø 27
1700000



DF-DL-9318

Length: 600
Ø: 50
Hole Distance: 130 / 130
0646373, 0655695, 0655697, 1284860,
1620438



DF-DL-10186

Length: 860
Ø: 38
Cone Ø: d1 Ø 30 / d2 Ø 27
1451118



DF-DL-10188

Length: 860
Ø: 36
Cone Ø: d1 Ø 30 / d2 Ø 27
1380417, 1451129



DF-DL-10193

Length: 1646
Ø: 40
Cone Ø: d1 Ø 26 / d2 Ø 23,5
1351205, 1353395



DF-DL-12425

Length: 865
Ø: 52
Cone Ø: d1 Ø 30 / d2 Ø 27
1373878, 1448064



DF-ES-8362

Length: 150
Cone Ø: d1 Ø 26 / d2 Ø 23,5
Thread: M30 x 1,5 RHT
1389190



DF-ES-8602

Length: 95
Cone Ø: d1 Ø 30 / d2 Ø 27
Thread: M22 x 1,5 RHT
0273203, 1399724



DF-RK-9336

Ø: 108
1445656



DF-SB-10402

Ø: 62
Thick/Height: 60
1291233, 1732887



DF-VB-8561

Length: 609
Ø: 48
Hole Distance: 152 / 152
0080521, 080521, 1361651, 1368270,
1390932, 1617096, 1793875, 1817808,
1892492



MN-RK-7280

Ø: 75
Hole Distance: 115
Thick/Height: 24
0689748, 689748





CF 75 ...

FAD 75.250 ...	01/01→05/13	Tie Rod End	CV-ES-12462		for Steering Rod
	01/01→05/13	Tie Rod End	CV-ES-14162		for Steering Rod
	01/01→05/13	Tie Rod End	CV-ES-14163		for Steering Rod
	01/01→05/13	Tie Rod End	SC-ES-8517		for Push Rod
	01/01→05/13	Track Control Arm		DF-DL-8158	Trailing Arm
	01/01→05/13	Track Control Arm		DF-TC-12262	Control Arm
	01/01→05/13	Track Control Arm		DF-VB-9343	Wishbone (CV), 1st RA;2nd RA, for Leaf-Spring Suspension vehicles
FAD 75.310	01/01→05/13	Centre Rod	DF-DL-5237		Push Rod
	01/01→05/13	Centre Rod	DF-DL-8196		Push Rod
	01/01→05/13	Stabiliser Mounting	DF-SB-10402		
	01/01→05/13	Suspension Arm Repair Kit		DF-RK-9336	
	01/01→05/13	Tie Rod	DF-DL-5403		
	01/01→05/13	Tie Rod	DF-DL-7780		
	01/01→05/13	Tie Rod End	CV-ES-12461		for Steering Rod
	01/01→05/13	Tie Rod End	CV-ES-12462		for Steering Rod
	01/01→05/13	Tie Rod End	CV-ES-14162		for Steering Rod
	01/01→05/13	Tie Rod End	CV-ES-14163		for Steering Rod
	01/01→05/13	Tie Rod End	SC-ES-8517		for Push Rod
	01/01→05/13	Track Control Arm		DF-DL-8158	Trailing Arm
	01/01→05/13	Track Control Arm		DF-DL-9318	Trailing Arm, 1st RA;2nd RA, for Leaf-Spring Suspension vehicles
	01/01→05/13	Track Control Arm		DF-TC-12262	Control Arm
	01/01→05/13	Track Control Arm		DF-VB-8561	Wishbone (CV)
01/01→05/13	Track Control Arm		DF-VB-9343	Wishbone (CV), 1st RA;2nd RA, for Leaf-Spring Suspension vehicles	
FAD 75.360	01/01→01/06	Centre Rod	DF-DL-8703		Push Rod
	01/01→01/06	Centre Rod	DF-DL-10186		Push Rod
	01/01→01/06	Tie Rod	DF-DL-5403		1st FA;2nd FA
	01/01→01/06	Tie Rod End	DF-ES-8602		
	01/01→05/13	Centre Rod	DF-DL-5237		Push Rod
	01/01→05/13	Centre Rod	DF-DL-8196		Push Rod
	01/01→05/13	Centre Rod	DF-DL-10188		Push Rod
	01/01→05/13	Stabiliser Mounting	DF-SB-10402		
	01/01→05/13	Suspension Arm Repair Kit		DF-RK-9336	
	01/01→05/13	Tie Rod End	CV-ES-12461		for Steering Rod
	01/01→05/13	Tie Rod End	CV-ES-12462		for Steering Rod
	01/01→05/13	Tie Rod End	CV-ES-14162		for Steering Rod
	01/01→05/13	Tie Rod End	CV-ES-14163		for Steering Rod
	01/01→05/13	Tie Rod End	SC-ES-8517		for Push Rod
	01/01→05/13	Track Control Arm		DF-DL-8158	Trailing Arm
	01/01→05/13	Track Control Arm		DF-DL-9318	Trailing Arm
	01/01→05/13	Track Control Arm		DF-TC-12262	Control Arm
	01/01→05/13	Track Control Arm		DF-VB-8561	Wishbone (CV)
	01/01→05/13	Track Control Arm		DF-VB-9343	Wishbone (CV), 1st RA;2nd RA, for Leaf-Spring Suspension vehicles
	01/06→05/13	Tie Rod	DF-DL-5403		1st FA
	01/06→05/13	Tie Rod	DF-DL-7780		2nd FA
	01/06→05/13	Tie Rod	DF-DL-8718		2nd FA
FAG 75.250, FAN 75.250	01/01→04/06	Centre Rod	DF-DL-8363		Push Rod
	01/01→04/06	Tie Rod		DF-DL-7780	Leading Axle
	01/01→04/06	Tie Rod	DF-DL-7836		1st FA
	01/01→05/13	Centre Rod	DF-DL-5237		Push Rod
	01/01→05/13	Centre Rod	DF-DL-8196		Push Rod
	01/01→05/13	Centre Rod	DF-DL-10192	DF-DL-10192	Push Rod, for vehicles with Hinged Leading Axle
	01/01→05/13	Centre Rod	DF-DL-12425		Push Rod
	01/01→05/13	Stabiliser Mounting	DF-SB-10402		
	01/01→05/13	Suspension Arm Repair Kit		DF-RK-9336	
	01/01→05/13	Suspension Arm Repair Kit	MN-RK-7280	MN-RK-7280	for Drag Link;for Semi-Trailing Arm; for Wishbone (CV)
	01/01→05/13	Tie Rod		DF-DL-5403	Tag Axle
	01/01→05/13	Tie Rod		DF-ES-5761	Leading Axle
	01/01→05/13	Tie Rod	DF-DL-5403		1st FA

CV-ES-12461

Length: 120
Cone Ø: d1 Ø 26 / d2 Ø 23,5
Thread: M30 x 1,5 LHT
0069513, 69513, 0311300, 311300,
0607998, 607998, 1190653, 1315447,
1319838, 1332123, 1338714, 1401934,
1407394, ACHB063, ACHF241, MAK1295



CV-ES-12462

Length: 120
Cone Ø: d1 Ø 26 / d2 Ø 23,5
Thread: M30 x 1,5 RHT
0069514, 0586753, 0607999, 0694298,
0694360, 0698609, 1137230, 1229944,
1326862, 1326896, 1331925, ACHB064,
ACHF242, MAK1296



CV-ES-14162

Length: 125
Cone Ø: d1 Ø 30 / d2 Ø 27
Thread: M30 x 1,5 LHT
607053, 690225, 696225, 1228115,
1611088



CV-ES-14163

Length: 125
Cone Ø: d1 Ø 30 / d2 Ø 27
Thread: M30 x 1,5 RHT
0607981, 0698450, 1149907, 1152350,
1257890, 1603789, 1618048, ACHF060



DF-DL-5237

Length: 880 Ø: 52
Cone Ø: d1 Ø 26 / d2 Ø 23,5
1283211, 1351714, 1385497, 10201000A



DF-DL-5403

Length: 1742 Ø: 40
Cone Ø: d1 Ø 26 / d2 Ø 23,5
0288281, 1270854, 1337644



DF-DL-7780

Length: 1690 Ø: 40
Cone Ø: d1 Ø 26 / d2 Ø 23,5
1270853, 1353391, 10212000A



DF-DL-7836

Length: 1698 Ø: 52
Cone Ø: d1 Ø 26 / d2 Ø 23,5
0754922, 1286343, 1353396



DF-DL-8158

Length: 611 Ø: 48
Hole Distance: 130 / 130
0267743, 1361649, 1361650, 1656428



DF-DL-8196

Length: 867 Ø: 50
Cone Ø: d1 Ø 30 / d2 Ø 27
1363859, 1448063, 1602821



DF-DL-8363

Length: 855 Ø: 50
Cone Ø: d1 Ø 30 / d2 Ø 27
1363858, 1448062, 1602820



DF-DL-8703

Length: 1977 Ø: 52
Cone Ø: d1 Ø 30 / d2 Ø 27
1451122



DF-DL-8718

Length: 1690 Ø: 40
Cone Ø: d1 Ø 30 / d2 Ø 27
1700000



DF-DL-9318

Length: 600 Ø: 50
Hole Distance: 130 / 130
0646373, 0655695, 0655697, 1284860,
1620438



DF-DL-10186

Length: 860 Ø: 38
Cone Ø: d1 Ø 30 / d2 Ø 27
1451118



DF-DL-10188

Length: 860 Ø: 36
Cone Ø: d1 Ø 30 / d2 Ø 27
1380417, 1451129



DF-DL-10192

Length: 590 Ø: 38
Cone Ø: d1 Ø 30 / d2 Ø 27
1440171, 1451119



DF-DL-12425

Length: 865 Ø: 52
Cone Ø: d1 Ø 30 / d2 Ø 27
1373878, 1448064



DF-ES-5761

Length: 1512 Ø: 52
Cone Ø: d1 Ø 26 / d2 Ø 23,5
1297572, 1361155



DF-ES-8602

Length: 95
Cone Ø: d1 Ø 30 / d2 Ø 27
Thread: M22 x 1,5 RHT
0273203, 1399724



DF-RK-9336

Ø: 108
1445656



DF-SB-10402

Ø: 62
Thick/Height: 60
1291233, 1732887



DF-TC-12262

Length: 595
Ø: 50
Hole Distance: 130 / 130
0661406, 661406, 0661407, 661407,
1620439



DF-VB-8561

Length: 609
Ø: 48
Hole Distance: 152 / 152
080521, 0080521, 1361651, 1368270,
1390932, 1617096, 1793875, 1817808,
1892492



DF-VB-9343

Length: 608,2
Ø: 48
Hole Distance: 152 / 152
1361652, 1620436, 1793876, 10309600A



MN-RK-7280

Ø: 75
Hole Distance: 115
Thick/Height: 24
0689748, 689748



SC-ES-8517

Length: 140
Cone Ø: d1 Ø 30 / d2 Ø 27
Thread: M30 x 1,5 RHT
1685552





CF 75 ...

FAG 75.250, FAN 75.250 ...	01/01→05/13	Tie Rod	DF-DL-7780		1st FA	
	01/01→05/13	Tie Rod	DF-DL-10193		1st FA	
	01/01→05/13	Tie Rod End	CV-ES-12461		for Steering Rod	
	01/01→05/13	Tie Rod End	CV-ES-12462		for Steering Rod	
	01/01→05/13	Tie Rod End	CV-ES-14162	CV-ES-14162	for Steering Rod	
	01/01→05/13	Tie Rod End	CV-ES-14163		for Steering Rod	
	01/01→05/13	Tie Rod End	DF-ES-8362		for Steering Rod	
	01/01→05/13	Tie Rod End	DF-ES-12428		for Steering Rod	
	01/01→05/13	Track Control Arm		DF-DL-8158	Trailing Arm	
	01/01→05/13	Track Control Arm		DF-TC-12492	Control Arm	
	01/01→05/13	Track Control Arm		DF-TC-12492	Trailing Arm, Leading Axle Steered, for Pneumatic Suspension vehicles	
	01/01→05/13	Track Control Arm		DF-VB-8561	Wishbone (CV)	
	04/06→05/13	Centre Rod	DF-DL-10192		Push Rod, for vehicles with Hinged Leading Axle	
	04/06→05/13	Tie Rod		DF-DL-8718	Tag Axle	
	04/06→05/13	Tie Rod	DF-DL-8718		1st FA	
	04/06→05/13	Track Control Arm		DF-DL-9331	Wishbone (CV)	
	FAG 75.310, FAN 75.310	01/01→04/06	Centre Rod	DF-DL-8363		Push Rod
		01/01→04/06	Centre Rod	DF-DL-10192	DF-DL-10192	Push Rod, for vehicles with Hinged Leading Axle
		01/01→04/06	Tie Rod		DF-ES-5761	Tag Axle
		01/01→04/06	Tie Rod	DF-DL-7836		1st FA
		01/01→05/13	Centre Rod	DF-DL-5237		Push Rod
		01/01→05/13	Centre Rod	DF-DL-8196		Push Rod
		01/01→05/13	Centre Rod	DF-DL-12425		Push Rod
		01/01→05/13	Stabiliser Mounting	DF-SB-10402		
01/01→05/13		Suspension Arm Repair Kit		DF-RK-9336		
01/01→05/13		Suspension Arm Repair Kit	MN-RK-7280	MN-RK-7280	for Drag Link;for Semi-Trailing Arm; for Wishbone (CV)	
01/01→05/13		Tie Rod		DF-DL-5403	Tag Axle	
01/01→05/13		Tie Rod		DF-DL-7780	Leading Axle	
01/01→05/13		Tie Rod		DF-ES-5761	Leading Axle	
01/01→05/13		Tie Rod	DF-DL-5403		1st FA	
01/01→05/13		Tie Rod	DF-DL-7780		1st FA	
01/01→05/13		Tie Rod	DF-DL-10193		1st FA	
01/01→05/13		Tie Rod End	CV-ES-12461		for Steering Rod	
01/01→05/13		Tie Rod End	CV-ES-12462		for Steering Rod	
01/01→05/13		Tie Rod End	CV-ES-14162	CV-ES-14162	for Steering Rod	
01/01→05/13		Tie Rod End	CV-ES-14163		for Steering Rod	
01/01→05/13		Tie Rod End	DF-ES-8362		for Steering Rod	
01/01→05/13		Tie Rod End	DF-ES-12428		for Steering Rod	
01/01→05/13		Track Control Arm		DF-DL-8158	Trailing Arm	
01/01→05/13		Track Control Arm		DF-TC-12492	Control Arm	
01/01→05/13		Track Control Arm		DF-TC-12492	Trailing Arm, Leading Axle Steered, for Pneumatic Suspension vehicles	
01/01→05/13		Track Control Arm		DF-VB-8561	Wishbone (CV)	
04/06→05/13		Centre Rod	DF-DL-10192		Push Rod, for vehicles with Hinged Leading Axle	
04/06→05/13		Tie Rod		DF-DL-8718	Tag Axle	
04/06→05/13		Tie Rod	DF-DL-8718		1st FA	
04/06→05/13		Track Control Arm		DF-DL-9331	Wishbone (CV)	
FAG 75.360, FAN 75.360		01/01→04/06	Centre Rod	DF-DL-8363		Push Rod
		01/01→04/06	Centre Rod	DF-DL-10192	DF-DL-10192	Push Rod, for vehicles with Hinged Leading Axle
		01/01→04/06	Tie Rod	DF-DL-10193		1st FA
		01/01→04/06	Tie Rod	DF-ES-5761		1st FA
		01/01→05/13	Centre Rod	DF-DL-5237		Push Rod
		01/01→05/13	Centre Rod	DF-DL-8196		Push Rod
	01/01→05/13	Centre Rod	DF-DL-12425		Push Rod	
	01/01→05/13	Stabiliser Mounting	DF-SB-10402			
	01/01→05/13	Suspension Arm Repair Kit		DF-RK-9336		
	01/01→05/13	Suspension Arm Repair Kit	MN-RK-7280	MN-RK-7280	for Drag Link;for Semi-Trailing Arm; for Wishbone (CV)	
	01/01→05/13	Tie Rod		DF-DL-5403	Tag Axle	
	01/01→05/13	Tie Rod		DF-DL-7780	Leading Axle	
01/01→05/13	Tie Rod		DF-ES-5761	Leading Axle		

CV-ES-12461

Length: 120
Cone Ø: d1 Ø 26 / d2 Ø 23,5
Thread: M30 x 1,5 LHT
0069513, 69513, 0311300, 311300,
0607998, 607998, 1190653, 1315447,
1319838, 1332123, 1338714, 1401934,
1407394, ACHB063, ACHF241, MAK1295



CV-ES-12462

Length: 120
Cone Ø: d1 Ø 26 / d2 Ø 23,5
Thread: M30 x 1,5 RHT
0069514, 0586753, 0607999, 0694298,
0694360, 0698609, 1137230, 1229944,
1326862, 1326896, 1331925, ACHB064,
ACHF242, MAK1296



CV-ES-14162

Length: 125
Cone Ø: d1 Ø 30 / d2 Ø 27
Thread: M30 x 1,5 LHT
607053, 690225, 696225, 1228115,
1611088



CV-ES-14163

Length: 125
Cone Ø: d1 Ø 30 / d2 Ø 27
Thread: M30 x 1,5 RHT
0607981, 0698450, 1149907, 1152350,
1257890, 1603789, 1618048, ACHF060



DF-DL-5237

Length: 880
Ø: 52
Cone Ø: d1 Ø 26 / d2 Ø 23,5
1283211, 1351714, 1385497, 10201000A



DF-DL-5403

Length: 1742
Ø: 40
Cone Ø: d1 Ø 26 / d2 Ø 23,5
0288281, 1270854, 1337644



DF-DL-7780

Length: 1690
Ø: 40
Cone Ø: d1 Ø 26 / d2 Ø 23,5
1270853, 1353391, 10212000A



DF-DL-7836

Length: 1698
Ø: 52
Cone Ø: d1 Ø 26 / d2 Ø 23,5
0754922, 1286343, 1353396



DF-DL-8158

Length: 611
Ø: 48
Hole Distance: 130 / 130
0267743, 1361649, 1361650, 1656428



DF-DL-8196

Length: 867
Ø: 50
Cone Ø: d1 Ø 30 / d2 Ø 27
1363859, 1448063, 1602821



DF-DL-8363

Length: 855
Ø: 50
Cone Ø: d1 Ø 30 / d2 Ø 27
1363858, 1448062, 1602820



DF-DL-8718

Length: 1690
Ø: 40
Cone Ø: d1 Ø 30 / d2 Ø 27
1700000



DF-DL-9331

Length: 390
Ø: 50
Hole Distance: 130 / 152
1261101



DF-DL-10192

Length: 590
Ø: 38
Cone Ø: d1 Ø 30 / d2 Ø 27
1440171, 1451119



DF-DL-10193

Length: 1646
Ø: 40
Cone Ø: d1 Ø 26 / d2 Ø 23,5
1351205, 1353395



DF-DL-12425

Length: 865
Ø: 52
Cone Ø: d1 Ø 30 / d2 Ø 27
1373878, 1448064



DF-ES-5761

Length: 1512
Ø: 52
Cone Ø: d1 Ø 26 / d2 Ø 23,5
1297572, 1361155



DF-ES-8362

Length: 150
Cone Ø: d1 Ø 26 / d2 Ø 23,5
Thread: M30 x 1,5 RHT
1389190



DF-ES-12428

Length: 120
Cone Ø: d1 Ø 30
Thread: M24 x 1,5 RHT
1603788, 1604105



DF-RK-9336

Ø: 108
1445656



DF-SB-10402

Ø: 62
Thick/Height: 60
1291233, 1732887



DF-TC-12492

Length: 600
Ø: 40
Hole Distance: 115 / 115
1274741

No Image

DF-VB-8561

Length: 609
Ø: 48
Hole Distance: 152 / 152
0080521, 080521, 1361651, 1368270,
1390932, 1617096, 1793875, 1817808,
1892492



MN-RK-7280

Ø: 75
Hole Distance: 115
Thick/Height: 24
0689748, 689748





CF 75 ...

FAG 75.360, FAN 75.360 ...

01/01→05/13	Tie Rod	DF-DL-5403		1st FA
01/01→05/13	Tie Rod	DF-DL-7780		1st FA
01/01→05/13	Tie Rod	DF-DL-7836		1st FA
01/01→05/13	Tie Rod End	CV-ES-12461		for Steering Rod
01/01→05/13	Tie Rod End	CV-ES-12462		for Steering Rod
01/01→05/13	Tie Rod End	CV-ES-14162	CV-ES-14162	for Steering Rod
01/01→05/13	Tie Rod End	CV-ES-14163		for Steering Rod
01/01→05/13	Tie Rod End	DF-ES-8362		for Steering Rod
01/01→05/13	Tie Rod End	DF-ES-12428		for Steering Rod
01/01→05/13	Track Control Arm		DF-DL-8158	Trailing Arm
01/01→05/13	Track Control Arm		DF-TC-12492	Control Arm
01/01→05/13	Track Control Arm		DF-TC-12492	Trailing Arm, Leading Axle Steered, for Pneumatic Suspension vehicles
01/01→05/13	Track Control Arm		DF-VB-8561	Wishbone (CV)
04/06→05/13	Centre Rod	DF-DL-10192		Push Rod, for vehicles with Hinged Leading Axle
04/06→05/13	Tie Rod		DF-DL-8718	Tag Axle
04/06→05/13	Tie Rod	DF-DL-8718		1st FA

FAR 75.250, FAS 75.250

01/01→04/06	Centre Rod	DF-DL-10188		Push Rod
01/01→04/06	Tie Rod	DF-DL-5403		1st FA
01/01→04/06	Tie Rod	DF-DL-7780		1st FA
01/01→04/06	Tie Rod	DF-DL-7836		1st FA
01/01→04/06	Tie Rod	DF-DL-10193		1st FA
01/01→05/13	Centre Rod	DF-DL-5237		Push Rod
01/01→05/13	Centre Rod	DF-DL-8196		Push Rod
01/01→05/13	Centre Rod	DF-DL-8363		Push Rod
01/01→05/13	Centre Rod	DF-DL-12425		Push Rod
01/01→05/13	Stabiliser Mounting	DF-SB-10402		
01/01→05/13	Suspension Arm Repair Kit		DF-RK-9336	
01/01→05/13	Tie Rod End	CV-ES-12461		for Steering Rod
01/01→05/13	Tie Rod End	CV-ES-12462		for Steering Rod
01/01→05/13	Tie Rod End	CV-ES-14162		for Steering Rod
01/01→05/13	Tie Rod End	CV-ES-14163		for Steering Rod
01/01→05/13	Tie Rod End	DF-ES-8362		for Steering Rod
01/01→05/13	Track Control Arm		DF-DL-8158	Trailing Arm
01/01→05/13	Track Control Arm		DF-DL-9331	Wishbone (CV), 1st RA, for Pneumatic Suspension vehicles
01/01→05/13	Track Control Arm		DF-VB-8561	Wishbone (CV)
04/06→05/13	Tie Rod	DF-DL-8718		1st FA
10/06→05/13	Suspension Arm Repair Kit		MN-RK-7291	for Drag Link
10/06→05/13	Suspension Arm Repair Kit	CV-RK-1583	CV-RK-1583	Trailing Arm
10/06→05/13	Suspension Arm Repair Kit	MN-RK-7280	MN-RK-7280	for Drag Link;for Semi-Trailing Arm; for Wishbone (CV)
10/06→05/13	Tie Rod	DF-DL-5403		
10/06→05/13	Tie Rod	DF-DL-7780		
10/06→05/13	Tie Rod	DF-DL-7836		
10/06→05/13	Tie Rod	DF-DL-8718		

FAR 75.310, FAS 75.310

01/01→04/06	Centre Rod	DF-DL-10188		Push Rod
01/01→04/06	Tie Rod	DF-DL-7836		1st FA
01/01→04/06	Tie Rod	DF-DL-10193		1st FA
01/01→05/13	Centre Rod	DF-DL-5237		Push Rod
01/01→05/13	Centre Rod	DF-DL-8196		Push Rod
01/01→05/13	Centre Rod	DF-DL-8363		Push Rod
01/01→05/13	Centre Rod	DF-DL-12425		Push Rod
01/01→05/13	Stabiliser Mounting	DF-SB-10402		
01/01→05/13	Suspension Arm Repair Kit		DF-RK-9336	
01/01→05/13	Suspension Arm Repair Kit		MN-RK-7291	for Drag Link
01/01→05/13	Suspension Arm Repair Kit	CV-RK-1583	CV-RK-1583	Trailing Arm
01/01→05/13	Suspension Arm Repair Kit	MN-RK-7280	MN-RK-7280	for Drag Link;for Semi-Trailing Arm; for Wishbone (CV)
01/01→05/13	Tie Rod	DF-DL-5403		
01/01→05/13	Tie Rod	DF-DL-5403		1st FA
01/01→05/13	Tie Rod	DF-DL-7780		
01/01→05/13	Tie Rod	DF-DL-7780		1st FA

CV-ES-12461

Length: 120
Cone Ø: d1 Ø 26 / d2 Ø 23,5
Thread: M30 x 1,5 LHT
69513, 0069513, 0311300, 311300,
0607998, 607998, 1190653, 1315447,
1319838, 1332123, 1338714, 1401934,
1407394, ACHB063, ACHF241, MAK1295



CV-ES-12462

Length: 120
Cone Ø: d1 Ø 26 / d2 Ø 23,5
Thread: M30 x 1,5 RHT
0069514, 0586753, 0607999, 0694298,
0694360, 0698609, 1137230, 1229944,
1326862, 1326896, 1331925, ACHB064,
ACHF242, MAK1296



CV-ES-14162

Length: 125
Cone Ø: d1 Ø 30 / d2 Ø 27
Thread: M30 x 1,5 LHT
607053, 690225, 696225, 1228115,
1611088



CV-ES-14163

Length: 125
Cone Ø: d1 Ø 30 / d2 Ø 27
Thread: M30 x 1,5 RHT
0607981, 0698450, 1149907, 1152350,
1257890, 1603789, 1618048, ACHF060



CV-RK-1583



DF-DL-5237

Length: 880 Ø: 52
Cone Ø: d1 Ø 26 / d2 Ø 23,5
1283211, 1351714, 1385497, 10201000A



DF-DL-5403

Length: 1742 Ø: 40
Cone Ø: d1 Ø 26 / d2 Ø 23,5
0288281, 1270854, 1337644



DF-DL-7780

Length: 1690 Ø: 40
Cone Ø: d1 Ø 26 / d2 Ø 23,5
1270853, 1353391, 10212000A



DF-DL-7836

Length: 1698 Ø: 52
Cone Ø: d1 Ø 26 / d2 Ø 23,5
0754922, 1286343, 1353396



DF-DL-8158

Length: 611 Ø: 48
Hole Distance: 130 / 130
0267743, 1361649, 1361650, 1656428



DF-DL-8196

Length: 867 Ø: 50
Cone Ø: d1 Ø 30 / d2 Ø 27
1363859, 1448063, 1602821



DF-DL-8363

Length: 855 Ø: 50
Cone Ø: d1 Ø 30 / d2 Ø 27
1363858, 1448062, 1602820



DF-DL-8718

Length: 1690 Ø: 40
Cone Ø: d1 Ø 30 / d2 Ø 27
1700000



DF-DL-9331

Length: 390 Ø: 50
Hole Distance: 130 / 152
1261101



DF-DL-10188

Length: 860 Ø: 36
Cone Ø: d1 Ø 30 / d2 Ø 27
1380417, 1451129



DF-DL-10192

Length: 590 Ø: 38
Cone Ø: d1 Ø 30 / d2 Ø 27
1440171, 1451119



DF-DL-10193

Length: 1646 Ø: 40
Cone Ø: d1 Ø 26 / d2 Ø 23,5
1351205, 1353395



DF-DL-12425

Length: 865 Ø: 52
Cone Ø: d1 Ø 30 / d2 Ø 27
1373878, 1448064



DF-ES-8362

Length: 150
Cone Ø: d1 Ø 26 / d2 Ø 23,5
Thread: M30 x 1,5 RHT
1389190



DF-ES-12428

Length: 120
Cone Ø: d1 Ø 30
Thread: M24 x 1,5 RHT
1603788, 1604105



DF-RK-9336

Ø: 108
1445656



DF-SB-10402

Ø: 62 Thick/Height: 60
1291233, 1732887



DF-TC-12492

Length: 600 Ø: 40
Hole Distance: 115 / 115
1274741

No Image

DF-VB-8561

Length: 609 Ø: 48
Hole Distance: 152 / 152
0080521, 080521, 1361651, 1368270,
1390932, 1617096, 1793875, 1817808,
1892492



MN-RK-7280

Ø: 75
Hole Distance: 115
Thick/Height: 24
0689748, 689748



MN-RK-7291

Ø: 72
Hole Distance: 130
Thick/Height: 30
1271124





CF 75 ...

FAR 75.310, FAS 75.310 ...	01/01→05/13	Tie Rod	DF-DL-7836			
	01/01→05/13	Tie Rod	DF-DL-8718			
	01/01→05/13	Tie Rod End	CV-ES-12461		for Steering Rod	
	01/01→05/13	Tie Rod End	CV-ES-12462		for Steering Rod	
	01/01→05/13	Tie Rod End	CV-ES-14162		for Steering Rod	
	01/01→05/13	Tie Rod End	CV-ES-14163		for Steering Rod	
	01/01→05/13	Tie Rod End	DF-ES-8362		for Steering Rod	
	01/01→05/13	Track Control Arm		DF-DL-8158	Trailing Arm	
	01/01→05/13	Track Control Arm		DF-DL-9331	Wishbone (CV), 1st RA, for Pneumatic Suspension vehicles	
	01/01→05/13	Track Control Arm		DF-VB-8561	Wishbone (CV)	
FAR 75.360, FAS 75.360	04/06→05/13	Tie Rod	DF-DL-8718		1st FA	
	01/01→04/06	Tie Rod	DF-DL-5403		1st FA	
	01/01→05/13	Centre Rod	DF-DL-5237		Push Rod	
	01/01→05/13	Centre Rod	DF-DL-8196		Push Rod	
	01/01→05/13	Centre Rod	DF-DL-8363		Push Rod	
	01/01→05/13	Centre Rod	DF-DL-12425		Push Rod	
	01/01→05/13	Stabiliser Mounting	DF-SB-10402			
	01/01→05/13	Suspension Arm Repair Kit		DF-RK-9336		
	01/01→05/13	Tie Rod	DF-DL-7780		1st FA	
	01/01→05/13	Tie Rod	DF-DL-7836		1st FA	
	01/01→05/13	Tie Rod	DF-DL-10193		1st FA	
	01/01→05/13	Tie Rod End	CV-ES-12461		for Steering Rod	
	01/01→05/13	Tie Rod End	CV-ES-12462		for Steering Rod	
	01/01→05/13	Tie Rod End	CV-ES-14162		for Steering Rod	
	01/01→05/13	Tie Rod End	CV-ES-14163		for Steering Rod	
	01/01→05/13	Tie Rod End	DF-ES-8362		for Steering Rod	
	01/01→05/13	Track Control Arm		DF-DL-8158	Trailing Arm	
	01/01→05/13	Track Control Arm		DF-DL-9331	Wishbone (CV), 1st RA, for Pneumatic Suspension vehicles	
	01/01→05/13	Track Control Arm		DF-VB-8561	Wishbone (CV)	
	04/06→05/13	Tie Rod	DF-DL-8718		1st FA	
	10/06→05/13	Suspension Arm Repair Kit		MN-RK-7291	for Drag Link	
	10/06→05/13	Suspension Arm Repair Kit	CV-RK-1583	CV-RK-1583	Trailing Arm	
	10/06→05/13	Suspension Arm Repair Kit	MN-RK-7280	MN-RK-7280	for Drag Link;for Semi-Trailing Arm; for Wishbone (CV)	
	10/06→05/13	Tie Rod	DF-DL-5403			
	10/06→05/13	Tie Rod	DF-DL-7780			
	10/06→05/13	Tie Rod	DF-DL-7836			
	10/06→05/13	Tie Rod	DF-DL-8718			
	FAT 75.250	01/01→04/06	Tie Rod	DF-DL-7780		1st FA
		01/01→04/06	Tie Rod	DF-DL-10193		1st FA
		01/01→05/13	Centre Rod	DF-DL-5237		Push Rod
		01/01→05/13	Centre Rod	DF-DL-8196		Push Rod
		01/01→05/13	Centre Rod	DF-DL-8363		Push Rod
01/01→05/13		Stabiliser Mounting	DF-SB-10402			
01/01→05/13		Suspension Arm Repair Kit		DF-RK-9336		
01/01→05/13		Tie Rod	DF-DL-5403		1st FA	
01/01→05/13		Tie Rod End	CV-ES-12461		for Steering Rod	
01/01→05/13		Tie Rod End	CV-ES-12462		for Steering Rod	
01/01→05/13		Tie Rod End	CV-ES-14162		for Steering Rod	
01/01→05/13		Tie Rod End	CV-ES-14163		for Steering Rod	
01/01→05/13		Track Control Arm		DF-DL-8158	Trailing Arm	
01/01→05/13		Track Control Arm		DF-DL-9318	Trailing Arm	
01/01→05/13		Track Control Arm		DF-TC-12262	Control Arm	
01/01→05/13		Track Control Arm		DF-VB-8561	Wishbone (CV)	
04/06→05/13		Track Control Arm		DF-VB-9343	Wishbone (CV)	
10/06→05/13		Suspension Arm Repair Kit		DF-RK-8633	for Wishbone (CV)	
10/06→05/13		Suspension Arm Repair Kit	MN-RK-7280	MN-RK-7280	for Drag Link;for Semi-Trailing Arm; for Wishbone (CV)	
10/06→05/13		Suspension Strut Repair Kit		DF-RK-8685		
10/06→05/13		Tie Rod	DF-DL-5403			
10/06→05/13		Tie Rod	DF-DL-7780			
10/06→05/13		Tie Rod	DF-DL-8718			

CV-ES-12461

Length: 120
Cone Ø: d1 Ø 26 / d2 Ø 23,5
Thread: M30 x 1,5 LHT
0069513, 69513, 0311300, 311300, 607998, 0607998, 1190653, 1315447, 1319838, 1332123, 1338714, 1401934, 1407394, ACHB063, ACHF241, MAK1295



CV-ES-12462

Length: 120
Cone Ø: d1 Ø 26 / d2 Ø 23,5
Thread: M30 x 1,5 RHT
0069514, 0586753, 0607999, 0694298, 0694360, 0698609, 1137230, 1229944, 1326862, 1326896, 1331925, ACHB064, ACHF242, MAK1296



CV-ES-14162

Length: 125
Cone Ø: d1 Ø 30 / d2 Ø 27
Thread: M30 x 1,5 LHT
607053, 690225, 696225, 1228115, 1611088



CV-ES-14163

Length: 125
Cone Ø: d1 Ø 30 / d2 Ø 27
Thread: M30 x 1,5 RHT
0607981, 0698450, 1149907, 1152350, 1257890, 1603789, 1618048, ACHF060



CV-RK-1583



DF-DL-5237

Length: 880 Ø: 52
Cone Ø: d1 Ø 26 / d2 Ø 23,5
1283211, 1351714, 1385497, 10201000A



DF-DL-5403

Length: 1742 Ø: 40
Cone Ø: d1 Ø 26 / d2 Ø 23,5
0288281, 1270854, 1337644



DF-DL-7780

Length: 1690 Ø: 40
Cone Ø: d1 Ø 26 / d2 Ø 23,5
1270853, 1353391, 10212000A



DF-DL-7836

Length: 1698 Ø: 52
Cone Ø: d1 Ø 26 / d2 Ø 23,5
0754922, 1286343, 1353396



DF-DL-8158

Length: 611 Ø: 48
Hole Distance: 130 / 130
0267743, 1361649, 1361650, 1656428



DF-DL-8196

Length: 867 Ø: 50
Cone Ø: d1 Ø 30 / d2 Ø 27
1363859, 1448063, 1602821



DF-DL-8363

Length: 855 Ø: 50
Cone Ø: d1 Ø 30 / d2 Ø 27
1363858, 1448062, 1602820



DF-DL-8718

Length: 1690 Ø: 40
Cone Ø: d1 Ø 30 / d2 Ø 27
1700000



DF-DL-9318

Length: 600 Ø: 50
Hole Distance: 130 / 130
0646373, 0655695, 0655697, 1284860, 1620438



DF-DL-9331

Length: 390 Ø: 50
Hole Distance: 130 / 152
1261101



DF-DL-10193

Length: 1646 Ø: 40
Cone Ø: d1 Ø 26 / d2 Ø 23,5
1351205, 1353395



DF-DL-12425

Length: 865 Ø: 52
Cone Ø: d1 Ø 30 / d2 Ø 27
1373878, 1448064



DF-ES-8362

Length: 150
Cone Ø: d1 Ø 26 / d2 Ø 23,5
Thread: M30 x 1,5 RHT
1389190



DF-RK-8633

Ø: 90
696320, 0696320



DF-RK-8685

Ø: 67
Hole Distance: 130
Thick/Height: 24
1321936



DF-RK-9336

Ø: 108
1445656



DF-SB-10402

Ø: 62
Thick/Height: 60
1291233, 1732887



DF-TC-12262

Length: 595 Ø: 50
Hole Distance: 130 / 130
0661406, 661406, 0661407, 661407, 1620439



DF-VB-8561

Length: 609 Ø: 48
Hole Distance: 152 / 152
0080521, 080521, 1361651, 1368270, 1390932, 1617096, 1793875, 1817808, 1892492



DF-VB-9343

Length: 608,2 Ø: 48
Hole Distance: 152 / 152
1361652, 1620436, 1793876, 10309600A



MN-RK-7280

Ø: 75
Hole Distance: 115
Thick/Height: 24
689748, 0689748



MN-RK-7291

Ø: 72
Hole Distance: 130
Thick/Height: 30
1271124



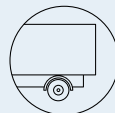

CF 75 ...

FAT 75.310	01/01→05/13	Centre Rod	DF-DL-5237		Push Rod	
	01/01→05/13	Centre Rod	DF-DL-8196		Push Rod	
	01/01→05/13	Centre Rod	DF-DL-8363		Push Rod	
	01/01→05/13	Stabiliser Mounting	DF-SB-10402			
	01/01→05/13	Suspension Arm Repair Kit		DF-RK-9336		
	01/01→05/13	Tie Rod	DF-DL-5403		1st FA	
	01/01→05/13	Tie Rod	DF-DL-7780		1st FA	
	01/01→05/13	Tie Rod	DF-DL-10193		1st FA	
	01/01→05/13	Tie Rod End	CV-ES-12461		for Steering Rod	
	01/01→05/13	Tie Rod End	CV-ES-12462		for Steering Rod	
	01/01→05/13	Tie Rod End	CV-ES-14162		for Steering Rod	
	01/01→05/13	Tie Rod End	CV-ES-14163		for Steering Rod	
	01/01→05/13	Track Control Arm		DF-DL-8158	Trailing Arm	
	01/01→05/13	Track Control Arm		DF-DL-9318	Trailing Arm	
	01/01→05/13	Track Control Arm		DF-TC-12262	Control Arm	
	01/01→05/13	Track Control Arm		DF-VB-8561	Wishbone (CV)	
	04/06→05/13	Tie Rod	DF-DL-8718		1st FA	
	04/06→05/13	Track Control Arm		DF-VB-9343	Wishbone (CV)	
	10/06→05/13	Suspension Arm Repair Kit		DF-RK-8633	for Wishbone (CV)	
	10/06→05/13	Suspension Arm Repair Kit	MN-RK-7280	MN-RK-7280	for Drag Link;for Semi-Trailing Arm; for Wishbone (CV)	
	10/06→05/13	Suspension Strut Repair Kit		DF-RK-8685		
	10/06→05/13	Tie Rod	DF-DL-5403			
	10/06→05/13	Tie Rod	DF-DL-7780			
	10/06→05/13	Tie Rod	DF-DL-8718			
	FAT 75.360	01/01→04/06	Centre Rod	DF-DL-10188		Push Rod
		01/01→05/13	Centre Rod	DF-DL-5237		Push Rod
		01/01→05/13	Centre Rod	DF-DL-8196		Push Rod
		01/01→05/13	Centre Rod	DF-DL-8363		Push Rod
		01/01→05/13	Stabiliser Mounting	DF-SB-10402		
		01/01→05/13	Suspension Arm Repair Kit		DF-RK-9336	
		01/01→05/13	Tie Rod	DF-DL-5403		1st FA
		01/01→05/13	Tie Rod	DF-DL-7780		1st FA
		01/01→05/13	Tie Rod	DF-DL-10193		1st FA
01/01→05/13		Tie Rod End	CV-ES-12461		for Steering Rod	
01/01→05/13		Tie Rod End	CV-ES-12462		for Steering Rod	
01/01→05/13		Tie Rod End	CV-ES-14162		for Steering Rod	
01/01→05/13		Tie Rod End	CV-ES-14163		for Steering Rod	
01/01→05/13		Track Control Arm		DF-DL-8158	Trailing Arm	
01/01→05/13		Track Control Arm		DF-DL-9318	Trailing Arm	
01/01→05/13		Track Control Arm		DF-TC-12262	Control Arm	
01/01→05/13		Track Control Arm		DF-VB-8561	Wishbone (CV)	
01/01→05/13		Track Control Arm		DF-VB-9343	Wishbone (CV)	
01/06→05/13		Tie Rod	DF-DL-8718		1st FA	
10/06→05/13		Suspension Arm Repair Kit		DF-RK-8633	for Wishbone (CV)	
10/06→05/13		Suspension Arm Repair Kit	MN-RK-7280	MN-RK-7280	for Drag Link;for Semi-Trailing Arm; for Wishbone (CV)	
10/06→05/13		Suspension Strut Repair Kit		DF-RK-8685		
10/06→05/13		Tie Rod	DF-DL-5403			
10/06→05/13		Tie Rod	DF-DL-7780			
10/06→05/13		Tie Rod	DF-DL-8718			
FT 75.250		01/01→05/13	Centre Rod	DF-DL-5237		Push Rod
		01/01→05/13	Centre Rod	DF-DL-8196		Push Rod
		01/01→05/13	Centre Rod	DF-DL-8363		Push Rod
		01/01→05/13	Stabiliser Mounting	DF-SB-10402		
		01/01→05/13	Suspension Arm Repair Kit		DF-RK-9336	
		01/01→05/13	Tie Rod	DF-DL-5403		
		01/01→05/13	Tie Rod	DF-DL-7780		1st FA
		01/01→05/13	Tie Rod End	CV-ES-12461		for Steering Rod
	01/01→05/13	Tie Rod End	CV-ES-12462		for Steering Rod	
	01/01→05/13	Tie Rod End	CV-ES-14162		for Steering Rod	
	01/01→05/13	Tie Rod End	CV-ES-14163		for Steering Rod	
	01/01→05/13	Tie Rod End	DF-ES-8362		for Steering Rod	

CV-ES-12461

Length: 120
Cone Ø: d1 Ø 26 / d2 Ø 23,5
Thread: M30 x 1,5 LHT
69513, 0069513, 0311300, 311300,
0607998, 607998, 1190653, 1315447,
1319838, 1332123, 1338714, 1401934,
1407394, ACHB063, ACHF241, MAK1295



CV-ES-12462

Length: 120
Cone Ø: d1 Ø 26 / d2 Ø 23,5
Thread: M30 x 1,5 RHT
0069514, 0586753, 0607999, 0694298,
0694360, 0698609, 1137230, 1229944,
1326862, 1326896, 1331925, ACHB064,
ACHF242, MAK1296



CV-ES-14162

Length: 125
Cone Ø: d1 Ø 30 / d2 Ø 27
Thread: M30 x 1,5 LHT
607053, 690225, 696225, 1228115,
1611088



CV-ES-14163

Length: 125
Cone Ø: d1 Ø 30 / d2 Ø 27
Thread: M30 x 1,5 RHT
0607981, 0698450, 1149907, 1152350,
1257890, 1603789, 1618048, ACHF060



DF-DL-5237

Length: 880 Ø: 52
Cone Ø: d1 Ø 26 / d2 Ø 23,5
1283211, 1351714, 1385497, 10201000A



DF-DL-5403

Length: 1742 Ø: 40
Cone Ø: d1 Ø 26 / d2 Ø 23,5
0288281, 1270854, 1337644



DF-DL-7780

Length: 1690
Ø: 40
Cone Ø: d1 Ø 26 / d2 Ø 23,5
1270853, 1353391, 10212000A



DF-DL-8158

Length: 611 Ø: 48
Hole Distance: 130 / 130
0267743, 1361649, 1361650, 1656428



DF-DL-8196

Length: 867 Ø: 50
Cone Ø: d1 Ø 30 / d2 Ø 27
1363859, 1448063, 1602821



DF-DL-8363

Length: 855 Ø: 50
Cone Ø: d1 Ø 30 / d2 Ø 27
1363858, 1448062, 1602820



DF-DL-8718

Length: 1690 Ø: 40
Cone Ø: d1 Ø 30 / d2 Ø 27
1700000



DF-DL-9318

Length: 600 Ø: 50
Hole Distance: 130 / 130
0646373, 0655695, 0655697, 1284860,
1620438



DF-DL-10188

Length: 860 Ø: 36
Cone Ø: d1 Ø 30 / d2 Ø 27
1380417, 1451129



DF-DL-10193

Length: 1646 Ø: 40
Cone Ø: d1 Ø 26 / d2 Ø 23,5
1351205, 1353395



DF-ES-8362

Length: 150
Cone Ø: d1 Ø 26 / d2 Ø 23,5
Thread: M30 x 1,5 RHT
1389190



DF-RK-8633

Ø: 90
696320, 0696320



DF-RK-8685

Ø: 67
Hole Distance: 130
Thick/Height: 24
1321936



DF-RK-9336

Ø: 108
1445656



DF-SB-10402

Ø: 62
Thick/Height: 60
1291233, 1732887



DF-TC-12262

Length: 595 Ø: 50
Hole Distance: 130 / 130
0661406, 661406, 0661407, 661407,
1620439



DF-VB-8561

Length: 609 Ø: 48
Hole Distance: 152 / 152
080521, 0080521, 1361651, 1368270,
1390932, 1617096, 1793875, 1817808,
1892492



DF-VB-9343

Length: 608,2 Ø: 48
Hole Distance: 152 / 152
1361652, 1620436, 1793876, 10309600A



MN-RK-7280

Ø: 75
Hole Distance: 115
Thick/Height: 24
689748, 0689748





CF 75 ...

FT 75.250 ...	01/01→05/13	Track Control Arm		DF-DL-8158	Trailing Arm
	01/01→05/13	Track Control Arm		DF-DL-9331	Wishbone (CV), 1st RA, for Pneumatic Suspension vehicles
	01/01→05/13	Track Control Arm		DF-VB-8561	Wishbone (CV)
	04/06→05/13	Tie Rod	DF-DL-8718		1st FA
	10/06→05/13	Suspension Arm Repair Kit		MN-RK-7291	for Drag Link
	10/06→05/13	Suspension Arm Repair Kit	CV-RK-1583	CV-RK-1583	Trailing Arm
	10/06→05/13	Suspension Arm Repair Kit	MN-RK-7280	MN-RK-7280	for Drag Link;for Semi-Trailing Arm; for Wishbone (CV)
	10/06→05/13	Tie Rod	DF-DL-7780		
	10/06→05/13	Tie Rod	DF-DL-7836		
	10/06→05/13	Tie Rod	DF-DL-8718		
FT 75.310	10/06→05/13	Track Control Arm		DF-DL-9331	Wishbone (CV)
	01/01→05/13	Centre Rod	DF-DL-5237		Push Rod
	01/01→05/13	Centre Rod	DF-DL-8196		Push Rod
	01/01→05/13	Centre Rod	DF-DL-8363		Push Rod
	01/01→05/13	Stabiliser Mounting	DF-SB-10402		
	01/01→05/13	Suspension Arm Repair Kit		DF-RK-9336	
	01/01→05/13	Tie Rod	DF-DL-5403		
	01/01→05/13	Tie Rod	DF-DL-7780		1st FA
	01/01→05/13	Tie Rod End	CV-ES-12461		for Steering Rod
	01/01→05/13	Tie Rod End	CV-ES-12462		for Steering Rod
	01/01→05/13	Tie Rod End	CV-ES-14162		for Steering Rod
	01/01→05/13	Tie Rod End	CV-ES-14163		for Steering Rod
	01/01→05/13	Tie Rod End	DF-ES-8362		for Steering Rod
	01/01→05/13	Track Control Arm		DF-DL-8158	Trailing Arm
	01/01→05/13	Track Control Arm		DF-DL-9331	Wishbone (CV), 1st RA, for Pneumatic Suspension vehicles
	01/01→05/13	Track Control Arm		DF-VB-8561	Wishbone (CV)
	04/06→05/13	Tie Rod	DF-DL-8718		1st FA
	10/06→05/13	Suspension Arm Repair Kit		MN-RK-7291	for Drag Link
	10/06→05/13	Suspension Arm Repair Kit	CV-RK-1583	CV-RK-1583	Trailing Arm
	10/06→05/13	Suspension Arm Repair Kit	MN-RK-7280	MN-RK-7280	for Drag Link;for Semi-Trailing Arm; for Wishbone (CV)
10/06→05/13	Tie Rod	DF-DL-7780			
10/06→05/13	Tie Rod	DF-DL-7836			
10/06→05/13	Tie Rod	DF-DL-8718			
10/06→05/13	Track Control Arm		DF-DL-9331	Wishbone (CV)	
FT 75.360	01/01→04/06	Tie Rod	DF-DL-5403		1st FA
	01/01→05/13	Centre Rod	DF-DL-5237		Push Rod
	01/01→05/13	Centre Rod	DF-DL-8196		Push Rod
	01/01→05/13	Stabiliser Mounting	DF-SB-10402		
	01/01→05/13	Suspension Arm Repair Kit		DF-RK-9336	
	01/01→05/13	Tie Rod	DF-DL-7780		1st FA
	01/01→05/13	Tie Rod End	CV-ES-12461		for Steering Rod
	01/01→05/13	Tie Rod End	CV-ES-12462		for Steering Rod
	01/01→05/13	Tie Rod End	CV-ES-14162		for Steering Rod
	01/01→05/13	Tie Rod End	CV-ES-14163		for Steering Rod
	01/01→05/13	Tie Rod End	DF-ES-8362		for Steering Rod
	01/01→05/13	Track Control Arm		DF-DL-8158	Trailing Arm
	01/01→05/13	Track Control Arm		DF-DL-9331	Wishbone (CV), 1st RA, for Pneumatic Suspension vehicles
	01/01→05/13	Track Control Arm		DF-VB-8561	Wishbone (CV)
	04/06→05/13	Tie Rod	DF-DL-8718		1st FA
	10/06→05/13	Centre Rod	DF-DL-8363		Push Rod
	10/06→05/13	Suspension Arm Repair Kit		MN-RK-7291	for Drag Link
	10/06→05/13	Suspension Arm Repair Kit	CV-RK-1583	CV-RK-1583	Trailing Arm
	10/06→05/13	Suspension Arm Repair Kit	MN-RK-7280	MN-RK-7280	for Drag Link;for Semi-Trailing Arm; for Wishbone (CV)
	10/06→05/13	Tie Rod	DF-DL-7780		
10/06→05/13	Tie Rod	DF-DL-7836			
10/06→05/13	Tie Rod	DF-DL-8718			
10/06→05/13	Track Control Arm		DF-DL-9331	Wishbone (CV)	

CV-ES-12461

Length: 120
Cone Ø: d1 Ø 26 / d2 Ø 23,5
Thread: M30 x 1,5 LHT
0069513, 69513, 0311300, 311300,
0607998, 607998, 1190653, 1315447,
1319838, 1332123, 1338714, 1401934,
1407394, ACHB063, ACHF241, MAK1295



CV-ES-12462

Length: 120
Cone Ø: d1 Ø 26 / d2 Ø 23,5
Thread: M30 x 1,5 RHT
0069514, 0586753, 0607999, 0694298,
0694360, 0698609, 1137230, 1229944,
1326862, 1326896, 1331925, ACHB064,
ACHF242, MAK1296



CV-ES-14162

Length: 125
Cone Ø: d1 Ø 30 / d2 Ø 27
Thread: M30 x 1,5 LHT
607053, 690225, 696225, 1228115,
1611088



CV-ES-14163

Length: 125
Cone Ø: d1 Ø 30 / d2 Ø 27
Thread: M30 x 1,5 RHT
0607981, 0698450, 1149907, 1152350,
1257890, 1603789, 1618048, ACHF060



CV-RK-1583



DF-DL-5237

Length: 880
Ø: 52
Cone Ø: d1 Ø 26 / d2 Ø 23,5
1283211, 1351714, 1385497, 10201000A



DF-DL-5403

Length: 1742
Ø: 40
Cone Ø: d1 Ø 26 / d2 Ø 23,5
0288281, 1270854, 1337644



DF-DL-7780

Length: 1690
Ø: 40
Cone Ø: d1 Ø 26 / d2 Ø 23,5
1270853, 1353391, 10212000A



DF-DL-7836

Length: 1698
Ø: 52
Cone Ø: d1 Ø 26 / d2 Ø 23,5
0754922, 1286343, 1353396



DF-DL-8158

Length: 611
Ø: 48
Hole Distance: 130 / 130
0267743, 1361649, 1361650, 1656428



DF-DL-8196

Length: 867
Ø: 50
Cone Ø: d1 Ø 30 / d2 Ø 27
1363859, 1448063, 1602821



DF-DL-8363

Length: 855
Ø: 50
Cone Ø: d1 Ø 30 / d2 Ø 27
1363858, 1448062, 1602820



DF-DL-8718

Length: 1690
Ø: 40
Cone Ø: d1 Ø 30 / d2 Ø 27
1700000



DF-DL-9331

Length: 390
Ø: 50
Hole Distance: 130 / 152
1261101



DF-ES-8362

Length: 150
Cone Ø: d1 Ø 26 / d2 Ø 23,5
Thread: M30 x 1,5 RHT
1389190



DF-RK-9336

Ø: 108
1445656



DF-SB-10402

Ø: 62
Thick/Height: 60
1291233, 1732887



DF-VB-8561

Length: 609
Ø: 48
Hole Distance: 152 / 152
080521, 0080521, 1361651, 1368270,
1390932, 1617096, 1793875, 1817808,
1892492



MN-RK-7280

Ø: 75
Hole Distance: 115
Thick/Height: 24
689748, 0689748



MN-RK-7291

Ø: 72
Hole Distance: 130
Thick/Height: 30
1271124



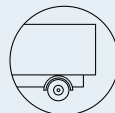

CF 85

FA 85.340	01/01→05/13	Centre Rod	DF-DL-5237		Push Rod	
	01/01→05/13	Centre Rod	DF-DL-8196		Push Rod	
	01/01→05/13	Centre Rod	DF-DL-8363		Push Rod	
	01/01→05/13	Centre Rod	DF-DL-12425		Push Rod	
	01/01→05/13	Stabiliser Mounting	DF-SB-10402			
	01/01→05/13	Suspension Arm Repair Kit		DF-RK-9336		
	01/01→05/13	Tie Rod	DF-DL-5403		1st FA	
	01/01→05/13	Tie Rod	DF-DL-7780		1st FA	
	01/01→05/13	Tie Rod	DF-DL-7836		1st FA	
	01/01→05/13	Tie Rod	DF-DL-10193		1st FA	
	01/01→05/13	Tie Rod End	CV-ES-12461		for Steering Rod	
	01/01→05/13	Tie Rod End	CV-ES-12462		for Steering Rod	
	01/01→05/13	Tie Rod End	CV-ES-14162		for Steering Rod	
	01/01→05/13	Tie Rod End	CV-ES-14163		for Steering Rod	
	01/01→05/13	Tie Rod End	DF-ES-8362		for Steering Rod	
	01/01→05/13	Track Control Arm		DF-DL-8158	Trailing Arm	
	01/01→05/13	Track Control Arm		DF-VB-8561	Wishbone (CV)	
	FA 85.360	10/06→05/13	Centre Rod	DF-DL-5237		Push Rod
		10/06→05/13	Centre Rod	DF-DL-8196		Push Rod
		10/06→05/13	Centre Rod	DF-DL-8363		Push Rod
10/06→05/13		Stabiliser Mounting	DF-SB-10402			
10/06→05/13		Suspension Arm Repair Kit		DF-RK-9336		
10/06→05/13		Suspension Arm Repair Kit	MN-RK-7280	MN-RK-7280	for Drag Link;for Semi-Trailing Arm; for Wishbone (CV)	
10/06→05/13		Tie Rod	DF-DL-5403			
10/06→05/13		Tie Rod	DF-DL-5403		1st FA	
10/06→05/13		Tie Rod	DF-DL-7780			
10/06→05/13		Tie Rod	DF-DL-7780		1st FA	
10/06→05/13		Tie Rod	DF-DL-7836			
10/06→05/13		Tie Rod	DF-DL-7836		1st FA	
10/06→05/13		Tie Rod	DF-DL-8718			
10/06→05/13		Tie Rod End	CV-ES-12461		for Steering Rod	
10/06→05/13		Tie Rod End	CV-ES-12462		for Steering Rod	
10/06→05/13		Tie Rod End	CV-ES-14162		for Steering Rod	
10/06→05/13		Tie Rod End	CV-ES-14163		for Steering Rod	
10/06→05/13		Tie Rod End	DF-ES-8362		for Steering Rod	
10/06→05/13		Track Control Arm		DF-DL-8158	Trailing Arm	
10/06→05/13		Track Control Arm		DF-VB-8561	Wishbone (CV)	
FA 85.380	01/01→05/13	Centre Rod	DF-DL-5237		Push Rod	
	01/01→05/13	Centre Rod	DF-DL-8196		Push Rod	
	01/01→05/13	Centre Rod	DF-DL-8363		Push Rod	
	01/01→05/13	Centre Rod	DF-DL-8703		Push Rod	
	01/01→05/13	Centre Rod	DF-DL-10188		Push Rod	
	01/01→05/13	Centre Rod	DF-DL-12425		Push Rod	
	01/01→05/13	Stabiliser Mounting	DF-SB-10402			
	01/01→05/13	Suspension Arm Repair Kit		DF-RK-9336		
	01/01→05/13	Tie Rod	DF-DL-5403		1st FA	
	01/01→05/13	Tie Rod	DF-DL-7780		1st FA	
	01/01→05/13	Tie Rod	DF-DL-7836		1st FA	
	01/01→05/13	Tie Rod	DF-DL-10193		1st FA	
	01/01→05/13	Tie Rod End	CV-ES-12461		for Steering Rod	
	01/01→05/13	Tie Rod End	CV-ES-12462		for Steering Rod	
	01/01→05/13	Tie Rod End	CV-ES-14162		for Steering Rod	
	01/01→05/13	Tie Rod End	CV-ES-14163		for Steering Rod	
	01/01→05/13	Tie Rod End	DF-ES-8362		for Steering Rod	
	01/01→05/13	Tie Rod End	DF-ES-8602		for Steering Rod	
	01/01→05/13	Track Control Arm		DF-DL-8158	Trailing Arm	
	01/01→05/13	Track Control Arm		DF-TC-12262	Control Arm	
01/01→05/13	Track Control Arm		DF-VB-8561	Wishbone (CV)		

CV-ES-12461

Length: 120
Cone Ø: d1 Ø 26 / d2 Ø 23,5
Thread: M30 x 1,5 LHT
0069513, 69513, 0311300, 311300,
0607998, 607998, 1190653, 1315447,
1319838, 1332123, 1338714, 1401934,
1407394, ACHB063, ACHF241, MAK1295



CV-ES-12462

Length: 120
Cone Ø: d1 Ø 26 / d2 Ø 23,5
Thread: M30 x 1,5 RHT
0069514, 0586753, 0607999, 0694298,
0694360, 0698609, 1137230, 1229944,
1326862, 1326896, 1331925, ACHB064,
ACHF242, MAK1296



CV-ES-14162

Length: 125
Cone Ø: d1 Ø 30 / d2 Ø 27
Thread: M30 x 1,5 LHT
607053, 690225, 696225, 1228115,
1611088



CV-ES-14163

Length: 125
Cone Ø: d1 Ø 30 / d2 Ø 27
Thread: M30 x 1,5 RHT
0607981, 0698450, 1149907, 1152350,
1257890, 1603789, 1618048, ACHF060



DF-DL-5237

Length: 880
Ø: 52
Cone Ø: d1 Ø 26 / d2 Ø 23,5
1283211, 1351714, 1385497, 10201000A



DF-DL-5403

Length: 1742
Ø: 40
Cone Ø: d1 Ø 26 / d2 Ø 23,5
0288281, 1270854, 1337644



DF-DL-7780

Length: 1690
Ø: 40
Cone Ø: d1 Ø 26 / d2 Ø 23,5
1270853, 1353391, 10212000A



DF-DL-7836

Length: 1698
Ø: 52
Cone Ø: d1 Ø 26 / d2 Ø 23,5
0754922, 1286343, 1353396



DF-DL-8158

Length: 611
Ø: 48
Hole Distance: 130 / 130
0267743, 1361649, 1361650, 1656428



DF-DL-8196

Length: 867
Ø: 50
Cone Ø: d1 Ø 30 / d2 Ø 27
1363859, 1448063, 1602821



DF-DL-8363

Length: 855
Ø: 50
Cone Ø: d1 Ø 30 / d2 Ø 27
1363858, 1448062, 1602820



DF-DL-8703

Length: 1977
Ø: 52
Cone Ø: d1 Ø 30 / d2 Ø 27
1451122



DF-DL-8718

Length: 1690
Ø: 40
Cone Ø: d1 Ø 30 / d2 Ø 27
1700000



DF-DL-10188

Length: 860
Ø: 36
Cone Ø: d1 Ø 30 / d2 Ø 27
1380417, 1451129



DF-DL-10193

Length: 1646
Ø: 40
Cone Ø: d1 Ø 26 / d2 Ø 23,5
1351205, 1353395



DF-DL-12425

Length: 865
Ø: 52
Cone Ø: d1 Ø 30 / d2 Ø 27
1373878, 1448064



DF-ES-8362

Length: 150
Cone Ø: d1 Ø 26 / d2 Ø 23,5
Thread: M30 x 1,5 RHT
1389190



DF-ES-8602

Length: 95
Cone Ø: d1 Ø 30 / d2 Ø 27
Thread: M22 x 1,5 RHT
0273203, 1399724



DF-RK-9336

Ø: 108
1445656



DF-SB-10402

Ø: 62
Thick/Height: 60
1291233, 1732887



DF-TC-12262

Length: 595
Ø: 50
Hole Distance: 130 / 130
0661406, 661406, 0661407, 661407,
1620439



DF-VB-8561

Length: 609
Ø: 48
Hole Distance: 152 / 152
0080521, 080521, 1361651, 1368270,
1390932, 1617096, 1793875, 1817808,
1892492



MN-RK-7280

Ø: 75
Hole Distance: 115
Thick/Height: 24
0689748, 689748





CF 85 ...

FA 85.410	10/06→05/13	Centre Rod	DF-DL-5237		Push Rod
	10/06→05/13	Centre Rod	DF-DL-8196		Push Rod
	10/06→05/13	Centre Rod	DF-DL-8363		Push Rod
	10/06→05/13	Stabiliser Mounting	DF-SB-10402		
	10/06→05/13	Suspension Arm Repair Kit		DF-RK-9336	
	10/06→05/13	Suspension Arm Repair Kit	MN-RK-7280	MN-RK-7280	for Drag Link;for Semi-Trailing Arm; for Wishbone (CV)
	10/06→05/13	Tie Rod	DF-DL-5403		
	10/06→05/13	Tie Rod	DF-DL-5403		1st FA
	10/06→05/13	Tie Rod	DF-DL-7780		
	10/06→05/13	Tie Rod	DF-DL-7780		1st FA
	10/06→05/13	Tie Rod	DF-DL-7836		
	10/06→05/13	Tie Rod	DF-DL-7836		1st FA
	10/06→05/13	Tie Rod	DF-DL-8718		
	10/06→05/13	Tie Rod	DF-DL-8718		1st FA
	10/06→05/13	Tie Rod End	CV-ES-12461		for Steering Rod
	10/06→05/13	Tie Rod End	CV-ES-12462		for Steering Rod
	10/06→05/13	Tie Rod End	CV-ES-14162		for Steering Rod
	10/06→05/13	Tie Rod End	CV-ES-14163		for Steering Rod
	10/06→05/13	Tie Rod End	DF-ES-8362		for Steering Rod
	10/06→05/13	Track Control Arm		DF-DL-8158	Trailing Arm
10/06→05/13	Track Control Arm		DF-VB-8561	Wishbone (CV)	
FA 85.430	01/01→05/13	Centre Rod	DF-DL-5237		Push Rod
	01/01→05/13	Centre Rod	DF-DL-8196		Push Rod
	01/01→05/13	Centre Rod	DF-DL-8363		Push Rod
	01/01→05/13	Centre Rod	DF-DL-12425		Push Rod
	01/01→05/13	Stabiliser Mounting	DF-SB-10402		
	01/01→05/13	Suspension Arm Repair Kit		DF-RK-9336	
	01/01→05/13	Tie Rod	DF-DL-5403		1st FA
	01/01→05/13	Tie Rod	DF-DL-7780		1st FA
	01/01→05/13	Tie Rod	DF-DL-7836		1st FA
	01/01→05/13	Tie Rod	DF-DL-10193		1st FA
	01/01→05/13	Tie Rod End	CV-ES-12461		for Steering Rod
	01/01→05/13	Tie Rod End	CV-ES-12462		for Steering Rod
	01/01→05/13	Tie Rod End	CV-ES-14162		for Steering Rod
	01/01→05/13	Tie Rod End	CV-ES-14163		for Steering Rod
	01/01→05/13	Tie Rod End	DF-ES-8362		for Steering Rod
	01/01→05/13	Track Control Arm		DF-DL-8158	Trailing Arm
01/01→05/13	Track Control Arm		DF-VB-8561	Wishbone (CV)	
FA 85.460	10/06→05/13	Centre Rod	DF-DL-5237		Push Rod
	10/06→05/13	Centre Rod	DF-DL-8196		Push Rod
	10/06→05/13	Centre Rod	DF-DL-8363		Push Rod
	10/06→05/13	Stabiliser Mounting	DF-SB-10402		
	10/06→05/13	Suspension Arm Repair Kit		DF-RK-9336	
	10/06→05/13	Suspension Arm Repair Kit	MN-RK-7280	MN-RK-7280	for Drag Link;for Semi-Trailing Arm; for Wishbone (CV)
	10/06→05/13	Tie Rod	DF-DL-5403		
	10/06→05/13	Tie Rod	DF-DL-7780		
	10/06→05/13	Tie Rod	DF-DL-7836		
	10/06→05/13	Tie Rod	DF-DL-7836		1st FA
	10/06→05/13	Tie Rod	DF-DL-8718		
	10/06→05/13	Tie Rod End	CV-ES-12461		for Steering Rod
	10/06→05/13	Tie Rod End	CV-ES-12462		for Steering Rod
	10/06→05/13	Tie Rod End	CV-ES-14162		for Steering Rod
	10/06→05/13	Tie Rod End	CV-ES-14163		for Steering Rod
	10/06→05/13	Tie Rod End	DF-ES-8362		for Steering Rod
10/06→05/13	Track Control Arm		DF-DL-8158	Trailing Arm	
10/06→05/13	Track Control Arm		DF-VB-8561	Wishbone (CV)	

CV-ES-12461

Length: 120
Cone Ø: d1 Ø 26 / d2 Ø 23,5
Thread: M30 x 1,5 LHT
0069513, 69513, 0311300, 311300,
0607998, 607998, 1190653, 1315447,
1319838, 1332123, 1338714, 1401934,
1407394, ACHB063, ACHF241, MAK1295



CV-ES-12462

Length: 120
Cone Ø: d1 Ø 26 / d2 Ø 23,5
Thread: M30 x 1,5 RHT
0069514, 0586753, 0607999, 0694298,
0694360, 0698609, 1137230, 1229944,
1326862, 1326896, 1331925, ACHB064,
ACHF242, MAK1296



CV-ES-14162

Length: 125
Cone Ø: d1 Ø 30 / d2 Ø 27
Thread: M30 x 1,5 LHT
607053, 690225, 696225, 1228115,
1611088



CV-ES-14163

Length: 125
Cone Ø: d1 Ø 30 / d2 Ø 27
Thread: M30 x 1,5 RHT
0607981, 0698450, 1149907, 1152350,
1257890, 1603789, 1618048, ACHF060



DF-DL-5237

Length: 880
Ø: 52
Cone Ø: d1 Ø 26 / d2 Ø 23,5
1283211, 1351714, 1385497, 10201000A



DF-DL-5403

Length: 1742
Ø: 40
Cone Ø: d1 Ø 26 / d2 Ø 23,5
0288281, 1270854, 1337644



DF-DL-7780

Length: 1690
Ø: 40
Cone Ø: d1 Ø 26 / d2 Ø 23,5
1270853, 1353391, 10212000A



DF-DL-7836

Length: 1698
Ø: 52
Cone Ø: d1 Ø 26 / d2 Ø 23,5
0754922, 1286343, 1353396



DF-DL-8158

Length: 611
Ø: 48
Hole Distance: 130 / 130
0267743, 1361649, 1361650, 1656428



DF-DL-8196

Length: 867
Ø: 50
Cone Ø: d1 Ø 30 / d2 Ø 27
1363859, 1448063, 1602821



DF-DL-8363

Length: 855
Ø: 50
Cone Ø: d1 Ø 30 / d2 Ø 27
1363858, 1448062, 1602820



DF-DL-8718

Length: 1690
Ø: 40
Cone Ø: d1 Ø 30 / d2 Ø 27
1700000



DF-DL-10193

Length: 1646
Ø: 40
Cone Ø: d1 Ø 26 / d2 Ø 23,5
1351205, 1353395



DF-DL-12425

Length: 865
Ø: 52
Cone Ø: d1 Ø 30 / d2 Ø 27
1373878, 1448064



DF-ES-8362

Length: 150
Cone Ø: d1 Ø 26 / d2 Ø 23,5
Thread: M30 x 1,5 RHT
1389190



DF-RK-9336

Ø: 108
1445656



DF-SB-10402

Ø: 62
Thick/Height: 60
1291233, 1732887



DF-VB-8561

Length: 609
Ø: 48
Hole Distance: 152 / 152
080521, 0080521, 1361651, 1368270,
1390932, 1617096, 1793875, 1817808,
1892492



MN-RK-7280

Ø: 75
Hole Distance: 115
Thick/Height: 24
0689748, 689748



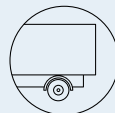

CF 85 ...

FA 85.480	01/01→05/13	Centre Rod	DF-DL-5237		Push Rod	
	01/01→05/13	Centre Rod	DF-DL-8196		Push Rod	
	01/01→05/13	Centre Rod	DF-DL-8363		Push Rod	
	01/01→05/13	Centre Rod	DF-DL-12425		Push Rod	
	01/01→05/13	Stabiliser Mounting	DF-SB-10402			
	01/01→05/13	Suspension Arm Repair Kit		DF-RK-9336		
	01/01→05/13	Tie Rod	DF-DL-5403		1st FA	
	01/01→05/13	Tie Rod	DF-DL-7780		1st FA	
	01/01→05/13	Tie Rod	DF-DL-7836		1st FA	
	01/01→05/13	Tie Rod	DF-DL-10193		1st FA	
	01/01→05/13	Tie Rod End	CV-ES-12461		for Steering Rod	
	01/01→05/13	Tie Rod End	CV-ES-12462		for Steering Rod	
	01/01→05/13	Tie Rod End	CV-ES-14162		for Steering Rod	
	01/01→05/13	Tie Rod End	CV-ES-14163		for Steering Rod	
	01/01→05/13	Tie Rod End	DF-ES-8362		for Steering Rod	
	01/01→05/13	Track Control Arm		DF-DL-8158	Trailing Arm	
	01/01→05/13	Track Control Arm		DF-VB-8561	Wishbone (CV)	
	FA 85.510	10/06→05/13	Centre Rod	DF-DL-5237		Push Rod
		10/06→05/13	Centre Rod	DF-DL-8196		Push Rod
		10/06→05/13	Centre Rod	DF-DL-8363		Push Rod
10/06→05/13		Stabiliser Mounting	DF-SB-10402			
10/06→05/13		Suspension Arm Repair Kit		DF-RK-9336		
10/06→05/13		Suspension Arm Repair Kit	MN-RK-7280	MN-RK-7280	for Drag Link;for Semi-Trailing Arm; for Wishbone (CV)	
10/06→05/13		Tie Rod	DF-DL-5403			
10/06→05/13		Tie Rod	DF-DL-7780			
10/06→05/13		Tie Rod	DF-DL-7836			
10/06→05/13		Tie Rod	DF-DL-8718			
10/06→05/13		Tie Rod End	CV-ES-12461		for Steering Rod	
10/06→05/13		Tie Rod End	CV-ES-12462		for Steering Rod	
10/06→05/13		Tie Rod End	CV-ES-14162		for Steering Rod	
10/06→05/13		Tie Rod End	CV-ES-14163		for Steering Rod	
10/06→05/13		Tie Rod End	DF-ES-8362		for Steering Rod	
10/06→05/13		Track Control Arm		DF-DL-8158	Trailing Arm	
10/06→05/13		Track Control Arm		DF-VB-8561	Wishbone (CV)	
FAC 85.340		12/05→05/13	Centre Rod	DF-DL-5237		Push Rod
		12/05→05/13	Centre Rod	DF-DL-8196		Push Rod
		12/05→05/13	Centre Rod	DF-DL-8703		Push Rod
	12/05→05/13	Centre Rod	DF-DL-10186		Push Rod	
	12/05→05/13	Centre Rod	DF-DL-10188		Push Rod	
	12/05→05/13	Stabiliser Link	DF-DL-12427		Suspension Rod	
	12/05→05/13	Stabiliser Mounting	DF-SB-10402			
	12/05→05/13	Suspension Arm Repair Kit		DF-RK-9336		
	12/05→05/13	Tie Rod	DF-DL-5403		1st FA;2nd FA	
	12/05→05/13	Tie Rod	DF-DL-7780		2nd FA	
	12/05→05/13	Tie Rod	DF-DL-10193		2nd FA	
	12/05→05/13	Tie Rod End	CV-ES-12461		for Steering Rod	
	12/05→05/13	Tie Rod End	CV-ES-12462		for Steering Rod	
	12/05→05/13	Tie Rod End	CV-ES-14162		for Steering Rod	
	12/05→05/13	Tie Rod End	CV-ES-14163		for Steering Rod	
	12/05→05/13	Tie Rod End	DF-ES-8602			
	12/05→05/13	Track Control Arm		DF-DL-8158	Trailing Arm	
	12/05→05/13	Track Control Arm		DF-TC-12492	Trailing Arm, Leading Axle Steered, for Pneumatic Suspension vehicles	
	12/05→05/13	Track Control Arm		DF-VB-8561	Wishbone (CV)	
	FAC 85.360	10/06→05/13	Centre Rod	DF-DL-5237		Push Rod
10/06→05/13		Centre Rod	DF-DL-8196		Push Rod	
10/06→05/13		Stabiliser Mounting	DF-SB-10402			
10/06→05/13		Suspension Arm Repair Kit		DF-RK-9336		
10/06→05/13		Tie Rod	DF-DL-5403			
10/06→05/13		Tie Rod	DF-DL-7780			
10/06→05/13		Tie Rod End	CV-ES-12461		for Steering Rod	
10/06→05/13		Tie Rod End	CV-ES-12462		for Steering Rod	

CV-ES-12461

Length: 120
Cone Ø: d1 Ø 26 / d2 Ø 23,5
Thread: M30 x 1,5 LHT
0069513, 69513, 311300, 0311300,
0607998, 607998, 1190653, 1315447,
1319838, 1332123, 1338714, 1401934,
1407394, ACHB063, ACHF241, MAK1295



CV-ES-12462

Length: 120
Cone Ø: d1 Ø 26 / d2 Ø 23,5
Thread: M30 x 1,5 RHT
0069514, 0586753, 0607999, 0694298,
0694360, 0698609, 1137230, 1229944,
1326862, 1326896, 1331925, ACHB064,
ACHF242, MAK1296



CV-ES-14162

Length: 125
Cone Ø: d1 Ø 30 / d2 Ø 27
Thread: M30 x 1,5 LHT
607053, 690225, 696225, 1228115,
1611088



CV-ES-14163

Length: 125
Cone Ø: d1 Ø 30 / d2 Ø 27
Thread: M30 x 1,5 RHT
0607981, 0698450, 1149907, 1152350,
1257890, 1603789, 1618048, ACHF060



DF-DL-5237

Length: 880 Ø: 52
Cone Ø: d1 Ø 26 / d2 Ø 23,5
1283211, 1351714, 1385497, 1020100A



DF-DL-5403

Length: 1742 Ø: 40
Cone Ø: d1 Ø 26 / d2 Ø 23,5
0288281, 1270854, 1337644



DF-DL-7780

Length: 1690 Ø: 40
Cone Ø: d1 Ø 26 / d2 Ø 23,5
1270853, 1353391, 1021200A



DF-DL-7836

Length: 1698 Ø: 52
Cone Ø: d1 Ø 26 / d2 Ø 23,5
0754922, 1286343, 1353396



DF-DL-8158

Length: 611 Ø: 48
Hole Distance: 130 / 130
0267743, 1361649, 1361650, 1656428



DF-DL-8196

Length: 867 Ø: 50
Cone Ø: d1 Ø 30 / d2 Ø 27
1363859, 1448063, 1602821



DF-DL-8363

Length: 855 Ø: 50
Cone Ø: d1 Ø 30 / d2 Ø 27
1363858, 1448062, 1602820



DF-DL-8703

Length: 1977 Ø: 52
Cone Ø: d1 Ø 30 / d2 Ø 27
1451122



DF-DL-8718

Length: 1690 Ø: 40
Cone Ø: d1 Ø 30 / d2 Ø 27
1700000



DF-DL-10186

Length: 860 Ø: 38
Cone Ø: d1 Ø 30 / d2 Ø 27
1451118



DF-DL-10188

Length: 860 Ø: 36
Cone Ø: d1 Ø 30 / d2 Ø 27
1380417, 1451129



DF-DL-10193

Length: 1646 Ø: 40
Cone Ø: d1 Ø 26 / d2 Ø 23,5
1351205, 1353395



DF-DL-12425

Length: 865 Ø: 52
Cone Ø: d1 Ø 30 / d2 Ø 27
1373878, 1448064



DF-DL-12427

Length: 2028 Ø: 36
Cone Ø: d1 Ø 30 / d2 Ø 27
1392962, 1801332



DF-ES-8362

Length: 150
Cone Ø: d1 Ø 26 / d2 Ø 23,5
Thread: M30 x 1,5 RHT
1389190



DF-ES-8602

Length: 95
Cone Ø: d1 Ø 30 / d2 Ø 27
Thread: M22 x 1,5 RHT
0273203, 1399724



DF-RK-9336

Ø: 108
1445656



DF-SB-10402

Ø: 62
Thick/Height: 60
1291233, 1732887



DF-TC-12492

Length: 600
Ø: 40
Hole Distance: 115 / 115
1274741

No Image

DF-VB-8561

Length: 609 Ø: 48
Hole Distance: 152 / 152
0080521, 080521, 1361651, 1368270,
1390932, 1617096, 1793875, 1817808,
1892492



MN-RK-7280

Ø: 75
Hole Distance: 115
Thick/Height: 24
0689748, 689748





CF 85 ...

FAC 85.360 ...	10/06→05/13	Tie Rod End	CV-ES-14162	CV-ES-14162	for Steering Rod
	10/06→05/13	Tie Rod End	CV-ES-14163		for Steering Rod
	10/06→05/13	Track Control Arm		DF-DL-8158	Trailing Arm
	10/06→05/13	Track Control Arm		DF-TC-12492	Trailing Arm, Leading Axle Steered, for Pneumatic Suspension vehicles
	10/06→05/13	Track Control Arm		DF-VB-8561	Wishbone (CV)
FAC 85.380	12/05→05/13	Centre Rod	DF-DL-5237		Push Rod
	12/05→05/13	Centre Rod	DF-DL-8196		Push Rod
	12/05→05/13	Centre Rod	DF-DL-8703		Push Rod
	12/05→05/13	Centre Rod	DF-DL-10186		Push Rod
	12/05→05/13	Centre Rod	DF-DL-10188		Push Rod
	12/05→05/13	Stabiliser Link	DF-DL-12427		Suspension Rod
	12/05→05/13	Stabiliser Mounting	DF-SB-10402		
	12/05→05/13	Suspension Arm Repair Kit		DF-RK-9336	
	12/05→05/13	Tie Rod	DF-DL-5403		1st FA;2nd FA
	12/05→05/13	Tie Rod	DF-DL-7780		1st FA;2nd FA
	12/05→05/13	Tie Rod	DF-DL-10193		2nd FA
	12/05→05/13	Tie Rod End	CV-ES-12461		for Steering Rod
	12/05→05/13	Tie Rod End	CV-ES-12462		for Steering Rod
	12/05→05/13	Tie Rod End	CV-ES-14162		for Steering Rod
	12/05→05/13	Tie Rod End	CV-ES-14163		for Steering Rod
	12/05→05/13	Tie Rod End	DF-ES-8602		
	12/05→05/13	Track Control Arm		DF-DL-8158	Trailing Arm
	12/05→05/13	Track Control Arm		DF-TC-12492	Trailing Arm, Leading Axle Steered, for Pneumatic Suspension vehicles
	12/05→05/13	Track Control Arm		DF-VB-8561	Wishbone (CV)
	FAC 85.410	10/05→05/13	Centre Rod	DF-DL-5237	
10/05→05/13		Centre Rod	DF-DL-8196		Push Rod
10/05→05/13		Centre Rod	DF-DL-8703		Push Rod
10/05→05/13		Centre Rod	DF-DL-10186		Push Rod
10/05→05/13		Centre Rod	DF-DL-10188		Push Rod
10/05→05/13		Stabiliser Link	DF-DL-12427		Suspension Rod
10/05→05/13		Stabiliser Mounting	DF-SB-10402		
10/05→05/13		Suspension Arm Repair Kit		DF-RK-9336	
10/05→05/13		Tie Rod		DF-DL-5403	Tag Axle
10/05→05/13		Tie Rod		DF-DL-7780	Tag Axle
10/05→05/13		Tie Rod	DF-DL-5403		1st FA;2nd FA
10/05→05/13		Tie Rod	DF-DL-7780		1st FA;2nd FA
10/05→05/13		Tie Rod	DF-DL-10193		1st FA;2nd FA
10/05→05/13		Tie Rod End	CV-ES-12461		for Steering Rod
10/05→05/13		Tie Rod End	CV-ES-12462		for Steering Rod
10/05→05/13		Tie Rod End	CV-ES-14162	CV-ES-14162	for Steering Rod
10/05→05/13		Tie Rod End	CV-ES-14163		for Steering Rod
10/05→05/13		Tie Rod End	DF-ES-8602		
10/05→05/13		Track Control Arm		DF-DL-8158	Trailing Arm
10/05→05/13		Track Control Arm		DF-TC-12492	Trailing Arm, Leading Axle Steered, for Pneumatic Suspension vehicles
10/05→05/13	Track Control Arm		DF-VB-8561	Wishbone (CV)	
FAC 85.430	12/05→05/13	Centre Rod	DF-DL-5237		Push Rod
	12/05→05/13	Centre Rod	DF-DL-8196		Push Rod
	12/05→05/13	Centre Rod	DF-DL-8703		Push Rod
	12/05→05/13	Centre Rod	DF-DL-10186		Push Rod
	12/05→05/13	Centre Rod	DF-DL-10188		Push Rod
	12/05→05/13	Stabiliser Link	DF-DL-12427		Suspension Rod
	12/05→05/13	Stabiliser Mounting	DF-SB-10402		
	12/05→05/13	Suspension Arm Repair Kit		DF-RK-9336	
	12/05→05/13	Tie Rod	DF-DL-5403		1st FA;2nd FA
	12/05→05/13	Tie Rod	DF-DL-7780		1st FA;2nd FA
	12/05→05/13	Tie Rod	DF-DL-10193		2nd FA
	12/05→05/13	Tie Rod End	CV-ES-12461		for Steering Rod
	12/05→05/13	Tie Rod End	CV-ES-12462		for Steering Rod
	12/05→05/13	Tie Rod End	CV-ES-14162		for Steering Rod
12/05→05/13	Tie Rod End	CV-ES-14163		for Steering Rod	

CV-ES-12461

Length: 120
 Cone Ø: d1 Ø 26 / d2 Ø 23,5
 Thread: M30 x 1,5 LHT
 0069513, 69513, 311300, 0311300,
 0607998, 607998, 1190653, 1315447,
 1319838, 1332123, 1338714, 1401934,
 1407394, ACHB063, ACHF241, MAK1295

**CV-ES-12462**

Length: 120
 Cone Ø: d1 Ø 26 / d2 Ø 23,5
 Thread: M30 x 1,5 RHT
 0069514, 0586753, 0607999, 0694298,
 0694360, 0698609, 1137230, 1229944,
 1326862, 1326896, 1331925, ACHB064,
 ACHF242, MAK1296

**CV-ES-14162**

Length: 125
 Cone Ø: d1 Ø 30 / d2 Ø 27
 Thread: M30 x 1,5 LHT
 607053, 690225, 696225, 1228115,
 1611088

**CV-ES-14163**

Length: 125
 Cone Ø: d1 Ø 30 / d2 Ø 27
 Thread: M30 x 1,5 RHT
 0607981, 0698450, 1149907, 1152350,
 1257890, 1603789, 1618048, ACHF060

**DF-DL-5237**

Length: 880
 Ø: 52
 Cone Ø: d1 Ø 26 / d2 Ø 23,5
 1283211, 1351714, 1385497, 10201000A

**DF-DL-5403**

Length: 1742
 Ø: 40
 Cone Ø: d1 Ø 26 / d2 Ø 23,5
 0288281, 1270854, 1337644

**DF-DL-7780**

Length: 1690
 Ø: 40
 Cone Ø: d1 Ø 26 / d2 Ø 23,5
 1270853, 1353391, 10212000A

**DF-DL-8158**

Length: 611
 Ø: 48
 Hole Distance: 130 / 130
 0267743, 1361649, 1361650, 1656428

**DF-DL-8196**

Length: 867
 Ø: 50
 Cone Ø: d1 Ø 30 / d2 Ø 27
 1363859, 1448063, 1602821

**DF-DL-8703**

Length: 1977
 Ø: 52
 Cone Ø: d1 Ø 30 / d2 Ø 27
 1451122

**DF-DL-10186**

Length: 860
 Ø: 38
 Cone Ø: d1 Ø 30 / d2 Ø 27
 1451118

**DF-DL-10188**

Length: 860
 Ø: 36
 Cone Ø: d1 Ø 30 / d2 Ø 27
 1380417, 1451129

**DF-DL-10193**

Length: 1646
 Ø: 40
 Cone Ø: d1 Ø 26 / d2 Ø 23,5
 1351205, 1353395

**DF-DL-12427**

Length: 2028
 Ø: 36
 Cone Ø: d1 Ø 30 / d2 Ø 27
 1392962, 1801332

**DF-ES-8602**

Length: 95
 Cone Ø: d1 Ø 30 / d2 Ø 27
 Thread: M22 x 1,5 RHT
 0273203, 1399724

**DF-RK-9336**

Ø: 108
 1445656

**DF-SB-10402**

Ø: 62
 Thick/Height: 60
 1291233, 1732887

**DF-TC-12492**

Length: 600
 Ø: 40
 Hole Distance: 115 / 115
 1274741

No Image

DF-VB-8561

Length: 609
 Ø: 48
 Hole Distance: 152 / 152
 0080521, 080521, 1361651, 1368270,
 1390932, 1617096, 1793875, 1817808,
 1892492





CF 85 ...

FAC 85.430 ...	12/05→05/13	Tie Rod End	DF-ES-8602		
	12/05→05/13	Track Control Arm		DF-DL-8158	Trailing Arm
	12/05→05/13	Track Control Arm		DF-TC-12492	Trailing Arm, Leading Axle Steered, for Pneumatic Suspension vehicles
	12/05→05/13	Track Control Arm		DF-VB-8561	Wishbone (CV)
FAC 85.460	10/05→05/13	Centre Rod	DF-DL-5237		Push Rod
	10/05→05/13	Centre Rod	DF-DL-8196		Push Rod
	10/05→05/13	Centre Rod	DF-DL-8703		Push Rod
	10/05→05/13	Centre Rod	DF-DL-10186		Push Rod
	10/05→05/13	Centre Rod	DF-DL-10188		Push Rod
	10/05→05/13	Stabiliser Link	DF-DL-12427		Suspension Rod
	10/05→05/13	Stabiliser Mounting	DF-SB-10402		
	10/05→05/13	Suspension Arm Repair Kit		DF-RK-9336	
	10/05→05/13	Tie Rod		DF-DL-5403	Tag Axle
	10/05→05/13	Tie Rod		DF-DL-7780	Tag Axle
	10/05→05/13	Tie Rod	DF-DL-5403		1st FA;2nd FA
	10/05→05/13	Tie Rod	DF-DL-10193		2nd FA
	10/05→05/13	Tie Rod End	CV-ES-12461		for Steering Rod
	10/05→05/13	Tie Rod End	CV-ES-12462		for Steering Rod
	10/05→05/13	Tie Rod End	CV-ES-14162	CV-ES-14162	for Steering Rod
	10/05→05/13	Tie Rod End	CV-ES-14163		for Steering Rod
	10/05→05/13	Tie Rod End	DF-ES-8602		
	10/05→05/13	Track Control Arm		DF-DL-8158	Trailing Arm
	10/05→05/13	Track Control Arm		DF-TC-12492	Trailing Arm, Leading Axle Steered, for Pneumatic Suspension vehicles
	10/05→05/13	Track Control Arm		DF-VB-8561	Wishbone (CV)
FAC 85.480	12/05→05/13	Centre Rod	DF-DL-5237		Push Rod
	12/05→05/13	Centre Rod	DF-DL-8196		Push Rod
	12/05→05/13	Centre Rod	DF-DL-8703		Push Rod
	12/05→05/13	Centre Rod	DF-DL-10186		Push Rod
	12/05→05/13	Centre Rod	DF-DL-10188		Push Rod
	12/05→05/13	Stabiliser Link	DF-DL-12427		Suspension Rod
	12/05→05/13	Stabiliser Mounting	DF-SB-10402		
	12/05→05/13	Suspension Arm Repair Kit		DF-RK-9336	
	12/05→05/13	Tie Rod	DF-DL-5403		1st FA;2nd FA
	12/05→05/13	Tie Rod	DF-DL-7780		1st FA;2nd FA
	12/05→05/13	Tie Rod	DF-DL-10193		2nd FA
	12/05→05/13	Tie Rod End	CV-ES-12461		for Steering Rod
	12/05→05/13	Tie Rod End	CV-ES-12462		for Steering Rod
	12/05→05/13	Tie Rod End	CV-ES-14162		for Steering Rod
	12/05→05/13	Tie Rod End	CV-ES-14163		for Steering Rod
	12/05→05/13	Tie Rod End	DF-ES-8602		
	12/05→05/13	Track Control Arm		DF-DL-8158	Trailing Arm
	12/05→05/13	Track Control Arm		DF-TC-12492	Trailing Arm, Leading Axle Steered, for Pneumatic Suspension vehicles
	12/05→05/13	Track Control Arm		DF-VB-8561	Wishbone (CV)
	FAC 85.510	10/05→05/13	Centre Rod	DF-DL-5237	
10/05→05/13		Centre Rod	DF-DL-8196		Push Rod
10/05→05/13		Centre Rod	DF-DL-8703		Push Rod
10/05→05/13		Centre Rod	DF-DL-10186		Push Rod
10/05→05/13		Centre Rod	DF-DL-10188		Push Rod
10/05→05/13		Stabiliser Link	DF-DL-12427		Suspension Rod
10/05→05/13		Stabiliser Mounting	DF-SB-10402		
10/05→05/13		Suspension Arm Repair Kit		DF-RK-9336	
10/05→05/13		Tie Rod		DF-DL-5403	Tag Axle
10/05→05/13		Tie Rod		DF-DL-7780	Tag Axle
10/05→05/13		Tie Rod	DF-DL-5403		1st FA;2nd FA
10/05→05/13		Tie Rod End	CV-ES-12461		for Steering Rod
10/05→05/13		Tie Rod End	CV-ES-12462		for Steering Rod
10/05→05/13		Tie Rod End	CV-ES-14162	CV-ES-14162	for Steering Rod
10/05→05/13		Tie Rod End	CV-ES-14163		for Steering Rod
10/05→05/13		Tie Rod End	DF-ES-8602		
10/05→05/13		Track Control Arm		DF-DL-8158	Trailing Arm

CV-ES-12461

Length: 120
Cone Ø: d1 Ø 26 / d2 Ø 23,5
Thread: M30 x 1,5 LHT
0069513, 69513, 0311300, 311300,
0607998, 607998, 1190653, 1315447,
1319838, 1332123, 1338714, 1401934,
1407394, ACHB063, ACHF241, MAK1295



CV-ES-12462

Length: 120
Cone Ø: d1 Ø 26 / d2 Ø 23,5
Thread: M30 x 1,5 RHT
0069514, 0586753, 0607999, 0694298,
0694360, 0698609, 1137230, 1229944,
1326862, 1326896, 1331925, ACHB064,
ACHF242, MAK1296



CV-ES-14162

Length: 125
Cone Ø: d1 Ø 30 / d2 Ø 27
Thread: M30 x 1,5 LHT
607053, 690225, 696225, 1228115,
1611088



CV-ES-14163

Length: 125
Cone Ø: d1 Ø 30 / d2 Ø 27
Thread: M30 x 1,5 RHT
0607981, 0698450, 1149907, 1152350,
1257890, 1603789, 1618048, ACHF060



DF-DL-5237

Length: 880
Ø: 52
Cone Ø: d1 Ø 26 / d2 Ø 23,5
1283211, 1351714, 1385497, 10201000A



DF-DL-5403

Length: 1742
Ø: 40
Cone Ø: d1 Ø 26 / d2 Ø 23,5
0288281, 1270854, 1337644



DF-DL-7780

Length: 1690
Ø: 40
Cone Ø: d1 Ø 26 / d2 Ø 23,5
1270853, 1353391, 10212000A



DF-DL-8158

Length: 611
Ø: 48
Hole Distance: 130 / 130
0267743, 1361649, 1361650, 1656428



DF-DL-8196

Length: 867
Ø: 50
Cone Ø: d1 Ø 30 / d2 Ø 27
1363859, 1448063, 1602821



DF-DL-8703

Length: 1977
Ø: 52
Cone Ø: d1 Ø 30 / d2 Ø 27
1451122



DF-DL-10186

Length: 860
Ø: 38
Cone Ø: d1 Ø 30 / d2 Ø 27
1451118



DF-DL-10188

Length: 860
Ø: 36
Cone Ø: d1 Ø 30 / d2 Ø 27
1380417, 1451129



DF-DL-10193

Length: 1646
Ø: 40
Cone Ø: d1 Ø 26 / d2 Ø 23,5
1351205, 1353395



DF-DL-12427

Length: 2028
Ø: 36
Cone Ø: d1 Ø 30 / d2 Ø 27
1392962, 1801332



DF-ES-8602

Length: 95
Cone Ø: d1 Ø 30 / d2 Ø 27
Thread: M22 x 1,5 RHT
0273203, 1399724



DF-RK-9336

Ø: 108
1445656



DF-SB-10402

Ø: 62
Thick/Height: 60
1291233, 1732887

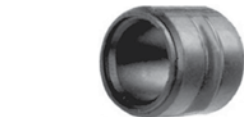

DF-TC-12492

Length: 600
Ø: 40
Hole Distance: 115 / 115
1274741

No Image

DF-VB-8561

Length: 609
Ø: 48
Hole Distance: 152 / 152
0080521, 080521, 1361651, 1368270,
1390932, 1617096, 1793875, 1817808,
1892492





CF 85 ...

FAC 85.510 ...	10/05→05/13	Track Control Arm		DF-TC-12492	Trailing Arm, Leading Axle Steered, for Pneumatic Suspension vehicles
	10/05→05/13	Track Control Arm		DF-VB-8561	Wishbone (CV)
FAD 85.340	01/01→05/13	Centre Rod	DF-DL-5237		Push Rod
	01/01→05/13	Centre Rod	DF-DL-8196		Push Rod
	01/01→05/13	Centre Rod	DF-DL-8703		Push Rod
	01/01→05/13	Centre Rod	DF-DL-10186		Push Rod
	01/01→05/13	Centre Rod	DF-DL-10188		Push Rod
	01/01→05/13	Stabiliser Link	DF-DL-12427		Suspension Rod
	01/01→05/13	Stabiliser Mounting	DF-SB-10402		
	01/01→05/13	Suspension Arm Repair Kit		DF-RK-9336	
	01/01→05/13	Tie Rod	DF-DL-5403		1st FA;2nd FA
	01/01→05/13	Tie Rod	DF-DL-7780		1st FA;2nd FA
	01/01→05/13	Tie Rod	DF-DL-10193		1st FA;2nd FA
	01/01→05/13	Tie Rod End	CV-ES-12461		for Steering Rod
	01/01→05/13	Tie Rod End	CV-ES-12462		for Steering Rod
	01/01→05/13	Tie Rod End	CV-ES-14162		for Steering Rod
	01/01→05/13	Tie Rod End	CV-ES-14163		for Steering Rod
	01/01→05/13	Tie Rod End	DF-ES-8602		
	01/01→05/13	Tie Rod End	SC-ES-8517		for Push Rod
	01/01→05/13	Track Control Arm		DF-DL-8158	Trailing Arm
	01/01→05/13	Track Control Arm		DF-DL-9318	Trailing Arm, 1st RA;2nd RA, for Leaf-Spring Suspension vehicles
	01/01→05/13	Track Control Arm		DF-TC-12262	Control Arm
	01/01→05/13	Track Control Arm		DF-VB-8561	Wishbone (CV)
	01/01→05/13	Track Control Arm		DF-VB-9343	Wishbone (CV), 1st RA;2nd RA, for Leaf-Spring Suspension vehicles
FAD 85.360	10/06→05/13	Centre Rod	DF-DL-5237		Push Rod
	10/06→05/13	Centre Rod	DF-DL-8196		Push Rod
	10/06→05/13	Centre Rod	DF-DL-8703		Push Rod
	10/06→05/13	Centre Rod	DF-DL-10186		Push Rod
	10/06→05/13	Centre Rod	DF-DL-10188		Push Rod
	10/06→05/13	Centre Rod	DF-DL-10192		Push Rod, for vehicles with Hinged Leading Axle
	10/06→05/13	Stabiliser Mounting	DF-SB-10402		
	10/06→05/13	Suspension Arm Repair Kit		DF-RK-8633	for Wishbone (CV)
	10/06→05/13	Suspension Arm Repair Kit		DF-RK-9336	
	10/06→05/13	Suspension Arm Repair Kit	MN-RK-7280	MN-RK-7280	for Drag Link;for Semi-Trailing Arm; for Wishbone (CV)
	10/06→05/13	Suspension Strut Repair Kit		DF-RK-8685	
	10/06→05/13	Tie Rod	DF-DL-5403		
	10/06→05/13	Tie Rod	DF-DL-5403		1st FA
	10/06→05/13	Tie Rod	DF-DL-7780		
	10/06→05/13	Tie Rod	DF-DL-8718		1st Front Axle
	10/06→05/13	Tie Rod	DF-DL-10193		2nd FA
	10/06→05/13	Tie Rod	DF-ES-5761		2nd FA
	10/06→05/13	Tie Rod End	CV-ES-12461		for Steering Rod
	10/06→05/13	Tie Rod End	CV-ES-12462		for Steering Rod
	10/06→05/13	Tie Rod End	CV-ES-14162		for Steering Rod
	10/06→05/13	Tie Rod End	CV-ES-14163		for Steering Rod
	10/06→05/13	Tie Rod End	DF-ES-8602		
	10/06→05/13	Tie Rod End	SC-ES-8517		for Push Rod
	10/06→05/13	Track Control Arm		DF-DL-8158	Trailing Arm
	10/06→05/13	Track Control Arm		DF-DL-9318	Trailing Arm
	10/06→05/13	Track Control Arm		DF-DL-9318	Trailing Arm, 1st RA;2nd RA, for Leaf-Spring Suspension vehicles
	10/06→05/13	Track Control Arm		DF-TC-12262	Control Arm
	10/06→05/13	Track Control Arm		DF-TC-12492	Control Arm
	10/06→05/13	Track Control Arm		DF-VB-8561	Wishbone (CV)
	10/06→05/13	Track Control Arm		DF-VB-9343	Wishbone (CV), 1st RA;2nd RA, for Leaf-Spring Suspension vehicles

CV-ES-12461

Length: 120
Cone Ø: d1 Ø 26 / d2 Ø 23,5
Thread: M30 x 1,5 LHT
0069513, 69513, 0311300, 311300,
0607998, 607998, 1190653, 1315447,
1319838, 1332123, 1338714, 1401934,
1407394, ACHB063, ACHF241, MAK1295



CV-ES-12462

Length: 120
Cone Ø: d1 Ø 26 / d2 Ø 23,5
Thread: M30 x 1,5 RHT
0069514, 0586753, 0607999, 0694298,
0694360, 0698609, 1137230, 1229944,
1326862, 1326896, 1331925, ACHB064,
ACHF242, MAK1296



CV-ES-14162

Length: 125
Cone Ø: d1 Ø 30 / d2 Ø 27
Thread: M30 x 1,5 LHT
607053, 690225, 696225, 1228115,
1611088



CV-ES-14163

Length: 125
Cone Ø: d1 Ø 30 / d2 Ø 27
Thread: M30 x 1,5 RHT
0607981, 0698450, 1149907, 1152350,
1257890, 1603789, 1618048, ACHF060



DF-DL-5237

Length: 880 Ø: 52
Cone Ø: d1 Ø 26 / d2 Ø 23,5
1283211, 1351714, 1385497, 10201000A



DF-DL-5403

Length: 1742 Ø: 40
Cone Ø: d1 Ø 26 / d2 Ø 23,5
0288281, 1270854, 1337644



DF-DL-7780

Length: 1690 Ø: 40
Cone Ø: d1 Ø 26 / d2 Ø 23,5
1270853, 1353391, 10212000A



DF-DL-8158

Length: 611 Ø: 48
Hole Distance: 130 / 130
0267743, 1361649, 1361650, 1656428



DF-DL-8196

Length: 867 Ø: 50
Cone Ø: d1 Ø 30 / d2 Ø 27
1363859, 1448063, 1602821



DF-DL-8703

Length: 1977 Ø: 52
Cone Ø: d1 Ø 30 / d2 Ø 27
1451122



DF-DL-8718

Length: 1690 Ø: 40
Cone Ø: d1 Ø 30 / d2 Ø 27
1700000



DF-DL-9318

Length: 600 Ø: 50
Hole Distance: 130 / 130
0646373, 0655695, 0655697, 1284860,
1620438



DF-DL-10186

Length: 860 Ø: 38
Cone Ø: d1 Ø 30 / d2 Ø 27
1451118



DF-DL-10188

Length: 860 Ø: 36
Cone Ø: d1 Ø 30 / d2 Ø 27
1380417, 1451129



DF-DL-10192

Length: 590 Ø: 38
Cone Ø: d1 Ø 30 / d2 Ø 27
1440171, 1451119



DF-DL-10193

Length: 1646 Ø: 40
Cone Ø: d1 Ø 26 / d2 Ø 23,5
1351205, 1353395



DF-DL-12427

Length: 2028 Ø: 36
Cone Ø: d1 Ø 30 / d2 Ø 27
1392962, 1801332



DF-ES-5761

Length: 1512 Ø: 52
Cone Ø: d1 Ø 26 / d2 Ø 23,5
1297572, 1361155



DF-ES-8602

Length: 95
Cone Ø: d1 Ø 30 / d2 Ø 27
Thread: M22 x 1,5 RHT
0273203, 1399724



DF-RK-8633

Ø: 90
0696320, 696320



DF-RK-8685

Ø: 67
Hole Distance: 130
Thick/Height: 24
1321936



DF-RK-9336

Ø: 108
1445656



DF-SB-10402

Ø: 62
Thick/Height: 60
1291233, 1732887



DF-TC-12262

Length: 595 Ø: 50
Hole Distance: 130 / 130
0661406, 661406, 0661407, 661407,
1620439



DF-TC-12492

Length: 600
Ø: 40
Hole Distance: 115 / 115
1274741

No Image

DF-VB-8561

Length: 609 Ø: 48
Hole Distance: 152 / 152
0080521, 080521, 1361651, 1368270,
1390932, 1617096, 1793875, 1817808,
1892492



DF-VB-9343

Length: 608,2 Ø: 48
Hole Distance: 152 / 152
1361652, 1620436, 1793876, 10309600A



MN-RK-7280

Ø: 75
Hole Distance: 115
Thick/Height: 24
689748, 0689748



SC-ES-8517

Length: 140
Cone Ø: d1 Ø 30 / d2 Ø 27
Thread: M30 x 1,5 RHT
1685552



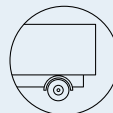

CF 85 ...

FAD 85.380	01/01→05/13	Centre Rod	DF-DL-5237		Push Rod
	01/01→05/13	Centre Rod	DF-DL-8196		Push Rod
	01/01→05/13	Centre Rod	DF-DL-8363		Push Rod
	01/01→05/13	Centre Rod	DF-DL-8703		Push Rod
	01/01→05/13	Centre Rod	DF-DL-10186		Push Rod
	01/01→05/13	Centre Rod	DF-DL-10188		Push Rod
	01/01→05/13	Stabiliser Link	DF-DL-12427		Suspension Rod
	01/01→05/13	Stabiliser Mounting	DF-SB-10402		
	01/01→05/13	Suspension Arm Repair Kit		DF-RK-9336	
	01/01→05/13	Tie Rod	DF-DL-5403		1st FA;2nd FA
	01/01→05/13	Tie Rod	DF-DL-7780		1st FA;2nd FA
	01/01→05/13	Tie Rod	DF-DL-10193		1st FA;2nd FA
	01/01→05/13	Tie Rod End	CV-ES-12461		for Steering Rod
	01/01→05/13	Tie Rod End	CV-ES-12462		for Steering Rod
	01/01→05/13	Tie Rod End	CV-ES-14162		for Steering Rod
	01/01→05/13	Tie Rod End	CV-ES-14163		for Steering Rod
	01/01→05/13	Tie Rod End	DF-ES-8602		
	01/01→05/13	Tie Rod End	SC-ES-8517		for Push Rod
	01/01→05/13	Track Control Arm		DF-DL-8158	Trailing Arm
	01/01→05/13	Track Control Arm		DF-DL-9318	Trailing Arm
	01/01→05/13	Track Control Arm		DF-TC-12262	Control Arm
	01/01→05/13	Track Control Arm		DF-VB-8561	Wishbone (CV)
	01/01→05/13	Track Control Arm		DF-VB-9343	Wishbone (CV)
FAD 85.410	10/05→05/13	Centre Rod	DF-DL-5237		Push Rod
	10/05→05/13	Centre Rod	DF-DL-8196		Push Rod
	10/05→05/13	Centre Rod	DF-DL-8703		Push Rod
	10/05→05/13	Centre Rod	DF-DL-10186		Push Rod
	10/05→05/13	Centre Rod	DF-DL-10188		Push Rod
	10/05→05/13	Stabiliser Mounting	DF-SB-10402		
	10/05→05/13	Suspension Arm Repair Kit		DF-RK-9336	
	10/05→05/13	Tie Rod	DF-DL-5403		1st FA;2nd FA
	10/05→05/13	Tie Rod	DF-DL-7780		1st FA;2nd FA
	10/05→05/13	Tie Rod	DF-DL-8718		1st FA
	10/05→05/13	Tie Rod	DF-DL-10193		2nd FA
	10/05→05/13	Tie Rod End	CV-ES-12461		for Steering Rod
	10/05→05/13	Tie Rod End	CV-ES-12462		for Steering Rod
	10/05→05/13	Tie Rod End	CV-ES-14162		for Steering Rod
	10/05→05/13	Tie Rod End	CV-ES-14163		for Steering Rod
	10/05→05/13	Tie Rod End	DF-ES-8602		
	10/05→05/13	Tie Rod End	SC-ES-8517		for Push Rod
	10/05→05/13	Track Control Arm		DF-DL-8158	Trailing Arm
	10/05→05/13	Track Control Arm		DF-DL-9318	Trailing Arm, 1st RA;2nd RA, for Leaf-Spring Suspension vehicles
	10/05→05/13	Track Control Arm		DF-TC-12262	Control Arm
	10/05→05/13	Track Control Arm		DF-VB-8561	Wishbone (CV)
	10/05→05/13	Track Control Arm		DF-VB-9343	Wishbone (CV), 1st RA;2nd RA, for Leaf-Spring Suspension vehicles
	10/06→05/13	Tie Rod	DF-DL-5403		
10/06→05/13	Tie Rod	DF-DL-7780			
FAD 85.430	01/01→05/13	Centre Rod	DF-DL-5237		Push Rod
	01/01→05/13	Centre Rod	DF-DL-8196		Push Rod
	01/01→05/13	Centre Rod	DF-DL-8363		Push Rod
	01/01→05/13	Centre Rod	DF-DL-8703		Push Rod
	01/01→05/13	Centre Rod	DF-DL-10186		Push Rod
	01/01→05/13	Centre Rod	DF-DL-10188		Push Rod
	01/01→05/13	Stabiliser Link	DF-DL-12427		Suspension Rod
	01/01→05/13	Stabiliser Mounting	DF-SB-10402		
	01/01→05/13	Suspension Arm Repair Kit		DF-RK-9336	
	01/01→05/13	Tie Rod	DF-DL-5403		1st FA;2nd FA
	01/01→05/13	Tie Rod	DF-DL-7780		
	01/01→05/13	Tie Rod	DF-DL-10193		1st FA;2nd FA
	01/01→05/13	Tie Rod End	CV-ES-12461		for Steering Rod
01/01→05/13	Tie Rod End	CV-ES-12462		for Steering Rod	

CV-ES-12461

Length: 120
Cone Ø: d1 Ø 26 / d2 Ø 23,5
Thread: M30 x 1,5 LHT
69513, 0069513, 0311300, 311300,
0607998, 607998, 1190653, 1315447,
1319838, 1332123, 1338714, 1401934,
1407394, ACHB063, ACHF241, MAK1295



CV-ES-12462

Length: 120
Cone Ø: d1 Ø 26 / d2 Ø 23,5
Thread: M30 x 1,5 RHT
0069514, 0586753, 0607999, 0694298,
0694360, 0698609, 1137230, 1229944,
1326862, 1326896, 1331925, ACHB064,
ACHF242, MAK1296



CV-ES-14162

Length: 125
Cone Ø: d1 Ø 30 / d2 Ø 27
Thread: M30 x 1,5 LHT
607053, 690225, 696225, 1228115,
1611088



CV-ES-14163

Length: 125
Cone Ø: d1 Ø 30 / d2 Ø 27
Thread: M30 x 1,5 RHT
0607981, 0698450, 1149907, 1152350,
1257890, 1603789, 1618048, ACHF060



DF-DL-5237

Length: 880 Ø: 52
Cone Ø: d1 Ø 26 / d2 Ø 23,5
1283211, 1351714, 1385497, 10201000A



DF-DL-5403

Length: 1742 Ø: 40
Cone Ø: d1 Ø 26 / d2 Ø 23,5
0288281, 1270854, 1337644



DF-DL-7780

Length: 1690 Ø: 40
Cone Ø: d1 Ø 26 / d2 Ø 23,5
1270853, 1353391, 10212000A



DF-DL-8158

Length: 611 Ø: 48
Hole Distance: 130 / 130
0267743, 1361649, 1361650, 1656428



DF-DL-8196

Length: 867 Ø: 50
Cone Ø: d1 Ø 30 / d2 Ø 27
1363859, 1448063, 1602821



DF-DL-8363

Length: 855 Ø: 50
Cone Ø: d1 Ø 30 / d2 Ø 27
1363858, 1448062, 1602820



DF-DL-8703

Length: 1977 Ø: 52
Cone Ø: d1 Ø 30 / d2 Ø 27
1451122



DF-DL-8718

Length: 1690 Ø: 40
Cone Ø: d1 Ø 30 / d2 Ø 27
1700000



DF-DL-9318

Length: 600 Ø: 50
Hole Distance: 130 / 130
0646373, 0655695, 0655697, 1284860,
1620438



DF-DL-10186

Length: 860 Ø: 38
Cone Ø: d1 Ø 30 / d2 Ø 27
1451118



DF-DL-10188

Length: 860 Ø: 36
Cone Ø: d1 Ø 30 / d2 Ø 27
1380417, 1451129



DF-DL-10193

Length: 1646 Ø: 40
Cone Ø: d1 Ø 26 / d2 Ø 23,5
1351205, 1353395



DF-DL-12427

Length: 2028 Ø: 36
Cone Ø: d1 Ø 30 / d2 Ø 27
1392962, 1801332



DF-ES-8602

Length: 95
Cone Ø: d1 Ø 30 / d2 Ø 27
Thread: M22 x 1,5 RHT
0273203, 1399724



DF-RK-9336

Ø: 108
1445656



DF-SB-10402

Ø: 62
Thick/Height: 60
1291233, 1732887



DF-TC-12262

Length: 595 Ø: 50
Hole Distance: 130 / 130
0661406, 661406, 0661407, 661407,
1620439



DF-VB-8561

Length: 609 Ø: 48
Hole Distance: 152 / 152
0080521, 080521, 1361651, 1368270,
1390932, 1617096, 1793875, 1817808,
1892492



DF-VB-9343

Length: 608,2 Ø: 48
Hole Distance: 152 / 152
1361652, 1620436, 1793876, 10309600A



SC-ES-8517

Length: 140
Cone Ø: d1 Ø 30 / d2 Ø 27
Thread: M30 x 1,5 RHT
1685552





CF 85 ...

FAD 85.430 ...	01/01→05/13	Tie Rod End	CV-ES-14162		for Steering Rod
	01/01→05/13	Tie Rod End	CV-ES-14163		for Steering Rod
	01/01→05/13	Tie Rod End	DF-ES-8602		
	01/01→05/13	Tie Rod End	SC-ES-8517		for Push Rod
	01/01→05/13	Track Control Arm		DF-DL-8158	Trailing Arm
	01/01→05/13	Track Control Arm		DF-DL-9318	Trailing Arm
	01/01→05/13	Track Control Arm		DF-TC-12262	Control Arm
	01/01→05/13	Track Control Arm		DF-VB-8561	Wishbone (CV)
	01/01→05/13	Track Control Arm		DF-VB-9343	Wishbone (CV)
FAD 85.460	10/05→05/13	Centre Rod	DF-DL-5237		Push Rod
	10/05→05/13	Centre Rod	DF-DL-8196		Push Rod
	10/05→05/13	Centre Rod	DF-DL-8703		Push Rod
	10/05→05/13	Centre Rod	DF-DL-10186		Push Rod
	10/05→05/13	Centre Rod	DF-DL-10188		Push Rod
	10/05→05/13	Stabiliser Mounting	DF-SB-10402		
	10/05→05/13	Suspension Arm Repair Kit		DF-RK-9336	
	10/05→05/13	Tie Rod	DF-DL-5403		
	10/05→05/13	Tie Rod	DF-DL-5403		1st FA
	10/05→05/13	Tie Rod	DF-DL-7780		
	10/05→05/13	Tie Rod	DF-DL-7780		1st FA;2nd FA
	10/05→05/13	Tie Rod	DF-DL-10193		1st FA;2nd FA
	10/05→05/13	Tie Rod End	CV-ES-12461		for Steering Rod
	10/05→05/13	Tie Rod End	CV-ES-12462		for Steering Rod
	10/05→05/13	Tie Rod End	CV-ES-14162		for Steering Rod
	10/05→05/13	Tie Rod End	CV-ES-14163		for Steering Rod
	10/05→05/13	Tie Rod End	DF-ES-8602		
	10/05→05/13	Tie Rod End	SC-ES-8517		for Push Rod
	10/05→05/13	Track Control Arm		DF-DL-8158	Trailing Arm
	10/05→05/13	Track Control Arm		DF-DL-9318	Trailing Arm, 1st RA;2nd RA, for Leaf-Spring Suspension vehicles
	10/05→05/13	Track Control Arm		DF-TC-12262	Control Arm
	10/05→05/13	Track Control Arm		DF-VB-8561	Wishbone (CV)
	10/05→05/13	Track Control Arm		DF-VB-9343	Wishbone (CV), 1st RA;2nd RA, for Leaf-Spring Suspension vehicles
FAD 85.480	01/01→05/13	Centre Rod	DF-DL-5237		Push Rod
	01/01→05/13	Centre Rod	DF-DL-8196		Push Rod
	01/01→05/13	Centre Rod	DF-DL-8703		Push Rod
	01/01→05/13	Centre Rod	DF-DL-10186		Push Rod
	01/01→05/13	Centre Rod	DF-DL-10188		Push Rod
	01/01→05/13	Stabiliser Link	DF-DL-12427		Suspension Rod
	01/01→05/13	Stabiliser Mounting	DF-SB-10402		
	01/01→05/13	Suspension Arm Repair Kit		DF-RK-9336	
	01/01→05/13	Tie Rod	DF-DL-5403		1st FA;2nd FA
	01/01→05/13	Tie Rod	DF-DL-7780		1st FA;2nd FA
	01/01→05/13	Tie Rod	DF-DL-10193		1st FA;2nd FA
	01/01→05/13	Tie Rod End	CV-ES-12461		for Steering Rod
	01/01→05/13	Tie Rod End	CV-ES-12462		for Steering Rod
	01/01→05/13	Tie Rod End	CV-ES-14162		for Steering Rod
	01/01→05/13	Tie Rod End	CV-ES-14163		for Steering Rod
	01/01→05/13	Tie Rod End	DF-ES-8602		
	01/01→05/13	Tie Rod End	SC-ES-8517		for Push Rod
	01/01→05/13	Track Control Arm		DF-DL-8158	Trailing Arm
	01/01→05/13	Track Control Arm		DF-DL-9318	Trailing Arm
	01/01→05/13	Track Control Arm		DF-TC-12262	Control Arm
	01/01→05/13	Track Control Arm		DF-VB-8561	Wishbone (CV)
	01/01→05/13	Track Control Arm		DF-VB-9343	Wishbone (CV), 1st RA;2nd RA, for Leaf-Spring Suspension vehicles
	FAD 85.510	10/05→05/13	Centre Rod	DF-DL-5237	
10/05→05/13		Centre Rod	DF-DL-8196		Push Rod
10/05→05/13		Stabiliser Mounting	DF-SB-10402		
10/05→05/13		Suspension Arm Repair Kit		DF-RK-9336	
10/05→05/13		Tie Rod	DF-DL-5403		
10/05→05/13		Tie Rod	DF-DL-7780		

CV-ES-12461

Length: 120
Cone Ø: d1 Ø 26 / d2 Ø 23,5
Thread: M30 x 1,5 LHT
0069513, 69513, 0311300, 311300,
0607998, 607998, 1190653, 1315447,
1319838, 1332123, 1338714, 1401934,
1407394, ACHB063, ACHF241, MAK1295



CV-ES-12462

Length: 120
Cone Ø: d1 Ø 26 / d2 Ø 23,5
Thread: M30 x 1,5 RHT
0069514, 0586753, 0607999, 0694298,
0694360, 0698609, 1137230, 1229944,
1326862, 1326896, 1331925, ACHB064,
ACHF242, MAK1296



CV-ES-14162

Length: 125
Cone Ø: d1 Ø 30 / d2 Ø 27
Thread: M30 x 1,5 LHT
607053, 690225, 696225, 1228115,
1611088



CV-ES-14163

Length: 125
Cone Ø: d1 Ø 30 / d2 Ø 27
Thread: M30 x 1,5 RHT
0607981, 0698450, 1149907, 1152350,
1257890, 1603789, 1618048, ACHF060



DF-DL-5237

Length: 880
Ø: 52
Cone Ø: d1 Ø 26 / d2 Ø 23,5
1283211, 1351714, 1385497, 10201000A



DF-DL-5403

Length: 1742
Ø: 40
Cone Ø: d1 Ø 26 / d2 Ø 23,5
0288281, 1270854, 1337644



DF-DL-7780

Length: 1690
Ø: 40
Cone Ø: d1 Ø 26 / d2 Ø 23,5
1270853, 1353391, 10212000A



DF-DL-8158

Length: 611
Ø: 48
Hole Distance: 130 / 130
0267743, 1361649, 1361650, 1656428



DF-DL-8196

Length: 867
Ø: 50
Cone Ø: d1 Ø 30 / d2 Ø 27
1363859, 1448063, 1602821



DF-DL-8703

Length: 1977
Ø: 52
Cone Ø: d1 Ø 30 / d2 Ø 27
1451122



DF-DL-9318

Length: 600
Ø: 50
Hole Distance: 130 / 130
0646373, 0655695, 0655697, 1284860,
1620438



DF-DL-10186

Length: 860
Ø: 38
Cone Ø: d1 Ø 30 / d2 Ø 27
1451118



DF-DL-10188

Length: 860
Ø: 36
Cone Ø: d1 Ø 30 / d2 Ø 27
1380417, 1451129



DF-DL-10193

Length: 1646
Ø: 40
Cone Ø: d1 Ø 26 / d2 Ø 23,5
1351205, 1353395



DF-DL-12427

Length: 2028
Ø: 36
Cone Ø: d1 Ø 30 / d2 Ø 27
1392962, 1801332



DF-ES-8602

Length: 95
Cone Ø: d1 Ø 30 / d2 Ø 27
Thread: M22 x 1,5 RHT
0273203, 1399724



DF-RK-9336

Ø: 108
1445656



DF-SB-10402

Ø: 62
Thick/Height: 60
1291233, 1732887



DF-TC-12262

Length: 595
Ø: 50
Hole Distance: 130 / 130
0661406, 661406, 661407, 0661407,
1620439



DF-VB-8561

Length: 609
Ø: 48
Hole Distance: 152 / 152
0080521, 080521, 1361651, 1368270,
1390932, 1617096, 1793875, 1817808,
1892492



DF-VB-9343

Length: 608,2
Ø: 48
Hole Distance: 152 / 152
1361652, 1620436, 1793876, 10309600A



SC-ES-8517

Length: 140
Cone Ø: d1 Ø 30 / d2 Ø 27
Thread: M30 x 1,5 RHT
1685552





CF 85 ...

FAD 85.510 ...	10/05→05/13	Tie Rod End	CV-ES-12461		for Steering Rod	
	10/05→05/13	Tie Rod End	CV-ES-12462		for Steering Rod	
	10/05→05/13	Tie Rod End	CV-ES-14162		for Steering Rod	
	10/05→05/13	Tie Rod End	CV-ES-14163		for Steering Rod	
	10/05→05/13	Tie Rod End	SG-ES-8517		for Push Rod	
	10/05→05/13	Track Control Arm		DF-DL-8158	Trailing Arm	
	10/05→05/13	Track Control Arm		DF-DL-9318	Trailing Arm, 1st RA;2nd RA, for Leaf-Spring Suspension vehicles	
	10/05→05/13	Track Control Arm		DF-TC-12262	Control Arm	
	10/05→05/13	Track Control Arm		DF-VB-8561	Wishbone (CV)	
	10/05→05/13	Track Control Arm		DF-VB-9343	Wishbone (CV), 1st RA;2nd RA, for Leaf-Spring Suspension vehicles	
FAG 85.340, FAN 85.340	01/01→05/13	Centre Rod	DF-DL-5237		Push Rod	
	01/01→05/13	Centre Rod	DF-DL-8196		Push Rod	
	01/01→05/13	Centre Rod	DF-DL-10188		Push Rod	
	01/01→05/13	Centre Rod	DF-DL-10192		Push Rod, for vehicles with Hinged Leading Axle	
	01/01→05/13	Centre Rod	DF-DL-12425		Push Rod	
	01/01→05/13	Stabiliser Mounting	DF-SB-10402			
	01/01→05/13	Suspension Arm Repair Kit		DF-RK-9336		
	01/01→05/13	Tie Rod		DF-DL-5403	Tag Axle	
	01/01→05/13	Tie Rod		DF-DL-7780	Tag Axle	
	01/01→05/13	Tie Rod		DF-ES-5761	Leading Axle	
	01/01→05/13	Tie Rod	DF-DL-5403		1st FA	
	01/01→05/13	Tie Rod	DF-DL-7780		1st FA	
	01/01→05/13	Tie Rod	DF-DL-10193		1st FA	
	01/01→05/13	Tie Rod End	CV-ES-12461		for Steering Rod	
	01/01→05/13	Tie Rod End	CV-ES-12462		for Steering Rod	
	01/01→05/13	Tie Rod End	CV-ES-14162	CV-ES-14162	for Steering Rod	
	01/01→05/13	Tie Rod End	CV-ES-14163		for Steering Rod	
	01/01→05/13	Tie Rod End	DF-ES-8362		for Steering Rod	
	01/01→05/13	Tie Rod End	DF-ES-12428		for Steering Rod	
	01/01→05/13	Track Control Arm		DF-DL-8158	Trailing Arm	
	01/01→05/13	Track Control Arm		DF-TC-12492	Control Arm	
	01/01→05/13	Track Control Arm		DF-VB-8561	Wishbone (CV)	
	FAG 85.360, FAN 85.360	10/06→05/13	Centre Rod	DF-DL-5237		Push Rod
		10/06→05/13	Centre Rod	DF-DL-8196		Push Rod
10/06→05/13		Centre Rod	DF-DL-10188		Push Rod	
10/06→05/13		Centre Rod	DF-DL-10192		Push Rod, for vehicles with Hinged Leading Axle	
10/06→05/13		Stabiliser Mounting	DF-SB-10402			
10/06→05/13		Suspension Arm Repair Kit		DF-RK-9336		
10/06→05/13		Suspension Arm Repair Kit	MN-RK-7280	MN-RK-7280	for Drag Link;for Semi-Trailing Arm; for Wishbone (CV)	
10/06→05/13		Tie Rod		DF-DL-5403	Tag Axle	
10/06→05/13		Tie Rod		DF-DL-7780	Tag Axle	
10/06→05/13		Tie Rod		DF-ES-5761	Leading Axle	
10/06→05/13		Tie Rod	DF-DL-5403		1st FA	
10/06→05/13		Tie Rod	DF-DL-7780		1st FA	
10/06→05/13		Tie Rod	DF-DL-8718		1st FA	
10/06→05/13		Tie Rod	DF-DL-10193		1st FA	
10/06→05/13		Tie Rod End	CV-ES-12461		for Steering Rod	
10/06→05/13		Tie Rod End	CV-ES-12462		for Steering Rod	
10/06→05/13		Tie Rod End	CV-ES-14162	CV-ES-14162	for Steering Rod	
10/06→05/13		Tie Rod End	CV-ES-14163		for Steering Rod	
10/06→05/13		Tie Rod End	DF-ES-8362		for Steering Rod	
10/06→05/13		Tie Rod End	DF-ES-12428		for Steering Rod	
10/06→05/13		Track Control Arm		DF-DL-8158	Trailing Arm	
10/06→05/13		Track Control Arm		DF-TC-12492	Control Arm	
10/06→05/13		Track Control Arm		DF-TC-12492	Trailing Arm, Leading Axle Steered, for Pneumatic Suspension vehicles	
10/06→05/13		Track Control Arm		DF-VB-8561	Wishbone (CV)	

CV-ES-12461

Length: 120
 Cone Ø: d1 Ø 26 / d2 Ø 23,5
 Thread: M30 x 1,5 LHT
 0069513, 69513, 0311300, 311300,
 0607998, 607998, 1190653, 1315447,
 1319838, 1332123, 1338714, 1401934,
 1407394, ACHB063, ACHF241, MAK1295

**CV-ES-12462**

Length: 120
 Cone Ø: d1 Ø 26 / d2 Ø 23,5
 Thread: M30 x 1,5 RHT
 0069514, 0586753, 0607999, 0694298,
 0694360, 0698609, 1137230, 1229944,
 1326862, 1326896, 1331925, ACHB064,
 ACHF242, MAK1296

**CV-ES-14162**

Length: 125
 Cone Ø: d1 Ø 30 / d2 Ø 27
 Thread: M30 x 1,5 LHT
 607053, 690225, 696225, 1228115,
 1611088

**CV-ES-14163**

Length: 125
 Cone Ø: d1 Ø 30 / d2 Ø 27
 Thread: M30 x 1,5 RHT
 0607981, 0698450, 1149907, 1152350,
 1257890, 1603789, 1618048, ACHF060

**DF-DL-5237**

Length: 880 Ø: 52
 Cone Ø: d1 Ø 26 / d2 Ø 23,5
 1283211, 1351714, 1385497, 10201000A

**DF-DL-5403**

Length: 1742 Ø: 40
 Cone Ø: d1 Ø 26 / d2 Ø 23,5
 0288281, 1270854, 1337644

**DF-DL-7780**

Length: 1690 Ø: 40
 Cone Ø: d1 Ø 26 / d2 Ø 23,5
 1270853, 1353391, 10212000A

**DF-DL-8158**

Length: 611 Ø: 48
 Hole Distance: 130 / 130
 0267743, 1361649, 1361650, 1656428

**DF-DL-8196**

Length: 867 Ø: 50
 Cone Ø: d1 Ø 30 / d2 Ø 27
 1363859, 1448063, 1602821

**DF-DL-8718**

Length: 1690 Ø: 40
 Cone Ø: d1 Ø 30 / d2 Ø 27
 1700000

**DF-DL-9318**

Length: 600 Ø: 50
 Hole Distance: 130 / 130
 0646373, 0655695, 0655697, 1284860,
 1620438

**DF-DL-10188**

Length: 860 Ø: 36
 Cone Ø: d1 Ø 30 / d2 Ø 27
 1380417, 1451129

**DF-DL-10192**

Length: 590 Ø: 38
 Cone Ø: d1 Ø 30 / d2 Ø 27
 1440171, 1451119

**DF-DL-10193**

Length: 1646 Ø: 40
 Cone Ø: d1 Ø 26 / d2 Ø 23,5
 1351205, 1353395

**DF-DL-12425**

Length: 865 Ø: 52
 Cone Ø: d1 Ø 30 / d2 Ø 27
 1373878, 1448064

**DF-ES-5761**

Length: 1512 Ø: 52
 Cone Ø: d1 Ø 26 / d2 Ø 23,5
 1297572, 1361155

**DF-ES-8362**

Length: 150
 Cone Ø: d1 Ø 26 / d2 Ø 23,5
 Thread: M30 x 1,5 RHT
 1389190

**DF-ES-12428**

Length: 120
 Cone Ø: d1 Ø 30
 Thread: M24 x 1,5 RHT
 1603788, 1604105

**DF-RK-9336**

Ø: 108
 1445656

**DF-SB-10402**

Ø: 62
 Thick/Height: 60
 1291233, 1732887

**DF-TC-12262**

Length: 595 Ø: 50
 Hole Distance: 130 / 130
 0661406, 661406, 0661407, 661407,
 1620439

**DF-TC-12492**

Length: 600 Ø: 40
 Hole Distance: 115 / 115
 1274741

No Image

DF-VB-8561

Length: 609 Ø: 48
 Hole Distance: 152 / 152
 0080521, 080521, 1361651, 1368270,
 1390932, 1617096, 1793875, 1817808,
 1892492

**DF-VB-9343**

Length: 608,2 Ø: 48
 Hole Distance: 152 / 152
 1361652, 1620436, 1793876, 10309600A

**MN-RK-7280**

Ø: 75
 Hole Distance: 115
 Thick/Height: 24
 0689748, 689748

**SC-ES-8517**

Length: 140
 Cone Ø: d1 Ø 30 / d2 Ø 27
 Thread: M30 x 1,5 RHT
 1685552





CF 85 ...

FAG 85.380, FAN 85.380	01/01→05/13	Centre Rod	DF-DL-5237		Push Rod	
	01/01→05/13	Centre Rod	DF-DL-8196		Push Rod	
	01/01→05/13	Centre Rod	DF-DL-8363		Push Rod	
	01/01→05/13	Centre Rod	DF-DL-10188		Push Rod	
	01/01→05/13	Centre Rod	DF-DL-10192		Push Rod, for vehicles with Hinged Leading Axle	
	01/01→05/13	Centre Rod	DF-DL-12425		Push Rod	
	01/01→05/13	Stabiliser Mounting	DF-SB-10402			
	01/01→05/13	Suspension Arm Repair Kit		DF-RK-9336		
	01/01→05/13	Tie Rod		DF-DL-5403	Tag Axle	
	01/01→05/13	Tie Rod		DF-DL-7780	Tag Axle	
	01/01→05/13	Tie Rod		DF-ES-5761	Leading Axle	
	01/01→05/13	Tie Rod	DF-DL-5403		1st FA	
	01/01→05/13	Tie Rod	DF-DL-7780		1st FA	
	01/01→05/13	Tie Rod	DF-DL-10193		1st FA	
	01/01→05/13	Tie Rod End	CV-ES-12461		for Steering Rod	
	01/01→05/13	Tie Rod End	CV-ES-12462		for Steering Rod	
	01/01→05/13	Tie Rod End	CV-ES-14162	CV-ES-14162	for Steering Rod	
	01/01→05/13	Tie Rod End	CV-ES-14163		for Steering Rod	
	01/01→05/13	Tie Rod End	DF-ES-8362		for Steering Rod	
	01/01→05/13	Tie Rod End	DF-ES-12428		for Steering Rod	
	01/01→05/13	Track Control Arm		DF-DL-8158	Trailing Arm	
	01/01→05/13	Track Control Arm		DF-TC-12492	Control Arm	
	01/01→05/13	Track Control Arm		DF-VB-8561	Wishbone (CV)	
	FAG 85.410, FAN 85.410	10/05→05/13	Centre Rod	DF-DL-5237		Push Rod
		10/05→05/13	Centre Rod	DF-DL-8196		Push Rod
		10/05→05/13	Centre Rod	DF-DL-10188		Push Rod
		10/05→05/13	Centre Rod	DF-DL-10192		Push Rod, for vehicles with Hinged Leading Axle
10/05→05/13		Centre Rod	DF-DL-12425		Push Rod	
10/05→05/13		Stabiliser Mounting	DF-SB-10402			
10/05→05/13		Suspension Arm Repair Kit		DF-RK-9336		
10/05→05/13		Tie Rod		DF-DL-5403	Tag Axle	
10/05→05/13		Tie Rod		DF-DL-7780	Tag Axle	
10/05→05/13		Tie Rod		DF-ES-5761	Leading Axle	
10/05→05/13		Tie Rod	DF-DL-5403		1st FA	
10/05→05/13		Tie Rod	DF-DL-7780		1st FA	
10/05→05/13		Tie Rod	DF-DL-7836		1st FA	
10/05→05/13		Tie Rod End	CV-ES-12461		for Steering Rod	
10/05→05/13		Tie Rod End	CV-ES-12462		for Steering Rod	
10/05→05/13		Tie Rod End	CV-ES-14162	CV-ES-14162	for Steering Rod	
10/05→05/13		Tie Rod End	CV-ES-14163		for Steering Rod	
10/05→05/13		Tie Rod End	DF-ES-8362		for Steering Rod	
10/05→05/13		Tie Rod End	DF-ES-12428		for Steering Rod	
10/05→05/13		Track Control Arm		DF-DL-8158	Trailing Arm	
10/05→05/13		Track Control Arm		DF-TC-12492	Control Arm	
10/05→05/13		Track Control Arm		DF-VB-8561	Wishbone (CV)	
10/06→05/13		Suspension Arm Repair Kit	MN-RK-7280	MN-RK-7280	for Drag Link; for Semi-Trailing Arm; for Wishbone (CV)	
10/06→05/13		Track Control Arm		DF-TC-12492	Trailing Arm, Leading Axle Steered, for Pneumatic Suspension vehicles	
FAG 85.430, FAN 85.430		01/01→05/13	Centre Rod	DF-DL-5237		Push Rod
		01/01→05/13	Centre Rod	DF-DL-8196		Push Rod
		01/01→05/13	Centre Rod	DF-DL-8363		Push Rod
	01/01→05/13	Centre Rod	DF-DL-10188		Push Rod	
	01/01→05/13	Centre Rod	DF-DL-10192		Push Rod, for vehicles with Hinged Leading Axle	
	01/01→05/13	Centre Rod	DF-DL-12425		Push Rod	
	01/01→05/13	Stabiliser Mounting	DF-SB-10402			
	01/01→05/13	Suspension Arm Repair Kit		DF-RK-9336		
	01/01→05/13	Tie Rod		DF-DL-5403	Tag Axle	
	01/01→05/13	Tie Rod		DF-DL-7780	Tag Axle	
	01/01→05/13	Tie Rod		DF-ES-5761	Leading Axle	
	01/01→05/13	Tie Rod	DF-DL-5403		1st FA	
	01/01→05/13	Tie Rod	DF-DL-7780		1st FA	
	01/01→05/13	Tie Rod	DF-DL-10193		1st FA	

CV-ES-12461

Length: 120
Cone Ø: d1 Ø 26 / d2 Ø 23,5
Thread: M30 x 1,5 LHT
0069513, 69513, 311300, 0311300, 607998, 0607998, 1190653, 1315447, 1319838, 1332123, 1338714, 1401934, 1407394, ACHB063, ACHF241, MAK1295



CV-ES-12462

Length: 120
Cone Ø: d1 Ø 26 / d2 Ø 23,5
Thread: M30 x 1,5 RHT
0069514, 0586753, 0607999, 0694298, 0694360, 0698609, 1137230, 1229944, 1326862, 1326896, 1331925, ACHB064, ACHF242, MAK1296



CV-ES-14162

Length: 125
Cone Ø: d1 Ø 30 / d2 Ø 27
Thread: M30 x 1,5 LHT
607053, 690225, 696225, 1228115, 1611088



CV-ES-14163

Length: 125
Cone Ø: d1 Ø 30 / d2 Ø 27
Thread: M30 x 1,5 RHT
0607981, 0698450, 1149907, 1152350, 1257890, 1603789, 1618048, ACHF060



DF-DL-5237

Length: 880
Ø: 52
Cone Ø: d1 Ø 26 / d2 Ø 23,5
1283211, 1351714, 1385497, 10201000A



DF-DL-5403

Length: 1742
Ø: 40
Cone Ø: d1 Ø 26 / d2 Ø 23,5
0288281, 1270854, 1337644



DF-DL-7780

Length: 1690
Ø: 40
Cone Ø: d1 Ø 26 / d2 Ø 23,5
1270853, 1353391, 10212000A



DF-DL-7836

Length: 1698
Ø: 52
Cone Ø: d1 Ø 26 / d2 Ø 23,5
0754922, 1286343, 1353396



DF-DL-8158

Length: 611
Ø: 48
Hole Distance: 130 / 130
0267743, 1361649, 1361650, 1656428



DF-DL-8196

Length: 867
Ø: 50
Cone Ø: d1 Ø 30 / d2 Ø 27
1363859, 1448063, 1602821



DF-DL-8363

Length: 855
Ø: 50
Cone Ø: d1 Ø 30 / d2 Ø 27
1363858, 1448062, 1602820



DF-DL-10188

Length: 860
Ø: 36
Cone Ø: d1 Ø 30 / d2 Ø 27
1380417, 1451129



DF-DL-10192

Length: 590
Ø: 38
Cone Ø: d1 Ø 30 / d2 Ø 27
1440171, 1451119



DF-DL-10193

Length: 1646
Ø: 40
Cone Ø: d1 Ø 26 / d2 Ø 23,5
1351205, 1353395



DF-DL-12425

Length: 865
Ø: 52
Cone Ø: d1 Ø 30 / d2 Ø 27
1373878, 1448064



DF-ES-5761

Length: 1512
Ø: 52
Cone Ø: d1 Ø 26 / d2 Ø 23,5
1297572, 1361155



DF-ES-8362

Length: 150
Cone Ø: d1 Ø 26 / d2 Ø 23,5
Thread: M30 x 1,5 RHT
1389190



DF-ES-12428

Length: 120
Cone Ø: d1 Ø 30
Thread: M24 x 1,5 RHT
1603788, 1604105



DF-RK-9336

Ø: 108
1445656



DF-SB-10402

Ø: 62
Thick/Height: 60
1291233, 1732887



DF-TC-12492

Length: 600
Ø: 40
Hole Distance: 115 / 115
1274741

No Image

DF-VB-8561

Length: 609
Ø: 48
Hole Distance: 152 / 152
0080521, 080521, 1361651, 1368270, 1390932, 1617096, 1793875, 1817808, 1892492



MN-RK-7280

Ø: 75
Hole Distance: 115
Thick/Height: 24
0689748, 689748





CF 85 ...

FAG 85.430, FAN 85.430 ...	01/01→05/13	Tie Rod End	CV-ES-12461		for Steering Rod	
	01/01→05/13	Tie Rod End	CV-ES-12462		for Steering Rod	
	01/01→05/13	Tie Rod End	CV-ES-14162	CV-ES-14162	for Steering Rod	
	01/01→05/13	Tie Rod End	CV-ES-14163		for Steering Rod	
	01/01→05/13	Tie Rod End	DF-ES-8362		for Steering Rod	
	01/01→05/13	Tie Rod End	DF-ES-12428		for Steering Rod	
	01/01→05/13	Track Control Arm		DF-DL-8158	Trailing Arm	
	01/01→05/13	Track Control Arm		DF-TC-12492	Control Arm	
	01/01→05/13	Track Control Arm		DF-VB-8561	Wishbone (CV)	
FAG 85.460, FAN 85.460	10/05→05/13	Centre Rod	DF-DL-5237		Push Rod	
	10/05→05/13	Centre Rod	DF-DL-8196		Push Rod	
	10/05→05/13	Centre Rod	DF-DL-10188		Push Rod	
	10/05→05/13	Centre Rod	DF-DL-12425		Push Rod	
	10/05→05/13	Stabiliser Mounting	DF-SB-10402			
	10/05→05/13	Suspension Arm Repair Kit		DF-RK-9336		
	10/05→05/13	Tie Rod		DF-DL-5403	Tag Axle	
	10/05→05/13	Tie Rod		DF-DL-7780	Tag Axle	
	10/05→05/13	Tie Rod		DF-DL-8718	Tag Axle	
	10/05→05/13	Tie Rod	DF-DL-5403		1st FA	
	10/05→05/13	Tie Rod	DF-DL-7780		1st FA	
	10/05→05/13	Tie Rod	DF-DL-7836		1st FA	
	10/05→05/13	Tie Rod	DF-DL-8718		1st FA	
	10/05→05/13	Tie Rod	DF-DL-10193		1st FA	
	10/05→05/13	Tie Rod End	CV-ES-12461		for Steering Rod	
	10/05→05/13	Tie Rod End	CV-ES-12462		for Steering Rod	
	10/05→05/13	Tie Rod End	CV-ES-14162	CV-ES-14162	for Steering Rod	
	10/05→05/13	Tie Rod End	CV-ES-14163		for Steering Rod	
	10/05→05/13	Tie Rod End	DF-ES-8362		for Steering Rod	
	10/05→05/13	Tie Rod End	DF-ES-12428		for Steering Rod	
	10/05→05/13	Track Control Arm		DF-DL-8158	Trailing Arm	
	10/05→05/13	Track Control Arm		DF-TC-12492	Trailing Arm, Leading Axle Steered, for Pneumatic Suspension vehicles	
	10/05→05/13	Track Control Arm		DF-VB-8561	Wishbone (CV)	
	10/06→05/13	Suspension Arm Repair Kit	MN-RK-7280	MN-RK-7280	for Drag Link; for Semi-Trailing Arm; for Wishbone (CV)	
	FAG 85.480, FAN 85.480	01/01→05/13	Centre Rod	DF-DL-5237		Push Rod
		01/01→05/13	Centre Rod	DF-DL-8196		Push Rod
		01/01→05/13	Centre Rod	DF-DL-8363		Push Rod
01/01→05/13		Centre Rod	DF-DL-10188		Push Rod	
01/01→05/13		Centre Rod	DF-DL-10192		Push Rod, for vehicles with Hinged Leading Axle	
01/01→05/13		Centre Rod	DF-DL-12425		Push Rod	
01/01→05/13		Stabiliser Mounting	DF-SB-10402			
01/01→05/13		Suspension Arm Repair Kit		DF-RK-9336		
01/01→05/13		Tie Rod		DF-DL-5403	Tag Axle	
01/01→05/13		Tie Rod		DF-DL-7780	Tag Axle	
01/01→05/13		Tie Rod		DF-ES-5761	Leading Axle	
01/01→05/13		Tie Rod	DF-DL-5403		1st FA	
01/01→05/13		Tie Rod	DF-DL-7780		1st FA	
01/01→05/13		Tie Rod	DF-DL-10193		1st FA	
01/01→05/13		Tie Rod End	CV-ES-12461		for Steering Rod	
01/01→05/13		Tie Rod End	CV-ES-12462		for Steering Rod	
01/01→05/13		Tie Rod End	CV-ES-14162	CV-ES-14162	for Steering Rod	
01/01→05/13		Tie Rod End	CV-ES-14163		for Steering Rod	
01/01→05/13		Tie Rod End	DF-ES-8362		for Steering Rod	
01/01→05/13		Tie Rod End	DF-ES-12428		for Steering Rod	
01/01→05/13		Track Control Arm		DF-DL-8158	Trailing Arm	
01/01→05/13		Track Control Arm		DF-TC-12492	Control Arm	
01/01→05/13		Track Control Arm		DF-VB-8561	Wishbone (CV)	
FAG 85.510, FAN 85.510		10/05→05/13	Centre Rod	DF-DL-5237		Push Rod
		10/05→05/13	Centre Rod	DF-DL-8196		Push Rod
		10/05→05/13	Stabiliser Mounting	DF-SB-10402		
		10/05→05/13	Suspension Arm Repair Kit		DF-RK-9336	
	10/05→05/13	Tie Rod	DF-DL-5403			

CV-ES-12461

Length: 120
Cone Ø: d1 Ø 26 / d2 Ø 23,5
Thread: M30 x 1,5 LHT
0069513, 69513, 0311300, 311300,
0607998, 607998, 1190653, 1315447,
1319838, 1332123, 1338714, 1401934,
1407394, ACHB063, ACHF241, MAK1295



CV-ES-12462

Length: 120
Cone Ø: d1 Ø 26 / d2 Ø 23,5
Thread: M30 x 1,5 RHT
0069514, 0586753, 0607999, 0694298,
0694360, 0698609, 1137230, 1229944,
1326862, 1326896, 1331925, ACHB064,
ACHF242, MAK1296



CV-ES-14162

Length: 125
Cone Ø: d1 Ø 30 / d2 Ø 27
Thread: M30 x 1,5 LHT
607053, 690225, 696225, 1228115,
1611088



CV-ES-14163

Length: 125
Cone Ø: d1 Ø 30 / d2 Ø 27
Thread: M30 x 1,5 RHT
0607981, 0698450, 1149907, 1152350,
1257890, 1603789, 1618048, ACHF060



DF-DL-5237

Length: 880 Ø: 52
Cone Ø: d1 Ø 26 / d2 Ø 23,5
1283211, 1351714, 1385497, 10201000A



DF-DL-5403

Length: 1742 Ø: 40
Cone Ø: d1 Ø 26 / d2 Ø 23,5
0288281, 1270854, 1337644



DF-DL-7780

Length: 1690 Ø: 40
Cone Ø: d1 Ø 26 / d2 Ø 23,5
1270853, 1353391, 10212000A



DF-DL-7836

Length: 1698 Ø: 52
Cone Ø: d1 Ø 26 / d2 Ø 23,5
0754922, 1286343, 1353396



DF-DL-8158

Length: 611 Ø: 48
Hole Distance: 130 / 130
0267743, 1361649, 1361650, 1656428



DF-DL-8196

Length: 867 Ø: 50
Cone Ø: d1 Ø 30 / d2 Ø 27
1363859, 1448063, 1602821



DF-DL-8363

Length: 855 Ø: 50
Cone Ø: d1 Ø 30 / d2 Ø 27
1363858, 1448062, 1602820



DF-DL-8718

Length: 1690 Ø: 40
Cone Ø: d1 Ø 30 / d2 Ø 27
1700000



DF-DL-10188

Length: 860 Ø: 36
Cone Ø: d1 Ø 30 / d2 Ø 27
1380417, 1451129



DF-DL-10192

Length: 590 Ø: 38
Cone Ø: d1 Ø 30 / d2 Ø 27
1440171, 1451119



DF-DL-10193

Length: 1646 Ø: 40
Cone Ø: d1 Ø 26 / d2 Ø 23,5
1351205, 1353395



DF-DL-12425

Length: 865 Ø: 52
Cone Ø: d1 Ø 30 / d2 Ø 27
1373878, 1448064



DF-ES-5761

Length: 1512 Ø: 52
Cone Ø: d1 Ø 26 / d2 Ø 23,5
1297572, 1361155



DF-ES-8362

Length: 150
Cone Ø: d1 Ø 26 / d2 Ø 23,5
Thread: M30 x 1,5 RHT
1389190



DF-ES-12428

Length: 120
Cone Ø: d1 Ø 30
Thread: M24 x 1,5 RHT
1603788, 1604105



DF-RK-9336

Ø: 108
1445656



DF-SB-10402

Ø: 62
Thick/Height: 60
1291233, 1732887



DF-TC-12492

Length: 600 Ø: 40
Hole Distance: 115 / 115
1274741

No Image

DF-VB-8561

Length: 609 Ø: 48
Hole Distance: 152 / 152
0080521, 080521, 1361651, 1368270,
1390932, 1617096, 1793875, 1817808,
1892492



MN-RK-7280

Ø: 75
Hole Distance: 115
Thick/Height: 24
0689748, 689748





CF 85 ...

FAG 85.510, FAN 85.510 ...	10/05→05/13	Tie Rod	DF-DL-7780		
	10/05→05/13	Tie Rod End	CV-ES-12461		for Steering Rod
	10/05→05/13	Tie Rod End	CV-ES-12462		for Steering Rod
	10/05→05/13	Tie Rod End	CV-ES-14162	CV-ES-14162	for Steering Rod
	10/05→05/13	Tie Rod End	CV-ES-14163		for Steering Rod
	10/05→05/13	Tie Rod End	DF-ES-8362		for Steering Rod
	10/05→05/13	Tie Rod End	DF-ES-12428		for Steering Rod
	10/05→05/13	Track Control Arm		DF-DL-8158	Trailing Arm
	10/05→05/13	Track Control Arm		DF-TC-12492	Trailing Arm, Leading Axle Steered, for Pneumatic Suspension vehicles
FAN 85.360	10/05→05/13	Track Control Arm		DF-VB-8561	Wishbone (CV)
	10/06→05/13	Centre Rod	DF-DL-8196		Push Rod
	10/06→05/13	Centre Rod	DF-DL-8363		Push Rod
	10/06→05/13	Centre Rod	DF-DL-10188		Push Rod
	10/06→05/13	Centre Rod	DF-DL-10192		Push Rod
	10/06→05/13	Suspension Arm Repair Kit		DF-RK-9336	
	10/06→05/13	Suspension Arm Repair Kit	MN-RK-7280	MN-RK-7280	for Drag Link;for Semi-Trailing Arm; for Wishbone (CV)
	10/06→05/13	Tie Rod		DF-DL-7780	
	10/06→05/13	Tie Rod		DF-DL-8718	
	10/06→05/13	Tie Rod		DF-ES-5761	Leading Axle
	10/06→05/13	Tie Rod	DF-DL-5403		
	10/06→05/13	Tie Rod	DF-DL-7836		
	10/06→05/13	Tie Rod End	CV-ES-12461		for Steering Rod
	10/06→05/13	Tie Rod End	CV-ES-12462		for Steering Rod
	10/06→05/13	Tie Rod End	CV-ES-14162	CV-ES-14162	for Steering Rod
	10/06→05/13	Tie Rod End	CV-ES-14163		for Steering Rod
	10/06→05/13	Tie Rod End	DF-ES-8362		for Steering Rod
	10/06→05/13	Track Control Arm		DF-DL-8158	Trailing Arm
	10/06→05/13	Track Control Arm		DF-TC-12492	Trailing Arm, Leading Axle Steered, for Pneumatic Suspension vehicles
FAN 85.410	10/06→05/13	Track Control Arm		DF-VB-8561	Wishbone (CV)
	10/06→05/13	Centre Rod	DF-DL-8196		Push Rod
	10/06→05/13	Centre Rod	DF-DL-8363		Push Rod
	10/06→05/13	Centre Rod	DF-DL-10188		Push Rod
	10/06→05/13	Centre Rod	DF-DL-10192		Push Rod
	10/06→05/13	Suspension Arm Repair Kit		DF-RK-9336	
	10/06→05/13	Suspension Arm Repair Kit	MN-RK-7280	MN-RK-7280	for Drag Link;for Semi-Trailing Arm; for Wishbone (CV)
	10/06→05/13	Tie Rod		DF-DL-7780	
	10/06→05/13	Tie Rod		DF-DL-8718	
	10/06→05/13	Tie Rod		DF-ES-5761	Leading Axle
	10/06→05/13	Tie Rod	DF-DL-5403		
	10/06→05/13	Tie Rod	DF-DL-7836		
	10/06→05/13	Tie Rod End	CV-ES-12461		for Steering Rod
	10/06→05/13	Tie Rod End	CV-ES-12462		for Steering Rod
	10/06→05/13	Tie Rod End	CV-ES-14162	CV-ES-14162	for Steering Rod
	10/06→05/13	Tie Rod End	CV-ES-14163		for Steering Rod
	10/06→05/13	Tie Rod End	DF-ES-8362		for Steering Rod
	10/06→05/13	Track Control Arm		DF-DL-8158	Trailing Arm
	10/06→05/13	Track Control Arm		DF-TC-12492	Trailing Arm, Leading Axle Steered, for Pneumatic Suspension vehicles
FAN 85.460	10/06→05/13	Track Control Arm		DF-VB-8561	Wishbone (CV)
	10/06→05/13	Centre Rod	DF-DL-8196		Push Rod
	10/06→05/13	Centre Rod	DF-DL-8363		Push Rod
	10/06→05/13	Centre Rod	DF-DL-10188		Push Rod
	10/06→05/13	Centre Rod	DF-DL-10192		Push Rod
	10/06→05/13	Suspension Arm Repair Kit		DF-RK-9336	
	10/06→05/13	Suspension Arm Repair Kit	MN-RK-7280	MN-RK-7280	for Drag Link;for Semi-Trailing Arm; for Wishbone (CV)
	10/06→05/13	Tie Rod		DF-DL-7780	
	10/06→05/13	Tie Rod		DF-DL-8718	
	10/06→05/13	Tie Rod		DF-ES-5761	Leading Axle

CV-ES-12461

Length: 120
Cone Ø: d1 Ø 26 / d2 Ø 23,5
Thread: M30 x 1,5 LHT
0069513, 69513, 0311300, 311300,
0607998, 607998, 1190653, 1315447,
1319838, 1332123, 1338714, 1401934,
1407394, ACHB063, ACHF241, MAK1295



CV-ES-12462

Length: 120
Cone Ø: d1 Ø 26 / d2 Ø 23,5
Thread: M30 x 1,5 RHT
0069514, 0586753, 0607999, 0694298,
0694360, 0698609, 1137230, 1229944,
1326862, 1326896, 1331925, ACHB064,
ACHF242, MAK1296



CV-ES-14162

Length: 125
Cone Ø: d1 Ø 30 / d2 Ø 27
Thread: M30 x 1,5 LHT
607053, 690225, 696225, 1228115,
1611088



CV-ES-14163

Length: 125
Cone Ø: d1 Ø 30 / d2 Ø 27
Thread: M30 x 1,5 RHT
0607981, 0698450, 1149907, 1152350,
1257890, 1603789, 1618048, ACHF060



DF-DL-5403

Length: 1742
Ø: 40
Cone Ø: d1 Ø 26 / d2 Ø 23,5
0288281, 1270854, 1337644



DF-DL-7780

Length: 1690
Ø: 40
Cone Ø: d1 Ø 26 / d2 Ø 23,5
1270853, 1353391, 10212000A



DF-DL-7836

Length: 1698
Ø: 52
Cone Ø: d1 Ø 26 / d2 Ø 23,5
0754922, 1286343, 1353396



DF-DL-8158

Length: 611
Ø: 48
Hole Distance: 130 / 130
0267743, 1361649, 1361650, 1656428



DF-DL-8196

Length: 867
Ø: 50
Cone Ø: d1 Ø 30 / d2 Ø 27
1363859, 1448063, 1602821



DF-DL-8363

Length: 855
Ø: 50
Cone Ø: d1 Ø 30 / d2 Ø 27
1363858, 1448062, 1602820



DF-DL-8718

Length: 1690
Ø: 40
Cone Ø: d1 Ø 30 / d2 Ø 27
1700000



DF-DL-10188

Length: 860
Ø: 36
Cone Ø: d1 Ø 30 / d2 Ø 27
1380417, 1451129



DF-DL-10192

Length: 590
Ø: 38
Cone Ø: d1 Ø 30 / d2 Ø 27
1440171, 1451119



DF-ES-5761

Length: 1512
Ø: 52
Cone Ø: d1 Ø 26 / d2 Ø 23,5
1297572, 1361155



DF-ES-8362

Length: 150
Cone Ø: d1 Ø 26 / d2 Ø 23,5
Thread: M30 x 1,5 RHT
1389190



DF-ES-12428

Length: 120
Cone Ø: d1 Ø 30
Thread: M24 x 1,5 RHT
1603788, 1604105



DF-RK-9336

Ø: 108
1445656



DF-TC-12492

Length: 600
Ø: 40
Hole Distance: 115 / 115
1274741

No Image

DF-VB-8561

Length: 609
Ø: 48
Hole Distance: 152 / 152
0080521, 080521, 1361651, 1368270,
1390932, 1617096, 1793875, 1817808,
1892492



MN-RK-7280

Ø: 75
Hole Distance: 115
Thick/Height: 24
0689748, 689748





CF 85 ...

FAN 85.460 ...	10/06→05/13	Tie Rod	DF-DL-5403			
	10/06→05/13	Tie Rod	DF-DL-7836			
	10/06→05/13	Tie Rod End	CV-ES-12461		for Steering Rod	
	10/06→05/13	Tie Rod End	CV-ES-12462		for Steering Rod	
	10/06→05/13	Tie Rod End	CV-ES-14162	CV-ES-14162	for Steering Rod	
	10/06→05/13	Tie Rod End	CV-ES-14163		for Steering Rod	
	10/06→05/13	Tie Rod End	DF-ES-8362		for Steering Rod	
	10/06→05/13	Track Control Arm		DF-DL-8158	Trailing Arm	
	10/06→05/13	Track Control Arm		DF-TC-12492	Trailing Arm, Leading Axle Steered, for Pneumatic Suspension vehicles	
FAN 85.510	10/06→05/13	Track Control Arm		DF-VB-8561	Wishbone (CV)	
	10/06→05/13	Tie Rod End	CV-ES-12461		for Steering Rod	
	10/06→05/13	Tie Rod End	CV-ES-12462		for Steering Rod	
FAQ 85.360	10/06→05/13	Tie Rod End	CV-ES-14163		for Steering Rod	
	10/06→05/13	Tie Rod End	CV-ES-12461		for Steering Rod	
	10/06→05/13	Tie Rod End	CV-ES-12462		for Steering Rod	
FAQ 85.410	10/06→05/13	Tie Rod End	CV-ES-14163		for Steering Rod	
	10/06→05/13	Tie Rod End	CV-ES-12461		for Steering Rod	
	10/06→05/13	Tie Rod End	CV-ES-12462		for Steering Rod	
FAQ 85.460	10/06→05/13	Tie Rod End	CV-ES-14163		for Steering Rod	
	10/06→05/13	Tie Rod End	CV-ES-12461		for Steering Rod	
	10/06→05/13	Tie Rod End	CV-ES-12462		for Steering Rod	
FAQ 85.510	10/06→05/13	Tie Rod End	CV-ES-14163		for Steering Rod	
	10/06→05/13	Tie Rod End	CV-ES-12461		for Steering Rod	
	10/06→05/13	Tie Rod End	CV-ES-12462		for Steering Rod	
FAR 85.340, FAS 85.340	01/01→05/13	Centre Rod	DF-DL-5237		Push Rod	
	01/01→05/13	Centre Rod	DF-DL-8196		Push Rod	
	01/01→05/13	Centre Rod	DF-DL-8363		Push Rod	
	01/01→05/13	Centre Rod	DF-DL-10188		Push Rod	
	01/01→05/13	Centre Rod	DF-DL-12425		Push Rod	
	01/01→05/13	Stabiliser Mounting	DF-SB-10402			
	01/01→05/13	Suspension Arm Repair Kit		DF-RK-9336		
	01/01→05/13	Tie Rod	DF-DL-5403		1st FA	
	01/01→05/13	Tie Rod	DF-DL-7780		1st FA	
	01/01→05/13	Tie Rod	DF-DL-7836		1st FA	
	01/01→05/13	Tie Rod	DF-DL-10193		1st FA	
	01/01→05/13	Tie Rod End	CV-ES-12461		for Steering Rod	
	01/01→05/13	Tie Rod End	CV-ES-12462		for Steering Rod	
	01/01→05/13	Tie Rod End	CV-ES-14162		for Steering Rod	
	01/01→05/13	Tie Rod End	CV-ES-14163		for Steering Rod	
	01/01→05/13	Tie Rod End	DF-ES-8362		for Steering Rod	
	01/01→05/13	Track Control Arm		DF-DL-8158	Trailing Arm	
	01/01→05/13	Track Control Arm		DF-DL-9331	Wishbone (CV), 1st RA, for Pneumatic Suspension vehicles	
	01/01→05/13	Track Control Arm		DF-VB-8561	Wishbone (CV)	
	FAR 85.360	10/06→05/13	Centre Rod	DF-DL-8196		Push Rod
		10/06→05/13	Centre Rod	DF-DL-8363		Push Rod
10/06→05/13		Suspension Arm Repair Kit		DF-RK-9336		
10/06→05/13		Suspension Arm Repair Kit		MN-RK-7291	for Drag Link	
10/06→05/13		Suspension Arm Repair Kit	CV-RK-1583	CV-RK-1583	Trailing Arm	
10/06→05/13		Suspension Arm Repair Kit	MN-RK-7280	MN-RK-7280	for Drag Link;for Semi-Trailing Arm; for Wishbone (CV)	
10/06→05/13		Tie Rod	DF-DL-5403			
10/06→05/13		Tie Rod	DF-DL-7780			
10/06→05/13		Tie Rod	DF-DL-7836			
10/06→05/13		Tie Rod	DF-DL-8718			
10/06→05/13		Tie Rod End	CV-ES-12461		for Steering Rod	
10/06→05/13		Tie Rod End	CV-ES-12462		for Steering Rod	
10/06→05/13		Tie Rod End	CV-ES-14162		for Steering Rod	
10/06→05/13		Tie Rod End	CV-ES-14163		for Steering Rod	
10/06→05/13		Tie Rod End	DF-ES-8362		for Steering Rod	

CV-ES-12461

Length: 120
Cone Ø: d1 Ø 26 / d2 Ø 23,5
Thread: M30 x 1,5 LHT
0069513, 69513, 0311300, 311300,
0607998, 607998, 1190653, 1315447,
1319838, 1332123, 1338714, 1401934,
1407394, ACHB063, ACHF241, MAK1295



CV-ES-12462

Length: 120
Cone Ø: d1 Ø 26 / d2 Ø 23,5
Thread: M30 x 1,5 RHT
0069514, 0586753, 0607999, 0694298,
0694360, 0698609, 1137230, 1229944,
1326862, 1326896, 1331925, ACHB064,
ACHF242, MAK1296



CV-ES-14162

Length: 125
Cone Ø: d1 Ø 30 / d2 Ø 27
Thread: M30 x 1,5 LHT
607053, 690225, 696225, 1228115,
1611088



CV-ES-14163

Length: 125
Cone Ø: d1 Ø 30 / d2 Ø 27
Thread: M30 x 1,5 RHT
0607981, 0698450, 1149907, 1152350,
1257890, 1603789, 1618048, ACHF060



CV-RK-1583



DF-DL-5237

Length: 880 Ø: 52
Cone Ø: d1 Ø 26 / d2 Ø 23,5
1283211, 1351714, 1385497, 10201000A



DF-DL-5403

Length: 1742 Ø: 40
Cone Ø: d1 Ø 26 / d2 Ø 23,5
0288281, 1270854, 1337644



DF-DL-7780

Length: 1690 Ø: 40
Cone Ø: d1 Ø 26 / d2 Ø 23,5
1270853, 1353391, 10212000A



DF-DL-7836

Length: 1698 Ø: 52
Cone Ø: d1 Ø 26 / d2 Ø 23,5
0754922, 1286343, 1353396



DF-DL-8158

Length: 611 Ø: 48
Hole Distance: 130 / 130
0267743, 1361649, 1361650, 1656428



DF-DL-8196

Length: 867 Ø: 50
Cone Ø: d1 Ø 30 / d2 Ø 27
1363859, 1448063, 1602821



DF-DL-8363

Length: 855 Ø: 50
Cone Ø: d1 Ø 30 / d2 Ø 27
1363858, 1448062, 1602820



DF-DL-8718

Length: 1690 Ø: 40
Cone Ø: d1 Ø 30 / d2 Ø 27
1700000



DF-DL-9331

Length: 390 Ø: 50
Hole Distance: 130 / 152
1261101



DF-DL-10188

Length: 860 Ø: 36
Cone Ø: d1 Ø 30 / d2 Ø 27
1380417, 1451129



DF-DL-10193

Length: 1646 Ø: 40
Cone Ø: d1 Ø 26 / d2 Ø 23,5
1351205, 1353395



DF-DL-12425

Length: 865 Ø: 52
Cone Ø: d1 Ø 30 / d2 Ø 27
1373878, 1448064



DF-ES-8362

Length: 150
Cone Ø: d1 Ø 26 / d2 Ø 23,5
Thread: M30 x 1,5 RHT
1389190



DF-RK-9336

Ø: 108
1445656



DF-SB-10402

Ø: 62
Thick/Height: 60
1291233, 1732887



DF-TC-12492

Length: 600
Ø: 40
Hole Distance: 115 / 115
1274741

No Image

DF-VB-8561

Length: 609 Ø: 48
Hole Distance: 152 / 152
0080521, 080521, 1361651, 1368270,
1390932, 1617096, 1793875, 1817808,
1892492



MN-RK-7280

Ø: 75
Hole Distance: 115
Thick/Height: 24
0689748, 689748



MN-RK-7291

Ø: 72
Hole Distance: 130
Thick/Height: 30
1271124



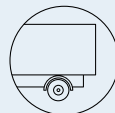

CF 85 ...

FAR 85.360, FAS 85.360	10/06→05/13	Centre Rod	DF-DL-5237		Push Rod
	10/06→05/13	Centre Rod	DF-DL-8196		Push Rod
	10/06→05/13	Centre Rod	DF-DL-8363		Push Rod
	10/06→05/13	Centre Rod	DF-DL-8703		Push Rod
	10/06→05/13	Centre Rod	DF-DL-10186		Push Rod
	10/06→05/13	Centre Rod	DF-DL-10188		Push Rod
	10/06→05/13	Centre Rod	DF-DL-12425		Push Rod
	10/06→05/13	Stabiliser Mounting	DF-SB-10402		
	10/06→05/13	Suspension Arm Repair Kit		DF-RK-9336	
	10/06→05/13	Suspension Arm Repair Kit		MN-RK-7291	for Drag Link
	10/06→05/13	Suspension Arm Repair Kit	CV-RK-1583	CV-RK-1583	Trailing Arm
	10/06→05/13	Suspension Arm Repair Kit	MN-RK-7280	MN-RK-7280	for Drag Link;for Semi-Trailing Arm; for Wishbone (CV)
	10/06→05/13	Tie Rod	DF-DL-5403		
	10/06→05/13	Tie Rod	DF-DL-5403		1st FA
	10/06→05/13	Tie Rod	DF-DL-7780		
	10/06→05/13	Tie Rod	DF-DL-7780		1st FA
	10/06→05/13	Tie Rod	DF-DL-7836		
	10/06→05/13	Tie Rod	DF-DL-7836		1st FA
	10/06→05/13	Tie Rod	DF-DL-8718		
	10/06→05/13	Tie Rod	DF-DL-8718		1st FA
	10/06→05/13	Tie Rod End	CV-ES-12461		for Steering Rod
	10/06→05/13	Tie Rod End	CV-ES-12462		for Steering Rod
	10/06→05/13	Tie Rod End	CV-ES-14162		for Steering Rod
	10/06→05/13	Tie Rod End	CV-ES-14163		for Steering Rod
	10/06→05/13	Tie Rod End	DF-ES-8362		for Steering Rod
10/06→05/13	Tie Rod End	DF-ES-8602			
10/06→05/13	Track Control Arm		DF-DL-8158	Trailing Arm	
10/06→05/13	Track Control Arm		DF-DL-9331	Wishbone (CV)	
10/06→05/13	Track Control Arm		DF-TC-12262	Control Arm	
10/06→05/13	Track Control Arm		DF-VB-8561	Wishbone (CV)	
FAR 85.380, FAS 85.380	01/01→05/13	Centre Rod	DF-DL-5237		Push Rod
	01/01→05/13	Centre Rod	DF-DL-8196		Push Rod
	01/01→05/13	Centre Rod	DF-DL-12425		Push Rod
	01/01→05/13	Stabiliser Mounting	DF-SB-10402		
	01/01→05/13	Suspension Arm Repair Kit		DF-RK-9336	
	01/01→05/13	Tie Rod	DF-DL-5403		1st FA
	01/01→05/13	Tie Rod	DF-DL-7780		1st FA
	01/01→05/13	Tie Rod	DF-DL-7836		1st FA
	01/01→05/13	Tie Rod	DF-DL-10193		1st FA
	01/01→05/13	Tie Rod End	CV-ES-12461		for Steering Rod
	01/01→05/13	Tie Rod End	CV-ES-12462		for Steering Rod
	01/01→05/13	Tie Rod End	CV-ES-14162		for Steering Rod
	01/01→05/13	Tie Rod End	CV-ES-14163		for Steering Rod
	01/01→05/13	Tie Rod End	DF-ES-8362		for Steering Rod
	01/01→05/13	Track Control Arm		DF-DL-8158	Trailing Arm
	01/01→05/13	Track Control Arm		DF-DL-9331	Wishbone (CV), 1st RA, for Pneumatic Suspension vehicles
	01/01→05/13	Track Control Arm		DF-VB-8561	Wishbone (CV)
FAR 85.410	10/05→05/13	Centre Rod	DF-DL-8196		Push Rod
	10/05→05/13	Centre Rod	DF-DL-8363		Push Rod
	10/05→05/13	Suspension Arm Repair Kit		DF-RK-9336	
	10/05→05/13	Suspension Arm Repair Kit		MN-RK-7291	for Drag Link
	10/05→05/13	Suspension Arm Repair Kit	CV-RK-1583	CV-RK-1583	Trailing Arm
	10/05→05/13	Suspension Arm Repair Kit	MN-RK-7280	MN-RK-7280	for Drag Link;for Semi-Trailing Arm; for Wishbone (CV)
	10/05→05/13	Tie Rod	DF-DL-5403		
	10/05→05/13	Tie Rod	DF-DL-7780		
	10/05→05/13	Tie Rod	DF-DL-7836		
	10/05→05/13	Tie Rod	DF-DL-8718		
	10/05→05/13	Tie Rod End	CV-ES-12461		for Steering Rod
	10/05→05/13	Tie Rod End	CV-ES-12462		for Steering Rod
	10/05→05/13	Tie Rod End	CV-ES-14162		for Steering Rod

CV-ES-12461

Length: 120
Cone Ø: d1 Ø 26 / d2 Ø 23,5
Thread: M30 x 1,5 LHT
0069513, 69513, 0311300, 311300, 607998, 0607998, 1190653, 1315447, 1319838, 1332123, 1338714, 1401934, 1407394, ACHB063, ACHF241, MAK1295



CV-ES-12462

Length: 120
Cone Ø: d1 Ø 26 / d2 Ø 23,5
Thread: M30 x 1,5 RHT
0069514, 0586753, 0607999, 0694298, 0694360, 0698609, 1137230, 1229944, 1326862, 1326896, 1331925, ACHB064, ACHF242, MAK1296



CV-ES-14162

Length: 125
Cone Ø: d1 Ø 30 / d2 Ø 27
Thread: M30 x 1,5 LHT
607053, 690225, 696225, 1228115, 1611088



CV-ES-14163

Length: 125
Cone Ø: d1 Ø 30 / d2 Ø 27
Thread: M30 x 1,5 RHT
0607981, 0698450, 1149907, 1152350, 1257890, 1603789, 1618048, ACHF060



CV-RK-1583



DF-DL-5237

Length: 880 Ø: 52
Cone Ø: d1 Ø 26 / d2 Ø 23,5
1283211, 1351714, 1385497, 10201000A



DF-DL-5403

Length: 1742 Ø: 40
Cone Ø: d1 Ø 26 / d2 Ø 23,5
0288281, 1270854, 1337644



DF-DL-7780

Length: 1690 Ø: 40
Cone Ø: d1 Ø 26 / d2 Ø 23,5
1270853, 1353391, 10212000A



DF-DL-7836

Length: 1698 Ø: 52
Cone Ø: d1 Ø 26 / d2 Ø 23,5
0754922, 1286343, 1353396



DF-DL-8158

Length: 611 Ø: 48
Hole Distance: 130 / 130
0267743, 1361649, 1361650, 1656428



DF-DL-8196

Length: 867 Ø: 50
Cone Ø: d1 Ø 30 / d2 Ø 27
1363859, 1448063, 1602821



DF-DL-8363

Length: 855 Ø: 50
Cone Ø: d1 Ø 30 / d2 Ø 27
1363858, 1448062, 1602820



DF-DL-8703

Length: 1977 Ø: 52
Cone Ø: d1 Ø 30 / d2 Ø 27
1451122



DF-DL-8718

Length: 1690 Ø: 40
Cone Ø: d1 Ø 30 / d2 Ø 27
1700000



DF-DL-9331

Length: 390 Ø: 50
Hole Distance: 130 / 152
1261101



DF-DL-10186

Length: 860 Ø: 38
Cone Ø: d1 Ø 30 / d2 Ø 27
1451118



DF-DL-10188

Length: 860 Ø: 36
Cone Ø: d1 Ø 30 / d2 Ø 27
1380417, 1451129



DF-DL-10193

Length: 1646 Ø: 40
Cone Ø: d1 Ø 26 / d2 Ø 23,5
1351205, 1353395



DF-DL-12425

Length: 865 Ø: 52
Cone Ø: d1 Ø 30 / d2 Ø 27
1373878, 1448064



DF-ES-8362

Length: 150
Cone Ø: d1 Ø 26 / d2 Ø 23,5
Thread: M30 x 1,5 RHT
1389190



DF-ES-8602

Length: 95
Cone Ø: d1 Ø 30 / d2 Ø 27
Thread: M22 x 1,5 RHT
0273203, 1399724



DF-RK-9336

Ø: 108
1445656



DF-SB-10402

Ø: 62
Thick/Height: 60
1291233, 1732887



DF-TC-12262

Length: 595 Ø: 50
Hole Distance: 130 / 130
0661406, 661406, 0661407, 661407, 1620439



DF-VB-8561

Length: 609 Ø: 48
Hole Distance: 152 / 152
0080521, 080521, 1361651, 1368270, 1390932, 1617096, 1793875, 1817808, 1892492



MN-RK-7280

Ø: 75
Hole Distance: 115
Thick/Height: 24
0689748, 689748



MN-RK-7291

Ø: 72
Hole Distance: 130
Thick/Height: 30
1271124





CF 85 ...

FAR 85.410 ...	10/05→05/13	Tie Rod End	CV-ES-14163		for Steering Rod	
	10/05→05/13	Tie Rod End	DF-ES-8362		for Steering Rod	
	10/05→05/13	Track Control Arm		DF-DL-9331	Wishbone (CV), 1st RA, for Pneumatic Suspension vehicles	
FAR 85.410, FAS 85.410	10/05→05/13	Centre Rod	DF-DL-5237		Push Rod	
	10/05→05/13	Centre Rod	DF-DL-8196		Push Rod	
	10/05→05/13	Centre Rod	DF-DL-8363		Push Rod	
	10/05→05/13	Centre Rod	DF-DL-12425		Push Rod	
	10/05→05/13	Stabiliser Mounting	DF-SB-10402			
	10/05→05/13	Suspension Arm Repair Kit		DF-RK-9336		
	10/05→05/13	Suspension Arm Repair Kit		MN-RK-7291	for Drag Link	
	10/05→05/13	Suspension Arm Repair Kit	CV-RK-1583	CV-RK-1583	Trailing Arm	
	10/05→05/13	Suspension Arm Repair Kit	MN-RK-7280	MN-RK-7280	for Drag Link;for Semi-Trailing Arm; for Wishbone (CV)	
	10/05→05/13	Tie Rod	DF-DL-5403			
	10/05→05/13	Tie Rod	DF-DL-5403		1st FA	
	10/05→05/13	Tie Rod	DF-DL-7780			
	10/05→05/13	Tie Rod	DF-DL-7780		1st FA	
	10/05→05/13	Tie Rod	DF-DL-7836			
	10/05→05/13	Tie Rod	DF-DL-7836		1st FA	
	10/05→05/13	Tie Rod	DF-DL-8718			
	10/05→05/13	Tie Rod	DF-DL-10193		1st FA	
	10/05→05/13	Tie Rod End	CV-ES-12461		for Steering Rod	
	10/05→05/13	Tie Rod End	CV-ES-12462		for Steering Rod	
	10/05→05/13	Tie Rod End	CV-ES-14162		for Steering Rod	
	10/05→05/13	Tie Rod End	CV-ES-14163		for Steering Rod	
	10/05→05/13	Tie Rod End	DF-ES-8362		for Steering Rod	
	10/05→05/13	Track Control Arm		DF-DL-8158	Trailing Arm	
	10/05→05/13	Track Control Arm		DF-DL-9331	Wishbone (CV), 1st RA, for Pneumatic Suspension vehicles	
	10/05→05/13	Track Control Arm		DF-VB-8561	Wishbone (CV)	
	FAR 85.430, FAS 85.430	01/01→05/13	Centre Rod	DF-DL-5237		Push Rod
		01/01→05/13	Centre Rod	DF-DL-8196		Push Rod
		01/01→05/13	Centre Rod	DF-DL-8363		Push Rod
		01/01→05/13	Centre Rod	DF-DL-12425		Push Rod
		01/01→05/13	Stabiliser Mounting	DF-SB-10402		
		01/01→05/13	Suspension Arm Repair Kit		DF-RK-9336	
		01/01→05/13	Tie Rod	DF-DL-5403		1st FA
		01/01→05/13	Tie Rod	DF-DL-7780		1st FA
01/01→05/13		Tie Rod	DF-DL-7836		1st FA	
01/01→05/13		Tie Rod	DF-DL-10193		1st FA	
01/01→05/13		Tie Rod End	CV-ES-12461		for Steering Rod	
01/01→05/13		Tie Rod End	CV-ES-12462		for Steering Rod	
01/01→05/13		Tie Rod End	CV-ES-14162		for Steering Rod	
01/01→05/13		Tie Rod End	CV-ES-14163		for Steering Rod	
01/01→05/13		Tie Rod End	DF-ES-8362		for Steering Rod	
01/01→05/13		Track Control Arm		DF-DL-8158	Trailing Arm	
01/01→05/13		Track Control Arm		DF-DL-9331	Wishbone (CV), 1st RA, for Pneumatic Suspension vehicles	
01/01→05/13		Track Control Arm		DF-VB-8561	Wishbone (CV)	
FAR 85.460		10/05→05/13	Centre Rod	DF-DL-8196		Push Rod
		10/05→05/13	Centre Rod	DF-DL-8363		Push Rod
		10/05→05/13	Suspension Arm Repair Kit		DF-RK-9336	
	10/05→05/13	Suspension Arm Repair Kit		MN-RK-7291	for Drag Link	
	10/05→05/13	Suspension Arm Repair Kit	CV-RK-1583	CV-RK-1583	Trailing Arm	
	10/05→05/13	Suspension Arm Repair Kit	MN-RK-7280	MN-RK-7280	for Drag Link;for Semi-Trailing Arm; for Wishbone (CV)	
	10/05→05/13	Tie Rod	DF-DL-5403			
	10/05→05/13	Tie Rod	DF-DL-7780			
	10/05→05/13	Tie Rod	DF-DL-7836			
	10/05→05/13	Tie Rod	DF-DL-8718			
	10/05→05/13	Tie Rod End	CV-ES-12461		for Steering Rod	
	10/05→05/13	Tie Rod End	CV-ES-12462		for Steering Rod	

CV-ES-12461

Length: 120
Cone Ø: d1 Ø 26 / d2 Ø 23,5
Thread: M30 x 1,5 LHT
0069513, 69513, 0311300, 311300,
0607998, 607998, 1190653, 1315447,
1319838, 1332123, 1338714, 1401934,
1407394, ACHB063, ACHF241, MAK1295



CV-ES-12462

Length: 120
Cone Ø: d1 Ø 26 / d2 Ø 23,5
Thread: M30 x 1,5 RHT
0069514, 0586753, 0607999, 0694298,
0694360, 0698609, 1137230, 1229944,
1326862, 1326896, 1331925, ACHB064,
ACHF242, MAK1296



CV-ES-14162

Length: 125
Cone Ø: d1 Ø 30 / d2 Ø 27
Thread: M30 x 1,5 LHT
607053, 690225, 696225, 1228115,
1611088



CV-ES-14163

Length: 125
Cone Ø: d1 Ø 30 / d2 Ø 27
Thread: M30 x 1,5 RHT
0607981, 0698450, 1149907, 1152350,
1257890, 1603789, 1618048, ACHF060



CV-RK-1583



DF-DL-5237

Length: 880
Ø: 52
Cone Ø: d1 Ø 26 / d2 Ø 23,5
1283211, 1351714, 1385497, 10201000A



DF-DL-5403

Length: 1742
Ø: 40
Cone Ø: d1 Ø 26 / d2 Ø 23,5
0288281, 1270854, 1337644



DF-DL-7780

Length: 1690
Ø: 40
Cone Ø: d1 Ø 26 / d2 Ø 23,5
1270853, 1353391, 10212000A



DF-DL-7836

Length: 1698
Ø: 52
Cone Ø: d1 Ø 26 / d2 Ø 23,5
0754922, 1286343, 1353396



DF-DL-8158

Length: 611
Ø: 48
Hole Distance: 130 / 130
0267743, 1361649, 1361650, 1656428



DF-DL-8196

Length: 867
Ø: 50
Cone Ø: d1 Ø 30 / d2 Ø 27
1363859, 1448063, 1602821



DF-DL-8363

Length: 855
Ø: 50
Cone Ø: d1 Ø 30 / d2 Ø 27
1363858, 1448062, 1602820



DF-DL-8718

Length: 1690
Ø: 40
Cone Ø: d1 Ø 30 / d2 Ø 27
1700000



DF-DL-9331

Length: 390
Ø: 50
Hole Distance: 130 / 152
1261101



DF-DL-10193

Length: 1646
Ø: 40
Cone Ø: d1 Ø 26 / d2 Ø 23,5
1351205, 1353395



DF-DL-12425

Length: 865
Ø: 52
Cone Ø: d1 Ø 30 / d2 Ø 27
1373878, 1448064



DF-ES-8362

Length: 150
Cone Ø: d1 Ø 26 / d2 Ø 23,5
Thread: M30 x 1,5 RHT
1389190

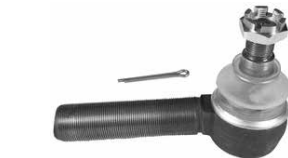

DF-RK-9336

Ø: 108
1445656



DF-SB-10402

Ø: 62
Thick/Height: 60
1291233, 1732887



DF-VB-8561

Length: 609
Ø: 48
Hole Distance: 152 / 152
0080521, 080521, 1361651, 1368270,
1390932, 1617096, 1793875, 1817808,
1892492



MN-RK-7280

Ø: 75
Hole Distance: 115
Thick/Height: 24
0689748, 689748



MN-RK-7291

Ø: 72
Hole Distance: 130
Thick/Height: 30
1271124





CF 85 ...

FAR 85.460 ...	10/05→05/13	Tie Rod End	CV-ES-14162		for Steering Rod	
	10/05→05/13	Tie Rod End	CV-ES-14163		for Steering Rod	
	10/05→05/13	Tie Rod End	DF-ES-8362		for Steering Rod	
	10/05→05/13	Track Control Arm		DF-DL-8158	Trailing Arm	
	10/05→05/13	Track Control Arm		DF-DL-9331	Wishbone (CV)	
	10/05→05/13	Track Control Arm		DF-VB-8561	Wishbone (CV)	
FAR 85.460, FAS 85.460	10/05→05/13	Centre Rod	DF-DL-5237		Push Rod	
	10/05→05/13	Centre Rod	DF-DL-8196		Push Rod	
	10/05→05/13	Centre Rod	DF-DL-8363		Push Rod	
	10/05→05/13	Stabiliser Mounting	DF-SB-10402			
	10/05→05/13	Suspension Arm Repair Kit		DF-RK-9336		
	10/05→05/13	Suspension Arm Repair Kit		MN-RK-7291	for Drag Link	
	10/05→05/13	Suspension Arm Repair Kit	CV-RK-1583	CV-RK-1583	Trailing Arm	
	10/05→05/13	Suspension Arm Repair Kit	MN-RK-7280	MN-RK-7280	for Drag Link;for Semi-Trailing Arm; for Wishbone (CV)	
	10/05→05/13	Tie Rod	DF-DL-5403			
	10/05→05/13	Tie Rod	DF-DL-5403		1st FA	
	10/05→05/13	Tie Rod	DF-DL-7780			
	10/05→05/13	Tie Rod	DF-DL-7780		1st FA	
	10/05→05/13	Tie Rod	DF-DL-7836			
	10/05→05/13	Tie Rod	DF-DL-8718			
	10/05→05/13	Tie Rod	DF-DL-10193		1st FA	
	10/05→05/13	Tie Rod End	CV-ES-12461		for Steering Rod	
	10/05→05/13	Tie Rod End	CV-ES-12462		for Steering Rod	
	10/05→05/13	Tie Rod End	CV-ES-14162		for Steering Rod	
	10/05→05/13	Tie Rod End	CV-ES-14163		for Steering Rod	
	10/05→05/13	Tie Rod End	DF-ES-8362		for Steering Rod	
	10/05→05/13	Track Control Arm		DF-DL-8158	Trailing Arm	
	10/05→05/13	Track Control Arm		DF-DL-9331	Wishbone (CV)	
	10/05→05/13	Track Control Arm		DF-DL-9331	Wishbone (CV), 1st RA, for Pneumatic Suspension vehicles	
	10/05→05/13	Track Control Arm		DF-VB-8561	Wishbone (CV)	
	FAR 85.480, FAS 85.480	01/01→05/13	Centre Rod	DF-DL-5237		Push Rod
		01/01→05/13	Centre Rod	DF-DL-8196		Push Rod
		01/01→05/13	Centre Rod	DF-DL-8363		Push Rod
01/01→05/13		Centre Rod	DF-DL-12425		Push Rod	
01/01→05/13		Stabiliser Mounting	DF-SB-10402			
01/01→05/13		Suspension Arm Repair Kit		DF-RK-9336		
01/01→05/13		Tie Rod	DF-DL-5403		1st FA	
01/01→05/13		Tie Rod	DF-DL-7780		1st FA	
01/01→05/13		Tie Rod	DF-DL-7836		1st FA	
01/01→05/13		Tie Rod	DF-DL-10193		1st FA	
01/01→05/13		Tie Rod End	CV-ES-12461		for Steering Rod	
01/01→05/13		Tie Rod End	CV-ES-12462		for Steering Rod	
01/01→05/13		Tie Rod End	CV-ES-14162		for Steering Rod	
01/01→05/13		Tie Rod End	CV-ES-14163		for Steering Rod	
01/01→05/13		Tie Rod End	DF-ES-8362		for Steering Rod	
01/01→05/13		Track Control Arm		DF-DL-8158	Trailing Arm	
01/01→05/13		Track Control Arm		DF-DL-9331	Wishbone (CV), 1st RA, for Pneumatic Suspension vehicles	
01/01→05/13		Track Control Arm		DF-VB-8561	Wishbone (CV)	
FAR 85.510		10/05→05/13	Centre Rod	DF-DL-8196		Push Rod
		10/05→05/13	Centre Rod	DF-DL-8363		Push Rod
	10/05→05/13	Suspension Arm Repair Kit		DF-RK-9336		
	10/05→05/13	Suspension Arm Repair Kit		MN-RK-7291	for Drag Link	
	10/05→05/13	Suspension Arm Repair Kit	CV-RK-1583	CV-RK-1583	Trailing Arm	
	10/05→05/13	Suspension Arm Repair Kit	MN-RK-7280	MN-RK-7280	for Drag Link;for Semi-Trailing Arm; for Wishbone (CV)	
	10/05→05/13	Tie Rod	DF-DL-5403			
	10/05→05/13	Tie Rod	DF-DL-7780			
	10/05→05/13	Tie Rod	DF-DL-7836			
	10/05→05/13	Tie Rod	DF-DL-8718			
	10/05→05/13	Tie Rod End	CV-ES-12461		for Steering Rod	

CV-ES-12461

Length: 120
Cone Ø: d1 Ø 26 / d2 Ø 23,5
Thread: M30 x 1,5 LHT
0069513, 69513, 0311300, 311300, 607998, 0607998, 1190653, 1315447, 1319838, 1332123, 1338714, 1401934, 1407394, ACHB063, ACHF241, MAK1295



CV-ES-12462

Length: 120
Cone Ø: d1 Ø 26 / d2 Ø 23,5
Thread: M30 x 1,5 RHT
0069514, 0586753, 0607999, 0694298, 0694360, 0698609, 1137230, 1229944, 1326862, 1326896, 1331925, ACHB064, ACHF242, MAK1296



CV-ES-14162

Length: 125
Cone Ø: d1 Ø 30 / d2 Ø 27
Thread: M30 x 1,5 LHT
607053, 690225, 696225, 1228115, 1611088



CV-ES-14163

Length: 125
Cone Ø: d1 Ø 30 / d2 Ø 27
Thread: M30 x 1,5 RHT
0607981, 0698450, 1149907, 1152350, 1257890, 1603789, 1618048, ACHF060



CV-RK-1583



DF-DL-5237

Length: 880
Ø: 52
Cone Ø: d1 Ø 26 / d2 Ø 23,5
1283211, 1351714, 1385497, 10201000A



DF-DL-5403

Length: 1742
Ø: 40
Cone Ø: d1 Ø 26 / d2 Ø 23,5
0288281, 1270854, 1337644



DF-DL-7780

Length: 1690
Ø: 40
Cone Ø: d1 Ø 26 / d2 Ø 23,5
1270853, 1353391, 10212000A



DF-DL-7836

Length: 1698
Ø: 52
Cone Ø: d1 Ø 26 / d2 Ø 23,5
0754922, 1286343, 1353396



DF-DL-8158

Length: 611
Ø: 48
Hole Distance: 130 / 130
0267743, 1361649, 1361650, 1656428



DF-DL-8196

Length: 867
Ø: 50
Cone Ø: d1 Ø 30 / d2 Ø 27
1363859, 1448063, 1602821



DF-DL-8363

Length: 855
Ø: 50
Cone Ø: d1 Ø 30 / d2 Ø 27
1363858, 1448062, 1602820



DF-DL-8718

Length: 1690
Ø: 40
Cone Ø: d1 Ø 30 / d2 Ø 27
1700000



DF-DL-9331

Length: 390
Ø: 50
Hole Distance: 130 / 152
1261101



DF-DL-10193

Length: 1646
Ø: 40
Cone Ø: d1 Ø 26 / d2 Ø 23,5
1351205, 1353395



DF-DL-12425

Length: 865
Ø: 52
Cone Ø: d1 Ø 30 / d2 Ø 27
1373878, 1448064



DF-ES-8362

Length: 150
Cone Ø: d1 Ø 26 / d2 Ø 23,5
Thread: M30 x 1,5 RHT
1389190



DF-RK-9336

Ø: 108
1445656



DF-SB-10402

Ø: 62
Thick/Height: 60
1291233, 1732887



DF-VB-8561

Length: 609
Ø: 48
Hole Distance: 152 / 152
0080521, 080521, 1361651, 1368270, 1390932, 1617096, 1793875, 1817808, 1892492



MN-RK-7280

Ø: 75
Hole Distance: 115
Thick/Height: 24
0689748, 689748



MN-RK-7291

Ø: 72
Hole Distance: 130
Thick/Height: 30
1271124



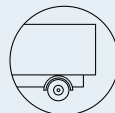

CF 85 ...

FAR 85.510 ...	10/05→05/13	Tie Rod End	CV-ES-12462		for Steering Rod
	10/05→05/13	Tie Rod End	CV-ES-14162		for Steering Rod
	10/05→05/13	Tie Rod End	CV-ES-14163		for Steering Rod
	10/05→05/13	Tie Rod End	DF-ES-8362		for Steering Rod
	10/05→05/13	Track Control Arm		DF-DL-8158	Trailing Arm
	10/05→05/13	Track Control Arm		DF-DL-9331	Wishbone (CV)
	10/05→05/13	Track Control Arm		DF-VB-8561	Wishbone (CV)
FAR 85.510, FAS 85.510	10/05→05/13	Centre Rod	DF-DL-5237		Push Rod
	10/05→05/13	Centre Rod	DF-DL-8196		Push Rod
	10/05→05/13	Centre Rod	DF-DL-8363		Push Rod
	10/05→05/13	Stabiliser Mounting	DF-SB-10402		
	10/05→05/13	Suspension Arm Repair Kit		DF-RK-9336	
	10/05→05/13	Suspension Arm Repair Kit		MN-RK-7291	for Drag Link
	10/05→05/13	Suspension Arm Repair Kit	CV-RK-1583	CV-RK-1583	Trailing Arm
	10/05→05/13	Suspension Arm Repair Kit	MN-RK-7280	MN-RK-7280	for Drag Link;for Semi-Trailing Arm; for Wishbone (CV)
	10/05→05/13	Tie Rod	DF-DL-5403		
	10/05→05/13	Tie Rod	DF-DL-7780		
	10/05→05/13	Tie Rod	DF-DL-7836		
	10/05→05/13	Tie Rod	DF-DL-8718		
	10/05→05/13	Tie Rod End	CV-ES-12461		for Steering Rod
	10/05→05/13	Tie Rod End	CV-ES-12462		for Steering Rod
	10/05→05/13	Tie Rod End	CV-ES-14162		for Steering Rod
	10/05→05/13	Tie Rod End	CV-ES-14163		for Steering Rod
	10/05→05/13	Tie Rod End	DF-ES-8362		for Steering Rod
	10/05→05/13	Track Control Arm		DF-DL-8158	Trailing Arm
	10/05→05/13	Track Control Arm		DF-DL-9331	Wishbone (CV)
	10/05→05/13	Track Control Arm		DF-DL-9331	Wishbone (CV), 1st RA, for Pneumatic Suspension vehicles
10/05→05/13	Track Control Arm		DF-VB-8561	Wishbone (CV)	
FAT 85.340	01/01→05/13	Centre Rod	DF-DL-5237		Push Rod
	01/01→05/13	Centre Rod	DF-DL-8196		Push Rod
	01/01→05/13	Centre Rod	DF-DL-8363		Push Rod
	01/01→05/13	Centre Rod	DF-DL-10188		Push Rod
	01/01→05/13	Stabiliser Mounting	DF-SB-10402		
	01/01→05/13	Suspension Arm Repair Kit		DF-RK-9336	
	01/01→05/13	Tie Rod	DF-DL-5403		1st FA
	01/01→05/13	Tie Rod	DF-DL-7780		
	01/01→05/13	Tie Rod	DF-DL-10193		1st FA
	01/01→05/13	Tie Rod End	CV-ES-12461		for Steering Rod
	01/01→05/13	Tie Rod End	CV-ES-12462		for Steering Rod
	01/01→05/13	Tie Rod End	CV-ES-14162		for Steering Rod
	01/01→05/13	Tie Rod End	CV-ES-14163		for Steering Rod
	01/01→05/13	Track Control Arm		DF-DL-8158	Trailing Arm
	01/01→05/13	Track Control Arm		DF-DL-9318	Trailing Arm
	01/01→05/13	Track Control Arm		DF-TC-12262	Control Arm
	01/01→05/13	Track Control Arm		DF-VB-8561	Wishbone (CV)
01/01→05/13	Track Control Arm		DF-VB-9343	Wishbone (CV), 1st RA;2nd RA, for Leaf-Spring Suspension vehicles	
FAT 85.360	10/06→05/13	Centre Rod	DF-DL-5237		Push Rod
	10/06→05/13	Centre Rod	DF-DL-8196		Push Rod
	10/06→05/13	Centre Rod	DF-DL-8363		Push Rod
	10/06→05/13	Stabiliser Mounting	DF-SB-10402		
	10/06→05/13	Suspension Arm Repair Kit		DF-RK-9336	
	10/06→05/13	Tie Rod	DF-DL-5403		
	10/06→05/13	Tie Rod	DF-DL-5403		1st FA
	10/06→05/13	Tie Rod	DF-DL-7780		
	10/06→05/13	Tie Rod	DF-DL-7780		1st FA
	10/06→05/13	Tie Rod	DF-DL-10193		1st FA
	10/06→05/13	Tie Rod End	CV-ES-12461		for Steering Rod
	10/06→05/13	Tie Rod End	CV-ES-12462		for Steering Rod
	10/06→05/13	Tie Rod End	CV-ES-14162		for Steering Rod
	10/06→05/13	Tie Rod End	CV-ES-14163		for Steering Rod

CV-ES-12461

Length: 120
Cone Ø: d1 Ø 26 / d2 Ø 23,5
Thread: M30 x 1,5 LHT
0069513, 69513, 0311300, 311300,
0607998, 607998, 1190653, 1315447,
1319838, 1332123, 1338714, 1401934,
1407394, ACHB063, ACHF241, MAK1295



CV-ES-12462

Length: 120
Cone Ø: d1 Ø 26 / d2 Ø 23,5
Thread: M30 x 1,5 RHT
0069514, 0586753, 0607999, 0694298,
0694360, 0698609, 1137230, 1229944,
1326862, 1326896, 1331925, ACHB064,
ACHF242, MAK1296



CV-ES-14162

Length: 125
Cone Ø: d1 Ø 30 / d2 Ø 27
Thread: M30 x 1,5 LHT
607053, 690225, 696225, 1228115,
1611088



CV-ES-14163

Length: 125
Cone Ø: d1 Ø 30 / d2 Ø 27
Thread: M30 x 1,5 RHT
0607981, 0698450, 1149907, 1152350,
1257890, 1603789, 1618048, ACHF060



CV-RK-1583



DF-DL-5237

Length: 880 Ø: 52
Cone Ø: d1 Ø 26 / d2 Ø 23,5
1283211, 1351714, 1385497, 10201000A



DF-DL-5403

Length: 1742 Ø: 40
Cone Ø: d1 Ø 26 / d2 Ø 23,5
0288281, 1270854, 1337644



DF-DL-7780

Length: 1690 Ø: 40
Cone Ø: d1 Ø 26 / d2 Ø 23,5
1270853, 1353391, 10212000A



DF-DL-7836

Length: 1698 Ø: 52
Cone Ø: d1 Ø 26 / d2 Ø 23,5
0754922, 1286343, 1353396



DF-DL-8158

Length: 611 Ø: 48
Hole Distance: 130 / 130
0267743, 1361649, 1361650, 1656428



DF-DL-8196

Length: 867 Ø: 50
Cone Ø: d1 Ø 30 / d2 Ø 27
1363859, 1448063, 1602821



DF-DL-8363

Length: 855 Ø: 50
Cone Ø: d1 Ø 30 / d2 Ø 27
1363858, 1448062, 1602820



DF-DL-8718

Length: 1690 Ø: 40
Cone Ø: d1 Ø 30 / d2 Ø 27
1700000



DF-DL-9318

Length: 600 Ø: 50
Hole Distance: 130 / 130
0646373, 0655695, 0655697, 1284860,
1620438



DF-DL-9331

Length: 390 Ø: 50
Hole Distance: 130 / 152
1261101



DF-DL-10188

Length: 860 Ø: 36
Cone Ø: d1 Ø 30 / d2 Ø 27
1380417, 1451129



DF-DL-10193

Length: 1646 Ø: 40
Cone Ø: d1 Ø 26 / d2 Ø 23,5
1351205, 1353395



DF-ES-8362

Length: 150
Cone Ø: d1 Ø 26 / d2 Ø 23,5
Thread: M30 x 1,5 RHT
1389190



DF-RK-9336

Ø: 108
1445656



DF-SB-10402

Ø: 62
Thick/Height: 60
1291233, 1732887



DF-TC-12262

Length: 595 Ø: 50
Hole Distance: 130 / 130
0661406, 661406, 0661407, 661407,
1620439



DF-VB-8561

Length: 609 Ø: 48
Hole Distance: 152 / 152
0080521, 080521, 1361651, 1368270,
1390932, 1617096, 1793875, 1817808,
1892492



DF-VB-9343

Length: 608,2 Ø: 48
Hole Distance: 152 / 152
1361652, 1620436, 1793876, 10309600A



MN-RK-7280

Ø: 75
Hole Distance: 115
Thick/Height: 24
689748, 0689748



MN-RK-7291

Ø: 72
Hole Distance: 130
Thick/Height: 30
1271124





CF 85 ...

FAT 85.360 ...	10/06→05/13	Track Control Arm		DF-DL-8158	Trailing Arm
	10/06→05/13	Track Control Arm		DF-DL-9318	Trailing Arm, 1st RA;2nd RA, for Leaf-Spring Suspension vehicles
	10/06→05/13	Track Control Arm		DF-DL-9318	Trailing Arm, for Leaf-Spring Suspension vehicles
	10/06→05/13	Track Control Arm		DF-TC-12262	Control Arm
	10/06→05/13	Track Control Arm		DF-VB-8561	Wishbone (CV)
	10/06→05/13	Track Control Arm		DF-VB-9343	Wishbone (CV), 1st RA;2nd RA, for Leaf-Spring Suspension vehicles
FAT 85.380	01/01→05/13	Centre Rod	DF-DL-5237		Push Rod
	01/01→05/13	Centre Rod	DF-DL-8196		Push Rod
	01/01→05/13	Centre Rod	DF-DL-8363		Push Rod
	01/01→05/13	Centre Rod	DF-DL-10188		Push Rod
	01/01→05/13	Centre Rod	DF-DL-10192		Push Rod, for vehicles with Hinged Leading Axle
	01/01→05/13	Stabiliser Mounting	DF-SB-10402		
	01/01→05/13	Suspension Arm Repair Kit		DF-RK-9336	
	01/01→05/13	Tie Rod		DF-ES-5761	Leading Axle
	01/01→05/13	Tie Rod	DF-DL-5403		1st FA
	01/01→05/13	Tie Rod	DF-DL-7780		1st FA
	01/01→05/13	Tie Rod	DF-DL-10193		1st FA
	01/01→05/13	Tie Rod End	CV-ES-12461		for Steering Rod
	01/01→05/13	Tie Rod End	CV-ES-12462		for Steering Rod
	01/01→05/13	Tie Rod End	CV-ES-14162		for Steering Rod
	01/01→05/13	Tie Rod End	CV-ES-14163		for Steering Rod
	01/01→05/13	Track Control Arm		DF-DL-8158	Trailing Arm
	01/01→05/13	Track Control Arm		DF-DL-9318	Trailing Arm
	01/01→05/13	Track Control Arm		DF-TC-12262	Control Arm
	01/01→05/13	Track Control Arm		DF-TC-12492	Control Arm
	01/01→05/13	Track Control Arm		DF-VB-8561	Wishbone (CV)
01/01→05/13	Track Control Arm		DF-VB-9343	Wishbone (CV), 1st RA;2nd RA, for Leaf-Spring Suspension vehicles	
FAT 85.410	10/05→05/13	Centre Rod	DF-DL-5237		Push Rod
	10/05→05/13	Centre Rod	DF-DL-8196		Push Rod
	10/05→05/13	Centre Rod	DF-DL-8363		Push Rod
	10/05→05/13	Stabiliser Mounting	DF-SB-10402		
	10/05→05/13	Suspension Arm Repair Kit		DF-RK-9336	
	10/05→05/13	Tie Rod	DF-DL-5403		
	10/05→05/13	Tie Rod	DF-DL-5403		1st FA
	10/05→05/13	Tie Rod	DF-DL-7780		
	10/05→05/13	Tie Rod	DF-DL-7780		1st FA
	10/05→05/13	Tie Rod	DF-DL-10193		1st FA
	10/05→05/13	Tie Rod End	CV-ES-12461		for Steering Rod
	10/05→05/13	Tie Rod End	CV-ES-12462		for Steering Rod
	10/05→05/13	Tie Rod End	CV-ES-14162		for Steering Rod
	10/05→05/13	Tie Rod End	CV-ES-14163		for Steering Rod
	10/05→05/13	Track Control Arm		DF-DL-8158	Trailing Arm
	10/05→05/13	Track Control Arm		DF-DL-9318	Trailing Arm, 1st RA;2nd RA, for Leaf-Spring Suspension vehicles
	10/05→05/13	Track Control Arm		DF-TC-12262	Control Arm
10/05→05/13	Track Control Arm		DF-VB-8561	Wishbone (CV)	
10/05→05/13	Track Control Arm		DF-VB-9343	Wishbone (CV), 1st RA;2nd RA, for Leaf-Spring Suspension vehicles	
FAT 85.430	01/01→05/13	Centre Rod	DF-DL-5237		Push Rod
	01/01→05/13	Centre Rod	DF-DL-8196		Push Rod
	01/01→05/13	Centre Rod	DF-DL-8363		Push Rod
	01/01→05/13	Stabiliser Mounting	DF-SB-10402		
	01/01→05/13	Suspension Arm Repair Kit		DF-RK-9336	
	01/01→05/13	Tie Rod	DF-DL-5403		1st FA
	01/01→05/13	Tie Rod	DF-DL-7780		1st FA
	01/01→05/13	Tie Rod	DF-DL-10193		1st FA
	01/01→05/13	Tie Rod End	CV-ES-12461		for Steering Rod
	01/01→05/13	Tie Rod End	CV-ES-12462		for Steering Rod
	01/01→05/13	Tie Rod End	CV-ES-14162		for Steering Rod
	01/01→05/13	Tie Rod End	CV-ES-14163		for Steering Rod

CV-ES-12461

Length: 120
Cone Ø: d1 Ø 26 / d2 Ø 23,5
Thread: M30 x 1,5 LHT
0069513, 69513, 0311300, 311300,
0607998, 607998, 1190653, 1315447,
1319838, 1332123, 1338714, 1401934,
1407394, ACHB063, ACHF241, MAK1295



CV-ES-12462

Length: 120
Cone Ø: d1 Ø 26 / d2 Ø 23,5
Thread: M30 x 1,5 RHT
0069514, 0586753, 0607999, 0694298,
0694360, 0698609, 1137230, 1229944,
1326862, 1326896, 1331925, ACHB064,
ACHF242, MAK1296



CV-ES-14162

Length: 125
Cone Ø: d1 Ø 30 / d2 Ø 27
Thread: M30 x 1,5 LHT
607053, 690225, 696225, 1228115,
1611088



CV-ES-14163

Length: 125
Cone Ø: d1 Ø 30 / d2 Ø 27
Thread: M30 x 1,5 RHT
0607981, 0698450, 1149907, 1152350,
1257890, 1603789, 1618048, ACHF060



DF-DL-5237

Length: 880
Ø: 52
Cone Ø: d1 Ø 26 / d2 Ø 23,5
1283211, 1351714, 1385497, 10201000A



DF-DL-5403

Length: 1742
Ø: 40
Cone Ø: d1 Ø 26 / d2 Ø 23,5
0288281, 1270854, 1337644



DF-DL-7780

Length: 1690
Ø: 40
Cone Ø: d1 Ø 26 / d2 Ø 23,5
1270853, 1353391, 10212000A



DF-DL-8158

Length: 611
Ø: 48
Hole Distance: 130 / 130
0267743, 1361649, 1361650, 1656428



DF-DL-8196

Length: 867
Ø: 50
Cone Ø: d1 Ø 30 / d2 Ø 27
1363859, 1448063, 1602821



DF-DL-8363

Length: 855
Ø: 50
Cone Ø: d1 Ø 30 / d2 Ø 27
1363858, 1448062, 1602820



DF-DL-9318

Length: 600
Ø: 50
Hole Distance: 130 / 130
0646373, 0655695, 0655697, 1284860,
1620438



DF-DL-10188

Length: 860
Ø: 36
Cone Ø: d1 Ø 30 / d2 Ø 27
1380417, 1451129



DF-DL-10192

Length: 590
Ø: 38
Cone Ø: d1 Ø 30 / d2 Ø 27
1440171, 1451119



DF-DL-10193

Length: 1646
Ø: 40
Cone Ø: d1 Ø 26 / d2 Ø 23,5
1351205, 1353395



DF-ES-5761

Length: 1512
Ø: 52
Cone Ø: d1 Ø 26 / d2 Ø 23,5
1297572, 1361155



DF-RK-9336

Ø: 108
1445656



DF-SB-10402

Ø: 62
Thick/Height: 60
1291233, 1732887



DF-TC-12262

Length: 595
Ø: 50
Hole Distance: 130 / 130
0661406, 661406, 0661407, 661407,
1620439



DF-TC-12492

Length: 600
Ø: 40
Hole Distance: 115 / 115
1274741

No Image

DF-VB-8561

Length: 609
Ø: 48
Hole Distance: 152 / 152
0080521, 080521, 1361651, 1368270,
1390932, 1617096, 1793875, 1817808,
1892492



DF-VB-9343

Length: 608,2
Ø: 48
Hole Distance: 152 / 152
1361652, 1620436, 1793876, 10309600A





CF 85 ...

FAT 85.430 ...	01/01→05/13	Track Control Arm		DF-DL-8158	Trailing Arm
	01/01→05/13	Track Control Arm		DF-DL-9318	Trailing Arm
	01/01→05/13	Track Control Arm		DF-TC-12262	Control Arm
	01/01→05/13	Track Control Arm		DF-VB-8561	Wishbone (CV)
	01/01→05/13	Track Control Arm		DF-VB-9343	Wishbone (CV), 1st RA;2nd RA, for Leaf-Spring Suspension vehicles
FAT 85.460	10/05→05/13	Centre Rod	DF-DL-5237		Push Rod
	10/05→05/13	Centre Rod	DF-DL-8196		Push Rod
	10/05→05/13	Centre Rod	DF-DL-8363		Push Rod
	10/05→05/13	Stabiliser Mounting	DF-SB-10402		
	10/05→05/13	Suspension Arm Repair Kit		DF-RK-9336	
	10/05→05/13	Tie Rod	DF-DL-5403		
	10/05→05/13	Tie Rod	DF-DL-5403		1st FA
	10/05→05/13	Tie Rod	DF-DL-7780		
	10/05→05/13	Tie Rod	DF-DL-7780		1st FA
	10/05→05/13	Tie Rod	DF-DL-10193		1st FA
	10/05→05/13	Tie Rod End	CV-ES-12461		for Steering Rod
	10/05→05/13	Tie Rod End	CV-ES-12462		for Steering Rod
	10/05→05/13	Tie Rod End	CV-ES-14162		for Steering Rod
	10/05→05/13	Tie Rod End	CV-ES-14163		for Steering Rod
	10/05→05/13	Track Control Arm		DF-DL-8158	Trailing Arm
	10/05→05/13	Track Control Arm		DF-DL-9318	Trailing Arm, 1st RA;2nd RA, for Leaf-Spring Suspension vehicles
	10/05→05/13	Track Control Arm		DF-TC-12262	Control Arm
	10/05→05/13	Track Control Arm		DF-VB-8561	Wishbone (CV)
10/05→05/13	Track Control Arm		DF-VB-9343	Wishbone (CV), 1st RA;2nd RA, for Leaf-Spring Suspension vehicles	
FAT 85.480	01/01→05/13	Centre Rod	DF-DL-5237		Push Rod
	01/01→05/13	Centre Rod	DF-DL-8196		Push Rod
	01/01→05/13	Centre Rod	DF-DL-8363		Push Rod
	01/01→05/13	Stabiliser Mounting	DF-SB-10402		
	01/01→05/13	Suspension Arm Repair Kit		DF-RK-9336	
	01/01→05/13	Tie Rod	DF-DL-5403		1st FA
	01/01→05/13	Tie Rod	DF-DL-7780		1st FA
	01/01→05/13	Tie Rod	DF-DL-10193		1st FA
	01/01→05/13	Tie Rod End	CV-ES-12461		for Steering Rod
	01/01→05/13	Tie Rod End	CV-ES-12462		for Steering Rod
	01/01→05/13	Tie Rod End	CV-ES-14162		for Steering Rod
	01/01→05/13	Tie Rod End	CV-ES-14163		for Steering Rod
	01/01→05/13	Track Control Arm		DF-DL-8158	Trailing Arm
	01/01→05/13	Track Control Arm		DF-DL-9318	Trailing Arm
	01/01→05/13	Track Control Arm		DF-TC-12262	Control Arm
	01/01→05/13	Track Control Arm		DF-VB-8561	Wishbone (CV)
	01/01→05/13	Track Control Arm		DF-VB-9343	Wishbone (CV), 1st RA;2nd RA, for Leaf-Spring Suspension vehicles
	FAT 85.510	10/05→05/13	Centre Rod	DF-DL-5237	
10/05→05/13		Centre Rod	DF-DL-8196		Push Rod
10/05→05/13		Stabiliser Mounting	DF-SB-10402		
10/05→05/13		Suspension Arm Repair Kit		DF-RK-9336	
10/05→05/13		Tie Rod	DF-DL-5403		
10/05→05/13		Tie Rod	DF-DL-7780		
10/05→05/13		Tie Rod End	CV-ES-12461		for Steering Rod
10/05→05/13		Tie Rod End	CV-ES-12462		for Steering Rod
10/05→05/13		Tie Rod End	CV-ES-14162		for Steering Rod
10/05→05/13		Tie Rod End	CV-ES-14163		for Steering Rod
10/05→05/13		Track Control Arm		DF-DL-8158	Trailing Arm
10/05→05/13		Track Control Arm		DF-DL-9318	Trailing Arm, 1st RA;2nd RA, for Leaf-Spring Suspension vehicles
10/05→05/13		Track Control Arm		DF-TC-12262	Control Arm
10/05→05/13		Track Control Arm		DF-VB-8561	Wishbone (CV)
10/05→05/13		Track Control Arm		DF-VB-9343	Wishbone (CV), 1st RA;2nd RA, for Leaf-Spring Suspension vehicles

CV-ES-12461

Length: 120
Cone Ø: d1 Ø 26 / d2 Ø 23,5
Thread: M30 x 1,5 LHT
0069513, 69513, 0311300, 311300,
0607998, 607998, 1190653, 1315447,
1319838, 1332123, 1338714, 1401934,
1407394, ACHB063, ACHF241, MAK1295



CV-ES-12462

Length: 120
Cone Ø: d1 Ø 26 / d2 Ø 23,5
Thread: M30 x 1,5 RHT
0069514, 0586753, 0607999, 0694298,
0694360, 0698609, 1137230, 1229944,
1326862, 1326896, 1331925, ACHB064,
ACHF242, MAK1296



CV-ES-14162

Length: 125
Cone Ø: d1 Ø 30 / d2 Ø 27
Thread: M30 x 1,5 LHT
607053, 690225, 696225, 1228115,
1611088



CV-ES-14163

Length: 125
Cone Ø: d1 Ø 30 / d2 Ø 27
Thread: M30 x 1,5 RHT
0607981, 0698450, 1149907, 1152350,
1257890, 1603789, 1618048, ACHF060



DF-DL-5237

Length: 880
Ø: 52
Cone Ø: d1 Ø 26 / d2 Ø 23,5
1283211, 1351714, 1385497, 10201000A



DF-DL-5403

Length: 1742
Ø: 40
Cone Ø: d1 Ø 26 / d2 Ø 23,5
0288281, 1270854, 1337644



DF-DL-7780

Length: 1690
Ø: 40
Cone Ø: d1 Ø 26 / d2 Ø 23,5
1270853, 1353391, 10212000A



DF-DL-8158

Length: 611
Ø: 48
Hole Distance: 130 / 130
0267743, 1361649, 1361650, 1656428



DF-DL-8196

Length: 867
Ø: 50
Cone Ø: d1 Ø 30 / d2 Ø 27
1363859, 1448063, 1602821



DF-DL-8363

Length: 855
Ø: 50
Cone Ø: d1 Ø 30 / d2 Ø 27
1363858, 1448062, 1602820



DF-DL-9318

Length: 600
Ø: 50
Hole Distance: 130 / 130
0646373, 0655695, 0655697, 1284860,
1620438



DF-DL-10193

Length: 1646
Ø: 40
Cone Ø: d1 Ø 26 / d2 Ø 23,5
1351205, 1353395



DF-RK-9336

Ø: 108
1445656



DF-SB-10402

Ø: 62
Thick/Height: 60
1291233, 1732887



DF-TC-12262

Length: 595
Ø: 50
Hole Distance: 130 / 130
0661406, 661406, 0661407, 661407,
1620439



DF-VB-8561

Length: 609
Ø: 48
Hole Distance: 152 / 152
0080521, 080521, 1361651, 1368270,
1390932, 1617096, 1793875, 1817808,
1892492



DF-VB-9343

Length: 608,2
Ø: 48
Hole Distance: 152 / 152
1361652, 1620436, 1793876, 10309600A



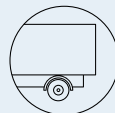

CF 85 ...

FAX 85.340	01/01→05/13	Centre Rod	DF-DL-5237		Push Rod	
	01/01→05/13	Centre Rod	DF-DL-8196		Push Rod	
	01/01→05/13	Centre Rod	DF-DL-8703		Push Rod	
	01/01→05/13	Centre Rod	DF-DL-10186		Push Rod	
	01/01→05/13	Centre Rod	DF-DL-10188		Push Rod	
	01/01→05/13	Stabiliser Mounting	DF-SB-10402			
	01/01→05/13	Suspension Arm Repair Kit		DF-RK-9336		
	01/01→05/13	Tie Rod		DF-DL-5403	Tag Axle	
	01/01→05/13	Tie Rod		DF-DL-7780	Tag Axle	
	01/01→05/13	Tie Rod	DF-DL-5403		1st FA;2nd FA	
	01/01→05/13	Tie Rod	DF-DL-7780		1st FA;2nd FA	
	01/01→05/13	Tie Rod	DF-DL-10193		2nd FA	
	01/01→05/13	Tie Rod End	CV-ES-12461		for Steering Rod	
	01/01→05/13	Tie Rod End	CV-ES-12462		for Steering Rod	
	01/01→05/13	Tie Rod End	CV-ES-14162	CV-ES-14162	for Steering Rod	
	01/01→05/13	Tie Rod End	CV-ES-14163		for Steering Rod	
	01/01→05/13	Tie Rod End	DF-ES-8602			
	01/01→05/13	Tie Rod End	SC-ES-8517		for Push Rod	
	01/01→05/13	Track Control Arm		DF-DL-8158	Trailing Arm	
	01/01→05/13	Track Control Arm		DF-VB-8561	Wishbone (CV)	
	FAX 85.360	10/05→05/13	Centre Rod	DF-DL-5237		Push Rod
		10/05→05/13	Centre Rod	DF-DL-8196		Push Rod
		10/05→05/13	Centre Rod	DF-DL-8703		Push Rod
		10/05→05/13	Centre Rod	DF-DL-10186		Push Rod
		10/05→05/13	Centre Rod	DF-DL-10188		Push Rod
		10/05→05/13	Stabiliser Link	DF-DL-12427		Suspension Rod
		10/05→05/13	Stabiliser Mounting	DF-SB-10402		
10/05→05/13		Suspension Arm Repair Kit		DF-RK-9336		
10/05→05/13		Tie Rod		DF-DL-5403	Tag Axle	
10/05→05/13		Tie Rod		DF-DL-7780	Tag Axle	
10/05→05/13		Tie Rod		DF-DL-8718	Tag Axle	
10/05→05/13		Tie Rod	DF-DL-5403		1st FA;2nd FA	
10/05→05/13		Tie Rod	DF-DL-7780		1st FA;2nd FA	
10/05→05/13		Tie Rod	DF-DL-8718		2nd FA	
10/05→05/13		Tie Rod	DF-DL-10193		2nd FA	
10/05→05/13		Tie Rod End	CV-ES-12461		for Steering Rod	
10/05→05/13		Tie Rod End	CV-ES-12462		for Steering Rod	
10/05→05/13		Tie Rod End	CV-ES-14163		for Steering Rod	
10/05→05/13		Tie Rod End	DF-ES-8602			
10/05→05/13		Track Control Arm		DF-DL-8158	Trailing Arm	
10/05→05/13		Track Control Arm		DF-VB-8561	Wishbone (CV)	
FAX 85.380		01/01→05/13	Centre Rod	DF-DL-5237		Push Rod
		01/01→05/13	Centre Rod	DF-DL-8196		Push Rod
		01/01→05/13	Centre Rod	DF-DL-8703		Push Rod
		01/01→05/13	Centre Rod	DF-DL-10186		Push Rod
		01/01→05/13	Centre Rod	DF-DL-10188		Push Rod
		01/01→05/13	Stabiliser Mounting	DF-SB-10402		
	01/01→05/13	Suspension Arm Repair Kit		DF-RK-9336		
	01/01→05/13	Tie Rod		DF-DL-5403	Tag Axle	
	01/01→05/13	Tie Rod		DF-DL-7780	Tag Axle	
	01/01→05/13	Tie Rod	DF-DL-5403		1st FA;2nd FA	
	01/01→05/13	Tie Rod	DF-DL-7780		1st FA;2nd FA	
	01/01→05/13	Tie Rod	DF-DL-10193		1st FA;2nd FA	
	01/01→05/13	Tie Rod End	CV-ES-12461		for Steering Rod	
	01/01→05/13	Tie Rod End	CV-ES-12462		for Steering Rod	
	01/01→05/13	Tie Rod End	CV-ES-14162	CV-ES-14162	for Steering Rod	
	01/01→05/13	Tie Rod End	CV-ES-14163		for Steering Rod	
	01/01→05/13	Tie Rod End	DF-ES-8602			
	01/01→05/13	Tie Rod End	SC-ES-8517		for Push Rod	
	01/01→05/13	Track Control Arm		DF-DL-8158	Trailing Arm	
	01/01→05/13	Track Control Arm		DF-VB-8561	Wishbone (CV)	

CV-ES-12461

Length: 120
Cone Ø: d1 Ø 26 / d2 Ø 23,5
Thread: M30 x 1,5 LHT
0069513, 69513, 311300, 0311300, 607998, 0607998, 1190653, 1315447, 1319838, 1332123, 1338714, 1401934, 1407394, ACHB063, ACHF241, MAK1295



CV-ES-12462

Length: 120
Cone Ø: d1 Ø 26 / d2 Ø 23,5
Thread: M30 x 1,5 RHT
0069514, 0586753, 0607999, 0694298, 0694360, 0698609, 1137230, 1229944, 1326862, 1326896, 1331925, ACHB064, ACHF242, MAK1296



CV-ES-14162

Length: 125
Cone Ø: d1 Ø 30 / d2 Ø 27
Thread: M30 x 1,5 LHT
607053, 690225, 696225, 1228115, 1611088



CV-ES-14163

Length: 125
Cone Ø: d1 Ø 30 / d2 Ø 27
Thread: M30 x 1,5 RHT
0607981, 0698450, 1149907, 1152350, 1257890, 1603789, 1618048, ACHF060



DF-DL-5237

Length: 880
Ø: 52
Cone Ø: d1 Ø 26 / d2 Ø 23,5
1283211, 1351714, 1385497, 10201000A



DF-DL-5403

Length: 1742
Ø: 40
Cone Ø: d1 Ø 26 / d2 Ø 23,5
0288281, 1270854, 1337644



DF-DL-7780

Length: 1690
Ø: 40
Cone Ø: d1 Ø 26 / d2 Ø 23,5
1270853, 1353391, 10212000A



DF-DL-8158

Length: 611
Ø: 48
Hole Distance: 130 / 130
0267743, 1361649, 1361650, 1656428



DF-DL-8196

Length: 867
Ø: 50
Cone Ø: d1 Ø 30 / d2 Ø 27
1363859, 1448063, 1602821



DF-DL-8703

Length: 1977
Ø: 52
Cone Ø: d1 Ø 30 / d2 Ø 27
1451122



DF-DL-8718

Length: 1690
Ø: 40
Cone Ø: d1 Ø 30 / d2 Ø 27
1700000



DF-DL-10186

Length: 860
Ø: 38
Cone Ø: d1 Ø 30 / d2 Ø 27
1451118



DF-DL-10188

Length: 860
Ø: 36
Cone Ø: d1 Ø 30 / d2 Ø 27
1380417, 1451129



DF-DL-10193

Length: 1646
Ø: 40
Cone Ø: d1 Ø 26 / d2 Ø 23,5
1351205, 1353395



DF-DL-12427

Length: 2028
Ø: 36
Cone Ø: d1 Ø 30 / d2 Ø 27
1392962, 1801332



DF-ES-8602

Length: 95
Cone Ø: d1 Ø 30 / d2 Ø 27
Thread: M22 x 1,5 RHT
0273203, 1399724



DF-RK-9336

Ø: 108
1445656



DF-SB-10402

Ø: 62
Thick/Height: 60
1291233, 1732887



DF-VB-8561

Length: 609
Ø: 48
Hole Distance: 152 / 152
0080521, 080521, 1361651, 1368270, 1390932, 1617096, 1793875, 1817808, 1892492



SC-ES-8517

Length: 140
Cone Ø: d1 Ø 30 / d2 Ø 27
Thread: M30 x 1,5 RHT
1685552



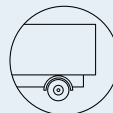

CF 85 ...

FAX 85.430	01/01→05/13	Centre Rod	DF-DL-5237		Push Rod	
	01/01→05/13	Centre Rod	DF-DL-8196		Push Rod	
	01/01→05/13	Centre Rod	DF-DL-8703		Push Rod	
	01/01→05/13	Centre Rod	DF-DL-10186		Push Rod	
	01/01→05/13	Centre Rod	DF-DL-10188		Push Rod	
	01/01→05/13	Stabiliser Mounting	DF-SB-10402			
	01/01→05/13	Suspension Arm Repair Kit		DF-RK-9336		
	01/01→05/13	Tie Rod		DF-DL-5403	Tag Axle	
	01/01→05/13	Tie Rod		DF-DL-7780	Tag Axle	
	01/01→05/13	Tie Rod	DF-DL-5403		1st FA;2nd FA	
	01/01→05/13	Tie Rod	DF-DL-7780		1st FA;2nd FA	
	01/01→05/13	Tie Rod	DF-DL-10193		1st FA;2nd FA	
	01/01→05/13	Tie Rod End	CV-ES-12461		for Steering Rod	
	01/01→05/13	Tie Rod End	CV-ES-12462		for Steering Rod	
	01/01→05/13	Tie Rod End	CV-ES-14162	CV-ES-14162	for Steering Rod	
	01/01→05/13	Tie Rod End	CV-ES-14163		for Steering Rod	
	01/01→05/13	Tie Rod End	DF-ES-8602			
	01/01→05/13	Tie Rod End	SC-ES-8517		for Push Rod	
	01/01→05/13	Track Control Arm		DF-DL-8158	Trailing Arm	
	01/01→05/13	Track Control Arm		DF-VB-8561	Wishbone (CV)	
	FAX 85.480	01/01→05/13	Centre Rod	DF-DL-5237		Push Rod
		01/01→05/13	Centre Rod	DF-DL-8196		Push Rod
		01/01→05/13	Centre Rod	DF-DL-8703		Push Rod
		01/01→05/13	Centre Rod	DF-DL-10186		Push Rod
		01/01→05/13	Centre Rod	DF-DL-10188		Push Rod
01/01→05/13		Stabiliser Mounting	DF-SB-10402			
01/01→05/13		Suspension Arm Repair Kit		DF-RK-9336		
01/01→05/13		Tie Rod		DF-DL-5403	Tag Axle	
01/01→05/13		Tie Rod		DF-DL-7780	Tag Axle	
01/01→05/13		Tie Rod	DF-DL-5403		1st FA;2nd FA	
01/01→05/13		Tie Rod	DF-DL-7780		1st FA;2nd FA	
01/01→05/13		Tie Rod	DF-DL-10193		1st FA;2nd FA	
01/01→05/13		Tie Rod End	CV-ES-12461		for Steering Rod	
01/01→05/13		Tie Rod End	CV-ES-12462		for Steering Rod	
01/01→05/13		Tie Rod End	CV-ES-14162	CV-ES-14162	for Steering Rod	
01/01→05/13		Tie Rod End	CV-ES-14163		for Steering Rod	
01/01→05/13		Tie Rod End	DF-ES-8602			
01/01→05/13		Tie Rod End	SC-ES-8517		for Push Rod	
01/01→05/13		Track Control Arm		DF-DL-8158	Trailing Arm	
01/01→05/13		Track Control Arm		DF-VB-8561	Wishbone (CV)	
FT 85.340		01/01→05/13	Centre Rod	DF-DL-5237		Push Rod
		01/01→05/13	Centre Rod	DF-DL-8196		Push Rod
		01/01→05/13	Centre Rod	DF-DL-8363		Push Rod
		01/01→05/13	Stabiliser Mounting	DF-SB-10402		
		01/01→05/13	Suspension Arm Repair Kit		DF-RK-9336	
	01/01→05/13	Tie Rod	DF-DL-5403			
	01/01→05/13	Tie Rod	DF-DL-7780		1st FA	
	01/01→05/13	Tie Rod	DF-DL-10193		1st FA	
	01/01→05/13	Tie Rod End	CV-ES-12461		for Steering Rod	
	01/01→05/13	Tie Rod End	CV-ES-12462		for Steering Rod	
	01/01→05/13	Tie Rod End	CV-ES-14162		for Steering Rod	
	01/01→05/13	Tie Rod End	CV-ES-14163		for Steering Rod	
	01/01→05/13	Tie Rod End	DF-ES-8362		for Steering Rod	
	01/01→05/13	Track Control Arm		DF-DL-8158	Trailing Arm	
	01/01→05/13	Track Control Arm		DF-DL-9331	Wishbone (CV)	
	01/01→05/13	Track Control Arm		DF-VB-8561	Wishbone (CV)	
	FT 85.360	10/06→05/13	Centre Rod	DF-DL-5237		Push Rod
		10/06→05/13	Centre Rod	DF-DL-8196		Push Rod
		10/06→05/13	Centre Rod	DF-DL-8363		Push Rod
		10/06→05/13	Stabiliser Mounting	DF-SB-10402		
		10/06→05/13	Suspension Arm Repair Kit		DF-RK-9336	
		10/06→05/13	Tie Rod	DF-DL-5403		
		10/06→05/13	Tie Rod	DF-DL-7780		1st FA

CV-ES-12461

Length: 120
Cone Ø: d1 Ø 26 / d2 Ø 23,5
Thread: M30 x 1,5 LHT
0069513, 69513, 0311300, 311300,
0607998, 607998, 1190653, 1315447,
1319838, 1332123, 1338714, 1401934,
1407394, ACHB063, ACHF241, MAK1295



CV-ES-12462

Length: 120
Cone Ø: d1 Ø 26 / d2 Ø 23,5
Thread: M30 x 1,5 RHT
0069514, 0586753, 0607999, 0694298,
0694360, 0698609, 1137230, 1229944,
1326862, 1326896, 1331925, ACHB064,
ACHF242, MAK1296



CV-ES-14162

Length: 125
Cone Ø: d1 Ø 30 / d2 Ø 27
Thread: M30 x 1,5 LHT
607053, 690225, 696225, 1228115,
1611088



CV-ES-14163

Length: 125
Cone Ø: d1 Ø 30 / d2 Ø 27
Thread: M30 x 1,5 RHT
0607981, 0698450, 1149907, 1152350,
1257890, 1603789, 1618048, ACHF060



DF-DL-5237

Length: 880
Ø: 52
Cone Ø: d1 Ø 26 / d2 Ø 23,5
1283211, 1351714, 1385497, 10201000A



DF-DL-5403

Length: 1742
Ø: 40
Cone Ø: d1 Ø 26 / d2 Ø 23,5
0288281, 1270854, 1337644



DF-DL-7780

Length: 1690
Ø: 40
Cone Ø: d1 Ø 26 / d2 Ø 23,5
1270853, 1353391, 10212000A



DF-DL-8158

Length: 611
Ø: 48
Hole Distance: 130 / 130
0267743, 1361649, 1361650, 1656428



DF-DL-8196

Length: 867
Ø: 50
Cone Ø: d1 Ø 30 / d2 Ø 27
1363859, 1448063, 1602821



DF-DL-8363

Length: 855
Ø: 50
Cone Ø: d1 Ø 30 / d2 Ø 27
1363858, 1448062, 1602820



DF-DL-8703

Length: 1977
Ø: 52
Cone Ø: d1 Ø 30 / d2 Ø 27
1451122



DF-DL-9331

Length: 390
Ø: 50
Hole Distance: 130 / 152
1261101



DF-DL-10186

Length: 860
Ø: 38
Cone Ø: d1 Ø 30 / d2 Ø 27
1451118



DF-DL-10188

Length: 860
Ø: 36
Cone Ø: d1 Ø 30 / d2 Ø 27
1380417, 1451129



DF-DL-10193

Length: 1646
Ø: 40
Cone Ø: d1 Ø 26 / d2 Ø 23,5
1351205, 1353395



DF-ES-8362

Length: 150
Cone Ø: d1 Ø 26 / d2 Ø 23,5
Thread: M30 x 1,5 RHT
1389190



DF-ES-8602

Length: 95
Cone Ø: d1 Ø 30 / d2 Ø 27
Thread: M22 x 1,5 RHT
0273203, 1399724



DF-RK-9336

Ø: 108
1445656



DF-SB-10402

Ø: 62
Thick/Height: 60
1291233, 1732887



DF-VB-8561

Length: 609
Ø: 48
Hole Distance: 152 / 152
0080521, 080521, 1361651, 1368270,
1390932, 1617096, 1793875, 1817808,
1892492



SC-ES-8517

Length: 140
Cone Ø: d1 Ø 30 / d2 Ø 27
Thread: M30 x 1,5 RHT
1685552





CF 85 ...

FT 85.360 ...	10/06→05/13	Tie Rod	DF-DL-8718		1st FA	
	10/06→05/13	Tie Rod	DF-DL-10193		1st FA	
	10/06→05/13	Tie Rod End	CV-ES-12461		for Steering Rod	
	10/06→05/13	Tie Rod End	CV-ES-12462		for Steering Rod	
	10/06→05/13	Tie Rod End	CV-ES-14162		for Steering Rod	
	10/06→05/13	Tie Rod End	CV-ES-14163		for Steering Rod	
	10/06→05/13	Tie Rod End	DF-ES-8362		for Steering Rod	
	10/06→05/13	Track Control Arm		DF-DL-8158	Trailing Arm	
	10/06→05/13	Track Control Arm		DF-DL-9331	Wishbone (CV), 1st RA, for Pneumatic Suspension vehicles	
	10/06→05/13	Track Control Arm		DF-VB-8561	Wishbone (CV)	
FT 85.380	01/01→05/13	Centre Rod	DF-DL-5237		Push Rod	
	01/01→05/13	Centre Rod	DF-DL-8196		Push Rod	
	01/01→05/13	Centre Rod	DF-DL-8363		Push Rod	
	01/01→05/13	Stabiliser Mounting	DF-SB-10402			
	01/01→05/13	Suspension Arm Repair Kit		DF-RK-9336		
	01/01→05/13	Tie Rod	DF-DL-5403			
	01/01→05/13	Tie Rod	DF-DL-7780		1st FA	
	01/01→05/13	Tie Rod	DF-DL-10193		1st FA	
	01/01→05/13	Tie Rod End	CV-ES-12461		for Steering Rod	
	01/01→05/13	Tie Rod End	CV-ES-12462		for Steering Rod	
	01/01→05/13	Tie Rod End	CV-ES-14162		for Steering Rod	
	01/01→05/13	Tie Rod End	CV-ES-14163		for Steering Rod	
	01/01→05/13	Tie Rod End	DF-ES-8362		for Steering Rod	
	01/01→05/13	Track Control Arm		DF-DL-8158	Trailing Arm	
	01/01→05/13	Track Control Arm		DF-DL-9331	Wishbone (CV)	
01/01→05/13	Track Control Arm		DF-VB-8561	Wishbone (CV)		
FT 85.410	10/05→05/13	Centre Rod	DF-DL-5237		Push Rod	
	10/05→05/13	Centre Rod	DF-DL-8196		Push Rod	
	10/05→05/13	Stabiliser Mounting	DF-SB-10402			
	10/05→05/13	Suspension Arm Repair Kit		DF-RK-9336		
	10/05→05/13	Tie Rod	DF-DL-5403			
	10/05→05/13	Tie Rod	DF-DL-7780		1st FA	
	10/05→05/13	Tie Rod	DF-DL-7836		1st FA	
	10/05→05/13	Tie Rod	DF-DL-8718		1st FA	
	10/05→05/13	Tie Rod	DF-DL-10193		1st FA	
	10/05→05/13	Tie Rod End	CV-ES-12461		for Steering Rod	
	10/05→05/13	Tie Rod End	CV-ES-12462		for Steering Rod	
	10/05→05/13	Tie Rod End	CV-ES-14162		for Steering Rod	
	10/05→05/13	Tie Rod End	CV-ES-14163		for Steering Rod	
	10/05→05/13	Tie Rod End	DF-ES-8362		for Steering Rod	
	10/05→05/13	Track Control Arm		DF-DL-8158	Trailing Arm	
	10/05→05/13	Track Control Arm		DF-DL-9331	Wishbone (CV)	
	10/05→05/13	Track Control Arm		DF-VB-8561	Wishbone (CV)	
	FT 85.430	01/01→05/13	Centre Rod	DF-DL-5237		Push Rod
		01/01→05/13	Centre Rod	DF-DL-8196		Push Rod
		01/01→05/13	Centre Rod	DF-DL-8363		Push Rod
01/01→05/13		Centre Rod	DF-DL-12425		Push Rod	
01/01→05/13		Stabiliser Mounting	DF-SB-10402			
01/01→05/13		Suspension Arm Repair Kit		DF-RK-9336		
01/01→05/13		Tie Rod	DF-DL-5403			
01/01→05/13		Tie Rod	DF-DL-7780		1st FA	
01/01→05/13		Tie Rod	DF-DL-7836		1st FA	
01/01→05/13		Tie Rod	DF-DL-10193		1st FA	
01/01→05/13		Tie Rod End	CV-ES-12461		for Steering Rod	
01/01→05/13		Tie Rod End	CV-ES-12462		for Steering Rod	
01/01→05/13		Tie Rod End	CV-ES-14162		for Steering Rod	
01/01→05/13		Tie Rod End	CV-ES-14163		for Steering Rod	
01/01→05/13		Tie Rod End	DF-ES-8362		for Steering Rod	
01/01→05/13		Track Control Arm		DF-DL-8158	Trailing Arm	
01/01→05/13		Track Control Arm		DF-DL-9331	Wishbone (CV)	
01/01→05/13		Track Control Arm		DF-VB-8561	Wishbone (CV)	

CV-ES-12461

Length: 120
Cone Ø: d1 Ø 26 / d2 Ø 23,5
Thread: M30 x 1,5 LHT
0069513, 69513, 0311300, 311300,
0607998, 607998, 1190653, 1315447,
1319838, 1332123, 1338714, 1401934,
1407394, ACHB063, ACHF241, MAK1295



CV-ES-12462

Length: 120
Cone Ø: d1 Ø 26 / d2 Ø 23,5
Thread: M30 x 1,5 RHT
0069514, 0586753, 0607999, 0694298,
0694360, 0698609, 1137230, 1229944,
1326862, 1326896, 1331925, ACHB064,
ACHF242, MAK1296



CV-ES-14162

Length: 125
Cone Ø: d1 Ø 30 / d2 Ø 27
Thread: M30 x 1,5 LHT
607053, 690225, 696225, 1228115,
1611088



CV-ES-14163

Length: 125
Cone Ø: d1 Ø 30 / d2 Ø 27
Thread: M30 x 1,5 RHT
0607981, 0698450, 1149907, 1152350,
1257890, 1603789, 1618048, ACHF060



DF-DL-5237

Length: 880
Ø: 52
Cone Ø: d1 Ø 26 / d2 Ø 23,5
1283211, 1351714, 1385497, 10201000A



DF-DL-5403

Length: 1742
Ø: 40
Cone Ø: d1 Ø 26 / d2 Ø 23,5
0288281, 1270854, 1337644



DF-DL-7780

Length: 1690
Ø: 40
Cone Ø: d1 Ø 26 / d2 Ø 23,5
1270853, 1353391, 10212000A



DF-DL-7836

Length: 1698
Ø: 52
Cone Ø: d1 Ø 26 / d2 Ø 23,5
0754922, 1286343, 1353396



DF-DL-8158

Length: 611
Ø: 48
Hole Distance: 130 / 130
0267743, 1361649, 1361650, 1656428



DF-DL-8196

Length: 867
Ø: 50
Cone Ø: d1 Ø 30 / d2 Ø 27
1363859, 1448063, 1602821



DF-DL-8363

Length: 855
Ø: 50
Cone Ø: d1 Ø 30 / d2 Ø 27
1363858, 1448062, 1602820



DF-DL-8718

Length: 1690
Ø: 40
Cone Ø: d1 Ø 30 / d2 Ø 27
1700000



DF-DL-9331

Length: 390
Ø: 50
Hole Distance: 130 / 152
1261101



DF-DL-10193

Length: 1646
Ø: 40
Cone Ø: d1 Ø 26 / d2 Ø 23,5
1351205, 1353395



DF-DL-12425

Length: 865
Ø: 52
Cone Ø: d1 Ø 30 / d2 Ø 27
1373878, 1448064



DF-ES-8362

Length: 150
Cone Ø: d1 Ø 26 / d2 Ø 23,5
Thread: M30 x 1,5 RHT
1389190



DF-RK-9336

Ø: 108
1445656



DF-SB-10402

Ø: 62
Thick/Height: 60
1291233, 1732887



DF-VB-8561

Length: 609
Ø: 48
Hole Distance: 152 / 152
0080521, 080521, 1361651, 1368270,
1390932, 1617096, 1793875, 1817808,
1892492



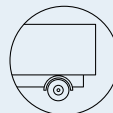

CF 85 ...

FT 85.460	10/05→05/13	Centre Rod	DF-DL-5237		Push Rod
	10/05→05/13	Centre Rod	DF-DL-8196		Push Rod
	10/05→05/13	Stabiliser Mounting	DF-SB-10402		
	10/05→05/13	Suspension Arm Repair Kit		DF-RK-9336	
	10/05→05/13	Tie Rod	DF-DL-5403		
	10/05→05/13	Tie Rod	DF-DL-7780		1st FA
	10/05→05/13	Tie Rod	DF-DL-8718		1st FA
	10/05→05/13	Tie Rod	DF-DL-10193		1st FA
	10/05→05/13	Tie Rod End	CV-ES-12461		for Steering Rod
	10/05→05/13	Tie Rod End	CV-ES-12462		for Steering Rod
	10/05→05/13	Tie Rod End	CV-ES-14162		for Steering Rod
	10/05→05/13	Tie Rod End	CV-ES-14163		for Steering Rod
	10/05→05/13	Tie Rod End	DF-ES-8362		for Steering Rod
	10/05→05/13	Track Control Arm		DF-DL-8158	Trailing Arm
	10/05→05/13	Track Control Arm		DF-DL-9331	Wishbone (CV), 1st RA, for Pneumatic Suspension vehicles
10/05→05/13	Track Control Arm		DF-VB-8561	Wishbone (CV)	
FT 85.480	01/01→05/13	Centre Rod	DF-DL-5237		Push Rod
	01/01→05/13	Centre Rod	DF-DL-8196		Push Rod
	01/01→05/13	Centre Rod	DF-DL-8363		Push Rod
	01/01→05/13	Stabiliser Mounting	DF-SB-10402		
	01/01→05/13	Suspension Arm Repair Kit		DF-RK-9336	
	01/01→05/13	Tie Rod	DF-DL-5403		
	01/01→05/13	Tie Rod	DF-DL-7780		1st FA
	01/01→05/13	Tie Rod	DF-DL-10193		1st FA
	01/01→05/13	Tie Rod End	CV-ES-12461		for Steering Rod
	01/01→05/13	Tie Rod End	CV-ES-12462		for Steering Rod
	01/01→05/13	Tie Rod End	CV-ES-14162		for Steering Rod
	01/01→05/13	Tie Rod End	CV-ES-14163		for Steering Rod
	01/01→05/13	Tie Rod End	DF-ES-8362		for Steering Rod
	01/01→05/13	Track Control Arm		DF-DL-8158	Trailing Arm
	01/01→05/13	Track Control Arm		DF-DL-9331	Wishbone (CV), 1st RA, for Pneumatic Suspension vehicles
01/01→05/13	Track Control Arm		DF-VB-8561	Wishbone (CV)	
FT 85.510	10/05→05/13	Centre Rod	DF-DL-5237		Push Rod
	10/05→05/13	Centre Rod	DF-DL-8196		Push Rod
	10/05→05/13	Centre Rod	DF-DL-8363		Push Rod
	10/05→05/13	Stabiliser Mounting	DF-SB-10402		
	10/05→05/13	Suspension Arm Repair Kit		DF-RK-9336	
	10/05→05/13	Tie Rod	DF-DL-5403		
	10/05→05/13	Tie Rod	DF-DL-7780		1st FA
	10/05→05/13	Tie Rod	DF-DL-8718		1st FA
	10/05→05/13	Tie Rod End	CV-ES-12461		for Steering Rod
	10/05→05/13	Tie Rod End	CV-ES-12462		for Steering Rod
	10/05→05/13	Tie Rod End	CV-ES-14162		for Steering Rod
	10/05→05/13	Tie Rod End	CV-ES-14163		for Steering Rod
	10/05→05/13	Tie Rod End	DF-ES-8362		for Steering Rod
	10/05→05/13	Track Control Arm		DF-DL-8158	Trailing Arm
	10/05→05/13	Track Control Arm		DF-DL-9331	Wishbone (CV), 1st RA, for Pneumatic Suspension vehicles
10/05→05/13	Track Control Arm		DF-VB-8561	Wishbone (CV)	
FTG 85.340	01/01→05/13	Centre Rod	DF-DL-5237		Push Rod
	01/01→05/13	Centre Rod	DF-DL-8196		Push Rod
	01/01→05/13	Centre Rod	DF-DL-10188		Push Rod
	01/01→05/13	Centre Rod	DF-DL-10192		Push Rod, for vehicles with Hinged Leading Axle
	01/01→05/13	Stabiliser Mounting	DF-SB-10402		
	01/01→05/13	Suspension Arm Repair Kit		DF-RK-9336	
	01/01→05/13	Tie Rod		DF-ES-5761	Leading Axle
	01/01→05/13	Tie Rod	DF-DL-5403		
	01/01→05/13	Tie Rod	DF-DL-7780		1st FA
	01/01→05/13	Tie Rod	DF-DL-10193		1st FA
	01/01→05/13	Tie Rod End	CV-ES-12461		for Steering Rod
	01/01→05/13	Tie Rod End	CV-ES-12462		for Steering Rod

CV-ES-12461

Length: 120
Cone Ø: d1 Ø 26 / d2 Ø 23,5
Thread: M30 x 1,5 LHT
0069513, 69513, 0311300, 311300, 607998, 0607998, 1190653, 1315447, 1319838, 1332123, 1338714, 1401934, 1407394, ACHB063, ACHF241, MAK1295



CV-ES-12462

Length: 120
Cone Ø: d1 Ø 26 / d2 Ø 23,5
Thread: M30 x 1,5 RHT
0069514, 0586753, 0607999, 0694298, 0694360, 0698609, 1137230, 1229944, 1326862, 1326896, 1331925, ACHB064, ACHF242, MAK1296



CV-ES-14162

Length: 125
Cone Ø: d1 Ø 30 / d2 Ø 27
Thread: M30 x 1,5 LHT
607053, 690225, 696225, 1228115, 1611088



CV-ES-14163

Length: 125
Cone Ø: d1 Ø 30 / d2 Ø 27
Thread: M30 x 1,5 RHT
0607981, 0698450, 1149907, 1152350, 1257890, 1603789, 1618048, ACHF060



DF-DL-5237

Length: 880
Ø: 52
Cone Ø: d1 Ø 26 / d2 Ø 23,5
1283211, 1351714, 1385497, 10201000A



DF-DL-5403

Length: 1742
Ø: 40
Cone Ø: d1 Ø 26 / d2 Ø 23,5
0288281, 1270854, 1337644



DF-DL-7780

Length: 1690
Ø: 40
Cone Ø: d1 Ø 26 / d2 Ø 23,5
1270853, 1353391, 10212000A



DF-DL-8158

Length: 611
Ø: 48
Hole Distance: 130 / 130
0267743, 1361649, 1361650, 1656428



DF-DL-8196

Length: 867
Ø: 50
Cone Ø: d1 Ø 30 / d2 Ø 27
1363859, 1448063, 1602821



DF-DL-8363

Length: 855
Ø: 50
Cone Ø: d1 Ø 30 / d2 Ø 27
1363858, 1448062, 1602820



DF-DL-8718

Length: 1690
Ø: 40
Cone Ø: d1 Ø 30 / d2 Ø 27
1700000



DF-DL-9331

Length: 390
Ø: 50
Hole Distance: 130 / 152
1261101



DF-DL-10188

Length: 860
Ø: 36
Cone Ø: d1 Ø 30 / d2 Ø 27
1380417, 1451129



DF-DL-10192

Length: 590
Ø: 38
Cone Ø: d1 Ø 30 / d2 Ø 27
1440171, 1451119



DF-DL-10193

Length: 1646
Ø: 40
Cone Ø: d1 Ø 26 / d2 Ø 23,5
1351205, 1353395



DF-ES-5761

Length: 1512
Ø: 52
Cone Ø: d1 Ø 26 / d2 Ø 23,5
1297572, 1361155



DF-ES-8362

Length: 150
Cone Ø: d1 Ø 26 / d2 Ø 23,5
Thread: M30 x 1,5 RHT
1389190



DF-RK-9336

Ø: 108
1445656



DF-SB-10402

Ø: 62
Thick/Height: 60
1291233, 1732887



DF-VB-8561

Length: 609
Ø: 48
Hole Distance: 152 / 152
080521, 0080521, 1361651, 1368270, 1390932, 1617096, 1793875, 1817808, 1892492



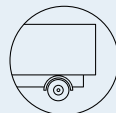

CF 85 ...

FTG 85.340 ...	01/01→05/13	Tie Rod End	CV-ES-14162		for Steering Rod	
	01/01→05/13	Tie Rod End	CV-ES-14163		for Steering Rod	
	01/01→05/13	Tie Rod End	DF-ES-8362		for Steering Rod	
	01/01→05/13	Track Control Arm		DF-DL-8158	Trailing Arm	
	01/01→05/13	Track Control Arm		DF-TC-12492	Control Arm	
	01/01→05/13	Track Control Arm		DF-VB-8561	Wishbone (CV)	
FTG 85.360	10/06→05/13	Centre Rod	DF-DL-5237		Push Rod	
	10/06→05/13	Centre Rod	DF-DL-8196		Push Rod	
	10/06→05/13	Centre Rod	DF-DL-8703		Push Rod	
	10/06→05/13	Centre Rod	DF-DL-10188		Push Rod	
	10/06→05/13	Centre Rod	DF-DL-10192		Push Rod, for vehicles with Hinged Leading Axle	
	10/06→05/13	Stabiliser Mounting	DF-SB-10402			
	10/06→05/13	Suspension Arm Repair Kit		DF-RK-9336		
	10/06→05/13	Tie Rod		DF-ES-5761	Leading Axle	
	10/06→05/13	Tie Rod	DF-DL-5403			
	10/06→05/13	Tie Rod	DF-DL-7780		1st FA	
	10/06→05/13	Tie Rod End	CV-ES-12461		for Steering Rod	
	10/06→05/13	Tie Rod End	CV-ES-12462		for Steering Rod	
	10/06→05/13	Tie Rod End	CV-ES-14162		for Steering Rod	
	10/06→05/13	Tie Rod End	CV-ES-14163		for Steering Rod	
	10/06→05/13	Tie Rod End	DF-ES-8362		for Steering Rod	
	10/06→05/13	Track Control Arm		DF-DL-8158	Trailing Arm	
	10/06→05/13	Track Control Arm		DF-TC-12492	Control Arm	
	10/06→05/13	Track Control Arm		DF-VB-8561	Wishbone (CV)	
	FTG 85.380	01/01→05/13	Centre Rod	DF-DL-5237		Push Rod
		01/01→05/13	Centre Rod	DF-DL-8196		Push Rod
01/01→05/13		Centre Rod	DF-DL-10188		Push Rod	
01/01→05/13		Centre Rod	DF-DL-10192		Push Rod, for vehicles with Hinged Leading Axle	
01/01→05/13		Stabiliser Mounting	DF-SB-10402			
01/01→05/13		Suspension Arm Repair Kit		DF-RK-9336		
01/01→05/13		Tie Rod		DF-ES-5761	Leading Axle	
01/01→05/13		Tie Rod	DF-DL-5403			
01/01→05/13		Tie Rod	DF-DL-7780		1st FA	
01/01→05/13		Tie Rod	DF-DL-10193		1st FA	
01/01→05/13		Tie Rod End	CV-ES-12461		for Steering Rod	
01/01→05/13		Tie Rod End	CV-ES-12462		for Steering Rod	
01/01→05/13		Tie Rod End	CV-ES-14162		for Steering Rod	
01/01→05/13		Tie Rod End	CV-ES-14163		for Steering Rod	
01/01→05/13		Tie Rod End	DF-ES-8362		for Steering Rod	
01/01→05/13		Track Control Arm		DF-DL-8158	Trailing Arm	
01/01→05/13		Track Control Arm		DF-TC-12492	Control Arm	
01/01→05/13		Track Control Arm		DF-VB-8561	Wishbone (CV)	
FTG 85.410		10/05→05/13	Centre Rod	DF-DL-5237		Push Rod
		10/05→05/13	Centre Rod	DF-DL-8196		Push Rod
	10/05→05/13	Centre Rod	DF-DL-10188		Push Rod	
	10/05→05/13	Centre Rod	DF-DL-10192		Push Rod, for vehicles with Hinged Leading Axle	
	10/05→05/13	Stabiliser Mounting	DF-SB-10402			
	10/05→05/13	Suspension Arm Repair Kit		DF-RK-9336		
	10/05→05/13	Tie Rod		DF-ES-5761	Leading Axle	
	10/05→05/13	Tie Rod	DF-DL-5403			
	10/05→05/13	Tie Rod	DF-DL-7780		1st FA	
	10/05→05/13	Tie Rod	DF-DL-8718		1st FA	
	10/05→05/13	Tie Rod End	CV-ES-12461		for Steering Rod	
	10/05→05/13	Tie Rod End	CV-ES-12462		for Steering Rod	
	10/05→05/13	Tie Rod End	CV-ES-14162		for Steering Rod	
	10/05→05/13	Tie Rod End	CV-ES-14163		for Steering Rod	
	10/05→05/13	Tie Rod End	DF-ES-8362		for Steering Rod	
	10/05→05/13	Track Control Arm		DF-DL-8158	Trailing Arm	
	10/05→05/13	Track Control Arm		DF-TC-12492	Control Arm	
	10/05→05/13	Track Control Arm		DF-VB-8561	Wishbone (CV)	

CV-ES-12461

Length: 120
Cone Ø: d1 Ø 26 / d2 Ø 23,5
Thread: M30 x 1,5 LHT
0069513, 69513, 0311300, 311300, 607998, 0607998, 1190653, 1315447, 1319838, 1332123, 1338714, 1401934, 1407394, ACHB063, ACHF241, MAK1295



CV-ES-12462

Length: 120
Cone Ø: d1 Ø 26 / d2 Ø 23,5
Thread: M30 x 1,5 RHT
0069514, 0586753, 0607999, 0694298, 0694360, 0698609, 1137230, 1229944, 1326862, 1326896, 1331925, ACHB064, ACHF242, MAK1296



CV-ES-14162

Length: 125
Cone Ø: d1 Ø 30 / d2 Ø 27
Thread: M30 x 1,5 LHT
607053, 690225, 696225, 1228115, 1611088



CV-ES-14163

Length: 125
Cone Ø: d1 Ø 30 / d2 Ø 27
Thread: M30 x 1,5 RHT
0607981, 0698450, 1149907, 1152350, 1257890, 1603789, 1618048, ACHF060



DF-DL-5237

Length: 880
Ø: 52
Cone Ø: d1 Ø 26 / d2 Ø 23,5
1283211, 1351714, 1385497, 10201000A



DF-DL-5403

Length: 1742
Ø: 40
Cone Ø: d1 Ø 26 / d2 Ø 23,5
0288281, 1270854, 1337644



DF-DL-7780

Length: 1690
Ø: 40
Cone Ø: d1 Ø 26 / d2 Ø 23,5
1270853, 1353391, 10212000A



DF-DL-8158

Length: 611
Ø: 48
Hole Distance: 130 / 130
0267743, 1361649, 1361650, 1656428



DF-DL-8196

Length: 867
Ø: 50
Cone Ø: d1 Ø 30 / d2 Ø 27
1363859, 1448063, 1602821



DF-DL-8703

Length: 1977
Ø: 52
Cone Ø: d1 Ø 30 / d2 Ø 27
1451122



DF-DL-8718

Length: 1690
Ø: 40
Cone Ø: d1 Ø 30 / d2 Ø 27
1700000



DF-DL-10188

Length: 860
Ø: 36
Cone Ø: d1 Ø 30 / d2 Ø 27
1380417, 1451129



DF-DL-10192

Length: 590
Ø: 38
Cone Ø: d1 Ø 30 / d2 Ø 27
1440171, 1451119



DF-DL-10193

Length: 1646
Ø: 40
Cone Ø: d1 Ø 26 / d2 Ø 23,5
1351205, 1353395



DF-ES-5761

Length: 1512
Ø: 52
Cone Ø: d1 Ø 26 / d2 Ø 23,5
1297572, 1361155



DF-ES-8362

Length: 150
Cone Ø: d1 Ø 26 / d2 Ø 23,5
Thread: M30 x 1,5 RHT
1389190

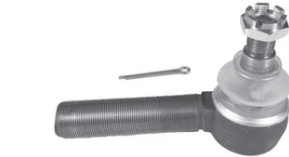

DF-RK-9336

Ø: 108
1445656



DF-SB-10402

Ø: 62
Thick/Height: 60
1291233, 1732887



DF-TC-12492

Length: 600
Ø: 40
Hole Distance: 115 / 115
1274741

No Image

DF-VB-8561

Length: 609
Ø: 48
Hole Distance: 152 / 152
0080521, 080521, 1361651, 1368270, 1390932, 1617096, 1793875, 1817808, 1892492





CF 85 ...

FTG 85.430	01/01→05/13	Centre Rod	DF-DL-5237		Push Rod
	01/01→05/13	Centre Rod	DF-DL-8196		Push Rod
	01/01→05/13	Centre Rod	DF-DL-8363		Push Rod
	01/01→05/13	Stabiliser Mounting	DF-SB-10402		
	01/01→05/13	Suspension Arm Repair Kit		DF-RK-9336	
	01/01→05/13	Tie Rod		DF-ES-5761	Leading Axle
	01/01→05/13	Tie Rod	DF-DL-5403		
	01/01→05/13	Tie Rod	DF-DL-7780		1st FA
	01/01→05/13	Tie Rod	DF-DL-10193		1st FA
	01/01→05/13	Tie Rod End	CV-ES-12461		for Steering Rod
	01/01→05/13	Tie Rod End	CV-ES-12462		for Steering Rod
	01/01→05/13	Tie Rod End	CV-ES-14162		for Steering Rod
	01/01→05/13	Tie Rod End	CV-ES-14163		for Steering Rod
	01/01→05/13	Tie Rod End	DF-ES-8362		for Steering Rod
	FTG 85.460	01/01→05/13	Track Control Arm		DF-DL-8158
01/01→05/13		Track Control Arm		DF-TC-12492	Trailing Arm, Leading Axle Steered, for Pneumatic Suspension vehicles
01/01→05/13		Track Control Arm		DF-VB-8561	Wishbone (CV)
10/05→05/13		Centre Rod	DF-DL-5237		Push Rod
10/05→05/13		Centre Rod	DF-DL-8196		Push Rod
10/05→05/13		Centre Rod	DF-DL-10188		Push Rod
10/05→05/13		Centre Rod	DF-DL-10192		Push Rod, for vehicles with Hinged Leading Axle
10/05→05/13		Stabiliser Mounting	DF-SB-10402		
10/05→05/13		Suspension Arm Repair Kit		DF-RK-9336	
10/05→05/13		Tie Rod		DF-ES-5761	Leading Axle
10/05→05/13		Tie Rod	DF-DL-5403		
10/05→05/13		Tie Rod	DF-DL-7780		1st FA
10/05→05/13		Tie Rod	DF-DL-8718		1st FA
10/05→05/13		Tie Rod End	CV-ES-12461		for Steering Rod
10/05→05/13		Tie Rod End	CV-ES-12462		for Steering Rod
10/05→05/13	Tie Rod End	CV-ES-14162		for Steering Rod	
10/05→05/13	Tie Rod End	CV-ES-14163		for Steering Rod	
10/05→05/13	Tie Rod End	DF-ES-8362		for Steering Rod	
10/05→05/13	Track Control Arm		DF-DL-8158	Trailing Arm	
10/05→05/13	Track Control Arm		DF-TC-12492	Control Arm	
10/05→05/13	Track Control Arm		DF-VB-8561	Wishbone (CV)	
FTG 85.480	01/01→05/13	Centre Rod	DF-DL-5237		Push Rod
	01/01→05/13	Centre Rod	DF-DL-8196		Push Rod
	01/01→05/13	Centre Rod	DF-DL-10188		Push Rod
	01/01→05/13	Centre Rod	DF-DL-10192		Push Rod, for vehicles with Hinged Leading Axle
	01/01→05/13	Stabiliser Mounting	DF-SB-10402		
	01/01→05/13	Suspension Arm Repair Kit		DF-RK-9336	
	01/01→05/13	Tie Rod		DF-ES-5761	Leading Axle
	01/01→05/13	Tie Rod	DF-DL-5403		
	01/01→05/13	Tie Rod	DF-DL-7780		1st FA
	01/01→05/13	Tie Rod End	CV-ES-12461		for Steering Rod
	01/01→05/13	Tie Rod End	CV-ES-12462		for Steering Rod
	01/01→05/13	Tie Rod End	CV-ES-14162		for Steering Rod
	01/01→05/13	Tie Rod End	CV-ES-14163		for Steering Rod
	01/01→05/13	Tie Rod End	DF-ES-8362		for Steering Rod
	01/01→05/13	Track Control Arm		DF-DL-8158	Trailing Arm
01/01→05/13	Track Control Arm		DF-TC-12492	Control Arm	
01/01→05/13	Track Control Arm		DF-VB-8561	Wishbone (CV)	
FTG 85.510	10/05→05/13	Centre Rod	DF-DL-5237		Push Rod
	10/05→05/13	Centre Rod	DF-DL-8196		Push Rod
	10/05→05/13	Centre Rod	DF-DL-10188		Push Rod
	10/05→05/13	Centre Rod	DF-DL-10192		Push Rod, for vehicles with Hinged Leading Axle
	10/05→05/13	Stabiliser Mounting	DF-SB-10402		
	10/05→05/13	Suspension Arm Repair Kit		DF-RK-9336	
	10/05→05/13	Suspension Arm Repair Kit	MN-RK-7280	MN-RK-7280	for Drag Link; for Semi-Trailing Arm; for Wishbone (CV)
	10/05→05/13	Tie Rod		DF-ES-5761	Leading Axle
	10/05→05/13	Tie Rod	DF-DL-5403		

CV-ES-12461

Length: 120
Cone Ø: d1 Ø 26 / d2 Ø 23,5
Thread: M30 x 1,5 LHT
0069513, 69513, 0311300, 311300,
0607998, 607998, 1190653, 1315447,
1319838, 1332123, 1338714, 1401934,
1407394, ACHB063, ACHF241, MAK1295



CV-ES-12462

Length: 120
Cone Ø: d1 Ø 26 / d2 Ø 23,5
Thread: M30 x 1,5 RHT
0069514, 0586753, 0607999, 0694298,
0694360, 0698609, 1137230, 1229944,
1326862, 1326896, 1331925, ACHB064,
ACHF242, MAK1296



CV-ES-14162

Length: 125
Cone Ø: d1 Ø 30 / d2 Ø 27
Thread: M30 x 1,5 LHT
607053, 690225, 696225, 1228115,
1611088



CV-ES-14163

Length: 125
Cone Ø: d1 Ø 30 / d2 Ø 27
Thread: M30 x 1,5 RHT
0607981, 0698450, 1149907, 1152350,
1257890, 1603789, 1618048, ACHF060



DF-DL-5237

Length: 880
Ø: 52
Cone Ø: d1 Ø 26 / d2 Ø 23,5
1283211, 1351714, 1385497, 10201000A



DF-DL-5403

Length: 1742
Ø: 40
Cone Ø: d1 Ø 26 / d2 Ø 23,5
0288281, 1270854, 1337644



DF-DL-7780

Length: 1690
Ø: 40
Cone Ø: d1 Ø 26 / d2 Ø 23,5
1270853, 1353391, 10212000A



DF-DL-8158

Length: 611
Ø: 48
Hole Distance: 130 / 130
0267743, 1361649, 1361650, 1656428



DF-DL-8196

Length: 867
Ø: 50
Cone Ø: d1 Ø 30 / d2 Ø 27
1363859, 1448063, 1602821



DF-DL-8363

Length: 855
Ø: 50
Cone Ø: d1 Ø 30 / d2 Ø 27
1363858, 1448062, 1602820



DF-DL-8718

Length: 1690
Ø: 40
Cone Ø: d1 Ø 30 / d2 Ø 27
1700000



DF-DL-10188

Length: 860
Ø: 36
Cone Ø: d1 Ø 30 / d2 Ø 27
1380417, 1451129



DF-DL-10192

Length: 590
Ø: 38
Cone Ø: d1 Ø 30 / d2 Ø 27
1440171, 1451119



DF-DL-10193

Length: 1646
Ø: 40
Cone Ø: d1 Ø 26 / d2 Ø 23,5
1351205, 1353395



DF-ES-5761

Length: 1512
Ø: 52
Cone Ø: d1 Ø 26 / d2 Ø 23,5
1297572, 1361155



DF-ES-8362

Length: 150
Cone Ø: d1 Ø 26 / d2 Ø 23,5
Thread: M30 x 1,5 RHT
1389190



DF-RK-9336

Ø: 108
1445656



DF-SB-10402

Ø: 62
Thick/Height: 60
1291233, 1732887



DF-TC-12492

Length: 600
Ø: 40
Hole Distance: 115 / 115
1274741

No Image

DF-VB-8561

Length: 609
Ø: 48
Hole Distance: 152 / 152
0080521, 080521, 1361651, 1368270,
1390932, 1617096, 1793875, 1817808,
1892492



MN-RK-7280

Ø: 75
Hole Distance: 115
Thick/Height: 24
0689748, 689748





CF 85 ...

FTG 85.510 ...	10/05→05/13	Tie Rod	DF-DL-7780		1st FA
	10/05→05/13	Tie Rod End	CV-ES-12461		for Steering Rod
	10/05→05/13	Tie Rod End	CV-ES-12462		for Steering Rod
	10/05→05/13	Tie Rod End	CV-ES-14162		for Steering Rod
	10/05→05/13	Tie Rod End	CV-ES-14163		for Steering Rod
	10/05→05/13	Tie Rod End	DF-ES-8362		for Steering Rod
	10/05→05/13	Track Control Arm		DF-DL-8158	Trailing Arm
	10/05→05/13	Track Control Arm		DF-TC-12492	Control Arm
	10/05→05/13	Track Control Arm		DF-TC-12492	Trailing Arm, Leading Axle Steered, for Pneumatic Suspension vehicles
	10/05→05/13	Track Control Arm		DF-VB-8561	Wishbone (CV)
FTP 85.340	01/01→05/13	Centre Rod	DF-DL-5237		Push Rod
	01/01→05/13	Centre Rod	DF-DL-8196		Push Rod
	01/01→05/13	Centre Rod	DF-DL-8363		Push Rod
	01/01→05/13	Stabiliser Mounting	DF-SB-10402		
	01/01→05/13	Suspension Arm Repair Kit		DF-RK-9336	
	01/01→05/13	Tie Rod	DF-DL-5403		
	01/01→05/13	Tie Rod	DF-DL-7780		1st FA
	01/01→05/13	Tie Rod End	CV-ES-12461		for Steering Rod
	01/01→05/13	Tie Rod End	CV-ES-12462		for Steering Rod
	01/01→05/13	Tie Rod End	CV-ES-14163		for Steering Rod
	01/01→05/13	Track Control Arm		DF-DL-8158	Trailing Arm
01/01→05/13	Track Control Arm		DF-VB-8561	Wishbone (CV)	
FTP 85.380	01/01→05/13	Centre Rod	DF-DL-5237		Push Rod
	01/01→05/13	Centre Rod	DF-DL-8196		Push Rod
	01/01→05/13	Centre Rod	DF-DL-8363		Push Rod
	01/01→05/13	Stabiliser Mounting	DF-SB-10402		
	01/01→05/13	Suspension Arm Repair Kit		DF-RK-9336	
	01/01→05/13	Tie Rod	DF-DL-5403		
	01/01→05/13	Tie Rod	DF-DL-7780		1st FA
	01/01→05/13	Tie Rod	DF-DL-10193		1st FA
	01/01→05/13	Tie Rod End	CV-ES-12461		for Steering Rod
	01/01→05/13	Tie Rod End	CV-ES-12462		for Steering Rod
	01/01→05/13	Tie Rod End	CV-ES-14163		for Steering Rod
	01/01→05/13	Track Control Arm		DF-DL-8158	Trailing Arm
	01/01→05/13	Track Control Arm		DF-VB-8561	Wishbone (CV)
FTP 85.430	01/01→05/13	Centre Rod	DF-DL-5237		Push Rod
	01/01→05/13	Centre Rod	DF-DL-8196		Push Rod
	01/01→05/13	Centre Rod	DF-DL-8363		Push Rod
	01/01→05/13	Stabiliser Mounting	DF-SB-10402		
	01/01→05/13	Suspension Arm Repair Kit		DF-RK-9336	
	01/01→05/13	Tie Rod	DF-DL-5403		
	01/01→05/13	Tie Rod	DF-DL-7780		1st FA
	01/01→05/13	Tie Rod	DF-DL-10193		1st FA
	01/01→05/13	Tie Rod End	CV-ES-12461		for Steering Rod
	01/01→05/13	Tie Rod End	CV-ES-12462		for Steering Rod
	01/01→05/13	Tie Rod End	CV-ES-14163		for Steering Rod
	01/01→05/13	Track Control Arm		DF-DL-8158	Trailing Arm
	01/01→05/13	Track Control Arm		DF-VB-8561	Wishbone (CV)
FTP 85.480	01/01→05/13	Centre Rod	DF-DL-5237		Push Rod
	01/01→05/13	Centre Rod	DF-DL-8196		Push Rod
	01/01→05/13	Centre Rod	DF-DL-8363		Push Rod
	01/01→05/13	Stabiliser Mounting	DF-SB-10402		
	01/01→05/13	Suspension Arm Repair Kit		DF-RK-9336	
	01/01→05/13	Tie Rod	DF-DL-5403		
	01/01→05/13	Tie Rod	DF-DL-7780		1st FA
	01/01→05/13	Tie Rod End	CV-ES-12461		for Steering Rod
	01/01→05/13	Tie Rod End	CV-ES-12462		for Steering Rod
	01/01→05/13	Tie Rod End	CV-ES-14163		for Steering Rod
	01/01→05/13	Track Control Arm		DF-DL-8158	Trailing Arm
01/01→05/13	Track Control Arm		DF-VB-8561	Wishbone (CV)	

CV-ES-12461

Length: 120
Cone Ø: d1 Ø 26 / d2 Ø 23,5
Thread: M30 x 1,5 LHT
0069513, 69513, 0311300, 311300,
0607998, 607998, 1190653, 1315447,
1319838, 1332123, 1338714, 1401934,
1407394, ACHB063, ACHF241, MAK1295



CV-ES-12462

Length: 120
Cone Ø: d1 Ø 26 / d2 Ø 23,5
Thread: M30 x 1,5 RHT
0069514, 0586753, 0607999, 0694298,
0694360, 0698609, 1137230, 1229944,
1326862, 1326896, 1331925, ACHB064,
ACHF242, MAK1296



CV-ES-14162

Length: 125
Cone Ø: d1 Ø 30 / d2 Ø 27
Thread: M30 x 1,5 LHT
607053, 690225, 696225, 1228115,
1611088



CV-ES-14163

Length: 125
Cone Ø: d1 Ø 30 / d2 Ø 27
Thread: M30 x 1,5 RHT
0607981, 0698450, 1149907, 1152350,
1257890, 1603789, 1618048, ACHF060



DF-DL-5237

Length: 880
Ø: 52
Cone Ø: d1 Ø 26 / d2 Ø 23,5
1283211, 1351714, 1385497, 1020100A



DF-DL-5403

Length: 1742
Ø: 40
Cone Ø: d1 Ø 26 / d2 Ø 23,5
0288281, 1270854, 1337644



DF-DL-7780

Length: 1690
Ø: 40
Cone Ø: d1 Ø 26 / d2 Ø 23,5
1270853, 1353391, 1021200A



DF-DL-8158

Length: 611
Ø: 48
Hole Distance: 130 / 130
0267743, 1361649, 1361650, 1656428



DF-DL-8196

Length: 867
Ø: 50
Cone Ø: d1 Ø 30 / d2 Ø 27
1363859, 1448063, 1602821



DF-DL-8363

Length: 855
Ø: 50
Cone Ø: d1 Ø 30 / d2 Ø 27
1363858, 1448062, 1602820



DF-DL-10193

Length: 1646
Ø: 40
Cone Ø: d1 Ø 26 / d2 Ø 23,5
1351205, 1353395



DF-ES-8362

Length: 150
Cone Ø: d1 Ø 26 / d2 Ø 23,5
Thread: M30 x 1,5 RHT
1389190



DF-RK-9336

Ø: 108
1445656



DF-SB-10402

Ø: 62
Thick/Height: 60
1291233, 1732887



DF-TC-12492

Length: 600
Ø: 40
Hole Distance: 115 / 115
1274741

No Image

DF-VB-8561

Length: 609
Ø: 48
Hole Distance: 152 / 152
0080521, 080521, 1361651, 1368270,
1390932, 1617096, 1793875, 1817808,
1892492



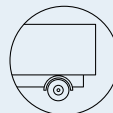

CF 85 ...

FTR 85.360, FTS 85.360, FTP 85.360	10/06→05/13	Centre Rod	DF-DL-5237		Push Rod
	10/06→05/13	Centre Rod	DF-DL-8196		Push Rod
	10/06→05/13	Centre Rod	DF-DL-8363		Push Rod
	10/06→05/13	Stabiliser Mounting	DF-SB-10402		
	10/06→05/13	Suspension Arm Repair Kit		DF-RK-9336	
	10/06→05/13	Tie Rod	DF-DL-5403		1st FA
	10/06→05/13	Tie Rod	DF-DL-7780		
	10/06→05/13	Tie Rod End	CV-ES-12461		for Steering Rod
	10/06→05/13	Tie Rod End	CV-ES-12462		for Steering Rod
	10/06→05/13	Tie Rod End	CV-ES-14162		for Steering Rod
	10/06→05/13	Tie Rod End	CV-ES-14163		for Steering Rod
	10/06→05/13	Track Control Arm		DF-DL-8158	Trailing Arm
	10/06→05/13	Track Control Arm		DF-VB-8561	Wishbone (CV)
	FTR 85.410, FTS 85.410, FTP 85.410	10/05→05/13	Centre Rod	DF-DL-5237	
10/05→05/13		Centre Rod	DF-DL-8196		Push Rod
10/05→05/13		Centre Rod	DF-DL-8363		Push Rod
10/05→05/13		Stabiliser Mounting	DF-SB-10402		
10/05→05/13		Suspension Arm Repair Kit		DF-RK-9336	
10/05→05/13		Tie Rod	DF-DL-5403		1st FA
10/05→05/13		Tie Rod	DF-DL-7780		
10/05→05/13		Tie Rod	DF-DL-10193		1st FA
10/05→05/13		Tie Rod End	CV-ES-12461		for Steering Rod
10/05→05/13		Tie Rod End	CV-ES-12462		for Steering Rod
10/05→05/13		Tie Rod End	CV-ES-14162		for Steering Rod
10/05→05/13		Tie Rod End	CV-ES-14163		for Steering Rod
10/05→05/13		Track Control Arm		DF-DL-8158	Trailing Arm
10/05→05/13		Track Control Arm		DF-VB-8561	Wishbone (CV)
FTR 85.460, FTS 85.460, FTP 85.460	10/05→05/13	Centre Rod	DF-DL-5237		Push Rod
	10/05→05/13	Centre Rod	DF-DL-8196		Push Rod
	10/05→05/13	Centre Rod	DF-DL-8363		Push Rod
	10/05→05/13	Stabiliser Mounting	DF-SB-10402		
	10/05→05/13	Suspension Arm Repair Kit		DF-RK-9336	
	10/05→05/13	Tie Rod	DF-DL-5403		1st FA
	10/05→05/13	Tie Rod	DF-DL-7780		
	10/05→05/13	Tie Rod End	CV-ES-12461		for Steering Rod
	10/05→05/13	Tie Rod End	CV-ES-12462		for Steering Rod
	10/05→05/13	Tie Rod End	CV-ES-14162		for Steering Rod
	10/05→05/13	Tie Rod End	CV-ES-14163		for Steering Rod
	10/05→05/13	Track Control Arm		DF-DL-8158	Trailing Arm
	10/05→05/13	Track Control Arm		DF-VB-8561	Wishbone (CV)
	FTR 85.510, FTS 85.510, FTP 85.510	10/05→05/13	Centre Rod	DF-DL-5237	
10/05→05/13		Centre Rod	DF-DL-8196		Push Rod
10/05→05/13		Centre Rod	DF-DL-8363		Push Rod
10/05→05/13		Stabiliser Mounting	DF-SB-10402		
10/05→05/13		Suspension Arm Repair Kit		DF-RK-9336	
10/05→05/13		Tie Rod	DF-DL-5403		1st FA
10/05→05/13		Tie Rod	DF-DL-7780		
10/05→05/13		Tie Rod End	CV-ES-12461		for Steering Rod
10/05→05/13		Tie Rod End	CV-ES-12462		for Steering Rod
10/05→05/13		Tie Rod End	CV-ES-14162		for Steering Rod
10/05→05/13		Tie Rod End	CV-ES-14163		for Steering Rod
10/05→05/13		Track Control Arm		DF-DL-8158	Trailing Arm
10/05→05/13		Track Control Arm		DF-VB-8561	Wishbone (CV)
FTS 85.340		01/01→05/13	Centre Rod	DF-DL-5237	
	01/01→05/13	Centre Rod	DF-DL-8196		Push Rod
	01/01→05/13	Centre Rod	DF-DL-8363		Push Rod
	01/01→05/13	Stabiliser Mounting	DF-SB-10402		
	01/01→05/13	Suspension Arm Repair Kit		DF-RK-9336	
	01/01→05/13	Tie Rod	DF-DL-5403		
	01/01→05/13	Tie Rod	DF-DL-7780		1st FA
	01/01→05/13	Tie Rod End	CV-ES-12461		for Steering Rod
	01/01→05/13	Tie Rod End	CV-ES-12462		for Steering Rod
	01/01→05/13	Tie Rod End	CV-ES-14162		for Steering Rod

CV-ES-12461

Length: 120
Cone Ø: d1 Ø 26 / d2 Ø 23,5
Thread: M30 x 1,5 LHT
69513, 0069513, 0311300, 311300,
0607998, 607998, 1190653, 1315447,
1319838, 1332123, 1338714, 1401934,
1407394, ACHB063, ACHF241, MAK1295



CV-ES-12462

Length: 120
Cone Ø: d1 Ø 26 / d2 Ø 23,5
Thread: M30 x 1,5 RHT
0069514, 0586753, 0607999, 0694298,
0694360, 0698609, 1137230, 1229944,
1326862, 1326896, 1331925, ACHB064,
ACHF242, MAK1296



CV-ES-14162

Length: 125
Cone Ø: d1 Ø 30 / d2 Ø 27
Thread: M30 x 1,5 LHT
607053, 690225, 696225, 1228115,
1611088



CV-ES-14163

Length: 125
Cone Ø: d1 Ø 30 / d2 Ø 27
Thread: M30 x 1,5 RHT
0607981, 0698450, 1149907, 1152350,
1257890, 1603789, 1618048, ACHF060



DF-DL-5237

Length: 880
Ø: 52
Cone Ø: d1 Ø 26 / d2 Ø 23,5
1283211, 1351714, 1385497, 10201000A



DF-DL-5403

Length: 1742
Ø: 40
Cone Ø: d1 Ø 26 / d2 Ø 23,5
0288281, 1270854, 1337644



DF-DL-7780

Length: 1690
Ø: 40
Cone Ø: d1 Ø 26 / d2 Ø 23,5
1270853, 1353391, 10212000A



DF-DL-8158

Length: 611
Ø: 48
Hole Distance: 130 / 130
0267743, 1361649, 1361650, 1656428



DF-DL-8196

Length: 867
Ø: 50
Cone Ø: d1 Ø 30 / d2 Ø 27
1363859, 1448063, 1602821



DF-DL-8363

Length: 855
Ø: 50
Cone Ø: d1 Ø 30 / d2 Ø 27
1363858, 1448062, 1602820



DF-DL-10193

Length: 1646
Ø: 40
Cone Ø: d1 Ø 26 / d2 Ø 23,5
1351205, 1353395



DF-RK-9336

Ø: 108
1445656



DF-SB-10402

Ø: 62
Thick/Height: 60
1291233, 1732887



DF-VB-8561

Length: 609
Ø: 48
Hole Distance: 152 / 152
0080521, 080521, 1361651, 1368270,
1390932, 1617096, 1793875, 1817808,
1892492



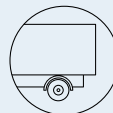

CF 85 ...

FTS 85.340 ...	01/01→05/13	Tie Rod End	CV-ES-14163		for Steering Rod	
	01/01→05/13	Track Control Arm		DF-DL-8158	Trailing Arm	
	01/01→05/13	Track Control Arm		DF-VB-8561	Wishbone (CV)	
FTS 85.380	01/01→05/13	Centre Rod	DF-DL-5237		Push Rod	
	01/01→05/13	Centre Rod	DF-DL-8196		Push Rod	
	01/01→05/13	Centre Rod	DF-DL-8363		Push Rod	
	01/01→05/13	Stabiliser Mounting	DF-SB-10402			
	01/01→05/13	Suspension Arm Repair Kit		DF-RK-9336		
	01/01→05/13	Tie Rod	DF-DL-5403			
	01/01→05/13	Tie Rod	DF-DL-7780		1st FA	
	01/01→05/13	Tie Rod	DF-DL-10193		1st FA	
	01/01→05/13	Tie Rod End	CV-ES-12461		for Steering Rod	
	01/01→05/13	Tie Rod End	CV-ES-12462		for Steering Rod	
	01/01→05/13	Tie Rod End	CV-ES-14162		for Steering Rod	
	01/01→05/13	Tie Rod End	CV-ES-14163		for Steering Rod	
	01/01→05/13	Track Control Arm		DF-DL-8158	Trailing Arm	
	01/01→05/13	Track Control Arm		DF-VB-8561	Wishbone (CV)	
	FTS 85.430	01/01→05/13	Centre Rod	DF-DL-5237		Push Rod
01/01→05/13		Centre Rod	DF-DL-8196		Push Rod	
01/01→05/13		Centre Rod	DF-DL-8363		Push Rod	
01/01→05/13		Stabiliser Mounting	DF-SB-10402			
01/01→05/13		Suspension Arm Repair Kit		DF-RK-9336		
01/01→05/13		Tie Rod	DF-DL-5403			
01/01→05/13		Tie Rod	DF-DL-7780		1st FA	
01/01→05/13		Tie Rod End	CV-ES-12461		for Steering Rod	
01/01→05/13		Tie Rod End	CV-ES-12462		for Steering Rod	
01/01→05/13		Tie Rod End	CV-ES-14162		for Steering Rod	
01/01→05/13		Tie Rod End	CV-ES-14163		for Steering Rod	
01/01→05/13		Track Control Arm		DF-DL-8158	Trailing Arm	
01/01→05/13		Track Control Arm		DF-VB-8561	Wishbone (CV)	
FTS 85.480		01/01→05/13	Centre Rod	DF-DL-5237		Push Rod
		01/01→05/13	Centre Rod	DF-DL-8196		Push Rod
	01/01→05/13	Centre Rod	DF-DL-8363		Push Rod	
	01/01→05/13	Centre Rod	DF-DL-12425		Push Rod	
	01/01→05/13	Stabiliser Mounting	DF-SB-10402			
	01/01→05/13	Suspension Arm Repair Kit		DF-RK-9336		
	01/01→05/13	Tie Rod	DF-DL-5403		1st FA	
	01/01→05/13	Tie Rod	DF-DL-7780		1st FA	
	01/01→05/13	Tie Rod	DF-DL-7836		1st FA	
	01/01→05/13	Tie Rod End	CV-ES-12461		for Steering Rod	
	01/01→05/13	Tie Rod End	CV-ES-12462		for Steering Rod	
	01/01→05/13	Tie Rod End	CV-ES-14162		for Steering Rod	
	01/01→05/13	Tie Rod End	CV-ES-14163		for Steering Rod	
	01/01→05/13	Track Control Arm		DF-DL-8158	Trailing Arm	
	01/01→05/13	Track Control Arm		DF-VB-8561	Wishbone (CV)	
	FTT 85.340	01/01→05/13	Centre Rod	DF-DL-5237		Push Rod
		01/01→05/13	Centre Rod	DF-DL-8196		Push Rod
		01/01→05/13	Stabiliser Mounting	DF-SB-10402		
01/01→05/13		Suspension Arm Repair Kit		DF-RK-9336		
01/01→05/13		Tie Rod	DF-DL-5403			
01/01→05/13		Tie Rod	DF-DL-7780			
01/01→05/13		Tie Rod End	CV-ES-12461		for Steering Rod	
01/01→05/13		Tie Rod End	CV-ES-12462		for Steering Rod	
01/01→05/13		Tie Rod End	CV-ES-14162		for Steering Rod	
01/01→05/13		Tie Rod End	CV-ES-14163		for Steering Rod	
01/01→05/13		Track Control Arm		DF-DL-8158	Trailing Arm	
01/01→05/13		Track Control Arm		DF-DL-9318	Trailing Arm, 1st RA;2nd RA, for Leaf-Spring Suspension vehicles	
01/01→05/13		Track Control Arm		DF-TC-12262	Control Arm	
01/01→05/13		Track Control Arm		DF-VB-8561	Wishbone (CV)	

CV-ES-12461

Length: 120
Cone Ø: d1 Ø 26 / d2 Ø 23,5
Thread: M30 x 1,5 LHT
0069513, 69513, 0311300, 311300,
0607998, 607998, 1190653, 1315447,
1319838, 1332123, 1338714, 1401934,
1407394, ACHB063, ACHF241, MAK1295



CV-ES-12462

Length: 120
Cone Ø: d1 Ø 26 / d2 Ø 23,5
Thread: M30 x 1,5 RHT
0069514, 0586753, 0607999, 0694298,
0694360, 0698609, 1137230, 1229944,
1326862, 1326896, 1331925, ACHB064,
ACHF242, MAK1296



CV-ES-14162

Length: 125
Cone Ø: d1 Ø 30 / d2 Ø 27
Thread: M30 x 1,5 LHT
607053, 690225, 696225, 1228115,
1611088



CV-ES-14163

Length: 125
Cone Ø: d1 Ø 30 / d2 Ø 27
Thread: M30 x 1,5 RHT
0607981, 0698450, 1149907, 1152350,
1257890, 1603789, 1618048, ACHF060



DF-DL-5237

Length: 880
Ø: 52
Cone Ø: d1 Ø 26 / d2 Ø 23,5
1283211, 1351714, 1385497, 10201000A



DF-DL-5403

Length: 1742
Ø: 40
Cone Ø: d1 Ø 26 / d2 Ø 23,5
0288281, 1270854, 1337644



DF-DL-7780

Length: 1690
Ø: 40
Cone Ø: d1 Ø 26 / d2 Ø 23,5
1270853, 1353391, 10212000A



DF-DL-7836

Length: 1698
Ø: 52
Cone Ø: d1 Ø 26 / d2 Ø 23,5
0754922, 1286343, 1353396



DF-DL-8158

Length: 611
Ø: 48
Hole Distance: 130 / 130
0267743, 1361649, 1361650, 1656428



DF-DL-8196

Length: 867
Ø: 50
Cone Ø: d1 Ø 30 / d2 Ø 27
1363859, 1448063, 1602821



DF-DL-8363

Length: 855
Ø: 50
Cone Ø: d1 Ø 30 / d2 Ø 27
1363858, 1448062, 1602820



DF-DL-9318

Length: 600
Ø: 50
Hole Distance: 130 / 130
0646373, 0655695, 0655697, 1284860,
1620438



DF-DL-10193

Length: 1646
Ø: 40
Cone Ø: d1 Ø 26 / d2 Ø 23,5
1351205, 1353395



DF-DL-12425

Length: 865
Ø: 52
Cone Ø: d1 Ø 30 / d2 Ø 27
1373878, 1448064



DF-RK-9336

Ø: 108
1445656



DF-SB-10402

Ø: 62
Thick/Height: 60
1291233, 1732887



DF-TC-12262

Length: 595
Ø: 50
Hole Distance: 130 / 130
0661406, 661406, 661407, 0661407,
1620439



DF-VB-8561

Length: 609
Ø: 48
Hole Distance: 152 / 152
080521, 0080521, 1361651, 1368270,
1390932, 1617096, 1793875, 1817808,
1892492





CF 85 ...

FTT 85.360	10/06→05/13	Centre Rod	DF-DL-5237		Push Rod
	10/06→05/13	Centre Rod	DF-DL-8196		Push Rod
	10/06→05/13	Stabiliser Mounting	DF-SB-10402		
	10/06→05/13	Suspension Arm Repair Kit		DF-RK-9336	
	10/06→05/13	Tie Rod	DF-DL-5403		
	10/06→05/13	Tie Rod	DF-DL-7780		
	10/06→05/13	Tie Rod End	CV-ES-12461		for Steering Rod
	10/06→05/13	Tie Rod End	CV-ES-12462		for Steering Rod
	10/06→05/13	Tie Rod End	CV-ES-14162		for Steering Rod
	10/06→05/13	Tie Rod End	CV-ES-14163		for Steering Rod
	10/06→05/13	Track Control Arm		DF-DL-8158	Trailing Arm
	10/06→05/13	Track Control Arm		DF-DL-9318	Trailing Arm, 1st RA;2nd RA, for Leaf-Spring Suspension vehicles
	10/06→05/13	Track Control Arm		DF-TC-12262	Control Arm
	10/06→05/13	Track Control Arm		DF-VB-8561	Wishbone (CV)
FTT 85.380	01/01→05/13	Centre Rod	DF-DL-5237		Push Rod
	01/01→05/13	Centre Rod	DF-DL-8196		Push Rod
	01/01→05/13	Centre Rod	DF-DL-8363		Push Rod
	01/01→05/13	Stabiliser Mounting	DF-SB-10402		
	01/01→05/13	Suspension Arm Repair Kit		DF-RK-9336	
	01/01→05/13	Tie Rod	DF-DL-5403		
	01/01→05/13	Tie Rod	DF-DL-7780		1st FA
	01/01→05/13	Tie Rod	DF-DL-10193		1st FA
	01/01→05/13	Tie Rod End	CV-ES-12461		for Steering Rod
	01/01→05/13	Tie Rod End	CV-ES-12462		for Steering Rod
	01/01→05/13	Tie Rod End	CV-ES-14162		for Steering Rod
	01/01→05/13	Tie Rod End	CV-ES-14163		for Steering Rod
	01/01→05/13	Track Control Arm		DF-DL-8158	Trailing Arm
	01/01→05/13	Track Control Arm		DF-DL-9318	Trailing Arm
01/01→05/13	Track Control Arm		DF-TC-12262	Control Arm	
01/01→05/13	Track Control Arm		DF-VB-8561	Wishbone (CV)	
FTT 85.410	10/05→05/13	Centre Rod	DF-DL-5237		Push Rod
	10/05→05/13	Centre Rod	DF-DL-8196		Push Rod
	10/05→05/13	Centre Rod	DF-DL-8363		Push Rod
	10/05→05/13	Stabiliser Mounting	DF-SB-10402		
	10/05→05/13	Suspension Arm Repair Kit		DF-RK-8633	for Wishbone (CV)
	10/05→05/13	Suspension Arm Repair Kit		DF-RK-9336	
	10/05→05/13	Suspension Arm Repair Kit	MN-RK-7280	MN-RK-7280	for Drag Link;for Semi-Trailing Arm; for Wishbone (CV)
	10/05→05/13	Tie Rod	DF-DL-5403		
	10/05→05/13	Tie Rod	DF-DL-7780		
	10/05→05/13	Tie Rod	DF-DL-8718		
	10/05→05/13	Tie Rod End	CV-ES-12461		for Steering Rod
	10/05→05/13	Tie Rod End	CV-ES-12462		for Steering Rod
	10/05→05/13	Tie Rod End	CV-ES-14162		for Steering Rod
	10/05→05/13	Tie Rod End	CV-ES-14163		for Steering Rod
	10/05→05/13	Track Control Arm		DF-DL-8158	Trailing Arm
	10/05→05/13	Track Control Arm		DF-DL-9318	Trailing Arm, 1st RA;2nd RA, for Leaf-Spring Suspension vehicles
	10/05→05/13	Track Control Arm		DF-TC-12262	Control Arm
	10/05→05/13	Track Control Arm		DF-VB-8561	Wishbone (CV)
FTT 85.430	01/01→05/13	Centre Rod	DF-DL-5237		Push Rod
	01/01→05/13	Centre Rod	DF-DL-8196		Push Rod
	01/01→05/13	Centre Rod	DF-DL-8363		Push Rod
	01/01→05/13	Centre Rod	DF-DL-8704		Push Rod
	01/01→05/13	Centre Rod	DF-DL-12420		for Steering Rod
	01/01→05/13	Stabiliser Mounting	DF-SB-10402		
	01/01→05/13	Suspension Arm Repair Kit		DF-RK-9336	
	01/01→05/13	Tie Rod	DF-DL-5403		
	01/01→05/13	Tie Rod	DF-DL-5403		1st FA
	01/01→05/13	Tie Rod	DF-DL-7780		1st FA
	01/01→05/13	Tie Rod	DF-DL-10193		1st FA
01/01→05/13	Tie Rod End	CV-ES-12461		for Steering Rod	

CV-ES-12461

Length: 120
Cone Ø: d1 Ø 26 / d2 Ø 23,5
Thread: M30 x 1,5 LHT
69513, 0069513, 311300, 0311300,
0607998, 607998, 1190653, 1315447,
1319838, 1332123, 1338714, 1401934,
1407394, ACHB063, ACHF241, MAK1295



CV-ES-12462

Length: 120
Cone Ø: d1 Ø 26 / d2 Ø 23,5
Thread: M30 x 1,5 RHT
0069514, 0586753, 0607999, 0694298,
0694360, 0698609, 1137230, 1229944,
1326862, 1326896, 1331925, ACHB064,
ACHF242, MAK1296



CV-ES-14162

Length: 125
Cone Ø: d1 Ø 30 / d2 Ø 27
Thread: M30 x 1,5 LHT
607053, 690225, 696225, 1228115,
1611088



CV-ES-14163

Length: 125
Cone Ø: d1 Ø 30 / d2 Ø 27
Thread: M30 x 1,5 RHT
0607981, 0698450, 1149907, 1152350,
1257890, 1603789, 1618048, ACHF060



DF-DL-5237

Length: 880
Ø: 52
Cone Ø: d1 Ø 26 / d2 Ø 23,5
1283211, 1351714, 1385497, 10201000A



DF-DL-5403

Length: 1742
Ø: 40
Cone Ø: d1 Ø 26 / d2 Ø 23,5
0288281, 1270854, 1337644



DF-DL-7780

Length: 1690
Ø: 40
Cone Ø: d1 Ø 26 / d2 Ø 23,5
1270853, 1353391, 10212000A



DF-DL-8158

Length: 611
Ø: 48
Hole Distance: 130 / 130
0267743, 1361649, 1361650, 1656428



DF-DL-8196

Length: 867
Ø: 50
Cone Ø: d1 Ø 30 / d2 Ø 27
1363859, 1448063, 1602821



DF-DL-8363

Length: 855
Ø: 50
Cone Ø: d1 Ø 30 / d2 Ø 27
1363858, 1448062, 1602820



DF-DL-8704

Length: 991
Ø: 50
Cone Ø: d1 Ø 30 / d2 Ø 27
1395994



DF-DL-8718

Length: 1690
Ø: 40
Cone Ø: d1 Ø 30 / d2 Ø 27
1700000



DF-DL-9318

Length: 600
Ø: 50
Hole Distance: 130 / 130
0646373, 0655695, 0655697, 1284860,
1620438



DF-DL-10193

Length: 1646
Ø: 40
Cone Ø: d1 Ø 26 / d2 Ø 23,5
1351205, 1353395



DF-DL-12420

Length: 1004
Ø: 52
Cone Ø: d1 Ø 30 / d2 Ø 27
Thread: M24 x 1,5 / M30 x 1,5
0094613, 094613, 94613, 0362413, 362413,
1426101



DF-RK-8633

Ø: 90
0696320, 696320



DF-RK-9336

Ø: 108
1445656



DF-SB-10402

Ø: 62
Thick/Height: 60
1291233, 1732887



DF-TC-12262

Length: 595
Ø: 50
Hole Distance: 130 / 130
0661406, 661406, 0661407, 661407,
1620439



DF-VB-8561

Length: 609
Ø: 48
Hole Distance: 152 / 152
0080521, 080521, 1361651, 1368270,
1390932, 1617096, 1793875, 1817808,
1892492



MN-RK-7280

Ø: 75
Hole Distance: 115
Thick/Height: 24
0689748, 689748





CF 85 ...

FTT 85.430 ...	01/01→05/13	Tie Rod End	CV-ES-12462		for Steering Rod
	01/01→05/13	Tie Rod End	CV-ES-14162		for Steering Rod
	01/01→05/13	Tie Rod End	CV-ES-14163		for Steering Rod
	01/01→05/13	Track Control Arm		DF-DL-8158	Trailing Arm
	01/01→05/13	Track Control Arm		DF-DL-9318	Trailing Arm
	01/01→05/13	Track Control Arm		DF-TC-12262	Control Arm
	01/01→05/13	Track Control Arm		DF-VB-8561	Wishbone (CV)
FTT 85.460	10/05→05/13	Centre Rod	DF-DL-5237		Push Rod
	10/05→05/13	Centre Rod	DF-DL-8196		Push Rod
	10/05→05/13	Centre Rod	DF-DL-8363		Push Rod
	10/05→05/13	Stabiliser Mounting	DF-SB-10402		
	10/05→05/13	Suspension Arm Repair Kit		DF-RK-9336	
	10/05→05/13	Tie Rod	DF-DL-5403		
	10/05→05/13	Tie Rod	DF-DL-7780		1st FA
	10/05→05/13	Tie Rod	DF-DL-10193		1st FA
	10/05→05/13	Tie Rod End	CV-ES-12461		for Steering Rod
	10/05→05/13	Tie Rod End	CV-ES-12462		for Steering Rod
	10/05→05/13	Tie Rod End	CV-ES-14162		for Steering Rod
	10/05→05/13	Tie Rod End	CV-ES-14163		for Steering Rod
	10/05→05/13	Track Control Arm		DF-DL-8158	Trailing Arm
	10/05→05/13	Track Control Arm		DF-DL-9318	Trailing Arm, 1st RA;2nd RA, for Leaf-Spring Suspension vehicles
	10/05→05/13	Track Control Arm		DF-TC-12262	Control Arm
10/05→05/13	Track Control Arm		DF-VB-8561	Wishbone (CV)	
FTT 85.480	01/01→05/13	Centre Rod	DF-DL-5237		Push Rod
	01/01→05/13	Centre Rod	DF-DL-8196		Push Rod
	01/01→05/13	Centre Rod	DF-DL-8363		Push Rod
	01/01→05/13	Stabiliser Mounting	DF-SB-10402		
	01/01→05/13	Suspension Arm Repair Kit		DF-RK-9336	
	01/01→05/13	Tie Rod	DF-DL-5403		1st FA
	01/01→05/13	Tie Rod	DF-DL-7780		1st FA
	01/01→05/13	Tie Rod	DF-DL-10193		1st FA
	01/01→05/13	Tie Rod End	CV-ES-12461		for Steering Rod
	01/01→05/13	Tie Rod End	CV-ES-12462		for Steering Rod
	01/01→05/13	Tie Rod End	CV-ES-14162		for Steering Rod
	01/01→05/13	Tie Rod End	CV-ES-14163		for Steering Rod
	01/01→05/13	Track Control Arm		DF-DL-8158	Trailing Arm
	01/01→05/13	Track Control Arm		DF-DL-9318	Trailing Arm
	01/01→05/13	Track Control Arm		DF-TC-12262	Control Arm
01/01→05/13	Track Control Arm		DF-VB-8561	Wishbone (CV)	
FTT 85.510	10/05→05/13	Centre Rod	DF-DL-5237		Push Rod
	10/05→05/13	Centre Rod	DF-DL-8196		Push Rod
	10/05→05/13	Centre Rod	DF-DL-8363		Push Rod
	10/05→05/13	Stabiliser Mounting	DF-SB-10402		
	10/05→05/13	Suspension Arm Repair Kit		DF-RK-9336	
	10/05→05/13	Tie Rod	DF-DL-5403		
	10/05→05/13	Tie Rod	DF-DL-7780		1st FA
	10/05→05/13	Tie Rod End	CV-ES-12461		for Steering Rod
	10/05→05/13	Tie Rod End	CV-ES-12462		for Steering Rod
	10/05→05/13	Tie Rod End	CV-ES-14162		for Steering Rod
	10/05→05/13	Tie Rod End	CV-ES-14163		for Steering Rod
	10/05→05/13	Track Control Arm		DF-DL-8158	Trailing Arm
	10/05→05/13	Track Control Arm		DF-DL-9318	Trailing Arm, 1st RA;2nd RA, for Leaf-Spring Suspension vehicles
	10/05→05/13	Track Control Arm		DF-TC-12262	Control Arm
	10/05→05/13	Track Control Arm		DF-VB-8561	Wishbone (CV)

F 500

FA 500 DE	12/77→12/79	Tie Rod End	CV-ES-14163		for Steering Rod
-----------	-------------	-------------	--------------------	--	------------------

F 600

FA 600 CD	12/86→12/92	Tie Rod End	CV-ES-14163		for Steering Rod
-----------	-------------	-------------	--------------------	--	------------------

CV-ES-12461

Length: 120
Cone Ø: d1 Ø 26 / d2 Ø 23,5
Thread: M30 x 1,5 LHT
0069513, 69513, 0311300, 311300,
0607998, 607998, 1190653, 1315447,
1319838, 1332123, 1338714, 1401934,
1407394, ACHB063, ACHF241, MAK1295



CV-ES-12462

Length: 120
Cone Ø: d1 Ø 26 / d2 Ø 23,5
Thread: M30 x 1,5 RHT
0069514, 0586753, 0607999, 0694298,
0694360, 0698609, 1137230, 1229944,
1326862, 1326896, 1331925, ACHB064,
ACHF242, MAK1296



CV-ES-14162

Length: 125
Cone Ø: d1 Ø 30 / d2 Ø 27
Thread: M30 x 1,5 LHT
607053, 690225, 696225, 1228115,
1611088



CV-ES-14163

Length: 125
Cone Ø: d1 Ø 30 / d2 Ø 27
Thread: M30 x 1,5 RHT
0607981, 0698450, 1149907, 1152350,
1257890, 1603789, 1618048, ACHF060



DF-DL-5237

Length: 880
Ø: 52
Cone Ø: d1 Ø 26 / d2 Ø 23,5
1283211, 1351714, 1385497, 1020100A



DF-DL-5403

Length: 1742
Ø: 40
Cone Ø: d1 Ø 26 / d2 Ø 23,5
0288281, 1270854, 1337644



DF-DL-7780

Length: 1690
Ø: 40
Cone Ø: d1 Ø 26 / d2 Ø 23,5
1270853, 1353391, 1021200A



DF-DL-8158

Length: 611
Ø: 48
Hole Distance: 130 / 130
0267743, 1361649, 1361650, 1656428



DF-DL-8196

Length: 867
Ø: 50
Cone Ø: d1 Ø 30 / d2 Ø 27
1363859, 1448063, 1602821



DF-DL-8363

Length: 855
Ø: 50
Cone Ø: d1 Ø 30 / d2 Ø 27
1363858, 1448062, 1602820



DF-DL-9318

Length: 600
Ø: 50
Hole Distance: 130 / 130
0646373, 0655695, 0655697, 1284860,
1620438



DF-DL-10193

Length: 1646
Ø: 40
Cone Ø: d1 Ø 26 / d2 Ø 23,5
1351205, 1353395



DF-RK-9336

Ø: 108
1445656



DF-SB-10402

Ø: 62
Thick/Height: 60
1291233, 1732887



DF-TC-12262

Length: 595
Ø: 50
Hole Distance: 130 / 130
661406, 0661406, 661407, 0661407,
1620439



DF-VB-8561

Length: 609
Ø: 48
Hole Distance: 152 / 152
0080521, 080521, 1361651, 1368270,
1390932, 1617096, 1793875, 1817808,
1892492



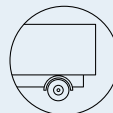

F 700

FA 700 DE	12/75→12/79	Tie Rod End	CV-ES-14163		for Steering Rod
-----------	-------------	-------------	-------------	--	------------------

F 800

FA 800 CB	05/87→08/91	Tie Rod End	CV-ES-14163		for Steering Rod
FA 800 CN	12/86→08/91	Tie Rod End	CV-ES-14163		for Steering Rod

F 900

FA 900 BDD	01/75→12/81	Tie Rod End	CV-ES-14163		for Steering Rod
FA 900 BDF	11/81→11/88	Tie Rod End	CV-ES-14163		for Steering Rod
FA 900 BDT	11/83→11/88	Tie Rod End	CV-ES-14163		for Steering Rod
FA 900 DE	01/75→12/81	Tie Rod End	CV-ES-14163		for Steering Rod

F 1000

FA 1000 CB	05/87→12/92	Tie Rod End	CV-ES-14163		for Steering Rod
FA 1000 CN	12/86→12/92	Tie Rod End	CV-ES-14163		for Steering Rod

F 1100

FA 1100 DD	01/78→12/81	Ball Head, gearshift linkage	DF-ES-9335		
	01/78→12/81	Tie Rod End	CV-ES-14163		for Steering Rod
FA 1100 DF	11/81→11/88	Ball Head, gearshift linkage	DF-ES-9335		
	11/81→11/88	Tie Rod End	CV-ES-14163		for Steering Rod
FA 1100 DNTD	12/86→11/90	Ball Head, gearshift linkage	DF-ES-9335		
	12/86→11/90	Tie Rod End	CV-ES-14163		for Steering Rod
FA 1100 DT	11/83→11/88	Ball Head, gearshift linkage	DF-ES-9335		
	11/83→11/88	Tie Rod End	CV-ES-14163		for Steering Rod

F 1200

FA 1200 DD	01/69→12/81	Ball Head, gearshift linkage	CV-ES-2119		
	01/69→12/81	Ball Head, gearshift linkage	CV-ES-2182		
	01/69→12/81	Tie Rod End	CV-ES-2534		
	01/69→12/81	Tie Rod End	CV-ES-12461		for Steering Rod
	01/69→12/81	Tie Rod End	CV-ES-12462		for Steering Rod
	01/69→12/81	Tie Rod End	CV-ES-14163		for Steering Rod

F 1300

FA 1300 DF	07/78→10/88	Ball Head, gearshift linkage	DF-ES-9335		
	07/78→10/88	Tie Rod End	CV-ES-12461		for Steering Rod
	07/78→10/88	Tie Rod End	CV-ES-12462		for Steering Rod
	07/78→10/88	Tie Rod End	CV-ES-14163		for Steering Rod
FA 1300 DNT,FA 1300 NT	12/86→12/92	Ball Head, gearshift linkage	DF-ES-9335		
	12/86→12/92	Tie Rod End	CV-ES-12461		for Steering Rod
	12/86→12/92	Tie Rod End	CV-ES-12462		for Steering Rod
	12/86→12/92	Tie Rod End	CV-ES-14163		for Steering Rod
FA 1300 DNTD,FA 1300 NB	12/86→12/92	Ball Head, gearshift linkage	DF-ES-9335		
	12/86→12/92	Tie Rod End	CV-ES-12461		for Steering Rod
	12/86→12/92	Tie Rod End	CV-ES-12462		for Steering Rod
	12/86→12/92	Tie Rod End	CV-ES-14163		for Steering Rod
FA 1300 DT	07/78→02/90	Ball Head, gearshift linkage	DF-ES-9335		
	07/78→02/90	Tie Rod End	CV-ES-12461		for Steering Rod
	07/78→02/90	Tie Rod End	CV-ES-12462		for Steering Rod
	07/78→02/90	Tie Rod End	CV-ES-14163		for Steering Rod
FA 1300 DT-B	07/78→02/90	Ball Head, gearshift linkage	DF-ES-9335		
	07/78→02/90	Tie Rod End	CV-ES-12461		for Steering Rod
	07/78→02/90	Tie Rod End	CV-ES-12462		for Steering Rod
	07/78→02/90	Tie Rod End	CV-ES-14163		for Steering Rod
FA 1305 DT	07/78→02/90	Ball Head, gearshift linkage	DF-ES-9335		
	07/78→02/90	Tie Rod End	CV-ES-12461		for Steering Rod
	07/78→02/90	Tie Rod End	CV-ES-12462		for Steering Rod
	07/78→02/90	Tie Rod End	CV-ES-14163		for Steering Rod

F 1400

FA 1400 DD	02/72→12/81	Ball Head, gearshift linkage	CV-ES-2119		
	02/72→12/81	Ball Head, gearshift linkage	CV-ES-2182		
	02/72→12/81	Tie Rod End	CV-ES-12461		for Steering Rod
	02/72→12/81	Tie Rod End	CV-ES-12462		for Steering Rod
	02/72→12/81	Tie Rod End	CV-ES-14163		for Steering Rod

CV-ES-2119

Length: 55
Cone Ø: d1 Ø 10 / d2 Ø 10
Thread: M12 x 1,75 LHT
592106, 1249088



CV-ES-14163

Length: 125
Cone Ø: d1 Ø 30 / d2 Ø 27
Thread: M30 x 1,5 RHT
0607981, 0698450, 1149907, 1152350,
1257890, 1603789, 1618048, ACHF060



CV-ES-2182

Length: 55
Cone Ø: d1 Ø 10 / d2 Ø 10
Thread: M12 x 1,75 RHT
589333, 1249129



DF-ES-9335

Length: 85
Cone Ø: d1 Ø 12 / d2 Ø 10,75
Thread: M14 x 1,5 RHT
0386930, 386930



CV-ES-2534

Length: 101
Cone Ø: d1 Ø 22 / d2 Ø 20
Thread: M28 x 1,5 LHT
607452



CV-ES-12461

Length: 120
Cone Ø: d1 Ø 26 / d2 Ø 23,5
Thread: M30 x 1,5 LHT
0069513, 69513, 0311300, 311300,
0607998, 607998, 1190653, 1315447,
1319838, 1332123, 1338714, 1401934,
1407394, ACHB063, ACHF241, MAK1295



CV-ES-12462

Length: 120
Cone Ø: d1 Ø 26 / d2 Ø 23,5
Thread: M30 x 1,5 RHT
0069514, 0586753, 0607999, 0694298,
0694360, 0698609, 1137230, 1229944,
1326862, 1326896, 1331925, ACHB064,
ACHF242, MAK1296





F 1500

FA 1500 DF,FD 1500 DF	07/78→08/91	Ball Head, gearshift linkage	CV-ES-2119	
	07/78→08/91	Ball Head, gearshift linkage	CV-ES-2182	
	07/78→08/91	Tie Rod End	CV-ES-12461	for Steering Rod
	07/78→08/91	Tie Rod End	CV-ES-12462	for Steering Rod
	07/78→08/91	Tie Rod End	CV-ES-14163	for Steering Rod
FA 1500 DT,FD 1500 DT	07/78→08/91	Ball Head, gearshift linkage	CV-ES-2119	
	07/78→08/91	Ball Head, gearshift linkage	CV-ES-2182	
	07/78→08/91	Tie Rod End	CV-ES-12461	for Steering Rod
	07/78→08/91	Tie Rod End	CV-ES-12462	for Steering Rod
	07/78→08/91	Tie Rod End	CV-ES-14163	for Steering Rod
FT 1500 DT	07/78→05/86	Ball Head, gearshift linkage	CV-ES-2119	
	07/78→05/86	Ball Head, gearshift linkage	CV-ES-2182	
	07/78→05/86	Tie Rod End	CV-ES-12461	for Steering Rod
	07/78→05/86	Tie Rod End	CV-ES-12462	for Steering Rod
	07/78→05/86	Tie Rod End	CV-ES-14163	for Steering Rod

F 1600

FA 1600 DF	01/70→08/91	Ball Head, gearshift linkage	CV-ES-2119	
	01/70→08/91	Ball Head, gearshift linkage	CV-ES-2182	
	01/70→08/91	Ball Head, gearshift linkage	DF-ES-9335	
	01/70→08/91	Tie Rod End	CV-ES-12461	for Steering Rod
	01/70→08/91	Tie Rod End	CV-ES-12462	for Steering Rod
	01/70→08/91	Tie Rod End	CV-ES-14163	for Steering Rod
	01/70→08/91	Tie Rod End	DF-ES-3634	
	01/70→08/91	Tie Rod End	DF-ES-3635	
FA 1600 DT	01/73→08/91	Ball Head, gearshift linkage	CV-ES-2119	
	01/73→08/91	Ball Head, gearshift linkage	CV-ES-2182	
	01/73→08/91	Ball Head, gearshift linkage	DF-ES-9335	
	01/73→08/91	Tie Rod End	CV-ES-12461	for Steering Rod
	01/73→08/91	Tie Rod End	CV-ES-12462	for Steering Rod
	01/73→08/91	Tie Rod End	CV-ES-14163	for Steering Rod
	01/73→08/91	Tie Rod End	DF-ES-3634	
01/73→08/91	Tie Rod End	DF-ES-3635		
FGG 1600 DT,FGG 1621 DT	01/73→08/91	Ball Head, gearshift linkage	CV-ES-2119	
	01/73→08/91	Ball Head, gearshift linkage	CV-ES-2182	
	01/73→08/91	Ball Head, gearshift linkage	DF-ES-9335	
	01/73→08/91	Tie Rod End	CV-ES-12461	for Steering Rod
	01/73→08/91	Tie Rod End	CV-ES-12462	for Steering Rod
	01/73→08/91	Tie Rod End	CV-ES-14163	for Steering Rod
	01/73→08/91	Tie Rod End	DF-ES-3634	
01/73→08/91	Tie Rod End	DF-ES-3635		
FT 1600 DT	01/73→08/91	Ball Head, gearshift linkage	CV-ES-2119	
	01/73→08/91	Ball Head, gearshift linkage	CV-ES-2182	
	01/73→08/91	Ball Head, gearshift linkage	DF-ES-9335	
	01/73→08/91	Tie Rod End	CV-ES-12461	for Steering Rod
	01/73→08/91	Tie Rod End	CV-ES-12462	for Steering Rod
	01/73→08/91	Tie Rod End	CV-ES-14163	for Steering Rod
	01/73→08/91	Tie Rod End	DF-ES-3634	
01/73→08/91	Tie Rod End	DF-ES-3635		

F 1700

FA 1700 DNS	01/88→02/95	Ball Head, gearshift linkage	CV-ES-2119	
	01/88→02/95	Ball Head, gearshift linkage	CV-ES-2182	
	01/88→02/95	Ball Head, gearshift linkage	DF-ES-9335	
	01/88→02/95	Tie Rod End	CV-ES-12461	for Steering Rod
	01/88→02/95	Tie Rod End	CV-ES-12462	for Steering Rod
	01/88→02/95	Tie Rod End	CV-ES-14163	for Steering Rod
	01/88→02/95	Tie Rod End	DF-ES-3634	
	01/88→02/95	Tie Rod End	DF-ES-3635	
FA 1700 DNT,FA 1700 NT	12/86→02/95	Ball Head, gearshift linkage	CV-ES-2119	
	12/86→02/95	Ball Head, gearshift linkage	CV-ES-2182	
	12/86→02/95	Ball Head, gearshift linkage	DF-ES-9335	
	12/86→02/95	Tie Rod End	CV-ES-12461	for Steering Rod
	12/86→02/95	Tie Rod End	CV-ES-12462	for Steering Rod

CV-ES-2119

Length: 55
Cone Ø: d1 Ø 10 / d2 Ø 10
Thread: M12 x 1,75 LHT
592106, 1249088



DF-ES-3634

Length: 130
Cone Ø: d1 Ø 30 / d2 Ø 27
Thread: M46 x 1,5 LHT
0606922, 606922



CV-ES-2182

Length: 55
Cone Ø: d1 Ø 10 / d2 Ø 10
Thread: M12 x 1,75 RHT
589333, 1249129



DF-ES-3635

Length: 130
Cone Ø: d1 Ø 30 / d2 Ø 27
Thread: M46 x 1,5 RHT
0606923, 606923



CV-ES-12461

Length: 120
Cone Ø: d1 Ø 26 / d2 Ø 23,5
Thread: M30 x 1,5 LHT
0069513, 69513, 0311300, 311300,
0607998, 607998, 1190653, 1315447,
1319838, 1332123, 1338714, 1401934,
1407394, ACHB063, ACHF241, MAK1295



DF-ES-9335

Length: 85
Cone Ø: d1 Ø 12 / d2 Ø 10,75
Thread: M14 x 1,5 RHT
0386930, 386930



CV-ES-12462

Length: 120
Cone Ø: d1 Ø 26 / d2 Ø 23,5
Thread: M30 x 1,5 RHT
0069514, 0586753, 0607999, 0694298,
0694360, 0698609, 1137230, 1229944,
1326862, 1326896, 1331925, ACHB064,
ACHF242, MAK1296



CV-ES-14163

Length: 125
Cone Ø: d1 Ø 30 / d2 Ø 27
Thread: M30 x 1,5 RHT
0607981, 0698450, 1149907, 1152350,
1257890, 1603789, 1618048, ACHF060





F 1700 ...

FA 1700 DNT,FA 1700 NT ...	12/86→02/95	Tie Rod End	CV-ES-14163		for Steering Rod
	12/86→02/95	Tie Rod End	DF-ES-3634		
	12/86→02/95	Tie Rod End	DF-ES-3635		
FA 1700 DNTD,FA 1700 NB, FD 1700 DNTD,FD 1700 NB	12/86→02/95	Ball Head, gearshift linkage	CV-ES-2119		
	12/86→02/95	Ball Head, gearshift linkage	CV-ES-2182		
	12/86→02/95	Ball Head, gearshift linkage	DF-ES-9335		
	12/86→02/95	Tie Rod End	CV-ES-12461		for Steering Rod
	12/86→02/95	Tie Rod End	CV-ES-12462		for Steering Rod
	12/86→02/95	Tie Rod End	CV-ES-14163		for Steering Rod
	12/86→02/95	Tie Rod End	DF-ES-3634		
FAG 1700 DNT,FAG 1700 NT	12/86→02/95	Tie Rod End	DF-ES-3635		
	12/86→02/95	Ball Head, gearshift linkage	CV-ES-2119		
	12/86→02/95	Ball Head, gearshift linkage	CV-ES-2182		
	12/86→02/95	Ball Head, gearshift linkage	DF-ES-9335		
	12/86→02/95	Tie Rod End	CV-ES-12461		for Steering Rod
	12/86→02/95	Tie Rod End	CV-ES-12462		for Steering Rod
	12/86→02/95	Tie Rod End	CV-ES-14163		for Steering Rod
FAG 1700 DNTD,FAG 1700 NB	12/86→02/95	Tie Rod End	DF-ES-3634		
	12/86→02/95	Tie Rod End	DF-ES-3635		
	12/86→02/95	Ball Head, gearshift linkage	CV-ES-2119		
	12/86→02/95	Ball Head, gearshift linkage	CV-ES-2182		
	12/86→02/95	Ball Head, gearshift linkage	DF-ES-9335		
	12/86→02/95	Tie Rod End	CV-ES-12461		for Steering Rod
	12/86→02/95	Tie Rod End	CV-ES-12462		for Steering Rod
FAG 1700 DNTD,FAG 1700 NB	12/86→02/95	Tie Rod End	CV-ES-14163		for Steering Rod
	12/86→02/95	Tie Rod End	DF-ES-3634		
	12/86→02/95	Tie Rod End	DF-ES-3635		

F 1800

FAV 1800 DT	01/70→08/91	Ball Head, gearshift linkage	DF-ES-9335		
	01/70→08/91	Tie Rod End	CV-ES-14163		for Steering Rod

F 1900

FA 1900 DNS	12/86→09/93	Ball Head, gearshift linkage	CV-ES-2119		
	12/86→09/93	Ball Head, gearshift linkage	CV-ES-2182		
	12/86→09/93	Ball Head, gearshift linkage	DF-ES-9335		
	12/86→09/93	Suspension Arm Repair Kit		CV-RK-5322	for Wishbone (CV)
	12/86→09/93	Suspension Arm Repair Kit		IV-RK-8998	for Wishbone (CV)
	12/86→09/93	Tie Rod End	CV-ES-12461		for Steering Rod
	12/86→09/93	Tie Rod End	CV-ES-12462		for Steering Rod
	12/86→09/93	Tie Rod End	CV-ES-14163		for Steering Rod
	12/86→09/93	Tie Rod End	DF-ES-3634		
	12/86→09/93	Tie Rod End	DF-ES-3635		
FA 1900 DNS,FA 1900 NS	12/86→09/93	Ball Head, gearshift linkage	CV-ES-2119		
	12/86→09/93	Ball Head, gearshift linkage	CV-ES-2182		
	12/86→09/93	Ball Head, gearshift linkage	DF-ES-9335		
	12/86→09/93	Suspension Arm Repair Kit		CV-RK-5322	for Wishbone (CV)
	12/86→09/93	Suspension Arm Repair Kit		IV-RK-8998	for Wishbone (CV)
	12/86→09/93	Tie Rod End	CV-ES-12461		for Steering Rod
	12/86→09/93	Tie Rod End	CV-ES-12462		for Steering Rod
	12/86→09/93	Tie Rod End	CV-ES-14163		for Steering Rod
	12/86→09/93	Tie Rod End	DF-ES-3634		
	12/86→09/93	Tie Rod End	DF-ES-3635		
FA 1900 DNT,FA 1900 NT	12/86→09/93	Ball Head, gearshift linkage	CV-ES-2119		
	12/86→09/93	Ball Head, gearshift linkage	CV-ES-2182		
	12/86→09/93	Ball Head, gearshift linkage	DF-ES-9335		
	12/86→09/93	Suspension Arm Repair Kit		CV-RK-5322	for Wishbone (CV)
	12/86→09/93	Suspension Arm Repair Kit		IV-RK-8998	for Wishbone (CV)
	12/86→09/93	Tie Rod End	CV-ES-12461		for Steering Rod
	12/86→09/93	Tie Rod End	CV-ES-12462		for Steering Rod
	12/86→09/93	Tie Rod End	CV-ES-14163		for Steering Rod
FA 1900 DNT,FA 1900 NT	12/86→09/93	Tie Rod End	DF-ES-3634		
	12/86→09/93	Tie Rod End	DF-ES-3635		

CV-ES-2119

Length: 55
Cone Ø: d1 Ø 10 / d2 Ø 10
Thread: M12 x 1,75 LHT
592106, 1249088



DF-ES-3634

Length: 130
Cone Ø: d1 Ø 30 / d2 Ø 27
Thread: M46 x 1,5 LHT
0606922, 606922



CV-ES-2182

Length: 55
Cone Ø: d1 Ø 10 / d2 Ø 10
Thread: M12 x 1,75 RHT
589333, 1249129



DF-ES-3635

Length: 130
Cone Ø: d1 Ø 30 / d2 Ø 27
Thread: M46 x 1,5 RHT
0606923, 606923



CV-ES-12461

Length: 120
Cone Ø: d1 Ø 26 / d2 Ø 23,5
Thread: M30 x 1,5 LHT
0069513, 69513, 311300, 0311300,
0607998, 607998, 1190653, 1315447,
1319838, 1332123, 1338714, 1401934,
1407394, ACHB063, ACHF241, MAK1295



DF-ES-9335

Length: 85
Cone Ø: d1 Ø 12 / d2 Ø 10,75
Thread: M14 x 1,5 RHT
0386930, 386930



CV-ES-12462

Length: 120
Cone Ø: d1 Ø 26 / d2 Ø 23,5
Thread: M30 x 1,5 RHT
0069514, 0586753, 0607999, 0694298,
0694360, 0698609, 1137230, 1229944,
1326862, 1326896, 1331925, ACHB064,
ACHF242, MAK1296



IV-RK-8998

Ø: 85
Hole Distance: 130
Thick/Height: 30
0513757, 0531757, 0691709, 691709



CV-ES-14163

Length: 125
Cone Ø: d1 Ø 30 / d2 Ø 27
Thread: M30 x 1,5 RHT
0607981, 0698450, 1149907, 1152350,
1257890, 1603789, 1618048, ACHF060



CV-RK-5322

Ø: 72
Thick/Height: 50
0691704





F 1900 ...

FA 1900 DNT,FD 1900 DNT, FD 1900 NT	12/86→09/93	Ball Head, gearshift linkage	CV-ES-2119		
	12/86→09/93	Ball Head, gearshift linkage	CV-ES-2182		
	12/86→09/93	Ball Head, gearshift linkage	DF-ES-9335		
	12/86→09/93	Suspension Arm Repair Kit		CV-RK-5322	for Wishbone (CV)
	12/86→09/93	Suspension Arm Repair Kit		IV-RK-8998	for Wishbone (CV)
	12/86→09/93	Tie Rod End	CV-ES-12461		for Steering Rod
	12/86→09/93	Tie Rod End	CV-ES-12462		for Steering Rod
	12/86→09/93	Tie Rod End	CV-ES-14163		for Steering Rod
	12/86→09/93	Tie Rod End	DF-ES-3634		
	12/86→09/93	Tie Rod End	DF-ES-3635		
FAV 1900 DNT,FAV 1900 NT	12/86→09/93	Ball Head, gearshift linkage	CV-ES-2119		
	12/86→09/93	Ball Head, gearshift linkage	CV-ES-2182		
	12/86→09/93	Ball Head, gearshift linkage	DF-ES-9335		
	12/86→09/93	Suspension Arm Repair Kit		CV-RK-5322	for Wishbone (CV)
	12/86→09/93	Suspension Arm Repair Kit		IV-RK-8998	for Wishbone (CV)
	12/86→09/93	Tie Rod End	CV-ES-12461		for Steering Rod
	12/86→09/93	Tie Rod End	CV-ES-12462		for Steering Rod
	12/86→09/93	Tie Rod End	CV-ES-14163		for Steering Rod
	12/86→09/93	Tie Rod End	DF-ES-3634		
	12/86→09/93	Tie Rod End	DF-ES-3635		
FT 1900 DNS,FT 1900 NS	12/86→09/93	Ball Head, gearshift linkage	CV-ES-2119		
	12/86→09/93	Ball Head, gearshift linkage	CV-ES-2182		
	12/86→09/93	Ball Head, gearshift linkage	DF-ES-9335		
	12/86→09/93	Suspension Arm Repair Kit		CV-RK-5322	for Wishbone (CV)
	12/86→09/93	Suspension Arm Repair Kit		IV-RK-8998	for Wishbone (CV)
	12/86→09/93	Tie Rod End	CV-ES-12461		for Steering Rod
	12/86→09/93	Tie Rod End	CV-ES-12462		for Steering Rod
	12/86→09/93	Tie Rod End	CV-ES-14163		for Steering Rod
	12/86→09/93	Tie Rod End	DF-ES-3634		
	12/86→09/93	Tie Rod End	DF-ES-3635		

F 2000

FA 2000 DH	01/70→12/79	Ball Head, gearshift linkage	CV-ES-2119		
	01/70→12/79	Ball Head, gearshift linkage	CV-ES-2182		
	01/70→12/79	Tie Rod End	CV-ES-14163		for Steering Rod
	01/70→12/79	Tie Rod End	DF-ES-3634		
	01/70→12/79	Tie Rod End	DF-ES-3635		
FA 2000 DHB	01/70→12/79	Ball Head, gearshift linkage	CV-ES-2119		
	01/70→12/79	Ball Head, gearshift linkage	CV-ES-2182		
	01/70→12/79	Tie Rod End	CV-ES-14163		for Steering Rod
	01/70→12/79	Tie Rod End	DF-ES-3634		
	01/70→12/79	Tie Rod End	DF-ES-3635		
FAS 2000 DH	01/70→12/79	Ball Head, gearshift linkage	CV-ES-2119		
	01/70→12/79	Ball Head, gearshift linkage	CV-ES-2182		
	01/70→12/79	Tie Rod End	CV-ES-14163		for Steering Rod
	01/70→12/79	Tie Rod End	DF-ES-3634		
	01/70→12/79	Tie Rod End	DF-ES-3635		
FAS 2000 DHB	01/70→12/79	Ball Head, gearshift linkage	CV-ES-2119		
	01/70→12/79	Ball Head, gearshift linkage	CV-ES-2182		
	01/70→12/79	Tie Rod End	CV-ES-14163		for Steering Rod
	01/70→12/79	Tie Rod End	DF-ES-3634		
	01/70→12/79	Tie Rod End	DF-ES-3635		
FAT 2000 DH	01/70→12/79	Ball Head, gearshift linkage	CV-ES-2119		
	01/70→12/79	Ball Head, gearshift linkage	CV-ES-2182		
	01/70→12/79	Tie Rod End	CV-ES-14163		for Steering Rod
	01/70→12/79	Tie Rod End	DF-ES-3634		
	01/70→12/79	Tie Rod End	DF-ES-3635		
FAT 2000 DHB	01/70→12/79	Ball Head, gearshift linkage	CV-ES-2119		
	01/70→12/79	Ball Head, gearshift linkage	CV-ES-2182		
	01/70→12/79	Tie Rod End	CV-ES-14163		for Steering Rod
	01/70→12/79	Tie Rod End	DF-ES-3634		
	01/70→12/79	Tie Rod End	DF-ES-3635		

CV-ES-2119

Length: 55
Cone Ø: d1 Ø 10 / d2 Ø 10
Thread: M12 x 1,75 LHT
592106, 1249088



DF-ES-3634

Length: 130
Cone Ø: d1 Ø 30 / d2 Ø 27
Thread: M46 x 1,5 LHT
0606922, 606922



CV-ES-2182

Length: 55
Cone Ø: d1 Ø 10 / d2 Ø 10
Thread: M12 x 1,75 RHT
589333, 1249129



DF-ES-3635

Length: 130
Cone Ø: d1 Ø 30 / d2 Ø 27
Thread: M46 x 1,5 RHT
0606923, 606923



CV-ES-12461

Length: 120
Cone Ø: d1 Ø 26 / d2 Ø 23,5
Thread: M30 x 1,5 LHT
0069513, 69513, 0311300, 311300,
0607998, 607998, 1190653, 1315447,
1319838, 1332123, 1338714, 1401934,
1407394, ACHB063, ACHF241, MAK1295



DF-ES-9335

Length: 85
Cone Ø: d1 Ø 12 / d2 Ø 10,75
Thread: M14 x 1,5 RHT
386930, 0386930



CV-ES-12462

Length: 120
Cone Ø: d1 Ø 26 / d2 Ø 23,5
Thread: M30 x 1,5 RHT
0069514, 0586753, 0607999, 0694298,
0694360, 0698609, 1137230, 1229944,
1326862, 1326896, 1331925, ACHB064,
ACHF242, MAK1296



IV-RK-8998

Ø: 85
Hole Distance: 130
Thick/Height: 30
0513757, 0531757, 0691709, 691709



CV-ES-14163

Length: 125
Cone Ø: d1 Ø 30 / d2 Ø 27
Thread: M30 x 1,5 RHT
0607981, 0698450, 1149907, 1152350,
1257890, 1603789, 1618048, ACHF060



CV-RK-5322

Ø: 72
Thick/Height: 50
0691704





F 2000 ...

FM 2000 DH	01/70→12/79	Ball Head, gearshift linkage	CV-ES-2119		
	01/70→12/79	Ball Head, gearshift linkage	CV-ES-2182		
	01/70→12/79	Tie Rod End	CV-ES-14163		for Steering Rod
	01/70→12/79	Tie Rod End	DF-ES-3634		
	01/70→12/79	Tie Rod End	DF-ES-3635		
FM 2000 DHB	01/70→12/79	Ball Head, gearshift linkage	CV-ES-2119		
	01/70→12/79	Ball Head, gearshift linkage	CV-ES-2182		
	01/70→12/79	Tie Rod End	CV-ES-14163		for Steering Rod
	01/70→12/79	Tie Rod End	DF-ES-3634		
	01/70→12/79	Tie Rod End	DF-ES-3635		
FT 2000 DH	01/70→12/79	Ball Head, gearshift linkage	CV-ES-2119		
	01/70→12/79	Ball Head, gearshift linkage	CV-ES-2182		
	01/70→12/79	Tie Rod End	CV-ES-14163		for Steering Rod
	01/70→12/79	Tie Rod End	DF-ES-3634		
	01/70→12/79	Tie Rod End	DF-ES-3635		
FT 2000 DHB	01/70→12/79	Ball Head, gearshift linkage	CV-ES-2119		
	01/70→12/79	Ball Head, gearshift linkage	CV-ES-2182		
	01/70→12/79	Tie Rod End	CV-ES-14163		for Steering Rod
	01/70→12/79	Tie Rod End	DF-ES-3634		
	01/70→12/79	Tie Rod End	DF-ES-3635		

F 2100

FA 2100 DF,FA 2105 DF	07/78→09/86	Ball Head, gearshift linkage	CV-ES-2119			
	07/78→09/86	Ball Head, gearshift linkage	CV-ES-2182			
	07/78→09/86	Ball Head, gearshift linkage	DF-ES-9335			
	07/78→09/86	Suspension Arm Repair Kit		DF-RK-8994	for Wishbone (CV)	
	07/78→09/86	Suspension Arm Repair Kit		IV-RK-8998	for Wishbone (CV)	
	07/78→09/86	Suspension Arm Repair Kit		SC-RK-8575	for Wishbone (CV)	
	07/78→09/86	Suspension Strut Repair Kit		MN-RK-8537		
	07/78→09/86	Tie Rod End	CV-ES-14163		for Steering Rod	
	07/78→09/86	Tie Rod End	DF-ES-3634			
	07/78→09/86	Tie Rod End	DF-ES-3635			
	07/78→09/86	Track Control Arm		DF-VB-8561	Wishbone (CV)	
	FA 2100 DH	07/78→09/86	Ball Head, gearshift linkage	CV-ES-2119		
		07/78→09/86	Ball Head, gearshift linkage	CV-ES-2182		
		07/78→09/86	Ball Head, gearshift linkage	DF-ES-9335		
07/78→09/86		Suspension Arm Repair Kit		DF-RK-8994	for Wishbone (CV)	
07/78→09/86		Suspension Arm Repair Kit		IV-RK-8998	for Wishbone (CV)	
07/78→09/86		Suspension Arm Repair Kit		SC-RK-8575	for Wishbone (CV)	
07/78→09/86		Suspension Strut Repair Kit		MN-RK-8537		
07/78→09/86		Tie Rod End	CV-ES-14163		for Steering Rod	
07/78→09/86		Tie Rod End	DF-ES-3634			
07/78→09/86		Tie Rod End	DF-ES-3635			
FA 2105 DH	06/86→08/91	Ball Head, gearshift linkage	CV-ES-2119			
	06/86→08/91	Ball Head, gearshift linkage	CV-ES-2182			
	06/86→08/91	Ball Head, gearshift linkage	DF-ES-9335			
	06/86→08/91	Suspension Arm Repair Kit		DF-RK-8994	for Wishbone (CV)	
	06/86→08/91	Suspension Arm Repair Kit		IV-RK-8998	for Wishbone (CV)	
	06/86→08/91	Suspension Arm Repair Kit		SC-RK-8575	for Wishbone (CV)	
	06/86→08/91	Suspension Strut Repair Kit		MN-RK-8537		
	06/86→08/91	Tie Rod End	CV-ES-14163		for Steering Rod	
	06/86→08/91	Tie Rod End	DF-ES-3634			
	06/86→08/91	Tie Rod End	DF-ES-3635			
FA 2105 DHR,FA 2105 DHTD	07/78→09/86	Ball Head, gearshift linkage	CV-ES-2119			
	07/78→09/86	Ball Head, gearshift linkage	CV-ES-2182			
	07/78→09/86	Ball Head, gearshift linkage	DF-ES-9335			
	07/78→09/86	Suspension Arm Repair Kit		DF-RK-8994	for Wishbone (CV)	
	07/78→09/86	Suspension Arm Repair Kit		IV-RK-8998	for Wishbone (CV)	
	07/78→09/86	Suspension Arm Repair Kit		SC-RK-8575	for Wishbone (CV)	
	07/78→09/86	Suspension Strut Repair Kit		MN-RK-8537		
	07/78→09/86	Tie Rod End	CV-ES-14163		for Steering Rod	

CV-ES-2119

Length: 55
Cone Ø: d1 Ø 10 / d2 Ø 10
Thread: M12 x 1,75 LHT
592106, 1249088



DF-RK-8994

Ø: 75
Hole Distance: 130
Thick/Height: 24
1252284



CV-ES-2182

Length: 55
Cone Ø: d1 Ø 10 / d2 Ø 10
Thread: M12 x 1,75 RHT
589333, 1249129



DF-VB-8561

Length: 609
Ø: 48
Hole Distance: 152 / 152
0080521, 080521, 1361651, 1368270,
1390932, 1617096, 1793875, 1817808,
1892492



CV-ES-14163

Length: 125
Cone Ø: d1 Ø 30 / d2 Ø 27
Thread: M30 x 1,5 RHT
0607981, 0698450, 1149907, 1152350,
1257890, 1603789, 1618048, ACHF060



IV-RK-8998

Ø: 85
Hole Distance: 130
Thick/Height: 30
0513757, 0531757, 0691709, 691709



DF-ES-3634

Length: 130
Cone Ø: d1 Ø 30 / d2 Ø 27
Thread: M46 x 1,5 LHT
0606922, 606922



MN-RK-8537

Ø: 95
Hole Distance: 152
Thick/Height: 24
696321, 81432706099



DF-ES-3635

Length: 130
Cone Ø: d1 Ø 30 / d2 Ø 27
Thread: M46 x 1,5 RHT
0606923, 606923



SC-RK-8575

Ø: 95
Hole Distance: 152
Thick/Height: 35
0696321



DF-ES-9335

Length: 85
Cone Ø: d1 Ø 12 / d2 Ø 10,75
Thread: M14 x 1,5 RHT
0386930, 386930





F 2100 ...

FA 2105 DHR,FA 2105 DHTD ...	07/78→09/86	Tie Rod End	DF-ES-3634		
	07/78→09/86	Tie Rod End	DF-ES-3635		
	07/78→09/86	Track Control Arm		DF-VB-8561	Wishbone (CV)
FA 2105 DHT	07/81→08/91	Ball Head, gearshift linkage	CV-ES-2119		
	07/81→08/91	Ball Head, gearshift linkage	CV-ES-2182		
	07/81→08/91	Ball Head, gearshift linkage	DF-ES-9335		
	07/81→08/91	Suspension Arm Repair Kit		DF-RK-8994	for Wishbone (CV)
	07/81→08/91	Suspension Arm Repair Kit		IV-RK-8998	for Wishbone (CV)
	07/81→08/91	Suspension Arm Repair Kit		SC-RK-8575	for Wishbone (CV)
	07/81→08/91	Suspension Strut Repair Kit		MN-RK-8537	
	07/81→08/91	Tie Rod End	CV-ES-14163		for Steering Rod
	07/81→08/91	Tie Rod End	DF-ES-3634		
	07/81→08/91	Tie Rod End	DF-ES-3635		
FA 2105 DHTD	06/86→08/91	Ball Head, gearshift linkage	CV-ES-2119		
	06/86→08/91	Ball Head, gearshift linkage	CV-ES-2182		
	06/86→08/91	Ball Head, gearshift linkage	DF-ES-9335		
	06/86→08/91	Suspension Arm Repair Kit		DF-RK-8994	for Wishbone (CV)
	06/86→08/91	Suspension Arm Repair Kit		IV-RK-8998	for Wishbone (CV)
	06/86→08/91	Suspension Arm Repair Kit		SC-RK-8575	for Wishbone (CV)
	06/86→08/91	Suspension Strut Repair Kit		MN-RK-8537	
	06/86→08/91	Tie Rod End	CV-ES-14163		for Steering Rod
	06/86→08/91	Tie Rod End	DF-ES-3634		
	06/86→08/91	Tie Rod End	DF-ES-3635		
FAG 2100 DH,FAG 2105 DH	07/78→09/86	Ball Head, gearshift linkage	CV-ES-2119		
	07/78→09/86	Ball Head, gearshift linkage	CV-ES-2182		
	07/78→09/86	Ball Head, gearshift linkage	DF-ES-9335		
	07/78→09/86	Suspension Arm Repair Kit		DF-RK-8994	for Wishbone (CV)
	07/78→09/86	Suspension Arm Repair Kit		IV-RK-8998	for Wishbone (CV)
	07/78→09/86	Suspension Arm Repair Kit		SC-RK-8575	for Wishbone (CV)
	07/78→09/86	Suspension Strut Repair Kit		MN-RK-8537	
	07/78→09/86	Tie Rod End	CV-ES-14163		for Steering Rod
	07/78→09/86	Tie Rod End	DF-ES-3634		
	07/78→09/86	Tie Rod End	DF-ES-3635		
FAG 2100 DHR,FAG 2105 DHR, FAG 2100 DHTD	07/78→09/86	Ball Head, gearshift linkage	CV-ES-2119		
	07/78→09/86	Ball Head, gearshift linkage	CV-ES-2182		
	07/78→09/86	Ball Head, gearshift linkage	DF-ES-9335		
	07/78→09/86	Suspension Arm Repair Kit		DF-RK-8994	for Wishbone (CV)
	07/78→09/86	Suspension Arm Repair Kit		IV-RK-8998	for Wishbone (CV)
	07/78→09/86	Suspension Arm Repair Kit		SC-RK-8575	for Wishbone (CV)
	07/78→09/86	Suspension Strut Repair Kit		MN-RK-8537	
	07/78→09/86	Tie Rod End	CV-ES-14163		for Steering Rod
	07/78→09/86	Tie Rod End	DF-ES-3634		
	07/78→09/86	Tie Rod End	DF-ES-3635		
FAS 2100 DHR,FAS 2103 DHR, FAS 2105 DHR,FAS 2103 DHTD	07/78→09/86	Ball Head, gearshift linkage	CV-ES-2119		
	07/78→09/86	Ball Head, gearshift linkage	CV-ES-2182		
	07/78→09/86	Ball Head, gearshift linkage	DF-ES-9335		
	07/78→09/86	Suspension Arm Repair Kit		DF-RK-8994	for Wishbone (CV)
	07/78→09/86	Suspension Arm Repair Kit		IV-RK-8998	for Wishbone (CV)
	07/78→09/86	Suspension Arm Repair Kit		SC-RK-8575	for Wishbone (CV)
	07/78→09/86	Suspension Strut Repair Kit		MN-RK-8537	
	07/78→09/86	Tie Rod End	CV-ES-14163		for Steering Rod
	07/78→09/86	Tie Rod End	DF-ES-3634		
	07/78→09/86	Tie Rod End	DF-ES-3635		
FAS 2103 DH	07/78→09/86	Ball Head, gearshift linkage	CV-ES-2119		
	07/78→09/86	Ball Head, gearshift linkage	CV-ES-2182		
	07/78→09/86	Ball Head, gearshift linkage	DF-ES-9335		
	07/78→09/86	Suspension Arm Repair Kit		DF-RK-8994	for Wishbone (CV)

CV-ES-2119

Length: 55
Cone Ø: d1 Ø 10 / d2 Ø 10
Thread: M12 x 1,75 LHT
592106, 1249088



DF-RK-8994

Ø: 75
Hole Distance: 130
Thick/Height: 24
1252284



CV-ES-2182

Length: 55
Cone Ø: d1 Ø 10 / d2 Ø 10
Thread: M12 x 1,75 RHT
589333, 1249129



DF-VB-8561

Length: 609
Ø: 48
Hole Distance: 152 / 152
0080521, 080521, 1361651, 1368270,
1390932, 1617096, 1793875, 1817808,
1892492



CV-ES-14163

Length: 125
Cone Ø: d1 Ø 30 / d2 Ø 27
Thread: M30 x 1,5 RHT
0607981, 0698450, 1149907, 1152350,
1257890, 1603789, 1618048, ACHF060



IV-RK-8998

Ø: 85
Hole Distance: 130
Thick/Height: 30
0513757, 0531757, 0691709, 691709



DF-ES-3634

Length: 130
Cone Ø: d1 Ø 30 / d2 Ø 27
Thread: M46 x 1,5 LHT
0606922, 606922



MN-RK-8537

Ø: 95
Hole Distance: 152
Thick/Height: 24
696321, 81432706099



DF-ES-3635

Length: 130
Cone Ø: d1 Ø 30 / d2 Ø 27
Thread: M46 x 1,5 RHT
0606923, 606923



SC-RK-8575

Ø: 95
Hole Distance: 152
Thick/Height: 35
0696321



DF-ES-9335

Length: 85
Cone Ø: d1 Ø 12 / d2 Ø 10,75
Thread: M14 x 1,5 RHT
0386930, 386930





F 2100 ...

FAS 2103 DH ...	07/78→09/86	Suspension Arm Repair Kit		SC-RK-8575	for Wishbone (CV)
	07/78→09/86	Suspension Strut Repair Kit		MN-RK-8537	
	07/78→09/86	Tie Rod End	CV-ES-14163		for Steering Rod
	07/78→09/86	Tie Rod End	DF-ES-3634		
	07/78→09/86	Tie Rod End	DF-ES-3635		
	07/78→09/86	Track Control Arm		DF-VB-8561	Wishbone (CV)
FAS 2103 DH,FAS 2105 DH	06/86→08/91	Ball Head, gearshift linkage	CV-ES-2119		
	06/86→08/91	Ball Head, gearshift linkage	CV-ES-2182		
	06/86→08/91	Ball Head, gearshift linkage	DF-ES-9335		
	06/86→08/91	Suspension Arm Repair Kit		DF-RK-8994	for Wishbone (CV)
	06/86→08/91	Suspension Arm Repair Kit		IV-RK-8998	for Wishbone (CV)
	06/86→08/91	Suspension Arm Repair Kit		SC-RK-8575	for Wishbone (CV)
	06/86→08/91	Suspension Strut Repair Kit		MN-RK-8537	
	06/86→08/91	Tie Rod End	CV-ES-14163		for Steering Rod
	06/86→08/91	Tie Rod End	DF-ES-3634		
	06/86→08/91	Tie Rod End	DF-ES-3635		
	06/86→08/91	Track Control Arm		DF-VB-8561	Wishbone (CV)
	FAS 2103 DHT	07/81→09/86	Ball Head, gearshift linkage	CV-ES-2119	
07/81→09/86		Ball Head, gearshift linkage	CV-ES-2182		
07/81→09/86		Ball Head, gearshift linkage	DF-ES-9335		
07/81→09/86		Suspension Arm Repair Kit		DF-RK-8994	for Wishbone (CV)
07/81→09/86		Suspension Arm Repair Kit		IV-RK-8998	for Wishbone (CV)
07/81→09/86		Suspension Arm Repair Kit		SC-RK-8575	for Wishbone (CV)
07/81→09/86		Suspension Strut Repair Kit		MN-RK-8537	
07/81→09/86		Tie Rod End	CV-ES-14163		for Steering Rod
07/81→09/86		Tie Rod End	DF-ES-3634		
07/81→09/86		Tie Rod End	DF-ES-3635		
07/81→09/86		Track Control Arm		DF-VB-8561	Wishbone (CV)
FAS 2103 DHTD		06/86→08/91	Ball Head, gearshift linkage	CV-ES-2119	
	06/86→08/91	Ball Head, gearshift linkage	CV-ES-2182		
	06/86→08/91	Ball Head, gearshift linkage	DF-ES-9335		
	06/86→08/91	Suspension Arm Repair Kit		DF-RK-8994	for Wishbone (CV)
	06/86→08/91	Suspension Arm Repair Kit		IV-RK-8998	for Wishbone (CV)
	06/86→08/91	Suspension Arm Repair Kit		SC-RK-8575	for Wishbone (CV)
	06/86→08/91	Suspension Strut Repair Kit		MN-RK-8537	
	06/86→08/91	Tie Rod End	CV-ES-14163		for Steering Rod
	06/86→08/91	Tie Rod End	DF-ES-3634		
	06/86→08/91	Tie Rod End	DF-ES-3635		
	06/86→08/91	Track Control Arm		DF-VB-8561	Wishbone (CV)
	FT 2100 DH,FT 2105 DH	07/78→08/91	Ball Head, gearshift linkage	CV-ES-2119	
07/78→08/91		Ball Head, gearshift linkage	CV-ES-2182		
07/78→08/91		Ball Head, gearshift linkage	DF-ES-9335		
07/78→08/91		Suspension Arm Repair Kit		DF-RK-8994	for Wishbone (CV)
07/78→08/91		Suspension Arm Repair Kit		IV-RK-8998	for Wishbone (CV)
07/78→08/91		Suspension Arm Repair Kit		SC-RK-8575	for Wishbone (CV)
07/78→08/91		Suspension Strut Repair Kit		MN-RK-8537	
07/78→08/91		Tie Rod End	CV-ES-14163		for Steering Rod
07/78→08/91		Tie Rod End	DF-ES-3634		
07/78→08/91		Tie Rod End	DF-ES-3635		
07/78→08/91		Track Control Arm		DF-VB-8561	Wishbone (CV)
FT 2100 DHR		07/78→08/91	Ball Head, gearshift linkage	CV-ES-2119	
	07/78→08/91	Ball Head, gearshift linkage	CV-ES-2182		
	07/78→08/91	Tie Rod End	CV-ES-14163		for Steering Rod
	07/78→08/91	Tie Rod End	DF-ES-3634		
	07/78→08/91	Tie Rod End	DF-ES-3635		
	07/78→08/91	Track Control Arm		DF-VB-8561	Wishbone (CV)
FT 2105 DHT	07/81→09/86	Ball Head, gearshift linkage	CV-ES-2119		
	07/81→09/86	Ball Head, gearshift linkage	CV-ES-2182		
	07/81→09/86	Ball Head, gearshift linkage	DF-ES-9335		
	07/81→09/86	Suspension Arm Repair Kit		DF-RK-8994	for Wishbone (CV)
	07/81→09/86	Suspension Arm Repair Kit		IV-RK-8998	for Wishbone (CV)
	07/81→09/86	Suspension Arm Repair Kit		SC-RK-8575	for Wishbone (CV)
07/81→09/86	Suspension Strut Repair Kit		MN-RK-8537		

CV-ES-2119

Length: 55
Cone Ø: d1 Ø 10 / d2 Ø 10
Thread: M12 x 1,75 LHT
592106, 1249088



DF-RK-8994

Ø: 75
Hole Distance: 130
Thick/Height: 24
1252284



CV-ES-2182

Length: 55
Cone Ø: d1 Ø 10 / d2 Ø 10
Thread: M12 x 1,75 RHT
589333, 1249129



DF-VB-8561

Length: 609
Ø: 48
Hole Distance: 152 / 152
0080521, 080521, 1361651, 1368270,
1390932, 1617096, 1793875, 1817808,
1892492



CV-ES-14163

Length: 125
Cone Ø: d1 Ø 30 / d2 Ø 27
Thread: M30 x 1,5 RHT
0607981, 0698450, 1149907, 1152350,
1257890, 1603789, 1618048, ACHF060



IV-RK-8998

Ø: 85
Hole Distance: 130
Thick/Height: 30
0513757, 0531757, 0691709, 691709



DF-ES-3634

Length: 130
Cone Ø: d1 Ø 30 / d2 Ø 27
Thread: M46 x 1,5 LHT
606922, 0606922



MN-RK-8537

Ø: 95
Hole Distance: 152
Thick/Height: 24
696321, 81432706099



DF-ES-3635

Length: 130
Cone Ø: d1 Ø 30 / d2 Ø 27
Thread: M46 x 1,5 RHT
0606923, 606923



SC-RK-8575

Ø: 95
Hole Distance: 152
Thick/Height: 35
0696321



DF-ES-9335

Length: 85
Cone Ø: d1 Ø 12 / d2 Ø 10,75
Thread: M14 x 1,5 RHT
0386930, 386930



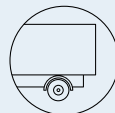

F 2100 ...

FT 2105 DHT ...	07/81→09/86	Tie Rod End	CV-ES-14163		for Steering Rod
	07/81→09/86	Tie Rod End	DF-ES-3634		
	07/81→09/86	Tie Rod End	DF-ES-3635		
	07/81→09/86	Track Control Arm		DF-VB-8561	Wishbone (CV)
FT 2105 DHTD	07/81→08/91	Ball Head, gearshift linkage	CV-ES-2119		
	07/81→08/91	Ball Head, gearshift linkage	CV-ES-2182		
	07/81→08/91	Ball Head, gearshift linkage	DF-ES-9335		
	07/81→08/91	Suspension Arm Repair Kit		DF-RK-8994	for Wishbone (CV)
	07/81→08/91	Suspension Arm Repair Kit		IV-RK-8998	for Wishbone (CV)
	07/81→08/91	Suspension Arm Repair Kit		SC-RK-8575	for Wishbone (CV)
	07/81→08/91	Suspension Strut Repair Kit		MN-RK-8537	
	07/81→08/91	Tie Rod End	CV-ES-14163		for Steering Rod
	07/81→08/91	Tie Rod End	DF-ES-3634		
	07/81→08/91	Tie Rod End	DF-ES-3635		
07/81→08/91	Track Control Arm		DF-VB-8561	Wishbone (CV)	

F 2200

FA 2200 DU	01/71→11/80	Tie Rod End	CV-ES-14163		for Steering Rod
FAD 2205 DU	01/71→11/80	Tie Rod End	CV-ES-14163		for Steering Rod
FAS 2205 DU	01/71→11/80	Tie Rod End	CV-ES-14163		for Steering Rod
FAT 2205 DU	01/71→11/80	Tie Rod End	CV-ES-14163		for Steering Rod
FAZ 2205 DU	01/71→11/80	Tie Rod End	CV-ES-14163		for Steering Rod
FT 2200 DU	01/71→11/80	Tie Rod End	CV-ES-14163		for Steering Rod

F 2300

FA 2300 DHR	07/78→12/81	Ball Head, gearshift linkage	CV-ES-2119		
	07/78→12/81	Ball Head, gearshift linkage	CV-ES-2182		
	07/78→12/81	Ball Head, gearshift linkage	DF-ES-9335		
	07/78→12/81	Stabiliser Mounting	DF-SB-5253	DF-SB-5253	
	07/78→12/81	Suspension Arm Repair Kit		CV-RK-5322	for Wishbone (CV)
	07/78→12/81	Suspension Arm Repair Kit		IV-RK-8998	for Wishbone (CV)
	07/78→12/81	Suspension Arm Repair Kit		SC-RK-8575	for Wishbone (CV)
	07/78→12/81	Suspension Strut Repair Kit		MN-RK-8537	
	07/78→12/81	Tie Rod End	CV-ES-14163		for Steering Rod
	07/78→12/81	Tie Rod End	DF-ES-3634		
	07/78→12/81	Tie Rod End	DF-ES-3635		
	07/78→12/81	Track Control Arm		DF-VB-8561	Wishbone (CV)
	FA 2300 DHU	07/78→12/81	Ball Head, gearshift linkage	CV-ES-2119	
07/78→12/81		Ball Head, gearshift linkage	CV-ES-2182		
07/78→12/81		Ball Head, gearshift linkage	DF-ES-9335		
07/78→12/81		Stabiliser Mounting	DF-SB-5253	DF-SB-5253	
07/78→12/81		Suspension Arm Repair Kit		CV-RK-5322	for Wishbone (CV)
07/78→12/81		Suspension Arm Repair Kit		IV-RK-8998	for Wishbone (CV)
07/78→12/81		Suspension Arm Repair Kit		SC-RK-8575	for Wishbone (CV)
07/78→12/81		Suspension Strut Repair Kit		MN-RK-8537	
07/78→12/81		Tie Rod End	CV-ES-14163		for Steering Rod
07/78→12/81		Tie Rod End	DF-ES-3634		
07/78→12/81		Tie Rod End	DF-ES-3635		
07/78→12/81		Track Control Arm		DF-VB-8561	Wishbone (CV)
FA 2300 HT		01/90→10/93	Ball Head, gearshift linkage	CV-ES-2119	
	01/90→10/93	Ball Head, gearshift linkage	CV-ES-2182		
	01/90→10/93	Ball Head, gearshift linkage	DF-ES-9335		
	01/90→10/93	Stabiliser Mounting	DF-SB-5253	DF-SB-5253	
	01/90→10/93	Suspension Arm Repair Kit		CV-RK-5322	for Wishbone (CV)
	01/90→10/93	Suspension Arm Repair Kit		IV-RK-8998	for Wishbone (CV)
	01/90→10/93	Suspension Arm Repair Kit		SC-RK-8575	for Wishbone (CV)
	01/90→10/93	Suspension Strut Repair Kit		MN-RK-8537	
	01/90→10/93	Tie Rod End	CV-ES-14163		for Steering Rod
	01/90→10/93	Tie Rod End	DF-ES-3634		
	01/90→10/93	Tie Rod End	DF-ES-3635		
	01/90→10/93	Track Control Arm		DF-VB-8561	Wishbone (CV)

CV-ES-2119

Length: 55
Cone Ø: d1 Ø 10 / d2 Ø 10
Thread: M12 x 1,75 LHT
592106, 1249088



DF-ES-9335

Length: 85
Cone Ø: d1 Ø 12 / d2 Ø 10,75
Thread: M14 x 1,5 RHT
0386930, 386930



SC-RK-8575

Ø: 95
Hole Distance: 152
Thick/Height: 35
0696321



CV-ES-2182

Length: 55
Cone Ø: d1 Ø 10 / d2 Ø 10
Thread: M12 x 1,75 RHT
589333, 1249129



DF-RK-8994

Ø: 75
Hole Distance: 130
Thick/Height: 24
1252284



CV-ES-14163

Length: 125
Cone Ø: d1 Ø 30 / d2 Ø 27
Thread: M30 x 1,5 RHT
0607981, 0698450, 1149907, 1152350,
1257890, 1603789, 1618048, ACHF060



DF-SB-5253

Ø: 86
Thick/Height: 60,5
0371586, 0558864, 10306500A



CV-RK-5322

Ø: 72
Thick/Height: 50
0691704



DF-VB-8561

Length: 609
Ø: 48
Hole Distance: 152 / 152
0080521, 080521, 1361651, 1368270,
1390932, 1617096, 1793875, 1817808,
1892492



DF-ES-3634

Length: 130
Cone Ø: d1 Ø 30 / d2 Ø 27
Thread: M46 x 1,5 LHT
0606922, 606922



IV-RK-8998

Ø: 85
Hole Distance: 130
Thick/Height: 30
0513757, 0531757, 0691709, 691709



DF-ES-3635

Length: 130
Cone Ø: d1 Ø 30 / d2 Ø 27
Thread: M46 x 1,5 RHT
0606923, 606923



MN-RK-8537

Ø: 95
Hole Distance: 152
Thick/Height: 24
696321, 81432706099





F 2300 ...

FAB 2305 DHT,FAG 2305 DHT, FAS 2300 DHU,FAS 2303 DHU, FAS 2305	07/78→09/86	Ball Head, gearshift linkage	CV-ES-2119		
	07/78→09/86	Ball Head, gearshift linkage	CV-ES-2182		
	07/78→09/86	Ball Head, gearshift linkage	DF-ES-9335		
	07/78→09/86	Stabiliser Mounting	DF-SB-5253	DF-SB-5253	
	07/78→09/86	Suspension Arm Repair Kit		CV-RK-5322	for Wishbone (CV)
	07/78→09/86	Suspension Arm Repair Kit		IV-RK-8998	for Wishbone (CV)
	07/78→09/86	Suspension Arm Repair Kit		SC-RK-8575	for Wishbone (CV)
	07/78→09/86	Suspension Strut Repair Kit		MN-RK-8537	
	07/78→09/86	Tie Rod End	CV-ES-14163		for Steering Rod
	07/78→09/86	Tie Rod End	DF-ES-3634		
	07/78→09/86	Tie Rod End	DF-ES-3635		
	07/78→09/86	Track Control Arm		DF-VB-8561	Wishbone (CV)
	FAG 2300 DHT,FAG 2305 DHT	11/81→08/91	Ball Head, gearshift linkage	CV-ES-2119	
11/81→08/91		Ball Head, gearshift linkage	CV-ES-2182		
11/81→08/91		Ball Head, gearshift linkage	DF-ES-9335		
11/81→08/91		Stabiliser Mounting	DF-SB-5253	DF-SB-5253	
11/81→08/91		Suspension Arm Repair Kit		CV-RK-5322	for Wishbone (CV)
11/81→08/91		Suspension Arm Repair Kit		IV-RK-8998	for Wishbone (CV)
11/81→08/91		Suspension Arm Repair Kit		SC-RK-8575	for Wishbone (CV)
11/81→08/91		Suspension Strut Repair Kit		MN-RK-8537	
11/81→08/91		Tie Rod End	CV-ES-14163		for Steering Rod
11/81→08/91		Tie Rod End	DF-ES-3634		
11/81→08/91		Tie Rod End	DF-ES-3635		
11/81→08/91		Track Control Arm		DF-VB-8561	Wishbone (CV)
FAG 2300 DHTD,FAG 2305 DHTD		06/86→08/91	Ball Head, gearshift linkage	CV-ES-2119	
	06/86→08/91	Ball Head, gearshift linkage	CV-ES-2182		
	06/86→08/91	Ball Head, gearshift linkage	DF-ES-9335		
	06/86→08/91	Stabiliser Mounting	DF-SB-5253	DF-SB-5253	
	06/86→08/91	Suspension Arm Repair Kit		CV-RK-5322	for Wishbone (CV)
	06/86→08/91	Suspension Arm Repair Kit		IV-RK-8998	for Wishbone (CV)
	06/86→08/91	Suspension Arm Repair Kit		SC-RK-8575	for Wishbone (CV)
	06/86→08/91	Suspension Strut Repair Kit		MN-RK-8537	
	06/86→08/91	Tie Rod End	CV-ES-14163		for Steering Rod
	06/86→08/91	Tie Rod End	DF-ES-3634		
	06/86→08/91	Tie Rod End	DF-ES-3635		
	06/86→08/91	Track Control Arm		DF-VB-8561	Wishbone (CV)
	FAG 2300 HT,FAR 2300 HT	01/90→10/93	Ball Head, gearshift linkage	CV-ES-2119	
01/90→10/93		Ball Head, gearshift linkage	CV-ES-2182		
01/90→10/93		Ball Head, gearshift linkage	DF-ES-9335		
01/90→10/93		Stabiliser Mounting	DF-SB-5253	DF-SB-5253	
01/90→10/93		Suspension Arm Repair Kit		CV-RK-5322	for Wishbone (CV)
01/90→10/93		Suspension Arm Repair Kit		IV-RK-8998	for Wishbone (CV)
01/90→10/93		Suspension Arm Repair Kit		SC-RK-8575	for Wishbone (CV)
01/90→10/93		Suspension Strut Repair Kit		MN-RK-8537	
01/90→10/93		Tie Rod End	CV-ES-14163		for Steering Rod
01/90→10/93		Tie Rod End	DF-ES-3634		
01/90→10/93		Tie Rod End	DF-ES-3635		
01/90→10/93		Track Control Arm		DF-VB-8561	Wishbone (CV)
FAG 2305 DH		07/78→12/81	Ball Head, gearshift linkage	CV-ES-2119	
	07/78→12/81	Ball Head, gearshift linkage	CV-ES-2182		
	07/78→12/81	Ball Head, gearshift linkage	DF-ES-9335		
	07/78→12/81	Stabiliser Mounting	DF-SB-5253	DF-SB-5253	
	07/78→12/81	Suspension Arm Repair Kit		CV-RK-5322	for Wishbone (CV)
	07/78→12/81	Suspension Arm Repair Kit		IV-RK-8998	for Wishbone (CV)
	07/78→12/81	Suspension Arm Repair Kit		SC-RK-8575	for Wishbone (CV)
	07/78→12/81	Suspension Strut Repair Kit		MN-RK-8537	
	07/78→12/81	Tie Rod End	CV-ES-14163		for Steering Rod
	07/78→12/81	Tie Rod End	DF-ES-3634		
07/78→12/81	Tie Rod End	DF-ES-3635			
07/78→12/81	Track Control Arm		DF-VB-8561	Wishbone (CV)	

CV-ES-2119

Length: 55
Cone Ø: d1 Ø 10 / d2 Ø 10
Thread: M12 x 1,75 LHT
592106, 1249088



DF-ES-9335

Length: 85
Cone Ø: d1 Ø 12 / d2 Ø 10,75
Thread: M14 x 1,5 RHT
0386930, 386930



CV-ES-2182

Length: 55
Cone Ø: d1 Ø 10 / d2 Ø 10
Thread: M12 x 1,75 RHT
589333, 1249129



DF-SB-5253

Ø: 86
Thick/Height: 60,5
0371586, 0558864, 10306500A



CV-ES-14163

Length: 125
Cone Ø: d1 Ø 30 / d2 Ø 27
Thread: M30 x 1,5 RHT
0607981, 0698450, 1149907, 1152350,
1257890, 1603789, 1618048, ACHF060



DF-VB-8561

Length: 609
Ø: 48
Hole Distance: 152 / 152
0080521, 080521, 1361651, 1368270,
1390932, 1617096, 1793875, 1817808,
1892492



CV-RK-5322

Ø: 72
Thick/Height: 50
0691704



IV-RK-8998

Ø: 85
Hole Distance: 130
Thick/Height: 30
0513757, 0531757, 0691709, 691709



DF-ES-3634

Length: 130
Cone Ø: d1 Ø 30 / d2 Ø 27
Thread: M46 x 1,5 LHT
0606922, 606922



MN-RK-8537

Ø: 95
Hole Distance: 152
Thick/Height: 24
696321, 81432706099



DF-ES-3635

Length: 130
Cone Ø: d1 Ø 30 / d2 Ø 27
Thread: M46 x 1,5 RHT
0606923, 606923



SC-RK-8575

Ø: 95
Hole Distance: 152
Thick/Height: 35
0696321





F 2300 ...

FAS 2300 DHR,FAS 2305 DHR	07/78→12/81	Ball Head, gearshift linkage	CV-ES-2119		
	07/78→12/81	Ball Head, gearshift linkage	CV-ES-2182		
	07/78→12/81	Ball Head, gearshift linkage	DF-ES-9335		
	07/78→12/81	Stabiliser Mounting	DF-SB-5253	DF-SB-5253	
	07/78→12/81	Suspension Arm Repair Kit		CV-RK-5322	for Wishbone (CV)
	07/78→12/81	Suspension Arm Repair Kit		IV-RK-8998	for Wishbone (CV)
	07/78→12/81	Suspension Arm Repair Kit		SC-RK-8575	for Wishbone (CV)
	07/78→12/81	Suspension Strut Repair Kit		MN-RK-8537	
	07/78→12/81	Tie Rod End	CV-ES-14163		for Steering Rod
	07/78→12/81	Tie Rod End	DF-ES-3634		
	07/78→12/81	Tie Rod End	DF-ES-3635		
	07/78→12/81	Track Control Arm		DF-VB-8561	Wishbone (CV)
	FAT 2300 HT	01/90→10/93	Ball Head, gearshift linkage	CV-ES-2119	
01/90→10/93		Ball Head, gearshift linkage	CV-ES-2182		
01/90→10/93		Ball Head, gearshift linkage	DF-ES-9335		
01/90→10/93		Stabiliser Mounting	DF-SB-5253	DF-SB-5253	
01/90→10/93		Suspension Arm Repair Kit		CV-RK-5322	for Wishbone (CV)
01/90→10/93		Suspension Arm Repair Kit		IV-RK-8998	for Wishbone (CV)
01/90→10/93		Suspension Arm Repair Kit		SC-RK-8575	for Wishbone (CV)
01/90→10/93		Suspension Strut Repair Kit		MN-RK-8537	
01/90→10/93		Tie Rod End	CV-ES-14163		for Steering Rod
01/90→10/93		Tie Rod End	DF-ES-3634		
01/90→10/93		Tie Rod End	DF-ES-3635		
01/90→10/93		Track Control Arm		DF-VB-8561	Wishbone (CV)
FAT 2305 DH		07/78→12/81	Ball Head, gearshift linkage	CV-ES-2119	
	07/78→12/81	Ball Head, gearshift linkage	CV-ES-2182		
	07/78→12/81	Ball Head, gearshift linkage	DF-ES-9335		
	07/78→12/81	Stabiliser Mounting	DF-SB-5253	DF-SB-5253	
	07/78→12/81	Suspension Arm Repair Kit		CV-RK-5322	for Wishbone (CV)
	07/78→12/81	Suspension Arm Repair Kit		IV-RK-8998	for Wishbone (CV)
	07/78→12/81	Suspension Arm Repair Kit		SC-RK-8575	for Wishbone (CV)
	07/78→12/81	Suspension Strut Repair Kit		MN-RK-8537	
	07/78→12/81	Tie Rod End	CV-ES-14163		for Steering Rod
	07/78→12/81	Tie Rod End	DF-ES-3634		
	07/78→12/81	Tie Rod End	DF-ES-3635		
	07/78→12/81	Track Control Arm		DF-VB-8561	Wishbone (CV)
	FAT 2305 DHR	07/78→12/81	Ball Head, gearshift linkage	CV-ES-2119	
07/78→12/81		Ball Head, gearshift linkage	CV-ES-2182		
07/78→12/81		Ball Head, gearshift linkage	DF-ES-9335		
07/78→12/81		Stabiliser Mounting	DF-SB-5253	DF-SB-5253	
07/78→12/81		Suspension Arm Repair Kit		CV-RK-5322	for Wishbone (CV)
07/78→12/81		Suspension Arm Repair Kit		IV-RK-8998	for Wishbone (CV)
07/78→12/81		Suspension Arm Repair Kit		SC-RK-8575	for Wishbone (CV)
07/78→12/81		Suspension Strut Repair Kit		MN-RK-8537	
07/78→12/81		Tie Rod End	CV-ES-14163		for Steering Rod
07/78→12/81		Tie Rod End	DF-ES-3634		
07/78→12/81		Tie Rod End	DF-ES-3635		
07/78→12/81		Track Control Arm		DF-VB-8561	Wishbone (CV)
FAT 2305 DHU,FAT 2335 DHT		07/78→09/86	Ball Head, gearshift linkage	CV-ES-2119	
	07/78→09/86	Ball Head, gearshift linkage	CV-ES-2182		
	07/78→09/86	Ball Head, gearshift linkage	DF-ES-9335		
	07/78→09/86	Stabiliser Mounting	DF-SB-5253	DF-SB-5253	
	07/78→09/86	Suspension Arm Repair Kit		CV-RK-5322	for Wishbone (CV)
	07/78→09/86	Suspension Arm Repair Kit		IV-RK-8998	for Wishbone (CV)
	07/78→09/86	Suspension Arm Repair Kit		SC-RK-8575	for Wishbone (CV)
	07/78→09/86	Suspension Strut Repair Kit		MN-RK-8537	
	07/78→09/86	Tie Rod End	CV-ES-14163		for Steering Rod
	07/78→09/86	Tie Rod End	DF-ES-3634		
	07/78→09/86	Tie Rod End	DF-ES-3635		
	07/78→09/86	Track Control Arm		DF-VB-8561	Wishbone (CV)

CV-ES-2119

Length: 55
Cone Ø: d1 Ø 10 / d2 Ø 10
Thread: M12 x 1,75 LHT
592106, 1249088



DF-ES-9335

Length: 85
Cone Ø: d1 Ø 12 / d2 Ø 10,75
Thread: M14 x 1,5 RHT
0386930, 386930



CV-ES-2182

Length: 55
Cone Ø: d1 Ø 10 / d2 Ø 10
Thread: M12 x 1,75 RHT
589333, 1249129



DF-SB-5253

Ø: 86
Thick/Height: 60,5
0371586, 0558864, 10306500A



CV-ES-14163

Length: 125
Cone Ø: d1 Ø 30 / d2 Ø 27
Thread: M30 x 1,5 RHT
0607981, 0698450, 1149907, 1152350,
1257890, 1603789, 1618048, ACHF060



DF-VB-8561

Length: 609
Ø: 48
Hole Distance: 152 / 152
080521, 0080521, 1361651, 1368270,
1390932, 1617096, 1793875, 1817808,
1892492



CV-RK-5322

Ø: 72
Thick/Height: 50
0691704



IV-RK-8998

Ø: 85
Hole Distance: 130
Thick/Height: 30
0513757, 0531757, 0691709, 691709



DF-ES-3634

Length: 130
Cone Ø: d1 Ø 30 / d2 Ø 27
Thread: M46 x 1,5 LHT
0606922, 606922



MN-RK-8537

Ø: 95
Hole Distance: 152
Thick/Height: 24
696321, 81432706099



DF-ES-3635

Length: 130
Cone Ø: d1 Ø 30 / d2 Ø 27
Thread: M46 x 1,5 RHT
0606923, 606923



SC-RK-8575

Ø: 95
Hole Distance: 152
Thick/Height: 35
0696321





F 2300 ...

FAT 2335 DHT	06/86→08/91	Ball Head, gearshift linkage	CV-ES-2119		
	06/86→08/91	Ball Head, gearshift linkage	CV-ES-2182		
	06/86→08/91	Ball Head, gearshift linkage	DF-ES-9335		
	06/86→08/91	Stabiliser Mounting	DF-SB-5253	DF-SB-5253	
	06/86→08/91	Suspension Arm Repair Kit		CV-RK-5322	for Wishbone (CV)
	06/86→08/91	Suspension Arm Repair Kit		IV-RK-8998	for Wishbone (CV)
	06/86→08/91	Suspension Arm Repair Kit		SC-RK-8575	for Wishbone (CV)
	06/86→08/91	Suspension Strut Repair Kit		MN-RK-8537	
	06/86→08/91	Tie Rod End	CV-ES-14163		for Steering Rod
	06/86→08/91	Tie Rod End	DF-ES-3634		
	06/86→08/91	Tie Rod End	DF-ES-3635		
	06/86→08/91	Track Control Arm		DF-VB-8561	Wishbone (CV)
	FAV 2300 HT	01/90→10/93	Ball Head, gearshift linkage	CV-ES-2119	
01/90→10/93		Ball Head, gearshift linkage	CV-ES-2182		
01/90→10/93		Ball Head, gearshift linkage	DF-ES-9335		
01/90→10/93		Stabiliser Mounting	DF-SB-5253	DF-SB-5253	
01/90→10/93		Suspension Arm Repair Kit		CV-RK-5322	for Wishbone (CV)
01/90→10/93		Suspension Arm Repair Kit		IV-RK-8998	for Wishbone (CV)
01/90→10/93		Suspension Arm Repair Kit		SC-RK-8575	for Wishbone (CV)
01/90→10/93		Suspension Strut Repair Kit		MN-RK-8537	
01/90→10/93		Tie Rod End	CV-ES-14163		for Steering Rod
01/90→10/93		Tie Rod End	DF-ES-3634		
01/90→10/93		Tie Rod End	DF-ES-3635		
01/90→10/93		Track Control Arm		DF-VB-8561	Wishbone (CV)
FMB 2305 DHU		07/78→12/83	Ball Head, gearshift linkage	CV-ES-2119	
	07/78→12/83	Ball Head, gearshift linkage	CV-ES-2182		
	07/78→12/83	Ball Head, gearshift linkage	DF-ES-9335		
	07/78→12/83	Stabiliser Mounting	DF-SB-5253	DF-SB-5253	
	07/78→12/83	Suspension Arm Repair Kit		CV-RK-5322	for Wishbone (CV)
	07/78→12/83	Suspension Arm Repair Kit		IV-RK-8998	for Wishbone (CV)
	07/78→12/83	Suspension Arm Repair Kit		SC-RK-8575	for Wishbone (CV)
	07/78→12/83	Suspension Strut Repair Kit		MN-RK-8537	
	07/78→12/83	Tie Rod End	CV-ES-14163		for Steering Rod
	07/78→12/83	Tie Rod End	DF-ES-3634		
	07/78→12/83	Tie Rod End	DF-ES-3635		
	07/78→12/83	Track Control Arm		DF-VB-8561	Wishbone (CV)
	FMT 2300 HT	01/90→10/93	Ball Head, gearshift linkage	CV-ES-2119	
01/90→10/93		Ball Head, gearshift linkage	CV-ES-2182		
01/90→10/93		Ball Head, gearshift linkage	DF-ES-9335		
01/90→10/93		Stabiliser Mounting	DF-SB-5253	DF-SB-5253	
01/90→10/93		Suspension Arm Repair Kit		CV-RK-5322	for Wishbone (CV)
01/90→10/93		Suspension Arm Repair Kit		IV-RK-8998	for Wishbone (CV)
01/90→10/93		Suspension Arm Repair Kit		SC-RK-8575	for Wishbone (CV)
01/90→10/93		Suspension Strut Repair Kit		MN-RK-8537	
01/90→10/93		Tie Rod End	CV-ES-14163		for Steering Rod
01/90→10/93		Tie Rod End	DF-ES-3634		
01/90→10/93		Tie Rod End	DF-ES-3635		
01/90→10/93		Track Control Arm		DF-VB-8561	Wishbone (CV)
FMT 2305 DHR		07/78→12/81	Ball Head, gearshift linkage	CV-ES-2119	
	07/78→12/81	Ball Head, gearshift linkage	CV-ES-2182		
	07/78→12/81	Ball Head, gearshift linkage	DF-ES-9335		
	07/78→12/81	Stabiliser Mounting	DF-SB-5253	DF-SB-5253	
	07/78→12/81	Suspension Arm Repair Kit		CV-RK-5322	for Wishbone (CV)
	07/78→12/81	Suspension Arm Repair Kit		IV-RK-8998	for Wishbone (CV)
	07/78→12/81	Suspension Arm Repair Kit		SC-RK-8575	for Wishbone (CV)
	07/78→12/81	Suspension Strut Repair Kit		MN-RK-8537	
	07/78→12/81	Tie Rod End	CV-ES-14163		for Steering Rod
	07/78→12/81	Tie Rod End	DF-ES-3634		
	07/78→12/81	Tie Rod End	DF-ES-3635		
	07/78→12/81	Track Control Arm		DF-VB-8561	Wishbone (CV)

CV-ES-2119

Length: 55
Cone Ø: d1 Ø 10 / d2 Ø 10
Thread: M12 x 1,75 LHT
592106, 1249088



DF-ES-9335

Length: 85
Cone Ø: d1 Ø 12 / d2 Ø 10,75
Thread: M14 x 1,5 RHT
0386930, 386930



CV-ES-2182

Length: 55
Cone Ø: d1 Ø 10 / d2 Ø 10
Thread: M12 x 1,75 RHT
589333, 1249129



DF-SB-5253

Ø: 86
Thick/Height: 60,5
0371586, 0558864, 10306500A



CV-ES-14163

Length: 125
Cone Ø: d1 Ø 30 / d2 Ø 27
Thread: M30 x 1,5 RHT
0607981, 0698450, 1149907, 1152350,
1257890, 1603789, 1618048, ACHF060



DF-VB-8561

Length: 609
Ø: 48
Hole Distance: 152 / 152
080521, 0080521, 1361651, 1368270,
1390932, 1617096, 1793875, 1817808,
1892492



CV-RK-5322

Ø: 72
Thick/Height: 50
0691704



IV-RK-8998

Ø: 85
Hole Distance: 130
Thick/Height: 30
0513757, 0531757, 691709, 0691709



DF-ES-3634

Length: 130
Cone Ø: d1 Ø 30 / d2 Ø 27
Thread: M46 x 1,5 LHT
0606922, 606922



MN-RK-8537

Ø: 95
Hole Distance: 152
Thick/Height: 24
696321, 81432706099



DF-ES-3635

Length: 130
Cone Ø: d1 Ø 30 / d2 Ø 27
Thread: M46 x 1,5 RHT
0606923, 606923



SC-RK-8575

Ø: 95
Hole Distance: 152
Thick/Height: 35
0696321





F 2300 ...

FMT 2305 DHU,FMT 2335 DHT	07/78→09/86	Ball Head, gearshift linkage	CV-ES-2119			
	07/78→09/86	Ball Head, gearshift linkage	CV-ES-2182			
	07/78→09/86	Ball Head, gearshift linkage	DF-ES-9335			
	07/78→09/86	Stabiliser Mounting	DF-SB-5253	DF-SB-5253		
	07/78→09/86	Suspension Arm Repair Kit		CV-RK-5322	for Wishbone (CV)	
	07/78→09/86	Suspension Arm Repair Kit		IV-RK-8998	for Wishbone (CV)	
	07/78→09/86	Suspension Arm Repair Kit		SC-RK-8575	for Wishbone (CV)	
	07/78→09/86	Suspension Strut Repair Kit		MN-RK-8537		
	07/78→09/86	Tie Rod End	CV-ES-14163		for Steering Rod	
	07/78→09/86	Tie Rod End	DF-ES-3634			
	07/78→09/86	Tie Rod End	DF-ES-3635			
	07/78→09/86	Track Control Arm		DF-VB-8561	Wishbone (CV)	
	FMT 2335 DHT	06/86→08/91	Ball Head, gearshift linkage	CV-ES-2119		
		06/86→08/91	Ball Head, gearshift linkage	CV-ES-2182		
06/86→08/91		Ball Head, gearshift linkage	DF-ES-9335			
06/86→08/91		Stabiliser Mounting	DF-SB-5253	DF-SB-5253		
06/86→08/91		Suspension Arm Repair Kit		CV-RK-5322	for Wishbone (CV)	
06/86→08/91		Suspension Arm Repair Kit		IV-RK-8998	for Wishbone (CV)	
06/86→08/91		Suspension Arm Repair Kit		SC-RK-8575	for Wishbone (CV)	
06/86→08/91		Suspension Strut Repair Kit		MN-RK-8537		
06/86→08/91		Tie Rod End	CV-ES-14163		for Steering Rod	
06/86→08/91		Tie Rod End	DF-ES-3634			
06/86→08/91		Tie Rod End	DF-ES-3635			
06/86→08/91		Track Control Arm		DF-VB-8561	Wishbone (CV)	
FT 2300 DHU,FT 2305 DHU		07/78→12/83	Ball Head, gearshift linkage	CV-ES-2119		
		07/78→12/83	Ball Head, gearshift linkage	CV-ES-2182		
	07/78→12/83	Ball Head, gearshift linkage	DF-ES-9335			
	07/78→12/83	Stabiliser Mounting	DF-SB-5253	DF-SB-5253		
	07/78→12/83	Suspension Arm Repair Kit		CV-RK-5322	for Wishbone (CV)	
	07/78→12/83	Suspension Arm Repair Kit		IV-RK-8998	for Wishbone (CV)	
	07/78→12/83	Suspension Arm Repair Kit		SC-RK-8575	for Wishbone (CV)	
	07/78→12/83	Suspension Strut Repair Kit		MN-RK-8537		
	07/78→12/83	Tie Rod End	CV-ES-14163		for Steering Rod	
	07/78→12/83	Tie Rod End	DF-ES-3634			
	07/78→12/83	Tie Rod End	DF-ES-3635			
	07/78→12/83	Track Control Arm		DF-VB-8561	Wishbone (CV)	
	FT 2300 HT	01/90→10/93	Ball Head, gearshift linkage	CV-ES-2119		
		01/90→10/93	Ball Head, gearshift linkage	CV-ES-2182		
01/90→10/93		Ball Head, gearshift linkage	DF-ES-9335			
01/90→10/93		Stabiliser Mounting	DF-SB-5253	DF-SB-5253		
01/90→10/93		Suspension Arm Repair Kit		CV-RK-5322	for Wishbone (CV)	
01/90→10/93		Suspension Arm Repair Kit		IV-RK-8998	for Wishbone (CV)	
01/90→10/93		Suspension Arm Repair Kit		SC-RK-8575	for Wishbone (CV)	
01/90→10/93		Suspension Strut Repair Kit		MN-RK-8537		
01/90→10/93		Tie Rod End	CV-ES-14163		for Steering Rod	
01/90→10/93		Tie Rod End	DF-ES-3634			
01/90→10/93		Tie Rod End	DF-ES-3635			
01/90→10/93		Track Control Arm		DF-VB-8561	Wishbone (CV)	

F 2500

FA 2500 DHS	02/82→08/86	Ball Head, gearshift linkage	CV-ES-2119		
	02/82→08/86	Ball Head, gearshift linkage	CV-ES-2182		
	02/82→08/86	Ball Head, gearshift linkage	DF-ES-9335		
	02/82→08/86	Suspension Arm Repair Kit		IV-RK-8998	for Wishbone (CV)
	02/82→08/86	Suspension Arm Repair Kit		SC-RK-8575	for Wishbone (CV)
	02/82→08/86	Suspension Strut Repair Kit		MN-RK-8537	
	02/82→08/86	Tie Rod End	CV-ES-14163		for Steering Rod
	02/82→08/86	Tie Rod End	DF-ES-3634		
	02/82→08/86	Tie Rod End	DF-ES-3635		
	02/82→08/86	Track Control Arm		DF-VB-8561	Wishbone (CV)

CV-ES-2119

Length: 55
Cone Ø: d1 Ø 10 / d2 Ø 10
Thread: M12 x 1,75 LHT
592106, 1249088



DF-ES-9335

Length: 85
Cone Ø: d1 Ø 12 / d2 Ø 10,75
Thread: M14 x 1,5 RHT
0386930, 386930



CV-ES-2182

Length: 55
Cone Ø: d1 Ø 10 / d2 Ø 10
Thread: M12 x 1,75 RHT
589333, 1249129



DF-SB-5253

Ø: 86
Thick/Height: 60,5
0371586, 0558864, 10306500A



CV-ES-14163

Length: 125
Cone Ø: d1 Ø 30 / d2 Ø 27
Thread: M30 x 1,5 RHT
0607981, 0698450, 1149907, 1152350,
1257890, 1603789, 1618048, ACHF060



DF-VB-8561

Length: 609
Ø: 48
Hole Distance: 152 / 152
0080521, 080521, 1361651, 1368270,
1390932, 1617096, 1793875, 1817808,
1892492



CV-RK-5322

Ø: 72
Thick/Height: 50
0691704



IV-RK-8998

Ø: 85
Hole Distance: 130
Thick/Height: 30
0513757, 0531757, 691709, 0691709



DF-ES-3634

Length: 130
Cone Ø: d1 Ø 30 / d2 Ø 27
Thread: M46 x 1,5 LHT
0606922, 606922



MN-RK-8537

Ø: 95
Hole Distance: 152
Thick/Height: 24
696321, 81432706099



DF-ES-3635

Length: 130
Cone Ø: d1 Ø 30 / d2 Ø 27
Thread: M46 x 1,5 RHT
0606923, 606923



SC-RK-8575

Ø: 95
Hole Distance: 152
Thick/Height: 35
0696321





F 2500 ...

FA 2505 DHS	06/86→08/91	Ball Head, gearshift linkage	CV-ES-2119		
	06/86→08/91	Ball Head, gearshift linkage	CV-ES-2182		
	06/86→08/91	Ball Head, gearshift linkage	DF-ES-9335		
	06/86→08/91	Suspension Arm Repair Kit		IV-RK-8998	for Wishbone (CV)
	06/86→08/91	Suspension Arm Repair Kit		SC-RK-8575	for Wishbone (CV)
	06/86→08/91	Suspension Strut Repair Kit		MN-RK-8537	
	06/86→08/91	Tie Rod End	CV-ES-14163		for Steering Rod
	06/86→08/91	Tie Rod End	DF-ES-3634		
	06/86→08/91	Tie Rod End	DF-ES-3635		
FAD 2535 DHS	02/82→08/91	Track Control Arm		DF-VB-8561	Wishbone (CV)
	02/82→08/91	Ball Head, gearshift linkage	CV-ES-2119		
	02/82→08/91	Ball Head, gearshift linkage	CV-ES-2182		
	02/82→08/91	Ball Head, gearshift linkage	DF-ES-9335		
	02/82→08/91	Suspension Arm Repair Kit		IV-RK-8998	for Wishbone (CV)
	02/82→08/91	Suspension Arm Repair Kit		SC-RK-8575	for Wishbone (CV)
	02/82→08/91	Suspension Strut Repair Kit		MN-RK-8537	
	02/82→08/91	Tie Rod End	CV-ES-14163		for Steering Rod
	02/82→08/91	Tie Rod End	DF-ES-3634		
FAG 2500 DHS, FAG 2505 DHS, FAS 2503 DHS	02/82→08/91	Tie Rod End	DF-ES-3635		
	02/82→08/91	Track Control Arm		DF-VB-8561	Wishbone (CV)
	06/86→08/91	Ball Head, gearshift linkage	CV-ES-2119		
	06/86→08/91	Ball Head, gearshift linkage	CV-ES-2182		
	06/86→08/91	Ball Head, gearshift linkage	DF-ES-9335		
	06/86→08/91	Suspension Arm Repair Kit		IV-RK-8998	for Wishbone (CV)
	06/86→08/91	Suspension Arm Repair Kit		SC-RK-8575	for Wishbone (CV)
	06/86→08/91	Suspension Strut Repair Kit		MN-RK-8537	
	06/86→08/91	Tie Rod End	CV-ES-14163		for Steering Rod
FAG 2505 DHS, FAS 2503 DHS	06/86→08/91	Tie Rod End	DF-ES-3634		
	06/86→08/91	Tie Rod End	DF-ES-3635		
	02/82→09/86	Track Control Arm		DF-VB-8561	Wishbone (CV)
	02/82→09/86	Ball Head, gearshift linkage	CV-ES-2119		
	02/82→09/86	Ball Head, gearshift linkage	CV-ES-2182		
	02/82→09/86	Ball Head, gearshift linkage	DF-ES-9335		
	02/82→09/86	Suspension Arm Repair Kit		IV-RK-8998	for Wishbone (CV)
	02/82→09/86	Suspension Arm Repair Kit		SC-RK-8575	for Wishbone (CV)
	02/82→09/86	Suspension Strut Repair Kit		MN-RK-8537	
FAT 2525 DHS	02/82→09/86	Tie Rod End	CV-ES-14163		for Steering Rod
	02/82→09/86	Tie Rod End	DF-ES-3634		
	02/82→09/86	Tie Rod End	DF-ES-3635		
	02/82→08/91	Track Control Arm		DF-VB-8561	Wishbone (CV)
	02/82→08/91	Ball Head, gearshift linkage	CV-ES-2119		
	02/82→08/91	Ball Head, gearshift linkage	CV-ES-2182		
	02/82→08/91	Ball Head, gearshift linkage	DF-ES-9335		
	02/82→08/91	Suspension Arm Repair Kit		IV-RK-8998	for Wishbone (CV)
	02/82→08/91	Suspension Arm Repair Kit		SC-RK-8575	for Wishbone (CV)
FAT 2525 DHS, FAT 2535 DHS	02/82→08/91	Suspension Strut Repair Kit		MN-RK-8537	
	06/86→08/91	Tie Rod End	CV-ES-14163		for Steering Rod
	06/86→08/91	Tie Rod End	DF-ES-3634		
	06/86→08/91	Tie Rod End	DF-ES-3635		
	06/86→08/91	Track Control Arm		DF-VB-8561	Wishbone (CV)
	06/86→08/91	Ball Head, gearshift linkage	CV-ES-2119		
	06/86→08/91	Ball Head, gearshift linkage	CV-ES-2182		
	06/86→08/91	Ball Head, gearshift linkage	DF-ES-9335		
	06/86→08/91	Suspension Arm Repair Kit		IV-RK-8998	for Wishbone (CV)

CV-ES-2119

Length: 55
Cone Ø: d1 Ø 10 / d2 Ø 10
Thread: M12 x 1,75 LHT
592106, 1249088



DF-VB-8561

Length: 609
Ø: 48
Hole Distance: 152 / 152
0080521, 080521, 1361651, 1368270,
1390932, 1617096, 1793875, 1817808,
1892492



CV-ES-2182

Length: 55
Cone Ø: d1 Ø 10 / d2 Ø 10
Thread: M12 x 1,75 RHT
589333, 1249129



IV-RK-8998

Ø: 85
Hole Distance: 130
Thick/Height: 30
0513757, 0531757, 691709, 0691709



CV-ES-14163

Length: 125
Cone Ø: d1 Ø 30 / d2 Ø 27
Thread: M30 x 1,5 RHT
0607981, 0698450, 1149907, 1152350,
1257890, 1603789, 1618048, ACHF060



MN-RK-8537

Ø: 95
Hole Distance: 152
Thick/Height: 24
696321, 81432706099



DF-ES-3634

Length: 130
Cone Ø: d1 Ø 30 / d2 Ø 27
Thread: M46 x 1,5 LHT
0606922, 606922



SC-RK-8575

Ø: 95
Hole Distance: 152
Thick/Height: 35
0696321



DF-ES-3635

Length: 130
Cone Ø: d1 Ø 30 / d2 Ø 27
Thread: M46 x 1,5 RHT
0606923, 606923



DF-ES-9335

Length: 85
Cone Ø: d1 Ø 12 / d2 Ø 10,75
Thread: M14 x 1,5 RHT
386930, 0386930





F 2500 ...

FAT 2535 DHS	02/82→09/86	Ball Head, gearshift linkage	CV-ES-2119		
	02/82→09/86	Ball Head, gearshift linkage	CV-ES-2182		
	02/82→09/86	Ball Head, gearshift linkage	DF-ES-9335		
	02/82→09/86	Suspension Arm Repair Kit		IV-RK-8998	for Wishbone (CV)
	02/82→09/86	Suspension Arm Repair Kit		SC-RK-8575	for Wishbone (CV)
	02/82→09/86	Suspension Strut Repair Kit		MN-RK-8537	
	02/82→09/86	Tie Rod End	CV-ES-14163		for Steering Rod
	02/82→09/86	Tie Rod End	DF-ES-3634		
	02/82→09/86	Tie Rod End	DF-ES-3635		
FMD 2525 DHS	02/82→09/86	Track Control Arm		DF-VB-8561	Wishbone (CV)
	02/82→09/86	Ball Head, gearshift linkage	CV-ES-2119		
	02/82→09/86	Ball Head, gearshift linkage	CV-ES-2182		
	02/82→09/86	Ball Head, gearshift linkage	DF-ES-9335		
	02/82→09/86	Suspension Arm Repair Kit		IV-RK-8998	for Wishbone (CV)
	02/82→09/86	Suspension Arm Repair Kit		SC-RK-8575	for Wishbone (CV)
	02/82→09/86	Suspension Strut Repair Kit		MN-RK-8537	
	02/82→09/86	Tie Rod End	CV-ES-14163		for Steering Rod
	02/82→09/86	Tie Rod End	DF-ES-3634		
FMD 2525 DHS,FMD 2535 DHS	02/82→09/86	Tie Rod End	DF-ES-3635		
	02/82→09/86	Track Control Arm		DF-VB-8561	Wishbone (CV)
	06/86→08/91	Ball Head, gearshift linkage	CV-ES-2119		
	06/86→08/91	Ball Head, gearshift linkage	CV-ES-2182		
	06/86→08/91	Ball Head, gearshift linkage	DF-ES-9335		
	06/86→08/91	Suspension Arm Repair Kit		IV-RK-8998	for Wishbone (CV)
	06/86→08/91	Suspension Arm Repair Kit		SC-RK-8575	for Wishbone (CV)
	06/86→08/91	Suspension Strut Repair Kit		MN-RK-8537	
	06/86→08/91	Tie Rod End	CV-ES-14163		for Steering Rod
FMT 2525 DHS	06/86→08/91	Tie Rod End	DF-ES-3634		
	06/86→08/91	Tie Rod End	DF-ES-3635		
	06/86→08/91	Track Control Arm		DF-VB-8561	Wishbone (CV)
	02/82→09/86	Ball Head, gearshift linkage	CV-ES-2119		
	02/82→09/86	Ball Head, gearshift linkage	CV-ES-2182		
	02/82→09/86	Ball Head, gearshift linkage	DF-ES-9335		
	02/82→09/86	Suspension Arm Repair Kit		IV-RK-8998	for Wishbone (CV)
	02/82→09/86	Suspension Arm Repair Kit		SC-RK-8575	for Wishbone (CV)
	02/82→09/86	Suspension Strut Repair Kit		MN-RK-8537	
FMT 2525 DHS,FMT 2535 DHS	02/82→09/86	Tie Rod End	CV-ES-14163		for Steering Rod
	02/82→09/86	Tie Rod End	DF-ES-3634		
	02/82→09/86	Tie Rod End	DF-ES-3635		
	02/82→09/86	Track Control Arm		DF-VB-8561	Wishbone (CV)
	06/86→08/91	Ball Head, gearshift linkage	CV-ES-2119		
	06/86→08/91	Ball Head, gearshift linkage	CV-ES-2182		
	06/86→08/91	Ball Head, gearshift linkage	DF-ES-9335		
	06/86→08/91	Suspension Arm Repair Kit		IV-RK-8998	for Wishbone (CV)
	06/86→08/91	Suspension Arm Repair Kit		SC-RK-8575	for Wishbone (CV)
FT 2500 DHS	06/86→08/91	Suspension Strut Repair Kit		MN-RK-8537	
	06/86→08/91	Tie Rod End	CV-ES-14163		for Steering Rod
	06/86→08/91	Tie Rod End	DF-ES-3634		
	06/86→08/91	Tie Rod End	DF-ES-3635		
	06/86→08/91	Track Control Arm		DF-VB-8561	Wishbone (CV)
	02/82→09/86	Ball Head, gearshift linkage	CV-ES-2119		
	02/82→09/86	Ball Head, gearshift linkage	CV-ES-2182		
	02/82→09/86	Ball Head, gearshift linkage	DF-ES-9335		
	02/82→09/86	Suspension Arm Repair Kit		IV-RK-8998	for Wishbone (CV)
02/82→09/86	Suspension Arm Repair Kit		SC-RK-8575	for Wishbone (CV)	
02/82→09/86	Suspension Strut Repair Kit		MN-RK-8537		
02/82→09/86	Tie Rod End	CV-ES-14163		for Steering Rod	
02/82→09/86	Tie Rod End	DF-ES-3634			
02/82→09/86	Tie Rod End	DF-ES-3635			
02/82→09/86	Track Control Arm		DF-VB-8561	Wishbone (CV)	

CV-ES-2119

Length: 55
Cone Ø: d1 Ø 10 / d2 Ø 10
Thread: M12 x 1,75 LHT
592106, 1249088



DF-VB-8561

Length: 609
Ø: 48
Hole Distance: 152 / 152
0080521, 080521, 1361651, 1368270,
1390932, 1617096, 1793875, 1817808,
1892492



CV-ES-2182

Length: 55
Cone Ø: d1 Ø 10 / d2 Ø 10
Thread: M12 x 1,75 RHT
589333, 1249129



IV-RK-8998

Ø: 85
Hole Distance: 130
Thick/Height: 30
0513757, 0531757, 0691709, 691709



CV-ES-14163

Length: 125
Cone Ø: d1 Ø 30 / d2 Ø 27
Thread: M30 x 1,5 RHT
0607981, 0698450, 1149907, 1152350,
1257890, 1603789, 1618048, ACHF060



MN-RK-8537

Ø: 95
Hole Distance: 152
Thick/Height: 24
696321, 81432706099



DF-ES-3634

Length: 130
Cone Ø: d1 Ø 30 / d2 Ø 27
Thread: M46 x 1,5 LHT
0606922, 606922



SC-RK-8575

Ø: 95
Hole Distance: 152
Thick/Height: 35
0696321



DF-ES-3635

Length: 130
Cone Ø: d1 Ø 30 / d2 Ø 27
Thread: M46 x 1,5 RHT
0606923, 606923



DF-ES-9335

Length: 85
Cone Ø: d1 Ø 12 / d2 Ø 10,75
Thread: M14 x 1,5 RHT
0386930, 386930





F 2500 ...

FT 2505 DHS	06/86→08/91	Ball Head, gearshift linkage	CV-ES-2119		
	06/86→08/91	Ball Head, gearshift linkage	CV-ES-2182		
	06/86→08/91	Ball Head, gearshift linkage	DF-ES-9335		
	06/86→08/91	Suspension Arm Repair Kit		IV-RK-8998	for Wishbone (CV)
	06/86→08/91	Suspension Arm Repair Kit		SC-RK-8575	for Wishbone (CV)
	06/86→08/91	Suspension Strut Repair Kit		MN-RK-8537	
	06/86→08/91	Tie Rod End	CV-ES-14163		for Steering Rod
	06/86→08/91	Tie Rod End	DF-ES-3634		
	06/86→08/91	Tie Rod End	DF-ES-3635		
06/86→08/91	Track Control Arm		DF-VB-8561	Wishbone (CV)	

F 2700

FA 2700 HS	01/90→10/93	Ball Head, gearshift linkage	CV-ES-2119		
	01/90→10/93	Ball Head, gearshift linkage	CV-ES-2182		
	01/90→10/93	Stabiliser Mounting	DF-SB-5253	DF-SB-5253	
	01/90→10/93	Suspension Arm Repair Kit		CV-RK-5322	for Wishbone (CV)
	01/90→10/93	Suspension Arm Repair Kit		IV-RK-8998	for Wishbone (CV)
	01/90→10/93	Suspension Arm Repair Kit		SC-RK-8575	for Wishbone (CV)
	01/90→10/93	Suspension Strut Repair Kit		DF-RK-8637	
	01/90→10/93	Suspension Strut Repair Kit		MN-RK-8537	
	01/90→10/93	Tie Rod End	CV-ES-14163		for Steering Rod
	01/90→10/93	Tie Rod End	DF-ES-3634		
	01/90→10/93	Tie Rod End	DF-ES-3635		
	01/90→10/93	Track Control Arm		DF-VB-8561	Wishbone (CV)

FAB 2700 HS, FAG 2700 HS, FAR 2700 HS

	01/90→10/93	Ball Head, gearshift linkage	CV-ES-2119		
	01/90→10/93	Ball Head, gearshift linkage	CV-ES-2182		
	01/90→10/93	Stabiliser Mounting	DF-SB-5253	DF-SB-5253	
	01/90→10/93	Suspension Arm Repair Kit		CV-RK-5322	for Wishbone (CV)
	01/90→10/93	Suspension Arm Repair Kit		IV-RK-8998	for Wishbone (CV)
	01/90→10/93	Suspension Arm Repair Kit		SC-RK-8575	for Wishbone (CV)
	01/90→10/93	Suspension Strut Repair Kit		DF-RK-8637	
	01/90→10/93	Suspension Strut Repair Kit		MN-RK-8537	
	01/90→10/93	Tie Rod End	CV-ES-14163		for Steering Rod
	01/90→10/93	Tie Rod End	DF-ES-3634		
	01/90→10/93	Tie Rod End	DF-ES-3635		
	01/90→10/93	Track Control Arm		DF-VB-8561	Wishbone (CV)

FAT 2700 HS

	01/90→10/93	Ball Head, gearshift linkage	CV-ES-2119		
	01/90→10/93	Ball Head, gearshift linkage	CV-ES-2182		
	01/90→10/93	Stabiliser Mounting	DF-SB-5253	DF-SB-5253	
	01/90→10/93	Suspension Arm Repair Kit		CV-RK-5322	for Wishbone (CV)
	01/90→10/93	Suspension Arm Repair Kit		IV-RK-8998	for Wishbone (CV)
	01/90→10/93	Suspension Arm Repair Kit		SC-RK-8575	for Wishbone (CV)
	01/90→10/93	Suspension Strut Repair Kit		DF-RK-8637	
	01/90→10/93	Suspension Strut Repair Kit		MN-RK-8537	
	01/90→10/93	Tie Rod End	CV-ES-14163		for Steering Rod
	01/90→10/93	Tie Rod End	DF-ES-3634		
	01/90→10/93	Tie Rod End	DF-ES-3635		
	01/90→10/93	Track Control Arm		DF-VB-8561	Wishbone (CV)

FMT 2700 HS

	01/90→10/93	Ball Head, gearshift linkage	CV-ES-2119		
	01/90→10/93	Ball Head, gearshift linkage	CV-ES-2182		
	01/90→10/93	Stabiliser Mounting	DF-SB-5253	DF-SB-5253	
	01/90→10/93	Suspension Arm Repair Kit		CV-RK-5322	for Wishbone (CV)
	01/90→10/93	Suspension Arm Repair Kit		IV-RK-8998	for Wishbone (CV)
	01/90→10/93	Suspension Arm Repair Kit		SC-RK-8575	for Wishbone (CV)
	01/90→10/93	Suspension Strut Repair Kit		DF-RK-8637	
	01/90→10/93	Suspension Strut Repair Kit		MN-RK-8537	
	01/90→10/93	Tie Rod End	CV-ES-14163		for Steering Rod
	01/90→10/93	Tie Rod End	DF-ES-3634		
	01/90→10/93	Tie Rod End	DF-ES-3635		
	01/90→10/93	Track Control Arm		DF-VB-8561	Wishbone (CV)

CV-ES-2119

Length: 55
Cone Ø: d1 Ø 10 / d2 Ø 10
Thread: M12 x 1,75 LHT
592106, 1249088



DF-ES-9335

Length: 85
Cone Ø: d1 Ø 12 / d2 Ø 10,75
Thread: M14 x 1,5 RHT
0386930, 386930



SC-RK-8575

Ø: 95
Hole Distance: 152
Thick/Height: 35
0696321



CV-ES-2182

Length: 55
Cone Ø: d1 Ø 10 / d2 Ø 10
Thread: M12 x 1,75 RHT
589333, 1249129



DF-RK-8637

Ø: 72
1376730



CV-ES-14163

Length: 125
Cone Ø: d1 Ø 30 / d2 Ø 27
Thread: M30 x 1,5 RHT
0607981, 0698450, 1149907, 1152350,
1257890, 1603789, 1618048, ACHF060



DF-SB-5253

Ø: 86
Thick/Height: 60,5
0371586, 0558864, 10306500A



CV-RK-5322

Ø: 72
Thick/Height: 50
0691704



DF-VB-8561

Length: 609
Ø: 48
Hole Distance: 152 / 152
0080521, 080521, 1361651, 1368270,
1390932, 1617096, 1793875, 1817808,
1892492



DF-ES-3634

Length: 130
Cone Ø: d1 Ø 30 / d2 Ø 27
Thread: M46 x 1,5 LHT
0606922, 606922



IV-RK-8998

Ø: 85
Hole Distance: 130
Thick/Height: 30
0513757, 0531757, 691709, 0691709



DF-ES-3635

Length: 130
Cone Ø: d1 Ø 30 / d2 Ø 27
Thread: M46 x 1,5 RHT
0606923, 606923



MN-RK-8537

Ø: 95
Hole Distance: 152
Thick/Height: 24
696321, 81432706099





F 2700 ...

FT 2700 HS	01/90→10/93	Ball Head, gearshift linkage	CV-ES-2119		
	01/90→10/93	Ball Head, gearshift linkage	CV-ES-2182		
	01/90→10/93	Stabiliser Mounting	DF-SB-5253	DF-SB-5253	
	01/90→10/93	Suspension Arm Repair Kit		CV-RK-5322	for Wishbone (CV)
	01/90→10/93	Suspension Arm Repair Kit		IV-RK-8998	for Wishbone (CV)
	01/90→10/93	Suspension Arm Repair Kit		SC-RK-8575	for Wishbone (CV)
	01/90→10/93	Suspension Strut Repair Kit		DF-RK-8637	
	01/90→10/93	Suspension Strut Repair Kit		MN-RK-8537	
	01/90→10/93	Tie Rod End	CV-ES-14163		for Steering Rod
	01/90→10/93	Tie Rod End	DF-ES-3634		
	01/90→10/93	Tie Rod End	DF-ES-3635		
	01/90→10/93	Track Control Arm		DF-VB-8561	Wishbone (CV)

F 2800

FA 2800 DKA	01/74→08/80	Ball Head, gearshift linkage	CV-ES-2119		
	01/74→08/80	Ball Head, gearshift linkage	CV-ES-2182		
	01/74→08/80	Ball Head, gearshift linkage	DF-ES-9335		
	01/74→08/80	Suspension Arm Repair Kit		IV-RK-8998	for Wishbone (CV)
	01/74→08/80	Suspension Arm Repair Kit		SC-RK-8575	for Wishbone (CV)
	01/74→08/80	Suspension Strut Repair Kit		MN-RK-8537	
	01/74→08/80	Tie Rod End	DF-ES-3634		
	01/74→08/80	Tie Rod End	DF-ES-3635		
FA 2800 DKS	01/74→09/86	Ball Head, gearshift linkage	CV-ES-2119		
	01/74→09/86	Ball Head, gearshift linkage	CV-ES-2182		
	01/74→09/86	Ball Head, gearshift linkage	DF-ES-9335		
	01/74→09/86	Suspension Arm Repair Kit		IV-RK-8998	for Wishbone (CV)
	01/74→09/86	Suspension Arm Repair Kit		SC-RK-8575	for Wishbone (CV)
	01/74→09/86	Suspension Strut Repair Kit		MN-RK-8537	
	01/74→09/86	Tie Rod End	DF-ES-3634		
	01/74→09/86	Tie Rod End	DF-ES-3635		
FA 2800 DKSE	01/80→09/86	Ball Head, gearshift linkage	CV-ES-2119		
	01/80→09/86	Ball Head, gearshift linkage	CV-ES-2182		
	01/80→09/86	Ball Head, gearshift linkage	DF-ES-9335		
	01/80→09/86	Suspension Arm Repair Kit		IV-RK-8998	for Wishbone (CV)
	01/80→09/86	Suspension Arm Repair Kit		SC-RK-8575	for Wishbone (CV)
	01/80→09/86	Suspension Strut Repair Kit		MN-RK-8537	
	01/80→09/86	Tie Rod End	DF-ES-3634		
	01/80→09/86	Tie Rod End	DF-ES-3635		
FA 2800 DKT	01/74→11/80	Ball Head, gearshift linkage	CV-ES-2119		
	01/74→11/80	Ball Head, gearshift linkage	CV-ES-2182		
	01/74→11/80	Ball Head, gearshift linkage	DF-ES-9335		
	01/74→11/80	Suspension Arm Repair Kit		IV-RK-8998	for Wishbone (CV)
	01/74→11/80	Suspension Arm Repair Kit		SC-RK-8575	for Wishbone (CV)
	01/74→11/80	Suspension Strut Repair Kit		MN-RK-8537	
	01/74→11/80	Tie Rod End	DF-ES-3634		
	01/74→11/80	Tie Rod End	DF-ES-3635		
FA 2800 DKTD	01/74→09/91	Ball Head, gearshift linkage	CV-ES-2119		
	01/74→09/91	Ball Head, gearshift linkage	CV-ES-2182		
	01/74→09/91	Ball Head, gearshift linkage	DF-ES-9335		
	01/74→09/91	Suspension Arm Repair Kit		IV-RK-8998	for Wishbone (CV)
	01/74→09/91	Suspension Arm Repair Kit		SC-RK-8575	for Wishbone (CV)
	01/74→09/91	Suspension Strut Repair Kit		MN-RK-8537	
	01/74→09/91	Tie Rod End	DF-ES-3634		
	01/74→09/91	Tie Rod End	DF-ES-3635		
FA 2805 DKSE,FA 2800 DKV, FA 2800 DKXE	05/83→09/91	Ball Head, gearshift linkage	CV-ES-2119		
	05/83→09/91	Ball Head, gearshift linkage	CV-ES-2182		
	05/83→09/91	Ball Head, gearshift linkage	DF-ES-9335		
	05/83→09/91	Suspension Arm Repair Kit		IV-RK-8998	for Wishbone (CV)
	05/83→09/91	Suspension Arm Repair Kit		SC-RK-8575	for Wishbone (CV)
	05/83→09/91	Suspension Strut Repair Kit		MN-RK-8537	
	05/83→09/91	Tie Rod End	DF-ES-3634		
	05/83→09/91	Tie Rod End	DF-ES-3635		

CV-ES-2119

Length: 55
Cone Ø: d1 Ø 10 / d2 Ø 10
Thread: M12 x 1,75 LHT
592106, 1249088



DF-ES-9335

Length: 85
Cone Ø: d1 Ø 12 / d2 Ø 10,75
Thread: M14 x 1,5 RHT
0386930, 386930



SC-RK-8575

Ø: 95
Hole Distance: 152
Thick/Height: 35
0696321



CV-ES-2182

Length: 55
Cone Ø: d1 Ø 10 / d2 Ø 10
Thread: M12 x 1,75 RHT
589333, 1249129



DF-RK-8637

Ø: 72
1376730



CV-ES-14163

Length: 125
Cone Ø: d1 Ø 30 / d2 Ø 27
Thread: M30 x 1,5 RHT
0607981, 0698450, 1149907, 1152350,
1257890, 1603789, 1618048, ACHF060



DF-SB-5253

Ø: 86
Thick/Height: 60,5
0371586, 0558864, 10306500A



DF-VB-8561

Length: 609
Ø: 48
Hole Distance: 152 / 152
0080521, 080521, 1361651, 1368270,
1390932, 1617096, 1793875, 1817808,
1892492



CV-RK-5322

Ø: 72
Thick/Height: 50
0691704



IV-RK-8998

Ø: 85
Hole Distance: 130
Thick/Height: 30
0513757, 0531757, 0691709, 691709



DF-ES-3634

Length: 130
Cone Ø: d1 Ø 30 / d2 Ø 27
Thread: M46 x 1,5 LHT
0606922, 606922



MN-RK-8537

Ø: 95
Hole Distance: 152
Thick/Height: 24
696321, 81432706099



DF-ES-3635

Length: 130
Cone Ø: d1 Ø 30 / d2 Ø 27
Thread: M46 x 1,5 RHT
0606923, 606923



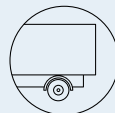

DAF ...

F 2800 ...

FAB 2805 DKS,FAR 2800 DKS, FAS 2800 DKS	01/74→09/86	Ball Head, gearshift linkage	CV-ES-2119		
	01/74→09/86	Ball Head, gearshift linkage	CV-ES-2182		
	01/74→09/86	Ball Head, gearshift linkage	DF-ES-9335		
	01/74→09/86	Suspension Arm Repair Kit		IV-RK-8998	for Wishbone (CV)
	01/74→09/86	Suspension Arm Repair Kit		SC-RK-8575	for Wishbone (CV)
	01/74→09/86	Suspension Strut Repair Kit		MN-RK-8537	
	01/74→09/86	Tie Rod End	DF-ES-3634		
	01/74→09/86	Tie Rod End	DF-ES-3635		
FAB 2805 DKTD,FAS 2800 DKTD	01/74→09/86	Ball Head, gearshift linkage	CV-ES-2119		
	01/74→09/86	Ball Head, gearshift linkage	CV-ES-2182		
	01/74→09/86	Ball Head, gearshift linkage	DF-ES-9335		
	01/74→09/86	Suspension Arm Repair Kit		IV-RK-8998	for Wishbone (CV)
	01/74→09/86	Suspension Arm Repair Kit		SC-RK-8575	for Wishbone (CV)
	01/74→09/86	Suspension Strut Repair Kit		MN-RK-8537	
	01/74→09/86	Tie Rod End	DF-ES-3634		
	01/74→09/86	Tie Rod End	DF-ES-3635		
FAC 2803 DKS	01/74→09/86	Ball Head, gearshift linkage	CV-ES-2119		
	01/74→09/86	Ball Head, gearshift linkage	CV-ES-2182		
	01/74→09/86	Ball Head, gearshift linkage	DF-ES-9335		
	01/74→09/86	Suspension Arm Repair Kit		IV-RK-8998	for Wishbone (CV)
	01/74→09/86	Suspension Arm Repair Kit		SC-RK-8575	for Wishbone (CV)
	01/74→09/86	Suspension Strut Repair Kit		MN-RK-8537	
	01/74→09/86	Tie Rod End	DF-ES-3634		
	01/74→09/86	Tie Rod End	DF-ES-3635		
FAC 2803 DKSE	01/80→07/90	Ball Head, gearshift linkage	CV-ES-2119		
	01/80→07/90	Ball Head, gearshift linkage	CV-ES-2182		
	01/80→07/90	Ball Head, gearshift linkage	DF-ES-9335		
	01/80→07/90	Suspension Arm Repair Kit		IV-RK-8998	for Wishbone (CV)
	01/80→07/90	Suspension Arm Repair Kit		SC-RK-8575	for Wishbone (CV)
	01/80→07/90	Suspension Strut Repair Kit		MN-RK-8537	
	01/80→07/90	Tie Rod End	DF-ES-3634		
	01/80→07/90	Tie Rod End	DF-ES-3635		
FAC 2803 DKTD	01/74→09/91	Ball Head, gearshift linkage	CV-ES-2119		
	01/74→09/91	Ball Head, gearshift linkage	CV-ES-2182		
	01/74→09/91	Ball Head, gearshift linkage	DF-ES-9335		
	01/74→09/91	Suspension Arm Repair Kit		IV-RK-8998	for Wishbone (CV)
	01/74→09/91	Suspension Arm Repair Kit		SC-RK-8575	for Wishbone (CV)
	01/74→09/91	Suspension Strut Repair Kit		MN-RK-8537	
	01/74→09/91	Tie Rod End	DF-ES-3634		
	01/74→09/91	Tie Rod End	DF-ES-3635		
FAD 2805 DKS	01/74→09/86	Ball Head, gearshift linkage	CV-ES-2119		
	01/74→09/86	Ball Head, gearshift linkage	CV-ES-2182		
	01/74→09/86	Ball Head, gearshift linkage	DF-ES-9335		
	01/74→09/86	Suspension Arm Repair Kit		IV-RK-8998	for Wishbone (CV)
	01/74→09/86	Suspension Arm Repair Kit		SC-RK-8575	for Wishbone (CV)
	01/74→09/86	Suspension Strut Repair Kit		MN-RK-8537	
	01/74→09/86	Tie Rod End	DF-ES-3634		
	01/74→09/86	Tie Rod End	DF-ES-3635		
FAD 2805 DKTD	01/74→06/86	Ball Head, gearshift linkage	CV-ES-2119		
	01/74→06/86	Ball Head, gearshift linkage	CV-ES-2182		
	01/74→06/86	Ball Head, gearshift linkage	DF-ES-9335		
	01/74→06/86	Suspension Arm Repair Kit		IV-RK-8998	for Wishbone (CV)
	01/74→06/86	Suspension Arm Repair Kit		SC-RK-8575	for Wishbone (CV)
	01/74→06/86	Suspension Strut Repair Kit		MN-RK-8537	
	01/74→06/86	Tie Rod End	DF-ES-3634		
	01/74→06/86	Tie Rod End	DF-ES-3635		
FAD 2825 DKTD	01/74→09/91	Ball Head, gearshift linkage	CV-ES-2119		
	01/74→09/91	Ball Head, gearshift linkage	CV-ES-2182		
	01/74→09/91	Ball Head, gearshift linkage	DF-ES-9335		
	01/74→09/91	Suspension Arm Repair Kit		IV-RK-8998	for Wishbone (CV)
	01/74→09/91	Suspension Arm Repair Kit		SC-RK-8575	for Wishbone (CV)
	01/74→09/91	Suspension Strut Repair Kit		MN-RK-8537	
	01/74→09/91	Tie Rod End	DF-ES-3634		
	01/74→09/91	Tie Rod End	DF-ES-3635		

CV-ES-2119

Length: 55
Cone Ø: d1 Ø 10 / d2 Ø 10
Thread: M12 x 1,75 LHT
592106, 1249088



MN-RK-8537

Ø: 95
Hole Distance: 152
Thick/Height: 24
696321, 81432706099



CV-ES-2182

Length: 55
Cone Ø: d1 Ø 10 / d2 Ø 10
Thread: M12 x 1,75 RHT
589333, 1249129



SC-RK-8575

Ø: 95
Hole Distance: 152
Thick/Height: 35
0696321



DF-ES-3634

Length: 130
Cone Ø: d1 Ø 30 / d2 Ø 27
Thread: M46 x 1,5 LHT
0606922, 606922



DF-ES-3635

Length: 130
Cone Ø: d1 Ø 30 / d2 Ø 27
Thread: M46 x 1,5 RHT
0606923, 606923



DF-ES-9335

Length: 85
Cone Ø: d1 Ø 12 / d2 Ø 10,75
Thread: M14 x 1,5 RHT
0386930, 386930



IV-RK-8998

Ø: 85
Hole Distance: 130
Thick/Height: 30
0513757, 0531757, 0691709, 691709





F 2800 ...

FAD 2825 DKV	05/83→09/91	Ball Head, gearshift linkage	CV-ES-2119		
	05/83→09/91	Ball Head, gearshift linkage	CV-ES-2182		
	05/83→09/91	Tie Rod End	DF-ES-3634		
	05/83→09/91	Tie Rod End	DF-ES-3635		
FAG 2800 DKV,FAR 2804 DKXE, FAS 2803 DKXE,DKSE,DKV	05/83→09/91	Ball Head, gearshift linkage	CV-ES-2119		
	05/83→09/91	Ball Head, gearshift linkage	CV-ES-2182		
	05/83→09/91	Ball Head, gearshift linkage	DF-ES-9335		
	05/83→09/91	Suspension Arm Repair Kit		IV-RK-8998	for Wishbone (CV)
	05/83→09/91	Suspension Arm Repair Kit		SC-RK-8575	for Wishbone (CV)
	05/83→09/91	Suspension Strut Repair Kit		MN-RK-8537	
	05/83→09/91	Tie Rod End	DF-ES-3634		
	05/83→09/91	Tie Rod End	DF-ES-3635		
FAR 2804 DKSE,FAS 2800 DKT	01/80→09/86	Ball Head, gearshift linkage	CV-ES-2119		
	01/80→09/86	Ball Head, gearshift linkage	CV-ES-2182		
	01/80→09/86	Tie Rod End	DF-ES-3634		
	01/80→09/86	Tie Rod End	DF-ES-3635		
FAS 2800 DKA	01/74→11/80	Ball Head, gearshift linkage	CV-ES-2119		
	01/74→11/80	Ball Head, gearshift linkage	CV-ES-2182		
	01/74→11/80	Ball Head, gearshift linkage	DF-ES-9335		
	01/74→11/80	Suspension Arm Repair Kit		IV-RK-8998	for Wishbone (CV)
	01/74→11/80	Suspension Arm Repair Kit		SC-RK-8575	for Wishbone (CV)
	01/74→11/80	Suspension Strut Repair Kit		MN-RK-8537	
	01/74→11/80	Tie Rod End	DF-ES-3634		
	01/74→11/80	Tie Rod End	DF-ES-3635		
FAS 2803 DKS	06/86→09/91	Ball Head, gearshift linkage	CV-ES-2119		
	06/86→09/91	Ball Head, gearshift linkage	CV-ES-2182		
	06/86→09/91	Ball Head, gearshift linkage	DF-ES-9335		
	06/86→09/91	Suspension Arm Repair Kit		IV-RK-8998	for Wishbone (CV)
	06/86→09/91	Suspension Arm Repair Kit		SC-RK-8575	for Wishbone (CV)
	06/86→09/91	Suspension Strut Repair Kit		MN-RK-8537	
	06/86→09/91	Tie Rod End	DF-ES-3634		
	06/86→09/91	Tie Rod End	DF-ES-3635		
FAS 2803 DKTD	06/86→09/91	Ball Head, gearshift linkage	CV-ES-2119		
	06/86→09/91	Ball Head, gearshift linkage	CV-ES-2182		
	06/86→09/91	Ball Head, gearshift linkage	DF-ES-9335		
	06/86→09/91	Suspension Arm Repair Kit		IV-RK-8998	for Wishbone (CV)
	06/86→09/91	Suspension Arm Repair Kit		SC-RK-8575	for Wishbone (CV)
	06/86→09/91	Suspension Strut Repair Kit		MN-RK-8537	
	06/86→09/91	Tie Rod End	DF-ES-3634		
	06/86→09/91	Tie Rod End	DF-ES-3635		
FAT 2800 DKA	01/74→11/80	Ball Head, gearshift linkage	CV-ES-2119		
	01/74→11/80	Ball Head, gearshift linkage	CV-ES-2182		
	01/74→11/80	Ball Head, gearshift linkage	DF-ES-9335		
	01/74→11/80	Suspension Arm Repair Kit		IV-RK-8998	for Wishbone (CV)
	01/74→11/80	Suspension Arm Repair Kit		SC-RK-8575	for Wishbone (CV)
	01/74→11/80	Suspension Strut Repair Kit		MN-RK-8537	
	01/74→11/80	Tie Rod End	DF-ES-3634		
	01/74→11/80	Tie Rod End	DF-ES-3635		
FAT 2800 DKS	01/74→09/86	Ball Head, gearshift linkage	CV-ES-2119		
	01/74→09/86	Ball Head, gearshift linkage	CV-ES-2182		
	01/74→09/86	Ball Head, gearshift linkage	DF-ES-9335		
	01/74→09/86	Suspension Arm Repair Kit		IV-RK-8998	for Wishbone (CV)
	01/74→09/86	Suspension Arm Repair Kit		SC-RK-8575	for Wishbone (CV)
	01/74→09/86	Suspension Strut Repair Kit		MN-RK-8537	
	01/74→09/86	Tie Rod End	DF-ES-3634		
	01/74→09/86	Tie Rod End	DF-ES-3635		
FAT 2800 DKT	01/74→11/80	Ball Head, gearshift linkage	CV-ES-2119		
	01/74→11/80	Ball Head, gearshift linkage	CV-ES-2182		
	01/74→11/80	Ball Head, gearshift linkage	DF-ES-9335		
	01/74→11/80	Suspension Arm Repair Kit		IV-RK-8998	for Wishbone (CV)
	01/74→11/80	Suspension Arm Repair Kit		SC-RK-8575	for Wishbone (CV)
	01/74→11/80	Suspension Strut Repair Kit		MN-RK-8537	
	01/74→11/80	Tie Rod End	DF-ES-3634		
	01/74→11/80	Tie Rod End	DF-ES-3635		

CV-ES-2119

Length: 55
Cone Ø: d1 Ø 10 / d2 Ø 10
Thread: M12 x 1,75 LHT
592106, 1249088



MN-RK-8537

Ø: 95
Hole Distance: 152
Thick/Height: 24
696321, 81432706099



CV-ES-2182

Length: 55
Cone Ø: d1 Ø 10 / d2 Ø 10
Thread: M12 x 1,75 RHT
589333, 1249129



SC-RK-8575

Ø: 95
Hole Distance: 152
Thick/Height: 35
0696321



DF-ES-3634

Length: 130
Cone Ø: d1 Ø 30 / d2 Ø 27
Thread: M46 x 1,5 LHT
0606922, 606922



DF-ES-3635

Length: 130
Cone Ø: d1 Ø 30 / d2 Ø 27
Thread: M46 x 1,5 RHT
0606923, 606923



DF-ES-9335

Length: 85
Cone Ø: d1 Ø 12 / d2 Ø 10,75
Thread: M14 x 1,5 RHT
0386930, 386930



IV-RK-8998

Ø: 85
Hole Distance: 130
Thick/Height: 30
0513757, 0531757, 0691709, 691709





F 2800 ...

FAT 2800 DKTD	01/74→09/86	Ball Head, gearshift linkage	CV-ES-2119		
	01/74→09/86	Ball Head, gearshift linkage	CV-ES-2182		
	01/74→09/86	Ball Head, gearshift linkage	DF-ES-9335		
	01/74→09/86	Suspension Arm Repair Kit		IV-RK-8998	for Wishbone (CV)
	01/74→09/86	Suspension Arm Repair Kit		SC-RK-8575	for Wishbone (CV)
	01/74→09/86	Suspension Strut Repair Kit		MN-RK-8537	
	01/74→09/86	Tie Rod End	DF-ES-3634		
	01/74→09/86	Tie Rod End	DF-ES-3635		
FAT 2805 DKS,FAT 2825 DKS	06/86→09/91	Ball Head, gearshift linkage	CV-ES-2119		
	06/86→09/91	Ball Head, gearshift linkage	CV-ES-2182		
	06/86→09/91	Ball Head, gearshift linkage	DF-ES-9335		
	06/86→09/91	Suspension Arm Repair Kit		IV-RK-8998	for Wishbone (CV)
	06/86→09/91	Suspension Arm Repair Kit		SC-RK-8575	for Wishbone (CV)
	06/86→09/91	Suspension Strut Repair Kit		MN-RK-8537	
	06/86→09/91	Tie Rod End	DF-ES-3634		
	06/86→09/91	Tie Rod End	DF-ES-3635		
FAT 2805 DKTD,FAT 2825 DKTD	06/86→09/91	Ball Head, gearshift linkage	CV-ES-2119		
	06/86→09/91	Ball Head, gearshift linkage	CV-ES-2182		
	06/86→09/91	Ball Head, gearshift linkage	DF-ES-9335		
	06/86→09/91	Suspension Arm Repair Kit		IV-RK-8998	for Wishbone (CV)
	06/86→09/91	Suspension Arm Repair Kit		SC-RK-8575	for Wishbone (CV)
	06/86→09/91	Suspension Strut Repair Kit		MN-RK-8537	
	06/86→09/91	Tie Rod End	DF-ES-3634		
	06/86→09/91	Tie Rod End	DF-ES-3635		
FMD 2805 DKTD,FMD 2825 DKTD	01/74→09/91	Ball Head, gearshift linkage	CV-ES-2119		
	01/74→09/91	Ball Head, gearshift linkage	CV-ES-2182		
	01/74→09/91	Ball Head, gearshift linkage	DF-ES-9335		
	01/74→09/91	Suspension Arm Repair Kit		IV-RK-8998	for Wishbone (CV)
	01/74→09/91	Suspension Arm Repair Kit		SC-RK-8575	for Wishbone (CV)
	01/74→09/91	Suspension Strut Repair Kit		MN-RK-8537	
	01/74→09/91	Tie Rod End	DF-ES-3634		
	01/74→09/91	Tie Rod End	DF-ES-3635		
FMD 2825 DKV	05/83→09/91	Ball Head, gearshift linkage	CV-ES-2119		
	05/83→09/91	Ball Head, gearshift linkage	CV-ES-2182		
	05/83→09/91	Ball Head, gearshift linkage	DF-ES-9335		
	05/83→09/91	Suspension Arm Repair Kit		IV-RK-8998	for Wishbone (CV)
	05/83→09/91	Suspension Arm Repair Kit		SC-RK-8575	for Wishbone (CV)
	05/83→09/91	Suspension Strut Repair Kit		MN-RK-8537	
	05/83→09/91	Tie Rod End	DF-ES-3634		
	05/83→09/91	Tie Rod End	DF-ES-3635		
FT 2800 DKA	01/74→11/80	Ball Head, gearshift linkage	CV-ES-2119		
	01/74→11/80	Ball Head, gearshift linkage	CV-ES-2182		
	01/74→11/80	Ball Head, gearshift linkage	DF-ES-9335		
	01/74→11/80	Suspension Arm Repair Kit		IV-RK-8998	for Wishbone (CV)
	01/74→11/80	Suspension Arm Repair Kit		SC-RK-8575	for Wishbone (CV)
	01/74→11/80	Suspension Strut Repair Kit		MN-RK-8537	
	01/74→11/80	Tie Rod End	DF-ES-3634		
	01/74→11/80	Tie Rod End	DF-ES-3635		
FT 2800 DKS	01/74→09/86	Ball Head, gearshift linkage	CV-ES-2119		
	01/74→09/86	Ball Head, gearshift linkage	CV-ES-2182		
	01/74→09/86	Ball Head, gearshift linkage	DF-ES-9335		
	01/74→09/86	Suspension Arm Repair Kit		IV-RK-8998	for Wishbone (CV)
	01/74→09/86	Suspension Arm Repair Kit		SC-RK-8575	for Wishbone (CV)
	01/74→09/86	Suspension Strut Repair Kit		MN-RK-8537	
	01/74→09/86	Tie Rod End	DF-ES-3634		
	01/74→09/86	Tie Rod End	DF-ES-3635		
FT 2800 DKSE,FT 2800DKXE, FT 2800 DKV	01/80→09/91	Ball Head, gearshift linkage	CV-ES-2119		
	01/80→09/91	Ball Head, gearshift linkage	CV-ES-2182		
	01/80→09/91	Ball Head, gearshift linkage	DF-ES-9335		
	01/80→09/91	Suspension Arm Repair Kit		IV-RK-8998	for Wishbone (CV)
	01/80→09/91	Suspension Arm Repair Kit		SC-RK-8575	for Wishbone (CV)
	01/80→09/91	Suspension Strut Repair Kit		MN-RK-8537	
	01/80→09/91	Tie Rod End	DF-ES-3634		
	01/80→09/91	Tie Rod End	DF-ES-3635		

CV-ES-2119

Length: 55
Cone Ø: d1 Ø 10 / d2 Ø 10
Thread: M12 x 1,75 LHT
592106, 1249088



MN-RK-8537

Ø: 95
Hole Distance: 152
Thick/Height: 24
696321, 81432706099



CV-ES-2182

Length: 55
Cone Ø: d1 Ø 10 / d2 Ø 10
Thread: M12 x 1,75 RHT
589333, 1249129



SC-RK-8575

Ø: 95
Hole Distance: 152
Thick/Height: 35
0696321



DF-ES-3634

Length: 130
Cone Ø: d1 Ø 30 / d2 Ø 27
Thread: M46 x 1,5 LHT
0606922, 606922



DF-ES-3635

Length: 130
Cone Ø: d1 Ø 30 / d2 Ø 27
Thread: M46 x 1,5 RHT
0606923, 606923



DF-ES-9335

Length: 85
Cone Ø: d1 Ø 12 / d2 Ø 10,75
Thread: M14 x 1,5 RHT
386930, 0386930



IV-RK-8998

Ø: 85
Hole Distance: 130
Thick/Height: 30
0513757, 0531757, 0691709, 691709





F 2800 ...

FT 2800 DKT	01/74→11/80	Ball Head, gearshift linkage	CV-ES-2119		
	01/74→11/80	Ball Head, gearshift linkage	CV-ES-2182		
	01/74→11/80	Ball Head, gearshift linkage	DF-ES-9335		
	01/74→11/80	Suspension Arm Repair Kit		IV-RK-8998	for Wishbone (CV)
	01/74→11/80	Suspension Arm Repair Kit		SC-RK-8575	for Wishbone (CV)
	01/74→11/80	Suspension Strut Repair Kit		MN-RK-8537	
	01/74→11/80	Tie Rod End	DF-ES-3634		
	01/74→11/80	Tie Rod End	DF-ES-3635		
FT 2800 DKTD	01/74→09/86	Ball Head, gearshift linkage	CV-ES-2119		
	01/74→09/86	Ball Head, gearshift linkage	CV-ES-2182		
	01/74→09/86	Ball Head, gearshift linkage	DF-ES-9335		
	01/74→09/86	Suspension Arm Repair Kit		IV-RK-8998	for Wishbone (CV)
	01/74→09/86	Suspension Arm Repair Kit		SC-RK-8575	for Wishbone (CV)
	01/74→09/86	Suspension Strut Repair Kit		MN-RK-8537	
	01/74→09/86	Tie Rod End	DF-ES-3634		
	01/74→09/86	Tie Rod End	DF-ES-3635		
FT 2805 DKS	06/86→09/91	Ball Head, gearshift linkage	CV-ES-2119		
	06/86→09/91	Ball Head, gearshift linkage	CV-ES-2182		
	06/86→09/91	Ball Head, gearshift linkage	DF-ES-9335		
	06/86→09/91	Suspension Arm Repair Kit		IV-RK-8998	for Wishbone (CV)
	06/86→09/91	Suspension Arm Repair Kit		SC-RK-8575	for Wishbone (CV)
	06/86→09/91	Suspension Strut Repair Kit		MN-RK-8537	
	06/86→09/91	Tie Rod End	DF-ES-3634		
	06/86→09/91	Tie Rod End	DF-ES-3635		
FT 2805 DKTD	06/86→09/91	Ball Head, gearshift linkage	CV-ES-2119		
	06/86→09/91	Ball Head, gearshift linkage	CV-ES-2182		
	06/86→09/91	Ball Head, gearshift linkage	DF-ES-9335		
	06/86→09/91	Suspension Arm Repair Kit		IV-RK-8998	for Wishbone (CV)
	06/86→09/91	Suspension Arm Repair Kit		SC-RK-8575	for Wishbone (CV)
	06/86→09/91	Suspension Strut Repair Kit		MN-RK-8537	
	06/86→09/91	Tie Rod End	DF-ES-3634		
	06/86→09/91	Tie Rod End	DF-ES-3635		
FTS 2800 DKA	01/74→11/80	Ball Head, gearshift linkage	CV-ES-2119		
	01/74→11/80	Ball Head, gearshift linkage	CV-ES-2182		
	01/74→11/80	Ball Head, gearshift linkage	DF-ES-9335		
	01/74→11/80	Suspension Arm Repair Kit		IV-RK-8998	for Wishbone (CV)
	01/74→11/80	Suspension Arm Repair Kit		SC-RK-8575	for Wishbone (CV)
	01/74→11/80	Suspension Strut Repair Kit		MN-RK-8537	
	01/74→11/80	Tie Rod End	DF-ES-3634		
	01/74→11/80	Tie Rod End	DF-ES-3635		
FTS 2800 DKS	01/74→09/86	Ball Head, gearshift linkage	CV-ES-2119		
	01/74→09/86	Ball Head, gearshift linkage	CV-ES-2182		
	01/74→09/86	Ball Head, gearshift linkage	DF-ES-9335		
	01/74→09/86	Suspension Arm Repair Kit		IV-RK-8998	for Wishbone (CV)
	01/74→09/86	Suspension Arm Repair Kit		SC-RK-8575	for Wishbone (CV)
	01/74→09/86	Suspension Strut Repair Kit		MN-RK-8537	
	01/74→09/86	Tie Rod End	DF-ES-3634		
	01/74→09/86	Tie Rod End	DF-ES-3635		
FTS 2800 DKT	01/74→11/80	Ball Head, gearshift linkage	CV-ES-2119		
	01/74→11/80	Ball Head, gearshift linkage	CV-ES-2182		
	01/74→11/80	Ball Head, gearshift linkage	DF-ES-9335		
	01/74→11/80	Suspension Arm Repair Kit		IV-RK-8998	for Wishbone (CV)
	01/74→11/80	Suspension Arm Repair Kit		SC-RK-8575	for Wishbone (CV)
	01/74→11/80	Suspension Strut Repair Kit		MN-RK-8537	
	01/74→11/80	Tie Rod End	DF-ES-3634		
	01/74→11/80	Tie Rod End	DF-ES-3635		
FTS 2800 DKTD	01/74→09/86	Ball Head, gearshift linkage	CV-ES-2119		
	01/74→09/86	Ball Head, gearshift linkage	CV-ES-2182		
	01/74→09/86	Ball Head, gearshift linkage	DF-ES-9335		
	01/74→09/86	Suspension Arm Repair Kit		IV-RK-8998	for Wishbone (CV)
	01/74→09/86	Suspension Arm Repair Kit		SC-RK-8575	for Wishbone (CV)
	01/74→09/86	Suspension Strut Repair Kit		MN-RK-8537	
	01/74→09/86	Tie Rod End	DF-ES-3634		
	01/74→09/86	Tie Rod End	DF-ES-3635		

CV-ES-2119

Length: 55
Cone Ø: d1 Ø 10 / d2 Ø 10
Thread: M12 x 1,75 LHT
592106, 1249088



MN-RK-8537

Ø: 95
Hole Distance: 152
Thick/Height: 24
696321, 81432706099



CV-ES-2182

Length: 55
Cone Ø: d1 Ø 10 / d2 Ø 10
Thread: M12 x 1,75 RHT
589333, 1249129



SC-RK-8575

Ø: 95
Hole Distance: 152
Thick/Height: 35
0696321



DF-ES-3634

Length: 130
Cone Ø: d1 Ø 30 / d2 Ø 27
Thread: M46 x 1,5 LHT
0606922, 606922



DF-ES-3635

Length: 130
Cone Ø: d1 Ø 30 / d2 Ø 27
Thread: M46 x 1,5 RHT
0606923, 606923



DF-ES-9335

Length: 85
Cone Ø: d1 Ø 12 / d2 Ø 10,75
Thread: M14 x 1,5 RHT
0386930, 386930



IV-RK-8998

Ø: 85
Hole Distance: 130
Thick/Height: 30
0513757, 0531757, 0691709, 691709





F 2800 ...

FTS 2803 DKS	06/86→09/91	Ball Head, gearshift linkage	CV-ES-2119		
	06/86→09/91	Ball Head, gearshift linkage	CV-ES-2182		
	06/86→09/91	Ball Head, gearshift linkage	DF-ES-9335		
	06/86→09/91	Suspension Arm Repair Kit		IV-RK-8998	for Wishbone (CV)
	06/86→09/91	Suspension Arm Repair Kit		SC-RK-8575	for Wishbone (CV)
	06/86→09/91	Suspension Strut Repair Kit		MN-RK-8537	
	06/86→09/91	Tie Rod End	DF-ES-3634		
	06/86→09/91	Tie Rod End	DF-ES-3635		
FTS 2803 DKTD	06/86→09/91	Ball Head, gearshift linkage	CV-ES-2119		
	06/86→09/91	Ball Head, gearshift linkage	CV-ES-2182		
	06/86→09/91	Ball Head, gearshift linkage	DF-ES-9335		
	06/86→09/91	Suspension Arm Repair Kit		IV-RK-8998	for Wishbone (CV)
	06/86→09/91	Suspension Arm Repair Kit		SC-RK-8575	for Wishbone (CV)
	06/86→09/91	Suspension Strut Repair Kit		MN-RK-8537	
	06/86→09/91	Tie Rod End	DF-ES-3634		
	06/86→09/91	Tie Rod End	DF-ES-3635		
FTT 2800 DKA	01/74→11/80	Ball Head, gearshift linkage	CV-ES-2119		
	01/74→11/80	Ball Head, gearshift linkage	CV-ES-2182		
	01/74→11/80	Ball Head, gearshift linkage	DF-ES-9335		
	01/74→11/80	Suspension Arm Repair Kit		IV-RK-8998	for Wishbone (CV)
	01/74→11/80	Suspension Arm Repair Kit		SC-RK-8575	for Wishbone (CV)
	01/74→11/80	Suspension Strut Repair Kit		MN-RK-8537	
	01/74→11/80	Tie Rod End	DF-ES-3634		
	01/74→11/80	Tie Rod End	DF-ES-3635		
FTT 2800 DKS	01/74→09/86	Ball Head, gearshift linkage	CV-ES-2119		
	01/74→09/86	Ball Head, gearshift linkage	CV-ES-2182		
	01/74→09/86	Ball Head, gearshift linkage	DF-ES-9335		
	01/74→09/86	Suspension Arm Repair Kit		IV-RK-8998	for Wishbone (CV)
	01/74→09/86	Suspension Arm Repair Kit		SC-RK-8575	for Wishbone (CV)
	01/74→09/86	Suspension Strut Repair Kit		MN-RK-8537	
	01/74→09/86	Tie Rod End	DF-ES-3634		
	01/74→09/86	Tie Rod End	DF-ES-3635		
FTT 2800 DKT	01/74→11/80	Ball Head, gearshift linkage	CV-ES-2119		
	01/74→11/80	Ball Head, gearshift linkage	CV-ES-2182		
	01/74→11/80	Ball Head, gearshift linkage	DF-ES-9335		
	01/74→11/80	Suspension Arm Repair Kit		IV-RK-8998	for Wishbone (CV)
	01/74→11/80	Suspension Arm Repair Kit		SC-RK-8575	for Wishbone (CV)
	01/74→11/80	Suspension Strut Repair Kit		MN-RK-8537	
	01/74→11/80	Tie Rod End	DF-ES-3634		
	01/74→11/80	Tie Rod End	DF-ES-3635		
FTT 2800 DKTD	01/74→09/86	Ball Head, gearshift linkage	CV-ES-2119		
	01/74→09/86	Ball Head, gearshift linkage	CV-ES-2182		
	01/74→09/86	Ball Head, gearshift linkage	DF-ES-9335		
	01/74→09/86	Suspension Arm Repair Kit		IV-RK-8998	for Wishbone (CV)
	01/74→09/86	Suspension Arm Repair Kit		SC-RK-8575	for Wishbone (CV)
	01/74→09/86	Suspension Strut Repair Kit		MN-RK-8537	
	01/74→09/86	Tie Rod End	DF-ES-3634		
	01/74→09/86	Tie Rod End	DF-ES-3635		
FTT 2805 DKS,FTT 2815 DKS, FTT2825 DKS	06/86→09/91	Ball Head, gearshift linkage	CV-ES-2119		
	06/86→09/91	Ball Head, gearshift linkage	CV-ES-2182		
	06/86→09/91	Ball Head, gearshift linkage	DF-ES-9335		
	06/86→09/91	Suspension Arm Repair Kit		IV-RK-8998	for Wishbone (CV)
	06/86→09/91	Suspension Arm Repair Kit		SC-RK-8575	for Wishbone (CV)
	06/86→09/91	Suspension Strut Repair Kit		MN-RK-8537	
	06/86→09/91	Tie Rod End	DF-ES-3634		
	06/86→09/91	Tie Rod End	DF-ES-3635		
FTT 2805 DKTD	06/86→09/91	Ball Head, gearshift linkage	CV-ES-2119		
	06/86→09/91	Ball Head, gearshift linkage	CV-ES-2182		
	06/86→09/91	Ball Head, gearshift linkage	DF-ES-9335		
	06/86→09/91	Suspension Arm Repair Kit		IV-RK-8998	for Wishbone (CV)
	06/86→09/91	Suspension Arm Repair Kit		SC-RK-8575	for Wishbone (CV)
	06/86→09/91	Suspension Strut Repair Kit		MN-RK-8537	
	06/86→09/91	Tie Rod End	DF-ES-3634		
	06/86→09/91	Tie Rod End	DF-ES-3635		

CV-ES-2119

Length: 55
Cone Ø: d1 Ø 10 / d2 Ø 10
Thread: M12 x 1,75 LHT
592106, 1249088



MN-RK-8537

Ø: 95
Hole Distance: 152
Thick/Height: 24
696321, 81432706099



CV-ES-2182

Length: 55
Cone Ø: d1 Ø 10 / d2 Ø 10
Thread: M12 x 1,75 RHT
589333, 1249129



SC-RK-8575

Ø: 95
Hole Distance: 152
Thick/Height: 35
0696321



DF-ES-3634

Length: 130
Cone Ø: d1 Ø 30 / d2 Ø 27
Thread: M46 x 1,5 LHT
0606922, 606922



DF-ES-3635

Length: 130
Cone Ø: d1 Ø 30 / d2 Ø 27
Thread: M46 x 1,5 RHT
0606923, 606923



DF-ES-9335

Length: 85
Cone Ø: d1 Ø 12 / d2 Ø 10,75
Thread: M14 x 1,5 RHT
0386930, 386930



IV-RK-8998

Ø: 85
Hole Distance: 130
Thick/Height: 30
0513757, 0531757, 0691709, 691709





F 2900

FA 2900 KV	01/90→10/93	Suspension Arm Repair Kit	IV-RK-8998	for Wishbone (CV)
	01/90→10/93	Suspension Arm Repair Kit	SC-RK-8575	for Wishbone (CV)
	01/90→10/93	Suspension Strut Repair Kit	MN-RK-8537	
FAD 2900 KV	01/90→10/93	Suspension Arm Repair Kit	IV-RK-8998	for Wishbone (CV)
	01/90→10/93	Suspension Arm Repair Kit	SC-RK-8575	for Wishbone (CV)
	01/90→10/93	Suspension Strut Repair Kit	MN-RK-8537	
FAG 2900 KV,FAR 2900 KV, FAS 2900 KV	01/90→10/93	Suspension Arm Repair Kit	IV-RK-8998	for Wishbone (CV)
	01/90→10/93	Suspension Arm Repair Kit	SC-RK-8575	for Wishbone (CV)
	01/90→10/93	Suspension Strut Repair Kit	MN-RK-8537	
FMD 2900 KV	01/90→10/93	Suspension Arm Repair Kit	IV-RK-8998	for Wishbone (CV)
	01/90→10/93	Suspension Arm Repair Kit	SC-RK-8575	for Wishbone (CV)
	01/90→10/93	Suspension Strut Repair Kit	MN-RK-8537	
FT 2900 KV	01/90→10/93	Suspension Arm Repair Kit	IV-RK-8998	for Wishbone (CV)
	01/90→10/93	Suspension Arm Repair Kit	SC-RK-8575	for Wishbone (CV)
	01/90→10/93	Suspension Strut Repair Kit	MN-RK-8537	

F 3200

FA 3200 KS	01/90→10/93	Suspension Arm Repair Kit	SC-RK-8575	for Wishbone (CV)
	01/90→10/93	Suspension Strut Repair Kit	MN-RK-8537	
FAB 3200 KS,FAR 3200 KS, FAS 3200 KS	01/90→10/93	Suspension Arm Repair Kit	SC-RK-8575	for Wishbone (CV)
	01/90→10/93	Suspension Strut Repair Kit	MN-RK-8537	
FAD 3200 KS	01/90→10/93	Suspension Arm Repair Kit	SC-RK-8575	for Wishbone (CV)
	01/90→10/93	Suspension Strut Repair Kit	MN-RK-8537	
FAT 3200 KV	01/90→10/93	Suspension Arm Repair Kit	SC-RK-8575	for Wishbone (CV)
	01/90→10/93	Suspension Strut Repair Kit	MN-RK-8537	
FMD 3200 KS	01/90→10/93	Suspension Arm Repair Kit	SC-RK-8575	for Wishbone (CV)
	01/90→10/93	Suspension Strut Repair Kit	MN-RK-8537	
FT 3200 KS	01/90→10/93	Suspension Arm Repair Kit	SC-RK-8575	for Wishbone (CV)
	01/90→10/93	Suspension Strut Repair Kit	MN-RK-8537	

F 3300

FA 3300 DKX,FA 3305 DKX	06/81→09/91	Ball Head, gearshift linkage	CV-ES-2119	
	06/81→09/91	Ball Head, gearshift linkage	CV-ES-2182	
	06/81→09/91	Ball Head, gearshift linkage	DF-ES-9335	
	06/81→09/91	Suspension Arm Repair Kit		IV-RK-8998 for Wishbone (CV)
	06/81→09/91	Suspension Arm Repair Kit		SC-RK-8575 for Wishbone (CV)
	06/81→09/91	Suspension Strut Repair Kit		MN-RK-8537
	06/81→09/91	Tie Rod End	DF-ES-3634	
	06/81→09/91	Tie Rod End	DF-ES-3635	
FAB 3305 DKX,FAG 3300 DKX, FAR 3300 DKX,FAS 3303 DKX	06/81→09/86	Ball Head, gearshift linkage	CV-ES-2119	
	06/81→09/86	Ball Head, gearshift linkage	CV-ES-2182	
	06/81→09/86	Ball Head, gearshift linkage	DF-ES-9335	
	06/81→09/86	Suspension Arm Repair Kit		IV-RK-8998 for Wishbone (CV)
	06/81→09/86	Suspension Arm Repair Kit		SC-RK-8575 for Wishbone (CV)
	06/81→09/86	Suspension Strut Repair Kit		MN-RK-8537
	06/81→09/86	Tie Rod End	DF-ES-3634	
	06/81→09/86	Tie Rod End	DF-ES-3635	
FAC 3303 DKX	06/81→09/91	Ball Head, gearshift linkage	CV-ES-2119	
	06/81→09/91	Ball Head, gearshift linkage	CV-ES-2182	
	06/81→09/91	Ball Head, gearshift linkage	DF-ES-9335	
	06/81→09/91	Suspension Arm Repair Kit		IV-RK-8998 for Wishbone (CV)
	06/81→09/91	Suspension Arm Repair Kit		SC-RK-8575 for Wishbone (CV)
	06/81→09/91	Suspension Strut Repair Kit		MN-RK-8537
	06/81→09/91	Tie Rod End	DF-ES-3634	
	06/81→09/91	Tie Rod End	DF-ES-3635	
FAD 3325 DKX	06/81→09/91	Ball Head, gearshift linkage	CV-ES-2119	
	06/81→09/91	Ball Head, gearshift linkage	CV-ES-2182	
	06/81→09/91	Ball Head, gearshift linkage	DF-ES-9335	
	06/81→09/91	Suspension Arm Repair Kit		IV-RK-8998 for Wishbone (CV)
	06/81→09/91	Suspension Arm Repair Kit		SC-RK-8575 for Wishbone (CV)
	06/81→09/91	Suspension Strut Repair Kit		MN-RK-8537
	06/81→09/91	Tie Rod End	DF-ES-3634	
	06/81→09/91	Tie Rod End	DF-ES-3635	

CV-ES-2119

Length: 55
Cone Ø: d1 Ø 10 / d2 Ø 10
Thread: M12 x 1,75 LHT
592106, 1249088



MN-RK-8537

Ø: 95
Hole Distance: 152
Thick/Height: 24
696321, 81432706099



CV-ES-2182

Length: 55
Cone Ø: d1 Ø 10 / d2 Ø 10
Thread: M12 x 1,75 RHT
589333, 1249129



SC-RK-8575

Ø: 95
Hole Distance: 152
Thick/Height: 35
0696321



DF-ES-3634

Length: 130
Cone Ø: d1 Ø 30 / d2 Ø 27
Thread: M46 x 1,5 LHT
0606922, 606922



DF-ES-3635

Length: 130
Cone Ø: d1 Ø 30 / d2 Ø 27
Thread: M46 x 1,5 RHT
606923, 0606923



DF-ES-9335

Length: 85
Cone Ø: d1 Ø 12 / d2 Ø 10,75
Thread: M14 x 1,5 RHT
0386930, 386930



IV-RK-8998

Ø: 85
Hole Distance: 130
Thick/Height: 30
0513757, 0531757, 0691709, 691709



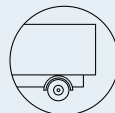

DAF ...

F 3300 ...

FAG 3300 DKX,FAR 3304 DKX, FAS 3303 DKX	06/85→09/91	Ball Head, gearshift linkage	CV-ES-2119		
	06/85→09/91	Ball Head, gearshift linkage	CV-ES-2182		
	06/85→09/91	Ball Head, gearshift linkage	DF-ES-9335		
	06/85→09/91	Suspension Arm Repair Kit		IV-RK-8998	for Wishbone (CV)
	06/85→09/91	Suspension Arm Repair Kit		SC-RK-8575	for Wishbone (CV)
	06/85→09/91	Suspension Strut Repair Kit		MN-RK-8537	
	06/85→09/91	Tie Rod End	DF-ES-3634		
FAT 3325 DKX	06/85→09/91	Tie Rod End	DF-ES-3635		
	06/81→09/91	Ball Head, gearshift linkage	CV-ES-2119		
	06/81→09/91	Ball Head, gearshift linkage	CV-ES-2182		
	06/81→09/91	Ball Head, gearshift linkage	DF-ES-9335		
	06/81→09/91	Suspension Arm Repair Kit		IV-RK-8998	for Wishbone (CV)
	06/81→09/91	Suspension Arm Repair Kit		SC-RK-8575	for Wishbone (CV)
	06/81→09/91	Suspension Strut Repair Kit		MN-RK-8537	
FT 3305 DKX	06/81→09/91	Tie Rod End	DF-ES-3634		
	06/81→09/91	Tie Rod End	DF-ES-3635		
	06/81→09/91	Ball Head, gearshift linkage	CV-ES-2119		
	06/81→09/91	Ball Head, gearshift linkage	CV-ES-2182		
	06/81→09/91	Ball Head, gearshift linkage	DF-ES-9335		
	06/81→09/91	Suspension Arm Repair Kit		IV-RK-8998	for Wishbone (CV)
	06/81→09/91	Suspension Arm Repair Kit		SC-RK-8575	for Wishbone (CV)
FTG 3300 DKX,FTS 3300 DKX	06/81→09/91	Suspension Strut Repair Kit		MN-RK-8537	
	06/81→09/86	Tie Rod End	DF-ES-3634		
	06/81→09/86	Tie Rod End	DF-ES-3635		
	06/81→09/86	Ball Head, gearshift linkage	CV-ES-2119		
	06/81→09/86	Ball Head, gearshift linkage	CV-ES-2182		
	06/81→09/86	Ball Head, gearshift linkage	DF-ES-9335		
	06/81→09/86	Suspension Arm Repair Kit		IV-RK-8998	for Wishbone (CV)
FTG 3300 DKX,FTS 3303 DKX	06/81→09/86	Suspension Arm Repair Kit		SC-RK-8575	for Wishbone (CV)
	06/85→09/91	Suspension Strut Repair Kit		MN-RK-8537	
	06/85→09/91	Tie Rod End	DF-ES-3634		
	06/85→09/91	Tie Rod End	DF-ES-3635		
	06/85→09/91	Ball Head, gearshift linkage	CV-ES-2119		
	06/85→09/91	Ball Head, gearshift linkage	CV-ES-2182		
	06/85→09/91	Ball Head, gearshift linkage	DF-ES-9335		
FTT 3325 DKX	06/85→09/91	Suspension Arm Repair Kit		IV-RK-8998	for Wishbone (CV)
	06/85→09/91	Suspension Arm Repair Kit		SC-RK-8575	for Wishbone (CV)
	06/85→09/91	Suspension Strut Repair Kit		MN-RK-8537	
	06/81→09/91	Tie Rod End	DF-ES-3634		
	06/81→09/91	Tie Rod End	DF-ES-3635		
	06/81→09/91	Ball Head, gearshift linkage	CV-ES-2119		
	06/81→09/91	Ball Head, gearshift linkage	CV-ES-2182		

F 3600

FA 3605 DKZ	06/85→09/91	Ball Head, gearshift linkage	CV-ES-2119		
	06/85→09/91	Ball Head, gearshift linkage	CV-ES-2182		
	06/85→09/91	Ball Head, gearshift linkage	DF-ES-9335		
	06/85→09/91	Suspension Arm Repair Kit		IV-RK-8998	for Wishbone (CV)
	06/85→09/91	Suspension Arm Repair Kit		SC-RK-8575	for Wishbone (CV)
	06/85→09/91	Suspension Strut Repair Kit		MN-RK-8537	
	06/85→09/91	Tie Rod End	DF-ES-3634		
FA 3605 DKZE	06/85→09/91	Tie Rod End	DF-ES-3635		
	06/85→09/91	Ball Head, gearshift linkage	CV-ES-2119		
	06/85→09/91	Ball Head, gearshift linkage	CV-ES-2182		
	06/85→09/91	Ball Head, gearshift linkage	DF-ES-9335		
	06/85→09/91	Suspension Arm Repair Kit		IV-RK-8998	for Wishbone (CV)
	06/85→09/91	Suspension Arm Repair Kit		SC-RK-8575	for Wishbone (CV)
	06/85→09/91	Suspension Arm Repair Kit			

CV-ES-2119

Length: 55
Cone Ø: d1 Ø 10 / d2 Ø 10
Thread: M12 x 1,75 LHT
592106, 1249088



MN-RK-8537

Ø: 95
Hole Distance: 152
Thick/Height: 24
696321, 81432706099



CV-ES-2182

Length: 55
Cone Ø: d1 Ø 10 / d2 Ø 10
Thread: M12 x 1,75 RHT
589333, 1249129



SC-RK-8575

Ø: 95
Hole Distance: 152
Thick/Height: 35
0696321



DF-ES-3634

Length: 130
Cone Ø: d1 Ø 30 / d2 Ø 27
Thread: M46 x 1,5 LHT
0606922, 606922



DF-ES-3635

Length: 130
Cone Ø: d1 Ø 30 / d2 Ø 27
Thread: M46 x 1,5 RHT
0606923, 606923



DF-ES-9335

Length: 85
Cone Ø: d1 Ø 12 / d2 Ø 10,75
Thread: M14 x 1,5 RHT
0386930, 386930



IV-RK-8998

Ø: 85
Hole Distance: 130
Thick/Height: 30
0513757, 0531757, 0691709, 691709



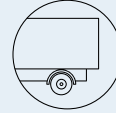

F 3600 ...

FA 3605 DKZE ...	06/85→09/91	Suspension Strut Repair Kit		MN-RK-8537	
	06/85→09/91	Tie Rod End	DF-ES-3634		
	06/85→09/91	Tie Rod End	DF-ES-3635		
FAC 3603 DKZ	06/85→09/91	Ball Head, gearshift linkage	CV-ES-2119		
	06/85→09/91	Ball Head, gearshift linkage	CV-ES-2182		
	06/85→09/91	Ball Head, gearshift linkage	DF-ES-9335		
	06/85→09/91	Suspension Arm Repair Kit		IV-RK-8998	for Wishbone (CV)
	06/85→09/91	Suspension Arm Repair Kit		SC-RK-8575	for Wishbone (CV)
	06/85→09/91	Suspension Strut Repair Kit		MN-RK-8537	
	06/85→09/91	Tie Rod End	DF-ES-3634		
	06/85→09/91	Tie Rod End	DF-ES-3635		
	FAG 3600 DKZ, FAR 3604 DKZ, FAS 3603 DKZ	06/85→09/91	Ball Head, gearshift linkage	CV-ES-2119	
06/85→09/91		Ball Head, gearshift linkage	CV-ES-2182		
06/85→09/91		Ball Head, gearshift linkage	DF-ES-9335		
06/85→09/91		Suspension Arm Repair Kit		IV-RK-8998	for Wishbone (CV)
06/85→09/91		Suspension Arm Repair Kit		SC-RK-8575	for Wishbone (CV)
06/85→09/91		Suspension Strut Repair Kit		MN-RK-8537	
06/85→09/91		Tie Rod End	DF-ES-3634		
06/85→09/91		Tie Rod End	DF-ES-3635		
FAR 3604 DKZE, FAS 3603 DKZE		06/85→09/91	Ball Head, gearshift linkage	CV-ES-2119	
	06/85→09/91	Ball Head, gearshift linkage	CV-ES-2182		
	06/85→09/91	Ball Head, gearshift linkage	DF-ES-9335		
	06/85→09/91	Suspension Arm Repair Kit		IV-RK-8998	for Wishbone (CV)
	06/85→09/91	Suspension Arm Repair Kit		SC-RK-8575	for Wishbone (CV)
	06/85→09/91	Suspension Strut Repair Kit		MN-RK-8537	
	06/85→09/91	Tie Rod End	DF-ES-3634		
	06/85→09/91	Tie Rod End	DF-ES-3635		
	FT 3605 DKZ	06/85→09/91	Ball Head, gearshift linkage	CV-ES-2119	
06/85→09/91		Ball Head, gearshift linkage	CV-ES-2182		
06/85→09/91		Ball Head, gearshift linkage	DF-ES-9335		
06/85→09/91		Suspension Arm Repair Kit		IV-RK-8998	for Wishbone (CV)
06/85→09/91		Suspension Arm Repair Kit		SC-RK-8575	for Wishbone (CV)
06/85→09/91		Suspension Strut Repair Kit		MN-RK-8537	
06/85→09/91		Tie Rod End	DF-ES-3634		
06/85→09/91		Tie Rod End	DF-ES-3635		
FT 3605 DKZE		06/85→09/91	Ball Head, gearshift linkage	CV-ES-2119	
	06/85→09/91	Ball Head, gearshift linkage	CV-ES-2182		
	06/85→09/91	Ball Head, gearshift linkage	DF-ES-9335		
	06/85→09/91	Suspension Arm Repair Kit		IV-RK-8998	for Wishbone (CV)
	06/85→09/91	Suspension Arm Repair Kit		SC-RK-8575	for Wishbone (CV)
	06/85→09/91	Suspension Strut Repair Kit		MN-RK-8537	
	06/85→09/91	Tie Rod End	DF-ES-3634		
	06/85→09/91	Tie Rod End	DF-ES-3635		
	FTG 3600 DKZ, FTS 3603 DKZ	06/85→09/91	Ball Head, gearshift linkage	CV-ES-2119	
06/85→09/91		Ball Head, gearshift linkage	CV-ES-2182		
06/85→09/91		Ball Head, gearshift linkage	DF-ES-9335		
06/85→09/91		Suspension Arm Repair Kit		IV-RK-8998	for Wishbone (CV)
06/85→09/91		Suspension Arm Repair Kit		SC-RK-8575	for Wishbone (CV)
06/85→09/91		Suspension Strut Repair Kit		MN-RK-8537	
06/85→09/91		Tie Rod End	DF-ES-3634		
06/85→09/91		Tie Rod End	DF-ES-3635		
FTT 3625 DKZ		06/85→09/91	Ball Head, gearshift linkage	CV-ES-2119	
	06/85→09/91	Ball Head, gearshift linkage	CV-ES-2182		
	06/85→09/91	Ball Head, gearshift linkage	DF-ES-9335		
	06/85→09/91	Suspension Arm Repair Kit		IV-RK-8998	for Wishbone (CV)
	06/85→09/91	Suspension Arm Repair Kit		SC-RK-8575	for Wishbone (CV)
	06/85→09/91	Suspension Strut Repair Kit		MN-RK-8537	
	06/85→09/91	Tie Rod End	DF-ES-3634		
	06/85→09/91	Tie Rod End	DF-ES-3635		

CV-ES-2119

Length: 55
Cone Ø: d1 Ø 10 / d2 Ø 10
Thread: M12 x 1,75 LHT
592106, 1249088



MN-RK-8537

Ø: 95
Hole Distance: 152
Thick/Height: 24
696321, 81432706099



CV-ES-2182

Length: 55
Cone Ø: d1 Ø 10 / d2 Ø 10
Thread: M12 x 1,75 RHT
589333, 1249129



SC-RK-8575

Ø: 95
Hole Distance: 152
Thick/Height: 35
0696321



DF-ES-3634

Length: 130
Cone Ø: d1 Ø 30 / d2 Ø 27
Thread: M46 x 1,5 LHT
0606922, 606922



DF-ES-3635

Length: 130
Cone Ø: d1 Ø 30 / d2 Ø 27
Thread: M46 x 1,5 RHT
0606923, 606923



DF-ES-9335

Length: 85
Cone Ø: d1 Ø 12 / d2 Ø 10,75
Thread: M14 x 1,5 RHT
0386930, 386930



IV-RK-8998

Ø: 85
Hole Distance: 130
Thick/Height: 30
0513757, 0531757, 0691709, 691709





LF 45

FA 45.130	12/05→	Centre Rod	DF-DL-8506		Push Rod
	12/05→	Centre Rod	DF-DL-8516		Push Rod
	12/05→	Tie Rod End	CV-ES-2135		for Steering Rod
	12/05→	Tie Rod End	CV-ES-5336		for Steering Rod
	12/05→	Tie Rod End	DF-ES-5404		for Steering Rod
	12/05→	Tie Rod End	DF-ES-8496		for Steering Rod
	12/05→	Tie Rod End	DF-ES-8497		for Steering Rod
	12/05→	Tie Rod End	DF-ES-8508		for Steering Rod
FA 45.140	05/06→	Centre Rod	DF-DL-8506		Push Rod
	05/06→	Centre Rod	DF-DL-8516		Push Rod
	05/06→	Tie Rod End	CV-ES-2135		for Steering Rod
	05/06→	Tie Rod End	CV-ES-5336		for Steering Rod
	05/06→	Tie Rod End	DF-ES-5404		for Steering Rod
	05/06→	Tie Rod End	DF-ES-8496		for Steering Rod
	05/06→	Tie Rod End	DF-ES-8497		for Steering Rod
	05/06→	Tie Rod End	DF-ES-8508		for Steering Rod
FA 45.150	01/01→	Centre Rod	DF-DL-8506		Push Rod
	01/01→	Centre Rod	DF-DL-8516		Push Rod
	01/01→	Stabiliser Mounting	DF-SB-10402		
	01/01→	Suspension Arm Repair Kit		DF-RK-9336	
	01/01→	Tie Rod End	CV-ES-2135		for Steering Rod
	01/01→	Tie Rod End	CV-ES-5336		for Steering Rod
	01/01→	Tie Rod End	CV-ES-12461		for Steering Rod
	01/01→	Tie Rod End	CV-ES-12462		for Steering Rod
	01/01→	Tie Rod End	DF-ES-5404		for Steering Rod
	01/01→	Tie Rod End	DF-ES-8496		for Steering Rod
	01/01→	Tie Rod End	DF-ES-8497		for Steering Rod
	01/01→	Tie Rod End	DF-ES-8508		for Steering Rod
	FA 45.160	05/06→	Centre Rod	DF-DL-8506	
05/06→		Centre Rod	DF-DL-8516		Push Rod
05/06→		Tie Rod End	CV-ES-2135		for Steering Rod
05/06→		Tie Rod End	CV-ES-5336		for Steering Rod
05/06→		Tie Rod End	DF-ES-5404		for Steering Rod
05/06→		Tie Rod End	DF-ES-8496		for Steering Rod
05/06→		Tie Rod End	DF-ES-8497		for Steering Rod
05/06→		Tie Rod End	DF-ES-8508		for Steering Rod
FA 45.160 HYBRID	05/06→	Centre Rod	DF-DL-8506		Push Rod
	05/06→	Centre Rod	DF-DL-8516		Push Rod
	05/06→	Tie Rod End	CV-ES-2135		for Steering Rod
	05/06→	Tie Rod End	CV-ES-5336		for Steering Rod
	05/06→	Tie Rod End	DF-ES-5404		for Steering Rod
	05/06→	Tie Rod End	DF-ES-8496		for Steering Rod
	05/06→	Tie Rod End	DF-ES-8497		for Steering Rod
	05/06→	Tie Rod End	DF-ES-8508		for Steering Rod
FA 45.170	01/01→	Centre Rod	DF-DL-8506		Push Rod
	01/01→	Centre Rod	DF-DL-8516		Push Rod
	01/01→	Stabiliser Mounting	DF-SB-10402		
	01/01→	Suspension Arm Repair Kit		DF-RK-9336	
	01/01→	Tie Rod End	CV-ES-2135		for Steering Rod
	01/01→	Tie Rod End	CV-ES-5336		for Steering Rod
	01/01→	Tie Rod End	CV-ES-12461		for Steering Rod
	01/01→	Tie Rod End	CV-ES-12462		for Steering Rod
	01/01→	Tie Rod End	DF-ES-5404		for Steering Rod
	01/01→	Tie Rod End	DF-ES-8496		for Steering Rod
	01/01→	Tie Rod End	DF-ES-8497		for Steering Rod
	01/01→	Tie Rod End	DF-ES-8508		for Steering Rod
	FA 45.180	01/01→	Centre Rod	DF-DL-8506	
01/01→		Centre Rod	DF-DL-8516		Push Rod
01/01→		Stabiliser Mounting	DF-SB-10402		
01/01→		Suspension Arm Repair Kit		DF-RK-9336	
01/01→		Tie Rod End	CV-ES-2135		for Steering Rod
01/01→		Tie Rod End	CV-ES-5336		for Steering Rod
01/01→	Tie Rod End	CV-ES-12461		for Steering Rod	

CV-ES-2135

Length: 115
Cone Ø: d1 Ø 26 / d2 Ø 23,5
Thread: M28 x 1,5 RHT
1689604, 1923963



DF-ES-5404

Length: 115
Cone Ø: d1 Ø 26 / d2 Ø 23,5
Thread: M28 x 1,5 LHT
1689605, 1923962, 8123326, AMPA345



CV-ES-5336

Length: 140
Cone Ø: d1 Ø 26 / d2 Ø 23,5
Thread: M30 x 1,5 LHT
1310760, 1603418



DF-ES-8496

Length: 148
Cone Ø: d1 Ø 26 / d2 Ø 23,5
Thread: M28 x 1,5 LHT
1604247, 1902996



CV-ES-12461

Length: 120
Cone Ø: d1 Ø 26 / d2 Ø 23,5
Thread: M30 x 1,5 LHT
69513, 0069513, 0311300, 311300,
0607998, 607998, 1190653, 1315447,
1319838, 1332123, 1338714, 1401934,
1407394, ACHB063, ACHF241, MAK1295



DF-ES-8497

Length: 148
Cone Ø: d1 Ø 26 / d2 Ø 23,5
Thread: M28 x 1,5 RHT
1604248



CV-ES-12462

Length: 120
Cone Ø: d1 Ø 26 / d2 Ø 23,5
Thread: M30 x 1,5 RHT
0069514, 0586753, 0607999, 0694298,
0694360, 0698609, 1137230, 1229944,
1326862, 1326896, 1331925, ACHB064,
ACHF242, MAK1296



DF-ES-8508

Length: 120
Cone Ø: d1 Ø 22 / d2 Ø 19,9
Thread: M30 x 1,5 LHT
1401942, AFRA635



DF-DL-8506

Length: 900
Ø: 38
Cone Ø: d1 Ø 22 / d2 Ø 19,9
1405655, 1406025, 1407144, 1700912



DF-RK-9336

Ø: 108
1445656



DF-DL-8516

Length: 900
Ø: 38
Cone Ø: d1 Ø 22 / d2 Ø 19,9
1406600, 1700913



DF-SB-10402

Ø: 62
Thick/Height: 60
1291233, 1732887





LF 45 ...

FA 45.180 ...	01/01→	Tie Rod End	CV-ES-12462		for Steering Rod	
	01/01→	Tie Rod End	DF-ES-5404		for Steering Rod	
	01/01→	Tie Rod End	DF-ES-8496		for Steering Rod	
	01/01→	Tie Rod End	DF-ES-8497		for Steering Rod	
	01/01→	Tie Rod End	DF-ES-8508		for Steering Rod	
FA 45.210	01/09→	Centre Rod	DF-DL-8506		Push Rod	
	01/09→	Centre Rod	DF-DL-8516		Push Rod	
	01/09→	Tie Rod End	CV-ES-2135		for Steering Rod	
	01/09→	Tie Rod End	CV-ES-5336		for Steering Rod	
	01/09→	Tie Rod End	DF-ES-5404		for Steering Rod	
	01/09→	Tie Rod End	DF-ES-8496		for Steering Rod	
	01/09→	Tie Rod End	DF-ES-8497		for Steering Rod	
FA 45.220	01/01→	Centre Rod	DF-DL-8506		Push Rod	
	01/01→	Centre Rod	DF-DL-8516		Push Rod	
	01/01→	Stabiliser Mounting	DF-SB-10402			
	01/01→	Suspension Arm Repair Kit		DF-RK-9336		
	01/01→	Tie Rod End	CV-ES-2135		for Steering Rod	
	01/01→	Tie Rod End	CV-ES-5336		for Steering Rod	
	01/01→	Tie Rod End	CV-ES-12461		for Steering Rod	
	01/01→	Tie Rod End	CV-ES-12462		for Steering Rod	
	01/01→	Tie Rod End	DF-ES-5404		for Steering Rod	
	01/01→	Tie Rod End	DF-ES-8496		for Steering Rod	
	01/01→	Tie Rod End	DF-ES-8497		for Steering Rod	
	01/01→	Tie Rod End	DF-ES-8508		for Steering Rod	
	FA 45.250	03/06→	Centre Rod	DF-DL-8506		Push Rod
		03/06→	Centre Rod	DF-DL-8516		Push Rod
03/06→		Tie Rod End	CV-ES-2135		for Steering Rod	
03/06→		Tie Rod End	CV-ES-5336		for Steering Rod	
03/06→		Tie Rod End	DF-ES-5404		for Steering Rod	
03/06→		Tie Rod End	DF-ES-8496		for Steering Rod	
03/06→		Tie Rod End	DF-ES-8497		for Steering Rod	
03/06→		Tie Rod End	DF-ES-8508		for Steering Rod	

LF 55

FA 55.160	05/06→	Centre Rod	DF-DL-12426		for Steering Rod
	05/06→	Suspension Arm Repair Kit		DF-RK-9336	
	05/06→	Tie Rod	DF-DL-7780		
	05/06→	Tie Rod End	CV-ES-12461		for Steering Rod
	05/06→	Tie Rod End	CV-ES-12462		for Steering Rod
	05/06→	Tie Rod End	CV-ES-14162		for Steering Rod
	05/06→	Tie Rod End	CV-ES-14163		for Steering Rod
	05/06→	Tie Rod End	SC-ES-7279		for Steering Rod
	05/06→	Track Control Arm		DF-DL-8158	Trailing Arm
FA 55.170	01/01→	Centre Rod	DF-DL-8551		Push Rod
	01/01→	Centre Rod	DF-DL-9325		Push Rod
	01/01→	Centre Rod	DF-DL-12426		for Steering Rod
	01/01→	Suspension Arm Repair Kit		DF-RK-9336	
	01/01→	Tie Rod	DF-DL-7780		
	01/01→	Tie Rod End	CV-ES-12461		for Steering Rod
	01/01→	Tie Rod End	CV-ES-12462		for Steering Rod
	01/01→	Tie Rod End	SC-ES-7279		for Steering Rod
	01/01→	Track Control Arm		DF-DL-8158	Trailing Arm
FA 55.180	01/01→	Centre Rod	DF-DL-6052		Push Rod
	01/01→	Centre Rod	DF-DL-8551		Push Rod
	01/01→	Centre Rod	DF-DL-9325		Push Rod
	01/01→	Centre Rod	DF-DL-12424		for Steering Rod
	01/01→	Centre Rod	DF-DL-12426		for Steering Rod
	01/01→	Suspension Arm Repair Kit		DF-RK-9336	
	01/01→	Tie Rod	DF-DL-5403		1st FA
	01/01→	Tie Rod	DF-DL-7780		

CV-ES-2135

Length: 115
Cone Ø: d1 Ø 26 / d2 Ø 23,5
Thread: M28 x 1,5 RHT
1689604, 1923963



CV-ES-5336

Length: 140
Cone Ø: d1 Ø 26 / d2 Ø 23,5
Thread: M30 x 1,5 LHT
1310760, 1603418



CV-ES-12461

Length: 120
Cone Ø: d1 Ø 26 / d2 Ø 23,5
Thread: M30 x 1,5 LHT
69513, 0069513, 0311300, 311300,
0607998, 607998, 1190653, 1315447,
1319838, 1332123, 1338714, 1401934,
1407394, ACHB063, ACHF241, MAK1295



CV-ES-12462

Length: 120
Cone Ø: d1 Ø 26 / d2 Ø 23,5
Thread: M30 x 1,5 RHT
0069514, 0586753, 0607999, 0694298,
0694360, 0698609, 1137230, 1229944,
1326862, 1326896, 1331925, ACHB064,
ACHF242, MAK1296



CV-ES-14162

Length: 125
Cone Ø: d1 Ø 30 / d2 Ø 27
Thread: M30 x 1,5 LHT
607053, 690225, 696225, 1228115,
1611088



CV-ES-14163

Length: 125
Cone Ø: d1 Ø 30 / d2 Ø 27
Thread: M30 x 1,5 RHT
0607981, 0698450, 1149907, 1152350,
1257890, 1603789, 1618048, ACHF060



DF-DL-5403

Length: 1742 Ø: 40
Cone Ø: d1 Ø 26 / d2 Ø 23,5
0288281, 1270854, 1337644



DF-DL-6052

Length: 926 Ø: 46
Cone Ø: d1 Ø 30 / d2 Ø 27
1405309



DF-DL-7780

Length: 1690 Ø: 40
Cone Ø: d1 Ø 26 / d2 Ø 23,5
1270853, 1353391, 10212000A



DF-DL-8158

Length: 611 Ø: 48
Hole Distance: 130 / 130
0267743, 1361649, 1361650, 1656428



DF-DL-8506

Length: 900 Ø: 38
Cone Ø: d1 Ø 22 / d2 Ø 19,9
1405655, 1406025, 1407144, 1700912



DF-DL-8516

Length: 900 Ø: 38
Cone Ø: d1 Ø 22 / d2 Ø 19,9
1406600, 1700913



DF-DL-8551

Length: 910 Ø: 40
Cone Ø: d1 Ø 26 / d2 Ø 23,5
1401937



DF-DL-9325

Length: 909 Ø: 42
Cone Ø: d1 Ø 26 / d2 Ø 23,5
1405363



DF-DL-12424

Length: 925 Ø: 46
Cone Ø: d1 Ø 30 / d2 Ø 27
1405499



DF-DL-12426

Length: 919 Ø: 41
Cone Ø: d1 Ø 26 / d2 Ø 23,5
1407774



DF-ES-5404

Length: 115
Cone Ø: d1 Ø 26 / d2 Ø 23,5
Thread: M28 x 1,5 LHT
1689605, 1923962, 8123326, AMPA345



DF-ES-8496

Length: 148
Cone Ø: d1 Ø 26 / d2 Ø 23,5
Thread: M28 x 1,5 LHT
1604247, 1902996



DF-ES-8497

Length: 148
Cone Ø: d1 Ø 26 / d2 Ø 23,5
Thread: M28 x 1,5 RHT
1604248



DF-ES-8508

Length: 120
Cone Ø: d1 Ø 22 / d2 Ø 19,9
Thread: M30 x 1,5 LHT
1401942, AFRA635



DF-RK-9336

Ø: 108
1445656



DF-SB-10402

Ø: 62
Thick/Height: 60
1291233, 1732887



DF-VB-8561

Length: 609 Ø: 48
Hole Distance: 152 / 152
0080521, 080521, 1361651, 1368270,
1390932, 1617096, 1793875, 1817808,
1892492



SC-ES-7279

Length: 150
Cone Ø: d1 Ø 30 / d2 Ø 27
Thread: M30 x 1,5 RHT
1603883





LF 55 ...

FA 55.180 ...	01/01→	Tie Rod	DF-DL-7780		1st FA	
	01/01→	Tie Rod End	CV-ES-12461		for Steering Rod	
	01/01→	Tie Rod End	CV-ES-12462		for Steering Rod	
	01/01→	Tie Rod End	CV-ES-14163		for Steering Rod	
	01/01→	Tie Rod End	SC-ES-7279		for Steering Rod	
	01/01→	Track Control Arm		DF-DL-8158	Trailing Arm	
	01/01→	Track Control Arm		DF-DL-8158	Trailing Arm, 1st RA;Air Suspension Axle	
	01/01→	Track Control Arm		DF-VB-8561	Wishbone (CV)	
	01/01→	Track Control Arm		DF-VB-8561	Wishbone (CV), 1st RA;Air Suspension Axle	
	05/06→	Tie Rod End	CV-ES-14162		for Steering Rod	
FA 55.210	01/09→	Centre Rod	DF-DL-6052		Push Rod	
	01/09→	Centre Rod	DF-DL-8551		Push Rod	
	01/09→	Centre Rod	DF-DL-9325		Push Rod	
	01/09→	Centre Rod	DF-DL-12424		for Steering Rod	
	01/09→	Centre Rod	DF-DL-12426		for Steering Rod	
	01/09→	Suspension Arm Repair Kit		DF-RK-9336		
	01/09→	Tie Rod	DF-DL-5403			
	01/09→	Tie Rod	DF-DL-7780			
	01/09→	Tie Rod End	CV-ES-12461		for Steering Rod	
	01/09→	Tie Rod End	CV-ES-12462		for Steering Rod	
	01/09→	Tie Rod End	CV-ES-14162		for Steering Rod	
	01/09→	Tie Rod End	CV-ES-14163		for Steering Rod	
	01/09→	Tie Rod End	SC-ES-7279		for Steering Rod	
	01/09→	Track Control Arm		DF-DL-8158	Trailing Arm	
01/09→	Track Control Arm		DF-VB-8561	Wishbone (CV)		
FA 55.220	01/01→	Centre Rod	DF-DL-6052		Push Rod	
	01/01→	Centre Rod	DF-DL-8551		Push Rod	
	01/01→	Centre Rod	DF-DL-9325		Push Rod	
	01/01→	Centre Rod	DF-DL-12424		for Steering Rod	
	01/01→	Centre Rod	DF-DL-12426		for Steering Rod	
	01/01→	Suspension Arm Repair Kit		DF-RK-9336		
	01/01→	Tie Rod	DF-DL-5403		1st FA	
	01/01→	Tie Rod	DF-DL-7780		1st FA	
	01/01→	Tie Rod End	CV-ES-12461		for Steering Rod	
	01/01→	Tie Rod End	CV-ES-12462		for Steering Rod	
	01/01→	Tie Rod End	CV-ES-14163		for Steering Rod	
	01/01→	Tie Rod End	SC-ES-7279		for Steering Rod	
	01/01→	Track Control Arm		DF-DL-8158	Trailing Arm, 1st RA;Air Suspension Axle	
	01/01→	Track Control Arm		DF-VB-8561	Wishbone (CV), 1st RA;Air Suspension Axle	
	05/06→	Tie Rod End	CV-ES-14162		for Steering Rod	
	05/06→	Track Control Arm		DF-DL-8158	Trailing Arm	
	05/06→	Track Control Arm		DF-VB-8561	Wishbone (CV)	
	FA 55.250	01/01→	Centre Rod	DF-DL-6052		Push Rod
		01/01→	Centre Rod	DF-DL-8551		Push Rod
		01/01→	Centre Rod	DF-DL-9325		Push Rod
01/01→		Centre Rod	DF-DL-12424		for Steering Rod	
01/01→		Suspension Arm Repair Kit		DF-RK-9336		
01/01→		Tie Rod	DF-DL-5403		1st FA	
01/01→		Tie Rod	DF-DL-7780		1st FA	
01/01→		Tie Rod End	CV-ES-12461		for Steering Rod	
01/01→		Tie Rod End	CV-ES-12462		for Steering Rod	
01/01→		Tie Rod End	CV-ES-14163		for Steering Rod	
01/01→		Tie Rod End	SC-ES-7279		for Steering Rod	
01/01→		Track Control Arm		DF-DL-8158	Trailing Arm, 1st RA;Air Suspension Axle	
01/01→		Track Control Arm		DF-VB-8561	Wishbone (CV), 1st RA;Air Suspension Axle	
05/06→		Tie Rod End	CV-ES-14162		for Steering Rod	
05/06→		Track Control Arm		DF-DL-8158	Trailing Arm	
05/06→		Track Control Arm		DF-VB-8561	Wishbone (CV)	
FA 55.280	05/06→	Centre Rod	DF-DL-6052		Push Rod	
	05/06→	Centre Rod	DF-DL-8551		Push Rod	
	05/06→	Centre Rod	DF-DL-9325		Push Rod	
	05/06→	Centre Rod	DF-DL-12424		for Steering Rod	
	05/06→	Centre Rod	DF-DL-12426		for Steering Rod	

CV-ES-12461

Length: 120
Cone Ø: d1 Ø 26 / d2 Ø 23,5
Thread: M30 x 1,5 LHT
0069513, 69513, 0311300, 311300,
0607998, 607998, 1190653, 1315447,
1319838, 1332123, 1338714, 1401934,
1407394, ACHB063, ACHF241, MAK1295



CV-ES-12462

Length: 120
Cone Ø: d1 Ø 26 / d2 Ø 23,5
Thread: M30 x 1,5 RHT
0069514, 0586753, 0607999, 0694298,
0694360, 0698609, 1137230, 1229944,
1326862, 1326896, 1331925, ACHB064,
ACHF242, MAK1296



CV-ES-14162

Length: 125
Cone Ø: d1 Ø 30 / d2 Ø 27
Thread: M30 x 1,5 LHT
607053, 690225, 696225, 1228115,
1611088



CV-ES-14163

Length: 125
Cone Ø: d1 Ø 30 / d2 Ø 27
Thread: M30 x 1,5 RHT
0607981, 0698450, 1149907, 1152350,
1257890, 1603789, 1618048, ACHF060



DF-DL-5403

Length: 1742
Ø: 40
Cone Ø: d1 Ø 26 / d2 Ø 23,5
0288281, 1270854, 1337644



DF-DL-6052

Length: 926
Ø: 46
Cone Ø: d1 Ø 30 / d2 Ø 27
1405309



DF-DL-7780

Length: 1690
Ø: 40
Cone Ø: d1 Ø 26 / d2 Ø 23,5
1270853, 1353391, 10212000A



DF-DL-8158

Length: 611
Ø: 48
Hole Distance: 130 / 130
0267743, 1361649, 1361650, 1656428



DF-DL-8551

Length: 910
Ø: 40
Cone Ø: d1 Ø 26 / d2 Ø 23,5
1401937



DF-DL-9325

Length: 909
Ø: 42
Cone Ø: d1 Ø 26 / d2 Ø 23,5
1405363



DF-DL-12424

Length: 925
Ø: 46
Cone Ø: d1 Ø 30 / d2 Ø 27
1405499



DF-DL-12426

Length: 919
Ø: 41
Cone Ø: d1 Ø 26 / d2 Ø 23,5
1407774



DF-RK-9336

Ø: 108
1445656



DF-VB-8561

Length: 609
Ø: 48
Hole Distance: 152 / 152
0080521, 080521, 1361651, 1368270,
1390932, 1617096, 1793875, 1817808,
1892492



SC-ES-7279

Length: 150
Cone Ø: d1 Ø 30 / d2 Ø 27
Thread: M30 x 1,5 RHT
1603883





LF 55 ...

FA 55.280 ...	05/06→	Suspension Arm Repair Kit		DF-RK-9336	
	05/06→	Tie Rod	DF-DL-5403		
	05/06→	Tie Rod	DF-DL-7780		
	05/06→	Tie Rod End	CV-ES-12461		for Steering Rod
	05/06→	Tie Rod End	CV-ES-12462		for Steering Rod
	05/06→	Tie Rod End	CV-ES-14162		for Steering Rod
	05/06→	Tie Rod End	CV-ES-14163		for Steering Rod
	05/06→	Tie Rod End	SC-ES-7279		for Steering Rod
	05/06→	Track Control Arm		DF-DL-8158	Trailing Arm
	05/06→	Track Control Arm		DF-VB-8561	Wishbone (CV)
FA 55.290	05/06→	Centre Rod	DF-DL-6052		Push Rod
	05/06→	Centre Rod	DF-DL-8551		Push Rod
	05/06→	Centre Rod	DF-DL-12424		for Steering Rod
	05/06→	Suspension Arm Repair Kit		DF-RK-9336	
	05/06→	Tie Rod	DF-DL-5403		1st FA
	05/06→	Tie Rod	DF-DL-7780		1st FA
	05/06→	Tie Rod End	CV-ES-12461		for Steering Rod
	05/06→	Tie Rod End	CV-ES-12462		for Steering Rod
	05/06→	Tie Rod End	CV-ES-14162		for Steering Rod
	05/06→	Tie Rod End	CV-ES-14163		for Steering Rod
	05/06→	Tie Rod End	SC-ES-7279		for Steering Rod
	05/06→	Track Control Arm		DF-DL-8158	Trailing Arm, 1st RA;Air Suspension Axle
	05/06→	Track Control Arm		DF-VB-8561	Wishbone (CV), 1st RA;Air Suspension Axle
	FA 55.300	01/09→	Suspension Arm Repair Kit		DF-RK-9336
01/09→		Tie Rod	DF-DL-7780		
01/09→		Tie Rod End	CV-ES-12461		for Steering Rod
01/09→		Tie Rod End	CV-ES-12462		for Steering Rod
01/09→		Tie Rod End	CV-ES-14162		for Steering Rod
01/09→		Tie Rod End	CV-ES-14163		for Steering Rod
01/09→		Tie Rod End	SC-ES-7279		for Steering Rod
01/09→		Track Control Arm		DF-DL-8158	Trailing Arm
01/09→		Track Control Arm		DF-VB-8561	Wishbone (CV)
FAN 55.180		05/06→	Suspension Arm Repair Kit		DF-RK-9336
	05/06→	Tie Rod	DF-DL-7780		
	05/06→	Tie Rod End	CV-ES-12462		for Steering Rod
	05/06→	Track Control Arm		DF-DL-8158	Trailing Arm
	05/06→	Track Control Arm		DF-VB-8561	Wishbone (CV)
FAN 55.220	05/06→	Centre Rod	DF-DL-8551		Push Rod
	05/06→	Centre Rod	DF-DL-9325		Push Rod
	05/06→	Suspension Arm Repair Kit		DF-RK-9336	
	05/06→	Tie Rod	DF-DL-7780		
	05/06→	Tie Rod End	CV-ES-12461		for Steering Rod
	05/06→	Tie Rod End	CV-ES-12462		for Steering Rod
	05/06→	Tie Rod End	CV-ES-14162		for Steering Rod
	05/06→	Tie Rod End	CV-ES-14163		for Steering Rod
	05/06→	Tie Rod End	SC-ES-7279		for Steering Rod
	05/06→	Track Control Arm		DF-DL-8158	Trailing Arm
FAN 55.250	05/06→	Track Control Arm		DF-VB-8561	Wishbone (CV)
	05/06→	Centre Rod	DF-DL-8551		Push Rod
	05/06→	Centre Rod	DF-DL-9325		Push Rod
	05/06→	Suspension Arm Repair Kit		DF-RK-9336	
	05/06→	Tie Rod	DF-DL-7780		
	05/06→	Tie Rod End	CV-ES-12461		for Steering Rod
	05/06→	Tie Rod End	CV-ES-12462		for Steering Rod
	05/06→	Tie Rod End	CV-ES-14162		for Steering Rod
	05/06→	Tie Rod End	CV-ES-14163		for Steering Rod
	05/06→	Tie Rod End	SC-ES-7279		for Steering Rod
FAN 55.290	05/06→	Track Control Arm		DF-DL-8158	Trailing Arm
	05/06→	Track Control Arm		DF-VB-8561	Wishbone (CV)
	05/06→	Centre Rod	DF-DL-9325		Push Rod
	05/06→	Suspension Arm Repair Kit		DF-RK-9336	
	05/06→	Tie Rod	DF-DL-7780		
	05/06→	Tie Rod End	CV-ES-12461		for Steering Rod

CV-ES-12461

Length: 120
Cone Ø: d1 Ø 26 / d2 Ø 23,5
Thread: M30 x 1,5 LHT
69513, 0069513, 311300, 0311300,
0607998, 607998, 1190653, 1315447,
1319838, 1332123, 1338714, 1401934,
1407394, ACHB063, ACHF241, MAK1295



CV-ES-12462

Length: 120
Cone Ø: d1 Ø 26 / d2 Ø 23,5
Thread: M30 x 1,5 RHT
0069514, 0586753, 0607999, 0694298,
0694360, 0698609, 1137230, 1229944,
1326862, 1326896, 1331925, ACHB064,
ACHF242, MAK1296



CV-ES-14162

Length: 125
Cone Ø: d1 Ø 30 / d2 Ø 27
Thread: M30 x 1,5 LHT
607053, 690225, 696225, 1228115,
1611088



CV-ES-14163

Length: 125
Cone Ø: d1 Ø 30 / d2 Ø 27
Thread: M30 x 1,5 RHT
0607981, 0698450, 1149907, 1152350,
1257890, 1603789, 1618048, ACHF060



DF-DL-5403

Length: 1742
Ø: 40
Cone Ø: d1 Ø 26 / d2 Ø 23,5
0288281, 1270854, 1337644



DF-DL-6052

Length: 926
Ø: 46
Cone Ø: d1 Ø 30 / d2 Ø 27
1405309



DF-DL-7780

Length: 1690
Ø: 40
Cone Ø: d1 Ø 26 / d2 Ø 23,5
1270853, 1353391, 1021200A



DF-DL-8158

Length: 611
Ø: 48
Hole Distance: 130 / 130
0267743, 1361649, 1361650, 1656428



DF-DL-8551

Length: 910
Ø: 40
Cone Ø: d1 Ø 26 / d2 Ø 23,5
1401937



DF-DL-9325

Length: 909
Ø: 42
Cone Ø: d1 Ø 26 / d2 Ø 23,5
1405363



DF-DL-12424

Length: 925
Ø: 46
Cone Ø: d1 Ø 30 / d2 Ø 27
1405499



DF-RK-9336

Ø: 108
1445656



DF-VB-8561

Length: 609
Ø: 48
Hole Distance: 152 / 152
0080521, 080521, 1361651, 1368270,
1390932, 1617096, 1793875, 1817808,
1892492



SC-ES-7279

Length: 150
Cone Ø: d1 Ø 30 / d2 Ø 27
Thread: M30 x 1,5 RHT
1603883



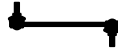

LF 55 ...

FAN 55.290 ...	05/06→	Tie Rod End	CV-ES-12462		for Steering Rod	
	05/06→	Tie Rod End	CV-ES-14162		for Steering Rod	
	05/06→	Tie Rod End	CV-ES-14163		for Steering Rod	
	05/06→	Tie Rod End	SC-ES-7279		for Steering Rod	
	05/06→	Track Control Arm		DF-DL-8158	Trailing Arm	
	05/06→	Track Control Arm		DF-VB-8561	Wishbone (CV)	
FT 55.180	01/01→	Centre Rod	DF-DL-8551		Push Rod	
	01/01→	Suspension Arm Repair Kit		DF-RK-9336		
	01/01→	Tie Rod	DF-DL-7780			
	01/01→	Tie Rod End	CV-ES-12461		for Steering Rod	
	01/01→	Tie Rod End	CV-ES-12462		for Steering Rod	
	01/01→	Tie Rod End	SC-ES-7279		for Steering Rod	
	01/01→	Track Control Arm		DF-DL-8158	Trailing Arm	
	01/01→	Track Control Arm		DF-VB-8561	Wishbone (CV)	
FT 55.220	01/01→	Centre Rod	DF-DL-8551		Push Rod	
	01/01→	Centre Rod	DF-DL-9325		Push Rod	
	01/01→	Suspension Arm Repair Kit		DF-RK-9336		
	01/01→	Tie Rod	DF-DL-7780			
	01/01→	Tie Rod End	CV-ES-12461		for Steering Rod	
	01/01→	Tie Rod End	CV-ES-12462		for Steering Rod	
	01/01→	Tie Rod End	CV-ES-14163		for Steering Rod	
	01/01→	Tie Rod End	SC-ES-7279		for Steering Rod	
	01/01→	Track Control Arm		DF-DL-8158	Trailing Arm	
	01/01→	Track Control Arm		DF-VB-8561	Wishbone (CV)	
	05/06→	Tie Rod End	CV-ES-14162		for Steering Rod	
	FT 55.250	01/01→	Centre Rod	DF-DL-8551		Push Rod
01/01→		Centre Rod	DF-DL-9325		Push Rod	
01/01→		Suspension Arm Repair Kit		DF-RK-9336		
01/01→		Tie Rod	DF-DL-7780			
01/01→		Tie Rod End	CV-ES-12461		for Steering Rod	
01/01→		Tie Rod End	CV-ES-12462		for Steering Rod	
01/01→		Tie Rod End	CV-ES-14163		for Steering Rod	
01/01→		Tie Rod End	SC-ES-7279		for Steering Rod	
01/01→		Track Control Arm		DF-DL-8158	Trailing Arm	
01/01→		Track Control Arm		DF-VB-8561	Wishbone (CV)	
05/06→		Tie Rod End	CV-ES-14162		for Steering Rod	
FT 55.280		05/06→	Centre Rod	DF-DL-6052		Push Rod
		05/06→	Centre Rod	DF-DL-8551		Push Rod
		05/06→	Centre Rod	DF-DL-9325		Push Rod
	05/06→	Centre Rod	DF-DL-12424		for Steering Rod	
	05/06→	Centre Rod	DF-DL-12426		for Steering Rod	
	05/06→	Suspension Arm Repair Kit		DF-RK-9336		
	05/06→	Tie Rod	DF-DL-5403			
	05/06→	Tie Rod	DF-DL-7780			
	05/06→	Tie Rod End	CV-ES-12461		for Steering Rod	
	05/06→	Tie Rod End	CV-ES-12462		for Steering Rod	
	05/06→	Tie Rod End	CV-ES-14162		for Steering Rod	
	05/06→	Tie Rod End	CV-ES-14163		for Steering Rod	
	05/06→	Tie Rod End	SC-ES-7279		for Steering Rod	
	05/06→	Track Control Arm		DF-DL-8158	Trailing Arm	
	05/06→	Track Control Arm		DF-VB-8561	Wishbone (CV)	
	FT 55.290	05/06→	Suspension Arm Repair Kit		DF-RK-9336	
		05/06→	Tie Rod	DF-DL-7780		
		05/06→	Tie Rod End	CV-ES-12461		for Steering Rod
05/06→		Tie Rod End	CV-ES-12462		for Steering Rod	
05/06→		Tie Rod End	CV-ES-14162		for Steering Rod	
05/06→		Tie Rod End	CV-ES-14163		for Steering Rod	
05/06→		Tie Rod End	SC-ES-7279		for Steering Rod	
05/06→		Track Control Arm		DF-DL-8158	Trailing Arm	
05/06→	Track Control Arm		DF-VB-8561	Wishbone (CV)		

CV-ES-12461

Length: 120
Cone Ø: d1 Ø 26 / d2 Ø 23,5
Thread: M30 x 1,5 LHT
0069513, 69513, 0311300, 311300,
0607998, 607998, 1190653, 1315447,
1319838, 1332123, 1338714, 1401934,
1407394, ACHB063, ACHF241, MAK1295



CV-ES-12462

Length: 120
Cone Ø: d1 Ø 26 / d2 Ø 23,5
Thread: M30 x 1,5 RHT
0069514, 0586753, 0607999, 0694298,
0694360, 0698609, 1137230, 1229944,
1326862, 1326896, 1331925, ACHB064,
ACHF242, MAK1296



CV-ES-14162

Length: 125
Cone Ø: d1 Ø 30 / d2 Ø 27
Thread: M30 x 1,5 LHT
607053, 690225, 696225, 1228115,
1611088



CV-ES-14163

Length: 125
Cone Ø: d1 Ø 30 / d2 Ø 27
Thread: M30 x 1,5 RHT
0607981, 0698450, 1149907, 1152350,
1257890, 1603789, 1618048, ACHF060



DF-DL-5403

Length: 1742
Ø: 40
Cone Ø: d1 Ø 26 / d2 Ø 23,5
0288281, 1270854, 1337644



DF-DL-6052

Length: 926
Ø: 46
Cone Ø: d1 Ø 30 / d2 Ø 27
1405309



DF-DL-7780

Length: 1690
Ø: 40
Cone Ø: d1 Ø 26 / d2 Ø 23,5
1270853, 1353391, 10212000A



DF-DL-8158

Length: 611
Ø: 48
Hole Distance: 130 / 130
0267743, 1361649, 1361650, 1656428



DF-DL-8551

Length: 910
Ø: 40
Cone Ø: d1 Ø 26 / d2 Ø 23,5
1401937



DF-DL-9325

Length: 909
Ø: 42
Cone Ø: d1 Ø 26 / d2 Ø 23,5
1405363



DF-DL-12424

Length: 925
Ø: 46
Cone Ø: d1 Ø 30 / d2 Ø 27
1405499



DF-DL-12426

Length: 919
Ø: 41
Cone Ø: d1 Ø 26 / d2 Ø 23,5
1407774



DF-RK-9336

Ø: 108
1445656



DF-VB-8561

Length: 609
Ø: 48
Hole Distance: 152 / 152
0080521, 080521, 1361651, 1368270,
1390932, 1617096, 1793875, 1817808,
1892492



SC-ES-7279

Length: 150
Cone Ø: d1 Ø 30 / d2 Ø 27
Thread: M30 x 1,5 RHT
1603883





XF 95

FA 95.380	09/02→12/06	Centre Rod	DF-DL-2142		Push Rod	
	09/02→12/06	Centre Rod	DF-DL-3798		Push Rod	
	09/02→12/06	Centre Rod	DF-DL-8704		Push Rod	
	09/02→12/06	Centre Rod	DF-DL-8705		Push Rod	
	09/02→12/06	Centre Rod	DF-DL-10187		Push Rod	
	09/02→12/06	Centre Rod	DF-DL-12420		for Steering Rod	
	09/02→12/06	Suspension Arm Repair Kit		DF-RK-9336		
	09/02→12/06	Suspension Arm Repair Kit	MN-RK-7280	MN-RK-7280	for Drag Link;for Semi-Trailing Arm; for Wishbone (CV)	
	09/02→12/06	Tie Rod	DF-DL-5403		1st FA	
	09/02→12/06	Tie Rod	DF-DL-7780		1st FA	
	09/02→12/06	Tie Rod	DF-DL-7836		1st FA	
	09/02→12/06	Tie Rod End	CV-ES-12461		for Steering Rod	
	09/02→12/06	Tie Rod End	CV-ES-12462		for Steering Rod	
	09/02→12/06	Tie Rod End	CV-ES-14163		for Steering Rod	
	09/02→12/06	Tie Rod End	DF-ES-8362		for Steering Rod	
	09/02→12/06	Track Control Arm		DF-DL-8158	Trailing Arm	
	09/02→12/06	Track Control Arm		DF-VB-8561	Wishbone (CV)	
	FA 95.430	09/02→12/06	Centre Rod	DF-DL-2142		Push Rod
		09/02→12/06	Centre Rod	DF-DL-3798		Push Rod
		09/02→12/06	Centre Rod	DF-DL-8704		Push Rod
09/02→12/06		Centre Rod	DF-DL-8705		Push Rod	
09/02→12/06		Centre Rod	DF-DL-12420		for Steering Rod	
09/02→12/06		Suspension Arm Repair Kit		DF-RK-9336		
09/02→12/06		Suspension Arm Repair Kit	MN-RK-7280	MN-RK-7280	for Drag Link;for Semi-Trailing Arm; for Wishbone (CV)	
09/02→12/06		Tie Rod	DF-DL-5403		1st FA	
09/02→12/06		Tie Rod	DF-DL-7780		1st FA	
09/02→12/06		Tie Rod	DF-DL-7836		1st FA	
09/02→12/06		Tie Rod	DF-DL-10193		1st FA	
09/02→12/06		Tie Rod End	CV-ES-12461		for Steering Rod	
09/02→12/06		Tie Rod End	CV-ES-12462		for Steering Rod	
09/02→12/06		Tie Rod End	CV-ES-14163		for Steering Rod	
09/02→12/06		Tie Rod End	DF-ES-8362		for Steering Rod	
09/02→12/06		Track Control Arm		DF-DL-8158	Trailing Arm	
09/02→12/06		Track Control Arm		DF-VB-8561	Wishbone (CV)	
FA 95.480		09/02→12/06	Centre Rod	DF-DL-2142		Push Rod
		09/02→12/06	Centre Rod	DF-DL-3798		Push Rod
		09/02→12/06	Centre Rod	DF-DL-8704		Push Rod
	09/02→12/06	Centre Rod	DF-DL-8705		Push Rod	
	09/02→12/06	Centre Rod	DF-DL-10187		Push Rod	
	09/02→12/06	Centre Rod	DF-DL-12420		for Steering Rod	
	09/02→12/06	Suspension Arm Repair Kit		DF-RK-9336		
	09/02→12/06	Suspension Arm Repair Kit	MN-RK-7280	MN-RK-7280	for Drag Link;for Semi-Trailing Arm; for Wishbone (CV)	
	09/02→12/06	Tie Rod	DF-DL-5403		1st FA	
	09/02→12/06	Tie Rod	DF-DL-7780		1st FA	
	09/02→12/06	Tie Rod	DF-DL-7836		1st FA	
	09/02→12/06	Tie Rod End	CV-ES-12461		for Steering Rod	
	09/02→12/06	Tie Rod End	CV-ES-12462		for Steering Rod	
	09/02→12/06	Tie Rod End	CV-ES-14163		for Steering Rod	
	09/02→12/06	Tie Rod End	DF-ES-8362		for Steering Rod	
	09/02→12/06	Track Control Arm		DF-DL-8158	Trailing Arm	
	09/02→12/06	Track Control Arm		DF-VB-8561	Wishbone (CV)	
	FA 95.530	09/02→12/06	Centre Rod	DF-DL-2142		Push Rod
		09/02→12/06	Centre Rod	DF-DL-3798		Push Rod
		09/02→12/06	Centre Rod	DF-DL-8704		Push Rod
09/02→12/06		Centre Rod	DF-DL-10187		Push Rod	
09/02→12/06		Centre Rod	DF-DL-12420		for Steering Rod	
09/02→12/06		Suspension Arm Repair Kit		DF-RK-9336		
09/02→12/06		Suspension Arm Repair Kit	MN-RK-7280	MN-RK-7280	for Drag Link;for Semi-Trailing Arm; for Wishbone (CV)	
09/02→12/06		Tie Rod	DF-DL-5403		1st FA	

CV-ES-12461

Length: 120
Cone Ø: d1 Ø 26 / d2 Ø 23,5
Thread: M30 x 1,5 LHT
0069513, 69513, 0311300, 311300,
0607998, 607998, 1190653, 1315447,
1319838, 1332123, 1338714, 1401934,
1407394, ACHB063, ACHF241, MAK1295



CV-ES-12462

Length: 120
Cone Ø: d1 Ø 26 / d2 Ø 23,5
Thread: M30 x 1,5 RHT
0069514, 0586753, 0607999, 0694298,
0694360, 0698609, 1137230, 1229944,
1326862, 1326896, 1331925, ACHB064,
ACHF242, MAK1296



CV-ES-14163

Length: 125
Cone Ø: d1 Ø 30 / d2 Ø 27
Thread: M30 x 1,5 RHT
0607981, 0698450, 1149907, 1152350,
1257890, 1603789, 1618048, ACHF060



DF-DL-2142

Length: 1005
Ø: 52
Cone Ø: d1 Ø 26 / d2 Ø 23,5
1291060, 1351734, 1385499



DF-DL-3798

Length: 1015
Ø: 50
Cone Ø: d1 Ø 30 / d2 Ø 27
0094038, 0525433

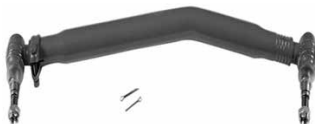

DF-DL-5403

Length: 1742
Ø: 40
Cone Ø: d1 Ø 26 / d2 Ø 23,5
0288281, 1270854, 1337644



DF-DL-7780

Length: 1690
Ø: 40
Cone Ø: d1 Ø 26 / d2 Ø 23,5
1270853, 1353391, 10212000A



DF-DL-7836

Length: 1698
Ø: 52
Cone Ø: d1 Ø 26 / d2 Ø 23,5
0754922, 1286343, 1353396



DF-DL-8158

Length: 611
Ø: 48
Hole Distance: 130 / 130
0267743, 1361649, 1361650, 1656428



DF-DL-8704

Length: 991
Ø: 50
Cone Ø: d1 Ø 30 / d2 Ø 27
1395994



DF-DL-8705

Length: 996
Ø: 38
Cone Ø: d1 Ø 30 / d2 Ø 27
1395993



DF-DL-10187

Length: 1000
Ø: 52
Cone Ø: d1 Ø 30 / d2 Ø 27
1395995



DF-DL-10193

Length: 1646
Ø: 40
Cone Ø: d1 Ø 26 / d2 Ø 23,5
1351205, 1353395



DF-DL-12420

Length: 1004
Ø: 52
Cone Ø: d1 Ø 30 / d2 Ø 27
Thread: M24 x 1,5 / M30 x 1,5
94613, 094613, 0094613, 0362413, 362413,
1426101



DF-ES-8362

Length: 150
Cone Ø: d1 Ø 26 / d2 Ø 23,5
Thread: M30 x 1,5 RHT
1389190



DF-RK-9336

Ø: 108
1445656



DF-VB-8561

Length: 609
Ø: 48
Hole Distance: 152 / 152
0080521, 080521, 1361651, 1368270,
1390932, 1617096, 1793875, 1817808,
1892492



MN-RK-7280

Ø: 75
Hole Distance: 115
Thick/Height: 24
0689748, 689748





XF 95 ...

FA 95.530 ...	09/02→12/06	Tie Rod	DF-DL-7780		1st FA	
	09/02→12/06	Tie Rod	DF-DL-7836		1st FA	
	09/02→12/06	Tie Rod End	CV-ES-12461		for Steering Rod	
	09/02→12/06	Tie Rod End	CV-ES-12462		for Steering Rod	
	09/02→12/06	Tie Rod End	CV-ES-14163		for Steering Rod	
	09/02→12/06	Tie Rod End	DF-ES-8362		for Steering Rod	
	09/02→12/06	Track Control Arm		DF-DL-8158	Trailing Arm	
	09/02→12/06	Track Control Arm		DF-VB-8561	Wishbone (CV)	
	FAD 95.380	01/02→12/06	Centre Rod	DF-DL-10186		Push Rod
01/02→12/06		Suspension Arm Repair Kit		DF-RK-8633	for Wishbone (CV)	
01/02→12/06		Tie Rod	DF-DL-5403			
01/02→12/06		Tie Rod	DF-DL-7780			
01/02→12/06		Tie Rod End	CV-ES-12461		for Steering Rod	
01/02→12/06		Tie Rod End	CV-ES-12462		for Steering Rod	
01/02→12/06		Tie Rod End	CV-ES-14162		for Steering Rod	
01/02→12/06		Tie Rod End	CV-ES-14163		for Steering Rod	
01/02→12/06		Tie Rod End	SC-ES-8517		for Push Rod	
01/02→12/06		Track Control Arm		DF-DL-8158	Trailing Arm	
FAD 95.430		01/02→12/06	Centre Rod	DF-DL-8705		Push Rod
		01/02→12/06	Centre Rod	DF-DL-10186		Push Rod
		01/02→12/06	Suspension Arm Repair Kit		DF-RK-8633	for Wishbone (CV)
	01/02→12/06	Tie Rod	DF-DL-5403		1st FA	
	01/02→12/06	Tie Rod	DF-DL-7780		1st FA;2nd FA	
	01/02→12/06	Tie Rod	DF-DL-10193		2nd FA	
	01/02→12/06	Tie Rod End	CV-ES-12461		for Steering Rod	
	01/02→12/06	Tie Rod End	CV-ES-12462		for Steering Rod	
	01/02→12/06	Tie Rod End	CV-ES-14162		for Steering Rod	
	01/02→12/06	Tie Rod End	CV-ES-14163		for Steering Rod	
	01/02→12/06	Tie Rod End	DF-ES-8602			
	01/02→12/06	Track Control Arm		DF-DL-8158	Trailing Arm	
	01/02→12/06	Track Control Arm		DF-TC-12262	Control Arm	
	FAD 95.480	01/02→12/06	Centre Rod	DF-DL-8705		Push Rod
		01/02→12/06	Centre Rod	DF-DL-10186		Push Rod
01/02→12/06		Suspension Arm Repair Kit		DF-RK-8633	for Wishbone (CV)	
01/02→12/06		Tie Rod	DF-DL-5403		1st FA	
01/02→12/06		Tie Rod	DF-DL-7780		1st FA;2nd FA	
01/02→12/06		Tie Rod	DF-DL-10193		1st FA;2nd FA	
01/02→12/06		Tie Rod End	CV-ES-12461		for Steering Rod	
01/02→12/06		Tie Rod End	CV-ES-12462		for Steering Rod	
01/02→12/06		Tie Rod End	CV-ES-14162		for Steering Rod	
01/02→12/06		Tie Rod End	CV-ES-14163		for Steering Rod	
01/02→12/06		Tie Rod End	DF-ES-8602			
01/02→12/06		Track Control Arm		DF-DL-8158	Trailing Arm	
01/02→12/06		Track Control Arm		DF-TC-12262	Control Arm	
FAD 95.530	09/02→	Centre Rod	DF-DL-8705		Push Rod	
	09/02→	Centre Rod	DF-DL-10186		Push Rod	
	09/02→	Suspension Arm Repair Kit		DF-RK-8633	for Wishbone (CV)	
	09/02→	Tie Rod	DF-DL-5403		1st FA	
	09/02→	Tie Rod	DF-DL-7780		1st FA;2nd FA	
	09/02→	Tie Rod	DF-DL-10193		2nd FA	
	09/02→	Tie Rod End	CV-ES-12461		for Steering Rod	
	09/02→	Tie Rod End	CV-ES-12462		for Steering Rod	
	09/02→	Tie Rod End	CV-ES-14162		for Steering Rod	
	09/02→	Tie Rod End	CV-ES-14163		for Steering Rod	
	09/02→	Tie Rod End	DF-ES-8602			
	09/02→	Track Control Arm		DF-DL-8158	Trailing Arm	
	09/02→	Track Control Arm		DF-TC-12262	Control Arm	
	FAK 95.380	01/02→12/06	Centre Rod	DF-DL-5355		Push Rod
		01/02→12/06	Centre Rod	DF-DL-8705		Push Rod
01/02→12/06		Centre Rod	DF-DL-10183		Push Rod, for vehicles with Hinged Leading Axle	
01/02→12/06		Centre Rod	DF-DL-10192		Push Rod, for vehicles with Hinged Leading Axle	
01/02→12/06		Suspension Arm Repair Kit		DF-RK-9336		
01/02→12/06		Tie Rod		DF-ES-5761	Leading Axle	

CV-ES-12461

Length: 120
Cone Ø: d1 Ø 26 / d2 Ø 23,5
Thread: M30 x 1,5 LHT
0069513, 69513, 0311300, 311300, 607998, 0607998, 1190653, 1315447, 1319838, 1332123, 1338714, 1401934, 1407394, ACHB063, ACHF241, MAK1295



CV-ES-12462

Length: 120
Cone Ø: d1 Ø 26 / d2 Ø 23,5
Thread: M30 x 1,5 RHT
0069514, 0586753, 0607999, 0694298, 0694360, 0698609, 1137230, 1229944, 1326862, 1326896, 1331925, ACHB064, ACHF242, MAK1296



CV-ES-14162

Length: 125
Cone Ø: d1 Ø 30 / d2 Ø 27
Thread: M30 x 1,5 LHT
607053, 690225, 696225, 1228115, 1611088



CV-ES-14163

Length: 125
Cone Ø: d1 Ø 30 / d2 Ø 27
Thread: M30 x 1,5 RHT
0607981, 0698450, 1149907, 1152350, 1257890, 1603789, 1618048, ACHF060



DF-DL-5355

Length: 995
Ø: 36
Cone Ø: d1 Ø 26 / d2 Ø 23,5
1311048, 1351737, 1385498



DF-DL-5403

Length: 1742
Ø: 40
Cone Ø: d1 Ø 26 / d2 Ø 23,5
0288281, 1270854, 1337644



DF-DL-7780

Length: 1690
Ø: 40
Cone Ø: d1 Ø 26 / d2 Ø 23,5
1270853, 1353391, 10212000A



DF-DL-7836

Length: 1698
Ø: 52
Cone Ø: d1 Ø 26 / d2 Ø 23,5
0754922, 1286343, 1353396



DF-DL-8158

Length: 611
Ø: 48
Hole Distance: 130 / 130
0267743, 1361649, 1361650, 1656428



DF-DL-8705

Length: 996
Ø: 38
Cone Ø: d1 Ø 30 / d2 Ø 27
1395993



DF-DL-10183

Length: 588
Ø: 36
Cone Ø: d1 Ø 26 / d2 Ø 23,5
1306333, 1351741, 1385487



DF-DL-10186

Length: 860
Ø: 38
Cone Ø: d1 Ø 30 / d2 Ø 27
1451118



DF-DL-10192

Length: 590
Ø: 38
Cone Ø: d1 Ø 30 / d2 Ø 27
1440171, 1451119



DF-DL-10193

Length: 1646
Ø: 40
Cone Ø: d1 Ø 26 / d2 Ø 23,5
1351205, 1353395



DF-ES-5761

Length: 1512
Ø: 52
Cone Ø: d1 Ø 26 / d2 Ø 23,5
1297572, 1361155



DF-ES-8362

Length: 150
Cone Ø: d1 Ø 26 / d2 Ø 23,5
Thread: M30 x 1,5 RHT
1389190



DF-ES-8602

Length: 95
Cone Ø: d1 Ø 30 / d2 Ø 27
Thread: M22 x 1,5 RHT
0273203, 1399724



DF-RK-8633

Ø: 90
0696320, 696320



DF-RK-9336

Ø: 108
1445656



DF-TC-12262

Length: 595
Ø: 50
Hole Distance: 130 / 130
0661406, 661406, 0661407, 661407, 1620439



DF-VB-8561

Length: 609
Ø: 48
Hole Distance: 152 / 152
0080521, 080521, 1361651, 1368270, 1390932, 1617096, 1793875, 1817808, 1892492



SC-ES-8517

Length: 140
Cone Ø: d1 Ø 30 / d2 Ø 27
Thread: M30 x 1,5 RHT
1685552



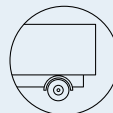

XF 95 ...

FAK 95.380 ...	01/02→12/06	Tie Rod	DF-DL-7780		1st FA
	01/02→12/06	Tie Rod End	CV-ES-12461		for Steering Rod
	01/02→12/06	Tie Rod End	CV-ES-12462		for Steering Rod
	01/02→12/06	Tie Rod End	CV-ES-14162		for Steering Rod
	01/02→12/06	Tie Rod End	CV-ES-14163		for Steering Rod
	01/02→12/06	Tie Rod End	DF-ES-8362		for Steering Rod
	01/02→12/06	Tie Rod End	DF-ES-8602		
	01/02→12/06	Tie Rod End	DF-ES-12428		for Steering Rod
	01/02→12/06	Tie Rod End	DF-ES-12429		for Steering Rod
	01/02→12/06	Track Control Arm		DF-DL-8158	Trailing Arm
	01/02→12/06	Track Control Arm		DF-TC-12492	Control Arm
	01/02→12/06	Track Control Arm		DF-VB-8561	Wishbone (CV)
	FAK 95.430	01/02→12/06	Centre Rod	DF-DL-5355	
01/02→12/06		Centre Rod	DF-DL-8705		Push Rod
01/02→12/06		Centre Rod	DF-DL-10183		Push Rod, for vehicles with Hinged Leading Axle
01/02→12/06		Centre Rod	DF-DL-10192		Push Rod, for vehicles with Hinged Leading Axle
01/02→12/06		Suspension Arm Repair Kit		DF-RK-9336	
01/02→12/06		Tie Rod		DF-ES-5761	Leading Axle
01/02→12/06		Tie Rod	DF-DL-7780		1st FA
01/02→12/06		Tie Rod End	CV-ES-12461		for Steering Rod
01/02→12/06		Tie Rod End	CV-ES-12462		for Steering Rod
01/02→12/06		Tie Rod End	CV-ES-14162		for Steering Rod
01/02→12/06		Tie Rod End	CV-ES-14163		for Steering Rod
01/02→12/06		Tie Rod End	DF-ES-8362		for Steering Rod
01/02→12/06		Tie Rod End	DF-ES-8602		
01/02→12/06		Tie Rod End	DF-ES-12428		for Steering Rod
01/02→12/06		Tie Rod End	DF-ES-12429		for Steering Rod
01/02→12/06		Track Control Arm		DF-DL-8158	Trailing Arm
01/02→12/06		Track Control Arm		DF-TC-12492	Control Arm
01/02→12/06	Track Control Arm		DF-VB-8561	Wishbone (CV)	
FAK 95.480	01/02→12/06	Centre Rod	DF-DL-5355		Push Rod
	01/02→12/06	Centre Rod	DF-DL-8705		Push Rod
	01/02→12/06	Centre Rod	DF-DL-10183		Push Rod, for vehicles with Hinged Leading Axle
	01/02→12/06	Centre Rod	DF-DL-10192		Push Rod, for vehicles with Hinged Leading Axle
	01/02→12/06	Suspension Arm Repair Kit		DF-RK-9336	
	01/02→12/06	Tie Rod		DF-ES-5761	Leading Axle
	01/02→12/06	Tie Rod	DF-DL-7780		1st FA
	01/02→12/06	Tie Rod End	CV-ES-12461		for Steering Rod
	01/02→12/06	Tie Rod End	CV-ES-12462		for Steering Rod
	01/02→12/06	Tie Rod End	CV-ES-14162		for Steering Rod
	01/02→12/06	Tie Rod End	CV-ES-14163		for Steering Rod
	01/02→12/06	Tie Rod End	DF-ES-8362		for Steering Rod
	01/02→12/06	Tie Rod End	DF-ES-8602		
	01/02→12/06	Tie Rod End	DF-ES-12428		for Steering Rod
	01/02→12/06	Tie Rod End	DF-ES-12429		for Steering Rod
	01/02→12/06	Track Control Arm		DF-DL-8158	Trailing Arm
	01/02→12/06	Track Control Arm		DF-TC-12492	Control Arm
01/02→12/06	Track Control Arm		DF-VB-8561	Wishbone (CV)	
FAK 95.530	09/02→	Centre Rod	DF-DL-5355		Push Rod
	09/02→	Centre Rod	DF-DL-8705		Push Rod
	09/02→	Centre Rod	DF-DL-10183		Push Rod, for vehicles with Hinged Leading Axle
	09/02→	Centre Rod	DF-DL-10192		Push Rod, for vehicles with Hinged Leading Axle
	09/02→	Suspension Arm Repair Kit		DF-RK-9336	
	09/02→	Tie Rod		DF-ES-5761	Leading Axle
	09/02→	Tie Rod	DF-DL-7780		1st FA
	09/02→	Tie Rod End	CV-ES-12461		for Steering Rod
	09/02→	Tie Rod End	CV-ES-12462		for Steering Rod
	09/02→	Tie Rod End	CV-ES-14162		for Steering Rod
	09/02→	Tie Rod End	CV-ES-14163		for Steering Rod
	09/02→	Tie Rod End	DF-ES-8362		for Steering Rod
	09/02→	Tie Rod End	DF-ES-8602		
09/02→	Tie Rod End	DF-ES-12428		for Steering Rod	
09/02→	Tie Rod End	DF-ES-12429		for Steering Rod	

CV-ES-12461

Length: 120
Cone Ø: d1 Ø 26 / d2 Ø 23,5
Thread: M30 x 1,5 LHT
0069513, 69513, 0311300, 311300,
0607998, 607998, 1190653, 1315447,
1319838, 1332123, 1338714, 1401934,
1407394, ACHB063, ACHF241, MAK1295



CV-ES-12462

Length: 120
Cone Ø: d1 Ø 26 / d2 Ø 23,5
Thread: M30 x 1,5 RHT
0069514, 0586753, 0607999, 0694298,
0694360, 0698609, 1137230, 1229944,
1326862, 1326896, 1331925, ACHB064,
ACHF242, MAK1296



CV-ES-14162

Length: 125
Cone Ø: d1 Ø 30 / d2 Ø 27
Thread: M30 x 1,5 LHT
607053, 690225, 696225, 1228115,
1611088



CV-ES-14163

Length: 125
Cone Ø: d1 Ø 30 / d2 Ø 27
Thread: M30 x 1,5 RHT
0607981, 0698450, 1149907, 1152350,
1257890, 1603789, 1618048, ACHF060



DF-DL-5355

Length: 995
Ø: 36
Cone Ø: d1 Ø 26 / d2 Ø 23,5
1311048, 1351737, 1385498



DF-DL-7780

Length: 1690
Ø: 40
Cone Ø: d1 Ø 26 / d2 Ø 23,5
1270853, 1353391, 10212000A



DF-DL-8158

Length: 611
Ø: 48
Hole Distance: 130 / 130
0267743, 1361649, 1361650, 1656428



DF-DL-8705

Length: 996
Ø: 38
Cone Ø: d1 Ø 30 / d2 Ø 27
1395993



DF-DL-10183

Length: 588
Ø: 36
Cone Ø: d1 Ø 26 / d2 Ø 23,5
1306333, 1351741, 1385487



DF-DL-10192

Length: 590
Ø: 38
Cone Ø: d1 Ø 30 / d2 Ø 27
1440171, 1451119



DF-ES-5761

Length: 1512
Ø: 52
Cone Ø: d1 Ø 26 / d2 Ø 23,5
1297572, 1361155



DF-ES-8362

Length: 150
Cone Ø: d1 Ø 26 / d2 Ø 23,5
Thread: M30 x 1,5 RHT
1389190



DF-ES-8602

Length: 95
Cone Ø: d1 Ø 30 / d2 Ø 27
Thread: M22 x 1,5 RHT
0273203, 1399724



DF-ES-12428

Length: 120
Cone Ø: d1 Ø 30
Thread: M24 x 1,5 RHT
1603788, 1604105



DF-ES-12429

Length: 90
Cone Ø: d1 Ø 26 / d2 Ø 23,5
1299555, 4125657, 0004632329,
0004632629, 120110404, 1605300141



DF-RK-9336

Ø: 108
1445656



DF-TC-12492

Length: 600
Ø: 40
Hole Distance: 115 / 115
1274741

No Image

DF-VB-8561

Length: 609
Ø: 48
Hole Distance: 152 / 152
0080521, 080521, 1361651, 1368270,
1390932, 1617096, 1793875, 1817808,
1892492



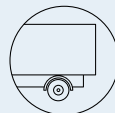

XF 95 ...

FAK 95.530 ...	09/02→	Track Control Arm		DF-DL-8158	Trailing Arm	
	09/02→	Track Control Arm		DF-TC-12492	Control Arm	
	09/02→	Track Control Arm		DF-VB-8561	Wishbone (CV)	
FAN 95.380	01/02→12/06	Centre Rod	DF-DL-8704		Push Rod	
	01/02→12/06	Centre Rod	DF-DL-10187		Push Rod	
	01/02→12/06	Centre Rod	DF-DL-12420		for Steering Rod	
	01/02→12/06	Suspension Arm Repair Kit		DF-RK-9336		
	01/02→12/06	Suspension Arm Repair Kit	MN-RK-7280	MN-RK-7280	for Drag Link;for Semi-Trailing Arm; for Wishbone (CV)	
	01/02→12/06	Tie Rod		DF-DL-5403	Tag Axle	
	01/02→12/06	Tie Rod		DF-DL-7780	Tag Axle	
	01/02→12/06	Tie Rod	DF-DL-5403		1st FA	
	01/02→12/06	Tie Rod	DF-DL-7780		1st FA	
	01/02→12/06	Tie Rod	DF-DL-7836		1st FA	
	01/02→12/06	Tie Rod	DF-DL-10193		1st FA	
	01/02→12/06	Tie Rod End	CV-ES-12461	CV-ES-12461	for Steering Rod	
	01/02→12/06	Tie Rod End	CV-ES-12462	CV-ES-12462	for Steering Rod	
	01/02→12/06	Tie Rod End	CV-ES-14163		for Steering Rod	
	01/02→12/06	Tie Rod End	DF-ES-8362		for Steering Rod	
	01/02→12/06	Track Control Arm		DF-DL-8158	Trailing Arm	
	01/02→12/06	Track Control Arm		DF-VB-8561	Wishbone (CV)	
	FAN 95.430	01/02→12/06	Centre Rod	DF-DL-8704		Push Rod
		01/02→12/06	Centre Rod	DF-DL-8705		Push Rod
		01/02→12/06	Centre Rod	DF-DL-10187		Push Rod
01/02→12/06		Centre Rod	DF-DL-12420		for Steering Rod	
01/02→12/06		Suspension Arm Repair Kit		DF-RK-9336		
01/02→12/06		Suspension Arm Repair Kit	MN-RK-7280	MN-RK-7280	for Drag Link;for Semi-Trailing Arm; for Wishbone (CV)	
01/02→12/06		Tie Rod		DF-DL-5403	Tag Axle	
01/02→12/06		Tie Rod		DF-DL-7780	Tag Axle	
01/02→12/06		Tie Rod	DF-DL-5403		1st FA	
01/02→12/06		Tie Rod	DF-DL-7780		1st FA	
01/02→12/06		Tie Rod	DF-DL-7836		1st FA	
01/02→12/06		Tie Rod	DF-DL-10193		1st FA	
01/02→12/06		Tie Rod End	CV-ES-12461	CV-ES-12461	for Steering Rod	
01/02→12/06		Tie Rod End	CV-ES-12462	CV-ES-12462	for Steering Rod	
01/02→12/06		Tie Rod End	CV-ES-14163		for Steering Rod	
01/02→12/06		Tie Rod End	DF-ES-8362		for Steering Rod	
01/02→12/06		Track Control Arm		DF-DL-8158	Trailing Arm	
01/02→12/06		Track Control Arm		DF-VB-8561	Wishbone (CV)	
FAN 95.480		01/02→12/06	Centre Rod	DF-DL-8704		Push Rod
		01/02→12/06	Centre Rod	DF-DL-8705		Push Rod
	01/02→12/06	Centre Rod	DF-DL-10187		Push Rod	
	01/02→12/06	Centre Rod	DF-DL-12420		for Steering Rod	
	01/02→12/06	Suspension Arm Repair Kit		DF-RK-9336		
	01/02→12/06	Suspension Arm Repair Kit	MN-RK-7280	MN-RK-7280	for Drag Link;for Semi-Trailing Arm; for Wishbone (CV)	
	01/02→12/06	Tie Rod		DF-DL-5403	Tag Axle	
	01/02→12/06	Tie Rod		DF-DL-7780	Tag Axle	
	01/02→12/06	Tie Rod	DF-DL-5403		1st FA	
	01/02→12/06	Tie Rod	DF-DL-7780		1st FA	
	01/02→12/06	Tie Rod	DF-DL-7836		1st FA	
	01/02→12/06	Tie Rod	DF-DL-10193		1st FA	
	01/02→12/06	Tie Rod End	CV-ES-12461	CV-ES-12461	for Steering Rod	
	01/02→12/06	Tie Rod End	CV-ES-12462	CV-ES-12462	for Steering Rod	
	01/02→12/06	Tie Rod End	CV-ES-14163		for Steering Rod	
	01/02→12/06	Tie Rod End	DF-ES-8362		for Steering Rod	
	01/02→12/06	Track Control Arm		DF-DL-8158	Trailing Arm	
	01/02→12/06	Track Control Arm		DF-VB-8561	Wishbone (CV)	
	FAN 95.530	09/02→	Centre Rod	DF-DL-8704		Push Rod
		09/02→	Centre Rod	DF-DL-8705		Push Rod
09/02→		Centre Rod	DF-DL-10187		Push Rod	
09/02→		Centre Rod	DF-DL-12420		for Steering Rod	

CV-ES-12461

Length: 120
Cone Ø: d1 Ø 26 / d2 Ø 23,5
Thread: M30 x 1,5 LHT
0069513, 69513, 0311300, 311300,
0607998, 607998, 1190653, 1315447,
1319838, 1332123, 1338714, 1401934,
1407394, ACHB063, ACHF241, MAK1295



CV-ES-12462

Length: 120
Cone Ø: d1 Ø 26 / d2 Ø 23,5
Thread: M30 x 1,5 RHT
0069514, 0586753, 0607999, 0694298,
0694360, 0698609, 1137230, 1229944,
1326862, 1326896, 1331925, ACHB064,
ACHF242, MAK1296



CV-ES-14163

Length: 125
Cone Ø: d1 Ø 30 / d2 Ø 27
Thread: M30 x 1,5 RHT
0607981, 0698450, 1149907, 1152350,
1257890, 1603789, 1618048, ACHF060



DF-DL-5403

Length: 1742
Ø: 40
Cone Ø: d1 Ø 26 / d2 Ø 23,5
0288281, 1270854, 1337644



DF-DL-7780

Length: 1690
Ø: 40
Cone Ø: d1 Ø 26 / d2 Ø 23,5
1270853, 1353391, 10212000A



DF-DL-7836

Length: 1698
Ø: 52
Cone Ø: d1 Ø 26 / d2 Ø 23,5
0754922, 1286343, 1353396



DF-DL-8158

Length: 611
Ø: 48
Hole Distance: 130 / 130
0267743, 1361649, 1361650, 1656428



DF-DL-8704

Length: 991
Ø: 50
Cone Ø: d1 Ø 30 / d2 Ø 27
1395994



DF-DL-8705

Length: 996
Ø: 38
Cone Ø: d1 Ø 30 / d2 Ø 27
1395993



DF-DL-10187

Length: 1000
Ø: 52
Cone Ø: d1 Ø 30 / d2 Ø 27
1395995



DF-DL-10193

Length: 1646
Ø: 40
Cone Ø: d1 Ø 26 / d2 Ø 23,5
1351205, 1353395



DF-DL-12420

Length: 1004
Ø: 52
Cone Ø: d1 Ø 30 / d2 Ø 27
Thread: M24 x 1,5 / M30 x 1,5
0094613, 094613, 94613, 0362413, 362413,
1426101



DF-ES-8362

Length: 150
Cone Ø: d1 Ø 26 / d2 Ø 23,5
Thread: M30 x 1,5 RHT
1389190



DF-RK-9336

Ø: 108
1445656



DF-TC-12492

Length: 600
Ø: 40
Hole Distance: 115 / 115
1274741

No Image

DF-VB-8561

Length: 609
Ø: 48
Hole Distance: 152 / 152
080521, 0080521, 1361651, 1368270,
1390932, 1617096, 1793875, 1817808,
1892492



MN-RK-7280

Ø: 75
Hole Distance: 115
Thick/Height: 24
0689748, 689748



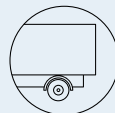

XF 95 ...

FAN 95.530 ...	09/02→	Suspension Arm Repair Kit		DF-RK-9336	
	09/02→	Suspension Arm Repair Kit	MN-RK-7280	MN-RK-7280	for Drag Link;for Semi-Trailing Arm; for Wishbone (CV)
	09/02→	Tie Rod		DF-DL-5403	Tag Axle
	09/02→	Tie Rod		DF-DL-7780	Tag Axle
	09/02→	Tie Rod	DF-DL-5403		1st FA
	09/02→	Tie Rod	DF-DL-7780		1st FA
	09/02→	Tie Rod	DF-DL-7836		1st FA
	09/02→	Tie Rod End	CV-ES-12461	CV-ES-12461	for Steering Rod
	09/02→	Tie Rod End	CV-ES-12462	CV-ES-12462	for Steering Rod
	09/02→	Tie Rod End	CV-ES-14163		for Steering Rod
	09/02→	Tie Rod End	DF-ES-8362		for Steering Rod
	09/02→	Track Control Arm		DF-DL-8158	Trailing Arm
	09/02→	Track Control Arm		DF-VB-8561	Wishbone (CV)
FAR 95.380	09/02→12/06	Centre Rod	DF-DL-8704		Push Rod
	09/02→12/06	Centre Rod	DF-DL-8705		Push Rod
	09/02→12/06	Centre Rod	DF-DL-10187		Push Rod
	09/02→12/06	Centre Rod	DF-DL-12420		for Steering Rod
	09/02→12/06	Suspension Arm Repair Kit		DF-RK-9336	
	09/02→12/06	Suspension Arm Repair Kit	MN-RK-7280	MN-RK-7280	for Drag Link;for Semi-Trailing Arm; for Wishbone (CV)
	09/02→12/06	Tie Rod	DF-DL-5403		1st FA
	09/02→12/06	Tie Rod	DF-DL-7780		1st FA
	09/02→12/06	Tie Rod	DF-DL-7836		1st FA
	09/02→12/06	Tie Rod End	CV-ES-12461		for Steering Rod
	09/02→12/06	Tie Rod End	CV-ES-12462		for Steering Rod
	09/02→12/06	Tie Rod End	CV-ES-14163		for Steering Rod
	09/02→12/06	Tie Rod End	DF-ES-8362		for Steering Rod
09/02→12/06	Track Control Arm		DF-DL-8158	Trailing Arm	
09/02→12/06	Track Control Arm		DF-VB-8561	Wishbone (CV)	
FAR 95.430	09/02→12/06	Centre Rod	DF-DL-8704		Push Rod
	09/02→12/06	Centre Rod	DF-DL-8705		Push Rod
	09/02→12/06	Centre Rod	DF-DL-10187		Push Rod
	09/02→12/06	Centre Rod	DF-DL-10192		Push Rod, for vehicles with Hinged Leading Axle
	09/02→12/06	Centre Rod	DF-DL-12420		for Steering Rod
	09/02→12/06	Suspension Arm Repair Kit		DF-RK-9336	
	09/02→12/06	Suspension Arm Repair Kit	MN-RK-7280	MN-RK-7280	for Drag Link;for Semi-Trailing Arm; for Wishbone (CV)
	09/02→12/06	Tie Rod		DF-DL-5403	Leading Axle
	09/02→12/06	Tie Rod		DF-DL-7780	Leading Axle
	09/02→12/06	Tie Rod	DF-DL-5403		1st FA
	09/02→12/06	Tie Rod	DF-DL-7780		1st FA
	09/02→12/06	Tie Rod	DF-DL-7836		1st FA
	09/02→12/06	Tie Rod End	CV-ES-12461		for Steering Rod
09/02→12/06	Tie Rod End	CV-ES-12462		for Steering Rod	
09/02→12/06	Tie Rod End	CV-ES-14163		for Steering Rod	
09/02→12/06	Tie Rod End	DF-ES-8362		for Steering Rod	
09/02→12/06	Track Control Arm		DF-DL-8158	Trailing Arm	
09/02→12/06	Track Control Arm		DF-TC-12492	Control Arm	
09/02→12/06	Track Control Arm		DF-VB-8561	Wishbone (CV)	
FAR 95.480	09/02→12/06	Centre Rod	DF-DL-8704		Push Rod
	09/02→12/06	Centre Rod	DF-DL-8705		Push Rod
	09/02→12/06	Centre Rod	DF-DL-10187		Push Rod
	09/02→12/06	Centre Rod	DF-DL-10192		Push Rod
	09/02→12/06	Centre Rod	DF-DL-12420		for Steering Rod
	09/02→12/06	Suspension Arm Repair Kit		DF-RK-9336	
	09/02→12/06	Suspension Arm Repair Kit	MN-RK-7280	MN-RK-7280	for Drag Link;for Semi-Trailing Arm; for Wishbone (CV)
	09/02→12/06	Tie Rod	DF-DL-5403		1st FA
	09/02→12/06	Tie Rod	DF-DL-7780		1st FA
	09/02→12/06	Tie Rod	DF-DL-7836		1st FA
	09/02→12/06	Tie Rod End	CV-ES-12461		for Steering Rod
	09/02→12/06	Tie Rod End	CV-ES-12462		for Steering Rod

CV-ES-12461

Length: 120
Cone Ø: d1 Ø 26 / d2 Ø 23,5
Thread: M30 x 1,5 LHT
0069513, 69513, 0311300, 311300,
0607998, 607998, 1190653, 1315447,
1319838, 1332123, 1338714, 1401934,
1407394, ACHB063, ACHF241, MAK1295



CV-ES-12462

Length: 120
Cone Ø: d1 Ø 26 / d2 Ø 23,5
Thread: M30 x 1,5 RHT
0069514, 0586753, 0607999, 0694298,
0694360, 0698609, 1137230, 1229944,
1326862, 1326896, 1331925, ACHB064,
ACHF242, MAK1296



CV-ES-14163

Length: 125
Cone Ø: d1 Ø 30 / d2 Ø 27
Thread: M30 x 1,5 RHT
0607981, 0698450, 1149907, 1152350,
1257890, 1603789, 1618048, ACHF060



DF-DL-5403

Length: 1742
Ø: 40
Cone Ø: d1 Ø 26 / d2 Ø 23,5
0288281, 1270854, 1337644



DF-DL-7780

Length: 1690
Ø: 40
Cone Ø: d1 Ø 26 / d2 Ø 23,5
1270853, 1353391, 10212000A



DF-DL-7836

Length: 1698
Ø: 52
Cone Ø: d1 Ø 26 / d2 Ø 23,5
0754922, 1286343, 1353396



DF-DL-8158

Length: 611
Ø: 48
Hole Distance: 130 / 130
0267743, 1361649, 1361650, 1656428



DF-DL-8704

Length: 991
Ø: 50
Cone Ø: d1 Ø 30 / d2 Ø 27
1395994



DF-DL-8705

Length: 996
Ø: 38
Cone Ø: d1 Ø 30 / d2 Ø 27
1395993



DF-DL-10187

Length: 1000
Ø: 52
Cone Ø: d1 Ø 30 / d2 Ø 27
1395995



DF-DL-10192

Length: 590
Ø: 38
Cone Ø: d1 Ø 30 / d2 Ø 27
1440171, 1451119



DF-DL-12420

Length: 1004
Ø: 52
Cone Ø: d1 Ø 30 / d2 Ø 27
Thread: M24 x 1,5 / M30 x 1,5
0094613, 094613, 94613, 0362413, 362413,
1426101



DF-ES-8362

Length: 150
Cone Ø: d1 Ø 26 / d2 Ø 23,5
Thread: M30 x 1,5 RHT
1389190



DF-RK-9336

Ø: 108
1445656



DF-TC-12492

Length: 600
Ø: 40
Hole Distance: 115 / 115
1274741

No Image

DF-VB-8561

Length: 609
Ø: 48
Hole Distance: 152 / 152
0080521, 080521, 1361651, 1368270,
1390932, 1617096, 1793875, 1817808,
1892492



MN-RK-7280

Ø: 75
Hole Distance: 115
Thick/Height: 24
689748, 0689748





XF 95 ...

FAR 95.480 ...	09/02→12/06	Tie Rod End	CV-ES-14163		for Steering Rod	
	09/02→12/06	Tie Rod End	DF-ES-8362		for Steering Rod	
	09/02→12/06	Track Control Arm		DF-DL-8158	Trailing Arm	
	09/02→12/06	Track Control Arm		DF-TC-12492	Control Arm	
	09/02→12/06	Track Control Arm		DF-VB-8561	Wishbone (CV)	
FAR 95.530	09/02→12/06	Centre Rod	DF-DL-8704		Push Rod	
	09/02→12/06	Centre Rod	DF-DL-8705		Push Rod	
	09/02→12/06	Centre Rod	DF-DL-10187		Push Rod	
	09/02→12/06	Centre Rod	DF-DL-12420		for Steering Rod	
	09/02→12/06	Suspension Arm Repair Kit		DF-RK-9336		
	09/02→12/06	Suspension Arm Repair Kit	MN-RK-7280	MN-RK-7280	for Drag Link;for Semi-Trailing Arm; for Wishbone (CV)	
	09/02→12/06	Tie Rod	DF-DL-5403		1st FA	
	09/02→12/06	Tie Rod	DF-DL-7780		1st FA	
	09/02→12/06	Tie Rod	DF-DL-7836		1st FA	
	09/02→12/06	Tie Rod End	CV-ES-12461		for Steering Rod	
	09/02→12/06	Tie Rod End	CV-ES-12462		for Steering Rod	
	09/02→12/06	Tie Rod End	CV-ES-14163		for Steering Rod	
	09/02→12/06	Tie Rod End	DF-ES-8362		for Steering Rod	
	09/02→12/06	Track Control Arm		DF-DL-8158	Trailing Arm	
	09/02→12/06	Track Control Arm		DF-VB-8561	Wishbone (CV)	
	FAS 95.380	01/02→12/06	Centre Rod	DF-DL-8704		Push Rod
		01/02→12/06	Centre Rod	DF-DL-8705		Push Rod
01/02→12/06		Centre Rod	DF-DL-10187		Push Rod	
01/02→12/06		Centre Rod	DF-DL-12420		for Steering Rod	
01/02→12/06		Suspension Arm Repair Kit		DF-RK-9336		
01/02→12/06		Suspension Arm Repair Kit	MN-RK-7280	MN-RK-7280	for Drag Link;for Semi-Trailing Arm; for Wishbone (CV)	
01/02→12/06		Tie Rod	DF-DL-5403		1st FA	
01/02→12/06		Tie Rod	DF-DL-7780		1st FA	
01/02→12/06		Tie Rod	DF-DL-7836		1st FA	
01/02→12/06		Tie Rod	DF-DL-10193		1st FA	
01/02→12/06		Tie Rod End	CV-ES-12461		for Steering Rod	
01/02→12/06		Tie Rod End	CV-ES-12462		for Steering Rod	
01/02→12/06		Tie Rod End	CV-ES-14163		for Steering Rod	
01/02→12/06		Tie Rod End	DF-ES-8362		for Steering Rod	
01/02→12/06		Track Control Arm		DF-DL-8158	Trailing Arm	
01/02→12/06		Track Control Arm		DF-VB-8561	Wishbone (CV)	
FAS 95.430		01/02→12/06	Centre Rod	DF-DL-8704		Push Rod
	01/02→12/06	Centre Rod	DF-DL-8705		Push Rod	
	01/02→12/06	Centre Rod	DF-DL-12420		for Steering Rod	
	01/02→12/06	Suspension Arm Repair Kit		DF-RK-9336		
	01/02→12/06	Suspension Arm Repair Kit	MN-RK-7280	MN-RK-7280	for Drag Link;for Semi-Trailing Arm; for Wishbone (CV)	
	01/02→12/06	Tie Rod	DF-DL-5403		1st FA	
	01/02→12/06	Tie Rod	DF-DL-7780		1st FA	
	01/02→12/06	Tie Rod	DF-DL-7836		1st FA	
	01/02→12/06	Tie Rod	DF-DL-10193		1st FA	
	01/02→12/06	Tie Rod End	CV-ES-12461		for Steering Rod	
	01/02→12/06	Tie Rod End	CV-ES-12462		for Steering Rod	
	01/02→12/06	Tie Rod End	CV-ES-14163		for Steering Rod	
	01/02→12/06	Tie Rod End	DF-ES-8362		for Steering Rod	
	01/02→12/06	Track Control Arm		DF-DL-8158	Trailing Arm	
	01/02→12/06	Track Control Arm		DF-VB-8561	Wishbone (CV)	
	FAS 95.480	01/02→12/06	Centre Rod	DF-DL-8704		Push Rod
		01/02→12/06	Centre Rod	DF-DL-8705		Push Rod
01/02→12/06		Centre Rod	DF-DL-10187		Push Rod	
01/02→12/06		Centre Rod	DF-DL-12420		for Steering Rod	
01/02→12/06		Suspension Arm Repair Kit		DF-RK-9336		
01/02→12/06		Suspension Arm Repair Kit	MN-RK-7280	MN-RK-7280	for Drag Link;for Semi-Trailing Arm; for Wishbone (CV)	
01/02→12/06		Tie Rod	DF-DL-5403		1st FA	
01/02→12/06		Tie Rod	DF-DL-7780		1st FA	

CV-ES-12461

Length: 120
Cone Ø: d1 Ø 26 / d2 Ø 23,5
Thread: M30 x 1,5 LHT
0069513, 69513, 0311300, 311300,
0607998, 607998, 1190653, 1315447,
1319838, 1332123, 1338714, 1401934,
1407394, ACHB063, ACHF241, MAK1295



CV-ES-12462

Length: 120
Cone Ø: d1 Ø 26 / d2 Ø 23,5
Thread: M30 x 1,5 RHT
0069514, 0586753, 0607999, 0694298,
0694360, 0698609, 1137230, 1229944,
1326862, 1326896, 1331925, ACHB064,
ACHF242, MAK1296



CV-ES-14163

Length: 125
Cone Ø: d1 Ø 30 / d2 Ø 27
Thread: M30 x 1,5 RHT
0607981, 0698450, 1149907, 1152350,
1257890, 1603789, 1618048, ACHF060



DF-DL-5403

Length: 1742
Ø: 40
Cone Ø: d1 Ø 26 / d2 Ø 23,5
0288281, 1270854, 1337644



DF-DL-7780

Length: 1690
Ø: 40
Cone Ø: d1 Ø 26 / d2 Ø 23,5
1270853, 1353391, 10212000A



DF-DL-7836

Length: 1698
Ø: 52
Cone Ø: d1 Ø 26 / d2 Ø 23,5
0754922, 1286343, 1353396



DF-DL-8158

Length: 611
Ø: 48
Hole Distance: 130 / 130
0267743, 1361649, 1361650, 1656428



DF-DL-8704

Length: 991
Ø: 50
Cone Ø: d1 Ø 30 / d2 Ø 27
1395994



DF-DL-8705

Length: 996
Ø: 38
Cone Ø: d1 Ø 30 / d2 Ø 27
1395993



DF-DL-10187

Length: 1000
Ø: 52
Cone Ø: d1 Ø 30 / d2 Ø 27
1395995



DF-DL-10193

Length: 1646
Ø: 40
Cone Ø: d1 Ø 26 / d2 Ø 23,5
1351205, 1353395



DF-DL-12420

Length: 1004
Ø: 52
Cone Ø: d1 Ø 30 / d2 Ø 27
Thread: M24 x 1,5 / M30 x 1,5
94613, 0094613, 094613, 0362413, 362413,
1426101



DF-ES-8362

Length: 150
Cone Ø: d1 Ø 26 / d2 Ø 23,5
Thread: M30 x 1,5 RHT
1389190



DF-RK-9336

Ø: 108
1445656



DF-TC-12492

Length: 600
Ø: 40
Hole Distance: 115 / 115
1274741

No Image

DF-VB-8561

Length: 609
Ø: 48
Hole Distance: 152 / 152
0080521, 080521, 1361651, 1368270,
1390932, 1617096, 1793875, 1817808,
1892492



MN-RK-7280

Ø: 75
Hole Distance: 115
Thick/Height: 24
0689748, 689748





XF 95 ...

FAS 95.480 ...	01/02→12/06	Tie Rod	DF-DL-7836		1st FA
	01/02→12/06	Tie Rod	DF-DL-10193		1st FA
	01/02→12/06	Tie Rod End	CV-ES-12461		for Steering Rod
	01/02→12/06	Tie Rod End	CV-ES-12462		for Steering Rod
	01/02→12/06	Tie Rod End	CV-ES-14163		for Steering Rod
	01/02→12/06	Tie Rod End	DF-ES-8362		for Steering Rod
	01/02→12/06	Track Control Arm		DF-DL-8158	Trailing Arm
	01/02→12/06	Track Control Arm		DF-VB-8561	Wishbone (CV)
FAS 95.530	09/02→	Centre Rod	DF-DL-8704		Push Rod
	09/02→	Centre Rod	DF-DL-8705		Push Rod
	09/02→	Centre Rod	DF-DL-10187		Push Rod
	09/02→	Centre Rod	DF-DL-12420		for Steering Rod
	09/02→	Suspension Arm Repair Kit		DF-RK-9336	
	09/02→	Suspension Arm Repair Kit	MN-RK-7280	MN-RK-7280	for Drag Link;for Semi-Trailing Arm; for Wishbone (CV)
	09/02→	Tie Rod	DF-DL-5403		1st FA
	09/02→	Tie Rod	DF-DL-7780		1st FA
	09/02→	Tie Rod	DF-DL-7836		1st FA
	09/02→	Tie Rod	DF-DL-10193		1st FA
	09/02→	Tie Rod End	CV-ES-12461		for Steering Rod
	09/02→	Tie Rod End	CV-ES-12462		for Steering Rod
	09/02→	Tie Rod End	CV-ES-14163		for Steering Rod
	09/02→	Tie Rod End	DF-ES-8362		for Steering Rod
	09/02→	Track Control Arm		DF-DL-8158	Trailing Arm
	09/02→	Track Control Arm		DF-VB-8561	Wishbone (CV)
FAT 95.380	01/02→12/06	Centre Rod	DF-DL-12420		for Steering Rod
	01/02→12/06	Suspension Arm Repair Kit		DF-RK-8633	for Wishbone (CV)
	01/02→12/06	Tie Rod	DF-DL-5403		1st FA
	01/02→12/06	Tie Rod End	CV-ES-12461		for Steering Rod
	01/02→12/06	Tie Rod End	CV-ES-12462		for Steering Rod
	01/02→12/06	Tie Rod End	CV-ES-14163		for Steering Rod
	01/02→12/06	Track Control Arm		DF-DL-8158	Trailing Arm, 1st RA;2nd RA, for Pneumatic Suspension vehicles
	01/02→12/06	Track Control Arm		DF-DL-9318	Trailing Arm
FAT 95.430	01/02→12/06	Centre Rod	DF-DL-8704		Push Rod
	01/02→12/06	Centre Rod	DF-DL-8705		Push Rod
	01/02→12/06	Centre Rod	DF-DL-12420		for Steering Rod
	01/02→12/06	Suspension Arm Repair Kit		DF-RK-8633	for Wishbone (CV)
	01/02→12/06	Tie Rod	DF-DL-5403		1st FA
	01/02→12/06	Tie Rod	DF-DL-7780		1st FA
	01/02→12/06	Tie Rod	DF-DL-10193		1st FA
	01/02→12/06	Tie Rod End	CV-ES-12461		for Steering Rod
	01/02→12/06	Tie Rod End	CV-ES-12462		for Steering Rod
	01/02→12/06	Tie Rod End	CV-ES-14163		for Steering Rod
	01/02→12/06	Track Control Arm		DF-DL-8158	Trailing Arm
	01/02→12/06	Track Control Arm		DF-DL-9318	Trailing Arm
FAT 95.480	01/02→12/06	Centre Rod	DF-DL-8704		Push Rod
	01/02→12/06	Centre Rod	DF-DL-8705		Push Rod
	01/02→12/06	Centre Rod	DF-DL-10187		Push Rod
	01/02→12/06	Centre Rod	DF-DL-12420		for Steering Rod
	01/02→12/06	Suspension Arm Repair Kit		DF-RK-8633	for Wishbone (CV)
	01/02→12/06	Tie Rod	DF-DL-5403		1st FA
	01/02→12/06	Tie Rod	DF-DL-7780		1st FA
	01/02→12/06	Tie Rod	DF-DL-7836		1st FA
	01/02→12/06	Tie Rod	DF-DL-10193		1st FA
	01/02→12/06	Tie Rod End	CV-ES-12461		for Steering Rod
	01/02→12/06	Tie Rod End	CV-ES-12462		for Steering Rod
	01/02→12/06	Tie Rod End	CV-ES-14163		for Steering Rod
	01/02→12/06	Track Control Arm		DF-DL-8158	Trailing Arm
	01/02→12/06	Track Control Arm		DF-DL-9318	Trailing Arm
	01/02→12/06	Track Control Arm		DF-TC-12262	Control Arm
	01/02→12/06	Track Control Arm		DF-VB-8561	Wishbone (CV)

CV-ES-12461

Length: 120
Cone Ø: d1 Ø 26 / d2 Ø 23,5
Thread: M30 x 1,5 LHT
0069513, 69513, 0311300, 311300,
0607998, 607998, 1190653, 1315447,
1319838, 1332123, 1338714, 1401934,
1407394, ACHB063, ACHF241, MAK1295



CV-ES-12462

Length: 120
Cone Ø: d1 Ø 26 / d2 Ø 23,5
Thread: M30 x 1,5 RHT
0069514, 0586753, 0607999, 0694298,
0694360, 0698609, 1137230, 1229944,
1326862, 1326896, 1331925, ACHB064,
ACHF242, MAK1296



CV-ES-14163

Length: 125
Cone Ø: d1 Ø 30 / d2 Ø 27
Thread: M30 x 1,5 RHT
0607981, 0698450, 1149907, 1152350,
1257890, 1603789, 1618048, ACHF060



DF-DL-5403

Length: 1742
Ø: 40
Cone Ø: d1 Ø 26 / d2 Ø 23,5
0288281, 1270854, 1337644



DF-DL-7780

Length: 1690
Ø: 40
Cone Ø: d1 Ø 26 / d2 Ø 23,5
1270853, 1353391, 10212000A



DF-DL-7836

Length: 1698
Ø: 52
Cone Ø: d1 Ø 26 / d2 Ø 23,5
0754922, 1286343, 1353396



DF-DL-8158

Length: 611
Ø: 48
Hole Distance: 130 / 130
0267743, 1361649, 1361650, 1656428



DF-DL-8704

Length: 991
Ø: 50
Cone Ø: d1 Ø 30 / d2 Ø 27
1395994



DF-DL-8705

Length: 996
Ø: 38
Cone Ø: d1 Ø 30 / d2 Ø 27
1395993



DF-DL-9318

Length: 600
Ø: 50
Hole Distance: 130 / 130
0646373, 0655695, 0655697, 1284860,
1620438



DF-DL-10187

Length: 1000
Ø: 52
Cone Ø: d1 Ø 30 / d2 Ø 27
1395995



DF-DL-10193

Length: 1646
Ø: 40
Cone Ø: d1 Ø 26 / d2 Ø 23,5
1351205, 1353395



DF-DL-12420

Length: 1004
Ø: 52
Cone Ø: d1 Ø 30 / d2 Ø 27
Thread: M24 x 1,5 / M30 x 1,5
0094613, 094613, 94613, 0362413, 362413,
1426101



DF-ES-8362

Length: 150
Cone Ø: d1 Ø 26 / d2 Ø 23,5
Thread: M30 x 1,5 RHT
1389190



DF-RK-8633

Ø: 90
0696320, 696320



DF-RK-9336

Ø: 108
1445656



DF-TC-12262

Length: 595
Ø: 50
Hole Distance: 130 / 130
0661406, 661406, 0661407, 661407,
1620439



DF-VB-8561

Length: 609
Ø: 48
Hole Distance: 152 / 152
0080521, 080521, 1361651, 1368270,
1390932, 1617096, 1793875, 1817808,
1892492



MN-RK-7280

Ø: 75
Hole Distance: 115
Thick/Height: 24
0689748, 689748



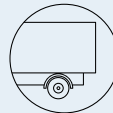

XF 95 ...

FAT 95.530	09/02→	Centre Rod	DF-DL-8704		Push Rod
	09/02→	Centre Rod	DF-DL-8705		Push Rod
	09/02→	Centre Rod	DF-DL-12420		for Steering Rod
	09/02→	Suspension Arm Repair Kit		DF-RK-8633	for Wishbone (CV)
	09/02→	Tie Rod	DF-DL-5403		1st FA
	09/02→	Tie Rod	DF-DL-7780		1st FA
	09/02→	Tie Rod	DF-DL-10193		1st FA
	09/02→	Tie Rod End	CV-ES-12461		for Steering Rod
	09/02→	Tie Rod End	CV-ES-12462		for Steering Rod
	09/02→	Tie Rod End	CV-ES-14163		for Steering Rod
	09/02→	Track Control Arm		DF-DL-8158	Trailing Arm
	09/02→	Track Control Arm		DF-DL-9318	Trailing Arm
	09/02→	Track Control Arm		DF-TC-12262	Control Arm
FT 95.380	09/02→12/06	Centre Rod	DF-DL-2142		Push Rod
	09/02→12/06	Centre Rod	DF-DL-3798		Push Rod
	09/02→12/06	Centre Rod	DF-DL-8705		Push Rod
	09/02→12/06	Centre Rod	DF-DL-10187		Push Rod
	09/02→12/06	Suspension Arm Repair Kit		DF-RK-9336	
	09/02→12/06	Suspension Arm Repair Kit		MN-RK-7291	for Drag Link
	09/02→12/06	Suspension Arm Repair Kit	CV-RK-1583	CV-RK-1583	Trailing Arm
	09/02→12/06	Suspension Arm Repair Kit	MN-RK-7280	MN-RK-7280	for Drag Link;for Semi-Trailing Arm; for Wishbone (CV)
	09/02→12/06	Tie Rod	DF-DL-5403		1st FA
	09/02→12/06	Tie Rod	DF-DL-7780		1st FA
	09/02→12/06	Tie Rod	DF-DL-7836		1st FA
	09/02→12/06	Tie Rod	DF-DL-10193		1st FA
	09/02→12/06	Tie Rod End	CV-ES-12461		for Steering Rod
	09/02→12/06	Tie Rod End	CV-ES-12462		for Steering Rod
	09/02→12/06	Tie Rod End	CV-ES-14163		for Steering Rod
	09/02→12/06	Tie Rod End	DF-ES-8362		for Steering Rod
	09/02→12/06	Track Control Arm		DF-DL-8158	Trailing Arm
	09/02→12/06	Track Control Arm		DF-DL-9318	Trailing Arm
	09/02→12/06	Track Control Arm		DF-DL-9331	Wishbone (CV)
	09/02→12/06	Track Control Arm		DF-VB-8561	Wishbone (CV)
	FT 95.430	09/02→12/06	Centre Rod	DF-DL-2142	
09/02→12/06		Centre Rod	DF-DL-3798		Push Rod
09/02→12/06		Centre Rod	DF-DL-8705		Push Rod
09/02→12/06		Centre Rod	DF-DL-12420		for Steering Rod
09/02→12/06		Suspension Arm Repair Kit		DF-RK-9336	
09/02→12/06		Suspension Arm Repair Kit		MN-RK-7291	for Drag Link
09/02→12/06		Suspension Arm Repair Kit	CV-RK-1583	CV-RK-1583	Trailing Arm
09/02→12/06		Suspension Arm Repair Kit	MN-RK-7280	MN-RK-7280	for Drag Link;for Semi-Trailing Arm; for Wishbone (CV)
09/02→12/06		Tie Rod		DF-DL-5403	Tag Axle
09/02→12/06		Tie Rod		DF-DL-7780	Tag Axle
09/02→12/06		Tie Rod	DF-DL-7780		1st FA
09/02→12/06		Tie Rod	DF-DL-7836		1st FA
09/02→12/06		Tie Rod	DF-DL-8718		1st FA
09/02→12/06		Tie Rod	DF-DL-10193		1st FA
09/02→12/06		Tie Rod End	CV-ES-12461		for Steering Rod
09/02→12/06		Tie Rod End	CV-ES-12462		for Steering Rod
09/02→12/06		Tie Rod End	CV-ES-14163		for Steering Rod
09/02→12/06		Tie Rod End	DF-ES-8362		for Steering Rod
09/02→12/06		Track Control Arm		DF-DL-8158	Trailing Arm
09/02→12/06		Track Control Arm		DF-DL-9318	Trailing Arm
09/02→12/06		Track Control Arm		DF-DL-9331	Wishbone (CV)
09/02→12/06	Track Control Arm		DF-VB-8561	Wishbone (CV)	
FT 95.480	09/02→12/06	Centre Rod	DF-DL-2142		Push Rod
	09/02→12/06	Centre Rod	DF-DL-3798		Push Rod
	09/02→12/06	Suspension Arm Repair Kit		DF-RK-9336	
	09/02→12/06	Suspension Arm Repair Kit		MN-RK-7291	for Drag Link
	09/02→12/06	Suspension Arm Repair Kit	CV-RK-1583	CV-RK-1583	Trailing Arm

CV-ES-12461

Length: 120
Cone Ø: d1 Ø 26 / d2 Ø 23,5
Thread: M30 x 1,5 LHT
0069513, 69513, 0311300, 311300,
0607998, 607998, 1190653, 1315447,
1319838, 1332123, 1338714, 1401934,
1407394, ACHB063, ACHF241, MAK1295



CV-ES-12462

Length: 120
Cone Ø: d1 Ø 26 / d2 Ø 23,5
Thread: M30 x 1,5 RHT
0069514, 0586753, 0607999, 0694298,
0694360, 0698609, 1137230, 1229944,
1326862, 1326896, 1331925, ACHB064,
ACHF242, MAK1296



CV-ES-14163

Length: 125
Cone Ø: d1 Ø 30 / d2 Ø 27
Thread: M30 x 1,5 RHT
0607981, 0698450, 1149907, 1152350,
1257890, 1603789, 1618048, ACHF060



CV-RK-1583



DF-DL-2142

Length: 1005 Ø: 52
Cone Ø: d1 Ø 26 / d2 Ø 23,5
1291060, 1351734, 1385499



DF-DL-3798

Length: 1015 Ø: 50
Cone Ø: d1 Ø 30 / d2 Ø 27
0094038, 0525433

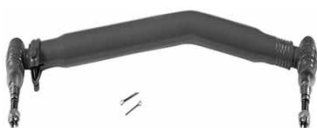

DF-DL-5403

Length: 1742 Ø: 40
Cone Ø: d1 Ø 26 / d2 Ø 23,5
0288281, 1270854, 1337644



DF-DL-7780

Length: 1690 Ø: 40
Cone Ø: d1 Ø 26 / d2 Ø 23,5
1270853, 1353391, 10212000A



DF-DL-7836

Length: 1698 Ø: 52
Cone Ø: d1 Ø 26 / d2 Ø 23,5
0754922, 1286343, 1353396



DF-DL-8158

Length: 611 Ø: 48
Hole Distance: 130 / 130
0267743, 1361649, 1361650, 1656428



DF-DL-8704

Length: 991 Ø: 50
Cone Ø: d1 Ø 30 / d2 Ø 27
1395994



DF-DL-8705

Length: 996 Ø: 38
Cone Ø: d1 Ø 30 / d2 Ø 27
1395993



DF-DL-8718

Length: 1690 Ø: 40
Cone Ø: d1 Ø 30 / d2 Ø 27
1700000



DF-DL-9318

Length: 600 Ø: 50
Hole Distance: 130 / 130
0646373, 0655695, 0655697, 1284860,
1620438



DF-DL-9331

Length: 390 Ø: 50
Hole Distance: 130 / 152
1261101



DF-DL-10187

Length: 1000 Ø: 52
Cone Ø: d1 Ø 30 / d2 Ø 27
1395995



DF-DL-10193

Length: 1646 Ø: 40
Cone Ø: d1 Ø 26 / d2 Ø 23,5
1351205, 1353395



DF-DL-12420

Length: 1004
Ø: 52
Cone Ø: d1 Ø 30 / d2 Ø 27
Thread: M24 x 1,5 / M30 x 1,5
094613, 94613, 0094613, 0362413, 362413,
1426101



DF-ES-8362

Length: 150
Cone Ø: d1 Ø 26 / d2 Ø 23,5
Thread: M30 x 1,5 RHT
1389190



DF-RK-8633

Ø: 90
0696320, 696320



DF-RK-9336

Ø: 108
1445656



DF-TC-12262

Length: 595 Ø: 50
Hole Distance: 130 / 130
0661406, 661406, 0661407, 661407,
1620439



DF-VB-8561

Length: 609 Ø: 48
Hole Distance: 152 / 152
0080521, 080521, 1361651, 1368270,
1390932, 1617096, 1793875, 1817808,
1892492



MN-RK-7280

Ø: 75
Hole Distance: 115
Thick/Height: 24
689748, 0689748



MN-RK-7291

Ø: 72
Hole Distance: 130
Thick/Height: 30
1271124





XF 95 ...

FT 95.480 ...	09/02→12/06	Suspension Arm Repair Kit	MN-RK-7280	MN-RK-7280	for Drag Link;for Semi-Trailing Arm; for Wishbone (CV)	
	09/02→12/06	Tie Rod End	CV-ES-12461		for Steering Rod	
	09/02→12/06	Tie Rod End	CV-ES-12462		for Steering Rod	
	09/02→12/06	Tie Rod End	CV-ES-14163		for Steering Rod	
	09/02→12/06	Tie Rod End	DF-ES-8362		for Steering Rod	
	09/02→12/06	Track Control Arm		DF-DL-8158	Trailing Arm	
	09/02→12/06	Track Control Arm		DF-DL-9331	Wishbone (CV)	
	09/02→12/06	Track Control Arm		DF-VB-8561	Wishbone (CV)	
	FT 95.530	09/02→12/06	Centre Rod	DF-DL-2142		Push Rod
09/02→12/06		Centre Rod	DF-DL-3798		Push Rod	
09/02→12/06		Centre Rod	DF-DL-5355		Push Rod	
09/02→12/06		Centre Rod	DF-DL-8705		Push Rod	
09/02→12/06		Centre Rod	DF-DL-10187		Push Rod	
09/02→12/06		Suspension Arm Repair Kit		DF-RK-9336		
09/02→12/06		Suspension Arm Repair Kit		MN-RK-7291	for Drag Link	
09/02→12/06		Suspension Arm Repair Kit	CV-RK-1583	CV-RK-1583	Trailing Arm	
09/02→12/06		Suspension Arm Repair Kit	MN-RK-7280	MN-RK-7280	for Drag Link;for Semi-Trailing Arm; for Wishbone (CV)	
09/02→12/06		Tie Rod	DF-DL-7780		1st FA	
09/02→12/06		Tie Rod	DF-DL-7836		1st FA	
09/02→12/06		Tie Rod	DF-DL-10193		1st FA	
09/02→12/06		Tie Rod End	CV-ES-12461		for Steering Rod	
09/02→12/06		Tie Rod End	CV-ES-12462		for Steering Rod	
09/02→12/06		Tie Rod End	CV-ES-14163		for Steering Rod	
09/02→12/06		Tie Rod End	DF-ES-8362		for Steering Rod	
09/02→12/06		Track Control Arm		DF-DL-8158	Trailing Arm	
09/02→12/06		Track Control Arm		DF-DL-9331	Wishbone (CV)	
09/02→12/06		Track Control Arm		DF-VB-8561	Wishbone (CV)	
FTG 95.380		09/02→12/06	Centre Rod	DF-DL-8705		Push Rod
		09/02→12/06	Suspension Arm Repair Kit		DF-RK-9336	
		09/02→12/06	Tie Rod		DF-ES-5761	Leading Axle
		09/02→12/06	Tie Rod	DF-DL-7780		1st FA
		09/02→12/06	Tie Rod End		DF-ES-8362	for Steering Rod
	09/02→12/06	Tie Rod End	CV-ES-12461		for Steering Rod	
	09/02→12/06	Tie Rod End	CV-ES-12462		for Steering Rod	
	09/02→12/06	Tie Rod End	CV-ES-14162		for Steering Rod	
	09/02→12/06	Tie Rod End	CV-ES-14163		for Steering Rod	
	09/02→12/06	Tie Rod End	DF-ES-12428		for Steering Rod	
	09/02→12/06	Track Control Arm		DF-DL-8158	Trailing Arm	
	09/02→12/06	Track Control Arm		DF-TC-12492	Control Arm	
	09/02→12/06	Track Control Arm		DF-VB-8561	Wishbone (CV)	
	FTG 95.430	12/05→12/06	Centre Rod	DF-DL-10192		Push Rod, for vehicles with Hinged Leading Axle
		12/05→12/06	Suspension Arm Repair Kit		DF-RK-9336	
12/05→12/06		Tie Rod	DF-DL-7780		1st FA	
12/05→12/06		Tie Rod End		DF-ES-8362	for Steering Rod	
12/05→12/06		Tie Rod End	CV-ES-12461		for Steering Rod	
12/05→12/06		Tie Rod End	CV-ES-12462		for Steering Rod	
12/05→12/06		Tie Rod End	CV-ES-14162		for Steering Rod	
12/05→12/06		Tie Rod End	CV-ES-14163		for Steering Rod	
12/05→12/06		Tie Rod End	DF-ES-12428		for Steering Rod	
12/05→12/06		Track Control Arm		DF-DL-8158	Trailing Arm	
12/05→12/06		Track Control Arm		DF-TC-12492	Trailing Arm, Leading Axle Steered, for Pneumatic Suspension vehicles	
12/05→12/06		Track Control Arm		DF-VB-8561	Wishbone (CV), 1st RA, for Pneumatic Suspension vehicles	
FTG 95.480		12/05→12/06	Centre Rod	DF-DL-8705		Push Rod
	12/05→12/06	Centre Rod	DF-DL-10192		Push Rod, for vehicles with Hinged Leading Axle	
	12/05→12/06	Suspension Arm Repair Kit		DF-RK-9336		
	12/05→12/06	Tie Rod		DF-ES-5761	Leading Axle	
	12/05→12/06	Tie Rod	DF-DL-7780		1st FA	
	12/05→12/06	Tie Rod	DF-DL-10193		1st FA	
	12/05→12/06	Tie Rod End		DF-ES-8362	for Steering Rod	

CV-ES-12461

Length: 120
Cone Ø: d1 Ø 26 / d2 Ø 23,5
Thread: M30 x 1,5 LHT
0069513, 69513, 0311300, 311300,
0607998, 607998, 1190653, 1315447,
1319838, 1332123, 1338714, 1401934,
1407394, ACHB063, ACHF241, MAK1295



CV-ES-12462

Length: 120
Cone Ø: d1 Ø 26 / d2 Ø 23,5
Thread: M30 x 1,5 RHT
0069514, 0586753, 0607999, 0694298,
0694360, 0698609, 1137230, 1229944,
1326862, 1326896, 1331925, ACHB064,
ACHF242, MAK1296



CV-ES-14162

Length: 125
Cone Ø: d1 Ø 30 / d2 Ø 27
Thread: M30 x 1,5 LHT
607053, 690225, 696225, 1228115,
1611088



CV-ES-14163

Length: 125
Cone Ø: d1 Ø 30 / d2 Ø 27
Thread: M30 x 1,5 RHT
0607981, 0698450, 1149907, 1152350,
1257890, 1603789, 1618048, ACHF060



CV-RK-1583



DF-DL-2142

Length: 1005 Ø: 52
Cone Ø: d1 Ø 26 / d2 Ø 23,5
1291060, 1351734, 1385499



DF-DL-3798

Length: 1015 Ø: 50
Cone Ø: d1 Ø 30 / d2 Ø 27
0094038, 0525433

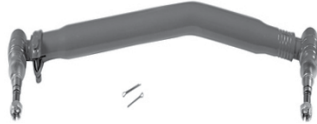

DF-DL-5355

Length: 995 Ø: 36
Cone Ø: d1 Ø 26 / d2 Ø 23,5
1311048, 1351737, 1385498



DF-DL-7780

Length: 1690 Ø: 40
Cone Ø: d1 Ø 26 / d2 Ø 23,5
1270853, 1353391, 10212000A



DF-DL-7836

Length: 1698 Ø: 52
Cone Ø: d1 Ø 26 / d2 Ø 23,5
0754922, 1286343, 1353396



DF-DL-8158

Length: 611 Ø: 48
Hole Distance: 130 / 130
0267743, 1361649, 1361650, 1656428



DF-DL-8705

Length: 996
Ø: 38
Cone Ø: d1 Ø 30 / d2 Ø 27
1395993



DF-DL-9331

Length: 390 Ø: 50
Hole Distance: 130 / 152
1261101



DF-DL-10187

Length: 1000 Ø: 52
Cone Ø: d1 Ø 30 / d2 Ø 27
1395995



DF-DL-10192

Length: 590 Ø: 38
Cone Ø: d1 Ø 30 / d2 Ø 27
1440171, 1451119



DF-DL-10193

Length: 1646 Ø: 40
Cone Ø: d1 Ø 26 / d2 Ø 23,5
1351205, 1353395



DF-ES-5761

Length: 1512 Ø: 52
Cone Ø: d1 Ø 26 / d2 Ø 23,5
1297572, 1361155



DF-ES-8362

Length: 150
Cone Ø: d1 Ø 26 / d2 Ø 23,5
Thread: M30 x 1,5 RHT
1389190



DF-ES-12428

Length: 120
Cone Ø: d1 Ø 30
Thread: M24 x 1,5 RHT
1603788, 1604105



DF-RK-9336

Ø: 108
1445656



DF-TC-12492

Length: 600 Ø: 40
Hole Distance: 115 / 115
1274741

No Image

DF-VB-8561

Length: 609 Ø: 48
Hole Distance: 152 / 152
0080521, 080521, 1361651, 1368270,
1390932, 1617096, 1793875, 1817808,
1892492



MN-RK-7280

Ø: 75
Hole Distance: 115
Thick/Height: 24
0689748, 689748



MN-RK-7291

Ø: 72
Hole Distance: 130
Thick/Height: 30
1271124





XF 95 ...

FTG 95.480 ...	12/05→12/06	Tie Rod End	CV-ES-12461		for Steering Rod	
	12/05→12/06	Tie Rod End	CV-ES-12462		for Steering Rod	
	12/05→12/06	Tie Rod End	CV-ES-14162		for Steering Rod	
	12/05→12/06	Tie Rod End	CV-ES-14163		for Steering Rod	
	12/05→12/06	Tie Rod End	DF-ES-12428		for Steering Rod	
	12/05→12/06	Track Control Arm		DF-DL-8158	Trailing Arm	
	12/05→12/06	Track Control Arm		DF-TC-12492	Control Arm	
	12/05→12/06	Track Control Arm		DF-VB-8561	Wishbone (CV)	
	FTG 95.530	09/02→12/06	Centre Rod	DF-DL-8705		Push Rod
09/02→12/06		Centre Rod	DF-DL-10192		Push Rod, for vehicles with Hinged Leading Axle	
09/02→12/06		Suspension Arm Repair Kit		DF-RK-9336		
09/02→12/06		Tie Rod		DF-ES-5761	Leading Axle	
09/02→12/06		Tie Rod	DF-DL-5403		1st FA	
09/02→12/06		Tie Rod	DF-DL-7780		1st FA	
09/02→12/06		Tie Rod	DF-DL-10193		1st FA	
09/02→12/06		Tie Rod End		DF-ES-8362	for Steering Rod	
09/02→12/06		Tie Rod End	CV-ES-12461		for Steering Rod	
09/02→12/06		Tie Rod End	CV-ES-12462		for Steering Rod	
09/02→12/06		Tie Rod End	CV-ES-14162		for Steering Rod	
09/02→12/06		Tie Rod End	CV-ES-14163		for Steering Rod	
09/02→12/06		Tie Rod End	DF-ES-12428		for Steering Rod	
09/02→12/06		Track Control Arm		DF-DL-8158	Trailing Arm	
09/02→12/06		Track Control Arm		DF-TC-12492	Control Arm	
09/02→12/06		Track Control Arm		DF-VB-8561	Wishbone (CV)	
FTM 95.380		12/05→12/06	Centre Rod	DF-DL-10192		Push Rod
		12/05→12/06	Tie Rod		DF-ES-5761	
		12/05→12/06	Tie Rod	DF-DL-7780		
		12/05→12/06	Tie Rod End		DF-ES-8362	for Steering Rod
		12/05→12/06	Tie Rod End	CV-ES-12461		for Steering Rod
	12/05→12/06	Tie Rod End	CV-ES-12462		for Steering Rod	
	12/05→12/06	Tie Rod End	CV-ES-14162		for Steering Rod	
	12/05→12/06	Tie Rod End	CV-ES-14163		for Steering Rod	
	12/05→12/06	Tie Rod End	DF-ES-12428		for Steering Rod	
	12/05→12/06	Track Control Arm		DF-TC-12492	Trailing Arm, Leading Axle Steered, for Pneumatic Suspension vehicles	
	FTM 95.430	12/05→12/06	Centre Rod	DF-DL-8705		Push Rod
12/05→12/06		Centre Rod	DF-DL-10192		Push Rod, for vehicles with Hinged Leading Axle	
12/05→12/06		Tie Rod		DF-ES-5761	Leading Axle	
12/05→12/06		Tie Rod	DF-DL-5403		1st FA	
12/05→12/06		Tie Rod End		DF-ES-8362	for Steering Rod	
12/05→12/06		Tie Rod End	CV-ES-12461		for Steering Rod	
12/05→12/06		Tie Rod End	CV-ES-12462		for Steering Rod	
12/05→12/06		Tie Rod End	CV-ES-14162		for Steering Rod	
12/05→12/06		Tie Rod End	CV-ES-14163		for Steering Rod	
12/05→12/06		Tie Rod End	DF-ES-12428		for Steering Rod	
12/05→12/06		Track Control Arm		DF-DL-8158	Trailing Arm	
12/05→12/06		Track Control Arm		DF-TC-12492	Control Arm	
FTM 95.480		12/05→12/06	Centre Rod	DF-DL-8705		Push Rod
	12/05→12/06	Centre Rod	DF-DL-10192		Push Rod, for vehicles with Hinged Leading Axle	
	12/05→12/06	Tie Rod		DF-ES-5761	Leading Axle	
	12/05→12/06	Tie Rod	DF-DL-5403		1st FA	
	12/05→12/06	Tie Rod	DF-DL-7780		1st FA	
	12/05→12/06	Tie Rod End		DF-ES-8362	for Steering Rod	
	12/05→12/06	Tie Rod End	CV-ES-12461		for Steering Rod	
	12/05→12/06	Tie Rod End	CV-ES-12462		for Steering Rod	
	12/05→12/06	Tie Rod End	CV-ES-14162		for Steering Rod	
	12/05→12/06	Tie Rod End	CV-ES-14163		for Steering Rod	
	12/05→12/06	Tie Rod End	DF-ES-12428		for Steering Rod	
	12/05→12/06	Track Control Arm		DF-DL-8158	Trailing Arm	
	12/05→12/06	Track Control Arm		DF-DL-9318	Trailing Arm	
	12/05→12/06	Track Control Arm		DF-TC-12262	Control Arm	
12/05→12/06	Track Control Arm		DF-TC-12492	Control Arm		

CV-ES-12461

Length: 120
Cone Ø: d1 Ø 26 / d2 Ø 23,5
Thread: M30 x 1,5 LHT
0069513, 69513, 0311300, 311300,
0607998, 607998, 1190653, 1315447,
1319838, 1332123, 1338714, 1401934,
1407394, ACHB063, ACHF241, MAK1295



CV-ES-12462

Length: 120
Cone Ø: d1 Ø 26 / d2 Ø 23,5
Thread: M30 x 1,5 RHT
0069514, 0586753, 0607999, 0694298,
0694360, 0698609, 1137230, 1229944,
1326862, 1326896, 1331925, ACHB064,
ACHF242, MAK1296



CV-ES-14162

Length: 125
Cone Ø: d1 Ø 30 / d2 Ø 27
Thread: M30 x 1,5 LHT
607053, 690225, 696225, 1228115,
1611088



CV-ES-14163

Length: 125
Cone Ø: d1 Ø 30 / d2 Ø 27
Thread: M30 x 1,5 RHT
0607981, 0698450, 1149907, 1152350,
1257890, 1603789, 1618048, ACHF060



DF-DL-5403

Length: 1742
Ø: 40
Cone Ø: d1 Ø 26 / d2 Ø 23,5
0288281, 1270854, 1337644



DF-DL-7780

Length: 1690
Ø: 40
Cone Ø: d1 Ø 26 / d2 Ø 23,5
1270853, 1353391, 10212000A



DF-DL-8158

Length: 611
Ø: 48
Hole Distance: 130 / 130
0267743, 1361649, 1361650, 1656428



DF-DL-8705

Length: 996
Ø: 38
Cone Ø: d1 Ø 30 / d2 Ø 27
1395993



DF-DL-9318

Length: 600
Ø: 50
Hole Distance: 130 / 130
0646373, 0655695, 0655697, 1284860,
1620438



DF-DL-10192

Length: 590
Ø: 38
Cone Ø: d1 Ø 30 / d2 Ø 27
1440171, 1451119



DF-DL-10193

Length: 1646
Ø: 40
Cone Ø: d1 Ø 26 / d2 Ø 23,5
1351205, 1353395



DF-ES-5761

Length: 1512
Ø: 52
Cone Ø: d1 Ø 26 / d2 Ø 23,5
1297572, 1361155



DF-ES-8362

Length: 150
Cone Ø: d1 Ø 26 / d2 Ø 23,5
Thread: M30 x 1,5 RHT
1389190



DF-ES-12428

Length: 120
Cone Ø: d1 Ø 30
Thread: M24 x 1,5 RHT
1603788, 1604105



DF-RK-9336

Ø: 108
1445656



DF-TC-12262

Length: 595
Ø: 50
Hole Distance: 130 / 130
661406, 0661406, 0661407, 661407,
1620439



DF-TC-12492

Length: 600
Ø: 40
Hole Distance: 115 / 115
1274741

No Image

DF-VB-8561

Length: 609
Ø: 48
Hole Distance: 152 / 152
0080521, 080521, 1361651, 1368270,
1390932, 1617096, 1793875, 1817808,
1892492





XF 95 ...

FTM 95.530	09/02→12/06	Centre Rod	DF-DL-8705		Push Rod
	09/02→12/06	Centre Rod	DF-DL-10192		Push Rod, for vehicles with Hinged Leading Axle
	09/02→12/06	Tie Rod		DF-ES-5761	Leading Axle
	09/02→12/06	Tie Rod	DF-DL-5403		1st FA
	09/02→12/06	Tie Rod	DF-DL-7780		1st FA
	09/02→12/06	Tie Rod End		DF-ES-8362	for Steering Rod
	09/02→12/06	Tie Rod End	CV-ES-12461		for Steering Rod
	09/02→12/06	Tie Rod End	CV-ES-12462		for Steering Rod
	09/02→12/06	Tie Rod End	CV-ES-14162		for Steering Rod
	09/02→12/06	Tie Rod End	CV-ES-14163		for Steering Rod
	09/02→12/06	Tie Rod End	DF-ES-12428		for Steering Rod
	09/02→12/06	Track Control Arm		DF-DL-8158	Trailing Arm
	09/02→12/06	Track Control Arm		DF-DL-9318	Trailing Arm
	09/02→12/06	Track Control Arm		DF-TC-12262	Control Arm
09/02→12/06	Track Control Arm		DF-TC-12492	Control Arm	
FTP 95.380	01/02→12/06	Centre Rod	DF-DL-8704		Push Rod
	01/02→12/06	Centre Rod	DF-DL-12420		for Steering Rod
	01/02→12/06	Suspension Arm Repair Kit		DF-RK-9336	
	01/02→12/06	Tie Rod	DF-DL-7780		1st FA
	01/02→12/06	Tie Rod End	CV-ES-12461		for Steering Rod
	01/02→12/06	Tie Rod End	CV-ES-12462		for Steering Rod
	01/02→12/06	Tie Rod End	CV-ES-14163		for Steering Rod
	01/02→12/06	Track Control Arm		DF-DL-8158	Trailing Arm
01/02→12/06	Track Control Arm		DF-VB-8561	Wishbone (CV)	
FTP 95.430	01/02→12/06	Centre Rod	DF-DL-8704		Push Rod
	01/02→12/06	Centre Rod	DF-DL-12420		for Steering Rod
	01/02→12/06	Suspension Arm Repair Kit		DF-RK-9336	
	01/02→12/06	Tie Rod	DF-DL-7780		1st FA
	01/02→12/06	Tie Rod End	CV-ES-12461		for Steering Rod
	01/02→12/06	Tie Rod End	CV-ES-12462		for Steering Rod
	01/02→12/06	Tie Rod End	CV-ES-14163		for Steering Rod
	01/02→12/06	Track Control Arm		DF-DL-8158	Trailing Arm
01/02→12/06	Track Control Arm		DF-VB-8561	Wishbone (CV)	
FTP 95.480	01/02→12/06	Centre Rod	DF-DL-8704		Push Rod
	01/02→12/06	Centre Rod	DF-DL-12420		for Steering Rod
	01/02→12/06	Suspension Arm Repair Kit		DF-RK-9336	
	01/02→12/06	Tie Rod	DF-DL-7780		1st FA
	01/02→12/06	Tie Rod End	CV-ES-12461		for Steering Rod
	01/02→12/06	Tie Rod End	CV-ES-12462		for Steering Rod
	01/02→12/06	Tie Rod End	CV-ES-14163		for Steering Rod
	01/02→12/06	Track Control Arm		DF-DL-8158	Trailing Arm
01/02→12/06	Track Control Arm		DF-VB-8561	Wishbone (CV)	
FTP 95.530	09/02→	Centre Rod	DF-DL-8704		Push Rod
	09/02→	Centre Rod	DF-DL-12420		for Steering Rod
	09/02→	Suspension Arm Repair Kit		DF-RK-9336	
	09/02→	Tie Rod	DF-DL-7780		1st FA
	09/02→	Tie Rod End	CV-ES-12461		for Steering Rod
	09/02→	Tie Rod End	CV-ES-12462		for Steering Rod
	09/02→	Tie Rod End	CV-ES-14163		for Steering Rod
	09/02→	Track Control Arm		DF-DL-8158	Trailing Arm
09/02→	Track Control Arm		DF-VB-8561	Wishbone (CV)	
FTR 95.380	01/02→12/06	Centre Rod	DF-DL-8704		Push Rod
	01/02→12/06	Centre Rod	DF-DL-12420		for Steering Rod
	01/02→12/06	Suspension Arm Repair Kit		DF-RK-9336	
	01/02→12/06	Tie Rod	DF-DL-7780		
	01/02→12/06	Tie Rod End	CV-ES-12461		for Steering Rod
	01/02→12/06	Tie Rod End	CV-ES-12462		for Steering Rod
	01/02→12/06	Tie Rod End	CV-ES-14163		for Steering Rod
	01/02→12/06	Track Control Arm		DF-DL-8158	Trailing Arm
01/02→12/06	Track Control Arm		DF-VB-8561	Wishbone (CV)	

CV-ES-12461

Length: 120
Cone Ø: d1 Ø 26 / d2 Ø 23,5
Thread: M30 x 1,5 LHT
0069513, 69513, 0311300, 311300,
0607998, 607998, 1190653, 1315447,
1319838, 1332123, 1338714, 1401934,
1407394, ACHB063, ACHF241, MAK1295



CV-ES-12462

Length: 120
Cone Ø: d1 Ø 26 / d2 Ø 23,5
Thread: M30 x 1,5 RHT
0069514, 0586753, 0607999, 0694298,
0694360, 0698609, 1137230, 1229944,
1326862, 1326896, 1331925, ACHB064,
ACHF242, MAK1296



CV-ES-14162

Length: 125
Cone Ø: d1 Ø 30 / d2 Ø 27
Thread: M30 x 1,5 LHT
607053, 690225, 696225, 1228115,
1611088



CV-ES-14163

Length: 125
Cone Ø: d1 Ø 30 / d2 Ø 27
Thread: M30 x 1,5 RHT
0607981, 0698450, 1149907, 1152350,
1257890, 1603789, 1618048, ACHF060



DF-DL-5403

Length: 1742
Ø: 40
Cone Ø: d1 Ø 26 / d2 Ø 23,5
0288281, 1270854, 1337644



DF-DL-7780

Length: 1690
Ø: 40
Cone Ø: d1 Ø 26 / d2 Ø 23,5
1270853, 1353391, 10212000A



DF-DL-8158

Length: 611
Ø: 48
Hole Distance: 130 / 130
0267743, 1361649, 1361650, 1656428



DF-DL-8704

Length: 991
Ø: 50
Cone Ø: d1 Ø 30 / d2 Ø 27
1395994



DF-DL-8705

Length: 996
Ø: 38
Cone Ø: d1 Ø 30 / d2 Ø 27
1395993



DF-DL-9318

Length: 600
Ø: 50
Hole Distance: 130 / 130
0646373, 0655695, 0655697, 1284860,
1620438



DF-DL-10192

Length: 590
Ø: 38
Cone Ø: d1 Ø 30 / d2 Ø 27
1440171, 1451119



DF-DL-12420

Length: 1004
Ø: 52
Cone Ø: d1 Ø 30 / d2 Ø 27
Thread: M24 x 1,5 / M30 x 1,5
0094613, 094613, 94613, 0362413, 362413,
1426101



DF-ES-5761

Length: 1512
Ø: 52
Cone Ø: d1 Ø 26 / d2 Ø 23,5
1297572, 1361155



DF-ES-8362

Length: 150
Cone Ø: d1 Ø 26 / d2 Ø 23,5
Thread: M30 x 1,5 RHT
1389190



DF-ES-12428

Length: 120
Cone Ø: d1 Ø 30
Thread: M24 x 1,5 RHT
1603788, 1604105



DF-RK-9336

Ø: 108
1445656



DF-TC-12262

Length: 595
Ø: 50
Hole Distance: 130 / 130
0661406, 661406, 0661407, 661407,
1620439



DF-TC-12492

Length: 600
Ø: 40
Hole Distance: 115 / 115
1274741

No Image

DF-VB-8561

Length: 609
Ø: 48
Hole Distance: 152 / 152
0080521, 080521, 1361651, 1368270,
1390932, 1617096, 1793875, 1817808,
1892492



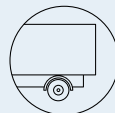

XF 95 ...

FTR 95.430	01/02→12/06	Centre Rod	DF-DL-8704		Push Rod
	01/02→12/06	Suspension Arm Repair Kit		DF-RK-9336	
	01/02→12/06	Tie Rod	DF-DL-7780		1st FA
	01/02→12/06	Tie Rod	DF-DL-10193		1st FA
	01/02→12/06	Tie Rod End	CV-ES-12461		for Steering Rod
	01/02→12/06	Tie Rod End	CV-ES-12462		for Steering Rod
	01/02→12/06	Tie Rod End	CV-ES-14163		for Steering Rod
	01/02→12/06	Track Control Arm		DF-DL-8158	Trailing Arm
	01/02→12/06	Track Control Arm		DF-VB-8561	Wishbone (CV)
FTR 95.480	01/02→12/06	Centre Rod	DF-DL-8704		Push Rod
	01/02→12/06	Centre Rod	DF-DL-12420		for Steering Rod
	01/02→12/06	Suspension Arm Repair Kit		DF-RK-9336	
	01/02→12/06	Tie Rod	DF-DL-7780		1st FA
	01/02→12/06	Tie Rod	DF-DL-10193		1st FA
	01/02→12/06	Tie Rod End	CV-ES-12461		for Steering Rod
	01/02→12/06	Tie Rod End	CV-ES-12462		for Steering Rod
	01/02→12/06	Tie Rod End	CV-ES-14163		for Steering Rod
	01/02→12/06	Track Control Arm		DF-DL-8158	Trailing Arm
01/02→12/06	Track Control Arm		DF-VB-8561	Wishbone (CV)	
FTR 95.530	09/02→	Centre Rod	DF-DL-8704		Push Rod
	09/02→	Suspension Arm Repair Kit		DF-RK-9336	
	09/02→	Tie Rod	DF-DL-7780		1st FA
	09/02→	Tie Rod	DF-DL-10193		1st FA
	09/02→	Tie Rod End	CV-ES-12461		for Steering Rod
	09/02→	Tie Rod End	CV-ES-12462		for Steering Rod
	09/02→	Tie Rod End	CV-ES-14163		for Steering Rod
	09/02→	Track Control Arm		DF-DL-8158	Trailing Arm
	09/02→	Track Control Arm		DF-VB-8561	Wishbone (CV)
FTS 95.380	01/02→12/06	Centre Rod	DF-DL-8704		Push Rod
	01/02→12/06	Suspension Arm Repair Kit		DF-RK-9336	
	01/02→12/06	Tie Rod	DF-DL-7780		1st FA
	01/02→12/06	Tie Rod	DF-DL-10193		1st FA
	01/02→12/06	Tie Rod End	CV-ES-12461		for Steering Rod
	01/02→12/06	Tie Rod End	CV-ES-12462		for Steering Rod
	01/02→12/06	Tie Rod End	CV-ES-14163		for Steering Rod
	01/02→12/06	Track Control Arm		DF-DL-8158	Trailing Arm
	01/02→12/06	Track Control Arm		DF-VB-8561	Wishbone (CV)
FTS 95.430	01/02→12/06	Centre Rod	DF-DL-8704		Push Rod
	01/02→12/06	Suspension Arm Repair Kit		DF-RK-9336	
	01/02→12/06	Tie Rod	DF-DL-7780		1st FA
	01/02→12/06	Tie Rod	DF-DL-10193		1st FA
	01/02→12/06	Tie Rod End	CV-ES-12461		for Steering Rod
	01/02→12/06	Tie Rod End	CV-ES-12462		for Steering Rod
	01/02→12/06	Tie Rod End	CV-ES-14163		for Steering Rod
	01/02→12/06	Track Control Arm		DF-DL-8158	Trailing Arm
	01/02→12/06	Track Control Arm		DF-VB-8561	Wishbone (CV)
FTS 95.480	01/02→12/06	Centre Rod	DF-DL-8704		Push Rod
	01/02→12/06	Centre Rod	DF-DL-8705		Push Rod
	01/02→12/06	Centre Rod	DF-DL-12420		for Steering Rod
	01/02→12/06	Suspension Arm Repair Kit		DF-RK-9336	
	01/02→12/06	Tie Rod	DF-DL-7780		1st FA
	01/02→12/06	Tie Rod	DF-DL-10193		1st FA
	01/02→12/06	Tie Rod End	CV-ES-12461		for Steering Rod
	01/02→12/06	Tie Rod End	CV-ES-12462		for Steering Rod
	01/02→12/06	Tie Rod End	CV-ES-14163		for Steering Rod
FTS 95.530	01/02→12/06	Track Control Arm		DF-DL-8158	Trailing Arm
	01/02→12/06	Track Control Arm		DF-VB-8561	Wishbone (CV)
	09/02→	Centre Rod	DF-DL-8704		Push Rod
	09/02→	Centre Rod	DF-DL-12420		for Steering Rod
	09/02→	Suspension Arm Repair Kit		DF-RK-9336	
	09/02→	Tie Rod	DF-DL-7780		1st FA
	09/02→	Tie Rod	DF-DL-10193		1st FA
	09/02→	Tie Rod End	CV-ES-12461		for Steering Rod
	09/02→	Tie Rod End	CV-ES-12462		for Steering Rod

CV-ES-12461

Length: 120
Cone Ø: d1 Ø 26 / d2 Ø 23,5
Thread: M30 x 1,5 LHT
0069513, 69513, 0311300, 311300, 607998,
0607998, 1190653, 1315447, 1319838,
1332123, 1338714, 1401934, 1407394,
ACHB063, ACHF241, MAK1295



CV-ES-12462

Length: 120
Cone Ø: d1 Ø 26 / d2 Ø 23,5
Thread: M30 x 1,5 RHT
0069514, 0586753, 0607999, 0694298,
0694360, 0698609, 1137230, 1229944,
1326862, 1326896, 1331925, ACHB064,
ACHF242, MAK1296



CV-ES-14163

Length: 125
Cone Ø: d1 Ø 30 / d2 Ø 27
Thread: M30 x 1,5 RHT
0607981, 0698450, 1149907, 1152350,
1257890, 1603789, 1618048, ACHF060



DF-DL-7780

Length: 1690
Ø: 40
Cone Ø: d1 Ø 26 / d2 Ø 23,5
1270853, 1353391, 10212000A



DF-DL-8158

Length: 611
Ø: 48
Hole Distance: 130 / 130
0267743, 1361649, 1361650, 1656428



DF-DL-8704

Length: 991
Ø: 50
Cone Ø: d1 Ø 30 / d2 Ø 27
1395994



DF-DL-8705

Length: 996
Ø: 38
Cone Ø: d1 Ø 30 / d2 Ø 27
1395993



DF-DL-10193

Length: 1646
Ø: 40
Cone Ø: d1 Ø 26 / d2 Ø 23,5
1351205, 1353395



DF-DL-12420

Length: 1004
Ø: 52
Cone Ø: d1 Ø 30 / d2 Ø 27
Thread: M24 x 1,5 / M30 x 1,5
0094613, 094613, 94613, 0362413, 362413,
1426101



DF-RK-9336

Ø: 108
1445656



DF-VB-8561

Length: 609
Ø: 48
Hole Distance: 152 / 152
080521, 0080521, 1361651, 1368270,
1390932, 1617096, 1793875, 1817808,
1892492





XF 95 ...

FTS 95.530 ...	09/02→	Tie Rod End	CV-ES-12462		for Steering Rod	
	09/02→	Tie Rod End	CV-ES-14163		for Steering Rod	
	09/02→	Track Control Arm		DF-DL-8158	Trailing Arm	
	09/02→	Track Control Arm		DF-VB-8561	Wishbone (CV)	
FTT 95.380	01/02→03/06	Centre Rod	DF-DL-8704		Push Rod	
	01/02→03/06	Suspension Arm Repair Kit		DF-RK-9336		
	01/02→03/06	Tie Rod	DF-DL-7780			
	01/02→03/06	Tie Rod End	CV-ES-12461		for Steering Rod	
	01/02→03/06	Tie Rod End	CV-ES-12462		for Steering Rod	
	01/02→03/06	Tie Rod End	CV-ES-14163		for Steering Rod	
	01/02→03/06	Track Control Arm		DF-DL-8158	Trailing Arm	
	01/02→03/06	Track Control Arm		DF-VB-8561	Wishbone (CV)	
FTT 95.430	01/02→03/06	Centre Rod	DF-DL-8704		Push Rod	
	01/02→03/06	Centre Rod	DF-DL-12420		for Steering Rod	
	01/02→03/06	Suspension Arm Repair Kit		DF-RK-9336		
	01/02→03/06	Tie Rod	DF-DL-5403		1st FA	
	01/02→03/06	Tie Rod	DF-DL-7780		1st FA	
	01/02→03/06	Tie Rod	DF-DL-10193		1st FA	
	01/02→03/06	Tie Rod End	CV-ES-12461		for Steering Rod	
	01/02→03/06	Tie Rod End	CV-ES-12462		for Steering Rod	
	01/02→03/06	Tie Rod End	CV-ES-14163		for Steering Rod	
	01/02→03/06	Track Control Arm		DF-DL-8158	Trailing Arm	
	01/02→03/06	Track Control Arm		DF-DL-9318	Trailing Arm	
	01/02→03/06	Track Control Arm		DF-TC-12262	Control Arm	
	01/02→03/06	Track Control Arm		DF-VB-8561	Wishbone (CV), 1st RA;2nd RA, for Pneumatic Suspension vehicles	
	FTT 95.480	01/02→03/06	Centre Rod	DF-DL-8704		Push Rod
		01/02→03/06	Centre Rod	DF-DL-12420		for Steering Rod
01/02→03/06		Suspension Arm Repair Kit		DF-RK-9336		
01/02→03/06		Tie Rod	DF-DL-5403		Tag Axle	
01/02→03/06		Tie Rod	DF-DL-7780		1st FA	
01/02→03/06		Tie Rod	DF-DL-10193		1st FA	
01/02→03/06		Tie Rod End	CV-ES-12461		for Steering Rod	
01/02→03/06		Tie Rod End	CV-ES-12462		for Steering Rod	
01/02→03/06		Tie Rod End	CV-ES-14163		for Steering Rod	
01/02→03/06		Track Control Arm		DF-DL-8158	Trailing Arm	
01/02→03/06		Track Control Arm		DF-DL-9318	Trailing Arm	
01/02→03/06		Track Control Arm		DF-TC-12262	Control Arm	
01/02→03/06		Track Control Arm		DF-VB-8561	Wishbone (CV)	
FTT 95.530		09/02→	Centre Rod	DF-DL-8704		Push Rod
	09/02→	Centre Rod	DF-DL-12420		for Steering Rod	
	09/02→	Suspension Arm Repair Kit		DF-RK-9336		
	09/02→	Tie Rod	DF-DL-5403		1st FA	
	09/02→	Tie Rod	DF-DL-7780		1st FA	
	09/02→	Tie Rod	DF-DL-10193		1st FA	
	09/02→	Tie Rod End	CV-ES-12461		for Steering Rod	
	09/02→	Tie Rod End	CV-ES-12462		for Steering Rod	
	09/02→	Tie Rod End	CV-ES-14163		for Steering Rod	
	09/02→	Track Control Arm		DF-DL-8158	Trailing Arm, 1st RA;Air Suspension Axle	
	09/02→	Track Control Arm		DF-TC-12262	Control Arm	
	09/02→	Track Control Arm		DF-VB-8561	Wishbone (CV), 1st RA;2nd RA, for Pneumatic Suspension vehicles	

XF 105

FA 105.410	10/05→	Centre Rod	DF-DL-8704		Push Rod
	10/05→	Centre Rod	DF-DL-8705		Push Rod
	10/05→	Centre Rod	DF-DL-10187		Push Rod
	10/05→	Centre Rod	DF-DL-12420		for Steering Rod
	10/05→	Suspension Arm Repair Kit	MN-RK-7280	MN-RK-7280	for Drag Link;for Semi-Trailing Arm; for Wishbone (CV)
	10/05→	Tie Rod	DF-DL-5403		1st FA
	10/05→	Tie Rod	DF-DL-7836		1st FA
	10/05→	Tie Rod	DF-DL-10193		1st FA

CV-ES-12461

Length: 120
Cone Ø: d1 Ø 26 / d2 Ø 23,5
Thread: M30 x 1,5 LHT
69513, 0069513, 311300, 0311300,
0607998, 607998, 1190653, 1315447,
1319838, 1332123, 1338714, 1401934,
1407394, ACHB063, ACHF241, MAK1295



CV-ES-12462

Length: 120
Cone Ø: d1 Ø 26 / d2 Ø 23,5
Thread: M30 x 1,5 RHT
0069514, 0586753, 0607999, 0694298,
0694360, 0698609, 1137230, 1229944,
1326862, 1326896, 1331925, ACHB064,
ACHF242, MAK1296



CV-ES-14163

Length: 125
Cone Ø: d1 Ø 30 / d2 Ø 27
Thread: M30 x 1,5 RHT
0607981, 0698450, 1149907, 1152350,
1257890, 1603789, 1618048, ACHF060



DF-DL-5403

Length: 1742
Ø: 40
Cone Ø: d1 Ø 26 / d2 Ø 23,5
0288281, 1270854, 1337644



DF-DL-7780

Length: 1690
Ø: 40
Cone Ø: d1 Ø 26 / d2 Ø 23,5
1270853, 1353391, 1021200A



DF-DL-7836

Length: 1698
Ø: 52
Cone Ø: d1 Ø 26 / d2 Ø 23,5
0754922, 1286343, 1353396



DF-DL-8158

Length: 611
Ø: 48
Hole Distance: 130 / 130
0267743, 1361649, 1361650, 1656428



DF-DL-8704

Length: 991
Ø: 50
Cone Ø: d1 Ø 30 / d2 Ø 27
1395994



DF-DL-8705

Length: 996
Ø: 38
Cone Ø: d1 Ø 30 / d2 Ø 27
1395993



DF-DL-9318

Length: 600
Ø: 50
Hole Distance: 130 / 130
0646373, 0655695, 0655697, 1284860,
1620438



DF-DL-10187

Length: 1000
Ø: 52
Cone Ø: d1 Ø 30 / d2 Ø 27
1395995



DF-DL-10193

Length: 1646
Ø: 40
Cone Ø: d1 Ø 26 / d2 Ø 23,5
1351205, 1353395



DF-DL-12420

Length: 1004
Ø: 52
Cone Ø: d1 Ø 30 / d2 Ø 27
Thread: M24 x 1,5 / M30 x 1,5
094613, 94613, 0094613, 362413, 0362413,
1426101



DF-RK-9336

Ø: 108
1445656



DF-TC-12262

Length: 595
Ø: 50
Hole Distance: 130 / 130
0661406, 661406, 0661407, 661407,
1620439



DF-VB-8561

Length: 609
Ø: 48
Hole Distance: 152 / 152
0080521, 080521, 1361651, 1368270,
1390932, 1617096, 1793875, 1817808,
1892492



MN-RK-7280

Ø: 75
Hole Distance: 115
Thick/Height: 24
0689748, 689748



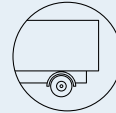

XF 105 ...

FA 105.410 ...	10/05→	Tie Rod	MN-ES-10334		for Push Rod	
	10/05→	Tie Rod End	CV-ES-12461		for Steering Rod	
	10/05→	Tie Rod End	CV-ES-12462		for Steering Rod	
	10/05→	Tie Rod End	CV-ES-14162		for Steering Rod	
	10/05→	Tie Rod End	CV-ES-14163		for Steering Rod	
	10/05→	Tie Rod End	DF-ES-8362		for Steering Rod	
	10/05→	Track Control Arm		DF-DL-8158	Trailing Arm	
	10/05→	Track Control Arm		DF-VB-8561	Wishbone (CV)	
FA 105.460	10/05→	Centre Rod	DF-DL-8704		Push Rod	
	10/05→	Centre Rod	DF-DL-8705		Push Rod	
	10/05→	Centre Rod	DF-DL-10187		Push Rod	
	10/05→	Centre Rod	DF-DL-12420		for Steering Rod	
	10/05→	Suspension Arm Repair Kit	MN-RK-7280	MN-RK-7280	for Drag Link;for Semi-Trailing Arm; for Wishbone (CV)	
	10/05→	Tie Rod	DF-DL-5403		1st FA	
	10/05→	Tie Rod	DF-DL-7780		1st FA	
	10/05→	Tie Rod	DF-DL-7836		1st FA	
	10/05→	Tie Rod	DF-DL-10193		1st FA	
	10/05→	Tie Rod	MN-ES-10334		for Push Rod	
	10/05→	Tie Rod End	CV-ES-12461		for Steering Rod	
	10/05→	Tie Rod End	CV-ES-12462		for Steering Rod	
	10/05→	Tie Rod End	CV-ES-14162		for Steering Rod	
	10/05→	Tie Rod End	CV-ES-14163		for Steering Rod	
	10/05→	Tie Rod End	DF-ES-8362		for Steering Rod	
	10/05→	Track Control Arm		DF-DL-8158	Trailing Arm	
	10/05→	Track Control Arm		DF-VB-8561	Wishbone (CV)	
	FA 105.510	10/05→	Centre Rod	DF-DL-10187		Push Rod
		10/05→	Centre Rod	DF-DL-12420		for Steering Rod
		10/05→	Suspension Arm Repair Kit	MN-RK-7280	MN-RK-7280	for Drag Link;for Semi-Trailing Arm; for Wishbone (CV)
10/05→		Tie Rod	DF-DL-5403			
10/05→		Tie Rod	DF-DL-7836			
10/05→		Tie Rod	MN-ES-10334		for Push Rod	
10/05→		Tie Rod End	CV-ES-12461		for Steering Rod	
10/05→		Tie Rod End	CV-ES-12462		for Steering Rod	
10/05→		Tie Rod End	CV-ES-14162		for Steering Rod	
10/05→		Tie Rod End	CV-ES-14163		for Steering Rod	
10/05→		Tie Rod End	DF-ES-8362		for Steering Rod	
10/05→		Track Control Arm		DF-DL-8158	Trailing Arm	
10/05→		Track Control Arm		DF-VB-8561	Wishbone (CV)	
FAD 105.410		10/05→	Centre Rod	DF-DL-8705		Push Rod
		10/05→	Centre Rod	DF-DL-10186		Push Rod
		10/05→	Suspension Arm Repair Kit		DF-RK-8633	for Wishbone (CV)
	10/05→	Suspension Arm Repair Kit	MN-RK-7280	MN-RK-7280	for Drag Link;for Semi-Trailing Arm; for Wishbone (CV)	
	10/05→	Tie Rod End	CV-ES-14162	CV-ES-14162	for Steering Rod	
	10/05→	Tie Rod End	CV-ES-14163	CV-ES-14163	for Steering Rod	
	10/05→	Tie Rod End	DF-ES-8602			
	10/05→	Track Control Arm		DF-DL-8158	Trailing Arm	
	10/05→	Track Control Arm		DF-TC-12262	Control Arm	
	FAD 105.460	10/05→	Centre Rod	DF-DL-10186		Push Rod
10/05→		Suspension Arm Repair Kit		DF-RK-8633	for Wishbone (CV)	
10/05→		Suspension Arm Repair Kit	MN-RK-7280	MN-RK-7280	for Drag Link;for Semi-Trailing Arm; for Wishbone (CV)	
10/05→		Tie Rod		DF-DL-8718		
10/05→		Tie Rod End	CV-ES-14162		for Steering Rod	
10/05→		Tie Rod End	CV-ES-14163		for Steering Rod	
10/05→		Tie Rod End	SC-ES-8517		for Push Rod	
10/05→		Track Control Arm		DF-DL-8158	Trailing Arm	
10/05→		Track Control Arm		DF-TC-12262	Control Arm	

CV-ES-12461

Length: 120
Cone Ø: d1 Ø 26 / d2 Ø 23,5
Thread: M30 x 1,5 LHT
0069513, 69513, 311300, 0311300,
0607998, 607998, 1190653, 1315447,
1319838, 1332123, 1338714, 1401934,
1407394, ACHB063, ACHF241, MAK1295



CV-ES-12462

Length: 120
Cone Ø: d1 Ø 26 / d2 Ø 23,5
Thread: M30 x 1,5 RHT
0069514, 0586753, 0607999, 0694298,
0694360, 0698609, 1137230, 1229944,
1326862, 1326896, 1331925, ACHB064,
ACHF242, MAK1296



CV-ES-14162

Length: 125
Cone Ø: d1 Ø 30 / d2 Ø 27
Thread: M30 x 1,5 LHT
607053, 690225, 696225, 1228115,
1611088



CV-ES-14163

Length: 125
Cone Ø: d1 Ø 30 / d2 Ø 27
Thread: M30 x 1,5 RHT
0607981, 0698450, 1149907, 1152350,
1257890, 1603789, 1618048, ACHF060



DF-DL-5403

Length: 1742
Ø: 40
Cone Ø: d1 Ø 26 / d2 Ø 23,5
0288281, 1270854, 1337644



DF-DL-7780

Length: 1690
Ø: 40
Cone Ø: d1 Ø 26 / d2 Ø 23,5
1270853, 1353391, 10212000A



DF-DL-7836

Length: 1698
Ø: 52
Cone Ø: d1 Ø 26 / d2 Ø 23,5
0754922, 1286343, 1353396



DF-DL-8158

Length: 611
Ø: 48
Hole Distance: 130 / 130
0267743, 1361649, 1361650, 1656428



DF-DL-8704

Length: 991
Ø: 50
Cone Ø: d1 Ø 30 / d2 Ø 27
1395994



DF-DL-8705

Length: 996
Ø: 38
Cone Ø: d1 Ø 30 / d2 Ø 27
1395993



DF-DL-8718

Length: 1690
Ø: 40
Cone Ø: d1 Ø 30 / d2 Ø 27
1700000



DF-DL-10186

Length: 860
Ø: 38
Cone Ø: d1 Ø 30 / d2 Ø 27
1451118



DF-DL-10187

Length: 1000
Ø: 52
Cone Ø: d1 Ø 30 / d2 Ø 27
1395995



DF-DL-10193

Length: 1646
Ø: 40
Cone Ø: d1 Ø 26 / d2 Ø 23,5
1351205, 1353395



DF-DL-12420

Length: 1004
Ø: 52
Cone Ø: d1 Ø 30 / d2 Ø 27
Thread: M24 x 1,5 / M30 x 1,5
094613, 94613, 0094613, 0362413, 362413,
1426101



DF-ES-8362

Length: 150
Cone Ø: d1 Ø 26 / d2 Ø 23,5
Thread: M30 x 1,5 RHT
1389190



DF-ES-8602

Length: 95
Cone Ø: d1 Ø 30 / d2 Ø 27
Thread: M22 x 1,5 RHT
0273203, 1399724



DF-RK-8633

Ø: 90
0696320, 696320



DF-TC-12262

Length: 595
Ø: 50
Hole Distance: 130 / 130
0661406, 661406, 0661407, 661407,
1620439



DF-VB-8561

Length: 609
Ø: 48
Hole Distance: 152 / 152
0080521, 080521, 1361651, 1368270,
1390932, 1617096, 1793875, 1817808,
1892492



MN-ES-10334

Length: 140
Cone Ø: d1 Ø 26 / d2 Ø 23,5
Thread: M30 x 1,5 RHT
1320855, 1342026, 3093714, 10220897,
81953016236, 81953016331



MN-RK-7280

Ø: 75
Hole Distance: 115
Thick/Height: 24
0689748, 689748



SC-ES-8517

Length: 140
Cone Ø: d1 Ø 30 / d2 Ø 27
Thread: M30 x 1,5 RHT
1685552





XF 105 ...

FAD 105.510	10/05→	Suspension Arm Repair Kit		DF-RK-8633	for Wishbone (CV)
	10/05→	Suspension Arm Repair Kit	MN-RK-7280	MN-RK-7280	for Drag Link;for Semi-Trailing Arm; for Wishbone (CV)
	10/05→	Tie Rod	DF-DL-7780		1st FA
	10/05→	Tie Rod	DF-DL-10193		2nd FA
	10/05→	Tie Rod End	CV-ES-14162		for Steering Rod
	10/05→	Tie Rod End	CV-ES-14163		for Steering Rod
	10/05→	Tie Rod End	SC-ES-8517		for Push Rod
	10/05→	Track Control Arm		DF-DL-8158	Trailing Arm
	10/05→	Track Control Arm		DF-TC-12262	Trailing Arm, 1st RA;2nd RA, for Leaf-Spring Suspension vehicles
FAK 105.410	10/05→	Centre Rod	DF-DL-10192		Push Rod
	10/05→	Suspension Arm Repair Kit	MN-RK-7280	MN-RK-7280	for Drag Link;for Semi-Trailing Arm; for Wishbone (CV)
	10/05→	Tie Rod		DF-ES-5761	Leading Axle Steered
	10/05→	Tie Rod	DF-DL-7780		
	10/05→	Tie Rod	DF-DL-8718		1st FA
	10/05→	Tie Rod End		DF-ES-8362	for Steering Rod
	10/05→	Tie Rod End	CV-ES-12461		for Steering Rod
	10/05→	Tie Rod End	CV-ES-12462		for Steering Rod
	10/05→	Tie Rod End	CV-ES-14162		for Steering Rod
	10/05→	Tie Rod End	CV-ES-14163		for Steering Rod
	10/05→	Tie Rod End	DF-ES-12428		for Steering Rod
	10/05→	Track Control Arm		DF-DL-8158	Trailing Arm
	10/05→	Track Control Arm		DF-TC-12492	Trailing Arm, Leading Axle Steered, for Pneumatic Suspension vehicles
FAK 105.460	10/05→	Track Control Arm		DF-VB-8561	Wishbone (CV)
	10/05→	Centre Rod	DF-DL-8705		Push Rod
	10/05→	Centre Rod	DF-DL-10192		Push Rod
	10/05→	Suspension Arm Repair Kit	MN-RK-7280	MN-RK-7280	for Drag Link;for Semi-Trailing Arm; for Wishbone (CV)
	10/05→	Tie Rod		DF-ES-5761	Leading Axle
	10/05→	Tie Rod	DF-DL-7780		1st FA
	10/05→	Tie Rod End		DF-ES-8362	for Steering Rod
	10/05→	Tie Rod End	CV-ES-12461		for Steering Rod
	10/05→	Tie Rod End	CV-ES-12462		for Steering Rod
	10/05→	Tie Rod End	CV-ES-14162		for Steering Rod
	10/05→	Tie Rod End	CV-ES-14163		for Steering Rod
	10/05→	Tie Rod End	DF-ES-12428		for Steering Rod
	10/05→	Track Control Arm		DF-DL-8158	Trailing Arm
	10/05→	Track Control Arm		DF-TC-12492	Control Arm
	10/05→	Track Control Arm		DF-VB-8561	Wishbone (CV)
FAK 105.510	10/05→	Centre Rod	DF-DL-10192		Push Rod
	10/05→	Suspension Arm Repair Kit	MN-RK-7280	MN-RK-7280	for Drag Link;for Semi-Trailing Arm; for Wishbone (CV)
	10/05→	Tie Rod		DF-ES-5761	Leading Axle Steered
	10/05→	Tie Rod	DF-DL-7780		
	10/05→	Tie Rod	DF-DL-8718		1st FA
	10/05→	Tie Rod End		DF-ES-8362	for Steering Rod
	10/05→	Tie Rod End	CV-ES-12461		for Steering Rod
	10/05→	Tie Rod End	CV-ES-12462		for Steering Rod
	10/05→	Tie Rod End	CV-ES-14162		for Steering Rod
	10/05→	Tie Rod End	CV-ES-14163		for Steering Rod
	10/05→	Tie Rod End	DF-ES-12428		for Steering Rod
	10/05→	Track Control Arm		DF-DL-8158	Trailing Arm
	10/05→	Track Control Arm		DF-TC-12492	Trailing Arm, Leading Axle Steered, for Pneumatic Suspension vehicles
	10/05→	Track Control Arm		DF-VB-8561	Wishbone (CV)
	FAR 105.410	10/05→	Centre Rod	DF-DL-8704	
10/05→		Centre Rod	DF-DL-10187		Push Rod
10/05→		Centre Rod	DF-DL-12420		for Steering Rod
10/05→		Suspension Arm Repair Kit	MN-RK-7280	MN-RK-7280	for Drag Link;for Semi-Trailing Arm; for Wishbone (CV)

CV-ES-12461

Length: 120
Cone Ø: d1 Ø 26 / d2 Ø 23,5
Thread: M30 x 1,5 LHT
0069513, 69513, 0311300, 311300,
0607998, 607998, 1190653, 1315447,
1319838, 1332123, 1338714, 1401934,
1407394, ACHB063, ACHF241, MAK1295



CV-ES-12462

Length: 120
Cone Ø: d1 Ø 26 / d2 Ø 23,5
Thread: M30 x 1,5 RHT
0069514, 0586753, 0607999, 0694298,
0694360, 0698609, 1137230, 1229944,
1326862, 1326896, 1331925, ACHB064,
ACHF242, MAK1296



CV-ES-14162

Length: 125
Cone Ø: d1 Ø 30 / d2 Ø 27
Thread: M30 x 1,5 LHT
607053, 690225, 696225, 1228115,
1611088



CV-ES-14163

Length: 125
Cone Ø: d1 Ø 30 / d2 Ø 27
Thread: M30 x 1,5 RHT
0607981, 0698450, 1149907, 1152350,
1257890, 1603789, 1618048, ACHF060



DF-DL-7780

Length: 1690
Ø: 40
Cone Ø: d1 Ø 26 / d2 Ø 23,5
1270853, 1353391, 10212000A



DF-DL-8158

Length: 611
Ø: 48
Hole Distance: 130 / 130
0267743, 1361649, 1361650, 1656428



DF-DL-8704

Length: 991
Ø: 50
Cone Ø: d1 Ø 30 / d2 Ø 27
1395994



DF-DL-8705

Length: 996
Ø: 38
Cone Ø: d1 Ø 30 / d2 Ø 27
1395993



DF-DL-8718

Length: 1690
Ø: 40
Cone Ø: d1 Ø 30 / d2 Ø 27
1700000



DF-DL-10187

Length: 1000
Ø: 52
Cone Ø: d1 Ø 30 / d2 Ø 27
1395995



DF-DL-10192

Length: 590
Ø: 38
Cone Ø: d1 Ø 30 / d2 Ø 27
1440171, 1451119



DF-DL-10193

Length: 1646
Ø: 40
Cone Ø: d1 Ø 26 / d2 Ø 23,5
1351205, 1353395



DF-DL-12420

Length: 1004
Ø: 52
Cone Ø: d1 Ø 30 / d2 Ø 27
Thread: M24 x 1,5 / M30 x 1,5
0094613, 094613, 94613, 0362413, 362413,
1426101



DF-ES-5761

Length: 1512
Ø: 52
Cone Ø: d1 Ø 26 / d2 Ø 23,5
1297572, 1361155



DF-ES-8362

Length: 150
Cone Ø: d1 Ø 26 / d2 Ø 23,5
Thread: M30 x 1,5 RHT
1389190



DF-ES-12428

Length: 120
Cone Ø: d1 Ø 30
Thread: M24 x 1,5 RHT
1603788, 1604105



DF-RK-8633

Ø: 90
0696320, 696320



DF-TC-12262

Length: 595
Ø: 50
Hole Distance: 130 / 130
0661406, 661406, 0661407, 661407,
1620439



DF-TC-12492

Length: 600
Ø: 40
Hole Distance: 115 / 115
1274741

No Image

DF-VB-8561

Length: 609
Ø: 48
Hole Distance: 152 / 152
0080521, 080521, 1361651, 1368270,
1390932, 1617096, 1793875, 1817808,
1892492



MN-RK-7280

Ø: 75
Hole Distance: 115
Thick/Height: 24
0689748, 689748



SC-ES-8517

Length: 140
Cone Ø: d1 Ø 30 / d2 Ø 27
Thread: M30 x 1,5 RHT
1685552



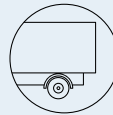

DAF ...

XF 105 ...

FAR 105.410 ...	10/05→	Tie Rod	DF-DL-5403			
	10/05→	Tie Rod	DF-DL-7780			
	10/05→	Tie Rod	DF-DL-7836			
	10/05→	Tie Rod	DF-DL-8718			
	10/05→	Tie Rod	MN-ES-10334		for Push Rod	
	10/05→	Tie Rod End	CV-ES-12461		for Steering Rod	
	10/05→	Tie Rod End	CV-ES-12462		for Steering Rod	
	10/05→	Tie Rod End	CV-ES-14162		for Steering Rod	
	10/05→	Tie Rod End	CV-ES-14163		for Steering Rod	
	10/05→	Tie Rod End	DF-ES-8362		for Steering Rod	
	10/05→	Track Control Arm		DF-DL-8158	Trailing Arm	
	10/05→	Track Control Arm		DF-VB-8561	Wishbone (CV)	
	FAR 105.460	10/05→	Centre Rod	DF-DL-12420		for Steering Rod
		10/05→	Suspension Arm Repair Kit	MN-RK-7280	MN-RK-7280	for Drag Link;for Semi-Trailing Arm; for Wishbone (CV)
10/05→		Tie Rod	MN-ES-10334		for Push Rod	
10/05→		Tie Rod End	CV-ES-12461		for Steering Rod	
10/05→		Tie Rod End	CV-ES-12462		for Steering Rod	
10/05→		Tie Rod End	CV-ES-14162		for Steering Rod	
10/05→		Tie Rod End	CV-ES-14163		for Steering Rod	
10/05→		Tie Rod End	DF-ES-8362		for Steering Rod	
10/05→		Track Control Arm		DF-DL-8158	Trailing Arm	
10/05→		Track Control Arm		DF-VB-8561	Wishbone (CV)	
FAR 105.510	10/05→	Centre Rod	DF-DL-12420		for Steering Rod	
	10/05→	Suspension Arm Repair Kit	MN-RK-7280	MN-RK-7280	for Drag Link;for Semi-Trailing Arm; for Wishbone (CV)	
	10/05→	Tie Rod	MN-ES-10334		for Push Rod	
	10/05→	Tie Rod End	CV-ES-12461		for Steering Rod	
	10/05→	Tie Rod End	CV-ES-12462		for Steering Rod	
	10/05→	Tie Rod End	CV-ES-14162		for Steering Rod	
	10/05→	Tie Rod End	CV-ES-14163		for Steering Rod	
	10/05→	Tie Rod End	DF-ES-8362		for Steering Rod	
	10/05→	Track Control Arm		DF-DL-8158	Trailing Arm	
	10/05→	Track Control Arm		DF-VB-8561	Wishbone (CV)	
FAS 105.410, FAR 105.410	10/05→	Centre Rod	DF-DL-8704		Push Rod	
	10/05→	Centre Rod	DF-DL-8705		Push Rod	
	10/05→	Centre Rod	DF-DL-10187		Push Rod	
	10/05→	Centre Rod	DF-DL-12420		for Steering Rod	
	10/05→	Suspension Arm Repair Kit	MN-RK-7280	MN-RK-7280	for Drag Link;for Semi-Trailing Arm; for Wishbone (CV)	
	10/05→	Tie Rod		DF-DL-5403	Tag Axle	
	10/05→	Tie Rod		DF-DL-7780	Tag Axle	
	10/05→	Tie Rod		DF-DL-8718	Tag Axle	
	10/05→	Tie Rod	DF-DL-5403		1st FA	
	10/05→	Tie Rod	DF-DL-7780		1st FA	
	10/05→	Tie Rod	DF-DL-7836		1st FA	
	10/05→	Tie Rod	DF-DL-8718		1st FA	
	10/05→	Tie Rod	MN-ES-10334		for Push Rod	
	10/05→	Tie Rod End	CV-ES-12461		for Steering Rod	
	10/05→	Tie Rod End	CV-ES-12462		for Steering Rod	
	10/05→	Tie Rod End	CV-ES-14162		for Steering Rod	
	10/05→	Tie Rod End	CV-ES-14163		for Steering Rod	
	10/05→	Tie Rod End	DF-ES-8362		for Steering Rod	
	10/05→	Track Control Arm		DF-DL-8158	Trailing Arm	
	10/05→	Track Control Arm		DF-VB-8561	Wishbone (CV)	
	FAS 105.460, FAR 105.460	10/05→	Centre Rod	DF-DL-8704		Push Rod
		10/05→	Centre Rod	DF-DL-8705		Push Rod
10/05→		Centre Rod	DF-DL-10187		Push Rod	
10/05→		Centre Rod	DF-DL-12420		for Steering Rod	
10/05→		Suspension Arm Repair Kit	MN-RK-7280	MN-RK-7280	for Drag Link;for Semi-Trailing Arm; for Wishbone (CV)	
10/05→		Tie Rod		DF-DL-5403	Tag Axle	
10/05→		Tie Rod		DF-DL-7780	Tag Axle	
10/05→		Tie Rod		DF-DL-8718	Tag Axle	

CV-ES-12461

Length: 120
Cone Ø: d1 Ø 26 / d2 Ø 23,5
Thread: M30 x 1,5 LHT
69513, 0069513, 311300, 0311300,
0607998, 607998, 1190653, 1315447,
1319838, 1332123, 1338714, 1401934,
1407394, ACHB063, ACHF241, MAK1295



CV-ES-12462

Length: 120
Cone Ø: d1 Ø 26 / d2 Ø 23,5
Thread: M30 x 1,5 RHT
0069514, 0586753, 0607999, 0694298,
0694360, 0698609, 1137230, 1229944,
1326862, 1326896, 1331925, ACHB064,
ACHF242, MAK1296



CV-ES-14162

Length: 125
Cone Ø: d1 Ø 30 / d2 Ø 27
Thread: M30 x 1,5 LHT
607053, 690225, 696225, 1228115,
1611088



CV-ES-14163

Length: 125
Cone Ø: d1 Ø 30 / d2 Ø 27
Thread: M30 x 1,5 RHT
0607981, 0698450, 1149907, 1152350,
1257890, 1603789, 1618048, ACHF060



DF-DL-5403

Length: 1742
Ø: 40
Cone Ø: d1 Ø 26 / d2 Ø 23,5
0288281, 1270854, 1337644



DF-DL-7780

Length: 1690
Ø: 40
Cone Ø: d1 Ø 26 / d2 Ø 23,5
1270853, 1353391, 10212000A



DF-DL-7836

Length: 1698
Ø: 52
Cone Ø: d1 Ø 26 / d2 Ø 23,5
0754922, 1286343, 1353396



DF-DL-8158

Length: 611
Ø: 48
Hole Distance: 130 / 130
0267743, 1361649, 1361650, 1656428



DF-DL-8704

Length: 991
Ø: 50
Cone Ø: d1 Ø 30 / d2 Ø 27
1395994



DF-DL-8705

Length: 996
Ø: 38
Cone Ø: d1 Ø 30 / d2 Ø 27
1395993



DF-DL-8718

Length: 1690
Ø: 40
Cone Ø: d1 Ø 30 / d2 Ø 27
1700000



DF-DL-10187

Length: 1000
Ø: 52
Cone Ø: d1 Ø 30 / d2 Ø 27
1395995



DF-DL-12420

Length: 1004
Ø: 52
Cone Ø: d1 Ø 30 / d2 Ø 27
Thread: M24 x 1,5 / M30 x 1,5
94613, 0094613, 094613, 0362413, 362413,
1426101



DF-ES-8362

Length: 150
Cone Ø: d1 Ø 26 / d2 Ø 23,5
Thread: M30 x 1,5 RHT
1389190



DF-VB-8561

Length: 609
Ø: 48
Hole Distance: 152 / 152
0080521, 080521, 1361651, 1368270,
1390932, 1617096, 1793875, 1817808,
1892492



MN-ES-10334

Length: 140
Cone Ø: d1 Ø 26 / d2 Ø 23,5
Thread: M30 x 1,5 RHT
1320855, 1342026, 3093714, 10220897,
81953016236, 81953016331



MN-RK-7280

Ø: 75
Hole Distance: 115
Thick/Height: 24
0689748, 689748





XF 105 ...

FAS 105.460, FAR 105.460 ...	10/05→	Tie Rod	DF-DL-5403		1st FA
	10/05→	Tie Rod	DF-DL-7780		1st FA
	10/05→	Tie Rod	DF-DL-7836		1st FA
	10/05→	Tie Rod	DF-DL-8718		1st FA
	10/05→	Tie Rod	DF-DL-10193		1st FA
	10/05→	Tie Rod	MN-ES-10334		for Push Rod
	10/05→	Tie Rod End	CV-ES-12461		for Steering Rod
	10/05→	Tie Rod End	CV-ES-12462		for Steering Rod
	10/05→	Tie Rod End	CV-ES-14162		for Steering Rod
	10/05→	Tie Rod End	CV-ES-14163		for Steering Rod
	10/05→	Tie Rod End	DF-ES-8362		for Steering Rod
	10/05→	Track Control Arm		DF-DL-8158	Trailing Arm
	10/05→	Track Control Arm		DF-VB-8561	Wishbone (CV)
	FAS 105.510, FAR 105.510	10/05→	Centre Rod	DF-DL-8704	
10/05→		Centre Rod	DF-DL-8705		Push Rod
10/05→		Centre Rod	DF-DL-10187		Push Rod
10/05→		Centre Rod	DF-DL-12420		for Steering Rod
10/05→		Suspension Arm Repair Kit	MN-RK-7280	MN-RK-7280	for Drag Link;for Semi-Trailing Arm; for Wishbone (CV)
10/05→		Tie Rod		DF-DL-5403	Tag Axle
10/05→		Tie Rod		DF-DL-7780	Tag Axle
10/05→		Tie Rod	DF-DL-5403		1st FA
10/05→		Tie Rod	DF-DL-7780		1st FA
10/05→		Tie Rod	DF-DL-7836		1st FA
10/05→		Tie Rod	DF-DL-8718		1st FA
10/05→		Tie Rod	DF-DL-10193		1st FA
10/05→		Tie Rod	MN-ES-10334		for Push Rod
10/05→		Tie Rod End	CV-ES-12461		for Steering Rod
10/05→		Tie Rod End	CV-ES-12462		for Steering Rod
10/05→		Tie Rod End	CV-ES-14162		for Steering Rod
10/05→		Tie Rod End	CV-ES-14163		for Steering Rod
10/05→		Tie Rod End	DF-ES-8362		for Steering Rod
10/05→		Track Control Arm		DF-DL-8158	Trailing Arm
10/05→		Track Control Arm		DF-VB-8561	Wishbone (CV)
FAT 105.410	10/05→	Centre Rod	DF-DL-12420		for Steering Rod
	10/05→	Suspension Arm Repair Kit		DF-RK-8633	for Wishbone (CV)
	10/05→	Suspension Arm Repair Kit	MN-RK-7280	MN-RK-7280	for Drag Link;for Semi-Trailing Arm; for Wishbone (CV)
	10/05→	Tie Rod End	CV-ES-12461		for Steering Rod
	10/05→	Tie Rod End	CV-ES-12462		for Steering Rod
	10/05→	Tie Rod End	CV-ES-14162		for Steering Rod
	10/05→	Tie Rod End	CV-ES-14163		for Steering Rod
	10/05→	Track Control Arm		DF-TC-12262	Control Arm
FAT 105.460	10/05→	Centre Rod	DF-DL-12420		for Steering Rod
	10/05→	Suspension Arm Repair Kit		DF-RK-8633	for Wishbone (CV)
	10/05→	Suspension Arm Repair Kit	MN-RK-7280	MN-RK-7280	for Drag Link;for Semi-Trailing Arm; for Wishbone (CV)
	10/05→	Tie Rod	DF-DL-5403		1st FA
	10/05→	Tie Rod End	CV-ES-12461		for Steering Rod
	10/05→	Tie Rod End	CV-ES-12462		for Steering Rod
	10/05→	Tie Rod End	CV-ES-14162		for Steering Rod
	10/05→	Tie Rod End	CV-ES-14163		for Steering Rod
	10/05→	Track Control Arm		DF-TC-12262	Control Arm
	FAT 105.510	10/05→	Centre Rod	DF-DL-8704	
10/05→		Centre Rod	DF-DL-8705		Push Rod
10/05→		Centre Rod	DF-DL-12420		for Steering Rod
10/05→		Suspension Arm Repair Kit		DF-RK-8633	for Wishbone (CV)
10/05→		Suspension Arm Repair Kit	MN-RK-7280	MN-RK-7280	for Drag Link;for Semi-Trailing Arm; for Wishbone (CV)
10/05→		Tie Rod	DF-DL-7780		1st FA
10/05→		Tie Rod End	CV-ES-12461		for Steering Rod
10/05→		Tie Rod End	CV-ES-12462		for Steering Rod
10/05→		Tie Rod End	CV-ES-14162		for Steering Rod

CV-ES-12461

Length: 120
Cone Ø: d1 Ø 26 / d2 Ø 23,5
Thread: M30 x 1,5 LHT
0069513, 69513, 0311300, 311300, 607998, 0607998, 1190653, 1315447, 1319838, 1332123, 1338714, 1401934, 1407394, ACHB063, ACHF241, MAK1295



CV-ES-12462

Length: 120
Cone Ø: d1 Ø 26 / d2 Ø 23,5
Thread: M30 x 1,5 RHT
0069514, 0586753, 0607999, 0694298, 0694360, 0698609, 1137230, 1229944, 1326862, 1326896, 1331925, ACHB064, ACHF242, MAK1296



CV-ES-14162

Length: 125
Cone Ø: d1 Ø 30 / d2 Ø 27
Thread: M30 x 1,5 LHT
607053, 690225, 696225, 1228115, 1611088



CV-ES-14163

Length: 125
Cone Ø: d1 Ø 30 / d2 Ø 27
Thread: M30 x 1,5 RHT
0607981, 0698450, 1149907, 1152350, 1257890, 1603789, 1618048, ACHF060



DF-DL-5403

Length: 1742
Ø: 40
Cone Ø: d1 Ø 26 / d2 Ø 23,5
0288281, 1270854, 1337644



DF-DL-7780

Length: 1690
Ø: 40
Cone Ø: d1 Ø 26 / d2 Ø 23,5
1270853, 1353391, 10212000A



DF-DL-7836

Length: 1698
Ø: 52
Cone Ø: d1 Ø 26 / d2 Ø 23,5
0754922, 1286343, 1353396



DF-DL-8158

Length: 611
Ø: 48
Hole Distance: 130 / 130
0267743, 1361649, 1361650, 1656428



DF-DL-8704

Length: 991
Ø: 50
Cone Ø: d1 Ø 30 / d2 Ø 27
1395994



DF-DL-8705

Length: 996
Ø: 38
Cone Ø: d1 Ø 30 / d2 Ø 27
1395993



DF-DL-8718

Length: 1690
Ø: 40
Cone Ø: d1 Ø 30 / d2 Ø 27
1700000



DF-DL-10187

Length: 1000
Ø: 52
Cone Ø: d1 Ø 30 / d2 Ø 27
1395995



DF-DL-10193

Length: 1646
Ø: 40
Cone Ø: d1 Ø 26 / d2 Ø 23,5
1351205, 1353395



DF-DL-12420

Length: 1004
Ø: 52
Cone Ø: d1 Ø 30 / d2 Ø 27
Thread: M24 x 1,5 / M30 x 1,5
94613, 0094613, 094613, 362413, 0362413, 1426101



DF-ES-8362

Length: 150
Cone Ø: d1 Ø 26 / d2 Ø 23,5
Thread: M30 x 1,5 RHT
1389190



DF-RK-8633

Ø: 90
0696320, 696320



DF-TC-12262

Length: 595
Ø: 50
Hole Distance: 130 / 130
0661406, 661406, 0661407, 661407, 1620439



DF-VB-8561

Length: 609
Ø: 48
Hole Distance: 152 / 152
0080521, 080521, 1361651, 1368270, 1390932, 1617096, 1793875, 1817808, 1892492



MN-ES-10334

Length: 140
Cone Ø: d1 Ø 26 / d2 Ø 23,5
Thread: M30 x 1,5 RHT
1320855, 1342026, 3093714, 10220897, 81953016236, 81953016331



MN-RK-7280

Ø: 75
Hole Distance: 115
Thick/Height: 24
0689748, 689748





XF 105 ...

FAT 105.510 ...	10/05→	Tie Rod End	CV-ES-14163		for Steering Rod	
	10/05→	Track Control Arm		DF-DL-8158	Trailing Arm	
	10/05→	Track Control Arm		DF-TC-12262	Trailing Arm, 1st RA;2nd RA, for Leaf-Spring Suspension vehicles	
FT 105.410	10/05→	Centre Rod	DF-DL-8704		Push Rod	
	10/05→	Centre Rod	DF-DL-8705		Push Rod	
	10/05→	Centre Rod	DF-DL-10187		Push Rod	
	10/05→	Suspension Arm Repair Kit		MN-RK-7291	for Drag Link	
	10/05→	Suspension Arm Repair Kit	CV-RK-1583	CV-RK-1583	Trailing Arm	
	10/05→	Suspension Arm Repair Kit	MN-RK-7280	MN-RK-7280	for Drag Link;for Semi-Trailing Arm; for Wishbone (CV)	
	10/05→	Tie Rod	DF-DL-7780		1st FA	
	10/05→	Tie Rod	DF-DL-7836		1st FA	
	10/05→	Tie Rod	DF-DL-8718		1st FA	
	10/05→	Tie Rod	DF-DL-10193		1st FA	
	10/05→	Tie Rod End	CV-ES-12461		for Steering Rod	
	10/05→	Tie Rod End	CV-ES-12462		for Steering Rod	
	10/05→	Tie Rod End	CV-ES-14162		for Steering Rod	
	10/05→	Tie Rod End	CV-ES-14163		for Steering Rod	
	10/05→	Track Control Arm		DF-DL-8158	Trailing Arm	
	10/05→	Track Control Arm		DF-DL-9331	Wishbone (CV)	
	10/05→	Track Control Arm		DF-VB-8561	Wishbone (CV)	
	FT 105.460	10/05→	Centre Rod	DF-DL-8704		Push Rod
		10/05→	Centre Rod	DF-DL-8705		Push Rod
		10/05→	Centre Rod	DF-DL-10187		Push Rod
10/05→		Suspension Arm Repair Kit		MN-RK-7291	for Drag Link	
10/05→		Suspension Arm Repair Kit	CV-RK-1583	CV-RK-1583	Trailing Arm	
10/05→		Suspension Arm Repair Kit	MN-RK-7280	MN-RK-7280	for Drag Link;for Semi-Trailing Arm; for Wishbone (CV)	
10/05→		Tie Rod	DF-DL-7780		1st FA	
10/05→		Tie Rod	DF-DL-7836		1st FA	
10/05→		Tie Rod	DF-DL-8718		1st FA	
10/05→		Tie Rod	DF-DL-10193		1st FA	
10/05→		Tie Rod End	CV-ES-12461		for Steering Rod	
10/05→		Tie Rod End	CV-ES-12462		for Steering Rod	
10/05→		Tie Rod End	CV-ES-14162		for Steering Rod	
10/05→		Tie Rod End	CV-ES-14163		for Steering Rod	
10/05→		Track Control Arm		DF-DL-8158	Trailing Arm	
10/05→		Track Control Arm		DF-DL-9331	Wishbone (CV)	
10/05→		Track Control Arm		DF-VB-8561	Wishbone (CV)	
FT 105.510		10/05→	Centre Rod	DF-DL-8704		Push Rod
		10/05→	Centre Rod	DF-DL-8705		Push Rod
		10/05→	Centre Rod	DF-DL-10187		Push Rod
	10/05→	Suspension Arm Repair Kit		MN-RK-7291	for Drag Link	
	10/05→	Suspension Arm Repair Kit	CV-RK-1583	CV-RK-1583	Trailing Arm	
	10/05→	Suspension Arm Repair Kit	MN-RK-7280	MN-RK-7280	for Drag Link;for Semi-Trailing Arm; for Wishbone (CV)	
	10/05→	Tie Rod	DF-DL-7780		1st FA	
	10/05→	Tie Rod	DF-DL-7836		1st FA	
	10/05→	Tie Rod	DF-DL-8718		1st FA	
	10/05→	Tie Rod End	CV-ES-12461		for Steering Rod	
	10/05→	Tie Rod End	CV-ES-12462		for Steering Rod	
	10/05→	Tie Rod End	CV-ES-14162		for Steering Rod	
	10/05→	Tie Rod End	CV-ES-14163		for Steering Rod	
	10/05→	Track Control Arm		DF-DL-8158	Trailing Arm	
	10/05→	Track Control Arm		DF-DL-9331	Wishbone (CV)	
	10/05→	Track Control Arm		DF-VB-8561	Wishbone (CV)	
	FTG 105.410	10/05→	Centre Rod	DF-DL-12420		for Steering Rod
		10/05→	Suspension Arm Repair Kit		MN-RK-7291	for Drag Link
		10/05→	Suspension Arm Repair Kit	CV-RK-1583	CV-RK-1583	Trailing Arm
		10/05→	Suspension Arm Repair Kit	MN-RK-7280	MN-RK-7280	for Drag Link;for Semi-Trailing Arm; for Wishbone (CV)
10/05→		Tie Rod	DF-DL-7780		1st FA	



CV-ES-12461

Length: 120
Cone Ø: d1 Ø 26 / d2 Ø 23,5
Thread: M30 x 1,5 LHT
0069513, 69513, 0311300, 311300,
0607998, 607998, 1190653, 1315447,
1319838, 1332123, 1338714, 1401934,
1407394, ACHB063, ACHF241, MAK1295



CV-ES-12462

Length: 120
Cone Ø: d1 Ø 26 / d2 Ø 23,5
Thread: M30 x 1,5 RHT
0069514, 0586753, 0607999, 0694298,
0694360, 0698609, 1137230, 1229944,
1326862, 1326896, 1331925, ACHB064,
ACHF242, MAK1296



CV-ES-14162

Length: 125
Cone Ø: d1 Ø 30 / d2 Ø 27
Thread: M30 x 1,5 LHT
607053, 690225, 696225, 1228115,
1611088



CV-ES-14163

Length: 125
Cone Ø: d1 Ø 30 / d2 Ø 27
Thread: M30 x 1,5 RHT
0607981, 0698450, 1149907, 1152350,
1257890, 1603789, 1618048, ACHF060



CV-RK-1583



DF-DL-7780

Length: 1690
Ø: 40
Cone Ø: d1 Ø 26 / d2 Ø 23,5
1270853, 1353391, 10212000A



DF-DL-7836

Length: 1698
Ø: 52
Cone Ø: d1 Ø 26 / d2 Ø 23,5
0754922, 1286343, 1353396



DF-DL-8158

Length: 611
Ø: 48
Hole Distance: 130 / 130
0267743, 1361649, 1361650, 1656428



DF-DL-8704

Length: 991
Ø: 50
Cone Ø: d1 Ø 30 / d2 Ø 27
1395994



DF-DL-8705

Length: 996
Ø: 38
Cone Ø: d1 Ø 30 / d2 Ø 27
1395993



DF-DL-8718

Length: 1690
Ø: 40
Cone Ø: d1 Ø 30 / d2 Ø 27
1700000



DF-DL-9331

Length: 390
Ø: 50
Hole Distance: 130 / 152
1261101



DF-DL-10187

Length: 1000
Ø: 52
Cone Ø: d1 Ø 30 / d2 Ø 27
1395995



DF-DL-10193

Length: 1646
Ø: 40
Cone Ø: d1 Ø 26 / d2 Ø 23,5
1351205, 1353395



DF-DL-12420

Length: 1004
Ø: 52
Cone Ø: d1 Ø 30 / d2 Ø 27
Thread: M24 x 1,5 / M30 x 1,5
0094613, 094613, 94613, 0362413, 362413,
1426101



DF-TC-12262

Length: 595
Ø: 50
Hole Distance: 130 / 130
0661406, 661406, 661407, 0661407,
1620439



DF-VB-8561

Length: 609
Ø: 48
Hole Distance: 152 / 152
0080521, 080521, 1361651, 1368270,
1390932, 1617096, 1793875, 1817808,
1892492



MN-RK-7280

Ø: 75
Hole Distance: 115
Thick/Height: 24
689748, 0689748



MN-RK-7291

Ø: 72
Hole Distance: 130
Thick/Height: 30
1271124





XF 105 ...

FTG 105.410 ...	10/05→	Tie Rod End	CV-ES-12461		for Steering Rod	
	10/05→	Tie Rod End	CV-ES-12462		for Steering Rod	
	10/05→	Tie Rod End	CV-ES-14162		for Steering Rod	
	10/05→	Tie Rod End	CV-ES-14163		for Steering Rod	
	10/05→	Track Control Arm		DF-DL-8158	Trailing Arm	
	10/05→	Track Control Arm		DF-DL-9331	Wishbone (CV), 1st RA, for Pneumatic Suspension vehicles	
	10/05→	Track Control Arm		DF-VB-8561	Wishbone (CV)	
FTG 105.460	10/05→	Centre Rod	DF-DL-12420		for Steering Rod	
	10/05→	Suspension Arm Repair Kit		MN-RK-7291	for Drag Link	
	10/05→	Suspension Arm Repair Kit	CV-RK-1583	CV-RK-1583	Trailing Arm	
	10/05→	Suspension Arm Repair Kit	MN-RK-7280	MN-RK-7280	for Drag Link;for Semi-Trailing Arm; for Wishbone (CV)	
	10/05→	Tie Rod	DF-DL-7780		1st FA	
	10/05→	Tie Rod End	CV-ES-12461		for Steering Rod	
	10/05→	Tie Rod End	CV-ES-12462		for Steering Rod	
	10/05→	Tie Rod End	CV-ES-14162		for Steering Rod	
	10/05→	Tie Rod End	CV-ES-14163		for Steering Rod	
	10/05→	Track Control Arm		DF-DL-8158	Trailing Arm	
	10/05→	Track Control Arm		DF-DL-9331	Wishbone (CV), 1st RA, for Pneumatic Suspension vehicles	
	10/05→	Track Control Arm		DF-VB-8561	Wishbone (CV)	
	FTG 105.510	10/05→	Centre Rod	DF-DL-12420		for Steering Rod
		10/05→	Suspension Arm Repair Kit		MN-RK-7291	for Drag Link
10/05→		Suspension Arm Repair Kit	CV-RK-1583	CV-RK-1583	Trailing Arm	
10/05→		Suspension Arm Repair Kit	MN-RK-7280	MN-RK-7280	for Drag Link;for Semi-Trailing Arm; for Wishbone (CV)	
10/05→		Tie Rod	DF-DL-7780		1st FA	
10/05→		Tie Rod End	CV-ES-12461		for Steering Rod	
10/05→		Tie Rod End	CV-ES-12462		for Steering Rod	
10/05→		Tie Rod End	CV-ES-14162		for Steering Rod	
10/05→		Tie Rod End	CV-ES-14163		for Steering Rod	
10/05→		Track Control Arm		DF-DL-8158	Trailing Arm	
10/05→		Track Control Arm		DF-DL-9331	Wishbone (CV), 1st RA, for Pneumatic Suspension vehicles	
10/05→		Track Control Arm		DF-VB-8561	Wishbone (CV)	
FTM 105.410		10/05→	Centre Rod	DF-DL-10192	DF-DL-10192	Push Rod, for vehicles with Hinged Leading Axle
		10/05→	Suspension Arm Repair Kit		DF-RK-8633	for Wishbone (CV)
	10/05→	Suspension Arm Repair Kit	MN-RK-7280	MN-RK-7280	for Drag Link;for Semi-Trailing Arm; for Wishbone (CV)	
	10/05→	Tie Rod End		DF-ES-8362	for Steering Rod	
	10/05→	Tie Rod End	CV-ES-12461		for Steering Rod	
	10/05→	Tie Rod End	CV-ES-12462		for Steering Rod	
	10/05→	Tie Rod End	CV-ES-14162		for Steering Rod	
	10/05→	Tie Rod End	CV-ES-14163		for Steering Rod	
	10/05→	Tie Rod End	DF-ES-12428		for Steering Rod	
	10/05→	Track Control Arm		DF-DL-8158	Trailing Arm	
	10/05→	Track Control Arm		DF-TC-12262	Control Arm	
	10/05→	Track Control Arm		DF-TC-12492	Trailing Arm, Leading Axle Steered, for Pneumatic Suspension vehicles	
	FTM 105.460	10/05→	Centre Rod	DF-DL-10192		Push Rod
		10/05→	Suspension Arm Repair Kit		DF-RK-8633	for Wishbone (CV)
10/05→		Suspension Arm Repair Kit	MN-RK-7280	MN-RK-7280	for Drag Link;for Semi-Trailing Arm; for Wishbone (CV)	
10/05→		Tie Rod		DF-ES-5761		
10/05→		Tie Rod	DF-DL-7780			
10/05→		Tie Rod	DF-DL-8718			
10/05→		Tie Rod End		DF-ES-8362	for Steering Rod	
10/05→		Tie Rod End	CV-ES-12461		for Steering Rod	
10/05→		Tie Rod End	CV-ES-12462		for Steering Rod	
10/05→		Tie Rod End	CV-ES-14162		for Steering Rod	
10/05→		Tie Rod End	CV-ES-14163		for Steering Rod	
10/05→		Tie Rod End	DF-ES-12428		for Steering Rod	

CV-ES-12461

Length: 120
Cone Ø: d1 Ø 26 / d2 Ø 23,5
Thread: M30 x 1,5 LHT
69513, 0069513, 0311300, 311300,
0607998, 607998, 1190653, 1315447,
1319838, 1332123, 1338714, 1401934,
1407394, ACHB063, ACHF241, MAK1295



CV-ES-12462

Length: 120
Cone Ø: d1 Ø 26 / d2 Ø 23,5
Thread: M30 x 1,5 RHT
0069514, 0586753, 0607999, 0694298,
0694360, 0698609, 1137230, 1229944,
1326862, 1326896, 1331925, ACHB064,
ACHF242, MAK1296



CV-ES-14162

Length: 125
Cone Ø: d1 Ø 30 / d2 Ø 27
Thread: M30 x 1,5 LHT
607053, 690225, 696225, 1228115,
1611088



CV-ES-14163

Length: 125
Cone Ø: d1 Ø 30 / d2 Ø 27
Thread: M30 x 1,5 RHT
0607981, 0698450, 1149907, 1152350,
1257890, 1603789, 1618048, ACHF060



CV-RK-1583



DF-DL-7780

Length: 1690
Ø: 40
Cone Ø: d1 Ø 26 / d2 Ø 23,5
1270853, 1353391, 10212000A



DF-DL-8158

Length: 611
Ø: 48
Hole Distance: 130 / 130
0267743, 1361649, 1361650, 1656428



DF-DL-8718

Length: 1690
Ø: 40
Cone Ø: d1 Ø 30 / d2 Ø 27
1700000



DF-DL-9331

Length: 390
Ø: 50
Hole Distance: 130 / 152
1261101



DF-DL-10192

Length: 590
Ø: 38
Cone Ø: d1 Ø 30 / d2 Ø 27
1440171, 1451119



DF-DL-12420

Length: 1004
Ø: 52
Cone Ø: d1 Ø 30 / d2 Ø 27
Thread: M24 x 1,5 / M30 x 1,5
0094613, 094613, 94613, 0362413, 362413,
1426101



DF-ES-5761

Length: 1512
Ø: 52
Cone Ø: d1 Ø 26 / d2 Ø 23,5
1297572, 1361155



DF-ES-8362

Length: 150
Cone Ø: d1 Ø 26 / d2 Ø 23,5
Thread: M30 x 1,5 RHT
1389190



DF-ES-12428

Length: 120
Cone Ø: d1 Ø 30
Thread: M24 x 1,5 RHT
1603788, 1604105



DF-RK-8633

Ø: 90
0696320, 696320



DF-TC-12262

Length: 595
Ø: 50
Hole Distance: 130 / 130
0661406, 661406, 0661407, 661407,
1620439



DF-TC-12492

Length: 600
Ø: 40
Hole Distance: 115 / 115
1274741

No Image

DF-VB-8561

Length: 609
Ø: 48
Hole Distance: 152 / 152
080521, 0080521, 1361651, 1368270,
1390932, 1617096, 1793875, 1817808,
1892492



MN-RK-7280

Ø: 75
Hole Distance: 115
Thick/Height: 24
0689748, 689748



MN-RK-7291

Ø: 72
Hole Distance: 130
Thick/Height: 30
1271124





XF 105 ...

FTM 105.460 ...	10/05→	Track Control Arm		DF-DL-8158	Trailing Arm	
	10/05→	Track Control Arm		DF-TC-12262	Control Arm	
	10/05→	Track Control Arm		DF-TC-12492	Trailing Arm, Leading Axle Steered, for Pneumatic Suspension vehicles	
FTM 105.510	10/05→	Suspension Arm Repair Kit		DF-RK-8633	for Wishbone (CV)	
	10/05→	Suspension Arm Repair Kit	MN-RK-7280	MN-RK-7280	for Drag Link;for Semi-Trailing Arm; for Wishbone (CV)	
	10/05→	Tie Rod		DF-ES-5761	Leading Axle	
	10/05→	Tie Rod	DF-DL-7780		1st FA	
	10/05→	Tie Rod End		DF-ES-8362	for Steering Rod	
	10/05→	Tie Rod End	CV-ES-12461		for Steering Rod	
	10/05→	Tie Rod End	CV-ES-12462		for Steering Rod	
	10/05→	Tie Rod End	CV-ES-14162		for Steering Rod	
	10/05→	Tie Rod End	CV-ES-14163		for Steering Rod	
	10/05→	Tie Rod End	DF-ES-12428		for Steering Rod	
	10/05→	Track Control Arm		DF-DL-8158	Trailing Arm	
	10/05→	Track Control Arm		DF-TC-12262	Trailing Arm, 1st RA;2nd RA, for Leaf-Spring Suspension vehicles	
	10/05→	Track Control Arm		DF-TC-12492	Control Arm	
	FTS 105.410, FTR 105.410	10/05→	Centre Rod	DF-DL-10192	DF-DL-10192	Push Rod, for vehicles with Hinged Leading Axle
10/05→		Centre Rod	DF-DL-12420		for Steering Rod	
10/05→		Suspension Arm Repair Kit		MN-RK-7291	for Drag Link	
10/05→		Suspension Arm Repair Kit	CV-RK-1583	CV-RK-1583	Trailing Arm	
10/05→		Suspension Arm Repair Kit	MN-RK-7280	MN-RK-7280	for Drag Link;for Semi-Trailing Arm; for Wishbone (CV)	
10/05→		Tie Rod		DF-ES-5761	Leading Axle	
10/05→		Tie Rod	DF-DL-7780		1st FA	
10/05→		Tie Rod	DF-DL-8718		1st FA	
10/05→		Tie Rod End	CV-ES-12461		for Steering Rod	
10/05→		Tie Rod End	CV-ES-12462		for Steering Rod	
10/05→		Tie Rod End	CV-ES-14162		for Steering Rod	
10/05→		Tie Rod End	CV-ES-14163		for Steering Rod	
10/05→		Track Control Arm		DF-DL-8158	Trailing Arm	
10/05→		Track Control Arm		DF-DL-9331	Wishbone (CV), 1st RA, for Pneumatic Suspension vehicles	
10/05→		Track Control Arm		DF-TC-12492	Control Arm	
10/05→		Track Control Arm		DF-VB-8561	Wishbone (CV)	
FTS 105.460, FTR 105.460		10/05→	Centre Rod	DF-DL-8704		Push Rod
		10/05→	Centre Rod	DF-DL-8705		Push Rod
	10/05→	Centre Rod	DF-DL-10192		Push Rod, 1st FA	
	10/05→	Centre Rod	DF-DL-10192	DF-DL-10192	Push Rod, for vehicles with Hinged Leading Axle	
	10/05→	Centre Rod	DF-DL-12420		for Steering Rod	
	10/05→	Suspension Arm Repair Kit		MN-RK-7291	for Drag Link	
	10/05→	Suspension Arm Repair Kit	CV-RK-1583	CV-RK-1583	Trailing Arm	
	10/05→	Suspension Arm Repair Kit	MN-RK-7280	MN-RK-7280	for Drag Link;for Semi-Trailing Arm; for Wishbone (CV)	
	10/05→	Tie Rod		DF-ES-5761	Leading Axle	
	10/05→	Tie Rod	DF-DL-7780		1st FA	
	10/05→	Tie Rod	DF-DL-8718		1st FA	
	10/05→	Tie Rod	DF-DL-10193		1st FA	
	10/05→	Tie Rod End	CV-ES-12461		for Steering Rod	
	10/05→	Tie Rod End	CV-ES-12462		for Steering Rod	
	10/05→	Tie Rod End	CV-ES-14162		for Steering Rod	
	10/05→	Tie Rod End	CV-ES-14163		for Steering Rod	
	10/05→	Track Control Arm		DF-DL-8158	Trailing Arm	
	10/05→	Track Control Arm		DF-DL-9331	Wishbone (CV), 1st RA, for Pneumatic Suspension vehicles	
10/05→	Track Control Arm		DF-TC-12492	Control Arm		
10/05→	Track Control Arm		DF-VB-8561	Wishbone (CV)		
FTS 105.510, FTR 105.510	10/05→	Centre Rod	DF-DL-10192	DF-DL-10192	Push Rod, for vehicles with Hinged Leading Axle	
	10/05→	Centre Rod	DF-DL-12420		for Steering Rod	
	10/05→	Suspension Arm Repair Kit		MN-RK-7291	for Drag Link	
	10/05→	Suspension Arm Repair Kit	CV-RK-1583	CV-RK-1583	Trailing Arm	

CV-ES-12461

Length: 120
Cone Ø: d1 Ø 26 / d2 Ø 23,5
Thread: M30 x 1,5 LHT
69513, 0069513, 0311300, 311300,
0607998, 607998, 1190653, 1315447,
1319838, 1332123, 1338714, 1401934,
1407394, ACHB063, ACHF241, MAK1295



CV-ES-12462

Length: 120
Cone Ø: d1 Ø 26 / d2 Ø 23,5
Thread: M30 x 1,5 RHT
0069514, 0586753, 0607999, 0694298,
0694360, 0698609, 1137230, 1229944,
1326862, 1326896, 1331925, ACHB064,
ACHF242, MAK1296



CV-ES-14162

Length: 125
Cone Ø: d1 Ø 30 / d2 Ø 27
Thread: M30 x 1,5 LHT
607053, 690225, 696225, 1228115,
1611088



CV-ES-14163

Length: 125
Cone Ø: d1 Ø 30 / d2 Ø 27
Thread: M30 x 1,5 RHT
0607981, 0698450, 1149907, 1152350,
1257890, 1603789, 1618048, ACHF060



CV-RK-1583



DF-DL-7780

Length: 1690
Ø: 40
Cone Ø: d1 Ø 26 / d2 Ø 23,5
1270853, 1353391, 1021200A



DF-DL-8158

Length: 611
Ø: 48
Hole Distance: 130 / 130
0267743, 1361649, 1361650, 1656428



DF-DL-8704

Length: 991
Ø: 50
Cone Ø: d1 Ø 30 / d2 Ø 27
1395994



DF-DL-8705

Length: 996
Ø: 38
Cone Ø: d1 Ø 30 / d2 Ø 27
1395993



DF-DL-8718

Length: 1690
Ø: 40
Cone Ø: d1 Ø 30 / d2 Ø 27
1700000



DF-DL-9331

Length: 390
Ø: 50
Hole Distance: 130 / 152
1261101



DF-DL-10192

Length: 590
Ø: 38
Cone Ø: d1 Ø 30 / d2 Ø 27
1440171, 1451119



DF-DL-10193

Length: 1646
Ø: 40
Cone Ø: d1 Ø 26 / d2 Ø 23,5
1351205, 1353395



DF-DL-12420

Length: 1004
Ø: 52
Cone Ø: d1 Ø 30 / d2 Ø 27
Thread: M24 x 1,5 / M30 x 1,5
94613, 0094613, 094613, 0362413, 362413,
1426101



DF-ES-5761

Length: 1512
Ø: 52
Cone Ø: d1 Ø 26 / d2 Ø 23,5
1297572, 1361155



DF-ES-8362

Length: 150
Cone Ø: d1 Ø 26 / d2 Ø 23,5
Thread: M30 x 1,5 RHT
1389190



DF-ES-12428

Length: 120
Cone Ø: d1 Ø 30
Thread: M24 x 1,5 RHT
1603788, 1604105



DF-RK-8633

Ø: 90
0696320, 696320



DF-TC-12262

Length: 595
Ø: 50
Hole Distance: 130 / 130
661406, 0661406, 661407, 0661407,
1620439



DF-TC-12492

Length: 600
Ø: 40
Hole Distance: 115 / 115
1274741

No Image

DF-VB-8561

Length: 609
Ø: 48
Hole Distance: 152 / 152
0080521, 080521, 1361651, 1368270,
1390932, 1617096, 1793875, 1817808,
1892492



MN-RK-7280

Ø: 75
Hole Distance: 115
Thick/Height: 24
689748, 0689748



MN-RK-7291

Ø: 72
Hole Distance: 130
Thick/Height: 30
1271124





XF 105 ...

FTS 105.510, FTR 105.510 ...	10/05→	Suspension Arm Repair Kit	MN-RK-7280	MN-RK-7280	for Drag Link;for Semi-Trailing Arm; for Wishbone (CV)	
	10/05→	Tie Rod		DF-ES-5761	Leading Axle	
	10/05→	Tie Rod	DF-DL-7780		1st FA	
	10/05→	Tie Rod	DF-DL-8718		1st FA	
	10/05→	Tie Rod	DF-DL-10193		1st FA	
	10/05→	Tie Rod End	CV-ES-12461		for Steering Rod	
	10/05→	Tie Rod End	CV-ES-12462		for Steering Rod	
	10/05→	Tie Rod End	CV-ES-14162		for Steering Rod	
	10/05→	Tie Rod End	CV-ES-14163		for Steering Rod	
	10/05→	Track Control Arm		DF-DL-8158	Trailing Arm	
	10/05→	Track Control Arm		DF-DL-9331	Wishbone (CV), 1st RA, for Pneumatic Suspension vehicles	
	10/05→	Track Control Arm		DF-TC-12492	Control Arm	
	10/05→	Track Control Arm		DF-VB-8561	Wishbone (CV)	
	FTT 105.410	10/05→	Centre Rod	DF-DL-12420		for Steering Rod
10/05→		Suspension Arm Repair Kit		DF-RK-8633	for Wishbone (CV)	
10/05→		Suspension Arm Repair Kit	MN-RK-7280	MN-RK-7280	for Drag Link;for Semi-Trailing Arm; for Wishbone (CV)	
10/05→		Tie Rod	MN-ES-10334		for Push Rod	
10/05→		Tie Rod End	CV-ES-12461		for Steering Rod	
10/05→		Tie Rod End	CV-ES-12462		for Steering Rod	
10/05→		Tie Rod End	CV-ES-14162		for Steering Rod	
10/05→		Tie Rod End	CV-ES-14163		for Steering Rod	
10/05→		Tie Rod End	DF-ES-8362		for Steering Rod	
10/05→		Track Control Arm		DF-DL-8158	Trailing Arm	
10/05→		Track Control Arm		DF-TC-12262	Control Arm	
FTT 105.460		10/05→	Centre Rod	DF-DL-8704		Push Rod
		10/05→	Centre Rod	DF-DL-8705		Push Rod
		10/05→	Centre Rod	DF-DL-12420		for Steering Rod
	10/05→	Suspension Arm Repair Kit		DF-RK-8633	for Wishbone (CV)	
	10/05→	Suspension Arm Repair Kit	MN-RK-7280	MN-RK-7280	for Drag Link;for Semi-Trailing Arm; for Wishbone (CV)	
	10/05→	Tie Rod	DF-DL-7780		1st FA	
	10/05→	Tie Rod	DF-DL-10193		1st FA	
	10/05→	Tie Rod	MN-ES-10334		for Push Rod	
	10/05→	Tie Rod End	CV-ES-12461		for Steering Rod	
	10/05→	Tie Rod End	CV-ES-12462		for Steering Rod	
	10/05→	Tie Rod End	CV-ES-14162		for Steering Rod	
	10/05→	Tie Rod End	CV-ES-14163		for Steering Rod	
	10/05→	Tie Rod End	DF-ES-8362		for Steering Rod	
	10/05→	Track Control Arm		DF-DL-8158	Trailing Arm	
10/05→	Track Control Arm		DF-TC-12262	Trailing Arm, 1st RA;2nd RA, for Leaf-Spring Suspension vehicles		
FTT 105.510	10/05→	Centre Rod	DF-DL-8704		Push Rod	
	10/05→	Centre Rod	DF-DL-8705		Push Rod	
	10/05→	Centre Rod	DF-DL-12420		for Steering Rod	
	10/05→	Suspension Arm Repair Kit		DF-RK-8633	for Wishbone (CV)	
	10/05→	Suspension Arm Repair Kit	MN-RK-7280	MN-RK-7280	for Drag Link;for Semi-Trailing Arm; for Wishbone (CV)	
	10/05→	Tie Rod	DF-DL-5403		1st FA	
	10/05→	Tie Rod	DF-DL-7780		1st FA	
	10/05→	Tie Rod	DF-DL-10193		1st FA	
	10/05→	Tie Rod	MN-ES-10334		for Push Rod	
	10/05→	Tie Rod End	CV-ES-12461		for Steering Rod	
	10/05→	Tie Rod End	CV-ES-12462		for Steering Rod	
	10/05→	Tie Rod End	CV-ES-14162		for Steering Rod	
	10/05→	Tie Rod End	CV-ES-14163		for Steering Rod	
	10/05→	Tie Rod End	DF-ES-8362		for Steering Rod	
10/05→	Track Control Arm		DF-DL-8158	Trailing Arm		
10/05→	Track Control Arm		DF-TC-12262	Control Arm		
10/05→	Track Control Arm		DF-VB-8561	Wishbone (CV)		

CV-ES-12461

Length: 120
Cone Ø: d1 Ø 26 / d2 Ø 23,5
Thread: M30 x 1,5 LHT
0069513, 69513, 0311300, 311300,
0607998, 607998, 1190653, 1315447,
1319838, 1332123, 1338714, 1401934,
1407394, ACHB063, ACHF241, MAK1295



CV-ES-12462

Length: 120
Cone Ø: d1 Ø 26 / d2 Ø 23,5
Thread: M30 x 1,5 RHT
0069514, 0586753, 0607999, 0694298,
0694360, 0698609, 1137230, 1229944,
1326862, 1326896, 1331925, ACHB064,
ACHF242, MAK1296



CV-ES-14162

Length: 125
Cone Ø: d1 Ø 30 / d2 Ø 27
Thread: M30 x 1,5 LHT
607053, 690225, 696225, 1228115,
1611088



CV-ES-14163

Length: 125
Cone Ø: d1 Ø 30 / d2 Ø 27
Thread: M30 x 1,5 RHT
0607981, 0698450, 1149907, 1152350,
1257890, 1603789, 1618048, ACHF060



DF-DL-5403

Length: 1742
Ø: 40
Cone Ø: d1 Ø 26 / d2 Ø 23,5
0288281, 1270854, 1337644



DF-DL-7780

Length: 1690
Ø: 40
Cone Ø: d1 Ø 26 / d2 Ø 23,5
1270853, 1353391, 10212000A



DF-DL-8158

Length: 611
Ø: 48
Hole Distance: 130 / 130
0267743, 1361649, 1361650, 1656428



DF-DL-8704

Length: 991
Ø: 50
Cone Ø: d1 Ø 30 / d2 Ø 27
1395994



DF-DL-8705

Length: 996
Ø: 38
Cone Ø: d1 Ø 30 / d2 Ø 27
1395993



DF-DL-8718

Length: 1690
Ø: 40
Cone Ø: d1 Ø 30 / d2 Ø 27
1700000



DF-DL-9331

Length: 390
Ø: 50
Hole Distance: 130 / 152
1261101



DF-DL-10193

Length: 1646
Ø: 40
Cone Ø: d1 Ø 26 / d2 Ø 23,5
1351205, 1353395



DF-DL-12420

Length: 1004
Ø: 52
Cone Ø: d1 Ø 30 / d2 Ø 27
Thread: M24 x 1,5 / M30 x 1,5
0094613, 094613, 94613, 0362413, 362413,
1426101



DF-ES-5761

Length: 1512
Ø: 52
Cone Ø: d1 Ø 26 / d2 Ø 23,5
1297572, 1361155



DF-ES-8362

Length: 150
Cone Ø: d1 Ø 26 / d2 Ø 23,5
Thread: M30 x 1,5 RHT
1389190

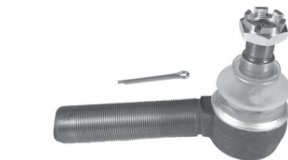

DF-RK-8633

Ø: 90
696320, 0696320



DF-TC-12262

Length: 595
Ø: 50
Hole Distance: 130 / 130
0661406, 661406, 0661407, 661407,
1620439



DF-TC-12492

Length: 600
Ø: 40
Hole Distance: 115 / 115
1274741

No Image

DF-VB-8561

Length: 609
Ø: 48
Hole Distance: 152 / 152
0080521, 080521, 1361651, 1368270,
1390932, 1617096, 1793875, 1817808,
1892492



MN-ES-10334

Length: 140
Cone Ø: d1 Ø 26 / d2 Ø 23,5
Thread: M30 x 1,5 RHT
1320855, 1342026, 3093714, 10220897,
81953016236, 81953016331



MN-RK-7280

Ø: 75
Hole Distance: 115
Thick/Height: 24
0689748, 689748





ECT

18.380 FLRC	06/03→	Centre Rod	MN-DL-7801		Push Rod	
	06/03→	Tie Rod	MN-DL-7802			
	06/03→	Track Control Arm		MN-DL-5225	Trailing Arm	
	06/03→	Track Control Arm		MN-DL-8709	Trailing Arm	
	06/03→	Track Control Arm		MN-VB-5238	Wishbone (CV), Drive Axle;Air Suspension Axle	
18.380 FLRS	07/05→	Centre Rod	MN-DL-7801		Push Rod	
	07/05→	Tie Rod	MN-DL-7802			
	07/05→	Track Control Arm		MN-DL-5225	Trailing Arm	
	07/05→	Track Control Arm		MN-DL-8709	Trailing Arm	
	07/05→	Track Control Arm		MN-VB-5238	Wishbone (CV), Drive Axle;Air Suspension Axle	
18.420 FLRC	06/03→	Centre Rod	MN-DL-7801		Push Rod	
	06/03→	Tie Rod	MN-DL-7802			
	06/03→	Track Control Arm		MN-DL-5225	Trailing Arm	
	06/03→	Track Control Arm		MN-DL-8709	Trailing Arm	
	06/03→	Track Control Arm		MN-VB-5238	Wishbone (CV), Drive Axle;Air Suspension Axle	
18.420 FLRS	07/05→	Centre Rod	MN-DL-7801		Push Rod	
	07/05→	Tie Rod	MN-DL-7802			
	07/05→	Track Control Arm		MN-DL-5225	Trailing Arm	
	07/05→	Track Control Arm		MN-DL-8709	Trailing Arm	
	07/05→	Track Control Arm		MN-VB-5238	Wishbone (CV), Drive Axle;Air Suspension Axle	
24.380 FPLRS	07/05→	Centre Rod	MN-DL-7801		Push Rod	
	07/05→	Tie Rod	MN-DL-7802			
	07/05→	Track Control Arm		MN-DL-5225	Trailing Arm	
	07/05→	Track Control Arm		MN-VB-5238	Wishbone (CV), Drive Axle	
24.420 FPLRS	07/05→	Centre Rod	MN-DL-7801		Push Rod	
	07/05→	Tie Rod	MN-DL-7802			
	07/05→	Track Control Arm		MN-DL-5225	Trailing Arm	
	07/05→	Track Control Arm		MN-VB-5238	Wishbone (CV), Drive Axle	
26.380 FNLRC, FNLLRC	06/03→12/04	Track Control Arm		MN-DL-5212	Trailing Arm, Tag Axle;for vehicles with Hinged Trailing Axle	
	06/03→	Centre Rod	MN-DL-7801		Push Rod, Leaf Spring Axle	
	06/03→	Centre Rod	MN-DL-8560		Push Rod, Air Suspension Axle	
	06/03→	Tie Rod	MN-DL-7802			
	06/03→	Tie Rod	MN-DL-12284			
	06/03→	Track Control Arm		MN-DL-5225	Trailing Arm, Drive Axle	
	06/03→	Track Control Arm		MN-DL-8709	Trailing Arm, Tag Axle;for vehicles with Hinged Trailing Axle	
	06/03→	Track Control Arm		MN-VB-5238	Wishbone (CV), Drive Axle	
	06/03→	Track Control Arm		MN-VB-9403	Wishbone (CV), Tag Axle	
	06/03→	Track Control Arm	MN-DL-8663		Control Arm	
	04/04→	Track Control Arm		MN-DL-5225	Trailing Arm, Tag Axle;for vehicles with Hinged Trailing Axle	
	26.380 FPLRS	07/05→	Centre Rod	MN-DL-7801		Push Rod
		07/05→	Tie Rod	MN-DL-7802		
07/05→		Track Control Arm		MN-DL-5225	Trailing Arm	
07/05→		Track Control Arm		MN-VB-5238	Wishbone (CV), Drive Axle	
26.420 FNLRC, FNLLRC	06/03→12/04	Track Control Arm		MN-DL-5212	Trailing Arm, Tag Axle;for vehicles with Hinged Trailing Axle	
	06/03→	Centre Rod	MN-DL-7801		Push Rod, Leaf Spring Axle	
	06/03→	Centre Rod	MN-DL-8560		Push Rod, Air Suspension Axle	
	06/03→	Tie Rod	MN-DL-7802			
	06/03→	Tie Rod	MN-DL-12284			
	06/03→	Track Control Arm		MN-DL-5225	Trailing Arm, Drive Axle	
	06/03→	Track Control Arm		MN-DL-8709	Trailing Arm, Tag Axle;for vehicles with Hinged Trailing Axle	
	06/03→	Track Control Arm		MN-VB-5238	Wishbone (CV), Drive Axle	
	06/03→	Track Control Arm		MN-VB-9403	Wishbone (CV), Tag Axle	
	06/03→	Track Control Arm	MN-DL-8663		Control Arm	
	04/04→	Track Control Arm		MN-DL-5225	Trailing Arm, Tag Axle;for vehicles with Hinged Trailing Axle	
	26.420 FPLRS	07/05→	Centre Rod	MN-DL-7801		Push Rod
		07/05→	Tie Rod	MN-DL-7802		
07/05→		Track Control Arm		MN-DL-5225	Trailing Arm	
07/05→		Track Control Arm		MN-VB-5238	Wishbone (CV), Drive Axle	

MN-DL-5212

MN-DL-5225

MN-DL-7801

MN-DL-7802

MN-DL-8560

MN-DL-8663

MN-DL-8709

MN-DL-12284

Length: 1530

Ø: 50

Cone Ø: d1 Ø 30 / d2 Ø 27

81466106624, 81467116720



MN-VB-5238

MN-VB-9403

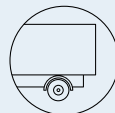

ACCESS BUS 127

GX 127	03/06→	Suspension Arm Repair Kit	RV-RK-7849	RV-RK-7849	for Drag Link;for Control Arm
GX 127 L	03/06→	Suspension Arm Repair Kit	RV-RK-7849	RV-RK-7849	for Drag Link;for Control Arm

AGORA

Agora L	01/03→	Suspension Arm Repair Kit	RV-RK-7849	RV-RK-7849	for Drag Link;for Control Arm
	01/03→	Tie Rod	RV-DL-8587		
Agora S	01/03→12/05	Suspension Arm Repair Kit	RV-RK-7849	RV-RK-7849	for Drag Link;for Control Arm
	01/03→	Tie Rod	RV-DL-8587		

ARWAY

10.6M, 12M, 12.8M	06/06→	Suspension Arm Repair Kit	DB-RK-8366	DB-RK-8366	for Control Arm;for Drag Link
	06/06→	Tie Rod	RV-DL-12381		
15M	01/05→12/13	Suspension Arm Repair Kit	DB-RK-8366	DB-RK-8366	for Control Arm;for Drag Link
	01/05→12/13	Tie Rod	RV-DL-12381		

AXER

12.8m	03/05→01/07	Suspension Arm Repair Kit	DB-RK-8366	DB-RK-8366	for Control Arm;for Drag Link
	03/05→01/07	Tie Rod	RV-DL-12381		
12m, 12.8m	03/05→01/07	Suspension Arm Repair Kit	DB-RK-8366	DB-RK-8366	for Control Arm;for Drag Link
	03/05→01/07	Tie Rod	RV-DL-12381		

CITELIS

10.5 CNG, 12 CNG	07/05→12/13	Suspension Arm Repair Kit	DB-RK-8366	DB-RK-8366	for Control Arm;for Drag Link
10.5, 12, Line	09/05→	Suspension Arm Repair Kit	DB-RK-8366	DB-RK-8366	for Control Arm;for Drag Link

CREALIS

12, 12 NEO	01/09→	Suspension Arm Repair Kit	DB-RK-8366	DB-RK-8366	for Control Arm;for Drag Link
------------	--------	---------------------------	------------	------------	-------------------------------

CROSSWAY

10.6m, 12m, 12.8m	06/06→	Suspension Arm Repair Kit	DB-RK-8366	DB-RK-8366	for Control Arm;for Drag Link
-------------------	--------	---------------------------	------------	------------	-------------------------------

EVADYS

H 12m, 12.8m	10/03→	Suspension Arm Repair Kit	DB-RK-8366	DB-RK-8366	for Control Arm;for Drag Link
HD 12m	10/03→	Suspension Arm Repair Kit	DB-RK-8366	DB-RK-8366	for Control Arm;for Drag Link

MAGELYS

HD	08/08→12/13	Suspension Arm Repair Kit	DB-RK-8366	DB-RK-8366	for Control Arm;for Drag Link
----	-------------	---------------------------	------------	------------	-------------------------------

RECRCO

12m, 12.8m	10/03→01/07	Suspension Arm Repair Kit	DB-RK-8366	DB-RK-8366	for Control Arm;for Drag Link
------------	-------------	---------------------------	------------	------------	-------------------------------

IRIZAR

PB

PB 12, PB 13	10/09→	Centre Rod	IV-DL-8162		Push Rod
	10/09→	Tie Rod	IV-DL-8367		Guide Rod
PB 14, PB 14.6, PB 16	10/09→	Centre Rod	IV-DL-8162		Push Rod
	10/09→	Centre Rod	VL-DL-4895		Push Rod
	10/09→	Centre Rod	VL-DL-4912		Push Rod
	10/09→	Centre Rod	VL-DL-8405		Push Rod
	10/09→	Stabiliser Link		DB-DL-12364	Coupling Rod
	10/09→	Stabiliser Link	DB-DL-12363		Coupling Rod
	10/09→	Stabiliser Link	VL-DL-8595		Coupling Rod
	10/09→	Stabiliser Link	VL-DL-12415		Suspension Rod
	10/09→	Stabiliser Link	VL-DL-12416		Suspension Rod
	10/09→	Tie Rod	IV-DL-8367		Guide Rod
	10/09→	Tie Rod	IV-DL-9360		
	10/09→	Tie Rod	MN-DL-10268		
	10/09→	Tie Rod	MN-DL-10269		
	10/09→	Tie Rod	VL-DL-8404		
	10/09→	Tie Rod	VL-DL-8597		
	10/09→	Tie Rod End		MN-ES-8490	
10/09→	Track Control Arm		MN-DL-10283	Trailing Arm	
10/09→	Track Control Arm		MN-DL-10286	Trailing Arm	
10/09→	Track Control Arm	VL-VB-10430		Wishbone (CV)	

DB-DL-12363



MN-DL-10283



VL-DL-8404



DB-DL-12364



MN-DL-10286



VL-DL-8405



DB-RK-8366



MN-ES-8490



VL-DL-8595



IV-DL-8162



RV-DL-8587



VL-DL-8597



IV-DL-8367



RV-DL-12381



VL-DL-12415



IV-DL-9360



RV-RK-7849



VL-DL-12416



MN-DL-10268



VL-DL-4895



VL-VB-10430



MN-DL-10269



VL-DL-4912



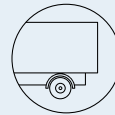

EuroCargo I-III

100 E 15 K	01/91→09/15	Ball Head, gearshift linkage	CV-ES-2119			
	01/91→09/15	Ball Head, gearshift linkage	CV-ES-2182			
	01/91→09/15	Centre Rod	IV-DL-0215		Push Rod	
	01/91→09/15	Suspension Arm Repair Kit		DF-RK-8503	for Control Arm	
	01/91→09/15	Tie Rod	IV-DL-7785			
	01/91→09/15	Tie Rod End	CV-ES-12461		for Steering Rod	
	01/91→09/15	Tie Rod End	CV-ES-12462		for Steering Rod	
	01/91→09/15	Tie Rod End	IV-ES-12419		for Steering Rod	
100 E 15, 100 E 15 P	01/91→09/15	Ball Head, gearshift linkage	CV-ES-2119			
	01/91→09/15	Ball Head, gearshift linkage	CV-ES-2182			
	01/91→09/15	Centre Rod	IV-DL-0215		Push Rod	
	01/91→09/15	Suspension Arm Repair Kit		DF-RK-8503	for Control Arm	
	01/91→09/15	Tie Rod	IV-DL-7785			
	01/91→09/15	Tie Rod End	CV-ES-12461		for Steering Rod	
	01/91→09/15	Tie Rod End	CV-ES-12462		for Steering Rod	
	01/91→09/15	Tie Rod End	IV-ES-12419		for Steering Rod	
100 E 17 K tector, 100 E 17 DK tector	09/00→09/15	Suspension Arm Repair Kit		DF-RK-8503	for Control Arm	
	09/00→09/15	Tie Rod	IV-DL-7785			
	09/00→09/15	Tie Rod End	CV-ES-12461		for Steering Rod	
	09/00→09/15	Tie Rod End	CV-ES-12462		for Steering Rod	
	09/00→09/15	Tie Rod End	IV-ES-12419		for Steering Rod	
100 E 17, 100 E 17 DP tector, 100 E 18 tector	09/00→09/15	Suspension Arm Repair Kit		DF-RK-8503	for Control Arm	
	09/00→09/15	Tie Rod	IV-DL-7785			
	09/00→09/15	Tie Rod End	CV-ES-12461		for Steering Rod	
	09/00→09/15	Tie Rod End	CV-ES-12462		for Steering Rod	
	09/00→09/15	Tie Rod End	IV-ES-12419		for Steering Rod	
100 E 18 K	01/91→09/15	Ball Head, gearshift linkage	CV-ES-2119			
	01/91→09/15	Ball Head, gearshift linkage	CV-ES-2182			
	01/91→09/15	Centre Rod	IV-DL-0215		Push Rod	
	01/91→09/15	Centre Rod	IV-DL-12264		for Steering Rod	
	01/91→09/15	Suspension Arm Repair Kit		DF-RK-8503	for Control Arm	
	01/91→09/15	Tie Rod	IV-DL-7785			
	01/91→09/15	Tie Rod End	CV-ES-12461		for Steering Rod	
	01/91→09/15	Tie Rod End	CV-ES-12462		for Steering Rod	
	01/91→09/15	Tie Rod End	CV-ES-14163		for Steering Rod	
	01/91→09/15	Tie Rod End	IV-ES-12419		for Steering Rod	
100 E 18 K tector	09/06→09/15	Centre Rod	IV-DL-12264		for Steering Rod	
	09/06→09/15	Suspension Arm Repair Kit		DF-RK-8503	for Control Arm	
	09/06→09/15	Tie Rod	IV-DL-7785			
	09/06→09/15	Tie Rod End	CV-ES-14163		for Steering Rod	
100 E 18 K tector, 100 E 18 DK tector	09/00→09/15	Centre Rod	IV-DL-5371		Push Rod	
	09/00→09/15	Centre Rod	IV-DL-12264		for Steering Rod	
	09/00→09/15	Suspension Arm Repair Kit		DF-RK-8503	for Control Arm	
	09/00→09/15	Tie Rod	IV-DL-7785			
	09/00→09/15	Tie Rod End	CV-ES-12461		for Steering Rod	
	09/00→09/15	Tie Rod End	CV-ES-12462		for Steering Rod	
	09/00→09/15	Tie Rod End	CV-ES-14163		for Steering Rod	
	09/00→09/15	Tie Rod End	IV-ES-12419		for Steering Rod	
	100 E 18 tector, 100 E 18 P tector, 100 E 18 FP tector	09/00→09/15	Centre Rod	IV-DL-5371		Push Rod
		09/00→09/15	Centre Rod	IV-DL-12264		for Steering Rod
09/00→09/15		Suspension Arm Repair Kit		DF-RK-8503	for Control Arm	
09/00→09/15		Tie Rod	IV-DL-7785			
09/00→09/15		Tie Rod End	CV-ES-12461		for Steering Rod	
09/00→09/15		Tie Rod End	CV-ES-12462		for Steering Rod	
09/00→09/15		Tie Rod End	CV-ES-14163		for Steering Rod	
09/00→09/15		Tie Rod End	IV-ES-12419		for Steering Rod	
100 E 18 W tector, 100 E 18 WS tector	09/00→09/15	Centre Rod	IV-DL-5371		Push Rod	
	09/00→09/15	Centre Rod	IV-DL-12264		for Steering Rod	
	09/00→09/15	Suspension Arm Repair Kit		DF-RK-8503	for Control Arm	
	09/00→09/15	Tie Rod	IV-DL-7785			
	09/00→09/15	Tie Rod End	CV-ES-14163		for Steering Rod	
	09/00→09/15	Tie Rod End	IV-ES-12419		for Steering Rod	

CV-ES-2119

Length: 55
Cone Ø: d1 Ø 10 / d2 Ø 10
Thread: M12 x 1,75 LHT
8198188, 42485638



IV-DL-0215

Length: 822
Ø: 40
Cone Ø: d1 Ø 26 / d2 Ø 23,5
98402544, 98467459



CV-ES-2182

Length: 55
Cone Ø: d1 Ø 10 / d2 Ø 10
Thread: M12 x 1,75 RHT
8198187



IV-DL-5371

Length: 878
Ø: 36
Cone Ø: d1 Ø 30 / d2 Ø 27
98449025, 98469650



CV-ES-12461

Length: 120
Cone Ø: d1 Ø 26 / d2 Ø 23,5
Thread: M30 x 1,5 LHT
2980129, 002984511, 02984511, 2984511,
4833821, 004833828, 04833828, 4833828,
8122755, 42493782, 042493782



IV-DL-7785

Length: 1490
Ø: 38
Cone Ø: d1 Ø 26 / d2 Ø 23,5
98402553, 500307556



CV-ES-12462

Length: 120
Cone Ø: d1 Ø 26 / d2 Ø 23,5
Thread: M30 x 1,5 RHT
2966688, 2980323, 3096213, 4833820,
004833827, 4833827, 8122754, 42483520,
42485718, 42493781



IV-DL-12264

Length: 966
Ø: 50
Cone Ø: d1 Ø 30 / d2 Ø 27
98473328



CV-ES-14163

Length: 125
Cone Ø: d1 Ø 30 / d2 Ø 27
Thread: M30 x 1,5 RHT
2966252, 2969808, 4802443, 4833829,
7138967, 8122752, 42483386, 42488269,
42489573, 42489594, 42491638, 42537936



IV-ES-12419

Length: 55
Cone Ø: d1 Ø 10 / d2 Ø 10
Thread: M10 x 1,5 RHT
2041327, 41002118, 41203863, 42079853



DF-RK-8503

Ø: 75
Hole Distance: 130
Thick/Height: 24
93192361





EuroCargo I-III ...

100 E 18, 100 E 18 P	01/91→09/15	Ball Head, gearshift linkage	CV-ES-2119		
	01/91→09/15	Ball Head, gearshift linkage	CV-ES-2182		
	01/91→09/15	Centre Rod	IV-DL-0215		Push Rod
	01/91→09/15	Centre Rod	IV-DL-12264		for Steering Rod
	01/91→09/15	Suspension Arm Repair Kit		DF-RK-8503	for Control Arm
	01/91→09/15	Tie Rod	IV-DL-7785		
	01/91→09/15	Tie Rod End	CV-ES-12461		for Steering Rod
	01/91→09/15	Tie Rod End	CV-ES-12462		for Steering Rod
	01/91→09/15	Tie Rod End	CV-ES-14163		for Steering Rod
100 E 21 K tector, 100 E 21 DK tector	09/00→09/15	Centre Rod	IV-DL-5371		Push Rod
	09/00→09/15	Centre Rod	IV-DL-12264		for Steering Rod
	09/00→09/15	Suspension Arm Repair Kit		DF-RK-8503	for Control Arm
	09/00→09/15	Tie Rod	IV-DL-7785		
	09/00→09/15	Tie Rod End	CV-ES-12461		for Steering Rod
	09/00→09/15	Tie Rod End	CV-ES-12462		for Steering Rod
	09/00→09/15	Tie Rod End	CV-ES-14163		for Steering Rod
	09/00→09/15	Tie Rod End	IV-ES-12419		for Steering Rod
	100 E 21 W tector, 100 E 21 WS tector	09/00→09/15	Centre Rod	IV-DL-5371	
09/00→09/15		Centre Rod	IV-DL-12264		for Steering Rod
09/00→09/15		Suspension Arm Repair Kit		DF-RK-8503	for Control Arm
09/00→09/15		Tie Rod	IV-DL-7785		
09/00→09/15		Tie Rod End	CV-ES-14163		for Steering Rod
09/00→09/15		Tie Rod End	IV-ES-12419		for Steering Rod
100 E 21, 100 E 21 DP tector, 100 E 22 tector	09/00→09/15	Centre Rod	IV-DL-5371		Push Rod
	09/00→09/15	Centre Rod	IV-DL-12264		for Steering Rod
	09/00→09/15	Suspension Arm Repair Kit		DF-RK-8503	for Control Arm
	09/00→09/15	Tie Rod	IV-DL-7785		
	09/00→09/15	Tie Rod End	CV-ES-12461		for Steering Rod
	09/00→09/15	Tie Rod End	CV-ES-12462		for Steering Rod
	09/00→09/15	Tie Rod End	CV-ES-14163		for Steering Rod
	09/00→09/15	Tie Rod End	IV-ES-12419		for Steering Rod
100 E 21, 100 E 21 P	01/91→09/15	Ball Head, gearshift linkage	CV-ES-2119		
	01/91→09/15	Ball Head, gearshift linkage	CV-ES-2182		
	01/91→09/15	Centre Rod	IV-DL-0215		Push Rod
	01/91→09/15	Centre Rod	IV-DL-12264		for Steering Rod
	01/91→09/15	Suspension Arm Repair Kit		DF-RK-8503	for Control Arm
	01/91→09/15	Tie Rod	IV-DL-7785		
	01/91→09/15	Tie Rod End	CV-ES-12461		for Steering Rod
	01/91→09/15	Tie Rod End	CV-ES-12462		for Steering Rod
	01/91→09/15	Tie Rod End	CV-ES-14163		for Steering Rod
	01/91→09/15	Tie Rod End	IV-ES-12419		for Steering Rod
	100 E 22 tector, 100 E 22 P tector, 100 E 22 FP tector	09/06→09/15	Centre Rod	IV-DL-12264	
09/06→09/15		Suspension Arm Repair Kit		DF-RK-8503	for Control Arm
09/06→09/15		Tie Rod End	CV-ES-14163		for Steering Rod
100 E 22 W tector, 100 E 22 WS tector	09/06→09/15	Centre Rod	IV-DL-12264		for Steering Rod
	09/06→09/15	Suspension Arm Repair Kit		DF-RK-8503	for Control Arm
110 E 18 tector, 110 E 18 P tector, 110 EL 18 P tector	09/06→09/15	Suspension Arm Repair Kit		DF-RK-8503	for Control Arm
	09/06→09/15	Suspension Arm Repair Kit		DF-RK-8503	for Control Arm
110 E 22 tector, 110 E 22 P tector, 110 EL 22 P tector	09/06→09/15	Suspension Arm Repair Kit		DF-RK-8503	for Control Arm
	09/06→09/15	Tie Rod End	CV-ES-14163		for Steering Rod
110 E 22 W tector	05/06→09/15	Centre Rod	IV-DL-12264		for Steering Rod
	05/06→09/15	Suspension Arm Repair Kit		DF-RK-8503	for Control Arm
	05/06→09/15	Tie Rod End	CV-ES-14163		for Steering Rod
110 E 22 WS tector	05/06→09/15	Centre Rod	IV-DL-12264		for Steering Rod
	05/06→09/15	Suspension Arm Repair Kit		DF-RK-8503	for Control Arm
110 E 25 W tector	05/06→09/15	Suspension Arm Repair Kit		DF-RK-8503	for Control Arm
	05/06→09/15	Suspension Arm Repair Kit		DF-RK-8503	for Control Arm
120 E 15	01/91→09/15	Centre Rod	IV-DS-0284		Push Rod
	01/91→09/15	Suspension Arm Repair Kit		DF-RK-8503	for Control Arm
	01/91→09/15	Tie Rod	IV-DL-7785		

CV-ES-2119

Length: 55
Cone Ø: d1 Ø 10 / d2 Ø 10
Thread: M12 x 1,75 LHT
8198188, 42485638



IV-DL-0215

Length: 822
Ø: 40
Cone Ø: d1 Ø 26 / d2 Ø 23,5
98402544, 98467459



CV-ES-2182

Length: 55
Cone Ø: d1 Ø 10 / d2 Ø 10
Thread: M12 x 1,75 RHT
8198187



IV-DL-5371

Length: 878
Ø: 36
Cone Ø: d1 Ø 30 / d2 Ø 27
98449025, 98469650



CV-ES-12461

Length: 120
Cone Ø: d1 Ø 26 / d2 Ø 23,5
Thread: M30 x 1,5 LHT
2980129, 002984511, 02984511, 2984511,
4833821, 004833828, 04833828, 4833828,
8122755, 042493782, 42493782



IV-DL-7785

Length: 1490
Ø: 38
Cone Ø: d1 Ø 26 / d2 Ø 23,5
98402553, 500307556



CV-ES-12462

Length: 120
Cone Ø: d1 Ø 26 / d2 Ø 23,5
Thread: M30 x 1,5 RHT
2966688, 2980323, 3096213, 4833820,
004833827, 4833827, 8122754, 42483520,
42485718, 42493781



IV-DL-12264

Length: 966
Ø: 50
Cone Ø: d1 Ø 30 / d2 Ø 27
98473328



CV-ES-14163

Length: 125
Cone Ø: d1 Ø 30 / d2 Ø 27
Thread: M30 x 1,5 RHT
2966252, 2969808, 4802443, 4833829,
7138967, 8122752, 42483386, 42488269,
42489573, 42489594, 42491638, 42537936



IV-DS-0284

Length: 902
Ø: 42
Cone Ø: d1 Ø 26 / d2 Ø 23,5
04854874, 4854874



DF-RK-8503

Ø: 75
Hole Distance: 130
Thick/Height: 24
93192361



IV-ES-12419

Length: 55
Cone Ø: d1 Ø 10 / d2 Ø 10
Thread: M10 x 1,5 RHT
2041327, 41002118, 41203863, 42079853





EuroCargo I-III ...

120 E 15 ...	01/91→09/15	Tie Rod	IV-DL-8183		Guide Rod
	01/91→09/15	Tie Rod End	CV-ES-12461		for Steering Rod
	01/91→09/15	Tie Rod End	CV-ES-12462		for Steering Rod
	01/91→09/15	Tie Rod End	IV-ES-12419		for Steering Rod
	01/91→09/15	Track Control Arm		IV-DL-8613	Trailing Arm, Drive Axle;Air Suspension Axle
	01/91→09/15	Track Control Arm		IV-TC-12431	Trailing Arm
	01/91→09/15	Track Control Arm		IV-VB-8146	Wishbone (CV), Drive Axle;Air Suspension Axle
120 E 15 K	01/91→09/15	Centre Rod	IV-DS-0284		Push Rod
	01/91→09/15	Suspension Arm Repair Kit		DF-RK-8503	for Control Arm
	01/91→09/15	Tie Rod	IV-DL-7785		
	01/91→09/15	Tie Rod	IV-DL-8183		Guide Rod
	01/91→09/15	Tie Rod End	CV-ES-12461		for Steering Rod
	01/91→09/15	Tie Rod End	CV-ES-12462		for Steering Rod
	01/91→09/15	Tie Rod End	IV-ES-12419		for Steering Rod
	01/91→09/15	Track Control Arm		IV-TC-12431	Trailing Arm
120 E 18 K	01/91→09/15	Track Control Arm		IV-VB-8146	Wishbone (CV), Drive Axle;Air Suspension Axle
	01/91→09/15	Centre Rod	IV-DS-0284		Push Rod
	01/91→09/15	Suspension Arm Repair Kit		DF-RK-8503	for Control Arm
	01/91→09/15	Tie Rod	IV-DL-8183		Guide Rod
	01/91→09/15	Tie Rod End	CV-ES-12461		for Steering Rod
	01/91→09/15	Tie Rod End	CV-ES-12462		for Steering Rod
	01/91→09/15	Tie Rod End	IV-ES-12419		for Steering Rod
120 E 18 K tector, 120 E 18 DK tector	01/91→09/15	Track Control Arm		IV-TC-12431	Trailing Arm
	01/91→09/15	Track Control Arm		IV-VB-8146	Wishbone (CV), Drive Axle;Air Suspension Axle
	09/00→09/15	Centre Rod	IV-DL-5371		Push Rod
	09/00→09/15	Suspension Arm Repair Kit		DF-RK-8503	for Control Arm
	09/00→09/15	Tie Rod	IV-DL-7785		
	09/00→09/15	Tie Rod	IV-DL-8183		Guide Rod
	09/00→09/15	Track Control Arm		IV-TC-12431	Trailing Arm
120 E 18 K tector, 120 E 18 DP tector	09/00→09/15	Track Control Arm		IV-VB-8146	Wishbone (CV), Drive Axle;Air Suspension Axle
	09/06→09/15	Centre Rod	IV-DL-9359		Push Rod
	09/06→09/15	Tie Rod End	CV-ES-12461		for Steering Rod
	09/06→09/15	Tie Rod End	CV-ES-12462		for Steering Rod
	09/06→09/15	Tie Rod End	CV-ES-14162		for Steering Rod
	09/06→09/15	Tie Rod End	CV-ES-14163		for Steering Rod
	09/06→09/15	Track Control Arm		IV-DL-8613	Trailing Arm, 1st Drive Axle, for Pneumatic Suspension vehicles
	09/00→09/15	Centre Rod	IV-DL-5371		Push Rod
	09/00→09/15	Suspension Arm Repair Kit		DF-RK-8503	for Control Arm
	09/00→09/15	Tie Rod	IV-DL-7785		
120 E 18 tector, 120 E 18 D tector, 120 E 18 DP tector	09/00→09/15	Tie Rod	IV-DL-8183		Guide Rod
	09/00→09/15	Track Control Arm		IV-TC-12431	Trailing Arm
	09/00→09/15	Track Control Arm		IV-VB-8146	Wishbone (CV), Drive Axle;Air Suspension Axle
	01/91→09/15	Centre Rod	IV-DS-0284		Push Rod
	01/91→09/15	Suspension Arm Repair Kit		DF-RK-8503	for Control Arm
	01/91→09/15	Tie Rod	IV-DL-8183		Guide Rod
	01/91→09/15	Tie Rod End	CV-ES-12461		for Steering Rod
120 E 18, 120 E 18 P, 120 E 18 H	01/91→09/15	Tie Rod End	CV-ES-12462		for Steering Rod
	01/91→09/15	Tie Rod End	IV-ES-12419		for Steering Rod
	01/91→09/15	Track Control Arm		IV-DL-8613	Trailing Arm, Drive Axle;Air Suspension Axle
	01/91→09/15	Track Control Arm		IV-TC-12431	Trailing Arm
	01/91→09/15	Track Control Arm		IV-VB-8146	Wishbone (CV), Drive Axle;Air Suspension Axle
	01/92→09/15	Tie Rod	IV-DL-8183		Guide Rod
	01/92→09/15	Tie Rod End	CV-ES-12461		for Steering Rod
120 E 21 H	09/00→09/15	Centre Rod	IV-DL-5371		Push Rod
	09/00→09/15	Centre Rod	IV-DL-9359		Push Rod
	09/00→09/15	Suspension Arm Repair Kit		DF-RK-8503	for Control Arm
	09/00→09/15	Tie Rod	IV-DL-7785		
	09/00→09/15	Tie Rod End	CV-ES-12461		for Steering Rod
	09/00→09/15	Tie Rod End	CV-ES-12462		for Steering Rod
120 E 21 tector,120 E 21 P tector, 120 E 21 FP tector	09/00→09/15	Centre Rod	IV-DL-5371		Push Rod
	09/00→09/15	Centre Rod	IV-DL-9359		Push Rod
	09/00→09/15	Suspension Arm Repair Kit		DF-RK-8503	for Control Arm

CV-ES-12461

Length: 120
Cone Ø: d1 Ø 26 / d2 Ø 23,5
Thread: M30 x 1,5 LHT
2980129, 002984511, 02984511, 2984511,
4833821, 004833828, 04833828, 4833828,
8122755, 042493782, 42493782



CV-ES-12462

Length: 120
Cone Ø: d1 Ø 26 / d2 Ø 23,5
Thread: M30 x 1,5 RHT
2966688, 2980323, 3096213, 4833820,
004833827, 4833827, 8122754, 42483520,
42485718, 42493781



CV-ES-14162

Length: 125
Cone Ø: d1 Ø 30 / d2 Ø 27
Thread: M30 x 1,5 LHT
2984061, 4802444, 4833830, 7138966,
8190225, 42489395, 42491957



CV-ES-14163

Length: 125
Cone Ø: d1 Ø 30 / d2 Ø 27
Thread: M30 x 1,5 RHT
2966252, 2969808, 4802443, 4833829,
7138967, 8122752, 42483386, 42488269,
42489573, 42489594, 42491638, 42537936



DF-RK-8503

Ø: 75
Hole Distance: 130
Thick/Height: 24
93192361



IV-DL-5371

Length: 878
Ø: 36
Cone Ø: d1 Ø 30 / d2 Ø 27
98449025, 98469650



IV-DL-7785

Length: 1490
Ø: 38
Cone Ø: d1 Ø 26 / d2 Ø 23,5
98402553, 500307556



IV-DL-8183

Length: 1584
Ø: 42
Cone Ø: d1 Ø 26 / d2 Ø 23,5
4854871



IV-DL-8613

Length: 594
Ø: 50
Hole Distance: 130 / 130
41009661, 41009666, 41035951, 41272429,
98472446, 98472466



IV-DL-9359

Length: 785
Ø: 40
Cone Ø: d1 Ø 26 / d2 Ø 23,5
500324282



IV-DS-0284

Length: 902
Ø: 42
Cone Ø: d1 Ø 26 / d2 Ø 23,5
04854874, 4854874



IV-ES-12419

Length: 55
Cone Ø: d1 Ø 10 / d2 Ø 10
Thread: M10 x 1,5 RHT
2041327, 41002118, 41203863, 42079853



IV-TC-12431

Length: 594
Ø: 40
Hole Distance: 130 / 130
8137027



IV-VB-8146

Length: 659
Ø: 46
Hole Distance: 130 / 130
41028599, 41042092, 98405832, 98472468,
504064007





EuroCargo I-III ...

120 E 21 tector, 120 E 21 P tector,	09/00→09/15	Tie Rod	IV-DL-7785		
120 E 21 FP tector ...	09/00→09/15	Tie Rod End	CV-ES-12461		for Steering Rod
	09/00→09/15	Tie Rod End	CV-ES-12462		for Steering Rod
	09/00→09/15	Tie Rod End	IV-ES-12419		for Steering Rod
120 E 22 D tector, 120 E 22 P tector,	09/06→09/15	Suspension Arm Repair Kit		DF-RK-8503	for Control Arm
120 E 22 FP tector					
120 E 22 K tector	09/06→09/15	Suspension Arm Repair Kit		DF-RK-8503	for Control Arm
120 E 23, 120 E 23 P, 120 E 23 FP,	01/91→09/15	Centre Rod	IV-DS-0284		Push Rod
120 E 23 H	01/91→09/15	Suspension Arm Repair Kit		DF-RK-8503	for Control Arm
	01/91→09/15	Tie Rod	IV-DL-8183		Guide Rod
	01/91→09/15	Tie Rod End	CV-ES-12461		for Steering Rod
	01/91→09/15	Tie Rod End	CV-ES-12462		for Steering Rod
	01/91→09/15	Tie Rod End	IV-ES-12419		for Steering Rod
	01/91→09/15	Track Control Arm		IV-DL-8613	Trailing Arm, Drive Axle; Air Suspension Axle
	01/91→09/15	Track Control Arm		IV-TC-12431	Trailing Arm
	01/91→09/15	Track Control Arm		IV-VB-8146	Wishbone (CV), Drive Axle; Air Suspension Axle
120 E 24 K tector,	09/00→09/15	Centre Rod	IV-DL-5371		Push Rod
120 E 24 DK tector	09/00→09/15	Suspension Arm Repair Kit		DF-RK-8503	for Control Arm
	09/00→09/15	Tie Rod	IV-DL-7785		
120 E 24, 120 E 24 DP tector,	09/00→09/15	Centre Rod	IV-DL-5371		Push Rod
120 E 25 FP tector	09/00→09/15	Suspension Arm Repair Kit		DF-RK-8503	for Control Arm
	09/00→09/15	Tie Rod	IV-DL-7785		
120 E 25 K tector,	09/06→09/15	Suspension Arm Repair Kit		DF-RK-8503	for Control Arm
120 E 25 DK tector					
120 E 28 K tector	09/00→09/15	Centre Rod	IV-DL-5371		Push Rod
	09/00→09/15	Suspension Arm Repair Kit		DF-RK-8503	for Control Arm
	09/00→09/15	Tie Rod	IV-DL-7785		
120 E 28 tector, 120 E 28 P tector,	09/00→09/15	Centre Rod	IV-DL-5371		Push Rod
120 E 28 FP tector	09/00→09/15	Suspension Arm Repair Kit		DF-RK-8503	for Control Arm
	09/00→09/15	Tie Rod	IV-DL-7785		
120 EL 17, 120 EL 17 P tector,	09/00→09/15	Centre Rod	IV-DL-9359		Push Rod
120 E 18, 120 EL 18 tector	09/00→09/15	Suspension Arm Repair Kit		DF-RK-8503	for Control Arm
	09/00→09/15	Tie Rod	IV-DL-7785		
	09/00→09/15	Tie Rod End	CV-ES-12461		for Steering Rod
	09/00→09/15	Tie Rod End	CV-ES-12462		for Steering Rod
	09/00→09/15	Tie Rod End	IV-ES-12419		for Steering Rod
120 EL 21, 120 EL 21 P tector,	09/00→09/15	Centre Rod	IV-DL-5371		Push Rod
120 E 22, 120 EL 22 tector	09/00→09/15	Centre Rod	IV-DL-9359		Push Rod
	09/00→09/15	Suspension Arm Repair Kit		DF-RK-8503	for Control Arm
	09/00→09/15	Tie Rod	IV-DL-7785		
	09/00→09/15	Tie Rod End	CV-ES-12461		for Steering Rod
	09/00→09/15	Tie Rod End	CV-ES-12462		for Steering Rod
	09/00→09/15	Tie Rod End	IV-ES-12419		for Steering Rod
130 E 15	01/91→09/15	Centre Rod	IV-DS-0284		Push Rod
	01/91→09/15	Suspension Arm Repair Kit		DF-RK-8503	for Control Arm
	01/91→09/15	Tie Rod	IV-DL-7785		
	01/91→09/15	Tie Rod	IV-DL-8183		Guide Rod
	01/91→09/15	Tie Rod End	CV-ES-12461		for Steering Rod
	01/91→09/15	Tie Rod End	CV-ES-12462		for Steering Rod
	01/91→09/15	Tie Rod End	IV-ES-12419		for Steering Rod
	01/91→09/15	Track Control Arm		IV-TC-12431	Trailing Arm
	01/91→09/15	Track Control Arm		IV-VB-8146	Wishbone (CV), Drive Axle; Air Suspension Axle
130 E 15 K	01/91→09/15	Centre Rod	IV-DS-0284		Push Rod
	01/91→09/15	Suspension Arm Repair Kit		DF-RK-8503	for Control Arm
	01/91→09/15	Tie Rod	IV-DL-7785		
	01/91→09/15	Tie Rod	IV-DL-8183		Guide Rod
	01/91→09/15	Tie Rod End	CV-ES-12461		for Steering Rod
	01/91→09/15	Tie Rod End	CV-ES-12462		for Steering Rod
	01/91→09/15	Tie Rod End	IV-ES-12419		for Steering Rod
	01/91→09/15	Track Control Arm		IV-TC-12431	Trailing Arm
	01/91→09/15	Track Control Arm		IV-VB-8146	Wishbone (CV), Drive Axle; Air Suspension Axle

CV-ES-12461

Length: 120
Cone Ø: d1 Ø 26 / d2 Ø 23,5
Thread: M30 x 1,5 LHT
2980129, 002984511, 02984511, 2984511,
4833821, 4833828, 004833828, 04833828,
8122755, 42493782, 042493782



IV-DL-8613

Length: 594
Ø: 50
Hole Distance: 130 / 130
41009661, 41009666, 41035951, 41272429,
98472446, 98472466



CV-ES-12462

Length: 120
Cone Ø: d1 Ø 26 / d2 Ø 23,5
Thread: M30 x 1,5 RHT
2966688, 2980323, 3096213, 4833820,
004833827, 4833827, 8122754, 42483520,
42485718, 42493781



IV-DL-9359

Length: 785
Ø: 40
Cone Ø: d1 Ø 26 / d2 Ø 23,5
500324282



DF-RK-8503

Ø: 75
Hole Distance: 130
Thick/Height: 24
93192361



IV-DS-0284

Length: 902
Ø: 42
Cone Ø: d1 Ø 26 / d2 Ø 23,5
04854874, 4854874



IV-DL-5371

Length: 878
Ø: 36
Cone Ø: d1 Ø 30 / d2 Ø 27
98449025, 98469650



IV-ES-12419

Length: 55
Cone Ø: d1 Ø 10 / d2 Ø 10
Thread: M10 x 1,5 RHT
2041327, 41002118, 41203863, 42079853



IV-DL-7785

Length: 1490
Ø: 38
Cone Ø: d1 Ø 26 / d2 Ø 23,5
98402553, 500307556



IV-TC-12431

Length: 594
Ø: 40
Hole Distance: 130 / 130
8137027



IV-DL-8183

Length: 1584
Ø: 42
Cone Ø: d1 Ø 26 / d2 Ø 23,5
4854871



IV-VB-8146

Length: 659
Ø: 46
Hole Distance: 130 / 130
41028599, 41042092, 98405832, 98472468,
504064007





EuroCargo I-III ...

130 E 18	01/91→09/15	Centre Rod	IV-DS-0284		Push Rod	
	01/91→09/15	Suspension Arm Repair Kit		DF-RK-8503	for Control Arm	
	01/91→09/15	Tie Rod	IV-DL-8183		Guide Rod	
	01/91→09/15	Tie Rod End	CV-ES-12461		for Steering Rod	
	01/91→09/15	Tie Rod End	CV-ES-12462		for Steering Rod	
	01/91→09/15	Tie Rod End	IV-ES-12419		for Steering Rod	
	01/91→09/15	Track Control Arm		IV-DL-8613	Trailing Arm, Drive Axle;Air Suspension Axle	
	01/91→09/15	Track Control Arm		IV-TC-12431	Trailing Arm	
	01/91→09/15	Track Control Arm		IV-VB-8146	Wishbone (CV), Drive Axle;Air Suspension Axle	
130 E 18 D tector, 130 E 18 DP tector	09/06→09/15	Suspension Arm Repair Kit		DF-RK-8503	for Control Arm	
130 E 18 K	01/91→09/15	Centre Rod	IV-DS-0284		Push Rod	
	01/91→09/15	Suspension Arm Repair Kit		DF-RK-8503	for Control Arm	
	01/91→09/15	Tie Rod	IV-DL-8183		Guide Rod	
	01/91→09/15	Tie Rod End	CV-ES-12461		for Steering Rod	
	01/91→09/15	Tie Rod End	CV-ES-12462		for Steering Rod	
	01/91→09/15	Tie Rod End	IV-ES-12419		for Steering Rod	
	01/91→09/15	Track Control Arm		IV-TC-12431	Trailing Arm	
	01/91→09/15	Track Control Arm		IV-VB-8146	Wishbone (CV), Drive Axle;Air Suspension Axle	
	130 E 18 K tector, 130 E 18 DK tector	09/00→09/15	Centre Rod	IV-DL-5371		Push Rod
09/00→09/15		Suspension Arm Repair Kit		DF-RK-8503	for Control Arm	
09/00→09/15		Tie Rod	IV-DL-7785			
09/00→09/15		Tie Rod	IV-DL-8183		Guide Rod	
09/00→09/15		Tie Rod End	CV-ES-12461		for Steering Rod	
09/00→09/15		Tie Rod End	CV-ES-12462		for Steering Rod	
09/00→09/15		Tie Rod End	IV-ES-12419		for Steering Rod	
09/00→09/15		Track Control Arm		IV-DL-8613	Trailing Arm, 1st Drive Axle, for Pneumatic Suspension vehicles	
09/00→09/15		Track Control Arm		IV-TC-12431	Trailing Arm	
09/00→09/15		Track Control Arm		IV-VB-8146	Wishbone (CV), Drive Axle;Air Suspension Axle	
130 E 18 tector, 130 E 18 D tector, 130 E 18 DP tector		09/00→09/15	Centre Rod	IV-DL-5371		Push Rod
		09/00→09/15	Suspension Arm Repair Kit		DF-RK-8503	for Control Arm
		09/00→09/15	Tie Rod	IV-DL-7785		
	09/00→09/15	Tie Rod	IV-DL-8183		Guide Rod	
	09/00→09/15	Tie Rod End	CV-ES-12461		for Steering Rod	
	09/00→09/15	Tie Rod End	CV-ES-12462		for Steering Rod	
	09/00→09/15	Tie Rod End	IV-ES-12419		for Steering Rod	
	09/00→09/15	Track Control Arm		IV-DL-8613	Trailing Arm, 1st Drive Axle, for Pneumatic Suspension vehicles	
	09/00→09/15	Track Control Arm		IV-TC-12431	Trailing Arm	
	09/00→09/15	Track Control Arm		IV-VB-8146	Wishbone (CV), Drive Axle;Air Suspension Axle	
	130 E 21 K tector	09/00→09/15	Centre Rod	IV-DL-5371		Push Rod
		09/00→09/15	Suspension Arm Repair Kit		DF-RK-8503	for Control Arm
		09/00→09/15	Tie Rod	IV-DL-7785		
09/00→09/15		Tie Rod	IV-DL-8183		Guide Rod	
09/00→09/15		Tie Rod End	CV-ES-12461		for Steering Rod	
09/00→09/15		Tie Rod End	CV-ES-12462		for Steering Rod	
09/00→09/15		Tie Rod End	IV-ES-12419		for Steering Rod	
09/00→09/15		Track Control Arm		IV-DL-8613	Trailing Arm, Drive Axle;Air Suspension Axle	
09/00→09/15		Track Control Arm		IV-TC-12431	Trailing Arm, 1st RA, for Pneumatic Suspension vehicles	
09/00→09/15		Track Control Arm		IV-VB-8146	Wishbone (CV), Drive Axle;Air Suspension Axle	
130 E 21 tector, 130 E21 P tector, 130 E 21 FP tector		09/00→09/15	Centre Rod	IV-DL-5371		Push Rod
		09/00→09/15	Suspension Arm Repair Kit		DF-RK-8503	for Control Arm
		09/00→09/15	Tie Rod	IV-DL-7785		
	09/00→09/15	Tie Rod	IV-DL-8183		Guide Rod	
	09/00→09/15	Tie Rod End	CV-ES-12461		for Steering Rod	
	09/00→09/15	Tie Rod End	CV-ES-12462		for Steering Rod	
	09/00→09/15	Tie Rod End	IV-ES-12419		for Steering Rod	
	09/00→09/15	Track Control Arm		IV-DL-8613	Trailing Arm, Drive Axle;Air Suspension Axle	
	09/00→09/15	Track Control Arm		IV-TC-12431	Trailing Arm, 1st RA, for Pneumatic Suspension vehicles	
	09/00→09/15	Track Control Arm		IV-VB-8146	Wishbone (CV), Drive Axle;Air Suspension Axle	

CV-ES-12461

Length: 120
Cone Ø: d1 Ø 26 / d2 Ø 23,5
Thread: M30 x 1,5 LHT
2980129, 002984511, 02984511, 2984511,
4833821, 004833828, 04833828, 4833828,
8122755, 42493782, 042493782



IV-DL-8613

Length: 594
Ø: 50
Hole Distance: 130 / 130
41009661, 41009666, 41035951, 41272429,
98472446, 98472466



CV-ES-12462

Length: 120
Cone Ø: d1 Ø 26 / d2 Ø 23,5
Thread: M30 x 1,5 RHT
2966688, 2980323, 3096213, 4833820,
004833827, 4833827, 8122754, 42483520,
42485718, 42493781



IV-DS-0284

Length: 902
Ø: 42
Cone Ø: d1 Ø 26 / d2 Ø 23,5
4854874, 04854874



DF-RK-8503

Ø: 75
Hole Distance: 130
Thick/Height: 24
93192361



IV-ES-12419

Length: 55
Cone Ø: d1 Ø 10 / d2 Ø 10
Thread: M10 x 1,5 RHT
2041327, 41002118, 41203863, 42079853



IV-DL-5371

Length: 878
Ø: 36
Cone Ø: d1 Ø 30 / d2 Ø 27
98449025, 98469650



IV-TC-12431

Length: 594
Ø: 40
Hole Distance: 130 / 130
8137027



IV-DL-7785

Length: 1490
Ø: 38
Cone Ø: d1 Ø 26 / d2 Ø 23,5
98402553, 500307556



IV-VB-8146

Length: 659
Ø: 46
Hole Distance: 130 / 130
41028599, 41042092, 98405832, 98472468,
504064007



IV-DL-8183

Length: 1584
Ø: 42
Cone Ø: d1 Ø 26 / d2 Ø 23,5
4854871



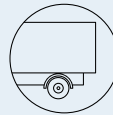

EuroCargo I-III ...

130 E 23	01/91→09/15	Centre Rod	IV-DS-0284		Push Rod	
	01/91→09/15	Suspension Arm Repair Kit		DF-RK-8503	for Control Arm	
	01/91→09/15	Tie Rod	IV-DL-8183		Guide Rod	
	01/91→09/15	Tie Rod End	CV-ES-12461		for Steering Rod	
	01/91→09/15	Tie Rod End	CV-ES-12462		for Steering Rod	
	01/91→09/15	Tie Rod End	IV-ES-12419		for Steering Rod	
	01/91→09/15	Track Control Arm		IV-DL-8613	Trailing Arm, Drive Axle;Air Suspension Axle	
	01/91→09/15	Track Control Arm		IV-TC-12431	Trailing Arm	
	01/91→09/15	Track Control Arm		IV-VB-8146	Wishbone (CV), Drive Axle;Air Suspension Axle	
130 E 24 K tector, 130 E 24 DK tector	09/00→09/15	Centre Rod	IV-DL-5371		Push Rod	
	09/00→09/15	Centre Rod	IV-DL-8665		Push Rod	
	09/00→09/15	Suspension Arm Repair Kit		DF-RK-8503	for Control Arm	
	09/00→09/15	Tie Rod	IV-DL-7785			
	09/00→09/15	Tie Rod	IV-DL-8183		Guide Rod	
	09/00→09/15	Tie Rod End	CV-ES-12461		for Steering Rod	
	09/00→09/15	Tie Rod End	CV-ES-12462		for Steering Rod	
	09/00→09/15	Tie Rod End	CV-ES-14163		for Steering Rod	
	09/00→09/15	Tie Rod End	IV-ES-12419		for Steering Rod	
130 E 24 tector, 130 E 24 D tector, 130 E 24 DP tector	09/00→09/15	Track Control Arm		IV-DL-8613	Trailing Arm, Drive Axle;Air Suspension Axle	
	09/00→09/15	Track Control Arm		IV-TC-12431	Trailing Arm, 1st RA, for Pneumatic Suspension vehicles, Ch.2398023→	
	09/00→09/15	Track Control Arm		IV-VB-8146	Wishbone (CV), Drive Axle;Air Suspension Axle	
	09/00→09/15	Centre Rod	IV-DL-5371		Push Rod	
	09/00→09/15	Centre Rod	IV-DL-8665		Push Rod	
	09/00→09/15	Suspension Arm Repair Kit		DF-RK-8503	for Control Arm	
	09/00→09/15	Tie Rod	IV-DL-7785			
	09/00→09/15	Tie Rod	IV-DL-8183		Guide Rod	
	09/00→09/15	Tie Rod End	CV-ES-12461		for Steering Rod	
130 E 25 D tector, 130 E 25 DP tector	09/00→09/15	Tie Rod End	CV-ES-12462		for Steering Rod	
	09/00→09/15	Tie Rod End	CV-ES-14163		for Steering Rod	
	09/00→09/15	Tie Rod End	IV-ES-12419		for Steering Rod	
	09/00→09/15	Track Control Arm		IV-DL-8613	Trailing Arm, Drive Axle;Air Suspension Axle	
	09/00→09/15	Track Control Arm		IV-TC-12431	Trailing Arm, 1st RA, for Pneumatic Suspension vehicles, Ch.2398023→	
	09/00→09/15	Track Control Arm		IV-VB-8146	Wishbone (CV), Drive Axle;Air Suspension Axle	
	09/06→09/15	Suspension Arm Repair Kit		DF-RK-8503	for Control Arm	
	130 E 25 DK tector	09/06→09/15	Suspension Arm Repair Kit		DF-RK-8503	for Control Arm
	130 E 28 K tector	09/00→09/15	Centre Rod	IV-DL-5371		Push Rod
09/00→09/15		Suspension Arm Repair Kit		DF-RK-8503	for Control Arm	
09/00→09/15		Tie Rod	IV-DL-7785			
09/00→09/15		Tie Rod	IV-DL-8183		Guide Rod	
09/00→09/15		Tie Rod End	CV-ES-12461		for Steering Rod	
09/00→09/15		Tie Rod End	CV-ES-12462		for Steering Rod	
09/00→09/15		Tie Rod End	IV-ES-12419		for Steering Rod	
09/00→09/15		Track Control Arm		IV-DL-8613	Trailing Arm, 1st Drive Axle, for Pneumatic Suspension vehicles	
09/00→09/15		Track Control Arm		IV-TC-12431	Trailing Arm	
130 E 28 tector	09/00→09/15	Track Control Arm		IV-VB-8146	Wishbone (CV), Drive Axle;Air Suspension Axle	
	09/00→09/15	Centre Rod	IV-DL-5371		Push Rod	
	09/00→09/15	Suspension Arm Repair Kit		DF-RK-8503	for Control Arm	
	09/00→09/15	Tie Rod	IV-DL-7785			
	09/00→09/15	Tie Rod	IV-DL-8183		Guide Rod	
	09/00→09/15	Tie Rod End	CV-ES-12461		for Steering Rod	
	09/00→09/15	Tie Rod End	CV-ES-12462		for Steering Rod	
	09/00→09/15	Tie Rod End	IV-ES-12419		for Steering Rod	
	09/00→09/15	Track Control Arm		IV-DL-8613	Trailing Arm, 1st Drive Axle, for Pneumatic Suspension vehicles	
135 E 18 W	09/00→09/15	Track Control Arm		IV-TC-12431	Trailing Arm	
	09/00→09/15	Track Control Arm		IV-VB-8146	Wishbone (CV), Drive Axle;Air Suspension Axle	
	01/91→09/15	Centre Rod	IV-DL-12264		for Steering Rod	
	01/91→09/15	Centre Rod	IV-DS-0284		Push Rod	
	01/91→09/15	Suspension Arm Repair Kit		DF-RK-8503	for Control Arm	

CV-ES-12461

Length: 120
Cone Ø: d1 Ø 26 / d2 Ø 23,5
Thread: M30 x 1,5 LHT
2980129, 02984511, 2984511, 002984511,
4833821, 004833828, 04833828, 4833828,
8122755, 042493782, 42493782



CV-ES-12462

Length: 120
Cone Ø: d1 Ø 26 / d2 Ø 23,5
Thread: M30 x 1,5 RHT
2966688, 2980323, 3096213, 4833820,
004833827, 4833827, 8122754, 42483520,
42485718, 42493781



CV-ES-14163

Length: 125
Cone Ø: d1 Ø 30 / d2 Ø 27
Thread: M30 x 1,5 RHT
2966252, 2969808, 4802443, 4833829,
7138967, 8122752, 42483386, 42488269,
42489573, 42489594, 42491638, 42537936



DF-RK-8503

Ø: 75
Hole Distance: 130
Thick/Height: 24
93192361



IV-DL-5371

Length: 878
Ø: 36
Cone Ø: d1 Ø 30 / d2 Ø 27
98449025, 98469650



IV-DL-7785

Length: 1490
Ø: 38
Cone Ø: d1 Ø 26 / d2 Ø 23,5
98402553, 500307556



IV-DL-8183

Length: 1584
Ø: 42
Cone Ø: d1 Ø 26 / d2 Ø 23,5
4854871



IV-DL-8613

Length: 594
Ø: 50
Hole Distance: 130 / 130
41009661, 41009666, 41035951, 41272429,
98472446, 98472466



IV-DL-8665

Length: 892
Ø: 42
Cone Ø: d1 Ø 30 / d2 Ø 27
504049893



IV-DL-12264

Length: 966
Ø: 50
Cone Ø: d1 Ø 30 / d2 Ø 27
98473328



IV-DS-0284

Length: 902
Ø: 42
Cone Ø: d1 Ø 26 / d2 Ø 23,5
04854874, 4854874



IV-ES-12419

Length: 55
Cone Ø: d1 Ø 10 / d2 Ø 10
Thread: M10 x 1,5 RHT
2041327, 41002118, 41203863, 42079853



IV-TC-12431

Length: 594
Ø: 40
Hole Distance: 130 / 130
8137027



IV-VB-8146

Length: 659
Ø: 46
Hole Distance: 130 / 130
41028599, 41042092, 98405832, 98472468,
504064007





EuroCargo I-III ...

135 E 18 W ...	01/91→09/15	Tie Rod	IV-DL-8183		Guide Rod
	01/91→09/15	Tie Rod End	CV-ES-12461		for Steering Rod
	01/91→09/15	Tie Rod End	CV-ES-12462		for Steering Rod
	01/91→09/15	Tie Rod End	CV-ES-14163		for Steering Rod
	01/91→09/15	Tie Rod End	IV-ES-12419		for Steering Rod
135 E 18 WR	01/91→09/15	Centre Rod	IV-DL-12264		for Steering Rod
	01/91→09/15	Centre Rod	IV-DS-0284		Push Rod
	01/91→09/15	Suspension Arm Repair Kit		DF-RK-8503	for Control Arm
	01/91→09/15	Tie Rod End	CV-ES-12461		for Steering Rod
	01/91→09/15	Tie Rod End	CV-ES-12462		for Steering Rod
	01/91→09/15	Tie Rod End	CV-ES-14163		for Steering Rod
135 E 21 W	01/91→09/15	Tie Rod End	IV-ES-12419		for Steering Rod
	01/91→09/15	Centre Rod	IV-DL-12264		for Steering Rod
	01/91→09/15	Suspension Arm Repair Kit		DF-RK-8503	for Control Arm
	01/91→09/15	Tie Rod End	CV-ES-14163		for Steering Rod
135 E 23 W	01/91→09/15	Tie Rod End	IV-ES-12419		for Steering Rod
	01/91→09/15	Centre Rod	IV-DL-12264		for Steering Rod
135 E 23 W	01/91→09/15	Centre Rod	IV-DL-12264		for Steering Rod
	01/91→09/15	Centre Rod	IV-DS-0284		Push Rod
	01/91→09/15	Suspension Arm Repair Kit		DF-RK-8503	for Control Arm
	01/91→09/15	Tie Rod	IV-DL-8183		Guide Rod
	01/91→09/15	Tie Rod End	CV-ES-12461		for Steering Rod
	01/91→09/15	Tie Rod End	CV-ES-12462		for Steering Rod
	01/91→09/15	Tie Rod End	CV-ES-14163		for Steering Rod
	01/91→09/15	Tie Rod End	IV-ES-12419		for Steering Rod
	01/91→09/15	Tie Rod End	IV-ES-12419		for Steering Rod
	01/91→09/15	Tie Rod End	IV-ES-12419		for Steering Rod
135 E 23 WR	01/91→09/15	Centre Rod	IV-DL-12264		for Steering Rod
	01/91→09/15	Centre Rod	IV-DS-0284		Push Rod
	01/91→09/15	Suspension Arm Repair Kit		DF-RK-8503	for Control Arm
	01/91→09/15	Tie Rod End	CV-ES-12461		for Steering Rod
	01/91→09/15	Tie Rod End	CV-ES-12462		for Steering Rod
	01/91→09/15	Tie Rod End	CV-ES-14163		for Steering Rod
	01/91→09/15	Tie Rod End	IV-ES-12419		for Steering Rod
	01/91→09/15	Tie Rod End	IV-ES-12419		for Steering Rod
140 E 18 K	05/05→09/15	Centre Rod	IV-DL-5371		Push Rod
	05/05→09/15	Centre Rod	IV-DL-8665		Push Rod
	05/05→09/15	Centre Rod	IV-DL-12264		for Steering Rod
	05/05→09/15	Suspension Arm Repair Kit		DF-RK-8503	for Control Arm
	05/05→09/15	Tie Rod	IV-DL-7785		
	05/05→09/15	Tie Rod End	CV-ES-12461		for Steering Rod
	05/05→09/15	Tie Rod End	CV-ES-12462		for Steering Rod
	05/05→09/15	Tie Rod End	CV-ES-14163		for Steering Rod
	05/05→09/15	Tie Rod End	IV-ES-12419		for Steering Rod
	05/05→09/15	Track Control Arm		IV-DL-8613	Trailing Arm, Drive Axle;Air Suspension Axle
140 E 18 K tector, 140 E 18 DK tector	05/05→09/15	Track Control Arm		IV-TC-12431	Trailing Arm, 1st RA, for Pneumatic Suspension vehicles
	05/05→09/15	Track Control Arm		IV-VB-8146	Wishbone (CV), Drive Axle;Air Suspension Axle
	09/06→09/15	Centre Rod	IV-DL-8665		Push Rod
	09/06→09/15	Centre Rod	IV-DL-12264		for Steering Rod
	09/06→09/15	Suspension Arm Repair Kit		DF-RK-8503	for Control Arm
	09/06→09/15	Tie Rod	IV-DL-8183		Guide Rod
	09/06→09/15	Tie Rod End	CV-ES-14163		for Steering Rod
	09/06→09/15	Track Control Arm		IV-TC-12431	Trailing Arm
	09/06→09/15	Track Control Arm		IV-VB-8146	Wishbone (CV), Drive Axle;Air Suspension Axle
	09/06→09/15	Track Control Arm		IV-VB-8146	Wishbone (CV), Drive Axle;Air Suspension Axle
140 E 18 tector, 140 E 18 P tector, 140 E 18 D FP tector	09/06→09/15	Centre Rod	IV-DL-8665		Push Rod
	09/06→09/15	Centre Rod	IV-DL-12264		for Steering Rod
	09/06→09/15	Suspension Arm Repair Kit		DF-RK-8503	for Control Arm
	09/06→09/15	Tie Rod	IV-DL-8183		Guide Rod
	09/06→09/15	Tie Rod End	CV-ES-14163		for Steering Rod
	09/06→09/15	Track Control Arm		IV-TC-12431	Trailing Arm
	09/06→09/15	Track Control Arm		IV-VB-8146	Wishbone (CV), Drive Axle;Air Suspension Axle
	09/06→09/15	Track Control Arm		IV-VB-8146	Wishbone (CV), Drive Axle;Air Suspension Axle
140 E 18 W tector	09/00→09/15	Centre Rod	IV-DL-5371		Push Rod
	09/00→09/15	Centre Rod	IV-DL-8665		Push Rod
	09/00→09/15	Centre Rod	IV-DL-12264		for Steering Rod
	09/00→09/15	Suspension Arm Repair Kit		DF-RK-8503	for Control Arm
	09/00→09/15	Tie Rod	IV-DL-7785		
	09/00→09/15	Tie Rod	IV-DL-7785		

CV-ES-12461

Length: 120
Cone Ø: d1 Ø 26 / d2 Ø 23,5
Thread: M30 x 1,5 LHT
2980129, 002984511, 02984511, 2984511,
4833821, 4833828, 004833828, 04833828,
8122755, 042493782, 42493782



CV-ES-12462

Length: 120
Cone Ø: d1 Ø 26 / d2 Ø 23,5
Thread: M30 x 1,5 RHT
2966688, 2980323, 3096213, 4833820,
4833827, 004833827, 8122754, 42483520,
42485718, 42493781



CV-ES-14163

Length: 125
Cone Ø: d1 Ø 30 / d2 Ø 27
Thread: M30 x 1,5 RHT
2966252, 2969808, 4802443, 4833829,
7138967, 8122752, 42483386, 42488269,
42489573, 42489594, 42491638, 42537936



DF-RK-8503

Ø: 75
Hole Distance: 130
Thick/Height: 24
93192361



IV-DL-5371

Length: 878
Ø: 36
Cone Ø: d1 Ø 30 / d2 Ø 27
98449025, 98469650



IV-DL-7785

Length: 1490
Ø: 38
Cone Ø: d1 Ø 26 / d2 Ø 23,5
98402553, 500307556



IV-DL-8183

Length: 1584
Ø: 42
Cone Ø: d1 Ø 26 / d2 Ø 23,5
4854871



IV-DL-8613

Length: 594
Ø: 50
Hole Distance: 130 / 130
41009661, 41009666, 41035951, 41272429,
98472446, 98472466



IV-DL-8665

Length: 892
Ø: 42
Cone Ø: d1 Ø 30 / d2 Ø 27
504049893



IV-DL-12264

Length: 966
Ø: 50
Cone Ø: d1 Ø 30 / d2 Ø 27
98473328



IV-DS-0284

Length: 902
Ø: 42
Cone Ø: d1 Ø 26 / d2 Ø 23,5
04854874, 4854874



IV-ES-12419

Length: 55
Cone Ø: d1 Ø 10 / d2 Ø 10
Thread: M10 x 1,5 RHT
2041327, 41002118, 41203863, 42079853



IV-TC-12431

Length: 594
Ø: 40
Hole Distance: 130 / 130
8137027



IV-VB-8146

Length: 659
Ø: 46
Hole Distance: 130 / 130
41028599, 41042092, 98405832, 98472468,
504064007





EuroCargo I-III ...

140 E 18 W tector ...	09/00→09/15	Tie Rod End	CV-ES-14163		for Steering Rod	
	09/00→09/15	Tie Rod End	IV-ES-12419		for Steering Rod	
140 E 18, 140 E 18 P, 140 E 18 FP	05/05→09/15	Centre Rod	IV-DL-5371		Push Rod	
	05/05→09/15	Centre Rod	IV-DL-8665		Push Rod	
	05/05→09/15	Centre Rod	IV-DL-12264		for Steering Rod	
	05/05→09/15	Suspension Arm Repair Kit		DF-RK-8503	for Control Arm	
	05/05→09/15	Tie Rod	IV-DL-7785			
	05/05→09/15	Tie Rod End	CV-ES-12461		for Steering Rod	
	05/05→09/15	Tie Rod End	CV-ES-12462		for Steering Rod	
	05/05→09/15	Tie Rod End	CV-ES-14163		for Steering Rod	
	05/05→09/15	Tie Rod End	IV-ES-12419		for Steering Rod	
	05/05→09/15	Track Control Arm		IV-DL-8613	Trailing Arm, Drive Axle;Air Suspension Axle	
	05/05→09/15	Track Control Arm		IV-TC-12431	Trailing Arm, 1st RA, for Pneumatic Suspension vehicles	
140 E 21 K	05/05→09/15	Centre Rod	IV-DL-5371		Push Rod	
	05/05→09/15	Centre Rod	IV-DL-8665		Push Rod	
	05/05→09/15	Suspension Arm Repair Kit		DF-RK-8503	for Control Arm	
	05/05→09/15	Tie Rod	IV-DL-7785			
	05/05→09/15	Tie Rod End	CV-ES-12461		for Steering Rod	
	05/05→09/15	Tie Rod End	CV-ES-12462		for Steering Rod	
	05/05→09/15	Tie Rod End	CV-ES-14163		for Steering Rod	
	05/05→09/15	Tie Rod End	IV-ES-12419		for Steering Rod	
	05/05→09/15	Track Control Arm		IV-DL-8613	Trailing Arm, Drive Axle;Air Suspension Axle	
	05/05→09/15	Track Control Arm		IV-TC-12431	Trailing Arm, 1st RA, for Pneumatic Suspension vehicles	
	05/05→09/15	Track Control Arm		IV-VB-8146	Wishbone (CV), Drive Axle;Air Suspension Axle	
140 E 21 tector, 140 E 21 P, 140 E 21 FP	03/05→09/15	Centre Rod	IV-DL-5371		Push Rod	
	03/05→09/15	Centre Rod	IV-DL-8665		Push Rod	
	03/05→09/15	Suspension Arm Repair Kit		DF-RK-8503	for Control Arm	
	03/05→09/15	Tie Rod	IV-DL-7785			
	03/05→09/15	Tie Rod End	CV-ES-12461		for Steering Rod	
	03/05→09/15	Tie Rod End	CV-ES-12462		for Steering Rod	
	03/05→09/15	Tie Rod End	CV-ES-14163		for Steering Rod	
	03/05→09/15	Tie Rod End	IV-ES-12419		for Steering Rod	
	03/05→09/15	Track Control Arm		IV-DL-8613	Trailing Arm, Drive Axle;Air Suspension Axle	
	03/05→09/15	Track Control Arm		IV-TC-12431	Trailing Arm, 1st RA, for Pneumatic Suspension vehicles	
	03/05→09/15	Track Control Arm		IV-VB-8146	Wishbone (CV), Drive Axle;Air Suspension Axle	
140 E 22 K tector	09/06→09/15	Centre Rod	IV-DL-8665		Push Rod	
	09/06→09/15	Suspension Arm Repair Kit		DF-RK-8503	for Control Arm	
	09/06→09/15	Tie Rod End	CV-ES-14163		for Steering Rod	
140 E 22 tector, 140 E 22 P tector, 140 E 22 D FP tector	09/06→09/15	Centre Rod	IV-DL-8665		Push Rod	
	09/06→09/15	Suspension Arm Repair Kit		DF-RK-8503	for Control Arm	
	09/06→09/15	Tie Rod End	CV-ES-14163		for Steering Rod	
140 E 24 K tector	09/00→09/15	Centre Rod	IV-DL-5371		Push Rod	
	09/00→09/15	Centre Rod	IV-DL-8665		Push Rod	
	09/00→09/15	Centre Rod	IV-DL-12264		for Steering Rod	
	09/00→09/15	Suspension Arm Repair Kit		DF-RK-8503	for Control Arm	
	09/00→09/15	Tie Rod	IV-DL-7785			
	09/00→09/15	Tie Rod End	CV-ES-12461		for Steering Rod	
	09/00→09/15	Tie Rod End	CV-ES-12462		for Steering Rod	
	09/00→09/15	Tie Rod End	CV-ES-14163		for Steering Rod	
	09/00→09/15	Tie Rod End	IV-ES-12419		for Steering Rod	
	09/00→09/15	Track Control Arm		IV-DL-8613	Trailing Arm, Drive Axle;Air Suspension Axle	
	09/00→09/15	Track Control Arm		IV-TC-12431	Trailing Arm, 1st RA, for Pneumatic Suspension vehicles	
	09/00→09/15	Track Control Arm		IV-VB-8146	Wishbone (CV), Drive Axle;Air Suspension Axle	
	140 E 24 tector, 14 E 24 P tector, 140 E 24 FP tector	09/00→09/15	Centre Rod	IV-DL-5371		Push Rod
		09/00→09/15	Centre Rod	IV-DL-8665		Push Rod
		09/00→09/15	Centre Rod	IV-DL-12264		for Steering Rod
09/00→09/15		Suspension Arm Repair Kit		DF-RK-8503	for Control Arm	
09/00→09/15		Tie Rod	IV-DL-7785			

CV-ES-12461

Length: 120
Cone Ø: d1 Ø 26 / d2 Ø 23,5
Thread: M30 x 1,5 LHT
2980129, 002984511, 02984511, 2984511,
4833821, 4833828, 04833828, 004833828,
8122755, 042493782, 42493782



CV-ES-12462

Length: 120
Cone Ø: d1 Ø 26 / d2 Ø 23,5
Thread: M30 x 1,5 RHT
2966688, 2980323, 3096213, 4833820,
004833827, 4833827, 8122754, 42483520,
42485718, 42493781



CV-ES-14163

Length: 125
Cone Ø: d1 Ø 30 / d2 Ø 27
Thread: M30 x 1,5 RHT
2966252, 2969808, 4802443, 4833829,
7138967, 8122752, 42483386, 42488269,
42489573, 42489594, 42491638, 42537936



DF-RK-8503

Ø: 75
Hole Distance: 130
Thick/Height: 24
93192361



IV-DL-5371

Length: 878
Ø: 36
Cone Ø: d1 Ø 30 / d2 Ø 27
98449025, 98469650



IV-DL-7785

Length: 1490
Ø: 38
Cone Ø: d1 Ø 26 / d2 Ø 23,5
98402553, 500307556



IV-DL-8613

Length: 594
Ø: 50
Hole Distance: 130 / 130
41009661, 41009666, 41035951, 41272429,
98472446, 98472466



IV-DL-8665

Length: 892
Ø: 42
Cone Ø: d1 Ø 30 / d2 Ø 27
504049893



IV-DL-12264

Length: 966
Ø: 50
Cone Ø: d1 Ø 30 / d2 Ø 27
98473328



IV-ES-12419

Length: 55
Cone Ø: d1 Ø 10 / d2 Ø 10
Thread: M10 x 1,5 RHT
2041327, 41002118, 41203863, 42079853



IV-TC-12431

Length: 594
Ø: 40
Hole Distance: 130 / 130
8137027



IV-VB-8146

Length: 659
Ø: 46
Hole Distance: 130 / 130
41028599, 41042092, 98405832, 98472468,
504064007





EuroCargo I-III ...

140 E 24 tector, 14 E 24 P tector, 140 E 24 FP tector ...	09/00→09/15	Tie Rod End	CV-ES-12461		for Steering Rod
	09/00→09/15	Tie Rod End	CV-ES-12462		for Steering Rod
	09/00→09/15	Tie Rod End	CV-ES-14163		for Steering Rod
	09/00→09/15	Tie Rod End	IV-ES-12419		for Steering Rod
	09/00→09/15	Track Control Arm		IV-DL-8613	Trailing Arm, Drive Axle;Air Suspension Axle
	09/00→09/15	Track Control Arm		IV-TC-12431	Trailing Arm, 1st RA, for Pneumatic Suspension vehicles
140 E 24 W tector, 140 E 24 WS tector	09/00→09/15	Centre Rod	IV-DL-5371		Push Rod
	09/00→09/15	Centre Rod	IV-DL-8665		Push Rod
	09/00→09/15	Centre Rod	IV-DL-12264		for Steering Rod
	09/00→09/15	Suspension Arm Repair Kit		DF-RK-8503	for Control Arm
	09/00→09/15	Tie Rod	IV-DL-7785		
	09/00→09/15	Tie Rod End	CV-ES-14163		for Steering Rod
140 E 25 K tector, 140 E 25 DK tector	09/06→09/15	Centre Rod	IV-DL-8665		Push Rod
	09/06→09/15	Centre Rod	IV-DL-12264		for Steering Rod
	09/06→09/15	Suspension Arm Repair Kit		DF-RK-8503	for Control Arm
	09/06→09/15	Tie Rod End	CV-ES-14163		for Steering Rod
	09/06→09/15	Centre Rod	IV-DL-8665		Push Rod
	09/06→09/15	Centre Rod	IV-DL-12264		for Steering Rod
140 E 25 W tector, 140 E 25 WS tector	09/06→09/15	Centre Rod	IV-DL-8665		Push Rod
	09/06→09/15	Centre Rod	IV-DL-12264		for Steering Rod
	09/06→09/15	Suspension Arm Repair Kit		DF-RK-8503	for Control Arm
	09/06→09/15	Tie Rod End	CV-ES-14163		for Steering Rod
	09/06→09/15	Centre Rod	IV-DL-5371		Push Rod
	09/06→09/15	Centre Rod	IV-DL-8665		Push Rod
140 E 28 K tector	09/06→09/15	Centre Rod	IV-DL-12264		for Steering Rod
	09/06→09/15	Suspension Arm Repair Kit		DF-RK-8503	for Control Arm
	09/06→09/15	Tie Rod	IV-DL-7785		
	09/06→09/15	Tie Rod End	CV-ES-14163		for Steering Rod
	09/06→09/15	Tie Rod End	IV-ES-12419		for Steering Rod
	09/06→09/15	Centre Rod	IV-DL-5371		Push Rod
140 E 28 tector, 140 E 28 P tector, 140 E 28 FP tector	09/06→09/15	Centre Rod	IV-DL-8665		Push Rod
	09/06→09/15	Centre Rod	IV-DL-12264		for Steering Rod
	09/06→09/15	Suspension Arm Repair Kit		DF-RK-8503	for Control Arm
	09/06→09/15	Tie Rod	IV-DL-7785		
	09/06→09/15	Tie Rod End	CV-ES-12461		for Steering Rod
	09/06→09/15	Tie Rod End	CV-ES-12462		for Steering Rod
	09/06→09/15	Tie Rod End	CV-ES-14163		for Steering Rod
	09/06→09/15	Tie Rod End	IV-ES-12419		for Steering Rod
	09/06→09/15	Track Control Arm		IV-DL-8613	Trailing Arm, Drive Axle;Air Suspension Axle
	09/06→09/15	Track Control Arm		IV-TC-12431	Trailing Arm, 1st RA, for Pneumatic Suspension vehicles
	09/06→09/15	Track Control Arm		IV-VB-8146	Wishbone (CV), Drive Axle;Air Suspension Axle
	09/06→09/15	Centre Rod	IV-DL-8665		Push Rod
	09/06→09/15	Centre Rod	IV-DL-12264		for Steering Rod
	140 E 28 W tector, 140 E 28 WS tector	09/06→09/15	Suspension Arm Repair Kit		DF-RK-8503
09/06→09/15		Tie Rod End	CV-ES-14163		for Steering Rod
09/06→09/15		Tie Rod End	IV-ES-12419		for Steering Rod
09/06→09/15		Suspension Arm Repair Kit		DF-RK-8503	for Control Arm
09/06→09/15		Suspension Arm Repair Kit		DF-RK-8503	for Control Arm
09/06→09/15		Suspension Arm Repair Kit		DF-RK-8503	for Control Arm
140 E D 25 tector, 140 E 25 P tector, 140 E 25 FP tector	01/91→09/15	Suspension Arm Repair Kit		DF-RK-8503	for Control Arm
	01/91→09/15	Tie Rod	IV-DL-7785		
	01/91→09/15	Tie Rod	IV-DL-8183		Guide Rod
	01/91→09/15	Tie Rod	IV-DL-12265		
	01/91→09/15	Tie Rod End	CV-ES-12461		for Steering Rod
	01/91→09/15	Tie Rod End	IV-ES-12419		for Steering Rod
	01/91→09/15	Track Control Arm		IV-DL-8613	Trailing Arm, Drive Axle;Air Suspension Axle
	01/91→09/15	Track Control Arm		IV-TC-12431	Trailing Arm
	01/91→09/15	Track Control Arm		IV-VB-8146	Wishbone (CV), Drive Axle;Air Suspension Axle
	01/91→09/15	Suspension Arm Repair Kit		DF-RK-8503	for Control Arm
150 E 15 K	01/91→09/15	Tie Rod	IV-DL-7785		
	01/91→09/15	Tie Rod	IV-DL-8183		Guide Rod
	01/91→09/15	Tie Rod	IV-DL-12265		
	01/91→09/15	Tie Rod	IV-DL-12265		

CV-ES-12461

Length: 120
Cone Ø: d1 Ø 26 / d2 Ø 23,5
Thread: M30 x 1,5 LHT
2980129, 002984511, 02984511, 2984511,
4833821, 004833828, 04833828, 4833828,
8122755, 42493782, 042493782



CV-ES-12462

Length: 120
Cone Ø: d1 Ø 26 / d2 Ø 23,5
Thread: M30 x 1,5 RHT
2966688, 2980323, 3096213, 4833820,
004833827, 4833827, 8122754, 42483520,
42485718, 42493781



CV-ES-14163

Length: 125
Cone Ø: d1 Ø 30 / d2 Ø 27
Thread: M30 x 1,5 RHT
2966252, 2969808, 4802443, 4833829,
7138967, 8122752, 42483386, 42488269,
42489573, 42489594, 42491638, 42537936



DF-RK-8503

Ø: 75
Hole Distance: 130
Thick/Height: 24
93192361



IV-DL-5371

Length: 878
Ø: 36
Cone Ø: d1 Ø 30 / d2 Ø 27
98449025, 98469650



IV-DL-7785

Length: 1490
Ø: 38
Cone Ø: d1 Ø 26 / d2 Ø 23,5
98402553, 500307556



IV-DL-8183

Length: 1584
Ø: 42
Cone Ø: d1 Ø 26 / d2 Ø 23,5
4854871



IV-DL-8613

Length: 594
Ø: 50
Hole Distance: 130 / 130
41009661, 41009666, 41035951, 41272429,
98472446, 98472466



IV-DL-8665

Length: 892
Ø: 42
Cone Ø: d1 Ø 30 / d2 Ø 27
504049893



IV-DL-12264

Length: 966
Ø: 50
Cone Ø: d1 Ø 30 / d2 Ø 27
98473328



IV-DL-12265

Length: 1577
Ø: 48
Cone Ø: d1 Ø 30 / d2 Ø 27
8165309, 41005309, 41005460



IV-ES-12419

Length: 55
Cone Ø: d1 Ø 10 / d2 Ø 10
Thread: M10 x 1,5 RHT
2041327, 41002118, 41203863, 42079853



IV-TC-12431

Length: 594
Ø: 40
Hole Distance: 130 / 130
8137027



IV-VB-8146

Length: 659
Ø: 46
Hole Distance: 130 / 130
41028599, 41042092, 98405832, 98472468,
504064007





EuroCargo I-III ...

150 E 15 K ...	01/91→09/15	Tie Rod End	CV-ES-12461		for Steering Rod	
	01/91→09/15	Tie Rod End	IV-ES-12419		for Steering Rod	
	01/91→09/15	Track Control Arm		IV-TC-12431	Trailing Arm	
	01/91→09/15	Track Control Arm		IV-VB-8146	Wishbone (CV), Drive Axle;Air Suspension Axle	
150 E 18 K	01/91→09/15	Centre Rod	IV-DL-8665		Push Rod	
	01/91→09/15	Centre Rod	IV-DL-12264		for Steering Rod	
	01/91→09/15	Centre Rod	IV-DS-0284		Push Rod	
	01/91→09/15	Suspension Arm Repair Kit		DF-RK-8503	for Control Arm	
	01/91→09/15	Tie Rod	IV-DL-8183		Guide Rod	
	01/91→09/15	Tie Rod	IV-DL-12265			
	01/91→09/15	Tie Rod End	CV-ES-12461		for Steering Rod	
	01/91→09/15	Tie Rod End	CV-ES-12462		for Steering Rod	
	01/91→09/15	Tie Rod End	CV-ES-14163		for Steering Rod	
	01/91→09/15	Tie Rod End	IV-ES-12419		for Steering Rod	
	01/91→09/15	Track Control Arm		IV-TC-12431	Trailing Arm	
	01/91→09/15	Track Control Arm		IV-VB-8146	Wishbone (CV), Drive Axle;Air Suspension Axle	
	150 E 18 K tector	09/00→09/15	Centre Rod	IV-DL-5371		Push Rod
		09/00→09/15	Centre Rod	IV-DL-8665		Push Rod
09/00→09/15		Centre Rod	IV-DL-12264		for Steering Rod	
09/00→09/15		Suspension Arm Repair Kit		DF-RK-8503	for Control Arm	
09/00→09/15		Tie Rod	IV-DL-7785			
09/00→09/15		Tie Rod	IV-DL-8183		Guide Rod	
09/00→09/15		Tie Rod	IV-DL-12265			
09/00→09/15		Tie Rod End	CV-ES-12461		for Steering Rod	
09/00→09/15		Tie Rod End	CV-ES-12462		for Steering Rod	
09/00→09/15		Tie Rod End	CV-ES-14163		for Steering Rod	
09/00→09/15		Tie Rod End	IV-ES-12419		for Steering Rod	
09/00→09/15		Track Control Arm		IV-DL-8613	Trailing Arm, 1st Drive Axle, for Pneumatic Suspension vehicles	
09/00→09/15		Track Control Arm		IV-TC-12431	Trailing Arm	
09/00→09/15		Track Control Arm		IV-VB-8146	Wishbone (CV), Drive Axle;Air Suspension Axle	
150 E 18 tector	09/00→09/15	Centre Rod	IV-DL-5371		Push Rod	
	09/00→09/15	Centre Rod	IV-DL-8665		Push Rod	
	09/00→09/15	Centre Rod	IV-DL-12264		for Steering Rod	
	09/00→09/15	Suspension Arm Repair Kit		DF-RK-8503	for Control Arm	
	09/00→09/15	Tie Rod	IV-DL-7785			
	09/00→09/15	Tie Rod	IV-DL-8183		Guide Rod	
	09/00→09/15	Tie Rod	IV-DL-12265			
	09/00→09/15	Tie Rod End	CV-ES-12461		for Steering Rod	
	09/00→09/15	Tie Rod End	CV-ES-12462		for Steering Rod	
	09/00→09/15	Tie Rod End	CV-ES-14163		for Steering Rod	
	09/00→09/15	Tie Rod End	IV-ES-12419		for Steering Rod	
	09/00→09/15	Track Control Arm		IV-DL-8613	Trailing Arm, 1st Drive Axle, for Pneumatic Suspension vehicles	
	09/00→09/15	Track Control Arm		IV-TC-12431	Trailing Arm	
	09/00→09/15	Track Control Arm		IV-VB-8146	Wishbone (CV), Drive Axle;Air Suspension Axle	
150 E 18 tector, 150 E 18 P tector, 150 E 18 FP tector	09/06→09/15	Centre Rod	IV-DL-8665		Push Rod	
	09/06→09/15	Centre Rod	IV-DL-12264		for Steering Rod	
	09/06→09/15	Suspension Arm Repair Kit		DF-RK-8503	for Control Arm	
	09/06→09/15	Tie Rod End	CV-ES-14163		for Steering Rod	
150 E 18, 150 E 18 P	01/91→09/15	Centre Rod	IV-DL-8665		Push Rod	
	01/91→09/15	Centre Rod	IV-DL-12264		for Steering Rod	
	01/91→09/15	Centre Rod	IV-DS-0284		Push Rod	
	01/91→09/15	Suspension Arm Repair Kit		DF-RK-8503	for Control Arm	
	01/91→09/15	Tie Rod	IV-DL-8183		Guide Rod	
	01/91→09/15	Tie Rod	IV-DL-12265			
	01/91→09/15	Tie Rod End	CV-ES-12461		for Steering Rod	
	01/91→09/15	Tie Rod End	CV-ES-12462		for Steering Rod	
	01/91→09/15	Tie Rod End	CV-ES-14163		for Steering Rod	
	01/91→09/15	Tie Rod End	IV-ES-12419		for Steering Rod	
	01/91→09/15	Track Control Arm		IV-DL-8613	Trailing Arm, Drive Axle;Air Suspension Axle	
	01/91→09/15	Track Control Arm		IV-TC-12431	Trailing Arm	
	01/91→09/15	Track Control Arm		IV-VB-8146	Wishbone (CV), Drive Axle;Air Suspension Axle	

CV-ES-12461

Length: 120
Cone Ø: d1 Ø 26 / d2 Ø 23,5
Thread: M30 x 1,5 LHT
2980129, 002984511, 02984511, 2984511,
4833821, 004833828, 04833828, 4833828,
8122755, 42493782, 042493782



CV-ES-12462

Length: 120
Cone Ø: d1 Ø 26 / d2 Ø 23,5
Thread: M30 x 1,5 RHT
2966688, 2980323, 3096213, 4833820,
004833827, 4833827, 8122754, 42483520,
42485718, 42493781



CV-ES-14163

Length: 125
Cone Ø: d1 Ø 30 / d2 Ø 27
Thread: M30 x 1,5 RHT
2966252, 2969808, 4802443, 4833829,
7138967, 8122752, 42483386, 42488269,
42489573, 42489594, 42491638, 42537936



DF-RK-8503

Ø: 75
Hole Distance: 130
Thick/Height: 24
93192361



IV-DL-5371

Length: 878
Ø: 36
Cone Ø: d1 Ø 30 / d2 Ø 27
98449025, 98469650



IV-DL-7785

Length: 1490
Ø: 38
Cone Ø: d1 Ø 26 / d2 Ø 23,5
98402553, 500307556



IV-DL-8183

Length: 1584
Ø: 42
Cone Ø: d1 Ø 26 / d2 Ø 23,5
4854871



IV-DL-8613

Length: 594
Ø: 50
Hole Distance: 130 / 130
41009661, 41009666, 41035951, 41272429,
98472446, 98472466



IV-DL-8665

Length: 892
Ø: 42
Cone Ø: d1 Ø 30 / d2 Ø 27
504049893



IV-DL-12264

Length: 966
Ø: 50
Cone Ø: d1 Ø 30 / d2 Ø 27
98473328



IV-DL-12265

Length: 1577
Ø: 48
Cone Ø: d1 Ø 30 / d2 Ø 27
8165309, 41005309, 41005460



IV-DS-0284

Length: 902
Ø: 42
Cone Ø: d1 Ø 26 / d2 Ø 23,5
04854874, 4854874



IV-ES-12419

Length: 55
Cone Ø: d1 Ø 10 / d2 Ø 10
Thread: M10 x 1,5 RHT
2041327, 41002118, 41203863, 42079853



IV-TC-12431

Length: 594
Ø: 40
Hole Distance: 130 / 130
8137027



IV-VB-8146

Length: 659
Ø: 46
Hole Distance: 130 / 130
41028599, 41042092, 98405832, 98472468,
504064007





EuroCargo I-III ...

150 E 21 K tector	09/00→09/15	Centre Rod	IV-DL-5371		Push Rod
	09/00→09/15	Suspension Arm Repair Kit		DF-RK-8503	for Control Arm
	09/00→09/15	Tie Rod	IV-DL-7785		
	09/00→09/15	Tie Rod	IV-DL-8183		Guide Rod
	09/00→09/15	Tie Rod	IV-DL-12265		
	09/00→09/15	Tie Rod End	CV-ES-12461		for Steering Rod
	09/00→09/15	Tie Rod End	CV-ES-12462		for Steering Rod
	09/00→09/15	Tie Rod End	CV-ES-14162		for Steering Rod
	09/00→09/15	Tie Rod End	CV-ES-14163		for Steering Rod
	09/00→09/15	Tie Rod End	IV-ES-12419		for Steering Rod
	09/00→09/15	Track Control Arm		IV-DL-8613	Trailing Arm, 1st Drive Axle, for Pneumatic Suspension vehicles
	09/00→09/15	Track Control Arm		IV-TC-12431	Trailing Arm
	09/00→09/15	Track Control Arm		IV-VB-8146	Wishbone (CV), Drive Axle;Air Suspension Axle
150 E 21 tector, 150 E 21 P tector, 150 E 21 FP tector	09/00→09/15	Centre Rod	IV-DL-5371		Push Rod
	09/00→09/15	Suspension Arm Repair Kit		DF-RK-8503	for Control Arm
	09/00→09/15	Tie Rod	IV-DL-7785		
	09/00→09/15	Tie Rod	IV-DL-8183		Guide Rod
	09/00→09/15	Tie Rod	IV-DL-12265		
	09/00→09/15	Tie Rod End	CV-ES-12461		for Steering Rod
	09/00→09/15	Tie Rod End	CV-ES-12462		for Steering Rod
	09/00→09/15	Tie Rod End	CV-ES-14162		for Steering Rod
	09/00→09/15	Tie Rod End	CV-ES-14163		for Steering Rod
	09/00→09/15	Tie Rod End	IV-ES-12419		for Steering Rod
	09/00→09/15	Track Control Arm		IV-DL-8613	Trailing Arm, 1st Drive Axle, for Pneumatic Suspension vehicles
	09/00→09/15	Track Control Arm		IV-TC-12431	Trailing Arm
	09/00→09/15	Track Control Arm		IV-VB-8146	Wishbone (CV), Drive Axle;Air Suspension Axle
150 E 22 K tector	09/06→09/15	Suspension Arm Repair Kit		DF-RK-8503	for Control Arm
150 E 22 tector, 150 E 22 P tector, 150 E 22 FP tector	09/06→09/15	Suspension Arm Repair Kit		DF-RK-8503	for Control Arm
150 E 23, 150 E 23 P, 150 E 23 FP	01/91→09/15	Centre Rod	IV-DS-0284		Push Rod
	01/91→09/15	Suspension Arm Repair Kit		DF-RK-8503	for Control Arm
	01/91→09/15	Tie Rod	IV-DL-8183		Guide Rod
	01/91→09/15	Tie Rod	IV-DL-12265		
	01/91→09/15	Tie Rod End	CV-ES-12461		for Steering Rod
	01/91→09/15	Tie Rod End	CV-ES-12462		for Steering Rod
	01/91→09/15	Tie Rod End	IV-ES-12419		for Steering Rod
	01/91→09/15	Track Control Arm		IV-DL-8613	Trailing Arm, Drive Axle;Air Suspension Axle
	01/91→09/15	Track Control Arm		IV-TC-12431	Trailing Arm
	01/91→09/15	Track Control Arm		IV-VB-8146	Wishbone (CV), Drive Axle;Air Suspension Axle
150 E 24 K tector	09/00→09/15	Centre Rod	IV-DL-5371		Push Rod
	09/00→09/15	Centre Rod	IV-DL-12264		for Steering Rod
	09/00→09/15	Suspension Arm Repair Kit		DF-RK-8503	for Control Arm
	09/00→09/15	Tie Rod	IV-DL-7785		
	09/00→09/15	Tie Rod	IV-DL-8183		Guide Rod
	09/00→09/15	Tie Rod End	CV-ES-12461		for Steering Rod
	09/00→09/15	Tie Rod End	CV-ES-12462		for Steering Rod
	09/00→09/15	Tie Rod End	CV-ES-14162		for Steering Rod
	09/00→09/15	Tie Rod End	CV-ES-14163		for Steering Rod
	09/00→09/15	Tie Rod End	IV-ES-12419		for Steering Rod
	09/00→09/15	Track Control Arm		IV-DL-8613	Trailing Arm, 1st Drive Axle, for Pneumatic Suspension vehicles
	09/00→09/15	Track Control Arm		IV-TC-12431	Trailing Arm
	09/00→09/15	Track Control Arm		IV-VB-8146	Wishbone (CV), Drive Axle;Air Suspension Axle
150 E 24 tector, 150 E 25 tector	09/00→09/15	Centre Rod	IV-DL-5371		Push Rod
	09/00→09/15	Centre Rod	IV-DL-12264		for Steering Rod
	09/00→09/15	Suspension Arm Repair Kit		DF-RK-8503	for Control Arm
	09/00→09/15	Tie Rod	IV-DL-7785		
	09/00→09/15	Tie Rod	IV-DL-8183		Guide Rod
	09/00→09/15	Tie Rod End	CV-ES-12461		for Steering Rod
	09/00→09/15	Tie Rod End	CV-ES-12462		for Steering Rod
	09/00→09/15	Tie Rod End	CV-ES-14162		for Steering Rod

CV-ES-12461

Length: 120
Cone Ø: d1 Ø 26 / d2 Ø 23,5
Thread: M30 x 1,5 LHT
2980129, 002984511, 02984511, 2984511,
4833821, 004833828, 04833828, 4833828,
8122755, 042493782, 42493782



CV-ES-12462

Length: 120
Cone Ø: d1 Ø 26 / d2 Ø 23,5
Thread: M30 x 1,5 RHT
2966688, 2980323, 3096213, 4833820,
004833827, 4833827, 8122754, 42483520,
42485718, 42493781



CV-ES-14162

Length: 125
Cone Ø: d1 Ø 30 / d2 Ø 27
Thread: M30 x 1,5 LHT
2984061, 4802444, 4833830, 7138966,
8190225, 42489395, 42491957



CV-ES-14163

Length: 125
Cone Ø: d1 Ø 30 / d2 Ø 27
Thread: M30 x 1,5 RHT
2966252, 2969808, 4802443, 4833829,
7138967, 8122752, 42483386, 42488269,
42489573, 42489594, 42491638, 42537936



DF-RK-8503

Ø: 75
Hole Distance: 130
Thick/Height: 24
93192361



IV-DL-5371

Length: 878
Ø: 36
Cone Ø: d1 Ø 30 / d2 Ø 27
98449025, 98469650



IV-DL-7785

Length: 1490
Ø: 38
Cone Ø: d1 Ø 26 / d2 Ø 23,5
98402553, 500307556



IV-DL-8183

Length: 1584
Ø: 42
Cone Ø: d1 Ø 26 / d2 Ø 23,5
4854871



IV-DL-8613

Length: 594
Ø: 50
Hole Distance: 130 / 130
41009661, 41009666, 41035951, 41272429,
98472446, 98472466



IV-DL-12264

Length: 966
Ø: 50
Cone Ø: d1 Ø 30 / d2 Ø 27
98473328



IV-DL-12265

Length: 1577
Ø: 48
Cone Ø: d1 Ø 30 / d2 Ø 27
8165309, 41005309, 41005460



IV-DS-0284

Length: 902
Ø: 42
Cone Ø: d1 Ø 26 / d2 Ø 23,5
4854874, 04854874



IV-ES-12419

Length: 55
Cone Ø: d1 Ø 10 / d2 Ø 10
Thread: M10 x 1,5 RHT
2041327, 41002118, 41203863, 42079853



IV-TC-12431

Length: 594
Ø: 40
Hole Distance: 130 / 130
8137027



IV-VB-8146

Length: 659
Ø: 46
Hole Distance: 130 / 130
41028599, 41042092, 98405832, 98472468,
504064007





EuroCargo I-III ...

150 E 24 tector, 150 E 25 tector ...	09/00→09/15	Tie Rod End	CV-ES-14163		for Steering Rod
	09/00→09/15	Tie Rod End	IV-ES-12419		for Steering Rod
	09/00→09/15	Track Control Arm		IV-DL-8613	Trailing Arm, 1st Drive Axle, for Pneumatic Suspension vehicles
	09/00→09/15	Track Control Arm		IV-TC-12431	Trailing Arm
	09/00→09/15	Track Control Arm		IV-VB-8146	Wishbone (CV), Drive Axle;Air Suspension Axle
150 E 25 K tector	09/06→09/15	Centre Rod	IV-DL-8665		Push Rod
	09/06→09/15	Suspension Arm Repair Kit		DF-RK-8503	for Control Arm
	09/06→09/15	Tie Rod End	CV-ES-14163		for Steering Rod
150 E 25 W tector	09/06→09/15	Centre Rod	IV-DL-8665		Push Rod
	09/06→09/15	Centre Rod	IV-DL-12264		for Steering Rod
	09/06→09/15	Suspension Arm Repair Kit		DF-RK-8503	for Control Arm
	09/06→09/15	Tie Rod End	CV-ES-14163		for Steering Rod
150 E 25 WS tector	09/06→09/15	Centre Rod	IV-DL-8665		Push Rod
	09/06→09/15	Centre Rod	IV-DL-12264		for Steering Rod
	09/06→09/15	Suspension Arm Repair Kit		DF-RK-8503	for Control Arm
	09/06→09/15	Tie Rod End	CV-ES-14163		for Steering Rod
150 E 27, 150 E 27 P, 150 E27FP, 150 E 27 R	01/91→09/15	Centre Rod	IV-DS-0284		Push Rod
	01/91→09/15	Suspension Arm Repair Kit		DF-RK-8503	for Control Arm
	01/91→09/15	Tie Rod	IV-DL-8183		Guide Rod
	01/91→09/15	Tie Rod	IV-DL-12265		
	01/91→09/15	Tie Rod End	CV-ES-12461		for Steering Rod
	01/91→09/15	Tie Rod End	CV-ES-12462		for Steering Rod
	01/91→09/15	Tie Rod End	IV-ES-12419		for Steering Rod
	01/91→09/15	Track Control Arm		IV-DL-8613	Trailing Arm, Drive Axle;Air Suspension Axle
	01/91→09/15	Track Control Arm		IV-TC-12431	Trailing Arm
	01/91→09/15	Track Control Arm		IV-VB-8146	Wishbone (CV), Drive Axle;Air Suspension Axle
	150 E 28 K tector	09/00→09/15	Centre Rod	IV-DL-5371	
09/00→09/15		Centre Rod	IV-DL-8665		Push Rod
09/00→09/15		Suspension Arm Repair Kit		DF-RK-8503	for Control Arm
09/00→09/15		Tie Rod	IV-DL-7785		
09/00→09/15		Tie Rod	IV-DL-8183		Guide Rod
09/00→09/15		Tie Rod End	CV-ES-12461		for Steering Rod
09/00→09/15		Tie Rod End	CV-ES-12462		for Steering Rod
09/00→09/15		Tie Rod End	CV-ES-14163		for Steering Rod
09/00→09/15		Tie Rod End	IV-ES-12419		for Steering Rod
09/00→09/15		Track Control Arm		IV-DL-8613	Trailing Arm, 1st Drive Axle, for Pneumatic Suspension vehicles
09/00→09/15		Track Control Arm		IV-TC-12431	Trailing Arm
09/00→09/15		Track Control Arm		IV-VB-8146	Wishbone (CV), Drive Axle;Air Suspension Axle
150 E 28 tector		09/00→09/15	Centre Rod	IV-DL-5371	
	09/00→09/15	Centre Rod	IV-DL-8665		Push Rod
	09/00→09/15	Suspension Arm Repair Kit		DF-RK-8503	for Control Arm
	09/00→09/15	Tie Rod	IV-DL-7785		
	09/00→09/15	Tie Rod	IV-DL-8183		Guide Rod
	09/00→09/15	Tie Rod End	CV-ES-12461		for Steering Rod
	09/00→09/15	Tie Rod End	CV-ES-12462		for Steering Rod
	09/00→09/15	Tie Rod End	CV-ES-14163		for Steering Rod
	09/00→09/15	Tie Rod End	IV-ES-12419		for Steering Rod
	09/00→09/15	Track Control Arm		IV-DL-8613	Trailing Arm, 1st Drive Axle, for Pneumatic Suspension vehicles
	09/00→09/15	Track Control Arm		IV-TC-12431	Trailing Arm
09/00→09/15	Track Control Arm		IV-VB-8146	Wishbone (CV), Drive Axle;Air Suspension Axle	
150 E 28 W tector	09/06→09/15	Centre Rod	IV-DL-8665		Push Rod
	09/06→09/15	Centre Rod	IV-DL-12264		for Steering Rod
	09/06→09/15	Suspension Arm Repair Kit		DF-RK-8503	for Control Arm
	09/06→09/15	Tie Rod End	CV-ES-14163		for Steering Rod
	09/06→09/15	Tie Rod End	IV-ES-12419		for Steering Rod
	09/06→09/15	Tie Rod End	IV-ES-12419		for Steering Rod
150 E 28 WS tector	09/06→09/15	Centre Rod	IV-DL-8665		Push Rod
	09/06→09/15	Centre Rod	IV-DL-12264		for Steering Rod
	09/06→09/15	Suspension Arm Repair Kit		DF-RK-8503	for Control Arm
	09/06→09/15	Tie Rod End	CV-ES-14163		for Steering Rod
	09/06→09/15	Tie Rod End	IV-ES-12419		for Steering Rod

CV-ES-12461

Length: 120
Cone Ø: d1 Ø 26 / d2 Ø 23,5
Thread: M30 x 1,5 LHT
2980129, 002984511, 2984511, 02984511,
4833821, 004833828, 04833828, 4833828,
8122755, 042493782, 42493782



CV-ES-12462

Length: 120
Cone Ø: d1 Ø 26 / d2 Ø 23,5
Thread: M30 x 1,5 RHT
2966688, 2980323, 3096213, 4833820,
4833827, 004833827, 8122754, 42483520,
42485718, 42493781



CV-ES-14163

Length: 125
Cone Ø: d1 Ø 30 / d2 Ø 27
Thread: M30 x 1,5 RHT
2966252, 2969808, 4802443, 4833829,
7138967, 8122752, 42483386, 42488269,
42489573, 42489594, 42491638, 42537936



DF-RK-8503

Ø: 75
Hole Distance: 130
Thick/Height: 24
93192361



IV-DL-5371

Length: 878
Ø: 36
Cone Ø: d1 Ø 30 / d2 Ø 27
98449025, 98469650



IV-DL-7785

Length: 1490
Ø: 38
Cone Ø: d1 Ø 26 / d2 Ø 23,5
98402553, 500307556



IV-DL-8183

Length: 1584
Ø: 42
Cone Ø: d1 Ø 26 / d2 Ø 23,5
4854871



IV-DL-8613

Length: 594
Ø: 50
Hole Distance: 130 / 130
41009661, 41009666, 41035951, 41272429,
98472446, 98472466



IV-DL-8665

Length: 892
Ø: 42
Cone Ø: d1 Ø 30 / d2 Ø 27
504049893



IV-DL-12264

Length: 966
Ø: 50
Cone Ø: d1 Ø 30 / d2 Ø 27
98473328



IV-DL-12265

Length: 1577
Ø: 48
Cone Ø: d1 Ø 30 / d2 Ø 27
8165309, 41005309, 41005460



IV-DS-0284

Length: 902
Ø: 42
Cone Ø: d1 Ø 26 / d2 Ø 23,5
04854874, 4854874



IV-ES-12419

Length: 55
Cone Ø: d1 Ø 10 / d2 Ø 10
Thread: M10 x 1,5 RHT
2041327, 41002118, 41203863, 42079853



IV-TC-12431

Length: 594
Ø: 40
Hole Distance: 130 / 130
8137027



IV-VB-8146

Length: 659
Ø: 46
Hole Distance: 130 / 130
41028599, 41042092, 98405832, 98472468,
504064007





EuroCargo I-III ...

150 E 30 K tector	09/06→09/15	Centre Rod	IV-DL-5371		Push Rod
	09/06→09/15	Centre Rod	IV-DL-8665		Push Rod
	09/06→09/15	Suspension Arm Repair Kit		DF-RK-8503	for Control Arm
	09/06→09/15	Tie Rod	IV-DL-7785		
	09/06→09/15	Tie Rod End	CV-ES-14163		for Steering Rod
	09/06→09/15	Track Control Arm		IV-TC-12431	Trailing Arm
	09/06→09/15	Track Control Arm		IV-VB-8146	Wishbone (CV), Drive Axle;Air Suspension Axle
150 E 30 tector, 150 E 30 P tector, 150 E 30 FP tector	09/06→09/15	Centre Rod	IV-DL-5371		Push Rod
	09/06→09/15	Centre Rod	IV-DL-8665		Push Rod
	09/06→09/15	Suspension Arm Repair Kit		DF-RK-8503	for Control Arm
	09/06→09/15	Tie Rod	IV-DL-7785		
	09/06→09/15	Tie Rod End	CV-ES-14163		for Steering Rod
	09/06→09/15	Track Control Arm		IV-TC-12431	Trailing Arm
	09/06→09/15	Track Control Arm		IV-VB-8146	Wishbone (CV), Drive Axle;Air Suspension Axle
160 E 18 K tector	09/06→09/15	Centre Rod	IV-DL-8665		Push Rod
	09/06→09/15	Suspension Arm Repair Kit		DF-RK-8503	for Control Arm
	09/06→09/15	Tie Rod End	CV-ES-14163		for Steering Rod
	09/06→09/15	Track Control Arm		IV-TC-12431	Trailing Arm
	09/06→09/15	Track Control Arm		IV-VB-8146	Wishbone (CV), Drive Axle;Air Suspension Axle
160 E 18 tector, 160 E 18 P tector	09/06→09/15	Centre Rod	IV-DL-8665		Push Rod
	09/06→09/15	Suspension Arm Repair Kit		DF-RK-8503	for Control Arm
	09/06→09/15	Tie Rod End	CV-ES-14163		for Steering Rod
	09/06→09/15	Track Control Arm		IV-TC-12431	Trailing Arm
	09/06→09/15	Track Control Arm		IV-VB-8146	Wishbone (CV), Drive Axle;Air Suspension Axle
160 E 21 tector, 160 E 21 P tector	09/00→09/15	Centre Rod	IV-DL-5371		Push Rod
	09/00→09/15	Centre Rod	IV-DL-8665		Push Rod
	09/00→09/15	Suspension Arm Repair Kit		DF-RK-8503	for Control Arm
	09/00→09/15	Tie Rod	IV-DL-7785		
	09/00→09/15	Tie Rod	IV-DL-8183		Guide Rod
	09/00→09/15	Tie Rod End	CV-ES-12461		for Steering Rod
	09/00→09/15	Tie Rod End	CV-ES-12462		for Steering Rod
	09/00→09/15	Tie Rod End	CV-ES-14163		for Steering Rod
	09/00→09/15	Tie Rod End	IV-ES-12419		for Steering Rod
	09/00→09/15	Track Control Arm		IV-DL-8613	Trailing Arm, 1st Drive Axle, for Pneumatic Suspension vehicles
	09/00→09/15	Track Control Arm		IV-TC-12431	Trailing Arm
	09/00→09/15	Track Control Arm		IV-VB-8146	Wishbone (CV), Drive Axle;Air Suspension Axle
	160 E 22 K tector	09/06→09/15	Centre Rod	IV-DL-8665	
09/06→09/15		Suspension Arm Repair Kit		DF-RK-8503	for Control Arm
09/06→09/15		Tie Rod End	CV-ES-14163		for Steering Rod
09/06→09/15		Track Control Arm		IV-TC-12431	Trailing Arm
09/06→09/15		Track Control Arm		IV-VB-8146	Wishbone (CV), Drive Axle;Air Suspension Axle
160 E 22 tector, 160 E 22 P tector	09/06→09/15	Centre Rod	IV-DL-8665		Push Rod
	09/06→09/15	Suspension Arm Repair Kit		DF-RK-8503	for Control Arm
	09/06→09/15	Tie Rod End	CV-ES-14163		for Steering Rod
	09/06→09/15	Track Control Arm		IV-TC-12431	Trailing Arm
	09/06→09/15	Track Control Arm		IV-VB-8146	Wishbone (CV), Drive Axle;Air Suspension Axle
160 E 24 tector, 160 E 24 P tector	09/00→09/15	Centre Rod	IV-DL-5371		Push Rod
	09/00→09/15	Centre Rod	IV-DL-8665		Push Rod
	09/00→09/15	Suspension Arm Repair Kit		DF-RK-8503	for Control Arm
	09/00→09/15	Tie Rod	IV-DL-7785		
	09/00→09/15	Tie Rod	IV-DL-8183		Guide Rod
	09/00→09/15	Tie Rod End	CV-ES-12461		for Steering Rod
	09/00→09/15	Tie Rod End	CV-ES-12462		for Steering Rod
	09/00→09/15	Tie Rod End	CV-ES-14163		for Steering Rod
	09/00→09/15	Tie Rod End	IV-ES-12419		for Steering Rod
	09/00→09/15	Track Control Arm		IV-DL-8613	Trailing Arm, 1st Drive Axle, for Pneumatic Suspension vehicles
	09/00→09/15	Track Control Arm		IV-TC-12431	Trailing Arm
09/00→09/15	Track Control Arm		IV-VB-8146	Wishbone (CV), Drive Axle;Air Suspension Axle	

CV-ES-12461

Length: 120
Cone Ø: d1 Ø 26 / d2 Ø 23,5
Thread: M30 x 1,5 LHT
2980129, 2984511, 002984511, 02984511,
4833821, 004833828, 04833828, 4833828,
8122755, 042493782, 42493782



CV-ES-12462

Length: 120
Cone Ø: d1 Ø 26 / d2 Ø 23,5
Thread: M30 x 1,5 RHT
2966688, 2980323, 3096213, 4833820,
004833827, 4833827, 8122754, 42483520,
42485718, 42493781



CV-ES-14163

Length: 125
Cone Ø: d1 Ø 30 / d2 Ø 27
Thread: M30 x 1,5 RHT
2966252, 2969808, 4802443, 4833829,
7138967, 8122752, 42483386, 42488269,
42489573, 42489594, 42491638, 42537936



DF-RK-8503

Ø: 75
Hole Distance: 130
Thick/Height: 24
93192361



IV-DL-5371

Length: 878
Ø: 36
Cone Ø: d1 Ø 30 / d2 Ø 27
98449025, 98469650



IV-DL-7785

Length: 1490
Ø: 38
Cone Ø: d1 Ø 26 / d2 Ø 23,5
98402553, 500307556



IV-DL-8183

Length: 1584
Ø: 42
Cone Ø: d1 Ø 26 / d2 Ø 23,5
4854871



IV-DL-8613

Length: 594
Ø: 50
Hole Distance: 130 / 130
41009661, 41009666, 41035951, 41272429,
98472446, 98472466



IV-DL-8665

Length: 892
Ø: 42
Cone Ø: d1 Ø 30 / d2 Ø 27
504049893



IV-ES-12419

Length: 55
Cone Ø: d1 Ø 10 / d2 Ø 10
Thread: M10 x 1,5 RHT
2041327, 41002118, 41203863, 42079853



IV-TC-12431

Length: 594
Ø: 40
Hole Distance: 130 / 130
8137027



IV-VB-8146

Length: 659
Ø: 46
Hole Distance: 130 / 130
41028599, 41042092, 98405832, 98472468,
504064007





EuroCargo I-III ...

160 E 25 K tector	09/06→09/15	Centre Rod	IV-DL-8665		Push Rod
	09/06→09/15	Suspension Arm Repair Kit		DF-RK-8503	for Control Arm
	09/06→09/15	Tie Rod End	CV-ES-14163		for Steering Rod
	09/06→09/15	Track Control Arm		IV-TC-12431	Trailing Arm
	09/06→09/15	Track Control Arm		IV-VB-8146	Wishbone (CV), Drive Axle;Air Suspension Axle
160 E 25 tector, 160 E 25 P tector	09/06→09/15	Centre Rod	IV-DL-8665		Push Rod
	09/06→09/15	Suspension Arm Repair Kit		DF-RK-8503	for Control Arm
	09/06→09/15	Tie Rod End	CV-ES-14163		for Steering Rod
	09/06→09/15	Track Control Arm		IV-TC-12431	Trailing Arm
	09/06→09/15	Track Control Arm		IV-VB-8146	Wishbone (CV), Drive Axle;Air Suspension Axle
160 E 28 K tector	09/06→09/15	Centre Rod	IV-DL-8665		Push Rod
	09/06→09/15	Suspension Arm Repair Kit		DF-RK-8503	for Control Arm
	09/06→09/15	Tie Rod End	CV-ES-14163		for Steering Rod
	09/06→09/15	Track Control Arm		IV-TC-12431	Trailing Arm
	09/06→09/15	Track Control Arm		IV-VB-8146	Wishbone (CV), Drive Axle;Air Suspension Axle
160 E 28 tector, 160 E 28 P tector	09/00→09/15	Centre Rod	IV-DL-5371		Push Rod
	09/00→09/15	Centre Rod	IV-DL-8665		Push Rod
	09/00→09/15	Suspension Arm Repair Kit		DF-RK-8503	for Control Arm
	09/00→09/15	Tie Rod	IV-DL-7785		
	09/00→09/15	Tie Rod End	CV-ES-12461		for Steering Rod
	09/00→09/15	Tie Rod End	CV-ES-12462		for Steering Rod
	09/00→09/15	Tie Rod End	CV-ES-14163		for Steering Rod
	09/00→09/15	Tie Rod End	IV-ES-12419		for Steering Rod
	09/00→09/15	Track Control Arm		IV-DL-8613	Trailing Arm, 1st Drive Axle, for Pneumatic Suspension vehicles
	09/00→09/15	Track Control Arm		IV-TC-12431	Trailing Arm
	09/00→09/15	Track Control Arm		IV-VB-8146	Wishbone (CV), Drive Axle;Air Suspension Axle
160 E 30 K tector	09/06→09/15	Centre Rod	IV-DL-5371		Push Rod
	09/06→09/15	Centre Rod	IV-DL-8665		Push Rod
	09/06→09/15	Suspension Arm Repair Kit		DF-RK-8503	for Control Arm
	09/06→09/15	Tie Rod	IV-DL-7785		
	09/06→09/15	Tie Rod End	CV-ES-14163		for Steering Rod
160 E 30 tector, 160 E 30 P tector	09/06→09/15	Centre Rod	IV-DL-5371		Push Rod
	09/06→09/15	Centre Rod	IV-DL-8665		Push Rod
	09/06→09/15	Suspension Arm Repair Kit		DF-RK-8503	for Control Arm
	09/06→09/15	Tie Rod	IV-DL-7785		
	09/06→09/15	Tie Rod End	CV-ES-14163		for Steering Rod
170 E 15 K	12/91→07/00	Centre Rod	IV-DL-5371		Push Rod
	12/91→07/00	Tie Rod End	IV-ES-12419		for Steering Rod
170 E 18 K, 180 E 18 K	01/91→09/15	Centre Rod	IV-DL-5371		Push Rod
	01/91→09/15	Suspension Arm Repair Kit		DF-RK-8503	for Control Arm
	01/91→09/15	Tie Rod	IV-DL-7785		
	01/91→09/15	Tie Rod End	IV-ES-12419		for Steering Rod
	01/91→09/15	Track Control Arm		IV-DL-8613	Trailing Arm, Drive Axle;Air Suspension Axle
	01/91→09/15	Track Control Arm		IV-VB-8146	Wishbone (CV), Drive Axle;Air Suspension Axle
170 E 18, 180 E 18	01/91→09/15	Centre Rod	IV-DL-5371		Push Rod
	01/91→09/15	Suspension Arm Repair Kit		DF-RK-8503	for Control Arm
	01/91→09/15	Tie Rod	IV-DL-7785		
	01/91→09/15	Tie Rod End	IV-ES-12419		for Steering Rod
	01/91→09/15	Track Control Arm		IV-DL-8613	Trailing Arm, Drive Axle;Air Suspension Axle
	01/91→09/15	Track Control Arm		IV-VB-8146	Wishbone (CV), Drive Axle;Air Suspension Axle
170 E 23 K,180 E 23 K	01/91→09/15	Centre Rod	IV-DL-5371		Push Rod
	01/91→09/15	Suspension Arm Repair Kit		DF-RK-8503	for Control Arm
	01/91→09/15	Tie Rod End	IV-ES-12419		for Steering Rod
	01/91→09/15	Track Control Arm		IV-DL-8613	Trailing Arm, Drive Axle;Air Suspension Axle
	01/91→09/15	Track Control Arm		IV-VB-8146	Wishbone (CV), Drive Axle;Air Suspension Axle
	01/91→09/15	Track Control Arm		IV-VB-8146	Wishbone (CV), Drive Axle;Air Suspension Axle
170 E 23,180 E 23	01/91→09/15	Centre Rod	IV-DL-5371		Push Rod
	01/91→09/15	Suspension Arm Repair Kit		DF-RK-8503	for Control Arm
	01/91→09/15	Tie Rod End	IV-ES-12419		for Steering Rod
	01/91→09/15	Track Control Arm		IV-DL-8613	Trailing Arm, Drive Axle;Air Suspension Axle
	01/91→09/15	Track Control Arm		IV-VB-8146	Wishbone (CV), Drive Axle;Air Suspension Axle
	01/91→09/15	Track Control Arm		IV-VB-8146	Wishbone (CV), Drive Axle;Air Suspension Axle

CV-ES-12461

Length: 120
Cone Ø: d1 Ø 26 / d2 Ø 23,5
Thread: M30 x 1,5 LHT
2980129, 002984511, 02984511, 2984511,
4833821, 004833828, 4833828, 04833828,
8122755, 042493782, 42493782



IV-DL-8613

Length: 594
Ø: 50
Hole Distance: 130 / 130
41009661, 41009666, 41035951, 41272429,
98472446, 98472466



CV-ES-12462

Length: 120
Cone Ø: d1 Ø 26 / d2 Ø 23,5
Thread: M30 x 1,5 RHT
2966688, 2980323, 3096213, 4833820,
004833827, 4833827, 8122754, 42483520,
42485718, 42493781



IV-DL-8665

Length: 892
Ø: 42
Cone Ø: d1 Ø 30 / d2 Ø 27
504049893



CV-ES-14163

Length: 125
Cone Ø: d1 Ø 30 / d2 Ø 27
Thread: M30 x 1,5 RHT
2966252, 2969808, 4802443, 4833829,
7138967, 8122752, 42483386, 42488269,
42489573, 42489594, 42491638, 42537936



IV-ES-12419

Length: 55
Cone Ø: d1 Ø 10 / d2 Ø 10
Thread: M10 x 1,5 RHT
2041327, 41002118, 41203863, 42079853



DF-RK-8503

Ø: 75
Hole Distance: 130
Thick/Height: 24
93192361



IV-TC-12431

Length: 594
Ø: 40
Hole Distance: 130 / 130
8137027



IV-DL-5371

Length: 878
Ø: 36
Cone Ø: d1 Ø 30 / d2 Ø 27
98449025, 98469650



IV-VB-8146

Length: 659
Ø: 46
Hole Distance: 130 / 130
41028599, 41042092, 98405832, 98472468,
504064007



IV-DL-7785

Length: 1490
Ø: 38
Cone Ø: d1 Ø 26 / d2 Ø 23,5
98402553, 500307556





EuroCargo I-III ...

170 E 27, 180 E 27	01/91→09/15	Centre Rod	IV-DL-5371		Push Rod
	01/91→09/15	Suspension Arm Repair Kit		DF-RK-8503	for Control Arm
	01/91→09/15	Tie Rod End	IV-ES-12419		for Steering Rod
	01/91→09/15	Track Control Arm		IV-DL-8613	Trailing Arm, Drive Axle; Air Suspension Axle
	01/91→09/15	Track Control Arm		IV-VB-8146	Wishbone (CV), Drive Axle; Air Suspension Axle
180 E 21 Ktector	09/00→09/15	Centre Rod	IV-DL-5371		Push Rod
	09/00→09/15	Suspension Arm Repair Kit		DF-RK-8503	for Control Arm
	09/00→09/15	Tie Rod	IV-DL-7785		
	09/00→09/15	Tie Rod End	CV-ES-12462		for Steering Rod
	09/00→09/15	Tie Rod End	CV-ES-14162		for Steering Rod
	09/00→09/15	Tie Rod End	CV-ES-14163		for Steering Rod
	09/00→09/15	Tie Rod End	IV-ES-12419		for Steering Rod
	09/00→09/15	Track Control Arm		IV-DL-8613	Trailing Arm, Drive Axle; Air Suspension Axle
	09/00→09/15	Track Control Arm		IV-VB-8146	Wishbone (CV), Drive Axle; Air Suspension Axle
180 E 21 T	01/91→09/15	Ball Head, gearshift linkage	CV-ES-2119		
	01/91→09/15	Ball Head, gearshift linkage	CV-ES-2182		
	01/91→09/15	Centre Rod	IV-DL-0215		Push Rod
	01/91→09/15	Suspension Arm Repair Kit		DF-RK-8503	for Control Arm
	01/91→09/15	Tie Rod	IV-DL-7785		
	01/91→09/15	Tie Rod End	CV-ES-12461		for Steering Rod
	01/91→09/15	Tie Rod End	CV-ES-12462		for Steering Rod
	01/91→09/15	Tie Rod End	IV-ES-12419		for Steering Rod
180 E 21 tector	09/00→09/15	Centre Rod	IV-DL-5371		Push Rod
	09/00→09/15	Suspension Arm Repair Kit		DF-RK-8503	for Control Arm
	09/00→09/15	Tie Rod	IV-DL-7785		
	09/00→09/15	Tie Rod End	CV-ES-12462		for Steering Rod
	09/00→09/15	Tie Rod End	CV-ES-14162		for Steering Rod
	09/00→09/15	Tie Rod End	CV-ES-14163		for Steering Rod
	09/00→09/15	Tie Rod End	IV-ES-12419		for Steering Rod
	09/00→09/15	Track Control Arm		IV-DL-8613	Trailing Arm, Drive Axle; Air Suspension Axle
	09/00→09/15	Track Control Arm		IV-VB-8146	Wishbone (CV), Drive Axle; Air Suspension Axle
180 E 22 tector, 180 E 22 P tector	09/06→09/15	Centre Rod	IV-DL-8665		Push Rod
	09/06→09/15	Suspension Arm Repair Kit		DF-RK-8503	for Control Arm
	09/06→09/15	Track Control Arm		IV-TC-12431	Trailing Arm
	09/06→09/15	Track Control Arm		IV-VB-8146	Wishbone (CV), Drive Axle; Air Suspension Axle
180 E 24 K tector	09/00→09/15	Centre Rod	IV-DL-5371		Push Rod
	09/00→09/15	Suspension Arm Repair Kit		DF-RK-8503	for Control Arm
	09/00→09/15	Tie Rod	IV-DL-7785		
	09/00→09/15	Tie Rod End	CV-ES-14163		for Steering Rod
	09/00→09/15	Tie Rod End	IV-ES-12419		for Steering Rod
	09/00→09/15	Track Control Arm		IV-DL-8613	Trailing Arm, Drive Axle; Air Suspension Axle
	09/00→09/15	Track Control Arm		IV-VB-8146	Wishbone (CV), Drive Axle; Air Suspension Axle
180 E 24, 180 E 25 tector	09/00→09/15	Centre Rod	IV-DL-5371		Push Rod
	09/00→09/15	Suspension Arm Repair Kit		DF-RK-8503	for Control Arm
	09/00→09/15	Tie Rod	IV-DL-7785		
	09/00→09/15	Tie Rod End	CV-ES-14162		for Steering Rod
	09/00→09/15	Tie Rod End	CV-ES-14163		for Steering Rod
	09/00→09/15	Tie Rod End	IV-ES-12419		for Steering Rod
	09/00→09/15	Track Control Arm		IV-DL-8613	Trailing Arm, Drive Axle; Air Suspension Axle
09/00→09/15	Track Control Arm		IV-VB-8146	Wishbone (CV), Drive Axle; Air Suspension Axle	
180 E 25 K tector	09/06→09/15	Suspension Arm Repair Kit		DF-RK-8503	for Control Arm
	09/06→09/15	Tie Rod End	CV-ES-14163		for Steering Rod
180 E 28 K tector	09/00→09/15	Centre Rod	IV-DL-5371		Push Rod
	09/00→09/15	Suspension Arm Repair Kit		DF-RK-8503	for Control Arm
	09/00→09/15	Tie Rod	IV-DL-7785		
	09/00→09/15	Tie Rod End	CV-ES-14163		for Steering Rod
	09/00→09/15	Tie Rod End	IV-ES-12419		for Steering Rod
	09/00→09/15	Track Control Arm		IV-DL-8613	Trailing Arm, Drive Axle; Air Suspension Axle
09/00→09/15	Track Control Arm		IV-VB-8146	Wishbone (CV), Drive Axle; Air Suspension Axle	
180 E 28 tector, 180 E 28 P tector	09/00→09/15	Centre Rod	IV-DL-5371		Push Rod
	09/00→09/15	Suspension Arm Repair Kit		DF-RK-8503	for Control Arm
	09/00→09/15	Tie Rod	IV-DL-7785		
	09/00→09/15	Tie Rod End	CV-ES-14163		for Steering Rod

CV-ES-2119

Length: 55
Cone Ø: d1 Ø 10 / d2 Ø 10
Thread: M12 x 1,75 LHT
8198188, 42485638



CV-ES-2182

Length: 55
Cone Ø: d1 Ø 10 / d2 Ø 10
Thread: M12 x 1,75 RHT
8198187



CV-ES-12461

Length: 120
Cone Ø: d1 Ø 26 / d2 Ø 23,5
Thread: M30 x 1,5 LHT
2980129, 002984511, 02984511, 2984511,
4833821, 4833828, 004833828, 04833828,
8122755, 42493782, 042493782



CV-ES-12462

Length: 120
Cone Ø: d1 Ø 26 / d2 Ø 23,5
Thread: M30 x 1,5 RHT
2966688, 2980323, 3096213, 4833820,
004833827, 4833827, 8122754, 42483520,
42485718, 42493781



CV-ES-14162

Length: 125
Cone Ø: d1 Ø 30 / d2 Ø 27
Thread: M30 x 1,5 LHT
2984061, 4802444, 4833830, 7138966,
8190225, 42489395, 42491957



CV-ES-14163

Length: 125
Cone Ø: d1 Ø 30 / d2 Ø 27
Thread: M30 x 1,5 RHT
2966252, 2969808, 4802443, 4833829,
7138967, 8122752, 42483386, 42488269,
42489573, 42489594, 42491638, 42537936



DF-RK-8503

Ø: 75
Hole Distance: 130
Thick/Height: 24
93192361



IV-DL-0215

Length: 822
Ø: 40
Cone Ø: d1 Ø 26 / d2 Ø 23,5
98402544, 98467459



IV-DL-5371

Length: 878
Ø: 36
Cone Ø: d1 Ø 30 / d2 Ø 27
98449025, 98469650



IV-DL-7785

Length: 1490
Ø: 38
Cone Ø: d1 Ø 26 / d2 Ø 23,5
98402553, 500307556



IV-DL-8613

Length: 594
Ø: 50
Hole Distance: 130 / 130
41009661, 41009666, 41035951, 41272429,
98472446, 98472466



IV-DL-8665

Length: 892
Ø: 42
Cone Ø: d1 Ø 30 / d2 Ø 27
504049893



IV-ES-12419

Length: 55
Cone Ø: d1 Ø 10 / d2 Ø 10
Thread: M10 x 1,5 RHT
2041327, 41002118, 41203863, 42079853



IV-TC-12431

Length: 594
Ø: 40
Hole Distance: 130 / 130
8137027



IV-VB-8146

Length: 659
Ø: 46
Hole Distance: 130 / 130
41028599, 41042092, 98405832, 98472468,
504064007





EuroCargo I-III ...

180 E 28 tector, 180 E 28 P tector ...	09/00→09/15	Tie Rod End	IV-ES-12419		for Steering Rod	
	09/00→09/15	Track Control Arm		IV-DL-8613	Trailing Arm, Drive Axle;Air Suspension Axle	
	09/00→09/15	Track Control Arm		IV-VB-8146	Wishbone (CV), Drive Axle;Air Suspension Axle	
180 E 30 K tector	09/06→09/15	Centre Rod	IV-DL-5371		Push Rod	
	09/06→09/15	Suspension Arm Repair Kit		DF-RK-8503	for Control Arm	
	09/06→09/15	Tie Rod	IV-DL-7785			
	09/06→09/15	Track Control Arm		IV-DL-8613	Trailing Arm, Drive Axle;Air Suspension Axle	
	09/06→09/15	Track Control Arm		IV-VB-8146	Wishbone (CV), Drive Axle;Air Suspension Axle	
180 E 30 tector, 180 E 30 P tector	08/06→09/15	Centre Rod	IV-DL-5371		Push Rod	
	08/06→09/15	Suspension Arm Repair Kit		DF-RK-8503	for Control Arm	
	08/06→09/15	Tie Rod	IV-DL-7785			
	08/06→09/15	Track Control Arm		IV-DL-8613	Trailing Arm, Drive Axle;Air Suspension Axle	
	08/06→09/15	Track Control Arm		IV-VB-8146	Wishbone (CV), Drive Axle;Air Suspension Axle	
190 E 25 tector, 190 E 25 P tector	05/08→09/15	Suspension Arm Repair Kit		DF-RK-8503	for Control Arm	
190 E 28 tector, 190 E 28 P tector	05/08→09/15	Suspension Arm Repair Kit		DF-RK-8503	for Control Arm	
190 E 30 tector, 190 E 30 P tector	05/08→09/15	Suspension Arm Repair Kit		DF-RK-8503	for Control Arm	
	05/08→09/15	Tie Rod End	CV-ES-14163		for Steering Rod	
225 E 28 tector	09/06→09/15	Centre Rod	IV-DL-5371		Push Rod	
	09/06→09/15	Suspension Arm Repair Kit		DF-RK-8503	for Control Arm	
	09/06→09/15	Tie Rod	IV-DL-7785			
230 E 25 tector	05/09→09/15	Suspension Arm Repair Kit		DF-RK-8503	for Control Arm	
230 E 28 tector	09/06→09/15	Centre Rod	IV-DL-5371		Push Rod	
	09/06→09/15	Suspension Arm Repair Kit		DF-RK-8503	for Control Arm	
	09/06→09/15	Tie Rod	IV-DL-7785			
230 E 30 tector	02/08→09/15	Suspension Arm Repair Kit		DF-RK-8503	for Control Arm	
260 E 23	01/92→09/15	Suspension Arm Repair Kit		DF-RK-8503	for Control Arm	
	01/92→09/15	Tie Rod End	IV-ES-12419		for Steering Rod	
260 E 23 KE	01/92→09/15	Centre Rod	IV-DL-5371		Push Rod	
	01/92→09/15	Suspension Arm Repair Kit		DF-RK-8503	for Control Arm	
	01/92→09/15	Tie Rod End	IV-ES-12419		for Steering Rod	
260 E 23 T	01/91→09/15	Centre Rod	IV-DS-0284		Push Rod	
	01/91→09/15	Suspension Arm Repair Kit		DF-RK-8503	for Control Arm	
	01/91→09/15	Tie Rod	IV-DL-8183		Guide Rod	
	01/91→09/15	Tie Rod End	CV-ES-12461		for Steering Rod	
	01/91→09/15	Tie Rod End	CV-ES-12462		for Steering Rod	
	01/91→09/15	Tie Rod End	IV-ES-12419		for Steering Rod	
	01/91→09/15	Track Control Arm		IV-DL-8613	Trailing Arm, Drive Axle;Air Suspension Axle	
	01/91→09/15	Track Control Arm		IV-TC-12431	Trailing Arm	
	01/91→09/15	Track Control Arm		IV-VB-8146	Wishbone (CV), Drive Axle;Air Suspension Axle	
	260 E 27 KE	09/00→09/15	Suspension Arm Repair Kit		DF-RK-8503	for Control Arm
	260 E 28 K tector, 260 E 28 KE tector	09/00→09/15	Centre Rod	IV-DL-5371		Push Rod
09/00→09/15		Suspension Arm Repair Kit		DF-RK-8503	for Control Arm	
09/00→09/15		Tie Rod	IV-DL-7785			
09/00→09/15		Tie Rod End	CV-ES-14162		for Steering Rod	
09/00→09/15		Tie Rod End	CV-ES-14163		for Steering Rod	
09/00→09/15		Tie Rod End	IV-ES-12419		for Steering Rod	
280 E 23 T	01/91→09/15	Centre Rod	IV-DS-0284		Push Rod	
	01/91→09/15	Suspension Arm Repair Kit		DF-RK-8503	for Control Arm	
	01/91→09/15	Tie Rod	IV-DL-8183		Guide Rod	
	01/91→09/15	Tie Rod End	CV-ES-12461		for Steering Rod	
	01/91→09/15	Tie Rod End	CV-ES-12462		for Steering Rod	
	01/91→09/15	Tie Rod End	IV-ES-12419		for Steering Rod	
	01/91→09/15	Track Control Arm		IV-DL-8613	Trailing Arm, Drive Axle;Air Suspension Axle	
	01/91→09/15	Track Control Arm		IV-TC-12431	Trailing Arm	
	01/91→09/15	Track Control Arm		IV-VB-8146	Wishbone (CV), Drive Axle;Air Suspension Axle	
	280 E 23, 280 E 23 P	01/09→09/15	Suspension Arm Repair Kit		DF-RK-8503	for Control Arm
01/09→09/15		Tie Rod End	IV-ES-12419		for Steering Rod	
320 E 27 T	01/91→09/15	Centre Rod	IV-DS-0284		Push Rod	
	01/91→09/15	Suspension Arm Repair Kit		DF-RK-8503	for Control Arm	
	01/91→09/15	Tie Rod	IV-DL-8183		Guide Rod	
	01/91→09/15	Tie Rod End	CV-ES-12461		for Steering Rod	
	01/91→09/15	Tie Rod End	CV-ES-12462		for Steering Rod	
	01/91→09/15	Tie Rod End	IV-ES-12419		for Steering Rod	

CV-ES-12461

Length: 120
Cone Ø: d1 Ø 26 / d2 Ø 23,5
Thread: M30 x 1,5 LHT
2980129, 2984511, 002984511, 02984511,
4833821, 004833828, 04833828, 4833828,
8122755, 042493782, 42493782



CV-ES-12462

Length: 120
Cone Ø: d1 Ø 26 / d2 Ø 23,5
Thread: M30 x 1,5 RHT
2966688, 2980323, 3096213, 4833820,
004833827, 4833827, 8122754, 42483520,
42485718, 42493781



CV-ES-14162

Length: 125
Cone Ø: d1 Ø 30 / d2 Ø 27
Thread: M30 x 1,5 LHT
2984061, 4802444, 4833830, 7138966,
8190225, 42489395, 42491957



CV-ES-14163

Length: 125
Cone Ø: d1 Ø 30 / d2 Ø 27
Thread: M30 x 1,5 RHT
2966252, 2969808, 4802443, 4833829,
7138967, 8122752, 42483386, 42488269,
42489573, 42489594, 42491638, 42537936



DF-RK-8503

Ø: 75
Hole Distance: 130
Thick/Height: 24
93192361



IV-DL-5371

Length: 878
Ø: 36
Cone Ø: d1 Ø 30 / d2 Ø 27
98449025, 98469650



IV-DL-7785

Length: 1490
Ø: 38
Cone Ø: d1 Ø 26 / d2 Ø 23,5
98402553, 500307556



IV-DL-8183

Length: 1584
Ø: 42
Cone Ø: d1 Ø 26 / d2 Ø 23,5
4854871



IV-DL-8613

Length: 594
Ø: 50
Hole Distance: 130 / 130
41009661, 41009666, 41035951, 41272429,
98472446, 98472466



IV-DS-0284

Length: 902
Ø: 42
Cone Ø: d1 Ø 26 / d2 Ø 23,5
4854874, 04854874



IV-ES-12419

Length: 55
Cone Ø: d1 Ø 10 / d2 Ø 10
Thread: M10 x 1,5 RHT
2041327, 41002118, 41203863, 42079853



IV-TC-12431

Length: 594
Ø: 40
Hole Distance: 130 / 130
8137027



IV-VB-8146

Length: 659
Ø: 46
Hole Distance: 130 / 130
41028599, 41042092, 98405832, 98472468,
504064007



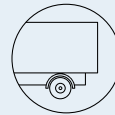

EuroCargo I-III ...

320 E 27 T ...	01/91→09/15	Track Control Arm		IV-TC-12431	Trailing Arm
	01/91→09/15	Track Control Arm		IV-VB-8146	Wishbone (CV), Drive Axle;Air Suspension Axle
320 E 27, 320 E 27 P	01/92→09/15	Suspension Arm Repair Kit		DF-RK-8503	for Control Arm
	01/92→09/15	Tie Rod End	IV-ES-12419		for Steering Rod
320 E 28 T tector	09/00→09/15	Centre Rod	IV-DL-5371		Push Rod
	09/00→09/15	Suspension Arm Repair Kit		DF-RK-8503	for Control Arm
	09/00→09/15	Tie Rod	IV-DL-7785		
	09/00→09/15	Tie Rod End	CV-ES-12461		for Steering Rod
	09/00→09/15	Tie Rod End	CV-ES-12462		for Steering Rod
	09/00→09/15	Tie Rod End	IV-ES-12419		for Steering Rod
	09/00→09/15	Track Control Arm		IV-TC-12431	Trailing Arm, 1st RA, for Pneumatic Suspension vehicles
	09/00→09/15	Track Control Arm		IV-VB-8146	Wishbone (CV), Drive Axle;Air Suspension Axle
	320 E 28 tector	09/00→09/15	Centre Rod	IV-DL-5371	
09/00→09/15		Suspension Arm Repair Kit		DF-RK-8503	for Control Arm
09/00→09/15		Tie Rod	IV-DL-7785		
60 E 10	01/91→09/15	Ball Head, gearshift linkage	CV-ES-2119		
	01/91→09/15	Ball Head, gearshift linkage	CV-ES-2182		
	01/91→09/15	Centre Rod	IV-DL-0215		Push Rod
	01/91→09/15	Suspension Arm Repair Kit		DF-RK-8503	for Control Arm
	01/91→09/15	Tie Rod	IV-DL-7785		
	01/91→09/15	Tie Rod End	CV-ES-12461		for Steering Rod
	01/91→09/15	Tie Rod End	CV-ES-12462		for Steering Rod
	01/91→09/15	Tie Rod End	IV-ES-12419		for Steering Rod
60 E 12	01/91→09/15	Ball Head, gearshift linkage	CV-ES-2119		
	01/91→09/15	Ball Head, gearshift linkage	CV-ES-2182		
	01/91→09/15	Centre Rod	IV-DL-0215		Push Rod
	01/91→09/15	Suspension Arm Repair Kit		DF-RK-8503	for Control Arm
	01/91→09/15	Tie Rod	IV-DL-7785		
	01/91→09/15	Tie Rod End	CV-ES-12461		for Steering Rod
	01/91→09/15	Tie Rod End	CV-ES-12462		for Steering Rod
	01/91→09/15	Tie Rod End	IV-ES-12419		for Steering Rod
60 E 13 K tector	09/00→09/15	Suspension Arm Repair Kit		DF-RK-8503	for Control Arm
	09/00→09/15	Tie Rod	IV-DL-7785		
60 E 13 tector, 60 E 13 P tector	09/00→09/15	Suspension Arm Repair Kit		DF-RK-8503	for Control Arm
	09/00→09/15	Tie Rod	IV-DL-7785		
60 E 14 K	01/91→09/15	Ball Head, gearshift linkage	CV-ES-2119		
	01/91→09/15	Ball Head, gearshift linkage	CV-ES-2182		
	01/91→09/15	Centre Rod	IV-DL-0215		Push Rod
	01/91→09/15	Suspension Arm Repair Kit		DF-RK-8503	for Control Arm
	01/91→09/15	Tie Rod	IV-DL-7785		
	01/91→09/15	Tie Rod End	CV-ES-12461		for Steering Rod
	01/91→09/15	Tie Rod End	CV-ES-12462		for Steering Rod
	01/91→09/15	Tie Rod End	IV-ES-12419		for Steering Rod
60 E 14 K tector	09/06→09/15	Suspension Arm Repair Kit		DF-RK-8503	for Control Arm
60 E 14 tector, 60 E 14 P tector	09/06→09/15	Suspension Arm Repair Kit		DF-RK-8503	for Control Arm
60 E 14, 60 E 14 P	01/91→09/15	Ball Head, gearshift linkage	CV-ES-2119		
	01/91→09/15	Ball Head, gearshift linkage	CV-ES-2182		
	01/91→09/15	Centre Rod	IV-DL-0215		Push Rod
	01/91→09/15	Suspension Arm Repair Kit		DF-RK-8503	for Control Arm
	01/91→09/15	Tie Rod	IV-DL-7785		
	01/91→09/15	Tie Rod End	CV-ES-12461		for Steering Rod
	01/91→09/15	Tie Rod End	CV-ES-12462		for Steering Rod
	01/91→09/15	Tie Rod End	IV-ES-12419		for Steering Rod
60 E 15 K tector	09/00→09/15	Suspension Arm Repair Kit		DF-RK-8503	for Control Arm
	09/00→09/15	Tie Rod	IV-DL-7785		
60 E 15 tector, 60 E 15 P tector	09/00→09/15	Suspension Arm Repair Kit		DF-RK-8503	for Control Arm
	09/00→09/15	Tie Rod	IV-DL-7785		
60 E 16 K tector	09/06→09/15	Suspension Arm Repair Kit		DF-RK-8503	for Control Arm
60 E 16 tector, 60 E 16 P tector	09/06→09/15	Suspension Arm Repair Kit		DF-RK-8503	for Control Arm
65 E 10	01/91→09/15	Ball Head, gearshift linkage	CV-ES-2119		
	01/91→09/15	Ball Head, gearshift linkage	CV-ES-2182		
	01/91→09/15	Centre Rod	IV-DL-0215		Push Rod
	01/91→09/15	Suspension Arm Repair Kit		DF-RK-8503	for Control Arm

CV-ES-2119

Length: 55
Cone Ø: d1 Ø 10 / d2 Ø 10
Thread: M12 x 1,75 LHT
8198188, 42485638



IV-DL-5371

Length: 878
Ø: 36
Cone Ø: d1 Ø 30 / d2 Ø 27
98449025, 98469650



CV-ES-2182

Length: 55
Cone Ø: d1 Ø 10 / d2 Ø 10
Thread: M12 x 1,75 RHT
8198187



IV-DL-7785

Length: 1490
Ø: 38
Cone Ø: d1 Ø 26 / d2 Ø 23,5
98402553, 500307556



CV-ES-12461

Length: 120
Cone Ø: d1 Ø 26 / d2 Ø 23,5
Thread: M30 x 1,5 LHT
2980129, 002984511, 02984511, 2984511,
4833821, 004833828, 04833828, 4833828,
8122755, 042493782, 42493782



IV-ES-12419

Length: 55
Cone Ø: d1 Ø 10 / d2 Ø 10
Thread: M10 x 1,5 RHT
2041327, 41002118, 41203863, 42079853



CV-ES-12462

Length: 120
Cone Ø: d1 Ø 26 / d2 Ø 23,5
Thread: M30 x 1,5 RHT
2966688, 2980323, 3096213, 4833820,
004833827, 4833827, 8122754, 42483520,
42485718, 42493781



IV-TC-12431

Length: 594
Ø: 40
Hole Distance: 130 / 130
8137027



DF-RK-8503

Ø: 75
Hole Distance: 130
Thick/Height: 24
93192361



IV-VB-8146

Length: 659
Ø: 46
Hole Distance: 130 / 130
41028599, 41042092, 98405832, 98472468,
504064007



IV-DL-0215

Length: 822
Ø: 40
Cone Ø: d1 Ø 26 / d2 Ø 23,5
98402544, 98467459





EuroCargo I-III ...

65 E 10 ...	01/91→09/15	Tie Rod	IV-DL-7785		
	01/91→09/15	Tie Rod End	CV-ES-12461		for Steering Rod
	01/91→09/15	Tie Rod End	CV-ES-12462		for Steering Rod
	01/91→09/15	Tie Rod End	IV-ES-12419		for Steering Rod
65 E 10 K	01/91→09/15	Ball Head, gearshift linkage	CV-ES-2119		
	01/91→09/15	Ball Head, gearshift linkage	CV-ES-2182		
	01/91→09/15	Centre Rod	IV-DL-0215		Push Rod
	01/91→09/15	Suspension Arm Repair Kit		DF-RK-8503	for Control Arm
	01/91→09/15	Tie Rod	IV-DL-7785		
	01/91→09/15	Tie Rod End	CV-ES-12461		for Steering Rod
	01/91→09/15	Tie Rod End	CV-ES-12462		for Steering Rod
	01/91→09/15	Tie Rod End	IV-ES-12419		for Steering Rod
65 E 12 K	01/91→09/15	Ball Head, gearshift linkage	CV-ES-2119		
	01/91→09/15	Ball Head, gearshift linkage	CV-ES-2182		
	01/91→09/15	Centre Rod	IV-DL-0215		Push Rod
	01/91→09/15	Suspension Arm Repair Kit		DF-RK-8503	for Control Arm
	01/91→09/15	Tie Rod	IV-DL-7785		
	01/91→09/15	Tie Rod End	CV-ES-12461		for Steering Rod
	01/91→09/15	Tie Rod End	CV-ES-12462		for Steering Rod
	01/91→09/15	Tie Rod End	IV-ES-12419		for Steering Rod
65 E 12, 65 E 12 P	01/91→09/15	Ball Head, gearshift linkage	CV-ES-2119		
	01/91→09/15	Ball Head, gearshift linkage	CV-ES-2182		
	01/91→09/15	Centre Rod	IV-DL-0215		Push Rod
	01/91→09/15	Suspension Arm Repair Kit		DF-RK-8503	for Control Arm
	01/91→09/15	Tie Rod	IV-DL-7785		
	01/91→09/15	Tie Rod End	CV-ES-12461		for Steering Rod
	01/91→09/15	Tie Rod End	CV-ES-12462		for Steering Rod
	01/91→09/15	Tie Rod End	IV-ES-12419		for Steering Rod
65 E 13 K tector	09/00→09/15	Suspension Arm Repair Kit		DF-RK-8503	for Control Arm
	09/00→09/15	Tie Rod	IV-DL-7785		
65 E 13 tector	09/00→09/15	Suspension Arm Repair Kit		DF-RK-8503	for Control Arm
	09/00→09/15	Tie Rod	IV-DL-7785		
65 E 14 K	01/91→09/15	Ball Head, gearshift linkage	CV-ES-2119		
	01/91→09/15	Ball Head, gearshift linkage	CV-ES-2182		
	01/91→09/15	Centre Rod	IV-DL-0215		Push Rod
	01/91→09/15	Suspension Arm Repair Kit		DF-RK-8503	for Control Arm
	01/91→09/15	Tie Rod	IV-DL-7785		
	01/91→09/15	Tie Rod End	CV-ES-12461		for Steering Rod
	01/91→09/15	Tie Rod End	CV-ES-12462		for Steering Rod
	01/91→09/15	Tie Rod End	IV-ES-12419		for Steering Rod
65 E 14 K tector	09/06→09/15	Suspension Arm Repair Kit		DF-RK-8503	for Control Arm
65 E 14 tector, 65 E 14 P tector	09/06→09/15	Suspension Arm Repair Kit		DF-RK-8503	for Control Arm
65 E 14, 65 E 14 P	01/91→09/15	Ball Head, gearshift linkage	CV-ES-2119		
	01/91→09/15	Ball Head, gearshift linkage	CV-ES-2182		
	01/91→09/15	Centre Rod	IV-DL-0215		Push Rod
	01/91→09/15	Suspension Arm Repair Kit		DF-RK-8503	for Control Arm
	01/91→09/15	Tie Rod	IV-DL-7785		
	01/91→09/15	Tie Rod End	CV-ES-12461		for Steering Rod
	01/91→09/15	Tie Rod End	CV-ES-12462		for Steering Rod
	01/91→09/15	Tie Rod End	IV-ES-12419		for Steering Rod
65 E 15 tector, 65 E 15 P tector	09/00→09/15	Suspension Arm Repair Kit		DF-RK-8503	for Control Arm
	09/00→09/15	Tie Rod	IV-DL-7785		
65 E 16 K tector	09/06→09/15	Suspension Arm Repair Kit		DF-RK-8503	for Control Arm
65 E 16 tector, 65 E 16 P tector	09/06→09/15	Suspension Arm Repair Kit		DF-RK-8503	for Control Arm
65 E15 K tector	09/00→09/15	Suspension Arm Repair Kit		DF-RK-8503	for Control Arm
	09/00→09/15	Tie Rod	IV-DL-7785		
75 E 12 K	01/91→09/15	Ball Head, gearshift linkage	CV-ES-2119		
	01/91→09/15	Ball Head, gearshift linkage	CV-ES-2182		
	01/91→09/15	Centre Rod	IV-DL-0215		Push Rod
	01/91→09/15	Suspension Arm Repair Kit		DF-RK-8503	for Control Arm
	01/91→09/15	Tie Rod	IV-DL-7785		
	01/91→09/15	Tie Rod End	CV-ES-12461		for Steering Rod
	01/91→09/15	Tie Rod End	CV-ES-12462		for Steering Rod
	01/91→09/15	Tie Rod End	IV-ES-12419		for Steering Rod

CV-ES-2119

Length: 55
Cone Ø: d1 Ø 10 / d2 Ø 10
Thread: M12 x 1,75 LHT
8198188, 42485638



IV-DL-7785

Length: 1490
Ø: 38
Cone Ø: d1 Ø 26 / d2 Ø 23,5
98402553, 500307556



CV-ES-2182

Length: 55
Cone Ø: d1 Ø 10 / d2 Ø 10
Thread: M12 x 1,75 RHT
8198187



IV-ES-12419

Length: 55
Cone Ø: d1 Ø 10 / d2 Ø 10
Thread: M10 x 1,5 RHT
2041327, 41002118, 41203863, 42079853



CV-ES-12461

Length: 120
Cone Ø: d1 Ø 26 / d2 Ø 23,5
Thread: M30 x 1,5 LHT
2980129, 002984511, 02984511, 2984511,
4833821, 4833828, 004833828, 04833828,
8122755, 042493782, 42493782



CV-ES-12462

Length: 120
Cone Ø: d1 Ø 26 / d2 Ø 23,5
Thread: M30 x 1,5 RHT
2966688, 2980323, 3096213, 4833820,
4833827, 004833827, 8122754, 42483520,
42485718, 42493781



DF-RK-8503

Ø: 75
Hole Distance: 130
Thick/Height: 24
93192361



IV-DL-0215

Length: 822
Ø: 40
Cone Ø: d1 Ø 26 / d2 Ø 23,5
98402544, 98467459



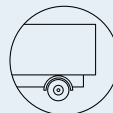

EuroCargo I-III ...

75 E 12, 75 E 12 P	01/91→09/15	Ball Head, gearshift linkage	CV-ES-2119		
	01/91→09/15	Ball Head, gearshift linkage	CV-ES-2182		
	01/91→09/15	Centre Rod	IV-DL-0215		Push Rod
	01/91→09/15	Suspension Arm Repair Kit		DF-RK-8503	for Control Arm
	01/91→09/15	Tie Rod	IV-DL-7785		
	01/91→09/15	Tie Rod End	CV-ES-12461		for Steering Rod
	01/91→09/15	Tie Rod End	CV-ES-12462		for Steering Rod
	01/91→09/15	Tie Rod End	IV-ES-12419		for Steering Rod
75 E 13 K tector	09/00→09/15	Suspension Arm Repair Kit		DF-RK-8503	for Control Arm
	09/00→09/15	Tie Rod	IV-DL-7785		
	09/00→09/15	Tie Rod End	CV-ES-12461		for Steering Rod
	09/00→09/15	Tie Rod End	CV-ES-12462		for Steering Rod
	09/00→09/15	Tie Rod End	IV-ES-12419		for Steering Rod
75 E 13 tector, 75 E 13 P tector	09/00→09/15	Suspension Arm Repair Kit		DF-RK-8503	for Control Arm
	09/00→09/15	Tie Rod	IV-DL-7785		
	09/00→09/15	Tie Rod End	CV-ES-12461		for Steering Rod
	09/00→09/15	Tie Rod End	CV-ES-12462		for Steering Rod
	09/00→09/15	Tie Rod End	IV-ES-12419		for Steering Rod
75 E 14 K	01/91→09/15	Ball Head, gearshift linkage	CV-ES-2119		
	01/91→09/15	Ball Head, gearshift linkage	CV-ES-2182		
	01/91→09/15	Centre Rod	IV-DL-0215		Push Rod
	01/91→09/15	Suspension Arm Repair Kit		DF-RK-8503	for Control Arm
	01/91→09/15	Tie Rod	IV-DL-7785		
	01/91→09/15	Tie Rod End	CV-ES-12461		for Steering Rod
	01/91→09/15	Tie Rod End	CV-ES-12462		for Steering Rod
	01/91→09/15	Tie Rod End	IV-ES-12419		for Steering Rod
75 E 14 K tector	09/06→09/15	Suspension Arm Repair Kit		DF-RK-8503	for Control Arm
	09/06→09/15	Tie Rod	IV-DL-7785		
	09/06→09/15	Tie Rod End	IV-ES-12419		for Steering Rod
75 E 14 tector, 75 E 14 P tector	09/06→09/15	Suspension Arm Repair Kit		DF-RK-8503	for Control Arm
	09/06→09/15	Tie Rod	IV-DL-7785		
	09/06→09/15	Tie Rod End	CV-ES-12461		for Steering Rod
	09/06→09/15	Tie Rod End	CV-ES-12462		for Steering Rod
	09/06→09/15	Tie Rod End	IV-ES-12419		for Steering Rod
75 E 14, 75 E 14 P	01/91→09/15	Ball Head, gearshift linkage	CV-ES-2119		
	01/91→09/15	Ball Head, gearshift linkage	CV-ES-2182		
	01/91→09/15	Centre Rod	IV-DL-0215		Push Rod
	01/91→09/15	Suspension Arm Repair Kit		DF-RK-8503	for Control Arm
	01/91→09/15	Tie Rod	IV-DL-7785		
	01/91→09/15	Tie Rod End	CV-ES-12461		for Steering Rod
	01/91→09/15	Tie Rod End	CV-ES-12462		for Steering Rod
	01/91→09/15	Tie Rod End	IV-ES-12419		for Steering Rod
75 E 15 K	01/91→09/15	Ball Head, gearshift linkage	CV-ES-2119		
	01/91→09/15	Ball Head, gearshift linkage	CV-ES-2182		
	01/91→09/15	Centre Rod	IV-DL-0215		Push Rod
	01/91→09/15	Suspension Arm Repair Kit		DF-RK-8503	for Control Arm
	01/91→09/15	Tie Rod	IV-DL-7785		
	01/91→09/15	Tie Rod End	CV-ES-12461		for Steering Rod
	01/91→09/15	Tie Rod End	CV-ES-12462		for Steering Rod
	01/91→09/15	Tie Rod End	IV-ES-12419		for Steering Rod
75 E 15 K tector	09/00→09/15	Suspension Arm Repair Kit		DF-RK-8503	for Control Arm
	09/00→09/15	Tie Rod	IV-DL-7785		
	09/00→09/15	Tie Rod End	CV-ES-12461		for Steering Rod
	09/00→09/15	Tie Rod End	CV-ES-12462		for Steering Rod
	09/00→09/15	Tie Rod End	IV-ES-12419		for Steering Rod
75 E 15 tector, 75 E 15 P tector	09/00→09/15	Suspension Arm Repair Kit		DF-RK-8503	for Control Arm
	09/00→09/15	Tie Rod	IV-DL-7785		
	09/00→09/15	Tie Rod End	CV-ES-12461		for Steering Rod
	09/00→09/15	Tie Rod End	CV-ES-12462		for Steering Rod
	09/00→09/15	Tie Rod End	IV-ES-12419		for Steering Rod
75 E 15, 75 E 15 P, 80 E 15	01/91→09/15	Ball Head, gearshift linkage	CV-ES-2119		
	01/91→09/15	Ball Head, gearshift linkage	CV-ES-2182		
	01/91→09/15	Centre Rod	IV-DL-0215		Push Rod
	01/91→09/15	Suspension Arm Repair Kit		DF-RK-8503	for Control Arm

CV-ES-2119

Length: 55
Cone Ø: d1 Ø 10 / d2 Ø 10
Thread: M12 x 1,75 LHT
8198188, 42485638



IV-DL-7785

Length: 1490
Ø: 38
Cone Ø: d1 Ø 26 / d2 Ø 23,5
98402553, 500307556



CV-ES-2182

Length: 55
Cone Ø: d1 Ø 10 / d2 Ø 10
Thread: M12 x 1,75 RHT
8198187



IV-ES-12419

Length: 55
Cone Ø: d1 Ø 10 / d2 Ø 10
Thread: M10 x 1,5 RHT
2041327, 41002118, 41203863, 42079853



CV-ES-12461

Length: 120
Cone Ø: d1 Ø 26 / d2 Ø 23,5
Thread: M30 x 1,5 LHT
2980129, 002984511, 02984511, 2984511,
4833821, 4833828, 004833828, 04833828,
8122755, 042493782, 42493782



CV-ES-12462

Length: 120
Cone Ø: d1 Ø 26 / d2 Ø 23,5
Thread: M30 x 1,5 RHT
2966688, 2980323, 3096213, 4833820,
004833827, 4833827, 8122754, 42483520,
42485718, 42493781



DF-RK-8503

Ø: 75
Hole Distance: 130
Thick/Height: 24
93192361



IV-DL-0215

Length: 822
Ø: 40
Cone Ø: d1 Ø 26 / d2 Ø 23,5
98402544, 98467459





EuroCargo I-III ...

75 E 15, 75 E 15 P, 80 E 15 ...	01/91→09/15	Tie Rod	IV-DL-7785		
	01/91→09/15	Tie Rod End	CV-ES-12461		for Steering Rod
	01/91→09/15	Tie Rod End	CV-ES-12462		for Steering Rod
	01/91→09/15	Tie Rod End	IV-ES-12419		for Steering Rod
75 E 16 K tector	09/06→09/15	Suspension Arm Repair Kit		DF-RK-8503	for Control Arm
	09/06→09/15	Tie Rod	IV-DL-7785		
75 E 16 tector, 75 E 16 P tector	09/06→09/15	Suspension Arm Repair Kit		DF-RK-8503	for Control Arm
	09/06→09/15	Tie Rod	IV-DL-7785		
	09/06→09/15	Tie Rod End	CV-ES-12461		for Steering Rod
	09/06→09/15	Tie Rod End	CV-ES-12462		for Steering Rod
75 E 17 K, 75 E 18 K tector	09/00→09/15	Suspension Arm Repair Kit		DF-RK-8503	for Control Arm
	09/00→09/15	Tie Rod	IV-DL-7785		
	09/00→09/15	Tie Rod End	CV-ES-12461		for Steering Rod
	09/00→09/15	Tie Rod End	CV-ES-12462		for Steering Rod
75 E 17, 75 E 17 P, 75 E 18 tector	09/00→09/15	Suspension Arm Repair Kit		DF-RK-8503	for Control Arm
	09/00→09/15	Tie Rod	IV-DL-7785		
	09/00→09/15	Tie Rod End	CV-ES-12461		for Steering Rod
	09/00→09/15	Tie Rod End	CV-ES-12462		for Steering Rod
75 E 18 K tector	09/00→09/15	Tie Rod End	IV-ES-12419		for Steering Rod
	09/00→09/15	Centre Rod	IV-DL-5371		Push Rod
	09/00→09/15	Suspension Arm Repair Kit		DF-RK-8503	for Control Arm
	09/00→09/15	Tie Rod	IV-DL-7785		
75 E 18 tector, 75 E 18 P tector	09/00→09/15	Tie Rod End	CV-ES-12461		for Steering Rod
	09/00→09/15	Tie Rod End	CV-ES-12462		for Steering Rod
	09/00→09/15	Tie Rod End	IV-ES-12419		for Steering Rod
	09/00→09/15	Centre Rod	IV-DL-5371		Push Rod
80 E 15 K	09/00→09/15	Suspension Arm Repair Kit		DF-RK-8503	for Control Arm
	09/00→09/15	Tie Rod	IV-DL-7785		
	09/00→09/15	Tie Rod End	CV-ES-12461		for Steering Rod
	09/00→09/15	Tie Rod End	CV-ES-12462		for Steering Rod
80 E 15 K	09/00→09/15	Tie Rod End	IV-ES-12419		for Steering Rod
	01/91→09/15	Ball Head, gearshift linkage	CV-ES-2119		
	01/91→09/15	Ball Head, gearshift linkage	CV-ES-2182		
	01/91→09/15	Centre Rod	IV-DL-0215		Push Rod
80 E 15 K	01/91→09/15	Suspension Arm Repair Kit		DF-RK-8503	for Control Arm
	01/91→09/15	Tie Rod	IV-DL-7785		
	01/91→09/15	Tie Rod End	CV-ES-12461		for Steering Rod
	01/91→09/15	Tie Rod End	CV-ES-12462		for Steering Rod
80 E 15, 80 E 15 P	01/91→09/15	Tie Rod End	IV-ES-12419		for Steering Rod
	01/91→09/15	Ball Head, gearshift linkage	CV-ES-2119		
	01/91→09/15	Ball Head, gearshift linkage	CV-ES-2182		
	01/91→09/15	Centre Rod	IV-DL-0215		Push Rod
80 E 15, 80 E 15 P	01/91→09/15	Suspension Arm Repair Kit		DF-RK-8503	for Control Arm
	01/91→09/15	Tie Rod	IV-DL-7785		
	01/91→09/15	Tie Rod End	CV-ES-12461		for Steering Rod
	01/91→09/15	Tie Rod End	CV-ES-12462		for Steering Rod
80 E 15, 80 E 15 P	01/91→09/15	Tie Rod End	IV-ES-12419		for Steering Rod
	09/00→09/15	Suspension Arm Repair Kit		DF-RK-8503	for Control Arm
	09/00→09/15	Tie Rod	IV-DL-7785		
	09/00→09/15	Tie Rod End	CV-ES-12461		for Steering Rod
80 E 17 K, 80 E 17 DK tector, 80 E 18 K tector	09/00→09/15	Tie Rod End	CV-ES-12462		for Steering Rod
	09/00→09/15	Suspension Arm Repair Kit		DF-RK-8503	for Control Arm
	09/00→09/15	Tie Rod	IV-DL-7785		
	09/00→09/15	Suspension Arm Repair Kit		DF-RK-8503	for Control Arm
80 E 17, 80 E 17 D tector, 80 E 17 DP tector, 80 E 18 tector	09/00→09/15	Tie Rod	IV-DL-7785		
	01/91→09/15	Ball Head, gearshift linkage	CV-ES-2119		
	01/91→09/15	Ball Head, gearshift linkage	CV-ES-2182		
	01/91→09/15	Centre Rod	IV-DL-0215		Push Rod
80 E 18 K	01/91→09/15	Suspension Arm Repair Kit		DF-RK-8503	for Control Arm
	01/91→09/15	Tie Rod	IV-DL-7785		
	01/91→09/15	Tie Rod End	CV-ES-12461		for Steering Rod
	01/91→09/15	Tie Rod End	CV-ES-12462		for Steering Rod
80 E 18 K	01/91→09/15	Tie Rod End	IV-ES-12419		for Steering Rod
	09/06→09/15	Suspension Arm Repair Kit		DF-RK-8503	for Control Arm

CV-ES-2119

Length: 55
Cone Ø: d1 Ø 10 / d2 Ø 10
Thread: M12 x 1,75 LHT
8198188, 42485638



IV-DL-5371

Length: 878
Ø: 36
Cone Ø: d1 Ø 30 / d2 Ø 27
98449025, 98469650



CV-ES-2182

Length: 55
Cone Ø: d1 Ø 10 / d2 Ø 10
Thread: M12 x 1,75 RHT
8198187



IV-DL-7785

Length: 1490
Ø: 38
Cone Ø: d1 Ø 26 / d2 Ø 23,5
98402553, 500307556



CV-ES-12461

Length: 120
Cone Ø: d1 Ø 26 / d2 Ø 23,5
Thread: M30 x 1,5 LHT
2980129, 002984511, 02984511, 2984511,
4833821, 004833828, 04833828, 4833828,
8122755, 042493782, 42493782



IV-ES-12419

Length: 55
Cone Ø: d1 Ø 10 / d2 Ø 10
Thread: M10 x 1,5 RHT
2041327, 41002118, 41203863, 42079853



CV-ES-12462

Length: 120
Cone Ø: d1 Ø 26 / d2 Ø 23,5
Thread: M30 x 1,5 RHT
2966688, 2980323, 3096213, 4833820,
004833827, 4833827, 8122754, 42483520,
42485718, 42493781



DF-RK-8503

Ø: 75
Hole Distance: 130
Thick/Height: 24
93192361



IV-DL-0215

Length: 822
Ø: 40
Cone Ø: d1 Ø 26 / d2 Ø 23,5
98402544, 98467459



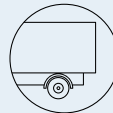

EuroCargo I-III ...

80 E 18 K tector, 80 E 18 DK tector	09/00→09/15	Centre Rod	IV-DL-5371		Push Rod
	09/00→09/15	Suspension Arm Repair Kit		DF-RK-8503	for Control Arm
	09/00→09/15	Tie Rod	IV-DL-7785		
80 E 18 tector, 80 E 18 D tector, 80 E 18 DP tector	09/00→09/15	Centre Rod	IV-DL-5371		Push Rod
	09/00→09/15	Suspension Arm Repair Kit		DF-RK-8503	for Control Arm
	09/00→09/15	Tie Rod	IV-DL-7785		
80 E 18 tector, 80 E 18 P tector, 80 E 18 FP tector	09/06→09/15	Suspension Arm Repair Kit		DF-RK-8503	for Control Arm
80 E 18, 80 E 18 P, 18 E 80 FP	01/91→09/15	Ball Head, gearshift linkage	CV-ES-2119		
	01/91→09/15	Ball Head, gearshift linkage	CV-ES-2182		
	01/91→09/15	Centre Rod	IV-DL-0215		Push Rod
	01/91→09/15	Suspension Arm Repair Kit		DF-RK-8503	for Control Arm
	01/91→09/15	Tie Rod	IV-DL-7785		
	01/91→09/15	Tie Rod End	CV-ES-12461		for Steering Rod
	01/91→09/15	Tie Rod End	CV-ES-12462		for Steering Rod
80 E 21 K, 80 E 21 DK tector, 80 E 22 K tector	09/00→09/15	Centre Rod	IV-DL-5371		Push Rod
	09/00→09/15	Suspension Arm Repair Kit		DF-RK-8503	for Control Arm
	09/00→09/15	Tie Rod	IV-DL-7785		
	09/00→09/15	Tie Rod End	IV-ES-12419		for Steering Rod
80 E 21, 80 E 21 D tector, 80 E 21 DP tector, 80 E 22 tector	09/00→09/15	Centre Rod	IV-DL-5371		Push Rod
	09/00→09/15	Suspension Arm Repair Kit		DF-RK-8503	for Control Arm
	09/00→09/15	Tie Rod	IV-DL-7785		
80 E 21, 80 E 21 P, 21 E 80 FP	01/91→09/15	Ball Head, gearshift linkage	CV-ES-2119		
	01/91→09/15	Ball Head, gearshift linkage	CV-ES-2182		
	01/91→09/15	Centre Rod	IV-DL-0215		Push Rod
	01/91→09/15	Suspension Arm Repair Kit		DF-RK-8503	for Control Arm
	01/91→09/15	Tie Rod	IV-DL-7785		
	01/91→09/15	Tie Rod End	CV-ES-12461		for Steering Rod
	01/91→09/15	Tie Rod End	CV-ES-12462		for Steering Rod
80 E 21, 80 E 21 P, 80 E 21 FP	01/91→09/15	Ball Head, gearshift linkage	CV-ES-2119		
	01/91→09/15	Ball Head, gearshift linkage	CV-ES-2182		
	01/91→09/15	Centre Rod	IV-DL-0215		Push Rod
	01/91→09/15	Suspension Arm Repair Kit		DF-RK-8503	for Control Arm
	01/91→09/15	Tie Rod	IV-DL-7785		
	01/91→09/15	Tie Rod End	CV-ES-12461		for Steering Rod
80 EL 15 tector	09/00→09/15	Suspension Arm Repair Kit		DF-RK-8503	for Control Arm
	09/00→09/15	Tie Rod	IV-DL-7785		
	09/06→09/15	Suspension Arm Repair Kit		DF-RK-8503	for Control Arm
	09/00→09/15	Suspension Arm Repair Kit		DF-RK-8503	for Control Arm
80 EL 16 tector, 80 EL 16 P tector	09/00→09/15	Suspension Arm Repair Kit		DF-RK-8503	for Control Arm
	09/00→09/15	Tie Rod	IV-DL-7785		
80 EL 17 tector, 80 EL 17 P tector	09/06→09/15	Suspension Arm Repair Kit		DF-RK-8503	for Control Arm
	09/00→09/15	Suspension Arm Repair Kit		DF-RK-8503	for Control Arm
80 EL 18 tector, 80 EL 18 P tector	09/00→09/15	Suspension Arm Repair Kit		DF-RK-8503	for Control Arm
	09/00→09/15	Tie Rod	IV-DL-7785		
90 E 17 K tector, 90 E 17 DK tector	09/00→09/15	Suspension Arm Repair Kit		DF-RK-8503	for Control Arm
	09/00→09/15	Tie Rod	IV-DL-7785		
90 E 17, 90 E 17D tector, 90 E 17 DP tector, 90 E 18 tector	09/00→09/15	Suspension Arm Repair Kit		DF-RK-8503	for Control Arm
	09/00→09/15	Tie Rod	IV-DL-7785		
	09/00→09/15	Centre Rod	IV-DL-5371		Push Rod
90 E 18 K tector, 90 E 18 DK tector	09/00→09/15	Suspension Arm Repair Kit		DF-RK-8503	for Control Arm
	09/00→09/15	Tie Rod	IV-DL-7785		
	09/00→09/15	Centre Rod	IV-DL-5371		Push Rod
90 E 18 tector, 90 E 18 D tector, 90 E 18 DP tector	09/00→09/15	Suspension Arm Repair Kit		DF-RK-8503	for Control Arm
	09/00→09/15	Tie Rod	IV-DL-7785		
	09/00→09/15	Centre Rod	IV-DL-5371		Push Rod
90 E 21 K tector, 90 E 21 DK tector	09/00→09/15	Suspension Arm Repair Kit		DF-RK-8503	for Control Arm
	09/00→09/15	Tie Rod	IV-DL-7785		
	09/00→09/15	Centre Rod	IV-DL-5371		Push Rod
90 E 21, 90 E 21 D tector, 90 E 21 DP tector, 90 E 22 tector	09/00→09/15	Suspension Arm Repair Kit		DF-RK-8503	for Control Arm
	09/00→09/15	Tie Rod	IV-DL-7785		
90 E 22 K tector	09/06→09/15	Suspension Arm Repair Kit		DF-RK-8503	for Control Arm

CV-ES-2119

Length: 55
Cone Ø: d1 Ø 10 / d2 Ø 10
Thread: M12 x 1,75 LHT
8198188, 42485638



IV-DL-5371

Length: 878
Ø: 36
Cone Ø: d1 Ø 30 / d2 Ø 27
98449025, 98469650



CV-ES-2182

Length: 55
Cone Ø: d1 Ø 10 / d2 Ø 10
Thread: M12 x 1,75 RHT
8198187



IV-DL-7785

Length: 1490
Ø: 38
Cone Ø: d1 Ø 26 / d2 Ø 23,5
98402553, 500307556



CV-ES-12461

Length: 120
Cone Ø: d1 Ø 26 / d2 Ø 23,5
Thread: M30 x 1,5 LHT
2980129, 2984511, 002984511, 02984511,
4833821, 004833828, 04833828, 4833828,
8122755, 042493782, 42493782



IV-ES-12419

Length: 55
Cone Ø: d1 Ø 10 / d2 Ø 10
Thread: M10 x 1,5 RHT
2041327, 41002118, 41203863, 42079853



CV-ES-12462

Length: 120
Cone Ø: d1 Ø 26 / d2 Ø 23,5
Thread: M30 x 1,5 RHT
2966688, 2980323, 3096213, 4833820,
004833827, 4833827, 8122754, 42483520,
42485718, 42493781



DF-RK-8503

Ø: 75
Hole Distance: 130
Thick/Height: 24
93192361



IV-DL-0215

Length: 822
Ø: 40
Cone Ø: d1 Ø 26 / d2 Ø 23,5
98402544, 98467459



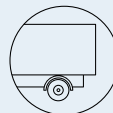

IVECO ...

EuroCargo I-III ...

95 E 15 W	01/91→09/15	Centre Rod	IV-DL-12264		for Steering Rod
	01/91→09/15	Suspension Arm Repair Kit		DF-RK-8503	for Control Arm
	01/91→09/15	Tie Rod	IV-DL-7785		
	01/91→09/15	Tie Rod End	CV-ES-14163		for Steering Rod
	01/91→09/15	Tie Rod End	IV-ES-12419		for Steering Rod
95 E 21 W	01/91→09/15	Centre Rod	IV-DL-12264		for Steering Rod
	01/91→09/15	Suspension Arm Repair Kit		DF-RK-8503	for Control Arm
	01/91→09/15	Tie Rod	IV-DL-7785		
	01/91→09/15	Tie Rod End	CV-ES-14163		for Steering Rod
	01/91→09/15	Tie Rod End	IV-ES-12419		for Steering Rod

EuroFire

100 E 21 tector	09/00→	Tie Rod End	IV-ES-12419		for Steering Rod
130 E 24	01/91→	Tie Rod End	IV-ES-12419		for Steering Rod
130 E 24 tector	09/00→	Tie Rod End	IV-ES-12419		for Steering Rod
135 E 22 W	01/91→	Tie Rod End	IV-ES-12419		for Steering Rod
135 E 24 W	01/91→	Tie Rod End	IV-ES-12419		for Steering Rod
140 E 24 tector	09/00→	Tie Rod End	IV-ES-12419		for Steering Rod
140 E 28 tector	09/06→	Tie Rod End	IV-ES-12419		for Steering Rod
150 E 27	09/06→	Tie Rod End	IV-ES-12419		for Steering Rod
150 E 28 tector	09/06→	Tie Rod End	IV-ES-12419		for Steering Rod
75 E 14	01/91→	Tie Rod End	IV-ES-12419		for Steering Rod
75 E 15 tector	09/00→	Tie Rod End	IV-ES-12419		for Steering Rod
95 E 18 W	01/93→	Tie Rod End	IV-ES-12419		for Steering Rod

EuroStar

LD 190 E 38 P	01/93→02/02	Centre Rod	IV-DL-2155		Push Rod
	01/93→02/02	Suspension Arm Repair Kit		DF-RK-8503	for Control Arm
	01/93→02/02	Tie Rod	IV-DL-8367		Guide Rod
	01/93→02/02	Tie Rod End	CV-ES-14162		for Steering Rod
	01/93→02/02	Tie Rod End	CV-ES-14163		for Steering Rod
	01/93→02/02	Tie Rod End	IV-ES-12419		for Steering Rod
	01/93→02/02	Track Control Arm		IV-DL-8613	Trailing Arm
	01/93→02/02	Track Control Arm		IV-VB-5228	Wishbone (CV)
LD 190 E 39 P, LD 190 E 39 FP	11/99→02/02	Centre Rod	IV-DL-2155		Push Rod
	11/99→02/02	Suspension Arm Repair Kit		DF-RK-8503	for Control Arm
	11/99→02/02	Tie Rod	IV-DL-8367		Guide Rod
	11/99→02/02	Tie Rod End	CV-ES-14163		for Steering Rod
LD 190 E 40	09/00→02/02	Suspension Arm Repair Kit		DF-RK-8503	for Control Arm
	09/00→02/02	Tie Rod End	CV-ES-14162		for Steering Rod
	09/00→02/02	Tie Rod End	CV-ES-14163		for Steering Rod
	09/00→02/02	Tie Rod End	IV-ES-8365		for Push Rod
LD 190 E 42, LD 190 E 42 P	01/93→02/02	Centre Rod	IV-DL-2155		Push Rod
	01/93→02/02	Suspension Arm Repair Kit		DF-RK-8503	for Control Arm
	01/93→02/02	Tie Rod	IV-DL-8367		Guide Rod
	01/93→02/02	Tie Rod End	CV-ES-14162		for Steering Rod
	01/93→02/02	Tie Rod End	CV-ES-14163		for Steering Rod
	01/93→02/02	Tie Rod End	IV-ES-12419		for Steering Rod
	01/93→02/02	Track Control Arm		IV-DL-8613	Trailing Arm
01/93→02/02	Track Control Arm		IV-VB-5228	Wishbone (CV)	
LD 190 E 43, LD 190 E 43 P, LD 190 E 43 FP	11/99→02/02	Centre Rod	IV-DL-2155		Push Rod
	11/99→02/02	Centre Rod	IV-DL-8304		Push Rod
	11/99→02/02	Suspension Arm Repair Kit		DF-RK-8503	for Control Arm
	11/99→02/02	Suspension Arm Repair Kit	DB-RK-9300	DB-RK-9300	for Drag Link
	11/99→02/02	Tie Rod	IV-DL-8367		Guide Rod
	11/99→02/02	Tie Rod End	CV-ES-14163		for Steering Rod
	11/99→02/02	Track Control Arm		IV-DL-8613	Trailing Arm
LD 190 E 47	01/93→02/02	Centre Rod	IV-DL-2155		Push Rod
	01/93→02/02	Suspension Arm Repair Kit		DF-RK-8503	for Control Arm
	01/93→02/02	Tie Rod	IV-DL-8367		Guide Rod
	01/93→02/02	Tie Rod End	CV-ES-14162		for Steering Rod
	01/93→02/02	Tie Rod End	CV-ES-14163		for Steering Rod
	01/93→02/02	Tie Rod End	IV-ES-12419		for Steering Rod

CV-ES-14162

Length: 125
Cone Ø: d1 Ø 30 / d2 Ø 27
Thread: M30 x 1,5 LHT
2984061, 4802444, 4833830, 7138966,
8190225, 42489395, 42491957



CV-ES-14163

Length: 125
Cone Ø: d1 Ø 30 / d2 Ø 27
Thread: M30 x 1,5 RHT
2966252, 2969808, 4802443, 4833829,
7138967, 8122752, 42483386, 42488269,
42489573, 42489594, 42491638, 42537936



DB-RK-9300

Ø: 75
Hole Distance: 130
Thick/Height: 24
500333284



DF-RK-8503

Ø: 75
Hole Distance: 130
Thick/Height: 24
93192361



IV-DL-2155

Length: 953
Ø: 52
Cone Ø: d1 Ø 30 / d2 Ø 27
8131582, 41005463, 41042919



IV-DL-7785

Length: 1490
Ø: 38
Cone Ø: d1 Ø 26 / d2 Ø 23,5
98402553, 500307556



IV-DL-8304

Length: 953
Ø: 52
Cone Ø: d1 Ø 30 / d2 Ø 27
500397738



IV-DL-8367

Length: 1620
Ø: 48
Cone Ø: d1 Ø 30 / d2 Ø 27
8163773, 41005450, 41005451, 41036943,
41036944



IV-DL-8613

Length: 594
Ø: 50
Hole Distance: 130 / 130
41009661, 41009666, 41035951, 41272429,
98472446, 98472466



IV-DL-12264

Length: 966
Ø: 50
Cone Ø: d1 Ø 30 / d2 Ø 27
98473328



IV-ES-8365

Length: 139
Cone Ø: d1 Ø 30 / d2 Ø 27
Thread: M30 x 1,5 RHT
500309296, 500340769



IV-ES-12419

Length: 55
Cone Ø: d1 Ø 10 / d2 Ø 10
Thread: M10 x 1,5 RHT
2041327, 41002118, 41203863, 42079853



IV-VB-5228

Length: 665
Ø: 46
Hole Distance: 130 / 130
937104, 08137026, 8137026, 41002770,
41009665, 41028598, 41028600, 41034479,
41042050





EuroStar ...

LD 190 E 47 ...	01/93→02/02	Track Control Arm		IV-DL-8613	Trailing Arm
	01/93→02/02	Track Control Arm		IV-VB-5228	Wishbone (CV)
LD 190 E 52	01/93→02/02	Centre Rod	IV-DL-2155		Push Rod
	01/93→02/02	Suspension Arm Repair Kit		DF-RK-8503	for Control Arm
	01/93→02/02	Tie Rod	IV-DL-8367		Guide Rod
	01/93→02/02	Tie Rod End	CV-ES-14162		for Steering Rod
	01/93→02/02	Tie Rod End	CV-ES-14163		for Steering Rod
	01/93→02/02	Tie Rod End	IV-ES-12419		for Steering Rod
	01/93→02/02	Track Control Arm		IV-DL-8613	Trailing Arm
	01/93→02/02	Track Control Arm		IV-VB-5228	Wishbone (CV)
LD 240 E 38	01/93→02/02	Centre Rod	IV-DL-2155		Push Rod
	01/93→02/02	Suspension Arm Repair Kit		DF-RK-8503	for Control Arm
	01/93→02/02	Tie Rod		IV-DL-9361	Guide Rod
	01/93→02/02	Tie Rod	IV-DL-8367		Guide Rod
	01/93→02/02	Tie Rod End		CV-ES-2146	for vehicles with Hinged Trailing Axle
	01/93→02/02	Tie Rod End		IV-ES-8507	Tag Axle
	01/93→02/02	Tie Rod End		MN-ES-8490	for vehicles with Hinged Trailing Axle
	01/93→02/02	Tie Rod End	CV-ES-14162		for Steering Rod
	01/93→02/02	Tie Rod End	CV-ES-14163		for Steering Rod
	01/93→02/02	Tie Rod End	IV-ES-12419		for Steering Rod
	01/93→02/02	Track Control Arm		IV-DL-8613	Trailing Arm
	01/93→02/02	Track Control Arm		IV-VB-5228	Wishbone (CV)
	LD 240 E 42 FS, LD 240 E 42 PS	01/93→02/02	Centre Rod	IV-DL-2155	
01/93→02/02		Suspension Arm Repair Kit		DF-RK-8503	for Control Arm
01/93→02/02		Tie Rod		IV-DL-9361	Guide Rod
01/93→02/02		Tie Rod	IV-DL-8367		Guide Rod
01/93→02/02		Tie Rod End		CV-ES-2146	for vehicles with Hinged Trailing Axle
01/93→02/02		Tie Rod End		IV-ES-8507	Tag Axle
01/93→02/02		Tie Rod End		MN-ES-8490	for vehicles with Hinged Trailing Axle
01/93→02/02		Tie Rod End	CV-ES-14162		for Steering Rod
01/93→02/02		Tie Rod End	CV-ES-14163		for Steering Rod
01/93→02/02		Tie Rod End	IV-ES-12419		for Steering Rod
01/93→02/02		Track Control Arm		IV-DL-8613	Trailing Arm
01/93→02/02		Track Control Arm		IV-VB-5228	Wishbone (CV)
LD 240 E 47 PS		01/93→02/02	Centre Rod	IV-DL-2155	
	01/93→02/02	Suspension Arm Repair Kit		DF-RK-8503	for Control Arm
	01/93→02/02	Tie Rod		IV-DL-9361	Guide Rod
	01/93→02/02	Tie Rod	IV-DL-8367		Guide Rod
	01/93→02/02	Tie Rod End		CV-ES-2146	for vehicles with Hinged Trailing Axle
	01/93→02/02	Tie Rod End		IV-ES-8507	Tag Axle
	01/93→02/02	Tie Rod End		MN-ES-8490	for vehicles with Hinged Trailing Axle
	01/93→02/02	Tie Rod End	CV-ES-14162		for Steering Rod
	01/93→02/02	Tie Rod End	CV-ES-14163		for Steering Rod
	01/93→02/02	Tie Rod End	IV-ES-12419		for Steering Rod
	01/93→02/02	Track Control Arm		IV-DL-8613	Trailing Arm
	01/93→02/02	Track Control Arm		IV-VB-5228	Wishbone (CV)
	LD 240 E 52 PS	01/93→02/02	Suspension Arm Repair Kit		DF-RK-8503
01/93→02/02		Tie Rod		IV-DL-9361	Guide Rod
01/93→02/02		Tie Rod	IV-DL-8367		Guide Rod
01/93→02/02		Tie Rod End		CV-ES-2146	for vehicles with Hinged Trailing Axle
01/93→02/02		Tie Rod End		IV-ES-8507	Tag Axle
01/93→02/02		Tie Rod End		MN-ES-8490	for vehicles with Hinged Trailing Axle
01/93→02/02		Tie Rod End	IV-ES-12419		for Steering Rod
01/93→02/02		Track Control Arm		IV-DL-8613	Trailing Arm
LD 260 E 38 P	01/93→02/02	Suspension Arm Repair Kit		DF-RK-8503	for Control Arm
	01/93→02/02	Tie Rod	IV-DL-8367		Guide Rod
	01/93→02/02	Tie Rod End	IV-ES-12419		for Steering Rod
	01/93→02/02	Track Control Arm		IV-DL-8613	Trailing Arm
	01/93→02/02	Track Control Arm		IV-VB-5228	Wishbone (CV)

CV-ES-2146

Length: 80
Cone Ø: d1 Ø 30 / d2 Ø 27
Thread: M26 x 1,5 RHT
42533102



IV-DL-8613

Length: 594
Ø: 50
Hole Distance: 130 / 130
41009661, 41009666, 41035951, 41272429,
98472446, 98472466



CV-ES-14162

Length: 125
Cone Ø: d1 Ø 30 / d2 Ø 27
Thread: M30 x 1,5 LHT
2984061, 4802444, 4833830, 7138966,
8190225, 42489395, 42491957



IV-DL-9361

Length: 1477
Ø: 48
Cone Ø: d1 Ø 30 / d2 Ø 27
41032608, 41033237



CV-ES-14163

Length: 125
Cone Ø: d1 Ø 30 / d2 Ø 27
Thread: M30 x 1,5 RHT
2966252, 2969808, 4802443, 4833829,
7138967, 8122752, 42483386, 42488269,
42489573, 42489594, 42491638, 42537936



IV-ES-8507

Length: 80
Cone Ø: d1 Ø 30 / d2 Ø 27
Thread: M30 x 1,5 RHT
11019869, 12216380, 55175540, 93192809,
81953016238



DF-RK-8503

Ø: 75
Hole Distance: 130
Thick/Height: 24
93192361



IV-ES-12419

Length: 55
Cone Ø: d1 Ø 10 / d2 Ø 10
Thread: M10 x 1,5 RHT
2041327, 41002118, 41203863, 42079853



IV-DL-2155

Length: 953
Ø: 52
Cone Ø: d1 Ø 30 / d2 Ø 27
8131582, 41005463, 41042919



IV-VB-5228

Length: 665
Ø: 46
Hole Distance: 130 / 130
937104, 08137026, 8137026, 41002770,
41009665, 41028598, 41028600, 41034479,
41042050



IV-DL-8367

Length: 1620
Ø: 48
Cone Ø: d1 Ø 30 / d2 Ø 27
8163773, 41005450, 41005451, 41036943,
41036944



MN-ES-8490

Length: 90
Cone Ø: d1 Ø 30 / d2 Ø 27
Thread: M26 x 1,5 RHT
0014606948, 14606948, 42533101



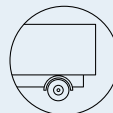

EuroStar ...

LD 260 E 39 P, LD 260 E 39 FP	11/99→02/02	Centre Rod	IV-DL-2155		Push Rod
	11/99→02/02	Centre Rod	IV-DL-8304		Push Rod
	11/99→02/02	Suspension Arm Repair Kit		DF-RK-8503	for Control Arm
	11/99→02/02	Suspension Arm Repair Kit	DB-RK-9300	DB-RK-9300	for Drag Link
	11/99→02/02	Tie Rod	IV-DL-8367		Guide Rod
	11/99→02/02	Tie Rod End	CV-ES-14163		for Steering Rod
	11/99→02/02	Track Control Arm		IV-DL-8613	Trailing Arm
LD 260 E 40	09/00→02/02	Centre Rod	IV-DL-2155		Push Rod
	09/00→02/02	Centre Rod	IV-DL-8304		Push Rod
	09/00→02/02	Suspension Arm Repair Kit		DF-RK-8503	for Control Arm
	09/00→02/02	Suspension Arm Repair Kit	DB-RK-9300	DB-RK-9300	for Drag Link
	09/00→02/02	Tie Rod		IV-DL-9361	Guide Rod
	09/00→02/02	Tie Rod	IV-DL-8367		Guide Rod
	09/00→02/02	Tie Rod End	CV-ES-14162		for Steering Rod
	09/00→02/02	Tie Rod End	CV-ES-14163		for Steering Rod
	09/00→02/02	Tie Rod End	IV-ES-8365		for Push Rod
	09/00→02/02	Track Control Arm		IV-DL-8613	Trailing Arm, Drive Axle;Trailing Axle
09/00→02/02	Track Control Arm		IV-VB-5228	Wishbone (CV)	
LD 260 E 42 P	01/93→02/02	Centre Rod	IV-DL-2155		Push Rod
	01/93→02/02	Suspension Arm Repair Kit		DF-RK-8503	for Control Arm
	01/93→02/02	Tie Rod	IV-DL-8367		Guide Rod
	01/93→02/02	Tie Rod End	CV-ES-14162		for Steering Rod
	01/93→02/02	Tie Rod End	CV-ES-14163		for Steering Rod
	01/93→02/02	Tie Rod End	IV-ES-12419		for Steering Rod
	01/93→02/02	Track Control Arm		IV-DL-8613	Trailing Arm
01/93→02/02	Track Control Arm		IV-VB-5228	Wishbone (CV)	
LD 260 E 43 Y/PS, LD 260 E 43 FP	01/93→02/02	Centre Rod	IV-DL-2155		Push Rod
	01/93→02/02	Centre Rod	IV-DL-8304		Push Rod
	01/93→02/02	Suspension Arm Repair Kit		DF-RK-8503	for Control Arm
	01/93→02/02	Suspension Arm Repair Kit	DB-RK-9300	DB-RK-9300	for Drag Link
	01/93→02/02	Tie Rod		IV-DL-9361	Guide Rod
	01/93→02/02	Tie Rod	IV-DL-8367		Guide Rod
	01/93→02/02	Tie Rod End	CV-ES-14163		for Steering Rod
	01/93→02/02	Tie Rod End	IV-ES-12419		for Steering Rod
	01/93→02/02	Track Control Arm		IV-DL-8613	Trailing Arm
LD 260 E 47	01/93→02/02	Centre Rod	IV-DL-2155		Push Rod
	01/93→02/02	Suspension Arm Repair Kit		DF-RK-8503	for Control Arm
	01/93→02/02	Tie Rod	IV-DL-8367		Guide Rod
	01/93→02/02	Tie Rod End	CV-ES-14162		for Steering Rod
	01/93→02/02	Tie Rod End	CV-ES-14163		for Steering Rod
	01/93→02/02	Tie Rod End	IV-ES-12419		for Steering Rod
	01/93→02/02	Track Control Arm		IV-DL-8142	Trailing Arm
	01/93→02/02	Track Control Arm		IV-DL-8613	Trailing Arm
01/93→02/02	Track Control Arm		IV-VB-5228	Wishbone (CV)	
LD 260 E 48 Y/PS	01/93→02/02	Centre Rod	IV-DL-2155		Push Rod
	01/93→02/02	Centre Rod	IV-DL-8304		Push Rod
	01/93→02/02	Suspension Arm Repair Kit		DF-RK-8503	for Control Arm
	01/93→02/02	Tie Rod		IV-DL-9361	Guide Rod
	01/93→02/02	Tie Rod	IV-DL-8367		Guide Rod
	01/93→02/02	Tie Rod End	IV-ES-12419		for Steering Rod
	01/93→02/02	Track Control Arm		IV-DL-8613	Trailing Arm, Drive Axle;Trailing Axle
	01/93→02/02	Track Control Arm		IV-VB-5228	Wishbone (CV)
LD 260 E 52	01/93→02/02	Centre Rod	IV-DL-2155		Push Rod
	01/93→02/02	Suspension Arm Repair Kit		DF-RK-8503	for Control Arm
	01/93→02/02	Tie Rod	IV-DL-8367		Guide Rod
	01/93→02/02	Tie Rod End	CV-ES-14162		for Steering Rod
	01/93→02/02	Tie Rod End	CV-ES-14163		for Steering Rod
	01/93→02/02	Tie Rod End	IV-ES-12419		for Steering Rod
	01/93→02/02	Track Control Arm		IV-DL-8142	Trailing Arm
	01/93→02/02	Track Control Arm		IV-DL-8613	Trailing Arm
01/93→02/02	Track Control Arm		IV-VB-5228	Wishbone (CV)	

CV-ES-14162

Length: 125
Cone Ø: d1 Ø 30 / d2 Ø 27
Thread: M30 x 1,5 LHT
2984061, 4802444, 4833830, 7138966,
8190225, 42489395, 42491957



CV-ES-14163

Length: 125
Cone Ø: d1 Ø 30 / d2 Ø 27
Thread: M30 x 1,5 RHT
2966252, 2969808, 4802443, 4833829,
7138967, 8122752, 42483386, 42488269,
42489573, 42489594, 42491638, 42537936



DB-RK-9300

Ø: 75
Hole Distance: 130
Thick/Height: 24
500333284



DF-RK-8503

Ø: 75
Hole Distance: 130
Thick/Height: 24
93192361



IV-DL-2155

Length: 953
Ø: 52
Cone Ø: d1 Ø 30 / d2 Ø 27
8131582, 41005463, 41042919



IV-DL-8142

Length: 610
Ø: 50
Hole Distance: 152 / 152
41011008, 42041107



IV-DL-8304

Length: 953
Ø: 52
Cone Ø: d1 Ø 30 / d2 Ø 27
500397738



IV-DL-8367

Length: 1620
Ø: 48
Cone Ø: d1 Ø 30 / d2 Ø 27
8163773, 41005450, 41005451, 41036943,
41036944



IV-DL-8613

Length: 594
Ø: 50
Hole Distance: 130 / 130
41009661, 41009666, 41035951, 41272429,
98472446, 98472466



IV-DL-9361

Length: 1477
Ø: 48
Cone Ø: d1 Ø 30 / d2 Ø 27
41032608, 41033237



IV-ES-8365

Length: 139
Cone Ø: d1 Ø 30 / d2 Ø 27
Thread: M30 x 1,5 RHT
500309296, 500340769



IV-ES-12419

Length: 55
Cone Ø: d1 Ø 10 / d2 Ø 10
Thread: M10 x 1,5 RHT
2041327, 41002118, 41203863, 42079853



IV-VB-5228

Length: 665
Ø: 46
Hole Distance: 130 / 130
937104, 08137026, 8137026, 41002770,
41009665, 41028598, 41028600, 41034479,
41042050





EuroStar ...

LD 400 E 38 TX/P, LD 440 E 38 TX/P	01/93→02/02	Centre Rod	IV-DL-2155		Push Rod	
	01/93→02/02	Centre Rod	IV-DL-8697		Push Rod	
	01/93→02/02	Suspension Arm Repair Kit		DF-RK-8503	for Control Arm	
	01/93→02/02	Tie Rod	IV-DL-8367		Guide Rod	
	01/93→02/02	Tie Rod End	CV-ES-14162		for Steering Rod	
	01/93→02/02	Tie Rod End	CV-ES-14163		for Steering Rod	
	01/93→02/02	Tie Rod End	IV-ES-12419		for Steering Rod	
	01/93→02/02	Track Control Arm		IV-DL-8613	Trailing Arm	
LD 400 E 42 TX/P, LD 440 E 42 TX/P	01/93→02/02	Centre Rod	IV-DL-2155		Push Rod	
	01/93→02/02	Centre Rod	IV-DL-8697		Push Rod	
	01/93→02/02	Suspension Arm Repair Kit		DF-RK-8503	for Control Arm	
	01/93→02/02	Tie Rod	IV-DL-8367		Guide Rod	
	01/93→02/02	Tie Rod End	CV-ES-14162		for Steering Rod	
	01/93→02/02	Tie Rod End	CV-ES-14163		for Steering Rod	
	01/93→02/02	Tie Rod End	IV-ES-12419		for Steering Rod	
	01/93→02/02	Track Control Arm		IV-DL-8613	Trailing Arm	
LD 440 E 38 T	01/93→02/02	Centre Rod	IV-DL-2155		Push Rod	
	01/93→02/02	Suspension Arm Repair Kit		DF-RK-8503	for Control Arm	
	01/93→02/02	Tie Rod	IV-DL-8367		Guide Rod	
	01/93→02/02	Tie Rod End	CV-ES-14162		for Steering Rod	
	01/93→02/02	Tie Rod End	CV-ES-14163		for Steering Rod	
	01/93→02/02	Tie Rod End	IV-ES-12419		for Steering Rod	
	01/93→02/02	Track Control Arm		IV-DL-8613	Trailing Arm	
	01/93→02/02	Track Control Arm		IV-DL-9351	Wishbone (CV); Trailing Arm	
LD 440 E 38 TZ	01/93→02/02	Centre Rod	IV-DL-2155		Push Rod	
	01/93→02/02	Suspension Arm Repair Kit		DF-RK-8503	for Control Arm	
	01/93→02/02	Tie Rod	IV-DL-8367		Guide Rod	
	01/93→02/02	Tie Rod End	CV-ES-14162		for Steering Rod	
	01/93→02/02	Tie Rod End	CV-ES-14163		for Steering Rod	
	01/93→02/02	Tie Rod End	IV-ES-12419		for Steering Rod	
	01/93→02/02	Track Control Arm		IV-DL-8613	Trailing Arm, 1st & 2nd Drive Axle, for Pneumatic Suspension vehicles	
	01/93→02/02	Track Control Arm		IV-DL-9351	Wishbone (CV); Trailing Arm	
LD 440 E 39 T, LD 440 E 39 T/P	11/99→02/02	Centre Rod	IV-DL-2155		Push Rod	
	11/99→02/02	Suspension Arm Repair Kit		DF-RK-8503	for Control Arm	
	11/99→02/02	Tie Rod	IV-DL-8367		Guide Rod	
	11/99→02/02	Tie Rod End	IV-ES-12419		for Steering Rod	
	11/99→02/02	Track Control Arm		IV-DL-9351	Wishbone (CV); Trailing Arm	
	LD 440 E 39 TX, LD 440 E 39 TX/P	11/99→	Centre Rod	IV-DL-2155		Push Rod
		11/99→	Suspension Arm Repair Kit		DF-RK-8503	for Control Arm
		11/99→	Tie Rod	IV-DL-8367		Guide Rod
11/99→		Tie Rod End	IV-ES-12419		for Steering Rod	
11/99→		Track Control Arm		IV-DL-8613	Trailing Arm, Drive Axle; Trailing Axle	
11/99→		Track Control Arm		IV-VB-5228	Wishbone (CV)	
LD 440 E 40 T	09/00→02/02	Centre Rod	IV-DL-2155		Push Rod	
	09/00→02/02	Suspension Arm Repair Kit		DF-RK-8503	for Control Arm	
	09/00→02/02	Tie Rod	IV-DL-8367		Guide Rod	
	09/00→02/02	Tie Rod End	CV-ES-14162		for Steering Rod	
	09/00→02/02	Tie Rod End	CV-ES-14163		for Steering Rod	
	09/00→02/02	Track Control Arm		IV-DL-8613	Trailing Arm	
	09/00→02/02	Track Control Arm		IV-DL-9351	Wishbone (CV); Trailing Arm	
	09/00→02/02	Track Control Arm		IV-VB-5228	Wishbone (CV)	
LD 440 E 40 TX/P	01/01→02/02	Suspension Arm Repair Kit		DF-RK-8503	for Control Arm	
LD 440 E 42 T/P	01/93→02/02	Centre Rod	IV-DL-2155		Push Rod	
	01/93→02/02	Suspension Arm Repair Kit		DF-RK-8503	for Control Arm	
	01/93→02/02	Tie Rod	IV-DL-8367		Guide Rod	
	01/93→02/02	Tie Rod End	CV-ES-14162		for Steering Rod	
	01/93→02/02	Tie Rod End	CV-ES-14163		for Steering Rod	
	01/93→02/02	Tie Rod End	IV-ES-12419		for Steering Rod	

CV-ES-14162

Length: 125
Cone Ø: d1 Ø 30 / d2 Ø 27
Thread: M30 x 1,5 LHT
2984061, 4802444, 4833830, 7138966,
8190225, 42489395, 42491957



IV-DL-8697

Length: 824
Ø: 52
Cone Ø: d1 Ø 30 / d2 Ø 27
08135492, 8135492, 41005469, 41011476,
41016960, 41016961



CV-ES-14163

Length: 125
Cone Ø: d1 Ø 30 / d2 Ø 27
Thread: M30 x 1,5 RHT
2966252, 2969808, 4802443, 4833829,
7138967, 8122752, 42483386, 42488269,
42489573, 42489594, 42491638, 42537936



IV-DL-9351

Length: 455
Ø: 50
Hole Distance: 130 / 130
41033731



DF-RK-8503

Ø: 75
Hole Distance: 130
Thick/Height: 24
93192361



IV-ES-12419

Length: 55
Cone Ø: d1 Ø 10 / d2 Ø 10
Thread: M10 x 1,5 RHT
2041327, 41002118, 41203863, 42079853



IV-DL-2155

Length: 953
Ø: 52
Cone Ø: d1 Ø 30 / d2 Ø 27
8131582, 41005463, 41042919



IV-VB-5228

Length: 665
Ø: 46
Hole Distance: 130 / 130
937104, 08137026, 8137026, 41002770,
41009665, 41028598, 41028600, 41034479,
41042050



IV-DL-8367

Length: 1620
Ø: 48
Cone Ø: d1 Ø 30 / d2 Ø 27
8163773, 41005450, 41005451, 41036943,
41036944



IV-DL-8613

Length: 594
Ø: 50
Hole Distance: 130 / 130
41009661, 41009666, 41035951, 41272429,
98472446, 98472466





EuroStar ...

LD 440 E 42 T/P ...	01/93→02/02	Track Control Arm		IV-DL-8613	Trailing Arm
	01/93→02/02	Track Control Arm		IV-DL-9351	Wishbone (CV);Trailing Arm
	01/93→02/02	Track Control Arm		IV-VB-5228	Wishbone (CV)
LD 440 E 42 TZ	01/93→02/02	Centre Rod	IV-DL-2155		Push Rod
	01/93→02/02	Suspension Arm Repair Kit		DF-RK-8503	for Control Arm
	01/93→02/02	Tie Rod	IV-DL-8367		Guide Rod
	01/93→02/02	Tie Rod End	CV-ES-14162		for Steering Rod
	01/93→02/02	Tie Rod End	CV-ES-14163		for Steering Rod
	01/93→02/02	Tie Rod End	IV-ES-12419		for Steering Rod
	01/93→02/02	Track Control Arm		IV-DL-8613	Trailing Arm, Drive Axle, for Pneumatic Suspension vehicles
	01/93→02/02	Track Control Arm		IV-DL-9351	Wishbone (CV);Trailing Arm
	01/93→02/02	Track Control Arm		IV-VB-5228	Wishbone (CV)
LD 440 E 43 T/P	01/93→02/02	Centre Rod	IV-DL-2155		Push Rod
	01/93→02/02	Suspension Arm Repair Kit		DF-RK-8503	for Control Arm
	01/93→02/02	Tie Rod	IV-DL-8367		Guide Rod
	01/93→02/02	Tie Rod End	IV-ES-12419		for Steering Rod
	01/93→02/02	Track Control Arm		IV-DL-9351	Wishbone (CV);Trailing Arm
LD 440 E 43 TX/P	11/99→02/02	Centre Rod	IV-DL-2155		Push Rod
	11/99→02/02	Suspension Arm Repair Kit		DF-RK-8503	for Control Arm
	11/99→02/02	Tie Rod	IV-DL-8367		Guide Rod
	11/99→02/02	Tie Rod End	IV-ES-12419		for Steering Rod
	11/99→02/02	Track Control Arm		IV-DL-9351	Wishbone (CV);Trailing Arm
LD 440 E 47 T/P	01/93→02/02	Centre Rod	IV-DL-2155		Push Rod
	01/93→02/02	Suspension Arm Repair Kit		DF-RK-8503	for Control Arm
	01/93→02/02	Tie Rod	IV-DL-8367		Guide Rod
	01/93→02/02	Tie Rod End	CV-ES-14162		for Steering Rod
	01/93→02/02	Tie Rod End	CV-ES-14163		for Steering Rod
	01/93→02/02	Tie Rod End	IV-ES-12419		for Steering Rod
	01/93→02/02	Track Control Arm		IV-DL-8613	Trailing Arm
	01/93→02/02	Track Control Arm		IV-DL-9351	Wishbone (CV);Trailing Arm
LD 440 E 47 TZ	01/93→02/02	Track Control Arm		IV-VB-5228	Wishbone (CV)
	01/93→02/02	Centre Rod	IV-DL-2155		Push Rod
	01/93→02/02	Suspension Arm Repair Kit		DF-RK-8503	for Control Arm
	01/93→02/02	Tie Rod	IV-DL-8367		Guide Rod
	01/93→02/02	Tie Rod End	CV-ES-14162		for Steering Rod
	01/93→02/02	Tie Rod End	CV-ES-14163		for Steering Rod
	01/93→02/02	Tie Rod End	IV-ES-12419		for Steering Rod
	01/93→02/02	Track Control Arm		IV-DL-8613	Trailing Arm, Drive Axle, for Pneumatic Suspension vehicles
	01/93→02/02	Track Control Arm		IV-DL-9351	Wishbone (CV);Trailing Arm
	01/93→02/02	Track Control Arm		IV-VB-5228	Wishbone (CV)
	LD 440 E 48 T/P	01/01→02/02	Centre Rod	IV-DL-2155	
01/01→02/02		Suspension Arm Repair Kit		DF-RK-8503	for Control Arm
01/01→02/02		Tie Rod	IV-DL-8367		Guide Rod
01/01→02/02		Tie Rod End	IV-ES-12419		for Steering Rod
01/01→02/02		Track Control Arm		IV-DL-8613	Trailing Arm
01/01→02/02		Track Control Arm		IV-VB-5228	Wishbone (CV)
LD 440 E 52 T	01/93→02/02	Centre Rod	IV-DL-2155		Push Rod
	01/93→02/02	Suspension Arm Repair Kit		DF-RK-8503	for Control Arm
	01/93→02/02	Tie Rod	IV-DL-8367		Guide Rod
	01/93→02/02	Tie Rod End	CV-ES-14162		for Steering Rod
	01/93→02/02	Tie Rod End	CV-ES-14163		for Steering Rod
	01/93→02/02	Tie Rod End	IV-ES-12419		for Steering Rod
	01/93→02/02	Track Control Arm		IV-DL-8142	Trailing Arm
	01/93→02/02	Track Control Arm		IV-DL-8613	Trailing Arm
	01/93→02/02	Track Control Arm		IV-DL-9351	Wishbone (CV);Trailing Arm
LD 440 E 52 TZ	01/93→02/02	Track Control Arm		IV-VB-5228	Wishbone (CV)
	01/93→02/02	Centre Rod	IV-DL-2155		Push Rod
	01/93→02/02	Suspension Arm Repair Kit		DF-RK-8503	for Control Arm
	01/93→02/02	Tie Rod	IV-DL-8367		Guide Rod
	01/93→02/02	Tie Rod End	CV-ES-14162		for Steering Rod
	01/93→02/02	Tie Rod End	CV-ES-14163		for Steering Rod

CV-ES-14162

Length: 125
Cone Ø: d1 Ø 30 / d2 Ø 27
Thread: M30 x 1,5 LHT
2984061, 4802444, 4833830, 7138966,
8190225, 42489395, 42491957



IV-DL-8613

Length: 594
Ø: 50
Hole Distance: 130 / 130
41009661, 41009666, 41035951, 41272429,
98472446, 98472466



CV-ES-14163

Length: 125
Cone Ø: d1 Ø 30 / d2 Ø 27
Thread: M30 x 1,5 RHT
2966252, 2969808, 4802443, 4833829,
7138967, 8122752, 42483386, 42488269,
42489573, 42489594, 42491638, 42537936



IV-DL-9351

Length: 455
Ø: 50
Hole Distance: 130 / 130
41033731



DF-RK-8503

Ø: 75
Hole Distance: 130
Thick/Height: 24
93192361



IV-ES-12419

Length: 55
Cone Ø: d1 Ø 10 / d2 Ø 10
Thread: M10 x 1,5 RHT
2041327, 41002118, 41203863, 42079853



IV-DL-2155

Length: 953
Ø: 52
Cone Ø: d1 Ø 30 / d2 Ø 27
8131582, 41005463, 41042919



IV-VB-5228

Length: 665
Ø: 46
Hole Distance: 130 / 130
937104, 08137026, 8137026, 41002770,
41009665, 41028598, 41028600, 41034479,
41042050



IV-DL-8142

Length: 610
Ø: 50
Hole Distance: 152 / 152
41011008, 42041107



IV-DL-8367

Length: 1620
Ø: 48
Cone Ø: d1 Ø 30 / d2 Ø 27
8163773, 41005450, 41005451, 41036943,
41036944





EuroStar ...

LD 440 E 52 TZ ...	01/93→02/02	Tie Rod End	IV-ES-12419		for Steering Rod
	01/93→02/02	Track Control Arm		IV-DL-8142	Trailing Arm
	01/93→02/02	Track Control Arm		IV-DL-8613	Trailing Arm
	01/93→02/02	Track Control Arm		IV-DL-9351	Wishbone (CV);Trailing Arm
	01/93→02/02	Track Control Arm		IV-VB-5228	Wishbone (CV)

EuroTech MH

190 E 24 K	09/98→	Centre Rod	IV-DL-2155		Push Rod
	09/98→	Centre Rod	IV-DL-2156		Push Rod
	09/98→	Suspension Arm Repair Kit		DF-RK-8503	for Control Arm
	09/98→	Tie Rod	IV-DL-8367		Guide Rod
	09/98→	Tie Rod End	CV-ES-14162		for Steering Rod
	09/98→	Tie Rod End	CV-ES-14163		for Steering Rod
	09/98→	Tie Rod End	IV-ES-12419		for Steering Rod
190 E 24, 190 E 24 /P	09/98→	Centre Rod	IV-DL-2155		Push Rod
	09/98→	Centre Rod	IV-DL-2156		Push Rod
	09/98→	Suspension Arm Repair Kit		DF-RK-8503	for Control Arm
	09/98→	Suspension Strut Repair Kit		DF-RK-8685	
	09/98→	Tie Rod	IV-DL-8367		Guide Rod
	09/98→	Tie Rod End	CV-ES-14162		for Steering Rod
	09/98→	Tie Rod End	CV-ES-14163		for Steering Rod
	09/98→	Tie Rod End	IV-ES-12419		for Steering Rod
	09/98→	Track Control Arm		IV-DL-8613	Trailing Arm
	190 E 27 K	09/98→	Centre Rod	IV-DL-2155	
09/98→		Centre Rod	IV-DL-2156		Push Rod
09/98→		Suspension Arm Repair Kit		DF-RK-8503	for Control Arm
09/98→		Tie Rod	IV-DL-8367		Guide Rod
09/98→		Tie Rod End	CV-ES-14162		for Steering Rod
09/98→		Tie Rod End	CV-ES-14163		for Steering Rod
09/98→		Tie Rod End	IV-ES-12419		for Steering Rod
190 E 27, 190 E 27 /P	09/98→	Centre Rod	IV-DL-2155		Push Rod
	09/98→	Centre Rod	IV-DL-2156		Push Rod
	09/98→	Suspension Arm Repair Kit		DF-RK-8503	for Control Arm
	09/98→	Suspension Strut Repair Kit		DF-RK-8685	
	09/98→	Tie Rod	IV-DL-8367		Guide Rod
	09/98→	Tie Rod End	CV-ES-14162		for Steering Rod
	09/98→	Tie Rod End	CV-ES-14163		for Steering Rod
190 E 30, 190 E 30 /P	01/00→	Suspension Arm Repair Kit		DF-RK-8503	for Control Arm
	01/00→	Tie Rod End	CV-ES-14163		for Steering Rod
	09/98→	Centre Rod	IV-DL-2155		Push Rod
	09/98→	Suspension Arm Repair Kit		DF-RK-8503	for Control Arm
190 E 31 K	09/98→	Centre Rod	IV-DL-2155		Push Rod
	09/98→	Suspension Arm Repair Kit		DF-RK-8503	for Control Arm
	09/98→	Suspension Arm Repair Kit	DB-RK-9300	DB-RK-9300	for Drag Link
	09/98→	Tie Rod	IV-DL-8367		Guide Rod
	09/98→	Tie Rod End	CV-ES-14162		for Steering Rod
	09/98→	Tie Rod End	CV-ES-14163		for Steering Rod
	09/98→	Tie Rod End	IV-ES-12419		for Steering Rod
	09/98→	Track Control Arm		IV-DL-8613	Trailing Arm
	09/98→	Track Control Arm		IV-VB-5228	Wishbone (CV)
	190 E 31, 190 E 31 /P	09/98→	Centre Rod	IV-DL-2155	
09/98→		Suspension Arm Repair Kit		DF-RK-8503	for Control Arm
09/98→		Tie Rod	IV-DL-8367		Guide Rod
09/98→		Tie Rod End	CV-ES-14162		for Steering Rod
09/98→		Tie Rod End	CV-ES-14163		for Steering Rod
09/98→		Tie Rod End	IV-ES-12419		for Steering Rod
09/98→		Track Control Arm		IV-DL-8613	Trailing Arm
190 E 35, 190 E 35 /P, 190 E 35 /FP	09/98→	Suspension Arm Repair Kit		DF-RK-8503	for Control Arm
	09/98→	Suspension Arm Repair Kit	DB-RK-9300	DB-RK-9300	for Drag Link
	09/98→	Tie Rod	IV-DL-8367		Guide Rod
	09/98→	Tie Rod End	IV-ES-12419		for Steering Rod
	09/98→	Track Control Arm		IV-DL-8613	Trailing Arm
	09/98→	Track Control Arm		IV-DL-8613	Trailing Arm

CV-ES-14162

Length: 125
Cone Ø: d1 Ø 30 / d2 Ø 27
Thread: M30 x 1,5 LHT
2984061, 4802444, 4833830, 7138966,
8190225, 42489395, 42491957



IV-DL-2156

Length: 900
Ø: 50
Cone Ø: d1 Ø 30 / d2 Ø 27
98446354



IV-VB-5228

Length: 665
Ø: 46
Hole Distance: 130 / 130
937104, 08137026, 8137026, 41002770,
41009665, 41028598, 41028600, 41034479,
41042050



CV-ES-14163

Length: 125
Cone Ø: d1 Ø 30 / d2 Ø 27
Thread: M30 x 1,5 RHT
2966252, 2969808, 4802443, 4833829,
7138967, 8122752, 42483386, 42488269,
42489573, 42489594, 42491638, 42537936



IV-DL-8142

Length: 610
Ø: 50
Hole Distance: 152 / 152
41011008, 42041107



IV-DL-8367

Length: 1620
Ø: 48
Cone Ø: d1 Ø 30 / d2 Ø 27
8163773, 41005450, 41005451, 41036943,
41036944



DB-RK-9300

Ø: 75
Hole Distance: 130
Thick/Height: 24
500333284



DF-RK-8503

Ø: 75
Hole Distance: 130
Thick/Height: 24
93192361



IV-DL-8613

Length: 594
Ø: 50
Hole Distance: 130 / 130
41009661, 41009666, 41035951, 41272429,
98472446, 98472466



DF-RK-8685

Ø: 67
Hole Distance: 130
Thick/Height: 24
093163617, 93163617



IV-DL-9351

Length: 455
Ø: 50
Hole Distance: 130 / 130
41033731



IV-DL-2155

Length: 953
Ø: 52
Cone Ø: d1 Ø 30 / d2 Ø 27
8131582, 41005463, 41042919



IV-ES-12419

Length: 55
Cone Ø: d1 Ø 10 / d2 Ø 10
Thread: M10 x 1,5 RHT
2041327, 41002118, 41203863, 42079853



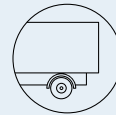

EuroTech MH ...

260 E 24 Y/P, 260 E 24 Y/PS, 260 E 24 Y/PT	11/99→	Suspension Arm Repair Kit		DF-RK-8503	for Control Arm
	11/99→	Tie Rod	IV-DL-8367		Guide Rod
	11/99→	Tie Rod End		CV-ES-2146	for vehicles with Hinged Trailing Axle
	11/99→	Tie Rod End		MN-ES-8490	for vehicles with Hinged Trailing Axle
	11/99→	Tie Rod End	CV-ES-14163		for Steering Rod
	11/99→	Track Control Arm		IV-DL-8142	Trailing Arm
260 E 27 Y/P, 260 E 27 Y/PS, 260 E 27 RY/PS, 260 E 27 RY/PT 260 E 30 Y/PS	11/99→	Suspension Arm Repair Kit		DF-RK-8503	for Control Arm
	11/99→	Track Control Arm		IV-DL-8142	Trailing Arm
	01/00→	Suspension Arm Repair Kit		DF-RK-8503	for Control Arm
	11/99→	Centre Rod	IV-DL-2155		Push Rod
	11/99→	Suspension Arm Repair Kit		DF-RK-8503	for Control Arm
	11/99→	Tie Rod	IV-DL-8367		Guide Rod
260 E 31 Y/P, 260 E 31 Y/PS, T 260 E 31 Y/P	11/99→	Tie Rod End	CV-ES-14162		for Steering Rod
	11/99→	Tie Rod End	CV-ES-14163		for Steering Rod
	11/99→	Track Control Arm		IV-DL-8142	Trailing Arm
	11/99→	Centre Rod	IV-DL-2155		Push Rod
	11/99→	Suspension Arm Repair Kit		DF-RK-8503	for Control Arm
	11/99→	Tie Rod	IV-DL-8367		Guide Rod
260 E 35 Y/P, 260 E 35 Y/PT, 260 E 35 Y/TN	11/99→	Tie Rod End	CV-ES-14162		for Steering Rod
	11/99→	Tie Rod End	CV-ES-14163		for Steering Rod
	11/99→	Track Control Arm		IV-DL-8142	Trailing Arm
	11/99→	Centre Rod	IV-DL-2155		Push Rod
	11/99→	Suspension Arm Repair Kit		DF-RK-8503	for Control Arm
	11/99→	Tie Rod	IV-DL-8367		Guide Rod
400 E 31 TP, 440 E 31 T, 440 E 31 TP	11/99→	Tie Rod End	CV-ES-14162		for Steering Rod
	11/99→	Tie Rod End	CV-ES-14163		for Steering Rod
	11/99→	Track Control Arm		IV-DL-8142	Trailing Arm
	09/98→	Suspension Arm Repair Kit		DF-RK-8503	for Control Arm
	09/98→	Tie Rod	IV-DL-8367		Guide Rod
	09/98→	Tie Rod End	IV-ES-12419		for Steering Rod
400 E 35 TP, 440 E 35 T, 440 E 35 T/P, 440 E 35 T/FP	09/98→	Track Control Arm		IV-DL-8613	Trailing Arm
	09/98→	Track Control Arm		IV-VB-5228	Wishbone (CV)
	09/98→	Centre Rod	IV-DL-2155		Push Rod
	09/98→	Suspension Arm Repair Kit		DF-RK-8503	for Control Arm
	09/98→	Tie Rod	IV-DL-8367		Guide Rod
	09/98→	Tie Rod End	CV-ES-14162		for Steering Rod
440 E 35 TX/P	09/98→	Tie Rod End	CV-ES-14163		for Steering Rod
	09/98→	Tie Rod End	IV-ES-12419		for Steering Rod
	09/98→	Track Control Arm		IV-DL-8613	Trailing Arm
	09/98→	Track Control Arm		IV-DL-9351	Wishbone (CV); Trailing Arm
	09/98→	Track Control Arm		IV-VB-5228	Wishbone (CV)
	02/00→	Centre Rod	IV-DL-2155		Push Rod
180 E 34	02/00→	Suspension Arm Repair Kit		DF-RK-8503	for Control Arm
	02/00→	Tie Rod	IV-DL-8367		Guide Rod
	02/00→	Tie Rod End	CV-ES-14162		for Steering Rod
	02/00→	Tie Rod End	CV-ES-14163		for Steering Rod
	02/00→	Track Control Arm		IV-DL-8613	Trailing Arm
	02/00→	Track Control Arm		IV-VB-5228	Wishbone (CV)

EuroTech MP

180 E 34	01/92→12/93	Suspension Arm Repair Kit		DF-RK-8503	for Control Arm
	01/92→12/93	Suspension Strut Repair Kit		DF-RK-8685	
	01/92→12/93	Tie Rod	IV-DL-8367		Guide Rod
	01/92→12/93	Tie Rod End	IV-ES-12419		for Steering Rod
	01/92→12/93	Track Control Arm		IV-DL-8613	Trailing Arm
	01/92→12/93	Track Control Arm		IV-VB-5228	Wishbone (CV)
180 E 38	01/92→12/93	Centre Rod	IV-DL-2155		Push Rod
	01/92→12/93	Suspension Arm Repair Kit		DF-RK-8503	for Control Arm
	01/92→12/93	Tie Rod	IV-DL-8367		Guide Rod
	01/92→12/93	Tie Rod End	CV-ES-14162		for Steering Rod
	01/92→12/93	Tie Rod End	CV-ES-14163		for Steering Rod
	01/92→12/93	Tie Rod End	IV-ES-12419		for Steering Rod
180 E 42	01/92→12/93	Track Control Arm		IV-DL-8613	Trailing Arm
	01/92→12/93	Track Control Arm		IV-VB-5228	Wishbone (CV)
	01/92→12/93	Centre Rod	IV-DL-2155		Push Rod
	01/92→12/93	Suspension Arm Repair Kit		DF-RK-8503	for Control Arm
	01/92→12/93	Tie Rod	IV-DL-8367		Guide Rod
	01/92→12/93	Tie Rod End	CV-ES-14162		for Steering Rod
	01/92→12/93	Tie Rod End	CV-ES-14163		for Steering Rod

CV-ES-2146

Length: 80
Cone Ø: d1 Ø 30 / d2 Ø 27
Thread: M26 x 1,5 RHT
42533102



IV-DL-8142

Length: 610
Ø: 50
Hole Distance: 152 / 152
41011008, 42041107



MN-ES-8490

Length: 90
Cone Ø: d1 Ø 30 / d2 Ø 27
Thread: M26 x 1,5 RHT
14606948, 0014606948, 42533101



CV-ES-14162

Length: 125
Cone Ø: d1 Ø 30 / d2 Ø 27
Thread: M30 x 1,5 LHT
2984061, 4802444, 4833830, 7138966,
8190225, 42489395, 42491957



IV-DL-8367

Length: 1620
Ø: 48
Cone Ø: d1 Ø 30 / d2 Ø 27
8163773, 41005450, 41005451, 41036943,
41036944



CV-ES-14163

Length: 125
Cone Ø: d1 Ø 30 / d2 Ø 27
Thread: M30 x 1,5 RHT
2966252, 2969808, 4802443, 4833829,
7138967, 8122752, 42483386, 42488269,
42489573, 42489594, 42491638, 42537936



IV-DL-8613

Length: 594
Ø: 50
Hole Distance: 130 / 130
41009661, 41009666, 41035951, 41272429,
98472446, 98472466



DF-RK-8503

Ø: 75
Hole Distance: 130
Thick/Height: 24
93192361



IV-DL-9351

Length: 455
Ø: 50
Hole Distance: 130 / 130
41033731



DF-RK-8685

Ø: 67
Hole Distance: 130
Thick/Height: 24
093163617, 93163617



IV-ES-12419

Length: 55
Cone Ø: d1 Ø 10 / d2 Ø 10
Thread: M10 x 1,5 RHT
2041327, 41002118, 41203863, 42079853



IV-DL-2155

Length: 953
Ø: 52
Cone Ø: d1 Ø 30 / d2 Ø 27
8131582, 41005463, 41042919



IV-VB-5228

Length: 665
Ø: 46
Hole Distance: 130 / 130
937104, 08137026, 8137026, 41002770,
41009665, 41028598, 41028600, 41034479,
41042050





EuroTech MP ...

180 E 42 ...	01/92→12/93	Tie Rod End	IV-ES-12419		for Steering Rod
	01/92→12/93	Track Control Arm		IV-DL-8613	Trailing Arm
	01/92→12/93	Track Control Arm		IV-VB-5228	Wishbone (CV)
190 E 34	01/93→	Centre Rod	IV-DL-2155		Push Rod
	01/93→	Suspension Arm Repair Kit		DF-RK-8503	for Control Arm
	01/93→	Tie Rod	IV-DL-8367		Guide Rod
	01/93→	Tie Rod End	CV-ES-14162		for Steering Rod
	01/93→	Tie Rod End	CV-ES-14163		for Steering Rod
	01/93→	Tie Rod End	IV-ES-12419		for Steering Rod
	01/93→	Track Control Arm		IV-DL-8613	Trailing Arm
	01/93→	Track Control Arm		IV-VB-5228	Wishbone (CV)
190 E 38	01/93→	Centre Rod	IV-DL-2155		Push Rod
	01/93→	Suspension Arm Repair Kit		DF-RK-8503	for Control Arm
	01/93→	Tie Rod	IV-DL-8367		Guide Rod
	01/93→	Tie Rod End	CV-ES-14162		for Steering Rod
	01/93→	Tie Rod End	CV-ES-14163		for Steering Rod
	01/93→	Tie Rod End	IV-ES-12419		for Steering Rod
	01/93→	Track Control Arm		IV-DL-8613	Trailing Arm
	01/93→	Track Control Arm		IV-VB-5228	Wishbone (CV)
190 E 39, 190 E 39 /P, 190 E39 /FP	11/99→	Suspension Arm Repair Kit		DF-RK-8503	for Control Arm
	11/99→	Suspension Arm Repair Kit	DB-RK-9300	DB-RK-9300	for Drag Link
	11/99→	Tie Rod	IV-DL-8367		Guide Rod
	11/99→	Tie Rod End	CV-ES-14163		for Steering Rod
	11/99→	Track Control Arm		IV-DL-8613	Trailing Arm
190 E 40 /P	01/01→	Suspension Arm Repair Kit		DF-RK-8503	for Control Arm
190 E 42, 190 E 42 /P	01/93→	Centre Rod	IV-DL-2155		Push Rod
	01/93→	Suspension Arm Repair Kit		DF-RK-8503	for Control Arm
	01/93→	Suspension Arm Repair Kit		MN-RK-7291	for Drag Link
	01/93→	Tie Rod	IV-DL-8367		Guide Rod
	01/93→	Tie Rod End	CV-ES-14162		for Steering Rod
	01/93→	Tie Rod End	CV-ES-14163		for Steering Rod
	01/93→	Tie Rod End	IV-ES-12419		for Steering Rod
	01/93→	Track Control Arm		IV-DL-8613	Trailing Arm
	01/93→	Track Control Arm		IV-VB-5228	Wishbone (CV)
	190 E 43, 190 E 43 /P	01/01→	Suspension Arm Repair Kit		DF-RK-8503
01/01→		Suspension Arm Repair Kit	DB-RK-9300	DB-RK-9300	for Drag Link
01/01→		Tie Rod	IV-DL-8367		Guide Rod
01/01→		Tie Rod End	CV-ES-14163		for Steering Rod
01/01→		Track Control Arm		IV-DL-8613	Trailing Arm
240 E 30 PS	01/97→	Suspension Arm Repair Kit		DF-RK-8503	for Control Arm
	01/97→	Tie Rod	IV-DL-8367		Guide Rod
	01/97→	Tie Rod End		IV-ES-8507	Tag Axle
	01/97→	Tie Rod End	CV-ES-14163		for Steering Rod
	01/97→	Tie Rod End	IV-ES-12419		for Steering Rod
	01/97→	Track Control Arm		IV-DL-8613	Trailing Arm
240 E 34	01/97→	Track Control Arm		IV-VB-5228	Wishbone (CV)
	09/95→12/96	Centre Rod	IV-DL-2155		Push Rod
	09/95→12/96	Suspension Arm Repair Kit		DF-RK-8503	for Control Arm
	09/95→12/96	Tie Rod	IV-DL-8367		Guide Rod
	09/95→12/96	Tie Rod End	CV-ES-14162		for Steering Rod
	09/95→12/96	Tie Rod End	CV-ES-14163		for Steering Rod
	09/95→12/96	Tie Rod End	IV-ES-12419		for Steering Rod
	09/95→12/96	Track Control Arm		IV-DL-8142	Trailing Arm
240 E 38	09/95→12/96	Track Control Arm		IV-DL-8613	Trailing Arm
	09/95→12/96	Track Control Arm		IV-VB-5228	Wishbone (CV)
	01/92→	Centre Rod	IV-DL-2155		Push Rod
	01/92→	Suspension Arm Repair Kit		DF-RK-8503	for Control Arm
	01/92→	Tie Rod		IV-DL-9361	Guide Rod
	01/92→	Tie Rod	IV-DL-8367		Guide Rod
	01/92→	Tie Rod End		CV-ES-2146	for vehicles with Hinged Trailing Axle
	01/92→	Tie Rod End		IV-ES-8507	Tag Axle
240 E 38	01/92→	Tie Rod End		MN-ES-8490	for vehicles with Hinged Trailing Axle
	01/92→	Tie Rod End	CV-ES-14162		for Steering Rod

CV-ES-2146

Length: 80
Cone Ø: d1 Ø 30 / d2 Ø 27
Thread: M26 x 1,5 RHT
42533102



IV-DL-8142

Length: 610
Ø: 50
Hole Distance: 152 / 152
41011008, 42041107



IV-VB-5228

Length: 665
Ø: 46
Hole Distance: 130 / 130
937104, 08137026, 8137026, 41002770,
41009665, 41028598, 41028600, 41034479,
41042050



CV-ES-14162

Length: 125
Cone Ø: d1 Ø 30 / d2 Ø 27
Thread: M30 x 1,5 LHT
2984061, 4802444, 4833830, 7138966,
8190225, 42489395, 42491957



IV-DL-8367

Length: 1620
Ø: 48
Cone Ø: d1 Ø 30 / d2 Ø 27
8163773, 41005450, 41005451, 41036943,
41036944



MN-ES-8490

Length: 90
Cone Ø: d1 Ø 30 / d2 Ø 27
Thread: M26 x 1,5 RHT
14606948, 0014606948, 42533101



CV-ES-14163

Length: 125
Cone Ø: d1 Ø 30 / d2 Ø 27
Thread: M30 x 1,5 RHT
2966252, 2969808, 4802443, 4833829,
7138967, 8122752, 42483386, 42488269,
42489573, 42489594, 42491638, 42537936



IV-DL-8613

Length: 594
Ø: 50
Hole Distance: 130 / 130
41009661, 41009666, 41035951, 41272429,
98472446, 98472466



MN-RK-7291

Ø: 72
Hole Distance: 130
Thick/Height: 30
2980884



DB-RK-9300

Ø: 75
Hole Distance: 130
Thick/Height: 24
500333284



IV-DL-9361

Length: 1477
Ø: 48
Cone Ø: d1 Ø 30 / d2 Ø 27
41032608, 41033237



DF-RK-8503

Ø: 75
Hole Distance: 130
Thick/Height: 24
93192361



IV-ES-8507

Length: 80
Cone Ø: d1 Ø 30 / d2 Ø 27
Thread: M30 x 1,5 RHT
11019869, 12216380, 55175540, 93192809,
81953016238



IV-DL-2155

Length: 953
Ø: 52
Cone Ø: d1 Ø 30 / d2 Ø 27
8131582, 41005463, 41042919



IV-ES-12419

Length: 55
Cone Ø: d1 Ø 10 / d2 Ø 10
Thread: M10 x 1,5 RHT
2041327, 41002118, 41203863, 42079853





EuroTech MP ...

240 E 38 ...	01/92→	Tie Rod End	CV-ES-14163		for Steering Rod
	01/92→	Tie Rod End	IV-ES-12419		for Steering Rod
	01/92→	Track Control Arm		IV-DL-8142	Trailing Arm
	01/92→	Track Control Arm		IV-DL-8613	Trailing Arm
	01/92→	Track Control Arm		IV-VB-5228	Wishbone (CV)
240 E 42	01/92→	Centre Rod	IV-DL-2155		Push Rod
	01/92→	Suspension Arm Repair Kit		DF-RK-8503	for Control Arm
	01/92→	Tie Rod		IV-DL-9361	Guide Rod
	01/92→	Tie Rod	IV-DL-8367		Guide Rod
	01/92→	Tie Rod End		CV-ES-2146	for vehicles with Hinged Trailing Axle
	01/92→	Tie Rod End		IV-ES-8507	Tag Axle
	01/92→	Tie Rod End		MN-ES-8490	for vehicles with Hinged Trailing Axle
	01/92→	Tie Rod End	CV-ES-14162		for Steering Rod
	01/92→	Tie Rod End	CV-ES-14163		for Steering Rod
	01/92→	Tie Rod End	IV-ES-12419		for Steering Rod
	01/92→	Track Control Arm		IV-DL-8142	Trailing Arm
	01/92→	Track Control Arm		IV-DL-8613	Trailing Arm
	01/92→	Track Control Arm		IV-VB-5228	Wishbone (CV)
	260 E 38 P	01/94→	Centre Rod	IV-DL-2155	
01/94→		Suspension Arm Repair Kit		DF-RK-8503	for Control Arm
01/94→		Tie Rod	IV-DL-8367		Guide Rod
01/94→		Tie Rod End	CV-ES-14162		for Steering Rod
01/94→		Tie Rod End	CV-ES-14163		for Steering Rod
01/94→		Tie Rod End	IV-ES-12419		for Steering Rod
01/94→		Track Control Arm		IV-DL-8142	Trailing Arm
01/94→		Track Control Arm		IV-DL-8613	Trailing Arm
01/94→		Track Control Arm		IV-VB-5228	Wishbone (CV)
260 E 39 Y, 260 E 39 Y/P, 260 E 39 Y/FP, 260 E 39 Y/FS	11/99→	Suspension Arm Repair Kit		DF-RK-8503	for Control Arm
	11/99→	Tie Rod	IV-DL-8367		Guide Rod
	11/99→	Tie Rod End	CV-ES-14163		for Steering Rod
	11/99→	Track Control Arm		IV-DL-8613	Trailing Arm
	11/99→	Track Control Arm		IV-VB-5228	Wishbone (CV)
260 E 40	01/01→	Suspension Arm Repair Kit		DF-RK-8503	for Control Arm
260 E 42	01/94→	Centre Rod	IV-DL-2155		Push Rod
	01/94→	Suspension Arm Repair Kit		DF-RK-8503	for Control Arm
	01/94→	Tie Rod	IV-DL-8367		Guide Rod
	01/94→	Tie Rod End	CV-ES-14162		for Steering Rod
	01/94→	Tie Rod End	CV-ES-14163		for Steering Rod
	01/94→	Tie Rod End	IV-ES-12419		for Steering Rod
	01/94→	Track Control Arm		IV-DL-8142	Trailing Arm
	01/94→	Track Control Arm		IV-DL-8613	Trailing Arm
	01/94→	Track Control Arm		IV-VB-5228	Wishbone (CV)
	260 E 43 Y, 260 E 43 Y/P	11/99→	Centre Rod	IV-DL-2155	
11/99→		Centre Rod	IV-DL-8304		Push Rod
11/99→		Suspension Arm Repair Kit		DF-RK-8503	for Control Arm
11/99→		Tie Rod		IV-DL-9361	Guide Rod
11/99→		Tie Rod	IV-DL-8367		Guide Rod, 1st Front Axle
11/99→		Tie Rod End	CV-ES-14162		for Steering Rod
11/99→		Tie Rod End	CV-ES-14163		for Steering Rod
11/99→		Track Control Arm		IV-DL-8142	Trailing Arm
400 E 34 T, 440 E 34 T		01/92→	Centre Rod	IV-DL-2155	
	01/92→	Centre Rod	IV-DL-2156		Push Rod
	01/92→	Suspension Arm Repair Kit		DF-RK-8503	for Control Arm
	01/92→	Tie Rod	IV-DL-8367		Guide Rod
	01/92→	Tie Rod End	CV-ES-14162		for Steering Rod
	01/92→	Tie Rod End	CV-ES-14163		for Steering Rod
	01/92→	Tie Rod End	IV-ES-12419		for Steering Rod
	01/92→	Track Control Arm		IV-DL-8613	Trailing Arm
	01/92→	Track Control Arm		IV-VB-5228	Wishbone (CV)
	400 E 38 T, 440 E 38 T, 440 E 38 T /P	01/92→	Centre Rod	IV-DL-2155	
01/92→		Suspension Arm Repair Kit		DF-RK-8503	for Control Arm
01/92→		Tie Rod	IV-DL-8367		Guide Rod
01/92→		Tie Rod End	CV-ES-14162		for Steering Rod

CV-ES-2146

Length: 80
Cone Ø: d1 Ø 30 / d2 Ø 27
Thread: M26 x 1,5 RHT
42533102



IV-DL-8142

Length: 610
Ø: 50
Hole Distance: 152 / 152
41011008, 42041107



IV-ES-12419

Length: 55
Cone Ø: d1 Ø 10 / d2 Ø 10
Thread: M10 x 1,5 RHT
2041327, 41002118, 41203863, 42079853



CV-ES-14162

Length: 125
Cone Ø: d1 Ø 30 / d2 Ø 27
Thread: M30 x 1,5 LHT
2984061, 4802444, 4833830, 7138966,
8190225, 42489395, 42491957



IV-DL-8304

Length: 953
Ø: 52
Cone Ø: d1 Ø 30 / d2 Ø 27
500397738



IV-VB-5228

Length: 665
Ø: 46
Hole Distance: 130 / 130
937104, 08137026, 8137026, 41002770,
41009665, 41028598, 41028600, 41034479,
41042050



CV-ES-14163

Length: 125
Cone Ø: d1 Ø 30 / d2 Ø 27
Thread: M30 x 1,5 RHT
2966252, 2969808, 4802443, 4833829,
7138967, 8122752, 42483386, 42488269,
42489573, 42489594, 42491638, 42537936



IV-DL-8367

Length: 1620
Ø: 48
Cone Ø: d1 Ø 30 / d2 Ø 27
8163773, 41005450, 41005451, 41036943,
41036944



MN-ES-8490

Length: 90
Cone Ø: d1 Ø 30 / d2 Ø 27
Thread: M26 x 1,5 RHT
14606948, 0014606948, 42533101



DF-RK-8503

Ø: 75
Hole Distance: 130
Thick/Height: 24
93192361



IV-DL-8613

Length: 594
Ø: 50
Hole Distance: 130 / 130
41009661, 41009666, 41035951, 41272429,
98472446, 98472466



IV-DL-2155

Length: 953
Ø: 52
Cone Ø: d1 Ø 30 / d2 Ø 27
8131582, 41005463, 41042919



IV-DL-9361

Length: 1477
Ø: 48
Cone Ø: d1 Ø 30 / d2 Ø 27
41032608, 41033237



IV-DL-2156

Length: 900
Ø: 50
Cone Ø: d1 Ø 30 / d2 Ø 27
98446354



IV-ES-8507

Length: 80
Cone Ø: d1 Ø 30 / d2 Ø 27
Thread: M30 x 1,5 RHT
11019869, 12216380, 55175540, 93192809,
81953016238



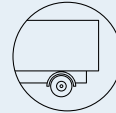

EuroTech MP ...

400 E 38 T, 440 E 38 T, 440 E 38 T /P ...	01/92 →	Tie Rod End	CV-ES-14163		for Steering Rod	
	01/92 →	Tie Rod End	IV-ES-12419		for Steering Rod	
	01/92 →	Track Control Arm		IV-DL-8142	Trailing Arm	
	01/92 →	Track Control Arm		IV-DL-8613	Trailing Arm	
	01/92 →	Track Control Arm		IV-VB-5228	Wishbone (CV)	
400 E 38 TXP	11/93 →12/96	Centre Rod	IV-DL-2155		Push Rod	
	11/93 →12/96	Suspension Arm Repair Kit		DF-RK-8503	for Control Arm	
	11/93 →12/96	Tie Rod	IV-DL-8367		Guide Rod	
	11/93 →12/96	Tie Rod End	CV-ES-14162		for Steering Rod	
	11/93 →12/96	Tie Rod End	CV-ES-14163		for Steering Rod	
	11/93 →12/96	Tie Rod End	IV-ES-12419		for Steering Rod	
	11/93 →12/96	Track Control Arm		IV-DL-8613	Trailing Arm	
	11/93 →12/96	Track Control Arm		IV-VB-5228	Wishbone (CV)	
400 E 42 T, 440 E 42 T, 440 E 42 T/P	01/92 →	Centre Rod	IV-DL-2155		Push Rod	
	01/92 →	Suspension Arm Repair Kit		DF-RK-8503	for Control Arm	
	01/92 →	Tie Rod	IV-DL-8367		Guide Rod	
	01/92 →	Tie Rod End	CV-ES-14162		for Steering Rod	
	01/92 →	Tie Rod End	CV-ES-14163		for Steering Rod	
	01/92 →	Tie Rod End	IV-ES-12419		for Steering Rod	
	01/92 →	Track Control Arm		IV-DL-8142	Trailing Arm	
	01/92 →	Track Control Arm		IV-DL-8613	Trailing Arm	
	01/92 →	Track Control Arm		IV-VB-5228	Wishbone (CV)	
	01/92 →	Suspension Arm Repair Kit		DF-RK-8503	for Control Arm	
4300	01/02 →	Suspension Arm Repair Kit		DF-RK-8503	for Control Arm	
440 E 38 TZ	01/93 →	Centre Rod	IV-DL-2155		Push Rod	
	01/93 →	Suspension Arm Repair Kit		DF-RK-8503	for Control Arm	
	01/93 →	Tie Rod	IV-DL-8367		Guide Rod	
	01/93 →	Tie Rod End	CV-ES-14162		for Steering Rod	
	01/93 →	Tie Rod End	CV-ES-14163		for Steering Rod	
	01/93 →	Tie Rod End	IV-ES-12419		for Steering Rod	
	01/93 →	Track Control Arm		IV-DL-8142	Trailing Arm	
	01/93 →	Track Control Arm		IV-DL-8613	Trailing Arm	
	01/93 →	Track Control Arm		IV-DL-9351	Wishbone (CV); Trailing Arm	
	01/93 →	Track Control Arm		IV-VB-5228	Wishbone (CV)	
	440 E 39 T, 440 E 39 T/P, 440 E 39 T/FP-CT	11/99 →	Stabiliser Mounting		DF-SB-9342	
		11/99 →	Suspension Arm Repair Kit		DF-RK-8503	for Control Arm
		11/99 →	Tie Rod	IV-DL-8367		Guide Rod
11/99 →		Tie Rod End	CV-ES-14163		for Steering Rod	
11/99 →		Track Control Arm		IV-DL-8613	Trailing Arm	
11/99 →		Track Control Arm		IV-DL-9351	Wishbone (CV); Trailing Arm	
11/99 →		Track Control Arm		IV-VB-5228	Wishbone (CV)	
440 E 39 TX/P		11/99 →	Suspension Arm Repair Kit		DF-RK-8503	for Control Arm
	11/99 →	Tie Rod	IV-DL-8367		Guide Rod	
	11/99 →	Tie Rod End	CV-ES-14163		for Steering Rod	
	11/99 →	Track Control Arm		IV-DL-8613	Trailing Arm	
	11/99 →	Track Control Arm		IV-VB-5228	Wishbone (CV)	
	440 E 40 T/P 440 E 40 TX/P	09/00 →	Suspension Arm Repair Kit		DF-RK-8503	for Control Arm
		01/01 →	Suspension Arm Repair Kit		DF-RK-8503	for Control Arm
440 E 42 TZ	01/93 →	Centre Rod	IV-DL-2155		Push Rod	
	01/93 →	Suspension Arm Repair Kit		DF-RK-8503	for Control Arm	
	01/93 →	Tie Rod	IV-DL-8367		Guide Rod	
	01/93 →	Tie Rod End	CV-ES-14162		for Steering Rod	
	01/93 →	Tie Rod End	CV-ES-14163		for Steering Rod	
	01/93 →	Tie Rod End	IV-ES-12419		for Steering Rod	
	01/93 →	Track Control Arm		IV-DL-8142	Trailing Arm	
	01/93 →	Track Control Arm		IV-DL-8613	Trailing Arm	
	01/93 →	Track Control Arm		IV-DL-9351	Wishbone (CV); Trailing Arm	
	01/93 →	Track Control Arm		IV-VB-5228	Wishbone (CV)	
	440 E 43 T, 440 E 43 T/P	11/99 →	Stabiliser Mounting		DF-SB-9342	
		11/99 →	Suspension Arm Repair Kit		DF-RK-8503	for Control Arm
		11/99 →	Tie Rod	IV-DL-8367		Guide Rod
		11/99 →	Tie Rod End	CV-ES-14162		for Steering Rod
11/99 →		Tie Rod End	CV-ES-14163		for Steering Rod	
11/99 →		Track Control Arm		IV-DL-8613	Trailing Arm	

CV-ES-14162

Length: 125
Cone Ø: d1 Ø 30 / d2 Ø 27
Thread: M30 x 1,5 LHT
2984061, 4802444, 4833830, 7138966,
8190225, 42489395, 42491957



IV-DL-8367

Length: 1620
Ø: 48
Cone Ø: d1 Ø 30 / d2 Ø 27
8163773, 41005450, 41005451, 41036943,
41036944



CV-ES-14163

Length: 125
Cone Ø: d1 Ø 30 / d2 Ø 27
Thread: M30 x 1,5 RHT
2966252, 2969808, 4802443, 4833829,
7138967, 8122752, 42483386, 42488269,
42489573, 42489594, 42491638, 42537936



IV-DL-8613

Length: 594
Ø: 50
Hole Distance: 130 / 130
41009661, 41009666, 41035951, 41272429,
98472446, 98472466



DF-RK-8503

Ø: 75
Hole Distance: 130
Thick/Height: 24
93192361



IV-DL-9351

Length: 455
Ø: 50
Hole Distance: 130 / 130
41033731



DF-SB-9342



IV-ES-12419

Length: 55
Cone Ø: d1 Ø 10 / d2 Ø 10
Thread: M10 x 1,5 RHT
2041327, 41002118, 41203863, 42079853



IV-DL-2155

Length: 953
Ø: 52
Cone Ø: d1 Ø 30 / d2 Ø 27
8131582, 41005463, 41042919



IV-VB-5228

Length: 665
Ø: 46
Hole Distance: 130 / 130
937104, 8137026, 08137026, 41002770,
41009665, 41028598, 41028600, 41034479,
41042050



IV-DL-8142

Length: 610
Ø: 50
Hole Distance: 152 / 152
41011008, 42041107





EuroTech MP ...

440 E 43 T, 440 E 43 T/P ...	11/99→	Track Control Arm		IV-DL-9351	Wishbone (CV);Trailing Arm
	11/99→	Track Control Arm		IV-VB-5228	Wishbone (CV)
440 E 43 TX/P	11/99→	Centre Rod	IV-DL-2155		Push Rod
	11/99→	Suspension Arm Repair Kit		DF-RK-8503	for Control Arm
	11/99→	Tie Rod End	CV-ES-14163		for Steering Rod
	11/99→	Track Control Arm		IV-DL-8613	Trailing Arm, Drive Axle
	11/99→	Track Control Arm		IV-VB-5228	Wishbone (CV)
4500	01/02→	Suspension Arm Repair Kit		DF-RK-8503	for Control Arm

EuroTech MT

180 E 24	01/92→12/96	Suspension Arm Repair Kit		DF-RK-8503	for Control Arm
	01/92→12/96	Suspension Strut Repair Kit		DF-RK-8685	
	01/92→12/96	Tie Rod End	IV-ES-12419		for Steering Rod
	01/92→12/96	Track Control Arm		IV-DL-8613	Trailing Arm
	01/92→12/96	Track Control Arm		IV-VB-5228	Wishbone (CV)
180 E 24 K	01/93→12/96	Centre Rod	IV-DL-2156		Push Rod
	01/93→12/96	Suspension Arm Repair Kit		DF-RK-8503	for Control Arm
	01/93→12/96	Tie Rod End	CV-ES-14162		for Steering Rod
	01/93→12/96	Tie Rod End	CV-ES-14163		for Steering Rod
	01/93→12/96	Tie Rod End	IV-ES-12419		for Steering Rod
	01/93→12/96	Track Control Arm		IV-DL-8613	Trailing Arm
	01/93→12/96	Track Control Arm		IV-VB-5228	Wishbone (CV)
	01/93→12/96	Track Control Arm		IV-VB-5228	Wishbone (CV)
180 E 27	01/92→12/96	Centre Rod	IV-DL-2156		Push Rod
	01/92→12/96	Suspension Arm Repair Kit		DF-RK-8503	for Control Arm
	01/92→12/96	Suspension Strut Repair Kit		DF-RK-8685	
	01/92→12/96	Tie Rod End	CV-ES-14162		for Steering Rod
	01/92→12/96	Tie Rod End	CV-ES-14163		for Steering Rod
	01/92→12/96	Tie Rod End	IV-ES-12419		for Steering Rod
	01/92→12/96	Track Control Arm		IV-DL-8613	Trailing Arm
180 E 27 K	01/92→12/96	Track Control Arm		IV-VB-5228	Wishbone (CV)
	01/92→12/96	Centre Rod	IV-DL-2156		Push Rod
	01/92→12/96	Suspension Arm Repair Kit		DF-RK-8503	for Control Arm
	01/92→12/96	Tie Rod End	CV-ES-14162		for Steering Rod
	01/92→12/96	Tie Rod End	CV-ES-14163		for Steering Rod
	01/92→12/96	Tie Rod End	IV-ES-12419		for Steering Rod
	01/92→12/96	Track Control Arm		IV-DL-8613	Trailing Arm
	01/92→12/96	Track Control Arm		IV-VB-5228	Wishbone (CV)
180 E 30 R	01/92→12/96	Centre Rod	IV-DL-2156		Push Rod
	01/92→12/96	Suspension Arm Repair Kit		DF-RK-8503	for Control Arm
	01/92→12/96	Suspension Strut Repair Kit		DF-RK-8685	
	01/92→12/96	Tie Rod End	CV-ES-14162		for Steering Rod
	01/92→12/96	Tie Rod End	CV-ES-14163		for Steering Rod
	01/92→12/96	Tie Rod End	IV-ES-12419		for Steering Rod
	01/92→12/96	Track Control Arm		IV-DL-8613	Trailing Arm
	01/92→12/96	Track Control Arm		IV-VB-5228	Wishbone (CV)
180 E 34 R	01/92→12/93	Centre Rod	IV-DL-2155		Push Rod
	01/92→12/93	Centre Rod	IV-DL-2156		Push Rod
	01/92→12/93	Suspension Arm Repair Kit		DF-RK-8503	for Control Arm
	01/92→12/93	Tie Rod End	CV-ES-14162		for Steering Rod
	01/92→12/93	Tie Rod End	CV-ES-14163		for Steering Rod
	01/92→12/93	Tie Rod End	IV-ES-12419		for Steering Rod
	01/92→12/93	Track Control Arm		IV-DL-8613	Trailing Arm
	01/92→12/93	Track Control Arm		IV-VB-5228	Wishbone (CV)
190 E 24	01/97→08/98	Centre Rod	IV-DL-2155		Push Rod
	01/97→08/98	Centre Rod	IV-DL-2156		Push Rod
	01/97→08/98	Suspension Arm Repair Kit		DF-RK-8503	for Control Arm
	01/97→08/98	Suspension Strut Repair Kit		DF-RK-8685	
	01/97→08/98	Tie Rod	IV-DL-8367		Guide Rod
	01/97→08/98	Tie Rod End	CV-ES-14162		for Steering Rod
	01/97→08/98	Tie Rod End	CV-ES-14163		for Steering Rod
	01/97→08/98	Tie Rod End	IV-ES-12419		for Steering Rod
	01/97→08/98	Track Control Arm		IV-DL-8613	Trailing Arm
	01/97→08/98	Track Control Arm		IV-VB-5228	Wishbone (CV)
	01/97→08/98	Track Control Arm		IV-VB-5228	Wishbone (CV)
	01/97→08/98	Track Control Arm		IV-VB-5228	Wishbone (CV)

CV-ES-14162

Length: 125
Cone Ø: d1 Ø 30 / d2 Ø 27
Thread: M30 x 1,5 LHT
2984061, 4802444, 4833830, 7138966,
8190225, 42489395, 42491957



IV-DL-8367

Length: 1620
Ø: 48
Cone Ø: d1 Ø 30 / d2 Ø 27
8163773, 41005450, 41005451, 41036943,
41036944



CV-ES-14163

Length: 125
Cone Ø: d1 Ø 30 / d2 Ø 27
Thread: M30 x 1,5 RHT
2966252, 2969808, 4802443, 4833829,
7138967, 8122752, 42483386, 42488269,
42489573, 42489594, 42491638, 42537936



IV-DL-8613

Length: 594
Ø: 50
Hole Distance: 130 / 130
41009661, 41009666, 41035951, 41272429,
98472446, 98472466



DF-RK-8503

Ø: 75
Hole Distance: 130
Thick/Height: 24
93192361



IV-DL-9351

Length: 455
Ø: 50
Hole Distance: 130 / 130
41033731



DF-RK-8685

Ø: 67
Hole Distance: 130
Thick/Height: 24
093163617, 93163617



IV-ES-12419

Length: 55
Cone Ø: d1 Ø 10 / d2 Ø 10
Thread: M10 x 1,5 RHT
2041327, 41002118, 41203863, 42079853



IV-DL-2155

Length: 953
Ø: 52
Cone Ø: d1 Ø 30 / d2 Ø 27
8131582, 41005463, 41042919



IV-VB-5228

Length: 665
Ø: 46
Hole Distance: 130 / 130
937104, 8137026, 08137026, 41002770,
41009665, 41028598, 41028600, 41034479,
41042050



IV-DL-2156

Length: 900
Ø: 50
Cone Ø: d1 Ø 30 / d2 Ø 27
98446354





EuroTech MT ...

190 E 24 K	01/97→08/98	Centre Rod	IV-DL-2155		Push Rod
	01/97→08/98	Centre Rod	IV-DL-2156		Push Rod
	01/97→08/98	Suspension Arm Repair Kit		DF-RK-8503	for Control Arm
	01/97→08/98	Tie Rod End	CV-ES-14162		for Steering Rod
	01/97→08/98	Tie Rod End	CV-ES-14163		for Steering Rod
	01/97→08/98	Tie Rod End	IV-ES-12419		for Steering Rod
	01/97→08/98	Track Control Arm		IV-DL-8613	Trailing Arm
	01/97→08/98	Track Control Arm		IV-VB-5228	Wishbone (CV)
190 E 27	01/97→08/98	Centre Rod	IV-DL-2155		Push Rod
	01/97→08/98	Centre Rod	IV-DL-2156		Push Rod
	01/97→08/98	Suspension Arm Repair Kit		DF-RK-8503	for Control Arm
	01/97→08/98	Suspension Strut Repair Kit		DF-RK-8685	
	01/97→08/98	Tie Rod End	CV-ES-14162		for Steering Rod
	01/97→08/98	Tie Rod End	CV-ES-14163		for Steering Rod
	01/97→08/98	Tie Rod End	IV-ES-12419		for Steering Rod
	01/97→08/98	Track Control Arm		IV-DL-8613	Trailing Arm
01/97→08/98	Track Control Arm		IV-VB-5228	Wishbone (CV)	
190 E 27 K	01/97→08/98	Centre Rod	IV-DL-2155		Push Rod
	01/97→08/98	Centre Rod	IV-DL-2156		Push Rod
	01/97→08/98	Suspension Arm Repair Kit		DF-RK-8503	for Control Arm
	01/97→08/98	Tie Rod End	CV-ES-14162		for Steering Rod
	01/97→08/98	Tie Rod End	CV-ES-14163		for Steering Rod
	01/97→08/98	Tie Rod End	IV-ES-12419		for Steering Rod
	01/97→08/98	Track Control Arm		IV-DL-8613	Trailing Arm
	01/97→08/98	Track Control Arm		IV-VB-5228	Wishbone (CV)
190 E 30	01/97→08/98	Centre Rod	IV-DL-2156		Push Rod
	01/97→08/98	Suspension Arm Repair Kit		DF-RK-8503	for Control Arm
	01/97→08/98	Suspension Strut Repair Kit		DF-RK-8685	
	01/97→08/98	Tie Rod End	CV-ES-14162		for Steering Rod
	01/97→08/98	Tie Rod End	CV-ES-14163		for Steering Rod
	01/97→08/98	Tie Rod End	IV-ES-12419		for Steering Rod
	01/97→08/98	Track Control Arm		IV-DL-8613	Trailing Arm
	01/97→08/98	Track Control Arm		IV-VB-5228	Wishbone (CV)
190 E 30 K	01/97→08/98	Centre Rod	IV-DL-2156		Push Rod
	01/97→08/98	Suspension Arm Repair Kit		DF-RK-8503	for Control Arm
	01/97→08/98	Tie Rod End	CV-ES-14162		for Steering Rod
	01/97→08/98	Tie Rod End	CV-ES-14163		for Steering Rod
	01/97→08/98	Tie Rod End	IV-ES-12419		for Steering Rod
	01/97→08/98	Track Control Arm		IV-DL-8613	Trailing Arm
	01/97→08/98	Track Control Arm		IV-VB-5228	Wishbone (CV)
	01/97→08/98	Track Control Arm		IV-VB-5228	Wishbone (CV)
400 E 30 T	01/92→08/98	Centre Rod	IV-DL-2156		Push Rod
	01/92→08/98	Suspension Arm Repair Kit		DF-RK-8503	for Control Arm
	01/92→08/98	Suspension Strut Repair Kit		DF-RK-8685	
	01/92→08/98	Tie Rod End	CV-ES-14162		for Steering Rod
	01/92→08/98	Tie Rod End	CV-ES-14163		for Steering Rod
	01/92→08/98	Tie Rod End	IV-ES-12419		for Steering Rod
	01/92→08/98	Track Control Arm		IV-DL-8613	Trailing Arm
	01/92→08/98	Track Control Arm		IV-VB-5228	Wishbone (CV)
400 E 34 T	01/92→08/98	Centre Rod	IV-DL-2155		Push Rod
	01/92→08/98	Centre Rod	IV-DL-2156		Push Rod
	01/92→08/98	Suspension Arm Repair Kit		DF-RK-8503	for Control Arm
	01/92→08/98	Suspension Strut Repair Kit		DF-RK-8685	
	01/92→08/98	Tie Rod	IV-DL-8367		Guide Rod
	01/92→08/98	Tie Rod End	CV-ES-14162		for Steering Rod
	01/92→08/98	Tie Rod End	CV-ES-14163		for Steering Rod
	01/92→08/98	Tie Rod End	IV-ES-12419		for Steering Rod
	01/92→08/98	Track Control Arm		IV-DL-8613	Trailing Arm
	01/92→08/98	Track Control Arm		IV-VB-5228	Wishbone (CV)
	01/92→08/98	Track Control Arm		IV-VB-5228	Wishbone (CV)

CV-ES-14162

Length: 125
Cone Ø: d1 Ø 30 / d2 Ø 27
Thread: M30 x 1,5 LHT
2984061, 4802444, 4833830, 7138966,
8190225, 42489395, 42491957



IV-DL-8367

Length: 1620
Ø: 48
Cone Ø: d1 Ø 30 / d2 Ø 27
8163773, 41005450, 41005451, 41036943,
41036944



CV-ES-14163

Length: 125
Cone Ø: d1 Ø 30 / d2 Ø 27
Thread: M30 x 1,5 RHT
2966252, 2969808, 4802443, 4833829,
7138967, 8122752, 42483386, 42488269,
42489573, 42489594, 42491638, 42537936



IV-DL-8613

Length: 594
Ø: 50
Hole Distance: 130 / 130
41009661, 41009666, 41035951, 41272429,
98472446, 98472466



DF-RK-8503

Ø: 75
Hole Distance: 130
Thick/Height: 24
93192361



IV-ES-12419

Length: 55
Cone Ø: d1 Ø 10 / d2 Ø 10
Thread: M10 x 1,5 RHT
2041327, 41002118, 41203863, 42079853



DF-RK-8685

Ø: 67
Hole Distance: 130
Thick/Height: 24
093163617, 93163617



IV-VB-5228

Length: 665
Ø: 46
Hole Distance: 130 / 130
937104, 08137026, 8137026, 41002770,
41009665, 41028598, 41028600, 41034479,
41042050



IV-DL-2155

Length: 953
Ø: 52
Cone Ø: d1 Ø 30 / d2 Ø 27
8131582, 41005463, 41042919



IV-DL-2156

Length: 900
Ø: 50
Cone Ø: d1 Ø 30 / d2 Ø 27
98446354





EuroTrakker

MP 180 E 24 W Cursor	09/99 → 11/04	Tie Rod End	IV-ES-12419		for Steering Rod
MP 180 E 25 W	05/99 → 11/04	Tie Rod End	IV-ES-12419		for Steering Rod
MP 190 E 24 H Cursor	09/99 → 11/04	Tie Rod End	IV-ES-12419		for Steering Rod
MP 190 E 30 H	01/93 → 11/04	Centre Rod	IV-DL-2155		Push Rod
	01/93 → 11/04	Tie Rod	IV-DL-8367		Guide Rod
	01/93 → 11/04	Tie Rod End	CV-ES-14162		for Steering Rod
	01/93 → 11/04	Tie Rod End	CV-ES-14163		for Steering Rod
	01/93 → 11/04	Tie Rod End	IV-ES-12419		for Steering Rod
MP 190 E 30 W	01/93 → 11/04	Centre Rod	IV-DL-2155		Push Rod
	01/93 → 11/04	Tie Rod	IV-DL-8367		Guide Rod
	01/93 → 11/04	Tie Rod End	CV-ES-14162		for Steering Rod
	01/93 → 11/04	Tie Rod End	CV-ES-14163		for Steering Rod
	01/93 → 11/04	Tie Rod End	IV-ES-12419		for Steering Rod
MP 190 E 31 H Cursor	09/99 → 11/04	Centre Rod	IV-DL-2155		Push Rod
	09/99 → 11/04	Centre Rod	IV-DL-8654		Push Rod
	09/99 → 11/04	Tie Rod	IV-DL-8367		Guide Rod
	09/99 → 11/04	Tie Rod	IV-DL-12265		
	09/99 → 11/04	Tie Rod End	CV-ES-14162		for Steering Rod
	09/99 → 11/04	Tie Rod End	CV-ES-14163		for Steering Rod
	09/99 → 11/04	Tie Rod End	IV-ES-12419		for Steering Rod
	09/99 → 11/04	Track Control Arm		IV-DL-8613	Trailing Arm
	09/99 → 11/04	Track Control Arm		IV-VB-5228	Wishbone (CV)
	MP 190 E 31 W Cursor	09/99 → 11/04	Centre Rod	IV-DL-2155	
09/99 → 11/04		Centre Rod	IV-DL-8654		Push Rod
09/99 → 11/04		Tie Rod	IV-DL-8367		Guide Rod
09/99 → 11/04		Tie Rod	IV-DL-12265		
09/99 → 11/04		Tie Rod End	CV-ES-14162		for Steering Rod
09/99 → 11/04		Tie Rod End	CV-ES-14163		for Steering Rod
09/99 → 11/04		Tie Rod End	IV-ES-12419		for Steering Rod
09/99 → 11/04		Track Control Arm		IV-DL-8613	Trailing Arm
09/99 → 11/04		Track Control Arm		IV-VB-5228	Wishbone (CV)
MP 190 E 34 H	01/93 → 11/04	Centre Rod	IV-DL-2155		Push Rod
	01/93 → 11/04	Tie Rod	IV-DL-8367		Guide Rod
	01/93 → 11/04	Tie Rod End	CV-ES-14162		for Steering Rod
	01/93 → 11/04	Tie Rod End	CV-ES-14163		for Steering Rod
	01/93 → 11/04	Tie Rod End	IV-ES-12419		for Steering Rod
MP 190 E 34 W	01/93 → 11/04	Centre Rod	IV-DL-2155		Push Rod
	01/93 → 11/04	Tie Rod	IV-DL-8367		Guide Rod
	01/93 → 11/04	Tie Rod End	CV-ES-14162		for Steering Rod
	01/93 → 11/04	Tie Rod End	CV-ES-14163		for Steering Rod
	01/93 → 11/04	Tie Rod End	IV-ES-12419		for Steering Rod
MP 190 E 35 H Cursor	09/99 → 11/04	Centre Rod	IV-DL-2155		Push Rod
	09/99 → 11/04	Centre Rod	IV-DL-8166		Push Rod
	09/99 → 11/04	Centre Rod	IV-DL-8654		Push Rod
	09/99 → 11/04	Tie Rod	IV-DL-8367		Guide Rod
	09/99 → 11/04	Tie Rod End	CV-ES-14162		for Steering Rod
	09/99 → 11/04	Tie Rod End	CV-ES-14163		for Steering Rod
	09/99 → 11/04	Tie Rod End	IV-ES-12419		for Steering Rod
	09/99 → 11/04	Track Control Arm		IV-DL-8613	Trailing Arm
	09/99 → 11/04	Track Control Arm		IV-VB-5228	Wishbone (CV)
MP 190 E 35 W Cursor	09/99 → 11/04	Centre Rod	IV-DL-2155		Push Rod
	09/99 → 11/04	Centre Rod	IV-DL-8166		Push Rod
	09/99 → 11/04	Centre Rod	IV-DL-8654		Push Rod
	09/99 → 11/04	Tie Rod	IV-DL-8367		Guide Rod
	09/99 → 11/04	Tie Rod End	CV-ES-14162		for Steering Rod
	09/99 → 11/04	Tie Rod End	CV-ES-14163		for Steering Rod
	09/99 → 11/04	Tie Rod End	IV-ES-12419		for Steering Rod
	09/99 → 11/04	Track Control Arm		IV-DL-8613	Trailing Arm
	09/99 → 11/04	Track Control Arm		IV-VB-5228	Wishbone (CV)
MP 190 E 37 H	01/93 → 11/04	Centre Rod	IV-DL-2155		Push Rod
	01/93 → 11/04	Centre Rod	IV-DL-8654		Push Rod
	01/93 → 11/04	Tie Rod	IV-DL-8367		Guide Rod
	01/93 → 11/04	Tie Rod End	CV-ES-14162		for Steering Rod

CV-ES-14162

Length: 125
Cone Ø: d1 Ø 30 / d2 Ø 27
Thread: M30 x 1,5 LHT
2984061, 4802444, 4833830, 7138966,
8190225, 42489395, 42491957



IV-DL-8654

Length: 959
Ø: 52
Cone Ø: d1 Ø 30 / d2 Ø 27
41215165, 41226580



CV-ES-14163

Length: 125
Cone Ø: d1 Ø 30 / d2 Ø 27
Thread: M30 x 1,5 RHT
2966252, 2969808, 4802443, 4833829,
7138967, 8122752, 42483386, 42488269,
42489573, 42489594, 42491638, 42537936



IV-DL-12265

Length: 1577
Ø: 48
Cone Ø: d1 Ø 30 / d2 Ø 27
8165309, 41005309, 41005460



IV-DL-2155

Length: 953
Ø: 52
Cone Ø: d1 Ø 30 / d2 Ø 27
8131582, 41005463, 41042919



IV-ES-12419

Length: 55
Cone Ø: d1 Ø 10 / d2 Ø 10
Thread: M10 x 1,5 RHT
2041327, 41002118, 41203863, 42079853



IV-DL-8166

Length: 952
Ø: 52
Cone Ø: d1 Ø 30 / d2 Ø 27
41005475, 41006093



IV-VB-5228

Length: 665
Ø: 46
Hole Distance: 130 / 130
937104, 08137026, 8137026, 41002770,
41009665, 41028598, 41028600, 41034479,
41042050



IV-DL-8367

Length: 1620
Ø: 48
Cone Ø: d1 Ø 30 / d2 Ø 27
8163773, 41005450, 41005451, 41036943,
41036944



IV-DL-8613

Length: 594
Ø: 50
Hole Distance: 130 / 130
41009661, 41009666, 41035951, 41272429,
98472446, 98472466





EuroTrakker ...

MP 190 E 37 H ...	01/93→11/04	Tie Rod End	CV-ES-14163		for Steering Rod
	01/93→11/04	Tie Rod End	IV-ES-12419		for Steering Rod
MP 190 E 37 W	01/93→11/04	Centre Rod	IV-DL-2155		Push Rod
	01/93→11/04	Tie Rod	IV-DL-8367		Guide Rod
	01/93→11/04	Tie Rod End	CV-ES-14162		for Steering Rod
	01/93→11/04	Tie Rod End	CV-ES-14163		for Steering Rod
	01/93→11/04	Tie Rod End	IV-ES-12419		for Steering Rod
MP 190 E 38 W Cursor	01/01→11/04	Centre Rod	IV-DL-2155		Push Rod
	01/01→11/04	Centre Rod	IV-DL-8654		Push Rod
	01/01→11/04	Tie Rod	IV-DL-8367		Guide Rod
	01/01→11/04	Tie Rod End	CV-ES-14162		for Steering Rod
	01/01→11/04	Tie Rod End	CV-ES-14163		for Steering Rod
MP 190 E 42 H	01/93→11/04	Centre Rod	IV-DL-2155		Push Rod
	01/93→11/04	Centre Rod	IV-DL-8654		Push Rod
	01/93→11/04	Tie Rod	IV-DL-8367		Guide Rod
	01/93→11/04	Tie Rod End	CV-ES-14162		for Steering Rod
	01/93→11/04	Tie Rod End	CV-ES-14163		for Steering Rod
MP 190 E 42 W	01/93→11/04	Centre Rod	IV-DL-2155		Push Rod
	01/93→11/04	Centre Rod	IV-DL-8654		Push Rod
	01/93→11/04	Tie Rod	IV-DL-8367		Guide Rod
	01/93→11/04	Tie Rod End	CV-ES-14162		for Steering Rod
	01/93→11/04	Tie Rod End	CV-ES-14163		for Steering Rod
MP 190 E 44 W Cursor	09/00→11/04	Centre Rod	IV-DL-2155		Push Rod
	09/00→11/04	Centre Rod	IV-DL-8654		Push Rod
	09/00→11/04	Tie Rod	IV-DL-8367		Guide Rod
	09/00→11/04	Tie Rod End	IV-ES-12419		for Steering Rod
MP 260 E 27 H Cursor	11/99→11/04	Tie Rod End	IV-ES-12419		for Steering Rod
MP 260 E 30 H	01/93→11/04	Centre Rod	IV-DL-2155		Push Rod
	01/93→11/04	Tie Rod	IV-DL-8367		Guide Rod
	01/93→11/04	Tie Rod End	CV-ES-14162		for Steering Rod
	01/93→11/04	Tie Rod End	CV-ES-14163		for Steering Rod
	01/93→11/04	Tie Rod End	IV-ES-12419		for Steering Rod
MP 260 E 30 W	01/93→11/04	Track Control Arm		IV-DL-8142	Trailing Arm
	11/99→11/04	Tie Rod End	IV-ES-12419		for Steering Rod
	09/99→11/04	Centre Rod	IV-DL-2155		Push Rod
	09/99→11/04	Suspension Arm Repair Kit		DF-RK-8503	for Control Arm
	09/99→11/04	Tie Rod	IV-DL-8367		Guide Rod
MP 260 E 31 H Cursor	09/99→11/04	Tie Rod End	CV-ES-14162		for Steering Rod
	09/99→11/04	Tie Rod End	CV-ES-14163		for Steering Rod
	09/99→11/04	Tie Rod End	IV-ES-12419		for Steering Rod
	09/99→11/04	Track Control Arm		IV-DL-8142	Trailing Arm
	09/99→11/04	Track Control Arm		IV-DL-8613	Trailing Arm
	09/99→11/04	Track Control Arm		IV-VB-5228	Wishbone (CV)
	11/99→11/04	Centre Rod	IV-DL-2155		Push Rod
	11/99→11/04	Suspension Arm Repair Kit		DF-RK-8503	for Control Arm
MP 260 E 31 HB Cursor	11/99→11/04	Tie Rod	IV-DL-8367		Guide Rod
	11/99→11/04	Tie Rod End	CV-ES-14162		for Steering Rod
	11/99→11/04	Tie Rod End	CV-ES-14163		for Steering Rod
	11/99→11/04	Tie Rod End	IV-ES-12419		for Steering Rod
	11/99→11/04	Track Control Arm		IV-DL-8142	Trailing Arm
	11/99→11/04	Track Control Arm		IV-DL-8613	Trailing Arm
	11/99→11/04	Track Control Arm		IV-VB-5228	Wishbone (CV)
	11/99→11/04	Track Control Arm		IV-DL-8142	Trailing Arm
MP 260 E 34 H	01/93→11/04	Centre Rod	IV-DL-2155		Push Rod
	01/93→11/04	Tie Rod	IV-DL-8367		Guide Rod
	01/93→11/04	Tie Rod End	CV-ES-14162		for Steering Rod
	01/93→11/04	Tie Rod End	CV-ES-14163		for Steering Rod
	01/93→11/04	Tie Rod End	IV-ES-12419		for Steering Rod
01/93→11/04	Track Control Arm		IV-DL-8142	Trailing Arm	

CV-ES-14162

Length: 125
Cone Ø: d1 Ø 30 / d2 Ø 27
Thread: M30 x 1,5 LHT
2984061, 4802444, 4833830, 7138966,
8190225, 42489395, 42491957



IV-DL-8613

Length: 594
Ø: 50
Hole Distance: 130 / 130
41009661, 41009666, 41035951, 41272429,
98472446, 98472466



CV-ES-14163

Length: 125
Cone Ø: d1 Ø 30 / d2 Ø 27
Thread: M30 x 1,5 RHT
2966252, 2969808, 4802443, 4833829,
7138967, 8122752, 42483386, 42488269,
42489573, 42489594, 42491638, 42537936



IV-DL-8654

Length: 959
Ø: 52
Cone Ø: d1 Ø 30 / d2 Ø 27
41215165, 41226580



DF-RK-8503

Ø: 75
Hole Distance: 130
Thick/Height: 24
93192361



IV-ES-12419

Length: 55
Cone Ø: d1 Ø 10 / d2 Ø 10
Thread: M10 x 1,5 RHT
2041327, 41002118, 41203863, 42079853



IV-DL-2155

Length: 953
Ø: 52
Cone Ø: d1 Ø 30 / d2 Ø 27
8131582, 41005463, 41042919



IV-VB-5228

Length: 665
Ø: 46
Hole Distance: 130 / 130
937104, 08137026, 8137026, 41002770,
41009665, 41028598, 41028600, 41034479,
41042050



IV-DL-8142

Length: 610
Ø: 50
Hole Distance: 152 / 152
41011008, 42041107



IV-DL-8367

Length: 1620
Ø: 48
Cone Ø: d1 Ø 30 / d2 Ø 27
8163773, 41005450, 41005451, 41036943,
41036944





EuroTrakker ...

MP 260 E 34 W	01/93→11/04	Centre Rod	IV-DL-2155		Push Rod	
	01/93→11/04	Tie Rod	IV-DL-8367		Guide Rod	
	01/93→11/04	Tie Rod End	CV-ES-14162		for Steering Rod	
	01/93→11/04	Tie Rod End	CV-ES-14163		for Steering Rod	
	01/93→11/04	Tie Rod End	IV-ES-12419		for Steering Rod	
	01/93→11/04	Track Control Arm			IV-DL-8142	Trailing Arm
MP 260 E 35 H Cursor	01/00→11/04	Centre Rod	IV-DL-2155		Push Rod	
	01/00→11/04	Centre Rod	IV-DL-8654		Push Rod	
	01/00→11/04	Suspension Arm Repair Kit			DF-RK-8503	for Control Arm
	01/00→11/04	Tie Rod	IV-DL-8367		Guide Rod	
	01/00→11/04	Tie Rod End	CV-ES-14162		for Steering Rod	
	01/00→11/04	Tie Rod End	CV-ES-14163		for Steering Rod	
	01/00→11/04	Tie Rod End	IV-ES-12419		for Steering Rod	
	01/00→11/04	Track Control Arm			IV-DL-8142	Trailing Arm
MP 260 E 35 W Cursor	01/00→11/04	Track Control Arm			IV-DL-8613	Trailing Arm
	01/00→11/04	Track Control Arm			IV-VB-5228	Wishbone (CV)
	09/99→11/04	Centre Rod	IV-DL-2155		Push Rod	
	09/99→11/04	Suspension Arm Repair Kit			DF-RK-8503	for Control Arm
	09/99→11/04	Tie Rod End	CV-ES-14162		for Steering Rod	
	09/99→11/04	Tie Rod End	CV-ES-14163		for Steering Rod	
	09/99→11/04	Tie Rod End	IV-ES-12419		for Steering Rod	
	09/99→11/04	Track Control Arm			IV-DL-8613	Trailing Arm
MP 260 E 37 H	01/93→11/04	Centre Rod	IV-DL-2155		Push Rod	
	01/93→11/04	Centre Rod	IV-DL-8654		Push Rod	
	01/93→11/04	Tie Rod	IV-DL-8367		Guide Rod	
	01/93→11/04	Tie Rod	IV-DL-12265			
	01/93→11/04	Tie Rod End	CV-ES-14162		for Steering Rod	
	01/93→11/04	Tie Rod End	CV-ES-14163		for Steering Rod	
	01/93→11/04	Tie Rod End	IV-ES-12419		for Steering Rod	
	01/93→11/04	Track Control Arm			IV-DL-8142	Trailing Arm
MP 260 E 37 W	01/93→11/04	Centre Rod	IV-DL-2155		Push Rod	
	01/93→11/04	Centre Rod	IV-DL-8654		Push Rod	
	01/93→11/04	Tie Rod	IV-DL-8367		Guide Rod	
	01/93→11/04	Tie Rod	IV-DL-12265			
	01/93→11/04	Tie Rod End	CV-ES-14162		for Steering Rod	
	01/93→11/04	Tie Rod End	CV-ES-14163		for Steering Rod	
	01/93→11/04	Tie Rod End	IV-ES-12419		for Steering Rod	
MP 260 E 38 H Cursor	01/93→11/04	Track Control Arm			IV-DL-8142	Trailing Arm
	01/01→11/04	Centre Rod	IV-DL-2155		Push Rod	
	01/01→11/04	Centre Rod	IV-DL-8654		Push Rod	
	01/01→11/04	Suspension Arm Repair Kit			DF-RK-8503	for Control Arm
	01/01→11/04	Tie Rod	IV-DL-8367		Guide Rod	
	01/01→11/04	Tie Rod End	IV-ES-12419		for Steering Rod	
	01/01→11/04	Track Control Arm			IV-DL-8142	Trailing Arm
MP 260 E 38 W Cursor	01/01→11/04	Track Control Arm			IV-DL-8613	Trailing Arm
	01/01→11/04	Centre Rod	IV-DL-2155		Push Rod	
	01/01→11/04	Centre Rod	IV-DL-8654		Push Rod	
	01/01→11/04	Suspension Arm Repair Kit			DF-RK-8503	for Control Arm
	01/01→11/04	Tie Rod	IV-DL-8367		Guide Rod	
	01/01→11/04	Tie Rod End	IV-ES-12419		for Steering Rod	
	01/01→11/04	Track Control Arm			IV-DL-8142	Trailing Arm
MP 260 E 42 H	01/01→11/04	Track Control Arm			IV-DL-8613	Trailing Arm
	01/93→11/04	Centre Rod	IV-DL-2155		Push Rod	
	01/93→11/04	Centre Rod	IV-DL-8654		Push Rod	
	01/93→11/04	Tie Rod	IV-DL-8367		Guide Rod	
	01/93→11/04	Tie Rod End	CV-ES-14162		for Steering Rod	
	01/93→11/04	Tie Rod End	CV-ES-14163		for Steering Rod	
	01/93→11/04	Tie Rod End	IV-ES-12419		for Steering Rod	
MP 260 E 42 W	01/93→11/04	Track Control Arm			IV-DL-8142	Trailing Arm
	01/93→11/04	Centre Rod	IV-DL-2155		Push Rod	
	01/93→11/04	Centre Rod	IV-DL-8654		Push Rod	
	01/93→11/04	Tie Rod	IV-DL-8367		Guide Rod	
	01/93→11/04	Tie Rod End	CV-ES-14162		for Steering Rod	

CV-ES-14162

Length: 125
Cone Ø: d1 Ø 30 / d2 Ø 27
Thread: M30 x 1,5 LHT
2984061, 4802444, 4833830, 7138966,
8190225, 42489395, 42491957



IV-DL-8613

Length: 594
Ø: 50
Hole Distance: 130 / 130
41009661, 41009666, 41035951, 41272429,
98472446, 98472466



CV-ES-14163

Length: 125
Cone Ø: d1 Ø 30 / d2 Ø 27
Thread: M30 x 1,5 RHT
2966252, 2969808, 4802443, 4833829,
7138967, 8122752, 42483386, 42488269,
42489573, 42489594, 42491638, 42537936



IV-DL-8654

Length: 959
Ø: 52
Cone Ø: d1 Ø 30 / d2 Ø 27
41215165, 41226580



DF-RK-8503

Ø: 75
Hole Distance: 130
Thick/Height: 24
93192361



IV-DL-12265

Length: 1577
Ø: 48
Cone Ø: d1 Ø 30 / d2 Ø 27
8165309, 41005309, 41005460



IV-DL-2155

Length: 953
Ø: 52
Cone Ø: d1 Ø 30 / d2 Ø 27
8131582, 41005463, 41042919



IV-ES-12419

Length: 55
Cone Ø: d1 Ø 10 / d2 Ø 10
Thread: M10 x 1,5 RHT
2041327, 41002118, 41203863, 42079853



IV-DL-8142

Length: 610
Ø: 50
Hole Distance: 152 / 152
41011008, 42041107



IV-VB-5228

Length: 665
Ø: 46
Hole Distance: 130 / 130
937104, 08137026, 8137026, 41002770,
41009665, 41028598, 41028600, 41034479,
41042050



IV-DL-8367

Length: 1620
Ø: 48
Cone Ø: d1 Ø 30 / d2 Ø 27
8163773, 41005450, 41005451, 41036943,
41036944



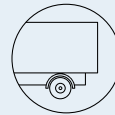

EuroTrakker ...

MP 260 E 42 W ...	01/93→11/04	Tie Rod End	CV-ES-14163		for Steering Rod	
	01/93→11/04	Tie Rod End	IV-ES-12419		for Steering Rod	
	01/93→11/04	Track Control Arm		IV-DL-8142	Trailing Arm	
MP 260 E 44 H Cursor	01/00→11/04	Centre Rod	IV-DL-8654		Push Rod	
	01/00→11/04	Tie Rod	IV-DL-8367		Guide Rod	
	01/00→11/04	Tie Rod End	IV-ES-12419		for Steering Rod	
	01/00→11/04	Track Control Arm		IV-DL-8142	Trailing Arm	
	01/01→11/04	Centre Rod	IV-DL-2155		Push Rod	
MP 260 E 44 W Cursor	01/01→11/04	Centre Rod	IV-DL-2155		Push Rod	
	01/01→11/04	Centre Rod	IV-DL-8654		Push Rod	
	01/01→11/04	Tie Rod	IV-DL-8367		Guide Rod	
	01/01→11/04	Tie Rod End	IV-ES-12419		for Steering Rod	
	01/01→11/04	Track Control Arm		IV-DL-8142	Trailing Arm	
MP 260 E 47 H	11/99→11/04	Tie Rod End	IV-ES-12419		for Steering Rod	
MP 260 E 47 W	11/99→11/04	Tie Rod End	IV-ES-12419		for Steering Rod	
MP 340 E 34 H	01/93→11/04	Centre Rod	IV-DL-2155		Push Rod	
	01/93→11/04	Centre Rod	IV-DL-8124		Push Rod	
	01/93→11/04	Centre Rod	IV-DL-8193		Push Rod	
	01/93→11/04	Tie Rod	IV-DL-8367		Guide Rod	
	01/93→11/04	Tie Rod	IV-DL-12265			
	01/93→11/04	Tie Rod End	CV-ES-14162		for Steering Rod	
	01/93→11/04	Tie Rod End	CV-ES-14163		for Steering Rod	
	01/93→11/04	Tie Rod End	DF-ES-7777			
	01/93→11/04	Tie Rod End	IV-ES-8515			
	01/93→11/04	Tie Rod End	IV-ES-12419		for Steering Rod	
	01/93→11/04	Track Control Arm		IV-DL-8142	Trailing Arm	
	MP 340 E 35 H Cursor	09/99→11/04	Centre Rod	IV-DL-2155		Push Rod
		09/99→11/04	Centre Rod	IV-DL-8193		Push Rod
		09/99→11/04	Tie Rod	IV-DL-8367		Guide Rod
		09/99→11/04	Tie Rod	IV-DL-12265		
09/99→11/04		Tie Rod End	CV-ES-14162		for Steering Rod	
09/99→11/04		Tie Rod End	CV-ES-14163		for Steering Rod	
09/99→11/04		Tie Rod End	IV-ES-12419		for Steering Rod	
09/99→11/04		Track Control Arm		IV-DL-8142	Trailing Arm	
09/99→11/04		Track Control Arm		IV-DL-8613	Trailing Arm	
MP 340 E 35 HB Cursor	09/99→11/04	Track Control Arm		IV-VB-5228	Wishbone (CV)	
	01/01→11/04	Centre Rod	IV-DL-2155		Push Rod	
	01/01→11/04	Centre Rod	IV-DL-8193		Push Rod	
	01/01→11/04	Tie Rod	IV-DL-8367		Guide Rod	
	01/01→11/04	Tie Rod	IV-DL-12265			
	01/01→11/04	Tie Rod End	CV-ES-14162		for Steering Rod	
	01/01→11/04	Tie Rod End	CV-ES-14163		for Steering Rod	
	01/01→11/04	Tie Rod End	IV-ES-12419		for Steering Rod	
	01/01→11/04	Track Control Arm		IV-DL-8142	Trailing Arm	
MP 340 E 37 H	01/01→11/04	Track Control Arm		IV-DL-8613	Trailing Arm	
	01/01→11/04	Track Control Arm		IV-VB-5228	Wishbone (CV)	
	01/93→11/04	Centre Rod	IV-DL-2155		Push Rod	
	01/93→11/04	Centre Rod	IV-DL-8124		Push Rod	
	01/93→11/04	Centre Rod	IV-DL-8193		Push Rod	
	01/93→11/04	Tie Rod	IV-DL-8367		Guide Rod	
	01/93→11/04	Tie Rod	IV-DL-12265			
	01/93→11/04	Tie Rod End	CV-ES-14162		for Steering Rod	
	01/93→11/04	Tie Rod End	CV-ES-14163		for Steering Rod	
	01/93→11/04	Tie Rod End	DF-ES-7777			
MP 340 E 38 H Cursor	01/93→11/04	Tie Rod End	IV-ES-8515			
	01/93→11/04	Tie Rod End	IV-ES-12419		for Steering Rod	
	01/93→11/04	Track Control Arm		IV-DL-8142	Trailing Arm	
	01/01→11/04	Centre Rod	IV-DL-8193		Push Rod	
	01/01→11/04	Centre Rod	IV-DL-8193		Suspension Rod	
	01/01→11/04	Tie Rod	IV-DL-8367		Guide Rod	
	01/01→11/04	Tie Rod	IV-DL-12265			
	01/01→11/04	Tie Rod End	IV-ES-12419		for Steering Rod	
	01/01→11/04	Track Control Arm		IV-DL-8142	Trailing Arm	

CV-ES-14162

Length: 125
Cone Ø: d1 Ø 30 / d2 Ø 27
Thread: M30 x 1,5 LHT
2984061, 4802444, 4833830, 7138966,
8190225, 42489395, 42491957



CV-ES-14163

Length: 125
Cone Ø: d1 Ø 30 / d2 Ø 27
Thread: M30 x 1,5 RHT
2966252, 2969808, 4802443, 4833829,
7138967, 8122752, 42483386, 42488269,
42489573, 42489594, 42491638, 42537936



DF-ES-7777

Length: 85
Cone Ø: d1 Ø 38 / d2 Ø 34,3
Thread: M26 x 1,5 RHT
42105474, 42532294



IV-DL-2155

Length: 953
Ø: 52
Cone Ø: d1 Ø 30 / d2 Ø 27
8131582, 41005463, 41042919



IV-DL-8124

Length: 698
Ø: 52
Cone Ø: d1 Ø 30 / d2 Ø 27
41005466, 41016964



IV-DL-8142

Length: 610
Ø: 50
Hole Distance: 152 / 152
41011008, 42041107



IV-DL-8193

Length: 887
Ø: 52
Cone Ø: d1 Ø 30 / d2 Ø 27
41028269, 41298449



IV-DL-8367

Length: 1620
Ø: 48
Cone Ø: d1 Ø 30 / d2 Ø 27
8163773, 41005450, 41005451, 41036943,
41036944



IV-DL-8613

Length: 594
Ø: 50
Hole Distance: 130 / 130
41009661, 41009666, 41035951, 41272429,
98472446, 98472466



IV-DL-8654

Length: 959
Ø: 52
Cone Ø: d1 Ø 30 / d2 Ø 27
41215165, 41226580



IV-DL-12265

Length: 1577
Ø: 48
Cone Ø: d1 Ø 30 / d2 Ø 27
8165309, 41005309, 41005460



IV-ES-8515

Length: 86
Cone Ø: d1 Ø 38 / d2 Ø 34,3
Thread: M30 x 1,5 RHT
4143415, 42530316, 42538047,
7364001574



IV-ES-12419

Length: 55
Cone Ø: d1 Ø 10 / d2 Ø 10
Thread: M10 x 1,5 RHT
2041327, 41002118, 41203863, 42079853



IV-VB-5228

Length: 665
Ø: 46
Hole Distance: 130 / 130
937104, 08137026, 8137026, 41002770,
41009665, 41028598, 41028600, 41034479,
41042050





EuroTrakker ...

MP 340 E 38 H Cursor ...	01/01→11/04	Track Control Arm		IV-DL-8613	Trailing Arm	
	01/01→11/04	Track Control Arm		IV-VB-5228	Wishbone (CV)	
MP 340 E 38 HB Cursor	01/01→11/04	Centre Rod	IV-DL-8193		Push Rod	
	01/01→11/04	Tie Rod	IV-DL-8367		Guide Rod	
	01/01→11/04	Tie Rod	IV-DL-12265			
	01/01→11/04	Tie Rod End	IV-ES-12419		for Steering Rod	
	01/01→11/04	Track Control Arm		IV-DL-8142	Trailing Arm	
	01/01→11/04	Track Control Arm		IV-DL-8613	Trailing Arm	
	01/01→11/04	Track Control Arm		IV-VB-5228	Wishbone (CV)	
MP 340 E 42 H	01/93→11/04	Centre Rod	IV-DL-2155		Push Rod	
	01/93→11/04	Centre Rod	IV-DL-8124		Push Rod	
	01/93→11/04	Centre Rod	IV-DL-8193		Push Rod	
	01/93→11/04	Tie Rod	IV-DL-8367		Guide Rod	
	01/93→11/04	Tie Rod	IV-DL-12265			
	01/93→11/04	Tie Rod End	CV-ES-14162		for Steering Rod	
	01/93→11/04	Tie Rod End	CV-ES-14163		for Steering Rod	
	01/93→11/04	Tie Rod End	DF-ES-7777			
	01/93→11/04	Tie Rod End	IV-ES-8515			
	01/93→11/04	Tie Rod End	IV-ES-12419		for Steering Rod	
	01/93→11/04	Track Control Arm		IV-DL-8142	Trailing Arm	
	MP 340 E 44 H Cursor	01/01→11/04	Centre Rod	IV-DL-8193		Push Rod
		01/01→11/04	Centre Rod	IV-DL-8193		Suspension Rod
01/01→11/04		Tie Rod	IV-DL-8367		Guide Rod	
01/01→11/04		Tie Rod	IV-DL-12265			
01/01→11/04		Tie Rod End	IV-ES-12419		for Steering Rod	
01/01→11/04		Track Control Arm		IV-DL-8142	Trailing Arm	
MP 340 E 44 HB Cursor	01/01→11/04	Centre Rod	IV-DL-8193		Push Rod	
	01/01→11/04	Tie Rod	IV-DL-8367		Guide Rod	
	01/01→11/04	Tie Rod	IV-DL-12265			
	01/01→11/04	Tie Rod End	IV-ES-12419		for Steering Rod	
	01/01→11/04	Track Control Arm		IV-DL-8142	Trailing Arm	
MP 380 E 34 H	01/93→11/04	Centre Rod	IV-DL-2155		Push Rod	
	01/93→11/04	Suspension Arm Repair Kit		DB-RK-7267	for Drag Link	
	01/93→11/04	Tie Rod	IV-DL-8367		Guide Rod	
	01/93→11/04	Tie Rod End	CV-ES-14162		for Steering Rod	
	01/93→11/04	Tie Rod End	CV-ES-14163		for Steering Rod	
	01/93→11/04	Tie Rod End	IV-ES-12419		for Steering Rod	
	01/93→11/04	Tie Rod End	IV-ES-12419		for Steering Rod	
MP 380 E 34 W	11/99→11/04	Tie Rod End	IV-ES-12419		for Steering Rod	
MP 380 E 35 H Cursor	01/00→11/04	Tie Rod End	IV-ES-12419		for Steering Rod	
MP 380 E 35 W Cursor	01/00→11/04	Tie Rod End	IV-ES-12419		for Steering Rod	
MP 380 E 37 H	01/93→11/04	Centre Rod	IV-DL-2155		Push Rod	
	01/93→11/04	Centre Rod	IV-DL-8654		Push Rod	
	01/93→11/04	Suspension Arm Repair Kit		DB-RK-7267	for Drag Link	
	01/93→11/04	Tie Rod	IV-DL-8367		Guide Rod	
	01/93→11/04	Tie Rod	IV-DL-12265			
	01/93→11/04	Tie Rod End	CV-ES-14162		for Steering Rod	
	01/93→11/04	Tie Rod End	CV-ES-14163		for Steering Rod	
	01/93→11/04	Tie Rod End	IV-ES-12419		for Steering Rod	
	01/93→11/04	Tie Rod End	IV-ES-12419		for Steering Rod	
	01/93→11/04	Tie Rod End	IV-ES-12419		for Steering Rod	
MP 380 E 37 W	01/93→11/04	Centre Rod	IV-DL-2155		Push Rod	
	01/93→11/04	Centre Rod	IV-DL-8654		Push Rod	
	01/93→11/04	Suspension Arm Repair Kit		DB-RK-7267	for Drag Link	
	01/93→11/04	Tie Rod	IV-DL-8367		Guide Rod	
	01/93→11/04	Tie Rod	IV-DL-12265			
	01/93→11/04	Tie Rod End	CV-ES-14162		for Steering Rod	
	01/93→11/04	Tie Rod End	CV-ES-14163		for Steering Rod	
	01/93→11/04	Tie Rod End	IV-ES-12419		for Steering Rod	
MP 380 E 38 H Cursor	01/01→11/04	Centre Rod	IV-DL-8654		Push Rod	
	01/01→11/04	Suspension Arm Repair Kit		DB-RK-7267	for Drag Link	
	01/01→11/04	Tie Rod	IV-DL-8367		Guide Rod	
	01/01→11/04	Tie Rod	IV-DL-12265			
	01/01→11/04	Tie Rod	IV-DL-8367		Guide Rod	
	01/01→11/04	Tie Rod End	IV-ES-12419		for Steering Rod	

CV-ES-14162

Length: 125
Cone Ø: d1 Ø 30 / d2 Ø 27
Thread: M30 x 1,5 LHT
2984061, 4802444, 4833830, 7138966,
8190225, 42489395, 42491957



CV-ES-14163

Length: 125
Cone Ø: d1 Ø 30 / d2 Ø 27
Thread: M30 x 1,5 RHT
2966252, 2969808, 4802443, 4833829,
7138967, 8122752, 42483386, 42488269,
42489573, 42489594, 42491638, 42537936



DB-RK-7267

Ø: 95
Hole Distance: 152
Thick/Height: 24
42493431, 93192619



DF-ES-7777

Length: 85
Cone Ø: d1 Ø 38 / d2 Ø 34,3
Thread: M26 x 1,5 RHT
42105474, 42532294



IV-DL-2155

Length: 953
Ø: 52
Cone Ø: d1 Ø 30 / d2 Ø 27
8131582, 41005463, 41042919



IV-DL-8124

Length: 698
Ø: 52
Cone Ø: d1 Ø 30 / d2 Ø 27
41005466, 41016964



IV-DL-8142

Length: 610
Ø: 50
Hole Distance: 152 / 152
41011008, 42041107



IV-DL-8193

Length: 887
Ø: 52
Cone Ø: d1 Ø 30 / d2 Ø 27
41028269, 41298449



IV-DL-8367

Length: 1620
Ø: 48
Cone Ø: d1 Ø 30 / d2 Ø 27
8163773, 41005450, 41005451, 41036943,
41036944



IV-DL-8613

Length: 594
Ø: 50
Hole Distance: 130 / 130
41009661, 41009666, 41035951, 41272429,
98472446, 98472466



IV-DL-8654

Length: 959
Ø: 52
Cone Ø: d1 Ø 30 / d2 Ø 27
41215165, 41226580



IV-DL-12265

Length: 1577
Ø: 48
Cone Ø: d1 Ø 30 / d2 Ø 27
8165309, 41005309, 41005460



IV-ES-8515

Length: 86
Cone Ø: d1 Ø 38 / d2 Ø 34,3
Thread: M30 x 1,5 RHT
4143415, 42530316, 42538047,
7364001574



IV-ES-12419

Length: 55
Cone Ø: d1 Ø 10 / d2 Ø 10
Thread: M10 x 1,5 RHT
2041327, 41002118, 41203863, 42079853



IV-VB-5228

Length: 665
Ø: 46
Hole Distance: 130 / 130
937104, 8137026, 08137026, 41002770,
41009665, 41028598, 41028600, 41034479,
41042050





EuroTrakker ...

MP 380 E 38 W Cursor	01/01→11/04	Centre Rod	IV-DL-8654		Push Rod
	01/01→11/04	Suspension Arm Repair Kit		DB-RK-7267	for Drag Link
	01/01→11/04	Tie Rod	IV-DL-8367		Guide Rod
	01/01→11/04	Tie Rod	IV-DL-12265		
	01/01→11/04	Tie Rod End	IV-ES-12419		for Steering Rod
MP 380 E 42 H	01/93→11/04	Centre Rod	IV-DL-2155		Push Rod
	01/93→11/04	Suspension Arm Repair Kit		DB-RK-7267	for Drag Link
	01/93→11/04	Tie Rod	IV-DL-8367		Guide Rod
	01/93→11/04	Tie Rod	IV-DL-12265		
	01/93→11/04	Tie Rod End	CV-ES-14162		for Steering Rod
	01/93→11/04	Tie Rod End	CV-ES-14163		for Steering Rod
MP 380 E 42 W	01/93→11/04	Centre Rod	IV-DL-2155		Push Rod
	01/93→11/04	Suspension Arm Repair Kit		DB-RK-7267	for Drag Link
	01/93→11/04	Tie Rod	IV-DL-8367		Guide Rod
	01/93→11/04	Tie Rod	IV-DL-12265		
	01/93→11/04	Tie Rod End	CV-ES-14162		for Steering Rod
	01/93→11/04	Tie Rod End	CV-ES-14163		for Steering Rod
MP 380 E 44 H Cursor	01/01→11/04	Centre Rod	IV-DL-8654		Push Rod
	01/01→11/04	Suspension Arm Repair Kit		DB-RK-7267	for Drag Link
	01/01→11/04	Tie Rod	IV-DL-8367		Guide Rod
	01/01→11/04	Tie Rod	IV-DL-12265		
	01/01→11/04	Tie Rod End	IV-ES-12419		for Steering Rod
MP 380 E 44 HB Cursor	01/01→11/04	Tie Rod End	IV-ES-12419		for Steering Rod
MP 380 E 44 W Cursor	01/01→11/04	Centre Rod	IV-DL-8654		Push Rod
	01/01→11/04	Suspension Arm Repair Kit		DB-RK-7267	for Drag Link
	01/01→11/04	Tie Rod	IV-DL-8367		Guide Rod
	01/01→11/04	Tie Rod	IV-DL-12265		
	01/01→11/04	Tie Rod End	IV-ES-12419		for Steering Rod
MP 380 E 47 H	11/99→11/04	Tie Rod End	IV-ES-12419		for Steering Rod
MP 380 E 47 W	11/99→11/04	Tie Rod End	IV-ES-12419		for Steering Rod
MP 400 E 34 HT	01/93→11/04	Centre Rod	IV-DL-2155		Push Rod
	01/93→11/04	Tie Rod	IV-DL-8367		Guide Rod
	01/93→11/04	Tie Rod End	CV-ES-14162		for Steering Rod
	01/93→11/04	Tie Rod End	CV-ES-14163		for Steering Rod
	01/93→11/04	Tie Rod End	IV-ES-12419		for Steering Rod
MP 400 E 35 HT Cursor	01/00→11/04	Tie Rod End	IV-ES-12419		for Steering Rod
MP 400 E 37 HT	01/93→11/04	Centre Rod	IV-DL-2155		Push Rod
	01/93→11/04	Centre Rod	IV-DL-8654		Push Rod
	01/93→11/04	Tie Rod	IV-DL-8367		Guide Rod
	01/93→11/04	Tie Rod End	CV-ES-14162		for Steering Rod
	01/93→11/04	Tie Rod End	CV-ES-14163		for Steering Rod
	01/93→11/04	Tie Rod End	IV-ES-12419		for Steering Rod
MP 400 E 37 WT	01/93→11/04	Centre Rod	IV-DL-2155		Push Rod
	01/93→11/04	Centre Rod	IV-DL-8654		Push Rod
	01/93→11/04	Tie Rod	IV-DL-8367		Guide Rod
	01/93→11/04	Tie Rod End	CV-ES-14162		for Steering Rod
	01/93→11/04	Tie Rod End	CV-ES-14163		for Steering Rod
	01/93→11/04	Tie Rod End	IV-ES-12419		for Steering Rod
MP 400 E 42 HT	01/93→11/04	Centre Rod	IV-DL-2155		Push Rod
	01/93→11/04	Centre Rod	IV-DL-8654		Push Rod
	01/93→11/04	Tie Rod	IV-DL-8367		Guide Rod
	01/93→11/04	Tie Rod End	CV-ES-14162		for Steering Rod
	01/93→11/04	Tie Rod End	CV-ES-14163		for Steering Rod
	01/93→11/04	Tie Rod End	IV-ES-12419		for Steering Rod
MP 400 E 42 WT	01/93→11/04	Centre Rod	IV-DL-2155		Push Rod
	01/93→11/04	Centre Rod	IV-DL-8654		Push Rod
	01/93→11/04	Tie Rod	IV-DL-8367		Guide Rod
	01/93→11/04	Tie Rod End	CV-ES-14162		for Steering Rod
	01/93→11/04	Tie Rod End	CV-ES-14163		for Steering Rod
	01/93→11/04	Tie Rod End	IV-ES-12419		for Steering Rod
MP 410 E 35 H Cursor	01/00→11/04	Tie Rod End	IV-ES-12419		for Steering Rod

CV-ES-14162

Length: 125
Cone Ø: d1 Ø 30 / d2 Ø 27
Thread: M30 x 1,5 LHT
2984061, 4802444, 4833830, 7138966,
8190225, 42489395, 42491957



IV-DL-12265

Length: 1577
Ø: 48
Cone Ø: d1 Ø 30 / d2 Ø 27
8165309, 41005309, 41005460



CV-ES-14163

Length: 125
Cone Ø: d1 Ø 30 / d2 Ø 27
Thread: M30 x 1,5 RHT
2966252, 2969808, 4802443, 4833829,
7138967, 8122752, 42483386, 42488269,
42489573, 42489594, 42491638, 42537936



IV-ES-12419

Length: 55
Cone Ø: d1 Ø 10 / d2 Ø 10
Thread: M10 x 1,5 RHT
2041327, 41002118, 41203863, 42079853



DB-RK-7267

Ø: 95
Hole Distance: 152
Thick/Height: 24
42493431, 93192619



IV-DL-2155

Length: 953
Ø: 52
Cone Ø: d1 Ø 30 / d2 Ø 27
8131582, 41005463, 41042919



IV-DL-8367

Length: 1620
Ø: 48
Cone Ø: d1 Ø 30 / d2 Ø 27
8163773, 41005450, 41005451, 41036943,
41036944



IV-DL-8654

Length: 959
Ø: 52
Cone Ø: d1 Ø 30 / d2 Ø 27
41215165, 41226580



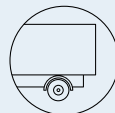

EuroTrakker ...

MP 410 E 37 H	01/93→11/04	Centre Rod	IV-DL-2155		Push Rod	
	01/93→11/04	Centre Rod	IV-DL-8124		Push Rod	
	01/93→11/04	Centre Rod	IV-DL-8193		Push Rod	
	01/93→11/04	Suspension Arm Repair Kit		DB-RK-7267	for Drag Link	
	01/93→11/04	Tie Rod	IV-DL-8367		Guide Rod	
	01/93→11/04	Tie Rod	IV-DL-12265			
	01/93→11/04	Tie Rod End	CV-ES-14162		for Steering Rod	
	01/93→11/04	Tie Rod End	CV-ES-14163		for Steering Rod	
	01/93→11/04	Tie Rod End	DF-ES-7777			
	01/93→11/04	Tie Rod End	IV-ES-8515			
01/93→11/04	Tie Rod End	IV-ES-12419		for Steering Rod		
MP 410 E 37 W	11/99→11/04	Tie Rod End	IV-ES-12419		for Steering Rod	
MP 410 E 38 H Cursor	01/01→11/04	Centre Rod	IV-DL-8193		Push Rod	
	01/01→11/04	Suspension Arm Repair Kit		DB-RK-7267	for Drag Link	
	01/01→11/04	Tie Rod	IV-DL-8367		Guide Rod	
	01/01→11/04	Tie Rod	IV-DL-12265			
	01/01→11/04	Tie Rod End	IV-ES-12419		for Steering Rod	
MP 410 E 38 HB Cursor	01/01→11/04	Tie Rod End	IV-ES-12419		for Steering Rod	
MP 410 E 42 H	01/93→11/04	Centre Rod	IV-DL-2155		Push Rod	
	01/93→11/04	Centre Rod	IV-DL-8124		Push Rod	
	01/93→11/04	Centre Rod	IV-DL-8193		Push Rod	
	01/93→11/04	Suspension Arm Repair Kit		DB-RK-7267	for Drag Link	
	01/93→11/04	Tie Rod	IV-DL-8367		Guide Rod	
	01/93→11/04	Tie Rod	IV-DL-12265			
	01/93→11/04	Tie Rod End	CV-ES-14162		for Steering Rod	
	01/93→11/04	Tie Rod End	CV-ES-14163		for Steering Rod	
	01/93→11/04	Tie Rod End	DF-ES-7777			
	01/93→11/04	Tie Rod End	IV-ES-8515			
	01/93→11/04	Tie Rod End	IV-ES-12419		for Steering Rod	
	01/93→11/04	Track Control Arm		IV-DL-8142	Trailing Arm	
	MP 410 E 42 W	01/93→11/04	Centre Rod	IV-DL-2155		Push Rod
		01/93→11/04	Centre Rod	IV-DL-8124		Push Rod
01/93→11/04		Centre Rod	IV-DL-8166		Push Rod	
01/93→11/04		Centre Rod	IV-DL-8193		Push Rod	
01/93→11/04		Suspension Arm Repair Kit		DB-RK-7267	for Drag Link	
01/93→11/04		Tie Rod	IV-DL-8367		Guide Rod	
01/93→11/04		Tie Rod	IV-DL-12265			
01/93→11/04		Tie Rod End	CV-ES-14162		for Steering Rod	
01/93→11/04		Tie Rod End	CV-ES-14163		for Steering Rod	
01/93→11/04		Tie Rod End	DF-ES-7777			
01/93→11/04		Tie Rod End	IV-ES-8515			
01/93→11/04		Tie Rod End	IV-ES-12419		for Steering Rod	
01/93→11/04		Track Control Arm		IV-DL-8142	Trailing Arm	
MP 410 E 44 H Cursor		01/01→11/04	Centre Rod	IV-DL-8193		Push Rod
	01/01→11/04	Suspension Arm Repair Kit		DB-RK-7267	for Drag Link	
	01/01→11/04	Tie Rod	IV-DL-8367		Guide Rod	
	01/01→11/04	Tie Rod	IV-DL-12265			
	01/01→11/04	Tie Rod End	IV-ES-12419		for Steering Rod	
MP 410 E 44 HB Cursor	01/01→11/04	Tie Rod End	IV-ES-12419		for Steering Rod	
MP 440 E 34 HT	01/93→11/04	Centre Rod	IV-DL-2155		Push Rod	
	01/93→11/04	Tie Rod	IV-DL-8367		Guide Rod	
	01/93→11/04	Tie Rod End	CV-ES-14162		for Steering Rod	
	01/93→11/04	Tie Rod End	CV-ES-14163		for Steering Rod	
	01/93→11/04	Tie Rod End	IV-ES-12419		for Steering Rod	
	01/93→11/04	Track Control Arm		IV-DL-8142	Trailing Arm	
MP 440 E 37 HT	01/93→11/04	Centre Rod	IV-DL-2155		Push Rod	
	01/93→11/04	Tie Rod	IV-DL-8367		Guide Rod	
	01/93→11/04	Tie Rod End	CV-ES-14162		for Steering Rod	
	01/93→11/04	Tie Rod End	CV-ES-14163		for Steering Rod	
	01/93→11/04	Tie Rod End	IV-ES-12419		for Steering Rod	
	01/93→11/04	Track Control Arm		IV-DL-8142	Trailing Arm	
MP 440 E 38 HT Cursor	01/01→11/04	Tie Rod End	IV-ES-12419		for Steering Rod	

CV-ES-14162

Length: 125
Cone Ø: d1 Ø 30 / d2 Ø 27
Thread: M30 x 1,5 LHT
2984061, 4802444, 4833830, 7138966,
8190225, 42489395, 42491957



CV-ES-14163

Length: 125
Cone Ø: d1 Ø 30 / d2 Ø 27
Thread: M30 x 1,5 RHT
2966252, 2969808, 4802443, 4833829,
7138967, 8122752, 42483386, 42488269,
42489573, 42489594, 42491638, 42537936



DB-RK-7267

Ø: 95
Hole Distance: 152
Thick/Height: 24
42493431, 93192619



DF-ES-7777

Length: 85
Cone Ø: d1 Ø 38 / d2 Ø 34,3
Thread: M26 x 1,5 RHT
42105474, 42532294



IV-DL-2155

Length: 953
Ø: 52
Cone Ø: d1 Ø 30 / d2 Ø 27
8131582, 41005463, 41042919



IV-DL-8124

Length: 698
Ø: 52
Cone Ø: d1 Ø 30 / d2 Ø 27
41005466, 41016964



IV-DL-8142

Length: 610
Ø: 50
Hole Distance: 152 / 152
41011008, 42041107



IV-DL-8166

Length: 952
Ø: 52
Cone Ø: d1 Ø 30 / d2 Ø 27
41005475, 41006093



IV-DL-8193

Length: 887
Ø: 52
Cone Ø: d1 Ø 30 / d2 Ø 27
41028269, 41298449



IV-DL-8367

Length: 1620
Ø: 48
Cone Ø: d1 Ø 30 / d2 Ø 27
8163773, 41005450, 41005451, 41036943,
41036944



IV-DL-12265

Length: 1577
Ø: 48
Cone Ø: d1 Ø 30 / d2 Ø 27
8165309, 41005309, 41005460



IV-ES-8515

Length: 86
Cone Ø: d1 Ø 38 / d2 Ø 34,3
Thread: M30 x 1,5 RHT
4143415, 42530316, 42538047,
7364001574



IV-ES-12419

Length: 55
Cone Ø: d1 Ø 10 / d2 Ø 10
Thread: M10 x 1,5 RHT
2041327, 41002118, 41203863, 42079853



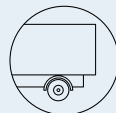

EuroTrakker ...

MP 440 E 42 HT	01/93→11/04	Centre Rod	IV-DL-2155		Push Rod
	01/93→11/04	Tie Rod	IV-DL-8367		Guide Rod
	01/93→11/04	Tie Rod End	CV-ES-14162		for Steering Rod
	01/93→11/04	Tie Rod End	CV-ES-14163		for Steering Rod
	01/93→11/04	Tie Rod End	IV-ES-12419		for Steering Rod
	01/93→11/04	Track Control Arm		IV-DL-8142	
MP 440 E 44 HT Cursor	01/01→11/04	Tie Rod End	IV-ES-12419		for Steering Rod
MP 720 E 37 HT	01/93→11/04	Centre Rod	IV-DL-2155		Push Rod
	01/93→11/04	Centre Rod	IV-DL-8654		Push Rod
	01/93→11/04	Suspension Arm Repair Kit		DB-RK-7267	for Drag Link
	01/93→11/04	Tie Rod	IV-DL-8367		Guide Rod
	01/93→11/04	Tie Rod	IV-DL-12265		
	01/93→11/04	Tie Rod End	CV-ES-14162		for Steering Rod
	01/93→11/04	Tie Rod End	CV-ES-14163		for Steering Rod
	01/93→11/04	Tie Rod End	IV-ES-12419		for Steering Rod
MP 720 E 37 WT	01/93→11/04	Centre Rod	IV-DL-2155		Push Rod
	01/93→11/04	Centre Rod	IV-DL-8654		Push Rod
	01/93→11/04	Suspension Arm Repair Kit		DB-RK-7267	for Drag Link
	01/93→11/04	Tie Rod	IV-DL-8367		Guide Rod
	01/93→11/04	Tie Rod	IV-DL-12265		
	01/93→11/04	Tie Rod End	CV-ES-14162		for Steering Rod
	01/93→11/04	Tie Rod End	CV-ES-14163		for Steering Rod
	01/93→11/04	Tie Rod End	IV-ES-12419		for Steering Rod
MP 720 E 38 HT Cursor	01/01→11/04	Tie Rod End	IV-ES-12419		for Steering Rod
MP 720 E 42 HT	01/93→11/04	Centre Rod	IV-DL-2155		Push Rod
	01/93→11/04	Centre Rod	IV-DL-8654		Push Rod
	01/93→11/04	Suspension Arm Repair Kit		DB-RK-7267	for Drag Link
	01/93→11/04	Tie Rod	IV-DL-8367		Guide Rod
	01/93→11/04	Tie Rod	IV-DL-12265		
	01/93→11/04	Tie Rod End	CV-ES-14162		for Steering Rod
	01/93→11/04	Tie Rod End	CV-ES-14163		for Steering Rod
	01/93→11/04	Tie Rod End	IV-ES-12419		for Steering Rod
MP 720 E 42 WT	01/93→11/04	Centre Rod	IV-DL-2155		Push Rod
	01/93→11/04	Centre Rod	IV-DL-8654		Push Rod
	01/93→11/04	Suspension Arm Repair Kit		DB-RK-7267	for Drag Link
	01/93→11/04	Tie Rod	IV-DL-8367		Guide Rod
	01/93→11/04	Tie Rod	IV-DL-12265		
	01/93→11/04	Tie Rod End	CV-ES-14162		for Steering Rod
	01/93→11/04	Tie Rod End	CV-ES-14163		for Steering Rod
	01/93→11/04	Tie Rod End	IV-ES-12419		for Steering Rod
MP 720 E 44 HT Cursor	01/01→11/04	Tie Rod End	IV-ES-12419		for Steering Rod
MP 720 E 47 HT	01/93→11/04	Centre Rod	IV-DL-2155		Push Rod
	01/93→11/04	Suspension Arm Repair Kit		DB-RK-7267	for Drag Link
	01/93→11/04	Tie Rod	IV-DL-8367		Guide Rod
	01/93→11/04	Tie Rod End	CV-ES-14162		for Steering Rod
	01/93→11/04	Tie Rod End	CV-ES-14163		for Steering Rod
	01/93→11/04	Tie Rod End	IV-ES-12419		for Steering Rod
MP 720 E 48 HT Cursor	01/01→11/04	Tie Rod End	IV-ES-12419		for Steering Rod

M

115-17	09/83→12/91	Centre Rod	IV-DL-2136		Push Rod
	09/83→12/91	Tie Rod End	CV-ES-2135		for Steering Rod
	09/83→12/91	Tie Rod End	DF-ES-5404		for Steering Rod
115-17 H	01/86→12/91	Tie Rod End	DF-ES-5404		for Steering Rod
135-17	09/83→12/91	Ball Head, gearshift linkage	CV-ES-2121		
	09/83→12/91	Centre Rod	IV-DL-2136		Push Rod
	09/83→12/91	Tie Rod End	CV-ES-2135		for Steering Rod
	09/83→12/91	Tie Rod End	DF-ES-5404		for Steering Rod
135-17 H	01/86→12/92	Ball Head, gearshift linkage	CV-ES-2121		
	01/86→12/92	Tie Rod End	DF-ES-5404		for Steering Rod
135-17 T	09/83→12/91	Tie Rod End	DF-ES-5404		for Steering Rod
145-17	02/86→12/91	Centre Rod	IV-DL-2136		Push Rod
	02/86→12/91	Centre Rod	IV-DL-8562		Push Rod
	02/86→12/91	Tie Rod End	CV-ES-2135		for Steering Rod

CV-ES-2121

Length: 85
Cone Ø: d1 Ø 12 / d2 Ø 10,8
Thread: M14 x 1,5 RHT
3435786, 7981909, 86027074



IV-DL-2136

Length: 980
Ø: 35
Cone Ø: d1 Ø 26 / d2 Ø 23,5
4773359, 4834037



IV-DL-12265

Length: 1577
Ø: 48
Cone Ø: d1 Ø 30 / d2 Ø 27
8165309, 41005309, 41005460



CV-ES-2135

Length: 115
Cone Ø: d1 Ø 26 / d2 Ø 23,5
Thread: M28 x 1,5 RHT
4688941, 8582332



IV-DL-2155

Length: 953
Ø: 52
Cone Ø: d1 Ø 30 / d2 Ø 27
8131582, 41005463, 41042919



IV-ES-12419

Length: 55
Cone Ø: d1 Ø 10 / d2 Ø 10
Thread: M10 x 1,5 RHT
2041327, 41002118, 41203863, 42079853



CV-ES-14162

Length: 125
Cone Ø: d1 Ø 30 / d2 Ø 27
Thread: M30 x 1,5 LHT
2984061, 4802444, 4833830, 7138966,
8190225, 42489395, 42491957



IV-DL-8142

Length: 610
Ø: 50
Hole Distance: 152 / 152
41011008, 42041107



CV-ES-14163

Length: 125
Cone Ø: d1 Ø 30 / d2 Ø 27
Thread: M30 x 1,5 RHT
2966252, 2969808, 4802443, 4833829,
7138967, 8122752, 42483386, 42488269,
42489573, 42489594, 42491638, 42537936



IV-DL-8367

Length: 1620
Ø: 48
Cone Ø: d1 Ø 30 / d2 Ø 27
8163773, 41005450, 41005451, 41036943,
41036944



DB-RK-7267

Ø: 95
Hole Distance: 152
Thick/Height: 24
42493431, 93192619



IV-DL-8562

4815933, 4834039



DF-ES-5404

Length: 115
Cone Ø: d1 Ø 26 / d2 Ø 23,5
Thread: M28 x 1,5 LHT
4688942, 8582333



IV-DL-8654

Length: 959
Ø: 52
Cone Ø: d1 Ø 30 / d2 Ø 27
41215165, 41226580





M ...

165-24 R	06/82→09/86	Ball Head, gearshift linkage	CV-ES-2119		
	06/82→09/86	Ball Head, gearshift linkage	CV-ES-2182		
	06/82→09/86	Centre Rod	IV-DL-3234		Push Rod
	06/82→09/86	Tie Rod End	CV-ES-0912		
	06/82→09/86	Tie Rod End	CV-ES-0914		for Steering Rod
	06/82→09/86	Tie Rod End	CV-ES-14163		for Steering Rod
165-24 T	06/82→09/86	Ball Head, gearshift linkage	CV-ES-2119		
	06/82→09/86	Ball Head, gearshift linkage	CV-ES-2182		
	06/82→09/86	Centre Rod	IV-DL-3234		Push Rod
	06/82→09/86	Tie Rod End	CV-ES-0912		
	06/82→09/86	Tie Rod End	CV-ES-0914		for Steering Rod
	06/82→09/86	Tie Rod End	CV-ES-14163		for Steering Rod
175-17	09/86→12/92	Centre Rod	IV-DL-3234		Push Rod
	09/86→12/92	Tie Rod End	CV-ES-14163		for Steering Rod
175-24	09/86→11/92	Ball Head, gearshift linkage	CV-ES-2121		
	09/86→11/92	Centre Rod	IV-DL-3234		Push Rod
	09/86→11/92	Stabiliser Link		IV-DL-8542	Coupling Rod
	09/86→11/92	Suspension Arm Repair Kit		MN-RK-7291	for Drag Link
	09/86→11/92	Tie Rod End	CV-ES-14163		for Steering Rod
175-24 T	09/86→11/92	Ball Head, gearshift linkage	CV-ES-2119		
	09/86→11/92	Ball Head, gearshift linkage	CV-ES-2121		
	09/86→11/92	Ball Head, gearshift linkage	CV-ES-2182		
	09/86→11/92	Centre Rod	IV-DL-3234		Push Rod
	09/86→11/92	Stabiliser Link		IV-DL-8542	Coupling Rod
	09/86→11/92	Suspension Arm Repair Kit		MN-RK-7291	for Drag Link
	09/86→11/92	Tie Rod End	CV-ES-0912		
	09/86→11/92	Tie Rod End	CV-ES-0914		for Steering Rod
	09/86→11/92	Tie Rod End	CV-ES-14163		for Steering Rod

MK

110-13 A	01/83→12/91	Ball Head, gearshift linkage	CV-ES-2121		
	01/83→12/91	Tie Rod End	CV-ES-12461		for Steering Rod
	01/83→12/91	Tie Rod End	CV-ES-12462		for Steering Rod
110-13 AH	01/83→12/85	Ball Head, gearshift linkage	CV-ES-2121		
	01/83→12/85	Tie Rod End	CV-ES-12461		for Steering Rod
	01/83→12/85	Tie Rod End	CV-ES-12462		for Steering Rod
110-16 A	01/83→12/91	Ball Head, gearshift linkage	CV-ES-2121		
	01/83→12/91	Tie Rod End	CV-ES-12461		for Steering Rod
	01/83→12/91	Tie Rod End	CV-ES-12462		for Steering Rod
130-13 A	01/83→12/91	Ball Head, gearshift linkage	CV-ES-2121		
	01/83→12/91	Tie Rod End	CV-ES-12461		for Steering Rod
	01/83→12/91	Tie Rod End	CV-ES-12462		for Steering Rod
130-16 A	01/83→12/91	Ball Head, gearshift linkage	CV-ES-2121		
	01/83→12/91	Tie Rod End	CV-ES-12461		for Steering Rod
	01/83→12/91	Tie Rod End	CV-ES-12462		for Steering Rod
75-9 A	01/83→05/89	Ball Head, gearshift linkage	CV-ES-2121		
75-9 H	01/83→08/85	Ball Head, gearshift linkage	CV-ES-2121		
80-13 A	01/83→12/91	Ball Head, gearshift linkage	CV-ES-2121		
	01/83→12/91	Centre Rod	IV-DL-8689		Push Rod
	01/83→12/91	Tie Rod	RV-DL-8170		
80-13 AH	01/83→12/91	Ball Head, gearshift linkage	CV-ES-2121		
	01/83→12/91	Centre Rod	IV-DL-8689		Push Rod
	01/83→12/91	Tie Rod	RV-DL-8170		
80-13 AT	01/83→12/91	Ball Head, gearshift linkage	CV-ES-2121		
	01/83→12/91	Centre Rod	IV-DL-8689		Push Rod
	01/83→12/91	Tie Rod	RV-DL-8170		
80-13 AW	01/83→12/91	Ball Head, gearshift linkage	CV-ES-2121		
	01/83→12/91	Centre Rod	IV-DL-8689		Push Rod
	01/83→12/91	Tie Rod	RV-DL-8170		
80-16 A	01/83→12/91	Centre Rod	IV-DL-8689		Push Rod
	01/83→12/91	Tie Rod	RV-DL-8170		
80-16 AW	01/86→12/89	Centre Rod	IV-DL-8689		Push Rod
	01/86→12/89	Tie Rod	RV-DL-8170		

CV-ES-0912

Length: 125
Cone Ø: d1 Ø 30 / d2 Ø 27
Thread: M38 x 1,5 LHT
04688949



CV-ES-12462

Length: 120
Cone Ø: d1 Ø 26 / d2 Ø 23,5
Thread: M30 x 1,5 RHT
2966688, 2980323, 3096213, 4833820,
004833827, 4833827, 8122754, 42483520,
42485718, 42493781



RV-DL-8170

Length: 1404
Ø: 34
Cone Ø: d1 Ø 22 / d2 Ø 20
42037386, 86012923, 7485114941



CV-ES-0914

Length: 125
Cone Ø: d1 Ø 30 / d2 Ø 27
Thread: M38 x 1,5 RHT
04688948



CV-ES-14163

Length: 125
Cone Ø: d1 Ø 30 / d2 Ø 27
Thread: M30 x 1,5 RHT
2966252, 2969808, 4802443, 4833829,
7138967, 8122752, 42483386, 42488269,
42489573, 42489594, 42491638, 42537936



CV-ES-2119

Length: 55
Cone Ø: d1 Ø 10 / d2 Ø 10
Thread: M12 x 1,75 LHT
8198188, 42485638



IV-DL-3234

Length: 1001
Ø: 46
Cone Ø: d1 Ø 30 / d2 Ø 27
4793166, 4834041



CV-ES-2121

Length: 85
Cone Ø: d1 Ø 12 / d2 Ø 10,8
Thread: M14 x 1,5 RHT
3435786, 7981909, 86027074



IV-DL-8542

Length: 355
Ø: 40
Cone Ø: d1 Ø 30 / d2 Ø 27
4741171



CV-ES-2182

Length: 55
Cone Ø: d1 Ø 10 / d2 Ø 10
Thread: M12 x 1,75 RHT
8198187



IV-DL-8689

Length: 874
Ø: 36
Cone Ø: d1 Ø 22 / d2 Ø 20
42200700, 42204475, 42211146, 42211148



CV-ES-12461

Length: 120
Cone Ø: d1 Ø 26 / d2 Ø 23,5
Thread: M30 x 1,5 LHT
2980129, 002984511, 02984511, 2984511,
4833821, 4833828, 04833828, 004833828,
8122755, 042493782, 42493782



MN-RK-7291

Ø: 72
Hole Distance: 130
Thick/Height: 30
2980884





MK ...

90-13 A	01/83→12/91	Ball Head, gearshift linkage	CV-ES-2121	
	01/83→12/91	Centre Rod	IV-DL-8689	Push Rod
	01/83→12/91	Tie Rod	RV-DL-8170	
90-13 AH	01/83→12/91	Ball Head, gearshift linkage	CV-ES-2121	
	01/83→12/91	Centre Rod	IV-DL-8689	Push Rod
	01/83→12/91	Tie Rod	RV-DL-8170	

P/PA

160-23 AH	04/84→05/89	Centre Rod	IV-DS-1914	Push Rod
	04/84→05/89	Tie Rod End	CV-ES-14162	for Steering Rod
	04/84→05/89	Tie Rod End	CV-ES-14163	for Steering Rod
160-23 AHW	04/84→05/89	Tie Rod	DF-DL-8571	
160-30 AH	06/86→05/89	Tie Rod	IV-DL-12268	
160-30 AHW	06/86→05/89	Centre Rod	IV-DS-1914	Push Rod
	06/86→05/89	Tie Rod	DF-DL-8571	
	06/86→05/89	Tie Rod End	CV-ES-14162	for Steering Rod
	06/86→05/89	Tie Rod End	CV-ES-14163	for Steering Rod
170-23 AH	04/88→12/90	Centre Rod	IV-DS-1914	Push Rod
	04/88→12/90	Tie Rod	IV-DL-12268	
	04/88→12/90	Tie Rod End	CV-ES-14162	for Steering Rod
	04/88→12/90	Tie Rod End	CV-ES-14163	for Steering Rod
170-23 AH,180-23 AH	01/91→12/93	Centre Rod	IV-DS-1914	Push Rod
	01/91→12/93	Tie Rod	IV-DL-12268	
	01/91→12/93	Tie Rod End	CV-ES-14162	for Steering Rod
	01/91→12/93	Tie Rod End	CV-ES-14163	for Steering Rod
170-23 AHW	04/88→12/90	Tie Rod	DF-DL-8571	
	04/88→12/90	Tie Rod	IV-DL-12268	
170-23 AHW,180-23 AHW	01/91→12/93	Tie Rod	DF-DL-8571	
	01/91→12/93	Tie Rod	IV-DL-12268	
170-25 AH	03/89→12/90	Centre Rod	IV-DS-1914	Push Rod
	03/89→12/90	Tie Rod	IV-DL-12268	
	03/89→12/90	Tie Rod End	CV-ES-14162	for Steering Rod
	03/89→12/90	Tie Rod End	CV-ES-14163	for Steering Rod
170-25 AH,180-25 AH	01/91→12/93	Centre Rod	IV-DS-1914	Push Rod
	01/91→12/93	Tie Rod	IV-DL-12268	
	01/91→12/93	Tie Rod End	CV-ES-14162	for Steering Rod
	01/91→12/93	Tie Rod End	CV-ES-14163	for Steering Rod
170-25 AHW	03/89→12/90	Centre Rod	IV-DS-1914	Push Rod
	03/89→12/90	Tie Rod	DF-DL-8571	
	03/89→12/90	Tie Rod	IV-DL-12268	
	03/89→12/90	Tie Rod End	CV-ES-14162	for Steering Rod
	03/89→12/90	Tie Rod End	CV-ES-14163	for Steering Rod
170-25 AHW,180-25 AHW	01/91→12/93	Centre Rod	IV-DS-1914	Push Rod
	01/91→12/93	Tie Rod	DF-DL-8571	Drive Axle
	01/91→12/93	Tie Rod	IV-DL-12268	
	01/91→12/93	Tie Rod End	CV-ES-14162	for Steering Rod
	01/91→12/93	Tie Rod End	CV-ES-14163	for Steering Rod
170-34 AH	04/89→12/93	Centre Rod	IV-DS-1914	Push Rod
	04/89→12/93	Tie Rod	IV-DL-12268	
	04/89→12/93	Tie Rod End	CV-ES-14162	for Steering Rod
	04/89→12/93	Tie Rod End	CV-ES-14163	for Steering Rod
170-34 AH,180-34 AH	01/91→12/93	Centre Rod	IV-DS-1914	Push Rod
	01/91→12/93	Tie Rod	IV-DL-12268	
	01/91→12/93	Tie Rod End	CV-ES-14162	for Steering Rod
	01/91→12/93	Tie Rod End	CV-ES-14163	for Steering Rod
170-34 AHW	04/89→12/90	Tie Rod	DF-DL-8571	
	04/89→12/90	Tie Rod	IV-DL-12268	
170-34 AHW,180-34 AHW	01/91→12/93	Tie Rod	DF-DL-8571	
	01/91→12/93	Tie Rod	IV-DL-12268	
190-25 AH	07/83→06/86	Centre Rod	IV-DS-1914	Push Rod
	07/83→06/86	Tie Rod	IV-DL-12268	
	07/83→06/86	Tie Rod End	CV-ES-14162	for Steering Rod
	07/83→06/86	Tie Rod End	CV-ES-14163	for Steering Rod

CV-ES-2121

Length: 85
Cone Ø: d1 Ø 12 / d2 Ø 10,8
Thread: M14 x 1,5 RHT
3435786, 7981909, 86027074



IV-DS-1914

Length: 890
Ø: 46
Cone Ø: d1 Ø 30 / d2 Ø 27
42001325, 42001326



CV-ES-14162

Length: 125
Cone Ø: d1 Ø 30 / d2 Ø 27
Thread: M30 x 1,5 LHT
2984061, 4802444, 4833830, 7138966,
8190225, 42489395, 42491957



RV-DL-8170

Length: 1404
Ø: 34
Cone Ø: d1 Ø 22 / d2 Ø 20
42037386, 86012923, 7485114941



CV-ES-14163

Length: 125
Cone Ø: d1 Ø 30 / d2 Ø 27
Thread: M30 x 1,5 RHT
2966252, 2969808, 4802443, 4833829,
7138967, 8122752, 42483386, 42488269,
42489573, 42489594, 42491638, 42537936



DF-DL-8571

Length: 1524
Ø: 60
Cone Ø: d1 Ø 30 / d2 Ø 27
2478910, 42037040, 42037041, 42100262,
42100263



IV-DL-8689

Length: 874
Ø: 36
Cone Ø: d1 Ø 22 / d2 Ø 20
42200700, 42204475, 42211146, 42211148



IV-DL-12268

Length: 1640
Ø: 46
Cone Ø: d1 Ø 30 / d2 Ø 27
42003432





P/PA ...

190-25 AHW	07/83→06/86	Centre Rod	IV-DS-1914		Push Rod
	07/83→06/86	Tie Rod	DF-DL-8571		
	07/83→06/86	Tie Rod End	CV-ES-14162		for Steering Rod
	07/83→06/86	Tie Rod End	CV-ES-14163		for Steering Rod
190-30 H	04/87→12/92	Centre Rod	IV-DS-1914		Push Rod
	04/87→12/92	Tie Rod	DF-DL-8571		
	04/87→12/92	Tie Rod	IV-DL-12268		
	04/87→12/92	Tie Rod End	CV-ES-14162		for Steering Rod
190-30 HT	04/87→12/92	Tie Rod End	CV-ES-14163		for Steering Rod
	01/89→12/92	Centre Rod	IV-DS-1914		Push Rod
	01/89→12/92	Tie Rod	IV-DL-12268		
	01/89→12/92	Tie Rod End	CV-ES-14162		for Steering Rod
190-30 HW	01/89→12/92	Tie Rod End	CV-ES-14163		for Steering Rod
	04/87→12/92	Centre Rod	IV-DS-1914		Push Rod
	04/87→12/92	Tie Rod	DF-DL-8571		
	04/87→12/92	Tie Rod End	CV-ES-14162		for Steering Rod
190-32 AH	04/87→12/92	Tie Rod End	CV-ES-14163		for Steering Rod
	01/83→12/85	Suspension Arm Repair Kit		MN-RK-7291	for Drag Link
	01/83→12/85	Tie Rod	DF-DL-8571		
	01/83→12/85	Tie Rod End	IV-ES-12419		for Steering Rod
190-32 AHW	01/83→12/85	Suspension Arm Repair Kit		MN-RK-7291	for Drag Link
	01/83→12/85	Tie Rod	DF-DL-8571		
	01/83→12/85	Tie Rod End	IV-ES-12419		for Steering Rod
	01/83→12/85	Tie Rod End	CV-ES-14162		for Steering Rod
260-25 AH	03/84→12/92	Centre Rod	IV-DS-1914		Push Rod
	03/84→12/92	Tie Rod	IV-DL-12268		
	03/84→12/92	Tie Rod End	CV-ES-14162		for Steering Rod
	03/84→12/92	Tie Rod End	CV-ES-14163		for Steering Rod
260-25 AHB	03/84→12/92	Track Control Arm		IV-DL-8142	Trailing Arm
	12/79→06/86	Tie Rod	IV-DL-12268		
	12/79→06/86	Track Control Arm		IV-DL-8142	Trailing Arm
	03/84→06/86	Tie Rod	DF-DL-8571		
260-25 AHW	03/84→06/86	Track Control Arm		IV-DL-8142	Trailing Arm
	03/84→06/86	Track Control Arm		IV-DL-8142	Trailing Arm
260-30 AH	06/86→05/90	Centre Rod	IV-DS-1914		Push Rod
	06/86→05/90	Tie Rod	IV-DL-12268		
	06/86→05/90	Tie Rod End	CV-ES-14162		for Steering Rod
	06/86→05/90	Tie Rod End	CV-ES-14163		for Steering Rod
260-30 AHT	06/86→05/90	Track Control Arm		IV-DL-8142	Trailing Arm
	06/86→05/90	Centre Rod	IV-DS-1914		Push Rod
	06/86→05/90	Tie Rod	IV-DL-12268		
	06/86→05/90	Tie Rod End	CV-ES-14162		for Steering Rod
260-30 AHW	06/86→05/90	Tie Rod End	CV-ES-14163		for Steering Rod
	06/86→05/90	Track Control Arm		IV-DL-8142	Trailing Arm
	06/86→05/90	Centre Rod	IV-DS-1914		Push Rod
	06/86→05/90	Tie Rod	DF-DL-8571		
260-32 AH	06/86→05/90	Tie Rod End	CV-ES-14162		for Steering Rod
	06/86→05/90	Tie Rod End	CV-ES-14163		for Steering Rod
	01/83→12/85	Centre Rod	IV-DS-1914		Push Rod
	01/83→12/85	Tie Rod End	CV-ES-14162		for Steering Rod
260-32 AHT	01/83→12/85	Tie Rod End	CV-ES-14163		for Steering Rod
	01/83→12/85	Track Control Arm		IV-DL-8142	Trailing Arm
	01/83→12/85	Tie Rod	DF-DL-8571		
	01/83→12/85	Track Control Arm		IV-DL-8142	Trailing Arm
260-32 AHW	01/83→12/85	Tie Rod	DF-DL-8571		
	01/83→12/85	Track Control Arm		IV-DL-8142	Trailing Arm
	01/83→12/85	Track Control Arm		IV-DL-8142	Trailing Arm
	01/83→12/85	Tie Rod	DF-DL-8571		
260-34 AH	04/89→12/92	Centre Rod	IV-DS-1914		Push Rod
	04/89→12/92	Tie Rod	IV-DL-12268		
	04/89→12/92	Tie Rod End	CV-ES-14162		for Steering Rod
	04/89→12/92	Tie Rod End	CV-ES-14163		for Steering Rod
260-34 AHT	04/89→12/92	Track Control Arm		IV-DL-8142	Trailing Arm
	04/89→12/92	Tie Rod	DF-DL-8571		
	04/89→12/92	Tie Rod	DF-DL-8571		
	04/89→12/92	Track Control Arm		IV-DL-8142	Trailing Arm

CV-ES-14162

Length: 125

Cone Ø: d1 Ø 30 / d2 Ø 27

Thread: M30 x 1,5 LHT

2984061, 4802444, 4833830, 7138966,
8190225, 42489395, 42491957



IV-ES-12419

Length: 55

Cone Ø: d1 Ø 10 / d2 Ø 10

Thread: M10 x 1,5 RHT

2041327, 41002118, 41203863, 42079853



CV-ES-14163

Length: 125

Cone Ø: d1 Ø 30 / d2 Ø 27

Thread: M30 x 1,5 RHT

2966252, 2969808, 4802443, 4833829,
7138967, 8122752, 42483386, 42488269,
42489573, 42489594, 42491638, 42537936



MN-RK-7291

Ø: 72

Hole Distance: 130

Thick/Height: 30

2980884



DF-DL-8571

Length: 1524

Ø: 60

Cone Ø: d1 Ø 30 / d2 Ø 27

2478910, 42037040, 42037041, 42100262,
42100263



IV-DL-8142

Length: 610

Ø: 50

Hole Distance: 152 / 152

41011008, 42041107



IV-DL-12268

Length: 1640

Ø: 46

Cone Ø: d1 Ø 30 / d2 Ø 27

42003432



IV-DS-1914

Length: 890

Ø: 46

Cone Ø: d1 Ø 30 / d2 Ø 27

42001325, 42001326





P/PA ...

260-34 AHW	01/91→12/92	Tie Rod	DF-DL-8571		
	01/91→12/92	Track Control Arm		IV-DL-8142	Trailing Arm
300-30 AH	04/87→05/89	Centre Rod	IV-DS-1914		Push Rod
	04/87→05/89	Tie Rod	IV-DL-12268		
	04/87→05/89	Tie Rod End	CV-ES-14162		for Steering Rod
	04/87→05/89	Tie Rod End	CV-ES-14163		for Steering Rod
	04/87→05/89	Track Control Arm		IV-DL-8142	Trailing Arm
300-30 AHB	04/87→05/89	Centre Rod	IV-DS-1914		Push Rod
	04/87→05/89	Tie Rod	IV-DL-12268		
	04/87→05/89	Tie Rod End	CV-ES-14162		for Steering Rod
	04/87→05/89	Tie Rod End	CV-ES-14163		for Steering Rod
	04/87→05/89	Track Control Arm		IV-DL-8142	Trailing Arm
330-30 H	06/84→12/92	Centre Rod	IV-DS-1914		Push Rod
	06/84→12/92	Tie Rod	IV-DL-12268		
	06/84→12/92	Tie Rod End	CV-ES-14162		for Steering Rod
	06/84→12/92	Tie Rod End	CV-ES-14163		for Steering Rod
	06/84→12/92	Track Control Arm		IV-DL-8142	Trailing Arm
330-30 HT	01/88→12/92	Centre Rod	IV-DS-1914		Push Rod
	01/88→12/92	Tie Rod	IV-DL-12268		
	01/88→12/92	Tie Rod End	CV-ES-14162		for Steering Rod
	01/88→12/92	Tie Rod End	CV-ES-14163		for Steering Rod
	01/88→12/92	Track Control Arm		IV-DL-8142	Trailing Arm
330-30 HW	01/88→12/92	Centre Rod	IV-DS-1914		Push Rod
	01/88→12/92	Tie Rod	DF-DL-8571		
	01/88→12/92	Tie Rod End	CV-ES-14162		for Steering Rod
	01/88→12/92	Tie Rod End	CV-ES-14163		for Steering Rod
	01/88→12/92	Track Control Arm		IV-DL-8142	Trailing Arm
330-36 H	01/89→12/92	Tie Rod	DF-DL-8571		
	01/89→12/92	Tie Rod	IV-DL-12268		
	01/89→12/92	Track Control Arm		IV-DL-8142	Trailing Arm
330-36 HT	01/89→12/92	Tie Rod	IV-DL-12268		
	01/89→12/92	Track Control Arm		IV-DL-8142	Trailing Arm
330-36 HW	01/89→12/92	Tie Rod	DF-DL-8571		
	01/89→12/92	Track Control Arm		IV-DL-8142	Trailing Arm
340-34 AH	03/89→12/92	Centre Rod	IV-DS-1914		Push Rod
	03/89→12/92	Tie Rod	IV-DL-12268		
	03/89→12/92	Tie Rod End	CV-ES-14162		for Steering Rod
	03/89→12/92	Tie Rod End	CV-ES-14163		for Steering Rod
	03/89→12/92	Tie Rod End	IV-ES-8515		
	03/89→12/92	Track Control Arm		IV-DL-8142	Trailing Arm

P/PA-Haubenfahrzeuge

150-16 AN	01/83→12/91	Tie Rod End	CV-ES-12461		for Steering Rod
	01/83→12/91	Tie Rod End	CV-ES-12462		for Steering Rod
150-16 ANW	01/83→12/91	Tie Rod	DF-DL-8571		
	01/83→12/91	Tie Rod End	CV-ES-12461		for Steering Rod
	01/83→12/91	Tie Rod End	CV-ES-12462		for Steering Rod
160-17 ANW	07/89→12/93	Tie Rod	DF-DL-8571		
	07/89→12/93	Tie Rod End	CV-ES-12461		for Steering Rod
	07/89→12/93	Tie Rod End	CV-ES-12462		for Steering Rod
160-23 ANW	04/84→05/89	Tie Rod	DF-DL-8571		
170-23 ANW	04/88→12/93	Tie Rod	DF-DL-8571		
190-25 ANW	07/83→09/90	Tie Rod	DF-DL-8571		
190-30 N	04/87→12/93	Tie Rod	IV-DL-12268		
190-30 NT	04/87→12/93	Tie Rod	IV-DL-12268		
260-25 AN	07/83→06/86	Tie Rod	IV-DL-12268		
	07/83→06/86	Track Control Arm		IV-DL-8142	Trailing Arm
260-25 ANW	07/83→06/86	Tie Rod	DF-DL-8571		
	07/83→06/86	Track Control Arm		IV-DL-8142	Trailing Arm
330-30 AN	05/86→09/90	Tie Rod	DF-DL-8571		
	05/86→09/90	Tie Rod	IV-DL-12268		
	05/86→09/90	Track Control Arm		IV-DL-8142	Trailing Arm

CV-ES-12461

Length: 120
Cone Ø: d1 Ø 26 / d2 Ø 23,5
Thread: M30 x 1,5 LHT
2980129, 002984511, 02984511, 2984511,
4833821, 004833828, 04833828, 4833828,
8122755, 42493782, 042493782



CV-ES-12462

Length: 120
Cone Ø: d1 Ø 26 / d2 Ø 23,5
Thread: M30 x 1,5 RHT
2966688, 2980323, 3096213, 4833820,
004833827, 4833827, 8122754, 42483520,
42485718, 42493781



CV-ES-14162

Length: 125
Cone Ø: d1 Ø 30 / d2 Ø 27
Thread: M30 x 1,5 LHT
2984061, 4802444, 4833830, 7138966,
8190225, 42489395, 42491957



CV-ES-14163

Length: 125
Cone Ø: d1 Ø 30 / d2 Ø 27
Thread: M30 x 1,5 RHT
2966252, 2969808, 4802443, 4833829,
7138967, 8122752, 42483386, 42488269,
42489573, 42489594, 42491638, 42537936



DF-DL-8571

Length: 1524
Ø: 60
Cone Ø: d1 Ø 30 / d2 Ø 27
2478910, 42037040, 42037041, 42100262,
42100263



IV-DL-8142

Length: 610
Ø: 50
Hole Distance: 152 / 152
41011008, 42041107



IV-DL-12268

Length: 1640
Ø: 46
Cone Ø: d1 Ø 30 / d2 Ø 27
42003432



IV-DS-1914

Length: 890
Ø: 46
Cone Ø: d1 Ø 30 / d2 Ø 27
42001325, 42001326



IV-ES-8515

Length: 86
Cone Ø: d1 Ø 38 / d2 Ø 34,3
Thread: M30 x 1,5 RHT
4143415, 42530316, 42538047,
7364001574



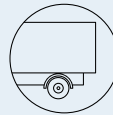

P/PA-Haubenfahrzeuge ...

330-30 ANW	05/86→09/90	Tie Rod	DF-DL-8571		
	05/86→09/90	Track Control Arm		IV-DL-8142	Trailing Arm
330-30 N	10/87→12/92	Tie Rod	IV-DL-12268		
	10/87→12/92	Track Control Arm		IV-DL-8142	Trailing Arm
330-30 NW	10/87→12/92	Tie Rod	IV-DL-12268		
	10/87→12/92	Track Control Arm		IV-DL-8142	Trailing Arm

Stralis

AD 190S27, AT 190S27	06/03→	Suspension Arm Repair Kit		DF-RK-8994	for Drag Link;For Wishbone (CV)	
	06/03→	Suspension Arm Repair Kit	DB-RK-6111	DB-RK-6111	Trailing Arm	
	06/03→	Suspension Arm Repair Kit	DB-RK-9300	DB-RK-9300	for Drag Link	
	06/03→	Suspension Strut Repair Kit		DF-RK-8637		
	06/03→	Tie Rod	IV-DL-8367		Guide Rod	
	06/03→	Tie Rod End	CV-ES-14162		for Steering Rod	
	06/03→	Tie Rod End	CV-ES-14163		for Steering Rod	
	06/03→	Tie Rod End	IV-ES-8365		for Push Rod	
	06/03→	Tie Rod End	IV-ES-12419		for Steering Rod	
	06/03→	Track Control Arm		IV-DL-8142	Trailing Arm, Drive Axle;Leave Spring Axle, for Pneumatic Suspension vehicles	
	06/03→	Track Control Arm		IV-DL-8613	Trailing Arm, Drive Axle;Air Suspension Axle	
	06/03→	Track Control Arm		IV-DL-9351	Wishbone (CV);Trailing Arm, 1st RA, for pneumatic suspension vehicles	
	06/03→	Track Control Arm		IV-VB-5228	Wishbone (CV), Drive Axle;Air Suspension Axle	
	06/03→	Track Control Arm		IV-VB-12390	Wishbone (CV), 1st RA, for Pneumatic Suspension vehicles, Ch.C217300/4353375→	
	06/03→	Track Control Arm	IV-TC-12341	IV-TC-12341	Suspension Rod, Trailing Arm, for Pneumatic Suspension vehicles	
	04/04→	Centre Rod	IV-DL-2155		Push Rod	
	04/04→	Centre Rod	IV-DL-8304		Push Rod	
	04/04→	Track Control Arm		IV-VB-5228	Wishbone (CV), Drive Axle, for Pneumatic Suspension vehicles, →Ch.C217299/4353374	
	AD 190S30	04/04→	Centre Rod	IV-DL-2155		Push Rod
		04/04→	Suspension Arm Repair Kit		DF-RK-8994	for Drag Link;For Wishbone (CV)
04/04→		Suspension Arm Repair Kit	DB-RK-6111	DB-RK-6111	Trailing Arm	
04/04→		Suspension Strut Repair Kit		DF-RK-8637		
04/04→		Tie Rod	IV-DL-8367		Guide Rod	
04/04→		Tie Rod End	CV-ES-14162		for Steering Rod	
04/04→		Tie Rod End	CV-ES-14163		for Steering Rod	
04/04→		Track Control Arm		IV-DL-8142	Trailing Arm, Drive Axle;Leave Spring Axle, for Pneumatic Suspension vehicles	
04/04→		Track Control Arm		IV-DL-8613	Trailing Arm, Drive Axle;Air Suspension Axle	
04/04→		Track Control Arm		IV-DL-9351	Wishbone (CV);Trailing Arm, 1st RA, for pneumatic suspension vehicles	
04/04→		Track Control Arm		IV-VB-5228	Wishbone (CV), Drive Axle, for Pneumatic Suspension vehicles, →Ch.C217299/4353374	
04/04→		Track Control Arm		IV-VB-12390	Wishbone (CV), 1st RA, for Pneumatic Suspension vehicles, Ch.C217300/4353375→	
AD 190S30, AD 190S31, AT 190S31		06/03→	Centre Rod	IV-DL-8304		Push Rod
	06/03→	Suspension Arm Repair Kit		DF-RK-8503	for Control Arm	
	06/03→	Suspension Arm Repair Kit	DB-RK-9300	DB-RK-9300	for Drag Link	
	06/03→	Tie Rod	IV-DL-8367		Guide Rod	
	06/03→	Tie Rod End	CV-ES-14162		for Steering Rod	
	06/03→	Tie Rod End	CV-ES-14163		for Steering Rod	
	06/03→	Tie Rod End	IV-ES-8365		for Push Rod	
	06/03→	Track Control Arm		IV-DL-8142	Trailing Arm, Drive Axle;Leave Spring Axle, for Pneumatic Suspension vehicles	
	06/03→	Track Control Arm		IV-DL-8613	Trailing Arm, Drive Axle;Air Suspension Axle	
	06/03→	Track Control Arm		IV-DL-9351	Wishbone (CV);Trailing Arm, 1st RA, for pneumatic suspension vehicles	

CV-ES-14162

Length: 125
Cone Ø: d1 Ø 30 / d2 Ø 27
Thread: M30 x 1,5 LHT
2984061, 4802444, 4833830, 7138966,
8190225, 42489395, 42491957



CV-ES-14163

Length: 125
Cone Ø: d1 Ø 30 / d2 Ø 27
Thread: M30 x 1,5 RHT
2966252, 2969808, 4802443, 4833829,
7138967, 8122752, 42483386, 42488269,
42489573, 42489594, 42491638, 42537936



DB-RK-6111



DB-RK-9300

Ø: 75
Hole Distance: 130
Thick/Height: 24
500333284



DF-DL-8571

Length: 1524
Ø: 60
Cone Ø: d1 Ø 30 / d2 Ø 27
2478910, 42037040, 42037041, 42100262,
42100263



DF-RK-8503

Ø: 75
Hole Distance: 130
Thick/Height: 24
93192361



DF-RK-8637

Ø: 72
93161958, 93162239



DF-RK-8994

Ø: 75
Hole Distance: 130
Thick/Height: 24
93161960



IV-DL-2155

Length: 953
Ø: 52
Cone Ø: d1 Ø 30 / d2 Ø 27
8131582, 41005463, 41042919



IV-DL-8142

Length: 610
Ø: 50
Hole Distance: 152 / 152
41011008, 42041107



IV-DL-8304

Length: 953
Ø: 52
Cone Ø: d1 Ø 30 / d2 Ø 27
500397738



IV-DL-8367

Length: 1620
Ø: 48
Cone Ø: d1 Ø 30 / d2 Ø 27
8163773, 41005450, 41005451, 41036943,
41036944



IV-DL-8613

Length: 594
Ø: 50
Hole Distance: 130 / 130
41009661, 41009666, 41035951, 41272429,
98472446, 98472466



IV-DL-9351

Length: 455
Ø: 50
Hole Distance: 130 / 130
41033731



IV-DL-12268

Length: 1640
Ø: 46
Cone Ø: d1 Ø 30 / d2 Ø 27
42003432



IV-ES-8365

Length: 139
Cone Ø: d1 Ø 30 / d2 Ø 27
Thread: M30 x 1,5 RHT
500309296, 500340769



IV-ES-12419

Length: 55
Cone Ø: d1 Ø 10 / d2 Ø 10
Thread: M10 x 1,5 RHT
2041327, 41002118, 41203863, 42079853



IV-TC-12341

Length: 695
Ø: 46
Hole Distance: 130 / 130
500338783



IV-VB-5228

Length: 665
Ø: 46
Hole Distance: 130 / 130
937104, 08137026, 8137026, 41002770,
41009665, 41028598, 41028600, 41034479,
41042050



IV-VB-12390

Length: 665
Ø: 48
Hole Distance: 152 / 130 / 130
41218620

No Image



Stralis ...

AD 190S30, AD 190S31, AT 190S31 ...	06/03 →	Track Control Arm		IV-TC-12341	Suspension Rod, Control Arm	
	06/03 →	Track Control Arm		IV-VB-5228	Wishbone (CV), Drive Axle; Air Suspension Axle	
	06/03 →	Track Control Arm		IV-VB-12390	Wishbone (CV), 1st RA, for Pneumatic Suspension vehicles, Ch.C217300/4353375 →	
AD 190S31, AT 190S31	04/04 →	Centre Rod	IV-DL-2155		Push Rod	
	04/04 →	Centre Rod	IV-DL-8304		Push Rod	
	04/04 →	Suspension Arm Repair Kit		DF-RK-8994	for Drag Link; For Wishbone (CV)	
	04/04 →	Suspension Arm Repair Kit	DB-RK-6111	DB-RK-6111	Trailing Arm	
	04/04 →	Suspension Arm Repair Kit	DB-RK-9300	DB-RK-9300	for Drag Link	
	04/04 →	Suspension Strut Repair Kit		DF-RK-8637		
	04/04 →	Tie Rod	IV-DL-8367		Guide Rod	
	04/04 →	Tie Rod End	CV-ES-14162		for Steering Rod	
	04/04 →	Tie Rod End	CV-ES-14163		for Steering Rod	
	04/04 →	Tie Rod End	IV-ES-8365		for Push Rod	
	04/04 →	Tie Rod End	IV-ES-12419		for Steering Rod	
	04/04 →	Track Control Arm		IV-DL-8142	Trailing Arm, Drive Axle; Leave Spring Axle, for Pneumatic Suspension vehicles	
	04/04 →	Track Control Arm		IV-DL-8613	Trailing Arm, Drive Axle; Air Suspension Axle	
	04/04 →	Track Control Arm		IV-DL-9351	Wishbone (CV); Trailing Arm, 1st RA, for pneumatic suspension vehicles	
	04/04 →	Track Control Arm		IV-VB-5228	Wishbone (CV), Drive Axle, for Pneumatic Suspension vehicles, → Ch.C217299/4353374	
	04/04 →	Track Control Arm		IV-VB-12390	Wishbone (CV), 1st RA, for Pneumatic Suspension vehicles, Ch.C217300/4353375 →	
	04/04 →	Track Control Arm	IV-TC-12341	IV-TC-12341	Suspension Rod, Trailing Arm, for Pneumatic Suspension vehicles	
	AD 190S33, AT 190S33	12/06 →	Suspension Arm Repair Kit		DF-RK-8503	for Control Arm
		12/06 →	Tie Rod	IV-DL-8367		Guide Rod
		12/06 →	Tie Rod End	CV-ES-14163		for Steering Rod
12/06 →		Tie Rod End	IV-ES-12419		for Steering Rod	
12/06 →		Track Control Arm		IV-DL-8613	Trailing Arm, Drive Axle; Air Suspension Axle	
12/06 →		Track Control Arm		IV-TC-12341	Suspension Rod, Control Arm	
12/06 →		Track Control Arm		IV-VB-5228	Wishbone (CV), Drive Axle; Air Suspension Axle	
12/06 →		Track Control Arm		IV-VB-10418	Wishbone (CV), Drive Axle; Air Suspension Axle	
05/07 →		Centre Rod	IV-DL-2155		Push Rod	
05/07 →		Centre Rod	IV-DL-8304		Push Rod	
05/07 →		Suspension Arm Repair Kit		DF-RK-8994	for Drag Link; For Wishbone (CV)	
05/07 →		Suspension Arm Repair Kit	DB-RK-6111	DB-RK-6111	Trailing Arm	
05/07 →		Suspension Arm Repair Kit	DB-RK-9300	DB-RK-9300	for Drag Link	
05/07 →		Suspension Strut Repair Kit		DF-RK-8637		
05/07 →		Tie Rod End	CV-ES-14162		for Steering Rod	
05/07 →		Tie Rod End	IV-ES-8365		for Push Rod	
05/07 →		Track Control Arm		IV-DL-8142	Trailing Arm, Drive Axle; Leave Spring Axle, for Pneumatic Suspension vehicles	
05/07 →		Track Control Arm		IV-DL-8613	Trailing Arm, 1st Drive Axle, for Pneumatic Suspension vehicles	
05/07 →		Track Control Arm		IV-DL-9351	Wishbone (CV); Trailing Arm, 1st RA, for pneumatic suspension vehicles	
05/07 →		Track Control Arm		IV-VB-5228	Wishbone (CV), Drive Axle, for Pneumatic Suspension vehicles, → Ch.C217299/4353374	
05/07 →		Track Control Arm		IV-VB-12390	Wishbone (CV), 1st RA, for Pneumatic Suspension vehicles, Ch.C217300/4353375 →	
AD 190S35		04/04 →	Centre Rod	IV-DL-2155		Push Rod
		04/04 →	Centre Rod	IV-DL-8304		Push Rod
	04/04 →	Suspension Arm Repair Kit		DF-RK-8994	for Drag Link; For Wishbone (CV)	
	04/04 →	Suspension Arm Repair Kit	DB-RK-6111	DB-RK-6111	Trailing Arm	
	04/04 →	Suspension Arm Repair Kit	DB-RK-9300	DB-RK-9300	for Drag Link	
	04/04 →	Suspension Strut Repair Kit		DF-RK-8637		

CV-ES-14162

Length: 125
Cone Ø: d1 Ø 30 / d2 Ø 27
Thread: M30 x 1,5 LHT
2984061, 4802444, 4833830, 7138966,
8190225, 42489395, 42491957



CV-ES-14163

Length: 125
Cone Ø: d1 Ø 30 / d2 Ø 27
Thread: M30 x 1,5 RHT
2966252, 2969808, 4802443, 4833829,
7138967, 8122752, 42483386, 42488269,
42489573, 42489594, 42491638, 42537936



DB-RK-6111



DB-RK-9300

Ø: 75
Hole Distance: 130
Thick/Height: 24
500333284



DF-RK-8503

Ø: 75
Hole Distance: 130
Thick/Height: 24
93192361



DF-RK-8637

Ø: 72
93161958, 93162239



DF-RK-8994

Ø: 75
Hole Distance: 130
Thick/Height: 24
93161960



IV-DL-2155

Length: 953
Ø: 52
Cone Ø: d1 Ø 30 / d2 Ø 27
8131582, 41005463, 41042919



IV-DL-8142

Length: 610
Ø: 50
Hole Distance: 152 / 152
41011008, 42041107



IV-DL-8304

Length: 953
Ø: 52
Cone Ø: d1 Ø 30 / d2 Ø 27
500397738



IV-DL-8367

Length: 1620
Ø: 48
Cone Ø: d1 Ø 30 / d2 Ø 27
8163773, 41005450, 41005451, 41036943,
41036944



IV-DL-8613

Length: 594
Ø: 50
Hole Distance: 130 / 130
41009661, 41009666, 41035951, 41272429,
98472446, 98472466



IV-DL-9351

Length: 455
Ø: 50
Hole Distance: 130 / 130
41033731



IV-ES-8365

Length: 139
Cone Ø: d1 Ø 30 / d2 Ø 27
Thread: M30 x 1,5 RHT
500309296, 500340769



IV-ES-12419

Length: 55
Cone Ø: d1 Ø 10 / d2 Ø 10
Thread: M10 x 1,5 RHT
2041327, 41002118, 41203863, 42079853



IV-TC-12341

Length: 695
Ø: 46
Hole Distance: 130 / 130
500338783



IV-VB-5228

Length: 665
Ø: 46
Hole Distance: 130 / 130
937104, 08137026, 8137026, 41002770,
41009665, 41028598, 41028600, 41034479,
41042050



IV-VB-10418

Length: 665
Ø: 46
Hole Distance: 130 / 130
41042093, 500340451



IV-VB-12390

Length: 665
Ø: 48
Hole Distance: 152 / 130 / 130
41218620

No Image



Stralis ...

AD 190S35 ...	04/04 →	Tie Rod	IV-DL-8367		Guide Rod
	04/04 →	Tie Rod End	CV-ES-14162		for Steering Rod
	04/04 →	Tie Rod End	CV-ES-14163		for Steering Rod
	04/04 →	Tie Rod End	IV-ES-8365		for Push Rod
	04/04 →	Tie Rod End	IV-ES-12419		for Steering Rod
	04/04 →	Track Control Arm		IV-DL-8142	Trailing Arm, Drive Axle;Leave Spring Axle, for Pneumatic Suspension vehicles
	04/04 →	Track Control Arm		IV-DL-8613	Trailing Arm, Drive Axle;Air Suspension Axle
	04/04 →	Track Control Arm		IV-DL-9351	Wishbone (CV);Trailing Arm, 1st RA, for pneumatic suspension vehicles
	04/04 →	Track Control Arm		IV-VB-5228	Wishbone (CV), Drive Axle, for Pneumatic Suspension vehicles, →Ch.C217299/4353374
	04/04 →	Track Control Arm		IV-VB-12390	Wishbone (CV), 1st RA, for Pneumatic Suspension vehicles, Ch.C217300/4353375 →
AD 190S35, AT 190S35, AD 190S36, AT 190S36	06/03 →	Centre Rod	IV-DL-8304		Push Rod, Air Suspension Axle
	06/03 →	Suspension Arm Repair Kit		DF-RK-8503	for Control Arm
	06/03 →	Suspension Arm Repair Kit	DB-RK-9300	DB-RK-9300	for Drag Link
	06/03 →	Tie Rod	IV-DL-8367		Guide Rod
	06/03 →	Tie Rod End	CV-ES-14162		for Steering Rod
	06/03 →	Tie Rod End	CV-ES-14163		for Steering Rod
	06/03 →	Tie Rod End	IV-ES-8365		for Push Rod
	06/03 →	Tie Rod End	IV-ES-12419		for Steering Rod
	06/03 →	Track Control Arm		IV-DL-8142	Trailing Arm, Drive Axle;Leave Spring Axle, for Pneumatic Suspension vehicles
	06/03 →	Track Control Arm		IV-DL-8613	Trailing Arm, Drive Axle;Air Suspension Axle
	06/03 →	Track Control Arm		IV-DL-9351	Wishbone (CV);Trailing Arm, 1st RA, for pneumatic suspension vehicles
	06/03 →	Track Control Arm		IV-TC-12341	Suspension Rod, Control Arm
	06/03 →	Track Control Arm		IV-VB-5228	Wishbone (CV), Drive Axle;Air Suspension Axle
	06/03 →	Track Control Arm		IV-VB-10418	Wishbone (CV), Drive Axle;Air Suspension Axle
	06/03 →	Track Control Arm		IV-VB-12390	Wishbone (CV), 1st RA, for Pneumatic Suspension vehicles, Ch.C217300/4353375 →
	AD 190S36, AT 190S36	05/07 →	Centre Rod	IV-DL-2155	
05/07 →		Centre Rod	IV-DL-8304		Push Rod
05/07 →		Suspension Arm Repair Kit		DF-RK-8994	for Drag Link;For Wishbone (CV)
05/07 →		Suspension Arm Repair Kit	DB-RK-6111	DB-RK-6111	Trailing Arm
05/07 →		Suspension Arm Repair Kit	DB-RK-9300	DB-RK-9300	for Drag Link
05/07 →		Suspension Strut Repair Kit		DF-RK-8637	
05/07 →		Tie Rod	IV-DL-8367		Guide Rod
05/07 →		Tie Rod End	CV-ES-14162		for Steering Rod
05/07 →		Tie Rod End	CV-ES-14163		for Steering Rod
05/07 →		Tie Rod End	IV-ES-8365		for Push Rod
05/07 →		Tie Rod End	IV-ES-12419		for Steering Rod
05/07 →		Track Control Arm		IV-DL-8142	Trailing Arm, Drive Axle;Leave Spring Axle, for Pneumatic Suspension vehicles
05/07 →		Track Control Arm		IV-DL-8613	Trailing Arm, Drive Axle;Air Suspension Axle
05/07 →		Track Control Arm		IV-DL-9351	Wishbone (CV);Trailing Arm, 1st RA, for pneumatic suspension vehicles
05/07 →		Track Control Arm		IV-VB-5228	Wishbone (CV), Drive Axle, for Pneumatic Suspension vehicles, →Ch.C217299/4353374
05/07 →		Track Control Arm		IV-VB-12390	Wishbone (CV), 1st RA, for Pneumatic Suspension vehicles, Ch.C217300/4353375 →
05/07 →	Track Control Arm	IV-TC-12341	IV-TC-12341	Suspension Rod, Trailing Arm, for Pneumatic Suspension vehicles	

CV-ES-14162

Length: 125
Cone Ø: d1 Ø 30 / d2 Ø 27
Thread: M30 x 1,5 LHT
2984061, 4802444, 4833830, 7138966,
8190225, 42489395, 42491957



DF-RK-8994

Ø: 75
Hole Distance: 130
Thick/Height: 24
93161960



IV-DL-9351

Length: 455
Ø: 50
Hole Distance: 130 / 130
41033731



IV-VB-12390

Length: 665
Ø: 48
Hole Distance: 152 / 130 / 130
41218620

No Image

CV-ES-14163

Length: 125
Cone Ø: d1 Ø 30 / d2 Ø 27
Thread: M30 x 1,5 RHT
2966252, 2969808, 4802443, 4833829,
7138967, 8122752, 42483386, 42488269,
42489573, 42489594, 42491638, 42537936



IV-DL-2155

Length: 953
Ø: 52
Cone Ø: d1 Ø 30 / d2 Ø 27
8131582, 41005463, 41042919



IV-ES-8365

Length: 139
Cone Ø: d1 Ø 30 / d2 Ø 27
Thread: M30 x 1,5 RHT
500309296, 500340769



DB-RK-6111



IV-DL-8142

Length: 610
Ø: 50
Hole Distance: 152 / 152
41011008, 42041107



IV-ES-12419

Length: 55
Cone Ø: d1 Ø 10 / d2 Ø 10
Thread: M10 x 1,5 RHT
2041327, 41002118, 41203863, 42079853



DB-RK-9300

Ø: 75
Hole Distance: 130
Thick/Height: 24
500333284

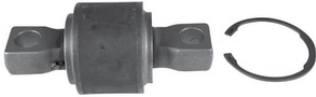

IV-DL-8304

Length: 953
Ø: 52
Cone Ø: d1 Ø 30 / d2 Ø 27
500397738



IV-TC-12341

Length: 695
Ø: 46
Hole Distance: 130 / 130
500338783



DF-RK-8503

Ø: 75
Hole Distance: 130
Thick/Height: 24
93192361



IV-DL-8367

Length: 1620
Ø: 48
Cone Ø: d1 Ø 30 / d2 Ø 27
8163773, 41005450, 41005451, 41036943,
41036944



IV-VB-5228

Length: 665
Ø: 46
Hole Distance: 130 / 130
937104, 08137026, 8137026, 41002770,
41009665, 41028598, 41028600, 41034479,
41042050



DF-RK-8637

Ø: 72
93161958, 93162239



IV-DL-8613

Length: 594
Ø: 50
Hole Distance: 130 / 130
41009661, 41009666, 41035951, 41272429,
98472446, 98472466



IV-VB-10418

Length: 665
Ø: 46
Hole Distance: 130 / 130
41042093, 500340451





Stralis ...

AD 190S40, AT 190S40	03/03→	Centre Rod	IV-DL-8304		Push Rod
	03/03→	Suspension Arm Repair Kit		DF-RK-8503	for Control Arm
	03/03→	Suspension Arm Repair Kit	DB-RK-9300	DB-RK-9300	for Drag Link
	03/03→	Tie Rod	IV-DL-8367		Guide Rod
	03/03→	Tie Rod End	CV-ES-14162		for Steering Rod
	03/03→	Tie Rod End	CV-ES-14163		for Steering Rod
	03/03→	Tie Rod End	IV-ES-12419		for Steering Rod
	03/03→	Track Control Arm		IV-DL-8142	Trailing Arm, Drive Axle;Leave Spring Axle, for Pneumatic Suspension vehicles
	03/03→	Track Control Arm		IV-DL-8613	Trailing Arm, Drive Axle;Air Suspension Axle
	03/03→	Track Control Arm		IV-DL-9351	Wishbone (CV);Trailing Arm, 1st RA, for pneumatic suspension vehicles
	03/03→	Track Control Arm		IV-VB-5228	Wishbone (CV), Drive Axle;Air Suspension Axle
	03/03→	Track Control Arm		IV-VB-12390	Wishbone (CV), 1st RA, for Pneumatic Suspension vehicles, Ch.C217300/4353375→
	03/03→	Track Control Arm	IV-TC-12341	IV-TC-12341	Suspension Rod, Trailing Arm, for Pneumatic Suspension vehicles
	AD 190S42, AT 190S42, AS 190S42	07/06→	Centre Rod	IV-DL-8304	
07/06→		Suspension Arm Repair Kit		DF-RK-8503	for Control Arm
07/06→		Tie Rod	IV-DL-8367		Guide Rod
07/06→		Tie Rod End	IV-ES-12419		for Steering Rod
07/06→		Track Control Arm		IV-DL-8613	Trailing Arm, Drive Axle;Air Suspension Axle
07/06→		Track Control Arm		IV-TC-12341	Suspension Rod, Control Arm
07/06→		Track Control Arm		IV-VB-5228	Wishbone (CV), Drive Axle;Air Suspension Axle
AD 190S43, AT 190S43	06/03→	Centre Rod	IV-DL-8304		Push Rod
	06/03→	Suspension Arm Repair Kit		DF-RK-8503	for Control Arm
	06/03→	Suspension Arm Repair Kit	DB-RK-9300	DB-RK-9300	for Drag Link
	06/03→	Tie Rod	IV-DL-8367		Guide Rod
	06/03→	Tie Rod End	CV-ES-14162		for Steering Rod
	06/03→	Tie Rod End	CV-ES-14163		for Steering Rod
	06/03→	Tie Rod End	IV-ES-12419		for Steering Rod
	06/03→	Track Control Arm		IV-DL-8142	Trailing Arm, Drive Axle;Leave Spring Axle, for Pneumatic Suspension vehicles
	06/03→	Track Control Arm		IV-DL-8613	Trailing Arm, Drive Axle;Air Suspension Axle
	06/03→	Track Control Arm		IV-DL-9351	Wishbone (CV);Trailing Arm, 1st RA, for pneumatic suspension vehicles
	06/03→	Track Control Arm		IV-VB-5228	Wishbone (CV), Drive Axle;Air Suspension Axle
	06/03→	Track Control Arm		IV-VB-12390	Wishbone (CV), 1st RA, for Pneumatic Suspension vehicles, Ch.C217300/4353375→
	06/03→	Track Control Arm	IV-TC-12341	IV-TC-12341	Suspension Rod, Trailing Arm, for Pneumatic Suspension vehicles
	AD 190S45, AT 190S45	12/06→	Centre Rod	IV-DL-8304	
12/06→		Suspension Arm Repair Kit		DF-RK-8503	for Control Arm
12/06→		Suspension Arm Repair Kit	DB-RK-9300	DB-RK-9300	for Drag Link
12/06→		Tie Rod	IV-DL-8367		Guide Rod
12/06→		Tie Rod End	CV-ES-14162		for Steering Rod
12/06→		Tie Rod End	CV-ES-14163		for Steering Rod
12/06→		Tie Rod End	IV-ES-8365		for Push Rod
12/06→		Tie Rod End	IV-ES-12419		for Steering Rod
12/06→		Track Control Arm		IV-DL-8613	Trailing Arm, Drive Axle;Air Suspension Axle
12/06→		Track Control Arm		IV-DL-9351	Wishbone (CV);Trailing Arm, 1st RA, for pneumatic suspension vehicles
12/06→		Track Control Arm		IV-TC-12341	Suspension Rod, Control Arm
12/06→		Track Control Arm		IV-VB-5228	Wishbone (CV), Drive Axle;Air Suspension Axle
12/06→		Track Control Arm		IV-VB-10418	Wishbone (CV), Drive Axle;Air Suspension Axle
12/06→		Track Control Arm		IV-VB-12390	Wishbone (CV), 1st RA, for Pneumatic Suspension vehicles, Ch.C217300/4353375→

CV-ES-14162

Length: 125
Cone Ø: d1 Ø 30 / d2 Ø 27
Thread: M30 x 1,5 LHT
2984061, 4802444, 4833830, 7138966,
8190225, 42489395, 42491957



CV-ES-14163

Length: 125
Cone Ø: d1 Ø 30 / d2 Ø 27
Thread: M30 x 1,5 RHT
2966252, 2969808, 4802443, 4833829,
7138967, 8122752, 42483386, 42488269,
42489573, 42489594, 42491638, 42537936



DB-RK-9300

Ø: 75
Hole Distance: 130
Thick/Height: 24
500333284

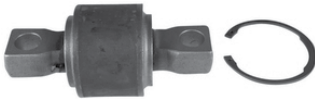

DF-RK-8503

Ø: 75
Hole Distance: 130
Thick/Height: 24
93192361



IV-DL-8142

Length: 610
Ø: 50
Hole Distance: 152 / 152
41011008, 42041107



IV-DL-8304

Length: 953
Ø: 52
Cone Ø: d1 Ø 30 / d2 Ø 27
500397738



IV-DL-8367

Length: 1620
Ø: 48
Cone Ø: d1 Ø 30 / d2 Ø 27
8163773, 41005450, 41005451, 41036943,
41036944



IV-DL-8613

Length: 594
Ø: 50
Hole Distance: 130 / 130
41009661, 41009666, 41035951, 41272429,
98472446, 98472466



IV-DL-9351

Length: 455
Ø: 50
Hole Distance: 130 / 130
41033731



IV-ES-8365

Length: 139
Cone Ø: d1 Ø 30 / d2 Ø 27
Thread: M30 x 1,5 RHT
500309296, 500340769



IV-ES-12419

Length: 55
Cone Ø: d1 Ø 10 / d2 Ø 10
Thread: M10 x 1,5 RHT
2041327, 41002118, 41203863, 42079853



IV-TC-12341

Length: 695
Ø: 46
Hole Distance: 130 / 130
500338783



IV-VB-5228

Length: 665
Ø: 46
Hole Distance: 130 / 130
937104, 08137026, 8137026, 41002770,
41009665, 41028598, 41028600, 41034479,
41042050



IV-VB-10418

Length: 665
Ø: 46
Hole Distance: 130 / 130
41042093, 500340451



IV-VB-12390

Length: 665
Ø: 48
Hole Distance: 152 / 130 / 130
41218620

No Image



Stralis ...

AD 260S27 CNG, AT 260S27 CNG	01/08→	Suspension Arm Repair Kit		DF-RK-8994	for Drag Link;For Wishbone (CV)
	01/08→	Suspension Strut Repair Kit		DF-RK-8637	
	01/08→	Tie Rod		IV-DL-9361	Guide Rod, Tag Axle;for vehicles with Hinged Trailing Axle
	01/08→	Tie Rod	IV-DL-8367		Guide Rod
	01/08→	Tie Rod End		CV-ES-2146	for vehicles with Hinged Trailing Axle
	01/08→	Tie Rod End		MN-ES-8490	for vehicles with Hinged Trailing Axle
	01/08→	Tie Rod End	CV-ES-14162	CV-ES-14162	for Steering Rod
	01/08→	Tie Rod End	CV-ES-14163		for Steering Rod
	01/08→	Tie Rod End	IV-ES-12272		for Steering Rod
	01/08→	Track Control Arm		IV-DL-8613	Trailing Arm, 1st Drive Axle, for Pneumatic Suspension vehicles
	01/08→	Track Control Arm		IV-TC-12431	Trailing Arm
	01/08→	Track Control Arm		IV-VB-5228	Wishbone (CV), Drive Axle;Air Suspension Axle
	AD 260S27, AT 260S27	04/04→	Centre Rod	IV-DL-2155	
04/04→		Suspension Arm Repair Kit		DF-RK-8994	for Drag Link;For Wishbone (CV)
04/04→		Suspension Arm Repair Kit	DB-RK-9300	DB-RK-9300	for Drag Link
04/04→		Suspension Strut Repair Kit		DF-RK-8637	
04/04→		Tie Rod		IV-DL-9361	Guide Rod
04/04→		Tie Rod	IV-DL-8367		Guide Rod
04/04→		Tie Rod End	CV-ES-14162	CV-ES-14162	for Steering Rod
04/04→		Tie Rod End	CV-ES-14163		for Steering Rod
04/04→		Tie Rod End	IV-ES-12419		for Steering Rod
04/04→		Track Control Arm		IV-DL-8613	Trailing Arm, Drive Axle;Air Suspension Axle
04/04→		Track Control Arm		IV-VB-5228	Wishbone (CV), Drive Axle, for Pneumatic Suspension vehicles, →Ch.C217187/4353599
04/04→		Track Control Arm	IV-TC-12341	IV-TC-12341	Suspension Rod, Trailing Arm, for Pneumatic Suspension vehicles
AD 260S30, AT 260S30		04/04→	Tie Rod		IV-DL-9361
	04/04→	Tie Rod	IV-DL-8367		Guide Rod
	04/04→	Tie Rod End		CV-ES-2146	for vehicles with Hinged Trailing Axle
	04/04→	Tie Rod End		MN-ES-8490	for vehicles with Hinged Trailing Axle
	04/04→	Tie Rod End	CV-ES-14163		for Steering Rod
	04/04→	Track Control Arm		IV-DL-8613	Trailing Arm, Drive Axle;Air Suspension Axle
	04/04→	Track Control Arm		IV-TC-12431	Trailing Arm
	04/04→	Track Control Arm		IV-VB-5228	Wishbone (CV), Drive Axle;Air Suspension Axle
	04/04→	Track Control Arm		IV-VB-5228	Wishbone (CV), Tag Axle;Air Suspension Axle
	10/05→	Suspension Arm Repair Kit		DF-RK-8994	for Drag Link;For Wishbone (CV)
	10/05→	Suspension Strut Repair Kit		DF-RK-8637	
	10/05→	Tie Rod End	CV-ES-14162	CV-ES-14162	for Steering Rod
	10/05→	Tie Rod End	IV-ES-12272		for Steering Rod
AD 260S31, AT 260S31	06/03→	Centre Rod	IV-DL-8304		Push Rod, Air Suspension Axle
	06/03→	Suspension Arm Repair Kit		DF-RK-8994	for Drag Link;For Wishbone (CV)
	06/03→	Suspension Arm Repair Kit	DB-RK-6111	DB-RK-6111	Trailing Arm
	06/03→	Suspension Arm Repair Kit	DB-RK-9300	DB-RK-9300	for Drag Link
	06/03→	Suspension Strut Repair Kit		DF-RK-8637	
	06/03→	Tie Rod	IV-DL-8367		Guide Rod
	06/03→	Tie Rod	IV-DL-12266		
	06/03→	Tie Rod	IV-DL-12385		
	06/03→	Tie Rod End		IV-ES-8515	not for vehicles with Hinged Leading Axle
	06/03→	Tie Rod End	CV-ES-14162	CV-ES-14162	for Steering Rod
	06/03→	Tie Rod End	CV-ES-14163		for Steering Rod
	06/03→	Tie Rod End	IV-ES-8365		for Push Rod
	06/03→	Tie Rod End	IV-ES-12419		for Steering Rod
06/03→	Track Control Arm		IV-DL-8142	Trailing Arm, Drive Axle;Leave Spring Axle, for Pneumatic Suspension vehicles	
06/03→	Track Control Arm		IV-DL-8613	Trailing Arm, Drive Axle;Air Suspension Axle	
06/03→	Track Control Arm		IV-TC-12341	Suspension Rod, Control Arm	
06/03→	Track Control Arm		IV-TC-12431	Trailing Arm	
06/03→	Track Control Arm		IV-VB-5228	Wishbone (CV), Drive Axle;Air Suspension Axle	

CV-ES-2146

Length: 80
Cone Ø: d1 Ø 30 / d2 Ø 27
Thread: M26 x 1,5 RHT
42533102



DF-RK-8994

Ø: 75
Hole Distance: 130
Thick/Height: 24
93161960



IV-DL-9361

Length: 1477
Ø: 48
Cone Ø: d1 Ø 30 / d2 Ø 27
41032608, 41033237



IV-ES-12419

Length: 55
Cone Ø: d1 Ø 10 / d2 Ø 10
Thread: M10 x 1,5 RHT
2041327, 41002118, 41203863, 42079853



CV-ES-14162

Length: 125
Cone Ø: d1 Ø 30 / d2 Ø 27
Thread: M30 x 1,5 LHT
2984061, 4802444, 4833830, 7138966,
8190225, 42489395, 42491957



IV-DL-2155

Length: 953
Ø: 52
Cone Ø: d1 Ø 30 / d2 Ø 27
8131582, 41005463, 41042919



IV-DL-12266

Length: 1315
Ø: 50
Cone Ø: d1 Ø 30 / d2 Ø 27
41296162



IV-TC-12341

Length: 695
Ø: 46
Hole Distance: 130 / 130
500338783



CV-ES-14163

Length: 125
Cone Ø: d1 Ø 30 / d2 Ø 27
Thread: M30 x 1,5 RHT
2966252, 2969808, 4802443, 4833829,
7138967, 8122752, 42483386, 42488269,
42489573, 42489594, 42491638, 42537936



IV-DL-8142

Length: 610
Ø: 50
Hole Distance: 152 / 152
41011008, 42041107



IV-DL-12385

Length: 1385
Ø: 58
Cone Ø: d1 Ø 30 / d2 Ø 27
41042749



IV-TC-12431

Length: 594
Ø: 40
Hole Distance: 130 / 130
8137027



DB-RK-6111



IV-DL-8304

Length: 953
Ø: 52
Cone Ø: d1 Ø 30 / d2 Ø 27
500397738



IV-ES-8365

Length: 139
Cone Ø: d1 Ø 30 / d2 Ø 27
Thread: M30 x 1,5 RHT
500309296, 500340769



IV-VB-5228

Length: 665
Ø: 46
Hole Distance: 130 / 130
937104, 08137026, 8137026, 41002770,
41009665, 41028598, 41028600, 41034479,
41042050



DB-RK-9300

Ø: 75
Hole Distance: 130
Thick/Height: 24
500333284



IV-DL-8367

Length: 1620
Ø: 48
Cone Ø: d1 Ø 30 / d2 Ø 27
8163773, 41005450, 41005451, 41036943,
41036944



IV-ES-8515

Length: 86
Cone Ø: d1 Ø 38 / d2 Ø 34,3
Thread: M30 x 1,5 RHT
4143415, 42530316, 42538047,
7364001574



MN-ES-8490

Length: 90
Cone Ø: d1 Ø 30 / d2 Ø 27
Thread: M26 x 1,5 RHT
0014606948, 14606948, 42533101



DF-RK-8637

Ø: 72
93161958, 93162239



IV-DL-8613

Length: 594
Ø: 50
Hole Distance: 130 / 130
41009661, 41009666, 41035951, 41272429,
98472446, 98472466



IV-ES-12272

Length: 75
Cone Ø: d1 Ø 30 / d2 Ø 27
Thread: M26 x 1,5 RHT
42533073





Stralis ...

AD 260S31, AT 260S31 ...	06/03→	Track Control Arm		IV-VB-5228	Wishbone (CV), Tag Axle;Air Suspension Axle	
	04/04→	Tie Rod		IV-DL-9361	Guide Rod, Tag Axle;for vehicles with Hinged Trailing Axle	
	04/04→	Tie Rod End		CV-ES-2146	not for vehicles with Hinged Leading Axle; for vehicles with Hinged Trailing Axle	
	04/04→	Tie Rod End		MN-ES-8490	not for vehicles with Hinged Leading Axle; for vehicles with Hinged Trailing Axle	
	04/04→	Tie Rod End	IV-ES-12272		for Steering Rod	
AD 260S33, AT 260S33	12/06→	Centre Rod	IV-DL-8304		Push Rod, Air Suspension Axle	
	12/06→	Suspension Arm Repair Kit		DF-RK-8503	for Control Arm	
	12/06→	Suspension Arm Repair Kit		DF-RK-8994	for Drag Link;For Wishbone (CV)	
	12/06→	Suspension Arm Repair Kit	DB-RK-9300	DB-RK-9300	for Drag Link	
	12/06→	Suspension Strut Repair Kit		DF-RK-8637		
	12/06→	Tie Rod		IV-DL-9361	Guide Rod, Tag Axle;for vehicles with Hinged Trailing Axle	
	12/06→	Tie Rod	IV-DL-8367		Guide Rod	
	12/06→	Tie Rod End		CV-ES-2146	for vehicles with Hinged Trailing Axle	
	12/06→	Tie Rod End		MN-ES-8490	for vehicles with Hinged Trailing Axle	
	12/06→	Tie Rod End	CV-ES-14162		for Steering Rod	
	12/06→	Tie Rod End	CV-ES-14162	CV-ES-14162	for Steering Rod	
	12/06→	Tie Rod End	CV-ES-14163		for Steering Rod	
	12/06→	Tie Rod End	IV-ES-8365		for Push Rod	
	12/06→	Tie Rod End	IV-ES-12272		for Steering Rod	
	12/06→	Tie Rod End	IV-ES-12419		for Steering Rod	
	12/06→	Track Control Arm		IV-DL-8142	Trailing Arm	
	12/06→	Track Control Arm		IV-DL-8613	Trailing Arm, Drive Axle;Air Suspension Axle	
	12/06→	Track Control Arm		IV-TC-12341	Suspension Rod, Control Arm	
	12/06→	Track Control Arm		IV-TC-12431	Trailing Arm	
	12/06→	Track Control Arm		IV-VB-5228	Wishbone (CV), Drive Axle;Air Suspension Axle	
	12/06→	Track Control Arm		IV-VB-5228	Wishbone (CV), Tag Axle;Air Suspension Axle	
	06/07→	Suspension Arm Repair Kit	DB-RK-6111	DB-RK-6111	Trailing Arm	
	06/07→	Track Control Arm		IV-DL-8142	Trailing Arm, Drive Axle;Leave Spring Axle, for Pneumatic Suspension vehicles	
	AD 260S35	04/04→	Tie Rod		IV-DL-9361	Guide Rod, Tag Axle;for vehicles with Hinged Trailing Axle
		04/04→	Tie Rod	IV-DL-8367		Guide Rod
		04/04→	Tie Rod End		CV-ES-2146	for vehicles with Hinged Trailing Axle
		04/04→	Tie Rod End		MN-ES-8490	for vehicles with Hinged Trailing Axle
04/04→		Tie Rod End	IV-ES-12419		for Steering Rod	
04/04→		Track Control Arm		IV-DL-8613	Trailing Arm, Drive Axle;Air Suspension Axle	
04/04→		Track Control Arm		IV-TC-12431	Trailing Arm	
04/04→		Track Control Arm		IV-VB-10418	Wishbone (CV), Drive Axle;Air Suspension Axle	
AD 260S35, AT 260S35, AD 260S36, AT 260S36	06/03→	Centre Rod	IV-DL-8304		Push Rod, Air Suspension Axle	
	06/03→	Suspension Arm Repair Kit		DF-RK-8994	for Drag Link;For Wishbone (CV)	
	06/03→	Suspension Arm Repair Kit	DB-RK-9300	DB-RK-9300	for Drag Link	
	06/03→	Suspension Strut Repair Kit		DF-RK-8637		
	06/03→	Tie Rod		IV-DL-9361	Guide Rod, Tag Axle;for vehicles with Hinged Trailing Axle	
	06/03→	Tie Rod	IV-DL-8367		Guide Rod	
	06/03→	Tie Rod End		CV-ES-2146	for vehicles with Hinged Trailing Axle	
	06/03→	Tie Rod End		MN-ES-8490	for vehicles with Hinged Trailing Axle	
	06/03→	Tie Rod End	CV-ES-14162	CV-ES-14162	for Steering Rod	
	06/03→	Tie Rod End	CV-ES-14163		for Steering Rod	
	06/03→	Tie Rod End	IV-ES-12272		for Steering Rod	
	06/03→	Tie Rod End	IV-ES-12419		for Steering Rod	
	06/03→	Track Control Arm		IV-DL-8613	Trailing Arm, Drive Axle;Air Suspension Axle	
	06/03→	Track Control Arm		IV-TC-12341	Suspension Rod, Control Arm	
	06/03→	Track Control Arm		IV-TC-12431	Trailing Arm	
	06/03→	Track Control Arm		IV-VB-5228	Wishbone (CV), Drive Axle;Air Suspension Axle	
	06/03→	Track Control Arm		IV-VB-5228	Wishbone (CV), Tag Axle;Air Suspension Axle	
	06/03→	Track Control Arm		IV-VB-10418	Wishbone (CV), Drive Axle;Air Suspension Axle	
	06/03→	Track Control Arm		IV-VB-10418	Wishbone (CV), Tag Axle;Air Suspension Axle	

CV-ES-2146

Length: 80
Cone Ø: d1 Ø 30 / d2 Ø 27
Thread: M26 x 1,5 RHT
42533102



DF-RK-8637

Ø: 72
93161958, 93162239



IV-DL-9361

Length: 1477
Ø: 48
Cone Ø: d1 Ø 30 / d2 Ø 27
41032608, 41033237



IV-VB-5228

Length: 665
Ø: 46
Hole Distance: 130 / 130
937104, 08137026, 8137026, 41002770,
41009665, 41028598, 41028600, 41034479,
41042050



CV-ES-14162

Length: 125
Cone Ø: d1 Ø 30 / d2 Ø 27
Thread: M30 x 1,5 LHT
2984061, 4802444, 4833830, 7138966,
8190225, 42489395, 42491957



DF-RK-8994

Ø: 75
Hole Distance: 130
Thick/Height: 24
93161960



IV-ES-8365

Length: 139
Cone Ø: d1 Ø 30 / d2 Ø 27
Thread: M30 x 1,5 RHT
500309296, 500340769



IV-VB-10418

Length: 665
Ø: 46
Hole Distance: 130 / 130
41042093, 500340451



CV-ES-14163

Length: 125
Cone Ø: d1 Ø 30 / d2 Ø 27
Thread: M30 x 1,5 RHT
2966252, 2969808, 4802443, 4833829,
7138967, 8122752, 42483386, 42488269,
42489573, 42489594, 42491638, 42537936



IV-DL-8142

Length: 610
Ø: 50
Hole Distance: 152 / 152
41011008, 42041107



IV-ES-12272

Length: 75
Cone Ø: d1 Ø 30 / d2 Ø 27
Thread: M26 x 1,5 RHT
42533073



MN-ES-8490

Length: 90
Cone Ø: d1 Ø 30 / d2 Ø 27
Thread: M26 x 1,5 RHT
0014606948, 14606948, 42533101



DB-RK-6111



IV-DL-8304

Length: 953
Ø: 52
Cone Ø: d1 Ø 30 / d2 Ø 27
500397738



IV-ES-12419

Length: 55
Cone Ø: d1 Ø 10 / d2 Ø 10
Thread: M10 x 1,5 RHT
2041327, 41002118, 41203863, 42079853



DB-RK-9300

Ø: 75
Hole Distance: 130
Thick/Height: 24
500333284



IV-DL-8367

Length: 1620
Ø: 48
Cone Ø: d1 Ø 30 / d2 Ø 27
8163773, 41005450, 41005451, 41036943,
41036944



IV-TC-12341

Length: 695
Ø: 46
Hole Distance: 130 / 130
500338783



DF-RK-8503

Ø: 75
Hole Distance: 130
Thick/Height: 24
93192361



IV-DL-8613

Length: 594
Ø: 50
Hole Distance: 130 / 130
41009661, 41009666, 41035951, 41272429,
98472446, 98472466



IV-TC-12431

Length: 594
Ø: 40
Hole Distance: 130 / 130
8137027





Stralis ...

AD 260S36, AT 260S36	07/07→	Centre Rod	IV-DL-8304		Push Rod, Air Suspension Axle	
	07/07→	Suspension Arm Repair Kit		DF-RK-8994	for Drag Link;For Wishbone (CV)	
	07/07→	Suspension Arm Repair Kit	DB-RK-6111	DB-RK-6111	Trailing Arm	
	07/07→	Suspension Arm Repair Kit	DB-RK-9300	DB-RK-9300	for Drag Link	
	07/07→	Suspension Strut Repair Kit		DF-RK-8637		
	07/07→	Tie Rod		IV-DL-9361	Guide Rod, Tag Axle;for vehicles with Hinged Trailing Axle	
	07/07→	Tie Rod	IV-DL-8367		Guide Rod	
	07/07→	Tie Rod End		CV-ES-2146	for vehicles with Hinged Trailing Axle	
	07/07→	Tie Rod End		MN-ES-8490	for vehicles with Hinged Trailing Axle	
	07/07→	Tie Rod End	CV-ES-14162	CV-ES-14162	for Steering Rod	
	07/07→	Tie Rod End	CV-ES-14163		for Steering Rod	
	07/07→	Tie Rod End	IV-ES-8365		for Push Rod	
	07/07→	Tie Rod End	IV-ES-12272		for Steering Rod	
	07/07→	Tie Rod End	IV-ES-12419		for Steering Rod	
	07/07→	Track Control Arm		IV-DL-8142	Trailing Arm, Drive Axle;Leave Spring Axle, for Pneumatic Suspension vehicles	
	07/07→	Track Control Arm		IV-DL-8613	Trailing Arm, Drive Axle;Air Suspension Axle	
	07/07→	Track Control Arm		IV-TC-12341	Suspension Rod, Control Arm	
	07/07→	Track Control Arm		IV-TC-12431	Trailing Arm	
	AD 260S40, AT 260S40	07/07→	Track Control Arm		IV-VB-5228	Wishbone (CV), Drive Axle;Air Suspension Axle
		07/07→	Track Control Arm		IV-VB-5228	Wishbone (CV), Tag Axle;Air Suspension Axle
06/03→		Centre Rod	IV-DL-8304		Push Rod, Air Suspension Axle	
06/03→		Suspension Arm Repair Kit		DF-RK-8994	for Drag Link;For Wishbone (CV)	
06/03→		Suspension Arm Repair Kit	DB-RK-9300	DB-RK-9300	for Drag Link	
06/03→		Suspension Strut Repair Kit		DF-RK-8637		
06/03→		Tie Rod		IV-DL-9361	Guide Rod, Tag Axle;for vehicles with Hinged Trailing Axle	
06/03→		Tie Rod	IV-DL-8367		Guide Rod	
06/03→		Tie Rod End		CV-ES-2146	for vehicles with Hinged Trailing Axle	
06/03→		Tie Rod End		MN-ES-8490	for vehicles with Hinged Trailing Axle	
06/03→		Tie Rod End	CV-ES-14162	CV-ES-14162	for Steering Rod	
06/03→		Tie Rod End	CV-ES-14163		for Steering Rod	
06/03→		Tie Rod End	IV-ES-12272		for Steering Rod	
06/03→		Tie Rod End	IV-ES-12419		for Steering Rod	
06/03→		Track Control Arm		IV-DL-8613	Trailing Arm, Drive Axle;Air Suspension Axle	
06/03→		Track Control Arm		IV-TC-12341	Suspension Rod, Control Arm	
06/03→		Track Control Arm		IV-TC-12431	Trailing Arm	
06/03→		Track Control Arm		IV-VB-5228	Wishbone (CV), Tag Axle;Air Suspension Axle	
AD 260S42, AT 260S42		12/06→	Centre Rod	IV-DL-2155		Push Rod
		12/06→	Centre Rod	IV-DL-8304		Push Rod
	12/06→	Centre Rod	IV-DL-8304		Push Rod, Air Suspension Axle	
	12/06→	Suspension Arm Repair Kit		DF-RK-8503	for Control Arm	
	12/06→	Suspension Arm Repair Kit		DF-RK-8994	for Drag Link;For Wishbone (CV)	
	12/06→	Suspension Arm Repair Kit	DB-RK-6111	DB-RK-6111	Trailing Arm	
	12/06→	Suspension Arm Repair Kit	DB-RK-9300	DB-RK-9300	for Drag Link	
	12/06→	Suspension Strut Repair Kit		DF-RK-8637		
	12/06→	Tie Rod		IV-DL-9361	Guide Rod, Tag Axle;for vehicles with Hinged Trailing Axle	
	12/06→	Tie Rod	IV-DL-8367		Guide Rod	
	12/06→	Tie Rod End		CV-ES-2146	for vehicles with Hinged Trailing Axle	
	12/06→	Tie Rod End		MN-ES-8490	for vehicles with Hinged Trailing Axle	
	12/06→	Tie Rod End	CV-ES-14162		for Steering Rod	
	12/06→	Tie Rod End	CV-ES-14163		for Steering Rod	
	12/06→	Tie Rod End	IV-ES-8365		for Push Rod	
	12/06→	Tie Rod End	IV-ES-12419		for Steering Rod	
	12/06→	Track Control Arm		IV-DL-8142	Trailing Arm	
	12/06→	Track Control Arm		IV-DL-8142	Trailing Arm, Drive Axle;Leave Spring Axle, for Pneumatic Suspension vehicles	
	12/06→	Track Control Arm		IV-DL-8613	Trailing Arm, 1st Drive Axle, for Pneumatic Suspension vehicles	
	12/06→	Track Control Arm		IV-DL-8613	Trailing Arm, Drive Axle;Air Suspension Axle	
12/06→	Track Control Arm		IV-TC-12341	Suspension Rod, Control Arm		

CV-ES-2146

Length: 80
Cone Ø: d1 Ø 30 / d2 Ø 27
Thread: M26 x 1,5 RHT
42533102



DF-RK-8637

Ø: 72
93161958, 93162239



IV-DL-8613

Length: 594
Ø: 50
Hole Distance: 130 / 130
41009661, 41009666, 41035951, 41272429,
98472446, 98472466



IV-TC-12431

Length: 594
Ø: 40
Hole Distance: 130 / 130
8137027



CV-ES-14162

Length: 125
Cone Ø: d1 Ø 30 / d2 Ø 27
Thread: M30 x 1,5 LHT
2984061, 4802444, 4833830, 7138966,
8190225, 42489395, 42491957



DF-RK-8994

Ø: 75
Hole Distance: 130
Thick/Height: 24
93161960



IV-DL-9361

Length: 1477
Ø: 48
Cone Ø: d1 Ø 30 / d2 Ø 27
41032608, 41033237



IV-VB-5228

Length: 665
Ø: 46
Hole Distance: 130 / 130
937104, 08137026, 8137026, 41002770,
41009665, 41028598, 41028600, 41034479,
41042050



CV-ES-14163

Length: 125
Cone Ø: d1 Ø 30 / d2 Ø 27
Thread: M30 x 1,5 RHT
2966252, 2969808, 4802443, 4833829,
7138967, 8122752, 42483386, 42488269,
42489573, 42489594, 42491638, 42537936



IV-DL-2155

Length: 953
Ø: 52
Cone Ø: d1 Ø 30 / d2 Ø 27
8131582, 41005463, 41042919



IV-ES-8365

Length: 139
Cone Ø: d1 Ø 30 / d2 Ø 27
Thread: M30 x 1,5 RHT
500309296, 500340769



MN-ES-8490

Length: 90
Cone Ø: d1 Ø 30 / d2 Ø 27
Thread: M26 x 1,5 RHT
14606948, 0014606948, 42533101



DB-RK-6111



IV-DL-8142

Length: 610
Ø: 50
Hole Distance: 152 / 152
41011008, 42041107



IV-ES-12272

Length: 75
Cone Ø: d1 Ø 30 / d2 Ø 27
Thread: M26 x 1,5 RHT
42533073



DB-RK-9300

Ø: 75
Hole Distance: 130
Thick/Height: 24
500333284



IV-DL-8304

Length: 953
Ø: 52
Cone Ø: d1 Ø 30 / d2 Ø 27
500397738



IV-ES-12419

Length: 55
Cone Ø: d1 Ø 10 / d2 Ø 10
Thread: M10 x 1,5 RHT
2041327, 41002118, 41203863, 42079853



DF-RK-8503

Ø: 75
Hole Distance: 130
Thick/Height: 24
93192361



IV-DL-8367

Length: 1620
Ø: 48
Cone Ø: d1 Ø 30 / d2 Ø 27
8163773, 41005450, 41005451, 41036943,
41036944



IV-TC-12341

Length: 695
Ø: 46
Hole Distance: 130 / 130
500338783





Stralis ...

AD 260S42, AT 260S42 ...	12/06→	Track Control Arm		IV-TC-12431	Trailing Arm
	12/06→	Track Control Arm		IV-VB-5228	Wishbone (CV), Drive Axle, for Pneumatic Suspension vehicles, →Ch.C217187/4353599
	12/06→	Track Control Arm		IV-VB-5228	Wishbone (CV), Drive Axle;Air Suspension Axle
	12/06→	Track Control Arm		IV-VB-5228	Wishbone (CV), Tag Axle;Air Suspension Axle
AD 260S42, AT 260S42, AS 260S42	05/07→	Centre Rod	IV-DL-8304		Push Rod, Air Suspension Axle
	05/07→	Suspension Arm Repair Kit		DF-RK-8994	for Drag Link;For Wishbone (CV)
	05/07→	Suspension Arm Repair Kit	DB-RK-9300	DB-RK-9300	for Drag Link
	05/07→	Suspension Strut Repair Kit		DF-RK-8637	
	05/07→	Tie Rod		IV-DL-9361	Guide Rod, Tag Axle;for vehicles with Hinged Trailing Axle
	05/07→	Tie Rod	IV-DL-8367		Guide Rod
	05/07→	Tie Rod End		CV-ES-2146	for vehicles with Hinged Trailing Axle
	05/07→	Tie Rod End		MN-ES-8490	for vehicles with Hinged Trailing Axle
	05/07→	Tie Rod End	CV-ES-14162	CV-ES-14162	for Steering Rod
	05/07→	Tie Rod End	CV-ES-14163		for Steering Rod
	05/07→	Tie Rod End	IV-ES-8365		for Push Rod
	05/07→	Tie Rod End	IV-ES-12272		for Steering Rod
	05/07→	Tie Rod End	IV-ES-12419		for Steering Rod
	05/07→	Track Control Arm		IV-DL-8613	Trailing Arm, Drive Axle;Air Suspension Axle
	05/07→	Track Control Arm		IV-TC-12341	Suspension Rod, Control Arm
	05/07→	Track Control Arm		IV-TC-12431	Trailing Arm
	05/07→	Track Control Arm		IV-VB-5228	Wishbone (CV), Drive Axle;Air Suspension Axle
05/07→	Track Control Arm		IV-VB-5228	Wishbone (CV), Tag Axle;Air Suspension Axle	
AD 260S43, AT 260S43	06/03→	Centre Rod	IV-DL-8304		Push Rod, Air Suspension Axle
	06/03→	Suspension Arm Repair Kit		DF-RK-8994	for Drag Link;For Wishbone (CV)
	06/03→	Suspension Arm Repair Kit	DB-RK-9300	DB-RK-9300	for Drag Link
	06/03→	Suspension Strut Repair Kit		DF-RK-8637	
	06/03→	Tie Rod		IV-DL-9361	Guide Rod, Tag Axle;for vehicles with Hinged Trailing Axle
	06/03→	Tie Rod	IV-DL-8367		Guide Rod
	06/03→	Tie Rod End		CV-ES-2146	for vehicles with Hinged Trailing Axle
	06/03→	Tie Rod End		MN-ES-8490	for vehicles with Hinged Trailing Axle
	06/03→	Tie Rod End	CV-ES-14162	CV-ES-14162	for Steering Rod
	06/03→	Tie Rod End	CV-ES-14163		for Steering Rod
	06/03→	Tie Rod End	IV-ES-8365		for Push Rod
	06/03→	Tie Rod End	IV-ES-12272		for Steering Rod
	06/03→	Tie Rod End	IV-ES-12419		for Steering Rod
	06/03→	Track Control Arm		IV-DL-8613	Trailing Arm, Drive Axle;Air Suspension Axle
	06/03→	Track Control Arm		IV-TC-12341	Suspension Rod, Control Arm
	06/03→	Track Control Arm		IV-TC-12431	Trailing Arm
	06/03→	Track Control Arm		IV-VB-5228	Wishbone (CV), Drive Axle;Air Suspension Axle
06/03→	Track Control Arm		IV-VB-5228	Wishbone (CV), Tag Axle;Air Suspension Axle	
AD 260S45, AT 260S45	12/06→	Centre Rod	IV-DL-8304		Push Rod, Air Suspension Axle
	12/06→	Suspension Arm Repair Kit		DF-RK-8503	for Control Arm
	12/06→	Suspension Arm Repair Kit	DB-RK-9300	DB-RK-9300	for Drag Link
	12/06→	Tie Rod		IV-DL-9361	Guide Rod, Tag Axle;for vehicles with Hinged Trailing Axle
	12/06→	Tie Rod	IV-DL-8367		Guide Rod
	12/06→	Tie Rod End		CV-ES-2146	for vehicles with Hinged Trailing Axle
	12/06→	Tie Rod End		MN-ES-8490	for vehicles with Hinged Trailing Axle
	12/06→	Tie Rod End	CV-ES-14162		for Steering Rod
	12/06→	Tie Rod End	CV-ES-14163		for Steering Rod
	12/06→	Tie Rod End	IV-ES-8365		for Push Rod
	12/06→	Tie Rod End	IV-ES-12272		for Steering Rod
	12/06→	Tie Rod End	IV-ES-12419		for Steering Rod
	12/06→	Track Control Arm		IV-DL-8142	Trailing Arm
	12/06→	Track Control Arm		IV-DL-8613	Trailing Arm, Drive Axle;Air Suspension Axle
	12/06→	Track Control Arm		IV-TC-12341	Suspension Rod, Control Arm
	12/06→	Track Control Arm		IV-VB-5228	Wishbone (CV), Drive Axle;Air Suspension Axle
	12/06→	Track Control Arm		IV-VB-5228	Wishbone (CV), Tag Axle;Air Suspension Axle

CV-ES-2146

Length: 80
Cone Ø: d1 Ø 30 / d2 Ø 27
Thread: M26 x 1,5 RHT
42533102



DF-RK-8994

Ø: 75
Hole Distance: 130
Thick/Height: 24
93161960



IV-ES-8365

Length: 139
Cone Ø: d1 Ø 30 / d2 Ø 27
Thread: M30 x 1,5 RHT
500309296, 500340769



MN-ES-8490

Length: 90
Cone Ø: d1 Ø 30 / d2 Ø 27
Thread: M26 x 1,5 RHT
0014606948, 14606948, 42533101



CV-ES-14162

Length: 125
Cone Ø: d1 Ø 30 / d2 Ø 27
Thread: M30 x 1,5 LHT
2984061, 4802444, 4833830, 7138966,
8190225, 42489395, 42491957



IV-DL-8142

Length: 610
Ø: 50
Hole Distance: 152 / 152
41011008, 42041107



IV-ES-12272

Length: 75
Cone Ø: d1 Ø 30 / d2 Ø 27
Thread: M26 x 1,5 RHT
42533073



CV-ES-14163

Length: 125
Cone Ø: d1 Ø 30 / d2 Ø 27
Thread: M30 x 1,5 RHT
2966252, 2969808, 4802443, 4833829,
7138967, 8122752, 42483386, 42488269,
42489573, 42489594, 42491638, 42537936



IV-DL-8304

Length: 953
Ø: 52
Cone Ø: d1 Ø 30 / d2 Ø 27
500397738



IV-ES-12419

Length: 55
Cone Ø: d1 Ø 10 / d2 Ø 10
Thread: M10 x 1,5 RHT
2041327, 41002118, 41203863, 42079853



DB-RK-9300

Ø: 75
Hole Distance: 130
Thick/Height: 24
500333284



IV-DL-8367

Length: 1620
Ø: 48
Cone Ø: d1 Ø 30 / d2 Ø 27
8163773, 41005450, 41005451, 41036943,
41036944



IV-TC-12341

Length: 695
Ø: 46
Hole Distance: 130 / 130
500338783



DF-RK-8503

Ø: 75
Hole Distance: 130
Thick/Height: 24
93192361



IV-DL-8613

Length: 594
Ø: 50
Hole Distance: 130 / 130
41009661, 41009666, 41035951, 41272429,
98472446, 98472466



IV-TC-12431

Length: 594
Ø: 40
Hole Distance: 130 / 130
8137027



DF-RK-8637

Ø: 72
93161958, 93162239



IV-DL-9361

Length: 1477
Ø: 48
Cone Ø: d1 Ø 30 / d2 Ø 27
41032608, 41033237



IV-VB-5228

Length: 665
Ø: 46
Hole Distance: 130 / 130
937104, 08137026, 8137026, 41002770,
41009665, 41028598, 41028600, 41034479,
41042050





Stralis ...

AD 260S45, AT 260S45, AS 260S45	05/07→	Centre Rod	IV-DL-8304		Push Rod, Air Suspension Axle
	05/07→	Suspension Arm Repair Kit		DF-RK-8994	for Drag Link;For Wishbone (CV)
	05/07→	Suspension Arm Repair Kit	DB-RK-9300	DB-RK-9300	for Drag Link
	05/07→	Suspension Strut Repair Kit		DF-RK-8637	
	05/07→	Tie Rod		IV-DL-9361	Guide Rod, Tag Axle;for vehicles with Hinged Trailing Axle
	05/07→	Tie Rod	IV-DL-8367		Guide Rod
	05/07→	Tie Rod End		CV-ES-2146	for vehicles with Hinged Trailing Axle
	05/07→	Tie Rod End		MN-ES-8490	for vehicles with Hinged Trailing Axle
	05/07→	Tie Rod End	CV-ES-14162	CV-ES-14162	for Steering Rod
	05/07→	Tie Rod End	CV-ES-14163		for Steering Rod
	05/07→	Tie Rod End	IV-ES-8365		for Push Rod
	05/07→	Tie Rod End	IV-ES-12272		for Steering Rod
	05/07→	Tie Rod End	IV-ES-12419		for Steering Rod
	05/07→	Track Control Arm		IV-DL-8142	Trailing Arm, 1st RA;2nd RA;Leaf Spring Axle
	05/07→	Track Control Arm		IV-DL-8613	Trailing Arm, Drive Axle;Air Suspension Axle
	05/07→	Track Control Arm		IV-TC-12341	Suspension Rod, Control Arm
	05/07→	Track Control Arm		IV-TC-12431	Trailing Arm
	05/07→	Track Control Arm		IV-VB-5228	Wishbone (CV), Drive Axle;Air Suspension Axle
	05/07→	Track Control Arm		IV-VB-5228	Wishbone (CV), Tag Axle;Air Suspension Axle
	05/07→	Track Control Arm		IV-VB-10418	Wishbone (CV), Drive Axle;Air Suspension Axle
05/07→	Track Control Arm		IV-VB-10418	Wishbone (CV), Tag Axle;Air Suspension Axle	
AD 320S36	05/07→	Tie Rod End	IV-ES-12419		for Steering Rod
	05/07→	Track Control Arm		IV-DL-8613	Trailing Arm, Drive Axle;Air Suspension Axle
AD 320S42, AT 320S42	05/07→	Tie Rod End	IV-ES-12419		for Steering Rod
	05/07→	Track Control Arm		IV-DL-8613	Trailing Arm, Drive Axle;Air Suspension Axle
AD 320S45, AT 320S45, AD 320S46, AT320S46	05/07→	Centre Rod	IV-DL-2155		Push Rod
	05/07→	Tie Rod		IV-DL-9361	Guide Rod
	05/07→	Tie Rod	IV-DL-8367		Guide Rod
	05/07→	Tie Rod End	CV-ES-14162	CV-ES-14162	for Steering Rod
	05/07→	Tie Rod End	CV-ES-14163		for Steering Rod
	05/07→	Tie Rod End	IV-ES-12419		for Steering Rod
	05/07→	Track Control Arm		IV-DL-8613	Trailing Arm, Drive Axle;Air Suspension Axle
AD 440S31, AT 440S31	06/03→	Suspension Arm Repair Kit		DF-RK-8994	for Drag Link;For Wishbone (CV)
	06/03→	Suspension Strut Repair Kit		DF-RK-8637	
	06/03→	Tie Rod	IV-DL-8367		Guide Rod
	06/03→	Tie Rod End	CV-ES-14162		for Steering Rod
	06/03→	Tie Rod End	CV-ES-14163		for Steering Rod
	06/03→	Tie Rod End	IV-ES-12419		for Steering Rod
	06/03→	Track Control Arm		IV-DL-8613	Trailing Arm, Drive Axle;Air Suspension Axle
	06/03→	Track Control Arm		IV-DL-9351	Wishbone (CV);Trailing Arm, 1st RA, for pneumatic suspension vehicles
	06/03→	Track Control Arm		IV-VB-5228	Wishbone (CV), Drive Axle;Air Suspension Axle
	06/03→	Track Control Arm		IV-VB-12390	Wishbone (CV), 1st RA, for Pneumatic Suspension vehicles, Ch.C217300/4353375→
AD 440S33, AT 440S33	12/06→	Suspension Arm Repair Kit		DF-RK-8994	for Drag Link;For Wishbone (CV)
	12/06→	Suspension Strut Repair Kit		DF-RK-8637	
	12/06→	Tie Rod	IV-DL-8367		Guide Rod
	12/06→	Tie Rod End	CV-ES-14162		for Steering Rod
	12/06→	Tie Rod End	CV-ES-14163		for Steering Rod
	12/06→	Tie Rod End	IV-ES-12419		for Steering Rod
	12/06→	Track Control Arm		IV-DL-8613	Trailing Arm, Drive Axle;Air Suspension Axle
	12/06→	Track Control Arm		IV-DL-9351	Wishbone (CV);Trailing Arm, 1st RA, for pneumatic suspension vehicles
	12/06→	Track Control Arm		IV-VB-5228	Wishbone (CV), Drive Axle;Air Suspension Axle
	12/06→	Track Control Arm		IV-VB-12390	Wishbone (CV), 1st RA, for Pneumatic Suspension vehicles, Ch.C217300/4353375→
AD 440S35, AT 440S35, AD 440S36, AT 440S36	06/03→	Suspension Arm Repair Kit		DF-RK-8994	for Drag Link;For Wishbone (CV)
	06/03→	Suspension Strut Repair Kit		DF-RK-8637	
	06/03→	Tie Rod	IV-DL-8367		Guide Rod
	06/03→	Tie Rod End	CV-ES-14162		for Steering Rod

CV-ES-2146

Length: 80
Cone Ø: d1 Ø 30 / d2 Ø 27
Thread: M26 x 1,5 RHT
42533102



IV-DL-2155

Length: 953
Ø: 52
Cone Ø: d1 Ø 30 / d2 Ø 27
8131582, 41005463, 41042919



IV-DL-9361

Length: 1477
Ø: 48
Cone Ø: d1 Ø 30 / d2 Ø 27
41032608, 41033237



IV-VB-5228

Length: 665
Ø: 46
Hole Distance: 130 / 130
937104, 08137026, 8137026, 41002770,
41009665, 41028598, 41028600, 41034479,
41042050



CV-ES-14162

Length: 125
Cone Ø: d1 Ø 30 / d2 Ø 27
Thread: M30 x 1,5 LHT
2984061, 4802444, 4833830, 7138966,
8190225, 42489395, 42491957

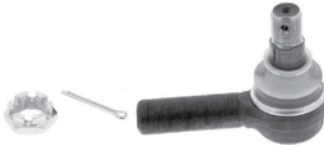

IV-DL-8142

Length: 610
Ø: 50
Hole Distance: 152 / 152
41011008, 42041107



IV-ES-8365

Length: 139
Cone Ø: d1 Ø 30 / d2 Ø 27
Thread: M30 x 1,5 RHT
500309296, 500340769



IV-VB-10418

Length: 665
Ø: 46
Hole Distance: 130 / 130
41042093, 500340451



CV-ES-14163

Length: 125
Cone Ø: d1 Ø 30 / d2 Ø 27
Thread: M30 x 1,5 RHT
2966252, 2969808, 4802443, 4833829,
7138967, 8122752, 42483386, 42488269,
42489573, 42489594, 42491638, 42537936



IV-DL-8304

Length: 953
Ø: 52
Cone Ø: d1 Ø 30 / d2 Ø 27
500397738



IV-ES-12272

Length: 75
Cone Ø: d1 Ø 30 / d2 Ø 27
Thread: M26 x 1,5 RHT
42533073



IV-VB-12390

Length: 665
Ø: 48
Hole Distance: 152 / 130 / 130
41218620

No Image

DB-RK-9300

Ø: 75
Hole Distance: 130
Thick/Height: 24
500333284

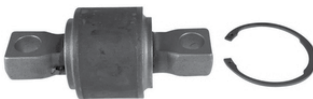

IV-DL-8367

Length: 1620
Ø: 48
Cone Ø: d1 Ø 30 / d2 Ø 27
8163773, 41005450, 41005451, 41036943,
41036944



IV-ES-12419

Length: 55
Cone Ø: d1 Ø 10 / d2 Ø 10
Thread: M10 x 1,5 RHT
2041327, 41002118, 41203863, 42079853



MN-ES-8490

Length: 90
Cone Ø: d1 Ø 30 / d2 Ø 27
Thread: M26 x 1,5 RHT
0014606948, 14606948, 42533101



DF-RK-8637

Ø: 72
93161958, 93162239



IV-DL-8613

Length: 594
Ø: 50
Hole Distance: 130 / 130
41009661, 41009666, 41035951, 41272429,
98472446, 98472466



IV-TC-12341

Length: 695
Ø: 46
Hole Distance: 130 / 130
500338783



DF-RK-8994

Ø: 75
Hole Distance: 130
Thick/Height: 24
93161960



IV-DL-9351

Length: 455
Ø: 50
Hole Distance: 130 / 130
41033731



IV-TC-12431

Length: 594
Ø: 40
Hole Distance: 130 / 130
8137027





Stralis ...

AD 440S35, AT 440S35,	06/03 →	Tie Rod End	CV-ES-14163		for Steering Rod
AD 440S36, AT 440S36 ...	06/03 →	Tie Rod End	IV-ES-12419		for Steering Rod
	06/03 →	Track Control Arm		IV-DL-8613	Trailing Arm, Drive Axle; Air Suspension Axle
	06/03 →	Track Control Arm		IV-DL-9351	Wishbone (CV); Trailing Arm, 1st RA, for pneumatic suspension vehicles
	06/03 →	Track Control Arm		IV-VB-5228	Wishbone (CV), Drive Axle; Air Suspension Axle
	06/03 →	Track Control Arm		IV-VB-12390	Wishbone (CV), Drive Axle; Air Suspension Axle
	01/07 →	Track Control Arm		IV-VB-5228	Wishbone (CV), Drive Axle; Air Suspension Axle, →* C187956 *; * 4333950 *
AD 440S40, AT 440S40	03/03 →	Centre Rod	IV-DL-8697	IV-DL-8697	Push Rod, for vehicles with Hinged Leading Axle
	03/03 →	Suspension Arm Repair Kit		DF-RK-8994	for Drag Link; For Wishbone (CV)
	03/03 →	Suspension Strut Repair Kit		DF-RK-8637	
	03/03 →	Tie Rod	IV-DL-8367		Guide Rod
	03/03 →	Tie Rod	IV-DL-12385		
	03/03 →	Tie Rod End	CV-ES-14162	CV-ES-14162	for Steering Rod
	03/03 →	Tie Rod End	CV-ES-14163		for Steering Rod
	03/03 →	Tie Rod End	IV-ES-12419		for Steering Rod
	03/03 →	Track Control Arm		IV-DL-8613	Trailing Arm, Drive Axle; Air Suspension Axle
	03/03 →	Track Control Arm		IV-VB-5228	Wishbone (CV), Drive Axle; Air Suspension Axle
	06/03 →	Centre Rod	IV-DL-8304		Push Rod
	06/03 →	Suspension Arm Repair Kit	DB-RK-9300	DB-RK-9300	for Drag Link
	06/03 →	Tie Rod End	CV-ES-14162		for Steering Rod
	06/03 →	Track Control Arm		IV-DL-9351	Wishbone (CV); Trailing Arm, 1st RA, for pneumatic suspension vehicles
	06/03 →	Track Control Arm		IV-VB-12390	Wishbone (CV), 1st RA, for Pneumatic Suspension vehicles, Ch.C217300/4353375 →
	06/03 →	Track Control Arm	IV-TC-12341	IV-TC-12341	Suspension Rod, Trailing Arm, for Pneumatic Suspension vehicles
AD 440S42, AT 440S42	04/06 →	Suspension Arm Repair Kit		DF-RK-8994	for Drag Link; For Wishbone (CV)
	04/06 →	Suspension Arm Repair Kit	DB-RK-9300	DB-RK-9300	for Drag Link
	04/06 →	Suspension Strut Repair Kit		DF-RK-8637	
	04/06 →	Tie Rod	IV-DL-8367		Guide Rod
	04/06 →	Tie Rod End	CV-ES-14162		for Steering Rod
	04/06 →	Tie Rod End	CV-ES-14163		for Steering Rod
	04/06 →	Tie Rod End	IV-ES-12419		for Steering Rod
	04/06 →	Track Control Arm		IV-DL-8613	Trailing Arm, Drive Axle; Air Suspension Axle
	04/06 →	Track Control Arm		IV-DL-9351	Wishbone (CV); Trailing Arm, 1st RA, for pneumatic suspension vehicles
	04/06 →	Track Control Arm		IV-VB-5228	Wishbone (CV), Drive Axle, for Pneumatic Suspension vehicles, →Ch.C217299/4353374
	04/06 →	Track Control Arm		IV-VB-12390	Wishbone (CV), 1st RA, for Pneumatic Suspension vehicles, Ch.C217300/4353375 →
	04/06 →	Track Control Arm	IV-TC-12341	IV-TC-12341	Suspension Rod, Trailing Arm, for Pneumatic Suspension vehicles
AD 440S43, AT 440S43	06/03 →	Centre Rod	IV-DL-8304		Push Rod
	06/03 →	Centre Rod	IV-DL-8697	IV-DL-8697	Push Rod, for vehicles with Hinged Leading Axle
	06/03 →	Suspension Arm Repair Kit		DF-RK-8994	for Drag Link; For Wishbone (CV)
	06/03 →	Suspension Arm Repair Kit	DB-RK-9300	DB-RK-9300	for Drag Link
	06/03 →	Suspension Strut Repair Kit		DF-RK-8637	
	06/03 →	Tie Rod	IV-DL-8367		Guide Rod
	06/03 →	Tie Rod	IV-DL-12385		
	06/03 →	Tie Rod End	CV-ES-14162		for Steering Rod
	06/03 →	Tie Rod End	CV-ES-14162	CV-ES-14162	for Steering Rod
	06/03 →	Tie Rod End	CV-ES-14163		for Steering Rod
	06/03 →	Tie Rod End	IV-ES-12419		for Steering Rod
	06/03 →	Track Control Arm		IV-DL-8613	Trailing Arm, Drive Axle; Air Suspension Axle
	06/03 →	Track Control Arm		IV-DL-9351	Wishbone (CV); Trailing Arm, 1st RA, for pneumatic suspension vehicles
	06/03 →	Track Control Arm		IV-VB-5228	Wishbone (CV), Drive Axle; Air Suspension Axle

CV-ES-14162

Length: 125
Cone Ø: d1 Ø 30 / d2 Ø 27
Thread: M30 x 1,5 LHT
2984061, 4802444, 4833830, 7138966,
8190225, 42489395, 42491957



CV-ES-14163

Length: 125
Cone Ø: d1 Ø 30 / d2 Ø 27
Thread: M30 x 1,5 RHT
2966252, 2969808, 4802443, 4833829,
7138967, 8122752, 42483386, 42488269,
42489573, 42489594, 42491638, 42537936



DB-RK-9300

Ø: 75
Hole Distance: 130
Thick/Height: 24
500333284

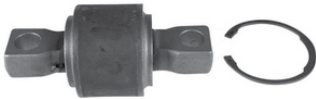

DF-RK-8637

Ø: 72
93161958, 93162239



DF-RK-8994

Ø: 75
Hole Distance: 130
Thick/Height: 24
93161960



IV-DL-8304

Length: 953
Ø: 52
Cone Ø: d1 Ø 30 / d2 Ø 27
500397738



IV-DL-8367

Length: 1620
Ø: 48
Cone Ø: d1 Ø 30 / d2 Ø 27
8163773, 41005450, 41005451, 41036943,
41036944



IV-DL-8613

Length: 594
Ø: 50
Hole Distance: 130 / 130
41009661, 41009666, 41035951, 41272429,
98472446, 98472466



IV-DL-8697

Length: 824
Ø: 52
Cone Ø: d1 Ø 30 / d2 Ø 27
08135492, 8135492, 41005469, 41011476,
41016960, 41016961



IV-DL-9351

Length: 455
Ø: 50
Hole Distance: 130 / 130
41033731



IV-DL-12385

Length: 1385
Ø: 58
Cone Ø: d1 Ø 30 / d2 Ø 27
41042749



IV-ES-12419

Length: 55
Cone Ø: d1 Ø 10 / d2 Ø 10
Thread: M10 x 1,5 RHT
2041327, 41002118, 41203863, 42079853



IV-TC-12341

Length: 695
Ø: 46
Hole Distance: 130 / 130
500338783



IV-VB-5228

Length: 665
Ø: 46
Hole Distance: 130 / 130
937104, 8137026, 08137026, 41002770,
41009665, 41028598, 41028600, 41034479,
41042050



IV-VB-12390

Length: 665
Ø: 48
Hole Distance: 152 / 130 / 130
41218620

No Image



Stralis ...

AD 440S43, AT 440S43 ...	06/03→	Track Control Arm		IV-VB-12390	Wishbone (CV), 1st RA, for Pneumatic Suspension vehicles, Ch.C217300/4353375→
AD 440S45, AT 440S45	12/06→	Suspension Arm Repair Kit		DF-RK-8994	for Drag Link;For Wishbone (CV)
	12/06→	Suspension Arm Repair Kit	DB-RK-9300	DB-RK-9300	for Drag Link
	12/06→	Suspension Strut Repair Kit		DF-RK-8637	
	12/06→	Tie Rod	IV-DL-8367		Guide Rod
	12/06→	Tie Rod End	CV-ES-14162		for Steering Rod
	12/06→	Tie Rod End	CV-ES-14163		for Steering Rod
	12/06→	Tie Rod End	IV-ES-12419		for Steering Rod
	12/06→	Track Control Arm		IV-DL-8613	Trailing Arm, Drive Axle;Air Suspension Axle
	12/06→	Track Control Arm		IV-DL-9351	Wishbone (CV);Trailing Arm, 1st RA, for pneumatic suspension vehicles
	12/06→	Track Control Arm		IV-VB-5228	Wishbone (CV), Drive Axle;Air Suspension Axle, →* C187956 *,* 4333950 *
	12/06→	Track Control Arm		IV-VB-12390	Wishbone (CV), Drive Axle;Air Suspension Axle
	12/06→	Track Control Arm	IV-TC-12341	IV-TC-12341	Suspension Rod, Trailing Arm, for Pneumatic Suspension vehicles
	AS 190S40	02/02→	Centre Rod	IV-DL-8304	
02/02→		Suspension Arm Repair Kit		DF-RK-8994	for Drag Link;For Wishbone (CV)
02/02→		Suspension Arm Repair Kit	DB-RK-9300	DB-RK-9300	for Drag Link
02/02→		Suspension Strut Repair Kit		DF-RK-8637	
02/02→		Tie Rod	IV-DL-8367		Guide Rod
02/02→		Tie Rod End	CV-ES-14162		for Steering Rod
02/02→		Tie Rod End	CV-ES-14163		for Steering Rod
02/02→		Tie Rod End	IV-ES-8365		for Push Rod
02/02→		Tie Rod End	IV-ES-12419		for Steering Rod
02/02→		Track Control Arm		IV-DL-8613	Trailing Arm, Drive Axle;Air Suspension Axle
02/02→		Track Control Arm		IV-DL-9351	Wishbone (CV);Trailing Arm, 1st RA, for pneumatic suspension vehicles
02/02→		Track Control Arm		IV-VB-5228	Wishbone (CV), Drive Axle;Air Suspension Axle
02/02→		Track Control Arm		IV-VB-12390	Wishbone (CV), 1st RA, for Pneumatic Suspension vehicles, Ch.C217300/4353375→
02/02→	Track Control Arm	IV-TC-12341	IV-TC-12341	Suspension Rod, Trailing Arm, for Pneumatic Suspension vehicles	
AS 190S43	02/02→	Centre Rod	IV-DL-8304		Push Rod
	02/02→	Tie Rod	IV-DL-8367		Guide Rod
	02/02→	Tie Rod End	IV-ES-12419		for Steering Rod
	02/02→	Track Control Arm		IV-DL-8613	Trailing Arm, Drive Axle;Air Suspension Axle
	02/02→	Track Control Arm		IV-VB-5228	Wishbone (CV), Drive Axle;Air Suspension Axle
AS 190S45	12/06→	Centre Rod	IV-DL-8304		Push Rod, Air Suspension Axle
	12/06→	Suspension Arm Repair Kit		DF-RK-8994	for Drag Link;For Wishbone (CV)
	12/06→	Suspension Arm Repair Kit	DB-RK-9300	DB-RK-9300	for Drag Link
	12/06→	Suspension Strut Repair Kit		DF-RK-8637	
	12/06→	Tie Rod	IV-DL-8367		Guide Rod
	12/06→	Tie Rod End	CV-ES-14162		for Steering Rod
	12/06→	Tie Rod End	CV-ES-14163		for Steering Rod
	12/06→	Tie Rod End	IV-ES-8365		for Push Rod
	12/06→	Tie Rod End	IV-ES-12419		for Steering Rod
	12/06→	Track Control Arm		IV-DL-8613	Trailing Arm, Drive Axle;Air Suspension Axle
	12/06→	Track Control Arm		IV-DL-9351	Wishbone (CV);Trailing Arm, 1st RA, for pneumatic suspension vehicles
	12/06→	Track Control Arm		IV-TC-12341	Suspension Rod, Control Arm
	12/06→	Track Control Arm		IV-VB-5228	Wishbone (CV), Drive Axle;Air Suspension Axle
12/06→	Track Control Arm		IV-VB-10418	Wishbone (CV), Drive Axle;Air Suspension Axle	
12/06→	Track Control Arm		IV-VB-12390	Wishbone (CV), 1st RA, for Pneumatic Suspension vehicles, Ch.C217300/4353375→	
AS 190S48	02/02→	Suspension Arm Repair Kit		DF-RK-8994	for Drag Link;For Wishbone (CV)
	02/02→	Suspension Arm Repair Kit	DB-RK-9300	DB-RK-9300	for Drag Link
	02/02→	Suspension Strut Repair Kit		DF-RK-8637	
	02/02→	Tie Rod	IV-DL-8367		Guide Rod

CV-ES-14162

Length: 125
Cone Ø: d1 Ø 30 / d2 Ø 27
Thread: M30 x 1,5 LHT
2984061, 4802444, 4833830, 7138966,
8190225, 42489395, 42491957



CV-ES-14163

Length: 125
Cone Ø: d1 Ø 30 / d2 Ø 27
Thread: M30 x 1,5 RHT
2966252, 2969808, 4802443, 4833829,
7138967, 8122752, 42483386, 42488269,
42489573, 42489594, 42491638, 42537936



DB-RK-9300

Ø: 75
Hole Distance: 130
Thick/Height: 24
500333284

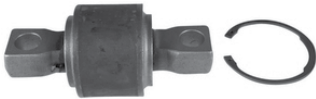

DF-RK-8637

Ø: 72
93161958, 93162239



DF-RK-8994

Ø: 75
Hole Distance: 130
Thick/Height: 24
93161960



IV-DL-8304

Length: 953
Ø: 52
Cone Ø: d1 Ø 30 / d2 Ø 27
500397738



IV-DL-8367

Length: 1620
Ø: 48
Cone Ø: d1 Ø 30 / d2 Ø 27
8163773, 41005450, 41005451, 41036943,
41036944



IV-DL-8613

Length: 594
Ø: 50
Hole Distance: 130 / 130
41009661, 41009666, 41035951, 41272429,
98472446, 98472466



IV-DL-9351

Length: 455
Ø: 50
Hole Distance: 130 / 130
41033731



IV-ES-8365

Length: 139
Cone Ø: d1 Ø 30 / d2 Ø 27
Thread: M30 x 1,5 RHT
500309296, 500340769



IV-ES-12419

Length: 55
Cone Ø: d1 Ø 10 / d2 Ø 10
Thread: M10 x 1,5 RHT
2041327, 41002118, 41203863, 42079853



IV-TC-12341

Length: 695
Ø: 46
Hole Distance: 130 / 130
500338783



IV-VB-5228

Length: 665
Ø: 46
Hole Distance: 130 / 130
937104, 08137026, 8137026, 41002770,
41009665, 41028598, 41028600, 41034479,
41042050



IV-VB-10418

Length: 665
Ø: 46
Hole Distance: 130 / 130
41042093, 500340451



IV-VB-12390

Length: 665
Ø: 48
Hole Distance: 152 / 130 / 130
41218620

No Image



Stralis ...

AS 190S48 ...	02/02→	Tie Rod End	CV-ES-14162		for Steering Rod	
	02/02→	Tie Rod End	CV-ES-14163		for Steering Rod	
	02/02→	Tie Rod End	IV-ES-8365		for Push Rod	
	02/02→	Tie Rod End	IV-ES-12419		for Steering Rod	
	02/02→	Track Control Arm		IV-DL-8613	Trailing Arm, Drive Axle;Air Suspension Axle	
	02/02→	Track Control Arm		IV-DL-9351	Wishbone (CV);Trailing Arm, 1st RA, for pneumatic suspension vehicles	
	02/02→	Track Control Arm		IV-VB-5228	Wishbone (CV), Drive Axle;Air Suspension Axle	
	02/02→	Track Control Arm		IV-VB-12390	Wishbone (CV), 1st RA, for Pneumatic Suspension vehicles, Ch.C217300/4353375→	
	02/02→	Track Control Arm	IV-TC-12341	IV-TC-12341	Suspension Rod, Trailing Arm, for Pneumatic Suspension vehicles	
AS 190S50	12/06→	Centre Rod	IV-DL-8304		Push Rod, Air Suspension Axle	
	12/06→	Suspension Arm Repair Kit		DF-RK-8503	for Control Arm	
	12/06→	Tie Rod	IV-DL-8367		Guide Rod	
	12/06→	Tie Rod End	CV-ES-14163		for Steering Rod	
	12/06→	Tie Rod End	IV-ES-12419		for Steering Rod	
	12/06→	Track Control Arm		IV-DL-8613	Trailing Arm, Drive Axle;Air Suspension Axle	
	12/06→	Track Control Arm		IV-TC-12341	Suspension Rod, Control Arm	
	12/06→	Track Control Arm		IV-VB-5228	Wishbone (CV), Drive Axle;Air Suspension Axle	
AS 260S40	02/02→	Centre Rod	IV-DL-2155		Push Rod	
	02/02→	Centre Rod	IV-DL-8304		Push Rod, Air Suspension Axle	
	02/02→	Suspension Arm Repair Kit		DF-RK-8994	for Drag Link;For Wishbone (CV)	
	02/02→	Suspension Arm Repair Kit	DB-RK-9300	DB-RK-9300	for Drag Link	
	02/02→	Suspension Strut Repair Kit		DF-RK-8637		
	02/02→	Tie Rod		IV-DL-9361	Guide Rod, Tag Axle;for vehicles with Hinged Trailing Axle	
	02/02→	Tie Rod	IV-DL-8367		Guide Rod	
	02/02→	Tie Rod End		CV-ES-2146	for vehicles with Hinged Trailing Axle	
	02/02→	Tie Rod End		MN-ES-8490	for vehicles with Hinged Trailing Axle	
	02/02→	Tie Rod End	CV-ES-14162		for Steering Rod	
	02/02→	Tie Rod End	CV-ES-14163		for Steering Rod	
	02/02→	Tie Rod End	IV-ES-8365		for Push Rod	
	02/02→	Tie Rod End	IV-ES-12272		for Steering Rod	
	02/02→	Tie Rod End	IV-ES-12419		for Steering Rod	
	02/02→	Track Control Arm		IV-DL-8613	Trailing Arm, Drive Axle;Air Suspension Axle	
	02/02→	Track Control Arm		IV-TC-12341	Suspension Rod, Control Arm	
	02/02→	Track Control Arm		IV-TC-12431	Trailing Arm	
	02/02→	Track Control Arm		IV-VB-5228	Wishbone (CV), Drive Axle;Air Suspension Axle	
	02/02→	Track Control Arm		IV-VB-5228	Wishbone (CV), Tag Axle;Air Suspension Axle	
	AS 260S43	02/02→	Centre Rod	IV-DL-2155		Push Rod
		02/02→	Centre Rod	IV-DL-8304		Push Rod, Air Suspension Axle
02/02→		Suspension Arm Repair Kit		DF-RK-8994	for Drag Link;For Wishbone (CV)	
02/02→		Suspension Arm Repair Kit	DB-RK-9300	DB-RK-9300	for Drag Link	
02/02→		Suspension Strut Repair Kit		DF-RK-8637		
02/02→		Tie Rod		IV-DL-9361	Guide Rod, Tag Axle;for vehicles with Hinged Trailing Axle	
02/02→		Tie Rod	IV-DL-8367		Guide Rod	
02/02→		Tie Rod End		CV-ES-2146	for vehicles with Hinged Trailing Axle	
02/02→		Tie Rod End		MN-ES-8490	for vehicles with Hinged Trailing Axle	
02/02→		Tie Rod End	CV-ES-14162		for Steering Rod	
02/02→		Tie Rod End	CV-ES-14163		for Steering Rod	
02/02→		Tie Rod End	IV-ES-8365		for Push Rod	
02/02→		Tie Rod End	IV-ES-12272		for Steering Rod	
02/02→		Tie Rod End	IV-ES-12419		for Steering Rod	
02/02→		Track Control Arm		IV-DL-8613	Trailing Arm, Drive Axle;Air Suspension Axle	
02/02→		Track Control Arm		IV-TC-12341	Suspension Rod, Control Arm	
02/02→		Track Control Arm		IV-TC-12431	Trailing Arm	
02/02→		Track Control Arm		IV-VB-5228	Wishbone (CV), Drive Axle;Air Suspension Axle	
02/02→		Track Control Arm		IV-VB-5228	Wishbone (CV), Tag Axle;Air Suspension Axle	
05/05→		Centre Rod	IV-DL-8304		Push Rod	

CV-ES-2146

Length: 80
Cone Ø: d1 Ø 30 / d2 Ø 27
Thread: M26 x 1,5 RHT
42533102



DF-RK-8994

Ø: 75
Hole Distance: 130
Thick/Height: 24
93161960



IV-DL-9361

Length: 1477
Ø: 48
Cone Ø: d1 Ø 30 / d2 Ø 27
41032608, 41033237



IV-VB-5228

Length: 665
Ø: 46
Hole Distance: 130 / 130
937104, 08137026, 8137026, 41002770,
41009665, 41028598, 41028600, 41034479,
41042050



CV-ES-14162

Length: 125
Cone Ø: d1 Ø 30 / d2 Ø 27
Thread: M30 x 1,5 LHT
2984061, 4802444, 4833830, 7138966,
8190225, 42489395, 42491957

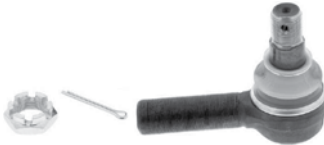

IV-DL-2155

Length: 953
Ø: 52
Cone Ø: d1 Ø 30 / d2 Ø 27
8131582, 41005463, 41042919



IV-ES-8365

Length: 139
Cone Ø: d1 Ø 30 / d2 Ø 27
Thread: M30 x 1,5 RHT
500309296, 500340769



IV-VB-10418

Length: 665
Ø: 46
Hole Distance: 130 / 130
41042093, 500340451



CV-ES-14163

Length: 125
Cone Ø: d1 Ø 30 / d2 Ø 27
Thread: M30 x 1,5 RHT
2966252, 2969808, 4802443, 4833829,
7138967, 8122752, 42483386, 42488269,
42489573, 42489594, 42491638, 42537936



IV-DL-8304

Length: 953
Ø: 52
Cone Ø: d1 Ø 30 / d2 Ø 27
500397738



IV-ES-12272

Length: 75
Cone Ø: d1 Ø 30 / d2 Ø 27
Thread: M26 x 1,5 RHT
42533073



IV-VB-12390

Length: 665
Ø: 48
Hole Distance: 152 / 130 / 130
41218620

No Image

DB-RK-9300

Ø: 75
Hole Distance: 130
Thick/Height: 24
500333284

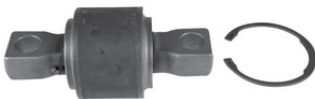

IV-DL-8367

Length: 1620
Ø: 48
Cone Ø: d1 Ø 30 / d2 Ø 27
8163773, 41005450, 41005451, 41036943,
41036944



IV-ES-12419

Length: 55
Cone Ø: d1 Ø 10 / d2 Ø 10
Thread: M10 x 1,5 RHT
2041327, 41002118, 41203863, 42079853



MN-ES-8490

Length: 90
Cone Ø: d1 Ø 30 / d2 Ø 27
Thread: M26 x 1,5 RHT
0014606948, 14606948, 42533101



DF-RK-8503

Ø: 75
Hole Distance: 130
Thick/Height: 24
93192361



IV-DL-8613

Length: 594
Ø: 50
Hole Distance: 130 / 130
41009661, 41009666, 41035951, 41272429,
98472446, 98472466



IV-TC-12341

Length: 695
Ø: 46
Hole Distance: 130 / 130
500338783



DF-RK-8637

Ø: 72
93161958, 93162239



IV-DL-9351

Length: 455
Ø: 50
Hole Distance: 130 / 130
41033731



IV-TC-12431

Length: 594
Ø: 40
Hole Distance: 130 / 130
8137027





Stralis ...

AS 260S48	02/02→	Centre Rod	IV-DL-8304		Push Rod, Air Suspension Axle	
	02/02→	Suspension Arm Repair Kit		DF-RK-8994	for Drag Link;For Wishbone (CV)	
	02/02→	Suspension Strut Repair Kit		DF-RK-8637		
	02/02→	Tie Rod		IV-DL-9361	Guide Rod, Tag Axle;for vehicles with Hinged Trailing Axle	
	02/02→	Tie Rod	IV-DL-8367		Guide Rod	
	02/02→	Tie Rod End		CV-ES-2146	for vehicles with Hinged Trailing Axle	
	02/02→	Tie Rod End		MN-ES-8490	for vehicles with Hinged Trailing Axle	
	02/02→	Tie Rod End	CV-ES-14162	CV-ES-14162	for Steering Rod	
	02/02→	Tie Rod End	CV-ES-14163		for Steering Rod	
	02/02→	Tie Rod End	IV-ES-12272		for Steering Rod	
	02/02→	Tie Rod End	IV-ES-12419		for Steering Rod	
	02/02→	Track Control Arm		IV-DL-8142	Trailing Arm, 1st RA;2nd RA;Leaf Spring Axle	
	02/02→	Track Control Arm		IV-DL-8613	Trailing Arm, Drive Axle;Air Suspension Axle	
	02/02→	Track Control Arm		IV-TC-12341	Suspension Rod, Control Arm	
	02/02→	Track Control Arm		IV-TC-12431	Trailing Arm	
	02/02→	Track Control Arm		IV-VB-5228	Wishbone (CV), Drive Axle;Air Suspension Axle	
	02/02→	Track Control Arm		IV-VB-5228	Wishbone (CV), Tag Axle;Air Suspension Axle	
	02/02→	Track Control Arm		IV-VB-10418	Wishbone (CV), Drive Axle;Air Suspension Axle	
02/02→	Track Control Arm		IV-VB-10418	Wishbone (CV), Tag Axle;Air Suspension Axle		
AS 260S48, AT260S48	02/02→	Centre Rod	IV-DL-2155		Push Rod	
	02/02→	Centre Rod	IV-DL-8304		Push Rod, Air Suspension Axle	
	02/02→	Suspension Arm Repair Kit		DF-RK-8994	for Drag Link;For Wishbone (CV)	
	02/02→	Suspension Arm Repair Kit	DB-RK-9300	DB-RK-9300	for Drag Link	
	02/02→	Suspension Strut Repair Kit		DF-RK-8637		
	02/02→	Tie Rod		IV-DL-9361	Guide Rod, Tag Axle;for vehicles with Hinged Trailing Axle	
	02/02→	Tie Rod	IV-DL-8367		Guide Rod	
	02/02→	Tie Rod End		CV-ES-2146	for vehicles with Hinged Trailing Axle	
	02/02→	Tie Rod End		MN-ES-8490	for vehicles with Hinged Trailing Axle	
	02/02→	Tie Rod End	CV-ES-14162		for Steering Rod	
	02/02→	Tie Rod End	CV-ES-14163		for Steering Rod	
	02/02→	Tie Rod End	IV-ES-8365		for Push Rod	
	02/02→	Tie Rod End	IV-ES-12272		for Steering Rod	
	02/02→	Tie Rod End	IV-ES-12419		for Steering Rod	
	02/02→	Track Control Arm		IV-DL-8142	Trailing Arm, 1st RA;2nd RA;Leaf Spring Axle	
	02/02→	Track Control Arm		IV-DL-8613	Trailing Arm, Drive Axle;Air Suspension Axle	
	02/02→	Track Control Arm		IV-TC-12341	Suspension Rod, Control Arm	
	02/02→	Track Control Arm		IV-TC-12431	Trailing Arm	
02/02→	Track Control Arm		IV-VB-5228	Wishbone (CV), Tag Axle;Air Suspension Axle		
02/02→	Track Control Arm		IV-VB-10418	Wishbone (CV), Drive Axle;Air Suspension Axle		
02/02→	Track Control Arm		IV-VB-10418	Wishbone (CV), Tag Axle;Air Suspension Axle		
AS 260S50	07/06→	Centre Rod	IV-DL-8304		Push Rod, Air Suspension Axle	
	07/06→	Tie Rod		IV-DL-9361	Guide Rod, Tag Axle;for vehicles with Hinged Trailing Axle	
	07/06→	Tie Rod	IV-DL-8367		Guide Rod	
	07/06→	Tie Rod End		CV-ES-2146	for vehicles with Hinged Trailing Axle	
	07/06→	Tie Rod End		MN-ES-8490	for vehicles with Hinged Trailing Axle	
	07/06→	Track Control Arm		IV-DL-8142	Trailing Arm, 1st RA;2nd RA;Leaf Spring Axle	
	07/06→	Track Control Arm		IV-DL-8613	Trailing Arm, Drive Axle;Air Suspension Axle	
	07/06→	Track Control Arm		IV-TC-12341	Suspension Rod, Control Arm	
	07/06→	Track Control Arm		IV-TC-12431	Trailing Arm	
	07/06→	Track Control Arm		IV-VB-5228	Wishbone (CV), Drive Axle;Air Suspension Axle	
	07/06→	Track Control Arm		IV-VB-5228	Wishbone (CV), Tag Axle;Air Suspension Axle	
	07/06→	Track Control Arm		IV-VB-10418	Wishbone (CV), Drive Axle;Air Suspension Axle	
	07/06→	Track Control Arm		IV-VB-10418	Wishbone (CV), Tag Axle;Air Suspension Axle	
	12/06→	Suspension Arm Repair Kit		DF-RK-8503	for Control Arm	
	AS 260S54	02/02→	Centre Rod	IV-DL-2155		Push Rod
		02/02→	Centre Rod	IV-DL-8304		Push Rod, Air Suspension Axle
		02/02→	Suspension Arm Repair Kit		DF-RK-8994	for Drag Link;For Wishbone (CV)
		02/02→	Suspension Arm Repair Kit	DB-RK-9300	DB-RK-9300	for Drag Link
02/02→		Suspension Strut Repair Kit		DF-RK-8637		

CV-ES-2146

Length: 80
Cone Ø: d1 Ø 30 / d2 Ø 27
Thread: M26 x 1,5 RHT
42533102



DF-RK-8994

Ø: 75
Hole Distance: 130
Thick/Height: 24
93161960



IV-DL-9361

Length: 1477
Ø: 48
Cone Ø: d1 Ø 30 / d2 Ø 27
41032608, 41033237



IV-VB-5228

Length: 665
Ø: 46
Hole Distance: 130 / 130
937104, 08137026, 8137026, 41002770,
41009665, 41028598, 41028600, 41034479,
41042050



CV-ES-14162

Length: 125
Cone Ø: d1 Ø 30 / d2 Ø 27
Thread: M30 x 1,5 LHT
2984061, 4802444, 4833830, 7138966,
8190225, 42489395, 42491957



IV-DL-2155

Length: 953
Ø: 52
Cone Ø: d1 Ø 30 / d2 Ø 27
8131582, 41005463, 41042919



IV-ES-8365

Length: 139
Cone Ø: d1 Ø 30 / d2 Ø 27
Thread: M30 x 1,5 RHT
500309296, 500340769



IV-VB-10418

Length: 665
Ø: 46
Hole Distance: 130 / 130
41042093, 500340451



CV-ES-14163

Length: 125
Cone Ø: d1 Ø 30 / d2 Ø 27
Thread: M30 x 1,5 RHT
2966252, 2969808, 4802443, 4833829,
7138967, 8122752, 42483386, 42488269,
42489573, 42489594, 42491638, 42537936



IV-DL-8142

Length: 610
Ø: 50
Hole Distance: 152 / 152
41011008, 42041107



IV-ES-12272

Length: 75
Cone Ø: d1 Ø 30 / d2 Ø 27
Thread: M26 x 1,5 RHT
42533073



MN-ES-8490

Length: 90
Cone Ø: d1 Ø 30 / d2 Ø 27
Thread: M26 x 1,5 RHT
0014606948, 14606948, 42533101



DB-RK-9300

Ø: 75
Hole Distance: 130
Thick/Height: 24
500333284



IV-DL-8304

Length: 953
Ø: 52
Cone Ø: d1 Ø 30 / d2 Ø 27
500397738



IV-ES-12419

Length: 55
Cone Ø: d1 Ø 10 / d2 Ø 10
Thread: M10 x 1,5 RHT
2041327, 41002118, 41203863, 42079853



DF-RK-8503

Ø: 75
Hole Distance: 130
Thick/Height: 24
93192361



IV-DL-8367

Length: 1620
Ø: 48
Cone Ø: d1 Ø 30 / d2 Ø 27
8163773, 41005450, 41005451, 41036943,
41036944



IV-TC-12341

Length: 695
Ø: 46
Hole Distance: 130 / 130
500338783



DF-RK-8637

Ø: 72
93161958, 93162239



IV-DL-8613

Length: 594
Ø: 50
Hole Distance: 130 / 130
41009661, 41009666, 41035951, 41272429,
98472446, 98472466



IV-TC-12431

Length: 594
Ø: 40
Hole Distance: 130 / 130
8137027



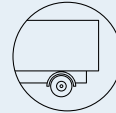

Stralis ...

AS 260S54 ...	02/02→	Tie Rod		IV-DL-9361	Guide Rod, Tag Axle;for vehicles with Hinged Trailing Axle
	02/02→	Tie Rod	IV-DL-8367		Guide Rod
	02/02→	Tie Rod End		CV-ES-2146	for vehicles with Hinged Trailing Axle
	02/02→	Tie Rod End		MN-ES-8490	for vehicles with Hinged Trailing Axle
	02/02→	Tie Rod End	CV-ES-14162		for Steering Rod
	02/02→	Tie Rod End	CV-ES-14162	CV-ES-14162	for Steering Rod
	02/02→	Tie Rod End	CV-ES-14163		for Steering Rod
	02/02→	Tie Rod End	IV-ES-8365		for Push Rod
	02/02→	Tie Rod End	IV-ES-12272		for Steering Rod
	02/02→	Track Control Arm		IV-DL-8142	Trailing Arm, 1st RA;2nd RA;Leaf Spring Axle
	02/02→	Track Control Arm		IV-DL-8613	Trailing Arm, Drive Axle;Air Suspension Axle
	02/02→	Track Control Arm		IV-TC-12341	Suspension Rod, Control Arm
	02/02→	Track Control Arm		IV-TC-12431	Trailing Arm
	02/02→	Track Control Arm		IV-VB-5228	Wishbone (CV), Drive Axle;Air Suspension Axle
	02/02→	Track Control Arm		IV-VB-5228	Wishbone (CV), Tag Axle;Air Suspension Axle
AS 260S56	07/06→	Track Control Arm		IV-DL-8613	Trailing Arm, Drive Axle;Air Suspension Axle
	12/06→	Suspension Arm Repair Kit		DF-RK-8503	for Control Arm
AS 320S50	05/07→	Centre Rod	IV-DL-2155		Push Rod
	05/07→	Tie Rod		IV-DL-9361	Guide Rod
	05/07→	Tie Rod	IV-DL-8367		Guide Rod
	05/07→	Tie Rod End	CV-ES-14162	CV-ES-14162	for Steering Rod
	05/07→	Tie Rod End	CV-ES-14163		for Steering Rod
	05/07→	Tie Rod End	IV-ES-12419		for Steering Rod
	05/07→	Track Control Arm		IV-DL-8613	Trailing Arm, Drive Axle;Air Suspension Axle
AS 440S40	02/02→	Centre Rod	IV-DL-2155		Push Rod
	02/02→	Centre Rod	IV-DL-8304		Push Rod
	02/02→	Centre Rod	IV-DL-8697	IV-DL-8697	Push Rod, for vehicles with Hinged Leading Axle
	02/02→	Suspension Arm Repair Kit		DF-RK-8994	for Drag Link;For Wishbone (CV)
	02/02→	Suspension Arm Repair Kit	DB-RK-9300	DB-RK-9300	for Drag Link
	02/02→	Suspension Strut Repair Kit		DF-RK-8637	
	02/02→	Tie Rod	IV-DL-8367		Guide Rod
	02/02→	Tie Rod	IV-DL-12385		
	02/02→	Tie Rod End	CV-ES-14162		for Steering Rod
	02/02→	Tie Rod End	CV-ES-14162	CV-ES-14162	for Steering Rod
	02/02→	Tie Rod End	CV-ES-14163		for Steering Rod
	02/02→	Tie Rod End	IV-ES-12419		for Steering Rod
	02/02→	Track Control Arm		IV-DL-8613	Trailing Arm, Drive Axle;Air Suspension Axle
	02/02→	Track Control Arm		IV-DL-9351	Wishbone (CV);Trailing Arm
	02/02→	Track Control Arm		IV-VB-5228	Wishbone (CV), Drive Axle;Air Suspension Axle
	02/02→	Track Control Arm		IV-VB-12390	Wishbone (CV), 1st RA, for Pneumatic Suspension vehicles, Ch.C217300/4353375→
	02/02→	Track Control Arm	IV-TC-12341	IV-TC-12341	Suspension Rod, Trailing Arm, for Pneumatic Suspension vehicles
AS 440S42	05/06→	Centre Rod	IV-DL-2155		Push Rod
	05/06→	Suspension Arm Repair Kit		DF-RK-8994	for Drag Link;For Wishbone (CV)
	05/06→	Suspension Strut Repair Kit		DF-RK-8637	
	05/06→	Tie Rod	IV-DL-8367		Guide Rod
	05/06→	Tie Rod End	CV-ES-14162		for Steering Rod
	05/06→	Tie Rod End	CV-ES-14163		for Steering Rod
	05/06→	Tie Rod End	IV-ES-12419		for Steering Rod
	05/06→	Track Control Arm		IV-DL-8613	Trailing Arm, Drive Axle;Air Suspension Axle
	05/06→	Track Control Arm		IV-DL-9351	Wishbone (CV);Trailing Arm, 1st RA, for pneumatic suspension vehicles
	05/06→	Track Control Arm		IV-VB-5228	Wishbone (CV), Drive Axle, for Pneumatic Suspension vehicles, →Ch.C217299/4353374
	05/06→	Track Control Arm		IV-VB-12390	Wishbone (CV), 1st RA, for Pneumatic Suspension vehicles, Ch.C217300/4353375→
	07/06→	Track Control Arm		IV-VB-5228	Wishbone (CV), Drive Axle, for Pneumatic Suspension vehicles, →Ch.C217187/4353599

CV-ES-2146

Length: 80
 Cone Ø: d1 Ø 30 / d2 Ø 27
 Thread: M26 x 1,5 RHT
 42533102

**CV-ES-14162**

Length: 125
 Cone Ø: d1 Ø 30 / d2 Ø 27
 Thread: M30 x 1,5 LHT
 2984061, 4802444, 4833830, 7138966,
 8190225, 42489395, 42491957

**CV-ES-14163**

Length: 125
 Cone Ø: d1 Ø 30 / d2 Ø 27
 Thread: M30 x 1,5 RHT
 2966252, 2969808, 4802443, 4833829,
 7138967, 8122752, 42483386, 42488269,
 42489573, 42489594, 42491638, 42537936

**DB-RK-9300**

Ø: 75
 Hole Distance: 130
 Thick/Height: 24
 500333284

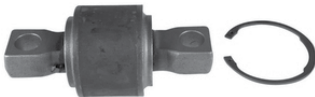
**DF-RK-8503**

Ø: 75
 Hole Distance: 130
 Thick/Height: 24
 93192361

**DF-RK-8637**

Ø: 72
 93161958, 93162239

**DF-RK-8994**

Ø: 75
 Hole Distance: 130
 Thick/Height: 24
 93161960

**IV-DL-2155**

Length: 953
 Ø: 52
 Cone Ø: d1 Ø 30 / d2 Ø 27
 8131582, 41005463, 41042919

**IV-DL-8142**

Length: 610
 Ø: 50
 Hole Distance: 152 / 152
 41011008, 42041107

**IV-DL-8304**

Length: 953
 Ø: 52
 Cone Ø: d1 Ø 30 / d2 Ø 27
 500397738

**IV-DL-8367**

Length: 1620
 Ø: 48
 Cone Ø: d1 Ø 30 / d2 Ø 27
 8163773, 41005450, 41005451, 41036943,
 41036944

**IV-DL-8613**

Length: 594
 Ø: 50
 Hole Distance: 130 / 130
 41009661, 41009666, 41035951, 41272429,
 98472446, 98472466

**IV-DL-8697**

Length: 824
 Ø: 52
 Cone Ø: d1 Ø 30 / d2 Ø 27
 08135492, 8135492, 41005469, 41011476,
 41016960, 41016961

**IV-DL-9351**

Length: 455
 Ø: 50
 Hole Distance: 130 / 130
 41033731

**IV-DL-9361**

Length: 1477
 Ø: 48
 Cone Ø: d1 Ø 30 / d2 Ø 27
 41032608, 41033237

**IV-DL-12385**

Length: 1385
 Ø: 58
 Cone Ø: d1 Ø 30 / d2 Ø 27
 41042749

**IV-ES-8365**

Length: 139
 Cone Ø: d1 Ø 30 / d2 Ø 27
 Thread: M30 x 1,5 RHT
 500309296, 500340769

**IV-ES-12272**

Length: 75
 Cone Ø: d1 Ø 30 / d2 Ø 27
 Thread: M26 x 1,5 RHT
 42533073

**IV-ES-12419**

Length: 55
 Cone Ø: d1 Ø 10 / d2 Ø 10
 Thread: M10 x 1,5 RHT
 2041327, 41002118, 41203863, 42079853

**IV-TC-12341**

Length: 695
 Ø: 46
 Hole Distance: 130 / 130
 500338783

**IV-TC-12431**

Length: 594
 Ø: 40
 Hole Distance: 130 / 130
 8137027

**IV-VB-5228**

Length: 665
 Ø: 46
 Hole Distance: 130 / 130
 937104, 08137026, 8137026, 41002770,
 41009665, 41028598, 41028600, 41034479,
 41042050

**IV-VB-12390**

Length: 665
 Ø: 48
 Hole Distance: 152 / 130 / 130
 41218620

No Image

MN-ES-8490

Length: 90
 Cone Ø: d1 Ø 30 / d2 Ø 27
 Thread: M26 x 1,5 RHT
 14606948, 0014606948, 42533101





Stralis ...

AS 440S42, AT 440S42	12/06→	Tie Rod End	IV-ES-12419		for Steering Rod
	12/06→	Track Control Arm		IV-DL-8613	Trailing Arm, Drive Axle;Air Suspension Axle
AS 440S43	02/02→	Centre Rod	IV-DL-2155		Push Rod
	02/02→	Centre Rod	IV-DL-8304		Push Rod
	02/02→	Centre Rod	IV-DL-8697	IV-DL-8697	Push Rod, for vehicles with Hinged Leading Axle
	02/02→	Suspension Arm Repair Kit		DF-RK-8994	for Drag Link;For Wishbone (CV)
	02/02→	Suspension Arm Repair Kit	DB-RK-9300	DB-RK-9300	for Drag Link
	02/02→	Suspension Strut Repair Kit		DF-RK-8637	
	02/02→	Tie Rod	IV-DL-8367		Guide Rod
	02/02→	Tie Rod	IV-DL-12385		
	02/02→	Tie Rod End	CV-ES-14162		for Steering Rod
	02/02→	Tie Rod End	CV-ES-14163		for Steering Rod
	02/02→	Tie Rod End	IV-ES-12419		for Steering Rod
	02/02→	Track Control Arm		IV-DL-8613	Trailing Arm, Drive Axle;Air Suspension Axle
	02/02→	Track Control Arm		IV-DL-9351	Wishbone (CV);Trailing Arm, 1st RA, for pneumatic suspension vehicles
	02/02→	Track Control Arm		IV-VB-5228	Wishbone (CV)
	02/02→	Track Control Arm		IV-VB-5228	Wishbone (CV), Drive Axle;Air Suspension Axle
	02/02→	Track Control Arm		IV-VB-12390	Wishbone (CV), 1st RA, for Pneumatic Suspension vehicles, Ch.C217300/4353375→
	02/02→	Track Control Arm	IV-TC-12341	IV-TC-12341	Suspension Rod, Trailing Arm, for Pneumatic Suspension vehicles
AS 440S45	12/06→	Suspension Arm Repair Kit		DF-RK-8994	for Drag Link;For Wishbone (CV)
	12/06→	Suspension Strut Repair Kit		DF-RK-8637	
	12/06→	Tie Rod	IV-DL-8367		Guide Rod
	12/06→	Tie Rod End	CV-ES-14162		for Steering Rod
	12/06→	Tie Rod End	CV-ES-14163		for Steering Rod
	12/06→	Tie Rod End	IV-ES-12419		for Steering Rod
	12/06→	Track Control Arm		IV-DL-8613	Trailing Arm, Drive Axle;Air Suspension Axle
	12/06→	Track Control Arm		IV-DL-9351	Wishbone (CV);Trailing Arm
	12/06→	Track Control Arm		IV-VB-5228	Wishbone (CV), Drive Axle;Air Suspension Axle
12/06→	Track Control Arm		IV-VB-12390	Wishbone (CV), 1st RA, for Pneumatic Suspension vehicles, Ch.C217300/4353375→	
AS 440S45, AT 440S45	12/06→	Centre Rod	IV-DL-2155		Push Rod
	12/06→	Suspension Arm Repair Kit		DF-RK-8994	for Drag Link;For Wishbone (CV)
	12/06→	Suspension Strut Repair Kit		DF-RK-8637	
	12/06→	Tie Rod	IV-DL-8367		Guide Rod
	12/06→	Tie Rod End	CV-ES-14162		for Steering Rod
	12/06→	Tie Rod End	CV-ES-14163		for Steering Rod
	12/06→	Tie Rod End	IV-ES-12419		for Steering Rod
	12/06→	Track Control Arm		IV-DL-8613	Trailing Arm, Drive Axle;Air Suspension Axle
	12/06→	Track Control Arm		IV-DL-9351	Wishbone (CV);Trailing Arm
	12/06→	Track Control Arm		IV-VB-5228	Wishbone (CV), Drive Axle, for Pneumatic Suspension vehicles, →Ch.C217187/4353599
12/06→	Track Control Arm		IV-VB-5228	Wishbone (CV), Drive Axle;Air Suspension Axle	
AS 440S48	02/02→	Centre Rod	IV-DL-2155		Push Rod
	02/02→	Centre Rod	IV-DL-8304		Push Rod
	02/02→	Centre Rod	IV-DL-8697	IV-DL-8697	Push Rod, for vehicles with Hinged Leading Axle
	02/02→	Suspension Arm Repair Kit		DF-RK-8503	for Control Arm
	02/02→	Suspension Arm Repair Kit		DF-RK-8994	for Drag Link;For Wishbone (CV)
	02/02→	Suspension Arm Repair Kit	DB-RK-9300	DB-RK-9300	for Drag Link
	02/02→	Suspension Strut Repair Kit		DF-RK-8637	
	02/02→	Tie Rod	IV-DL-8367		Guide Rod
	02/02→	Tie Rod	IV-DL-12385		
	02/02→	Tie Rod End	CV-ES-14162		for Steering Rod
	02/02→	Tie Rod End	CV-ES-14162	CV-ES-14162	for Steering Rod
	02/02→	Tie Rod End	CV-ES-14163		for Steering Rod
	02/02→	Tie Rod End	IV-ES-12419		for Steering Rod
	02/02→	Track Control Arm		IV-DL-8613	Trailing Arm, Drive Axle;Air Suspension Axle
02/02→	Track Control Arm		IV-DL-9351	Wishbone (CV);Trailing Arm	

CV-ES-14162

Length: 125
Cone Ø: d1 Ø 30 / d2 Ø 27
Thread: M30 x 1,5 LHT
2984061, 4802444, 4833830, 7138966,
8190225, 42489395, 42491957



CV-ES-14163

Length: 125
Cone Ø: d1 Ø 30 / d2 Ø 27
Thread: M30 x 1,5 RHT
2966252, 2969808, 4802443, 4833829,
7138967, 8122752, 42483386, 42488269,
42489573, 42489594, 42491638, 42537936



DB-RK-9300

Ø: 75
Hole Distance: 130
Thick/Height: 24
500333284



DF-RK-8503

Ø: 75
Hole Distance: 130
Thick/Height: 24
93192361



DF-RK-8637

Ø: 72
93161958, 93162239



DF-RK-8994

Ø: 75
Hole Distance: 130
Thick/Height: 24
93161960



IV-DL-2155

Length: 953
Ø: 52
Cone Ø: d1 Ø 30 / d2 Ø 27
8131582, 41005463, 41042919



IV-DL-8304

Length: 953
Ø: 52
Cone Ø: d1 Ø 30 / d2 Ø 27
500397738



IV-DL-8367

Length: 1620
Ø: 48
Cone Ø: d1 Ø 30 / d2 Ø 27
8163773, 41005450, 41005451, 41036943,
41036944



IV-DL-8613

Length: 594
Ø: 50
Hole Distance: 130 / 130
41009661, 41009666, 41035951, 41272429,
98472446, 98472466



IV-DL-8697

Length: 824
Ø: 52
Cone Ø: d1 Ø 30 / d2 Ø 27
08135492, 8135492, 41005469, 41011476,
41016960, 41016961



IV-DL-9351

Length: 455
Ø: 50
Hole Distance: 130 / 130
41033731



IV-DL-12385

Length: 1385
Ø: 58
Cone Ø: d1 Ø 30 / d2 Ø 27
41042749



IV-ES-12419

Length: 55
Cone Ø: d1 Ø 10 / d2 Ø 10
Thread: M10 x 1,5 RHT
2041327, 41002118, 41203863, 42079853



IV-TC-12341

Length: 695
Ø: 46
Hole Distance: 130 / 130
500338783



IV-VB-5228

Length: 665
Ø: 46
Hole Distance: 130 / 130
937104, 08137026, 8137026, 41002770,
41009665, 41028598, 41028600, 41034479,
41042050



IV-VB-12390

Length: 665
Ø: 48
Hole Distance: 152 / 130 / 130
41218620

No Image



Stralis ...

AS 440S48 ...	02/02→	Track Control Arm		IV-DL-9351	Wishbone (CV);Trailing Arm, 1st RA, for pneumatic suspension vehicles
	02/02→	Track Control Arm		IV-VB-5228	Wishbone (CV)
	02/02→	Track Control Arm		IV-VB-5228	Wishbone (CV), Drive Axle;Air Suspension Axle
	02/02→	Track Control Arm		IV-VB-12390	Wishbone (CV), 1st RA, for Pneumatic Suspension vehicles, Ch.C217300/4353375→
	02/02→	Track Control Arm	IV-TC-12341	IV-TC-12341	Suspension Rod, Trailing Arm, for Pneumatic Suspension vehicles
AS 440S50	07/06→	Tie Rod	IV-DL-8367		Guide Rod
	07/06→	Tie Rod	IV-DL-12266		
	07/06→	Tie Rod End		CV-ES-2146	not for vehicles with Hinged Leading Axle
	07/06→	Tie Rod End		MN-ES-8490	not for vehicles with Hinged Leading Axle
	07/06→	Tie Rod End	IV-ES-12419		for Steering Rod
	07/06→	Track Control Arm		IV-DL-8613	Trailing Arm, Drive Axle;Air Suspension Axle
	07/06→	Track Control Arm		IV-DL-9351	Wishbone (CV);Trailing Arm
	07/06→	Track Control Arm		IV-VB-5228	Wishbone (CV), Drive Axle;Air Suspension Axle
	12/06→	Track Control Arm		IV-VB-5228	Wishbone (CV), Drive Axle;Air Suspension Axle, →* C187956 *,* 4333950 *
	12/06→	Track Control Arm		IV-VB-12390	Wishbone (CV), Drive Axle;Air Suspension Axle
AS 440S50, AT 440S50	12/06→	Suspension Arm Repair Kit		DF-RK-8503	for Control Arm
	12/06→	Tie Rod	IV-DL-8367		Guide Rod
	12/06→	Tie Rod End	CV-ES-14162		for Steering Rod
	12/06→	Tie Rod End	CV-ES-14163		for Steering Rod
	12/06→	Tie Rod End	IV-ES-12419		for Steering Rod
	12/06→	Track Control Arm		IV-DL-8613	Trailing Arm, Drive Axle;Air Suspension Axle
	12/06→	Track Control Arm		IV-DL-9351	Wishbone (CV);Trailing Arm
	12/06→	Track Control Arm		IV-VB-5228	Wishbone (CV), Drive Axle;Air Suspension Axle, →* C187956 *,* 4333950 *
	12/06→	Track Control Arm		IV-VB-12390	Wishbone (CV), Drive Axle;Air Suspension Axle
	AS 440S54	02/02→	Centre Rod	IV-DL-8304	
02/02→		Suspension Arm Repair Kit		DF-RK-8994	for Drag Link;For Wishbone (CV)
02/02→		Suspension Strut Repair Kit		DF-RK-8637	
02/02→		Tie Rod	IV-DL-8367		Guide Rod
02/02→		Tie Rod	IV-DL-12385		
02/02→		Tie Rod End	CV-ES-14162		for Steering Rod
02/02→		Tie Rod End	CV-ES-14162	CV-ES-14162	for Steering Rod
02/02→		Tie Rod End	CV-ES-14163		for Steering Rod
02/02→		Track Control Arm		IV-DL-8613	Trailing Arm, Drive Axle;Air Suspension Axle
02/02→		Track Control Arm		IV-DL-9351	Wishbone (CV);Trailing Arm
02/02→		Track Control Arm		IV-VB-5228	Wishbone (CV), Drive Axle;Air Suspension Axle
02/02→		Track Control Arm		IV-VB-12390	Wishbone (CV), 1st RA, for Pneumatic Suspension vehicles, Ch.C217300/4353375→
AS 440S54, ES 440S54		02/02→	Centre Rod	IV-DL-8697	IV-DL-8697
	02/02→	Tie Rod	IV-DL-8367		Guide Rod
	02/02→	Tie Rod	IV-DL-12385		
	02/02→	Tie Rod End	CV-ES-14162		for Steering Rod
	02/02→	Tie Rod End	CV-ES-14163		for Steering Rod
	02/02→	Track Control Arm		IV-DL-8613	Trailing Arm, Drive Axle;Air Suspension Axle
	02/02→	Track Control Arm		IV-DL-9351	Wishbone (CV);Trailing Arm
	02/02→	Track Control Arm		IV-VB-5228	Wishbone (CV), Drive Axle;Air Suspension Axle
AS 440S56	05/06→	Centre Rod	IV-DL-2155		Push Rod
	05/06→	Tie Rod	IV-DL-8367		Guide Rod
	05/06→	Tie Rod End	CV-ES-14162		for Steering Rod
	05/06→	Tie Rod End	CV-ES-14163		for Steering Rod
	05/06→	Tie Rod End	IV-ES-12419		for Steering Rod
	05/06→	Track Control Arm		IV-DL-8613	Trailing Arm, Drive Axle;Air Suspension Axle
	05/06→	Track Control Arm		IV-DL-9351	Wishbone (CV);Trailing Arm, 1st RA, for pneumatic suspension vehicles
05/06→	Track Control Arm		IV-VB-5228	Wishbone (CV), Drive Axle, for Pneumatic Suspension vehicles, →Ch.C217299/4353374	

CV-ES-2146

Length: 80
Cone Ø: d1 Ø 30 / d2 Ø 27
Thread: M26 x 1,5 RHT
42533102



IV-DL-2155

Length: 953
Ø: 52
Cone Ø: d1 Ø 30 / d2 Ø 27
8131582, 41005463, 41042919



IV-DL-12266

Length: 1315
Ø: 50
Cone Ø: d1 Ø 30 / d2 Ø 27
41296162



MN-ES-8490

Length: 90
Cone Ø: d1 Ø 30 / d2 Ø 27
Thread: M26 x 1,5 RHT
0014606948, 14606948, 42533101



CV-ES-14162

Length: 125
Cone Ø: d1 Ø 30 / d2 Ø 27
Thread: M30 x 1,5 LHT
2984061, 4802444, 4833830, 7138966,
8190225, 42489395, 42491957

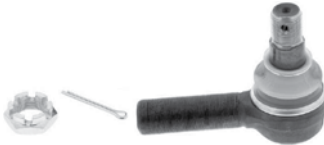

IV-DL-8304

Length: 953
Ø: 52
Cone Ø: d1 Ø 30 / d2 Ø 27
500397738



IV-DL-12385

Length: 1385
Ø: 58
Cone Ø: d1 Ø 30 / d2 Ø 27
41042749



CV-ES-14163

Length: 125
Cone Ø: d1 Ø 30 / d2 Ø 27
Thread: M30 x 1,5 RHT
2966252, 2969808, 4802443, 4833829,
7138967, 8122752, 42483386, 42488269,
42489573, 42489594, 42491638, 42537936



IV-DL-8367

Length: 1620
Ø: 48
Cone Ø: d1 Ø 30 / d2 Ø 27
8163773, 41005450, 41005451, 41036943,
41036944



IV-ES-12419

Length: 55
Cone Ø: d1 Ø 10 / d2 Ø 10
Thread: M10 x 1,5 RHT
2041327, 41002118, 41203863, 42079853



DF-RK-8503

Ø: 75
Hole Distance: 130
Thick/Height: 24
93192361



IV-DL-8613

Length: 594
Ø: 50
Hole Distance: 130 / 130
41009661, 41009666, 41035951, 41272429,
98472446, 98472466



IV-TC-12341

Length: 695
Ø: 46
Hole Distance: 130 / 130
500338783



DF-RK-8637

Ø: 72
93161958, 93162239



IV-DL-8697

Length: 824
Ø: 52
Cone Ø: d1 Ø 30 / d2 Ø 27
08135492, 8135492, 41005469, 41011476,
41016960, 41016961



IV-VB-5228

Length: 665
Ø: 46
Hole Distance: 130 / 130
937104, 8137026, 08137026, 41002770,
41009665, 41028598, 41028600, 41034479,
41042050



DF-RK-8994

Ø: 75
Hole Distance: 130
Thick/Height: 24
93161960



IV-DL-9351

Length: 455
Ø: 50
Hole Distance: 130 / 130
41033731



IV-VB-12390

Length: 665
Ø: 48
Hole Distance: 152 / 130 / 130
41218620

No Image

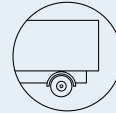

Stralis ...

AS 440S56 ...	05/06 →	Track Control Arm		IV-VB-12390	Wishbone (CV), 1st RA, for Pneumatic Suspension vehicles, Ch.C217300/4353375 →
AS 440S56, AT 440S56	12/06 →	Centre Rod	IV-DL-2155		Push Rod
	12/06 →	Suspension Arm Repair Kit		DF-RK-8503	for Control Arm
	12/06 →	Tie Rod	IV-DL-8367		Guide Rod
	12/06 →	Tie Rod End	CV-ES-14162		for Steering Rod
	12/06 →	Tie Rod End	CV-ES-14163		for Steering Rod
	12/06 →	Tie Rod End	IV-ES-12419		for Steering Rod
	12/06 →	Track Control Arm		IV-DL-8613	Trailing Arm, Drive Axle; Air Suspension Axle
	12/06 →	Track Control Arm		IV-VB-5228	Wishbone (CV), Drive Axle, for Pneumatic Suspension vehicles, →Ch.C217187/4353599
AT 440S33 CNG	01/13 →	Centre Rod	IV-DL-2155		Push Rod
	01/13 →	Tie Rod	IV-DL-8367		Guide Rod
	01/13 →	Tie Rod End	CV-ES-14162		for Steering Rod
	01/13 →	Tie Rod End	CV-ES-14163		for Steering Rod
	01/13 →	Track Control Arm		IV-DL-8613	Trailing Arm, Drive Axle; Air Suspension Axle
	01/13 →	Track Control Arm		IV-DL-9351	Wishbone (CV); Trailing Arm
	01/13 →	Track Control Arm		IV-VB-5228	Wishbone (CV)
	01/13 →	Track Control Arm		IV-VB-12390	Wishbone (CV), 1st RA, for Pneumatic Suspension vehicles, Ch.C217300/4353375 →
AT 440S42	07/06 →	Centre Rod	IV-DL-2155		Push Rod
	07/06 →	Suspension Arm Repair Kit		DF-RK-8994	for Drag Link; For Wishbone (CV)
	07/06 →	Suspension Strut Repair Kit		DF-RK-8637	
	07/06 →	Tie Rod	IV-DL-8367		Guide Rod
	07/06 →	Tie Rod End	CV-ES-14162		for Steering Rod
	07/06 →	Tie Rod End	CV-ES-14163		for Steering Rod
	07/06 →	Tie Rod End	IV-ES-12419		for Steering Rod
	07/06 →	Track Control Arm		IV-DL-8613	Trailing Arm, Drive Axle; Air Suspension Axle
	07/06 →	Track Control Arm		IV-VB-5228	Wishbone (CV), Drive Axle, for Pneumatic Suspension vehicles, →Ch.C217187/4353599
AT 440S43	06/03 →	Centre Rod	IV-DL-8304		Push Rod
	06/03 →	Suspension Arm Repair Kit		DF-RK-8994	for Drag Link; For Wishbone (CV)
	06/03 →	Suspension Strut Repair Kit		DF-RK-8637	
	06/03 →	Tie Rod	IV-DL-8367		Guide Rod
	06/03 →	Tie Rod End	CV-ES-14162	CV-ES-14162	for Steering Rod
	06/03 →	Tie Rod End	CV-ES-14163		for Steering Rod
	06/03 →	Tie Rod End	IV-ES-12419		for Steering Rod
	06/03 →	Track Control Arm		IV-DL-8613	Trailing Arm, Drive Axle; Air Suspension Axle
	06/03 →	Track Control Arm		IV-VB-5228	Wishbone (CV), Drive Axle; Air Suspension Axle
AT 440S45	07/06 →	Suspension Arm Repair Kit		DF-RK-8994	for Drag Link; For Wishbone (CV)
	07/06 →	Suspension Strut Repair Kit		DF-RK-8637	
	07/06 →	Tie Rod	IV-DL-8367		Guide Rod
	07/06 →	Tie Rod End	CV-ES-14162		for Steering Rod
	07/06 →	Tie Rod End	CV-ES-14163		for Steering Rod
	07/06 →	Tie Rod End	IV-ES-12419		for Steering Rod
	07/06 →	Track Control Arm		IV-DL-8613	Trailing Arm, Drive Axle; Air Suspension Axle
	07/06 →	Track Control Arm		IV-DL-9351	Wishbone (CV); Trailing Arm
	07/06 →	Track Control Arm		IV-VB-5228	Wishbone (CV), Drive Axle; Air Suspension Axle
ES 440S48	10/04 →	Suspension Arm Repair Kit		DF-RK-8994	for Drag Link; For Wishbone (CV)
	10/04 →	Suspension Strut Repair Kit		DF-RK-8637	
	10/04 →	Tie Rod	IV-DL-8367		Guide Rod
	10/04 →	Tie Rod End	CV-ES-14162		for Steering Rod
	10/04 →	Tie Rod End	CV-ES-14163		for Steering Rod
	10/04 →	Track Control Arm		IV-DL-8613	Trailing Arm, Drive Axle; Air Suspension Axle
	10/04 →	Track Control Arm		IV-DL-9351	Wishbone (CV); Trailing Arm
	10/04 →	Track Control Arm		IV-VB-5228	Wishbone (CV), Drive Axle; Air Suspension Axle, →* C187902 *; * 4333950 *

CV-ES-14162

Length: 125
Cone Ø: d1 Ø 30 / d2 Ø 27
Thread: M30 x 1,5 LHT
2984061, 4802444, 4833830, 7138966,
8190225, 42489395, 42491957



CV-ES-14163

Length: 125
Cone Ø: d1 Ø 30 / d2 Ø 27
Thread: M30 x 1,5 RHT
2966252, 2969808, 4802443, 4833829,
7138967, 8122752, 42483386, 42488269,
42489573, 42489594, 42491638, 42537936



DF-RK-8503

Ø: 75
Hole Distance: 130
Thick/Height: 24
93192361



DF-RK-8637

Ø: 72
93161958, 93162239



DF-RK-8994

Ø: 75
Hole Distance: 130
Thick/Height: 24
93161960



IV-DL-2155

Length: 953
Ø: 52
Cone Ø: d1 Ø 30 / d2 Ø 27
8131582, 41005463, 41042919



IV-DL-8304

Length: 953
Ø: 52
Cone Ø: d1 Ø 30 / d2 Ø 27
500397738



IV-DL-8367

Length: 1620
Ø: 48
Cone Ø: d1 Ø 30 / d2 Ø 27
8163773, 41005450, 41005451, 41036943,
41036944



IV-DL-8613

Length: 594
Ø: 50
Hole Distance: 130 / 130
41009661, 41009666, 41035951, 41272429,
98472446, 98472466



IV-DL-9351

Length: 455
Ø: 50
Hole Distance: 130 / 130
41033731



IV-ES-12419

Length: 55
Cone Ø: d1 Ø 10 / d2 Ø 10
Thread: M10 x 1,5 RHT
2041327, 41002118, 41203863, 42079853



IV-VB-5228

Length: 665
Ø: 46
Hole Distance: 130 / 130
937104, 08137026, 8137026, 41002770,
41009665, 41028598, 41028600, 41034479,
41042050



IV-VB-12390

Length: 665
Ø: 48
Hole Distance: 152 / 130 / 130
41218620

No Image



Stralis ...

ES 440S48 ...	10/04 →	Track Control Arm		IV-VB-12390	Wishbone (CV), 1st RA, for Pneumatic Suspension vehicles, Ch.C217300/4353375 →
ES 440S54	10/04 →	Tie Rod	IV-DL-8367		Guide Rod
	10/04 →	Track Control Arm		IV-DL-8613	Trailing Arm, Drive Axle; Air Suspension Axle
	10/04 →	Track Control Arm		IV-DL-9351	Wishbone (CV); Trailing Arm
	10/04 →	Track Control Arm		IV-VB-5228	Wishbone (CV), Drive Axle; Air Suspension Axle

Trakker

AD 180T27 W, AT 180T27 W	06/05 →	Centre Rod	IV-DL-8654		Push Rod
	06/05 →	Tie Rod End	IV-ES-12419		for Steering Rod
AD 190T27, AT 190T27	06/05 →	Tie Rod	IV-DL-8367		Guide Rod
	06/05 →	Tie Rod End	IV-ES-12419		for Steering Rod
AD 190T31 W, AT 190T31 W	10/04 →	Centre Rod	IV-DL-8654		Push Rod
	10/04 →	Tie Rod End	IV-ES-12419		for Steering Rod
	10/04 →	Track Control Arm		IV-TC-12431	Trailing Arm
	10/04 →	Track Control Arm		IV-VB-5228	Wishbone (CV), Drive Axle; Air Suspension Axle
AD 190T31, AT 190T31	10/04 →	Tie Rod	IV-DL-8367		Guide Rod
	10/04 →	Tie Rod End	IV-ES-12419		for Steering Rod
	10/04 →	Track Control Arm		IV-DL-8613	Trailing Arm
	10/04 →	Track Control Arm		IV-TC-12431	Trailing Arm
	10/04 →	Track Control Arm		IV-VB-5228	Wishbone (CV), Drive Axle; Air Suspension Axle
	10/04 →	Track Control Arm		IV-VB-5228	Wishbone (CV), Drive Axle; Air Suspension Axle
AD 190T33 W, AT 190T33 W	03/06 →	Centre Rod	IV-DL-8654		Push Rod
	03/06 →	Tie Rod End	IV-ES-12419		for Steering Rod
	03/06 →	Track Control Arm		IV-TC-12431	Trailing Arm
	03/06 →	Track Control Arm		IV-VB-5228	Wishbone (CV), Drive Axle; Air Suspension Axle, →* C187956 *
	03/06 →	Track Control Arm		IV-VB-12390	Wishbone (CV), Drive Axle; Air Suspension Axle
	03/06 →	Track Control Arm		IV-VB-12390	Wishbone (CV), Drive Axle; Air Suspension Axle
AD 190T33, AT 190T33	03/06 →	Tie Rod	IV-DL-8367		Guide Rod
	03/06 →	Track Control Arm		IV-DL-8613	Trailing Arm
	03/06 →	Track Control Arm		IV-TC-12431	Trailing Arm
	03/06 →	Track Control Arm		IV-VB-5228	Wishbone (CV), Drive Axle; Air Suspension Axle, →* C187956 *
	03/06 →	Track Control Arm		IV-VB-12390	Wishbone (CV), Drive Axle; Air Suspension Axle
	03/06 →	Track Control Arm		IV-VB-12390	Wishbone (CV), Drive Axle; Air Suspension Axle
AD 190T35 W, AD 190T36 W, AT 190T35 W, AT 190T36 W	10/04 → 01/07	Track Control Arm		IV-VB-5228	Wishbone (CV), Drive Axle; Air Suspension Axle
	10/04 →	Centre Rod	IV-DL-8654		Push Rod
	10/04 →	Tie Rod End	IV-ES-12419		for Steering Rod
	10/04 →	Track Control Arm		IV-TC-12431	Trailing Arm
	10/04 →	Track Control Arm		IV-VB-12390	Wishbone (CV), Drive Axle; Air Suspension Axle
	10/04 →	Track Control Arm		IV-VB-12390	Wishbone (CV), Drive Axle; Air Suspension Axle
AD 190T35 W, AT 190T35 W, AD 190T36 W, AT 190T36 W	01/05 →	Centre Rod	IV-DL-8654		Push Rod
	01/05 →	Tie Rod End	IV-ES-12419		for Steering Rod
	01/05 →	Track Control Arm		IV-TC-12431	Trailing Arm
	01/05 →	Track Control Arm		IV-VB-12390	Wishbone (CV), Drive Axle; Air Suspension Axle
	01/06 →	Track Control Arm		IV-VB-5228	Wishbone (CV), Drive Axle; Air Suspension Axle, →* C187956 *
	01/06 →	Track Control Arm		IV-VB-5228	Wishbone (CV), Drive Axle; Air Suspension Axle, →* C187956 *
AD 190T35, AD 190T36, AT 190T35, AT 190T36	10/04 →	Tie Rod	IV-DL-8367		Guide Rod
	10/04 →	Tie Rod End	IV-ES-12419		for Steering Rod
	10/04 →	Track Control Arm		IV-DL-8613	Trailing Arm
	10/04 →	Track Control Arm		IV-TC-12431	Trailing Arm
	10/04 →	Track Control Arm		IV-VB-5228	Wishbone (CV), Drive Axle; Air Suspension Axle
	10/04 →	Track Control Arm		IV-VB-12390	Wishbone (CV), Drive Axle; Air Suspension Axle
AD 190T35, AT 190T35, AD 190T36, AT 190T36	06/05 →	Tie Rod	IV-DL-8367		Guide Rod
	06/05 →	Tie Rod End	IV-ES-12419		for Steering Rod
	06/05 →	Track Control Arm		IV-DL-8613	Trailing Arm
	06/05 →	Track Control Arm		IV-TC-12431	Trailing Arm
	06/05 →	Track Control Arm		IV-VB-5228	Wishbone (CV), Drive Axle; Air Suspension Axle
	06/05 →	Track Control Arm		IV-VB-12390	Wishbone (CV), Drive Axle; Air Suspension Axle
	01/06 →	Track Control Arm		IV-VB-5228	Wishbone (CV), Drive Axle; Air Suspension Axle, →* C187956 *
AD 190T38 W, AT 190T38 W	10/04 →	Centre Rod	IV-DL-8654		Push Rod
	10/04 →	Tie Rod End	IV-ES-12419		for Steering Rod
AD 190T38, AT 190T38	10/04 →	Tie Rod	IV-DL-8367		Guide Rod
	10/04 →	Tie Rod End	IV-ES-12419		for Steering Rod

IV-DL-8367**Length:** 1620**Ø:** 48**Cone Ø:** d1 Ø 30 / d2 Ø 278163773, 41005450, 41005451, 41036943,
41036944

IV-VB-5228**Length:** 665**Ø:** 46**Hole Distance:** 130 / 130937104, 8137026, 08137026, 41002770,
41009665, 41028598, 41028600, 41034479,
41042050

IV-DL-8613**Length:** 594**Ø:** 50**Hole Distance:** 130 / 13041009661, 41009666, 41035951, 41272429,
98472446, 98472466

IV-VB-12390**Length:** 665**Ø:** 48**Hole Distance:** 152 / 130 / 130

41218620

No Image

IV-DL-8654**Length:** 959**Ø:** 52**Cone Ø:** d1 Ø 30 / d2 Ø 27

41215165, 41226580



IV-DL-9351**Length:** 455**Ø:** 50**Hole Distance:** 130 / 130

41033731



IV-ES-12419**Length:** 55**Cone Ø:** d1 Ø 10 / d2 Ø 10**Thread:** M10 x 1,5 RHT

2041327, 41002118, 41203863, 42079853



IV-TC-12431**Length:** 594**Ø:** 40**Hole Distance:** 130 / 130

8137027



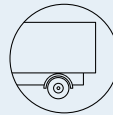

IVECO ...

Trakker ...

AD 190T41 W, AT 190T41 W	03/06→	Centre Rod	IV-DL-8654	Push Rod
AD 190T41, AT 190T41	03/06→	Tie Rod	IV-DL-8367	Guide Rod
AD 190T44 W, AD 190T45 W,	10/04→	Centre Rod	IV-DL-8654	Push Rod
AT 190T44 W, AD 190T45W	10/04→	Tie Rod End	IV-ES-12419	for Steering Rod
AD 190T44 W, AT 190T44 W,	06/05→	Centre Rod	IV-DL-8654	Push Rod
AD 190T45W, AT 190T45W	06/05→	Tie Rod End	IV-ES-12419	for Steering Rod
AD 190T44, AD 190T45,	10/04→	Tie Rod	IV-DL-8367	Guide Rod
AT 190T44, AT 190T45	10/04→	Tie Rod End	IV-ES-12419	for Steering Rod
AD 190T44, AT 190T44,	06/05→	Tie Rod	IV-DL-8367	Guide Rod
AD 19T45, AT 190T45	06/05→	Tie Rod End	IV-ES-12419	for Steering Rod
AD 260T31 B	06/05→	Tie Rod	IV-DL-8367	Guide Rod
	06/05→	Tie Rod End	IV-ES-12419	for Steering Rod
	06/05→	Track Control Arm		IV-DL-8142 Trailing Arm, 1st RA
	06/05→	Track Control Arm		IV-DL-8142 Trailing Arm, 1st RA;2nd RA
	06/05→	Track Control Arm		IV-DL-8142 Trailing Arm, 1st RA;2nd RA;Leaf Spring Axle
	06/05→	Track Control Arm		IV-TC-12387 Suspension Rod, Control Arm
AD 260T31, AT 260T31	10/04→	Tie Rod	IV-DL-8367	Guide Rod
	10/04→	Tie Rod End	IV-ES-12419	for Steering Rod
	10/04→	Track Control Arm		IV-DL-8142 Trailing Arm, 1st RA
	10/04→	Track Control Arm		IV-DL-8142 Trailing Arm, 1st RA;2nd RA
	10/04→	Track Control Arm		IV-DL-8142 Trailing Arm, 1st RA;2nd RA;Leaf Spring Axle
	10/04→	Track Control Arm		IV-DL-8613 Trailing Arm
	10/04→	Track Control Arm		IV-TC-12387 Suspension Rod, Control Arm
AD 260T33 B	07/07→	Tie Rod	IV-DL-8367	Guide Rod
	07/07→	Tie Rod End	IV-ES-12419	for Steering Rod
	07/07→	Track Control Arm		IV-DL-8142 Trailing Arm, 1st RA
	07/07→	Track Control Arm		IV-DL-8142 Trailing Arm, 1st RA;2nd RA
	07/07→	Track Control Arm		IV-DL-8142 Trailing Arm, 1st RA;2nd RA;Leaf Spring Axle
	07/07→	Track Control Arm		IV-TC-12387 Suspension Rod, Control Arm
AD 260T33, AD 380T33,	03/06→	Tie Rod	IV-DL-8367	Guide Rod
AT 260T33, AT 380T33	03/06→	Tie Rod End	IV-ES-12419	for Steering Rod
	03/06→	Track Control Arm		IV-DL-8142 Trailing Arm, 1st RA
	03/06→	Track Control Arm		IV-DL-8142 Trailing Arm, 1st RA;2nd RA
	03/06→	Track Control Arm		IV-DL-8613 Trailing Arm
	03/06→	Track Control Arm		IV-TC-12387 Suspension Rod, Control Arm
AD 260T35 B	06/05→	Tie Rod	IV-DL-8367	Guide Rod
	06/05→	Tie Rod End	IV-ES-12419	for Steering Rod
	06/05→	Track Control Arm		IV-DL-8142 Trailing Arm, 1st RA
	06/05→	Track Control Arm		IV-DL-8142 Trailing Arm, 1st RA;2nd RA
	06/05→	Track Control Arm		IV-DL-8142 Trailing Arm, 1st RA;2nd RA;Leaf Spring Axle
	06/05→	Track Control Arm		IV-TC-12387 Suspension Rod, Control Arm
AD 260T35 W, AT 260T35 W	06/05→	Tie Rod End	IV-ES-12419	for Steering Rod
AD 260T35, 260T36, 380T36,	10/04→	Tie Rod	IV-DL-8367	Guide Rod
AT 260T35, 260T36, 380T36	10/04→	Tie Rod End	IV-ES-12419	for Steering Rod
	10/04→	Track Control Arm		IV-DL-8142 Trailing Arm, 1st RA
	10/04→	Track Control Arm		IV-DL-8142 Trailing Arm, 1st RA;2nd RA
	10/04→	Track Control Arm		IV-DL-8142 Trailing Arm, 1st RA;2nd RA;Leaf Spring Axle
	10/04→	Track Control Arm		IV-TC-12387 Suspension Rod, Control Arm
AD 260T35, AT 260T35	10/04→	Tie Rod	IV-DL-8367	Guide Rod
	10/04→	Tie Rod End	IV-ES-12419	for Steering Rod
	10/04→	Track Control Arm		IV-DL-8142 Trailing Arm, 1st RA
	10/04→	Track Control Arm		IV-DL-8142 Trailing Arm, 1st RA;2nd RA
	10/04→	Track Control Arm		IV-DL-8142 Trailing Arm, 1st RA;2nd RA;Leaf Spring Axle
	10/04→	Track Control Arm		IV-TC-12387 Suspension Rod, Control Arm
AD 260T36 B	07/07→	Tie Rod	IV-DL-8367	Guide Rod
	07/07→	Tie Rod End	IV-ES-12419	for Steering Rod
	07/07→	Track Control Arm		IV-DL-8142 Trailing Arm, 1st RA
	07/07→	Track Control Arm		IV-DL-8142 Trailing Arm, 1st RA;2nd RA
	07/07→	Track Control Arm		IV-DL-8142 Trailing Arm, 1st RA;2nd RA;Leaf Spring Axle
	07/07→	Track Control Arm		IV-TC-12387 Suspension Rod, Control Arm
AD 260T36 W, AD 380T36 W,	10/04→	Tie Rod End	IV-ES-12419	for Steering Rod
AT 260T36 W, AT 380T36 W				

IV-DL-8142

Length: 610

Ø: 50

Hole Distance: 152 / 152

41011008, 42041107



IV-DL-8367

Length: 1620

Ø: 48

Cone Ø: d1 Ø 30 / d2 Ø 27

8163773, 41005450, 41005451, 41036943,
41036944



IV-DL-8613

Length: 594

Ø: 50

Hole Distance: 130 / 130

41009661, 41009666, 41035951, 41272429,
98472446, 98472466



IV-DL-8654

Length: 959

Ø: 52

Cone Ø: d1 Ø 30 / d2 Ø 27

41215165, 41226580



IV-ES-12419

Length: 55

Cone Ø: d1 Ø 10 / d2 Ø 10

Thread: M10 x 1,5 RHT

2041327, 41002118, 41203863, 42079853



IV-TC-12387

Length: 582

Ø: 50

Hole Distance: 152 / 152

41218020



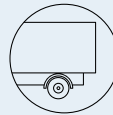

IVECO ...

Trakker ...

AD 260T36, AT 260T36	03/06→	Tie Rod	IV-DL-8367		Guide Rod
	03/06→	Tie Rod End	IV-ES-12419		for Steering Rod
	03/06→	Track Control Arm		IV-DL-8142	Trailing Arm, 1st RA
	03/06→	Track Control Arm		IV-DL-8142	Trailing Arm, 1st RA;2nd RA
	03/06→	Track Control Arm		IV-DL-8142	Trailing Arm, 1st RA;2nd RA;Leaf Spring Axle
	03/06→	Track Control Arm		IV-DL-8613	Trailing Arm
	03/06→	Track Control Arm		IV-TC-12387	Suspension Rod, Control Arm
AD 260T38 , AT 260T38	10/04→	Tie Rod	IV-DL-8367		Guide Rod
	10/04→	Tie Rod End	IV-ES-12419		for Steering Rod
	10/04→	Track Control Arm		IV-DL-8142	Trailing Arm, 1st RA;2nd RA;Leaf Spring Axle
	10/04→	Track Control Arm		IV-DL-8142	Trailing Arm, 1st RA;Leaf Spring Axle
	10/04→	Track Control Arm		IV-DL-8613	Trailing Arm
	10/04→	Track Control Arm		IV-TC-12387	Suspension Rod, Control Arm
	10/04→	Track Control Arm		IV-VB-5228	Wishbone (CV), 1st RA;2nd RA; Air Suspension Axle
AD 260T38 B	06/05→	Tie Rod	IV-DL-8367		Guide Rod
	06/05→	Tie Rod End	IV-ES-12419		for Steering Rod
	06/05→	Track Control Arm		IV-DL-8142	Trailing Arm, 1st RA;2nd RA;Leaf Spring Axle
	06/05→	Track Control Arm		IV-DL-8613	Trailing Arm
	06/05→	Track Control Arm		IV-TC-12387	Suspension Rod, Control Arm
	06/05→	Track Control Arm		IV-VB-5228	Wishbone (CV), 1st RA;2nd RA; Air Suspension Axle
AD 260T38 W, AT 260T38 W	06/05→	Centre Rod	IV-DL-8654		Push Rod
	06/05→	Tie Rod End	IV-ES-12419		for Steering Rod
	06/05→	Track Control Arm		IV-DL-8142	Trailing Arm, 1st RA;2nd RA;Leaf Spring Axle
AD 260T38, AD 260T38 /P, AT 260T38	06/05→	Tie Rod	IV-DL-8367		Guide Rod
	06/05→	Tie Rod End	IV-ES-12419		for Steering Rod
	06/05→	Track Control Arm		IV-DL-8142	Trailing Arm, 1st RA;2nd RA;Leaf Spring Axle
	06/05→	Track Control Arm		IV-DL-8613	Trailing Arm
	06/05→	Track Control Arm		IV-TC-12387	Suspension Rod, Control Arm
	06/05→	Track Control Arm		IV-VB-5228	Wishbone (CV), 1st RA;2nd RA; Air Suspension Axle
AD 260T41 W, AD 380T41 W, AT 260T41 W, AT 380T41 W	03/06→	Centre Rod	IV-DL-8654		Push Rod
	03/06→	Tie Rod End	IV-ES-12419		for Steering Rod
	03/06→	Track Control Arm		IV-DL-8142	Trailing Arm, 1st RA;2nd RA;Leaf Spring Axle
	03/06→	Track Control Arm		IV-DL-8142	Trailing Arm, 1st RA;Leaf Spring Axle
	03/06→	Track Control Arm		IV-TC-12387	Suspension Rod, Control Arm
	03/06→	Track Control Arm		IV-TC-12388	Suspension Rod, Control Arm
	03/06→	Track Control Arm		IV-TC-12431	Trailing Arm
	03/06→	Track Control Arm		IV-VB-5228	Wishbone (CV), 1st RA;2nd RA; Air Suspension Axle, →* C187956 *
	03/06→	Track Control Arm		IV-VB-12389	Wishbone (CV), 1st RA;2nd RA
	03/06→	Tie Rod	IV-DL-8367		Guide Rod
AD 260T41, AD 380T41, AT 260T41, AT 380T41	03/06→	Track Control Arm		IV-DL-8142	Trailing Arm, 1st RA;2nd RA;Leaf Spring Axle
	03/06→	Track Control Arm		IV-DL-8613	Trailing Arm
	03/06→	Track Control Arm		IV-TC-12388	Suspension Rod, Control Arm
	03/06→	Track Control Arm		IV-TC-12431	Trailing Arm
	03/06→	Track Control Arm		IV-VB-5228	Wishbone (CV), 1st RA;2nd RA; Air Suspension Axle, →* C187956 *
	03/06→	Track Control Arm		IV-VB-12389	Wishbone (CV), 1st RA;2nd RA
AD 260T44 W, AT 260T44 W	06/05→	Tie Rod End	IV-ES-12419		for Steering Rod
AD 260T44, AD 260T44 /P, AT 260T44	06/05→	Tie Rod	IV-DL-8367		Guide Rod
	06/05→	Tie Rod End	IV-ES-12419		for Steering Rod
	06/05→	Track Control Arm		IV-DL-8142	Trailing Arm, 1st RA
	06/05→	Track Control Arm		IV-DL-8142	Trailing Arm, 1st RA;2nd RA
	06/05→	Track Control Arm		IV-DL-8142	Trailing Arm, 1st RA;2nd RA;Leaf Spring Axle
	06/05→	Track Control Arm		IV-DL-8613	Trailing Arm
	06/05→	Track Control Arm		IV-TC-12387	Suspension Rod, Control Arm
	06/05→	Track Control Arm		IV-VB-5228	Wishbone (CV), 1st RA;2nd RA; Air Suspension Axle

IV-DL-8142**Length:** 610**Ø:** 50**Hole Distance:** 152 / 152

41011008, 42041107



IV-TC-12388**Length:** 594**Ø:** 46**Hole Distance:** 130 / 130

41272426



IV-DL-8367**Length:** 1620**Ø:** 48**Cone Ø:** d1 Ø 30 / d2 Ø 278163773, 41005450, 41005451, 41036943,
41036944

IV-TC-12431**Length:** 594**Ø:** 40**Hole Distance:** 130 / 130

8137027



IV-DL-8613**Length:** 594**Ø:** 50**Hole Distance:** 130 / 13041009661, 41009666, 41035951, 41272429,
98472446, 98472466

IV-VB-5228**Length:** 665**Ø:** 46**Hole Distance:** 130 / 130937104, 08137026, 8137026, 41002770,
41009665, 41028598, 41028600, 41034479,
41042050

IV-DL-8654**Length:** 959**Ø:** 52**Cone Ø:** d1 Ø 30 / d2 Ø 27

41215165, 41226580



IV-VB-12389**Length:** 665**Ø:** 48**Hole Distance:** 152 / 130 / 130

41272428

No Image

IV-ES-12419**Length:** 55**Cone Ø:** d1 Ø 10 / d2 Ø 10**Thread:** M10 x 1,5 RHT

2041327, 41002118, 41203863, 42079853



IV-TC-12387**Length:** 582**Ø:** 50**Hole Distance:** 152 / 152

41218020



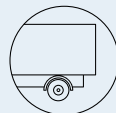

IVECO ...

Trakker ...

AD 260T45 W, AD 380T45 W, AT 260T45 W, AT 380T45 W	03/06 →	Centre Rod	IV-DL-8654		Push Rod
	03/06 →	Tie Rod End	IV-ES-12419		for Steering Rod
	03/06 →	Track Control Arm		IV-DL-8142	Trailing Arm, 1st RA;2nd RA;Leaf Spring Axle
	03/06 →	Track Control Arm		IV-TC-12388	Suspension Rod, Control Arm
	03/06 →	Track Control Arm		IV-VB-12389	Wishbone (CV), 1st RA;2nd RA
AD 260T45, AD 380T45, AT 260T45, AT 380T45	03/06 →	Tie Rod	IV-DL-8367		Guide Rod
	03/06 →	Track Control Arm		IV-DL-8142	Trailing Arm, 1st RA;2nd RA;Leaf Spring Axle
	03/06 →	Track Control Arm		IV-DL-8613	Trailing Arm
	03/06 →	Track Control Arm		IV-TC-12387	Suspension Rod, Control Arm
	03/06 →	Track Control Arm		IV-TC-12388	Suspension Rod, Control Arm
	03/06 →	Track Control Arm		IV-VB-12389	Wishbone (CV), 1st RA;2nd RA
AD 260T48, AT 260T48	06/05 →	Tie Rod	IV-DL-8367		Guide Rod
	06/05 →	Tie Rod End	IV-ES-12419		for Steering Rod
	06/05 →	Track Control Arm		IV-DL-8142	Trailing Arm, 1st RA
	06/05 →	Track Control Arm		IV-DL-8142	Trailing Arm, 1st RA;2nd RA
	06/05 →	Track Control Arm		IV-DL-8142	Trailing Arm, 1st RA;2nd RA;Leaf Spring Axle
	06/05 →	Track Control Arm		IV-DL-8613	Trailing Arm
	06/05 →	Track Control Arm		IV-TC-12387	Suspension Rod, Control Arm
	06/05 →	Track Control Arm		IV-TC-12431	Trailing Arm
	06/05 →	Track Control Arm		IV-VB-5228	Wishbone (CV), 1st RA;2nd RA; Air Suspension Axle
AD 260T50, AD 380T50, AT 260T50, AT 380T50	03/06 →	Tie Rod	IV-DL-8367		Guide Rod
	03/06 →	Track Control Arm		IV-DL-8142	Trailing Arm, 1st RA;2nd RA;Leaf Spring Axle
	03/06 →	Track Control Arm		IV-DL-8613	Trailing Arm
	03/06 →	Track Control Arm		IV-TC-12388	Suspension Rod, Control Arm
	03/06 →	Track Control Arm		IV-TC-12431	Trailing Arm
	03/06 →	Track Control Arm		IV-VB-5228	Wishbone (CV), 1st RA;2nd RA; Air Suspension Axle, →* C187956 *
AD 340T35 B, AT 340T35 B	03/06 →	Track Control Arm		IV-VB-12389	Wishbone (CV), 1st RA;2nd RA
	06/05 →	Centre Rod	IV-DL-8193		Push Rod
	06/05 →	Tie Rod	IV-DL-8367		Guide Rod
	06/05 →	Tie Rod	IV-DL-12265		
	06/05 →	Tie Rod End	IV-ES-8515		
	06/05 →	Tie Rod End	IV-ES-12419		for Steering Rod
	06/05 →	Track Control Arm		IV-DL-8142	Trailing Arm, 1st RA;2nd RA;Leaf Spring Axle
	06/05 →	Track Control Arm		IV-TC-12387	Suspension Rod, Control Arm
	06/05 →	Track Control Arm		IV-TC-12431	Trailing Arm
AD 340T35, AT 340T35	06/05 →	Track Control Arm		IV-VB-5228	Wishbone (CV), 1st RA;2nd RA; Air Suspension Axle
	06/05 →	Centre Rod	IV-DL-8193		Push Rod
	06/05 →	Tie Rod	IV-DL-8367		Guide Rod
	06/05 →	Tie Rod	IV-DL-12265		
	06/05 →	Tie Rod End	IV-ES-8515		
	06/05 →	Tie Rod End	IV-ES-12419		for Steering Rod
	06/05 →	Track Control Arm		IV-DL-8142	Trailing Arm, 1st RA;2nd RA;Leaf Spring Axle
	06/05 →	Track Control Arm		IV-DL-8613	Trailing Arm
	06/05 →	Track Control Arm		IV-TC-12387	Suspension Rod, Control Arm
AD 340T36 B	06/05 →	Track Control Arm		IV-TC-12431	Trailing Arm
	06/05 →	Track Control Arm		IV-VB-5228	Wishbone (CV), 1st RA;2nd RA; Air Suspension Axle
	06/06 →	Centre Rod	IV-DL-8193		Push Rod
	06/06 →	Tie Rod	IV-DL-8367		Guide Rod
	06/06 →	Tie Rod	IV-DL-12265		
	06/06 →	Tie Rod End	IV-ES-8515		
	06/06 →	Tie Rod End	IV-ES-12419		for Steering Rod
	06/06 →	Track Control Arm		IV-DL-8142	Trailing Arm, 1st RA;2nd RA;Leaf Spring Axle
AD 340T36, AT 340T36	06/06 →	Track Control Arm		IV-DL-8142	Trailing Arm, 1st RA;Leaf Spring Axle
	06/06 →	Track Control Arm		IV-TC-12387	Suspension Rod, Control Arm
	03/06 →	Centre Rod	IV-DL-8193		Push Rod
	03/06 →	Tie Rod	IV-DL-8367		Guide Rod
	03/06 →	Tie Rod	IV-DL-12265		
	03/06 →	Tie Rod End	IV-ES-8515		
	03/06 →	Tie Rod End	IV-ES-12419		for Steering Rod

IV-DL-8142

Length: 610
Ø: 50
Hole Distance: 152 / 152
41011008, 42041107



IV-ES-8515

Length: 86
Cone Ø: d1 Ø 38 / d2 Ø 34,3
Thread: M30 x 1,5 RHT
4143415, 42530316, 42538047,
7364001574



IV-VB-12389

Length: 665
Ø: 48
Hole Distance: 152 / 130 / 130
41272428

No Image

IV-DL-8193

Length: 887
Ø: 52
Cone Ø: d1 Ø 30 / d2 Ø 27
41028269, 41298449



IV-ES-12419

Length: 55
Cone Ø: d1 Ø 10 / d2 Ø 10
Thread: M10 x 1,5 RHT
2041327, 41002118, 41203863, 42079853



IV-DL-8367

Length: 1620
Ø: 48
Cone Ø: d1 Ø 30 / d2 Ø 27
8163773, 41005450, 41005451, 41036943,
41036944



IV-TC-12387

Length: 582
Ø: 50
Hole Distance: 152 / 152
41218020



IV-DL-8613

Length: 594
Ø: 50
Hole Distance: 130 / 130
41009661, 41009666, 41035951, 41272429,
98472446, 98472466



IV-TC-12388

Length: 594
Ø: 46
Hole Distance: 130 / 130
41272426



IV-DL-8654

Length: 959
Ø: 52
Cone Ø: d1 Ø 30 / d2 Ø 27
41215165, 41226580



IV-TC-12431

Length: 594
Ø: 40
Hole Distance: 130 / 130
8137027



IV-DL-12265

Length: 1577
Ø: 48
Cone Ø: d1 Ø 30 / d2 Ø 27
8165309, 41005309, 41005460



IV-VB-5228

Length: 665
Ø: 46
Hole Distance: 130 / 130
937104, 08137026, 8137026, 41002770,
41009665, 41028598, 41028600, 41034479,
41042050





Trakker ...

AD 340T36, AT 340T36 ...	03/06→	Track Control Arm		IV-DL-8142	Trailing Arm, 1st RA;2nd RA;Leaf Spring Axle
	03/06→	Track Control Arm		IV-DL-8613	Trailing Arm
	03/06→	Track Control Arm		IV-TC-12387	Suspension Rod, Control Arm
	03/06→	Track Control Arm		IV-TC-12431	Trailing Arm
	07/07→	Track Control Arm		IV-VB-5228	Wishbone (CV), 1st RA;2nd RA; Air Suspension Axle
AD 340T38 B, AT 34T38 B	06/05→	Centre Rod	IV-DL-8193		Push Rod
	06/05→	Tie Rod	IV-DL-8367		Guide Rod
	06/05→	Tie Rod	IV-DL-12265		
	06/05→	Tie Rod End	IV-ES-8515		
	06/05→	Tie Rod End	IV-ES-12419		for Steering Rod
	06/05→	Track Control Arm		IV-DL-8142	Trailing Arm, 1st RA;2nd RA;Leaf Spring Axle
	06/05→	Track Control Arm		IV-DL-8142	Trailing Arm, 1st RA;Leaf Spring Axle
	06/05→	Track Control Arm		IV-DL-8142	Trailing Arm, 2nd RA;Leaf Spring Axle
	06/05→	Track Control Arm		IV-TC-12387	Suspension Rod, Control Arm
	06/05→	Track Control Arm		IV-TC-12431	Trailing Arm
	06/05→	Track Control Arm		IV-VB-5228	Wishbone (CV), 1st RA;2nd RA; Air Suspension Axle
	AD 340T41 B	06/06→	Centre Rod	IV-DL-8193	
06/06→		Tie Rod	IV-DL-8367		Guide Rod
06/06→		Tie Rod	IV-DL-12265		
06/06→		Tie Rod End	IV-ES-8515		
06/06→		Tie Rod End	IV-ES-12419		for Steering Rod
AD 340T41, AT 340T41	06/06→	Track Control Arm		IV-DL-8142	Trailing Arm, 1st RA;2nd RA;Leaf Spring Axle
	03/06→	Centre Rod	IV-DL-8193		Push Rod
	03/06→	Tie Rod	IV-DL-8367		Guide Rod
	03/06→	Tie Rod	IV-DL-12265		
	03/06→	Tie Rod End	IV-ES-8515		
	03/06→	Tie Rod End	IV-ES-12419		for Steering Rod
	03/06→	Track Control Arm		IV-DL-8142	Trailing Arm, 1st RA;2nd RA;Leaf Spring Axle
	03/06→	Track Control Arm		IV-DL-8613	Trailing Arm
	03/06→	Track Control Arm		IV-TC-12387	Suspension Rod, Control Arm
	03/06→	Track Control Arm		IV-TC-12431	Trailing Arm
	03/06→	Track Control Arm		IV-VB-5228	Wishbone (CV), 1st RA;2nd RA; Air Suspension Axle
	AD 340T44 B, AT 340T44 B	06/05→	Centre Rod	IV-DL-8193	
06/05→		Tie Rod	IV-DL-8367		Guide Rod
06/05→		Tie Rod	IV-DL-12265		
06/05→		Tie Rod End	IV-ES-8515		
06/05→		Tie Rod End	IV-ES-12419		for Steering Rod
06/05→		Track Control Arm		IV-DL-8142	Trailing Arm, 1st RA;2nd RA;Leaf Spring Axle
06/05→		Track Control Arm		IV-DL-8142	Trailing Arm, 1st RA;Leaf Spring Axle
06/05→		Track Control Arm		IV-TC-12387	Suspension Rod, Control Arm
06/05→		Track Control Arm		IV-TC-12431	Trailing Arm
06/05→		Track Control Arm		IV-VB-5228	Wishbone (CV), 1st RA;2nd RA; Air Suspension Axle
AD 340T44, AT 340T44	06/05→	Centre Rod	IV-DL-8193		Push Rod
	06/05→	Tie Rod	IV-DL-8367		Guide Rod
	06/05→	Tie Rod	IV-DL-12265		
	06/05→	Tie Rod End	IV-ES-8515		
	06/05→	Tie Rod End	IV-ES-12419		for Steering Rod
	06/05→	Track Control Arm		IV-DL-8142	Trailing Arm, 1st RA;2nd RA;Leaf Spring Axle
	06/05→	Track Control Arm		IV-DL-8142	Trailing Arm, 1st RA;Leaf Spring Axle
	06/05→	Track Control Arm		IV-DL-8142	Trailing Arm, 2nd RA;Leaf Spring Axle
	06/05→	Track Control Arm		IV-DL-8613	Trailing Arm
	06/05→	Track Control Arm		IV-TC-12387	Suspension Rod, Control Arm
	06/05→	Track Control Arm		IV-TC-12431	Trailing Arm
	AD 340T45 B	06/06→	Centre Rod	IV-DL-8193	
06/06→		Tie Rod	IV-DL-8367		Guide Rod
06/06→		Tie Rod	IV-DL-12265		
06/06→		Tie Rod End	IV-ES-8515		
06/06→		Tie Rod End	IV-ES-12419		for Steering Rod

IV-DL-8142

Length: 610
Ø: 50
Hole Distance: 152 / 152
41011008, 42041107



IV-ES-12419

Length: 55
Cone Ø: d1 Ø 10 / d2 Ø 10
Thread: M10 x 1,5 RHT
2041327, 41002118, 41203863, 42079853



IV-DL-8193

Length: 887
Ø: 52
Cone Ø: d1 Ø 30 / d2 Ø 27
41028269, 41298449



IV-TC-12387

Length: 582
Ø: 50
Hole Distance: 152 / 152
41218020



IV-DL-8367

Length: 1620
Ø: 48
Cone Ø: d1 Ø 30 / d2 Ø 27
8163773, 41005450, 41005451, 41036943,
41036944



IV-TC-12431

Length: 594
Ø: 40
Hole Distance: 130 / 130
8137027



IV-DL-8613

Length: 594
Ø: 50
Hole Distance: 130 / 130
41009661, 41009666, 41035951, 41272429,
98472446, 98472466



IV-VB-5228

Length: 665
Ø: 46
Hole Distance: 130 / 130
937104, 08137026, 8137026, 41002770,
41009665, 41028598, 41028600, 41034479,
41042050



IV-DL-12265

Length: 1577
Ø: 48
Cone Ø: d1 Ø 30 / d2 Ø 27
8165309, 41005309, 41005460



IV-ES-8515

Length: 86
Cone Ø: d1 Ø 38 / d2 Ø 34,3
Thread: M30 x 1,5 RHT
4143415, 42530316, 42538047,
7364001574





Trakker ...

AD 340T45 B ...	06/06→	Tie Rod End	IV-ES-12419		for Steering Rod
	06/06→	Track Control Arm		IV-DL-8142	Trailing Arm, 1st RA;2nd RA;Leaf Spring Axle
	06/06→	Track Control Arm		IV-TC-12387	Suspension Rod, Control Arm
	06/06→	Track Control Arm		IV-TC-12431	Trailing Arm
	06/06→	Track Control Arm		IV-VB-5228	Wishbone (CV), 1st RA;2nd RA; Air Suspension Axle
AD 340T45, AD 340T45 /P, AT 340T45, AT 34T45 /P	06/06→	Centre Rod	IV-DL-8193		Push Rod
	06/06→	Tie Rod	IV-DL-8367		Guide Rod
	06/06→	Tie Rod	IV-DL-12265		
	06/06→	Tie Rod End	IV-ES-8515		
	06/06→	Track Control Arm		IV-DL-8142	Trailing Arm, 1st RA;2nd RA;Leaf Spring Axle
	06/06→	Track Control Arm		IV-TC-12431	Trailing Arm
	06/06→	Track Control Arm		IV-VB-5228	Wishbone (CV), 1st RA;2nd RA; Air Suspension Axle
AD 340T45, AT 340T45	03/06→	Centre Rod	IV-DL-8193		Push Rod
	03/06→	Tie Rod	IV-DL-8367		Guide Rod
	03/06→	Tie Rod	IV-DL-12265		
	03/06→	Tie Rod End	IV-ES-8515		
	03/06→	Tie Rod End	IV-ES-12419		for Steering Rod
	03/06→	Track Control Arm		IV-DL-8142	Trailing Arm, 1st RA;2nd RA;Leaf Spring Axle
	03/06→	Track Control Arm		IV-DL-8142	Trailing Arm, 2nd RA;Leaf Spring Axle
	03/06→	Track Control Arm		IV-TC-12387	Suspension Rod, Control Arm
	03/06→	Track Control Arm		IV-TC-12431	Trailing Arm
	03/06→	Track Control Arm		IV-VB-5228	Wishbone (CV), 1st RA;2nd RA; Air Suspension Axle
AD 380T35	01/05→	Tie Rod End	IV-ES-12419		for Steering Rod
AD 380T36 W, AT 380T36 W	04/06→	Centre Rod	IV-DL-8193		Push Rod
	04/06→	Tie Rod End	IV-ES-12419		for Steering Rod
AD 380T38 B	06/05→	Centre Rod	IV-DL-8193		Push Rod
	06/05→	Tie Rod End	IV-ES-12419		for Steering Rod
AD 380T38 W, AT 380T38 W	06/05→	Centre Rod	IV-DL-8193		Push Rod
	06/05→	Tie Rod End	IV-ES-12419		for Steering Rod
AD 380T38, AT 380T38	01/05→	Centre Rod	IV-DL-8193		Push Rod
	01/05→	Tie Rod End	IV-ES-12419		for Steering Rod
AD 380T41 W, AT 380T41 W	09/06→	Tie Rod End	IV-ES-12419		for Steering Rod
AD 380T41, AT 380T41	09/06→	Tie Rod End	IV-ES-12419		for Steering Rod
AD 380T44 B	06/05→	Tie Rod End	IV-ES-12419		for Steering Rod
AD 380T44 W, AT 380T44 W	06/05→	Tie Rod End	IV-ES-12419		for Steering Rod
AD 380T44, AT 380T44	06/05→	Tie Rod End	IV-ES-12419		for Steering Rod
AD 380T45 W, AT 380T45 W	09/06→	Centre Rod	IV-DL-8193		Push Rod
	09/06→	Tie Rod End	IV-ES-12419		for Steering Rod
	09/06→	Track Control Arm		IV-TC-12388	Suspension Rod, Control Arm
	09/06→	Track Control Arm		IV-VB-12389	Wishbone (CV)
AD 380T48, AD 380T48	06/05→	Tie Rod End	IV-ES-12419		for Steering Rod
AD 400T35 T, AT 400T35 T	06/05→	Tie Rod	IV-DL-8367		Guide Rod
	06/05→	Tie Rod End	IV-ES-12419		for Steering Rod
AD 400T36 T, AT 400T36 T	10/04→	Tie Rod	IV-DL-8367		Guide Rod
	10/04→	Tie Rod End	IV-ES-12419		for Steering Rod
AD 400T38 T, AT 400T38 T	06/05→	Centre Rod	IV-DL-8193		Push Rod
	06/05→	Tie Rod	IV-DL-8367		Guide Rod
	06/05→	Tie Rod End	IV-ES-12419		for Steering Rod
AD 400T38 WT, AT 400T38 WT	06/05→	Centre Rod	IV-DL-8193		Push Rod
	06/05→	Centre Rod	IV-DL-8654		Push Rod
	06/05→	Tie Rod End	IV-ES-12419		for Steering Rod
	06/05→	Tie Rod	IV-DL-8367		Guide Rod
AD 400T41 T, AT 400T41 T	03/06→	Tie Rod	IV-DL-8367		Guide Rod
	03/06→	Track Control Arm		IV-TC-12431	Trailing Arm
	03/06→	Track Control Arm		IV-VB-5228	Wishbone (CV), 1st RA;Air Suspension Axle, →* C187956 *
	03/06→	Track Control Arm		IV-VB-12390	Wishbone (CV), 1st RA
AD 400T41 WT, AT 400T41 WT	03/06→	Centre Rod	IV-DL-8654		Push Rod
	03/06→	Tie Rod End	IV-ES-12419		for Steering Rod
	03/06→	Track Control Arm		IV-TC-12431	Trailing Arm

IV-DL-8142

Length: 610
Ø: 50
Hole Distance: 152 / 152
41011008, 42041107



IV-ES-12419

Length: 55
Cone Ø: d1 Ø 10 / d2 Ø 10
Thread: M10 x 1,5 RHT
2041327, 41002118, 41203863, 42079853



IV-VB-12390

Length: 665
Ø: 48
Hole Distance: 152 / 130 / 130
41218620

No Image

IV-DL-8193

Length: 887
Ø: 52
Cone Ø: d1 Ø 30 / d2 Ø 27
41028269, 41298449



IV-TC-12387

Length: 582
Ø: 50
Hole Distance: 152 / 152
41218020



IV-DL-8367

Length: 1620
Ø: 48
Cone Ø: d1 Ø 30 / d2 Ø 27
8163773, 41005450, 41005451, 41036943,
41036944



IV-TC-12388

Length: 594
Ø: 46
Hole Distance: 130 / 130
41272426



IV-DL-8654

Length: 959
Ø: 52
Cone Ø: d1 Ø 30 / d2 Ø 27
41215165, 41226580



IV-TC-12431

Length: 594
Ø: 40
Hole Distance: 130 / 130
8137027



IV-DL-12265

Length: 1577
Ø: 48
Cone Ø: d1 Ø 30 / d2 Ø 27
8165309, 41005309, 41005460



IV-VB-5228

Length: 665
Ø: 46
Hole Distance: 130 / 130
937104, 08137026, 8137026, 41002770,
41009665, 41028598, 41028600, 41034479,
41042050



IV-ES-8515

Length: 86
Cone Ø: d1 Ø 38 / d2 Ø 34,3
Thread: M30 x 1,5 RHT
4143415, 42530316, 42538047,
7364001574



IV-VB-12389

Length: 665
Ø: 48
Hole Distance: 152 / 130 / 130
41272428

No Image



Trakker ...

AD 400T41 WT, AT 400T41 WT ...	03/06→	Track Control Arm		IV-VB-5228	Wishbone (CV), 1st RA;Air Suspension Axle, →* C187956 *
	03/06→	Track Control Arm		IV-VB-12390	Wishbone (CV), 1st RA
AD 400T44 T, AT 400T44 T	06/05→	Tie Rod	IV-DL-8367		Guide Rod
	06/05→	Tie Rod End	IV-ES-12419		for Steering Rod
	06/05→	Track Control Arm		IV-TC-12431	Trailing Arm
	06/05→	Track Control Arm		IV-VB-5228	Wishbone (CV), 1st RA;Air Suspension Axle
AD 400T44 WT, AT 400T44 WT	06/05→	Centre Rod	IV-DL-8654		Push Rod
	06/05→	Tie Rod End	IV-ES-12419		for Steering Rod
	06/05→	Track Control Arm		IV-TC-12431	Trailing Arm
	06/05→	Track Control Arm		IV-VB-5228	Wishbone (CV), 1st RA;Air Suspension Axle
AD 400T45 T, AT 400T45 T	03/06→	Tie Rod	IV-DL-8367		Guide Rod
	03/06→	Track Control Arm		IV-TC-12431	Trailing Arm
	03/06→	Track Control Arm		IV-VB-5228	Wishbone (CV), 1st RA;Air Suspension Axle, →* C187956 *
	03/06→	Track Control Arm		IV-VB-12390	Wishbone (CV), 1st RA
AD 400T45 WT, AT 400T45 WT	03/06→	Centre Rod	IV-DL-8654		Push Rod
	03/06→	Tie Rod End	IV-ES-12419		for Steering Rod
	03/06→	Track Control Arm		IV-TC-12431	Trailing Arm
	03/06→	Track Control Arm		IV-VB-5228	Wishbone (CV), 1st RA;Air Suspension Axle, →* C187956 *
	03/06→	Track Control Arm		IV-VB-12390	Wishbone (CV), 1st RA
AD 400T50 T, AT 400T50 T	03/06→	Tie Rod	IV-DL-8367		Guide Rod
	03/06→	Track Control Arm		IV-TC-12431	Trailing Arm
	03/06→	Track Control Arm		IV-VB-12390	Wishbone (CV), 1st RA
AD 410T35	02/05→	Centre Rod	IV-DL-8193		Push Rod
	02/05→	Tie Rod	IV-DL-8367		Guide Rod
	02/05→	Tie Rod	IV-DL-12265		
	02/05→	Tie Rod End	IV-ES-8515		
	02/05→	Tie Rod End	IV-ES-12419		for Steering Rod
AD 410T36, AT 410T36	03/06→	Centre Rod	IV-DL-8193		Push Rod
	03/06→	Tie Rod	IV-DL-8367		Guide Rod
	03/06→	Tie Rod	IV-DL-12265		
	03/06→	Tie Rod End	IV-ES-8515		
	03/06→	Tie Rod End	IV-ES-12419		for Steering Rod
AD 410T38	02/05→	Centre Rod	IV-DL-8193		Push Rod
	02/05→	Tie Rod	IV-DL-8367		Guide Rod
	02/05→	Tie Rod	IV-DL-12265		
	02/05→	Tie Rod End	IV-ES-8515		
	02/05→	Tie Rod End	IV-ES-12419		for Steering Rod
AD 410T38 B, AT 410T38 B	06/05→	Centre Rod	IV-DL-8193		Push Rod
	06/05→	Tie Rod	IV-DL-8367		Guide Rod
	06/05→	Tie Rod	IV-DL-12265		
	06/05→	Tie Rod End	IV-ES-8515		
	06/05→	Tie Rod End	IV-ES-12419		for Steering Rod
AD 410T38 H	04/05→	Centre Rod	IV-DL-8193		Push Rod
	04/05→	Tie Rod	IV-DL-8367		Guide Rod
	04/05→	Tie Rod	IV-DL-12265		
	04/05→	Tie Rod End	IV-ES-8515		
	04/05→	Tie Rod End	IV-ES-12419		for Steering Rod
AD 410T41, AT 410T41	03/06→	Centre Rod	IV-DL-8193		Push Rod
	03/06→	Tie Rod	IV-DL-8367		Guide Rod
	03/06→	Tie Rod	IV-DL-12265		
	03/06→	Tie Rod End	IV-ES-8515		
	03/06→	Tie Rod End	IV-ES-12419		for Steering Rod
AD 410T44 B, AT 410T44 B	06/05→	Centre Rod	IV-DL-8193		Push Rod
	06/05→	Tie Rod	IV-DL-8367		Guide Rod
	06/05→	Tie Rod	IV-DL-12265		
	06/05→	Tie Rod End	IV-ES-8515		
	06/05→	Tie Rod End	IV-ES-12419		for Steering Rod
AD 410T44 W , AT 410T44 W	06/05→	Centre Rod	IV-DL-8193		Push Rod
	06/05→	Tie Rod	IV-DL-12386		
	06/05→	Tie Rod End	IV-ES-8515		
	06/05→	Tie Rod End	IV-ES-12419		for Steering Rod

IV-DL-8193

Length: 887
Ø: 52
Cone Ø: d1 Ø 30 / d2 Ø 27
41028269, 41298449



IV-ES-12419

Length: 55
Cone Ø: d1 Ø 10 / d2 Ø 10
Thread: M10 x 1,5 RHT
2041327, 41002118, 41203863, 42079853



IV-DL-8367

Length: 1620
Ø: 48
Cone Ø: d1 Ø 30 / d2 Ø 27
8163773, 41005450, 41005451, 41036943,
41036944



IV-TC-12431

Length: 594
Ø: 40
Hole Distance: 130 / 130
8137027



IV-DL-8654

Length: 959
Ø: 52
Cone Ø: d1 Ø 30 / d2 Ø 27
41215165, 41226580



IV-VB-5228

Length: 665
Ø: 46
Hole Distance: 130 / 130
937104, 08137026, 8137026, 41002770,
41009665, 41028598, 41028600, 41034479,
41042050



IV-DL-12265

Length: 1577
Ø: 48
Cone Ø: d1 Ø 30 / d2 Ø 27
8165309, 41005309, 41005460



IV-VB-12390

Length: 665
Ø: 48
Hole Distance: 152 / 130 / 130
41218620

No Image

IV-DL-12386

Length: 1485
Ø: 62
Cone Ø: d1 Ø 30 / d2 Ø 27
41042245, 42530929



IV-ES-8515

Length: 86
Cone Ø: d1 Ø 38 / d2 Ø 34,3
Thread: M30 x 1,5 RHT
4143415, 42530316, 42538047,
7364001574





Trakker ...

AD 410T44, AT 410T44	02/05 →	Centre Rod	IV-DL-8193		Push Rod
	02/05 →	Tie Rod	IV-DL-8367		Guide Rod
	02/05 →	Tie Rod	IV-DL-12265		
	02/05 →	Tie Rod End	IV-ES-8515		
	02/05 →	Tie Rod End	IV-ES-12419		for Steering Rod
AD 410T44, AT410T44	02/05 →	Track Control Arm		IV-TC-12431	Trailing Arm
AD 410T45 W	03/06 →	Centre Rod	IV-DL-8193		Push Rod
	03/06 →	Tie Rod	IV-DL-12386		
	03/06 →	Tie Rod End	IV-ES-8515		
	03/06 →	Tie Rod End	IV-ES-12419		for Steering Rod
	03/06 →	Centre Rod	IV-DL-8193		Push Rod
AD 410T45, AT 410T45	03/06 →	Tie Rod	IV-DL-8367		Guide Rod
	03/06 →	Tie Rod	IV-DL-12265		
	03/06 →	Tie Rod End	IV-ES-8515		
	03/06 →	Tie Rod End	IV-ES-12419		for Steering Rod
	AD 410T48 B, AT 410T48 B	06/05 →	Centre Rod	IV-DL-8193	
06/05 →		Tie Rod	IV-DL-8367		Guide Rod
06/05 →		Tie Rod	IV-DL-12265		
06/05 →		Tie Rod End	IV-ES-8515		
06/05 →		Tie Rod End	IV-ES-12419		for Steering Rod
AD 410T48, AT 410T48	02/05 →	Centre Rod	IV-DL-8193		Push Rod
	02/05 →	Tie Rod	IV-DL-8367		Guide Rod
	02/05 →	Tie Rod	IV-DL-12265		
	02/05 →	Tie Rod End	IV-ES-8515		
	02/05 →	Tie Rod End	IV-ES-12419		for Steering Rod
	02/05 →	Track Control Arm		IV-TC-12431	Trailing Arm
AD 410T50, AT 410T50	03/06 →	Centre Rod	IV-DL-8193		Push Rod
	03/06 →	Tie Rod	IV-DL-8367		Guide Rod
	03/06 →	Tie Rod	IV-DL-12265		
	03/06 →	Tie Rod End	IV-ES-8515		
	03/06 →	Tie Rod End	IV-ES-12419		for Steering Rod
	03/06 →	Track Control Arm		IV-TC-12388	Suspension Rod, Control Arm
	03/06 →	Track Control Arm		IV-VB-12389	Wishbone (CV), 1st RA;2nd RA
AD 440T38 T, AT 440T38 T	04/05 →	Tie Rod	IV-DL-8367		Guide Rod
	04/05 →	Tie Rod End	IV-ES-12419		for Steering Rod
	04/05 →	Track Control Arm		IV-TC-12431	Trailing Arm
	04/05 →	Track Control Arm		IV-VB-5228	Wishbone (CV), 1st RA;2nd RA; Air Suspension Axle
AD 440T41 T, AT 440T41 T	03/06 →	Tie Rod	IV-DL-8367		Guide Rod
	03/06 →	Track Control Arm		IV-TC-12431	Trailing Arm
	03/06 →	Track Control Arm		IV-VB-5228	Wishbone (CV), 1st RA;2nd RA; Air Suspension Axle
AD 440T44 B	06/05 →	Tie Rod End	IV-ES-12419		for Steering Rod
AD 440T44 T, AT 440T44T	06/05 →	Tie Rod	IV-DL-8367		Guide Rod
	06/05 →	Tie Rod End	IV-ES-12419		for Steering Rod
	06/05 →	Track Control Arm		IV-DL-8142	Trailing Arm, 1st RA;2nd RA;Leaf Spring Axle
	06/05 →	Track Control Arm		IV-TC-12431	Trailing Arm
	06/05 →	Track Control Arm		IV-VB-5228	Wishbone (CV), 1st RA;2nd RA; Air Suspension Axle
AD 440T45 T, AT 440T45 T	03/06 →	Tie Rod	IV-DL-8367		Guide Rod
	03/06 →	Track Control Arm		IV-DL-8142	Trailing Arm, 1st RA;2nd RA;Leaf Spring Axle
	03/06 →	Track Control Arm		IV-TC-12388	Suspension Rod, Control Arm
	03/06 →	Track Control Arm		IV-TC-12431	Trailing Arm
	03/06 →	Track Control Arm		IV-VB-5228	Wishbone (CV), 1st RA;2nd RA; Air Suspension Axle, →* C187956 *
	03/06 →	Track Control Arm		IV-VB-12389	Wishbone (CV), 1st RA;2nd RA
AD 440T50 T, AT 440T50 T	03/06 →	Tie Rod	IV-DL-8367		Guide Rod
	03/06 →	Track Control Arm		IV-DL-8142	Trailing Arm, 1st RA;2nd RA;Leaf Spring Axle
	03/06 →	Track Control Arm		IV-TC-12388	Suspension Rod, Control Arm
	03/06 →	Track Control Arm		IV-TC-12431	Trailing Arm
	03/06 →	Track Control Arm		IV-VB-5228	Wishbone (CV), 1st RA;2nd RA; Air Suspension Axle, →* C187956 *
	03/06 →	Track Control Arm		IV-VB-12389	Wishbone (CV), 1st RA;2nd RA

IV-DL-8142

Length: 610
Ø: 50
Hole Distance: 152 / 152
41011008, 42041107



IV-ES-12419

Length: 55
Cone Ø: d1 Ø 10 / d2 Ø 10
Thread: M10 x 1,5 RHT
2041327, 41002118, 41203863, 42079853



IV-DL-8193

Length: 887
Ø: 52
Cone Ø: d1 Ø 30 / d2 Ø 27
41028269, 41298449



IV-TC-12388

Length: 594
Ø: 46
Hole Distance: 130 / 130
41272426



IV-DL-8367

Length: 1620
Ø: 48
Cone Ø: d1 Ø 30 / d2 Ø 27
8163773, 41005450, 41005451, 41036943,
41036944



IV-TC-12431

Length: 594
Ø: 40
Hole Distance: 130 / 130
8137027



IV-DL-12265

Length: 1577
Ø: 48
Cone Ø: d1 Ø 30 / d2 Ø 27
8165309, 41005309, 41005460



IV-VB-5228

Length: 665
Ø: 46
Hole Distance: 130 / 130
937104, 08137026, 8137026, 41002770,
41009665, 41028598, 41028600, 41034479,
41042050



IV-DL-12386

Length: 1485
Ø: 62
Cone Ø: d1 Ø 30 / d2 Ø 27
41042245, 42530929



IV-VB-12389

Length: 665
Ø: 48
Hole Distance: 152 / 130 / 130
41272428

No Image

IV-ES-8515

Length: 86
Cone Ø: d1 Ø 38 / d2 Ø 34,3
Thread: M30 x 1,5 RHT
4143415, 42530316, 42538047,
7364001574



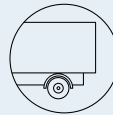

Trakker ...

AD 720T38 T, AT 720T38 T	06/05→	Tie Rod	IV-DL-8367	Guide Rod
	06/05→	Tie Rod End	IV-ES-12419	for Steering Rod
AD 720T38 WT, AT 720T38 WT	06/05→	Centre Rod	IV-DL-8654	Push Rod
	06/05→	Tie Rod End	IV-ES-12419	for Steering Rod
AD 720T41 T, AT 720T41 T	03/06→	Tie Rod	IV-DL-8367	Guide Rod
AD 720T41 WT, AT 720T41 WT	03/06→	Centre Rod	IV-DL-8654	Push Rod
AD 720T44 T, AT 720T44 T	06/05→	Tie Rod	IV-DL-8367	Guide Rod
	06/05→	Tie Rod End	IV-ES-12419	for Steering Rod
AD 720T44 WT, AT 720T44 WT	06/05→	Centre Rod	IV-DL-8654	Push Rod
	06/05→	Tie Rod End	IV-ES-12419	for Steering Rod
	03/06→	Tie Rod	IV-DL-8367	Guide Rod
AD 720T45 T, AT 720T45 T	03/06→	Centre Rod	IV-DL-8654	Push Rod
AD 720T48 T, AT 720T48 T	06/05→	Tie Rod	IV-DL-8367	Guide Rod
AD 720T50 T, AT 720T50 T, AT 720T50 TP, AT 720T50 HT	06/05→	Tie Rod End	IV-ES-12419	for Steering Rod
	03/06→	Tie Rod	IV-DL-8367	Guide Rod
AT 400T42 TH	03/06→	Track Control Arm	IV-TC-12388	Suspension Rod, Control Arm
	03/06→	Track Control Arm	IV-VB-12389	Wishbone (CV), 1st RA;2nd RA
AT 720T42 T	06/05→	Tie Rod	IV-DL-8367	Guide Rod
	06/05→	Tie Rod End	IV-ES-12419	for Steering Rod
AT 720T42 WT	04/05→	Tie Rod	IV-DL-8367	Guide Rod
	06/05→	Centre Rod	IV-DL-8654	Push Rod

TurboStar

190-33	07/84→05/87	Ball Head, gearshift linkage	CV-ES-2119	
	07/84→05/87	Ball Head, gearshift linkage	CV-ES-2182	
	07/84→05/87	Centre Rod	IV-DL-0214	Push Rod
	07/84→05/87	Stabiliser Link		IV-DL-8542 Coupling Rod
	07/84→05/87	Tie Rod	IV-DL-12268	
	07/84→05/87	Tie Rod End	CV-ES-0912	
	07/84→05/87	Tie Rod End	CV-ES-0914	for Steering Rod
	07/84→05/87	Tie Rod End	CV-ES-14162	for Steering Rod
	07/84→05/87	Tie Rod End	CV-ES-14163	for Steering Rod
	190-33 P	01/86→12/87	Ball Head, gearshift linkage	CV-ES-2119
01/86→12/87		Ball Head, gearshift linkage	CV-ES-2182	
01/86→12/87		Centre Rod	IV-DL-0214	Push Rod
01/86→12/87		Stabiliser Link		IV-DL-8542 Coupling Rod
01/86→12/87		Suspension Arm Repair Kit		MN-RK-7291 for Drag Link
01/86→12/87		Tie Rod	IV-DL-12268	
01/86→12/87		Tie Rod End	CV-ES-0912	
01/86→12/87		Tie Rod End	CV-ES-0914	for Steering Rod
01/86→12/87		Tie Rod End	CV-ES-14162	for Steering Rod
01/86→12/87		Tie Rod End	CV-ES-14163	for Steering Rod
190-33 T	07/84→05/87	Ball Head, gearshift linkage	CV-ES-2119	
	07/84→05/87	Ball Head, gearshift linkage	CV-ES-2182	
	07/84→05/87	Centre Rod	IV-DL-0214	Push Rod
	07/84→05/87	Stabiliser Link		IV-DL-8542 Coupling Rod
	07/84→05/87	Tie Rod	IV-DL-12268	
	07/84→05/87	Tie Rod End	CV-ES-0912	
	07/84→05/87	Tie Rod End	CV-ES-0914	for Steering Rod
	07/84→05/87	Tie Rod End	CV-ES-14162	for Steering Rod
	07/84→05/87	Tie Rod End	CV-ES-14163	for Steering Rod
190-36	07/87→12/93	Ball Head, gearshift linkage	CV-ES-2119	
	07/87→12/93	Ball Head, gearshift linkage	CV-ES-2121	
	07/87→12/93	Ball Head, gearshift linkage	CV-ES-2182	
	07/87→12/93	Centre Rod	IV-DL-0214	Push Rod
	07/87→12/93	Stabiliser Link		IV-DL-8542 Coupling Rod
	07/87→12/93	Suspension Arm Repair Kit		MN-RK-7291 for Drag Link
	07/87→12/93	Tie Rod	IV-DL-12268	
	07/87→12/93	Tie Rod End	CV-ES-0912	
	07/87→12/93	Tie Rod End	CV-ES-0914	for Steering Rod
	07/87→12/93	Tie Rod End	CV-ES-14162	for Steering Rod
	07/87→12/93	Tie Rod End	CV-ES-14163	for Steering Rod

CV-ES-0912

Length: 125
Cone Ø: d1 Ø 30 / d2 Ø 27
Thread: M38 x 1,5 LHT
04688949



CV-ES-14163

Length: 125
Cone Ø: d1 Ø 30 / d2 Ø 27
Thread: M30 x 1,5 RHT
2966252, 2969808, 4802443, 4833829,
7138967, 8122752, 42483386, 42488269,
42489573, 42489594, 42491638, 42537936



IV-ES-12419

Length: 55
Cone Ø: d1 Ø 10 / d2 Ø 10
Thread: M10 x 1,5 RHT
2041327, 41002118, 41203863, 42079853



CV-ES-0914

Length: 125
Cone Ø: d1 Ø 30 / d2 Ø 27
Thread: M38 x 1,5 RHT
04688948



IV-DL-0214

Length: 982
Ø: 48
Cone Ø: d1 Ø 30 / d2 Ø 27
42087841, 42087842



IV-TC-12388

Length: 594
Ø: 46
Hole Distance: 130 / 130
41272426



CV-ES-2119

Length: 55
Cone Ø: d1 Ø 10 / d2 Ø 10
Thread: M12 x 1,75 LHT
8198188, 42485638



IV-DL-8367

Length: 1620
Ø: 48
Cone Ø: d1 Ø 30 / d2 Ø 27
8163773, 41005450, 41005451, 41036943,
41036944



IV-VB-12389

Length: 665
Ø: 48
Hole Distance: 152 / 130 / 130
41272428

No Image

CV-ES-2121

Length: 85
Cone Ø: d1 Ø 12 / d2 Ø 10,8
Thread: M14 x 1,5 RHT
3435786, 7981909, 86027074



IV-DL-8542

Length: 355
Ø: 40
Cone Ø: d1 Ø 30 / d2 Ø 27
4741171



MN-RK-7291

Ø: 72
Hole Distance: 130
Thick/Height: 30
2980884



CV-ES-2182

Length: 55
Cone Ø: d1 Ø 10 / d2 Ø 10
Thread: M12 x 1,75 RHT
8198187



IV-DL-8654

Length: 959
Ø: 52
Cone Ø: d1 Ø 30 / d2 Ø 27
41215165, 41226580



CV-ES-14162

Length: 125
Cone Ø: d1 Ø 30 / d2 Ø 27
Thread: M30 x 1,5 LHT
2984061, 4802444, 4833830, 7138966,
8190225, 42489395, 42491957

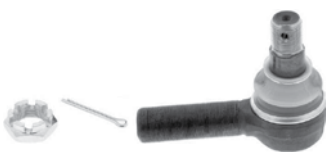

IV-DL-12268

Length: 1640
Ø: 46
Cone Ø: d1 Ø 30 / d2 Ø 27
42003432





TurboStar ...

190-36 P	07/87→12/93	Ball Head, gearshift linkage	CV-ES-2119		
	07/87→12/93	Ball Head, gearshift linkage	CV-ES-2182		
	07/87→12/93	Centre Rod	IV-DL-0214		Push Rod
	07/87→12/93	Stabiliser Link		IV-DL-8542	Coupling Rod
	07/87→12/93	Suspension Arm Repair Kit		MN-RK-7291	for Drag Link
	07/87→12/93	Tie Rod	IV-DL-12268		
	07/87→12/93	Tie Rod End	CV-ES-0912		
	07/87→12/93	Tie Rod End	CV-ES-0914		for Steering Rod
	07/87→12/93	Tie Rod End	CV-ES-14162		for Steering Rod
190-36 T	07/87→12/93	Ball Head, gearshift linkage	CV-ES-2119		
	07/87→12/93	Ball Head, gearshift linkage	CV-ES-2121		
	07/87→12/93	Ball Head, gearshift linkage	CV-ES-2182		
	07/87→12/93	Centre Rod	IV-DL-0214		Push Rod
	07/87→12/93	Stabiliser Link		IV-DL-8542	Coupling Rod
	07/87→12/93	Suspension Arm Repair Kit		MN-RK-7291	for Drag Link
	07/87→12/93	Tie Rod	IV-DL-12268		
	07/87→12/93	Tie Rod End	CV-ES-0912		
	07/87→12/93	Tie Rod End	CV-ES-0914		for Steering Rod
190-42	07/84→12/90	Ball Head, gearshift linkage	CV-ES-2119		
	07/84→12/90	Ball Head, gearshift linkage	CV-ES-2182		
	07/84→12/90	Centre Rod	IV-DL-0214		Push Rod
	07/84→12/90	Stabiliser Link		IV-DL-8542	Coupling Rod
	07/84→12/90	Tie Rod	IV-DL-12268		
	07/84→12/90	Tie Rod End	CV-ES-0912		
	07/84→12/90	Tie Rod End	CV-ES-0914		for Steering Rod
	07/84→12/90	Tie Rod End	CV-ES-14162		for Steering Rod
	07/84→12/90	Tie Rod End	CV-ES-14163		for Steering Rod
190-42 T	07/84→12/90	Ball Head, gearshift linkage	CV-ES-2119		
	07/84→12/90	Ball Head, gearshift linkage	CV-ES-2182		
	07/84→12/90	Centre Rod	IV-DL-0214		Push Rod
	07/84→12/90	Stabiliser Link		IV-DL-8542	Coupling Rod
	07/84→12/90	Tie Rod	IV-DL-12268		
	07/84→12/90	Tie Rod End	CV-ES-0912		
	07/84→12/90	Tie Rod End	CV-ES-0914		for Steering Rod
	07/84→12/90	Tie Rod End	CV-ES-14162		for Steering Rod
190-48	03/89→12/93	Ball Head, gearshift linkage	CV-ES-2119		
	03/89→12/93	Ball Head, gearshift linkage	CV-ES-2182		
	03/89→12/93	Centre Rod	IV-DL-0214		Push Rod
	03/89→12/93	Stabiliser Link		IV-DL-8542	Coupling Rod
	03/89→12/93	Tie Rod	IV-DL-12268		
	03/89→12/93	Tie Rod End	CV-ES-0912		
	03/89→12/93	Tie Rod End	CV-ES-0914		for Steering Rod
	03/89→12/93	Tie Rod End	CV-ES-14162		for Steering Rod
190-48 T	03/89→12/93	Ball Head, gearshift linkage	CV-ES-2119		
	03/89→12/93	Ball Head, gearshift linkage	CV-ES-2182		
	03/89→12/93	Centre Rod	IV-DL-0214		Push Rod
	03/89→12/93	Stabiliser Link		IV-DL-8542	Coupling Rod
	03/89→12/93	Tie Rod	IV-DL-12268		
	03/89→12/93	Tie Rod End	CV-ES-0912		
	03/89→12/93	Tie Rod End	CV-ES-0914		for Steering Rod
	03/89→12/93	Tie Rod End	CV-ES-14162		for Steering Rod

CV-ES-0912

Length: 125
Cone Ø: d1 Ø 30 / d2 Ø 27
Thread: M38 x 1,5 LHT
04688949



CV-ES-14163

Length: 125
Cone Ø: d1 Ø 30 / d2 Ø 27
Thread: M30 x 1,5 RHT
2966252, 2969808, 4802443, 4833829,
7138967, 8122752, 42483386, 42488269,
42489573, 42489594, 42491638, 42537936



CV-ES-0914

Length: 125
Cone Ø: d1 Ø 30 / d2 Ø 27
Thread: M38 x 1,5 RHT
04688948



IV-DL-0214

Length: 982
Ø: 48
Cone Ø: d1 Ø 30 / d2 Ø 27
42087841, 42087842



CV-ES-2119

Length: 55
Cone Ø: d1 Ø 10 / d2 Ø 10
Thread: M12 x 1,75 LHT
8198188, 42485638



IV-DL-8542

Length: 355
Ø: 40
Cone Ø: d1 Ø 30 / d2 Ø 27
4741171



CV-ES-2121

Length: 85
Cone Ø: d1 Ø 12 / d2 Ø 10,8
Thread: M14 x 1,5 RHT
3435786, 7981909, 86027074



IV-DL-12268

Length: 1640
Ø: 46
Cone Ø: d1 Ø 30 / d2 Ø 27
42003432



CV-ES-2182

Length: 55
Cone Ø: d1 Ø 10 / d2 Ø 10
Thread: M12 x 1,75 RHT
8198187



MN-RK-7291

Ø: 72
Hole Distance: 130
Thick/Height: 30
2980884



CV-ES-14162

Length: 125
Cone Ø: d1 Ø 30 / d2 Ø 27
Thread: M30 x 1,5 LHT
2984061, 4802444, 4833830, 7138966,
8190225, 42489395, 42491957





TurboTech

190-26	01/90→12/92	Ball Head, gearshift linkage	CV-ES-2119		
	01/90→12/92	Ball Head, gearshift linkage	CV-ES-2182		
	01/90→12/92	Centre Rod	IV-DL-0214		Push Rod
	01/90→12/92	Tie Rod	IV-DL-12268		
	01/90→12/92	Tie Rod End	CV-ES-0912		
	01/90→12/92	Tie Rod End	CV-ES-0914		for Steering Rod
	01/90→12/92	Tie Rod End	CV-ES-14162		for Steering Rod
	01/90→12/92	Tie Rod End	CV-ES-14163		for Steering Rod
190-26 T	01/90→12/92	Ball Head, gearshift linkage	CV-ES-2119		
	01/90→12/92	Ball Head, gearshift linkage	CV-ES-2182		
	01/90→12/92	Centre Rod	IV-DL-0214		Push Rod
	01/90→12/92	Tie Rod	IV-DL-12268		
	01/90→12/92	Tie Rod End	CV-ES-0912		
	01/90→12/92	Tie Rod End	CV-ES-0914		for Steering Rod
	01/90→12/92	Tie Rod End	CV-ES-14162		for Steering Rod
	01/90→12/92	Tie Rod End	CV-ES-14163		for Steering Rod
190-32	01/90→12/92	Ball Head, gearshift linkage	CV-ES-2119		
	01/90→12/92	Ball Head, gearshift linkage	CV-ES-2182		
	01/90→12/92	Centre Rod	IV-DL-0214		Push Rod
	01/90→12/92	Stabiliser Link		IV-DL-8542	Coupling Rod
	01/90→12/92	Suspension Arm Repair Kit		MN-RK-7291	for Drag Link
	01/90→12/92	Tie Rod	IV-DL-12268		
	01/90→12/92	Tie Rod End	CV-ES-0912		
	01/90→12/92	Tie Rod End	CV-ES-0914		for Steering Rod
190-32 T	01/90→12/92	Ball Head, gearshift linkage	CV-ES-2119		
	01/90→12/92	Ball Head, gearshift linkage	CV-ES-2182		
	01/90→12/92	Centre Rod	IV-DL-0214		Push Rod
	01/90→12/92	Stabiliser Link		IV-DL-8542	Coupling Rod
	01/90→12/92	Suspension Arm Repair Kit		MN-RK-7291	for Drag Link
	01/90→12/92	Tie Rod	IV-DL-12268		
	01/90→12/92	Tie Rod End	CV-ES-0912		
	01/90→12/92	Tie Rod End	CV-ES-0914		for Steering Rod
190-36	01/90→12/92	Ball Head, gearshift linkage	CV-ES-2119		
	01/90→12/92	Ball Head, gearshift linkage	CV-ES-2121		
	01/90→12/92	Ball Head, gearshift linkage	CV-ES-2182		
	01/90→12/92	Centre Rod	IV-DL-0214		Push Rod
	01/90→12/92	Stabiliser Link		IV-DL-8542	Coupling Rod
	01/90→12/92	Suspension Arm Repair Kit		MN-RK-7291	for Drag Link
	01/90→12/92	Tie Rod	IV-DL-12268		
	01/90→12/92	Tie Rod End	CV-ES-0912		

CV-ES-0912

Length: 125
Cone Ø: d1 Ø 30 / d2 Ø 27
Thread: M38 x 1,5 LHT
04688949



CV-ES-14163

Length: 125
Cone Ø: d1 Ø 30 / d2 Ø 27
Thread: M30 x 1,5 RHT
2966252, 2969808, 4802443, 4833829,
7138967, 8122752, 42483386, 42488269,
42489573, 42489594, 42491638, 42537936



CV-ES-0914

Length: 125
Cone Ø: d1 Ø 30 / d2 Ø 27
Thread: M38 x 1,5 RHT
04688948



IV-DL-0214

Length: 982
Ø: 48
Cone Ø: d1 Ø 30 / d2 Ø 27
42087841, 42087842



CV-ES-2119

Length: 55
Cone Ø: d1 Ø 10 / d2 Ø 10
Thread: M12 x 1,75 LHT
8198188, 42485638



IV-DL-8542

Length: 355
Ø: 40
Cone Ø: d1 Ø 30 / d2 Ø 27
4741171



CV-ES-2121

Length: 85
Cone Ø: d1 Ø 12 / d2 Ø 10,8
Thread: M14 x 1,5 RHT
3435786, 7981909, 86027074



IV-DL-12268

Length: 1640
Ø: 46
Cone Ø: d1 Ø 30 / d2 Ø 27
42003432



CV-ES-2182

Length: 55
Cone Ø: d1 Ø 10 / d2 Ø 10
Thread: M12 x 1,75 RHT
8198187



IV-ES-12419

Length: 55
Cone Ø: d1 Ø 10 / d2 Ø 10
Thread: M10 x 1,5 RHT
2041327, 41002118, 41203863, 42079853



CV-ES-14162

Length: 125
Cone Ø: d1 Ø 30 / d2 Ø 27
Thread: M30 x 1,5 LHT
2984061, 4802444, 4833830, 7138966,
8190225, 42489395, 42491957



MN-RK-7291

Ø: 72
Hole Distance: 130
Thick/Height: 30
2980884





TurboTech ...

190-36 T	01/90→12/92	Ball Head, gearshift linkage	CV-ES-2119		
	01/90→12/92	Ball Head, gearshift linkage	CV-ES-2121		
	01/90→12/92	Ball Head, gearshift linkage	CV-ES-2182		
	01/90→12/92	Centre Rod	IV-DL-0214		Push Rod
	01/90→12/92	Stabiliser Link		IV-DL-8542	Coupling Rod
	01/90→12/92	Suspension Arm Repair Kit		MN-RK-7291	for Drag Link
	01/90→12/92	Tie Rod	IV-DL-12268		
	01/90→12/92	Tie Rod End	CV-ES-0912		
	01/90→12/92	Tie Rod End	CV-ES-0914		for Steering Rod
	01/90→12/92	Tie Rod End	CV-ES-14162		for Steering Rod
220-36 PT	01/90→12/92	Ball Head, gearshift linkage	CV-ES-2119		
	01/90→12/92	Ball Head, gearshift linkage	CV-ES-2121		
	01/90→12/92	Ball Head, gearshift linkage	CV-ES-2182		
	01/90→12/92	Centre Rod	IV-DL-0214		Push Rod
	01/90→12/92	Stabiliser Link		IV-DL-8542	Coupling Rod
	01/90→12/92	Suspension Arm Repair Kit		MN-RK-7291	for Drag Link
	01/90→12/92	Tie Rod End	CV-ES-0912		
	01/90→12/92	Tie Rod End	CV-ES-0914		for Steering Rod
	01/90→12/92	Tie Rod End	CV-ES-14162		for Steering Rod
	01/90→12/92	Tie Rod End	CV-ES-14163		for Steering Rod
240-36 P	01/90→12/92	Ball Head, gearshift linkage	CV-ES-2121		
	01/90→12/92	Centre Rod	IV-DL-0214		Push Rod
	01/90→12/92	Tie Rod End	CV-ES-0912		
	01/90→12/92	Tie Rod End	CV-ES-0914		for Steering Rod
	01/90→12/92	Tie Rod End	CV-ES-14162		for Steering Rod
	01/90→12/92	Tie Rod End	CV-ES-14163		for Steering Rod
	01/90→12/92	Tie Rod End	IV-ES-12419		for Steering Rod

Zeta

109-14	06/83→03/91	Tie Rod End	CV-ES-2135		for Steering Rod
	06/83→03/91	Tie Rod End	DF-ES-5404		for Steering Rod
109-14 H	06/83→03/91	Tie Rod End	CV-ES-2135		for Steering Rod
	06/83→03/91	Tie Rod End	DF-ES-5404		for Steering Rod
50-10	01/79→12/86	Tie Rod End	CV-ES-2135		for Steering Rod
	01/79→12/86	Tie Rod End	DF-ES-5404		for Steering Rod
50-10 H	01/79→12/86	Tie Rod End	CV-ES-2135		for Steering Rod
	01/79→12/86	Tie Rod End	DF-ES-5404		for Steering Rod
50-10 V	01/79→12/86	Tie Rod End	CV-ES-2135		for Steering Rod
	01/79→12/86	Tie Rod End	DF-ES-5404		for Steering Rod
50-8	01/83→12/86	Tie Rod End	CV-ES-2135		for Steering Rod
	01/83→12/86	Tie Rod End	DF-ES-5404		for Steering Rod
50-8 H	01/83→12/86	Tie Rod End	CV-ES-2135		for Steering Rod
	01/83→12/86	Tie Rod End	DF-ES-5404		for Steering Rod
50-8 V	01/83→12/86	Tie Rod End	CV-ES-2135		for Steering Rod
	01/83→12/86	Tie Rod End	DF-ES-5404		for Steering Rod
50-9	01/87→03/91	Tie Rod End	CV-ES-2135		for Steering Rod
	01/87→03/91	Tie Rod End	DF-ES-5404		for Steering Rod
50-9 H	01/87→03/91	Tie Rod End	CV-ES-2135		for Steering Rod
	01/87→03/91	Tie Rod End	DF-ES-5404		for Steering Rod
50-9 V	01/87→03/91	Tie Rod End	CV-ES-2135		for Steering Rod
	01/87→03/91	Tie Rod End	DF-ES-5404		for Steering Rod
60-10	11/79→12/86	Tie Rod End	CV-ES-2135		for Steering Rod
	11/79→12/86	Tie Rod End	DF-ES-5404		for Steering Rod
60-10 H	11/79→12/86	Tie Rod End	CV-ES-2135		for Steering Rod
	11/79→12/86	Tie Rod End	DF-ES-5404		for Steering Rod
60-10 V	11/79→12/86	Tie Rod End	CV-ES-2135		for Steering Rod
	11/79→12/86	Tie Rod End	DF-ES-5404		for Steering Rod
60-11	01/87→03/91	Tie Rod End	CV-ES-2135		for Steering Rod
	01/87→03/91	Tie Rod End	DF-ES-5404		for Steering Rod
60-11 V	01/87→03/91	Tie Rod End	CV-ES-2135		for Steering Rod
	01/87→03/91	Tie Rod End	DF-ES-5404		for Steering Rod

CV-ES-0912

Length: 125
Cone Ø: d1 Ø 30 / d2 Ø 27
Thread: M38 x 1,5 LHT
04688949



CV-ES-14162

Length: 125
Cone Ø: d1 Ø 30 / d2 Ø 27
Thread: M30 x 1,5 LHT
2984061, 4802444, 4833830, 7138966,
8190225, 42489395, 42491957



IV-ES-12419

Length: 55
Cone Ø: d1 Ø 10 / d2 Ø 10
Thread: M10 x 1,5 RHT
2041327, 41002118, 41203863, 42079853



CV-ES-0914

Length: 125
Cone Ø: d1 Ø 30 / d2 Ø 27
Thread: M38 x 1,5 RHT
04688948



CV-ES-14163

Length: 125
Cone Ø: d1 Ø 30 / d2 Ø 27
Thread: M30 x 1,5 RHT
2966252, 2969808, 4802443, 4833829,
7138967, 8122752, 42483386, 42488269,
42489573, 42489594, 42491638, 42537936



MN-RK-7291

Ø: 72
Hole Distance: 130
Thick/Height: 30
2980884



CV-ES-2119

Length: 55
Cone Ø: d1 Ø 10 / d2 Ø 10
Thread: M12 x 1,75 LHT
8198188, 42485638



DF-ES-5404

Length: 115
Cone Ø: d1 Ø 26 / d2 Ø 23,5
Thread: M28 x 1,5 LHT
4688942, 8582333



CV-ES-2121

Length: 85
Cone Ø: d1 Ø 12 / d2 Ø 10,8
Thread: M14 x 1,5 RHT
3435786, 7981909, 86027074



IV-DL-0214

Length: 982
Ø: 48
Cone Ø: d1 Ø 30 / d2 Ø 27
42087841, 42087842



CV-ES-2135

Length: 115
Cone Ø: d1 Ø 26 / d2 Ø 23,5
Thread: M28 x 1,5 RHT
4688941, 8582332



IV-DL-8542

Length: 355
Ø: 40
Cone Ø: d1 Ø 30 / d2 Ø 27
4741171



CV-ES-2182

Length: 55
Cone Ø: d1 Ø 10 / d2 Ø 10
Thread: M12 x 1,75 RHT
8198187



IV-DL-12268

Length: 1640
Ø: 46
Cone Ø: d1 Ø 30 / d2 Ø 27
42003432





Zeta ...

60-8	11/79→12/83	Tie Rod End	DF-ES-5404		for Steering Rod
65-10	11/79→01/87	Tie Rod End	DF-ES-5404		for Steering Rod
65-10 H	11/79→01/87	Tie Rod End	DF-ES-5404		for Steering Rod
65-10 V	11/79→01/87	Tie Rod End	DF-ES-5404		for Steering Rod
65-12	01/87→03/91	Tie Rod End	CV-ES-2135		for Steering Rod
	01/87→03/91	Tie Rod End	DF-ES-5404		for Steering Rod
65-12 H	01/87→03/91	Tie Rod End	CV-ES-2135		for Steering Rod
	01/87→03/91	Tie Rod End	DF-ES-5404		for Steering Rod
65-12 V	01/87→03/91	Tie Rod End	CV-ES-2135		for Steering Rod
	01/87→03/91	Tie Rod End	DF-ES-5404		for Steering Rod
65-9	01/87→03/91	Tie Rod End	CV-ES-2135		for Steering Rod
	01/87→03/91	Tie Rod End	DF-ES-5404		for Steering Rod
79-10	01/83→01/87	Tie Rod End	CV-ES-2135		for Steering Rod
	01/83→01/87	Tie Rod End	DF-ES-5404		for Steering Rod
79-10 H	01/83→01/87	Tie Rod End	CV-ES-2135		for Steering Rod
	01/83→01/87	Tie Rod End	DF-ES-5404		for Steering Rod
79-10 V	01/83→01/87	Tie Rod End	CV-ES-2135		for Steering Rod
	01/83→01/87	Tie Rod End	DF-ES-5404		for Steering Rod
79-12	01/87→03/91	Tie Rod End	CV-ES-2135		for Steering Rod
	01/87→03/91	Tie Rod End	DF-ES-5404		for Steering Rod
79-12 H	01/87→03/91	Tie Rod End	CV-ES-2135		for Steering Rod
	01/87→03/91	Tie Rod End	DF-ES-5404		for Steering Rod
79-12 V	01/87→03/91	Tie Rod End	CV-ES-2135		for Steering Rod
	01/87→03/91	Tie Rod End	DF-ES-5404		for Steering Rod
79-13	11/79→12/83	Tie Rod End	CV-ES-2135		for Steering Rod
	11/79→12/83	Tie Rod End	DF-ES-5404		for Steering Rod
79-14	01/83→03/91	Tie Rod End	CV-ES-2135		for Steering Rod
	01/83→03/91	Tie Rod End	DF-ES-5404		for Steering Rod
79-14 H	01/83→03/91	Tie Rod End	CV-ES-2135		for Steering Rod
	01/83→03/91	Tie Rod End	DF-ES-5404		for Steering Rod
79-14 V	01/83→03/91	Tie Rod End	CV-ES-2135		for Steering Rod
	01/83→03/91	Tie Rod End	DF-ES-5404		for Steering Rod
95-14	07/83→03/91	Tie Rod End	DF-ES-5404		for Steering Rod
95-14 H	07/83→03/91	Tie Rod End	DF-ES-5404		for Steering Rod
A 60-10	11/79→06/88	Tie Rod End	CV-ES-2135		for Steering Rod
	11/79→06/88	Tie Rod End	DF-ES-5404		for Steering Rod
A 60-9	09/88→12/92	Tie Rod End	CV-ES-2135		for Steering Rod
	09/88→12/92	Tie Rod End	DF-ES-5404		for Steering Rod
A 70-12	01/83→01/85	Tie Rod End	CV-ES-2135		for Steering Rod
	01/83→01/85	Tie Rod End	DF-ES-5404		for Steering Rod
A 70-14	05/88→12/92	Tie Rod End	CV-ES-2135		for Steering Rod
	05/88→12/92	Tie Rod End	DF-ES-5404		for Steering Rod

CV-ES-2135

Length: 115

Cone Ø: d1 Ø 26 / d2 Ø 23,5

Thread: M28 x 1,5 RHT

4688941, 8582332



DF-ES-5404

Length: 115

Cone Ø: d1 Ø 26 / d2 Ø 23,5

Thread: M28 x 1,5 LHT

4688942, 8582333



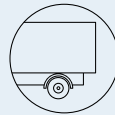

CLA

15.220 FRC	01/06→	Centre Rod	MN-DL-8378	Push Rod
16.220 FK	01/06→	Centre Rod	MN-DL-8378	Push Rod
18.280 FC, FRC	01/06→	Centre Rod	MN-DL-8378	Push Rod
18.280 FRS, FS	01/06→	Centre Rod	MN-DL-8378	Push Rod
25.280 FDRC, FDC	01/06→	Centre Rod	MN-DL-8378	Push Rod
25.280 FDS, FDRS	01/06→	Centre Rod	MN-DL-8378	Push Rod
26.280 FDC, FDRC	01/06→	Centre Rod	MN-DL-8378	Push Rod
26.280 FDK, FDRK	01/06→	Centre Rod	MN-DL-8378	Push Rod
26.280 FDS, FDRS	01/06→	Centre Rod	MN-DL-8378	Push Rod
26.280 FD-TM, FDR-TM	01/06→	Centre Rod	MN-DL-8378	Push Rod

E 2000

19.310 FALK, FALK-L	05/00→	Centre Rod	MN-DL-12391	for Steering Rod
	05/00→	Tie Rod End	CV-ES-2146	
	05/00→	Track Control Arm		MN-DL-5212 Trailing Arm, Air Suspension Axle
	05/00→	Track Control Arm		MN-VB-5222 Wishbone (CV), Air Suspension Axle
19.310 FALS	05/00→	Centre Rod	MN-DL-12391	for Steering Rod
	05/00→	Centre Rod	MN-DL-12421	for Steering Rod
	05/00→	Tie Rod End	CV-ES-2146	
	05/00→	Track Control Arm		MN-DL-5212 Trailing Arm, Air Suspension Axle
19.360 FALK, FALK-L	05/00→	Track Control Arm		MN-VB-5222 Wishbone (CV), Air Suspension Axle
	05/00→	Centre Rod	MN-DL-12391	for Steering Rod
	05/00→	Tie Rod End	CV-ES-2146	
	05/00→	Track Control Arm		MN-DL-5212 Trailing Arm, Air Suspension Axle
19.360 FALS	05/00→	Track Control Arm		MN-VB-5222 Wishbone (CV), Air Suspension Axle
	05/00→	Centre Rod	MN-DL-12391	for Steering Rod
	05/00→	Centre Rod	MN-DL-12421	for Steering Rod
	05/00→	Tie Rod End	CV-ES-2146	
19.410 FALK, FALK-L	05/00→	Track Control Arm		MN-DL-5212 Trailing Arm, Air Suspension Axle
	05/00→	Track Control Arm		MN-VB-5222 Wishbone (CV), Air Suspension Axle
	05/00→	Centre Rod	MN-DL-12391	for Steering Rod
	05/00→	Tie Rod End	CV-ES-2146	
19.410 FALS	05/00→	Track Control Arm		MN-DL-5212 Trailing Arm, Air Suspension Axle
	05/00→	Track Control Arm		MN-VB-5222 Wishbone (CV), Air Suspension Axle
	05/00→	Centre Rod	MN-DL-12391	for Steering Rod
	05/00→	Centre Rod	MN-DL-12421	for Steering Rod
19.460 FALK, FALK-L	05/00→	Tie Rod End	CV-ES-2146	
	05/00→	Track Control Arm		MN-DL-5212 Trailing Arm, Air Suspension Axle
	05/00→	Track Control Arm		MN-VB-5222 Wishbone (CV), Air Suspension Axle
	05/00→	Centre Rod	MN-DL-12391	for Steering Rod
19.460 FALS	05/00→	Centre Rod	MN-DL-12421	for Steering Rod
	05/00→	Tie Rod End	CV-ES-2146	
	05/00→	Track Control Arm		MN-DL-5212 Trailing Arm, Air Suspension Axle
	05/00→	Track Control Arm		MN-VB-5222 Wishbone (CV), Air Suspension Axle
26.310 FAVLC	05/00→	Centre Rod	MN-DL-12421	for Steering Rod
26.310 FAVLK	05/00→	Centre Rod	MN-DL-12421	for Steering Rod
26.360 FAVLC	05/00→	Centre Rod	MN-DL-12421	for Steering Rod
26.360 FAVLK	05/00→	Centre Rod	MN-DL-12421	for Steering Rod
26.410 DFARC	05/00→	Centre Rod	MN-DL-12421	for Steering Rod
	05/00→	Track Control Arm		MN-VB-8514 Suspension Rod, Wishbone (CV)
26.410 DFRC, FAVLC	05/00→	Centre Rod	MN-DL-12421	for Steering Rod
	05/00→	Track Control Arm		MN-VB-8514 Suspension Rod, Wishbone (CV)
26.410 FAVLK	05/00→	Centre Rod	MN-DL-12421	for Steering Rod
26.460 DFARC	05/00→	Centre Rod	MN-DL-12421	for Steering Rod
	05/00→	Track Control Arm		MN-VB-8514 Suspension Rod, Wishbone (CV)
26.460 DFLS, DFLRS	05/00→	Centre Rod	MN-DL-12421	for Steering Rod
	05/00→	Track Control Arm		MN-VB-8514 Suspension Rod, Wishbone (CV)
26.460 FAVLC	05/00→	Centre Rod	MN-DL-12421	for Steering Rod
26.460 FAVLK	05/00→	Centre Rod	MN-DL-12421	for Steering Rod

CV-ES-2146

Length: 80
Cone Ø: d1 Ø 30 / d2 Ø 27
Thread: M26 x 1,5 RHT
42533102, 81953016219, 81953016225,
81953016226, 81953016267, 81953016291



MN-VB-8514

Length: 627 Ø: 48
Hole Ø 25 / 25 / 25
Hole Distance: 152 / 130 / 130
81432706087, 81432706088, 81432706094,
81432706095, 81432796094



MN-DL-5212

Length: 577 Ø: 48
Hole Distance: 130 / 130
81432206096, 81432206097, 81432206098,
81432206129, 81432209096, 81432209129,
81432306014, 81432306030



MN-DL-8378

Length: 882 Ø: 38
Cone Ø: d1 Ø 30 / d2 Ø 26
85466106156



MN-DL-12391

Length: 1050
Ø: 52
Cone Ø: d1 Ø 30 / d2 Ø 27
82466106057, 82466106147



MN-DL-12421

Length: 1070
Ø: 48
Cone Ø: d1 Ø 30 / d2 Ø 27
Thread: M30 x 1,5 RHT
81466106656, 81466106659, 81466106669,
81466116006, 81466116007



MN-VB-5222

Length: 627 Ø: 50
Hole Distance: 152 / 152
81432706030, 81432706034, 81432706054,
81432706055, 81432706056, 81432706057,
81432706067, 81432706068, 81432706074,
81432706075, 81432706076, 81432706077,
81432706078, 81432706081, 81432706082,
81432709034, 81432709076, 81432709078,
8143706054



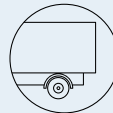

E 2000 ...

28.360 FANLC	05/00→	Centre Rod	MN-DL-12421		for Steering Rod
28.360 FANLK	05/00→	Centre Rod	MN-DL-12421		for Steering Rod
28.360 FNALC	05/00→	Centre Rod	MN-DL-12421		for Steering Rod
28.410 FANLC	05/00→	Centre Rod	MN-DL-12421		for Steering Rod
28.410 FANLK	05/00→	Centre Rod	MN-DL-12421		for Steering Rod
28.460 FANLC	05/00→	Centre Rod	MN-DL-12421		for Steering Rod
28.460 FANLK	05/00→	Centre Rod	MN-DL-12421		for Steering Rod
30.310 FNLC	05/00→	Centre Rod	MN-DL-8197		Push Rod
	05/00→	Track Control Arm		MN-DL-3402	Trailing Arm, Double Axle with Two Driven Axles
	05/00→	Track Control Arm		MN-DL-5212	Trailing Arm, Double Axle with Two Driven Axles
	05/00→	Track Control Arm		MN-DL-5212	Trailing Arm, Drive Axle;Trailing Axle
	05/00→	Track Control Arm		MN-VB-5222	Wishbone (CV), Air Suspension Axle
30.360 FANLC	05/00→	Centre Rod	MN-DL-12421		for Steering Rod
30.360 FANLK	05/00→	Centre Rod	MN-DL-12421		for Steering Rod
30.360 FNLC	05/00→	Centre Rod	MN-DL-8197		Push Rod
	05/00→	Track Control Arm		MN-DL-3402	Trailing Arm, Double Axle with Two Driven Axles
	05/00→	Track Control Arm		MN-DL-5212	Trailing Arm, Double Axle with Two Driven Axles
	05/00→	Track Control Arm		MN-DL-5212	Trailing Arm, Drive Axle;Trailing Axle
	05/00→	Track Control Arm		MN-VB-5222	Wishbone (CV), Air Suspension Axle
30.410 FANLC	05/00→	Centre Rod	MN-DL-12421		for Steering Rod
30.410 FANLK	05/00→	Centre Rod	MN-DL-12421		for Steering Rod
30.410 FNLC	05/00→	Centre Rod	MN-DL-8197		Push Rod
	05/00→	Track Control Arm		MN-DL-3402	Trailing Arm, Double Axle with Two Driven Axles
	05/00→	Track Control Arm		MN-DL-5212	Trailing Arm, Double Axle with Two Driven Axles
	05/00→	Track Control Arm		MN-DL-5212	Trailing Arm, Drive Axle;Trailing Axle
	05/00→	Track Control Arm		MN-VB-5222	Wishbone (CV), Air Suspension Axle
30.460 FANLC	05/00→	Centre Rod	MN-DL-12421		for Steering Rod
30.460 FANLK	05/00→	Centre Rod	MN-DL-12421		for Steering Rod
30.460 FNLC	05/00→	Centre Rod	MN-DL-8197		Push Rod
	05/00→	Track Control Arm		MN-DL-3402	Trailing Arm, Double Axle with Two Driven Axles
	05/00→	Track Control Arm		MN-DL-5212	Trailing Arm, Double Axle with Two Driven Axles
	05/00→	Track Control Arm		MN-DL-5212	Trailing Arm, Drive Axle;Trailing Axle
	05/00→	Track Control Arm		MN-VB-5222	Wishbone (CV), Air Suspension Axle
32.310 VFCLC	05/00→	Centre Rod	MN-DL-12421		for Steering Rod
32.310 VFNLC	05/00→	Centre Rod	MN-DL-12421		for Steering Rod
32.360 VFCLC	05/00→	Centre Rod	MN-DL-12421		for Steering Rod
32.360 VFNLC	05/00→	Centre Rod	MN-DL-12421		for Steering Rod
32.410 VFARK	05/00→	Track Control Arm		MN-VB-8514	Suspension Rod, Wishbone (CV)
32.410 VFCLC,VFRC, VFRLC	05/00→	Centre Rod	MN-DL-12421		for Steering Rod
32.410 VFNLC	05/00→	Centre Rod	MN-DL-12421		for Steering Rod
32.460 VFCLC, VFRLC	05/00→	Centre Rod	MN-DL-12421		for Steering Rod
32.460 VFNLC	05/00→	Centre Rod	MN-DL-12421		for Steering Rod
33.360 DFAK, DFALK	05/00→	Centre Rod	MN-DL-12421		for Steering Rod
33.360 DFALC	05/00→	Centre Rod	MN-DL-12421		for Steering Rod
33.360 DFALS	04/01→	Centre Rod	MN-DL-12421		for Steering Rod
33.360 DFCLC	05/00→	Centre Rod	MN-DL-8197		Push Rod
	05/00→	Track Control Arm		MN-DL-3402	Trailing Arm, Double Axle with Two Driven Axles
	05/00→	Track Control Arm		MN-DL-5212	Trailing Arm, Double Axle with Two Driven Axles
	05/00→	Track Control Arm		MN-DL-5212	Trailing Arm, Drive Axle;Trailing Axle
	05/00→	Track Control Arm		MN-VB-5222	Wishbone (CV), Air Suspension Axle
33.360 DFLK	05/00→	Centre Rod	MN-DL-8197		Push Rod
	05/00→	Track Control Arm		MN-DL-3402	Trailing Arm, Double Axle with Two Driven Axles
	05/00→	Track Control Arm		MN-DL-5212	Trailing Arm, Double Axle with Two Driven Axles
	05/00→	Track Control Arm		MN-DL-5212	Trailing Arm, Drive Axle;Trailing Axle
	05/00→	Track Control Arm		MN-VB-5222	Wishbone (CV), Air Suspension Axle
33.360 DFCLS	05/00→	Centre Rod	MN-DL-8197		Push Rod
	05/00→	Track Control Arm		MN-DL-3402	Trailing Arm, Double Axle with Two Driven Axles
	05/00→	Track Control Arm		MN-DL-5212	Trailing Arm, Drive Axle;Trailing Axle
	05/00→	Track Control Arm		MN-VB-5222	Wishbone (CV), Air Suspension Axle
33.410 DFAK, DFALK	05/00→	Centre Rod	MN-DL-12421		for Steering Rod
33.410 DFALC	05/00→	Centre Rod	MN-DL-12421		for Steering Rod
33.410 DFALS	04/01→	Centre Rod	MN-DL-12421		for Steering Rod

MN-DL-3402

Length: 590 Ø: 48
Hole Distance: 130 / 130

03307200A, 81432206067, 81432206068,
81432206090, 81432206092, 81432209092



MN-DL-5212

Length: 577 Ø: 48
Hole Distance: 130 / 130

81432206096, 81432206097, 81432206098,
81432206129, 81432209096, 81432209129,
81432306014, 81432306030



MN-DL-8197

Length: 1055
Ø: 42

Cone Ø: d1 Ø 30 / d2 Ø 27
03207500A, 81466116003, 81466116004,
81466116005



MN-DL-12421

Length: 1070
Ø: 48

Cone Ø: d1 Ø 30 / d2 Ø 27
Thread: M30 x 1,5 RHT
81466106656, 81466106659, 81466106669,
81466116006, 81466116007



MN-VB-5222

Length: 627 Ø: 50
Hole Distance: 152 / 152

81432706030, 81432706034, 81432706054,
81432706055, 81432706056, 81432706057,
81432706067, 81432706068, 81432706074,
81432706075, 81432706076, 81432706077,
81432706078, 81432706081, 81432706082,
81432709034, 81432709076, 81432709078,
8143706054



MN-VB-8514

Length: 627 Ø: 48
Hole Ø 25 / 25 / 25

Hole Distance: 152 / 130 / 130
81432706087, 81432706088, 81432706094,
81432706095, 81432796094





E 2000 ...

33.410 DFCL	05/00→	Centre Rod	MN-DL-8197		Push Rod	
	05/00→	Track Control Arm		MN-DL-3402	Trailing Arm, Double Axle with Two Driven Axles	
	05/00→	Track Control Arm		MN-DL-5212	Trailing Arm, Double Axle with Two Driven Axles	
	05/00→	Track Control Arm		MN-DL-5212	Trailing Arm, Drive Axle;Trailing Axle	
	05/00→	Track Control Arm		MN-VB-5222	Wishbone (CV), Air Suspension Axle	
33.410 DFLK	05/00→	Centre Rod	MN-DL-8197		Push Rod	
	05/00→	Track Control Arm		MN-DL-3402	Trailing Arm, Double Axle with Two Driven Axles	
	05/00→	Track Control Arm		MN-DL-5212	Trailing Arm, Double Axle with Two Driven Axles	
	05/00→	Track Control Arm		MN-DL-5212	Trailing Arm, Drive Axle;Trailing Axle	
	05/00→	Track Control Arm		MN-VB-5222	Wishbone (CV), Air Suspension Axle	
33.410 DFSL	05/00→	Centre Rod	MN-DL-8197		Push Rod	
	05/00→	Track Control Arm		MN-DL-3402	Trailing Arm, Double Axle with Two Driven Axles	
	05/00→	Track Control Arm		MN-DL-5212	Trailing Arm, Double Axle with Two Driven Axles	
	05/00→	Track Control Arm		MN-DL-5212	Trailing Arm, Drive Axle;Trailing Axle	
	05/00→	Track Control Arm		MN-VB-5222	Wishbone (CV), Air Suspension Axle	
33.460 DFAK, DFALK	05/00→	Centre Rod	MN-DL-12421		for Steering Rod	
33.460 DFALC	05/00→	Centre Rod	MN-DL-12421		for Steering Rod	
33.460 DFALS	04/01→	Centre Rod	MN-DL-12421		for Steering Rod	
33.460 DFCL	05/00→	Centre Rod	MN-DL-8197		Push Rod	
	05/00→	Track Control Arm		MN-DL-3402	Trailing Arm, Double Axle with Two Driven Axles	
	05/00→	Track Control Arm		MN-DL-5212	Trailing Arm, Double Axle with Two Driven Axles	
	05/00→	Track Control Arm		MN-DL-5212	Trailing Arm, Drive Axle;Trailing Axle	
	05/00→	Track Control Arm		MN-VB-5222	Wishbone (CV), Air Suspension Axle	
33.460 DFLK	05/00→	Centre Rod	MN-DL-8197		Push Rod	
	05/00→	Track Control Arm		MN-DL-3402	Trailing Arm, Double Axle with Two Driven Axles	
	05/00→	Track Control Arm		MN-DL-5212	Trailing Arm, Drive Axle;Trailing Axle	
	05/00→	Track Control Arm		MN-VB-5222	Wishbone (CV), Air Suspension Axle	
33.460 DFSL	05/00→	Centre Rod	MN-DL-8197		Push Rod	
	05/00→	Track Control Arm		MN-DL-3402	Trailing Arm, Double Axle with Two Driven Axles	
	05/00→	Track Control Arm		MN-DL-5212	Trailing Arm, Double Axle with Two Driven Axles	
	05/00→	Track Control Arm		MN-DL-5212	Trailing Arm, Drive Axle;Trailing Axle	
	05/00→	Track Control Arm		MN-VB-5222	Wishbone (CV), Air Suspension Axle	
33.600 DFALS, DFAS	06/00→	Centre Rod	MN-DL-12421		for Steering Rod	
35.360 VFAK	05/00→	Centre Rod	MN-DL-7792		Push Rod	
	05/00→	Centre Rod	MN-DL-8197		Push Rod	
	05/00→	Centre Rod	MN-DL-12391		for Steering Rod	
	05/00→	Suspension Arm Repair Kit		MN-SB-5244	for Wishbone (CV)	
	05/00→	Tie Rod End	CV-ES-2146			
	05/00→	Tie Rod End	MN-ES-10333		for Steering Rod	
	05/00→	Track Control Arm		MN-DL-3402	Trailing Arm, Double Axle with Two Driven Axles	
	05/00→	Track Control Arm		MN-DL-8609	Trailing Arm, Double Axle with Two Driven Axles	
	35.410 VFAK	05/00→	Centre Rod	MN-DL-7792		Push Rod
		05/00→	Centre Rod	MN-DL-8197		Push Rod
05/00→		Centre Rod	MN-DL-12391		for Steering Rod	
05/00→		Suspension Arm Repair Kit		MN-SB-5244	for Wishbone (CV)	
05/00→		Tie Rod End	CV-ES-2146			
05/00→		Tie Rod End	MN-ES-10333		for Steering Rod	
05/00→		Track Control Arm		MN-DL-3402	Trailing Arm, Double Axle with Two Driven Axles	
05/00→		Track Control Arm		MN-DL-8609	Trailing Arm, Double Axle with Two Driven Axles	
35.460 VFAK	05/00→	Centre Rod	MN-DL-7792		Push Rod	
	05/00→	Centre Rod	MN-DL-8197		Push Rod	
	05/00→	Centre Rod	MN-DL-12391		for Steering Rod	
	05/00→	Suspension Arm Repair Kit		MN-SB-5244	for Wishbone (CV)	
	05/00→	Tie Rod End	CV-ES-2146			
	05/00→	Tie Rod End	MN-ES-10333		for Steering Rod	
	05/00→	Track Control Arm		MN-DL-3402	Trailing Arm, Double Axle with Two Driven Axles	
40.600 DFAS	06/00→	Centre Rod	MN-DL-12421		for Steering Rod	
	41.360 VFAK	05/00→	Centre Rod	MN-DL-7792		Push Rod
		05/00→	Centre Rod	MN-DL-8197		Push Rod
		05/00→	Centre Rod	MN-DL-12391		for Steering Rod
		05/00→	Suspension Arm Repair Kit		MN-SB-5244	for Wishbone (CV)
05/00→	Tie Rod End	CV-ES-2146				

CV-ES-2146

Length: 80
Cone Ø: d1 Ø 30 / d2 Ø 27
Thread: M26 x 1,5 RHT
42533102, 81953016219, 81953016225,
81953016226, 81953016267, 81953016291



MN-DL-12391

Length: 1050
Ø: 52
Cone Ø: d1 Ø 30 / d2 Ø 27
82466106057, 82466106147



MN-DL-3402

Length: 590 Ø: 48
Hole Distance: 130 / 130
03307200A, 81432206067, 81432206068,
81432206090, 81432206092, 81432209092



MN-DL-12421

Length: 1070
Ø: 48
Cone Ø: d1 Ø 30 / d2 Ø 27
Thread: M30 x 1,5 RHT
81466106656, 81466106659, 81466106669,
81466116006, 81466116007



MN-DL-5212

Length: 577 Ø: 48
Hole Distance: 130 / 130
81432206096, 81432206097, 81432206098,
81432206129, 81432209096, 81432209129,
81432306014, 81432306030



MN-ES-10333

Length: 90
Cone Ø: d1 Ø 38 / d2 Ø 34,35
Thread: M36 x 1,5 RHT
1271126, 3090291, 3099128, 42538048,
81953016268, 82953016018, 82953016019



MN-DL-7792

Length: 1750
Ø: 52
Cone Ø: d1 Ø 30 / d2 Ø 27
81466106790, 81466106791, 82466106191



MN-SB-5244

Ø: 65
Hole Distance: 125
Thick/Height: 22
03312000A, 81432710027, 81432710082



MN-DL-8197

Length: 1055
Ø: 42
Cone Ø: d1 Ø 30 / d2 Ø 27
03207500A, 81466116003, 81466116004,
81466116005



MN-VB-5222

Length: 627 Ø: 50
Hole Distance: 152 / 152
81432706030, 81432706034, 81432706054,
81432706055, 81432706056, 81432706057,
81432706067, 81432706068, 81432706074,
81432706075, 81432706076, 81432706077,
81432706078, 81432706081, 81432706082,
81432709034, 81432709076, 81432709078,
8143706054



MN-DL-8609

Length: 585 Ø: 58
Hole Distance: 130 / 130
81432206070, 81432206071, 81432206072,
81432206091, 81432206093, 81432206119



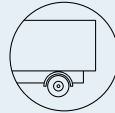

E 2000 ...

41.360 VFAK ...	05/00→	Tie Rod End	MN-ES-10333		for Steering Rod
	05/00→	Track Control Arm		MN-DL-3402	Trailing Arm, Double Axle with Two Driven Axles
	05/00→	Track Control Arm		MN-DL-8609	Trailing Arm, Double Axle with Two Driven Axles
41.410 VFAK	05/00→	Centre Rod	MN-DL-7792		Push Rod
	05/00→	Centre Rod	MN-DL-8197		Push Rod
	05/00→	Centre Rod	MN-DL-12391		for Steering Rod
	05/00→	Suspension Arm Repair Kit		MN-SB-5244	for Wishbone (CV)
	05/00→	Tie Rod End	CV-ES-2146		
	05/00→	Tie Rod End	MN-ES-10333		for Steering Rod
	05/00→	Track Control Arm		MN-DL-3402	Trailing Arm, Double Axle with Two Driven Axles
	05/00→	Track Control Arm		MN-DL-8609	Trailing Arm, Double Axle with Two Driven Axles
41.460 VFAK	05/00→	Centre Rod	MN-DL-7792		Push Rod
	05/00→	Centre Rod	MN-DL-8197		Push Rod
	05/00→	Centre Rod	MN-DL-12391		for Steering Rod
	05/00→	Suspension Arm Repair Kit		MN-SB-5244	for Wishbone (CV)
	05/00→	Tie Rod End	CV-ES-2146		
	05/00→	Tie Rod End	MN-ES-10333		for Steering Rod
	05/00→	Track Control Arm		MN-DL-3402	Trailing Arm, Double Axle with Two Driven Axles
	05/00→	Track Control Arm		MN-DL-8609	Trailing Arm, Double Axle with Two Driven Axles
50.410 VFAK	05/00→	Centre Rod	MN-DL-7792		Push Rod
	05/00→	Centre Rod	MN-DL-8197		Push Rod
	05/00→	Centre Rod	MN-DL-12391		for Steering Rod
	05/00→	Suspension Arm Repair Kit		MN-SB-5244	for Wishbone (CV)
	05/00→	Tie Rod End	CV-ES-2146		
	05/00→	Tie Rod End	MN-ES-10333		for Steering Rod
	05/00→	Track Control Arm		MN-DL-3402	Trailing Arm, Double Axle with Two Driven Axles
	05/00→	Track Control Arm		MN-DL-8609	Trailing Arm, Double Axle with Two Driven Axles
50.410 VFK	05/00→	Centre Rod	MN-DL-7792		Push Rod
	05/00→	Centre Rod	MN-DL-8197		Push Rod
	05/00→	Centre Rod	MN-DL-12391		for Steering Rod
	05/00→	Suspension Arm Repair Kit		MN-SB-5244	for Wishbone (CV)
	05/00→	Tie Rod End	CV-ES-2146		
	05/00→	Tie Rod End	MN-ES-10333		for Steering Rod
	05/00→	Track Control Arm		MN-DL-3402	Trailing Arm, Double Axle with Two Driven Axles
	05/00→	Track Control Arm		MN-DL-8609	Trailing Arm, Double Axle with Two Driven Axles
50.460 VFAK	05/00→	Centre Rod	MN-DL-7792		Push Rod
	05/00→	Centre Rod	MN-DL-8197		Push Rod
	05/00→	Centre Rod	MN-DL-12391		for Steering Rod
	05/00→	Suspension Arm Repair Kit		MN-SB-5244	for Wishbone (CV)
	05/00→	Tie Rod End	CV-ES-2146		
	05/00→	Tie Rod End	MN-ES-10333		for Steering Rod
	05/00→	Track Control Arm		MN-DL-3402	Trailing Arm, Double Axle with Two Driven Axles
	05/00→	Track Control Arm		MN-DL-8609	Trailing Arm, Double Axle with Two Driven Axles
50.460 VFK	05/00→	Centre Rod	MN-DL-7792		Push Rod
	05/00→	Centre Rod	MN-DL-8197		Push Rod
	05/00→	Centre Rod	MN-DL-12391		for Steering Rod
	05/00→	Suspension Arm Repair Kit		MN-SB-5244	for Wishbone (CV)
	05/00→	Tie Rod End	CV-ES-2146		
	05/00→	Tie Rod End	MN-ES-10333		for Steering Rod
	05/00→	Track Control Arm		MN-DL-3402	Trailing Arm, Double Axle with Two Driven Axles
	05/00→	Track Control Arm		MN-DL-8609	Trailing Arm, Double Axle with Two Driven Axles

EL

EL 202,EL 222	01/93→06/97	Ball Head, gearshift linkage	CV-ES-2119		
	01/93→06/97	Ball Head, gearshift linkage	CV-ES-2120		
	01/93→06/97	Ball Head, gearshift linkage	CV-ES-2182		
	01/93→06/97	Centre Rod	MN-DL-2141		Push Rod
	01/93→06/97	Centre Rod	MN-DL-2172		Push Rod
	01/93→06/97	Centre Rod	MN-DL-7786		Push Rod
	01/93→06/97	Suspension Arm Repair Kit		DF-RK-8503	for Control Arm
	01/93→06/97	Suspension Strut Repair Kit		CV-RK-5311	
	01/93→06/97	Tie Rod End	CV-ES-14162		for Steering Rod
	01/93→06/97	Tie Rod End	CV-ES-14163		for Steering Rod

CV-ES-2119

Length: 55
Cone Ø: d1 Ø 10 / d2 Ø 10
Thread: M12 x 1,75 LHT
81953016063, 81953016131



CV-ES-2120

Length: 115
Cone Ø: d1 Ø 12,4 / d2 Ø 10,8
Thread: M14 x 1,5 RHT
03008500A, 81953016200, 81953016202, 81953016203, 81953016227



CV-ES-2146

Length: 80
Cone Ø: d1 Ø 30 / d2 Ø 27
Thread: M26 x 1,5 RHT
42533102, 81953016219, 81953016225, 81953016226, 81953016267, 81953016291



CV-ES-2182

Length: 55
Cone Ø: d1 Ø 10 / d2 Ø 10
Thread: M12 x 1,75 RHT
81953016064, 81953016170



CV-ES-14162

Length: 125
Cone Ø: d1 Ø 30 / d2 Ø 27
Thread: M30 x 1,5 LHT
81953010015, 81953010083, 81953010087, 81953016029, 81953016030, 81953016043, 81953016044, 81953016050, 81953016054, 81953016087, 81953016091, 81953016107, 81953016120, 81953016125, 81953016152, 81953016155, 81953016157, 81953016168, 81953016179, 81953016181, 81953016223, 81953016237, 81953016254, 81953016275, 81953016279, 81953016351



CV-ES-14163

Length: 125
Cone Ø: d1 Ø 30 / d2 Ø 27
Thread: M30 x 1,5 RHT
95301.0084, 90804102156, 90804102272, 90804102696, 90804102710, 81953010016, 81953010075, 81953010084, 81953010088, 81953010094, 81953010103, 81953016030, 81953016043, 81953016048, 81953016049, 81953016053, 81953016061, 81953016090, 81953016108, 81953016112, 81953016126, 81953016143, 81953016149, 81953016154, 81953016156, 81953016168, 81953016178, 81953016194, 81953016206, 81953016224, 81953016234, 81953016242, 81953016252, 81953016274, 81953016278, 81953016284, 81953016286, 81953016308, 81953016310, 81953016312, 81953016347, 81953016350, 81953016352, 82953016012, 88953016014, N2953016001



CV-RK-5311

638862, 639287, 938423, 1104335, 1953248, 0003500506, 3500506, 11013547, 42488722, 070550504, 634303610, 81432206055, 81432206073, 82262320660, 5001842823, 7000307001, 8226232066



DF-RK-8503

Ø: 75
Hole Distance: 130
Thick/Height: 24
81432306061



MN-DL-2141

Length: 1689
Ø: 50
Cone Ø: d1 Ø 26 / d2 Ø 23,5
81467106862, 81467116712



MN-DL-2172

Length: 1050 Ø: 42
Cone Ø: d1 Ø 30 / d2 Ø 27
81466106374, 81466116019, 82466106080, 82466106189, 82466106190



MN-DL-3402

Length: 590 Ø: 48
Hole Distance: 130 / 130
03307200A, 81432206067, 81432206068, 81432206090, 81432206092, 81432209092



MN-DL-7786

Length: 1245
Ø: 60
Cone Ø: d1 Ø 30
81466106375, 81466106684, 81466116016, 3574602005, 3574602305



MN-DL-7792

Length: 1750
Ø: 52
Cone Ø: d1 Ø 30 / d2 Ø 27
81466106790, 81466106791, 82466106191



MN-DL-8197

Length: 1055
Ø: 42
Cone Ø: d1 Ø 30 / d2 Ø 27
03207500A, 81466116003, 81466116004, 81466116005



MN-DL-8609

Length: 585 Ø: 58
Hole Distance: 130 / 130
81432206070, 81432206071, 81432206072, 81432206091, 81432206093, 81432206119



MN-DL-12391

Length: 1050
Ø: 52
Cone Ø: d1 Ø 30 / d2 Ø 27
82466106057, 82466106147



MN-ES-10333

Length: 90
Cone Ø: d1 Ø 38 / d2 Ø 34,35
Thread: M36 x 1,5 RHT
1271126, 3090291, 3099128, 42538048, 81953016268, 82953016018, 82953016019



MN-SB-5244

Ø: 65
Hole Distance: 125
Thick/Height: 22
03312000A, 81432710027, 81432710082



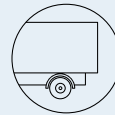

EL ...

EL 202,EL 222 ...	01/93→06/97	Tie Rod End	MN-ES-8611		
	01/93→06/97	Track Control Arm		MN-DL-7797	Suspension Rod, Control Arm;Trailing Arm
EL 202,EL 262	04/94→06/97	Ball Head, gearshift linkage	CV-ES-2119		
	04/94→06/97	Ball Head, gearshift linkage	CV-ES-2120		
	04/94→06/97	Ball Head, gearshift linkage	CV-ES-2182		
	04/94→06/97	Centre Rod	MN-DL-2141		Push Rod
	04/94→06/97	Centre Rod	MN-DL-2172		Push Rod
	04/94→06/97	Centre Rod	MN-DL-7786		Push Rod
	04/94→06/97	Suspension Arm Repair Kit		DF-RK-8503	for Control Arm
	04/94→06/97	Suspension Strut Repair Kit		CV-RK-5311	
	04/94→06/97	Tie Rod End	CV-ES-14162		for Steering Rod
	04/94→06/97	Tie Rod End	CV-ES-14163		for Steering Rod
	04/94→06/97	Tie Rod End	DF-ES-8362		for Steering Rod
	04/94→06/97	Track Control Arm		MN-DL-7797	Suspension Rod, Control Arm;Trailing Arm
	EL 262	07/98→	Ball Head, gearshift linkage	CV-ES-2119	
07/98→		Ball Head, gearshift linkage	CV-ES-2120		
07/98→		Ball Head, gearshift linkage	CV-ES-2182		
07/98→		Centre Rod	MN-DL-2141		Push Rod
07/98→		Centre Rod	MN-DL-2172		Push Rod
07/98→		Centre Rod	MN-DL-7786		Push Rod
07/98→		Suspension Arm Repair Kit		DF-RK-8503	for Control Arm
07/98→		Suspension Strut Repair Kit		CV-RK-5311	
07/98→		Tie Rod End	CV-ES-14162		for Steering Rod
07/98→		Tie Rod End	CV-ES-14163		for Steering Rod
07/98→		Tie Rod End	DF-ES-8362		for Steering Rod
07/98→		Tie Rod End	MN-ES-8611		
07/98→		Track Control Arm		MN-DL-7797	Suspension Rod, Control Arm;Trailing Arm

EM

EM 192	10/93→06/97	Ball Head, gearshift linkage	CV-ES-2120		
	10/93→06/97	Tie Rod End	CV-ES-12462		for Steering Rod
	10/93→06/97	Tie Rod End	CV-ES-14163		for Steering Rod
EM 222,EM 223	02/96→	Ball Head, gearshift linkage	CV-ES-2119		
	02/96→	Ball Head, gearshift linkage	CV-ES-2120		
	02/96→	Ball Head, gearshift linkage	CV-ES-2182		
	02/96→	Centre Rod	MN-DL-8686		Push Rod
	02/96→	Tie Rod End	CV-ES-14163		for Steering Rod
EM 223	08/87→	Ball Head, gearshift linkage	CV-ES-2119		
	08/87→	Ball Head, gearshift linkage	CV-ES-2120		
	08/87→	Ball Head, gearshift linkage	CV-ES-2182		
	08/87→	Tie Rod End	CV-ES-12462		for Steering Rod
	08/87→	Tie Rod End	CV-ES-14163		for Steering Rod

F 90

19.242 F,19.242 FL,19.242 FLL	01/88→01/89	Ball Head, gearshift linkage	CV-ES-2119		
	01/88→01/89	Ball Head, gearshift linkage	CV-ES-2120		
	01/88→01/89	Ball Head, gearshift linkage	CV-ES-2182		
	01/88→01/89	Centre Rod	MN-DL-2160		Coupling Rod
	01/88→01/89	Centre Rod	MN-DL-2174		Push Rod
	01/88→01/89	Centre Rod	MN-DL-2175		Push Rod
	01/88→01/89	Centre Rod	MN-DL-3588		Push Rod
	01/88→01/89	Centre Rod	MN-DL-12421		for Steering Rod
	01/88→01/89	Engine Mounting		MN-SB-10390	
	01/88→01/89	Engine Mounting	MN-SB-10389		
	01/88→01/89	Mounting, stabilizer coupling rod	MN-SB-5246		
	01/88→01/89	Mounting, stabilizer coupling rod	MN-SB-5246		1st FA
	01/88→01/89	Stabiliser Mounting		MN-SB-5265	
	01/88→01/89	Stabiliser Mounting		MN-SB-5265	1st RA
	01/88→01/89	Suspension Arm Repair Kit		CV-RK-5313	for Wishbone (CV)
	01/88→01/89	Suspension Arm Repair Kit		CV-RK-8118	for Control Arm
	01/88→01/89	Suspension Arm Repair Kit		MN-RK-7280	for Drag Link
	01/88→01/89	Suspension Arm Repair Kit		MN-RK-7287	for Wishbone (CV)
	01/88→01/89	Suspension Arm Repair Kit		MN-RK-7291	for Drag Link
	01/88→01/89	Tie Rod	MN-DL-12284		

CV-ES-2119

Length: 55
Cone Ø: d1 Ø 10 / d2 Ø 10
Thread: M12 x 1,75 LHT
81953016063, 81953016131



CV-ES-2120

Length: 115
Cone Ø: d1 Ø 12,4 / d2 Ø 10,8
Thread: M14 x 1,5 RHT
03008500A, 81953016200, 81953016202, 81953016203, 81953016227



CV-ES-2182

Length: 55
Cone Ø: d1 Ø 10 / d2 Ø 10
Thread: M12 x 1,75 RHT
81953016064, 81953016170



CV-ES-12462

Length: 120
Cone Ø: d1 Ø 26 / d2 Ø 23,5
Thread: M30 x 1,5 RHT
90804102218, 90804153111, 81953010014, 81953010042, 81953010064, 81953010068, 81953016065, 81953016067, 81953016073, 81953016162, 81953016239, 81953016240, 81953016246, 81953016250, 81953016272, 81953016282, 81953016319, 81953016360, 82953016014



CV-ES-14162

Length: 125
Cone Ø: d1 Ø 30 / d2 Ø 27
Thread: M30 x 1,5 LHT
81953010015, 81953010083, 81953010087, 81953016029, 81953016030, 81953016043, 81953016044, 81953016050, 81953016054, 81953016087, 81953016091, 81953016107, 81953016120, 81953016125, 81953016152, 81953016155, 81953016157, 81953016168, 81953016179, 81953016181, 81953016223, 81953016237, 81953016254, 81953016275, 81953016279, 81953016351



CV-ES-14163

Length: 125
Cone Ø: d1 Ø 30 / d2 Ø 27
Thread: M30 x 1,5 RHT
95301.0084, 90804102156, 90804102272, 90804102696, 90804102710, 81953010016, 81953010075, 81953010084, 81953010088, 81953010094, 81953010103, 81953016030, 81953016043, 81953016048, 81953016049, 81953016053, 81953016061, 81953016090, 81953016108, 81953016112, 81953016126, 81953016143, 81953016149, 81953016154, 81953016156, 81953016168, 81953016178, 81953016194, 81953016206, 81953016224, 81953016234, 81953016242, 81953016252, 81953016274, 81953016278, 81953016284, 81953016286, 81953016308, 81953016310, 81953016312, 81953016347, 81953016350, 81953016352, 82953016012, 88953016014, N2953016001



CV-RK-5311

638862, 639287, 938423, 1104335, 1953248, 0003500506, 3500506, 11013547, 42488722, 070550504, 634303610, 81432206055, 81432206073, 82262320660, 5001842823, 7000307001, 8226232066



CV-RK-5313

Ø: 90
03304800A, 81953016132



CV-RK-8118

Ø: 85
Hole Distance: 130
Thick/Height: 30
638862, 639287, 775201, 938423, 1104335, 1953248, 3500506, 0003500506, 11013547, 21032592, 42065912, 42488722, 070550504, 93192618, 070400009000, 634303610, 81432206055, 81432206073, 82262320660, 9544171010099, 5001842823, 7000307001, 8226232066



DF-ES-8362

Length: 150
Cone Ø: d1 Ø 26 / d2 Ø 23,5
Thread: M30 x 1,5 RHT
81953016270



DF-RK-8503

Ø: 75
Hole Distance: 130
Thick/Height: 24
81432306061



MN-DL-2141

Length: 1689 Ø: 50
Cone Ø: d1 Ø 26 / d2 Ø 23,5
81467106862, 81467116712



MN-DL-2160

Length: 1652 Ø: 50
Cone Ø: d1 Ø 30 / d2 Ø 27
81467106112, 81467106163, 81467106165, 81467106198, 81467106353, 81467106354, 81467106361, 81467116725



MN-DL-2172

Length: 1050 Ø: 42
Cone Ø: d1 Ø 30 / d2 Ø 27
81466106374, 81466116019, 82466106080, 82466106189, 82466106190



MN-DL-2174

Length: 1588 Ø: 52
Cone Ø: d1 Ø 30 / d2 Ø 27
81467106378, 81467106912



MN-DL-2175

Length: 1628 Ø: 50
Cone Ø: d1 Ø 30 / d2 Ø 27
81467106396, 81467106904



MN-DL-3588

Length: 1035 Ø: 48
Cone Ø: d1 Ø 30 / d2 Ø 27
81466106333, 81466106334, 81466106354, 81466106355, 81466106360, 81466106361, 81466106721, 81466106722, 81466106723, 81466116216



MN-DL-7786

Length: 1245 Ø: 60
Cone Ø: d1 Ø 30
81466106375, 81466106684, 81466116016, 3574602005, 3574602305



MN-DL-7797

Length: 750 Ø: 48
Hole Distance: 130 / 130
81432206099, 81432206100, 81432206185, 3573330205



MN-DL-8686

Length: 1375 Ø: 40
Cone Ø: d1 Ø 30 / d2 Ø 26
81466106654, 81466116061



MN-DL-12284

Length: 1530 Ø: 50
Cone Ø: d1 Ø 30 / d2 Ø 27
81466106579, 81466106580, 81466106624, 81466116720, 81467116720, 81467116730, 81467116952



MN-DL-12421

Length: 1070 Ø: 48
Cone Ø: d1 Ø 30 / d2 Ø 27
Thread: M30 x 1,5 RHT
81466106656, 81466106659, 81466106669, 81466116006, 81466116007



MN-ES-8611

Length: 168
Cone Ø: d1 Ø 30 / d2 Ø 27
Thread: M52 x 1,5 RHT
0004606748, 81953016233, 81953016255, 81953016277



MN-RK-7280

Ø: 75
Hole Distance: 115
Thick/Height: 24
0550806, 0639370, 689748, 10307400A, 81432306051, 81432306068, 81432706064



MN-RK-7287

Ø: 90
Hole Distance: 152
Thick/Height: 35
03304700A, 81953016133



MN-RK-7291

Ø: 72
Hole Distance: 130
Thick/Height: 30
10307800A, 81432206108, 81432206132



MN-SB-5246

Ø: 45 **Thick/Height:** 47
81437220022, 81437220038, 81962100450, 81962100469



MN-SB-5265

Ø: 85 **Thick/Height:** 80
03310300A, 81437040032



MN-SB-10389

Ø: 70 **Thick/Height:** 72
8196200340



MN-SB-10390

Ø: 70 **Thick/Height:** 85/85
8196200341, 8196200373, 8196200385, 8196200408, 8196200418





F 90 ...

19.242 F,19.242 FL,19.242 FLL ...	01/88→01/89	Tie Rod End	CV-ES-2149		for Push Rod	
	01/88→01/89	Tie Rod End	CV-ES-14162		for Steering Rod	
	01/88→01/89	Tie Rod End	CV-ES-14163		for Steering Rod	
	01/88→01/89	Track Control Arm		MN-DL-5212	Trailing Arm, Air Suspension Axle	
	01/88→01/89	Track Control Arm		MN-VB-5222	Wishbone (CV), Air Suspension Axle	
19.242 FK	01/88→02/89	Ball Head, gearshift linkage	CV-ES-2119			
	01/88→02/89	Ball Head, gearshift linkage	CV-ES-2120			
	01/88→02/89	Ball Head, gearshift linkage	CV-ES-2182			
	01/88→02/89	Centre Rod	MN-DL-2160		Coupling Rod	
	01/88→02/89	Centre Rod	MN-DL-2174		Push Rod	
	01/88→02/89	Centre Rod	MN-DL-2175		Push Rod	
	01/88→02/89	Centre Rod	MN-DL-3588		Push Rod	
	01/88→02/89	Centre Rod	MN-DL-12421		for Steering Rod	
	01/88→02/89	Engine Mounting		MN-SB-10390		
	01/88→02/89	Engine Mounting	MN-SB-10389			
	01/88→02/89	Mounting, stabilizer coupling rod	MN-SB-5246			
	01/88→02/89	Mounting, stabilizer coupling rod	MN-SB-5246		1st FA	
	01/88→02/89	Suspension Arm Repair Kit		MN-RK-7280	for Drag Link	
	01/88→02/89	Tie Rod	MN-DL-12284			
	01/88→02/89	Tie Rod End	CV-ES-2149		for Push Rod	
	01/88→02/89	Tie Rod End	CV-ES-14162		for Steering Rod	
	01/88→02/89	Tie Rod End	CV-ES-14163		for Steering Rod	
19.242 FS,19.242 FLS,19.242 FLLS	01/88→01/89	Ball Head, gearshift linkage	CV-ES-2119			
	01/88→01/89	Ball Head, gearshift linkage	CV-ES-2120			
	01/88→01/89	Ball Head, gearshift linkage	CV-ES-2182			
	01/88→01/89	Centre Rod	MN-DL-2160		Coupling Rod	
	01/88→01/89	Centre Rod	MN-DL-2174		Push Rod	
	01/88→01/89	Centre Rod	MN-DL-2175		Push Rod	
	01/88→01/89	Centre Rod	MN-DL-3588		Push Rod	
	01/88→01/89	Centre Rod	MN-DL-12421		for Steering Rod	
	01/88→01/89	Engine Mounting		MN-SB-10390		
	01/88→01/89	Engine Mounting	MN-SB-10389			
	01/88→01/89	Mounting, stabilizer coupling rod	MN-SB-5246			
	01/88→01/89	Mounting, stabilizer coupling rod	MN-SB-5246		1st FA	
	01/88→01/89	Stabiliser Mounting		MN-SB-5265		
	01/88→01/89	Stabiliser Mounting		MN-SB-5265	1st RA	
	01/88→01/89	Suspension Arm Repair Kit		CV-RK-5313	for Wishbone (CV)	
	01/88→01/89	Suspension Arm Repair Kit		CV-RK-8118	for Control Arm	
	01/88→01/89	Suspension Arm Repair Kit		MN-RK-7280	for Drag Link	
	01/88→01/89	Suspension Arm Repair Kit		MN-RK-7287	for Wishbone (CV)	
	01/88→01/89	Suspension Arm Repair Kit		MN-RK-7291	for Drag Link	
	01/88→01/89	Tie Rod	MN-DL-12284			
	01/88→01/89	Tie Rod End	CV-ES-2149		for Push Rod	
	01/88→01/89	Tie Rod End	CV-ES-14162		for Steering Rod	
	01/88→01/89	Tie Rod End	CV-ES-14163		for Steering Rod	
	01/88→01/89	Track Control Arm		MN-DL-5212	Trailing Arm, Air Suspension Axle	
	01/88→01/89	Track Control Arm		MN-VB-5222	Wishbone (CV), Air Suspension Axle	
	19.262 F,19.262 FL,19.262 FLL	01/88→02/90	Ball Head, gearshift linkage	CV-ES-2119		
		01/88→02/90	Ball Head, gearshift linkage	CV-ES-2120		
		01/88→02/90	Ball Head, gearshift linkage	CV-ES-2182		
		01/88→02/90	Centre Rod	MN-DL-2160		Coupling Rod
01/88→02/90		Centre Rod	MN-DL-2174		Push Rod	
01/88→02/90		Centre Rod	MN-DL-2175		Push Rod	
01/88→02/90		Centre Rod	MN-DL-3588		Push Rod	
01/88→02/90		Centre Rod	MN-DL-12421		for Steering Rod	
01/88→02/90		Engine Mounting		MN-SB-10390		
01/88→02/90		Engine Mounting	MN-SB-10389			
01/88→02/90		Mounting, stabilizer coupling rod	MN-SB-5246			
01/88→02/90		Mounting, stabilizer coupling rod	MN-SB-5246		1st FA	
01/88→02/90		Stabiliser Mounting		MN-SB-5265		
01/88→02/90		Stabiliser Mounting		MN-SB-5265	1st RA	
01/88→02/90		Suspension Arm Repair Kit		CV-RK-5313	for Wishbone (CV)	
01/88→02/90	Suspension Arm Repair Kit		CV-RK-8118	for Control Arm		

CV-ES-2119

Length: 55
Cone Ø: d1 Ø 10 / d2 Ø 10
Thread: M12 x 1,75 LHT
81953016063, 81953016131



CV-ES-2120

Length: 115
Cone Ø: d1 Ø 12,4 / d2 Ø 10,8
Thread: M14 x 1,5 RHT
03008500A, 81953016200, 81953016202,
81953016203, 81953016227



CV-ES-2149

Length: 160
Cone Ø: d1 Ø 30 / d2 Ø 27
Thread: M30 x 1,5 RHT
81953016263



CV-ES-2182

Length: 55
Cone Ø: d1 Ø 10 / d2 Ø 10
Thread: M12 x 1,75 RHT
81953016064, 81953016170



CV-ES-14162

Length: 125
Cone Ø: d1 Ø 30 / d2 Ø 27
Thread: M30 x 1,5 LHT
81953010015, 81953010083, 81953010087,
81953016029, 81953016030, 81953016043,
81953016044, 81953016050, 81953016054,
81953016087, 81953016091, 81953016107,
81953016120, 81953016125, 81953016152,
81953016155, 81953016157, 81953016168,
81953016179, 81953016181, 81953016223,
81953016237, 81953016254, 81953016275,
81953016279, 81953016351



CV-ES-14163

Length: 125
Cone Ø: d1 Ø 30 / d2 Ø 27
Thread: M30 x 1,5 RHT
95301.0084, 90804102156, 90804102272,
90804102696, 90804102710, 81953010016,
81953010075, 81953010084, 81953010088,
81953010094, 81953010103, 81953016030,
81953016043, 81953016048, 81953016049,
81953016053, 81953016061, 81953016090,
81953016108, 81953016112, 81953016126,
81953016143, 81953016149, 81953016154,
81953016156, 81953016168, 81953016178,
81953016194, 81953016206, 81953016224,
81953016234, 81953016242, 81953016252,
81953016274, 81953016278, 81953016284,
81953016286, 81953016308, 81953016310,
81953016312, 81953016347, 81953016350,
81953016352, 82953016012, 88953016014,
N2953016001



CV-RK-5313

Ø: 90
03304800A, 81953016132



CV-RK-8118

Ø: 85
Hole Distance: 130
Thick/Height: 30
638862, 639287, 775201, 938423,
1104335, 1953248, 0003500506, 3500506,
11013547, 21032592, 42065912, 42488722,
070550504, 93192618, 070400009000,
634303610, 81432206055, 81432206073,
82262320660, 9544171010099,
5001842823, 7000307001, 8226232066



MN-DL-2160

Length: 1652 Ø: 50
Cone Ø: d1 Ø 30 / d2 Ø 27
81467106112, 81467106163, 81467106165,
81467106198, 81467106353, 81467106354,
81467106361, 81467116725



MN-DL-2174

Length: 1588 Ø: 52
Cone Ø: d1 Ø 30 / d2 Ø 27
81467106378, 81467106912



MN-DL-2175

Length: 1628 Ø: 50
Cone Ø: d1 Ø 30 / d2 Ø 27
81467106396, 81467106904



MN-DL-3588

Length: 1035 Ø: 48
Cone Ø: d1 Ø 30 / d2 Ø 27
81466106333, 81466106334, 81466106354,
81466106355, 81466106360, 81466106361,
81466106721, 81466106722, 81466106723,
81466116216



MN-DL-5212

Length: 577 Ø: 48
Hole Distance: 130 / 130
81432206096, 81432206097, 81432206098,
81432206129, 81432209096, 81432209129,
81432306014, 81432306030



MN-DL-12284

Length: 1530 Ø: 50
Cone Ø: d1 Ø 30 / d2 Ø 27
81466106579, 81466106580, 81466106624,
81466116720, 81467116720, 81467116730,
81467116952



MN-DL-12421

Length: 1070 Ø: 48
Cone Ø: d1 Ø 30 / d2 Ø 27
Thread: M30 x 1,5 RHT
81466106656, 81466106659, 81466106669,
81466116006, 81466116007



MN-RK-7280

Ø: 75
Hole Distance: 115
Thick/Height: 24
0550806, 0639370, 689748, 10307400A,
81432306051, 81432306068, 81432706064



MN-RK-7287

Ø: 90
Hole Distance: 152
Thick/Height: 35
03304700A, 81953016133



MN-RK-7291

Ø: 72
Hole Distance: 130
Thick/Height: 30
10307800A, 81432206108, 81432206132



MN-SB-5246

Ø: 45 Thick/Height: 47
81437220022, 81437220038, 81962100450,
81962100469



MN-SB-5265

Ø: 85 Thick/Height: 80
03310300A, 81437040032



MN-SB-10389

Ø: 70 Thick/Height: 72
81960200340



MN-SB-10390

Ø: 70 Thick/Height: 85/85
81960200341, 81960200373, 81960200385,
81960200408, 81960200418



MN-VB-5222

Length: 627 Ø: 50
Hole Distance: 152 / 152
81432706030, 81432706034, 81432706054,
81432706055, 81432706056, 81432706057,
81432706067, 81432706068, 81432706074,
81432706075, 81432706076, 81432706077,
81432706078, 81432706081, 81432706082,
81432709034, 81432709076, 81432709078,
8143706054





F 90 ...

19.262 F,19.262 FL,19.262 FLL ...	01/88→02/90	Suspension Arm Repair Kit		MN-RK-7280	for Drag Link
	01/88→02/90	Suspension Arm Repair Kit		MN-RK-7287	for Wishbone (CV)
	01/88→02/90	Suspension Arm Repair Kit		MN-RK-7291	for Drag Link
	01/88→02/90	Tie Rod	MN-DL-12284		
	01/88→02/90	Tie Rod End	CV-ES-2149		for Push Rod
	01/88→02/90	Tie Rod End	CV-ES-14162		for Steering Rod
	01/88→02/90	Tie Rod End	CV-ES-14163		for Steering Rod
	01/88→02/90	Track Control Arm		MN-DL-5212	Trailing Arm, Air Suspension Axle
	01/88→02/90	Track Control Arm		MN-VB-5222	Wishbone (CV), Air Suspension Axle
19.262 FA	02/89→02/90	Ball Head, gearshift linkage	CV-ES-2119		
	02/89→02/90	Ball Head, gearshift linkage	CV-ES-2120		
	02/89→02/90	Ball Head, gearshift linkage	CV-ES-2182		
	02/89→02/90	Centre Rod	MN-DL-2160		Coupling Rod
	02/89→02/90	Centre Rod	MN-DL-2174		Push Rod
	02/89→02/90	Centre Rod	MN-DL-2175		Push Rod
	02/89→02/90	Centre Rod	MN-DL-3588		Push Rod
	02/89→02/90	Centre Rod	MN-DL-12421		for Steering Rod
	02/89→02/90	Engine Mounting	MN-SB-10389		
	02/89→02/90	Mounting, stabilizer coupling rod	MN-SB-5246		
	02/89→02/90	Mounting, stabilizer coupling rod	MN-SB-5246		1st FA
	02/89→02/90	Stabiliser Mounting		MN-SB-5254	
	02/89→02/90	Stabiliser Mounting		MN-SB-5265	
	02/89→02/90	Stabiliser Mounting	MN-SB-9396		
	02/89→02/90	Suspension Arm Repair Kit		MN-RK-7280	for Drag Link
	02/89→02/90	Tie Rod End	CV-ES-2149		for Push Rod
	02/89→02/90	Tie Rod End	CV-ES-14162		for Steering Rod
	02/89→02/90	Tie Rod End	CV-ES-14163		for Steering Rod
	19.262 FAK	02/89→02/90	Ball Head, gearshift linkage	CV-ES-2119	
02/89→02/90		Ball Head, gearshift linkage	CV-ES-2120		
02/89→02/90		Ball Head, gearshift linkage	CV-ES-2182		
02/89→02/90		Centre Rod	MN-DL-2160		Coupling Rod
02/89→02/90		Centre Rod	MN-DL-2174		Push Rod
02/89→02/90		Centre Rod	MN-DL-2175		Push Rod
02/89→02/90		Centre Rod	MN-DL-3588		Push Rod
02/89→02/90		Centre Rod	MN-DL-12421		for Steering Rod
02/89→02/90		Engine Mounting	MN-SB-10389		
02/89→02/90		Mounting, stabilizer coupling rod	MN-SB-5246		
02/89→02/90		Mounting, stabilizer coupling rod	MN-SB-5246		1st FA
02/89→02/90		Stabiliser Mounting		MN-SB-5254	
02/89→02/90		Stabiliser Mounting		MN-SB-5265	
02/89→02/90		Stabiliser Mounting	MN-SB-9396		
02/89→02/90		Suspension Arm Repair Kit		MN-RK-7280	for Drag Link
02/89→02/90		Tie Rod End	CV-ES-2149		for Push Rod
02/89→02/90		Tie Rod End	CV-ES-14162		for Steering Rod
02/89→02/90		Tie Rod End	CV-ES-14163		for Steering Rod
19.262 FAS		02/89→02/90	Ball Head, gearshift linkage	CV-ES-2119	
	02/89→02/90	Ball Head, gearshift linkage	CV-ES-2120		
	02/89→02/90	Ball Head, gearshift linkage	CV-ES-2182		
	02/89→02/90	Centre Rod	MN-DL-2160		Coupling Rod
	02/89→02/90	Centre Rod	MN-DL-2174		Push Rod
	02/89→02/90	Centre Rod	MN-DL-2175		Push Rod
	02/89→02/90	Centre Rod	MN-DL-3588		Push Rod
	02/89→02/90	Centre Rod	MN-DL-12421		for Steering Rod
	02/89→02/90	Engine Mounting	MN-SB-10389		
	02/89→02/90	Mounting, stabilizer coupling rod	MN-SB-5246		
	02/89→02/90	Mounting, stabilizer coupling rod	MN-SB-5246		1st FA
	02/89→02/90	Stabiliser Mounting		MN-SB-5254	
	02/89→02/90	Stabiliser Mounting		MN-SB-5265	
	02/89→02/90	Stabiliser Mounting	MN-SB-9396		
	02/89→02/90	Suspension Arm Repair Kit		MN-RK-7280	for Drag Link
	02/89→02/90	Tie Rod End	CV-ES-2149		for Push Rod
	02/89→02/90	Tie Rod End	CV-ES-14162		for Steering Rod
	02/89→02/90	Tie Rod End	CV-ES-14163		for Steering Rod

CV-ES-2119

Length: 55
Cone Ø: d1 Ø 10 / d2 Ø 10
Thread: M12 x 1,75 LHT
81953016063, 81953016131



CV-ES-2120

Length: 115
Cone Ø: d1 Ø 12,4 / d2 Ø 10,8
Thread: M14 x 1,5 RHT
03008500A, 81953016200, 81953016202,
81953016203, 81953016227



CV-ES-2149

Length: 160
Cone Ø: d1 Ø 30 / d2 Ø 27
Thread: M30 x 1,5 RHT
81953016263



CV-ES-2182

Length: 55
Cone Ø: d1 Ø 10 / d2 Ø 10
Thread: M12 x 1,75 RHT
81953016064, 81953016170



CV-ES-14162

Length: 125
Cone Ø: d1 Ø 30 / d2 Ø 27
Thread: M30 x 1,5 LHT

81953010015, 81953010083, 81953010087,
81953016029, 81953016030, 81953016043,
81953016044, 81953016050, 81953016054,
81953016087, 81953016091, 81953016107,
81953016120, 81953016125, 81953016152,
81953016155, 81953016157, 81953016168,
81953016179, 81953016181, 81953016223,
81953016237, 81953016254, 81953016275,
81953016279, 81953016351



CV-ES-14163

Length: 125
Cone Ø: d1 Ø 30 / d2 Ø 27
Thread: M30 x 1,5 RHT

95301.0084, 90804102156, 90804102272,
90804102696, 90804102710, 81953010016,
81953010075, 81953010084, 81953010088,
81953010094, 81953010103, 81953016030,
81953016043, 81953016048, 81953016049,
81953016053, 81953016061, 81953016090,
81953016108, 81953016112, 81953016126,
81953016143, 81953016149, 81953016154,
81953016156, 81953016168, 81953016178,
81953016194, 81953016206, 81953016224,
81953016234, 81953016242, 81953016252,
81953016274, 81953016278, 81953016284,
81953016286, 81953016308, 81953016310,
81953016312, 81953016347, 81953016350,
81953016352, 82953016012, 88953016014,
N2953016001



MN-DL-2160

Length: 1652 Ø: 50
Cone Ø: d1 Ø 30 / d2 Ø 27
81467106112, 81467106163, 81467106165,
81467106198, 81467106353, 81467106354,
81467106361, 81467116725



MN-DL-2174

Length: 1588 Ø: 52
Cone Ø: d1 Ø 30 / d2 Ø 27
81467106378, 81467106912



MN-DL-2175

Length: 1628 Ø: 50
Cone Ø: d1 Ø 30 / d2 Ø 27
81467106396, 81467106904



MN-DL-3588

Length: 1035 Ø: 48
Cone Ø: d1 Ø 30 / d2 Ø 27
81466106333, 81466106334, 81466106354,
81466106355, 81466106360, 81466106361,
81466106721, 81466106722, 81466106723,
81466116216



MN-DL-5212

Length: 577 Ø: 48
Hole Distance: 130 / 130
81432206096, 81432206097, 81432206098,
81432206129, 81432209096, 81432209129,
81432306014, 81432306030



MN-DL-12284

Length: 1530 Ø: 50
Cone Ø: d1 Ø 30 / d2 Ø 27
81466106579, 81466106580, 81466106624,
81466116720, 81467116720, 81467116730,
81467116952



MN-DL-12421

Length: 1070 Ø: 48
Cone Ø: d1 Ø 30 / d2 Ø 27
Thread: M30 x 1,5 RHT
81466106656, 81466106659, 81466106669,
81466116006, 81466116007



MN-RK-7280

Ø: 75
Hole Distance: 115
Thick/Height: 24
0550806, 0639370, 689748, 10307400A,
81432306051, 81432306068, 81432706064



MN-RK-7287

Ø: 90
Hole Distance: 152
Thick/Height: 35
03304700A, 81953016133



MN-RK-7291

Ø: 72
Hole Distance: 130
Thick/Height: 30
10307800A, 81432206108, 81432206132



MN-SB-5246

Ø: 45 Thick/Height: 47
81437220022, 81437220038, 81962100450,
81962100469



MN-SB-5254

Length: 100 Ø: 93
Thick/Height: 70
81432710081



MN-SB-5265

Ø: 85 Thick/Height: 80
03310300A, 81437040032



MN-SB-9396

Ø: 67 Thick/Height: 60
81437040057



MN-SB-10389

Ø: 70 Thick/Height: 72
81960200340



MN-VB-5222

Length: 627 Ø: 50
Hole Distance: 152 / 152
81432706030, 81432706034, 81432706054,
81432706055, 81432706056, 81432706057,
81432706067, 81432706068, 81432706074,
81432706075, 81432706076, 81432706077,
81432706078, 81432706081, 81432706082,
81432709034, 81432709076, 81432709078,
8143706054





F 90 ...

19.262 FK	01/88→02/90	Ball Head, gearshift linkage	CV-ES-2119		
	01/88→02/90	Ball Head, gearshift linkage	CV-ES-2120		
	01/88→02/90	Ball Head, gearshift linkage	CV-ES-2182		
	01/88→02/90	Centre Rod	MN-DL-2160		Coupling Rod
	01/88→02/90	Centre Rod	MN-DL-2174		Push Rod
	01/88→02/90	Centre Rod	MN-DL-2175		Push Rod
	01/88→02/90	Centre Rod	MN-DL-3588		Push Rod
	01/88→02/90	Centre Rod	MN-DL-12421		for Steering Rod
	01/88→02/90	Engine Mounting		MN-SB-10390	
	01/88→02/90	Engine Mounting	MN-SB-10389		
	01/88→02/90	Mounting, stabilizer coupling rod	MN-SB-5246		
	01/88→02/90	Mounting, stabilizer coupling rod	MN-SB-5246		1st FA
	01/88→02/90	Suspension Arm Repair Kit		MN-RK-7280	for Drag Link
	01/88→02/90	Tie Rod	MN-DL-12284		
01/88→02/90	Tie Rod End	CV-ES-2149		for Push Rod	
01/88→02/90	Tie Rod End	CV-ES-14162		for Steering Rod	
01/88→02/90	Tie Rod End	CV-ES-14163		for Steering Rod	
19.262 FS,19.262 FLS,19.262 FLLS	01/88→02/90	Ball Head, gearshift linkage	CV-ES-2119		
	01/88→02/90	Ball Head, gearshift linkage	CV-ES-2120		
	01/88→02/90	Ball Head, gearshift linkage	CV-ES-2182		
	01/88→02/90	Centre Rod	MN-DL-2160		Coupling Rod
	01/88→02/90	Centre Rod	MN-DL-2174		Push Rod
	01/88→02/90	Centre Rod	MN-DL-2175		Push Rod
	01/88→02/90	Centre Rod	MN-DL-3588		Push Rod
	01/88→02/90	Centre Rod	MN-DL-12421		for Steering Rod
	01/88→02/90	Engine Mounting		MN-SB-10390	
	01/88→02/90	Engine Mounting	MN-SB-10389		
	01/88→02/90	Mounting, stabilizer coupling rod	MN-SB-5246		
	01/88→02/90	Mounting, stabilizer coupling rod	MN-SB-5246		1st FA
	01/88→02/90	Stabiliser Mounting		MN-SB-5265	
	01/88→02/90	Stabiliser Mounting		MN-SB-5265	1st RA
	01/88→02/90	Suspension Arm Repair Kit		CV-RK-5313	for Wishbone (CV)
	01/88→02/90	Suspension Arm Repair Kit		CV-RK-8118	for Control Arm
	01/88→02/90	Suspension Arm Repair Kit		MN-RK-7280	for Drag Link
	01/88→02/90	Suspension Arm Repair Kit		MN-RK-7287	for Wishbone (CV)
	01/88→02/90	Suspension Arm Repair Kit		MN-RK-7291	for Drag Link
	01/88→02/90	Tie Rod	MN-DL-12284		
	01/88→02/90	Tie Rod End	CV-ES-2149		for Push Rod
	01/88→02/90	Tie Rod End	CV-ES-14162		for Steering Rod
	01/88→02/90	Tie Rod End	CV-ES-14163		for Steering Rod
	01/88→02/90	Track Control Arm		MN-DL-5212	Trailing Arm, Air Suspension Axle
01/88→02/90	Track Control Arm		MN-VB-5222	Wishbone (CV), Air Suspension Axle	
19.272 F,19.272 FL,19.272 FLL	02/90→05/95	Ball Head, gearshift linkage	CV-ES-2119		
	02/90→05/95	Ball Head, gearshift linkage	CV-ES-2120		
	02/90→05/95	Ball Head, gearshift linkage	CV-ES-2182		
	02/90→05/95	Centre Rod	MN-DL-2160		Coupling Rod
	02/90→05/95	Centre Rod	MN-DL-2174		Push Rod
	02/90→05/95	Centre Rod	MN-DL-2175		Push Rod
	02/90→05/95	Centre Rod	MN-DL-3588		Push Rod
	02/90→05/95	Centre Rod	MN-DL-12421		for Steering Rod
	02/90→05/95	Engine Mounting		MN-SB-10390	
	02/90→05/95	Engine Mounting	MN-SB-10389		
	02/90→05/95	Mounting, stabilizer coupling rod	MN-SB-5246		
	02/90→05/95	Mounting, stabilizer coupling rod	MN-SB-5246		1st FA
	02/90→05/95	Stabiliser Mounting		MN-SB-5265	
	02/90→05/95	Stabiliser Mounting		MN-SB-5265	1st RA
	02/90→05/95	Suspension Arm Repair Kit		CV-RK-5313	for Wishbone (CV)
	02/90→05/95	Suspension Arm Repair Kit		CV-RK-8118	for Control Arm
	02/90→05/95	Suspension Arm Repair Kit		MN-RK-7280	for Drag Link
	02/90→05/95	Suspension Arm Repair Kit		MN-RK-7287	for Wishbone (CV)
	02/90→05/95	Suspension Arm Repair Kit		MN-RK-7291	for Drag Link
	02/90→05/95	Tie Rod	MN-DL-12284		
	02/90→05/95	Tie Rod End	CV-ES-2149		for Push Rod

CV-ES-2119

Length: 55
Cone Ø: d1 Ø 10 / d2 Ø 10
Thread: M12 x 1,75 LHT
81953016063, 81953016131



CV-ES-2120

Length: 115
Cone Ø: d1 Ø 12,4 / d2 Ø 10,8
Thread: M14 x 1,5 RHT
03008500A, 81953016200, 81953016202, 81953016203, 81953016227



CV-ES-2149

Length: 160
Cone Ø: d1 Ø 30 / d2 Ø 27
Thread: M30 x 1,5 RHT
81953016263



CV-ES-2182

Length: 55
Cone Ø: d1 Ø 10 / d2 Ø 10
Thread: M12 x 1,75 RHT
81953016064, 81953016170



CV-ES-14162

Length: 125
Cone Ø: d1 Ø 30 / d2 Ø 27
Thread: M30 x 1,5 LHT
81953010015, 81953010083, 81953010087, 81953016029, 81953016030, 81953016043, 81953016044, 81953016050, 81953016054, 81953016087, 81953016091, 81953016107, 81953016120, 81953016125, 81953016152, 81953016155, 81953016157, 81953016168, 81953016179, 81953016181, 81953016223, 81953016237, 81953016254, 81953016275, 81953016279, 81953016351



CV-ES-14163

Length: 125
Cone Ø: d1 Ø 30 / d2 Ø 27
Thread: M30 x 1,5 RHT
95301.0084, 90804102156, 90804102272, 90804102696, 90804102710, 81953010016, 81953010075, 81953010084, 81953010088, 81953010094, 81953010103, 81953016030, 81953016043, 81953016048, 81953016049, 81953016053, 81953016061, 81953016090, 81953016108, 81953016112, 81953016126, 81953016143, 81953016149, 81953016154, 81953016156, 81953016168, 81953016178, 81953016194, 81953016206, 81953016224, 81953016234, 81953016242, 81953016252, 81953016274, 81953016278, 81953016284, 81953016286, 81953016308, 81953016310, 81953016312, 81953016347, 81953016350, 81953016352, 82953016012, 88953016014, N2953016001



CV-RK-5313

Ø: 90
03304800A, 81953016132



CV-RK-8118

Ø: 85
Hole Distance: 130
Thick/Height: 30
638862, 639287, 775201, 938423, 1104335, 1953248, 0003500506, 3500506, 11013547, 21032592, 42065912, 42488722, 070550504, 93192618, 070400009000, 634303610, 81432206055, 81432206073, 82262320660, 9544171010099, 5001842823, 7000307001, 8226232066



MN-DL-2160

Length: 1652 Ø: 50
Cone Ø: d1 Ø 30 / d2 Ø 27
81467106112, 81467106163, 81467106165, 81467106198, 81467106353, 81467106354, 81467106361, 81467116725



MN-DL-2174

Length: 1588 Ø: 52
Cone Ø: d1 Ø 30 / d2 Ø 27
81467106378, 81467106912



MN-DL-2175

Length: 1628 Ø: 50
Cone Ø: d1 Ø 30 / d2 Ø 27
81467106396, 81467106904



MN-DL-3588

Length: 1035 Ø: 48
Cone Ø: d1 Ø 30 / d2 Ø 27
81466106333, 81466106334, 81466106354, 81466106355, 81466106360, 81466106361, 81466106721, 81466106722, 81466106723, 81466116216



MN-DL-5212

Length: 577 Ø: 48
Hole Distance: 130 / 130
81432206096, 81432206097, 81432206098, 81432206129, 81432209096, 81432209129, 81432306014, 81432306030



MN-DL-12284

Length: 1530 Ø: 50
Cone Ø: d1 Ø 30 / d2 Ø 27
81466106579, 81466106580, 81466106624, 81466116720, 81467116720, 81467116730, 81467116952



MN-DL-12421

Length: 1070 Ø: 48
Cone Ø: d1 Ø 30 / d2 Ø 27
Thread: M30 x 1,5 RHT
81466106656, 81466106659, 81466106669, 81466116006, 81466116007



MN-RK-7280

Ø: 75
Hole Distance: 115
Thick/Height: 24
0550806, 0639370, 689748, 10307400A, 81432306051, 81432306068, 81432706064



MN-RK-7287

Ø: 90
Hole Distance: 152
Thick/Height: 35
03304700A, 81953016133



MN-RK-7291

Ø: 72
Hole Distance: 130
Thick/Height: 30
10307800A, 81432206108, 81432206132



MN-SB-5246

Ø: 45 Thick/Height: 47
81437220022, 81437220038, 81962100450, 81962100469



MN-SB-5265

Ø: 85 Thick/Height: 80
03310300A, 81437040032



MN-SB-10389

Ø: 70 Thick/Height: 72
81960200340



MN-SB-10390

Ø: 70 Thick/Height: 85/85
81960200341, 81960200373, 81960200385, 81960200408, 81960200418



MN-VB-5222

Length: 627 Ø: 50
Hole Distance: 152 / 152
81432706030, 81432706034, 81432706054, 81432706055, 81432706056, 81432706057, 81432706067, 81432706068, 81432706074, 81432706075, 81432706076, 81432706077, 81432706078, 81432706081, 81432706082, 81432709034, 81432709076, 81432709078, 8143706054





F 90 ...

19.272 F,19.272 FL,19.272 FLL ...	02/90→05/95	Tie Rod End	CV-ES-14162		for Steering Rod
	02/90→05/95	Tie Rod End	CV-ES-14163		for Steering Rod
	02/90→05/95	Track Control Arm		MN-DL-5212	Trailing Arm, Air Suspension Axle
	02/90→05/95	Track Control Arm		MN-VB-5222	Wishbone (CV), Air Suspension Axle
19.272 FA	02/90→05/95	Ball Head, gearshift linkage	CV-ES-2119		
	02/90→05/95	Ball Head, gearshift linkage	CV-ES-2120		
	02/90→05/95	Ball Head, gearshift linkage	CV-ES-2182		
	02/90→05/95	Centre Rod	MN-DL-2160		Coupling Rod
	02/90→05/95	Centre Rod	MN-DL-2174		Push Rod
	02/90→05/95	Centre Rod	MN-DL-2175		Push Rod
	02/90→05/95	Centre Rod	MN-DL-3588		Push Rod
	02/90→05/95	Centre Rod	MN-DL-12421		for Steering Rod
	02/90→05/95	Engine Mounting	MN-SB-10389		
	02/90→05/95	Mounting, stabilizer coupling rod	MN-SB-5246		
	02/90→05/95	Mounting, stabilizer coupling rod	MN-SB-5246		1st FA
	02/90→05/95	Stabiliser Mounting		MN-SB-5254	
	02/90→05/95	Stabiliser Mounting		MN-SB-5265	
	02/90→05/95	Stabiliser Mounting	MN-SB-9396		
	02/90→05/95	Suspension Arm Repair Kit		MN-RK-7280	for Drag Link
	02/90→05/95	Tie Rod End	CV-ES-2149		for Push Rod
	02/90→05/95	Tie Rod End	CV-ES-14162		for Steering Rod
	02/90→05/95	Tie Rod End	CV-ES-14163		for Steering Rod
	19.272 FAK	02/90→05/95	Ball Head, gearshift linkage	CV-ES-2119	
02/90→05/95		Ball Head, gearshift linkage	CV-ES-2120		
02/90→05/95		Ball Head, gearshift linkage	CV-ES-2182		
02/90→05/95		Centre Rod	MN-DL-2160		Coupling Rod
02/90→05/95		Centre Rod	MN-DL-2174		Push Rod
02/90→05/95		Centre Rod	MN-DL-2175		Push Rod
02/90→05/95		Centre Rod	MN-DL-3588		Push Rod
02/90→05/95		Centre Rod	MN-DL-12421		for Steering Rod
02/90→05/95		Engine Mounting	MN-SB-10389		
02/90→05/95		Mounting, stabilizer coupling rod	MN-SB-5246		
02/90→05/95		Mounting, stabilizer coupling rod	MN-SB-5246		1st FA
02/90→05/95		Stabiliser Mounting		MN-SB-5254	
02/90→05/95		Stabiliser Mounting		MN-SB-5265	
02/90→05/95		Stabiliser Mounting	MN-SB-9396		
02/90→05/95		Suspension Arm Repair Kit		MN-RK-7280	for Drag Link
02/90→05/95		Tie Rod End	CV-ES-2149		for Push Rod
02/90→05/95		Tie Rod End	CV-ES-14162		for Steering Rod
02/90→05/95		Tie Rod End	CV-ES-14163		for Steering Rod
19.272 FAS		02/90→05/95	Ball Head, gearshift linkage	CV-ES-2119	
	02/90→05/95	Ball Head, gearshift linkage	CV-ES-2120		
	02/90→05/95	Ball Head, gearshift linkage	CV-ES-2182		
	02/90→05/95	Centre Rod	MN-DL-2160		Coupling Rod
	02/90→05/95	Centre Rod	MN-DL-2174		Push Rod
	02/90→05/95	Centre Rod	MN-DL-2175		Push Rod
	02/90→05/95	Centre Rod	MN-DL-3588		Push Rod
	02/90→05/95	Centre Rod	MN-DL-12421		for Steering Rod
	02/90→05/95	Engine Mounting	MN-SB-10389		
	02/90→05/95	Mounting, stabilizer coupling rod	MN-SB-5246		
	02/90→05/95	Mounting, stabilizer coupling rod	MN-SB-5246		1st FA
	02/90→05/95	Stabiliser Mounting		MN-SB-5254	
	02/90→05/95	Stabiliser Mounting		MN-SB-5265	
	02/90→05/95	Stabiliser Mounting	MN-SB-9396		
	02/90→05/95	Suspension Arm Repair Kit		MN-RK-7280	for Drag Link
	02/90→05/95	Tie Rod End	CV-ES-2149		for Push Rod
	02/90→05/95	Tie Rod End	CV-ES-14162		for Steering Rod
	02/90→05/95	Tie Rod End	CV-ES-14163		for Steering Rod
	19.272 FK	02/90→05/95	Ball Head, gearshift linkage	CV-ES-2119	
02/90→05/95		Ball Head, gearshift linkage	CV-ES-2120		
02/90→05/95		Ball Head, gearshift linkage	CV-ES-2182		
02/90→05/95		Centre Rod	MN-DL-2160		Coupling Rod
02/90→05/95		Centre Rod	MN-DL-2174		Push Rod

CV-ES-2119

Length: 55
Cone Ø: d1 Ø 10 / d2 Ø 10
Thread: M12 x 1,75 LHT
81953016063, 81953016131



CV-ES-2120

Length: 115
Cone Ø: d1 Ø 12,4 / d2 Ø 10,8
Thread: M14 x 1,5 RHT
03008500A, 81953016200, 81953016202, 81953016203, 81953016227



CV-ES-2149

Length: 160
Cone Ø: d1 Ø 30 / d2 Ø 27
Thread: M30 x 1,5 RHT
81953016263



CV-ES-2182

Length: 55
Cone Ø: d1 Ø 10 / d2 Ø 10
Thread: M12 x 1,75 RHT
81953016064, 81953016170



CV-ES-14162

Length: 125
Cone Ø: d1 Ø 30 / d2 Ø 27
Thread: M30 x 1,5 LHT
81953010015, 81953010083, 81953010087, 81953016029, 81953016030, 81953016043, 81953016044, 81953016050, 81953016054, 81953016087, 81953016091, 81953016107, 81953016120, 81953016125, 81953016152, 81953016155, 81953016157, 81953016168, 81953016179, 81953016181, 81953016223, 81953016237, 81953016254, 81953016275, 81953016279, 81953016351



CV-ES-14163

Length: 125
Cone Ø: d1 Ø 30 / d2 Ø 27
Thread: M30 x 1,5 RHT
95301.0084, 90804102156, 90804102272, 90804102696, 90804102710, 81953010016, 81953010075, 81953010084, 81953010088, 81953010094, 81953010103, 81953016030, 81953016043, 81953016048, 81953016049, 81953016053, 81953016061, 81953016090, 81953016108, 81953016112, 81953016126, 81953016143, 81953016149, 81953016154, 81953016156, 81953016168, 81953016178, 81953016194, 81953016206, 81953016224, 81953016234, 81953016242, 81953016252, 81953016274, 81953016278, 81953016284, 81953016286, 81953016308, 81953016310, 81953016312, 81953016347, 81953016350, 81953016352, 82953016012, 88953016014, N2953016001



MN-DL-2160

Length: 1652 Ø: 50
Cone Ø: d1 Ø 30 / d2 Ø 27
81467106112, 81467106163, 81467106165, 81467106198, 81467106353, 81467106354, 81467106361, 81467116725



MN-DL-2174

Length: 1588 Ø: 52
Cone Ø: d1 Ø 30 / d2 Ø 27
81467106378, 81467106912



MN-DL-2175

Length: 1628
Ø: 50
Cone Ø: d1 Ø 30 / d2 Ø 27
81467106396, 81467106904



MN-DL-3588

Length: 1035
Ø: 48
Cone Ø: d1 Ø 30 / d2 Ø 27
81466106333, 81466106334, 81466106354, 81466106355, 81466106360, 81466106361, 81466106721, 81466106722, 81466106723, 81466116216



MN-DL-5212

Length: 577 Ø: 48
Hole Distance: 130 / 130
81432206096, 81432206097, 81432206098, 81432206129, 81432209096, 81432209129, 81432306014, 81432306030



MN-DL-12421

Length: 1070
Ø: 48
Cone Ø: d1 Ø 30 / d2 Ø 27
Thread: M30 x 1,5 RHT
81466106656, 81466106659, 81466106669, 81466116006, 81466116007



MN-RK-7280

Ø: 75
Hole Distance: 115
Thick/Height: 24
0550806, 0639370, 689748, 10307400A, 81432306051, 81432306068, 81432706064



MN-SB-5246

Ø: 45 Thick/Height: 47
81437220022, 81437220038, 81962100450, 81962100469



MN-SB-5254

Length: 100
Ø: 93
Thick/Height: 70
81432710081



MN-SB-5265

Ø: 85
Thick/Height: 80
03310300A, 81437040032



MN-SB-9396

Ø: 67
Thick/Height: 60
81437040057



MN-SB-10389

Ø: 70
Thick/Height: 72
81960200340



MN-VB-5222

Length: 627 Ø: 50
Hole Distance: 152 / 152
81432706030, 81432706034, 81432706054, 81432706055, 81432706056, 81432706057, 81432706067, 81432706068, 81432706074, 81432706075, 81432706076, 81432706077, 81432706078, 81432706081, 81432706082, 81432709034, 81432709076, 81432709078, 8143706054





F 90 ...

19.272 FK ...	02/90→05/95	Centre Rod	MN-DL-2175		Push Rod
	02/90→05/95	Centre Rod	MN-DL-3588		Push Rod
	02/90→05/95	Centre Rod	MN-DL-12421		for Steering Rod
	02/90→05/95	Engine Mounting		MN-SB-10390	
	02/90→05/95	Engine Mounting	MN-SB-10389		
	02/90→05/95	Mounting, stabilizer coupling rod	MN-SB-5246		
	02/90→05/95	Mounting, stabilizer coupling rod	MN-SB-5246		1st FA
	02/90→05/95	Suspension Arm Repair Kit		MN-RK-7280	for Drag Link
	02/90→05/95	Tie Rod	MN-DL-12284		
	02/90→05/95	Tie Rod End	CV-ES-2149		for Push Rod
	02/90→05/95	Tie Rod End	CV-ES-14162		for Steering Rod
	02/90→05/95	Tie Rod End	CV-ES-14163		for Steering Rod
	19.272 FS,19.272 FLS,19.272 FLLS	02/90→05/95	Ball Head, gearshift linkage	CV-ES-2119	
02/90→05/95		Ball Head, gearshift linkage	CV-ES-2120		
02/90→05/95		Ball Head, gearshift linkage	CV-ES-2182		
02/90→05/95		Centre Rod	MN-DL-2160		Coupling Rod
02/90→05/95		Centre Rod	MN-DL-2174		Push Rod
02/90→05/95		Centre Rod	MN-DL-2175		Push Rod
02/90→05/95		Centre Rod	MN-DL-3588		Push Rod
02/90→05/95		Centre Rod	MN-DL-12421		for Steering Rod
02/90→05/95		Engine Mounting		MN-SB-10390	
02/90→05/95		Engine Mounting	MN-SB-10389		
02/90→05/95		Mounting, stabilizer coupling rod	MN-SB-5246		
02/90→05/95		Mounting, stabilizer coupling rod	MN-SB-5246		1st FA
02/90→05/95		Stabiliser Mounting		MN-SB-5265	
02/90→05/95		Stabiliser Mounting		MN-SB-5265	1st RA
02/90→05/95		Suspension Arm Repair Kit		CV-RK-5313	for Wishbone (CV)
02/90→05/95		Suspension Arm Repair Kit		CV-RK-8118	for Control Arm
02/90→05/95		Suspension Arm Repair Kit		MN-RK-7280	for Drag Link
02/90→05/95		Suspension Arm Repair Kit		MN-RK-7287	for Wishbone (CV)
02/90→05/95		Suspension Arm Repair Kit		MN-RK-7291	for Drag Link
02/90→05/95		Tie Rod	MN-DL-12284		
02/90→05/95		Tie Rod End	CV-ES-2149		for Push Rod
02/90→05/95		Tie Rod End	CV-ES-14162		for Steering Rod
02/90→05/95		Tie Rod End	CV-ES-14163		for Steering Rod
02/90→05/95		Track Control Arm		MN-DL-5212	Trailing Arm, Air Suspension Axle
02/90→05/95		Track Control Arm		MN-VB-5222	Wishbone (CV), Air Suspension Axle
19.292 F,19.292 FL,19.292 FLL		07/86→02/90	Ball Head, gearshift linkage	CV-ES-2119	
	07/86→02/90	Ball Head, gearshift linkage	CV-ES-2120		
	07/86→02/90	Ball Head, gearshift linkage	CV-ES-2182		
	07/86→02/90	Centre Rod	MN-DL-2160		Coupling Rod
	07/86→02/90	Centre Rod	MN-DL-2174		Push Rod
	07/86→02/90	Centre Rod	MN-DL-2175		Push Rod
	07/86→02/90	Centre Rod	MN-DL-3588		Push Rod
	07/86→02/90	Centre Rod	MN-DL-12421		for Steering Rod
	07/86→02/90	Engine Mounting		MN-SB-10390	
	07/86→02/90	Engine Mounting	MN-SB-10389		
	07/86→02/90	Mounting, stabilizer coupling rod	MN-SB-5246		
	07/86→02/90	Mounting, stabilizer coupling rod	MN-SB-5246		1st FA
	07/86→02/90	Stabiliser Mounting		MN-SB-5265	
	07/86→02/90	Stabiliser Mounting		MN-SB-5265	1st RA
	07/86→02/90	Suspension Arm Repair Kit		CV-RK-5313	for Wishbone (CV)
	07/86→02/90	Suspension Arm Repair Kit		CV-RK-8118	for Control Arm
	07/86→02/90	Suspension Arm Repair Kit		MN-RK-7280	for Drag Link
	07/86→02/90	Suspension Arm Repair Kit		MN-RK-7287	for Wishbone (CV)
	07/86→02/90	Suspension Arm Repair Kit		MN-RK-7291	for Drag Link
	07/86→02/90	Tie Rod	MN-DL-12284		
	07/86→02/90	Tie Rod End	CV-ES-2149		for Push Rod
	07/86→02/90	Tie Rod End	CV-ES-14162		for Steering Rod
	07/86→02/90	Tie Rod End	CV-ES-14163		for Steering Rod
	07/86→02/90	Track Control Arm		MN-DL-5212	Trailing Arm, Air Suspension Axle
	07/86→02/90	Track Control Arm		MN-VB-5222	Wishbone (CV), Air Suspension Axle

CV-ES-2119

Length: 55
Cone Ø: d1 Ø 10 / d2 Ø 10
Thread: M12 x 1,75 LHT
81953016063, 81953016131



CV-ES-2120

Length: 115
Cone Ø: d1 Ø 12,4 / d2 Ø 10,8
Thread: M14 x 1,5 RHT
03008500A, 81953016200, 81953016202, 81953016203, 81953016227



CV-ES-2149

Length: 160
Cone Ø: d1 Ø 30 / d2 Ø 27
Thread: M30 x 1,5 RHT
81953016263



CV-ES-2182

Length: 55
Cone Ø: d1 Ø 10 / d2 Ø 10
Thread: M12 x 1,75 RHT
81953016064, 81953016170



CV-ES-14162

Length: 125
Cone Ø: d1 Ø 30 / d2 Ø 27
Thread: M30 x 1,5 LHT

81953010015, 81953010083, 81953010087, 81953016029, 81953016030, 81953016043, 81953016044, 81953016050, 81953016054, 81953016087, 81953016091, 81953016107, 81953016120, 81953016125, 81953016152, 81953016155, 81953016157, 81953016168, 81953016179, 81953016181, 81953016223, 81953016237, 81953016254, 81953016275, 81953016279, 81953016351



CV-ES-14163

Length: 125
Cone Ø: d1 Ø 30 / d2 Ø 27
Thread: M30 x 1,5 RHT

95301.0084, 90804102156, 90804102272, 90804102696, 90804102710, 81953010016, 81953010075, 81953010084, 81953010088, 81953010094, 81953010103, 81953016030, 81953016043, 81953016048, 81953016049, 81953016053, 81953016061, 81953016090, 81953016108, 81953016112, 81953016126, 81953016143, 81953016149, 81953016154, 81953016156, 81953016168, 81953016178, 81953016194, 81953016206, 81953016224, 81953016234, 81953016242, 81953016252, 81953016274, 81953016278, 81953016284, 81953016286, 81953016308, 81953016310, 81953016312, 81953016347, 81953016350, 81953016352, 82953016012, 88953016014, N2953016001



CV-RK-5313

Ø: 90
03304800A, 81953016132



CV-RK-8118

Ø: 85
Hole Distance: 130
Thick/Height: 30

638862, 639287, 775201, 938423, 1104335, 1953248, 0003500506, 3500506, 11013547, 21032592, 42065912, 42488722, 070550504, 93192618, 070400009000, 634303610, 81432206055, 81432206073, 82262320660, 9544171010099, 5001842823, 7000307001, 8226232066



MN-DL-2160

Length: 1652 Ø: 50
Cone Ø: d1 Ø 30 / d2 Ø 27

81467106112, 81467106163, 81467106165, 81467106198, 81467106353, 81467106354, 81467106361, 81467116725



MN-DL-2174

Length: 1588 Ø: 52
Cone Ø: d1 Ø 30 / d2 Ø 27
81467106378, 81467106912



MN-DL-2175

Length: 1628 Ø: 50
Cone Ø: d1 Ø 30 / d2 Ø 27
81467106396, 81467106904



MN-DL-3588

Length: 1035 Ø: 48
Cone Ø: d1 Ø 30 / d2 Ø 27

81466106333, 81466106334, 81466106354, 81466106355, 81466106360, 81466106361, 81466106721, 81466106722, 81466106723, 81466116216



MN-DL-5212

Length: 577 Ø: 48
Hole Distance: 130 / 130

81432206096, 81432206097, 81432206098, 81432206129, 81432209096, 81432209129, 81432306014, 81432306030



MN-DL-12284

Length: 1530 Ø: 50
Cone Ø: d1 Ø 30 / d2 Ø 27

81466106579, 81466106580, 81466106624, 81466116720, 81467116720, 81467116730, 81467116952



MN-DL-12421

Length: 1070 Ø: 48
Cone Ø: d1 Ø 30 / d2 Ø 27

Thread: M30 x 1,5 RHT
81466106656, 81466106659, 81466106669, 81466116006, 81466116007



MN-RK-7280

Ø: 75
Hole Distance: 115
Thick/Height: 24

0550806, 0639370, 689748, 10307400A, 81432306051, 81432306068, 81432706064



MN-RK-7287

Ø: 90
Hole Distance: 152
Thick/Height: 35
03304700A, 81953016133



MN-RK-7291

Ø: 72
Hole Distance: 130
Thick/Height: 30
10307800A, 81432206108, 81432206132



MN-SB-5246

Ø: 45 Thick/Height: 47
81437220022, 81437220038, 81962100450, 81962100469



MN-SB-5265

Ø: 85 Thick/Height: 80
03310300A, 81437040032



MN-SB-10389

Ø: 70 Thick/Height: 72
81960200340



MN-SB-10390

Ø: 70 Thick/Height: 85/85
81960200341, 81960200373, 81960200385, 81960200408, 81960200418



MN-VB-5222

Length: 627 Ø: 50
Hole Distance: 152 / 152
81432706030, 81432706034, 81432706054, 81432706055, 81432706056, 81432706057, 81432706067, 81432706068, 81432706074, 81432706075, 81432706076, 81432706077, 81432706078, 81432706081, 81432706082, 81432709034, 81432709076, 81432709078, 8143706054





F 90 ...

19.292 FA	05/88→02/90	Ball Head, gearshift linkage	CV-ES-2119		
	05/88→02/90	Ball Head, gearshift linkage	CV-ES-2120		
	05/88→02/90	Ball Head, gearshift linkage	CV-ES-2182		
	05/88→02/90	Centre Rod	MN-DL-2160		Coupling Rod
	05/88→02/90	Centre Rod	MN-DL-2174		Push Rod
	05/88→02/90	Centre Rod	MN-DL-2175		Push Rod
	05/88→02/90	Centre Rod	MN-DL-3588		Push Rod
	05/88→02/90	Centre Rod	MN-DL-12421		for Steering Rod
	05/88→02/90	Engine Mounting	MN-SB-10389		
	05/88→02/90	Mounting, stabilizer coupling rod	MN-SB-5246		
	05/88→02/90	Mounting, stabilizer coupling rod	MN-SB-5246		1st FA
	05/88→02/90	Stabiliser Mounting		MN-SB-5254	
	05/88→02/90	Stabiliser Mounting		MN-SB-5265	
	05/88→02/90	Stabiliser Mounting	MN-SB-9396		
	05/88→02/90	Suspension Arm Repair Kit		MN-RK-7280	for Drag Link
05/88→02/90	Tie Rod End	CV-ES-2149		for Push Rod	
05/88→02/90	Tie Rod End	CV-ES-14162		for Steering Rod	
05/88→02/90	Tie Rod End	CV-ES-14163		for Steering Rod	
19.292 FAK	05/88→02/90	Ball Head, gearshift linkage	CV-ES-2119		
	05/88→02/90	Ball Head, gearshift linkage	CV-ES-2120		
	05/88→02/90	Ball Head, gearshift linkage	CV-ES-2182		
	05/88→02/90	Centre Rod	MN-DL-2160		Coupling Rod
	05/88→02/90	Centre Rod	MN-DL-2174		Push Rod
	05/88→02/90	Centre Rod	MN-DL-2175		Push Rod
	05/88→02/90	Centre Rod	MN-DL-3588		Push Rod
	05/88→02/90	Centre Rod	MN-DL-12421		for Steering Rod
	05/88→02/90	Engine Mounting	MN-SB-10389		
	05/88→02/90	Mounting, stabilizer coupling rod	MN-SB-5246		
	05/88→02/90	Mounting, stabilizer coupling rod	MN-SB-5246		1st FA
	05/88→02/90	Stabiliser Mounting		MN-SB-5254	
	05/88→02/90	Stabiliser Mounting		MN-SB-5265	
	05/88→02/90	Stabiliser Mounting	MN-SB-9396		
	05/88→02/90	Suspension Arm Repair Kit		MN-RK-7280	for Drag Link
05/88→02/90	Tie Rod End	CV-ES-2149		for Push Rod	
05/88→02/90	Tie Rod End	CV-ES-14162		for Steering Rod	
05/88→02/90	Tie Rod End	CV-ES-14163		for Steering Rod	
19.292 FAS	05/88→02/90	Ball Head, gearshift linkage	CV-ES-2119		
	05/88→02/90	Ball Head, gearshift linkage	CV-ES-2120		
	05/88→02/90	Ball Head, gearshift linkage	CV-ES-2182		
	05/88→02/90	Centre Rod	MN-DL-2160		Coupling Rod
	05/88→02/90	Centre Rod	MN-DL-2174		Push Rod
	05/88→02/90	Centre Rod	MN-DL-2175		Push Rod
	05/88→02/90	Centre Rod	MN-DL-3588		Push Rod
	05/88→02/90	Centre Rod	MN-DL-12421		for Steering Rod
	05/88→02/90	Engine Mounting	MN-SB-10389		
	05/88→02/90	Mounting, stabilizer coupling rod	MN-SB-5246		
	05/88→02/90	Mounting, stabilizer coupling rod	MN-SB-5246		1st FA
	05/88→02/90	Stabiliser Mounting		MN-SB-5254	
	05/88→02/90	Stabiliser Mounting		MN-SB-5265	
	05/88→02/90	Stabiliser Mounting	MN-SB-9396		
	05/88→02/90	Suspension Arm Repair Kit		MN-RK-7280	for Drag Link
05/88→02/90	Tie Rod End	CV-ES-2149		for Push Rod	
05/88→02/90	Tie Rod End	CV-ES-14162		for Steering Rod	
05/88→02/90	Tie Rod End	CV-ES-14163		for Steering Rod	
19.292 FK	07/86→02/90	Ball Head, gearshift linkage	CV-ES-2119		
	07/86→02/90	Ball Head, gearshift linkage	CV-ES-2120		
	07/86→02/90	Ball Head, gearshift linkage	CV-ES-2182		
	07/86→02/90	Centre Rod	MN-DL-2160		Coupling Rod
	07/86→02/90	Centre Rod	MN-DL-2174		Push Rod
	07/86→02/90	Centre Rod	MN-DL-2175		Push Rod
	07/86→02/90	Centre Rod	MN-DL-3588		Push Rod
	07/86→02/90	Centre Rod	MN-DL-12421		for Steering Rod
07/86→02/90	Engine Mounting		MN-SB-10390		

CV-ES-2119

Length: 55
Cone Ø: d1 Ø 10 / d2 Ø 10
Thread: M12 x 1,75 LHT
81953016063, 81953016131



CV-ES-2120

Length: 115
Cone Ø: d1 Ø 12,4 / d2 Ø 10,8
Thread: M14 x 1,5 RHT
03008500A, 81953016200, 81953016202, 81953016203, 81953016227



CV-ES-2149

Length: 160
Cone Ø: d1 Ø 30 / d2 Ø 27
Thread: M30 x 1,5 RHT
81953016263



CV-ES-2182

Length: 55
Cone Ø: d1 Ø 10 / d2 Ø 10
Thread: M12 x 1,75 RHT
81953016064, 81953016170



CV-ES-14162

Length: 125
Cone Ø: d1 Ø 30 / d2 Ø 27
Thread: M30 x 1,5 LHT
81953010015, 81953010083, 81953010087, 81953016029, 81953016030, 81953016043, 81953016044, 81953016050, 81953016054, 81953016087, 81953016091, 81953016107, 81953016120, 81953016125, 81953016152, 81953016155, 81953016157, 81953016168, 81953016179, 81953016181, 81953016223, 81953016237, 81953016254, 81953016275, 81953016279, 81953016351



CV-ES-14163

Length: 125
Cone Ø: d1 Ø 30 / d2 Ø 27
Thread: M30 x 1,5 RHT
95301.0084, 90804102156, 90804102272, 90804102696, 90804102710, 81953010016, 81953010075, 81953010084, 81953010088, 81953010094, 81953010103, 81953016030, 81953016043, 81953016048, 81953016049, 81953016053, 81953016061, 81953016090, 81953016108, 81953016112, 81953016126, 81953016143, 81953016149, 81953016154, 81953016156, 81953016168, 81953016178, 81953016194, 81953016206, 81953016224, 81953016234, 81953016242, 81953016252, 81953016274, 81953016278, 81953016284, 81953016286, 81953016308, 81953016310, 81953016312, 81953016347, 81953016350, 81953016352, 82953016012, 88953016014, N2953016001



MN-DL-2160

Length: 1652 Ø: 50
Cone Ø: d1 Ø 30 / d2 Ø 27
81467106112, 81467106163, 81467106165, 81467106198, 81467106353, 81467106354, 81467106361, 81467116725



MN-DL-2174

Length: 1588 Ø: 52
Cone Ø: d1 Ø 30 / d2 Ø 27
81467106378, 81467106912



MN-DL-2175

Length: 1628 Ø: 50
Cone Ø: d1 Ø 30 / d2 Ø 27
81467106396, 81467106904



MN-DL-3588

Length: 1035 Ø: 48
Cone Ø: d1 Ø 30 / d2 Ø 27
81466106333, 81466106334, 81466106354, 81466106355, 81466106360, 81466106361, 81466106721, 81466106722, 81466106723, 81466116216



MN-DL-12421

Length: 1070 Ø: 48
Cone Ø: d1 Ø 30 / d2 Ø 27
Thread: M30 x 1,5 RHT
81466106656, 81466106659, 81466106669, 81466116006, 81466116007



MN-RK-7280

Ø: 75
Hole Distance: 115
Thick/Height: 24
0550806, 0639370, 689748, 10307400A, 81432306051, 81432306068, 81432706064



MN-SB-5246

Ø: 45 Thick/Height: 47
81437220022, 81437220038, 81962100450, 81962100469



MN-SB-5254

Length: 100 Ø: 93
Thick/Height: 70
81432710081



MN-SB-5265

Ø: 85 Thick/Height: 80
03310300A, 81437040032



MN-SB-9396

Ø: 67 Thick/Height: 60
81437040057



MN-SB-10389

Ø: 70 Thick/Height: 72
81960200340



MN-SB-10390

Ø: 70 Thick/Height: 85/85
81960200341, 81960200373, 81960200385, 81960200408, 81960200418





F 90 ...

19.292 FK ...	07/86→02/90	Engine Mounting	MN-SB-10389		
	07/86→02/90	Mounting, stabilizer coupling rod	MN-SB-5246		
	07/86→02/90	Mounting, stabilizer coupling rod	MN-SB-5246	1st FA	
	07/86→02/90	Suspension Arm Repair Kit		MN-RK-7280 for Drag Link	
	07/86→02/90	Tie Rod	MN-DL-12284		
	07/86→02/90	Tie Rod End	CV-ES-2149	for Push Rod	
	07/86→02/90	Tie Rod End	CV-ES-14162	for Steering Rod	
	07/86→02/90	Tie Rod End	CV-ES-14163	for Steering Rod	
	19.292 FS,19.292 FLS,19.292 FLLS	07/86→02/90	Ball Head, gearshift linkage	CV-ES-2119	
07/86→02/90		Ball Head, gearshift linkage	CV-ES-2120		
07/86→02/90		Ball Head, gearshift linkage	CV-ES-2182		
07/86→02/90		Centre Rod	MN-DL-2160	Coupling Rod	
07/86→02/90		Centre Rod	MN-DL-2174	Push Rod	
07/86→02/90		Centre Rod	MN-DL-2175	Push Rod	
07/86→02/90		Centre Rod	MN-DL-3588	Push Rod	
07/86→02/90		Centre Rod	MN-DL-12421	for Steering Rod	
07/86→02/90		Engine Mounting		MN-SB-10390	
07/86→02/90		Engine Mounting	MN-SB-10389		
07/86→02/90		Mounting, stabilizer coupling rod	MN-SB-5246		
07/86→02/90		Mounting, stabilizer coupling rod	MN-SB-5246	1st FA	
07/86→02/90		Stabiliser Mounting		MN-SB-5265	
07/86→02/90		Stabiliser Mounting		MN-SB-5265 1st RA	
07/86→02/90		Suspension Arm Repair Kit		CV-RK-5313 for Wishbone (CV)	
07/86→02/90		Suspension Arm Repair Kit		CV-RK-8118 for Control Arm	
07/86→02/90		Suspension Arm Repair Kit		MN-RK-7280 for Drag Link	
07/86→02/90		Suspension Arm Repair Kit		MN-RK-7287 for Wishbone (CV)	
07/86→02/90		Suspension Arm Repair Kit		MN-RK-7291 for Drag Link	
07/86→02/90		Tie Rod	MN-DL-12284		
07/86→02/90		Tie Rod End	CV-ES-2149	for Push Rod	
07/86→02/90		Tie Rod End	CV-ES-14162	for Steering Rod	
07/86→02/90		Tie Rod End	CV-ES-14163	for Steering Rod	
07/86→02/90		Track Control Arm		MN-DL-5212 Trailing Arm, Air Suspension Axle	
07/86→02/90		Track Control Arm		MN-VB-5222 Wishbone (CV), Air Suspension Axle	
19.322 F,19.322 FL,19.322 FLL		02/90→05/95	Ball Head, gearshift linkage	CV-ES-2119	
		02/90→05/95	Ball Head, gearshift linkage	CV-ES-2120	
		02/90→05/95	Ball Head, gearshift linkage	CV-ES-2182	
		02/90→05/95	Centre Rod	MN-DL-2160	Coupling Rod
		02/90→05/95	Centre Rod	MN-DL-2174	Push Rod
	02/90→05/95	Centre Rod	MN-DL-2175	Push Rod	
	02/90→05/95	Centre Rod	MN-DL-3588	Push Rod	
	02/90→05/95	Centre Rod	MN-DL-12421	for Steering Rod	
	02/90→05/95	Engine Mounting		MN-SB-10390	
	02/90→05/95	Engine Mounting	MN-SB-10389		
	02/90→05/95	Mounting, stabilizer coupling rod	MN-SB-5246		
	02/90→05/95	Mounting, stabilizer coupling rod	MN-SB-5246	1st FA	
	02/90→05/95	Stabiliser Mounting		MN-SB-5265	
	02/90→05/95	Stabiliser Mounting		MN-SB-5265 1st RA	
	02/90→05/95	Suspension Arm Repair Kit		CV-RK-5313 for Wishbone (CV)	
	02/90→05/95	Suspension Arm Repair Kit		CV-RK-8118 for Control Arm	
	02/90→05/95	Suspension Arm Repair Kit		MN-RK-7280 for Drag Link	
	02/90→05/95	Suspension Arm Repair Kit		MN-RK-7287 for Wishbone (CV)	
	02/90→05/95	Suspension Arm Repair Kit		MN-RK-7291 for Drag Link	
	02/90→05/95	Tie Rod	MN-DL-12284		
	02/90→05/95	Tie Rod End	CV-ES-2149	for Push Rod	
	02/90→05/95	Tie Rod End	CV-ES-14162	for Steering Rod	
	02/90→05/95	Tie Rod End	CV-ES-14163	for Steering Rod	
	02/90→05/95	Track Control Arm		MN-DL-5212 Trailing Arm, Air Suspension Axle	
	02/90→05/95	Track Control Arm		MN-VB-5222 Wishbone (CV), Air Suspension Axle	
	19.322 FA	02/90→06/96	Ball Head, gearshift linkage	CV-ES-2119	
		02/90→06/96	Ball Head, gearshift linkage	CV-ES-2120	
		02/90→06/96	Ball Head, gearshift linkage	CV-ES-2182	
		02/90→06/96	Centre Rod	MN-DL-2160	Coupling Rod
		02/90→06/96	Centre Rod	MN-DL-2174	Push Rod

CV-ES-2119

Length: 55
Cone Ø: d1 Ø 10 / d2 Ø 10
Thread: M12 x 1,75 LHT
81953016063, 81953016131



CV-ES-2120

Length: 115
Cone Ø: d1 Ø 12,4 / d2 Ø 10,8
Thread: M14 x 1,5 RHT
03008500A, 81953016200, 81953016202, 81953016203, 81953016227



CV-ES-2149

Length: 160
Cone Ø: d1 Ø 30 / d2 Ø 27
Thread: M30 x 1,5 RHT
81953016263



CV-ES-2182

Length: 55
Cone Ø: d1 Ø 10 / d2 Ø 10
Thread: M12 x 1,75 RHT
81953016064, 81953016170



CV-ES-14162

Length: 125
Cone Ø: d1 Ø 30 / d2 Ø 27
Thread: M30 x 1,5 LHT
81953010015, 81953010083, 81953010087, 81953016029, 81953016030, 81953016043, 81953016044, 81953016050, 81953016054, 81953016087, 81953016091, 81953016107, 81953016120, 81953016125, 81953016152, 81953016155, 81953016157, 81953016168, 81953016179, 81953016181, 81953016223, 81953016237, 81953016254, 81953016275, 81953016279, 81953016351



CV-ES-14163

Length: 125
Cone Ø: d1 Ø 30 / d2 Ø 27
Thread: M30 x 1,5 RHT
95301.0084, 90804102156, 90804102272, 90804102696, 90804102710, 81953010016, 81953010075, 81953010084, 81953010088, 81953010094, 81953010103, 81953016030, 81953016043, 81953016048, 81953016049, 81953016053, 81953016061, 81953016090, 81953016108, 81953016112, 81953016126, 81953016143, 81953016149, 81953016154, 81953016156, 81953016168, 81953016178, 81953016194, 81953016206, 81953016224, 81953016234, 81953016242, 81953016252, 81953016274, 81953016278, 81953016284, 81953016286, 81953016308, 81953016310, 81953016312, 81953016347, 81953016350, 81953016352, 82953016012, 88953016014, N2953016001



CV-RK-5313

Ø: 90
03304800A, 81953016132



CV-RK-8118

Ø: 85
Hole Distance: 130
Thick/Height: 30
638862, 639287, 775201, 938423, 1104335, 1953248, 0003500506, 3500506, 11013547, 21032592, 42065912, 42488722, 070550504, 93192618, 070400009000, 634303610, 81432206055, 81432206073, 82262320660, 9544171010099, 5001842823, 7000307001, 8226232066



MN-DL-2160

Length: 1652 Ø: 50
Cone Ø: d1 Ø 30 / d2 Ø 27
81467106112, 81467106163, 81467106165, 81467106198, 81467106353, 81467106354, 81467106361, 81467116725



MN-DL-2174

Length: 1588 Ø: 52
Cone Ø: d1 Ø 30 / d2 Ø 27
81467106378, 81467106912



MN-DL-2175

Length: 1628 Ø: 50
Cone Ø: d1 Ø 30 / d2 Ø 27
81467106396, 81467106904



MN-DL-3588

Length: 1035 Ø: 48
Cone Ø: d1 Ø 30 / d2 Ø 27
81466106333, 81466106334, 81466106354, 81466106355, 81466106360, 81466106361, 81466106721, 81466106722, 81466106723, 81466116216



MN-DL-5212

Length: 577 Ø: 48
Hole Distance: 130 / 130
81432206096, 81432206097, 81432206098, 81432206129, 81432209096, 81432209129, 81432306014, 81432306030



MN-DL-12284

Length: 1530 Ø: 50
Cone Ø: d1 Ø 30 / d2 Ø 27
81466106579, 81466106580, 81466106624, 81466116720, 81467116720, 81467116730, 81467116952



MN-DL-12421

Length: 1070 Ø: 48
Cone Ø: d1 Ø 30 / d2 Ø 27
Thread: M30 x 1,5 RHT
81466106656, 81466106659, 81466106669, 81466116006, 81466116007



MN-RK-7280

Ø: 75
Hole Distance: 115
Thick/Height: 24
0550806, 0639370, 689748, 10307400A, 81432306051, 81432306068, 81432706064



MN-RK-7287

Ø: 90
Hole Distance: 152
Thick/Height: 35
03304700A, 81953016133



MN-RK-7291

Ø: 72
Hole Distance: 130
Thick/Height: 30
10307800A, 81432206108, 81432206132



MN-SB-5246

Ø: 45 Thick/Height: 47
81437220022, 81437220038, 81962100450, 81962100469



MN-SB-5265

Ø: 85 Thick/Height: 80
03310300A, 81437040032



MN-SB-10389

Ø: 70 Thick/Height: 72
81960200340



MN-SB-10390

Ø: 70 Thick/Height: 85/85
81960200341, 81960200373, 81960200385, 81960200408, 81960200418



MN-VB-5222

Length: 627 Ø: 50
Hole Distance: 152 / 152
81432706030, 81432706034, 81432706054, 81432706055, 81432706056, 81432706057, 81432706067, 81432706068, 81432706074, 81432706075, 81432706076, 81432706077, 81432706078, 81432706081, 81432706082, 81432709034, 81432709076, 81432709078, 8143706054





F 90 ...

19.322 FA ...	02/90→06/96	Centre Rod	MN-DL-2175		Push Rod	
	02/90→06/96	Centre Rod	MN-DL-3588		Push Rod	
	02/90→06/96	Centre Rod	MN-DL-12421		for Steering Rod	
	02/90→06/96	Engine Mounting	MN-SB-10389			
	02/90→06/96	Mounting, stabilizer coupling rod	MN-SB-5246			
	02/90→06/96	Mounting, stabilizer coupling rod	MN-SB-5246		1st FA	
	02/90→06/96	Stabiliser Mounting		MN-SB-5254		
	02/90→06/96	Stabiliser Mounting		MN-SB-5265		
	02/90→06/96	Stabiliser Mounting	MN-SB-9396			
	02/90→06/96	Suspension Arm Repair Kit		MN-RK-7280	for Drag Link	
	02/90→06/96	Tie Rod End	CV-ES-2149		for Push Rod	
	02/90→06/96	Tie Rod End	CV-ES-14162		for Steering Rod	
	02/90→06/96	Tie Rod End	CV-ES-14163		for Steering Rod	
	19.322 FAK	02/90→06/96	Ball Head, gearshift linkage	CV-ES-2119		
		02/90→06/96	Ball Head, gearshift linkage	CV-ES-2120		
02/90→06/96		Ball Head, gearshift linkage	CV-ES-2182			
02/90→06/96		Centre Rod	MN-DL-2160		Coupling Rod	
02/90→06/96		Centre Rod	MN-DL-2174		Push Rod	
02/90→06/96		Centre Rod	MN-DL-2175		Push Rod	
02/90→06/96		Centre Rod	MN-DL-3588		Push Rod	
02/90→06/96		Centre Rod	MN-DL-12421		for Steering Rod	
02/90→06/96		Engine Mounting	MN-SB-10389			
02/90→06/96		Mounting, stabilizer coupling rod	MN-SB-5246			
02/90→06/96		Mounting, stabilizer coupling rod	MN-SB-5246		1st FA	
02/90→06/96		Stabiliser Mounting		MN-SB-5254		
02/90→06/96		Stabiliser Mounting		MN-SB-5265		
02/90→06/96		Stabiliser Mounting	MN-SB-9396			
02/90→06/96		Suspension Arm Repair Kit		MN-RK-7280	for Drag Link	
02/90→06/96	Tie Rod End	CV-ES-2149		for Push Rod		
02/90→06/96	Tie Rod End	CV-ES-14162		for Steering Rod		
02/90→06/96	Tie Rod End	CV-ES-14163		for Steering Rod		
19.322 FAS	02/90→06/96	Ball Head, gearshift linkage	CV-ES-2119			
	02/90→06/96	Ball Head, gearshift linkage	CV-ES-2120			
	02/90→06/96	Ball Head, gearshift linkage	CV-ES-2182			
	02/90→06/96	Centre Rod	MN-DL-2160		Coupling Rod	
	02/90→06/96	Centre Rod	MN-DL-2174		Push Rod	
	02/90→06/96	Centre Rod	MN-DL-2175		Push Rod	
	02/90→06/96	Centre Rod	MN-DL-3588		Push Rod	
	02/90→06/96	Centre Rod	MN-DL-12421		for Steering Rod	
	02/90→06/96	Engine Mounting	MN-SB-10389			
	02/90→06/96	Mounting, stabilizer coupling rod	MN-SB-5246			
	02/90→06/96	Mounting, stabilizer coupling rod	MN-SB-5246		1st FA	
	02/90→06/96	Stabiliser Mounting		MN-SB-5254		
	02/90→06/96	Stabiliser Mounting		MN-SB-5265		
	02/90→06/96	Stabiliser Mounting	MN-SB-9396			
	02/90→06/96	Suspension Arm Repair Kit		MN-RK-7280	for Drag Link	
02/90→06/96	Tie Rod End	CV-ES-2149		for Push Rod		
02/90→06/96	Tie Rod End	CV-ES-14162		for Steering Rod		
02/90→06/96	Tie Rod End	CV-ES-14163		for Steering Rod		
19.322 FK	02/90→05/95	Ball Head, gearshift linkage	CV-ES-2119			
	02/90→05/95	Ball Head, gearshift linkage	CV-ES-2120			
	02/90→05/95	Ball Head, gearshift linkage	CV-ES-2182			
	02/90→05/95	Centre Rod	MN-DL-2160		Coupling Rod	
	02/90→05/95	Centre Rod	MN-DL-2174		Push Rod	
	02/90→05/95	Centre Rod	MN-DL-2175		Push Rod	
	02/90→05/95	Centre Rod	MN-DL-3588		Push Rod	
	02/90→05/95	Centre Rod	MN-DL-12421		for Steering Rod	
	02/90→05/95	Engine Mounting		MN-SB-10390		
	02/90→05/95	Engine Mounting	MN-SB-10389			
	02/90→05/95	Mounting, stabilizer coupling rod	MN-SB-5246			
	02/90→05/95	Mounting, stabilizer coupling rod	MN-SB-5246		1st FA	
	02/90→05/95	Suspension Arm Repair Kit		MN-RK-7280	for Drag Link	
	02/90→05/95	Tie Rod	MN-DL-12284			

CV-ES-2119

Length: 55
Cone Ø: d1 Ø 10 / d2 Ø 10
Thread: M12 x 1,75 LHT
81953016063, 81953016131



CV-ES-2120

Length: 115
Cone Ø: d1 Ø 12,4 / d2 Ø 10,8
Thread: M14 x 1,5 RHT
03008500A, 81953016200, 81953016202,
81953016203, 81953016227



CV-ES-2149

Length: 160
Cone Ø: d1 Ø 30 / d2 Ø 27
Thread: M30 x 1,5 RHT
81953016263



CV-ES-2182

Length: 55
Cone Ø: d1 Ø 10 / d2 Ø 10
Thread: M12 x 1,75 RHT
81953016064, 81953016170



CV-ES-14162

Length: 125
Cone Ø: d1 Ø 30 / d2 Ø 27
Thread: M30 x 1,5 LHT
81953010015, 81953010083, 81953010087,
81953016029, 81953016030, 81953016043,
81953016044, 81953016050, 81953016054,
81953016087, 81953016091, 81953016107,
81953016120, 81953016125, 81953016152,
81953016155, 81953016157, 81953016168,
81953016179, 81953016181, 81953016223,
81953016237, 81953016254, 81953016275,
81953016279, 81953016351



CV-ES-14163

Length: 125
Cone Ø: d1 Ø 30 / d2 Ø 27
Thread: M30 x 1,5 RHT
95301.0084, 90804102156, 90804102272,
90804102696, 90804102710, 81953010016,
81953010075, 81953010084, 81953010088,
81953010094, 81953010103, 81953016030,
81953016043, 81953016048, 81953016049,
81953016053, 81953016061, 81953016090,
81953016108, 81953016112, 81953016126,
81953016143, 81953016149, 81953016154,
81953016156, 81953016168, 81953016178,
81953016194, 81953016206, 81953016224,
81953016234, 81953016242, 81953016252,
81953016274, 81953016278, 81953016284,
81953016286, 81953016308, 81953016310,
81953016312, 81953016347, 81953016350,
81953016352, 82953016012, 88953016014,
N2953016001



MN-DL-2160

Length: 1652 Ø: 50
Cone Ø: d1 Ø 30 / d2 Ø 27
81467106112, 81467106163, 81467106165,
81467106198, 81467106353, 81467106354,
81467106361, 81467116725



MN-DL-2174

Length: 1588 Ø: 52
Cone Ø: d1 Ø 30 / d2 Ø 27
81467106378, 81467106912



MN-DL-2175

Length: 1628
Ø: 50
Cone Ø: d1 Ø 30 / d2 Ø 27
81467106396, 81467106904



MN-DL-3588

Length: 1035
Ø: 48
Cone Ø: d1 Ø 30 / d2 Ø 27
81466106333, 81466106334, 81466106354,
81466106355, 81466106360, 81466106361,
81466106721, 81466106722, 81466106723,
81466116216



MN-DL-12284

Length: 1530 Ø: 50
Cone Ø: d1 Ø 30 / d2 Ø 27
81466106579, 81466106580, 81466106624,
81466116720, 81467116730, 81467116952



MN-DL-12421

Length: 1070
Ø: 48
Cone Ø: d1 Ø 30 / d2 Ø 27
Thread: M30 x 1,5 RHT
81466106656, 81466106659, 81466106669,
81466116006, 81466116007



MN-RK-7280

Ø: 75
Hole Distance: 115
Thick/Height: 24
0550806, 0639370, 689748, 10307400A,
81432306051, 81432306068, 81432706064



MN-SB-5246

Ø: 45 Thick/Height: 47
81437220022, 81437220038, 81962100450,
81962100469



MN-SB-5254

Length: 100
Ø: 93
Thick/Height: 70
81432710081



MN-SB-5265

Ø: 85
Thick/Height: 80
03310300A, 81437040032



MN-SB-9396

Ø: 67
Thick/Height: 60
81437040057



MN-SB-10389

Ø: 70
Thick/Height: 72
81960200340



MN-SB-10390

Ø: 70
Thick/Height: 85/85
81960200341, 81960200373, 81960200385,
81960200408, 81960200418





F 90 ...

19.322 FK ...	02/90→05/95	Tie Rod End	CV-ES-2149		for Push Rod	
	02/90→05/95	Tie Rod End	CV-ES-14162		for Steering Rod	
	02/90→05/95	Tie Rod End	CV-ES-14163		for Steering Rod	
19.322 FS,19.322 FLS,19.322 FLLS	02/90→05/95	Ball Head, gearshift linkage	CV-ES-2119			
	02/90→05/95	Ball Head, gearshift linkage	CV-ES-2120			
	02/90→05/95	Ball Head, gearshift linkage	CV-ES-2182			
	02/90→05/95	Centre Rod	MN-DL-2160		Coupling Rod	
	02/90→05/95	Centre Rod	MN-DL-2174		Push Rod	
	02/90→05/95	Centre Rod	MN-DL-2175		Push Rod	
	02/90→05/95	Centre Rod	MN-DL-3588		Push Rod	
	02/90→05/95	Centre Rod	MN-DL-12421		for Steering Rod	
	02/90→05/95	Engine Mounting		MN-SB-10390		
	02/90→05/95	Engine Mounting	MN-SB-10389			
	02/90→05/95	Mounting, stabilizer coupling rod	MN-SB-5246			
	02/90→05/95	Mounting, stabilizer coupling rod	MN-SB-5246		1st FA	
	02/90→05/95	Stabiliser Mounting		MN-SB-5265		
	02/90→05/95	Stabiliser Mounting		MN-SB-5265	1st RA	
	02/90→05/95	Suspension Arm Repair Kit		CV-RK-5313	for Wishbone (CV)	
	02/90→05/95	Suspension Arm Repair Kit		CV-RK-8118	for Control Arm	
	02/90→05/95	Suspension Arm Repair Kit		MN-RK-7280	for Drag Link	
	02/90→05/95	Suspension Arm Repair Kit		MN-RK-7287	for Wishbone (CV)	
	02/90→05/95	Suspension Arm Repair Kit		MN-RK-7291	for Drag Link	
	02/90→05/95	Tie Rod	MN-DL-12284			
	02/90→05/95	Tie Rod End	CV-ES-2149		for Push Rod	
	02/90→05/95	Tie Rod End	CV-ES-14162		for Steering Rod	
	02/90→05/95	Tie Rod End	CV-ES-14163		for Steering Rod	
	02/90→05/95	Track Control Arm		MN-DL-5212	Trailing Arm, Air Suspension Axle	
	02/90→05/95	Track Control Arm		MN-VB-5222	Wishbone (CV), Air Suspension Axle	
	19.332 F,19.332 FL,19.332 FLL	07/86→02/90	Ball Head, gearshift linkage	CV-ES-2119		
		07/86→02/90	Ball Head, gearshift linkage	CV-ES-2120		
07/86→02/90		Ball Head, gearshift linkage	CV-ES-2182			
07/86→02/90		Centre Rod	MN-DL-2160		Coupling Rod	
07/86→02/90		Centre Rod	MN-DL-2174		Push Rod	
07/86→02/90		Centre Rod	MN-DL-2175		Push Rod	
07/86→02/90		Centre Rod	MN-DL-3588		Push Rod	
07/86→02/90		Centre Rod	MN-DL-12421		for Steering Rod	
07/86→02/90		Engine Mounting		MN-SB-10390		
07/86→02/90		Engine Mounting	MN-SB-10389			
07/86→02/90		Mounting, stabilizer coupling rod	MN-SB-5246			
07/86→02/90		Mounting, stabilizer coupling rod	MN-SB-5246		1st FA	
07/86→02/90		Stabiliser Mounting		MN-SB-5265		
07/86→02/90		Stabiliser Mounting		MN-SB-5265	1st RA	
07/86→02/90		Suspension Arm Repair Kit		CV-RK-5313	for Wishbone (CV)	
07/86→02/90		Suspension Arm Repair Kit		CV-RK-8118	for Control Arm	
07/86→02/90		Suspension Arm Repair Kit		MN-RK-7280	for Drag Link	
07/86→02/90		Suspension Arm Repair Kit		MN-RK-7287	for Wishbone (CV)	
07/86→02/90		Suspension Arm Repair Kit		MN-RK-7291	for Drag Link	
07/86→02/90		Tie Rod	MN-DL-12284			
07/86→02/90		Tie Rod End	CV-ES-2149		for Push Rod	
07/86→02/90		Tie Rod End	CV-ES-14162		for Steering Rod	
07/86→02/90		Tie Rod End	CV-ES-14163		for Steering Rod	
07/86→02/90		Track Control Arm		MN-DL-5212	Trailing Arm, Air Suspension Axle	
07/86→02/90		Track Control Arm		MN-VB-5222	Wishbone (CV), Air Suspension Axle	
19.332 FA		05/88→02/90	Ball Head, gearshift linkage	CV-ES-2119		
		05/88→02/90	Ball Head, gearshift linkage	CV-ES-2120		
	05/88→02/90	Ball Head, gearshift linkage	CV-ES-2182			
	05/88→02/90	Centre Rod	MN-DL-2160		Coupling Rod	
	05/88→02/90	Centre Rod	MN-DL-2174		Push Rod	
	05/88→02/90	Centre Rod	MN-DL-2175		Push Rod	
	05/88→02/90	Centre Rod	MN-DL-3588		Push Rod	
	05/88→02/90	Centre Rod	MN-DL-12421		for Steering Rod	
	05/88→02/90	Engine Mounting	MN-SB-10389			
	05/88→02/90	Mounting, stabilizer coupling rod	MN-SB-5246			

CV-ES-2119

Length: 55
Cone Ø: d1 Ø 10 / d2 Ø 10
Thread: M12 x 1,75 LHT
81953016063, 81953016131



CV-ES-2120

Length: 115
Cone Ø: d1 Ø 12,4 / d2 Ø 10,8
Thread: M14 x 1,5 RHT
03008500A, 81953016200, 81953016202, 81953016203, 81953016227



CV-ES-2149

Length: 160
Cone Ø: d1 Ø 30 / d2 Ø 27
Thread: M30 x 1,5 RHT
81953016263



CV-ES-2182

Length: 55
Cone Ø: d1 Ø 10 / d2 Ø 10
Thread: M12 x 1,75 RHT
81953016064, 81953016170



CV-ES-14162

Length: 125
Cone Ø: d1 Ø 30 / d2 Ø 27
Thread: M30 x 1,5 LHT
81953010015, 81953010083, 81953010087, 81953016029, 81953016030, 81953016043, 81953016044, 81953016050, 81953016054, 81953016087, 81953016091, 81953016107, 81953016120, 81953016125, 81953016152, 81953016155, 81953016157, 81953016168, 81953016179, 81953016181, 81953016223, 81953016237, 81953016254, 81953016275, 81953016279, 81953016351



CV-ES-14163

Length: 125
Cone Ø: d1 Ø 30 / d2 Ø 27
Thread: M30 x 1,5 RHT
95301.0084, 90804102156, 90804102272, 90804102696, 90804102710, 81953010016, 81953010075, 81953010084, 81953010088, 81953010094, 81953010103, 81953016030, 81953016043, 81953016048, 81953016049, 81953016053, 81953016061, 81953016090, 81953016108, 81953016112, 81953016126, 81953016143, 81953016149, 81953016154, 81953016156, 81953016168, 81953016178, 81953016194, 81953016206, 81953016224, 81953016234, 81953016242, 81953016252, 81953016274, 81953016278, 81953016284, 81953016286, 81953016308, 81953016310, 81953016312, 81953016347, 81953016350, 81953016352, 82953016012, 88953016014, N2953016001



CV-RK-5313

Ø: 90
03304800A, 81953016132



CV-RK-8118

Ø: 85
Hole Distance: 130
Thick/Height: 30
638862, 639287, 775201, 938423, 1104335, 1953248, 0003500506, 3500506, 11013547, 21032592, 42065912, 42488722, 070550504, 93192618, 070400009000, 634303610, 81432206055, 81432206073, 82262320660, 9544171010099, 5001842823, 7000307001, 8226232066



MN-DL-2160

Length: 1652 Ø: 50
Cone Ø: d1 Ø 30 / d2 Ø 27
81467106112, 81467106163, 81467106165, 81467106198, 81467106353, 81467106354, 81467106361, 81467116725



MN-DL-2174

Length: 1588 Ø: 52
Cone Ø: d1 Ø 30 / d2 Ø 27
81467106378, 81467106912



MN-DL-2175

Length: 1628 Ø: 50
Cone Ø: d1 Ø 30 / d2 Ø 27
81467106396, 81467106904



MN-DL-3588

Length: 1035 Ø: 48
Cone Ø: d1 Ø 30 / d2 Ø 27
81466106333, 81466106334, 81466106354, 81466106355, 81466106360, 81466106361, 81466106721, 81466106722, 81466106723, 81466116216



MN-DL-5212

Length: 577 Ø: 48
Hole Distance: 130 / 130
81432206096, 81432206097, 81432206098, 81432206129, 81432209096, 81432209129, 81432306014, 81432306030



MN-DL-12284

Length: 1530 Ø: 50
Cone Ø: d1 Ø 30 / d2 Ø 27
81466106579, 81466106580, 81466106624, 81466116720, 81467116720, 81467116730, 81467116952



MN-DL-12421

Length: 1070 Ø: 48
Cone Ø: d1 Ø 30 / d2 Ø 27
Thread: M30 x 1,5 RHT
81466106656, 81466106659, 81466106669, 81466116006, 81466116007



MN-RK-7280

Ø: 75
Hole Distance: 115
Thick/Height: 24
0550806, 0639370, 689748, 10307400A, 81432306051, 81432306068, 81432706064



MN-RK-7287

Ø: 90
Hole Distance: 152
Thick/Height: 35
03304700A, 81953016133



MN-RK-7291

Ø: 72
Hole Distance: 130
Thick/Height: 30
10307800A, 81432206108, 81432206132



MN-SB-5246

Ø: 45 Thick/Height: 47
81437220022, 81437220038, 81962100450, 81962100469



MN-SB-5265

Ø: 85 Thick/Height: 80
03310300A, 81437040032



MN-SB-10389

Ø: 70 Thick/Height: 72
81960200340



MN-SB-10390

Ø: 70 Thick/Height: 85/85
81960200341, 81960200373, 81960200385, 81960200408, 81960200418



MN-VB-5222

Length: 627 Ø: 50
Hole Distance: 152 / 152
81432706030, 81432706034, 81432706054, 81432706055, 81432706056, 81432706057, 81432706067, 81432706068, 81432706074, 81432706075, 81432706076, 81432706077, 81432706078, 81432706081, 81432706082, 81432709034, 81432709076, 81432709078, 8143706054





F 90 ...

19.332 FA ...	05/88→02/90	Mounting, stabilizer coupling rod	MN-SB-5246		1st FA
	05/88→02/90	Stabiliser Mounting		MN-SB-5254	
	05/88→02/90	Stabiliser Mounting		MN-SB-5265	
	05/88→02/90	Stabiliser Mounting	MN-SB-9396		
	05/88→02/90	Suspension Arm Repair Kit		MN-RK-7280	for Drag Link
	05/88→02/90	Tie Rod End	CV-ES-2149		for Push Rod
	05/88→02/90	Tie Rod End	CV-ES-14162		for Steering Rod
	05/88→02/90	Tie Rod End	CV-ES-14163		for Steering Rod
19.332 FAK	05/88→02/90	Ball Head, gearshift linkage	CV-ES-2119		
	05/88→02/90	Ball Head, gearshift linkage	CV-ES-2120		
	05/88→02/90	Ball Head, gearshift linkage	CV-ES-2182		
	05/88→02/90	Centre Rod	MN-DL-2160		Coupling Rod
	05/88→02/90	Centre Rod	MN-DL-2174		Push Rod
	05/88→02/90	Centre Rod	MN-DL-2175		Push Rod
	05/88→02/90	Centre Rod	MN-DL-3588		Push Rod
	05/88→02/90	Centre Rod	MN-DL-12421		for Steering Rod
	05/88→02/90	Engine Mounting	MN-SB-10389		
	05/88→02/90	Mounting, stabilizer coupling rod	MN-SB-5246		
	05/88→02/90	Mounting, stabilizer coupling rod	MN-SB-5246		1st FA
	05/88→02/90	Stabiliser Mounting		MN-SB-5254	
	05/88→02/90	Stabiliser Mounting		MN-SB-5265	
	05/88→02/90	Stabiliser Mounting	MN-SB-9396		
	05/88→02/90	Suspension Arm Repair Kit		MN-RK-7280	for Drag Link
	05/88→02/90	Tie Rod End	CV-ES-2149		for Push Rod
	05/88→02/90	Tie Rod End	CV-ES-14162		for Steering Rod
	05/88→02/90	Tie Rod End	CV-ES-14163		for Steering Rod
19.332 FAS	05/88→02/90	Ball Head, gearshift linkage	CV-ES-2119		
	05/88→02/90	Ball Head, gearshift linkage	CV-ES-2120		
	05/88→02/90	Ball Head, gearshift linkage	CV-ES-2182		
	05/88→02/90	Centre Rod	MN-DL-2160		Coupling Rod
	05/88→02/90	Centre Rod	MN-DL-2174		Push Rod
	05/88→02/90	Centre Rod	MN-DL-2175		Push Rod
	05/88→02/90	Centre Rod	MN-DL-3588		Push Rod
	05/88→02/90	Centre Rod	MN-DL-12421		for Steering Rod
	05/88→02/90	Engine Mounting	MN-SB-10389		
	05/88→02/90	Mounting, stabilizer coupling rod	MN-SB-5246		
	05/88→02/90	Mounting, stabilizer coupling rod	MN-SB-5246		1st FA
	05/88→02/90	Stabiliser Mounting		MN-SB-5254	
	05/88→02/90	Stabiliser Mounting		MN-SB-5265	
	05/88→02/90	Stabiliser Mounting	MN-SB-9396		
	05/88→02/90	Suspension Arm Repair Kit		MN-RK-7280	for Drag Link
	05/88→02/90	Tie Rod End	CV-ES-2149		for Push Rod
	05/88→02/90	Tie Rod End	CV-ES-14162		for Steering Rod
	05/88→02/90	Tie Rod End	CV-ES-14163		for Steering Rod
19.332 FK	07/86→02/90	Ball Head, gearshift linkage	CV-ES-2119		
	07/86→02/90	Ball Head, gearshift linkage	CV-ES-2120		
	07/86→02/90	Ball Head, gearshift linkage	CV-ES-2182		
	07/86→02/90	Centre Rod	MN-DL-2160		Coupling Rod
	07/86→02/90	Centre Rod	MN-DL-2174		Push Rod
	07/86→02/90	Centre Rod	MN-DL-2175		Push Rod
	07/86→02/90	Centre Rod	MN-DL-3588		Push Rod
	07/86→02/90	Centre Rod	MN-DL-12421		for Steering Rod
	07/86→02/90	Engine Mounting		MN-SB-10390	
	07/86→02/90	Engine Mounting	MN-SB-10389		
	07/86→02/90	Mounting, stabilizer coupling rod	MN-SB-5246		
	07/86→02/90	Mounting, stabilizer coupling rod	MN-SB-5246		1st FA
	07/86→02/90	Suspension Arm Repair Kit		MN-RK-7280	for Drag Link
	07/86→02/90	Tie Rod	MN-DL-12284		
	07/86→02/90	Tie Rod End	CV-ES-2149		for Push Rod
	07/86→02/90	Tie Rod End	CV-ES-14162		for Steering Rod
	07/86→02/90	Tie Rod End	CV-ES-14163		for Steering Rod

CV-ES-2119

Length: 55
Cone Ø: d1 Ø 10 / d2 Ø 10
Thread: M12 x 1,75 LHT
81953016063, 81953016131



CV-ES-2120

Length: 115
Cone Ø: d1 Ø 12,4 / d2 Ø 10,8
Thread: M14 x 1,5 RHT
03008500A, 81953016200, 81953016202,
81953016203, 81953016227



CV-ES-2149

Length: 160
Cone Ø: d1 Ø 30 / d2 Ø 27
Thread: M30 x 1,5 RHT
81953016263



CV-ES-2182

Length: 55
Cone Ø: d1 Ø 10 / d2 Ø 10
Thread: M12 x 1,75 RHT
81953016064, 81953016170



CV-ES-14162

Length: 125
Cone Ø: d1 Ø 30 / d2 Ø 27
Thread: M30 x 1,5 LHT
81953010015, 81953010083, 81953010087,
81953016029, 81953016030, 81953016043,
81953016044, 81953016050, 81953016054,
81953016087, 81953016091, 81953016107,
81953016120, 81953016125, 81953016152,
81953016155, 81953016157, 81953016168,
81953016179, 81953016181, 81953016223,
81953016237, 81953016254, 81953016275,
81953016279, 81953016351



CV-ES-14163

Length: 125
Cone Ø: d1 Ø 30 / d2 Ø 27
Thread: M30 x 1,5 RHT
95301.0084, 90804102156, 90804102272,
90804102696, 90804102710, 81953010016,
81953010075, 81953010084, 81953010088,
81953010094, 81953010103, 81953016030,
81953016043, 81953016048, 81953016049,
81953016053, 81953016061, 81953016090,
81953016108, 81953016112, 81953016126,
81953016143, 81953016149, 81953016154,
81953016156, 81953016168, 81953016178,
81953016194, 81953016206, 81953016224,
81953016234, 81953016242, 81953016252,
81953016274, 81953016278, 81953016284,
81953016286, 81953016308, 81953016310,
81953016312, 81953016347, 81953016350,
81953016352, 82953016012, 88953016014,
N2953016001



MN-DL-2160

Length: 1652 Ø: 50
Cone Ø: d1 Ø 30 / d2 Ø 27
81467106112, 81467106163, 81467106165,
81467106198, 81467106353, 81467106354,
81467106361, 81467116725



MN-DL-2174

Length: 1588 Ø: 52
Cone Ø: d1 Ø 30 / d2 Ø 27
81467106378, 81467106912



MN-DL-2175

Length: 1628
Ø: 50
Cone Ø: d1 Ø 30 / d2 Ø 27
81467106396, 81467106904



MN-DL-3588

Length: 1035
Ø: 48
Cone Ø: d1 Ø 30 / d2 Ø 27
81466106333, 81466106334, 81466106354,
81466106355, 81466106360, 81466106361,
81466106721, 81466106722, 81466106723,
81466116216



MN-DL-12284

Length: 1530 Ø: 50
Cone Ø: d1 Ø 30 / d2 Ø 27
81466106579, 81466106580, 81466106624,
81466116720, 81467116730, 81467116952



MN-DL-12421

Length: 1070
Ø: 48
Cone Ø: d1 Ø 30 / d2 Ø 27
Thread: M30 x 1,5 RHT
81466106656, 81466106659, 81466106669,
81466116006, 81466116007



MN-RK-7280

Ø: 75
Hole Distance: 115
Thick/Height: 24
0550806, 0639370, 689748, 10307400A,
81432306051, 81432306068, 81432706064



MN-SB-5246

Ø: 45 Thick/Height: 47
81437220022, 81437220038, 81962100450,
81962100469



MN-SB-5254

Length: 100
Ø: 93
Thick/Height: 70
81432710081



MN-SB-5265

Ø: 85
Thick/Height: 80
03310300A, 81437040032



MN-SB-9396

Ø: 67
Thick/Height: 60
81437040057



MN-SB-10389

Ø: 70
Thick/Height: 72
81960200340



MN-SB-10390

Ø: 70
Thick/Height: 85/85
81960200341, 81960200373, 81960200385,
81960200408, 81960200418





F 90 ...

19.332 FS,19.332 FLS,19.332 FLLS	07/86→02/90	Ball Head, gearshift linkage	CV-ES-2119		
	07/86→02/90	Ball Head, gearshift linkage	CV-ES-2120		
	07/86→02/90	Ball Head, gearshift linkage	CV-ES-2182		
	07/86→02/90	Centre Rod	MN-DL-2160		Coupling Rod
	07/86→02/90	Centre Rod	MN-DL-2174		Push Rod
	07/86→02/90	Centre Rod	MN-DL-2175		Push Rod
	07/86→02/90	Centre Rod	MN-DL-3588		Push Rod
	07/86→02/90	Centre Rod	MN-DL-12421		for Steering Rod
	07/86→02/90	Engine Mounting		MN-SB-10390	
	07/86→02/90	Engine Mounting	MN-SB-10389		
	07/86→02/90	Mounting, stabilizer coupling rod	MN-SB-5246		
	07/86→02/90	Mounting, stabilizer coupling rod	MN-SB-5246		1st FA
	07/86→02/90	Stabiliser Mounting		MN-SB-5265	
	07/86→02/90	Stabiliser Mounting		MN-SB-5265	1st RA
	07/86→02/90	Suspension Arm Repair Kit		CV-RK-5313	for Wishbone (CV)
	07/86→02/90	Suspension Arm Repair Kit		CV-RK-8118	for Control Arm
	07/86→02/90	Suspension Arm Repair Kit		MN-RK-7280	for Drag Link
	07/86→02/90	Suspension Arm Repair Kit		MN-RK-7287	for Wishbone (CV)
	07/86→02/90	Suspension Arm Repair Kit		MN-RK-7291	for Drag Link
	07/86→02/90	Tie Rod	MN-DL-12284		
	07/86→02/90	Tie Rod End	CV-ES-2149		for Push Rod
	07/86→02/90	Tie Rod End	CV-ES-14162		for Steering Rod
	07/86→02/90	Tie Rod End	CV-ES-14163		for Steering Rod
	07/86→02/90	Track Control Arm		MN-DL-5212	Trailing Arm, Air Suspension Axle
	07/86→02/90	Track Control Arm		MN-VB-5222	Wishbone (CV), Air Suspension Axle
	19.342 F,19.342 FL,19.342 FLL	05/94→05/95	Ball Head, gearshift linkage	CV-ES-2119	
05/94→05/95		Ball Head, gearshift linkage	CV-ES-2120		
05/94→05/95		Ball Head, gearshift linkage	CV-ES-2182		
05/94→05/95		Centre Rod	MN-DL-2160		Coupling Rod
05/94→05/95		Centre Rod	MN-DL-2174		Push Rod
05/94→05/95		Centre Rod	MN-DL-2175		Push Rod
05/94→05/95		Centre Rod	MN-DL-3588		Push Rod
05/94→05/95		Centre Rod	MN-DL-12421		for Steering Rod
05/94→05/95		Engine Mounting		MN-SB-10390	
05/94→05/95		Engine Mounting	MN-SB-10389		
05/94→05/95		Mounting, stabilizer coupling rod	MN-SB-5246		
05/94→05/95		Mounting, stabilizer coupling rod	MN-SB-5246		1st FA
05/94→05/95		Stabiliser Mounting		MN-SB-5265	
05/94→05/95		Stabiliser Mounting		MN-SB-5265	1st RA
05/94→05/95		Suspension Arm Repair Kit		CV-RK-5313	for Wishbone (CV)
05/94→05/95		Suspension Arm Repair Kit		CV-RK-8118	for Control Arm
05/94→05/95		Suspension Arm Repair Kit		MN-RK-7280	for Drag Link
05/94→05/95		Suspension Arm Repair Kit		MN-RK-7287	for Wishbone (CV)
05/94→05/95		Suspension Arm Repair Kit		MN-RK-7291	for Drag Link
05/94→05/95		Tie Rod	MN-DL-12284		
05/94→05/95		Tie Rod End	CV-ES-2149		for Push Rod
05/94→05/95		Tie Rod End	CV-ES-14162		for Steering Rod
05/94→05/95		Tie Rod End	CV-ES-14163		for Steering Rod
05/94→05/95		Track Control Arm		MN-DL-5212	Trailing Arm, Air Suspension Axle
05/94→05/95		Track Control Arm		MN-VB-5222	Wishbone (CV), Air Suspension Axle
19.342 FA		05/94→06/96	Ball Head, gearshift linkage	CV-ES-2119	
	05/94→06/96	Ball Head, gearshift linkage	CV-ES-2120		
	05/94→06/96	Ball Head, gearshift linkage	CV-ES-2182		
	05/94→06/96	Centre Rod	MN-DL-2160		Coupling Rod
	05/94→06/96	Centre Rod	MN-DL-2174		Push Rod
	05/94→06/96	Centre Rod	MN-DL-2175		Push Rod
	05/94→06/96	Centre Rod	MN-DL-3588		Push Rod
	05/94→06/96	Centre Rod	MN-DL-12421		for Steering Rod
	05/94→06/96	Engine Mounting	MN-SB-10389		
	05/94→06/96	Mounting, stabilizer coupling rod	MN-SB-5246		
	05/94→06/96	Mounting, stabilizer coupling rod	MN-SB-5246		1st FA
	05/94→06/96	Stabiliser Mounting		MN-SB-5254	
	05/94→06/96	Stabiliser Mounting		MN-SB-5265	

CV-ES-2119

Length: 55
Cone Ø: d1 Ø 10 / d2 Ø 10
Thread: M12 x 1,75 LHT
81953016063, 81953016131



CV-ES-2120

Length: 115
Cone Ø: d1 Ø 12,4 / d2 Ø 10,8
Thread: M14 x 1,5 RHT
03008500A, 81953016200, 81953016202, 81953016203, 81953016227



CV-ES-2149

Length: 160
Cone Ø: d1 Ø 30 / d2 Ø 27
Thread: M30 x 1,5 RHT
81953016263



CV-ES-2182

Length: 55
Cone Ø: d1 Ø 10 / d2 Ø 10
Thread: M12 x 1,75 RHT
81953016064, 81953016170



CV-ES-14162

Length: 125
Cone Ø: d1 Ø 30 / d2 Ø 27
Thread: M30 x 1,5 LHT

81953010015, 81953010083, 81953010087, 81953016029, 81953016030, 81953016043, 81953016044, 81953016050, 81953016054, 81953016087, 81953016091, 81953016107, 81953016120, 81953016125, 81953016152, 81953016155, 81953016157, 81953016168, 81953016179, 81953016181, 81953016223, 81953016237, 81953016254, 81953016275, 81953016279, 81953016351



CV-ES-14163

Length: 125
Cone Ø: d1 Ø 30 / d2 Ø 27
Thread: M30 x 1,5 RHT

95301.0084, 90804102156, 90804102272, 90804102696, 90804102710, 81953010016, 81953010075, 81953010084, 81953010088, 81953010094, 81953010103, 81953016030, 81953016043, 81953016048, 81953016049, 81953016053, 81953016061, 81953016090, 81953016108, 81953016112, 81953016126, 81953016143, 81953016149, 81953016154, 81953016156, 81953016168, 81953016178, 81953016194, 81953016206, 81953016224, 81953016234, 81953016242, 81953016252, 81953016274, 81953016278, 81953016284, 81953016286, 81953016308, 81953016310, 81953016312, 81953016347, 81953016350, 81953016352, 82953016012, 88953016014, N2953016001



CV-RK-5313

Ø: 90
03304800A, 81953016132



CV-RK-8118

Ø: 85
Hole Distance: 130
Thick/Height: 30

638862, 639287, 775201, 938423, 1104335, 1953248, 0003500506, 3500506, 11013547, 21032592, 42065912, 42488722, 070550504, 93192618, 070400009000, 634303610, 81432206055, 81432206073, 82262320660, 9544171010099, 5001842823, 7000307001, 82262320666



MN-DL-2160

Length: 1652 Ø: 50
Cone Ø: d1 Ø 30 / d2 Ø 27

81467106112, 81467106163, 81467106165, 81467106198, 81467106353, 81467106354, 81467106361, 81467116725



MN-DL-2174

Length: 1588 Ø: 52
Cone Ø: d1 Ø 30 / d2 Ø 27
81467106378, 81467106912



MN-DL-2175

Length: 1628 Ø: 50
Cone Ø: d1 Ø 30 / d2 Ø 27
81467106396, 81467106904



MN-DL-3588

Length: 1035 Ø: 48
Cone Ø: d1 Ø 30 / d2 Ø 27

81466106333, 81466106334, 81466106354, 81466106355, 81466106360, 81466106361, 81466106721, 81466106722, 81466106723, 81466116216



MN-DL-5212

Length: 577 Ø: 48
Hole Distance: 130 / 130

81432206096, 81432206097, 81432206098, 81432206129, 81432209096, 81432209129, 81432306014, 81432306030



MN-DL-12284

Length: 1530 Ø: 50
Cone Ø: d1 Ø 30 / d2 Ø 27

81466106579, 81466106580, 81466106624, 81466116720, 81467116720, 81467116730, 81467116952



MN-DL-12421

Length: 1070 Ø: 48
Cone Ø: d1 Ø 30 / d2 Ø 27
Thread: M30 x 1,5 RHT

81466106656, 81466106659, 81466106669, 81466116006, 81466116007



MN-RK-7280

Ø: 75
Hole Distance: 115
Thick/Height: 24

0550806, 0639370, 689748, 10307400A, 81432306051, 81432306068, 81432706064



MN-RK-7287

Ø: 90
Hole Distance: 152
Thick/Height: 35

03304700A, 81953016133



MN-RK-7291

Ø: 72
Hole Distance: 130
Thick/Height: 30
10307800A, 81432206108, 81432206132



MN-SB-5246

Ø: 45 Thick/Height: 47
81437220022, 81437220038, 81962100450, 81962100469



MN-SB-5254

Length: 100 Ø: 93
Thick/Height: 70
81432710081



MN-SB-5265

Ø: 85 Thick/Height: 80
03310300A, 81437040032



MN-SB-10389

Ø: 70 Thick/Height: 72
81960200340



MN-SB-10390

Ø: 70 Thick/Height: 85/85
81960200341, 81960200373, 81960200385, 81960200408, 81960200418



MN-VB-5222

Length: 627 Ø: 50
Hole Distance: 152 / 152

81432706030, 81432706034, 81432706054, 81432706055, 81432706056, 81432706057, 81432706067, 81432706068, 81432706074, 81432706075, 81432706076, 81432706077, 81432706078, 81432706081, 81432706082, 81432709034, 81432709076, 81432709078, 8143706054





F 90 ...

19.342 FA ...	05/94 → 06/96	Stabiliser Mounting	MN-SB-9396		
	05/94 → 06/96	Suspension Arm Repair Kit		MN-RK-7280	for Drag Link
	05/94 → 06/96	Tie Rod End	CV-ES-2149		for Push Rod
	05/94 → 06/96	Tie Rod End	CV-ES-14162		for Steering Rod
	05/94 → 06/96	Tie Rod End	CV-ES-14163		for Steering Rod
19.342 FAK	05/94 → 06/96	Ball Head, gearshift linkage	CV-ES-2119		
	05/94 → 06/96	Ball Head, gearshift linkage	CV-ES-2120		
	05/94 → 06/96	Ball Head, gearshift linkage	CV-ES-2182		
	05/94 → 06/96	Centre Rod	MN-DL-2160		Coupling Rod
	05/94 → 06/96	Centre Rod	MN-DL-2174		Push Rod
	05/94 → 06/96	Centre Rod	MN-DL-2175		Push Rod
	05/94 → 06/96	Centre Rod	MN-DL-3588		Push Rod
	05/94 → 06/96	Centre Rod	MN-DL-12421		for Steering Rod
	05/94 → 06/96	Engine Mounting	MN-SB-10389		
	05/94 → 06/96	Mounting, stabilizer coupling rod	MN-SB-5246		
	05/94 → 06/96	Mounting, stabilizer coupling rod	MN-SB-5246		1st FA
	05/94 → 06/96	Stabiliser Mounting		MN-SB-5254	
	05/94 → 06/96	Stabiliser Mounting		MN-SB-5265	
	05/94 → 06/96	Stabiliser Mounting	MN-SB-9396		
	05/94 → 06/96	Suspension Arm Repair Kit		MN-RK-7280	for Drag Link
	05/94 → 06/96	Tie Rod End	CV-ES-2149		for Push Rod
	05/94 → 06/96	Tie Rod End	CV-ES-14162		for Steering Rod
05/94 → 06/96	Tie Rod End	CV-ES-14163		for Steering Rod	
19.342 FAS	05/94 → 06/96	Ball Head, gearshift linkage	CV-ES-2119		
	05/94 → 06/96	Ball Head, gearshift linkage	CV-ES-2120		
	05/94 → 06/96	Ball Head, gearshift linkage	CV-ES-2182		
	05/94 → 06/96	Centre Rod	MN-DL-2160		Coupling Rod
	05/94 → 06/96	Centre Rod	MN-DL-2174		Push Rod
	05/94 → 06/96	Centre Rod	MN-DL-2175		Push Rod
	05/94 → 06/96	Centre Rod	MN-DL-3588		Push Rod
	05/94 → 06/96	Centre Rod	MN-DL-12421		for Steering Rod
	05/94 → 06/96	Engine Mounting	MN-SB-10389		
	05/94 → 06/96	Mounting, stabilizer coupling rod	MN-SB-5246		
	05/94 → 06/96	Mounting, stabilizer coupling rod	MN-SB-5246		1st FA
	05/94 → 06/96	Stabiliser Mounting		MN-SB-5254	
	05/94 → 06/96	Stabiliser Mounting		MN-SB-5265	
	05/94 → 06/96	Stabiliser Mounting	MN-SB-9396		
	05/94 → 06/96	Suspension Arm Repair Kit		MN-RK-7280	for Drag Link
	05/94 → 06/96	Tie Rod End	CV-ES-2149		for Push Rod
	05/94 → 06/96	Tie Rod End	CV-ES-14162		for Steering Rod
05/94 → 06/96	Tie Rod End	CV-ES-14163		for Steering Rod	
19.342 FK	05/94 → 05/95	Ball Head, gearshift linkage	CV-ES-2119		
	05/94 → 05/95	Ball Head, gearshift linkage	CV-ES-2120		
	05/94 → 05/95	Ball Head, gearshift linkage	CV-ES-2182		
	05/94 → 05/95	Centre Rod	MN-DL-2160		Coupling Rod
	05/94 → 05/95	Centre Rod	MN-DL-2174		Push Rod
	05/94 → 05/95	Centre Rod	MN-DL-2175		Push Rod
	05/94 → 05/95	Centre Rod	MN-DL-3588		Push Rod
	05/94 → 05/95	Centre Rod	MN-DL-12421		for Steering Rod
	05/94 → 05/95	Engine Mounting		MN-SB-10390	
	05/94 → 05/95	Engine Mounting	MN-SB-10389		
	05/94 → 05/95	Mounting, stabilizer coupling rod	MN-SB-5246		
	05/94 → 05/95	Mounting, stabilizer coupling rod	MN-SB-5246		1st FA
	05/94 → 05/95	Suspension Arm Repair Kit		MN-RK-7280	for Drag Link
	05/94 → 05/95	Tie Rod	MN-DL-12284		
	05/94 → 05/95	Tie Rod End	CV-ES-2149		for Push Rod
	05/94 → 05/95	Tie Rod End	CV-ES-14162		for Steering Rod
	05/94 → 05/95	Tie Rod End	CV-ES-14163		for Steering Rod
19.342 FS, 19.342 FLS, 19.342 FLLS	05/94 → 05/95	Ball Head, gearshift linkage	CV-ES-2119		
	05/94 → 05/95	Ball Head, gearshift linkage	CV-ES-2120		
	05/94 → 05/95	Ball Head, gearshift linkage	CV-ES-2182		
	05/94 → 05/95	Centre Rod	MN-DL-2160		Coupling Rod
	05/94 → 05/95	Centre Rod	MN-DL-2174		Push Rod

CV-ES-2119

Length: 55
Cone Ø: d1 Ø 10 / d2 Ø 20
Thread: M12 x 1,75 LHT
81953016063, 81953016131



CV-ES-2120

Length: 115
Cone Ø: d1 Ø 12,4 / d2 Ø 10,8
Thread: M14 x 1,5 RHT
03008500A, 81953016200, 81953016202,
81953016203, 81953016227



CV-ES-2149

Length: 160
Cone Ø: d1 Ø 30 / d2 Ø 27
Thread: M30 x 1,5 RHT
81953016263



CV-ES-2182

Length: 55
Cone Ø: d1 Ø 10 / d2 Ø 10
Thread: M12 x 1,75 RHT
81953016064, 81953016170



CV-ES-14162

Length: 125
Cone Ø: d1 Ø 30 / d2 Ø 27
Thread: M30 x 1,5 LHT
81953010015, 81953010083, 81953010087,
81953016029, 81953016030, 81953016043,
81953016044, 81953016050, 81953016054,
81953016087, 81953016091, 81953016107,
81953016120, 81953016125, 81953016152,
81953016155, 81953016157, 81953016168,
81953016179, 81953016181, 81953016223,
81953016237, 81953016254, 81953016275,
81953016279, 81953016351



CV-ES-14163

Length: 125
Cone Ø: d1 Ø 30 / d2 Ø 27
Thread: M30 x 1,5 RHT
95301.0084, 90804102156, 90804102272,
90804102696, 90804102710, 81953010016,
81953010075, 81953010084, 81953010088,
81953010094, 81953010103, 81953016030,
81953016043, 81953016048, 81953016049,
81953016053, 81953016061, 81953016090,
81953016108, 81953016112, 81953016126,
81953016143, 81953016149, 81953016154,
81953016156, 81953016168, 81953016178,
81953016194, 81953016206, 81953016224,
81953016234, 81953016242, 81953016252,
81953016274, 81953016278, 81953016284,
81953016286, 81953016308, 81953016310,
81953016312, 81953016347, 81953016350,
81953016352, 82953016012, 88953016014,
N2953016001



MN-DL-2160

Length: 1652 Ø: 50
Cone Ø: d1 Ø 30 / d2 Ø 27
81467106112, 81467106163, 81467106165,
81467106198, 81467106353, 81467106354,
81467106361, 81467116725



MN-DL-2174

Length: 1588 Ø: 52
Cone Ø: d1 Ø 30 / d2 Ø 27
81467106378, 81467106912



MN-DL-2175

Length: 1628
Ø: 50
Cone Ø: d1 Ø 30 / d2 Ø 27
81467106396, 81467106904



MN-DL-3588

Length: 1035
Ø: 48
Cone Ø: d1 Ø 30 / d2 Ø 27
81466106333, 81466106334, 81466106354,
81466106355, 81466106360, 81466106361,
81466106721, 81466106722, 81466106723,
81466116216



MN-DL-12284

Length: 1530 Ø: 50
Cone Ø: d1 Ø 30 / d2 Ø 27
81466106579, 81466106580, 81466106624,
81466116720, 81467116730, 81467116952



MN-DL-12421

Length: 1070
Ø: 48
Cone Ø: d1 Ø 30 / d2 Ø 27
Thread: M30 x 1,5 RHT
81466106656, 81466106659, 81466106669,
81466116006, 81466116007



MN-RK-7280

Ø: 75
Hole Distance: 115
Thick/Height: 24
0550806, 0639370, 689748, 10307400A,
81432306051, 81432306068, 81432706064



MN-SB-5246

Ø: 45 Thick/Height: 47
81437220022, 81437220038, 81962100450,
81962100469



MN-SB-5254

Length: 100
Ø: 93
Thick/Height: 70
81432710081



MN-SB-5265

Ø: 85
Thick/Height: 80
03310300A, 81437040032



MN-SB-9396

Ø: 67
Thick/Height: 60
81437040057



MN-SB-10389

Ø: 70
Thick/Height: 72
81960200340



MN-SB-10390

Ø: 70
Thick/Height: 85/85
81960200341, 81960200373, 81960200385,
81960200408, 81960200418





F 90 ...

19.342 FS,19.342 FLS, 19.342 FLLS ...	05/94 →05/95	Centre Rod	MN-DL-2175		Push Rod	
	05/94 →05/95	Centre Rod	MN-DL-3588		Push Rod	
	05/94 →05/95	Centre Rod	MN-DL-12421		for Steering Rod	
	05/94 →05/95	Engine Mounting		MN-SB-10390		
	05/94 →05/95	Engine Mounting	MN-SB-10389			
	05/94 →05/95	Mounting, stabilizer coupling rod	MN-SB-5246			
	05/94 →05/95	Mounting, stabilizer coupling rod	MN-SB-5246		1st FA	
	05/94 →05/95	Stabiliser Mounting		MN-SB-5265		
	05/94 →05/95	Stabiliser Mounting		MN-SB-5265	1st RA	
	05/94 →05/95	Suspension Arm Repair Kit		CV-RK-5313	for Wishbone (CV)	
	05/94 →05/95	Suspension Arm Repair Kit		CV-RK-8118	for Control Arm	
	05/94 →05/95	Suspension Arm Repair Kit		MN-RK-7280	for Drag Link	
	05/94 →05/95	Suspension Arm Repair Kit		MN-RK-7287	for Wishbone (CV)	
	05/94 →05/95	Suspension Arm Repair Kit		MN-RK-7291	for Drag Link	
	05/94 →05/95	Tie Rod	MN-DL-12284			
	05/94 →05/95	Tie Rod End	CV-ES-2149		for Push Rod	
	05/94 →05/95	Tie Rod End	CV-ES-14162		for Steering Rod	
	05/94 →05/95	Tie Rod End	CV-ES-14163		for Steering Rod	
	05/94 →05/95	Track Control Arm		MN-DL-5212	Trailing Arm, Air Suspension Axle	
	05/94 →05/95	Track Control Arm		MN-VB-5222	Wishbone (CV), Air Suspension Axle	
	19.362 F,19.362 FL,19.362 FLL	07/86 →02/90	Ball Head, gearshift linkage	CV-ES-2119		
		07/86 →02/90	Ball Head, gearshift linkage	CV-ES-2120		
		07/86 →02/90	Ball Head, gearshift linkage	CV-ES-2182		
		07/86 →02/90	Centre Rod	MN-DL-2160		Coupling Rod
		07/86 →02/90	Centre Rod	MN-DL-2174		Push Rod
		07/86 →02/90	Centre Rod	MN-DL-2175		Push Rod
07/86 →02/90		Centre Rod	MN-DL-3588		Push Rod	
07/86 →02/90		Centre Rod	MN-DL-12421		for Steering Rod	
07/86 →02/90		Engine Mounting		MN-SB-10390		
07/86 →02/90		Engine Mounting	MN-SB-10389			
07/86 →02/90		Mounting, stabilizer coupling rod	MN-SB-5246			
07/86 →02/90		Mounting, stabilizer coupling rod	MN-SB-5246		1st FA	
07/86 →02/90		Stabiliser Mounting		MN-SB-5265		
07/86 →02/90		Stabiliser Mounting		MN-SB-5265	1st RA	
07/86 →02/90		Suspension Arm Repair Kit		CV-RK-5313	for Wishbone (CV)	
07/86 →02/90		Suspension Arm Repair Kit		CV-RK-8118	for Control Arm	
07/86 →02/90		Suspension Arm Repair Kit		MN-RK-7280	for Drag Link	
07/86 →02/90		Suspension Arm Repair Kit		MN-RK-7287	for Wishbone (CV)	
07/86 →02/90		Suspension Arm Repair Kit		MN-RK-7291	for Drag Link	
07/86 →02/90		Tie Rod End	CV-ES-2149		for Push Rod	
07/86 →02/90		Tie Rod End	CV-ES-14162		for Steering Rod	
07/86 →02/90		Tie Rod End	CV-ES-14163		for Steering Rod	
07/86 →02/90		Track Control Arm		MN-DL-5212	Trailing Arm, Air Suspension Axle	
07/86 →02/90		Track Control Arm		MN-VB-5222	Wishbone (CV), Air Suspension Axle	
19.362 FA		05/88 →02/90	Ball Head, gearshift linkage	CV-ES-2119		
		05/88 →02/90	Ball Head, gearshift linkage	CV-ES-2120		
	05/88 →02/90	Ball Head, gearshift linkage	CV-ES-2182			
	05/88 →02/90	Centre Rod	MN-DL-2160		Coupling Rod	
	05/88 →02/90	Centre Rod	MN-DL-2174		Push Rod	
	05/88 →02/90	Centre Rod	MN-DL-2175		Push Rod	
	05/88 →02/90	Centre Rod	MN-DL-3588		Push Rod	
	05/88 →02/90	Centre Rod	MN-DL-12421		for Steering Rod	
	05/88 →02/90	Engine Mounting	MN-SB-10389			
	05/88 →02/90	Mounting, stabilizer coupling rod	MN-SB-5246			
	05/88 →02/90	Mounting, stabilizer coupling rod	MN-SB-5246		1st FA	
	05/88 →02/90	Stabiliser Mounting		MN-SB-5254		
	05/88 →02/90	Stabiliser Mounting		MN-SB-5265		
	05/88 →02/90	Stabiliser Mounting	MN-SB-9396			
	05/88 →02/90	Suspension Arm Repair Kit		MN-RK-7280	for Drag Link	
	05/88 →02/90	Tie Rod End	CV-ES-2149		for Push Rod	
05/88 →02/90	Tie Rod End	CV-ES-14162		for Steering Rod		
05/88 →02/90	Tie Rod End	CV-ES-14163		for Steering Rod		

CV-ES-2119

Length: 55
Cone Ø: d1 Ø 10 / d2 Ø 10
Thread: M12 x 1,75 LHT
81953016063, 81953016131



CV-ES-2120

Length: 115
Cone Ø: d1 Ø 12,4 / d2 Ø 10,8
Thread: M14 x 1,5 RHT
03008500A, 81953016200, 81953016202, 81953016203, 81953016227



CV-ES-2149

Length: 160
Cone Ø: d1 Ø 30 / d2 Ø 27
Thread: M30 x 1,5 RHT
81953016263



CV-ES-2182

Length: 55
Cone Ø: d1 Ø 10 / d2 Ø 10
Thread: M12 x 1,75 RHT
81953016064, 81953016170



CV-ES-14162

Length: 125
Cone Ø: d1 Ø 30 / d2 Ø 27
Thread: M30 x 1,5 LHT

81953010015, 81953010083, 81953010087, 81953016029, 81953016030, 81953016043, 81953016044, 81953016050, 81953016054, 81953016087, 81953016091, 81953016107, 81953016120, 81953016125, 81953016152, 81953016155, 81953016157, 81953016168, 81953016179, 81953016181, 81953016223, 81953016237, 81953016254, 81953016275, 81953016279, 81953016351



CV-ES-14163

Length: 125
Cone Ø: d1 Ø 30 / d2 Ø 27
Thread: M30 x 1,5 RHT

95301.0084, 90804102156, 90804102272, 90804102696, 90804102710, 81953010016, 81953010075, 81953010084, 81953010088, 81953010094, 81953010103, 81953016030, 81953016043, 81953016048, 81953016049, 81953016053, 81953016061, 81953016090, 81953016108, 81953016112, 81953016126, 81953016143, 81953016149, 81953016154, 81953016156, 81953016168, 81953016178, 81953016194, 81953016206, 81953016224, 81953016234, 81953016242, 81953016252, 81953016274, 81953016278, 81953016284, 81953016286, 81953016308, 81953016310, 81953016312, 81953016347, 81953016350, 81953016352, 82953016012, 88953016014, N2953016001



CV-RK-5313

Ø: 90
03304800A, 81953016132



CV-RK-8118

Ø: 85
Hole Distance: 130
Thick/Height: 30

638862, 639287, 775201, 938423, 1104335, 1953248, 0003500506, 3500506, 11013547, 21032592, 42065912, 42488272, 070550504, 93192618, 070400009000, 634303610, 81432206055, 81432206073, 82262320660, 9544171010099, 5001842823, 7000307001, 8226232066



MN-DL-2160

Length: 1652 Ø: 50
Cone Ø: d1 Ø 30 / d2 Ø 27
81467106112, 81467106163, 81467106165, 81467106198, 81467106353, 81467106354, 81467106361, 81467116725



MN-DL-2174

Length: 1588 Ø: 52
Cone Ø: d1 Ø 30 / d2 Ø 27
81467106378, 81467106912



MN-DL-2175

Length: 1628 Ø: 50
Cone Ø: d1 Ø 30 / d2 Ø 27
81467106396, 81467106904



MN-DL-3588

Length: 1035 Ø: 48
Cone Ø: d1 Ø 30 / d2 Ø 27
81466106333, 81466106334, 81466106354, 81466106355, 81466106360, 81466106361, 81466106721, 81466106722, 81466106723, 81466116216



MN-DL-5212

Length: 577 Ø: 48
Hole Distance: 130 / 130
81432206096, 81432206097, 81432206098, 81432206129, 81432209096, 81432209129, 81432306014, 81432306030



MN-DL-12284

Length: 1530 Ø: 50
Cone Ø: d1 Ø 30 / d2 Ø 27
81466106579, 81466106580, 81466106624, 81466116720, 81467116720, 81467116730, 81467116952



MN-DL-12421

Length: 1070 Ø: 48
Cone Ø: d1 Ø 30 / d2 Ø 27
Thread: M30 x 1,5 RHT
81466106656, 81466106659, 81466106669, 81466116006, 81466116007



MN-RK-7280

Ø: 75
Hole Distance: 115
Thick/Height: 24
0550806, 0639370, 689748, 10307400A, 81432306051, 81432306068, 81432706064



MN-RK-7287

Ø: 90
Hole Distance: 152
Thick/Height: 35
03304700A, 81953016133



MN-RK-7291

Ø: 72
Hole Distance: 130
Thick/Height: 30
10307800A, 81432206108, 81432206132



MN-SB-5246

Ø: 45 Thick/Height: 47
81437220022, 81437220038, 81962100450, 81962100469



MN-SB-5254

Length: 100 Ø: 93
Thick/Height: 70
81432710081



MN-SB-5265

Ø: 85 Thick/Height: 80
03310300A, 81437040032



MN-SB-9396

Ø: 67 Thick/Height: 60
81437040057



MN-SB-10389

Ø: 70 Thick/Height: 72
81960200340



MN-SB-10390

Ø: 70 Thick/Height: 85/85
81960200341, 81960200373, 81960200385, 81960200408, 81960200418



MN-VB-5222

Length: 627 Ø: 50
Hole Distance: 152 / 152
81432706030, 81432706034, 81432706054, 81432706055, 81432706056, 81432706057, 81432706067, 81432706068, 81432706074, 81432706075, 81432706076, 81432706077, 81432706078, 81432706081, 81432706082, 81432709034, 81432709076, 81432709078, 8143706054





F 90 ...

19.362 FAK	05/88→02/90	Ball Head, gearshift linkage	CV-ES-2119			
	05/88→02/90	Ball Head, gearshift linkage	CV-ES-2120			
	05/88→02/90	Ball Head, gearshift linkage	CV-ES-2182			
	05/88→02/90	Centre Rod	MN-DL-2160		Coupling Rod	
	05/88→02/90	Centre Rod	MN-DL-2174		Push Rod	
	05/88→02/90	Centre Rod	MN-DL-2175		Push Rod	
	05/88→02/90	Centre Rod	MN-DL-3588		Push Rod	
	05/88→02/90	Centre Rod	MN-DL-12421		for Steering Rod	
	05/88→02/90	Engine Mounting	MN-SB-10389			
	05/88→02/90	Mounting, stabilizer coupling rod	MN-SB-5246			
	05/88→02/90	Mounting, stabilizer coupling rod	MN-SB-5246		1st FA	
	05/88→02/90	Stabiliser Mounting		MN-SB-5254		
	05/88→02/90	Stabiliser Mounting		MN-SB-5265		
	05/88→02/90	Stabiliser Mounting	MN-SB-9396			
	05/88→02/90	Suspension Arm Repair Kit		MN-RK-7280	for Drag Link	
	05/88→02/90	Tie Rod End	CV-ES-2149		for Push Rod	
	05/88→02/90	Tie Rod End	CV-ES-14162		for Steering Rod	
	05/88→02/90	Tie Rod End	CV-ES-14163		for Steering Rod	
	19.362 FAS	05/88→02/90	Ball Head, gearshift linkage	CV-ES-2119		
		05/88→02/90	Ball Head, gearshift linkage	CV-ES-2120		
05/88→02/90		Ball Head, gearshift linkage	CV-ES-2182			
05/88→02/90		Centre Rod	MN-DL-2160		Coupling Rod	
05/88→02/90		Centre Rod	MN-DL-2174		Push Rod	
05/88→02/90		Centre Rod	MN-DL-2175		Push Rod	
05/88→02/90		Centre Rod	MN-DL-3588		Push Rod	
05/88→02/90		Centre Rod	MN-DL-12421		for Steering Rod	
05/88→02/90		Engine Mounting	MN-SB-10389			
05/88→02/90		Mounting, stabilizer coupling rod	MN-SB-5246			
05/88→02/90		Mounting, stabilizer coupling rod	MN-SB-5246		1st FA	
05/88→02/90		Stabiliser Mounting		MN-SB-5254		
05/88→02/90		Stabiliser Mounting		MN-SB-5265		
05/88→02/90		Stabiliser Mounting	MN-SB-9396			
05/88→02/90		Suspension Arm Repair Kit		MN-RK-7280	for Drag Link	
05/88→02/90		Tie Rod End	CV-ES-2149		for Push Rod	
05/88→02/90		Tie Rod End	CV-ES-14162		for Steering Rod	
05/88→02/90		Tie Rod End	CV-ES-14163		for Steering Rod	
19.362 FK		07/86→02/90	Ball Head, gearshift linkage	CV-ES-2119		
		07/86→02/90	Ball Head, gearshift linkage	CV-ES-2120		
	07/86→02/90	Ball Head, gearshift linkage	CV-ES-2182			
	07/86→02/90	Centre Rod	MN-DL-2160		Coupling Rod	
	07/86→02/90	Centre Rod	MN-DL-2174		Push Rod	
	07/86→02/90	Centre Rod	MN-DL-2175		Push Rod	
	07/86→02/90	Centre Rod	MN-DL-3588		Push Rod	
	07/86→02/90	Centre Rod	MN-DL-12421		for Steering Rod	
	07/86→02/90	Engine Mounting		MN-SB-10390		
	07/86→02/90	Engine Mounting	MN-SB-10389			
	07/86→02/90	Mounting, stabilizer coupling rod	MN-SB-5246			
	07/86→02/90	Mounting, stabilizer coupling rod	MN-SB-5246		1st FA	
	07/86→02/90	Suspension Arm Repair Kit		MN-RK-7280	for Drag Link	
	07/86→02/90	Tie Rod	MN-DL-12284			
	07/86→02/90	Tie Rod End	CV-ES-2149		for Push Rod	
	07/86→02/90	Tie Rod End	CV-ES-14162		for Steering Rod	
	07/86→02/90	Tie Rod End	CV-ES-14163		for Steering Rod	
	19.362 FS,19.362 FLS,19.362 FLLS	07/86→02/90	Ball Head, gearshift linkage	CV-ES-2119		
		07/86→02/90	Ball Head, gearshift linkage	CV-ES-2120		
		07/86→02/90	Ball Head, gearshift linkage	CV-ES-2182		
07/86→02/90		Centre Rod	MN-DL-2160		Coupling Rod	
07/86→02/90		Centre Rod	MN-DL-2174		Push Rod	
07/86→02/90		Centre Rod	MN-DL-2175		Push Rod	
07/86→02/90		Centre Rod	MN-DL-3588		Push Rod	
07/86→02/90		Centre Rod	MN-DL-12421		for Steering Rod	
07/86→02/90		Engine Mounting		MN-SB-10390		
07/86→02/90		Engine Mounting	MN-SB-10389			

CV-ES-2119

Length: 55
Cone Ø: d1 Ø 10 / d2 Ø 10
Thread: M12 x 1,75 LHT
81953016063, 81953016131



CV-ES-2120

Length: 115
Cone Ø: d1 Ø 12,4 / d2 Ø 10,8
Thread: M14 x 1,5 RHT
03008500A, 81953016200, 81953016202,
81953016203, 81953016227



CV-ES-2149

Length: 160
Cone Ø: d1 Ø 30 / d2 Ø 27
Thread: M30 x 1,5 RHT
81953016263



CV-ES-2182

Length: 55
Cone Ø: d1 Ø 10 / d2 Ø 10
Thread: M12 x 1,75 RHT
81953016064, 81953016170



CV-ES-14162

Length: 125
Cone Ø: d1 Ø 30 / d2 Ø 27
Thread: M30 x 1,5 LHT
81953010015, 81953010083, 81953010087,
81953016029, 81953016030, 81953016043,
81953016044, 81953016050, 81953016054,
81953016087, 81953016091, 81953016107,
81953016120, 81953016125, 81953016152,
81953016155, 81953016157, 81953016168,
81953016179, 81953016181, 81953016223,
81953016237, 81953016254, 81953016275,
81953016279, 81953016351



CV-ES-14163

Length: 125
Cone Ø: d1 Ø 30 / d2 Ø 27
Thread: M30 x 1,5 RHT
95301.0084, 90804102156, 90804102272,
90804102696, 90804102710, 81953010016,
81953010075, 81953010084, 81953010088,
81953010094, 81953010103, 81953016030,
81953016043, 81953016048, 81953016049,
81953016053, 81953016061, 81953016090,
81953016108, 81953016112, 81953016126,
81953016143, 81953016149, 81953016154,
81953016156, 81953016168, 81953016178,
81953016194, 81953016206, 81953016224,
81953016234, 81953016242, 81953016252,
81953016274, 81953016278, 81953016284,
81953016286, 81953016308, 81953016310,
81953016312, 81953016347, 81953016350,
81953016352, 82953016012, 88953016014,
N2953016001



MN-DL-2160

Length: 1652 Ø: 50
Cone Ø: d1 Ø 30 / d2 Ø 27
81467106112, 81467106163, 81467106165,
81467106198, 81467106353, 81467106354,
81467106361, 81467116725



MN-DL-2174

Length: 1588 Ø: 52
Cone Ø: d1 Ø 30 / d2 Ø 27
81467106378, 81467106912



MN-DL-2175

Length: 1628
Ø: 50
Cone Ø: d1 Ø 30 / d2 Ø 27
81467106396, 81467106904



MN-DL-3588

Length: 1035
Ø: 48
Cone Ø: d1 Ø 30 / d2 Ø 27
81466106333, 81466106334, 81466106354,
81466106355, 81466106360, 81466106361,
81466106721, 81466106722, 81466106723,
81466116216



MN-DL-12284

Length: 1530 Ø: 50
Cone Ø: d1 Ø 30 / d2 Ø 27
81466106579, 81466106580, 81466106624,
81466116720, 81467116730, 81467116952



MN-DL-12421

Length: 1070
Ø: 48
Cone Ø: d1 Ø 30 / d2 Ø 27
Thread: M30 x 1,5 RHT
81466106656, 81466106659, 81466106669,
81466116006, 81466116007



MN-RK-7280

Ø: 75
Hole Distance: 115
Thick/Height: 24
0550806, 0639370, 689748, 10307400A,
81432306051, 81432306068, 81432706064



MN-SB-5246

Ø: 45 Thick/Height: 47
81437220022, 81437220038, 81962100450,
81962100469



MN-SB-5254

Length: 100
Ø: 93
Thick/Height: 70
81432710081



MN-SB-5265

Ø: 85
Thick/Height: 80
03310300A, 81437040032



MN-SB-9396

Ø: 67
Thick/Height: 60
81437040057



MN-SB-10389

Ø: 70
Thick/Height: 72
81960200340



MN-SB-10390

Ø: 70
Thick/Height: 85/85
81960200341, 81960200373, 81960200385,
81960200408, 81960200418





F 90 ...

19.362 FS, 19.362 FLS, 19.362 FLLS ...	07/86→02/90	Mounting, stabilizer coupling rod	MN-SB-5246			
	07/86→02/90	Mounting, stabilizer coupling rod	MN-SB-5246		1st FA	
	07/86→02/90	Stabiliser Mounting		MN-SB-5265		
	07/86→02/90	Stabiliser Mounting		MN-SB-5265	1st RA	
	07/86→02/90	Suspension Arm Repair Kit		CV-RK-5313	for Wishbone (CV)	
	07/86→02/90	Suspension Arm Repair Kit		CV-RK-8118	for Control Arm	
	07/86→02/90	Suspension Arm Repair Kit		MN-RK-7280	for Drag Link	
	07/86→02/90	Suspension Arm Repair Kit		MN-RK-7287	for Wishbone (CV)	
	07/86→02/90	Suspension Arm Repair Kit		MN-RK-7291	for Drag Link	
	07/86→02/90	Tie Rod	MN-DL-12284			
	07/86→02/90	Tie Rod End	CV-ES-2149		for Push Rod	
	07/86→02/90	Tie Rod End	CV-ES-14162		for Steering Rod	
	07/86→02/90	Tie Rod End	CV-ES-14163		for Steering Rod	
	07/86→02/90	Track Control Arm		MN-DL-5212	Trailing Arm, Air Suspension Axle	
	07/86→02/90	Track Control Arm		MN-VB-5222	Wishbone (CV), Air Suspension Axle	
	19.372 F, 19.372 FL, 19.372 FLL	02/90→05/95	Ball Head, gearshift linkage	CV-ES-2119		
02/90→05/95		Ball Head, gearshift linkage	CV-ES-2120			
02/90→05/95		Ball Head, gearshift linkage	CV-ES-2182			
02/90→05/95		Centre Rod	MN-DL-2160		Coupling Rod	
02/90→05/95		Centre Rod	MN-DL-2174		Push Rod	
02/90→05/95		Centre Rod	MN-DL-2175		Push Rod	
02/90→05/95		Centre Rod	MN-DL-3588		Push Rod	
02/90→05/95		Centre Rod	MN-DL-12421		for Steering Rod	
02/90→05/95		Engine Mounting		MN-SB-10390		
02/90→05/95		Engine Mounting	MN-SB-10389			
02/90→05/95		Mounting, stabilizer coupling rod	MN-SB-5246			
02/90→05/95		Mounting, stabilizer coupling rod	MN-SB-5246		1st FA	
02/90→05/95		Stabiliser Mounting		MN-SB-5265		
02/90→05/95		Stabiliser Mounting		MN-SB-5265	1st RA	
02/90→05/95		Suspension Arm Repair Kit		CV-RK-5313	for Wishbone (CV)	
02/90→05/95		Suspension Arm Repair Kit		CV-RK-8118	for Control Arm	
02/90→05/95		Suspension Arm Repair Kit		MN-RK-7280	for Drag Link	
02/90→05/95		Suspension Arm Repair Kit		MN-RK-7287	for Wishbone (CV)	
02/90→05/95		Suspension Arm Repair Kit		MN-RK-7291	for Drag Link	
02/90→05/95		Tie Rod	MN-DL-12284			
02/90→05/95		Tie Rod End	CV-ES-2149		for Push Rod	
02/90→05/95		Tie Rod End	CV-ES-14162		for Steering Rod	
02/90→05/95		Tie Rod End	CV-ES-14163		for Steering Rod	
02/90→05/95		Track Control Arm		MN-DL-5212	Trailing Arm, Air Suspension Axle	
02/90→05/95		Track Control Arm		MN-VB-5222	Wishbone (CV), Air Suspension Axle	
19.372 FA		02/90→06/96	Ball Head, gearshift linkage	CV-ES-2119		
		02/90→06/96	Ball Head, gearshift linkage	CV-ES-2120		
		02/90→06/96	Ball Head, gearshift linkage	CV-ES-2182		
		02/90→06/96	Centre Rod	MN-DL-2160		Coupling Rod
		02/90→06/96	Centre Rod	MN-DL-2174		Push Rod
		02/90→06/96	Centre Rod	MN-DL-2175		Push Rod
		02/90→06/96	Centre Rod	MN-DL-3588		Push Rod
	02/90→06/96	Centre Rod	MN-DL-12421		for Steering Rod	
	02/90→06/96	Engine Mounting	MN-SB-10389			
	02/90→06/96	Mounting, stabilizer coupling rod	MN-SB-5246			
	02/90→06/96	Mounting, stabilizer coupling rod	MN-SB-5246		1st FA	
	02/90→06/96	Stabiliser Mounting		MN-SB-5254		
	02/90→06/96	Stabiliser Mounting		MN-SB-5265		
	02/90→06/96	Stabiliser Mounting	MN-SB-9396			
	02/90→06/96	Suspension Arm Repair Kit		MN-RK-7280	for Drag Link	
	02/90→06/96	Tie Rod End	CV-ES-2149		for Push Rod	
	02/90→06/96	Tie Rod End	CV-ES-14162		for Steering Rod	
	02/90→06/96	Tie Rod End	CV-ES-14163		for Steering Rod	
	02/90→06/96	Track Control Arm		MN-DL-5212	Trailing Arm, Tag Axle; Drive Axle; Air Suspension Axle	

CV-ES-2119

Length: 55
Cone Ø: d1 Ø 10 / d2 Ø 10
Thread: M12 x 1,75 LHT
81953016063, 81953016131



CV-ES-2120

Length: 115
Cone Ø: d1 Ø 12,4 / d2 Ø 10,8
Thread: M14 x 1,5 RHT
03008500A, 81953016200, 81953016202, 81953016203, 81953016227



CV-ES-2149

Length: 160
Cone Ø: d1 Ø 30 / d2 Ø 27
Thread: M30 x 1,5 RHT
81953016263



CV-ES-2182

Length: 55
Cone Ø: d1 Ø 10 / d2 Ø 10
Thread: M12 x 1,75 RHT
81953016064, 81953016170



CV-ES-14162

Length: 125
Cone Ø: d1 Ø 30 / d2 Ø 27
Thread: M30 x 1,5 LHT
81953010015, 81953010083, 81953010087, 81953016029, 81953016030, 81953016043, 81953016044, 81953016050, 81953016054, 81953016087, 81953016091, 81953016107, 81953016120, 81953016125, 81953016152, 81953016155, 81953016157, 81953016168, 81953016179, 81953016181, 81953016223, 81953016237, 81953016254, 81953016275, 81953016279, 81953016351



CV-ES-14163

Length: 125
Cone Ø: d1 Ø 30 / d2 Ø 27
Thread: M30 x 1,5 RHT
95301.0084, 90804102156, 90804102272, 90804102696, 90804102710, 81953010016, 81953010075, 81953010084, 81953010088, 81953010094, 81953010103, 81953016030, 81953016043, 81953016048, 81953016049, 81953016053, 81953016061, 81953016090, 81953016108, 81953016112, 81953016126, 81953016143, 81953016149, 81953016154, 81953016156, 81953016168, 81953016178, 81953016194, 81953016206, 81953016224, 81953016234, 81953016242, 81953016252, 81953016274, 81953016278, 81953016284, 81953016286, 81953016308, 81953016310, 81953016312, 81953016347, 81953016350, 81953016352, 82953016012, 88953016014, N2953016001



CV-RK-5313

Ø: 90
03304800A, 81953016132



CV-RK-8118

Ø: 85
Hole Distance: 130
Thick/Height: 30
638862, 639287, 775201, 938423, 1104335, 1953248, 0003500506, 3500506, 11013547, 21032592, 42065912, 42488722, 070550504, 93192618, 070400009000, 634303610, 81432206055, 81432206073, 82262320660, 9544171010099, 5001842823, 7000307001, 8226232066



MN-DL-2160

Length: 1652 Ø: 50
Cone Ø: d1 Ø 30 / d2 Ø 27
81467106112, 81467106163, 81467106165, 81467106198, 81467106353, 81467106354, 81467106361, 81467116725



MN-DL-2174

Length: 1588 Ø: 52
Cone Ø: d1 Ø 30 / d2 Ø 27
81467106378, 81467106912



MN-DL-2175

Length: 1628 Ø: 50
Cone Ø: d1 Ø 30 / d2 Ø 27
81467106396, 81467106904



MN-DL-3588

Length: 1035 Ø: 48
Cone Ø: d1 Ø 30 / d2 Ø 27
81466106333, 81466106334, 81466106354, 81466106355, 81466106360, 81466106361, 81466106721, 81466106722, 81466106723, 81466116216



MN-DL-5212

Length: 577 Ø: 48
Hole Distance: 130 / 130
81432206096, 81432206097, 81432206098, 81432206129, 81432209096, 81432209129, 81432306014, 81432306030



MN-DL-12284

Length: 1530 Ø: 50
Cone Ø: d1 Ø 30 / d2 Ø 27
81466106579, 81466106580, 81466106624, 81466116720, 81467116720, 81467116730, 81467116952



MN-DL-12421

Length: 1070 Ø: 48
Cone Ø: d1 Ø 30 / d2 Ø 27
Thread: M30 x 1,5 RHT
81466106656, 81466106659, 81466106669, 81466116006, 81466116007



MN-RK-7280

Ø: 75
Hole Distance: 115
Thick/Height: 24
0550806, 0639370, 689748, 10307400A, 81432306051, 81432306068, 81432706064



MN-RK-7287

Ø: 90
Hole Distance: 152
Thick/Height: 35
03304700A, 81953016133



MN-RK-7291

Ø: 72
Hole Distance: 130
Thick/Height: 30
10307800A, 81432206108, 81432206132



MN-SB-5246

Ø: 45 Thick/Height: 47
81437220022, 81437220038, 81962100450, 81962100469



MN-SB-5254

Length: 100 Ø: 93
Thick/Height: 70
81432710081



MN-SB-5265

Ø: 85 Thick/Height: 80
03310300A, 81437040032



MN-SB-9396

Ø: 67 Thick/Height: 60
81437040057



MN-SB-10389

Ø: 70 Thick/Height: 72
81960200340



MN-SB-10390

Ø: 70 Thick/Height: 85/85
81960200341, 81960200373, 81960200385, 81960200408, 81960200418



MN-VB-5222

Length: 627 Ø: 50
Hole Distance: 152 / 152
81432706030, 81432706034, 81432706054, 81432706055, 81432706056, 81432706057, 81432706067, 81432706068, 81432706074, 81432706075, 81432706076, 81432706077, 81432706078, 81432706081, 81432706082, 81432709034, 81432709076, 81432709078, 8143706054





F 90 ...

19.372 FAK	02/90→06/96	Ball Head, gearshift linkage	CV-ES-2119			
	02/90→06/96	Ball Head, gearshift linkage	CV-ES-2120			
	02/90→06/96	Ball Head, gearshift linkage	CV-ES-2182			
	02/90→06/96	Centre Rod	MN-DL-2160		Coupling Rod	
	02/90→06/96	Centre Rod	MN-DL-2174		Push Rod	
	02/90→06/96	Centre Rod	MN-DL-2175		Push Rod	
	02/90→06/96	Centre Rod	MN-DL-3588		Push Rod	
	02/90→06/96	Centre Rod	MN-DL-12421		for Steering Rod	
	02/90→06/96	Engine Mounting	MN-SB-10389			
	02/90→06/96	Mounting, stabilizer coupling rod	MN-SB-5246			
	02/90→06/96	Mounting, stabilizer coupling rod	MN-SB-5246		1st FA	
	02/90→06/96	Stabiliser Mounting		MN-SB-5254		
	02/90→06/96	Stabiliser Mounting		MN-SB-5265		
	02/90→06/96	Stabiliser Mounting	MN-SB-9396			
	02/90→06/96	Suspension Arm Repair Kit		MN-RK-7280	for Drag Link	
	02/90→06/96	Tie Rod End	CV-ES-2149		for Push Rod	
	02/90→06/96	Tie Rod End	CV-ES-14162		for Steering Rod	
	02/90→06/96	Tie Rod End	CV-ES-14163		for Steering Rod	
	19.372 FAS	02/90→06/96	Ball Head, gearshift linkage	CV-ES-2119		
		02/90→06/96	Ball Head, gearshift linkage	CV-ES-2120		
02/90→06/96		Ball Head, gearshift linkage	CV-ES-2182			
02/90→06/96		Centre Rod	MN-DL-2160		Coupling Rod	
02/90→06/96		Centre Rod	MN-DL-2174		Push Rod	
02/90→06/96		Centre Rod	MN-DL-2175		Push Rod	
02/90→06/96		Centre Rod	MN-DL-3588		Push Rod	
02/90→06/96		Centre Rod	MN-DL-12421		for Steering Rod	
02/90→06/96		Engine Mounting	MN-SB-10389			
02/90→06/96		Mounting, stabilizer coupling rod	MN-SB-5246			
02/90→06/96		Mounting, stabilizer coupling rod	MN-SB-5246		1st FA	
02/90→06/96		Stabiliser Mounting		MN-SB-5254		
02/90→06/96		Stabiliser Mounting		MN-SB-5265		
02/90→06/96		Stabiliser Mounting	MN-SB-9396			
02/90→06/96		Suspension Arm Repair Kit		MN-RK-7280	for Drag Link	
02/90→06/96		Tie Rod End	CV-ES-2149		for Push Rod	
02/90→06/96		Tie Rod End	CV-ES-14162		for Steering Rod	
02/90→06/96		Tie Rod End	CV-ES-14163		for Steering Rod	
19.372 FK		02/90→05/95	Ball Head, gearshift linkage	CV-ES-2119		
		02/90→05/95	Ball Head, gearshift linkage	CV-ES-2120		
	02/90→05/95	Ball Head, gearshift linkage	CV-ES-2182			
	02/90→05/95	Centre Rod	MN-DL-2160		Coupling Rod	
	02/90→05/95	Centre Rod	MN-DL-2174		Push Rod	
	02/90→05/95	Centre Rod	MN-DL-2175		Push Rod	
	02/90→05/95	Centre Rod	MN-DL-3588		Push Rod	
	02/90→05/95	Centre Rod	MN-DL-12421		for Steering Rod	
	02/90→05/95	Engine Mounting		MN-SB-10390		
	02/90→05/95	Engine Mounting	MN-SB-10389			
	02/90→05/95	Mounting, stabilizer coupling rod	MN-SB-5246			
	02/90→05/95	Mounting, stabilizer coupling rod	MN-SB-5246		1st FA	
	02/90→05/95	Suspension Arm Repair Kit		MN-RK-7280	for Drag Link	
	02/90→05/95	Tie Rod	MN-DL-12284			
	02/90→05/95	Tie Rod End	CV-ES-2149		for Push Rod	
	02/90→05/95	Tie Rod End	CV-ES-14162		for Steering Rod	
	02/90→05/95	Tie Rod End	CV-ES-14163		for Steering Rod	
	19.372 FS,19.372 FLS,19.372 FLLS	02/90→05/95	Ball Head, gearshift linkage	CV-ES-2119		
		02/90→05/95	Ball Head, gearshift linkage	CV-ES-2120		
		02/90→05/95	Ball Head, gearshift linkage	CV-ES-2182		
02/90→05/95		Centre Rod	MN-DL-2160		Coupling Rod	
02/90→05/95		Centre Rod	MN-DL-2174		Push Rod	
02/90→05/95		Centre Rod	MN-DL-2175		Push Rod	
02/90→05/95		Centre Rod	MN-DL-3588		Push Rod	
02/90→05/95		Centre Rod	MN-DL-12421		for Steering Rod	
02/90→05/95		Engine Mounting		MN-SB-10390		
02/90→05/95		Engine Mounting	MN-SB-10389			

CV-ES-2119

Length: 55
Cone Ø: d1 Ø 10 / d2 Ø 10
Thread: M12 x 1,75 LHT
81953016063, 81953016131



CV-ES-2120

Length: 115
Cone Ø: d1 Ø 12,4 / d2 Ø 10,8
Thread: M14 x 1,5 RHT
03008500A, 81953016200, 81953016202,
81953016203, 81953016227



CV-ES-2149

Length: 160
Cone Ø: d1 Ø 30 / d2 Ø 27
Thread: M30 x 1,5 RHT
81953016263



CV-ES-2182

Length: 55
Cone Ø: d1 Ø 10 / d2 Ø 10
Thread: M12 x 1,75 RHT
81953016064, 81953016170



CV-ES-14162

Length: 125
Cone Ø: d1 Ø 30 / d2 Ø 27
Thread: M30 x 1,5 LHT
81953010015, 81953010083, 81953010087,
81953016029, 81953016030, 81953016043,
81953016044, 81953016050, 81953016054,
81953016087, 81953016091, 81953016107,
81953016120, 81953016125, 81953016152,
81953016155, 81953016157, 81953016168,
81953016179, 81953016181, 81953016223,
81953016237, 81953016254, 81953016275,
81953016279, 81953016351



CV-ES-14163

Length: 125
Cone Ø: d1 Ø 30 / d2 Ø 27
Thread: M30 x 1,5 RHT
95301.0084, 90804102156, 90804102272,
90804102696, 90804102710, 81953010016,
81953010075, 81953010084, 81953010088,
81953010094, 81953010103, 81953016030,
81953016043, 81953016048, 81953016049,
81953016053, 81953016061, 81953016090,
81953016108, 81953016112, 81953016126,
81953016143, 81953016149, 81953016154,
81953016156, 81953016168, 81953016178,
81953016194, 81953016206, 81953016224,
81953016234, 81953016242, 81953016252,
81953016274, 81953016278, 81953016284,
81953016286, 81953016308, 81953016310,
81953016312, 81953016347, 81953016350,
81953016352, 82953016012, 88953016014,
N2953016001



MN-DL-2160

Length: 1652 Ø: 50
Cone Ø: d1 Ø 30 / d2 Ø 27
81467106112, 81467106163, 81467106165,
81467106198, 81467106353, 81467106354,
81467106361, 81467116725



MN-DL-2174

Length: 1588 Ø: 52
Cone Ø: d1 Ø 30 / d2 Ø 27
81467106378, 81467106912



MN-DL-2175

Length: 1628
Ø: 50
Cone Ø: d1 Ø 30 / d2 Ø 27
81467106396, 81467106904



MN-DL-3588

Length: 1035
Ø: 48
Cone Ø: d1 Ø 30 / d2 Ø 27
81466106333, 81466106334, 81466106354,
81466106355, 81466106360, 81466106361,
81466106721, 81466106722, 81466106723,
81466116216



MN-DL-12284

Length: 1530 Ø: 50
Cone Ø: d1 Ø 30 / d2 Ø 27
81466106579, 81466106580, 81466106624,
81466116720, 81467116730, 81467116952



MN-DL-12421

Length: 1070
Ø: 48
Cone Ø: d1 Ø 30 / d2 Ø 27
Thread: M30 x 1,5 RHT
81466106656, 81466106659, 81466106669,
81466116006, 81466116007



MN-RK-7280

Ø: 75
Hole Distance: 115
Thick/Height: 24
0550806, 0639370, 689748, 10307400A,
81432306051, 81432306068, 81432706064



MN-SB-5246

Ø: 45 Thick/Height: 47
81437220022, 81437220038, 81962100450,
81962100469



MN-SB-5254

Length: 100
Ø: 93
Thick/Height: 70
81432710081



MN-SB-5265

Ø: 85
Thick/Height: 80
03310300A, 81437040032



MN-SB-9396

Ø: 67
Thick/Height: 60
81437040057



MN-SB-10389

Ø: 70
Thick/Height: 72
81960200340



MN-SB-10390

Ø: 70
Thick/Height: 85/85
81960200341, 81960200373, 81960200385,
81960200408, 81960200418





F 90 ...

19.372 FS, 19.372 FLS, 19.372 FLLS ...	02/90 → 05/95	Mounting, stabilizer coupling rod	MN-SB-5246			
	02/90 → 05/95	Mounting, stabilizer coupling rod	MN-SB-5246		1st FA	
	02/90 → 05/95	Stabiliser Mounting		MN-SB-5265		
	02/90 → 05/95	Stabiliser Mounting		MN-SB-5265	1st RA	
	02/90 → 05/95	Suspension Arm Repair Kit		CV-RK-5313	for Wishbone (CV)	
	02/90 → 05/95	Suspension Arm Repair Kit		CV-RK-8118	for Control Arm	
	02/90 → 05/95	Suspension Arm Repair Kit		MN-RK-7280	for Drag Link	
	02/90 → 05/95	Suspension Arm Repair Kit		MN-RK-7287	for Wishbone (CV)	
	02/90 → 05/95	Suspension Arm Repair Kit		MN-RK-7291	for Drag Link	
	02/90 → 05/95	Tie Rod	MN-DL-12284			
	02/90 → 05/95	Tie Rod End	CV-ES-2149		for Push Rod	
	02/90 → 05/95	Tie Rod End	CV-ES-14162		for Steering Rod	
	02/90 → 05/95	Tie Rod End	CV-ES-14163		for Steering Rod	
	02/90 → 05/95	Track Control Arm		MN-DL-5212	Trailing Arm, Air Suspension Axle	
	02/90 → 05/95	Track Control Arm		MN-VB-5222	Wishbone (CV), Air Suspension Axle	
19.402 F, 19.402 FL, 19.402 FLL	05/94 → 05/95	Ball Head, gearshift linkage	CV-ES-2119			
	05/94 → 05/95	Ball Head, gearshift linkage	CV-ES-2120			
	05/94 → 05/95	Ball Head, gearshift linkage	CV-ES-2182			
	05/94 → 05/95	Centre Rod	MN-DL-2160		Coupling Rod	
	05/94 → 05/95	Centre Rod	MN-DL-2174		Push Rod	
	05/94 → 05/95	Centre Rod	MN-DL-2175		Push Rod	
	05/94 → 05/95	Centre Rod	MN-DL-3588		Push Rod	
	05/94 → 05/95	Centre Rod	MN-DL-12421		for Steering Rod	
	05/94 → 05/95	Engine Mounting		MN-SB-10390		
	05/94 → 05/95	Engine Mounting	MN-SB-10389			
	05/94 → 05/95	Mounting, stabilizer coupling rod	MN-SB-5246			
	05/94 → 05/95	Mounting, stabilizer coupling rod	MN-SB-5246		1st FA	
	05/94 → 05/95	Stabiliser Mounting		MN-SB-5265		
	05/94 → 05/95	Stabiliser Mounting		MN-SB-5265	1st RA	
	05/94 → 05/95	Suspension Arm Repair Kit		CV-RK-5313	for Wishbone (CV)	
	05/94 → 05/95	Suspension Arm Repair Kit		CV-RK-8118	for Control Arm	
	05/94 → 05/95	Suspension Arm Repair Kit		MN-RK-7280	for Drag Link	
	05/94 → 05/95	Suspension Arm Repair Kit		MN-RK-7287	for Wishbone (CV)	
	05/94 → 05/95	Suspension Arm Repair Kit		MN-RK-7291	for Drag Link	
	05/94 → 05/95	Tie Rod	MN-DL-12284			
	05/94 → 05/95	Tie Rod End	CV-ES-2149		for Push Rod	
	05/94 → 05/95	Tie Rod End	CV-ES-14162		for Steering Rod	
	05/94 → 05/95	Tie Rod End	CV-ES-14163		for Steering Rod	
	05/94 → 05/95	Track Control Arm		MN-DL-5212	Trailing Arm, Air Suspension Axle	
	05/94 → 05/95	Track Control Arm		MN-VB-5222	Wishbone (CV), Air Suspension Axle	
19.402 FA	05/94 → 06/96	Ball Head, gearshift linkage	CV-ES-2119			
	05/94 → 06/96	Ball Head, gearshift linkage	CV-ES-2120			
	05/94 → 06/96	Ball Head, gearshift linkage	CV-ES-2182			
	05/94 → 06/96	Centre Rod	MN-DL-2160		Coupling Rod	
	05/94 → 06/96	Centre Rod	MN-DL-2174		Push Rod	
	05/94 → 06/96	Centre Rod	MN-DL-2175		Push Rod	
	05/94 → 06/96	Centre Rod	MN-DL-3588		Push Rod	
	05/94 → 06/96	Centre Rod	MN-DL-12421		for Steering Rod	
	05/94 → 06/96	Engine Mounting	MN-SB-10389			
	05/94 → 06/96	Mounting, stabilizer coupling rod	MN-SB-5246			
	05/94 → 06/96	Mounting, stabilizer coupling rod	MN-SB-5246		1st FA	
	05/94 → 06/96	Stabiliser Mounting		MN-SB-5254		
	05/94 → 06/96	Stabiliser Mounting		MN-SB-5265		
	05/94 → 06/96	Stabiliser Mounting	MN-SB-9396			
	05/94 → 06/96	Suspension Arm Repair Kit		MN-RK-7280	for Drag Link	
	05/94 → 06/96	Tie Rod End	CV-ES-2149		for Push Rod	
	05/94 → 06/96	Tie Rod End	CV-ES-14162		for Steering Rod	
	05/94 → 06/96	Tie Rod End	CV-ES-14163		for Steering Rod	
	19.402 FAK	05/94 → 06/96	Ball Head, gearshift linkage	CV-ES-2119		
		05/94 → 06/96	Ball Head, gearshift linkage	CV-ES-2120		
		05/94 → 06/96	Ball Head, gearshift linkage	CV-ES-2182		
		05/94 → 06/96	Centre Rod	MN-DL-2160		Coupling Rod
		05/94 → 06/96	Centre Rod	MN-DL-2174		Push Rod

CV-ES-2119

Length: 55
 Cone Ø: d1 Ø 10 / d2 Ø 10
 Thread: M12 x 1,75 LHT
 81953016063, 81953016131



CV-ES-2120

Length: 115
 Cone Ø: d1 Ø 12,4 / d2 Ø 10,8
 Thread: M14 x 1,5 RHT
 03008500A, 81953016200, 81953016202,
 81953016203, 81953016227



CV-ES-2149

Length: 160
 Cone Ø: d1 Ø 30 / d2 Ø 27
 Thread: M30 x 1,5 RHT
 81953016263



CV-ES-2182

Length: 55
 Cone Ø: d1 Ø 10 / d2 Ø 10
 Thread: M12 x 1,75 RHT
 81953016064, 81953016170



CV-ES-14162

Length: 125
 Cone Ø: d1 Ø 30 / d2 Ø 27
 Thread: M30 x 1,5 LHT
 81953010015, 81953010083, 81953010087,
 81953016029, 81953016030, 81953016043,
 81953016044, 81953016050, 81953016054,
 81953016087, 81953016091, 81953016107,
 81953016120, 81953016125, 81953016152,
 81953016155, 81953016157, 81953016168,
 81953016179, 81953016181, 81953016223,
 81953016237, 81953016254, 81953016275,
 81953016279, 81953016351



CV-ES-14163

Length: 125
 Cone Ø: d1 Ø 30 / d2 Ø 27
 Thread: M30 x 1,5 RHT
 95301.0084, 90804102156, 90804102272,
 90804102696, 90804102710, 81953010016,
 81953010075, 81953010084, 81953010088,
 81953010094, 81953010103, 81953016030,
 81953016043, 81953016048, 81953016049,
 81953016053, 81953016061, 81953016090,
 81953016108, 81953016112, 81953016126,
 81953016143, 81953016149, 81953016154,
 81953016156, 81953016168, 81953016178,
 81953016194, 81953016206, 81953016224,
 81953016234, 81953016242, 81953016252,
 81953016274, 81953016278, 81953016284,
 81953016286, 81953016308, 81953016310,
 81953016312, 81953016347, 81953016350,
 81953016352, 82953016012, 88953016014,
 N2953016001



CV-RK-5313

Ø: 90
 03304800A, 81953016132



CV-RK-8118

Ø: 85
 Hole Distance: 130
 Thick/Height: 30
 638862, 639287, 775201, 938423,
 1104335, 1953248, 0003500506, 3500506,
 11013547, 21032592, 42065912, 42488272,
 070550504, 93192618, 070400009000,
 634303610, 81432206055, 81432206073,
 82262320660, 9544171010099,
 5001842823, 7000307001, 8226232066



MN-DL-2160

Length: 1652 Ø: 50
 Cone Ø: d1 Ø 30 / d2 Ø 27
 81467106112, 81467106163, 81467106165,
 81467106198, 81467106353, 81467106354,
 81467106361, 81467116725



MN-DL-2174

Length: 1588 Ø: 52
 Cone Ø: d1 Ø 30 / d2 Ø 27
 81467106378, 81467106912



MN-DL-2175

Length: 1628 Ø: 50
 Cone Ø: d1 Ø 30 / d2 Ø 27
 81467106396, 81467106904



MN-DL-3588

Length: 1035 Ø: 48
 Cone Ø: d1 Ø 30 / d2 Ø 27
 81466106333, 81466106334, 81466106354,
 81466106355, 81466106360, 81466106361,
 81466106721, 81466106722, 81466106723,
 81466116216



MN-DL-5212

Length: 577 Ø: 48
 Hole Distance: 130 / 130
 81432206096, 81432206097, 81432206098,
 81432206129, 81432209096, 81432209129,
 81432306014, 81432306030



MN-DL-12284

Length: 1530 Ø: 50
 Cone Ø: d1 Ø 30 / d2 Ø 27
 81466106579, 81466106580, 81466106624,
 81466116720, 81467116720, 81467116730,
 81467116952



MN-DL-12421

Length: 1070 Ø: 48
 Cone Ø: d1 Ø 30 / d2 Ø 27
 Thread: M30 x 1,5 RHT
 81466106656, 81466106659, 81466106669,
 81466116006, 81466116007



MN-RK-7280

Ø: 75
 Hole Distance: 115
 Thick/Height: 24
 0550806, 0639370, 689748, 10307400A,
 81432306051, 81432306068, 81432706064



MN-RK-7287

Ø: 90
 Hole Distance: 152
 Thick/Height: 35
 03304700A, 81953016133



MN-RK-7291

Ø: 72
 Hole Distance: 130
 Thick/Height: 30
 10307800A, 81432206108, 81432206132



MN-SB-5246

Ø: 45 Thick/Height: 47
 81437220022, 81437220038, 81962100450,
 81962100469



MN-SB-5254

Length: 100 Ø: 93
 Thick/Height: 70
 81432710081



MN-SB-5265

Ø: 85 Thick/Height: 80
 03310300A, 81437040032



MN-SB-9396

Ø: 67 Thick/Height: 60
 81437040057



MN-SB-10389

Ø: 70 Thick/Height: 72
 81960200340



MN-SB-10390

Ø: 70 Thick/Height: 85/85
 81960200341, 81960200373, 81960200385,
 81960200408, 81960200418



MN-VB-5222

Length: 627 Ø: 50
 Hole Distance: 152 / 152
 81432706030, 81432706034, 81432706054,
 81432706055, 81432706056, 81432706057,
 81432706067, 81432706068, 81432706074,
 81432706075, 81432706076, 81432706077,
 81432706078, 81432706081, 81432706082,
 81432709034, 81432709076, 81432709078,
 8143706054





F 90 ...

19.402 FAK ...	05/94 → 06/96	Centre Rod	MN-DL-2175		Push Rod	
	05/94 → 06/96	Centre Rod	MN-DL-3588		Push Rod	
	05/94 → 06/96	Centre Rod	MN-DL-12421		for Steering Rod	
	05/94 → 06/96	Engine Mounting	MN-SB-10389			
	05/94 → 06/96	Mounting, stabilizer coupling rod	MN-SB-5246			
	05/94 → 06/96	Mounting, stabilizer coupling rod	MN-SB-5246		1st FA	
	05/94 → 06/96	Stabiliser Mounting		MN-SB-5254		
	05/94 → 06/96	Stabiliser Mounting		MN-SB-5265		
	05/94 → 06/96	Stabiliser Mounting	MN-SB-9396			
	05/94 → 06/96	Suspension Arm Repair Kit		MN-RK-7280	for Drag Link	
	05/94 → 06/96	Tie Rod End	CV-ES-2149		for Push Rod	
	05/94 → 06/96	Tie Rod End	CV-ES-14162		for Steering Rod	
	05/94 → 06/96	Tie Rod End	CV-ES-14163		for Steering Rod	
	19.402 FAS	05/94 → 06/96	Ball Head, gearshift linkage	CV-ES-2119		
		05/94 → 06/96	Ball Head, gearshift linkage	CV-ES-2120		
05/94 → 06/96		Ball Head, gearshift linkage	CV-ES-2182			
05/94 → 06/96		Centre Rod	MN-DL-2160		Coupling Rod	
05/94 → 06/96		Centre Rod	MN-DL-2174		Push Rod	
05/94 → 06/96		Centre Rod	MN-DL-2175		Push Rod	
05/94 → 06/96		Centre Rod	MN-DL-3588		Push Rod	
05/94 → 06/96		Centre Rod	MN-DL-12421		for Steering Rod	
05/94 → 06/96		Engine Mounting	MN-SB-10389			
05/94 → 06/96		Mounting, stabilizer coupling rod	MN-SB-5246			
05/94 → 06/96		Mounting, stabilizer coupling rod	MN-SB-5246		1st FA	
05/94 → 06/96		Stabiliser Mounting		MN-SB-5254		
05/94 → 06/96		Stabiliser Mounting		MN-SB-5265		
05/94 → 06/96		Stabiliser Mounting	MN-SB-9396			
05/94 → 06/96		Suspension Arm Repair Kit		MN-RK-7280	for Drag Link	
05/94 → 06/96		Tie Rod End	CV-ES-2149		for Push Rod	
05/94 → 06/96		Tie Rod End	CV-ES-14162		for Steering Rod	
05/94 → 06/96		Tie Rod End	CV-ES-14163		for Steering Rod	
19.402 FK	05/94 → 05/95	Ball Head, gearshift linkage	CV-ES-2119			
	05/94 → 05/95	Ball Head, gearshift linkage	CV-ES-2120			
	05/94 → 05/95	Ball Head, gearshift linkage	CV-ES-2182			
	05/94 → 05/95	Centre Rod	MN-DL-2160		Coupling Rod	
	05/94 → 05/95	Centre Rod	MN-DL-2174		Push Rod	
	05/94 → 05/95	Centre Rod	MN-DL-2175		Push Rod	
	05/94 → 05/95	Centre Rod	MN-DL-3588		Push Rod	
	05/94 → 05/95	Centre Rod	MN-DL-12421		for Steering Rod	
	05/94 → 05/95	Engine Mounting		MN-SB-10390		
	05/94 → 05/95	Engine Mounting	MN-SB-10389			
	05/94 → 05/95	Mounting, stabilizer coupling rod	MN-SB-5246			
	05/94 → 05/95	Mounting, stabilizer coupling rod	MN-SB-5246		1st FA	
	05/94 → 05/95	Suspension Arm Repair Kit		MN-RK-7280	for Drag Link	
	05/94 → 05/95	Tie Rod	MN-DL-12284			
	05/94 → 05/95	Tie Rod End	CV-ES-2149		for Push Rod	
	05/94 → 05/95	Tie Rod End	CV-ES-14162		for Steering Rod	
	05/94 → 05/95	Tie Rod End	CV-ES-14163		for Steering Rod	
	19.402 FS, 19.402 FLS, 19.402 FLLS	05/94 → 05/95	Ball Head, gearshift linkage	CV-ES-2119		
05/94 → 05/95		Ball Head, gearshift linkage	CV-ES-2120			
05/94 → 05/95		Ball Head, gearshift linkage	CV-ES-2182			
05/94 → 05/95		Centre Rod	MN-DL-2160		Coupling Rod	
05/94 → 05/95		Centre Rod	MN-DL-2174		Push Rod	
05/94 → 05/95		Centre Rod	MN-DL-2175		Push Rod	
05/94 → 05/95		Centre Rod	MN-DL-3588		Push Rod	
05/94 → 05/95		Centre Rod	MN-DL-12421		for Steering Rod	
05/94 → 05/95		Engine Mounting		MN-SB-10390		
05/94 → 05/95		Engine Mounting	MN-SB-10389			
05/94 → 05/95		Mounting, stabilizer coupling rod	MN-SB-5246			
05/94 → 05/95		Mounting, stabilizer coupling rod	MN-SB-5246		1st FA	
05/94 → 05/95		Stabiliser Mounting		MN-SB-5265		
05/94 → 05/95		Stabiliser Mounting		MN-SB-5265	1st RA	
05/94 → 05/95		Suspension Arm Repair Kit		CV-RK-5313	for Wishbone (CV)	

CV-ES-2119

Length: 55
Cone Ø: d1 Ø 10 / d2 Ø 10
Thread: M12 x 1,75 LHT
81953016063, 81953016131



CV-ES-2120

Length: 115
Cone Ø: d1 Ø 12,4 / d2 Ø 10,8
Thread: M14 x 1,5 RHT
03008500A, 81953016200, 81953016202,
81953016203, 81953016227



CV-ES-2149

Length: 160
Cone Ø: d1 Ø 30 / d2 Ø 27
Thread: M30 x 1,5 RHT
81953016263



CV-ES-2182

Length: 55
Cone Ø: d1 Ø 10 / d2 Ø 10
Thread: M12 x 1,75 RHT
81953016064, 81953016170



CV-ES-14162

Length: 125
Cone Ø: d1 Ø 30 / d2 Ø 27
Thread: M30 x 1,5 LHT
81953010015, 81953010083, 81953010087,
81953016029, 81953016030, 81953016043,
81953016044, 81953016050, 81953016054,
81953016087, 81953016091, 81953016107,
81953016120, 81953016125, 81953016152,
81953016155, 81953016157, 81953016168,
81953016179, 81953016181, 81953016223,
81953016237, 81953016254, 81953016275,
81953016279, 81953016351



CV-ES-14163

Length: 125
Cone Ø: d1 Ø 30 / d2 Ø 27
Thread: M30 x 1,5 RHT
95301.0084, 90804102156, 90804102272,
90804102696, 90804102710, 81953010016,
81953010075, 81953010084, 81953010088,
81953010094, 81953010103, 81953016030,
81953016043, 81953016048, 81953016049,
81953016053, 81953016061, 81953016090,
81953016108, 81953016112, 81953016126,
81953016143, 81953016149, 81953016154,
81953016156, 81953016168, 81953016178,
81953016194, 81953016206, 81953016224,
81953016234, 81953016242, 81953016252,
81953016274, 81953016278, 81953016284,
81953016286, 81953016308, 81953016310,
81953016312, 81953016347, 81953016350,
81953016352, 82953016012, 88953016014,
N2953016001



CV-RK-5313

Ø: 90
03304800A, 81953016132



MN-DL-2160

Length: 1652 Ø: 50
Cone Ø: d1 Ø 30 / d2 Ø 27
81467106112, 81467106163, 81467106165,
81467106198, 81467106353, 81467106354,
81467106361, 81467116725



MN-DL-2174

Length: 1588 Ø: 52
Cone Ø: d1 Ø 30 / d2 Ø 27
81467106378, 81467106912



MN-DL-2175

Length: 1628
Ø: 50
Cone Ø: d1 Ø 30 / d2 Ø 27
81467106396, 81467106904



MN-DL-3588

Length: 1035
Ø: 48
Cone Ø: d1 Ø 30 / d2 Ø 27
81466106333, 81466106334, 81466106354,
81466106355, 81466106360, 81466106361,
81466106721, 81466106722, 81466106723,
81466116216



MN-DL-12284

Length: 1530 Ø: 50
Cone Ø: d1 Ø 30 / d2 Ø 27
81466106579, 81466106580, 81466106624,
81466116720, 81467116720, 81467116730,
81467116952



MN-DL-12421

Length: 1070
Ø: 48
Cone Ø: d1 Ø 30 / d2 Ø 27
Thread: M30 x 1,5 RHT
81466106656, 81466106659, 81466106669,
81466116006, 81466116007



MN-RK-7280

Ø: 75
Hole Distance: 115
Thick/Height: 24
0550806, 0639370, 689748, 10307400A,
81432306051, 81432306068, 81432706064



MN-SB-5246

Ø: 45 Thick/Height: 47
81437220022, 81437220038, 81962100450,
81962100469



MN-SB-5254

Length: 100
Ø: 93
Thick/Height: 70
81432710081



MN-SB-5265

Ø: 85
Thick/Height: 80
03310300A, 81437040032



MN-SB-9396

Ø: 67
Thick/Height: 60
81437040057



MN-SB-10389

Ø: 70
Thick/Height: 72
81960200340



MN-SB-10390

Ø: 70
Thick/Height: 85/85
81960200341, 81960200373, 81960200385,
81960200408, 81960200418



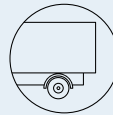

F 90 ...

19.402 FS,19.402 FLS, 19.402 FLLS ...	05/94 →05/95	Suspension Arm Repair Kit		CV-RK-8118	for Control Arm
	05/94 →05/95	Suspension Arm Repair Kit		MN-RK-7280	for Drag Link
	05/94 →05/95	Suspension Arm Repair Kit		MN-RK-7287	for Wishbone (CV)
	05/94 →05/95	Suspension Arm Repair Kit		MN-RK-7291	for Drag Link
	05/94 →05/95	Tie Rod	MN-DL-12284		
	05/94 →05/95	Tie Rod End	CV-ES-2149		for Push Rod
	05/94 →05/95	Tie Rod End	CV-ES-14162		for Steering Rod
	05/94 →05/95	Tie Rod End	CV-ES-14163		for Steering Rod
	05/94 →05/95	Track Control Arm		MN-DL-5212	Trailing Arm, Air Suspension Axle
	05/94 →05/95	Track Control Arm		MN-VB-5222	Wishbone (CV), Air Suspension Axle
19.422 F,19.422 FL,19.422 FLL	02/90 →05/95	Ball Head, gearshift linkage	CV-ES-2119		
	02/90 →05/95	Ball Head, gearshift linkage	CV-ES-2120		
	02/90 →05/95	Ball Head, gearshift linkage	CV-ES-2182		
	02/90 →05/95	Centre Rod	MN-DL-2160		Coupling Rod
	02/90 →05/95	Centre Rod	MN-DL-2174		Push Rod
	02/90 →05/95	Centre Rod	MN-DL-2175		Push Rod
	02/90 →05/95	Centre Rod	MN-DL-3588		Push Rod
	02/90 →05/95	Centre Rod	MN-DL-12421		for Steering Rod
	02/90 →05/95	Engine Mounting		MN-SB-10390	
	02/90 →05/95	Engine Mounting	MN-SB-10389		
	02/90 →05/95	Mounting, stabilizer coupling rod	MN-SB-5246		
	02/90 →05/95	Mounting, stabilizer coupling rod	MN-SB-5246		1st FA
	02/90 →05/95	Stabiliser Mounting		MN-SB-5243	
	02/90 →05/95	Stabiliser Mounting		MN-SB-5265	
	02/90 →05/95	Stabiliser Mounting		MN-SB-5265	1st RA
	02/90 →05/95	Suspension Arm Repair Kit		CV-RK-5313	for Wishbone (CV)
	02/90 →05/95	Suspension Arm Repair Kit		CV-RK-8118	for Control Arm
	02/90 →05/95	Suspension Arm Repair Kit		MN-RK-7280	for Drag Link
	02/90 →05/95	Suspension Arm Repair Kit		MN-RK-7287	for Wishbone (CV)
	02/90 →05/95	Suspension Arm Repair Kit		MN-RK-7291	for Drag Link
	02/90 →05/95	Tie Rod	MN-DL-12284		
	02/90 →05/95	Tie Rod End	CV-ES-2149		for Push Rod
	02/90 →05/95	Tie Rod End	CV-ES-14162		for Steering Rod
	02/90 →05/95	Tie Rod End	CV-ES-14163		for Steering Rod
	02/90 →05/95	Track Control Arm		MN-DL-5212	Trailing Arm, Air Suspension Axle
	02/90 →05/95	Track Control Arm		MN-VB-5222	Wishbone (CV)
19.422 FA	02/90 →06/96	Ball Head, gearshift linkage	CV-ES-2119		
	02/90 →06/96	Ball Head, gearshift linkage	CV-ES-2120		
	02/90 →06/96	Ball Head, gearshift linkage	CV-ES-2182		
	02/90 →06/96	Centre Rod	MN-DL-2160		Coupling Rod
	02/90 →06/96	Centre Rod	MN-DL-2174		Push Rod
	02/90 →06/96	Centre Rod	MN-DL-2175		Push Rod
	02/90 →06/96	Centre Rod	MN-DL-3588		Push Rod
	02/90 →06/96	Centre Rod	MN-DL-12421		for Steering Rod
	02/90 →06/96	Engine Mounting	MN-SB-10389		
	02/90 →06/96	Mounting, stabilizer coupling rod	MN-SB-5246		
	02/90 →06/96	Mounting, stabilizer coupling rod	MN-SB-5246		1st FA
	02/90 →06/96	Stabiliser Mounting		MN-SB-5254	
	02/90 →06/96	Stabiliser Mounting		MN-SB-5265	
	02/90 →06/96	Stabiliser Mounting	MN-SB-9396		
	02/90 →06/96	Suspension Arm Repair Kit		MN-RK-7280	for Drag Link
	02/90 →06/96	Tie Rod End	CV-ES-2149		for Push Rod
	02/90 →06/96	Tie Rod End	CV-ES-14162		for Steering Rod
	02/90 →06/96	Tie Rod End	CV-ES-14163		for Steering Rod
19.422 FAK	02/90 →06/96	Ball Head, gearshift linkage	CV-ES-2119		
	02/90 →06/96	Ball Head, gearshift linkage	CV-ES-2120		
	02/90 →06/96	Ball Head, gearshift linkage	CV-ES-2182		
	02/90 →06/96	Centre Rod	MN-DL-2160		Coupling Rod
	02/90 →06/96	Centre Rod	MN-DL-2174		Push Rod
	02/90 →06/96	Centre Rod	MN-DL-2175		Push Rod
	02/90 →06/96	Centre Rod	MN-DL-3588		Push Rod
	02/90 →06/96	Centre Rod	MN-DL-12421		for Steering Rod
	02/90 →06/96	Engine Mounting	MN-SB-10389		

CV-ES-2119

Length: 55
Cone Ø: d1 Ø 10 / d2 Ø 10
Thread: M12 x 1,75 LHT
81953016063, 81953016131



CV-ES-2120

Length: 115
Cone Ø: d1 Ø 12,4 / d2 Ø 10,8
Thread: M14 x 1,5 RHT
03008500A, 81953016200, 81953016202,
81953016203, 81953016227



CV-ES-2149

Length: 160
Cone Ø: d1 Ø 30 / d2 Ø 27
Thread: M30 x 1,5 RHT
81953016263



CV-ES-2182

Length: 55
Cone Ø: d1 Ø 10 / d2 Ø 10
Thread: M12 x 1,75 RHT
81953016064, 81953016170



CV-ES-14162

Length: 125
Cone Ø: d1 Ø 30 / d2 Ø 27
Thread: M30 x 1,5 LHT
81953010015, 81953010083, 81953010087,
81953016029, 81953016030, 81953016043,
81953016044, 81953016050, 81953016054,
81953016087, 81953016091, 81953016107,
81953016120, 81953016125, 81953016152,
81953016155, 81953016157, 81953016168,
81953016179, 81953016181, 81953016223,
81953016237, 81953016254, 81953016275,
81953016279, 81953016351



CV-ES-14163

Length: 125
Cone Ø: d1 Ø 30 / d2 Ø 27
Thread: M30 x 1,5 RHT
95301.0084, 90804102156, 90804102272,
90804102696, 90804102710, 81953010016,
81953010075, 81953010084, 81953010088,
81953010094, 81953010103, 81953016030,
81953016043, 81953016048, 81953016049,
81953016053, 81953016061, 81953016090,
81953016108, 81953016112, 81953016126,
81953016143, 81953016149, 81953016154,
81953016156, 81953016168, 81953016178,
81953016194, 81953016206, 81953016224,
81953016234, 81953016242, 81953016252,
81953016274, 81953016278, 81953016284,
81953016286, 81953016308, 81953016310,
81953016312, 81953016347, 81953016350,
81953016352, 82953016012, 88953016014,
N2953016001



CV-RK-5313

Ø: 90
03304800A, 81953016132



CV-RK-8118

Ø: 85
Hole Distance: 130
Thick/Height: 30
638862, 639287, 775201, 938423,
1104335, 1953248, 0003500506, 3500506,
11013547, 21032592, 42065912, 42488722,
070550504, 93192618, 070400009000,
634303610, 81432206055, 81432206073,
82262320660, 9544171010099,
5001842823, 7000307001, 8226232066



MN-DL-2160

Length: 1652 Ø: 50
Cone Ø: d1 Ø 30 / d2 Ø 27
81467106112, 81467106163, 81467106165,
81467106198, 81467106353, 81467106354,
81467106361, 81467116725



MN-DL-2174

Length: 1588 Ø: 52
Cone Ø: d1 Ø 30 / d2 Ø 27
81467106378, 81467106912



MN-DL-2175

Length: 1628 Ø: 50
Cone Ø: d1 Ø 30 / d2 Ø 27
81467106396, 81467106904



MN-DL-3588

Length: 1035 Ø: 48
Cone Ø: d1 Ø 30 / d2 Ø 27
81466106333, 81466106334, 81466106354,
81466106355, 81466106360, 81466106361,
81466106721, 81466106722, 81466106723,
81466116216



MN-DL-5212

Length: 577 Ø: 48
Hole Distance: 130 / 130
81432206096, 81432206097, 81432206098,
81432206129, 81432209096, 81432209129,
81432306014, 81432306030



MN-DL-12284

Length: 1530 Ø: 50
Cone Ø: d1 Ø 30 / d2 Ø 27
81466106579, 81466106580, 81466106624,
81466116720, 81467116720, 81467116730,
81467116952



MN-DL-12421

Length: 1070 Ø: 48
Cone Ø: d1 Ø 30 / d2 Ø 27
Thread: M30 x 1,5 RHT
81466106656, 81466106659, 81466106669,
81466116006, 81466116007



MN-RK-7280

Ø: 75
Hole Distance: 115
Thick/Height: 24
0550806, 0639370, 689748, 10307400A,
81432306051, 81432306068, 81432706064



MN-RK-7287

Ø: 90
Hole Distance: 152
Thick/Height: 35
03304700A, 81953016133



MN-RK-7291

Ø: 72
Hole Distance: 130
Thick/Height: 30
10307800A, 81432206108, 81432206132



MN-SB-5243

Length: 55 Ø: 78
Thick/Height: 60
03311100A, 81437040061, 81437220020



MN-SB-5246

Ø: 45 Thick/Height: 47
81437220022, 81437220038, 81962100450,
81962100469



MN-SB-5254

Length: 100 Ø: 93
Thick/Height: 70
81432710081



MN-SB-5265

Ø: 85 Thick/Height: 80
03310300A, 81437040032



MN-SB-9396

Ø: 67 Thick/Height: 60
81437040057



MN-SB-10389

Ø: 70 Thick/Height: 72
81960200340



MN-SB-10390

Ø: 70 Thick/Height: 85/85
81960200341, 81960200373, 81960200385,
81960200408, 81960200418



MN-VB-5222

Length: 627 Ø: 50
Hole Distance: 152 / 152
81432706030, 81432706034, 81432706054,
81432706055, 81432706056, 81432706057,
81432706067, 81432706068, 81432706074,
81432706075, 81432706076, 81432706077,
81432706078, 81432706081, 81432706082,
81432709034, 81432709076, 81432709078,
8143706054





F 90 ...

19.422 FAK ...	02/90→06/96	Mounting, stabilizer coupling rod	MN-SB-5246			
	02/90→06/96	Mounting, stabilizer coupling rod	MN-SB-5246		1st FA	
	02/90→06/96	Stabiliser Mounting		MN-SB-5254		
	02/90→06/96	Stabiliser Mounting		MN-SB-5265		
	02/90→06/96	Stabiliser Mounting	MN-SB-9396			
	02/90→06/96	Suspension Arm Repair Kit		MN-RK-7280	for Drag Link	
	02/90→06/96	Tie Rod End	CV-ES-2149		for Push Rod	
	02/90→06/96	Tie Rod End	CV-ES-14162		for Steering Rod	
	02/90→06/96	Tie Rod End	CV-ES-14163		for Steering Rod	
	19.422 FAS	02/90→06/96	Ball Head, gearshift linkage	CV-ES-2119		
		02/90→06/96	Ball Head, gearshift linkage	CV-ES-2120		
		02/90→06/96	Ball Head, gearshift linkage	CV-ES-2182		
		02/90→06/96	Centre Rod	MN-DL-2160		Coupling Rod
02/90→06/96		Centre Rod	MN-DL-2174		Push Rod	
02/90→06/96		Centre Rod	MN-DL-2175		Push Rod	
02/90→06/96		Centre Rod	MN-DL-3588		Push Rod	
02/90→06/96		Centre Rod	MN-DL-12421		for Steering Rod	
02/90→06/96		Engine Mounting	MN-SB-10389			
02/90→06/96		Mounting, stabilizer coupling rod	MN-SB-5246			
02/90→06/96		Mounting, stabilizer coupling rod	MN-SB-5246		1st FA	
02/90→06/96		Stabiliser Mounting		MN-SB-5254		
02/90→06/96		Stabiliser Mounting		MN-SB-5265		
02/90→06/96		Stabiliser Mounting	MN-SB-9396			
02/90→06/96		Suspension Arm Repair Kit		MN-RK-7280	for Drag Link	
02/90→06/96		Tie Rod End	CV-ES-2149		for Push Rod	
02/90→06/96		Tie Rod End	CV-ES-14162		for Steering Rod	
02/90→06/96		Tie Rod End	CV-ES-14163		for Steering Rod	
19.422 FK		02/90→05/95	Ball Head, gearshift linkage	CV-ES-2119		
		02/90→05/95	Ball Head, gearshift linkage	CV-ES-2120		
	02/90→05/95	Ball Head, gearshift linkage	CV-ES-2182			
	02/90→05/95	Centre Rod	MN-DL-2160		Coupling Rod	
	02/90→05/95	Centre Rod	MN-DL-2174		Push Rod	
	02/90→05/95	Centre Rod	MN-DL-2175		Push Rod	
	02/90→05/95	Centre Rod	MN-DL-3588		Push Rod	
	02/90→05/95	Centre Rod	MN-DL-12421		for Steering Rod	
	02/90→05/95	Engine Mounting		MN-SB-10390		
	02/90→05/95	Engine Mounting	MN-SB-10389			
	02/90→05/95	Mounting, stabilizer coupling rod	MN-SB-5246			
	02/90→05/95	Mounting, stabilizer coupling rod	MN-SB-5246		1st FA	
	02/90→05/95	Suspension Arm Repair Kit		MN-RK-7280	for Drag Link	
	02/90→05/95	Tie Rod	MN-DL-12284			
	02/90→05/95	Tie Rod End	CV-ES-2149		for Push Rod	
	02/90→05/95	Tie Rod End	CV-ES-14162		for Steering Rod	
	02/90→05/95	Tie Rod End	CV-ES-14163		for Steering Rod	
	19.422 FS,19.422 FLS,19.422 FLLS	02/90→05/95	Ball Head, gearshift linkage	CV-ES-2119		
		02/90→05/95	Ball Head, gearshift linkage	CV-ES-2120		
		02/90→05/95	Ball Head, gearshift linkage	CV-ES-2182		
02/90→05/95		Centre Rod	MN-DL-2160		Coupling Rod	
02/90→05/95		Centre Rod	MN-DL-2174		Push Rod	
02/90→05/95		Centre Rod	MN-DL-2175		Push Rod	
02/90→05/95		Centre Rod	MN-DL-3588		Push Rod	
02/90→05/95		Centre Rod	MN-DL-12421		for Steering Rod	
02/90→05/95		Engine Mounting		MN-SB-10390		
02/90→05/95		Engine Mounting	MN-SB-10389			
02/90→05/95		Mounting, stabilizer coupling rod	MN-SB-5246			
02/90→05/95		Mounting, stabilizer coupling rod	MN-SB-5246		1st FA	
02/90→05/95		Stabiliser Mounting		MN-SB-5265		
02/90→05/95		Stabiliser Mounting		MN-SB-5265	1st RA	
02/90→05/95		Suspension Arm Repair Kit		CV-RK-5313	for Wishbone (CV)	
02/90→05/95		Suspension Arm Repair Kit		CV-RK-8118	for Control Arm	
02/90→05/95		Suspension Arm Repair Kit		MN-RK-7280	for Drag Link	
02/90→05/95		Suspension Arm Repair Kit		MN-RK-7287	for Wishbone (CV)	
02/90→05/95		Suspension Arm Repair Kit		MN-RK-7291	for Drag Link	

CV-ES-2119

Length: 55
Cone Ø: d1 Ø 10 / d2 Ø 10
Thread: M12 x 1,75 LHT
81953016063, 81953016131



CV-ES-2120

Length: 115
Cone Ø: d1 Ø 12,4 / d2 Ø 10,8
Thread: M14 x 1,5 RHT
03008500A, 81953016200, 81953016202,
81953016203, 81953016227



CV-ES-2149

Length: 160
Cone Ø: d1 Ø 30 / d2 Ø 27
Thread: M30 x 1,5 RHT
81953016263



CV-ES-2182

Length: 55
Cone Ø: d1 Ø 10 / d2 Ø 10
Thread: M12 x 1,75 RHT
81953016064, 81953016170



CV-ES-14162

Length: 125
Cone Ø: d1 Ø 30 / d2 Ø 27
Thread: M30 x 1,5 LHT
81953010015, 81953010083, 81953010087,
81953016029, 81953016030, 81953016043,
81953016044, 81953016050, 81953016054,
81953016087, 81953016091, 81953016107,
81953016120, 81953016125, 81953016152,
81953016155, 81953016157, 81953016168,
81953016179, 81953016181, 81953016223,
81953016237, 81953016254, 81953016275,
81953016279, 81953016351



CV-ES-14163

Length: 125
Cone Ø: d1 Ø 30 / d2 Ø 27
Thread: M30 x 1,5 RHT
95301.0084, 90804102156, 90804102272,
90804102696, 90804102710, 81953010016,
81953010075, 81953010084, 81953010088,
81953010094, 81953010103, 81953016030,
81953016043, 81953016048, 81953016049,
81953016053, 81953016061, 81953016090,
81953016108, 81953016112, 81953016126,
81953016143, 81953016149, 81953016154,
81953016156, 81953016168, 81953016178,
81953016194, 81953016206, 81953016224,
81953016234, 81953016242, 81953016252,
81953016274, 81953016278, 81953016284,
81953016286, 81953016308, 81953016310,
81953016312, 81953016347, 81953016350,
81953016352, 82953016012, 88953016014,
N2953016001



CV-RK-5313

Ø: 90
03304800A, 81953016132



CV-RK-8118

Ø: 85
Hole Distance: 130
Thick/Height: 30
638862, 639287, 775201, 938423,
1104335, 1953248, 0003500506, 3500506,
11013547, 21032592, 42065912, 42488722,
070550504, 93192618, 070400009000,
634303610, 81432206055, 81432206073,
82262320660, 9544171010099,
5001842823, 7000307001, 8226232066



MN-DL-2160

Length: 1652 Ø: 50
Cone Ø: d1 Ø 30 / d2 Ø 27
81467106112, 81467106163, 81467106165,
81467106198, 81467106353, 81467106354,
81467106361, 81467116725



MN-DL-2174

Length: 1588 Ø: 52
Cone Ø: d1 Ø 30 / d2 Ø 27
81467106378, 81467106912



MN-DL-2175

Length: 1628 Ø: 50
Cone Ø: d1 Ø 30 / d2 Ø 27
81467106396, 81467106904



MN-DL-3588

Length: 1035 Ø: 48
Cone Ø: d1 Ø 30 / d2 Ø 27
81466106333, 81466106334, 81466106354,
81466106355, 81466106360, 81466106361,
81466106721, 81466106722, 81466106723,
81466116216



MN-DL-12284

Length: 1530 Ø: 50
Cone Ø: d1 Ø 30 / d2 Ø 27
81466106579, 81466106580, 81466106624,
81466116720, 81467116720, 81467116730,
81467116952



MN-DL-12421

Length: 1070 Ø: 48
Cone Ø: d1 Ø 30 / d2 Ø 27
Thread: M30 x 1,5 RHT
81466106656, 81466106659, 81466106669,
81466116006, 81466116007



MN-RK-7280

Ø: 75
Hole Distance: 115
Thick/Height: 24
0550806, 0639370, 689748, 10307400A,
81432306051, 81432306068, 81432706064



MN-RK-7287

Ø: 90
Hole Distance: 152
Thick/Height: 35
03304700A, 81953016133



MN-RK-7291

Ø: 72
Hole Distance: 130
Thick/Height: 30
10307800A, 81432206108, 81432206132



MN-SB-5246

Ø: 45 Thick/Height: 47
81437220022, 81437220038, 81962100450,
81962100469



MN-SB-5254

Length: 100 Ø: 93
Thick/Height: 70
81432710081



MN-SB-5265

Ø: 85 Thick/Height: 80
03310300A, 81437040032



MN-SB-9396

Ø: 67 Thick/Height: 60
81437040057



MN-SB-10389

Ø: 70 Thick/Height: 72
81960200340



MN-SB-10390

Ø: 70 Thick/Height: 85/85
81960200341, 81960200373, 81960200385,
81960200408, 81960200418



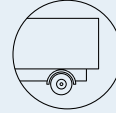

F 90 ...

19.422 FS, 19.422 FLS, 19.422 FLLS ...	02/90→05/95	Tie Rod	MN-DL-12284		
	02/90→05/95	Tie Rod End	CV-ES-2149	for Push Rod	
	02/90→05/95	Tie Rod End	CV-ES-14162	for Steering Rod	
	02/90→05/95	Tie Rod End	CV-ES-14163	for Steering Rod	
	02/90→05/95	Track Control Arm		MN-DL-5212 Trailing Arm, Air Suspension Axle	
	02/90→05/95	Track Control Arm		MN-VB-5222 Wishbone (CV), Air Suspension Axle	
19.462 F, 19.462 FL	05/87→02/90	Ball Head, gearshift linkage	CV-ES-2120		
	05/87→02/90	Centre Rod	MN-DL-12421	for Steering Rod	
	05/87→02/90	Engine Mounting		MN-SB-10390	
	05/87→02/90	Engine Mounting	MN-SB-10389		
	05/87→02/90	Mounting, stabilizer coupling rod	MN-SB-5246		
	05/87→02/90	Mounting, stabilizer coupling rod	MN-SB-5246	1st FA	
	05/87→02/90	Stabiliser Mounting		MN-SB-5265	
	05/87→02/90	Stabiliser Mounting		MN-SB-5265 1st RA	
	05/87→02/90	Suspension Arm Repair Kit	CV-RK-5313	for Wishbone (CV)	
	05/87→02/90	Suspension Arm Repair Kit	CV-RK-8118	for Control Arm	
	05/87→02/90	Suspension Arm Repair Kit	MN-RK-7280	for Drag Link	
	05/87→02/90	Suspension Arm Repair Kit	MN-RK-7287	for Wishbone (CV)	
	05/87→02/90	Suspension Arm Repair Kit	MN-RK-7291	for Drag Link	
	05/87→02/90	Tie Rod	MN-DL-12284		
	05/87→02/90	Tie Rod End	CV-ES-14163	for Steering Rod	
	05/87→02/90	Track Control Arm		MN-DL-5212 Trailing Arm, Air Suspension Axle	
	05/87→02/90	Track Control Arm		MN-VB-5222 Wishbone (CV), Air Suspension Axle	
	19.462 FK	05/87→02/90	Ball Head, gearshift linkage	CV-ES-2120	
		05/87→02/90	Centre Rod	MN-DL-12421	for Steering Rod
		05/87→02/90	Engine Mounting		MN-SB-10390
05/87→02/90		Engine Mounting	MN-SB-10389		
05/87→02/90		Mounting, stabilizer coupling rod	MN-SB-5246		
05/87→02/90		Mounting, stabilizer coupling rod	MN-SB-5246	1st FA	
05/87→02/90		Suspension Arm Repair Kit		MN-RK-7280 for Drag Link	
05/87→02/90		Tie Rod	MN-DL-12284		
05/87→02/90		Tie Rod End	CV-ES-14163	for Steering Rod	
19.462 FS, 19.462 FLS		05/87→02/90	Ball Head, gearshift linkage	CV-ES-2120	
		05/87→02/90	Centre Rod	MN-DL-12421	for Steering Rod
		05/87→02/90	Engine Mounting		MN-SB-10390
		05/87→02/90	Engine Mounting	MN-SB-10389	
		05/87→02/90	Mounting, stabilizer coupling rod	MN-SB-5246	
	05/87→02/90	Mounting, stabilizer coupling rod	MN-SB-5246	1st FA	
	05/87→02/90	Stabiliser Mounting		MN-SB-5265	
	05/87→02/90	Stabiliser Mounting		MN-SB-5265 1st RA	
	05/87→02/90	Suspension Arm Repair Kit	CV-RK-5313	for Wishbone (CV)	
	05/87→02/90	Suspension Arm Repair Kit	CV-RK-8118	for Control Arm	
	05/87→02/90	Suspension Arm Repair Kit	MN-RK-7280	for Drag Link	
	05/87→02/90	Suspension Arm Repair Kit	MN-RK-7287	for Wishbone (CV)	
	05/87→02/90	Suspension Arm Repair Kit	MN-RK-7291	for Drag Link	
	05/87→02/90	Tie Rod	MN-DL-12284		
	05/87→02/90	Tie Rod End	CV-ES-14163	for Steering Rod	
	05/87→02/90	Track Control Arm		MN-DL-5212 Trailing Arm, Air Suspension Axle	
	05/87→02/90	Track Control Arm		MN-VB-5222 Wishbone (CV), Air Suspension Axle	
	19.502 F, 19.502 FL, 19.502 FLL	02/90→06/96	Ball Head, gearshift linkage	CV-ES-2120	
		02/90→06/96	Centre Rod	MN-DL-12421	for Steering Rod
		02/90→06/96	Mounting, stabilizer coupling rod	MN-SB-5246	
02/90→06/96		Mounting, stabilizer coupling rod	MN-SB-5246	1st FA	
02/90→06/96		Suspension Arm Repair Kit		CV-RK-5313 for Wishbone (CV)	
02/90→06/96		Suspension Arm Repair Kit		CV-RK-8118 for Control Arm	
02/90→06/96		Suspension Arm Repair Kit		MN-RK-7287 for Wishbone (CV)	
02/90→06/96		Suspension Arm Repair Kit		MN-RK-7291 for Drag Link	
02/90→06/96		Tie Rod End	CV-ES-14163	for Steering Rod	
02/90→06/96		Track Control Arm		MN-DL-5212 Trailing Arm, Air Suspension Axle	
02/90→06/96		Track Control Arm		MN-VB-5222 Wishbone (CV), Air Suspension Axle	

CV-ES-2120

Length: 115
Cone Ø: d1 Ø 12,4 / d2 Ø 10,8
Thread: M14 x 1,5 RHT
03008500A, 81953016200, 81953016202, 81953016203, 81953016227



CV-ES-2149

Length: 160
Cone Ø: d1 Ø 30 / d2 Ø 27
Thread: M30 x 1,5 RHT
81953016263



CV-ES-14162

Length: 125
Cone Ø: d1 Ø 30 / d2 Ø 27
Thread: M30 x 1,5 LHT

81953010015, 81953010083, 81953010087, 81953016029, 81953016030, 81953016043, 81953016044, 81953016050, 81953016054, 81953016087, 81953016091, 81953016107, 81953016120, 81953016125, 81953016152, 81953016155, 81953016157, 81953016168, 81953016179, 81953016181, 81953016223, 81953016237, 81953016254, 81953016275, 81953016279, 81953016351



CV-ES-14163

Length: 125
Cone Ø: d1 Ø 30 / d2 Ø 27
Thread: M30 x 1,5 RHT

95301.0084, 90804102156, 90804102272, 90804102696, 90804102710, 81953010016, 81953010075, 81953010084, 81953010088, 81953010094, 81953010103, 81953016030, 81953016043, 81953016048, 81953016049, 81953016053, 81953016061, 81953016090, 81953016108, 81953016112, 81953016126, 81953016143, 81953016149, 81953016154, 81953016156, 81953016168, 81953016178, 81953016194, 81953016206, 81953016224, 81953016234, 81953016242, 81953016252, 81953016274, 81953016278, 81953016284, 81953016286, 81953016308, 81953016310, 81953016312, 81953016347, 81953016350, 81953016352, 82953016012, 88953016014, N2953016001



CV-RK-5313

Ø: 90
03304800A, 81953016132



CV-RK-8118

Ø: 85
Hole Distance: 130
Thick/Height: 30
638862, 639287, 775201, 938423, 1104335, 1953248, 0003500506, 3500506, 11013547, 21032592, 42065912, 42488722, 070550504, 93192618, 070400009000, 634303610, 81432206055, 81432206073, 82262320660, 9544171010099, 5001842823, 7000307001, 8226232066



MN-DL-5212

Length: 577 Ø: 48
Hole Distance: 130 / 130
81432206096, 81432206097, 81432206098, 81432206129, 81432209096, 81432209129, 81432306014, 81432306030



MN-DL-12284

Length: 1530 Ø: 50
Cone Ø: d1 Ø 30 / d2 Ø 27
81466106579, 81466106580, 81466106624, 81466116720, 81467116720, 81467116730, 81467116952



MN-DL-12421

Length: 1070
Ø: 48
Cone Ø: d1 Ø 30 / d2 Ø 27
Thread: M30 x 1,5 RHT
81466106656, 81466106659, 81466106669, 81466116006, 81466116007



MN-RK-7280

Ø: 75
Hole Distance: 115
Thick/Height: 24
0550806, 0639370, 689748, 10307400A, 81432306051, 81432306068, 81432706064



MN-RK-7287

Ø: 90
Hole Distance: 152
Thick/Height: 35
03304700A, 81953016133



MN-RK-7291

Ø: 72
Hole Distance: 130
Thick/Height: 30
10307800A, 81432206108, 81432206132



MN-SB-5246

Ø: 45 Thick/Height: 47
81437220022, 81437220038, 81962100450, 81962100469



MN-SB-5265

Ø: 85
Thick/Height: 80
03310300A, 81437040032



MN-SB-10389

Ø: 70
Thick/Height: 72
81960200340



MN-SB-10390

Ø: 70
Thick/Height: 85/85
81960200341, 81960200373, 81960200385, 81960200408, 81960200418



MN-VB-5222

Length: 627 Ø: 50
Hole Distance: 152 / 152
81432706030, 81432706034, 81432706054, 81432706055, 81432706056, 81432706057, 81432706067, 81432706068, 81432706074, 81432706075, 81432706076, 81432706077, 81432706078, 81432706081, 81432706082, 81432709034, 81432709076, 81432709078, 8143706054





F 90 ...

19.502 FS,19.502 FLS,19.502 FLS	02/90→06/96	Ball Head, gearshift linkage	CV-ES-2120			
	02/90→06/96	Centre Rod	MN-DL-12421		for Steering Rod	
	02/90→06/96	Mounting, stabilizer coupling rod	MN-SB-5246			
	02/90→06/96	Mounting, stabilizer coupling rod	MN-SB-5246		1st FA	
	02/90→06/96	Suspension Arm Repair Kit		CV-RK-5313	for Wishbone (CV)	
	02/90→06/96	Suspension Arm Repair Kit		CV-RK-8118	for Control Arm	
	02/90→06/96	Suspension Arm Repair Kit		MN-RK-7287	for Wishbone (CV)	
	02/90→06/96	Suspension Arm Repair Kit		MN-RK-7291	for Drag Link	
	02/90→06/96	Tie Rod End	CV-ES-14163		for Steering Rod	
	02/90→06/96	Track Control Arm		MN-DL-5212	Trailing Arm, Air Suspension Axle	
	02/90→06/96	Track Control Arm		MN-VB-5222	Wishbone (CV), Air Suspension Axle	
	24.242 DF	01/88→07/89	Ball Head, gearshift linkage	CV-ES-2119		
		01/88→07/89	Ball Head, gearshift linkage	CV-ES-2120		
01/88→07/89		Ball Head, gearshift linkage	CV-ES-2182			
01/88→07/89		Centre Rod	MN-DL-2160		Coupling Rod	
01/88→07/89		Centre Rod	MN-DL-2175		Push Rod	
01/88→07/89		Centre Rod	MN-DL-3588		Push Rod	
01/88→07/89		Centre Rod	MN-DL-12421		for Steering Rod	
01/88→07/89		Engine Mounting	MN-SB-10389			
01/88→07/89		Mounting, stabilizer coupling rod	MN-SB-5246			
01/88→07/89		Stabiliser Mounting		MN-SB-5254		
01/88→07/89		Stabiliser Mounting	MN-SB-9396			
01/88→07/89		Suspension Arm Repair Kit		CV-RK-5313	for Wishbone (CV)	
01/88→07/89		Suspension Arm Repair Kit		MN-RK-7287	for Wishbone (CV)	
01/88→07/89		Suspension Arm Repair Kit		MN-SB-5244	for Wishbone (CV)	
01/88→07/89		Suspension Arm Repair Kit		MN-SB-5244	for Wishbone (CV), 1st RA	
01/88→07/89		Tie Rod End	CV-ES-2149		for Push Rod	
01/88→07/89		Tie Rod End	CV-ES-14162		for Steering Rod	
01/88→07/89		Tie Rod End	CV-ES-14163		for Steering Rod	
01/88→07/89		Track Control Arm		MN-DL-3402	Trailing Arm	
01/88→07/89		Track Control Arm		MN-VB-5222	Wishbone (CV)	
01/88→07/89		Track Control Arm		MN-VB-5222	Wishbone (CV), Drive Axle	
01/88→07/89		Track Control Arm		MN-VB-8569	Wishbone (CV)	
24.242 DFK		01/88→07/89	Ball Head, gearshift linkage	CV-ES-2119		
	01/88→07/89	Ball Head, gearshift linkage	CV-ES-2120			
	01/88→07/89	Ball Head, gearshift linkage	CV-ES-2182			
	01/88→07/89	Centre Rod	MN-DL-2160		Coupling Rod	
	01/88→07/89	Centre Rod	MN-DL-2175		Push Rod	
	01/88→07/89	Centre Rod	MN-DL-3588		Push Rod	
	01/88→07/89	Centre Rod	MN-DL-12421		for Steering Rod	
	01/88→07/89	Engine Mounting	MN-SB-10389			
	01/88→07/89	Mounting, stabilizer coupling rod	MN-SB-5246			
	01/88→07/89	Stabiliser Mounting		MN-SB-5254		
	01/88→07/89	Stabiliser Mounting	MN-SB-9396			
	01/88→07/89	Suspension Arm Repair Kit		CV-RK-5313	for Wishbone (CV)	
	01/88→07/89	Suspension Arm Repair Kit		MN-RK-7287	for Wishbone (CV)	
	01/88→07/89	Suspension Arm Repair Kit		MN-SB-5244	for Wishbone (CV)	
	01/88→07/89	Suspension Arm Repair Kit		MN-SB-5244	for Wishbone (CV), 1st RA	
	01/88→07/89	Tie Rod End	CV-ES-2149		for Push Rod	
	01/88→07/89	Tie Rod End	CV-ES-14162		for Steering Rod	
	01/88→07/89	Tie Rod End	CV-ES-14163		for Steering Rod	
	01/88→07/89	Track Control Arm		MN-DL-3402	Trailing Arm	
	01/88→07/89	Track Control Arm		MN-VB-5222	Wishbone (CV)	
	01/88→07/89	Track Control Arm		MN-VB-5222	Wishbone (CV), Drive Axle	
	01/88→07/89	Track Control Arm		MN-VB-8569	Wishbone (CV)	
	24.242 DFS	01/88→07/89	Ball Head, gearshift linkage	CV-ES-2119		
01/88→07/89		Ball Head, gearshift linkage	CV-ES-2120			
01/88→07/89		Ball Head, gearshift linkage	CV-ES-2182			
01/88→07/89		Centre Rod	MN-DL-2160		Coupling Rod	
01/88→07/89		Centre Rod	MN-DL-2175		Push Rod	
01/88→07/89		Centre Rod	MN-DL-3588		Push Rod	
01/88→07/89		Centre Rod	MN-DL-12421		for Steering Rod	
01/88→07/89		Engine Mounting	MN-SB-10389			

CV-ES-2119

Length: 55
Cone Ø: d1 Ø 10 / d2 Ø 10
Thread: M12 x 1,75 LHT
81953016063, 81953016131



CV-ES-2120

Length: 115
Cone Ø: d1 Ø 12,4 / d2 Ø 10,8
Thread: M14 x 1,5 RHT
03008500A, 81953016200, 81953016202, 81953016203, 81953016227



CV-ES-2149

Length: 160
Cone Ø: d1 Ø 30 / d2 Ø 27
Thread: M30 x 1,5 RHT
81953016263



CV-ES-2182

Length: 55
Cone Ø: d1 Ø 10 / d2 Ø 10
Thread: M12 x 1,75 RHT
81953016064, 81953016170



CV-ES-14162

Length: 125
Cone Ø: d1 Ø 30 / d2 Ø 27
Thread: M30 x 1,5 LHT
81953010015, 81953010083, 81953010087, 81953016029, 81953016030, 81953016043, 81953016044, 81953016050, 81953016054, 81953016087, 81953016091, 81953016107, 81953016120, 81953016125, 81953016152, 81953016155, 81953016157, 81953016168, 81953016179, 81953016181, 81953016223, 81953016237, 81953016254, 81953016275, 81953016279, 81953016351



CV-ES-14163

Length: 125
Cone Ø: d1 Ø 30 / d2 Ø 27
Thread: M30 x 1,5 RHT
95301.0084, 90804102156, 90804102272, 90804102696, 90804102710, 81953010016, 81953010075, 81953010084, 81953010088, 81953010094, 81953010103, 81953016030, 81953016043, 81953016048, 81953016049, 81953016053, 81953016061, 81953016090, 81953016108, 81953016112, 81953016126, 81953016143, 81953016149, 81953016154, 81953016156, 81953016168, 81953016178, 81953016194, 81953016206, 81953016224, 81953016234, 81953016242, 81953016252, 81953016274, 81953016278, 81953016284, 81953016286, 81953016308, 81953016310, 81953016312, 81953016347, 81953016350, 81953016352, 82953016012, 88953016014, N2953016001



CV-RK-5313

Ø: 90
03304800A, 81953016132



CV-RK-8118

Ø: 85
Hole Distance: 130
Thick/Height: 30
638862, 639287, 775201, 938423, 1104335, 1953248, 0003500506, 3500506, 11013547, 21032592, 42065912, 42488722, 070550504, 93192618, 070400009000, 634303610, 81432206055, 81432206073, 82262320660, 9544171010099, 5001842823, 7000307001, 8226232066



MN-DL-2160

Length: 1652 Ø: 50
Cone Ø: d1 Ø 30 / d2 Ø 27
81467106112, 81467106163, 81467106165, 81467106198, 81467106353, 81467106354, 81467106361, 81467116725



MN-DL-2175

Length: 1628 Ø: 50
Cone Ø: d1 Ø 30 / d2 Ø 27
81467106396, 81467106904



MN-DL-3402

Length: 590 Ø: 48
Hole Distance: 130 / 130
03307200A, 81432206067, 81432206068, 81432206090, 81432206092, 81432206099



MN-DL-3588

Length: 1035 Ø: 48
Cone Ø: d1 Ø 30 / d2 Ø 27
81466106333, 81466106334, 81466106354, 81466106355, 81466106360, 81466106361, 81466106721, 81466106722, 81466106723, 81466116216



MN-DL-5212

Length: 577 Ø: 48
Hole Distance: 130 / 130
81432206096, 81432206097, 81432206098, 81432206129, 81432209096, 81432209129, 81432306014, 81432306030



MN-DL-12421

Length: 1070 Ø: 48
Cone Ø: d1 Ø 30 / d2 Ø 27
Thread: M30 x 1,5 RHT
81466106656, 81466106659, 81466106669, 81466116006, 81466116007



MN-RK-7287

Ø: 90
Hole Distance: 152
Thick/Height: 35
03304700A, 81953016133



MN-RK-7291

Ø: 72
Hole Distance: 130
Thick/Height: 30
10307800A, 81432206108, 81432206132



MN-SB-5244

Ø: 65
Hole Distance: 125
Thick/Height: 22
03312000A, 81432710027, 81432710082



MN-SB-5246

Ø: 45 Thick/Height: 47
81437220022, 81437220038, 81962100450, 81962100469



MN-SB-5254

Length: 100
Ø: 93
Thick/Height: 70
81432710081



MN-SB-9396

Ø: 67
Thick/Height: 60
81437040057



MN-SB-10389

Ø: 70 Thick/Height: 72
81960200340



MN-VB-5222

Length: 627 Ø: 50
Hole Distance: 152 / 152
81432706030, 81432706034, 81432706054, 81432706055, 81432706056, 81432706057, 81432706067, 81432706068, 81432706074, 81432706075, 81432706076, 81432706077, 81432706078, 81432706081, 81432706082, 81432709034, 81432709076, 81432709078, 8143706054



MN-VB-8569

Length: 627 Ø: 58
Hole Distance: 152 / 152
81432706055, 81432706056, 81432706067, 81432706068, 81432706075, 81432706077, 81432706081, 81432709056





F 90 ...

24.242 DFS ...	01/88→07/89	Mounting, stabilizer coupling rod	MN-SB-5246			
	01/88→07/89	Stabiliser Mounting		MN-SB-5254		
	01/88→07/89	Stabiliser Mounting	MN-SB-9396			
	01/88→07/89	Suspension Arm Repair Kit		CV-RK-5313	for Wishbone (CV)	
	01/88→07/89	Suspension Arm Repair Kit		MN-RK-7287	for Wishbone (CV)	
	01/88→07/89	Suspension Arm Repair Kit		MN-SB-5244	for Wishbone (CV)	
	01/88→07/89	Suspension Arm Repair Kit		MN-SB-5244	for Wishbone (CV), 1st RA	
	01/88→07/89	Tie Rod End	CV-ES-2149		for Push Rod	
	01/88→07/89	Tie Rod End	CV-ES-14162		for Steering Rod	
	01/88→07/89	Tie Rod End	CV-ES-14163		for Steering Rod	
	01/88→07/89	Track Control Arm		MN-DL-3402	Trailing Arm	
	01/88→07/89	Track Control Arm		MN-VB-5222	Wishbone (CV)	
	01/88→07/89	Track Control Arm		MN-VB-5222	Wishbone (CV), Drive Axle	
	01/88→07/89	Track Control Arm		MN-VB-8569	Wishbone (CV)	
	24.242 FNL, 24.242 FNLL, 24.242 FVL	01/88→02/90	Ball Head, gearshift linkage	CV-ES-2119		
01/88→02/90		Ball Head, gearshift linkage	CV-ES-2120			
01/88→02/90		Ball Head, gearshift linkage	CV-ES-2182			
01/88→02/90		Centre Rod	MN-DL-2160		Coupling Rod	
01/88→02/90		Centre Rod	MN-DL-2175		Push Rod	
01/88→02/90		Centre Rod	MN-DL-3588		Push Rod	
01/88→02/90		Centre Rod	MN-DL-12421		for Steering Rod	
01/88→02/90		Engine Mounting	MN-SB-10389			
01/88→02/90		Stabiliser Mounting		MN-SB-5243		
01/88→02/90		Stabiliser Mounting		MN-SB-5265		
01/88→02/90		Stabiliser Mounting		MN-SB-5265	1st RA	
01/88→02/90		Suspension Arm Repair Kit		CV-RK-5313	for Wishbone (CV)	
01/88→02/90		Suspension Arm Repair Kit		CV-RK-8118	for Control Arm	
01/88→02/90		Suspension Arm Repair Kit		MN-RK-7280	for Drag Link	
01/88→02/90		Suspension Arm Repair Kit		MN-RK-7287	for Wishbone (CV)	
01/88→02/90		Suspension Arm Repair Kit		MN-RK-7291	for Drag Link	
01/88→02/90		Tie Rod End	CV-ES-2149		for Push Rod	
01/88→02/90		Tie Rod End	CV-ES-14162		for Steering Rod	
01/88→02/90		Tie Rod End	CV-ES-14163		for Steering Rod	
01/88→02/90		Track Control Arm		MN-DL-5212	Trailing Arm, Air Suspension Axle; Drive Axle	
01/88→02/90		Track Control Arm		MN-DL-5212	Trailing Arm, Air Suspension Axle; Drive Axle; Tag Axle	
01/88→02/90		Track Control Arm		MN-VB-5222	Wishbone (CV), Drive Axle; Air Suspension Axle	
01/88→02/90		Track Control Arm		MN-VB-5222	Wishbone (CV), Tag Axle	
24.262 DF		01/88→02/90	Ball Head, gearshift linkage	CV-ES-2119		
		01/88→02/90	Ball Head, gearshift linkage	CV-ES-2120		
		01/88→02/90	Ball Head, gearshift linkage	CV-ES-2182		
		01/88→02/90	Centre Rod	MN-DL-2160		Coupling Rod
	01/88→02/90	Centre Rod	MN-DL-2175		Push Rod	
	01/88→02/90	Centre Rod	MN-DL-3588		Push Rod	
	01/88→02/90	Centre Rod	MN-DL-12421		for Steering Rod	
	01/88→02/90	Engine Mounting	MN-SB-10389			
	01/88→02/90	Mounting, stabilizer coupling rod	MN-SB-5246			
	01/88→02/90	Stabiliser Mounting		MN-SB-5254		
	01/88→02/90	Stabiliser Mounting	MN-SB-9396			
	01/88→02/90	Suspension Arm Repair Kit		CV-RK-5313	for Wishbone (CV)	
	01/88→02/90	Suspension Arm Repair Kit		MN-RK-7287	for Wishbone (CV)	
	01/88→02/90	Suspension Arm Repair Kit		MN-SB-5244	for Wishbone (CV)	
	01/88→02/90	Suspension Arm Repair Kit		MN-SB-5244	for Wishbone (CV), 1st RA	
	01/88→02/90	Tie Rod End	CV-ES-2149		for Push Rod	
	01/88→02/90	Tie Rod End	CV-ES-14162		for Steering Rod	
	01/88→02/90	Tie Rod End	CV-ES-14163		for Steering Rod	
	01/88→02/90	Track Control Arm		MN-DL-3402	Trailing Arm	
	01/88→02/90	Track Control Arm		MN-VB-5222	Wishbone (CV)	
	01/88→02/90	Track Control Arm		MN-VB-5222	Wishbone (CV), Drive Axle	
	01/88→02/90	Track Control Arm		MN-VB-8569	Wishbone (CV)	

CV-ES-2119

Length: 55
Cone Ø: d1 Ø 10 / d2 Ø 10
Thread: M12 x 1,75 LHT
81953016063, 81953016131



CV-ES-2120

Length: 115
Cone Ø: d1 Ø 12,4 / d2 Ø 10,8
Thread: M14 x 1,5 RHT
03008500A, 81953016200, 81953016202, 81953016203, 81953016227



CV-ES-2149

Length: 160
Cone Ø: d1 Ø 30 / d2 Ø 27
Thread: M30 x 1,5 RHT
81953016263



CV-ES-2182

Length: 55
Cone Ø: d1 Ø 10 / d2 Ø 10
Thread: M12 x 1,75 RHT
81953016064, 81953016170



CV-ES-14162

Length: 125
Cone Ø: d1 Ø 30 / d2 Ø 27
Thread: M30 x 1,5 LHT

81953010015, 81953010083, 81953010087, 81953016029, 81953016030, 81953016043, 81953016044, 81953016050, 81953016054, 81953016087, 81953016091, 81953016107, 81953016120, 81953016125, 81953016152, 81953016155, 81953016157, 81953016168, 81953016179, 81953016181, 81953016223, 81953016237, 81953016254, 81953016275, 81953016279, 81953016351



CV-ES-14163

Length: 125
Cone Ø: d1 Ø 30 / d2 Ø 27
Thread: M30 x 1,5 RHT

95301.0084, 90804102156, 90804102272, 90804102696, 90804102710, 81953010016, 81953010075, 81953010084, 81953010088, 81953010094, 81953010103, 81953016030, 81953016043, 81953016048, 81953016049, 81953016053, 81953016061, 81953016090, 81953016108, 81953016112, 81953016126, 81953016143, 81953016149, 81953016154, 81953016156, 81953016168, 81953016178, 81953016194, 81953016206, 81953016224, 81953016234, 81953016242, 81953016252, 81953016274, 81953016278, 81953016284, 81953016286, 81953016308, 81953016310, 81953016312, 81953016347, 81953016350, 81953016352, 82953016012, 88953016014, N2953016001



CV-RK-5313

Ø: 90
03304800A, 81953016132



CV-RK-8118

Ø: 85
Hole Distance: 130
Thick/Height: 30

638862, 639287, 775201, 938423, 1104335, 1953248, 3500506, 0003500506, 11013547, 21032592, 42065912, 42488722, 070550504, 93192618, 070400009000, 634303610, 81432206055, 81432206073, 82262320660, 9544171010099, 5001842823, 7000307001, 8226232066



MN-DL-2160

Length: 1652 Ø: 50
Cone Ø: d1 Ø 30 / d2 Ø 27
81467106112, 81467106163, 81467106165, 81467106198, 81467106353, 81467106354, 81467106361, 81467116725



MN-DL-2175

Length: 1628 Ø: 50
Cone Ø: d1 Ø 30 / d2 Ø 27
81467106396, 81467106904



MN-DL-3402

Length: 590 Ø: 48
Hole Distance: 130 / 130
03307200A, 81432206067, 81432206068, 81432206090, 81432206092, 81432209099



MN-DL-3588

Length: 1035 Ø: 48
Cone Ø: d1 Ø 30 / d2 Ø 27
81466106333, 81466106334, 81466106354, 81466106355, 81466106360, 81466106361, 81466106721, 81466106722, 81466106723, 81466116216



MN-DL-5212

Length: 577 Ø: 48
Hole Distance: 130 / 130
81432206096, 81432206097, 81432206098, 81432206129, 81432209096, 81432209129, 81432306014, 81432306030



MN-DL-12421

Length: 1070 Ø: 48
Cone Ø: d1 Ø 30 / d2 Ø 27
Thread: M30 x 1,5 RHT
81466106656, 81466106659, 81466106669, 81466116006, 81466116007



MN-RK-7280

Ø: 75
Hole Distance: 115
Thick/Height: 24
0550806, 0639370, 689748, 10307400A, 81432306051, 81432306068, 81432706064



MN-RK-7287

Ø: 90
Hole Distance: 152
Thick/Height: 35
03304700A, 81953016133



MN-RK-7291

Ø: 72
Hole Distance: 130
Thick/Height: 30
10307800A, 81432206108, 81432206132



MN-SB-5243

Length: 55 Ø: 78
Thick/Height: 60
03311100A, 81437040061, 81437220020



MN-SB-5244

Ø: 65
Hole Distance: 125
Thick/Height: 22
03312000A, 81432710027, 81432710082



MN-SB-5246

Ø: 45 Thick/Height: 47
81437220022, 81437220038, 81962100450, 81962100469



MN-SB-5254

Length: 100 Ø: 93
Thick/Height: 70
81432710081



MN-SB-5265

Ø: 85 Thick/Height: 80
03310300A, 81437040032



MN-SB-9396

Ø: 67 Thick/Height: 60
81437040057



MN-SB-10389

Ø: 70 Thick/Height: 72
81960200340



MN-VB-5222

Length: 627 Ø: 50
Hole Distance: 152 / 152
81432706030, 81432706034, 81432706054, 81432706055, 81432706056, 81432706057, 81432706067, 81432706068, 81432706074, 81432706075, 81432706076, 81432706077, 81432706078, 81432706081, 81432706082, 81432709034, 81432709076, 81432709078, 8143706054



MN-VB-8569

Length: 627 Ø: 58
Hole Distance: 152 / 152
81432706055, 81432706056, 81432706067, 81432706068, 81432706075, 81432706077, 81432706081, 81432709056



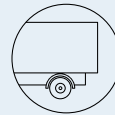

F 90 ...

24.262 DFK	01/88→02/90	Ball Head, gearshift linkage	CV-ES-2119			
	01/88→02/90	Ball Head, gearshift linkage	CV-ES-2120			
	01/88→02/90	Ball Head, gearshift linkage	CV-ES-2182			
	01/88→02/90	Centre Rod	MN-DL-2160		Coupling Rod	
	01/88→02/90	Centre Rod	MN-DL-2175		Push Rod	
	01/88→02/90	Centre Rod	MN-DL-3588		Push Rod	
	01/88→02/90	Centre Rod	MN-DL-12421		for Steering Rod	
	01/88→02/90	Engine Mounting	MN-SB-10389			
	01/88→02/90	Mounting, stabilizer coupling rod	MN-SB-5246			
	01/88→02/90	Stabiliser Mounting		MN-SB-5254		
	01/88→02/90	Stabiliser Mounting	MN-SB-9396			
	01/88→02/90	Suspension Arm Repair Kit		CV-RK-5313	for Wishbone (CV)	
	01/88→02/90	Suspension Arm Repair Kit		MN-RK-7287	for Wishbone (CV)	
	01/88→02/90	Suspension Arm Repair Kit		MN-SB-5244	for Wishbone (CV)	
	01/88→02/90	Suspension Arm Repair Kit		MN-SB-5244	for Wishbone (CV), 1st RA	
	01/88→02/90	Tie Rod End	CV-ES-2149		for Push Rod	
	01/88→02/90	Tie Rod End	CV-ES-14162		for Steering Rod	
	01/88→02/90	Tie Rod End	CV-ES-14163		for Steering Rod	
	24.262 DFS,24.262 DFSL	01/88→02/90	Ball Head, gearshift linkage	CV-ES-2119		
		01/88→02/90	Ball Head, gearshift linkage	CV-ES-2120		
01/88→02/90		Ball Head, gearshift linkage	CV-ES-2182			
01/88→02/90		Centre Rod	MN-DL-2160		Coupling Rod	
01/88→02/90		Centre Rod	MN-DL-2175		Push Rod	
01/88→02/90		Centre Rod	MN-DL-3588		Push Rod	
01/88→02/90		Centre Rod	MN-DL-12421		for Steering Rod	
01/88→02/90		Engine Mounting	MN-SB-10389			
01/88→02/90		Mounting, stabilizer coupling rod	MN-SB-5246			
01/88→02/90		Stabiliser Mounting		MN-SB-5254		
01/88→02/90		Stabiliser Mounting	MN-SB-9396			
01/88→02/90		Suspension Arm Repair Kit		CV-RK-5313	for Wishbone (CV)	
01/88→02/90		Suspension Arm Repair Kit		CV-RK-8118	for Control Arm	
01/88→02/90		Suspension Arm Repair Kit		MN-RK-7287	for Wishbone (CV)	
01/88→02/90		Suspension Arm Repair Kit		MN-RK-7291	for Drag Link	
01/88→02/90		Suspension Arm Repair Kit		MN-SB-5244	for Wishbone (CV)	
01/88→02/90		Suspension Arm Repair Kit		MN-SB-5244	for Wishbone (CV), 1st RA	
01/88→02/90		Tie Rod End	CV-ES-2149		for Push Rod	
01/88→02/90		Tie Rod End	CV-ES-14162		for Steering Rod	
01/88→02/90		Tie Rod End	CV-ES-14163		for Steering Rod	
24.262 FNL,24.262 FNLL, 24.262 FVL	01/88→02/90	Ball Head, gearshift linkage	CV-ES-2119			
	01/88→02/90	Ball Head, gearshift linkage	CV-ES-2120			
	01/88→02/90	Ball Head, gearshift linkage	CV-ES-2182			
	01/88→02/90	Centre Rod	MN-DL-2160		Coupling Rod	
	01/88→02/90	Centre Rod	MN-DL-2175		Push Rod	
	01/88→02/90	Centre Rod	MN-DL-3588		Push Rod	
	01/88→02/90	Centre Rod	MN-DL-12421		for Steering Rod	
	01/88→02/90	Engine Mounting	MN-SB-10389			
	01/88→02/90	Stabiliser Mounting		MN-SB-5243		
	01/88→02/90	Stabiliser Mounting		MN-SB-5265		
	01/88→02/90	Stabiliser Mounting		MN-SB-5265	1st RA	
	01/88→02/90	Suspension Arm Repair Kit		CV-RK-5313	for Wishbone (CV)	
	01/88→02/90	Suspension Arm Repair Kit		CV-RK-8118	for Control Arm	
	01/88→02/90	Suspension Arm Repair Kit		MN-RK-7280	for Drag Link	
	01/88→02/90	Suspension Arm Repair Kit		MN-RK-7287	for Wishbone (CV)	
	01/88→02/90	Suspension Arm Repair Kit		MN-RK-7291	for Drag Link	

CV-ES-2119

Length: 55
Cone Ø: d1 Ø 10 / d2 Ø 10
Thread: M12 x 1,75 LHT
81953016063, 81953016131



CV-ES-2120

Length: 115
Cone Ø: d1 Ø 12,4 / d2 Ø 10,8
Thread: M14 x 1,5 RHT
03008500A, 81953016200, 81953016202,
81953016203, 81953016227



CV-ES-2149

Length: 160
Cone Ø: d1 Ø 30 / d2 Ø 27
Thread: M30 x 1,5 RHT
81953016263



CV-ES-2182

Length: 55
Cone Ø: d1 Ø 10 / d2 Ø 10
Thread: M12 x 1,75 RHT
81953016064, 81953016170



CV-ES-14162

Length: 125
Cone Ø: d1 Ø 30 / d2 Ø 27
Thread: M30 x 1,5 LHT

81953010015, 81953010083, 81953010087,
81953016029, 81953016030, 81953016043,
81953016044, 81953016050, 81953016054,
81953016087, 81953016091, 81953016107,
81953016120, 81953016125, 81953016152,
81953016155, 81953016157, 81953016168,
81953016179, 81953016181, 81953016223,
81953016237, 81953016254, 81953016275,
81953016279, 81953016351



CV-ES-14163

Length: 125
Cone Ø: d1 Ø 30 / d2 Ø 27
Thread: M30 x 1,5 RHT

95301.0084, 90804102156, 90804102272,
90804102696, 90804102710, 81953010016,
81953010075, 81953010084, 81953010088,
81953010094, 81953010103, 81953016030,
81953016043, 81953016048, 81953016049,
81953016053, 81953016061, 81953016090,
81953016108, 81953016112, 81953016126,
81953016143, 81953016149, 81953016154,
81953016156, 81953016168, 81953016178,
81953016194, 81953016206, 81953016224,
81953016234, 81953016242, 81953016252,
81953016274, 81953016278, 81953016284,
81953016286, 81953016308, 81953016310,
81953016312, 81953016347, 81953016350,
81953016352, 82953016012, 88953016014,
N2953016001



CV-RK-5313

Ø: 90
03304800A, 81953016132



CV-RK-8118

Ø: 85
Hole Distance: 130
Thick/Height: 30

638862, 639287, 775201, 938423,
1104335, 1953248, 0003500506, 3500506,
11013547, 21032592, 42065912, 42488722,
070550504, 93192618, 070400009000,
634303610, 81432206055, 81432206073,
82262320660, 9544171010099,
5001842823, 7000307001, 8226232066



MN-DL-2160

Length: 1652 Ø: 50
Cone Ø: d1 Ø 30 / d2 Ø 27
81467106112, 81467106163, 81467106165,
81467106198, 81467106353, 81467106354,
81467106361, 81467116725



MN-DL-2175

Length: 1628 Ø: 50
Cone Ø: d1 Ø 30 / d2 Ø 27
81467106396, 81467106904



MN-DL-3402

Length: 590 Ø: 48
Hole Distance: 130 / 130
03307200A, 81432206067, 81432206068,
81432206090, 81432206092, 81432209092



MN-DL-3588

Length: 1035 Ø: 48
Cone Ø: d1 Ø 30 / d2 Ø 27
81466106333, 81466106334, 81466106354,
81466106355, 81466106360, 81466106361,
81466106721, 81466106722, 81466106723,
81466116216



MN-DL-5212

Length: 577 Ø: 48
Hole Distance: 130 / 130
81432206096, 81432206097, 81432206098,
81432206129, 81432209096, 81432209129,
81432306014, 81432306030



MN-DL-12421

Length: 1070 Ø: 48
Cone Ø: d1 Ø 30 / d2 Ø 27
Thread: M30 x 1,5 RHT
81466106656, 81466106659, 81466106669,
81466116006, 81466116007



MN-RK-7280

Ø: 75
Hole Distance: 115
Thick/Height: 24
0550806, 0639370, 689748, 10307400A,
81432306051, 81432306068, 81432706064



MN-RK-7287

Ø: 90
Hole Distance: 152
Thick/Height: 35
03304700A, 81953016133



MN-RK-7291

Ø: 72
Hole Distance: 130
Thick/Height: 30
10307800A, 81432206108, 81432206132



MN-SB-5243

Length: 55 Ø: 78
Thick/Height: 60
03311100A, 81437040061, 81437220020



MN-SB-5244

Ø: 65
Hole Distance: 125
Thick/Height: 22
03312000A, 81432710027, 81432710082



MN-SB-5246

Ø: 45 Thick/Height: 47
81437220022, 81437220038, 81962100450,
81962100469



MN-SB-5254

Length: 100 Ø: 93
Thick/Height: 70
81432710081



MN-SB-5265

Ø: 85 Thick/Height: 80
03310300A, 81437040032



MN-SB-9396

Ø: 67 Thick/Height: 60
81437040057



MN-SB-10389

Ø: 70 Thick/Height: 72
81960200340



MN-VB-5222

Length: 627 Ø: 50
Hole Distance: 152 / 152
81432706030, 81432706034, 81432706054,
81432706055, 81432706056, 81432706057,
81432706067, 81432706068, 81432706074,
81432706075, 81432706076, 81432706077,
81432706078, 81432706081, 81432706082,
81432709034, 81432709076, 81432709078,
8143706054



MN-VB-8569

Length: 627 Ø: 58
Hole Distance: 152 / 152
81432706055, 81432706056, 81432706067,
81432706068, 81432706075, 81432706077,
81432706081, 81432709056





F 90 ...

24.262 FNL,24.262 FNLL, 24.262 FVL ...	01/88→02/90	Tie Rod End	CV-ES-2149		for Push Rod	
	01/88→02/90	Tie Rod End	CV-ES-14162		for Steering Rod	
	01/88→02/90	Tie Rod End	CV-ES-14163		for Steering Rod	
	01/88→02/90	Track Control Arm		MN-DL-5212	Trailing Arm, Air Suspension Axle;Drive Axle	
	01/88→02/90	Track Control Arm		MN-DL-5212	Trailing Arm, Air Suspension Axle;Drive Axle; Tag Axle	
	01/88→02/90	Track Control Arm		MN-VB-5222	Wishbone (CV), Drive Axle;Air Suspension Axle	
24.272 DF	01/88→02/90	Track Control Arm		MN-VB-5222	Wishbone (CV), Tag Axle	
	02/90→12/90	Ball Head, gearshift linkage	CV-ES-2119			
	02/90→12/90	Ball Head, gearshift linkage	CV-ES-2120			
	02/90→12/90	Ball Head, gearshift linkage	CV-ES-2182			
	02/90→12/90	Centre Rod	MN-DL-2160		Coupling Rod	
	02/90→12/90	Centre Rod	MN-DL-2175		Push Rod	
	02/90→12/90	Centre Rod	MN-DL-3588		Push Rod	
	02/90→12/90	Centre Rod	MN-DL-12421		for Steering Rod	
	02/90→12/90	Engine Mounting	MN-SB-10389			
	02/90→12/90	Mounting, stabilizer coupling rod	MN-SB-5246			
	02/90→12/90	Stabiliser Mounting		MN-SB-5254		
	02/90→12/90	Stabiliser Mounting	MN-SB-9396			
	02/90→12/90	Suspension Arm Repair Kit		CV-RK-5313	for Wishbone (CV)	
	02/90→12/90	Suspension Arm Repair Kit		MN-RK-7287	for Wishbone (CV)	
	02/90→12/90	Suspension Arm Repair Kit		MN-SB-5244	for Wishbone (CV)	
	02/90→12/90	Suspension Arm Repair Kit		MN-SB-5244	for Wishbone (CV), 1st RA	
	02/90→12/90	Tie Rod End	CV-ES-2149		for Push Rod	
	02/90→12/90	Tie Rod End	CV-ES-14162		for Steering Rod	
	02/90→12/90	Tie Rod End	CV-ES-14163		for Steering Rod	
	02/90→12/90	Track Control Arm		MN-DL-3402	Trailing Arm	
	02/90→12/90	Track Control Arm		MN-VB-5222	Wishbone (CV)	
	02/90→12/90	Track Control Arm		MN-VB-5222	Wishbone (CV), Drive Axle	
	02/90→12/90	Track Control Arm		MN-VB-8569	Wishbone (CV)	
	24.272 DFK	02/90→12/90	Ball Head, gearshift linkage	CV-ES-2119		
02/90→12/90		Ball Head, gearshift linkage	CV-ES-2120			
02/90→12/90		Ball Head, gearshift linkage	CV-ES-2182			
02/90→12/90		Centre Rod	MN-DL-2160		Coupling Rod	
02/90→12/90		Centre Rod	MN-DL-2175		Push Rod	
02/90→12/90		Centre Rod	MN-DL-3588		Push Rod	
02/90→12/90		Centre Rod	MN-DL-12421		for Steering Rod	
02/90→12/90		Engine Mounting	MN-SB-10389			
02/90→12/90		Mounting, stabilizer coupling rod	MN-SB-5246			
02/90→12/90		Stabiliser Mounting		MN-SB-5254		
02/90→12/90		Stabiliser Mounting	MN-SB-9396			
02/90→12/90		Suspension Arm Repair Kit		CV-RK-5313	for Wishbone (CV)	
02/90→12/90		Suspension Arm Repair Kit		MN-RK-7287	for Wishbone (CV)	
02/90→12/90		Suspension Arm Repair Kit		MN-SB-5244	for Wishbone (CV)	
02/90→12/90		Suspension Arm Repair Kit		MN-SB-5244	for Wishbone (CV), 1st RA	
02/90→12/90		Tie Rod End	CV-ES-2149		for Push Rod	
02/90→12/90		Tie Rod End	CV-ES-14162		for Steering Rod	
02/90→12/90		Tie Rod End	CV-ES-14163		for Steering Rod	
02/90→12/90		Track Control Arm		MN-DL-3402	Trailing Arm	
02/90→12/90		Track Control Arm		MN-VB-5222	Wishbone (CV)	
02/90→12/90		Track Control Arm		MN-VB-5222	Wishbone (CV), Drive Axle	
02/90→12/90		Track Control Arm		MN-VB-8569	Wishbone (CV)	
24.272 DFS,24.272 DFLS		02/90→01/91	Track Control Arm		MN-VB-5222	Wishbone (CV), Drive Axle
		02/90→04/95	Ball Head, gearshift linkage	CV-ES-2119		
	02/90→04/95	Ball Head, gearshift linkage	CV-ES-2120			
	02/90→04/95	Ball Head, gearshift linkage	CV-ES-2182			
	02/90→04/95	Centre Rod	MN-DL-2160		Coupling Rod	
	02/90→04/95	Centre Rod	MN-DL-2175		Push Rod	
	02/90→04/95	Centre Rod	MN-DL-3588		Push Rod	
	02/90→04/95	Centre Rod	MN-DL-12421		for Steering Rod	
	02/90→04/95	Engine Mounting	MN-SB-10389			
	02/90→04/95	Mounting, stabilizer coupling rod	MN-SB-5246			
	02/90→04/95	Stabiliser Mounting		MN-SB-5254		

CV-ES-2119

Length: 55
Cone Ø: d1 Ø 10 / d2 Ø 10
Thread: M12 x 1,75 LHT
81953016063, 81953016131



CV-ES-2120

Length: 115
Cone Ø: d1 Ø 12,4 / d2 Ø 10,8
Thread: M14 x 1,5 RHT
03008500A, 81953016200, 81953016202, 81953016203, 81953016227



CV-ES-2149

Length: 160
Cone Ø: d1 Ø 30 / d2 Ø 27
Thread: M30 x 1,5 RHT
81953016263



CV-ES-2182

Length: 55
Cone Ø: d1 Ø 10 / d2 Ø 10
Thread: M12 x 1,75 RHT
81953016064, 81953016170



CV-ES-14162

Length: 125
Cone Ø: d1 Ø 30 / d2 Ø 27
Thread: M30 x 1,5 LHT
81953010015, 81953010083, 81953010087, 81953016029, 81953016030, 81953016043, 81953016044, 81953016050, 81953016054, 81953016087, 81953016091, 81953016107, 81953016120, 81953016125, 81953016152, 81953016155, 81953016157, 81953016168, 81953016179, 81953016181, 81953016223, 81953016237, 81953016254, 81953016275, 81953016279, 81953016351



CV-ES-14163

Length: 125
Cone Ø: d1 Ø 30 / d2 Ø 27
Thread: M30 x 1,5 RHT
95301.0084, 90804102156, 90804102272, 90804102696, 90804102710, 81953010016, 81953010075, 81953010084, 81953010088, 81953010094, 81953010103, 81953016030, 81953016043, 81953016048, 81953016049, 81953016053, 81953016061, 81953016090, 81953016108, 81953016112, 81953016126, 81953016143, 81953016149, 81953016154, 81953016156, 81953016168, 81953016178, 81953016194, 81953016206, 81953016224, 81953016234, 81953016242, 81953016252, 81953016274, 81953016278, 81953016284, 81953016286, 81953016308, 81953016310, 81953016312, 81953016347, 81953016350, 81953016352, 82953016012, 88953016014, N2953016001



CV-RK-5313

Ø: 90
03304800A, 81953016132



MN-DL-2160

Length: 1652 Ø: 50
Cone Ø: d1 Ø 30 / d2 Ø 27
81467106112, 81467106163, 81467106165, 81467106198, 81467106353, 81467106354, 81467106361, 81467116725



MN-DL-2175

Length: 1628
Ø: 50
Cone Ø: d1 Ø 30 / d2 Ø 27
81467106396, 81467106904



MN-DL-3402

Length: 590 Ø: 48
Hole Distance: 130 / 130
03307200A, 81432206067, 81432206068, 81432206090, 81432206092, 81432209092



MN-DL-3588

Length: 1035
Ø: 48
Cone Ø: d1 Ø 30 / d2 Ø 27
81466106333, 81466106334, 81466106354, 81466106355, 81466106360, 81466106361, 81466106721, 81466106722, 81466106723, 81466116216



MN-DL-5212

Length: 577 Ø: 48
Hole Distance: 130 / 130
81432206096, 81432206097, 81432206098, 81432206129, 81432209096, 81432209129, 81432306014, 81432306030



MN-DL-12421

Length: 1070
Ø: 48
Cone Ø: d1 Ø 30 / d2 Ø 27
Thread: M30 x 1,5 RHT
81466106656, 81466106659, 81466106669, 81466116006, 81466116007



MN-RK-7287

Ø: 90
Hole Distance: 152
Thick/Height: 35
03304700A, 81953016133



MN-SB-5244

Ø: 65
Hole Distance: 125
Thick/Height: 22
03312000A, 81432710027, 81432710082



MN-SB-5246

Ø: 45 Thick/Height: 47
81437220022, 81437220038, 81962100450, 81962100469



MN-SB-5254

Length: 100
Ø: 93
Thick/Height: 70
81432710081



MN-SB-9396

Ø: 67
Thick/Height: 60
81437040057



MN-SB-10389

Ø: 70
Thick/Height: 72
81960200340



MN-VB-5222

Length: 627 Ø: 50
Hole Distance: 152 / 152
81432706030, 81432706034, 81432706054, 81432706055, 81432706056, 81432706057, 81432706067, 81432706068, 81432706074, 81432706075, 81432706076, 81432706077, 81432706078, 81432706081, 81432706082, 81432709034, 81432709076, 81432709078, 8143706054



MN-VB-8569

Length: 627 Ø: 58
Hole Distance: 152 / 152
81432706055, 81432706056, 81432706067, 81432706068, 81432706075, 81432706077, 81432706081, 81432709056





F 90 ...

24.272 DFS,24.272 DFLS ...	02/90→04/95	Stabiliser Mounting	MN-SB-9396			
	02/90→04/95	Suspension Arm Repair Kit		CV-RK-5313	for Wishbone (CV)	
	02/90→04/95	Suspension Arm Repair Kit		CV-RK-8118	for Control Arm	
	02/90→04/95	Suspension Arm Repair Kit		MN-RK-7287	for Wishbone (CV)	
	02/90→04/95	Suspension Arm Repair Kit		MN-RK-7291	for Drag Link	
	02/90→04/95	Suspension Arm Repair Kit		MN-SB-5244	for Wishbone (CV)	
	02/90→04/95	Suspension Arm Repair Kit		MN-SB-5244	for Wishbone (CV), 1st RA	
	02/90→04/95	Tie Rod End	CV-ES-2149		for Push Rod	
	02/90→04/95	Tie Rod End	CV-ES-14162		for Steering Rod	
	02/90→04/95	Tie Rod End	CV-ES-14163		for Steering Rod	
	02/90→04/95	Track Control Arm		MN-DL-3402	Trailing Arm	
	02/90→04/95	Track Control Arm		MN-DL-5212	Trailing Arm, Air Suspension Axle;Drive Axle	
	02/90→04/95	Track Control Arm		MN-VB-5222	Wishbone (CV)	
	02/90→04/95	Track Control Arm		MN-VB-5222	Wishbone (CV), Drive Axle;Air Suspension Axle	
	02/90→04/95	Track Control Arm		MN-VB-8569	Wishbone (CV)	
	01/91→04/95	Track Control Arm		MN-VB-8569	Wishbone (CV), Drive Axle	
	24.272 FNL,24.272 FNLL, 24.272 FVL	02/90→05/95	Ball Head, gearshift linkage	CV-ES-2119		
		02/90→05/95	Ball Head, gearshift linkage	CV-ES-2120		
		02/90→05/95	Ball Head, gearshift linkage	CV-ES-2182		
		02/90→05/95	Centre Rod	MN-DL-2160		Coupling Rod
02/90→05/95		Centre Rod	MN-DL-2175		Push Rod	
02/90→05/95		Centre Rod	MN-DL-3588		Push Rod	
02/90→05/95		Centre Rod	MN-DL-12421		for Steering Rod	
02/90→05/95		Engine Mounting	MN-SB-10389			
02/90→05/95		Stabiliser Mounting		MN-SB-5243		
02/90→05/95		Stabiliser Mounting		MN-SB-5265		
02/90→05/95		Stabiliser Mounting		MN-SB-5265	1st RA	
02/90→05/95		Suspension Arm Repair Kit		CV-RK-5313	for Wishbone (CV)	
02/90→05/95		Suspension Arm Repair Kit		CV-RK-8118	for Control Arm	
02/90→05/95		Suspension Arm Repair Kit		MN-RK-7280	for Drag Link	
02/90→05/95		Suspension Arm Repair Kit		MN-RK-7287	for Wishbone (CV)	
02/90→05/95		Suspension Arm Repair Kit		MN-RK-7291	for Drag Link	
02/90→05/95		Tie Rod	MN-DL-12284			
02/90→05/95		Tie Rod End	CV-ES-2149		for Push Rod	
02/90→05/95		Tie Rod End	CV-ES-14162		for Steering Rod	
02/90→05/95		Tie Rod End	CV-ES-14163		for Steering Rod	
02/90→05/95		Track Control Arm		MN-DL-5212	Trailing Arm, Air Suspension Axle;Drive Axle	
02/90→05/95		Track Control Arm		MN-DL-5212	Trailing Arm, Air Suspension Axle;Drive Axle; Tag Axle	
02/90→05/95		Track Control Arm		MN-VB-5222	Wishbone (CV), Drive Axle;Air Suspension Axle	
02/90→05/95		Track Control Arm		MN-VB-5222	Wishbone (CV), Tag Axle	
24.272 FNLS,24.272 FVLS		02/90→05/95	Ball Head, gearshift linkage	CV-ES-2119		
		02/90→05/95	Ball Head, gearshift linkage	CV-ES-2120		
		02/90→05/95	Ball Head, gearshift linkage	CV-ES-2182		
	02/90→05/95	Centre Rod	MN-DL-2160		Coupling Rod	
	02/90→05/95	Centre Rod	MN-DL-2175		Push Rod	
	02/90→05/95	Centre Rod	MN-DL-3588		Push Rod	
	02/90→05/95	Centre Rod	MN-DL-12421		for Steering Rod	
	02/90→05/95	Engine Mounting	MN-SB-10389			
	02/90→05/95	Stabiliser Mounting		MN-SB-5243		
	02/90→05/95	Stabiliser Mounting		MN-SB-5265		
	02/90→05/95	Stabiliser Mounting		MN-SB-5265	1st RA	
	02/90→05/95	Suspension Arm Repair Kit		CV-RK-5313	for Wishbone (CV)	
	02/90→05/95	Suspension Arm Repair Kit		CV-RK-8118	for Control Arm	
	02/90→05/95	Suspension Arm Repair Kit		MN-RK-7280	for Drag Link	
	02/90→05/95	Suspension Arm Repair Kit		MN-RK-7287	for Wishbone (CV)	
	02/90→05/95	Suspension Arm Repair Kit		MN-RK-7291	for Drag Link	
	02/90→05/95	Tie Rod	MN-DL-12284			
	02/90→05/95	Tie Rod End	CV-ES-2149		for Push Rod	
	02/90→05/95	Tie Rod End	CV-ES-14162		for Steering Rod	
	02/90→05/95	Tie Rod End	CV-ES-14163		for Steering Rod	
	02/90→05/95	Track Control Arm		MN-DL-5212	Trailing Arm, Air Suspension Axle;Drive Axle	
	02/90→05/95	Track Control Arm		MN-VB-5222	Wishbone (CV), Drive Axle;Air Suspension Axle	
	02/90→05/95	Track Control Arm		MN-VB-5222	Wishbone (CV), Tag Axle	

CV-ES-2119

Length: 55
Cone Ø: d1 Ø 10 / d2 Ø 10
Thread: M12 x 1,75 LHT
81953016063, 81953016131



CV-ES-2120

Length: 115
Cone Ø: d1 Ø 12,4 / d2 Ø 10,8
Thread: M14 x 1,5 RHT
03008500A, 81953016200, 81953016202,
81953016203, 81953016227



CV-ES-2149

Length: 160
Cone Ø: d1 Ø 30 / d2 Ø 27
Thread: M30 x 1,5 RHT
81953016263



CV-ES-2182

Length: 55
Cone Ø: d1 Ø 10 / d2 Ø 10
Thread: M12 x 1,75 RHT
81953016064, 81953016170



CV-ES-14162

Length: 125
Cone Ø: d1 Ø 30 / d2 Ø 27
Thread: M30 x 1,5 LHT

81953010015, 81953010083, 81953010087,
81953016029, 81953016030, 81953016043,
81953016044, 81953016050, 81953016054,
81953016087, 81953016091, 81953016107,
81953016120, 81953016125, 81953016152,
81953016155, 81953016157, 81953016168,
81953016179, 81953016181, 81953016223,
81953016237, 81953016254, 81953016275,
81953016279, 81953016351



CV-ES-14163

Length: 125
Cone Ø: d1 Ø 30 / d2 Ø 27
Thread: M30 x 1,5 RHT

95301.0084, 90804102156, 90804102272,
90804102696, 90804102710, 81953010016,
81953010075, 81953010084, 81953010088,
81953010094, 81953010103, 81953016030,
81953016043, 81953016048, 81953016049,
81953016053, 81953016061, 81953016090,
81953016108, 81953016112, 81953016126,
81953016143, 81953016149, 81953016154,
81953016156, 81953016168, 81953016178,
81953016194, 81953016206, 81953016224,
81953016234, 81953016242, 81953016252,
81953016274, 81953016278, 81953016284,
81953016286, 81953016308, 81953016310,
81953016312, 81953016347, 81953016350,
81953016352, 82953016012, 88953016014,
N2953016001



CV-RK-5313

Ø: 90
03304800A, 81953016132



CV-RK-8118

Ø: 85
Hole Distance: 130
Thick/Height: 30
638862, 639287, 775201, 938423,
1104335, 1953248, 0003500506, 3500506,
11013547, 21032592, 42065912, 42488722,
070550504, 93192618, 070400009000,
634303610, 81432206055, 81432206073,
82262320660, 9544171010099,
5001842823, 7000307001, 8226232066



MN-DL-2160

Length: 1652 Ø: 50
Cone Ø: d1 Ø 30 / d2 Ø 27
81467106112, 81467106163, 81467106165,
81467106198, 81467106353, 81467106354,
81467106361, 81467116725



MN-DL-2175

Length: 1628 Ø: 50
Cone Ø: d1 Ø 30 / d2 Ø 27
81467106396, 81467106904



MN-DL-3402

Length: 590 Ø: 48
Hole Distance: 130 / 130
03307200A, 81432206067, 81432206068,
81432206090, 81432206092, 81432209092



MN-DL-3588

Length: 1035 Ø: 48
Cone Ø: d1 Ø 30 / d2 Ø 27
81466106333, 81466106334, 81466106354,
81466106355, 81466106360, 81466106361,
81466106721, 81466106722, 81466106723,
81466116216



MN-DL-5212

Length: 577 Ø: 48
Hole Distance: 130 / 130
81432206096, 81432206097, 81432206098,
81432206129, 81432209096, 81432209129,
81432306014, 81432306030



MN-DL-12284

Length: 1530 Ø: 50
Cone Ø: d1 Ø 30 / d2 Ø 27
81466106579, 81466106580, 81466106624,
81466116720, 81467116720, 81467116730,
81467116952



MN-DL-12421

Length: 1070 Ø: 48
Cone Ø: d1 Ø 30 / d2 Ø 27
Thread: M30 x 1,5 RHT
81466106656, 81466106659, 81466106669,
81466116006, 81466116007



MN-RK-7280

Ø: 75
Hole Distance: 115
Thick/Height: 24
0550806, 0639370, 689748, 10307400A,
81432306051, 81432306068, 81432706064



MN-RK-7287

Ø: 90
Hole Distance: 152
Thick/Height: 35
03304700A, 81953016133



MN-RK-7291

Ø: 72
Hole Distance: 130
Thick/Height: 30
10307800A, 81432206108, 81432206132



MN-SB-5243

Length: 55 Ø: 78
Thick/Height: 60
03311100A, 81437040061, 81437220020



MN-SB-5244

Ø: 65
Hole Distance: 125
Thick/Height: 22
03312000A, 81432710027, 81432710082



MN-SB-5265

Ø: 85 Thick/Height: 80
03310300A, 81437040032



MN-SB-9396

Ø: 67 Thick/Height: 60
81437040057



MN-SB-10389

Ø: 70 Thick/Height: 72
81960200340



MN-VB-5222

Length: 627 Ø: 50
Hole Distance: 152 / 152
81432706030, 81432706034, 81432706054,
81432706055, 81432706056, 81432706057,
81432706067, 81432706068, 81432706074,
81432706075, 81432706076, 81432706077,
81432706078, 81432706081, 81432706082,
81432709034, 81432709076, 81432709078,
8143706054



MN-VB-8569

Length: 627 Ø: 58
Hole Distance: 152 / 152
81432706055, 81432706056, 81432706067,
81432706068, 81432706075, 81432706077,
81432706081, 81432709056





F 90 ...

24.292 DF	04/87→02/90	Ball Head, gearshift linkage	CV-ES-2119			
	04/87→02/90	Ball Head, gearshift linkage	CV-ES-2120			
	04/87→02/90	Ball Head, gearshift linkage	CV-ES-2182			
	04/87→02/90	Centre Rod	MN-DL-2160		Coupling Rod	
	04/87→02/90	Centre Rod	MN-DL-2175		Push Rod	
	04/87→02/90	Centre Rod	MN-DL-3588		Push Rod	
	04/87→02/90	Centre Rod	MN-DL-12421		for Steering Rod	
	04/87→02/90	Engine Mounting	MN-SB-10389			
	04/87→02/90	Mounting, stabilizer coupling rod	MN-SB-5246			
	04/87→02/90	Stabiliser Mounting		MN-SB-5254		
	04/87→02/90	Stabiliser Mounting	MN-SB-9396			
	04/87→02/90	Suspension Arm Repair Kit		CV-RK-5313	for Wishbone (CV)	
	04/87→02/90	Suspension Arm Repair Kit		MN-RK-7287	for Wishbone (CV)	
	04/87→02/90	Suspension Arm Repair Kit		MN-SB-5244	for Wishbone (CV)	
	04/87→02/90	Suspension Arm Repair Kit		MN-SB-5244	for Wishbone (CV), 1st RA	
	04/87→02/90	Tie Rod End	CV-ES-2149		for Push Rod	
	04/87→02/90	Tie Rod End	CV-ES-14162		for Steering Rod	
	04/87→02/90	Tie Rod End	CV-ES-14163		for Steering Rod	
	24.292 DFK	04/87→02/90	Track Control Arm		MN-DL-3402	Trailing Arm
		04/87→02/90	Track Control Arm		MN-VB-5222	Wishbone (CV)
04/87→02/90		Track Control Arm		MN-VB-5222	Wishbone (CV), Drive Axle	
04/87→02/90		Track Control Arm		MN-VB-8569	Wishbone (CV)	
04/87→02/90		Ball Head, gearshift linkage	CV-ES-2119			
04/87→02/90		Ball Head, gearshift linkage	CV-ES-2120			
04/87→02/90		Ball Head, gearshift linkage	CV-ES-2182			
04/87→02/90		Centre Rod	MN-DL-2160		Coupling Rod	
04/87→02/90		Centre Rod	MN-DL-2175		Push Rod	
04/87→02/90		Centre Rod	MN-DL-3588		Push Rod	
24.292 DFS,24.292 DFLS	04/87→02/90	Centre Rod	MN-DL-12421		for Steering Rod	
	04/87→02/90	Engine Mounting	MN-SB-10389			
	04/87→02/90	Mounting, stabilizer coupling rod	MN-SB-5246			
	04/87→02/90	Stabiliser Mounting		MN-SB-5254		
	04/87→02/90	Stabiliser Mounting	MN-SB-9396			
	04/87→02/90	Suspension Arm Repair Kit		CV-RK-5313	for Wishbone (CV)	
	04/87→02/90	Suspension Arm Repair Kit		MN-RK-7287	for Wishbone (CV)	
	04/87→02/90	Suspension Arm Repair Kit		MN-SB-5244	for Wishbone (CV)	
	04/87→02/90	Suspension Arm Repair Kit		MN-SB-5244	for Wishbone (CV), 1st RA	
	04/87→02/90	Tie Rod End	CV-ES-2149		for Push Rod	
	04/87→02/90	Tie Rod End	CV-ES-14162		for Steering Rod	
	04/87→02/90	Tie Rod End	CV-ES-14163		for Steering Rod	
	04/87→02/90	Track Control Arm		MN-DL-3402	Trailing Arm	
	04/87→02/90	Track Control Arm		MN-VB-5222	Wishbone (CV)	
	04/87→02/90	Track Control Arm		MN-VB-5222	Wishbone (CV), Drive Axle	
	04/87→02/90	Track Control Arm		MN-VB-8569	Wishbone (CV)	
	04/87→02/90	Ball Head, gearshift linkage	CV-ES-2119			
	04/87→02/90	Ball Head, gearshift linkage	CV-ES-2120			
	04/87→02/90	Ball Head, gearshift linkage	CV-ES-2182			
	04/87→02/90	Centre Rod	MN-DL-2160		Coupling Rod	
04/87→02/90	Centre Rod	MN-DL-2175		Push Rod		
04/87→02/90	Centre Rod	MN-DL-3588		Push Rod		
04/87→02/90	Centre Rod	MN-DL-12421		for Steering Rod		
04/87→02/90	Engine Mounting	MN-SB-10389				
04/87→02/90	Mounting, stabilizer coupling rod	MN-SB-5246				
04/87→02/90	Stabiliser Mounting		MN-SB-5254			
04/87→02/90	Stabiliser Mounting	MN-SB-9396				
04/87→02/90	Suspension Arm Repair Kit		CV-RK-5313	for Wishbone (CV)		
04/87→02/90	Suspension Arm Repair Kit		CV-RK-8118	for Control Arm		
04/87→02/90	Suspension Arm Repair Kit		MN-RK-7287	for Wishbone (CV)		
04/87→02/90	Suspension Arm Repair Kit		MN-RK-7291	for Drag Link		
04/87→02/90	Suspension Arm Repair Kit		MN-SB-5244	for Wishbone (CV)		
04/87→02/90	Suspension Arm Repair Kit		MN-SB-5244	for Wishbone (CV), 1st RA		
04/87→02/90	Tie Rod End	CV-ES-2149		for Push Rod		
04/87→02/90	Tie Rod End	CV-ES-14162		for Steering Rod		

CV-ES-2119

Length: 55
Cone Ø: d1 Ø 10 / d2 Ø 10
Thread: M12 x 1,75 LHT
81953016063, 81953016131



CV-ES-2120

Length: 115
Cone Ø: d1 Ø 12,4 / d2 Ø 10,8
Thread: M14 x 1,5 RHT
03008500A, 81953016200, 81953016202,
81953016203, 81953016227



CV-ES-2149

Length: 160
Cone Ø: d1 Ø 30 / d2 Ø 27
Thread: M30 x 1,5 RHT
81953016263



CV-ES-2182

Length: 55
Cone Ø: d1 Ø 10 / d2 Ø 10
Thread: M12 x 1,75 RHT
81953016064, 81953016170



CV-ES-14162

Length: 125
Cone Ø: d1 Ø 30 / d2 Ø 27
Thread: M30 x 1,5 LHT

81953010015, 81953010083, 81953010087,
81953016029, 81953016030, 81953016043,
81953016044, 81953016050, 81953016054,
81953016087, 81953016091, 81953016107,
81953016120, 81953016125, 81953016152,
81953016155, 81953016157, 81953016168,
81953016179, 81953016181, 81953016223,
81953016237, 81953016254, 81953016275,
81953016279, 81953016351



CV-ES-14163

Length: 125
Cone Ø: d1 Ø 30 / d2 Ø 27
Thread: M30 x 1,5 RHT

95301.0084, 90804102156, 90804102272,
90804102696, 90804102710, 81953010016,
81953010075, 81953010084, 81953010088,
81953010094, 81953010103, 81953016030,
81953016043, 81953016048, 81953016049,
81953016053, 81953016061, 81953016090,
81953016108, 81953016112, 81953016126,
81953016143, 81953016149, 81953016154,
81953016156, 81953016168, 81953016178,
81953016194, 81953016206, 81953016224,
81953016234, 81953016242, 81953016252,
81953016274, 81953016278, 81953016284,
81953016286, 81953016308, 81953016310,
81953016312, 81953016347, 81953016350,
81953016352, 82953016012, 88953016014,
N2953016001



CV-RK-5313

Ø: 90
03304800A, 81953016132



CV-RK-8118

Ø: 85
Hole Distance: 130
Thick/Height: 30

638862, 639287, 775201, 938423,
1104335, 1953248, 0003500506, 3500506,
11013547, 21032592, 42065912, 42488722,
070550504, 93192618, 070400009000,
634303610, 81432206055, 81432206073,
82262320660, 9544171010099,
5001842823, 7000307001, 8226232066



MN-DL-2160

Length: 1652 Ø: 50
Cone Ø: d1 Ø 30 / d2 Ø 27

81467106112, 81467106163, 81467106165,
81467106198, 81467106353, 81467106354,
81467106361, 81467116725



MN-DL-2175

Length: 1628 Ø: 50
Cone Ø: d1 Ø 30 / d2 Ø 27
81467106396, 81467106904



MN-DL-3402

Length: 590 Ø: 48
Hole Distance: 130 / 130
03307200A, 81432206067, 81432206068,
81432206090, 81432206092, 81432209092



MN-DL-3588

Length: 1035 Ø: 48
Cone Ø: d1 Ø 30 / d2 Ø 27
81466106333, 81466106334, 81466106354,
81466106355, 81466106360, 81466106361,
81466106721, 81466106722, 81466106723,
81466116216



MN-DL-12421

Length: 1070 Ø: 48
Cone Ø: d1 Ø 30 / d2 Ø 27
Thread: M30 x 1,5 RHT
81466106656, 81466106659, 81466106669,
81466116006, 81466116007



MN-RK-7287

Ø: 90
Hole Distance: 152
Thick/Height: 35
03304700A, 81953016133



MN-RK-7291

Ø: 72
Hole Distance: 130
Thick/Height: 30
10307800A, 81432206108, 81432206132



MN-SB-5244

Ø: 65
Hole Distance: 125
Thick/Height: 22
03312000A, 81432710027, 81432710082



MN-SB-5246

Ø: 45 Thick/Height: 47
81437220022, 81437220038, 81962100450,
81962100469



MN-SB-5254

Length: 100
Ø: 93
Thick/Height: 70
81432710081



MN-SB-9396

Ø: 67
Thick/Height: 60
81437040057



MN-SB-10389

Ø: 70
Thick/Height: 72
81960200340



MN-VB-5222

Length: 627 Ø: 50
Hole Distance: 152 / 152
81432706030, 81432706034, 81432706054,
81432706055, 81432706056, 81432706057,
81432706067, 81432706068, 81432706074,
81432706075, 81432706076, 81432706077,
81432706078, 81432706081, 81432706082,
81432709034, 81432709076, 81432709078,
8143706054



MN-VB-8569

Length: 627 Ø: 58
Hole Distance: 152 / 152
81432706055, 81432706056, 81432706067,
81432706068, 81432706075, 81432706077,
81432706081, 81432709056



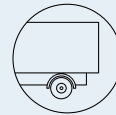

F 90 ...

24.292 DFS,24.292 DFLS ...	04/87→02/90	Tie Rod End	CV-ES-14163		for Steering Rod
	04/87→02/90	Track Control Arm		MN-DL-3402	Trailing Arm
	04/87→02/90	Track Control Arm		MN-DL-5212	Trailing Arm, Air Suspension Axle;Drive Axle
	04/87→02/90	Track Control Arm		MN-VB-5222	Wishbone (CV)
	04/87→02/90	Track Control Arm		MN-VB-5222	Wishbone (CV), Drive Axle
	04/87→02/90	Track Control Arm		MN-VB-5222	Wishbone (CV), Drive Axle;Air Suspension Axle
	04/87→02/90	Track Control Arm		MN-VB-8569	Wishbone (CV)
24.292 FNL,24.292 FNLL, 24.292 FVL	10/86→02/90	Ball Head, gearshift linkage	CV-ES-2119		
	10/86→02/90	Ball Head, gearshift linkage	CV-ES-2120		
	10/86→02/90	Ball Head, gearshift linkage	CV-ES-2182		
	10/86→02/90	Centre Rod	MN-DL-2160		Coupling Rod
	10/86→02/90	Centre Rod	MN-DL-2175		Push Rod
	10/86→02/90	Centre Rod	MN-DL-3588		Push Rod
	10/86→02/90	Centre Rod	MN-DL-12421		for Steering Rod
	10/86→02/90	Engine Mounting	MN-SB-10389		
	10/86→02/90	Stabiliser Mounting		MN-SB-5243	
	10/86→02/90	Stabiliser Mounting		MN-SB-5265	
	10/86→02/90	Stabiliser Mounting		MN-SB-5265	1st RA
	10/86→02/90	Suspension Arm Repair Kit		CV-RK-5313	for Wishbone (CV)
	10/86→02/90	Suspension Arm Repair Kit		CV-RK-8118	for Control Arm
	10/86→02/90	Suspension Arm Repair Kit		MN-RK-7280	for Drag Link
	10/86→02/90	Suspension Arm Repair Kit		MN-RK-7287	for Wishbone (CV)
	10/86→02/90	Suspension Arm Repair Kit		MN-RK-7291	for Drag Link
	10/86→02/90	Tie Rod End	CV-ES-2149		for Push Rod
	10/86→02/90	Tie Rod End	CV-ES-14162		for Steering Rod
	10/86→02/90	Tie Rod End	CV-ES-14163		for Steering Rod
	10/86→02/90	Track Control Arm		MN-DL-5212	Trailing Arm, Air Suspension Axle;Drive Axle
	10/86→02/90	Track Control Arm		MN-DL-5212	Trailing Arm, Air Suspension Axle;Drive Axle; Tag Axle
	10/86→02/90	Track Control Arm		MN-VB-5222	Wishbone (CV), Drive Axle;Air Suspension Axle
	10/86→02/90	Track Control Arm		MN-VB-5222	Wishbone (CV), Tag Axle
24.292 FNLS,24.292 FVLS	10/86→02/90	Ball Head, gearshift linkage	CV-ES-2119		
	10/86→02/90	Ball Head, gearshift linkage	CV-ES-2120		
	10/86→02/90	Ball Head, gearshift linkage	CV-ES-2182		
	10/86→02/90	Centre Rod	MN-DL-2160		Coupling Rod
	10/86→02/90	Centre Rod	MN-DL-2175		Push Rod
	10/86→02/90	Centre Rod	MN-DL-3588		Push Rod
	10/86→02/90	Centre Rod	MN-DL-12421		for Steering Rod
	10/86→02/90	Engine Mounting	MN-SB-10389		
	10/86→02/90	Stabiliser Mounting		MN-SB-5243	
	10/86→02/90	Stabiliser Mounting		MN-SB-5265	
	10/86→02/90	Stabiliser Mounting		MN-SB-5265	1st RA
	10/86→02/90	Suspension Arm Repair Kit		CV-RK-5313	for Wishbone (CV)
	10/86→02/90	Suspension Arm Repair Kit		CV-RK-8118	for Control Arm
	10/86→02/90	Suspension Arm Repair Kit		MN-RK-7280	for Drag Link
	10/86→02/90	Suspension Arm Repair Kit		MN-RK-7287	for Wishbone (CV)
	10/86→02/90	Suspension Arm Repair Kit		MN-RK-7291	for Drag Link
	10/86→02/90	Tie Rod End	CV-ES-2149		for Push Rod
	10/86→02/90	Tie Rod End	CV-ES-14162		for Steering Rod
	10/86→02/90	Tie Rod End	CV-ES-14163		for Steering Rod
	10/86→02/90	Track Control Arm		MN-DL-5212	Trailing Arm, Air Suspension Axle;Drive Axle
	10/86→02/90	Track Control Arm		MN-VB-5222	Wishbone (CV), Drive Axle;Air Suspension Axle
	10/86→02/90	Track Control Arm		MN-VB-5222	Wishbone (CV), Tag Axle
	24.302 DF	05/90→12/90	Ball Head, gearshift linkage	CV-ES-2119	
05/90→12/90		Ball Head, gearshift linkage	CV-ES-2120		
05/90→12/90		Ball Head, gearshift linkage	CV-ES-2182		
05/90→12/90		Centre Rod	MN-DL-2160		Coupling Rod
05/90→12/90		Centre Rod	MN-DL-2175		Push Rod
05/90→12/90		Centre Rod	MN-DL-3588		Push Rod
05/90→12/90		Centre Rod	MN-DL-12421		for Steering Rod
05/90→12/90		Engine Mounting	MN-SB-10389		
05/90→12/90		Mounting, stabilizer coupling rod	MN-SB-5246		
05/90→12/90		Stabiliser Mounting		MN-SB-5254	

CV-ES-2119

Length: 55
Cone Ø: d1 Ø 10 / d2 Ø 10
Thread: M12 x 1,75 LHT
81953016063, 81953016131



CV-ES-2120

Length: 115
Cone Ø: d1 Ø 12,4 / d2 Ø 10,8
Thread: M14 x 1,5 RHT
03008500A, 81953016200, 81953016202,
81953016203, 81953016227



CV-ES-2149

Length: 160
Cone Ø: d1 Ø 30 / d2 Ø 27
Thread: M30 x 1,5 RHT
81953016263



CV-ES-2182

Length: 55
Cone Ø: d1 Ø 10 / d2 Ø 10
Thread: M12 x 1,75 RHT
81953016064, 81953016170



CV-ES-14162

Length: 125
Cone Ø: d1 Ø 30 / d2 Ø 27
Thread: M30 x 1,5 LHT

81953010015, 81953010083, 81953010087,
81953016029, 81953016030, 81953016043,
81953016044, 81953016050, 81953016054,
81953016087, 81953016091, 81953016107,
81953016120, 81953016125, 81953016152,
81953016155, 81953016157, 81953016168,
81953016179, 81953016181, 81953016223,
81953016237, 81953016254, 81953016275,
81953016279, 81953016351



CV-ES-14163

Length: 125
Cone Ø: d1 Ø 30 / d2 Ø 27
Thread: M30 x 1,5 RHT

95301.0084, 90804102156, 90804102272,
90804102696, 90804102710, 81953010016,
81953010075, 81953010084, 81953010088,
81953010094, 81953010103, 81953016030,
81953016043, 81953016048, 81953016049,
81953016053, 81953016061, 81953016090,
81953016108, 81953016112, 81953016126,
81953016143, 81953016149, 81953016154,
81953016156, 81953016168, 81953016178,
81953016194, 81953016206, 81953016224,
81953016234, 81953016242, 81953016252,
81953016274, 81953016278, 81953016284,
81953016286, 81953016308, 81953016310,
81953016312, 81953016347, 81953016350,
81953016352, 82953016012, 88953016014,
N2953016001



CV-RK-5313

Ø: 90
03304800A, 81953016132



CV-RK-8118

Ø: 85
Hole Distance: 130
Thick/Height: 30

638862, 639287, 775201, 938423,
1104335, 1953248, 0003500506, 3500506,
11013547, 21032592, 42065912, 42488722,
070550504, 93192618, 070400009000,
634303610, 81432206055, 81432206073,
82262320660, 9544171010099,
5001842823, 7000307001, 8226232066



MN-DL-2160

Length: 1652 Ø: 50
Cone Ø: d1 Ø 30 / d2 Ø 27

81467106112, 81467106163, 81467106165,
81467106198, 81467106353, 81467106354,
81467106361, 81467116725



MN-DL-2175

Length: 1628 Ø: 50
Cone Ø: d1 Ø 30 / d2 Ø 27
81467106396, 81467106904



MN-DL-3402

Length: 590 Ø: 48
Hole Distance: 130 / 130
03307200A, 81432206067, 81432206068,
81432206090, 81432206092, 81432209092



MN-DL-3588

Length: 1035 Ø: 48
Cone Ø: d1 Ø 30 / d2 Ø 27

81466106333, 81466106334, 81466106354,
81466106355, 81466106360, 81466106361,
81466106721, 81466106722, 81466106723,
81466116216



MN-DL-5212

Length: 577 Ø: 48
Hole Distance: 130 / 130

81432206096, 81432206097, 81432206098,
81432206129, 81432209096, 81432209129,
81432306014, 81432306030



MN-DL-12421

Length: 1070 Ø: 48
Cone Ø: d1 Ø 30 / d2 Ø 27
Thread: M30 x 1,5 RHT

81466106656, 81466106659, 81466106669,
81466116006, 81466116007



MN-RK-7280

Ø: 75
Hole Distance: 115
Thick/Height: 24

0550806, 0639370, 689748, 10307400A,
81432306051, 81432306068, 81432706064



MN-RK-7287

Ø: 90
Hole Distance: 152
Thick/Height: 35

03304700A, 81953016133



MN-RK-7291

Ø: 72
Hole Distance: 130
Thick/Height: 30

10307800A, 81432206108, 81432206132



MN-SB-5243

Length: 55 Ø: 78
Thick/Height: 60

03311100A, 81437040061, 81437220020



MN-SB-5246

Ø: 45 Thick/Height: 47
81437220022, 81437220038, 81962100450,
81962100469



MN-SB-5254

Length: 100 Ø: 93
Thick/Height: 70

81432710081



MN-SB-5265

Ø: 85 Thick/Height: 80
03310300A, 81437040032



MN-SB-10389

Ø: 70 Thick/Height: 72
81960200340



MN-VB-5222

Length: 627 Ø: 50
Hole Distance: 152 / 152

81432706030, 81432706034, 81432706054,
81432706055, 81432706056, 81432706057,
81432706067, 81432706068, 81432706074,
81432706075, 81432706076, 81432706077,
81432706078, 81432706081, 81432706082,
81432709034, 81432709076, 81432709078,
8143706054



MN-VB-8569

Length: 627 Ø: 58
Hole Distance: 152 / 152

81432706055, 81432706056, 81432706067,
81432706068, 81432706075, 81432706077,
81432706081, 81432709056





F 90 ...

24.302 DF ...	05/90→12/90	Stabiliser Mounting	MN-SB-9396			
	05/90→12/90	Suspension Arm Repair Kit		CV-RK-5313	for Wishbone (CV)	
	05/90→12/90	Suspension Arm Repair Kit		MN-RK-7287	for Wishbone (CV)	
	05/90→12/90	Suspension Arm Repair Kit		MN-SB-5244	for Wishbone (CV)	
	05/90→12/90	Suspension Arm Repair Kit		MN-SB-5244	for Wishbone (CV), 1st RA	
	05/90→12/90	Tie Rod End	CV-ES-2149		for Push Rod	
	05/90→12/90	Tie Rod End	CV-ES-14162		for Steering Rod	
	05/90→12/90	Tie Rod End	CV-ES-14163		for Steering Rod	
	05/90→12/90	Track Control Arm		MN-DL-3402	Trailing Arm	
	05/90→12/90	Track Control Arm		MN-VB-5222	Wishbone (CV)	
	05/90→12/90	Track Control Arm		MN-VB-5222	Wishbone (CV), Drive Axle	
	05/90→12/90	Track Control Arm		MN-VB-8569	Wishbone (CV)	
	24.302 DFK	05/90→12/90	Ball Head, gearshift linkage	CV-ES-2119		
		05/90→12/90	Ball Head, gearshift linkage	CV-ES-2120		
		05/90→12/90	Ball Head, gearshift linkage	CV-ES-2182		
		05/90→12/90	Centre Rod	MN-DL-2160		Coupling Rod
05/90→12/90		Centre Rod	MN-DL-2175		Push Rod	
05/90→12/90		Centre Rod	MN-DL-3588		Push Rod	
05/90→12/90		Centre Rod	MN-DL-12421		for Steering Rod	
05/90→12/90		Engine Mounting	MN-SB-10389			
05/90→12/90		Mounting, stabilizer coupling rod	MN-SB-5246			
05/90→12/90		Stabiliser Mounting		MN-SB-5254		
05/90→12/90		Stabiliser Mounting	MN-SB-9396			
05/90→12/90		Suspension Arm Repair Kit		CV-RK-5313	for Wishbone (CV)	
05/90→12/90		Suspension Arm Repair Kit		MN-RK-7287	for Wishbone (CV)	
05/90→12/90		Suspension Arm Repair Kit		MN-SB-5244	for Wishbone (CV)	
05/90→12/90		Suspension Arm Repair Kit		MN-SB-5244	for Wishbone (CV), 1st RA	
05/90→12/90		Tie Rod End	CV-ES-2149		for Push Rod	
05/90→12/90		Tie Rod End	CV-ES-14162		for Steering Rod	
05/90→12/90		Tie Rod End	CV-ES-14163		for Steering Rod	
05/90→12/90		Track Control Arm		MN-DL-3402	Trailing Arm	
05/90→12/90		Track Control Arm		MN-VB-5222	Wishbone (CV)	
05/90→12/90		Track Control Arm		MN-VB-5222	Wishbone (CV), Drive Axle	
05/90→12/90		Track Control Arm		MN-VB-8569	Wishbone (CV)	
24.302 DFS,24.302 DFLS		05/90→01/91	Track Control Arm		MN-VB-5222	Wishbone (CV), Drive Axle
		05/90→04/95	Ball Head, gearshift linkage	CV-ES-2119		
	05/90→04/95	Ball Head, gearshift linkage	CV-ES-2120			
	05/90→04/95	Ball Head, gearshift linkage	CV-ES-2182			
	05/90→04/95	Centre Rod	MN-DL-2160		Coupling Rod	
	05/90→04/95	Centre Rod	MN-DL-2175		Push Rod	
	05/90→04/95	Centre Rod	MN-DL-3588		Push Rod	
	05/90→04/95	Centre Rod	MN-DL-12421		for Steering Rod	
	05/90→04/95	Engine Mounting	MN-SB-10389			
	05/90→04/95	Mounting, stabilizer coupling rod	MN-SB-5246			
	05/90→04/95	Stabiliser Mounting		MN-SB-5254		
	05/90→04/95	Stabiliser Mounting	MN-SB-9396			
	05/90→04/95	Suspension Arm Repair Kit		CV-RK-5313	for Wishbone (CV)	
	05/90→04/95	Suspension Arm Repair Kit		CV-RK-8118	for Control Arm	
	05/90→04/95	Suspension Arm Repair Kit		MN-RK-7287	for Wishbone (CV)	
	05/90→04/95	Suspension Arm Repair Kit		MN-RK-7291	for Drag Link	
	05/90→04/95	Suspension Arm Repair Kit		MN-SB-5244	for Wishbone (CV)	
	05/90→04/95	Suspension Arm Repair Kit		MN-SB-5244	for Wishbone (CV), 1st RA	
	05/90→04/95	Tie Rod End	CV-ES-2149		for Push Rod	
	05/90→04/95	Tie Rod End	CV-ES-14162		for Steering Rod	
	05/90→04/95	Tie Rod End	CV-ES-14163		for Steering Rod	
	05/90→04/95	Track Control Arm		MN-DL-3402	Trailing Arm	
	05/90→04/95	Track Control Arm		MN-DL-5212	Trailing Arm, Air Suspension Axle;Drive Axle	
	05/90→04/95	Track Control Arm		MN-VB-5222	Wishbone (CV)	
	05/90→04/95	Track Control Arm		MN-VB-5222	Wishbone (CV), Drive Axle;Air Suspension Axle	
	05/90→04/95	Track Control Arm		MN-VB-8569	Wishbone (CV)	
	01/91→04/95	Track Control Arm		MN-VB-8569	Wishbone (CV), Drive Axle	

CV-ES-2119

Length: 55
Cone Ø: d1 Ø 10 / d2 Ø 10
Thread: M12 x 1,75 LHT
81953016063, 81953016131



CV-ES-2120

Length: 115
Cone Ø: d1 Ø 12,4 / d2 Ø 10,8
Thread: M14 x 1,5 RHT
03008500A, 81953016200, 81953016202,
81953016203, 81953016227



CV-ES-2149

Length: 160
Cone Ø: d1 Ø 30 / d2 Ø 27
Thread: M30 x 1,5 RHT
81953016263



CV-ES-2182

Length: 55
Cone Ø: d1 Ø 10 / d2 Ø 10
Thread: M12 x 1,75 RHT
81953016064, 81953016170



CV-ES-14162

Length: 125
Cone Ø: d1 Ø 30 / d2 Ø 27
Thread: M30 x 1,5 LHT
81953010015, 81953010083, 81953010087,
81953016029, 81953016030, 81953016043,
81953016044, 81953016050, 81953016054,
81953016087, 81953016091, 81953016107,
81953016120, 81953016125, 81953016152,
81953016155, 81953016157, 81953016168,
81953016179, 81953016181, 81953016223,
81953016237, 81953016254, 81953016275,
81953016279, 81953016351



CV-ES-14163

Length: 125
Cone Ø: d1 Ø 30 / d2 Ø 27
Thread: M30 x 1,5 RHT
95301.0084, 90804102156, 90804102272,
90804102696, 90804102710, 81953010016,
81953010075, 81953010084, 81953010088,
81953010094, 81953010103, 81953016030,
81953016043, 81953016048, 81953016049,
81953016053, 81953016061, 81953016090,
81953016108, 81953016112, 81953016126,
81953016143, 81953016149, 81953016154,
81953016156, 81953016168, 81953016178,
81953016194, 81953016206, 81953016224,
81953016234, 81953016242, 81953016252,
81953016274, 81953016278, 81953016284,
81953016286, 81953016308, 81953016310,
81953016312, 81953016347, 81953016350,
81953016352, 82953016012, 88953016014,
N2953016001



CV-RK-5313

Ø: 90
03304800A, 81953016132



CV-RK-8118

Ø: 85
Hole Distance: 130
Thick/Height: 30
638862, 639287, 775201, 938423,
1104335, 1953248, 0003500506, 3500056,
11013547, 21032592, 42065912, 42488722,
070550504, 93192618, 070400009000,
634303610, 81432206055, 81432206073,
82262320660, 9544171010099,
5001842823, 7000307001, 8226232066



MN-DL-2160

Length: 1652 Ø: 50
Cone Ø: d1 Ø 30 / d2 Ø 27
81467106112, 81467106163, 81467106165,
81467106198, 81467106353, 81467106354,
81467106361, 81467116725



MN-DL-2175

Length: 1628 Ø: 50
Cone Ø: d1 Ø 30 / d2 Ø 27
81467106396, 81467106904



MN-DL-3402

Length: 590 Ø: 48
Hole Distance: 130 / 130
03307200A, 81432206067, 81432206068,
81432206090, 81432206092, 81432209099



MN-DL-3588

Length: 1035 Ø: 48
Cone Ø: d1 Ø 30 / d2 Ø 27
81466106333, 81466106334, 81466106354,
81466106355, 81466106360, 81466106361,
81466106721, 81466106722, 81466106723,
81466116216



MN-DL-5212

Length: 577 Ø: 48
Hole Distance: 130 / 130
81432206096, 81432206097, 81432206098,
81432206129, 81432209096, 81432209129,
81432306014, 81432306030



MN-DL-12421

Length: 1070 Ø: 48
Cone Ø: d1 Ø 30 / d2 Ø 27
Thread: M30 x 1,5 RHT
81466106656, 81466106659, 81466106669,
81466116006, 81466116007



MN-RK-7287

Ø: 90
Hole Distance: 152
Thick/Height: 35
03304700A, 81953016133



MN-RK-7291

Ø: 72
Hole Distance: 130
Thick/Height: 30
10307800A, 81432206108, 81432206132



MN-SB-5244

Ø: 65
Hole Distance: 125
Thick/Height: 22
03312000A, 81432710027, 81432710082



MN-SB-5246

Ø: 45 Thick/Height: 47
81437220022, 81437220038, 81962100450,
81962100469



MN-SB-5254

Length: 100 Ø: 93
Thick/Height: 70
81432710081



MN-SB-9396

Ø: 67
Thick/Height: 60
81437040057



MN-SB-10389

Ø: 70 Thick/Height: 72
8196200340



MN-VB-5222

Length: 627 Ø: 50
Hole Distance: 152 / 152
81432706030, 81432706034, 81432706054,
81432706055, 81432706056, 81432706057,
81432706067, 81432706068, 81432706074,
81432706075, 81432706076, 81432706077,
81432706078, 81432706081, 81432706082,
81432709034, 81432709076, 81432709078,
8143706054



MN-VB-8569

Length: 627 Ø: 58
Hole Distance: 152 / 152
81432706055, 81432706056, 81432706067,
81432706068, 81432706075, 81432706077,
81432706081, 81432709056



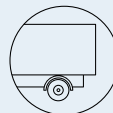

F 90 ...

24.302 FNL, 24.302 FNLL, 24.302 FVL	05/90→10/90	Ball Head, gearshift linkage	CV-ES-2119			
	05/90→10/90	Ball Head, gearshift linkage	CV-ES-2120			
	05/90→10/90	Ball Head, gearshift linkage	CV-ES-2182			
	05/90→10/90	Centre Rod	MN-DL-2160		Coupling Rod	
	05/90→10/90	Centre Rod	MN-DL-2175		Push Rod	
	05/90→10/90	Centre Rod	MN-DL-3588		Push Rod	
	05/90→10/90	Centre Rod	MN-DL-12421		for Steering Rod	
	05/90→10/90	Engine Mounting	MN-SB-10389			
	05/90→10/90	Stabiliser Mounting		MN-SB-5243		
	05/90→10/90	Stabiliser Mounting		MN-SB-5265		
	05/90→10/90	Stabiliser Mounting		MN-SB-5265	1st RA	
	05/90→10/90	Suspension Arm Repair Kit		CV-RK-5313	for Wishbone (CV)	
	05/90→10/90	Suspension Arm Repair Kit		CV-RK-8118	for Control Arm	
	05/90→10/90	Suspension Arm Repair Kit		MN-RK-7280	for Drag Link	
	05/90→10/90	Suspension Arm Repair Kit		MN-RK-7287	for Wishbone (CV)	
	05/90→10/90	Suspension Arm Repair Kit		MN-RK-7291	for Drag Link	
	05/90→10/90	Tie Rod End	CV-ES-2149		for Push Rod	
	05/90→10/90	Tie Rod End	CV-ES-14162		for Steering Rod	
	05/90→10/90	Tie Rod End	CV-ES-14163		for Steering Rod	
	05/90→10/90	Track Control Arm		MN-DL-5212	Trailing Arm, Air Suspension Axle; Drive Axle	
	05/90→10/90	Track Control Arm		MN-DL-5212	Trailing Arm, Air Suspension Axle; Drive Axle; Tag Axle	
	05/90→10/90	Track Control Arm		MN-VB-5222	Wishbone (CV), Drive Axle; Air Suspension Axle	
	05/90→10/90	Track Control Arm		MN-VB-5222	Wishbone (CV), Tag Axle	
	24.322 DF	02/90→12/90	Ball Head, gearshift linkage	CV-ES-2119		
		02/90→12/90	Ball Head, gearshift linkage	CV-ES-2120		
02/90→12/90		Ball Head, gearshift linkage	CV-ES-2182			
02/90→12/90		Centre Rod	MN-DL-2160		Coupling Rod	
02/90→12/90		Centre Rod	MN-DL-2175		Push Rod	
02/90→12/90		Centre Rod	MN-DL-3588		Push Rod	
02/90→12/90		Centre Rod	MN-DL-12421		for Steering Rod	
02/90→12/90		Engine Mounting	MN-SB-10389			
02/90→12/90		Mounting, stabilizer coupling rod	MN-SB-5246			
02/90→12/90		Stabiliser Mounting		MN-SB-5254		
02/90→12/90		Stabiliser Mounting	MN-SB-9396			
02/90→12/90		Suspension Arm Repair Kit		CV-RK-5313	for Wishbone (CV)	
02/90→12/90		Suspension Arm Repair Kit		MN-RK-7287	for Wishbone (CV)	
02/90→12/90		Suspension Arm Repair Kit		MN-SB-5244	for Wishbone (CV)	
02/90→12/90		Suspension Arm Repair Kit		MN-SB-5244	for Wishbone (CV), 1st RA	
02/90→12/90		Tie Rod End	CV-ES-2149		for Push Rod	
02/90→12/90		Tie Rod End	CV-ES-14162		for Steering Rod	
02/90→12/90		Tie Rod End	CV-ES-14163		for Steering Rod	
02/90→12/90		Track Control Arm		MN-DL-3402	Trailing Arm	
02/90→12/90		Track Control Arm		MN-VB-5222	Wishbone (CV)	
02/90→12/90		Track Control Arm		MN-VB-5222	Wishbone (CV), Drive Axle	
02/90→12/90		Track Control Arm		MN-VB-8569	Wishbone (CV)	
24.322 DFK		02/90→12/90	Ball Head, gearshift linkage	CV-ES-2119		
		02/90→12/90	Ball Head, gearshift linkage	CV-ES-2120		
		02/90→12/90	Ball Head, gearshift linkage	CV-ES-2182		
	02/90→12/90	Centre Rod	MN-DL-2160		Coupling Rod	
	02/90→12/90	Centre Rod	MN-DL-2175		Push Rod	
	02/90→12/90	Centre Rod	MN-DL-3588		Push Rod	
	02/90→12/90	Centre Rod	MN-DL-12421		for Steering Rod	
	02/90→12/90	Engine Mounting	MN-SB-10389			
	02/90→12/90	Mounting, stabilizer coupling rod	MN-SB-5246			
	02/90→12/90	Stabiliser Mounting		MN-SB-5254		
	02/90→12/90	Stabiliser Mounting	MN-SB-9396			
	02/90→12/90	Suspension Arm Repair Kit		CV-RK-5313	for Wishbone (CV)	
	02/90→12/90	Suspension Arm Repair Kit		MN-RK-7287	for Wishbone (CV)	
	02/90→12/90	Suspension Arm Repair Kit		MN-SB-5244	for Wishbone (CV)	
	02/90→12/90	Suspension Arm Repair Kit		MN-SB-5244	for Wishbone (CV), 1st RA	
	02/90→12/90	Tie Rod End	CV-ES-2149		for Push Rod	
	02/90→12/90	Tie Rod End	CV-ES-14162		for Steering Rod	

CV-ES-2119

Length: 55
Cone Ø: d1 Ø 10 / d2 Ø 10
Thread: M12 x 1,75 LHT
81953016063, 81953016131



CV-ES-2120

Length: 115
Cone Ø: d1 Ø 12,4 / d2 Ø 10,8
Thread: M14 x 1,5 RHT
03008500A, 81953016200, 81953016202,
81953016203, 81953016227



CV-ES-2149

Length: 160
Cone Ø: d1 Ø 30 / d2 Ø 27
Thread: M30 x 1,5 RHT
81953016263



CV-ES-2182

Length: 55
Cone Ø: d1 Ø 10 / d2 Ø 10
Thread: M12 x 1,75 RHT
81953016064, 81953016170



CV-ES-14162

Length: 125
Cone Ø: d1 Ø 30 / d2 Ø 27
Thread: M30 x 1,5 LHT

81953010015, 81953010083, 81953010087,
81953016029, 81953016030, 81953016043,
81953016044, 81953016050, 81953016054,
81953016087, 81953016091, 81953016107,
81953016120, 81953016125, 81953016152,
81953016155, 81953016157, 81953016168,
81953016179, 81953016181, 81953016223,
81953016237, 81953016254, 81953016275,
81953016279, 81953016351



CV-ES-14163

Length: 125
Cone Ø: d1 Ø 30 / d2 Ø 27
Thread: M30 x 1,5 RHT

95301.0084, 90804102156, 90804102272,
90804102696, 90804102710, 81953010016,
81953010075, 81953010084, 81953010088,
81953010094, 81953010103, 81953016030,
81953016043, 81953016048, 81953016049,
81953016053, 81953016061, 81953016090,
81953016108, 81953016112, 81953016126,
81953016143, 81953016149, 81953016154,
81953016156, 81953016168, 81953016178,
81953016194, 81953016206, 81953016224,
81953016234, 81953016242, 81953016252,
81953016274, 81953016278, 81953016284,
81953016286, 81953016308, 81953016310,
81953016312, 81953016347, 81953016350,
81953016352, 82953016012, 88953016014,
N2953016001



CV-RK-5313

Ø: 90
03304800A, 81953016132



CV-RK-8118

Ø: 85
Hole Distance: 130
Thick/Height: 30

638862, 639287, 775201, 938423,
1104335, 1953248, 0003500506, 3500506,
11013547, 21032592, 42065912, 42488722,
070550504, 93192618, 070400009000,
634303610, 81432206055, 81432206073,
82262320660, 9544171010099,
5001842823, 7000307001, 8226232066



MN-DL-2160

Length: 1652 Ø: 50
Cone Ø: d1 Ø 30 / d2 Ø 27
81467106112, 81467106163, 81467106165,
81467106198, 81467106353, 81467106354,
81467106361, 81467116725



MN-DL-2175

Length: 1628 Ø: 50
Cone Ø: d1 Ø 30 / d2 Ø 27
81467106396, 81467106904



MN-DL-3402

Length: 590 Ø: 48
Hole Distance: 130 / 130
03307200A, 81432206067, 81432206068,
81432206090, 81432206092, 81432209092



MN-DL-3588

Length: 1035 Ø: 48
Cone Ø: d1 Ø 30 / d2 Ø 27
81466106333, 81466106334, 81466106354,
81466106355, 81466106360, 81466106361,
81466106721, 81466106722, 81466106723,
81466116216



MN-DL-5212

Length: 577 Ø: 48
Hole Distance: 130 / 130
81432206096, 81432206097, 81432206098,
81432206129, 81432209096, 81432209129,
81432306014, 81432306030



MN-DL-12421

Length: 1070 Ø: 48
Cone Ø: d1 Ø 30 / d2 Ø 27
Thread: M30 x 1,5 RHT
81466106656, 81466106659, 81466106669,
81466116006, 81466116007



MN-RK-7280

Ø: 75
Hole Distance: 115
Thick/Height: 24
0550806, 0639370, 689748, 10307400A,
81432306051, 81432306068, 81432706064



MN-RK-7287

Ø: 90
Hole Distance: 152
Thick/Height: 35
03304700A, 81953016133



MN-RK-7291

Ø: 72
Hole Distance: 130
Thick/Height: 30
10307800A, 81432206108, 81432206132



MN-SB-5243

Length: 55 Ø: 78
Thick/Height: 60
03311100A, 81437040061, 81437220020



MN-SB-5244

Ø: 65
Hole Distance: 125
Thick/Height: 22
03312000A, 81432710027, 81432710082



MN-SB-5246

Ø: 45 Thick/Height: 47
81437220022, 81437220038, 81962100450,
81962100469



MN-SB-5254

Length: 100 Ø: 93
Thick/Height: 70
81432710081



MN-SB-5265

Ø: 85 Thick/Height: 80
03310300A, 81437040032



MN-SB-9396

Ø: 67 Thick/Height: 60
81437040057



MN-SB-10389

Ø: 70 Thick/Height: 72
81962000340



MN-VB-5222

Length: 627 Ø: 50
Hole Distance: 152 / 152
81432706030, 81432706034, 81432706054,
81432706055, 81432706056, 81432706057,
81432706067, 81432706068, 81432706074,
81432706075, 81432706076, 81432706077,
81432706078, 81432706081, 81432706082,
81432709034, 81432709076, 81432709078,
8143706054



MN-VB-8569

Length: 627 Ø: 58
Hole Distance: 152 / 152
81432706055, 81432706056, 81432706067,
81432706068, 81432706075, 81432706077,
81432706081, 81432709056





F 90 ...

24.322 DFK ...	02/90→12/90	Tie Rod End	CV-ES-14163		for Steering Rod
	02/90→12/90	Track Control Arm		MN-DL-3402	Trailing Arm
	02/90→12/90	Track Control Arm		MN-VB-5222	Wishbone (CV)
	02/90→12/90	Track Control Arm		MN-VB-5222	Wishbone (CV), Drive Axle
	02/90→12/90	Track Control Arm		MN-VB-8569	Wishbone (CV)
24.322 DFS,24.322 DFLS	02/90→12/90	Ball Head, gearshift linkage	CV-ES-2119		
	02/90→12/90	Ball Head, gearshift linkage	CV-ES-2120		
	02/90→12/90	Ball Head, gearshift linkage	CV-ES-2182		
	02/90→12/90	Centre Rod	MN-DL-2160		Coupling Rod
	02/90→12/90	Centre Rod	MN-DL-2175		Push Rod
	02/90→12/90	Centre Rod	MN-DL-3588		Push Rod
	02/90→12/90	Centre Rod	MN-DL-12421		for Steering Rod
	02/90→12/90	Engine Mounting	MN-SB-10389		
	02/90→12/90	Mounting, stabilizer coupling rod	MN-SB-5246		
	02/90→12/90	Stabiliser Mounting		MN-SB-5254	
	02/90→12/90	Stabiliser Mounting	MN-SB-9396		
	02/90→12/90	Suspension Arm Repair Kit		CV-RK-5313	for Wishbone (CV)
	02/90→12/90	Suspension Arm Repair Kit		CV-RK-8118	for Control Arm
	02/90→12/90	Suspension Arm Repair Kit		MN-RK-7287	for Wishbone (CV)
	02/90→12/90	Suspension Arm Repair Kit		MN-RK-7291	for Drag Link
	02/90→12/90	Suspension Arm Repair Kit		MN-SB-5244	for Wishbone (CV)
	02/90→12/90	Suspension Arm Repair Kit		MN-SB-5244	for Wishbone (CV), 1st RA
	02/90→12/90	Tie Rod End	CV-ES-2149		for Push Rod
	02/90→12/90	Tie Rod End	CV-ES-14162		for Steering Rod
	02/90→12/90	Tie Rod End	CV-ES-14163		for Steering Rod
	02/90→12/90	Track Control Arm		MN-DL-3402	Trailing Arm
	02/90→12/90	Track Control Arm		MN-DL-5212	Trailing Arm, Air Suspension Axle;Drive Axle
	02/90→12/90	Track Control Arm		MN-VB-5222	Wishbone (CV)
	02/90→12/90	Track Control Arm		MN-VB-5222	Wishbone (CV), Drive Axle
02/90→12/90	Track Control Arm		MN-VB-5222	Wishbone (CV), Drive Axle;Air Suspension Axle	
02/90→12/90	Track Control Arm		MN-VB-8569	Wishbone (CV)	
24.322 FNL,24.322 FNLL, 24.322 FVL	02/90→05/95	Ball Head, gearshift linkage	CV-ES-2119		
	02/90→05/95	Ball Head, gearshift linkage	CV-ES-2120		
	02/90→05/95	Ball Head, gearshift linkage	CV-ES-2182		
	02/90→05/95	Centre Rod	MN-DL-2160		Coupling Rod
	02/90→05/95	Centre Rod	MN-DL-2175		Push Rod
	02/90→05/95	Centre Rod	MN-DL-3588		Push Rod
	02/90→05/95	Centre Rod	MN-DL-12421		for Steering Rod
	02/90→05/95	Engine Mounting	MN-SB-10389		
	02/90→05/95	Stabiliser Mounting		MN-SB-5243	
	02/90→05/95	Stabiliser Mounting		MN-SB-5265	
	02/90→05/95	Stabiliser Mounting		MN-SB-5265	1st RA
	02/90→05/95	Suspension Arm Repair Kit		CV-RK-5313	for Wishbone (CV)
	02/90→05/95	Suspension Arm Repair Kit		CV-RK-8118	for Control Arm
	02/90→05/95	Suspension Arm Repair Kit		MN-RK-7280	for Drag Link
	02/90→05/95	Suspension Arm Repair Kit		MN-RK-7287	for Wishbone (CV)
	02/90→05/95	Suspension Arm Repair Kit		MN-RK-7291	for Drag Link
	02/90→05/95	Tie Rod	MN-DL-12284		
	02/90→05/95	Tie Rod End	CV-ES-2149		for Push Rod
	02/90→05/95	Tie Rod End	CV-ES-14162		for Steering Rod
	02/90→05/95	Tie Rod End	CV-ES-14163		for Steering Rod
	02/90→05/95	Track Control Arm		MN-DL-5212	Trailing Arm, Air Suspension Axle;Drive Axle
	02/90→05/95	Track Control Arm		MN-DL-5212	Trailing Arm, Air Suspension Axle;Drive Axle; Tag Axle
	02/90→05/95	Track Control Arm		MN-VB-5222	Wishbone (CV), Drive Axle;Air Suspension Axle
	02/90→05/95	Track Control Arm		MN-VB-5222	Wishbone (CV), Tag Axle
24.322 FNLS,24.322 FVLS	02/90→05/95	Ball Head, gearshift linkage	CV-ES-2119		
	02/90→05/95	Ball Head, gearshift linkage	CV-ES-2120		
	02/90→05/95	Ball Head, gearshift linkage	CV-ES-2182		
	02/90→05/95	Centre Rod	MN-DL-2160		Coupling Rod
	02/90→05/95	Centre Rod	MN-DL-2175		Push Rod
	02/90→05/95	Centre Rod	MN-DL-3588		Push Rod
02/90→05/95	Centre Rod	MN-DL-12421		for Steering Rod	

CV-ES-2119

Length: 55
Cone Ø: d1 Ø 10 / d2 Ø 10
Thread: M12 x 1,75 LHT
81953016063, 81953016131



CV-ES-2120

Length: 115
Cone Ø: d1 Ø 12,4 / d2 Ø 10,8
Thread: M14 x 1,5 RHT
03008500A, 81953016200, 81953016202,
81953016203, 81953016227



CV-ES-2149

Length: 160
Cone Ø: d1 Ø 30 / d2 Ø 27
Thread: M30 x 1,5 RHT
81953016263



CV-ES-2182

Length: 55
Cone Ø: d1 Ø 10 / d2 Ø 10
Thread: M12 x 1,75 RHT
81953016064, 81953016170



CV-ES-14162

Length: 125
Cone Ø: d1 Ø 30 / d2 Ø 27
Thread: M30 x 1,5 LHT
81953010015, 81953010083, 81953010087,
81953016029, 81953016030, 81953016043,
81953016044, 81953016050, 81953016054,
81953016087, 81953016091, 81953016107,
81953016120, 81953016125, 81953016152,
81953016155, 81953016157, 81953016168,
81953016179, 81953016181, 81953016223,
81953016237, 81953016254, 81953016275,
81953016279, 81953016351



CV-ES-14163

Length: 125
Cone Ø: d1 Ø 30 / d2 Ø 27
Thread: M30 x 1,5 RHT
95301.0084, 90804102156, 90804102272,
90804102696, 90804102710, 81953010016,
81953010075, 81953010084, 81953010088,
81953010094, 81953010103, 81953016030,
81953016043, 81953016048, 81953016049,
81953016053, 81953016061, 81953016090,
81953016108, 81953016112, 81953016126,
81953016143, 81953016149, 81953016154,
81953016156, 81953016168, 81953016178,
81953016194, 81953016206, 81953016224,
81953016234, 81953016242, 81953016252,
81953016274, 81953016278, 81953016284,
81953016286, 81953016308, 81953016310,
81953016312, 81953016347, 81953016350,
81953016352, 82953016012, 88953016014,
N2953016001



CV-RK-5313

Ø: 90
03304800A, 81953016132



CV-RK-8118

Ø: 85
Hole Distance: 130
Thick/Height: 30
638862, 639287, 775201, 938423,
1104335, 1953248, 0003500506, 3500506,
11013547, 21032592, 42065912, 42488722,
070550504, 93192618, 070400009000,
634303610, 81432206055, 81432206073,
82262320660, 9544171010099,
5001842823, 7000307001, 8226232066



MN-DL-2160

Length: 1652 Ø: 50
Cone Ø: d1 Ø 30 / d2 Ø 27
81467106112, 81467106163, 81467106165,
81467106198, 81467106353, 81467106354,
81467106361, 81467116725



MN-DL-2175

Length: 1628 Ø: 50
Cone Ø: d1 Ø 30 / d2 Ø 27
81467106396, 81467106904



MN-DL-3402

Length: 590 Ø: 48
Hole Distance: 130 / 130
03307200A, 81432206067, 81432206068,
81432206090, 81432206092, 81432209092



MN-DL-3588

Length: 1035 Ø: 48
Cone Ø: d1 Ø 30 / d2 Ø 27
81466106333, 81466106334, 81466106354,
81466106355, 81466106360, 81466106361,
81466106721, 81466106722, 81466106723,
81466116216



MN-DL-5212

Length: 577 Ø: 48
Hole Distance: 130 / 130
81432206096, 81432206097, 81432206098,
81432206129, 81432209096, 81432209129,
81432306014, 81432306030



MN-DL-12284

Length: 1530 Ø: 50
Cone Ø: d1 Ø 30 / d2 Ø 27
81466106579, 81466106580, 81466106624,
81466116720, 81467116720, 81467116730,
81467116952



MN-DL-12421

Length: 1070 Ø: 48
Cone Ø: d1 Ø 30 / d2 Ø 27
Thread: M30 x 1,5 RHT
81466106656, 81466106659, 81466106669,
81466116006, 81466116007



MN-RK-7280

Ø: 75
Hole Distance: 115
Thick/Height: 24
0550806, 0639370, 689748, 10307400A,
81432306051, 81432306068, 81432706064



MN-RK-7287

Ø: 90
Hole Distance: 152
Thick/Height: 35
03304700A, 81953016133



MN-RK-7291

Ø: 72
Hole Distance: 130
Thick/Height: 30
10307800A, 81432206108, 81432206132



MN-SB-5243

Length: 55 Ø: 78
Thick/Height: 60
03311100A, 81437040061, 81437220020



MN-SB-5244

Ø: 65
Hole Distance: 125
Thick/Height: 22
03312000A, 81432710027, 81432710082



MN-SB-5246

Ø: 45 Thick/Height: 47
81437220022, 81437220038, 81962100450,
81962100469



MN-SB-5254

Length: 100 Ø: 93
Thick/Height: 70
81432710081



MN-SB-5265

Ø: 85 Thick/Height: 80
03310300A, 81437040032



MN-SB-9396

Ø: 67 Thick/Height: 60
81437040057



MN-SB-10389

Ø: 70 Thick/Height: 72
81960200340



MN-VB-5222

Length: 627 Ø: 50
Hole Distance: 152 / 152
81432706030, 81432706034, 81432706054,
81432706055, 81432706056, 81432706057,
81432706067, 81432706068, 81432706074,
81432706075, 81432706076, 81432706077,
81432706078, 81432706081, 81432706082,
81432709034, 81432709076, 81432709078,
8143706054



MN-VB-8569

Length: 627 Ø: 58
Hole Distance: 152 / 152
81432706055, 81432706056, 81432706067,
81432706068, 81432706075, 81432706077,
81432706081, 81432709056





F 90 ...

24.322 FNLS,24.322 FVLS ...	02/90→05/95	Engine Mounting	MN-SB-10389			
	02/90→05/95	Stabiliser Mounting		MN-SB-5243		
	02/90→05/95	Stabiliser Mounting		MN-SB-5265		
	02/90→05/95	Stabiliser Mounting		MN-SB-5265	1st RA	
	02/90→05/95	Suspension Arm Repair Kit		CV-RK-5313	for Wishbone (CV)	
	02/90→05/95	Suspension Arm Repair Kit		CV-RK-8118	for Control Arm	
	02/90→05/95	Suspension Arm Repair Kit		MN-RK-7280	for Drag Link	
	02/90→05/95	Suspension Arm Repair Kit		MN-RK-7287	for Wishbone (CV)	
	02/90→05/95	Suspension Arm Repair Kit		MN-RK-7291	for Drag Link	
	02/90→05/95	Tie Rod	MN-DL-12284			
	02/90→05/95	Tie Rod End	CV-ES-2149		for Push Rod	
	02/90→05/95	Tie Rod End	CV-ES-14162		for Steering Rod	
	02/90→05/95	Tie Rod End	CV-ES-14163		for Steering Rod	
	02/90→05/95	Track Control Arm		MN-DL-5212	Trailing Arm, Air Suspension Axle;Drive Axle	
	02/90→05/95	Track Control Arm		MN-DL-5212	Trailing Arm, Air Suspension Axle;Drive Axle; Tag Axle	
	02/90→05/95	Track Control Arm		MN-VB-5222	Wishbone (CV), Drive Axle;Air Suspension Axle	
	02/90→05/95	Track Control Arm		MN-VB-5222	Wishbone (CV), Tag Axle	
	24.332 DF	04/87→02/90	Ball Head, gearshift linkage	CV-ES-2119		
		04/87→02/90	Ball Head, gearshift linkage	CV-ES-2120		
		04/87→02/90	Ball Head, gearshift linkage	CV-ES-2182		
04/87→02/90		Centre Rod	MN-DL-2160		Coupling Rod	
04/87→02/90		Centre Rod	MN-DL-2175		Push Rod	
04/87→02/90		Centre Rod	MN-DL-3588		Push Rod	
04/87→02/90		Centre Rod	MN-DL-12421		for Steering Rod	
04/87→02/90		Engine Mounting	MN-SB-10389			
04/87→02/90		Mounting, stabilizer coupling rod	MN-SB-5246			
04/87→02/90		Stabiliser Mounting		MN-SB-5254		
04/87→02/90		Stabiliser Mounting	MN-SB-9396			
04/87→02/90		Suspension Arm Repair Kit		CV-RK-5313	for Wishbone (CV)	
04/87→02/90		Suspension Arm Repair Kit		MN-RK-7287	for Wishbone (CV)	
04/87→02/90		Suspension Arm Repair Kit		MN-SB-5244	for Wishbone (CV)	
04/87→02/90		Suspension Arm Repair Kit		MN-SB-5244	for Wishbone (CV), 1st RA	
04/87→02/90		Tie Rod End	CV-ES-2149		for Push Rod	
04/87→02/90		Tie Rod End	CV-ES-14162		for Steering Rod	
04/87→02/90		Tie Rod End	CV-ES-14163		for Steering Rod	
04/87→02/90		Track Control Arm		MN-DL-3402	Trailing Arm	
04/87→02/90		Track Control Arm		MN-VB-5222	Wishbone (CV)	
04/87→02/90	Track Control Arm		MN-VB-5222	Wishbone (CV), Drive Axle		
04/87→02/90	Track Control Arm		MN-VB-8569	Wishbone (CV)		
24.332 DFK	04/87→02/90	Ball Head, gearshift linkage	CV-ES-2119			
	04/87→02/90	Ball Head, gearshift linkage	CV-ES-2120			
	04/87→02/90	Ball Head, gearshift linkage	CV-ES-2182			
	04/87→02/90	Centre Rod	MN-DL-2160		Coupling Rod	
	04/87→02/90	Centre Rod	MN-DL-2175		Push Rod	
	04/87→02/90	Centre Rod	MN-DL-3588		Push Rod	
	04/87→02/90	Centre Rod	MN-DL-12421		for Steering Rod	
	04/87→02/90	Engine Mounting	MN-SB-10389			
	04/87→02/90	Mounting, stabilizer coupling rod	MN-SB-5246			
	04/87→02/90	Stabiliser Mounting		MN-SB-5254		
	04/87→02/90	Stabiliser Mounting	MN-SB-9396			
	04/87→02/90	Suspension Arm Repair Kit		CV-RK-5313	for Wishbone (CV)	
	04/87→02/90	Suspension Arm Repair Kit		MN-RK-7287	for Wishbone (CV)	
	04/87→02/90	Suspension Arm Repair Kit		MN-SB-5244	for Wishbone (CV)	
	04/87→02/90	Suspension Arm Repair Kit		MN-SB-5244	for Wishbone (CV), 1st RA	
	04/87→02/90	Tie Rod End	CV-ES-2149		for Push Rod	
	04/87→02/90	Tie Rod End	CV-ES-14162		for Steering Rod	
	04/87→02/90	Tie Rod End	CV-ES-14163		for Steering Rod	
	04/87→02/90	Track Control Arm		MN-DL-3402	Trailing Arm	
	04/87→02/90	Track Control Arm		MN-VB-5222	Wishbone (CV)	
04/87→02/90	Track Control Arm		MN-VB-5222	Wishbone (CV), Drive Axle		
04/87→02/90	Track Control Arm		MN-VB-8569	Wishbone (CV)		

CV-ES-2119

Length: 55
Cone Ø: d1 Ø 10 / d2 Ø 10
Thread: M12 x 1,75 LHT
81953016063, 81953016131



CV-ES-2120

Length: 115
Cone Ø: d1 Ø 12,4 / d2 Ø 10,8
Thread: M14 x 1,5 RHT
03008500A, 81953016200, 81953016202,
81953016203, 81953016227



CV-ES-2149

Length: 160
Cone Ø: d1 Ø 30 / d2 Ø 27
Thread: M30 x 1,5 RHT
81953016263



CV-ES-2182

Length: 55
Cone Ø: d1 Ø 10 / d2 Ø 10
Thread: M12 x 1,75 RHT
81953016064, 81953016170



CV-ES-14162

Length: 125
Cone Ø: d1 Ø 30 / d2 Ø 27
Thread: M30 x 1,5 LHT
81953010015, 81953010083, 81953010087,
81953016029, 81953016030, 81953016043,
81953016044, 81953016050, 81953016054,
81953016087, 81953016091, 81953016107,
81953016120, 81953016125, 81953016152,
81953016155, 81953016157, 81953016168,
81953016179, 81953016181, 81953016223,
81953016237, 81953016254, 81953016275,
81953016279, 81953016351



CV-ES-14163

Length: 125
Cone Ø: d1 Ø 30 / d2 Ø 27
Thread: M30 x 1,5 RHT
95301.0084, 90804102156, 90804102272,
90804102696, 90804102710, 81953010016,
81953010075, 81953010084, 81953010088,
81953010094, 81953010103, 81953016030,
81953016043, 81953016048, 81953016049,
81953016053, 81953016061, 81953016090,
81953016108, 81953016112, 81953016126,
81953016143, 81953016149, 81953016154,
81953016156, 81953016168, 81953016178,
81953016194, 81953016206, 81953016224,
81953016234, 81953016242, 81953016252,
81953016274, 81953016278, 81953016284,
81953016286, 81953016308, 81953016310,
81953016312, 81953016347, 81953016350,
81953016352, 82953016012, 88953016014,
N2953016001



CV-RK-5313

Ø: 90
03304800A, 81953016132



CV-RK-8118

Ø: 85
Hole Distance: 130
Thick/Height: 30
638862, 639287, 775201, 938423,
1104335, 1953248, 0003500506, 3500506,
11013547, 21032592, 42065912, 42488722,
070550504, 93192618, 070400009000,
634303610, 81432206055, 81432206073,
82262320660, 9544171010099,
5001842823, 7000307001, 8226232066



MN-DL-2160

Length: 1652 Ø: 50
Cone Ø: d1 Ø 30 / d2 Ø 27
81467106112, 81467106163, 81467106165,
81467106198, 81467106353, 81467106354,
81467106361, 81467116725



MN-DL-2175

Length: 1628 Ø: 50
Cone Ø: d1 Ø 30 / d2 Ø 27
81467106396, 81467106904



MN-DL-3402

Length: 590 Ø: 48
Hole Distance: 130 / 130
03307200A, 81432206067, 81432206068,
81432206090, 81432206092, 81432209092



MN-DL-3588

Length: 1035 Ø: 48
Cone Ø: d1 Ø 30 / d2 Ø 27
81466106333, 81466106334, 81466106354,
81466106355, 81466106360, 81466106361,
81466106721, 81466106722, 81466106723,
81466116216



MN-DL-5212

Length: 577 Ø: 48
Hole Distance: 130 / 130
81432206096, 81432206097, 81432206098,
81432206129, 81432209096, 81432209129,
81432306014, 81432306030



MN-DL-12284

Length: 1530 Ø: 50
Cone Ø: d1 Ø 30 / d2 Ø 27
81466106579, 81466106580, 81466106624,
81466116720, 81467116720, 81467116730,
81467116952



MN-DL-12421

Length: 1070 Ø: 48
Cone Ø: d1 Ø 30 / d2 Ø 27
Thread: M30 x 1,5 RHT
81466106656, 81466106659, 81466106669,
81466116006, 81466116007



MN-RK-7280

Ø: 75
Hole Distance: 115
Thick/Height: 24
0550806, 0639370, 689748, 10307400A,
81432306051, 81432306068, 81432706064



MN-RK-7287

Ø: 90
Hole Distance: 152
Thick/Height: 35
03304700A, 81953016133



MN-RK-7291

Ø: 72
Hole Distance: 130
Thick/Height: 30
10307800A, 81432206108, 81432206132



MN-SB-5243

Length: 55 Ø: 78
Thick/Height: 60
03311100A, 81437040061, 81437220020



MN-SB-5244

Ø: 65
Hole Distance: 125
Thick/Height: 22
03312000A, 81432710027, 81432710082



MN-SB-5246

Ø: 45 Thick/Height: 47
81437220022, 81437220038, 81962100450,
81962100469



MN-SB-5254

Length: 100 Ø: 93
Thick/Height: 70
81432710081



MN-SB-5265

Ø: 85 Thick/Height: 80
03310300A, 81437040032



MN-SB-9396

Ø: 67 Thick/Height: 60
81437040057



MN-SB-10389

Ø: 70 Thick/Height: 72
81960200340



MN-VB-5222

Length: 627 Ø: 50
Hole Distance: 152 / 152
81432706030, 81432706034, 81432706054,
81432706055, 81432706056, 81432706057,
81432706067, 81432706068, 81432706074,
81432706075, 81432706076, 81432706077,
81432706078, 81432706081, 81432706082,
81432709034, 81432709076, 81432709078,
8143706054



MN-VB-8569

Length: 627 Ø: 58
Hole Distance: 152 / 152
81432706055, 81432706056, 81432706067,
81432706068, 81432706075, 81432706077,
81432706081, 81432709056





F 90 ...

24.332 DFS,24.332 DFLS	04/87→02/90	Ball Head, gearshift linkage	CV-ES-2119			
	04/87→02/90	Ball Head, gearshift linkage	CV-ES-2120			
	04/87→02/90	Ball Head, gearshift linkage	CV-ES-2182			
	04/87→02/90	Centre Rod	MN-DL-2160		Coupling Rod	
	04/87→02/90	Centre Rod	MN-DL-2175		Push Rod	
	04/87→02/90	Centre Rod	MN-DL-3588		Push Rod	
	04/87→02/90	Centre Rod	MN-DL-12421		for Steering Rod	
	04/87→02/90	Engine Mounting	MN-SB-10389			
	04/87→02/90	Mounting, stabilizer coupling rod	MN-SB-5246			
	04/87→02/90	Stabiliser Mounting		MN-SB-5254		
	04/87→02/90	Stabiliser Mounting	MN-SB-9396			
	04/87→02/90	Suspension Arm Repair Kit		CV-RK-5313	for Wishbone (CV)	
	04/87→02/90	Suspension Arm Repair Kit		CV-RK-8118	for Control Arm	
	04/87→02/90	Suspension Arm Repair Kit		MN-RK-7287	for Wishbone (CV)	
	04/87→02/90	Suspension Arm Repair Kit		MN-RK-7291	for Drag Link	
	04/87→02/90	Suspension Arm Repair Kit		MN-SB-5244	for Wishbone (CV)	
	04/87→02/90	Suspension Arm Repair Kit		MN-SB-5244	for Wishbone (CV), 1st RA	
	04/87→02/90	Tie Rod End	CV-ES-2149		for Push Rod	
	04/87→02/90	Tie Rod End	CV-ES-14162		for Steering Rod	
	04/87→02/90	Tie Rod End	CV-ES-14163		for Steering Rod	
	04/87→02/90	Track Control Arm		MN-DL-3402	Trailing Arm	
	04/87→02/90	Track Control Arm		MN-DL-5212	Trailing Arm, Air Suspension Axle;Drive Axle	
	04/87→02/90	Track Control Arm		MN-VB-5222	Wishbone (CV)	
	04/87→02/90	Track Control Arm		MN-VB-5222	Wishbone (CV), Drive Axle	
	04/87→02/90	Track Control Arm		MN-VB-5222	Wishbone (CV), Drive Axle;Air Suspension Axle	
	04/87→02/90	Track Control Arm		MN-VB-8569	Wishbone (CV)	
	24.332 FNL,24.332 FNLL, 24.332 FVL	10/86→02/90	Ball Head, gearshift linkage	CV-ES-2119		
		10/86→02/90	Ball Head, gearshift linkage	CV-ES-2120		
		10/86→02/90	Ball Head, gearshift linkage	CV-ES-2182		
		10/86→02/90	Centre Rod	MN-DL-2160		Coupling Rod
		10/86→02/90	Centre Rod	MN-DL-2175		Push Rod
		10/86→02/90	Centre Rod	MN-DL-3588		Push Rod
10/86→02/90		Centre Rod	MN-DL-12421		for Steering Rod	
10/86→02/90		Engine Mounting	MN-SB-10389			
10/86→02/90		Stabiliser Mounting		MN-SB-5243		
10/86→02/90		Stabiliser Mounting		MN-SB-5265		
10/86→02/90		Stabiliser Mounting		MN-SB-5265	1st RA	
10/86→02/90		Suspension Arm Repair Kit		CV-RK-5313	for Wishbone (CV)	
10/86→02/90		Suspension Arm Repair Kit		CV-RK-8118	for Control Arm	
10/86→02/90		Suspension Arm Repair Kit		MN-RK-7280	for Drag Link	
10/86→02/90		Suspension Arm Repair Kit		MN-RK-7287	for Wishbone (CV)	
10/86→02/90		Suspension Arm Repair Kit		MN-RK-7291	for Drag Link	
10/86→02/90		Tie Rod End	CV-ES-2149		for Push Rod	
10/86→02/90		Tie Rod End	CV-ES-14162		for Steering Rod	
10/86→02/90		Tie Rod End	CV-ES-14163		for Steering Rod	
10/86→02/90		Track Control Arm		MN-DL-5212	Trailing Arm, Air Suspension Axle;Drive Axle	
10/86→02/90		Track Control Arm		MN-DL-5212	Trailing Arm, Air Suspension Axle;Drive Axle; Tag Axle	
10/86→02/90		Track Control Arm		MN-VB-5222	Wishbone (CV), Drive Axle;Air Suspension Axle	
10/86→02/90		Track Control Arm		MN-VB-5222	Wishbone (CV), Tag Axle	
24.332 FNLS,24.332 FVLS		10/86→02/90	Ball Head, gearshift linkage	CV-ES-2119		
		10/86→02/90	Ball Head, gearshift linkage	CV-ES-2120		
		10/86→02/90	Ball Head, gearshift linkage	CV-ES-2182		
	10/86→02/90	Centre Rod	MN-DL-2160		Coupling Rod	
	10/86→02/90	Centre Rod	MN-DL-2175		Push Rod	
	10/86→02/90	Centre Rod	MN-DL-3588		Push Rod	
	10/86→02/90	Centre Rod	MN-DL-12421		for Steering Rod	
	10/86→02/90	Engine Mounting	MN-SB-10389			
	10/86→02/90	Stabiliser Mounting		MN-SB-5243		
	10/86→02/90	Stabiliser Mounting		MN-SB-5265		
	10/86→02/90	Stabiliser Mounting		MN-SB-5265	1st RA	
	10/86→02/90	Suspension Arm Repair Kit		CV-RK-5313	for Wishbone (CV)	
10/86→02/90	Suspension Arm Repair Kit		CV-RK-8118	for Control Arm		

CV-ES-2119

Length: 55
Cone Ø: d1 Ø 10 / d2 Ø 10
Thread: M12 x 1,75 LHT
81953016063, 81953016131



CV-ES-2120

Length: 115
Cone Ø: d1 Ø 12,4 / d2 Ø 10,8
Thread: M14 x 1,5 RHT
03008500A, 81953016200, 81953016202,
81953016203, 81953016227



CV-ES-2149

Length: 160
Cone Ø: d1 Ø 30 / d2 Ø 27
Thread: M30 x 1,5 RHT
81953016263



CV-ES-2182

Length: 55
Cone Ø: d1 Ø 10 / d2 Ø 10
Thread: M12 x 1,75 RHT
81953016064, 81953016170



CV-ES-14162

Length: 125
Cone Ø: d1 Ø 30 / d2 Ø 27
Thread: M30 x 1,5 LHT
81953010015, 81953010083, 81953010087,
81953016029, 81953016030, 81953016043,
81953016044, 81953016050, 81953016054,
81953016087, 81953016091, 81953016107,
81953016120, 81953016125, 81953016152,
81953016155, 81953016157, 81953016168,
81953016179, 81953016181, 81953016223,
81953016237, 81953016254, 81953016275,
81953016279, 81953016351



CV-ES-14163

Length: 125
Cone Ø: d1 Ø 30 / d2 Ø 27
Thread: M30 x 1,5 RHT
95301.0084, 90804102156, 90804102272,
90804102696, 90804102710, 81953010016,
81953010075, 81953010084, 81953010088,
81953010094, 81953010103, 81953016030,
81953016043, 81953016048, 81953016049,
81953016053, 81953016061, 81953016090,
81953016108, 81953016112, 81953016126,
81953016143, 81953016149, 81953016154,
81953016156, 81953016168, 81953016178,
81953016194, 81953016206, 81953016224,
81953016234, 81953016242, 81953016252,
81953016274, 81953016278, 81953016284,
81953016286, 81953016308, 81953016310,
81953016312, 81953016347, 81953016350,
81953016352, 82953016012, 88953016014,
N2953016001



CV-RK-5313

Ø: 90
03304800A, 81953016132



CV-RK-8118

Ø: 85
Hole Distance: 130
Thick/Height: 30
638862, 639287, 775201, 938423,
1104335, 1953248, 0003500506, 3500506,
11013547, 21032592, 42065912, 42488722,
070550504, 93192618, 070400009000,
634303610, 81432206055, 81432206073,
82262320660, 9544171010099,
5001842823, 7000307001, 8226232066



MN-DL-2160

Length: 1652 Ø: 50
Cone Ø: d1 Ø 30 / d2 Ø 27
81467106112, 81467106163, 81467106165,
81467106198, 81467106353, 81467106354,
81467106361, 81467116725



MN-DL-2175

Length: 1628 Ø: 50
Cone Ø: d1 Ø 30 / d2 Ø 27
81467106396, 81467106904



MN-DL-3402

Length: 590 Ø: 48
Hole Distance: 130 / 130
03307200A, 81432206067, 81432206068,
81432206090, 81432206092, 81432209092



MN-DL-3588

Length: 1035 Ø: 48
Cone Ø: d1 Ø 30 / d2 Ø 27
81466106333, 81466106334, 81466106354,
81466106355, 81466106360, 81466106361,
81466106721, 81466106722, 81466106723,
81466116216



MN-DL-5212

Length: 577 Ø: 48
Hole Distance: 130 / 130
81432206096, 81432206097, 81432206098,
81432206129, 81432209096, 81432209129,
81432306014, 81432306030



MN-DL-12421

Length: 1070 Ø: 48
Cone Ø: d1 Ø 30 / d2 Ø 27
Thread: M30 x 1,5 RHT
81466106656, 81466106659, 81466106669,
81466116006, 81466116007



MN-RK-7280

Ø: 75
Hole Distance: 115
Thick/Height: 24
0550806, 0639370, 689748, 10307400A,
81432306051, 81432306068, 81432706064



MN-RK-7287

Ø: 90
Hole Distance: 152
Thick/Height: 35
03304700A, 81953016133



MN-RK-7291

Ø: 72
Hole Distance: 130
Thick/Height: 30
10307800A, 81432206108, 81432206132



MN-SB-5243

Length: 55 Ø: 78
Thick/Height: 60
03311100A, 81437040061, 81437220020



MN-SB-5244

Ø: 65
Hole Distance: 125
Thick/Height: 22
03312000A, 81432710027, 81432710082



MN-SB-5246

Ø: 45 Thick/Height: 47
81437220022, 81437220038, 81962100450,
81962100469



MN-SB-5254

Length: 100 Ø: 93
Thick/Height: 70
81432710081



MN-SB-5265

Ø: 85 Thick/Height: 80
03310300A, 81437040032



MN-SB-9396

Ø: 67 Thick/Height: 60
81437040057



MN-SB-10389

Ø: 70 Thick/Height: 72
81960200340



MN-VB-5222

Length: 627 Ø: 50
Hole Distance: 152 / 152
81432706030, 81432706034, 81432706054,
81432706055, 81432706056, 81432706057,
81432706067, 81432706068, 81432706074,
81432706075, 81432706076, 81432706077,
81432706078, 81432706081, 81432706082,
81432709034, 81432709076, 81432709078,
8143706054



MN-VB-8569

Length: 627 Ø: 58
Hole Distance: 152 / 152
81432706055, 81432706056, 81432706067,
81432706068, 81432706075, 81432706077,
81432706081, 81432709056





F 90 ...

24.332 FNLS,24.332 FVLS ...	10/86→02/90	Suspension Arm Repair Kit		MN-RK-7280	for Drag Link
	10/86→02/90	Suspension Arm Repair Kit		MN-RK-7287	for Wishbone (CV)
	10/86→02/90	Suspension Arm Repair Kit		MN-RK-7291	for Drag Link
	10/86→02/90	Tie Rod End	CV-ES-2149		for Push Rod
	10/86→02/90	Tie Rod End	CV-ES-14162		for Steering Rod
	10/86→02/90	Tie Rod End	CV-ES-14163		for Steering Rod
	10/86→02/90	Track Control Arm		MN-DL-5212	Trailing Arm, Air Suspension Axle;Drive Axle
	10/86→02/90	Track Control Arm		MN-DL-5212	Trailing Arm, Air Suspension Axle;Drive Axle; Tag Axle
24.342 FNL,24.342 FNLL	10/86→02/90	Track Control Arm		MN-VB-5222	Wishbone (CV), Drive Axle;Air Suspension Axle
	05/94→05/95	Ball Head, gearshift linkage	CV-ES-2120		
	05/94→05/95	Centre Rod	MN-DL-12421		for Steering Rod
	05/94→05/95	Engine Mounting	MN-SB-10389		
	05/94→05/95	Suspension Arm Repair Kit		CV-RK-5313	for Wishbone (CV)
	05/94→05/95	Suspension Arm Repair Kit		CV-RK-8118	for Control Arm
	05/94→05/95	Suspension Arm Repair Kit		MN-RK-7280	for Drag Link
	05/94→05/95	Suspension Arm Repair Kit		MN-RK-7287	for Wishbone (CV)
	05/94→05/95	Suspension Arm Repair Kit		MN-RK-7291	for Drag Link
	05/94→05/95	Tie Rod	MN-DL-12284		
	05/94→05/95	Tie Rod End	CV-ES-14163		for Steering Rod
	05/94→05/95	Track Control Arm		MN-DL-5212	Trailing Arm, Air Suspension Axle;Drive Axle; Tag Axle
	05/94→05/95	Track Control Arm		MN-VB-5222	Wishbone (CV), Drive Axle;Air Suspension Axle
	05/94→05/95	Track Control Arm		MN-VB-5222	Wishbone (CV), Tag Axle
24.362 DF	04/87→02/90	Ball Head, gearshift linkage	CV-ES-2119		
	04/87→02/90	Ball Head, gearshift linkage	CV-ES-2120		
	04/87→02/90	Ball Head, gearshift linkage	CV-ES-2182		
	04/87→02/90	Centre Rod	MN-DL-2160		Coupling Rod
	04/87→02/90	Centre Rod	MN-DL-2175		Push Rod
	04/87→02/90	Centre Rod	MN-DL-3588		Push Rod
	04/87→02/90	Centre Rod	MN-DL-12421		for Steering Rod
	04/87→02/90	Engine Mounting	MN-SB-10389		
	04/87→02/90	Mounting, stabilizer coupling rod	MN-SB-5246		
	04/87→02/90	Stabiliser Mounting		MN-SB-5254	
	04/87→02/90	Stabiliser Mounting	MN-SB-9396		
	04/87→02/90	Suspension Arm Repair Kit		CV-RK-5313	for Wishbone (CV)
	04/87→02/90	Suspension Arm Repair Kit		MN-RK-7287	for Wishbone (CV)
	04/87→02/90	Suspension Arm Repair Kit		MN-SB-5244	for Wishbone (CV)
	04/87→02/90	Suspension Arm Repair Kit		MN-SB-5244	for Wishbone (CV), 1st RA
	04/87→02/90	Tie Rod End	CV-ES-2149		for Push Rod
	04/87→02/90	Tie Rod End	CV-ES-14162		for Steering Rod
	04/87→02/90	Tie Rod End	CV-ES-14163		for Steering Rod
	04/87→02/90	Track Control Arm		MN-DL-3402	Trailing Arm
	04/87→02/90	Track Control Arm		MN-VB-5222	Wishbone (CV)
	04/87→02/90	Track Control Arm		MN-VB-5222	Wishbone (CV), Drive Axle
04/87→02/90	Track Control Arm		MN-VB-8569	Wishbone (CV)	
24.362 DFK	04/87→02/90	Ball Head, gearshift linkage	CV-ES-2119		
	04/87→02/90	Ball Head, gearshift linkage	CV-ES-2120		
	04/87→02/90	Ball Head, gearshift linkage	CV-ES-2182		
	04/87→02/90	Centre Rod	MN-DL-2160		Coupling Rod
	04/87→02/90	Centre Rod	MN-DL-2175		Push Rod
	04/87→02/90	Centre Rod	MN-DL-3588		Push Rod
	04/87→02/90	Centre Rod	MN-DL-12421		for Steering Rod
	04/87→02/90	Engine Mounting	MN-SB-10389		
	04/87→02/90	Mounting, stabilizer coupling rod	MN-SB-5246		
	04/87→02/90	Stabiliser Mounting		MN-SB-5254	
	04/87→02/90	Stabiliser Mounting	MN-SB-9396		
	04/87→02/90	Suspension Arm Repair Kit		CV-RK-5313	for Wishbone (CV)
	04/87→02/90	Suspension Arm Repair Kit		MN-RK-7287	for Wishbone (CV)
	04/87→02/90	Suspension Arm Repair Kit		MN-SB-5244	for Wishbone (CV)
	04/87→02/90	Suspension Arm Repair Kit		MN-SB-5244	for Wishbone (CV), 1st RA
	04/87→02/90	Tie Rod End	CV-ES-2149		for Push Rod
	04/87→02/90	Tie Rod End	CV-ES-14162		for Steering Rod

CV-ES-2119

Length: 55
Cone Ø: d1 Ø 10 / d2 Ø 10
Thread: M12 x 1,75 LHT
81953016063, 81953016131



CV-ES-2120

Length: 115
Cone Ø: d1 Ø 12,4 / d2 Ø 10,8
Thread: M14 x 1,5 RHT
03008500A, 81953016200, 81953016202, 81953016203, 81953016227



CV-ES-2149

Length: 160
Cone Ø: d1 Ø 30 / d2 Ø 27
Thread: M30 x 1,5 RHT
81953016263



CV-ES-2182

Length: 55
Cone Ø: d1 Ø 10 / d2 Ø 10
Thread: M12 x 1,75 RHT
81953016064, 81953016170



CV-ES-14162

Length: 125
Cone Ø: d1 Ø 30 / d2 Ø 27
Thread: M30 x 1,5 LHT

81953010015, 81953010083, 81953010087, 81953016029, 81953016030, 81953016043, 81953016044, 81953016050, 81953016054, 81953016087, 81953016091, 81953016107, 81953016120, 81953016125, 81953016152, 81953016155, 81953016157, 81953016168, 81953016179, 81953016181, 81953016223, 81953016237, 81953016254, 81953016275, 81953016279, 81953016351



CV-ES-14163

Length: 125
Cone Ø: d1 Ø 30 / d2 Ø 27
Thread: M30 x 1,5 RHT

95301.0084, 90804102156, 90804102272, 90804102696, 90804102710, 81953010016, 81953010075, 81953010084, 81953010088, 81953010094, 81953010103, 81953016030, 81953016043, 81953016048, 81953016049, 81953016053, 81953016061, 81953016090, 81953016108, 81953016112, 81953016126, 81953016143, 81953016149, 81953016154, 81953016156, 81953016168, 81953016178, 81953016194, 81953016206, 81953016224, 81953016234, 81953016242, 81953016252, 81953016274, 81953016278, 81953016284, 81953016286, 81953016308, 81953016310, 81953016312, 81953016347, 81953016350, 81953016352, 82953016012, 88953016014, N2953016001



CV-RK-5313

Ø: 90
03304800A, 81953016132



CV-RK-8118

Ø: 85
Hole Distance: 130
Thick/Height: 30

638862, 639287, 775201, 938423, 1104335, 1953248, 0003500506, 3500506, 11013547, 21032592, 42065912, 42488722, 070550504, 93192618, 070400009000, 634303610, 81432206055, 81432206073, 82262320660, 9544171010099, 5001842823, 7000307001, 8226232066



MN-DL-2160

Length: 1652 Ø: 50
Cone Ø: d1 Ø 30 / d2 Ø 27
81467106112, 81467106163, 81467106165, 81467106198, 81467106353, 81467106354, 81467106361, 81467116725



MN-DL-2175

Length: 1628 Ø: 50
Cone Ø: d1 Ø 30 / d2 Ø 27
81467106396, 81467106904



MN-DL-3402

Length: 590 Ø: 48
Hole Distance: 130 / 130
03307200A, 81432206067, 81432206068, 81432206090, 81432206092, 81432209092



MN-DL-3588

Length: 1035 Ø: 48
Cone Ø: d1 Ø 30 / d2 Ø 27
81466106333, 81466106334, 81466106354, 81466106355, 81466106360, 81466106361, 81466106721, 81466106722, 81466106723, 81466116216



MN-DL-5212

Length: 577 Ø: 48
Hole Distance: 130 / 130
81432206096, 81432206097, 81432206098, 81432206129, 81432209096, 81432209129, 81432306014, 81432306030



MN-DL-12284

Length: 1530 Ø: 50
Cone Ø: d1 Ø 30 / d2 Ø 27
81466106579, 81466106580, 81466106624, 81466116720, 81467116720, 81467116730, 81467116952



MN-DL-12421

Length: 1070 Ø: 48
Cone Ø: d1 Ø 30 / d2 Ø 27
Thread: M30 x 1,5 RHT
81466106656, 81466106659, 81466106669, 81466116006, 81466116007



MN-RK-7280

Ø: 75
Hole Distance: 115
Thick/Height: 24
0550806, 0639370, 689748, 10307400A, 81432306051, 81432306068, 81432706064



MN-RK-7287

Ø: 90
Hole Distance: 152
Thick/Height: 35
03304700A, 81953016133



MN-RK-7291

Ø: 72
Hole Distance: 130
Thick/Height: 30
10307800A, 81432206108, 81432206132



MN-SB-5244

Ø: 65
Hole Distance: 125
Thick/Height: 22
03312000A, 81432710027, 81432710082



MN-SB-5246

Ø: 45 Thick/Height: 47
81437220022, 81437220038, 81962100450, 81962100469



MN-SB-5254

Length: 100 Ø: 93
Thick/Height: 70
81432710081



MN-SB-9396

Ø: 67 Thick/Height: 60
81437040057



MN-SB-10389

Ø: 70 Thick/Height: 72
8196200340



MN-VB-5222

Length: 627 Ø: 50
Hole Distance: 152 / 152
81432706030, 81432706034, 81432706054, 81432706055, 81432706056, 81432706057, 81432706067, 81432706068, 81432706074, 81432706075, 81432706076, 81432706077, 81432706078, 81432706081, 81432706082, 81432709034, 81432709076, 81432709078, 8143706054



MN-VB-8569

Length: 627 Ø: 58
Hole Distance: 152 / 152
81432706055, 81432706056, 81432706067, 81432706068, 81432706075, 81432706077, 81432706081, 81432709056





F 90 ...

24.362 DFK ...	04/87→02/90	Tie Rod End	CV-ES-14163		for Steering Rod
	04/87→02/90	Track Control Arm		MN-DL-3402	Trailing Arm
	04/87→02/90	Track Control Arm		MN-VB-5222	Wishbone (CV)
	04/87→02/90	Track Control Arm		MN-VB-5222	Wishbone (CV), Drive Axle
	04/87→02/90	Track Control Arm		MN-VB-8569	Wishbone (CV)
24.362 DFS,24.362 DFLS	04/87→02/90	Ball Head, gearshift linkage	CV-ES-2119		
	04/87→02/90	Ball Head, gearshift linkage	CV-ES-2120		
	04/87→02/90	Ball Head, gearshift linkage	CV-ES-2182		
	04/87→02/90	Centre Rod	MN-DL-2160		Coupling Rod
	04/87→02/90	Centre Rod	MN-DL-2175		Push Rod
	04/87→02/90	Centre Rod	MN-DL-3588		Push Rod
	04/87→02/90	Centre Rod	MN-DL-12421		for Steering Rod
	04/87→02/90	Engine Mounting	MN-SB-10389		
	04/87→02/90	Mounting, stabilizer coupling rod	MN-SB-5246		
	04/87→02/90	Stabiliser Mounting		MN-SB-5254	
	04/87→02/90	Stabiliser Mounting	MN-SB-9396		
	04/87→02/90	Suspension Arm Repair Kit		CV-RK-5313	for Wishbone (CV)
	04/87→02/90	Suspension Arm Repair Kit		CV-RK-8118	for Control Arm
	04/87→02/90	Suspension Arm Repair Kit		MN-RK-7287	for Wishbone (CV)
	04/87→02/90	Suspension Arm Repair Kit		MN-RK-7291	for Drag Link
	04/87→02/90	Suspension Arm Repair Kit		MN-SB-5244	for Wishbone (CV)
	04/87→02/90	Suspension Arm Repair Kit		MN-SB-5244	for Wishbone (CV), 1st RA
	04/87→02/90	Tie Rod End	CV-ES-2149		for Push Rod
	04/87→02/90	Tie Rod End	CV-ES-14162		for Steering Rod
	04/87→02/90	Tie Rod End	CV-ES-14163		for Steering Rod
	04/87→02/90	Track Control Arm		MN-DL-3402	Trailing Arm
	04/87→02/90	Track Control Arm		MN-DL-5212	Trailing Arm, Air Suspension Axle;Drive Axle
	04/87→02/90	Track Control Arm		MN-VB-5222	Wishbone (CV)
	04/87→02/90	Track Control Arm		MN-VB-5222	Wishbone (CV), Drive Axle
	04/87→02/90	Track Control Arm		MN-VB-5222	Wishbone (CV), Drive Axle;Air Suspension Axle
	04/87→02/90	Track Control Arm		MN-VB-8569	Wishbone (CV)
	24.362 FNL,24.362 FNLL, 24.362 FVL	10/86→02/90	Ball Head, gearshift linkage	CV-ES-2119	
10/86→02/90		Ball Head, gearshift linkage	CV-ES-2120		
10/86→02/90		Ball Head, gearshift linkage	CV-ES-2182		
10/86→02/90		Centre Rod	MN-DL-2160		Coupling Rod
10/86→02/90		Centre Rod	MN-DL-2175		Push Rod
10/86→02/90		Centre Rod	MN-DL-3588		Push Rod
10/86→02/90		Centre Rod	MN-DL-12421		for Steering Rod
10/86→02/90		Engine Mounting	MN-SB-10389		
10/86→02/90		Stabiliser Mounting		MN-SB-5243	
10/86→02/90		Stabiliser Mounting		MN-SB-5265	
10/86→02/90		Stabiliser Mounting		MN-SB-5265	1st RA
10/86→02/90		Suspension Arm Repair Kit		CV-RK-5313	for Wishbone (CV)
10/86→02/90		Suspension Arm Repair Kit		CV-RK-8118	for Control Arm
10/86→02/90		Suspension Arm Repair Kit		MN-RK-7280	for Drag Link
10/86→02/90		Suspension Arm Repair Kit		MN-RK-7287	for Wishbone (CV)
10/86→02/90		Suspension Arm Repair Kit		MN-RK-7291	for Drag Link
10/86→02/90		Tie Rod End	CV-ES-2149		for Push Rod
10/86→02/90		Tie Rod End	CV-ES-14162		for Steering Rod
10/86→02/90		Tie Rod End	CV-ES-14163		for Steering Rod
10/86→02/90		Track Control Arm		MN-DL-5212	Trailing Arm, Air Suspension Axle;Drive Axle
10/86→02/90		Track Control Arm		MN-DL-5212	Trailing Arm, Air Suspension Axle;Drive Axle; Tag Axle
10/86→02/90	Track Control Arm		MN-VB-5222	Wishbone (CV), Drive Axle;Air Suspension Axle	
10/86→02/90	Track Control Arm		MN-VB-5222	Wishbone (CV), Tag Axle	
24.362 FNLS,24.362 FVLS	10/86→02/90	Ball Head, gearshift linkage	CV-ES-2119		
	10/86→02/90	Ball Head, gearshift linkage	CV-ES-2120		
	10/86→02/90	Ball Head, gearshift linkage	CV-ES-2182		
	10/86→02/90	Centre Rod	MN-DL-2160		Coupling Rod
	10/86→02/90	Centre Rod	MN-DL-2175		Push Rod
	10/86→02/90	Centre Rod	MN-DL-3588		Push Rod
	10/86→02/90	Centre Rod	MN-DL-12421		for Steering Rod
10/86→02/90	Engine Mounting	MN-SB-10389			

CV-ES-2119

Length: 55
Cone Ø: d1 Ø 10 / d2 Ø 10
Thread: M12 x 1,75 LHT
81953016063, 81953016131



CV-ES-2120

Length: 115
Cone Ø: d1 Ø 12,4 / d2 Ø 10,8
Thread: M14 x 1,5 RHT
03008500A, 81953016200, 81953016202,
81953016203, 81953016227



CV-ES-2149

Length: 160
Cone Ø: d1 Ø 30 / d2 Ø 27
Thread: M30 x 1,5 RHT
81953016263



CV-ES-2182

Length: 55
Cone Ø: d1 Ø 10 / d2 Ø 10
Thread: M12 x 1,75 RHT
81953016064, 81953016170



CV-ES-14162

Length: 125
Cone Ø: d1 Ø 30 / d2 Ø 27
Thread: M30 x 1,5 LHT
81953010015, 81953010083, 81953010087,
81953016029, 81953016030, 81953016043,
81953016044, 81953016050, 81953016054,
81953016087, 81953016091, 81953016107,
81953016120, 81953016125, 81953016152,
81953016155, 81953016157, 81953016168,
81953016179, 81953016181, 81953016223,
81953016237, 81953016254, 81953016275,
81953016279, 81953016351



CV-ES-14163

Length: 125
Cone Ø: d1 Ø 30 / d2 Ø 27
Thread: M30 x 1,5 RHT
95301.0084, 90804102156, 90804102272,
90804102696, 90804102710, 81953010016,
81953010075, 81953010084, 81953010088,
81953010094, 81953010103, 81953016030,
81953016043, 81953016048, 81953016049,
81953016053, 81953016061, 81953016090,
81953016108, 81953016112, 81953016126,
81953016143, 81953016149, 81953016154,
81953016156, 81953016168, 81953016178,
81953016194, 81953016206, 81953016224,
81953016234, 81953016242, 81953016252,
81953016274, 81953016278, 81953016284,
81953016286, 81953016308, 81953016310,
81953016312, 81953016347, 81953016350,
81953016352, 82953016012, 88953016014,
N2953016001



CV-RK-5313

Ø: 90
03304800A, 81953016132



CV-RK-8118

Ø: 85
Hole Distance: 130
Thick/Height: 30
638862, 639287, 775201, 938423,
1104335, 1953248, 0003500506, 3500506,
11013547, 21032592, 42065912, 42488722,
070550504, 93192618, 070400009000,
634303610, 81432206055, 81432206073,
82262320660, 9544171010099,
5001842823, 7000307001, 8226232066



MN-DL-2160

Length: 1652 Ø: 50
Cone Ø: d1 Ø 30 / d2 Ø 27
81467106112, 81467106163, 81467106165,
81467106198, 81467106353, 81467106354,
81467106361, 81467116725



MN-DL-2175

Length: 1628 Ø: 50
Cone Ø: d1 Ø 30 / d2 Ø 27
81467106396, 81467106904



MN-DL-3402

Length: 590 Ø: 48
Hole Distance: 130 / 130
03307200A, 81432206067, 81432206068,
81432206090, 81432206092, 81432209092



MN-DL-3588

Length: 1035 Ø: 48
Cone Ø: d1 Ø 30 / d2 Ø 27
81466106333, 81466106334, 81466106354,
81466106355, 81466106360, 81466106361,
81466106721, 81466106722, 81466106723,
81466116216



MN-DL-5212

Length: 577 Ø: 48
Hole Distance: 130 / 130
81432206096, 81432206097, 81432206098,
81432206129, 81432209096, 81432209129,
81432306014, 81432306030



MN-DL-12421

Length: 1070 Ø: 48
Cone Ø: d1 Ø 30 / d2 Ø 27
Thread: M30 x 1,5 RHT
81466106656, 81466106659, 81466106669,
81466116006, 81466116007



MN-RK-7280

Ø: 75
Hole Distance: 115
Thick/Height: 24
0550806, 0639370, 689748, 10307400A,
81432306051, 81432306068, 81432706064



MN-RK-7287

Ø: 90
Hole Distance: 152
Thick/Height: 35
03304700A, 81953016133



MN-RK-7291

Ø: 72
Hole Distance: 130
Thick/Height: 30
10307800A, 81432206108, 81432206132



MN-SB-5243

Length: 55 Ø: 78
Thick/Height: 60
03311100A, 81437040061, 81437220020



MN-SB-5244

Ø: 65
Hole Distance: 125
Thick/Height: 22
03312000A, 81432710027, 81432710082



MN-SB-5246

Ø: 45 Thick/Height: 47
81437220022, 81437220038, 81962100450,
81962100469



MN-SB-5254

Length: 100 Ø: 93
Thick/Height: 70
81432710081



MN-SB-5265

Ø: 85 Thick/Height: 80
03310300A, 81437040032



MN-SB-9396

Ø: 67 Thick/Height: 60
81437040057



MN-SB-10389

Ø: 70 Thick/Height: 72
81960200340



MN-VB-5222

Length: 627 Ø: 50
Hole Distance: 152 / 152
81432706030, 81432706034, 81432706054,
81432706055, 81432706056, 81432706057,
81432706067, 81432706068, 81432706074,
81432706075, 81432706076, 81432706077,
81432706078, 81432706081, 81432706082,
81432709034, 81432709076, 81432709078,
8143706054



MN-VB-8569

Length: 627 Ø: 58
Hole Distance: 152 / 152
81432706055, 81432706056, 81432706067,
81432706068, 81432706075, 81432706077,
81432706081, 81432709056





F 90 ...

24.362 FNLS,24.362 FVLS ...	10/86→02/90	Stabiliser Mounting		MN-SB-5243	
	10/86→02/90	Stabiliser Mounting		MN-SB-5265	
	10/86→02/90	Stabiliser Mounting		MN-SB-5265	1st RA
	10/86→02/90	Suspension Arm Repair Kit		CV-RK-5313	for Wishbone (CV)
	10/86→02/90	Suspension Arm Repair Kit		CV-RK-8118	for Control Arm
	10/86→02/90	Suspension Arm Repair Kit		MN-RK-7280	for Drag Link
	10/86→02/90	Suspension Arm Repair Kit		MN-RK-7287	for Wishbone (CV)
	10/86→02/90	Suspension Arm Repair Kit		MN-RK-7291	for Drag Link
	10/86→02/90	Tie Rod End	CV-ES-2149		for Push Rod
	10/86→02/90	Tie Rod End	CV-ES-14162		for Steering Rod
	10/86→02/90	Tie Rod End	CV-ES-14163		for Steering Rod
	10/86→02/90	Track Control Arm		MN-DL-5212	Trailing Arm, Air Suspension Axle;Drive Axle
	10/86→02/90	Track Control Arm		MN-DL-5212	Trailing Arm, Air Suspension Axle;Drive Axle; Tag Axle
	10/86→02/90	Track Control Arm		MN-VB-5222	Wishbone (CV), Drive Axle;Air Suspension Axle
	10/86→02/90	Track Control Arm		MN-VB-5222	Wishbone (CV), Tag Axle
24.372 DF	02/90→12/90	Ball Head, gearshift linkage	CV-ES-2119		
	02/90→12/90	Ball Head, gearshift linkage	CV-ES-2120		
	02/90→12/90	Ball Head, gearshift linkage	CV-ES-2182		
	02/90→12/90	Centre Rod	MN-DL-2160		Coupling Rod
	02/90→12/90	Centre Rod	MN-DL-2175		Push Rod
	02/90→12/90	Centre Rod	MN-DL-3588		Push Rod
	02/90→12/90	Centre Rod	MN-DL-12421		for Steering Rod
	02/90→12/90	Engine Mounting	MN-SB-10389		
	02/90→12/90	Mounting, stabilizer coupling rod	MN-SB-5246		
	02/90→12/90	Stabiliser Mounting		MN-SB-5254	
	02/90→12/90	Stabiliser Mounting	MN-SB-9396		
	02/90→12/90	Suspension Arm Repair Kit		CV-RK-5313	for Wishbone (CV)
	02/90→12/90	Suspension Arm Repair Kit		CV-RK-8118	for Control Arm
	02/90→12/90	Suspension Arm Repair Kit		MN-RK-7287	for Wishbone (CV)
	02/90→12/90	Suspension Arm Repair Kit		MN-RK-7291	for Drag Link
	02/90→12/90	Suspension Arm Repair Kit		MN-SB-5244	for Wishbone (CV)
	02/90→12/90	Suspension Arm Repair Kit		MN-SB-5244	for Wishbone (CV), 1st RA
	02/90→12/90	Tie Rod End	CV-ES-2149		for Push Rod
	02/90→12/90	Tie Rod End	CV-ES-14162		for Steering Rod
	02/90→12/90	Tie Rod End	CV-ES-14163		for Steering Rod
	02/90→12/90	Track Control Arm		MN-DL-3402	Trailing Arm
	02/90→12/90	Track Control Arm		MN-DL-5212	Trailing Arm, Air Suspension Axle;Drive Axle
	02/90→12/90	Track Control Arm		MN-VB-5222	Wishbone (CV)
	02/90→12/90	Track Control Arm		MN-VB-5222	Wishbone (CV), Drive Axle
	02/90→12/90	Track Control Arm		MN-VB-5222	Wishbone (CV), Drive Axle;Air Suspension Axle
02/90→12/90	Track Control Arm		MN-VB-8569	Wishbone (CV)	
24.372 DFK	02/90→12/90	Ball Head, gearshift linkage	CV-ES-2119		
	02/90→12/90	Ball Head, gearshift linkage	CV-ES-2120		
	02/90→12/90	Ball Head, gearshift linkage	CV-ES-2182		
	02/90→12/90	Centre Rod	MN-DL-2160		Coupling Rod
	02/90→12/90	Centre Rod	MN-DL-2175		Push Rod
	02/90→12/90	Centre Rod	MN-DL-3588		Push Rod
	02/90→12/90	Centre Rod	MN-DL-12421		for Steering Rod
	02/90→12/90	Engine Mounting	MN-SB-10389		
	02/90→12/90	Mounting, stabilizer coupling rod	MN-SB-5246		
	02/90→12/90	Stabiliser Mounting		MN-SB-5254	
	02/90→12/90	Stabiliser Mounting	MN-SB-9396		
	02/90→12/90	Suspension Arm Repair Kit		CV-RK-5313	for Wishbone (CV)
	02/90→12/90	Suspension Arm Repair Kit		MN-RK-7287	for Wishbone (CV)
	02/90→12/90	Suspension Arm Repair Kit		MN-SB-5244	for Wishbone (CV)
	02/90→12/90	Suspension Arm Repair Kit		MN-SB-5244	for Wishbone (CV), 1st RA
	02/90→12/90	Tie Rod End	CV-ES-2149		for Push Rod
	02/90→12/90	Tie Rod End	CV-ES-14162		for Steering Rod
	02/90→12/90	Tie Rod End	CV-ES-14163		for Steering Rod
	02/90→12/90	Track Control Arm		MN-DL-3402	Trailing Arm
	02/90→12/90	Track Control Arm		MN-VB-5222	Wishbone (CV)
	02/90→12/90	Track Control Arm		MN-VB-5222	Wishbone (CV), Drive Axle
	02/90→12/90	Track Control Arm		MN-VB-8569	Wishbone (CV)

CV-ES-2119

Length: 55
Cone Ø: d1 Ø 10 / d2 Ø 10
Thread: M12 x 1,75 LHT
81953016063, 81953016131



CV-ES-2120

Length: 115
Cone Ø: d1 Ø 12,4 / d2 Ø 10,8
Thread: M14 x 1,5 RHT
03008500A, 81953016200, 81953016202,
81953016203, 81953016227



CV-ES-2149

Length: 160
Cone Ø: d1 Ø 30 / d2 Ø 27
Thread: M30 x 1,5 RHT
81953016263



CV-ES-2182

Length: 55
Cone Ø: d1 Ø 10 / d2 Ø 10
Thread: M12 x 1,75 RHT
81953016064, 81953016170



CV-ES-14162

Length: 125
Cone Ø: d1 Ø 30 / d2 Ø 27
Thread: M30 x 1,5 LHT
81953010015, 81953010083, 81953010087,
81953016029, 81953016030, 81953016043,
81953016044, 81953016050, 81953016054,
81953016087, 81953016091, 81953016107,
81953016120, 81953016125, 81953016152,
81953016155, 81953016157, 81953016168,
81953016179, 81953016181, 81953016223,
81953016237, 81953016254, 81953016275,
81953016279, 81953016351



CV-ES-14163

Length: 125
Cone Ø: d1 Ø 30 / d2 Ø 27
Thread: M30 x 1,5 RHT
95301.0084, 90804102156, 90804102272,
90804102696, 90804102710, 81953010016,
81953010075, 81953010084, 81953010088,
81953010094, 81953010103, 81953016030,
81953016043, 81953016048, 81953016049,
81953016053, 81953016061, 81953016090,
81953016108, 81953016112, 81953016126,
81953016143, 81953016149, 81953016154,
81953016156, 81953016168, 81953016178,
81953016194, 81953016206, 81953016224,
81953016234, 81953016242, 81953016252,
81953016274, 81953016278, 81953016284,
81953016286, 81953016308, 81953016310,
81953016312, 81953016347, 81953016350,
81953016352, 82953016012, 88953016014,
N2953016001



CV-RK-5313

Ø: 90
03304800A, 81953016132



CV-RK-8118

Ø: 85
Hole Distance: 130
Thick/Height: 30
638862, 639287, 775201, 938423,
1104335, 1953248, 0003500506, 3500506,
11013547, 21032592, 42065912, 42488722,
070550504, 93192618, 070400009000,
634303610, 81432206055, 81432206073,
82262320660, 9544171010099,
5001842823, 7000307001, 8226232066



MN-DL-2160

Length: 1652 Ø: 50
Cone Ø: d1 Ø 30 / d2 Ø 27
81467106112, 81467106163, 81467106165,
81467106198, 81467106353, 81467106354,
81467106361, 81467116725



MN-DL-2175

Length: 1628 Ø: 50
Cone Ø: d1 Ø 30 / d2 Ø 27
81467106396, 81467106904



MN-DL-3402

Length: 590 Ø: 48
Hole Distance: 130 / 130
03307200A, 81432206067, 81432206068,
81432206090, 81432206092, 81432209092



MN-DL-3588

Length: 1035 Ø: 48
Cone Ø: d1 Ø 30 / d2 Ø 27
81466106333, 81466106334, 81466106354,
81466106355, 81466106360, 81466106361,
81466106721, 81466106722, 81466106723,
81466116216



MN-DL-5212

Length: 577 Ø: 48
Hole Distance: 130 / 130
81432206096, 81432206097, 81432206098,
81432206129, 81432209096, 81432209129,
81432306014, 81432306030



MN-DL-12421

Length: 1070 Ø: 48
Cone Ø: d1 Ø 30 / d2 Ø 27
Thread: M30 x 1,5 RHT
81466106656, 81466106659, 81466106669,
81466116006, 81466116007



MN-RK-7280

Ø: 75
Hole Distance: 115
Thick/Height: 24
0550806, 0639370, 689748, 10307400A,
81432306051, 81432306068, 81432706064



MN-RK-7287

Ø: 90
Hole Distance: 152
Thick/Height: 35
03304700A, 81953016133



MN-RK-7291

Ø: 72
Hole Distance: 130
Thick/Height: 30
10307800A, 81432206108, 81432206132



MN-SB-5243

Length: 55 Ø: 78
Thick/Height: 60
03311100A, 81437040061, 81437220020



MN-SB-5244

Ø: 65
Hole Distance: 125
Thick/Height: 22
03312000A, 81432710027, 81432710082



MN-SB-5246

Ø: 45 Thick/Height: 47
81437220022, 81437220038, 81962100450,
81962100469



MN-SB-5254

Length: 100 Ø: 93
Thick/Height: 70
81432710081



MN-SB-5265

Ø: 85 Thick/Height: 80
03310300A, 81437040032



MN-SB-9396

Ø: 67 Thick/Height: 60
81437040057



MN-SB-10389

Ø: 70 Thick/Height: 72
8196200340



MN-VB-5222

Length: 627 Ø: 50
Hole Distance: 152 / 152
81432706030, 81432706034, 81432706054,
81432706055, 81432706056, 81432706057,
81432706067, 81432706068, 81432706074,
81432706075, 81432706076, 81432706077,
81432706078, 81432706081, 81432706082,
81432709034, 81432709076, 81432709078,
8143706054



MN-VB-8569

Length: 627 Ø: 58
Hole Distance: 152 / 152
81432706055, 81432706056, 81432706067,
81432706068, 81432706075, 81432706077,
81432706081, 81432709056



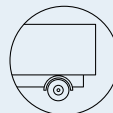

F 90 ...

24.372 DFS	05/90→12/90	Ball Head, gearshift linkage	CV-ES-2119			
	05/90→12/90	Ball Head, gearshift linkage	CV-ES-2120			
	05/90→12/90	Ball Head, gearshift linkage	CV-ES-2182			
	05/90→12/90	Centre Rod	MN-DL-2160		Coupling Rod	
	05/90→12/90	Centre Rod	MN-DL-2175		Push Rod	
	05/90→12/90	Centre Rod	MN-DL-3588		Push Rod	
	05/90→12/90	Centre Rod	MN-DL-12421		for Steering Rod	
	05/90→12/90	Engine Mounting	MN-SB-10389			
	05/90→12/90	Mounting, stabilizer coupling rod	MN-SB-5246			
	05/90→12/90	Stabiliser Mounting		MN-SB-5254		
	05/90→12/90	Stabiliser Mounting	MN-SB-9396			
	05/90→12/90	Suspension Arm Repair Kit		CV-RK-5313	for Wishbone (CV)	
	05/90→12/90	Suspension Arm Repair Kit		MN-RK-7287	for Wishbone (CV)	
	05/90→12/90	Suspension Arm Repair Kit		MN-SB-5244	for Wishbone (CV)	
	05/90→12/90	Suspension Arm Repair Kit		MN-SB-5244	for Wishbone (CV), 1st RA	
	05/90→12/90	Tie Rod End	CV-ES-2149		for Push Rod	
	05/90→12/90	Tie Rod End	CV-ES-14162		for Steering Rod	
	05/90→12/90	Tie Rod End	CV-ES-14163		for Steering Rod	
	24.372 DFS, 24.372 DFLS	02/90→01/91	Track Control Arm		MN-VB-5222	Wishbone (CV), Drive Axle
		02/90→04/95	Ball Head, gearshift linkage	CV-ES-2119		
02/90→04/95		Ball Head, gearshift linkage	CV-ES-2120			
02/90→04/95		Ball Head, gearshift linkage	CV-ES-2182			
02/90→04/95		Centre Rod	MN-DL-2160		Coupling Rod	
02/90→04/95		Centre Rod	MN-DL-2175		Push Rod	
02/90→04/95		Centre Rod	MN-DL-3588		Push Rod	
02/90→04/95		Centre Rod	MN-DL-12421		for Steering Rod	
02/90→04/95		Engine Mounting	MN-SB-10389			
02/90→04/95		Mounting, stabilizer coupling rod	MN-SB-5246			
02/90→04/95		Stabiliser Mounting		MN-SB-5254		
02/90→04/95		Stabiliser Mounting	MN-SB-9396			
02/90→04/95		Suspension Arm Repair Kit		CV-RK-5313	for Wishbone (CV)	
02/90→04/95		Suspension Arm Repair Kit		CV-RK-8118	for Control Arm	
02/90→04/95		Suspension Arm Repair Kit		MN-RK-7287	for Wishbone (CV)	
02/90→04/95		Suspension Arm Repair Kit		MN-RK-7291	for Drag Link	
02/90→04/95		Suspension Arm Repair Kit		MN-SB-5244	for Wishbone (CV)	
02/90→04/95		Suspension Arm Repair Kit		MN-SB-5244	for Wishbone (CV), 1st RA	
02/90→04/95		Tie Rod End	CV-ES-2149		for Push Rod	
02/90→04/95		Tie Rod End	CV-ES-14162		for Steering Rod	
02/90→04/95	Tie Rod End	CV-ES-14163		for Steering Rod		
02/90→04/95	Track Control Arm		MN-DL-3402	Trailing Arm		
02/90→04/95	Track Control Arm		MN-DL-5212	Trailing Arm, Air Suspension Axle; Drive Axle		
02/90→04/95	Track Control Arm		MN-VB-5222	Wishbone (CV)		
02/90→04/95	Track Control Arm		MN-VB-5222	Wishbone (CV), Drive Axle; Air Suspension Axle		
02/90→04/95	Track Control Arm		MN-VB-8569	Wishbone (CV)		
01/91→04/95	Track Control Arm		MN-VB-8569	Wishbone (CV), Drive Axle		
24.372 FNL, 24.372 FNLL, 24.372 FVL	02/90→05/95	Ball Head, gearshift linkage	CV-ES-2119			
	02/90→05/95	Ball Head, gearshift linkage	CV-ES-2120			
	02/90→05/95	Ball Head, gearshift linkage	CV-ES-2182			
	02/90→05/95	Centre Rod	MN-DL-2160		Coupling Rod	
	02/90→05/95	Centre Rod	MN-DL-2175		Push Rod	
	02/90→05/95	Centre Rod	MN-DL-3588		Push Rod	
	02/90→05/95	Centre Rod	MN-DL-12421		for Steering Rod	
	02/90→05/95	Engine Mounting	MN-SB-10389			
	02/90→05/95	Stabiliser Mounting		MN-SB-5243		
	02/90→05/95	Stabiliser Mounting		MN-SB-5265		
	02/90→05/95	Stabiliser Mounting		MN-SB-5265	1st RA	
	02/90→05/95	Suspension Arm Repair Kit		CV-RK-5313	for Wishbone (CV)	
	02/90→05/95	Suspension Arm Repair Kit		CV-RK-8118	for Control Arm	
	02/90→05/95	Suspension Arm Repair Kit		MN-RK-7280	for Drag Link	

CV-ES-2119

Length: 55
Cone Ø: d1 Ø 10 / d2 Ø 10
Thread: M12 x 1,75 LHT
81953016063, 81953016131



CV-ES-2120

Length: 115
Cone Ø: d1 Ø 12,4 / d2 Ø 10,8
Thread: M14 x 1,5 RHT
03008500A, 81953016200, 81953016202,
81953016203, 81953016227



CV-ES-2149

Length: 160
Cone Ø: d1 Ø 30 / d2 Ø 27
Thread: M30 x 1,5 RHT
81953016263



CV-ES-2182

Length: 55
Cone Ø: d1 Ø 10 / d2 Ø 10
Thread: M12 x 1,75 RHT
81953016064, 81953016170



CV-ES-14162

Length: 125
Cone Ø: d1 Ø 30 / d2 Ø 27
Thread: M30 x 1,5 LHT
81953010015, 81953010083, 81953010087,
81953016029, 81953016030, 81953016043,
81953016044, 81953016050, 81953016054,
81953016087, 81953016091, 81953016107,
81953016120, 81953016125, 81953016152,
81953016155, 81953016157, 81953016168,
81953016179, 81953016181, 81953016223,
81953016237, 81953016254, 81953016275,
81953016279, 81953016351



CV-ES-14163

Length: 125
Cone Ø: d1 Ø 30 / d2 Ø 27
Thread: M30 x 1,5 RHT
95301.0084, 90804102156, 90804102272,
90804102696, 90804102710, 81953010016,
81953010075, 81953010084, 81953010088,
81953010094, 81953010103, 81953016030,
81953016043, 81953016048, 81953016049,
81953016053, 81953016061, 81953016090,
81953016108, 81953016112, 81953016126,
81953016143, 81953016149, 81953016154,
81953016156, 81953016168, 81953016178,
81953016194, 81953016206, 81953016224,
81953016234, 81953016242, 81953016252,
81953016274, 81953016278, 81953016284,
81953016286, 81953016308, 81953016310,
81953016312, 81953016347, 81953016350,
81953016352, 82953016012, 88953016014,
N2953016001



CV-RK-5313

Ø: 90
03304800A, 81953016132



CV-RK-8118

Ø: 85
Hole Distance: 130
Thick/Height: 30
638862, 639287, 775201, 938423,
1104335, 1953248, 0003500506, 3500506,
11013547, 21032592, 42065912, 42488722,
070550504, 93192618, 070400009000,
634303610, 81432206055, 81432206073,
82262320660, 9544171010099,
5001842823, 7000307001, 8226232066



MN-DL-2160

Length: 1652 Ø: 50
Cone Ø: d1 Ø 30 / d2 Ø 27
81467106112, 81467106163, 81467106165,
81467106198, 81467106353, 81467106354,
81467106361, 81467116725



MN-DL-2175

Length: 1628 Ø: 50
Cone Ø: d1 Ø 30 / d2 Ø 27
81467106396, 81467106904



MN-DL-3402

Length: 590 Ø: 48
Hole Distance: 130 / 130
03307200A, 81432206067, 81432206068,
81432206090, 81432206092, 81432209092



MN-DL-3588

Length: 1035 Ø: 48
Cone Ø: d1 Ø 30 / d2 Ø 27
81466106333, 81466106334, 81466106354,
81466106355, 81466106360, 81466106361,
81466106721, 81466106722, 81466106723,
81466116216



MN-DL-5212

Length: 577 Ø: 48
Hole Distance: 130 / 130
81432206096, 81432206097, 81432206098,
81432206129, 81432209096, 81432209129,
81432306014, 81432306030



MN-DL-12421

Length: 1070 Ø: 48
Cone Ø: d1 Ø 30 / d2 Ø 27
Thread: M30 x 1,5 RHT
81466106656, 81466106659, 81466106669,
81466116006, 81466116007



MN-RK-7280

Ø: 75
Hole Distance: 115
Thick/Height: 24
0550806, 0639370, 689748, 10307400A,
81432306051, 81432306068, 81432706064



MN-RK-7287

Ø: 90
Hole Distance: 152
Thick/Height: 35
03304700A, 81953016133



MN-RK-7291

Ø: 72
Hole Distance: 130
Thick/Height: 30
10307800A, 81432206108, 81432206132



MN-SB-5243

Length: 55 Ø: 78
Thick/Height: 60
03311100A, 81437040061, 81437220020



MN-SB-5244

Ø: 65
Hole Distance: 125
Thick/Height: 22
03312000A, 81432710027, 81432710082



MN-SB-5246

Ø: 45 Thick/Height: 47
81437220022, 81437220038, 81962100450,
81962100469



MN-SB-5254

Length: 100 Ø: 93
Thick/Height: 70
81432710081



MN-SB-5265

Ø: 85 Thick/Height: 80
03310300A, 81437040032



MN-SB-9396

Ø: 67 Thick/Height: 60
81437040057



MN-SB-10389

Ø: 70 Thick/Height: 72
81960200340



MN-VB-5222

Length: 627 Ø: 50
Hole Distance: 152 / 152
81432706030, 81432706034, 81432706054,
81432706055, 81432706056, 81432706057,
81432706067, 81432706068, 81432706074,
81432706075, 81432706076, 81432706077,
81432706078, 81432706081, 81432706082,
81432709034, 81432709076, 81432709078,
8143706054



MN-VB-8569

Length: 627
Ø: 58
Hole Distance: 152 / 152
81432706055, 81432706056, 81432706067,
81432706068, 81432706075, 81432706077,
81432706081, 81432709056





F 90 ...

24.372 FNL,24.372 FNLL, 24.372 FVL ...	02/90→05/95	Suspension Arm Repair Kit		MN-RK-7287	for Wishbone (CV)	
	02/90→05/95	Suspension Arm Repair Kit		MN-RK-7291	for Drag Link	
	02/90→05/95	Tie Rod	MN-DL-12284			
	02/90→05/95	Tie Rod End	CV-ES-2149		for Push Rod	
	02/90→05/95	Tie Rod End	CV-ES-14162		for Steering Rod	
	02/90→05/95	Tie Rod End	CV-ES-14163		for Steering Rod	
	02/90→05/95	Track Control Arm		MN-DL-5212	Trailing Arm, Air Suspension Axle;Drive Axle	
	02/90→05/95	Track Control Arm		MN-DL-5212	Trailing Arm, Air Suspension Axle;Drive Axle; Tag Axle	
	02/90→05/95	Track Control Arm		MN-VB-5222	Wishbone (CV), Drive Axle;Air Suspension Axle	
	02/90→05/95	Track Control Arm		MN-VB-5222	Wishbone (CV), Tag Axle	
24.372 FNLS,24.372 FVLS	02/90→05/95	Ball Head, gearshift linkage	CV-ES-2119			
	02/90→05/95	Ball Head, gearshift linkage	CV-ES-2120			
	02/90→05/95	Ball Head, gearshift linkage	CV-ES-2182			
	02/90→05/95	Centre Rod	MN-DL-2160		Coupling Rod	
	02/90→05/95	Centre Rod	MN-DL-2175		Push Rod	
	02/90→05/95	Centre Rod	MN-DL-3588		Push Rod	
	02/90→05/95	Centre Rod	MN-DL-12421		for Steering Rod	
	02/90→05/95	Engine Mounting	MN-SB-10389			
	02/90→05/95	Stabiliser Mounting		MN-SB-5243		
	02/90→05/95	Stabiliser Mounting		MN-SB-5265		
	02/90→05/95	Stabiliser Mounting		MN-SB-5265	1st RA	
	02/90→05/95	Suspension Arm Repair Kit		CV-RK-5313	for Wishbone (CV)	
	02/90→05/95	Suspension Arm Repair Kit		CV-RK-8118	for Control Arm	
	02/90→05/95	Suspension Arm Repair Kit		MN-RK-7280	for Drag Link	
	02/90→05/95	Suspension Arm Repair Kit		MN-RK-7287	for Wishbone (CV)	
	02/90→05/95	Suspension Arm Repair Kit		MN-RK-7291	for Drag Link	
	02/90→05/95	Tie Rod	MN-DL-12284			
	02/90→05/95	Tie Rod End	CV-ES-2149		for Push Rod	
	02/90→05/95	Tie Rod End	CV-ES-14162		for Steering Rod	
	02/90→05/95	Tie Rod End	CV-ES-14163		for Steering Rod	
	02/90→05/95	Track Control Arm		MN-DL-5212	Trailing Arm, Air Suspension Axle;Drive Axle	
	02/90→05/95	Track Control Arm		MN-DL-5212	Trailing Arm, Air Suspension Axle;Drive Axle; Tag Axle	
	02/90→05/95	Track Control Arm		MN-VB-5222	Wishbone (CV), Drive Axle;Air Suspension Axle	
	02/90→05/95	Track Control Arm		MN-VB-5222	Wishbone (CV), Tag Axle	
	24.372 FVL	05/90→12/90	Ball Head, gearshift linkage	CV-ES-2119		
		05/90→12/90	Ball Head, gearshift linkage	CV-ES-2120		
		05/90→12/90	Ball Head, gearshift linkage	CV-ES-2182		
		05/90→12/90	Centre Rod	MN-DL-2160		Coupling Rod
		05/90→12/90	Centre Rod	MN-DL-2175		Push Rod
		05/90→12/90	Centre Rod	MN-DL-3588		Push Rod
05/90→12/90		Centre Rod	MN-DL-12421		for Steering Rod	
05/90→12/90		Engine Mounting	MN-SB-10389			
05/90→12/90		Stabiliser Mounting		MN-SB-5265		
05/90→12/90		Stabiliser Mounting		MN-SB-5265	1st RA	
05/90→12/90		Suspension Arm Repair Kit		CV-RK-5313	for Wishbone (CV)	
05/90→12/90		Suspension Arm Repair Kit		CV-RK-8118	for Control Arm	
05/90→12/90		Suspension Arm Repair Kit		MN-RK-7280	for Drag Link	
05/90→12/90		Suspension Arm Repair Kit		MN-RK-7287	for Wishbone (CV)	
05/90→12/90		Suspension Arm Repair Kit		MN-RK-7291	for Drag Link	
05/90→12/90		Tie Rod End	CV-ES-2149		for Push Rod	
05/90→12/90		Tie Rod End	CV-ES-14162		for Steering Rod	
05/90→12/90		Tie Rod End	CV-ES-14163		for Steering Rod	
05/90→12/90		Track Control Arm		MN-DL-5212	Trailing Arm, Air Suspension Axle;Drive Axle	
05/90→12/90		Track Control Arm		MN-VB-5222	Wishbone (CV), Drive Axle;Air Suspension Axle	
24.372 FVLS		05/90→12/90	Ball Head, gearshift linkage	CV-ES-2119		
		05/90→12/90	Ball Head, gearshift linkage	CV-ES-2120		
		05/90→12/90	Ball Head, gearshift linkage	CV-ES-2182		
		05/90→12/90	Centre Rod	MN-DL-2160		Coupling Rod
	05/90→12/90	Centre Rod	MN-DL-2175		Push Rod	
	05/90→12/90	Centre Rod	MN-DL-3588		Push Rod	
	05/90→12/90	Centre Rod	MN-DL-12421		for Steering Rod	
	05/90→12/90	Centre Rod	MN-DL-12421		for Steering Rod	

CV-ES-2119

Length: 55
Cone Ø: d1 Ø 10 / d2 Ø 10
Thread: M12 x 1,75 LHT
81953016063, 81953016131



CV-ES-2120

Length: 115
Cone Ø: d1 Ø 12,4 / d2 Ø 10,8
Thread: M14 x 1,5 RHT
03008500A, 81953016200, 81953016202, 81953016203, 81953016227



CV-ES-2149

Length: 160
Cone Ø: d1 Ø 30 / d2 Ø 27
Thread: M30 x 1,5 RHT
81953016263



CV-ES-2182

Length: 55
Cone Ø: d1 Ø 10 / d2 Ø 10
Thread: M12 x 1,75 RHT
81953016064, 81953016170



CV-ES-14162

Length: 125
Cone Ø: d1 Ø 30 / d2 Ø 27
Thread: M30 x 1,5 LHT

81953010015, 81953010083, 81953010087, 81953016029, 81953016030, 81953016043, 81953016044, 81953016050, 81953016054, 81953016087, 81953016091, 81953016107, 81953016120, 81953016125, 81953016152, 81953016155, 81953016157, 81953016168, 81953016179, 81953016181, 81953016223, 81953016237, 81953016254, 81953016275, 81953016279, 81953016351



CV-ES-14163

Length: 125
Cone Ø: d1 Ø 30 / d2 Ø 27
Thread: M30 x 1,5 RHT

95301.0084, 90804102156, 90804102272, 90804102696, 90804102710, 81953010016, 81953010075, 81953010084, 81953010088, 81953010094, 81953010103, 81953016030, 81953016043, 81953016048, 81953016049, 81953016053, 81953016061, 81953016090, 81953016108, 81953016112, 81953016126, 81953016143, 81953016149, 81953016154, 81953016156, 81953016168, 81953016178, 81953016194, 81953016206, 81953016224, 81953016234, 81953016242, 81953016252, 81953016274, 81953016278, 81953016284, 81953016286, 81953016308, 81953016310, 81953016312, 81953016347, 81953016350, 81953016352, 82953016012, 88953016014, N2953016001



CV-RK-5313

Ø: 90
03304800A, 81953016132



CV-RK-8118

Ø: 85
Hole Distance: 130
Thick/Height: 30

638862, 639287, 775201, 938423, 1104335, 1953248, 0003500506, 3500506, 11013547, 21032592, 42065912, 42488722, 070550504, 93192618, 070400009000, 634303610, 81432206055, 81432206073, 82262320660, 9544171010099, 5001842823, 7000307001, 8226232066



MN-DL-2160

Length: 1652 Ø: 50
Cone Ø: d1 Ø 30 / d2 Ø 27

81467106112, 81467106163, 81467106165, 81467106198, 81467106353, 81467106354, 81467106361, 81467116725



MN-DL-2175

Length: 1628 Ø: 50
Cone Ø: d1 Ø 30 / d2 Ø 27

81467106396, 81467106904



MN-DL-3588

Length: 1035 Ø: 48
Cone Ø: d1 Ø 30 / d2 Ø 27

81466106333, 81466106334, 81466106354, 81466106355, 81466106360, 81466106361, 81466106721, 81466106722, 81466106723, 81466116216



MN-DL-5212

Length: 577 Ø: 48
Hole Distance: 130 / 130

81432206096, 81432206097, 81432206098, 81432206129, 81432209096, 81432209129, 81432306014, 81432306030



MN-DL-12284

Length: 1530 Ø: 50
Cone Ø: d1 Ø 30 / d2 Ø 27

81466106579, 81466106580, 81466106624, 81466116720, 81467116720, 81467116730, 81467116952



MN-DL-12421

Length: 1070 Ø: 48
Cone Ø: d1 Ø 30 / d2 Ø 27
Thread: M30 x 1,5 RHT

81466106656, 81466106659, 81466106669, 81466116006, 81466116007



MN-RK-7280

Ø: 75
Hole Distance: 115
Thick/Height: 24

0550806, 0639370, 689748, 10307400A, 81432306051, 81432306068, 81432706064



MN-RK-7287

Ø: 90
Hole Distance: 152
Thick/Height: 35

03304700A, 81953016133



MN-RK-7291

Ø: 72
Hole Distance: 130
Thick/Height: 30

10307800A, 81432206108, 81432206132



MN-SB-5243

Length: 55
Ø: 78
Thick/Height: 60

03311100A, 81437040061, 81437220020



MN-SB-5265

Ø: 85
Thick/Height: 80

03310300A, 81437040032



MN-SB-10389

Ø: 70
Thick/Height: 72

81960200340



MN-VB-5222

Length: 627 Ø: 50
Hole Distance: 152 / 152

81432706030, 81432706034, 81432706054, 81432706055, 81432706056, 81432706057, 81432706067, 81432706068, 81432706074, 81432706075, 81432706076, 81432706077, 81432706078, 81432706081, 81432706082, 81432709034, 81432709076, 81432709078, 8143706054





F 90 ...

24.372 FVLS ...	05/90→12/90	Engine Mounting	MN-SB-10389			
	05/90→12/90	Stabiliser Mounting		MN-SB-5265		
	05/90→12/90	Stabiliser Mounting		MN-SB-5265	1st RA	
	05/90→12/90	Suspension Arm Repair Kit		CV-RK-5313	for Wishbone (CV)	
	05/90→12/90	Suspension Arm Repair Kit		CV-RK-8118	for Control Arm	
	05/90→12/90	Suspension Arm Repair Kit		MN-RK-7280	for Drag Link	
	05/90→12/90	Suspension Arm Repair Kit		MN-RK-7287	for Wishbone (CV)	
	05/90→12/90	Suspension Arm Repair Kit		MN-RK-7291	for Drag Link	
	05/90→12/90	Tie Rod End	CV-ES-2149		for Push Rod	
	05/90→12/90	Tie Rod End	CV-ES-14162		for Steering Rod	
	05/90→12/90	Tie Rod End	CV-ES-14163		for Steering Rod	
	05/90→12/90	Track Control Arm		MN-DL-5212	Trailing Arm, Air Suspension Axle; Drive Axle	
	05/90→12/90	Track Control Arm		MN-VB-5222	Wishbone (CV), Drive Axle; Air Suspension Axle	
	24.402 FNL, 24.402 FNLL	05/94→05/95	Ball Head, gearshift linkage	CV-ES-2120		
		05/94→05/95	Centre Rod	MN-DL-12421		for Steering Rod
05/94→05/95		Engine Mounting	MN-SB-10389			
05/94→05/95		Suspension Arm Repair Kit		CV-RK-5313	for Wishbone (CV)	
05/94→05/95		Suspension Arm Repair Kit		CV-RK-8118	for Control Arm	
05/94→05/95		Suspension Arm Repair Kit		MN-RK-7280	for Drag Link	
05/94→05/95		Suspension Arm Repair Kit		MN-RK-7287	for Wishbone (CV)	
05/94→05/95		Suspension Arm Repair Kit		MN-RK-7291	for Drag Link	
05/94→05/95		Tie Rod	MN-DL-12284			
05/94→05/95		Tie Rod End	CV-ES-14163		for Steering Rod	
05/94→05/95		Track Control Arm		MN-DL-5212	Trailing Arm, Air Suspension Axle; Drive Axle; Tag Axle	
05/94→05/95		Track Control Arm		MN-VB-5222	Wishbone (CV), Drive Axle; Air Suspension Axle	
05/94→05/95		Track Control Arm		MN-VB-5222	Wishbone (CV), Tag Axle	
24.422 DF	02/90→12/90	Ball Head, gearshift linkage	CV-ES-2119			
	02/90→12/90	Ball Head, gearshift linkage	CV-ES-2120			
	02/90→12/90	Ball Head, gearshift linkage	CV-ES-2182			
	02/90→12/90	Centre Rod	MN-DL-2160		Coupling Rod	
	02/90→12/90	Centre Rod	MN-DL-2175		Push Rod	
	02/90→12/90	Centre Rod	MN-DL-3588		Push Rod	
	02/90→12/90	Centre Rod	MN-DL-12421		for Steering Rod	
	02/90→12/90	Engine Mounting	MN-SB-10389			
	02/90→12/90	Mounting, stabilizer coupling rod	MN-SB-5246			
	02/90→12/90	Stabiliser Mounting		MN-SB-5254		
	02/90→12/90	Stabiliser Mounting	MN-SB-9396			
	02/90→12/90	Suspension Arm Repair Kit		CV-RK-5313	for Wishbone (CV)	
	02/90→12/90	Suspension Arm Repair Kit		MN-RK-7287	for Wishbone (CV)	
	02/90→12/90	Suspension Arm Repair Kit		MN-SB-5244	for Wishbone (CV)	
	02/90→12/90	Suspension Arm Repair Kit		MN-SB-5244	for Wishbone (CV), 1st RA	
	02/90→12/90	Tie Rod End	CV-ES-2149		for Push Rod	
	02/90→12/90	Tie Rod End	CV-ES-14162		for Steering Rod	
	02/90→12/90	Tie Rod End	CV-ES-14163		for Steering Rod	
	02/90→12/90	Track Control Arm		MN-DL-3402	Trailing Arm	
	02/90→12/90	Track Control Arm		MN-VB-5222	Wishbone (CV)	
	02/90→12/90	Track Control Arm		MN-VB-5222	Wishbone (CV), Drive Axle	
02/90→12/90	Track Control Arm		MN-VB-8569	Wishbone (CV)		
24.422 DFK	02/90→12/90	Ball Head, gearshift linkage	CV-ES-2119			
	02/90→12/90	Ball Head, gearshift linkage	CV-ES-2120			
	02/90→12/90	Ball Head, gearshift linkage	CV-ES-2182			
	02/90→12/90	Centre Rod	MN-DL-2160		Coupling Rod	
	02/90→12/90	Centre Rod	MN-DL-2175		Push Rod	
	02/90→12/90	Centre Rod	MN-DL-3588		Push Rod	
	02/90→12/90	Centre Rod	MN-DL-12421		for Steering Rod	
	02/90→12/90	Engine Mounting	MN-SB-10389			
	02/90→12/90	Mounting, stabilizer coupling rod	MN-SB-5246			
	02/90→12/90	Stabiliser Mounting		MN-SB-5254		
	02/90→12/90	Stabiliser Mounting	MN-SB-9396			
	02/90→12/90	Suspension Arm Repair Kit		CV-RK-5313	for Wishbone (CV)	
	02/90→12/90	Suspension Arm Repair Kit		MN-RK-7287	for Wishbone (CV)	
	02/90→12/90	Suspension Arm Repair Kit		MN-SB-5244	for Wishbone (CV)	

CV-ES-2119

Length: 55
Cone Ø: d1 Ø 10 / d2 Ø 10
Thread: M12 x 1,75 LHT
81953016063, 81953016131



CV-ES-2120

Length: 115
Cone Ø: d1 Ø 12,4 / d2 Ø 10,8
Thread: M14 x 1,5 RHT
03008500A, 81953016200, 81953016202, 81953016203, 81953016227



CV-ES-2149

Length: 160
Cone Ø: d1 Ø 30 / d2 Ø 27
Thread: M30 x 1,5 RHT
81953016263



CV-ES-2182

Length: 55
Cone Ø: d1 Ø 10 / d2 Ø 10
Thread: M12 x 1,75 RHT
81953016064, 81953016170



CV-ES-14162

Length: 125
Cone Ø: d1 Ø 30 / d2 Ø 27
Thread: M30 x 1,5 LHT
81953010015, 81953010083, 81953010087, 81953016029, 81953016030, 81953016043, 81953016044, 81953016050, 81953016054, 81953016087, 81953016091, 81953016107, 81953016120, 81953016125, 81953016152, 81953016155, 81953016157, 81953016168, 81953016179, 81953016181, 81953016223, 81953016237, 81953016254, 81953016275, 81953016279, 81953016351



CV-ES-14163

Length: 125
Cone Ø: d1 Ø 30 / d2 Ø 27
Thread: M30 x 1,5 RHT
95301.0084, 90804102156, 90804102272, 90804102696, 90804102710, 81953010016, 81953010075, 81953010084, 81953010088, 81953010094, 81953010103, 81953016030, 81953016043, 81953016048, 81953016049, 81953016053, 81953016061, 81953016090, 81953016108, 81953016112, 81953016126, 81953016143, 81953016149, 81953016154, 81953016156, 81953016168, 81953016178, 81953016194, 81953016206, 81953016224, 81953016234, 81953016242, 81953016252, 81953016274, 81953016278, 81953016284, 81953016286, 81953016308, 81953016310, 81953016312, 81953016347, 81953016350, 81953016352, 82953016012, 88953016014, N2953016001



CV-RK-5313

Ø: 90
03304800A, 81953016132



CV-RK-8118

Ø: 85
Hole Distance: 130
Thick/Height: 30
638862, 639287, 775201, 938423, 1104335, 1953248, 0003500506, 3500506, 11013547, 21032592, 42065912, 42488722, 070550504, 93192618, 070400009000, 634303610, 81432206055, 81432206073, 82262320660, 9544171010099, 5001842823, 7000307001, 8226232066



MN-DL-2160

Length: 1652 Ø: 50
Cone Ø: d1 Ø 30 / d2 Ø 27
81467106112, 81467106163, 81467106165, 81467106198, 81467106353, 81467106354, 81467106361, 81467116725



MN-DL-2175

Length: 1628 Ø: 50
Cone Ø: d1 Ø 30 / d2 Ø 27
81467106396, 81467106904



MN-DL-3402

Length: 590 Ø: 48
Hole Distance: 130 / 130
03307200A, 81432206067, 81432206068, 81432206090, 81432206092, 81432209092



MN-DL-3588

Length: 1035 Ø: 48
Cone Ø: d1 Ø 30 / d2 Ø 27
81466106333, 81466106334, 81466106354, 81466106355, 81466106360, 81466106361, 81466106721, 81466106722, 81466106723, 81466116216



MN-DL-5212

Length: 577 Ø: 48
Hole Distance: 130 / 130
81432206096, 81432206097, 81432206098, 81432206129, 81432209096, 81432209129, 81432306014, 81432306030



MN-DL-12284

Length: 1530 Ø: 50
Cone Ø: d1 Ø 30 / d2 Ø 27
81466106579, 81466106580, 81466106624, 81466116720, 81467116720, 81467116730, 81467116952



MN-DL-12421

Length: 1070 Ø: 48
Cone Ø: d1 Ø 30 / d2 Ø 27
Thread: M30 x 1,5 RHT
81466106656, 81466106659, 81466106669, 81466116006, 81466116007



MN-RK-7280

Ø: 75
Hole Distance: 115
Thick/Height: 24
0550806, 0639370, 689748, 10307400A, 81432306051, 81432306068, 81432706064



MN-RK-7287

Ø: 90
Hole Distance: 152
Thick/Height: 35
03304700A, 81953016133



MN-RK-7291

Ø: 72
Hole Distance: 130
Thick/Height: 30
10307800A, 81432206108, 81432206132



MN-SB-5244

Ø: 65
Hole Distance: 125
Thick/Height: 22
03312000A, 81432710027, 81432710082



MN-SB-5246

Ø: 45 Thick/Height: 47
81437220022, 81437220038, 81962100450, 81962100469



MN-SB-5254

Length: 100 Ø: 93
Thick/Height: 70
81432710081



MN-SB-5265

Ø: 85 Thick/Height: 80
03310300A, 81437040032



MN-SB-9396

Ø: 67 Thick/Height: 60
81437040057



MN-SB-10389

Ø: 70 Thick/Height: 72
8196200340



MN-VB-5222

Length: 627 Ø: 50
Hole Distance: 152 / 152
81432706030, 81432706034, 81432706054, 81432706055, 81432706056, 81432706057, 81432706067, 81432706068, 81432706074, 81432706075, 81432706076, 81432706077, 81432706078, 81432706081, 81432706082, 81432709034, 81432709076, 81432709078, 8143706054



MN-VB-8569

Length: 627 Ø: 58
Hole Distance: 152 / 152
81432706055, 81432706056, 81432706067, 81432706068, 81432706075, 81432706077, 81432706081, 81432709056





F 90 ...

24.422 DFK ...	02/90→12/90	Suspension Arm Repair Kit		MN-SB-5244	for Wishbone (CV), 1st RA	
	02/90→12/90	Tie Rod End	CV-ES-2149		for Push Rod	
	02/90→12/90	Tie Rod End	CV-ES-14162		for Steering Rod	
	02/90→12/90	Tie Rod End	CV-ES-14163		for Steering Rod	
	02/90→12/90	Track Control Arm		MN-DL-3402	Trailing Arm	
	02/90→12/90	Track Control Arm		MN-VB-5222	Wishbone (CV)	
	02/90→12/90	Track Control Arm		MN-VB-5222	Wishbone (CV), Drive Axle	
	02/90→12/90	Track Control Arm		MN-VB-8569	Wishbone (CV)	
24.422 DFS,24.422 DFLS	02/90→12/90	Ball Head, gearshift linkage	CV-ES-2119			
	02/90→12/90	Ball Head, gearshift linkage	CV-ES-2120			
	02/90→12/90	Ball Head, gearshift linkage	CV-ES-2182			
	02/90→12/90	Centre Rod	MN-DL-2160		Coupling Rod	
	02/90→12/90	Centre Rod	MN-DL-2175		Push Rod	
	02/90→12/90	Centre Rod	MN-DL-3588		Push Rod	
	02/90→12/90	Centre Rod	MN-DL-12421		for Steering Rod	
	02/90→12/90	Engine Mounting	MN-SB-10389			
	02/90→12/90	Mounting, stabilizer coupling rod	MN-SB-5246			
	02/90→12/90	Stabiliser Mounting		MN-SB-5254		
	02/90→12/90	Stabiliser Mounting	MN-SB-9396			
	02/90→12/90	Suspension Arm Repair Kit		CV-RK-5313	for Wishbone (CV)	
	02/90→12/90	Suspension Arm Repair Kit		CV-RK-8118	for Control Arm	
	02/90→12/90	Suspension Arm Repair Kit		MN-RK-7287	for Wishbone (CV)	
	02/90→12/90	Suspension Arm Repair Kit		MN-RK-7291	for Drag Link	
	02/90→12/90	Suspension Arm Repair Kit		MN-SB-5244	for Wishbone (CV)	
	02/90→12/90	Suspension Arm Repair Kit		MN-SB-5244	for Wishbone (CV), 1st RA	
	02/90→12/90	Tie Rod End	CV-ES-2149		for Push Rod	
	02/90→12/90	Tie Rod End	CV-ES-14162		for Steering Rod	
	02/90→12/90	Tie Rod End	CV-ES-14163		for Steering Rod	
	02/90→12/90	Track Control Arm		MN-DL-3402	Trailing Arm	
	02/90→12/90	Track Control Arm		MN-DL-5212	Trailing Arm, Air Suspension Axle;Drive Axle	
	02/90→12/90	Track Control Arm		MN-VB-5222	Wishbone (CV)	
	02/90→12/90	Track Control Arm		MN-VB-5222	Wishbone (CV), Drive Axle	
	02/90→12/90	Track Control Arm		MN-VB-5222	Wishbone (CV), Drive Axle;Air Suspension Axle	
	02/90→12/90	Track Control Arm		MN-VB-8569	Wishbone (CV)	
	24.422 FNL,24.422 FNLL, 24.422 FVL	02/90→05/95	Ball Head, gearshift linkage	CV-ES-2119		
		02/90→05/95	Ball Head, gearshift linkage	CV-ES-2120		
		02/90→05/95	Ball Head, gearshift linkage	CV-ES-2182		
		02/90→05/95	Centre Rod	MN-DL-2160		Coupling Rod
02/90→05/95		Centre Rod	MN-DL-2175		Push Rod	
02/90→05/95		Centre Rod	MN-DL-3588		Push Rod	
02/90→05/95		Centre Rod	MN-DL-12421		for Steering Rod	
02/90→05/95		Engine Mounting	MN-SB-10389			
02/90→05/95		Stabiliser Mounting		MN-SB-5243		
02/90→05/95		Stabiliser Mounting		MN-SB-5265		
02/90→05/95		Stabiliser Mounting		MN-SB-5265	1st RA	
02/90→05/95		Suspension Arm Repair Kit		CV-RK-5313	for Wishbone (CV)	
02/90→05/95		Suspension Arm Repair Kit		CV-RK-8118	for Control Arm	
02/90→05/95		Suspension Arm Repair Kit		MN-RK-7280	for Drag Link	
02/90→05/95		Suspension Arm Repair Kit		MN-RK-7287	for Wishbone (CV)	
02/90→05/95		Suspension Arm Repair Kit		MN-RK-7291	for Drag Link	
02/90→05/95		Tie Rod	MN-DL-12284			
02/90→05/95		Tie Rod End	CV-ES-2149		for Push Rod	
02/90→05/95		Tie Rod End	CV-ES-14162		for Steering Rod	
02/90→05/95		Tie Rod End	CV-ES-14163		for Steering Rod	
02/90→05/95		Track Control Arm		MN-DL-5212	Trailing Arm, Air Suspension Axle;Drive Axle	
02/90→05/95		Track Control Arm		MN-DL-5212	Trailing Arm, Air Suspension Axle;Drive Axle; Tag Axle	
02/90→05/95		Track Control Arm		MN-VB-5222	Wishbone (CV), Drive Axle;Air Suspension Axle	
02/90→05/95		Track Control Arm		MN-VB-5222	Wishbone (CV), Tag Axle	
24.462 DF		02/89→02/90	Ball Head, gearshift linkage	CV-ES-2120		
		02/89→02/90	Mounting, stabilizer coupling rod	MN-SB-5246		
		02/89→02/90	Stabiliser Mounting		MN-SB-5254	
		02/89→02/90	Stabiliser Mounting	MN-SB-9396		

CV-ES-2119

Length: 55
Cone Ø: d1 Ø 10 / d2 Ø 10
Thread: M12 x 1,75 LHT
81953016063, 81953016131



CV-ES-2120

Length: 115
Cone Ø: d1 Ø 12,4 / d2 Ø 10,8
Thread: M14 x 1,5 RHT
03008500A, 81953016200, 81953016202,
81953016203, 81953016227



CV-ES-2149

Length: 160
Cone Ø: d1 Ø 30 / d2 Ø 27
Thread: M30 x 1,5 RHT
81953016263



CV-ES-2182

Length: 55
Cone Ø: d1 Ø 10 / d2 Ø 10
Thread: M12 x 1,75 RHT
81953016064, 81953016170



CV-ES-14162

Length: 125
Cone Ø: d1 Ø 30 / d2 Ø 27
Thread: M30 x 1,5 LHT
81953010015, 81953010083, 81953010087,
81953016029, 81953016030, 81953016043,
81953016044, 81953016050, 81953016054,
81953016087, 81953016091, 81953016107,
81953016120, 81953016125, 81953016152,
81953016155, 81953016157, 81953016168,
81953016179, 81953016181, 81953016223,
81953016237, 81953016254, 81953016275,
81953016279, 81953016351



CV-ES-14163

Length: 125
Cone Ø: d1 Ø 30 / d2 Ø 27
Thread: M30 x 1,5 RHT
95301.0084, 90804102156, 90804102272,
90804102696, 90804102710, 81953010016,
81953010075, 81953010084, 81953010088,
81953010094, 81953010103, 81953016030,
81953016043, 81953016048, 81953016049,
81953016053, 81953016061, 81953016090,
81953016108, 81953016112, 81953016126,
81953016143, 81953016149, 81953016154,
81953016156, 81953016168, 81953016178,
81953016194, 81953016206, 81953016224,
81953016234, 81953016242, 81953016252,
81953016274, 81953016278, 81953016284,
81953016286, 81953016308, 81953016310,
81953016312, 81953016347, 81953016350,
81953016352, 82953016012, 88953016014,
N2953016001



CV-RK-5313

Ø: 90
03304800A, 81953016132



CV-RK-8118

Ø: 85
Hole Distance: 130
Thick/Height: 30
638862, 639287, 775201, 938423,
1104335, 1953248, 0003500506, 3500506,
11013547, 21032592, 42065912, 42488722,
070550504, 93192618, 070400009000,
634303610, 81432206055, 81432206073,
82262320660, 9544171010099,
5001842823, 7000307001, 8226232066



MN-DL-2160

Length: 1652 Ø: 50
Cone Ø: d1 Ø 30 / d2 Ø 27
81467106112, 81467106163, 81467106165,
81467106198, 81467106353, 81467106354,
81467106361, 81467116725



MN-DL-2175

Length: 1628 Ø: 50
Cone Ø: d1 Ø 30 / d2 Ø 27
81467106396, 81467106904



MN-DL-3402

Length: 590 Ø: 48
Hole Distance: 130 / 130
03307200A, 81432206067, 81432206068,
81432206090, 81432206092, 81432209092



MN-DL-3588

Length: 1035 Ø: 48
Cone Ø: d1 Ø 30 / d2 Ø 27
81466106333, 81466106334, 81466106354,
81466106355, 81466106360, 81466106361,
81466106721, 81466106722, 81466106723,
81466116216



MN-DL-5212

Length: 577 Ø: 48
Hole Distance: 130 / 130
81432206096, 81432206097, 81432206098,
81432206129, 81432209096, 81432209129,
81432306014, 81432306030



MN-DL-12284

Length: 1530 Ø: 50
Cone Ø: d1 Ø 30 / d2 Ø 27
81466106579, 81466106580, 81466106624,
81466116720, 81467116720, 81467116730,
81467116952



MN-DL-12421

Length: 1070 Ø: 48
Cone Ø: d1 Ø 30 / d2 Ø 27
Thread: M30 x 1,5 RHT
81466106656, 81466106659, 81466106669,
81466116006, 81466116007



MN-RK-7280

Ø: 75
Hole Distance: 115
Thick/Height: 24
0550806, 0639370, 689748, 10307400A,
81432306051, 81432306068, 81432706064



MN-RK-7287

Ø: 90
Hole Distance: 152
Thick/Height: 35
03304700A, 81953016133



MN-RK-7291

Ø: 72
Hole Distance: 130
Thick/Height: 30
10307800A, 81432206108, 81432206132



MN-SB-5243

Length: 55 Ø: 78
Thick/Height: 60
03311100A, 81437040061, 81437220020



MN-SB-5244

Ø: 65
Hole Distance: 125
Thick/Height: 22
03312000A, 81432710027, 81432710082



MN-SB-5246

Ø: 45 Thick/Height: 47
81437220022, 81437220038, 81962100450,
81962100469



MN-SB-5254

Length: 100 Ø: 93
Thick/Height: 70
81432710081



MN-SB-5265

Ø: 85 Thick/Height: 80
03310300A, 81437040032



MN-SB-9396

Ø: 67 Thick/Height: 60
81437040057



MN-SB-10389

Ø: 70 Thick/Height: 72
81960200340



MN-VB-5222

Length: 627 Ø: 50
Hole Distance: 152 / 152
81432706030, 81432706034, 81432706054,
81432706055, 81432706056, 81432706057,
81432706067, 81432706068, 81432706074,
81432706075, 81432706076, 81432706077,
81432706078, 81432706081, 81432706082,
81432709034, 81432709076, 81432709078,
8143706054



MN-VB-8569

Length: 627 Ø: 58
Hole Distance: 152 / 152
81432706055, 81432706056, 81432706067,
81432706068, 81432706075, 81432706077,
81432706081, 81432709056





F 90 ...

24.462 DF ...	02/89→02/90	Suspension Arm Repair Kit		CV-RK-5313	for Wishbone (CV)
	02/89→02/90	Suspension Arm Repair Kit		MN-RK-7287	for Wishbone (CV)
	02/89→02/90	Tie Rod End	CV-ES-14163		for Steering Rod
	02/89→02/90	Track Control Arm		MN-DL-3402	Trailing Arm, Drive Axle
	02/89→02/90	Track Control Arm		MN-VB-5222	Wishbone (CV), Drive Axle
	02/89→02/90	Track Control Arm		MN-VB-8569	Wishbone (CV)
24.462 DFS	02/89→02/90	Ball Head, gearshift linkage	CV-ES-2120		
	02/89→02/90	Mounting, stabilizer coupling rod	MN-SB-5246		
	02/89→02/90	Stabiliser Mounting		MN-SB-5254	
	02/89→02/90	Stabiliser Mounting	MN-SB-9396		
	02/89→02/90	Suspension Arm Repair Kit		CV-RK-5313	for Wishbone (CV)
	02/89→02/90	Suspension Arm Repair Kit		MN-RK-7287	for Wishbone (CV)
	02/89→02/90	Tie Rod End	CV-ES-14163		for Steering Rod
	02/89→02/90	Track Control Arm		MN-DL-3402	Trailing Arm, Drive Axle
	02/89→02/90	Track Control Arm		MN-VB-5222	Wishbone (CV), Drive Axle
	02/89→02/90	Track Control Arm		MN-VB-8569	Wishbone (CV)
24.462 FNL	04/89→02/90	Ball Head, gearshift linkage	CV-ES-2120		
	04/89→02/90	Centre Rod	MN-DL-12421		for Steering Rod
	04/89→02/90	Mounting, stabilizer coupling rod	MN-SB-5246		
	04/89→02/90	Mounting, stabilizer coupling rod	MN-SB-5246		1st FA
	04/89→02/90	Stabiliser Mounting		MN-SB-5242	
	04/89→02/90	Stabiliser Mounting		MN-SB-5243	
	04/89→02/90	Stabiliser Mounting	MN-SB-9396		
	04/89→02/90	Suspension Arm Repair Kit		CV-RK-5313	for Wishbone (CV)
	04/89→02/90	Suspension Arm Repair Kit		CV-RK-8118	for Control Arm
	04/89→02/90	Suspension Arm Repair Kit		MN-RK-7287	for Wishbone (CV)
	04/89→02/90	Suspension Arm Repair Kit		MN-RK-7291	for Drag Link
	04/89→02/90	Tie Rod End	CV-ES-14163		for Steering Rod
	04/89→02/90	Track Control Arm		MN-DL-5212	Trailing Arm, Air Suspension Axle; Drive Axle; Tag Axle
	04/89→02/90	Track Control Arm		MN-VB-5222	Wishbone (CV), Drive Axle
24.462 FVLS	05/87→07/87	Ball Head, gearshift linkage	CV-ES-2120		
	05/87→07/87	Centre Rod	MN-DL-12421		for Steering Rod
	05/87→07/87	Engine Mounting	MN-SB-10389		
	05/87→07/87	Stabiliser Mounting		MN-SB-5265	
	05/87→07/87	Stabiliser Mounting		MN-SB-5265	1st RA
	05/87→07/87	Suspension Arm Repair Kit		CV-RK-5313	for Wishbone (CV)
	05/87→07/87	Suspension Arm Repair Kit		CV-RK-8118	for Control Arm
	05/87→07/87	Suspension Arm Repair Kit		MN-RK-7280	for Drag Link
	05/87→07/87	Suspension Arm Repair Kit		MN-RK-7287	for Wishbone (CV)
	05/87→07/87	Suspension Arm Repair Kit		MN-RK-7291	for Drag Link
	05/87→07/87	Tie Rod End	CV-ES-14163		for Steering Rod
	05/87→07/87	Track Control Arm		MN-DL-5212	Trailing Arm, Air Suspension Axle; Drive Axle
	05/87→07/87	Track Control Arm		MN-VB-5222	Wishbone (CV), Drive Axle; Air Suspension Axle
24.502 DF	02/90→12/90	Ball Head, gearshift linkage	CV-ES-2120		
	02/90→12/90	Mounting, stabilizer coupling rod	MN-SB-5246		
	02/90→12/90	Stabiliser Mounting		MN-SB-5254	
	02/90→12/90	Stabiliser Mounting	MN-SB-9396		
	02/90→12/90	Suspension Arm Repair Kit		CV-RK-5313	for Wishbone (CV)
	02/90→12/90	Suspension Arm Repair Kit		MN-RK-7287	for Wishbone (CV)
	02/90→12/90	Tie Rod End	CV-ES-14163		for Steering Rod
	02/90→12/90	Track Control Arm		MN-DL-3402	Trailing Arm, Drive Axle
	02/90→12/90	Track Control Arm		MN-VB-5222	Wishbone (CV), Drive Axle
	02/90→12/90	Track Control Arm		MN-VB-8569	Wishbone (CV)
24.502 DFK	02/90→12/90	Ball Head, gearshift linkage	CV-ES-2120		
	02/90→12/90	Mounting, stabilizer coupling rod	MN-SB-5246		
	02/90→12/90	Stabiliser Mounting		MN-SB-5254	
	02/90→12/90	Stabiliser Mounting	MN-SB-9396		
	02/90→12/90	Suspension Arm Repair Kit		CV-RK-5313	for Wishbone (CV)
	02/90→12/90	Suspension Arm Repair Kit		MN-RK-7287	for Wishbone (CV)
	02/90→12/90	Tie Rod End	CV-ES-14163		for Steering Rod
	02/90→12/90	Track Control Arm		MN-DL-3402	Trailing Arm, Drive Axle
	02/90→12/90	Track Control Arm		MN-VB-5222	Wishbone (CV), Drive Axle
02/90→12/90	Track Control Arm		MN-VB-8569	Wishbone (CV)	

CV-ES-2120

Length: 115
Cone Ø: d1 Ø 12,4 / d2 Ø 10,8
Thread: M14 x 1,5 RHT
03008500A, 81953016200, 81953016202, 81953016203, 81953016227



CV-ES-14163

Length: 125
Cone Ø: d1 Ø 30 / d2 Ø 27
Thread: M30 x 1,5 RHT

95301.0084, 90804102156, 90804102272, 90804102696, 90804102710, 81953010016, 81953010075, 81953010084, 81953010088, 81953010094, 81953010103, 81953016030, 81953016043, 81953016048, 81953016049, 81953016053, 81953016061, 81953016090, 81953016108, 81953016112, 81953016126, 81953016143, 81953016149, 81953016154, 81953016156, 81953016168, 81953016178, 81953016194, 81953016206, 81953016224, 81953016234, 81953016242, 81953016252, 81953016274, 81953016278, 81953016284, 81953016286, 81953016308, 81953016310, 81953016312, 81953016347, 81953016350, 81953016352, 82953016012, 88953016014, N2953016001



CV-RK-5313

Ø: 90
03304800A, 81953016132



CV-RK-8118

Ø: 85
Hole Distance: 130
Thick/Height: 30
638862, 639287, 775201, 938423, 1104335, 1953248, 0003500506, 3500506, 11013547, 21032592, 42065912, 42488722, 070550504, 93192618, 070400009000, 634303610, 81432206055, 81432206073, 82262320660, 9544171010099, 5001842823, 7000307001, 8226232066



MN-DL-3402

Length: 590 Ø: 48
Hole Distance: 130 / 130
03307200A, 81432206067, 81432206068, 81432206090, 81432206092, 81432209092



MN-DL-5212

Length: 577 Ø: 48
Hole Distance: 130 / 130
81432206096, 81432206097, 81432206098, 81432206129, 81432209096, 81432209129, 81432306014, 81432306030



MN-DL-12421

Length: 1070
Ø: 48
Cone Ø: d1 Ø 30 / d2 Ø 27
Thread: M30 x 1,5 RHT
81466106656, 81466106659, 81466106669, 81466116006, 81466116007



MN-RK-7280

Ø: 75
Hole Distance: 115
Thick/Height: 24
0550806, 0639370, 689748, 10307400A, 81432306051, 81432306068, 81432706064



MN-RK-7287

Ø: 90
Hole Distance: 152
Thick/Height: 35
03304700A, 81953016133



MN-RK-7291

Ø: 72
Hole Distance: 130
Thick/Height: 30
10307800A, 81432206108, 81432206132



MN-SB-5242

Ø: 65
Thick/Height: 62
03310800A, 81437220021, 81437220039, 81437220063



MN-SB-5243

Length: 55
Ø: 78
Thick/Height: 60
03311100A, 81437040061, 81437220020



MN-SB-5246

Ø: 45 Thick/Height: 47
81437220022, 81437220038, 81962100450, 81962100469



MN-SB-5254

Length: 100
Ø: 93
Thick/Height: 70
81432710081



MN-SB-5265

Ø: 85
Thick/Height: 80
03310300A, 81437040032



MN-SB-9396

Ø: 67
Thick/Height: 60
81437040057



MN-SB-10389

Ø: 70
Thick/Height: 72
81960200340



MN-VB-5222

Length: 627 Ø: 50
Hole Distance: 152 / 152
81432706030, 81432706034, 81432706054, 81432706055, 81432706056, 81432706057, 81432706067, 81432706068, 81432706074, 81432706075, 81432706076, 81432706077, 81432706078, 81432706081, 81432706082, 81432709034, 81432709076, 81432709078, 8143706054



MN-VB-8569

Length: 627
Ø: 58
Hole Distance: 152 / 152
81432706055, 81432706056, 81432706067, 81432706068, 81432706075, 81432706077, 81432706081, 81432709056





F 90 ...

24.502 DFS	02/90→12/90	Ball Head, gearshift linkage	CV-ES-2120			
	02/90→12/90	Mounting, stabilizer coupling rod	MN-SB-5246			
	02/90→12/90	Stabiliser Mounting		MN-SB-5254		
	02/90→12/90	Stabiliser Mounting	MN-SB-9396			
	02/90→12/90	Suspension Arm Repair Kit		CV-RK-5313	for Wishbone (CV)	
	02/90→12/90	Suspension Arm Repair Kit		MN-RK-7287	for Wishbone (CV)	
	02/90→12/90	Tie Rod End	CV-ES-14163		for Steering Rod	
	02/90→12/90	Track Control Arm		MN-DL-3402	Trailing Arm, Drive Axle	
	02/90→12/90	Track Control Arm		MN-VB-5222	Wishbone (CV), Drive Axle	
	02/90→12/90	Track Control Arm		MN-VB-8569	Wishbone (CV)	
24.502 FNL	02/90→12/90	Ball Head, gearshift linkage	CV-ES-2120			
	02/90→12/90	Centre Rod	MN-DL-12421		for Steering Rod	
	02/90→12/90	Mounting, stabilizer coupling rod	MN-SB-5246			
	02/90→12/90	Mounting, stabilizer coupling rod	MN-SB-5246		1st FA	
	02/90→12/90	Stabiliser Mounting		MN-SB-5242		
	02/90→12/90	Stabiliser Mounting		MN-SB-5243		
	02/90→12/90	Stabiliser Mounting	MN-SB-9396			
	02/90→12/90	Suspension Arm Repair Kit		CV-RK-5313	for Wishbone (CV)	
	02/90→12/90	Suspension Arm Repair Kit		CV-RK-8118	for Control Arm	
	02/90→12/90	Suspension Arm Repair Kit		MN-RK-7287	for Wishbone (CV)	
	02/90→12/90	Suspension Arm Repair Kit		MN-RK-7291	for Drag Link	
	02/90→12/90	Tie Rod End	CV-ES-14163		for Steering Rod	
	02/90→12/90	Track Control Arm		MN-DL-5212	Trailing Arm, Air Suspension Axle; Drive Axle; Tag Axle	
	02/90→12/90	Track Control Arm		MN-VB-5222	Wishbone (CV), Drive Axle	
25.272 DF	09/90→01/91	Track Control Arm		MN-VB-5222	Wishbone (CV), Drive Axle	
	09/90→12/92	Ball Head, gearshift linkage	CV-ES-2119			
	09/90→12/92	Ball Head, gearshift linkage	CV-ES-2120			
	09/90→12/92	Ball Head, gearshift linkage	CV-ES-2182			
	09/90→12/92	Centre Rod	MN-DL-2160		Coupling Rod	
	09/90→12/92	Centre Rod	MN-DL-2175		Push Rod	
	09/90→12/92	Centre Rod	MN-DL-3588		Push Rod	
	09/90→12/92	Centre Rod	MN-DL-12421		for Steering Rod	
	09/90→12/92	Engine Mounting	MN-SB-10389			
	09/90→12/92	Mounting, stabilizer coupling rod	MN-SB-5246			
	09/90→12/92	Stabiliser Mounting		MN-SB-5254		
	09/90→12/92	Stabiliser Mounting	MN-SB-9396			
	09/90→12/92	Suspension Arm Repair Kit		CV-RK-5313	for Wishbone (CV)	
	09/90→12/92	Suspension Arm Repair Kit		MN-RK-7287	for Wishbone (CV)	
	09/90→12/92	Suspension Arm Repair Kit		MN-SB-5244	for Wishbone (CV)	
	09/90→12/92	Suspension Arm Repair Kit		MN-SB-5244	for Wishbone (CV), 1st RA	
	09/90→12/92	Tie Rod End	CV-ES-2149		for Push Rod	
	09/90→12/92	Tie Rod End	CV-ES-14162		for Steering Rod	
	09/90→12/92	Tie Rod End	CV-ES-14163		for Steering Rod	
	09/90→12/92	Track Control Arm		MN-DL-3402	Trailing Arm	
	09/90→12/92	Track Control Arm		MN-VB-5222	Wishbone (CV)	
	09/90→12/92	Track Control Arm		MN-VB-8569	Wishbone (CV)	
	01/91→12/92	Track Control Arm		MN-VB-8569	Wishbone (CV), Drive Axle	
	25.272 DFK	09/90→01/91	Track Control Arm		MN-VB-5222	Wishbone (CV), Drive Axle
		09/90→12/92	Ball Head, gearshift linkage	CV-ES-2119		
		09/90→12/92	Ball Head, gearshift linkage	CV-ES-2120		
		09/90→12/92	Ball Head, gearshift linkage	CV-ES-2182		
09/90→12/92		Centre Rod	MN-DL-2160		Coupling Rod	
09/90→12/92		Centre Rod	MN-DL-2175		Push Rod	
09/90→12/92		Centre Rod	MN-DL-3588		Push Rod	
09/90→12/92		Centre Rod	MN-DL-12421		for Steering Rod	
09/90→12/92		Engine Mounting	MN-SB-10389			
09/90→12/92		Mounting, stabilizer coupling rod	MN-SB-5246			
09/90→12/92		Stabiliser Mounting		MN-SB-5254		
09/90→12/92		Stabiliser Mounting	MN-SB-9396			
09/90→12/92		Suspension Arm Repair Kit		CV-RK-5313	for Wishbone (CV)	
09/90→12/92		Suspension Arm Repair Kit		MN-RK-7287	for Wishbone (CV)	
09/90→12/92		Suspension Arm Repair Kit		MN-SB-5244	for Wishbone (CV)	

CV-ES-2119

Length: 55
Cone Ø: d1 Ø 10 / d2 Ø 10
Thread: M12 x 1,75 LHT
81953016063, 81953016131



CV-ES-2120

Length: 115
Cone Ø: d1 Ø 12,4 / d2 Ø 10,8
Thread: M14 x 1,5 RHT
03008500A, 81953016200, 81953016202, 81953016203, 81953016227



CV-ES-2149

Length: 160
Cone Ø: d1 Ø 30 / d2 Ø 27
Thread: M30 x 1,5 RHT
81953016263



CV-ES-2182

Length: 55
Cone Ø: d1 Ø 10 / d2 Ø 10
Thread: M12 x 1,75 RHT
81953016064, 81953016170



CV-ES-14162

Length: 125
Cone Ø: d1 Ø 30 / d2 Ø 27
Thread: M30 x 1,5 LHT

81953010015, 81953010083, 81953010087, 81953016029, 81953016030, 81953016043, 81953016044, 81953016050, 81953016054, 81953016087, 81953016091, 81953016107, 81953016120, 81953016125, 81953016152, 81953016155, 81953016157, 81953016168, 81953016179, 81953016181, 81953016223, 81953016237, 81953016254, 81953016275, 81953016279, 81953016351



CV-ES-14163

Length: 125
Cone Ø: d1 Ø 30 / d2 Ø 27
Thread: M30 x 1,5 RHT

95301.0084, 90804102156, 90804102272, 90804102696, 90804102710, 81953010016, 81953010075, 81953010084, 81953010088, 81953010094, 81953010103, 81953016030, 81953016043, 81953016048, 81953016049, 81953016053, 81953016061, 81953016090, 81953016108, 81953016112, 81953016126, 81953016143, 81953016149, 81953016154, 81953016156, 81953016168, 81953016178, 81953016194, 81953016206, 81953016224, 81953016234, 81953016242, 81953016252, 81953016274, 81953016278, 81953016284, 81953016286, 81953016308, 81953016310, 81953016312, 81953016347, 81953016350, 81953016352, 82953016012, 88953016014, N2953016001



CV-RK-5313

Ø: 90
03304800A, 81953016132



CV-RK-8118

Ø: 85
Hole Distance: 130
Thick/Height: 30

638862, 639287, 775201, 938423, 1104335, 1953248, 0003500506, 3500506, 11013547, 21032592, 42065912, 42488722, 070550504, 93192618, 070400009000, 634303610, 81432206055, 81432206073, 82262320660, 9544171010099, 5001842823, 7000307001, 8226232066



MN-DL-2160

Length: 1652 Ø: 50
Cone Ø: d1 Ø 30 / d2 Ø 27

81467106112, 81467106163, 81467106165, 81467106198, 81467106353, 81467106354, 81467106361, 81467116725



MN-DL-2175

Length: 1628 Ø: 50
Cone Ø: d1 Ø 30 / d2 Ø 27
81467106396, 81467106904



MN-DL-3402

Length: 590 Ø: 48
Hole Distance: 130 / 130
03307200A, 81432206067, 81432206092, 81432206099, 81432209092



MN-DL-3588

Length: 1035 Ø: 48
Cone Ø: d1 Ø 30 / d2 Ø 27
81466106333, 81466106334, 81466106354, 81466106355, 81466106360, 81466106361, 81466106721, 81466106722, 81466106723, 81466116216



MN-DL-5212

Length: 577 Ø: 48
Hole Distance: 130 / 130
81432206096, 81432206097, 81432206098, 81432206129, 81432209096, 81432209129, 81432306014, 81432306030



MN-DL-12421

Length: 1070 Ø: 48
Cone Ø: d1 Ø 30 / d2 Ø 27
Thread: M30 x 1,5 RHT
81466106656, 81466106659, 81466106669, 81466116006, 81466116007



MN-RK-7287

Ø: 90
Hole Distance: 152
Thick/Height: 35
03304700A, 81953016133



MN-RK-7291

Ø: 72
Hole Distance: 130
Thick/Height: 30
10307800A, 81432206108, 81432206132



MN-SB-5242

Ø: 65 Thick/Height: 62
03310800A, 81437220021, 81437220039, 81437220063



MN-SB-5243

Length: 55 Ø: 78
Thick/Height: 60
03311100A, 81437040061, 81437220020



MN-SB-5244

Ø: 65
Hole Distance: 125
Thick/Height: 22
03312000A, 81432710027, 81432710082



MN-SB-5246

Ø: 45 Thick/Height: 47
81437220022, 81437220038, 81962100450, 81962100469



MN-SB-5254

Length: 100 Ø: 93
Thick/Height: 70
81432710081



MN-SB-9396

Ø: 67 Thick/Height: 60
81437040057



MN-SB-10389

Ø: 70 Thick/Height: 72
8196200340



MN-VB-5222

Length: 627 Ø: 50
Hole Distance: 152 / 152
81432706030, 81432706034, 81432706054, 81432706055, 81432706056, 81432706057, 81432706067, 81432706068, 81432706074, 81432706075, 81432706076, 81432706077, 81432706078, 81432706081, 81432706082, 81432709034, 81432709076, 81432709078, 8143706054



MN-VB-8569

Length: 627 Ø: 58
Hole Distance: 152 / 152
81432706055, 81432706056, 81432706067, 81432706068, 81432706075, 81432706077, 81432706081, 81432709056



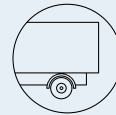

F 90 ...

25.272 DFK ...	09/90→12/92	Suspension Arm Repair Kit		MN-SB-5244	for Wishbone (CV), 1st RA	
	09/90→12/92	Tie Rod End	CV-ES-2149		for Push Rod	
	09/90→12/92	Tie Rod End	CV-ES-14162		for Steering Rod	
	09/90→12/92	Tie Rod End	CV-ES-14163		for Steering Rod	
	09/90→12/92	Track Control Arm		MN-DL-3402	Trailing Arm	
	09/90→12/92	Track Control Arm		MN-VB-5222	Wishbone (CV)	
	09/90→12/92	Track Control Arm		MN-VB-8569	Wishbone (CV)	
	01/91→12/92	Track Control Arm		MN-VB-8569	Wishbone (CV), Drive Axle	
	09/90→01/91	Track Control Arm		MN-VB-5222	Wishbone (CV), Drive Axle	
	25.272 DFS,25.272 DFLS	09/90→12/92	Ball Head, gearshift linkage	CV-ES-2119		
09/90→12/92		Ball Head, gearshift linkage	CV-ES-2120			
09/90→12/92		Ball Head, gearshift linkage	CV-ES-2182			
09/90→12/92		Centre Rod	MN-DL-2160		Coupling Rod	
09/90→12/92		Centre Rod	MN-DL-2175		Push Rod	
09/90→12/92		Centre Rod	MN-DL-3588		Push Rod	
09/90→12/92		Centre Rod	MN-DL-12421		for Steering Rod	
09/90→12/92		Engine Mounting	MN-SB-10389			
09/90→12/92		Mounting, stabilizer coupling rod	MN-SB-5246			
09/90→12/92		Stabiliser Mounting		MN-SB-5254		
09/90→12/92		Stabiliser Mounting	MN-SB-9396			
09/90→12/92		Suspension Arm Repair Kit		CV-RK-5313	for Wishbone (CV)	
09/90→12/92		Suspension Arm Repair Kit		CV-RK-8118	for Control Arm	
09/90→12/92		Suspension Arm Repair Kit		MN-RK-7287	for Wishbone (CV)	
09/90→12/92		Suspension Arm Repair Kit		MN-RK-7291	for Drag Link	
09/90→12/92		Suspension Arm Repair Kit		MN-SB-5244	for Wishbone (CV)	
09/90→12/92		Suspension Arm Repair Kit		MN-SB-5244	for Wishbone (CV), 1st RA	
09/90→12/92		Tie Rod End	CV-ES-2149		for Push Rod	
09/90→12/92		Tie Rod End	CV-ES-14162		for Steering Rod	
09/90→12/92		Tie Rod End	CV-ES-14163		for Steering Rod	
09/90→12/92		Track Control Arm		MN-DL-3402	Trailing Arm	
09/90→12/92		Track Control Arm		MN-DL-5212	Trailing Arm, Air Suspension Axle;Drive Axle	
09/90→12/92		Track Control Arm		MN-VB-5222	Wishbone (CV)	
09/90→12/92		Track Control Arm		MN-VB-5222	Wishbone (CV), Drive Axle;Air Suspension Axle	
09/90→12/92		Track Control Arm		MN-VB-8569	Wishbone (CV)	
01/91→12/92		Track Control Arm		MN-VB-8569	Wishbone (CV), Drive Axle	
25.272 FNL,25.272 FNLL, 25.272 FVL		09/90→10/93	Ball Head, gearshift linkage	CV-ES-2119		
		09/90→10/93	Ball Head, gearshift linkage	CV-ES-2120		
		09/90→10/93	Ball Head, gearshift linkage	CV-ES-2182		
		09/90→10/93	Centre Rod	MN-DL-2160		Coupling Rod
	09/90→10/93	Centre Rod	MN-DL-2175		Push Rod	
	09/90→10/93	Centre Rod	MN-DL-3588		Push Rod	
	09/90→10/93	Centre Rod	MN-DL-12421		for Steering Rod	
	09/90→10/93	Engine Mounting	MN-SB-10389			
	09/90→10/93	Stabiliser Mounting		MN-SB-5243		
	09/90→10/93	Stabiliser Mounting		MN-SB-5265		
	09/90→10/93	Stabiliser Mounting		MN-SB-5265	1st RA	
	09/90→10/93	Suspension Arm Repair Kit		CV-RK-5313	for Wishbone (CV)	
	09/90→10/93	Suspension Arm Repair Kit		CV-RK-8118	for Control Arm	
	09/90→10/93	Suspension Arm Repair Kit		MN-RK-7280	for Drag Link	
	09/90→10/93	Suspension Arm Repair Kit		MN-RK-7287	for Wishbone (CV)	
	09/90→10/93	Suspension Arm Repair Kit		MN-RK-7291	for Drag Link	
	09/90→10/93	Tie Rod End	CV-ES-2149		for Push Rod	
	09/90→10/93	Tie Rod End	CV-ES-14162		for Steering Rod	
	09/90→10/93	Tie Rod End	CV-ES-14163		for Steering Rod	
	09/90→10/93	Track Control Arm		MN-DL-5212	Trailing Arm, Air Suspension Axle;Drive Axle	
	09/90→10/93	Track Control Arm		MN-DL-5212	Trailing Arm, Air Suspension Axle;Drive Axle; Tag Axle	
	09/90→10/93	Track Control Arm		MN-VB-5222	Wishbone (CV), Drive Axle;Air Suspension Axle	
	09/90→10/93	Track Control Arm		MN-VB-5222	Wishbone (CV), Tag Axle	
	25.302 DF	09/90→01/91	Track Control Arm		MN-VB-5222	Wishbone (CV), Drive Axle
09/90→12/91		Ball Head, gearshift linkage	CV-ES-2119			
09/90→12/91		Ball Head, gearshift linkage	CV-ES-2120			
09/90→12/91		Ball Head, gearshift linkage	CV-ES-2182			

CV-ES-2119

Length: 55
Cone Ø: d1 Ø 10 / d2 Ø 10
Thread: M12 x 1,75 LHT
81953016063, 81953016131



CV-ES-2120

Length: 115
Cone Ø: d1 Ø 12,4 / d2 Ø 10,8
Thread: M14 x 1,5 RHT
03008500A, 81953016200, 81953016202,
81953016203, 81953016227



CV-ES-2149

Length: 160
Cone Ø: d1 Ø 30 / d2 Ø 27
Thread: M30 x 1,5 RHT
81953016263



CV-ES-2182

Length: 55
Cone Ø: d1 Ø 10 / d2 Ø 10
Thread: M12 x 1,75 RHT
81953016064, 81953016170



CV-ES-14162

Length: 125
Cone Ø: d1 Ø 30 / d2 Ø 27
Thread: M30 x 1,5 LHT
81953010015, 81953010083, 81953010087,
81953016029, 81953016030, 81953016043,
81953016044, 81953016050, 81953016054,
81953016087, 81953016091, 81953016107,
81953016120, 81953016125, 81953016152,
81953016155, 81953016157, 81953016168,
81953016179, 81953016181, 81953016223,
81953016237, 81953016254, 81953016275,
81953016279, 81953016351



CV-ES-14163

Length: 125
Cone Ø: d1 Ø 30 / d2 Ø 27
Thread: M30 x 1,5 RHT
95301.0084, 90804102156, 90804102272,
90804102696, 90804102710, 81953010016,
81953010075, 81953010084, 81953010088,
81953010094, 81953010103, 81953016030,
81953016043, 81953016048, 81953016049,
81953016053, 81953016061, 81953016090,
81953016108, 81953016112, 81953016126,
81953016143, 81953016149, 81953016154,
81953016156, 81953016168, 81953016178,
81953016194, 81953016206, 81953016224,
81953016234, 81953016242, 81953016252,
81953016274, 81953016278, 81953016284,
81953016286, 81953016308, 81953016310,
81953016312, 81953016347, 81953016350,
81953016352, 82953016012, 88953016014,
N2953016001



CV-RK-5313

Ø: 90
03304800A, 81953016132



CV-RK-8118

Ø: 85
Hole Distance: 130
Thick/Height: 30
638862, 639287, 775201, 938423,
1104335, 1953248, 0003500506, 3500506,
11013547, 21032592, 42065912, 42488722,
070550504, 93192618, 070400009000,
634303610, 81432206055, 81432206073,
82262320660, 9544171010099,
5001842823, 7000307001, 8226232066



MN-DL-2160

Length: 1652 Ø: 50
Cone Ø: d1 Ø 30 / d2 Ø 27
81467106112, 81467106163, 81467106165,
81467106198, 81467106353, 81467106354,
81467106361, 81467116725



MN-DL-2175

Length: 1628 Ø: 50
Cone Ø: d1 Ø 30 / d2 Ø 27
81467106396, 81467106904



MN-DL-3402

Length: 590 Ø: 48
Hole Distance: 130 / 130
03307200A, 81432206067, 81432206068,
81432206090, 81432206092, 81432209092



MN-DL-3588

Length: 1035 Ø: 48
Cone Ø: d1 Ø 30 / d2 Ø 27
81466106333, 81466106334, 81466106354,
81466106355, 81466106360, 81466106361,
81466106721, 81466106722, 81466106723,
81466116216



MN-DL-5212

Length: 577 Ø: 48
Hole Distance: 130 / 130
81432206096, 81432206097, 81432206098,
81432206129, 81432209096, 81432209129,
81432306014, 81432306030



MN-DL-12421

Length: 1070 Ø: 48
Cone Ø: d1 Ø 30 / d2 Ø 27
Thread: M30 x 1,5 RHT
81466106656, 81466106659, 81466106669,
81466116006, 81466116007



MN-RK-7280

Ø: 75
Hole Distance: 115
Thick/Height: 24
0550806, 0639370, 689748, 10307400A,
81432306051, 81432306068, 81432706064



MN-RK-7287

Ø: 90
Hole Distance: 152
Thick/Height: 35
03304700A, 81953016133



MN-RK-7291

Ø: 72
Hole Distance: 130
Thick/Height: 30
10307800A, 81432206108, 81432206132



MN-SB-5243

Length: 55 Ø: 78
Thick/Height: 60
03311100A, 81437040061, 81437220020



MN-SB-5244

Ø: 65
Hole Distance: 125
Thick/Height: 22
03312000A, 81432710027, 81432710082



MN-SB-5246

Ø: 45 Thick/Height: 47
81437220022, 81437220038, 81962100450,
81962100469



MN-SB-5254

Length: 100 Ø: 93
Thick/Height: 70
81432710081



MN-SB-5265

Ø: 85 Thick/Height: 80
03310300A, 81437040032



MN-SB-9396

Ø: 67 Thick/Height: 60
81437040057



MN-SB-10389

Ø: 70 Thick/Height: 72
81960200340



MN-VB-5222

Length: 627 Ø: 50
Hole Distance: 152 / 152
81432706030, 81432706034, 81432706054,
81432706055, 81432706056, 81432706057,
81432706067, 81432706068, 81432706074,
81432706075, 81432706076, 81432706077,
81432706078, 81432706081, 81432706082,
81432709034, 81432709076, 81432709078,
8143706054



MN-VB-8569

Length: 627 Ø: 58
Hole Distance: 152 / 152
81432706055, 81432706056, 81432706067,
81432706068, 81432706075, 81432706077,
81432706081, 81432709056





F 90 ...

25.302 DF ...	09/90→12/91	Centre Rod	MN-DL-2160		Coupling Rod	
	09/90→12/91	Centre Rod	MN-DL-2175		Push Rod	
	09/90→12/91	Centre Rod	MN-DL-3588		Push Rod	
	09/90→12/91	Centre Rod	MN-DL-12421		for Steering Rod	
	09/90→12/91	Engine Mounting	MN-SB-10389			
	09/90→12/91	Mounting, stabilizer coupling rod	MN-SB-5246			
	09/90→12/91	Stabiliser Mounting		MN-SB-5254		
	09/90→12/91	Stabiliser Mounting	MN-SB-9396			
	09/90→12/91	Suspension Arm Repair Kit		CV-RK-5313	for Wishbone (CV)	
	09/90→12/91	Suspension Arm Repair Kit		MN-RK-7287	for Wishbone (CV)	
	09/90→12/91	Suspension Arm Repair Kit		MN-SB-5244	for Wishbone (CV)	
	09/90→12/91	Suspension Arm Repair Kit		MN-SB-5244	for Wishbone (CV), 1st RA	
	09/90→12/91	Tie Rod End	CV-ES-2149		for Push Rod	
	09/90→12/91	Tie Rod End	CV-ES-14162		for Steering Rod	
	09/90→12/91	Tie Rod End	CV-ES-14163		for Steering Rod	
	09/90→12/91	Track Control Arm		MN-DL-3402	Trailing Arm	
	09/90→12/91	Track Control Arm		MN-VB-5222	Wishbone (CV)	
	09/90→12/91	Track Control Arm		MN-VB-8569	Wishbone (CV)	
	01/91→12/91	Track Control Arm		MN-VB-8569	Wishbone (CV), Drive Axle	
	25.302 DFK	09/90→01/91	Track Control Arm		MN-VB-5222	Wishbone (CV), Drive Axle
		09/90→12/91	Ball Head, gearshift linkage	CV-ES-2119		
		09/90→12/91	Ball Head, gearshift linkage	CV-ES-2120		
		09/90→12/91	Ball Head, gearshift linkage	CV-ES-2182		
		09/90→12/91	Centre Rod	MN-DL-2160		Coupling Rod
		09/90→12/91	Centre Rod	MN-DL-2175		Push Rod
09/90→12/91		Centre Rod	MN-DL-3588		Push Rod	
09/90→12/91		Centre Rod	MN-DL-12421		for Steering Rod	
09/90→12/91		Engine Mounting	MN-SB-10389			
09/90→12/91		Mounting, stabilizer coupling rod	MN-SB-5246			
09/90→12/91		Stabiliser Mounting		MN-SB-5254		
09/90→12/91		Stabiliser Mounting	MN-SB-9396			
09/90→12/91		Suspension Arm Repair Kit		CV-RK-5313	for Wishbone (CV)	
09/90→12/91		Suspension Arm Repair Kit		MN-RK-7287	for Wishbone (CV)	
09/90→12/91		Suspension Arm Repair Kit		MN-SB-5244	for Wishbone (CV)	
09/90→12/91		Suspension Arm Repair Kit		MN-SB-5244	for Wishbone (CV), 1st RA	
09/90→12/91		Tie Rod End	CV-ES-2149		for Push Rod	
09/90→12/91		Tie Rod End	CV-ES-14162		for Steering Rod	
09/90→12/91		Tie Rod End	CV-ES-14163		for Steering Rod	
09/90→12/91		Track Control Arm		MN-DL-3402	Trailing Arm	
09/90→12/91		Track Control Arm		MN-VB-5222	Wishbone (CV)	
09/90→12/91		Track Control Arm		MN-VB-8569	Wishbone (CV)	
01/91→12/91		Track Control Arm		MN-VB-8569	Wishbone (CV), Drive Axle	
25.302 DFS, 25.302 DFLS		09/90→01/91	Track Control Arm		MN-VB-5222	Wishbone (CV), Drive Axle
		09/90→12/91	Ball Head, gearshift linkage	CV-ES-2119		
	09/90→12/91	Ball Head, gearshift linkage	CV-ES-2120			
	09/90→12/91	Ball Head, gearshift linkage	CV-ES-2182			
	09/90→12/91	Centre Rod	MN-DL-2160		Coupling Rod	
	09/90→12/91	Centre Rod	MN-DL-2175		Push Rod	
	09/90→12/91	Centre Rod	MN-DL-3588		Push Rod	
	09/90→12/91	Centre Rod	MN-DL-12421		for Steering Rod	
	09/90→12/91	Engine Mounting	MN-SB-10389			
	09/90→12/91	Mounting, stabilizer coupling rod	MN-SB-5246			
	09/90→12/91	Stabiliser Mounting		MN-SB-5254		
	09/90→12/91	Stabiliser Mounting	MN-SB-9396			
	09/90→12/91	Suspension Arm Repair Kit		CV-RK-5313	for Wishbone (CV)	
	09/90→12/91	Suspension Arm Repair Kit		CV-RK-8118	for Control Arm	
	09/90→12/91	Suspension Arm Repair Kit		MN-RK-7287	for Wishbone (CV)	
	09/90→12/91	Suspension Arm Repair Kit		MN-RK-7291	for Drag Link	
	09/90→12/91	Suspension Arm Repair Kit		MN-SB-5244	for Wishbone (CV)	
	09/90→12/91	Suspension Arm Repair Kit		MN-SB-5244	for Wishbone (CV), 1st RA	
	09/90→12/91	Tie Rod End	CV-ES-2149		for Push Rod	
	09/90→12/91	Tie Rod End	CV-ES-14162		for Steering Rod	
	09/90→12/91	Tie Rod End	CV-ES-14163		for Steering Rod	

CV-ES-2119

Length: 55
Cone Ø: d1 Ø 10 / d2 Ø 10
Thread: M12 x 1,75 LHT
81953016063, 81953016131



CV-ES-2120

Length: 115
Cone Ø: d1 Ø 12,4 / d2 Ø 10,8
Thread: M14 x 1,5 RHT
03008500A, 81953016200, 81953016202, 81953016203, 81953016227



CV-ES-2149

Length: 160
Cone Ø: d1 Ø 30 / d2 Ø 27
Thread: M30 x 1,5 RHT
81953016263



CV-ES-2182

Length: 55
Cone Ø: d1 Ø 10 / d2 Ø 10
Thread: M12 x 1,75 RHT
81953016064, 81953016170



CV-ES-14162

Length: 125
Cone Ø: d1 Ø 30 / d2 Ø 27
Thread: M30 x 1,5 LHT
81953010015, 81953010083, 81953010087, 81953016029, 81953016030, 81953016043, 81953016044, 81953016050, 81953016054, 81953016087, 81953016091, 81953016107, 81953016120, 81953016125, 81953016152, 81953016155, 81953016157, 81953016168, 81953016179, 81953016181, 81953016223, 81953016237, 81953016254, 81953016275, 81953016279, 81953016351



CV-ES-14163

Length: 125
Cone Ø: d1 Ø 30 / d2 Ø 27
Thread: M30 x 1,5 RHT
95301.0084, 90804102156, 90804102272, 90804102696, 90804102710, 81953010016, 81953010075, 81953010084, 81953010088, 81953010094, 81953010103, 81953016030, 81953016043, 81953016048, 81953016049, 81953016053, 81953016061, 81953016090, 81953016108, 81953016112, 81953016126, 81953016143, 81953016149, 81953016154, 81953016156, 81953016168, 81953016178, 81953016194, 81953016206, 81953016224, 81953016234, 81953016242, 81953016252, 81953016274, 81953016278, 81953016284, 81953016286, 81953016308, 81953016310, 81953016312, 81953016347, 81953016350, 81953016352, 82953016012, 88953016014, N2953016001



CV-RK-5313

Ø: 90
03304800A, 81953016132



CV-RK-8118

Ø: 85
Hole Distance: 130
Thick/Height: 30
638862, 639287, 775201, 938423, 1104335, 1953248, 0003500506, 3500506, 11013547, 21032592, 42065912, 42488722, 070550504, 93192618, 070400009000, 634303610, 81432206055, 81432206073, 82262320660, 9544171010099, 5001842823, 7000307001, 8226232066



MN-DL-2160

Length: 1652 Ø: 50
Cone Ø: d1 Ø 30 / d2 Ø 27
81467106112, 81467106163, 81467106165, 81467106198, 81467106353, 81467106354, 81467106361, 81467116725



MN-DL-2175

Length: 1628 Ø: 50
Cone Ø: d1 Ø 30 / d2 Ø 27
81467106396, 81467106904



MN-DL-3402

Length: 590 Ø: 48
Hole Distance: 130 / 130
03307200A, 81432206067, 81432206068, 81432206090, 81432206092, 81432209092



MN-DL-3588

Length: 1035 Ø: 48
Cone Ø: d1 Ø 30 / d2 Ø 27
81466106333, 81466106334, 81466106354, 81466106355, 81466106360, 81466106361, 81466106721, 81466106722, 81466106723, 81466116216



MN-DL-12421

Length: 1070 Ø: 48
Cone Ø: d1 Ø 30 / d2 Ø 27
Thread: M30 x 1,5 RHT
81466106656, 81466106659, 81466106669, 81466116006, 81466116007



MN-RK-7287

Ø: 90
Hole Distance: 152
Thick/Height: 35
03304700A, 81953016133



MN-RK-7291

Ø: 72
Hole Distance: 130
Thick/Height: 30
10307800A, 81432206108, 81432206132



MN-SB-5244

Ø: 65
Hole Distance: 125
Thick/Height: 22
03312000A, 81432710027, 81432710082



MN-SB-5246

Ø: 45 Thick/Height: 47
81437220022, 81437220038, 81962100450, 81962100469



MN-SB-5254

Length: 100 Ø: 93
Thick/Height: 70
81432710081



MN-SB-9396

Ø: 67 Thick/Height: 60
81437040057



MN-SB-10389

Ø: 70 Thick/Height: 72
81960200340



MN-VB-5222

Length: 627 Ø: 50
Hole Distance: 152 / 152
81432706030, 81432706034, 81432706054, 81432706055, 81432706056, 81432706057, 81432706067, 81432706068, 81432706074, 81432706075, 81432706076, 81432706077, 81432706078, 81432706081, 81432706082, 81432709034, 81432709076, 81432709078, 8143706054



MN-VB-8569

Length: 627 Ø: 58
Hole Distance: 152 / 152
81432706055, 81432706056, 81432706067, 81432706068, 81432706075, 81432706077, 81432706081, 81432709056





F 90 ...

25.302 DFS, 25.302 DFLS ...	09/90→12/91	Track Control Arm		MN-DL-3402	Trailing Arm	
	09/90→12/91	Track Control Arm		MN-DL-5212	Trailing Arm, Air Suspension Axle; Drive Axle	
	09/90→12/91	Track Control Arm		MN-VB-5222	Wishbone (CV)	
	09/90→12/91	Track Control Arm		MN-VB-5222	Wishbone (CV), Drive Axle; Air Suspension Axle	
	09/90→12/91	Track Control Arm		MN-VB-8569	Wishbone (CV)	
	01/91→12/91	Track Control Arm		MN-VB-8569	Wishbone (CV), Drive Axle	
25.302 FNL, 25.302 FNLL, 25.302 FVL	09/90→12/91	Ball Head, gearshift linkage	CV-ES-2119			
	09/90→12/91	Ball Head, gearshift linkage	CV-ES-2120			
	09/90→12/91	Ball Head, gearshift linkage	CV-ES-2182			
	09/90→12/91	Centre Rod	MN-DL-2160		Coupling Rod	
	09/90→12/91	Centre Rod	MN-DL-2175		Push Rod	
	09/90→12/91	Centre Rod	MN-DL-3588		Push Rod	
	09/90→12/91	Centre Rod	MN-DL-12421		for Steering Rod	
	09/90→12/91	Engine Mounting	MN-SB-10389			
	09/90→12/91	Stabiliser Mounting		MN-SB-5265		
	09/90→12/91	Stabiliser Mounting		MN-SB-5265	1st RA	
	09/90→12/91	Suspension Arm Repair Kit		CV-RK-5313	for Wishbone (CV)	
	09/90→12/91	Suspension Arm Repair Kit		CV-RK-8118	for Control Arm	
	09/90→12/91	Suspension Arm Repair Kit		MN-RK-7280	for Drag Link	
	09/90→12/91	Suspension Arm Repair Kit		MN-RK-7287	for Wishbone (CV)	
	09/90→12/91	Suspension Arm Repair Kit		MN-RK-7291	for Drag Link	
	09/90→12/91	Tie Rod End	CV-ES-2149		for Push Rod	
	09/90→12/91	Tie Rod End	CV-ES-14162		for Steering Rod	
	09/90→12/91	Tie Rod End	CV-ES-14163		for Steering Rod	
	09/90→12/91	Track Control Arm		MN-DL-5212	Trailing Arm, Air Suspension Axle; Drive Axle; Tag Axle	
	09/90→12/91	Track Control Arm		MN-VB-5222	Wishbone (CV), Drive Axle; Air Suspension Axle	
	09/90→12/91	Track Control Arm		MN-VB-5222	Wishbone (CV), Tag Axle	
	25.302 FNLS, 25.302 FVLS	09/90→12/91	Ball Head, gearshift linkage	CV-ES-2119		
		09/90→12/91	Ball Head, gearshift linkage	CV-ES-2120		
09/90→12/91		Ball Head, gearshift linkage	CV-ES-2182			
09/90→12/91		Centre Rod	MN-DL-2160		Coupling Rod	
09/90→12/91		Centre Rod	MN-DL-2175		Push Rod	
09/90→12/91		Centre Rod	MN-DL-3588		Push Rod	
09/90→12/91		Centre Rod	MN-DL-12421		for Steering Rod	
09/90→12/91		Engine Mounting	MN-SB-10389			
09/90→12/91		Stabiliser Mounting		MN-SB-5265		
09/90→12/91		Stabiliser Mounting		MN-SB-5265	1st RA	
09/90→12/91		Suspension Arm Repair Kit		CV-RK-5313	for Wishbone (CV)	
09/90→12/91		Suspension Arm Repair Kit		CV-RK-8118	for Control Arm	
09/90→12/91		Suspension Arm Repair Kit		MN-RK-7280	for Drag Link	
09/90→12/91		Suspension Arm Repair Kit		MN-RK-7287	for Wishbone (CV)	
09/90→12/91		Suspension Arm Repair Kit		MN-RK-7291	for Drag Link	
09/90→12/91		Tie Rod End	CV-ES-2149		for Push Rod	
09/90→12/91		Tie Rod End	CV-ES-14162		for Steering Rod	
09/90→12/91		Tie Rod End	CV-ES-14163		for Steering Rod	
09/90→12/91		Track Control Arm		MN-DL-5212	Trailing Arm, Air Suspension Axle; Drive Axle	
09/90→12/91		Track Control Arm		MN-DL-5212	Trailing Arm, Air Suspension Axle; Drive Axle; Tag Axle	
09/90→12/91		Track Control Arm		MN-VB-5222	Wishbone (CV), Drive Axle; Air Suspension Axle	
09/90→12/91		Track Control Arm		MN-VB-5222	Wishbone (CV), Tag Axle	
25.322 DF, 25.322 DFL		09/90→01/91	Track Control Arm		MN-VB-5222	Wishbone (CV), Drive Axle
	09/90→12/92	Ball Head, gearshift linkage	CV-ES-2119			
	09/90→12/92	Ball Head, gearshift linkage	CV-ES-2120			
	09/90→12/92	Ball Head, gearshift linkage	CV-ES-2182			
	09/90→12/92	Centre Rod	MN-DL-2160		Coupling Rod	
	09/90→12/92	Centre Rod	MN-DL-2175		Push Rod	
	09/90→12/92	Centre Rod	MN-DL-3588		Push Rod	
	09/90→12/92	Centre Rod	MN-DL-12421		for Steering Rod	
	09/90→12/92	Engine Mounting	MN-SB-10389			
	09/90→12/92	Mounting, stabilizer coupling rod	MN-SB-5246			
	09/90→12/92	Stabiliser Mounting		MN-SB-5254		
	09/90→12/92	Stabiliser Mounting	MN-SB-9396			

CV-ES-2119

Length: 55
Cone Ø: d1 Ø 10 / d2 Ø 10
Thread: M12 x 1,75 LHT
81953016063, 81953016131



CV-ES-2120

Length: 115
Cone Ø: d1 Ø 12,4 / d2 Ø 10,8
Thread: M14 x 1,5 RHT
03008500A, 81953016200, 81953016202,
81953016203, 81953016227



CV-ES-2149

Length: 160
Cone Ø: d1 Ø 30 / d2 Ø 27
Thread: M30 x 1,5 RHT
81953016263



CV-ES-2182

Length: 55
Cone Ø: d1 Ø 10 / d2 Ø 10
Thread: M12 x 1,75 RHT
81953016064, 81953016170



CV-ES-14162

Length: 125
Cone Ø: d1 Ø 30 / d2 Ø 27
Thread: M30 x 1,5 LHT

81953010015, 81953010083, 81953010087,
81953016029, 81953016030, 81953016043,
81953016044, 81953016050, 81953016054,
81953016087, 81953016091, 81953016107,
81953016120, 81953016125, 81953016152,
81953016155, 81953016157, 81953016168,
81953016179, 81953016181, 81953016223,
81953016237, 81953016254, 81953016275,
81953016279, 81953016351



CV-ES-14163

Length: 125
Cone Ø: d1 Ø 30 / d2 Ø 27
Thread: M30 x 1,5 RHT

95301.0084, 90804102156, 90804102272,
90804102696, 90804102710, 81953010016,
81953010075, 81953010084, 81953010088,
81953010094, 81953010103, 81953016030,
81953016043, 81953016048, 81953016049,
81953016053, 81953016061, 81953016090,
81953016108, 81953016112, 81953016126,
81953016143, 81953016149, 81953016154,
81953016156, 81953016168, 81953016178,
81953016194, 81953016206, 81953016224,
81953016234, 81953016242, 81953016252,
81953016274, 81953016278, 81953016284,
81953016286, 81953016308, 81953016310,
81953016312, 81953016347, 81953016350,
81953016352, 82953016012, 88953016014,
N2953016001



CV-RK-5313

Ø: 90
03304800A, 81953016132



CV-RK-8118

Ø: 85
Hole Distance: 130
Thick/Height: 30

638862, 639287, 775201, 938423,
1104335, 1953248, 0003500506, 3500506,
11013547, 21032592, 42065912, 42488722,
070550504, 93192618, 070400009000,
634303610, 81432206055, 81432206073,
82262320660, 9544171010099,
5001842823, 7000307001, 8226232066



MN-DL-2160

Length: 1652 Ø: 50
Cone Ø: d1 Ø 30 / d2 Ø 27

81467106112, 81467106163, 81467106165,
81467106198, 81467106353, 81467106354,
81467106361, 81467116725



MN-DL-2175

Length: 1628 Ø: 50
Cone Ø: d1 Ø 30 / d2 Ø 27
81467106396, 81467106904



MN-DL-3402

Length: 590 Ø: 48
Hole Distance: 130 / 130
03307200A, 81432206067, 81432206068,
81432206090, 81432206092, 81432209092



MN-DL-3588

Length: 1035 Ø: 48
Cone Ø: d1 Ø 30 / d2 Ø 27

81466106333, 81466106334, 81466106354,
81466106355, 81466106360, 81466106361,
81466106721, 81466106722, 81466106723,
81466116216



MN-DL-5212

Length: 577 Ø: 48
Hole Distance: 130 / 130

81432206096, 81432206097, 81432206098,
81432206129, 81432209096, 81432209129,
81432306014, 81432306030



MN-DL-12421

Length: 1070 Ø: 48
Cone Ø: d1 Ø 30 / d2 Ø 27
Thread: M30 x 1,5 RHT

81466106656, 81466106659, 81466106669,
81466116006, 81466116007



MN-RK-7280

Ø: 75
Hole Distance: 115
Thick/Height: 24

0550806, 0639370, 689748, 10307400A,
81432306051, 81432306068, 81432706064



MN-RK-7287

Ø: 90
Hole Distance: 152
Thick/Height: 35
03304700A, 81953016133



MN-RK-7291

Ø: 72
Hole Distance: 130
Thick/Height: 30
10307800A, 81432206108, 81432206132



MN-SB-5246

Ø: 45 Thick/Height: 47
81437220022, 81437220038, 81962100450,
81962100469



MN-SB-5254

Length: 100 Ø: 93
Thick/Height: 70
81432710081



MN-SB-5265

Ø: 85 Thick/Height: 80
03310300A, 81437040032



MN-SB-9396

Ø: 67 Thick/Height: 60
81437040057



MN-SB-10389

Ø: 70 Thick/Height: 72
81960200340



MN-VB-5222

Length: 627 Ø: 50
Hole Distance: 152 / 152
81432706030, 81432706034, 81432706054,
81432706055, 81432706056, 81432706057,
81432706067, 81432706068, 81432706074,
81432706075, 81432706076, 81432706077,
81432706078, 81432706081, 81432706082,
81432709034, 81432709076, 81432709078,
8143706054



MN-VB-8569

Length: 627 Ø: 58
Hole Distance: 152 / 152
81432706055, 81432706056, 81432706067,
81432706068, 81432706075, 81432706077,
81432706081, 81432709056





F 90 ...

25.322 DF, 25.322 DFL ...	09/90→12/92	Suspension Arm Repair Kit		CV-RK-5313	for Wishbone (CV)	
	09/90→12/92	Suspension Arm Repair Kit		MN-RK-7287	for Wishbone (CV)	
	09/90→12/92	Suspension Arm Repair Kit		MN-SB-5244	for Wishbone (CV)	
	09/90→12/92	Suspension Arm Repair Kit		MN-SB-5244	for Wishbone (CV), 1st RA	
	09/90→12/92	Tie Rod End	CV-ES-2149		for Push Rod	
	09/90→12/92	Tie Rod End	CV-ES-14162		for Steering Rod	
	09/90→12/92	Tie Rod End	CV-ES-14163		for Steering Rod	
	09/90→12/92	Track Control Arm		MN-DL-3402	Trailing Arm	
	09/90→12/92	Track Control Arm		MN-VB-5222	Wishbone (CV)	
	09/90→12/92	Track Control Arm		MN-VB-8569	Wishbone (CV)	
	01/91→12/92	Track Control Arm		MN-VB-8569	Wishbone (CV), Drive Axle	
	25.322 DFK	09/90→01/91	Track Control Arm		MN-VB-5222	Wishbone (CV), Drive Axle
		09/90→12/92	Ball Head, gearshift linkage	CV-ES-2119		
		09/90→12/92	Ball Head, gearshift linkage	CV-ES-2120		
09/90→12/92		Ball Head, gearshift linkage	CV-ES-2182			
09/90→12/92		Centre Rod	MN-DL-2160		Coupling Rod	
09/90→12/92		Centre Rod	MN-DL-2175		Push Rod	
09/90→12/92		Centre Rod	MN-DL-3588		Push Rod	
09/90→12/92		Centre Rod	MN-DL-12421		for Steering Rod	
09/90→12/92		Engine Mounting	MN-SB-10389			
09/90→12/92		Mounting, stabilizer coupling rod	MN-SB-5246			
09/90→12/92		Stabiliser Mounting		MN-SB-5254		
09/90→12/92		Stabiliser Mounting	MN-SB-9396			
09/90→12/92		Suspension Arm Repair Kit		CV-RK-5313	for Wishbone (CV)	
09/90→12/92		Suspension Arm Repair Kit		MN-RK-7287	for Wishbone (CV)	
09/90→12/92		Suspension Arm Repair Kit		MN-SB-5244	for Wishbone (CV)	
09/90→12/92		Suspension Arm Repair Kit		MN-SB-5244	for Wishbone (CV), 1st RA	
09/90→12/92		Tie Rod End	CV-ES-2149		for Push Rod	
09/90→12/92		Tie Rod End	CV-ES-14162		for Steering Rod	
09/90→12/92		Tie Rod End	CV-ES-14163		for Steering Rod	
09/90→12/92		Track Control Arm		MN-DL-3402	Trailing Arm	
09/90→12/92		Track Control Arm		MN-VB-5222	Wishbone (CV)	
09/90→12/92		Track Control Arm		MN-VB-8569	Wishbone (CV)	
01/91→12/92		Track Control Arm		MN-VB-8569	Wishbone (CV), Drive Axle	
25.322 DFS, 25.322 DFLS		09/90→01/91	Track Control Arm		MN-VB-5222	Wishbone (CV), Drive Axle
		09/90→12/92	Ball Head, gearshift linkage	CV-ES-2119		
		09/90→12/92	Ball Head, gearshift linkage	CV-ES-2120		
		09/90→12/92	Ball Head, gearshift linkage	CV-ES-2182		
	09/90→12/92	Centre Rod	MN-DL-2160		Coupling Rod	
	09/90→12/92	Centre Rod	MN-DL-2175		Push Rod	
	09/90→12/92	Centre Rod	MN-DL-3588		Push Rod	
	09/90→12/92	Centre Rod	MN-DL-12421		for Steering Rod	
	09/90→12/92	Engine Mounting	MN-SB-10389			
	09/90→12/92	Mounting, stabilizer coupling rod	MN-SB-5246			
	09/90→12/92	Stabiliser Mounting		MN-SB-5254		
	09/90→12/92	Stabiliser Mounting	MN-SB-9396			
	09/90→12/92	Suspension Arm Repair Kit		CV-RK-5313	for Wishbone (CV)	
	09/90→12/92	Suspension Arm Repair Kit		CV-RK-8118	for Control Arm	
	09/90→12/92	Suspension Arm Repair Kit		MN-RK-7287	for Wishbone (CV)	
	09/90→12/92	Suspension Arm Repair Kit		MN-RK-7291	for Drag Link	
	09/90→12/92	Suspension Arm Repair Kit		MN-SB-5244	for Wishbone (CV)	
	09/90→12/92	Suspension Arm Repair Kit		MN-SB-5244	for Wishbone (CV), 1st RA	
	09/90→12/92	Tie Rod End	CV-ES-2149		for Push Rod	
	09/90→12/92	Tie Rod End	CV-ES-14162		for Steering Rod	
	09/90→12/92	Tie Rod End	CV-ES-14163		for Steering Rod	
	09/90→12/92	Track Control Arm		MN-DL-3402	Trailing Arm	
	09/90→12/92	Track Control Arm		MN-DL-5212	Trailing Arm, Air Suspension Axle; Drive Axle	
	09/90→12/92	Track Control Arm		MN-VB-5222	Wishbone (CV)	
	09/90→12/92	Track Control Arm		MN-VB-5222	Wishbone (CV), Drive Axle; Air Suspension Axle	
	09/90→12/92	Track Control Arm		MN-VB-8569	Wishbone (CV)	
	01/91→12/92	Track Control Arm		MN-VB-8569	Wishbone (CV), Drive Axle	

CV-ES-2119

Length: 55
Cone Ø: d1 Ø 10 / d2 Ø 10
Thread: M12 x 1,75 LHT
81953016063, 81953016131



CV-ES-2120

Length: 115
Cone Ø: d1 Ø 12,4 / d2 Ø 10,8
Thread: M14 x 1,5 RHT
03008500A, 81953016200, 81953016202, 81953016203, 81953016227



CV-ES-2149

Length: 160
Cone Ø: d1 Ø 30 / d2 Ø 27
Thread: M30 x 1,5 RHT
81953016263



CV-ES-2182

Length: 55
Cone Ø: d1 Ø 10 / d2 Ø 10
Thread: M12 x 1,75 RHT
81953016064, 81953016170



CV-ES-14162

Length: 125
Cone Ø: d1 Ø 30 / d2 Ø 27
Thread: M30 x 1,5 LHT

81953010015, 81953010083, 81953010087, 81953016029, 81953016030, 81953016043, 81953016044, 81953016050, 81953016054, 81953016087, 81953016091, 81953016107, 81953016120, 81953016125, 81953016152, 81953016155, 81953016157, 81953016168, 81953016179, 81953016181, 81953016223, 81953016237, 81953016254, 81953016275, 81953016279, 81953016351



CV-ES-14163

Length: 125
Cone Ø: d1 Ø 30 / d2 Ø 27
Thread: M30 x 1,5 RHT

95301.0084, 90804102156, 90804102272, 90804102696, 90804102710, 81953010016, 81953010075, 81953010084, 81953010088, 81953010094, 81953010103, 81953016030, 81953016043, 81953016048, 81953016049, 81953016053, 81953016061, 81953016090, 81953016108, 81953016112, 81953016126, 81953016143, 81953016149, 81953016154, 81953016156, 81953016168, 81953016178, 81953016194, 81953016206, 81953016224, 81953016234, 81953016242, 81953016252, 81953016274, 81953016278, 81953016284, 81953016286, 81953016308, 81953016310, 81953016312, 81953016347, 81953016350, 81953016352, 82953016012, 88953016014, N2953016001



CV-RK-5313

Ø: 90
03304800A, 81953016132



CV-RK-8118

Ø: 85
Hole Distance: 130
Thick/Height: 30

638862, 639287, 775201, 938423, 1104335, 1953248, 3500506, 0003500056, 11013547, 21032592, 42065912, 42488722, 070550504, 93192618, 070400009000, 634303610, 81432206055, 81432206073, 82262320660, 9544171010099, 5001842823, 7000307001, 8226232066



MN-DL-2160

Length: 1652 Ø: 50
Cone Ø: d1 Ø 30 / d2 Ø 27

81467106112, 81467106163, 81467106165, 81467106198, 81467106353, 81467106354, 81467106361, 81467116725



MN-DL-2175

Length: 1628 Ø: 50
Cone Ø: d1 Ø 30 / d2 Ø 27
81467106396, 81467106904



MN-DL-3402

Length: 590 Ø: 48
Hole Distance: 130 / 130
03307200A, 81432206067, 81432206068, 81432206090, 81432206092, 81432209092



MN-DL-3588

Length: 1035 Ø: 48
Cone Ø: d1 Ø 30 / d2 Ø 27
81466106333, 81466106334, 81466106354, 81466106355, 81466106360, 81466106361, 81466106721, 81466106722, 81466106723, 81466116216



MN-DL-5212

Length: 577 Ø: 48
Hole Distance: 130 / 130
81432206096, 81432206097, 81432206098, 81432206129, 81432209096, 81432209129, 81432306014, 81432306030



MN-DL-12421

Length: 1070
Ø: 48
Cone Ø: d1 Ø 30 / d2 Ø 27
Thread: M30 x 1,5 RHT
81466106656, 81466106659, 81466106669, 81466116006, 81466116007



MN-RK-7287

Ø: 90
Hole Distance: 152
Thick/Height: 35
03304700A, 81953016133



MN-RK-7291

Ø: 72
Hole Distance: 130
Thick/Height: 30
10307800A, 81432206108, 81432206132



MN-SB-5244

Ø: 65
Hole Distance: 125
Thick/Height: 22
03312000A, 81432710027, 81432710082



MN-SB-5246

Ø: 45 Thick/Height: 47
81437220022, 81437220038, 81962100450, 81962100469



MN-SB-5254

Length: 100 Ø: 93
Thick/Height: 70
81432710081



MN-SB-9396

Ø: 67 Thick/Height: 60
81437040057



MN-SB-10389

Ø: 70 Thick/Height: 72
8196200340



MN-VB-5222

Length: 627 Ø: 50
Hole Distance: 152 / 152
81432706030, 81432706034, 81432706054, 81432706055, 81432706056, 81432706057, 81432706067, 81432706068, 81432706074, 81432706075, 81432706076, 81432706077, 81432706078, 81432706081, 81432706082, 81432709034, 81432709076, 81432709078, 8143706054



MN-VB-8569

Length: 627 Ø: 58
Hole Distance: 152 / 152
81432706055, 81432706056, 81432706067, 81432706068, 81432706075, 81432706077, 81432706081, 81432709056





F 90 ...

25.322 FNL, 25.322 FNLL, 25.322 FVL	09/90→12/92	Ball Head, gearshift linkage	CV-ES-2119		
	09/90→12/92	Ball Head, gearshift linkage	CV-ES-2120		
	09/90→12/92	Ball Head, gearshift linkage	CV-ES-2182		
	09/90→12/92	Centre Rod	MN-DL-2160		Coupling Rod
	09/90→12/92	Centre Rod	MN-DL-2175		Push Rod
	09/90→12/92	Centre Rod	MN-DL-3588		Push Rod
	09/90→12/92	Centre Rod	MN-DL-12421		for Steering Rod
	09/90→12/92	Engine Mounting	MN-SB-10389		
	09/90→12/92	Stabiliser Mounting		MN-SB-5265	
	09/90→12/92	Stabiliser Mounting		MN-SB-5265	1st RA
	09/90→12/92	Suspension Arm Repair Kit		CV-RK-5313	for Wishbone (CV)
	09/90→12/92	Suspension Arm Repair Kit		CV-RK-8118	for Control Arm
	09/90→12/92	Suspension Arm Repair Kit		MN-RK-7280	for Drag Link
	09/90→12/92	Suspension Arm Repair Kit		MN-RK-7287	for Wishbone (CV)
	09/90→12/92	Suspension Arm Repair Kit		MN-RK-7291	for Drag Link
	09/90→12/92	Tie Rod End	CV-ES-2149		for Push Rod
	09/90→12/92	Tie Rod End	CV-ES-14162		for Steering Rod
	09/90→12/92	Tie Rod End	CV-ES-14163		for Steering Rod
	09/90→12/92	Track Control Arm		MN-DL-5212	Trailing Arm, Air Suspension Axle; Drive Axle; Tag Axle
	09/90→12/92	Track Control Arm		MN-VB-5222	Wishbone (CV), Drive Axle; Air Suspension Axle
09/90→12/92	Track Control Arm		MN-VB-5222	Wishbone (CV), Tag Axle	
25.322 FNLS, 25.322 FVLS	09/90→12/92	Ball Head, gearshift linkage	CV-ES-2119		
	09/90→12/92	Ball Head, gearshift linkage	CV-ES-2120		
	09/90→12/92	Ball Head, gearshift linkage	CV-ES-2182		
	09/90→12/92	Centre Rod	MN-DL-2160		Coupling Rod
	09/90→12/92	Centre Rod	MN-DL-2175		Push Rod
	09/90→12/92	Centre Rod	MN-DL-3588		Push Rod
	09/90→12/92	Centre Rod	MN-DL-12421		for Steering Rod
	09/90→12/92	Engine Mounting	MN-SB-10389		
	09/90→12/92	Stabiliser Mounting		MN-SB-5265	
	09/90→12/92	Stabiliser Mounting		MN-SB-5265	1st RA
	09/90→12/92	Suspension Arm Repair Kit		CV-RK-5313	for Wishbone (CV)
	09/90→12/92	Suspension Arm Repair Kit		CV-RK-8118	for Control Arm
	09/90→12/92	Suspension Arm Repair Kit		MN-RK-7280	for Drag Link
	09/90→12/92	Suspension Arm Repair Kit		MN-RK-7287	for Wishbone (CV)
	09/90→12/92	Suspension Arm Repair Kit		MN-RK-7291	for Drag Link
	09/90→12/92	Tie Rod End	CV-ES-2149		for Push Rod
	09/90→12/92	Tie Rod End	CV-ES-14162		for Steering Rod
	09/90→12/92	Tie Rod End	CV-ES-14163		for Steering Rod
	09/90→12/92	Track Control Arm		MN-VB-5222	Wishbone (CV), Drive Axle; Air Suspension Axle
	09/90→12/92	Track Control Arm		MN-VB-5222	Wishbone (CV), Tag Axle
25.372 DF	09/90→01/91	Track Control Arm		MN-VB-5222	Wishbone (CV), Drive Axle
	09/90→12/92	Ball Head, gearshift linkage	CV-ES-2119		
	09/90→12/92	Ball Head, gearshift linkage	CV-ES-2120		
	09/90→12/92	Ball Head, gearshift linkage	CV-ES-2182		
	09/90→12/92	Centre Rod	MN-DL-2160		Coupling Rod
	09/90→12/92	Centre Rod	MN-DL-2175		Push Rod
	09/90→12/92	Centre Rod	MN-DL-3588		Push Rod
	09/90→12/92	Centre Rod	MN-DL-12421		for Steering Rod
	09/90→12/92	Engine Mounting	MN-SB-10389		
	09/90→12/92	Mounting, stabilizer coupling rod	MN-SB-5246		
	09/90→12/92	Stabiliser Mounting		MN-SB-5254	
	09/90→12/92	Stabiliser Mounting	MN-SB-9396		
	09/90→12/92	Suspension Arm Repair Kit		CV-RK-5313	for Wishbone (CV)
	09/90→12/92	Suspension Arm Repair Kit		MN-RK-7287	for Wishbone (CV)
	09/90→12/92	Suspension Arm Repair Kit		MN-SB-5244	for Wishbone (CV)
	09/90→12/92	Suspension Arm Repair Kit		MN-SB-5244	for Wishbone (CV), 1st RA
	09/90→12/92	Tie Rod End	CV-ES-2149		for Push Rod
	09/90→12/92	Tie Rod End	CV-ES-14162		for Steering Rod
	09/90→12/92	Tie Rod End	CV-ES-14163		for Steering Rod
	09/90→12/92	Track Control Arm		MN-DL-3402	Trailing Arm
09/90→12/92	Track Control Arm		MN-VB-5222	Wishbone (CV)	

CV-ES-2119

Length: 55
Cone Ø: d1 Ø 10 / d2 Ø 10
Thread: M12 x 1,75 LHT
81953016063, 81953016131



CV-ES-2120

Length: 115
Cone Ø: d1 Ø 12,4 / d2 Ø 10,8
Thread: M14 x 1,5 RHT
03008500A, 81953016200, 81953016202,
81953016203, 81953016227



CV-ES-2149

Length: 160
Cone Ø: d1 Ø 30 / d2 Ø 27
Thread: M30 x 1,5 RHT
81953016263



CV-ES-2182

Length: 55
Cone Ø: d1 Ø 10 / d2 Ø 10
Thread: M12 x 1,75 RHT
81953016064, 81953016170



CV-ES-14162

Length: 125
Cone Ø: d1 Ø 30 / d2 Ø 27
Thread: M30 x 1,5 LHT
81953010015, 81953010083, 81953010087,
81953016029, 81953016030, 81953016043,
81953016044, 81953016050, 81953016054,
81953016087, 81953016091, 81953016107,
81953016120, 81953016125, 81953016152,
81953016155, 81953016157, 81953016168,
81953016179, 81953016181, 81953016223,
81953016237, 81953016254, 81953016275,
81953016279, 81953016351



CV-ES-14163

Length: 125
Cone Ø: d1 Ø 30 / d2 Ø 27
Thread: M30 x 1,5 RHT
95301.0084, 90804102156, 90804102272,
90804102696, 90804102710, 81953010016,
81953010075, 81953010084, 81953010088,
81953010094, 81953010103, 81953016030,
81953016043, 81953016048, 81953016049,
81953016053, 81953016061, 81953016090,
81953016108, 81953016112, 81953016126,
81953016143, 81953016149, 81953016154,
81953016156, 81953016168, 81953016178,
81953016194, 81953016206, 81953016224,
81953016234, 81953016242, 81953016252,
81953016274, 81953016278, 81953016284,
81953016286, 81953016308, 81953016310,
81953016312, 81953016347, 81953016350,
81953016352, 82953016012, 88953016014,
N2953016001



CV-RK-5313

Ø: 90
03304800A, 81953016132



CV-RK-8118

Ø: 85
Hole Distance: 130
Thick/Height: 30
638862, 639287, 775201, 938423,
1104335, 1953248, 3500506, 0003500506,
11013547, 21032592, 42065912, 42488722,
070550504, 93192618, 070400009000,
634303610, 81432206055, 81432206073,
82262320660, 9544171010099,
5001842823, 7000307001, 8226232066



MN-DL-2160

Length: 1652 Ø: 50
Cone Ø: d1 Ø 30 / d2 Ø 27
81467106112, 81467106163, 81467106165,
81467106198, 81467106353, 81467106354,
81467106361, 81467116725



MN-DL-2175

Length: 1628 Ø: 50
Cone Ø: d1 Ø 30 / d2 Ø 27
81467106396, 81467106904



MN-DL-3402

Length: 590 Ø: 48
Hole Distance: 130 / 130
03307200A, 81432206067, 81432206068,
81432206090, 81432206092, 81432209099



MN-DL-3588

Length: 1035 Ø: 48
Cone Ø: d1 Ø 30 / d2 Ø 27
81466106333, 81466106334, 81466106354,
81466106355, 81466106360, 81466106361,
81466106721, 81466106722, 81466106723,
81466116216



MN-DL-5212

Length: 577 Ø: 48
Hole Distance: 130 / 130
81432206096, 81432206097, 81432206098,
81432206129, 81432209096, 81432209129,
81432306014, 81432306030



MN-DL-12421

Length: 1070 Ø: 48
Cone Ø: d1 Ø 30 / d2 Ø 27
Thread: M30 x 1,5 RHT
81466106656, 81466106659, 81466106669,
81466116006, 81466116007



MN-RK-7280

Ø: 75
Hole Distance: 115
Thick/Height: 24
0550806, 0639370, 689748, 10307400A,
81432306051, 81432306068, 81432706064



MN-RK-7287

Ø: 90
Hole Distance: 152
Thick/Height: 35
03304700A, 81953016133



MN-RK-7291

Ø: 72
Hole Distance: 130
Thick/Height: 30
10307800A, 81432206108, 81432206132



MN-SB-5244

Ø: 65
Hole Distance: 125
Thick/Height: 22
03312000A, 81432710027, 81432710082



MN-SB-5246

Ø: 45 Thick/Height: 47
81437220022, 81437220038, 81962100450,
81962100469



MN-SB-5254

Length: 100 Ø: 93
Thick/Height: 70
81432710081



MN-SB-5265

Ø: 85 Thick/Height: 80
03310300A, 81437040032



MN-SB-9396

Ø: 67 Thick/Height: 60
81437040057



MN-SB-10389

Ø: 70 Thick/Height: 72
81960200340



MN-VB-5222

Length: 627 Ø: 50
Hole Distance: 152 / 152
81432706030, 81432706034, 81432706054,
81432706055, 81432706056, 81432706057,
81432706067, 81432706068, 81432706074,
81432706075, 81432706076, 81432706077,
81432706078, 81432706081, 81432706082,
81432709034, 81432709076, 81432709078,
8143706054





F 90 ...

25.372 DF ...	09/90→12/92	Track Control Arm		MN-VB-8569	Wishbone (CV)	
	01/91→12/92	Track Control Arm		MN-VB-8569	Wishbone (CV), Drive Axle	
25.372 DFK	09/90→01/91	Track Control Arm		MN-VB-5222	Wishbone (CV), Drive Axle	
	09/90→12/92	Ball Head, gearshift linkage	CV-ES-2119			
	09/90→12/92	Ball Head, gearshift linkage	CV-ES-2120			
	09/90→12/92	Ball Head, gearshift linkage	CV-ES-2182			
	09/90→12/92	Centre Rod	MN-DL-2160		Coupling Rod	
	09/90→12/92	Centre Rod	MN-DL-2175		Push Rod	
	09/90→12/92	Centre Rod	MN-DL-3588		Push Rod	
	09/90→12/92	Centre Rod	MN-DL-12421		for Steering Rod	
	09/90→12/92	Engine Mounting	MN-SB-10389			
	09/90→12/92	Mounting, stabilizer coupling rod	MN-SB-5246			
	09/90→12/92	Stabiliser Mounting		MN-SB-5254		
	09/90→12/92	Stabiliser Mounting	MN-SB-9396			
	09/90→12/92	Suspension Arm Repair Kit		CV-RK-5313	for Wishbone (CV)	
	09/90→12/92	Suspension Arm Repair Kit		MN-RK-7287	for Wishbone (CV)	
	09/90→12/92	Suspension Arm Repair Kit		MN-SB-5244	for Wishbone (CV)	
	09/90→12/92	Suspension Arm Repair Kit		MN-SB-5244	for Wishbone (CV), 1st RA	
	09/90→12/92	Tie Rod End	CV-ES-2149		for Push Rod	
	09/90→12/92	Tie Rod End	CV-ES-14162		for Steering Rod	
	09/90→12/92	Tie Rod End	CV-ES-14163		for Steering Rod	
	09/90→12/92	Track Control Arm		MN-DL-3402	Trailing Arm	
	09/90→12/92	Track Control Arm		MN-VB-5222	Wishbone (CV)	
	09/90→12/92	Track Control Arm		MN-VB-8569	Wishbone (CV)	
	01/91→12/92	Track Control Arm		MN-VB-8569	Wishbone (CV), Drive Axle	
	25.372 DFS	09/90→01/91	Track Control Arm		MN-VB-5222	Wishbone (CV), Drive Axle
		09/90→12/92	Ball Head, gearshift linkage	CV-ES-2119		
		09/90→12/92	Ball Head, gearshift linkage	CV-ES-2120		
		09/90→12/92	Ball Head, gearshift linkage	CV-ES-2182		
		09/90→12/92	Centre Rod	MN-DL-2160		Coupling Rod
		09/90→12/92	Centre Rod	MN-DL-2175		Push Rod
		09/90→12/92	Centre Rod	MN-DL-3588		Push Rod
09/90→12/92		Centre Rod	MN-DL-12421		for Steering Rod	
09/90→12/92		Engine Mounting	MN-SB-10389			
09/90→12/92		Mounting, stabilizer coupling rod	MN-SB-5246			
09/90→12/92		Stabiliser Mounting		MN-SB-5254		
09/90→12/92		Stabiliser Mounting	MN-SB-9396			
09/90→12/92		Suspension Arm Repair Kit		CV-RK-5313	for Wishbone (CV)	
09/90→12/92		Suspension Arm Repair Kit		MN-RK-7287	for Wishbone (CV)	
09/90→12/92		Suspension Arm Repair Kit		MN-SB-5244	for Wishbone (CV)	
09/90→12/92		Suspension Arm Repair Kit		MN-SB-5244	for Wishbone (CV), 1st RA	
09/90→12/92		Tie Rod End	CV-ES-2149		for Push Rod	
09/90→12/92		Tie Rod End	CV-ES-14162		for Steering Rod	
09/90→12/92		Tie Rod End	CV-ES-14163		for Steering Rod	
09/90→12/92		Track Control Arm		MN-DL-3402	Trailing Arm	
09/90→12/92		Track Control Arm		MN-VB-5222	Wishbone (CV)	
09/90→12/92		Track Control Arm		MN-VB-8569	Wishbone (CV)	
01/91→12/92		Track Control Arm		MN-VB-8569	Wishbone (CV), Drive Axle	
25.372 DFS,25.372 DFLS		09/90→01/91	Track Control Arm		MN-VB-5222	Wishbone (CV), Drive Axle
		09/90→12/92	Ball Head, gearshift linkage	CV-ES-2119		
		09/90→12/92	Ball Head, gearshift linkage	CV-ES-2120		
		09/90→12/92	Ball Head, gearshift linkage	CV-ES-2182		
		09/90→12/92	Centre Rod	MN-DL-2160		Coupling Rod
		09/90→12/92	Centre Rod	MN-DL-2175		Push Rod
		09/90→12/92	Centre Rod	MN-DL-3588		Push Rod
	09/90→12/92	Centre Rod	MN-DL-12421		for Steering Rod	
	09/90→12/92	Engine Mounting	MN-SB-10389			
	09/90→12/92	Mounting, stabilizer coupling rod	MN-SB-5246			
	09/90→12/92	Stabiliser Mounting		MN-SB-5254		
	09/90→12/92	Stabiliser Mounting	MN-SB-9396			
	09/90→12/92	Suspension Arm Repair Kit		CV-RK-5313	for Wishbone (CV)	
	09/90→12/92	Suspension Arm Repair Kit		CV-RK-8118	for Control Arm	
	09/90→12/92	Suspension Arm Repair Kit		MN-RK-7287	for Wishbone (CV)	

CV-ES-2119

Length: 55
Cone Ø: d1 Ø 10 / d2 Ø 10
Thread: M12 x 1,75 LHT
81953016063, 81953016131



CV-ES-2120

Length: 115
Cone Ø: d1 Ø 12,4 / d2 Ø 10,8
Thread: M14 x 1,5 RHT
03008500A, 81953016200, 81953016202,
81953016203, 81953016227



CV-ES-2149

Length: 160
Cone Ø: d1 Ø 30 / d2 Ø 27
Thread: M30 x 1,5 RHT
81953016263



CV-ES-2182

Length: 55
Cone Ø: d1 Ø 10 / d2 Ø 10
Thread: M12 x 1,75 RHT
81953016064, 81953016170



CV-ES-14162

Length: 125
Cone Ø: d1 Ø 30 / d2 Ø 27
Thread: M30 x 1,5 LHT
81953010015, 81953010083, 81953010087,
81953016029, 81953016030, 81953016043,
81953016044, 81953016050, 81953016054,
81953016087, 81953016091, 81953016107,
81953016120, 81953016125, 81953016152,
81953016155, 81953016157, 81953016168,
81953016179, 81953016181, 81953016223,
81953016237, 81953016254, 81953016275,
81953016279, 81953016351



CV-ES-14163

Length: 125
Cone Ø: d1 Ø 30 / d2 Ø 27
Thread: M30 x 1,5 RHT
95301.0084, 90804102156, 90804102272,
90804102696, 90804102710, 81953010016,
81953010075, 81953010084, 81953010088,
81953010094, 81953010103, 81953016030,
81953016043, 81953016048, 81953016049,
81953016053, 81953016061, 81953016090,
81953016108, 81953016112, 81953016126,
81953016143, 81953016149, 81953016154,
81953016156, 81953016168, 81953016178,
81953016194, 81953016206, 81953016224,
81953016234, 81953016242, 81953016252,
81953016274, 81953016278, 81953016284,
81953016286, 81953016308, 81953016310,
81953016312, 81953016347, 81953016350,
81953016352, 82953016012, 88953016014,
N2953016001



CV-RK-5313

Ø: 90
03304800A, 81953016132



CV-RK-8118

Ø: 85
Hole Distance: 130
Thick/Height: 30
638862, 639287, 775201, 938423,
1104335, 1953248, 0003500506, 3500506,
11013547, 21032592, 42065912, 42488722,
070550504, 93192618, 070400009000,
634303610, 81432206055, 81432206073,
82262320660, 9544171010099,
5001842823, 7000307001, 8226232066



MN-DL-2160

Length: 1652 Ø: 50
Cone Ø: d1 Ø 30 / d2 Ø 27
81467106112, 81467106163, 81467106165,
81467106198, 81467106353, 81467106354,
81467106361, 81467116725



MN-DL-2175

Length: 1628
Ø: 50
Cone Ø: d1 Ø 30 / d2 Ø 27
81467106396, 81467106904



MN-DL-3402

Length: 590 Ø: 48
Hole Distance: 130 / 130
03307200A, 81432206067, 81432206068,
81432206090, 81432206092, 81432209099



MN-DL-3588

Length: 1035
Ø: 48
Cone Ø: d1 Ø 30 / d2 Ø 27
81466106333, 81466106334, 81466106354,
81466106355, 81466106360, 81466106361,
81466106721, 81466106722, 81466106723,
81466116216



MN-DL-12421

Length: 1070
Ø: 48
Cone Ø: d1 Ø 30 / d2 Ø 27
Thread: M30 x 1,5 RHT
81466106656, 81466106659, 81466106669,
81466116006, 81466116007



MN-RK-7287

Ø: 90
Hole Distance: 152
Thick/Height: 35
03304700A, 81953016133



MN-SB-5244

Ø: 65
Hole Distance: 125
Thick/Height: 22
03312000A, 81432710027, 81432710082



MN-SB-5246

Ø: 45 Thick/Height: 47
81437220022, 81437220038, 81962100450,
81962100469



MN-SB-5254

Length: 100 Ø: 93
Thick/Height: 70
81432710081



MN-SB-9396

Ø: 67 Thick/Height: 60
81437040057



MN-SB-10389

Ø: 70 Thick/Height: 72
81960200340



MN-VB-5222

Length: 627 Ø: 50
Hole Distance: 152 / 152
81432706030, 81432706034, 81432706054,
81432706055, 81432706056, 81432706057,
81432706067, 81432706068, 81432706074,
81432706075, 81432706076, 81432706077,
81432706078, 81432706081, 81432706082,
81432709034, 81432709076, 81432709078,
8143706054



MN-VB-8569

Length: 627 Ø: 58
Hole Distance: 152 / 152
81432706055, 81432706056, 81432706067,
81432706068, 81432706075, 81432706077,
81432706081, 81432709056





F 90 ...

25.372 DFS,25.372 DFLS ...	09/90→12/92	Suspension Arm Repair Kit		MN-RK-7291	for Drag Link	
	09/90→12/92	Suspension Arm Repair Kit		MN-SB-5244	for Wishbone (CV)	
	09/90→12/92	Suspension Arm Repair Kit		MN-SB-5244	for Wishbone (CV), 1st RA	
	09/90→12/92	Tie Rod End	CV-ES-2149		for Push Rod	
	09/90→12/92	Tie Rod End	CV-ES-14162		for Steering Rod	
	09/90→12/92	Tie Rod End	CV-ES-14163		for Steering Rod	
	09/90→12/92	Track Control Arm		MN-DL-3402	Trailing Arm	
	09/90→12/92	Track Control Arm		MN-DL-5212	Trailing Arm, Air Suspension Axle;Drive Axle	
	09/90→12/92	Track Control Arm		MN-VB-5222	Wishbone (CV)	
	09/90→12/92	Track Control Arm		MN-VB-5222	Wishbone (CV), Drive Axle;Air Suspension Axle	
	09/90→12/92	Track Control Arm		MN-VB-8569	Wishbone (CV)	
	01/91→12/92	Track Control Arm		MN-VB-8569	Wishbone (CV), Drive Axle	
	25.372 FNL, 25.372 FNLL, 25.372 FVL	09/90→12/92	Ball Head, gearshift linkage	CV-ES-2119		
09/90→12/92		Ball Head, gearshift linkage	CV-ES-2120			
09/90→12/92		Ball Head, gearshift linkage	CV-ES-2182			
09/90→12/92		Centre Rod	MN-DL-2160		Coupling Rod	
09/90→12/92		Centre Rod	MN-DL-2175		Push Rod	
09/90→12/92		Centre Rod	MN-DL-3588		Push Rod	
09/90→12/92		Centre Rod	MN-DL-12421		for Steering Rod	
09/90→12/92		Engine Mounting	MN-SB-10389			
09/90→12/92		Stabiliser Mounting		MN-SB-5265		
09/90→12/92		Stabiliser Mounting		MN-SB-5265	1st RA	
09/90→12/92		Suspension Arm Repair Kit		CV-RK-5313	for Wishbone (CV)	
09/90→12/92		Suspension Arm Repair Kit		CV-RK-8118	for Control Arm	
09/90→12/92		Suspension Arm Repair Kit		MN-RK-7280	for Drag Link	
09/90→12/92		Suspension Arm Repair Kit		MN-RK-7287	for Wishbone (CV)	
09/90→12/92		Suspension Arm Repair Kit		MN-RK-7291	for Drag Link	
09/90→12/92		Tie Rod End	CV-ES-2149		for Push Rod	
09/90→12/92		Tie Rod End	CV-ES-14162		for Steering Rod	
09/90→12/92		Tie Rod End	CV-ES-14163		for Steering Rod	
09/90→12/92		Track Control Arm		MN-VB-5222	Wishbone (CV), Drive Axle;Air Suspension Axle	
09/90→12/92		Track Control Arm		MN-VB-5222	Wishbone (CV), Tag Axle	
25.372 FNLS,25.372 FVLS		09/90→10/93	Ball Head, gearshift linkage	CV-ES-2119		
		09/90→10/93	Ball Head, gearshift linkage	CV-ES-2120		
		09/90→10/93	Ball Head, gearshift linkage	CV-ES-2182		
	09/90→10/93	Centre Rod	MN-DL-2160		Coupling Rod	
	09/90→10/93	Centre Rod	MN-DL-2175		Push Rod	
	09/90→10/93	Centre Rod	MN-DL-3588		Push Rod	
	09/90→10/93	Centre Rod	MN-DL-12421		for Steering Rod	
	09/90→10/93	Engine Mounting	MN-SB-10389			
	09/90→10/93	Stabiliser Mounting		MN-SB-5265		
	09/90→10/93	Stabiliser Mounting		MN-SB-5265	1st RA	
	09/90→10/93	Suspension Arm Repair Kit		CV-RK-5313	for Wishbone (CV)	
	09/90→10/93	Suspension Arm Repair Kit		CV-RK-8118	for Control Arm	
	09/90→10/93	Suspension Arm Repair Kit		MN-RK-7280	for Drag Link	
	09/90→10/93	Suspension Arm Repair Kit		MN-RK-7287	for Wishbone (CV)	
	09/90→10/93	Suspension Arm Repair Kit		MN-RK-7291	for Drag Link	
	09/90→10/93	Tie Rod End	CV-ES-2149		for Push Rod	
	09/90→10/93	Tie Rod End	CV-ES-14162		for Steering Rod	
	09/90→10/93	Tie Rod End	CV-ES-14163		for Steering Rod	
	09/90→10/93	Track Control Arm		MN-VB-5222	Wishbone (CV), Drive Axle;Air Suspension Axle	
	09/90→10/93	Track Control Arm		MN-VB-5222	Wishbone (CV), Tag Axle	
	25.372 FVLS	09/90→10/93	Ball Head, gearshift linkage	CV-ES-2119		
		09/90→10/93	Ball Head, gearshift linkage	CV-ES-2120		
		09/90→10/93	Ball Head, gearshift linkage	CV-ES-2182		
09/90→10/93		Centre Rod	MN-DL-2160		Coupling Rod	
09/90→10/93		Centre Rod	MN-DL-2175		Push Rod	
09/90→10/93		Centre Rod	MN-DL-3588		Push Rod	
09/90→10/93		Centre Rod	MN-DL-12421		for Steering Rod	
09/90→10/93		Engine Mounting	MN-SB-10389			
09/90→10/93		Stabiliser Mounting		MN-SB-5265		
09/90→10/93		Stabiliser Mounting		MN-SB-5265	1st RA	
09/90→10/93		Suspension Arm Repair Kit		CV-RK-5313	for Wishbone (CV)	

CV-ES-2119

Length: 55
Cone Ø: d1 Ø 10 / d2 Ø 10
Thread: M12 x 1,75 LHT
81953016063, 81953016131



CV-ES-2120

Length: 115
Cone Ø: d1 Ø 12,4 / d2 Ø 10,8
Thread: M14 x 1,5 RHT
03008500A, 81953016200, 81953016202,
81953016203, 81953016227



CV-ES-2149

Length: 160
Cone Ø: d1 Ø 30 / d2 Ø 27
Thread: M30 x 1,5 RHT
81953016263



CV-ES-2182

Length: 55
Cone Ø: d1 Ø 10 / d2 Ø 10
Thread: M12 x 1,75 RHT
81953016064, 81953016170



CV-ES-14162

Length: 125
Cone Ø: d1 Ø 30 / d2 Ø 27
Thread: M30 x 1,5 LHT
81953010015, 81953010083, 81953010087,
81953016029, 81953016030, 81953016043,
81953016044, 81953016050, 81953016054,
81953016087, 81953016091, 81953016107,
81953016120, 81953016125, 81953016152,
81953016155, 81953016157, 81953016168,
81953016179, 81953016181, 81953016223,
81953016237, 81953016254, 81953016275,
81953016279, 81953016351



CV-ES-14163

Length: 125
Cone Ø: d1 Ø 30 / d2 Ø 27
Thread: M30 x 1,5 RHT
95301.0084, 90804102156, 90804102272,
90804102696, 90804102710, 81953010016,
81953010075, 81953010084, 81953010088,
81953010094, 81953010103, 81953016030,
81953016043, 81953016048, 81953016049,
81953016053, 81953016061, 81953016090,
81953016108, 81953016112, 81953016126,
81953016143, 81953016149, 81953016154,
81953016156, 81953016168, 81953016178,
81953016194, 81953016206, 81953016224,
81953016234, 81953016242, 81953016252,
81953016274, 81953016278, 81953016284,
81953016286, 81953016308, 81953016310,
81953016312, 81953016347, 81953016350,
81953016352, 82953016012, 88953016014,
N2953016001



CV-RK-5313

Ø: 90
03304800A, 81953016132



CV-RK-8118

Ø: 85
Hole Distance: 130
Thick/Height: 30
638862, 639287, 775201, 938423,
1104335, 1953248, 0003500506, 3500506,
11013547, 21032592, 42065912, 42488722,
070550504, 93192618, 070400009000,
634303610, 81432206055, 81432206073,
82262320660, 9544171010099,
5001842823, 7000307001, 8226232066



MN-DL-2160

Length: 1652 Ø: 50
Cone Ø: d1 Ø 30 / d2 Ø 27
81467106112, 81467106163, 81467106165,
81467106198, 81467106353, 81467106354,
81467106361, 81467116725



MN-DL-2175

Length: 1628 Ø: 50
Cone Ø: d1 Ø 30 / d2 Ø 27
81467106396, 81467106904



MN-DL-3402

Length: 590 Ø: 48
Hole Distance: 130 / 130
03307200A, 81432206067, 81432206068,
81432206090, 81432206092, 81432209092



MN-DL-3588

Length: 1035 Ø: 48
Cone Ø: d1 Ø 30 / d2 Ø 27
81466106333, 81466106334, 81466106354,
81466106355, 81466106360, 81466106361,
81466106721, 81466106722, 81466106723,
81466116216



MN-DL-5212

Length: 577 Ø: 48
Hole Distance: 130 / 130
81432206096, 81432206097, 81432206098,
81432206129, 81432209096, 81432209129,
81432306014, 81432306030



MN-DL-12421

Length: 1070 Ø: 48
Cone Ø: d1 Ø 30 / d2 Ø 27
Thread: M30 x 1,5 RHT
81466106656, 81466106659, 81466106669,
81466116006, 81466116007



MN-RK-7280

Ø: 75
Hole Distance: 115
Thick/Height: 24
0550806, 0639370, 689748, 10307400A,
81432306051, 81432306068, 81432706064



MN-RK-7287

Ø: 90
Hole Distance: 152
Thick/Height: 35
03304700A, 81953016133



MN-RK-7291

Ø: 72
Hole Distance: 130
Thick/Height: 30
10307800A, 81432206108, 81432206132



MN-SB-5244

Ø: 65
Hole Distance: 125
Thick/Height: 22
03312000A, 81432710027, 81432710082



MN-SB-5265

Ø: 85
Thick/Height: 80
03310300A, 81437040032



MN-SB-10389

Ø: 70
Thick/Height: 72
8196200340



MN-VB-5222

Length: 627 Ø: 50
Hole Distance: 152 / 152
81432706030, 81432706034, 81432706054,
81432706055, 81432706056, 81432706057,
81432706067, 81432706068, 81432706074,
81432706075, 81432706076, 81432706077,
81432706078, 81432706081, 81432706082,
81432709034, 81432709076, 81432709078,
8143706054



MN-VB-8569

Length: 627 Ø: 58
Hole Distance: 152 / 152
81432706055, 81432706056, 81432706067,
81432706068, 81432706075, 81432706077,
81432706081, 81432709056





F 90 ...

25.372 FVLS ...	09/90→10/93	Suspension Arm Repair Kit		CV-RK-8118	for Control Arm
	09/90→10/93	Suspension Arm Repair Kit		MN-RK-7280	for Drag Link
	09/90→10/93	Suspension Arm Repair Kit		MN-RK-7287	for Wishbone (CV)
	09/90→10/93	Suspension Arm Repair Kit		MN-RK-7291	for Drag Link
	09/90→10/93	Tie Rod End	CV-ES-2149		for Push Rod
	09/90→10/93	Tie Rod End	CV-ES-14162		for Steering Rod
	09/90→10/93	Tie Rod End	CV-ES-14163		for Steering Rod
	09/90→10/93	Track Control Arm		MN-DL-5212	Trailing Arm, Air Suspension Axle; Drive Axle
	09/90→10/93	Track Control Arm		MN-VB-5222	Wishbone (CV), Drive Axle; Air Suspension Axle
	09/90→10/93	Track Control Arm		MN-VB-5222	Wishbone (CV), Drive Axle
25.422 DF	09/90→12/92	Ball Head, gearshift linkage	CV-ES-2119		
	09/90→12/92	Ball Head, gearshift linkage	CV-ES-2120		
	09/90→12/92	Ball Head, gearshift linkage	CV-ES-2182		
	09/90→12/92	Centre Rod	MN-DL-2160		Coupling Rod
	09/90→12/92	Centre Rod	MN-DL-2175		Push Rod
	09/90→12/92	Centre Rod	MN-DL-3588		Push Rod
	09/90→12/92	Centre Rod	MN-DL-12421		for Steering Rod
	09/90→12/92	Engine Mounting	MN-SB-10389		
	09/90→12/92	Mounting, stabilizer coupling rod	MN-SB-5246		
	09/90→12/92	Stabiliser Mounting		MN-SB-5254	
	09/90→12/92	Stabiliser Mounting	MN-SB-9396		
	09/90→12/92	Suspension Arm Repair Kit		CV-RK-5313	for Wishbone (CV)
	09/90→12/92	Suspension Arm Repair Kit		MN-RK-7287	for Wishbone (CV)
	09/90→12/92	Suspension Arm Repair Kit		MN-SB-5244	for Wishbone (CV)
	09/90→12/92	Suspension Arm Repair Kit		MN-SB-5244	for Wishbone (CV), 1st RA
	09/90→12/92	Tie Rod End	CV-ES-2149		for Push Rod
	09/90→12/92	Tie Rod End	CV-ES-14162		for Steering Rod
	09/90→12/92	Tie Rod End	CV-ES-14163		for Steering Rod
	09/90→12/92	Track Control Arm		MN-DL-3402	Trailing Arm
	09/90→12/92	Track Control Arm		MN-VB-5222	Wishbone (CV)
09/90→12/92	Track Control Arm		MN-VB-8569	Wishbone (CV)	
01/91→12/92	Track Control Arm		MN-VB-8569	Wishbone (CV), Drive Axle	
25.422 DFK	09/90→12/92	Ball Head, gearshift linkage	CV-ES-2119		
	09/90→12/92	Ball Head, gearshift linkage	CV-ES-2120		
	09/90→12/92	Ball Head, gearshift linkage	CV-ES-2182		
	09/90→12/92	Centre Rod	MN-DL-2160		Coupling Rod
	09/90→12/92	Centre Rod	MN-DL-2175		Push Rod
	09/90→12/92	Centre Rod	MN-DL-3588		Push Rod
	09/90→12/92	Centre Rod	MN-DL-12421		for Steering Rod
	09/90→12/92	Engine Mounting	MN-SB-10389		
	09/90→12/92	Mounting, stabilizer coupling rod	MN-SB-5246		
	09/90→12/92	Stabiliser Mounting		MN-SB-5254	
	09/90→12/92	Stabiliser Mounting	MN-SB-9396		
	09/90→12/92	Suspension Arm Repair Kit		CV-RK-5313	for Wishbone (CV)
	09/90→12/92	Suspension Arm Repair Kit		MN-RK-7287	for Wishbone (CV)
	09/90→12/92	Suspension Arm Repair Kit		MN-SB-5244	for Wishbone (CV)
	09/90→12/92	Suspension Arm Repair Kit		MN-SB-5244	for Wishbone (CV), 1st RA
	09/90→12/92	Tie Rod End	CV-ES-2149		for Push Rod
	09/90→12/92	Tie Rod End	CV-ES-14162		for Steering Rod
	09/90→12/92	Tie Rod End	CV-ES-14163		for Steering Rod
	09/90→12/92	Track Control Arm		MN-DL-3402	Trailing Arm
	09/90→12/92	Track Control Arm		MN-VB-5222	Wishbone (CV)
09/90→12/92	Track Control Arm		MN-VB-8569	Wishbone (CV)	
01/91→12/92	Track Control Arm		MN-VB-8569	Wishbone (CV), Drive Axle	
25.422 DFS, 25.422 DFLS	09/90→12/92	Ball Head, gearshift linkage	CV-ES-2119		
	09/90→12/92	Ball Head, gearshift linkage	CV-ES-2120		
	09/90→12/92	Ball Head, gearshift linkage	CV-ES-2182		
	09/90→12/92	Centre Rod	MN-DL-2160		Coupling Rod
	09/90→12/92	Centre Rod	MN-DL-2175		Push Rod
	09/90→12/92	Centre Rod	MN-DL-3588		Push Rod
	09/90→12/92	Centre Rod	MN-DL-12421		for Steering Rod
	09/90→12/92	Engine Mounting	MN-SB-10389		
	09/90→12/92	Mounting, stabilizer coupling rod	MN-SB-5246		
	09/90→12/92	Stabiliser Mounting		MN-SB-5254	

CV-ES-2119

Length: 55
Cone Ø: d1 Ø 10 / d2 Ø 10
Thread: M12 x 1,75 LHT
81953016063, 81953016131



CV-ES-2120

Length: 115
Cone Ø: d1 Ø 12,4 / d2 Ø 10,8
Thread: M14 x 1,5 RHT
03008500A, 81953016200, 81953016202,
81953016203, 81953016227



CV-ES-2149

Length: 160
Cone Ø: d1 Ø 30 / d2 Ø 27
Thread: M30 x 1,5 RHT
81953016263



CV-ES-2182

Length: 55
Cone Ø: d1 Ø 10 / d2 Ø 10
Thread: M12 x 1,75 RHT
81953016064, 81953016170



CV-ES-14162

Length: 125
Cone Ø: d1 Ø 30 / d2 Ø 27
Thread: M30 x 1,5 LHT
81953010015, 81953010083, 81953010087,
81953016029, 81953016030, 81953016043,
81953016044, 81953016050, 81953016054,
81953016087, 81953016091, 81953016107,
81953016120, 81953016125, 81953016152,
81953016155, 81953016157, 81953016168,
81953016179, 81953016181, 81953016223,
81953016237, 81953016254, 81953016275,
81953016279, 81953016351



CV-ES-14163

Length: 125
Cone Ø: d1 Ø 30 / d2 Ø 27
Thread: M30 x 1,5 RHT
95301.0084, 90804102156, 90804102272,
90804102696, 90804102710, 81953010016,
81953010075, 81953010084, 81953010088,
81953010094, 81953010103, 81953016030,
81953016043, 81953016048, 81953016049,
81953016053, 81953016061, 81953016090,
81953016108, 81953016112, 81953016126,
81953016143, 81953016149, 81953016154,
81953016156, 81953016168, 81953016178,
81953016194, 81953016206, 81953016224,
81953016234, 81953016242, 81953016252,
81953016274, 81953016278, 81953016284,
81953016286, 81953016308, 81953016310,
81953016312, 81953016347, 81953016350,
81953016352, 82953016012, 88953016014,
N2953016001



CV-RK-5313

Ø: 90
03304800A, 81953016132



CV-RK-8118

Ø: 85
Hole Distance: 130
Thick/Height: 30
638862, 639287, 775201, 938423,
1104335, 1953248, 0003500506, 3500506,
11013547, 21032592, 42065912, 42488722,
070550504, 93192618, 070400009000,
634303610, 81432206055, 81432206073,
82262320660, 9544171010099,
5001842823, 7000307001, 8226232066



MN-DL-2160

Length: 1652 Ø: 50
Cone Ø: d1 Ø 30 / d2 Ø 27
81467106112, 81467106163, 81467106165,
81467106198, 81467106353, 81467106354,
81467106361, 81467116725



MN-DL-2175

Length: 1628 Ø: 50
Cone Ø: d1 Ø 30 / d2 Ø 27
81467106396, 81467106904



MN-DL-3402

Length: 590 Ø: 48
Hole Distance: 130 / 130
03307200A, 81432206067, 81432206068,
81432206090, 81432206092, 81432209092



MN-DL-3588

Length: 1035 Ø: 48
Cone Ø: d1 Ø 30 / d2 Ø 27
81466106333, 81466106334, 81466106354,
81466106355, 81466106360, 81466106361,
81466106721, 81466106722, 81466106723,
81466116216



MN-DL-5212

Length: 577 Ø: 48
Hole Distance: 130 / 130
81432206096, 81432206097, 81432206098,
81432206129, 81432209096, 81432209129,
81432306014, 81432306030



MN-DL-12421

Length: 1070 Ø: 48
Cone Ø: d1 Ø 30 / d2 Ø 27
Thread: M30 x 1,5 RHT
81466106656, 81466106659, 81466106669,
81466116006, 81466116007



MN-RK-7280

Ø: 75
Hole Distance: 115
Thick/Height: 24
0550806, 0639370, 689748, 10307400A,
81432306051, 81432306068, 81432706064



MN-RK-7287

Ø: 90
Hole Distance: 152
Thick/Height: 35
03304700A, 81953016133



MN-RK-7291

Ø: 72
Hole Distance: 130
Thick/Height: 30
10307800A, 81432206108, 81432206132



MN-SB-5244

Ø: 65
Hole Distance: 125
Thick/Height: 22
03312000A, 81432710027, 81432710082



MN-SB-5246

Ø: 45 Thick/Height: 47
81437220022, 81437220038, 81962100450,
81962100469



MN-SB-5254

Length: 100 Ø: 93
Thick/Height: 70
81432710081



MN-SB-9396

Ø: 67 Thick/Height: 60
81437040057



MN-SB-10389

Ø: 70 Thick/Height: 72
81960200340



MN-VB-5222

Length: 627 Ø: 50
Hole Distance: 152 / 152
81432706030, 81432706034, 81432706054,
81432706055, 81432706056, 81432706057,
81432706067, 81432706068, 81432706074,
81432706075, 81432706076, 81432706077,
81432706078, 81432706081, 81432706082,
81432709034, 81432709076, 81432709078,
8143706054



MN-VB-8569

Length: 627 Ø: 58
Hole Distance: 152 / 152
81432706055, 81432706056, 81432706067,
81432706068, 81432706075, 81432706077,
81432706081, 81432709056





F 90 ...

25.422 DFS,25.422 DFLS ...	09/90→12/92	Engine Mounting	MN-SB-10389			
	09/90→12/92	Mounting, stabilizer coupling rod	MN-SB-5246			
	09/90→12/92	Stabiliser Mounting		MN-SB-5254		
	09/90→12/92	Stabiliser Mounting	MN-SB-9396			
	09/90→12/92	Suspension Arm Repair Kit		CV-RK-5313	for Wishbone (CV)	
	09/90→12/92	Suspension Arm Repair Kit		CV-RK-8118	for Control Arm	
	09/90→12/92	Suspension Arm Repair Kit		MN-RK-7287	for Wishbone (CV)	
	09/90→12/92	Suspension Arm Repair Kit		MN-RK-7291	for Drag Link	
	09/90→12/92	Suspension Arm Repair Kit		MN-SB-5244	for Wishbone (CV)	
	09/90→12/92	Suspension Arm Repair Kit		MN-SB-5244	for Wishbone (CV), 1st RA	
	09/90→12/92	Tie Rod End	CV-ES-2149		for Push Rod	
	09/90→12/92	Tie Rod End	CV-ES-14162		for Steering Rod	
	09/90→12/92	Tie Rod End	CV-ES-14163		for Steering Rod	
	09/90→12/92	Track Control Arm		MN-DL-3402	Trailing Arm	
	09/90→12/92	Track Control Arm		MN-DL-5212	Trailing Arm, Air Suspension Axle;Drive Axle	
	09/90→12/92	Track Control Arm		MN-VB-5222	Wishbone (CV)	
	09/90→12/92	Track Control Arm		MN-VB-5222	Wishbone (CV), Drive Axle;Air Suspension Axle	
	09/90→12/92	Track Control Arm		MN-VB-8569	Wishbone (CV)	
	01/91→12/92	Track Control Arm		MN-VB-8569	Wishbone (CV), Drive Axle	
	25.422 FNL,25.422 FNLL	09/90→12/92	Ball Head, gearshift linkage	CV-ES-2119		
		09/90→12/92	Ball Head, gearshift linkage	CV-ES-2120		
		09/90→12/92	Ball Head, gearshift linkage	CV-ES-2182		
		09/90→12/92	Centre Rod	MN-DL-2160		Coupling Rod
		09/90→12/92	Centre Rod	MN-DL-2175		Push Rod
		09/90→12/92	Centre Rod	MN-DL-3588		Push Rod
09/90→12/92		Centre Rod	MN-DL-12421		for Steering Rod	
09/90→12/92		Engine Mounting	MN-SB-10389			
09/90→12/92		Stabiliser Mounting		MN-SB-5265		
09/90→12/92		Stabiliser Mounting		MN-SB-5265	1st RA	
09/90→12/92		Suspension Arm Repair Kit		CV-RK-5313	for Wishbone (CV)	
09/90→12/92		Suspension Arm Repair Kit		CV-RK-8118	for Control Arm	
09/90→12/92		Suspension Arm Repair Kit		MN-RK-7280	for Drag Link	
09/90→12/92		Suspension Arm Repair Kit		MN-RK-7287	for Wishbone (CV)	
09/90→12/92		Suspension Arm Repair Kit		MN-RK-7291	for Drag Link	
09/90→12/92		Tie Rod End	CV-ES-2149		for Push Rod	
09/90→12/92		Tie Rod End	CV-ES-14162		for Steering Rod	
09/90→12/92		Tie Rod End	CV-ES-14163		for Steering Rod	
09/90→12/92		Track Control Arm		MN-VB-5222	Wishbone (CV), Drive Axle;Air Suspension Axle	
09/90→12/92		Track Control Arm		MN-VB-5222	Wishbone (CV), Tag Axle	
25.422 FNLS,25.422 FVLS		09/90→12/92	Ball Head, gearshift linkage	CV-ES-2119		
		09/90→12/92	Ball Head, gearshift linkage	CV-ES-2120		
		09/90→12/92	Ball Head, gearshift linkage	CV-ES-2182		
		09/90→12/92	Centre Rod	MN-DL-2160		Coupling Rod
		09/90→12/92	Centre Rod	MN-DL-2175		Push Rod
	09/90→12/92	Centre Rod	MN-DL-3588		Push Rod	
	09/90→12/92	Centre Rod	MN-DL-12421		for Steering Rod	
	09/90→12/92	Engine Mounting	MN-SB-10389			
	09/90→12/92	Stabiliser Mounting		MN-SB-5265		
	09/90→12/92	Stabiliser Mounting		MN-SB-5265	1st RA	
	09/90→12/92	Suspension Arm Repair Kit		CV-RK-5313	for Wishbone (CV)	
	09/90→12/92	Suspension Arm Repair Kit		CV-RK-8118	for Control Arm	
	09/90→12/92	Suspension Arm Repair Kit		MN-RK-7280	for Drag Link	
	09/90→12/92	Suspension Arm Repair Kit		MN-RK-7287	for Wishbone (CV)	
	09/90→12/92	Suspension Arm Repair Kit		MN-RK-7291	for Drag Link	
	09/90→12/92	Tie Rod End	CV-ES-2149		for Push Rod	
	09/90→12/92	Tie Rod End	CV-ES-14162		for Steering Rod	
	09/90→12/92	Tie Rod End	CV-ES-14163		for Steering Rod	
	09/90→12/92	Track Control Arm		MN-VB-5222	Wishbone (CV), Drive Axle;Air Suspension Axle	
	09/90→12/92	Track Control Arm		MN-VB-5222	Wishbone (CV), Tag Axle	
	25.502 DF	09/90→01/91	Track Control Arm		MN-VB-5222	Wishbone (CV), Drive Axle
		09/90→12/92	Ball Head, gearshift linkage	CV-ES-2120		
		09/90→12/92	Suspension Arm Repair Kit		CV-RK-5313	for Wishbone (CV)
		09/90→12/92	Suspension Arm Repair Kit		MN-RK-7287	for Wishbone (CV)

CV-ES-2119

Length: 55
Cone Ø: d1 Ø 10 / d2 Ø 10
Thread: M12 x 1,75 LHT
81953016063, 81953016131



CV-ES-2120

Length: 115
Cone Ø: d1 Ø 12,4 / d2 Ø 10,8
Thread: M14 x 1,5 RHT
03008500A, 81953016200, 81953016202, 81953016203, 81953016227



CV-ES-2149

Length: 160
Cone Ø: d1 Ø 30 / d2 Ø 27
Thread: M30 x 1,5 RHT
81953016263



CV-ES-2182

Length: 55
Cone Ø: d1 Ø 10 / d2 Ø 10
Thread: M12 x 1,75 RHT
81953016064, 81953016170



CV-ES-14162

Length: 125
Cone Ø: d1 Ø 30 / d2 Ø 27
Thread: M30 x 1,5 LHT

81953010015, 81953010083, 81953010087, 81953016029, 81953016030, 81953016043, 81953016044, 81953016050, 81953016054, 81953016087, 81953016091, 81953016107, 81953016120, 81953016125, 81953016152, 81953016155, 81953016157, 81953016168, 81953016179, 81953016181, 81953016223, 81953016237, 81953016254, 81953016275, 81953016279, 81953016351



CV-ES-14163

Length: 125
Cone Ø: d1 Ø 30 / d2 Ø 27
Thread: M30 x 1,5 RHT

95301.0084, 90804102156, 90804102272, 90804102696, 90804102710, 81953010016, 81953010075, 81953010084, 81953010088, 81953010094, 81953010103, 81953016030, 81953016043, 81953016048, 81953016049, 81953016053, 81953016061, 81953016090, 81953016108, 81953016112, 81953016126, 81953016143, 81953016149, 81953016154, 81953016156, 81953016168, 81953016178, 81953016194, 81953016206, 81953016224, 81953016234, 81953016242, 81953016252, 81953016274, 81953016278, 81953016284, 81953016286, 81953016308, 81953016310, 81953016312, 81953016347, 81953016350, 81953016352, 82953016012, 88953016014, N2953016001



CV-RK-5313

Ø: 90
03304800A, 81953016132



CV-RK-8118

Ø: 85
Hole Distance: 130
Thick/Height: 30

638862, 639287, 775201, 938423, 1104335, 1953248, 0003500506, 3500506, 11013547, 21032592, 42065912, 42488722, 070550504, 93192618, 070400009000, 634303610, 81432206055, 81432206073, 82262320660, 9544171010099, 5001842823, 7000307001, 8226232066



MN-DL-2160

Length: 1652 Ø: 50
Cone Ø: d1 Ø 30 / d2 Ø 27

81467106112, 81467106163, 81467106165, 81467106198, 81467106353, 81467106354, 81467106361, 81467116725



MN-DL-2175

Length: 1628 Ø: 50
Cone Ø: d1 Ø 30 / d2 Ø 27
81467106396, 81467106904



MN-DL-3402

Length: 590 Ø: 48
Hole Distance: 130 / 130
03307200A, 81432206067, 81432206068, 81432206090, 81432206092, 81432209092



MN-DL-3588

Length: 1035 Ø: 48
Cone Ø: d1 Ø 30 / d2 Ø 27
81466106333, 81466106334, 81466106354, 81466106355, 81466106360, 81466106361, 81466106721, 81466106722, 81466106723, 81466116216



MN-DL-5212

Length: 577 Ø: 48
Hole Distance: 130 / 130
81432206096, 81432206097, 81432206098, 81432206129, 81432209096, 81432209129, 81432306014, 81432306030



MN-DL-12421

Length: 1070 Ø: 48
Cone Ø: d1 Ø 30 / d2 Ø 27
Thread: M30 x 1,5 RHT
81466106656, 81466106659, 81466106669, 81466116006, 81466116007



MN-RK-7280

Ø: 75
Hole Distance: 115
Thick/Height: 24
0550806, 0639370, 689748, 10307400A, 81432306051, 81432306068, 81432706064



MN-RK-7287

Ø: 90
Hole Distance: 152
Thick/Height: 35
03304700A, 81953016133



MN-RK-7291

Ø: 72
Hole Distance: 130
Thick/Height: 30
10307800A, 81432206108, 81432206132



MN-SB-5244

Ø: 65
Hole Distance: 125
Thick/Height: 22
03312000A, 81432710027, 81432710082



MN-SB-5246

Ø: 45 Thick/Height: 47
81437220022, 81437220038, 81962100450, 81962100469



MN-SB-5254

Length: 100 Ø: 93
Thick/Height: 70
81432710081



MN-SB-5265

Ø: 85 Thick/Height: 80
03310300A, 81437040032



MN-SB-9396

Ø: 67 Thick/Height: 60
81437040057



MN-SB-10389

Ø: 70 Thick/Height: 72
81960200340



MN-VB-5222

Length: 627 Ø: 50
Hole Distance: 152 / 152
81432706030, 81432706034, 81432706054, 81432706055, 81432706056, 81432706057, 81432706067, 81432706068, 81432706074, 81432706075, 81432706076, 81432706077, 81432706078, 81432706081, 81432706082, 81432709034, 81432709076, 81432709078, 8143706054



MN-VB-8569

Length: 627 Ø: 58
Hole Distance: 152 / 152
81432706055, 81432706056, 81432706067, 81432706068, 81432706075, 81432706077, 81432706081, 81432709056



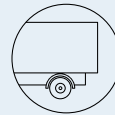

F 90 ...

25.502 DF ...	09/90→12/92	Tie Rod End	CV-ES-14163		for Steering Rod	
	09/90→12/92	Track Control Arm		MN-DL-3402	Trailing Arm, Drive Axle	
	01/91→12/92	Track Control Arm		MN-VB-8569	Wishbone (CV), Drive Axle	
25.502 DFS	09/90→01/91	Track Control Arm		MN-VB-5222	Wishbone (CV), Drive Axle	
	09/90→12/92	Ball Head, gearshift linkage	CV-ES-2120			
	09/90→12/92	Suspension Arm Repair Kit		CV-RK-5313	for Wishbone (CV)	
	09/90→12/92	Suspension Arm Repair Kit		MN-RK-7287	for Wishbone (CV)	
	09/90→12/92	Tie Rod End	CV-ES-14163		for Steering Rod	
	09/90→12/92	Track Control Arm		MN-DL-3402	Trailing Arm, Drive Axle	
	01/91→12/92	Track Control Arm		MN-VB-8569	Wishbone (CV), Drive Axle	
	25.502 FNL	09/90→12/92	Ball Head, gearshift linkage	CV-ES-2120		
09/90→12/92		Centre Rod	MN-DL-2160		Coupling Rod	
09/90→12/92		Centre Rod	MN-DL-3588		Push Rod	
09/90→12/92		Mounting, stabilizer coupling rod	MN-SB-5246			
09/90→12/92		Mounting, stabilizer coupling rod	MN-SB-5246		1st FA	
09/90→12/92		Suspension Arm Repair Kit		CV-RK-5313	for Wishbone (CV)	
09/90→12/92		Suspension Arm Repair Kit		CV-RK-8118	for Control Arm	
09/90→12/92		Suspension Arm Repair Kit		MN-RK-7287	for Wishbone (CV)	
09/90→12/92		Suspension Arm Repair Kit		MN-RK-7291	for Drag Link	
09/90→12/92		Tie Rod End	CV-ES-14163		for Steering Rod	
09/90→12/92		Track Control Arm		MN-DL-5212	Trailing Arm, Air Suspension Axle; Drive Axle; Tag Axle	
09/90→12/92		Track Control Arm		MN-VB-5222	Wishbone (CV), Drive Axle	
26.242 DF		02/90→	Ball Head, gearshift linkage	CV-ES-2119		
		02/90→	Ball Head, gearshift linkage	CV-ES-2120		
		02/90→	Ball Head, gearshift linkage	CV-ES-2182		
	02/90→	Centre Rod	MN-DL-2160		Coupling Rod	
	02/90→	Centre Rod	MN-DL-3588		Push Rod	
	02/90→	Centre Rod	MN-DL-12421		for Steering Rod	
	02/90→	Engine Mounting		MN-SB-10390		
	02/90→	Engine Mounting	MN-SB-10389			
	02/90→	Mounting, stabilizer coupling rod	MN-SB-5246			
	02/90→	Stabiliser Mounting		MN-SB-5245		
	02/90→	Stabiliser Mounting		MN-SB-5254		
	02/90→	Stabiliser Mounting	MN-SB-9396			
	02/90→	Suspension Arm Repair Kit		MN-SB-5244	for Wishbone (CV)	
	02/90→	Suspension Arm Repair Kit		MN-SB-5244	for Wishbone (CV), 1st RA	
	02/90→	Tie Rod End	CV-ES-2149		for Push Rod	
	02/90→	Tie Rod End	CV-ES-14162		for Steering Rod	
	02/90→	Tie Rod End	CV-ES-14163		for Steering Rod	
	02/90→	Track Control Arm		MN-DL-3402	Trailing Arm	
	02/90→	Track Control Arm		MN-DL-3402	Trailing Arm, Drive Axle	
	26.242 DFAK	01/90→01/90	Ball Head, gearshift linkage	CV-ES-2119		
01/90→01/90		Ball Head, gearshift linkage	CV-ES-2120			
01/90→01/90		Ball Head, gearshift linkage	CV-ES-2182			
01/90→01/90		Centre Rod	MN-DL-2160		Coupling Rod	
01/90→01/90		Centre Rod	MN-DL-3588		Push Rod	
01/90→01/90		Centre Rod	MN-DL-12421		for Steering Rod	
01/90→01/90		Engine Mounting	MN-SB-10389			
01/90→01/90		Mounting, stabilizer coupling rod	MN-SB-5246			
01/90→01/90		Stabiliser Mounting		MN-SB-5245		
01/90→01/90		Stabiliser Mounting		MN-SB-5254		
01/90→01/90		Stabiliser Mounting	MN-SB-9396			
01/90→01/90		Suspension Arm Repair Kit		MN-SB-5244	for Wishbone (CV)	
01/90→01/90		Suspension Arm Repair Kit		MN-SB-5244	for Wishbone (CV), 1st RA	
01/90→01/90		Tie Rod End	CV-ES-2149		for Push Rod	
01/90→01/90		Tie Rod End	CV-ES-14162		for Steering Rod	
01/90→01/90	Tie Rod End	CV-ES-14163		for Steering Rod		
01/90→01/90	Track Control Arm		MN-DL-3402	Trailing Arm		
26.242 DFK	02/90→	Ball Head, gearshift linkage	CV-ES-2119			
	02/90→	Ball Head, gearshift linkage	CV-ES-2120			
	02/90→	Ball Head, gearshift linkage	CV-ES-2182			
	02/90→	Centre Rod	MN-DL-2160		Coupling Rod	

CV-ES-2119

Length: 55
Cone Ø: d1 Ø 10 / d2 Ø 10
Thread: M12 x 1,75 LHT
81953016063, 81953016131



CV-ES-2120

Length: 115
Cone Ø: d1 Ø 12,4 / d2 Ø 10,8
Thread: M14 x 1,5 RHT
03008500A, 81953016200, 81953016202, 81953016203, 81953016227



CV-ES-2149

Length: 160
Cone Ø: d1 Ø 30 / d2 Ø 27
Thread: M30 x 1,5 RHT
81953016263



CV-ES-2182

Length: 55
Cone Ø: d1 Ø 10 / d2 Ø 10
Thread: M12 x 1,75 RHT
81953016064, 81953016170



CV-ES-14162

Length: 125
Cone Ø: d1 Ø 30 / d2 Ø 27
Thread: M30 x 1,5 LHT
81953010015, 81953010083, 81953010087, 81953016029, 81953016030, 81953016043, 81953016044, 81953016050, 81953016054, 81953016087, 81953016091, 81953016107, 81953016120, 81953016125, 81953016152, 81953016155, 81953016157, 81953016168, 81953016179, 81953016181, 81953016223, 81953016237, 81953016254, 81953016275, 81953016279, 81953016351



CV-ES-14163

Length: 125
Cone Ø: d1 Ø 30 / d2 Ø 27
Thread: M30 x 1,5 RHT
95301.0084, 90804102156, 90804102272, 90804102696, 90804102710, 81953010016, 81953010075, 81953010084, 81953010088, 81953010094, 81953010103, 81953016030, 81953016043, 81953016048, 81953016049, 81953016053, 81953016061, 81953016090, 81953016108, 81953016112, 81953016126, 81953016143, 81953016149, 81953016154, 81953016156, 81953016168, 81953016178, 81953016194, 81953016206, 81953016224, 81953016234, 81953016242, 81953016252, 81953016274, 81953016278, 81953016284, 81953016286, 81953016308, 81953016310, 81953016312, 81953016347, 81953016350, 81953016352, 82953016012, 88953016014, N2953016001



CV-RK-5313

Ø: 90
03304800A, 81953016132



CV-RK-8118

Ø: 85
Hole Distance: 130
Thick/Height: 30
638862, 639287, 775201, 938423, 1104335, 1953248, 0003500506, 3500506, 11013547, 21032592, 42065912, 42488722, 070550504, 93192618, 070400009000, 634303610, 81432206055, 81432206073, 82262320660, 9544171010099, 5001842823, 7000307001, 8226232066



MN-DL-2160

Length: 1652 Ø: 50
Cone Ø: d1 Ø 30 / d2 Ø 27
81467106112, 81467106163, 81467106165, 81467106198, 81467106353, 81467106354, 81467106361, 81467116725



MN-DL-3402

Length: 590 Ø: 48
Hole Distance: 130 / 130
03307200A, 81432206067, 81432206068, 81432206090, 81432206092, 81432209092



MN-DL-3588

Length: 1035 Ø: 48
Cone Ø: d1 Ø 30 / d2 Ø 27
81466106333, 81466106334, 81466106354, 81466106355, 81466106360, 81466106361, 81466106721, 81466106722, 81466106723, 81466116216



MN-DL-5212

Length: 577 Ø: 48
Hole Distance: 130 / 130
81432206096, 81432206097, 81432206098, 81432206129, 81432209096, 81432209129, 81432306014, 81432306030



MN-DL-12421

Length: 1070 Ø: 48
Cone Ø: d1 Ø 30 / d2 Ø 27
Thread: M30 x 1,5 RHT
81466106656, 81466106659, 81466106669, 81466116006, 81466116007



MN-RK-7287

Ø: 90
Hole Distance: 152
Thick/Height: 35
03304700A, 81953016133



MN-RK-7291

Ø: 72
Hole Distance: 130
Thick/Height: 30
10307800A, 81432206108, 81432206132



MN-SB-5244

Ø: 65
Hole Distance: 125
Thick/Height: 22
03312000A, 81432710027, 81432710082



MN-SB-5245

Ø: 75
Hole Distance: 125
Thick/Height: 22
03311900A, 81432710046, 81432710079, 81432710083



MN-SB-5246

Ø: 45 Thick/Height: 47
81437220022, 81437220038, 81962100450, 81962100469



MN-SB-5254

Length: 100 Ø: 93
Thick/Height: 70
81432710081



MN-SB-9396

Ø: 67 Thick/Height: 60
81437040057



MN-SB-10389

Ø: 70 Thick/Height: 72
81960200340



MN-SB-10390

Ø: 70 Thick/Height: 85/85
81960200341, 81960200373, 81960200385, 81960200408, 81960200418



MN-VB-5222

Length: 627 Ø: 50
Hole Distance: 152 / 152
81432706030, 81432706034, 81432706054, 81432706055, 81432706056, 81432706057, 81432706067, 81432706068, 81432706074, 81432706075, 81432706076, 81432706077, 81432706078, 81432706081, 81432706082, 81432709034, 81432709076, 81432709078, 8143706054



MN-VB-8569

Length: 627 Ø: 58
Hole Distance: 152 / 152
81432706055, 81432706056, 81432706067, 81432706068, 81432706075, 81432706077, 81432706081, 81432709056





F 90 ...

26.242 DFK ...	02/90→	Centre Rod	MN-DL-3588		Push Rod
	02/90→	Centre Rod	MN-DL-12421		for Steering Rod
	02/90→	Engine Mounting		MN-SB-10390	
	02/90→	Engine Mounting	MN-SB-10389		
	02/90→	Mounting, stabilizer coupling rod	MN-SB-5246		
	02/90→	Stabiliser Mounting		MN-SB-5245	
	02/90→	Stabiliser Mounting		MN-SB-5254	
	02/90→	Stabiliser Mounting	MN-SB-9396		
	02/90→	Suspension Arm Repair Kit		MN-SB-5244	for Wishbone (CV)
	02/90→	Suspension Arm Repair Kit		MN-SB-5244	for Wishbone (CV), 1st RA
	02/90→	Tie Rod End	CV-ES-2149		for Push Rod
	02/90→	Tie Rod End	CV-ES-14162		for Steering Rod
	02/90→	Tie Rod End	CV-ES-14163		for Steering Rod
	02/90→	Track Control Arm		MN-DL-3402	Trailing Arm
	02/90→	Track Control Arm		MN-DL-3402	Trailing Arm, Drive Axle
26.242 DFS	02/90→	Ball Head, gearshift linkage	CV-ES-2119		
	02/90→	Ball Head, gearshift linkage	CV-ES-2120		
	02/90→	Ball Head, gearshift linkage	CV-ES-2182		
	02/90→	Centre Rod	MN-DL-2160		Coupling Rod
	02/90→	Centre Rod	MN-DL-3588		Push Rod
	02/90→	Centre Rod	MN-DL-12421		for Steering Rod
	02/90→	Engine Mounting		MN-SB-10390	
	02/90→	Engine Mounting	MN-SB-10389		
	02/90→	Mounting, stabilizer coupling rod	MN-SB-5246		
	02/90→	Stabiliser Mounting		MN-SB-5245	
	02/90→	Stabiliser Mounting		MN-SB-5254	
	02/90→	Stabiliser Mounting	MN-SB-9396		
	02/90→	Suspension Arm Repair Kit		MN-SB-5244	for Wishbone (CV)
	02/90→	Suspension Arm Repair Kit		MN-SB-5244	for Wishbone (CV), 1st RA
	02/90→	Tie Rod End	CV-ES-2149		for Push Rod
	02/90→	Tie Rod End	CV-ES-14162		for Steering Rod
	02/90→	Tie Rod End	CV-ES-14163		for Steering Rod
	02/90→	Track Control Arm		MN-DL-3402	Trailing Arm
02/90→	Track Control Arm		MN-DL-3402	Trailing Arm, Drive Axle	
26.262 DF	01/88→02/90	Ball Head, gearshift linkage	CV-ES-2119		
	01/88→02/90	Ball Head, gearshift linkage	CV-ES-2120		
	01/88→02/90	Ball Head, gearshift linkage	CV-ES-2182		
	01/88→02/90	Centre Rod	MN-DL-2160		Coupling Rod
	01/88→02/90	Centre Rod	MN-DL-3588		Push Rod
	01/88→02/90	Centre Rod	MN-DL-12421		for Steering Rod
	01/88→02/90	Engine Mounting		MN-SB-10390	
	01/88→02/90	Engine Mounting	MN-SB-10389		
	01/88→02/90	Mounting, stabilizer coupling rod	MN-SB-5246		
	01/88→02/90	Stabiliser Mounting		MN-SB-5245	
	01/88→02/90	Stabiliser Mounting		MN-SB-5254	
	01/88→02/90	Stabiliser Mounting	MN-SB-9396		
	01/88→02/90	Suspension Arm Repair Kit		MN-SB-5244	for Wishbone (CV)
	01/88→02/90	Suspension Arm Repair Kit		MN-SB-5244	for Wishbone (CV), 1st RA
	01/88→02/90	Tie Rod End	CV-ES-2149		for Push Rod
	01/88→02/90	Tie Rod End	CV-ES-14162		for Steering Rod
	01/88→02/90	Tie Rod End	CV-ES-14163		for Steering Rod
	01/88→02/90	Track Control Arm		MN-DL-3402	Trailing Arm
01/88→02/90	Track Control Arm		MN-DL-3402	Trailing Arm, Drive Axle	
26.262 DFA	02/89→02/90	Ball Head, gearshift linkage	CV-ES-2119		
	02/89→02/90	Ball Head, gearshift linkage	CV-ES-2120		
	02/89→02/90	Ball Head, gearshift linkage	CV-ES-2182		
	02/89→02/90	Centre Rod	MN-DL-2160		Coupling Rod
	02/89→02/90	Centre Rod	MN-DL-3588		Push Rod
	02/89→02/90	Centre Rod	MN-DL-12421		for Steering Rod
	02/89→02/90	Engine Mounting	MN-SB-10389		
	02/89→02/90	Mounting, stabilizer coupling rod	MN-SB-5246		
	02/89→02/90	Stabiliser Mounting		MN-SB-5245	
	02/89→02/90	Stabiliser Mounting		MN-SB-5254	

CV-ES-2119

Length: 55
Cone Ø: d1 Ø 10 / d2 Ø 10
Thread: M12 x 1,75 LHT
81953016063, 81953016131



CV-ES-2120

Length: 115
Cone Ø: d1 Ø 12,4 / d2 Ø 10,8
Thread: M14 x 1,5 RHT
03008500A, 81953016200, 81953016202,
81953016203, 81953016227



CV-ES-2149

Length: 160
Cone Ø: d1 Ø 30 / d2 Ø 27
Thread: M30 x 1,5 RHT
81953016263



CV-ES-2182

Length: 55
Cone Ø: d1 Ø 10 / d2 Ø 10
Thread: M12 x 1,75 RHT
81953016064, 81953016170



CV-ES-14162

Length: 125
Cone Ø: d1 Ø 30 / d2 Ø 27
Thread: M30 x 1,5 LHT
81953010015, 81953010083, 81953010087,
81953016029, 81953016030, 81953016043,
81953016044, 81953016050, 81953016054,
81953016087, 81953016091, 81953016107,
81953016120, 81953016125, 81953016152,
81953016155, 81953016157, 81953016168,
81953016179, 81953016181, 81953016223,
81953016237, 81953016254, 81953016275,
81953016279, 81953016351



CV-ES-14163

Length: 125
Cone Ø: d1 Ø 30 / d2 Ø 27
Thread: M30 x 1,5 RHT
95301.0084, 90804102156, 90804102272,
90804102696, 90804102710, 81953010016,
81953010075, 81953010084, 81953010088,
81953010094, 81953010103, 81953016030,
81953016043, 81953016048, 81953016049,
81953016053, 81953016061, 81953016090,
81953016108, 81953016112, 81953016126,
81953016143, 81953016149, 81953016154,
81953016156, 81953016168, 81953016178,
81953016194, 81953016206, 81953016224,
81953016234, 81953016242, 81953016252,
81953016274, 81953016278, 81953016284,
81953016286, 81953016308, 81953016310,
81953016312, 81953016347, 81953016350,
81953016352, 82953016012, 88953016014,
N2953016001



MN-DL-2160

Length: 1652 Ø: 50
Cone Ø: d1 Ø 30 / d2 Ø 27
81467106112, 81467106163, 81467106165,
81467106198, 81467106353, 81467106354,
81467106361, 81467116725



MN-DL-3402

Length: 590 Ø: 48
Hole Distance: 130 / 130
03307200A, 81432206067, 81432206068,
81432206090, 81432206092, 81432209092



MN-DL-3588

Length: 1035
Ø: 48
Cone Ø: d1 Ø 30 / d2 Ø 27
81466106333, 81466106334, 81466106354,
81466106355, 81466106360, 81466106361,
81466106721, 81466106722, 81466106723,
81466116216



MN-DL-12421

Length: 1070
Ø: 48
Cone Ø: d1 Ø 30 / d2 Ø 27
Thread: M30 x 1,5 RHT
81466106656, 81466106659, 81466106669,
81466116006, 81466116007



MN-SB-5244

Ø: 65
Hole Distance: 125
Thick/Height: 22
03312000A, 81432710027, 81432710082



MN-SB-5245

Ø: 75
Hole Distance: 125
Thick/Height: 22
03311900A, 81432710046, 81432710079,
81432710083



MN-SB-5246

Ø: 45 Thick/Height: 47
81437220022, 81437220038, 81962100450,
81962100469



MN-SB-5254

Length: 100
Ø: 93
Thick/Height: 70
81432710081



MN-SB-9396

Ø: 67
Thick/Height: 60
81437040057



MN-SB-10389

Ø: 70
Thick/Height: 72
81960200340



MN-SB-10390

Ø: 70
Thick/Height: 85/85
81960200341, 81960200373, 81960200385,
81960200408, 81960200418





F 90 ...

26.262 DFA ...	02/89→02/90	Stabiliser Mounting	MN-SB-9396		
	02/89→02/90	Suspension Arm Repair Kit		MN-SB-5244	for Wishbone (CV)
	02/89→02/90	Suspension Arm Repair Kit		MN-SB-5244	for Wishbone (CV), 1st RA
	02/89→02/90	Tie Rod End	CV-ES-2149		for Push Rod
	02/89→02/90	Tie Rod End	CV-ES-14162		for Steering Rod
	02/89→02/90	Tie Rod End	CV-ES-14163		for Steering Rod
	02/89→02/90	Track Control Arm		MN-DL-3402	Trailing Arm
26.262 DFAK	02/89→02/90	Ball Head, gearshift linkage	CV-ES-2119		
	02/89→02/90	Ball Head, gearshift linkage	CV-ES-2120		
	02/89→02/90	Ball Head, gearshift linkage	CV-ES-2182		
	02/89→02/90	Centre Rod	MN-DL-2160		Coupling Rod
	02/89→02/90	Centre Rod	MN-DL-3588		Push Rod
	02/89→02/90	Centre Rod	MN-DL-12421		for Steering Rod
	02/89→02/90	Engine Mounting	MN-SB-10389		
	02/89→02/90	Mounting, stabilizer coupling rod	MN-SB-5246		
	02/89→02/90	Stabiliser Mounting		MN-SB-5245	
	02/89→02/90	Stabiliser Mounting		MN-SB-5254	
	02/89→02/90	Stabiliser Mounting	MN-SB-9396		
	02/89→02/90	Suspension Arm Repair Kit		MN-SB-5244	for Wishbone (CV)
	02/89→02/90	Suspension Arm Repair Kit		MN-SB-5244	for Wishbone (CV), 1st RA
	02/89→02/90	Tie Rod End	CV-ES-2149		for Push Rod
	02/89→02/90	Tie Rod End	CV-ES-14162		for Steering Rod
02/89→02/90	Tie Rod End	CV-ES-14163		for Steering Rod	
02/89→02/90	Track Control Arm		MN-DL-3402	Trailing Arm	
26.262 DFAS	02/89→02/90	Ball Head, gearshift linkage	CV-ES-2119		
	02/89→02/90	Ball Head, gearshift linkage	CV-ES-2120		
	02/89→02/90	Ball Head, gearshift linkage	CV-ES-2182		
	02/89→02/90	Centre Rod	MN-DL-2160		Coupling Rod
	02/89→02/90	Centre Rod	MN-DL-3588		Push Rod
	02/89→02/90	Centre Rod	MN-DL-12421		for Steering Rod
	02/89→02/90	Engine Mounting	MN-SB-10389		
	02/89→02/90	Mounting, stabilizer coupling rod	MN-SB-5246		
	02/89→02/90	Stabiliser Mounting		MN-SB-5245	
	02/89→02/90	Stabiliser Mounting		MN-SB-5254	
	02/89→02/90	Stabiliser Mounting	MN-SB-9396		
	02/89→02/90	Suspension Arm Repair Kit		MN-SB-5244	for Wishbone (CV)
	02/89→02/90	Suspension Arm Repair Kit		MN-SB-5244	for Wishbone (CV), 1st RA
	02/89→02/90	Tie Rod End	CV-ES-2149		for Push Rod
	02/89→02/90	Tie Rod End	CV-ES-14162		for Steering Rod
02/89→02/90	Tie Rod End	CV-ES-14163		for Steering Rod	
02/89→02/90	Track Control Arm		MN-DL-3402	Trailing Arm	
26.262 DFK	01/88→02/90	Ball Head, gearshift linkage	CV-ES-2119		
	01/88→02/90	Ball Head, gearshift linkage	CV-ES-2120		
	01/88→02/90	Ball Head, gearshift linkage	CV-ES-2182		
	01/88→02/90	Centre Rod	MN-DL-2160		Coupling Rod
	01/88→02/90	Centre Rod	MN-DL-3588		Push Rod
	01/88→02/90	Centre Rod	MN-DL-12421		for Steering Rod
	01/88→02/90	Engine Mounting		MN-SB-10390	
	01/88→02/90	Engine Mounting	MN-SB-10389		
	01/88→02/90	Mounting, stabilizer coupling rod	MN-SB-5246		
	01/88→02/90	Stabiliser Mounting		MN-SB-5245	
	01/88→02/90	Stabiliser Mounting		MN-SB-5254	
	01/88→02/90	Stabiliser Mounting	MN-SB-9396		
	01/88→02/90	Suspension Arm Repair Kit		MN-SB-5244	for Wishbone (CV)
	01/88→02/90	Suspension Arm Repair Kit		MN-SB-5244	for Wishbone (CV), 1st RA
	01/88→02/90	Tie Rod End	CV-ES-2149		for Push Rod
01/88→02/90	Tie Rod End	CV-ES-14162		for Steering Rod	
01/88→02/90	Tie Rod End	CV-ES-14163		for Steering Rod	
01/88→02/90	Track Control Arm		MN-DL-3402	Trailing Arm	
01/88→02/90	Track Control Arm		MN-DL-3402	Trailing Arm, Drive Axle	

CV-ES-2119

Length: 55
Cone Ø: d1 Ø 10 / d2 Ø 10
Thread: M12 x 1,75 LHT
81953016063, 81953016131



CV-ES-2120

Length: 115
Cone Ø: d1 Ø 12,4 / d2 Ø 10,8
Thread: M14 x 1,5 RHT
03008500A, 81953016200, 81953016202,
81953016203, 81953016227



CV-ES-2149

Length: 160
Cone Ø: d1 Ø 30 / d2 Ø 27
Thread: M30 x 1,5 RHT
81953016263



CV-ES-2182

Length: 55
Cone Ø: d1 Ø 10 / d2 Ø 10
Thread: M12 x 1,75 RHT
81953016064, 81953016170



CV-ES-14162

Length: 125
Cone Ø: d1 Ø 30 / d2 Ø 27
Thread: M30 x 1,5 LHT
81953010015, 81953010083, 81953010087,
81953016029, 81953016030, 81953016043,
81953016044, 81953016050, 81953016054,
81953016087, 81953016091, 81953016107,
81953016120, 81953016125, 81953016152,
81953016155, 81953016157, 81953016168,
81953016179, 81953016181, 81953016223,
81953016237, 81953016254, 81953016275,
81953016279, 81953016351



CV-ES-14163

Length: 125
Cone Ø: d1 Ø 30 / d2 Ø 27
Thread: M30 x 1,5 RHT
95301.0084, 90804102156, 90804102272,
90804102696, 90804102710, 81953010016,
81953010075, 81953010084, 81953010088,
81953010094, 81953010103, 81953016030,
81953016043, 81953016048, 81953016049,
81953016053, 81953016061, 81953016090,
81953016108, 81953016112, 81953016126,
81953016143, 81953016149, 81953016154,
81953016156, 81953016168, 81953016178,
81953016194, 81953016206, 81953016224,
81953016234, 81953016242, 81953016252,
81953016274, 81953016278, 81953016284,
81953016286, 81953016308, 81953016310,
81953016312, 81953016347, 81953016350,
81953016352, 82953016012, 88953016014,
N2953016001



MN-DL-2160

Length: 1652 Ø: 50
Cone Ø: d1 Ø 30 / d2 Ø 27
81467106112, 81467106163, 81467106165,
81467106198, 81467106353, 81467106354,
81467106361, 81467116725



MN-DL-3402

Length: 590 Ø: 48
Hole Distance: 130 / 130
03307200A, 81432206067, 81432206068,
81432206090, 81432206092, 81432209092



MN-DL-3588

Length: 1035
Ø: 48
Cone Ø: d1 Ø 30 / d2 Ø 27
81466106333, 81466106334, 81466106354,
81466106355, 81466106360, 81466106361,
81466106721, 81466106722, 81466106723,
81466116216



MN-DL-12421

Length: 1070
Ø: 48
Cone Ø: d1 Ø 30 / d2 Ø 27
Thread: M30 x 1,5 RHT
81466106656, 81466106659, 81466106669,
81466116006, 81466116007



MN-SB-5244

Ø: 65
Hole Distance: 125
Thick/Height: 22
03312000A, 81432710027, 81432710082



MN-SB-5245

Ø: 75
Hole Distance: 125
Thick/Height: 22
03311900A, 81432710046, 81432710079,
81432710083



MN-SB-5246

Ø: 45 Thick/Height: 47
81437220022, 81437220038, 81962100450,
81962100469



MN-SB-5254

Length: 100
Ø: 93
Thick/Height: 70
81432710081



MN-SB-9396

Ø: 67
Thick/Height: 60
81437040057



MN-SB-10389

Ø: 70
Thick/Height: 72
81960200340



MN-SB-10390

Ø: 70
Thick/Height: 85/85
81960200341, 81960200373, 81960200385,
81960200408, 81960200418





F 90 ...

26.262 DFS	01/88→02/90	Ball Head, gearshift linkage	CV-ES-2119			
	01/88→02/90	Ball Head, gearshift linkage	CV-ES-2120			
	01/88→02/90	Ball Head, gearshift linkage	CV-ES-2182			
	01/88→02/90	Centre Rod	MN-DL-2160		Coupling Rod	
	01/88→02/90	Centre Rod	MN-DL-3588		Push Rod	
	01/88→02/90	Centre Rod	MN-DL-12421		for Steering Rod	
	01/88→02/90	Engine Mounting		MN-SB-10390		
	01/88→02/90	Engine Mounting	MN-SB-10389			
	01/88→02/90	Mounting, stabilizer coupling rod	MN-SB-5246			
	01/88→02/90	Stabiliser Mounting		MN-SB-5245		
	01/88→02/90	Stabiliser Mounting		MN-SB-5254		
	01/88→02/90	Stabiliser Mounting	MN-SB-9396			
	01/88→02/90	Suspension Arm Repair Kit		MN-SB-5244	for Wishbone (CV)	
	01/88→02/90	Suspension Arm Repair Kit		MN-SB-5244	for Wishbone (CV), 1st RA	
	01/88→02/90	Tie Rod End	CV-ES-2149		for Push Rod	
	01/88→02/90	Tie Rod End	CV-ES-14162		for Steering Rod	
	01/88→02/90	Tie Rod End	CV-ES-14163		for Steering Rod	
	01/88→02/90	Track Control Arm		MN-DL-3402	Trailing Arm	
	01/88→02/90	Track Control Arm		MN-DL-3402	Trailing Arm, Drive Axle	
	26.272 DF	02/90→01/91	Track Control Arm		MN-VB-5222	Wishbone (CV), Drive Axle
		02/90→06/96	Ball Head, gearshift linkage	CV-ES-2120		
		02/90→06/96	Centre Rod	MN-DL-12421		for Steering Rod
		02/90→06/96	Engine Mounting		MN-SB-10390	
		02/90→06/96	Engine Mounting	MN-SB-10389		
		02/90→06/96	Mounting, stabilizer coupling rod	MN-SB-5246		
02/90→06/96		Stabiliser Mounting		MN-SB-5245		
02/90→06/96		Stabiliser Mounting		MN-SB-5254		
02/90→06/96		Stabiliser Mounting	MN-SB-9396			
02/90→06/96		Suspension Arm Repair Kit		CV-RK-5313	for Wishbone (CV)	
02/90→06/96		Suspension Arm Repair Kit		MN-RK-7287	for Wishbone (CV)	
02/90→06/96		Suspension Arm Repair Kit		MN-SB-5244	for Wishbone (CV)	
02/90→06/96		Suspension Arm Repair Kit		MN-SB-5244	for Wishbone (CV), 1st RA	
02/90→06/96		Tie Rod End	CV-ES-14163		for Steering Rod	
02/90→06/96		Track Control Arm		MN-DL-3402	Trailing Arm	
02/90→06/96		Track Control Arm		MN-DL-3402	Trailing Arm, Drive Axle	
02/90→06/96		Track Control Arm		MN-VB-5222	Wishbone (CV)	
02/90→06/96		Track Control Arm		MN-VB-8569	Wishbone (CV)	
01/91→06/96		Track Control Arm		MN-VB-8569	Wishbone (CV), Drive Axle	
26.272 DFA		02/90→12/92	Ball Head, gearshift linkage	CV-ES-2120		
		02/90→12/92	Centre Rod	MN-DL-12421		for Steering Rod
		02/90→12/92	Engine Mounting	MN-SB-10389		
		02/90→12/92	Mounting, stabilizer coupling rod	MN-SB-5246		
		02/90→12/92	Stabiliser Mounting		MN-SB-5245	
		02/90→12/92	Stabiliser Mounting		MN-SB-5254	
	02/90→12/92	Stabiliser Mounting	MN-SB-9396			
	02/90→12/92	Suspension Arm Repair Kit		MN-SB-5244	for Wishbone (CV)	
	02/90→12/92	Suspension Arm Repair Kit		MN-SB-5244	for Wishbone (CV), 1st RA	
	02/90→12/92	Tie Rod End	CV-ES-14163		for Steering Rod	
	02/90→12/92	Track Control Arm		MN-DL-3402	Trailing Arm	
26.272 DFAK	02/90→12/92	Ball Head, gearshift linkage	CV-ES-2120			
	02/90→12/92	Centre Rod	MN-DL-12421		for Steering Rod	
	02/90→12/92	Engine Mounting	MN-SB-10389			
	02/90→12/92	Mounting, stabilizer coupling rod	MN-SB-5246			
	02/90→12/92	Stabiliser Mounting		MN-SB-5245		
	02/90→12/92	Stabiliser Mounting		MN-SB-5254		
	02/90→12/92	Stabiliser Mounting	MN-SB-9396			
	02/90→12/92	Suspension Arm Repair Kit		MN-SB-5244	for Wishbone (CV)	
	02/90→12/92	Suspension Arm Repair Kit		MN-SB-5244	for Wishbone (CV), 1st RA	
	02/90→12/92	Tie Rod End	CV-ES-14163		for Steering Rod	
02/90→12/92	Track Control Arm		MN-DL-3402	Trailing Arm		

CV-ES-2119

Length: 55
Cone Ø: d1 Ø 10 / d2 Ø 10
Thread: M12 x 1,75 LHT
81953016063, 81953016131



CV-ES-2120

Length: 115
Cone Ø: d1 Ø 12,4 / d2 Ø 10,8
Thread: M14 x 1,5 RHT
03008500A, 81953016200, 81953016202, 81953016203, 81953016227



CV-ES-2149

Length: 160
Cone Ø: d1 Ø 30 / d2 Ø 27
Thread: M30 x 1,5 RHT
81953016263



CV-ES-2182

Length: 55
Cone Ø: d1 Ø 10 / d2 Ø 10
Thread: M12 x 1,75 RHT
81953016064, 81953016170



CV-ES-14162

Length: 125
Cone Ø: d1 Ø 30 / d2 Ø 27
Thread: M30 x 1,5 LHT
81953010015, 81953010083, 81953010087, 81953016029, 81953016030, 81953016043, 81953016044, 81953016050, 81953016054, 81953016087, 81953016091, 81953016107, 81953016120, 81953016125, 81953016152, 81953016155, 81953016157, 81953016168, 81953016179, 81953016181, 81953016223, 81953016237, 81953016254, 81953016275, 81953016279, 81953016351



CV-ES-14163

Length: 125
Cone Ø: d1 Ø 30 / d2 Ø 27
Thread: M30 x 1,5 RHT
95301.0084, 90804102156, 90804102272, 90804102696, 90804102710, 81953010016, 81953010075, 81953010084, 81953010088, 81953010094, 81953010103, 81953016030, 81953016043, 81953016048, 81953016049, 81953016053, 81953016061, 81953016090, 81953016108, 81953016112, 81953016126, 81953016143, 81953016149, 81953016154, 81953016156, 81953016168, 81953016178, 81953016194, 81953016206, 81953016224, 81953016234, 81953016242, 81953016252, 81953016274, 81953016278, 81953016284, 81953016286, 81953016308, 81953016310, 81953016312, 81953016347, 81953016350, 81953016352, 82953016012, 88953016014, N2953016001



CV-RK-5313

Ø: 90
03304800A, 81953016132



MN-DL-2160

Length: 1652 Ø: 50
Cone Ø: d1 Ø 30 / d2 Ø 27
81467106112, 81467106163, 81467106165, 81467106198, 81467106353, 81467106354, 81467106361, 81467116725



MN-DL-3402

Length: 590 Ø: 48
Hole Distance: 130 / 130
03307200A, 81432206067, 81432206068, 81432206090, 81432206092, 81432209092



MN-DL-3588

Length: 1035
Ø: 48
Cone Ø: d1 Ø 30 / d2 Ø 27
81466106333, 81466106334, 81466106354, 81466106355, 81466106360, 81466106361, 81466106721, 81466106722, 81466106723, 81466116216



MN-DL-12421

Length: 1070
Ø: 48
Cone Ø: d1 Ø 30 / d2 Ø 27
Thread: M30 x 1,5 RHT
81466106656, 81466106659, 81466106669, 81466116006, 81466116007



MN-RK-7287

Ø: 90
Hole Distance: 152
Thick/Height: 35
03304700A, 81953016133



MN-SB-5244

Ø: 65
Hole Distance: 125
Thick/Height: 22
03312000A, 81432710027, 81432710082



MN-SB-5245

Ø: 75
Hole Distance: 125
Thick/Height: 22
03311900A, 81432710046, 81432710079, 81432710083



MN-SB-5246

Ø: 45 Thick/Height: 47
81437220022, 81437220038, 81962100450, 81962100469



MN-SB-5254

Length: 100
Ø: 93
Thick/Height: 70
81432710081



MN-SB-9396

Ø: 67
Thick/Height: 60
81437040057



MN-SB-10389

Ø: 70
Thick/Height: 72
81960200340



MN-SB-10390

Ø: 70
Thick/Height: 85/85
81960200341, 81960200373, 81960200385, 81960200408, 81960200418



MN-VB-5222

Length: 627 Ø: 50
Hole Distance: 152 / 152
81432706030, 81432706034, 81432706054, 81432706055, 81432706056, 81432706057, 81432706067, 81432706068, 81432706074, 81432706075, 81432706076, 81432706077, 81432706078, 81432706081, 81432706082, 81432709034, 81432709076, 81432709078, 8143706054



MN-VB-8569

Length: 627
Ø: 58
Hole Distance: 152 / 152
81432706055, 81432706056, 81432706067, 81432706068, 81432706075, 81432706077, 81432706081, 81432709056





F 90 ...

26.272 DFAS	02/90→12/92	Ball Head, gearshift linkage	CV-ES-2120			
	02/90→12/92	Centre Rod	MN-DL-12421		for Steering Rod	
	02/90→12/92	Engine Mounting	MN-SB-10389			
	02/90→12/92	Mounting, stabilizer coupling rod	MN-SB-5246			
	02/90→12/92	Stabiliser Mounting		MN-SB-5245		
	02/90→12/92	Stabiliser Mounting		MN-SB-5254		
	02/90→12/92	Stabiliser Mounting	MN-SB-9396			
	02/90→12/92	Suspension Arm Repair Kit		MN-SB-5244	for Wishbone (CV)	
	02/90→12/92	Suspension Arm Repair Kit		MN-SB-5244	for Wishbone (CV), 1st RA	
	02/90→12/92	Tie Rod End	CV-ES-14163		for Steering Rod	
	02/90→12/92	Track Control Arm		MN-DL-3402	Trailing Arm	
	26.272 DFK	02/90→01/91	Track Control Arm		MN-VB-5222	Wishbone (CV), Drive Axle
		02/90→06/96	Ball Head, gearshift linkage	CV-ES-2120		
		02/90→06/96	Centre Rod	MN-DL-12421		for Steering Rod
02/90→06/96		Engine Mounting		MN-SB-10390		
02/90→06/96		Engine Mounting	MN-SB-10389			
02/90→06/96		Mounting, stabilizer coupling rod	MN-SB-5246			
02/90→06/96		Stabiliser Mounting		MN-SB-5245		
02/90→06/96		Stabiliser Mounting		MN-SB-5254		
02/90→06/96		Stabiliser Mounting	MN-SB-9396			
02/90→06/96		Suspension Arm Repair Kit		CV-RK-5313	for Wishbone (CV)	
02/90→06/96		Suspension Arm Repair Kit		MN-RK-7287	for Wishbone (CV)	
02/90→06/96		Suspension Arm Repair Kit		MN-SB-5244	for Wishbone (CV)	
02/90→06/96		Suspension Arm Repair Kit		MN-SB-5244	for Wishbone (CV), 1st RA	
02/90→06/96		Tie Rod End	CV-ES-14163		for Steering Rod	
02/90→06/96		Track Control Arm		MN-DL-3402	Trailing Arm	
02/90→06/96		Track Control Arm		MN-DL-3402	Trailing Arm, Drive Axle	
02/90→06/96		Track Control Arm		MN-VB-5222	Wishbone (CV)	
02/90→06/96		Track Control Arm		MN-VB-8569	Wishbone (CV)	
26.272 DFS,26.272 DFLS		01/91→06/96	Track Control Arm		MN-VB-8569	Wishbone (CV), Drive Axle
	02/90→01/91	Track Control Arm		MN-VB-5222	Wishbone (CV), Drive Axle	
	02/90→06/96	Ball Head, gearshift linkage	CV-ES-2120			
	02/90→06/96	Centre Rod	MN-DL-12421		for Steering Rod	
	02/90→06/96	Engine Mounting		MN-SB-10390		
	02/90→06/96	Engine Mounting	MN-SB-10389			
	02/90→06/96	Mounting, stabilizer coupling rod	MN-SB-5246			
	02/90→06/96	Stabiliser Mounting		MN-SB-5245		
	02/90→06/96	Stabiliser Mounting		MN-SB-5254		
	02/90→06/96	Stabiliser Mounting	MN-SB-9396			
	02/90→06/96	Suspension Arm Repair Kit		CV-RK-5313	for Wishbone (CV)	
	02/90→06/96	Suspension Arm Repair Kit		CV-RK-8118	for Control Arm	
	02/90→06/96	Suspension Arm Repair Kit		MN-RK-7287	for Wishbone (CV)	
	02/90→06/96	Suspension Arm Repair Kit		MN-RK-7291	for Drag Link	
	02/90→06/96	Suspension Arm Repair Kit		MN-SB-5244	for Wishbone (CV)	
	02/90→06/96	Suspension Arm Repair Kit		MN-SB-5244	for Wishbone (CV), 1st RA	
	02/90→06/96	Tie Rod End	CV-ES-14163		for Steering Rod	
	02/90→06/96	Track Control Arm		MN-DL-3402	Trailing Arm	
	02/90→06/96	Track Control Arm		MN-DL-3402	Trailing Arm, Drive Axle	
	02/90→06/96	Track Control Arm		MN-DL-5212	Trailing Arm, Air Suspension Axle;Drive Axle	
	02/90→06/96	Track Control Arm		MN-VB-5222	Wishbone (CV)	
02/90→06/96	Track Control Arm		MN-VB-5222	Wishbone (CV), Drive Axle;Air Suspension Axle		
02/90→06/96	Track Control Arm		MN-VB-8569	Wishbone (CV)		
01/91→06/96	Track Control Arm		MN-VB-8569	Wishbone (CV), Drive Axle		
26.272 FNL,26.272 FNLL	03/91→05/95	Ball Head, gearshift linkage	CV-ES-2120			
	03/91→05/95	Centre Rod	MN-DL-12421		for Steering Rod	
	03/91→05/95	Engine Mounting	MN-SB-10389			
	03/91→05/95	Suspension Arm Repair Kit		CV-RK-5313	for Wishbone (CV)	
	03/91→05/95	Suspension Arm Repair Kit		CV-RK-8118	for Control Arm	
	03/91→05/95	Suspension Arm Repair Kit		MN-RK-7280	for Drag Link	
	03/91→05/95	Suspension Arm Repair Kit		MN-RK-7287	for Wishbone (CV)	
	03/91→05/95	Suspension Arm Repair Kit		MN-RK-7291	for Drag Link	
	03/91→05/95	Tie Rod	MN-DL-12284			
	03/91→05/95	Tie Rod End	CV-ES-14163		for Steering Rod	

CV-ES-2120

Length: 115
Cone Ø: d1 Ø 12,4 / d2 Ø 10,8
Thread: M14 x 1,5 RHT
03008500A, 81953016200, 81953016202, 81953016203, 81953016227



CV-ES-14163

Length: 125
Cone Ø: d1 Ø 30 / d2 Ø 27
Thread: M30 x 1,5 RHT
95301.0084, 90804102156, 90804102272, 90804102696, 90804102710, 81953010016, 81953010075, 81953010084, 81953010088, 81953010094, 81953010103, 81953016030, 81953016043, 81953016048, 81953016049, 81953016053, 81953016061, 81953016090, 81953016108, 81953016112, 81953016126, 81953016143, 81953016149, 81953016154, 81953016156, 81953016168, 81953016178, 81953016194, 81953016206, 81953016224, 81953016234, 81953016242, 81953016252, 81953016274, 81953016278, 81953016284, 81953016286, 81953016308, 81953016310, 81953016312, 81953016347, 81953016350, 81953016352, 82953016012, 88953016014, N2953016001



CV-RK-5313

Ø: 90
03304800A, 81953016132



CV-RK-8118

Ø: 85
Hole Distance: 130
Thick/Height: 30
638862, 639287, 775201, 938423, 1104335, 1953248, 0003500506, 3500506, 11013547, 21032592, 42065912, 42488722, 070550504, 93192618, 070400009000, 634303610, 81432206055, 81432206073, 82262320660, 9544171010099, 5001842823, 7000307001, 8226232066



MN-DL-3402

Length: 590 Ø: 48
Hole Distance: 130 / 130
03307200A, 81432206067, 81432206068, 81432206090, 81432206092, 81432209092



MN-DL-5212

Length: 577 Ø: 48
Hole Distance: 130 / 130
81432206096, 81432206097, 81432206098, 81432206129, 81432209096, 81432209129, 81432306014, 81432306030



MN-DL-12284

Length: 1530 Ø: 50
Cone Ø: d1 Ø 30 / d2 Ø 27
81466106579, 81466106580, 81466106624, 81466116720, 81467116720, 81467116730, 81467116952



MN-DL-12421

Length: 1070
Ø: 48
Cone Ø: d1 Ø 30 / d2 Ø 27
Thread: M30 x 1,5 RHT
81466106656, 81466106659, 81466106669, 81466116006, 81466116007



MN-RK-7280

Ø: 75
Hole Distance: 115
Thick/Height: 24
0550806, 0639370, 689748, 10307400A, 81432306051, 81432306068, 81432706064



MN-RK-7287

Ø: 90
Hole Distance: 152
Thick/Height: 35
03304700A, 81953016133



MN-RK-7291

Ø: 72
Hole Distance: 130
Thick/Height: 30
10307800A, 81432206108, 81432206132



MN-SB-5244

Ø: 65
Hole Distance: 125
Thick/Height: 22
03312000A, 81432710027, 81432710082



MN-SB-5245

Ø: 75
Hole Distance: 125
Thick/Height: 22
03311900A, 81432710046, 81432710079, 81432710083



MN-SB-5246

Ø: 45 Thick/Height: 47
81437220022, 81437220038, 81962100450, 81962100469



MN-SB-5254

Length: 100
Ø: 93
Thick/Height: 70
81432710081



MN-SB-9396

Ø: 67
Thick/Height: 60
81437040057



MN-SB-10389

Ø: 70
Thick/Height: 72
81960200340



MN-SB-10390

Ø: 70
Thick/Height: 85/85
81960200341, 81960200373, 81960200385, 81960200408, 81960200418



MN-VB-5222

Length: 627 Ø: 50
Hole Distance: 152 / 152
81432706030, 81432706034, 81432706054, 81432706055, 81432706056, 81432706057, 81432706067, 81432706068, 81432706074, 81432706075, 81432706076, 81432706077, 81432706078, 81432706081, 81432706082, 81432709034, 81432709076, 81432709078, 8143706054



MN-VB-8569

Length: 627
Ø: 58
Hole Distance: 152 / 152
81432706055, 81432706056, 81432706067, 81432706068, 81432706075, 81432706077, 81432706081, 81432709056





F 90 ...

26.272 FNL,26.272 FNLL ...	03/91→05/95	Track Control Arm		MN-DL-5212	Trailing Arm, Air Suspension Axle;Drive Axle; Tag Axle
	03/91→05/95	Track Control Arm		MN-VB-5222	Wishbone (CV), Drive Axle;Air Suspension Axle
	03/91→05/95	Track Control Arm		MN-VB-5222	Wishbone (CV), Tag Axle
26.272 FNLS,26.272 FVLS	09/90→12/95	Ball Head, gearshift linkage	CV-ES-2120		
	09/90→12/95	Centre Rod	MN-DL-12421		for Steering Rod
	09/90→12/95	Engine Mounting	MN-SB-10389		
	09/90→12/95	Stabiliser Mounting		MN-SB-5243	
	09/90→12/95	Stabiliser Mounting		MN-SB-5265	
	09/90→12/95	Stabiliser Mounting		MN-SB-5265	1st RA
	09/90→12/95	Suspension Arm Repair Kit		CV-RK-5313	for Wishbone (CV)
	09/90→12/95	Suspension Arm Repair Kit		CV-RK-8118	for Control Arm
	09/90→12/95	Suspension Arm Repair Kit		MN-RK-7280	for Drag Link
	09/90→12/95	Suspension Arm Repair Kit		MN-RK-7287	for Wishbone (CV)
	09/90→12/95	Suspension Arm Repair Kit		MN-RK-7291	for Drag Link
	09/90→12/95	Tie Rod	MN-DL-12284		
	09/90→12/95	Tie Rod End	CV-ES-14163		for Steering Rod
	09/90→12/95	Track Control Arm		MN-VB-5222	Wishbone (CV), Drive Axle;Air Suspension Axle
	09/90→12/95	Track Control Arm		MN-VB-5222	Wishbone (CV), Tag Axle
26.292 DF, 26.292 DFL	09/87→02/90	Ball Head, gearshift linkage	CV-ES-2119		
	09/87→02/90	Ball Head, gearshift linkage	CV-ES-2120		
	09/87→02/90	Ball Head, gearshift linkage	CV-ES-2182		
	09/87→02/90	Centre Rod	MN-DL-2160		Coupling Rod
	09/87→02/90	Centre Rod	MN-DL-3588		Push Rod
	09/87→02/90	Centre Rod	MN-DL-12421		for Steering Rod
	09/87→02/90	Engine Mounting		MN-SB-10390	
	09/87→02/90	Engine Mounting	MN-SB-10389		
	09/87→02/90	Mounting, stabilizer coupling rod	MN-SB-5246		
	09/87→02/90	Stabiliser Mounting		MN-SB-5245	
	09/87→02/90	Stabiliser Mounting		MN-SB-5254	
	09/87→02/90	Stabiliser Mounting	MN-SB-9396		
	09/87→02/90	Suspension Arm Repair Kit		MN-SB-5244	for Wishbone (CV)
	09/87→02/90	Suspension Arm Repair Kit		MN-SB-5244	for Wishbone (CV), 1st RA
	09/87→02/90	Tie Rod End	CV-ES-2149		for Push Rod
	09/87→02/90	Tie Rod End	CV-ES-14162		for Steering Rod
	09/87→02/90	Tie Rod End	CV-ES-14163		for Steering Rod
	09/87→02/90	Track Control Arm		MN-DL-3402	Trailing Arm
09/87→02/90	Track Control Arm		MN-DL-3402	Trailing Arm, Drive Axle	
26.292 DFA	05/88→02/90	Ball Head, gearshift linkage	CV-ES-2119		
	05/88→02/90	Ball Head, gearshift linkage	CV-ES-2120		
	05/88→02/90	Ball Head, gearshift linkage	CV-ES-2182		
	05/88→02/90	Centre Rod	MN-DL-2160		Coupling Rod
	05/88→02/90	Centre Rod	MN-DL-3588		Push Rod
	05/88→02/90	Centre Rod	MN-DL-12421		for Steering Rod
	05/88→02/90	Engine Mounting	MN-SB-10389		
	05/88→02/90	Mounting, stabilizer coupling rod	MN-SB-5246		
	05/88→02/90	Stabiliser Mounting		MN-SB-5245	
	05/88→02/90	Stabiliser Mounting		MN-SB-5254	
	05/88→02/90	Stabiliser Mounting	MN-SB-9396		
	05/88→02/90	Suspension Arm Repair Kit		MN-SB-5244	for Wishbone (CV)
	05/88→02/90	Suspension Arm Repair Kit		MN-SB-5244	for Wishbone (CV), 1st RA
	05/88→02/90	Tie Rod End	CV-ES-2149		for Push Rod
	05/88→02/90	Tie Rod End	CV-ES-14162		for Steering Rod
	05/88→02/90	Tie Rod End	CV-ES-14163		for Steering Rod
	05/88→02/90	Track Control Arm		MN-DL-3402	Trailing Arm
	26.292 DFAK	05/88→02/90	Ball Head, gearshift linkage	CV-ES-2119	
05/88→02/90		Ball Head, gearshift linkage	CV-ES-2120		
05/88→02/90		Ball Head, gearshift linkage	CV-ES-2182		
05/88→02/90		Centre Rod	MN-DL-2160		Coupling Rod
05/88→02/90		Centre Rod	MN-DL-3588		Push Rod
05/88→02/90		Centre Rod	MN-DL-12421		for Steering Rod
05/88→02/90		Engine Mounting	MN-SB-10389		
05/88→02/90		Mounting, stabilizer coupling rod	MN-SB-5246		

CV-ES-2119

Length: 55
Cone Ø: d1 Ø 10 / d2 Ø 10
Thread: M12 x 1,75 LHT
81953016063, 81953016131

**CV-ES-2120**

Length: 115
Cone Ø: d1 Ø 12,4 / d2 Ø 10,8
Thread: M14 x 1,5 RHT
03008500A, 81953016200, 81953016202,
81953016203, 81953016227

**CV-ES-2149**

Length: 160
Cone Ø: d1 Ø 30 / d2 Ø 27
Thread: M30 x 1,5 RHT
81953016263

**CV-ES-2182**

Length: 55
Cone Ø: d1 Ø 10 / d2 Ø 10
Thread: M12 x 1,75 RHT
81953016064, 81953016170

**CV-ES-14162**

Length: 125
Cone Ø: d1 Ø 30 / d2 Ø 27
Thread: M30 x 1,5 LHT
81953010015, 81953010083, 81953010087,
81953016029, 81953016030, 81953016043,
81953016044, 81953016050, 81953016054,
81953016087, 81953016091, 81953016107,
81953016120, 81953016125, 81953016152,
81953016155, 81953016157, 81953016168,
81953016179, 81953016181, 81953016223,
81953016237, 81953016254, 81953016275,
81953016279, 81953016351

**CV-ES-14163**

Length: 125
Cone Ø: d1 Ø 30 / d2 Ø 27
Thread: M30 x 1,5 RHT
95301.0084, 90804102156, 90804102272,
90804102696, 90804102710, 81953010016,
81953010075, 81953010084, 81953010088,
81953010094, 81953010103, 81953016030,
81953016043, 81953016048, 81953016049,
81953016053, 81953016061, 81953016090,
81953016108, 81953016112, 81953016126,
81953016143, 81953016149, 81953016154,
81953016156, 81953016168, 81953016178,
81953016194, 81953016206, 81953016224,
81953016234, 81953016242, 81953016252,
81953016274, 81953016278, 81953016284,
81953016286, 81953016308, 81953016310,
81953016312, 81953016347, 81953016350,
81953016352, 82953016012, 88953016014,
N2953016001

**CV-RK-5313**

Ø: 90
03304800A, 81953016132

**CV-RK-8118**

Ø: 85
Hole Distance: 130
Thick/Height: 30
638862, 639287, 775201, 938423,
1104335, 1953248, 0003500506, 3500506,
11013547, 21032592, 42065912, 42488722,
070550504, 93192618, 070400009000,
634303610, 81432206055, 81432206073,
82262320660, 9544171010099,
5001842823, 7000307001, 8226232066

**MN-DL-2160**

Length: 1652 Ø: 50
Cone Ø: d1 Ø 30 / d2 Ø 27
81467106112, 81467106163, 81467106165,
81467106198, 81467106353, 81467106354,
81467106361, 81467116725

**MN-DL-3402**

Length: 590 Ø: 48
Hole Distance: 130 / 130
03307200A, 81432206067, 81432206068,
81432206090, 81432206092, 81432209092

**MN-DL-3588**

Length: 1035 Ø: 48
Cone Ø: d1 Ø 30 / d2 Ø 27
81466106333, 81466106334, 81466106354,
81466106355, 81466106360, 81466106361,
81466106721, 81466106722, 81466106723,
81466116216

**MN-DL-5212**

Length: 577 Ø: 48
Hole Distance: 130 / 130
81432206096, 81432206097, 81432206098,
81432206129, 81432209096, 81432209129,
81432306014, 81432306030

**MN-DL-12284**

Length: 1530 Ø: 50
Cone Ø: d1 Ø 30 / d2 Ø 27
81466106579, 81466106580, 81466106624,
81466116720, 81467116720, 81467116730,
81467116952

**MN-DL-12421**

Length: 1070 Ø: 48
Cone Ø: d1 Ø 30 / d2 Ø 27
Thread: M30 x 1,5 RHT
81466106656, 81466106659, 81466106669,
81466116006, 81466116007

**MN-RK-7280**

Ø: 75
Hole Distance: 115
Thick/Height: 24
0550806, 0639370, 689748, 10307400A,
81432306051, 81432306068, 81432706064

**MN-RK-7287**

Ø: 90
Hole Distance: 152
Thick/Height: 35
03304700A, 81953016133

**MN-RK-7291**

Ø: 72
Hole Distance: 130
Thick/Height: 30
10307800A, 81432206108, 81432206132

**MN-SB-5243**

Length: 55 Ø: 78
Thick/Height: 60
03311100A, 81437040061, 81437220020

**MN-SB-5244**

Ø: 65
Hole Distance: 125
Thick/Height: 22
03312000A, 81432710027, 81432710082

**MN-SB-5245**

Ø: 75
Hole Distance: 125
Thick/Height: 22
03311900A, 81432710046, 81432710079,
81432710083

**MN-SB-5246**

Ø: 45 Thick/Height: 47
81437220022, 81437220038, 81962100450,
81962100469

**MN-SB-5254**

Length: 100 Ø: 93
Thick/Height: 70
81432710081

**MN-SB-5265**

Ø: 85 Thick/Height: 80
03310300A, 81437040032

**MN-SB-9396**

Ø: 67 Thick/Height: 60
81437040057

**MN-SB-10389**

Ø: 70 Thick/Height: 72
81960200340

**MN-SB-10390**

Ø: 70 Thick/Height: 85/85
81960200341, 81960200373, 81960200385,
81960200408, 81960200418

**MN-VB-5222**

Length: 627 Ø: 50
Hole Distance: 152 / 152
81432706030, 81432706034, 81432706054,
81432706055, 81432706056, 81432706057,
81432706067, 81432706068, 81432706074,
81432706075, 81432706076, 81432706077,
81432706078, 81432706081, 81432706082,
81432709034, 81432709076, 81432709078,
8143706054



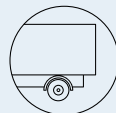

F 90 ...

26.292 DFAK ...	05/88→02/90	Stabiliser Mounting		MN-SB-5245	
	05/88→02/90	Stabiliser Mounting		MN-SB-5254	
	05/88→02/90	Stabiliser Mounting	MN-SB-9396		
	05/88→02/90	Suspension Arm Repair Kit		MN-SB-5244	for Wishbone (CV)
	05/88→02/90	Suspension Arm Repair Kit		MN-SB-5244	for Wishbone (CV), 1st RA
	05/88→02/90	Tie Rod End	CV-ES-2149		for Push Rod
	05/88→02/90	Tie Rod End	CV-ES-14162		for Steering Rod
	05/88→02/90	Tie Rod End	CV-ES-14163		for Steering Rod
	05/88→02/90	Track Control Arm		MN-DL-3402	Trailing Arm
26.292 DFAS	05/88→02/90	Ball Head, gearshift linkage	CV-ES-2119		
	05/88→02/90	Ball Head, gearshift linkage	CV-ES-2120		
	05/88→02/90	Ball Head, gearshift linkage	CV-ES-2182		
	05/88→02/90	Centre Rod	MN-DL-2160		Coupling Rod
	05/88→02/90	Centre Rod	MN-DL-3588		Push Rod
	05/88→02/90	Centre Rod	MN-DL-12421		for Steering Rod
	05/88→02/90	Engine Mounting	MN-SB-10389		
	05/88→02/90	Mounting, stabilizer coupling rod	MN-SB-5246		
	05/88→02/90	Stabiliser Mounting		MN-SB-5245	
	05/88→02/90	Stabiliser Mounting		MN-SB-5254	
	05/88→02/90	Stabiliser Mounting	MN-SB-9396		
	05/88→02/90	Suspension Arm Repair Kit		MN-SB-5244	for Wishbone (CV)
	05/88→02/90	Suspension Arm Repair Kit		MN-SB-5244	for Wishbone (CV), 1st RA
	05/88→02/90	Tie Rod End	CV-ES-2149		for Push Rod
	05/88→02/90	Tie Rod End	CV-ES-14162		for Steering Rod
	05/88→02/90	Tie Rod End	CV-ES-14163		for Steering Rod
	05/88→02/90	Track Control Arm		MN-DL-3402	Trailing Arm
26.292 DFK	09/87→02/90	Ball Head, gearshift linkage	CV-ES-2119		
	09/87→02/90	Ball Head, gearshift linkage	CV-ES-2120		
	09/87→02/90	Ball Head, gearshift linkage	CV-ES-2182		
	09/87→02/90	Centre Rod	MN-DL-2160		Coupling Rod
	09/87→02/90	Centre Rod	MN-DL-3588		Push Rod
	09/87→02/90	Centre Rod	MN-DL-12421		for Steering Rod
	09/87→02/90	Engine Mounting		MN-SB-10390	
	09/87→02/90	Engine Mounting	MN-SB-10389		
	09/87→02/90	Mounting, stabilizer coupling rod	MN-SB-5246		
	09/87→02/90	Stabiliser Mounting		MN-SB-5245	
	09/87→02/90	Stabiliser Mounting		MN-SB-5254	
	09/87→02/90	Stabiliser Mounting	MN-SB-9396		
	09/87→02/90	Suspension Arm Repair Kit		MN-SB-5244	for Wishbone (CV)
	09/87→02/90	Suspension Arm Repair Kit		MN-SB-5244	for Wishbone (CV), 1st RA
	09/87→02/90	Tie Rod End	CV-ES-2149		for Push Rod
	09/87→02/90	Tie Rod End	CV-ES-14162		for Steering Rod
	09/87→02/90	Tie Rod End	CV-ES-14163		for Steering Rod
	09/87→02/90	Track Control Arm		MN-DL-3402	Trailing Arm
	09/87→02/90	Track Control Arm		MN-DL-3402	Trailing Arm, Drive Axle
26.292 DFS	09/87→02/90	Ball Head, gearshift linkage	CV-ES-2119		
	09/87→02/90	Ball Head, gearshift linkage	CV-ES-2120		
	09/87→02/90	Ball Head, gearshift linkage	CV-ES-2182		
	09/87→02/90	Centre Rod	MN-DL-2160		Coupling Rod
	09/87→02/90	Centre Rod	MN-DL-3588		Push Rod
	09/87→02/90	Centre Rod	MN-DL-12421		for Steering Rod
	09/87→02/90	Engine Mounting		MN-SB-10390	
	09/87→02/90	Engine Mounting	MN-SB-10389		
	09/87→02/90	Mounting, stabilizer coupling rod	MN-SB-5246		
	09/87→02/90	Stabiliser Mounting		MN-SB-5245	
	09/87→02/90	Stabiliser Mounting		MN-SB-5254	
	09/87→02/90	Stabiliser Mounting	MN-SB-9396		
	09/87→02/90	Suspension Arm Repair Kit		MN-SB-5244	for Wishbone (CV)
	09/87→02/90	Suspension Arm Repair Kit		MN-SB-5244	for Wishbone (CV), 1st RA
	09/87→02/90	Tie Rod End	CV-ES-2149		for Push Rod
	09/87→02/90	Tie Rod End	CV-ES-14162		for Steering Rod
	09/87→02/90	Tie Rod End	CV-ES-14163		for Steering Rod
	09/87→02/90	Track Control Arm		MN-DL-3402	Trailing Arm
	09/87→02/90	Track Control Arm		MN-DL-3402	Trailing Arm, Drive Axle

CV-ES-2119

Length: 55
Cone Ø: d1 Ø 10 / d2 Ø 10
Thread: M12 x 1,75 LHT
81953016063, 81953016131



CV-ES-2120

Length: 115
Cone Ø: d1 Ø 12,4 / d2 Ø 10,8
Thread: M14 x 1,5 RHT
03008500A, 81953016200, 81953016202,
81953016203, 81953016227



CV-ES-2149

Length: 160
Cone Ø: d1 Ø 30 / d2 Ø 27
Thread: M30 x 1,5 RHT
81953016263



CV-ES-2182

Length: 55
Cone Ø: d1 Ø 10 / d2 Ø 10
Thread: M12 x 1,75 RHT
81953016064, 81953016170



CV-ES-14162

Length: 125
Cone Ø: d1 Ø 30 / d2 Ø 27
Thread: M30 x 1,5 LHT
81953010015, 81953010083, 81953010087,
81953016029, 81953016030, 81953016043,
81953016044, 81953016050, 81953016054,
81953016087, 81953016091, 81953016107,
81953016120, 81953016125, 81953016152,
81953016155, 81953016157, 81953016168,
81953016179, 81953016181, 81953016223,
81953016237, 81953016254, 81953016275,
81953016279, 81953016351



CV-ES-14163

Length: 125
Cone Ø: d1 Ø 30 / d2 Ø 27
Thread: M30 x 1,5 RHT
95301.0084, 90804102156, 90804102272,
90804102696, 90804102710, 81953010016,
81953010075, 81953010084, 81953010088,
81953010094, 81953010103, 81953016030,
81953016043, 81953016048, 81953016049,
81953016053, 81953016061, 81953016090,
81953016108, 81953016112, 81953016126,
81953016143, 81953016149, 81953016154,
81953016156, 81953016168, 81953016178,
81953016194, 81953016206, 81953016224,
81953016234, 81953016242, 81953016252,
81953016274, 81953016278, 81953016284,
81953016286, 81953016308, 81953016310,
81953016312, 81953016347, 81953016350,
81953016352, 82953016012, 88953016014,
N2953016001



MN-DL-2160

Length: 1652 Ø: 50
Cone Ø: d1 Ø 30 / d2 Ø 27
81467106112, 81467106163, 81467106165,
81467106198, 81467106353, 81467106354,
81467106361, 81467116725



MN-DL-3402

Length: 590 Ø: 48
Hole Distance: 130 / 130
03307200A, 81432206067, 81432206068,
81432206090, 81432206092, 81432209092



MN-DL-3588

Length: 1035
Ø: 48
Cone Ø: d1 Ø 30 / d2 Ø 27
81466106333, 81466106334, 81466106354,
81466106355, 81466106360, 81466106361,
81466106721, 81466106722, 81466106723,
81466116216



MN-DL-12421

Length: 1070
Ø: 48
Cone Ø: d1 Ø 30 / d2 Ø 27
Thread: M30 x 1,5 RHT
81466106656, 81466106659, 81466106669,
81466116006, 81466116007



MN-SB-5244

Ø: 65
Hole Distance: 125
Thick/Height: 22
03312000A, 81432710027, 81432710082



MN-SB-5245

Ø: 75
Hole Distance: 125
Thick/Height: 22
03311900A, 81432710046, 81432710079,
81432710083



MN-SB-5246

Ø: 45 Thick/Height: 47
81437220022, 81437220038, 81962100450,
81962100469



MN-SB-5254

Length: 100
Ø: 93
Thick/Height: 70
81432710081



MN-SB-9396

Ø: 67
Thick/Height: 60
81437040057



MN-SB-10389

Ø: 70
Thick/Height: 72
81960200340



MN-SB-10390

Ø: 70
Thick/Height: 85/85
81960200341, 81960200373, 81960200385,
81960200408, 81960200418





F 90 ...

26.302 DF	05/90→12/91	Ball Head, gearshift linkage	CV-ES-2119			
	05/90→12/91	Ball Head, gearshift linkage	CV-ES-2120			
	05/90→12/91	Ball Head, gearshift linkage	CV-ES-2182			
	05/90→12/91	Centre Rod	MN-DL-2160		Coupling Rod	
	05/90→12/91	Centre Rod	MN-DL-3588		Push Rod	
	05/90→12/91	Centre Rod	MN-DL-12421		for Steering Rod	
	05/90→12/91	Engine Mounting		MN-SB-10390		
	05/90→12/91	Engine Mounting	MN-SB-10389			
	05/90→12/91	Mounting, stabilizer coupling rod	MN-SB-5246			
	05/90→12/91	Stabiliser Mounting		MN-SB-5245		
	05/90→12/91	Stabiliser Mounting		MN-SB-5254		
	05/90→12/91	Stabiliser Mounting	MN-SB-9396			
	05/90→12/91	Suspension Arm Repair Kit		MN-SB-5244	for Wishbone (CV)	
	05/90→12/91	Suspension Arm Repair Kit		MN-SB-5244	for Wishbone (CV), 1st RA	
	05/90→12/91	Tie Rod End	CV-ES-2149		for Push Rod	
	05/90→12/91	Tie Rod End	CV-ES-14162		for Steering Rod	
	05/90→12/91	Tie Rod End	CV-ES-14163		for Steering Rod	
	05/90→12/91	Track Control Arm		MN-DL-3402	Trailing Arm	
	05/90→12/91	Track Control Arm		MN-DL-3402	Trailing Arm, Drive Axle	
	26.302 DFA	05/90→12/91	Ball Head, gearshift linkage	CV-ES-2119		
		05/90→12/91	Ball Head, gearshift linkage	CV-ES-2120		
		05/90→12/91	Ball Head, gearshift linkage	CV-ES-2182		
		05/90→12/91	Centre Rod	MN-DL-2160		Coupling Rod
		05/90→12/91	Centre Rod	MN-DL-3588		Push Rod
		05/90→12/91	Centre Rod	MN-DL-12421		for Steering Rod
05/90→12/91		Engine Mounting	MN-SB-10389			
05/90→12/91		Mounting, stabilizer coupling rod	MN-SB-5246			
05/90→12/91		Stabiliser Mounting		MN-SB-5245		
05/90→12/91		Stabiliser Mounting		MN-SB-5254		
05/90→12/91		Stabiliser Mounting	MN-SB-9396			
05/90→12/91		Suspension Arm Repair Kit		MN-SB-5244	for Wishbone (CV)	
05/90→12/91		Suspension Arm Repair Kit		MN-SB-5244	for Wishbone (CV), 1st RA	
05/90→12/91		Tie Rod End	CV-ES-2149		for Push Rod	
05/90→12/91		Tie Rod End	CV-ES-14162		for Steering Rod	
05/90→12/91		Tie Rod End	CV-ES-14163		for Steering Rod	
05/90→12/91		Track Control Arm		MN-DL-3402	Trailing Arm	
26.302 DFAK	05/90→12/91	Ball Head, gearshift linkage	CV-ES-2119			
	05/90→12/91	Ball Head, gearshift linkage	CV-ES-2120			
	05/90→12/91	Ball Head, gearshift linkage	CV-ES-2182			
	05/90→12/91	Centre Rod	MN-DL-2160		Coupling Rod	
	05/90→12/91	Centre Rod	MN-DL-3588		Push Rod	
	05/90→12/91	Centre Rod	MN-DL-12421		for Steering Rod	
	05/90→12/91	Engine Mounting	MN-SB-10389			
	05/90→12/91	Mounting, stabilizer coupling rod	MN-SB-5246			
	05/90→12/91	Stabiliser Mounting		MN-SB-5245		
	05/90→12/91	Stabiliser Mounting		MN-SB-5254		
	05/90→12/91	Stabiliser Mounting	MN-SB-9396			
	05/90→12/91	Suspension Arm Repair Kit		MN-SB-5244	for Wishbone (CV)	
	05/90→12/91	Suspension Arm Repair Kit		MN-SB-5244	for Wishbone (CV), 1st RA	
	05/90→12/91	Tie Rod End	CV-ES-2149		for Push Rod	
	05/90→12/91	Tie Rod End	CV-ES-14162		for Steering Rod	
	05/90→12/91	Tie Rod End	CV-ES-14163		for Steering Rod	
	05/90→12/91	Track Control Arm		MN-DL-3402	Trailing Arm	
26.302 DFAS	05/90→12/91	Ball Head, gearshift linkage	CV-ES-2119			
	05/90→12/91	Ball Head, gearshift linkage	CV-ES-2120			
	05/90→12/91	Ball Head, gearshift linkage	CV-ES-2182			
	05/90→12/91	Centre Rod	MN-DL-2160		Coupling Rod	
	05/90→12/91	Centre Rod	MN-DL-3588		Push Rod	
	05/90→12/91	Centre Rod	MN-DL-12421		for Steering Rod	
	05/90→12/91	Engine Mounting	MN-SB-10389			
	05/90→12/91	Mounting, stabilizer coupling rod	MN-SB-5246			
	05/90→12/91	Stabiliser Mounting		MN-SB-5245		
	05/90→12/91	Stabiliser Mounting		MN-SB-5254		

CV-ES-2119

Length: 55
Cone Ø: d1 Ø 10 / d2 Ø 10
Thread: M12 x 1,75 LHT
81953016063, 81953016131



CV-ES-2120

Length: 115
Cone Ø: d1 Ø 12,4 / d2 Ø 10,8
Thread: M14 x 1,5 RHT
03008500A, 81953016200, 81953016202,
81953016203, 81953016227



CV-ES-2149

Length: 160
Cone Ø: d1 Ø 30 / d2 Ø 27
Thread: M30 x 1,5 RHT
81953016263



CV-ES-2182

Length: 55
Cone Ø: d1 Ø 10 / d2 Ø 10
Thread: M12 x 1,75 RHT
81953016064, 81953016170



CV-ES-14162

Length: 125
Cone Ø: d1 Ø 30 / d2 Ø 27
Thread: M30 x 1,5 LHT
81953010015, 81953010083, 81953010087,
81953016029, 81953016030, 81953016043,
81953016044, 81953016050, 81953016054,
81953016087, 81953016091, 81953016107,
81953016120, 81953016125, 81953016152,
81953016155, 81953016157, 81953016168,
81953016179, 81953016181, 81953016223,
81953016237, 81953016254, 81953016275,
81953016279, 81953016351



CV-ES-14163

Length: 125
Cone Ø: d1 Ø 30 / d2 Ø 27
Thread: M30 x 1,5 RHT
95301.0084, 90804102156, 90804102272,
90804102696, 90804102710, 81953010016,
81953010075, 81953010084, 81953010088,
81953010094, 81953010103, 81953016030,
81953016043, 81953016048, 81953016049,
81953016053, 81953016061, 81953016090,
81953016108, 81953016112, 81953016126,
81953016143, 81953016149, 81953016154,
81953016156, 81953016168, 81953016178,
81953016194, 81953016206, 81953016224,
81953016234, 81953016242, 81953016252,
81953016274, 81953016278, 81953016284,
81953016286, 81953016308, 81953016310,
81953016312, 81953016347, 81953016350,
81953016352, 82953016012, 88953016014,
N2953016001



MN-DL-2160

Length: 1652 Ø: 50
Cone Ø: d1 Ø 30 / d2 Ø 27
81467106112, 81467106163, 81467106165,
81467106198, 81467106353, 81467106354,
81467106361, 81467116725



MN-DL-3402

Length: 590 Ø: 48
Hole Distance: 130 / 130
03307200A, 81432206067, 81432206068,
81432206090, 81432206092, 81432209092



MN-DL-3588

Length: 1035
Ø: 48
Cone Ø: d1 Ø 30 / d2 Ø 27
81466106333, 81466106334, 81466106354,
81466106355, 81466106360, 81466106361,
81466106721, 81466106722, 81466106723,
81466116216



MN-DL-12421

Length: 1070
Ø: 48
Cone Ø: d1 Ø 30 / d2 Ø 27
Thread: M30 x 1,5 RHT
81466106656, 81466106659, 81466106669,
81466116006, 81466116007



MN-SB-5244

Ø: 65
Hole Distance: 125
Thick/Height: 22
03312000A, 81432710027, 81432710082



MN-SB-5245

Ø: 75
Hole Distance: 125
Thick/Height: 22
03311900A, 81432710046, 81432710079,
81432710083



MN-SB-5246

Ø: 45 Thick/Height: 47
81437220022, 81437220038, 81962100450,
81962100469



MN-SB-5254

Length: 100
Ø: 93
Thick/Height: 70
81432710081



MN-SB-9396

Ø: 67
Thick/Height: 60
81437040057



MN-SB-10389

Ø: 70
Thick/Height: 72
81960200340



MN-SB-10390

Ø: 70
Thick/Height: 85/85
81960200341, 81960200373, 81960200385,
81960200408, 81960200418



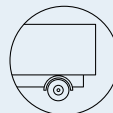

F 90 ...

26.302 DFAS ...	05/90→12/91	Stabiliser Mounting	MN-SB-9396		
	05/90→12/91	Suspension Arm Repair Kit		MN-SB-5244	for Wishbone (CV)
	05/90→12/91	Suspension Arm Repair Kit		MN-SB-5244	for Wishbone (CV), 1st RA
	05/90→12/91	Tie Rod End	CV-ES-2149		for Push Rod
	05/90→12/91	Tie Rod End	CV-ES-14162		for Steering Rod
	05/90→12/91	Tie Rod End	CV-ES-14163		for Steering Rod
	05/90→12/91	Track Control Arm		MN-DL-3402	Trailing Arm
26.302 DFK	05/90→12/91	Ball Head, gearshift linkage	CV-ES-2119		
	05/90→12/91	Ball Head, gearshift linkage	CV-ES-2120		
	05/90→12/91	Ball Head, gearshift linkage	CV-ES-2182		
	05/90→12/91	Centre Rod	MN-DL-2160		Coupling Rod
	05/90→12/91	Centre Rod	MN-DL-3588		Push Rod
	05/90→12/91	Centre Rod	MN-DL-12421		for Steering Rod
	05/90→12/91	Engine Mounting		MN-SB-10390	
	05/90→12/91	Engine Mounting	MN-SB-10389		
	05/90→12/91	Mounting, stabilizer coupling rod	MN-SB-5246		
	05/90→12/91	Stabiliser Mounting		MN-SB-5245	
	05/90→12/91	Stabiliser Mounting		MN-SB-5254	
	05/90→12/91	Stabiliser Mounting	MN-SB-9396		
	05/90→12/91	Suspension Arm Repair Kit		MN-SB-5244	for Wishbone (CV)
	05/90→12/91	Suspension Arm Repair Kit		MN-SB-5244	for Wishbone (CV), 1st RA
	05/90→12/91	Tie Rod End	CV-ES-2149		for Push Rod
	05/90→12/91	Tie Rod End	CV-ES-14162		for Steering Rod
	05/90→12/91	Tie Rod End	CV-ES-14163		for Steering Rod
	05/90→12/91	Track Control Arm		MN-DL-3402	Trailing Arm
	05/90→12/91	Track Control Arm		MN-DL-3402	Trailing Arm, Drive Axle
	26.302 DFS	05/90→12/91	Ball Head, gearshift linkage	CV-ES-2119	
05/90→12/91		Ball Head, gearshift linkage	CV-ES-2120		
05/90→12/91		Ball Head, gearshift linkage	CV-ES-2182		
05/90→12/91		Centre Rod	MN-DL-2160		Coupling Rod
05/90→12/91		Centre Rod	MN-DL-3588		Push Rod
05/90→12/91		Centre Rod	MN-DL-12421		for Steering Rod
05/90→12/91		Engine Mounting		MN-SB-10390	
05/90→12/91		Engine Mounting	MN-SB-10389		
05/90→12/91		Mounting, stabilizer coupling rod	MN-SB-5246		
05/90→12/91		Stabiliser Mounting		MN-SB-5245	
05/90→12/91		Stabiliser Mounting		MN-SB-5254	
05/90→12/91		Stabiliser Mounting	MN-SB-9396		
05/90→12/91		Suspension Arm Repair Kit		MN-SB-5244	for Wishbone (CV)
05/90→12/91		Suspension Arm Repair Kit		MN-SB-5244	for Wishbone (CV), 1st RA
05/90→12/91		Tie Rod End	CV-ES-2149		for Push Rod
05/90→12/91		Tie Rod End	CV-ES-14162		for Steering Rod
05/90→12/91		Tie Rod End	CV-ES-14163		for Steering Rod
05/90→12/91		Track Control Arm		MN-DL-3402	Trailing Arm
05/90→12/91		Track Control Arm		MN-DL-3402	Trailing Arm, Drive Axle
26.302 FNL, 26.302 FNLL, 26.302 FVL		03/91→12/91	Ball Head, gearshift linkage	CV-ES-2119	
	03/91→12/91	Ball Head, gearshift linkage	CV-ES-2120		
	03/91→12/91	Ball Head, gearshift linkage	CV-ES-2182		
	03/91→12/91	Centre Rod	MN-DL-2160		Coupling Rod
	03/91→12/91	Centre Rod	MN-DL-3588		Push Rod
	03/91→12/91	Centre Rod	MN-DL-12421		for Steering Rod
	03/91→12/91	Engine Mounting	MN-SB-10389		
	03/91→12/91	Suspension Arm Repair Kit		CV-RK-5313	for Wishbone (CV)
	03/91→12/91	Suspension Arm Repair Kit		CV-RK-8118	for Control Arm
	03/91→12/91	Suspension Arm Repair Kit		MN-RK-7280	for Drag Link
	03/91→12/91	Suspension Arm Repair Kit		MN-RK-7287	for Wishbone (CV)
	03/91→12/91	Suspension Arm Repair Kit		MN-RK-7291	for Drag Link
	03/91→12/91	Tie Rod	MN-DL-12284		
	03/91→12/91	Tie Rod End	CV-ES-2149		for Push Rod
	03/91→12/91	Tie Rod End	CV-ES-14162		for Steering Rod
	03/91→12/91	Tie Rod End	CV-ES-14163		for Steering Rod
	03/91→12/91	Track Control Arm		MN-DL-5212	Trailing Arm, Air Suspension Axle; Drive Axle; Tag Axle

CV-ES-2119

Length: 55
Cone Ø: d1 Ø 10 / d2 Ø 10
Thread: M12 x 1,75 LHT
81953016063, 81953016131



CV-ES-2120

Length: 115
Cone Ø: d1 Ø 12,4 / d2 Ø 10,8
Thread: M14 x 1,5 RHT
03008500A, 81953016200, 81953016202, 81953016203, 81953016227



CV-ES-2149

Length: 160
Cone Ø: d1 Ø 30 / d2 Ø 27
Thread: M30 x 1,5 RHT
81953016263



CV-ES-2182

Length: 55
Cone Ø: d1 Ø 10 / d2 Ø 10
Thread: M12 x 1,75 RHT
81953016064, 81953016170



CV-ES-14162

Length: 125
Cone Ø: d1 Ø 30 / d2 Ø 27
Thread: M30 x 1,5 LHT

81953010015, 81953010083, 81953010087, 81953016029, 81953016030, 81953016043, 81953016044, 81953016050, 81953016054, 81953016087, 81953016091, 81953016107, 81953016120, 81953016125, 81953016152, 81953016155, 81953016157, 81953016168, 81953016179, 81953016181, 81953016223, 81953016237, 81953016254, 81953016275, 81953016279, 81953016351



CV-ES-14163

Length: 125
Cone Ø: d1 Ø 30 / d2 Ø 27
Thread: M30 x 1,5 RHT

95301.0084, 90804102156, 90804102272, 90804102696, 90804102710, 81953010016, 81953010075, 81953010084, 81953010088, 81953010094, 81953010103, 81953016030, 81953016043, 81953016048, 81953016049, 81953016053, 81953016061, 81953016090, 81953016108, 81953016112, 81953016126, 81953016143, 81953016149, 81953016154, 81953016156, 81953016168, 81953016178, 81953016194, 81953016206, 81953016224, 81953016234, 81953016242, 81953016252, 81953016274, 81953016278, 81953016284, 81953016286, 81953016308, 81953016310, 81953016312, 81953016347, 81953016350, 81953016352, 82953016012, 88953016014, N2953016001



CV-RK-5313

Ø: 90
03304800A, 81953016132



CV-RK-8118

Ø: 85
Hole Distance: 130
Thick/Height: 30

638862, 639287, 775201, 938423, 1104335, 1953248, 3500506, 0003500506, 11013547, 21032592, 42065912, 42488722, 070550504, 93192618, 070400009000, 634303610, 81432206055, 81432206073, 82262320660, 9544171010099, 5001842823, 7000307001, 8226232066



MN-DL-2160

Length: 1652 Ø: 50
Cone Ø: d1 Ø 30 / d2 Ø 27

81467106112, 81467106163, 81467106165, 81467106198, 81467106353, 81467106354, 81467106361, 81467116725



MN-DL-3402

Length: 590 Ø: 48
Hole Distance: 130 / 130

03307200A, 81432206067, 81432206068, 81432206090, 81432206092, 81432209092



MN-DL-3588

Length: 1035 Ø: 48
Cone Ø: d1 Ø 30 / d2 Ø 27

81466106333, 81466106334, 81466106354, 81466106355, 81466106360, 81466106361, 81466106721, 81466106722, 81466106723, 81466116216



MN-DL-5212

Length: 577 Ø: 48
Hole Distance: 130 / 130

81432206096, 81432206097, 81432206098, 81432206129, 81432209096, 81432209129, 81432306014, 81432306030



MN-DL-12284

Length: 1530 Ø: 50
Cone Ø: d1 Ø 30 / d2 Ø 27

81466106579, 81466106580, 81466106624, 81466116720, 81467116720, 81467116730, 81467116952



MN-DL-12421

Length: 1070 Ø: 48
Cone Ø: d1 Ø 30 / d2 Ø 27
Thread: M30 x 1,5 RHT

81466106656, 81466106659, 81466106669, 81466116006, 81466116007



MN-RK-7280

Ø: 75
Hole Distance: 115
Thick/Height: 24

0550806, 0639370, 689748, 10307400A, 81432306051, 81432306068, 81432706064



MN-RK-7287

Ø: 90
Hole Distance: 152
Thick/Height: 35

03304700A, 81953016133



MN-RK-7291

Ø: 72
Hole Distance: 130
Thick/Height: 30

10307800A, 81432206108, 81432206132



MN-SB-5244

Ø: 65
Hole Distance: 125
Thick/Height: 22

03312000A, 81432710027, 81432710082



MN-SB-5245

Ø: 75
Hole Distance: 125
Thick/Height: 22

03311900A, 81432710046, 81432710079, 81432710083



MN-SB-5246

Ø: 45 Thick/Height: 47
81437220022, 81437220038, 81962100450, 81962100469



MN-SB-5254

Length: 100 Ø: 93
Thick/Height: 70

81432710081



MN-SB-9396

Ø: 67 Thick/Height: 60
81437040057



MN-SB-10389

Ø: 70 Thick/Height: 72
81960200340



MN-SB-10390

Ø: 70 Thick/Height: 85/85
81960200341, 81960200373, 81960200385, 81960200408, 81960200418



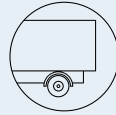

F 90 ...

26.302 FNL, 26.302 FNLL, 26.302 FVL ...	03/91→12/91	Track Control Arm		MN-VB-5222	Wishbone (CV), Drive Axle;Air Suspension Axle
	03/91→12/91	Track Control Arm		MN-VB-5222	Wishbone (CV), Tag Axle
26.302 FNLS,26.302 FVLS	09/90→12/91	Ball Head, gearshift linkage	CV-ES-2119		
	09/90→12/91	Ball Head, gearshift linkage	CV-ES-2120		
	09/90→12/91	Ball Head, gearshift linkage	CV-ES-2182		
	09/90→12/91	Centre Rod	MN-DL-2160		Coupling Rod
	09/90→12/91	Centre Rod	MN-DL-3588		Push Rod
	09/90→12/91	Centre Rod	MN-DL-12421		for Steering Rod
	09/90→12/91	Engine Mounting	MN-SB-10389		
	09/90→12/91	Stabiliser Mounting		MN-SB-5243	
	09/90→12/91	Stabiliser Mounting		MN-SB-5265	
	09/90→12/91	Stabiliser Mounting		MN-SB-5265	1st RA
	09/90→12/91	Suspension Arm Repair Kit		CV-RK-5313	for Wishbone (CV)
	09/90→12/91	Suspension Arm Repair Kit		CV-RK-8118	for Control Arm
	09/90→12/91	Suspension Arm Repair Kit		MN-RK-7280	for Drag Link
	09/90→12/91	Suspension Arm Repair Kit		MN-RK-7287	for Wishbone (CV)
	09/90→12/91	Suspension Arm Repair Kit		MN-RK-7291	for Drag Link
	09/90→12/91	Tie Rod	MN-DL-12284		
	09/90→12/91	Tie Rod End	CV-ES-2149		for Push Rod
	09/90→12/91	Tie Rod End	CV-ES-14162		for Steering Rod
	09/90→12/91	Tie Rod End	CV-ES-14163		for Steering Rod
	09/90→12/91	Track Control Arm		MN-VB-5222	Wishbone (CV), Drive Axle;Air Suspension Axle
	09/90→12/91	Track Control Arm		MN-VB-5222	Wishbone (CV), Tag Axle
26.322 DF	02/90→01/91	Track Control Arm		MN-VB-5222	Wishbone (CV), Drive Axle
	02/90→06/96	Ball Head, gearshift linkage	CV-ES-2119		
	02/90→06/96	Ball Head, gearshift linkage	CV-ES-2120		
	02/90→06/96	Ball Head, gearshift linkage	CV-ES-2182		
	02/90→06/96	Centre Rod	MN-DL-2160		Coupling Rod
	02/90→06/96	Centre Rod	MN-DL-3588		Push Rod
	02/90→06/96	Centre Rod	MN-DL-12421		for Steering Rod
	02/90→06/96	Engine Mounting		MN-SB-10390	
	02/90→06/96	Engine Mounting	MN-SB-10389		
	02/90→06/96	Mounting, stabilizer coupling rod	MN-SB-5246		
	02/90→06/96	Stabiliser Mounting		MN-SB-5245	
	02/90→06/96	Stabiliser Mounting		MN-SB-5254	
	02/90→06/96	Stabiliser Mounting	MN-SB-9396		
	02/90→06/96	Suspension Arm Repair Kit		CV-RK-5313	for Wishbone (CV)
	02/90→06/96	Suspension Arm Repair Kit		MN-RK-7287	for Wishbone (CV)
	02/90→06/96	Suspension Arm Repair Kit		MN-SB-5244	for Wishbone (CV)
	02/90→06/96	Suspension Arm Repair Kit		MN-SB-5244	for Wishbone (CV), 1st RA
	02/90→06/96	Tie Rod End	CV-ES-2149		for Push Rod
	02/90→06/96	Tie Rod End	CV-ES-14162		for Steering Rod
	02/90→06/96	Tie Rod End	CV-ES-14163		for Steering Rod
	02/90→06/96	Track Control Arm		MN-DL-3402	Trailing Arm
	02/90→06/96	Track Control Arm		MN-DL-3402	Trailing Arm, Drive Axle
	02/90→06/96	Track Control Arm		MN-VB-5222	Wishbone (CV)
	02/90→06/96	Track Control Arm		MN-VB-8569	Wishbone (CV)
	01/91→06/96	Track Control Arm		MN-VB-8569	Wishbone (CV), Drive Axle
26.322 DFA	02/90→12/92	Ball Head, gearshift linkage	CV-ES-2119		
	02/90→12/92	Ball Head, gearshift linkage	CV-ES-2120		
	02/90→12/92	Ball Head, gearshift linkage	CV-ES-2182		
	02/90→12/92	Centre Rod	MN-DL-2160		Coupling Rod
	02/90→12/92	Centre Rod	MN-DL-3588		Push Rod
	02/90→12/92	Centre Rod	MN-DL-12421		for Steering Rod
	02/90→12/92	Engine Mounting	MN-SB-10389		
	02/90→12/92	Mounting, stabilizer coupling rod	MN-SB-5246		
	02/90→12/92	Stabiliser Mounting		MN-SB-5245	
	02/90→12/92	Stabiliser Mounting		MN-SB-5254	
	02/90→12/92	Stabiliser Mounting	MN-SB-9396		
	02/90→12/92	Suspension Arm Repair Kit		MN-SB-5244	for Wishbone (CV)
	02/90→12/92	Suspension Arm Repair Kit		MN-SB-5244	for Wishbone (CV), 1st RA
	02/90→12/92	Tie Rod End	CV-ES-2149		for Push Rod
	02/90→12/92	Tie Rod End	CV-ES-14162		for Steering Rod

CV-ES-2119

Length: 55
Cone Ø: d1 Ø 10 / d2 Ø 10
Thread: M12 x 1,75 LHT
81953016063, 81953016131



CV-ES-2120

Length: 115
Cone Ø: d1 Ø 12,4 / d2 Ø 10,8
Thread: M14 x 1,5 RHT
03008500A, 81953016200, 81953016202,
81953016203, 81953016227



CV-ES-2149

Length: 160
Cone Ø: d1 Ø 30 / d2 Ø 27
Thread: M30 x 1,5 RHT
81953016263



CV-ES-2182

Length: 55
Cone Ø: d1 Ø 10 / d2 Ø 10
Thread: M12 x 1,75 RHT
81953016064, 81953016170



CV-ES-14162

Length: 125
Cone Ø: d1 Ø 30 / d2 Ø 27
Thread: M30 x 1,5 LHT
81953010015, 81953010083, 81953010087,
81953016029, 81953016030, 81953016043,
81953016044, 81953016050, 81953016054,
81953016087, 81953016091, 81953016107,
81953016120, 81953016125, 81953016152,
81953016155, 81953016157, 81953016168,
81953016179, 81953016181, 81953016223,
81953016237, 81953016254, 81953016275,
81953016279, 81953016351



CV-ES-14163

Length: 125
Cone Ø: d1 Ø 30 / d2 Ø 27
Thread: M30 x 1,5 RHT
95301.0084, 90804102156, 90804102272,
90804102696, 90804102710, 81953010016,
81953010075, 81953010084, 81953010088,
81953010094, 81953010103, 81953016030,
81953016043, 81953016048, 81953016049,
81953016053, 81953016061, 81953016090,
81953016108, 81953016112, 81953016126,
81953016143, 81953016149, 81953016154,
81953016156, 81953016168, 81953016178,
81953016194, 81953016206, 81953016224,
81953016234, 81953016242, 81953016252,
81953016274, 81953016278, 81953016284,
81953016286, 81953016308, 81953016310,
81953016312, 81953016347, 81953016350,
81953016352, 82953016012, 88953016014,
N2953016001



CV-RK-5313

Ø: 90
03304800A, 81953016132



CV-RK-8118

Ø: 85
Hole Distance: 130
Thick/Height: 30
638862, 639287, 775201, 938423,
1104335, 1953248, 3500506, 0003500506,
11013547, 21032592, 42065912, 42488722,
070550504, 93192618, 070400009000,
634303610, 81432206055, 81432206073,
82262320660, 9544171010099,
5001842823, 7000307001, 8226232066



MN-DL-2160

Length: 1652 Ø: 50
Cone Ø: d1 Ø 30 / d2 Ø 27
81467106112, 81467106163, 81467106165,
81467106198, 81467106353, 81467106354,
81467106361, 81467116725



MN-DL-3402

Length: 590 Ø: 48
Hole Distance: 130 / 130
03307200A, 81432206067, 81432206068,
81432206090, 81432206092, 81432209092



MN-DL-3588

Length: 1035 Ø: 48
Cone Ø: d1 Ø 30 / d2 Ø 27
81466106333, 81466106334, 81466106354,
81466106355, 81466106360, 81466106361,
81466106721, 81466106722, 81466106723,
81466116216



MN-DL-12284

Length: 1530 Ø: 50
Cone Ø: d1 Ø 30 / d2 Ø 27
81466106579, 81466106580, 81466106624,
81466116720, 81467116720, 81467116730,
81467116952



MN-DL-12421

Length: 1070 Ø: 48
Cone Ø: d1 Ø 30 / d2 Ø 27
Thread: M30 x 1,5 RHT
81466106656, 81466106659, 81466106669,
81466116006, 81466116007



MN-RK-7280

Ø: 75
Hole Distance: 115
Thick/Height: 24
0550806, 0639370, 689748, 10307400A,
81432306051, 81432306068, 81432706064



MN-RK-7287

Ø: 90
Hole Distance: 152
Thick/Height: 35
03304700A, 81953016133



MN-RK-7291

Ø: 72
Hole Distance: 130
Thick/Height: 30
10307800A, 81432206108, 81432206132



MN-SB-5243

Length: 55
Ø: 78
Thick/Height: 60
03311100A, 81437040061, 81437220020



MN-SB-5244

Ø: 65
Hole Distance: 125
Thick/Height: 22
03312000A, 81432710027, 81432710082



MN-SB-5245

Ø: 75
Hole Distance: 125
Thick/Height: 22
03311900A, 81432710046, 81432710079,
81432710083



MN-SB-5246

Ø: 45 Thick/Height: 47
81437220022, 81437220038, 81962100450,
81962100469



MN-SB-5254

Length: 100 Ø: 93
Thick/Height: 70
81432710081



MN-SB-5265

Ø: 85 Thick/Height: 80
03310300A, 81437040032



MN-SB-9396

Ø: 67 Thick/Height: 60
81437040057



MN-SB-10389

Ø: 70 Thick/Height: 72
81960200340



MN-SB-10390

Ø: 70 Thick/Height: 85/85
81960200341, 81960200373, 81960200385,
81960200408, 81960200418



MN-VB-5222

Length: 627 Ø: 50
Hole Distance: 152 / 152
81432706030, 81432706034, 81432706054,
81432706055, 81432706056, 81432706057,
81432706067, 81432706068, 81432706074,
81432706075, 81432706076, 81432706077,
81432706078, 81432706081, 81432706082,
81432709034, 81432709076, 81432709078,
8143706054



MN-VB-8569

Length: 627 Ø: 58
Hole Distance: 152 / 152
81432706055, 81432706056, 81432706067,
81432706068, 81432706075, 81432706077,
81432706081, 81432709056





F 90 ...

26.322 DFA ...	02/90→12/92	Tie Rod End	CV-ES-14163		for Steering Rod
	02/90→12/92	Track Control Arm		MN-DL-3402	Trailing Arm
26.322 DFAK	02/90→12/92	Ball Head, gearshift linkage	CV-ES-2119		
	02/90→12/92	Ball Head, gearshift linkage	CV-ES-2120		
	02/90→12/92	Ball Head, gearshift linkage	CV-ES-2182		
	02/90→12/92	Centre Rod	MN-DL-2160		Coupling Rod
	02/90→12/92	Centre Rod	MN-DL-3588		Push Rod
	02/90→12/92	Centre Rod	MN-DL-12421		for Steering Rod
	02/90→12/92	Engine Mounting	MN-SB-10389		
	02/90→12/92	Mounting, stabilizer coupling rod	MN-SB-5246		
	02/90→12/92	Stabiliser Mounting		MN-SB-5245	
	02/90→12/92	Stabiliser Mounting		MN-SB-5254	
	02/90→12/92	Stabiliser Mounting	MN-SB-9396		
	02/90→12/92	Suspension Arm Repair Kit		MN-SB-5244	for Wishbone (CV)
	02/90→12/92	Suspension Arm Repair Kit		MN-SB-5244	for Wishbone (CV), 1st RA
	02/90→12/92	Tie Rod End	CV-ES-2149		for Push Rod
	02/90→12/92	Tie Rod End	CV-ES-14162		for Steering Rod
	02/90→12/92	Tie Rod End	CV-ES-14163		for Steering Rod
	02/90→12/92	Track Control Arm		MN-DL-3402	Trailing Arm
26.322 DFAS	02/90→12/92	Ball Head, gearshift linkage	CV-ES-2119		
	02/90→12/92	Ball Head, gearshift linkage	CV-ES-2120		
	02/90→12/92	Ball Head, gearshift linkage	CV-ES-2182		
	02/90→12/92	Centre Rod	MN-DL-2160		Coupling Rod
	02/90→12/92	Centre Rod	MN-DL-3588		Push Rod
	02/90→12/92	Centre Rod	MN-DL-12421		for Steering Rod
	02/90→12/92	Engine Mounting	MN-SB-10389		
	02/90→12/92	Mounting, stabilizer coupling rod	MN-SB-5246		
	02/90→12/92	Stabiliser Mounting		MN-SB-5245	
	02/90→12/92	Stabiliser Mounting		MN-SB-5254	
	02/90→12/92	Stabiliser Mounting	MN-SB-9396		
	02/90→12/92	Suspension Arm Repair Kit		MN-SB-5244	for Wishbone (CV)
	02/90→12/92	Suspension Arm Repair Kit		MN-SB-5244	for Wishbone (CV), 1st RA
	02/90→12/92	Tie Rod End	CV-ES-2149		for Push Rod
	02/90→12/92	Tie Rod End	CV-ES-14162		for Steering Rod
	02/90→12/92	Tie Rod End	CV-ES-14163		for Steering Rod
	02/90→12/92	Track Control Arm		MN-DL-3402	Trailing Arm
26.322 DFK	02/92→06/96	Ball Head, gearshift linkage	CV-ES-2119		
	02/92→06/96	Ball Head, gearshift linkage	CV-ES-2120		
	02/92→06/96	Ball Head, gearshift linkage	CV-ES-2182		
	02/92→06/96	Centre Rod	MN-DL-2160		Coupling Rod
	02/92→06/96	Centre Rod	MN-DL-3588		Push Rod
	02/92→06/96	Centre Rod	MN-DL-12421		for Steering Rod
	02/92→06/96	Engine Mounting		MN-SB-10390	
	02/92→06/96	Engine Mounting	MN-SB-10389		
	02/92→06/96	Mounting, stabilizer coupling rod	MN-SB-5246		
	02/92→06/96	Stabiliser Mounting		MN-SB-5245	
	02/92→06/96	Stabiliser Mounting		MN-SB-5254	
	02/92→06/96	Stabiliser Mounting	MN-SB-9396		
	02/92→06/96	Suspension Arm Repair Kit		CV-RK-5313	for Wishbone (CV)
	02/92→06/96	Suspension Arm Repair Kit		MN-RK-7287	for Wishbone (CV)
	02/92→06/96	Suspension Arm Repair Kit		MN-SB-5244	for Wishbone (CV)
	02/92→06/96	Suspension Arm Repair Kit		MN-SB-5244	for Wishbone (CV), 1st RA
	02/92→06/96	Tie Rod End	CV-ES-2149		for Push Rod
	02/92→06/96	Tie Rod End	CV-ES-14162		for Steering Rod
	02/92→06/96	Tie Rod End	CV-ES-14163		for Steering Rod
	02/92→06/96	Track Control Arm		MN-DL-3402	Trailing Arm
	02/92→06/96	Track Control Arm		MN-DL-3402	Trailing Arm, Drive Axle
	02/92→06/96	Track Control Arm		MN-VB-5222	Wishbone (CV)
	02/92→06/96	Track Control Arm		MN-VB-8569	Wishbone (CV), Drive Axle
26.322 DFS,26.322 DFLS	02/90→01/91	Track Control Arm		MN-VB-5222	Wishbone (CV), Drive Axle
	02/90→06/96	Ball Head, gearshift linkage	CV-ES-2119		
	02/90→06/96	Ball Head, gearshift linkage	CV-ES-2120		
02/90→06/96	Ball Head, gearshift linkage	CV-ES-2182			

CV-ES-2119

Length: 55
Cone Ø: d1 Ø 10 / d2 Ø 10
Thread: M12 x 1,75 LHT
81953016063, 81953016131



CV-ES-2120

Length: 115
Cone Ø: d1 Ø 12,4 / d2 Ø 10,8
Thread: M14 x 1,5 RHT
03008500A, 81953016200, 81953016202, 81953016203, 81953016227



CV-ES-2149

Length: 160
Cone Ø: d1 Ø 30 / d2 Ø 27
Thread: M30 x 1,5 RHT
81953016263



CV-ES-2182

Length: 55
Cone Ø: d1 Ø 10 / d2 Ø 10
Thread: M12 x 1,75 RHT
81953016064, 81953016170



CV-ES-14162

Length: 125
Cone Ø: d1 Ø 30 / d2 Ø 27
Thread: M30 x 1,5 LHT
81953010015, 81953010083, 81953010087, 81953016029, 81953016030, 81953016043, 81953016044, 81953016050, 81953016054, 81953016087, 81953016091, 81953016107, 81953016120, 81953016125, 81953016152, 81953016155, 81953016157, 81953016168, 81953016179, 81953016181, 81953016223, 81953016237, 81953016254, 81953016275, 81953016279, 81953016351



CV-ES-14163

Length: 125
Cone Ø: d1 Ø 30 / d2 Ø 27
Thread: M30 x 1,5 RHT
95301.0084, 90804102156, 90804102272, 90804102696, 90804102710, 81953010016, 81953010075, 81953010084, 81953010088, 81953010094, 81953010103, 81953016030, 81953016043, 81953016048, 81953016049, 81953016053, 81953016061, 81953016090, 81953016108, 81953016112, 81953016126, 81953016143, 81953016149, 81953016154, 81953016156, 81953016168, 81953016178, 81953016194, 81953016206, 81953016224, 81953016234, 81953016242, 81953016252, 81953016274, 81953016278, 81953016284, 81953016286, 81953016308, 81953016310, 81953016312, 81953016347, 81953016350, 81953016352, 82953016012, 88953016014, N2953016001



CV-RK-5313

Ø: 90
03304800A, 81953016132



MN-DL-2160

Length: 1652 Ø: 50
Cone Ø: d1 Ø 30 / d2 Ø 27
81467106112, 81467106163, 81467106165, 81467106198, 81467106353, 81467106354, 81467106361, 81467116725



MN-DL-3402

Length: 590 Ø: 48
Hole Distance: 130 / 130
03307200A, 81432206067, 81432206068, 81432206090, 81432206092, 81432209092



MN-DL-3588

Length: 1035
Ø: 48
Cone Ø: d1 Ø 30 / d2 Ø 27
81466106333, 81466106334, 81466106354, 81466106355, 81466106360, 81466106361, 81466106721, 81466106722, 81466106723, 81466116216



MN-DL-12421

Length: 1070
Ø: 48
Cone Ø: d1 Ø 30 / d2 Ø 27
Thread: M30 x 1,5 RHT
81466106656, 81466106659, 81466106669, 81466116006, 81466116007



MN-RK-7287

Ø: 90
Hole Distance: 152
Thick/Height: 35
03304700A, 81953016133



MN-SB-5244

Ø: 65
Hole Distance: 125
Thick/Height: 22
03312000A, 81432710027, 81432710082



MN-SB-5245

Ø: 75
Hole Distance: 125
Thick/Height: 22
03311900A, 81432710046, 81432710079, 81432710083



MN-SB-5246

Ø: 45 Thick/Height: 47
81437220022, 81437220038, 81962100450, 81962100469



MN-SB-5254

Length: 100
Ø: 93
Thick/Height: 70
81432710081



MN-SB-9396

Ø: 67
Thick/Height: 60
81437040057



MN-SB-10389

Ø: 70
Thick/Height: 72
81960200340



MN-SB-10390

Ø: 70
Thick/Height: 85/85
81960200341, 81960200373, 81960200385, 81960200408, 81960200418



MN-VB-5222

Length: 627 Ø: 50
Hole Distance: 152 / 152
81432706030, 81432706034, 81432706054, 81432706055, 81432706056, 81432706057, 81432706067, 81432706068, 81432706074, 81432706075, 81432706076, 81432706077, 81432706078, 81432706081, 81432706082, 81432709034, 81432709076, 81432709078, 8143706054



MN-VB-8569

Length: 627
Ø: 58
Hole Distance: 152 / 152
81432706055, 81432706056, 81432706067, 81432706068, 81432706075, 81432706077, 81432706081, 81432709056





F 90 ...

26.322 DFS,26.322 DFLS ...	02/90→06/96	Centre Rod	MN-DL-2160		Coupling Rod
	02/90→06/96	Centre Rod	MN-DL-3588		Push Rod
	02/90→06/96	Centre Rod	MN-DL-12421		for Steering Rod
	02/90→06/96	Engine Mounting		MN-SB-10390	
	02/90→06/96	Engine Mounting	MN-SB-10389		
	02/90→06/96	Mounting, stabilizer coupling rod	MN-SB-5246		
	02/90→06/96	Stabiliser Mounting		MN-SB-5245	
	02/90→06/96	Stabiliser Mounting		MN-SB-5254	
	02/90→06/96	Stabiliser Mounting	MN-SB-9396		
	02/90→06/96	Suspension Arm Repair Kit		CV-RK-5313	for Wishbone (CV)
	02/90→06/96	Suspension Arm Repair Kit		CV-RK-8118	for Control Arm
	02/90→06/96	Suspension Arm Repair Kit		MN-RK-7287	for Wishbone (CV)
	02/90→06/96	Suspension Arm Repair Kit		MN-RK-7291	for Drag Link
	02/90→06/96	Suspension Arm Repair Kit		MN-SB-5244	for Wishbone (CV)
	02/90→06/96	Suspension Arm Repair Kit		MN-SB-5244	for Wishbone (CV), 1st RA
	02/90→06/96	Tie Rod End	CV-ES-2149		for Push Rod
	02/90→06/96	Tie Rod End	CV-ES-14162		for Steering Rod
	02/90→06/96	Tie Rod End	CV-ES-14163		for Steering Rod
	02/90→06/96	Track Control Arm		MN-DL-3402	Trailing Arm
	02/90→06/96	Track Control Arm		MN-DL-3402	Trailing Arm, Drive Axle
	02/90→06/96	Track Control Arm		MN-DL-5212	Trailing Arm, Air Suspension Axle;Drive Axle
	02/90→06/96	Track Control Arm		MN-VB-5222	Wishbone (CV)
	02/90→06/96	Track Control Arm		MN-VB-5222	Wishbone (CV), Drive Axle;Air Suspension Axle
	02/90→06/96	Track Control Arm		MN-VB-8569	Wishbone (CV)
01/91→06/96	Track Control Arm		MN-VB-8569	Wishbone (CV), Drive Axle	
26.322 FNL,26.322 FNLL	03/91→05/95	Ball Head, gearshift linkage	CV-ES-2119		
	03/91→05/95	Ball Head, gearshift linkage	CV-ES-2120		
	03/91→05/95	Ball Head, gearshift linkage	CV-ES-2182		
	03/91→05/95	Centre Rod	MN-DL-2160		Coupling Rod
	03/91→05/95	Centre Rod	MN-DL-3588		Push Rod
	03/91→05/95	Centre Rod	MN-DL-12421		for Steering Rod
	03/91→05/95	Engine Mounting	MN-SB-10389		
	03/91→05/95	Suspension Arm Repair Kit		CV-RK-5313	for Wishbone (CV)
	03/91→05/95	Suspension Arm Repair Kit		CV-RK-8118	for Control Arm
	03/91→05/95	Suspension Arm Repair Kit		MN-RK-7280	for Drag Link
	03/91→05/95	Suspension Arm Repair Kit		MN-RK-7287	for Wishbone (CV)
	03/91→05/95	Suspension Arm Repair Kit		MN-RK-7291	for Drag Link
	03/91→05/95	Tie Rod	MN-DL-12284		
	03/91→05/95	Tie Rod End	CV-ES-2149		for Push Rod
	03/91→05/95	Tie Rod End	CV-ES-14162		for Steering Rod
	03/91→05/95	Tie Rod End	CV-ES-14163		for Steering Rod
	03/91→05/95	Track Control Arm		MN-DL-5212	Trailing Arm, Air Suspension Axle;Drive Axle; Tag Axle
	03/91→05/95	Track Control Arm		MN-VB-5222	Wishbone (CV), Drive Axle;Air Suspension Axle
03/91→05/95	Track Control Arm		MN-VB-5222	Wishbone (CV), Tag Axle	
26.322 FNLS,26.322 FVLS	09/90→12/95	Ball Head, gearshift linkage	CV-ES-2119		
	09/90→12/95	Ball Head, gearshift linkage	CV-ES-2120		
	09/90→12/95	Ball Head, gearshift linkage	CV-ES-2182		
	09/90→12/95	Centre Rod	MN-DL-2160		Coupling Rod
	09/90→12/95	Centre Rod	MN-DL-3588		Push Rod
	09/90→12/95	Centre Rod	MN-DL-12421		for Steering Rod
	09/90→12/95	Engine Mounting	MN-SB-10389		
	09/90→12/95	Stabiliser Mounting		MN-SB-5243	
	09/90→12/95	Stabiliser Mounting		MN-SB-5265	
	09/90→12/95	Stabiliser Mounting		MN-SB-5265	1st RA
	09/90→12/95	Suspension Arm Repair Kit		CV-RK-5313	for Wishbone (CV)
	09/90→12/95	Suspension Arm Repair Kit		CV-RK-8118	for Control Arm
	09/90→12/95	Suspension Arm Repair Kit		MN-RK-7280	for Drag Link
	09/90→12/95	Suspension Arm Repair Kit		MN-RK-7287	for Wishbone (CV)
	09/90→12/95	Suspension Arm Repair Kit		MN-RK-7291	for Drag Link
	09/90→12/95	Tie Rod	MN-DL-12284		
	09/90→12/95	Tie Rod End	CV-ES-2149		for Push Rod
	09/90→12/95	Tie Rod End	CV-ES-14162		for Steering Rod

CV-ES-2119

Length: 55
 Cone Ø: d1 Ø 10 / d2 Ø 10
 Thread: M12 x 1,75 LHT
 81953016063, 81953016131

**CV-ES-2120**

Length: 115
 Cone Ø: d1 Ø 12,4 / d2 Ø 10,8
 Thread: M14 x 1,5 RHT
 03008500A, 81953016200, 81953016202,
 81953016203, 81953016227

**CV-ES-2149**

Length: 160
 Cone Ø: d1 Ø 30 / d2 Ø 27
 Thread: M30 x 1,5 RHT
 81953016263

**CV-ES-2182**

Length: 55
 Cone Ø: d1 Ø 10 / d2 Ø 10
 Thread: M12 x 1,75 RHT
 81953016064, 81953016170

**CV-ES-14162**

Length: 125
 Cone Ø: d1 Ø 30 / d2 Ø 27
 Thread: M30 x 1,5 LHT
 81953010015, 81953010083, 81953010087,
 81953016029, 81953016030, 81953016043,
 81953016044, 81953016050, 81953016054,
 81953016087, 81953016091, 81953016107,
 81953016120, 81953016125, 81953016152,
 81953016155, 81953016157, 81953016168,
 81953016179, 81953016181, 81953016223,
 81953016237, 81953016254, 81953016275,
 81953016279, 81953016351

**CV-ES-14163**

Length: 125
 Cone Ø: d1 Ø 30 / d2 Ø 27
 Thread: M30 x 1,5 RHT
 95301.0084, 90804102156, 90804102272,
 90804102696, 90804102710, 81953010016,
 81953010075, 81953010084, 81953010088,
 81953010094, 81953010103, 81953016030,
 81953016043, 81953016048, 81953016049,
 81953016053, 81953016061, 81953016090,
 81953016108, 81953016112, 81953016126,
 81953016143, 81953016149, 81953016154,
 81953016156, 81953016168, 81953016178,
 81953016194, 81953016206, 81953016224,
 81953016234, 81953016242, 81953016252,
 81953016274, 81953016278, 81953016284,
 81953016286, 81953016308, 81953016310,
 81953016312, 81953016347, 81953016350,
 81953016352, 82953016012, 88953016014,
 N2953016001

**CV-RK-5313**

Ø: 90
 03304800A, 81953016132

**CV-RK-8118**

Ø: 85
 Hole Distance: 130
 Thick/Height: 30
 638862, 639287, 775201, 938423,
 1104335, 1953248, 0003500506, 3500506,
 11013547, 21032592, 42065912, 42488722,
 070550504, 93192618, 070400009000,
 634303610, 81432206055, 81432206073,
 82262320660, 9544171010099,
 5001842823, 7000307001, 8226232066

**MN-DL-2160**

Length: 1652 Ø: 50
 Cone Ø: d1 Ø 30 / d2 Ø 27
 81467106112, 81467106163, 81467106165,
 81467106198, 81467106353, 81467106354,
 81467106361, 81467116725

**MN-DL-3402**

Length: 590 Ø: 48
 Hole Distance: 130 / 130
 03307200A, 81432206067, 81432206068,
 81432206090, 81432206092, 81432209092

**MN-DL-3588**

Length: 1035 Ø: 48
 Cone Ø: d1 Ø 30 / d2 Ø 27
 81466106333, 81466106334, 81466106354,
 81466106355, 81466106360, 81466106361,
 81466106721, 81466106722, 81466106723,
 81466116216

**MN-DL-5212**

Length: 577 Ø: 48
 Hole Distance: 130 / 130
 81432206096, 81432206097, 81432206098,
 81432206129, 81432209096, 81432209129,
 81432306014, 81432306030

**MN-DL-12284**

Length: 1530 Ø: 50
 Cone Ø: d1 Ø 30 / d2 Ø 27
 81466106579, 81466106580, 81466106624,
 81466116720, 81467116720, 81467116730,
 81467116952

**MN-DL-12421**

Length: 1070 Ø: 48
 Cone Ø: d1 Ø 30 / d2 Ø 27
 Thread: M30 x 1,5 RHT
 81466106656, 81466106659, 81466106669,
 81466116006, 81466116007

**MN-RK-7280**

Ø: 75
 Hole Distance: 115
 Thick/Height: 24
 0550806, 0639370, 689748, 10307400A,
 81432306051, 81432306068, 81432706064

**MN-RK-7287**

Ø: 90
 Hole Distance: 152
 Thick/Height: 35
 03304700A, 81953016133

**MN-RK-7291**

Ø: 72
 Hole Distance: 130
 Thick/Height: 30
 10307800A, 81432206108, 81432206132

**MN-SB-5243**

Length: 55 Ø: 78
 Thick/Height: 60
 03311100A, 81437040061, 81437220020

**MN-SB-5244**

Ø: 65
 Hole Distance: 125
 Thick/Height: 22
 03312000A, 81432710027, 81432710082

**MN-SB-5245**

Ø: 75
 Hole Distance: 125
 Thick/Height: 22
 03311900A, 81432710046, 81432710079,
 81432710083

**MN-SB-5246**

Ø: 45 Thick/Height: 47
 81437220022, 81437220038, 81962100450,
 81962100469

**MN-SB-5254**

Length: 100 Ø: 93
 Thick/Height: 70
 81432710081

**MN-SB-5265**

Ø: 85 Thick/Height: 80
 03310300A, 81437040032

**MN-SB-9396**

Ø: 67 Thick/Height: 60
 81437040057

**MN-SB-10389**

Ø: 70 Thick/Height: 72
 81960200340

**MN-SB-10390**

Ø: 70 Thick/Height: 85/85
 81960200341, 81960200373, 81960200385,
 81960200408, 81960200418

**MN-VB-5222**

Length: 627 Ø: 50
 Hole Distance: 152 / 152
 81432706030, 81432706034, 81432706054,
 81432706055, 81432706056, 81432706057,
 81432706067, 81432706068, 81432706074,
 81432706075, 81432706076, 81432706077,
 81432706078, 81432706081, 81432706082,
 81432709034, 81432709076, 81432709078,
 8143706054

**MN-VB-8569**

Length: 627 Ø: 58
 Hole Distance: 152 / 152
 81432706055, 81432706056, 81432706067,
 81432706068, 81432706075, 81432706077,
 81432706081, 81432709056



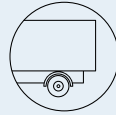
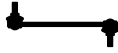

F 90 ...

26.322 FNLS, 26.322 FVLS ...	09/90→12/95	Tie Rod End	CV-ES-14163		for Steering Rod	
	09/90→12/95	Track Control Arm		MN-VB-5222	Wishbone (CV), Drive Axle; Air Suspension Axle	
	09/90→12/95	Track Control Arm		MN-VB-5222	Wishbone (CV), Tag Axle	
26.332 DF, 26.332 DFL	09/87→02/90	Ball Head, gearshift linkage	CV-ES-2119			
	09/87→02/90	Ball Head, gearshift linkage	CV-ES-2120			
	09/87→02/90	Ball Head, gearshift linkage	CV-ES-2182			
	09/87→02/90	Centre Rod	MN-DL-2160		Coupling Rod	
	09/87→02/90	Centre Rod	MN-DL-3588		Push Rod	
	09/87→02/90	Centre Rod	MN-DL-12421		for Steering Rod	
	09/87→02/90	Engine Mounting		MN-SB-10390		
	09/87→02/90	Engine Mounting	MN-SB-10389			
	09/87→02/90	Mounting, stabilizer coupling rod	MN-SB-5246			
	09/87→02/90	Stabiliser Mounting		MN-SB-5245		
	09/87→02/90	Stabiliser Mounting		MN-SB-5254		
	09/87→02/90	Stabiliser Mounting	MN-SB-9396			
	09/87→02/90	Suspension Arm Repair Kit		MN-SB-5244	for Wishbone (CV)	
	09/87→02/90	Suspension Arm Repair Kit		MN-SB-5244	for Wishbone (CV), 1st RA	
	09/87→02/90	Tie Rod End	CV-ES-2149		for Push Rod	
	09/87→02/90	Tie Rod End	CV-ES-14162		for Steering Rod	
	09/87→02/90	Tie Rod End	CV-ES-14163		for Steering Rod	
	09/87→02/90	Track Control Arm		MN-DL-3402	Trailing Arm	
	09/87→02/90	Track Control Arm		MN-DL-3402	Trailing Arm, Drive Axle	
	26.332 DFA	05/88→02/90	Ball Head, gearshift linkage	CV-ES-2119		
05/88→02/90		Ball Head, gearshift linkage	CV-ES-2120			
05/88→02/90		Ball Head, gearshift linkage	CV-ES-2182			
05/88→02/90		Centre Rod	MN-DL-2160		Coupling Rod	
05/88→02/90		Centre Rod	MN-DL-3588		Push Rod	
05/88→02/90		Centre Rod	MN-DL-12421		for Steering Rod	
05/88→02/90		Engine Mounting	MN-SB-10389			
05/88→02/90		Mounting, stabilizer coupling rod	MN-SB-5246			
05/88→02/90		Stabiliser Mounting		MN-SB-5245		
05/88→02/90		Stabiliser Mounting		MN-SB-5254		
05/88→02/90		Stabiliser Mounting	MN-SB-9396			
05/88→02/90		Suspension Arm Repair Kit		MN-SB-5244	for Wishbone (CV)	
05/88→02/90		Suspension Arm Repair Kit		MN-SB-5244	for Wishbone (CV), 1st RA	
05/88→02/90		Tie Rod End	CV-ES-2149		for Push Rod	
05/88→02/90		Tie Rod End	CV-ES-14162		for Steering Rod	
05/88→02/90		Tie Rod End	CV-ES-14163		for Steering Rod	
05/88→02/90		Track Control Arm		MN-DL-3402	Trailing Arm	
26.332 DFAK		05/88→02/90	Ball Head, gearshift linkage	CV-ES-2119		
		05/88→02/90	Ball Head, gearshift linkage	CV-ES-2120		
		05/88→02/90	Ball Head, gearshift linkage	CV-ES-2182		
	05/88→02/90	Centre Rod	MN-DL-2160		Coupling Rod	
	05/88→02/90	Centre Rod	MN-DL-3588		Push Rod	
	05/88→02/90	Centre Rod	MN-DL-12421		for Steering Rod	
	05/88→02/90	Engine Mounting	MN-SB-10389			
	05/88→02/90	Mounting, stabilizer coupling rod	MN-SB-5246			
	05/88→02/90	Stabiliser Mounting		MN-SB-5245		
	05/88→02/90	Stabiliser Mounting		MN-SB-5254		
	05/88→02/90	Stabiliser Mounting	MN-SB-9396			
	05/88→02/90	Suspension Arm Repair Kit		MN-SB-5244	for Wishbone (CV)	
	05/88→02/90	Suspension Arm Repair Kit		MN-SB-5244	for Wishbone (CV), 1st RA	
	05/88→02/90	Tie Rod End	CV-ES-2149		for Push Rod	
	05/88→02/90	Tie Rod End	CV-ES-14162		for Steering Rod	
	05/88→02/90	Tie Rod End	CV-ES-14163		for Steering Rod	
	05/88→02/90	Track Control Arm		MN-DL-3402	Trailing Arm	
	26.332 DFAS	05/88→02/90	Ball Head, gearshift linkage	CV-ES-2119		
		05/88→02/90	Ball Head, gearshift linkage	CV-ES-2120		
		05/88→02/90	Ball Head, gearshift linkage	CV-ES-2182		
05/88→02/90		Centre Rod	MN-DL-2160		Coupling Rod	
05/88→02/90		Centre Rod	MN-DL-3588		Push Rod	
05/88→02/90		Centre Rod	MN-DL-12421		for Steering Rod	
05/88→02/90		Engine Mounting	MN-SB-10389			

CV-ES-2119

Length: 55
Cone Ø: d1 Ø 10 / d2 Ø 10
Thread: M12 x 1,75 LHT
81953016063, 81953016131



CV-ES-2120

Length: 115
Cone Ø: d1 Ø 12,4 / d2 Ø 10,8
Thread: M14 x 1,5 RHT
03008500A, 81953016200, 81953016202,
81953016203, 81953016227



CV-ES-2149

Length: 160
Cone Ø: d1 Ø 30 / d2 Ø 27
Thread: M30 x 1,5 RHT
81953016263



CV-ES-2182

Length: 55
Cone Ø: d1 Ø 10 / d2 Ø 10
Thread: M12 x 1,75 RHT
81953016064, 81953016170



CV-ES-14162

Length: 125
Cone Ø: d1 Ø 30 / d2 Ø 27
Thread: M30 x 1,5 LHT
81953010015, 81953010083, 81953010087,
81953016029, 81953016030, 81953016043,
81953016044, 81953016050, 81953016054,
81953016087, 81953016091, 81953016107,
81953016120, 81953016125, 81953016152,
81953016155, 81953016157, 81953016168,
81953016179, 81953016181, 81953016223,
81953016237, 81953016254, 81953016275,
81953016279, 81953016351



CV-ES-14163

Length: 125
Cone Ø: d1 Ø 30 / d2 Ø 27
Thread: M30 x 1,5 RHT
95301.0084, 90804102156, 90804102272,
90804102696, 90804102710, 81953010016,
81953010075, 81953010084, 81953010088,
81953010094, 81953010103, 81953016030,
81953016043, 81953016048, 81953016049,
81953016053, 81953016061, 81953016090,
81953016108, 81953016112, 81953016126,
81953016143, 81953016149, 81953016154,
81953016156, 81953016168, 81953016178,
81953016194, 81953016206, 81953016224,
81953016234, 81953016242, 81953016252,
81953016274, 81953016278, 81953016284,
81953016286, 81953016308, 81953016310,
81953016312, 81953016347, 81953016350,
81953016352, 82953016012, 88953016014,
N2953016001



MN-DL-2160

Length: 1652 Ø: 50
Cone Ø: d1 Ø 30 / d2 Ø 27
81467106112, 81467106163, 81467106165,
81467106198, 81467106353, 81467106354,
81467106361, 81467116725



MN-DL-3402

Length: 590 Ø: 48
Hole Distance: 130 / 130
03307200A, 81432206067, 81432206068,
81432206090, 81432206092, 81432209092



MN-DL-3588

Length: 1035
Ø: 48
Cone Ø: d1 Ø 30 / d2 Ø 27
81466106333, 81466106334, 81466106354,
81466106355, 81466106360, 81466106361,
81466106721, 81466106722, 81466106723,
81466116216



MN-DL-12421

Length: 1070
Ø: 48
Cone Ø: d1 Ø 30 / d2 Ø 27
Thread: M30 x 1,5 RHT
81466106656, 81466106659, 81466106669,
81466116006, 81466116007



MN-SB-5244

Ø: 65
Hole Distance: 125
Thick/Height: 22
03312000A, 81432710027, 81432710082



MN-SB-5245

Ø: 75
Hole Distance: 125
Thick/Height: 22
03311900A, 81432710046, 81432710079,
81432710083



MN-SB-5246

Ø: 45 Thick/Height: 47
81437220022, 81437220038, 81962100450,
81962100469



MN-SB-5254

Length: 100
Ø: 93
Thick/Height: 70
81432710081



MN-SB-9396

Ø: 67
Thick/Height: 60
81437040057



MN-SB-10389

Ø: 70
Thick/Height: 72
81960200340



MN-SB-10390

Ø: 70
Thick/Height: 85/85
81960200341, 81960200373, 81960200385,
81960200408, 81960200418



MN-VB-5222

Length: 627 Ø: 50
Hole Distance: 152 / 152
81432706030, 81432706034, 81432706054,
81432706055, 81432706056, 81432706057,
81432706067, 81432706068, 81432706074,
81432706075, 81432706076, 81432706077,
81432706078, 81432706081, 81432706082,
81432709034, 81432709076, 81432709078,
8143706054





F 90 ...

26.332 DFAS ...	05/88→02/90	Mounting, stabilizer coupling rod	MN-SB-5246		
	05/88→02/90	Stabiliser Mounting		MN-SB-5245	
	05/88→02/90	Stabiliser Mounting		MN-SB-5254	
	05/88→02/90	Stabiliser Mounting	MN-SB-9396		
	05/88→02/90	Suspension Arm Repair Kit		MN-SB-5244	for Wishbone (CV)
	05/88→02/90	Suspension Arm Repair Kit		MN-SB-5244	for Wishbone (CV), 1st RA
	05/88→02/90	Tie Rod End	CV-ES-2149		for Push Rod
	05/88→02/90	Tie Rod End	CV-ES-14162		for Steering Rod
	05/88→02/90	Tie Rod End	CV-ES-14163		for Steering Rod
	05/88→02/90	Track Control Arm		MN-DL-3402	Trailing Arm
26.332 DFK	09/87→02/90	Ball Head, gearshift linkage	CV-ES-2119		
	09/87→02/90	Ball Head, gearshift linkage	CV-ES-2120		
	09/87→02/90	Ball Head, gearshift linkage	CV-ES-2182		
	09/87→02/90	Centre Rod	MN-DL-2160		Coupling Rod
	09/87→02/90	Centre Rod	MN-DL-3588		Push Rod
	09/87→02/90	Centre Rod	MN-DL-12421		for Steering Rod
	09/87→02/90	Engine Mounting		MN-SB-10390	
	09/87→02/90	Engine Mounting	MN-SB-10389		
	09/87→02/90	Mounting, stabilizer coupling rod	MN-SB-5246		
	09/87→02/90	Stabiliser Mounting		MN-SB-5245	
	09/87→02/90	Stabiliser Mounting		MN-SB-5254	
	09/87→02/90	Stabiliser Mounting	MN-SB-9396		
	09/87→02/90	Suspension Arm Repair Kit		MN-SB-5244	for Wishbone (CV)
	09/87→02/90	Suspension Arm Repair Kit		MN-SB-5244	for Wishbone (CV), 1st RA
	09/87→02/90	Tie Rod End	CV-ES-2149		for Push Rod
	09/87→02/90	Tie Rod End	CV-ES-14162		for Steering Rod
	09/87→02/90	Tie Rod End	CV-ES-14163		for Steering Rod
09/87→02/90	Track Control Arm		MN-DL-3402	Trailing Arm	
09/87→02/90	Track Control Arm		MN-DL-3402	Trailing Arm, Drive Axle	
26.332 DFS	09/87→02/90	Ball Head, gearshift linkage	CV-ES-2119		
	09/87→02/90	Ball Head, gearshift linkage	CV-ES-2120		
	09/87→02/90	Ball Head, gearshift linkage	CV-ES-2182		
	09/87→02/90	Centre Rod	MN-DL-2160		Coupling Rod
	09/87→02/90	Centre Rod	MN-DL-3588		Push Rod
	09/87→02/90	Centre Rod	MN-DL-12421		for Steering Rod
	09/87→02/90	Engine Mounting		MN-SB-10390	
	09/87→02/90	Engine Mounting	MN-SB-10389		
	09/87→02/90	Mounting, stabilizer coupling rod	MN-SB-5246		
	09/87→02/90	Stabiliser Mounting		MN-SB-5245	
	09/87→02/90	Stabiliser Mounting		MN-SB-5254	
	09/87→02/90	Stabiliser Mounting	MN-SB-9396		
	09/87→02/90	Suspension Arm Repair Kit		MN-SB-5244	for Wishbone (CV)
	09/87→02/90	Suspension Arm Repair Kit		MN-SB-5244	for Wishbone (CV), 1st RA
	09/87→02/90	Tie Rod End	CV-ES-2149		for Push Rod
	09/87→02/90	Tie Rod End	CV-ES-14162		for Steering Rod
	09/87→02/90	Tie Rod End	CV-ES-14163		for Steering Rod
09/87→02/90	Track Control Arm		MN-DL-3402	Trailing Arm	
09/87→02/90	Track Control Arm		MN-DL-3402	Trailing Arm, Drive Axle	
26.342 DF,26.342 DFL	05/94→06/96	Ball Head, gearshift linkage	CV-ES-2119		
	05/94→06/96	Ball Head, gearshift linkage	CV-ES-2120		
	05/94→06/96	Ball Head, gearshift linkage	CV-ES-2182		
	05/94→06/96	Centre Rod	MN-DL-2160		Coupling Rod
	05/94→06/96	Centre Rod	MN-DL-3588		Push Rod
	05/94→06/96	Centre Rod	MN-DL-12421		for Steering Rod
	05/94→06/96	Engine Mounting	MN-SB-10389		
	05/94→06/96	Suspension Arm Repair Kit		CV-RK-5313	for Wishbone (CV)
	05/94→06/96	Suspension Arm Repair Kit		CV-RK-8118	for Control Arm
	05/94→06/96	Suspension Arm Repair Kit		MN-RK-7287	for Wishbone (CV)
	05/94→06/96	Suspension Arm Repair Kit		MN-RK-7291	for Drag Link
	05/94→06/96	Suspension Arm Repair Kit		MN-SB-5244	for Wishbone (CV)
	05/94→06/96	Suspension Arm Repair Kit		MN-SB-5244	for Wishbone (CV), 1st RA
	05/94→06/96	Tie Rod End	CV-ES-2149		for Push Rod
	05/94→06/96	Tie Rod End	CV-ES-14162		for Steering Rod

CV-ES-2119

Length: 55
Cone Ø: d1 Ø 10 / d2 Ø 10
Thread: M12 x 1,75 LHT
81953016063, 81953016131



CV-ES-2120

Length: 115
Cone Ø: d1 Ø 12,4 / d2 Ø 10,8
Thread: M14 x 1,5 RHT
03008500A, 81953016200, 81953016202, 81953016203, 81953016227



CV-ES-2149

Length: 160
Cone Ø: d1 Ø 30 / d2 Ø 27
Thread: M30 x 1,5 RHT
81953016263



CV-ES-2182

Length: 55
Cone Ø: d1 Ø 10 / d2 Ø 10
Thread: M12 x 1,75 RHT
81953016064, 81953016170



CV-ES-14162

Length: 125
Cone Ø: d1 Ø 30 / d2 Ø 27
Thread: M30 x 1,5 LHT
81953010015, 81953010083, 81953010087, 81953016029, 81953016030, 81953016043, 81953016044, 81953016050, 81953016054, 81953016087, 81953016091, 81953016107, 81953016120, 81953016125, 81953016152, 81953016155, 81953016157, 81953016168, 81953016179, 81953016181, 81953016223, 81953016237, 81953016254, 81953016275, 81953016279, 81953016351



CV-ES-14163

Length: 125
Cone Ø: d1 Ø 30 / d2 Ø 27
Thread: M30 x 1,5 RHT
95301.0084, 90804102156, 90804102272, 90804102696, 90804102710, 81953010016, 81953010075, 81953010084, 81953010088, 81953010094, 81953010103, 81953016030, 81953016043, 81953016048, 81953016049, 81953016053, 81953016061, 81953016090, 81953016108, 81953016112, 81953016126, 81953016143, 81953016149, 81953016154, 81953016156, 81953016168, 81953016178, 81953016194, 81953016206, 81953016224, 81953016234, 81953016242, 81953016252, 81953016274, 81953016278, 81953016284, 81953016286, 81953016308, 81953016310, 81953016312, 81953016347, 81953016350, 81953016352, 82953016012, 88953016014, N2953016001



CV-RK-5313

Ø: 90
03304800A, 81953016132



CV-RK-8118

Ø: 85
Hole Distance: 130
Thick/Height: 30
638862, 639287, 775201, 938423, 1104335, 1953248, 0003500506, 3500506, 11013547, 21032592, 42065912, 42488722, 070550504, 93192618, 070400009000, 634303610, 81432206055, 81432206073, 82262320660, 9544171010099, 5001842823, 7000307001, 8226232066



MN-DL-2160

Length: 1652 Ø: 50
Cone Ø: d1 Ø 30 / d2 Ø 27
81467106112, 81467106163, 81467106165, 81467106198, 81467106353, 81467106354, 81467106361, 81467116725



MN-DL-3402

Length: 590 Ø: 48
Hole Distance: 130 / 130
03307200A, 81432206067, 81432206068, 81432206090, 81432206092, 81432209092



MN-DL-3588

Length: 1035
Ø: 48
Cone Ø: d1 Ø 30 / d2 Ø 27
81466106333, 81466106334, 81466106354, 81466106355, 81466106360, 81466106361, 81466106721, 81466106722, 81466106723, 81466116216



MN-DL-12421

Length: 1070
Ø: 48
Cone Ø: d1 Ø 30 / d2 Ø 27
Thread: M30 x 1,5 RHT
81466106656, 81466106659, 81466106669, 81466116006, 81466116007



MN-RK-7287

Ø: 90
Hole Distance: 152
Thick/Height: 35
03304700A, 81953016133



MN-RK-7291

Ø: 72
Hole Distance: 130
Thick/Height: 30
10307800A, 81432206108, 81432206132



MN-SB-5244

Ø: 65
Hole Distance: 125
Thick/Height: 22
03312000A, 81432710027, 81432710082



MN-SB-5245

Ø: 75
Hole Distance: 125
Thick/Height: 22
03311900A, 81432710046, 81432710079, 81432710083



MN-SB-5246

Ø: 45 Thick/Height: 47
81437220022, 81437220038, 81962100450, 81962100469



MN-SB-5254

Length: 100
Ø: 93
Thick/Height: 70
81432710081



MN-SB-9396

Ø: 67
Thick/Height: 60
81437040057



MN-SB-10389

Ø: 70
Thick/Height: 72
81960200340



MN-SB-10390

Ø: 70
Thick/Height: 85/85
81960200341, 81960200373, 81960200385, 81960200408, 81960200418





F 90 ...

26.342 DF,26.342 DFL ...	05/94 →06/96	Tie Rod End	CV-ES-14163		for Steering Rod
	05/94 →06/96	Track Control Arm		MN-DL-3402	Trailing Arm
	05/94 →06/96	Track Control Arm		MN-DL-5212	Trailing Arm, Air Suspension Axle;Drive Axle
	05/94 →06/96	Track Control Arm		MN-VB-5222	Wishbone (CV)
	05/94 →06/96	Track Control Arm		MN-VB-8569	Wishbone (CV), Drive Axle
26.342 DFK,26.342 DFLK	05/94 →06/96	Ball Head, gearshift linkage	CV-ES-2119		
	05/94 →06/96	Ball Head, gearshift linkage	CV-ES-2120		
	05/94 →06/96	Ball Head, gearshift linkage	CV-ES-2182		
	05/94 →06/96	Centre Rod	MN-DL-2160		Coupling Rod
	05/94 →06/96	Centre Rod	MN-DL-3588		Push Rod
	05/94 →06/96	Centre Rod	MN-DL-12421		for Steering Rod
	05/94 →06/96	Engine Mounting	MN-SB-10389		
	05/94 →06/96	Suspension Arm Repair Kit		CV-RK-5313	for Wishbone (CV)
	05/94 →06/96	Suspension Arm Repair Kit		CV-RK-8118	for Control Arm
	05/94 →06/96	Suspension Arm Repair Kit		MN-RK-7287	for Wishbone (CV)
	05/94 →06/96	Suspension Arm Repair Kit		MN-RK-7291	for Drag Link
	05/94 →06/96	Suspension Arm Repair Kit		MN-SB-5244	for Wishbone (CV)
	05/94 →06/96	Suspension Arm Repair Kit		MN-SB-5244	for Wishbone (CV), 1st RA
	05/94 →06/96	Tie Rod End	CV-ES-2149		for Push Rod
	05/94 →06/96	Tie Rod End	CV-ES-14162		for Steering Rod
	05/94 →06/96	Tie Rod End	CV-ES-14163		for Steering Rod
	05/94 →06/96	Track Control Arm		MN-DL-3402	Trailing Arm
	05/94 →06/96	Track Control Arm		MN-DL-5212	Trailing Arm, Air Suspension Axle;Drive Axle
	05/94 →06/96	Track Control Arm		MN-VB-5222	Wishbone (CV)
	05/94 →06/96	Track Control Arm		MN-VB-8569	Wishbone (CV), Drive Axle
26.342 DFS	04/94 →06/96	Ball Head, gearshift linkage	CV-ES-2119		
	04/94 →06/96	Ball Head, gearshift linkage	CV-ES-2120		
	04/94 →06/96	Ball Head, gearshift linkage	CV-ES-2182		
	04/94 →06/96	Centre Rod	MN-DL-2160		Coupling Rod
	04/94 →06/96	Centre Rod	MN-DL-3588		Push Rod
	04/94 →06/96	Centre Rod	MN-DL-12421		for Steering Rod
	04/94 →06/96	Engine Mounting	MN-SB-10389		
	04/94 →06/96	Suspension Arm Repair Kit		CV-RK-5313	for Wishbone (CV)
	04/94 →06/96	Suspension Arm Repair Kit		MN-RK-7287	for Wishbone (CV)
	04/94 →06/96	Suspension Arm Repair Kit		MN-SB-5244	for Wishbone (CV)
	04/94 →06/96	Suspension Arm Repair Kit		MN-SB-5244	for Wishbone (CV), 1st RA
	04/94 →06/96	Tie Rod End	CV-ES-2149		for Push Rod
	04/94 →06/96	Tie Rod End	CV-ES-14162		for Steering Rod
	04/94 →06/96	Tie Rod End	CV-ES-14163		for Steering Rod
	04/94 →06/96	Track Control Arm		MN-DL-3402	Trailing Arm
	04/94 →06/96	Track Control Arm		MN-VB-5222	Wishbone (CV)
	04/94 →06/96	Track Control Arm		MN-VB-8569	Wishbone (CV), Drive Axle
26.362 DF, 26.362 DFL	09/87 →02/90	Ball Head, gearshift linkage	CV-ES-2119		
	09/87 →02/90	Ball Head, gearshift linkage	CV-ES-2120		
	09/87 →02/90	Ball Head, gearshift linkage	CV-ES-2182		
	09/87 →02/90	Centre Rod	MN-DL-2160		Coupling Rod
	09/87 →02/90	Centre Rod	MN-DL-3588		Push Rod
	09/87 →02/90	Centre Rod	MN-DL-12421		for Steering Rod
	09/87 →02/90	Engine Mounting		MN-SB-10390	
	09/87 →02/90	Engine Mounting	MN-SB-10389		
	09/87 →02/90	Mounting, stabilizer coupling rod	MN-SB-5246		
	09/87 →02/90	Stabiliser Mounting		MN-SB-5245	
	09/87 →02/90	Stabiliser Mounting		MN-SB-5254	
	09/87 →02/90	Stabiliser Mounting	MN-SB-9396		
	09/87 →02/90	Suspension Arm Repair Kit		CV-RK-5313	for Wishbone (CV)
	09/87 →02/90	Suspension Arm Repair Kit		CV-RK-8118	for Control Arm
	09/87 →02/90	Suspension Arm Repair Kit		MN-RK-7287	for Wishbone (CV)
	09/87 →02/90	Suspension Arm Repair Kit		MN-RK-7291	for Drag Link
	09/87 →02/90	Suspension Arm Repair Kit		MN-SB-5244	for Wishbone (CV)
	09/87 →02/90	Suspension Arm Repair Kit		MN-SB-5244	for Wishbone (CV), 1st RA
	09/87 →02/90	Tie Rod End	CV-ES-2149		for Push Rod
	09/87 →02/90	Tie Rod End	CV-ES-14162		for Steering Rod
09/87 →02/90	Tie Rod End	CV-ES-14163		for Steering Rod	

CV-ES-2119

Length: 55
Cone Ø: d1 Ø 10 / d2 Ø 10
Thread: M12 x 1,75 LHT
81953016063, 81953016131



CV-ES-2120

Length: 115
Cone Ø: d1 Ø 12,4 / d2 Ø 10,8
Thread: M14 x 1,5 RHT
03008500A, 81953016200, 81953016202, 81953016203, 81953016227



CV-ES-2149

Length: 160
Cone Ø: d1 Ø 30 / d2 Ø 27
Thread: M30 x 1,5 RHT
81953016263



CV-ES-2182

Length: 55
Cone Ø: d1 Ø 10 / d2 Ø 10
Thread: M12 x 1,75 RHT
81953016064, 81953016170



CV-ES-14162

Length: 125
Cone Ø: d1 Ø 30 / d2 Ø 27
Thread: M30 x 1,5 LHT
81953010015, 81953010083, 81953010087, 81953016029, 81953016030, 81953016043, 81953016044, 81953016050, 81953016054, 81953016087, 81953016091, 81953016107, 81953016120, 81953016125, 81953016152, 81953016155, 81953016157, 81953016168, 81953016179, 81953016181, 81953016223, 81953016237, 81953016254, 81953016275, 81953016279, 81953016351



CV-ES-14163

Length: 125
Cone Ø: d1 Ø 30 / d2 Ø 27
Thread: M30 x 1,5 RHT
95301.0084, 90804102156, 90804102272, 90804102696, 90804102710, 81953010016, 81953010075, 81953010084, 81953010088, 81953010094, 81953010103, 81953016030, 81953016043, 81953016048, 81953016049, 81953016053, 81953016061, 81953016090, 81953016108, 81953016112, 81953016126, 81953016143, 81953016149, 81953016154, 81953016156, 81953016168, 81953016178, 81953016194, 81953016206, 81953016224, 81953016234, 81953016242, 81953016252, 81953016274, 81953016278, 81953016284, 81953016286, 81953016308, 81953016310, 81953016312, 81953016347, 81953016350, 81953016352, 82953016012, 88953016014, N2953016001



CV-RK-5313

Ø: 90
03304800A, 81953016132



CV-RK-8118

Ø: 85
Hole Distance: 130
Thick/Height: 30
638862, 639287, 775201, 938423, 1104335, 1953248, 0003500506, 3500506, 11013547, 21032592, 42065912, 42488722, 070550504, 93192618, 070400009000, 634303610, 81432206055, 81432206073, 82262320660, 9544171010099, 5001842823, 7000307001, 8226232066



MN-DL-2160

Length: 1652 Ø: 50
Cone Ø: d1 Ø 30 / d2 Ø 27
81467106112, 81467106163, 81467106165, 81467106198, 81467106353, 81467106354, 81467106361, 81467116725



MN-DL-3402

Length: 590 Ø: 48
Hole Distance: 130 / 130
03307200A, 81432206067, 81432206068, 81432206090, 81432206092, 81432209092



MN-DL-3588

Length: 1035 Ø: 48
Cone Ø: d1 Ø 30 / d2 Ø 27
81466106333, 81466106334, 81466106354, 81466106355, 81466106360, 81466106361, 81466106721, 81466106722, 81466106723, 81466116216



MN-DL-5212

Length: 577 Ø: 48
Hole Distance: 130 / 130
81432206096, 81432206097, 81432206098, 81432206129, 81432209096, 81432209129, 81432306014, 81432306030



MN-DL-12421

Length: 1070 Ø: 48
Cone Ø: d1 Ø 30 / d2 Ø 27
Thread: M30 x 1,5 RHT
81466106656, 81466106659, 81466106669, 81466116006, 81466116007



MN-RK-7287

Ø: 90
Hole Distance: 152
Thick/Height: 35
03304700A, 81953016133



MN-RK-7291

Ø: 72
Hole Distance: 130
Thick/Height: 30
10307800A, 81432206108, 81432206132



MN-SB-5244

Ø: 65
Hole Distance: 125
Thick/Height: 22
03312000A, 81432710027, 81432710082



MN-SB-5245

Ø: 75
Hole Distance: 125
Thick/Height: 22
03311900A, 81432710046, 81432710079, 81432710083



MN-SB-5246

Ø: 45 Thick/Height: 47
81437220022, 81437220038, 81962100450, 81962100469



MN-SB-5254

Length: 100 Ø: 93
Thick/Height: 70
81432710081



MN-SB-9396

Ø: 67 Thick/Height: 60
81437040057



MN-SB-10389

Ø: 70 Thick/Height: 72
81960200340



MN-SB-10390

Ø: 70 Thick/Height: 85/85
81960200341, 81960200373, 81960200385, 81960200408, 81960200418



MN-VB-5222

Length: 627 Ø: 50
Hole Distance: 152 / 152
81432706030, 81432706034, 81432706054, 81432706055, 81432706056, 81432706057, 81432706067, 81432706068, 81432706074, 81432706075, 81432706076, 81432706077, 81432706078, 81432706081, 81432706082, 81432709034, 81432709076, 81432709078, 8143706054



MN-VB-8569

Length: 627 Ø: 58
Hole Distance: 152 / 152
81432706055, 81432706056, 81432706067, 81432706068, 81432706075, 81432706077, 81432706081, 81432709056



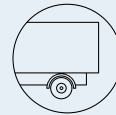

F 90 ...

26.362 DF, 26.362 DFL ...	09/87→02/90	Track Control Arm		MN-DL-3402	Trailing Arm, Drive Axle	
	09/87→02/90	Track Control Arm		MN-DL-5212	Trailing Arm, Air Suspension Axle; Drive Axle	
	09/87→02/90	Track Control Arm		MN-VB-5222	Wishbone (CV)	
26.362 DFA	05/88→02/90	Ball Head, gearshift linkage	CV-ES-2119			
	05/88→02/90	Ball Head, gearshift linkage	CV-ES-2120			
	05/88→02/90	Ball Head, gearshift linkage	CV-ES-2182			
	05/88→02/90	Centre Rod	MN-DL-2160		Coupling Rod	
	05/88→02/90	Centre Rod	MN-DL-3588		Push Rod	
	05/88→02/90	Centre Rod	MN-DL-12421		for Steering Rod	
	05/88→02/90	Engine Mounting	MN-SB-10389			
	05/88→02/90	Mounting, stabilizer coupling rod	MN-SB-5246			
	05/88→02/90	Stabiliser Mounting		MN-SB-5245		
	05/88→02/90	Stabiliser Mounting		MN-SB-5254		
	05/88→02/90	Stabiliser Mounting	MN-SB-9396			
	05/88→02/90	Suspension Arm Repair Kit		MN-SB-5244	for Wishbone (CV)	
	05/88→02/90	Suspension Arm Repair Kit		MN-SB-5244	for Wishbone (CV), 1st RA	
	05/88→02/90	Tie Rod End	CV-ES-2149		for Push Rod	
	05/88→02/90	Tie Rod End	CV-ES-14162		for Steering Rod	
	05/88→02/90	Tie Rod End	CV-ES-14163		for Steering Rod	
	05/88→02/90	Track Control Arm		MN-DL-3402	Trailing Arm	
	26.362 DFAK	05/88→02/90	Ball Head, gearshift linkage	CV-ES-2119		
		05/88→02/90	Ball Head, gearshift linkage	CV-ES-2120		
		05/88→02/90	Ball Head, gearshift linkage	CV-ES-2182		
05/88→02/90		Centre Rod	MN-DL-2160		Coupling Rod	
05/88→02/90		Centre Rod	MN-DL-3588		Push Rod	
05/88→02/90		Centre Rod	MN-DL-12421		for Steering Rod	
05/88→02/90		Engine Mounting	MN-SB-10389			
05/88→02/90		Mounting, stabilizer coupling rod	MN-SB-5246			
05/88→02/90		Stabiliser Mounting		MN-SB-5245		
05/88→02/90		Stabiliser Mounting		MN-SB-5254		
05/88→02/90		Stabiliser Mounting	MN-SB-9396			
05/88→02/90		Suspension Arm Repair Kit		MN-SB-5244	for Wishbone (CV)	
05/88→02/90		Suspension Arm Repair Kit		MN-SB-5244	for Wishbone (CV), 1st RA	
05/88→02/90		Tie Rod End	CV-ES-2149		for Push Rod	
05/88→02/90		Tie Rod End	CV-ES-14162		for Steering Rod	
05/88→02/90		Tie Rod End	CV-ES-14163		for Steering Rod	
05/88→02/90		Track Control Arm		MN-DL-3402	Trailing Arm	
26.362 DFAS		05/88→02/90	Ball Head, gearshift linkage	CV-ES-2119		
		05/88→02/90	Ball Head, gearshift linkage	CV-ES-2120		
		05/88→02/90	Ball Head, gearshift linkage	CV-ES-2182		
	05/88→02/90	Centre Rod	MN-DL-2160		Coupling Rod	
	05/88→02/90	Centre Rod	MN-DL-3588		Push Rod	
	05/88→02/90	Centre Rod	MN-DL-12421		for Steering Rod	
	05/88→02/90	Engine Mounting	MN-SB-10389			
	05/88→02/90	Mounting, stabilizer coupling rod	MN-SB-5246			
	05/88→02/90	Stabiliser Mounting		MN-SB-5245		
	05/88→02/90	Stabiliser Mounting		MN-SB-5254		
	05/88→02/90	Stabiliser Mounting	MN-SB-9396			
	05/88→02/90	Suspension Arm Repair Kit		MN-SB-5244	for Wishbone (CV)	
	05/88→02/90	Suspension Arm Repair Kit		MN-SB-5244	for Wishbone (CV), 1st RA	
	05/88→02/90	Tie Rod End	CV-ES-2149		for Push Rod	
	05/88→02/90	Tie Rod End	CV-ES-14162		for Steering Rod	
	05/88→02/90	Tie Rod End	CV-ES-14163		for Steering Rod	
	05/88→02/90	Track Control Arm		MN-DL-3402	Trailing Arm	
	26.362 DFK	09/87→02/90	Ball Head, gearshift linkage	CV-ES-2119		
		09/87→02/90	Ball Head, gearshift linkage	CV-ES-2120		
		09/87→02/90	Ball Head, gearshift linkage	CV-ES-2182		
09/87→02/90		Centre Rod	MN-DL-2160		Coupling Rod	
09/87→02/90		Centre Rod	MN-DL-3588		Push Rod	
09/87→02/90		Centre Rod	MN-DL-12421		for Steering Rod	
09/87→02/90		Engine Mounting		MN-SB-10390		
09/87→02/90		Engine Mounting	MN-SB-10389			
09/87→02/90		Mounting, stabilizer coupling rod	MN-SB-5246			

CV-ES-2119

Length: 55
Cone Ø: d1 Ø 10 / d2 Ø 10
Thread: M12 x 1,75 LHT
81953016063, 81953016131



CV-ES-2120

Length: 115
Cone Ø: d1 Ø 12,4 / d2 Ø 10,8
Thread: M14 x 1,5 RHT
03008500A, 81953016200, 81953016202, 81953016203, 81953016227



CV-ES-2149

Length: 160
Cone Ø: d1 Ø 30 / d2 Ø 27
Thread: M30 x 1,5 RHT
81953016263



CV-ES-2182

Length: 55
Cone Ø: d1 Ø 10 / d2 Ø 10
Thread: M12 x 1,75 RHT
81953016064, 81953016170



CV-ES-14162

Length: 125
Cone Ø: d1 Ø 30 / d2 Ø 27
Thread: M30 x 1,5 LHT

81953010015, 81953010083, 81953010087, 81953016029, 81953016030, 81953016043, 81953016044, 81953016050, 81953016054, 81953016087, 81953016091, 81953016107, 81953016120, 81953016125, 81953016152, 81953016155, 81953016157, 81953016168, 81953016179, 81953016181, 81953016223, 81953016237, 81953016254, 81953016275, 81953016279, 81953016351



CV-ES-14163

Length: 125
Cone Ø: d1 Ø 30 / d2 Ø 27
Thread: M30 x 1,5 RHT

95301.0084, 90804102156, 90804102272, 90804102696, 90804102710, 81953010016, 81953010075, 81953010084, 81953010088, 81953010094, 81953010103, 81953016030, 81953016043, 81953016048, 81953016049, 81953016053, 81953016061, 81953016090, 81953016108, 81953016112, 81953016126, 81953016143, 81953016149, 81953016154, 81953016156, 81953016168, 81953016178, 81953016194, 81953016206, 81953016224, 81953016234, 81953016242, 81953016252, 81953016274, 81953016278, 81953016284, 81953016286, 81953016308, 81953016310, 81953016312, 81953016347, 81953016350, 81953016352, 82953016012, 88953016014, N2953016001



MN-DL-2160

Length: 1652 Ø: 50
Cone Ø: d1 Ø 30 / d2 Ø 27
81467106112, 81467106163, 81467106165, 81467106198, 81467106353, 81467106354, 81467106361, 81467116725



MN-DL-3402

Length: 590 Ø: 48
Hole Distance: 130 / 130
03307200A, 81432206067, 81432206068, 81432206090, 81432206092, 81432209092



MN-DL-3588

Length: 1035
Ø: 48
Cone Ø: d1 Ø 30 / d2 Ø 27

81466106333, 81466106334, 81466106354, 81466106355, 81466106360, 81466106361, 81466106721, 81466106722, 81466106723, 81466116216



MN-DL-5212

Length: 577 Ø: 48
Hole Distance: 130 / 130
81432206096, 81432206097, 81432206098, 81432206129, 81432209096, 81432209129, 81432306014, 81432306030



MN-DL-12421

Length: 1070
Ø: 48
Cone Ø: d1 Ø 30 / d2 Ø 27
Thread: M30 x 1,5 RHT
81466106656, 81466106659, 81466106669, 81466116006, 81466116007



MN-SB-5244

Ø: 65
Hole Distance: 125
Thick/Height: 22
03312000A, 81432710027, 81432710082



MN-SB-5245

Ø: 75
Hole Distance: 125
Thick/Height: 22
03311900A, 81432710046, 81432710079, 81432710083



MN-SB-5246

Ø: 45 Thick/Height: 47
81437220022, 81437220038, 81962100450, 81962100469



MN-SB-5254

Length: 100
Ø: 93
Thick/Height: 70
81432710081



MN-SB-9396

Ø: 67
Thick/Height: 60
81437040057



MN-SB-10389

Ø: 70
Thick/Height: 72
81960200340



MN-SB-10390

Ø: 70
Thick/Height: 85/85
81960200341, 81960200373, 81960200385, 81960200408, 81960200418



MN-VB-5222

Length: 627 Ø: 50
Hole Distance: 152 / 152
81432706030, 81432706034, 81432706054, 81432706055, 81432706056, 81432706057, 81432706067, 81432706068, 81432706074, 81432706075, 81432706076, 81432706077, 81432706078, 81432706081, 81432706082, 81432709034, 81432709076, 81432709078, 8143706054





F 90 ...

26.362 DFK ...	09/87→02/90	Stabiliser Mounting		MN-SB-5245	
	09/87→02/90	Stabiliser Mounting		MN-SB-5254	
	09/87→02/90	Stabiliser Mounting	MN-SB-9396		
	09/87→02/90	Suspension Arm Repair Kit		MN-SB-5244	for Wishbone (CV)
	09/87→02/90	Suspension Arm Repair Kit		MN-SB-5244	for Wishbone (CV), 1st RA
	09/87→02/90	Tie Rod End	CV-ES-2149		for Push Rod
	09/87→02/90	Tie Rod End	CV-ES-14162		for Steering Rod
	09/87→02/90	Tie Rod End	CV-ES-14163		for Steering Rod
	09/87→02/90	Track Control Arm		MN-DL-3402	Trailing Arm
	09/87→02/90	Track Control Arm		MN-DL-3402	Trailing Arm, Drive Axle
26.362 DFS	09/87→02/90	Ball Head, gearshift linkage	CV-ES-2119		
	09/87→02/90	Ball Head, gearshift linkage	CV-ES-2120		
	09/87→02/90	Ball Head, gearshift linkage	CV-ES-2182		
	09/87→02/90	Centre Rod	MN-DL-2160		Coupling Rod
	09/87→02/90	Centre Rod	MN-DL-3588		Push Rod
	09/87→02/90	Centre Rod	MN-DL-12421		for Steering Rod
	09/87→02/90	Engine Mounting		MN-SB-10390	
	09/87→02/90	Engine Mounting	MN-SB-10389		
	09/87→02/90	Mounting, stabilizer coupling rod	MN-SB-5246		
	09/87→02/90	Stabiliser Mounting		MN-SB-5245	
	09/87→02/90	Stabiliser Mounting		MN-SB-5254	
	09/87→02/90	Stabiliser Mounting	MN-SB-9396		
	09/87→02/90	Suspension Arm Repair Kit		MN-SB-5244	for Wishbone (CV)
	09/87→02/90	Suspension Arm Repair Kit		MN-SB-5244	for Wishbone (CV), 1st RA
	09/87→02/90	Tie Rod End	CV-ES-2149		for Push Rod
	09/87→02/90	Tie Rod End	CV-ES-14162		for Steering Rod
	09/87→02/90	Tie Rod End	CV-ES-14163		for Steering Rod
	09/87→02/90	Track Control Arm		MN-DL-3402	Trailing Arm
	09/87→02/90	Track Control Arm		MN-DL-3402	Trailing Arm, Drive Axle
	26.372 DF,26.372 DFL	02/90→01/91	Track Control Arm		MN-VB-5222
02/90→06/96		Ball Head, gearshift linkage	CV-ES-2119		
02/90→06/96		Ball Head, gearshift linkage	CV-ES-2120		
02/90→06/96		Ball Head, gearshift linkage	CV-ES-2182		
02/90→06/96		Centre Rod	MN-DL-2160		Coupling Rod
02/90→06/96		Centre Rod	MN-DL-3588		Push Rod
02/90→06/96		Centre Rod	MN-DL-12421		for Steering Rod
02/90→06/96		Engine Mounting		MN-SB-10390	
02/90→06/96		Engine Mounting	MN-SB-10389		
02/90→06/96		Mounting, stabilizer coupling rod	MN-SB-5246		
02/90→06/96		Stabiliser Mounting		MN-SB-5245	
02/90→06/96		Stabiliser Mounting		MN-SB-5254	
02/90→06/96		Stabiliser Mounting	MN-SB-9396		
02/90→06/96		Suspension Arm Repair Kit		CV-RK-5313	for Wishbone (CV)
02/90→06/96		Suspension Arm Repair Kit		CV-RK-8118	for Control Arm
02/90→06/96		Suspension Arm Repair Kit		MN-RK-7287	for Wishbone (CV)
02/90→06/96		Suspension Arm Repair Kit		MN-RK-7291	for Drag Link
02/90→06/96		Suspension Arm Repair Kit		MN-SB-5244	for Wishbone (CV)
02/90→06/96		Suspension Arm Repair Kit		MN-SB-5244	for Wishbone (CV), 1st RA
02/90→06/96		Tie Rod End	CV-ES-2149		for Push Rod
02/90→06/96		Tie Rod End	CV-ES-14162		for Steering Rod
02/90→06/96		Tie Rod End	CV-ES-14163		for Steering Rod
02/90→06/96		Track Control Arm		MN-DL-3402	Trailing Arm
02/90→06/96		Track Control Arm		MN-DL-3402	Trailing Arm, Drive Axle
02/90→06/96		Track Control Arm		MN-DL-5212	Trailing Arm, Air Suspension Axle; Drive Axle
02/90→06/96		Track Control Arm		MN-VB-5222	Wishbone (CV)
02/90→06/96		Track Control Arm		MN-VB-5222	Wishbone (CV), Drive Axle; Air Suspension Axle
02/90→06/96		Track Control Arm		MN-VB-8569	Wishbone (CV)
02/90→06/96		Track Control Arm		MN-VB-8569	Wishbone (CV), Drive Axle
26.372 DFA		02/90→12/92	Ball Head, gearshift linkage	CV-ES-2119	
	02/90→12/92	Ball Head, gearshift linkage	CV-ES-2120		
	02/90→12/92	Ball Head, gearshift linkage	CV-ES-2182		
	02/90→12/92	Centre Rod	MN-DL-2160		Coupling Rod
	02/90→12/92	Centre Rod	MN-DL-3588		Push Rod

CV-ES-2119

Length: 55
Cone Ø: d1 Ø 10 / d2 Ø 10
Thread: M12 x 1,75 LHT
81953016063, 81953016131



CV-ES-2120

Length: 115
Cone Ø: d1 Ø 12,4 / d2 Ø 10,8
Thread: M14 x 1,5 RHT
03008500A, 81953016200, 81953016202,
81953016203, 81953016227



CV-ES-2149

Length: 160
Cone Ø: d1 Ø 30 / d2 Ø 27
Thread: M30 x 1,5 RHT
81953016263



CV-ES-2182

Length: 55
Cone Ø: d1 Ø 10 / d2 Ø 10
Thread: M12 x 1,75 RHT
81953016064, 81953016170



CV-ES-14162

Length: 125
Cone Ø: d1 Ø 30 / d2 Ø 27
Thread: M30 x 1,5 LHT
81953010015, 81953010083, 81953010087,
81953016029, 81953016030, 81953016043,
81953016044, 81953016050, 81953016054,
81953016087, 81953016091, 81953016107,
81953016120, 81953016125, 81953016152,
81953016155, 81953016157, 81953016168,
81953016179, 81953016181, 81953016223,
81953016237, 81953016254, 81953016275,
81953016279, 81953016351



CV-ES-14163

Length: 125
Cone Ø: d1 Ø 30 / d2 Ø 27
Thread: M30 x 1,5 RHT
95301.0084, 90804102156, 90804102272,
90804102696, 90804102710, 81953010016,
81953010075, 81953010084, 81953010088,
81953010094, 81953010103, 81953016030,
81953016043, 81953016048, 81953016049,
81953016053, 81953016061, 81953016090,
81953016108, 81953016112, 81953016126,
81953016143, 81953016149, 81953016154,
81953016156, 81953016168, 81953016178,
81953016194, 81953016206, 81953016224,
81953016234, 81953016242, 81953016252,
81953016274, 81953016278, 81953016284,
81953016286, 81953016308, 81953016310,
81953016312, 81953016347, 81953016350,
81953016352, 82953016012, 88953016014,
N2953016001



CV-RK-5313

Ø: 90
03304800A, 81953016132



CV-RK-8118

Ø: 85
Hole Distance: 130
Thick/Height: 30
638862, 639287, 775201, 938423,
1104335, 1953248, 0003500506, 35000506,
11013547, 21032592, 42065912, 42488722,
070550504, 93192618, 070400009000,
634303610, 81432206055, 81432206073,
82262320660, 9544171010099,
5001842823, 7000307001, 8226232066



MN-DL-2160

Length: 1652 Ø: 50
Cone Ø: d1 Ø 30 / d2 Ø 27
81467106112, 81467106163, 81467106165,
81467106198, 81467106353, 81467106354,
81467106361, 81467116725



MN-DL-3402

Length: 590 Ø: 48
Hole Distance: 130 / 130
03307200A, 81432206067, 81432206068,
81432206090, 81432206092, 81432209092



MN-DL-3588

Length: 1035 Ø: 48
Cone Ø: d1 Ø 30 / d2 Ø 27
81466106333, 81466106334, 81466106354,
81466106355, 81466106360, 81466106361,
81466106721, 81466106722, 81466106723,
81466116216



MN-DL-5212

Length: 577 Ø: 48
Hole Distance: 130 / 130
81432206096, 81432206097, 81432206098,
81432206129, 81432209096, 81432209129,
81432306014, 81432306030



MN-DL-12421

Length: 1070 Ø: 48
Cone Ø: d1 Ø 30 / d2 Ø 27
Thread: M30 x 1,5 RHT
81466106656, 81466106659, 81466106669,
81466116006, 81466116007



MN-RK-7287

Ø: 90
Hole Distance: 152
Thick/Height: 35
03304700A, 81953016133



MN-RK-7291

Ø: 72
Hole Distance: 130
Thick/Height: 30
10307800A, 81432206108, 81432206132



MN-SB-5244

Ø: 65
Hole Distance: 125
Thick/Height: 22
03312000A, 81432710027, 81432710082



MN-SB-5245

Ø: 75
Hole Distance: 125
Thick/Height: 22
03311900A, 81432710046, 81432710079,
81432710083



MN-SB-5246

Ø: 45 Thick/Height: 47
81437220022, 81437220038, 81962100450,
81962100469



MN-SB-5254

Length: 100 Ø: 93
Thick/Height: 70
81432710081



MN-SB-9396

Ø: 67 Thick/Height: 60
81437040057



MN-SB-10389

Ø: 70 Thick/Height: 72
81960200340



MN-SB-10390

Ø: 70 Thick/Height: 85/85
81960200341, 81960200373, 81960200385,
81960200408, 81960200418



MN-VB-5222

Length: 627 Ø: 50
Hole Distance: 152 / 152
81432706030, 81432706034, 81432706054,
81432706055, 81432706056, 81432706057,
81432706067, 81432706068, 81432706074,
81432706075, 81432706076, 81432706077,
81432706078, 81432706081, 81432706082,
81432709034, 81432709076, 81432709078,
8143706054



MN-VB-8569

Length: 627 Ø: 58
Hole Distance: 152 / 152
81432706055, 81432706056, 81432706067,
81432706068, 81432706075, 81432706077,
81432706081, 81432709056





F 90 ...

26.372 DFA ...	02/90→12/92	Centre Rod	MN-DL-12421		for Steering Rod	
	02/90→12/92	Engine Mounting	MN-SB-10389			
	02/90→12/92	Mounting, stabilizer coupling rod	MN-SB-5246			
	02/90→12/92	Stabiliser Mounting		MN-SB-5245		
	02/90→12/92	Stabiliser Mounting		MN-SB-5254		
	02/90→12/92	Stabiliser Mounting	MN-SB-9396			
	02/90→12/92	Suspension Arm Repair Kit		MN-SB-5244	for Wishbone (CV)	
	02/90→12/92	Suspension Arm Repair Kit		MN-SB-5244	for Wishbone (CV), 1st RA	
	02/90→12/92	Tie Rod End	CV-ES-2149		for Push Rod	
	02/90→12/92	Tie Rod End	CV-ES-14162		for Steering Rod	
	02/90→12/92	Tie Rod End	CV-ES-14163		for Steering Rod	
	02/90→12/92	Track Control Arm		MN-DL-3402	Trailing Arm	
	26.372 DFAK	01/92→06/96	Ball Head, gearshift linkage	CV-ES-2119		
		01/92→06/96	Ball Head, gearshift linkage	CV-ES-2120		
01/92→06/96		Ball Head, gearshift linkage	CV-ES-2182			
01/92→06/96		Centre Rod	MN-DL-2160		Coupling Rod	
01/92→06/96		Centre Rod	MN-DL-3588		Push Rod	
01/92→06/96		Centre Rod	MN-DL-12421		for Steering Rod	
01/92→06/96		Engine Mounting	MN-SB-10389			
01/92→06/96		Mounting, stabilizer coupling rod	MN-SB-5246			
01/92→06/96		Stabiliser Mounting		MN-SB-5245		
01/92→06/96		Stabiliser Mounting		MN-SB-5254		
01/92→06/96		Stabiliser Mounting	MN-SB-9396			
01/92→06/96		Suspension Arm Repair Kit		MN-SB-5244	for Wishbone (CV)	
01/92→06/96		Suspension Arm Repair Kit		MN-SB-5244	for Wishbone (CV), 1st RA	
01/92→06/96		Tie Rod End	CV-ES-2149		for Push Rod	
01/92→06/96	Tie Rod End	CV-ES-14162		for Steering Rod		
01/92→06/96	Tie Rod End	CV-ES-14163		for Steering Rod		
01/92→06/96	Track Control Arm		MN-DL-3402	Trailing Arm		
26.372 DFAS	02/90→12/92	Ball Head, gearshift linkage	CV-ES-2119			
	02/90→12/92	Ball Head, gearshift linkage	CV-ES-2120			
	02/90→12/92	Ball Head, gearshift linkage	CV-ES-2182			
	02/90→12/92	Centre Rod	MN-DL-2160		Coupling Rod	
	02/90→12/92	Centre Rod	MN-DL-3588		Push Rod	
	02/90→12/92	Centre Rod	MN-DL-12421		for Steering Rod	
	02/90→12/92	Engine Mounting	MN-SB-10389			
	02/90→12/92	Mounting, stabilizer coupling rod	MN-SB-5246			
	02/90→12/92	Stabiliser Mounting		MN-SB-5245		
	02/90→12/92	Stabiliser Mounting		MN-SB-5254		
	02/90→12/92	Stabiliser Mounting	MN-SB-9396			
	02/90→12/92	Suspension Arm Repair Kit		MN-SB-5244	for Wishbone (CV)	
	02/90→12/92	Suspension Arm Repair Kit		MN-SB-5244	for Wishbone (CV), 1st RA	
	02/90→12/92	Tie Rod End	CV-ES-2149		for Push Rod	
02/90→12/92	Tie Rod End	CV-ES-14162		for Steering Rod		
02/90→12/92	Tie Rod End	CV-ES-14163		for Steering Rod		
02/90→12/92	Track Control Arm		MN-DL-3402	Trailing Arm		
26.372 DFK	01/92→06/96	Ball Head, gearshift linkage	CV-ES-2119			
	01/92→06/96	Ball Head, gearshift linkage	CV-ES-2120			
	01/92→06/96	Ball Head, gearshift linkage	CV-ES-2182			
	01/92→06/96	Centre Rod	MN-DL-2160		Coupling Rod	
	01/92→06/96	Centre Rod	MN-DL-3588		Push Rod	
	01/92→06/96	Centre Rod	MN-DL-12421		for Steering Rod	
	01/92→06/96	Engine Mounting	MN-SB-10389			
	01/92→06/96	Suspension Arm Repair Kit		CV-RK-5313	for Wishbone (CV)	
	01/92→06/96	Suspension Arm Repair Kit		MN-RK-7287	for Wishbone (CV)	
	01/92→06/96	Suspension Arm Repair Kit		MN-SB-5244	for Wishbone (CV)	
	01/92→06/96	Suspension Arm Repair Kit		MN-SB-5244	for Wishbone (CV), 1st RA	
	01/92→06/96	Tie Rod End	CV-ES-2149		for Push Rod	
	01/92→06/96	Tie Rod End	CV-ES-14162		for Steering Rod	
	01/92→06/96	Tie Rod End	CV-ES-14163		for Steering Rod	
01/92→06/96	Track Control Arm		MN-DL-3402	Trailing Arm		
01/92→06/96	Track Control Arm		MN-VB-5222	Wishbone (CV)		
01/92→06/96	Track Control Arm		MN-VB-8569	Wishbone (CV), Drive Axle		

CV-ES-2119

Length: 55
Cone Ø: d1 Ø 10 / d2 Ø 10
Thread: M12 x 1,75 LHT
81953016063, 81953016131



CV-ES-2120

Length: 115
Cone Ø: d1 Ø 12,4 / d2 Ø 10,8
Thread: M14 x 1,5 RHT
03008500A, 81953016200, 81953016202,
81953016203, 81953016227



CV-ES-2149

Length: 160
Cone Ø: d1 Ø 30 / d2 Ø 27
Thread: M30 x 1,5 RHT
81953016263



CV-ES-2182

Length: 55
Cone Ø: d1 Ø 10 / d2 Ø 10
Thread: M12 x 1,75 RHT
81953016064, 81953016170



CV-ES-14162

Length: 125
Cone Ø: d1 Ø 30 / d2 Ø 27
Thread: M30 x 1,5 LHT
81953010015, 81953010083, 81953010087,
81953016029, 81953016030, 81953016043,
81953016044, 81953016050, 81953016054,
81953016087, 81953016091, 81953016107,
81953016120, 81953016125, 81953016152,
81953016155, 81953016157, 81953016168,
81953016179, 81953016181, 81953016223,
81953016237, 81953016254, 81953016275,
81953016279, 81953016351



CV-ES-14163

Length: 125
Cone Ø: d1 Ø 30 / d2 Ø 27
Thread: M30 x 1,5 RHT
95301.0084, 90804102156, 90804102272,
90804102696, 90804102710, 81953010016,
81953010075, 81953010084, 81953010088,
81953010094, 81953010103, 81953016030,
81953016043, 81953016048, 81953016049,
81953016053, 81953016061, 81953016090,
81953016108, 81953016112, 81953016126,
81953016143, 81953016149, 81953016154,
81953016156, 81953016168, 81953016178,
81953016194, 81953016206, 81953016224,
81953016234, 81953016242, 81953016252,
81953016274, 81953016278, 81953016284,
81953016286, 81953016308, 81953016310,
81953016312, 81953016347, 81953016350,
81953016352, 82953016012, 88953016014,
N2953016001



CV-RK-5313

Ø: 90
03304800A, 81953016132



MN-DL-2160

Length: 1652 Ø: 50
Cone Ø: d1 Ø 30 / d2 Ø 27
81467106112, 81467106163, 81467106165,
81467106198, 81467106353, 81467106354,
81467106361, 81467116725



MN-DL-3402

Length: 590 Ø: 48
Hole Distance: 130 / 130
03307200A, 81432206067, 81432206068,
81432206090, 81432206092, 81432209092



MN-DL-3588

Length: 1035
Ø: 48
Cone Ø: d1 Ø 30 / d2 Ø 27
81466106333, 81466106334, 81466106354,
81466106355, 81466106360, 81466106361,
81466106721, 81466106722, 81466106723,
81466116216



MN-DL-12421

Length: 1070
Ø: 48
Cone Ø: d1 Ø 30 / d2 Ø 27
Thread: M30 x 1,5 RHT
81466106656, 81466106659, 81466106669,
81466116006, 81466116007



MN-RK-7287

Ø: 90
Hole Distance: 152
Thick/Height: 35
03304700A, 81953016133



MN-SB-5244

Ø: 65
Hole Distance: 125
Thick/Height: 22
03312000A, 81432710027, 81432710082



MN-SB-5245

Ø: 75
Hole Distance: 125
Thick/Height: 22
03311900A, 81432710046, 81432710079,
81432710083



MN-SB-5246

Ø: 45 Thick/Height: 47
81437220022, 81437220038, 81962100450,
81962100469



MN-SB-5254

Length: 100
Ø: 93
Thick/Height: 70
81432710081



MN-SB-9396

Ø: 67
Thick/Height: 60
81437040057



MN-SB-10389

Ø: 70
Thick/Height: 72
8196200340



MN-VB-5222

Length: 627 Ø: 50
Hole Distance: 152 / 152
81432706030, 81432706034, 81432706054,
81432706055, 81432706056, 81432706057,
81432706067, 81432706068, 81432706074,
81432706075, 81432706076, 81432706077,
81432706078, 81432706081, 81432706082,
81432709034, 81432709076, 81432709078,
8143706054



MN-VB-8569

Length: 627
Ø: 58
Hole Distance: 152 / 152
81432706055, 81432706056, 81432706067,
81432706068, 81432706075, 81432706077,
81432706081, 81432709056



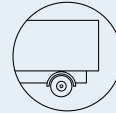

F 90 ...

26.372 DFS	02/90→01/91	Track Control Arm		MN-VB-5222	Wishbone (CV), Drive Axle	
	02/90→06/96	Ball Head, gearshift linkage	CV-ES-2119			
	02/90→06/96	Ball Head, gearshift linkage	CV-ES-2120			
	02/90→06/96	Ball Head, gearshift linkage	CV-ES-2182			
	02/90→06/96	Centre Rod	MN-DL-2160		Coupling Rod	
	02/90→06/96	Centre Rod	MN-DL-3588		Push Rod	
	02/90→06/96	Centre Rod	MN-DL-12421		for Steering Rod	
	02/90→06/96	Engine Mounting		MN-SB-10390		
	02/90→06/96	Engine Mounting	MN-SB-10389			
	02/90→06/96	Mounting, stabilizer coupling rod	MN-SB-5246			
	02/90→06/96	Stabiliser Mounting		MN-SB-5245		
	02/90→06/96	Stabiliser Mounting		MN-SB-5254		
	02/90→06/96	Stabiliser Mounting	MN-SB-9396			
	02/90→06/96	Suspension Arm Repair Kit		CV-RK-5313	for Wishbone (CV)	
	02/90→06/96	Suspension Arm Repair Kit		MN-RK-7287	for Wishbone (CV)	
	02/90→06/96	Suspension Arm Repair Kit		MN-SB-5244	for Wishbone (CV)	
	02/90→06/96	Suspension Arm Repair Kit		MN-SB-5244	for Wishbone (CV), 1st RA	
	02/90→06/96	Tie Rod End	CV-ES-2149		for Push Rod	
	02/90→06/96	Tie Rod End	CV-ES-14162		for Steering Rod	
	02/90→06/96	Tie Rod End	CV-ES-14163		for Steering Rod	
	02/90→06/96	Track Control Arm		MN-DL-3402	Trailing Arm	
	02/90→06/96	Track Control Arm		MN-DL-3402	Trailing Arm, Drive Axle	
	02/90→06/96	Track Control Arm		MN-VB-5222	Wishbone (CV)	
	02/90→06/96	Track Control Arm		MN-VB-8569	Wishbone (CV)	
	01/91→06/96	Track Control Arm		MN-VB-8569	Wishbone (CV), Drive Axle	
	26.372 FNL, 26.372 FNLL, 26.372 FVL	09/90→12/95	Ball Head, gearshift linkage	CV-ES-2119		
		09/90→12/95	Ball Head, gearshift linkage	CV-ES-2120		
		09/90→12/95	Ball Head, gearshift linkage	CV-ES-2182		
		09/90→12/95	Centre Rod	MN-DL-2160		Coupling Rod
		09/90→12/95	Centre Rod	MN-DL-3588		Push Rod
		09/90→12/95	Centre Rod	MN-DL-12421		for Steering Rod
		09/90→12/95	Engine Mounting	MN-SB-10389		
09/90→12/95		Stabiliser Mounting		MN-SB-5243		
09/90→12/95		Stabiliser Mounting		MN-SB-5265		
09/90→12/95		Stabiliser Mounting		MN-SB-5265	1st RA	
09/90→12/95		Suspension Arm Repair Kit		CV-RK-5313	for Wishbone (CV)	
09/90→12/95		Suspension Arm Repair Kit		CV-RK-8118	for Control Arm	
09/90→12/95		Suspension Arm Repair Kit		MN-RK-7280	for Drag Link	
09/90→12/95		Suspension Arm Repair Kit		MN-RK-7287	for Wishbone (CV)	
09/90→12/95		Suspension Arm Repair Kit		MN-RK-7291	for Drag Link	
09/90→12/95		Tie Rod	MN-DL-12284			
09/90→12/95		Tie Rod End	CV-ES-2149		for Push Rod	
09/90→12/95		Tie Rod End	CV-ES-14162		for Steering Rod	
09/90→12/95		Tie Rod End	CV-ES-14163		for Steering Rod	
09/90→12/95		Track Control Arm		MN-VB-5222	Wishbone (CV), Drive Axle; Air Suspension Axle	
09/90→12/95		Track Control Arm		MN-VB-5222	Wishbone (CV), Tag Axle	
26.372 FNLS, 26.372 FVLS		01/92→06/96	Ball Head, gearshift linkage	CV-ES-2119		
		01/92→06/96	Ball Head, gearshift linkage	CV-ES-2120		
	01/92→06/96	Ball Head, gearshift linkage	CV-ES-2182			
	01/92→06/96	Centre Rod	MN-DL-2160		Coupling Rod	
	01/92→06/96	Centre Rod	MN-DL-3588		Push Rod	
	01/92→06/96	Centre Rod	MN-DL-12421		for Steering Rod	
	01/92→06/96	Engine Mounting	MN-SB-10389			
	01/92→06/96	Stabiliser Mounting		MN-SB-5243		
	01/92→06/96	Stabiliser Mounting		MN-SB-5265		
	01/92→06/96	Stabiliser Mounting		MN-SB-5265	1st RA	
	01/92→06/96	Suspension Arm Repair Kit		CV-RK-5313	for Wishbone (CV)	
	01/92→06/96	Suspension Arm Repair Kit		CV-RK-8118	for Control Arm	
	01/92→06/96	Suspension Arm Repair Kit		MN-RK-7280	for Drag Link	
	01/92→06/96	Suspension Arm Repair Kit		MN-RK-7287	for Wishbone (CV)	
	01/92→06/96	Suspension Arm Repair Kit		MN-RK-7291	for Drag Link	
	01/92→06/96	Tie Rod	MN-DL-12284			
	01/92→06/96	Tie Rod End	CV-ES-2149		for Push Rod	

CV-ES-2119

Length: 55
Cone Ø: d1 Ø 10 / d2 Ø 10
Thread: M12 x 1,75 LHT
81953016063, 81953016131



CV-ES-2120

Length: 115
Cone Ø: d1 Ø 12,4 / d2 Ø 10,8
Thread: M14 x 1,5 RHT
03008500A, 81953016200, 81953016202,
81953016203, 81953016227



CV-ES-2149

Length: 160
Cone Ø: d1 Ø 30 / d2 Ø 27
Thread: M30 x 1,5 RHT
81953016263



CV-ES-2182

Length: 55
Cone Ø: d1 Ø 10 / d2 Ø 10
Thread: M12 x 1,75 RHT
81953016064, 81953016170



CV-ES-14162

Length: 125
Cone Ø: d1 Ø 30 / d2 Ø 27
Thread: M30 x 1,5 LHT
81953010015, 81953010083, 81953010087,
81953016029, 81953016030, 81953016043,
81953016044, 81953016050, 81953016054,
81953016087, 81953016091, 81953016107,
81953016120, 81953016125, 81953016152,
81953016155, 81953016157, 81953016168,
81953016179, 81953016181, 81953016223,
81953016237, 81953016254, 81953016275,
81953016279, 81953016351



CV-ES-14163

Length: 125
Cone Ø: d1 Ø 30 / d2 Ø 27
Thread: M30 x 1,5 RHT
95301.0084, 90804102156, 90804102272,
90804102696, 90804102710, 81953010016,
81953010075, 81953010084, 81953010088,
81953010094, 81953010103, 81953016030,
81953016043, 81953016048, 81953016049,
81953016053, 81953016061, 81953016090,
81953016108, 81953016112, 81953016126,
81953016143, 81953016149, 81953016154,
81953016156, 81953016168, 81953016178,
81953016194, 81953016206, 81953016224,
81953016234, 81953016242, 81953016252,
81953016274, 81953016278, 81953016284,
81953016286, 81953016308, 81953016310,
81953016312, 81953016347, 81953016350,
81953016352, 82953016012, 88953016014,
N2953016001



CV-RK-5313

Ø: 90
03304800A, 81953016132



CV-RK-8118

Ø: 85
Hole Distance: 130
Thick/Height: 30
638862, 639287, 775201, 938423,
1104335, 1953248, 0003500506, 3500506,
11013547, 21032592, 42065912, 42488722,
070550504, 93192618, 070400009000,
634303610, 81432206055, 81432206073,
82262320660, 9544171010099,
5001842823, 7000307001, 8226232066



MN-DL-2160

Length: 1652 Ø: 50
Cone Ø: d1 Ø 30 / d2 Ø 27
81467106112, 81467106163, 81467106165,
81467106198, 81467106353, 81467106354,
81467106361, 81467116725



MN-DL-3402

Length: 590 Ø: 48
Hole Distance: 130 / 130
03307200A, 81432206067, 81432206068,
81432206090, 81432206092, 81432209092



MN-DL-3588

Length: 1035 Ø: 48
Cone Ø: d1 Ø 30 / d2 Ø 27
81466106333, 81466106334, 81466106354,
81466106355, 81466106360, 81466106361,
81466106721, 81466106722, 81466106723,
81466116216



MN-DL-12284

Length: 1530 Ø: 50
Cone Ø: d1 Ø 30 / d2 Ø 27
81466106579, 81466106580, 81466106624,
81466116720, 81467116720, 81467116730,
81467116952



MN-DL-12421

Length: 1070 Ø: 48
Cone Ø: d1 Ø 30 / d2 Ø 27
Thread: M30 x 1,5 RHT
81466106656, 81466106659, 81466106669,
81466116006, 81466116007



MN-RK-7280

Ø: 75
Hole Distance: 115
Thick/Height: 24
0550806, 0639370, 689748, 10307400A,
81432306051, 81432306068, 81432706064



MN-RK-7287

Ø: 90
Hole Distance: 152
Thick/Height: 35
03304700A, 81953016133



MN-RK-7291

Ø: 72
Hole Distance: 130
Thick/Height: 30
10307800A, 81432206108, 81432206132



MN-SB-5243

Length: 55 Ø: 78
Thick/Height: 60
03311100A, 81437040061, 81437220020



MN-SB-5244

Ø: 65
Hole Distance: 125
Thick/Height: 22
03312000A, 81432710027, 81432710082



MN-SB-5245

Ø: 75
Hole Distance: 125
Thick/Height: 22
03311900A, 81432710046, 81432710079,
81432710083



MN-SB-5246

Ø: 45 Thick/Height: 47
81437220022, 81437220038, 81962100450,
81962100469



MN-SB-5254

Length: 100 Ø: 93
Thick/Height: 70
81432710081



MN-SB-5265

Ø: 85 Thick/Height: 80
03310300A, 81437040032



MN-SB-9396

Ø: 67 Thick/Height: 60
81437040057



MN-SB-10389

Ø: 70 Thick/Height: 72
81960200340



MN-SB-10390

Ø: 70 Thick/Height: 85/85
81960200341, 81960200373, 81960200385,
81960200408, 81960200418



MN-VB-5222

Length: 627 Ø: 50
Hole Distance: 152 / 152
81432706030, 81432706034, 81432706054,
81432706055, 81432706056, 81432706057,
81432706067, 81432706068, 81432706074,
81432706075, 81432706076, 81432706077,
81432706078, 81432706081, 81432706082,
81432709034, 81432709076, 81432709078,
8143706054



MN-VB-8569

Length: 627 Ø: 58
Hole Distance: 152 / 152
81432706055, 81432706056, 81432706067,
81432706068, 81432706075, 81432706077,
81432706081, 81432709056



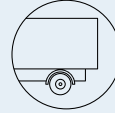

F 90 ...

26.372 FNLS,26.372 FVLS ...	01/92→06/96	Tie Rod End	CV-ES-14162		for Steering Rod
	01/92→06/96	Tie Rod End	CV-ES-14163		for Steering Rod
	01/92→06/96	Track Control Arm		MN-VB-5222	Wishbone (CV), Drive Axle;Air Suspension Axle
	01/92→06/96	Track Control Arm		MN-VB-5222	Wishbone (CV), Tag Axle
26.402 DF,26.402 DFL	05/94→06/96	Ball Head, gearshift linkage	CV-ES-2119		
	05/94→06/96	Ball Head, gearshift linkage	CV-ES-2120		
	05/94→06/96	Ball Head, gearshift linkage	CV-ES-2182		
	05/94→06/96	Centre Rod	MN-DL-2160		Coupling Rod
	05/94→06/96	Centre Rod	MN-DL-3588		Push Rod
	05/94→06/96	Centre Rod	MN-DL-12421		for Steering Rod
	05/94→06/96	Engine Mounting	MN-SB-10389		
	05/94→06/96	Suspension Arm Repair Kit		CV-RK-5313	for Wishbone (CV)
	05/94→06/96	Suspension Arm Repair Kit		CV-RK-8118	for Control Arm
	05/94→06/96	Suspension Arm Repair Kit		MN-RK-7287	for Wishbone (CV)
	05/94→06/96	Suspension Arm Repair Kit		MN-RK-7291	for Drag Link
	05/94→06/96	Suspension Arm Repair Kit		MN-SB-5244	for Wishbone (CV)
	05/94→06/96	Suspension Arm Repair Kit		MN-SB-5244	for Wishbone (CV), 1st RA
	05/94→06/96	Tie Rod End	CV-ES-2149		for Push Rod
	05/94→06/96	Tie Rod End	CV-ES-14162		for Steering Rod
	05/94→06/96	Tie Rod End	CV-ES-14163		for Steering Rod
	05/94→06/96	Track Control Arm		MN-DL-3402	Trailing Arm
	05/94→06/96	Track Control Arm		MN-DL-5212	Trailing Arm, Air Suspension Axle;Drive Axle
	05/94→06/96	Track Control Arm		MN-VB-5222	Wishbone (CV)
	05/94→06/96	Track Control Arm		MN-VB-8569	Wishbone (CV), Drive Axle
	26.402 DFK,26.402 DFLK	05/94→06/96	Ball Head, gearshift linkage	CV-ES-2119	
05/94→06/96		Ball Head, gearshift linkage	CV-ES-2120		
05/94→06/96		Ball Head, gearshift linkage	CV-ES-2182		
05/94→06/96		Centre Rod	MN-DL-2160		Coupling Rod
05/94→06/96		Centre Rod	MN-DL-3588		Push Rod
05/94→06/96		Centre Rod	MN-DL-12421		for Steering Rod
05/94→06/96		Engine Mounting	MN-SB-10389		
05/94→06/96		Suspension Arm Repair Kit		CV-RK-5313	for Wishbone (CV)
05/94→06/96		Suspension Arm Repair Kit		CV-RK-8118	for Control Arm
05/94→06/96		Suspension Arm Repair Kit		MN-RK-7287	for Wishbone (CV)
05/94→06/96		Suspension Arm Repair Kit		MN-RK-7291	for Drag Link
05/94→06/96		Suspension Arm Repair Kit		MN-SB-5244	for Wishbone (CV)
05/94→06/96		Suspension Arm Repair Kit		MN-SB-5244	for Wishbone (CV), 1st RA
05/94→06/96		Tie Rod End	CV-ES-2149		for Push Rod
05/94→06/96		Tie Rod End	CV-ES-14162		for Steering Rod
05/94→06/96		Tie Rod End	CV-ES-14163		for Steering Rod
05/94→06/96		Track Control Arm		MN-DL-3402	Trailing Arm
05/94→06/96		Track Control Arm		MN-DL-5212	Trailing Arm, Air Suspension Axle;Drive Axle
05/94→06/96		Track Control Arm		MN-VB-5222	Wishbone (CV)
05/94→06/96		Track Control Arm		MN-VB-8569	Wishbone (CV), Drive Axle
26.402 DFS		05/94→12/95	Ball Head, gearshift linkage	CV-ES-2119	
	05/94→12/95	Ball Head, gearshift linkage	CV-ES-2120		
	05/94→12/95	Ball Head, gearshift linkage	CV-ES-2182		
	05/94→12/95	Centre Rod	MN-DL-2160		Coupling Rod
	05/94→12/95	Centre Rod	MN-DL-3588		Push Rod
	05/94→12/95	Centre Rod	MN-DL-12421		for Steering Rod
	05/94→12/95	Engine Mounting	MN-SB-10389		
	05/94→12/95	Suspension Arm Repair Kit		CV-RK-5313	for Wishbone (CV)
	05/94→12/95	Suspension Arm Repair Kit		MN-RK-7287	for Wishbone (CV)
	05/94→12/95	Suspension Arm Repair Kit		MN-SB-5244	for Wishbone (CV)
	05/94→12/95	Suspension Arm Repair Kit		MN-SB-5244	for Wishbone (CV), 1st RA
	05/94→12/95	Tie Rod End	CV-ES-2149		for Push Rod
	05/94→12/95	Tie Rod End	CV-ES-14162		for Steering Rod
	05/94→12/95	Tie Rod End	CV-ES-14163		for Steering Rod
	05/94→12/95	Track Control Arm		MN-DL-3402	Trailing Arm
05/94→12/95	Track Control Arm		MN-VB-5222	Wishbone (CV)	
05/94→12/95	Track Control Arm		MN-VB-8569	Wishbone (CV), Drive Axle	

CV-ES-2119

Length: 55
Cone Ø: d1 Ø 10 / d2 Ø 10
Thread: M12 x 1,75 LHT
81953016063, 81953016131



CV-ES-2120

Length: 115
Cone Ø: d1 Ø 12,4 / d2 Ø 10,8
Thread: M14 x 1,5 RHT
03008500A, 81953016200, 81953016202, 81953016203, 81953016227



CV-ES-2149

Length: 160
Cone Ø: d1 Ø 30 / d2 Ø 27
Thread: M30 x 1,5 RHT
81953016263



CV-ES-2182

Length: 55
Cone Ø: d1 Ø 10 / d2 Ø 10
Thread: M12 x 1,75 RHT
81953016064, 81953016170



CV-ES-14162

Length: 125
Cone Ø: d1 Ø 30 / d2 Ø 27
Thread: M30 x 1,5 LHT
81953010015, 81953010083, 81953010087, 81953016029, 81953016030, 81953016043, 81953016044, 81953016050, 81953016054, 81953016087, 81953016091, 81953016107, 81953016120, 81953016125, 81953016152, 81953016155, 81953016157, 81953016168, 81953016179, 81953016181, 81953016223, 81953016237, 81953016254, 81953016275, 81953016279, 81953016351



CV-ES-14163

Length: 125
Cone Ø: d1 Ø 30 / d2 Ø 27
Thread: M30 x 1,5 RHT
95301.0084, 90804102156, 90804102272, 90804102696, 90804102710, 81953010016, 81953010075, 81953010084, 81953010088, 81953010094, 81953010103, 81953016030, 81953016043, 81953016048, 81953016049, 81953016053, 81953016061, 81953016090, 81953016108, 81953016112, 81953016126, 81953016143, 81953016149, 81953016154, 81953016156, 81953016168, 81953016178, 81953016194, 81953016206, 81953016224, 81953016234, 81953016242, 81953016252, 81953016274, 81953016278, 81953016284, 81953016286, 81953016308, 81953016310, 81953016312, 81953016347, 81953016350, 81953016352, 82953016012, 88953016014, N2953016001



CV-RK-5313

Ø: 90
03304800A, 81953016132



CV-RK-8118

Ø: 85
Hole Distance: 130
Thick/Height: 30
638862, 639287, 775201, 938423, 1104335, 1953248, 0003500506, 3500506, 11013547, 21032592, 42065912, 42488722, 070550504, 93192618, 070400009000, 634303610, 81432206055, 81432206073, 82262320660, 9544171010099, 5001842823, 7000307001, 8226232066



MN-DL-2160

Length: 1652 Ø: 50
Cone Ø: d1 Ø 30 / d2 Ø 27
81467106112, 81467106163, 81467106165, 81467106198, 81467106353, 81467106354, 81467106361, 81467116725



MN-DL-3402

Length: 590 Ø: 48
Hole Distance: 130 / 130
03307200A, 81432206067, 81432206068, 81432206090, 81432206092, 81432209092



MN-DL-3588

Length: 1035
Ø: 48
Cone Ø: d1 Ø 30 / d2 Ø 27
81466106333, 81466106334, 81466106354, 81466106355, 81466106360, 81466106361, 81466106721, 81466106722, 81466106723, 81466116216



MN-DL-5212

Length: 577 Ø: 48
Hole Distance: 130 / 130
81432206096, 81432206097, 81432206098, 81432206129, 81432209096, 81432209129, 81432306014, 81432306030



MN-DL-12421

Length: 1070
Ø: 48
Cone Ø: d1 Ø 30 / d2 Ø 27
Thread: M30 x 1,5 RHT
81466106656, 81466106659, 81466106669, 81466116006, 81466116007



MN-RK-7287

Ø: 90
Hole Distance: 152
Thick/Height: 35
03304700A, 81953016133



MN-RK-7291

Ø: 72
Hole Distance: 130
Thick/Height: 30
10307800A, 81432206108, 81432206132



MN-SB-5244

Ø: 65
Hole Distance: 125
Thick/Height: 22
03312000A, 81432710027, 81432710082



MN-SB-10389

Ø: 70
Thick/Height: 72
81960200340



MN-VB-5222

Length: 627 Ø: 50
Hole Distance: 152 / 152
81432706030, 81432706034, 81432706054, 81432706055, 81432706056, 81432706057, 81432706067, 81432706068, 81432706074, 81432706075, 81432706076, 81432706077, 81432706078, 81432706081, 81432706082, 81432709034, 81432709076, 81432709078, 8143706054



MN-VB-8569

Length: 627
Ø: 58
Hole Distance: 152 / 152
81432706055, 81432706056, 81432706067, 81432706068, 81432706075, 81432706077, 81432706081, 81432709056





F 90 ...

26.402 FNL,26.402 FNLL, 26.402 FVL	05/94→06/96	Ball Head, gearshift linkage	CV-ES-2119			
	05/94→06/96	Ball Head, gearshift linkage	CV-ES-2120			
	05/94→06/96	Ball Head, gearshift linkage	CV-ES-2182			
	05/94→06/96	Centre Rod	MN-DL-2160		Coupling Rod	
	05/94→06/96	Centre Rod	MN-DL-3588		Push Rod	
	05/94→06/96	Centre Rod	MN-DL-12421		for Steering Rod	
	05/94→06/96	Engine Mounting	MN-SB-10389			
	05/94→06/96	Stabiliser Mounting		MN-SB-5243		
	05/94→06/96	Stabiliser Mounting		MN-SB-5265		
	05/94→06/96	Stabiliser Mounting		MN-SB-5265	1st RA	
	05/94→06/96	Suspension Arm Repair Kit		CV-RK-5313	for Wishbone (CV)	
	05/94→06/96	Suspension Arm Repair Kit		CV-RK-8118	for Control Arm	
	05/94→06/96	Suspension Arm Repair Kit		MN-RK-7280	for Drag Link	
	05/94→06/96	Suspension Arm Repair Kit		MN-RK-7287	for Wishbone (CV)	
	05/94→06/96	Suspension Arm Repair Kit		MN-RK-7291	for Drag Link	
	05/94→06/96	Tie Rod	MN-DL-12284			
	05/94→06/96	Tie Rod End	CV-ES-2149		for Push Rod	
	05/94→06/96	Tie Rod End	CV-ES-14162		for Steering Rod	
	05/94→06/96	Tie Rod End	CV-ES-14163		for Steering Rod	
	05/94→06/96	Track Control Arm		MN-VB-5222	Wishbone (CV), Drive Axle;Air Suspension Axle	
	05/94→06/96	Track Control Arm		MN-VB-5222	Wishbone (CV), Tag Axle	
	26.402 FNLS,26.402 FVLS	05/94→06/96	Ball Head, gearshift linkage	CV-ES-2119		
		05/94→06/96	Ball Head, gearshift linkage	CV-ES-2120		
		05/94→06/96	Ball Head, gearshift linkage	CV-ES-2182		
05/94→06/96		Centre Rod	MN-DL-2160		Coupling Rod	
05/94→06/96		Centre Rod	MN-DL-3588		Push Rod	
05/94→06/96		Centre Rod	MN-DL-12421		for Steering Rod	
05/94→06/96		Engine Mounting	MN-SB-10389			
05/94→06/96		Stabiliser Mounting		MN-SB-5243		
05/94→06/96		Stabiliser Mounting		MN-SB-5265		
05/94→06/96		Stabiliser Mounting		MN-SB-5265	1st RA	
05/94→06/96		Suspension Arm Repair Kit		CV-RK-5313	for Wishbone (CV)	
05/94→06/96		Suspension Arm Repair Kit		CV-RK-8118	for Control Arm	
05/94→06/96		Suspension Arm Repair Kit		MN-RK-7280	for Drag Link	
05/94→06/96		Suspension Arm Repair Kit		MN-RK-7287	for Wishbone (CV)	
05/94→06/96		Suspension Arm Repair Kit		MN-RK-7291	for Drag Link	
05/94→06/96		Tie Rod	MN-DL-12284			
05/94→06/96		Tie Rod End	CV-ES-2149		for Push Rod	
05/94→06/96		Tie Rod End	CV-ES-14162		for Steering Rod	
05/94→06/96		Tie Rod End	CV-ES-14163		for Steering Rod	
05/94→06/96		Track Control Arm		MN-VB-5222	Wishbone (CV), Drive Axle;Air Suspension Axle	
05/94→06/96		Track Control Arm		MN-VB-5222	Wishbone (CV), Drive Axle	
26.422 DF,26.422 DFL		02/90→01/91	Track Control Arm		MN-VB-5222	Wishbone (CV), Drive Axle
		02/90→06/96	Ball Head, gearshift linkage	CV-ES-2119		
		02/90→06/96	Ball Head, gearshift linkage	CV-ES-2120		
	02/90→06/96	Ball Head, gearshift linkage	CV-ES-2182			
	02/90→06/96	Centre Rod	MN-DL-2160		Coupling Rod	
	02/90→06/96	Centre Rod	MN-DL-3588		Push Rod	
	02/90→06/96	Centre Rod	MN-DL-12421		for Steering Rod	
	02/90→06/96	Engine Mounting		MN-SB-10390		
	02/90→06/96	Engine Mounting	MN-SB-10389			
	02/90→06/96	Mounting, stabilizer coupling rod	MN-SB-5246			
	02/90→06/96	Stabiliser Mounting		MN-SB-5245		
	02/90→06/96	Stabiliser Mounting		MN-SB-5254		
	02/90→06/96	Stabiliser Mounting	MN-SB-9396			
	02/90→06/96	Suspension Arm Repair Kit		CV-RK-5313	for Wishbone (CV)	
	02/90→06/96	Suspension Arm Repair Kit		CV-RK-8118	for Control Arm	
	02/90→06/96	Suspension Arm Repair Kit		MN-RK-7287	for Wishbone (CV)	
	02/90→06/96	Suspension Arm Repair Kit		MN-RK-7291	for Drag Link	
	02/90→06/96	Suspension Arm Repair Kit		MN-SB-5244	for Wishbone (CV)	
	02/90→06/96	Suspension Arm Repair Kit		MN-SB-5244	for Wishbone (CV), 1st RA	
	02/90→06/96	Tie Rod End	CV-ES-2149		for Push Rod	
	02/90→06/96	Tie Rod End	CV-ES-14162		for Steering Rod	
	02/90→06/96	Tie Rod End	CV-ES-14163		for Steering Rod	

CV-ES-2119

Length: 55
Cone Ø: d1 Ø 10 / d2 Ø 10
Thread: M12 x 1,75 LHT
81953016063, 81953016131



CV-ES-2120

Length: 115
Cone Ø: d1 Ø 12,4 / d2 Ø 10,8
Thread: M14 x 1,5 RHT
03008500A, 81953016200, 81953016202,
81953016203, 81953016227



CV-ES-2149

Length: 160
Cone Ø: d1 Ø 30 / d2 Ø 27
Thread: M30 x 1,5 RHT
81953016263



CV-ES-2182

Length: 55
Cone Ø: d1 Ø 10 / d2 Ø 10
Thread: M12 x 1,75 RHT
81953016064, 81953016170



CV-ES-14162

Length: 125
Cone Ø: d1 Ø 30 / d2 Ø 27
Thread: M30 x 1,5 LHT
81953010015, 81953010083, 81953010087,
81953016029, 81953016030, 81953016043,
81953016044, 81953016050, 81953016054,
81953016087, 81953016091, 81953016107,
81953016120, 81953016125, 81953016152,
81953016155, 81953016157, 81953016168,
81953016179, 81953016181, 81953016223,
81953016237, 81953016254, 81953016275,
81953016279, 81953016351



CV-ES-14163

Length: 125
Cone Ø: d1 Ø 30 / d2 Ø 27
Thread: M30 x 1,5 RHT

95301.0084, 90804102156, 90804102272,
90804102696, 90804102710, 81953010016,
81953010075, 81953010084, 81953010088,
81953010094, 81953010103, 81953016030,
81953016043, 81953016048, 81953016049,
81953016053, 81953016061, 81953016090,
81953016108, 81953016112, 81953016126,
81953016143, 81953016149, 81953016154,
81953016156, 81953016168, 81953016178,
81953016194, 81953016206, 81953016224,
81953016234, 81953016242, 81953016252,
81953016274, 81953016278, 81953016284,
81953016286, 81953016308, 81953016310,
81953016312, 81953016347, 81953016350,
81953016352, 82953016012, 88953016014,
N2953016001



CV-RK-5313

Ø: 90
03304800A, 81953016132



CV-RK-8118

Ø: 85
Hole Distance: 130
Thick/Height: 30

638862, 639287, 775201, 938423,
1104335, 1953248, 0003500506, 3500506,
11013547, 21032592, 42065912, 42488722,
070550504, 93192618, 07040009000,
634303610, 81432206055, 81432206073,
82262320660, 9544171010099,
5001842823, 7000307001, 8226232066



MN-DL-2160

Length: 1652 Ø: 50
Cone Ø: d1 Ø 30 / d2 Ø 27
81467106112, 81467106163, 81467106165,
81467106198, 81467106353, 81467106354,
81467106361, 81467116725



MN-DL-3588

Length: 1035 Ø: 48
Cone Ø: d1 Ø 30 / d2 Ø 27
81466106333, 81466106334, 81466106354,
81466106355, 81466106360, 81466106361,
81466106721, 81466106722, 81466106723,
81466116216



MN-DL-12284

Length: 1530 Ø: 50
Cone Ø: d1 Ø 30 / d2 Ø 27
81466106579, 81466106580, 81466106624,
81466116720, 81467116720, 81467116730,
81467116952



MN-DL-12421

Length: 1070 Ø: 48
Cone Ø: d1 Ø 30 / d2 Ø 27
Thread: M30 x 1,5 RHT
81466106656, 81466106659, 81466106669,
81466116006, 81466116007



MN-RK-7280

Ø: 75
Hole Distance: 115
Thick/Height: 24
0550806, 0639370, 689748, 10307400A,
81432306051, 81432306068, 81432706064



MN-RK-7287

Ø: 90
Hole Distance: 152
Thick/Height: 35
03304700A, 81953016133



MN-RK-7291

Ø: 72
Hole Distance: 130
Thick/Height: 30
10307800A, 81432206108, 81432206132



MN-SB-5243

Length: 55 Ø: 78
Thick/Height: 60
03311100A, 81437040061, 81437220020



MN-SB-5244

Ø: 65
Hole Distance: 125
Thick/Height: 22
03312000A, 81432710027, 81432710082



MN-SB-5245

Ø: 75
Hole Distance: 125
Thick/Height: 22
03311900A, 81432710046, 81432710079,
81432710083



MN-SB-5246

Ø: 45 Thick/Height: 47
81437220022, 81437220038, 81962100450,
81962100469



MN-SB-5254

Length: 100 Ø: 93
Thick/Height: 70
81432710081



MN-SB-5265

Ø: 85 Thick/Height: 80
03310300A, 81437040032



MN-SB-9396

Ø: 67 Thick/Height: 60
81437040057



MN-SB-10389

Ø: 70 Thick/Height: 72
81960200340



MN-SB-10390

Ø: 70 Thick/Height: 85/85
81960200341, 81960200373, 81960200385,
81960200408, 81960200418



MN-VB-5222

Length: 627 Ø: 50
Hole Distance: 152 / 152
81432706030, 81432706034, 81432706054,
81432706055, 81432706056, 81432706057,
81432706067, 81432706068, 81432706074,
81432706075, 81432706076, 81432706077,
81432706078, 81432706081, 81432706082,
81432709034, 81432709076, 81432709078,
8143706054





F 90 ...

26.422 DF,26.422 DFL ...	02/90→06/96	Track Control Arm		MN-DL-3402	Trailing Arm
	02/90→06/96	Track Control Arm		MN-DL-3402	Trailing Arm, Drive Axle
	02/90→06/96	Track Control Arm		MN-DL-5212	Trailing Arm, Air Suspension Axle;Drive Axle
	02/90→06/96	Track Control Arm		MN-VB-5222	Wishbone (CV)
	02/90→06/96	Track Control Arm		MN-VB-5222	Wishbone (CV), Drive Axle;Air Suspension Axle
	02/90→06/96	Track Control Arm		MN-VB-8569	Wishbone (CV)
	01/91→06/96	Track Control Arm		MN-VB-8569	Wishbone (CV), Drive Axle
26.422 DFA	02/90→12/92	Ball Head, gearshift linkage	CV-ES-2119		
	02/90→12/92	Ball Head, gearshift linkage	CV-ES-2120		
	02/90→12/92	Ball Head, gearshift linkage	CV-ES-2182		
	02/90→12/92	Centre Rod	MN-DL-2160		Coupling Rod
	02/90→12/92	Centre Rod	MN-DL-3588		Push Rod
	02/90→12/92	Centre Rod	MN-DL-12421		for Steering Rod
	02/90→12/92	Engine Mounting	MN-SB-10389		
	02/90→12/92	Mounting, stabilizer coupling rod	MN-SB-5246		
	02/90→12/92	Stabiliser Mounting		MN-SB-5245	
	02/90→12/92	Stabiliser Mounting		MN-SB-5254	
	02/90→12/92	Stabiliser Mounting	MN-SB-9396		
	02/90→12/92	Suspension Arm Repair Kit		MN-SB-5244	for Wishbone (CV)
	02/90→12/92	Suspension Arm Repair Kit		MN-SB-5244	for Wishbone (CV), 1st RA
	02/90→12/92	Tie Rod End	CV-ES-2149		for Push Rod
	02/90→12/92	Tie Rod End	CV-ES-14162		for Steering Rod
	02/90→12/92	Tie Rod End	CV-ES-14163		for Steering Rod
02/90→12/92	Track Control Arm		MN-DL-3402	Trailing Arm	
26.422 DFAK	02/90→12/92	Ball Head, gearshift linkage	CV-ES-2119		
	02/90→12/92	Ball Head, gearshift linkage	CV-ES-2120		
	02/90→12/92	Ball Head, gearshift linkage	CV-ES-2182		
	02/90→12/92	Centre Rod	MN-DL-2160		Coupling Rod
	02/90→12/92	Centre Rod	MN-DL-3588		Push Rod
	02/90→12/92	Centre Rod	MN-DL-12421		for Steering Rod
	02/90→12/92	Engine Mounting	MN-SB-10389		
	02/90→12/92	Mounting, stabilizer coupling rod	MN-SB-5246		
	02/90→12/92	Stabiliser Mounting		MN-SB-5245	
	02/90→12/92	Stabiliser Mounting		MN-SB-5254	
	02/90→12/92	Stabiliser Mounting	MN-SB-9396		
	02/90→12/92	Suspension Arm Repair Kit		MN-SB-5244	for Wishbone (CV)
	02/90→12/92	Suspension Arm Repair Kit		MN-SB-5244	for Wishbone (CV), 1st RA
	02/90→12/92	Tie Rod End	CV-ES-2149		for Push Rod
	02/90→12/92	Tie Rod End	CV-ES-14162		for Steering Rod
	02/90→12/92	Tie Rod End	CV-ES-14163		for Steering Rod
02/90→12/92	Track Control Arm		MN-DL-3402	Trailing Arm	
26.422 DFAS	02/90→12/92	Ball Head, gearshift linkage	CV-ES-2119		
	02/90→12/92	Ball Head, gearshift linkage	CV-ES-2120		
	02/90→12/92	Ball Head, gearshift linkage	CV-ES-2182		
	02/90→12/92	Centre Rod	MN-DL-2160		Coupling Rod
	02/90→12/92	Centre Rod	MN-DL-3588		Push Rod
	02/90→12/92	Centre Rod	MN-DL-12421		for Steering Rod
	02/90→12/92	Engine Mounting	MN-SB-10389		
	02/90→12/92	Mounting, stabilizer coupling rod	MN-SB-5246		
	02/90→12/92	Stabiliser Mounting		MN-SB-5245	
	02/90→12/92	Stabiliser Mounting		MN-SB-5254	
	02/90→12/92	Stabiliser Mounting	MN-SB-9396		
	02/90→12/92	Suspension Arm Repair Kit		MN-SB-5244	for Wishbone (CV)
	02/90→12/92	Suspension Arm Repair Kit		MN-SB-5244	for Wishbone (CV), 1st RA
	02/90→12/92	Tie Rod End	CV-ES-2149		for Push Rod
	02/90→12/92	Tie Rod End	CV-ES-14162		for Steering Rod
	02/90→12/92	Tie Rod End	CV-ES-14163		for Steering Rod
02/90→12/92	Track Control Arm		MN-DL-3402	Trailing Arm	
26.422 DFK	02/90→01/91	Track Control Arm		MN-VB-5222	Wishbone (CV), Drive Axle
	02/90→12/95	Ball Head, gearshift linkage	CV-ES-2119		
	02/90→12/95	Ball Head, gearshift linkage	CV-ES-2120		
	02/90→12/95	Ball Head, gearshift linkage	CV-ES-2182		
	02/90→12/95	Centre Rod	MN-DL-2160		Coupling Rod

CV-ES-2119

Length: 55
Cone Ø: d1 Ø 10 / d2 Ø 10
Thread: M12 x 1,75 LHT
81953016063, 81953016131



CV-ES-2120

Length: 115
Cone Ø: d1 Ø 12,4 / d2 Ø 10,8
Thread: M14 x 1,5 RHT
03008500A, 81953016200, 81953016202,
81953016203, 81953016227



CV-ES-2149

Length: 160
Cone Ø: d1 Ø 30 / d2 Ø 27
Thread: M30 x 1,5 RHT
81953016263



CV-ES-2182

Length: 55
Cone Ø: d1 Ø 10 / d2 Ø 10
Thread: M12 x 1,75 RHT
81953016064, 81953016170



CV-ES-14162

Length: 125
Cone Ø: d1 Ø 30 / d2 Ø 27
Thread: M30 x 1,5 LHT

81953010015, 81953010083, 81953010087,
81953016029, 81953016030, 81953016043,
81953016044, 81953016050, 81953016054,
81953016087, 81953016091, 81953016107,
81953016120, 81953016125, 81953016152,
81953016155, 81953016157, 81953016168,
81953016179, 81953016181, 81953016223,
81953016237, 81953016254, 81953016275,
81953016279, 81953016351



CV-ES-14163

Length: 125
Cone Ø: d1 Ø 30 / d2 Ø 27
Thread: M30 x 1,5 RHT

95301.0084, 90804102156, 90804102272,
90804102696, 90804102710, 81953010016,
81953010075, 81953010084, 81953010088,
81953010094, 81953010103, 81953016030,
81953016043, 81953016048, 81953016049,
81953016053, 81953016061, 81953016090,
81953016108, 81953016112, 81953016126,
81953016143, 81953016149, 81953016154,
81953016156, 81953016168, 81953016178,
81953016194, 81953016206, 81953016224,
81953016234, 81953016242, 81953016252,
81953016274, 81953016278, 81953016284,
81953016286, 81953016308, 81953016310,
81953016312, 81953016347, 81953016350,
81953016352, 82953016012, 88953016014,
N2953016001



MN-DL-2160

Length: 1652 Ø: 50
Cone Ø: d1 Ø 30 / d2 Ø 27
81467106112, 81467106163, 81467106165,
81467106198, 81467106353, 81467106354,
81467106361, 81467116725



MN-DL-3402

Length: 590 Ø: 48
Hole Distance: 130 / 130
03307200A, 81432206067, 81432206068,
81432206090, 81432206092, 81432209092



MN-DL-3588

Length: 1035
Ø: 48
Cone Ø: d1 Ø 30 / d2 Ø 27

81466106333, 81466106334, 81466106354,
81466106355, 81466106360, 81466106361,
81466106721, 81466106722, 81466106723,
81466116216



MN-DL-5212

Length: 577 Ø: 48
Hole Distance: 130 / 130
81432206096, 81432206097, 81432206098,
81432206129, 81432209096, 81432209129,
81432306014, 81432306030



MN-DL-12421

Length: 1070
Ø: 48
Cone Ø: d1 Ø 30 / d2 Ø 27
Thread: M30 x 1,5 RHT
81466106656, 81466106659, 81466106669,
81466116006, 81466116007



MN-SB-5244

Ø: 65
Hole Distance: 125
Thick/Height: 22
03312000A, 81432710027, 81432710082



MN-SB-5245

Ø: 75
Hole Distance: 125
Thick/Height: 22
03311900A, 81432710046, 81432710079,
81432710083



MN-SB-5246

Ø: 45 Thick/Height: 47
81437220022, 81437220038, 81962100450,
81962100469



MN-SB-5254

Length: 100
Ø: 93
Thick/Height: 70
81432710081



MN-SB-9396

Ø: 67
Thick/Height: 60
81437040057



MN-SB-10389

Ø: 70
Thick/Height: 72
81960200340



MN-VB-5222

Length: 627 Ø: 50
Hole Distance: 152 / 152
81432706030, 81432706034, 81432706054,
81432706055, 81432706056, 81432706057,
81432706067, 81432706068, 81432706074,
81432706075, 81432706076, 81432706077,
81432706078, 81432706081, 81432706082,
81432709034, 81432709076, 81432709078,
8143706054



MN-VB-8569

Length: 627
Ø: 58
Hole Distance: 152 / 152
81432706055, 81432706056, 81432706067,
81432706068, 81432706075, 81432706077,
81432706081, 81432709056





F 90 ...

26.422 DFK ...	02/90→12/95	Centre Rod	MN-DL-3588		Push Rod	
	02/90→12/95	Centre Rod	MN-DL-12421		for Steering Rod	
	02/90→12/95	Engine Mounting		MN-SB-10390		
	02/90→12/95	Engine Mounting	MN-SB-10389			
	02/90→12/95	Mounting, stabilizer coupling rod	MN-SB-5246			
	02/90→12/95	Stabiliser Mounting		MN-SB-5245		
	02/90→12/95	Stabiliser Mounting		MN-SB-5254		
	02/90→12/95	Stabiliser Mounting	MN-SB-9396			
	02/90→12/95	Suspension Arm Repair Kit		CV-RK-5313	for Wishbone (CV)	
	02/90→12/95	Suspension Arm Repair Kit		MN-RK-7287	for Wishbone (CV)	
	02/90→12/95	Suspension Arm Repair Kit		MN-SB-5244	for Wishbone (CV)	
	02/90→12/95	Suspension Arm Repair Kit		MN-SB-5244	for Wishbone (CV), 1st RA	
	02/90→12/95	Tie Rod End	CV-ES-2149		for Push Rod	
	02/90→12/95	Tie Rod End	CV-ES-14162		for Steering Rod	
	02/90→12/95	Tie Rod End	CV-ES-14163		for Steering Rod	
	02/90→12/95	Track Control Arm		MN-DL-3402	Trailing Arm	
	02/90→12/95	Track Control Arm		MN-DL-3402	Trailing Arm, Drive Axle	
	02/90→12/95	Track Control Arm		MN-VB-5222	Wishbone (CV)	
	02/90→12/95	Track Control Arm		MN-VB-8569	Wishbone (CV)	
	26.422 DFS	01/91→12/95	Track Control Arm		MN-VB-8569	Wishbone (CV), Drive Axle
		02/90→01/91	Track Control Arm		MN-VB-5222	Wishbone (CV), Drive Axle
02/90→12/95		Ball Head, gearshift linkage	CV-ES-2119			
02/90→12/95		Ball Head, gearshift linkage	CV-ES-2120			
02/90→12/95		Ball Head, gearshift linkage	CV-ES-2182			
02/90→12/95		Centre Rod	MN-DL-2160		Coupling Rod	
02/90→12/95		Centre Rod	MN-DL-3588		Push Rod	
02/90→12/95		Centre Rod	MN-DL-12421		for Steering Rod	
02/90→12/95		Engine Mounting		MN-SB-10390		
02/90→12/95		Engine Mounting	MN-SB-10389			
02/90→12/95		Mounting, stabilizer coupling rod	MN-SB-5246			
02/90→12/95		Stabiliser Mounting		MN-SB-5245		
02/90→12/95		Stabiliser Mounting		MN-SB-5254		
02/90→12/95		Stabiliser Mounting	MN-SB-9396			
02/90→12/95		Suspension Arm Repair Kit		CV-RK-5313	for Wishbone (CV)	
02/90→12/95		Suspension Arm Repair Kit		MN-RK-7287	for Wishbone (CV)	
02/90→12/95		Suspension Arm Repair Kit		MN-SB-5244	for Wishbone (CV)	
02/90→12/95		Suspension Arm Repair Kit		MN-SB-5244	for Wishbone (CV), 1st RA	
02/90→12/95		Tie Rod End	CV-ES-2149		for Push Rod	
02/90→12/95		Tie Rod End	CV-ES-14162		for Steering Rod	
02/90→12/95		Tie Rod End	CV-ES-14163		for Steering Rod	
02/90→12/95	Track Control Arm		MN-DL-3402	Trailing Arm		
02/90→12/95	Track Control Arm		MN-DL-3402	Trailing Arm, Drive Axle		
02/90→12/95	Track Control Arm		MN-VB-5222	Wishbone (CV)		
02/90→12/95	Track Control Arm		MN-VB-8569	Wishbone (CV)		
01/91→12/95	Track Control Arm		MN-VB-8569	Wishbone (CV), Drive Axle		
26.422 FNL, 26.422 FNLL, 26.422 FVL	09/90→12/95	Ball Head, gearshift linkage	CV-ES-2119			
	09/90→12/95	Ball Head, gearshift linkage	CV-ES-2120			
	09/90→12/95	Ball Head, gearshift linkage	CV-ES-2182			
	09/90→12/95	Centre Rod	MN-DL-2160		Coupling Rod	
	09/90→12/95	Centre Rod	MN-DL-3588		Push Rod	
	09/90→12/95	Centre Rod	MN-DL-12421		for Steering Rod	
	09/90→12/95	Engine Mounting	MN-SB-10389			
	09/90→12/95	Stabiliser Mounting		MN-SB-5243		
	09/90→12/95	Stabiliser Mounting		MN-SB-5265		
	09/90→12/95	Stabiliser Mounting		MN-SB-5265	1st RA	
	09/90→12/95	Suspension Arm Repair Kit		CV-RK-5313	for Wishbone (CV)	
	09/90→12/95	Suspension Arm Repair Kit		CV-RK-8118	for Control Arm	
	09/90→12/95	Suspension Arm Repair Kit		MN-RK-7280	for Drag Link	
	09/90→12/95	Suspension Arm Repair Kit		MN-RK-7287	for Wishbone (CV)	
	09/90→12/95	Suspension Arm Repair Kit		MN-RK-7291	for Drag Link	
	09/90→12/95	Tie Rod	MN-DL-12284			
	09/90→12/95	Tie Rod End	CV-ES-2149		for Push Rod	
	09/90→12/95	Tie Rod End	CV-ES-14162		for Steering Rod	

CV-ES-2119

Length: 55
Cone Ø: d1 Ø 10 / d2 Ø 10
Thread: M12 x 1,75 LHT
81953016063, 81953016131



CV-ES-2120

Length: 115
Cone Ø: d1 Ø 12,4 / d2 Ø 10,8
Thread: M14 x 1,5 RHT
03008500A, 81953016200, 81953016202,
81953016203, 81953016227



CV-ES-2149

Length: 160
Cone Ø: d1 Ø 30 / d2 Ø 27
Thread: M30 x 1,5 RHT
81953016263



CV-ES-2182

Length: 55
Cone Ø: d1 Ø 10 / d2 Ø 10
Thread: M12 x 1,75 RHT
81953016064, 81953016170



CV-ES-14162

Length: 125
Cone Ø: d1 Ø 30 / d2 Ø 27
Thread: M30 x 1,5 LHT
81953010015, 81953010083, 81953010087,
81953016029, 81953016030, 81953016043,
81953016044, 81953016050, 81953016054,
81953016087, 81953016091, 81953016107,
81953016120, 81953016125, 81953016152,
81953016155, 81953016157, 81953016168,
81953016179, 81953016181, 81953016223,
81953016237, 81953016254, 81953016275,
81953016279, 81953016351



CV-ES-14163

Length: 125
Cone Ø: d1 Ø 30 / d2 Ø 27
Thread: M30 x 1,5 RHT
95301.0084, 90804102156, 90804102272,
90804102696, 90804102710, 81953010016,
81953010075, 81953010084, 81953010088,
81953010094, 81953010103, 81953016030,
81953016043, 81953016048, 81953016049,
81953016053, 81953016061, 81953016090,
81953016108, 81953016112, 81953016126,
81953016143, 81953016149, 81953016154,
81953016156, 81953016168, 81953016178,
81953016194, 81953016206, 81953016224,
81953016234, 81953016242, 81953016252,
81953016274, 81953016278, 81953016284,
81953016286, 81953016308, 81953016310,
81953016312, 81953016347, 81953016350,
81953016352, 82953016012, 88953016014,
N2953016001



CV-RK-5313

Ø: 90
03304800A, 81953016132



CV-RK-8118

Ø: 85
Hole Distance: 130
Thick/Height: 30
638862, 639287, 775201, 938423,
1104335, 1953248, 0003500506, 3500506,
11013547, 21032592, 42065912, 42488722,
070550504, 93192618, 07040009000,
634303610, 81432206055, 81432206073,
82262320660, 9544171010099,
5001842823, 7000307001, 8226232066



MN-DL-2160

Length: 1652 Ø: 50
Cone Ø: d1 Ø 30 / d2 Ø 27
81467106112, 81467106163, 81467106165,
81467106198, 81467106353, 81467106354,
81467106361, 81467116725



MN-DL-3402

Length: 590 Ø: 48
Hole Distance: 130 / 130
03307200A, 81432206067, 81432206068,
81432206090, 81432206092, 81432209092



MN-DL-3588

Length: 1035 Ø: 48
Cone Ø: d1 Ø 30 / d2 Ø 27
81466106333, 81466106334, 81466106354,
81466106355, 81466106360, 81466106361,
81466106721, 81466106722, 81466106723,
81466116216



MN-DL-12284

Length: 1530 Ø: 50
Cone Ø: d1 Ø 30 / d2 Ø 27
81466106579, 81466106580, 81466106624,
81466116720, 81467116720, 81467116730,
81467116952



MN-DL-12421

Length: 1070 Ø: 48
Cone Ø: d1 Ø 30 / d2 Ø 27
Thread: M30 x 1,5 RHT
81466106656, 81466106659, 81466106669,
81466116006, 81466116007



MN-RK-7280

Ø: 75
Hole Distance: 115
Thick/Height: 24
0550806, 0639370, 689748, 10307400A,
81432306051, 81432306068, 81432706064



MN-RK-7287

Ø: 90
Hole Distance: 152
Thick/Height: 35
03304700A, 81953016133



MN-RK-7291

Ø: 72
Hole Distance: 130
Thick/Height: 30
10307800A, 81432206108, 81432206132



MN-SB-5243

Length: 55 Ø: 78
Thick/Height: 60
03311100A, 81437040061, 81437220020



MN-SB-5244

Ø: 65
Hole Distance: 125
Thick/Height: 22
03312000A, 81432710027, 81432710082



MN-SB-5245

Ø: 75
Hole Distance: 125
Thick/Height: 22
03311900A, 81432710046, 81432710079,
81432710083



MN-SB-5246

Ø: 45
Thick/Height: 47
81437220022, 81437220038, 81962100450,
81962100469



MN-SB-5254

Length: 100 Ø: 93
Thick/Height: 70
81432710081



MN-SB-5265

Ø: 85
Thick/Height: 80
03310300A, 81437040032



MN-SB-9396

Ø: 67
Thick/Height: 60
81437040057



MN-SB-10389

Ø: 70
Thick/Height: 72
81960200340



MN-SB-10390

Ø: 70
Thick/Height: 85/85
81960200341, 81960200373, 81960200385,
81960200408, 81960200418



MN-VB-5222

Length: 627 Ø: 50
Hole Distance: 152 / 152
81432706030, 81432706034, 81432706054,
81432706055, 81432706056, 81432706057,
81432706067, 81432706068, 81432706074,
81432706075, 81432706076, 81432706077,
81432706078, 81432706081, 81432706082,
81432709034, 81432709076, 81432709078,
8143706054



MN-VB-8569

Length: 627 Ø: 58
Hole Distance: 152 / 152
81432706055, 81432706056, 81432706067,
81432706068, 81432706075, 81432706077,
81432706081, 81432709056





F 90 ...

26.422 FNL, 26.422 FNLL, 26.422 FVL ...	09/90 → 12/95	Tie Rod End	CV-ES-14163		for Steering Rod
	09/90 → 12/95	Track Control Arm		MN-VB-5222	Wishbone (CV), Drive Axle; Air Suspension Axle
	09/90 → 12/95	Track Control Arm		MN-VB-5222	Wishbone (CV), Tag Axle
26.422 FNLS, 26.422 FVLS	01/92 → 12/95	Ball Head, gearshift linkage	CV-ES-2119		
	01/92 → 12/95	Ball Head, gearshift linkage	CV-ES-2120		
	01/92 → 12/95	Ball Head, gearshift linkage	CV-ES-2182		
	01/92 → 12/95	Centre Rod	MN-DL-2160		Coupling Rod
	01/92 → 12/95	Centre Rod	MN-DL-3588		Push Rod
	01/92 → 12/95	Centre Rod	MN-DL-12421		for Steering Rod
	01/92 → 12/95	Engine Mounting	MN-SB-10389		
	01/92 → 12/95	Stabiliser Mounting		MN-SB-5243	
	01/92 → 12/95	Stabiliser Mounting		MN-SB-5265	
	01/92 → 12/95	Stabiliser Mounting		MN-SB-5265	1st RA
	01/92 → 12/95	Suspension Arm Repair Kit		CV-RK-5313	for Wishbone (CV)
	01/92 → 12/95	Suspension Arm Repair Kit		CV-RK-8118	for Control Arm
	01/92 → 12/95	Suspension Arm Repair Kit		MN-RK-7280	for Drag Link
	01/92 → 12/95	Suspension Arm Repair Kit		MN-RK-7287	for Wishbone (CV)
	01/92 → 12/95	Suspension Arm Repair Kit		MN-RK-7291	for Drag Link
	01/92 → 12/95	Tie Rod	MN-DL-12284		
	01/92 → 12/95	Tie Rod End	CV-ES-2149		for Push Rod
	01/92 → 12/95	Tie Rod End	CV-ES-14162		for Steering Rod
	01/92 → 12/95	Tie Rod End	CV-ES-14163		for Steering Rod
	01/92 → 12/95	Track Control Arm		MN-VB-5222	Wishbone (CV), Drive Axle; Air Suspension Axle
01/92 → 12/95	Track Control Arm		MN-VB-5222	Wishbone (CV), Tag Axle	
26.462 DF	02/89 → 02/90	Ball Head, gearshift linkage	CV-ES-2120		
	02/89 → 02/90	Tie Rod End	CV-ES-14163		for Steering Rod
	02/89 → 02/90	Track Control Arm		MN-DL-3402	Trailing Arm, Drive Axle
26.462 DFA	08/89 → 02/90	Ball Head, gearshift linkage	CV-ES-2120		
	08/89 → 02/90	Centre Rod	MN-DL-12421		for Steering Rod
	08/89 → 02/90	Mounting, stabilizer coupling rod	MN-SB-5246		
	08/89 → 02/90	Stabiliser Mounting		MN-SB-5254	
	08/89 → 02/90	Stabiliser Mounting	MN-SB-9396		
	08/89 → 02/90	Tie Rod End	CV-ES-14163		for Steering Rod
08/89 → 02/90	Track Control Arm		MN-DL-3402	Trailing Arm	
26.462 DFAS	08/89 → 02/90	Ball Head, gearshift linkage	CV-ES-2120		
	08/89 → 02/90	Centre Rod	MN-DL-12421		for Steering Rod
	08/89 → 02/90	Mounting, stabilizer coupling rod	MN-SB-5246		
	08/89 → 02/90	Stabiliser Mounting		MN-SB-5254	
	08/89 → 02/90	Stabiliser Mounting	MN-SB-9396		
	08/89 → 02/90	Tie Rod End	CV-ES-14163		for Steering Rod
08/89 → 02/90	Track Control Arm		MN-DL-3402	Trailing Arm	
26.462 DFS	02/89 → 02/90	Ball Head, gearshift linkage	CV-ES-2120		
	02/89 → 02/90	Tie Rod End	CV-ES-14163		for Steering Rod
	02/89 → 02/90	Track Control Arm		MN-DL-3402	Trailing Arm, Drive Axle
26.502 DF	02/90 → 01/91	Track Control Arm		MN-VB-5222	Wishbone (CV), Drive Axle
	02/90 → 06/96	Ball Head, gearshift linkage	CV-ES-2120		
	02/90 → 06/96	Suspension Arm Repair Kit		CV-RK-5313	for Wishbone (CV)
	02/90 → 06/96	Suspension Arm Repair Kit		MN-RK-7287	for Wishbone (CV)
	02/90 → 06/96	Tie Rod End	CV-ES-14163		for Steering Rod
	02/90 → 06/96	Track Control Arm		MN-DL-3402	Trailing Arm, Drive Axle
01/91 → 06/96	Track Control Arm		MN-VB-8569	Wishbone (CV), Drive Axle	
26.502 DFA	02/90 → 12/92	Ball Head, gearshift linkage	CV-ES-2120		
	02/90 → 12/92	Centre Rod	MN-DL-12421		for Steering Rod
	02/90 → 12/92	Mounting, stabilizer coupling rod	MN-SB-5246		
	02/90 → 12/92	Stabiliser Mounting		MN-SB-5254	
	02/90 → 12/92	Stabiliser Mounting	MN-SB-9396		
	02/90 → 12/92	Tie Rod End	CV-ES-14163		for Steering Rod
	02/90 → 12/92	Track Control Arm		MN-DL-3402	Trailing Arm
26.502 DFAS	02/90 → 12/92	Ball Head, gearshift linkage	CV-ES-2120		
	02/90 → 12/92	Centre Rod	MN-DL-12421		for Steering Rod
	02/90 → 12/92	Mounting, stabilizer coupling rod	MN-SB-5246		
	02/90 → 12/92	Stabiliser Mounting		MN-SB-5254	
	02/90 → 12/92	Stabiliser Mounting	MN-SB-9396		

CV-ES-2119

Length: 55
Cone Ø: d1 Ø 10 / d2 Ø 10
Thread: M12 x 1,75 LHT
 81953016063, 81953016131

**CV-ES-2120**

Length: 115
Cone Ø: d1 Ø 12,4 / d2 Ø 10,8
Thread: M14 x 1,5 RHT
 03008500A, 81953016200, 81953016202,
 81953016203, 81953016227

**CV-ES-2149**

Length: 160
Cone Ø: d1 Ø 30 / d2 Ø 27
Thread: M30 x 1,5 RHT
 81953016263

**CV-ES-2182**

Length: 55
Cone Ø: d1 Ø 10 / d2 Ø 10
Thread: M12 x 1,75 RHT
 81953016064, 81953016170

**CV-ES-14162**

Length: 125
Cone Ø: d1 Ø 30 / d2 Ø 27
Thread: M30 x 1,5 LHT
 81953010015, 81953010083, 81953010087,
 81953016029, 81953016030, 81953016043,
 81953016044, 81953016050, 81953016054,
 81953016087, 81953016091, 81953016107,
 81953016120, 81953016125, 81953016152,
 81953016155, 81953016157, 81953016168,
 81953016179, 81953016181, 81953016223,
 81953016237, 81953016254, 81953016275,
 81953016279, 81953016351

**CV-ES-14163**

Length: 125
Cone Ø: d1 Ø 30 / d2 Ø 27
Thread: M30 x 1,5 RHT
 95301.0084, 90804102156, 90804102272,
 90804102696, 90804102710, 81953010016,
 81953010075, 81953010084, 81953010088,
 81953010094, 81953010103, 81953016030,
 81953016043, 81953016048, 81953016049,
 81953016053, 81953016061, 81953016090,
 81953016108, 81953016112, 81953016126,
 81953016143, 81953016149, 81953016154,
 81953016156, 81953016168, 81953016178,
 81953016194, 81953016206, 81953016224,
 81953016234, 81953016242, 81953016252,
 81953016274, 81953016278, 81953016284,
 81953016286, 81953016308, 81953016310,
 81953016312, 81953016347, 81953016350,
 81953016352, 82953016012, 88953016014,
 N2953016001

**CV-RK-5313**

Ø: 90
 03304800A, 81953016132

**CV-RK-8118**

Ø: 85
Hole Distance: 130
Thick/Height: 30
 638862, 639287, 775201, 938423,
 1104335, 1953248, 0003500506, 3500506,
 11013547, 21032592, 42065912, 42488722,
 070550504, 93192618, 070400009000,
 634303610, 81432206055, 81432206073,
 82262320660, 9544171010099,
 5001842823, 7000307001, 8226232066

**MN-DL-2160**

Length: 1652 **Ø:** 50
Cone Ø: d1 Ø 30 / d2 Ø 27
 81467106112, 81467106163, 81467106165,
 81467106198, 81467106353, 81467106354,
 81467106361, 81467116725

**MN-DL-3402**

Length: 590 **Ø:** 48
Hole Distance: 130 / 130
 03307200A, 81432206067, 81432206068,
 81432206090, 81432206092, 81432209092

**MN-DL-3588**

Length: 1035 **Ø:** 48
Cone Ø: d1 Ø 30 / d2 Ø 27
 81466106333, 81466106334, 81466106354,
 81466106355, 81466106360, 81466106361,
 81466106721, 81466106722, 81466106723,
 81466116216

**MN-DL-12284**

Length: 1530 **Ø:** 50
Cone Ø: d1 Ø 30 / d2 Ø 27
 81466106579, 81466106580, 81466106624,
 81466116720, 81467116720, 81467116730,
 81467116952

**MN-DL-12421**

Length: 1070 **Ø:** 48
Cone Ø: d1 Ø 30 / d2 Ø 27
Thread: M30 x 1,5 RHT
 81466106656, 81466106659, 81466106669,
 81466116006, 81466116007

**MN-RK-7280**

Ø: 75
Hole Distance: 115
Thick/Height: 24
 0550806, 0639370, 689748, 10307400A,
 81432306051, 81432306068, 81432706064

**MN-RK-7287**

Ø: 90
Hole Distance: 152
Thick/Height: 35
 03304700A, 81953016133

**MN-RK-7291**

Ø: 72
Hole Distance: 130
Thick/Height: 30
 10307800A, 81432206108, 81432206132

**MN-SB-5243**

Length: 55 **Ø:** 78
Thick/Height: 60
 03311100A, 81437040061, 81437220020

**MN-SB-5246**

Ø: 45 **Thick/Height:** 47
 81437220022, 81437220038, 81962100450,
 81962100469

**MN-SB-5254**

Length: 100 **Ø:** 93
Thick/Height: 70
 81432710081

**MN-SB-5265**

Ø: 85 **Thick/Height:** 80
 03310300A, 81437040032

**MN-SB-9396**

Ø: 67 **Thick/Height:** 60
 81437040057

**MN-SB-10389**

Ø: 70 **Thick/Height:** 72
 81960200340

**MN-VB-5222**

Length: 627 **Ø:** 50
Hole Distance: 152 / 152
 81432706030, 81432706034, 81432706054,
 81432706055, 81432706056, 81432706057,
 81432706067, 81432706068, 81432706074,
 81432706075, 81432706076, 81432706077,
 81432706078, 81432706081, 81432706082,
 81432709034, 81432709076, 81432709078,
 8143706054

**MN-VB-8569**

Length: 627 **Ø:** 58
Hole Distance: 152 / 152
 81432706055, 81432706056, 81432706067,
 81432706068, 81432706075, 81432706077,
 81432706081, 81432709056



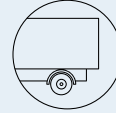

F 90 ...

26.502 DFAS ...	02/90→12/92	Tie Rod End	CV-ES-14163		for Steering Rod	
	02/90→12/92	Track Control Arm		MN-DL-3402	Trailing Arm	
26.502 DFS,26.502 DFSL	02/90→01/91	Track Control Arm		MN-VB-5222	Wishbone (CV), Drive Axle	
	02/90→06/96	Ball Head, gearshift linkage	CV-ES-2120			
	02/90→06/96	Centre Rod	MN-DL-2160		Coupling Rod	
	02/90→06/96	Centre Rod	MN-DL-3588		Push Rod	
	02/90→06/96	Mounting, stabilizer coupling rod	MN-SB-5246			
	02/90→06/96	Mounting, stabilizer coupling rod	MN-SB-5246		1st FA	
	02/90→06/96	Suspension Arm Repair Kit		CV-RK-5313	for Wishbone (CV)	
	02/90→06/96	Suspension Arm Repair Kit		CV-RK-8118	for Control Arm	
	02/90→06/96	Suspension Arm Repair Kit		MN-RK-7287	for Wishbone (CV)	
	02/90→06/96	Suspension Arm Repair Kit		MN-RK-7291	for Drag Link	
	02/90→06/96	Tie Rod End	CV-ES-14163		for Steering Rod	
	02/90→06/96	Track Control Arm		MN-DL-3402	Trailing Arm, Drive Axle	
	02/90→06/96	Track Control Arm		MN-DL-5212	Trailing Arm, Air Suspension Axle	
	02/90→06/96	Track Control Arm		MN-VB-5222	Wishbone (CV)	
	02/90→06/96	Track Control Arm		MN-VB-5222	Wishbone (CV), Drive Axle;Air Suspension Axle	
	26.502 FNL,26.502 FNLL	01/91→06/96	Track Control Arm		MN-VB-8569	Wishbone (CV), Drive Axle
		09/91→06/96	Ball Head, gearshift linkage	CV-ES-2120		
09/91→06/96		Centre Rod	MN-DL-12421		for Steering Rod	
09/91→06/96		Mounting, stabilizer coupling rod	MN-SB-5246			
09/91→06/96		Mounting, stabilizer coupling rod	MN-SB-5246		1st FA	
09/91→06/96		Suspension Arm Repair Kit		CV-RK-5313	for Wishbone (CV)	
09/91→06/96		Suspension Arm Repair Kit		CV-RK-8118	for Control Arm	
09/91→06/96		Suspension Arm Repair Kit		MN-RK-7287	for Wishbone (CV)	
09/91→06/96		Suspension Arm Repair Kit		MN-RK-7291	for Drag Link	
09/91→06/96		Tie Rod End	CV-ES-14163		for Steering Rod	
09/91→06/96		Track Control Arm		MN-DL-5212	Trailing Arm, Air Suspension Axle;Drive Axle; Tag Axle	
32.262 VF	09/91→06/96	Track Control Arm		MN-VB-5222	Wishbone (CV), Drive Axle	
	09/91→06/96	Track Control Arm		MN-VB-5222	Wishbone (CV), Drive Axle;Tag Axle	
	02/89→02/90	Ball Head, gearshift linkage	CV-ES-2120			
	02/89→02/90	Centre Rod	MN-DL-12278		for Steering Rod	
	02/89→02/90	Drag Link End	MN-ES-10348			
	02/89→02/90	Engine Mounting	MN-SB-10389			
	02/89→02/90	Mounting, stabilizer coupling rod	MN-SB-5246			
	02/89→02/90	Mounting, stabilizer coupling rod	MN-SB-5246		1st FA	
	02/89→02/90	Stabiliser Mounting		MN-SB-5254		
	02/89→02/90	Stabiliser Mounting	MN-SB-9396			
	02/89→02/90	Suspension Arm Repair Kit		CV-RK-5313	for Wishbone (CV)	
02/89→02/90	Suspension Arm Repair Kit		MN-RK-7287	for Wishbone (CV)		
02/89→02/90	Suspension Arm Repair Kit		MN-SB-5244	for Wishbone (CV)		
02/89→02/90	Suspension Arm Repair Kit		MN-SB-5244	for Wishbone (CV), 1st RA		
02/89→02/90	Tie Rod	MN-DL-12284				
02/89→02/90	Tie Rod End	CV-ES-2146				
02/89→02/90	Tie Rod End	CV-ES-14163		for Steering Rod		
02/89→02/90	Track Control Arm		MN-DL-3402	Trailing Arm		
02/89→02/90	Track Control Arm		MN-DL-3402	Trailing Arm, Drive Axle		
02/89→02/90	Track Control Arm		MN-DL-5212	Trailing Arm, Air Suspension Axle;Drive Axle; Tag Axle		
02/89→02/90	Track Control Arm		MN-VB-5222	Wishbone (CV)		
02/89→02/90	Track Control Arm		MN-VB-5222	Wishbone (CV), Drive Axle		
02/89→02/90	Track Control Arm		MN-VB-8569	Wishbone (CV)		
32.262 VFK	02/89→02/90	Ball Head, gearshift linkage	CV-ES-2120			
	02/89→02/90	Centre Rod	MN-DL-12278		for Steering Rod	
	02/89→02/90	Drag Link End	MN-ES-10348			
	02/89→02/90	Engine Mounting	MN-SB-10389			
	02/89→02/90	Mounting, stabilizer coupling rod	MN-SB-5246			
	02/89→02/90	Mounting, stabilizer coupling rod	MN-SB-5246		1st FA	
	02/89→02/90	Stabiliser Mounting		MN-SB-5254		
	02/89→02/90	Stabiliser Mounting	MN-SB-9396			
	02/89→02/90	Suspension Arm Repair Kit		CV-RK-5313	for Wishbone (CV)	
02/89→02/90	Suspension Arm Repair Kit		MN-RK-7287	for Wishbone (CV)		

CV-ES-2120

Length: 115
Cone Ø: d1 Ø 12,4 / d2 Ø 10,8
Thread: M14 x 1,5 RHT
03008500A, 81953016200, 81953016202,
81953016203, 81953016227



CV-ES-2146

Length: 80
Cone Ø: d1 Ø 30 / d2 Ø 27
Thread: M26 x 1,5 RHT
42533102, 81953016219, 81953016225,
81953016226, 81953016267, 81953016291



CV-ES-14163

Length: 125
Cone Ø: d1 Ø 30 / d2 Ø 27
Thread: M30 x 1,5 RHT
95301.0084, 90804102156, 90804102272,
90804102696, 90804102710, 81953010016,
81953010075, 81953010084, 81953010088,
81953010094, 81953010103, 81953016030,
81953016043, 81953016048, 81953016049,
81953016053, 81953016061, 81953016090,
81953016108, 81953016112, 81953016126,
81953016143, 81953016149, 81953016154,
81953016156, 81953016168, 81953016178,
81953016194, 81953016206, 81953016224,
81953016234, 81953016242, 81953016252,
81953016274, 81953016278, 81953016284,
81953016286, 81953016308, 81953016310,
81953016312, 81953016347, 81953016350,
81953016352, 82953016012, 88953016014,
N2953016001



CV-RK-5313

Ø: 90
03304800A, 81953016132



CV-RK-8118

Ø: 85
Hole Distance: 130
Thick/Height: 30
638862, 639287, 775201, 938423,
1104335, 1953248, 0003500506, 3500506,
11013547, 21032592, 42065912, 42488722,
070550504, 93192618, 070400009000,
634303610, 81432206055, 81432206073,
82262320660, 9544171010099,
5001842823, 7000307001, 8226232066



MN-DL-2160

Length: 1652 Ø: 50
Cone Ø: d1 Ø 30 / d2 Ø 27
81467106112, 81467106163, 81467106165,
81467106198, 81467106353, 81467106354,
81467106361, 81467116725



MN-DL-3402

Length: 590 Ø: 48
Hole Distance: 130 / 130
03307200A, 81432206067, 81432206068,
81432206090, 81432206092, 81432209092



MN-DL-3588

Length: 1035 Ø: 48
Cone Ø: d1 Ø 30 / d2 Ø 27
81466106333, 81466106334, 81466106354,
81466106355, 81466106360, 81466106361,
81466106721, 81466106722, 81466106723,
81466116216



MN-DL-5212

Length: 577 Ø: 48
Hole Distance: 130 / 130
81432206096, 81432206097, 81432206098,
81432206129, 81432209096, 81432209129,
81432306014, 81432306030



MN-DL-12278

Length: 770
Ø: 40
Cone Ø: d1 Ø 30 / d2 Ø 27
81466106348



MN-DL-12284

Length: 1530 Ø: 50
Cone Ø: d1 Ø 30 / d2 Ø 27
81466106579, 81466106580, 81466106624,
81466116720, 81467116720, 81467116730,
81467116952



MN-DL-12421

Length: 1070
Ø: 48
Cone Ø: d1 Ø 30 / d2 Ø 27
Thread: M30 x 1,5 RHT
81466106656, 81466106659, 81466106669,
81466116006, 81466116007



MN-ES-10348

Length: 80
Cone Ø: d1 Ø 30 / d2 Ø 27,2
Thread: M22 x 1,5 RHT
81953010040



MN-RK-7287

Ø: 90
Hole Distance: 152
Thick/Height: 35
03304700A, 81953016133



MN-RK-7291

Ø: 72
Hole Distance: 130
Thick/Height: 30
10307800A, 81432206108, 81432206132



MN-SB-5244

Ø: 65
Hole Distance: 125
Thick/Height: 22
03312000A, 81432710027, 81432710082



MN-SB-5246

Ø: 45 Thick/Height: 47
81437220022, 81437220038, 81962100450,
81962100469



MN-SB-5254

Length: 100
Ø: 93
Thick/Height: 70
81432710081



MN-SB-9396

Ø: 67
Thick/Height: 60
81437040057



MN-SB-10389

Ø: 70
Thick/Height: 72
81960200340



MN-VB-5222

Length: 627 Ø: 50
Hole Distance: 152 / 152
81432706030, 81432706034, 81432706054,
81432706055, 81432706056, 81432706057,
81432706067, 81432706068, 81432706074,
81432706075, 81432706076, 81432706077,
81432706078, 81432706081, 81432706082,
81432709034, 81432709076, 81432709078,
8143706054



MN-VB-8569

Length: 627
Ø: 58
Hole Distance: 152 / 152
81432706055, 81432706056, 81432706067,
81432706068, 81432706075, 81432706077,
81432706081, 81432709056





F 90 ...

32.262 VFK ...	02/89→02/90	Suspension Arm Repair Kit		MN-SB-5244	for Wishbone (CV)	
	02/89→02/90	Suspension Arm Repair Kit		MN-SB-5244	for Wishbone (CV), 1st RA	
	02/89→02/90	Tie Rod	MN-DL-12284			
	02/89→02/90	Tie Rod End	CV-ES-2146			
	02/89→02/90	Tie Rod End	CV-ES-14163		for Steering Rod	
	02/89→02/90	Track Control Arm		MN-DL-3402	Trailing Arm	
	02/89→02/90	Track Control Arm		MN-DL-3402	Trailing Arm, Drive Axle	
	02/89→02/90	Track Control Arm		MN-DL-5212	Trailing Arm, Air Suspension Axle; Drive Axle; Tag Axle	
	02/89→02/90	Track Control Arm		MN-VB-5222	Wishbone (CV)	
	02/89→02/90	Track Control Arm		MN-VB-5222	Wishbone (CV), Drive Axle	
	02/89→02/90	Track Control Arm		MN-VB-8569	Wishbone (CV)	
	32.262 VFTM	02/89→02/90	Ball Head, gearshift linkage	CV-ES-2120		
		02/89→02/90	Centre Rod	MN-DL-12278		for Steering Rod
02/89→02/90		Drag Link End	MN-ES-10348			
02/89→02/90		Engine Mounting	MN-SB-10389			
02/89→02/90		Mounting, stabilizer coupling rod	MN-SB-5246			
02/89→02/90		Mounting, stabilizer coupling rod	MN-SB-5246		1st FA	
02/89→02/90		Stabiliser Mounting		MN-SB-5254		
02/89→02/90		Stabiliser Mounting	MN-SB-9396			
02/89→02/90		Suspension Arm Repair Kit		CV-RK-5313	for Wishbone (CV)	
02/89→02/90		Suspension Arm Repair Kit		MN-RK-7287	for Wishbone (CV)	
02/89→02/90		Suspension Arm Repair Kit		MN-SB-5244	for Wishbone (CV)	
02/89→02/90		Suspension Arm Repair Kit		MN-SB-5244	for Wishbone (CV), 1st RA	
02/89→02/90		Tie Rod	MN-DL-12284			
02/89→02/90		Tie Rod End	CV-ES-2146			
02/89→02/90		Tie Rod End	CV-ES-14163		for Steering Rod	
02/89→02/90		Track Control Arm		MN-DL-3402	Trailing Arm	
02/89→02/90		Track Control Arm		MN-DL-3402	Trailing Arm, Drive Axle	
02/89→02/90		Track Control Arm		MN-DL-5212	Trailing Arm, Air Suspension Axle; Drive Axle; Tag Axle	
02/89→02/90		Track Control Arm		MN-VB-5222	Wishbone (CV)	
02/89→02/90		Track Control Arm		MN-VB-5222	Wishbone (CV), Drive Axle	
02/89→02/90		Track Control Arm		MN-VB-8569	Wishbone (CV)	
32.272 VF	02/90→01/91	Track Control Arm		MN-VB-5222	Wishbone (CV), Drive Axle	
	02/90→04/95	Ball Head, gearshift linkage	CV-ES-2120			
	02/90→04/95	Centre Rod	MN-DL-12278		for Steering Rod	
	02/90→04/95	Drag Link End	MN-ES-10348			
	02/90→04/95	Engine Mounting	MN-SB-10389			
	02/90→04/95	Mounting, stabilizer coupling rod	MN-SB-5246			
	02/90→04/95	Mounting, stabilizer coupling rod	MN-SB-5246		1st FA	
	02/90→04/95	Stabiliser Mounting		MN-SB-5254		
	02/90→04/95	Stabiliser Mounting	MN-SB-9396			
	02/90→04/95	Suspension Arm Repair Kit		CV-RK-5313	for Wishbone (CV)	
	02/90→04/95	Suspension Arm Repair Kit		MN-RK-7287	for Wishbone (CV)	
	02/90→04/95	Suspension Arm Repair Kit		MN-SB-5244	for Wishbone (CV)	
	02/90→04/95	Suspension Arm Repair Kit		MN-SB-5244	for Wishbone (CV), 1st RA	
	02/90→04/95	Tie Rod	MN-DL-12284			
	02/90→04/95	Tie Rod End	CV-ES-2146			
	02/90→04/95	Tie Rod End	CV-ES-14163		for Steering Rod	
	02/90→04/95	Track Control Arm		MN-DL-3402	Trailing Arm	
	02/90→04/95	Track Control Arm		MN-DL-3402	Trailing Arm, Drive Axle	
	02/90→04/95	Track Control Arm		MN-DL-5212	Trailing Arm, Air Suspension Axle; Drive Axle; Tag Axle	
	02/90→04/95	Track Control Arm		MN-VB-5222	Wishbone (CV)	
	02/90→04/95	Track Control Arm		MN-VB-8569	Wishbone (CV)	
01/91→04/95	Track Control Arm		MN-VB-8569	Wishbone (CV), Drive Axle		
32.272 VFK	02/90→01/91	Track Control Arm		MN-VB-5222	Wishbone (CV), Drive Axle	
	02/90→04/95	Ball Head, gearshift linkage	CV-ES-2120			
	02/90→04/95	Centre Rod	MN-DL-12278		for Steering Rod	
	02/90→04/95	Drag Link End	MN-ES-10348			
	02/90→04/95	Engine Mounting	MN-SB-10389			
	02/90→04/95	Mounting, stabilizer coupling rod	MN-SB-5246			

CV-ES-2120

Length: 115
Cone Ø: d1 Ø 12,4 / d2 Ø 10,8
Thread: M14 x 1,5 RHT
03008500A, 81953016200, 81953016202, 81953016203, 81953016227



CV-ES-2146

Length: 80
Cone Ø: d1 Ø 30 / d2 Ø 27
Thread: M26 x 1,5 RHT
42533102, 81953016219, 81953016225, 81953016226, 81953016267, 81953016291



CV-ES-14163

Length: 125
Cone Ø: d1 Ø 30 / d2 Ø 27
Thread: M30 x 1,5 RHT
95301.0084, 90804102156, 90804102272, 90804102696, 90804102710, 81953010016, 81953010075, 81953010084, 81953010088, 81953010094, 81953010103, 81953016030, 81953016043, 81953016048, 81953016049, 81953016053, 81953016061, 81953016090, 81953016108, 81953016112, 81953016126, 81953016143, 81953016149, 81953016154, 81953016156, 81953016168, 81953016178, 81953016194, 81953016206, 81953016224, 81953016234, 81953016242, 81953016252, 81953016274, 81953016278, 81953016284, 81953016286, 81953016308, 81953016310, 81953016312, 81953016347, 81953016350, 81953016352, 82953016012, 88953016014, N2953016001



CV-RK-5313

Ø: 90
03304800A, 81953016132



MN-DL-3402

Length: 590 Ø: 48
Hole Distance: 130 / 130
03307200A, 81432206067, 81432206068, 81432206090, 81432206092, 81432209092



MN-DL-5212

Length: 577 Ø: 48
Hole Distance: 130 / 130
81432206096, 81432206097, 81432206098, 81432206129, 81432209096, 81432209129, 81432306014, 81432306030



MN-DL-12278

Length: 770
Ø: 40
Cone Ø: d1 Ø 30 / d2 Ø 27
81466106348



MN-DL-12284

Length: 1530 Ø: 50
Cone Ø: d1 Ø 30 / d2 Ø 27
81466106579, 81466106580, 81466106624, 81466116720, 81467116720, 81467116730, 81467116952



MN-ES-10348

Length: 80
Cone Ø: d1 Ø 30 / d2 Ø 27,2
Thread: M22 x 1,5 RHT
81953010040



MN-RK-7287

Ø: 90
Hole Distance: 152
Thick/Height: 35
03304700A, 81953016133



MN-SB-5244

Ø: 65
Hole Distance: 125
Thick/Height: 22
03312000A, 81432710027, 81432710082



MN-SB-5246

Ø: 45 Thick/Height: 47
81437220022, 81437220038, 81962100450, 81962100469



MN-SB-5254

Length: 100
Ø: 93
Thick/Height: 70
81432710081



MN-SB-9396

Ø: 67
Thick/Height: 60
81437040057



MN-SB-10389

Ø: 70
Thick/Height: 72
81960200340



MN-VB-5222

Length: 627 Ø: 50
Hole Distance: 152 / 152
81432706030, 81432706034, 81432706054, 81432706055, 81432706056, 81432706057, 81432706067, 81432706068, 81432706074, 81432706075, 81432706076, 81432706077, 81432706078, 81432706081, 81432706082, 81432709034, 81432709076, 81432709078, 8143706054



MN-VB-8569

Length: 627
Ø: 58
Hole Distance: 152 / 152
81432706055, 81432706056, 81432706067, 81432706068, 81432706075, 81432706077, 81432706081, 81432709056





F 90 ...

32.272 VFK ...	02/90→04/95	Mounting, stabilizer coupling rod	MN-SB-5246		1st FA
	02/90→04/95	Stabiliser Mounting		MN-SB-5254	
	02/90→04/95	Stabiliser Mounting	MN-SB-9396		
	02/90→04/95	Suspension Arm Repair Kit		CV-RK-5313	for Wishbone (CV)
	02/90→04/95	Suspension Arm Repair Kit		MN-RK-7287	for Wishbone (CV)
	02/90→04/95	Suspension Arm Repair Kit		MN-SB-5244	for Wishbone (CV)
	02/90→04/95	Suspension Arm Repair Kit		MN-SB-5244	for Wishbone (CV), 1st RA
	02/90→04/95	Tie Rod	MN-DL-12284		
	02/90→04/95	Tie Rod End	CV-ES-2146		
	02/90→04/95	Tie Rod End	CV-ES-14163		for Steering Rod
	02/90→04/95	Track Control Arm		MN-DL-3402	Trailing Arm
	02/90→04/95	Track Control Arm		MN-DL-3402	Trailing Arm, Drive Axle
	02/90→04/95	Track Control Arm		MN-DL-5212	Trailing Arm, Air Suspension Axle; Drive Axle; Tag Axle
	02/90→04/95	Track Control Arm		MN-VB-5222	Wishbone (CV)
	02/90→04/95	Track Control Arm		MN-VB-8569	Wishbone (CV)
	01/91→04/95	Track Control Arm		MN-VB-8569	Wishbone (CV), Drive Axle
	32.292 VF	03/88→02/90	Ball Head, gearshift linkage	CV-ES-2120	
03/88→02/90		Centre Rod	MN-DL-12278		for Steering Rod
03/88→02/90		Drag Link End	MN-ES-10348		
03/88→02/90		Engine Mounting	MN-SB-10389		
03/88→02/90		Mounting, stabilizer coupling rod	MN-SB-5246		
03/88→02/90		Mounting, stabilizer coupling rod	MN-SB-5246		1st FA
03/88→02/90		Stabiliser Mounting		MN-SB-5254	
03/88→02/90		Stabiliser Mounting	MN-SB-9396		
03/88→02/90		Suspension Arm Repair Kit		CV-RK-5313	for Wishbone (CV)
03/88→02/90		Suspension Arm Repair Kit		MN-RK-7287	for Wishbone (CV)
03/88→02/90		Suspension Arm Repair Kit		MN-SB-5244	for Wishbone (CV)
03/88→02/90		Suspension Arm Repair Kit		MN-SB-5244	for Wishbone (CV), 1st RA
03/88→02/90		Tie Rod	MN-DL-12284		
03/88→02/90		Tie Rod End	CV-ES-2146		
03/88→02/90		Tie Rod End	CV-ES-14163		for Steering Rod
03/88→02/90		Track Control Arm		MN-DL-3402	Trailing Arm
03/88→02/90		Track Control Arm		MN-DL-3402	Trailing Arm, Drive Axle
03/88→02/90	Track Control Arm		MN-DL-5212	Trailing Arm, Air Suspension Axle; Drive Axle; Tag Axle	
03/88→02/90	Track Control Arm		MN-VB-5222	Wishbone (CV)	
03/88→02/90	Track Control Arm		MN-VB-5222	Wishbone (CV), Drive Axle	
03/88→02/90	Track Control Arm		MN-VB-8569	Wishbone (CV)	
32.292 VFK	03/88→02/90	Ball Head, gearshift linkage	CV-ES-2120		
	03/88→02/90	Centre Rod	MN-DL-12278		for Steering Rod
	03/88→02/90	Drag Link End	MN-ES-10348		
	03/88→02/90	Engine Mounting	MN-SB-10389		
	03/88→02/90	Mounting, stabilizer coupling rod	MN-SB-5246		
	03/88→02/90	Mounting, stabilizer coupling rod	MN-SB-5246		1st FA
	03/88→02/90	Stabiliser Mounting		MN-SB-5254	
	03/88→02/90	Stabiliser Mounting	MN-SB-9396		
	03/88→02/90	Suspension Arm Repair Kit		CV-RK-5313	for Wishbone (CV)
	03/88→02/90	Suspension Arm Repair Kit		MN-RK-7287	for Wishbone (CV)
	03/88→02/90	Suspension Arm Repair Kit		MN-SB-5244	for Wishbone (CV)
	03/88→02/90	Suspension Arm Repair Kit		MN-SB-5244	for Wishbone (CV), 1st RA
	03/88→02/90	Tie Rod	MN-DL-12284		
	03/88→02/90	Tie Rod End	CV-ES-2146		
	03/88→02/90	Tie Rod End	CV-ES-14163		for Steering Rod
	03/88→02/90	Track Control Arm		MN-DL-3402	Trailing Arm
	03/88→02/90	Track Control Arm		MN-DL-3402	Trailing Arm, Drive Axle
03/88→02/90	Track Control Arm		MN-DL-5212	Trailing Arm, Air Suspension Axle; Drive Axle; Tag Axle	
03/88→02/90	Track Control Arm		MN-VB-5222	Wishbone (CV)	
03/88→02/90	Track Control Arm		MN-VB-5222	Wishbone (CV), Drive Axle	
03/88→02/90	Track Control Arm		MN-VB-8569	Wishbone (CV)	

CV-ES-2120

Length: 115
Cone Ø: d1 Ø 12,4 / d2 Ø 10,8
Thread: M14 x 1,5 RHT
03008500A, 81953016200, 81953016202, 81953016203, 81953016227



CV-ES-2146

Length: 80
Cone Ø: d1 Ø 30 / d2 Ø 27
Thread: M26 x 1,5 RHT
42533102, 81953016219, 81953016225, 81953016226, 81953016267, 81953016291



CV-ES-14163

Length: 125
Cone Ø: d1 Ø 30 / d2 Ø 27
Thread: M30 x 1,5 RHT
95301.0084, 90804102156, 90804102272, 90804102696, 90804102710, 81953010016, 81953010075, 81953010084, 81953010088, 81953010094, 81953010103, 81953016030, 81953016043, 81953016048, 81953016049, 81953016053, 81953016061, 81953016090, 81953016108, 81953016112, 81953016126, 81953016143, 81953016149, 81953016154, 81953016156, 81953016168, 81953016178, 81953016194, 81953016206, 81953016224, 81953016234, 81953016242, 81953016252, 81953016274, 81953016278, 81953016284, 81953016286, 81953016308, 81953016310, 81953016312, 81953016347, 81953016350, 81953016352, 82953016012, 88953016014, N2953016001



CV-RK-5313

Ø: 90
03304800A, 81953016132



MN-DL-3402

Length: 590 Ø: 48
Hole Distance: 130 / 130
03307200A, 81432206067, 81432206068, 81432206090, 81432206092, 81432209092



MN-DL-5212

Length: 577 Ø: 48
Hole Distance: 130 / 130
81432206096, 81432206097, 81432206098, 81432206129, 81432209096, 81432209129, 81432306014, 81432306030



MN-DL-12278

Length: 770
Ø: 40
Cone Ø: d1 Ø 30 / d2 Ø 27
81466106348



MN-DL-12284

Length: 1530 Ø: 50
Cone Ø: d1 Ø 30 / d2 Ø 27
81466106579, 81466106580, 81466106624, 81466116720, 81467116720, 81467116730, 81467116952



MN-ES-10348

Length: 80
Cone Ø: d1 Ø 30 / d2 Ø 27,2
Thread: M22 x 1,5 RHT
81953010040



MN-RK-7287

Ø: 90
Hole Distance: 152
Thick/Height: 35
03304700A, 81953016133



MN-SB-5244

Ø: 65
Hole Distance: 125
Thick/Height: 22
03312000A, 81432710027, 81432710082



MN-SB-5246

Ø: 45 Thick/Height: 47
81437220022, 81437220038, 81962100450, 81962100469



MN-SB-5254

Length: 100
Ø: 93
Thick/Height: 70
81432710081



MN-SB-9396

Ø: 67
Thick/Height: 60
81437040057



MN-SB-10389

Ø: 70
Thick/Height: 72
81960200340



MN-VB-5222

Length: 627 Ø: 50
Hole Distance: 152 / 152
81432706030, 81432706034, 81432706054, 81432706055, 81432706056, 81432706057, 81432706067, 81432706068, 81432706074, 81432706075, 81432706076, 81432706077, 81432706078, 81432706081, 81432706082, 81432709034, 81432709076, 81432709078, 8143706054



MN-VB-8569

Length: 627
Ø: 58
Hole Distance: 152 / 152
81432706055, 81432706056, 81432706067, 81432706068, 81432706075, 81432706077, 81432706081, 81432709056





F 90 ...

32.302 VF	05/90→01/91	Track Control Arm		MN-VB-5222	Wishbone (CV), Drive Axle	
	05/90→09/91	Ball Head, gearshift linkage	CV-ES-2120			
	05/90→09/91	Centre Rod	MN-DL-12278		for Steering Rod	
	05/90→09/91	Drag Link End	MN-ES-10348			
	05/90→09/91	Engine Mounting	MN-SB-10389			
	05/90→09/91	Mounting, stabilizer coupling rod	MN-SB-5246			
	05/90→09/91	Mounting, stabilizer coupling rod	MN-SB-5246		1st FA	
	05/90→09/91	Stabiliser Mounting		MN-SB-5254		
	05/90→09/91	Stabiliser Mounting	MN-SB-9396			
	05/90→09/91	Suspension Arm Repair Kit		CV-RK-5313	for Wishbone (CV)	
	05/90→09/91	Suspension Arm Repair Kit		MN-RK-7287	for Wishbone (CV)	
	05/90→09/91	Suspension Arm Repair Kit		MN-SB-5244	for Wishbone (CV)	
	05/90→09/91	Suspension Arm Repair Kit		MN-SB-5244	for Wishbone (CV), 1st RA	
	05/90→09/91	Tie Rod	MN-DL-12284			
	05/90→09/91	Tie Rod End	CV-ES-2146			
	05/90→09/91	Tie Rod End	CV-ES-14163		for Steering Rod	
	05/90→09/91	Track Control Arm		MN-DL-3402	Trailing Arm	
	05/90→09/91	Track Control Arm		MN-DL-3402	Trailing Arm, Drive Axle	
	05/90→09/91	Track Control Arm		MN-DL-5212	Trailing Arm, Air Suspension Axle; Drive Axle; Tag Axle	
	05/90→09/91	Track Control Arm		MN-VB-5222	Wishbone (CV)	
	05/90→09/91	Track Control Arm		MN-VB-8569	Wishbone (CV)	
	32.302 VFK	01/91→09/91	Track Control Arm		MN-VB-8569	Wishbone (CV), Drive Axle
		05/90→01/91	Track Control Arm		MN-VB-5222	Wishbone (CV), Drive Axle
05/90→09/91		Ball Head, gearshift linkage	CV-ES-2120			
05/90→09/91		Centre Rod	MN-DL-12278		for Steering Rod	
05/90→09/91		Drag Link End	MN-ES-10348			
05/90→09/91		Engine Mounting	MN-SB-10389			
05/90→09/91		Mounting, stabilizer coupling rod	MN-SB-5246			
05/90→09/91		Mounting, stabilizer coupling rod	MN-SB-5246		1st FA	
05/90→09/91		Stabiliser Mounting		MN-SB-5254		
05/90→09/91		Stabiliser Mounting	MN-SB-9396			
05/90→09/91		Suspension Arm Repair Kit		CV-RK-5313	for Wishbone (CV)	
05/90→09/91		Suspension Arm Repair Kit		MN-RK-7287	for Wishbone (CV)	
05/90→09/91		Suspension Arm Repair Kit		MN-SB-5244	for Wishbone (CV)	
05/90→09/91		Suspension Arm Repair Kit		MN-SB-5244	for Wishbone (CV), 1st RA	
05/90→09/91		Tie Rod	MN-DL-12284			
05/90→09/91		Tie Rod End	CV-ES-2146			
05/90→09/91		Tie Rod End	CV-ES-14163		for Steering Rod	
05/90→09/91		Track Control Arm		MN-DL-3402	Trailing Arm	
05/90→09/91		Track Control Arm		MN-DL-3402	Trailing Arm, Drive Axle	
05/90→09/91		Track Control Arm		MN-DL-5212	Trailing Arm, Air Suspension Axle; Drive Axle; Tag Axle	
05/90→09/91		Track Control Arm		MN-VB-5222	Wishbone (CV)	
05/90→09/91		Track Control Arm		MN-VB-8569	Wishbone (CV)	
01/91→09/91		Track Control Arm		MN-VB-8569	Wishbone (CV), Drive Axle	
32.322 VF	02/90→01/91	Track Control Arm		MN-VB-5222	Wishbone (CV), Drive Axle	
	02/90→06/96	Ball Head, gearshift linkage	CV-ES-2120			
	02/90→06/96	Centre Rod	MN-DL-12278		for Steering Rod	
	02/90→06/96	Drag Link End	MN-ES-10348			
	02/90→06/96	Engine Mounting	MN-SB-10389			
	02/90→06/96	Mounting, stabilizer coupling rod	MN-SB-5246			
	02/90→06/96	Mounting, stabilizer coupling rod	MN-SB-5246		1st FA	
	02/90→06/96	Stabiliser Mounting		MN-SB-5254		
	02/90→06/96	Stabiliser Mounting	MN-SB-9396			
	02/90→06/96	Suspension Arm Repair Kit		CV-RK-5313	for Wishbone (CV)	
	02/90→06/96	Suspension Arm Repair Kit		MN-RK-7287	for Wishbone (CV)	
	02/90→06/96	Suspension Arm Repair Kit		MN-SB-5244	for Wishbone (CV)	
	02/90→06/96	Suspension Arm Repair Kit		MN-SB-5244	for Wishbone (CV), 1st RA	
	02/90→06/96	Tie Rod	MN-DL-12284			
	02/90→06/96	Tie Rod End	CV-ES-2146			
	02/90→06/96	Tie Rod End	CV-ES-14163		for Steering Rod	
	02/90→06/96	Track Control Arm		MN-DL-3402	Trailing Arm	

CV-ES-2120

Length: 115
 Cone Ø: d1 Ø 12,4 / d2 Ø 10,8
 Thread: M14 x 1,5 RHT
 03008500A, 81953016200, 81953016202,
 81953016203, 81953016227

**CV-ES-2146**

Length: 80
 Cone Ø: d1 Ø 30 / d2 Ø 27
 Thread: M26 x 1,5 RHT
 42533102, 81953016219, 81953016225,
 81953016226, 81953016267, 81953016291

**CV-ES-14163**

Length: 125
 Cone Ø: d1 Ø 30 / d2 Ø 27
 Thread: M30 x 1,5 RHT
 95301.0084, 90804102156, 90804102272,
 90804102696, 90804102710, 81953010016,
 81953010075, 81953010084, 81953010088,
 81953010094, 81953010103, 81953016030,
 81953016043, 81953016048, 81953016049,
 81953016053, 81953016061, 81953016090,
 81953016108, 81953016112, 81953016126,
 81953016143, 81953016149, 81953016154,
 81953016156, 81953016168, 81953016178,
 81953016194, 81953016206, 81953016224,
 81953016234, 81953016242, 81953016252,
 81953016274, 81953016278, 81953016284,
 81953016286, 81953016308, 81953016310,
 81953016312, 81953016347, 81953016350,
 81953016352, 82953016012, 88953016014,
 N2953016001

**CV-RK-5313**

Ø: 90
 03304800A, 81953016132

**MN-DL-3402**

Length: 590 Ø: 48
 Hole Distance: 130 / 130
 03307200A, 81432206067, 81432206068,
 81432206090, 81432206092, 81432209092

**MN-DL-5212**

Length: 577 Ø: 48
 Hole Distance: 130 / 130
 81432206096, 81432206097, 81432206098,
 81432206129, 81432209096, 81432209129,
 81432306014, 81432306030

**MN-DL-12278**

Length: 770
 Ø: 40
 Cone Ø: d1 Ø 30 / d2 Ø 27
 81466106348

**MN-DL-12284**

Length: 1530 Ø: 50
 Cone Ø: d1 Ø 30 / d2 Ø 27
 81466106579, 81466106580, 81466106624,
 81466116720, 81467116720, 81467116730,
 81467116952

**MN-ES-10348**

Length: 80
 Cone Ø: d1 Ø 30 / d2 Ø 27,2
 Thread: M22 x 1,5 RHT
 81953010040

**MN-RK-7287**

Ø: 90
 Hole Distance: 152
 Thick/Height: 35
 03304700A, 81953016133

**MN-SB-5244**

Ø: 65
 Hole Distance: 125
 Thick/Height: 22
 03312000A, 81432710027, 81432710082

**MN-SB-5246**

Ø: 45 Thick/Height: 47
 81437220022, 81437220038, 81962100450,
 81962100469

**MN-SB-5254**

Length: 100
 Ø: 93
 Thick/Height: 70
 81432710081

**MN-SB-9396**

Ø: 67
 Thick/Height: 60
 81437040057

**MN-SB-10389**

Ø: 70
 Thick/Height: 72
 81960200340

**MN-VB-5222**

Length: 627 Ø: 50
 Hole Distance: 152 / 152
 81432706030, 81432706034, 81432706054,
 81432706055, 81432706056, 81432706057,
 81432706067, 81432706068, 81432706074,
 81432706075, 81432706076, 81432706077,
 81432706078, 81432706081, 81432706082,
 81432709034, 81432709076, 81432709078,
 8143706054

**MN-VB-8569**

Length: 627
 Ø: 58
 Hole Distance: 152 / 152
 81432706055, 81432706056, 81432706067,
 81432706068, 81432706075, 81432706077,
 81432706081, 81432709056



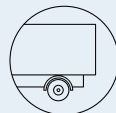

F 90 ...

32.322 VF ...	02/90→06/96	Track Control Arm		MN-DL-3402	Trailing Arm, Drive Axle	
	02/90→06/96	Track Control Arm		MN-DL-5212	Trailing Arm, Air Suspension Axle; Drive Axle; Tag Axle	
	02/90→06/96	Track Control Arm		MN-VB-5222	Wishbone (CV)	
	02/90→06/96	Track Control Arm		MN-VB-8569	Wishbone (CV)	
	01/91→06/96	Track Control Arm		MN-VB-8569	Wishbone (CV), Drive Axle	
32.322 VFK	02/90→01/91	Track Control Arm		MN-VB-5222	Wishbone (CV), Drive Axle	
	02/90→06/96	Ball Head, gearshift linkage	CV-ES-2120			
	02/90→06/96	Centre Rod	MN-DL-12278		for Steering Rod	
	02/90→06/96	Drag Link End	MN-ES-10348			
	02/90→06/96	Engine Mounting	MN-SB-10389			
	02/90→06/96	Mounting, stabilizer coupling rod	MN-SB-5246			
	02/90→06/96	Mounting, stabilizer coupling rod	MN-SB-5246		1st FA	
	02/90→06/96	Stabiliser Mounting		MN-SB-5254		
	02/90→06/96	Stabiliser Mounting	MN-SB-9396			
	02/90→06/96	Suspension Arm Repair Kit		CV-RK-5313	for Wishbone (CV)	
	02/90→06/96	Suspension Arm Repair Kit		MN-RK-7287	for Wishbone (CV)	
	02/90→06/96	Suspension Arm Repair Kit		MN-SB-5244	for Wishbone (CV)	
	02/90→06/96	Suspension Arm Repair Kit		MN-SB-5244	for Wishbone (CV), 1st RA	
	02/90→06/96	Tie Rod	MN-DL-12284			
	02/90→06/96	Tie Rod End	CV-ES-2146			
	02/90→06/96	Tie Rod End	CV-ES-14163		for Steering Rod	
	02/90→06/96	Track Control Arm		MN-DL-3402	Trailing Arm	
	02/90→06/96	Track Control Arm		MN-DL-3402	Trailing Arm, Drive Axle	
	02/90→06/96	Track Control Arm		MN-DL-5212	Trailing Arm, Air Suspension Axle; Drive Axle; Tag Axle	
	02/90→06/96	Track Control Arm		MN-VB-5222	Wishbone (CV)	
	02/90→06/96	Track Control Arm		MN-VB-8569	Wishbone (CV)	
	01/91→06/96	Track Control Arm		MN-VB-8569	Wishbone (CV), Drive Axle	
	32.332 VF	03/88→02/90	Ball Head, gearshift linkage	CV-ES-2120		
		03/88→02/90	Centre Rod	MN-DL-12278		for Steering Rod
		03/88→02/90	Drag Link End	MN-ES-10348		
03/88→02/90		Engine Mounting	MN-SB-10389			
03/88→02/90		Mounting, stabilizer coupling rod	MN-SB-5246			
03/88→02/90		Mounting, stabilizer coupling rod	MN-SB-5246		1st FA	
03/88→02/90		Stabiliser Mounting		MN-SB-5254		
03/88→02/90		Stabiliser Mounting	MN-SB-9396			
03/88→02/90		Suspension Arm Repair Kit		CV-RK-5313	for Wishbone (CV)	
03/88→02/90		Suspension Arm Repair Kit		MN-RK-7287	for Wishbone (CV)	
03/88→02/90		Suspension Arm Repair Kit		MN-SB-5244	for Wishbone (CV)	
03/88→02/90		Suspension Arm Repair Kit		MN-SB-5244	for Wishbone (CV), 1st RA	
03/88→02/90		Tie Rod	MN-DL-12284			
03/88→02/90		Tie Rod End	CV-ES-2146			
03/88→02/90		Tie Rod End	CV-ES-14163		for Steering Rod	
03/88→02/90		Track Control Arm		MN-DL-3402	Trailing Arm	
03/88→02/90		Track Control Arm		MN-DL-3402	Trailing Arm, Drive Axle	
03/88→02/90		Track Control Arm		MN-DL-5212	Trailing Arm, Air Suspension Axle; Drive Axle; Tag Axle	
03/88→02/90		Track Control Arm		MN-VB-5222	Wishbone (CV)	
03/88→02/90		Track Control Arm		MN-VB-5222	Wishbone (CV), Drive Axle	
03/88→02/90		Track Control Arm		MN-VB-8569	Wishbone (CV)	
32.332 VFK		03/88→02/90	Ball Head, gearshift linkage	CV-ES-2120		
		03/88→02/90	Centre Rod	MN-DL-12278		for Steering Rod
		03/88→02/90	Drag Link End	MN-ES-10348		
		03/88→02/90	Engine Mounting	MN-SB-10389		
	03/88→02/90	Mounting, stabilizer coupling rod	MN-SB-5246			
	03/88→02/90	Mounting, stabilizer coupling rod	MN-SB-5246		1st FA	
	03/88→02/90	Stabiliser Mounting		MN-SB-5254		
	03/88→02/90	Stabiliser Mounting	MN-SB-9396			
	03/88→02/90	Suspension Arm Repair Kit		CV-RK-5313	for Wishbone (CV)	
	03/88→02/90	Suspension Arm Repair Kit		MN-RK-7287	for Wishbone (CV)	
	03/88→02/90	Suspension Arm Repair Kit		MN-SB-5244	for Wishbone (CV)	
	03/88→02/90	Suspension Arm Repair Kit		MN-SB-5244	for Wishbone (CV), 1st RA	

CV-ES-2120

Length: 115
Cone Ø: d1 Ø 12,4 / d2 Ø 10,8
Thread: M14 x 1,5 RHT
 03008500A, 81953016200, 81953016202, 81953016203, 81953016227



CV-ES-2146

Length: 80
Cone Ø: d1 Ø 30 / d2 Ø 27
Thread: M26 x 1,5 RHT
 42533102, 81953016219, 81953016225, 81953016226, 81953016267, 81953016291



CV-ES-14163

Length: 125
Cone Ø: d1 Ø 30 / d2 Ø 27
Thread: M30 x 1,5 RHT
 95301.0084, 90804102156, 90804102272, 90804102696, 90804102710, 81953010016, 81953010075, 81953010084, 81953010088, 81953010094, 81953010103, 81953016030, 81953016043, 81953016048, 81953016049, 81953016053, 81953016061, 81953016090, 81953016108, 81953016112, 81953016126, 81953016143, 81953016149, 81953016154, 81953016156, 81953016168, 81953016178, 81953016194, 81953016206, 81953016224, 81953016234, 81953016242, 81953016252, 81953016274, 81953016278, 81953016284, 81953016286, 81953016308, 81953016310, 81953016312, 81953016347, 81953016350, 81953016352, 82953016012, 88953016014, N2953016001



CV-RK-5313

Ø: 90
 03304800A, 81953016132



MN-DL-3402

Length: 590 **Ø:** 48
Hole Distance: 130 / 130
 03307200A, 81432206067, 81432206068, 81432206090, 81432206092, 81432209092



MN-DL-5212

Length: 577 **Ø:** 48
Hole Distance: 130 / 130
 81432206096, 81432206097, 81432206098, 81432206129, 81432209096, 81432209129, 81432306014, 81432306030



MN-DL-12278

Length: 770
Ø: 40
Cone Ø: d1 Ø 30 / d2 Ø 27
 81466106348



MN-DL-12284

Length: 1530 **Ø:** 50
Cone Ø: d1 Ø 30 / d2 Ø 27
 81466106579, 81466106580, 81466106624, 81466116720, 81467116720, 81467116730, 81467116952



MN-ES-10348

Length: 80
Cone Ø: d1 Ø 30 / d2 Ø 27,2
Thread: M22 x 1,5 RHT
 81953010040



MN-RK-7287

Ø: 90
Hole Distance: 152
Thick/Height: 35
 03304700A, 81953016133



MN-SB-5244

Ø: 65
Hole Distance: 125
Thick/Height: 22
 03312000A, 81432710027, 81432710082



MN-SB-5246

Ø: 45 **Thick/Height:** 47
 81437220022, 81437220038, 81962100450, 81962100469



MN-SB-5254

Length: 100
Ø: 93
Thick/Height: 70
 81432710081



MN-SB-9396

Ø: 67
Thick/Height: 60
 81437040057



MN-SB-10389

Ø: 70
Thick/Height: 72
 81960200340



MN-VB-5222

Length: 627 **Ø:** 50
Hole Distance: 152 / 152
 81432706030, 81432706034, 81432706054, 81432706055, 81432706056, 81432706057, 81432706067, 81432706068, 81432706074, 81432706075, 81432706076, 81432706077, 81432706078, 81432706081, 81432706082, 81432709034, 81432709076, 81432709078, 8143706054



MN-VB-8569

Length: 627
Ø: 58
Hole Distance: 152 / 152
 81432706055, 81432706056, 81432706067, 81432706068, 81432706075, 81432706077, 81432706081, 81432709056



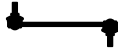

F 90 ...

32.332 VFK ...	03/88→02/90	Tie Rod	MN-DL-12284		
	03/88→02/90	Tie Rod End	CV-ES-2146		
	03/88→02/90	Tie Rod End	CV-ES-14163		for Steering Rod
	03/88→02/90	Track Control Arm		MN-DL-3402	Trailing Arm
	03/88→02/90	Track Control Arm		MN-DL-3402	Trailing Arm, Drive Axle
	03/88→02/90	Track Control Arm		MN-DL-5212	Trailing Arm, Air Suspension Axle; Drive Axle; Tag Axle
	03/88→02/90	Track Control Arm		MN-VB-5222	Wishbone (CV)
	03/88→02/90	Track Control Arm		MN-VB-5222	Wishbone (CV), Drive Axle
32.342 VFK	03/88→02/90	Track Control Arm		MN-VB-8569	Wishbone (CV)
	05/94→06/96	Ball Head, gearshift linkage	CV-ES-2120		
	05/94→06/96	Centre Rod	MN-DL-12278		for Steering Rod
	05/94→06/96	Drag Link End	MN-ES-10348		
	05/94→06/96	Engine Mounting	MN-SB-10389		
	05/94→06/96	Mounting, stabilizer coupling rod	MN-SB-5246		
	05/94→06/96	Mounting, stabilizer coupling rod	MN-SB-5246		1st FA
	05/94→06/96	Stabiliser Mounting		MN-SB-5254	
	05/94→06/96	Stabiliser Mounting	MN-SB-9396		
	05/94→06/96	Suspension Arm Repair Kit		CV-RK-5313	for Wishbone (CV)
	05/94→06/96	Suspension Arm Repair Kit		MN-RK-7287	for Wishbone (CV)
	05/94→06/96	Suspension Arm Repair Kit		MN-SB-5244	for Wishbone (CV)
	05/94→06/96	Suspension Arm Repair Kit		MN-SB-5244	for Wishbone (CV), 1st RA
	05/94→06/96	Tie Rod	MN-DL-12284		
	05/94→06/96	Tie Rod End	CV-ES-2146		
	05/94→06/96	Tie Rod End	CV-ES-14163		for Steering Rod
	05/94→06/96	Track Control Arm		MN-DL-3402	Trailing Arm
	05/94→06/96	Track Control Arm		MN-DL-3402	Trailing Arm, Drive Axle
	05/94→06/96	Track Control Arm		MN-DL-5212	Trailing Arm, Air Suspension Axle; Drive Axle; Tag Axle
	05/94→06/96	Track Control Arm		MN-VB-5222	Wishbone (CV)
05/94→06/96	Track Control Arm		MN-VB-8569	Wishbone (CV)	
05/94→06/96	Track Control Arm		MN-VB-8569	Wishbone (CV), Drive Axle	
32.362 VF	03/88→02/90	Ball Head, gearshift linkage	CV-ES-2120		
	03/88→02/90	Centre Rod	MN-DL-12278		for Steering Rod
	03/88→02/90	Drag Link End	MN-ES-10348		
	03/88→02/90	Engine Mounting	MN-SB-10389		
	03/88→02/90	Mounting, stabilizer coupling rod	MN-SB-5246		
	03/88→02/90	Mounting, stabilizer coupling rod	MN-SB-5246		1st FA
	03/88→02/90	Stabiliser Mounting		MN-SB-5254	
	03/88→02/90	Stabiliser Mounting	MN-SB-9396		
	03/88→02/90	Suspension Arm Repair Kit		CV-RK-5313	for Wishbone (CV)
	03/88→02/90	Suspension Arm Repair Kit		MN-RK-7287	for Wishbone (CV)
	03/88→02/90	Suspension Arm Repair Kit		MN-SB-5244	for Wishbone (CV)
	03/88→02/90	Suspension Arm Repair Kit		MN-SB-5244	for Wishbone (CV), 1st RA
	03/88→02/90	Tie Rod	MN-DL-12284		
	03/88→02/90	Tie Rod End	CV-ES-2146		
	03/88→02/90	Tie Rod End	CV-ES-14163		for Steering Rod
	03/88→02/90	Track Control Arm		MN-DL-3402	Trailing Arm
	03/88→02/90	Track Control Arm		MN-DL-3402	Trailing Arm, Drive Axle
	03/88→02/90	Track Control Arm		MN-DL-5212	Trailing Arm, Air Suspension Axle; Drive Axle; Tag Axle
	03/88→02/90	Track Control Arm		MN-VB-5222	Wishbone (CV)
	03/88→02/90	Track Control Arm		MN-VB-5222	Wishbone (CV), Drive Axle
03/88→02/90	Track Control Arm		MN-VB-8569	Wishbone (CV)	
32.362 VFK	03/88→02/90	Ball Head, gearshift linkage	CV-ES-2120		
	03/88→02/90	Centre Rod	MN-DL-12278		for Steering Rod
	03/88→02/90	Drag Link End	MN-ES-10348		
	03/88→02/90	Engine Mounting	MN-SB-10389		
	03/88→02/90	Mounting, stabilizer coupling rod	MN-SB-5246		
	03/88→02/90	Mounting, stabilizer coupling rod	MN-SB-5246		1st FA
	03/88→02/90	Stabiliser Mounting		MN-SB-5254	
	03/88→02/90	Stabiliser Mounting	MN-SB-9396		
	03/88→02/90	Suspension Arm Repair Kit		CV-RK-5313	for Wishbone (CV)

CV-ES-2120

Length: 115
Cone Ø: d1 Ø 12,4 / d2 Ø 10,8
Thread: M14 x 1,5 RHT
03008500A, 81953016200, 81953016202, 81953016203, 81953016227



CV-ES-2146

Length: 80
Cone Ø: d1 Ø 30 / d2 Ø 27
Thread: M26 x 1,5 RHT
42533102, 81953016219, 81953016225, 81953016226, 81953016267, 81953016291



CV-ES-14163

Length: 125
Cone Ø: d1 Ø 30 / d2 Ø 27
Thread: M30 x 1,5 RHT
95301.0084, 90804102156, 90804102272, 90804102696, 90804102710, 81953010016, 81953010075, 81953010084, 81953010088, 81953010094, 81953010103, 81953016030, 81953016043, 81953016048, 81953016049, 81953016053, 81953016061, 81953016090, 81953016108, 81953016112, 81953016126, 81953016143, 81953016149, 81953016154, 81953016156, 81953016168, 81953016178, 81953016194, 81953016206, 81953016224, 81953016234, 81953016242, 81953016252, 81953016274, 81953016278, 81953016284, 81953016286, 81953016308, 81953016310, 81953016312, 81953016347, 81953016350, 81953016352, 82953016012, 88953016014, N2953016001



CV-RK-5313

Ø: 90
03304800A, 81953016132



MN-DL-3402

Length: 590 Ø: 48
Hole Distance: 130 / 130
03307200A, 81432206067, 81432206068, 81432206090, 81432206092, 81432209092



MN-DL-5212

Length: 577 Ø: 48
Hole Distance: 130 / 130
81432206096, 81432206097, 81432206098, 81432206129, 81432209096, 81432209129, 81432306014, 81432306030



MN-DL-12278

Length: 770
Ø: 40
Cone Ø: d1 Ø 30 / d2 Ø 27
81466106348



MN-DL-12284

Length: 1530 Ø: 50
Cone Ø: d1 Ø 30 / d2 Ø 27
81466106579, 81466106580, 81466106624, 81466116720, 81467116720, 81467116730, 81467116952



MN-ES-10348

Length: 80
Cone Ø: d1 Ø 30 / d2 Ø 27,2
Thread: M22 x 1,5 RHT
81953010040



MN-RK-7287

Ø: 90
Hole Distance: 152
Thick/Height: 35
03304700A, 81953016133



MN-SB-5244

Ø: 65
Hole Distance: 125
Thick/Height: 22
03312000A, 81432710027, 81432710082



MN-SB-5246

Ø: 45 Thick/Height: 47
81437220022, 81437220038, 81962100450, 81962100469



MN-SB-5254

Length: 100
Ø: 93
Thick/Height: 70
81432710081



MN-SB-9396

Ø: 67
Thick/Height: 60
81437040057



MN-SB-10389

Ø: 70
Thick/Height: 72
81960200340



MN-VB-5222

Length: 627 Ø: 50
Hole Distance: 152 / 152
81432706030, 81432706034, 81432706054, 81432706055, 81432706056, 81432706057, 81432706067, 81432706068, 81432706074, 81432706075, 81432706076, 81432706077, 81432706078, 81432706081, 81432706082, 81432709034, 81432709076, 81432709078, 8143706054



MN-VB-8569

Length: 627
Ø: 58
Hole Distance: 152 / 152
81432706055, 81432706056, 81432706067, 81432706068, 81432706075, 81432706077, 81432706081, 81432709056



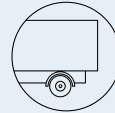

F 90 ...

32.362 VFK ...	03/88→02/90	Suspension Arm Repair Kit		MN-RK-7287	for Wishbone (CV)	
	03/88→02/90	Suspension Arm Repair Kit		MN-SB-5244	for Wishbone (CV)	
	03/88→02/90	Suspension Arm Repair Kit		MN-SB-5244	for Wishbone (CV), 1st RA	
	03/88→02/90	Tie Rod	MN-DL-12284			
	03/88→02/90	Tie Rod End	CV-ES-2146			
	03/88→02/90	Tie Rod End	CV-ES-14163		for Steering Rod	
	03/88→02/90	Track Control Arm		MN-DL-3402	Trailing Arm	
	03/88→02/90	Track Control Arm		MN-DL-3402	Trailing Arm, Drive Axle	
	03/88→02/90	Track Control Arm		MN-DL-5212	Trailing Arm, Air Suspension Axle; Drive Axle; Tag Axle	
	03/88→02/90	Track Control Arm		MN-VB-5222	Wishbone (CV)	
	03/88→02/90	Track Control Arm		MN-VB-5222	Wishbone (CV), Drive Axle	
	03/88→02/90	Track Control Arm		MN-VB-8569	Wishbone (CV)	
	32.372 VF	02/90→01/91	Track Control Arm		MN-VB-5222	Wishbone (CV), Drive Axle
		02/90→06/96	Ball Head, gearshift linkage	CV-ES-2120		
02/90→06/96		Centre Rod	MN-DL-12278		for Steering Rod	
02/90→06/96		Drag Link End	MN-ES-10348			
02/90→06/96		Engine Mounting	MN-SB-10389			
02/90→06/96		Mounting, stabilizer coupling rod	MN-SB-5246			
02/90→06/96		Mounting, stabilizer coupling rod	MN-SB-5246		1st FA	
02/90→06/96		Stabiliser Mounting		MN-SB-5254		
02/90→06/96		Stabiliser Mounting	MN-SB-9396			
02/90→06/96		Suspension Arm Repair Kit		CV-RK-5313	for Wishbone (CV)	
02/90→06/96		Suspension Arm Repair Kit		MN-RK-7287	for Wishbone (CV)	
02/90→06/96		Suspension Arm Repair Kit		MN-SB-5244	for Wishbone (CV)	
02/90→06/96		Suspension Arm Repair Kit		MN-SB-5244	for Wishbone (CV), 1st RA	
02/90→06/96		Tie Rod	MN-DL-12284			
02/90→06/96		Tie Rod End	CV-ES-2146			
02/90→06/96		Tie Rod End	CV-ES-14163		for Steering Rod	
02/90→06/96		Track Control Arm		MN-DL-3402	Trailing Arm	
02/90→06/96		Track Control Arm		MN-DL-3402	Trailing Arm, Drive Axle	
02/90→06/96		Track Control Arm		MN-DL-5212	Trailing Arm, Air Suspension Axle; Drive Axle; Tag Axle	
02/90→06/96		Track Control Arm		MN-VB-5222	Wishbone (CV)	
02/90→06/96		Track Control Arm		MN-VB-8569	Wishbone (CV)	
32.372 VFK		01/91→06/96	Track Control Arm		MN-VB-8569	Wishbone (CV), Drive Axle
		02/90→01/91	Track Control Arm		MN-VB-5222	Wishbone (CV), Drive Axle
		02/90→06/96	Ball Head, gearshift linkage	CV-ES-2120		
		02/90→06/96	Centre Rod	MN-DL-12278		for Steering Rod
		02/90→06/96	Drag Link End	MN-ES-10348		
		02/90→06/96	Engine Mounting	MN-SB-10389		
		02/90→06/96	Mounting, stabilizer coupling rod	MN-SB-5246		
		02/90→06/96	Mounting, stabilizer coupling rod	MN-SB-5246		1st FA
	02/90→06/96	Stabiliser Mounting		MN-SB-5254		
	02/90→06/96	Stabiliser Mounting	MN-SB-9396			
	02/90→06/96	Suspension Arm Repair Kit		CV-RK-5313	for Wishbone (CV)	
	02/90→06/96	Suspension Arm Repair Kit		MN-RK-7287	for Wishbone (CV)	
	02/90→06/96	Suspension Arm Repair Kit		MN-SB-5244	for Wishbone (CV)	
	02/90→06/96	Suspension Arm Repair Kit		MN-SB-5244	for Wishbone (CV), 1st RA	
	02/90→06/96	Tie Rod	MN-DL-12284			
	02/90→06/96	Tie Rod End	CV-ES-2146			
	02/90→06/96	Tie Rod End	CV-ES-14163		for Steering Rod	
	02/90→06/96	Track Control Arm		MN-DL-3402	Trailing Arm	
	02/90→06/96	Track Control Arm		MN-DL-3402	Trailing Arm, Drive Axle	
	02/90→06/96	Track Control Arm		MN-DL-5212	Trailing Arm, Air Suspension Axle; Drive Axle; Tag Axle	
	02/90→06/96	Track Control Arm		MN-VB-5222	Wishbone (CV)	
	02/90→06/96	Track Control Arm		MN-VB-8569	Wishbone (CV)	
	32.402 VFK	01/91→06/96	Track Control Arm		MN-VB-8569	Wishbone (CV), Drive Axle
		05/94→06/96	Ball Head, gearshift linkage	CV-ES-2120		
		05/94→06/96	Centre Rod	MN-DL-12278		for Steering Rod
		05/94→06/96	Drag Link End	MN-ES-10348		
		05/94→06/96	Engine Mounting	MN-SB-10389		

CV-ES-2120

Length: 115
Cone Ø: d1 Ø 12,4 / d2 Ø 10,8
Thread: M14 x 1,5 RHT
03008500A, 81953016200, 81953016202, 81953016203, 81953016227



CV-ES-2146

Length: 80
Cone Ø: d1 Ø 30 / d2 Ø 27
Thread: M26 x 1,5 RHT
42533102, 81953016219, 81953016225, 81953016226, 81953016267, 81953016291



CV-ES-14163

Length: 125
Cone Ø: d1 Ø 30 / d2 Ø 27
Thread: M30 x 1,5 RHT
95301.0084, 90804102156, 90804102272, 90804102696, 90804102710, 81953010016, 81953010075, 81953010084, 81953010088, 81953010094, 81953010103, 81953016030, 81953016043, 81953016048, 81953016049, 81953016053, 81953016061, 81953016090, 81953016108, 81953016112, 81953016126, 81953016143, 81953016149, 81953016154, 81953016156, 81953016168, 81953016178, 81953016194, 81953016206, 81953016224, 81953016234, 81953016242, 81953016252, 81953016274, 81953016278, 81953016284, 81953016286, 81953016308, 81953016310, 81953016312, 81953016347, 81953016350, 81953016352, 82953016012, 88953016014, N2953016001



CV-RK-5313

Ø: 90
03304800A, 81953016132



MN-DL-3402

Length: 590 Ø: 48
Hole Distance: 130 / 130
03307200A, 81432206067, 81432206068, 81432206090, 81432206092, 81432209092



MN-DL-5212

Length: 577 Ø: 48
Hole Distance: 130 / 130
81432206096, 81432206097, 81432206098, 81432206129, 81432209096, 81432209129, 81432306014, 81432306030



MN-DL-12278

Length: 770
Ø: 40
Cone Ø: d1 Ø 30 / d2 Ø 27
81466106348



MN-DL-12284

Length: 1530 Ø: 50
Cone Ø: d1 Ø 30 / d2 Ø 27
81466106579, 81466106580, 81466106624, 81466116720, 81467116720, 81467116730, 81467116952



MN-ES-10348

Length: 80
Cone Ø: d1 Ø 30 / d2 Ø 27,2
Thread: M22 x 1,5 RHT
81953010040



MN-RK-7287

Ø: 90
Hole Distance: 152
Thick/Height: 35
03304700A, 81953016133



MN-SB-5244

Ø: 65
Hole Distance: 125
Thick/Height: 22
03312000A, 81432710027, 81432710082



MN-SB-5246

Ø: 45 Thick/Height: 47
81437220022, 81437220038, 81962100450, 81962100469



MN-SB-5254

Length: 100
Ø: 93
Thick/Height: 70
81432710081



MN-SB-9396

Ø: 67
Thick/Height: 60
81437040057



MN-SB-10389

Ø: 70
Thick/Height: 72
81960200340



MN-VB-5222

Length: 627 Ø: 50
Hole Distance: 152 / 152
81432706030, 81432706034, 81432706054, 81432706055, 81432706056, 81432706057, 81432706067, 81432706068, 81432706074, 81432706075, 81432706076, 81432706077, 81432706078, 81432706081, 81432706082, 81432709034, 81432709076, 81432709078, 8143706054



MN-VB-8569

Length: 627
Ø: 58
Hole Distance: 152 / 152
81432706055, 81432706056, 81432706067, 81432706068, 81432706075, 81432706077, 81432706081, 81432709056





F 90 ...

32.402 VFK ...	05/94→06/96	Mounting, stabilizer coupling rod	MN-SB-5246		
	05/94→06/96	Mounting, stabilizer coupling rod	MN-SB-5246		1st FA
	05/94→06/96	Stabiliser Mounting		MN-SB-5254	
	05/94→06/96	Stabiliser Mounting	MN-SB-9396		
	05/94→06/96	Suspension Arm Repair Kit		CV-RK-5313	for Wishbone (CV)
	05/94→06/96	Suspension Arm Repair Kit		MN-RK-7287	for Wishbone (CV)
	05/94→06/96	Suspension Arm Repair Kit		MN-SB-5244	for Wishbone (CV)
	05/94→06/96	Suspension Arm Repair Kit		MN-SB-5244	for Wishbone (CV), 1st RA
	05/94→06/96	Tie Rod End	CV-ES-2146		
	05/94→06/96	Tie Rod End	CV-ES-14163		for Steering Rod
	05/94→06/96	Track Control Arm		MN-DL-3402	Trailing Arm
	05/94→06/96	Track Control Arm		MN-DL-3402	Trailing Arm, Drive Axle
	05/94→06/96	Track Control Arm		MN-DL-5212	Trailing Arm, Air Suspension Axle; Drive Axle; Tag Axle
	05/94→06/96	Track Control Arm		MN-VB-5222	Wishbone (CV)
	05/94→06/96	Track Control Arm		MN-VB-8569	Wishbone (CV)
05/94→06/96	Track Control Arm		MN-VB-8569	Wishbone (CV), Drive Axle	
32.422 VF	02/90→01/91	Track Control Arm		MN-VB-5222	Wishbone (CV), Drive Axle
	02/90→06/96	Ball Head, gearshift linkage	CV-ES-2120		
	02/90→06/96	Centre Rod	MN-DL-12278		for Steering Rod
	02/90→06/96	Drag Link End	MN-ES-10348		
	02/90→06/96	Engine Mounting	MN-SB-10389		
	02/90→06/96	Mounting, stabilizer coupling rod	MN-SB-5246		
	02/90→06/96	Mounting, stabilizer coupling rod	MN-SB-5246		1st FA
	02/90→06/96	Stabiliser Mounting		MN-SB-5254	
	02/90→06/96	Stabiliser Mounting	MN-SB-9396		
	02/90→06/96	Suspension Arm Repair Kit		CV-RK-5313	for Wishbone (CV)
	02/90→06/96	Suspension Arm Repair Kit		MN-RK-7287	for Wishbone (CV)
	02/90→06/96	Suspension Arm Repair Kit		MN-SB-5244	for Wishbone (CV)
	02/90→06/96	Suspension Arm Repair Kit		MN-SB-5244	for Wishbone (CV), 1st RA
	02/90→06/96	Tie Rod End	CV-ES-2146		
	02/90→06/96	Tie Rod End	CV-ES-14163		for Steering Rod
	02/90→06/96	Track Control Arm		MN-DL-3402	Trailing Arm
	02/90→06/96	Track Control Arm		MN-DL-3402	Trailing Arm, Drive Axle
02/90→06/96	Track Control Arm		MN-DL-5212	Trailing Arm, Air Suspension Axle; Drive Axle; Tag Axle	
02/90→06/96	Track Control Arm		MN-VB-5222	Wishbone (CV)	
02/90→06/96	Track Control Arm		MN-VB-8569	Wishbone (CV)	
01/91→06/96	Track Control Arm		MN-VB-8569	Wishbone (CV), Drive Axle	
33.242 DFAK	01/88→08/88	Ball Head, gearshift linkage	CV-ES-2120		
	01/88→08/88	Centre Rod	MN-DL-12421		for Steering Rod
	01/88→08/88	Engine Mounting		MN-SB-10390	
	01/88→08/88	Engine Mounting	MN-SB-10389		
	01/88→08/88	Suspension Arm Repair Kit		MN-SB-5244	for Wishbone (CV)
	01/88→08/88	Suspension Arm Repair Kit		MN-SB-5244	for Wishbone (CV), 1st RA
	01/88→08/88	Tie Rod End	CV-ES-14163		for Steering Rod
	01/88→08/88	Track Control Arm		MN-DL-3402	Trailing Arm
01/88→08/88	Track Control Arm		MN-DL-3402	Trailing Arm, Drive Axle	
01/88→08/88	Track Control Arm		MN-DL-8609	Trailing Arm, Leaf Spring Axle	
33.242 DFK	01/88→08/88	Ball Head, gearshift linkage	CV-ES-2120		
	01/88→08/88	Centre Rod	MN-DL-12421		for Steering Rod
	01/88→08/88	Engine Mounting		MN-SB-10390	
	01/88→08/88	Engine Mounting	MN-SB-10389		
	01/88→08/88	Mounting, stabilizer coupling rod	MN-SB-5246		
	01/88→08/88	Stabiliser Mounting		MN-SB-5245	
	01/88→08/88	Stabiliser Mounting		MN-SB-5254	
	01/88→08/88	Stabiliser Mounting	MN-SB-9396		
	01/88→08/88	Suspension Arm Repair Kit		MN-SB-5244	for Wishbone (CV)
	01/88→08/88	Suspension Arm Repair Kit		MN-SB-5244	for Wishbone (CV), 1st RA
	01/88→08/88	Tie Rod End	CV-ES-14163		for Steering Rod
	01/88→08/88	Track Control Arm		MN-DL-3402	Trailing Arm
01/88→08/88	Track Control Arm		MN-DL-3402	Trailing Arm, Drive Axle	
01/88→08/88	Track Control Arm		MN-DL-8609	Trailing Arm, Leaf Spring Axle	

CV-ES-2120

Length: 115
 Cone Ø: d1 Ø 12,4 / d2 Ø 10,8
 Thread: M14 x 1,5 RHT
 03008500A, 81953016200, 81953016202,
 81953016203, 81953016227

**CV-ES-2146**

Length: 80
 Cone Ø: d1 Ø 30 / d2 Ø 27
 Thread: M26 x 1,5 RHT
 42533102, 81953016219, 81953016225,
 81953016226, 81953016267, 81953016291

**CV-ES-14163**

Length: 125
 Cone Ø: d1 Ø 30 / d2 Ø 27
 Thread: M30 x 1,5 RHT
 95301.0084, 90804102156, 90804102272,
 90804102696, 90804102710, 81953010016,
 81953010075, 81953010084, 81953010088,
 81953010094, 81953010103, 81953016030,
 81953016043, 81953016048, 81953016049,
 81953016053, 81953016061, 81953016090,
 81953016108, 81953016112, 81953016126,
 81953016143, 81953016149, 81953016154,
 81953016156, 81953016168, 81953016178,
 81953016194, 81953016206, 81953016224,
 81953016234, 81953016242, 81953016252,
 81953016274, 81953016278, 81953016284,
 81953016286, 81953016308, 81953016310,
 81953016312, 81953016347, 81953016350,
 81953016352, 82953016012, 88953016014,
 N2953016001

**CV-RK-5313**

Ø: 90
 03304800A, 81953016132

**MN-DL-3402**

Length: 590 Ø: 48
 Hole Distance: 130 / 130
 03307200A, 81432206067, 81432206068,
 81432206090, 81432206092, 81432209092

**MN-DL-5212**

Length: 577 Ø: 48
 Hole Distance: 130 / 130
 81432206096, 81432206097, 81432206098,
 81432206129, 81432209096, 81432209129,
 81432306014, 81432306030

**MN-DL-8609**

Length: 585 Ø: 58
 Hole Distance: 130 / 130
 81432206070, 81432206071, 81432206072,
 81432206091, 81432206093, 81432206119

**MN-DL-12278**

Length: 770
 Ø: 40
 Cone Ø: d1 Ø 30 / d2 Ø 27
 81466106348

**MN-DL-12421**

Length: 1070
 Ø: 48
 Cone Ø: d1 Ø 30 / d2 Ø 27
 Thread: M30 x 1,5 RHT
 81466106656, 81466106659, 81466106669,
 81466116006, 81466116007

**MN-ES-10348**

Length: 80
 Cone Ø: d1 Ø 30 / d2 Ø 27,2
 Thread: M22 x 1,5 RHT
 81953010040

**MN-RK-7287**

Ø: 90
 Hole Distance: 152
 Thick/Height: 35
 03304700A, 81953016133

**MN-SB-5244**

Ø: 65
 Hole Distance: 125
 Thick/Height: 22
 03312000A, 81432710027, 81432710082

**MN-SB-5245**

Ø: 75
 Hole Distance: 125
 Thick/Height: 22
 03311900A, 81432710046, 81432710079,
 81432710083

**MN-SB-5246**

Ø: 45 Thick/Height: 47
 81437220022, 81437220038, 81962100450,
 81962100469

**MN-SB-5254**

Length: 100
 Ø: 93
 Thick/Height: 60
 81432710081

**MN-SB-9396**

Ø: 67
 Thick/Height: 60
 81437040057

**MN-SB-10389**

Ø: 70
 Thick/Height: 72
 81960200340

**MN-SB-10390**

Ø: 70
 Thick/Height: 85/85
 81960200341, 81960200373, 81960200385,
 81960200408, 81960200418

**MN-VB-5222**

Length: 627 Ø: 50
 Hole Distance: 152 / 152
 81432706030, 81432706034, 81432706054,
 81432706055, 81432706056, 81432706057,
 81432706067, 81432706068, 81432706074,
 81432706075, 81432706076, 81432706077,
 81432706078, 81432706081, 81432706082,
 81432709034, 81432709076, 81432709078,
 8143706054

**MN-VB-8569**

Length: 627
 Ø: 58
 Hole Distance: 152 / 152
 81432706055, 81432706056, 81432706067,
 81432706068, 81432706075, 81432706077,
 81432706081, 81432709056



Tuesday
21

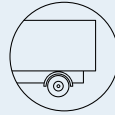

MAN ...

F 90 ...

33.262 DF	08/88→02/90	Ball Head, gearshift linkage	CV-ES-2119			
	08/88→02/90	Ball Head, gearshift linkage	CV-ES-2120			
	08/88→02/90	Ball Head, gearshift linkage	CV-ES-2182			
	08/88→02/90	Centre Rod	MN-DL-3588		Push Rod	
	08/88→02/90	Centre Rod	MN-DL-12421		for Steering Rod	
	08/88→02/90	Engine Mounting		MN-SB-10390		
	08/88→02/90	Engine Mounting	MN-SB-10389			
	08/88→02/90	Mounting, stabilizer coupling rod	MN-SB-5246			
	08/88→02/90	Stabiliser Mounting		MN-SB-5245		
	08/88→02/90	Stabiliser Mounting		MN-SB-5254		
	08/88→02/90	Stabiliser Mounting	MN-SB-9396			
	08/88→02/90	Suspension Arm Repair Kit		MN-SB-5244	for Wishbone (CV)	
	08/88→02/90	Suspension Arm Repair Kit		MN-SB-5244	for Wishbone (CV), 1st RA	
	08/88→02/90	Tie Rod End	CV-ES-2149		for Push Rod	
	08/88→02/90	Tie Rod End	CV-ES-14162		for Steering Rod	
	08/88→02/90	Tie Rod End	CV-ES-14163		for Steering Rod	
	33.262 DFA	07/89→02/90	Ball Head, gearshift linkage	CV-ES-2119		
		07/89→02/90	Ball Head, gearshift linkage	CV-ES-2120		
07/89→02/90		Ball Head, gearshift linkage	CV-ES-2182			
07/89→02/90		Centre Rod	MN-DL-3588		Push Rod	
07/89→02/90		Centre Rod	MN-DL-12421		for Steering Rod	
07/89→02/90		Engine Mounting	MN-SB-10389			
33.262 DFAK	07/89→02/90	Mounting, stabilizer coupling rod	MN-SB-5246			
	07/89→02/90	Stabiliser Mounting		MN-SB-5245		
	07/89→02/90	Stabiliser Mounting		MN-SB-5254		
	07/89→02/90	Stabiliser Mounting	MN-SB-9396			
	07/89→02/90	Suspension Arm Repair Kit		MN-SB-5244	for Wishbone (CV)	
	07/89→02/90	Suspension Arm Repair Kit		MN-SB-5244	for Wishbone (CV), 1st RA	
	07/89→02/90	Tie Rod End	CV-ES-2149		for Push Rod	
	07/89→02/90	Tie Rod End	CV-ES-14162		for Steering Rod	
	07/89→02/90	Tie Rod End	CV-ES-14163		for Steering Rod	
	07/89→02/90	Track Control Arm		MN-DL-3402	Trailing Arm	
	07/89→02/90	Track Control Arm		MN-DL-8609	Trailing Arm, Leaf Spring Axle	
	33.262 DFAK	07/89→02/90	Ball Head, gearshift linkage	CV-ES-2119		
		07/89→02/90	Ball Head, gearshift linkage	CV-ES-2120		
		07/89→02/90	Ball Head, gearshift linkage	CV-ES-2182		
07/89→02/90		Centre Rod	MN-DL-3588		Push Rod	
07/89→02/90		Centre Rod	MN-DL-12421		for Steering Rod	
07/89→02/90		Engine Mounting	MN-SB-10389			
07/89→02/90		Mounting, stabilizer coupling rod	MN-SB-5246			
07/89→02/90		Stabiliser Mounting		MN-SB-5245		
07/89→02/90		Stabiliser Mounting		MN-SB-5254		
07/89→02/90		Stabiliser Mounting	MN-SB-9396			
07/89→02/90		Suspension Arm Repair Kit		MN-SB-5244	for Wishbone (CV)	
07/89→02/90		Suspension Arm Repair Kit		MN-SB-5244	for Wishbone (CV), 1st RA	
33.262 DFK	07/89→02/90	Tie Rod End	CV-ES-2149		for Push Rod	
	07/89→02/90	Tie Rod End	CV-ES-14162		for Steering Rod	
	07/89→02/90	Tie Rod End	CV-ES-14163		for Steering Rod	
	07/89→02/90	Track Control Arm		MN-DL-3402	Trailing Arm	
	07/89→02/90	Track Control Arm		MN-DL-8609	Trailing Arm, Leaf Spring Axle	
	08/88→02/90	Ball Head, gearshift linkage	CV-ES-2119			
	08/88→02/90	Ball Head, gearshift linkage	CV-ES-2120			
	08/88→02/90	Ball Head, gearshift linkage	CV-ES-2182			
	08/88→02/90	Centre Rod	MN-DL-3588		Push Rod	
	08/88→02/90	Centre Rod	MN-DL-12421		for Steering Rod	
08/88→02/90	Engine Mounting		MN-SB-10390			
08/88→02/90	Engine Mounting	MN-SB-10389				
08/88→02/90	Mounting, stabilizer coupling rod	MN-SB-5246				
08/88→02/90	Stabiliser Mounting		MN-SB-5245			
08/88→02/90	Stabiliser Mounting		MN-SB-5254			

MAN

CV-ES-2119

Length: 55
Cone Ø: d1 Ø 10 / d2 Ø 10
Thread: M12 x 1,75 LHT
81953016063, 81953016131



CV-ES-2120

Length: 115
Cone Ø: d1 Ø 12,4 / d2 Ø 10,8
Thread: M14 x 1,5 RHT
03008500A, 81953016200, 81953016202, 81953016203, 81953016227



CV-ES-2149

Length: 160
Cone Ø: d1 Ø 30 / d2 Ø 27
Thread: M30 x 1,5 RHT
81953016263



CV-ES-2182

Length: 55
Cone Ø: d1 Ø 10 / d2 Ø 10
Thread: M12 x 1,75 RHT
81953016064, 81953016170



CV-ES-14162

Length: 125
Cone Ø: d1 Ø 30 / d2 Ø 27
Thread: M30 x 1,5 LHT
81953010015, 81953010083, 81953010087, 81953016029, 81953016030, 81953016043, 81953016044, 81953016050, 81953016054, 81953016087, 81953016091, 81953016107, 81953016120, 81953016125, 81953016152, 81953016155, 81953016157, 81953016168, 81953016179, 81953016181, 81953016223, 81953016237, 81953016254, 81953016275, 81953016279, 81953016351



CV-ES-14163

Length: 125
Cone Ø: d1 Ø 30 / d2 Ø 27
Thread: M30 x 1,5 RHT
95301.0084, 90804102156, 90804102272, 90804102696, 90804102710, 81953010016, 81953010075, 81953010084, 81953010088, 81953010094, 81953010103, 81953016030, 81953016043, 81953016048, 81953016049, 81953016053, 81953016061, 81953016090, 81953016108, 81953016112, 81953016126, 81953016143, 81953016149, 81953016154, 81953016156, 81953016168, 81953016178, 81953016194, 81953016206, 81953016224, 81953016234, 81953016242, 81953016252, 81953016274, 81953016278, 81953016284, 81953016286, 81953016308, 81953016310, 81953016312, 81953016347, 81953016350, 81953016352, 82953016012, 88953016014, N2953016001



MN-DL-3402

Length: 590 Ø: 48
Hole Distance: 130 / 130
03307200A, 81432206067, 81432206068, 81432206090, 81432206092, 81432209092



MN-DL-3588

Length: 1035
Ø: 48
Cone Ø: d1 Ø 30 / d2 Ø 27
81466106333, 81466106334, 81466106354, 81466106355, 81466106360, 81466106361, 81466106721, 81466106722, 81466106723, 81466116216



MN-DL-8609

Length: 585 Ø: 58
Hole Distance: 130 / 130
81432206070, 81432206071, 81432206072, 81432206091, 81432206093, 81432206119



MN-DL-12421

Length: 1070
Ø: 48
Cone Ø: d1 Ø 30 / d2 Ø 27
Thread: M30 x 1,5 RHT
81466106656, 81466106659, 81466106669, 81466116006, 81466116007



MN-SB-5244

Ø: 65
Hole Distance: 125
Thick/Height: 22
03312000A, 81432710027, 81432710082



MN-SB-5245

Ø: 75
Hole Distance: 125
Thick/Height: 22
03311900A, 81432710046, 81432710079, 81432710083



MN-SB-5246

Ø: 45 Thick/Height: 47
81437220022, 81437220038, 81962100450, 81962100469



MN-SB-5254

Length: 100
Ø: 93
Thick/Height: 70
81432710081



MN-SB-9396

Ø: 67
Thick/Height: 60
81437040057



MN-SB-10389

Ø: 70
Thick/Height: 72
81960200340



MN-SB-10390

Ø: 70
Thick/Height: 85/85
81960200341, 81960200373, 81960200385, 81960200408, 81960200418



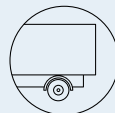

F 90 ...

33.262 DFK ...	08/88→02/90	Stabiliser Mounting	MN-SB-9396			
	08/88→02/90	Suspension Arm Repair Kit		MN-SB-5244	for Wishbone (CV)	
	08/88→02/90	Suspension Arm Repair Kit		MN-SB-5244	for Wishbone (CV), 1st RA	
	08/88→02/90	Tie Rod End	CV-ES-2149		for Push Rod	
	08/88→02/90	Tie Rod End	CV-ES-14162		for Steering Rod	
	08/88→02/90	Tie Rod End	CV-ES-14163		for Steering Rod	
	08/88→02/90	Track Control Arm		MN-DL-3402	Trailing Arm	
	08/88→02/90	Track Control Arm		MN-DL-3402	Trailing Arm, Drive Axle	
	08/88→02/90	Track Control Arm		MN-DL-8609	Trailing Arm, Leaf Spring Axle	
33.272 DF	10/92→04/95	Ball Head, gearshift linkage	CV-ES-2119			
	10/92→04/95	Ball Head, gearshift linkage	CV-ES-2120			
	10/92→04/95	Ball Head, gearshift linkage	CV-ES-2182			
	10/92→04/95	Centre Rod	MN-DL-3588		Push Rod	
	10/92→04/95	Centre Rod	MN-DL-12421		for Steering Rod	
	10/92→04/95	Engine Mounting		MN-SB-10390		
	10/92→04/95	Engine Mounting	MN-SB-10389			
	10/92→04/95	Mounting, stabilizer coupling rod	MN-SB-5246			
	10/92→04/95	Stabiliser Mounting		MN-SB-5245		
	10/92→04/95	Stabiliser Mounting		MN-SB-5254		
	10/92→04/95	Stabiliser Mounting	MN-SB-9396			
	10/92→04/95	Suspension Arm Repair Kit		MN-SB-5244	for Wishbone (CV)	
	10/92→04/95	Suspension Arm Repair Kit		MN-SB-5244	for Wishbone (CV), 1st RA	
	10/92→04/95	Tie Rod End	CV-ES-2149		for Push Rod	
	10/92→04/95	Tie Rod End	CV-ES-14162		for Steering Rod	
	10/92→04/95	Tie Rod End	CV-ES-14163		for Steering Rod	
	10/92→04/95	Track Control Arm		MN-DL-3402	Trailing Arm	
	10/92→04/95	Track Control Arm		MN-DL-3402	Trailing Arm, Drive Axle	
	10/92→04/95	Track Control Arm		MN-DL-8609	Trailing Arm, Leaf Spring Axle	
	33.272 DFA	10/92→04/95	Ball Head, gearshift linkage	CV-ES-2119		
10/92→04/95		Ball Head, gearshift linkage	CV-ES-2120			
10/92→04/95		Ball Head, gearshift linkage	CV-ES-2182			
10/92→04/95		Centre Rod	MN-DL-3588		Push Rod	
10/92→04/95		Centre Rod	MN-DL-12421		for Steering Rod	
10/92→04/95		Engine Mounting	MN-SB-10389			
10/92→04/95		Mounting, stabilizer coupling rod	MN-SB-5246			
10/92→04/95		Stabiliser Mounting		MN-SB-5245		
10/92→04/95		Stabiliser Mounting		MN-SB-5254		
10/92→04/95		Stabiliser Mounting	MN-SB-9396			
10/92→04/95		Suspension Arm Repair Kit		MN-SB-5244	for Wishbone (CV)	
10/92→04/95		Suspension Arm Repair Kit		MN-SB-5244	for Wishbone (CV), 1st RA	
10/92→04/95		Tie Rod End	CV-ES-2149		for Push Rod	
10/92→04/95		Tie Rod End	CV-ES-14162		for Steering Rod	
10/92→04/95		Tie Rod End	CV-ES-14163		for Steering Rod	
10/92→04/95		Track Control Arm		MN-DL-3402	Trailing Arm	
10/92→04/95		Track Control Arm		MN-DL-8609	Trailing Arm, Leaf Spring Axle	
33.272 FVL		10/92→04/95	Ball Head, gearshift linkage	CV-ES-2119		
		10/92→04/95	Ball Head, gearshift linkage	CV-ES-2120		
		10/92→04/95	Ball Head, gearshift linkage	CV-ES-2182		
	10/92→04/95	Centre Rod	MN-DL-3588		Push Rod	
	10/92→04/95	Centre Rod	MN-DL-12421		for Steering Rod	
	10/92→04/95	Engine Mounting	MN-SB-10389			
	10/92→04/95	Mounting, stabilizer coupling rod	MN-SB-5246			
	10/92→04/95	Stabiliser Mounting		MN-SB-5243		
	10/92→04/95	Stabiliser Mounting		MN-SB-5265		
	10/92→04/95	Stabiliser Mounting		MN-SB-5265	1st RA	
	10/92→04/95	Stabiliser Mounting	MN-SB-9396			
	10/92→04/95	Suspension Arm Repair Kit		CV-RK-5313	for Wishbone (CV)	
	10/92→04/95	Suspension Arm Repair Kit		CV-RK-8118	for Control Arm	
	10/92→04/95	Suspension Arm Repair Kit		MN-RK-7280	for Drag Link	
	10/92→04/95	Suspension Arm Repair Kit		MN-RK-7287	for Wishbone (CV)	
	10/92→04/95	Suspension Arm Repair Kit		MN-RK-7291	for Drag Link	
	10/92→04/95	Tie Rod End	CV-ES-2149		for Push Rod	
	10/92→04/95	Tie Rod End	CV-ES-14162		for Steering Rod	

CV-ES-2119

Length: 55
Cone Ø: d1 Ø 10 / d2 Ø 10
Thread: M12 x 1,75 LHT
81953016063, 81953016131



CV-ES-2120

Length: 115
Cone Ø: d1 Ø 12,4 / d2 Ø 10,8
Thread: M14 x 1,5 RHT
03008500A, 81953016200, 81953016202, 81953016203, 81953016227



CV-ES-2149

Length: 160
Cone Ø: d1 Ø 30 / d2 Ø 27
Thread: M30 x 1,5 RHT
81953016263



CV-ES-2182

Length: 55
Cone Ø: d1 Ø 10 / d2 Ø 10
Thread: M12 x 1,75 RHT
81953016064, 81953016170



CV-ES-14162

Length: 125
Cone Ø: d1 Ø 30 / d2 Ø 27
Thread: M30 x 1,5 LHT
81953010015, 81953010083, 81953010087, 81953016029, 81953016030, 81953016043, 81953016044, 81953016050, 81953016054, 81953016087, 81953016091, 81953016107, 81953016120, 81953016125, 81953016152, 81953016155, 81953016157, 81953016168, 81953016179, 81953016181, 81953016223, 81953016237, 81953016254, 81953016275, 81953016279, 81953016351



CV-ES-14163

Length: 125
Cone Ø: d1 Ø 30 / d2 Ø 27
Thread: M30 x 1,5 RHT
95301.0084, 90804102156, 90804102272, 90804102696, 90804102710, 81953010016, 81953010075, 81953010084, 81953010088, 81953010094, 81953010103, 81953016030, 81953016043, 81953016048, 81953016049, 81953016053, 81953016061, 81953016090, 81953016108, 81953016112, 81953016126, 81953016143, 81953016149, 81953016154, 81953016156, 81953016168, 81953016178, 81953016194, 81953016206, 81953016224, 81953016234, 81953016242, 81953016252, 81953016274, 81953016278, 81953016284, 81953016286, 81953016308, 81953016310, 81953016312, 81953016347, 81953016350, 81953016352, 82953016012, 88953016014, N2953016001



CV-RK-5313

Ø: 90
03304800A, 81953016132



CV-RK-8118

Ø: 85
Hole Distance: 130
Thick/Height: 30
638862, 639287, 775201, 938423, 1104335, 1953248, 0003500506, 3500506, 11013547, 21032592, 42065912, 42488722, 070550504, 93192618, 070400009000, 634303610, 81432206055, 81432206073, 82262320660, 9544171010099, 5001842823, 7000307001, 8226232066



MN-DL-3402

Length: 590 Ø: 48
Hole Distance: 130 / 130
03307200A, 81432206067, 81432206068, 81432206090, 81432206092, 81432209092



MN-DL-3588

Length: 1035 Ø: 48
Cone Ø: d1 Ø 30 / d2 Ø 27
81466106333, 81466106334, 81466106354, 81466106355, 81466106360, 81466106361, 81466106721, 81466106722, 81466106723, 81466116216



MN-DL-8609

Length: 585 Ø: 58
Hole Distance: 130 / 130
81432206070, 81432206071, 81432206072, 81432206091, 81432206093, 81432206119



MN-DL-12421

Length: 1070 Ø: 48
Cone Ø: d1 Ø 30 / d2 Ø 27
Thread: M30 x 1,5 RHT
81466106656, 81466106659, 81466106669, 81466116006, 81466116007



MN-RK-7280

Ø: 75
Hole Distance: 115
Thick/Height: 24
0550806, 0639370, 689748, 10307400A, 81432306051, 81432306068, 81432706064



MN-RK-7287

Ø: 90
Hole Distance: 152
Thick/Height: 35
03304700A, 81953016133



MN-RK-7291

Ø: 72
Hole Distance: 130
Thick/Height: 30
10307800A, 81432206108, 81432206132



MN-SB-5243

Length: 55 Ø: 78
Thick/Height: 60
03311100A, 81437040061, 81437220020



MN-SB-5244

Ø: 65
Hole Distance: 125
Thick/Height: 22
03312000A, 81432710027, 81432710082



MN-SB-5245

Ø: 75
Hole Distance: 125
Thick/Height: 22
03311900A, 81432710046, 81432710079, 81432710083



MN-SB-5246

Ø: 45 Thick/Height: 47
81437220022, 81437220038, 81962100450, 81962100469



MN-SB-5254

Length: 100 Ø: 93
Thick/Height: 70
81432710081



MN-SB-5265

Ø: 85 Thick/Height: 80
03310300A, 81437040032



MN-SB-9396

Ø: 67 Thick/Height: 60
81437040057



MN-SB-10389

Ø: 70 Thick/Height: 72
81960200340



MN-SB-10390

Ø: 70 Thick/Height: 85/85
81960200341, 81960200373, 81960200385, 81960200408, 81960200418



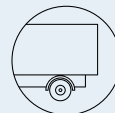

F 90 ...

33.272 FVL ...	10/92→04/95	Tie Rod End	CV-ES-14163		for Steering Rod
	10/92→04/95	Track Control Arm		MN-DL-5212	Trailing Arm, Air Suspension Axle; Drive Axle
	10/92→04/95	Track Control Arm		MN-VB-5222	Wishbone (CV), Drive Axle; Air Suspension Axle
33.292 DF	09/87→02/90	Ball Head, gearshift linkage	CV-ES-2119		
	09/87→02/90	Ball Head, gearshift linkage	CV-ES-2120		
	09/87→02/90	Ball Head, gearshift linkage	CV-ES-2182		
	09/87→02/90	Centre Rod	MN-DL-3588		Push Rod
	09/87→02/90	Centre Rod	MN-DL-12421		for Steering Rod
	09/87→02/90	Engine Mounting	MN-SB-10389		
	09/87→02/90	Mounting, stabilizer coupling rod	MN-SB-5246		
	09/87→02/90	Stabiliser Mounting		MN-SB-5245	
	09/87→02/90	Stabiliser Mounting		MN-SB-5254	
	09/87→02/90	Suspension Arm Repair Kit		MN-SB-5244	for Wishbone (CV)
	09/87→02/90	Suspension Arm Repair Kit		MN-SB-5244	for Wishbone (CV), 1st RA
	09/87→02/90	Tie Rod End	CV-ES-2149		for Push Rod
	09/87→02/90	Tie Rod End	CV-ES-14162		for Steering Rod
	09/87→02/90	Tie Rod End	CV-ES-14163		for Steering Rod
	09/87→02/90	Track Control Arm		MN-DL-3402	Trailing Arm
	09/87→02/90	Track Control Arm		MN-DL-8609	Trailing Arm, Leaf Spring Axle
33.292 DFA	05/88→02/90	Ball Head, gearshift linkage	CV-ES-2119		
	05/88→02/90	Ball Head, gearshift linkage	CV-ES-2120		
	05/88→02/90	Ball Head, gearshift linkage	CV-ES-2182		
	05/88→02/90	Centre Rod	MN-DL-3588		Push Rod
	05/88→02/90	Centre Rod	MN-DL-12421		for Steering Rod
	05/88→02/90	Engine Mounting	MN-SB-10389		
	05/88→02/90	Mounting, stabilizer coupling rod	MN-SB-5246		
	05/88→02/90	Stabiliser Mounting		MN-SB-5245	
	05/88→02/90	Stabiliser Mounting		MN-SB-5254	
	05/88→02/90	Stabiliser Mounting	MN-SB-9396		
	05/88→02/90	Suspension Arm Repair Kit		MN-SB-5244	for Wishbone (CV)
	05/88→02/90	Suspension Arm Repair Kit		MN-SB-5244	for Wishbone (CV), 1st RA
	05/88→02/90	Tie Rod End	CV-ES-2149		for Push Rod
	05/88→02/90	Tie Rod End	CV-ES-14162		for Steering Rod
	05/88→02/90	Tie Rod End	CV-ES-14163		for Steering Rod
	05/88→02/90	Track Control Arm		MN-DL-3402	Trailing Arm
05/88→02/90	Track Control Arm		MN-DL-8609	Trailing Arm, Leaf Spring Axle	
33.292 DFAK	05/88→02/90	Ball Head, gearshift linkage	CV-ES-2119		
	05/88→02/90	Ball Head, gearshift linkage	CV-ES-2120		
	05/88→02/90	Ball Head, gearshift linkage	CV-ES-2182		
	05/88→02/90	Centre Rod	MN-DL-3588		Push Rod
	05/88→02/90	Centre Rod	MN-DL-12421		for Steering Rod
	05/88→02/90	Engine Mounting	MN-SB-10389		
	05/88→02/90	Mounting, stabilizer coupling rod	MN-SB-5246		
	05/88→02/90	Stabiliser Mounting		MN-SB-5245	
	05/88→02/90	Stabiliser Mounting		MN-SB-5254	
	05/88→02/90	Stabiliser Mounting	MN-SB-9396		
	05/88→02/90	Suspension Arm Repair Kit		MN-SB-5244	for Wishbone (CV)
	05/88→02/90	Suspension Arm Repair Kit		MN-SB-5244	for Wishbone (CV), 1st RA
	05/88→02/90	Tie Rod End	CV-ES-2149		for Push Rod
	05/88→02/90	Tie Rod End	CV-ES-14162		for Steering Rod
	05/88→02/90	Tie Rod End	CV-ES-14163		for Steering Rod
	05/88→02/90	Track Control Arm		MN-DL-3402	Trailing Arm
05/88→02/90	Track Control Arm		MN-DL-8609	Trailing Arm, Leaf Spring Axle	
33.292 DFAS	05/88→02/90	Ball Head, gearshift linkage	CV-ES-2119		
	05/88→02/90	Ball Head, gearshift linkage	CV-ES-2120		
	05/88→02/90	Ball Head, gearshift linkage	CV-ES-2182		
	05/88→02/90	Centre Rod	MN-DL-3588		Push Rod
	05/88→02/90	Centre Rod	MN-DL-12421		for Steering Rod
	05/88→02/90	Engine Mounting	MN-SB-10389		
	05/88→02/90	Mounting, stabilizer coupling rod	MN-SB-5246		
	05/88→02/90	Stabiliser Mounting		MN-SB-5245	
	05/88→02/90	Stabiliser Mounting		MN-SB-5254	
	05/88→02/90	Stabiliser Mounting	MN-SB-9396		

CV-ES-2119

Length: 55
Cone Ø: d1 Ø 10 / d2 Ø 10
Thread: M12 x 1,75 LHT
81953016063, 81953016131



CV-ES-2120

Length: 115
Cone Ø: d1 Ø 12,4 / d2 Ø 10,8
Thread: M14 x 1,5 RHT
03008500A, 81953016200, 81953016202,
81953016203, 81953016227



CV-ES-2149

Length: 160
Cone Ø: d1 Ø 30 / d2 Ø 27
Thread: M30 x 1,5 RHT
81953016263



CV-ES-2182

Length: 55
Cone Ø: d1 Ø 10 / d2 Ø 10
Thread: M12 x 1,75 RHT
81953016064, 81953016170



CV-ES-14162

Length: 125
Cone Ø: d1 Ø 30 / d2 Ø 27
Thread: M30 x 1,5 LHT

81953010015, 81953010083, 81953010087,
81953016029, 81953016030, 81953016043,
81953016044, 81953016050, 81953016054,
81953016087, 81953016091, 81953016107,
81953016120, 81953016125, 81953016152,
81953016155, 81953016157, 81953016168,
81953016179, 81953016181, 81953016223,
81953016237, 81953016254, 81953016275,
81953016279, 81953016351



CV-ES-14163

Length: 125
Cone Ø: d1 Ø 30 / d2 Ø 27
Thread: M30 x 1,5 RHT

95301.0084, 90804102156, 90804102272,
90804102696, 90804102710, 81953010016,
81953010075, 81953010084, 81953010088,
81953010094, 81953010103, 81953016030,
81953016043, 81953016048, 81953016049,
81953016053, 81953016061, 81953016090,
81953016108, 81953016112, 81953016126,
81953016143, 81953016149, 81953016154,
81953016156, 81953016168, 81953016178,
81953016194, 81953016206, 81953016224,
81953016234, 81953016242, 81953016252,
81953016274, 81953016278, 81953016284,
81953016286, 81953016308, 81953016310,
81953016312, 81953016347, 81953016350,
81953016352, 82953016012, 88953016014,
N2953016001



MN-DL-3402

Length: 590 Ø: 48
Hole Distance: 130 / 130

03307200A, 81432206067, 81432206068,
81432206090, 81432206092, 81432209092



MN-DL-3588

Length: 1035
Ø: 48
Cone Ø: d1 Ø 30 / d2 Ø 27

81466106333, 81466106334, 81466106354,
81466106355, 81466106360, 81466106361,
81466106721, 81466106722, 81466106723,
81466116216



MN-DL-5212

Length: 577 Ø: 48
Hole Distance: 130 / 130

81432206096, 81432206097, 81432206098,
81432206129, 81432209096, 81432209129,
81432306014, 81432306030



MN-DL-8609

Length: 585 Ø: 58
Hole Distance: 130 / 130

81432206070, 81432206071, 81432206072,
81432206091, 81432206093, 81432206119



MN-DL-12421

Length: 1070
Ø: 48
Cone Ø: d1 Ø 30 / d2 Ø 27
Thread: M30 x 1,5 RHT
81466106656, 81466106659, 81466106669,
81466116006, 81466116007



MN-SB-5244

Ø: 65
Hole Distance: 125
Thick/Height: 22
03312000A, 81432710027, 81432710082



MN-SB-5245

Ø: 75
Hole Distance: 125
Thick/Height: 22
03311900A, 81432710046, 81432710079,
81432710083



MN-SB-5246

Ø: 45 Thick/Height: 47
81437220022, 81437220038, 81962100450,
81962100469



MN-SB-5254

Length: 100
Ø: 93
Thick/Height: 70
81432710081



MN-SB-9396

Ø: 67
Thick/Height: 60
81437040057



MN-SB-10389

Ø: 70
Thick/Height: 72
81960200340



MN-VB-5222

Length: 627 Ø: 50
Hole Distance: 152 / 152
81432706030, 81432706034, 81432706054,
81432706055, 81432706056, 81432706057,
81432706067, 81432706068, 81432706074,
81432706075, 81432706076, 81432706077,
81432706078, 81432706081, 81432706082,
81432709034, 81432709076, 81432709078,
8143706054





F 90 ...

33.292 DFAS ...	05/88→02/90	Suspension Arm Repair Kit		MN-SB-5244	for Wishbone (CV)
	05/88→02/90	Suspension Arm Repair Kit		MN-SB-5244	for Wishbone (CV), 1st RA
	05/88→02/90	Tie Rod End	CV-ES-2149		for Push Rod
	05/88→02/90	Tie Rod End	CV-ES-14162		for Steering Rod
	05/88→02/90	Tie Rod End	CV-ES-14163		for Steering Rod
	05/88→02/90	Track Control Arm		MN-DL-3402	Trailing Arm
	05/88→02/90	Track Control Arm		MN-DL-8609	Trailing Arm, Leaf Spring Axle
33.292 DFK	09/87→02/90	Ball Head, gearshift linkage	CV-ES-2119		
	09/87→02/90	Ball Head, gearshift linkage	CV-ES-2120		
	09/87→02/90	Ball Head, gearshift linkage	CV-ES-2182		
	09/87→02/90	Centre Rod	MN-DL-3588		Push Rod
	09/87→02/90	Centre Rod	MN-DL-12421		for Steering Rod
	09/87→02/90	Engine Mounting		MN-SB-10390	
	09/87→02/90	Engine Mounting	MN-SB-10389		
	09/87→02/90	Mounting, stabilizer coupling rod	MN-SB-5246		
	09/87→02/90	Stabiliser Mounting		MN-SB-5245	
	09/87→02/90	Stabiliser Mounting		MN-SB-5254	
	09/87→02/90	Stabiliser Mounting	MN-SB-9396		
	09/87→02/90	Suspension Arm Repair Kit		MN-SB-5244	for Wishbone (CV)
	09/87→02/90	Suspension Arm Repair Kit		MN-SB-5244	for Wishbone (CV), 1st RA
	09/87→02/90	Tie Rod End	CV-ES-2149		for Push Rod
	09/87→02/90	Tie Rod End	CV-ES-14162		for Steering Rod
	09/87→02/90	Tie Rod End	CV-ES-14163		for Steering Rod
	09/87→02/90	Track Control Arm		MN-DL-3402	Trailing Arm
09/87→02/90	Track Control Arm		MN-DL-3402	Trailing Arm, Drive Axle	
09/87→02/90	Track Control Arm		MN-DL-8609	Trailing Arm, Leaf Spring Axle	
33.292 DFS	09/87→02/90	Ball Head, gearshift linkage	CV-ES-2119		
	09/87→02/90	Ball Head, gearshift linkage	CV-ES-2120		
	09/87→02/90	Ball Head, gearshift linkage	CV-ES-2182		
	09/87→02/90	Centre Rod	MN-DL-3588		Push Rod
	09/87→02/90	Centre Rod	MN-DL-12421		for Steering Rod
	09/87→02/90	Engine Mounting		MN-SB-10390	
	09/87→02/90	Engine Mounting	MN-SB-10389		
	09/87→02/90	Mounting, stabilizer coupling rod	MN-SB-5246		
	09/87→02/90	Stabiliser Mounting		MN-SB-5245	
	09/87→02/90	Stabiliser Mounting		MN-SB-5254	
	09/87→02/90	Stabiliser Mounting	MN-SB-9396		
	09/87→02/90	Suspension Arm Repair Kit		MN-SB-5244	for Wishbone (CV)
	09/87→02/90	Suspension Arm Repair Kit		MN-SB-5244	for Wishbone (CV), 1st RA
	09/87→02/90	Tie Rod End	CV-ES-2149		for Push Rod
	09/87→02/90	Tie Rod End	CV-ES-14162		for Steering Rod
	09/87→02/90	Tie Rod End	CV-ES-14163		for Steering Rod
	09/87→02/90	Track Control Arm		MN-DL-3402	Trailing Arm
09/87→02/90	Track Control Arm		MN-DL-3402	Trailing Arm, Drive Axle	
09/87→02/90	Track Control Arm		MN-DL-8609	Trailing Arm, Leaf Spring Axle	
33.322 DF	09/91→06/96	Ball Head, gearshift linkage	CV-ES-2119		
	09/91→06/96	Ball Head, gearshift linkage	CV-ES-2120		
	09/91→06/96	Ball Head, gearshift linkage	CV-ES-2182		
	09/91→06/96	Centre Rod	MN-DL-3588		Push Rod
	09/91→06/96	Centre Rod	MN-DL-12421		for Steering Rod
	09/91→06/96	Engine Mounting		MN-SB-10390	
	09/91→06/96	Engine Mounting	MN-SB-10389		
	09/91→06/96	Mounting, stabilizer coupling rod	MN-SB-5246		
	09/91→06/96	Stabiliser Mounting		MN-SB-5245	
	09/91→06/96	Stabiliser Mounting		MN-SB-5254	
	09/91→06/96	Stabiliser Mounting	MN-SB-9396		
	09/91→06/96	Suspension Arm Repair Kit		MN-SB-5244	for Wishbone (CV)
	09/91→06/96	Suspension Arm Repair Kit		MN-SB-5244	for Wishbone (CV), 1st RA
	09/91→06/96	Tie Rod End	CV-ES-2149		for Push Rod
	09/91→06/96	Tie Rod End	CV-ES-14162		for Steering Rod
	09/91→06/96	Tie Rod End	CV-ES-14163		for Steering Rod
	09/91→06/96	Track Control Arm		MN-DL-3402	Trailing Arm
09/91→06/96	Track Control Arm		MN-DL-3402	Trailing Arm, Drive Axle	
09/91→06/96	Track Control Arm		MN-DL-8609	Trailing Arm, Leaf Spring Axle	

CV-ES-2119

Length: 55
Cone Ø: d1 Ø 10 / d2 Ø 10
Thread: M12 x 1,75 LHT
81953016063, 81953016131



CV-ES-2120

Length: 115
Cone Ø: d1 Ø 12,4 / d2 Ø 10,8
Thread: M14 x 1,5 RHT
03008500A, 81953016200, 81953016202,
81953016203, 81953016227



CV-ES-2149

Length: 160
Cone Ø: d1 Ø 30 / d2 Ø 27
Thread: M30 x 1,5 RHT
81953016263



CV-ES-2182

Length: 55
Cone Ø: d1 Ø 10 / d2 Ø 10
Thread: M12 x 1,75 RHT
81953016064, 81953016170



CV-ES-14162

Length: 125
Cone Ø: d1 Ø 30 / d2 Ø 27
Thread: M30 x 1,5 LHT

81953010015, 81953010083, 81953010087,
81953016029, 81953016030, 81953016043,
81953016044, 81953016050, 81953016054,
81953016087, 81953016091, 81953016107,
81953016120, 81953016125, 81953016152,
81953016155, 81953016157, 81953016168,
81953016179, 81953016181, 81953016223,
81953016237, 81953016254, 81953016275,
81953016279, 81953016351



CV-ES-14163

Length: 125
Cone Ø: d1 Ø 30 / d2 Ø 27
Thread: M30 x 1,5 RHT

95301.0084, 90804102156, 90804102272,
90804102696, 90804102710, 81953010016,
81953010075, 81953010084, 81953010088,
81953010094, 81953010103, 81953016030,
81953016043, 81953016048, 81953016049,
81953016053, 81953016061, 81953016090,
81953016108, 81953016112, 81953016126,
81953016143, 81953016149, 81953016154,
81953016156, 81953016168, 81953016178,
81953016194, 81953016206, 81953016224,
81953016234, 81953016242, 81953016252,
81953016274, 81953016278, 81953016284,
81953016286, 81953016308, 81953016310,
81953016312, 81953016347, 81953016350,
81953016352, 82953016012, 88953016014,
N2953016001



MN-DL-3402

Length: 590 Ø: 48
Hole Distance: 130 / 130

03307200A, 81432206067, 81432206068,
81432206090, 81432206092, 81432209092



MN-DL-3588

Length: 1035
Ø: 48
Cone Ø: d1 Ø 30 / d2 Ø 27

81466106333, 81466106334, 81466106354,
81466106355, 81466106360, 81466106361,
81466106721, 81466106722, 81466106723,
81466116216



MN-DL-8609

Length: 585 Ø: 58
Hole Distance: 130 / 130

81432206070, 81432206071, 81432206072,
81432206091, 81432206093, 81432206119



MN-DL-12421

Length: 1070
Ø: 48
Cone Ø: d1 Ø 30 / d2 Ø 27
Thread: M30 x 1,5 RHT

81466106656, 81466106659, 81466106669,
81466116006, 81466116007



MN-SB-5244

Ø: 65
Hole Distance: 125
Thick/Height: 22
03312000A, 81432710027, 81432710082



MN-SB-5245

Ø: 75
Hole Distance: 125
Thick/Height: 22
03311900A, 81432710046, 81432710079,
81432710083



MN-SB-5246

Ø: 45 Thick/Height: 47
81437220022, 81437220038, 81962100450,
81962100469



MN-SB-5254

Length: 100
Ø: 93
Thick/Height: 70
81432710081



MN-SB-9396

Ø: 67
Thick/Height: 60
81437040057



MN-SB-10389

Ø: 70
Thick/Height: 72
81960200340



MN-SB-10390

Ø: 70
Thick/Height: 85/85
81960200341, 81960200373, 81960200385,
81960200408, 81960200418





F 90 ...

33.322 DFA	09/91→06/96	Ball Head, gearshift linkage	CV-ES-2119			
	09/91→06/96	Ball Head, gearshift linkage	CV-ES-2120			
	09/91→06/96	Ball Head, gearshift linkage	CV-ES-2182			
	09/91→06/96	Centre Rod	MN-DL-3588		Push Rod	
	09/91→06/96	Centre Rod	MN-DL-12421		for Steering Rod	
	09/91→06/96	Engine Mounting	MN-SB-10389			
	09/91→06/96	Mounting, stabilizer coupling rod	MN-SB-5246			
	09/91→06/96	Stabiliser Mounting		MN-SB-5245		
	09/91→06/96	Stabiliser Mounting		MN-SB-5254		
	09/91→06/96	Stabiliser Mounting	MN-SB-9396			
	09/91→06/96	Suspension Arm Repair Kit		MN-SB-5244	for Wishbone (CV)	
	09/91→06/96	Suspension Arm Repair Kit		MN-SB-5244	for Wishbone (CV), 1st RA	
	09/91→06/96	Tie Rod End	CV-ES-2149		for Push Rod	
	09/91→06/96	Tie Rod End	CV-ES-14162		for Steering Rod	
	09/91→06/96	Tie Rod End	CV-ES-14163		for Steering Rod	
	09/91→06/96	Track Control Arm		MN-DL-3402	Trailing Arm	
	09/91→06/96	Track Control Arm		MN-DL-8609	Trailing Arm, Leaf Spring Axle	
	33.322 FVL	09/91→06/96	Ball Head, gearshift linkage	CV-ES-2119		
		09/91→06/96	Ball Head, gearshift linkage	CV-ES-2120		
		09/91→06/96	Ball Head, gearshift linkage	CV-ES-2182		
09/91→06/96		Centre Rod	MN-DL-3588		Push Rod	
09/91→06/96		Centre Rod	MN-DL-12421		for Steering Rod	
09/91→06/96		Engine Mounting	MN-SB-10389			
09/91→06/96		Mounting, stabilizer coupling rod	MN-SB-5246			
09/91→06/96		Stabiliser Mounting		MN-SB-5243		
09/91→06/96		Stabiliser Mounting		MN-SB-5265		
09/91→06/96		Stabiliser Mounting		MN-SB-5265	1st RA	
09/91→06/96		Stabiliser Mounting	MN-SB-9396			
09/91→06/96		Suspension Arm Repair Kit		CV-RK-5313	for Wishbone (CV)	
09/91→06/96		Suspension Arm Repair Kit		CV-RK-8118	for Control Arm	
09/91→06/96		Suspension Arm Repair Kit		MN-RK-7280	for Drag Link	
09/91→06/96		Suspension Arm Repair Kit		MN-RK-7287	for Wishbone (CV)	
09/91→06/96		Suspension Arm Repair Kit		MN-RK-7291	for Drag Link	
09/91→06/96		Tie Rod End	CV-ES-2149		for Push Rod	
09/91→06/96		Tie Rod End	CV-ES-14162		for Steering Rod	
09/91→06/96		Tie Rod End	CV-ES-14163		for Steering Rod	
09/91→06/96		Track Control Arm		MN-DL-5212	Trailing Arm, Air Suspension Axle; Drive Axle	
09/91→06/96	Track Control Arm		MN-VB-5222	Wishbone (CV), Drive Axle; Air Suspension Axle		
33.332 DF	09/87→02/90	Ball Head, gearshift linkage	CV-ES-2119			
	09/87→02/90	Ball Head, gearshift linkage	CV-ES-2120			
	09/87→02/90	Ball Head, gearshift linkage	CV-ES-2182			
	09/87→02/90	Centre Rod	MN-DL-3588		Push Rod	
	09/87→02/90	Centre Rod	MN-DL-12421		for Steering Rod	
	09/87→02/90	Engine Mounting		MN-SB-10390		
	09/87→02/90	Engine Mounting	MN-SB-10389			
	09/87→02/90	Mounting, stabilizer coupling rod	MN-SB-5246			
	09/87→02/90	Stabiliser Mounting		MN-SB-5245		
	09/87→02/90	Stabiliser Mounting		MN-SB-5254		
	09/87→02/90	Stabiliser Mounting	MN-SB-9396			
	09/87→02/90	Suspension Arm Repair Kit		MN-SB-5244	for Wishbone (CV)	
	09/87→02/90	Suspension Arm Repair Kit		MN-SB-5244	for Wishbone (CV), 1st RA	
	09/87→02/90	Tie Rod End	CV-ES-2149		for Push Rod	
	09/87→02/90	Tie Rod End	CV-ES-14162		for Steering Rod	
	09/87→02/90	Tie Rod End	CV-ES-14163		for Steering Rod	
	09/87→02/90	Track Control Arm		MN-DL-3402	Trailing Arm	
	09/87→02/90	Track Control Arm		MN-DL-3402	Trailing Arm, Drive Axle	
	09/87→02/90	Track Control Arm		MN-DL-8609	Trailing Arm, Leaf Spring Axle	
	33.332 DFA	05/88→02/90	Ball Head, gearshift linkage	CV-ES-2119		
05/88→02/90		Ball Head, gearshift linkage	CV-ES-2120			
05/88→02/90		Ball Head, gearshift linkage	CV-ES-2182			
05/88→02/90		Centre Rod	MN-DL-3588		Push Rod	
05/88→02/90		Centre Rod	MN-DL-12421		for Steering Rod	
05/88→02/90		Engine Mounting	MN-SB-10389			

CV-ES-2119

Length: 55
Cone Ø: d1 Ø 10 / d2 Ø 10
Thread: M12 x 1,75 LHT
81953016063, 81953016131



CV-ES-2120

Length: 115
Cone Ø: d1 Ø 12,4 / d2 Ø 10,8
Thread: M14 x 1,5 RHT
03008500A, 81953016200, 81953016202,
81953016203, 81953016227



CV-ES-2149

Length: 160
Cone Ø: d1 Ø 30 / d2 Ø 27
Thread: M30 x 1,5 RHT
81953016263



CV-ES-2182

Length: 55
Cone Ø: d1 Ø 10 / d2 Ø 10
Thread: M12 x 1,75 RHT
81953016064, 81953016170



CV-ES-14162

Length: 125
Cone Ø: d1 Ø 30 / d2 Ø 27
Thread: M30 x 1,5 LHT

81953010015, 81953010083, 81953010087,
81953016029, 81953016030, 81953016043,
81953016044, 81953016050, 81953016054,
81953016087, 81953016091, 81953016107,
81953016120, 81953016125, 81953016152,
81953016155, 81953016157, 81953016168,
81953016179, 81953016181, 81953016223,
81953016237, 81953016254, 81953016275,
81953016279, 81953016351



CV-ES-14163

Length: 125
Cone Ø: d1 Ø 30 / d2 Ø 27
Thread: M30 x 1,5 RHT

95301.0084, 90804102156, 90804102272,
90804102696, 90804102710, 81953010016,
81953010075, 81953010084, 81953010088,
81953010094, 81953010103, 81953016030,
81953016043, 81953016048, 81953016049,
81953016053, 81953016061, 81953016090,
81953016108, 81953016112, 81953016126,
81953016143, 81953016149, 81953016154,
81953016156, 81953016168, 81953016178,
81953016194, 81953016206, 81953016224,
81953016234, 81953016242, 81953016252,
81953016274, 81953016278, 81953016284,
81953016286, 81953016308, 81953016310,
81953016312, 81953016347, 81953016350,
81953016352, 82953016012, 88953016014,
N2953016001



CV-RK-5313

Ø: 90
03304800A, 81953016132



CV-RK-8118

Ø: 85
Hole Distance: 130
Thick/Height: 30

638862, 639287, 775201, 938423,
1104335, 1953248, 0003500506, 3500506,
11013547, 21032592, 42065912, 42488722,
070550504, 93192618, 070400009000,
634303610, 81432206055, 81432206073,
82262320660, 9544171010099,
5001842823, 7000307001, 8226232066



MN-DL-3402

Length: 590 Ø: 48
Hole Distance: 130 / 130
03307200A, 81432206067, 81432206068,
81432206090, 81432206092, 81432209092



MN-DL-3588

Length: 1035 Ø: 48
Cone Ø: d1 Ø 30 / d2 Ø 27
81466106333, 81466106334, 81466106354,
81466106355, 81466106360, 81466106361,
81466106721, 81466106722, 81466106723,
81466116216



MN-DL-5212

Length: 577 Ø: 48
Hole Distance: 130 / 130
81432206096, 81432206097, 81432206098,
81432206129, 81432209096, 81432209129,
81432306014, 81432306030



MN-DL-8609

Length: 585 Ø: 58
Hole Distance: 130 / 130
81432206070, 81432206071, 81432206072,
81432206091, 81432206093, 81432206119



MN-DL-12421

Length: 1070 Ø: 48
Cone Ø: d1 Ø 30 / d2 Ø 27
Thread: M30 x 1,5 RHT
81466106656, 81466106659, 81466106669,
81466116006, 81466116007



MN-RK-7280

Ø: 75
Hole Distance: 115
Thick/Height: 24
0550806, 0639370, 689748, 10307400A,
81432306051, 81432306068, 81432706064



MN-RK-7287

Ø: 90
Hole Distance: 152
Thick/Height: 35
03304700A, 81953016133



MN-RK-7291

Ø: 72
Hole Distance: 130
Thick/Height: 30
10307800A, 81432206108, 81432206132



MN-SB-5243

Length: 55 Ø: 78
Thick/Height: 60
03311100A, 81437040061, 81437220020



MN-SB-5244

Ø: 65
Hole Distance: 125
Thick/Height: 22
03312000A, 81432710027, 81432710082



MN-SB-5245

Ø: 75
Hole Distance: 125
Thick/Height: 22
03311900A, 81432710046, 81432710079,
81432710083



MN-SB-5246

Ø: 45 Thick/Height: 47
81437220022, 81437220038, 81962100450,
81962100469



MN-SB-5254

Length: 100 Ø: 93
Thick/Height: 70
81432710081



MN-SB-5265

Ø: 85 Thick/Height: 80
03310300A, 81437040032



MN-SB-9396

Ø: 67 Thick/Height: 60
81437040057



MN-SB-10389

Ø: 70 Thick/Height: 72
81960200340



MN-SB-10390

Ø: 70 Thick/Height: 85/85
81960200341, 81960200373, 81960200385,
81960200408, 81960200418



MN-VB-5222

Length: 627 Ø: 50
Hole Distance: 152 / 152
81432706030, 81432706034, 81432706054,
81432706055, 81432706056, 81432706057,
81432706067, 81432706068, 81432706074,
81432706075, 81432706076, 81432706077,
81432706078, 81432706081, 81432706082,
81432709034, 81432709076, 81432709078,
8143706054



Tuesday
21

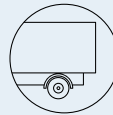

MAN ...

F 90 ...

33.332 DFA ...	05/88→02/90	Mounting, stabilizer coupling rod	MN-SB-5246			
	05/88→02/90	Stabiliser Mounting		MN-SB-5245		
	05/88→02/90	Stabiliser Mounting		MN-SB-5254		
	05/88→02/90	Stabiliser Mounting	MN-SB-9396			
	05/88→02/90	Suspension Arm Repair Kit		MN-SB-5244	for Wishbone (CV)	
	05/88→02/90	Suspension Arm Repair Kit		MN-SB-5244	for Wishbone (CV), 1st RA	
	05/88→02/90	Tie Rod End	CV-ES-2149		for Push Rod	
	05/88→02/90	Tie Rod End	CV-ES-14162		for Steering Rod	
	05/88→02/90	Tie Rod End	CV-ES-14163		for Steering Rod	
	05/88→02/90	Track Control Arm		MN-DL-3402	Trailing Arm	
	05/88→02/90	Track Control Arm		MN-DL-8609	Trailing Arm, Leaf Spring Axle	
	33.332 DFAK	05/88→02/90	Ball Head, gearshift linkage	CV-ES-2119		
		05/88→02/90	Ball Head, gearshift linkage	CV-ES-2120		
		05/88→02/90	Ball Head, gearshift linkage	CV-ES-2182		
05/88→02/90		Centre Rod	MN-DL-3588		Push Rod	
05/88→02/90		Centre Rod	MN-DL-12421		for Steering Rod	
05/88→02/90		Engine Mounting	MN-SB-10389			
05/88→02/90		Mounting, stabilizer coupling rod	MN-SB-5246			
05/88→02/90		Stabiliser Mounting		MN-SB-5245		
05/88→02/90		Stabiliser Mounting		MN-SB-5254		
05/88→02/90		Stabiliser Mounting	MN-SB-9396			
05/88→02/90		Suspension Arm Repair Kit		MN-SB-5244	for Wishbone (CV)	
05/88→02/90		Suspension Arm Repair Kit		MN-SB-5244	for Wishbone (CV), 1st RA	
05/88→02/90		Tie Rod End	CV-ES-2149		for Push Rod	
05/88→02/90		Tie Rod End	CV-ES-14162		for Steering Rod	
05/88→02/90		Tie Rod End	CV-ES-14163		for Steering Rod	
05/88→02/90		Track Control Arm		MN-DL-3402	Trailing Arm	
05/88→02/90		Track Control Arm		MN-DL-8609	Trailing Arm, Leaf Spring Axle	
33.332 DFAS	05/88→02/90	Ball Head, gearshift linkage	CV-ES-2119			
	05/88→02/90	Ball Head, gearshift linkage	CV-ES-2120			
	05/88→02/90	Ball Head, gearshift linkage	CV-ES-2182			
	05/88→02/90	Centre Rod	MN-DL-3588		Push Rod	
	05/88→02/90	Centre Rod	MN-DL-12421		for Steering Rod	
	05/88→02/90	Engine Mounting	MN-SB-10389			
	05/88→02/90	Mounting, stabilizer coupling rod	MN-SB-5246			
	05/88→02/90	Stabiliser Mounting		MN-SB-5245		
	05/88→02/90	Stabiliser Mounting		MN-SB-5254		
	05/88→02/90	Stabiliser Mounting	MN-SB-9396			
	05/88→02/90	Suspension Arm Repair Kit		MN-SB-5244	for Wishbone (CV)	
	05/88→02/90	Suspension Arm Repair Kit		MN-SB-5244	for Wishbone (CV), 1st RA	
	05/88→02/90	Tie Rod End	CV-ES-2149		for Push Rod	
	05/88→02/90	Tie Rod End	CV-ES-14162		for Steering Rod	
	05/88→02/90	Tie Rod End	CV-ES-14163		for Steering Rod	
	05/88→02/90	Track Control Arm		MN-DL-3402	Trailing Arm	
	05/88→02/90	Track Control Arm		MN-DL-8609	Trailing Arm, Leaf Spring Axle	
33.332 DFK	09/87→02/90	Ball Head, gearshift linkage	CV-ES-2119			
	09/87→02/90	Ball Head, gearshift linkage	CV-ES-2120			
	09/87→02/90	Ball Head, gearshift linkage	CV-ES-2182			
	09/87→02/90	Centre Rod	MN-DL-3588		Push Rod	
	09/87→02/90	Centre Rod	MN-DL-12421		for Steering Rod	
	09/87→02/90	Engine Mounting		MN-SB-10390		
	09/87→02/90	Engine Mounting	MN-SB-10389			
	09/87→02/90	Mounting, stabilizer coupling rod	MN-SB-5246			
	09/87→02/90	Stabiliser Mounting		MN-SB-5245		
	09/87→02/90	Stabiliser Mounting		MN-SB-5254		
	09/87→02/90	Stabiliser Mounting	MN-SB-9396			
	09/87→02/90	Suspension Arm Repair Kit		MN-SB-5244	for Wishbone (CV)	
	09/87→02/90	Suspension Arm Repair Kit		MN-SB-5244	for Wishbone (CV), 1st RA	
	09/87→02/90	Tie Rod End	CV-ES-2149		for Push Rod	
	09/87→02/90	Tie Rod End	CV-ES-14162		for Steering Rod	
	09/87→02/90	Tie Rod End	CV-ES-14163		for Steering Rod	
	09/87→02/90	Track Control Arm		MN-DL-3402	Trailing Arm	
09/87→02/90	Track Control Arm		MN-DL-3402	Trailing Arm, Drive Axle		
09/87→02/90	Track Control Arm		MN-DL-8609	Trailing Arm, Leaf Spring Axle		

MAN

CV-ES-2119

Length: 55
Cone Ø: d1 Ø 10 / d2 Ø 10
Thread: M12 x 1,75 LHT
81953016063, 81953016131



CV-ES-2120

Length: 115
Cone Ø: d1 Ø 12,4 / d2 Ø 10,8
Thread: M14 x 1,5 RHT
03008500A, 81953016200, 81953016202, 81953016203, 81953016227



CV-ES-2149

Length: 160
Cone Ø: d1 Ø 30 / d2 Ø 27
Thread: M30 x 1,5 RHT
81953016263



CV-ES-2182

Length: 55
Cone Ø: d1 Ø 10 / d2 Ø 10
Thread: M12 x 1,75 RHT
81953016064, 81953016170



CV-ES-14162

Length: 125
Cone Ø: d1 Ø 30 / d2 Ø 27
Thread: M30 x 1,5 LHT

81953010015, 81953010083, 81953010087, 81953016029, 81953016030, 81953016043, 81953016044, 81953016050, 81953016054, 81953016087, 81953016091, 81953016107, 81953016120, 81953016125, 81953016152, 81953016155, 81953016157, 81953016168, 81953016179, 81953016181, 81953016223, 81953016237, 81953016254, 81953016275, 81953016279, 81953016351



CV-ES-14163

Length: 125
Cone Ø: d1 Ø 30 / d2 Ø 27
Thread: M30 x 1,5 RHT

95301.0084, 90804102156, 90804102272, 90804102696, 90804102710, 81953010016, 81953010075, 81953010084, 81953010088, 81953010094, 81953010103, 81953016030, 81953016043, 81953016048, 81953016049, 81953016053, 81953016061, 81953016090, 81953016108, 81953016112, 81953016126, 81953016143, 81953016149, 81953016154, 81953016156, 81953016168, 81953016178, 81953016194, 81953016206, 81953016224, 81953016234, 81953016242, 81953016252, 81953016274, 81953016278, 81953016284, 81953016286, 81953016308, 81953016310, 81953016312, 81953016347, 81953016350, 81953016352, 82953016012, 88953016014, N2953016001



MN-DL-3402

Length: 590 Ø: 48
Hole Distance: 130 / 130
03307200A, 81432206067, 81432206068, 81432206090, 81432206092, 81432209092



MN-DL-3588

Length: 1035
Ø: 48
Cone Ø: d1 Ø 30 / d2 Ø 27

81466106333, 81466106334, 81466106354, 81466106355, 81466106360, 81466106361, 81466106721, 81466106722, 81466106723, 81466116216



MN-DL-8609

Length: 585 Ø: 58
Hole Distance: 130 / 130
81432206070, 81432206071, 81432206072, 81432206091, 81432206093, 81432206119



MN-DL-12421

Length: 1070
Ø: 48
Cone Ø: d1 Ø 30 / d2 Ø 27
Thread: M30 x 1,5 RHT

81466106656, 81466106659, 81466106669, 81466116006, 81466116007



MN-SB-5244

Ø: 65
Hole Distance: 125
Thick/Height: 22
03312000A, 81432710027, 81432710082



MN-SB-5245

Ø: 75
Hole Distance: 125
Thick/Height: 22
03311900A, 81432710046, 81432710079, 81432710083



MN-SB-5246

Ø: 45 Thick/Height: 47
81437220022, 81437220038, 81962100450, 81962100469



MN-SB-5254

Length: 100
Ø: 93
Thick/Height: 70
81432710081



MN-SB-9396

Ø: 67
Thick/Height: 60
81437040057



MN-SB-10389

Ø: 70
Thick/Height: 72
81960200340



MN-SB-10390

Ø: 70
Thick/Height: 85/85
81960200341, 81960200373, 81960200385, 81960200408, 81960200418



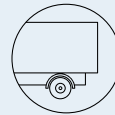

F 90 ...

33.332 DFS	09/87→02/90	Ball Head, gearshift linkage	CV-ES-2119			
	09/87→02/90	Ball Head, gearshift linkage	CV-ES-2120			
	09/87→02/90	Ball Head, gearshift linkage	CV-ES-2182			
	09/87→02/90	Centre Rod	MN-DL-3588		Push Rod	
	09/87→02/90	Centre Rod	MN-DL-12421		for Steering Rod	
	09/87→02/90	Engine Mounting		MN-SB-10390		
	09/87→02/90	Engine Mounting	MN-SB-10389			
	09/87→02/90	Mounting, stabilizer coupling rod	MN-SB-5246			
	09/87→02/90	Stabiliser Mounting		MN-SB-5245		
	09/87→02/90	Stabiliser Mounting		MN-SB-5254		
	09/87→02/90	Stabiliser Mounting	MN-SB-9396			
	09/87→02/90	Suspension Arm Repair Kit		MN-SB-5244	for Wishbone (CV)	
	09/87→02/90	Suspension Arm Repair Kit		MN-SB-5244	for Wishbone (CV), 1st RA	
	09/87→02/90	Tie Rod End	CV-ES-2149		for Push Rod	
	09/87→02/90	Tie Rod End	CV-ES-14162		for Steering Rod	
	09/87→02/90	Tie Rod End	CV-ES-14163		for Steering Rod	
	09/87→02/90	Track Control Arm		MN-DL-3402	Trailing Arm	
	09/87→02/90	Track Control Arm		MN-DL-3402	Trailing Arm, Drive Axle	
	09/87→02/90	Track Control Arm		MN-DL-8609	Trailing Arm, Leaf Spring Axle	
	33.342 DF	05/94→06/96	Ball Head, gearshift linkage	CV-ES-2119		
05/94→06/96		Ball Head, gearshift linkage	CV-ES-2120			
05/94→06/96		Ball Head, gearshift linkage	CV-ES-2182			
05/94→06/96		Centre Rod	MN-DL-3588		Push Rod	
05/94→06/96		Centre Rod	MN-DL-12421		for Steering Rod	
05/94→06/96		Engine Mounting		MN-SB-10390		
05/94→06/96		Engine Mounting	MN-SB-10389			
05/94→06/96		Mounting, stabilizer coupling rod	MN-SB-5246			
05/94→06/96		Stabiliser Mounting		MN-SB-5245		
05/94→06/96		Stabiliser Mounting		MN-SB-5254		
05/94→06/96		Stabiliser Mounting	MN-SB-9396			
05/94→06/96		Suspension Arm Repair Kit		MN-SB-5244	for Wishbone (CV)	
05/94→06/96		Suspension Arm Repair Kit		MN-SB-5244	for Wishbone (CV), 1st RA	
05/94→06/96		Tie Rod End	CV-ES-2149		for Push Rod	
05/94→06/96		Tie Rod End	CV-ES-14162		for Steering Rod	
05/94→06/96		Tie Rod End	CV-ES-14163		for Steering Rod	
05/94→06/96		Track Control Arm		MN-DL-3402	Trailing Arm	
05/94→06/96		Track Control Arm		MN-DL-3402	Trailing Arm, Drive Axle	
05/94→06/96		Track Control Arm		MN-DL-8609	Trailing Arm, Leaf Spring Axle	
33.342 DFA		05/94→06/96	Ball Head, gearshift linkage	CV-ES-2119		
	05/94→06/96	Ball Head, gearshift linkage	CV-ES-2120			
	05/94→06/96	Ball Head, gearshift linkage	CV-ES-2182			
	05/94→06/96	Centre Rod	MN-DL-3588		Push Rod	
	05/94→06/96	Centre Rod	MN-DL-12421		for Steering Rod	
	05/94→06/96	Engine Mounting	MN-SB-10389			
	05/94→06/96	Mounting, stabilizer coupling rod	MN-SB-5246			
	05/94→06/96	Stabiliser Mounting		MN-SB-5245		
	05/94→06/96	Stabiliser Mounting		MN-SB-5254		
	05/94→06/96	Stabiliser Mounting	MN-SB-9396			
	05/94→06/96	Suspension Arm Repair Kit		MN-SB-5244	for Wishbone (CV)	
	05/94→06/96	Suspension Arm Repair Kit		MN-SB-5244	for Wishbone (CV), 1st RA	
	05/94→06/96	Tie Rod End	CV-ES-2149		for Push Rod	
	05/94→06/96	Tie Rod End	CV-ES-14162		for Steering Rod	
	05/94→06/96	Tie Rod End	CV-ES-14163		for Steering Rod	
	05/94→06/96	Track Control Arm		MN-DL-3402	Trailing Arm	
	05/94→06/96	Track Control Arm		MN-DL-8609	Trailing Arm, Leaf Spring Axle	
	33.362 DF	09/87→02/90	Ball Head, gearshift linkage	CV-ES-2119		
		09/87→02/90	Ball Head, gearshift linkage	CV-ES-2120		
		09/87→02/90	Ball Head, gearshift linkage	CV-ES-2182		
09/87→02/90		Centre Rod	MN-DL-3588		Push Rod	
09/87→02/90		Centre Rod	MN-DL-12421		for Steering Rod	
09/87→02/90		Engine Mounting		MN-SB-10390		
09/87→02/90		Engine Mounting	MN-SB-10389			
09/87→02/90		Mounting, stabilizer coupling rod	MN-SB-5246			

CV-ES-2119

Length: 55
Cone Ø: d1 Ø 10 / d2 Ø 10
Thread: M12 x 1,75 LHT
81953016063, 81953016131



CV-ES-2120

Length: 115
Cone Ø: d1 Ø 12,4 / d2 Ø 10,8
Thread: M14 x 1,5 RHT
03008500A, 81953016200, 81953016202,
81953016203, 81953016227



CV-ES-2149

Length: 160
Cone Ø: d1 Ø 30 / d2 Ø 27
Thread: M30 x 1,5 RHT
81953016263



CV-ES-2182

Length: 55
Cone Ø: d1 Ø 10 / d2 Ø 10
Thread: M12 x 1,75 RHT
81953016064, 81953016170



CV-ES-14162

Length: 125
Cone Ø: d1 Ø 30 / d2 Ø 27
Thread: M30 x 1,5 LHT
81953010015, 81953010083, 81953010087,
81953016029, 81953016030, 81953016043,
81953016044, 81953016050, 81953016054,
81953016087, 81953016091, 81953016107,
81953016120, 81953016125, 81953016152,
81953016155, 81953016157, 81953016168,
81953016179, 81953016181, 81953016223,
81953016237, 81953016254, 81953016275,
81953016279, 81953016351



CV-ES-14163

Length: 125
Cone Ø: d1 Ø 30 / d2 Ø 27
Thread: M30 x 1,5 RHT
95301.0084, 90804102156, 90804102272,
90804102696, 90804102710, 81953010016,
81953010075, 81953010084, 81953010088,
81953010094, 81953010103, 81953016030,
81953016043, 81953016048, 81953016049,
81953016053, 81953016061, 81953016090,
81953016108, 81953016112, 81953016126,
81953016143, 81953016149, 81953016154,
81953016156, 81953016168, 81953016178,
81953016194, 81953016206, 81953016224,
81953016234, 81953016242, 81953016252,
81953016274, 81953016278, 81953016284,
81953016286, 81953016308, 81953016310,
81953016312, 81953016347, 81953016350,
81953016352, 82953016012, 88953016014,
N2953016001



MN-DL-3402

Length: 590 Ø: 48
Hole Distance: 130 / 130
03307200A, 81432206067, 81432206068,
81432206090, 81432206092, 81432209092



MN-DL-3588

Length: 1035
Ø: 48
Cone Ø: d1 Ø 30 / d2 Ø 27
81466106333, 81466106334, 81466106354,
81466106355, 81466106360, 81466106361,
81466106721, 81466106722, 81466106723,
81466116216



MN-DL-8609

Length: 585 Ø: 58
Hole Distance: 130 / 130
81432206070, 81432206071, 81432206072,
81432206091, 81432206093, 81432206119



MN-DL-12421

Length: 1070
Ø: 48
Cone Ø: d1 Ø 30 / d2 Ø 27
Thread: M30 x 1,5 RHT
81466106656, 81466106659, 81466106669,
81466116006, 81466116007



MN-SB-5244

Ø: 65
Hole Distance: 125
Thick/Height: 22
03312000A, 81432710027, 81432710082



MN-SB-5245

Ø: 75
Hole Distance: 125
Thick/Height: 22
03311900A, 81432710046, 81432710079,
81432710083



MN-SB-5246

Ø: 45 Thick/Height: 47
81437220022, 81437220038, 81962100450,
81962100469



MN-SB-5254

Length: 100
Ø: 93
Thick/Height: 70
81432710081



MN-SB-9396

Ø: 67
Thick/Height: 60
81437040057



MN-SB-10389

Ø: 70
Thick/Height: 72
81960200340



MN-SB-10390

Ø: 70
Thick/Height: 85/85
81960200341, 81960200373, 81960200385,
81960200408, 81960200418



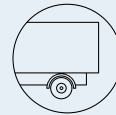

F 90 ...

33.362 DF ...	09/87→02/90	Stabiliser Mounting		MN-SB-5245		
	09/87→02/90	Stabiliser Mounting		MN-SB-5254		
	09/87→02/90	Stabiliser Mounting	MN-SB-9396			
	09/87→02/90	Suspension Arm Repair Kit		MN-SB-5244	for Wishbone (CV)	
	09/87→02/90	Suspension Arm Repair Kit		MN-SB-5244	for Wishbone (CV), 1st RA	
	09/87→02/90	Tie Rod End	CV-ES-2149		for Push Rod	
	09/87→02/90	Tie Rod End	CV-ES-14162		for Steering Rod	
	09/87→02/90	Tie Rod End	CV-ES-14163		for Steering Rod	
	09/87→02/90	Track Control Arm		MN-DL-3402	Trailing Arm	
	09/87→02/90	Track Control Arm		MN-DL-3402	Trailing Arm, Drive Axle	
	09/87→02/90	Track Control Arm		MN-DL-8609	Trailing Arm, Leaf Spring Axle	
	33.362 DFA	05/88→02/90	Ball Head, gearshift linkage	CV-ES-2119		
		05/88→02/90	Ball Head, gearshift linkage	CV-ES-2120		
05/88→02/90		Ball Head, gearshift linkage	CV-ES-2182			
05/88→02/90		Centre Rod	MN-DL-3588		Push Rod	
05/88→02/90		Centre Rod	MN-DL-12421		for Steering Rod	
05/88→02/90		Engine Mounting	MN-SB-10389			
05/88→02/90		Mounting, stabilizer coupling rod	MN-SB-5246			
05/88→02/90		Stabiliser Mounting		MN-SB-5245		
05/88→02/90		Stabiliser Mounting		MN-SB-5254		
05/88→02/90		Stabiliser Mounting	MN-SB-9396			
05/88→02/90		Suspension Arm Repair Kit		MN-SB-5244	for Wishbone (CV)	
05/88→02/90		Suspension Arm Repair Kit		MN-SB-5244	for Wishbone (CV), 1st RA	
05/88→02/90		Tie Rod End	CV-ES-2149		for Push Rod	
05/88→02/90		Tie Rod End	CV-ES-14162		for Steering Rod	
05/88→02/90		Tie Rod End	CV-ES-14163		for Steering Rod	
05/88→02/90		Track Control Arm		MN-DL-3402	Trailing Arm	
05/88→02/90		Track Control Arm		MN-DL-8609	Trailing Arm, Leaf Spring Axle	
33.362 DFAK	05/88→02/90	Ball Head, gearshift linkage	CV-ES-2119			
	05/88→02/90	Ball Head, gearshift linkage	CV-ES-2120			
	05/88→02/90	Ball Head, gearshift linkage	CV-ES-2182			
	05/88→02/90	Centre Rod	MN-DL-3588		Push Rod	
	05/88→02/90	Centre Rod	MN-DL-12421		for Steering Rod	
	05/88→02/90	Engine Mounting	MN-SB-10389			
	05/88→02/90	Mounting, stabilizer coupling rod	MN-SB-5246			
	05/88→02/90	Stabiliser Mounting		MN-SB-5245		
	05/88→02/90	Stabiliser Mounting		MN-SB-5254		
	05/88→02/90	Stabiliser Mounting	MN-SB-9396			
	05/88→02/90	Suspension Arm Repair Kit		MN-SB-5244	for Wishbone (CV)	
	05/88→02/90	Suspension Arm Repair Kit		MN-SB-5244	for Wishbone (CV), 1st RA	
	05/88→02/90	Tie Rod End	CV-ES-2149		for Push Rod	
	05/88→02/90	Tie Rod End	CV-ES-14162		for Steering Rod	
	05/88→02/90	Tie Rod End	CV-ES-14163		for Steering Rod	
	05/88→02/90	Track Control Arm		MN-DL-3402	Trailing Arm	
	05/88→02/90	Track Control Arm		MN-DL-8609	Trailing Arm, Leaf Spring Axle	
33.362 DFAS	05/88→02/90	Ball Head, gearshift linkage	CV-ES-2119			
	05/88→02/90	Ball Head, gearshift linkage	CV-ES-2120			
	05/88→02/90	Ball Head, gearshift linkage	CV-ES-2182			
	05/88→02/90	Centre Rod	MN-DL-3588		Push Rod	
	05/88→02/90	Centre Rod	MN-DL-12421		for Steering Rod	
	05/88→02/90	Engine Mounting	MN-SB-10389			
	05/88→02/90	Mounting, stabilizer coupling rod	MN-SB-5246			
	05/88→02/90	Stabiliser Mounting		MN-SB-5245		
	05/88→02/90	Stabiliser Mounting		MN-SB-5254		
	05/88→02/90	Stabiliser Mounting	MN-SB-9396			
	05/88→02/90	Suspension Arm Repair Kit		MN-SB-5244	for Wishbone (CV)	
	05/88→02/90	Suspension Arm Repair Kit		MN-SB-5244	for Wishbone (CV), 1st RA	
	05/88→02/90	Tie Rod End	CV-ES-2149		for Push Rod	
	05/88→02/90	Tie Rod End	CV-ES-14162		for Steering Rod	
	05/88→02/90	Tie Rod End	CV-ES-14163		for Steering Rod	
	05/88→02/90	Track Control Arm		MN-DL-3402	Trailing Arm	
	05/88→02/90	Track Control Arm		MN-DL-8609	Trailing Arm, Leaf Spring Axle	

CV-ES-2119

Length: 55
Cone Ø: d1 Ø 10 / d2 Ø 10
Thread: M12 x 1,75 LHT
81953016063, 81953016131



CV-ES-2120

Length: 115
Cone Ø: d1 Ø 12,4 / d2 Ø 10,8
Thread: M14 x 1,5 RHT
03008500A, 81953016200, 81953016202,
81953016203, 81953016227



CV-ES-2149

Length: 160
Cone Ø: d1 Ø 30 / d2 Ø 27
Thread: M30 x 1,5 RHT
81953016263



CV-ES-2182

Length: 55
Cone Ø: d1 Ø 10 / d2 Ø 10
Thread: M12 x 1,75 RHT
81953016064, 81953016170



CV-ES-14162

Length: 125
Cone Ø: d1 Ø 30 / d2 Ø 27
Thread: M30 x 1,5 LHT

81953010015, 81953010083, 81953010087,
81953016029, 81953016030, 81953016043,
81953016044, 81953016050, 81953016054,
81953016087, 81953016091, 81953016107,
81953016120, 81953016125, 81953016152,
81953016155, 81953016157, 81953016168,
81953016179, 81953016181, 81953016223,
81953016237, 81953016254, 81953016275,
81953016279, 81953016351



CV-ES-14163

Length: 125
Cone Ø: d1 Ø 30 / d2 Ø 27
Thread: M30 x 1,5 RHT

95301.0084, 90804102156, 90804102272,
90804102696, 90804102710, 81953010016,
81953010075, 81953010084, 81953010088,
81953010094, 81953010103, 81953016030,
81953016043, 81953016048, 81953016049,
81953016053, 81953016061, 81953016090,
81953016108, 81953016112, 81953016126,
81953016143, 81953016149, 81953016154,
81953016156, 81953016168, 81953016178,
81953016194, 81953016206, 81953016224,
81953016234, 81953016242, 81953016252,
81953016274, 81953016278, 81953016284,
81953016286, 81953016308, 81953016310,
81953016312, 81953016347, 81953016350,
81953016352, 82953016012, 88953016014,
N2953016001



MN-DL-3402

Length: 590 Ø: 48
Hole Distance: 130 / 130

03307200A, 81432206067, 81432206068,
81432206090, 81432206092, 81432209092



MN-DL-3588

Length: 1035
Ø: 48
Cone Ø: d1 Ø 30 / d2 Ø 27

81466106333, 81466106334, 81466106354,
81466106355, 81466106360, 81466106361,
81466106721, 81466106722, 81466106723,
81466116216



MN-DL-8609

Length: 585 Ø: 58
Hole Distance: 130 / 130

81432206070, 81432206071, 81432206072,
81432206091, 81432206093, 81432206119



MN-DL-12421

Length: 1070
Ø: 48
Cone Ø: d1 Ø 30 / d2 Ø 27
Thread: M30 x 1,5 RHT

81466106656, 81466106659, 81466106669,
81466116006, 81466116007



MN-SB-5244

Ø: 65
Hole Distance: 125
Thick/Height: 22
03312000A, 81432710027, 81432710082



MN-SB-5245

Ø: 75
Hole Distance: 125
Thick/Height: 22
03311900A, 81432710046, 81432710079,
81432710083



MN-SB-5246

Ø: 45 Thick/Height: 47
81437220022, 81437220038, 81962100450,
81962100469



MN-SB-5254

Length: 100
Ø: 93
Thick/Height: 70
81432710081



MN-SB-9396

Ø: 67
Thick/Height: 60
81437040057



MN-SB-10389

Ø: 70
Thick/Height: 72
81960200340



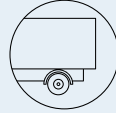

F 90 ...

33.362 DFK	09/87→02/90	Ball Head, gearshift linkage	CV-ES-2119			
	09/87→02/90	Ball Head, gearshift linkage	CV-ES-2120			
	09/87→02/90	Ball Head, gearshift linkage	CV-ES-2182			
	09/87→02/90	Centre Rod	MN-DL-3588		Push Rod	
	09/87→02/90	Centre Rod	MN-DL-12421		for Steering Rod	
	09/87→02/90	Engine Mounting		MN-SB-10390		
	09/87→02/90	Engine Mounting	MN-SB-10389			
	09/87→02/90	Mounting, stabilizer coupling rod	MN-SB-5246			
	09/87→02/90	Stabiliser Mounting		MN-SB-5245		
	09/87→02/90	Stabiliser Mounting		MN-SB-5254		
	09/87→02/90	Stabiliser Mounting	MN-SB-9396			
	09/87→02/90	Suspension Arm Repair Kit		MN-SB-5244	for Wishbone (CV)	
	09/87→02/90	Suspension Arm Repair Kit		MN-SB-5244	for Wishbone (CV), 1st RA	
	09/87→02/90	Tie Rod End	CV-ES-2149		for Push Rod	
	09/87→02/90	Tie Rod End	CV-ES-14162		for Steering Rod	
	09/87→02/90	Tie Rod End	CV-ES-14163		for Steering Rod	
	09/87→02/90	Track Control Arm		MN-DL-3402	Trailing Arm	
	09/87→02/90	Track Control Arm		MN-DL-3402	Trailing Arm, Drive Axle	
	09/87→02/90	Track Control Arm		MN-DL-8609	Trailing Arm, Leaf Spring Axle	
	33.362 DFS	09/87→02/90	Ball Head, gearshift linkage	CV-ES-2119		
09/87→02/90		Ball Head, gearshift linkage	CV-ES-2120			
09/87→02/90		Ball Head, gearshift linkage	CV-ES-2182			
09/87→02/90		Centre Rod	MN-DL-3588		Push Rod	
09/87→02/90		Centre Rod	MN-DL-12421		for Steering Rod	
09/87→02/90		Engine Mounting		MN-SB-10390		
09/87→02/90		Engine Mounting	MN-SB-10389			
09/87→02/90		Mounting, stabilizer coupling rod	MN-SB-5246			
09/87→02/90		Stabiliser Mounting		MN-SB-5245		
09/87→02/90		Stabiliser Mounting		MN-SB-5254		
09/87→02/90		Stabiliser Mounting	MN-SB-9396			
09/87→02/90		Suspension Arm Repair Kit		MN-SB-5244	for Wishbone (CV)	
09/87→02/90		Suspension Arm Repair Kit		MN-SB-5244	for Wishbone (CV), 1st RA	
09/87→02/90		Tie Rod End	CV-ES-2149		for Push Rod	
09/87→02/90		Tie Rod End	CV-ES-14162		for Steering Rod	
09/87→02/90		Tie Rod End	CV-ES-14163		for Steering Rod	
09/87→02/90		Track Control Arm		MN-DL-3402	Trailing Arm	
09/87→02/90		Track Control Arm		MN-DL-3402	Trailing Arm, Drive Axle	
09/87→02/90		Track Control Arm		MN-DL-8609	Trailing Arm, Leaf Spring Axle	
33.372 DF		09/91→06/96	Ball Head, gearshift linkage	CV-ES-2119		
	09/91→06/96	Ball Head, gearshift linkage	CV-ES-2120			
	09/91→06/96	Ball Head, gearshift linkage	CV-ES-2182			
	09/91→06/96	Centre Rod	MN-DL-3588		Push Rod	
	09/91→06/96	Centre Rod	MN-DL-12421		for Steering Rod	
	09/91→06/96	Engine Mounting	MN-SB-10389			
	09/91→06/96	Mounting, stabilizer coupling rod	MN-SB-5246			
	09/91→06/96	Stabiliser Mounting		MN-SB-5245		
	09/91→06/96	Stabiliser Mounting		MN-SB-5254		
	09/91→06/96	Suspension Arm Repair Kit		MN-SB-5244	for Wishbone (CV)	
	09/91→06/96	Suspension Arm Repair Kit		MN-SB-5244	for Wishbone (CV), 1st RA	
	09/91→06/96	Tie Rod End	CV-ES-2149		for Push Rod	
	09/91→06/96	Tie Rod End	CV-ES-14162		for Steering Rod	
	09/91→06/96	Tie Rod End	CV-ES-14163		for Steering Rod	
	09/91→06/96	Track Control Arm		MN-DL-3402	Trailing Arm	
	09/91→06/96	Track Control Arm		MN-DL-8609	Trailing Arm, Leaf Spring Axle	
	33.372 DFA	09/91→06/96	Ball Head, gearshift linkage	CV-ES-2119		
		09/91→06/96	Ball Head, gearshift linkage	CV-ES-2120		
		09/91→06/96	Ball Head, gearshift linkage	CV-ES-2182		
		09/91→06/96	Centre Rod	MN-DL-3588		Push Rod
09/91→06/96		Centre Rod	MN-DL-12421		for Steering Rod	
09/91→06/96		Engine Mounting	MN-SB-10389			
09/91→06/96		Mounting, stabilizer coupling rod	MN-SB-5246			
09/91→06/96		Stabiliser Mounting		MN-SB-5245		
09/91→06/96		Stabiliser Mounting		MN-SB-5254		

CV-ES-2119

Length: 55
Cone Ø: d1 Ø 10 / d2 Ø 10
Thread: M12 x 1,75 LHT
81953016063, 81953016131



CV-ES-2120

Length: 115
Cone Ø: d1 Ø 12,4 / d2 Ø 10,8
Thread: M14 x 1,5 RHT
03008500A, 81953016200, 81953016202,
81953016203, 81953016227



CV-ES-2149

Length: 160
Cone Ø: d1 Ø 30 / d2 Ø 27
Thread: M30 x 1,5 RHT
81953016263



CV-ES-2182

Length: 55
Cone Ø: d1 Ø 10 / d2 Ø 10
Thread: M12 x 1,75 RHT
81953016064, 81953016170



CV-ES-14162

Length: 125
Cone Ø: d1 Ø 30 / d2 Ø 27
Thread: M30 x 1,5 LHT
81953010015, 81953010083, 81953010087,
81953016029, 81953016030, 81953016043,
81953016044, 81953016050, 81953016054,
81953016087, 81953016091, 81953016107,
81953016120, 81953016125, 81953016152,
81953016155, 81953016157, 81953016168,
81953016179, 81953016181, 81953016223,
81953016237, 81953016254, 81953016275,
81953016279, 81953016351



CV-ES-14163

Length: 125
Cone Ø: d1 Ø 30 / d2 Ø 27
Thread: M30 x 1,5 RHT
95301.0084, 90804102156, 90804102272,
90804102696, 90804102710, 81953010016,
81953010075, 81953010084, 81953010088,
81953010094, 81953010103, 81953016030,
81953016043, 81953016048, 81953016049,
81953016053, 81953016061, 81953016090,
81953016108, 81953016112, 81953016126,
81953016143, 81953016149, 81953016154,
81953016156, 81953016168, 81953016178,
81953016194, 81953016206, 81953016224,
81953016234, 81953016242, 81953016252,
81953016274, 81953016278, 81953016284,
81953016286, 81953016308, 81953016310,
81953016312, 81953016347, 81953016350,
81953016352, 82953016012, 88953016014,
N2953016001



MN-DL-3402

Length: 590 Ø: 48
Hole Distance: 130 / 130
03307200A, 81432206067, 81432206068,
81432206090, 81432206092, 81432209092



MN-DL-3588

Length: 1035
Ø: 48
Cone Ø: d1 Ø 30 / d2 Ø 27
81466106333, 81466106334, 81466106354,
81466106355, 81466106360, 81466106361,
81466106721, 81466106722, 81466106723,
81466116216



MN-DL-8609

Length: 585 Ø: 58
Hole Distance: 130 / 130
81432206070, 81432206071, 81432206072,
81432206091, 81432206093, 81432206119



MN-DL-12421

Length: 1070
Ø: 48
Cone Ø: d1 Ø 30 / d2 Ø 27
Thread: M30 x 1,5 RHT
81466106656, 81466106659, 81466106669,
81466116006, 81466116007



MN-SB-5244

Ø: 65
Hole Distance: 125
Thick/Height: 22
03312000A, 81432710027, 81432710082



MN-SB-5245

Ø: 75
Hole Distance: 125
Thick/Height: 22
03311900A, 81432710046, 81432710079,
81432710083



MN-SB-5246

Ø: 45 Thick/Height: 47
81437220022, 81437220038, 81962100450,
81962100469



MN-SB-5254

Length: 100
Ø: 93
Thick/Height: 70
81432710081



MN-SB-9396

Ø: 67
Thick/Height: 60
81437040057



MN-SB-10389

Ø: 70
Thick/Height: 72
81960200340



MN-SB-10390

Ø: 70
Thick/Height: 85/85
81960200341, 81960200373, 81960200385,
81960200408, 81960200418





F 90 ...

33.372 DFA ...	09/91→06/96	Stabiliser Mounting	MN-SB-9396		
	09/91→06/96	Suspension Arm Repair Kit		MN-SB-5244	for Wishbone (CV)
	09/91→06/96	Suspension Arm Repair Kit		MN-SB-5244	for Wishbone (CV), 1st RA
	09/91→06/96	Tie Rod End	CV-ES-2149		for Push Rod
	09/91→06/96	Tie Rod End	CV-ES-14162		for Steering Rod
	09/91→06/96	Tie Rod End	CV-ES-14163		for Steering Rod
	09/91→06/96	Track Control Arm		MN-DL-3402	Trailing Arm
	09/91→06/96	Track Control Arm		MN-DL-8609	Trailing Arm, Leaf Spring Axle
33.372 DFAK	01/91→06/96	Ball Head, gearshift linkage	CV-ES-2119		
	01/91→06/96	Ball Head, gearshift linkage	CV-ES-2120		
	01/91→06/96	Ball Head, gearshift linkage	CV-ES-2182		
	01/91→06/96	Centre Rod	MN-DL-3588		Push Rod
	01/91→06/96	Centre Rod	MN-DL-12421		for Steering Rod
	01/91→06/96	Engine Mounting	MN-SB-10389		
	01/91→06/96	Mounting, stabilizer coupling rod	MN-SB-5246		
	01/91→06/96	Stabiliser Mounting		MN-SB-5245	
	01/91→06/96	Stabiliser Mounting		MN-SB-5254	
	01/91→06/96	Stabiliser Mounting	MN-SB-9396		
	01/91→06/96	Suspension Arm Repair Kit		MN-SB-5244	for Wishbone (CV)
	01/91→06/96	Suspension Arm Repair Kit		MN-SB-5244	for Wishbone (CV), 1st RA
	01/91→06/96	Tie Rod End	CV-ES-2149		for Push Rod
	01/91→06/96	Tie Rod End	CV-ES-14162		for Steering Rod
	01/91→06/96	Tie Rod End	CV-ES-14163		for Steering Rod
	01/91→06/96	Track Control Arm		MN-DL-3402	Trailing Arm
	01/91→06/96	Track Control Arm		MN-DL-8609	Trailing Arm, Leaf Spring Axle
	33.372 DFK	01/91→06/96	Ball Head, gearshift linkage	CV-ES-2119	
01/91→06/96		Ball Head, gearshift linkage	CV-ES-2120		
01/91→06/96		Ball Head, gearshift linkage	CV-ES-2182		
01/91→06/96		Centre Rod	MN-DL-3588		Push Rod
01/91→06/96		Centre Rod	MN-DL-12421		for Steering Rod
01/91→06/96		Engine Mounting		MN-SB-10390	
01/91→06/96		Engine Mounting	MN-SB-10389		
01/91→06/96		Mounting, stabilizer coupling rod	MN-SB-5246		
01/91→06/96		Stabiliser Mounting		MN-SB-5245	
01/91→06/96		Stabiliser Mounting		MN-SB-5254	
01/91→06/96		Stabiliser Mounting	MN-SB-9396		
01/91→06/96		Suspension Arm Repair Kit		MN-SB-5244	for Wishbone (CV)
01/91→06/96		Suspension Arm Repair Kit		MN-SB-5244	for Wishbone (CV), 1st RA
01/91→06/96		Tie Rod End	CV-ES-2149		for Push Rod
01/91→06/96		Tie Rod End	CV-ES-14162		for Steering Rod
01/91→06/96		Tie Rod End	CV-ES-14163		for Steering Rod
01/91→06/96		Track Control Arm		MN-DL-3402	Trailing Arm
01/91→06/96		Track Control Arm		MN-DL-3402	Trailing Arm, Drive Axle
01/91→06/96	Track Control Arm		MN-DL-8609	Trailing Arm, Leaf Spring Axle	
33.372 DFS	09/91→06/96	Ball Head, gearshift linkage	CV-ES-2119		
	09/91→06/96	Ball Head, gearshift linkage	CV-ES-2120		
	09/91→06/96	Ball Head, gearshift linkage	CV-ES-2182		
	09/91→06/96	Centre Rod	MN-DL-3588		Push Rod
	09/91→06/96	Centre Rod	MN-DL-12421		for Steering Rod
	09/91→06/96	Engine Mounting		MN-SB-10390	
	09/91→06/96	Engine Mounting	MN-SB-10389		
	09/91→06/96	Mounting, stabilizer coupling rod	MN-SB-5246		
	09/91→06/96	Stabiliser Mounting		MN-SB-5245	
	09/91→06/96	Stabiliser Mounting		MN-SB-5254	
	09/91→06/96	Stabiliser Mounting	MN-SB-9396		
	09/91→06/96	Suspension Arm Repair Kit		MN-SB-5244	for Wishbone (CV)
	09/91→06/96	Suspension Arm Repair Kit		MN-SB-5244	for Wishbone (CV), 1st RA
	09/91→06/96	Tie Rod End	CV-ES-2149		for Push Rod
	09/91→06/96	Tie Rod End	CV-ES-14162		for Steering Rod
	09/91→06/96	Tie Rod End	CV-ES-14163		for Steering Rod
	09/91→06/96	Track Control Arm		MN-DL-3402	Trailing Arm
	09/91→06/96	Track Control Arm		MN-DL-3402	Trailing Arm, Drive Axle
09/91→06/96	Track Control Arm		MN-DL-8609	Trailing Arm, Leaf Spring Axle	

CV-ES-2119

Length: 55
Cone Ø: d1 Ø 10 / d2 Ø 10
Thread: M12 x 1,75 LHT
81953016063, 81953016131



CV-ES-2120

Length: 115
Cone Ø: d1 Ø 12,4 / d2 Ø 10,8
Thread: M14 x 1,5 RHT
03008500A, 81953016200, 81953016202,
81953016203, 81953016227



CV-ES-2149

Length: 160
Cone Ø: d1 Ø 30 / d2 Ø 27
Thread: M30 x 1,5 RHT
81953016263



CV-ES-2182

Length: 55
Cone Ø: d1 Ø 10 / d2 Ø 10
Thread: M12 x 1,75 RHT
81953016064, 81953016170



CV-ES-14162

Length: 125
Cone Ø: d1 Ø 30 / d2 Ø 27
Thread: M30 x 1,5 LHT

81953010015, 81953010083, 81953010087,
81953016029, 81953016030, 81953016043,
81953016044, 81953016050, 81953016054,
81953016087, 81953016091, 81953016107,
81953016120, 81953016125, 81953016152,
81953016155, 81953016157, 81953016168,
81953016179, 81953016181, 81953016223,
81953016237, 81953016254, 81953016275,
81953016279, 81953016351



CV-ES-14163

Length: 125
Cone Ø: d1 Ø 30 / d2 Ø 27
Thread: M30 x 1,5 RHT

95301.0084, 90804102156, 90804102272,
90804102696, 90804102710, 81953010016,
81953010075, 81953010084, 81953010088,
81953010094, 81953010103, 81953016030,
81953016043, 81953016048, 81953016049,
81953016053, 81953016061, 81953016090,
81953016108, 81953016112, 81953016126,
81953016143, 81953016149, 81953016154,
81953016156, 81953016168, 81953016178,
81953016194, 81953016206, 81953016224,
81953016234, 81953016242, 81953016252,
81953016274, 81953016278, 81953016284,
81953016286, 81953016308, 81953016310,
81953016312, 81953016347, 81953016350,
81953016352, 82953016012, 88953016014,
N2953016001



MN-DL-3402

Length: 590 Ø: 48
Hole Distance: 130 / 130
03307200A, 81432206067, 81432206068,
81432206090, 81432206092, 81432209092



MN-DL-3588

Length: 1035
Ø: 48
Cone Ø: d1 Ø 30 / d2 Ø 27
81466106333, 81466106334, 81466106354,
81466106355, 81466106360, 81466106361,
81466106721, 81466106722, 81466106723,
81466116216



MN-DL-8609

Length: 585 Ø: 58
Hole Distance: 130 / 130
81432206070, 81432206071, 81432206072,
81432206091, 81432206093, 81432206119



MN-DL-12421

Length: 1070
Ø: 48
Cone Ø: d1 Ø 30 / d2 Ø 27
Thread: M30 x 1,5 RHT
81466106656, 81466106659, 81466106669,
81466116006, 81466116007



MN-SB-5244

Ø: 65
Hole Distance: 125
Thick/Height: 22
03312000A, 81432710027, 81432710082



MN-SB-5245

Ø: 75
Hole Distance: 125
Thick/Height: 22
03311900A, 81432710046, 81432710079,
81432710083



MN-SB-5246

Ø: 45 Thick/Height: 47
81437220022, 81437220038, 81962100450,
81962100469



MN-SB-5254

Length: 100
Ø: 93
Thick/Height: 70
81432710081



MN-SB-9396

Ø: 67
Thick/Height: 60
81437040057



MN-SB-10389

Ø: 70
Thick/Height: 72
81960200340



MN-SB-10390

Ø: 70
Thick/Height: 85/85
81960200341, 81960200373, 81960200385,
81960200408, 81960200418





F 90 ...

33.402 DF	05/94 →06/96	Ball Head, gearshift linkage	CV-ES-2119			
	05/94 →06/96	Ball Head, gearshift linkage	CV-ES-2120			
	05/94 →06/96	Ball Head, gearshift linkage	CV-ES-2182			
	05/94 →06/96	Centre Rod	MN-DL-3588		Push Rod	
	05/94 →06/96	Centre Rod	MN-DL-12421		for Steering Rod	
	05/94 →06/96	Engine Mounting		MN-SB-10390		
	05/94 →06/96	Engine Mounting	MN-SB-10389			
	05/94 →06/96	Mounting, stabilizer coupling rod	MN-SB-5246			
	05/94 →06/96	Stabiliser Mounting		MN-SB-5245		
	05/94 →06/96	Stabiliser Mounting		MN-SB-5254		
	05/94 →06/96	Stabiliser Mounting	MN-SB-9396			
	05/94 →06/96	Suspension Arm Repair Kit		MN-SB-5244	for Wishbone (CV)	
	05/94 →06/96	Suspension Arm Repair Kit		MN-SB-5244	for Wishbone (CV), 1st RA	
	05/94 →06/96	Tie Rod End	CV-ES-2149		for Push Rod	
	05/94 →06/96	Tie Rod End	CV-ES-14162		for Steering Rod	
	05/94 →06/96	Tie Rod End	CV-ES-14163		for Steering Rod	
	05/94 →06/96	Track Control Arm		MN-DL-3402	Trailing Arm	
	05/94 →06/96	Track Control Arm		MN-DL-8609	Trailing Arm, Leaf Spring Axle	
	33.402 DFA	05/94 →06/96	Ball Head, gearshift linkage	CV-ES-2119		
		05/94 →06/96	Ball Head, gearshift linkage	CV-ES-2120		
05/94 →06/96		Ball Head, gearshift linkage	CV-ES-2182			
05/94 →06/96		Centre Rod	MN-DL-3588		Push Rod	
05/94 →06/96		Centre Rod	MN-DL-12421		for Steering Rod	
05/94 →06/96		Engine Mounting	MN-SB-10389			
05/94 →06/96		Mounting, stabilizer coupling rod	MN-SB-5246			
05/94 →06/96		Stabiliser Mounting		MN-SB-5245		
05/94 →06/96		Stabiliser Mounting		MN-SB-5254		
05/94 →06/96		Stabiliser Mounting	MN-SB-9396			
05/94 →06/96		Suspension Arm Repair Kit		MN-SB-5244	for Wishbone (CV)	
05/94 →06/96		Suspension Arm Repair Kit		MN-SB-5244	for Wishbone (CV), 1st RA	
05/94 →06/96		Tie Rod End	CV-ES-2149		for Push Rod	
05/94 →06/96		Tie Rod End	CV-ES-14162		for Steering Rod	
05/94 →06/96		Tie Rod End	CV-ES-14163		for Steering Rod	
05/94 →06/96		Track Control Arm		MN-DL-3402	Trailing Arm	
05/94 →06/96		Track Control Arm		MN-DL-8609	Trailing Arm, Leaf Spring Axle	
33.402 DFAK		05/94 →06/96	Ball Head, gearshift linkage	CV-ES-2119		
		05/94 →06/96	Ball Head, gearshift linkage	CV-ES-2120		
		05/94 →06/96	Ball Head, gearshift linkage	CV-ES-2182		
	05/94 →06/96	Centre Rod	MN-DL-3588		Push Rod	
	05/94 →06/96	Centre Rod	MN-DL-12421		for Steering Rod	
	05/94 →06/96	Engine Mounting	MN-SB-10389			
	05/94 →06/96	Mounting, stabilizer coupling rod	MN-SB-5246			
	05/94 →06/96	Stabiliser Mounting		MN-SB-5245		
	05/94 →06/96	Stabiliser Mounting		MN-SB-5254		
	05/94 →06/96	Stabiliser Mounting	MN-SB-9396			
	05/94 →06/96	Suspension Arm Repair Kit		MN-SB-5244	for Wishbone (CV)	
	05/94 →06/96	Suspension Arm Repair Kit		MN-SB-5244	for Wishbone (CV), 1st RA	
	05/94 →06/96	Tie Rod End	CV-ES-2149		for Push Rod	
	05/94 →06/96	Tie Rod End	CV-ES-14162		for Steering Rod	
	05/94 →06/96	Tie Rod End	CV-ES-14163		for Steering Rod	
	05/94 →06/96	Track Control Arm		MN-DL-3402	Trailing Arm	
	05/94 →06/96	Track Control Arm		MN-DL-8609	Trailing Arm, Leaf Spring Axle	
	33.402 DFK	05/94 →06/96	Ball Head, gearshift linkage	CV-ES-2119		
		05/94 →06/96	Ball Head, gearshift linkage	CV-ES-2120		
		05/94 →06/96	Ball Head, gearshift linkage	CV-ES-2182		
05/94 →06/96		Centre Rod	MN-DL-3588		Push Rod	
05/94 →06/96		Centre Rod	MN-DL-12421		for Steering Rod	
05/94 →06/96		Engine Mounting	MN-SB-10389			
05/94 →06/96		Mounting, stabilizer coupling rod	MN-SB-5246			
05/94 →06/96		Stabiliser Mounting		MN-SB-5245		
05/94 →06/96		Stabiliser Mounting		MN-SB-5254		
05/94 →06/96		Stabiliser Mounting	MN-SB-9396			
05/94 →06/96		Suspension Arm Repair Kit		MN-SB-5244	for Wishbone (CV)	
05/94 →06/96		Suspension Arm Repair Kit		MN-SB-5244	for Wishbone (CV), 1st RA	
05/94 →06/96		Tie Rod End	CV-ES-2149		for Push Rod	
05/94 →06/96		Tie Rod End	CV-ES-14162		for Steering Rod	
05/94 →06/96		Tie Rod End	CV-ES-14163		for Steering Rod	
05/94 →06/96		Track Control Arm		MN-DL-3402	Trailing Arm	
05/94 →06/96		Track Control Arm		MN-DL-8609	Trailing Arm, Leaf Spring Axle	

CV-ES-2119

Length: 55
Cone Ø: d1 Ø 10 / d2 Ø 10
Thread: M12 x 1,75 LHT
81953016063, 81953016131



CV-ES-2120

Length: 115
Cone Ø: d1 Ø 12,4 / d2 Ø 10,8
Thread: M14 x 1,5 RHT
03008500A, 81953016200, 81953016202,
81953016203, 81953016227



CV-ES-2149

Length: 160
Cone Ø: d1 Ø 30 / d2 Ø 27
Thread: M30 x 1,5 RHT
81953016263



CV-ES-2182

Length: 55
Cone Ø: d1 Ø 10 / d2 Ø 10
Thread: M12 x 1,75 RHT
81953016064, 81953016170



CV-ES-14162

Length: 125
Cone Ø: d1 Ø 30 / d2 Ø 27
Thread: M30 x 1,5 LHT
81953010015, 81953010083, 81953010087,
81953016029, 81953016030, 81953016043,
81953016044, 81953016050, 81953016054,
81953016087, 81953016091, 81953016107,
81953016120, 81953016125, 81953016152,
81953016155, 81953016157, 81953016168,
81953016179, 81953016181, 81953016223,
81953016237, 81953016254, 81953016275,
81953016279, 81953016351



CV-ES-14163

Length: 125
Cone Ø: d1 Ø 30 / d2 Ø 27
Thread: M30 x 1,5 RHT
95301.0084, 90804102156, 90804102272,
90804102696, 90804102710, 81953010016,
81953010075, 81953010084, 81953010088,
81953010094, 81953010103, 81953016030,
81953016043, 81953016048, 81953016049,
81953016053, 81953016061, 81953016090,
81953016108, 81953016112, 81953016126,
81953016143, 81953016149, 81953016154,
81953016156, 81953016168, 81953016178,
81953016194, 81953016206, 81953016224,
81953016234, 81953016242, 81953016252,
81953016274, 81953016278, 81953016284,
81953016286, 81953016308, 81953016310,
81953016312, 81953016347, 81953016350,
81953016352, 82953016012, 88953016014,
N2953016001



MN-DL-3402

Length: 590 Ø: 48
Hole Distance: 130 / 130
03307200A, 81432206067, 81432206068,
81432206090, 81432206092, 81432209092



MN-DL-3588

Length: 1035
Ø: 48
Cone Ø: d1 Ø 30 / d2 Ø 27
81466106333, 81466106334, 81466106354,
81466106355, 81466106360, 81466106361,
81466106721, 81466106722, 81466106723,
81466116216



MN-DL-8609

Length: 585 Ø: 58
Hole Distance: 130 / 130
81432206070, 81432206071, 81432206072,
81432206091, 81432206093, 81432206119



MN-DL-12421

Length: 1070
Ø: 48
Cone Ø: d1 Ø 30 / d2 Ø 27
Thread: M30 x 1,5 RHT
81466106656, 81466106659, 81466106669,
81466116006, 81466116007



MN-SB-5244

Ø: 65
Hole Distance: 125
Thick/Height: 22
03312000A, 81432710027, 81432710082



MN-SB-5245

Ø: 75
Hole Distance: 125
Thick/Height: 22
03311900A, 81432710046, 81432710079,
81432710083



MN-SB-5246

Ø: 45 Thick/Height: 47
81437220022, 81437220038, 81962100450,
81962100469



MN-SB-5254

Length: 100
Ø: 93
Thick/Height: 70
81432710081



MN-SB-9396

Ø: 67
Thick/Height: 60
81437040057



MN-SB-10389

Ø: 70
Thick/Height: 72
81960200340



MN-SB-10390

Ø: 70
Thick/Height: 85/85
81960200341, 81960200373, 81960200385,
81960200408, 81960200418





F 90 ...

33.402 DFK ...	05/94 → 06/96	Suspension Arm Repair Kit		MN-SB-5244	for Wishbone (CV)	
	05/94 → 06/96	Suspension Arm Repair Kit		MN-SB-5244	for Wishbone (CV), 1st RA	
	05/94 → 06/96	Tie Rod End	CV-ES-2149		for Push Rod	
	05/94 → 06/96	Tie Rod End	CV-ES-14162		for Steering Rod	
	05/94 → 06/96	Tie Rod End	CV-ES-14163		for Steering Rod	
	05/94 → 06/96	Track Control Arm		MN-DL-3402	Trailing Arm	
	05/94 → 06/96	Track Control Arm		MN-DL-3402	Trailing Arm, Drive Axle	
33.402 DFS	05/94 → 06/96	Track Control Arm		MN-DL-8609	Trailing Arm, Leaf Spring Axle	
	05/94 → 06/96	Ball Head, gearshift linkage	CV-ES-2119			
	05/94 → 06/96	Ball Head, gearshift linkage	CV-ES-2120			
	05/94 → 06/96	Ball Head, gearshift linkage	CV-ES-2182			
	05/94 → 06/96	Centre Rod	MN-DL-3588		Push Rod	
	05/94 → 06/96	Centre Rod	MN-DL-12421		for Steering Rod	
	05/94 → 06/96	Engine Mounting		MN-SB-10390		
	05/94 → 06/96	Engine Mounting	MN-SB-10389			
	05/94 → 06/96	Mounting, stabilizer coupling rod	MN-SB-5246			
	05/94 → 06/96	Stabiliser Mounting		MN-SB-5245		
	05/94 → 06/96	Stabiliser Mounting		MN-SB-5254		
	05/94 → 06/96	Stabiliser Mounting	MN-SB-9396			
	05/94 → 06/96	Suspension Arm Repair Kit		MN-SB-5244	for Wishbone (CV)	
	05/94 → 06/96	Suspension Arm Repair Kit		MN-SB-5244	for Wishbone (CV), 1st RA	
	05/94 → 06/96	Tie Rod End	CV-ES-2149		for Push Rod	
	05/94 → 06/96	Tie Rod End	CV-ES-14162		for Steering Rod	
	05/94 → 06/96	Tie Rod End	CV-ES-14163		for Steering Rod	
	05/94 → 06/96	Track Control Arm		MN-DL-3402	Trailing Arm	
	05/94 → 06/96	Track Control Arm		MN-DL-3402	Trailing Arm, Drive Axle	
	05/94 → 06/96	Track Control Arm		MN-DL-8609	Trailing Arm, Leaf Spring Axle	
	33.422 DF	09/91 → 06/96	Ball Head, gearshift linkage	CV-ES-2119		
09/91 → 06/96		Ball Head, gearshift linkage	CV-ES-2120			
09/91 → 06/96		Ball Head, gearshift linkage	CV-ES-2182			
09/91 → 06/96		Centre Rod	MN-DL-3588		Push Rod	
09/91 → 06/96		Centre Rod	MN-DL-12421		for Steering Rod	
09/91 → 06/96		Engine Mounting		MN-SB-10390		
09/91 → 06/96		Engine Mounting	MN-SB-10389			
09/91 → 06/96		Mounting, stabilizer coupling rod	MN-SB-5246			
09/91 → 06/96		Stabiliser Mounting		MN-SB-5245		
09/91 → 06/96		Stabiliser Mounting		MN-SB-5254		
09/91 → 06/96		Stabiliser Mounting	MN-SB-9396			
09/91 → 06/96		Suspension Arm Repair Kit		MN-SB-5244	for Wishbone (CV)	
09/91 → 06/96		Suspension Arm Repair Kit		MN-SB-5244	for Wishbone (CV), 1st RA	
09/91 → 06/96		Tie Rod End	CV-ES-2149		for Push Rod	
09/91 → 06/96		Tie Rod End	CV-ES-14162		for Steering Rod	
09/91 → 06/96		Tie Rod End	CV-ES-14163		for Steering Rod	
09/91 → 06/96		Track Control Arm		MN-DL-3402	Trailing Arm	
09/91 → 06/96		Track Control Arm		MN-DL-3402	Trailing Arm, Drive Axle	
09/91 → 06/96		Track Control Arm		MN-DL-8609	Trailing Arm, Leaf Spring Axle	
33.422 DFA		09/91 → 06/96	Ball Head, gearshift linkage	CV-ES-2119		
		09/91 → 06/96	Ball Head, gearshift linkage	CV-ES-2120		
	09/91 → 06/96	Ball Head, gearshift linkage	CV-ES-2182			
	09/91 → 06/96	Centre Rod	MN-DL-3588		Push Rod	
	09/91 → 06/96	Centre Rod	MN-DL-12421		for Steering Rod	
	09/91 → 06/96	Engine Mounting	MN-SB-10389			
	09/91 → 06/96	Mounting, stabilizer coupling rod	MN-SB-5246			
	09/91 → 06/96	Stabiliser Mounting		MN-SB-5245		
	09/91 → 06/96	Stabiliser Mounting		MN-SB-5254		
	09/91 → 06/96	Stabiliser Mounting	MN-SB-9396			
	09/91 → 06/96	Suspension Arm Repair Kit		MN-SB-5244	for Wishbone (CV)	
	09/91 → 06/96	Suspension Arm Repair Kit		MN-SB-5244	for Wishbone (CV), 1st RA	
	09/91 → 06/96	Tie Rod End	CV-ES-2149		for Push Rod	
	09/91 → 06/96	Tie Rod End	CV-ES-14162		for Steering Rod	
	09/91 → 06/96	Tie Rod End	CV-ES-14163		for Steering Rod	
	09/91 → 06/96	Track Control Arm		MN-DL-3402	Trailing Arm	
	09/91 → 06/96	Track Control Arm		MN-DL-8609	Trailing Arm, Leaf Spring Axle	

CV-ES-2119

Length: 55
Cone Ø: d1 Ø 10 / d2 Ø 10
Thread: M12 x 1,75 LHT
81953016063, 81953016131



CV-ES-2120

Length: 115
Cone Ø: d1 Ø 12,4 / d2 Ø 10,8
Thread: M14 x 1,5 RHT
03008500A, 81953016200, 81953016202,
81953016203, 81953016227



CV-ES-2149

Length: 160
Cone Ø: d1 Ø 30 / d2 Ø 27
Thread: M30 x 1,5 RHT
81953016263



CV-ES-2182

Length: 55
Cone Ø: d1 Ø 10 / d2 Ø 10
Thread: M12 x 1,75 RHT
81953016064, 81953016170



CV-ES-14162

Length: 125
Cone Ø: d1 Ø 30 / d2 Ø 27
Thread: M30 x 1,5 LHT
81953010015, 81953010083, 81953010087,
81953016029, 81953016030, 81953016043,
81953016044, 81953016050, 81953016054,
81953016087, 81953016091, 81953016107,
81953016120, 81953016125, 81953016152,
81953016155, 81953016157, 81953016168,
81953016179, 81953016181, 81953016223,
81953016237, 81953016254, 81953016275,
81953016279, 81953016351



CV-ES-14163

Length: 125
Cone Ø: d1 Ø 30 / d2 Ø 27
Thread: M30 x 1,5 RHT
95301.0084, 90804102156, 90804102272,
90804102696, 90804102710, 81953010016,
81953010075, 81953010084, 81953010088,
81953010094, 81953010103, 81953016030,
81953016043, 81953016048, 81953016049,
81953016053, 81953016061, 81953016090,
81953016108, 81953016112, 81953016126,
81953016143, 81953016149, 81953016154,
81953016156, 81953016168, 81953016178,
81953016194, 81953016206, 81953016224,
81953016234, 81953016242, 81953016252,
81953016274, 81953016278, 81953016284,
81953016286, 81953016308, 81953016310,
81953016312, 81953016347, 81953016350,
81953016352, 82953016012, 88953016014,
N2953016001



MN-DL-3402

Length: 590 Ø: 48
Hole Distance: 130 / 130
03307200A, 81432206067, 81432206068,
81432206090, 81432206092, 81432209092



MN-DL-3588

Length: 1035
Ø: 48
Cone Ø: d1 Ø 30 / d2 Ø 27
81466106333, 81466106334, 81466106354,
81466106355, 81466106360, 81466106361,
81466106721, 81466106722, 81466106723,
81466116216



MN-DL-8609

Length: 585 Ø: 58
Hole Distance: 130 / 130
81432206070, 81432206071, 81432206072,
81432206091, 81432206093, 81432206119



MN-DL-12421

Length: 1070
Ø: 48
Cone Ø: d1 Ø 30 / d2 Ø 27
Thread: M30 x 1,5 RHT
81466106656, 81466106659, 81466106669,
81466116006, 81466116007



MN-SB-5244

Ø: 65
Hole Distance: 125
Thick/Height: 22
03312000A, 81432710027, 81432710082



MN-SB-5245

Ø: 75
Hole Distance: 125
Thick/Height: 22
03311900A, 81432710046, 81432710079,
81432710083



MN-SB-5246

Ø: 45 Thick/Height: 47
81437220022, 81437220038, 81962100450,
81962100469



MN-SB-5254

Length: 100
Ø: 93
Thick/Height: 70
81432710081



MN-SB-9396

Ø: 67
Thick/Height: 60
81437040057



MN-SB-10389

Ø: 70
Thick/Height: 72
81960200340



MN-SB-10390

Ø: 70
Thick/Height: 85/85
81960200341, 81960200373, 81960200385,
81960200408, 81960200418



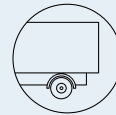

F 90 ...

33.422 DFAK	01/94 → 06/96	Ball Head, gearshift linkage	CV-ES-2119			
	01/94 → 06/96	Ball Head, gearshift linkage	CV-ES-2120			
	01/94 → 06/96	Ball Head, gearshift linkage	CV-ES-2182			
	01/94 → 06/96	Centre Rod	MN-DL-3588		Push Rod	
	01/94 → 06/96	Centre Rod	MN-DL-12421		for Steering Rod	
	01/94 → 06/96	Engine Mounting	MN-SB-10389			
	01/94 → 06/96	Mounting, stabilizer coupling rod	MN-SB-5246			
	01/94 → 06/96	Stabiliser Mounting		MN-SB-5245		
	01/94 → 06/96	Stabiliser Mounting		MN-SB-5254		
	01/94 → 06/96	Stabiliser Mounting	MN-SB-9396			
	01/94 → 06/96	Suspension Arm Repair Kit		MN-SB-5244	for Wishbone (CV)	
	01/94 → 06/96	Suspension Arm Repair Kit		MN-SB-5244	for Wishbone (CV), 1st RA	
	01/94 → 06/96	Tie Rod End	CV-ES-2149		for Push Rod	
	01/94 → 06/96	Tie Rod End	CV-ES-14162		for Steering Rod	
	01/94 → 06/96	Tie Rod End	CV-ES-14163		for Steering Rod	
	01/94 → 06/96	Track Control Arm		MN-DL-3402	Trailing Arm	
	01/94 → 06/96	Track Control Arm		MN-DL-8609	Trailing Arm, Leaf Spring Axle	
	33.422 DFK	01/94 → 06/96	Ball Head, gearshift linkage	CV-ES-2119		
		01/94 → 06/96	Ball Head, gearshift linkage	CV-ES-2120		
		01/94 → 06/96	Ball Head, gearshift linkage	CV-ES-2182		
01/94 → 06/96		Centre Rod	MN-DL-3588		Push Rod	
01/94 → 06/96		Centre Rod	MN-DL-12421		for Steering Rod	
01/94 → 06/96		Engine Mounting		MN-SB-10390		
01/94 → 06/96		Engine Mounting	MN-SB-10389			
01/94 → 06/96		Mounting, stabilizer coupling rod	MN-SB-5246			
01/94 → 06/96		Stabiliser Mounting		MN-SB-5245		
01/94 → 06/96		Stabiliser Mounting		MN-SB-5254		
01/94 → 06/96		Stabiliser Mounting	MN-SB-9396			
01/94 → 06/96		Suspension Arm Repair Kit		MN-SB-5244	for Wishbone (CV)	
01/94 → 06/96		Suspension Arm Repair Kit		MN-SB-5244	for Wishbone (CV), 1st RA	
01/94 → 06/96		Tie Rod End	CV-ES-2149		for Push Rod	
01/94 → 06/96		Tie Rod End	CV-ES-14162		for Steering Rod	
01/94 → 06/96		Tie Rod End	CV-ES-14163		for Steering Rod	
01/94 → 06/96		Track Control Arm		MN-DL-3402	Trailing Arm	
01/94 → 06/96		Track Control Arm		MN-DL-3402	Trailing Arm, Drive Axle	
01/94 → 06/96		Track Control Arm		MN-DL-8609	Trailing Arm, Leaf Spring Axle	
33.422 DFS		01/94 → 06/96	Ball Head, gearshift linkage	CV-ES-2119		
	01/94 → 06/96	Ball Head, gearshift linkage	CV-ES-2120			
	01/94 → 06/96	Ball Head, gearshift linkage	CV-ES-2182			
	01/94 → 06/96	Centre Rod	MN-DL-3588		Push Rod	
	01/94 → 06/96	Centre Rod	MN-DL-12421		for Steering Rod	
	01/94 → 06/96	Engine Mounting		MN-SB-10390		
	01/94 → 06/96	Engine Mounting	MN-SB-10389			
	01/94 → 06/96	Mounting, stabilizer coupling rod	MN-SB-5246			
	01/94 → 06/96	Stabiliser Mounting		MN-SB-5245		
	01/94 → 06/96	Stabiliser Mounting		MN-SB-5254		
	01/94 → 06/96	Stabiliser Mounting	MN-SB-9396			
	01/94 → 06/96	Suspension Arm Repair Kit		MN-SB-5244	for Wishbone (CV)	
	01/94 → 06/96	Suspension Arm Repair Kit		MN-SB-5244	for Wishbone (CV), 1st RA	
	01/94 → 06/96	Tie Rod End	CV-ES-2149		for Push Rod	
	01/94 → 06/96	Tie Rod End	CV-ES-14162		for Steering Rod	
	01/94 → 06/96	Tie Rod End	CV-ES-14163		for Steering Rod	
	01/94 → 06/96	Track Control Arm		MN-DL-3402	Trailing Arm	
	01/94 → 06/96	Track Control Arm		MN-DL-3402	Trailing Arm, Drive Axle	
	01/94 → 06/96	Track Control Arm		MN-DL-8609	Trailing Arm, Leaf Spring Axle	
	33.462 DF	07/89 → 02/90	Ball Head, gearshift linkage	CV-ES-2120		
07/89 → 02/90		Tie Rod End	CV-ES-14163		for Steering Rod	
07/89 → 02/90		Track Control Arm		MN-DL-3402	Trailing Arm, Drive Axle	
07/89 → 02/90		Track Control Arm		MN-DL-8609	Trailing Arm, Leaf Spring Axle	
33.462 DFA	07/89 → 02/90	Ball Head, gearshift linkage	CV-ES-2120			
	07/89 → 02/90	Centre Rod	MN-DL-12421		for Steering Rod	
	07/89 → 02/90	Mounting, stabilizer coupling rod	MN-SB-5246			
	07/89 → 02/90	Stabiliser Mounting		MN-SB-5254		

CV-ES-2119

Length: 55
Cone Ø: d1 Ø 10 / d2 Ø 10
Thread: M12 x 1,75 LHT
81953016063, 81953016131



CV-ES-2120

Length: 115
Cone Ø: d1 Ø 12,4 / d2 Ø 10,8
Thread: M14 x 1,5 RHT
03008500A, 81953016200, 81953016202,
81953016203, 81953016227



CV-ES-2149

Length: 160
Cone Ø: d1 Ø 30 / d2 Ø 27
Thread: M30 x 1,5 RHT
81953016263



CV-ES-2182

Length: 55
Cone Ø: d1 Ø 10 / d2 Ø 10
Thread: M12 x 1,75 RHT
81953016064, 81953016170



CV-ES-14162

Length: 125
Cone Ø: d1 Ø 30 / d2 Ø 27
Thread: M30 x 1,5 LHT

81953010015, 81953010083, 81953010087,
81953016029, 81953016030, 81953016043,
81953016044, 81953016050, 81953016054,
81953016087, 81953016091, 81953016107,
81953016120, 81953016125, 81953016152,
81953016155, 81953016157, 81953016168,
81953016179, 81953016181, 81953016223,
81953016237, 81953016254, 81953016275,
81953016279, 81953016351



CV-ES-14163

Length: 125
Cone Ø: d1 Ø 30 / d2 Ø 27
Thread: M30 x 1,5 RHT

95301.0084, 90804102156, 90804102272,
90804102696, 90804102710, 81953010016,
81953010075, 81953010084, 81953010088,
81953010094, 81953010103, 81953016030,
81953016043, 81953016048, 81953016049,
81953016053, 81953016061, 81953016090,
81953016108, 81953016112, 81953016126,
81953016143, 81953016149, 81953016154,
81953016156, 81953016168, 81953016178,
81953016194, 81953016206, 81953016224,
81953016234, 81953016242, 81953016252,
81953016274, 81953016278, 81953016284,
81953016286, 81953016308, 81953016310,
81953016312, 81953016347, 81953016350,
81953016352, 82953016012, 88953016014,
N2953016001



MN-DL-3402

Length: 590 Ø: 48
Hole Distance: 130 / 130

03307200A, 81432206067, 81432206068,
81432206090, 81432206092, 81432209092



MN-DL-3588

Length: 1035
Ø: 48
Cone Ø: d1 Ø 30 / d2 Ø 27

81466106333, 81466106334, 81466106354,
81466106355, 81466106360, 81466106361,
81466106721, 81466106722, 81466106723,
81466116216



MN-DL-8609

Length: 585 Ø: 58
Hole Distance: 130 / 130

81432206070, 81432206071, 81432206072,
81432206091, 81432206093, 81432206119



MN-DL-12421

Length: 1070
Ø: 48
Cone Ø: d1 Ø 30 / d2 Ø 27
Thread: M30 x 1,5 RHT

81466106656, 81466106659, 81466106669,
81466116006, 81466116007



MN-SB-5244

Ø: 65
Hole Distance: 125
Thick/Height: 22
03312000A, 81432710027, 81432710082



MN-SB-5245

Ø: 75
Hole Distance: 125
Thick/Height: 22
03311900A, 81432710046, 81432710079,
81432710083



MN-SB-5246

Ø: 45 Thick/Height: 47
81437220022, 81437220038, 81962100450,
81962100469



MN-SB-5254

Length: 100
Ø: 93
Thick/Height: 70
81432710081



MN-SB-9396

Ø: 67
Thick/Height: 60
81437040057



MN-SB-10389

Ø: 70
Thick/Height: 72
81960200340



MN-SB-10390

Ø: 70
Thick/Height: 85/85
81960200341, 81960200373, 81960200385,
81960200408, 81960200418





F 90 ...

33.462 DFA ...	07/89→02/90	Stabiliser Mounting	MN-SB-9396		
	07/89→02/90	Tie Rod End	CV-ES-14163		for Steering Rod
	07/89→02/90	Track Control Arm		MN-DL-3402	Trailing Arm
	07/89→02/90	Track Control Arm		MN-DL-8609	Trailing Arm, Leaf Spring Axle
33.502 DF	09/91→06/96	Ball Head, gearshift linkage	CV-ES-2120		
	09/91→06/96	Tie Rod End	CV-ES-14163		for Steering Rod
	09/91→06/96	Track Control Arm		MN-DL-3402	Trailing Arm, Drive Axle
33.502 DFA	09/91→06/96	Track Control Arm		MN-DL-8609	Trailing Arm, Leaf Spring Axle
	09/91→06/96	Ball Head, gearshift linkage	CV-ES-2120		
	09/91→06/96	Centre Rod	MN-DL-12421		for Steering Rod
35.262 VF	09/91→06/96	Mounting, stabilizer coupling rod	MN-SB-5246		
	09/91→06/96	Stabiliser Mounting		MN-SB-5254	
	09/91→06/96	Stabiliser Mounting	MN-SB-9396		
	09/91→06/96	Tie Rod End	CV-ES-14163		for Steering Rod
	09/91→06/96	Track Control Arm		MN-DL-3402	Trailing Arm
	09/91→06/96	Track Control Arm		MN-DL-8609	Trailing Arm, Leaf Spring Axle
	02/89→02/90	Ball Head, gearshift linkage	CV-ES-2119		
	02/89→02/90	Ball Head, gearshift linkage	CV-ES-2120		
	02/89→02/90	Ball Head, gearshift linkage	CV-ES-2182		
	02/89→02/90	Centre Rod	MN-DL-2160		Coupling Rod
02/89→02/90	Centre Rod	MN-DL-2166		Push Rod	
02/89→02/90	Centre Rod	MN-DL-3588		Push Rod	
02/89→02/90	Centre Rod	MN-DL-12278		for Steering Rod	
02/89→02/90	Engine Mounting	MN-SB-10389			
02/89→02/90	Mounting, stabilizer coupling rod	MN-SB-5246			
02/89→02/90	Mounting, stabilizer coupling rod	MN-SB-5246		1st FA	
02/89→02/90	Stabiliser Mounting		MN-SB-5245		
02/89→02/90	Stabiliser Mounting		MN-SB-5254		
02/89→02/90	Stabiliser Mounting	MN-SB-9396			
02/89→02/90	Suspension Arm Repair Kit		MN-SB-5244	for Wishbone (CV)	
02/89→02/90	Suspension Arm Repair Kit		MN-SB-5244	for Wishbone (CV), 2nd RA	
02/89→02/90	Tie Rod	MN-DL-12284			
02/89→02/90	Tie Rod End	CV-ES-2146			
02/89→02/90	Tie Rod End	CV-ES-2149		for Push Rod	
02/89→02/90	Tie Rod End	CV-ES-14162		for Steering Rod	
02/89→02/90	Tie Rod End	CV-ES-14163		for Steering Rod	
02/89→02/90	Track Control Arm		MN-DL-3402	Trailing Arm	
02/89→02/90	Track Control Arm		MN-DL-3402	Trailing Arm, Drive Axle	
02/89→02/90	Track Control Arm		MN-DL-8609	Trailing Arm, Leaf Spring Axle	
35.262 VFA	07/89→02/90	Ball Head, gearshift linkage	CV-ES-2119		
	07/89→02/90	Ball Head, gearshift linkage	CV-ES-2120		
	07/89→02/90	Ball Head, gearshift linkage	CV-ES-2182		
	07/89→02/90	Centre Rod	MN-DL-2160		Coupling Rod
	07/89→02/90	Centre Rod	MN-DL-2166		Push Rod
	07/89→02/90	Centre Rod	MN-DL-3588		Push Rod
	07/89→02/90	Centre Rod	MN-DL-12278		for Steering Rod
	07/89→02/90	Engine Mounting	MN-SB-10389		
	07/89→02/90	Mounting, stabilizer coupling rod	MN-SB-5246		
	07/89→02/90	Mounting, stabilizer coupling rod	MN-SB-5246		1st FA
	07/89→02/90	Suspension Arm Repair Kit		MN-SB-5244	for Wishbone (CV)
	07/89→02/90	Suspension Arm Repair Kit		MN-SB-5244	for Wishbone (CV), 2nd RA
	07/89→02/90	Tie Rod	MN-DL-12284		
	07/89→02/90	Tie Rod End	CV-ES-2146		
	07/89→02/90	Tie Rod End	CV-ES-2149		for Push Rod
	07/89→02/90	Tie Rod End	CV-ES-14162		for Steering Rod
	07/89→02/90	Tie Rod End	CV-ES-14163		for Steering Rod
	07/89→02/90	Track Control Arm		MN-DL-3402	Trailing Arm
	07/89→02/90	Track Control Arm		MN-DL-3402	Trailing Arm, Drive Axle
	07/89→02/90	Track Control Arm		MN-DL-8609	Trailing Arm, Leaf Spring Axle
35.262 VFK	02/89→02/90	Ball Head, gearshift linkage	CV-ES-2119		
	02/89→02/90	Ball Head, gearshift linkage	CV-ES-2120		
	02/89→02/90	Ball Head, gearshift linkage	CV-ES-2182		
	02/89→02/90	Centre Rod	MN-DL-2160		Coupling Rod

CV-ES-2119

Length: 55
Cone Ø: d1 Ø 10 / d2 Ø 10
Thread: M12 x 1,75 LHT
81953016063, 81953016131



CV-ES-2120

Length: 115
Cone Ø: d1 Ø 12,4 / d2 Ø 10,8
Thread: M14 x 1,5 RHT
03008500A, 81953016200, 81953016202,
81953016203, 81953016227



CV-ES-2146

Length: 80
Cone Ø: d1 Ø 30 / d2 Ø 27
Thread: M26 x 1,5 RHT
42533102, 81953016219, 81953016225,
81953016226, 81953016267, 81953016291



CV-ES-2149

Length: 160
Cone Ø: d1 Ø 30 / d2 Ø 27
Thread: M30 x 1,5 RHT
81953016263



CV-ES-2182

Length: 55
Cone Ø: d1 Ø 10 / d2 Ø 10
Thread: M12 x 1,75 RHT
81953016064, 81953016170



CV-ES-14162

Length: 125
Cone Ø: d1 Ø 30 / d2 Ø 27
Thread: M30 x 1,5 LHT
81953010015, 81953010083, 81953010087,
81953016029, 81953016030, 81953016043,
81953016044, 81953016050, 81953016054,
81953016087, 81953016091, 81953016107,
81953016120, 81953016125, 81953016152,
81953016155, 81953016157, 81953016168,
81953016179, 81953016181, 81953016223,
81953016237, 81953016254, 81953016275,
81953016279, 81953016351



CV-ES-14163

Length: 125
Cone Ø: d1 Ø 30 / d2 Ø 27
Thread: M30 x 1,5 RHT
95301.0084, 90804102156, 90804102272,
90804102696, 90804102710, 81953010016,
81953010075, 81953010084, 81953010088,
81953010094, 81953010103, 81953016030,
81953016043, 81953016048, 81953016049,
81953016053, 81953016061, 81953016090,
81953016108, 81953016112, 81953016126,
81953016143, 81953016149, 81953016154,
81953016156, 81953016168, 81953016178,
81953016194, 81953016206, 81953016224,
81953016234, 81953016242, 81953016252,
81953016274, 81953016278, 81953016284,
81953016286, 81953016308, 81953016310,
81953016312, 81953016347, 81953016350,
81953016352, 82953016012, 88953016014,
N2953016001



MN-DL-2160

Length: 1652 Ø: 50
Cone Ø: d1 Ø 30 / d2 Ø 27
81467106112, 81467106163, 81467106165,
81467106198, 81467106353, 81467106354,
81467106361, 81467116725



MN-DL-2166

Length: 1795 Ø: 50
Cone Ø: d1 Ø 30 / d2 Ø 27
81467106418



MN-DL-3402

Length: 590 Ø: 48
Hole Distance: 130 / 130
03307200A, 81432206067, 81432206068,
81432206090, 81432206092, 81432209092



MN-DL-3588

Length: 1035 Ø: 48
Cone Ø: d1 Ø 30 / d2 Ø 27
81466106333, 81466106334, 81466106354,
81466106355, 81466106360, 81466106361,
81466106721, 81466106722, 81466106723,
81466116216



MN-DL-8609

Length: 585 Ø: 58
Hole Distance: 130 / 130
81432206070, 81432206071, 81432206072,
81432206091, 81432206093, 81432206119



MN-DL-12278

Length: 770 Ø: 40
Cone Ø: d1 Ø 30 / d2 Ø 27
81466106348



MN-DL-12284

Length: 1530 Ø: 50
Cone Ø: d1 Ø 30 / d2 Ø 27
81466106579, 81466106580, 81466106624,
81466116720, 81467116720, 81467116730,
81467116952



MN-DL-12421

Length: 1070 Ø: 48
Cone Ø: d1 Ø 30 / d2 Ø 27
Thread: M30 x 1,5 RHT
81466106656, 81466106659, 81466106669,
81466116006, 81466116007



MN-SB-5244

Ø: 65
Hole Distance: 125
Thick/Height: 22
03312000A, 81432710027, 81432710082



MN-SB-5245

Ø: 75
Hole Distance: 125
Thick/Height: 22
03311900A, 81432710046, 81432710079,
81432710083



MN-SB-5246

Ø: 45 Thick/Height: 47
81437220022, 81437220038, 81962100450,
81962100469



MN-SB-5254

Length: 100 Ø: 93
Thick/Height: 70
81432710081



MN-SB-9396

Ø: 67 Thick/Height: 60
81437040057



MN-SB-10389

Ø: 70 Thick/Height: 72
81960200340





F 90 ...

35.262 VFK ...	02/89→02/90	Centre Rod	MN-DL-2166		Push Rod	
	02/89→02/90	Centre Rod	MN-DL-3588		Push Rod	
	02/89→02/90	Centre Rod	MN-DL-12278		for Steering Rod	
	02/89→02/90	Engine Mounting	MN-SB-10389			
	02/89→02/90	Mounting, stabilizer coupling rod	MN-SB-5246			
	02/89→02/90	Mounting, stabilizer coupling rod	MN-SB-5246		1st FA	
	02/89→02/90	Stabiliser Mounting		MN-SB-5245		
	02/89→02/90	Stabiliser Mounting		MN-SB-5254		
	02/89→02/90	Stabiliser Mounting	MN-SB-9396			
	02/89→02/90	Suspension Arm Repair Kit		MN-SB-5244	for Wishbone (CV)	
	02/89→02/90	Suspension Arm Repair Kit		MN-SB-5244	for Wishbone (CV), 2nd RA	
	02/89→02/90	Tie Rod	MN-DL-12284			
	02/89→02/90	Tie Rod End	CV-ES-2146			
	02/89→02/90	Tie Rod End	CV-ES-2149		for Push Rod	
	02/89→02/90	Tie Rod End	CV-ES-14162		for Steering Rod	
	02/89→02/90	Tie Rod End	CV-ES-14163		for Steering Rod	
	02/89→02/90	Track Control Arm		MN-DL-3402	Trailing Arm	
	02/89→02/90	Track Control Arm		MN-DL-3402	Trailing Arm, Drive Axle	
	02/89→02/90	Track Control Arm		MN-DL-8609	Trailing Arm, Leaf Spring Axle	
	35.272 VF	02/90→12/91	Ball Head, gearshift linkage	CV-ES-2119		
		02/90→12/91	Ball Head, gearshift linkage	CV-ES-2120		
		02/90→12/91	Ball Head, gearshift linkage	CV-ES-2182		
		02/90→12/91	Centre Rod	MN-DL-2160		Coupling Rod
		02/90→12/91	Centre Rod	MN-DL-2166		Push Rod
		02/90→12/91	Centre Rod	MN-DL-3588		Push Rod
02/90→12/91		Centre Rod	MN-DL-12278		for Steering Rod	
02/90→12/91		Engine Mounting	MN-SB-10389			
02/90→12/91		Mounting, stabilizer coupling rod	MN-SB-5246			
02/90→12/91		Mounting, stabilizer coupling rod	MN-SB-5246		1st FA	
02/90→12/91		Stabiliser Mounting		MN-SB-5245		
02/90→12/91		Stabiliser Mounting		MN-SB-5254		
02/90→12/91		Stabiliser Mounting	MN-SB-9396			
02/90→12/91		Suspension Arm Repair Kit		MN-SB-5244	for Wishbone (CV)	
02/90→12/91		Suspension Arm Repair Kit		MN-SB-5244	for Wishbone (CV), 2nd RA	
02/90→12/91		Tie Rod	MN-DL-12284			
02/90→12/91		Tie Rod End	CV-ES-2146			
02/90→12/91		Tie Rod End	CV-ES-2149		for Push Rod	
02/90→12/91		Tie Rod End	CV-ES-14162		for Steering Rod	
02/90→12/91		Tie Rod End	CV-ES-14163		for Steering Rod	
02/90→12/91		Track Control Arm		MN-DL-3402	Trailing Arm	
02/90→12/91		Track Control Arm		MN-DL-3402	Trailing Arm, Drive Axle	
02/90→12/91		Track Control Arm		MN-DL-8609	Trailing Arm, Leaf Spring Axle	
35.272 VFK		02/90→12/92	Ball Head, gearshift linkage	CV-ES-2119		
		02/90→12/92	Ball Head, gearshift linkage	CV-ES-2120		
	02/90→12/92	Ball Head, gearshift linkage	CV-ES-2182			
	02/90→12/92	Centre Rod	MN-DL-2160		Coupling Rod	
	02/90→12/92	Centre Rod	MN-DL-2166		Push Rod	
	02/90→12/92	Centre Rod	MN-DL-3588		Push Rod	
	02/90→12/92	Centre Rod	MN-DL-12278		for Steering Rod	
	02/90→12/92	Engine Mounting	MN-SB-10389			
	02/90→12/92	Mounting, stabilizer coupling rod	MN-SB-5246			
	02/90→12/92	Mounting, stabilizer coupling rod	MN-SB-5246		1st FA	
	02/90→12/92	Stabiliser Mounting		MN-SB-5245		
	02/90→12/92	Stabiliser Mounting		MN-SB-5254		
	02/90→12/92	Stabiliser Mounting	MN-SB-9396			
	02/90→12/92	Suspension Arm Repair Kit		MN-SB-5244	for Wishbone (CV)	
	02/90→12/92	Suspension Arm Repair Kit		MN-SB-5244	for Wishbone (CV), 2nd RA	
	02/90→12/92	Tie Rod	MN-DL-12284			
	02/90→12/92	Tie Rod End	CV-ES-2146			
	02/90→12/92	Tie Rod End	CV-ES-2149		for Push Rod	
	02/90→12/92	Tie Rod End	CV-ES-14162		for Steering Rod	
	02/90→12/92	Tie Rod End	CV-ES-14163		for Steering Rod	
	02/90→12/92	Track Control Arm		MN-DL-3402	Trailing Arm	

CV-ES-2119

Length: 55
Cone Ø: d1 Ø 10 / d2 Ø 10
Thread: M12 x 1,75 LHT
81953016063, 81953016131



CV-ES-2120

Length: 115
Cone Ø: d1 Ø 12,4 / d2 Ø 10,8
Thread: M14 x 1,5 RHT
03008500A, 81953016200, 81953016202,
81953016203, 81953016227



CV-ES-2146

Length: 80
Cone Ø: d1 Ø 30 / d2 Ø 27
Thread: M26 x 1,5 RHT
42533102, 81953016219, 81953016225,
81953016226, 81953016267, 81953016291



CV-ES-2149

Length: 160
Cone Ø: d1 Ø 30 / d2 Ø 27
Thread: M30 x 1,5 RHT
81953016263



CV-ES-2182

Length: 55
Cone Ø: d1 Ø 10 / d2 Ø 10
Thread: M12 x 1,75 RHT
81953016064, 81953016170



CV-ES-14162

Length: 125
Cone Ø: d1 Ø 30 / d2 Ø 27
Thread: M30 x 1,5 LHT
81953010015, 81953010083, 81953010087,
81953016029, 81953016030, 81953016043,
81953016044, 81953016050, 81953016054,
81953016087, 81953016091, 81953016107,
81953016120, 81953016125, 81953016152,
81953016155, 81953016157, 81953016168,
81953016179, 81953016181, 81953016223,
81953016237, 81953016254, 81953016275,
81953016279, 81953016351



CV-ES-14163

Length: 125
Cone Ø: d1 Ø 30 / d2 Ø 27
Thread: M30 x 1,5 RHT
95301.0084, 90804102156, 90804102272,
90804102696, 90804102710, 81953010016,
81953010075, 81953010084, 81953010088,
81953010094, 81953010103, 81953016030,
81953016043, 81953016048, 81953016049,
81953016053, 81953016061, 81953016090,
81953016108, 81953016112, 81953016126,
81953016143, 81953016149, 81953016154,
81953016156, 81953016168, 81953016178,
81953016194, 81953016206, 81953016224,
81953016234, 81953016242, 81953016252,
81953016274, 81953016278, 81953016284,
81953016286, 81953016308, 81953016310,
81953016312, 81953016347, 81953016350,
81953016352, 82953016012, 88953016014,
N2953016001



MN-DL-2160

Length: 1652 Ø: 50
Cone Ø: d1 Ø 30 / d2 Ø 27
81467106112, 81467106163, 81467106165,
81467106198, 81467106353, 81467106354,
81467106361, 81467116725



MN-DL-2166

Length: 1795
Ø: 50
Cone Ø: d1 Ø 30 / d2 Ø 27
81467106418



MN-DL-3402

Length: 590 Ø: 48
Hole Distance: 130 / 130
03307200A, 81432206067, 81432206068,
81432206090, 81432206092, 81432209092



MN-DL-3588

Length: 1035
Ø: 48
Cone Ø: d1 Ø 30 / d2 Ø 27
81466106333, 81466106334, 81466106354,
81466106355, 81466106360, 81466106361,
81466106721, 81466106722, 81466106723,
81466116216



MN-DL-8609

Length: 585 Ø: 58
Hole Distance: 130 / 130
81432206070, 81432206071, 81432206072,
81432206091, 81432206093, 81432206119



MN-DL-12278

Length: 770
Ø: 40
Cone Ø: d1 Ø 30 / d2 Ø 27
81466106348



MN-DL-12284

Length: 1530 Ø: 50
Cone Ø: d1 Ø 30 / d2 Ø 27
81466106579, 81466106580, 81466106624,
81466116720, 81467116720, 81467116730,
81467116952



MN-SB-5244

Ø: 65
Hole Distance: 125
Thick/Height: 22
03312000A, 81432710027, 81432710082



MN-SB-5245

Ø: 75
Hole Distance: 125
Thick/Height: 22
03311900A, 81432710046, 81432710079,
81432710083



MN-SB-5246

Ø: 45 Thick/Height: 47
81437220022, 81437220038, 81962100450,
81962100469



MN-SB-5254

Length: 100
Ø: 93
Thick/Height: 70
81432710081



MN-SB-9396

Ø: 67
Thick/Height: 60
81437040057



MN-SB-10389

Ø: 70
Thick/Height: 72
81960200340





F 90 ...

35.272 VFK ...	02/90→12/92	Track Control Arm		MN-DL-3402	Trailing Arm, Drive Axle
	02/90→12/92	Track Control Arm		MN-DL-8609	Trailing Arm, Leaf Spring Axle
35.292 VF	10/88→04/95	Ball Head, gearshift linkage	CV-ES-2119		
	10/88→04/95	Ball Head, gearshift linkage	CV-ES-2120		
	10/88→04/95	Ball Head, gearshift linkage	CV-ES-2182		
	10/88→04/95	Centre Rod	MN-DL-2160		Coupling Rod
	10/88→04/95	Centre Rod	MN-DL-2166		Push Rod
	10/88→04/95	Centre Rod	MN-DL-3588		Push Rod
	10/88→04/95	Centre Rod	MN-DL-12278		for Steering Rod
	10/88→04/95	Engine Mounting	MN-SB-10389		
	10/88→04/95	Mounting, stabilizer coupling rod	MN-SB-5246		
	10/88→04/95	Mounting, stabilizer coupling rod	MN-SB-5246		1st FA
	10/88→04/95	Stabiliser Mounting		MN-SB-5245	
	10/88→04/95	Stabiliser Mounting		MN-SB-5254	
	10/88→04/95	Stabiliser Mounting	MN-SB-9396		
	10/88→04/95	Suspension Arm Repair Kit		MN-SB-5244	for Wishbone (CV)
	10/88→04/95	Suspension Arm Repair Kit		MN-SB-5244	for Wishbone (CV), 2nd RA
	10/88→04/95	Tie Rod	MN-DL-12284		
	10/88→04/95	Tie Rod End	CV-ES-2146		
	10/88→04/95	Tie Rod End	CV-ES-2149		for Push Rod
	10/88→04/95	Tie Rod End	CV-ES-14162		for Steering Rod
	10/88→04/95	Tie Rod End	CV-ES-14163		for Steering Rod
	10/88→04/95	Track Control Arm		MN-DL-3402	Trailing Arm
	10/88→04/95	Track Control Arm		MN-DL-3402	Trailing Arm, Drive Axle
	10/88→04/95	Track Control Arm		MN-DL-8609	Trailing Arm, Leaf Spring Axle
35.292 VFK	10/88→04/95	Ball Head, gearshift linkage	CV-ES-2119		
	10/88→04/95	Ball Head, gearshift linkage	CV-ES-2120		
	10/88→04/95	Ball Head, gearshift linkage	CV-ES-2182		
	10/88→04/95	Centre Rod	MN-DL-2160		Coupling Rod
	10/88→04/95	Centre Rod	MN-DL-2166		Push Rod
	10/88→04/95	Centre Rod	MN-DL-3588		Push Rod
	10/88→04/95	Centre Rod	MN-DL-12278		for Steering Rod
	10/88→04/95	Engine Mounting	MN-SB-10389		
	10/88→04/95	Mounting, stabilizer coupling rod	MN-SB-5246		
	10/88→04/95	Mounting, stabilizer coupling rod	MN-SB-5246		1st FA
	10/88→04/95	Stabiliser Mounting		MN-SB-5245	
	10/88→04/95	Stabiliser Mounting		MN-SB-5254	
	10/88→04/95	Stabiliser Mounting	MN-SB-9396		
	10/88→04/95	Suspension Arm Repair Kit		MN-SB-5244	for Wishbone (CV)
	10/88→04/95	Suspension Arm Repair Kit		MN-SB-5244	for Wishbone (CV), 2nd RA
	10/88→04/95	Tie Rod	MN-DL-12284		
	10/88→04/95	Tie Rod End	CV-ES-2146		
	10/88→04/95	Tie Rod End	CV-ES-2149		for Push Rod
	10/88→04/95	Tie Rod End	CV-ES-14162		for Steering Rod
	10/88→04/95	Tie Rod End	CV-ES-14163		for Steering Rod
	10/88→04/95	Track Control Arm		MN-DL-3402	Trailing Arm
	10/88→04/95	Track Control Arm		MN-DL-3402	Trailing Arm, Drive Axle
	10/88→04/95	Track Control Arm		MN-DL-8609	Trailing Arm, Leaf Spring Axle
35.302 VF	05/90→09/91	Ball Head, gearshift linkage	CV-ES-2119		
	05/90→09/91	Ball Head, gearshift linkage	CV-ES-2120		
	05/90→09/91	Ball Head, gearshift linkage	CV-ES-2182		
	05/90→09/91	Centre Rod	MN-DL-2160		Coupling Rod
	05/90→09/91	Centre Rod	MN-DL-2166		Push Rod
	05/90→09/91	Centre Rod	MN-DL-3588		Push Rod
	05/90→09/91	Centre Rod	MN-DL-12278		for Steering Rod
	05/90→09/91	Engine Mounting	MN-SB-10389		
	05/90→09/91	Mounting, stabilizer coupling rod	MN-SB-5246		
	05/90→09/91	Mounting, stabilizer coupling rod	MN-SB-5246		1st FA
	05/90→09/91	Stabiliser Mounting		MN-SB-5245	
	05/90→09/91	Stabiliser Mounting		MN-SB-5254	
	05/90→09/91	Stabiliser Mounting	MN-SB-9396		
	05/90→09/91	Suspension Arm Repair Kit		MN-SB-5244	for Wishbone (CV)
	05/90→09/91	Suspension Arm Repair Kit		MN-SB-5244	for Wishbone (CV), 2nd RA

CV-ES-2119

Length: 55
Cone Ø: d1 Ø 10 / d2 Ø 10
Thread: M12 x 1,75 LHT
81953016063, 81953016131



CV-ES-2120

Length: 115
Cone Ø: d1 Ø 12,4 / d2 Ø 10,8
Thread: M14 x 1,5 RHT
03008500A, 81953016200, 81953016202,
81953016203, 81953016227



CV-ES-2146

Length: 80
Cone Ø: d1 Ø 30 / d2 Ø 27
Thread: M26 x 1,5 RHT
42533102, 81953016219, 81953016225,
81953016226, 81953016267, 81953016291



CV-ES-2149

Length: 160
Cone Ø: d1 Ø 30 / d2 Ø 27
Thread: M30 x 1,5 RHT
81953016263



CV-ES-2182

Length: 55
Cone Ø: d1 Ø 10 / d2 Ø 10
Thread: M12 x 1,75 RHT
81953016064, 81953016170



CV-ES-14162

Length: 125
Cone Ø: d1 Ø 30 / d2 Ø 27
Thread: M30 x 1,5 LHT
81953010015, 81953010083, 81953010087,
81953016029, 81953016030, 81953016043,
81953016044, 81953016050, 81953016054,
81953016087, 81953016091, 81953016107,
81953016120, 81953016125, 81953016152,
81953016155, 81953016157, 81953016168,
81953016179, 81953016181, 81953016223,
81953016237, 81953016254, 81953016275,
81953016279, 81953016351



CV-ES-14163

Length: 125
Cone Ø: d1 Ø 30 / d2 Ø 27
Thread: M30 x 1,5 RHT
95301.0084, 90804102156, 90804102272,
90804102696, 90804102710, 81953010016,
81953010075, 81953010084, 81953010088,
81953010094, 81953010103, 81953016030,
81953016043, 81953016048, 81953016049,
81953016053, 81953016061, 81953016090,
81953016108, 81953016112, 81953016126,
81953016143, 81953016149, 81953016154,
81953016156, 81953016168, 81953016178,
81953016194, 81953016206, 81953016224,
81953016234, 81953016242, 81953016252,
81953016274, 81953016278, 81953016284,
81953016286, 81953016308, 81953016310,
81953016312, 81953016347, 81953016350,
81953016352, 82953016012, 88953016014,
N2953016001



MN-DL-2160

Length: 1652 Ø: 50
Cone Ø: d1 Ø 30 / d2 Ø 27
81467106112, 81467106163, 81467106165,
81467106198, 81467106353, 81467106354,
81467106361, 81467116725



MN-DL-2166

Length: 1795
Ø: 50
Cone Ø: d1 Ø 30 / d2 Ø 27
81467106418



MN-DL-3402

Length: 590 Ø: 48
Hole Distance: 130 / 130
03307200A, 81432206067, 81432206068,
81432206090, 81432206092, 81432209092



MN-DL-3588

Length: 1035
Ø: 48
Cone Ø: d1 Ø 30 / d2 Ø 27
81466106333, 81466106334, 81466106354,
81466106355, 81466106360, 81466106361,
81466106721, 81466106722, 81466106723,
81466116216



MN-DL-8609

Length: 585 Ø: 58
Hole Distance: 130 / 130
81432206070, 81432206071, 81432206072,
81432206091, 81432206093, 81432206119



MN-DL-12278

Length: 770
Ø: 40
Cone Ø: d1 Ø 30 / d2 Ø 27
81466106348



MN-DL-12284

Length: 1530 Ø: 50
Cone Ø: d1 Ø 30 / d2 Ø 27
81466106579, 81466106580, 81466106624,
81466116720, 81467116720, 81467116730,
81467116952



MN-SB-5244

Ø: 65
Hole Distance: 125
Thick/Height: 22
03312000A, 81432710027, 81432710082



MN-SB-5245

Ø: 75
Hole Distance: 125
Thick/Height: 22
03311900A, 81432710046, 81432710079,
81432710083



MN-SB-5246

Ø: 45 Thick/Height: 47
81437220022, 81437220038, 81962100450,
81962100469



MN-SB-5254

Length: 100
Ø: 93
Thick/Height: 70
81432710081



MN-SB-9396

Ø: 67
Thick/Height: 60
81437040057



MN-SB-10389

Ø: 70
Thick/Height: 72
81960200340





F 90 ...

35.302 VF ...	05/90→09/91	Tie Rod	MN-DL-12284			
	05/90→09/91	Tie Rod End	CV-ES-2146			
	05/90→09/91	Tie Rod End	CV-ES-2149		for Push Rod	
	05/90→09/91	Tie Rod End	CV-ES-14162		for Steering Rod	
	05/90→09/91	Tie Rod End	CV-ES-14163		for Steering Rod	
	05/90→09/91	Track Control Arm		MN-DL-3402	Trailing Arm	
	05/90→09/91	Track Control Arm		MN-DL-3402	Trailing Arm, Drive Axle	
35.302 VFA	05/90→09/91	Ball Head, gearshift linkage	CV-ES-2119			
	05/90→09/91	Ball Head, gearshift linkage	CV-ES-2120			
	05/90→09/91	Ball Head, gearshift linkage	CV-ES-2182			
	05/90→09/91	Centre Rod	MN-DL-2160		Coupling Rod	
	05/90→09/91	Centre Rod	MN-DL-2166		Push Rod	
	05/90→09/91	Centre Rod	MN-DL-3588		Push Rod	
	05/90→09/91	Centre Rod	MN-DL-12279		for Steering Rod	
	05/90→09/91	Tie Rod End	CV-ES-2146			
	05/90→09/91	Tie Rod End	CV-ES-2149		for Push Rod	
	05/90→09/91	Tie Rod End	CV-ES-14162		for Steering Rod	
	05/90→09/91	Tie Rod End	CV-ES-14163		for Steering Rod	
	05/90→09/91	Track Control Arm		MN-DL-3402	Trailing Arm	
	05/90→09/91	Track Control Arm		MN-DL-8609	Trailing Arm, Leaf Spring Axle	
	35.302 VFAK	05/90→09/91	Ball Head, gearshift linkage	CV-ES-2119		
		05/90→09/91	Ball Head, gearshift linkage	CV-ES-2120		
		05/90→09/91	Ball Head, gearshift linkage	CV-ES-2182		
		05/90→09/91	Centre Rod	MN-DL-2160		Coupling Rod
05/90→09/91		Centre Rod	MN-DL-2166		Push Rod	
05/90→09/91		Centre Rod	MN-DL-3588		Push Rod	
05/90→09/91		Centre Rod	MN-DL-12279		for Steering Rod	
05/90→09/91		Tie Rod End	CV-ES-2146			
05/90→09/91		Tie Rod End	CV-ES-2149		for Push Rod	
05/90→09/91		Tie Rod End	CV-ES-14162		for Steering Rod	
05/90→09/91		Tie Rod End	CV-ES-14163		for Steering Rod	
05/90→09/91		Track Control Arm		MN-DL-3402	Trailing Arm	
05/90→09/91		Track Control Arm		MN-DL-8609	Trailing Arm, Leaf Spring Axle	
35.302 VFK		05/90→09/91	Ball Head, gearshift linkage	CV-ES-2119		
		05/90→09/91	Ball Head, gearshift linkage	CV-ES-2120		
		05/90→09/91	Ball Head, gearshift linkage	CV-ES-2182		
		05/90→09/91	Centre Rod	MN-DL-2160		Coupling Rod
	05/90→09/91	Centre Rod	MN-DL-2166		Push Rod	
	05/90→09/91	Centre Rod	MN-DL-3588		Push Rod	
	05/90→09/91	Centre Rod	MN-DL-12278		for Steering Rod	
	05/90→09/91	Engine Mounting	MN-SB-10389			
	05/90→09/91	Mounting, stabilizer coupling rod	MN-SB-5246			
	05/90→09/91	Mounting, stabilizer coupling rod	MN-SB-5246		1st FA	
	05/90→09/91	Stabiliser Mounting		MN-SB-5245		
	05/90→09/91	Stabiliser Mounting		MN-SB-5254		
	05/90→09/91	Stabiliser Mounting	MN-SB-9396			
	05/90→09/91	Suspension Arm Repair Kit		MN-SB-5244	for Wishbone (CV)	
	05/90→09/91	Suspension Arm Repair Kit		MN-SB-5244	for Wishbone (CV), 2nd RA	
	05/90→09/91	Tie Rod	MN-DL-12284			
	05/90→09/91	Tie Rod End	CV-ES-2146			
	05/90→09/91	Tie Rod End	CV-ES-2149		for Push Rod	
	05/90→09/91	Tie Rod End	CV-ES-14162		for Steering Rod	
	05/90→09/91	Tie Rod End	CV-ES-14163		for Steering Rod	
	05/90→09/91	Track Control Arm		MN-DL-3402	Trailing Arm	
	05/90→09/91	Track Control Arm		MN-DL-3402	Trailing Arm, Drive Axle	
	05/90→09/91	Track Control Arm		MN-DL-8609	Trailing Arm, Leaf Spring Axle	
	35.322 VFAK	02/90→06/96	Ball Head, gearshift linkage	CV-ES-2119		
		02/90→06/96	Ball Head, gearshift linkage	CV-ES-2120		
		02/90→06/96	Ball Head, gearshift linkage	CV-ES-2182		
		02/90→06/96	Centre Rod	MN-DL-2160		Coupling Rod
		02/90→06/96	Centre Rod	MN-DL-2166		Push Rod
		02/90→06/96	Centre Rod	MN-DL-3588		Push Rod

CV-ES-2119

Length: 55
Cone Ø: d1 Ø 10 / d2 Ø 10
Thread: M12 x 1,75 LHT
81953016063, 81953016131



CV-ES-2120

Length: 115
Cone Ø: d1 Ø 12,4 / d2 Ø 10,8
Thread: M14 x 1,5 RHT
03008500A, 81953016200, 81953016202,
81953016203, 81953016227



CV-ES-2146

Length: 80
Cone Ø: d1 Ø 30 / d2 Ø 27
Thread: M26 x 1,5 RHT
42533102, 81953016219, 81953016225,
81953016226, 81953016267, 81953016291



CV-ES-2149

Length: 160
Cone Ø: d1 Ø 30 / d2 Ø 27
Thread: M30 x 1,5 RHT
81953016263



CV-ES-2182

Length: 55
Cone Ø: d1 Ø 10 / d2 Ø 10
Thread: M12 x 1,75 RHT
81953016064, 81953016170



CV-ES-14162

Length: 125
Cone Ø: d1 Ø 30 / d2 Ø 27
Thread: M30 x 1,5 LHT
81953010015, 81953010083, 81953010087,
81953016029, 81953016030, 81953016043,
81953016044, 81953016050, 81953016054,
81953016087, 81953016091, 81953016107,
81953016120, 81953016125, 81953016152,
81953016155, 81953016157, 81953016168,
81953016179, 81953016181, 81953016223,
81953016237, 81953016254, 81953016275,
81953016279, 81953016351



CV-ES-14163

Length: 125
Cone Ø: d1 Ø 30 / d2 Ø 27
Thread: M30 x 1,5 RHT
95301.0084, 90804102156, 90804102272,
90804102696, 90804102710, 81953010016,
81953010075, 81953010084, 81953010088,
81953010094, 81953010103, 81953016030,
81953016043, 81953016048, 81953016049,
81953016053, 81953016061, 81953016090,
81953016108, 81953016112, 81953016126,
81953016143, 81953016149, 81953016154,
81953016156, 81953016168, 81953016178,
81953016194, 81953016206, 81953016224,
81953016234, 81953016242, 81953016252,
81953016274, 81953016278, 81953016284,
81953016286, 81953016308, 81953016310,
81953016312, 81953016347, 81953016350,
81953016352, 82953016012, 88953016014,
N2953016001



MN-DL-2160

Length: 1652 Ø: 50
Cone Ø: d1 Ø 30 / d2 Ø 27
81467106112, 81467106163, 81467106165,
81467106198, 81467106353, 81467106354,
81467106361, 81467116725



MN-DL-2166

Length: 1795 Ø: 50
Cone Ø: d1 Ø 30 / d2 Ø 27
81467106418



MN-DL-3402

Length: 590 Ø: 48
Hole Distance: 130 / 130
03307200A, 81432206067, 81432206068,
81432206090, 81432206092, 81432209092



MN-DL-3588

Length: 1035 Ø: 48
Cone Ø: d1 Ø 30 / d2 Ø 27
81466106333, 81466106334, 81466106354,
81466106355, 81466106360, 81466106361,
81466106721, 81466106722, 81466106723,
81466116216



MN-DL-8609

Length: 585 Ø: 58
Hole Distance: 130 / 130
81432206070, 81432206071, 81432206072,
81432206091, 81432206093, 81432206119



MN-DL-12278

Length: 770 Ø: 40
Cone Ø: d1 Ø 30 / d2 Ø 27
81466106348



MN-DL-12279

Length: 1010 Ø: 48
Cone Ø: d1 Ø 30 / d2 Ø 27
82466106079, 82466106143, 82466106153



MN-DL-12284

Length: 1530 Ø: 50
Cone Ø: d1 Ø 30 / d2 Ø 27
81466106579, 81466106580, 81466106624,
81466116720, 81467116720, 81467116730,
81467116952



MN-SB-5244

Ø: 65
Hole Distance: 125
Thick/Height: 22
03312000A, 81432710027, 81432710082



MN-SB-5245

Ø: 75
Hole Distance: 125
Thick/Height: 22
03311900A, 81432710046, 81432710079,
81432710083



MN-SB-5246

Ø: 45 Thick/Height: 47
81437220022, 81437220038, 81962100450,
81962100469



MN-SB-5254

Length: 100 Ø: 93
Thick/Height: 70
81432710081



MN-SB-9396

Ø: 67 Thick/Height: 60
81437040057



MN-SB-10389

Ø: 70 Thick/Height: 72
81960200340





F 90 ...

35.322 VFAK ...	02/90→06/96	Centre Rod	MN-DL-12279		for Steering Rod
	02/90→06/96	Tie Rod End	CV-ES-2146		
	02/90→06/96	Tie Rod End	CV-ES-2149		for Push Rod
	02/90→06/96	Tie Rod End	CV-ES-14162		for Steering Rod
	02/90→06/96	Tie Rod End	CV-ES-14163		for Steering Rod
	02/90→06/96	Track Control Arm		MN-DL-3402	Trailing Arm
	02/90→06/96	Track Control Arm		MN-DL-8609	Trailing Arm, Leaf Spring Axle
	35.322 VFK	02/90→06/96	Ball Head, gearshift linkage	CV-ES-2119	
02/90→06/96		Ball Head, gearshift linkage	CV-ES-2120		
02/90→06/96		Ball Head, gearshift linkage	CV-ES-2182		
02/90→06/96		Centre Rod	MN-DL-2160		Coupling Rod
02/90→06/96		Centre Rod	MN-DL-2166		Push Rod
02/90→06/96		Centre Rod	MN-DL-3588		Push Rod
02/90→06/96		Centre Rod	MN-DL-12278		for Steering Rod
02/90→06/96		Centre Rod	MN-DL-12279		for Steering Rod
02/90→06/96		Engine Mounting	MN-SB-10389		
02/90→06/96		Mounting, stabilizer coupling rod	MN-SB-5246		
02/90→06/96		Mounting, stabilizer coupling rod	MN-SB-5246		1st FA
02/90→06/96		Stabiliser Mounting		MN-SB-5245	
02/90→06/96		Stabiliser Mounting		MN-SB-5254	
02/90→06/96		Stabiliser Mounting	MN-SB-9396		
02/90→06/96		Suspension Arm Repair Kit		MN-SB-5244	for Wishbone (CV)
02/90→06/96		Suspension Arm Repair Kit		MN-SB-5244	for Wishbone (CV), 2nd RA
02/90→06/96		Tie Rod	MN-DL-12284		
02/90→06/96		Tie Rod End	CV-ES-2146		
02/90→06/96		Tie Rod End	CV-ES-2149		for Push Rod
02/90→06/96		Tie Rod End	CV-ES-14162		for Steering Rod
02/90→06/96		Tie Rod End	CV-ES-14163		for Steering Rod
02/90→06/96		Track Control Arm		MN-DL-3402	Trailing Arm
02/90→06/96		Track Control Arm		MN-DL-3402	Trailing Arm, Drive Axle
02/90→06/96		Track Control Arm		MN-DL-8609	Trailing Arm, Leaf Spring Axle
35.322 VK	02/90→06/96	Ball Head, gearshift linkage	CV-ES-2119		
	02/90→06/96	Ball Head, gearshift linkage	CV-ES-2120		
	02/90→06/96	Ball Head, gearshift linkage	CV-ES-2182		
	02/90→06/96	Centre Rod	MN-DL-2160		Coupling Rod
	02/90→06/96	Centre Rod	MN-DL-2166		Push Rod
	02/90→06/96	Centre Rod	MN-DL-3588		Push Rod
	02/90→06/96	Centre Rod	MN-DL-12278		for Steering Rod
	02/90→06/96	Engine Mounting	MN-SB-10389		
	02/90→06/96	Mounting, stabilizer coupling rod	MN-SB-5246		
	02/90→06/96	Mounting, stabilizer coupling rod	MN-SB-5246		1st FA
	02/90→06/96	Stabiliser Mounting		MN-SB-5245	
	02/90→06/96	Stabiliser Mounting		MN-SB-5254	
	02/90→06/96	Stabiliser Mounting	MN-SB-9396		
	02/90→06/96	Suspension Arm Repair Kit		MN-SB-5244	for Wishbone (CV)
	02/90→06/96	Suspension Arm Repair Kit		MN-SB-5244	for Wishbone (CV), 2nd RA
	02/90→06/96	Tie Rod	MN-DL-12284		
	02/90→06/96	Tie Rod End	CV-ES-2146		
	02/90→06/96	Tie Rod End	CV-ES-2149		for Push Rod
	02/90→06/96	Tie Rod End	CV-ES-14162		for Steering Rod
	02/90→06/96	Tie Rod End	CV-ES-14163		for Steering Rod
	02/90→06/96	Track Control Arm		MN-DL-3402	Trailing Arm
	02/90→06/96	Track Control Arm		MN-DL-3402	Trailing Arm, Drive Axle
	02/90→06/96	Track Control Arm		MN-DL-8609	Trailing Arm, Leaf Spring Axle
	35.332 VF	10/88→04/95	Ball Head, gearshift linkage	CV-ES-2119	
10/88→04/95		Ball Head, gearshift linkage	CV-ES-2120		
10/88→04/95		Ball Head, gearshift linkage	CV-ES-2182		
10/88→04/95		Centre Rod	MN-DL-2160		Coupling Rod
10/88→04/95		Centre Rod	MN-DL-2166		Push Rod
10/88→04/95		Centre Rod	MN-DL-3588		Push Rod
10/88→04/95		Centre Rod	MN-DL-12278		for Steering Rod
10/88→04/95		Engine Mounting	MN-SB-10389		
10/88→04/95	Mounting, stabilizer coupling rod	MN-SB-5246			

CV-ES-2119

Length: 55
Cone Ø: d1 Ø 10 / d2 Ø 10
Thread: M12 x 1,75 LHT
81953016063, 81953016131



CV-ES-2120

Length: 115
Cone Ø: d1 Ø 12,4 / d2 Ø 10,8
Thread: M14 x 1,5 RHT
03008500A, 81953016200, 81953016202,
81953016203, 81953016227



CV-ES-2146

Length: 80
Cone Ø: d1 Ø 30 / d2 Ø 27
Thread: M26 x 1,5 RHT
42533102, 81953016219, 81953016225,
81953016226, 81953016267, 81953016291



CV-ES-2149

Length: 160
Cone Ø: d1 Ø 30 / d2 Ø 27
Thread: M30 x 1,5 RHT
81953016263



CV-ES-2182

Length: 55
Cone Ø: d1 Ø 10 / d2 Ø 10
Thread: M12 x 1,75 RHT
81953016064, 81953016170



CV-ES-14162

Length: 125
Cone Ø: d1 Ø 30 / d2 Ø 27
Thread: M30 x 1,5 LHT
81953010015, 81953010083, 81953010087,
81953016029, 81953016030, 81953016043,
81953016044, 81953016050, 81953016054,
81953016087, 81953016091, 81953016107,
81953016120, 81953016125, 81953016152,
81953016155, 81953016157, 81953016168,
81953016179, 81953016181, 81953016223,
81953016237, 81953016254, 81953016275,
81953016279, 81953016351



CV-ES-14163

Length: 125
Cone Ø: d1 Ø 30 / d2 Ø 27
Thread: M30 x 1,5 RHT
95301.0084, 90804102156, 90804102272,
90804102696, 90804102710, 81953010016,
81953010075, 81953010084, 81953010088,
81953010094, 81953010103, 81953016030,
81953016043, 81953016048, 81953016049,
81953016053, 81953016061, 81953016090,
81953016108, 81953016112, 81953016126,
81953016143, 81953016149, 81953016154,
81953016156, 81953016168, 81953016178,
81953016194, 81953016206, 81953016224,
81953016234, 81953016242, 81953016252,
81953016274, 81953016278, 81953016284,
81953016286, 81953016308, 81953016310,
81953016312, 81953016347, 81953016350,
81953016352, 82953016012, 88953016014,
N2953016001



MN-DL-2160

Length: 1652 Ø: 50
Cone Ø: d1 Ø 30 / d2 Ø 27
81467106112, 81467106163, 81467106165,
81467106198, 81467106353, 81467106354,
81467106361, 81467116725



MN-DL-2166

Length: 1795 Ø: 50
Cone Ø: d1 Ø 30 / d2 Ø 27
81467106418



MN-DL-3402

Length: 590 Ø: 48
Hole Distance: 130 / 130
03307200A, 81432206067, 81432206068,
81432206090, 81432206092, 81432209092



MN-DL-3588

Length: 1035 Ø: 48
Cone Ø: d1 Ø 30 / d2 Ø 27
81466106333, 81466106334, 81466106354,
81466106355, 81466106360, 81466106361,
81466106721, 81466106722, 81466106723,
81466116216



MN-DL-8609

Length: 585 Ø: 58
Hole Distance: 130 / 130
81432206070, 81432206071, 81432206072,
81432206091, 81432206093, 81432206119



MN-DL-12278

Length: 770 Ø: 40
Cone Ø: d1 Ø 30 / d2 Ø 27
81466106348



MN-DL-12279

Length: 1010 Ø: 48
Cone Ø: d1 Ø 30 / d2 Ø 27
82466106079, 82466106143, 82466106153



MN-DL-12284

Length: 1530 Ø: 50
Cone Ø: d1 Ø 30 / d2 Ø 27
81466106579, 81466106580, 81466106624,
81466116720, 81467116720, 81467116730,
81467116952



MN-SB-5244

Ø: 65
Hole Distance: 125
Thick/Height: 22
03312000A, 81432710027, 81432710082



MN-SB-5245

Ø: 75
Hole Distance: 125
Thick/Height: 22
03311900A, 81432710046, 81432710079,
81432710083



MN-SB-5246

Ø: 45 Thick/Height: 47
81437220022, 81437220038, 81962100450,
81962100469



MN-SB-5254

Length: 100 Ø: 93
Thick/Height: 70
81432710081



MN-SB-9396

Ø: 67 Thick/Height: 60
81437040057



MN-SB-10389

Ø: 70 Thick/Height: 72
81960200340





F 90 ...

35.332 VF ...	10/88→04/95	Mounting, stabilizer coupling rod	MN-SB-5246		1st FA
	10/88→04/95	Stabiliser Mounting		MN-SB-5245	
	10/88→04/95	Stabiliser Mounting		MN-SB-5254	
	10/88→04/95	Stabiliser Mounting	MN-SB-9396		
	10/88→04/95	Suspension Arm Repair Kit		MN-SB-5244	for Wishbone (CV)
	10/88→04/95	Suspension Arm Repair Kit		MN-SB-5244	for Wishbone (CV), 2nd RA
	10/88→04/95	Tie Rod	MN-DL-12284		
	10/88→04/95	Tie Rod End	CV-ES-2146		
	10/88→04/95	Tie Rod End	CV-ES-2149		for Push Rod
	10/88→04/95	Tie Rod End	CV-ES-14162		for Steering Rod
	10/88→04/95	Tie Rod End	CV-ES-14163		for Steering Rod
	10/88→04/95	Track Control Arm		MN-DL-3402	Trailing Arm
	10/88→04/95	Track Control Arm		MN-DL-3402	Trailing Arm, Drive Axle
	10/88→04/95	Track Control Arm		MN-DL-8609	Trailing Arm, Leaf Spring Axle
35.332 VFK	10/88→04/95	Ball Head, gearshift linkage	CV-ES-2119		
	10/88→04/95	Ball Head, gearshift linkage	CV-ES-2120		
	10/88→04/95	Ball Head, gearshift linkage	CV-ES-2182		
	10/88→04/95	Centre Rod	MN-DL-2160		Coupling Rod
	10/88→04/95	Centre Rod	MN-DL-2166		Push Rod
	10/88→04/95	Centre Rod	MN-DL-3588		Push Rod
	10/88→04/95	Centre Rod	MN-DL-12278		for Steering Rod
	10/88→04/95	Engine Mounting	MN-SB-10389		
	10/88→04/95	Mounting, stabilizer coupling rod	MN-SB-5246		
	10/88→04/95	Mounting, stabilizer coupling rod	MN-SB-5246		1st FA
	10/88→04/95	Stabiliser Mounting		MN-SB-5245	
	10/88→04/95	Stabiliser Mounting		MN-SB-5254	
	10/88→04/95	Stabiliser Mounting	MN-SB-9396		
	10/88→04/95	Suspension Arm Repair Kit		MN-SB-5244	for Wishbone (CV)
	10/88→04/95	Suspension Arm Repair Kit		MN-SB-5244	for Wishbone (CV), 2nd RA
	10/88→04/95	Tie Rod	MN-DL-12284		
	10/88→04/95	Tie Rod End	CV-ES-2146		
	10/88→04/95	Tie Rod End	CV-ES-2149		for Push Rod
	10/88→04/95	Tie Rod End	CV-ES-14162		for Steering Rod
	10/88→04/95	Tie Rod End	CV-ES-14163		for Steering Rod
10/88→04/95	Track Control Arm		MN-DL-3402	Trailing Arm	
10/88→04/95	Track Control Arm		MN-DL-3402	Trailing Arm, Drive Axle	
10/88→04/95	Track Control Arm		MN-DL-8609	Trailing Arm, Leaf Spring Axle	
35.342 VF	05/94→06/96	Ball Head, gearshift linkage	CV-ES-2120		
	05/94→06/96	Centre Rod	MN-DL-12278		for Steering Rod
	05/94→06/96	Engine Mounting	MN-SB-10389		
	05/94→06/96	Mounting, stabilizer coupling rod	MN-SB-5246		
	05/94→06/96	Mounting, stabilizer coupling rod	MN-SB-5246		1st FA
	05/94→06/96	Stabiliser Mounting		MN-SB-5245	
	05/94→06/96	Stabiliser Mounting		MN-SB-5254	
	05/94→06/96	Stabiliser Mounting	MN-SB-9396		
	05/94→06/96	Suspension Arm Repair Kit		MN-SB-5244	for Wishbone (CV)
	05/94→06/96	Suspension Arm Repair Kit		MN-SB-5244	for Wishbone (CV), 2nd RA
	05/94→06/96	Tie Rod	MN-DL-12284		
	05/94→06/96	Tie Rod End	CV-ES-2146		
	05/94→06/96	Tie Rod End	CV-ES-14163		for Steering Rod
	05/94→06/96	Track Control Arm		MN-DL-3402	Trailing Arm
	05/94→06/96	Track Control Arm		MN-DL-3402	Trailing Arm, Drive Axle
	05/94→06/96	Track Control Arm		MN-DL-8609	Trailing Arm, Leaf Spring Axle
35.342 VFK	05/94→06/96	Ball Head, gearshift linkage	CV-ES-2120		
	05/94→06/96	Centre Rod	MN-DL-12278		for Steering Rod
	05/94→06/96	Engine Mounting	MN-SB-10389		
	05/94→06/96	Mounting, stabilizer coupling rod	MN-SB-5246		
	05/94→06/96	Mounting, stabilizer coupling rod	MN-SB-5246		1st FA
	05/94→06/96	Stabiliser Mounting		MN-SB-5245	
	05/94→06/96	Stabiliser Mounting		MN-SB-5254	
	05/94→06/96	Stabiliser Mounting	MN-SB-9396		
	05/94→06/96	Suspension Arm Repair Kit		MN-SB-5244	for Wishbone (CV)
	05/94→06/96	Suspension Arm Repair Kit		MN-SB-5244	for Wishbone (CV), 2nd RA
	05/94→06/96	Tie Rod	MN-DL-12284		
	05/94→06/96	Tie Rod End	CV-ES-2146		

CV-ES-2119

Length: 55
Cone Ø: d1 Ø 10 / d2 Ø 10
Thread: M12 x 1,75 LHT
81953016063, 81953016131



CV-ES-2120

Length: 115
Cone Ø: d1 Ø 12,4 / d2 Ø 10,8
Thread: M14 x 1,5 RHT
03008500A, 81953016200, 81953016202,
81953016203, 81953016227



CV-ES-2146

Length: 80
Cone Ø: d1 Ø 30 / d2 Ø 27
Thread: M26 x 1,5 RHT
42533102, 81953016219, 81953016225,
81953016226, 81953016267, 81953016291



CV-ES-2149

Length: 160
Cone Ø: d1 Ø 30 / d2 Ø 27
Thread: M30 x 1,5 RHT
81953016263



CV-ES-2182

Length: 55
Cone Ø: d1 Ø 10 / d2 Ø 10
Thread: M12 x 1,75 RHT
81953016064, 81953016170



CV-ES-14162

Length: 125
Cone Ø: d1 Ø 30 / d2 Ø 27
Thread: M30 x 1,5 LHT
81953010015, 81953010083, 81953010087,
81953016029, 81953016030, 81953016043,
81953016044, 81953016050, 81953016054,
81953016087, 81953016091, 81953016107,
81953016120, 81953016125, 81953016152,
81953016155, 81953016157, 81953016168,
81953016179, 81953016181, 81953016223,
81953016237, 81953016254, 81953016275,
81953016279, 81953016351



CV-ES-14163

Length: 125
Cone Ø: d1 Ø 30 / d2 Ø 27
Thread: M30 x 1,5 RHT
95301.0084, 90804102156, 90804102272,
90804102696, 90804102710, 81953010016,
81953010075, 81953010084, 81953010088,
81953010094, 81953010103, 81953016030,
81953016043, 81953016048, 81953016049,
81953016053, 81953016061, 81953016090,
81953016108, 81953016112, 81953016126,
81953016143, 81953016149, 81953016154,
81953016156, 81953016168, 81953016178,
81953016194, 81953016206, 81953016224,
81953016234, 81953016242, 81953016252,
81953016274, 81953016278, 81953016284,
81953016286, 81953016308, 81953016310,
81953016312, 81953016347, 81953016350,
81953016352, 82953016012, 88953016014,
N2953016001



MN-DL-2160

Length: 1652 Ø: 50
Cone Ø: d1 Ø 30 / d2 Ø 27
81467106112, 81467106163, 81467106165,
81467106198, 81467106353, 81467106354,
81467106361, 81467116725



MN-DL-2166

Length: 1795
Ø: 50
Cone Ø: d1 Ø 30 / d2 Ø 27
81467106418



MN-DL-3402

Length: 590 Ø: 48
Hole Distance: 130 / 130
03307200A, 81432206067, 81432206068,
81432206090, 81432206092, 81432209092



MN-DL-3588

Length: 1035
Ø: 48
Cone Ø: d1 Ø 30 / d2 Ø 27
81466106333, 81466106334, 81466106354,
81466106355, 81466106360, 81466106361,
81466106721, 81466106722, 81466106723,
81466116216



MN-DL-8609

Length: 585 Ø: 58
Hole Distance: 130 / 130
81432206070, 81432206071, 81432206072,
81432206091, 81432206093, 81432206119



MN-DL-12278

Length: 770
Ø: 40
Cone Ø: d1 Ø 30 / d2 Ø 27
81466106348



MN-DL-12284

Length: 1530 Ø: 50
Cone Ø: d1 Ø 30 / d2 Ø 27
81466106579, 81466106580, 81466106624,
81466116720, 81467116720, 81467116730,
81467116952



MN-SB-5244

Ø: 65
Hole Distance: 125
Thick/Height: 22
03312000A, 81432710027, 81432710082



MN-SB-5245

Ø: 75
Hole Distance: 125
Thick/Height: 22
03311900A, 81432710046, 81432710079,
81432710083



MN-SB-5246

Ø: 45 Thick/Height: 47
81437220022, 81437220038, 81962100450,
81962100469



MN-SB-5254

Length: 100
Ø: 93
Thick/Height: 70
81432710081



MN-SB-9396

Ø: 67
Thick/Height: 60
81437040057



MN-SB-10389

Ø: 70
Thick/Height: 72
81960200340



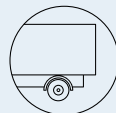

F 90 ...

35.342 VFK ...	05/94→06/96	Tie Rod	MN-DL-12284		
	05/94→06/96	Tie Rod End	CV-ES-2146		
	05/94→06/96	Tie Rod End	CV-ES-14163	for Steering Rod	
	05/94→06/96	Track Control Arm		MN-DL-3402 Trailing Arm	
	05/94→06/96	Track Control Arm		MN-DL-3402 Trailing Arm, Drive Axle	
	05/94→06/96	Track Control Arm		MN-DL-8609 Trailing Arm, Leaf Spring Axle	
35.362 VF	10/88→02/90	Ball Head, gearshift linkage	CV-ES-2119		
	10/88→02/90	Ball Head, gearshift linkage	CV-ES-2120		
	10/88→02/90	Ball Head, gearshift linkage	CV-ES-2182		
	10/88→02/90	Centre Rod	MN-DL-2160	Coupling Rod	
	10/88→02/90	Centre Rod	MN-DL-2166	Push Rod	
	10/88→02/90	Centre Rod	MN-DL-3588	Push Rod	
	10/88→02/90	Centre Rod	MN-DL-12278	for Steering Rod	
	10/88→02/90	Engine Mounting	MN-SB-10389		
	10/88→02/90	Mounting, stabilizer coupling rod	MN-SB-5246		
	10/88→02/90	Mounting, stabilizer coupling rod	MN-SB-5246	1st FA	
	10/88→02/90	Stabiliser Mounting		MN-SB-5245	
	10/88→02/90	Stabiliser Mounting		MN-SB-5254	
	10/88→02/90	Stabiliser Mounting	MN-SB-9396		
	10/88→02/90	Suspension Arm Repair Kit		MN-SB-5244 for Wishbone (CV)	
	10/88→02/90	Suspension Arm Repair Kit		MN-SB-5244 for Wishbone (CV), 2nd RA	
	10/88→02/90	Tie Rod	MN-DL-12284		
	10/88→02/90	Tie Rod End	CV-ES-2146		
	10/88→02/90	Tie Rod End	CV-ES-2149	for Push Rod	
	10/88→02/90	Tie Rod End	CV-ES-14162	for Steering Rod	
	10/88→02/90	Tie Rod End	CV-ES-14163	for Steering Rod	
	10/88→02/90	Track Control Arm		MN-DL-3402 Trailing Arm	
	10/88→02/90	Track Control Arm		MN-DL-3402 Trailing Arm, Drive Axle	
	10/88→02/90	Track Control Arm		MN-DL-8609 Trailing Arm, Leaf Spring Axle	
	35.362 VFK	10/88→02/90	Ball Head, gearshift linkage	CV-ES-2119	
		10/88→02/90	Ball Head, gearshift linkage	CV-ES-2120	
		10/88→02/90	Ball Head, gearshift linkage	CV-ES-2182	
		10/88→02/90	Centre Rod	MN-DL-2160	Coupling Rod
		10/88→02/90	Centre Rod	MN-DL-2166	Push Rod
10/88→02/90		Centre Rod	MN-DL-3588	Push Rod	
10/88→02/90		Centre Rod	MN-DL-12278	for Steering Rod	
10/88→02/90		Engine Mounting	MN-SB-10389		
10/88→02/90		Mounting, stabilizer coupling rod	MN-SB-5246		
10/88→02/90		Mounting, stabilizer coupling rod	MN-SB-5246	1st FA	
10/88→02/90		Stabiliser Mounting		MN-SB-5245	
10/88→02/90		Stabiliser Mounting		MN-SB-5254	
10/88→02/90		Stabiliser Mounting	MN-SB-9396		
10/88→02/90		Suspension Arm Repair Kit		MN-SB-5244 for Wishbone (CV)	
10/88→02/90		Suspension Arm Repair Kit		MN-SB-5244 for Wishbone (CV), 2nd RA	
10/88→02/90		Tie Rod	MN-DL-12284		
10/88→02/90		Tie Rod End	CV-ES-2146		
10/88→02/90		Tie Rod End	CV-ES-2149	for Push Rod	
10/88→02/90		Tie Rod End	CV-ES-14162	for Steering Rod	
10/88→02/90		Tie Rod End	CV-ES-14163	for Steering Rod	
10/88→02/90		Track Control Arm		MN-DL-3402 Trailing Arm	
10/88→02/90		Track Control Arm		MN-DL-3402 Trailing Arm, Drive Axle	
10/88→02/90		Track Control Arm		MN-DL-8609 Trailing Arm, Leaf Spring Axle	
35.372 VF		02/90→06/96	Ball Head, gearshift linkage	CV-ES-2120	
		02/90→06/96	Engine Mounting	MN-SB-10389	
		02/90→06/96	Mounting, stabilizer coupling rod	MN-SB-5246	
		02/90→06/96	Mounting, stabilizer coupling rod	MN-SB-5246	1st FA
		02/90→06/96	Stabiliser Mounting		MN-SB-5245
	02/90→06/96	Stabiliser Mounting		MN-SB-5254	
	02/90→06/96	Stabiliser Mounting	MN-SB-9396		
	02/90→06/96	Suspension Arm Repair Kit		MN-SB-5244 for Wishbone (CV)	
	02/90→06/96	Suspension Arm Repair Kit		MN-SB-5244 for Wishbone (CV), 2nd RA	
	02/90→06/96	Tie Rod End	CV-ES-2146		
	02/90→06/96	Track Control Arm		MN-DL-3402 Trailing Arm	

CV-ES-2119

Length: 55
Cone Ø: d1 Ø 10 / d2 Ø 10
Thread: M12 x 1,75 LHT
81953016063, 81953016131



CV-ES-2120

Length: 115
Cone Ø: d1 Ø 12,4 / d2 Ø 10,8
Thread: M14 x 1,5 RHT
03008500A, 81953016200, 81953016202,
81953016203, 81953016227



CV-ES-2146

Length: 80
Cone Ø: d1 Ø 30 / d2 Ø 27
Thread: M26 x 1,5 RHT
42533102, 81953016219, 81953016225,
81953016226, 81953016267, 81953016291



CV-ES-2149

Length: 160
Cone Ø: d1 Ø 30 / d2 Ø 27
Thread: M30 x 1,5 RHT
81953016263



CV-ES-2182

Length: 55
Cone Ø: d1 Ø 10 / d2 Ø 10
Thread: M12 x 1,75 RHT
81953016064, 81953016170



CV-ES-14162

Length: 125
Cone Ø: d1 Ø 30 / d2 Ø 27
Thread: M30 x 1,5 LHT
81953010015, 81953010083, 81953010087,
81953016029, 81953016030, 81953016043,
81953016044, 81953016050, 81953016054,
81953016087, 81953016091, 81953016107,
81953016120, 81953016125, 81953016152,
81953016155, 81953016157, 81953016168,
81953016179, 81953016181, 81953016223,
81953016237, 81953016254, 81953016275,
81953016279, 81953016351



CV-ES-14163

Length: 125
Cone Ø: d1 Ø 30 / d2 Ø 27
Thread: M30 x 1,5 RHT
95301.0084, 90804102156, 90804102272,
90804102696, 90804102710, 81953010016,
81953010075, 81953010084, 81953010088,
81953010094, 81953010103, 81953016030,
81953016043, 81953016048, 81953016049,
81953016053, 81953016061, 81953016090,
81953016108, 81953016112, 81953016126,
81953016143, 81953016149, 81953016154,
81953016156, 81953016168, 81953016178,
81953016194, 81953016206, 81953016224,
81953016234, 81953016242, 81953016252,
81953016274, 81953016278, 81953016284,
81953016286, 81953016308, 81953016310,
81953016312, 81953016347, 81953016350,
81953016352, 82953016012, 88953016014,
N2953016001



MN-DL-2160

Length: 1652 Ø: 50
Cone Ø: d1 Ø 30 / d2 Ø 27
81467106112, 81467106163, 81467106165,
81467106198, 81467106353, 81467106354,
81467106361, 81467116725



MN-DL-2166

Length: 1795
Ø: 50
Cone Ø: d1 Ø 30 / d2 Ø 27
81467106418



MN-DL-3402

Length: 590 Ø: 48
Hole Distance: 130 / 130
03307200A, 81432206067, 81432206068,
81432206090, 81432206092, 81432209092



MN-DL-3588

Length: 1035
Ø: 48
Cone Ø: d1 Ø 30 / d2 Ø 27
81466106333, 81466106334, 81466106354,
81466106355, 81466106360, 81466106361,
81466106721, 81466106722, 81466106723,
81466116216



MN-DL-8609

Length: 585 Ø: 58
Hole Distance: 130 / 130
81432206070, 81432206071, 81432206072,
81432206091, 81432206093, 81432206119



MN-DL-12278

Length: 770
Ø: 40
Cone Ø: d1 Ø 30 / d2 Ø 27
81466106348



MN-DL-12284

Length: 1530 Ø: 50
Cone Ø: d1 Ø 30 / d2 Ø 27
81466106579, 81466106580, 81466106624,
81466116720, 81467116720, 81467116730,
81467116952



MN-SB-5244

Ø: 65
Hole Distance: 125
Thick/Height: 22
03312000A, 81432710027, 81432710082



MN-SB-5245

Ø: 75
Hole Distance: 125
Thick/Height: 22
03311900A, 81432710046, 81432710079,
81432710083



MN-SB-5246

Ø: 45 Thick/Height: 47
81437220022, 81437220038, 81962100450,
81962100469



MN-SB-5254

Length: 100
Ø: 93
Thick/Height: 70
81432710081



MN-SB-9396

Ø: 67
Thick/Height: 60
81437040057



MN-SB-10389

Ø: 70
Thick/Height: 72
81960200340



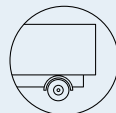

F 90 ...

35.372 VF ...	02/90→06/96	Track Control Arm		MN-DL-3402	Trailing Arm, Drive Axle	
	02/90→06/96	Track Control Arm		MN-DL-8609	Trailing Arm, Leaf Spring Axle	
	02/90→12/97	Ball Head, gearshift linkage	CV-ES-2119			
	02/90→12/97	Ball Head, gearshift linkage	CV-ES-2182			
	02/90→12/97	Centre Rod	MN-DL-2160		Coupling Rod	
	02/90→12/97	Centre Rod	MN-DL-2166		Push Rod	
	02/90→12/97	Centre Rod	MN-DL-3588		Push Rod	
	02/90→12/97	Centre Rod	MN-DL-12278		for Steering Rod	
	02/90→12/97	Tie Rod	MN-DL-12284			
	02/90→12/97	Tie Rod End	CV-ES-2149		for Push Rod	
	02/90→12/97	Tie Rod End	CV-ES-14162		for Steering Rod	
	02/90→12/97	Tie Rod End	CV-ES-14163		for Steering Rod	
	35.372 VFK	02/90→06/96	Ball Head, gearshift linkage	CV-ES-2120		
		02/90→06/96	Engine Mounting	MN-SB-10389		
02/90→06/96		Mounting, stabilizer coupling rod	MN-SB-5246			
02/90→06/96		Mounting, stabilizer coupling rod	MN-SB-5246		1st FA	
02/90→06/96		Stabiliser Mounting		MN-SB-5245		
02/90→06/96		Stabiliser Mounting		MN-SB-5254		
02/90→06/96		Stabiliser Mounting	MN-SB-9396			
02/90→06/96		Suspension Arm Repair Kit		MN-SB-5244	for Wishbone (CV)	
02/90→06/96		Suspension Arm Repair Kit		MN-SB-5244	for Wishbone (CV), 2nd RA	
02/90→06/96		Tie Rod End	CV-ES-2146			
02/90→06/96		Track Control Arm		MN-DL-3402	Trailing Arm	
02/90→06/96		Track Control Arm		MN-DL-3402	Trailing Arm, Drive Axle	
02/90→06/96		Track Control Arm		MN-DL-8609	Trailing Arm, Leaf Spring Axle	
02/90→12/97		Ball Head, gearshift linkage	CV-ES-2119			
02/90→12/97		Ball Head, gearshift linkage	CV-ES-2182			
02/90→12/97		Centre Rod	MN-DL-2160		Coupling Rod	
02/90→12/97		Centre Rod	MN-DL-2166		Push Rod	
02/90→12/97		Centre Rod	MN-DL-3588		Push Rod	
02/90→12/97		Centre Rod	MN-DL-12278		for Steering Rod	
02/90→12/97		Tie Rod	MN-DL-12284			
02/90→12/97		Tie Rod End	CV-ES-2149		for Push Rod	
02/90→12/97		Tie Rod End	CV-ES-14162		for Steering Rod	
02/90→12/97		Tie Rod End	CV-ES-14163		for Steering Rod	
35.402 VF		05/94→06/96	Ball Head, gearshift linkage	CV-ES-2120		
	05/94→06/96	Engine Mounting	MN-SB-10389			
	05/94→06/96	Mounting, stabilizer coupling rod	MN-SB-5246			
	05/94→06/96	Mounting, stabilizer coupling rod	MN-SB-5246		1st FA	
	05/94→06/96	Stabiliser Mounting		MN-SB-5245		
	05/94→06/96	Stabiliser Mounting		MN-SB-5254		
	05/94→06/96	Stabiliser Mounting	MN-SB-9396			
	05/94→06/96	Suspension Arm Repair Kit		MN-SB-5244	for Wishbone (CV)	
	05/94→06/96	Suspension Arm Repair Kit		MN-SB-5244	for Wishbone (CV), 2nd RA	
	05/94→06/96	Tie Rod End	CV-ES-2146			
	05/94→06/96	Track Control Arm		MN-DL-3402	Trailing Arm	
	05/94→06/96	Track Control Arm		MN-DL-3402	Trailing Arm, Drive Axle	
	05/94→06/96	Track Control Arm		MN-DL-8609	Trailing Arm, Leaf Spring Axle	
	05/94→12/97	Ball Head, gearshift linkage	CV-ES-2119			
	05/94→12/97	Ball Head, gearshift linkage	CV-ES-2182			
	05/94→12/97	Centre Rod	MN-DL-2160		Coupling Rod	
	05/94→12/97	Centre Rod	MN-DL-2166		Push Rod	
	05/94→12/97	Centre Rod	MN-DL-3588		Push Rod	
	05/94→12/97	Centre Rod	MN-DL-12278		for Steering Rod	
	05/94→12/97	Tie Rod	MN-DL-12284			
	05/94→12/97	Tie Rod End	CV-ES-2149		for Push Rod	
	05/94→12/97	Tie Rod End	CV-ES-14162		for Steering Rod	
	05/94→12/97	Tie Rod End	CV-ES-14163		for Steering Rod	
	35.402 VFK	05/94→06/96	Ball Head, gearshift linkage	CV-ES-2120		
05/94→06/96		Engine Mounting	MN-SB-10389			
05/94→06/96		Mounting, stabilizer coupling rod	MN-SB-5246			
05/94→06/96		Mounting, stabilizer coupling rod	MN-SB-5246		1st FA	
05/94→06/96		Stabiliser Mounting		MN-SB-5245		

CV-ES-2119

Length: 55
Cone Ø: d1 Ø 10 / d2 Ø 10
Thread: M12 x 1,75 LHT
81953016063, 81953016131



CV-ES-2120

Length: 115
Cone Ø: d1 Ø 12,4 / d2 Ø 10,8
Thread: M14 x 1,5 RHT
03008500A, 81953016200, 81953016202,
81953016203, 81953016227



CV-ES-2146

Length: 80
Cone Ø: d1 Ø 30 / d2 Ø 27
Thread: M26 x 1,5 RHT
42533102, 81953016219, 81953016225,
81953016226, 81953016267, 81953016291



CV-ES-2149

Length: 160
Cone Ø: d1 Ø 30 / d2 Ø 27
Thread: M30 x 1,5 RHT
81953016263



CV-ES-2182

Length: 55
Cone Ø: d1 Ø 10 / d2 Ø 10
Thread: M12 x 1,75 RHT
81953016064, 81953016170



CV-ES-14162

Length: 125
Cone Ø: d1 Ø 30 / d2 Ø 27
Thread: M30 x 1,5 LHT
81953010015, 81953010083, 81953010087,
81953016029, 81953016030, 81953016043,
81953016044, 81953016050, 81953016054,
81953016087, 81953016091, 81953016107,
81953016120, 81953016125, 81953016152,
81953016155, 81953016157, 81953016168,
81953016179, 81953016181, 81953016223,
81953016237, 81953016254, 81953016275,
81953016279, 81953016351



CV-ES-14163

Length: 125
Cone Ø: d1 Ø 30 / d2 Ø 27
Thread: M30 x 1,5 RHT
95301.0084, 90804102156, 90804102272,
90804102696, 90804102710, 81953010016,
81953010075, 81953010084, 81953010088,
81953010094, 81953010103, 81953016030,
81953016043, 81953016048, 81953016049,
81953016053, 81953016061, 81953016090,
81953016108, 81953016112, 81953016126,
81953016143, 81953016149, 81953016154,
81953016156, 81953016168, 81953016178,
81953016194, 81953016206, 81953016224,
81953016234, 81953016242, 81953016252,
81953016274, 81953016278, 81953016284,
81953016286, 81953016308, 81953016310,
81953016312, 81953016347, 81953016350,
81953016352, 82953016012, 88953016014,
N2953016001



MN-DL-2160

Length: 1652 Ø: 50
Cone Ø: d1 Ø 30 / d2 Ø 27
81467106112, 81467106163, 81467106165,
81467106198, 81467106353, 81467106354,
81467106361, 81467116725



MN-DL-2166

Length: 1795
Ø: 50
Cone Ø: d1 Ø 30 / d2 Ø 27
81467106418



MN-DL-3402

Length: 590 Ø: 48
Hole Distance: 130 / 130
03307200A, 81432206067, 81432206068,
81432206090, 81432206092, 81432209092



MN-DL-3588

Length: 1035
Ø: 48
Cone Ø: d1 Ø 30 / d2 Ø 27
81466106333, 81466106334, 81466106354,
81466106355, 81466106360, 81466106361,
81466106721, 81466106722, 81466106723,
81466116216



MN-DL-8609

Length: 585 Ø: 58
Hole Distance: 130 / 130
81432206070, 81432206071, 81432206072,
81432206091, 81432206093, 81432206119



MN-DL-12278

Length: 770
Ø: 40
Cone Ø: d1 Ø 30 / d2 Ø 27
81466106348



MN-DL-12284

Length: 1530 Ø: 50
Cone Ø: d1 Ø 30 / d2 Ø 27
81466106579, 81466106580, 81466106624,
81466116720, 81467116720, 81467116730,
81467116952



MN-SB-5244

Ø: 65
Hole Distance: 125
Thick/Height: 22
03312000A, 81432710027, 81432710082



MN-SB-5245

Ø: 75
Hole Distance: 125
Thick/Height: 22
03311900A, 81432710046, 81432710079,
81432710083



MN-SB-5246

Ø: 45 Thick/Height: 47
81437220022, 81437220038, 81962100450,
81962100469



MN-SB-5254

Length: 100
Ø: 93
Thick/Height: 70
81432710081



MN-SB-9396

Ø: 67
Thick/Height: 60
81437040057



MN-SB-10389

Ø: 70
Thick/Height: 72
81960200340





F 90 ...

35.402 VFK ...	05/94 → 06/96	Stabiliser Mounting		MN-SB-5254	
	05/94 → 06/96	Stabiliser Mounting	MN-SB-9396		
	05/94 → 06/96	Suspension Arm Repair Kit		MN-SB-5244	for Wishbone (CV)
	05/94 → 06/96	Suspension Arm Repair Kit		MN-SB-5244	for Wishbone (CV), 2nd RA
	05/94 → 06/96	Tie Rod End	CV-ES-2146		
	05/94 → 06/96	Track Control Arm		MN-DL-3402	Trailing Arm
	05/94 → 06/96	Track Control Arm		MN-DL-3402	Trailing Arm, Drive Axle
	05/94 → 06/96	Track Control Arm		MN-DL-8609	Trailing Arm, Leaf Spring Axle
	05/94 → 12/97	Ball Head, gearshift linkage	CV-ES-2119		
	05/94 → 12/97	Ball Head, gearshift linkage	CV-ES-2182		
	05/94 → 12/97	Centre Rod	MN-DL-2160		Coupling Rod
	05/94 → 12/97	Centre Rod	MN-DL-2166		Push Rod
	05/94 → 12/97	Centre Rod	MN-DL-3588		Push Rod
	05/94 → 12/97	Centre Rod	MN-DL-12278		for Steering Rod
	05/94 → 12/97	Tie Rod	MN-DL-12284		
	05/94 → 12/97	Tie Rod End	CV-ES-2149		for Push Rod
	05/94 → 12/97	Tie Rod End	CV-ES-14162		for Steering Rod
05/94 → 12/97	Tie Rod End	CV-ES-14163		for Steering Rod	
35.422 VF	02/90 → 06/96	Stabiliser Mounting		MN-SB-5245	
	02/90 → 06/96	Stabiliser Mounting		MN-SB-5254	
	02/90 → 06/96	Stabiliser Mounting	MN-SB-9396		
	02/90 → 12/97	Ball Head, gearshift linkage	CV-ES-2119		
	02/90 → 12/97	Ball Head, gearshift linkage	CV-ES-2120		
	02/90 → 12/97	Ball Head, gearshift linkage	CV-ES-2182		
	02/90 → 12/97	Centre Rod	MN-DL-2160		Coupling Rod
	02/90 → 12/97	Centre Rod	MN-DL-2166		Push Rod
	02/90 → 12/97	Centre Rod	MN-DL-3588		Push Rod
	02/90 → 12/97	Centre Rod	MN-DL-12278		for Steering Rod
	02/90 → 12/97	Engine Mounting	MN-SB-10389		
	02/90 → 12/97	Mounting, stabilizer coupling rod	MN-SB-5246		
	02/90 → 12/97	Mounting, stabilizer coupling rod	MN-SB-5246		1st FA
	02/90 → 12/97	Suspension Arm Repair Kit		MN-SB-5244	for Wishbone (CV)
	02/90 → 12/97	Suspension Arm Repair Kit		MN-SB-5244	for Wishbone (CV), 2nd RA
	02/90 → 12/97	Tie Rod	MN-DL-12284		
	02/90 → 12/97	Tie Rod End	CV-ES-2146		
	02/90 → 12/97	Tie Rod End	CV-ES-2149		for Push Rod
	02/90 → 12/97	Tie Rod End	CV-ES-14162		for Steering Rod
	02/90 → 12/97	Tie Rod End	CV-ES-14163		for Steering Rod
	02/90 → 12/97	Track Control Arm		MN-DL-3402	Trailing Arm
	02/90 → 12/97	Track Control Arm		MN-DL-3402	Trailing Arm, Drive Axle
02/90 → 12/97	Track Control Arm		MN-DL-8609	Trailing Arm, Leaf Spring Axle	
35.422 VFK	02/90 → 06/96	Stabiliser Mounting		MN-SB-5245	
	02/90 → 06/96	Stabiliser Mounting		MN-SB-5254	
	02/90 → 06/96	Stabiliser Mounting	MN-SB-9396		
	02/90 → 12/97	Ball Head, gearshift linkage	CV-ES-2119		
	02/90 → 12/97	Ball Head, gearshift linkage	CV-ES-2120		
	02/90 → 12/97	Ball Head, gearshift linkage	CV-ES-2182		
	02/90 → 12/97	Centre Rod	MN-DL-2160		Coupling Rod
	02/90 → 12/97	Centre Rod	MN-DL-2166		Push Rod
	02/90 → 12/97	Centre Rod	MN-DL-3588		Push Rod
	02/90 → 12/97	Centre Rod	MN-DL-12278		for Steering Rod
	02/90 → 12/97	Engine Mounting	MN-SB-10389		
	02/90 → 12/97	Mounting, stabilizer coupling rod	MN-SB-5246		
	02/90 → 12/97	Mounting, stabilizer coupling rod	MN-SB-5246		1st FA
	02/90 → 12/97	Suspension Arm Repair Kit		MN-SB-5244	for Wishbone (CV)
	02/90 → 12/97	Suspension Arm Repair Kit		MN-SB-5244	for Wishbone (CV), 2nd RA
	02/90 → 12/97	Tie Rod	MN-DL-12284		
	02/90 → 12/97	Tie Rod End	CV-ES-2146		
	02/90 → 12/97	Tie Rod End	CV-ES-2149		for Push Rod
	02/90 → 12/97	Tie Rod End	CV-ES-14162		for Steering Rod
	02/90 → 12/97	Tie Rod End	CV-ES-14163		for Steering Rod
	02/90 → 12/97	Track Control Arm		MN-DL-3402	Trailing Arm
	02/90 → 12/97	Track Control Arm		MN-DL-3402	Trailing Arm, Drive Axle
	02/90 → 12/97	Track Control Arm		MN-DL-8609	Trailing Arm, Leaf Spring Axle

CV-ES-2119

Length: 55
Cone Ø: d1 Ø 10 / d2 Ø 10
Thread: M12 x 1,75 LHT
81953016063, 81953016131



CV-ES-2120

Length: 115
Cone Ø: d1 Ø 12,4 / d2 Ø 10,8
Thread: M14 x 1,5 RHT
03008500A, 81953016200, 81953016202,
81953016203, 81953016227



CV-ES-2146

Length: 80
Cone Ø: d1 Ø 30 / d2 Ø 27
Thread: M26 x 1,5 RHT
42533102, 81953016219, 81953016225,
81953016226, 81953016267, 81953016291



CV-ES-2149

Length: 160
Cone Ø: d1 Ø 30 / d2 Ø 27
Thread: M30 x 1,5 RHT
81953016263



CV-ES-2182

Length: 55
Cone Ø: d1 Ø 10 / d2 Ø 10
Thread: M12 x 1,75 RHT
81953016064, 81953016170



CV-ES-14162

Length: 125
Cone Ø: d1 Ø 30 / d2 Ø 27
Thread: M30 x 1,5 LHT
81953010015, 81953010083, 81953010087,
81953016029, 81953016030, 81953016043,
81953016044, 81953016050, 81953016054,
81953016087, 81953016091, 81953016107,
81953016120, 81953016125, 81953016152,
81953016155, 81953016157, 81953016168,
81953016179, 81953016181, 81953016223,
81953016237, 81953016254, 81953016275,
81953016279, 81953016351



CV-ES-14163

Length: 125
Cone Ø: d1 Ø 30 / d2 Ø 27
Thread: M30 x 1,5 RHT
95301.0084, 90804102156, 90804102272,
90804102696, 90804102710, 81953010016,
81953010075, 81953010084, 81953010088,
81953010094, 81953010103, 81953016030,
81953016043, 81953016048, 81953016049,
81953016053, 81953016061, 81953016090,
81953016108, 81953016112, 81953016126,
81953016143, 81953016149, 81953016154,
81953016156, 81953016168, 81953016178,
81953016194, 81953016206, 81953016224,
81953016234, 81953016242, 81953016252,
81953016274, 81953016278, 81953016284,
81953016286, 81953016308, 81953016310,
81953016312, 81953016347, 81953016350,
81953016352, 82953016012, 88953016014,
N2953016001



MN-DL-2160

Length: 1652 Ø: 50
Cone Ø: d1 Ø 30 / d2 Ø 27
81467106112, 81467106163, 81467106165,
81467106198, 81467106353, 81467106354,
81467106361, 81467116725



MN-DL-2166

Length: 1795
Ø: 50
Cone Ø: d1 Ø 30 / d2 Ø 27
81467106418



MN-DL-3402

Length: 590 Ø: 48
Hole Distance: 130 / 130
03307200A, 81432206067, 81432206068,
81432206090, 81432206092, 81432209092



MN-DL-3588

Length: 1035
Ø: 48
Cone Ø: d1 Ø 30 / d2 Ø 27
81466106333, 81466106334, 81466106354,
81466106355, 81466106360, 81466106361,
81466106721, 81466106722, 81466106723,
81466116216



MN-DL-8609

Length: 585 Ø: 58
Hole Distance: 130 / 130
81432206070, 81432206071, 81432206072,
81432206091, 81432206093, 81432206119



MN-DL-12278

Length: 770
Ø: 40
Cone Ø: d1 Ø 30 / d2 Ø 27
81466106348



MN-DL-12284

Length: 1530 Ø: 50
Cone Ø: d1 Ø 30 / d2 Ø 27
81466106579, 81466106580, 81466106624,
81466116720, 81467116720, 81467116730,
81467116952



MN-SB-5244

Ø: 65
Hole Distance: 125
Thick/Height: 22
03312000A, 81432710027, 81432710082



MN-SB-5245

Ø: 75
Hole Distance: 125
Thick/Height: 22
03311900A, 81432710046, 81432710079,
81432710083



MN-SB-5246

Ø: 45 Thick/Height: 47
81437220022, 81437220038, 81962100450,
81962100469



MN-SB-5254

Length: 100
Ø: 93
Thick/Height: 70
81432710081



MN-SB-9396

Ø: 67
Thick/Height: 60
81437040057



MN-SB-10389

Ø: 70
Thick/Height: 72
81960200340





F 90 ...

40.372 DF	12/91→06/96	Ball Head, gearshift linkage	CV-ES-2120			
	12/91→06/96	Engine Mounting		MN-SB-10390		
	12/91→06/96	Engine Mounting	MN-SB-10389			
	12/91→06/96	Stabiliser Mounting		MN-SB-5254		
	12/91→06/96	Stabiliser Mounting	MN-SB-9396			
	12/91→06/96	Suspension Arm Repair Kit		MN-SB-5244	for Wishbone (CV)	
	12/91→06/96	Suspension Arm Repair Kit		MN-SB-5244	for Wishbone (CV), 1st RA	
	12/91→06/96	Tie Rod End	CV-ES-14163		for Steering Rod	
	12/91→06/96	Track Control Arm		MN-DL-8609	Trailing Arm, Leaf Spring Axle	
	40.372 DFA	12/91→06/96	Ball Head, gearshift linkage	CV-ES-2120		
12/91→06/96		Engine Mounting		MN-SB-10390		
12/91→06/96		Engine Mounting	MN-SB-10389			
12/91→06/96		Mounting, stabilizer coupling rod	MN-SB-5246			
12/91→06/96		Mounting, stabilizer coupling rod	MN-SB-5246		1st FA	
12/91→06/96		Stabiliser Mounting		MN-SB-5254		
12/91→06/96		Stabiliser Mounting	MN-SB-9396			
12/91→06/96		Suspension Arm Repair Kit		MN-SB-5244	for Wishbone (CV)	
12/91→06/96		Suspension Arm Repair Kit		MN-SB-5244	for Wishbone (CV), 1st RA	
12/91→06/96		Tie Rod End	CV-ES-14163		for Steering Rod	
40.402 DF	05/95→06/96	Ball Head, gearshift linkage	CV-ES-2120			
	05/95→06/96	Engine Mounting		MN-SB-10390		
	05/95→06/96	Engine Mounting	MN-SB-10389			
	05/95→06/96	Stabiliser Mounting		MN-SB-5254		
	05/95→06/96	Stabiliser Mounting	MN-SB-9396			
	05/95→06/96	Suspension Arm Repair Kit		MN-SB-5244	for Wishbone (CV)	
	05/95→06/96	Suspension Arm Repair Kit		MN-SB-5244	for Wishbone (CV), 1st RA	
	05/95→06/96	Tie Rod End	CV-ES-14163		for Steering Rod	
	05/95→06/96	Track Control Arm		MN-DL-8609	Trailing Arm, Leaf Spring Axle	
	40.402 DFA	05/95→06/96	Ball Head, gearshift linkage	CV-ES-2120		
05/95→06/96		Engine Mounting		MN-SB-10390		
05/95→06/96		Engine Mounting	MN-SB-10389			
05/95→06/96		Mounting, stabilizer coupling rod	MN-SB-5246			
05/95→06/96		Mounting, stabilizer coupling rod	MN-SB-5246		1st FA	
05/95→06/96		Stabiliser Mounting		MN-SB-5254		
05/95→06/96		Stabiliser Mounting	MN-SB-9396			
05/95→06/96		Suspension Arm Repair Kit		MN-SB-5244	for Wishbone (CV)	
05/95→06/96		Suspension Arm Repair Kit		MN-SB-5244	for Wishbone (CV), 1st RA	
05/95→06/96		Tie Rod End	CV-ES-14163		for Steering Rod	
40.422 DF	12/91→06/96	Ball Head, gearshift linkage	CV-ES-2120			
	12/91→06/96	Engine Mounting		MN-SB-10390		
	12/91→06/96	Engine Mounting	MN-SB-10389			
	12/91→06/96	Stabiliser Mounting		MN-SB-5254		
	12/91→06/96	Stabiliser Mounting	MN-SB-9396			
	12/91→06/96	Suspension Arm Repair Kit		MN-SB-5244	for Wishbone (CV)	
	12/91→06/96	Suspension Arm Repair Kit		MN-SB-5244	for Wishbone (CV), 1st RA	
	12/91→06/96	Tie Rod End	CV-ES-14163		for Steering Rod	
	12/91→06/96	Track Control Arm		MN-DL-8609	Trailing Arm, Leaf Spring Axle	
	40.422 DFA	12/91→06/96	Ball Head, gearshift linkage	CV-ES-2120		
12/91→06/96		Engine Mounting		MN-SB-10390		
12/91→06/96		Engine Mounting	MN-SB-10389			
12/91→06/96		Mounting, stabilizer coupling rod	MN-SB-5246			
12/91→06/96		Mounting, stabilizer coupling rod	MN-SB-5246		1st FA	
12/91→06/96		Stabiliser Mounting		MN-SB-5254		
12/91→06/96		Stabiliser Mounting	MN-SB-9396			
12/91→06/96		Suspension Arm Repair Kit		MN-SB-5244	for Wishbone (CV)	
12/91→06/96		Suspension Arm Repair Kit		MN-SB-5244	for Wishbone (CV), 1st RA	
12/91→06/96		Tie Rod End	CV-ES-14163		for Steering Rod	
40.462 DFA	07/89→02/90	Ball Head, gearshift linkage	CV-ES-2120			
	40.502 DFA	02/90→06/96	Ball Head, gearshift linkage	CV-ES-2120		

CV-ES-2120

Length: 115
Cone Ø: d1 Ø 12,4 / d2 Ø 10,8
Thread: M14 x 1,5 RHT
03008500A, 81953016200, 81953016202,
81953016203, 81953016227



CV-ES-14163

Length: 125
Cone Ø: d1 Ø 30 / d2 Ø 27
Thread: M30 x 1,5 RHT
95301.0084, 90804102156, 90804102272,
90804102696, 90804102710, 81953010016,
81953010075, 81953010084, 81953010088,
81953010094, 81953010103, 81953016030,
81953016043, 81953016048, 81953016049,
81953016053, 81953016061, 81953016090,
81953016108, 81953016112, 81953016126,
81953016143, 81953016149, 81953016154,
81953016156, 81953016168, 81953016178,
81953016194, 81953016206, 81953016224,
81953016234, 81953016242, 81953016252,
81953016274, 81953016278, 81953016284,
81953016286, 81953016308, 81953016310,
81953016312, 81953016347, 81953016350,
81953016352, 82953016012, 88953016014,
N2953016001



MN-DL-8609

Length: 585 Ø: 58
Hole Distance: 130 / 130
81432206070, 81432206071, 81432206072,
81432206091, 81432206093, 81432206119



MN-SB-5244

Ø: 65
Hole Distance: 125
Thick/Height: 22
03312000A, 81432710027, 81432710082



MN-SB-5246

Ø: 45 Thick/Height: 47
81437220022, 81437220038, 81962100450,
81962100469



MN-SB-5254

Length: 100
Ø: 93
Thick/Height: 70
81432710081



MN-SB-9396

Ø: 67
Thick/Height: 60
81437040057



MN-SB-10389

Ø: 70
Thick/Height: 72
81960200340



MN-SB-10390

Ø: 70
Thick/Height: 85/85
81960200341, 81960200373, 81960200385,
81960200408, 81960200418



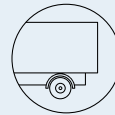

F 90 ...

41.262 VF	07/89→02/90	Ball Head, gearshift linkage	CV-ES-2119		
	07/89→02/90	Ball Head, gearshift linkage	CV-ES-2120		
	07/89→02/90	Ball Head, gearshift linkage	CV-ES-2182		
	07/89→02/90	Centre Rod	MN-DL-2160		Coupling Rod
	07/89→02/90	Centre Rod	MN-DL-2166		Push Rod
	07/89→02/90	Centre Rod	MN-DL-3588		Push Rod
	07/89→02/90	Centre Rod	MN-DL-12278		for Steering Rod
	07/89→02/90	Engine Mounting	MN-SB-10389		
	07/89→02/90	Mounting, stabilizer coupling rod	MN-SB-5246		
	07/89→02/90	Mounting, stabilizer coupling rod	MN-SB-5246		1st FA
	07/89→02/90	Stabiliser Mounting		MN-SB-5245	
	07/89→02/90	Stabiliser Mounting		MN-SB-5254	
	07/89→02/90	Stabiliser Mounting	MN-SB-9396		
	07/89→02/90	Suspension Arm Repair Kit		MN-SB-5244	for Wishbone (CV)
	07/89→02/90	Suspension Arm Repair Kit		MN-SB-5244	for Wishbone (CV), 2nd RA
	07/89→02/90	Tie Rod	MN-DL-12284		
	07/89→02/90	Tie Rod End	CV-ES-2146		
	07/89→02/90	Tie Rod End	CV-ES-2149		for Push Rod
	07/89→02/90	Tie Rod End	CV-ES-14162		for Steering Rod
	07/89→02/90	Tie Rod End	CV-ES-14163		for Steering Rod
	07/89→02/90	Track Control Arm		MN-DL-3402	Trailing Arm
	07/89→02/90	Track Control Arm		MN-DL-3402	Trailing Arm, Drive Axle
	07/89→02/90	Track Control Arm		MN-DL-8609	Trailing Arm, Leaf Spring Axle
41.262 VFK	07/89→02/90	Ball Head, gearshift linkage	CV-ES-2119		
	07/89→02/90	Ball Head, gearshift linkage	CV-ES-2120		
	07/89→02/90	Ball Head, gearshift linkage	CV-ES-2182		
	07/89→02/90	Centre Rod	MN-DL-2160		Coupling Rod
	07/89→02/90	Centre Rod	MN-DL-2166		Push Rod
	07/89→02/90	Centre Rod	MN-DL-3588		Push Rod
	07/89→02/90	Centre Rod	MN-DL-12278		for Steering Rod
	07/89→02/90	Engine Mounting	MN-SB-10389		
	07/89→02/90	Mounting, stabilizer coupling rod	MN-SB-5246		
	07/89→02/90	Mounting, stabilizer coupling rod	MN-SB-5246		1st FA
	07/89→02/90	Stabiliser Mounting		MN-SB-5245	
	07/89→02/90	Stabiliser Mounting		MN-SB-5254	
	07/89→02/90	Stabiliser Mounting	MN-SB-9396		
	07/89→02/90	Suspension Arm Repair Kit		MN-SB-5244	for Wishbone (CV)
	07/89→02/90	Suspension Arm Repair Kit		MN-SB-5244	for Wishbone (CV), 2nd RA
	07/89→02/90	Tie Rod	MN-DL-12284		
	07/89→02/90	Tie Rod End	CV-ES-2146		
	07/89→02/90	Tie Rod End	CV-ES-2149		for Push Rod
	07/89→02/90	Tie Rod End	CV-ES-14162		for Steering Rod
	07/89→02/90	Tie Rod End	CV-ES-14163		for Steering Rod
	07/89→02/90	Track Control Arm		MN-DL-3402	Trailing Arm
	07/89→02/90	Track Control Arm		MN-DL-3402	Trailing Arm, Drive Axle
	07/89→02/90	Track Control Arm		MN-DL-8609	Trailing Arm, Leaf Spring Axle
41.272 VF	02/90→12/91	Ball Head, gearshift linkage	CV-ES-2119		
	02/90→12/91	Ball Head, gearshift linkage	CV-ES-2120		
	02/90→12/91	Ball Head, gearshift linkage	CV-ES-2182		
	02/90→12/91	Centre Rod	MN-DL-2160		Coupling Rod
	02/90→12/91	Centre Rod	MN-DL-2166		Push Rod
	02/90→12/91	Centre Rod	MN-DL-3588		Push Rod
	02/90→12/91	Centre Rod	MN-DL-12278		for Steering Rod
	02/90→12/91	Engine Mounting	MN-SB-10389		
	02/90→12/91	Mounting, stabilizer coupling rod	MN-SB-5246		
	02/90→12/91	Mounting, stabilizer coupling rod	MN-SB-5246		1st FA
	02/90→12/91	Stabiliser Mounting		MN-SB-5245	
	02/90→12/91	Stabiliser Mounting		MN-SB-5254	
	02/90→12/91	Stabiliser Mounting	MN-SB-9396		
	02/90→12/91	Suspension Arm Repair Kit		MN-SB-5244	for Wishbone (CV)
	02/90→12/91	Suspension Arm Repair Kit		MN-SB-5244	for Wishbone (CV), 2nd RA
	02/90→12/91	Tie Rod	MN-DL-12284		
	02/90→12/91	Tie Rod End	CV-ES-2146		

CV-ES-2119

Length: 55
Cone Ø: d1 Ø 10 / d2 Ø 10
Thread: M12 x 1,75 LHT
81953016063, 81953016131



CV-ES-2120

Length: 115
Cone Ø: d1 Ø 12,4 / d2 Ø 10,8
Thread: M14 x 1,5 RHT
03008500A, 81953016200, 81953016202,
81953016203, 81953016227



CV-ES-2146

Length: 80
Cone Ø: d1 Ø 30 / d2 Ø 27
Thread: M26 x 1,5 RHT
42533102, 81953016219, 81953016225,
81953016226, 81953016267, 81953016291



CV-ES-2149

Length: 160
Cone Ø: d1 Ø 30 / d2 Ø 27
Thread: M30 x 1,5 RHT
81953016263



CV-ES-2182

Length: 55
Cone Ø: d1 Ø 10 / d2 Ø 10
Thread: M12 x 1,75 RHT
81953016064, 81953016170



CV-ES-14162

Length: 125
Cone Ø: d1 Ø 30 / d2 Ø 27
Thread: M30 x 1,5 LHT

81953010015, 81953010083, 81953010087,
81953016029, 81953016030, 81953016043,
81953016044, 81953016050, 81953016054,
81953016087, 81953016091, 81953016107,
81953016120, 81953016125, 81953016152,
81953016155, 81953016157, 81953016168,
81953016179, 81953016181, 81953016223,
81953016237, 81953016254, 81953016275,
81953016279, 81953016351



CV-ES-14163

Length: 125
Cone Ø: d1 Ø 30 / d2 Ø 27
Thread: M30 x 1,5 RHT

95301.0084, 90804102156, 90804102272,
90804102696, 90804102710, 81953010016,
81953010075, 81953010084, 81953010088,
81953010094, 81953010103, 81953016030,
81953016043, 81953016048, 81953016049,
81953016053, 81953016061, 81953016090,
81953016108, 81953016112, 81953016126,
81953016143, 81953016149, 81953016154,
81953016156, 81953016168, 81953016178,
81953016194, 81953016206, 81953016224,
81953016234, 81953016242, 81953016252,
81953016274, 81953016278, 81953016284,
81953016286, 81953016308, 81953016310,
81953016312, 81953016347, 81953016350,
81953016352, 82953016012, 88953016014,
N2953016001



MN-DL-2160

Length: 1652 Ø: 50
Cone Ø: d1 Ø 30 / d2 Ø 27

81467106112, 81467106163, 81467106165,
81467106198, 81467106353, 81467106354,
81467106361, 81467116725



MN-DL-2166

Length: 1795
Ø: 50
Cone Ø: d1 Ø 30 / d2 Ø 27
81467106418



MN-DL-3402

Length: 590 Ø: 48
Hole Distance: 130 / 130
03307200A, 81432206067, 81432206068,
81432206090, 81432206092, 81432209092



MN-DL-3588

Length: 1035
Ø: 48
Cone Ø: d1 Ø 30 / d2 Ø 27
81466106333, 81466106334, 81466106354,
81466106355, 81466106360, 81466106361,
81466106721, 81466106722, 81466106723,
81466116216



MN-DL-8609

Length: 585 Ø: 58
Hole Distance: 130 / 130
81432206070, 81432206071, 81432206072,
81432206091, 81432206093, 81432206119



MN-DL-12278

Length: 770
Ø: 40
Cone Ø: d1 Ø 30 / d2 Ø 27
81466106348



MN-DL-12284

Length: 1530 Ø: 50
Cone Ø: d1 Ø 30 / d2 Ø 27
81466106579, 81466106580, 81466106624,
81466116720, 81467116720, 81467116730,
81467116952



MN-SB-5244

Ø: 65
Hole Distance: 125
Thick/Height: 22
03312000A, 81432710027, 81432710082



MN-SB-5245

Ø: 75
Hole Distance: 125
Thick/Height: 22
03311900A, 81432710046, 81432710079,
81432710083



MN-SB-5246

Ø: 45 Thick/Height: 47
81437220022, 81437220038, 81962100450,
81962100469



MN-SB-5254

Length: 100
Ø: 93
Thick/Height: 70
81432710081



MN-SB-9396

Ø: 67
Thick/Height: 60
81437040057



MN-SB-10389

Ø: 70
Thick/Height: 72
81960200340





F 90 ...

41.272 VF ...	02/90→12/91	Tie Rod End	CV-ES-2149		for Push Rod
	02/90→12/91	Tie Rod End	CV-ES-14162		for Steering Rod
	02/90→12/91	Tie Rod End	CV-ES-14163		for Steering Rod
	02/90→12/91	Track Control Arm		MN-DL-3402	Trailing Arm
	02/90→12/91	Track Control Arm		MN-DL-3402	Trailing Arm, Drive Axle
	02/90→12/91	Track Control Arm		MN-DL-8609	Trailing Arm, Leaf Spring Axle
41.292 VF	10/88→02/90	Ball Head, gearshift linkage	CV-ES-2119		
	10/88→02/90	Ball Head, gearshift linkage	CV-ES-2120		
	10/88→02/90	Ball Head, gearshift linkage	CV-ES-2182		
	10/88→02/90	Centre Rod	MN-DL-2160		Coupling Rod
	10/88→02/90	Centre Rod	MN-DL-2166		Push Rod
	10/88→02/90	Centre Rod	MN-DL-3588		Push Rod
	10/88→02/90	Centre Rod	MN-DL-12278		for Steering Rod
	10/88→02/90	Engine Mounting	MN-SB-10389		
	10/88→02/90	Mounting, stabilizer coupling rod	MN-SB-5246		
	10/88→02/90	Mounting, stabilizer coupling rod	MN-SB-5246		1st FA
	10/88→02/90	Stabiliser Mounting		MN-SB-5245	
	10/88→02/90	Stabiliser Mounting		MN-SB-5254	
	10/88→02/90	Stabiliser Mounting	MN-SB-9396		
	10/88→02/90	Suspension Arm Repair Kit		MN-SB-5244	for Wishbone (CV)
	10/88→02/90	Suspension Arm Repair Kit		MN-SB-5244	for Wishbone (CV), 2nd RA
	10/88→02/90	Tie Rod	MN-DL-12284		
	10/88→02/90	Tie Rod End	CV-ES-2146		
	10/88→02/90	Tie Rod End	CV-ES-2149		for Push Rod
	10/88→02/90	Tie Rod End	CV-ES-14162		for Steering Rod
	10/88→02/90	Tie Rod End	CV-ES-14163		for Steering Rod
	10/88→02/90	Track Control Arm		MN-DL-3402	Trailing Arm
	10/88→02/90	Track Control Arm		MN-DL-3402	Trailing Arm, Drive Axle
	10/88→02/90	Track Control Arm		MN-DL-8609	Trailing Arm, Leaf Spring Axle
	41.292 VFK	10/88→02/90	Ball Head, gearshift linkage	CV-ES-2119	
10/88→02/90		Ball Head, gearshift linkage	CV-ES-2120		
10/88→02/90		Ball Head, gearshift linkage	CV-ES-2182		
10/88→02/90		Centre Rod	MN-DL-2160		Coupling Rod
10/88→02/90		Centre Rod	MN-DL-2166		Push Rod
10/88→02/90		Centre Rod	MN-DL-3588		Push Rod
10/88→02/90		Centre Rod	MN-DL-12278		for Steering Rod
10/88→02/90		Engine Mounting	MN-SB-10389		
10/88→02/90		Mounting, stabilizer coupling rod	MN-SB-5246		
10/88→02/90		Mounting, stabilizer coupling rod	MN-SB-5246		1st FA
10/88→02/90		Stabiliser Mounting		MN-SB-5245	
10/88→02/90		Stabiliser Mounting		MN-SB-5254	
10/88→02/90		Stabiliser Mounting	MN-SB-9396		
10/88→02/90		Suspension Arm Repair Kit		MN-SB-5244	for Wishbone (CV)
10/88→02/90		Suspension Arm Repair Kit		MN-SB-5244	for Wishbone (CV), 2nd RA
10/88→02/90		Tie Rod	MN-DL-12284		
10/88→02/90		Tie Rod End	CV-ES-2146		
10/88→02/90		Tie Rod End	CV-ES-2149		for Push Rod
10/88→02/90		Tie Rod End	CV-ES-14162		for Steering Rod
10/88→02/90		Tie Rod End	CV-ES-14163		for Steering Rod
10/88→02/90		Track Control Arm		MN-DL-3402	Trailing Arm
10/88→02/90		Track Control Arm		MN-DL-3402	Trailing Arm, Drive Axle
10/88→02/90		Track Control Arm		MN-DL-8609	Trailing Arm, Leaf Spring Axle
41.322 VF		02/90→06/96	Ball Head, gearshift linkage	CV-ES-2119	
	02/90→06/96	Ball Head, gearshift linkage	CV-ES-2120		
	02/90→06/96	Ball Head, gearshift linkage	CV-ES-2182		
	02/90→06/96	Centre Rod	MN-DL-2160		Coupling Rod
	02/90→06/96	Centre Rod	MN-DL-2166		Push Rod
	02/90→06/96	Centre Rod	MN-DL-3588		Push Rod
	02/90→06/96	Centre Rod	MN-DL-12278		for Steering Rod
	02/90→06/96	Engine Mounting	MN-SB-10389		
	02/90→06/96	Mounting, stabilizer coupling rod	MN-SB-5246		
	02/90→06/96	Mounting, stabilizer coupling rod	MN-SB-5246		1st FA
	02/90→06/96	Stabiliser Mounting		MN-SB-5245	

CV-ES-2119

Length: 55
Cone Ø: d1 Ø 10 / d2 Ø 10
Thread: M12 x 1,75 LHT
81953016063, 81953016131



CV-ES-2120

Length: 115
Cone Ø: d1 Ø 12,4 / d2 Ø 10,8
Thread: M14 x 1,5 RHT
03008500A, 81953016200, 81953016202,
81953016203, 81953016227



CV-ES-2146

Length: 80
Cone Ø: d1 Ø 30 / d2 Ø 27
Thread: M26 x 1,5 RHT
42533102, 81953016219, 81953016225,
81953016226, 81953016267, 81953016291



CV-ES-2149

Length: 160
Cone Ø: d1 Ø 30 / d2 Ø 27
Thread: M30 x 1,5 RHT
81953016263



CV-ES-2182

Length: 55
Cone Ø: d1 Ø 10 / d2 Ø 10
Thread: M12 x 1,75 RHT
81953016064, 81953016170



CV-ES-14162

Length: 125
Cone Ø: d1 Ø 30 / d2 Ø 27
Thread: M30 x 1,5 LHT
81953010015, 81953010083, 81953010087,
81953016029, 81953016030, 81953016043,
81953016044, 81953016050, 81953016054,
81953016087, 81953016091, 81953016107,
81953016120, 81953016125, 81953016152,
81953016155, 81953016157, 81953016168,
81953016179, 81953016181, 81953016223,
81953016237, 81953016254, 81953016275,
81953016279, 81953016351



CV-ES-14163

Length: 125
Cone Ø: d1 Ø 30 / d2 Ø 27
Thread: M30 x 1,5 RHT
95301.0084, 90804102156, 90804102272,
90804102696, 90804102710, 81953010016,
81953010075, 81953010084, 81953010088,
81953010094, 81953010103, 81953016030,
81953016043, 81953016048, 81953016049,
81953016053, 81953016061, 81953016090,
81953016108, 81953016112, 81953016126,
81953016143, 81953016149, 81953016154,
81953016156, 81953016168, 81953016178,
81953016194, 81953016206, 81953016224,
81953016234, 81953016242, 81953016252,
81953016274, 81953016278, 81953016284,
81953016286, 81953016308, 81953016310,
81953016312, 81953016347, 81953016350,
81953016352, 82953016012, 88953016014,
N2953016001



MN-DL-2160

Length: 1652 Ø: 50
Cone Ø: d1 Ø 30 / d2 Ø 27
81467106112, 81467106163, 81467106165,
81467106198, 81467106353, 81467106354,
81467106361, 81467116725



MN-DL-2166

Length: 1795
Ø: 50
Cone Ø: d1 Ø 30 / d2 Ø 27
81467106418



MN-DL-3402

Length: 590 Ø: 48
Hole Distance: 130 / 130
03307200A, 81432206067, 81432206068,
81432206090, 81432206092, 81432209092



MN-DL-3588

Length: 1035
Ø: 48
Cone Ø: d1 Ø 30 / d2 Ø 27
81466106333, 81466106334, 81466106354,
81466106355, 81466106360, 81466106361,
81466106721, 81466106722, 81466106723,
81466116216



MN-DL-8609

Length: 585 Ø: 58
Hole Distance: 130 / 130
81432206070, 81432206071, 81432206072,
81432206091, 81432206093, 81432206119



MN-DL-12278

Length: 770
Ø: 40
Cone Ø: d1 Ø 30 / d2 Ø 27
81466106348



MN-DL-12284

Length: 1530 Ø: 50
Cone Ø: d1 Ø 30 / d2 Ø 27
81466106579, 81466106580, 81466106624,
81466116720, 81467116720, 81467116730,
81467116952



MN-SB-5244

Ø: 65
Hole Distance: 125
Thick/Height: 22
03312000A, 81432710027, 81432710082



MN-SB-5245

Ø: 75
Hole Distance: 125
Thick/Height: 22
03311900A, 81432710046, 81432710079,
81432710083



MN-SB-5246

Ø: 45 Thick/Height: 47
81437220022, 81437220038, 81962100450,
81962100469



MN-SB-5254

Length: 100
Ø: 93
Thick/Height: 70
81432710081



MN-SB-9396

Ø: 67
Thick/Height: 60
81437040057



MN-SB-10389

Ø: 70
Thick/Height: 72
81960200340





F 90 ...

41.322 VF ...	02/90→06/96	Stabiliser Mounting		MN-SB-5254		
	02/90→06/96	Stabiliser Mounting	MN-SB-9396			
	02/90→06/96	Suspension Arm Repair Kit		MN-SB-5244	for Wishbone (CV)	
	02/90→06/96	Suspension Arm Repair Kit		MN-SB-5244	for Wishbone (CV), 2nd RA	
	02/90→06/96	Tie Rod	MN-DL-12284			
	02/90→06/96	Tie Rod End	CV-ES-2146			
	02/90→06/96	Tie Rod End	CV-ES-2149		for Push Rod	
	02/90→06/96	Tie Rod End	CV-ES-14162		for Steering Rod	
	02/90→06/96	Tie Rod End	CV-ES-14163		for Steering Rod	
	02/90→06/96	Track Control Arm		MN-DL-3402	Trailing Arm	
	02/90→06/96	Track Control Arm		MN-DL-3402	Trailing Arm, Drive Axle	
	02/90→06/96	Track Control Arm		MN-DL-8609	Trailing Arm, Leaf Spring Axle	
	41.332 VF	10/88→02/90	Ball Head, gearshift linkage	CV-ES-2119		
		10/88→02/90	Ball Head, gearshift linkage	CV-ES-2120		
10/88→02/90		Ball Head, gearshift linkage	CV-ES-2182			
10/88→02/90		Centre Rod	MN-DL-2160		Coupling Rod	
10/88→02/90		Centre Rod	MN-DL-2166		Push Rod	
10/88→02/90		Centre Rod	MN-DL-3588		Push Rod	
10/88→02/90		Centre Rod	MN-DL-12278		for Steering Rod	
10/88→02/90		Engine Mounting	MN-SB-10389			
10/88→02/90		Mounting, stabilizer coupling rod	MN-SB-5246			
10/88→02/90		Mounting, stabilizer coupling rod	MN-SB-5246		1st FA	
10/88→02/90		Stabiliser Mounting		MN-SB-5245		
10/88→02/90		Stabiliser Mounting		MN-SB-5254		
10/88→02/90		Stabiliser Mounting	MN-SB-9396			
10/88→02/90		Suspension Arm Repair Kit		MN-SB-5244	for Wishbone (CV)	
10/88→02/90		Suspension Arm Repair Kit		MN-SB-5244	for Wishbone (CV), 2nd RA	
10/88→02/90		Tie Rod	MN-DL-12284			
10/88→02/90		Tie Rod End	CV-ES-2146			
10/88→02/90		Tie Rod End	CV-ES-2149		for Push Rod	
10/88→02/90		Tie Rod End	CV-ES-14162		for Steering Rod	
10/88→02/90		Tie Rod End	CV-ES-14163		for Steering Rod	
10/88→02/90		Track Control Arm		MN-DL-3402	Trailing Arm	
10/88→02/90		Track Control Arm		MN-DL-3402	Trailing Arm, Drive Axle	
10/88→02/90		Track Control Arm		MN-DL-8609	Trailing Arm, Leaf Spring Axle	
41.332 VFK		10/88→02/90	Ball Head, gearshift linkage	CV-ES-2119		
	10/88→02/90	Ball Head, gearshift linkage	CV-ES-2120			
	10/88→02/90	Ball Head, gearshift linkage	CV-ES-2182			
	10/88→02/90	Centre Rod	MN-DL-2160		Coupling Rod	
	10/88→02/90	Centre Rod	MN-DL-2166		Push Rod	
	10/88→02/90	Centre Rod	MN-DL-3588		Push Rod	
	10/88→02/90	Centre Rod	MN-DL-12278		for Steering Rod	
	10/88→02/90	Engine Mounting	MN-SB-10389			
	10/88→02/90	Mounting, stabilizer coupling rod	MN-SB-5246			
	10/88→02/90	Mounting, stabilizer coupling rod	MN-SB-5246		1st FA	
	10/88→02/90	Stabiliser Mounting		MN-SB-5245		
	10/88→02/90	Stabiliser Mounting		MN-SB-5254		
	10/88→02/90	Stabiliser Mounting	MN-SB-9396			
	10/88→02/90	Suspension Arm Repair Kit		MN-SB-5244	for Wishbone (CV)	
	10/88→02/90	Suspension Arm Repair Kit		MN-SB-5244	for Wishbone (CV), 2nd RA	
	10/88→02/90	Tie Rod	MN-DL-12284			
	10/88→02/90	Tie Rod End	CV-ES-2146			
	10/88→02/90	Tie Rod End	CV-ES-2149		for Push Rod	
	10/88→02/90	Tie Rod End	CV-ES-14162		for Steering Rod	
	10/88→02/90	Tie Rod End	CV-ES-14163		for Steering Rod	
	10/88→02/90	Track Control Arm		MN-DL-3402	Trailing Arm	
	10/88→02/90	Track Control Arm		MN-DL-3402	Trailing Arm, Drive Axle	
	10/88→02/90	Track Control Arm		MN-DL-8609	Trailing Arm, Leaf Spring Axle	
	41.342 VF	05/94→06/96	Ball Head, gearshift linkage	CV-ES-2119		
05/94→06/96		Ball Head, gearshift linkage	CV-ES-2120			
05/94→06/96		Ball Head, gearshift linkage	CV-ES-2182			
05/94→06/96		Centre Rod	MN-DL-2160		Coupling Rod	
05/94→06/96		Centre Rod	MN-DL-2166		Push Rod	

CV-ES-2119

Length: 55
Cone Ø: d1 Ø 10 / d2 Ø 10
Thread: M12 x 1,75 LHT
81953016063, 81953016131



CV-ES-2120

Length: 115
Cone Ø: d1 Ø 12,4 / d2 Ø 10,8
Thread: M14 x 1,5 RHT
03008500A, 81953016200, 81953016202,
81953016203, 81953016227



CV-ES-2146

Length: 80
Cone Ø: d1 Ø 30 / d2 Ø 27
Thread: M26 x 1,5 RHT
42533102, 81953016219, 81953016225,
81953016226, 81953016267, 81953016291



CV-ES-2149

Length: 160
Cone Ø: d1 Ø 30 / d2 Ø 27
Thread: M30 x 1,5 RHT
81953016263



CV-ES-2182

Length: 55
Cone Ø: d1 Ø 10 / d2 Ø 10
Thread: M12 x 1,75 RHT
81953016064, 81953016170



CV-ES-14162

Length: 125
Cone Ø: d1 Ø 30 / d2 Ø 27
Thread: M30 x 1,5 LHT
81953010015, 81953010083, 81953010087,
81953016029, 81953016030, 81953016043,
81953016044, 81953016050, 81953016054,
81953016087, 81953016091, 81953016107,
81953016120, 81953016125, 81953016152,
81953016155, 81953016157, 81953016168,
81953016179, 81953016181, 81953016223,
81953016237, 81953016254, 81953016275,
81953016279, 81953016351



CV-ES-14163

Length: 125
Cone Ø: d1 Ø 30 / d2 Ø 27
Thread: M30 x 1,5 RHT
95301.0084, 90804102156, 90804102272,
90804102696, 90804102710, 81953010016,
81953010075, 81953010084, 81953010088,
81953010094, 81953010103, 81953016030,
81953016043, 81953016048, 81953016049,
81953016053, 81953016061, 81953016090,
81953016108, 81953016112, 81953016126,
81953016143, 81953016149, 81953016154,
81953016156, 81953016168, 81953016178,
81953016194, 81953016206, 81953016224,
81953016234, 81953016242, 81953016252,
81953016274, 81953016278, 81953016284,
81953016286, 81953016308, 81953016310,
81953016312, 81953016347, 81953016350,
81953016352, 82953016012, 88953016014,
N2953016001



MN-DL-2160

Length: 1652 Ø: 50
Cone Ø: d1 Ø 30 / d2 Ø 27
81467106112, 81467106163, 81467106165,
81467106198, 81467106353, 81467106354,
81467106361, 81467116725



MN-DL-2166

Length: 1795
Ø: 50
Cone Ø: d1 Ø 30 / d2 Ø 27
81467106418



MN-DL-3402

Length: 590 Ø: 48
Hole Distance: 130 / 130
03307200A, 81432206067, 81432206068,
81432206090, 81432206092, 81432209092



MN-DL-3588

Length: 1035
Ø: 48
Cone Ø: d1 Ø 30 / d2 Ø 27
81466106333, 81466106334, 81466106354,
81466106355, 81466106360, 81466106361,
81466106721, 81466106722, 81466106723,
81466116216



MN-DL-8609

Length: 585 Ø: 58
Hole Distance: 130 / 130
81432206070, 81432206071, 81432206072,
81432206091, 81432206093, 81432206119



MN-DL-12278

Length: 770
Ø: 40
Cone Ø: d1 Ø 30 / d2 Ø 27
81466106348



MN-DL-12284

Length: 1530 Ø: 50
Cone Ø: d1 Ø 30 / d2 Ø 27
81466106579, 81466106580, 81466106624,
81466116720, 81467116720, 81467116730,
81467116952



MN-SB-5244

Ø: 65
Hole Distance: 125
Thick/Height: 22
03312000A, 81432710027, 81432710082



MN-SB-5245

Ø: 75
Hole Distance: 125
Thick/Height: 22
03311900A, 81432710046, 81432710079,
81432710083



MN-SB-5246

Ø: 45 Thick/Height: 47
81437220022, 81437220038, 81962100450,
81962100469



MN-SB-5254

Length: 100
Ø: 93
Thick/Height: 70
81432710081



MN-SB-9396

Ø: 67
Thick/Height: 60
81437040057



MN-SB-10389

Ø: 70
Thick/Height: 72
81960200340





F 90 ...

41.342 VF ...	05/94 →06/96	Centre Rod	MN-DL-3588		Push Rod	
	05/94 →06/96	Centre Rod	MN-DL-12278		for Steering Rod	
	05/94 →06/96	Engine Mounting	MN-SB-10389			
	05/94 →06/96	Mounting, stabilizer coupling rod	MN-SB-5246			
	05/94 →06/96	Mounting, stabilizer coupling rod	MN-SB-5246		1st FA	
	05/94 →06/96	Stabiliser Mounting		MN-SB-5245		
	05/94 →06/96	Stabiliser Mounting		MN-SB-5254		
	05/94 →06/96	Stabiliser Mounting	MN-SB-9396			
	05/94 →06/96	Suspension Arm Repair Kit		MN-SB-5244	for Wishbone (CV)	
	05/94 →06/96	Suspension Arm Repair Kit		MN-SB-5244	for Wishbone (CV), 2nd RA	
	05/94 →06/96	Tie Rod	MN-DL-12284			
	05/94 →06/96	Tie Rod End	CV-ES-2146			
	05/94 →06/96	Tie Rod End	CV-ES-2149		for Push Rod	
	05/94 →06/96	Tie Rod End	CV-ES-14162		for Steering Rod	
	05/94 →06/96	Tie Rod End	CV-ES-14163		for Steering Rod	
	05/94 →06/96	Track Control Arm		MN-DL-3402	Trailing Arm	
	05/94 →06/96	Track Control Arm		MN-DL-3402	Trailing Arm, Drive Axle	
	05/94 →06/96	Track Control Arm		MN-DL-8609	Trailing Arm, Leaf Spring Axle	
	41.362 VF	10/88 →02/90	Ball Head, gearshift linkage	CV-ES-2119		
		10/88 →02/90	Ball Head, gearshift linkage	CV-ES-2120		
10/88 →02/90		Ball Head, gearshift linkage	CV-ES-2182			
10/88 →02/90		Centre Rod	MN-DL-2160		Coupling Rod	
10/88 →02/90		Centre Rod	MN-DL-2166		Push Rod	
10/88 →02/90		Centre Rod	MN-DL-3588		Push Rod	
10/88 →02/90		Centre Rod	MN-DL-12278		for Steering Rod	
10/88 →02/90		Engine Mounting	MN-SB-10389			
10/88 →02/90		Mounting, stabilizer coupling rod	MN-SB-5246			
10/88 →02/90		Mounting, stabilizer coupling rod	MN-SB-5246		1st FA	
10/88 →02/90		Stabiliser Mounting		MN-SB-5245		
10/88 →02/90		Stabiliser Mounting		MN-SB-5254		
10/88 →02/90		Stabiliser Mounting	MN-SB-9396			
10/88 →02/90		Suspension Arm Repair Kit		MN-SB-5244	for Wishbone (CV)	
10/88 →02/90		Suspension Arm Repair Kit		MN-SB-5244	for Wishbone (CV), 2nd RA	
10/88 →02/90		Tie Rod	MN-DL-12284			
10/88 →02/90		Tie Rod End	CV-ES-2146			
10/88 →02/90		Tie Rod End	CV-ES-2149		for Push Rod	
10/88 →02/90		Tie Rod End	CV-ES-14162		for Steering Rod	
10/88 →02/90		Tie Rod End	CV-ES-14163		for Steering Rod	
10/88 →02/90	Track Control Arm		MN-DL-3402	Trailing Arm		
10/88 →02/90	Track Control Arm		MN-DL-3402	Trailing Arm, Drive Axle		
10/88 →02/90	Track Control Arm		MN-DL-8609	Trailing Arm, Leaf Spring Axle		
41.362 VFK	10/88 →02/90	Ball Head, gearshift linkage	CV-ES-2119			
	10/88 →02/90	Ball Head, gearshift linkage	CV-ES-2120			
	10/88 →02/90	Ball Head, gearshift linkage	CV-ES-2182			
	10/88 →02/90	Centre Rod	MN-DL-2160		Coupling Rod	
	10/88 →02/90	Centre Rod	MN-DL-2166		Push Rod	
	10/88 →02/90	Centre Rod	MN-DL-3588		Push Rod	
	10/88 →02/90	Centre Rod	MN-DL-12278		for Steering Rod	
	10/88 →02/90	Engine Mounting	MN-SB-10389			
	10/88 →02/90	Mounting, stabilizer coupling rod	MN-SB-5246			
	10/88 →02/90	Mounting, stabilizer coupling rod	MN-SB-5246		1st FA	
	10/88 →02/90	Stabiliser Mounting		MN-SB-5245		
	10/88 →02/90	Stabiliser Mounting		MN-SB-5254		
	10/88 →02/90	Stabiliser Mounting	MN-SB-9396			
	10/88 →02/90	Suspension Arm Repair Kit		MN-SB-5244	for Wishbone (CV)	
	10/88 →02/90	Suspension Arm Repair Kit		MN-SB-5244	for Wishbone (CV), 2nd RA	
	10/88 →02/90	Tie Rod	MN-DL-12284			
	10/88 →02/90	Tie Rod End	CV-ES-2146			
	10/88 →02/90	Tie Rod End	CV-ES-2149		for Push Rod	
	10/88 →02/90	Tie Rod End	CV-ES-14162		for Steering Rod	
	10/88 →02/90	Tie Rod End	CV-ES-14163		for Steering Rod	
10/88 →02/90	Track Control Arm		MN-DL-3402	Trailing Arm		
10/88 →02/90	Track Control Arm		MN-DL-3402	Trailing Arm, Drive Axle		
10/88 →02/90	Track Control Arm		MN-DL-8609	Trailing Arm, Leaf Spring Axle		

CV-ES-2119

Length: 55
Cone Ø: d1 Ø 10 / d2 Ø 10
Thread: M12 x 1,75 LHT
81953016063, 81953016131



CV-ES-2120

Length: 115
Cone Ø: d1 Ø 12,4 / d2 Ø 10,8
Thread: M14 x 1,5 RHT
03008500A, 81953016200, 81953016202,
81953016203, 81953016227



CV-ES-2146

Length: 80
Cone Ø: d1 Ø 30 / d2 Ø 27
Thread: M26 x 1,5 RHT
42533102, 81953016219, 81953016225,
81953016226, 81953016267, 81953016291



CV-ES-2149

Length: 160
Cone Ø: d1 Ø 30 / d2 Ø 27
Thread: M30 x 1,5 RHT
81953016263



CV-ES-2182

Length: 55
Cone Ø: d1 Ø 10 / d2 Ø 10
Thread: M12 x 1,75 RHT
81953016064, 81953016170



CV-ES-14162

Length: 125
Cone Ø: d1 Ø 30 / d2 Ø 27
Thread: M30 x 1,5 LHT
81953010015, 81953010083, 81953010087,
81953016029, 81953016030, 81953016043,
81953016044, 81953016050, 81953016054,
81953016087, 81953016091, 81953016107,
81953016120, 81953016125, 81953016152,
81953016155, 81953016157, 81953016168,
81953016179, 81953016181, 81953016223,
81953016237, 81953016254, 81953016275,
81953016279, 81953016351



CV-ES-14163

Length: 125
Cone Ø: d1 Ø 30 / d2 Ø 27
Thread: M30 x 1,5 RHT
95301.0084, 90804102156, 90804102272,
90804102696, 90804102710, 81953010016,
81953010075, 81953010084, 81953010088,
81953010094, 81953010103, 81953016030,
81953016043, 81953016048, 81953016049,
81953016053, 81953016061, 81953016090,
81953016108, 81953016112, 81953016126,
81953016143, 81953016149, 81953016154,
81953016156, 81953016168, 81953016178,
81953016194, 81953016206, 81953016224,
81953016234, 81953016242, 81953016252,
81953016274, 81953016278, 81953016284,
81953016286, 81953016308, 81953016310,
81953016312, 81953016347, 81953016350,
81953016352, 82953016012, 88953016014,
N2953016001



MN-DL-2160

Length: 1652 Ø: 50
Cone Ø: d1 Ø 30 / d2 Ø 27
81467106112, 81467106163, 81467106165,
81467106198, 81467106353, 81467106354,
81467106361, 81467116725



MN-DL-2166

Length: 1795
Ø: 50
Cone Ø: d1 Ø 30 / d2 Ø 27
81467106418



MN-DL-3402

Length: 590 Ø: 48
Hole Distance: 130 / 130
03307200A, 81432206067, 81432206068,
81432206090, 81432206092, 81432209092



MN-DL-3588

Length: 1035
Ø: 48
Cone Ø: d1 Ø 30 / d2 Ø 27
81466106333, 81466106334, 81466106354,
81466106355, 81466106360, 81466106361,
81466106721, 81466106722, 81466106723,
81466116216



MN-DL-8609

Length: 585 Ø: 58
Hole Distance: 130 / 130
81432206070, 81432206071, 81432206072,
81432206091, 81432206093, 81432206119



MN-DL-12278

Length: 770
Ø: 40
Cone Ø: d1 Ø 30 / d2 Ø 27
81466106348



MN-DL-12284

Length: 1530 Ø: 50
Cone Ø: d1 Ø 30 / d2 Ø 27
81466106579, 81466106580, 81466106624,
81466116720, 81467116720, 81467116730,
81467116952



MN-SB-5244

Ø: 65
Hole Distance: 125
Thick/Height: 22
03312000A, 81432710027, 81432710082



MN-SB-5245

Ø: 75
Hole Distance: 125
Thick/Height: 22
03311900A, 81432710046, 81432710079,
81432710083



MN-SB-5246

Ø: 45 Thick/Height: 47
81437220022, 81437220038, 81962100450,
81962100469



MN-SB-5254

Length: 100
Ø: 93
Thick/Height: 70
81432710081



MN-SB-9396

Ø: 67
Thick/Height: 60
81437040057



MN-SB-10389

Ø: 70
Thick/Height: 72
81960200340





F 90 ...

41.372 VF	02/90→06/96	Ball Head, gearshift linkage	CV-ES-2119		
	02/90→06/96	Ball Head, gearshift linkage	CV-ES-2120		
	02/90→06/96	Ball Head, gearshift linkage	CV-ES-2182		
	02/90→06/96	Centre Rod	MN-DL-2160		Coupling Rod
	02/90→06/96	Centre Rod	MN-DL-2166		Push Rod
	02/90→06/96	Centre Rod	MN-DL-3588		Push Rod
	02/90→06/96	Centre Rod	MN-DL-12278		for Steering Rod
	02/90→06/96	Engine Mounting	MN-SB-10389		
	02/90→06/96	Mounting, stabilizer coupling rod	MN-SB-5246		
	02/90→06/96	Mounting, stabilizer coupling rod	MN-SB-5246		1st FA
	02/90→06/96	Stabiliser Mounting		MN-SB-5245	
	02/90→06/96	Stabiliser Mounting		MN-SB-5254	
	02/90→06/96	Stabiliser Mounting	MN-SB-9396		
	02/90→06/96	Suspension Arm Repair Kit		MN-SB-5244	for Wishbone (CV)
	02/90→06/96	Suspension Arm Repair Kit		MN-SB-5244	for Wishbone (CV), 2nd RA
	02/90→06/96	Tie Rod	MN-DL-12284		
	02/90→06/96	Tie Rod End	CV-ES-2146		
	02/90→06/96	Tie Rod End	CV-ES-2149		for Push Rod
	02/90→06/96	Tie Rod End	CV-ES-14162		for Steering Rod
	02/90→06/96	Tie Rod End	CV-ES-14163		for Steering Rod
	02/90→06/96	Track Control Arm		MN-DL-3402	Trailing Arm
	02/90→06/96	Track Control Arm		MN-DL-3402	Trailing Arm, Drive Axle
	02/90→06/96	Track Control Arm		MN-DL-8609	Trailing Arm, Leaf Spring Axle
41.402 VF	05/94→06/96	Ball Head, gearshift linkage	CV-ES-2119		
	05/94→06/96	Ball Head, gearshift linkage	CV-ES-2120		
	05/94→06/96	Ball Head, gearshift linkage	CV-ES-2182		
	05/94→06/96	Centre Rod	MN-DL-2160		Coupling Rod
	05/94→06/96	Centre Rod	MN-DL-2166		Push Rod
	05/94→06/96	Centre Rod	MN-DL-3588		Push Rod
	05/94→06/96	Centre Rod	MN-DL-12278		for Steering Rod
	05/94→06/96	Engine Mounting	MN-SB-10389		
	05/94→06/96	Mounting, stabilizer coupling rod	MN-SB-5246		
	05/94→06/96	Mounting, stabilizer coupling rod	MN-SB-5246		1st FA
	05/94→06/96	Stabiliser Mounting		MN-SB-5245	
	05/94→06/96	Stabiliser Mounting		MN-SB-5254	
	05/94→06/96	Stabiliser Mounting	MN-SB-9396		
	05/94→06/96	Suspension Arm Repair Kit		MN-SB-5244	for Wishbone (CV)
	05/94→06/96	Suspension Arm Repair Kit		MN-SB-5244	for Wishbone (CV), 2nd RA
	05/94→06/96	Tie Rod	MN-DL-12284		
	05/94→06/96	Tie Rod End	CV-ES-2146		
	05/94→06/96	Tie Rod End	CV-ES-2149		for Push Rod
	05/94→06/96	Tie Rod End	CV-ES-14162		for Steering Rod
	05/94→06/96	Tie Rod End	CV-ES-14163		for Steering Rod
	05/94→06/96	Track Control Arm		MN-DL-3402	Trailing Arm
	05/94→06/96	Track Control Arm		MN-DL-3402	Trailing Arm, Drive Axle
	05/94→06/96	Track Control Arm		MN-DL-8609	Trailing Arm, Leaf Spring Axle
41.422 VF	02/90→06/96	Ball Head, gearshift linkage	CV-ES-2119		
	02/90→06/96	Ball Head, gearshift linkage	CV-ES-2120		
	02/90→06/96	Ball Head, gearshift linkage	CV-ES-2182		
	02/90→06/96	Centre Rod	MN-DL-2160		Coupling Rod
	02/90→06/96	Centre Rod	MN-DL-2166		Push Rod
	02/90→06/96	Centre Rod	MN-DL-3588		Push Rod
	02/90→06/96	Centre Rod	MN-DL-12278		for Steering Rod
	02/90→06/96	Engine Mounting	MN-SB-10389		
	02/90→06/96	Mounting, stabilizer coupling rod	MN-SB-5246		
	02/90→06/96	Mounting, stabilizer coupling rod	MN-SB-5246		1st FA
	02/90→06/96	Stabiliser Mounting		MN-SB-5245	
	02/90→06/96	Stabiliser Mounting		MN-SB-5254	
	02/90→06/96	Stabiliser Mounting	MN-SB-9396		
	02/90→06/96	Suspension Arm Repair Kit		MN-SB-5244	for Wishbone (CV)
	02/90→06/96	Suspension Arm Repair Kit		MN-SB-5244	for Wishbone (CV), 2nd RA
	02/90→06/96	Tie Rod	MN-DL-12284		
	02/90→06/96	Tie Rod End	CV-ES-2146		

CV-ES-2119

Length: 55
Cone Ø: d1 Ø 10 / d2 Ø 10
Thread: M12 x 1,75 LHT
81953016063, 81953016131



CV-ES-2120

Length: 115
Cone Ø: d1 Ø 12,4 / d2 Ø 10,8
Thread: M14 x 1,5 RHT
03008500A, 81953016200, 81953016202,
81953016203, 81953016227



CV-ES-2146

Length: 80
Cone Ø: d1 Ø 30 / d2 Ø 27
Thread: M26 x 1,5 RHT
42533102, 81953016219, 81953016225,
81953016226, 81953016267, 81953016291



CV-ES-2149

Length: 160
Cone Ø: d1 Ø 30 / d2 Ø 27
Thread: M30 x 1,5 RHT
81953016263



CV-ES-2182

Length: 55
Cone Ø: d1 Ø 10 / d2 Ø 10
Thread: M12 x 1,75 RHT
81953016064, 81953016170



CV-ES-14162

Length: 125
Cone Ø: d1 Ø 30 / d2 Ø 27
Thread: M30 x 1,5 LHT
81953010015, 81953010083, 81953010087,
81953016029, 81953016030, 81953016043,
81953016044, 81953016050, 81953016054,
81953016087, 81953016091, 81953016107,
81953016120, 81953016125, 81953016152,
81953016155, 81953016157, 81953016168,
81953016179, 81953016181, 81953016223,
81953016237, 81953016254, 81953016275,
81953016279, 81953016351



CV-ES-14163

Length: 125
Cone Ø: d1 Ø 30 / d2 Ø 27
Thread: M30 x 1,5 RHT
95301.0084, 90804102156, 90804102272,
90804102696, 90804102710, 81953010016,
81953010075, 81953010084, 81953010088,
81953010094, 81953010103, 81953016030,
81953016043, 81953016048, 81953016049,
81953016053, 81953016061, 81953016090,
81953016108, 81953016112, 81953016126,
81953016143, 81953016149, 81953016154,
81953016156, 81953016168, 81953016178,
81953016194, 81953016206, 81953016224,
81953016234, 81953016242, 81953016252,
81953016274, 81953016278, 81953016284,
81953016286, 81953016308, 81953016310,
81953016312, 81953016347, 81953016350,
81953016352, 82953016012, 88953016014,
N2953016001



MN-DL-2160

Length: 1652 Ø: 50
Cone Ø: d1 Ø 30 / d2 Ø 27
81467106112, 81467106163, 81467106165,
81467106198, 81467106353, 81467106354,
81467106361, 81467116725



MN-DL-2166

Length: 1795
Ø: 50
Cone Ø: d1 Ø 30 / d2 Ø 27
81467106418



MN-DL-3402

Length: 590 Ø: 48
Hole Distance: 130 / 130
03307200A, 81432206067, 81432206068,
81432206090, 81432206092, 81432209092



MN-DL-3588

Length: 1035
Ø: 48
Cone Ø: d1 Ø 30 / d2 Ø 27
81466106333, 81466106334, 81466106354,
81466106355, 81466106360, 81466106361,
81466106721, 81466106722, 81466106723,
81466116216



MN-DL-8609

Length: 585 Ø: 58
Hole Distance: 130 / 130
81432206070, 81432206071, 81432206072,
81432206091, 81432206093, 81432206119



MN-DL-12278

Length: 770
Ø: 40
Cone Ø: d1 Ø 30 / d2 Ø 27
81466106348



MN-DL-12284

Length: 1530 Ø: 50
Cone Ø: d1 Ø 30 / d2 Ø 27
81466106579, 81466106580, 81466106624,
81466116720, 81467116720, 81467116730,
81467116952



MN-SB-5244

Ø: 65
Hole Distance: 125
Thick/Height: 22
03312000A, 81432710027, 81432710082



MN-SB-5245

Ø: 75
Hole Distance: 125
Thick/Height: 22
03311900A, 81432710046, 81432710079,
81432710083



MN-SB-5246

Ø: 45 Thick/Height: 47
81437220022, 81437220038, 81962100450,
81962100469



MN-SB-5254

Length: 100
Ø: 93
Thick/Height: 70
81432710081



MN-SB-9396

Ø: 67
Thick/Height: 60
81437040057



MN-SB-10389

Ø: 70
Thick/Height: 72
81960200340





F 90 ...

41.422 VF ...	02/90→06/96	Tie Rod End	CV-ES-2149		for Push Rod
	02/90→06/96	Tie Rod End	CV-ES-14162		for Steering Rod
	02/90→06/96	Tie Rod End	CV-ES-14163		for Steering Rod
	02/90→06/96	Track Control Arm		MN-DL-3402	Trailing Arm
	02/90→06/96	Track Control Arm		MN-DL-3402	Trailing Arm, Drive Axle
	02/90→06/96	Track Control Arm		MN-DL-8609	Trailing Arm, Leaf Spring Axle
48.292 VF	07/89→02/90	Ball Head, gearshift linkage	CV-ES-2120		
48.292 VFA	07/89→02/90	Ball Head, gearshift linkage	CV-ES-2120		
48.292 VFAK	07/89→02/90	Ball Head, gearshift linkage	CV-ES-2120		
48.332 VF	07/89→02/90	Ball Head, gearshift linkage	CV-ES-2120		
48.332 VFA	07/89→02/90	Ball Head, gearshift linkage	CV-ES-2120		
48.332 VFAK	07/89→02/90	Ball Head, gearshift linkage	CV-ES-2120		
48.362 VF	07/89→02/90	Ball Head, gearshift linkage	CV-ES-2120		
48.362 VFAK	07/89→02/90	Ball Head, gearshift linkage	CV-ES-2120		
48.462 VF	07/89→02/90	Ball Head, gearshift linkage	CV-ES-2120		

F 90 Unterflur

19.322 U, 19.322 UL, 19.322 ULL	02/90→05/94	Ball Head, gearshift linkage	CV-ES-2120		
	02/90→05/94	Centre Rod	MN-DL-2160		Coupling Rod
	02/90→05/94	Centre Rod	MN-DL-2174		Push Rod
	02/90→05/94	Centre Rod	MN-DL-2175		Push Rod
	02/90→05/94	Centre Rod	MN-DL-3588		Push Rod
	02/90→05/94	Centre Rod	MN-DL-12421		for Steering Rod
	02/90→05/94	Suspension Arm Repair Kit		MN-RK-7280	for Drag Link
	02/90→05/94	Suspension Arm Repair Kit		MN-RK-8523	for Wishbone (CV)
	02/90→05/94	Tie Rod End	CV-ES-2149		for Push Rod
	02/90→05/94	Tie Rod End	CV-ES-14162		for Steering Rod
	02/90→05/94	Tie Rod End	CV-ES-14163		for Steering Rod
	02/90→05/94	Track Control Arm		MN-DL-5212	Trailing Arm, Tag Axle
	02/90→05/94	Track Control Arm		MN-DL-5212	Trailing Arm, Tag Axle; Drive Axle; Air Suspension Axle
	02/90→05/94	Track Control Arm		MN-VB-8565	Wishbone (CV), Tag Axle
19.332 U, 19.322 UL, 19.322 ULL	07/86→02/90	Ball Head, gearshift linkage	CV-ES-2120		
	07/86→02/90	Centre Rod	MN-DL-2160		Coupling Rod
	07/86→02/90	Centre Rod	MN-DL-2174		Push Rod
	07/86→02/90	Centre Rod	MN-DL-2175		Push Rod
	07/86→02/90	Centre Rod	MN-DL-3588		Push Rod
	07/86→02/90	Centre Rod	MN-DL-12421		for Steering Rod
	07/86→02/90	Suspension Arm Repair Kit		MN-RK-7280	for Drag Link
	07/86→02/90	Tie Rod End	CV-ES-2149		for Push Rod
	07/86→02/90	Tie Rod End	CV-ES-14162		for Steering Rod
	07/86→02/90	Tie Rod End	CV-ES-14163		for Steering Rod
19.362 U, 19.362 UL, 19.362 ULL	07/86→01/91	Ball Head, gearshift linkage	CV-ES-2120		
	07/86→01/91	Centre Rod	MN-DL-2160		Coupling Rod
	07/86→01/91	Centre Rod	MN-DL-2174		Push Rod
	07/86→01/91	Centre Rod	MN-DL-2175		Push Rod
	07/86→01/91	Centre Rod	MN-DL-3588		Push Rod
	07/86→01/91	Centre Rod	MN-DL-12421		for Steering Rod
	07/86→01/91	Suspension Arm Repair Kit		MN-RK-7280	for Drag Link
	07/86→01/91	Tie Rod End	CV-ES-2149		for Push Rod
	07/86→01/91	Tie Rod End	CV-ES-14162		for Steering Rod
	07/86→01/91	Tie Rod End	CV-ES-14163		for Steering Rod
19.372 U, 19.372 ULL	02/90→05/94	Ball Head, gearshift linkage	CV-ES-2120		
	02/90→05/94	Centre Rod	MN-DL-2160		Coupling Rod
	02/90→05/94	Centre Rod	MN-DL-2174		Push Rod
	02/90→05/94	Centre Rod	MN-DL-2175		Push Rod
	02/90→05/94	Centre Rod	MN-DL-3588		Push Rod
	02/90→05/94	Centre Rod	MN-DL-12421		for Steering Rod
	02/90→05/94	Suspension Arm Repair Kit		MN-RK-7280	for Drag Link
	02/90→05/94	Suspension Arm Repair Kit		MN-RK-8523	for Wishbone (CV)
	02/90→05/94	Tie Rod End	CV-ES-2149		for Push Rod
	02/90→05/94	Tie Rod End	CV-ES-14162		for Steering Rod
02/90→05/94	Tie Rod End	CV-ES-14163		for Steering Rod	

CV-ES-2120

Length: 115
Cone Ø: d1 Ø 12,4 / d2 Ø 10,8
Thread: M14 x 1,5 RHT
03008500A, 81953016200, 81953016202, 81953016203, 81953016227



CV-ES-2149

Length: 160
Cone Ø: d1 Ø 30 / d2 Ø 27
Thread: M30 x 1,5 RHT
81953016263



CV-ES-14162

Length: 125
Cone Ø: d1 Ø 30 / d2 Ø 27
Thread: M30 x 1,5 LHT
81953010015, 81953010083, 81953010087, 81953016029, 81953016030, 81953016043, 81953016044, 81953016050, 81953016054, 81953016087, 81953016091, 81953016107, 81953016120, 81953016125, 81953016152, 81953016155, 81953016157, 81953016168, 81953016179, 81953016181, 81953016223, 81953016237, 81953016254, 81953016275, 81953016279, 81953016351



CV-ES-14163

Length: 125
Cone Ø: d1 Ø 30 / d2 Ø 27
Thread: M30 x 1,5 RHT
95301.0084, 90804102156, 90804102272, 90804102696, 90804102710, 81953010016, 81953010075, 81953010084, 81953010088, 81953010094, 81953010103, 81953016030, 81953016043, 81953016048, 81953016049, 81953016053, 81953016061, 81953016090, 81953016108, 81953016112, 81953016126, 81953016143, 81953016149, 81953016154, 81953016156, 81953016168, 81953016178, 81953016194, 81953016206, 81953016224, 81953016234, 81953016242, 81953016252, 81953016274, 81953016278, 81953016284, 81953016286, 81953016308, 81953016310, 81953016312, 81953016347, 81953016350, 81953016352, 82953016012, 88953016014, N2953016001



MN-DL-2160

Length: 1652 Ø: 50
Cone Ø: d1 Ø 30 / d2 Ø 27
81467106112, 81467106163, 81467106165, 81467106198, 81467106353, 81467106354, 81467106361, 81467116725



MN-DL-2174

Length: 1588 Ø: 52
Cone Ø: d1 Ø 30 / d2 Ø 27
81467106378, 81467106912



MN-DL-2175

Length: 1628
Ø: 50
Cone Ø: d1 Ø 30 / d2 Ø 27
81467106396, 81467106904



MN-DL-3402

Length: 590 Ø: 48
Hole Distance: 130 / 130
03307200A, 81432206067, 81432206068, 81432206090, 81432206092, 81432209092



MN-DL-3588

Length: 1035
Ø: 48
Cone Ø: d1 Ø 30 / d2 Ø 27
81466106333, 81466106334, 81466106354, 81466106355, 81466106360, 81466106361, 81466106721, 81466106722, 81466106723, 81466116216



MN-DL-5212

Length: 577 Ø: 48
Hole Distance: 130 / 130
81432206096, 81432206097, 81432206098, 81432206129, 81432209096, 81432209129, 81432306014, 81432306030



MN-DL-8609

Length: 585 Ø: 58
Hole Distance: 130 / 130
81432206070, 81432206071, 81432206072, 81432206091, 81432206093, 81432206119



MN-DL-12421

Length: 1070
Ø: 48
Cone Ø: d1 Ø 30 / d2 Ø 27
Thread: M30 x 1,5 RHT
81466106656, 81466106659, 81466106669, 81466116006, 81466116007



MN-RK-7280

Ø: 75
Hole Distance: 115
Thick/Height: 24
0550806, 0639370, 689748, 10307400A, 81432306051, 81432306068, 81432706064



MN-RK-8523

Ø: 72
03304900A, 81432706065



MN-VB-8565

Length: 693
Ø: 46
Hole Distance: 115 / 115
81432706053, 81432709053





F 90 Unterflur ...

19.372 U,19.372 ULL ...	02/90→05/94	Track Control Arm		MN-DL-5212	Trailing Arm, Tag Axle	
	02/90→05/94	Track Control Arm		MN-VB-8565	Wishbone (CV), Tag Axle	
19.422 U,19.422 ULL	02/90→05/94	Ball Head, gearshift linkage	CV-ES-2120			
	02/90→05/94	Centre Rod	MN-DL-2160		Coupling Rod	
	02/90→05/94	Centre Rod	MN-DL-2174		Push Rod	
	02/90→05/94	Centre Rod	MN-DL-2175		Push Rod	
	02/90→05/94	Centre Rod	MN-DL-3588		Push Rod	
	02/90→05/94	Centre Rod	MN-DL-12421		for Steering Rod	
	02/90→05/94	Suspension Arm Repair Kit		MN-RK-7280	for Drag Link	
	02/90→05/94	Suspension Arm Repair Kit		MN-RK-8523	for Wishbone (CV)	
	02/90→05/94	Tie Rod End	CV-ES-2149		for Push Rod	
	02/90→05/94	Tie Rod End	CV-ES-14162		for Steering Rod	
	02/90→05/94	Tie Rod End	CV-ES-14163		for Steering Rod	
	02/90→05/94	Track Control Arm		MN-DL-5212	Trailing Arm, Tag Axle	
	02/90→05/94	Track Control Arm		MN-DL-5212	Trailing Arm, Tag Axle; Drive Axle; Air Suspension Axle	
	02/90→05/94	Track Control Arm		MN-VB-8565	Wishbone (CV), Tag Axle	
24.322 UNL,24.322 UNLL	02/90→12/90	Ball Head, gearshift linkage	CV-ES-2120			
	02/90→12/90	Centre Rod	MN-DL-2160		Coupling Rod	
	02/90→12/90	Centre Rod	MN-DL-2175		Push Rod	
	02/90→12/90	Centre Rod	MN-DL-3588		Push Rod	
	02/90→12/90	Centre Rod	MN-DL-12421		for Steering Rod	
	02/90→12/90	Suspension Arm Repair Kit		MN-RK-7280	for Drag Link	
	02/90→12/90	Suspension Arm Repair Kit		MN-RK-8523	for Wishbone (CV)	
	02/90→12/90	Tie Rod End	CV-ES-2149		for Push Rod	
	02/90→12/90	Tie Rod End	CV-ES-14162		for Steering Rod	
	02/90→12/90	Tie Rod End	CV-ES-14163		for Steering Rod	
	02/90→12/90	Track Control Arm		MN-DL-5212	Trailing Arm, Drive Axle; Tag Axle; Air Suspension Axle	
	02/90→12/90	Track Control Arm		MN-VB-8565	Wishbone (CV), Tag Axle	
	24.332 UNL,24.332 UNLL	10/86→02/90	Ball Head, gearshift linkage	CV-ES-2120		
		10/86→02/90	Centre Rod	MN-DL-2160		Coupling Rod
10/86→02/90		Centre Rod	MN-DL-2175		Push Rod	
10/86→02/90		Centre Rod	MN-DL-3588		Push Rod	
10/86→02/90		Centre Rod	MN-DL-12421		for Steering Rod	
10/86→02/90		Suspension Arm Repair Kit		MN-RK-7280	for Drag Link	
10/86→02/90		Tie Rod End	CV-ES-2149		for Push Rod	
10/86→02/90		Tie Rod End	CV-ES-14162		for Steering Rod	
10/86→02/90		Tie Rod End	CV-ES-14163		for Steering Rod	
10/86→02/90		Track Control Arm		MN-DL-5212	Trailing Arm, Drive Axle; Tag Axle; Air Suspension Axle	
24.362 UNL,24.362 UNLL		10/86→02/90	Ball Head, gearshift linkage	CV-ES-2120		
		10/86→02/90	Centre Rod	MN-DL-2160		Coupling Rod
		10/86→02/90	Centre Rod	MN-DL-2175		Push Rod
		10/86→02/90	Centre Rod	MN-DL-3588		Push Rod
	10/86→02/90	Centre Rod	MN-DL-12421		for Steering Rod	
	10/86→02/90	Suspension Arm Repair Kit		MN-RK-7280	for Drag Link	
	10/86→02/90	Tie Rod End	CV-ES-2149		for Push Rod	
	10/86→02/90	Tie Rod End	CV-ES-14162		for Steering Rod	
	10/86→02/90	Tie Rod End	CV-ES-14163		for Steering Rod	
	10/86→02/90	Track Control Arm		MN-DL-5212	Trailing Arm, Drive Axle; Tag Axle; Air Suspension Axle	
	24.372 UNL,24.372 UNLL	02/90→12/90	Ball Head, gearshift linkage	CV-ES-2120		
		02/90→12/90	Centre Rod	MN-DL-2160		Coupling Rod
		02/90→12/90	Centre Rod	MN-DL-2175		Push Rod
		02/90→12/90	Centre Rod	MN-DL-3588		Push Rod
02/90→12/90		Centre Rod	MN-DL-12421		for Steering Rod	
02/90→12/90		Suspension Arm Repair Kit		MN-RK-7280	for Drag Link	
02/90→12/90		Suspension Arm Repair Kit		MN-RK-8523	for Wishbone (CV)	
02/90→12/90		Tie Rod End	CV-ES-2149		for Push Rod	
02/90→12/90		Tie Rod End	CV-ES-14162		for Steering Rod	
02/90→12/90		Tie Rod End	CV-ES-14163		for Steering Rod	

CV-ES-2120

Length: 115
Cone Ø: d1 Ø 12,4 / d2 Ø 10,8
Thread: M14 x 1,5 RHT
03008500A, 81953016200, 81953016202,
81953016203, 81953016227



CV-ES-2149

Length: 160
Cone Ø: d1 Ø 30 / d2 Ø 27
Thread: M30 x 1,5 RHT
81953016263



CV-ES-14162

Length: 125
Cone Ø: d1 Ø 30 / d2 Ø 27
Thread: M30 x 1,5 LHT
81953010015, 81953010083, 81953010087,
81953016029, 81953016030, 81953016043,
81953016044, 81953016050, 81953016054,
81953016087, 81953016091, 81953016107,
81953016120, 81953016125, 81953016152,
81953016155, 81953016157, 81953016168,
81953016179, 81953016181, 81953016223,
81953016237, 81953016254, 81953016275,
81953016279, 81953016351



CV-ES-14163

Length: 125
Cone Ø: d1 Ø 30 / d2 Ø 27
Thread: M30 x 1,5 RHT
95301.0084, 90804102156, 90804102272,
90804102696, 90804102710, 81953010016,
81953010075, 81953010084, 81953010088,
81953010094, 81953010103, 81953016030,
81953016043, 81953016048, 81953016049,
81953016053, 81953016061, 81953016090,
81953016108, 81953016112, 81953016126,
81953016143, 81953016149, 81953016154,
81953016156, 81953016168, 81953016178,
81953016194, 81953016206, 81953016224,
81953016234, 81953016242, 81953016252,
81953016274, 81953016278, 81953016284,
81953016286, 81953016308, 81953016310,
81953016312, 81953016347, 81953016350,
81953016352, 82953016012, 88953016014,
N2953016001



MN-DL-2160

Length: 1652 Ø: 50
Cone Ø: d1 Ø 30 / d2 Ø 27
81467106112, 81467106163, 81467106165,
81467106198, 81467106353, 81467106354,
81467106361, 81467116725



MN-DL-2174

Length: 1588 Ø: 52
Cone Ø: d1 Ø 30 / d2 Ø 27
81467106378, 81467106912



MN-DL-2175

Length: 1628
Ø: 50
Cone Ø: d1 Ø 30 / d2 Ø 27
81467106396, 81467106904



MN-DL-3588

Length: 1035
Ø: 48
Cone Ø: d1 Ø 30 / d2 Ø 27
81466106333, 81466106334, 81466106354,
81466106355, 81466106360, 81466106361,
81466106721, 81466106722, 81466106723,
81466116216



MN-DL-5212

Length: 577 Ø: 48
Hole Distance: 130 / 130
81432206096, 81432206097, 81432206098,
81432206129, 81432209096, 81432209129,
81432306014, 81432306030



MN-DL-12421

Length: 1070
Ø: 48
Cone Ø: d1 Ø 30 / d2 Ø 27
Thread: M30 x 1,5 RHT
81466106656, 81466106659, 81466106669,
81466116006, 81466116007



MN-RK-7280

Ø: 75
Hole Distance: 115
Thick/Height: 24
0550806, 0639370, 689748, 10307400A,
81432306051, 81432306068, 81432706064



MN-RK-8523

Ø: 72
03304900A, 81432706065



MN-VB-8565

Length: 693
Ø: 46
Hole Distance: 115 / 115
81432706053, 81432709053





F 90 Unterflur ...

24.372 UNL,24.372 UNLL ...	02/90→12/90	Track Control Arm		MN-DL-5212	Trailing Arm, Drive Axle;Tag Axle; Air Suspension Axle
	02/90→12/90	Track Control Arm		MN-VB-8565	Wishbone (CV), Tag Axle
24.422 UNL,24.422 UNLL	02/90→12/90	Ball Head, gearshift linkage	CV-ES-2120		
	02/90→12/90	Centre Rod	MN-DL-2160		Coupling Rod
	02/90→12/90	Centre Rod	MN-DL-2175		Push Rod
	02/90→12/90	Centre Rod	MN-DL-3588		Push Rod
	02/90→12/90	Centre Rod	MN-DL-12421		for Steering Rod
	02/90→12/90	Suspension Arm Repair Kit		MN-RK-7280	for Drag Link
	02/90→12/90	Suspension Arm Repair Kit		MN-RK-8523	for Wishbone (CV)
	02/90→12/90	Tie Rod End	CV-ES-2149		for Push Rod
	02/90→12/90	Tie Rod End	CV-ES-14162		for Steering Rod
	02/90→12/90	Tie Rod End	CV-ES-14163		for Steering Rod
	02/90→12/90	Track Control Arm		MN-DL-5212	Trailing Arm, Drive Axle;Tag Axle; Air Suspension Axle
	02/90→12/90	Track Control Arm		MN-VB-8565	Wishbone (CV), Tag Axle
25.322 UNL,25.322 UNLL	09/90→12/92	Ball Head, gearshift linkage	CV-ES-2120		
	09/90→12/92	Centre Rod	MN-DL-2160		Coupling Rod
	09/90→12/92	Centre Rod	MN-DL-2175		Push Rod
	09/90→12/92	Centre Rod	MN-DL-3588		Push Rod
	09/90→12/92	Centre Rod	MN-DL-12421		for Steering Rod
	09/90→12/92	Suspension Arm Repair Kit		MN-RK-7280	for Drag Link
	09/90→12/92	Suspension Arm Repair Kit		MN-RK-8523	for Wishbone (CV)
	09/90→12/92	Tie Rod End	CV-ES-2149		for Push Rod
	09/90→12/92	Tie Rod End	CV-ES-14162		for Steering Rod
	09/90→12/92	Tie Rod End	CV-ES-14163		for Steering Rod
	09/90→12/92	Track Control Arm		MN-DL-5212	Trailing Arm, Drive Axle;Tag Axle; Air Suspension Axle
	09/90→12/92	Track Control Arm		MN-VB-8565	Wishbone (CV), Tag Axle
25.372 UNL,25.372 UNLL	09/90→12/92	Ball Head, gearshift linkage	CV-ES-2120		
	09/90→12/92	Centre Rod	MN-DL-2160		Coupling Rod
	09/90→12/92	Centre Rod	MN-DL-2175		Push Rod
	09/90→12/92	Centre Rod	MN-DL-3588		Push Rod
	09/90→12/92	Centre Rod	MN-DL-12421		for Steering Rod
	09/90→12/92	Suspension Arm Repair Kit		MN-RK-7280	for Drag Link
	09/90→12/92	Suspension Arm Repair Kit		MN-RK-8523	for Wishbone (CV)
	09/90→12/92	Tie Rod End	CV-ES-2149		for Push Rod
	09/90→12/92	Tie Rod End	CV-ES-14162		for Steering Rod
	09/90→12/92	Tie Rod End	CV-ES-14163		for Steering Rod
	09/90→12/92	Track Control Arm		MN-DL-5212	Trailing Arm, Drive Axle;Tag Axle; Air Suspension Axle
	09/90→12/92	Track Control Arm		MN-VB-8565	Wishbone (CV), Tag Axle
25.422 UNL,25.422 UNLL	09/90→12/92	Ball Head, gearshift linkage	CV-ES-2120		
	09/90→12/92	Centre Rod	MN-DL-2160		Coupling Rod
	09/90→12/92	Centre Rod	MN-DL-2175		Push Rod
	09/90→12/92	Centre Rod	MN-DL-3588		Push Rod
	09/90→12/92	Centre Rod	MN-DL-12421		for Steering Rod
	09/90→12/92	Suspension Arm Repair Kit		MN-RK-7280	for Drag Link
	09/90→12/92	Suspension Arm Repair Kit		MN-RK-8523	for Wishbone (CV)
	09/90→12/92	Tie Rod End	CV-ES-2149		for Push Rod
	09/90→12/92	Tie Rod End	CV-ES-14162		for Steering Rod
	09/90→12/92	Tie Rod End	CV-ES-14163		for Steering Rod
	09/90→12/92	Track Control Arm		MN-DL-5212	Trailing Arm, Drive Axle;Tag Axle; Air Suspension Axle
	09/90→12/92	Track Control Arm		MN-VB-8565	Wishbone (CV), Tag Axle
26.322 UNL,26.322 UNLL	09/90→05/94	Ball Head, gearshift linkage	CV-ES-2120		
	09/90→05/94	Centre Rod	MN-DL-2160		Coupling Rod
	09/90→05/94	Centre Rod	MN-DL-3588		Push Rod
	09/90→05/94	Centre Rod	MN-DL-12421		for Steering Rod
	09/90→05/94	Suspension Arm Repair Kit		MN-RK-7280	for Drag Link
	09/90→05/94	Suspension Arm Repair Kit		MN-RK-8523	for Wishbone (CV)
	09/90→05/94	Tie Rod End	CV-ES-2149		for Push Rod
	09/90→05/94	Tie Rod End	CV-ES-14162		for Steering Rod

CV-ES-2120

Length: 115
Cone Ø: d1 Ø 12,4 / d2 Ø 10,8
Thread: M14 x 1,5 RHT
03008500A, 81953016200, 81953016202,
81953016203, 81953016227



CV-ES-2149

Length: 160
Cone Ø: d1 Ø 30 / d2 Ø 27
Thread: M30 x 1,5 RHT
81953016263



CV-ES-14162

Length: 125
Cone Ø: d1 Ø 30 / d2 Ø 27
Thread: M30 x 1,5 LHT
81953010015, 81953010083, 81953010087,
81953016029, 81953016030, 81953016043,
81953016044, 81953016050, 81953016054,
81953016087, 81953016091, 81953016107,
81953016120, 81953016125, 81953016152,
81953016155, 81953016157, 81953016168,
81953016179, 81953016181, 81953016223,
81953016237, 81953016254, 81953016275,
81953016279, 81953016351



CV-ES-14163

Length: 125
Cone Ø: d1 Ø 30 / d2 Ø 27
Thread: M30 x 1,5 RHT
95301.0084, 90804102156, 90804102272,
90804102696, 90804102710, 81953010016,
81953010075, 81953010084, 81953010088,
81953010094, 81953010103, 81953016030,
81953016043, 81953016048, 81953016049,
81953016053, 81953016061, 81953016090,
81953016108, 81953016112, 81953016126,
81953016143, 81953016149, 81953016154,
81953016156, 81953016168, 81953016178,
81953016194, 81953016206, 81953016224,
81953016234, 81953016242, 81953016252,
81953016274, 81953016278, 81953016284,
81953016286, 81953016308, 81953016310,
81953016312, 81953016347, 81953016350,
81953016352, 82953016012, 88953016014,
N2953016001



MN-DL-2160

Length: 1652 Ø: 50
Cone Ø: d1 Ø 30 / d2 Ø 27
81467106112, 81467106163, 81467106165,
81467106198, 81467106353, 81467106354,
81467106361, 81467116725



MN-DL-2175

Length: 1628
Ø: 50
Cone Ø: d1 Ø 30 / d2 Ø 27
81467106396, 81467106904



MN-DL-3588

Length: 1035
Ø: 48
Cone Ø: d1 Ø 30 / d2 Ø 27
81466106333, 81466106334, 81466106354,
81466106355, 81466106360, 81466106361,
81466106721, 81466106722, 81466106723,
81466116216



MN-DL-5212

Length: 577 Ø: 48
Hole Distance: 130 / 130
81432206096, 81432206097, 81432206098,
81432206129, 81432209096, 81432209129,
81432306014, 81432306030



MN-DL-12421

Length: 1070
Ø: 48
Cone Ø: d1 Ø 30 / d2 Ø 27
Thread: M30 x 1,5 RHT
81466106656, 81466106659, 81466106669,
81466116006, 81466116007



MN-RK-7280

Ø: 75
Hole Distance: 115
Thick/Height: 24
0550806, 0639370, 689748, 10307400A,
81432306051, 81432306068, 81432706064



MN-RK-8523

Ø: 72
03304900A, 81432706065



MN-VB-8565

Length: 693
Ø: 46
Hole Distance: 115 / 115
81432706053, 81432709053





F 90 Unterflur ...

26.322 UNL,26.322 UNLL ...	09/90→05/94	Tie Rod End	CV-ES-14163		for Steering Rod
	09/90→05/94	Track Control Arm		MN-DL-5212	Trailing Arm, Drive Axle;Tag Axle; Air Suspension Axle
	09/90→05/94	Track Control Arm		MN-VB-8565	Wishbone (CV), Tag Axle
26.372 UNL,26.372 UNLL	09/90→05/94	Ball Head, gearshift linkage	CV-ES-2120		
	09/90→05/94	Centre Rod	MN-DL-2160		Coupling Rod
	09/90→05/94	Centre Rod	MN-DL-3588		Push Rod
	09/90→05/94	Centre Rod	MN-DL-12421		for Steering Rod
	09/90→05/94	Suspension Arm Repair Kit		MN-RK-7280	for Drag Link
	09/90→05/94	Suspension Arm Repair Kit		MN-RK-8523	for Wishbone (CV)
	09/90→05/94	Tie Rod End	CV-ES-2149		for Push Rod
	09/90→05/94	Tie Rod End	CV-ES-14162		for Steering Rod
	09/90→05/94	Tie Rod End	CV-ES-14163		for Steering Rod
	09/90→05/94	Track Control Arm		MN-DL-5212	Trailing Arm, Drive Axle;Tag Axle; Air Suspension Axle
	09/90→05/94	Track Control Arm		MN-VB-8565	Wishbone (CV), Tag Axle
26.422 UNL,26.422 UNLL	09/90→05/94	Ball Head, gearshift linkage	CV-ES-2120		
	09/90→05/94	Centre Rod	MN-DL-2160		Coupling Rod
	09/90→05/94	Centre Rod	MN-DL-3588		Push Rod
	09/90→05/94	Centre Rod	MN-DL-12421		for Steering Rod
	09/90→05/94	Suspension Arm Repair Kit		MN-RK-7280	for Drag Link
	09/90→05/94	Suspension Arm Repair Kit		MN-RK-8523	for Wishbone (CV)
	09/90→05/94	Tie Rod End	CV-ES-2149		for Push Rod
	09/90→05/94	Tie Rod End	CV-ES-14162		for Steering Rod
	09/90→05/94	Tie Rod End	CV-ES-14163		for Steering Rod
	09/90→05/94	Track Control Arm		MN-DL-5212	Trailing Arm, Drive Axle;Tag Axle; Air Suspension Axle
	09/90→05/94	Track Control Arm		MN-VB-8565	Wishbone (CV), Tag Axle

F 2000

18.273 F, FL, FLL	06/94→	Ball Head, gearshift linkage	CV-ES-2120		
	06/94→	Centre Rod	MN-DL-8197		Push Rod
	06/94→	Engine Mounting	MN-SB-10389		
	06/94→	Suspension Arm Repair Kit	MN-RK-7280	MN-RK-7280	for Drag Link;for Semi-Trailing Arm; for Wishbone (CV)
	06/94→	Tie Rod	MN-DL-12284		
	06/94→	Tie Rod End	CV-ES-2149		for Push Rod
	06/94→	Tie Rod End	CV-ES-14162		for Steering Rod
	06/94→	Tie Rod End	CV-ES-14163		for Steering Rod
	06/94→	Tie Rod End	SC-ES-8517		for Push Rod
	06/94→	Track Control Arm		MN-DL-5212	Trailing Arm
	06/94→	Track Control Arm		MN-VB-5222	Wishbone (CV)
	06/94→	Track Control Arm	MN-TC-14112		Control Arm, 1st Front Axle, for Pneumatic Suspension vehicles
	19.233 FC CNG	03/00→	Ball Head, gearshift linkage	CV-ES-2119	
03/00→		Ball Head, gearshift linkage	CV-ES-2120		
03/00→		Ball Head, gearshift linkage	CV-ES-2182		
03/00→		Centre Rod	MN-DL-2160		Coupling Rod
03/00→		Centre Rod	MN-DL-2172		Push Rod
03/00→		Centre Rod	MN-DL-2174		Push Rod
03/00→		Centre Rod	MN-DL-2175		Push Rod
03/00→		Centre Rod	MN-DL-2176		Push Rod
03/00→		Centre Rod	MN-DL-2177		Push Rod
03/00→		Centre Rod	MN-DL-3588		Push Rod
03/00→		Centre Rod	MN-DL-8197		Push Rod
03/00→		Centre Rod	MN-DL-12421		for Steering Rod
03/00→		Engine Mounting		MN-SB-10390	
03/00→		Suspension Arm Repair Kit		MN-RK-7280	for Drag Link;for Semi-Trailing Arm; for Wishbone (CV)
03/00→		Tie Rod	MN-DL-12284		
03/00→		Tie Rod End	CV-ES-2149		for Push Rod
03/00→		Tie Rod End	CV-ES-14162		for Steering Rod
03/00→	Tie Rod End	CV-ES-14163		for Steering Rod	

CV-ES-2119

Length: 55
Cone Ø: d1 Ø 10 / d2 Ø 10
Thread: M12 x 1,75 LHT
81953016063, 81953016131



CV-ES-2120

Length: 115
Cone Ø: d1 Ø 12,4 / d2 Ø 10,8
Thread: M14 x 1,5 RHT
03008500A, 81953016200, 81953016202, 81953016203, 81953016227



CV-ES-2149

Length: 160
Cone Ø: d1 Ø 30 / d2 Ø 27
Thread: M30 x 1,5 RHT
81953016263



CV-ES-2182

Length: 55
Cone Ø: d1 Ø 10 / d2 Ø 10
Thread: M12 x 1,75 RHT
81953016064, 81953016170



CV-ES-14162

Length: 125
Cone Ø: d1 Ø 30 / d2 Ø 27
Thread: M30 x 1,5 LHT
81953010015, 81953010083, 81953010087, 81953016029, 81953016030, 81953016043, 81953016044, 81953016050, 81953016054, 81953016087, 81953016091, 81953016107, 81953016120, 81953016125, 81953016152, 81953016155, 81953016157, 81953016168, 81953016179, 81953016181, 81953016223, 81953016237, 81953016254, 81953016275, 81953016279, 81953016351



CV-ES-14163

Length: 125
Cone Ø: d1 Ø 30 / d2 Ø 27
Thread: M30 x 1,5 RHT
95301.0084, 90804102156, 90804102272, 90804102696, 90804102710, 81953010016, 81953010075, 81953010084, 81953010088, 81953010094, 81953010103, 81953016030, 81953016043, 81953016048, 81953016049, 81953016053, 81953016061, 81953016090, 81953016108, 81953016112, 81953016126, 81953016143, 81953016149, 81953016154, 81953016156, 81953016168, 81953016178, 81953016194, 81953016206, 81953016224, 81953016234, 81953016242, 81953016252, 81953016274, 81953016278, 81953016284, 81953016286, 81953016308, 81953016310, 81953016312, 81953016347, 81953016350, 81953016352, 82953016012, 88953016014, N2953016001



MN-DL-2160

Length: 1652 Ø: 50
Cone Ø: d1 Ø 30 / d2 Ø 27
81467106112, 81467106163, 81467106165, 81467106198, 81467106353, 81467106354, 81467106361, 81467116725



MN-DL-2172

Length: 1050 Ø: 42
Cone Ø: d1 Ø 30 / d2 Ø 27
81466106374, 81466116019, 82466106080, 82466106189, 82466106190



MN-DL-2174

Length: 1588 Ø: 52
Cone Ø: d1 Ø 30 / d2 Ø 27
81467106378, 81467106912



MN-DL-2175

Length: 1628 Ø: 50
Cone Ø: d1 Ø 30 / d2 Ø 27
81467106396, 81467106904



MN-DL-2176

Length: 1628 Ø: 48
Cone Ø: d1 Ø 30 / d2 Ø 27
81466106779, 81466106780, 81466106782



MN-DL-2177

Length: 1664 Ø: 50
Cone Ø: d1 Ø 30 / d2 Ø 27
81467106994, 81467116726



MN-DL-3588

Length: 1035 Ø: 48
Cone Ø: d1 Ø 30 / d2 Ø 27
81466106333, 81466106334, 81466106354, 81466106355, 81466106360, 81466106361, 81466106721, 81466106722, 81466106723, 81466116216



MN-DL-5212

Length: 577 Ø: 48
Hole Distance: 130 / 130
81432206096, 81432206097, 81432206098, 81432206129, 81432209096, 81432209129, 81432306014, 81432306030



MN-DL-8197

Length: 1055 Ø: 42
Cone Ø: d1 Ø 30 / d2 Ø 27
03207500A, 81466116003, 81466116004, 81466116005



MN-DL-12284

Length: 1530 Ø: 50
Cone Ø: d1 Ø 30 / d2 Ø 27
81466106579, 81466106580, 81466106624, 81466116720, 81467116720, 81467116730, 81467116952



MN-DL-12421

Length: 1070 Ø: 48
Cone Ø: d1 Ø 30 / d2 Ø 27
Thread: M30 x 1,5 RHT
81466106656, 81466106659, 81466106669, 81466116006, 81466116007



MN-RK-7280

Ø: 75
Hole Distance: 115
Thick/Height: 24
0550806, 0639370, 689748, 10307400A, 81432306051, 81432306068, 81432706064



MN-RK-8523

Ø: 72
03304900A, 81432706065



MN-SB-10389

Ø: 70 Thick/Height: 72
81960200340



MN-SB-10390

Ø: 70 Thick/Height: 85/85
81960200341, 81960200373, 81960200385, 81960200408, 81960200418



MN-TC-14112

Length: 777 Ø: 60
Hole Distance: 115 / 115
81432206106, 81432306049



MN-VB-5222

Length: 627 Ø: 50
Hole Distance: 152 / 152
81432706030, 81432706034, 81432706054, 81432706055, 81432706056, 81432706057, 81432706067, 81432706068, 81432706074, 81432706075, 81432706076, 81432706077, 81432706078, 81432706081, 81432706082, 81432709034, 81432709076, 81432709078, 8143706054



MN-VB-8565

Length: 693 Ø: 46
Hole Distance: 115 / 115
81432706053, 81432709053



SC-ES-8517

Length: 140
Cone Ø: d1 Ø 30 / d2 Ø 27
Thread: M30 x 1,5 RHT
81953016286





F 2000 ...

19.233 FC CNG ...	03/00 →	Track Control Arm		MN-DL-5212	Trailing Arm, Drive Axle; Tag Axle, for Pneumatic Suspension vehicles	
	03/00 →	Track Control Arm		MN-VB-5222	Wishbone (CV)	
19.233 FK, FK-L, CNG	03/00 →	Ball Head, gearshift linkage	CV-ES-2120			
	03/00 →	Centre Rod	MN-DL-8197		Push Rod	
	03/00 →	Suspension Arm Repair Kit		MN-RK-7291	for Drag Link	
	03/00 →	Tie Rod	MN-DL-12284			
	03/00 →	Tie Rod End	CV-ES-2149		for Push Rod	
	03/00 →	Tie Rod End	CV-ES-14162		for Steering Rod	
	03/00 →	Tie Rod End	CV-ES-14163		for Steering Rod	
	03/00 →	Track Control Arm		MN-DL-5212	Trailing Arm, Drive Axle; Tag Axle, for Pneumatic Suspension vehicles	
	03/00 →	Track Control Arm		MN-VB-5222	Wishbone (CV)	
	19.273 F, FL, FLL	01/94 →	Ball Head, gearshift linkage	CV-ES-2119		
01/94 →		Ball Head, gearshift linkage	CV-ES-2120			
01/94 →		Ball Head, gearshift linkage	CV-ES-2182			
01/94 →		Centre Rod	MN-DL-2160		Coupling Rod	
01/94 →		Centre Rod	MN-DL-2172		Push Rod	
01/94 →		Centre Rod	MN-DL-2174		Push Rod	
01/94 →		Centre Rod	MN-DL-2175		Push Rod	
01/94 →		Centre Rod	MN-DL-2176		Push Rod	
01/94 →		Centre Rod	MN-DL-2177		Push Rod	
01/94 →		Centre Rod	MN-DL-3588		Push Rod	
01/94 →		Centre Rod	MN-DL-8197		Push Rod	
01/94 →		Centre Rod	MN-DL-12421		for Steering Rod	
01/94 →		Engine Mounting		MN-SB-10390		
01/94 →		Engine Mounting	MN-SB-10389			
01/94 →		Mounting, stabilizer coupling rod	MN-SB-5246			
01/94 →		Stabiliser Mounting		MN-SB-5243		
01/94 →		Suspension Arm Repair Kit		CV-RK-5313	for Wishbone (CV)	
01/94 →		Suspension Arm Repair Kit		MN-RK-7280	for Drag Link; for Semi-Trailing Arm; for Wishbone (CV)	
01/94 →		Suspension Arm Repair Kit		MN-RK-7287	for Wishbone (CV)	
01/94 →		Tie Rod	MN-DL-12284			
01/94 →		Tie Rod End	CV-ES-2149		for Push Rod	
01/94 →		Tie Rod End	CV-ES-14162		for Steering Rod	
01/94 →		Tie Rod End	CV-ES-14163		for Steering Rod	
01/94 →		Tie Rod End	SC-ES-8517		for Push Rod	
01/94 →		Tie Rod End	SC-ES-8535		for Guide Rod	
01/94 →		Track Control Arm		MN-DL-5212	Trailing Arm, Drive Axle; Air Suspension Axle	
01/94 →		Track Control Arm		MN-VB-5222	Wishbone (CV), Air Suspension Axle	
01/94 →		Track Control Arm	MN-TC-14112		Control Arm, 1st Front Axle, for Pneumatic Suspension vehicles	
19.273 FA		01/94 →	Ball Head, gearshift linkage	CV-ES-2119		
		01/94 →	Ball Head, gearshift linkage	CV-ES-2120		
		01/94 →	Ball Head, gearshift linkage	CV-ES-2182		
		01/94 →	Centre Rod	MN-DL-2160		Coupling Rod
		01/94 →	Centre Rod	MN-DL-2172		Push Rod
	01/94 →	Centre Rod	MN-DL-2174		Push Rod	
	01/94 →	Centre Rod	MN-DL-2175		Push Rod	
	01/94 →	Centre Rod	MN-DL-2176		Push Rod	
	01/94 →	Centre Rod	MN-DL-2177		Push Rod	
	01/94 →	Centre Rod	MN-DL-3588		Push Rod	
	01/94 →	Centre Rod	MN-DL-12391		for Steering Rod	
	01/94 →	Centre Rod	MN-DL-12421		for Steering Rod	
	01/94 →	Engine Mounting		MN-SB-10390		
	01/94 →	Tie Rod End	CV-ES-2149		for Push Rod	
	01/94 →	Tie Rod End	CV-ES-14162		for Steering Rod	
	01/94 →	Tie Rod End	CV-ES-14163		for Steering Rod	
	01/94 →	Tie Rod End	SC-ES-8517		for Push Rod	

CV-ES-2119

Length: 55
 Cone Ø: d1 Ø 10 / d2 Ø 10
 Thread: M12 x 1,75 LHT
 81953016063, 81953016131

**CV-ES-2120**

Length: 115
 Cone Ø: d1 Ø 12,4 / d2 Ø 10,8
 Thread: M14 x 1,5 RHT
 03008500A, 81953016200, 81953016202, 81953016203, 81953016227

**CV-ES-2149**

Length: 160
 Cone Ø: d1 Ø 30 / d2 Ø 27
 Thread: M30 x 1,5 RHT
 81953016263

**CV-ES-2182**

Length: 55
 Cone Ø: d1 Ø 10 / d2 Ø 10
 Thread: M12 x 1,75 RHT
 81953016064, 81953016170

**CV-ES-14162**

Length: 125
 Cone Ø: d1 Ø 30 / d2 Ø 27
 Thread: M30 x 1,5 LHT
 81953010015, 81953010083, 81953010087, 81953016029, 81953016030, 81953016043, 81953016044, 81953016050, 81953016054, 81953016087, 81953016091, 81953016107, 81953016120, 81953016125, 81953016152, 81953016155, 81953016157, 81953016168, 81953016179, 81953016181, 81953016223, 81953016237, 81953016254, 81953016275, 81953016279, 81953016351

**CV-ES-14163**

Length: 125
 Cone Ø: d1 Ø 30 / d2 Ø 27
 Thread: M30 x 1,5 RHT
 95301.0084, 90804102156, 90804102272, 90804102696, 90804102710, 81953010016, 81953010075, 81953010084, 81953010088, 81953010094, 81953010103, 81953016030, 81953016043, 81953016048, 81953016049, 81953016053, 81953016061, 81953016090, 81953016108, 81953016112, 81953016126, 81953016143, 81953016149, 81953016154, 81953016156, 81953016168, 81953016178, 81953016194, 81953016206, 81953016224, 81953016234, 81953016242, 81953016252, 81953016274, 81953016278, 81953016284, 81953016286, 81953016308, 81953016310, 81953016312, 81953016347, 81953016350, 81953016352, 82953016012, 88953016014, N2953016001

**CV-RK-5313**

Ø: 90
 03304800A, 81953016132

**MN-DL-2160**

Length: 1652 Ø: 50
 Cone Ø: d1 Ø 30 / d2 Ø 27
 81467106112, 81467106163, 81467106165, 81467106198, 81467106353, 81467106354, 81467106361, 81467116725

**MN-DL-2172**

Length: 1050 Ø: 42
 Cone Ø: d1 Ø 30 / d2 Ø 27
 81466106374, 81466116019, 82466106080, 82466106189, 82466106190

**MN-DL-2174**

Length: 1588 Ø: 52
 Cone Ø: d1 Ø 30 / d2 Ø 27
 81467106378, 81467106912

**MN-DL-2175**

Length: 1628 Ø: 50
 Cone Ø: d1 Ø 30 / d2 Ø 27
 81467106396, 81467106904

**MN-DL-2176**

Length: 1628 Ø: 48
 Cone Ø: d1 Ø 30 / d2 Ø 27
 81466106779, 81466106780, 81466106782

**MN-DL-2177**

Length: 1664 Ø: 50
 Cone Ø: d1 Ø 30 / d2 Ø 27
 81467106994, 81467116726

**MN-DL-3588**

Length: 1035 Ø: 48
 Cone Ø: d1 Ø 30 / d2 Ø 27
 81466106333, 81466106334, 81466106354, 81466106355, 81466106360, 81466106361, 81466106721, 81466106722, 81466106723, 81466116216

**MN-DL-5212**

Length: 577 Ø: 48
 Hole Distance: 130 / 130
 81432206096, 81432206097, 81432206098, 81432206129, 81432209096, 81432209129, 81432306014, 81432306030

**MN-DL-8197**

Length: 1055 Ø: 42
 Cone Ø: d1 Ø 30 / d2 Ø 27
 03207500A, 81466116003, 81466116004, 81466116005

**MN-DL-12284**

Length: 1530 Ø: 50
 Cone Ø: d1 Ø 30 / d2 Ø 27
 81466106579, 81466106580, 81466106624, 81466116720, 81467116720, 81467116730, 81467116952

**MN-DL-12391**

Length: 1050 Ø: 52
 Cone Ø: d1 Ø 30 / d2 Ø 27
 82466106057, 82466106147

**MN-DL-12421**

Length: 1070 Ø: 48
 Cone Ø: d1 Ø 30 / d2 Ø 27
 Thread: M30 x 1,5 RHT
 81466106656, 81466106659, 81466106669, 81466116006, 81466116007

**MN-RK-7280**

Ø: 75
 Hole Distance: 115
 Thick/Height: 24
 0550806, 0639370, 689748, 10307400A, 81432306051, 81432306068, 81432706064

**MN-RK-7287**

Ø: 90
 Hole Distance: 152
 Thick/Height: 35
 03304700A, 81953016133

**MN-RK-7291**

Ø: 72
 Hole Distance: 130
 Thick/Height: 30
 10307800A, 81432206108, 81432206132

**MN-SB-5243**

Length: 55 Ø: 78
 Thick/Height: 60
 03311100A, 81437040061, 81437220020

**MN-SB-5246**

Ø: 45 Thick/Height: 47
 81437220022, 81437220038, 81962100450, 81962100469

**MN-SB-10389**

Ø: 70 Thick/Height: 72
 81960200340

**MN-SB-10390**

Ø: 70 Thick/Height: 85/85
 81960200341, 81960200373, 81960200385, 81960200408, 81960200418

**MN-TC-14112**

Length: 777 Ø: 60
 Hole Distance: 115 / 115
 81432206106, 81432306049

**MN-VB-5222**

Length: 627 Ø: 50
 Hole Distance: 152 / 152
 81432706030, 81432706034, 81432706054, 81432706055, 81432706056, 81432706057, 81432706067, 81432706068, 81432706074, 81432706075, 81432706076, 81432706077, 81432706078, 81432706081, 81432706082, 81432709034, 81432709076, 81432709078, 8143706054

**SC-ES-8517**

Length: 140
 Cone Ø: d1 Ø 30 / d2 Ø 27
 Thread: M30 x 1,5 RHT
 81953016286

**SC-ES-8535**

Length: 145
 Cone Ø: d1 Ø 30 / d2 Ø 27
 Thread: M30 x 1,5 RHT
 81953016271, 81953016325



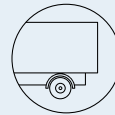

F 2000 ...

19.273 FAK	01/94 →	Ball Head, gearshift linkage	CV-ES-2119		
	01/94 →	Ball Head, gearshift linkage	CV-ES-2120		
	01/94 →	Ball Head, gearshift linkage	CV-ES-2182		
	01/94 →	Centre Rod	MN-DL-2160		Coupling Rod
	01/94 →	Centre Rod	MN-DL-2172		Push Rod
	01/94 →	Centre Rod	MN-DL-2174		Push Rod
	01/94 →	Centre Rod	MN-DL-2175		Push Rod
	01/94 →	Centre Rod	MN-DL-2176		Push Rod
	01/94 →	Centre Rod	MN-DL-2177		Push Rod
	01/94 →	Centre Rod	MN-DL-3588		Push Rod
	01/94 →	Centre Rod	MN-DL-12391		for Steering Rod
	01/94 →	Centre Rod	MN-DL-12421		for Steering Rod
	01/94 →	Engine Mounting		MN-SB-10390	
	01/94 →	Tie Rod End	CV-ES-2149		for Push Rod
19.273 FK	01/94 →	Tie Rod End	CV-ES-14162		for Steering Rod
	01/94 →	Tie Rod End	CV-ES-14163		for Steering Rod
	01/94 →	Tie Rod End	SC-ES-8517		for Push Rod
	01/94 →	Ball Head, gearshift linkage	CV-ES-2119		
	01/94 →	Ball Head, gearshift linkage	CV-ES-2120		
	01/94 →	Ball Head, gearshift linkage	CV-ES-2182		
	01/94 →	Centre Rod	MN-DL-2160		Coupling Rod
	01/94 →	Centre Rod	MN-DL-2172		Push Rod
	01/94 →	Centre Rod	MN-DL-2174		Push Rod
	01/94 →	Centre Rod	MN-DL-2175		Push Rod
	01/94 →	Centre Rod	MN-DL-2176		Push Rod
	01/94 →	Centre Rod	MN-DL-2177		Push Rod
	01/94 →	Centre Rod	MN-DL-3588		Push Rod
	01/94 →	Centre Rod	MN-DL-8197		Push Rod
01/94 →	Centre Rod	MN-DL-12421		for Steering Rod	
01/94 →	Engine Mounting		MN-SB-10390		
01/94 →	Engine Mounting	MN-SB-10389			
01/94 →	Mounting, stabilizer coupling rod	MN-SB-5246			
01/94 →	Suspension Arm Repair Kit		MN-RK-7280	for Drag Link;for Semi-Trailing Arm; for Wishbone (CV)	
01/94 →	Tie Rod	MN-DL-12284			
01/94 →	Tie Rod End	CV-ES-2149		for Push Rod	
01/94 →	Tie Rod End	CV-ES-14162		for Steering Rod	
01/94 →	Tie Rod End	CV-ES-14163		for Steering Rod	
01/94 →	Track Control Arm		MN-DL-5212	Trailing Arm, Drive Axle;Tag Axle, for Pneumatic Suspension vehicles	
01/94 →	Track Control Arm		MN-VB-5222	Wishbone (CV)	
19.273 FS,19.273 FLS	01/94 →12/95	Ball Head, gearshift linkage	CV-ES-2119		
	01/94 →12/95	Ball Head, gearshift linkage	CV-ES-2120		
	01/94 →12/95	Ball Head, gearshift linkage	CV-ES-2182		
	01/94 →12/95	Centre Rod	MN-DL-2160		Coupling Rod
	01/94 →12/95	Centre Rod	MN-DL-2172		Push Rod
	01/94 →12/95	Centre Rod	MN-DL-2174		Push Rod
	01/94 →12/95	Centre Rod	MN-DL-2175		Push Rod
	01/94 →12/95	Centre Rod	MN-DL-2176		Push Rod
	01/94 →12/95	Centre Rod	MN-DL-2177		Push Rod
	01/94 →12/95	Centre Rod	MN-DL-3588		Push Rod
	01/94 →12/95	Centre Rod	MN-DL-8197		Push Rod
	01/94 →12/95	Centre Rod	MN-DL-12421		for Steering Rod
	01/94 →12/95	Engine Mounting		MN-SB-10390	
	01/94 →12/95	Engine Mounting	MN-SB-10389		
	01/94 →12/95	Mounting, stabilizer coupling rod	MN-SB-5246		
	01/94 →12/95	Stabiliser Mounting		MN-SB-5243	
	01/94 →12/95	Suspension Arm Repair Kit		CV-RK-5313	for Wishbone (CV)
	01/94 →12/95	Suspension Arm Repair Kit		MN-RK-7280	for Drag Link;for Semi-Trailing Arm; for Wishbone (CV)
	01/94 →12/95	Suspension Arm Repair Kit		MN-RK-7287	for Wishbone (CV)
01/94 →12/95	Tie Rod	MN-DL-12284			
01/94 →12/95	Tie Rod End	CV-ES-2149		for Push Rod	

CV-ES-2119

Length: 55
Cone Ø: d1 Ø 10 / d2 Ø 10
Thread: M12 x 1,75 LHT
81953016063, 81953016131



CV-ES-2120

Length: 115
Cone Ø: d1 Ø 12,4 / d2 Ø 10,8
Thread: M14 x 1,5 RHT
03008500A, 81953016200, 81953016202,
81953016203, 81953016227



CV-ES-2149

Length: 160
Cone Ø: d1 Ø 30 / d2 Ø 27
Thread: M30 x 1,5 RHT
81953016263



CV-ES-2182

Length: 55
Cone Ø: d1 Ø 10 / d2 Ø 10
Thread: M12 x 1,75 RHT
81953016064, 81953016170



CV-ES-14162

Length: 125
Cone Ø: d1 Ø 30 / d2 Ø 27
Thread: M30 x 1,5 LHT
81953010015, 81953010083, 81953010087,
81953016029, 81953016030, 81953016043,
81953016044, 81953016050, 81953016054,
81953016087, 81953016091, 81953016107,
81953016120, 81953016125, 81953016152,
81953016155, 81953016157, 81953016168,
81953016179, 81953016181, 81953016223,
81953016237, 81953016254, 81953016275,
81953016279, 81953016351



CV-ES-14163

Length: 125
Cone Ø: d1 Ø 30 / d2 Ø 27
Thread: M30 x 1,5 RHT
95301.0084, 90804102156, 90804102272,
90804102696, 90804102710, 81953010016,
81953010075, 81953010084, 81953010088,
81953010094, 81953010103, 81953016030,
81953016043, 81953016048, 81953016049,
81953016053, 81953016061, 81953016090,
81953016108, 81953016112, 81953016126,
81953016143, 81953016149, 81953016154,
81953016156, 81953016168, 81953016178,
81953016194, 81953016206, 81953016224,
81953016234, 81953016242, 81953016252,
81953016274, 81953016278, 81953016284,
81953016286, 81953016308, 81953016310,
81953016312, 81953016347, 81953016350,
81953016352, 82953016012, 88953016014,
N2953016001



CV-RK-5313

Ø: 90
03304800A, 81953016132



MN-DL-2160

Length: 1652 Ø: 50
Cone Ø: d1 Ø 30 / d2 Ø 27
81467106112, 81467106163, 81467106165,
81467106198, 81467106353, 81467106354,
81467106361, 81467116725



MN-DL-2172

Length: 1050 Ø: 42
Cone Ø: d1 Ø 30 / d2 Ø 27
81466106374, 81466116019, 82466106080,
82466106189, 82466106190



MN-DL-2174

Length: 1588 Ø: 52
Cone Ø: d1 Ø 30 / d2 Ø 27
81467106378, 81467106912



MN-DL-2175

Length: 1628 Ø: 50
Cone Ø: d1 Ø 30 / d2 Ø 27
81467106396, 81467106904



MN-DL-2176

Length: 1628 Ø: 48
Cone Ø: d1 Ø 30 / d2 Ø 27
81466106779, 81466106780, 81466106782



MN-DL-2177

Length: 1664 Ø: 50
Cone Ø: d1 Ø 30 / d2 Ø 27
81467106994, 81467116726



MN-DL-3588

Length: 1035 Ø: 48
Cone Ø: d1 Ø 30 / d2 Ø 27
81466106333, 81466106334, 81466106354,
81466106355, 81466106360, 81466106361,
81466106721, 81466106722, 81466106723,
81466116216



MN-DL-5212

Length: 577 Ø: 48
Hole Distance: 130 / 130
81432206096, 81432206097, 81432206098,
81432206129, 81432209096, 81432209129,
81432306014, 81432306030



MN-DL-8197

Length: 1055 Ø: 42
Cone Ø: d1 Ø 30 / d2 Ø 27
03207500A, 81466116003, 81466116004,
81466116005



MN-DL-12284

Length: 1530 Ø: 50
Cone Ø: d1 Ø 30 / d2 Ø 27
81466106579, 81466106580, 81466106624,
81466116720, 81467116720, 81467116730,
81467116952



MN-DL-12391

Length: 1050 Ø: 52
Cone Ø: d1 Ø 30 / d2 Ø 27
82466106057, 82466106147



MN-DL-12421

Length: 1070 Ø: 48
Cone Ø: d1 Ø 30 / d2 Ø 27
Thread: M30 x 1,5 RHT
81466106656, 81466106659, 81466106669,
81466116006, 81466116007



MN-RK-7280

Ø: 75
Hole Distance: 115
Thick/Height: 24
0550806, 0639370, 689748, 10307400A,
81432306051, 81432306068, 81432706064



MN-RK-7287

Ø: 90
Hole Distance: 152
Thick/Height: 35
03304700A, 81953016133



MN-SB-5243

Length: 55 Ø: 78
Thick/Height: 60
03311100A, 81437040061, 81437220020



MN-SB-5246

Ø: 45 Thick/Height: 47
81437220022, 81437220038, 81962100450,
81962100469



MN-SB-10389

Ø: 70 Thick/Height: 72
81960200340



MN-SB-10390

Ø: 70 Thick/Height: 85/85
81960200341, 81960200373, 81960200385,
81960200408, 81960200418



MN-VB-5222

Length: 627 Ø: 50
Hole Distance: 152 / 152
81432706030, 81432706034, 81432706054,
81432706055, 81432706056, 81432706057,
81432706067, 81432706068, 81432706074,
81432706075, 81432706076, 81432706077,
81432706078, 81432706081, 81432706082,
81432709034, 81432709076, 81432709078,
8143706054



SC-ES-8517

Length: 140
Cone Ø: d1 Ø 30 / d2 Ø 27
Thread: M30 x 1,5 RHT
81953016286





F 2000 ...

19.273 FS,19.273 FLS ...	01/94 →12/95	Tie Rod End	CV-ES-14162		for Steering Rod
	01/94 →12/95	Tie Rod End	CV-ES-14163		for Steering Rod
	01/94 →12/95	Tie Rod End	SC-ES-8517		for Push Rod
	01/94 →12/95	Tie Rod End	SC-ES-8535		for Guide Rod
	01/94 →12/95	Track Control Arm		MN-DL-5212	Trailing Arm, Drive Axle;Air Suspension Axle
	01/94 →12/95	Track Control Arm		MN-VB-5222	Wishbone (CV), Air Suspension Axle
	01/94 →12/95	Track Control Arm	MN-TC-14112		Control Arm, 1st Front Axle, for Pneumatic Suspension vehicles
19.293 FAC	01/94 →	Ball Head, gearshift linkage	CV-ES-2119		
	01/94 →	Ball Head, gearshift linkage	CV-ES-2120		
	01/94 →	Ball Head, gearshift linkage	CV-ES-2182		
	01/94 →	Centre Rod	MN-DL-2160		Coupling Rod
	01/94 →	Centre Rod	MN-DL-2172		Push Rod
	01/94 →	Centre Rod	MN-DL-2174		Push Rod
	01/94 →	Centre Rod	MN-DL-2175		Push Rod
	01/94 →	Centre Rod	MN-DL-2176		Push Rod
	01/94 →	Centre Rod	MN-DL-2177		Push Rod
	01/94 →	Centre Rod	MN-DL-3588		Push Rod
	01/94 →	Centre Rod	MN-DL-12391		for Steering Rod
	01/94 →	Centre Rod	MN-DL-12421		for Steering Rod
	01/94 →	Engine Mounting		MN-SB-10390	
	01/94 →	Tie Rod End	CV-ES-2149		for Push Rod
	01/94 →	Tie Rod End	CV-ES-14162		for Steering Rod
	01/94 →	Tie Rod End	CV-ES-14163		for Steering Rod
	01/94 →	Tie Rod End	SC-ES-8517		for Push Rod
19.293 FAK	01/94 →	Ball Head, gearshift linkage	CV-ES-2119		
	01/94 →	Ball Head, gearshift linkage	CV-ES-2120		
	01/94 →	Ball Head, gearshift linkage	CV-ES-2182		
	01/94 →	Centre Rod	MN-DL-2160		Coupling Rod
	01/94 →	Centre Rod	MN-DL-2172		Push Rod
	01/94 →	Centre Rod	MN-DL-2174		Push Rod
	01/94 →	Centre Rod	MN-DL-2175		Push Rod
	01/94 →	Centre Rod	MN-DL-2176		Push Rod
	01/94 →	Centre Rod	MN-DL-2177		Push Rod
	01/94 →	Centre Rod	MN-DL-3588		Push Rod
	01/94 →	Centre Rod	MN-DL-12391		for Steering Rod
	01/94 →	Centre Rod	MN-DL-12421		for Steering Rod
	01/94 →	Engine Mounting		MN-SB-10390	
	01/94 →	Tie Rod End	CV-ES-2149		for Push Rod
	01/94 →	Tie Rod End	CV-ES-14162		for Steering Rod
	01/94 →	Tie Rod End	CV-ES-14163		for Steering Rod
	01/94 →	Tie Rod End	SC-ES-8517		for Push Rod
19.293 FAS	01/94 →	Ball Head, gearshift linkage	CV-ES-2119		
	01/94 →	Ball Head, gearshift linkage	CV-ES-2120		
	01/94 →	Ball Head, gearshift linkage	CV-ES-2182		
	01/94 →	Centre Rod	MN-DL-2160		Coupling Rod
	01/94 →	Centre Rod	MN-DL-2172		Push Rod
	01/94 →	Centre Rod	MN-DL-2174		Push Rod
	01/94 →	Centre Rod	MN-DL-2175		Push Rod
	01/94 →	Centre Rod	MN-DL-2176		Push Rod
	01/94 →	Centre Rod	MN-DL-2177		Push Rod
	01/94 →	Centre Rod	MN-DL-3588		Push Rod
	01/94 →	Centre Rod	MN-DL-12391		for Steering Rod
	01/94 →	Centre Rod	MN-DL-12421		for Steering Rod
	01/94 →	Engine Mounting		MN-SB-10390	
	01/94 →	Tie Rod End	CV-ES-2149		for Push Rod
	01/94 →	Tie Rod End	CV-ES-14162		for Steering Rod
	01/94 →	Tie Rod End	CV-ES-14163		for Steering Rod
	01/94 →	Tie Rod End	SC-ES-8517		for Push Rod
19.293 FC,19.293 FLC,19.293 FLLC	01/94 →	Ball Head, gearshift linkage	CV-ES-2119		
	01/94 →	Ball Head, gearshift linkage	CV-ES-2120		
	01/94 →	Ball Head, gearshift linkage	CV-ES-2182		
	01/94 →	Centre Rod	MN-DL-2160		Coupling Rod

CV-ES-2119

Length: 55
Cone Ø: d1 Ø 10 / d2 Ø 10
Thread: M12 x 1,75 LHT
81953016063, 81953016131



CV-ES-2120

Length: 115
Cone Ø: d1 Ø 12,4 / d2 Ø 10,8
Thread: M14 x 1,5 RHT
03008500A, 81953016200, 81953016202, 81953016203, 81953016227



CV-ES-2149

Length: 160
Cone Ø: d1 Ø 30 / d2 Ø 27
Thread: M30 x 1,5 RHT
81953016263



CV-ES-2182

Length: 55
Cone Ø: d1 Ø 10 / d2 Ø 10
Thread: M12 x 1,75 RHT
81953016064, 81953016170



CV-ES-14162

Length: 125
Cone Ø: d1 Ø 30 / d2 Ø 27
Thread: M30 x 1,5 LHT

81953010015, 81953010083, 81953010087, 81953016029, 81953016030, 81953016043, 81953016044, 81953016050, 81953016054, 81953016087, 81953016091, 81953016107, 81953016120, 81953016125, 81953016152, 81953016155, 81953016157, 81953016168, 81953016179, 81953016181, 81953016223, 81953016237, 81953016254, 81953016275, 81953016279, 81953016351



CV-ES-14163

Length: 125
Cone Ø: d1 Ø 30 / d2 Ø 27
Thread: M30 x 1,5 RHT

95301.0084, 90804102156, 90804102272, 90804102696, 90804102710, 81953010016, 81953010075, 81953010084, 81953010088, 81953010094, 81953010103, 81953016030, 81953016043, 81953016048, 81953016049, 81953016053, 81953016061, 81953016090, 81953016108, 81953016112, 81953016126, 81953016143, 81953016149, 81953016154, 81953016156, 81953016168, 81953016178, 81953016194, 81953016206, 81953016224, 81953016234, 81953016242, 81953016252, 81953016274, 81953016278, 81953016284, 81953016286, 81953016308, 81953016310, 81953016312, 81953016347, 81953016350, 81953016352, 82953016012, 88953016014, N2953016001



MN-DL-2160

Length: 1652 Ø: 50
Cone Ø: d1 Ø 30 / d2 Ø 27
81467106112, 81467106163, 81467106165, 81467106198, 81467106353, 81467106354, 81467106361, 81467116725



MN-DL-2172

Length: 1050 Ø: 42
Cone Ø: d1 Ø 30 / d2 Ø 27
81466106374, 81466116019, 82466106080, 82466106189, 82466106190



MN-DL-2174

Length: 1588 Ø: 52
Cone Ø: d1 Ø 30 / d2 Ø 27
81467106378, 81467106912



MN-DL-2175

Length: 1628 Ø: 50
Cone Ø: d1 Ø 30 / d2 Ø 27
81467106396, 81467106904



MN-DL-2176

Length: 1628 Ø: 48
Cone Ø: d1 Ø 30 / d2 Ø 27
81466106779, 81466106780, 81466106782



MN-DL-2177

Length: 1664 Ø: 50
Cone Ø: d1 Ø 30 / d2 Ø 27
81467106994, 81467116726



MN-DL-3588

Length: 1035 Ø: 48
Cone Ø: d1 Ø 30 / d2 Ø 27
81466106333, 81466106334, 81466106354, 81466106355, 81466106360, 81466106361, 81466106721, 81466106722, 81466106723, 81466116216



MN-DL-5212

Length: 577 Ø: 48
Hole Distance: 130 / 130
81432206096, 81432206097, 81432206098, 81432206129, 81432209096, 81432209129, 81432306014, 81432306030



MN-DL-12391

Length: 1050 Ø: 52
Cone Ø: d1 Ø 30 / d2 Ø 27
82466106057, 82466106147



MN-DL-12421

Length: 1070 Ø: 48
Cone Ø: d1 Ø 30 / d2 Ø 27
Thread: M30 x 1,5 RHT
81466106656, 81466106659, 81466106669, 81466116006, 81466116007



MN-SB-10390

Ø: 70 Thick/Height: 85/85
81960200341, 81960200373, 81960200385, 81960200408, 81960200418



MN-TC-14112

Length: 777 Ø: 60
Hole Distance: 115 / 115
81432206106, 81432306049



MN-VB-5222

Length: 627 Ø: 50
Hole Distance: 152 / 152
81432706030, 81432706034, 81432706054, 81432706055, 81432706056, 81432706057, 81432706067, 81432706068, 81432706074, 81432706075, 81432706076, 81432706077, 81432706078, 81432706081, 81432706082, 81432709034, 81432709076, 81432709078, 8143706054



SC-ES-8517

Length: 140
Cone Ø: d1 Ø 30 / d2 Ø 27
Thread: M30 x 1,5 RHT
81953016286



SC-ES-8535

Length: 145
Cone Ø: d1 Ø 30 / d2 Ø 27
Thread: M30 x 1,5 RHT
81953016271, 81953016325





F 2000 ...

19.293 FC, 19.293 FLC,
19.293 FLLC ...

01/94 →	Centre Rod	MN-DL-2172		Push Rod
01/94 →	Centre Rod	MN-DL-2174		Push Rod
01/94 →	Centre Rod	MN-DL-2175		Push Rod
01/94 →	Centre Rod	MN-DL-2176		Push Rod
01/94 →	Centre Rod	MN-DL-2177		Push Rod
01/94 →	Centre Rod	MN-DL-3588		Push Rod
01/94 →	Centre Rod	MN-DL-8197		Push Rod
01/94 →	Centre Rod	MN-DL-12421		for Steering Rod
01/94 →	Engine Mounting		MN-SB-10390	
01/94 →	Engine Mounting	MN-SB-10389		
01/94 →	Mounting, stabilizer coupling rod	MN-SB-5246		
01/94 →	Stabiliser Mounting		MN-SB-5243	
01/94 →	Suspension Arm Repair Kit		CV-RK-5313	for Wishbone (CV)
01/94 →	Suspension Arm Repair Kit		MN-RK-7280	for Drag Link;for Semi-Trailing Arm; for Wishbone (CV)
01/94 →	Suspension Arm Repair Kit		MN-RK-7287	for Wishbone (CV)
01/94 →	Tie Rod	MN-DL-8371		
01/94 →	Tie Rod	MN-DL-12284		
01/94 →	Tie Rod End	CV-ES-2149		for Push Rod
01/94 →	Tie Rod End	CV-ES-14162		for Steering Rod
01/94 →	Tie Rod End	CV-ES-14163		for Steering Rod
01/94 →	Tie Rod End	SC-ES-8517		for Push Rod
01/94 →	Tie Rod End	SC-ES-8535		for Guide Rod
01/94 →	Track Control Arm		MN-DL-5212	Trailing Arm, Drive Axle;Air Suspension Axle
01/94 →	Track Control Arm		MN-VB-5222	Wishbone (CV), Air Suspension Axle
01/94 →	Track Control Arm	MN-TC-14112		Control Arm, 1st Front Axle, for Pneumatic Suspension vehicles

19.293 FK, 19.293 FLK

01/94 →	Ball Head, gearshift linkage	CV-ES-2119		
01/94 →	Ball Head, gearshift linkage	CV-ES-2120		
01/94 →	Ball Head, gearshift linkage	CV-ES-2182		
01/94 →	Centre Rod	MN-DL-2160		Coupling Rod
01/94 →	Centre Rod	MN-DL-2172		Push Rod
01/94 →	Centre Rod	MN-DL-2174		Push Rod
01/94 →	Centre Rod	MN-DL-2175		Push Rod
01/94 →	Centre Rod	MN-DL-2176		Push Rod
01/94 →	Centre Rod	MN-DL-2177		Push Rod
01/94 →	Centre Rod	MN-DL-3588		Push Rod
01/94 →	Centre Rod	MN-DL-8197		Push Rod
01/94 →	Centre Rod	MN-DL-12421		for Steering Rod
01/94 →	Engine Mounting		MN-SB-10390	
01/94 →	Engine Mounting	MN-SB-10389		
01/94 →	Mounting, stabilizer coupling rod	MN-SB-5246		
01/94 →	Stabiliser Mounting		MN-SB-5243	
01/94 →	Suspension Arm Repair Kit		CV-RK-5313	for Wishbone (CV)
01/94 →	Suspension Arm Repair Kit		MN-RK-7280	for Drag Link;for Semi-Trailing Arm; for Wishbone (CV)
01/94 →	Suspension Arm Repair Kit		MN-RK-7287	for Wishbone (CV)
01/94 →	Tie Rod	MN-DL-12284		
01/94 →	Tie Rod End	CV-ES-2149		for Push Rod
01/94 →	Tie Rod End	CV-ES-14162		for Steering Rod
01/94 →	Tie Rod End	CV-ES-14163		for Steering Rod
01/94 →	Track Control Arm		MN-DL-5212	Trailing Arm, Drive Axle;Air Suspension Axle
01/94 →	Track Control Arm		MN-VB-5222	Wishbone (CV)

19.293 FS, 19.293 FLS, 19.293 FLLS

01/94 →	Ball Head, gearshift linkage	CV-ES-2119		
01/94 →	Ball Head, gearshift linkage	CV-ES-2120		
01/94 →	Ball Head, gearshift linkage	CV-ES-2182		
01/94 →	Centre Rod	MN-DL-2160		Coupling Rod
01/94 →	Centre Rod	MN-DL-2172		Push Rod
01/94 →	Centre Rod	MN-DL-2174		Push Rod
01/94 →	Centre Rod	MN-DL-2175		Push Rod
01/94 →	Centre Rod	MN-DL-2176		Push Rod
01/94 →	Centre Rod	MN-DL-2177		Push Rod
01/94 →	Centre Rod	MN-DL-3588		Push Rod

CV-ES-2119

Length: 55
Cone Ø: d1 Ø 10 / d2 Ø 10
Thread: M12 x 1,75 LHT
81953016063, 81953016131



CV-ES-2120

Length: 115
Cone Ø: d1 Ø 12,4 / d2 Ø 10,8
Thread: M14 x 1,5 RHT
03008500A, 81953016200, 81953016202,
81953016203, 81953016227



CV-ES-2149

Length: 160
Cone Ø: d1 Ø 30 / d2 Ø 27
Thread: M30 x 1,5 RHT
81953016263



CV-ES-2182

Length: 55
Cone Ø: d1 Ø 10 / d2 Ø 10
Thread: M12 x 1,75 RHT
81953016064, 81953016170



CV-ES-14162

Length: 125
Cone Ø: d1 Ø 30 / d2 Ø 27
Thread: M30 x 1,5 LHT
81953010015, 81953010083, 81953010087,
81953016029, 81953016030, 81953016043,
81953016044, 81953016050, 81953016054,
81953016087, 81953016091, 81953016107,
81953016120, 81953016125, 81953016152,
81953016155, 81953016157, 81953016168,
81953016179, 81953016181, 81953016223,
81953016237, 81953016254, 81953016275,
81953016279, 81953016351



CV-ES-14163

Length: 125
Cone Ø: d1 Ø 30 / d2 Ø 27
Thread: M30 x 1,5 RHT
95301.0084, 90804102156, 90804102272,
90804102696, 90804102710, 81953010016,
81953010075, 81953010084, 81953010088,
81953010094, 81953010103, 81953016030,
81953016043, 81953016048, 81953016049,
81953016053, 81953016061, 81953016090,
81953016108, 81953016112, 81953016126,
81953016143, 81953016149, 81953016154,
81953016156, 81953016168, 81953016178,
81953016194, 81953016206, 81953016224,
81953016234, 81953016242, 81953016252,
81953016274, 81953016278, 81953016284,
81953016286, 81953016308, 81953016310,
81953016312, 81953016347, 81953016350,
81953016352, 82953016012, 88953016014,
N2953016001



CV-RK-5313

Ø: 90
03304800A, 81953016132



MN-DL-2160

Length: 1652 Ø: 50
Cone Ø: d1 Ø 30 / d2 Ø 27
81467106112, 81467106163, 81467106165,
81467106198, 81467106353, 81467106354,
81467106361, 81467116725



MN-DL-2172

Length: 1050 Ø: 42
Cone Ø: d1 Ø 30 / d2 Ø 27
81466106374, 81466116019, 82466106080,
82466106189, 82466106190



MN-DL-2174

Length: 1588 Ø: 52
Cone Ø: d1 Ø 30 / d2 Ø 27
81467106378, 81467106912



MN-DL-2175

Length: 1628 Ø: 50
Cone Ø: d1 Ø 30 / d2 Ø 27
81467106396, 81467106904



MN-DL-2176

Length: 1628 Ø: 48
Cone Ø: d1 Ø 30 / d2 Ø 27
81466106779, 81466106780, 81466106782



MN-DL-2177

Length: 1664 Ø: 50
Cone Ø: d1 Ø 30 / d2 Ø 27
81467106994, 81467116726



MN-DL-3588

Length: 1035 Ø: 48
Cone Ø: d1 Ø 30 / d2 Ø 27
81466106333, 81466106334, 81466106354,
81466106355, 81466106360, 81466106361,
81466106721, 81466106722, 81466106723,
81466116216



MN-DL-5212

Length: 577 Ø: 48
Hole Distance: 130 / 130
81432206096, 81432206097, 81432206098,
81432206129, 81432209096, 81432209129,
81432306014, 81432306030



MN-DL-8197

Length: 1055 Ø: 42
Cone Ø: d1 Ø 30 / d2 Ø 27
03207500A, 81466116003, 81466116004,
81466116005



MN-DL-8371

Length: 1625 Ø: 50
Cone Ø: d1 Ø 30 / d2 Ø 27
81467106966, 81467116714



MN-DL-12284

Length: 1530 Ø: 50
Cone Ø: d1 Ø 30 / d2 Ø 27
81466106579, 81466106580, 81466106624,
81466116720, 81467116720, 81467116730,
81467116952



MN-DL-12421

Length: 1070 Ø: 48
Cone Ø: d1 Ø 30 / d2 Ø 27
Thread: M30 x 1,5 RHT
81466106656, 81466106659, 81466106669,
81466116006, 81466116007



MN-RK-7280

Ø: 75
Hole Distance: 115
Thick/Height: 24
0550806, 0639370, 689748, 10307400A,
81432306051, 81432306068, 81432706064



MN-RK-7287

Ø: 90
Hole Distance: 152
Thick/Height: 35
03304700A, 81953016133



MN-SB-5243

Length: 55 Ø: 78
Thick/Height: 60
03311100A, 81437040061, 81437220020



MN-SB-5246

Ø: 45 Thick/Height: 47
81437220022, 81437220038, 81962100450,
81962100469



MN-SB-10389

Ø: 70 Thick/Height: 72
81960200340



MN-SB-10390

Ø: 70 Thick/Height: 85/85
81960200341, 81960200373, 81960200385,
81960200408, 81960200418



MN-TC-14112

Length: 777 Ø: 60
Hole Distance: 115 / 115
81432206106, 81432306049



MN-VB-5222

Length: 627 Ø: 50
Hole Distance: 152 / 152
81432706030, 81432706034, 81432706054,
81432706055, 81432706056, 81432706057,
81432706067, 81432706068, 81432706074,
81432706075, 81432706076, 81432706077,
81432706078, 81432706081, 81432706082,
81432709034, 81432709076, 81432709078,
8143706054



SC-ES-8517

Length: 140
Cone Ø: d1 Ø 30 / d2 Ø 27
Thread: M30 x 1,5 RHT
81953016286



SC-ES-8535

Length: 145
Cone Ø: d1 Ø 30 / d2 Ø 27
Thread: M30 x 1,5 RHT
81953016271, 81953016325





F 2000 ...

19.293 FS,19.293 FLS, 19.293 FLLS ...	01/94 →	Centre Rod	MN-DL-8197		Push Rod
	01/94 →	Centre Rod	MN-DL-12421		for Steering Rod
	01/94 →	Engine Mounting		MN-SB-10390	
	01/94 →	Engine Mounting	MN-SB-10389		
	01/94 →	Mounting, stabilizer coupling rod	MN-SB-5246		
	01/94 →	Stabiliser Mounting		MN-SB-5243	
	01/94 →	Suspension Arm Repair Kit		CV-RK-5313	for Wishbone (CV)
	01/94 →	Suspension Arm Repair Kit		MN-RK-7280	for Drag Link;for Semi-Trailing Arm; for Wishbone (CV)
	01/94 →	Suspension Arm Repair Kit		MN-RK-7287	for Wishbone (CV)
	01/94 →	Tie Rod	MN-DL-8371		
	01/94 →	Tie Rod	MN-DL-12284		
	01/94 →	Tie Rod End	CV-ES-2149		for Push Rod
	01/94 →	Tie Rod End	CV-ES-14162		for Steering Rod
	01/94 →	Tie Rod End	CV-ES-14163		for Steering Rod
	01/94 →	Tie Rod End	SC-ES-8517		for Push Rod
	01/94 →	Tie Rod End	SC-ES-8535		for Guide Rod
	01/94 →	Track Control Arm		MN-DL-5212	Trailing Arm, Drive Axle;Air Suspension Axle
	01/94 →	Track Control Arm		MN-VB-5222	Wishbone (CV), Air Suspension Axle
	01/94 →	Track Control Arm	MN-TC-14112		Control Arm, 1st Front Axle, for Pneumatic Suspension vehicles
19.314 FAC	05/01 →	Ball Head, gearshift linkage	CV-ES-2120		
	05/01 →	Centre Rod	MN-DL-12391		for Steering Rod
	05/01 →	Centre Rod	MN-DL-12421		for Steering Rod
	05/01 →	Suspension Arm Repair Kit		MN-RK-7291	for Drag Link
	05/01 →	Tie Rod End	CV-ES-14163		for Steering Rod
	05/01 →	Tie Rod End	SC-ES-8517		for Push Rod
	05/01 →	Track Control Arm		MN-DL-5212	Trailing Arm, Drive Axle;Tag Axle, for Pneumatic Suspension vehicles
	05/01 →	Track Control Arm		MN-VB-5222	Wishbone (CV)
19.314 FAK, FA-KI, FAK-L	05/01 →	Ball Head, gearshift linkage	CV-ES-2120		
	05/01 →	Centre Rod	MN-DL-12391		for Steering Rod
	05/01 →	Centre Rod	MN-DL-12421		for Steering Rod
	05/01 →	Suspension Arm Repair Kit		MN-RK-7291	for Drag Link
	05/01 →	Tie Rod End	CV-ES-14163		for Steering Rod
	05/01 →	Tie Rod End	SC-ES-8517		for Push Rod
	05/01 →	Track Control Arm		MN-DL-5212	Trailing Arm, Drive Axle;Tag Axle, for Pneumatic Suspension vehicles
	05/01 →	Track Control Arm		MN-VB-5222	Wishbone (CV)
19.314 FAS	06/98 →	Ball Head, gearshift linkage	CV-ES-2120		
	06/98 →	Centre Rod	MN-DL-2174		Push Rod
	06/98 →	Centre Rod	MN-DL-12391		for Steering Rod
	06/98 →	Centre Rod	MN-DL-12421		for Steering Rod
	06/98 →	Suspension Arm Repair Kit		MN-RK-7291	for Drag Link
	06/98 →	Tie Rod End	CV-ES-14163		for Steering Rod
	06/98 →	Tie Rod End	SC-ES-8517		for Push Rod
	06/98 →	Track Control Arm		MN-DL-5212	Trailing Arm, Drive Axle;Tag Axle, for Pneumatic Suspension vehicles
	06/98 →	Track Control Arm		MN-VB-5222	Wishbone (CV)
19.314 FC, FLC, FLLC, FLLW, FRC, FLRC, FLLRC, FLL, FLLR, F-N	06/98 →	Ball Head, gearshift linkage	CV-ES-2120		
	06/98 →	Centre Rod	MN-DL-2160		Coupling Rod
	06/98 →	Centre Rod	MN-DL-2172		Push Rod
	06/98 →	Centre Rod	MN-DL-2175		Push Rod
	06/98 →	Centre Rod	MN-DL-2176		Push Rod
	06/98 →	Centre Rod	MN-DL-2177		Push Rod
	06/98 →	Centre Rod	MN-DL-3588		Push Rod
	06/98 →	Centre Rod	MN-DL-8197		Push Rod
	06/98 →	Centre Rod	MN-DL-12391		for Steering Rod
	06/98 →	Suspension Arm Repair Kit		MN-RK-7280	for Drag Link;for Semi-Trailing Arm; for Wishbone (CV)
	06/98 →	Suspension Arm Repair Kit	MN-RK-7280	MN-RK-7280	for Drag Link;for Semi-Trailing Arm; for Wishbone (CV)
	06/98 →	Tie Rod End	CV-ES-2149		for Push Rod

CV-ES-2120

Length: 115
Cone Ø: d1 Ø 12,4 / d2 Ø 10,8
Thread: M14 x 1,5 RHT
03008500A, 81953016200, 81953016202,
81953016203, 81953016227



CV-ES-2149

Length: 160
Cone Ø: d1 Ø 30 / d2 Ø 27
Thread: M30 x 1,5 RHT
81953016263



CV-ES-14162

Length: 125
Cone Ø: d1 Ø 30 / d2 Ø 27
Thread: M30 x 1,5 LHT
81953010015, 81953010083, 81953010087,
81953016029, 81953016030, 81953016043,
81953016044, 81953016050, 81953016054,
81953016087, 81953016091, 81953016107,
81953016120, 81953016125, 81953016152,
81953016155, 81953016157, 81953016168,
81953016179, 81953016181, 81953016223,
81953016237, 81953016254, 81953016275,
81953016279, 81953016351



CV-ES-14163

Length: 125
Cone Ø: d1 Ø 30 / d2 Ø 27
Thread: M30 x 1,5 RHT
95301.0084, 90804102156, 90804102272,
90804102696, 90804102710, 81953010016,
81953010075, 81953010084, 81953010088,
81953010094, 81953010103, 81953016030,
81953016043, 81953016048, 81953016049,
81953016053, 81953016061, 81953016090,
81953016108, 81953016112, 81953016126,
81953016143, 81953016149, 81953016154,
81953016156, 81953016168, 81953016178,
81953016194, 81953016206, 81953016224,
81953016234, 81953016242, 81953016252,
81953016274, 81953016278, 81953016284,
81953016286, 81953016308, 81953016310,
81953016312, 81953016347, 81953016350,
81953016352, 82953016012, 88953016014,
N2953016001



CV-RK-5313

Ø: 90
03304800A, 81953016132



MN-DL-2160

Length: 1652 Ø: 50
Cone Ø: d1 Ø 30 / d2 Ø 27
81467106112, 81467106163, 81467106165,
81467106198, 81467106353, 81467106354,
81467106361, 81467116725



MN-DL-2172

Length: 1050 Ø: 42
Cone Ø: d1 Ø 30 / d2 Ø 27
81466106374, 81466116019, 82466106080,
82466106189, 82466106190



MN-DL-2174

Length: 1588 Ø: 52
Cone Ø: d1 Ø 30 / d2 Ø 27
81467106378, 81467106912



MN-DL-2175

Length: 1628 Ø: 50
Cone Ø: d1 Ø 30 / d2 Ø 27
81467106396, 81467106904



MN-DL-2176

Length: 1628 Ø: 48
Cone Ø: d1 Ø 30 / d2 Ø 27
81466106779, 81466106780, 81466106782



MN-DL-2177

Length: 1664 Ø: 50
Cone Ø: d1 Ø 30 / d2 Ø 27
81467106994, 81467116726



MN-DL-3588

Length: 1035 Ø: 48
Cone Ø: d1 Ø 30 / d2 Ø 27
81466106333, 81466106334, 81466106354,
81466106355, 81466106360, 81466106361,
81466106721, 81466106722, 81466106723,
81466116216



MN-DL-5212

Length: 577 Ø: 48
Hole Distance: 130 / 130
81432206096, 81432206097, 81432206098,
81432206129, 81432209096, 81432209129,
81432306014, 81432306030



MN-DL-8197

Length: 1055 Ø: 42
Cone Ø: d1 Ø 30 / d2 Ø 27
03207500A, 81466116003, 81466116004,
81466116005



MN-DL-8371

Length: 1625 Ø: 50
Cone Ø: d1 Ø 30 / d2 Ø 27
81467106966, 81467116714



MN-DL-12284

Length: 1530 Ø: 50
Cone Ø: d1 Ø 30 / d2 Ø 27
81466106579, 81466106580, 81466106624,
81466116720, 81467116720, 81467116730,
81467116952



MN-DL-12391

Length: 1050 Ø: 52
Cone Ø: d1 Ø 30 / d2 Ø 27
82466106057, 82466106147



MN-DL-12421

Length: 1070 Ø: 48
Cone Ø: d1 Ø 30 / d2 Ø 27
Thread: M30 x 1,5 RHT
81466106656, 81466106659, 81466106669,
81466116006, 81466116007



MN-RK-7280

Ø: 75
Hole Distance: 115
Thick/Height: 24
0550806, 0639370, 689748, 10307400A,
81432306051, 81432306068, 81432706064



MN-RK-7287

Ø: 90
Hole Distance: 152
Thick/Height: 35
03304700A, 81953016133



MN-RK-7291

Ø: 72
Hole Distance: 130
Thick/Height: 30
10307800A, 81432206108, 81432206132



MN-SB-5243

Length: 55 Ø: 78
Thick/Height: 60
03311100A, 81437040061, 81437220020



MN-SB-5246

Ø: 45 Thick/Height: 47
81437220022, 81437220038, 81962100450,
81962100469



MN-SB-10389

Ø: 70 Thick/Height: 72
81960200340



MN-SB-10390

Ø: 70 Thick/Height: 85/85
81960200341, 81960200373, 81960200385,
81960200408, 81960200418



MN-TC-14112

Length: 777 Ø: 60
Hole Distance: 115 / 115
81432206106, 81432306049



MN-VB-5222

Length: 627 Ø: 50
Hole Distance: 152 / 152
81432706030, 81432706034, 81432706054,
81432706055, 81432706056, 81432706057,
81432706067, 81432706068, 81432706074,
81432706075, 81432706076, 81432706077,
81432706078, 81432706081, 81432706082,
81432709034, 81432709076, 81432709078,
8143706054



SC-ES-8517

Length: 140
Cone Ø: d1 Ø 30 / d2 Ø 27
Thread: M30 x 1,5 RHT
81953016286



SC-ES-8535

Length: 145
Cone Ø: d1 Ø 30 / d2 Ø 27
Thread: M30 x 1,5 RHT
81953016271, 81953016325





F 2000 ...

19.314 FC, FLC, FLLC, FLLW, FRC, FLRC, FLLRC, FLL, FLLR, F-N ...	06/98 →	Tie Rod End	CV-ES-14162		for Steering Rod	
	06/98 →	Tie Rod End	CV-ES-14163		for Steering Rod	
	06/98 →	Tie Rod End	SC-ES-8517		for Push Rod	
	06/98 →	Tie Rod End	SC-ES-8535		for Guide Rod	
	06/98 →	Track Control Arm		MN-DL-5212	Trailing Arm, Drive Axle; Tag Axle, for Pneumatic Suspension vehicles	
	06/98 →	Track Control Arm		MN-VB-5222	Wishbone (CV)	
	06/98 →	Track Control Arm	MN-TC-14112		Control Arm, 1st Front Axle, for Pneumatic Suspension vehicles	
19.314 FK, FK-L, F-KI, FL-KI, F-NL, FLK	06/98 →	Ball Head, gearshift linkage	CV-ES-2120			
	06/98 →	Centre Rod	MN-DL-2160		Coupling Rod	
	06/98 →	Centre Rod	MN-DL-2172		Push Rod	
	06/98 →	Centre Rod	MN-DL-2176		Push Rod	
	06/98 →	Centre Rod	MN-DL-3588		Push Rod	
	06/98 →	Centre Rod	MN-DL-8197		Push Rod	
	06/98 →	Centre Rod	MN-DL-12391		for Steering Rod	
	06/98 →	Suspension Arm Repair Kit		MN-RK-7280	for Drag Link; for Semi-Trailing Arm; for Wishbone (CV)	
	06/98 →	Tie Rod End	CV-ES-2149		for Push Rod	
	06/98 →	Tie Rod End	CV-ES-14162		for Steering Rod	
	06/98 →	Tie Rod End	CV-ES-14163		for Steering Rod	
	06/98 →	Track Control Arm		MN-DL-5212	Trailing Arm, Drive Axle; Tag Axle, for Pneumatic Suspension vehicles	
	06/98 →	Track Control Arm		MN-VB-5222	Wishbone (CV)	
	19.314 FS, FLS, FLLS, FRS, FLRS, FLLRS	06/98 →	Ball Head, gearshift linkage	CV-ES-2120		
		06/98 →	Centre Rod	MN-DL-2160		Coupling Rod
06/98 →		Centre Rod	MN-DL-2172		Push Rod	
06/98 →		Centre Rod	MN-DL-2175		Push Rod	
06/98 →		Centre Rod	MN-DL-2176		Push Rod	
06/98 →		Centre Rod	MN-DL-2177		Push Rod	
06/98 →		Centre Rod	MN-DL-3588		Push Rod	
06/98 →		Centre Rod	MN-DL-8197		Push Rod	
06/98 →		Centre Rod	MN-DL-12391		for Steering Rod	
06/98 →		Suspension Arm Repair Kit		MN-RK-7280	for Drag Link; for Semi-Trailing Arm; for Wishbone (CV)	
06/98 →		Suspension Arm Repair Kit	MN-RK-7280	MN-RK-7280	for Drag Link; for Semi-Trailing Arm; for Wishbone (CV)	
06/98 →		Tie Rod End	CV-ES-2149		for Push Rod	
06/98 →		Tie Rod End	CV-ES-14162		for Steering Rod	
06/98 →		Tie Rod End	CV-ES-14163		for Steering Rod	
06/98 →		Tie Rod End	SC-ES-8517		for Push Rod	
06/98 →		Track Control Arm		MN-DL-5212	Trailing Arm, Drive Axle; Tag Axle, for Pneumatic Suspension vehicles	
06/98 →		Track Control Arm		MN-VB-5222	Wishbone (CV)	
06/98 →		Track Control Arm	MN-TC-14112		Control Arm, 1st Front Axle, for Pneumatic Suspension vehicles	
19.323 FAC	01/94 →12/95	Ball Head, gearshift linkage	CV-ES-2119			
	01/94 →12/95	Ball Head, gearshift linkage	CV-ES-2120			
	01/94 →12/95	Ball Head, gearshift linkage	CV-ES-2182			
	01/94 →12/95	Centre Rod	MN-DL-2160		Coupling Rod	
	01/94 →12/95	Centre Rod	MN-DL-2172		Push Rod	
	01/94 →12/95	Centre Rod	MN-DL-2174		Push Rod	
	01/94 →12/95	Centre Rod	MN-DL-2175		Push Rod	
	01/94 →12/95	Centre Rod	MN-DL-2176		Push Rod	
	01/94 →12/95	Centre Rod	MN-DL-2177		Push Rod	
	01/94 →12/95	Centre Rod	MN-DL-3588		Push Rod	
	01/94 →12/95	Centre Rod	MN-DL-12391		for Steering Rod	
	01/94 →12/95	Centre Rod	MN-DL-12421		for Steering Rod	
	01/94 →12/95	Engine Mounting		MN-SB-10390		
	01/94 →12/95	Tie Rod End	CV-ES-2149		for Push Rod	
	01/94 →12/95	Tie Rod End	CV-ES-14162		for Steering Rod	
	01/94 →12/95	Tie Rod End	CV-ES-14163		for Steering Rod	
	01/94 →12/95	Tie Rod End	SC-ES-8517		for Push Rod	

CV-ES-2119

Length: 55
Cone Ø: d1 Ø 10 / d2 Ø 10
Thread: M12 x 1,75 LHT
81953016063, 81953016131



CV-ES-2120

Length: 115
Cone Ø: d1 Ø 12,4 / d2 Ø 10,8
Thread: M14 x 1,5 RHT
03008500A, 81953016200, 81953016202,
81953016203, 81953016227



CV-ES-2149

Length: 160
Cone Ø: d1 Ø 30 / d2 Ø 27
Thread: M30 x 1,5 RHT
81953016263



CV-ES-2182

Length: 55
Cone Ø: d1 Ø 10 / d2 Ø 10
Thread: M12 x 1,75 RHT
81953016064, 81953016170



CV-ES-14162

Length: 125
Cone Ø: d1 Ø 30 / d2 Ø 27
Thread: M30 x 1,5 LHT

81953010015, 81953010083, 81953010087,
81953016029, 81953016030, 81953016043,
81953016044, 81953016050, 81953016054,
81953016087, 81953016091, 81953016107,
81953016120, 81953016125, 81953016152,
81953016155, 81953016157, 81953016168,
81953016179, 81953016181, 81953016223,
81953016237, 81953016254, 81953016275,
81953016279, 81953016351



CV-ES-14163

Length: 125
Cone Ø: d1 Ø 30 / d2 Ø 27
Thread: M30 x 1,5 RHT

95301.0084, 90804102156, 90804102272,
90804102696, 90804102710, 81953010016,
81953010075, 81953010084, 81953010088,
81953010094, 81953010103, 81953016030,
81953016043, 81953016048, 81953016049,
81953016053, 81953016061, 81953016090,
81953016108, 81953016112, 81953016126,
81953016143, 81953016149, 81953016154,
81953016156, 81953016168, 81953016178,
81953016194, 81953016206, 81953016224,
81953016234, 81953016242, 81953016252,
81953016274, 81953016278, 81953016284,
81953016286, 81953016308, 81953016310,
81953016312, 81953016347, 81953016350,
81953016352, 82953016012, 88953016014,
N2953016001



MN-DL-2160

Length: 1652 Ø: 50
Cone Ø: d1 Ø 30 / d2 Ø 27
81467106112, 81467106163, 81467106165,
81467106198, 81467106353, 81467106354,
81467106361, 81467116725



MN-DL-2172

Length: 1050 Ø: 42
Cone Ø: d1 Ø 30 / d2 Ø 27
81466106374, 81466116019, 82466106080,
82466106189, 82466106190



MN-DL-2174

Length: 1588 Ø: 52
Cone Ø: d1 Ø 30 / d2 Ø 27
81467106378, 81467106912



MN-DL-2175

Length: 1628
Ø: 50
Cone Ø: d1 Ø 30 / d2 Ø 27
81467106396, 81467106904



MN-DL-2176

Length: 1628
Ø: 48
Cone Ø: d1 Ø 30 / d2 Ø 27
81466106779, 81466106780, 81466106782



MN-DL-2177

Length: 1664
Ø: 50
Cone Ø: d1 Ø 30 / d2 Ø 27
81467106994, 81467116726



MN-DL-3588

Length: 1035
Ø: 48
Cone Ø: d1 Ø 30 / d2 Ø 27
81466106333, 81466106334, 81466106354,
81466106355, 81466106360, 81466106361,
81466106721, 81466106722, 81466106723,
81466116216



MN-DL-5212

Length: 577 Ø: 48
Hole Distance: 130 / 130
81432206096, 81432206097, 81432206098,
81432206129, 81432209096, 81432209129,
81432306014, 81432306030



MN-DL-8197

Length: 1055
Ø: 42
Cone Ø: d1 Ø 30 / d2 Ø 27
03207500A, 81466116003, 81466116004,
81466116005



MN-DL-12391

Length: 1050
Ø: 52
Cone Ø: d1 Ø 30 / d2 Ø 27
82466106057, 82466106147



MN-DL-12421

Length: 1070
Ø: 48
Cone Ø: d1 Ø 30 / d2 Ø 27
Thread: M30 x 1,5 RHT
81466106656, 81466106659, 81466106669,
81466116006, 81466116007



MN-RK-7280

Ø: 75
Hole Distance: 115
Thick/Height: 24
0550806, 0639370, 689748, 10307400A,
81432306051, 81432306068, 81432706064



MN-SB-10390

Ø: 70
Thick/Height: 85/85
81960200341, 81960200373, 81960200385,
81960200408, 81960200418



MN-TC-14112

Length: 777
Ø: 60
Hole Distance: 115 / 115
81432206106, 81432306049



MN-VB-5222

Length: 627 Ø: 50
Hole Distance: 152 / 152
81432706030, 81432706034, 81432706054,
81432706055, 81432706056, 81432706057,
81432706067, 81432706068, 81432706074,
81432706075, 81432706076, 81432706077,
81432706078, 81432706081, 81432706082,
81432709034, 81432709076, 81432709078,
8143706054



SC-ES-8517

Length: 140
Cone Ø: d1 Ø 30 / d2 Ø 27
Thread: M30 x 1,5 RHT
81953016286



SC-ES-8535

Length: 145
Cone Ø: d1 Ø 30 / d2 Ø 27
Thread: M30 x 1,5 RHT
81953016271, 81953016325





F 2000 ...

19.323 FAK	01/94 →12/95	Ball Head, gearshift linkage	CV-ES-2119			
	01/94 →12/95	Ball Head, gearshift linkage	CV-ES-2120			
	01/94 →12/95	Ball Head, gearshift linkage	CV-ES-2182			
	01/94 →12/95	Centre Rod	MN-DL-2160		Coupling Rod	
	01/94 →12/95	Centre Rod	MN-DL-2172		Push Rod	
	01/94 →12/95	Centre Rod	MN-DL-2174		Push Rod	
	01/94 →12/95	Centre Rod	MN-DL-2175		Push Rod	
	01/94 →12/95	Centre Rod	MN-DL-2176		Push Rod	
	01/94 →12/95	Centre Rod	MN-DL-2177		Push Rod	
	01/94 →12/95	Centre Rod	MN-DL-3588		Push Rod	
	01/94 →12/95	Centre Rod	MN-DL-12391		for Steering Rod	
	01/94 →12/95	Centre Rod	MN-DL-12421		for Steering Rod	
	01/94 →12/95	Engine Mounting		MN-SB-10390		
	01/94 →12/95	Tie Rod End	CV-ES-2149		for Push Rod	
	01/94 →12/95	Tie Rod End	CV-ES-14162		for Steering Rod	
	01/94 →12/95	Tie Rod End	CV-ES-14163		for Steering Rod	
	01/94 →12/95	Tie Rod End	SC-ES-8517		for Push Rod	
	19.323 FAS	01/94 →12/95	Ball Head, gearshift linkage	CV-ES-2119		
		01/94 →12/95	Ball Head, gearshift linkage	CV-ES-2120		
		01/94 →12/95	Ball Head, gearshift linkage	CV-ES-2182		
01/94 →12/95		Centre Rod	MN-DL-2160		Coupling Rod	
01/94 →12/95		Centre Rod	MN-DL-2172		Push Rod	
01/94 →12/95		Centre Rod	MN-DL-2174		Push Rod	
01/94 →12/95		Centre Rod	MN-DL-2175		Push Rod	
01/94 →12/95		Centre Rod	MN-DL-2176		Push Rod	
01/94 →12/95		Centre Rod	MN-DL-2177		Push Rod	
01/94 →12/95		Centre Rod	MN-DL-3588		Push Rod	
01/94 →12/95		Centre Rod	MN-DL-12391		for Steering Rod	
01/94 →12/95		Centre Rod	MN-DL-12421		for Steering Rod	
01/94 →12/95		Engine Mounting		MN-SB-10390		
01/94 →12/95		Tie Rod End	CV-ES-2149		for Push Rod	
01/94 →12/95		Tie Rod End	CV-ES-14162		for Steering Rod	
01/94 →12/95		Tie Rod End	CV-ES-14163		for Steering Rod	
01/94 →12/95		Tie Rod End	SC-ES-8517		for Push Rod	
19.323 FC,19.323 FLC,19.323 FLLC		01/94 →12/95	Ball Head, gearshift linkage	CV-ES-2119		
		01/94 →12/95	Ball Head, gearshift linkage	CV-ES-2120		
		01/94 →12/95	Ball Head, gearshift linkage	CV-ES-2182		
	01/94 →12/95	Centre Rod	MN-DL-2160		Coupling Rod	
	01/94 →12/95	Centre Rod	MN-DL-2172		Push Rod	
	01/94 →12/95	Centre Rod	MN-DL-2174		Push Rod	
	01/94 →12/95	Centre Rod	MN-DL-2175		Push Rod	
	01/94 →12/95	Centre Rod	MN-DL-2176		Push Rod	
	01/94 →12/95	Centre Rod	MN-DL-2177		Push Rod	
	01/94 →12/95	Centre Rod	MN-DL-3588		Push Rod	
	01/94 →12/95	Centre Rod	MN-DL-12391		for Steering Rod	
	01/94 →12/95	Centre Rod	MN-DL-12421		for Steering Rod	
	01/94 →12/95	Engine Mounting		MN-SB-10390		
	01/94 →12/95	Tie Rod End	CV-ES-2149		for Push Rod	
	01/94 →12/95	Tie Rod End	CV-ES-14162		for Steering Rod	
	01/94 →12/95	Tie Rod End	CV-ES-14163		for Steering Rod	
	01/94 →12/95	Tie Rod End	SC-ES-8517		for Push Rod	
	01/94 →12/95	Ball Head, gearshift linkage	CV-ES-2119			
	01/94 →12/95	Ball Head, gearshift linkage	CV-ES-2120			
	01/94 →12/95	Ball Head, gearshift linkage	CV-ES-2182			
	01/94 →12/95	Centre Rod	MN-DL-2160		Coupling Rod	
	01/94 →12/95	Centre Rod	MN-DL-2172		Push Rod	
	01/94 →12/95	Centre Rod	MN-DL-2174		Push Rod	
	01/94 →12/95	Centre Rod	MN-DL-2175		Push Rod	
	01/94 →12/95	Centre Rod	MN-DL-2176		Push Rod	
	01/94 →12/95	Centre Rod	MN-DL-2177		Push Rod	
	01/94 →12/95	Centre Rod	MN-DL-3588		Push Rod	
	01/94 →12/95	Centre Rod	MN-DL-8197		Push Rod	
	01/94 →12/95	Centre Rod	MN-DL-12421		for Steering Rod	
	01/94 →12/95	Engine Mounting		MN-SB-10390		
	01/94 →12/95	Engine Mounting	MN-SB-10389			
	01/94 →12/95	Mounting, stabilizer coupling rod	MN-SB-5246			
01/94 →12/95	Stabiliser Mounting		MN-SB-5243			
01/94 →12/95	Suspension Arm Repair Kit		CV-RK-5313	for Wishbone (CV)		
01/94 →12/95	Suspension Arm Repair Kit		MN-RK-7280	for Drag Link;for Semi-Trailing Arm; for Wishbone (CV)		
01/94 →12/95	Suspension Arm Repair Kit		MN-RK-7287	for Wishbone (CV)		
01/94 →12/95	Tie Rod	MN-DL-12284				
01/94 →12/95	Tie Rod End	CV-ES-2149		for Push Rod		
01/94 →12/95	Tie Rod End	CV-ES-14162		for Steering Rod		
01/94 →12/95	Tie Rod End	CV-ES-14163		for Steering Rod		
01/94 →12/95	Tie Rod End	SC-ES-8517		for Push Rod		
01/94 →12/95	Tie Rod End	SC-ES-8535		for Guide Rod		
01/94 →12/95	Track Control Arm		MN-DL-5212	Trailing Arm, Drive Axle;Air Suspension Axle		
01/94 →12/95	Track Control Arm		MN-VB-5222	Wishbone (CV), Air Suspension Axle		
01/94 →12/95	Track Control Arm	MN-TC-14112		Control Arm, 1st Front Axle, for Pneumatic Suspension vehicles		

CV-ES-2119

Length: 55
 Cone Ø: d1 Ø 10 / d2 Ø 10
 Thread: M12 x 1,75 LHT
 81953016063, 81953016131

**CV-ES-2120**

Length: 115
 Cone Ø: d1 Ø 12,4 / d2 Ø 10,8
 Thread: M14 x 1,5 RHT
 03008500A, 81953016200, 81953016202,
 81953016203, 81953016227

**CV-ES-2149**

Length: 160
 Cone Ø: d1 Ø 30 / d2 Ø 27
 Thread: M30 x 1,5 RHT
 81953016263

**CV-ES-2182**

Length: 55
 Cone Ø: d1 Ø 10 / d2 Ø 10
 Thread: M12 x 1,75 RHT
 81953016064, 81953016170

**CV-ES-14162**

Length: 125
 Cone Ø: d1 Ø 30 / d2 Ø 27
 Thread: M30 x 1,5 LHT
 81953010015, 81953010083, 81953010087,
 81953016029, 81953016030, 81953016043,
 81953016044, 81953016050, 81953016054,
 81953016087, 81953016091, 81953016107,
 81953016120, 81953016125, 81953016152,
 81953016155, 81953016157, 81953016168,
 81953016179, 81953016181, 81953016223,
 81953016237, 81953016254, 81953016275,
 81953016279, 81953016351

**CV-ES-14163**

Length: 125
 Cone Ø: d1 Ø 30 / d2 Ø 27
 Thread: M30 x 1,5 RHT
 95301.0084, 90804102156, 90804102272,
 90804102696, 90804102710, 81953010016,
 81953010075, 81953010084, 81953010088,
 81953010094, 81953010103, 81953016030,
 81953016043, 81953016048, 81953016049,
 81953016053, 81953016061, 81953016090,
 81953016108, 81953016112, 81953016126,
 81953016143, 81953016149, 81953016154,
 81953016156, 81953016168, 81953016178,
 81953016194, 81953016206, 81953016224,
 81953016234, 81953016242, 81953016252,
 81953016274, 81953016278, 81953016284,
 81953016286, 81953016308, 81953016310,
 81953016312, 81953016347, 81953016350,
 81953016352, 82953016012, 88953016014,
 N2953016001

**CV-RK-5313**

Ø: 90
 03304800A, 81953016132

**MN-DL-2160**

Length: 1652 Ø: 50
 Cone Ø: d1 Ø 30 / d2 Ø 27
 81467106112, 81467106163, 81467106165,
 81467106198, 81467106353, 81467106354,
 81467106361, 81467116725

**MN-DL-2172**

Length: 1050 Ø: 42
 Cone Ø: d1 Ø 30 / d2 Ø 27
 81466106374, 81466116019, 82466106080,
 82466106189, 82466106190

**MN-DL-2174**

Length: 1588 Ø: 52
 Cone Ø: d1 Ø 30 / d2 Ø 27
 81467106378, 81467106912

**MN-DL-2175**

Length: 1628 Ø: 50
 Cone Ø: d1 Ø 30 / d2 Ø 27
 81467106396, 81467106904

**MN-DL-2176**

Length: 1628 Ø: 48
 Cone Ø: d1 Ø 30 / d2 Ø 27
 81466106779, 81466106780, 81466106782

**MN-DL-2177**

Length: 1664 Ø: 50
 Cone Ø: d1 Ø 30 / d2 Ø 27
 81467106994, 81467116726

**MN-DL-3588**

Length: 1035 Ø: 48
 Cone Ø: d1 Ø 30 / d2 Ø 27
 81466106333, 81466106334, 81466106354,
 81466106355, 81466106360, 81466106361,
 81466106721, 81466106722, 81466106723,
 81466116216

**MN-DL-5212**

Length: 577 Ø: 48
 Hole Distance: 130 / 130
 81432206096, 81432206097, 81432206098,
 81432206129, 81432209096, 81432209129,
 81432306014, 81432306030

**MN-DL-8197**

Length: 1055 Ø: 42
 Cone Ø: d1 Ø 30 / d2 Ø 27
 03207500A, 81466116003, 81466116004,
 81466116005

**MN-DL-12284**

Length: 1530 Ø: 50
 Cone Ø: d1 Ø 30 / d2 Ø 27
 81466106579, 81466106580, 81466106624,
 81466116720, 81467116720, 81467116730,
 81467116952

**MN-DL-12391**

Length: 1050 Ø: 52
 Cone Ø: d1 Ø 30 / d2 Ø 27
 82466106057, 82466106147

**MN-DL-12421**

Length: 1070 Ø: 48
 Cone Ø: d1 Ø 30 / d2 Ø 27
 Thread: M30 x 1,5 RHT
 81466106656, 81466106659, 81466106669,
 81466116006, 81466116007

**MN-RK-7280**

Ø: 75
 Hole Distance: 115
 Thick/Height: 24
 0550806, 0639370, 689748, 10307400A,
 81432306051, 81432306068, 81432706064

**MN-RK-7287**

Ø: 90
 Hole Distance: 152
 Thick/Height: 35
 03304700A, 81953016133

**MN-SB-5243**

Length: 55 Ø: 78
 Thick/Height: 60
 03311100A, 81437040061, 81437220020

**MN-SB-5246**

Ø: 45 Thick/Height: 47
 81437220022, 81437220038, 81962100450,
 81962100469

**MN-SB-10389**

Ø: 70 Thick/Height: 72
 81960200340

**MN-SB-10390**

Ø: 70 Thick/Height: 85/85
 81960200341, 81960200373, 81960200385,
 81960200408, 81960200418

**MN-TC-14112**

Length: 777 Ø: 60
 Hole Distance: 115 / 115
 81432206106, 81432306049

**MN-VB-5222**

Length: 627 Ø: 50
 Hole Distance: 152 / 152
 81432706030, 81432706034, 81432706054,
 81432706055, 81432706056, 81432706057,
 81432706067, 81432706068, 81432706074,
 81432706075, 81432706076, 81432706077,
 81432706078, 81432706081, 81432706082,
 81432709034, 81432709076, 81432709078,
 8143706054

**SC-ES-8517**

Length: 140
 Cone Ø: d1 Ø 30 / d2 Ø 27
 Thread: M30 x 1,5 RHT
 81953016286

**SC-ES-8535**

Length: 145
 Cone Ø: d1 Ø 30 / d2 Ø 27
 Thread: M30 x 1,5 RHT
 81953016271, 81953016325





F 2000 ...

19.323 FK,19.323 FLK	01/94 →12/95	Ball Head, gearshift linkage	CV-ES-2119		
	01/94 →12/95	Ball Head, gearshift linkage	CV-ES-2120		
	01/94 →12/95	Ball Head, gearshift linkage	CV-ES-2182		
	01/94 →12/95	Centre Rod	MN-DL-2160	Coupling Rod	
	01/94 →12/95	Centre Rod	MN-DL-2172	Push Rod	
	01/94 →12/95	Centre Rod	MN-DL-2174	Push Rod	
	01/94 →12/95	Centre Rod	MN-DL-2175	Push Rod	
	01/94 →12/95	Centre Rod	MN-DL-2176	Push Rod	
	01/94 →12/95	Centre Rod	MN-DL-2177	Push Rod	
	01/94 →12/95	Centre Rod	MN-DL-3588	Push Rod	
	01/94 →12/95	Centre Rod	MN-DL-8197	Push Rod	
	01/94 →12/95	Centre Rod	MN-DL-12421	for Steering Rod	
	01/94 →12/95	Engine Mounting		MN-SB-10390	
	01/94 →12/95	Engine Mounting	MN-SB-10389		
	01/94 →12/95	Mounting, stabilizer coupling rod	MN-SB-5246		
	01/94 →12/95	Stabiliser Mounting		MN-SB-5243	
	01/94 →12/95	Suspension Arm Repair Kit		CV-RK-5313 for Wishbone (CV)	
	01/94 →12/95	Suspension Arm Repair Kit		MN-RK-7280 for Drag Link;for Semi-Trailing Arm; for Wishbone (CV)	
	01/94 →12/95	Suspension Arm Repair Kit		MN-RK-7287 for Wishbone (CV)	
	01/94 →12/95	Tie Rod	MN-DL-12284		
	01/94 →12/95	Tie Rod End	CV-ES-2149	for Push Rod	
	01/94 →12/95	Tie Rod End	CV-ES-14162	for Steering Rod	
	01/94 →12/95	Tie Rod End	CV-ES-14163	for Steering Rod	
	01/94 →12/95	Track Control Arm		MN-DL-5212 Trailing Arm, Drive Axle;Air Suspension Axle	
	01/94 →12/95	Track Control Arm		MN-VB-5222 Wishbone (CV), Air Suspension Axle	
	19.323 FS,19.323 FLS,19.323 FLLS	01/94 →12/95	Ball Head, gearshift linkage	CV-ES-2119	
		01/94 →12/95	Ball Head, gearshift linkage	CV-ES-2120	
		01/94 →12/95	Ball Head, gearshift linkage	CV-ES-2182	
		01/94 →12/95	Centre Rod	MN-DL-2160	Coupling Rod
		01/94 →12/95	Centre Rod	MN-DL-2172	Push Rod
		01/94 →12/95	Centre Rod	MN-DL-2174	Push Rod
		01/94 →12/95	Centre Rod	MN-DL-2175	Push Rod
		01/94 →12/95	Centre Rod	MN-DL-2176	Push Rod
01/94 →12/95		Centre Rod	MN-DL-2177	Push Rod	
01/94 →12/95		Centre Rod	MN-DL-3588	Push Rod	
01/94 →12/95		Centre Rod	MN-DL-8197	Push Rod	
01/94 →12/95		Centre Rod	MN-DL-12421	for Steering Rod	
01/94 →12/95		Engine Mounting		MN-SB-10390	
01/94 →12/95		Engine Mounting	MN-SB-10389		
01/94 →12/95		Mounting, stabilizer coupling rod	MN-SB-5246		
01/94 →12/95		Stabiliser Mounting		MN-SB-5243	
01/94 →12/95		Suspension Arm Repair Kit		CV-RK-5313 for Wishbone (CV)	
01/94 →12/95		Suspension Arm Repair Kit		MN-RK-7280 for Drag Link;for Semi-Trailing Arm; for Wishbone (CV)	
01/94 →12/95		Suspension Arm Repair Kit		MN-RK-7287 for Wishbone (CV)	
01/94 →12/95		Tie Rod	MN-DL-12284		
01/94 →12/95		Tie Rod End	CV-ES-2149	for Push Rod	
01/94 →12/95		Tie Rod End	CV-ES-14162	for Steering Rod	
01/94 →12/95		Tie Rod End	CV-ES-14163	for Steering Rod	
01/94 →12/95		Tie Rod End	SC-ES-8517	for Push Rod	
01/94 →12/95		Tie Rod End	SC-ES-8535	for Guide Rod	
01/94 →12/95		Track Control Arm		MN-DL-5212 Trailing Arm, Drive Axle;Air Suspension Axle	
01/94 →12/95		Track Control Arm		MN-VB-5222 Wishbone (CV), Air Suspension Axle	
01/94 →12/95		Track Control Arm	MN-TC-14112	Control Arm, 1st Front Axle, for Pneumatic Suspension vehicles	
19.343 FAC		01/94 →	Ball Head, gearshift linkage	CV-ES-2119	
		01/94 →	Ball Head, gearshift linkage	CV-ES-2120	
		01/94 →	Ball Head, gearshift linkage	CV-ES-2182	
		01/94 →	Centre Rod	MN-DL-2160	Coupling Rod
		01/94 →	Centre Rod	MN-DL-2172	Push Rod
	01/94 →	Centre Rod	MN-DL-2174	Push Rod	
	01/94 →	Centre Rod	MN-DL-2175	Push Rod	

CV-ES-2119

Length: 55
Cone Ø: d1 Ø 10 / d2 Ø 10
Thread: M12 x 1,75 LHT
81953016063, 81953016131



CV-ES-2120

Length: 115
Cone Ø: d1 Ø 12,4 / d2 Ø 10,8
Thread: M14 x 1,5 RHT
03008500A, 81953016200, 81953016202,
81953016203, 81953016227



CV-ES-2149

Length: 160
Cone Ø: d1 Ø 30 / d2 Ø 27
Thread: M30 x 1,5 RHT
81953016263



CV-ES-2182

Length: 55
Cone Ø: d1 Ø 10 / d2 Ø 10
Thread: M12 x 1,75 RHT
81953016064, 81953016170



CV-ES-14162

Length: 125
Cone Ø: d1 Ø 30 / d2 Ø 27
Thread: M30 x 1,5 LHT
81953010015, 81953010083, 81953010087,
81953016029, 81953016030, 81953016043,
81953016044, 81953016050, 81953016054,
81953016087, 81953016091, 81953016107,
81953016120, 81953016125, 81953016152,
81953016155, 81953016157, 81953016168,
81953016179, 81953016181, 81953016223,
81953016237, 81953016254, 81953016275,
81953016279, 81953016351



CV-ES-14163

Length: 125
Cone Ø: d1 Ø 30 / d2 Ø 27
Thread: M30 x 1,5 RHT
95301.0084, 90804102156, 90804102272,
90804102696, 90804102710, 81953010016,
81953010075, 81953010084, 81953010088,
81953010094, 81953010103, 81953016030,
81953016043, 81953016048, 81953016049,
81953016053, 81953016061, 81953016090,
81953016108, 81953016112, 81953016126,
81953016143, 81953016149, 81953016154,
81953016156, 81953016168, 81953016178,
81953016194, 81953016206, 81953016224,
81953016234, 81953016242, 81953016252,
81953016274, 81953016278, 81953016284,
81953016286, 81953016308, 81953016310,
81953016312, 81953016347, 81953016350,
81953016352, 82953016012, 88953016014,
N2953016001



CV-RK-5313

Ø: 90
03304800A, 81953016132



MN-DL-2160

Length: 1652 Ø: 50
Cone Ø: d1 Ø 30 / d2 Ø 27
81467106112, 81467106163, 81467106165,
81467106198, 81467106353, 81467106354,
81467106361, 81467116725



MN-DL-2172

Length: 1050 Ø: 42
Cone Ø: d1 Ø 30 / d2 Ø 27
81466106374, 81466116019, 82466106080,
82466106189, 82466106190



MN-DL-2174

Length: 1588 Ø: 52
Cone Ø: d1 Ø 30 / d2 Ø 27
81467106378, 81467106912



MN-DL-2175

Length: 1628 Ø: 50
Cone Ø: d1 Ø 30 / d2 Ø 27
81467106396, 81467106904



MN-DL-2176

Length: 1628 Ø: 48
Cone Ø: d1 Ø 30 / d2 Ø 27
81466106779, 81466106780, 81466106782



MN-DL-2177

Length: 1664 Ø: 50
Cone Ø: d1 Ø 30 / d2 Ø 27
81467106994, 81467116726



MN-DL-3588

Length: 1035 Ø: 48
Cone Ø: d1 Ø 30 / d2 Ø 27
81466106333, 81466106334, 81466106354,
81466106355, 81466106360, 81466106361,
81466106721, 81466106722, 81466106723,
81466116216



MN-DL-5212

Length: 577 Ø: 48
Hole Distance: 130 / 130
81432206096, 81432206097, 81432206098,
81432206129, 81432209096, 81432209129,
81432306014, 81432306030



MN-DL-8197

Length: 1055
Ø: 42
Cone Ø: d1 Ø 30 / d2 Ø 27
03207500A, 81466116003, 81466116004,
81466116005



MN-DL-12284

Length: 1530 Ø: 50
Cone Ø: d1 Ø 30 / d2 Ø 27
81466106579, 81466106580, 81466106624,
81466116720, 81467116720, 81467116730,
81467116952



MN-DL-12421

Length: 1070 Ø: 48
Cone Ø: d1 Ø 30 / d2 Ø 27
Thread: M30 x 1,5 RHT
81466106656, 81466106659, 81466106669,
81466116006, 81466116007



MN-RK-7280

Ø: 75
Hole Distance: 115
Thick/Height: 24
0550806, 0639370, 689748, 10307400A,
81432306051, 81432306068, 81432706064



MN-RK-7287

Ø: 90
Hole Distance: 152
Thick/Height: 35
03304700A, 81953016133



MN-SB-5243

Length: 55 Ø: 78
Thick/Height: 60
03311100A, 81437040061, 81437220020



MN-SB-5246

Ø: 45 Thick/Height: 47
81437220022, 81437220038, 81962100450,
81962100469



MN-SB-10389

Ø: 70 Thick/Height: 72
81960200340



MN-SB-10390

Ø: 70 Thick/Height: 85/85
81960200341, 81960200373, 81960200385,
81960200408, 81960200418



MN-TC-14112

Length: 777 Ø: 60
Hole Distance: 115 / 115
81432206106, 81432306049



MN-VB-5222

Length: 627 Ø: 50
Hole Distance: 152 / 152
81432706030, 81432706034, 81432706054,
81432706055, 81432706056, 81432706057,
81432706067, 81432706068, 81432706074,
81432706075, 81432706076, 81432706077,
81432706078, 81432706081, 81432706082,
81432709034, 81432709076, 81432709078,
8143706054



SC-ES-8517

Length: 140
Cone Ø: d1 Ø 30 / d2 Ø 27
Thread: M30 x 1,5 RHT
81953016286



SC-ES-8535

Length: 145
Cone Ø: d1 Ø 30 / d2 Ø 27
Thread: M30 x 1,5 RHT
81953016271, 81953016325





F 2000 ...

19.343 FAC ...	01/94 →	Centre Rod	MN-DL-2176		Push Rod	
	01/94 →	Centre Rod	MN-DL-2177		Push Rod	
	01/94 →	Centre Rod	MN-DL-3588		Push Rod	
	01/94 →	Centre Rod	MN-DL-12391		for Steering Rod	
	01/94 →	Centre Rod	MN-DL-12421		for Steering Rod	
	01/94 →	Engine Mounting		MN-SB-10390		
	01/94 →	Tie Rod End	CV-ES-2146			
	01/94 →	Tie Rod End	CV-ES-2149		for Push Rod	
	01/94 →	Tie Rod End	CV-ES-14162		for Steering Rod	
	01/94 →	Tie Rod End	CV-ES-14163		for Steering Rod	
	01/94 →	Tie Rod End	SC-ES-8517		for Push Rod	
	19.343 FAK	01/94 →	Ball Head, gearshift linkage	CV-ES-2119		
		01/94 →	Ball Head, gearshift linkage	CV-ES-2120		
		01/94 →	Ball Head, gearshift linkage	CV-ES-2182		
		01/94 →	Centre Rod	MN-DL-2160		Coupling Rod
01/94 →		Centre Rod	MN-DL-2172		Push Rod	
01/94 →		Centre Rod	MN-DL-2174		Push Rod	
01/94 →		Centre Rod	MN-DL-2175		Push Rod	
01/94 →		Centre Rod	MN-DL-2176		Push Rod	
01/94 →		Centre Rod	MN-DL-2177		Push Rod	
01/94 →		Centre Rod	MN-DL-3588		Push Rod	
01/94 →		Centre Rod	MN-DL-12391		for Steering Rod	
01/94 →		Centre Rod	MN-DL-12421		for Steering Rod	
01/94 →		Engine Mounting		MN-SB-10390		
01/94 →		Tie Rod End	CV-ES-2146			
01/94 →		Tie Rod End	CV-ES-2149		for Push Rod	
01/94 →		Tie Rod End	CV-ES-14162		for Steering Rod	
01/94 →		Tie Rod End	CV-ES-14163		for Steering Rod	
01/94 →		Tie Rod End	SC-ES-8517		for Push Rod	
19.343 FAS		01/94 →	Ball Head, gearshift linkage	CV-ES-2119		
		01/94 →	Ball Head, gearshift linkage	CV-ES-2120		
	01/94 →	Ball Head, gearshift linkage	CV-ES-2182			
	01/94 →	Centre Rod	MN-DL-2160		Coupling Rod	
	01/94 →	Centre Rod	MN-DL-2172		Push Rod	
	01/94 →	Centre Rod	MN-DL-2174		Push Rod	
	01/94 →	Centre Rod	MN-DL-2175		Push Rod	
	01/94 →	Centre Rod	MN-DL-2176		Push Rod	
	01/94 →	Centre Rod	MN-DL-2177		Push Rod	
	01/94 →	Centre Rod	MN-DL-3588		Push Rod	
	01/94 →	Centre Rod	MN-DL-12391		for Steering Rod	
	01/94 →	Centre Rod	MN-DL-12421		for Steering Rod	
	01/94 →	Engine Mounting		MN-SB-10390		
	01/94 →	Tie Rod End	CV-ES-2146			
	01/94 →	Tie Rod End	CV-ES-2149		for Push Rod	
	01/94 →	Tie Rod End	CV-ES-14162		for Steering Rod	
	01/94 →	Tie Rod End	CV-ES-14163		for Steering Rod	
	01/94 →	Tie Rod End	SC-ES-8517		for Push Rod	
	19.343 FC,19.343 FLC,19.343 FLLC	01/94 →	Ball Head, gearshift linkage	CV-ES-2119		
		01/94 →	Ball Head, gearshift linkage	CV-ES-2120		
01/94 →		Ball Head, gearshift linkage	CV-ES-2182			
01/94 →		Centre Rod	MN-DL-2160		Coupling Rod	
01/94 →		Centre Rod	MN-DL-2172		Push Rod	
01/94 →		Centre Rod	MN-DL-2174		Push Rod	
01/94 →		Centre Rod	MN-DL-2175		Push Rod	
01/94 →		Centre Rod	MN-DL-2176		Push Rod	
01/94 →		Centre Rod	MN-DL-2177		Push Rod	
01/94 →		Centre Rod	MN-DL-3588		Push Rod	
01/94 →		Centre Rod	MN-DL-8197		Push Rod	
01/94 →		Centre Rod	MN-DL-12421		for Steering Rod	
01/94 →		Engine Mounting		MN-SB-10390		
01/94 →		Engine Mounting	MN-SB-10389			
01/94 →		Mounting, stabilizer coupling rod	MN-SB-5246			
01/94 →		Stabiliser Mounting		MN-SB-5243		

CV-ES-2119

Length: 55
Cone Ø: d1 Ø 10 / d2 Ø 10
Thread: M12 x 1,75 LHT
81953016063, 81953016131



CV-ES-2120

Length: 115
Cone Ø: d1 Ø 12,4 / d2 Ø 10,8
Thread: M14 x 1,5 RHT
03008500A, 81953016200, 81953016202,
81953016203, 81953016227



CV-ES-2146

Length: 80
Cone Ø: d1 Ø 30 / d2 Ø 27
Thread: M26 x 1,5 RHT
42533102, 81953016219, 81953016225,
81953016226, 81953016267, 81953016291



CV-ES-2149

Length: 160
Cone Ø: d1 Ø 30 / d2 Ø 27
Thread: M30 x 1,5 RHT
81953016263



CV-ES-2182

Length: 55
Cone Ø: d1 Ø 10 / d2 Ø 10
Thread: M12 x 1,75 RHT
81953016064, 81953016170



CV-ES-14162

Length: 125
Cone Ø: d1 Ø 30 / d2 Ø 27
Thread: M30 x 1,5 LHT
81953010015, 81953010083, 81953010087,
81953016029, 81953016030, 81953016043,
81953016044, 81953016050, 81953016054,
81953016087, 81953016091, 81953016107,
81953016120, 81953016125, 81953016152,
81953016155, 81953016157, 81953016168,
81953016179, 81953016181, 81953016223,
81953016237, 81953016254, 81953016275,
81953016279, 81953016351



CV-ES-14163

Length: 125
Cone Ø: d1 Ø 30 / d2 Ø 27
Thread: M30 x 1,5 RHT
95301.0084, 90804102156, 90804102272,
90804102696, 90804102710, 81953010016,
81953010075, 81953010084, 81953010088,
81953010094, 81953010103, 81953016030,
81953016043, 81953016048, 81953016049,
81953016053, 81953016061, 81953016090,
81953016108, 81953016112, 81953016126,
81953016143, 81953016149, 81953016154,
81953016156, 81953016168, 81953016178,
81953016194, 81953016206, 81953016224,
81953016234, 81953016242, 81953016252,
81953016274, 81953016278, 81953016284,
81953016286, 81953016308, 81953016310,
81953016312, 81953016347, 81953016350,
81953016352, 82953016012, 88953016014,
N2953016001



MN-DL-2160

Length: 1652 Ø: 50
Cone Ø: d1 Ø 30 / d2 Ø 27
81467106112, 81467106163, 81467106165,
81467106198, 81467106353, 81467106354,
81467106361, 81467116725



MN-DL-2172

Length: 1050 Ø: 42
Cone Ø: d1 Ø 30 / d2 Ø 27
81466106374, 81466116019, 82466106080,
82466106189, 82466106190



MN-DL-2174

Length: 1588 Ø: 52
Cone Ø: d1 Ø 30 / d2 Ø 27
81467106378, 81467106912



MN-DL-2175

Length: 1628
Ø: 50
Cone Ø: d1 Ø 30 / d2 Ø 27
81467106396, 81467106904



MN-DL-2176

Length: 1628
Ø: 48
Cone Ø: d1 Ø 30 / d2 Ø 27
81466106779, 81466106780, 81466106782



MN-DL-2177

Length: 1664
Ø: 50
Cone Ø: d1 Ø 30 / d2 Ø 27
81467106994, 81467116726



MN-DL-3588

Length: 1035
Ø: 48
Cone Ø: d1 Ø 30 / d2 Ø 27
81466106333, 81466106334, 81466106354,
81466106355, 81466106360, 81466106361,
81466106721, 81466106722, 81466106723,
81466116216



MN-DL-8197

Length: 1055
Ø: 42
Cone Ø: d1 Ø 30 / d2 Ø 27
03207500A, 81466116003, 81466116004,
81466116005



MN-DL-12391

Length: 1050
Ø: 52
Cone Ø: d1 Ø 30 / d2 Ø 27
82466106057, 82466106147



MN-DL-12421

Length: 1070
Ø: 48
Cone Ø: d1 Ø 30 / d2 Ø 27
Thread: M30 x 1,5 RHT
81466106656, 81466106659, 81466106669,
81466116006, 81466116007



MN-SB-5243

Length: 55
Ø: 78
Thick/Height: 60
03311100A, 81437040061, 81437220020



MN-SB-5246

Ø: 45 Thick/Height: 47
81437220022, 81437220038, 81962100450,
81962100469



MN-SB-10389

Ø: 70
Thick/Height: 72
81960200340



MN-SB-10390

Ø: 70
Thick/Height: 85/85
81960200341, 81960200373, 81960200385,
81960200408, 81960200418



SC-ES-8517

Length: 140
Cone Ø: d1 Ø 30 / d2 Ø 27
Thread: M30 x 1,5 RHT
81953016286





F 2000 ...

19.343 FC,19.343 FLC, 19.343 FLLC ...	01/94 →	Suspension Arm Repair Kit		CV-RK-5313	for Wishbone (CV)	
	01/94 →	Suspension Arm Repair Kit		MN-RK-7280	for Drag Link;for Semi-Trailing Arm; for Wishbone (CV)	
	01/94 →	Suspension Arm Repair Kit		MN-RK-7287	for Wishbone (CV)	
	01/94 →	Tie Rod	MN-DL-8371			
	01/94 →	Tie Rod	MN-DL-12284			
	01/94 →	Tie Rod End	CV-ES-2146			
	01/94 →	Tie Rod End	CV-ES-2149		for Push Rod	
	01/94 →	Tie Rod End	CV-ES-14162		for Steering Rod	
	01/94 →	Tie Rod End	CV-ES-14163		for Steering Rod	
	01/94 →	Tie Rod End	SC-ES-8517		for Push Rod	
	01/94 →	Tie Rod End	SC-ES-8535		for Guide Rod	
	01/94 →	Track Control Arm		MN-DL-5212	Trailing Arm, Drive Axle;Air Suspension Axle	
	01/94 →	Track Control Arm		MN-VB-5222	Wishbone (CV), Air Suspension Axle	
	01/94 →	Track Control Arm	MN-TC-14112		Control Arm, 1st Front Axle, for Pneumatic Suspension vehicles	
	19.343 FK,19.343 FLK	01/94 →	Ball Head, gearshift linkage	CV-ES-2119		
01/94 →		Ball Head, gearshift linkage	CV-ES-2120			
01/94 →		Ball Head, gearshift linkage	CV-ES-2182			
01/94 →		Centre Rod	MN-DL-2160		Coupling Rod	
01/94 →		Centre Rod	MN-DL-2172		Push Rod	
01/94 →		Centre Rod	MN-DL-2174		Push Rod	
01/94 →		Centre Rod	MN-DL-2175		Push Rod	
01/94 →		Centre Rod	MN-DL-2176		Push Rod	
01/94 →		Centre Rod	MN-DL-2177		Push Rod	
01/94 →		Centre Rod	MN-DL-3588		Push Rod	
01/94 →		Centre Rod	MN-DL-8197		Push Rod	
01/94 →		Centre Rod	MN-DL-12421		for Steering Rod	
01/94 →		Engine Mounting		MN-SB-10390		
01/94 →		Engine Mounting	MN-SB-10389			
01/94 →		Mounting, stabilizer coupling rod	MN-SB-5246			
01/94 →		Stabiliser Mounting		MN-SB-5243		
01/94 →		Suspension Arm Repair Kit		CV-RK-5313	for Wishbone (CV)	
01/94 →		Suspension Arm Repair Kit		MN-RK-7280	for Drag Link;for Semi-Trailing Arm; for Wishbone (CV)	
01/94 →		Suspension Arm Repair Kit		MN-RK-7287	for Wishbone (CV)	
01/94 →		Tie Rod	MN-DL-12284			
01/94 →		Tie Rod End	CV-ES-2146			
01/94 →		Tie Rod End	CV-ES-2149		for Push Rod	
01/94 →		Tie Rod End	CV-ES-14162		for Steering Rod	
01/94 →		Tie Rod End	CV-ES-14163		for Steering Rod	
01/94 →		Track Control Arm		MN-DL-5212	Trailing Arm, Drive Axle;Air Suspension Axle	
01/94 →		Track Control Arm		MN-VB-5222	Wishbone (CV), Air Suspension Axle	
19.343 FS,19.343 FLS,19.343 FLLS		01/94 →	Ball Head, gearshift linkage	CV-ES-2119		
		01/94 →	Ball Head, gearshift linkage	CV-ES-2120		
		01/94 →	Ball Head, gearshift linkage	CV-ES-2182		
		01/94 →	Centre Rod	MN-DL-2160		Coupling Rod
	01/94 →	Centre Rod	MN-DL-2172		Push Rod	
	01/94 →	Centre Rod	MN-DL-2174		Push Rod	
	01/94 →	Centre Rod	MN-DL-2175		Push Rod	
	01/94 →	Centre Rod	MN-DL-2176		Push Rod	
	01/94 →	Centre Rod	MN-DL-2177		Push Rod	
	01/94 →	Centre Rod	MN-DL-3588		Push Rod	
	01/94 →	Centre Rod	MN-DL-8197		Push Rod	
	01/94 →	Centre Rod	MN-DL-12421		for Steering Rod	
	01/94 →	Engine Mounting		MN-SB-10390		
	01/94 →	Engine Mounting	MN-SB-10389			
	01/94 →	Mounting, stabilizer coupling rod	MN-SB-5246			
	01/94 →	Stabiliser Mounting		MN-SB-5243		
	01/94 →	Suspension Arm Repair Kit		CV-RK-5313	for Wishbone (CV)	
	01/94 →	Suspension Arm Repair Kit		MN-RK-7280	for Drag Link;for Semi-Trailing Arm; for Wishbone (CV)	
	01/94 →	Suspension Arm Repair Kit		MN-RK-7287	for Wishbone (CV)	

CV-ES-2119

Length: 55
Cone Ø: d1 Ø 10 / d2 Ø 10
Thread: M12 x 1,75 LHT
81953016063, 81953016131



CV-ES-2120

Length: 115
Cone Ø: d1 Ø 12,4 / d2 Ø 10,8
Thread: M14 x 1,5 RHT
03008500A, 81953016200, 81953016202, 81953016203, 81953016227



CV-ES-2146

Length: 80
Cone Ø: d1 Ø 30 / d2 Ø 27
Thread: M26 x 1,5 RHT
42533102, 81953016219, 81953016225, 81953016226, 81953016267, 81953016291



CV-ES-2149

Length: 160
Cone Ø: d1 Ø 30 / d2 Ø 27
Thread: M30 x 1,5 RHT
81953016263



CV-ES-2182

Length: 55
Cone Ø: d1 Ø 10 / d2 Ø 10
Thread: M12 x 1,75 RHT
81953016064, 81953016170



CV-ES-14162

Length: 125
Cone Ø: d1 Ø 30 / d2 Ø 27
Thread: M30 x 1,5 LHT
81953010015, 81953010083, 81953010087, 81953016029, 81953016030, 81953016043, 81953016044, 81953016050, 81953016054, 81953016087, 81953016091, 81953016107, 81953016120, 81953016125, 81953016152, 81953016155, 81953016157, 81953016168, 81953016179, 81953016181, 81953016223, 81953016237, 81953016254, 81953016275, 81953016279, 81953016351



CV-ES-14163

Length: 125
Cone Ø: d1 Ø 30 / d2 Ø 27
Thread: M30 x 1,5 RHT
95301.0084, 90804102156, 90804102272, 90804102696, 90804102710, 81953010016, 81953010075, 81953010084, 81953010088, 81953010094, 81953010103, 81953016030, 81953016043, 81953016048, 81953016049, 81953016053, 81953016061, 81953016090, 81953016108, 81953016112, 81953016126, 81953016143, 81953016149, 81953016154, 81953016156, 81953016168, 81953016178, 81953016194, 81953016206, 81953016224, 81953016234, 81953016242, 81953016252, 81953016274, 81953016278, 81953016284, 81953016286, 81953016308, 81953016310, 81953016312, 81953016347, 81953016350, 81953016352, 82953016012, 88953016014, N2953016001



CV-RK-5313

Ø: 90
03304800A, 81953016132



MN-DL-2160

Length: 1652 Ø: 50
Cone Ø: d1 Ø 30 / d2 Ø 27
81467106112, 81467106163, 81467106165, 81467106198, 81467106353, 81467106354, 81467106361, 81467116725



MN-DL-2172

Length: 1050 Ø: 42
Cone Ø: d1 Ø 30 / d2 Ø 27
81466106374, 81466116019, 82466106080, 82466106189, 82466106190



MN-DL-2174

Length: 1588 Ø: 52
Cone Ø: d1 Ø 30 / d2 Ø 27
81467106378, 81467106912



MN-DL-2175

Length: 1628 Ø: 50
Cone Ø: d1 Ø 30 / d2 Ø 27
81467106396, 81467106904



MN-DL-2176

Length: 1628 Ø: 48
Cone Ø: d1 Ø 30 / d2 Ø 27
81466106779, 81466106780, 81466106782



MN-DL-2177

Length: 1664 Ø: 50
Cone Ø: d1 Ø 30 / d2 Ø 27
81467106994, 81467116726



MN-DL-3588

Length: 1035
Ø: 48
Cone Ø: d1 Ø 30 / d2 Ø 27
81466106333, 81466106334, 81466106354, 81466106355, 81466106360, 81466106361, 81466106721, 81466106722, 81466106723, 81466116216



MN-DL-5212

Length: 577 Ø: 48
Hole Distance: 130 / 130
81432206096, 81432206097, 81432206098, 81432206129, 81432209096, 81432209129, 81432306014, 81432306030



MN-DL-8197

Length: 1055 Ø: 42
Cone Ø: d1 Ø 30 / d2 Ø 27
03207500A, 81466116003, 81466116004, 81466116005



MN-DL-8371

Length: 1625 Ø: 50
Cone Ø: d1 Ø 30 / d2 Ø 27
81467106966, 81467116714



MN-DL-12284

Length: 1530 Ø: 50
Cone Ø: d1 Ø 30 / d2 Ø 27
81466106579, 81466106580, 81466106624, 81466116720, 81467116720, 81467116730, 81467116952



MN-DL-12421

Length: 1070 Ø: 48
Cone Ø: d1 Ø 30 / d2 Ø 27
Thread: M30 x 1,5 RHT
81466106656, 81466106659, 81466106669, 81466116006, 81466116007



MN-RK-7280

Ø: 75
Hole Distance: 115
Thick/Height: 24
0550806, 0639370, 689748, 10307400A, 81432306051, 81432306068, 81432706064



MN-RK-7287

Ø: 90
Hole Distance: 152
Thick/Height: 35
03304700A, 81953016133



MN-SB-5243

Length: 55 Ø: 78
Thick/Height: 60
03311100A, 81437040061, 81437220020



MN-SB-5246

Ø: 45 Thick/Height: 47
81437220022, 81437220038, 81962100450, 81962100469



MN-SB-10389

Ø: 70 Thick/Height: 72
81960200340



MN-SB-10390

Ø: 70 Thick/Height: 85/85
81960200341, 81960200373, 81960200385, 81960200408, 81960200418



MN-TC-14112

Length: 777 Ø: 60
Hole Distance: 115 / 115
81432206106, 81432306049



MN-VB-5222

Length: 627 Ø: 50
Hole Distance: 152 / 152
81432706030, 81432706034, 81432706054, 81432706055, 81432706056, 81432706057, 81432706067, 81432706068, 81432706074, 81432706075, 81432706076, 81432706077, 81432706078, 81432706081, 81432706082, 81432709034, 81432709076, 81432709078, 8143706054



SC-ES-8517

Length: 140
Cone Ø: d1 Ø 30 / d2 Ø 27
Thread: M30 x 1,5 RHT
81953016286



SC-ES-8535

Length: 145
Cone Ø: d1 Ø 30 / d2 Ø 27
Thread: M30 x 1,5 RHT
81953016271, 81953016325



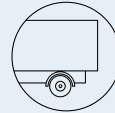

F 2000 ...

19.343 FS,19.343 FLS, 19.343 FLLS ...	01/94 →	Tie Rod	MN-DL-8371		
	01/94 →	Tie Rod	MN-DL-12284		
	01/94 →	Tie Rod End	CV-ES-2146		
	01/94 →	Tie Rod End	CV-ES-2149		for Push Rod
	01/94 →	Tie Rod End	CV-ES-14162		for Steering Rod
	01/94 →	Tie Rod End	CV-ES-14163		for Steering Rod
	01/94 →	Tie Rod End	SC-ES-8517		for Push Rod
	01/94 →	Tie Rod End	SC-ES-8535		for Guide Rod
	01/94 →	Track Control Arm		MN-DL-5212	Trailing Arm, Drive Axle;Air Suspension Axle
	01/94 →	Track Control Arm		MN-VB-5222	Wishbone (CV), Air Suspension Axle
01/94 →	Track Control Arm	MN-TC-14112		Control Arm, 1st Front Axle, for Pneumatic Suspension vehicles	
19.364 FAC	06/98 →	Ball Head, gearshift linkage	CV-ES-2120		
	06/98 →	Centre Rod	MN-DL-2174		Push Rod
	06/98 →	Centre Rod	MN-DL-12421		for Steering Rod
	06/98 →	Suspension Arm Repair Kit		MN-RK-7291	for Drag Link
	06/98 →	Tie Rod End	CV-ES-14163		for Steering Rod
	06/98 →	Tie Rod End	SC-ES-8517		for Push Rod
	06/98 →	Track Control Arm		MN-DL-5212	Trailing Arm, Drive Axle;Tag Axle, for Pneumatic Suspension vehicles
	06/98 →	Track Control Arm		MN-VB-5222	Wishbone (CV)
19.364 FAK, FA-KI, FAK-L	06/98 →	Ball Head, gearshift linkage	CV-ES-2120		
	06/98 →	Centre Rod	MN-DL-2174		Push Rod
	06/98 →	Centre Rod	MN-DL-12421		for Steering Rod
	06/98 →	Suspension Arm Repair Kit		MN-RK-7291	for Drag Link
	06/98 →	Tie Rod End	CV-ES-14163		for Steering Rod
	06/98 →	Tie Rod End	SC-ES-8517		for Push Rod
	06/98 →	Track Control Arm		MN-DL-5212	Trailing Arm, Drive Axle;Tag Axle, for Pneumatic Suspension vehicles
19.364 FAS	06/98 →	Track Control Arm		MN-VB-5222	Wishbone (CV)
	06/98 →	Ball Head, gearshift linkage	CV-ES-2120		
	06/98 →	Centre Rod	MN-DL-2174		Push Rod
	06/98 →	Centre Rod	MN-DL-12421		for Steering Rod
	06/98 →	Suspension Arm Repair Kit		MN-RK-7291	for Drag Link
	06/98 →	Tie Rod End	CV-ES-14163		for Steering Rod
	06/98 →	Tie Rod End	SC-ES-8517		for Push Rod
19.364 FC, FLC, FLLC, FLLW, FRC, FLRC, FLLRC, FLL, FLLR, F-N	06/98 →	Track Control Arm		MN-DL-5212	Trailing Arm, Drive Axle;Tag Axle, for Pneumatic Suspension vehicles
	06/98 →	Track Control Arm		MN-VB-5222	Wishbone (CV)
	06/98 →	Ball Head, gearshift linkage	CV-ES-2120		
	06/98 →	Centre Rod	MN-DL-2160		Coupling Rod
	06/98 →	Centre Rod	MN-DL-2172		Push Rod
	06/98 →	Centre Rod	MN-DL-2175		Push Rod
	06/98 →	Centre Rod	MN-DL-2176		Push Rod
	06/98 →	Centre Rod	MN-DL-2177		Push Rod
	06/98 →	Centre Rod	MN-DL-3588		Push Rod
	06/98 →	Centre Rod	MN-DL-8197		Push Rod
	06/98 →	Centre Rod	MN-DL-12391		for Steering Rod
	06/98 →	Suspension Arm Repair Kit		MN-RK-7280	for Drag Link;for Semi-Trailing Arm; for Wishbone (CV)
	06/98 →	Suspension Arm Repair Kit	MN-RK-7280	MN-RK-7280	for Drag Link;for Semi-Trailing Arm; for Wishbone (CV)
	06/98 →	Tie Rod End	CV-ES-2149		for Push Rod
	06/98 →	Tie Rod End	CV-ES-14162		for Steering Rod
	06/98 →	Tie Rod End	CV-ES-14163		for Steering Rod
	06/98 →	Tie Rod End	SC-ES-8517		for Push Rod
	06/98 →	Tie Rod End	SC-ES-8535		for Guide Rod
	06/98 →	Track Control Arm		MN-DL-5212	Trailing Arm, Drive Axle;Tag Axle, for Pneumatic Suspension vehicles
	06/98 →	Track Control Arm		MN-VB-5222	Wishbone (CV)
06/98 →	Track Control Arm	MN-TC-14112		Control Arm, 1st Front Axle, for Pneumatic Suspension vehicles	

CV-ES-2120

Length: 115
Cone Ø: d1 Ø 12,4 / d2 Ø 10,8
Thread: M14 x 1,5 RHT
03008500A, 81953016200, 81953016202,
81953016203, 81953016227



CV-ES-2146

Length: 80
Cone Ø: d1 Ø 30 / d2 Ø 27
Thread: M26 x 1,5 RHT
42533102, 81953016219, 81953016225,
81953016226, 81953016267, 81953016291



CV-ES-2149

Length: 160
Cone Ø: d1 Ø 30 / d2 Ø 27
Thread: M30 x 1,5 RHT
81953016263



CV-ES-14162

Length: 125
Cone Ø: d1 Ø 30 / d2 Ø 27
Thread: M30 x 1,5 LHT
81953010015, 81953010083, 81953010087,
81953016029, 81953016030, 81953016043,
81953016044, 81953016050, 81953016054,
81953016087, 81953016091, 81953016107,
81953016120, 81953016125, 81953016152,
81953016155, 81953016157, 81953016168,
81953016179, 81953016181, 81953016223,
81953016237, 81953016254, 81953016275,
81953016279, 81953016351



CV-ES-14163

Length: 125
Cone Ø: d1 Ø 30 / d2 Ø 27
Thread: M30 x 1,5 RHT
95301.0084, 90804102156, 90804102272,
90804102696, 90804102710, 81953010016,
81953010075, 81953010084, 81953010088,
81953010094, 81953010103, 81953016030,
81953016043, 81953016048, 81953016049,
81953016053, 81953016061, 81953016090,
81953016108, 81953016112, 81953016126,
81953016143, 81953016149, 81953016154,
81953016156, 81953016168, 81953016178,
81953016194, 81953016206, 81953016224,
81953016234, 81953016242, 81953016252,
81953016274, 81953016278, 81953016284,
81953016286, 81953016308, 81953016310,
81953016312, 81953016347, 81953016350,
81953016352, 82953016012, 88953016014,
N2953016001



MN-DL-2160

Length: 1652 Ø: 50
Cone Ø: d1 Ø 30 / d2 Ø 27
81467106112, 81467106163, 81467106165,
81467106198, 81467106353, 81467106354,
81467106361, 81467116725



MN-DL-2172

Length: 1050 Ø: 42
Cone Ø: d1 Ø 30 / d2 Ø 27
81466106374, 81466116019, 82466106080,
82466106189, 82466106190



MN-DL-2174

Length: 1588 Ø: 52
Cone Ø: d1 Ø 30 / d2 Ø 27
81467106378, 81467106912



MN-DL-2175

Length: 1628 Ø: 50
Cone Ø: d1 Ø 30 / d2 Ø 27
81467106396, 81467106904



MN-DL-2176

Length: 1628 Ø: 48
Cone Ø: d1 Ø 30 / d2 Ø 27
81466106779, 81466106780, 81466106782



MN-DL-2177

Length: 1664 Ø: 50
Cone Ø: d1 Ø 30 / d2 Ø 27
81467106994, 81467116726



MN-DL-3588

Length: 1035 Ø: 48
Cone Ø: d1 Ø 30 / d2 Ø 27
81466106333, 81466106334, 81466106354,
81466106355, 81466106360, 81466106361,
81466106721, 81466106722, 81466106723,
81466116216



MN-DL-5212

Length: 577 Ø: 48
Hole Distance: 130 / 130
81432206096, 81432206097, 81432206098,
81432206129, 81432209096, 81432209129,
81432306014, 81432306030



MN-DL-8197

Length: 1055 Ø: 42
Cone Ø: d1 Ø 30 / d2 Ø 27
03207500A, 81466116003, 81466116004,
81466116005



MN-DL-8371

Length: 1625 Ø: 50
Cone Ø: d1 Ø 30 / d2 Ø 27
81467106966, 81467116714



MN-DL-12284

Length: 1530 Ø: 50
Cone Ø: d1 Ø 30 / d2 Ø 27
81466106579, 81466106580, 81466106624,
81466116720, 81467116720, 81467116730,
81467116952



MN-DL-12391

Length: 1050 Ø: 52
Cone Ø: d1 Ø 30 / d2 Ø 27
82466106057, 82466106147



MN-DL-12421

Length: 1070 Ø: 48
Cone Ø: d1 Ø 30 / d2 Ø 27
Thread: M30 x 1,5 RHT
81466106656, 81466106659, 81466106669,
81466116006, 81466116007



MN-RK-7280

Ø: 75
Hole Distance: 115
Thick/Height: 24
0550806, 0639370, 689748, 10307400A,
81432306051, 81432306068, 81432706064



MN-RK-7291

Ø: 72
Hole Distance: 130
Thick/Height: 30
10307800A, 81432206108, 81432206132



MN-TC-14112

Length: 777 Ø: 60
Hole Distance: 115 / 115
81432206106, 81432306049



MN-VB-5222

Length: 627 Ø: 50
Hole Distance: 152 / 152
81432706030, 81432706034, 81432706054,
81432706055, 81432706056, 81432706057,
81432706067, 81432706068, 81432706074,
81432706075, 81432706076, 81432706077,
81432706078, 81432706081, 81432706082,
81432709034, 81432709076, 81432709078,
8143706054



SC-ES-8517

Length: 140
Cone Ø: d1 Ø 30 / d2 Ø 27
Thread: M30 x 1,5 RHT
81953016286



SC-ES-8535

Length: 145
Cone Ø: d1 Ø 30 / d2 Ø 27
Thread: M30 x 1,5 RHT
81953016271, 81953016325





F 2000 ...

19.364 FK, FK-L, F-KI, FL-KI, F-NL, FLK	06/98 →	Ball Head, gearshift linkage	CV-ES-2120		
	06/98 →	Centre Rod	MN-DL-2160		Coupling Rod
	06/98 →	Centre Rod	MN-DL-2172		Push Rod
	06/98 →	Centre Rod	MN-DL-2176		Push Rod
	06/98 →	Centre Rod	MN-DL-3588		Push Rod
	06/98 →	Centre Rod	MN-DL-8197		Push Rod
	06/98 →	Centre Rod	MN-DL-12391		for Steering Rod
	06/98 →	Suspension Arm Repair Kit		MN-RK-7280	for Drag Link;for Semi-Trailing Arm; for Wishbone (CV)
	06/98 →	Tie Rod End	CV-ES-2149		for Push Rod
	06/98 →	Tie Rod End	CV-ES-14162		for Steering Rod
	06/98 →	Tie Rod End	CV-ES-14163		for Steering Rod
	06/98 →	Track Control Arm		MN-DL-5212	Trailing Arm, Drive Axle;Tag Axle, for Pneumatic Suspension vehicles
	06/98 →	Track Control Arm		MN-VB-5222	Wishbone (CV)
	19.364 FS, FLS, FLLS, FRS, FLRS, FLLRS	06/98 →	Ball Head, gearshift linkage	CV-ES-2120	
06/98 →		Centre Rod	MN-DL-2160		Coupling Rod
06/98 →		Centre Rod	MN-DL-2172		Push Rod
06/98 →		Centre Rod	MN-DL-2175		Push Rod
06/98 →		Centre Rod	MN-DL-2176		Push Rod
06/98 →		Centre Rod	MN-DL-2177		Push Rod
06/98 →		Centre Rod	MN-DL-3588		Push Rod
06/98 →		Centre Rod	MN-DL-8197		Push Rod
06/98 →		Centre Rod	MN-DL-12391		for Steering Rod
06/98 →		Suspension Arm Repair Kit		MN-RK-7280	for Drag Link;for Semi-Trailing Arm; for Wishbone (CV)
06/98 →		Suspension Arm Repair Kit	MN-RK-7280	MN-RK-7280	for Drag Link;for Semi-Trailing Arm; for Wishbone (CV)
06/98 →		Tie Rod End	CV-ES-2149		for Push Rod
06/98 →		Tie Rod End	CV-ES-14162		for Steering Rod
06/98 →		Tie Rod End	CV-ES-14163		for Steering Rod
06/98 →		Tie Rod End	SC-ES-8517		for Push Rod
06/98 →		Track Control Arm		MN-DL-5212	Trailing Arm, Drive Axle;Tag Axle, for Pneumatic Suspension vehicles
06/98 →		Track Control Arm		MN-VB-5222	Wishbone (CV)
06/98 →		Track Control Arm	MN-TC-14112		Control Arm, 1st Front Axle, for Pneumatic Suspension vehicles
19.373 FAC	01/94 →	Ball Head, gearshift linkage	CV-ES-2119		
	01/94 →	Ball Head, gearshift linkage	CV-ES-2120		
	01/94 →	Ball Head, gearshift linkage	CV-ES-2182		
	01/94 →	Centre Rod	MN-DL-2160		Coupling Rod
	01/94 →	Centre Rod	MN-DL-2172		Push Rod
	01/94 →	Centre Rod	MN-DL-2174		Push Rod
	01/94 →	Centre Rod	MN-DL-2175		Push Rod
	01/94 →	Centre Rod	MN-DL-2176		Push Rod
	01/94 →	Centre Rod	MN-DL-2177		Push Rod
	01/94 →	Centre Rod	MN-DL-3588		Push Rod
	01/94 →	Centre Rod	MN-DL-12391		for Steering Rod
	01/94 →	Centre Rod	MN-DL-12421		for Steering Rod
	01/94 →	Engine Mounting		MN-SB-10390	
	01/94 →	Suspension Arm Repair Kit		MN-RK-7291	for Drag Link
	01/94 →	Tie Rod End	CV-ES-2149		for Push Rod
	01/94 →	Tie Rod End	CV-ES-14162		for Steering Rod
	01/94 →	Tie Rod End	CV-ES-14163		for Steering Rod
	01/94 →	Tie Rod End	SC-ES-8517		for Push Rod
	01/94 →	Track Control Arm		MN-DL-5212	Trailing Arm, Drive Axle;Tag Axle, for Pneumatic Suspension vehicles
	01/94 →	Track Control Arm		MN-VB-5222	Wishbone (CV)
19.373 FAK, FA-KI, FAK-L	01/94 →	Ball Head, gearshift linkage	CV-ES-2119		
	01/94 →	Ball Head, gearshift linkage	CV-ES-2120		
	01/94 →	Ball Head, gearshift linkage	CV-ES-2182		
	01/94 →	Centre Rod	MN-DL-2160		Coupling Rod
	01/94 →	Centre Rod	MN-DL-2172		Push Rod

CV-ES-2119

Length: 55
Cone Ø: d1 Ø 10 / d2 Ø 10
Thread: M12 x 1,75 LHT
81953016063, 81953016131



CV-ES-2120

Length: 115
Cone Ø: d1 Ø 12,4 / d2 Ø 10,8
Thread: M14 x 1,5 RHT
03008500A, 81953016200, 81953016202, 81953016203, 81953016227



CV-ES-2149

Length: 160
Cone Ø: d1 Ø 30 / d2 Ø 27
Thread: M30 x 1,5 RHT
81953016263



CV-ES-2182

Length: 55
Cone Ø: d1 Ø 10 / d2 Ø 10
Thread: M12 x 1,75 RHT
81953016064, 81953016170



CV-ES-14162

Length: 125
Cone Ø: d1 Ø 30 / d2 Ø 27
Thread: M30 x 1,5 LHT

81953010015, 81953010083, 81953010087, 81953016029, 81953016030, 81953016043, 81953016044, 81953016050, 81953016054, 81953016087, 81953016091, 81953016107, 81953016120, 81953016125, 81953016152, 81953016155, 81953016157, 81953016168, 81953016179, 81953016181, 81953016223, 81953016237, 81953016254, 81953016275, 81953016279, 81953016351



CV-ES-14163

Length: 125
Cone Ø: d1 Ø 30 / d2 Ø 27
Thread: M30 x 1,5 RHT

95301.0084, 90804102156, 90804102272, 90804102696, 90804102710, 81953010016, 81953010075, 81953010084, 81953010088, 81953010094, 81953010103, 81953016030, 81953016043, 81953016048, 81953016049, 81953016053, 81953016061, 81953016090, 81953016108, 81953016112, 81953016126, 81953016143, 81953016149, 81953016154, 81953016156, 81953016168, 81953016178, 81953016194, 81953016206, 81953016224, 81953016234, 81953016242, 81953016252, 81953016274, 81953016278, 81953016284, 81953016286, 81953016308, 81953016310, 81953016312, 81953016347, 81953016350, 81953016352, 82953016012, 88953016014, N2953016001



MN-DL-2160

Length: 1652 Ø: 50
Cone Ø: d1 Ø 30 / d2 Ø 27
81467106112, 81467106163, 81467106165, 81467106198, 81467106353, 81467106354, 81467106361, 81467116725



MN-DL-2172

Length: 1050 Ø: 42
Cone Ø: d1 Ø 30 / d2 Ø 27
81466106374, 81466116019, 82466106080, 82466106189, 82466106190



MN-DL-2174

Length: 1588 Ø: 52
Cone Ø: d1 Ø 30 / d2 Ø 27
81467106378, 81467106912



MN-DL-2175

Length: 1628 Ø: 50
Cone Ø: d1 Ø 30 / d2 Ø 27
81467106396, 81467106904



MN-DL-2176

Length: 1628 Ø: 48
Cone Ø: d1 Ø 30 / d2 Ø 27
81466106779, 81466106780, 81466106782



MN-DL-2177

Length: 1664 Ø: 50
Cone Ø: d1 Ø 30 / d2 Ø 27
81467106994, 81467116726



MN-DL-3588

Length: 1035 Ø: 48
Cone Ø: d1 Ø 30 / d2 Ø 27
81466106333, 81466106334, 81466106354, 81466106355, 81466106360, 81466106361, 81466106721, 81466106722, 81466106723, 81466116216



MN-DL-5212

Length: 577 Ø: 48
Hole Distance: 130 / 130
81432206096, 81432206097, 81432206098, 81432206129, 81432209096, 81432209129, 81432306014, 81432306030



MN-DL-8197

Length: 1055 Ø: 42
Cone Ø: d1 Ø 30 / d2 Ø 27
03207500A, 81466116003, 81466116004, 81466116005



MN-DL-12391

Length: 1050 Ø: 52
Cone Ø: d1 Ø 30 / d2 Ø 27
82466106057, 82466106147



MN-DL-12421

Length: 1070 Ø: 48
Cone Ø: d1 Ø 30 / d2 Ø 27
Thread: M30 x 1,5 RHT
81466106656, 81466106659, 81466106669, 81466116006, 81466116007



MN-RK-7280

Ø: 75
Hole Distance: 115
Thick/Height: 24
0550806, 0639370, 689748, 10307400A, 81432306051, 81432306068, 81432706064



MN-RK-7291

Ø: 72
Hole Distance: 130
Thick/Height: 30
10307800A, 81432206108, 81432206132



MN-SB-10390

Ø: 70 Thick/Height: 85/85
81960200341, 81960200373, 81960200385, 81960200408, 81960200418



MN-TC-14112

Length: 777 Ø: 60
Hole Distance: 115 / 115
81432206106, 81432306049



MN-VB-5222

Length: 627 Ø: 50
Hole Distance: 152 / 152
81432706030, 81432706034, 81432706054, 81432706055, 81432706056, 81432706057, 81432706067, 81432706068, 81432706074, 81432706075, 81432706076, 81432706077, 81432706078, 81432706081, 81432706082, 81432709034, 81432709076, 81432709078, 8143706054



SC-ES-8517

Length: 140
Cone Ø: d1 Ø 30 / d2 Ø 27
Thread: M30 x 1,5 RHT
81953016286





F 2000 ...

19.373 FAK, FA-KI, FAK-L ...	01/94 →	Centre Rod	MN-DL-2174		Push Rod
	01/94 →	Centre Rod	MN-DL-2175		Push Rod
	01/94 →	Centre Rod	MN-DL-2176		Push Rod
	01/94 →	Centre Rod	MN-DL-2177		Push Rod
	01/94 →	Centre Rod	MN-DL-3588		Push Rod
	01/94 →	Centre Rod	MN-DL-12391		for Steering Rod
	01/94 →	Centre Rod	MN-DL-12421		for Steering Rod
	01/94 →	Engine Mounting		MN-SB-10390	
	01/94 →	Suspension Arm Repair Kit		MN-RK-7291	for Drag Link
	01/94 →	Tie Rod End	CV-ES-2149		for Push Rod
	01/94 →	Tie Rod End	CV-ES-14162		for Steering Rod
	01/94 →	Tie Rod End	CV-ES-14163		for Steering Rod
	01/94 →	Tie Rod End	SC-ES-8517		for Push Rod
	01/94 →	Track Control Arm		MN-DL-5212	Trailing Arm, Drive Axle; Tag Axle, for Pneumatic Suspension vehicles
	01/94 →	Track Control Arm		MN-VB-5222	Wishbone (CV)
19.373 FAS	01/94 →	Ball Head, gearshift linkage	CV-ES-2119		
	01/94 →	Ball Head, gearshift linkage	CV-ES-2120		
	01/94 →	Ball Head, gearshift linkage	CV-ES-2182		
	01/94 →	Centre Rod	MN-DL-2160		Coupling Rod
	01/94 →	Centre Rod	MN-DL-2172		Push Rod
	01/94 →	Centre Rod	MN-DL-2174		Push Rod
	01/94 →	Centre Rod	MN-DL-2175		Push Rod
	01/94 →	Centre Rod	MN-DL-2176		Push Rod
	01/94 →	Centre Rod	MN-DL-2177		Push Rod
	01/94 →	Centre Rod	MN-DL-3588		Push Rod
	01/94 →	Centre Rod	MN-DL-12391		for Steering Rod
	01/94 →	Centre Rod	MN-DL-12421		for Steering Rod
	01/94 →	Engine Mounting		MN-SB-10390	
	01/94 →	Suspension Arm Repair Kit		MN-RK-7291	for Drag Link
	01/94 →	Tie Rod End	CV-ES-2149		for Push Rod
01/94 →	Tie Rod End	CV-ES-14162		for Steering Rod	
01/94 →	Tie Rod End	CV-ES-14163		for Steering Rod	
01/94 →	Tie Rod End	SC-ES-8517		for Push Rod	
01/94 →	Track Control Arm		MN-DL-5212	Trailing Arm, Drive Axle; Tag Axle, for Pneumatic Suspension vehicles	
01/94 →	Track Control Arm		MN-VB-5222	Wishbone (CV)	
19.373 FC, FLC, FLLC, FRC, FLRC, F-NL	01/94 →	Ball Head, gearshift linkage	CV-ES-2119		
	01/94 →	Ball Head, gearshift linkage	CV-ES-2120		
	01/94 →	Ball Head, gearshift linkage	CV-ES-2182		
	01/94 →	Centre Rod	MN-DL-2160		Coupling Rod
	01/94 →	Centre Rod	MN-DL-2172		Push Rod
	01/94 →	Centre Rod	MN-DL-2174		Push Rod
	01/94 →	Centre Rod	MN-DL-2175		Push Rod
	01/94 →	Centre Rod	MN-DL-2176		Push Rod
	01/94 →	Centre Rod	MN-DL-2177		Push Rod
	01/94 →	Centre Rod	MN-DL-3588		Push Rod
	01/94 →	Centre Rod	MN-DL-8197		Push Rod
	01/94 →	Centre Rod	MN-DL-12421		for Steering Rod
	01/94 →	Engine Mounting		MN-SB-10390	
	01/94 →	Stabiliser Mounting		MN-SB-5243	
	01/94 →	Suspension Arm Repair Kit		CV-RK-5313	for Wishbone (CV)
01/94 →	Suspension Arm Repair Kit		MN-RK-7280	for Drag Link; for Semi-Trailing Arm; for Wishbone (CV)	
01/94 →	Suspension Arm Repair Kit		MN-RK-7287	for Wishbone (CV)	
01/94 →	Tie Rod	MN-DL-12284			
01/94 →	Tie Rod End	CV-ES-2149		for Push Rod	
01/94 →	Tie Rod End	CV-ES-14162		for Steering Rod	
01/94 →	Tie Rod End	CV-ES-14163		for Steering Rod	
01/94 →	Track Control Arm		MN-DL-5212	Trailing Arm, Drive Axle; Air Suspension Axle	
01/94 →	Track Control Arm		MN-VB-5222	Wishbone (CV)	
01/94 →	Track Control Arm		MN-VB-5222	Wishbone (CV), Drive Axle; Air Suspension Axle	
01/94 →	Track Control Arm	MN-TC-14112		Control Arm	

CV-ES-2119

Length: 55
Cone Ø: d1 Ø 10 / d2 Ø 10
Thread: M12 x 1,75 LHT
81953016063, 81953016131



CV-ES-2120

Length: 115
Cone Ø: d1 Ø 12,4 / d2 Ø 10,8
Thread: M14 x 1,5 RHT
03008500A, 81953016200, 81953016202, 81953016203, 81953016227



CV-ES-2149

Length: 160
Cone Ø: d1 Ø 30 / d2 Ø 27
Thread: M30 x 1,5 RHT
81953016263



CV-ES-2182

Length: 55
Cone Ø: d1 Ø 10 / d2 Ø 10
Thread: M12 x 1,75 RHT
81953016064, 81953016170



CV-ES-14162

Length: 125
Cone Ø: d1 Ø 30 / d2 Ø 27
Thread: M30 x 1,5 LHT

81953010015, 81953010083, 81953010087, 81953016029, 81953016030, 81953016043, 81953016044, 81953016050, 81953016054, 81953016087, 81953016091, 81953016107, 81953016120, 81953016125, 81953016152, 81953016155, 81953016157, 81953016168, 81953016179, 81953016181, 81953016223, 81953016237, 81953016254, 81953016275, 81953016279, 81953016351



CV-ES-14163

Length: 125
Cone Ø: d1 Ø 30 / d2 Ø 27
Thread: M30 x 1,5 RHT

95301.0084, 90804102156, 90804102272, 90804102696, 90804102710, 81953010016, 81953010075, 81953010084, 81953010088, 81953010094, 81953010103, 81953016030, 81953016043, 81953016048, 81953016049, 81953016053, 81953016061, 81953016090, 81953016108, 81953016112, 81953016126, 81953016143, 81953016149, 81953016154, 81953016156, 81953016168, 81953016178, 81953016194, 81953016206, 81953016224, 81953016234, 81953016242, 81953016252, 81953016274, 81953016278, 81953016284, 81953016286, 81953016308, 81953016310, 81953016312, 81953016347, 81953016350, 81953016352, 82953016012, 88953016014, N2953016001



CV-RK-5313

Ø: 90
03304800A, 81953016132



MN-DL-2160

Length: 1652 Ø: 50
Cone Ø: d1 Ø 30 / d2 Ø 27
81467106112, 81467106163, 81467106165, 81467106198, 81467106353, 81467106354, 81467106361, 81467116725



MN-DL-2172

Length: 1050 Ø: 42
Cone Ø: d1 Ø 30 / d2 Ø 27
81466106374, 81466116019, 82466106080, 82466106189, 82466106190



MN-DL-2174

Length: 1588 Ø: 52
Cone Ø: d1 Ø 30 / d2 Ø 27
81467106378, 81467106912



MN-DL-2175

Length: 1628 Ø: 50
Cone Ø: d1 Ø 30 / d2 Ø 27
81467106396, 81467106904



MN-DL-2176

Length: 1628 Ø: 48
Cone Ø: d1 Ø 30 / d2 Ø 27
81466106779, 81466106780, 81466106782



MN-DL-2177

Length: 1664 Ø: 50
Cone Ø: d1 Ø 30 / d2 Ø 27
81467106994, 81467116726



MN-DL-3588

Length: 1035 Ø: 48
Cone Ø: d1 Ø 30 / d2 Ø 27
81466106333, 81466106334, 81466106354, 81466106355, 81466106360, 81466106361, 81466106721, 81466106722, 81466106723, 81466116216



MN-DL-5212

Length: 577 Ø: 48
Hole Distance: 130 / 130
81432206096, 81432206097, 81432206098, 81432206129, 81432209096, 81432209129, 81432306014, 81432306030



MN-DL-8197

Length: 1055 Ø: 42
Cone Ø: d1 Ø 30 / d2 Ø 27
03207500A, 81466116003, 81466116004, 81466116005



MN-DL-12284

Length: 1530 Ø: 50
Cone Ø: d1 Ø 30 / d2 Ø 27
81466106579, 81466106580, 81466106624, 81466116720, 81467116720, 81467116730, 81467116952



MN-DL-12391

Length: 1050 Ø: 52
Cone Ø: d1 Ø 30 / d2 Ø 27
82466106057, 82466106147



MN-DL-12421

Length: 1070 Ø: 48
Cone Ø: d1 Ø 30 / d2 Ø 27
Thread: M30 x 1,5 RHT
81466106656, 81466106659, 81466106669, 81466116006, 81466116007



MN-RK-7280

Ø: 75
Hole Distance: 115
Thick/Height: 24
0550806, 0639370, 689748, 10307400A, 81432306051, 81432306068, 81432706064



MN-RK-7287

Ø: 90
Hole Distance: 152
Thick/Height: 35
03304700A, 81953016133



MN-RK-7291

Ø: 72
Hole Distance: 130
Thick/Height: 30
10307800A, 81432206108, 81432206132



MN-SB-5243

Length: 55 Ø: 78
Thick/Height: 60
03311100A, 81437040061, 81437220020



MN-SB-10390

Ø: 70 Thick/Height: 85/85
81960200341, 81960200373, 81960200385, 81960200408, 81960200418



MN-TC-14112

Length: 777 Ø: 60
Hole Distance: 115 / 115
81432206106, 81432306049



MN-VB-5222

Length: 627 Ø: 50
Hole Distance: 152 / 152
81432706030, 81432706034, 81432706054, 81432706055, 81432706056, 81432706057, 81432706067, 81432706068, 81432706074, 81432706075, 81432706076, 81432706077, 81432706078, 81432706081, 81432706082, 81432709034, 81432709076, 81432709078, 8143706054



SC-ES-8517

Length: 140
Cone Ø: d1 Ø 30 / d2 Ø 27
Thread: M30 x 1,5 RHT
81953016286





F 2000 ...

19.373 FK, FK-L, F-KI, FL-KI,
F-NL, FLK

01/94 →	Ball Head, gearshift linkage	CV-ES-2119	
01/94 →	Ball Head, gearshift linkage	CV-ES-2120	
01/94 →	Ball Head, gearshift linkage	CV-ES-2182	
01/94 →	Centre Rod	MN-DL-2160	Coupling Rod
01/94 →	Centre Rod	MN-DL-2172	Push Rod
01/94 →	Centre Rod	MN-DL-2174	Push Rod
01/94 →	Centre Rod	MN-DL-2175	Push Rod
01/94 →	Centre Rod	MN-DL-2176	Push Rod
01/94 →	Centre Rod	MN-DL-2177	Push Rod
01/94 →	Centre Rod	MN-DL-3588	Push Rod
01/94 →	Centre Rod	MN-DL-8197	Push Rod
01/94 →	Centre Rod	MN-DL-12421	for Steering Rod
01/94 →	Engine Mounting		MN-SB-10390
01/94 →	Stabiliser Mounting		MN-SB-5243
01/94 →	Suspension Arm Repair Kit		CV-RK-5313 for Wishbone (CV)
01/94 →	Suspension Arm Repair Kit		MN-RK-7280 for Drag Link;for Semi-Trailing Arm; for Wishbone (CV)
01/94 →	Suspension Arm Repair Kit		MN-RK-7287 for Wishbone (CV)
01/94 →	Tie Rod	MN-DL-12284	
01/94 →	Tie Rod End	CV-ES-2149	for Push Rod
01/94 →	Tie Rod End	CV-ES-14162	for Steering Rod
01/94 →	Tie Rod End	CV-ES-14163	for Steering Rod
01/94 →	Track Control Arm		MN-DL-5212 Trailing Arm, Drive Axle;Air Suspension Axle
01/94 →	Track Control Arm		MN-VB-5222 Wishbone (CV), Drive Axle;Air Suspension Axle

19.373 FS, FLS, FLLS, FRS,
FLRS, FLLRS

01/94 →	Ball Head, gearshift linkage	CV-ES-2119	
01/94 →	Ball Head, gearshift linkage	CV-ES-2120	
01/94 →	Ball Head, gearshift linkage	CV-ES-2182	
01/94 →	Centre Rod	MN-DL-2160	Coupling Rod
01/94 →	Centre Rod	MN-DL-2172	Push Rod
01/94 →	Centre Rod	MN-DL-2174	Push Rod
01/94 →	Centre Rod	MN-DL-2175	Push Rod
01/94 →	Centre Rod	MN-DL-2176	Push Rod
01/94 →	Centre Rod	MN-DL-2177	Push Rod
01/94 →	Centre Rod	MN-DL-3588	Push Rod
01/94 →	Centre Rod	MN-DL-8197	Push Rod
01/94 →	Centre Rod	MN-DL-12421	for Steering Rod
01/94 →	Engine Mounting		MN-SB-10390
01/94 →	Stabiliser Mounting		MN-SB-5243
01/94 →	Suspension Arm Repair Kit		CV-RK-5313 for Wishbone (CV)
01/94 →	Suspension Arm Repair Kit		MN-RK-7280 for Drag Link;for Semi-Trailing Arm; for Wishbone (CV)
01/94 →	Suspension Arm Repair Kit		MN-RK-7287 for Wishbone (CV)
01/94 →	Tie Rod	MN-DL-12284	
01/94 →	Tie Rod End	CV-ES-2149	for Push Rod
01/94 →	Tie Rod End	CV-ES-14162	for Steering Rod
01/94 →	Tie Rod End	CV-ES-14163	for Steering Rod
01/94 →	Track Control Arm		MN-DL-5212 Trailing Arm, Drive Axle;Air Suspension Axle
01/94 →	Track Control Arm		MN-VB-5222 Wishbone (CV)
01/94 →	Track Control Arm		MN-VB-5222 Wishbone (CV), Drive Axle;Air Suspension Axle
01/94 →	Track Control Arm	MN-TC-14112	Control Arm

19.403 FAC

01/94 →	Ball Head, gearshift linkage	CV-ES-2119	
01/94 →	Ball Head, gearshift linkage	CV-ES-2120	
01/94 →	Ball Head, gearshift linkage	CV-ES-2182	
01/94 →	Centre Rod	MN-DL-2160	Coupling Rod
01/94 →	Centre Rod	MN-DL-2172	Push Rod
01/94 →	Centre Rod	MN-DL-2174	Push Rod
01/94 →	Centre Rod	MN-DL-2175	Push Rod
01/94 →	Centre Rod	MN-DL-2176	Push Rod
01/94 →	Centre Rod	MN-DL-2177	Push Rod
01/94 →	Centre Rod	MN-DL-3588	Push Rod
01/94 →	Centre Rod	MN-DL-12391	for Steering Rod
01/94 →	Centre Rod	MN-DL-12421	for Steering Rod
01/94 →	Engine Mounting		MN-SB-10390

CV-ES-2119

Length: 55
Cone Ø: d1 Ø 10 / d2 Ø 10
Thread: M12 x 1,75 LHT
81953016063, 81953016131



CV-ES-2120

Length: 115
Cone Ø: d1 Ø 12,4 / d2 Ø 10,8
Thread: M14 x 1,5 RHT
03008500A, 81953016200, 81953016202,
81953016203, 81953016227



CV-ES-2149

Length: 160
Cone Ø: d1 Ø 30 / d2 Ø 27
Thread: M30 x 1,5 RHT
81953016263



CV-ES-2182

Length: 55
Cone Ø: d1 Ø 10 / d2 Ø 10
Thread: M12 x 1,75 RHT
81953016064, 81953016170



CV-ES-14162

Length: 125
Cone Ø: d1 Ø 30 / d2 Ø 27
Thread: M30 x 1,5 LHT
81953010015, 81953010083, 81953010087,
81953016029, 81953016030, 81953016043,
81953016044, 81953016050, 81953016054,
81953016087, 81953016091, 81953016107,
81953016120, 81953016125, 81953016152,
81953016155, 81953016157, 81953016168,
81953016179, 81953016181, 81953016223,
81953016237, 81953016254, 81953016275,
81953016279, 81953016351



CV-ES-14163

Length: 125
Cone Ø: d1 Ø 30 / d2 Ø 27
Thread: M30 x 1,5 RHT
95301.0084, 90804102156, 90804102272,
90804102696, 90804102710, 81953010016,
81953010075, 81953010084, 81953010088,
81953010094, 81953010103, 81953016030,
81953016043, 81953016048, 81953016049,
81953016053, 81953016061, 81953016090,
81953016108, 81953016112, 81953016126,
81953016143, 81953016149, 81953016154,
81953016156, 81953016168, 81953016178,
81953016194, 81953016206, 81953016224,
81953016234, 81953016242, 81953016252,
81953016274, 81953016278, 81953016284,
81953016286, 81953016308, 81953016310,
81953016312, 81953016347, 81953016350,
81953016352, 82953016012, 88953016014,
N2953016001



CV-RK-5313

Ø: 90
03304800A, 81953016132



MN-DL-2160

Length: 1652 Ø: 50
Cone Ø: d1 Ø 30 / d2 Ø 27
81467106112, 81467106163, 81467106165,
81467106198, 81467106353, 81467106354,
81467106361, 81467116725



MN-DL-2172

Length: 1050 Ø: 42
Cone Ø: d1 Ø 30 / d2 Ø 27
81466106374, 81466116019, 82466106080,
82466106189, 82466106190



MN-DL-2174

Length: 1588 Ø: 52
Cone Ø: d1 Ø 30 / d2 Ø 27
81467106378, 81467106912



MN-DL-2175

Length: 1628 Ø: 50
Cone Ø: d1 Ø 30 / d2 Ø 27
81467106396, 81467106904



MN-DL-2176

Length: 1628 Ø: 48
Cone Ø: d1 Ø 30 / d2 Ø 27
81466106779, 81466106780, 81466106782



MN-DL-2177

Length: 1664 Ø: 50
Cone Ø: d1 Ø 30 / d2 Ø 27
81467106994, 81467116726



MN-DL-3588

Length: 1035 Ø: 48
Cone Ø: d1 Ø 30 / d2 Ø 27
81466106333, 81466106334, 81466106354,
81466106355, 81466106360, 81466106361,
81466106721, 81466106722, 81466106723,
81466116216



MN-DL-5212

Length: 577 Ø: 48
Hole Distance: 130 / 130
81432206096, 81432206097, 81432206098,
81432206129, 81432209096, 81432209129,
81432306014, 81432306030



MN-DL-8197

Length: 1055 Ø: 42
Cone Ø: d1 Ø 30 / d2 Ø 27
03207500A, 81466116003, 81466116004,
81466116005



MN-DL-12284

Length: 1530 Ø: 50
Cone Ø: d1 Ø 30 / d2 Ø 27
81466106579, 81466106580, 81466106624,
81466116720, 81467116720, 81467116730,
81467116952



MN-DL-12391

Length: 1050 Ø: 52
Cone Ø: d1 Ø 30 / d2 Ø 27
82466106057, 82466106147



MN-DL-12421

Length: 1070 Ø: 48
Cone Ø: d1 Ø 30 / d2 Ø 27
Thread: M30 x 1,5 RHT
81466106656, 81466106659, 81466106669,
81466116006, 81466116007



MN-RK-7280

Ø: 75
Hole Distance: 115
Thick/Height: 24
0550806, 0639370, 689748, 10307400A,
81432306051, 81432306068, 81432706064



MN-RK-7287

Ø: 90
Hole Distance: 152
Thick/Height: 35
03304700A, 81953016133



MN-SB-5243

Length: 55 Ø: 78
Thick/Height: 60
03311100A, 81437040061, 81437220020



MN-SB-10390

Ø: 70
Thick/Height: 85/85
81960200341, 81960200373, 81960200385,
81960200408, 81960200418



MN-TC-14112

Length: 777
Ø: 60
Hole Distance: 115 / 115
81432206106, 81432306049



MN-VB-5222

Length: 627 Ø: 50
Hole Distance: 152 / 152
81432706030, 81432706034, 81432706054,
81432706055, 81432706056, 81432706057,
81432706067, 81432706068, 81432706074,
81432706075, 81432706076, 81432706077,
81432706078, 81432706081, 81432706082,
81432709034, 81432709076, 81432709078,
8143706054





F 2000 ...

19.403 FAC ...	01/94 →	Suspension Arm Repair Kit		MN-RK-7291	for Drag Link
	01/94 →	Tie Rod End	CV-ES-2146		
	01/94 →	Tie Rod End	CV-ES-2149		for Push Rod
	01/94 →	Tie Rod End	CV-ES-14162		for Steering Rod
	01/94 →	Tie Rod End	CV-ES-14163		for Steering Rod
	01/94 →	Tie Rod End	SC-ES-8517		for Push Rod
	01/94 →	Track Control Arm		MN-DL-5212	Trailing Arm, Drive Axle; Tag Axle, for Pneumatic Suspension vehicles
	01/94 →	Track Control Arm		MN-VB-5222	Wishbone (CV)
19.403 FAK, FA-KI	01/94 →	Ball Head, gearshift linkage	CV-ES-2119		
	01/94 →	Ball Head, gearshift linkage	CV-ES-2120		
	01/94 →	Ball Head, gearshift linkage	CV-ES-2182		
	01/94 →	Centre Rod	MN-DL-2160		Coupling Rod
	01/94 →	Centre Rod	MN-DL-2172		Push Rod
	01/94 →	Centre Rod	MN-DL-2174		Push Rod
	01/94 →	Centre Rod	MN-DL-2175		Push Rod
	01/94 →	Centre Rod	MN-DL-2176		Push Rod
	01/94 →	Centre Rod	MN-DL-2177		Push Rod
	01/94 →	Centre Rod	MN-DL-3588		Push Rod
	01/94 →	Centre Rod	MN-DL-12391		for Steering Rod
	01/94 →	Centre Rod	MN-DL-12421		for Steering Rod
	01/94 →	Engine Mounting		MN-SB-10390	
	01/94 →	Suspension Arm Repair Kit		MN-RK-7291	for Drag Link
	01/94 →	Tie Rod End	CV-ES-2146		
	01/94 →	Tie Rod End	CV-ES-2149		for Push Rod
	01/94 →	Tie Rod End	CV-ES-14162		for Steering Rod
	01/94 →	Tie Rod End	CV-ES-14163		for Steering Rod
	01/94 →	Tie Rod End	SC-ES-8517		for Push Rod
	01/94 →	Track Control Arm		MN-DL-5212	Trailing Arm, Drive Axle; Tag Axle, for Pneumatic Suspension vehicles
	01/94 →	Track Control Arm		MN-VB-5222	Wishbone (CV)
	19.403 FAS	01/94 →	Ball Head, gearshift linkage	CV-ES-2119	
01/94 →		Ball Head, gearshift linkage	CV-ES-2120		
01/94 →		Ball Head, gearshift linkage	CV-ES-2182		
01/94 →		Centre Rod	MN-DL-2160		Coupling Rod
01/94 →		Centre Rod	MN-DL-2172		Push Rod
01/94 →		Centre Rod	MN-DL-2174		Push Rod
01/94 →		Centre Rod	MN-DL-2175		Push Rod
01/94 →		Centre Rod	MN-DL-2176		Push Rod
01/94 →		Centre Rod	MN-DL-2177		Push Rod
01/94 →		Centre Rod	MN-DL-3588		Push Rod
01/94 →		Centre Rod	MN-DL-12391		for Steering Rod
01/94 →		Centre Rod	MN-DL-12421		for Steering Rod
01/94 →		Engine Mounting		MN-SB-10390	
01/94 →		Suspension Arm Repair Kit		MN-RK-7291	for Drag Link
01/94 →		Tie Rod End	CV-ES-2146		
01/94 →		Tie Rod End	CV-ES-2149		for Push Rod
01/94 →		Tie Rod End	CV-ES-14162		for Steering Rod
01/94 →		Tie Rod End	CV-ES-14163		for Steering Rod
01/94 →		Tie Rod End	SC-ES-8517		for Push Rod
01/94 →		Track Control Arm		MN-DL-5212	Trailing Arm, Drive Axle; Tag Axle, for Pneumatic Suspension vehicles
01/94 →		Track Control Arm		MN-VB-5222	Wishbone (CV)
19.403 FC, FLC, FLLC, FRC, FLRC, F-NL		01/94 →	Ball Head, gearshift linkage	CV-ES-2119	
	01/94 →	Ball Head, gearshift linkage	CV-ES-2120		
	01/94 →	Ball Head, gearshift linkage	CV-ES-2182		
	01/94 →	Centre Rod	MN-DL-2160		Coupling Rod
	01/94 →	Centre Rod	MN-DL-2172		Push Rod
	01/94 →	Centre Rod	MN-DL-2174		Push Rod
	01/94 →	Centre Rod	MN-DL-2175		Push Rod
	01/94 →	Centre Rod	MN-DL-2176		Push Rod
	01/94 →	Centre Rod	MN-DL-2177		Push Rod
	01/94 →	Centre Rod	MN-DL-3588		Push Rod

CV-ES-2119

Length: 55
Cone Ø: d1 Ø 10 / d2 Ø 10
Thread: M12 x 1,75 LHT
81953016063, 81953016131



CV-ES-2120

Length: 115
Cone Ø: d1 Ø 12,4 / d2 Ø 10,8
Thread: M14 x 1,5 RHT
03008500A, 81953016200, 81953016202,
81953016203, 81953016227



CV-ES-2146

Length: 80
Cone Ø: d1 Ø 30 / d2 Ø 27
Thread: M26 x 1,5 RHT
42533102, 81953016219, 81953016225,
81953016226, 81953016267, 81953016291



CV-ES-2149

Length: 160
Cone Ø: d1 Ø 30 / d2 Ø 27
Thread: M30 x 1,5 RHT
81953016263



CV-ES-2182

Length: 55
Cone Ø: d1 Ø 10 / d2 Ø 10
Thread: M12 x 1,75 RHT
81953016064, 81953016170



CV-ES-14162

Length: 125
Cone Ø: d1 Ø 30 / d2 Ø 27
Thread: M30 x 1,5 LHT
81953010015, 81953010083, 81953010087,
81953016029, 81953016030, 81953016043,
81953016044, 81953016050, 81953016054,
81953016087, 81953016091, 81953016107,
81953016120, 81953016125, 81953016152,
81953016155, 81953016157, 81953016168,
81953016179, 81953016181, 81953016223,
81953016237, 81953016254, 81953016275,
81953016279, 81953016351



CV-ES-14163

Length: 125
Cone Ø: d1 Ø 30 / d2 Ø 27
Thread: M30 x 1,5 RHT
95301.0084, 90804102156, 90804102272,
90804102696, 90804102710, 81953010016,
81953010075, 81953010084, 81953010088,
81953010094, 81953010103, 81953016030,
81953016043, 81953016048, 81953016049,
81953016053, 81953016061, 81953016090,
81953016108, 81953016112, 81953016126,
81953016143, 81953016149, 81953016154,
81953016156, 81953016168, 81953016178,
81953016194, 81953016206, 81953016224,
81953016234, 81953016242, 81953016252,
81953016274, 81953016278, 81953016284,
81953016286, 81953016308, 81953016310,
81953016312, 81953016347, 81953016350,
81953016352, 82953016012, 88953016014,
N2953016001



MN-DL-2160

Length: 1652 Ø: 50
Cone Ø: d1 Ø 30 / d2 Ø 27
81467106112, 81467106163, 81467106165,
81467106198, 81467106353, 81467106354,
81467106361, 81467116725



MN-DL-2172

Length: 1050 Ø: 42
Cone Ø: d1 Ø 30 / d2 Ø 27
81466106374, 81466116019, 82466106080,
82466106189, 82466106190



MN-DL-2174

Length: 1588 Ø: 52
Cone Ø: d1 Ø 30 / d2 Ø 27
81467106378, 81467106912



MN-DL-2175

Length: 1628 Ø: 50
Cone Ø: d1 Ø 30 / d2 Ø 27
81467106396, 81467106904



MN-DL-2176

Length: 1628 Ø: 48
Cone Ø: d1 Ø 30 / d2 Ø 27
81466106779, 81466106780, 81466106782



MN-DL-2177

Length: 1664 Ø: 50
Cone Ø: d1 Ø 30 / d2 Ø 27
81467106994, 81467116726



MN-DL-3588

Length: 1035 Ø: 48
Cone Ø: d1 Ø 30 / d2 Ø 27
81466106333, 81466106334, 81466106354,
81466106355, 81466106360, 81466106361,
81466106721, 81466106722, 81466106723,
81466116216



MN-DL-5212

Length: 577 Ø: 48
Hole Distance: 130 / 130
81432206096, 81432206097, 81432206098,
81432206129, 81432209096, 81432209129,
81432306014, 81432306030



MN-DL-12391

Length: 1050 Ø: 52
Cone Ø: d1 Ø 30 / d2 Ø 27
82466106057, 82466106147



MN-DL-12421

Length: 1070 Ø: 48
Cone Ø: d1 Ø 30 / d2 Ø 27
Thread: M30 x 1,5 RHT
81466106656, 81466106659, 81466106669,
81466116006, 81466116007



MN-RK-7291

Ø: 72
Hole Distance: 130
Thick/Height: 30
10307800A, 81432206108, 81432206132



MN-SB-10390

Ø: 70 Thick/Height: 85/85
81960200341, 81960200373, 81960200385,
81960200408, 81960200418



MN-VB-5222

Length: 627 Ø: 50
Hole Distance: 152 / 152
81432706030, 81432706034, 81432706054,
81432706055, 81432706056, 81432706057,
81432706067, 81432706068, 81432706074,
81432706075, 81432706076, 81432706077,
81432706078, 81432706081, 81432706082,
81432709034, 81432709076, 81432709078,
8143706054



SC-ES-8517

Length: 140
Cone Ø: d1 Ø 30 / d2 Ø 27
Thread: M30 x 1,5 RHT
81953016286





F 2000 ...

19.403 FC, FLC, FLLC, FRC, FLRC, F-NL ...	01/94 →	Centre Rod	MN-DL-8197		Push Rod	
	01/94 →	Centre Rod	MN-DL-12421		for Steering Rod	
	01/94 →	Engine Mounting		MN-SB-10390		
	01/94 →	Stabiliser Mounting		MN-SB-5243		
	01/94 →	Suspension Arm Repair Kit		CV-RK-5313	for Wishbone (CV)	
	01/94 →	Suspension Arm Repair Kit		MN-RK-7280	for Drag Link;for Semi-Trailing Arm; for Wishbone (CV)	
	01/94 →	Suspension Arm Repair Kit		MN-RK-7287	for Wishbone (CV)	
	01/94 →	Tie Rod	MN-DL-8371			
	01/94 →	Tie Rod	MN-DL-12284			
	01/94 →	Tie Rod End	CV-ES-2146			
	01/94 →	Tie Rod End	CV-ES-2149		for Push Rod	
	01/94 →	Tie Rod End	CV-ES-14162		for Steering Rod	
	01/94 →	Tie Rod End	CV-ES-14163		for Steering Rod	
	01/94 →	Track Control Arm		MN-DL-5212	Trailing Arm, Drive Axle;Air Suspension Axle	
	01/94 →	Track Control Arm		MN-VB-5222	Wishbone (CV)	
	01/94 →	Track Control Arm		MN-VB-5222	Wishbone (CV), Drive Axle;Air Suspension Axle	
	01/94 →	Track Control Arm	MN-TC-14112		Control Arm	
	19.403 FK, F-KI, FK-L, FLK, FL-KI, F-NL	01/94 →	Ball Head, gearshift linkage	CV-ES-2119		
		01/94 →	Ball Head, gearshift linkage	CV-ES-2120		
		01/94 →	Ball Head, gearshift linkage	CV-ES-2182		
01/94 →		Centre Rod	MN-DL-2160		Coupling Rod	
01/94 →		Centre Rod	MN-DL-2172		Push Rod	
01/94 →		Centre Rod	MN-DL-2174		Push Rod	
01/94 →		Centre Rod	MN-DL-2175		Push Rod	
01/94 →		Centre Rod	MN-DL-2176		Push Rod	
01/94 →		Centre Rod	MN-DL-2177		Push Rod	
01/94 →		Centre Rod	MN-DL-3588		Push Rod	
01/94 →		Centre Rod	MN-DL-8197		Push Rod	
01/94 →		Centre Rod	MN-DL-12421		for Steering Rod	
01/94 →		Engine Mounting		MN-SB-10390		
01/94 →		Stabiliser Mounting		MN-SB-5243		
01/94 →		Suspension Arm Repair Kit		CV-RK-5313	for Wishbone (CV)	
01/94 →		Suspension Arm Repair Kit		MN-RK-7280	for Drag Link;for Semi-Trailing Arm; for Wishbone (CV)	
01/94 →		Suspension Arm Repair Kit		MN-RK-7287	for Wishbone (CV)	
01/94 →		Tie Rod	MN-DL-12284			
01/94 →		Tie Rod End	CV-ES-2146			
01/94 →		Tie Rod End	CV-ES-2149		for Push Rod	
01/94 →	Tie Rod End	CV-ES-14162		for Steering Rod		
01/94 →	Tie Rod End	CV-ES-14163		for Steering Rod		
01/94 →	Track Control Arm		MN-DL-5212	Trailing Arm, Drive Axle;Air Suspension Axle		
01/94 →	Track Control Arm		MN-VB-5222	Wishbone (CV), Drive Axle;Air Suspension Axle		
19.403 FS, FLS, FLLS, FRS, FLRS, FLLRS	01/94 →	Ball Head, gearshift linkage	CV-ES-2119			
	01/94 →	Ball Head, gearshift linkage	CV-ES-2120			
	01/94 →	Ball Head, gearshift linkage	CV-ES-2182			
	01/94 →	Centre Rod	MN-DL-2160		Coupling Rod	
	01/94 →	Centre Rod	MN-DL-2172		Push Rod	
	01/94 →	Centre Rod	MN-DL-2174		Push Rod	
	01/94 →	Centre Rod	MN-DL-2175		Push Rod	
	01/94 →	Centre Rod	MN-DL-2176		Push Rod	
	01/94 →	Centre Rod	MN-DL-2177		Push Rod	
	01/94 →	Centre Rod	MN-DL-3588		Push Rod	
	01/94 →	Centre Rod	MN-DL-8197		Push Rod	
	01/94 →	Centre Rod	MN-DL-12421		for Steering Rod	
	01/94 →	Engine Mounting		MN-SB-10390		
	01/94 →	Stabiliser Mounting		MN-SB-5243		
	01/94 →	Suspension Arm Repair Kit		CV-RK-5313	for Wishbone (CV)	
	01/94 →	Suspension Arm Repair Kit		MN-RK-7280	for Drag Link;for Semi-Trailing Arm; for Wishbone (CV)	
	01/94 →	Suspension Arm Repair Kit		MN-RK-7287	for Wishbone (CV)	
	01/94 →	Tie Rod	MN-DL-8371			
	01/94 →	Tie Rod	MN-DL-12284			

CV-ES-2119

Length: 55
Cone Ø: d1 Ø 10 / d2 Ø 10
Thread: M12 x 1,75 LHT
81953016063, 81953016131



CV-ES-2120

Length: 115
Cone Ø: d1 Ø 12,4 / d2 Ø 10,8
Thread: M14 x 1,5 RHT
03008500A, 81953016200, 81953016202,
81953016203, 81953016227



CV-ES-2146

Length: 80
Cone Ø: d1 Ø 30 / d2 Ø 27
Thread: M26 x 1,5 RHT
42533102, 81953016219, 81953016225,
81953016226, 81953016267, 81953016291



CV-ES-2149

Length: 160
Cone Ø: d1 Ø 30 / d2 Ø 27
Thread: M30 x 1,5 RHT
81953016263



CV-ES-2182

Length: 55
Cone Ø: d1 Ø 10 / d2 Ø 10
Thread: M12 x 1,75 RHT
81953016064, 81953016170



CV-ES-14162

Length: 125
Cone Ø: d1 Ø 30 / d2 Ø 27
Thread: M30 x 1,5 LHT
81953010015, 81953010083, 81953010087,
81953016029, 81953016030, 81953016043,
81953016044, 81953016050, 81953016054,
81953016087, 81953016091, 81953016107,
81953016120, 81953016125, 81953016152,
81953016155, 81953016157, 81953016168,
81953016179, 81953016181, 81953016223,
81953016237, 81953016254, 81953016275,
81953016279, 81953016351



CV-ES-14163

Length: 125
Cone Ø: d1 Ø 30 / d2 Ø 27
Thread: M30 x 1,5 RHT
95301.0084, 90804102156, 90804102272,
90804102696, 90804102710, 81953010016,
81953010075, 81953010084, 81953010088,
81953010094, 81953010103, 81953016030,
81953016043, 81953016048, 81953016049,
81953016053, 81953016061, 81953016090,
81953016108, 81953016112, 81953016126,
81953016143, 81953016149, 81953016154,
81953016156, 81953016168, 81953016178,
81953016194, 81953016206, 81953016224,
81953016234, 81953016242, 81953016252,
81953016274, 81953016278, 81953016284,
81953016286, 81953016308, 81953016310,
81953016312, 81953016347, 81953016350,
81953016352, 82953016012, 88953016014,
N2953016001



CV-RK-5313

Ø: 90
03304800A, 81953016132



MN-DL-2160

Length: 1652 Ø: 50
Cone Ø: d1 Ø 30 / d2 Ø 27
81467106112, 81467106163, 81467106165,
81467106198, 81467106353, 81467106354,
81467106361, 81467116725



MN-DL-2172

Length: 1050 Ø: 42
Cone Ø: d1 Ø 30 / d2 Ø 27
81466106374, 81466116019, 82466106080,
82466106189, 82466106190



MN-DL-2174

Length: 1588 Ø: 52
Cone Ø: d1 Ø 30 / d2 Ø 27
81467106378, 81467106912



MN-DL-2175

Length: 1628 Ø: 50
Cone Ø: d1 Ø 30 / d2 Ø 27
81467106396, 81467106904



MN-DL-2176

Length: 1628 Ø: 48
Cone Ø: d1 Ø 30 / d2 Ø 27
81466106779, 81466106780, 81466106782



MN-DL-2177

Length: 1664 Ø: 50
Cone Ø: d1 Ø 30 / d2 Ø 27
81467106994, 81467116726



MN-DL-3588

Length: 1035 Ø: 48
Cone Ø: d1 Ø 30 / d2 Ø 27
81466106333, 81466106334, 81466106354,
81466106355, 81466106360, 81466106361,
81466106721, 81466106722, 81466106723,
81466116216



MN-DL-5212

Length: 577 Ø: 48
Hole Distance: 130 / 130
81432206096, 81432206097, 81432206098,
81432206129, 81432209096, 81432209129,
81432306014, 81432306030



MN-DL-8197

Length: 1055 Ø: 42
Cone Ø: d1 Ø 30 / d2 Ø 27
03207500A, 81466116003, 81466116004,
81466116005



MN-DL-8371

Length: 1625 Ø: 50
Cone Ø: d1 Ø 30 / d2 Ø 27
81467106966, 81467116714



MN-DL-12284

Length: 1530 Ø: 50
Cone Ø: d1 Ø 30 / d2 Ø 27
81466106579, 81466106580, 81466106624,
81466116720, 81467116720, 81467116730,
81467116952



MN-DL-12421

Length: 1070 Ø: 48
Cone Ø: d1 Ø 30 / d2 Ø 27
Thread: M30 x 1,5 RHT
81466106656, 81466106659, 81466106669,
81466116006, 81466116007



MN-RK-7280

Ø: 75
Hole Distance: 115
Thick/Height: 24
0550806, 0639370, 689748, 10307400A,
81432306051, 81432306068, 81432706064



MN-RK-7287

Ø: 90
Hole Distance: 152
Thick/Height: 35
03304700A, 81953016133



MN-SB-5243

Length: 55 Ø: 78
Thick/Height: 60
03311100A, 81437040061, 81437220020



MN-SB-10390

Ø: 70 Thick/Height: 85/85
81960200341, 81960200373, 81960200385,
81960200408, 81960200418



MN-TC-14112

Length: 777 Ø: 60
Hole Distance: 115 / 115
81432206106, 81432306049



MN-VB-5222

Length: 627 Ø: 50
Hole Distance: 152 / 152
81432706030, 81432706034, 81432706054,
81432706055, 81432706056, 81432706057,
81432706067, 81432706068, 81432706074,
81432706075, 81432706076, 81432706077,
81432706078, 81432706081, 81432706082,
81432709034, 81432709076, 81432709078,
8143706054





F 2000 ...

19.403 FS, FLS, FLLS, FRS, FLRS, FLLRS ...	01/94 →	Tie Rod End	CV-ES-2146		
	01/94 →	Tie Rod End	CV-ES-2149		for Push Rod
	01/94 →	Tie Rod End	CV-ES-14162		for Steering Rod
	01/94 →	Tie Rod End	CV-ES-14163		for Steering Rod
	01/94 →	Track Control Arm		MN-DL-5212	Trailing Arm, Drive Axle; Air Suspension Axle
	01/94 →	Track Control Arm		MN-VB-5222	Wishbone (CV)
	01/94 →	Track Control Arm		MN-VB-5222	Wishbone (CV), Drive Axle; Air Suspension Axle
	01/94 →	Track Control Arm	MN-TC-14112		Control Arm
19.414 FAC	06/98 →	Ball Head, gearshift linkage	CV-ES-2120		
	06/98 →	Centre Rod	MN-DL-2174		Push Rod
	06/98 →	Centre Rod	MN-DL-12421		for Steering Rod
	06/98 →	Suspension Arm Repair Kit		MN-RK-7291	for Drag Link
	06/98 →	Tie Rod End	CV-ES-14163		for Steering Rod
	06/98 →	Tie Rod End	SC-ES-8517		for Push Rod
	06/98 →	Track Control Arm		MN-DL-5212	Trailing Arm, Drive Axle; Tag Axle, for Pneumatic Suspension vehicles
	06/98 →	Track Control Arm		MN-VB-5222	Wishbone (CV)
19.414 FAK, FA-KI, FAK-L	06/98 →	Ball Head, gearshift linkage	CV-ES-2120		
	06/98 →	Centre Rod	MN-DL-2174		Push Rod
	06/98 →	Centre Rod	MN-DL-12421		for Steering Rod
	06/98 →	Suspension Arm Repair Kit		MN-RK-7291	for Drag Link
	06/98 →	Tie Rod End	CV-ES-14163		for Steering Rod
	06/98 →	Tie Rod End	SC-ES-8517		for Push Rod
	06/98 →	Track Control Arm		MN-DL-5212	Trailing Arm, Drive Axle; Tag Axle, for Pneumatic Suspension vehicles
	06/98 →	Track Control Arm		MN-VB-5222	Wishbone (CV)
19.414 FAS	06/98 →	Ball Head, gearshift linkage	CV-ES-2120		
	06/98 →	Centre Rod	MN-DL-2174		Push Rod
	06/98 →	Centre Rod	MN-DL-12421		for Steering Rod
	06/98 →	Suspension Arm Repair Kit		MN-RK-7291	for Drag Link
	06/98 →	Tie Rod End	CV-ES-14163		for Steering Rod
	06/98 →	Tie Rod End	SC-ES-8517		for Push Rod
	06/98 →	Track Control Arm		MN-DL-5212	Trailing Arm, Drive Axle; Tag Axle, for Pneumatic Suspension vehicles
	06/98 →	Track Control Arm		MN-VB-5222	Wishbone (CV)
19.414 FC, FLC, FLLC, FRC, FLRC, FLLRC, FLL, FLLR, F-NL	06/98 →	Ball Head, gearshift linkage	CV-ES-2120		
	06/98 →	Centre Rod	MN-DL-2160		Coupling Rod
	06/98 →	Centre Rod	MN-DL-2172		Push Rod
	06/98 →	Centre Rod	MN-DL-2175		Push Rod
	06/98 →	Centre Rod	MN-DL-2176		Push Rod
	06/98 →	Centre Rod	MN-DL-2177		Push Rod
	06/98 →	Centre Rod	MN-DL-3588		Push Rod
	06/98 →	Centre Rod	MN-DL-8197		Push Rod
	06/98 →	Centre Rod	MN-DL-12391		for Steering Rod
	06/98 →	Suspension Arm Repair Kit		MN-RK-7280	for Drag Link; for Semi-Trailing Arm; for Wishbone (CV)
	06/98 →	Suspension Arm Repair Kit	MN-RK-7280	MN-RK-7280	for Drag Link; for Semi-Trailing Arm; for Wishbone (CV)
	06/98 →	Tie Rod End	CV-ES-2149		for Push Rod
	06/98 →	Tie Rod End	CV-ES-14162		for Steering Rod
	06/98 →	Tie Rod End	CV-ES-14163		for Steering Rod
	06/98 →	Tie Rod End	SC-ES-8517		for Push Rod
	06/98 →	Tie Rod End	SC-ES-8535		for Guide Rod
	06/98 →	Track Control Arm		MN-DL-5212	Trailing Arm, Drive Axle; Tag Axle, for Pneumatic Suspension vehicles
	06/98 →	Track Control Arm		MN-VB-5222	Wishbone (CV)
	06/98 →	Track Control Arm	MN-TC-14112		Control Arm, 1st Front Axle, for Pneumatic Suspension vehicles
	19.414 FK, F-KI, FK-L, FLK, FL-KI, F-NL	06/98 →	Ball Head, gearshift linkage	CV-ES-2120	
06/98 →		Centre Rod	MN-DL-2160		Coupling Rod
06/98 →		Centre Rod	MN-DL-2172		Push Rod
06/98 →		Centre Rod	MN-DL-2176		Push Rod
06/98 →		Centre Rod	MN-DL-3588		Push Rod

CV-ES-2120

Length: 115
Cone Ø: d1 Ø 12,4 / d2 Ø 10,8
Thread: M14 x 1,5 RHT
03008500A, 81953016200, 81953016202,
81953016203, 81953016227



CV-ES-2146

Length: 80
Cone Ø: d1 Ø 30 / d2 Ø 27
Thread: M26 x 1,5 RHT
42533102, 81953016219, 81953016225,
81953016226, 81953016267, 81953016291



CV-ES-2149

Length: 160
Cone Ø: d1 Ø 30 / d2 Ø 27
Thread: M30 x 1,5 RHT
81953016263



CV-ES-14162

Length: 125
Cone Ø: d1 Ø 30 / d2 Ø 27
Thread: M30 x 1,5 LHT
81953010015, 81953010083, 81953010087,
81953016029, 81953016030, 81953016043,
81953016044, 81953016050, 81953016054,
81953016087, 81953016091, 81953016107,
81953016120, 81953016125, 81953016152,
81953016155, 81953016157, 81953016168,
81953016179, 81953016181, 81953016223,
81953016237, 81953016254, 81953016275,
81953016279, 81953016351



CV-ES-14163

Length: 125
Cone Ø: d1 Ø 30 / d2 Ø 27
Thread: M30 x 1,5 RHT
95301.0084, 90804102156, 90804102272,
90804102696, 90804102710, 81953010016,
81953010075, 81953010084, 81953010088,
81953010094, 81953010103, 81953016030,
81953016043, 81953016048, 81953016049,
81953016053, 81953016061, 81953016090,
81953016108, 81953016112, 81953016126,
81953016143, 81953016149, 81953016154,
81953016156, 81953016168, 81953016178,
81953016194, 81953016206, 81953016224,
81953016234, 81953016242, 81953016252,
81953016274, 81953016278, 81953016284,
81953016286, 81953016308, 81953016310,
81953016312, 81953016347, 81953016350,
81953016352, 82953016012, 88953016014,
N2953016001



MN-DL-2160

Length: 1652 Ø: 50
Cone Ø: d1 Ø 30 / d2 Ø 27
81467106112, 81467106163, 81467106165,
81467106198, 81467106353, 81467106354,
81467106361, 81467116725



MN-DL-2172

Length: 1050 Ø: 42
Cone Ø: d1 Ø 30 / d2 Ø 27
81466106374, 81466116019, 82466106080,
82466106189, 82466106190



MN-DL-2174

Length: 1588 Ø: 52
Cone Ø: d1 Ø 30 / d2 Ø 27
81467106378, 81467106912



MN-DL-2175

Length: 1628 Ø: 50
Cone Ø: d1 Ø 30 / d2 Ø 27
81467106396, 81467106904



MN-DL-2176

Length: 1628 Ø: 48
Cone Ø: d1 Ø 30 / d2 Ø 27
81466106779, 81466106780, 81466106782



MN-DL-2177

Length: 1664 Ø: 50
Cone Ø: d1 Ø 30 / d2 Ø 27
81467106994, 81467116726



MN-DL-3588

Length: 1035 Ø: 48
Cone Ø: d1 Ø 30 / d2 Ø 27
81466106333, 81466106334, 81466106354,
81466106355, 81466106360, 81466106361,
81466106721, 81466106722, 81466106723,
81466116216



MN-DL-5212

Length: 577 Ø: 48
Hole Distance: 130 / 130
81432206096, 81432206097, 81432206098,
81432206129, 81432209096, 81432209129,
81432306014, 81432306030



MN-DL-8197

Length: 1055 Ø: 42
Cone Ø: d1 Ø 30 / d2 Ø 27
03207500A, 81466116003, 81466116004,
81466116005



MN-DL-12391

Length: 1050
Ø: 52
Cone Ø: d1 Ø 30 / d2 Ø 27
82466106057, 82466106147



MN-DL-12421

Length: 1070 Ø: 48
Cone Ø: d1 Ø 30 / d2 Ø 27
Thread: M30 x 1,5 RHT
81466106656, 81466106659, 81466106669,
81466116006, 81466116007



MN-RK-7280

Ø: 75
Hole Distance: 115
Thick/Height: 24
0550806, 0639370, 689748, 10307400A,
81432306051, 81432306068, 81432706064



MN-RK-7291

Ø: 72
Hole Distance: 130
Thick/Height: 30
10307800A, 81432206108, 81432206132



MN-TC-14112

Length: 777 Ø: 60
Hole Distance: 115 / 115
81432206106, 81432306049



MN-VB-5222

Length: 627 Ø: 50
Hole Distance: 152 / 152
81432706030, 81432706034, 81432706054,
81432706055, 81432706056, 81432706057,
81432706067, 81432706068, 81432706074,
81432706075, 81432706076, 81432706077,
81432706078, 81432706081, 81432706082,
81432709034, 81432709076, 81432709078,
8143706054



SC-ES-8517

Length: 140
Cone Ø: d1 Ø 30 / d2 Ø 27
Thread: M30 x 1,5 RHT
81953016286



SC-ES-8535

Length: 145
Cone Ø: d1 Ø 30 / d2 Ø 27
Thread: M30 x 1,5 RHT
81953016271, 81953016325





F 2000 ...

19.414 FK, F-KI, FK-L, FLK, FL-KI, F-NL ...	06/98 →	Centre Rod	MN-DL-8197		Push Rod	
	06/98 →	Centre Rod	MN-DL-12391		for Steering Rod	
	06/98 →	Suspension Arm Repair Kit		MN-RK-7280	for Drag Link; for Semi-Trailing Arm; for Wishbone (CV)	
	06/98 →	Tie Rod End	CV-ES-2149		for Push Rod	
	06/98 →	Tie Rod End	CV-ES-14162		for Steering Rod	
	06/98 →	Tie Rod End	CV-ES-14163		for Steering Rod	
	06/98 →	Track Control Arm		MN-DL-5212	Trailing Arm, Drive Axle; Tag Axle, for Pneumatic Suspension vehicles	
	06/98 →	Track Control Arm		MN-VB-5222	Wishbone (CV)	
19.414 FS, FLS, FLLS, FRS, FLRS, FLLRS	06/98 →	Ball Head, gearshift linkage	CV-ES-2120			
	06/98 →	Centre Rod	MN-DL-2160		Coupling Rod	
	06/98 →	Centre Rod	MN-DL-2172		Push Rod	
	06/98 →	Centre Rod	MN-DL-2175		Push Rod	
	06/98 →	Centre Rod	MN-DL-2176		Push Rod	
	06/98 →	Centre Rod	MN-DL-2177		Push Rod	
	06/98 →	Centre Rod	MN-DL-3588		Push Rod	
	06/98 →	Centre Rod	MN-DL-8197		Push Rod	
	06/98 →	Centre Rod	MN-DL-12391		for Steering Rod	
	06/98 →	Suspension Arm Repair Kit		MN-RK-7280	for Drag Link; for Semi-Trailing Arm; for Wishbone (CV)	
	06/98 →	Suspension Arm Repair Kit	MN-RK-7280	MN-RK-7280	for Drag Link; for Semi-Trailing Arm; for Wishbone (CV)	
	06/98 →	Tie Rod End	CV-ES-2149		for Push Rod	
	06/98 →	Tie Rod End	CV-ES-14162		for Steering Rod	
	06/98 →	Tie Rod End	CV-ES-14163		for Steering Rod	
	06/98 →	Tie Rod End	SC-ES-8517		for Push Rod	
	06/98 →	Track Control Arm		MN-DL-5212	Trailing Arm, Drive Axle; Tag Axle, for Pneumatic Suspension vehicles	
	06/98 →	Track Control Arm		MN-VB-5222	Wishbone (CV)	
	06/98 →	Track Control Arm	MN-TC-14112		Control Arm, 1st Front Axle, for Pneumatic Suspension vehicles	
	19.423 FAC	01/94 →12/95	Ball Head, gearshift linkage	CV-ES-2119		
		01/94 →12/95	Ball Head, gearshift linkage	CV-ES-2120		
01/94 →12/95		Ball Head, gearshift linkage	CV-ES-2182			
01/94 →12/95		Centre Rod	MN-DL-2160		Coupling Rod	
01/94 →12/95		Centre Rod	MN-DL-2172		Push Rod	
01/94 →12/95		Centre Rod	MN-DL-2174		Push Rod	
01/94 →12/95		Centre Rod	MN-DL-2175		Push Rod	
01/94 →12/95		Centre Rod	MN-DL-2176		Push Rod	
01/94 →12/95		Centre Rod	MN-DL-2177		Push Rod	
01/94 →12/95		Centre Rod	MN-DL-3588		Push Rod	
01/94 →12/95		Centre Rod	MN-DL-12391		for Steering Rod	
01/94 →12/95		Centre Rod	MN-DL-12421		for Steering Rod	
01/94 →12/95		Engine Mounting		MN-SB-10390		
01/94 →12/95		Suspension Arm Repair Kit		MN-RK-7291	for Drag Link	
01/94 →12/95		Tie Rod End	CV-ES-2149		for Push Rod	
01/94 →12/95		Tie Rod End	CV-ES-14162		for Steering Rod	
01/94 →12/95		Tie Rod End	CV-ES-14163		for Steering Rod	
01/94 →12/95		Tie Rod End	SC-ES-8517		for Push Rod	
01/94 →12/95		Track Control Arm		MN-DL-5212	Trailing Arm, Drive Axle; Tag Axle, for Pneumatic Suspension vehicles	
01/94 →12/95		Track Control Arm		MN-VB-5222	Wishbone (CV)	
19.423 FAK, FA-KI	01/94 →	Ball Head, gearshift linkage	CV-ES-2119			
	01/94 →	Ball Head, gearshift linkage	CV-ES-2120			
	01/94 →	Ball Head, gearshift linkage	CV-ES-2182			
	01/94 →	Centre Rod	MN-DL-2160		Coupling Rod	
	01/94 →	Centre Rod	MN-DL-2172		Push Rod	
	01/94 →	Centre Rod	MN-DL-2174		Push Rod	
	01/94 →	Centre Rod	MN-DL-2175		Push Rod	
	01/94 →	Centre Rod	MN-DL-2176		Push Rod	
	01/94 →	Centre Rod	MN-DL-2177		Push Rod	
	01/94 →	Centre Rod	MN-DL-3588		Push Rod	

CV-ES-2119

Length: 55
Cone Ø: d1 Ø 10 / d2 Ø 10
Thread: M12 x 1,75 LHT
81953016063, 81953016131



CV-ES-2120

Length: 115
Cone Ø: d1 Ø 12,4 / d2 Ø 10,8
Thread: M14 x 1,5 RHT
03008500A, 81953016200, 81953016202, 81953016203, 81953016227



CV-ES-2149

Length: 160
Cone Ø: d1 Ø 30 / d2 Ø 27
Thread: M30 x 1,5 RHT
81953016263



CV-ES-2182

Length: 55
Cone Ø: d1 Ø 10 / d2 Ø 10
Thread: M12 x 1,75 RHT
81953016064, 81953016170



CV-ES-14162

Length: 125
Cone Ø: d1 Ø 30 / d2 Ø 27
Thread: M30 x 1,5 LHT
81953010015, 81953010083, 81953010087, 81953016029, 81953016030, 81953016043, 81953016044, 81953016050, 81953016054, 81953016087, 81953016091, 81953016107, 81953016120, 81953016125, 81953016152, 81953016155, 81953016157, 81953016168, 81953016179, 81953016181, 81953016223, 81953016237, 81953016254, 81953016275, 81953016279, 81953016351



CV-ES-14163

Length: 125
Cone Ø: d1 Ø 30 / d2 Ø 27
Thread: M30 x 1,5 RHT
95301.0084, 90804102156, 90804102272, 90804102696, 90804102710, 81953010016, 81953010075, 81953010084, 81953010088, 81953010094, 81953010103, 81953016030, 81953016043, 81953016048, 81953016049, 81953016053, 81953016061, 81953016090, 81953016108, 81953016112, 81953016126, 81953016143, 81953016149, 81953016154, 81953016156, 81953016168, 81953016178, 81953016194, 81953016206, 81953016224, 81953016234, 81953016242, 81953016252, 81953016274, 81953016278, 81953016284, 81953016286, 81953016308, 81953016310, 81953016312, 81953016347, 81953016350, 81953016352, 82953016012, 88953016014, N2953016001



MN-DL-2160

Length: 1652 Ø: 50
Cone Ø: d1 Ø 30 / d2 Ø 27
81467106112, 81467106163, 81467106165, 81467106198, 81467106353, 81467106354, 81467106361, 81467116725



MN-DL-2172

Length: 1050 Ø: 42
Cone Ø: d1 Ø 30 / d2 Ø 27
81466106374, 81466116019, 82466106080, 82466106189, 82466106190



MN-DL-2174

Length: 1588 Ø: 52
Cone Ø: d1 Ø 30 / d2 Ø 27
81467106378, 81467106912



MN-DL-2175

Length: 1628 Ø: 50
Cone Ø: d1 Ø 30 / d2 Ø 27
81467106396, 81467106904



MN-DL-2176

Length: 1628 Ø: 48
Cone Ø: d1 Ø 30 / d2 Ø 27
81466106779, 81466106780, 81466106782



MN-DL-2177

Length: 1664 Ø: 50
Cone Ø: d1 Ø 30 / d2 Ø 27
81467106994, 81467116726



MN-DL-3588

Length: 1035 Ø: 48
Cone Ø: d1 Ø 30 / d2 Ø 27
81466106333, 81466106334, 81466106354, 81466106355, 81466106360, 81466106361, 81466106721, 81466106722, 81466106723, 81466116216



MN-DL-5212

Length: 577 Ø: 48
Hole Distance: 130 / 130
81432206096, 81432206097, 81432206098, 81432206129, 81432209096, 81432209129, 81432306014, 81432306030



MN-DL-8197

Length: 1055 Ø: 42
Cone Ø: d1 Ø 30 / d2 Ø 27
03207500A, 81466116003, 81466116004, 81466116005



MN-DL-12391

Length: 1050 Ø: 52
Cone Ø: d1 Ø 30 / d2 Ø 27
82466106057, 82466106147



MN-DL-12421

Length: 1070 Ø: 48
Cone Ø: d1 Ø 30 / d2 Ø 27
Thread: M30 x 1,5 RHT
81466106656, 81466106659, 81466106669, 81466116006, 81466116007



MN-RK-7280

Ø: 75
Hole Distance: 115
Thick/Height: 24
0550806, 0639370, 689748, 10307400A, 81432306051, 81432306068, 81432706064



MN-RK-7291

Ø: 72
Hole Distance: 130
Thick/Height: 30
10307800A, 81432206108, 81432206132



MN-SB-10390

Ø: 70 Thick/Height: 85/85
81960200341, 81960200373, 81960200385, 81960200408, 81960200418



MN-TC-14112

Length: 777 Ø: 60
Hole Distance: 115 / 115
81432206106, 81432306049



MN-VB-5222

Length: 627 Ø: 50
Hole Distance: 152 / 152
81432706030, 81432706034, 81432706054, 81432706055, 81432706056, 81432706057, 81432706067, 81432706068, 81432706074, 81432706075, 81432706076, 81432706077, 81432706078, 81432706081, 81432706082, 81432709034, 81432709076, 81432709078, 8143706054



SC-ES-8517

Length: 140
Cone Ø: d1 Ø 30 / d2 Ø 27
Thread: M30 x 1,5 RHT
81953016286





F 2000 ...

19.423 FAK, FA-KI ...	01/94 →	Centre Rod	MN-DL-12391		for Steering Rod	
	01/94 →	Centre Rod	MN-DL-12421		for Steering Rod	
	01/94 →	Engine Mounting		MN-SB-10390		
	01/94 →	Suspension Arm Repair Kit		MN-RK-7291	for Drag Link	
	01/94 →	Tie Rod End	CV-ES-2149		for Push Rod	
	01/94 →	Tie Rod End	CV-ES-14162		for Steering Rod	
	01/94 →	Tie Rod End	CV-ES-14163		for Steering Rod	
	01/94 →	Tie Rod End	SC-ES-8517		for Push Rod	
	01/94 →	Track Control Arm		MN-DL-5212	Trailing Arm, Drive Axle;Tag Axle, for Pneumatic Suspension vehicles	
	01/94 →	Track Control Arm		MN-VB-5222	Wishbone (CV)	
19.423 FAS	01/94 →12/95	Ball Head, gearshift linkage	CV-ES-2119			
	01/94 →12/95	Ball Head, gearshift linkage	CV-ES-2120			
	01/94 →12/95	Ball Head, gearshift linkage	CV-ES-2182			
	01/94 →12/95	Centre Rod	MN-DL-2160		Coupling Rod	
	01/94 →12/95	Centre Rod	MN-DL-2172		Push Rod	
	01/94 →12/95	Centre Rod	MN-DL-2174		Push Rod	
	01/94 →12/95	Centre Rod	MN-DL-2175		Push Rod	
	01/94 →12/95	Centre Rod	MN-DL-2176		Push Rod	
	01/94 →12/95	Centre Rod	MN-DL-2177		Push Rod	
	01/94 →12/95	Centre Rod	MN-DL-3588		Push Rod	
	01/94 →12/95	Centre Rod	MN-DL-12391		for Steering Rod	
	01/94 →12/95	Centre Rod	MN-DL-12421		for Steering Rod	
	01/94 →12/95	Engine Mounting		MN-SB-10390		
	01/94 →12/95	Suspension Arm Repair Kit		MN-RK-7291	for Drag Link	
	01/94 →12/95	Tie Rod End	CV-ES-2149		for Push Rod	
	01/94 →12/95	Tie Rod End	CV-ES-14162		for Steering Rod	
	01/94 →12/95	Tie Rod End	CV-ES-14163		for Steering Rod	
	01/94 →12/95	Tie Rod End	SC-ES-8517		for Push Rod	
	01/94 →12/95	Track Control Arm		MN-DL-5212	Trailing Arm, Drive Axle;Tag Axle, for Pneumatic Suspension vehicles	
	01/94 →12/95	Track Control Arm		MN-VB-5222	Wishbone (CV)	
19.423 FC, FLC, FLLC, F-NL	01/94 →	Ball Head, gearshift linkage	CV-ES-2119			
	01/94 →	Ball Head, gearshift linkage	CV-ES-2120			
	01/94 →	Ball Head, gearshift linkage	CV-ES-2182			
	01/94 →	Centre Rod	MN-DL-2160		Coupling Rod	
	01/94 →	Centre Rod	MN-DL-2172		Push Rod	
	01/94 →	Centre Rod	MN-DL-2174		Push Rod	
	01/94 →	Centre Rod	MN-DL-2175		Push Rod	
	01/94 →	Centre Rod	MN-DL-2176		Push Rod	
	01/94 →	Centre Rod	MN-DL-2177		Push Rod	
	01/94 →	Centre Rod	MN-DL-3588		Push Rod	
	01/94 →	Centre Rod	MN-DL-8197		Push Rod	
	01/94 →	Centre Rod	MN-DL-12421		for Steering Rod	
	01/94 →	Engine Mounting		MN-SB-10390		
	01/94 →	Stabiliser Mounting		MN-SB-5243		
	01/94 →	Suspension Arm Repair Kit		CV-RK-5313	for Wishbone (CV)	
	01/94 →	Suspension Arm Repair Kit		MN-RK-7280	for Drag Link;for Semi-Trailing Arm; for Wishbone (CV)	
	01/94 →	Suspension Arm Repair Kit		MN-RK-7287	for Wishbone (CV)	
	01/94 →	Tie Rod	MN-DL-12284			
	01/94 →	Tie Rod End	CV-ES-2149		for Push Rod	
	01/94 →	Tie Rod End	CV-ES-14162		for Steering Rod	
	01/94 →	Tie Rod End	CV-ES-14163		for Steering Rod	
	01/94 →	Track Control Arm		MN-DL-5212	Trailing Arm, Drive Axle;Air Suspension Axle	
	01/94 →	Track Control Arm		MN-VB-5222	Wishbone (CV)	
	01/94 →	Track Control Arm		MN-VB-5222	Wishbone (CV), Drive Axle;Air Suspension Axle Control Arm	
	01/94 →	Track Control Arm	MN-TC-14112			
	19.423 FK, F-KI, FK-L,FLK, FL-KI, F-NL	01/94 →	Ball Head, gearshift linkage	CV-ES-2119		
		01/94 →	Ball Head, gearshift linkage	CV-ES-2120		
		01/94 →	Ball Head, gearshift linkage	CV-ES-2182		
		01/94 →	Centre Rod	MN-DL-2160		Coupling Rod
		01/94 →	Centre Rod	MN-DL-2172		Push Rod

CV-ES-2119

Length: 55
Cone Ø: d1 Ø 10 / d2 Ø 10
Thread: M12 x 1,75 LHT
81953016063, 81953016131



CV-ES-2120

Length: 115
Cone Ø: d1 Ø 12,4 / d2 Ø 10,8
Thread: M14 x 1,5 RHT
03008500A, 81953016200, 81953016202,
81953016203, 81953016227



CV-ES-2149

Length: 160
Cone Ø: d1 Ø 30 / d2 Ø 27
Thread: M30 x 1,5 RHT
81953016263



CV-ES-2182

Length: 55
Cone Ø: d1 Ø 10 / d2 Ø 10
Thread: M12 x 1,75 RHT
81953016064, 81953016170



CV-ES-14162

Length: 125
Cone Ø: d1 Ø 30 / d2 Ø 27
Thread: M30 x 1,5 LHT
81953010015, 81953010083, 81953010087,
81953016029, 81953016030, 81953016043,
81953016044, 81953016050, 81953016054,
81953016087, 81953016091, 81953016107,
81953016120, 81953016125, 81953016152,
81953016155, 81953016157, 81953016168,
81953016179, 81953016181, 81953016223,
81953016237, 81953016254, 81953016275,
81953016279, 81953016351



CV-ES-14163

Length: 125
Cone Ø: d1 Ø 30 / d2 Ø 27
Thread: M30 x 1,5 RHT
95301.0084, 90804102156, 90804102272,
90804102696, 90804102710, 81953010016,
81953010075, 81953010084, 81953010088,
81953010094, 81953010103, 81953016030,
81953016043, 81953016048, 81953016049,
81953016053, 81953016061, 81953016090,
81953016108, 81953016112, 81953016126,
81953016143, 81953016149, 81953016154,
81953016156, 81953016168, 81953016178,
81953016194, 81953016206, 81953016224,
81953016234, 81953016242, 81953016252,
81953016274, 81953016278, 81953016284,
81953016286, 81953016308, 81953016310,
81953016312, 81953016347, 81953016350,
81953016352, 82953016012, 88953016014,
N2953016001



CV-RK-5313

Ø: 90
03304800A, 81953016132



MN-DL-2160

Length: 1652 Ø: 50
Cone Ø: d1 Ø 30 / d2 Ø 27
81467106112, 81467106163, 81467106165,
81467106198, 81467106353, 81467106354,
81467106361, 81467116725



MN-DL-2172

Length: 1050 Ø: 42
Cone Ø: d1 Ø 30 / d2 Ø 27
81466106374, 81466116019, 82466106080,
82466106189, 82466106190



MN-DL-2174

Length: 1588 Ø: 52
Cone Ø: d1 Ø 30 / d2 Ø 27
81467106378, 81467106912



MN-DL-2175

Length: 1628 Ø: 50
Cone Ø: d1 Ø 30 / d2 Ø 27
81467106396, 81467106904



MN-DL-2176

Length: 1628 Ø: 48
Cone Ø: d1 Ø 30 / d2 Ø 27
81466106779, 81466106780, 81466106782



MN-DL-2177

Length: 1664 Ø: 50
Cone Ø: d1 Ø 30 / d2 Ø 27
81467106994, 81467116726



MN-DL-3588

Length: 1035 Ø: 48
Cone Ø: d1 Ø 30 / d2 Ø 27
81466106333, 81466106334, 81466106354,
81466106355, 81466106360, 81466106361,
81466106721, 81466106722, 81466106723,
81466116216



MN-DL-5212

Length: 577 Ø: 48
Hole Distance: 130 / 130
81432206096, 81432206097, 81432206098,
81432206129, 81432209096, 81432209129,
81432306014, 81432306030



MN-DL-8197

Length: 1055 Ø: 42
Cone Ø: d1 Ø 30 / d2 Ø 27
03207500A, 81466116003, 81466116004,
81466116005



MN-DL-12284

Length: 1530 Ø: 50
Cone Ø: d1 Ø 30 / d2 Ø 27
81466106579, 81466106580, 81466106624,
81466116720, 81467116720, 81467116730,
81467116952



MN-DL-12391

Length: 1050 Ø: 52
Cone Ø: d1 Ø 30 / d2 Ø 27
82466106057, 82466106147



MN-DL-12421

Length: 1070
Ø: 48
Cone Ø: d1 Ø 30 / d2 Ø 27
Thread: M30 x 1,5 RHT
81466106656, 81466106659, 81466106669,
81466116006, 81466116007



MN-RK-7280

Ø: 75
Hole Distance: 115
Thick/Height: 24
0550806, 0639370, 689748, 10307400A,
81432306051, 81432306068, 81432706064



MN-RK-7287

Ø: 90
Hole Distance: 152
Thick/Height: 35
03304700A, 81953016133



MN-RK-7291

Ø: 72
Hole Distance: 130
Thick/Height: 30
10307800A, 81432206108, 81432206132



MN-SB-5243

Length: 55 Ø: 78
Thick/Height: 60
03311100A, 81437040061, 81437220020



MN-SB-10390

Ø: 70 Thick/Height: 85/85
81960200341, 81960200373, 81960200385,
81960200408, 81960200418



MN-TC-14112

Length: 777 Ø: 60
Hole Distance: 115 / 115
81432206106, 81432306049



MN-VB-5222

Length: 627 Ø: 50
Hole Distance: 152 / 152
81432706030, 81432706034, 81432706054,
81432706055, 81432706056, 81432706057,
81432706067, 81432706068, 81432706074,
81432706075, 81432706076, 81432706077,
81432706078, 81432706081, 81432706082,
81432709034, 81432709076, 81432709078,
8143706054



SC-ES-8517

Length: 140
Cone Ø: d1 Ø 30 / d2 Ø 27
Thread: M30 x 1,5 RHT
81953016286



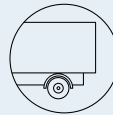

F 2000 ...

19.423 FK, F-KI, FK-L, FLK,
FL-KI, F-NL ...

01/94 →	Centre Rod	MN-DL-2174	Push Rod
01/94 →	Centre Rod	MN-DL-2175	Push Rod
01/94 →	Centre Rod	MN-DL-2176	Push Rod
01/94 →	Centre Rod	MN-DL-2177	Push Rod
01/94 →	Centre Rod	MN-DL-3588	Push Rod
01/94 →	Centre Rod	MN-DL-8197	Push Rod
01/94 →	Centre Rod	MN-DL-12421	for Steering Rod
01/94 →	Engine Mounting	MN-SB-10390	
01/94 →	Stabiliser Mounting	MN-SB-5243	
01/94 →	Suspension Arm Repair Kit	CV-RK-5313	for Wishbone (CV)
01/94 →	Suspension Arm Repair Kit	MN-RK-7280	for Drag Link;for Semi-Trailing Arm; for Wishbone (CV)
01/94 →	Suspension Arm Repair Kit	MN-RK-7287	for Wishbone (CV)
01/94 →	Tie Rod	MN-DL-12284	
01/94 →	Tie Rod End	CV-ES-2149	for Push Rod
01/94 →	Tie Rod End	CV-ES-14162	for Steering Rod
01/94 →	Tie Rod End	CV-ES-14163	for Steering Rod
01/94 →	Track Control Arm	MN-DL-5212	Trailing Arm, Drive Axle;Air Suspension Axle
01/94 →	Track Control Arm	MN-VB-5222	Wishbone (CV), Drive Axle;Air Suspension Axle

19.423 FS, FLS, FLLS

01/94 →	Ball Head, gearshift linkage	CV-ES-2119	
01/94 →	Ball Head, gearshift linkage	CV-ES-2120	
01/94 →	Ball Head, gearshift linkage	CV-ES-2182	
01/94 →	Centre Rod	MN-DL-2160	Coupling Rod
01/94 →	Centre Rod	MN-DL-2172	Push Rod
01/94 →	Centre Rod	MN-DL-2174	Push Rod
01/94 →	Centre Rod	MN-DL-2175	Push Rod
01/94 →	Centre Rod	MN-DL-2176	Push Rod
01/94 →	Centre Rod	MN-DL-2177	Push Rod
01/94 →	Centre Rod	MN-DL-3588	Push Rod
01/94 →	Centre Rod	MN-DL-8197	Push Rod
01/94 →	Centre Rod	MN-DL-12421	for Steering Rod
01/94 →	Engine Mounting	MN-SB-10390	
01/94 →	Stabiliser Mounting	MN-SB-5243	
01/94 →	Suspension Arm Repair Kit	CV-RK-5313	for Wishbone (CV)
01/94 →	Suspension Arm Repair Kit	MN-RK-7280	for Drag Link;for Semi-Trailing Arm; for Wishbone (CV)
01/94 →	Suspension Arm Repair Kit	MN-RK-7287	for Wishbone (CV)
01/94 →	Tie Rod	MN-DL-12284	
01/94 →	Tie Rod End	CV-ES-2149	for Push Rod
01/94 →	Tie Rod End	CV-ES-14162	for Steering Rod
01/94 →	Tie Rod End	CV-ES-14163	for Steering Rod
01/94 →	Track Control Arm	MN-DL-5212	Trailing Arm, Drive Axle;Air Suspension Axle
01/94 →	Track Control Arm	MN-VB-5222	Wishbone (CV)
01/94 →	Track Control Arm	MN-VB-5222	Wishbone (CV), Drive Axle;Air Suspension Axle
01/94 →	Track Control Arm	MN-TC-14112	Control Arm

19.463 FAC

01/94 →	Ball Head, gearshift linkage	CV-ES-2119	
01/94 →	Ball Head, gearshift linkage	CV-ES-2120	
01/94 →	Ball Head, gearshift linkage	CV-ES-2182	
01/94 →	Centre Rod	MN-DL-2160	Coupling Rod
01/94 →	Centre Rod	MN-DL-2172	Push Rod
01/94 →	Centre Rod	MN-DL-2174	Push Rod
01/94 →	Centre Rod	MN-DL-2175	Push Rod
01/94 →	Centre Rod	MN-DL-2176	Push Rod
01/94 →	Centre Rod	MN-DL-2177	Push Rod
01/94 →	Centre Rod	MN-DL-3588	Push Rod
01/94 →	Centre Rod	MN-DL-12391	for Steering Rod
01/94 →	Centre Rod	MN-DL-12421	for Steering Rod
01/94 →	Engine Mounting	MN-SB-10390	
01/94 →	Suspension Arm Repair Kit	MN-RK-7291	for Drag Link
01/94 →	Tie Rod End	CV-ES-2146	
01/94 →	Tie Rod End	CV-ES-2149	for Push Rod
01/94 →	Tie Rod End	CV-ES-14162	for Steering Rod
01/94 →	Tie Rod End	CV-ES-14163	for Steering Rod

CV-ES-2119

Length: 55
Cone Ø: d1 Ø 10 / d2 Ø 10
Thread: M12 x 1,75 LHT
81953016063, 81953016131



CV-ES-2120

Length: 115
Cone Ø: d1 Ø 12,4 / d2 Ø 10,8
Thread: M14 x 1,5 RHT
03008500A, 81953016200, 81953016202, 81953016203, 81953016227



CV-ES-2146

Length: 80
Cone Ø: d1 Ø 30 / d2 Ø 27
Thread: M26 x 1,5 RHT
42533102, 81953016219, 81953016225, 81953016226, 81953016267, 81953016291



CV-ES-2149

Length: 160
Cone Ø: d1 Ø 30 / d2 Ø 27
Thread: M30 x 1,5 RHT
81953016263



CV-ES-2182

Length: 55
Cone Ø: d1 Ø 10 / d2 Ø 10
Thread: M12 x 1,75 RHT
81953016064, 81953016170



CV-ES-14162

Length: 125
Cone Ø: d1 Ø 30 / d2 Ø 27
Thread: M30 x 1,5 LHT
81953010015, 81953010083, 81953010087, 81953016029, 81953016030, 81953016043, 81953016044, 81953016050, 81953016054, 81953016087, 81953016091, 81953016107, 81953016120, 81953016125, 81953016152, 81953016155, 81953016157, 81953016168, 81953016179, 81953016181, 81953016223, 81953016237, 81953016254, 81953016275, 81953016279, 81953016351



CV-ES-14163

Length: 125
Cone Ø: d1 Ø 30 / d2 Ø 27
Thread: M30 x 1,5 RHT
95301.0084, 90804102156, 90804102272, 90804102696, 90804102710, 81953010016, 81953010075, 81953010084, 81953010088, 81953010094, 81953010103, 81953016030, 81953016043, 81953016048, 81953016049, 81953016053, 81953016061, 81953016090, 81953016108, 81953016112, 81953016126, 81953016143, 81953016149, 81953016154, 81953016156, 81953016168, 81953016178, 81953016194, 81953016206, 81953016224, 81953016234, 81953016242, 81953016252, 81953016274, 81953016278, 81953016284, 81953016286, 81953016308, 81953016310, 81953016312, 81953016347, 81953016350, 81953016352, 82953016012, 88953016014, N2953016001



CV-RK-5313

Ø: 90
03304800A, 81953016132



MN-DL-2160

Length: 1652 Ø: 50
Cone Ø: d1 Ø 30 / d2 Ø 27
81467106112, 81467106163, 81467106165, 81467106198, 81467106353, 81467106354, 81467106361, 81467116725



MN-DL-2172

Length: 1050 Ø: 42
Cone Ø: d1 Ø 30 / d2 Ø 27
81466106374, 81466116019, 82466106080, 82466106189, 82466106190



MN-DL-2174

Length: 1588 Ø: 52
Cone Ø: d1 Ø 30 / d2 Ø 27
81467106378, 81467106912



MN-DL-2175

Length: 1628 Ø: 50
Cone Ø: d1 Ø 30 / d2 Ø 27
81467106396, 81467106904



MN-DL-2176

Length: 1628 Ø: 48
Cone Ø: d1 Ø 30 / d2 Ø 27
81466106779, 81466106780, 81466106782



MN-DL-2177

Length: 1664 Ø: 50
Cone Ø: d1 Ø 30 / d2 Ø 27
81467106994, 81467116726



MN-DL-3588

Length: 1035 Ø: 48
Cone Ø: d1 Ø 30 / d2 Ø 27
81466106333, 81466106334, 81466106354, 81466106355, 81466106360, 81466106361, 81466106721, 81466106722, 81466106723, 81466116216



MN-DL-5212

Length: 577 Ø: 48
Hole Distance: 130 / 130
81432206096, 81432206097, 81432206098, 81432206129, 81432209096, 81432209129, 81432306014, 81432306030



MN-DL-8197

Length: 1055 Ø: 42
Cone Ø: d1 Ø 30 / d2 Ø 27
03207500A, 81466116003, 81466116004, 81466116005



MN-DL-12284

Length: 1530 Ø: 50
Cone Ø: d1 Ø 30 / d2 Ø 27
81466106579, 81466106580, 81466106624, 81466116720, 81467116720, 81467116730, 81467116952



MN-DL-12391

Length: 1050 Ø: 52
Cone Ø: d1 Ø 30 / d2 Ø 27
82466106057, 82466106147



MN-DL-12421

Length: 1070 Ø: 48
Cone Ø: d1 Ø 30 / d2 Ø 27
Thread: M30 x 1,5 RHT
81466106656, 81466106659, 81466106669, 81466116006, 81466116007



MN-RK-7280

Ø: 75
Hole Distance: 115
Thick/Height: 24
0550806, 0639370, 689748, 10307400A, 81432306051, 81432306068, 81432706064



MN-RK-7287

Ø: 90
Hole Distance: 152
Thick/Height: 35
03304700A, 81953016133



MN-RK-7291

Ø: 72
Hole Distance: 130
Thick/Height: 30
10307800A, 81432206108, 81432206132



MN-SB-5243

Length: 55 Ø: 78
Thick/Height: 60
03311100A, 81437040061, 81437220020



MN-SB-10390

Ø: 70 Thick/Height: 85/85
81960200341, 81960200373, 81960200385, 81960200408, 81960200418



MN-TC-14112

Length: 777 Ø: 60
Hole Distance: 115 / 115
81432206106, 81432306049



MN-VB-5222

Length: 627 Ø: 50
Hole Distance: 152 / 152
81432706030, 81432706034, 81432706054, 81432706055, 81432706056, 81432706057, 81432706067, 81432706068, 81432706074, 81432706075, 81432706076, 81432706077, 81432706078, 81432706081, 81432706082, 81432709034, 81432709076, 81432709078, 8143706054





F 2000 ...

19.463 FAC ...	01/94 →	Tie Rod End	SC-ES-8517		for Push Rod
	01/94 →	Track Control Arm		MN-DL-5212	Trailing Arm, Drive Axle; Tag Axle, for Pneumatic Suspension vehicles
	01/94 →	Track Control Arm		MN-VB-5222	Wishbone (CV)
19.463 FAK, FA-KI, FAK-L	01/94 →	Ball Head, gearshift linkage	CV-ES-2119		
	01/94 →	Ball Head, gearshift linkage	CV-ES-2120		
	01/94 →	Ball Head, gearshift linkage	CV-ES-2182		
	01/94 →	Centre Rod	MN-DL-2160		Coupling Rod
	01/94 →	Centre Rod	MN-DL-2172		Push Rod
	01/94 →	Centre Rod	MN-DL-2174		Push Rod
	01/94 →	Centre Rod	MN-DL-2175		Push Rod
	01/94 →	Centre Rod	MN-DL-2176		Push Rod
	01/94 →	Centre Rod	MN-DL-2177		Push Rod
	01/94 →	Centre Rod	MN-DL-3588		Push Rod
	01/94 →	Centre Rod	MN-DL-12391		for Steering Rod
	01/94 →	Centre Rod	MN-DL-12421		for Steering Rod
	01/94 →	Engine Mounting		MN-SB-10390	
	01/94 →	Suspension Arm Repair Kit		MN-RK-7291	for Drag Link
	01/94 →	Tie Rod End	CV-ES-2146		
	01/94 →	Tie Rod End	CV-ES-2149		for Push Rod
	01/94 →	Tie Rod End	CV-ES-14162		for Steering Rod
	01/94 →	Tie Rod End	CV-ES-14163		for Steering Rod
	01/94 →	Tie Rod End	SC-ES-8517		for Push Rod
	01/94 →	Track Control Arm		MN-DL-5212	Trailing Arm, Drive Axle; Tag Axle, for Pneumatic Suspension vehicles
	01/94 →	Track Control Arm		MN-VB-5222	Wishbone (CV)
	19.463 FAS	01/94 →	Ball Head, gearshift linkage	CV-ES-2119	
01/94 →		Ball Head, gearshift linkage	CV-ES-2120		
01/94 →		Ball Head, gearshift linkage	CV-ES-2182		
01/94 →		Centre Rod	MN-DL-2160		Coupling Rod
01/94 →		Centre Rod	MN-DL-2172		Push Rod
01/94 →		Centre Rod	MN-DL-2174		Push Rod
01/94 →		Centre Rod	MN-DL-2175		Push Rod
01/94 →		Centre Rod	MN-DL-2176		Push Rod
01/94 →		Centre Rod	MN-DL-2177		Push Rod
01/94 →		Centre Rod	MN-DL-3588		Push Rod
01/94 →		Centre Rod	MN-DL-12391		for Steering Rod
01/94 →		Centre Rod	MN-DL-12421		for Steering Rod
01/94 →		Engine Mounting		MN-SB-10390	
01/94 →		Suspension Arm Repair Kit		MN-RK-7291	for Drag Link
01/94 →		Tie Rod End	CV-ES-2146		
01/94 →		Tie Rod End	CV-ES-2149		for Push Rod
01/94 →		Tie Rod End	CV-ES-14162		for Steering Rod
01/94 →		Tie Rod End	CV-ES-14163		for Steering Rod
01/94 →		Tie Rod End	SC-ES-8517		for Push Rod
01/94 →		Track Control Arm		MN-DL-5212	Trailing Arm, Drive Axle; Tag Axle, for Pneumatic Suspension vehicles
01/94 →		Track Control Arm		MN-VB-5222	Wishbone (CV)
19.463 FC, FLC, FLLC, FRC, FLRC, F-NL		01/94 →	Ball Head, gearshift linkage	CV-ES-2119	
	01/94 →	Ball Head, gearshift linkage	CV-ES-2120		
	01/94 →	Ball Head, gearshift linkage	CV-ES-2182		
	01/94 →	Centre Rod	MN-DL-2160		Coupling Rod
	01/94 →	Centre Rod	MN-DL-2172		Push Rod
	01/94 →	Centre Rod	MN-DL-2174		Push Rod
	01/94 →	Centre Rod	MN-DL-2175		Push Rod
	01/94 →	Centre Rod	MN-DL-2176		Push Rod
	01/94 →	Centre Rod	MN-DL-2177		Push Rod
	01/94 →	Centre Rod	MN-DL-3588		Push Rod
	01/94 →	Centre Rod	MN-DL-8197		Push Rod
	01/94 →	Centre Rod	MN-DL-12421		for Steering Rod
	01/94 →	Engine Mounting		MN-SB-10390	
	01/94 →	Stabiliser Mounting		MN-SB-5243	
	01/94 →	Suspension Arm Repair Kit		CV-RK-5313	for Wishbone (CV)

CV-ES-2119

Length: 55
Cone Ø: d1 Ø 10 / d2 Ø 10
Thread: M12 x 1,75 LHT
81953016063, 81953016131



CV-ES-2120

Length: 115
Cone Ø: d1 Ø 12,4 / d2 Ø 10,8
Thread: M14 x 1,5 RHT
03008500A, 81953016200, 81953016202,
81953016203, 81953016227



CV-ES-2146

Length: 80
Cone Ø: d1 Ø 30 / d2 Ø 27
Thread: M26 x 1,5 RHT
42533102, 81953016219, 81953016225,
81953016226, 81953016267, 81953016291



CV-ES-2149

Length: 160
Cone Ø: d1 Ø 30 / d2 Ø 27
Thread: M30 x 1,5 RHT
81953016263



CV-ES-2182

Length: 55
Cone Ø: d1 Ø 10 / d2 Ø 10
Thread: M12 x 1,75 RHT
81953016064, 81953016170



CV-ES-14162

Length: 125
Cone Ø: d1 Ø 30 / d2 Ø 27
Thread: M30 x 1,5 LHT
81953010015, 81953010083, 81953010087,
81953016029, 81953016030, 81953016043,
81953016044, 81953016050, 81953016054,
81953016087, 81953016091, 81953016107,
81953016120, 81953016125, 81953016152,
81953016155, 81953016157, 81953016168,
81953016179, 81953016181, 81953016223,
81953016237, 81953016254, 81953016275,
81953016279, 81953016351



CV-ES-14163

Length: 125
Cone Ø: d1 Ø 30 / d2 Ø 27
Thread: M30 x 1,5 RHT
95301.0084, 90804102156, 90804102272,
90804102696, 90804102710, 81953010016,
81953010075, 81953010084, 81953010088,
81953010094, 81953010103, 81953016030,
81953016043, 81953016048, 81953016049,
81953016053, 81953016061, 81953016090,
81953016108, 81953016112, 81953016126,
81953016143, 81953016149, 81953016154,
81953016156, 81953016168, 81953016178,
81953016194, 81953016206, 81953016224,
81953016234, 81953016242, 81953016252,
81953016274, 81953016278, 81953016284,
81953016286, 81953016308, 81953016310,
81953016312, 81953016347, 81953016350,
81953016352, 82953016012, 88953016014,
N2953016001



CV-RK-5313

Ø: 90
03304800A, 81953016132



MN-DL-2160

Length: 1652 Ø: 50
Cone Ø: d1 Ø 30 / d2 Ø 27
81467106112, 81467106163, 81467106165,
81467106198, 81467106353, 81467106354,
81467106361, 81467116725



MN-DL-2172

Length: 1050 Ø: 42
Cone Ø: d1 Ø 30 / d2 Ø 27
81466106374, 81466116019, 82466106080,
82466106189, 82466106190



MN-DL-2174

Length: 1588 Ø: 52
Cone Ø: d1 Ø 30 / d2 Ø 27
81467106378, 81467106912



MN-DL-2175

Length: 1628 Ø: 50
Cone Ø: d1 Ø 30 / d2 Ø 27
81467106396, 81467106904



MN-DL-2176

Length: 1628 Ø: 48
Cone Ø: d1 Ø 30 / d2 Ø 27
81466106779, 81466106780, 81466106782



MN-DL-2177

Length: 1664 Ø: 50
Cone Ø: d1 Ø 30 / d2 Ø 27
81467106994, 81467116726



MN-DL-3588

Length: 1035 Ø: 48
Cone Ø: d1 Ø 30 / d2 Ø 27
81466106333, 81466106334, 81466106354,
81466106355, 81466106360, 81466106361,
81466106721, 81466106722, 81466106723,
81466116216



MN-DL-5212

Length: 577 Ø: 48
Hole Distance: 130 / 130
81432206096, 81432206097, 81432206098,
81432206129, 81432209096, 81432209129,
81432306014, 81432306030



MN-DL-8197

Length: 1055 Ø: 42
Cone Ø: d1 Ø 30 / d2 Ø 27
03207500A, 81466116003, 81466116004,
81466116005



MN-DL-12391

Length: 1050 Ø: 52
Cone Ø: d1 Ø 30 / d2 Ø 27
82466106057, 82466106147



MN-DL-12421

Length: 1070 Ø: 48
Cone Ø: d1 Ø 30 / d2 Ø 27
Thread: M30 x 1,5 RHT
81466106656, 81466106659, 81466106669,
81466116006, 81466116007



MN-RK-7291

Ø: 72
Hole Distance: 130
Thick/Height: 30
10307800A, 81432206108, 81432206132



MN-SB-5243

Length: 55 Ø: 78
Thick/Height: 60
03311100A, 81437040061, 81437220020



MN-SB-10390

Ø: 70 Thick/Height: 85/85
81960200341, 81960200373, 81960200385,
81960200408, 81960200418



MN-VB-5222

Length: 627 Ø: 50
Hole Distance: 152 / 152
81432706030, 81432706034, 81432706054,
81432706055, 81432706056, 81432706057,
81432706067, 81432706068, 81432706074,
81432706075, 81432706076, 81432706077,
81432706078, 81432706081, 81432706082,
81432709034, 81432709076, 81432709078,
8143706054



SC-ES-8517

Length: 140
Cone Ø: d1 Ø 30 / d2 Ø 27
Thread: M30 x 1,5 RHT
81953016286





F 2000 ...

19.463 FC, FLC, FLLC, FRC, FLRC, F-NL ...	01/94 →	Suspension Arm Repair Kit		MN-RK-7280	for Drag Link;for Semi-Trailing Arm; for Wishbone (CV)	
	01/94 →	Suspension Arm Repair Kit		MN-RK-7287	for Wishbone (CV)	
	01/94 →	Tie Rod	MN-DL-8371			
	01/94 →	Tie Rod	MN-DL-12284			
	01/94 →	Tie Rod End	CV-ES-2146			
	01/94 →	Tie Rod End	CV-ES-2149		for Push Rod	
	01/94 →	Tie Rod End	CV-ES-14162		for Steering Rod	
	01/94 →	Tie Rod End	CV-ES-14163		for Steering Rod	
	01/94 →	Track Control Arm		MN-DL-5212	Trailing Arm, Drive Axle;Air Suspension Axle	
	01/94 →	Track Control Arm		MN-VB-5222	Wishbone (CV)	
	01/94 →	Track Control Arm		MN-VB-5222	Wishbone (CV), Drive Axle;Air Suspension Axle	
	01/94 →	Track Control Arm	MN-TC-14112		Control Arm	
	19.463 FK, F-KI, FK-L,FLK, FL-KI, F-NL	01/94 →	Ball Head, gearshift linkage	CV-ES-2119		
		01/94 →	Ball Head, gearshift linkage	CV-ES-2120		
		01/94 →	Ball Head, gearshift linkage	CV-ES-2182		
01/94 →		Centre Rod	MN-DL-2160		Coupling Rod	
01/94 →		Centre Rod	MN-DL-2172		Push Rod	
01/94 →		Centre Rod	MN-DL-2174		Push Rod	
01/94 →		Centre Rod	MN-DL-2175		Push Rod	
01/94 →		Centre Rod	MN-DL-2176		Push Rod	
01/94 →		Centre Rod	MN-DL-2177		Push Rod	
01/94 →		Centre Rod	MN-DL-3588		Push Rod	
01/94 →		Centre Rod	MN-DL-8197		Push Rod	
01/94 →		Centre Rod	MN-DL-12421		for Steering Rod	
01/94 →		Engine Mounting		MN-SB-10390		
01/94 →		Stabiliser Mounting		MN-SB-5243		
01/94 →		Suspension Arm Repair Kit		CV-RK-5313	for Wishbone (CV)	
01/94 →		Suspension Arm Repair Kit		MN-RK-7280	for Drag Link;for Semi-Trailing Arm; for Wishbone (CV)	
01/94 →		Suspension Arm Repair Kit		MN-RK-7287	for Wishbone (CV)	
01/94 →		Tie Rod	MN-DL-12284			
01/94 →		Tie Rod End	CV-ES-2146			
01/94 →		Tie Rod End	CV-ES-2149		for Push Rod	
01/94 →		Tie Rod End	CV-ES-14162		for Steering Rod	
01/94 →		Tie Rod End	CV-ES-14163		for Steering Rod	
01/94 →		Track Control Arm		MN-DL-5212	Trailing Arm, Drive Axle;Air Suspension Axle	
01/94 →		Track Control Arm		MN-VB-5222	Wishbone (CV), Drive Axle;Air Suspension Axle	
19.463 FS, FLS, FLLS, FRS, FLRS, FLLRS		01/94 →	Ball Head, gearshift linkage	CV-ES-2119		
	01/94 →	Ball Head, gearshift linkage	CV-ES-2120			
	01/94 →	Ball Head, gearshift linkage	CV-ES-2182			
	01/94 →	Centre Rod	MN-DL-2160		Coupling Rod	
	01/94 →	Centre Rod	MN-DL-2172		Push Rod	
	01/94 →	Centre Rod	MN-DL-2174		Push Rod	
	01/94 →	Centre Rod	MN-DL-2175		Push Rod	
	01/94 →	Centre Rod	MN-DL-2176		Push Rod	
	01/94 →	Centre Rod	MN-DL-2177		Push Rod	
	01/94 →	Centre Rod	MN-DL-3588		Push Rod	
	01/94 →	Centre Rod	MN-DL-8197		Push Rod	
	01/94 →	Centre Rod	MN-DL-12421		for Steering Rod	
	01/94 →	Engine Mounting		MN-SB-10390		
	01/94 →	Stabiliser Mounting		MN-SB-5243		
	01/94 →	Suspension Arm Repair Kit		CV-RK-5313	for Wishbone (CV)	
	01/94 →	Suspension Arm Repair Kit		MN-RK-7280	for Drag Link;for Semi-Trailing Arm; for Wishbone (CV)	
	01/94 →	Suspension Arm Repair Kit		MN-RK-7287	for Wishbone (CV)	
	01/94 →	Tie Rod	MN-DL-8371			
	01/94 →	Tie Rod	MN-DL-12284			
	01/94 →	Tie Rod End	CV-ES-2146			
	01/94 →	Tie Rod End	CV-ES-2149		for Push Rod	
	01/94 →	Tie Rod End	CV-ES-14162		for Steering Rod	
	01/94 →	Tie Rod End	CV-ES-14163		for Steering Rod	
	01/94 →	Track Control Arm		MN-DL-5212	Trailing Arm, Drive Axle;Air Suspension Axle	

CV-ES-2119

Length: 55
Cone Ø: d1 Ø 10 / d2 Ø 10
Thread: M12 x 1,75 LHT
81953016063, 81953016131



CV-ES-2120

Length: 115
Cone Ø: d1 Ø 12,4 / d2 Ø 10,8
Thread: M14 x 1,5 RHT
03008500A, 81953016200, 81953016202,
81953016203, 81953016227



CV-ES-2146

Length: 80
Cone Ø: d1 Ø 30 / d2 Ø 27
Thread: M26 x 1,5 RHT
42533102, 81953016219, 81953016225,
81953016226, 81953016267, 81953016291



CV-ES-2149

Length: 160
Cone Ø: d1 Ø 30 / d2 Ø 27
Thread: M30 x 1,5 RHT
81953016263



CV-ES-2182

Length: 55
Cone Ø: d1 Ø 10 / d2 Ø 10
Thread: M12 x 1,75 RHT
81953016064, 81953016170



CV-ES-14162

Length: 125
Cone Ø: d1 Ø 30 / d2 Ø 27
Thread: M30 x 1,5 LHT
81953010015, 81953010083, 81953010087,
81953016029, 81953016030, 81953016043,
81953016044, 81953016050, 81953016054,
81953016087, 81953016091, 81953016107,
81953016120, 81953016125, 81953016152,
81953016155, 81953016157, 81953016168,
81953016179, 81953016181, 81953016223,
81953016237, 81953016254, 81953016275,
81953016279, 81953016351



CV-ES-14163

Length: 125
Cone Ø: d1 Ø 30 / d2 Ø 27
Thread: M30 x 1,5 RHT
95301.0084, 90804102156, 90804102272,
90804102696, 90804102710, 81953010016,
81953010075, 81953010084, 81953010088,
81953010094, 81953010103, 81953016030,
81953016043, 81953016048, 81953016049,
81953016053, 81953016061, 81953016090,
81953016108, 81953016112, 81953016126,
81953016143, 81953016149, 81953016154,
81953016156, 81953016168, 81953016178,
81953016194, 81953016206, 81953016224,
81953016234, 81953016242, 81953016252,
81953016274, 81953016278, 81953016284,
81953016286, 81953016308, 81953016310,
81953016312, 81953016347, 81953016350,
81953016352, 82953016012, 88953016014,
N2953016001



CV-RK-5313

Ø: 90
03304800A, 81953016132



MN-DL-2160

Length: 1652 Ø: 50
Cone Ø: d1 Ø 30 / d2 Ø 27
81467106112, 81467106163, 81467106165,
81467106198, 81467106353, 81467106354,
81467106361, 81467116725



MN-DL-2172

Length: 1050 Ø: 42
Cone Ø: d1 Ø 30 / d2 Ø 27
81466106374, 81466116019, 82466106080,
82466106189, 82466106190



MN-DL-2174

Length: 1588 Ø: 52
Cone Ø: d1 Ø 30 / d2 Ø 27
81467106378, 81467106912



MN-DL-2175

Length: 1628 Ø: 50
Cone Ø: d1 Ø 30 / d2 Ø 27
81467106396, 81467106904



MN-DL-2176

Length: 1628 Ø: 48
Cone Ø: d1 Ø 30 / d2 Ø 27
81466106779, 81466106780, 81466106782



MN-DL-2177

Length: 1664 Ø: 50
Cone Ø: d1 Ø 30 / d2 Ø 27
81467106994, 81467116726



MN-DL-3588

Length: 1035 Ø: 48
Cone Ø: d1 Ø 30 / d2 Ø 27
81466106333, 81466106334, 81466106354,
81466106355, 81466106360, 81466106361,
81466106721, 81466106722, 81466106723,
81466116216



MN-DL-5212

Length: 577 Ø: 48
Hole Distance: 130 / 130
81432206096, 81432206097, 81432206098,
81432206129, 81432209096, 81432209129,
81432306014, 81432306030



MN-DL-8197

Length: 1055 Ø: 42
Cone Ø: d1 Ø 30 / d2 Ø 27
03207500A, 81466116003, 81466116004,
81466116005



MN-DL-8371

Length: 1625 Ø: 50
Cone Ø: d1 Ø 30 / d2 Ø 27
81467106966, 81467116714



MN-DL-12284

Length: 1530 Ø: 50
Cone Ø: d1 Ø 30 / d2 Ø 27
81466106579, 81466106580, 81466106624,
81466116720, 81467116720, 81467116730,
81467116952



MN-DL-12421

Length: 1070 Ø: 48
Cone Ø: d1 Ø 30 / d2 Ø 27
Thread: M30 x 1,5 RHT
81466106656, 81466106659, 81466106669,
81466116006, 81466116007



MN-RK-7280

Ø: 75
Hole Distance: 115
Thick/Height: 24
0550806, 0639370, 689748, 10307400A,
81432306051, 81432306068, 81432706064



MN-RK-7287

Ø: 90
Hole Distance: 152
Thick/Height: 35
03304700A, 81953016133



MN-SB-5243

Length: 55
Ø: 78
Thick/Height: 60
03311100A, 81437040061, 81437220020



MN-SB-10390

Ø: 70 Thick/Height: 85/85
81960200341, 81960200373, 81960200385,
81960200408, 81960200418



MN-TC-14112

Length: 777 Ø: 60
Hole Distance: 115 / 115
81432206106, 81432306049



MN-VB-5222

Length: 627 Ø: 50
Hole Distance: 152 / 152
81432706030, 81432706034, 81432706054,
81432706055, 81432706056, 81432706057,
81432706067, 81432706068, 81432706074,
81432706075, 81432706076, 81432706077,
81432706078, 81432706081, 81432706082,
81432709034, 81432709076, 81432709078,
8143706054



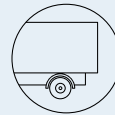

F 2000 ...

19.463 FS, FLS, FLLS, FRS, FLRS, FLLRS ...	01/94 →	Track Control Arm		MN-VB-5222	Wishbone (CV)
	01/94 →	Track Control Arm		MN-VB-5222	Wishbone (CV), Drive Axle; Air Suspension Axle
	01/94 →	Track Control Arm	MN-TC-14112		Control Arm
19.464 FAC	06/98 →	Ball Head, gearshift linkage	CV-ES-2120		
	06/98 →	Centre Rod	MN-DL-12391		for Steering Rod
	06/98 →	Centre Rod	MN-DL-12421		for Steering Rod
	06/98 →	Suspension Arm Repair Kit		MN-RK-7291	for Drag Link
	06/98 →	Tie Rod End	CV-ES-14163		for Steering Rod
	06/98 →	Tie Rod End	SC-ES-8517		for Push Rod
	06/98 →	Track Control Arm		MN-DL-5212	Trailing Arm, Drive Axle; Tag Axle, for Pneumatic Suspension vehicles
	06/98 →	Track Control Arm		MN-VB-5222	Wishbone (CV)
19.464 FAK, FA-KI, FAK-L	06/98 →	Ball Head, gearshift linkage	CV-ES-2120		
	06/98 →	Centre Rod	MN-DL-2174		Push Rod
	06/98 →	Centre Rod	MN-DL-12421		for Steering Rod
	06/98 →	Suspension Arm Repair Kit		MN-RK-7291	for Drag Link
	06/98 →	Tie Rod End	CV-ES-14163		for Steering Rod
	06/98 →	Tie Rod End	SC-ES-8517		for Push Rod
	06/98 →	Track Control Arm		MN-DL-5212	Trailing Arm, Drive Axle; Tag Axle, for Pneumatic Suspension vehicles
	06/98 →	Track Control Arm		MN-VB-5222	Wishbone (CV)
19.464 FAS	06/98 →	Ball Head, gearshift linkage	CV-ES-2120		
	06/98 →	Centre Rod	MN-DL-2174		Push Rod
	06/98 →	Centre Rod	MN-DL-12421		for Steering Rod
	06/98 →	Suspension Arm Repair Kit		MN-RK-7291	for Drag Link
	06/98 →	Tie Rod End	CV-ES-14163		for Steering Rod
	06/98 →	Tie Rod End	SC-ES-8517		for Push Rod
	06/98 →	Track Control Arm		MN-DL-5212	Trailing Arm, Drive Axle; Tag Axle, for Pneumatic Suspension vehicles
	06/98 →	Track Control Arm		MN-VB-5222	Wishbone (CV)
19.464 FC, FLC, FLLC, FLL, FRC, FLLR, FLLRC, FLLW, F-NL	06/98 →	Ball Head, gearshift linkage	CV-ES-2120		
	06/98 →	Centre Rod	MN-DL-2160		Coupling Rod
	06/98 →	Centre Rod	MN-DL-2172		Push Rod
	06/98 →	Centre Rod	MN-DL-2175		Push Rod
	06/98 →	Centre Rod	MN-DL-2176		Push Rod
	06/98 →	Centre Rod	MN-DL-2177		Push Rod
	06/98 →	Centre Rod	MN-DL-3588		Push Rod
	06/98 →	Centre Rod	MN-DL-8197		Push Rod
	06/98 →	Centre Rod	MN-DL-12391		for Steering Rod
	06/98 →	Suspension Arm Repair Kit		MN-RK-7280	for Drag Link; for Semi-Trailing Arm; for Wishbone (CV)
	06/98 →	Suspension Arm Repair Kit	MN-RK-7280	MN-RK-7280	for Drag Link; for Semi-Trailing Arm; for Wishbone (CV)
	06/98 →	Tie Rod End	CV-ES-2149		for Push Rod
	06/98 →	Tie Rod End	CV-ES-14162		for Steering Rod
	06/98 →	Tie Rod End	CV-ES-14163		for Steering Rod
	06/98 →	Tie Rod End	SC-ES-8517		for Push Rod
	06/98 →	Tie Rod End	SC-ES-8535		for Guide Rod
	06/98 →	Track Control Arm		MN-DL-5212	Trailing Arm, Drive Axle; Tag Axle, for Pneumatic Suspension vehicles
	06/98 →	Track Control Arm		MN-VB-5222	Wishbone (CV)
	06/98 →	Track Control Arm	MN-TC-14112		Control Arm, 1st Front Axle, for Pneumatic Suspension vehicles
	19.464 FK, F-KI, FK-L, FLK, FL-KI, F-NL	06/98 →	Ball Head, gearshift linkage	CV-ES-2120	
06/98 →		Centre Rod	MN-DL-2160		Coupling Rod
06/98 →		Centre Rod	MN-DL-2172		Push Rod
06/98 →		Centre Rod	MN-DL-2176		Push Rod
06/98 →		Centre Rod	MN-DL-3588		Push Rod
06/98 →		Centre Rod	MN-DL-8197		Push Rod
06/98 →		Centre Rod	MN-DL-12391		for Steering Rod
06/98 →		Suspension Arm Repair Kit		MN-RK-7280	for Drag Link; for Semi-Trailing Arm; for Wishbone (CV)
06/98 →		Tie Rod End	CV-ES-2149		for Push Rod

CV-ES-2120

Length: 115
Cone Ø: d1 Ø 12,4 / d2 Ø 10,8
Thread: M14 x 1,5 RHT
03008500A, 81953016200, 81953016202, 81953016203, 81953016227



CV-ES-2149

Length: 160
Cone Ø: d1 Ø 30 / d2 Ø 27
Thread: M30 x 1,5 RHT
81953016263



CV-ES-14162

Length: 125
Cone Ø: d1 Ø 30 / d2 Ø 27
Thread: M30 x 1,5 LHT

81953010015, 81953010083, 81953010087, 81953016029, 81953016030, 81953016043, 81953016044, 81953016050, 81953016054, 81953016087, 81953016091, 81953016107, 81953016120, 81953016125, 81953016152, 81953016155, 81953016157, 81953016168, 81953016179, 81953016181, 81953016223, 81953016237, 81953016254, 81953016275, 81953016279, 81953016351



CV-ES-14163

Length: 125
Cone Ø: d1 Ø 30 / d2 Ø 27
Thread: M30 x 1,5 RHT

95301.0084, 90804102156, 90804102272, 90804102696, 90804102710, 81953010016, 81953010075, 81953010084, 81953010088, 81953010094, 81953010103, 81953016030, 81953016043, 81953016048, 81953016049, 81953016053, 81953016061, 81953016090, 81953016108, 81953016112, 81953016126, 81953016143, 81953016149, 81953016154, 81953016156, 81953016168, 81953016178, 81953016194, 81953016206, 81953016224, 81953016234, 81953016242, 81953016252, 81953016274, 81953016278, 81953016284, 81953016286, 81953016308, 81953016310, 81953016312, 81953016347, 81953016350, 81953016352, 82953016012, 88953016014, N2953016001



MN-DL-2160

Length: 1652 Ø: 50
Cone Ø: d1 Ø 30 / d2 Ø 27
81467106112, 81467106163, 81467106165, 81467106198, 81467106353, 81467106354, 81467106361, 81467116725



MN-DL-2172

Length: 1050 Ø: 42
Cone Ø: d1 Ø 30 / d2 Ø 27
81466106374, 81466116019, 82466106080, 82466106189, 82466106190



MN-DL-2174

Length: 1588 Ø: 52
Cone Ø: d1 Ø 30 / d2 Ø 27
81467106378, 81467106912



MN-DL-2175

Length: 1628
Ø: 50
Cone Ø: d1 Ø 30 / d2 Ø 27
81467106396, 81467106904



MN-DL-2176

Length: 1628
Ø: 48
Cone Ø: d1 Ø 30 / d2 Ø 27
81466106779, 81466106780, 81466106782



MN-DL-2177

Length: 1664
Ø: 50
Cone Ø: d1 Ø 30 / d2 Ø 27
81467106994, 81467116726



MN-DL-3588

Length: 1035
Ø: 48
Cone Ø: d1 Ø 30 / d2 Ø 27
81466106333, 81466106334, 81466106354, 81466106355, 81466106360, 81466106361, 81466106721, 81466106722, 81466106723, 81466116216



MN-DL-5212

Length: 577 Ø: 48
Hole Distance: 130 / 130
81432206096, 81432206097, 81432206098, 81432206129, 81432209096, 81432209129, 81432306014, 81432306030



MN-DL-8197

Length: 1055
Ø: 42
Cone Ø: d1 Ø 30 / d2 Ø 27
03207500A, 81466116003, 81466116004, 81466116005



MN-DL-12391

Length: 1050
Ø: 52
Cone Ø: d1 Ø 30 / d2 Ø 27
82466106057, 82466106147



MN-DL-12421

Length: 1070
Ø: 48
Cone Ø: d1 Ø 30 / d2 Ø 27
Thread: M30 x 1,5 RHT
81466106656, 81466106659, 81466106669, 81466116006, 81466116007



MN-RK-7280

Ø: 75
Hole Distance: 115
Thick/Height: 24
0550806, 0639370, 689748, 10307400A, 81432306051, 81432306068, 81432706064



MN-RK-7291

Ø: 72
Hole Distance: 130
Thick/Height: 30
10307800A, 81432206108, 81432206132



MN-TC-14112

Length: 777 Ø: 60
Hole Distance: 115 / 115
81432206106, 81432306049



MN-VB-5222

Length: 627 Ø: 50
Hole Distance: 152 / 152
81432706030, 81432706034, 81432706054, 81432706055, 81432706056, 81432706057, 81432706067, 81432706068, 81432706074, 81432706075, 81432706076, 81432706077, 81432706078, 81432706081, 81432706082, 81432709034, 81432709076, 81432709078, 8143706054



SC-ES-8517

Length: 140
Cone Ø: d1 Ø 30 / d2 Ø 27
Thread: M30 x 1,5 RHT
81953016286



SC-ES-8535

Length: 145
Cone Ø: d1 Ø 30 / d2 Ø 27
Thread: M30 x 1,5 RHT
81953016271, 81953016325





F 2000 ...

19.464 FK, F-KI, FK-L, FLK, FL-KI, F-NL ...	06/98 →	Tie Rod End	CV-ES-14162		for Steering Rod	
	06/98 →	Tie Rod End	CV-ES-14163		for Steering Rod	
	06/98 →	Track Control Arm		MN-DL-5212	Trailing Arm, Drive Axle; Tag Axle, for Pneumatic Suspension vehicles	
	06/98 →	Track Control Arm		MN-VB-5222	Wishbone (CV)	
19.464 FS, FLS, FLLS, FRS, FLRS, FLLRS	06/98 →	Ball Head, gearshift linkage	CV-ES-2120			
	06/98 →	Centre Rod	MN-DL-2160		Coupling Rod	
	06/98 →	Centre Rod	MN-DL-2172		Push Rod	
	06/98 →	Centre Rod	MN-DL-2175		Push Rod	
	06/98 →	Centre Rod	MN-DL-2176		Push Rod	
	06/98 →	Centre Rod	MN-DL-2177		Push Rod	
	06/98 →	Centre Rod	MN-DL-3588		Push Rod	
	06/98 →	Centre Rod	MN-DL-8197		Push Rod	
	06/98 →	Centre Rod	MN-DL-12391		for Steering Rod	
	06/98 →	Suspension Arm Repair Kit		MN-RK-7280	for Drag Link; for Semi-Trailing Arm; for Wishbone (CV)	
	06/98 →	Suspension Arm Repair Kit	MN-RK-7280	MN-RK-7280	for Drag Link; for Semi-Trailing Arm; for Wishbone (CV)	
	06/98 →	Tie Rod End	CV-ES-2149		for Push Rod	
	06/98 →	Tie Rod End	CV-ES-14162		for Steering Rod	
	06/98 →	Tie Rod End	CV-ES-14163		for Steering Rod	
	06/98 →	Tie Rod End	SC-ES-8517		for Push Rod	
	06/98 →	Track Control Arm		MN-DL-5212	Trailing Arm, Drive Axle; Tag Axle, for Pneumatic Suspension vehicles	
	06/98 →	Track Control Arm		MN-VB-5222	Wishbone (CV)	
	06/98 →	Track Control Arm	MN-TC-14112		Control Arm, 1st Front Axle, for Pneumatic Suspension vehicles	
	19.603 FLS, 19604 FLS	04/96 →	Ball Head, gearshift linkage	CV-ES-2119		
		04/96 →	Ball Head, gearshift linkage	CV-ES-2120		
04/96 →		Ball Head, gearshift linkage	CV-ES-2182			
04/96 →		Centre Rod	MN-DL-2160		Coupling Rod	
04/96 →		Centre Rod	MN-DL-2172		Push Rod	
04/96 →		Centre Rod	MN-DL-2174		Push Rod	
04/96 →		Centre Rod	MN-DL-2175		Push Rod	
04/96 →		Centre Rod	MN-DL-2176		Push Rod	
04/96 →		Centre Rod	MN-DL-2177		Push Rod	
04/96 →		Centre Rod	MN-DL-3588		Push Rod	
04/96 →		Centre Rod	MN-DL-12421		for Steering Rod	
04/96 →		Engine Mounting		MN-SB-10390		
04/96 →		Stabiliser Mounting		MN-SB-5243		
04/96 →		Suspension Arm Repair Kit		CV-RK-5313	for Wishbone (CV)	
04/96 →		Suspension Arm Repair Kit		MN-RK-7287	for Wishbone (CV)	
04/96 →		Tie Rod End	CV-ES-2149		for Push Rod	
04/96 →		Tie Rod End	CV-ES-14162		for Steering Rod	
04/96 →		Tie Rod End	CV-ES-14163		for Steering Rod	
04/96 →		Track Control Arm		MN-DL-5212	Trailing Arm, Drive Axle; Air Suspension Axle	
04/96 →		Track Control Arm		MN-VB-5222	Wishbone (CV), Drive Axle; Air Suspension Axle	
23.293 FNLLC	01/94 →	Ball Head, gearshift linkage	CV-ES-2119			
	01/94 →	Ball Head, gearshift linkage	CV-ES-2120			
	01/94 →	Ball Head, gearshift linkage	CV-ES-2182			
	01/94 →	Centre Rod	MN-DL-2160		Coupling Rod	
	01/94 →	Centre Rod	MN-DL-2175		Push Rod	
	01/94 →	Centre Rod	MN-DL-3588		Push Rod	
	01/94 →	Centre Rod	MN-DL-12421		for Steering Rod	
	01/94 →	Engine Mounting		MN-SB-10390		
	01/94 →	Suspension Arm Repair Kit		MN-RK-7280	for Drag Link; for Semi-Trailing Arm; for Wishbone (CV)	
	01/94 →	Suspension Arm Repair Kit	MN-RK-7280	MN-RK-7280	for Drag Link; for Semi-Trailing Arm; for Wishbone (CV)	
	01/94 →	Tie Rod End	CV-ES-2149		for Push Rod	
	01/94 →	Tie Rod End	CV-ES-14162		for Steering Rod	
	01/94 →	Tie Rod End	CV-ES-14163		for Steering Rod	
	01/94 →	Tie Rod End	SC-ES-8517		for Push Rod	

CV-ES-2119

Length: 55
Cone Ø: d1 Ø 10 / d2 Ø 10
Thread: M12 x 1,75 LHT
81953016063, 81953016131



CV-ES-2120

Length: 115
Cone Ø: d1 Ø 12,4 / d2 Ø 10,8
Thread: M14 x 1,5 RHT
03008500A, 81953016200, 81953016202,
81953016203, 81953016227



CV-ES-2149

Length: 160
Cone Ø: d1 Ø 30 / d2 Ø 27
Thread: M30 x 1,5 RHT
81953016263



CV-ES-2182

Length: 55
Cone Ø: d1 Ø 10 / d2 Ø 10
Thread: M12 x 1,75 RHT
81953016064, 81953016170



CV-ES-14162

Length: 125
Cone Ø: d1 Ø 30 / d2 Ø 27
Thread: M30 x 1,5 LHT
81953010015, 81953010083, 81953010087,
81953016029, 81953016030, 81953016043,
81953016044, 81953016050, 81953016054,
81953016087, 81953016091, 81953016107,
81953016120, 81953016125, 81953016152,
81953016155, 81953016157, 81953016168,
81953016179, 81953016181, 81953016223,
81953016237, 81953016254, 81953016275,
81953016279, 81953016351



CV-ES-14163

Length: 125
Cone Ø: d1 Ø 30 / d2 Ø 27
Thread: M30 x 1,5 RHT
95301.0084, 90804102156, 90804102272,
90804102696, 90804102710, 81953010016,
81953010075, 81953010084, 81953010088,
81953010094, 81953010103, 81953016030,
81953016043, 81953016048, 81953016049,
81953016053, 81953016061, 81953016090,
81953016108, 81953016112, 81953016126,
81953016143, 81953016149, 81953016154,
81953016156, 81953016168, 81953016178,
81953016194, 81953016206, 81953016224,
81953016234, 81953016242, 81953016252,
81953016274, 81953016278, 81953016284,
81953016286, 81953016308, 81953016310,
81953016312, 81953016347, 81953016350,
81953016352, 82953016012, 88953016014,
N2953016001



CV-RK-5313

Ø: 90
03304800A, 81953016132



MN-DL-2160

Length: 1652 Ø: 50
Cone Ø: d1 Ø 30 / d2 Ø 27
81467106112, 81467106163, 81467106165,
81467106198, 81467106353, 81467106354,
81467106361, 81467116725



MN-DL-2172

Length: 1050 Ø: 42
Cone Ø: d1 Ø 30 / d2 Ø 27
81466106374, 81466116019, 82466106080,
82466106189, 82466106190



MN-DL-2174

Length: 1588 Ø: 52
Cone Ø: d1 Ø 30 / d2 Ø 27
81467106378, 81467106912



MN-DL-2175

Length: 1628 Ø: 50
Cone Ø: d1 Ø 30 / d2 Ø 27
81467106396, 81467106904



MN-DL-2176

Length: 1628 Ø: 48
Cone Ø: d1 Ø 30 / d2 Ø 27
81466106779, 81466106780, 81466106782



MN-DL-2177

Length: 1664 Ø: 50
Cone Ø: d1 Ø 30 / d2 Ø 27
81467106994, 81467116726



MN-DL-3588

Length: 1035 Ø: 48
Cone Ø: d1 Ø 30 / d2 Ø 27
81466106333, 81466106334, 81466106354,
81466106355, 81466106360, 81466106361,
81466106721, 81466106722, 81466106723,
81466116216



MN-DL-5212

Length: 577 Ø: 48
Hole Distance: 130 / 130
81432206096, 81432206097, 81432206098,
81432206129, 81432209096, 81432209129,
81432306014, 81432306030



MN-DL-8197

Length: 1055 Ø: 42
Cone Ø: d1 Ø 30 / d2 Ø 27
03207500A, 81466116003, 81466116004,
81466116005



MN-DL-12391

Length: 1050 Ø: 52
Cone Ø: d1 Ø 30 / d2 Ø 27
82466106057, 82466106147



MN-DL-12421

Length: 1070 Ø: 48
Cone Ø: d1 Ø 30 / d2 Ø 27
Thread: M30 x 1,5 RHT
81466106656, 81466106659, 81466106669,
81466116006, 81466116007



MN-RK-7280

Ø: 75
Hole Distance: 115
Thick/Height: 24
0550806, 0639370, 689748, 10307400A,
81432306051, 81432306068, 81432706064



MN-RK-7287

Ø: 90
Hole Distance: 152
Thick/Height: 35
03304700A, 81953016133



MN-SB-5243

Length: 55 Ø: 78
Thick/Height: 60
03311100A, 81437040061, 81437220020



MN-SB-10390

Ø: 70 Thick/Height: 85/85
81960200341, 81960200373, 81960200385,
81960200408, 81960200418



MN-TC-14112

Length: 777 Ø: 60
Hole Distance: 115 / 115
81432206106, 81432306049



MN-VB-5222

Length: 627 Ø: 50
Hole Distance: 152 / 152
81432706030, 81432706034, 81432706054,
81432706055, 81432706056, 81432706057,
81432706067, 81432706068, 81432706074,
81432706075, 81432706076, 81432706077,
81432706078, 81432706081, 81432706082,
81432709034, 81432709076, 81432709078,
8143706054



SC-ES-8517

Length: 140
Cone Ø: d1 Ø 30 / d2 Ø 27
Thread: M30 x 1,5 RHT
81953016286





F 2000 ...

23.293 FNLLC ...	01/94 →	Track Control Arm		MN-DL-5212	Trailing Arm, Drive Axle; Air Suspension Axle; Tag Axle
	01/94 →	Track Control Arm		MN-VB-5222	Wishbone (CV), Drive Axle; Tag Axle
	01/94 →	Track Control Arm	MN-TC-14112		Control Arm, 1st Front Axle, for Pneumatic Suspension vehicles
23.314 FNLLC	05/01 →	Ball Head, gearshift linkage	CV-ES-2120		
	05/01 →	Centre Rod	MN-DL-2160		Coupling Rod
	05/01 →	Centre Rod	MN-DL-2175		Push Rod
	05/01 →	Centre Rod	MN-DL-2177		Push Rod
	05/01 →	Centre Rod	MN-DL-3588		Push Rod
	05/01 →	Centre Rod	MN-DL-12391		for Steering Rod
	05/01 →	Suspension Arm Repair Kit		MN-RK-7291	for Drag Link
	05/01 →	Suspension Arm Repair Kit	MN-RK-7280	MN-RK-7280	for Drag Link; for Semi-Trailing Arm; for Wishbone (CV)
	05/01 →	Tie Rod End		MN-ES-8490	
	05/01 →	Tie Rod End	CV-ES-14162		for Steering Rod
	05/01 →	Tie Rod End	CV-ES-14163		for Steering Rod
	05/01 →	Tie Rod End	SC-ES-8517		for Push Rod
	05/01 →	Track Control Arm		MN-DL-5212	Trailing Arm
	05/01 →	Track Control Arm		MN-DL-5212	Trailing Arm, Drive Axle; Tag Axle, for Pneumatic Suspension vehicles
	05/01 →	Track Control Arm		MN-VB-5222	Wishbone (CV)
	05/01 →	Track Control Arm	MN-TC-14112		Control Arm, 1st Front Axle, for Pneumatic Suspension vehicles
23.343 FNLLC	01/94 →	Ball Head, gearshift linkage	CV-ES-2119		
	01/94 →	Ball Head, gearshift linkage	CV-ES-2120		
	01/94 →	Ball Head, gearshift linkage	CV-ES-2182		
	01/94 →	Centre Rod	MN-DL-2160		Coupling Rod
	01/94 →	Centre Rod	MN-DL-2175		Push Rod
	01/94 →	Centre Rod	MN-DL-3588		Push Rod
	01/94 →	Centre Rod	MN-DL-12421		for Steering Rod
	01/94 →	Engine Mounting		MN-SB-10390	
	01/94 →	Suspension Arm Repair Kit		MN-RK-7280	for Drag Link; for Semi-Trailing Arm; for Wishbone (CV)
	01/94 →	Suspension Arm Repair Kit	MN-RK-7280	MN-RK-7280	for Drag Link; for Semi-Trailing Arm; for Wishbone (CV)
	01/94 →	Tie Rod End	CV-ES-2146		
	01/94 →	Tie Rod End	CV-ES-2149		for Push Rod
	01/94 →	Tie Rod End	CV-ES-14162		for Steering Rod
	01/94 →	Tie Rod End	CV-ES-14163		for Steering Rod
	01/94 →	Tie Rod End	SC-ES-8517		for Push Rod
	01/94 →	Track Control Arm		MN-DL-5212	Trailing Arm, Drive Axle; Air Suspension Axle; Tag Axle
	01/94 →	Track Control Arm		MN-VB-5222	Wishbone (CV), Drive Axle; Tag Axle
	01/94 →	Track Control Arm	MN-TC-14112		Control Arm, 1st Front Axle, for Pneumatic Suspension vehicles
23.364 FNLLC	05/01 →	Ball Head, gearshift linkage	CV-ES-2120		
	05/01 →	Centre Rod	MN-DL-2160		Coupling Rod
	05/01 →	Centre Rod	MN-DL-2175		Push Rod
	05/01 →	Centre Rod	MN-DL-2177		Push Rod
	05/01 →	Centre Rod	MN-DL-3588		Push Rod
	05/01 →	Centre Rod	MN-DL-12391		for Steering Rod
	05/01 →	Suspension Arm Repair Kit		MN-RK-7291	for Drag Link
	05/01 →	Suspension Arm Repair Kit	MN-RK-7280	MN-RK-7280	for Drag Link; for Semi-Trailing Arm; for Wishbone (CV)
	05/01 →	Tie Rod End		MN-ES-8490	
	05/01 →	Tie Rod End	CV-ES-14162		for Steering Rod
	05/01 →	Tie Rod End	CV-ES-14163		for Steering Rod
	05/01 →	Tie Rod End	SC-ES-8517		for Push Rod
	05/01 →	Track Control Arm		MN-DL-5212	Trailing Arm
	05/01 →	Track Control Arm		MN-DL-5212	Trailing Arm, Drive Axle; Tag Axle, for Pneumatic Suspension vehicles
05/01 →	Track Control Arm		MN-VB-5222	Wishbone (CV)	

CV-ES-2119

Length: 55
Cone Ø: d1 Ø 10 / d2 Ø 10
Thread: M12 x 1,75 LHT
81953016063, 81953016131



CV-ES-2120

Length: 115
Cone Ø: d1 Ø 12,4 / d2 Ø 10,8
Thread: M14 x 1,5 RHT
03008500A, 81953016200, 81953016202,
81953016203, 81953016227



CV-ES-2146

Length: 80
Cone Ø: d1 Ø 30 / d2 Ø 27
Thread: M26 x 1,5 RHT
42533102, 81953016219, 81953016225,
81953016226, 81953016267, 81953016291



CV-ES-2149

Length: 160
Cone Ø: d1 Ø 30 / d2 Ø 27
Thread: M30 x 1,5 RHT
81953016263



CV-ES-2182

Length: 55
Cone Ø: d1 Ø 10 / d2 Ø 10
Thread: M12 x 1,75 RHT
81953016064, 81953016170



CV-ES-14162

Length: 125
Cone Ø: d1 Ø 30 / d2 Ø 27
Thread: M30 x 1,5 LHT
81953010015, 81953010083, 81953010087,
81953016029, 81953016030, 81953016043,
81953016044, 81953016050, 81953016054,
81953016087, 81953016091, 81953016107,
81953016120, 81953016125, 81953016152,
81953016155, 81953016157, 81953016168,
81953016179, 81953016181, 81953016223,
81953016237, 81953016254, 81953016275,
81953016279, 81953016351



CV-ES-14163

Length: 125
Cone Ø: d1 Ø 30 / d2 Ø 27
Thread: M30 x 1,5 RHT
95301.0084, 90804102156, 90804102272,
90804102696, 90804102710, 81953010016,
81953010075, 81953010084, 81953010088,
81953010094, 81953010103, 81953016030,
81953016043, 81953016048, 81953016049,
81953016053, 81953016061, 81953016090,
81953016108, 81953016112, 81953016126,
81953016143, 81953016149, 81953016154,
81953016156, 81953016168, 81953016178,
81953016194, 81953016206, 81953016224,
81953016234, 81953016242, 81953016252,
81953016274, 81953016278, 81953016284,
81953016286, 81953016308, 81953016310,
81953016312, 81953016347, 81953016350,
81953016352, 82953016012, 88953016014,
N2953016001



MN-DL-2160

Length: 1652 Ø: 50
Cone Ø: d1 Ø 30 / d2 Ø 27
81467106112, 81467106163, 81467106165,
81467106198, 81467106353, 81467106354,
81467106361, 81467116725



MN-DL-2175

Length: 1628 Ø: 50
Cone Ø: d1 Ø 30 / d2 Ø 27
81467106396, 81467106904



MN-DL-2177

Length: 1664 Ø: 50
Cone Ø: d1 Ø 30 / d2 Ø 27
81467106994, 81467116726



MN-DL-3588

Length: 1035 Ø: 48
Cone Ø: d1 Ø 30 / d2 Ø 27
81466106333, 81466106334, 81466106354,
81466106355, 81466106360, 81466106361,
81466106721, 81466106722, 81466106723,
81466116216



MN-DL-5212

Length: 577 Ø: 48
Hole Distance: 130 / 130
81432206096, 81432206097, 81432206098,
81432206129, 81432209096, 81432209129,
81432306014, 81432306030



MN-DL-12391

Length: 1050 Ø: 52
Cone Ø: d1 Ø 30 / d2 Ø 27
82466106057, 82466106147



MN-DL-12421

Length: 1070 Ø: 48
Cone Ø: d1 Ø 30 / d2 Ø 27
Thread: M30 x 1,5 RHT
81466106656, 81466106659, 81466106669,
81466116006, 81466116007



MN-ES-8490

Length: 90
Cone Ø: d1 Ø 30 / d2 Ø 27
Thread: M26 x 1,5 RHT
0014606948, 14606948, 81953016281,
81953016337, 82953016016



MN-RK-7280

Ø: 75
Hole Distance: 115
Thick/Height: 24
0550806, 0639370, 689748, 10307400A,
81432306051, 81432306068, 81432706064



MN-RK-7291

Ø: 72
Hole Distance: 130
Thick/Height: 30
10307800A, 81432206108, 81432206132



MN-SB-10390

Ø: 70 Thick/Height: 85/85
81960200341, 81960200373, 81960200385,
81960200408, 81960200418



MN-TC-14112

Length: 777 Ø: 60
Hole Distance: 115 / 115
81432206106, 81432306049



MN-VB-5222

Length: 627 Ø: 50
Hole Distance: 152 / 152
81432706030, 81432706034, 81432706054,
81432706055, 81432706056, 81432706057,
81432706067, 81432706068, 81432706074,
81432706075, 81432706076, 81432706077,
81432706078, 81432706081, 81432706082,
81432709034, 81432709076, 81432709078,
8143706054



SC-ES-8517

Length: 140
Cone Ø: d1 Ø 30 / d2 Ø 27
Thread: M30 x 1,5 RHT
81953016286





F 2000 ...

23.364 FNLLC ...	05/01 →	Track Control Arm	MN-TC-14112		Control Arm, 1st Front Axle, for Pneumatic Suspension vehicles	
23.403 FNLLC	01/94 →	Ball Head, gearshift linkage	CV-ES-2119			
	01/94 →	Ball Head, gearshift linkage	CV-ES-2120			
	01/94 →	Ball Head, gearshift linkage	CV-ES-2182			
	01/94 →	Centre Rod	MN-DL-2160		Coupling Rod	
	01/94 →	Centre Rod	MN-DL-2175		Push Rod	
	01/94 →	Centre Rod	MN-DL-3588		Push Rod	
	01/94 →	Centre Rod	MN-DL-12421		for Steering Rod	
	01/94 →	Engine Mounting		MN-SB-10390		
	01/94 →	Suspension Arm Repair Kit		MN-RK-7280		for Drag Link;for Semi-Trailing Arm; for Wishbone (CV)
	01/94 →	Suspension Arm Repair Kit	MN-RK-7280	MN-RK-7280		for Drag Link;for Semi-Trailing Arm; for Wishbone (CV)
	01/94 →	Tie Rod End		MN-ES-8490		for vehicles with Hinged Trailing Axle
	01/94 →	Tie Rod End	CV-ES-2146			
	01/94 →	Tie Rod End	CV-ES-2149			for Push Rod
	01/94 →	Tie Rod End	CV-ES-14162			for Steering Rod
	01/94 →	Tie Rod End	CV-ES-14163			for Steering Rod
	01/94 →	Tie Rod End	IV-ES-12272			for Steering Rod
	01/94 →	Tie Rod End	SC-ES-8517			for Push Rod
	01/94 →	Track Control Arm			MN-DL-5212	Trailing Arm, Drive Axle;Air Suspension Axle; Tag Axle
	01/94 →	Track Control Arm			MN-VB-5222	Wishbone (CV), Drive Axle;Tag Axle; Air Suspension Axle
	01/94 →	Track Control Arm	MN-TC-14112			Control Arm, 1st Front Axle, for Pneumatic Suspension vehicles
23.414 FNLLC	05/01 →	Ball Head, gearshift linkage	CV-ES-2120			
	05/01 →	Centre Rod	MN-DL-2160		Coupling Rod	
	05/01 →	Centre Rod	MN-DL-2175		Push Rod	
	05/01 →	Centre Rod	MN-DL-2177		Push Rod	
	05/01 →	Centre Rod	MN-DL-3588		Push Rod	
	05/01 →	Centre Rod	MN-DL-12391		for Steering Rod	
	05/01 →	Suspension Arm Repair Kit		MN-RK-7291		for Drag Link
	05/01 →	Suspension Arm Repair Kit	MN-RK-7280	MN-RK-7280		for Drag Link;for Semi-Trailing Arm; for Wishbone (CV)
	05/01 →	Tie Rod End		MN-ES-8490		
	05/01 →	Tie Rod End	CV-ES-14162			for Steering Rod
	05/01 →	Tie Rod End	CV-ES-14163			for Steering Rod
	05/01 →	Tie Rod End	SC-ES-8517			for Push Rod
	05/01 →	Track Control Arm			MN-DL-5212	Trailing Arm
	05/01 →	Track Control Arm			MN-DL-5212	Trailing Arm, Drive Axle;Tag Axle, for Pneumatic Suspension vehicles
	05/01 →	Track Control Arm			MN-VB-5222	Wishbone (CV)
	05/01 →	Track Control Arm	MN-TC-14112			Control Arm, 1st Front Axle, for Pneumatic Suspension vehicles
23.463 FNLLC	01/94 →	Ball Head, gearshift linkage	CV-ES-2120			
	01/94 →	Centre Rod	MN-DL-12421		for Steering Rod	
	01/94 →	Engine Mounting		MN-SB-10390		
	01/94 →	Suspension Arm Repair Kit		MN-RK-7280		for Drag Link;for Semi-Trailing Arm; for Wishbone (CV)
	01/94 →	Suspension Arm Repair Kit	MN-RK-7280	MN-RK-7280		for Drag Link;for Semi-Trailing Arm; for Wishbone (CV)
	01/94 →	Tie Rod End		MN-ES-8490		for vehicles with Hinged Trailing Axle
	01/94 →	Tie Rod End	CV-ES-2146			
	01/94 →	Tie Rod End	CV-ES-14162			for Steering Rod
	01/94 →	Tie Rod End	CV-ES-14163			for Steering Rod
	01/94 →	Tie Rod End	IV-ES-12272			for Steering Rod
	01/94 →	Tie Rod End	SC-ES-8517			for Push Rod
	01/94 →	Track Control Arm			MN-DL-5212	Trailing Arm, Drive Axle;Air Suspension Axle; Tag Axle
	01/94 →	Track Control Arm			MN-VB-5222	Wishbone (CV), Drive Axle;Tag Axle; Air Suspension Axle

CV-ES-2119

Length: 55
Cone Ø: d1 Ø 10 / d2 Ø 10
Thread: M12 x 1,75 LHT
81953016063, 81953016131



CV-ES-2120

Length: 115
Cone Ø: d1 Ø 12,4 / d2 Ø 10,8
Thread: M14 x 1,5 RHT
03008500A, 81953016200, 81953016202,
81953016203, 81953016227



CV-ES-2146

Length: 80
Cone Ø: d1 Ø 30 / d2 Ø 27
Thread: M26 x 1,5 RHT
42533102, 81953016219, 81953016225,
81953016226, 81953016267, 81953016291



CV-ES-2149

Length: 160
Cone Ø: d1 Ø 30 / d2 Ø 27
Thread: M30 x 1,5 RHT
81953016263



CV-ES-2182

Length: 55
Cone Ø: d1 Ø 10 / d2 Ø 10
Thread: M12 x 1,75 RHT
81953016064, 81953016170



CV-ES-14162

Length: 125
Cone Ø: d1 Ø 30 / d2 Ø 27
Thread: M30 x 1,5 LHT
81953010015, 81953010083, 81953010087,
81953016029, 81953016030, 81953016043,
81953016044, 81953016050, 81953016054,
81953016087, 81953016091, 81953016107,
81953016120, 81953016125, 81953016152,
81953016155, 81953016157, 81953016168,
81953016179, 81953016181, 81953016223,
81953016237, 81953016254, 81953016275,
81953016279, 81953016351



CV-ES-14163

Length: 125
Cone Ø: d1 Ø 30 / d2 Ø 27
Thread: M30 x 1,5 RHT
95301.0084, 90804102156, 90804102272,
90804102696, 90804102710, 81953010016,
81953010075, 81953010084, 81953010088,
81953010094, 81953010103, 81953016030,
81953016043, 81953016048, 81953016049,
81953016053, 81953016061, 81953016090,
81953016108, 81953016112, 81953016126,
81953016143, 81953016149, 81953016154,
81953016156, 81953016168, 81953016178,
81953016194, 81953016206, 81953016224,
81953016234, 81953016242, 81953016252,
81953016274, 81953016278, 81953016284,
81953016286, 81953016308, 81953016310,
81953016312, 81953016347, 81953016350,
81953016352, 82953016012, 88953016014,
N2953016001



IV-ES-12272

Length: 75
Cone Ø: d1 Ø 30 / d2 Ø 27
Thread: M26 x 1,5 RHT
81953016280, 82953010010



MN-DL-2160

Length: 1652 Ø: 50
Cone Ø: d1 Ø 30 / d2 Ø 27
81467106112, 81467106163, 81467106165,
81467106198, 81467106353, 81467106354,
81467106361, 81467116725



MN-DL-2175

Length: 1628 Ø: 50
Cone Ø: d1 Ø 30 / d2 Ø 27
81467106396, 81467106904



MN-DL-2177

Length: 1664 Ø: 50
Cone Ø: d1 Ø 30 / d2 Ø 27
81467106994, 81467116726



MN-DL-3588

Length: 1035 Ø: 48
Cone Ø: d1 Ø 30 / d2 Ø 27
81466106333, 81466106334, 81466106354,
81466106355, 81466106360, 81466106361,
81466106721, 81466106722, 81466106723,
81466116216



MN-DL-5212

Length: 577 Ø: 48
Hole Distance: 130 / 130
81432206096, 81432206097, 81432206098,
81432206129, 81432209096, 81432209129,
81432306014, 81432306030



MN-DL-12391

Length: 1050 Ø: 52
Cone Ø: d1 Ø 30 / d2 Ø 27
82466106057, 82466106147



MN-DL-12421

Length: 1070 Ø: 48
Cone Ø: d1 Ø 30 / d2 Ø 27
Thread: M30 x 1,5 RHT
81466106656, 81466106659, 81466106669,
81466116006, 81466116007



MN-ES-8490

Length: 90
Cone Ø: d1 Ø 30 / d2 Ø 27
Thread: M26 x 1,5 RHT
0014606948, 14606948, 81953016281,
81953016337, 82953016016



MN-RK-7280

Ø: 75
Hole Distance: 115
Thick/Height: 24
0550806, 0639370, 689748, 10307400A,
81432306051, 81432306068, 81432706064



MN-RK-7291

Ø: 72
Hole Distance: 130
Thick/Height: 30
10307800A, 81432206108, 81432206132



MN-SB-10390

Ø: 70 Thick/Height: 85/85
81960200341, 81960200373, 81960200385,
81960200408, 81960200418



MN-TC-14112

Length: 777 Ø: 60
Hole Distance: 115 / 115
81432206106, 81432306049



MN-VB-5222

Length: 627 Ø: 50
Hole Distance: 152 / 152
81432706030, 81432706034, 81432706054,
81432706055, 81432706056, 81432706057,
81432706067, 81432706068, 81432706074,
81432706075, 81432706076, 81432706077,
81432706078, 81432706081, 81432706082,
81432709034, 81432709076, 81432709078,
8143706054



SC-ES-8517

Length: 140
Cone Ø: d1 Ø 30 / d2 Ø 27
Thread: M30 x 1,5 RHT
81953016286





F 2000 ...

23.463 FNLLC ...	01/94 →	Track Control Arm	MN-TC-14112		Control Arm, 1st Front Axle, for Pneumatic Suspension vehicles
23.464 FNLLC	05/01 →	Ball Head, gearshift linkage	CV-ES-2120		
	05/01 →	Centre Rod	MN-DL-2160		Coupling Rod
	05/01 →	Centre Rod	MN-DL-2175		Push Rod
	05/01 →	Centre Rod	MN-DL-2177		Push Rod
	05/01 →	Centre Rod	MN-DL-3588		Push Rod
	05/01 →	Centre Rod	MN-DL-12391		for Steering Rod
	05/01 →	Suspension Arm Repair Kit		MN-RK-7291	for Drag Link
	05/01 →	Suspension Arm Repair Kit	MN-RK-7280	MN-RK-7280	for Drag Link;for Semi-Trailing Arm; for Wishbone (CV)
	05/01 →	Tie Rod End		MN-ES-8490	
	05/01 →	Tie Rod End	CV-ES-14162		for Steering Rod
	05/01 →	Tie Rod End	CV-ES-14163		for Steering Rod
	05/01 →	Tie Rod End	SC-ES-8517		for Push Rod
	05/01 →	Track Control Arm		MN-DL-5212	Trailing Arm
	05/01 →	Track Control Arm		MN-DL-5212	Trailing Arm, Drive Axle;Tag Axle, for Pneumatic Suspension vehicles
	05/01 →	Track Control Arm		MN-VB-5222	Wishbone (CV)
05/01 →	Track Control Arm	MN-TC-14112		Control Arm, 1st Front Axle, for Pneumatic Suspension vehicles	
24.273 FNLLC	01/94 →12/95	Ball Head, gearshift linkage	CV-ES-2119		
	01/94 →12/95	Ball Head, gearshift linkage	CV-ES-2120		
	01/94 →12/95	Ball Head, gearshift linkage	CV-ES-2182		
	01/94 →12/95	Centre Rod	MN-DL-2160		Coupling Rod
	01/94 →12/95	Centre Rod	MN-DL-2175		Push Rod
	01/94 →12/95	Centre Rod	MN-DL-2176		Push Rod
	01/94 →12/95	Centre Rod	MN-DL-2177		Push Rod
	01/94 →12/95	Centre Rod	MN-DL-3588		Push Rod
	01/94 →12/95	Engine Mounting		MN-SB-10390	
	01/94 →12/95	Engine Mounting	MN-SB-10389		
	01/94 →12/95	Suspension Arm Repair Kit		MN-RK-7280	for Drag Link;for Semi-Trailing Arm; for Wishbone (CV)
	01/94 →12/95	Suspension Arm Repair Kit	MN-RK-7280	MN-RK-7280	for Drag Link;for Semi-Trailing Arm; for Wishbone (CV)
	01/94 →12/95	Tie Rod End	CV-ES-2149		for Push Rod
	01/94 →12/95	Tie Rod End	CV-ES-14162		for Steering Rod
	01/94 →12/95	Tie Rod End	CV-ES-14163		for Steering Rod
	01/94 →12/95	Tie Rod End	SC-ES-8517		for Push Rod
	01/94 →12/95	Track Control Arm		MN-DL-5212	Trailing Arm, Drive Axle;Air Suspension Axle; Tag Axle
	01/94 →12/95	Track Control Arm		MN-VB-5222	Wishbone (CV), Drive Axle;Tag Axle; Air Suspension Axle
	01/94 →12/95	Track Control Arm	MN-TC-14112		Control Arm, 1st Front Axle, for Pneumatic Suspension vehicles
	24.293 FNLLC	01/94 →	Ball Head, gearshift linkage	CV-ES-2119	
01/94 →		Ball Head, gearshift linkage	CV-ES-2120		
01/94 →		Ball Head, gearshift linkage	CV-ES-2182		
01/94 →		Centre Rod	MN-DL-2160		Coupling Rod
01/94 →		Centre Rod	MN-DL-2175		Push Rod
01/94 →		Centre Rod	MN-DL-2176		Push Rod
01/94 →		Centre Rod	MN-DL-2177		Push Rod
01/94 →		Centre Rod	MN-DL-3588		Push Rod
01/94 →		Centre Rod	MN-DL-12421		for Steering Rod
01/94 →		Engine Mounting		MN-SB-10390	
01/94 →		Engine Mounting	MN-SB-10389		
01/94 →		Suspension Arm Repair Kit		MN-RK-7280	for Drag Link;for Semi-Trailing Arm; for Wishbone (CV)
01/94 →		Suspension Arm Repair Kit	MN-RK-7280	MN-RK-7280	for Drag Link;for Semi-Trailing Arm; for Wishbone (CV)
01/94 →		Tie Rod End	CV-ES-2149		for Push Rod
01/94 →		Tie Rod End	CV-ES-14162		for Steering Rod
01/94 →	Tie Rod End	CV-ES-14163		for Steering Rod	

CV-ES-2119

Length: 55
Cone Ø: d1 Ø 10 / d2 Ø 10
Thread: M12 x 1,75 LHT
81953016063, 81953016131



CV-ES-2120

Length: 115
Cone Ø: d1 Ø 12,4 / d2 Ø 10,8
Thread: M14 x 1,5 RHT
03008500A, 81953016200, 81953016202,
81953016203, 81953016227



CV-ES-2149

Length: 160
Cone Ø: d1 Ø 30 / d2 Ø 27
Thread: M30 x 1,5 RHT
81953016263



CV-ES-2182

Length: 55
Cone Ø: d1 Ø 10 / d2 Ø 10
Thread: M12 x 1,75 RHT
81953016064, 81953016170



CV-ES-14162

Length: 125
Cone Ø: d1 Ø 30 / d2 Ø 27
Thread: M30 x 1,5 LHT

81953010015, 81953010083, 81953010087,
81953016029, 81953016030, 81953016043,
81953016044, 81953016050, 81953016054,
81953016087, 81953016091, 81953016107,
81953016120, 81953016125, 81953016152,
81953016155, 81953016157, 81953016168,
81953016179, 81953016181, 81953016223,
81953016237, 81953016254, 81953016275,
81953016279, 81953016351



CV-ES-14163

Length: 125
Cone Ø: d1 Ø 30 / d2 Ø 27
Thread: M30 x 1,5 RHT

95301.0084, 90804102156, 90804102272,
90804102696, 90804102710, 81953010016,
81953010075, 81953010084, 81953010088,
81953010094, 81953010103, 81953016030,
81953016043, 81953016048, 81953016049,
81953016053, 81953016061, 81953016090,
81953016108, 81953016112, 81953016126,
81953016143, 81953016149, 81953016154,
81953016156, 81953016168, 81953016178,
81953016194, 81953016206, 81953016224,
81953016234, 81953016242, 81953016252,
81953016274, 81953016278, 81953016284,
81953016286, 81953016308, 81953016310,
81953016312, 81953016347, 81953016350,
81953016352, 82953016012, 88953016014,
N2953016001



MN-DL-2160

Length: 1652 Ø: 50
Cone Ø: d1 Ø 30 / d2 Ø 27
81467106112, 81467106163, 81467106165,
81467106198, 81467106353, 81467106354,
81467106361, 81467116725



MN-DL-2175

Length: 1628 Ø: 50
Cone Ø: d1 Ø 30 / d2 Ø 27
81467106396, 81467106904



MN-DL-2176

Length: 1628 Ø: 48
Cone Ø: d1 Ø 30 / d2 Ø 27
81466106779, 81466106780, 81466106782



MN-DL-2177

Length: 1664 Ø: 50
Cone Ø: d1 Ø 30 / d2 Ø 27
81467106994, 81467116726



MN-DL-3588

Length: 1035 Ø: 48
Cone Ø: d1 Ø 30 / d2 Ø 27
81466106333, 81466106334, 81466106354,
81466106355, 81466106360, 81466106361,
81466106721, 81466106722, 81466106723,
81466116216



MN-DL-5212

Length: 577 Ø: 48
Hole Distance: 130 / 130
81432206096, 81432206097, 81432206098,
81432206129, 81432209096, 81432209129,
81432306014, 81432306030



MN-DL-12391

Length: 1050 Ø: 52
Cone Ø: d1 Ø 30 / d2 Ø 27
82466106057, 82466106147



MN-DL-12421

Length: 1070 Ø: 48
Cone Ø: d1 Ø 30 / d2 Ø 27
Thread: M30 x 1,5 RHT
81466106656, 81466106659, 81466106669,
81466116006, 81466116007



MN-ES-8490

Length: 90
Cone Ø: d1 Ø 30 / d2 Ø 27
Thread: M26 x 1,5 RHT
0014606948, 14606948, 81953016281,
81953016337, 82953016016



MN-RK-7280

Ø: 75
Hole Distance: 115
Thick/Height: 24
0550806, 0639370, 689748, 10307400A,
81432306051, 81432306068, 81432706064



MN-RK-7291

Ø: 72
Hole Distance: 130
Thick/Height: 30
10307800A, 81432206108, 81432206132



MN-SB-10389

Ø: 70 Thick/Height: 72
81960200340



MN-SB-10390

Ø: 70 Thick/Height: 85/85
81960200341, 81960200373, 81960200385,
81960200408, 81960200418



MN-TC-14112

Length: 777 Ø: 60
Hole Distance: 115 / 115
81432206106, 81432306049



MN-VB-5222

Length: 627 Ø: 50
Hole Distance: 152 / 152
81432706030, 81432706034, 81432706054,
81432706055, 81432706056, 81432706057,
81432706067, 81432706068, 81432706074,
81432706075, 81432706076, 81432706077,
81432706078, 81432706081, 81432706082,
81432709034, 81432709076, 81432709078,
8143706054



SC-ES-8517

Length: 140
Cone Ø: d1 Ø 30 / d2 Ø 27
Thread: M30 x 1,5 RHT
81953016286





F 2000 ...

24.293 FNLLC ...	01/94 →	Tie Rod End	SC-ES-8517		for Push Rod
	01/94 →	Track Control Arm		MN-DL-5212	Trailing Arm, Drive Axle; Air Suspension Axle; Tag Axle
	01/94 →	Track Control Arm		MN-VB-5222	Wishbone (CV), Drive Axle; Tag Axle; Air Suspension Axle
	01/94 →	Track Control Arm	MN-TC-14112		Control Arm, 1st Front Axle, for Pneumatic Suspension vehicles
24.314 FNLLRC	05/01 →	Ball Head, gearshift linkage	CV-ES-2120		
	05/01 →	Suspension Arm Repair Kit		MN-RK-7291	for Drag Link
	05/01 →	Suspension Arm Repair Kit	MN-RK-7280	MN-RK-7280	for Drag Link; for Semi-Trailing Arm; for Wishbone (CV)
	05/01 →	Tie Rod End		MN-ES-8490	
	05/01 →	Tie Rod End	CV-ES-2149		for Push Rod
	05/01 →	Tie Rod End	CV-ES-14162		for Steering Rod
	05/01 →	Tie Rod End	CV-ES-14163		for Steering Rod
	05/01 →	Track Control Arm		MN-DL-5212	Trailing Arm
	05/01 →	Track Control Arm		MN-VB-5222	Wishbone (CV)
	05/01 →	Track Control Arm	MN-TC-14112		Control Arm, 1st Front Axle, for Pneumatic Suspension vehicles
24.323 FNLLC	01/94 →12/95	Ball Head, gearshift linkage	CV-ES-2119		
	01/94 →12/95	Ball Head, gearshift linkage	CV-ES-2120		
	01/94 →12/95	Ball Head, gearshift linkage	CV-ES-2182		
	01/94 →12/95	Centre Rod	MN-DL-2160		Coupling Rod
	01/94 →12/95	Centre Rod	MN-DL-2175		Push Rod
	01/94 →12/95	Centre Rod	MN-DL-2176		Push Rod
	01/94 →12/95	Centre Rod	MN-DL-2177		Push Rod
	01/94 →12/95	Centre Rod	MN-DL-3588		Push Rod
	01/94 →12/95	Engine Mounting		MN-SB-10390	
	01/94 →12/95	Engine Mounting	MN-SB-10389		
	01/94 →12/95	Suspension Arm Repair Kit		MN-RK-7280	for Drag Link; for Semi-Trailing Arm; for Wishbone (CV)
	01/94 →12/95	Suspension Arm Repair Kit	MN-RK-7280	MN-RK-7280	for Drag Link; for Semi-Trailing Arm; for Wishbone (CV)
	01/94 →12/95	Tie Rod End	CV-ES-2149		for Push Rod
	01/94 →12/95	Tie Rod End	CV-ES-14162		for Steering Rod
	01/94 →12/95	Tie Rod End	CV-ES-14163		for Steering Rod
	01/94 →12/95	Tie Rod End	SC-ES-8517		for Push Rod
	01/94 →12/95	Track Control Arm		MN-DL-5212	Trailing Arm, Drive Axle; Air Suspension Axle; Tag Axle
	01/94 →12/95	Track Control Arm		MN-VB-5222	Wishbone (CV), Drive Axle; Tag Axle; Air Suspension Axle
	01/94 →12/95	Track Control Arm	MN-TC-14112		Control Arm, 1st Front Axle, for Pneumatic Suspension vehicles
	24.343 FNLLC	01/94 →	Ball Head, gearshift linkage	CV-ES-2119	
01/94 →		Ball Head, gearshift linkage	CV-ES-2120		
01/94 →		Ball Head, gearshift linkage	CV-ES-2182		
01/94 →		Centre Rod	MN-DL-2160		Coupling Rod
01/94 →		Centre Rod	MN-DL-2175		Push Rod
01/94 →		Centre Rod	MN-DL-2176		Push Rod
01/94 →		Centre Rod	MN-DL-2177		Push Rod
01/94 →		Centre Rod	MN-DL-3588		Push Rod
01/94 →		Centre Rod	MN-DL-12421		for Steering Rod
01/94 →		Engine Mounting		MN-SB-10390	
01/94 →		Engine Mounting	MN-SB-10389		
01/94 →		Suspension Arm Repair Kit		MN-RK-7280	for Drag Link; for Semi-Trailing Arm; for Wishbone (CV)
01/94 →		Suspension Arm Repair Kit	MN-RK-7280	MN-RK-7280	for Drag Link; for Semi-Trailing Arm; for Wishbone (CV)
01/94 →		Tie Rod End	CV-ES-2146		
01/94 →		Tie Rod End	CV-ES-2149		for Push Rod
01/94 →		Tie Rod End	CV-ES-14162		for Steering Rod
01/94 →		Tie Rod End	CV-ES-14163		for Steering Rod
01/94 →		Tie Rod End	SC-ES-8517		for Push Rod

CV-ES-2119

Length: 55
Cone Ø: d1 Ø 10 / d2 Ø 10
Thread: M12 x 1,75 LHT
81953016063, 81953016131



CV-ES-2120

Length: 115
Cone Ø: d1 Ø 12,4 / d2 Ø 10,8
Thread: M14 x 1,5 RHT
03008500A, 81953016200, 81953016202,
81953016203, 81953016227



CV-ES-2146

Length: 80
Cone Ø: d1 Ø 30 / d2 Ø 27
Thread: M26 x 1,5 RHT
42533102, 81953016219, 81953016225,
81953016226, 81953016267, 81953016291



CV-ES-2149

Length: 160
Cone Ø: d1 Ø 30 / d2 Ø 27
Thread: M30 x 1,5 RHT
81953016263



CV-ES-2182

Length: 55
Cone Ø: d1 Ø 10 / d2 Ø 10
Thread: M12 x 1,75 RHT
81953016064, 81953016170



CV-ES-14162

Length: 125
Cone Ø: d1 Ø 30 / d2 Ø 27
Thread: M30 x 1,5 LHT
81953010015, 81953010083, 81953010087,
81953016029, 81953016030, 81953016043,
81953016044, 81953016050, 81953016054,
81953016087, 81953016091, 81953016107,
81953016120, 81953016125, 81953016152,
81953016155, 81953016157, 81953016168,
81953016179, 81953016181, 81953016223,
81953016237, 81953016254, 81953016275,
81953016279, 81953016351



CV-ES-14163

Length: 125
Cone Ø: d1 Ø 30 / d2 Ø 27
Thread: M30 x 1,5 RHT

95301.0084, 90804102156, 90804102272,
90804102696, 90804102710, 81953010016,
81953010075, 81953010084, 81953010088,
81953010094, 81953010103, 81953016030,
81953016043, 81953016048, 81953016049,
81953016053, 81953016061, 81953016090,
81953016108, 81953016112, 81953016126,
81953016143, 81953016149, 81953016154,
81953016156, 81953016168, 81953016178,
81953016194, 81953016206, 81953016224,
81953016234, 81953016242, 81953016252,
81953016274, 81953016278, 81953016284,
81953016286, 81953016308, 81953016310,
81953016312, 81953016347, 81953016350,
81953016352, 82953016012, 88953016014,
N2953016001



MN-DL-2160

Length: 1652 Ø: 50
Cone Ø: d1 Ø 30 / d2 Ø 27
81467106112, 81467106163, 81467106165,
81467106198, 81467106353, 81467106354,
81467106361, 81467116725



MN-DL-2175

Length: 1628 Ø: 50
Cone Ø: d1 Ø 30 / d2 Ø 27
81467106396, 81467106904



MN-DL-2176

Length: 1628 Ø: 48
Cone Ø: d1 Ø 30 / d2 Ø 27
81466106779, 81466106780, 81466106782



MN-DL-2177

Length: 1664 Ø: 50
Cone Ø: d1 Ø 30 / d2 Ø 27
81467106994, 81467116726



MN-DL-3588

Length: 1035 Ø: 48
Cone Ø: d1 Ø 30 / d2 Ø 27
81466106333, 81466106334, 81466106354,
81466106355, 81466106360, 81466106361,
81466106721, 81466106722, 81466106723,
81466116216



MN-DL-5212

Length: 577 Ø: 48
Hole Distance: 130 / 130
81432206096, 81432206097, 81432206098,
81432206129, 81432209096, 81432209129,
81432306014, 81432306030



MN-DL-12421

Length: 1070 Ø: 48
Cone Ø: d1 Ø 30 / d2 Ø 27
Thread: M30 x 1,5 RHT
81466106656, 81466106659, 81466106669,
81466116006, 81466116007



MN-ES-8490

Length: 90
Cone Ø: d1 Ø 30 / d2 Ø 27
Thread: M26 x 1,5 RHT
0014606948, 14606948, 81953016281,
81953016337, 82953016016



MN-RK-7280

Ø: 75
Hole Distance: 115
Thick/Height: 24
0550806, 0639370, 689748, 10307400A,
81432306051, 81432306068, 81432706064



MN-RK-7291

Ø: 72
Hole Distance: 130
Thick/Height: 30
10307800A, 81432206108, 81432206132



MN-SB-10389

Ø: 70 Thick/Height: 72
81960200340



MN-SB-10390

Ø: 70 Thick/Height: 85/85
81960200341, 81960200373, 81960200385,
81960200408, 81960200418



MN-TC-14112

Length: 777 Ø: 60
Hole Distance: 115 / 115
81432206106, 81432306049



MN-VB-5222

Length: 627 Ø: 50
Hole Distance: 152 / 152
81432706030, 81432706034, 81432706054,
81432706055, 81432706056, 81432706057,
81432706067, 81432706068, 81432706074,
81432706075, 81432706076, 81432706077,
81432706078, 81432706081, 81432706082,
81432709034, 81432709076, 81432709078,
8143706054



SC-ES-8517

Length: 140
Cone Ø: d1 Ø 30 / d2 Ø 27
Thread: M30 x 1,5 RHT
81953016286





F 2000 ...

24.343 FNLLC ...	01/94 →	Track Control Arm		MN-DL-5212	Trailing Arm, Drive Axle; Air Suspension Axle; Tag Axle
	01/94 →	Track Control Arm		MN-VB-5222	Wishbone (CV), Drive Axle; Tag Axle; Air Suspension Axle
	01/94 →	Track Control Arm	MN-TC-14112		Control Arm, 1st Front Axle, for Pneumatic Suspension vehicles
24.364 FNLLRC	05/01 →	Ball Head, gearshift linkage	CV-ES-2120		
	05/01 →	Suspension Arm Repair Kit		MN-RK-7291	for Drag Link
	05/01 →	Suspension Arm Repair Kit	MN-RK-7280	MN-RK-7280	for Drag Link; for Semi-Trailing Arm; for Wishbone (CV)
	05/01 →	Tie Rod End		MN-ES-8490	
	05/01 →	Tie Rod End	CV-ES-2149		for Push Rod
	05/01 →	Tie Rod End	CV-ES-14162		for Steering Rod
	05/01 →	Tie Rod End	CV-ES-14163		for Steering Rod
	05/01 →	Track Control Arm		MN-DL-5212	Trailing Arm
	05/01 →	Track Control Arm		MN-VB-5222	Wishbone (CV)
05/01 →	Track Control Arm	MN-TC-14112		Control Arm, 1st Front Axle, for Pneumatic Suspension vehicles	
24.373 FNLLC	01/94 →12/95	Ball Head, gearshift linkage	CV-ES-2119		
	01/94 →12/95	Ball Head, gearshift linkage	CV-ES-2120		
	01/94 →12/95	Ball Head, gearshift linkage	CV-ES-2182		
	01/94 →12/95	Centre Rod	MN-DL-2160		Coupling Rod
	01/94 →12/95	Centre Rod	MN-DL-2175		Push Rod
	01/94 →12/95	Centre Rod	MN-DL-2176		Push Rod
	01/94 →12/95	Centre Rod	MN-DL-2177		Push Rod
	01/94 →12/95	Centre Rod	MN-DL-3588		Push Rod
	01/94 →12/95	Engine Mounting		MN-SB-10390	
	01/94 →12/95	Stabiliser Mounting		MN-SB-5243	
	01/94 →12/95	Suspension Arm Repair Kit		CV-RK-5313	for Wishbone (CV)
	01/94 →12/95	Suspension Arm Repair Kit		MN-RK-7280	for Drag Link; for Semi-Trailing Arm; for Wishbone (CV)
	01/94 →12/95	Suspension Arm Repair Kit		MN-RK-7287	for Wishbone (CV)
	01/94 →12/95	Tie Rod End		MN-ES-8490	for vehicles with Hinged Trailing Axle
	01/94 →12/95	Tie Rod End	CV-ES-2149		for Push Rod
	01/94 →12/95	Tie Rod End	CV-ES-14162		for Steering Rod
	01/94 →12/95	Tie Rod End	CV-ES-14163		for Steering Rod
	01/94 →12/95	Tie Rod End	IV-ES-12272		for Steering Rod
	01/94 →12/95	Track Control Arm		MN-DL-5212	Trailing Arm, Drive Axle; Air Suspension Axle; Tag Axle
	01/94 →12/95	Track Control Arm		MN-VB-5222	Wishbone (CV), Drive Axle; Tag Axle; Air Suspension Axle
01/94 →12/95	Track Control Arm	MN-TC-14112		Control Arm, 1st Front Axle, for Pneumatic Suspension vehicles	
24.403 FNLLC	01/94 →	Ball Head, gearshift linkage	CV-ES-2119		
	01/94 →	Ball Head, gearshift linkage	CV-ES-2120		
	01/94 →	Ball Head, gearshift linkage	CV-ES-2182		
	01/94 →	Centre Rod	MN-DL-2160		Coupling Rod
	01/94 →	Centre Rod	MN-DL-2175		Push Rod
	01/94 →	Centre Rod	MN-DL-2176		Push Rod
	01/94 →	Centre Rod	MN-DL-2177		Push Rod
	01/94 →	Centre Rod	MN-DL-3588		Push Rod
	01/94 →	Centre Rod	MN-DL-12421		for Steering Rod
	01/94 →	Engine Mounting		MN-SB-10390	
	01/94 →	Stabiliser Mounting		MN-SB-5243	
	01/94 →	Suspension Arm Repair Kit		CV-RK-5313	for Wishbone (CV)
	01/94 →	Suspension Arm Repair Kit		MN-RK-7280	for Drag Link; for Semi-Trailing Arm; for Wishbone (CV)
	01/94 →	Suspension Arm Repair Kit		MN-RK-7287	for Wishbone (CV)
	01/94 →	Tie Rod End		MN-ES-8490	for vehicles with Hinged Trailing Axle
	01/94 →	Tie Rod End	CV-ES-2146		
	01/94 →	Tie Rod End	CV-ES-2149		for Push Rod
	01/94 →	Tie Rod End	CV-ES-14162		for Steering Rod
	01/94 →	Tie Rod End	CV-ES-14163		for Steering Rod

CV-ES-2119

Length: 55
Cone Ø: d1 Ø 10 / d2 Ø 10
Thread: M12 x 1,75 LHT
81953016063, 81953016131



CV-ES-2120

Length: 115
Cone Ø: d1 Ø 12,4 / d2 Ø 10,8
Thread: M14 x 1,5 RHT
03008500A, 81953016200, 81953016202,
81953016203, 81953016227



CV-ES-2146

Length: 80
Cone Ø: d1 Ø 30 / d2 Ø 27
Thread: M26 x 1,5 RHT
42533102, 81953016219, 81953016225,
81953016226, 81953016267, 81953016291



CV-ES-2149

Length: 160
Cone Ø: d1 Ø 30 / d2 Ø 27
Thread: M30 x 1,5 RHT
81953016263



CV-ES-2182

Length: 55
Cone Ø: d1 Ø 10 / d2 Ø 10
Thread: M12 x 1,75 RHT
81953016064, 81953016170



CV-ES-14162

Length: 125
Cone Ø: d1 Ø 30 / d2 Ø 27
Thread: M30 x 1,5 LHT
81953010015, 81953010083, 81953010087,
81953016029, 81953016030, 81953016043,
81953016044, 81953016050, 81953016054,
81953016087, 81953016091, 81953016107,
81953016120, 81953016125, 81953016152,
81953016155, 81953016157, 81953016168,
81953016179, 81953016181, 81953016223,
81953016237, 81953016254, 81953016275,
81953016279, 81953016351



CV-ES-14163

Length: 125
Cone Ø: d1 Ø 30 / d2 Ø 27
Thread: M30 x 1,5 RHT
95301.0084, 90804102156, 90804102272,
90804102696, 90804102710, 81953010016,
81953010075, 81953010084, 81953010088,
81953010094, 81953010103, 81953016030,
81953016043, 81953016048, 81953016049,
81953016053, 81953016061, 81953016090,
81953016108, 81953016112, 81953016126,
81953016143, 81953016149, 81953016154,
81953016156, 81953016168, 81953016178,
81953016194, 81953016206, 81953016224,
81953016234, 81953016242, 81953016252,
81953016274, 81953016278, 81953016284,
81953016286, 81953016308, 81953016310,
81953016312, 81953016347, 81953016350,
81953016352, 82953016012, 88953016014,
N2953016001



CV-RK-5313

Ø: 90
03304800A, 81953016132



IV-ES-12272

Length: 75
Cone Ø: d1 Ø 30 / d2 Ø 27
Thread: M26 x 1,5 RHT
81953016280, 82953010010



MN-DL-2160

Length: 1652 Ø: 50
Cone Ø: d1 Ø 30 / d2 Ø 27
81467106112, 81467106163, 81467106165,
81467106198, 81467106353, 81467106354,
81467106361, 81467116725



MN-DL-2175

Length: 1628 Ø: 50
Cone Ø: d1 Ø 30 / d2 Ø 27
81467106396, 81467106904



MN-DL-2176

Length: 1628 Ø: 48
Cone Ø: d1 Ø 30 / d2 Ø 27
81466106779, 81466106780, 81466106782



MN-DL-2177

Length: 1664 Ø: 50
Cone Ø: d1 Ø 30 / d2 Ø 27
81467106994, 81467116726



MN-DL-3588

Length: 1035 Ø: 48
Cone Ø: d1 Ø 30 / d2 Ø 27
81466106333, 81466106334, 81466106354,
81466106355, 81466106360, 81466106361,
81466106721, 81466106722, 81466106723,
81466116216



MN-DL-5212

Length: 577 Ø: 48
Hole Distance: 130 / 130
81432206096, 81432206097, 81432206098,
81432206129, 81432209096, 81432209129,
81432306014, 81432306030



MN-DL-12421

Length: 1070 Ø: 48
Cone Ø: d1 Ø 30 / d2 Ø 27
Thread: M30 x 1,5 RHT
81466106656, 81466106659, 81466106669,
81466116006, 81466116007



MN-ES-8490

Length: 90
Cone Ø: d1 Ø 30 / d2 Ø 27
Thread: M26 x 1,5 RHT
0014606948, 14606948, 81953016281,
81953016337, 82953016016



MN-RK-7280

Ø: 75
Hole Distance: 115
Thick/Height: 24
0550806, 0639370, 689748, 10307400A,
81432306051, 81432306068, 81432706064



MN-RK-7287

Ø: 90
Hole Distance: 152
Thick/Height: 35
03304700A, 81953016133



MN-RK-7291

Ø: 72
Hole Distance: 130
Thick/Height: 30
10307800A, 81432206108, 81432206132



MN-SB-5243

Length: 55 Ø: 78
Thick/Height: 60
03311100A, 81437040061, 81437220020



MN-SB-10390

Ø: 70 Thick/Height: 85/85
81960200341, 81960200373, 81960200385,
81960200408, 81960200418



MN-TC-14112

Length: 777 Ø: 60
Hole Distance: 115 / 115
81432206106, 81432306049



MN-VB-5222

Length: 627 Ø: 50
Hole Distance: 152 / 152
81432706030, 81432706034, 81432706054,
81432706055, 81432706056, 81432706057,
81432706067, 81432706068, 81432706074,
81432706075, 81432706076, 81432706077,
81432706078, 81432706081, 81432706082,
81432709034, 81432709076, 81432709078,
8143706054





F 2000 ...

24.403 FNLLC ...	01/94 →	Track Control Arm		MN-DL-5212	Trailing Arm, Drive Axle; Air Suspension Axle; Tag Axle
	01/94 →	Track Control Arm		MN-VB-5222	Wishbone (CV), Drive Axle; Tag Axle; Air Suspension Axle
24.414 FNLLRC	05/01 →	Ball Head, gearshift linkage	CV-ES-2120		
	05/01 →	Suspension Arm Repair Kit		MN-RK-7291	for Drag Link
	05/01 →	Suspension Arm Repair Kit	MN-RK-7280	MN-RK-7280	for Drag Link; for Semi-Trailing Arm; for Wishbone (CV)
	05/01 →	Tie Rod End		MN-ES-8490	
	05/01 →	Tie Rod End	CV-ES-2149		for Push Rod
	05/01 →	Tie Rod End	CV-ES-14162		for Steering Rod
	05/01 →	Tie Rod End	CV-ES-14163		for Steering Rod
	05/01 →	Track Control Arm		MN-DL-5212	Trailing Arm
	05/01 →	Track Control Arm		MN-VB-5222	Wishbone (CV)
	05/01 →	Track Control Arm	MN-TC-14112		Control Arm, 1st Front Axle, for Pneumatic Suspension vehicles
24.423 FNLLC	01/94 →12/95	Ball Head, gearshift linkage	CV-ES-2119		
	01/94 →12/95	Ball Head, gearshift linkage	CV-ES-2120		
	01/94 →12/95	Ball Head, gearshift linkage	CV-ES-2182		
	01/94 →12/95	Centre Rod	MN-DL-2160		Coupling Rod
	01/94 →12/95	Centre Rod	MN-DL-2175		Push Rod
	01/94 →12/95	Centre Rod	MN-DL-2176		Push Rod
	01/94 →12/95	Centre Rod	MN-DL-2177		Push Rod
	01/94 →12/95	Centre Rod	MN-DL-3588		Push Rod
	01/94 →12/95	Engine Mounting		MN-SB-10390	
	01/94 →12/95	Stabiliser Mounting		MN-SB-5243	
	01/94 →12/95	Suspension Arm Repair Kit		CV-RK-5313	for Wishbone (CV)
	01/94 →12/95	Suspension Arm Repair Kit		MN-RK-7280	for Drag Link; for Semi-Trailing Arm; for Wishbone (CV)
	01/94 →12/95	Suspension Arm Repair Kit		MN-RK-7287	for Wishbone (CV)
	01/94 →12/95	Tie Rod End		MN-ES-8490	for vehicles with Hinged Trailing Axle
	01/94 →12/95	Tie Rod End	CV-ES-2149		for Push Rod
	01/94 →12/95	Tie Rod End	CV-ES-14162		for Steering Rod
	01/94 →12/95	Tie Rod End	CV-ES-14163		for Steering Rod
	01/94 →12/95	Track Control Arm		MN-DL-5212	Trailing Arm, Drive Axle; Air Suspension Axle; Tag Axle
	01/94 →12/95	Track Control Arm		MN-VB-5222	Wishbone (CV), Drive Axle; Tag Axle; Air Suspension Axle
	24.463 FNLLC	01/94 →	Ball Head, gearshift linkage	CV-ES-2119	
01/94 →		Ball Head, gearshift linkage	CV-ES-2120		
01/94 →		Ball Head, gearshift linkage	CV-ES-2182		
01/94 →		Centre Rod	MN-DL-2160		Coupling Rod
01/94 →		Centre Rod	MN-DL-2175		Push Rod
01/94 →		Centre Rod	MN-DL-2176		Push Rod
01/94 →		Centre Rod	MN-DL-2177		Push Rod
01/94 →		Centre Rod	MN-DL-3588		Push Rod
01/94 →		Centre Rod	MN-DL-12421		for Steering Rod
01/94 →		Engine Mounting		MN-SB-10390	
01/94 →		Stabiliser Mounting		MN-SB-5243	
01/94 →		Suspension Arm Repair Kit		CV-RK-5313	for Wishbone (CV)
01/94 →		Suspension Arm Repair Kit		MN-RK-7280	for Drag Link; for Semi-Trailing Arm; for Wishbone (CV)
01/94 →		Suspension Arm Repair Kit		MN-RK-7287	for Wishbone (CV)
01/94 →		Tie Rod End		MN-ES-8490	for vehicles with Hinged Trailing Axle
01/94 →		Tie Rod End	CV-ES-2146		
01/94 →		Tie Rod End	CV-ES-2149		for Push Rod
01/94 →		Tie Rod End	CV-ES-14162		for Steering Rod
01/94 →		Tie Rod End	CV-ES-14163		for Steering Rod
01/94 →		Track Control Arm		MN-DL-5212	Trailing Arm, Drive Axle; Air Suspension Axle; Tag Axle
01/94 →		Track Control Arm		MN-VB-5222	Wishbone (CV), Drive Axle; Tag Axle; Air Suspension Axle

CV-ES-2119

Length: 55
Cone Ø: d1 Ø 10 / d2 Ø 10
Thread: M12 x 1,75 LHT
81953016063, 81953016131



CV-ES-2120

Length: 115
Cone Ø: d1 Ø 12,4 / d2 Ø 10,8
Thread: M14 x 1,5 RHT
03008500A, 81953016200, 81953016202,
81953016203, 81953016227



CV-ES-2146

Length: 80
Cone Ø: d1 Ø 30 / d2 Ø 27
Thread: M26 x 1,5 RHT
42533102, 81953016219, 81953016225,
81953016226, 81953016267, 81953016291



CV-ES-2149

Length: 160
Cone Ø: d1 Ø 30 / d2 Ø 27
Thread: M30 x 1,5 RHT
81953016263



CV-ES-2182

Length: 55
Cone Ø: d1 Ø 10 / d2 Ø 10
Thread: M12 x 1,75 RHT
81953016064, 81953016170



CV-ES-14162

Length: 125
Cone Ø: d1 Ø 30 / d2 Ø 27
Thread: M30 x 1,5 LHT
81953010015, 81953010083, 81953010087,
81953016029, 81953016030, 81953016043,
81953016044, 81953016050, 81953016054,
81953016087, 81953016091, 81953016107,
81953016120, 81953016125, 81953016152,
81953016155, 81953016157, 81953016168,
81953016179, 81953016181, 81953016223,
81953016237, 81953016254, 81953016275,
81953016279, 81953016351



CV-ES-14163

Length: 125
Cone Ø: d1 Ø 30 / d2 Ø 27
Thread: M30 x 1,5 RHT
95301.0084, 90804102156, 90804102272,
90804102696, 90804102710, 81953010016,
81953010075, 81953010084, 81953010088,
81953010094, 81953010103, 81953016030,
81953016043, 81953016048, 81953016049,
81953016053, 81953016061, 81953016090,
81953016108, 81953016112, 81953016126,
81953016143, 81953016149, 81953016154,
81953016156, 81953016168, 81953016178,
81953016194, 81953016206, 81953016224,
81953016234, 81953016242, 81953016252,
81953016274, 81953016278, 81953016284,
81953016286, 81953016308, 81953016310,
81953016312, 81953016347, 81953016350,
81953016352, 82953016012, 88953016014,
N2953016001



CV-RK-5313

Ø: 90
03304800A, 81953016132



MN-DL-2160

Length: 1652 Ø: 50
Cone Ø: d1 Ø 30 / d2 Ø 27
81467106112, 81467106163, 81467106165,
81467106198, 81467106353, 81467106354,
81467106361, 81467116725



MN-DL-2175

Length: 1628 Ø: 50
Cone Ø: d1 Ø 30 / d2 Ø 27
81467106396, 81467106904



MN-DL-2176

Length: 1628 Ø: 48
Cone Ø: d1 Ø 30 / d2 Ø 27
81466106779, 81466106780, 81466106782



MN-DL-2177

Length: 1664 Ø: 50
Cone Ø: d1 Ø 30 / d2 Ø 27
81467106994, 81467116726



MN-DL-3588

Length: 1035 Ø: 48
Cone Ø: d1 Ø 30 / d2 Ø 27
81466106333, 81466106334, 81466106354,
81466106355, 81466106360, 81466106361,
81466106721, 81466106722, 81466106723,
81466116216



MN-DL-5212

Length: 577 Ø: 48
Hole Distance: 130 / 130
81432206096, 81432206097, 81432206098,
81432206129, 81432209096, 81432209129,
81432306014, 81432306030



MN-DL-12421

Length: 1070 Ø: 48
Cone Ø: d1 Ø 30 / d2 Ø 27
Thread: M30 x 1,5 RHT
81466106656, 81466106659, 81466106669,
81466116006, 81466116007



MN-ES-8490

Length: 90
Cone Ø: d1 Ø 30 / d2 Ø 27
Thread: M26 x 1,5 RHT
0014606948, 14606948, 81953016281,
81953016337, 82953016016



MN-RK-7280

Ø: 75
Hole Distance: 115
Thick/Height: 24
0550806, 0639370, 689748, 10307400A,
81432306051, 81432306068, 81432706064



MN-RK-7287

Ø: 90
Hole Distance: 152
Thick/Height: 35
03304700A, 81953016133



MN-RK-7291

Ø: 72
Hole Distance: 130
Thick/Height: 30
10307800A, 81432206108, 81432206132



MN-SB-5243

Length: 55 Ø: 78
Thick/Height: 60
03311100A, 81437040061, 81437220020



MN-SB-10390

Ø: 70 Thick/Height: 85/85
81960200341, 81960200373, 81960200385,
81960200408, 81960200418



MN-TC-14112

Length: 777 Ø: 60
Hole Distance: 115 / 115
81432206106, 81432306049



MN-VB-5222

Length: 627 Ø: 50
Hole Distance: 152 / 152
81432706030, 81432706034, 81432706054,
81432706055, 81432706056, 81432706057,
81432706067, 81432706068, 81432706074,
81432706075, 81432706076, 81432706077,
81432706078, 81432706081, 81432706082,
81432709034, 81432709076, 81432709078,
8143706054



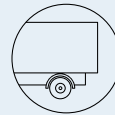

F 2000 ...

24.464 FNLLRC	05/01→	Ball Head, gearshift linkage	CV-ES-2120		
	05/01→	Suspension Arm Repair Kit		MN-RK-7291	for Drag Link
	05/01→	Suspension Arm Repair Kit	MN-RK-7280	MN-RK-7280	for Drag Link;for Semi-Trailing Arm; for Wishbone (CV)
	05/01→	Tie Rod End		MN-ES-8490	
	05/01→	Tie Rod End	CV-ES-2149		for Push Rod
	05/01→	Tie Rod End	CV-ES-14162		for Steering Rod
	05/01→	Tie Rod End	CV-ES-14163		for Steering Rod
	05/01→	Track Control Arm		MN-DL-5212	Trailing Arm
	05/01→	Track Control Arm		MN-VB-5222	Wishbone (CV)
05/01→	Track Control Arm	MN-TC-14112		Control Arm, 1st Front Axle, for Pneumatic Suspension vehicles	
26.233 FVLC CNG	09/96→	Ball Head, gearshift linkage	CV-ES-2119		
	09/96→	Ball Head, gearshift linkage	CV-ES-2120		
	09/96→	Ball Head, gearshift linkage	CV-ES-2182		
	09/96→	Centre Rod	MN-DL-2160		Coupling Rod
	09/96→	Centre Rod	MN-DL-2175		Push Rod
	09/96→	Centre Rod	MN-DL-2176		Push Rod
	09/96→	Centre Rod	MN-DL-3588		Push Rod
	09/96→	Centre Rod	MN-DL-8197		Push Rod
	09/96→	Centre Rod	MN-DL-8487		Push Rod
	09/96→	Engine Mounting		MN-SB-10390	
	09/96→	Suspension Arm Repair Kit		MN-RK-7280	for Drag Link;for Semi-Trailing Arm; for Wishbone (CV)
	09/96→	Suspension Arm Repair Kit	MN-RK-7280	MN-RK-7280	for Drag Link;for Semi-Trailing Arm; for Wishbone (CV)
	09/96→	Tie Rod End		SC-ES-8517	for Push Rod
	09/96→	Tie Rod End	CV-ES-2149		for Push Rod
	09/96→	Tie Rod End	CV-ES-14162		for Steering Rod
	09/96→	Tie Rod End	CV-ES-14163		for Steering Rod
	09/96→	Track Control Arm		MN-DL-5212	Trailing Arm, Drive Axle;Air Suspension Axle
	09/96→	Track Control Arm		MN-VB-5222	Wishbone (CV), Drive Axle, for Pneumatic Suspension vehicles
09/96→	Track Control Arm	MN-TC-14112		Control Arm, 1st Front Axle, for Pneumatic Suspension vehicles	
26.233 FVL-KO	03/00→	Ball Head, gearshift linkage	CV-ES-2120		
	03/00→	Centre Rod	MN-DL-8197		Push Rod
	03/00→	Centre Rod	MN-DL-8487		Push Rod
	03/00→	Suspension Arm Repair Kit		MN-RK-7291	for Drag Link
	03/00→	Suspension Arm Repair Kit	MN-RK-7280	MN-RK-7280	for Drag Link;for Semi-Trailing Arm; for Wishbone (CV)
	03/00→	Tie Rod End		SC-ES-8517	for Push Rod
	03/00→	Tie Rod End	CV-ES-14162		for Steering Rod
	03/00→	Tie Rod End	CV-ES-14163		for Steering Rod
	03/00→	Track Control Arm		MN-DL-5212	Trailing Arm
	03/00→	Track Control Arm		MN-VB-5222	Wishbone (CV), Drive Axle, for Pneumatic Suspension vehicles
03/00→	Track Control Arm	MN-TC-14112		Control Arm, 1st Front Axle, for Pneumatic Suspension vehicles	
26.273 DFC,26.273 DFLC	01/94→12/95	Ball Head, gearshift linkage	CV-ES-2119		
	01/94→12/95	Ball Head, gearshift linkage	CV-ES-2120		
	01/94→12/95	Ball Head, gearshift linkage	CV-ES-2182		
	01/94→12/95	Centre Rod	MN-DL-2160		Coupling Rod
	01/94→12/95	Centre Rod	MN-DL-2175		Push Rod
	01/94→12/95	Centre Rod	MN-DL-2176		Push Rod
	01/94→12/95	Centre Rod	MN-DL-3588		Push Rod
	01/94→12/95	Centre Rod	MN-DL-8197		Push Rod
	01/94→12/95	Engine Mounting		MN-SB-10390	
	01/94→12/95	Engine Mounting	MN-SB-10389		
	01/94→12/95	Stabiliser Mounting		MN-SB-5243	
	01/94→12/95	Suspension Arm Repair Kit		CV-RK-5313	for Wishbone (CV)
	01/94→12/95	Suspension Arm Repair Kit		MN-RK-7287	for Wishbone (CV)
	01/94→12/95	Tie Rod	MN-DL-12284		

CV-ES-2119

Length: 55
Cone Ø: d1 Ø 10 / d2 Ø 10
Thread: M12 x 1,75 LHT
81953016063, 81953016131



CV-ES-2120

Length: 115
Cone Ø: d1 Ø 12,4 / d2 Ø 10,8
Thread: M14 x 1,5 RHT
03008500A, 81953016200, 81953016202, 81953016203, 81953016227



CV-ES-2149

Length: 160
Cone Ø: d1 Ø 30 / d2 Ø 27
Thread: M30 x 1,5 RHT
81953016263



CV-ES-2182

Length: 55
Cone Ø: d1 Ø 10 / d2 Ø 10
Thread: M12 x 1,75 RHT
81953016064, 81953016170



CV-ES-14162

Length: 125
Cone Ø: d1 Ø 30 / d2 Ø 27
Thread: M30 x 1,5 LHT
81953010015, 81953010083, 81953010087, 81953016029, 81953016030, 81953016043, 81953016044, 81953016050, 81953016054, 81953016087, 81953016091, 81953016107, 81953016120, 81953016125, 81953016152, 81953016155, 81953016157, 81953016168, 81953016179, 81953016181, 81953016223, 81953016237, 81953016254, 81953016275, 81953016279, 81953016351



CV-ES-14163

Length: 125
Cone Ø: d1 Ø 30 / d2 Ø 27
Thread: M30 x 1,5 RHT
95301.0084, 90804102156, 90804102272, 90804102696, 90804102710, 81953010016, 81953010075, 81953010084, 81953010088, 81953010094, 81953010103, 81953016030, 81953016043, 81953016048, 81953016049, 81953016053, 81953016061, 81953016090, 81953016108, 81953016112, 81953016126, 81953016143, 81953016149, 81953016154, 81953016156, 81953016168, 81953016178, 81953016194, 81953016206, 81953016224, 81953016234, 81953016242, 81953016252, 81953016274, 81953016278, 81953016284, 81953016286, 81953016308, 81953016310, 81953016312, 81953016347, 81953016350, 81953016352, 82953016012, 88953016014, N2953016001



CV-RK-5313

Ø: 90
03304800A, 81953016132



MN-DL-2160

Length: 1652 Ø: 50
Cone Ø: d1 Ø 30 / d2 Ø 27
81467106112, 81467106163, 81467106165, 81467106198, 81467106353, 81467106354, 81467106361, 81467116725



MN-DL-2175

Length: 1628 Ø: 50
Cone Ø: d1 Ø 30 / d2 Ø 27
81467106396, 81467106904



MN-DL-2176

Length: 1628
Ø: 48
Cone Ø: d1 Ø 30 / d2 Ø 27
81466106779, 81466106780, 81466106782



MN-DL-3588

Length: 1035
Ø: 48
Cone Ø: d1 Ø 30 / d2 Ø 27
81466106333, 81466106334, 81466106354, 81466106355, 81466106360, 81466106361, 81466106721, 81466106722, 81466106723, 81466116216



MN-DL-5212

Length: 577 Ø: 48
Hole Distance: 130 / 130
81432206096, 81432206097, 81432206098, 81432206129, 81432209096, 81432209129, 81432306014, 81432306030



MN-DL-8197

Length: 1055 Ø: 42
Cone Ø: d1 Ø 30 / d2 Ø 27
03207500A, 81466116003, 81466116004, 81466116005



MN-DL-8487

Length: 900 Ø: 38
Cone Ø: d1 Ø 30 / d2 Ø 27
81466106767, 81466106768, 81466106774, 81466116014



MN-DL-12284

Length: 1530 Ø: 50
Cone Ø: d1 Ø 30 / d2 Ø 27
81466106579, 81466106580, 81466106624, 81466116720, 81467116720, 81467116730, 81467116952



MN-ES-8490

Length: 90
Cone Ø: d1 Ø 30 / d2 Ø 27
Thread: M26 x 1,5 RHT
14606948, 0014606948, 81953016281, 81953016337, 82953016016



MN-RK-7280

Ø: 75
Hole Distance: 115
Thick/Height: 24
0550806, 0639370, 689748, 10307400A, 81432306051, 81432306068, 81432706064



MN-RK-7287

Ø: 90
Hole Distance: 152
Thick/Height: 35
03304700A, 81953016133



MN-RK-7291

Ø: 72
Hole Distance: 130
Thick/Height: 30
10307800A, 81432206108, 81432206132



MN-SB-5243

Length: 55 Ø: 78
Thick/Height: 60
03311100A, 81437040061, 81437220020



MN-SB-10389

Ø: 70 Thick/Height: 72
81960200340



MN-SB-10390

Ø: 70 Thick/Height: 85/85
81960200341, 81960200373, 81960200385, 81960200408, 81960200418



MN-TC-14112

Length: 777 Ø: 60
Hole Distance: 115 / 115
81432206106, 81432306049



MN-VB-5222

Length: 627 Ø: 50
Hole Distance: 152 / 152
81432706030, 81432706034, 81432706054, 81432706055, 81432706056, 81432706057, 81432706067, 81432706068, 81432706074, 81432706075, 81432706076, 81432706077, 81432706078, 81432706081, 81432706082, 81432709034, 81432709076, 81432709078, 8143706054



SC-ES-8517

Length: 140
Cone Ø: d1 Ø 30 / d2 Ø 27
Thread: M30 x 1,5 RHT
81953016286



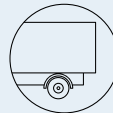

F 2000 ...

26.273 DFC,26.273 DFLC ...	01/94 →12/95	Tie Rod End	CV-ES-2149		for Push Rod
	01/94 →12/95	Tie Rod End	CV-ES-14162		for Steering Rod
	01/94 →12/95	Tie Rod End	CV-ES-14163		for Steering Rod
	01/94 →12/95	Track Control Arm		MN-DL-3402	Trailing Arm, Drive Axle
	01/94 →12/95	Track Control Arm		MN-DL-5212	Trailing Arm, Drive Axle;Air Suspension Axle
	01/94 →12/95	Track Control Arm		MN-DL-8609	Trailing Arm, 1st RA;2nd RA, for Leaf-Spring Suspension vehicles
	01/94 →12/95	Track Control Arm		MN-VB-5222	Wishbone (CV), Drive Axle
	01/94 →12/95	Track Control Arm		MN-VB-8569	Wishbone (CV), Drive Axle
26.273 DFK,26.273 DFLK	01/94 →12/95	Ball Head, gearshift linkage	CV-ES-2119		
	01/94 →12/95	Ball Head, gearshift linkage	CV-ES-2120		
	01/94 →12/95	Ball Head, gearshift linkage	CV-ES-2182		
	01/94 →12/95	Centre Rod	MN-DL-2160		Coupling Rod
	01/94 →12/95	Centre Rod	MN-DL-2175		Push Rod
	01/94 →12/95	Centre Rod	MN-DL-2176		Push Rod
	01/94 →12/95	Centre Rod	MN-DL-3588		Push Rod
	01/94 →12/95	Centre Rod	MN-DL-8197		Push Rod
	01/94 →12/95	Engine Mounting		MN-SB-10390	
	01/94 →12/95	Engine Mounting	MN-SB-10389		
	01/94 →12/95	Stabiliser Mounting		MN-SB-5243	
	01/94 →12/95	Suspension Arm Repair Kit		CV-RK-5313	for Wishbone (CV)
	01/94 →12/95	Suspension Arm Repair Kit		MN-RK-7287	for Wishbone (CV)
	01/94 →12/95	Tie Rod	MN-DL-12284		
	01/94 →12/95	Tie Rod End	CV-ES-2149		for Push Rod
	01/94 →12/95	Tie Rod End	CV-ES-14162		for Steering Rod
	01/94 →12/95	Tie Rod End	CV-ES-14163		for Steering Rod
	01/94 →12/95	Track Control Arm		MN-DL-3402	Trailing Arm, Drive Axle
	01/94 →12/95	Track Control Arm		MN-DL-5212	Trailing Arm, Drive Axle;Air Suspension Axle
	01/94 →12/95	Track Control Arm		MN-DL-8609	Trailing Arm, 1st RA;2nd RA, for Leaf-Spring Suspension vehicles
01/94 →12/95	Track Control Arm		MN-VB-5222	Wishbone (CV), Drive Axle	
01/94 →12/95	Track Control Arm		MN-VB-8569	Wishbone (CV), Drive Axle	
26.273 DFS,26.273 DFLS	01/94 →12/95	Ball Head, gearshift linkage	CV-ES-2119		
	01/94 →12/95	Ball Head, gearshift linkage	CV-ES-2120		
	01/94 →12/95	Ball Head, gearshift linkage	CV-ES-2182		
	01/94 →12/95	Centre Rod	MN-DL-2160		Coupling Rod
	01/94 →12/95	Centre Rod	MN-DL-2175		Push Rod
	01/94 →12/95	Centre Rod	MN-DL-2176		Push Rod
	01/94 →12/95	Centre Rod	MN-DL-3588		Push Rod
	01/94 →12/95	Centre Rod	MN-DL-8197		Push Rod
	01/94 →12/95	Engine Mounting		MN-SB-10390	
	01/94 →12/95	Engine Mounting	MN-SB-10389		
	01/94 →12/95	Stabiliser Mounting		MN-SB-5243	
	01/94 →12/95	Suspension Arm Repair Kit		CV-RK-5313	for Wishbone (CV)
	01/94 →12/95	Suspension Arm Repair Kit		MN-RK-7287	for Wishbone (CV)
	01/94 →12/95	Tie Rod	MN-DL-12284		
	01/94 →12/95	Tie Rod End	CV-ES-2149		for Push Rod
	01/94 →12/95	Tie Rod End	CV-ES-14162		for Steering Rod
	01/94 →12/95	Tie Rod End	CV-ES-14163		for Steering Rod
	01/94 →12/95	Track Control Arm		MN-DL-3402	Trailing Arm, Drive Axle
	01/94 →12/95	Track Control Arm		MN-DL-5212	Trailing Arm, Drive Axle;Air Suspension Axle
	01/94 →12/95	Track Control Arm		MN-DL-8609	Trailing Arm, 1st RA;2nd RA, for Leaf-Spring Suspension vehicles
01/94 →12/95	Track Control Arm		MN-VB-5222	Wishbone (CV), Drive Axle	
01/94 →12/95	Track Control Arm		MN-VB-8569	Wishbone (CV), Drive Axle	
26.273 FNLC,26.273 FNLLC, 26.273 FVLC	01/94 →12/95	Ball Head, gearshift linkage	CV-ES-2119		
	01/94 →12/95	Ball Head, gearshift linkage	CV-ES-2120		
	01/94 →12/95	Ball Head, gearshift linkage	CV-ES-2182		
	01/94 →12/95	Centre Rod	MN-DL-2160		Coupling Rod
	01/94 →12/95	Centre Rod	MN-DL-2175		Push Rod
	01/94 →12/95	Centre Rod	MN-DL-2176		Push Rod
	01/94 →12/95	Centre Rod	MN-DL-3588		Push Rod
01/94 →12/95	Centre Rod	MN-DL-8487		Push Rod	

CV-ES-2119

Length: 55
Cone Ø: d1 Ø 10 / d2 Ø 10
Thread: M12 x 1,75 LHT
81953016063, 81953016131



CV-ES-2120

Length: 115
Cone Ø: d1 Ø 12,4 / d2 Ø 10,8
Thread: M14 x 1,5 RHT
03008500A, 81953016200, 81953016202,
81953016203, 81953016227



CV-ES-2149

Length: 160
Cone Ø: d1 Ø 30 / d2 Ø 27
Thread: M30 x 1,5 RHT
81953016263



CV-ES-2182

Length: 55
Cone Ø: d1 Ø 10 / d2 Ø 10
Thread: M12 x 1,75 RHT
81953016064, 81953016170



CV-ES-14162

Length: 125
Cone Ø: d1 Ø 30 / d2 Ø 27
Thread: M30 x 1,5 LHT
81953010015, 81953010083, 81953010087,
81953016029, 81953016030, 81953016043,
81953016044, 81953016050, 81953016054,
81953016087, 81953016091, 81953016107,
81953016120, 81953016125, 81953016152,
81953016155, 81953016157, 81953016168,
81953016179, 81953016181, 81953016223,
81953016237, 81953016254, 81953016275,
81953016279, 81953016351



CV-ES-14163

Length: 125
Cone Ø: d1 Ø 30 / d2 Ø 27
Thread: M30 x 1,5 RHT
95301.0084, 90804102156, 90804102272,
90804102696, 90804102710, 81953010016,
81953010075, 81953010084, 81953010088,
81953010094, 81953010103, 81953016030,
81953016043, 81953016048, 81953016049,
81953016053, 81953016061, 81953016090,
81953016108, 81953016112, 81953016126,
81953016143, 81953016149, 81953016154,
81953016156, 81953016168, 81953016178,
81953016194, 81953016206, 81953016224,
81953016234, 81953016242, 81953016252,
81953016274, 81953016278, 81953016284,
81953016286, 81953016308, 81953016310,
81953016312, 81953016347, 81953016350,
81953016352, 82953016012, 88953016014,
N2953016001



CV-RK-5313

Ø: 90
03304800A, 81953016132



MN-DL-2160

Length: 1652 Ø: 50
Cone Ø: d1 Ø 30 / d2 Ø 27
81467106112, 81467106163, 81467106165,
81467106198, 81467106353, 81467106354,
81467106361, 81467116725



MN-DL-2175

Length: 1628 Ø: 50
Cone Ø: d1 Ø 30 / d2 Ø 27
81467106396, 81467106904



MN-DL-2176

Length: 1628 Ø: 48
Cone Ø: d1 Ø 30 / d2 Ø 27
81466106779, 81466106780, 81466106782



MN-DL-3402

Length: 590 Ø: 48
Hole Distance: 130 / 130
03307200A, 81432206067, 81432206068,
81432206090, 81432206092, 81432209092



MN-DL-3588

Length: 1035 Ø: 48
Cone Ø: d1 Ø 30 / d2 Ø 27
81466106333, 81466106334, 81466106354,
81466106355, 81466106360, 81466106361,
81466106721, 81466106722, 81466106723,
81466116216



MN-DL-5212

Length: 577 Ø: 48
Hole Distance: 130 / 130
81432206096, 81432206097, 81432206098,
81432206129, 81432209096, 81432209129,
81432306014, 81432306030



MN-DL-8197

Length: 1055 Ø: 42
Cone Ø: d1 Ø 30 / d2 Ø 27
03207500A, 81466116003, 81466116004,
81466116005



MN-DL-8487

Length: 900 Ø: 38
Cone Ø: d1 Ø 30 / d2 Ø 27
81466106767, 81466106768, 81466106774,
81466116014



MN-DL-8609

Length: 585 Ø: 58
Hole Distance: 130 / 130
81432206070, 81432206071, 81432206072,
81432206091, 81432206093, 81432206119



MN-DL-12284

Length: 1530 Ø: 50
Cone Ø: d1 Ø 30 / d2 Ø 27
81466106579, 81466106580, 81466106624,
81466116720, 81467116720, 81467116730,
81467116952



MN-RK-7287

Ø: 90
Hole Distance: 152
Thick/Height: 35
03304700A, 81953016133



MN-SB-5243

Length: 55 Ø: 78
Thick/Height: 60
03311100A, 81437040061, 81437220020



MN-SB-10389

Ø: 70 Thick/Height: 72
81960200340



MN-SB-10390

Ø: 70 Thick/Height: 85/85
81960200341, 81960200373, 81960200385,
81960200408, 81960200418



MN-VB-5222

Length: 627 Ø: 50
Hole Distance: 152 / 152
81432706030, 81432706034, 81432706054,
81432706055, 81432706056, 81432706057,
81432706067, 81432706068, 81432706074,
81432706075, 81432706076, 81432706077,
81432706078, 81432706081, 81432706082,
81432709034, 81432709076, 81432709078,
81432706054



MN-VB-8569

Length: 627 Ø: 58
Hole Distance: 152 / 152
81432706055, 81432706056, 81432706067,
81432706068, 81432706075, 81432706077,
81432706081, 81432709056



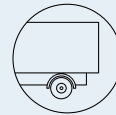

F 2000 ...

26.273 FNLC,26.273 FNLLC, 26.273 FVLC ...	01/94 →12/95	Centre Rod	MN-DL-12391		for Steering Rod
	01/94 →12/95	Engine Mounting		MN-SB-10390	
	01/94 →12/95	Engine Mounting	MN-SB-10389		
	01/94 →12/95	Suspension Arm Repair Kit		MN-RK-7280	for Drag Link;for Semi-Trailing Arm; for Wishbone (CV)
	01/94 →12/95	Suspension Arm Repair Kit	MN-RK-7280	MN-RK-7280	for Drag Link;for Semi-Trailing Arm; for Wishbone (CV)
	01/94 →12/95	Tie Rod End		SC-ES-8517	for Push Rod
	01/94 →12/95	Tie Rod End	CV-ES-2149		for Push Rod
	01/94 →12/95	Tie Rod End	CV-ES-14162		for Steering Rod
	01/94 →12/95	Tie Rod End	CV-ES-14163		for Steering Rod
	01/94 →12/95	Track Control Arm		MN-DL-5212	Trailing Arm, Drive Axle;Air Suspension Axle
	01/94 →12/95	Track Control Arm		MN-DL-5212	Trailing Arm, Drive Axle;Air Suspension Axle; Tag Axle
	01/94 →12/95	Track Control Arm		MN-VB-5222	Wishbone (CV), Drive Axle;Air Suspension Axle
	01/94 →12/95	Track Control Arm		MN-VB-5222	Wishbone (CV), Drive Axle;Tag Axle; Air Suspension Axle
	01/94 →12/95	Track Control Arm	MN-TC-14112		Control Arm, 1st Front Axle, for Pneumatic Suspension vehicles
	26.273 FNLS,26.273 FVLS	01/94 →12/95	Ball Head, gearshift linkage	CV-ES-2119	
01/94 →12/95		Ball Head, gearshift linkage	CV-ES-2120		
01/94 →12/95		Ball Head, gearshift linkage	CV-ES-2182		
01/94 →12/95		Centre Rod	MN-DL-2160		Coupling Rod
01/94 →12/95		Centre Rod	MN-DL-2175		Push Rod
01/94 →12/95		Centre Rod	MN-DL-2176		Push Rod
01/94 →12/95		Centre Rod	MN-DL-3588		Push Rod
01/94 →12/95		Centre Rod	MN-DL-8487		Push Rod
01/94 →12/95		Engine Mounting		MN-SB-10390	
01/94 →12/95		Engine Mounting	MN-SB-10389		
01/94 →12/95		Suspension Arm Repair Kit		MN-RK-7280	for Drag Link;for Semi-Trailing Arm; for Wishbone (CV)
01/94 →12/95		Tie Rod End		SC-ES-8517	for Push Rod
01/94 →12/95		Tie Rod End	CV-ES-2149		for Push Rod
01/94 →12/95		Tie Rod End	CV-ES-14162		for Steering Rod
01/94 →12/95		Tie Rod End	CV-ES-14163		for Steering Rod
01/94 →12/95		Track Control Arm		MN-DL-5212	Trailing Arm, Drive Axle;Air Suspension Axle
01/94 →12/95		Track Control Arm		MN-DL-5212	Trailing Arm, Drive Axle;Air Suspension Axle; Tag Axle
01/94 →12/95		Track Control Arm		MN-VB-5222	Wishbone (CV), Drive Axle;Air Suspension Axle
01/94 →12/95		Track Control Arm		MN-VB-5222	Wishbone (CV), Drive Axle;Tag Axle; Air Suspension Axle
01/94 →12/95		Track Control Arm	MN-TC-14112		Control Arm
26.293 DFC,26.293 DFLC	01/94 →	Ball Head, gearshift linkage	CV-ES-2119		
	01/94 →	Ball Head, gearshift linkage	CV-ES-2120		
	01/94 →	Ball Head, gearshift linkage	CV-ES-2182		
	01/94 →	Centre Rod	MN-DL-2160		Coupling Rod
	01/94 →	Centre Rod	MN-DL-2175		Push Rod
	01/94 →	Centre Rod	MN-DL-2176		Push Rod
	01/94 →	Centre Rod	MN-DL-3588		Push Rod
	01/94 →	Centre Rod	MN-DL-8197		Push Rod
	01/94 →	Centre Rod	MN-DL-12421		for Steering Rod
	01/94 →	Engine Mounting		MN-SB-10390	
	01/94 →	Engine Mounting	MN-SB-10389		
	01/94 →	Stabiliser Mounting		MN-SB-5243	
	01/94 →	Suspension Arm Repair Kit		CV-RK-5313	for Wishbone (CV)
	01/94 →	Suspension Arm Repair Kit		MN-RK-7287	for Wishbone (CV)
	01/94 →	Tie Rod	MN-DL-12284		
	01/94 →	Tie Rod End	CV-ES-2149		for Push Rod
	01/94 →	Tie Rod End	CV-ES-14162		for Steering Rod
	01/94 →	Tie Rod End	CV-ES-14163		for Steering Rod
	01/94 →	Track Control Arm		MN-DL-3402	Trailing Arm, Drive Axle
	01/94 →	Track Control Arm		MN-DL-5212	Trailing Arm, Drive Axle;Air Suspension Axle

CV-ES-2119

Length: 55
Cone Ø: d1 Ø 10 / d2 Ø 10
Thread: M12 x 1,75 LHT
81953016063, 81953016131



CV-ES-2120

Length: 115
Cone Ø: d1 Ø 12,4 / d2 Ø 10,8
Thread: M14 x 1,5 RHT
03008500A, 81953016200, 81953016202, 81953016203, 81953016227



CV-ES-2149

Length: 160
Cone Ø: d1 Ø 30 / d2 Ø 27
Thread: M30 x 1,5 RHT
81953016263



CV-ES-2182

Length: 55
Cone Ø: d1 Ø 10 / d2 Ø 10
Thread: M12 x 1,75 RHT
81953016064, 81953016170



CV-ES-14162

Length: 125
Cone Ø: d1 Ø 30 / d2 Ø 27
Thread: M30 x 1,5 LHT
81953010015, 81953010083, 81953010087, 81953016029, 81953016030, 81953016043, 81953016044, 81953016050, 81953016054, 81953016087, 81953016091, 81953016107, 81953016120, 81953016125, 81953016152, 81953016155, 81953016157, 81953016168, 81953016179, 81953016181, 81953016223, 81953016237, 81953016254, 81953016275, 81953016279, 81953016351



CV-ES-14163

Length: 125
Cone Ø: d1 Ø 30 / d2 Ø 27
Thread: M30 x 1,5 RHT
95301.0084, 90804102156, 90804102272, 90804102696, 90804102710, 81953010016, 81953010075, 81953010084, 81953010088, 81953010094, 81953010103, 81953016030, 81953016043, 81953016048, 81953016049, 81953016053, 81953016061, 81953016090, 81953016108, 81953016112, 81953016126, 81953016143, 81953016149, 81953016154, 81953016156, 81953016168, 81953016178, 81953016194, 81953016206, 81953016224, 81953016234, 81953016242, 81953016252, 81953016274, 81953016278, 81953016284, 81953016286, 81953016308, 81953016310, 81953016312, 81953016347, 81953016350, 81953016352, 82953016012, 88953016014, N2953016001



CV-RK-5313

Ø: 90
03304800A, 81953016132



MN-DL-2160

Length: 1652 Ø: 50
Cone Ø: d1 Ø 30 / d2 Ø 27
81467106112, 81467106163, 81467106165, 81467106198, 81467106353, 81467106354, 81467106361, 81467116725



MN-DL-2175

Length: 1628 Ø: 50
Cone Ø: d1 Ø 30 / d2 Ø 27
81467106396, 81467106904



MN-DL-2176

Length: 1628 Ø: 48
Cone Ø: d1 Ø 30 / d2 Ø 27
81466106779, 81466106780, 81466106782



MN-DL-3402

Length: 590 Ø: 48
Hole Distance: 130 / 130
03307200A, 81432206067, 81432206068, 81432206090, 81432206092, 81432209099



MN-DL-3588

Length: 1035 Ø: 48
Cone Ø: d1 Ø 30 / d2 Ø 27
81466106333, 81466106334, 81466106354, 81466106355, 81466106360, 81466106361, 81466106721, 81466106722, 81466106723, 81466116216



MN-DL-5212

Length: 577 Ø: 48
Hole Distance: 130 / 130
81432206096, 81432206097, 81432206098, 81432206129, 81432209096, 81432209129, 81432306014, 81432306030



MN-DL-8197

Length: 1055 Ø: 42
Cone Ø: d1 Ø 30 / d2 Ø 27
03207500A, 81466116003, 81466116004, 81466116005



MN-DL-8487

Length: 900 Ø: 38
Cone Ø: d1 Ø 30 / d2 Ø 27
81466106767, 81466106768, 81466106774, 81466116014



MN-DL-12284

Length: 1530 Ø: 50
Cone Ø: d1 Ø 30 / d2 Ø 27
81466106579, 81466106580, 81466106624, 81466116720, 81467116720, 81467116730, 81467116952



MN-DL-12391

Length: 1050 Ø: 52
Cone Ø: d1 Ø 30 / d2 Ø 27
82466106057, 82466106147



MN-DL-12421

Length: 1070 Ø: 48
Cone Ø: d1 Ø 30 / d2 Ø 27
Thread: M30 x 1,5 RHT
81466106656, 81466106659, 81466106669, 81466116006, 81466116007



MN-RK-7280

Ø: 75
Hole Distance: 115
Thick/Height: 24
0550806, 0639370, 689748, 10307400A, 81432306051, 81432306068, 81432706064



MN-RK-7287

Ø: 90
Hole Distance: 152
Thick/Height: 35
03304700A, 81953016133



MN-SB-5243

Length: 55 Ø: 78
Thick/Height: 60
03311100A, 81437040061, 81437220020



MN-SB-10389

Ø: 70 Thick/Height: 72
81960200340



MN-SB-10390

Ø: 70 Thick/Height: 85/85
81960200341, 81960200373, 81960200385, 81960200408, 81960200418



MN-TC-14112

Length: 777 Ø: 60
Hole Distance: 115 / 115
81432206106, 81432306049



MN-VB-5222

Length: 627 Ø: 50
Hole Distance: 152 / 152
81432706030, 81432706034, 81432706054, 81432706055, 81432706056, 81432706057, 81432706067, 81432706068, 81432706074, 81432706075, 81432706076, 81432706077, 81432706078, 81432706081, 81432706082, 81432709034, 81432709076, 81432709078, 8143706054



SC-ES-8517

Length: 140
Cone Ø: d1 Ø 30 / d2 Ø 27
Thread: M30 x 1,5 RHT
81953016286





F 2000 ...

26.293 DFC,26.293 DFLC ...	01/94 →	Track Control Arm		MN-DL-8609	Trailing Arm, 1st RA;2nd RA, for Leaf-Spring Suspension vehicles	
	01/94 →	Track Control Arm		MN-VB-5222	Wishbone (CV), Drive Axle	
	01/94 →	Track Control Arm		MN-VB-8569	Wishbone (CV), Drive Axle	
26.293 DFK,26.293 DFLK	01/94 →	Ball Head, gearshift linkage	CV-ES-2119			
	01/94 →	Ball Head, gearshift linkage	CV-ES-2120			
	01/94 →	Ball Head, gearshift linkage	CV-ES-2182			
	01/94 →	Centre Rod	MN-DL-2160		Coupling Rod	
	01/94 →	Centre Rod	MN-DL-2175		Push Rod	
	01/94 →	Centre Rod	MN-DL-2176		Push Rod	
	01/94 →	Centre Rod	MN-DL-3588		Push Rod	
	01/94 →	Centre Rod	MN-DL-8197		Push Rod	
	01/94 →	Centre Rod	MN-DL-12421		for Steering Rod	
	01/94 →	Engine Mounting		MN-SB-10390		
	01/94 →	Engine Mounting	MN-SB-10389			
	01/94 →	Stabiliser Mounting		MN-SB-5243		
	01/94 →	Suspension Arm Repair Kit		CV-RK-5313	for Wishbone (CV)	
	01/94 →	Suspension Arm Repair Kit		MN-RK-7287	for Wishbone (CV)	
	01/94 →	Tie Rod	MN-DL-12284			
	01/94 →	Tie Rod End	CV-ES-2149		for Push Rod	
	01/94 →	Tie Rod End	CV-ES-14162		for Steering Rod	
	01/94 →	Tie Rod End	CV-ES-14163		for Steering Rod	
	01/94 →	Track Control Arm		MN-DL-3402	Trailing Arm, Drive Axle	
	01/94 →	Track Control Arm		MN-DL-5212	Trailing Arm, Drive Axle;Air Suspension Axle	
	01/94 →	Track Control Arm		MN-DL-8609	Trailing Arm, 1st RA;2nd RA, for Leaf-Spring Suspension vehicles	
	01/94 →	Track Control Arm		MN-VB-5222	Wishbone (CV), Drive Axle	
	01/94 →	Track Control Arm		MN-VB-8569	Wishbone (CV), Drive Axle	
	26.293 DFS,26.293 DFLS	01/94 →	Ball Head, gearshift linkage	CV-ES-2119		
		01/94 →	Ball Head, gearshift linkage	CV-ES-2120		
01/94 →		Ball Head, gearshift linkage	CV-ES-2182			
01/94 →		Centre Rod	MN-DL-2160		Coupling Rod	
01/94 →		Centre Rod	MN-DL-2175		Push Rod	
01/94 →		Centre Rod	MN-DL-2176		Push Rod	
01/94 →		Centre Rod	MN-DL-3588		Push Rod	
01/94 →		Centre Rod	MN-DL-8197		Push Rod	
01/94 →		Centre Rod	MN-DL-12421		for Steering Rod	
01/94 →		Engine Mounting		MN-SB-10390		
01/94 →		Engine Mounting	MN-SB-10389			
01/94 →		Stabiliser Mounting		MN-SB-5243		
01/94 →		Suspension Arm Repair Kit		CV-RK-5313	for Wishbone (CV)	
01/94 →		Suspension Arm Repair Kit		MN-RK-7287	for Wishbone (CV)	
01/94 →		Tie Rod	MN-DL-12284			
01/94 →		Tie Rod End	CV-ES-2149		for Push Rod	
01/94 →		Tie Rod End	CV-ES-14162		for Steering Rod	
01/94 →		Tie Rod End	CV-ES-14163		for Steering Rod	
01/94 →		Track Control Arm		MN-DL-3402	Trailing Arm, Drive Axle	
01/94 →		Track Control Arm		MN-DL-5212	Trailing Arm, Drive Axle;Air Suspension Axle	
01/94 →		Track Control Arm		MN-DL-8609	Trailing Arm, 1st RA;2nd RA, for Leaf-Spring Suspension vehicles	
01/94 →		Track Control Arm		MN-VB-5222	Wishbone (CV), Drive Axle	
01/94 →		Track Control Arm		MN-VB-8569	Wishbone (CV), Drive Axle	
26.293 FNLC,26.293 FNLLC, 26.293 FVLC		01/94 →	Ball Head, gearshift linkage	CV-ES-2119		
		01/94 →	Ball Head, gearshift linkage	CV-ES-2120		
	01/94 →	Ball Head, gearshift linkage	CV-ES-2182			
	01/94 →	Centre Rod	MN-DL-2160		Coupling Rod	
	01/94 →	Centre Rod	MN-DL-2175		Push Rod	
	01/94 →	Centre Rod	MN-DL-2176		Push Rod	
	01/94 →	Centre Rod	MN-DL-3588		Push Rod	
	01/94 →	Centre Rod	MN-DL-8487		Push Rod	
	01/94 →	Centre Rod	MN-DL-12391		for Steering Rod	
	01/94 →	Centre Rod	MN-DL-12421		for Steering Rod	
	01/94 →	Engine Mounting		MN-SB-10390		

CV-ES-2119

Length: 55
Cone Ø: d1 Ø 10 / d2 Ø 10
Thread: M12 x 1,75 LHT
81953016063, 81953016131



CV-ES-2120

Length: 115
Cone Ø: d1 Ø 12,4 / d2 Ø 10,8
Thread: M14 x 1,5 RHT
03008500A, 81953016200, 81953016202, 81953016203, 81953016227



CV-ES-2149

Length: 160
Cone Ø: d1 Ø 30 / d2 Ø 27
Thread: M30 x 1,5 RHT
81953016263



CV-ES-2182

Length: 55
Cone Ø: d1 Ø 10 / d2 Ø 10
Thread: M12 x 1,75 RHT
81953016064, 81953016170



CV-ES-14162

Length: 125
Cone Ø: d1 Ø 30 / d2 Ø 27
Thread: M30 x 1,5 LHT
81953010015, 81953010083, 81953010087, 81953016029, 81953016030, 81953016043, 81953016044, 81953016050, 81953016054, 81953016087, 81953016091, 81953016107, 81953016120, 81953016125, 81953016152, 81953016155, 81953016157, 81953016168, 81953016179, 81953016181, 81953016223, 81953016237, 81953016254, 81953016275, 81953016279, 81953016351



CV-ES-14163

Length: 125
Cone Ø: d1 Ø 30 / d2 Ø 27
Thread: M30 x 1,5 RHT
95301.0084, 90804102156, 90804102272, 90804102696, 90804102710, 81953010016, 81953010075, 81953010084, 81953010088, 81953010094, 81953010103, 81953016030, 81953016043, 81953016048, 81953016049, 81953016053, 81953016061, 81953016090, 81953016108, 81953016112, 81953016126, 81953016143, 81953016149, 81953016154, 81953016156, 81953016168, 81953016178, 81953016194, 81953016206, 81953016224, 81953016234, 81953016242, 81953016252, 81953016274, 81953016278, 81953016284, 81953016286, 81953016308, 81953016310, 81953016312, 81953016347, 81953016350, 81953016352, 82953016012, 88953016014, N2953016001



CV-RK-5313

Ø: 90
03304800A, 81953016132



MN-DL-2160

Length: 1652 Ø: 50
Cone Ø: d1 Ø 30 / d2 Ø 27
81467106112, 81467106163, 81467106165, 81467106198, 81467106353, 81467106354, 81467106361, 81467116725



MN-DL-2175

Length: 1628 Ø: 50
Cone Ø: d1 Ø 30 / d2 Ø 27
81467106396, 81467106904



MN-DL-2176

Length: 1628 Ø: 48
Cone Ø: d1 Ø 30 / d2 Ø 27
81466106779, 81466106780, 81466106782



MN-DL-3402

Length: 590 Ø: 48
Hole Distance: 130 / 130
03307200A, 81432206067, 81432206068, 81432206090, 81432206092, 81432209092



MN-DL-3588

Length: 1035 Ø: 48
Cone Ø: d1 Ø 30 / d2 Ø 27
81466106333, 81466106334, 81466106354, 81466106355, 81466106360, 81466106361, 81466106721, 81466106722, 81466106723, 81466116216



MN-DL-5212

Length: 577 Ø: 48
Hole Distance: 130 / 130
81432206096, 81432206097, 81432206098, 81432206129, 81432209096, 81432209129, 81432306014, 81432306030



MN-DL-8197

Length: 1055 Ø: 42
Cone Ø: d1 Ø 30 / d2 Ø 27
03207500A, 81466116003, 81466116004, 81466116005



MN-DL-8487

Length: 900 Ø: 38
Cone Ø: d1 Ø 30 / d2 Ø 27
81466106767, 81466106768, 81466106774, 81466116014



MN-DL-8609

Length: 585 Ø: 58
Hole Distance: 130 / 130
81432206070, 81432206071, 81432206072, 81432206091, 81432206093, 81432206119



MN-DL-12284

Length: 1530 Ø: 50
Cone Ø: d1 Ø 30 / d2 Ø 27
81466106579, 81466106580, 81466106624, 81466116720, 81467116720, 81467116730, 81467116952



MN-DL-12391

Length: 1050 Ø: 52
Cone Ø: d1 Ø 30 / d2 Ø 27
82466106057, 82466106147



MN-DL-12421

Length: 1070 Ø: 48
Cone Ø: d1 Ø 30 / d2 Ø 27
Thread: M30 x 1,5 RHT
81466106656, 81466106659, 81466106669, 81466116006, 81466116007



MN-RK-7287

Ø: 90
Hole Distance: 152
Thick/Height: 35
03304700A, 81953016133



MN-SB-5243

Length: 55 Ø: 78
Thick/Height: 60
03311100A, 81437040061, 81437220020



MN-SB-10389

Ø: 70 Thick/Height: 72
81960200340



MN-SB-10390

Ø: 70 Thick/Height: 85/85
81960200341, 81960200373, 81960200385, 81960200408, 81960200418



MN-VB-5222

Length: 627 Ø: 50
Hole Distance: 152 / 152
81432706030, 81432706034, 81432706054, 81432706055, 81432706056, 81432706057, 81432706067, 81432706068, 81432706074, 81432706075, 81432706076, 81432706077, 81432706078, 81432706081, 81432706082, 81432709034, 81432709076, 81432709078, 8143706054



MN-VB-8569

Length: 627
Ø: 58
Hole Distance: 152 / 152
81432706055, 81432706056, 81432706067, 81432706068, 81432706075, 81432706077, 81432706081, 81432709056





F 2000 ...

26.293 FNLC,26.293 FNLLC, 26.293 FVLC ...	01/94 →	Engine Mounting	MN-SB-10389			
	01/94 →	Suspension Arm Repair Kit		MN-RK-7280	for Drag Link;for Semi-Trailing Arm; for Wishbone (CV)	
	01/94 →	Suspension Arm Repair Kit	MN-RK-7280	MN-RK-7280	for Drag Link;for Semi-Trailing Arm; for Wishbone (CV)	
	01/94 →	Tie Rod End		SC-ES-8517	for Push Rod	
	01/94 →	Tie Rod End	CV-ES-2149		for Push Rod	
	01/94 →	Tie Rod End	CV-ES-14162		for Steering Rod	
	01/94 →	Tie Rod End	CV-ES-14163		for Steering Rod	
	01/94 →	Track Control Arm		MN-DL-5212	Trailing Arm, Drive Axle;Air Suspension Axle	
	01/94 →	Track Control Arm		MN-DL-5212	Trailing Arm, Drive Axle;Air Suspension Axle; Tag Axle	
	01/94 →	Track Control Arm		MN-VB-5222	Wishbone (CV), Drive Axle;Air Suspension Axle	
	01/94 →	Track Control Arm		MN-VB-5222	Wishbone (CV), Drive Axle;Tag Axle; Air Suspension Axle	
	01/94 →	Track Control Arm	MN-TC-14112		Control Arm	
	26.293 FNLS,26.293 FVLS	01/94 →	Ball Head, gearshift linkage	CV-ES-2119		
		01/94 →	Ball Head, gearshift linkage	CV-ES-2120		
01/94 →		Ball Head, gearshift linkage	CV-ES-2182			
01/94 →		Centre Rod	MN-DL-2160		Coupling Rod	
01/94 →		Centre Rod	MN-DL-2175		Push Rod	
01/94 →		Centre Rod	MN-DL-2176		Push Rod	
01/94 →		Centre Rod	MN-DL-3588		Push Rod	
01/94 →		Centre Rod	MN-DL-8487		Push Rod	
01/94 →		Centre Rod	MN-DL-12421		for Steering Rod	
01/94 →		Engine Mounting		MN-SB-10390		
01/94 →		Engine Mounting	MN-SB-10389			
01/94 →		Suspension Arm Repair Kit		MN-RK-7280	for Drag Link;for Semi-Trailing Arm; for Wishbone (CV)	
01/94 →		Tie Rod End		SC-ES-8517	for Push Rod	
01/94 →		Tie Rod End	CV-ES-2149		for Push Rod	
01/94 →	Tie Rod End	CV-ES-14162		for Steering Rod		
01/94 →	Tie Rod End	CV-ES-14163		for Steering Rod		
01/94 →	Track Control Arm		MN-DL-5212	Trailing Arm, Drive Axle;Air Suspension Axle		
01/94 →	Track Control Arm		MN-DL-5212	Trailing Arm, Drive Axle;Air Suspension Axle; Tag Axle		
01/94 →	Track Control Arm		MN-VB-5222	Wishbone (CV), Drive Axle;Air Suspension Axle		
01/94 →	Track Control Arm		MN-VB-5222	Wishbone (CV), Drive Axle;Tag Axle; Air Suspension Axle		
01/94 →	Track Control Arm	MN-TC-14112		Control Arm		
26.314 DFC, DFLLC	05/01 →	Ball Head, gearshift linkage	CV-ES-2120			
	05/01 →	Centre Rod	MN-DL-8197		Push Rod	
	05/01 →	Centre Rod	MN-DL-8487		Push Rod	
	05/01 →	Suspension Arm Repair Kit		MN-SB-5244	for Wishbone (CV)	
	05/01 →	Tie Rod	MN-DL-12284			
	05/01 →	Tie Rod End	CV-ES-2149		for Push Rod	
	05/01 →	Tie Rod End	CV-ES-14162		for Steering Rod	
	05/01 →	Tie Rod End	CV-ES-14163		for Steering Rod	
	05/01 →	Tie Rod End	SC-ES-8517		for Push Rod	
	05/01 →	Track Control Arm		MN-DL-3402	Trailing Arm	
	05/01 →	Track Control Arm		MN-DL-5212	Trailing Arm	
	05/01 →	Track Control Arm		MN-VB-5222	Wishbone (CV)	
	05/01 →	Track Control Arm		MN-VB-8569	Wishbone (CV)	
	05/01 →	Track Control Arm	MN-TC-14112		Control Arm, 1st Front Axle, for Pneumatic Suspension vehicles	
26.314 DFK, DFLK, DFLK-L	05/01 →	Ball Head, gearshift linkage	CV-ES-2120			
	05/01 →	Centre Rod	MN-DL-8197		Push Rod	
	05/01 →	Centre Rod	MN-DL-8487		Push Rod	
	05/01 →	Suspension Arm Repair Kit		MN-SB-5244	for Wishbone (CV)	
	05/01 →	Tie Rod	MN-DL-12284			
	05/01 →	Tie Rod End	CV-ES-2149		for Push Rod	
	05/01 →	Tie Rod End	CV-ES-14162		for Steering Rod	
05/01 →	Tie Rod End	CV-ES-14163		for Steering Rod		

CV-ES-2119

Length: 55
Cone Ø: d1 Ø 10 / d2 Ø 10
Thread: M12 x 1,75 LHT
81953016063, 81953016131



CV-ES-2120

Length: 115
Cone Ø: d1 Ø 12,4 / d2 Ø 10,8
Thread: M14 x 1,5 RHT
03008500A, 81953016200, 81953016202, 81953016203, 81953016227



CV-ES-2149

Length: 160
Cone Ø: d1 Ø 30 / d2 Ø 27
Thread: M30 x 1,5 RHT
81953016263



CV-ES-2182

Length: 55
Cone Ø: d1 Ø 10 / d2 Ø 10
Thread: M12 x 1,75 RHT
81953016064, 81953016170



CV-ES-14162

Length: 125
Cone Ø: d1 Ø 30 / d2 Ø 27
Thread: M30 x 1,5 LHT

81953010015, 81953010083, 81953010087, 81953016029, 81953016030, 81953016043, 81953016044, 81953016050, 81953016054, 81953016087, 81953016091, 81953016107, 81953016120, 81953016125, 81953016152, 81953016155, 81953016157, 81953016168, 81953016179, 81953016181, 81953016223, 81953016237, 81953016254, 81953016275, 81953016279, 81953016351



CV-ES-14163

Length: 125
Cone Ø: d1 Ø 30 / d2 Ø 27
Thread: M30 x 1,5 RHT

95301.0084, 90804102156, 90804102272, 90804102696, 90804102710, 81953010016, 81953010075, 81953010084, 81953010088, 81953010094, 81953010103, 81953016030, 81953016043, 81953016048, 81953016049, 81953016053, 81953016061, 81953016090, 81953016108, 81953016112, 81953016126, 81953016143, 81953016149, 81953016154, 81953016156, 81953016168, 81953016178, 81953016194, 81953016206, 81953016224, 81953016234, 81953016242, 81953016252, 81953016274, 81953016278, 81953016284, 81953016286, 81953016308, 81953016310, 81953016312, 81953016347, 81953016350, 81953016352, 82953016012, 88953016014, N2953016001



MN-DL-2160

Length: 1652 Ø: 50
Cone Ø: d1 Ø 30 / d2 Ø 27
81467106112, 81467106163, 81467106165, 81467106198, 81467106353, 81467106354, 81467106361, 81467116725



MN-DL-2175

Length: 1628 Ø: 50
Cone Ø: d1 Ø 30 / d2 Ø 27
81467106396, 81467106904



MN-DL-2176

Length: 1628 Ø: 48
Cone Ø: d1 Ø 30 / d2 Ø 27
81466106779, 81466106780, 81466106782



MN-DL-3402

Length: 590 Ø: 48
Hole Distance: 130 / 130
03307200A, 81432206067, 81432206068, 81432206090, 81432206092, 81432209092



MN-DL-3588

Length: 1035 Ø: 48
Cone Ø: d1 Ø 30 / d2 Ø 27
81466106333, 81466106334, 81466106354, 81466106355, 81466106360, 81466106361, 81466106721, 81466106722, 81466106723, 81466116216



MN-DL-5212

Length: 577 Ø: 48
Hole Distance: 130 / 130
81432206096, 81432206097, 81432206098, 81432206129, 81432209096, 81432209129, 81432306014, 81432306030



MN-DL-8197

Length: 1055 Ø: 42
Cone Ø: d1 Ø 30 / d2 Ø 27
03207500A, 81466116003, 81466116004, 81466116005



MN-DL-8487

Length: 900 Ø: 38
Cone Ø: d1 Ø 30 / d2 Ø 27
81466106767, 81466106768, 81466106774, 81466116014



MN-DL-12284

Length: 1530 Ø: 50
Cone Ø: d1 Ø 30 / d2 Ø 27
81466106579, 81466106580, 81466106624, 81466116720, 81467116720, 81467116730, 81467116952



MN-DL-12421

Length: 1070 Ø: 48
Cone Ø: d1 Ø 30 / d2 Ø 27
Thread: M30 x 1,5 RHT
81466106656, 81466106659, 81466106669, 81466116006, 81466116007



MN-RK-7280

Ø: 75
Hole Distance: 115
Thick/Height: 24
0550806, 0639370, 689748, 10307400A, 81432306051, 81432306068, 81432706064



MN-SB-5244

Ø: 65
Hole Distance: 125
Thick/Height: 22
03312000A, 81432710027, 81432710082



MN-SB-10389

Ø: 70
Thick/Height: 72
81960200340



MN-SB-10390

Ø: 70
Thick/Height: 85/85
81960200341, 81960200373, 81960200385, 81960200408, 81960200418



MN-TC-14112

Length: 777 Ø: 60
Hole Distance: 115 / 115
81432206106, 81432306049



MN-VB-5222

Length: 627 Ø: 50
Hole Distance: 152 / 152
81432706030, 81432706034, 81432706054, 81432706055, 81432706056, 81432706057, 81432706067, 81432706068, 81432706074, 81432706075, 81432706076, 81432706077, 81432706078, 81432706081, 81432706082, 81432709034, 81432709076, 81432709078, 8143706054



MN-VB-8569

Length: 627 Ø: 58
Hole Distance: 152 / 152
81432706055, 81432706056, 81432706067, 81432706068, 81432706075, 81432706077, 81432706081, 81432709056



SC-ES-8517

Length: 140
Cone Ø: d1 Ø 30 / d2 Ø 27
Thread: M30 x 1,5 RHT
81953016286





F 2000 ...

26.314 DFK, DFLK, DFLK-L ...	05/01→	Tie Rod End	SC-ES-8517		for Push Rod	
	05/01→	Track Control Arm		MN-DL-3402	Trailing Arm	
	05/01→	Track Control Arm		MN-DL-5212	Trailing Arm	
	05/01→	Track Control Arm		MN-VB-5222	Wishbone (CV)	
	05/01→	Track Control Arm		MN-VB-8569	Wishbone (CV)	
	05/01→	Track Control Arm	MN-TC-14112			Control Arm, 1st Front Axle, for Pneumatic Suspension vehicles
26.314 DFS, DFLS	05/01→	Ball Head, gearshift linkage	CV-ES-2120			
	05/01→	Centre Rod	MN-DL-8197		Push Rod	
	05/01→	Centre Rod	MN-DL-8487		Push Rod	
	05/01→	Suspension Arm Repair Kit		MN-SB-5244	for Wishbone (CV)	
	05/01→	Tie Rod	MN-DL-12284			
	05/01→	Tie Rod End	CV-ES-2149		for Push Rod	
	05/01→	Tie Rod End	CV-ES-14162		for Steering Rod	
	05/01→	Tie Rod End	CV-ES-14163		for Steering Rod	
	05/01→	Track Control Arm		MN-DL-3402	Trailing Arm	
	05/01→	Track Control Arm		MN-DL-5212	Trailing Arm	
	05/01→	Track Control Arm		MN-VB-5222	Wishbone (CV)	
	05/01→	Track Control Arm		MN-VB-8569	Wishbone (CV)	
	05/01→	Track Control Arm	MN-TC-14112			Control Arm, 1st Front Axle, for Pneumatic Suspension vehicles
26.314 DF-TM	05/01→	Ball Head, gearshift linkage	CV-ES-2120			
	05/01→	Centre Rod	MN-DL-8197		Push Rod	
	05/01→	Centre Rod	MN-DL-8487		Push Rod	
	05/01→	Suspension Arm Repair Kit		MN-SB-5244	for Wishbone (CV)	
	05/01→	Tie Rod	MN-DL-12284			
	05/01→	Track Control Arm		MN-DL-3402	Trailing Arm	
	05/01→	Track Control Arm		MN-DL-5212	Trailing Arm	
	05/01→	Track Control Arm		MN-VB-5222	Wishbone (CV)	
	05/01→	Track Control Arm		MN-VB-8569	Wishbone (CV)	
26.314 FNLC, FNLLC, FNLLRC, FNLLW, FNLRC, FNLLRC, FVLC	05/01→	Ball Head, gearshift linkage	CV-ES-2120			
	05/01→	Centre Rod	MN-DL-8197		Push Rod	
	05/01→	Centre Rod	MN-DL-8487		Push Rod	
	05/01→	Suspension Arm Repair Kit		MN-RK-7291	for Drag Link	
	05/01→	Suspension Arm Repair Kit	MN-RK-7280	MN-RK-7280	for Drag Link;for Semi-Trailing Arm; for Wishbone (CV)	
	05/01→	Tie Rod End		SC-ES-8517	for Push Rod	
	05/01→	Tie Rod End	CV-ES-2149		for Push Rod	
	05/01→	Tie Rod End	CV-ES-14162		for Steering Rod	
	05/01→	Tie Rod End	CV-ES-14163		for Steering Rod	
	05/01→	Track Control Arm		MN-DL-5212	Trailing Arm	
	05/01→	Track Control Arm		MN-VB-5222	Wishbone (CV)	
	05/01→	Track Control Arm	MN-TC-14112			Control Arm, 1st Front Axle, for Pneumatic Suspension vehicles
	26.314 FNLS	05/01→	Ball Head, gearshift linkage	CV-ES-2120		
		05/01→	Centre Rod	MN-DL-8197		Push Rod
05/01→		Centre Rod	MN-DL-8487		Push Rod	
05/01→		Suspension Arm Repair Kit		MN-RK-7291	for Drag Link	
05/01→		Suspension Arm Repair Kit	MN-RK-7280	MN-RK-7280	for Drag Link;for Semi-Trailing Arm; for Wishbone (CV)	
05/01→		Tie Rod End	CV-ES-2149		for Push Rod	
05/01→		Tie Rod End	CV-ES-14162		for Steering Rod	
05/01→		Tie Rod End	CV-ES-14163		for Steering Rod	
05/01→		Tie Rod End	SC-ES-8517		for Push Rod	
05/01→		Track Control Arm		MN-DL-5212	Trailing Arm	
05/01→		Track Control Arm		MN-VB-5222	Wishbone (CV)	
05/01→		Track Control Arm	MN-TC-14112			Control Arm, 1st Front Axle, for Pneumatic Suspension vehicles
26.314 FVL-KO		05/01→	Ball Head, gearshift linkage	CV-ES-2120		
	05/01→	Centre Rod	MN-DL-8197		Push Rod	
	05/01→	Centre Rod	MN-DL-8487		Push Rod	
	05/01→	Suspension Arm Repair Kit		MN-RK-7291	for Drag Link	

CV-ES-2120

Length: 115
Cone Ø: d1 Ø 12,4 / d2 Ø 10,8
Thread: M14 x 1,5 RHT
03008500A, 81953016200, 81953016202,
81953016203, 81953016227



CV-ES-2149

Length: 160
Cone Ø: d1 Ø 30 / d2 Ø 27
Thread: M30 x 1,5 RHT
81953016263



CV-ES-14162

Length: 125
Cone Ø: d1 Ø 30 / d2 Ø 27
Thread: M30 x 1,5 LHT

81953010015, 81953010083, 81953010087,
81953016029, 81953016030, 81953016043,
81953016044, 81953016050, 81953016054,
81953016087, 81953016091, 81953016107,
81953016120, 81953016125, 81953016152,
81953016155, 81953016157, 81953016168,
81953016179, 81953016181, 81953016223,
81953016237, 81953016254, 81953016275,
81953016279, 81953016351



CV-ES-14163

Length: 125
Cone Ø: d1 Ø 30 / d2 Ø 27
Thread: M30 x 1,5 RHT

95301.0084, 90804102156, 90804102272,
90804102696, 90804102710, 81953010016,
81953010075, 81953010084, 81953010088,
81953010094, 81953010103, 81953016030,
81953016043, 81953016048, 81953016049,
81953016053, 81953016061, 81953016090,
81953016108, 81953016112, 81953016126,
81953016143, 81953016149, 81953016154,
81953016156, 81953016168, 81953016178,
81953016194, 81953016206, 81953016224,
81953016234, 81953016242, 81953016252,
81953016274, 81953016278, 81953016284,
81953016286, 81953016308, 81953016310,
81953016312, 81953016347, 81953016350,
81953016352, 82953016012, 88953016014,
N2953016001



MN-DL-3402

Length: 590 Ø: 48
Hole Distance: 130 / 130
03307200A, 81432206067, 81432206068,
81432206090, 81432206092, 81432209092



MN-DL-5212

Length: 577 Ø: 48
Hole Distance: 130 / 130
81432206096, 81432206097, 81432206098,
81432206129, 81432209096, 81432209129,
81432306014, 81432306030



MN-DL-8197

Length: 1055
Ø: 42
Cone Ø: d1 Ø 30 / d2 Ø 27
03207500A, 81466116003, 81466116004,
81466116005



MN-DL-8487

Length: 900
Ø: 38
Cone Ø: d1 Ø 30 / d2 Ø 27
81466106767, 81466106768, 81466106774,
81466116014



MN-DL-12284

Length: 1530 Ø: 50
Cone Ø: d1 Ø 30 / d2 Ø 27
81466106579, 81466106580, 81466106624,
81466116720, 81467116720, 81467116730,
81467116952



MN-RK-7280

Ø: 75
Hole Distance: 115
Thick/Height: 24
0550806, 0639370, 689748, 10307400A,
81432306051, 81432306068, 81432706064



MN-RK-7291

Ø: 72
Hole Distance: 130
Thick/Height: 30
10307800A, 81432206108, 81432206132



MN-SB-5244

Ø: 65
Hole Distance: 125
Thick/Height: 22
03312000A, 81432710027, 81432710082



MN-TC-14112

Length: 777
Ø: 60
Hole Distance: 115 / 115
81432206106, 81432306049



MN-VB-5222

Length: 627 Ø: 50
Hole Distance: 152 / 152
81432706030, 81432706034, 81432706054,
81432706055, 81432706056, 81432706057,
81432706067, 81432706068, 81432706074,
81432706075, 81432706076, 81432706077,
81432706078, 81432706081, 81432706082,
81432709034, 81432709076, 81432709078,
8143706054



MN-VB-8569

Length: 627
Ø: 58
Hole Distance: 152 / 152
81432706055, 81432706056, 81432706067,
81432706068, 81432706075, 81432706077,
81432706081, 81432709056



SC-ES-8517

Length: 140
Cone Ø: d1 Ø 30 / d2 Ø 27
Thread: M30 x 1,5 RHT
81953016286





F 2000 ...

26.314 FVL-KO ...	05/01→	Suspension Arm Repair Kit	MN-RK-7280	MN-RK-7280	for Drag Link;for Semi-Trailing Arm; for Wishbone (CV)
	05/01→	Tie Rod End		SC-ES-8517	for Push Rod
	05/01→	Tie Rod End	CV-ES-14162		for Steering Rod
	05/01→	Tie Rod End	CV-ES-14163		for Steering Rod
	05/01→	Track Control Arm		MN-DL-5212	Trailing Arm
	05/01→	Track Control Arm		MN-VB-5222	Wishbone (CV), Drive Axle, for Pneumatic Suspension vehicles
	05/01→	Track Control Arm	MN-TC-14112		Control Arm, 1st Front Axle, for Pneumatic Suspension vehicles
26.314 FVLS, FVLRS	05/01→	Ball Head, gearshift linkage	CV-ES-2120		
	05/01→	Centre Rod	MN-DL-8197		Push Rod
	05/01→	Centre Rod	MN-DL-8487		Push Rod
	05/01→	Suspension Arm Repair Kit		MN-RK-7291	for Drag Link
	05/01→	Suspension Arm Repair Kit	MN-RK-7280	MN-RK-7280	for Drag Link;for Semi-Trailing Arm; for Wishbone (CV)
	05/01→	Tie Rod End		SC-ES-8517	for Push Rod
	05/01→	Tie Rod End	CV-ES-2149		for Push Rod
	05/01→	Tie Rod End	CV-ES-14162		for Steering Rod
	05/01→	Tie Rod End	CV-ES-14163		for Steering Rod
	05/01→	Track Control Arm		MN-DL-5212	Trailing Arm
	05/01→	Track Control Arm		MN-VB-5222	Wishbone (CV), Drive Axle, for Pneumatic Suspension vehicles
05/01→	Track Control Arm	MN-TC-14112		Control Arm, 1st Front Axle, for Pneumatic Suspension vehicles	
26.323 DFC,26.323 DFLC	01/94→12/95	Ball Head, gearshift linkage	CV-ES-2119		
	01/94→12/95	Ball Head, gearshift linkage	CV-ES-2120		
	01/94→12/95	Ball Head, gearshift linkage	CV-ES-2182		
	01/94→12/95	Centre Rod	MN-DL-2160		Coupling Rod
	01/94→12/95	Centre Rod	MN-DL-2175		Push Rod
	01/94→12/95	Centre Rod	MN-DL-2176		Push Rod
	01/94→12/95	Centre Rod	MN-DL-3588		Push Rod
	01/94→12/95	Centre Rod	MN-DL-8197		Push Rod
	01/94→12/95	Engine Mounting		MN-SB-10390	
	01/94→12/95	Engine Mounting	MN-SB-10389		
	01/94→12/95	Stabiliser Mounting		MN-SB-5243	
	01/94→12/95	Suspension Arm Repair Kit		CV-RK-5313	for Wishbone (CV)
	01/94→12/95	Suspension Arm Repair Kit		MN-RK-7287	for Wishbone (CV)
	01/94→12/95	Tie Rod	MN-DL-12284		
	01/94→12/95	Tie Rod End	CV-ES-2149		for Push Rod
	01/94→12/95	Tie Rod End	CV-ES-14162		for Steering Rod
	01/94→12/95	Tie Rod End	CV-ES-14163		for Steering Rod
	01/94→12/95	Track Control Arm		MN-DL-3402	Trailing Arm, Drive Axle
	01/94→12/95	Track Control Arm		MN-DL-5212	Trailing Arm, Drive Axle;Air Suspension Axle
	01/94→12/95	Track Control Arm		MN-DL-8609	Trailing Arm, 1st RA;2nd RA, for Leaf-Spring Suspension vehicles
01/94→12/95	Track Control Arm		MN-VB-5222	Wishbone (CV), Drive Axle	
01/94→12/95	Track Control Arm		MN-VB-8569	Wishbone (CV), Drive Axle	
26.323 DFK,26.323 DFLK	01/94→12/95	Ball Head, gearshift linkage	CV-ES-2119		
	01/94→12/95	Ball Head, gearshift linkage	CV-ES-2120		
	01/94→12/95	Ball Head, gearshift linkage	CV-ES-2182		
	01/94→12/95	Centre Rod	MN-DL-2160		Coupling Rod
	01/94→12/95	Centre Rod	MN-DL-2175		Push Rod
	01/94→12/95	Centre Rod	MN-DL-2176		Push Rod
	01/94→12/95	Centre Rod	MN-DL-3588		Push Rod
	01/94→12/95	Centre Rod	MN-DL-8197		Push Rod
	01/94→12/95	Engine Mounting		MN-SB-10390	
	01/94→12/95	Engine Mounting	MN-SB-10389		
	01/94→12/95	Stabiliser Mounting		MN-SB-5243	
	01/94→12/95	Suspension Arm Repair Kit		CV-RK-5313	for Wishbone (CV)
	01/94→12/95	Suspension Arm Repair Kit		MN-RK-7287	for Wishbone (CV)
	01/94→12/95	Tie Rod	MN-DL-12284		
	01/94→12/95	Tie Rod End	CV-ES-2149		for Push Rod

CV-ES-2119

Length: 55
Cone Ø: d1 Ø 10 / d2 Ø 10
Thread: M12 x 1,75 LHT
81953016063, 81953016131



CV-ES-2120

Length: 115
Cone Ø: d1 Ø 12,4 / d2 Ø 10,8
Thread: M14 x 1,5 RHT
03008500A, 81953016200, 81953016202, 81953016203, 81953016227



CV-ES-2149

Length: 160
Cone Ø: d1 Ø 30 / d2 Ø 27
Thread: M30 x 1,5 RHT
81953016263



CV-ES-2182

Length: 55
Cone Ø: d1 Ø 10 / d2 Ø 10
Thread: M12 x 1,75 RHT
81953016064, 81953016170



CV-ES-14162

Length: 125
Cone Ø: d1 Ø 30 / d2 Ø 27
Thread: M30 x 1,5 LHT
81953010015, 81953010083, 81953010087, 81953016029, 81953016030, 81953016043, 81953016044, 81953016050, 81953016054, 81953016087, 81953016091, 81953016107, 81953016120, 81953016125, 81953016152, 81953016155, 81953016157, 81953016168, 81953016179, 81953016181, 81953016223, 81953016237, 81953016254, 81953016275, 81953016279, 81953016351



CV-ES-14163

Length: 125
Cone Ø: d1 Ø 30 / d2 Ø 27
Thread: M30 x 1,5 RHT
95301.0084, 90804102156, 90804102272, 90804102696, 90804102710, 81953010016, 81953010075, 81953010084, 81953010088, 81953010094, 81953010103, 81953016030, 81953016043, 81953016048, 81953016049, 81953016053, 81953016061, 81953016090, 81953016108, 81953016112, 81953016126, 81953016143, 81953016149, 81953016154, 81953016156, 81953016168, 81953016178, 81953016194, 81953016206, 81953016224, 81953016234, 81953016242, 81953016252, 81953016274, 81953016278, 81953016284, 81953016286, 81953016308, 81953016310, 81953016312, 81953016347, 81953016350, 81953016352, 82953016012, 88953016014, N2953016001



CV-RK-5313

Ø: 90
03304800A, 81953016132



MN-DL-2160

Length: 1652 Ø: 50
Cone Ø: d1 Ø 30 / d2 Ø 27
81467106112, 81467106163, 81467106165, 81467106198, 81467106353, 81467106354, 81467106361, 81467116725



MN-DL-2175

Length: 1628 Ø: 50
Cone Ø: d1 Ø 30 / d2 Ø 27
81467106396, 81467106904



MN-DL-2176

Length: 1628 Ø: 48
Cone Ø: d1 Ø 30 / d2 Ø 27
81466106779, 81466106780, 81466106782



MN-DL-3402

Length: 590 Ø: 48
Hole Distance: 130 / 130
03307200A, 81432206067, 81432206068, 81432206090, 81432206092, 81432209092



MN-DL-3588

Length: 1035 Ø: 48
Cone Ø: d1 Ø 30 / d2 Ø 27
81466106333, 81466106334, 81466106354, 81466106355, 81466106360, 81466106361, 81466106721, 81466106722, 81466106723, 81466116216



MN-DL-5212

Length: 577 Ø: 48
Hole Distance: 130 / 130
81432206096, 81432206097, 81432206098, 81432206129, 81432209096, 81432209129, 81432306014, 81432306030



MN-DL-8197

Length: 1055 Ø: 42
Cone Ø: d1 Ø 30 / d2 Ø 27
03207500A, 81466116003, 81466116004, 81466116005



MN-DL-8487

Length: 900 Ø: 38
Cone Ø: d1 Ø 30 / d2 Ø 27
81466106767, 81466106768, 81466106774, 81466116014



MN-DL-8609

Length: 585 Ø: 58
Hole Distance: 130 / 130
81432206070, 81432206071, 81432206072, 81432206091, 81432206093, 81432206119



MN-DL-12284

Length: 1530 Ø: 50
Cone Ø: d1 Ø 30 / d2 Ø 27
81466106579, 81466106580, 81466106624, 81466116720, 81467116720, 81467116730, 81467116952



MN-RK-7280

Ø: 75
Hole Distance: 115
Thick/Height: 24
0550806, 0639370, 689748, 10307400A, 81432306051, 81432306068, 81432706064



MN-RK-7287

Ø: 90
Hole Distance: 152
Thick/Height: 35
03304700A, 81953016133



MN-RK-7291

Ø: 72
Hole Distance: 130
Thick/Height: 30
10307800A, 81432206108, 81432206132



MN-SB-5243

Length: 55 Ø: 78
Thick/Height: 60
03311100A, 81437040061, 81437220020



MN-SB-10389

Ø: 70 Thick/Height: 72
81960200340



MN-SB-10390

Ø: 70 Thick/Height: 85/85
81960200341, 81960200373, 81960200385, 81960200408, 81960200418



MN-TC-14112

Length: 777 Ø: 60
Hole Distance: 115 / 115
81432206106, 81432306049



MN-VB-5222

Length: 627 Ø: 50
Hole Distance: 152 / 152
81432706030, 81432706034, 81432706054, 81432706055, 81432706056, 81432706057, 81432706067, 81432706068, 81432706074, 81432706075, 81432706076, 81432706077, 81432706078, 81432706081, 81432706082, 81432709034, 81432709076, 81432709078, 8143706054



MN-VB-8569

Length: 627 Ø: 58
Hole Distance: 152 / 152
81432706055, 81432706056, 81432706067, 81432706068, 81432706075, 81432706077, 81432706081, 81432709056



SC-ES-8517

Length: 140
Cone Ø: d1 Ø 30 / d2 Ø 27
Thread: M30 x 1,5 RHT
81953016286





F 2000 ...

26.323 DFK,26.323 DFLK ...	01/94 →12/95	Tie Rod End	CV-ES-14162		for Steering Rod	
	01/94 →12/95	Tie Rod End	CV-ES-14163		for Steering Rod	
	01/94 →12/95	Track Control Arm		MN-DL-3402	Trailing Arm, Drive Axle	
	01/94 →12/95	Track Control Arm		MN-DL-5212	Trailing Arm, Drive Axle;Air Suspension Axle	
	01/94 →12/95	Track Control Arm		MN-DL-8609	Trailing Arm, 1st RA;2nd RA, for Leaf-Spring Suspension vehicles	
	01/94 →12/95	Track Control Arm		MN-VB-5222	Wishbone (CV), Drive Axle	
26.323 DFS,26.323 DFLS	01/94 →12/95	Track Control Arm		MN-VB-8569	Wishbone (CV), Drive Axle	
	01/94 →12/95	Ball Head, gearshift linkage	CV-ES-2119			
	01/94 →12/95	Ball Head, gearshift linkage	CV-ES-2120			
	01/94 →12/95	Ball Head, gearshift linkage	CV-ES-2182			
	01/94 →12/95	Centre Rod	MN-DL-2160		Coupling Rod	
	01/94 →12/95	Centre Rod	MN-DL-2175		Push Rod	
	01/94 →12/95	Centre Rod	MN-DL-2176		Push Rod	
	01/94 →12/95	Centre Rod	MN-DL-3588		Push Rod	
	01/94 →12/95	Centre Rod	MN-DL-8197		Push Rod	
	01/94 →12/95	Engine Mounting		MN-SB-10390		
	01/94 →12/95	Engine Mounting	MN-SB-10389			
	01/94 →12/95	Stabiliser Mounting		MN-SB-5243		
	01/94 →12/95	Suspension Arm Repair Kit		CV-RK-5313	for Wishbone (CV)	
	01/94 →12/95	Suspension Arm Repair Kit		MN-RK-7287	for Wishbone (CV)	
	01/94 →12/95	Tie Rod	MN-DL-12284			
	01/94 →12/95	Tie Rod End	CV-ES-2149		for Push Rod	
	01/94 →12/95	Tie Rod End	CV-ES-14162		for Steering Rod	
	01/94 →12/95	Tie Rod End	CV-ES-14163		for Steering Rod	
	01/94 →12/95	Track Control Arm		MN-DL-3402	Trailing Arm, Drive Axle	
	01/94 →12/95	Track Control Arm		MN-DL-5212	Trailing Arm, Drive Axle;Air Suspension Axle	
	01/94 →12/95	Track Control Arm		MN-DL-8609	Trailing Arm, 1st RA;2nd RA, for Leaf-Spring Suspension vehicles	
	01/94 →12/95	Track Control Arm		MN-VB-5222	Wishbone (CV), Drive Axle	
	01/94 →12/95	Track Control Arm		MN-VB-8569	Wishbone (CV), Drive Axle	
	26.323 FNLC,26.323 FNLLC, 26.323 FVLC	01/94 →12/95	Ball Head, gearshift linkage	CV-ES-2119		
		01/94 →12/95	Ball Head, gearshift linkage	CV-ES-2120		
		01/94 →12/95	Ball Head, gearshift linkage	CV-ES-2182		
01/94 →12/95		Centre Rod	MN-DL-2160		Coupling Rod	
01/94 →12/95		Centre Rod	MN-DL-2175		Push Rod	
01/94 →12/95		Centre Rod	MN-DL-2176		Push Rod	
01/94 →12/95		Centre Rod	MN-DL-3588		Push Rod	
01/94 →12/95		Centre Rod	MN-DL-8487		Push Rod	
01/94 →12/95		Centre Rod	MN-DL-12391		for Steering Rod	
01/94 →12/95		Engine Mounting		MN-SB-10390		
01/94 →12/95		Engine Mounting	MN-SB-10389			
01/94 →12/95		Suspension Arm Repair Kit		MN-RK-7280	for Drag Link;for Semi-Trailing Arm; for Wishbone (CV)	
01/94 →12/95		Suspension Arm Repair Kit	MN-RK-7280	MN-RK-7280	for Drag Link;for Semi-Trailing Arm; for Wishbone (CV)	
01/94 →12/95		Tie Rod End		SC-ES-8517	for Push Rod	
01/94 →12/95		Tie Rod End	CV-ES-2149		for Push Rod	
01/94 →12/95		Tie Rod End	CV-ES-14162		for Steering Rod	
01/94 →12/95		Tie Rod End	CV-ES-14163		for Steering Rod	
01/94 →12/95		Track Control Arm		MN-DL-5212	Trailing Arm, Drive Axle;Air Suspension Axle	
01/94 →12/95		Track Control Arm		MN-DL-5212	Trailing Arm, Drive Axle;Air Suspension Axle; Tag Axle	
01/94 →12/95		Track Control Arm		MN-VB-5222	Wishbone (CV), Drive Axle;Air Suspension Axle	
01/94 →12/95		Track Control Arm	MN-TC-14112		Control Arm, 1st Front Axle, for Pneumatic Suspension vehicles	
26.323 FNLS,26.323 FVLS		01/94 →12/95	Ball Head, gearshift linkage	CV-ES-2119		
		01/94 →12/95	Ball Head, gearshift linkage	CV-ES-2120		
		01/94 →12/95	Ball Head, gearshift linkage	CV-ES-2182		
		01/94 →12/95	Centre Rod	MN-DL-2160		Coupling Rod
		01/94 →12/95	Centre Rod	MN-DL-2175		Push Rod
	01/94 →12/95	Centre Rod	MN-DL-2176		Push Rod	
01/94 →12/95	Centre Rod	MN-DL-3588		Push Rod		

CV-ES-2119

Length: 55
Cone Ø: d1 Ø 10 / d2 Ø 10
Thread: M12 x 1,75 LHT
81953016063, 81953016131



CV-ES-2120

Length: 115
Cone Ø: d1 Ø 12,4 / d2 Ø 10,8
Thread: M14 x 1,5 RHT
03008500A, 81953016200, 81953016202, 81953016203, 81953016227



CV-ES-2149

Length: 160
Cone Ø: d1 Ø 30 / d2 Ø 27
Thread: M30 x 1,5 RHT
81953016263



CV-ES-2182

Length: 55
Cone Ø: d1 Ø 10 / d2 Ø 10
Thread: M12 x 1,75 RHT
81953016064, 81953016170



CV-ES-14162

Length: 125
Cone Ø: d1 Ø 30 / d2 Ø 27
Thread: M30 x 1,5 LHT
81953010015, 81953010083, 81953010087, 81953016029, 81953016030, 81953016043, 81953016044, 81953016050, 81953016054, 81953016087, 81953016091, 81953016107, 81953016120, 81953016125, 81953016152, 81953016155, 81953016157, 81953016168, 81953016179, 81953016181, 81953016223, 81953016237, 81953016254, 81953016275, 81953016279, 81953016351



CV-ES-14163

Length: 125
Cone Ø: d1 Ø 30 / d2 Ø 27
Thread: M30 x 1,5 RHT
95301.0084, 90804102156, 90804102272, 90804102696, 90804102710, 81953010016, 81953010075, 81953010084, 81953010088, 81953010094, 81953010103, 81953016030, 81953016043, 81953016048, 81953016049, 81953016053, 81953016061, 81953016090, 81953016108, 81953016112, 81953016126, 81953016143, 81953016149, 81953016154, 81953016156, 81953016168, 81953016178, 81953016194, 81953016206, 81953016224, 81953016234, 81953016242, 81953016252, 81953016274, 81953016278, 81953016284, 81953016286, 81953016308, 81953016310, 81953016312, 81953016347, 81953016350, 81953016352, 82953016012, 88953016014, N2953016001



CV-RK-5313

Ø: 90
03304800A, 81953016132



MN-DL-2160

Length: 1652 Ø: 50
Cone Ø: d1 Ø 30 / d2 Ø 27
81467106112, 81467106163, 81467106165, 81467106198, 81467106353, 81467106354, 81467106361, 81467116725



MN-DL-2175

Length: 1628 Ø: 50
Cone Ø: d1 Ø 30 / d2 Ø 27
81467106396, 81467106904



MN-DL-2176

Length: 1628 Ø: 48
Cone Ø: d1 Ø 30 / d2 Ø 27
81466106779, 81466106780, 81466106782



MN-DL-3402

Length: 590 Ø: 48
Hole Distance: 130 / 130
03307200A, 81432206067, 81432206068, 81432206090, 81432206092, 81432209092



MN-DL-3588

Length: 1035 Ø: 48
Cone Ø: d1 Ø 30 / d2 Ø 27
81466106333, 81466106334, 81466106354, 81466106355, 81466106360, 81466106361, 81466106721, 81466106722, 81466106723, 81466116216



MN-DL-5212

Length: 577 Ø: 48
Hole Distance: 130 / 130
81432206096, 81432206097, 81432206098, 81432206129, 81432209096, 81432209129, 81432306014, 81432306030



MN-DL-8197

Length: 1055 Ø: 42
Cone Ø: d1 Ø 30 / d2 Ø 27
03207500A, 81466116003, 81466116004, 81466116005



MN-DL-8487

Length: 900 Ø: 38
Cone Ø: d1 Ø 30 / d2 Ø 27
81466106767, 81466106768, 81466106774, 81466116014



MN-DL-8609

Length: 585 Ø: 58
Hole Distance: 130 / 130
81432206070, 81432206071, 81432206072, 81432206091, 81432206093, 81432206119



MN-DL-12284

Length: 1530 Ø: 50
Cone Ø: d1 Ø 30 / d2 Ø 27
81466106579, 81466106580, 81466106624, 81466116720, 81467116720, 81467116730, 81467116952



MN-DL-12391

Length: 1050 Ø: 52
Cone Ø: d1 Ø 30 / d2 Ø 27
82466106057, 82466106147



MN-RK-7280

Ø: 75
Hole Distance: 115
Thick/Height: 24
0550806, 0639370, 689748, 10307400A, 81432306051, 81432306068, 81432706064



MN-RK-7287

Ø: 90
Hole Distance: 152
Thick/Height: 35
03304700A, 81953016133



MN-SB-5243

Length: 55 Ø: 78
Thick/Height: 60
03311100A, 81437040061, 81437220020



MN-SB-10389

Ø: 70 Thick/Height: 72
81960200340



MN-SB-10390

Ø: 70 Thick/Height: 85/85
81960200341, 81960200373, 81960200385, 81960200408, 81960200418



MN-TC-14112

Length: 777 Ø: 60
Hole Distance: 115 / 115
81432206106, 81432306049



MN-VB-5222

Length: 627 Ø: 50
Hole Distance: 152 / 152
81432706030, 81432706034, 81432706054, 81432706055, 81432706056, 81432706057, 81432706067, 81432706068, 81432706074, 81432706075, 81432706076, 81432706077, 81432706078, 81432706081, 81432706082, 81432709034, 81432709076, 81432709078, 8143706054



MN-VB-8569

Length: 627 Ø: 58
Hole Distance: 152 / 152
81432706055, 81432706067, 81432706068, 81432706075, 81432706077, 81432706081, 81432709056



SC-ES-8517

Length: 140
Cone Ø: d1 Ø 30 / d2 Ø 27
Thread: M30 x 1,5 RHT
81953016286





F 2000 ...

26.323 FNLS,26.323 FVLS ...	01/94 →12/95	Centre Rod	MN-DL-8487		Push Rod	
	01/94 →12/95	Engine Mounting		MN-SB-10390		
	01/94 →12/95	Engine Mounting	MN-SB-10389			
	01/94 →12/95	Suspension Arm Repair Kit		MN-RK-7280	for Drag Link;for Semi-Trailing Arm; for Wishbone (CV)	
	01/94 →12/95	Tie Rod End		SC-ES-8517	for Push Rod	
	01/94 →12/95	Tie Rod End	CV-ES-2149		for Push Rod	
	01/94 →12/95	Tie Rod End	CV-ES-14162		for Steering Rod	
	01/94 →12/95	Tie Rod End	CV-ES-14163		for Steering Rod	
	01/94 →12/95	Track Control Arm		MN-DL-5212	Trailing Arm, Drive Axle;Air Suspension Axle	
	01/94 →12/95	Track Control Arm		MN-DL-5212	Trailing Arm, Drive Axle;Air Suspension Axle; Tag Axle	
	01/94 →12/95	Track Control Arm		MN-VB-5222	Wishbone (CV), Drive Axle;Air Suspension Axle	
	01/94 →12/95	Track Control Arm		MN-VB-5222	Wishbone (CV), Drive Axle;Tag Axle; Air Suspension Axle	
	26.343 DFC,26.343 DFLC	01/94 →	Ball Head, gearshift linkage	CV-ES-2119		
01/94 →		Ball Head, gearshift linkage	CV-ES-2120			
01/94 →		Ball Head, gearshift linkage	CV-ES-2182			
01/94 →		Centre Rod	MN-DL-2160		Coupling Rod	
01/94 →		Centre Rod	MN-DL-2175		Push Rod	
01/94 →		Centre Rod	MN-DL-2176		Push Rod	
01/94 →		Centre Rod	MN-DL-3588		Push Rod	
01/94 →		Centre Rod	MN-DL-8197		Push Rod	
01/94 →		Centre Rod	MN-DL-12421		for Steering Rod	
01/94 →		Engine Mounting		MN-SB-10390		
01/94 →		Engine Mounting	MN-SB-10389			
01/94 →		Stabiliser Mounting		MN-SB-5243		
01/94 →		Suspension Arm Repair Kit		CV-RK-5313	for Wishbone (CV)	
01/94 →		Suspension Arm Repair Kit		MN-RK-7287	for Wishbone (CV)	
01/94 →		Tie Rod	MN-DL-12284			
01/94 →		Tie Rod End	CV-ES-2146			
01/94 →		Tie Rod End	CV-ES-2149		for Push Rod	
01/94 →		Tie Rod End	CV-ES-14162		for Steering Rod	
01/94 →		Tie Rod End	CV-ES-14163		for Steering Rod	
01/94 →		Track Control Arm		MN-DL-3402	Trailing Arm, Drive Axle	
01/94 →		Track Control Arm		MN-DL-5212	Trailing Arm, Drive Axle;Air Suspension Axle	
01/94 →		Track Control Arm		MN-DL-8609	Trailing Arm, 1st RA;2nd RA, for Leaf-Spring Suspension vehicles	
01/94 →		Track Control Arm		MN-VB-5222	Wishbone (CV), Drive Axle	
01/94 →		Track Control Arm		MN-VB-8569	Wishbone (CV), Drive Axle	
26.343 DFK,26.343 DFLK		01/94 →	Ball Head, gearshift linkage	CV-ES-2119		
		01/94 →	Ball Head, gearshift linkage	CV-ES-2120		
		01/94 →	Ball Head, gearshift linkage	CV-ES-2182		
	01/94 →	Centre Rod	MN-DL-2160		Coupling Rod	
	01/94 →	Centre Rod	MN-DL-2175		Push Rod	
	01/94 →	Centre Rod	MN-DL-2176		Push Rod	
	01/94 →	Centre Rod	MN-DL-3588		Push Rod	
	01/94 →	Centre Rod	MN-DL-8197		Push Rod	
	01/94 →	Centre Rod	MN-DL-12421		for Steering Rod	
	01/94 →	Engine Mounting		MN-SB-10390		
	01/94 →	Engine Mounting	MN-SB-10389			
	01/94 →	Stabiliser Mounting		MN-SB-5243		
	01/94 →	Suspension Arm Repair Kit		CV-RK-5313	for Wishbone (CV)	
	01/94 →	Suspension Arm Repair Kit		MN-RK-7287	for Wishbone (CV)	
	01/94 →	Tie Rod	MN-DL-12284			
	01/94 →	Tie Rod End	CV-ES-2146			
	01/94 →	Tie Rod End	CV-ES-2149		for Push Rod	
	01/94 →	Tie Rod End	CV-ES-14162		for Steering Rod	
	01/94 →	Tie Rod End	CV-ES-14163		for Steering Rod	
	01/94 →	Track Control Arm		MN-DL-3402	Trailing Arm, Drive Axle	
	01/94 →	Track Control Arm		MN-DL-5212	Trailing Arm, Drive Axle;Air Suspension Axle	

CV-ES-2119

Length: 55
Cone Ø: d1 Ø 10 / d2 Ø 10
Thread: M12 x 1,75 LHT
81953016063, 81953016131



CV-ES-2120

Length: 115
Cone Ø: d1 Ø 12,4 / d2 Ø 10,8
Thread: M14 x 1,5 RHT
03008500A, 81953016200, 81953016202,
81953016203, 81953016227



CV-ES-2146

Length: 80
Cone Ø: d1 Ø 30 / d2 Ø 27
Thread: M26 x 1,5 RHT
42533102, 81953016219, 81953016225,
81953016226, 81953016267, 81953016291



CV-ES-2149

Length: 160
Cone Ø: d1 Ø 30 / d2 Ø 27
Thread: M30 x 1,5 RHT
81953016263



CV-ES-2182

Length: 55
Cone Ø: d1 Ø 10 / d2 Ø 10
Thread: M12 x 1,75 RHT
81953016064, 81953016170



CV-ES-14162

Length: 125
Cone Ø: d1 Ø 30 / d2 Ø 27
Thread: M30 x 1,5 LHT
81953010015, 81953010083, 81953010087,
81953016029, 81953016030, 81953016043,
81953016044, 81953016050, 81953016054,
81953016087, 81953016091, 81953016107,
81953016120, 81953016125, 81953016152,
81953016155, 81953016157, 81953016168,
81953016179, 81953016181, 81953016223,
81953016237, 81953016254, 81953016275,
81953016279, 81953016351



CV-ES-14163

Length: 125
Cone Ø: d1 Ø 30 / d2 Ø 27
Thread: M30 x 1,5 RHT
95301.0084, 90804102156, 90804102272,
90804102696, 90804102710, 81953010016,
81953010075, 81953010084, 81953010088,
81953010094, 81953010103, 81953016030,
81953016043, 81953016048, 81953016049,
81953016053, 81953016061, 81953016090,
81953016108, 81953016112, 81953016126,
81953016143, 81953016149, 81953016154,
81953016156, 81953016168, 81953016178,
81953016194, 81953016206, 81953016224,
81953016234, 81953016242, 81953016252,
81953016274, 81953016278, 81953016284,
81953016286, 81953016308, 81953016310,
81953016312, 81953016347, 81953016350,
81953016352, 82953016012, 88953016014,
N2953016001



CV-RK-5313

Ø: 90
03304800A, 81953016132



MN-DL-2160

Length: 1652 Ø: 50
Cone Ø: d1 Ø 30 / d2 Ø 27
81467106112, 81467106163, 81467106165,
81467106198, 81467106353, 81467106354,
81467106361, 81467116725



MN-DL-2175

Length: 1628 Ø: 50
Cone Ø: d1 Ø 30 / d2 Ø 27
81467106396, 81467106904



MN-DL-2176

Length: 1628 Ø: 48
Cone Ø: d1 Ø 30 / d2 Ø 27
81466106779, 81466106780, 81466106782



MN-DL-3402

Length: 590 Ø: 48
Hole Distance: 130 / 130
03307200A, 81432206067, 81432206068,
81432206090, 81432206092, 81432209092



MN-DL-3588

Length: 1035 Ø: 48
Cone Ø: d1 Ø 30 / d2 Ø 27
81466106333, 81466106334, 81466106354,
81466106355, 81466106360, 81466106361,
81466106721, 81466106722, 81466106723,
81466116216



MN-DL-5212

Length: 577 Ø: 48
Hole Distance: 130 / 130
81432206096, 81432206097, 81432206098,
81432206129, 81432209096, 81432209129,
81432306014, 81432306030



MN-DL-8197

Length: 1055 Ø: 42
Cone Ø: d1 Ø 30 / d2 Ø 27
03207500A, 81466116003, 81466116004,
81466116005



MN-DL-8487

Length: 900 Ø: 38
Cone Ø: d1 Ø 30 / d2 Ø 27
81466106767, 81466106768, 81466106774,
81466116014



MN-DL-8609

Length: 585 Ø: 58
Hole Distance: 130 / 130
81432206070, 81432206071, 81432206072,
81432206091, 81432206093, 81432206119



MN-DL-12284

Length: 1530 Ø: 50
Cone Ø: d1 Ø 30 / d2 Ø 27
81466106579, 81466106580, 81466106624,
81466116720, 81467116720, 81467116730,
81467116952



MN-DL-12421

Length: 1070 Ø: 48
Cone Ø: d1 Ø 30 / d2 Ø 27
Thread: M30 x 1,5 RHT
81466106656, 81466106659, 81466106669,
81466116006, 81466116007



MN-RK-7280

Ø: 75
Hole Distance: 115
Thick/Height: 24
0550806, 0639370, 689748, 10307400A,
81432306051, 81432306068, 81432706064



MN-RK-7287

Ø: 90
Hole Distance: 152
Thick/Height: 35
03304700A, 81953016133



MN-SB-5243

Length: 55 Ø: 78
Thick/Height: 60
03311100A, 81437040061, 81437220020



MN-SB-10389

Ø: 70 Thick/Height: 72
81960200340



MN-SB-10390

Ø: 70 Thick/Height: 85/85
81960200341, 81960200373, 81960200385,
81960200408, 81960200418



MN-TC-14112

Length: 777 Ø: 60
Hole Distance: 115 / 115
81432206106, 81432306049



MN-VB-5222

Length: 627 Ø: 50
Hole Distance: 152 / 152
81432706030, 81432706034, 81432706054,
81432706055, 81432706056, 81432706057,
81432706067, 81432706068, 81432706074,
81432706075, 81432706076, 81432706077,
81432706078, 81432706081, 81432706082,
81432709034, 81432709076, 81432709078,
8143706054



MN-VB-8569

Length: 627 Ø: 58
Hole Distance: 152 / 152
81432706055, 81432706056, 81432706067,
81432706068, 81432706075, 81432706077,
81432706081, 81432709056



SC-ES-8517

Length: 140
Cone Ø: d1 Ø 30 / d2 Ø 27
Thread: M30 x 1,5 RHT
81953016286





F 2000 ...

26.343 DFK,26.343 DFLK ...	01/94 →	Track Control Arm		MN-DL-8609	Trailing Arm, 1st RA;2nd RA, for Leaf-Spring Suspension vehicles	
	01/94 →	Track Control Arm		MN-VB-5222	Wishbone (CV), Drive Axle	
	01/94 →	Track Control Arm		MN-VB-8569	Wishbone (CV), Drive Axle	
26.343 DFS,26.343 DFLS	01/94 →	Ball Head, gearshift linkage	CV-ES-2119			
	01/94 →	Ball Head, gearshift linkage	CV-ES-2120			
	01/94 →	Ball Head, gearshift linkage	CV-ES-2182			
	01/94 →	Centre Rod	MN-DL-2160		Coupling Rod	
	01/94 →	Centre Rod	MN-DL-2175		Push Rod	
	01/94 →	Centre Rod	MN-DL-2176		Push Rod	
	01/94 →	Centre Rod	MN-DL-3588		Push Rod	
	01/94 →	Centre Rod	MN-DL-8197		Push Rod	
	01/94 →	Centre Rod	MN-DL-12421		for Steering Rod	
	01/94 →	Engine Mounting		MN-SB-10390		
	01/94 →	Engine Mounting	MN-SB-10389			
	01/94 →	Stabiliser Mounting		MN-SB-5243		
	01/94 →	Suspension Arm Repair Kit		CV-RK-5313	for Wishbone (CV)	
	01/94 →	Suspension Arm Repair Kit		MN-RK-7287	for Wishbone (CV)	
	01/94 →	Tie Rod	MN-DL-12284			
	01/94 →	Tie Rod End	CV-ES-2146			
	01/94 →	Tie Rod End	CV-ES-2149		for Push Rod	
	01/94 →	Tie Rod End	CV-ES-14162		for Steering Rod	
	01/94 →	Tie Rod End	CV-ES-14163		for Steering Rod	
	01/94 →	Track Control Arm		MN-DL-3402	Trailing Arm, Drive Axle	
	01/94 →	Track Control Arm		MN-DL-5212	Trailing Arm, Drive Axle;Air Suspension Axle	
	01/94 →	Track Control Arm		MN-DL-8609	Trailing Arm, 1st RA;2nd RA, for Leaf-Spring Suspension vehicles	
	01/94 →	Track Control Arm		MN-VB-5222	Wishbone (CV), Drive Axle	
	01/94 →	Track Control Arm		MN-VB-8569	Wishbone (CV), Drive Axle	
	26.343 FNLC,26.343 FNLLC, 26.343 FVLC	01/94 →	Ball Head, gearshift linkage	CV-ES-2119		
		01/94 →	Ball Head, gearshift linkage	CV-ES-2120		
		01/94 →	Ball Head, gearshift linkage	CV-ES-2182		
01/94 →		Centre Rod	MN-DL-2160		Coupling Rod	
01/94 →		Centre Rod	MN-DL-2175		Push Rod	
01/94 →		Centre Rod	MN-DL-2176		Push Rod	
01/94 →		Centre Rod	MN-DL-3588		Push Rod	
01/94 →		Centre Rod	MN-DL-8487		Push Rod	
01/94 →		Centre Rod	MN-DL-12391		for Steering Rod	
01/94 →		Centre Rod	MN-DL-12421		for Steering Rod	
01/94 →		Engine Mounting		MN-SB-10390		
01/94 →		Engine Mounting	MN-SB-10389			
01/94 →		Suspension Arm Repair Kit		MN-RK-7280	for Drag Link;for Semi-Trailing Arm; for Wishbone (CV)	
01/94 →		Suspension Arm Repair Kit	MN-RK-7280	MN-RK-7280	for Drag Link;for Semi-Trailing Arm; for Wishbone (CV)	
01/94 →		Tie Rod End		SC-ES-8517	for Push Rod	
01/94 →		Tie Rod End	CV-ES-2146			
01/94 →		Tie Rod End	CV-ES-2149		for Push Rod	
01/94 →		Tie Rod End	CV-ES-14162		for Steering Rod	
01/94 →		Tie Rod End	CV-ES-14163		for Steering Rod	
01/94 →		Track Control Arm		MN-DL-5212	Trailing Arm, Drive Axle;Air Suspension Axle	
01/94 →		Track Control Arm		MN-DL-5212	Trailing Arm, Drive Axle;Air Suspension Axle; Tag Axle	
01/94 →		Track Control Arm		MN-VB-5222	Wishbone (CV), Drive Axle;Air Suspension Axle	
01/94 →		Track Control Arm		MN-VB-5222	Wishbone (CV), Drive Axle;Tag Axle; Air Suspension Axle	
01/94 →		Track Control Arm	MN-TC-14112		Control Arm, 1st Front Axle, for Pneumatic Suspension vehicles	
26.343 FNLS,26.343 FVLS		01/94 →	Ball Head, gearshift linkage	CV-ES-2119		
		01/94 →	Ball Head, gearshift linkage	CV-ES-2120		
		01/94 →	Ball Head, gearshift linkage	CV-ES-2182		
	01/94 →	Centre Rod	MN-DL-2160		Coupling Rod	
	01/94 →	Centre Rod	MN-DL-2175		Push Rod	

CV-ES-2119

Length: 55
Cone Ø: d1 Ø 10 / d2 Ø 10
Thread: M12 x 1,75 LHT
81953016063, 81953016131



CV-ES-2120

Length: 115
Cone Ø: d1 Ø 12,4 / d2 Ø 10,8
Thread: M14 x 1,5 RHT
03008500A, 81953016200, 81953016202,
81953016203, 81953016227



CV-ES-2146

Length: 80
Cone Ø: d1 Ø 30 / d2 Ø 27
Thread: M26 x 1,5 RHT
42533102, 81953016219, 81953016225,
81953016226, 81953016267, 81953016291



CV-ES-2149

Length: 160
Cone Ø: d1 Ø 30 / d2 Ø 27
Thread: M30 x 1,5 RHT
81953016263



CV-ES-2182

Length: 55
Cone Ø: d1 Ø 10 / d2 Ø 10
Thread: M12 x 1,75 RHT
81953016064, 81953016170



CV-ES-14162

Length: 125
Cone Ø: d1 Ø 30 / d2 Ø 27
Thread: M30 x 1,5 LHT
81953010015, 81953010083, 81953010087,
81953016029, 81953016030, 81953016043,
81953016044, 81953016050, 81953016054,
81953016087, 81953016091, 81953016107,
81953016120, 81953016125, 81953016152,
81953016155, 81953016157, 81953016168,
81953016179, 81953016181, 81953016223,
81953016237, 81953016254, 81953016275,
81953016279, 81953016351



CV-ES-14163

Length: 125
Cone Ø: d1 Ø 30 / d2 Ø 27
Thread: M30 x 1,5 RHT
95301.0084, 90804102156, 90804102272,
90804102696, 90804102710, 81953010016,
81953010075, 81953010084, 81953010088,
81953010094, 81953010103, 81953016030,
81953016043, 81953016048, 81953016049,
81953016053, 81953016061, 81953016090,
81953016108, 81953016112, 81953016126,
81953016143, 81953016149, 81953016154,
81953016156, 81953016168, 81953016178,
81953016194, 81953016206, 81953016224,
81953016234, 81953016242, 81953016252,
81953016274, 81953016278, 81953016284,
81953016286, 81953016308, 81953016310,
81953016312, 81953016347, 81953016350,
81953016352, 82953016012, 88953016014,
N2953016001



CV-RK-5313

Ø: 90
03304800A, 81953016132



MN-DL-2160

Length: 1652 Ø: 50
Cone Ø: d1 Ø 30 / d2 Ø 27
81467106112, 81467106163, 81467106165,
81467106198, 81467106353, 81467106354,
81467106361, 81467116725



MN-DL-2175

Length: 1628 Ø: 50
Cone Ø: d1 Ø 30 / d2 Ø 27
81467106396, 81467106904



MN-DL-2176

Length: 1628 Ø: 48
Cone Ø: d1 Ø 30 / d2 Ø 27
81466106779, 81466106780, 81466106782



MN-DL-3402

Length: 590 Ø: 48
Hole Distance: 130 / 130
03307200A, 81432206067, 81432206068,
81432206090, 81432206092, 81432209092



MN-DL-3588

Length: 1035 Ø: 48
Cone Ø: d1 Ø 30 / d2 Ø 27
81466106333, 81466106334, 81466106354,
81466106355, 81466106360, 81466106361,
81466106721, 81466106722, 81466106723,
81466116216



MN-DL-5212

Length: 577 Ø: 48
Hole Distance: 130 / 130
81432206096, 81432206097, 81432206098,
81432206129, 81432209096, 81432209129,
81432306014, 81432306030



MN-DL-8197

Length: 1055 Ø: 42
Cone Ø: d1 Ø 30 / d2 Ø 27
03207500A, 81466116003, 81466116004,
81466116005



MN-DL-8487

Length: 900
Ø: 38
Cone Ø: d1 Ø 30 / d2 Ø 27
81466106767, 81466106768, 81466106774,
81466116014



MN-DL-8609

Length: 585 Ø: 58
Hole Distance: 130 / 130
81432206070, 81432206071, 81432206072,
81432206091, 81432206093, 81432206119



MN-DL-12284

Length: 1530 Ø: 50
Cone Ø: d1 Ø 30 / d2 Ø 27
81466106579, 81466106580, 81466106624,
81466116720, 81467116720, 81467116730,
81467116952



MN-DL-12391

Length: 1050 Ø: 52
Cone Ø: d1 Ø 30 / d2 Ø 27
82466106057, 82466106147



MN-DL-12421

Length: 1070 Ø: 48
Cone Ø: d1 Ø 30 / d2 Ø 27
Thread: M30 x 1,5 RHT
81466106656, 81466106659, 81466106669,
81466116006, 81466116007



MN-RK-7280

Ø: 75
Hole Distance: 115
Thick/Height: 24
0550806, 0639370, 689748, 10307400A,
81432306051, 81432306068, 81432706064



MN-RK-7287

Ø: 90
Hole Distance: 152
Thick/Height: 35
03304700A, 81953016133



MN-SB-5243

Length: 55 Ø: 78
Thick/Height: 60
03311100A, 81437040061, 81437220020



MN-SB-10389

Ø: 70 Thick/Height: 72
81960200340



MN-SB-10390

Ø: 70 Thick/Height: 85/85
81960200341, 81960200373, 81960200385,
81960200408, 81960200418



MN-TC-14112

Length: 777 Ø: 60
Hole Distance: 115 / 115
81432206106, 81432306049



MN-VB-5222

Length: 627 Ø: 50
Hole Distance: 152 / 152
81432706030, 81432706034, 81432706054,
81432706055, 81432706056, 81432706057,
81432706067, 81432706068, 81432706074,
81432706075, 81432706076, 81432706077,
81432706078, 81432706081, 81432706082,
81432709034, 81432709076, 81432709078,
8143706054



MN-VB-8569

Length: 627 Ø: 58
Hole Distance: 152 / 152
81432706055, 81432706056, 81432706067,
81432706068, 81432706075, 81432706077,
81432706081, 81432709056



SC-ES-8517

Length: 140
Cone Ø: d1 Ø 30 / d2 Ø 27
Thread: M30 x 1,5 RHT
81953016286





F 2000 ...

26.343 FNLS,26.343 FVLS ...	01/94→	Centre Rod	MN-DL-2176		Push Rod
	01/94→	Centre Rod	MN-DL-3588		Push Rod
	01/94→	Centre Rod	MN-DL-8487		Push Rod
	01/94→	Centre Rod	MN-DL-12421		for Steering Rod
	01/94→	Engine Mounting		MN-SB-10390	
	01/94→	Engine Mounting	MN-SB-10389		
	01/94→	Suspension Arm Repair Kit		MN-RK-7280	for Drag Link;for Semi-Trailing Arm; for Wishbone (CV)
	01/94→	Tie Rod End		SC-ES-8517	for Push Rod
	01/94→	Tie Rod End	CV-ES-2146		
	01/94→	Tie Rod End	CV-ES-2149		for Push Rod
	01/94→	Tie Rod End	CV-ES-14162		for Steering Rod
	01/94→	Tie Rod End	CV-ES-14163		for Steering Rod
	01/94→	Track Control Arm		MN-DL-5212	Trailing Arm, Drive Axle;Air Suspension Axle
	01/94→	Track Control Arm		MN-DL-5212	Trailing Arm, Drive Axle;Air Suspension Axle; Tag Axle
	01/94→	Track Control Arm		MN-VB-5222	Wishbone (CV), Drive Axle;Air Suspension Axle
	01/94→	Track Control Arm		MN-VB-5222	Wishbone (CV), Drive Axle;Tag Axle; Air Suspension Axle
	26.364 DFC, DFLC	01/94→	Track Control Arm	MN-TC-14112	
05/01→		Ball Head, gearshift linkage	CV-ES-2120		
05/01→		Centre Rod	MN-DL-8197		Push Rod
05/01→		Centre Rod	MN-DL-8487		Push Rod
05/01→		Suspension Arm Repair Kit		MN-SB-5244	for Wishbone (CV)
05/01→		Tie Rod	MN-DL-12284		
05/01→		Tie Rod End	CV-ES-2149		for Push Rod
05/01→		Tie Rod End	CV-ES-14162		for Steering Rod
05/01→		Tie Rod End	CV-ES-14163		for Steering Rod
05/01→		Tie Rod End	SC-ES-8517		for Push Rod
05/01→		Track Control Arm		MN-DL-3402	Trailing Arm
05/01→		Track Control Arm		MN-DL-5212	Trailing Arm
05/01→		Track Control Arm		MN-VB-5222	Wishbone (CV)
05/01→		Track Control Arm		MN-VB-8569	Wishbone (CV)
05/01→		Track Control Arm	MN-TC-14112		Control Arm, 1st Front Axle, for Pneumatic Suspension vehicles
26.364 DFK, DFLK, DFLK-L	05/01→	Ball Head, gearshift linkage	CV-ES-2120		
	05/01→	Centre Rod	MN-DL-8197		Push Rod
	05/01→	Centre Rod	MN-DL-8487		Push Rod
	05/01→	Suspension Arm Repair Kit		MN-SB-5244	for Wishbone (CV)
	05/01→	Tie Rod	MN-DL-12284		
	05/01→	Tie Rod End	CV-ES-2149		for Push Rod
	05/01→	Tie Rod End	CV-ES-14162		for Steering Rod
	05/01→	Tie Rod End	CV-ES-14163		for Steering Rod
	05/01→	Tie Rod End	SC-ES-8517		for Push Rod
	05/01→	Track Control Arm		MN-DL-3402	Trailing Arm
	05/01→	Track Control Arm		MN-DL-5212	Trailing Arm
	05/01→	Track Control Arm		MN-VB-5222	Wishbone (CV)
	05/01→	Track Control Arm		MN-VB-8569	Wishbone (CV)
	05/01→	Track Control Arm	MN-TC-14112		Control Arm, 1st Front Axle, for Pneumatic Suspension vehicles
	26.364 DFS, DFLS	05/01→	Ball Head, gearshift linkage	CV-ES-2120	
05/01→		Centre Rod	MN-DL-8197		Push Rod
05/01→		Centre Rod	MN-DL-8487		Push Rod
05/01→		Suspension Arm Repair Kit		MN-SB-5244	for Wishbone (CV)
05/01→		Tie Rod	MN-DL-12284		
05/01→		Tie Rod End	CV-ES-2149		for Push Rod
05/01→		Tie Rod End	CV-ES-14162		for Steering Rod
05/01→		Tie Rod End	CV-ES-14163		for Steering Rod
05/01→		Tie Rod End	SC-ES-8517		for Push Rod
05/01→		Track Control Arm		MN-DL-3402	Trailing Arm
05/01→		Track Control Arm		MN-DL-5212	Trailing Arm
05/01→		Track Control Arm		MN-VB-5222	Wishbone (CV)
05/01→		Track Control Arm		MN-VB-8569	Wishbone (CV)

CV-ES-2120

Length: 115
Cone Ø: d1 Ø 12,4 / d2 Ø 10,8
Thread: M14 x 1,5 RHT
03008500A, 81953016200, 81953016202,
81953016203, 81953016227



CV-ES-2146

Length: 80
Cone Ø: d1 Ø 30 / d2 Ø 27
Thread: M26 x 1,5 RHT
42533102, 81953016219, 81953016225,
81953016226, 81953016267, 81953016291



CV-ES-2149

Length: 160
Cone Ø: d1 Ø 30 / d2 Ø 27
Thread: M30 x 1,5 RHT
81953016263



CV-ES-14162

Length: 125
Cone Ø: d1 Ø 30 / d2 Ø 27
Thread: M30 x 1,5 LHT
81953010015, 81953010083, 81953010087,
81953016029, 81953016030, 81953016043,
81953016044, 81953016050, 81953016054,
81953016087, 81953016091, 81953016107,
81953016120, 81953016125, 81953016152,
81953016155, 81953016157, 81953016168,
81953016179, 81953016181, 81953016223,
81953016237, 81953016254, 81953016275,
81953016279, 81953016351



CV-ES-14163

Length: 125
Cone Ø: d1 Ø 30 / d2 Ø 27
Thread: M30 x 1,5 RHT
95301.0084, 90804102156, 90804102272,
90804102696, 90804102710, 81953010016,
81953010075, 81953010084, 81953010088,
81953010094, 81953010103, 81953016030,
81953016043, 81953016048, 81953016049,
81953016053, 81953016061, 81953016090,
81953016108, 81953016112, 81953016126,
81953016143, 81953016149, 81953016154,
81953016156, 81953016168, 81953016178,
81953016194, 81953016206, 81953016224,
81953016234, 81953016242, 81953016252,
81953016274, 81953016278, 81953016284,
81953016286, 81953016308, 81953016310,
81953016312, 81953016347, 81953016350,
81953016352, 82953016012, 88953016014,
N2953016001



MN-DL-2176

Length: 1628 Ø: 48
Cone Ø: d1 Ø 30 / d2 Ø 27
81466106779, 81466106780, 81466106782



MN-DL-3402

Length: 590 Ø: 48
Hole Distance: 130 / 130
03307200A, 81432206067, 81432206068,
81432206090, 81432206092, 81432209092



MN-DL-3588

Length: 1035 Ø: 48
Cone Ø: d1 Ø 30 / d2 Ø 27
81466106333, 81466106334, 81466106354,
81466106355, 81466106360, 81466106361,
81466106721, 81466106722, 81466106723,
81466116216



MN-DL-5212

Length: 577 Ø: 48
Hole Distance: 130 / 130
81432206096, 81432206097, 81432206098,
81432206129, 81432209096, 81432209129,
81432306014, 81432306030



MN-DL-8197

Length: 1055 Ø: 42
Cone Ø: d1 Ø 30 / d2 Ø 27
03207500A, 81466116003, 81466116004,
81466116005



MN-DL-8487

Length: 900 Ø: 38
Cone Ø: d1 Ø 30 / d2 Ø 27
81466106767, 81466106768, 81466106774,
81466116014



MN-DL-12284

Length: 1530 Ø: 50
Cone Ø: d1 Ø 30 / d2 Ø 27
81466106579, 81466106580, 81466106624,
81466116720, 81467116720, 81467116730,
81467116952



MN-DL-12421

Length: 1070 Ø: 48
Cone Ø: d1 Ø 30 / d2 Ø 27
Thread: M30 x 1,5 RHT
81466106656, 81466106659, 81466106669,
81466116006, 81466116007



MN-RK-7280

Ø: 75
Hole Distance: 115
Thick/Height: 24
0550806, 0639370, 689748, 10307400A,
81432306051, 81432306068, 81432706064



MN-SB-5244

Ø: 65
Hole Distance: 125
Thick/Height: 22
03312000A, 81432710027, 81432710082



MN-SB-10389

Ø: 70 Thick/Height: 72
81960200340



MN-SB-10390

Ø: 70 Thick/Height: 85/85
81960200341, 81960200373, 81960200385,
81960200408, 81960200418



MN-TC-14112

Length: 777 Ø: 60
Hole Distance: 115 / 115
81432206106, 81432306049



MN-VB-5222

Length: 627 Ø: 50
Hole Distance: 152 / 152
81432706030, 81432706034, 81432706054,
81432706055, 81432706056, 81432706057,
81432706067, 81432706068, 81432706074,
81432706075, 81432706076, 81432706077,
81432706078, 81432706081, 81432706082,
81432709034, 81432709076, 81432709078,
8143706054



MN-VB-8569

Length: 627 Ø: 58
Hole Distance: 152 / 152
81432706055, 81432706056, 81432706067,
81432706068, 81432706075, 81432706077,
81432706081, 81432709056



SC-ES-8517

Length: 140
Cone Ø: d1 Ø 30 / d2 Ø 27
Thread: M30 x 1,5 RHT
81953016286





F 2000 ...

26.364 DFS, DFLS ...	05/01→	Track Control Arm	MN-TC-14112		Control Arm, 1st Front Axle, for Pneumatic Suspension vehicles	
26.364 DF-TM	05/01→	Ball Head, gearshift linkage	CV-ES-2120			
	05/01→	Centre Rod	MN-DL-8197		Push Rod	
	05/01→	Centre Rod	MN-DL-8487		Push Rod	
	05/01→	Suspension Arm Repair Kit		MN-SB-5244	for Wishbone (CV)	
	05/01→	Tie Rod	MN-DL-12284			
	05/01→	Track Control Arm		MN-DL-3402	Trailing Arm	
	05/01→	Track Control Arm		MN-DL-5212	Trailing Arm	
	05/01→	Track Control Arm		MN-VB-5222	Wishbone (CV)	
	05/01→	Track Control Arm		MN-VB-8569	Wishbone (CV)	
26.364 FNLC, FNLLC, FNLLRC, FNLLW, FNLRC, FNLLRC, FVLC	05/01→	Ball Head, gearshift linkage	CV-ES-2120			
	05/01→	Centre Rod	MN-DL-8197		Push Rod	
	05/01→	Centre Rod	MN-DL-8487		Push Rod	
	05/01→	Suspension Arm Repair Kit		MN-RK-7291	for Drag Link	
	05/01→	Suspension Arm Repair Kit	MN-RK-7280	MN-RK-7280	for Drag Link;for Semi-Trailing Arm; for Wishbone (CV)	
	05/01→	Tie Rod End		SC-ES-8517	for Push Rod	
	05/01→	Tie Rod End	CV-ES-2149		for Push Rod	
	05/01→	Tie Rod End	CV-ES-14162		for Steering Rod	
	05/01→	Tie Rod End	CV-ES-14163		for Steering Rod	
	05/01→	Track Control Arm		MN-DL-5212	Trailing Arm	
	05/01→	Track Control Arm		MN-VB-5222	Wishbone (CV)	
	05/01→	Track Control Arm	MN-TC-14112		Control Arm, 1st Front Axle, for Pneumatic Suspension vehicles	
	26.364 FNLS	05/01→	Ball Head, gearshift linkage	CV-ES-2120		
		05/01→	Centre Rod	MN-DL-8197		Push Rod
05/01→		Centre Rod	MN-DL-8487		Push Rod	
05/01→		Suspension Arm Repair Kit		MN-RK-7291	for Drag Link	
05/01→		Suspension Arm Repair Kit	MN-RK-7280	MN-RK-7280	for Drag Link;for Semi-Trailing Arm; for Wishbone (CV)	
05/01→		Tie Rod End	CV-ES-2149		for Push Rod	
05/01→		Tie Rod End	CV-ES-14162		for Steering Rod	
05/01→		Tie Rod End	CV-ES-14163		for Steering Rod	
05/01→		Tie Rod End	SC-ES-8517		for Push Rod	
05/01→		Track Control Arm		MN-DL-5212	Trailing Arm	
05/01→		Track Control Arm		MN-VB-5222	Wishbone (CV)	
05/01→		Track Control Arm	MN-TC-14112		Control Arm, 1st Front Axle, for Pneumatic Suspension vehicles	
26.364 FVL-KO		05/01→	Ball Head, gearshift linkage	CV-ES-2120		
		05/01→	Centre Rod	MN-DL-8197		Push Rod
	05/01→	Centre Rod	MN-DL-8487		Push Rod	
	05/01→	Suspension Arm Repair Kit		MN-RK-7291	for Drag Link	
	05/01→	Suspension Arm Repair Kit	MN-RK-7280	MN-RK-7280	for Drag Link;for Semi-Trailing Arm; for Wishbone (CV)	
	05/01→	Tie Rod End		SC-ES-8517	for Push Rod	
	05/01→	Tie Rod End	CV-ES-14162		for Steering Rod	
	05/01→	Tie Rod End	CV-ES-14163		for Steering Rod	
	05/01→	Track Control Arm		MN-DL-5212	Trailing Arm	
	05/01→	Track Control Arm		MN-VB-5222	Wishbone (CV), Drive Axle, for Pneumatic Suspension vehicles	
	05/01→	Track Control Arm	MN-TC-14112		Control Arm, 1st Front Axle, for Pneumatic Suspension vehicles	
	26.364 FVLS, FVLS	05/01→	Ball Head, gearshift linkage	CV-ES-2120		
		05/01→	Centre Rod	MN-DL-8197		Push Rod
		05/01→	Centre Rod	MN-DL-8487		Push Rod
05/01→		Suspension Arm Repair Kit		MN-RK-7291	for Drag Link	
05/01→		Suspension Arm Repair Kit	MN-RK-7280	MN-RK-7280	for Drag Link;for Semi-Trailing Arm; for Wishbone (CV)	
05/01→		Tie Rod End		SC-ES-8517	for Push Rod	
05/01→		Tie Rod End	CV-ES-2149		for Push Rod	
05/01→		Tie Rod End	CV-ES-14162		for Steering Rod	
05/01→		Tie Rod End	CV-ES-14163		for Steering Rod	

CV-ES-2120

Length: 115
Cone Ø: d1 Ø 12,4 / d2 Ø 10,8
Thread: M14 x 1,5 RHT
03008500A, 81953016200, 81953016202,
81953016203, 81953016227



CV-ES-2149

Length: 160
Cone Ø: d1 Ø 30 / d2 Ø 27
Thread: M30 x 1,5 RHT
81953016263



CV-ES-14162

Length: 125
Cone Ø: d1 Ø 30 / d2 Ø 27
Thread: M30 x 1,5 LHT
81953010015, 81953010083, 81953010087,
81953016029, 81953016030, 81953016043,
81953016044, 81953016050, 81953016054,
81953016087, 81953016091, 81953016107,
81953016120, 81953016125, 81953016152,
81953016155, 81953016157, 81953016168,
81953016179, 81953016181, 81953016223,
81953016237, 81953016254, 81953016275,
81953016279, 81953016351



CV-ES-14163

Length: 125
Cone Ø: d1 Ø 30 / d2 Ø 27
Thread: M30 x 1,5 RHT
95301.0084, 90804102156, 90804102272,
90804102696, 90804102710, 81953010016,
81953010075, 81953010084, 81953010088,
81953010094, 81953010103, 81953016030,
81953016043, 81953016048, 81953016049,
81953016053, 81953016061, 81953016090,
81953016108, 81953016112, 81953016126,
81953016143, 81953016149, 81953016154,
81953016156, 81953016168, 81953016178,
81953016194, 81953016206, 81953016224,
81953016234, 81953016242, 81953016252,
81953016274, 81953016278, 81953016284,
81953016286, 81953016308, 81953016310,
81953016312, 81953016347, 81953016350,
81953016352, 82953016012, 88953016014,
N2953016001



MN-DL-3402

Length: 590 Ø: 48
Hole Distance: 130 / 130
03307200A, 81432206067, 81432206068,
81432206090, 81432206092, 81432209092



MN-DL-5212

Length: 577 Ø: 48
Hole Distance: 130 / 130
81432206096, 81432206097, 81432206098,
81432206129, 81432209096, 81432209129,
81432306014, 81432306030



MN-DL-8197

Length: 1055
Ø: 42
Cone Ø: d1 Ø 30 / d2 Ø 27
03207500A, 81466116003, 81466116004,
81466116005



MN-DL-8487

Length: 900
Ø: 38
Cone Ø: d1 Ø 30 / d2 Ø 27
81466106767, 81466106768, 81466106774,
81466116014



MN-DL-12284

Length: 1530 Ø: 50
Cone Ø: d1 Ø 30 / d2 Ø 27
81466106579, 81466106580, 81466106624,
81466116720, 81467116720, 81467116730,
81467116952



MN-RK-7280

Ø: 75
Hole Distance: 115
Thick/Height: 24
0550806, 0639370, 689748, 10307400A,
81432306051, 81432306068, 81432706064



MN-RK-7291

Ø: 72
Hole Distance: 130
Thick/Height: 30
10307800A, 81432206108, 81432206132



MN-SB-5244

Ø: 65
Hole Distance: 125
Thick/Height: 22
03312000A, 81432710027, 81432710082



MN-TC-14112

Length: 777
Ø: 60
Hole Distance: 115 / 115
81432206106, 81432306049



MN-VB-5222

Length: 627 Ø: 50
Hole Distance: 152 / 152
81432706030, 81432706034, 81432706054,
81432706055, 81432706056, 81432706057,
81432706067, 81432706068, 81432706074,
81432706075, 81432706076, 81432706077,
81432706078, 81432706081, 81432706082,
81432709034, 81432709076, 81432709078,
8143706054



MN-VB-8569

Length: 627
Ø: 58
Hole Distance: 152 / 152
81432706055, 81432706056, 81432706067,
81432706068, 81432706075, 81432706077,
81432706081, 81432709056



SC-ES-8517

Length: 140
Cone Ø: d1 Ø 30 / d2 Ø 27
Thread: M30 x 1,5 RHT
81953016286





F 2000 ...

26.364 FVLS, FVLS ...	05/01 →	Track Control Arm		MN-DL-5212	Trailing Arm
	05/01 →	Track Control Arm		MN-VB-5222	Wishbone (CV), Drive Axle, for Pneumatic Suspension vehicles
	05/01 →	Track Control Arm	MN-TC-14112		Control Arm, 1st Front Axle, for Pneumatic Suspension vehicles
26.373 DFC, 26.373 DFCL	01/94 →12/95	Ball Head, gearshift linkage	CV-ES-2119		
	01/94 →12/95	Ball Head, gearshift linkage	CV-ES-2120		
	01/94 →12/95	Ball Head, gearshift linkage	CV-ES-2182		
	01/94 →12/95	Centre Rod	MN-DL-2160		Coupling Rod
	01/94 →12/95	Centre Rod	MN-DL-2175		Push Rod
	01/94 →12/95	Centre Rod	MN-DL-2176		Push Rod
	01/94 →12/95	Centre Rod	MN-DL-3588		Push Rod
	01/94 →12/95	Centre Rod	MN-DL-8197		Push Rod
	01/94 →12/95	Engine Mounting		MN-SB-10390	
	01/94 →12/95	Suspension Arm Repair Kit		MN-SB-5244	for Wishbone (CV)
	01/94 →12/95	Suspension Arm Repair Kit		MN-SB-5244	for Wishbone (CV), 1st RA
	01/94 →12/95	Tie Rod	MN-DL-12284		
	01/94 →12/95	Tie Rod End	CV-ES-2149		for Push Rod
	01/94 →12/95	Tie Rod End	CV-ES-14162		for Steering Rod
	01/94 →12/95	Tie Rod End	CV-ES-14163		for Steering Rod
	01/94 →12/95	Tie Rod End	SC-ES-8517		for Push Rod
	01/94 →12/95	Track Control Arm		MN-DL-3402	Trailing Arm
	01/94 →12/95	Track Control Arm		MN-DL-3402	Trailing Arm, Drive Axle
	01/94 →12/95	Track Control Arm		MN-DL-5212	Trailing Arm, Drive Axle; Air Suspension Axle
	01/94 →12/95	Track Control Arm		MN-VB-5222	Wishbone (CV)
	01/94 →12/95	Track Control Arm		MN-VB-5222	Wishbone (CV), Drive Axle; Air Suspension Axle
	01/94 →12/95	Track Control Arm		MN-VB-8569	Wishbone (CV)
	01/94 →12/95	Track Control Arm		MN-VB-8569	Wishbone (CV), Drive Axle
	01/94 →12/95	Track Control Arm	MN-TC-14112		Control Arm, 1st Front Axle, for Pneumatic Suspension vehicles
26.373 DFK, 26.373 DFLK	01/94 →12/95	Ball Head, gearshift linkage	CV-ES-2119		
	01/94 →12/95	Ball Head, gearshift linkage	CV-ES-2120		
	01/94 →12/95	Ball Head, gearshift linkage	CV-ES-2182		
	01/94 →12/95	Centre Rod	MN-DL-2160		Coupling Rod
	01/94 →12/95	Centre Rod	MN-DL-2175		Push Rod
	01/94 →12/95	Centre Rod	MN-DL-2176		Push Rod
	01/94 →12/95	Centre Rod	MN-DL-3588		Push Rod
	01/94 →12/95	Centre Rod	MN-DL-8197		Push Rod
	01/94 →12/95	Engine Mounting		MN-SB-10390	
	01/94 →12/95	Suspension Arm Repair Kit		MN-SB-5244	for Wishbone (CV)
	01/94 →12/95	Suspension Arm Repair Kit		MN-SB-5244	for Wishbone (CV), 1st RA
	01/94 →12/95	Tie Rod	MN-DL-12284		
	01/94 →12/95	Tie Rod End	CV-ES-2149		for Push Rod
	01/94 →12/95	Tie Rod End	CV-ES-14162		for Steering Rod
	01/94 →12/95	Tie Rod End	CV-ES-14163		for Steering Rod
	01/94 →12/95	Tie Rod End	SC-ES-8517		for Push Rod
	01/94 →12/95	Track Control Arm		MN-DL-3402	Trailing Arm
	01/94 →12/95	Track Control Arm		MN-DL-3402	Trailing Arm, Drive Axle
	01/94 →12/95	Track Control Arm		MN-DL-5212	Trailing Arm, Drive Axle; Air Suspension Axle
	01/94 →12/95	Track Control Arm		MN-VB-5222	Wishbone (CV)
	01/94 →12/95	Track Control Arm		MN-VB-5222	Wishbone (CV), Drive Axle; Air Suspension Axle
	01/94 →12/95	Track Control Arm		MN-VB-8569	Wishbone (CV)
	01/94 →12/95	Track Control Arm		MN-VB-8569	Wishbone (CV), Drive Axle
	01/94 →12/95	Track Control Arm	MN-TC-14112		Control Arm, 1st Front Axle, for Pneumatic Suspension vehicles
26.373 DFS, 26.373 DFSL	01/94 →12/95	Ball Head, gearshift linkage	CV-ES-2119		
	01/94 →12/95	Ball Head, gearshift linkage	CV-ES-2120		
	01/94 →12/95	Ball Head, gearshift linkage	CV-ES-2182		
	01/94 →12/95	Centre Rod	MN-DL-2160		Coupling Rod
	01/94 →12/95	Centre Rod	MN-DL-2175		Push Rod
	01/94 →12/95	Centre Rod	MN-DL-2176		Push Rod
	01/94 →12/95	Centre Rod	MN-DL-3588		Push Rod

CV-ES-2119

Length: 55
Cone Ø: d1 Ø 10 / d2 Ø 10
Thread: M12 x 1,75 LHT
81953016063, 81953016131



CV-ES-2120

Length: 115
Cone Ø: d1 Ø 12,4 / d2 Ø 10,8
Thread: M14 x 1,5 RHT
03008500A, 81953016200, 81953016202,
81953016203, 81953016227



CV-ES-2149

Length: 160
Cone Ø: d1 Ø 30 / d2 Ø 27
Thread: M30 x 1,5 RHT
81953016263



CV-ES-2182

Length: 55
Cone Ø: d1 Ø 10 / d2 Ø 10
Thread: M12 x 1,75 RHT
81953016064, 81953016170



CV-ES-14162

Length: 125
Cone Ø: d1 Ø 30 / d2 Ø 27
Thread: M30 x 1,5 LHT
81953010015, 81953010083, 81953010087,
81953016029, 81953016030, 81953016043,
81953016044, 81953016050, 81953016054,
81953016087, 81953016091, 81953016107,
81953016120, 81953016125, 81953016152,
81953016155, 81953016157, 81953016168,
81953016179, 81953016181, 81953016223,
81953016237, 81953016254, 81953016275,
81953016279, 81953016351



CV-ES-14163

Length: 125
Cone Ø: d1 Ø 30 / d2 Ø 27
Thread: M30 x 1,5 RHT
95301.0084, 90804102156, 90804102272,
90804102696, 90804102710, 81953010016,
81953010075, 81953010084, 81953010088,
81953010094, 81953010103, 81953016030,
81953016043, 81953016048, 81953016049,
81953016053, 81953016061, 81953016090,
81953016108, 81953016112, 81953016126,
81953016143, 81953016149, 81953016154,
81953016156, 81953016168, 81953016178,
81953016194, 81953016206, 81953016224,
81953016234, 81953016242, 81953016252,
81953016274, 81953016278, 81953016284,
81953016286, 81953016308, 81953016310,
81953016312, 81953016347, 81953016350,
81953016352, 82953016012, 88953016014,
N2953016001



MN-DL-2160

Length: 1652 Ø: 50
Cone Ø: d1 Ø 30 / d2 Ø 27
81467106112, 81467106163, 81467106165,
81467106198, 81467106353, 81467106354,
81467106361, 81467116725



MN-DL-2175

Length: 1628
Ø: 50
Cone Ø: d1 Ø 30 / d2 Ø 27
81467106396, 81467106904



MN-DL-2176

Length: 1628
Ø: 48
Cone Ø: d1 Ø 30 / d2 Ø 27
81466106779, 81466106780, 81466106782



MN-DL-3402

Length: 590 Ø: 48
Hole Distance: 130 / 130
03307200A, 81432206067, 81432206068,
81432206090, 81432206092, 81432209092



MN-DL-3588

Length: 1035
Ø: 48
Cone Ø: d1 Ø 30 / d2 Ø 27
81466106333, 81466106334, 81466106354,
81466106355, 81466106360, 81466106361,
81466106721, 81466106722, 81466106723,
81466116216



MN-DL-5212

Length: 577 Ø: 48
Hole Distance: 130 / 130
81432206096, 81432206097, 81432206098,
81432206129, 81432209096, 81432209129,
81432306014, 81432306030



MN-DL-8197

Length: 1055
Ø: 42
Cone Ø: d1 Ø 30 / d2 Ø 27
03207500A, 81466116003, 81466116004,
81466116005



MN-DL-12284

Length: 1530 Ø: 50
Cone Ø: d1 Ø 30 / d2 Ø 27
81466106579, 81466106580, 81466106624,
81466116720, 81467116720, 81467116730,
81467116952



MN-SB-5244

Ø: 65
Hole Distance: 125
Thick/Height: 22
03312000A, 81432710027, 81432710082



MN-SB-10390

Ø: 70
Thick/Height: 85/85
81960200341, 81960200373, 81960200385,
81960200408, 81960200418



MN-TC-14112

Length: 777
Ø: 60
Hole Distance: 115 / 115
81432206106, 81432306049



MN-VB-5222

Length: 627 Ø: 50
Hole Distance: 152 / 152
81432706030, 81432706034, 81432706054,
81432706055, 81432706056, 81432706057,
81432706067, 81432706068, 81432706074,
81432706075, 81432706076, 81432706077,
81432706078, 81432706081, 81432706082,
81432709034, 81432709076, 81432709078,
8143706054



MN-VB-8569

Length: 627
Ø: 58
Hole Distance: 152 / 152
81432706055, 81432706056, 81432706067,
81432706068, 81432706075, 81432706077,
81432706081, 81432709056



SC-ES-8517

Length: 140
Cone Ø: d1 Ø 30 / d2 Ø 27
Thread: M30 x 1,5 RHT
81953016286





F 2000 ...

26.373 DFS,26.373 DFLS ...	01/94 →12/95	Engine Mounting		MN-SB-10390	
	01/94 →12/95	Suspension Arm Repair Kit		MN-SB-5244	for Wishbone (CV)
	01/94 →12/95	Suspension Arm Repair Kit		MN-SB-5244	for Wishbone (CV), 1st RA
	01/94 →12/95	Tie Rod	MN-DL-12284		
	01/94 →12/95	Tie Rod End	CV-ES-2149		for Push Rod
	01/94 →12/95	Tie Rod End	CV-ES-14162		for Steering Rod
	01/94 →12/95	Tie Rod End	CV-ES-14163		for Steering Rod
	01/94 →12/95	Tie Rod End	SC-ES-8517		for Push Rod
	01/94 →12/95	Track Control Arm		MN-DL-3402	Trailing Arm
	01/94 →12/95	Track Control Arm		MN-DL-3402	Trailing Arm, Drive Axle
	01/94 →12/95	Track Control Arm		MN-DL-5212	Trailing Arm, Drive Axle;Air Suspension Axle
	01/94 →12/95	Track Control Arm		MN-VB-5222	Wishbone (CV)
	01/94 →12/95	Track Control Arm		MN-VB-5222	Wishbone (CV), Drive Axle;Air Suspension Axle
	01/94 →12/95	Track Control Arm		MN-VB-8569	Wishbone (CV)
	01/94 →12/95	Track Control Arm		MN-VB-8569	Wishbone (CV), Drive Axle
	01/94 →12/95	Track Control Arm	MN-TC-14112		Control Arm, 1st Front Axle, for Pneumatic Suspension vehicles
26.373 FNLC,26.373 FNLLC, 26.373 FVLC	01/94 →12/95	Ball Head, gearshift linkage	CV-ES-2119		
	01/94 →12/95	Ball Head, gearshift linkage	CV-ES-2120		
	01/94 →12/95	Ball Head, gearshift linkage	CV-ES-2182		
	01/94 →12/95	Centre Rod	MN-DL-2160		Coupling Rod
	01/94 →12/95	Centre Rod	MN-DL-2175		Push Rod
	01/94 →12/95	Centre Rod	MN-DL-2176		Push Rod
	01/94 →12/95	Centre Rod	MN-DL-3588		Push Rod
	01/94 →12/95	Centre Rod	MN-DL-8197		Push Rod
	01/94 →12/95	Centre Rod	MN-DL-8487		Push Rod
	01/94 →12/95	Engine Mounting		MN-SB-10390	
	01/94 →12/95	Stabiliser Mounting		MN-SB-5243	
	01/94 →12/95	Suspension Arm Repair Kit		CV-RK-5313	for Wishbone (CV)
	01/94 →12/95	Suspension Arm Repair Kit		MN-RK-7280	for Drag Link;for Semi-Trailing Arm; for Wishbone (CV)
	01/94 →12/95	Suspension Arm Repair Kit		MN-RK-7287	for Wishbone (CV)
	01/94 →12/95	Tie Rod End		MN-ES-8490	for vehicles with Hinged Trailing Axle
	01/94 →12/95	Tie Rod End		SC-ES-8517	for Push Rod
	01/94 →12/95	Tie Rod End	CV-ES-2149		for Push Rod
	01/94 →12/95	Tie Rod End	CV-ES-14162		for Steering Rod
	01/94 →12/95	Tie Rod End	CV-ES-14163		for Steering Rod
	01/94 →12/95	Tie Rod End	IV-ES-12272		for Steering Rod
01/94 →12/95	Track Control Arm		MN-DL-5212	Trailing Arm, Drive Axle;Air Suspension Axle	
01/94 →12/95	Track Control Arm		MN-DL-5212	Trailing Arm, Drive Axle;Air Suspension Axle; Tag Axle	
01/94 →12/95	Track Control Arm		MN-VB-5222	Wishbone (CV), Drive Axle;Air Suspension Axle	
01/94 →12/95	Track Control Arm		MN-VB-5222	Wishbone (CV), Drive Axle;Tag Axle; Air Suspension Axle	
01/94 →12/95	Track Control Arm	MN-TC-14112		Control Arm, 1st Front Axle, for Pneumatic Suspension vehicles	
26.373 FNLS,26.373 FVLS	01/94 →12/95	Ball Head, gearshift linkage	CV-ES-2119		
	01/94 →12/95	Ball Head, gearshift linkage	CV-ES-2120		
	01/94 →12/95	Ball Head, gearshift linkage	CV-ES-2182		
	01/94 →12/95	Centre Rod	MN-DL-2160		Coupling Rod
	01/94 →12/95	Centre Rod	MN-DL-2175		Push Rod
	01/94 →12/95	Centre Rod	MN-DL-2176		Push Rod
	01/94 →12/95	Centre Rod	MN-DL-3588		Push Rod
	01/94 →12/95	Centre Rod	MN-DL-8197		Push Rod
	01/94 →12/95	Centre Rod	MN-DL-8487		Push Rod
	01/94 →12/95	Engine Mounting		MN-SB-10390	
	01/94 →12/95	Suspension Arm Repair Kit		MN-RK-7280	for Drag Link;for Semi-Trailing Arm; for Wishbone (CV)
	01/94 →12/95	Suspension Arm Repair Kit	MN-RK-7280	MN-RK-7280	for Drag Link;for Semi-Trailing Arm; for Wishbone (CV)
	01/94 →12/95	Tie Rod End		MN-ES-8490	for vehicles with Hinged Trailing Axle
	01/94 →12/95	Tie Rod End		SC-ES-8517	for Push Rod
	01/94 →12/95	Tie Rod End	CV-ES-2149		for Push Rod

CV-ES-2119

Length: 55
Cone Ø: d1 Ø 10 / d2 Ø 10
Thread: M12 x 1,75 LHT
81953016063, 81953016131



CV-ES-2120

Length: 115
Cone Ø: d1 Ø 12,4 / d2 Ø 10,8
Thread: M14 x 1,5 RHT
03008500A, 81953016200, 81953016202,
81953016203, 81953016227



CV-ES-2149

Length: 160
Cone Ø: d1 Ø 30 / d2 Ø 27
Thread: M30 x 1,5 RHT
81953016263



CV-ES-2182

Length: 55
Cone Ø: d1 Ø 10 / d2 Ø 10
Thread: M12 x 1,75 RHT
81953016064, 81953016170



CV-ES-14162

Length: 125
Cone Ø: d1 Ø 30 / d2 Ø 27
Thread: M30 x 1,5 LHT
81953010015, 81953010083, 81953010087,
81953016029, 81953016030, 81953016043,
81953016044, 81953016050, 81953016054,
81953016087, 81953016091, 81953016107,
81953016120, 81953016125, 81953016152,
81953016155, 81953016157, 81953016168,
81953016179, 81953016181, 81953016223,
81953016237, 81953016254, 81953016275,
81953016279, 81953016351



CV-ES-14163

Length: 125
Cone Ø: d1 Ø 30 / d2 Ø 27
Thread: M30 x 1,5 RHT
95301.0084, 90804102156, 90804102272,
90804102696, 90804102710, 81953010016,
81953010075, 81953010084, 81953010088,
81953010094, 81953010103, 81953016030,
81953016043, 81953016048, 81953016049,
81953016053, 81953016061, 81953016090,
81953016108, 81953016112, 81953016126,
81953016143, 81953016149, 81953016154,
81953016156, 81953016168, 81953016178,
81953016194, 81953016206, 81953016224,
81953016234, 81953016242, 81953016252,
81953016274, 81953016278, 81953016284,
81953016286, 81953016308, 81953016310,
81953016312, 81953016347, 81953016350,
81953016352, 82953016012, 88953016014,
N2953016001



CV-RK-5313

Ø: 90
03304800A, 81953016132



IV-ES-12272

Length: 75
Cone Ø: d1 Ø 30 / d2 Ø 27
Thread: M26 x 1,5 RHT
81953016280, 82953010010



MN-DL-2160

Length: 1652 Ø: 50
Cone Ø: d1 Ø 30 / d2 Ø 27
81467106112, 81467106163, 81467106165,
81467106198, 81467106353, 81467106354,
81467106361, 81467116725



MN-DL-2175

Length: 1628 Ø: 50
Cone Ø: d1 Ø 30 / d2 Ø 27
81467106396, 81467106904



MN-DL-2176

Length: 1628
Ø: 48
Cone Ø: d1 Ø 30 / d2 Ø 27
81466106779, 81466106780, 81466106782



MN-DL-3402

Length: 590 Ø: 48
Hole Distance: 130 / 130
03307200A, 81432206067, 81432206068,
81432206090, 81432206092, 81432209092



MN-DL-3588

Length: 1035 Ø: 48
Cone Ø: d1 Ø 30 / d2 Ø 27
81466106333, 81466106334, 81466106354,
81466106355, 81466106360, 81466106361,
81466106721, 81466106722, 81466106723,
81466116216



MN-DL-5212

Length: 577 Ø: 48
Hole Distance: 130 / 130
81432206096, 81432206097, 81432206098,
81432206129, 81432209096, 81432209129,
81432306014, 81432306030



MN-DL-8197

Length: 1055 Ø: 42
Cone Ø: d1 Ø 30 / d2 Ø 27
03207500A, 81466116003, 81466116004,
81466116005



MN-DL-8487

Length: 900 Ø: 38
Cone Ø: d1 Ø 30 / d2 Ø 27
81466106767, 81466106768, 81466106774,
81466116014



MN-DL-12284

Length: 1530 Ø: 50
Cone Ø: d1 Ø 30 / d2 Ø 27
81466106579, 81466106580, 81466106624,
81466116720, 81467116720, 81467116730,
81467116952



MN-ES-8490

Length: 90
Cone Ø: d1 Ø 30 / d2 Ø 27
Thread: M26 x 1,5 RHT
14606948, 0014606948, 81953016281,
81953016337, 82953016016



MN-RK-7280

Ø: 75
Hole Distance: 115
Thick/Height: 24
0550806, 0639370, 689748, 10307400A,
81432306051, 81432306068, 81432706064



MN-RK-7287

Ø: 90
Hole Distance: 152
Thick/Height: 35
03304700A, 81953016133



MN-SB-5243

Length: 55 Ø: 78
Thick/Height: 60
03311100A, 81437040061, 81437220020



MN-SB-5244

Ø: 65
Hole Distance: 125
Thick/Height: 22
03312000A, 81432710027, 81432710082



MN-SB-10390

Ø: 70 Thick/Height: 85/85
81960200341, 81960200373, 81960200385,
81960200408, 81960200418



MN-TC-14112

Length: 777 Ø: 60
Hole Distance: 115 / 115
81432206106, 81432306049



MN-VB-5222

Length: 627 Ø: 50
Hole Distance: 152 / 152
81432706030, 81432706034, 81432706054,
81432706055, 81432706056, 81432706057,
81432706067, 81432706068, 81432706074,
81432706075, 81432706076, 81432706077,
81432706078, 81432706081, 81432706082,
81432709034, 81432709076, 81432709078,
8143706054



MN-VB-8569

Length: 627 Ø: 58
Hole Distance: 152 / 152
81432706055, 81432706056, 81432706067,
81432706068, 81432706075, 81432706077,
81432706081, 81432709056



SC-ES-8517

Length: 140
Cone Ø: d1 Ø 30 / d2 Ø 27
Thread: M30 x 1,5 RHT
81953016286





F 2000 ...

26.373 FNLS,26.373 FVLS ...	01/94 →12/95	Tie Rod End	CV-ES-14162		for Steering Rod	
	01/94 →12/95	Tie Rod End	CV-ES-14163		for Steering Rod	
	01/94 →12/95	Tie Rod End	IV-ES-12272		for Steering Rod	
	01/94 →12/95	Track Control Arm		MN-DL-5212	Trailing Arm, Drive Axle;Air Suspension Axle	
	01/94 →12/95	Track Control Arm		MN-DL-5212	Trailing Arm, Drive Axle;Air Suspension Axle; Tag Axle	
	01/94 →12/95	Track Control Arm		MN-VB-5222	Wishbone (CV), Drive Axle;Air Suspension Axle	
	01/94 →12/95	Track Control Arm		MN-VB-5222	Wishbone (CV), Drive Axle;Tag Axle; Air Suspension Axle	
	01/94 →12/95	Track Control Arm	MN-TC-14112		Control Arm, 1st Front Axle, for Pneumatic Suspension vehicles	
26.403 DFC,26.403 DFCL	01/94 →	Ball Head, gearshift linkage	CV-ES-2119			
	01/94 →	Ball Head, gearshift linkage	CV-ES-2120			
	01/94 →	Ball Head, gearshift linkage	CV-ES-2182			
	01/94 →	Centre Rod	MN-DL-2160		Coupling Rod	
	01/94 →	Centre Rod	MN-DL-2175		Push Rod	
	01/94 →	Centre Rod	MN-DL-2176		Push Rod	
	01/94 →	Centre Rod	MN-DL-3588		Push Rod	
	01/94 →	Centre Rod	MN-DL-8197		Push Rod	
	01/94 →	Centre Rod	MN-DL-12421		for Steering Rod	
	01/94 →	Engine Mounting		MN-SB-10390		
	01/94 →	Suspension Arm Repair Kit		MN-SB-5244	for Wishbone (CV)	
	01/94 →	Suspension Arm Repair Kit		MN-SB-5244	for Wishbone (CV), 1st RA	
	01/94 →	Tie Rod	MN-DL-12284			
	01/94 →	Tie Rod End	CV-ES-2146			
	01/94 →	Tie Rod End	CV-ES-2149		for Push Rod	
	01/94 →	Tie Rod End	CV-ES-14162		for Steering Rod	
	01/94 →	Tie Rod End	CV-ES-14163		for Steering Rod	
	01/94 →	Tie Rod End	SC-ES-8517		for Push Rod	
	01/94 →	Track Control Arm		MN-DL-3402	Trailing Arm	
	01/94 →	Track Control Arm		MN-DL-3402	Trailing Arm, Drive Axle	
	01/94 →	Track Control Arm		MN-DL-5212	Trailing Arm, Drive Axle;Air Suspension Axle	
	01/94 →	Track Control Arm		MN-VB-5222	Wishbone (CV)	
	01/94 →	Track Control Arm		MN-VB-5222	Wishbone (CV), Drive Axle;Air Suspension Axle	
	01/94 →	Track Control Arm		MN-VB-8569	Wishbone (CV)	
	01/94 →	Track Control Arm		MN-VB-8569	Wishbone (CV), Drive Axle	
	01/94 →	Track Control Arm	MN-TC-14112		Control Arm, 1st Front Axle, for Pneumatic Suspension vehicles	
	26.403 DFK,26.403 DFLK	01/94 →	Ball Head, gearshift linkage	CV-ES-2119		
		01/94 →	Ball Head, gearshift linkage	CV-ES-2120		
01/94 →		Ball Head, gearshift linkage	CV-ES-2182			
01/94 →		Centre Rod	MN-DL-2160		Coupling Rod	
01/94 →		Centre Rod	MN-DL-2175		Push Rod	
01/94 →		Centre Rod	MN-DL-2176		Push Rod	
01/94 →		Centre Rod	MN-DL-3588		Push Rod	
01/94 →		Centre Rod	MN-DL-8197		Push Rod	
01/94 →		Centre Rod	MN-DL-12421		for Steering Rod	
01/94 →		Engine Mounting		MN-SB-10390		
01/94 →		Suspension Arm Repair Kit		MN-SB-5244	for Wishbone (CV)	
01/94 →		Suspension Arm Repair Kit		MN-SB-5244	for Wishbone (CV), 1st RA	
01/94 →		Tie Rod	MN-DL-12284			
01/94 →		Tie Rod End	CV-ES-2146			
01/94 →		Tie Rod End	CV-ES-2149		for Push Rod	
01/94 →		Tie Rod End	CV-ES-14162		for Steering Rod	
01/94 →		Tie Rod End	CV-ES-14163		for Steering Rod	
01/94 →		Tie Rod End	SC-ES-8517		for Push Rod	
01/94 →		Track Control Arm		MN-DL-3402	Trailing Arm	
01/94 →		Track Control Arm		MN-DL-3402	Trailing Arm, Drive Axle	
01/94 →		Track Control Arm		MN-DL-5212	Trailing Arm, Drive Axle;Air Suspension Axle	
01/94 →		Track Control Arm		MN-VB-5222	Wishbone (CV)	
01/94 →		Track Control Arm		MN-VB-5222	Wishbone (CV), Drive Axle;Air Suspension Axle	
01/94 →		Track Control Arm		MN-VB-8569	Wishbone (CV)	
01/94 →		Track Control Arm		MN-VB-8569	Wishbone (CV), Drive Axle	

CV-ES-2119

Length: 55
Cone Ø: d1 Ø 10 / d2 Ø 10
Thread: M12 x 1,75 LHT
81953016063, 81953016131



CV-ES-2120

Length: 115
Cone Ø: d1 Ø 12,4 / d2 Ø 10,8
Thread: M14 x 1,5 RHT
03008500A, 81953016200, 81953016202,
81953016203, 81953016227



CV-ES-2146

Length: 80
Cone Ø: d1 Ø 30 / d2 Ø 27
Thread: M26 x 1,5 RHT
42533102, 81953016219, 81953016225,
81953016226, 81953016267, 81953016291



CV-ES-2149

Length: 160
Cone Ø: d1 Ø 30 / d2 Ø 27
Thread: M30 x 1,5 RHT
81953016263



CV-ES-2182

Length: 55
Cone Ø: d1 Ø 10 / d2 Ø 10
Thread: M12 x 1,75 RHT
81953016064, 81953016170



CV-ES-14162

Length: 125
Cone Ø: d1 Ø 30 / d2 Ø 27
Thread: M30 x 1,5 LHT
81953010015, 81953010083, 81953010087,
81953016029, 81953016030, 81953016043,
81953016044, 81953016050, 81953016054,
81953016087, 81953016091, 81953016107,
81953016120, 81953016125, 81953016152,
81953016155, 81953016157, 81953016168,
81953016179, 81953016181, 81953016223,
81953016237, 81953016254, 81953016275,
81953016279, 81953016351



CV-ES-14163

Length: 125
Cone Ø: d1 Ø 30 / d2 Ø 27
Thread: M30 x 1,5 RHT
95301.0084, 90804102156, 90804102272,
90804102696, 90804102710, 81953010016,
81953010075, 81953010084, 81953010088,
81953010094, 81953010103, 81953016030,
81953016043, 81953016048, 81953016049,
81953016053, 81953016061, 81953016090,
81953016108, 81953016112, 81953016126,
81953016143, 81953016149, 81953016154,
81953016156, 81953016168, 81953016178,
81953016194, 81953016206, 81953016224,
81953016234, 81953016242, 81953016252,
81953016274, 81953016278, 81953016284,
81953016286, 81953016308, 81953016310,
81953016312, 81953016347, 81953016350,
81953016352, 82953016012, 88953016014,
N2953016001



IV-ES-12272

Length: 75
Cone Ø: d1 Ø 30 / d2 Ø 27
Thread: M26 x 1,5 RHT
81953016280, 82953010010



MN-DL-2160

Length: 1652 Ø: 50
Cone Ø: d1 Ø 30 / d2 Ø 27
81467106112, 81467106163, 81467106165,
81467106198, 81467106353, 81467106354,
81467106361, 81467116725



MN-DL-2175

Length: 1628 Ø: 50
Cone Ø: d1 Ø 30 / d2 Ø 27
81467106396, 81467106904



MN-DL-2176

Length: 1628 Ø: 48
Cone Ø: d1 Ø 30 / d2 Ø 27
81466106779, 81466106780, 81466106782



MN-DL-3402

Length: 590 Ø: 48
Hole Distance: 130 / 130
03307200A, 81432206067, 81432206068,
81432206090, 81432206092, 81432209092



MN-DL-3588

Length: 1035 Ø: 48
Cone Ø: d1 Ø 30 / d2 Ø 27
81466106333, 81466106334, 81466106354,
81466106355, 81466106360, 81466106361,
81466106721, 81466106722, 81466106723,
81466116216



MN-DL-5212

Length: 577 Ø: 48
Hole Distance: 130 / 130
81432206096, 81432206097, 81432206098,
81432206129, 81432209096, 81432209129,
81432306014, 81432306030



MN-DL-8197

Length: 1055 Ø: 42
Cone Ø: d1 Ø 30 / d2 Ø 27
03207500A, 81466116003, 81466116004,
81466116005



MN-DL-12284

Length: 1530 Ø: 50
Cone Ø: d1 Ø 30 / d2 Ø 27
81466106579, 81466106580, 81466106624,
81466116720, 81467116720, 81467116730,
81467116952



MN-DL-12421

Length: 1070 Ø: 48
Cone Ø: d1 Ø 30 / d2 Ø 27
Thread: M30 x 1,5 RHT
81466106656, 81466106659, 81466106669,
81466116006, 81466116007



MN-SB-5244

Ø: 65
Hole Distance: 125
Thick/Height: 22
03312000A, 81432710027, 81432710082



MN-SB-10390

Ø: 70 Thick/Height: 85/85
81960200341, 81960200373, 81960200385,
81960200408, 81960200418



MN-TC-14112

Length: 777 Ø: 60
Hole Distance: 115 / 115
81432206106, 81432306049



MN-VB-5222

Length: 627 Ø: 50
Hole Distance: 152 / 152
81432706030, 81432706034, 81432706054,
81432706055, 81432706056, 81432706057,
81432706067, 81432706068, 81432706074,
81432706075, 81432706076, 81432706077,
81432706078, 81432706081, 81432706082,
81432709034, 81432709076, 81432709078,
8143706054



MN-VB-8569

Length: 627 Ø: 58
Hole Distance: 152 / 152
81432706055, 81432706056, 81432706067,
81432706068, 81432706075, 81432706077,
81432706081, 81432709056



SC-ES-8517

Length: 140
Cone Ø: d1 Ø 30 / d2 Ø 27
Thread: M30 x 1,5 RHT
81953016286





F 2000 ...

26.403 DFK,26.403 DFLK ...	01/94 →	Track Control Arm	MN-TC-14112		Control Arm, 1st Front Axle, for Pneumatic Suspension vehicles	
26.403 DFS,26.403 DFLS	01/94 →	Ball Head, gearshift linkage	CV-ES-2119			
	01/94 →	Ball Head, gearshift linkage	CV-ES-2120			
	01/94 →	Ball Head, gearshift linkage	CV-ES-2182			
	01/94 →	Centre Rod	MN-DL-2160		Coupling Rod	
	01/94 →	Centre Rod	MN-DL-2175		Push Rod	
	01/94 →	Centre Rod	MN-DL-2176		Push Rod	
	01/94 →	Centre Rod	MN-DL-3588		Push Rod	
	01/94 →	Centre Rod	MN-DL-8197		Push Rod	
	01/94 →	Centre Rod	MN-DL-12421		for Steering Rod	
	01/94 →	Engine Mounting		MN-SB-10390		
	01/94 →	Suspension Arm Repair Kit		MN-SB-5244		for Wishbone (CV)
	01/94 →	Suspension Arm Repair Kit		MN-SB-5244		for Wishbone (CV), 1st RA
	01/94 →	Tie Rod	MN-DL-12284			
	01/94 →	Tie Rod End	CV-ES-2146			
	01/94 →	Tie Rod End	CV-ES-2149			for Push Rod
	01/94 →	Tie Rod End	CV-ES-14162			for Steering Rod
	01/94 →	Tie Rod End	CV-ES-14163			for Steering Rod
	01/94 →	Tie Rod End	SC-ES-8517			for Push Rod
	01/94 →	Track Control Arm		MN-DL-3402		Trailing Arm
	01/94 →	Track Control Arm		MN-DL-3402		Trailing Arm, Drive Axle
	01/94 →	Track Control Arm		MN-DL-5212		Trailing Arm, Drive Axle;Air Suspension Axle
	01/94 →	Track Control Arm		MN-VB-5222		Wishbone (CV)
	01/94 →	Track Control Arm		MN-VB-5222		Wishbone (CV), Drive Axle;Air Suspension Axle
	01/94 →	Track Control Arm		MN-VB-8569		Wishbone (CV)
	01/94 →	Track Control Arm		MN-VB-8569		Wishbone (CV), Drive Axle
	01/94 →	Track Control Arm	MN-TC-14112			Control Arm, 1st Front Axle, for Pneumatic Suspension vehicles
	26.403 FNLC,26.403 FNLLC, 26.403 FVLC	01/94 →	Ball Head, gearshift linkage	CV-ES-2119		
01/94 →		Ball Head, gearshift linkage	CV-ES-2120			
01/94 →		Ball Head, gearshift linkage	CV-ES-2182			
01/94 →		Centre Rod	MN-DL-2160		Coupling Rod	
01/94 →		Centre Rod	MN-DL-2175		Push Rod	
01/94 →		Centre Rod	MN-DL-2176		Push Rod	
01/94 →		Centre Rod	MN-DL-3588		Push Rod	
01/94 →		Centre Rod	MN-DL-8197		Push Rod	
01/94 →		Centre Rod	MN-DL-8487		Push Rod	
01/94 →		Centre Rod	MN-DL-12421		for Steering Rod	
01/94 →		Engine Mounting		MN-SB-10390		
01/94 →		Stabiliser Mounting		MN-SB-5243		
01/94 →		Suspension Arm Repair Kit		CV-RK-5313		for Wishbone (CV)
01/94 →		Suspension Arm Repair Kit		MN-RK-7280		for Drag Link;for Semi-Trailing Arm; for Wishbone (CV)
01/94 →		Suspension Arm Repair Kit		MN-RK-7287		for Wishbone (CV)
01/94 →		Tie Rod End		MN-ES-8490		for vehicles with Hinged Trailing Axle
01/94 →		Tie Rod End		SC-ES-8517		for Push Rod
01/94 →		Tie Rod End	CV-ES-2146			
01/94 →		Tie Rod End	CV-ES-2149			for Push Rod
01/94 →		Tie Rod End	CV-ES-14162			for Steering Rod
01/94 →		Tie Rod End	CV-ES-14163			for Steering Rod
01/94 →		Tie Rod End	IV-ES-12272			for Steering Rod
01/94 →		Track Control Arm		MN-DL-5212		Trailing Arm, Drive Axle;Air Suspension Axle
01/94 →		Track Control Arm		MN-DL-5212		Trailing Arm, Drive Axle;Air Suspension Axle; Tag Axle
01/94 →		Track Control Arm		MN-VB-5222		Wishbone (CV), Drive Axle;Air Suspension Axle
01/94 →		Track Control Arm		MN-VB-5222		Wishbone (CV), Drive Axle;Tag Axle; Air Suspension Axle
01/94 →		Track Control Arm	MN-TC-14112			Control Arm, 1st Front Axle, for Pneumatic Suspension vehicles

CV-ES-2119

Length: 55
Cone Ø: d1 Ø 10 / d2 Ø 10
Thread: M12 x 1,75 LHT
81953016063, 81953016131



CV-ES-2120

Length: 115
Cone Ø: d1 Ø 12,4 / d2 Ø 10,8
Thread: M14 x 1,5 RHT
03008500A, 81953016200, 81953016202,
81953016203, 81953016227



CV-ES-2146

Length: 80
Cone Ø: d1 Ø 30 / d2 Ø 27
Thread: M26 x 1,5 RHT
42533102, 81953016219, 81953016225,
81953016226, 81953016267, 81953016291



CV-ES-2149

Length: 160
Cone Ø: d1 Ø 30 / d2 Ø 27
Thread: M30 x 1,5 RHT
81953016263



CV-ES-2182

Length: 55
Cone Ø: d1 Ø 10 / d2 Ø 10
Thread: M12 x 1,75 RHT
81953016064, 81953016170



CV-ES-14162

Length: 125
Cone Ø: d1 Ø 30 / d2 Ø 27
Thread: M30 x 1,5 LHT
81953010015, 81953010083, 81953010087,
81953016029, 81953016030, 81953016043,
81953016044, 81953016050, 81953016054,
81953016087, 81953016091, 81953016107,
81953016120, 81953016125, 81953016152,
81953016155, 81953016157, 81953016168,
81953016179, 81953016181, 81953016223,
81953016237, 81953016254, 81953016275,
81953016279, 81953016351



CV-ES-14163

Length: 125
Cone Ø: d1 Ø 30 / d2 Ø 27
Thread: M30 x 1,5 RHT
95301.0084, 90804102156, 90804102272,
90804102696, 90804102710, 81953010016,
81953010075, 81953010084, 81953010088,
81953010094, 81953010103, 81953016030,
81953016043, 81953016048, 81953016049,
81953016053, 81953016061, 81953016090,
81953016108, 81953016112, 81953016126,
81953016143, 81953016149, 81953016154,
81953016156, 81953016168, 81953016178,
81953016194, 81953016206, 81953016224,
81953016234, 81953016242, 81953016252,
81953016274, 81953016278, 81953016284,
81953016286, 81953016308, 81953016310,
81953016312, 81953016347, 81953016350,
81953016352, 82953016012, 88953016014,
N2953016001



CV-RK-5313

Ø: 90
03304800A, 81953016132



IV-ES-12272

Length: 75
Cone Ø: d1 Ø 30 / d2 Ø 27
Thread: M26 x 1,5 RHT
81953016280, 82953010010



MN-DL-2160

Length: 1652 Ø: 50
Cone Ø: d1 Ø 30 / d2 Ø 27
81467106112, 81467106163, 81467106165,
81467106198, 81467106353, 81467106354,
81467106361, 81467116725



MN-DL-2175

Length: 1628 Ø: 50
Cone Ø: d1 Ø 30 / d2 Ø 27
81467106396, 81467106904



MN-DL-2176

Length: 1628 Ø: 48
Cone Ø: d1 Ø 30 / d2 Ø 27
81466106779, 81466106780, 81466106782



MN-DL-3402

Length: 590 Ø: 48
Hole Distance: 130 / 130
03307200A, 81432206067, 81432206068,
81432206090, 81432206092, 81432209092



MN-DL-3588

Length: 1035 Ø: 48
Cone Ø: d1 Ø 30 / d2 Ø 27
81466106333, 81466106334, 81466106354,
81466106355, 81466106360, 81466106361,
81466106721, 81466106722, 81466106723,
81466116216



MN-DL-5212

Length: 577 Ø: 48
Hole Distance: 130 / 130
81432206096, 81432206097, 81432206098,
81432206129, 81432209096, 81432209129,
81432306014, 81432306030



MN-DL-8197

Length: 1055 Ø: 42
Cone Ø: d1 Ø 30 / d2 Ø 27
03207500A, 81466116003, 81466116004,
81466116005



MN-DL-8487

Length: 900 Ø: 38
Cone Ø: d1 Ø 30 / d2 Ø 27
81466106767, 81466106768, 81466106774,
81466116014



MN-DL-12284

Length: 1530 Ø: 50
Cone Ø: d1 Ø 30 / d2 Ø 27
81466106579, 81466106580, 81466106624,
81466116720, 81467116720, 81467116730,
81467116952



MN-DL-12421

Length: 1070 Ø: 48
Cone Ø: d1 Ø 30 / d2 Ø 27
Thread: M30 x 1,5 RHT
81466106656, 81466106659, 81466106669,
81466116006, 81466116007



MN-ES-8490

Length: 90
Cone Ø: d1 Ø 30 / d2 Ø 27
Thread: M26 x 1,5 RHT
0014606948, 14606948, 81953016281,
81953016337, 82953016016



MN-RK-7280

Ø: 75
Hole Distance: 115
Thick/Height: 24
0550806, 0639370, 689748, 10307400A,
81432306051, 81432306068, 81432706064



MN-RK-7287

Ø: 90
Hole Distance: 152
Thick/Height: 35
03304700A, 81953016133



MN-SB-5243

Length: 55 Ø: 78
Thick/Height: 60
03311100A, 81437040061, 81437220020



MN-SB-5244

Ø: 65
Hole Distance: 125
Thick/Height: 22
03312000A, 81432710027, 81432710082



MN-SB-10390

Ø: 70 Thick/Height: 85/85
81960200341, 81960200373, 81960200385,
81960200408, 81960200418



MN-TC-14112

Length: 777 Ø: 60
Hole Distance: 115 / 115
81432206106, 81432306049



MN-VB-5222

Length: 627 Ø: 50
Hole Distance: 152 / 152
81432706030, 81432706034, 81432706054,
81432706055, 81432706056, 81432706057,
81432706067, 81432706068, 81432706074,
81432706075, 81432706076, 81432706077,
81432706078, 81432706081, 81432706082,
81432709034, 81432709076, 81432709078,
81432706054



MN-VB-8569

Length: 627 Ø: 58
Hole Distance: 152 / 152
81432706055, 81432706056, 81432706067,
81432706068, 81432706075, 81432706077,
81432706081, 81432709056



SC-ES-8517

Length: 140
Cone Ø: d1 Ø 30 / d2 Ø 27
Thread: M30 x 1,5 RHT
81953016286





F 2000 ...

26.403 FNLS,26.403 FVLS	01/94→	Ball Head, gearshift linkage	CV-ES-2119			
	01/94→	Ball Head, gearshift linkage	CV-ES-2120			
	01/94→	Ball Head, gearshift linkage	CV-ES-2182			
	01/94→	Centre Rod	MN-DL-2160		Coupling Rod	
	01/94→	Centre Rod	MN-DL-2175		Push Rod	
	01/94→	Centre Rod	MN-DL-2176		Push Rod	
	01/94→	Centre Rod	MN-DL-3588		Push Rod	
	01/94→	Centre Rod	MN-DL-8197		Push Rod	
	01/94→	Centre Rod	MN-DL-8487		Push Rod	
	01/94→	Centre Rod	MN-DL-12421		for Steering Rod	
	01/94→	Engine Mounting		MN-SB-10390		
	01/94→	Suspension Arm Repair Kit		MN-RK-7280		for Drag Link;for Semi-Trailing Arm; for Wishbone (CV)
	01/94→	Suspension Arm Repair Kit	MN-RK-7280	MN-RK-7280		for Drag Link;for Semi-Trailing Arm; for Wishbone (CV)
	01/94→	Tie Rod End		MN-ES-8490		for vehicles with Hinged Trailing Axle
	01/94→	Tie Rod End		SC-ES-8517		for Push Rod
	01/94→	Tie Rod End	CV-ES-2146			
	01/94→	Tie Rod End	CV-ES-2149			for Push Rod
	01/94→	Tie Rod End	CV-ES-14162			for Steering Rod
	01/94→	Tie Rod End	CV-ES-14163			for Steering Rod
	01/94→	Tie Rod End	IV-ES-12272			for Steering Rod
	01/94→	Track Control Arm		MN-DL-5212		Trailing Arm, Drive Axle;Air Suspension Axle
	01/94→	Track Control Arm		MN-DL-5212		Trailing Arm, Drive Axle;Air Suspension Axle; Tag Axle
	01/94→	Track Control Arm		MN-VB-5222		Wishbone (CV), Drive Axle;Air Suspension Axle
	01/94→	Track Control Arm		MN-VB-5222		Wishbone (CV), Drive Axle;Tag Axle; Air Suspension Axle
	01/94→	Track Control Arm	MN-TC-14112			Control Arm, 1st Front Axle, for Pneumatic Suspension vehicles
26.414 DFC, DFLC	05/01→	Ball Head, gearshift linkage	CV-ES-2120			
	05/01→	Centre Rod	MN-DL-8197		Push Rod	
	05/01→	Centre Rod	MN-DL-8487		Push Rod	
	05/01→	Suspension Arm Repair Kit		MN-SB-5244		for Wishbone (CV)
	05/01→	Tie Rod	MN-DL-12284			
	05/01→	Tie Rod End	CV-ES-2149			for Push Rod
	05/01→	Tie Rod End	CV-ES-14162			for Steering Rod
	05/01→	Tie Rod End	CV-ES-14163			for Steering Rod
	05/01→	Tie Rod End	SC-ES-8517			for Push Rod
	05/01→	Track Control Arm		MN-DL-3402		Trailing Arm
	05/01→	Track Control Arm		MN-DL-5212		Trailing Arm
	05/01→	Track Control Arm		MN-VB-5222		Wishbone (CV)
	05/01→	Track Control Arm		MN-VB-8569		Wishbone (CV)
05/01→	Track Control Arm	MN-TC-14112			Control Arm, 1st Front Axle, for Pneumatic Suspension vehicles	
26.414 DFK, DFLK, DFLK-L	05/01→	Ball Head, gearshift linkage	CV-ES-2120			
	05/01→	Centre Rod	MN-DL-8197		Push Rod	
	05/01→	Centre Rod	MN-DL-8487		Push Rod	
	05/01→	Suspension Arm Repair Kit		MN-SB-5244		for Wishbone (CV)
	05/01→	Tie Rod	MN-DL-12284			
	05/01→	Tie Rod End	CV-ES-2149			for Push Rod
	05/01→	Tie Rod End	CV-ES-14162			for Steering Rod
	05/01→	Tie Rod End	CV-ES-14163			for Steering Rod
	05/01→	Tie Rod End	SC-ES-8517			for Push Rod
	05/01→	Track Control Arm		MN-DL-3402		Trailing Arm
	05/01→	Track Control Arm		MN-DL-5212		Trailing Arm
	05/01→	Track Control Arm		MN-VB-5222		Wishbone (CV)
	05/01→	Track Control Arm		MN-VB-8569		Wishbone (CV)
05/01→	Track Control Arm	MN-TC-14112			Control Arm, 1st Front Axle, for Pneumatic Suspension vehicles	

CV-ES-2119

Length: 55
Cone Ø: d1 Ø 10 / d2 Ø 10
Thread: M12 x 1,75 LHT
81953016063, 81953016131



CV-ES-2120

Length: 115
Cone Ø: d1 Ø 12,4 / d2 Ø 10,8
Thread: M14 x 1,5 RHT
03008500A, 81953016200, 81953016202,
81953016203, 81953016227



CV-ES-2146

Length: 80
Cone Ø: d1 Ø 30 / d2 Ø 27
Thread: M26 x 1,5 RHT
42533102, 81953016219, 81953016225,
81953016226, 81953016267, 81953016291



CV-ES-2149

Length: 160
Cone Ø: d1 Ø 30 / d2 Ø 27
Thread: M30 x 1,5 RHT
81953016263



CV-ES-2182

Length: 55
Cone Ø: d1 Ø 10 / d2 Ø 10
Thread: M12 x 1,75 RHT
81953016064, 81953016170



CV-ES-14162

Length: 125
Cone Ø: d1 Ø 30 / d2 Ø 27
Thread: M30 x 1,5 LHT
81953010015, 81953010083, 81953010087,
81953016029, 81953016030, 81953016043,
81953016044, 81953016050, 81953016054,
81953016087, 81953016091, 81953016107,
81953016120, 81953016125, 81953016152,
81953016155, 81953016157, 81953016168,
81953016179, 81953016181, 81953016223,
81953016237, 81953016254, 81953016275,
81953016279, 81953016351



CV-ES-14163

Length: 125
Cone Ø: d1 Ø 30 / d2 Ø 27
Thread: M30 x 1,5 RHT
95301.0084, 90804102156, 90804102272,
90804102696, 90804102710, 81953010016,
81953010075, 81953010084, 81953010088,
81953010094, 81953010103, 81953016030,
81953016043, 81953016048, 81953016049,
81953016053, 81953016061, 81953016090,
81953016108, 81953016112, 81953016126,
81953016143, 81953016149, 81953016154,
81953016156, 81953016168, 81953016178,
81953016194, 81953016206, 81953016224,
81953016234, 81953016242, 81953016252,
81953016274, 81953016278, 81953016284,
81953016286, 81953016308, 81953016310,
81953016312, 81953016347, 81953016350,
81953016352, 82953016012, 88953016014,
N2953016001



IV-ES-12272

Length: 75
Cone Ø: d1 Ø 30 / d2 Ø 27
Thread: M26 x 1,5 RHT
81953016280, 82953010010



MN-DL-2160

Length: 1652 Ø: 50
Cone Ø: d1 Ø 30 / d2 Ø 27
81467106112, 81467106163, 81467106165,
81467106198, 81467106353, 81467106354,
81467106361, 81467116725



MN-DL-2175

Length: 1628 Ø: 50
Cone Ø: d1 Ø 30 / d2 Ø 27
81467106396, 81467106904



MN-DL-2176

Length: 1628 Ø: 48
Cone Ø: d1 Ø 30 / d2 Ø 27
81466106779, 81466106780, 81466106782



MN-DL-3402

Length: 590 Ø: 48
Hole Distance: 130 / 130
03307200A, 81432206067, 81432206068,
81432206090, 81432206092, 81432209092



MN-DL-3588

Length: 1035 Ø: 48
Cone Ø: d1 Ø 30 / d2 Ø 27
81466106333, 81466106334, 81466106354,
81466106355, 81466106360, 81466106361,
81466106721, 81466106722, 81466106723,
81466116216



MN-DL-5212

Length: 577 Ø: 48
Hole Distance: 130 / 130
81432206096, 81432206097, 81432206098,
81432206129, 81432209096, 81432209129,
81432306014, 81432306030



MN-DL-8197

Length: 1055 Ø: 42
Cone Ø: d1 Ø 30 / d2 Ø 27
03207500A, 81466116003, 81466116004,
81466116005



MN-DL-8487

Length: 900 Ø: 38
Cone Ø: d1 Ø 30 / d2 Ø 27
81466106767, 81466106768, 81466106774,
81466116014



MN-DL-12284

Length: 1530 Ø: 50
Cone Ø: d1 Ø 30 / d2 Ø 27
81466106579, 81466106580, 81466106624,
81466116720, 81467116720, 81467116730,
81467116952



MN-DL-12421

Length: 1070 Ø: 48
Cone Ø: d1 Ø 30 / d2 Ø 27
Thread: M30 x 1,5 RHT
81466106656, 81466106659, 81466106669,
81466116006, 81466116007



MN-ES-8490

Length: 90
Cone Ø: d1 Ø 30 / d2 Ø 27
Thread: M26 x 1,5 RHT
0014606948, 14606948, 81953016281,
81953016337, 82953016016



MN-RK-7280

Ø: 75
Hole Distance: 115
Thick/Height: 24
0550806, 0639370, 689748, 10307400A,
81432306051, 81432306068, 81432706064



MN-SB-5244

Ø: 65
Hole Distance: 125
Thick/Height: 22
03312000A, 81432710027, 81432710082



MN-SB-10390

Ø: 70 Thick/Height: 85/85
81960200341, 81960200373, 81960200385,
81960200408, 81960200418



MN-TC-14112

Length: 777 Ø: 60
Hole Distance: 115 / 115
81432206106, 81432306049



MN-VB-5222

Length: 627 Ø: 50
Hole Distance: 152 / 152
81432706030, 81432706034, 81432706054,
81432706055, 81432706056, 81432706057,
81432706067, 81432706068, 81432706074,
81432706075, 81432706076, 81432706077,
81432706078, 81432706081, 81432706082,
81432709034, 81432709076, 81432709078,
8143706054



MN-VB-8569

Length: 627 Ø: 58
Hole Distance: 152 / 152
81432706055, 81432706056, 81432706067,
81432706068, 81432706075, 81432706077,
81432706081, 81432709056



SC-ES-8517

Length: 140
Cone Ø: d1 Ø 30 / d2 Ø 27
Thread: M30 x 1,5 RHT
81953016286





F 2000 ...

26.414 DFS, DFLS	05/01→	Ball Head, gearshift linkage	CV-ES-2120			
	05/01→	Centre Rod	MN-DL-8197		Push Rod	
	05/01→	Centre Rod	MN-DL-8487		Push Rod	
	05/01→	Suspension Arm Repair Kit		MN-SB-5244	for Wishbone (CV)	
	05/01→	Tie Rod	MN-DL-12284			
	05/01→	Tie Rod End	CV-ES-2149		for Push Rod	
	05/01→	Tie Rod End	CV-ES-14162		for Steering Rod	
	05/01→	Tie Rod End	CV-ES-14163		for Steering Rod	
	05/01→	Tie Rod End	SC-ES-8517		for Push Rod	
	05/01→	Track Control Arm		MN-DL-3402	Trailing Arm	
	05/01→	Track Control Arm		MN-DL-5212	Trailing Arm	
	05/01→	Track Control Arm		MN-VB-5222	Wishbone (CV)	
	05/01→	Track Control Arm		MN-VB-8569	Wishbone (CV)	
	05/01→	Track Control Arm	MN-TC-14112		Control Arm, 1st Front Axle, for Pneumatic Suspension vehicles	
26.414 DF-TM	05/01→	Ball Head, gearshift linkage	CV-ES-2120			
	05/01→	Centre Rod	MN-DL-8197		Push Rod	
	05/01→	Centre Rod	MN-DL-8487		Push Rod	
	05/01→	Suspension Arm Repair Kit		MN-SB-5244	for Wishbone (CV)	
	05/01→	Tie Rod	MN-DL-12284			
	05/01→	Track Control Arm		MN-DL-3402	Trailing Arm	
	05/01→	Track Control Arm		MN-DL-5212	Trailing Arm	
	05/01→	Track Control Arm		MN-VB-5222	Wishbone (CV)	
26.414 FNLC, FNLLC, FNLLRC, FNLLW, FNLR, FNLLRC, FVLC	05/01→	Ball Head, gearshift linkage	CV-ES-2120			
	05/01→	Centre Rod	MN-DL-8197		Push Rod	
	05/01→	Centre Rod	MN-DL-8487		Push Rod	
	05/01→	Suspension Arm Repair Kit		MN-RK-7291	for Drag Link	
	05/01→	Suspension Arm Repair Kit	MN-RK-7280	MN-RK-7280	for Drag Link;for Semi-Trailing Arm; for Wishbone (CV)	
	05/01→	Tie Rod End		SC-ES-8517	for Push Rod	
	05/01→	Tie Rod End	CV-ES-2149		for Push Rod	
	05/01→	Tie Rod End	CV-ES-14162		for Steering Rod	
	05/01→	Tie Rod End	CV-ES-14163		for Steering Rod	
	05/01→	Track Control Arm		MN-DL-5212	Trailing Arm	
	05/01→	Track Control Arm		MN-VB-5222	Wishbone (CV)	
	05/01→	Track Control Arm	MN-TC-14112		Control Arm, 1st Front Axle, for Pneumatic Suspension vehicles	
	26.414 FNLS	05/01→	Ball Head, gearshift linkage	CV-ES-2120		
		05/01→	Centre Rod	MN-DL-8197		Push Rod
05/01→		Centre Rod	MN-DL-8487		Push Rod	
05/01→		Suspension Arm Repair Kit		MN-RK-7291	for Drag Link	
05/01→		Suspension Arm Repair Kit	MN-RK-7280	MN-RK-7280	for Drag Link;for Semi-Trailing Arm; for Wishbone (CV)	
05/01→		Tie Rod End	CV-ES-2149		for Push Rod	
05/01→		Tie Rod End	CV-ES-14162		for Steering Rod	
05/01→		Tie Rod End	CV-ES-14163		for Steering Rod	
05/01→		Tie Rod End	SC-ES-8517		for Push Rod	
05/01→		Track Control Arm		MN-DL-5212	Trailing Arm	
05/01→		Track Control Arm		MN-VB-5222	Wishbone (CV)	
05/01→		Track Control Arm	MN-TC-14112		Control Arm, 1st Front Axle, for Pneumatic Suspension vehicles	
26.414 FVL-KO		05/01→	Ball Head, gearshift linkage	CV-ES-2120		
		05/01→	Centre Rod	MN-DL-8197		Push Rod
	05/01→	Centre Rod	MN-DL-8487		Push Rod	
	05/01→	Suspension Arm Repair Kit		MN-RK-7291	for Drag Link	
	05/01→	Suspension Arm Repair Kit	MN-RK-7280	MN-RK-7280	for Drag Link;for Semi-Trailing Arm; for Wishbone (CV)	
	05/01→	Tie Rod End		SC-ES-8517	for Push Rod	
	05/01→	Tie Rod End	CV-ES-14162		for Steering Rod	
	05/01→	Tie Rod End	CV-ES-14163		for Steering Rod	
	05/01→	Track Control Arm		MN-DL-5212	Trailing Arm	
	05/01→	Track Control Arm		MN-VB-5222	Wishbone (CV)	

CV-ES-2120

Length: 115
Cone Ø: d1 Ø 12,4 / d2 Ø 10,8
Thread: M14 x 1,5 RHT
03008500A, 81953016200, 81953016202,
81953016203, 81953016227



CV-ES-2149

Length: 160
Cone Ø: d1 Ø 30 / d2 Ø 27
Thread: M30 x 1,5 RHT
81953016263



CV-ES-14162

Length: 125
Cone Ø: d1 Ø 30 / d2 Ø 27
Thread: M30 x 1,5 LHT
81953010015, 81953010083, 81953010087,
81953016029, 81953016030, 81953016043,
81953016044, 81953016050, 81953016054,
81953016087, 81953016091, 81953016107,
81953016120, 81953016125, 81953016152,
81953016155, 81953016157, 81953016168,
81953016179, 81953016181, 81953016223,
81953016237, 81953016254, 81953016275,
81953016279, 81953016351



CV-ES-14163

Length: 125
Cone Ø: d1 Ø 30 / d2 Ø 27
Thread: M30 x 1,5 RHT
95301.0084, 90804102156, 90804102272,
90804102696, 90804102710, 81953010016,
81953010075, 81953010084, 81953010088,
81953010094, 81953010103, 81953016030,
81953016043, 81953016048, 81953016049,
81953016053, 81953016061, 81953016090,
81953016108, 81953016112, 81953016126,
81953016143, 81953016149, 81953016154,
81953016156, 81953016168, 81953016178,
81953016194, 81953016206, 81953016224,
81953016234, 81953016242, 81953016252,
81953016274, 81953016278, 81953016284,
81953016286, 81953016308, 81953016310,
81953016312, 81953016347, 81953016350,
81953016352, 82953016012, 88953016014,
N2953016001



MN-DL-3402

Length: 590 Ø: 48
Hole Distance: 130 / 130
03307200A, 81432206067, 81432206068,
81432206090, 81432206092, 81432209092



MN-DL-5212

Length: 577 Ø: 48
Hole Distance: 130 / 130
81432206096, 81432206097, 81432206098,
81432206129, 81432209096, 81432209129,
81432306014, 81432306030



MN-DL-8197

Length: 1055 Ø: 42
Cone Ø: d1 Ø 30 / d2 Ø 27
03207500A, 81466116003, 81466116004,
81466116005



MN-DL-8487

Length: 900 Ø: 38
Cone Ø: d1 Ø 30 / d2 Ø 27
81466106767, 81466106768, 81466106774,
81466116014



MN-DL-12284

Length: 1530 Ø: 50
Cone Ø: d1 Ø 30 / d2 Ø 27
81466106579, 81466106580, 81466106624,
81466116720, 81467116720, 81467116730,
81467116952



MN-RK-7280

Ø: 75
Hole Distance: 115
Thick/Height: 24
0550806, 0639370, 689748, 10307400A,
81432306051, 81432306068, 81432706064



MN-RK-7291

Ø: 72
Hole Distance: 130
Thick/Height: 30
10307800A, 81432206108, 81432206132



MN-SB-5244

Ø: 65
Hole Distance: 125
Thick/Height: 22
03312000A, 81432710027, 81432710082



MN-TC-14112

Length: 777 Ø: 60
Hole Distance: 115 / 115
81432206106, 81432306049



MN-VB-5222

Length: 627 Ø: 50
Hole Distance: 152 / 152
81432706030, 81432706034, 81432706054,
81432706055, 81432706056, 81432706057,
81432706067, 81432706068, 81432706074,
81432706075, 81432706076, 81432706077,
81432706078, 81432706081, 81432706082,
81432709034, 81432709076, 81432709078,
8143706054



MN-VB-8569

Length: 627 Ø: 58
Hole Distance: 152 / 152
81432706055, 81432706056, 81432706067,
81432706068, 81432706075, 81432706077,
81432706081, 81432709056



SC-ES-8517

Length: 140
Cone Ø: d1 Ø 30 / d2 Ø 27
Thread: M30 x 1,5 RHT
81953016286





F 2000 ...

26.414 FVL-KO ...	05/01 →	Track Control Arm		MN-VB-5222	Wishbone (CV), Drive Axle, for Pneumatic Suspension vehicles
	05/01 →	Track Control Arm	MN-TC-14112		Control Arm, 1st Front Axle, for Pneumatic Suspension vehicles
26.414 FVLS, FVLRS	05/01 →	Ball Head, gearshift linkage	CV-ES-2120		
	05/01 →	Centre Rod	MN-DL-8197		Push Rod
	05/01 →	Centre Rod	MN-DL-8487		Push Rod
	05/01 →	Suspension Arm Repair Kit		MN-RK-7291	for Drag Link
	05/01 →	Suspension Arm Repair Kit	MN-RK-7280	MN-RK-7280	for Drag Link; for Semi-Trailing Arm; for Wishbone (CV)
	05/01 →	Tie Rod End		SC-ES-8517	for Push Rod
	05/01 →	Tie Rod End	CV-ES-2149		for Push Rod
	05/01 →	Tie Rod End	CV-ES-14162		for Steering Rod
	05/01 →	Tie Rod End	CV-ES-14163		for Steering Rod
	05/01 →	Track Control Arm		MN-DL-5212	Trailing Arm
	05/01 →	Track Control Arm		MN-VB-5222	Wishbone (CV), Drive Axle, for Pneumatic Suspension vehicles
	05/01 →	Track Control Arm	MN-TC-14112		Control Arm, 1st Front Axle, for Pneumatic Suspension vehicles
26.423 DFC, 26.423 DFLC	01/94 → 12/95	Ball Head, gearshift linkage	CV-ES-2119		
	01/94 → 12/95	Ball Head, gearshift linkage	CV-ES-2120		
	01/94 → 12/95	Ball Head, gearshift linkage	CV-ES-2182		
	01/94 → 12/95	Centre Rod	MN-DL-2160		Coupling Rod
	01/94 → 12/95	Centre Rod	MN-DL-2175		Push Rod
	01/94 → 12/95	Centre Rod	MN-DL-2176		Push Rod
	01/94 → 12/95	Centre Rod	MN-DL-3588		Push Rod
	01/94 → 12/95	Centre Rod	MN-DL-8197		Push Rod
	01/94 → 12/95	Engine Mounting		MN-SB-10390	
	01/94 → 12/95	Suspension Arm Repair Kit		MN-SB-5244	for Wishbone (CV)
	01/94 → 12/95	Suspension Arm Repair Kit		MN-SB-5244	for Wishbone (CV), 1st RA
	01/94 → 12/95	Tie Rod	MN-DL-12284		
	01/94 → 12/95	Tie Rod End	CV-ES-2149		for Push Rod
	01/94 → 12/95	Tie Rod End	CV-ES-14162		for Steering Rod
	01/94 → 12/95	Tie Rod End	CV-ES-14163		for Steering Rod
	01/94 → 12/95	Tie Rod End	SC-ES-8517		for Push Rod
	01/94 → 12/95	Track Control Arm		MN-DL-3402	Trailing Arm
	01/94 → 12/95	Track Control Arm		MN-DL-3402	Trailing Arm, Drive Axle
	01/94 → 12/95	Track Control Arm		MN-DL-5212	Trailing Arm, Drive Axle; Air Suspension Axle
	01/94 → 12/95	Track Control Arm		MN-VB-5222	Wishbone (CV)
	01/94 → 12/95	Track Control Arm		MN-VB-5222	Wishbone (CV), Drive Axle; Air Suspension Axle
	01/94 → 12/95	Track Control Arm		MN-VB-8569	Wishbone (CV)
	01/94 → 12/95	Track Control Arm		MN-VB-8569	Wishbone (CV), Drive Axle
	01/94 → 12/95	Track Control Arm	MN-TC-14112		Control Arm, 1st Front Axle, for Pneumatic Suspension vehicles
26.423 DFK, 26.423 DFLK	01/94 → 12/95	Ball Head, gearshift linkage	CV-ES-2119		
	01/94 → 12/95	Ball Head, gearshift linkage	CV-ES-2120		
	01/94 → 12/95	Ball Head, gearshift linkage	CV-ES-2182		
	01/94 → 12/95	Centre Rod	MN-DL-2160		Coupling Rod
	01/94 → 12/95	Centre Rod	MN-DL-2175		Push Rod
	01/94 → 12/95	Centre Rod	MN-DL-2176		Push Rod
	01/94 → 12/95	Centre Rod	MN-DL-3588		Push Rod
	01/94 → 12/95	Centre Rod	MN-DL-8197		Push Rod
	01/94 → 12/95	Engine Mounting		MN-SB-10390	
	01/94 → 12/95	Suspension Arm Repair Kit		MN-SB-5244	for Wishbone (CV)
	01/94 → 12/95	Suspension Arm Repair Kit		MN-SB-5244	for Wishbone (CV), 1st RA
	01/94 → 12/95	Tie Rod	MN-DL-12284		
	01/94 → 12/95	Tie Rod End	CV-ES-2149		for Push Rod
	01/94 → 12/95	Tie Rod End	CV-ES-14162		for Steering Rod
	01/94 → 12/95	Tie Rod End	CV-ES-14163		for Steering Rod
	01/94 → 12/95	Tie Rod End	SC-ES-8517		for Push Rod
	01/94 → 12/95	Track Control Arm		MN-DL-3402	Trailing Arm
	01/94 → 12/95	Track Control Arm		MN-DL-3402	Trailing Arm, Drive Axle
	01/94 → 12/95	Track Control Arm		MN-DL-5212	Trailing Arm, Drive Axle; Air Suspension Axle

CV-ES-2119

Length: 55
Cone Ø: d1 Ø 10 / d2 Ø 10
Thread: M12 x 1,75 LHT
81953016063, 81953016131



CV-ES-2120

Length: 115
Cone Ø: d1 Ø 12,4 / d2 Ø 10,8
Thread: M14 x 1,5 RHT
03008500A, 81953016200, 81953016202, 81953016203, 81953016227



CV-ES-2149

Length: 160
Cone Ø: d1 Ø 30 / d2 Ø 27
Thread: M30 x 1,5 RHT
81953016263



CV-ES-2182

Length: 55
Cone Ø: d1 Ø 10 / d2 Ø 10
Thread: M12 x 1,75 RHT
81953016064, 81953016170



CV-ES-14162

Length: 125
Cone Ø: d1 Ø 30 / d2 Ø 27
Thread: M30 x 1,5 LHT

81953010015, 81953010083, 81953010087, 81953016029, 81953016030, 81953016043, 81953016044, 81953016050, 81953016054, 81953016087, 81953016091, 81953016107, 81953016120, 81953016125, 81953016152, 81953016155, 81953016157, 81953016168, 81953016179, 81953016181, 81953016223, 81953016237, 81953016254, 81953016275, 81953016279, 81953016351



CV-ES-14163

Length: 125
Cone Ø: d1 Ø 30 / d2 Ø 27
Thread: M30 x 1,5 RHT

95301.0084, 90804102156, 90804102272, 90804102696, 90804102710, 81953010016, 81953010075, 81953010084, 81953010088, 81953010094, 81953010103, 81953016030, 81953016043, 81953016048, 81953016049, 81953016053, 81953016061, 81953016090, 81953016108, 81953016112, 81953016126, 81953016143, 81953016149, 81953016154, 81953016156, 81953016168, 81953016178, 81953016194, 81953016206, 81953016224, 81953016234, 81953016242, 81953016252, 81953016274, 81953016278, 81953016284, 81953016286, 81953016308, 81953016310, 81953016312, 81953016347, 81953016350, 81953016352, 82953016012, 88953016014, N2953016001



MN-DL-2160

Length: 1652 Ø: 50
Cone Ø: d1 Ø 30 / d2 Ø 27
81467106112, 81467106163, 81467106165, 81467106198, 81467106353, 81467106354, 81467106361, 81467116725



MN-DL-2175

Length: 1628 Ø: 50
Cone Ø: d1 Ø 30 / d2 Ø 27
81467106396, 81467106904



MN-DL-2176

Length: 1628 Ø: 48
Cone Ø: d1 Ø 30 / d2 Ø 27
81466106779, 81466106780, 81466106782



MN-DL-3402

Length: 590 Ø: 48
Hole Distance: 130 / 130
03307200A, 81432206067, 81432206068, 81432206090, 81432206092, 81432209092



MN-DL-3588

Length: 1035 Ø: 48
Cone Ø: d1 Ø 30 / d2 Ø 27
81466106333, 81466106334, 81466106354, 81466106355, 81466106360, 81466106361, 81466106721, 81466106722, 81466106723, 81466116216



MN-DL-5212

Length: 577 Ø: 48
Hole Distance: 130 / 130
81432206096, 81432206097, 81432206098, 81432206129, 81432209096, 81432209129, 81432306014, 81432306030



MN-DL-8197

Length: 1055 Ø: 42
Cone Ø: d1 Ø 30 / d2 Ø 27
03207500A, 81466116003, 81466116004, 81466116005



MN-DL-8487

Length: 900 Ø: 38
Cone Ø: d1 Ø 30 / d2 Ø 27
81466106767, 81466106768, 81466106774, 81466116014



MN-DL-12284

Length: 1530 Ø: 50
Cone Ø: d1 Ø 30 / d2 Ø 27
81466106579, 81466106580, 81466106624, 81466116720, 81467116720, 81467116730, 81467116952



MN-RK-7280

Ø: 75
Hole Distance: 115
Thick/Height: 24
0550806, 0639370, 689748, 10307400A, 81432306051, 81432306068, 81432706064



MN-RK-7291

Ø: 72
Hole Distance: 130
Thick/Height: 30
10307800A, 81432206108, 81432206132



MN-SB-5244

Ø: 65
Hole Distance: 125
Thick/Height: 22
03312000A, 81432710027, 81432710082



MN-SB-10390

Ø: 70 Thick/Height: 85/85
81960200341, 81960200373, 81960200385, 81960200408, 81960200418



MN-TC-14112

Length: 777 Ø: 60
Hole Distance: 115 / 115
81432206106, 81432306049



MN-VB-5222

Length: 627 Ø: 50
Hole Distance: 152 / 152
81432706030, 81432706034, 81432706054, 81432706055, 81432706056, 81432706057, 81432706067, 81432706068, 81432706074, 81432706075, 81432706076, 81432706077, 81432706078, 81432706081, 81432706082, 81432709034, 81432709076, 81432709078, 8143706054



MN-VB-8569

Length: 627 Ø: 58
Hole Distance: 152 / 152
81432706055, 81432706056, 81432706067, 81432706068, 81432706075, 81432706077, 81432706081, 81432709056



SC-ES-8517

Length: 140
Cone Ø: d1 Ø 30 / d2 Ø 27
Thread: M30 x 1,5 RHT
81953016286





F 2000 ...

26.423 DFK,26.423 DFLK ...	01/94 →12/95	Track Control Arm		MN-VB-5222	Wishbone (CV)
	01/94 →12/95	Track Control Arm		MN-VB-5222	Wishbone (CV), Drive Axle;Air Suspension Axle
	01/94 →12/95	Track Control Arm		MN-VB-8569	Wishbone (CV)
	01/94 →12/95	Track Control Arm		MN-VB-8569	Wishbone (CV), Drive Axle
	01/94 →12/95	Track Control Arm	MN-TC-14112		Control Arm, 1st Front Axle, for Pneumatic Suspension vehicles
26.423 DFS,26.423 DFLS	01/94 →12/95	Ball Head, gearshift linkage	CV-ES-2119		
	01/94 →12/95	Ball Head, gearshift linkage	CV-ES-2120		
	01/94 →12/95	Ball Head, gearshift linkage	CV-ES-2182		
	01/94 →12/95	Centre Rod	MN-DL-2160		Coupling Rod
	01/94 →12/95	Centre Rod	MN-DL-2175		Push Rod
	01/94 →12/95	Centre Rod	MN-DL-2176		Push Rod
	01/94 →12/95	Centre Rod	MN-DL-3588		Push Rod
	01/94 →12/95	Centre Rod	MN-DL-8197		Push Rod
	01/94 →12/95	Engine Mounting		MN-SB-10390	
	01/94 →12/95	Suspension Arm Repair Kit		MN-SB-5244	for Wishbone (CV)
	01/94 →12/95	Suspension Arm Repair Kit		MN-SB-5244	for Wishbone (CV), 1st RA
	01/94 →12/95	Tie Rod	MN-DL-12284		
	01/94 →12/95	Tie Rod End	CV-ES-2149		for Push Rod
	01/94 →12/95	Tie Rod End	CV-ES-14162		for Steering Rod
	01/94 →12/95	Tie Rod End	CV-ES-14163		for Steering Rod
	01/94 →12/95	Tie Rod End	SC-ES-8517		for Push Rod
	01/94 →12/95	Track Control Arm		MN-DL-3402	Trailing Arm
	01/94 →12/95	Track Control Arm		MN-DL-3402	Trailing Arm, Drive Axle
	01/94 →12/95	Track Control Arm		MN-DL-5212	Trailing Arm, Drive Axle;Air Suspension Axle
	01/94 →12/95	Track Control Arm		MN-VB-5222	Wishbone (CV)
	01/94 →12/95	Track Control Arm		MN-VB-5222	Wishbone (CV), Drive Axle;Air Suspension Axle
	01/94 →12/95	Track Control Arm		MN-VB-8569	Wishbone (CV)
	01/94 →12/95	Track Control Arm		MN-VB-8569	Wishbone (CV), Drive Axle
01/94 →12/95	Track Control Arm	MN-TC-14112		Control Arm, 1st Front Axle, for Pneumatic Suspension vehicles	
26.423 FNLC,26.423 FNLLC, 26.423 FVLC	01/94 →12/95	Ball Head, gearshift linkage	CV-ES-2119		
	01/94 →12/95	Ball Head, gearshift linkage	CV-ES-2120		
	01/94 →12/95	Ball Head, gearshift linkage	CV-ES-2182		
	01/94 →12/95	Centre Rod	MN-DL-2160		Coupling Rod
	01/94 →12/95	Centre Rod	MN-DL-2175		Push Rod
	01/94 →12/95	Centre Rod	MN-DL-2176		Push Rod
	01/94 →12/95	Centre Rod	MN-DL-3588		Push Rod
	01/94 →12/95	Centre Rod	MN-DL-8197		Push Rod
	01/94 →12/95	Centre Rod	MN-DL-8487		Push Rod
	01/94 →12/95	Engine Mounting		MN-SB-10390	
	01/94 →12/95	Stabiliser Mounting		MN-SB-5243	
	01/94 →12/95	Suspension Arm Repair Kit		CV-RK-5313	for Wishbone (CV)
	01/94 →12/95	Suspension Arm Repair Kit		MN-RK-7280	for Drag Link;for Semi-Trailing Arm; for Wishbone (CV)
	01/94 →12/95	Suspension Arm Repair Kit		MN-RK-7287	for Wishbone (CV)
	01/94 →12/95	Tie Rod End		MN-ES-8490	for vehicles with Hinged Trailing Axle
	01/94 →12/95	Tie Rod End		SC-ES-8517	for Push Rod
	01/94 →12/95	Tie Rod End	CV-ES-2149		for Push Rod
	01/94 →12/95	Tie Rod End	CV-ES-14162		for Steering Rod
	01/94 →12/95	Tie Rod End	CV-ES-14163		for Steering Rod
	01/94 →12/95	Tie Rod End	IV-ES-12272		for Steering Rod
	01/94 →12/95	Track Control Arm		MN-DL-5212	Trailing Arm, Drive Axle;Air Suspension Axle
	01/94 →12/95	Track Control Arm		MN-DL-5212	Trailing Arm, Drive Axle;Air Suspension Axle; Tag Axle
	01/94 →12/95	Track Control Arm		MN-VB-5222	Wishbone (CV), Drive Axle;Air Suspension Axle
	01/94 →12/95	Track Control Arm		MN-VB-5222	Wishbone (CV), Drive Axle;Tag Axle; Air Suspension Axle
	01/94 →12/95	Track Control Arm	MN-TC-14112		Control Arm, Leading Axle Steered, for Pneumatic Suspension vehicles

CV-ES-2119

Length: 55
Cone Ø: d1 Ø 10 / d2 Ø 10
Thread: M12 x 1,75 LHT
81953016063, 81953016131



CV-ES-2120

Length: 115
Cone Ø: d1 Ø 12,4 / d2 Ø 10,8
Thread: M14 x 1,5 RHT
03008500A, 81953016200, 81953016202,
81953016203, 81953016227



CV-ES-2149

Length: 160
Cone Ø: d1 Ø 30 / d2 Ø 27
Thread: M30 x 1,5 RHT
81953016263



CV-ES-2182

Length: 55
Cone Ø: d1 Ø 10 / d2 Ø 10
Thread: M12 x 1,75 RHT
81953016064, 81953016170



CV-ES-14162

Length: 125
Cone Ø: d1 Ø 30 / d2 Ø 27
Thread: M30 x 1,5 LHT
81953010015, 81953010083, 81953010087,
81953016029, 81953016030, 81953016043,
81953016044, 81953016050, 81953016054,
81953016087, 81953016091, 81953016107,
81953016120, 81953016125, 81953016152,
81953016155, 81953016157, 81953016168,
81953016179, 81953016181, 81953016223,
81953016237, 81953016254, 81953016275,
81953016279, 81953016351



CV-ES-14163

Length: 125
Cone Ø: d1 Ø 30 / d2 Ø 27
Thread: M30 x 1,5 RHT
95301.0084, 90804102156, 90804102272,
90804102696, 90804102710, 81953010016,
81953010075, 81953010084, 81953010088,
81953010094, 81953010103, 81953016030,
81953016043, 81953016048, 81953016049,
81953016053, 81953016061, 81953016090,
81953016108, 81953016112, 81953016126,
81953016143, 81953016149, 81953016154,
81953016156, 81953016168, 81953016178,
81953016194, 81953016206, 81953016224,
81953016234, 81953016242, 81953016252,
81953016274, 81953016278, 81953016284,
81953016286, 81953016308, 81953016310,
81953016312, 81953016347, 81953016350,
81953016352, 82953016012, 88953016014,
N2953016001



CV-RK-5313

Ø: 90
03304800A, 81953016132



IV-ES-12272

Length: 75
Cone Ø: d1 Ø 30 / d2 Ø 27
Thread: M26 x 1,5 RHT
81953016280, 82953010010



MN-DL-2160

Length: 1652 Ø: 50
Cone Ø: d1 Ø 30 / d2 Ø 27
81467106112, 81467106163, 81467106165,
81467106198, 81467106353, 81467106354,
81467106361, 81467116725



MN-DL-2175

Length: 1628 Ø: 50
Cone Ø: d1 Ø 30 / d2 Ø 27
81467106396, 81467106904



MN-DL-2176

Length: 1628 Ø: 48
Cone Ø: d1 Ø 30 / d2 Ø 27
81466106779, 81466106780, 81466106782



MN-DL-3402

Length: 590 Ø: 48
Hole Distance: 130 / 130
03307200A, 81432206067, 81432206068,
81432206090, 81432206092, 81432209092



MN-DL-3588

Length: 1035 Ø: 48
Cone Ø: d1 Ø 30 / d2 Ø 27
81466106333, 81466106334, 81466106354,
81466106355, 81466106360, 81466106361,
81466106721, 81466106722, 81466106723,
81466116216



MN-DL-5212

Length: 577 Ø: 48
Hole Distance: 130 / 130
81432206096, 81432206097, 81432206098,
81432206129, 81432209096, 81432209129,
81432306014, 81432306030



MN-DL-8197

Length: 1055 Ø: 42
Cone Ø: d1 Ø 30 / d2 Ø 27
03207500A, 81466116003, 81466116004,
81466116005



MN-DL-8487

Length: 900 Ø: 38
Cone Ø: d1 Ø 30 / d2 Ø 27
81466106767, 81466106768, 81466106774,
81466116014



MN-DL-12284

Length: 1530 Ø: 50
Cone Ø: d1 Ø 30 / d2 Ø 27
81466106579, 81466106580, 81466106624,
81466116720, 81467116720, 81467116730,
81467116952



MN-ES-8490

Length: 90
Cone Ø: d1 Ø 30 / d2 Ø 27
Thread: M26 x 1,5 RHT
0014606948, 14606948, 81953016281,
81953016337, 82953016016



MN-RK-7280

Ø: 75
Hole Distance: 115
Thick/Height: 24
0550806, 0639370, 689748, 10307400A,
81432306051, 81432306068, 81432706064



MN-RK-7287

Ø: 90
Hole Distance: 152
Thick/Height: 35
03304700A, 81953016133



MN-SB-5243

Length: 55 Ø: 78
Thick/Height: 60
03311100A, 81437040061, 81437220020



MN-SB-5244

Ø: 65
Hole Distance: 125
Thick/Height: 22
03312000A, 81432710027, 81432710082



MN-SB-10390

Ø: 70 Thick/Height: 85/85
81960200341, 81960200373, 81960200385,
81960200408, 81960200418



MN-TC-14112

Length: 777 Ø: 60
Hole Distance: 115 / 115
81432206106, 81432306049



MN-VB-5222

Length: 627 Ø: 50
Hole Distance: 152 / 152
81432706030, 81432706034, 81432706054,
81432706055, 81432706056, 81432706057,
81432706067, 81432706068, 81432706074,
81432706075, 81432706076, 81432706077,
81432706078, 81432706081, 81432706082,
81432709034, 81432709076, 81432709078,
8143706054



MN-VB-8569

Length: 627 Ø: 58
Hole Distance: 152 / 152
81432706055, 81432706056, 81432706067,
81432706068, 81432706075, 81432706077,
81432706081, 81432709056



SC-ES-8517

Length: 140
Cone Ø: d1 Ø 30 / d2 Ø 27
Thread: M30 x 1,5 RHT
81953016286





F 2000 ...

26.423 FNLS,26.423 FVLS	01/94 →12/95	Ball Head, gearshift linkage	CV-ES-2119			
	01/94 →12/95	Ball Head, gearshift linkage	CV-ES-2120			
	01/94 →12/95	Ball Head, gearshift linkage	CV-ES-2182			
	01/94 →12/95	Centre Rod	MN-DL-2160		Coupling Rod	
	01/94 →12/95	Centre Rod	MN-DL-2175		Push Rod	
	01/94 →12/95	Centre Rod	MN-DL-2176		Push Rod	
	01/94 →12/95	Centre Rod	MN-DL-3588		Push Rod	
	01/94 →12/95	Centre Rod	MN-DL-8197		Push Rod	
	01/94 →12/95	Centre Rod	MN-DL-8487		Push Rod	
	01/94 →12/95	Engine Mounting		MN-SB-10390		
	01/94 →12/95	Suspension Arm Repair Kit		MN-RK-7280		for Drag Link;for Semi-Trailing Arm; for Wishbone (CV)
	01/94 →12/95	Suspension Arm Repair Kit	MN-RK-7280	MN-RK-7280		for Drag Link;for Semi-Trailing Arm; for Wishbone (CV)
	01/94 →12/95	Tie Rod End		MN-ES-8490		for vehicles with Hinged Trailing Axle
	01/94 →12/95	Tie Rod End		SC-ES-8517		for Push Rod
	01/94 →12/95	Tie Rod End	CV-ES-2149			for Push Rod
	01/94 →12/95	Tie Rod End	CV-ES-14162			for Steering Rod
	01/94 →12/95	Tie Rod End	CV-ES-14163			for Steering Rod
	01/94 →12/95	Tie Rod End	IV-ES-12272			for Steering Rod
	01/94 →12/95	Track Control Arm		MN-DL-5212		Trailing Arm, Drive Axle;Air Suspension Axle
	01/94 →12/95	Track Control Arm		MN-DL-5212		Trailing Arm, Drive Axle;Air Suspension Axle; Tag Axle
	01/94 →12/95	Track Control Arm		MN-VB-5222		Wishbone (CV), Drive Axle;Air Suspension Axle
	01/94 →12/95	Track Control Arm		MN-VB-5222		Wishbone (CV), Drive Axle;Tag Axle; Air Suspension Axle
	01/94 →12/95	Track Control Arm	MN-TC-14112			Control Arm, 1st Front Axle, for Pneumatic Suspension vehicles
	26.463 DFC, DFLC	01/94 →	Ball Head, gearshift linkage	CV-ES-2119		
		01/94 →	Ball Head, gearshift linkage	CV-ES-2120		
		01/94 →	Ball Head, gearshift linkage	CV-ES-2182		
01/94 →		Centre Rod	MN-DL-2160		Coupling Rod	
01/94 →		Centre Rod	MN-DL-2175		Push Rod	
01/94 →		Centre Rod	MN-DL-2176		Push Rod	
01/94 →		Centre Rod	MN-DL-3588		Push Rod	
01/94 →		Centre Rod	MN-DL-8197		Push Rod	
01/94 →		Centre Rod	MN-DL-12421		for Steering Rod	
01/94 →		Engine Mounting		MN-SB-10390		
01/94 →		Suspension Arm Repair Kit		MN-SB-5244		for Wishbone (CV)
01/94 →		Suspension Arm Repair Kit		MN-SB-5244		for Wishbone (CV), 1st RA
01/94 →		Tie Rod	MN-DL-12284			
01/94 →		Tie Rod End	CV-ES-2146			
01/94 →		Tie Rod End	CV-ES-2149			for Push Rod
01/94 →		Tie Rod End	CV-ES-14162			for Steering Rod
01/94 →		Tie Rod End	CV-ES-14163			for Steering Rod
01/94 →		Tie Rod End	SC-ES-8517			for Push Rod
01/94 →		Track Control Arm		MN-DL-3402		Trailing Arm
01/94 →		Track Control Arm		MN-DL-3402		Trailing Arm, Drive Axle
01/94 →		Track Control Arm		MN-DL-5212		Trailing Arm, Drive Axle;Air Suspension Axle
01/94 →		Track Control Arm		MN-VB-5222		Wishbone (CV)
01/94 →		Track Control Arm		MN-VB-5222		Wishbone (CV), Drive Axle;Air Suspension Axle
01/94 →		Track Control Arm		MN-VB-8569		Wishbone (CV)
01/94 →		Track Control Arm		MN-VB-8569		Wishbone (CV), Drive Axle
01/94 →		Track Control Arm	MN-TC-14112			Control Arm, 1st Front Axle, for Pneumatic Suspension vehicles
26.463 DFK, DFLK, DFLK-L	01/94 →	Ball Head, gearshift linkage	CV-ES-2119			
	01/94 →	Ball Head, gearshift linkage	CV-ES-2120			
	01/94 →	Ball Head, gearshift linkage	CV-ES-2182			
	01/94 →	Centre Rod	MN-DL-2160		Coupling Rod	
	01/94 →	Centre Rod	MN-DL-2175		Push Rod	
	01/94 →	Centre Rod	MN-DL-2176		Push Rod	
	01/94 →	Centre Rod	MN-DL-3588		Push Rod	
01/94 →	Centre Rod	MN-DL-8197		Push Rod		

CV-ES-2119

Length: 55
Cone Ø: d1 Ø 10 / d2 Ø 10
Thread: M12 x 1,75 LHT
81953016063, 81953016131



CV-ES-2120

Length: 115
Cone Ø: d1 Ø 12,4 / d2 Ø 10,8
Thread: M14 x 1,5 RHT
03008500A, 81953016200, 81953016202,
81953016203, 81953016227



CV-ES-2146

Length: 80
Cone Ø: d1 Ø 30 / d2 Ø 27
Thread: M26 x 1,5 RHT
42533102, 81953016219, 81953016225,
81953016226, 81953016267, 81953016291



CV-ES-2149

Length: 160
Cone Ø: d1 Ø 30 / d2 Ø 27
Thread: M30 x 1,5 RHT
81953016263



CV-ES-2182

Length: 55
Cone Ø: d1 Ø 10 / d2 Ø 10
Thread: M12 x 1,75 RHT
81953016064, 81953016170



CV-ES-14162

Length: 125
Cone Ø: d1 Ø 30 / d2 Ø 27
Thread: M30 x 1,5 LHT
81953010015, 81953010083, 81953010087,
81953016029, 81953016030, 81953016043,
81953016044, 81953016050, 81953016054,
81953016087, 81953016091, 81953016107,
81953016120, 81953016125, 81953016152,
81953016155, 81953016157, 81953016168,
81953016179, 81953016181, 81953016223,
81953016237, 81953016254, 81953016275,
81953016279, 81953016351



CV-ES-14163

Length: 125
Cone Ø: d1 Ø 30 / d2 Ø 27
Thread: M30 x 1,5 RHT
95301.0084, 90804102156, 90804102272,
90804102696, 90804102710, 81953010016,
81953010075, 81953010084, 81953010088,
81953010094, 81953010103, 81953016030,
81953016043, 81953016048, 81953016049,
81953016053, 81953016061, 81953016090,
81953016108, 81953016112, 81953016126,
81953016143, 81953016149, 81953016154,
81953016156, 81953016168, 81953016178,
81953016194, 81953016206, 81953016224,
81953016234, 81953016242, 81953016252,
81953016274, 81953016278, 81953016284,
81953016286, 81953016308, 81953016310,
81953016312, 81953016347, 81953016350,
81953016352, 82953016012, 88953016014,
N2953016001



IV-ES-12272

Length: 75
Cone Ø: d1 Ø 30 / d2 Ø 27
Thread: M26 x 1,5 RHT
81953016280, 82953010010



MN-DL-2160

Length: 1652 Ø: 50
Cone Ø: d1 Ø 30 / d2 Ø 27
81467106112, 81467106163, 81467106165,
81467106198, 81467106353, 81467106354,
81467106361, 81467116725



MN-DL-2175

Length: 1628 Ø: 50
Cone Ø: d1 Ø 30 / d2 Ø 27
81467106396, 81467106904



MN-DL-2176

Length: 1628 Ø: 48
Cone Ø: d1 Ø 30 / d2 Ø 27
81466106779, 81466106780, 81466106782



MN-DL-3402

Length: 590 Ø: 48
Hole Distance: 130 / 130
03307200A, 81432206067, 81432206068,
81432206090, 81432206092, 81432209092



MN-DL-3588

Length: 1035 Ø: 48
Cone Ø: d1 Ø 30 / d2 Ø 27
81466106333, 81466106334, 81466106354,
81466106355, 81466106360, 81466106361,
81466106721, 81466106722, 81466106723,
81466116216



MN-DL-5212

Length: 577 Ø: 48
Hole Distance: 130 / 130
81432206096, 81432206097, 81432206098,
81432206129, 81432209096, 81432209129,
81432306014, 81432306030



MN-DL-8197

Length: 1055 Ø: 42
Cone Ø: d1 Ø 30 / d2 Ø 27
03207500A, 81466116003, 81466116004,
81466116005



MN-DL-8487

Length: 900 Ø: 38
Cone Ø: d1 Ø 30 / d2 Ø 27
81466106767, 81466106768, 81466106774,
81466116014



MN-DL-12284

Length: 1530 Ø: 50
Cone Ø: d1 Ø 30 / d2 Ø 27
81466106579, 81466106580, 81466106624,
81466116720, 81467116720, 81467116730,
81467116952



MN-DL-12421

Length: 1070 Ø: 48
Cone Ø: d1 Ø 30 / d2 Ø 27
Thread: M30 x 1,5 RHT
81466106656, 81466106659, 81466106669,
81466116006, 81466116007



MN-ES-8490

Length: 90
Cone Ø: d1 Ø 30 / d2 Ø 27
Thread: M26 x 1,5 RHT
0014606948, 14606948, 81953016281,
81953016337, 82953016016



MN-RK-7280

Ø: 75
Hole Distance: 115
Thick/Height: 24
0550806, 0639370, 689748, 10307400A,
81432306051, 81432306068, 81432706064



MN-SB-5244

Ø: 65
Hole Distance: 125
Thick/Height: 22
03312000A, 81432710027, 81432710082



MN-SB-10390

Ø: 70 Thick/Height: 85/85
81960200341, 81960200373, 81960200385,
81960200408, 81960200418



MN-TC-14112

Length: 777 Ø: 60
Hole Distance: 115 / 115
81432206106, 81432306049



MN-VB-5222

Length: 627 Ø: 50
Hole Distance: 152 / 152
81432706030, 81432706034, 81432706054,
81432706055, 81432706056, 81432706057,
81432706067, 81432706068, 81432706074,
81432706075, 81432706076, 81432706077,
81432706078, 81432706081, 81432706082,
81432709034, 81432709076, 81432709078,
8143706054



MN-VB-8569

Length: 627 Ø: 58
Hole Distance: 152 / 152
81432706055, 81432706056, 81432706067,
81432706068, 81432706075, 81432706077,
81432706081, 81432709056



SC-ES-8517

Length: 140
Cone Ø: d1 Ø 30 / d2 Ø 27
Thread: M30 x 1,5 RHT
81953016286





F 2000 ...

26.463 DFK, DFLK, DFLK-L ...	01/94 →	Centre Rod	MN-DL-12421		for Steering Rod	
	01/94 →	Engine Mounting		MN-SB-10390		
	01/94 →	Suspension Arm Repair Kit		MN-SB-5244	for Wishbone (CV)	
	01/94 →	Suspension Arm Repair Kit		MN-SB-5244	for Wishbone (CV), 1st RA	
	01/94 →	Tie Rod	MN-DL-12284			
	01/94 →	Tie Rod End	CV-ES-2146			
	01/94 →	Tie Rod End	CV-ES-2149		for Push Rod	
	01/94 →	Tie Rod End	CV-ES-14162		for Steering Rod	
	01/94 →	Tie Rod End	CV-ES-14163		for Steering Rod	
	01/94 →	Tie Rod End	SC-ES-8517		for Push Rod	
	01/94 →	Track Control Arm		MN-DL-3402	Trailing Arm	
	01/94 →	Track Control Arm		MN-DL-3402	Trailing Arm, Drive Axle	
	01/94 →	Track Control Arm		MN-DL-5212	Trailing Arm, Drive Axle;Air Suspension Axle	
	01/94 →	Track Control Arm		MN-VB-5222	Wishbone (CV)	
	01/94 →	Track Control Arm		MN-VB-5222	Wishbone (CV), Drive Axle;Air Suspension Axle	
	01/94 →	Track Control Arm		MN-VB-8569	Wishbone (CV)	
	01/94 →	Track Control Arm		MN-VB-8569	Wishbone (CV), Drive Axle	
	01/94 →	Track Control Arm	MN-TC-14112		Control Arm, 1st Front Axle, for Pneumatic Suspension vehicles	
	26.463 DFS, DFLS	01/94 →	Ball Head, gearshift linkage	CV-ES-2119		
		01/94 →	Ball Head, gearshift linkage	CV-ES-2120		
01/94 →		Ball Head, gearshift linkage	CV-ES-2182			
01/94 →		Centre Rod	MN-DL-2160		Coupling Rod	
01/94 →		Centre Rod	MN-DL-2175		Push Rod	
01/94 →		Centre Rod	MN-DL-2176		Push Rod	
01/94 →		Centre Rod	MN-DL-3588		Push Rod	
01/94 →		Centre Rod	MN-DL-8197		Push Rod	
01/94 →		Centre Rod	MN-DL-12421		for Steering Rod	
01/94 →		Engine Mounting		MN-SB-10390		
01/94 →		Suspension Arm Repair Kit		MN-SB-5244	for Wishbone (CV)	
01/94 →		Suspension Arm Repair Kit		MN-SB-5244	for Wishbone (CV), 1st RA	
01/94 →		Tie Rod	MN-DL-12284			
01/94 →		Tie Rod End	CV-ES-2146			
01/94 →		Tie Rod End	CV-ES-2149		for Push Rod	
01/94 →		Tie Rod End	CV-ES-14162		for Steering Rod	
01/94 →		Tie Rod End	CV-ES-14163		for Steering Rod	
01/94 →		Tie Rod End	SC-ES-8517		for Push Rod	
01/94 →		Track Control Arm		MN-DL-3402	Trailing Arm	
01/94 →		Track Control Arm		MN-DL-3402	Trailing Arm, Drive Axle	
01/94 →	Track Control Arm		MN-DL-5212	Trailing Arm, Drive Axle;Air Suspension Axle		
01/94 →	Track Control Arm		MN-VB-5222	Wishbone (CV)		
01/94 →	Track Control Arm		MN-VB-5222	Wishbone (CV), Drive Axle;Air Suspension Axle		
01/94 →	Track Control Arm		MN-VB-8569	Wishbone (CV)		
01/94 →	Track Control Arm		MN-VB-8569	Wishbone (CV), Drive Axle		
01/94 →	Track Control Arm	MN-TC-14112		Control Arm, 1st Front Axle, for Pneumatic Suspension vehicles		
26.463 FNLC, FNLLC, FNLLRC, FNLLW, FNLRC, FNLLRC, FVLC	01/94 →	Ball Head, gearshift linkage	CV-ES-2119			
	01/94 →	Ball Head, gearshift linkage	CV-ES-2120			
	01/94 →	Ball Head, gearshift linkage	CV-ES-2182			
	01/94 →	Centre Rod	MN-DL-2160		Coupling Rod	
	01/94 →	Centre Rod	MN-DL-2175		Push Rod	
	01/94 →	Centre Rod	MN-DL-2176		Push Rod	
	01/94 →	Centre Rod	MN-DL-3588		Push Rod	
	01/94 →	Centre Rod	MN-DL-8197		Push Rod	
	01/94 →	Centre Rod	MN-DL-8487		Push Rod	
	01/94 →	Centre Rod	MN-DL-12421		for Steering Rod	
	01/94 →	Engine Mounting		MN-SB-10390		
	01/94 →	Stabiliser Mounting		MN-SB-5243		
	01/94 →	Suspension Arm Repair Kit		CV-RK-5313	for Wishbone (CV)	
	01/94 →	Suspension Arm Repair Kit		MN-RK-7280	for Drag Link;for Semi-Trailing Arm; for Wishbone (CV)	
	01/94 →	Suspension Arm Repair Kit		MN-RK-7287	for Wishbone (CV)	
	01/94 →	Tie Rod End		MN-ES-8490	for vehicles with Hinged Trailing Axle	

CV-ES-2119

Length: 55
Cone Ø: d1 Ø 10 / d2 Ø 10
Thread: M12 x 1,75 LHT
81953016063, 81953016131



CV-ES-2120

Length: 115
Cone Ø: d1 Ø 12,4 / d2 Ø 10,8
Thread: M14 x 1,5 RHT
03008500A, 81953016200, 81953016203, 81953016227



CV-ES-2146

Length: 80
Cone Ø: d1 Ø 30 / d2 Ø 27
Thread: M26 x 1,5 RHT
42533102, 81953016219, 81953016225, 81953016226, 81953016267, 81953016291



CV-ES-2149

Length: 160
Cone Ø: d1 Ø 30 / d2 Ø 27
Thread: M30 x 1,5 RHT
81953016263



CV-ES-2182

Length: 55
Cone Ø: d1 Ø 10 / d2 Ø 10
Thread: M12 x 1,75 RHT
81953016064, 81953016170



CV-ES-14162

Length: 125
Cone Ø: d1 Ø 30 / d2 Ø 27
Thread: M30 x 1,5 LHT
81953010015, 81953010083, 81953010087, 81953016029, 81953016030, 81953016043, 81953016044, 81953016050, 81953016054, 81953016087, 81953016091, 81953016107, 81953016120, 81953016125, 81953016152, 81953016155, 81953016157, 81953016168, 81953016179, 81953016181, 81953016223, 81953016237, 81953016254, 81953016275, 81953016279, 81953016351



CV-ES-14163

Length: 125
Cone Ø: d1 Ø 30 / d2 Ø 27
Thread: M30 x 1,5 RHT
95301.0084, 90804102156, 90804102272, 90804102696, 90804102710, 81953010016, 81953010075, 81953010084, 81953010088, 81953010094, 81953010103, 81953016030, 81953016043, 81953016048, 81953016049, 81953016053, 81953016061, 81953016090, 81953016108, 81953016112, 81953016126, 81953016143, 81953016149, 81953016154, 81953016156, 81953016168, 81953016178, 81953016194, 81953016206, 81953016224, 81953016234, 81953016242, 81953016252, 81953016274, 81953016278, 81953016284, 81953016286, 81953016308, 81953016310, 81953016312, 81953016347, 81953016350, 81953016352, 82953016012, 88953016014, N2953016001



CV-RK-5313

Ø: 90
03304800A, 81953016132



MN-DL-2160

Length: 1652 Ø: 50
Cone Ø: d1 Ø 30 / d2 Ø 27
81467106112, 81467106163, 81467106165, 81467106198, 81467106353, 81467106354, 81467106361, 81467116725



MN-DL-2175

Length: 1628 Ø: 50
Cone Ø: d1 Ø 30 / d2 Ø 27
81467106396, 81467106904



MN-DL-2176

Length: 1628 Ø: 48
Cone Ø: d1 Ø 30 / d2 Ø 27
81466106779, 81466106780, 81466106782



MN-DL-3402

Length: 590 Ø: 48
Hole Distance: 130 / 130
03307200A, 81432206067, 81432206068, 81432206090, 81432206092, 81432209092



MN-DL-3588

Length: 1035 Ø: 48
Cone Ø: d1 Ø 30 / d2 Ø 27
81466106333, 81466106334, 81466106354, 81466106355, 81466106360, 81466106361, 81466106721, 81466106722, 81466106723, 81466116216



MN-DL-5212

Length: 577 Ø: 48
Hole Distance: 130 / 130
81432206096, 81432206097, 81432206098, 81432206129, 81432209096, 81432209129, 81432306014, 81432306030



MN-DL-8197

Length: 1055 Ø: 42
Cone Ø: d1 Ø 30 / d2 Ø 27
03207500A, 81466116003, 81466116004, 81466116005



MN-DL-8487

Length: 900 Ø: 38
Cone Ø: d1 Ø 30 / d2 Ø 27
81466106767, 81466106768, 81466106774, 81466116014



MN-DL-12284

Length: 1530 Ø: 50
Cone Ø: d1 Ø 30 / d2 Ø 27
81466106579, 81466106580, 81466106624, 81466116720, 81467116720, 81467116730, 81467116952



MN-DL-12421

Length: 1070 Ø: 48
Cone Ø: d1 Ø 30 / d2 Ø 27
Thread: M30 x 1,5 RHT
81466106656, 81466106659, 81466106669, 81466116006, 81466116007



MN-ES-8490

Length: 90
Cone Ø: d1 Ø 30 / d2 Ø 27
Thread: M26 x 1,5 RHT
0014606948, 14606948, 81953016281, 81953016337, 82953016016



MN-RK-7280

Ø: 75
Hole Distance: 115
Thick/Height: 24
0550806, 0639370, 689748, 10307400A, 81432306051, 81432306068, 81432706064



MN-RK-7287

Ø: 90
Hole Distance: 152
Thick/Height: 35
03304700A, 81953016133



MN-SB-5243

Length: 55 Ø: 78
Thick/Height: 60
03311100A, 81437040061, 81437220020



MN-SB-5244

Ø: 65
Hole Distance: 125
Thick/Height: 22
03312000A, 81432710027, 81432710082



MN-SB-10390

Ø: 70 Thick/Height: 85/85
81960200341, 81960200373, 81960200385, 81960200408, 81960200418



MN-TC-14112

Length: 777 Ø: 60
Hole Distance: 115 / 115
81432206106, 81432306049



MN-VB-5222

Length: 627 Ø: 50
Hole Distance: 152 / 152
81432706030, 81432706034, 81432706054, 81432706055, 81432706056, 81432706057, 81432706067, 81432706068, 81432706074, 81432706075, 81432706076, 81432706077, 81432706078, 81432706081, 81432706082, 81432709034, 81432709076, 81432709078, 8143706054



MN-VB-8569

Length: 627 Ø: 58
Hole Distance: 152 / 152
81432706055, 81432706056, 81432706067, 81432706068, 81432706075, 81432706077, 81432706081, 81432709056



SC-ES-8517

Length: 140
Cone Ø: d1 Ø 30 / d2 Ø 27
Thread: M30 x 1,5 RHT
81953016286



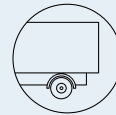

F 2000 ...

26.463 FNLC, FNLLC, FNLLRC, FNLLW, FNLRC, FNLLRC, FVLC ...	01/94 →	Tie Rod End		SC-ES-8517	for Push Rod	
	01/94 →	Tie Rod End	CV-ES-2146			
	01/94 →	Tie Rod End	CV-ES-2149		for Push Rod	
	01/94 →	Tie Rod End	CV-ES-14162		for Steering Rod	
	01/94 →	Tie Rod End	CV-ES-14163		for Steering Rod	
	01/94 →	Tie Rod End	IV-ES-12272		for Steering Rod	
	01/94 →	Track Control Arm		MN-DL-5212	Trailing Arm, Drive Axle; Air Suspension Axle	
	01/94 →	Track Control Arm		MN-DL-5212	Trailing Arm, Drive Axle; Air Suspension Axle; Tag Axle	
	01/94 →	Track Control Arm		MN-VB-5222	Wishbone (CV), Drive Axle; Air Suspension Axle	
	01/94 →	Track Control Arm		MN-VB-5222	Wishbone (CV), Drive Axle; Tag Axle; Air Suspension Axle	
	01/94 →	Track Control Arm	MN-TC-14112		Control Arm, 1st Front Axle, for Pneumatic Suspension vehicles	
	26.463 FNLS, FVLS, FVLR	01/94 →	Ball Head, gearshift linkage	CV-ES-2119		
01/94 →		Ball Head, gearshift linkage	CV-ES-2120			
01/94 →		Ball Head, gearshift linkage	CV-ES-2182			
01/94 →		Centre Rod	MN-DL-2160		Coupling Rod	
01/94 →		Centre Rod	MN-DL-2175		Push Rod	
01/94 →		Centre Rod	MN-DL-2176		Push Rod	
01/94 →		Centre Rod	MN-DL-3588		Push Rod	
01/94 →		Centre Rod	MN-DL-8197		Push Rod	
01/94 →		Centre Rod	MN-DL-8487		Push Rod	
01/94 →		Centre Rod	MN-DL-12421		for Steering Rod	
01/94 →		Engine Mounting		MN-SB-10390		
01/94 →		Suspension Arm Repair Kit		MN-RK-7280	for Drag Link; for Semi-Trailing Arm; for Wishbone (CV)	
01/94 →		Suspension Arm Repair Kit	MN-RK-7280	MN-RK-7280	for Drag Link; for Semi-Trailing Arm; for Wishbone (CV)	
01/94 →		Tie Rod End		MN-ES-8490	for vehicles with Hinged Trailing Axle	
01/94 →		Tie Rod End		SC-ES-8517	for Push Rod	
01/94 →		Tie Rod End	CV-ES-2146			
01/94 →		Tie Rod End	CV-ES-2149		for Push Rod	
01/94 →		Tie Rod End	CV-ES-14162		for Steering Rod	
01/94 →		Tie Rod End	CV-ES-14163		for Steering Rod	
01/94 →		Tie Rod End	IV-ES-12272		for Steering Rod	
01/94 →		Track Control Arm		MN-DL-5212	Trailing Arm, Drive Axle; Air Suspension Axle	
01/94 →		Track Control Arm		MN-DL-5212	Trailing Arm, Drive Axle; Air Suspension Axle; Tag Axle	
01/94 →		Track Control Arm		MN-VB-5222	Wishbone (CV), Drive Axle; Air Suspension Axle	
01/94 →		Track Control Arm		MN-VB-5222	Wishbone (CV), Drive Axle; Tag Axle; Air Suspension Axle	
01/94 →		Track Control Arm	MN-TC-14112		Control Arm, Leading Axle Steered, for Pneumatic Suspension vehicles	
26.464 DFC, DFLC		05/01 →	Ball Head, gearshift linkage	CV-ES-2120		
		05/01 →	Centre Rod	MN-DL-8197		Push Rod
		05/01 →	Centre Rod	MN-DL-8487		Push Rod
		05/01 →	Suspension Arm Repair Kit		MN-SB-5244	for Wishbone (CV)
		05/01 →	Tie Rod	MN-DL-12284		
	05/01 →	Tie Rod End	CV-ES-2149		for Push Rod	
	05/01 →	Tie Rod End	CV-ES-14162		for Steering Rod	
	05/01 →	Tie Rod End	CV-ES-14163		for Steering Rod	
	05/01 →	Tie Rod End	SC-ES-8517		for Push Rod	
	05/01 →	Track Control Arm		MN-DL-3402	Trailing Arm	
	05/01 →	Track Control Arm		MN-DL-5212	Trailing Arm	
	05/01 →	Track Control Arm		MN-VB-5222	Wishbone (CV)	
	05/01 →	Track Control Arm		MN-VB-8569	Wishbone (CV)	
	05/01 →	Track Control Arm	MN-TC-14112		Control Arm, 1st Front Axle, for Pneumatic Suspension vehicles	
26.464 DFK, DFLK, DFLK-L	05/01 →	Ball Head, gearshift linkage	CV-ES-2120			
	05/01 →	Centre Rod	MN-DL-8197		Push Rod	
	05/01 →	Centre Rod	MN-DL-8487		Push Rod	
	05/01 →	Suspension Arm Repair Kit		MN-SB-5244	for Wishbone (CV)	

CV-ES-2119

Length: 55
Cone Ø: d1 Ø 10 / d2 Ø 10
Thread: M12 x 1,75 LHT
81953016063, 81953016131



CV-ES-2120

Length: 115
Cone Ø: d1 Ø 12,4 / d2 Ø 10,8
Thread: M14 x 1,5 RHT
03008500A, 81953016200, 81953016202, 81953016203, 81953016227



CV-ES-2146

Length: 80
Cone Ø: d1 Ø 30 / d2 Ø 27
Thread: M26 x 1,5 RHT
42533102, 81953016219, 81953016225, 81953016226, 81953016267, 81953016291



CV-ES-2149

Length: 160
Cone Ø: d1 Ø 30 / d2 Ø 27
Thread: M30 x 1,5 RHT
81953016263



CV-ES-2182

Length: 55
Cone Ø: d1 Ø 10 / d2 Ø 10
Thread: M12 x 1,75 RHT
81953016064, 81953016170



CV-ES-14162

Length: 125
Cone Ø: d1 Ø 30 / d2 Ø 27
Thread: M30 x 1,5 LHT
81953010015, 81953010083, 81953010087, 81953016029, 81953016030, 81953016043, 81953016044, 81953016050, 81953016054, 81953016087, 81953016091, 81953016107, 81953016120, 81953016125, 81953016152, 81953016155, 81953016157, 81953016168, 81953016179, 81953016181, 81953016223, 81953016237, 81953016254, 81953016275, 81953016279, 81953016351



CV-ES-14163

Length: 125
Cone Ø: d1 Ø 30 / d2 Ø 27
Thread: M30 x 1,5 RHT
95301.0084, 90804102156, 90804102272, 90804102696, 90804102710, 81953010016, 81953010075, 81953010084, 81953010088, 81953010094, 81953010103, 81953016030, 81953016043, 81953016048, 81953016049, 81953016053, 81953016061, 81953016090, 81953016108, 81953016112, 81953016126, 81953016143, 81953016149, 81953016154, 81953016156, 81953016168, 81953016178, 81953016194, 81953016206, 81953016224, 81953016234, 81953016242, 81953016252, 81953016274, 81953016278, 81953016284, 81953016286, 81953016308, 81953016310, 81953016312, 81953016347, 81953016350, 81953016352, 82953016012, 88953016014, N2953016001



IV-ES-12272

Length: 75
Cone Ø: d1 Ø 30 / d2 Ø 27
Thread: M26 x 1,5 RHT
81953016280, 82953010010



MN-DL-2160

Length: 1652 Ø: 50
Cone Ø: d1 Ø 30 / d2 Ø 27
81467106112, 81467106163, 81467106165, 81467106198, 81467106353, 81467106354, 81467106361, 81467116725



MN-DL-2175

Length: 1628 Ø: 50
Cone Ø: d1 Ø 30 / d2 Ø 27
81467106396, 81467106904



MN-DL-2176

Length: 1628 Ø: 48
Cone Ø: d1 Ø 30 / d2 Ø 27
81466106779, 81466106780, 81466106782



MN-DL-3402

Length: 590 Ø: 48
Hole Distance: 130 / 130
03307200A, 81432206067, 81432206068, 81432206090, 81432206092



MN-DL-3588

Length: 1035 Ø: 48
Cone Ø: d1 Ø 30 / d2 Ø 27
81466106333, 81466106334, 81466106354, 81466106355, 81466106360, 81466106361, 81466106721, 81466106722, 81466106723, 81466116216



MN-DL-5212

Length: 577 Ø: 48
Hole Distance: 130 / 130
81432206096, 81432206097, 81432206098, 81432206129, 81432209096, 81432209129, 81432306014, 81432306030



MN-DL-8197

Length: 1055 Ø: 42
Cone Ø: d1 Ø 30 / d2 Ø 27
03207500A, 81466116003, 81466116004, 81466116005



MN-DL-8487

Length: 900 Ø: 38
Cone Ø: d1 Ø 30 / d2 Ø 27
81466106767, 81466106768, 81466106774, 81466116014



MN-DL-12284

Length: 1530 Ø: 50
Cone Ø: d1 Ø 30 / d2 Ø 27
81466106579, 81466106580, 81466106624, 81466116720, 81467116720, 81467116730, 81467116952



MN-DL-12421

Length: 1070 Ø: 48
Cone Ø: d1 Ø 30 / d2 Ø 27
Thread: M30 x 1,5 RHT
81466106656, 81466106659, 81466106669, 81466116006, 81466116007



MN-ES-8490

Length: 90
Cone Ø: d1 Ø 30 / d2 Ø 27
Thread: M26 x 1,5 RHT
0014606948, 14606948, 81953016281, 81953016337, 82953016016



MN-RK-7280

Ø: 75
Hole Distance: 115
Thick/Height: 24
0550806, 0639370, 689748, 10307400A, 81432306051, 81432306068, 81432706064



MN-SB-5244

Ø: 65
Hole Distance: 125
Thick/Height: 22
03312000A, 81432710027, 81432710082



MN-SB-10390

Ø: 70 Thick/Height: 85/85
81960200341, 81960200373, 81960200385, 81960200408, 81960200418



MN-TC-14112

Length: 777 Ø: 60
Hole Distance: 115 / 115
81432206106, 81432306049



MN-VB-5222

Length: 627 Ø: 50
Hole Distance: 152 / 152
81432706030, 81432706034, 81432706054, 81432706055, 81432706056, 81432706057, 81432706067, 81432706068, 81432706074, 81432706075, 81432706076, 81432706077, 81432706078, 81432706081, 81432706082, 81432709034, 81432709076, 81432709078, 8143706054



MN-VB-8569

Length: 627 Ø: 58
Hole Distance: 152 / 152
81432706055, 81432706056, 81432706067, 81432706068, 81432706075, 81432706077, 81432706081, 81432709056



SC-ES-8517

Length: 140
Cone Ø: d1 Ø 30 / d2 Ø 27
Thread: M30 x 1,5 RHT
81953016286





F 2000 ...

26.464 DFK, DFLK, DFLK-L ...	05/01→	Tie Rod	MN-DL-12284		
	05/01→	Tie Rod End	CV-ES-2149		for Push Rod
	05/01→	Tie Rod End	CV-ES-14162		for Steering Rod
	05/01→	Tie Rod End	CV-ES-14163		for Steering Rod
	05/01→	Tie Rod End	SC-ES-8517		for Push Rod
	05/01→	Track Control Arm		MN-DL-3402	Trailing Arm
	05/01→	Track Control Arm		MN-DL-5212	Trailing Arm
	05/01→	Track Control Arm		MN-VB-5222	Wishbone (CV)
	05/01→	Track Control Arm		MN-VB-8569	Wishbone (CV)
	05/01→	Track Control Arm	MN-TC-14112		Control Arm, 1st Front Axle, for Pneumatic Suspension vehicles
26.464 DFS, DFLS	05/01→	Ball Head, gearshift linkage	CV-ES-2120		
	05/01→	Centre Rod	MN-DL-8197		Push Rod
	05/01→	Centre Rod	MN-DL-8487		Push Rod
	05/01→	Suspension Arm Repair Kit		MN-SB-5244	for Wishbone (CV)
	05/01→	Tie Rod	MN-DL-12284		
	05/01→	Tie Rod End	CV-ES-2149		for Push Rod
	05/01→	Tie Rod End	CV-ES-14162		for Steering Rod
	05/01→	Tie Rod End	CV-ES-14163		for Steering Rod
	05/01→	Tie Rod End	SC-ES-8517		for Push Rod
	05/01→	Track Control Arm		MN-DL-3402	Trailing Arm
	05/01→	Track Control Arm		MN-DL-5212	Trailing Arm
	05/01→	Track Control Arm		MN-VB-5222	Wishbone (CV)
	05/01→	Track Control Arm		MN-VB-8569	Wishbone (CV)
05/01→	Track Control Arm	MN-TC-14112		Control Arm, 1st Front Axle, for Pneumatic Suspension vehicles	
26.464 DF-TM	05/01→	Ball Head, gearshift linkage	CV-ES-2120		
	05/01→	Centre Rod	MN-DL-8197		Push Rod
	05/01→	Centre Rod	MN-DL-8487		Push Rod
	05/01→	Suspension Arm Repair Kit		MN-SB-5244	for Wishbone (CV)
	05/01→	Tie Rod	MN-DL-12284		
	05/01→	Tie Rod End	CV-ES-2149		for Push Rod
	05/01→	Tie Rod End	CV-ES-14162		for Steering Rod
	05/01→	Tie Rod End	CV-ES-14163		for Steering Rod
	05/01→	Track Control Arm		MN-DL-3402	Trailing Arm
	05/01→	Track Control Arm		MN-DL-5212	Trailing Arm
	05/01→	Track Control Arm		MN-VB-5222	Wishbone (CV)
	05/01→	Track Control Arm		MN-VB-8569	Wishbone (CV)
	26.464 FNLC, FNLLC, FNLLRC, FNLLW, FNLRC, FNLLRC, FVLC	05/01→	Ball Head, gearshift linkage	CV-ES-2120	
05/01→		Centre Rod	MN-DL-8197		Push Rod
05/01→		Centre Rod	MN-DL-8487		Push Rod
05/01→		Suspension Arm Repair Kit		MN-RK-7291	for Drag Link
05/01→		Suspension Arm Repair Kit	MN-RK-7280	MN-RK-7280	for Drag Link;for Semi-Trailing Arm; for Wishbone (CV)
05/01→		Tie Rod End		SC-ES-8517	for Push Rod
05/01→		Tie Rod End	CV-ES-2149		for Push Rod
05/01→		Tie Rod End	CV-ES-14162		for Steering Rod
05/01→		Tie Rod End	CV-ES-14163		for Steering Rod
05/01→		Track Control Arm		MN-DL-5212	Trailing Arm
05/01→		Track Control Arm		MN-VB-5222	Wishbone (CV)
05/01→		Track Control Arm	MN-TC-14112		Control Arm, 1st Front Axle, for Pneumatic Suspension vehicles
26.464 FNLS		05/01→	Ball Head, gearshift linkage	CV-ES-2120	
	05/01→	Centre Rod	MN-DL-8197		Push Rod
	05/01→	Centre Rod	MN-DL-8487		Push Rod
	05/01→	Suspension Arm Repair Kit		MN-RK-7291	for Drag Link
	05/01→	Suspension Arm Repair Kit	MN-RK-7280	MN-RK-7280	for Drag Link;for Semi-Trailing Arm; for Wishbone (CV)
	05/01→	Tie Rod End	CV-ES-2149		for Push Rod
	05/01→	Tie Rod End	CV-ES-14162		for Steering Rod
	05/01→	Tie Rod End	CV-ES-14163		for Steering Rod
	05/01→	Tie Rod End	SC-ES-8517		for Push Rod
	05/01→	Track Control Arm		MN-DL-5212	Trailing Arm

CV-ES-2120

Length: 115
Cone Ø: d1 Ø 12,4 / d2 Ø 10,8
Thread: M14 x 1,5 RHT
03008500A, 81953016200, 81953016202,
81953016203, 81953016227



CV-ES-2149

Length: 160
Cone Ø: d1 Ø 30 / d2 Ø 27
Thread: M30 x 1,5 RHT
81953016263



CV-ES-14162

Length: 125
Cone Ø: d1 Ø 30 / d2 Ø 27
Thread: M30 x 1,5 LHT
81953010015, 81953010083, 81953010087,
81953016029, 81953016030, 81953016043,
81953016044, 81953016050, 81953016054,
81953016087, 81953016091, 81953016107,
81953016120, 81953016125, 81953016152,
81953016155, 81953016157, 81953016168,
81953016179, 81953016181, 81953016223,
81953016237, 81953016254, 81953016275,
81953016279, 81953016351



CV-ES-14163

Length: 125
Cone Ø: d1 Ø 30 / d2 Ø 27
Thread: M30 x 1,5 RHT
95301.0084, 90804102156, 90804102272,
90804102696, 90804102710, 81953010016,
81953010075, 81953010084, 81953010088,
81953010094, 81953010103, 81953016030,
81953016043, 81953016048, 81953016049,
81953016053, 81953016061, 81953016090,
81953016108, 81953016112, 81953016126,
81953016143, 81953016149, 81953016154,
81953016156, 81953016168, 81953016178,
81953016194, 81953016206, 81953016224,
81953016234, 81953016242, 81953016252,
81953016274, 81953016278, 81953016284,
81953016286, 81953016308, 81953016310,
81953016312, 81953016347, 81953016350,
81953016352, 82953016012, 88953016014,
N2953016001



MN-DL-3402

Length: 590 Ø: 48
Hole Distance: 130 / 130
03307200A, 81432206067, 81432206068,
81432206090, 81432206092, 81432209092



MN-DL-5212

Length: 577 Ø: 48
Hole Distance: 130 / 130
81432206096, 81432206097, 81432206098,
81432206129, 81432209096, 81432209129,
81432306014, 81432306030



MN-DL-8197

Length: 1055 Ø: 42
Cone Ø: d1 Ø 30 / d2 Ø 27
03207500A, 81466116003, 81466116004,
81466116005



MN-DL-8487

Length: 900 Ø: 38
Cone Ø: d1 Ø 30 / d2 Ø 27
81466106767, 81466106768, 81466106774,
81466116014



MN-DL-12284

Length: 1530 Ø: 50
Cone Ø: d1 Ø 30 / d2 Ø 27
81466106579, 81466106580, 81466106624,
81466116720, 81467116720, 81467116730,
81467116952



MN-RK-7280

Ø: 75
Hole Distance: 115
Thick/Height: 24
0550806, 0639370, 689748, 10307400A,
81432306051, 81432306068, 81432706064



MN-RK-7291

Ø: 72
Hole Distance: 130
Thick/Height: 30
10307800A, 81432206108, 81432206132



MN-SB-5244

Ø: 65
Hole Distance: 125
Thick/Height: 22
03312000A, 81432710027, 81432710082



MN-TC-14112

Length: 777 Ø: 60
Hole Distance: 115 / 115
81432206106, 81432306049



MN-VB-5222

Length: 627 Ø: 50
Hole Distance: 152 / 152
81432706030, 81432706034, 81432706054,
81432706055, 81432706056, 81432706057,
81432706067, 81432706068, 81432706074,
81432706075, 81432706076, 81432706077,
81432706078, 81432706081, 81432706082,
81432709034, 81432709076, 81432709078,
8143706054



MN-VB-8569

Length: 627 Ø: 58
Hole Distance: 152 / 152
81432706055, 81432706056, 81432706067,
81432706068, 81432706075, 81432706077,
81432706081, 81432709056



SC-ES-8517

Length: 140
Cone Ø: d1 Ø 30 / d2 Ø 27
Thread: M30 x 1,5 RHT
81953016286



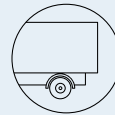

F 2000 ...

26.464 FNLS ...	05/01→	Track Control Arm		MN-VB-5222	Wishbone (CV)	
	05/01→	Track Control Arm	MN-TC-14112		Control Arm, 1st Front Axle, for Pneumatic Suspension vehicles	
26.464 FVL-KO	05/01→	Ball Head, gearshift linkage	CV-ES-2120			
	05/01→	Centre Rod	MN-DL-8197		Push Rod	
	05/01→	Centre Rod	MN-DL-8487		Push Rod	
	05/01→	Suspension Arm Repair Kit		MN-RK-7291	for Drag Link	
	05/01→	Suspension Arm Repair Kit	MN-RK-7280	MN-RK-7280	for Drag Link;for Semi-Trailing Arm; for Wishbone (CV)	
	05/01→	Tie Rod End		SC-ES-8517	for Push Rod	
	05/01→	Tie Rod End	CV-ES-14162		for Steering Rod	
	05/01→	Tie Rod End	CV-ES-14163		for Steering Rod	
	05/01→	Track Control Arm		MN-DL-5212	Trailing Arm	
	05/01→	Track Control Arm		MN-VB-5222	Wishbone (CV), Drive Axle, for Pneumatic Suspension vehicles	
	05/01→	Track Control Arm	MN-TC-14112		Control Arm, Leading Axle Steered, for Pneumatic Suspension vehicles	
	26.464 FVLS, FVLRS	05/01→	Ball Head, gearshift linkage	CV-ES-2120		
05/01→		Centre Rod	MN-DL-8197		Push Rod	
05/01→		Centre Rod	MN-DL-8487		Push Rod	
05/01→		Suspension Arm Repair Kit		MN-RK-7291	for Drag Link	
05/01→		Suspension Arm Repair Kit	MN-RK-7280	MN-RK-7280	for Drag Link;for Semi-Trailing Arm; for Wishbone (CV)	
05/01→		Tie Rod End		SC-ES-8517	for Push Rod	
05/01→		Tie Rod End	CV-ES-2149		for Push Rod	
05/01→		Tie Rod End	CV-ES-14162		for Steering Rod	
05/01→		Tie Rod End	CV-ES-14163		for Steering Rod	
05/01→		Track Control Arm		MN-DL-5212	Trailing Arm	
05/01→		Track Control Arm		MN-VB-5222	Wishbone (CV), Drive Axle, for Pneumatic Suspension vehicles	
05/01→		Track Control Arm	MN-TC-14112		Control Arm, 1st Front Axle, for Pneumatic Suspension vehicles	
26.603 DFC, DFLC		06/96→	Ball Head, gearshift linkage	CV-ES-2119		
		06/96→	Ball Head, gearshift linkage	CV-ES-2120		
	06/96→	Ball Head, gearshift linkage	CV-ES-2182			
	06/96→	Centre Rod	MN-DL-2160		Coupling Rod	
	06/96→	Centre Rod	MN-DL-2175		Push Rod	
	06/96→	Centre Rod	MN-DL-2176		Push Rod	
	06/96→	Centre Rod	MN-DL-3588		Push Rod	
	06/96→	Centre Rod	MN-DL-8197		Push Rod	
	06/96→	Engine Mounting	MN-SB-10390			
	06/96→	Suspension Arm Repair Kit		MN-RK-7280	for Drag Link;for Semi-Trailing Arm; for Wishbone (CV)	
	06/96→	Suspension Arm Repair Kit		MN-SB-5244	for Wishbone (CV)	
	06/96→	Suspension Arm Repair Kit		MN-SB-5244	for Wishbone (CV), 2nd RA	
	06/96→	Suspension Strut Repair Kit		DB-RK-8581		
	06/96→	Tie Rod End	CV-ES-2149		for Push Rod	
	06/96→	Tie Rod End	CV-ES-14162		for Steering Rod	
	06/96→	Tie Rod End	CV-ES-14163		for Steering Rod	
	06/96→	Track Control Arm		MN-DL-3402	Trailing Arm	
	06/96→	Track Control Arm		MN-DL-3402	Trailing Arm, Drive Axle	
	06/96→	Track Control Arm		MN-DL-5212	Trailing Arm, Drive Axle;Air Suspension Axle	
	06/96→	Track Control Arm		MN-DL-8544	Trailing Arm, Drive Axle;Leaf Spring Axle	
	06/96→	Track Control Arm		MN-DL-8609	Trailing Arm, Leaf Spring Axle	
	06/96→	Track Control Arm		MN-VB-5222	Wishbone (CV)	
06/96→	Track Control Arm		MN-VB-5222	Wishbone (CV), Drive Axle;Air Suspension Axle		
06/96→	Track Control Arm		MN-VB-8514	Suspension Rod, Wishbone (CV), Drive Axle;Leaf Spring Axle		
26.603 DFK, DFLK	06/96→	Ball Head, gearshift linkage	CV-ES-2119			
	06/96→	Ball Head, gearshift linkage	CV-ES-2120			
	06/96→	Ball Head, gearshift linkage	CV-ES-2182			
	06/96→	Centre Rod	MN-DL-2160		Coupling Rod	
	06/96→	Centre Rod	MN-DL-2175		Push Rod	

CV-ES-2119

Length: 55
Cone Ø: d1 Ø 10 / d2 Ø 10
Thread: M12 x 1,75 LHT
81953016063, 81953016131



CV-ES-2120

Length: 115
Cone Ø: d1 Ø 12,4 / d2 Ø 10,8
Thread: M14 x 1,5 RHT
03008500A, 81953016200, 81953016202, 81953016203, 81953016227



CV-ES-2149

Length: 160
Cone Ø: d1 Ø 30 / d2 Ø 27
Thread: M30 x 1,5 RHT
81953016263



CV-ES-2182

Length: 55
Cone Ø: d1 Ø 10 / d2 Ø 10
Thread: M12 x 1,75 RHT
81953016064, 81953016170



CV-ES-14162

Length: 125
Cone Ø: d1 Ø 30 / d2 Ø 27
Thread: M30 x 1,5 LHT
81953010015, 81953010083, 81953010087, 81953016029, 81953016030, 81953016043, 81953016044, 81953016050, 81953016054, 81953016087, 81953016091, 81953016107, 81953016120, 81953016125, 81953016152, 81953016155, 81953016157, 81953016168, 81953016179, 81953016181, 81953016223, 81953016237, 81953016254, 81953016275, 81953016279, 81953016351



CV-ES-14163

Length: 125
Cone Ø: d1 Ø 30 / d2 Ø 27
Thread: M30 x 1,5 RHT
95301.0084, 90804102156, 90804102272, 90804102696, 90804102710, 81953010016, 81953010075, 81953010084, 81953010088, 81953010094, 81953010103, 81953016030, 81953016043, 81953016048, 81953016049, 81953016053, 81953016061, 81953016090, 81953016108, 81953016112, 81953016126, 81953016143, 81953016149, 81953016154, 81953016156, 81953016168, 81953016178, 81953016194, 81953016206, 81953016224, 81953016234, 81953016242, 81953016252, 81953016274, 81953016278, 81953016284, 81953016286, 81953016308, 81953016310, 81953016312, 81953016347, 81953016350, 81953016352, 82953016012, 88953016014, N2953016001



DB-RK-8581

Ø: 85
Hole Distance: 130
Thick/Height: 24
03305800A, 81432706105



MN-DL-2160

Length: 1652 Ø: 50
Cone Ø: d1 Ø 30 / d2 Ø 27
81467106112, 81467106163, 81467106165, 81467106198, 81467106353, 81467106354, 81467106361, 81467116725



MN-DL-2175

Length: 1628 Ø: 50
Cone Ø: d1 Ø 30 / d2 Ø 27
81467106396, 81467106904



MN-DL-2176

Length: 1628 Ø: 48
Cone Ø: d1 Ø 30 / d2 Ø 27
81466106779, 81466106780, 81466106782



MN-DL-3402

Length: 590 Ø: 48
Hole Distance: 130 / 130
03307200A, 81432206067, 81432206068, 81432206090, 81432206092, 81432209092



MN-DL-3588

Length: 1035 Ø: 48
Cone Ø: d1 Ø 30 / d2 Ø 27
81466106333, 81466106334, 81466106354, 81466106355, 81466106360, 81466106361, 81466106721, 81466106722, 81466106723, 81466116216



MN-DL-5212

Length: 577 Ø: 48
Hole Distance: 130 / 130
81432206096, 81432206097, 81432206098, 81432206129, 81432209096, 81432209129, 81432306014, 81432306030



MN-DL-8197

Length: 1055 Ø: 42
Cone Ø: d1 Ø 30 / d2 Ø 27
03207500A, 81466116003, 81466116004, 81466116005



MN-DL-8487

Length: 900 Ø: 38
Cone Ø: d1 Ø 30 / d2 Ø 27
81466106767, 81466106768, 81466106774, 81466116014



MN-DL-8544

Length: 596 Ø: 48
Hole Distance: 130 / 130
81432206196, 81432206232, 81432206233



MN-DL-8609

Length: 585 Ø: 58
Hole Distance: 130 / 130
81432206070, 81432206071, 81432206072, 81432206091, 81432206093, 81432206119



MN-RK-7280

Ø: 75
Hole Distance: 115
Thick/Height: 24
0550806, 0639370, 689748, 10307400A, 81432306051, 81432306068, 81432706064



MN-RK-7291

Ø: 72
Hole Distance: 130
Thick/Height: 30
10307800A, 81432206108, 81432206132



MN-SB-5244

Ø: 65
Hole Distance: 125
Thick/Height: 22
03312000A, 81432710027, 81432710082



MN-SB-10390

Ø: 70 Thick/Height: 85/85
81960200341, 81960200373, 81960200385, 81960200408, 81960200418



MN-TC-14112

Length: 777 Ø: 60
Hole Distance: 115 / 115
81432206106, 81432306049



MN-VB-5222

Length: 627 Ø: 50
Hole Distance: 152 / 152
81432706030, 81432706034, 81432706054, 81432706055, 81432706056, 81432706057, 81432706067, 81432706068, 81432706074, 81432706075, 81432706076, 81432706077, 81432706078, 81432706081, 81432706082, 81432709034, 81432709076, 81432709078, 8143706054



MN-VB-8514

Length: 627 Ø: 48
Hole Ø 25 / 25 / 25
Hole Distance: 152 / 130 / 130
81432706087, 81432706088, 81432706094, 81432706095, 81432796094



SC-ES-8517

Length: 140
Cone Ø: d1 Ø 30 / d2 Ø 27
Thread: M30 x 1,5 RHT
81953016286





F 2000 ...

26.603 DFK, DFLK ...	06/96→	Centre Rod	MN-DL-2176	Push Rod
	06/96→	Centre Rod	MN-DL-3588	Push Rod
	06/96→	Centre Rod	MN-DL-8197	Push Rod
	06/96→	Engine Mounting	MN-SB-10390	
	06/96→	Suspension Arm Repair Kit		MN-RK-7280 for Drag Link;for Semi-Trailing Arm; for Wishbone (CV)
	06/96→	Suspension Arm Repair Kit		MN-SB-5244 for Wishbone (CV)
	06/96→	Suspension Arm Repair Kit		MN-SB-5244 for Wishbone (CV), 2nd RA
	06/96→	Suspension Strut Repair Kit		DB-RK-8581
	06/96→	Tie Rod End	CV-ES-2149	for Push Rod
	06/96→	Tie Rod End	CV-ES-14162	for Steering Rod
	06/96→	Tie Rod End	CV-ES-14163	for Steering Rod
	06/96→	Track Control Arm		MN-DL-3402 Trailing Arm
	06/96→	Track Control Arm		MN-DL-3402 Trailing Arm, Drive Axle
	06/96→	Track Control Arm		MN-DL-5212 Trailing Arm, Drive Axle;Air Suspension Axle
	06/96→	Track Control Arm		MN-DL-8544 Trailing Arm, Drive Axle;Leaf Spring Axle
	06/96→	Track Control Arm		MN-DL-8609 Trailing Arm, Leaf Spring Axle
	06/96→	Track Control Arm		MN-VB-5222 Wishbone (CV)
	06/96→	Track Control Arm		MN-VB-5222 Wishbone (CV), Drive Axle;Air Suspension Axle
	06/96→	Track Control Arm		MN-VB-8514 Suspension Rod, Wishbone (CV), Drive Axle; Leaf Spring Axle
26.603 DFS, DFLS	06/96→	Ball Head, gearshift linkage	CV-ES-2119	
	06/96→	Ball Head, gearshift linkage	CV-ES-2120	
	06/96→	Ball Head, gearshift linkage	CV-ES-2182	
	06/96→	Centre Rod	MN-DL-2160	Coupling Rod
	06/96→	Centre Rod	MN-DL-2175	Push Rod
	06/96→	Centre Rod	MN-DL-2176	Push Rod
	06/96→	Centre Rod	MN-DL-3588	Push Rod
	06/96→	Centre Rod	MN-DL-8197	Push Rod
	06/96→	Engine Mounting	MN-SB-10390	
	06/96→	Suspension Arm Repair Kit		MN-RK-7280 for Drag Link;for Semi-Trailing Arm; for Wishbone (CV)
	06/96→	Suspension Arm Repair Kit		MN-SB-5244 for Wishbone (CV)
	06/96→	Suspension Arm Repair Kit		MN-SB-5244 for Wishbone (CV), 2nd RA
	06/96→	Suspension Strut Repair Kit		DB-RK-8581
	06/96→	Tie Rod End	CV-ES-2149	for Push Rod
	06/96→	Tie Rod End	CV-ES-14162	for Steering Rod
	06/96→	Tie Rod End	CV-ES-14163	for Steering Rod
	06/96→	Track Control Arm		MN-DL-3402 Trailing Arm
	06/96→	Track Control Arm		MN-DL-3402 Trailing Arm, Drive Axle
	06/96→	Track Control Arm		MN-DL-5212 Trailing Arm, Drive Axle;Air Suspension Axle
	06/96→	Track Control Arm		MN-DL-8544 Trailing Arm, Drive Axle;Leaf Spring Axle
06/96→	Track Control Arm		MN-DL-8609 Trailing Arm, Leaf Spring Axle	
06/96→	Track Control Arm		MN-VB-5222 Wishbone (CV)	
06/96→	Track Control Arm		MN-VB-5222 Wishbone (CV), Drive Axle;Air Suspension Axle	
06/96→	Track Control Arm		MN-VB-8514 Suspension Rod, Wishbone (CV), Drive Axle; Leaf Spring Axle	
26.604 DFLS	04/00→	Centre Rod	MN-DL-2160	Coupling Rod
	04/00→	Centre Rod	MN-DL-2176	Push Rod
	04/00→	Suspension Arm Repair Kit		MN-RK-7291 for Drag Link
	04/00→	Tie Rod End	CV-ES-2149	for Push Rod
	04/00→	Tie Rod End	CV-ES-14162	for Steering Rod
	04/00→	Tie Rod End	CV-ES-14163	for Steering Rod
	04/00→	Track Control Arm		MN-DL-5212 Trailing Arm
	04/00→	Track Control Arm		MN-VB-5222 Wishbone (CV)
27.273 DFAC	01/94→12/95	Ball Head, gearshift linkage	CV-ES-2119	
	01/94→12/95	Ball Head, gearshift linkage	CV-ES-2120	
	01/94→12/95	Ball Head, gearshift linkage	CV-ES-2182	
	01/94→12/95	Centre Rod	MN-DL-2160	Coupling Rod
	01/94→12/95	Centre Rod	MN-DL-2176	Push Rod
	01/94→12/95	Centre Rod	MN-DL-12391	for Steering Rod
	01/94→12/95	Centre Rod	MN-DL-12421	for Steering Rod
	01/94→12/95	Engine Mounting		MN-SB-10390

CV-ES-2119

Length: 55
Cone Ø: d1 Ø 10 / d2 Ø 10
Thread: M12 x 1,75 LHT
81953016063, 81953016131



CV-ES-2120

Length: 115
Cone Ø: d1 Ø 12,4 / d2 Ø 10,8
Thread: M14 x 1,5 RHT
03008500A, 81953016200, 81953016202,
81953016203, 81953016227



CV-ES-2149

Length: 160
Cone Ø: d1 Ø 30 / d2 Ø 27
Thread: M30 x 1,5 RHT
81953016263



CV-ES-2182

Length: 55
Cone Ø: d1 Ø 10 / d2 Ø 10
Thread: M12 x 1,75 RHT
81953016064, 81953016170



CV-ES-14162

Length: 125
Cone Ø: d1 Ø 30 / d2 Ø 27
Thread: M30 x 1,5 LHT
81953010015, 81953010083, 81953010087,
81953016029, 81953016030, 81953016043,
81953016044, 81953016050, 81953016054,
81953016087, 81953016091, 81953016107,
81953016120, 81953016125, 81953016152,
81953016155, 81953016157, 81953016168,
81953016179, 81953016181, 81953016223,
81953016237, 81953016254, 81953016275,
81953016279, 81953016351



CV-ES-14163

Length: 125
Cone Ø: d1 Ø 30 / d2 Ø 27
Thread: M30 x 1,5 RHT
95301.0084, 90804102156, 90804102272,
90804102696, 90804102710, 81953010016,
81953010075, 81953010084, 81953010088,
81953010094, 81953010103, 81953016030,
81953016043, 81953016048, 81953016049,
81953016053, 81953016061, 81953016090,
81953016108, 81953016112, 81953016126,
81953016143, 81953016149, 81953016154,
81953016156, 81953016168, 81953016178,
81953016194, 81953016206, 81953016224,
81953016234, 81953016242, 81953016252,
81953016274, 81953016278, 81953016284,
81953016286, 81953016308, 81953016310,
81953016312, 81953016347, 81953016350,
81953016352, 82953016012, 88953016014,
N2953016001



DB-RK-8581

Ø: 85
Hole Distance: 130
Thick/Height: 24
03305800A, 81432706105



MN-DL-2160

Length: 1652 Ø: 50
Cone Ø: d1 Ø 30 / d2 Ø 27
81467106112, 81467106163, 81467106165,
81467106198, 81467106353, 81467106354,
81467106361, 81467116725



MN-DL-2175

Length: 1628 Ø: 50
Cone Ø: d1 Ø 30 / d2 Ø 27
81467106396, 81467106904



MN-DL-2176

Length: 1628 Ø: 48
Cone Ø: d1 Ø 30 / d2 Ø 27
81466106779, 81466106780, 81466106782



MN-DL-3402

Length: 590 Ø: 48
Hole Distance: 130 / 130
03307200A, 81432206067, 81432206068,
81432206090, 81432206092, 81432209092



MN-DL-3588

Length: 1035 Ø: 48
Cone Ø: d1 Ø 30 / d2 Ø 27
81466106333, 81466106334, 81466106354,
81466106355, 81466106360, 81466106361,
81466106721, 81466106722, 81466106723,
81466116216



MN-DL-5212

Length: 577 Ø: 48
Hole Distance: 130 / 130
81432206096, 81432206097, 81432206098,
81432206129, 81432209096, 81432209129,
81432306014, 81432306030



MN-DL-8197

Length: 1055 Ø: 42
Cone Ø: d1 Ø 30 / d2 Ø 27
03207500A, 81466116003, 81466116004,
81466116005



MN-DL-8544

Length: 596 Ø: 48
Hole Distance: 130 / 130
81432206196, 81432206232, 81432206233



MN-DL-8609

Length: 585 Ø: 58
Hole Distance: 130 / 130
81432206070, 81432206071, 81432206072,
81432206091, 81432206093, 81432206119



MN-DL-12391

Length: 1050 Ø: 52
Cone Ø: d1 Ø 30 / d2 Ø 27
82466106057, 82466106147



MN-DL-12421

Length: 1070 Ø: 48
Cone Ø: d1 Ø 30 / d2 Ø 27
Thread: M30 x 1,5 RHT
81466106656, 81466106659, 81466106669,
81466116006, 81466116007



MN-RK-7280

Ø: 75
Hole Distance: 115
Thick/Height: 24
0550806, 0639370, 689748, 10307400A,
81432306051, 81432306068, 81432706064



MN-RK-7291

Ø: 72
Hole Distance: 130
Thick/Height: 30
10307800A, 81432206108, 81432206132



MN-SB-5244

Ø: 65
Hole Distance: 125
Thick/Height: 22
03312000A, 81432710027, 81432710082



MN-SB-10390

Ø: 70
Thick/Height: 85/85
81960200341, 81960200373, 81960200385,
81960200408, 81960200418



MN-VB-5222

Length: 627 Ø: 50
Hole Distance: 152 / 152
81432706030, 81432706034, 81432706054,
81432706055, 81432706056, 81432706057,
81432706067, 81432706068, 81432706074,
81432706075, 81432706076, 81432706077,
81432706078, 81432706081, 81432706082,
81432709034, 81432709076, 81432709078,
8143706054



MN-VB-8514

Length: 627 Ø: 48
Hole Ø 25 / 25 / 25
Hole Distance: 152 / 130 / 130
81432706087, 81432706088, 81432706094,
81432706095, 81432796094



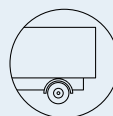

F 2000 ...

27.273 DFAC ...	01/94 →12/95	Suspension Arm Repair Kit		MN-SB-5244	for Wishbone (CV)
	01/94 →12/95	Suspension Arm Repair Kit		MN-SB-5244	for Wishbone (CV), 2nd RA
	01/94 →12/95	Tie Rod End	CV-ES-2149		for Push Rod
	01/94 →12/95	Tie Rod End	CV-ES-14162		for Steering Rod
	01/94 →12/95	Tie Rod End	CV-ES-14163		for Steering Rod
	01/94 →12/95	Tie Rod End	SC-ES-8517		for Push Rod
	01/94 →12/95	Track Control Arm		MN-DL-3402	Trailing Arm
	01/94 →12/95	Track Control Arm		MN-DL-8609	Trailing Arm, 1st RA;2nd RA, for Leaf-Spring Suspension vehicles
27.273 DFAK	01/94 →12/95	Ball Head, gearshift linkage	CV-ES-2119		
	01/94 →12/95	Ball Head, gearshift linkage	CV-ES-2120		
	01/94 →12/95	Ball Head, gearshift linkage	CV-ES-2182		
	01/94 →12/95	Centre Rod	MN-DL-2160		Coupling Rod
	01/94 →12/95	Centre Rod	MN-DL-2176		Push Rod
	01/94 →12/95	Centre Rod	MN-DL-12421		for Steering Rod
	01/94 →12/95	Engine Mounting		MN-SB-10390	
	01/94 →12/95	Suspension Arm Repair Kit		MN-SB-5244	for Wishbone (CV)
	01/94 →12/95	Suspension Arm Repair Kit		MN-SB-5244	for Wishbone (CV), 2nd RA
	01/94 →12/95	Tie Rod End	CV-ES-2149		for Push Rod
	01/94 →12/95	Tie Rod End	CV-ES-14162		for Steering Rod
	01/94 →12/95	Tie Rod End	CV-ES-14163		for Steering Rod
	01/94 →12/95	Tie Rod End	SC-ES-8517		for Push Rod
	01/94 →12/95	Track Control Arm		MN-DL-3402	Trailing Arm
01/94 →12/95	Track Control Arm		MN-DL-8609	Trailing Arm, 1st RA;2nd RA, for Leaf-Spring Suspension vehicles	
27.273 DFAS	01/94 →12/95	Ball Head, gearshift linkage	CV-ES-2119		
	01/94 →12/95	Ball Head, gearshift linkage	CV-ES-2120		
	01/94 →12/95	Ball Head, gearshift linkage	CV-ES-2182		
	01/94 →12/95	Centre Rod	MN-DL-2160		Coupling Rod
	01/94 →12/95	Centre Rod	MN-DL-2176		Push Rod
	01/94 →12/95	Centre Rod	MN-DL-12391		for Steering Rod
	01/94 →12/95	Centre Rod	MN-DL-12421		for Steering Rod
	01/94 →12/95	Engine Mounting		MN-SB-10390	
	01/94 →12/95	Suspension Arm Repair Kit		MN-SB-5244	for Wishbone (CV)
	01/94 →12/95	Suspension Arm Repair Kit		MN-SB-5244	for Wishbone (CV), 2nd RA
	01/94 →12/95	Tie Rod End	CV-ES-2149		for Push Rod
	01/94 →12/95	Tie Rod End	CV-ES-14162		for Steering Rod
	01/94 →12/95	Tie Rod End	CV-ES-14163		for Steering Rod
	01/94 →12/95	Tie Rod End	SC-ES-8517		for Push Rod
	01/94 →12/95	Track Control Arm		MN-DL-3402	Trailing Arm
	01/94 →12/95	Track Control Arm		MN-DL-8609	Trailing Arm, 1st RA;2nd RA, for Leaf-Spring Suspension vehicles
27.273 DFC	01/94 →12/95	Ball Head, gearshift linkage	CV-ES-2119		
	01/94 →12/95	Ball Head, gearshift linkage	CV-ES-2120		
	01/94 →12/95	Ball Head, gearshift linkage	CV-ES-2182		
	01/94 →12/95	Centre Rod	MN-DL-2160		Coupling Rod
	01/94 →12/95	Centre Rod	MN-DL-2176		Push Rod
	01/94 →12/95	Centre Rod	MN-DL-8197		Push Rod
	01/94 →12/95	Centre Rod	MN-DL-12421		for Steering Rod
	01/94 →12/95	Engine Mounting		MN-SB-10390	
	01/94 →12/95	Suspension Arm Repair Kit		MN-SB-5244	for Wishbone (CV)
	01/94 →12/95	Suspension Arm Repair Kit		MN-SB-5244	for Wishbone (CV), 1st RA
	01/94 →12/95	Suspension Arm Repair Kit		MN-SB-5244	for Wishbone (CV), 2nd RA
	01/94 →12/95	Tie Rod End	CV-ES-2149		for Push Rod
	01/94 →12/95	Tie Rod End	CV-ES-14162		for Steering Rod
	01/94 →12/95	Tie Rod End	CV-ES-14163		for Steering Rod
	01/94 →12/95	Track Control Arm		MN-DL-3402	Trailing Arm, Drive Axle
	01/94 →12/95	Track Control Arm		MN-DL-5212	Trailing Arm, 1st RA;2nd RA, for Pneumatic Suspension vehicles
	01/94 →12/95	Track Control Arm		MN-DL-8609	Trailing Arm, 1st RA;2nd RA, for Leaf-Spring Suspension vehicles
	01/94 →12/95	Track Control Arm		MN-VB-5222	Wishbone (CV), 1st RA;2nd RA, for Pneumatic Suspension vehicles

CV-ES-2119

Length: 55
Cone Ø: d1 Ø 10 / d2 Ø 10
Thread: M12 x 1,75 LHT
81953016063, 81953016131



CV-ES-2120

Length: 115
Cone Ø: d1 Ø 12,4 / d2 Ø 10,8
Thread: M14 x 1,5 RHT
03008500A, 81953016200, 81953016202, 81953016203, 81953016227



CV-ES-2149

Length: 160
Cone Ø: d1 Ø 30 / d2 Ø 27
Thread: M30 x 1,5 RHT
81953016263



CV-ES-2182

Length: 55
Cone Ø: d1 Ø 10 / d2 Ø 10
Thread: M12 x 1,75 RHT
81953016064, 81953016170



CV-ES-14162

Length: 125
Cone Ø: d1 Ø 30 / d2 Ø 27
Thread: M30 x 1,5 LHT
81953010015, 81953010083, 81953010087, 81953016029, 81953016030, 81953016043, 81953016044, 81953016050, 81953016054, 81953016087, 81953016091, 81953016107, 81953016120, 81953016125, 81953016152, 81953016155, 81953016157, 81953016168, 81953016179, 81953016181, 81953016223, 81953016237, 81953016254, 81953016275, 81953016279, 81953016351



CV-ES-14163

Length: 125
Cone Ø: d1 Ø 30 / d2 Ø 27
Thread: M30 x 1,5 RHT
95301.0084, 90804102156, 90804102272, 90804102696, 90804102710, 81953010016, 81953010075, 81953010084, 81953010088, 81953010094, 81953010103, 81953016030, 81953016043, 81953016048, 81953016049, 81953016053, 81953016061, 81953016090, 81953016108, 81953016112, 81953016126, 81953016143, 81953016149, 81953016154, 81953016156, 81953016168, 81953016178, 81953016194, 81953016206, 81953016224, 81953016234, 81953016242, 81953016252, 81953016274, 81953016278, 81953016284, 81953016286, 81953016308, 81953016310, 81953016312, 81953016347, 81953016350, 81953016352, 82953016012, 88953016014, N2953016001



MN-DL-2160

Length: 1652 Ø: 50
Cone Ø: d1 Ø 30 / d2 Ø 27
81467106112, 81467106163, 81467106165, 81467106198, 81467106353, 81467106354, 81467106361, 81467116725



MN-DL-2176

Length: 1628 Ø: 48
Cone Ø: d1 Ø 30 / d2 Ø 27
81466106779, 81466106780, 81466106782



MN-DL-3402

Length: 590 Ø: 48
Hole Distance: 130 / 130
03307200A, 81432206067, 81432206068, 81432206090, 81432206092, 81432209092



MN-DL-5212

Length: 577 Ø: 48
Hole Distance: 130 / 130
81432206096, 81432206097, 81432206098, 81432206129, 81432209096, 81432209129, 81432306014, 81432306030



MN-DL-8197

Length: 1055 Ø: 42
Cone Ø: d1 Ø 30 / d2 Ø 27
03207500A, 81466116003, 81466116004, 81466116005



MN-DL-8609

Length: 585 Ø: 58
Hole Distance: 130 / 130
81432206070, 81432206071, 81432206072, 81432206091, 81432206093, 81432206119



MN-DL-12391

Length: 1050 Ø: 52
Cone Ø: d1 Ø 30 / d2 Ø 27
82466106057, 82466106147



MN-DL-12421

Length: 1070
Ø: 48
Cone Ø: d1 Ø 30 / d2 Ø 27
Thread: M30 x 1,5 RHT
81466106656, 81466106659, 81466106669, 81466116006, 81466116007



MN-SB-5244

Ø: 65
Hole Distance: 125
Thick/Height: 22
03312000A, 81432710027, 81432710082



MN-SB-10390

Ø: 70
Thick/Height: 85/85
81960200341, 81960200373, 81960200385, 81960200408, 81960200418



MN-VB-5222

Length: 627 Ø: 50
Hole Distance: 152 / 152
81432706030, 81432706034, 81432706054, 81432706055, 81432706056, 81432706057, 81432706067, 81432706068, 81432706074, 81432706075, 81432706076, 81432706077, 81432706078, 81432706081, 81432706082, 81432709034, 81432709076, 81432709078, 8143706054



SC-ES-8517

Length: 140
Cone Ø: d1 Ø 30 / d2 Ø 27
Thread: M30 x 1,5 RHT
81953016286





F 2000 ...

27.273 DFK	01/94 → 12/95	Ball Head, gearshift linkage	CV-ES-2119		
	01/94 → 12/95	Ball Head, gearshift linkage	CV-ES-2120		
	01/94 → 12/95	Ball Head, gearshift linkage	CV-ES-2182		
	01/94 → 12/95	Centre Rod	MN-DL-2160		Coupling Rod
	01/94 → 12/95	Centre Rod	MN-DL-2176		Push Rod
	01/94 → 12/95	Centre Rod	MN-DL-8197		Push Rod
	01/94 → 12/95	Centre Rod	MN-DL-12421		for Steering Rod
	01/94 → 12/95	Engine Mounting		MN-SB-10390	
	01/94 → 12/95	Suspension Arm Repair Kit		MN-SB-5244	for Wishbone (CV)
	01/94 → 12/95	Suspension Arm Repair Kit		MN-SB-5244	for Wishbone (CV), 1st RA
	01/94 → 12/95	Suspension Arm Repair Kit		MN-SB-5244	for Wishbone (CV), 2nd RA
	01/94 → 12/95	Tie Rod End	CV-ES-2149		for Push Rod
	01/94 → 12/95	Tie Rod End	CV-ES-14162		for Steering Rod
	01/94 → 12/95	Tie Rod End	CV-ES-14163		for Steering Rod
	01/94 → 12/95	Track Control Arm		MN-DL-3402	Trailing Arm, Drive Axle
	01/94 → 12/95	Track Control Arm		MN-DL-5212	Trailing Arm, 1st RA;2nd RA, for Pneumatic Suspension vehicles
	01/94 → 12/95	Track Control Arm		MN-DL-8609	Trailing Arm, 1st RA;2nd RA, for Leaf-Spring Suspension vehicles
	01/94 → 12/95	Track Control Arm		MN-VB-5222	Wishbone (CV), 1st RA;2nd RA, for Pneumatic Suspension vehicles
27.273 DFS	01/94 → 12/95	Ball Head, gearshift linkage	CV-ES-2119		
	01/94 → 12/95	Ball Head, gearshift linkage	CV-ES-2120		
	01/94 → 12/95	Ball Head, gearshift linkage	CV-ES-2182		
	01/94 → 12/95	Centre Rod	MN-DL-2160		Coupling Rod
	01/94 → 12/95	Centre Rod	MN-DL-2176		Push Rod
	01/94 → 12/95	Centre Rod	MN-DL-8197		Push Rod
	01/94 → 12/95	Centre Rod	MN-DL-12421		for Steering Rod
	01/94 → 12/95	Engine Mounting		MN-SB-10390	
	01/94 → 12/95	Suspension Arm Repair Kit		MN-SB-5244	for Wishbone (CV)
	01/94 → 12/95	Suspension Arm Repair Kit		MN-SB-5244	for Wishbone (CV), 1st RA
	01/94 → 12/95	Suspension Arm Repair Kit		MN-SB-5244	for Wishbone (CV), 2nd RA
	01/94 → 12/95	Tie Rod End	CV-ES-2149		for Push Rod
	01/94 → 12/95	Tie Rod End	CV-ES-14162		for Steering Rod
	01/94 → 12/95	Tie Rod End	CV-ES-14163		for Steering Rod
	01/94 → 12/95	Track Control Arm		MN-DL-3402	Trailing Arm, Drive Axle
	01/94 → 12/95	Track Control Arm		MN-DL-5212	Trailing Arm, 1st RA;2nd RA, for Pneumatic Suspension vehicles
	01/94 → 12/95	Track Control Arm		MN-DL-8609	Trailing Arm, 1st RA;2nd RA, for Leaf-Spring Suspension vehicles
	01/94 → 12/95	Track Control Arm		MN-VB-5222	Wishbone (CV), 1st RA;2nd RA, for Pneumatic Suspension vehicles
27.293 DFAC	01/94 →	Ball Head, gearshift linkage	CV-ES-2119		
	01/94 →	Ball Head, gearshift linkage	CV-ES-2120		
	01/94 →	Ball Head, gearshift linkage	CV-ES-2182		
	01/94 →	Centre Rod	MN-DL-2160		Coupling Rod
	01/94 →	Centre Rod	MN-DL-2176		Push Rod
	01/94 →	Centre Rod	MN-DL-12391		for Steering Rod
	01/94 →	Centre Rod	MN-DL-12421		for Steering Rod
	01/94 →	Engine Mounting		MN-SB-10390	
	01/94 →	Suspension Arm Repair Kit		MN-SB-5244	for Wishbone (CV)
	01/94 →	Suspension Arm Repair Kit		MN-SB-5244	for Wishbone (CV), 2nd RA
	01/94 →	Tie Rod End	CV-ES-2149		for Push Rod
	01/94 →	Tie Rod End	CV-ES-14162		for Steering Rod
	01/94 →	Tie Rod End	CV-ES-14163		for Steering Rod
	01/94 →	Tie Rod End	SC-ES-8517		for Push Rod
	01/94 →	Track Control Arm		MN-DL-3402	Trailing Arm
01/94 →	Track Control Arm		MN-DL-8609	Trailing Arm, 1st RA;2nd RA, for Leaf-Spring Suspension vehicles	
27.293 DFAK	01/94 →	Ball Head, gearshift linkage	CV-ES-2119		
	01/94 →	Ball Head, gearshift linkage	CV-ES-2120		
	01/94 →	Ball Head, gearshift linkage	CV-ES-2182		
	01/94 →	Centre Rod	MN-DL-2160		Coupling Rod

CV-ES-2119

Length: 55
Cone Ø: d1 Ø 10 / d2 Ø 10
Thread: M12 x 1,75 LHT
81953016063, 81953016131



CV-ES-2120

Length: 115
Cone Ø: d1 Ø 12,4 / d2 Ø 10,8
Thread: M14 x 1,5 RHT
03008500A, 81953016200, 81953016202,
81953016203, 81953016227



CV-ES-2149

Length: 160
Cone Ø: d1 Ø 30 / d2 Ø 27
Thread: M30 x 1,5 RHT
81953016263



CV-ES-2182

Length: 55
Cone Ø: d1 Ø 10 / d2 Ø 10
Thread: M12 x 1,75 RHT
81953016064, 81953016170



CV-ES-14162

Length: 125
Cone Ø: d1 Ø 30 / d2 Ø 27
Thread: M30 x 1,5 LHT
81953010015, 81953010083, 81953010087,
81953016029, 81953016030, 81953016043,
81953016044, 81953016050, 81953016054,
81953016087, 81953016091, 81953016107,
81953016120, 81953016125, 81953016152,
81953016155, 81953016157, 81953016168,
81953016179, 81953016181, 81953016223,
81953016237, 81953016254, 81953016275,
81953016279, 81953016351



CV-ES-14163

Length: 125
Cone Ø: d1 Ø 30 / d2 Ø 27
Thread: M30 x 1,5 RHT
95301.0084, 90804102156, 90804102272,
90804102696, 90804102710, 81953010016,
81953010075, 81953010084, 81953010088,
81953010094, 81953010103, 81953016030,
81953016043, 81953016048, 81953016049,
81953016053, 81953016061, 81953016090,
81953016108, 81953016112, 81953016126,
81953016143, 81953016149, 81953016154,
81953016156, 81953016168, 81953016178,
81953016194, 81953016206, 81953016224,
81953016234, 81953016242, 81953016252,
81953016274, 81953016278, 81953016284,
81953016286, 81953016308, 81953016310,
81953016312, 81953016347, 81953016350,
81953016352, 82953016012, 88953016014,
N2953016001



MN-DL-2160

Length: 1652 Ø: 50
Cone Ø: d1 Ø 30 / d2 Ø 27
81467106112, 81467106163, 81467106165,
81467106198, 81467106353, 81467106354,
81467106361, 81467116725



MN-DL-2176

Length: 1628
Ø: 48
Cone Ø: d1 Ø 30 / d2 Ø 27
81466106779, 81466106780, 81466106782



MN-DL-3402

Length: 590 Ø: 48
Hole Distance: 130 / 130
03307200A, 81432206067, 81432206068,
81432206090, 81432206092, 81432209092



MN-DL-5212

Length: 577 Ø: 48
Hole Distance: 130 / 130
81432206096, 81432206097, 81432206098,
81432206129, 81432209096, 81432209129,
81432306014, 81432306030



MN-DL-8197

Length: 1055
Ø: 42
Cone Ø: d1 Ø 30 / d2 Ø 27
03207500A, 81466116003, 81466116004,
81466116005



MN-DL-8609

Length: 585 Ø: 58
Hole Distance: 130 / 130
81432206070, 81432206071, 81432206072,
81432206091, 81432206093, 81432206119



MN-DL-12391

Length: 1050
Ø: 52
Cone Ø: d1 Ø 30 / d2 Ø 27
82466106057, 82466106147



MN-DL-12421

Length: 1070
Ø: 48
Cone Ø: d1 Ø 30 / d2 Ø 27
Thread: M30 x 1,5 RHT
81466106656, 81466106659, 81466106669,
81466116006, 81466116007



MN-SB-5244

Ø: 65
Hole Distance: 125
Thick/Height: 22
03312000A, 81432710027, 81432710082



MN-SB-10390

Ø: 70
Thick/Height: 85/85
81960200341, 81960200373, 81960200385,
81960200408, 81960200418



MN-VB-5222

Length: 627 Ø: 50
Hole Distance: 152 / 152
81432706030, 81432706034, 81432706054,
81432706055, 81432706056, 81432706057,
81432706067, 81432706068, 81432706074,
81432706075, 81432706076, 81432706077,
81432706078, 81432706081, 81432706082,
81432709034, 81432709076, 81432709078,
8143706054



SC-ES-8517

Length: 140
Cone Ø: d1 Ø 30 / d2 Ø 27
Thread: M30 x 1,5 RHT
81953016286





F 2000 ...

27.293 DFAK ...	01/94 →	Centre Rod	MN-DL-2176		Push Rod
	01/94 →	Centre Rod	MN-DL-12391		for Steering Rod
	01/94 →	Centre Rod	MN-DL-12421		for Steering Rod
	01/94 →	Engine Mounting		MN-SB-10390	
	01/94 →	Suspension Arm Repair Kit		MN-SB-5244	for Wishbone (CV)
	01/94 →	Suspension Arm Repair Kit		MN-SB-5244	for Wishbone (CV), 2nd RA
	01/94 →	Tie Rod End	CV-ES-2149		for Push Rod
	01/94 →	Tie Rod End	CV-ES-14162		for Steering Rod
	01/94 →	Tie Rod End	CV-ES-14163		for Steering Rod
	01/94 →	Tie Rod End	SC-ES-8517		for Push Rod
	01/94 →	Track Control Arm		MN-DL-3402	Trailing Arm
	01/94 →	Track Control Arm		MN-DL-8609	Trailing Arm, 1st RA;2nd RA, for Leaf-Spring Suspension vehicles
	27.293 DFAS	01/94 →	Ball Head, gearshift linkage	CV-ES-2119	
01/94 →		Ball Head, gearshift linkage	CV-ES-2120		
01/94 →		Ball Head, gearshift linkage	CV-ES-2182		
01/94 →		Centre Rod	MN-DL-2160		Coupling Rod
01/94 →		Centre Rod	MN-DL-2176		Push Rod
01/94 →		Centre Rod	MN-DL-12391		for Steering Rod
01/94 →		Centre Rod	MN-DL-12421		for Steering Rod
01/94 →		Engine Mounting		MN-SB-10390	
01/94 →		Suspension Arm Repair Kit		MN-SB-5244	for Wishbone (CV)
01/94 →		Suspension Arm Repair Kit		MN-SB-5244	for Wishbone (CV), 2nd RA
01/94 →		Tie Rod End	CV-ES-2149		for Push Rod
01/94 →		Tie Rod End	CV-ES-14162		for Steering Rod
01/94 →		Tie Rod End	CV-ES-14163		for Steering Rod
01/94 →		Tie Rod End	SC-ES-8517		for Push Rod
01/94 →		Track Control Arm		MN-DL-3402	Trailing Arm
01/94 →	Track Control Arm		MN-DL-8609	Trailing Arm, 1st RA;2nd RA, for Leaf-Spring Suspension vehicles	
27.293 DFC	01/94 →	Ball Head, gearshift linkage	CV-ES-2119		
	01/94 →	Ball Head, gearshift linkage	CV-ES-2120		
	01/94 →	Ball Head, gearshift linkage	CV-ES-2182		
	01/94 →	Centre Rod	MN-DL-2160		Coupling Rod
	01/94 →	Centre Rod	MN-DL-2176		Push Rod
	01/94 →	Centre Rod	MN-DL-8197		Push Rod
	01/94 →	Centre Rod	MN-DL-12421		for Steering Rod
	01/94 →	Engine Mounting		MN-SB-10390	
	01/94 →	Suspension Arm Repair Kit		MN-SB-5244	for Wishbone (CV)
	01/94 →	Suspension Arm Repair Kit		MN-SB-5244	for Wishbone (CV), 1st RA
	01/94 →	Suspension Arm Repair Kit		MN-SB-5244	for Wishbone (CV), 2nd RA
	01/94 →	Tie Rod End	CV-ES-2149		for Push Rod
	01/94 →	Tie Rod End	CV-ES-14162		for Steering Rod
	01/94 →	Tie Rod End	CV-ES-14163		for Steering Rod
	01/94 →	Track Control Arm		MN-DL-3402	Trailing Arm, Drive Axle
	01/94 →	Track Control Arm		MN-DL-5212	Trailing Arm, 1st RA;2nd RA, for Pneumatic Suspension vehicles
	01/94 →	Track Control Arm		MN-DL-8609	Trailing Arm, 1st RA;2nd RA, for Leaf-Spring Suspension vehicles
01/94 →	Track Control Arm		MN-VB-5222	Wishbone (CV), 1st RA;2nd RA, for Pneumatic Suspension vehicles	
27.293 DFK	01/94 →	Ball Head, gearshift linkage	CV-ES-2119		
	01/94 →	Ball Head, gearshift linkage	CV-ES-2120		
	01/94 →	Ball Head, gearshift linkage	CV-ES-2182		
	01/94 →	Centre Rod	MN-DL-2160		Coupling Rod
	01/94 →	Centre Rod	MN-DL-2176		Push Rod
	01/94 →	Centre Rod	MN-DL-8197		Push Rod
	01/94 →	Centre Rod	MN-DL-12421		for Steering Rod
	01/94 →	Engine Mounting		MN-SB-10390	
	01/94 →	Suspension Arm Repair Kit		MN-SB-5244	for Wishbone (CV)
	01/94 →	Suspension Arm Repair Kit		MN-SB-5244	for Wishbone (CV), 1st RA
	01/94 →	Suspension Arm Repair Kit		MN-SB-5244	for Wishbone (CV), 2nd RA
	01/94 →	Tie Rod End	CV-ES-2149		for Push Rod

CV-ES-2119

Length: 55
Cone Ø: d1 Ø 10 / d2 Ø 10
Thread: M12 x 1,75 LHT
81953016063, 81953016131



CV-ES-2120

Length: 115
Cone Ø: d1 Ø 12,4 / d2 Ø 10,8
Thread: M14 x 1,5 RHT
03008500A, 81953016200, 81953016202,
81953016203, 81953016227



CV-ES-2149

Length: 160
Cone Ø: d1 Ø 30 / d2 Ø 27
Thread: M30 x 1,5 RHT
81953016263



CV-ES-2182

Length: 55
Cone Ø: d1 Ø 10 / d2 Ø 10
Thread: M12 x 1,75 RHT
81953016064, 81953016170



CV-ES-14162

Length: 125
Cone Ø: d1 Ø 30 / d2 Ø 27
Thread: M30 x 1,5 LHT
81953010015, 81953010083, 81953010087,
81953016029, 81953016030, 81953016043,
81953016044, 81953016050, 81953016054,
81953016087, 81953016091, 81953016107,
81953016120, 81953016125, 81953016152,
81953016155, 81953016157, 81953016168,
81953016179, 81953016181, 81953016223,
81953016237, 81953016254, 81953016275,
81953016279, 81953016351



CV-ES-14163

Length: 125
Cone Ø: d1 Ø 30 / d2 Ø 27
Thread: M30 x 1,5 RHT
95301.0084, 90804102156, 90804102272,
90804102696, 90804102710, 81953010016,
81953010075, 81953010084, 81953010088,
81953010094, 81953010103, 81953016030,
81953016043, 81953016048, 81953016049,
81953016053, 81953016061, 81953016090,
81953016108, 81953016112, 81953016126,
81953016143, 81953016149, 81953016154,
81953016156, 81953016168, 81953016178,
81953016194, 81953016206, 81953016224,
81953016234, 81953016242, 81953016252,
81953016274, 81953016278, 81953016284,
81953016286, 81953016308, 81953016310,
81953016312, 81953016347, 81953016350,
81953016352, 82953016012, 88953016014,
N2953016001



MN-DL-2160

Length: 1652 Ø: 50
Cone Ø: d1 Ø 30 / d2 Ø 27
81467106112, 81467106163, 81467106165,
81467106198, 81467106353, 81467106354,
81467106361, 81467116725



MN-DL-2176

Length: 1628
Ø: 48
Cone Ø: d1 Ø 30 / d2 Ø 27
81466106779, 81466106780, 81466106782



MN-DL-3402

Length: 590 Ø: 48
Hole Distance: 130 / 130
03307200A, 81432206067, 81432206068,
81432206090, 81432206092, 81432209092



MN-DL-5212

Length: 577 Ø: 48
Hole Distance: 130 / 130
81432206096, 81432206097, 81432206098,
81432206129, 81432209096, 81432209129,
81432306014, 81432306030



MN-DL-8197

Length: 1055
Ø: 42
Cone Ø: d1 Ø 30 / d2 Ø 27
03207500A, 81466116003, 81466116004,
81466116005



MN-DL-8609

Length: 585 Ø: 58
Hole Distance: 130 / 130
81432206070, 81432206071, 81432206072,
81432206091, 81432206093, 81432206119



MN-DL-12391

Length: 1050
Ø: 52
Cone Ø: d1 Ø 30 / d2 Ø 27
82466106057, 82466106147



MN-DL-12421

Length: 1070
Ø: 48
Cone Ø: d1 Ø 30 / d2 Ø 27
Thread: M30 x 1,5 RHT
81466106656, 81466106659, 81466106669,
81466116006, 81466116007



MN-SB-5244

Ø: 65
Hole Distance: 125
Thick/Height: 22
03312000A, 81432710027, 81432710082



MN-SB-10390

Ø: 70
Thick/Height: 85/85
81960200341, 81960200373, 81960200385,
81960200408, 81960200418



MN-VB-5222

Length: 627 Ø: 50
Hole Distance: 152 / 152
81432706030, 81432706034, 81432706054,
81432706055, 81432706056, 81432706057,
81432706067, 81432706068, 81432706074,
81432706075, 81432706076, 81432706077,
81432706078, 81432706081, 81432706082,
81432709034, 81432709076, 81432709078,
8143706054



SC-ES-8517

Length: 140
Cone Ø: d1 Ø 30 / d2 Ø 27
Thread: M30 x 1,5 RHT
81953016286





F 2000 ...

27.293 DFK ...	01/94 →	Tie Rod End	CV-ES-14162		for Steering Rod
	01/94 →	Tie Rod End	CV-ES-14163		for Steering Rod
	01/94 →	Track Control Arm		MN-DL-3402	Trailing Arm, Drive Axle
	01/94 →	Track Control Arm		MN-DL-5212	Trailing Arm, 1st RA;2nd RA, for Pneumatic Suspension vehicles
	01/94 →	Track Control Arm		MN-DL-8609	Trailing Arm, 1st RA;2nd RA, for Leaf-Spring Suspension vehicles
	01/94 →	Track Control Arm		MN-VB-5222	Wishbone (CV), 1st RA;2nd RA, for Pneumatic Suspension vehicles
27.293 DFS	01/94 →	Ball Head, gearshift linkage	CV-ES-2119		
	01/94 →	Ball Head, gearshift linkage	CV-ES-2120		
	01/94 →	Ball Head, gearshift linkage	CV-ES-2182		
	01/94 →	Centre Rod	MN-DL-2160		Coupling Rod
	01/94 →	Centre Rod	MN-DL-2176		Push Rod
	01/94 →	Centre Rod	MN-DL-8197		Push Rod
	01/94 →	Centre Rod	MN-DL-12421		for Steering Rod
	01/94 →	Engine Mounting		MN-SB-10390	
	01/94 →	Suspension Arm Repair Kit		MN-SB-5244	for Wishbone (CV)
	01/94 →	Suspension Arm Repair Kit		MN-SB-5244	for Wishbone (CV), 1st RA
	01/94 →	Suspension Arm Repair Kit		MN-SB-5244	for Wishbone (CV), 2nd RA
	01/94 →	Tie Rod End	CV-ES-2149		for Push Rod
	01/94 →	Tie Rod End	CV-ES-14162		for Steering Rod
	01/94 →	Tie Rod End	CV-ES-14163		for Steering Rod
	01/94 →	Track Control Arm		MN-DL-3402	Trailing Arm, Drive Axle
	01/94 →	Track Control Arm		MN-DL-5212	Trailing Arm, 1st RA;2nd RA, for Pneumatic Suspension vehicles
	01/94 →	Track Control Arm		MN-DL-8609	Trailing Arm, 1st RA;2nd RA, for Leaf-Spring Suspension vehicles
	01/94 →	Track Control Arm		MN-VB-5222	Wishbone (CV), 1st RA;2nd RA, for Pneumatic Suspension vehicles
27.314 DFAC	05/01 →	Ball Head, gearshift linkage	CV-ES-2120		
	05/01 →	Centre Rod	MN-DL-12391		for Steering Rod
	05/01 →	Centre Rod	MN-DL-12421		for Steering Rod
	05/01 →	Suspension Arm Repair Kit		MN-SB-5244	for Wishbone (CV)
	05/01 →	Tie Rod End	CV-ES-2146		
	05/01 →	Tie Rod End	CV-ES-14162		for Steering Rod
	05/01 →	Tie Rod End	CV-ES-14163		for Steering Rod
	05/01 →	Track Control Arm		MN-DL-3402	Trailing Arm
05/01 →	Track Control Arm		MN-DL-8609	Trailing Arm	
27.314 DFAK, DFA-KI, DFAK-L	05/01 →	Ball Head, gearshift linkage	CV-ES-2120		
	05/01 →	Centre Rod	MN-DL-12391		for Steering Rod
	05/01 →	Centre Rod	MN-DL-12421		for Steering Rod
	05/01 →	Suspension Arm Repair Kit		MN-SB-5244	for Wishbone (CV)
	05/01 →	Tie Rod End	CV-ES-2146		
	05/01 →	Tie Rod End	CV-ES-14162		for Steering Rod
	05/01 →	Tie Rod End	CV-ES-14163		for Steering Rod
	05/01 →	Track Control Arm		MN-DL-3402	Trailing Arm
05/01 →	Track Control Arm		MN-DL-8609	Trailing Arm	
27.314 DFAS	05/01 →	Ball Head, gearshift linkage	CV-ES-2120		
	05/01 →	Centre Rod	MN-DL-12391		for Steering Rod
	05/01 →	Centre Rod	MN-DL-12421		for Steering Rod
	05/01 →	Suspension Arm Repair Kit		MN-SB-5244	for Wishbone (CV)
	05/01 →	Tie Rod End	CV-ES-2146		
	05/01 →	Tie Rod End	CV-ES-14162		for Steering Rod
	05/01 →	Tie Rod End	CV-ES-14163		for Steering Rod
	05/01 →	Track Control Arm		MN-DL-3402	Trailing Arm
05/01 →	Track Control Arm		MN-DL-8609	Trailing Arm	
27.314 DFC	05/01 →	Ball Head, gearshift linkage	CV-ES-2120	CV-ES-2120	
	05/01 →	Centre Rod	MN-DL-8197		Push Rod
	05/01 →	Centre Rod	MN-DL-12391		for Steering Rod
	05/01 →	Centre Rod	MN-DL-12421		for Steering Rod
	05/01 →	Mounting, stabilizer coupling rod	MN-SB-5246		
	05/01 →	Suspension Arm Repair Kit		MN-SB-5244	for Wishbone (CV)

CV-ES-2119

Length: 55
Cone Ø: d1 Ø 10 / d2 Ø 10
Thread: M12 x 1,75 LHT
81953016063, 81953016131



CV-ES-2120

Length: 115
Cone Ø: d1 Ø 12,4 / d2 Ø 10,8
Thread: M14 x 1,5 RHT
03008500A, 81953016200, 81953016202,
81953016203, 81953016227



CV-ES-2146

Length: 80
Cone Ø: d1 Ø 30 / d2 Ø 27
Thread: M26 x 1,5 RHT
42533102, 81953016219, 81953016225,
81953016226, 81953016267, 81953016291



CV-ES-2149

Length: 160
Cone Ø: d1 Ø 30 / d2 Ø 27
Thread: M30 x 1,5 RHT
81953016263



CV-ES-2182

Length: 55
Cone Ø: d1 Ø 10 / d2 Ø 10
Thread: M12 x 1,75 RHT
81953016064, 81953016170



CV-ES-14162

Length: 125
Cone Ø: d1 Ø 30 / d2 Ø 27
Thread: M30 x 1,5 LHT
81953010015, 81953010083, 81953010087,
81953016029, 81953016030, 81953016043,
81953016044, 81953016050, 81953016054,
81953016087, 81953016091, 81953016107,
81953016120, 81953016125, 81953016152,
81953016155, 81953016157, 81953016168,
81953016179, 81953016181, 81953016223,
81953016237, 81953016254, 81953016275,
81953016279, 81953016351



CV-ES-14163

Length: 125
Cone Ø: d1 Ø 30 / d2 Ø 27
Thread: M30 x 1,5 RHT
95301.0084, 90804102156, 90804102272,
90804102696, 90804102710, 81953010016,
81953010075, 81953010084, 81953010088,
81953010094, 81953010103, 81953016030,
81953016043, 81953016048, 81953016049,
81953016053, 81953016061, 81953016090,
81953016108, 81953016112, 81953016126,
81953016143, 81953016149, 81953016154,
81953016156, 81953016168, 81953016178,
81953016194, 81953016206, 81953016224,
81953016234, 81953016242, 81953016252,
81953016274, 81953016278, 81953016284,
81953016286, 81953016308, 81953016310,
81953016312, 81953016347, 81953016350,
81953016352, 82953016012, 88953016014,
N2953016001



MN-DL-2160

Length: 1652 Ø: 50
Cone Ø: d1 Ø 30 / d2 Ø 27
81467106112, 81467106163, 81467106165,
81467106198, 81467106353, 81467106354,
81467106361, 81467116725



MN-DL-2176

Length: 1628
Ø: 48
Cone Ø: d1 Ø 30 / d2 Ø 27
81466106779, 81466106780, 81466106782



MN-DL-3402

Length: 590 Ø: 48
Hole Distance: 130 / 130
03307200A, 81432206067, 81432206068,
81432206090, 81432206092, 81432209092



MN-DL-5212

Length: 577 Ø: 48
Hole Distance: 130 / 130
81432206096, 81432206097, 81432206098,
81432206129, 81432209096, 81432209129,
81432306014, 81432306030



MN-DL-8197

Length: 1055
Ø: 42
Cone Ø: d1 Ø 30 / d2 Ø 27
03207500A, 81466116003, 81466116004,
81466116005



MN-DL-8609

Length: 585 Ø: 58
Hole Distance: 130 / 130
81432206070, 81432206071, 81432206072,
81432206091, 81432206093, 81432206119



MN-DL-12391

Length: 1050
Ø: 52
Cone Ø: d1 Ø 30 / d2 Ø 27
82466106057, 82466106147



MN-DL-12421

Length: 1070
Ø: 48
Cone Ø: d1 Ø 30 / d2 Ø 27
Thread: M30 x 1,5 RHT
81466106656, 81466106659, 81466106669,
81466116006, 81466116007



MN-SB-5244

Ø: 65
Hole Distance: 125
Thick/Height: 22
03312000A, 81432710027, 81432710082



MN-SB-5246

Ø: 45 Thick/Height: 47
81437220022, 81437220038, 81962100450,
81962100469



MN-SB-10390

Ø: 70
Thick/Height: 85/85
81960200341, 81960200373, 81960200385,
81960200408, 81960200418



MN-VB-5222

Length: 627 Ø: 50
Hole Distance: 152 / 152
81432706030, 81432706034, 81432706054,
81432706055, 81432706056, 81432706057,
81432706067, 81432706068, 81432706074,
81432706075, 81432706076, 81432706077,
81432706078, 81432706081, 81432706082,
81432709034, 81432709076, 81432709078,
8143706054





F 2000 ...

27.314 DFC ...	05/01→	Tie Rod	MN-DL-12284			
	05/01→	Tie Rod End	CV-ES-2149		for Push Rod	
	05/01→	Tie Rod End	CV-ES-14162		for Steering Rod	
	05/01→	Tie Rod End	CV-ES-14163		for Steering Rod	
	05/01→	Track Control Arm		MN-DL-3402	Trailing Arm	
	05/01→	Track Control Arm		MN-DL-8544	Trailing Arm	
	05/01→	Track Control Arm		MN-DL-8609	Trailing Arm	
	05/01→	Track Control Arm		MN-VB-8514	Suspension Rod, Wishbone (CV)	
27.314 DFK, DFLK, DFLK-L, DF-KI	05/01→	Ball Head, gearshift linkage	CV-ES-2120	CV-ES-2120		
	05/01→	Centre Rod	MN-DL-8197		Push Rod	
	05/01→	Centre Rod	MN-DL-12391		for Steering Rod	
	05/01→	Centre Rod	MN-DL-12421		for Steering Rod	
	05/01→	Mounting, stabilizer coupling rod	MN-SB-5246			
	05/01→	Suspension Arm Repair Kit		MN-SB-5244	for Wishbone (CV)	
	05/01→	Tie Rod	MN-DL-12284			
	05/01→	Tie Rod End	CV-ES-2149		for Push Rod	
	05/01→	Tie Rod End	CV-ES-14162		for Steering Rod	
	05/01→	Tie Rod End	CV-ES-14163		for Steering Rod	
	05/01→	Track Control Arm		MN-DL-3402	Trailing Arm	
	05/01→	Track Control Arm		MN-DL-8544	Trailing Arm	
	05/01→	Track Control Arm		MN-DL-8609	Trailing Arm	
	05/01→	Track Control Arm		MN-VB-8514	Suspension Rod, Wishbone (CV)	
	27.314 DFS	05/01→	Ball Head, gearshift linkage	CV-ES-2120	CV-ES-2120	
		05/01→	Centre Rod	MN-DL-8197		Push Rod
05/01→		Centre Rod	MN-DL-12391		for Steering Rod	
05/01→		Centre Rod	MN-DL-12421		for Steering Rod	
05/01→		Mounting, stabilizer coupling rod	MN-SB-5246			
05/01→		Suspension Arm Repair Kit		MN-SB-5244	for Wishbone (CV)	
05/01→		Tie Rod	MN-DL-12284			
05/01→		Tie Rod End	CV-ES-2149		for Push Rod	
05/01→		Tie Rod End	CV-ES-14162		for Steering Rod	
05/01→		Tie Rod End	CV-ES-14163		for Steering Rod	
05/01→		Track Control Arm		MN-DL-3402	Trailing Arm	
05/01→		Track Control Arm		MN-DL-8544	Trailing Arm	
05/01→		Track Control Arm		MN-DL-8609	Trailing Arm	
05/01→		Track Control Arm		MN-VB-8514	Suspension Rod, Wishbone (CV)	
27.314 DF-TM		05/01→	Ball Head, gearshift linkage	CV-ES-2120	CV-ES-2120	
		05/01→	Centre Rod	MN-DL-8197		Push Rod
	05/01→	Centre Rod	MN-DL-12391		for Steering Rod	
	05/01→	Centre Rod	MN-DL-12421		for Steering Rod	
	05/01→	Mounting, stabilizer coupling rod	MN-SB-5246			
	05/01→	Suspension Arm Repair Kit		MN-SB-5244	for Wishbone (CV)	
	05/01→	Tie Rod	MN-DL-12284			
	05/01→	Tie Rod End	CV-ES-2149		for Push Rod	
	05/01→	Tie Rod End	CV-ES-14162		for Steering Rod	
	05/01→	Tie Rod End	CV-ES-14163		for Steering Rod	
	05/01→	Track Control Arm		MN-DL-3402	Trailing Arm	
	05/01→	Track Control Arm		MN-DL-8544	Trailing Arm	
	05/01→	Track Control Arm		MN-DL-8609	Trailing Arm	
	05/01→	Track Control Arm		MN-VB-8514	Suspension Rod, Wishbone (CV)	
	27.314 FVL	06/98→	Ball Head, gearshift linkage	CV-ES-2120		
		06/98→	Centre Rod	MN-DL-8197		Push Rod
06/98→		Centre Rod	MN-DL-8487		Push Rod	
06/98→		Track Control Arm		MN-DL-5212	Trailing Arm	
27.323 DFAC	01/94→12/95	Ball Head, gearshift linkage	CV-ES-2119			
	01/94→12/95	Ball Head, gearshift linkage	CV-ES-2120			
	01/94→12/95	Ball Head, gearshift linkage	CV-ES-2182			
	01/94→12/95	Centre Rod	MN-DL-2160		Coupling Rod	
	01/94→12/95	Centre Rod	MN-DL-2176		Push Rod	
	01/94→12/95	Centre Rod	MN-DL-12391		for Steering Rod	
	01/94→12/95	Centre Rod	MN-DL-12421		for Steering Rod	
	01/94→12/95	Engine Mounting		MN-SB-10390		
01/94→12/95	Suspension Arm Repair Kit		MN-SB-5244	for Wishbone (CV)		

CV-ES-2119

Length: 55
Cone Ø: d1 Ø 10 / d2 Ø 10
Thread: M12 x 1,75 LHT
81953016063, 81953016131



CV-ES-2120

Length: 115
Cone Ø: d1 Ø 12,4 / d2 Ø 10,8
Thread: M14 x 1,5 RHT
03008500A, 81953016200, 81953016202,
81953016203, 81953016227



CV-ES-2149

Length: 160
Cone Ø: d1 Ø 30 / d2 Ø 27
Thread: M30 x 1,5 RHT
81953016263



CV-ES-2182

Length: 55
Cone Ø: d1 Ø 10 / d2 Ø 10
Thread: M12 x 1,75 RHT
81953016064, 81953016170



CV-ES-14162

Length: 125
Cone Ø: d1 Ø 30 / d2 Ø 27
Thread: M30 x 1,5 LHT

81953010015, 81953010083, 81953010087,
81953016029, 81953016030, 81953016043,
81953016044, 81953016050, 81953016054,
81953016087, 81953016091, 81953016107,
81953016120, 81953016125, 81953016152,
81953016155, 81953016157, 81953016168,
81953016179, 81953016181, 81953016223,
81953016237, 81953016254, 81953016275,
81953016279, 81953016351



CV-ES-14163

Length: 125
Cone Ø: d1 Ø 30 / d2 Ø 27
Thread: M30 x 1,5 RHT

95301.0084, 90804102156, 90804102272,
90804102696, 90804102710, 81953010016,
81953010075, 81953010084, 81953010088,
81953010094, 81953010103, 81953016030,
81953016043, 81953016048, 81953016049,
81953016053, 81953016061, 81953016090,
81953016108, 81953016112, 81953016126,
81953016143, 81953016149, 81953016154,
81953016156, 81953016168, 81953016178,
81953016194, 81953016206, 81953016224,
81953016234, 81953016242, 81953016252,
81953016274, 81953016278, 81953016284,
81953016286, 81953016308, 81953016310,
81953016312, 81953016347, 81953016350,
81953016352, 82953016012, 88953016014,
N2953016001



MN-DL-2160

Length: 1652 Ø: 50
Cone Ø: d1 Ø 30 / d2 Ø 27
81467106112, 81467106163, 81467106165,
81467106198, 81467106353, 81467106354,
81467106361, 81467116725



MN-DL-2176

Length: 1628
Ø: 48
Cone Ø: d1 Ø 30 / d2 Ø 27
81466106779, 81466106780, 81466106782



MN-DL-3402

Length: 590 Ø: 48
Hole Distance: 130 / 130
03307200A, 81432206067, 81432206068,
81432206090, 81432206092, 81432209092



MN-DL-5212

Length: 577 Ø: 48
Hole Distance: 130 / 130
81432206096, 81432206097, 81432206098,
81432206129, 81432209096, 81432209129,
81432306014, 81432306030



MN-DL-8197

Length: 1055
Ø: 42
Cone Ø: d1 Ø 30 / d2 Ø 27
03207500A, 81466116003, 81466116004,
81466116005



MN-DL-8487

Length: 900
Ø: 38
Cone Ø: d1 Ø 30 / d2 Ø 27
81466106767, 81466106768, 81466106774,
81466116014



MN-DL-8544

Length: 596 Ø: 48
Hole Distance: 130 / 130
81432206196, 81432206232, 81432206233



MN-DL-8609

Length: 585 Ø: 58
Hole Distance: 130 / 130
81432206070, 81432206071, 81432206072,
81432206091, 81432206093, 81432206119



MN-DL-12284

Length: 1530 Ø: 50
Cone Ø: d1 Ø 30 / d2 Ø 27
81466106579, 81466106580, 81466106624,
81466116720, 81467116720, 81467116730,
81467116952



MN-DL-12391

Length: 1050
Ø: 52
Cone Ø: d1 Ø 30 / d2 Ø 27
82466106057, 82466106147



MN-DL-12421

Length: 1070
Ø: 48
Cone Ø: d1 Ø 30 / d2 Ø 27
Thread: M30 x 1,5 RHT
81466106656, 81466106659, 81466106669,
81466116006, 81466116007



MN-SB-5244

Ø: 65
Hole Distance: 125
Thick/Height: 22
03312000A, 81432710027, 81432710082



MN-SB-5246

Ø: 45 Thick/Height: 47
81437220022, 81437220038, 81962100450,
81962100469



MN-SB-10390

Ø: 70
Thick/Height: 85/85
81960200341, 81960200373, 81960200385,
81960200408, 81960200418



MN-VB-8514

Length: 627 Ø: 48
Hole Ø 25 / 25 / 25
Hole Distance: 152 / 130 / 130
81432706087, 81432706088, 81432706094,
81432706095, 81432796094





F 2000 ...

27.323 DFAC ...	01/94 →12/95	Suspension Arm Repair Kit		MN-SB-5244	for Wishbone (CV), 2nd RA
	01/94 →12/95	Tie Rod End	CV-ES-2149		for Push Rod
	01/94 →12/95	Tie Rod End	CV-ES-14162		for Steering Rod
	01/94 →12/95	Tie Rod End	CV-ES-14163		for Steering Rod
	01/94 →12/95	Tie Rod End	SC-ES-8517		for Push Rod
	01/94 →12/95	Track Control Arm		MN-DL-3402	Trailing Arm
	01/94 →12/95	Track Control Arm		MN-DL-8609	Trailing Arm, 1st RA;2nd RA, for Leaf-Spring Suspension vehicles
27.323 DFAK, DFA-KI	01/94 →	Ball Head, gearshift linkage	CV-ES-2119		
	01/94 →	Ball Head, gearshift linkage	CV-ES-2120		
	01/94 →	Ball Head, gearshift linkage	CV-ES-2182		
	01/94 →	Centre Rod	MN-DL-2160		Coupling Rod
	01/94 →	Centre Rod	MN-DL-2176		Push Rod
	01/94 →	Centre Rod	MN-DL-12391		for Steering Rod
	01/94 →	Centre Rod	MN-DL-12421		for Steering Rod
	01/94 →	Engine Mounting		MN-SB-10390	
	01/94 →	Suspension Arm Repair Kit		MN-SB-5244	for Wishbone (CV)
	01/94 →	Suspension Arm Repair Kit		MN-SB-5244	for Wishbone (CV), 2nd RA
	01/94 →	Tie Rod End	CV-ES-2149		for Push Rod
	01/94 →	Tie Rod End	CV-ES-14162		for Steering Rod
	01/94 →	Tie Rod End	CV-ES-14163		for Steering Rod
	01/94 →	Tie Rod End	SC-ES-8517		for Push Rod
	01/94 →	Track Control Arm		MN-DL-3402	Trailing Arm
01/94 →	Track Control Arm		MN-DL-8609	Trailing Arm, 1st RA;2nd RA, for Leaf-Spring Suspension vehicles	
27.323 DFAS	01/94 →12/95	Ball Head, gearshift linkage	CV-ES-2119		
	01/94 →12/95	Ball Head, gearshift linkage	CV-ES-2120		
	01/94 →12/95	Ball Head, gearshift linkage	CV-ES-2182		
	01/94 →12/95	Centre Rod	MN-DL-2160		Coupling Rod
	01/94 →12/95	Centre Rod	MN-DL-2176		Push Rod
	01/94 →12/95	Centre Rod	MN-DL-12391		for Steering Rod
	01/94 →12/95	Centre Rod	MN-DL-12421		for Steering Rod
	01/94 →12/95	Engine Mounting		MN-SB-10390	
	01/94 →12/95	Suspension Arm Repair Kit		MN-SB-5244	for Wishbone (CV)
	01/94 →12/95	Suspension Arm Repair Kit		MN-SB-5244	for Wishbone (CV), 2nd RA
	01/94 →12/95	Tie Rod End	CV-ES-2149		for Push Rod
	01/94 →12/95	Tie Rod End	CV-ES-14162		for Steering Rod
	01/94 →12/95	Tie Rod End	CV-ES-14163		for Steering Rod
	01/94 →12/95	Tie Rod End	SC-ES-8517		for Push Rod
	01/94 →12/95	Track Control Arm		MN-DL-3402	Trailing Arm
01/94 →12/95	Track Control Arm		MN-DL-8609	Trailing Arm, 1st RA;2nd RA, for Leaf-Spring Suspension vehicles	
27.323 DFC	01/94 →12/95	Ball Head, gearshift linkage	CV-ES-2119		
	01/94 →12/95	Ball Head, gearshift linkage	CV-ES-2120		
	01/94 →12/95	Ball Head, gearshift linkage	CV-ES-2182		
	01/94 →12/95	Centre Rod	MN-DL-2160		Coupling Rod
	01/94 →12/95	Centre Rod	MN-DL-2176		Push Rod
	01/94 →12/95	Centre Rod	MN-DL-8197		Push Rod
	01/94 →12/95	Centre Rod	MN-DL-12421		for Steering Rod
	01/94 →12/95	Engine Mounting		MN-SB-10390	
	01/94 →12/95	Suspension Arm Repair Kit		MN-SB-5244	for Wishbone (CV)
	01/94 →12/95	Suspension Arm Repair Kit		MN-SB-5244	for Wishbone (CV), 1st RA
	01/94 →12/95	Suspension Arm Repair Kit		MN-SB-5244	for Wishbone (CV), 2nd RA
	01/94 →12/95	Tie Rod End	CV-ES-2149		for Push Rod
	01/94 →12/95	Tie Rod End	CV-ES-14162		for Steering Rod
	01/94 →12/95	Tie Rod End	CV-ES-14163		for Steering Rod
	01/94 →12/95	Track Control Arm		MN-DL-3402	Trailing Arm, Drive Axle
01/94 →12/95	Track Control Arm		MN-DL-5212	Trailing Arm, 1st RA;2nd RA, for Pneumatic Suspension vehicles	
01/94 →12/95	Track Control Arm		MN-DL-8609	Trailing Arm, 1st RA;2nd RA, for Leaf-Spring Suspension vehicles	
01/94 →12/95	Track Control Arm		MN-VB-5222	Wishbone (CV), 1st RA;2nd RA, for Pneumatic Suspension vehicles	

CV-ES-2119

Length: 55
Cone Ø: d1 Ø 10 / d2 Ø 10
Thread: M12 x 1,75 LHT
81953016063, 81953016131



CV-ES-2120

Length: 115
Cone Ø: d1 Ø 12,4 / d2 Ø 10,8
Thread: M14 x 1,5 RHT
03008500A, 81953016200, 81953016202,
81953016203, 81953016227



CV-ES-2149

Length: 160
Cone Ø: d1 Ø 30 / d2 Ø 27
Thread: M30 x 1,5 RHT
81953016263



CV-ES-2182

Length: 55
Cone Ø: d1 Ø 10 / d2 Ø 10
Thread: M12 x 1,75 RHT
81953016064, 81953016170



CV-ES-14162

Length: 125
Cone Ø: d1 Ø 30 / d2 Ø 27
Thread: M30 x 1,5 LHT
81953010015, 81953010083, 81953010087,
81953016029, 81953016030, 81953016043,
81953016044, 81953016050, 81953016054,
81953016087, 81953016091, 81953016107,
81953016120, 81953016125, 81953016152,
81953016155, 81953016157, 81953016168,
81953016179, 81953016181, 81953016223,
81953016237, 81953016254, 81953016275,
81953016279, 81953016351



CV-ES-14163

Length: 125
Cone Ø: d1 Ø 30 / d2 Ø 27
Thread: M30 x 1,5 RHT
95301.0084, 90804102156, 90804102272,
90804102696, 90804102710, 81953010016,
81953010075, 81953010084, 81953010088,
81953010094, 81953010103, 81953016030,
81953016043, 81953016048, 81953016049,
81953016053, 81953016061, 81953016090,
81953016108, 81953016112, 81953016126,
81953016143, 81953016149, 81953016154,
81953016156, 81953016168, 81953016178,
81953016194, 81953016206, 81953016224,
81953016234, 81953016242, 81953016252,
81953016274, 81953016278, 81953016284,
81953016286, 81953016308, 81953016310,
81953016312, 81953016347, 81953016350,
81953016352, 82953016012, 88953016014,
N2953016001



MN-DL-2160

Length: 1652 Ø: 50
Cone Ø: d1 Ø 30 / d2 Ø 27
81467106112, 81467106163, 81467106165,
81467106198, 81467106353, 81467106354,
81467106361, 81467116725



MN-DL-2176

Length: 1628
Ø: 48
Cone Ø: d1 Ø 30 / d2 Ø 27
81466106779, 81466106780, 81466106782



MN-DL-3402

Length: 590 Ø: 48
Hole Distance: 130 / 130
03307200A, 81432206067, 81432206068,
81432206090, 81432206092, 81432209092



MN-DL-5212

Length: 577 Ø: 48
Hole Distance: 130 / 130
81432206096, 81432206097, 81432206098,
81432206129, 81432209096, 81432209129,
81432306014, 81432306030



MN-DL-8197

Length: 1055
Ø: 42
Cone Ø: d1 Ø 30 / d2 Ø 27
03207500A, 81466116003, 81466116004,
81466116005



MN-DL-8609

Length: 585 Ø: 58
Hole Distance: 130 / 130
81432206070, 81432206071, 81432206072,
81432206091, 81432206093, 81432206119



MN-DL-12391

Length: 1050
Ø: 52
Cone Ø: d1 Ø 30 / d2 Ø 27
82466106057, 82466106147



MN-DL-12421

Length: 1070
Ø: 48
Cone Ø: d1 Ø 30 / d2 Ø 27
Thread: M30 x 1,5 RHT
81466106656, 81466106659, 81466106669,
81466116006, 81466116007



MN-SB-5244

Ø: 65
Hole Distance: 125
Thick/Height: 22
03312000A, 81432710027, 81432710082



MN-SB-10390

Ø: 70
Thick/Height: 85/85
81960200341, 81960200373, 81960200385,
81960200408, 81960200418



MN-VB-5222

Length: 627 Ø: 50
Hole Distance: 152 / 152
81432706030, 81432706034, 81432706054,
81432706055, 81432706056, 81432706057,
81432706067, 81432706068, 81432706074,
81432706075, 81432706076, 81432706077,
81432706078, 81432706081, 81432706082,
81432709034, 81432709076, 81432709078,
8143706054



SC-ES-8517

Length: 140
Cone Ø: d1 Ø 30 / d2 Ø 27
Thread: M30 x 1,5 RHT
81953016286





F 2000 ...

27.323 DFK, DF-KI	01/94 →	Ball Head, gearshift linkage	CV-ES-2119		
	01/94 →	Ball Head, gearshift linkage	CV-ES-2120		
	01/94 →	Ball Head, gearshift linkage	CV-ES-2182		
	01/94 →	Centre Rod	MN-DL-2160		Coupling Rod
	01/94 →	Centre Rod	MN-DL-2176		Push Rod
	01/94 →	Centre Rod	MN-DL-8197		Push Rod
	01/94 →	Centre Rod	MN-DL-12421		for Steering Rod
	01/94 →	Engine Mounting		MN-SB-10390	
	01/94 →	Suspension Arm Repair Kit		MN-SB-5244	for Wishbone (CV)
	01/94 →	Suspension Arm Repair Kit		MN-SB-5244	for Wishbone (CV), 1st RA
	01/94 →	Suspension Arm Repair Kit		MN-SB-5244	for Wishbone (CV), 2nd RA
	01/94 →	Tie Rod End	CV-ES-2149		for Push Rod
	01/94 →	Tie Rod End	CV-ES-14162		for Steering Rod
	01/94 →	Tie Rod End	CV-ES-14163		for Steering Rod
	01/94 →	Track Control Arm		MN-DL-3402	Trailing Arm, Drive Axle
	01/94 →	Track Control Arm		MN-DL-5212	Trailing Arm, 1st RA;2nd RA, for Pneumatic Suspension vehicles
	01/94 →	Track Control Arm		MN-DL-8609	Trailing Arm, 1st RA;2nd RA, for Leaf-Spring Suspension vehicles
	01/94 →	Track Control Arm		MN-VB-5222	Wishbone (CV), 1st RA;2nd RA, for Pneumatic Suspension vehicles
27.323 DFS	01/94 →12/95	Ball Head, gearshift linkage	CV-ES-2119		
	01/94 →12/95	Ball Head, gearshift linkage	CV-ES-2120		
	01/94 →12/95	Ball Head, gearshift linkage	CV-ES-2182		
	01/94 →12/95	Centre Rod	MN-DL-2160		Coupling Rod
	01/94 →12/95	Centre Rod	MN-DL-2176		Push Rod
	01/94 →12/95	Centre Rod	MN-DL-8197		Push Rod
	01/94 →12/95	Centre Rod	MN-DL-12421		for Steering Rod
	01/94 →12/95	Engine Mounting		MN-SB-10390	
	01/94 →12/95	Suspension Arm Repair Kit		MN-SB-5244	for Wishbone (CV)
	01/94 →12/95	Suspension Arm Repair Kit		MN-SB-5244	for Wishbone (CV), 1st RA
	01/94 →12/95	Suspension Arm Repair Kit		MN-SB-5244	for Wishbone (CV), 2nd RA
	01/94 →12/95	Tie Rod End	CV-ES-2149		for Push Rod
	01/94 →12/95	Tie Rod End	CV-ES-14162		for Steering Rod
	01/94 →12/95	Tie Rod End	CV-ES-14163		for Steering Rod
	01/94 →12/95	Track Control Arm		MN-DL-3402	Trailing Arm, Drive Axle
	01/94 →12/95	Track Control Arm		MN-DL-5212	Trailing Arm, 1st RA;2nd RA, for Pneumatic Suspension vehicles
	01/94 →12/95	Track Control Arm		MN-DL-8609	Trailing Arm, 1st RA;2nd RA, for Leaf-Spring Suspension vehicles
	01/94 →12/95	Track Control Arm		MN-VB-5222	Wishbone (CV), 1st RA;2nd RA, for Pneumatic Suspension vehicles
27.343 DFAC	01/94 →	Ball Head, gearshift linkage	CV-ES-2119		
	01/94 →	Ball Head, gearshift linkage	CV-ES-2120		
	01/94 →	Ball Head, gearshift linkage	CV-ES-2182		
	01/94 →	Centre Rod	MN-DL-2160		Coupling Rod
	01/94 →	Centre Rod	MN-DL-2176		Push Rod
	01/94 →	Centre Rod	MN-DL-12391		for Steering Rod
	01/94 →	Centre Rod	MN-DL-12421		for Steering Rod
	01/94 →	Engine Mounting		MN-SB-10390	
	01/94 →	Suspension Arm Repair Kit		MN-SB-5244	for Wishbone (CV)
	01/94 →	Suspension Arm Repair Kit		MN-SB-5244	for Wishbone (CV), 2nd RA
	01/94 →	Tie Rod End	CV-ES-2146		
	01/94 →	Tie Rod End	CV-ES-2149		for Push Rod
	01/94 →	Tie Rod End	CV-ES-14162		for Steering Rod
	01/94 →	Tie Rod End	CV-ES-14163		for Steering Rod
	01/94 →	Tie Rod End	SC-ES-8517		for Push Rod
	01/94 →	Track Control Arm		MN-DL-3402	Trailing Arm
	01/94 →	Track Control Arm		MN-DL-8609	Trailing Arm, 1st RA;2nd RA, for Leaf-Spring Suspension vehicles

CV-ES-2119

Length: 55
Cone Ø: d1 Ø 10 / d2 Ø 10
Thread: M12 x 1,75 LHT
81953016063, 81953016131



CV-ES-2120

Length: 115
Cone Ø: d1 Ø 12,4 / d2 Ø 10,8
Thread: M14 x 1,5 RHT
03008500A, 81953016200, 81953016202,
81953016203, 81953016227



CV-ES-2146

Length: 80
Cone Ø: d1 Ø 30 / d2 Ø 27
Thread: M26 x 1,5 RHT
42533102, 81953016219, 81953016225,
81953016226, 81953016267, 81953016291



CV-ES-2149

Length: 160
Cone Ø: d1 Ø 30 / d2 Ø 27
Thread: M30 x 1,5 RHT
81953016263



CV-ES-2182

Length: 55
Cone Ø: d1 Ø 10 / d2 Ø 10
Thread: M12 x 1,75 RHT
81953016064, 81953016170



CV-ES-14162

Length: 125
Cone Ø: d1 Ø 30 / d2 Ø 27
Thread: M30 x 1,5 LHT
81953010015, 81953010083, 81953010087,
81953016029, 81953016030, 81953016043,
81953016044, 81953016050, 81953016054,
81953016087, 81953016091, 81953016107,
81953016120, 81953016125, 81953016152,
81953016155, 81953016157, 81953016168,
81953016179, 81953016181, 81953016223,
81953016237, 81953016254, 81953016275,
81953016279, 81953016351



CV-ES-14163

Length: 125
Cone Ø: d1 Ø 30 / d2 Ø 27
Thread: M30 x 1,5 RHT
95301.0084, 90804102156, 90804102272,
90804102696, 90804102710, 81953010016,
81953010075, 81953010084, 81953010088,
81953010094, 81953010103, 81953016030,
81953016043, 81953016048, 81953016049,
81953016053, 81953016061, 81953016090,
81953016108, 81953016112, 81953016126,
81953016143, 81953016149, 81953016154,
81953016156, 81953016168, 81953016178,
81953016194, 81953016206, 81953016224,
81953016234, 81953016242, 81953016252,
81953016274, 81953016278, 81953016284,
81953016286, 81953016308, 81953016310,
81953016312, 81953016347, 81953016350,
81953016352, 82953016012, 88953016014,
N2953016001



MN-DL-2160

Length: 1652 Ø: 50
Cone Ø: d1 Ø 30 / d2 Ø 27
81467106112, 81467106163, 81467106165,
81467106198, 81467106353, 81467106354,
81467106361, 81467116725



MN-DL-2176

Length: 1628
Ø: 48
Cone Ø: d1 Ø 30 / d2 Ø 27
81466106779, 81466106780, 81466106782



MN-DL-3402

Length: 590 Ø: 48
Hole Distance: 130 / 130
03307200A, 81432206067, 81432206068,
81432206090, 81432206092, 81432209092



MN-DL-5212

Length: 577 Ø: 48
Hole Distance: 130 / 130
81432206096, 81432206097, 81432206098,
81432206129, 81432209096, 81432209129,
81432306014, 81432306030



MN-DL-8197

Length: 1055
Ø: 42
Cone Ø: d1 Ø 30 / d2 Ø 27
03207500A, 81466116003, 81466116004,
81466116005



MN-DL-8609

Length: 585 Ø: 58
Hole Distance: 130 / 130
81432206070, 81432206071, 81432206072,
81432206091, 81432206093, 81432206119



MN-DL-12391

Length: 1050
Ø: 52
Cone Ø: d1 Ø 30 / d2 Ø 27
82466106057, 82466106147



MN-DL-12421

Length: 1070
Ø: 48
Cone Ø: d1 Ø 30 / d2 Ø 27
Thread: M30 x 1,5 RHT
81466106656, 81466106659, 81466106669,
81466116006, 81466116007



MN-SB-5244

Ø: 65
Hole Distance: 125
Thick/Height: 22
03312000A, 81432710027, 81432710082



MN-SB-10390

Ø: 70
Thick/Height: 85/85
81960200341, 81960200373, 81960200385,
81960200408, 81960200418



MN-VB-5222

Length: 627 Ø: 50
Hole Distance: 152 / 152
81432706030, 81432706034, 81432706054,
81432706055, 81432706056, 81432706057,
81432706067, 81432706068, 81432706074,
81432706075, 81432706076, 81432706077,
81432706078, 81432706081, 81432706082,
81432709034, 81432709076, 81432709078,
8143706054



SC-ES-8517

Length: 140
Cone Ø: d1 Ø 30 / d2 Ø 27
Thread: M30 x 1,5 RHT
81953016286





F 2000 ...

27.343 DFAK	01/94 →	Ball Head, gearshift linkage	CV-ES-2119			
	01/94 →	Ball Head, gearshift linkage	CV-ES-2120			
	01/94 →	Ball Head, gearshift linkage	CV-ES-2182			
	01/94 →	Centre Rod	MN-DL-2160		Coupling Rod	
	01/94 →	Centre Rod	MN-DL-2176		Push Rod	
	01/94 →	Centre Rod	MN-DL-12391		for Steering Rod	
	01/94 →	Centre Rod	MN-DL-12421		for Steering Rod	
	01/94 →	Engine Mounting		MN-SB-10390		
	01/94 →	Suspension Arm Repair Kit		MN-SB-5244	for Wishbone (CV)	
	01/94 →	Suspension Arm Repair Kit		MN-SB-5244	for Wishbone (CV), 2nd RA	
	01/94 →	Tie Rod End	CV-ES-2146			
	01/94 →	Tie Rod End	CV-ES-2149		for Push Rod	
	01/94 →	Tie Rod End	CV-ES-14162		for Steering Rod	
	01/94 →	Tie Rod End	CV-ES-14163		for Steering Rod	
	01/94 →	Tie Rod End	SC-ES-8517		for Push Rod	
	01/94 →	Track Control Arm		MN-DL-3402	Trailing Arm	
	01/94 →	Track Control Arm		MN-DL-8609	Trailing Arm, 1st RA;2nd RA, for Leaf-Spring Suspension vehicles	
	27.343 DFAS	01/94 →	Ball Head, gearshift linkage	CV-ES-2119		
		01/94 →	Ball Head, gearshift linkage	CV-ES-2120		
		01/94 →	Ball Head, gearshift linkage	CV-ES-2182		
01/94 →		Centre Rod	MN-DL-2160		Coupling Rod	
01/94 →		Centre Rod	MN-DL-2176		Push Rod	
01/94 →		Centre Rod	MN-DL-12391		for Steering Rod	
01/94 →		Centre Rod	MN-DL-12421		for Steering Rod	
01/94 →		Engine Mounting		MN-SB-10390		
01/94 →		Suspension Arm Repair Kit		MN-SB-5244	for Wishbone (CV)	
01/94 →		Suspension Arm Repair Kit		MN-SB-5244	for Wishbone (CV), 2nd RA	
01/94 →		Tie Rod End	CV-ES-2146			
01/94 →		Tie Rod End	CV-ES-2149		for Push Rod	
01/94 →		Tie Rod End	CV-ES-14162		for Steering Rod	
01/94 →		Tie Rod End	CV-ES-14163		for Steering Rod	
01/94 →		Tie Rod End	SC-ES-8517		for Push Rod	
01/94 →		Track Control Arm		MN-DL-3402	Trailing Arm	
01/94 →		Track Control Arm		MN-DL-8609	Trailing Arm, 1st RA;2nd RA, for Leaf-Spring Suspension vehicles	
27.343 DFC		01/94 →	Ball Head, gearshift linkage	CV-ES-2119		
		01/94 →	Ball Head, gearshift linkage	CV-ES-2120		
		01/94 →	Ball Head, gearshift linkage	CV-ES-2182		
	01/94 →	Centre Rod	MN-DL-2160		Coupling Rod	
	01/94 →	Centre Rod	MN-DL-2176		Push Rod	
	01/94 →	Centre Rod	MN-DL-8197		Push Rod	
	01/94 →	Centre Rod	MN-DL-12421		for Steering Rod	
	01/94 →	Engine Mounting		MN-SB-10390		
	01/94 →	Suspension Arm Repair Kit		MN-SB-5244	for Wishbone (CV)	
	01/94 →	Suspension Arm Repair Kit		MN-SB-5244	for Wishbone (CV), 1st RA	
	01/94 →	Suspension Arm Repair Kit		MN-SB-5244	for Wishbone (CV), 2nd RA	
	01/94 →	Tie Rod End	CV-ES-2146			
	01/94 →	Tie Rod End	CV-ES-2149		for Push Rod	
	01/94 →	Tie Rod End	CV-ES-14162		for Steering Rod	
	01/94 →	Tie Rod End	CV-ES-14163		for Steering Rod	
	01/94 →	Track Control Arm		MN-DL-3402	Trailing Arm, Drive Axle	
	01/94 →	Track Control Arm		MN-DL-5212	Trailing Arm, 1st RA;2nd RA, for Pneumatic Suspension vehicles	
	01/94 →	Track Control Arm		MN-DL-8609	Trailing Arm, 1st RA;2nd RA, for Leaf-Spring Suspension vehicles	
	01/94 →	Track Control Arm		MN-VB-5222	Wishbone (CV), 1st RA;2nd RA, for Pneumatic Suspension vehicles	
	27.343 DFK	01/94 →	Ball Head, gearshift linkage	CV-ES-2119		
01/94 →		Ball Head, gearshift linkage	CV-ES-2120			
01/94 →		Ball Head, gearshift linkage	CV-ES-2182			
01/94 →		Centre Rod	MN-DL-2160		Coupling Rod	
01/94 →		Centre Rod	MN-DL-2176		Push Rod	

CV-ES-2119

Length: 55
Cone Ø: d1 Ø 10 / d2 Ø 10
Thread: M12 x 1,75 LHT
81953016063, 81953016131



CV-ES-2120

Length: 115
Cone Ø: d1 Ø 12,4 / d2 Ø 10,8
Thread: M14 x 1,5 RHT
03008500A, 81953016200, 81953016202,
81953016203, 81953016227



CV-ES-2146

Length: 80
Cone Ø: d1 Ø 30 / d2 Ø 27
Thread: M26 x 1,5 RHT
42533102, 81953016219, 81953016225,
81953016226, 81953016267, 81953016291



CV-ES-2149

Length: 160
Cone Ø: d1 Ø 30 / d2 Ø 27
Thread: M30 x 1,5 RHT
81953016263



CV-ES-2182

Length: 55
Cone Ø: d1 Ø 10 / d2 Ø 10
Thread: M12 x 1,75 RHT
81953016064, 81953016170



CV-ES-14162

Length: 125
Cone Ø: d1 Ø 30 / d2 Ø 27
Thread: M30 x 1,5 LHT
81953010015, 81953010083, 81953010087,
81953016029, 81953016030, 81953016043,
81953016044, 81953016050, 81953016054,
81953016087, 81953016091, 81953016107,
81953016120, 81953016125, 81953016152,
81953016155, 81953016157, 81953016168,
81953016179, 81953016181, 81953016223,
81953016237, 81953016254, 81953016275,
81953016279, 81953016351



CV-ES-14163

Length: 125
Cone Ø: d1 Ø 30 / d2 Ø 27
Thread: M30 x 1,5 RHT
95301.0084, 90804102156, 90804102272,
90804102696, 90804102710, 81953010016,
81953010075, 81953010084, 81953010088,
81953010094, 81953010103, 81953016030,
81953016043, 81953016048, 81953016049,
81953016053, 81953016061, 81953016090,
81953016108, 81953016112, 81953016126,
81953016143, 81953016149, 81953016154,
81953016156, 81953016168, 81953016178,
81953016194, 81953016206, 81953016224,
81953016234, 81953016242, 81953016252,
81953016274, 81953016278, 81953016284,
81953016286, 81953016308, 81953016310,
81953016312, 81953016347, 81953016350,
81953016352, 82953016012, 88953016014,
N2953016001



MN-DL-2160

Length: 1652 Ø: 50
Cone Ø: d1 Ø 30 / d2 Ø 27
81467106112, 81467106163, 81467106165,
81467106198, 81467106353, 81467106354,
81467106361, 81467116725



MN-DL-2176

Length: 1628
Ø: 48
Cone Ø: d1 Ø 30 / d2 Ø 27
81466106779, 81466106780, 81466106782



MN-DL-3402

Length: 590 Ø: 48
Hole Distance: 130 / 130
03307200A, 81432206067, 81432206068,
81432206090, 81432206092, 81432209092



MN-DL-5212

Length: 577 Ø: 48
Hole Distance: 130 / 130
81432206096, 81432206097, 81432206098,
81432206129, 81432209096, 81432209129,
81432306014, 81432306030



MN-DL-8197

Length: 1055
Ø: 42
Cone Ø: d1 Ø 30 / d2 Ø 27
03207500A, 81466116003, 81466116004,
81466116005



MN-DL-8609

Length: 585 Ø: 58
Hole Distance: 130 / 130
81432206070, 81432206071, 81432206072,
81432206091, 81432206093, 81432206119



MN-DL-12391

Length: 1050
Ø: 52
Cone Ø: d1 Ø 30 / d2 Ø 27
82466106057, 82466106147



MN-DL-12421

Length: 1070
Ø: 48
Cone Ø: d1 Ø 30 / d2 Ø 27
Thread: M30 x 1,5 RHT
81466106656, 81466106659, 81466106669,
81466116006, 81466116007



MN-SB-5244

Ø: 65
Hole Distance: 125
Thick/Height: 22
03312000A, 81432710027, 81432710082



MN-SB-10390

Ø: 70
Thick/Height: 85/85
81960200341, 81960200373, 81960200385,
81960200408, 81960200418



MN-VB-5222

Length: 627 Ø: 50
Hole Distance: 152 / 152
81432706030, 81432706034, 81432706054,
81432706055, 81432706056, 81432706057,
81432706067, 81432706068, 81432706074,
81432706075, 81432706076, 81432706077,
81432706078, 81432706081, 81432706082,
81432709034, 81432709076, 81432709078,
8143706054



SC-ES-8517

Length: 140
Cone Ø: d1 Ø 30 / d2 Ø 27
Thread: M30 x 1,5 RHT
81953016286





F 2000 ...

27.343 DFK ...	01/94 →	Centre Rod	MN-DL-8197		Push Rod
	01/94 →	Centre Rod	MN-DL-12421		for Steering Rod
	01/94 →	Engine Mounting		MN-SB-10390	
	01/94 →	Suspension Arm Repair Kit		MN-SB-5244	for Wishbone (CV)
	01/94 →	Suspension Arm Repair Kit		MN-SB-5244	for Wishbone (CV), 1st RA
	01/94 →	Suspension Arm Repair Kit		MN-SB-5244	for Wishbone (CV), 2nd RA
	01/94 →	Tie Rod End	CV-ES-2146		
	01/94 →	Tie Rod End	CV-ES-2149		for Push Rod
	01/94 →	Tie Rod End	CV-ES-14162		for Steering Rod
	01/94 →	Tie Rod End	CV-ES-14163		for Steering Rod
	01/94 →	Track Control Arm		MN-DL-3402	Trailing Arm, Drive Axle
	01/94 →	Track Control Arm		MN-DL-5212	Trailing Arm, 1st RA;2nd RA, for Pneumatic Suspension vehicles
	01/94 →	Track Control Arm		MN-DL-8609	Trailing Arm, 1st RA;2nd RA, for Leaf-Spring Suspension vehicles
	01/94 →	Track Control Arm		MN-VB-5222	Wishbone (CV), 1st RA;2nd RA, for Pneumatic Suspension vehicles
	27.343 DFS	01/94 →	Ball Head, gearshift linkage	CV-ES-2119	
01/94 →		Ball Head, gearshift linkage	CV-ES-2120		
01/94 →		Ball Head, gearshift linkage	CV-ES-2182		
01/94 →		Centre Rod	MN-DL-2160		Coupling Rod
01/94 →		Centre Rod	MN-DL-2176		Push Rod
01/94 →		Centre Rod	MN-DL-8197		Push Rod
01/94 →		Centre Rod	MN-DL-12421		for Steering Rod
01/94 →		Engine Mounting		MN-SB-10390	
01/94 →		Suspension Arm Repair Kit		MN-SB-5244	for Wishbone (CV)
01/94 →		Suspension Arm Repair Kit		MN-SB-5244	for Wishbone (CV), 1st RA
01/94 →		Suspension Arm Repair Kit		MN-SB-5244	for Wishbone (CV), 2nd RA
01/94 →		Tie Rod End	CV-ES-2146		
01/94 →		Tie Rod End	CV-ES-2149		for Push Rod
01/94 →		Tie Rod End	CV-ES-14162		for Steering Rod
01/94 →		Tie Rod End	CV-ES-14163		for Steering Rod
01/94 →		Track Control Arm		MN-DL-3402	Trailing Arm, Drive Axle
01/94 →		Track Control Arm		MN-DL-5212	Trailing Arm, 1st RA;2nd RA, for Pneumatic Suspension vehicles
01/94 →		Track Control Arm		MN-DL-8609	Trailing Arm, 1st RA;2nd RA, for Leaf-Spring Suspension vehicles
01/94 →	Track Control Arm		MN-VB-5222	Wishbone (CV), 1st RA;2nd RA, for Pneumatic Suspension vehicles	
27.364 DFAC	05/01 →	Ball Head, gearshift linkage	CV-ES-2120		
	05/01 →	Centre Rod	MN-DL-12391		for Steering Rod
	05/01 →	Centre Rod	MN-DL-12421		for Steering Rod
	05/01 →	Suspension Arm Repair Kit		MN-SB-5244	for Wishbone (CV)
	05/01 →	Tie Rod End	CV-ES-2146		
	05/01 →	Tie Rod End	CV-ES-14162		for Steering Rod
	05/01 →	Tie Rod End	CV-ES-14163		for Steering Rod
	05/01 →	Track Control Arm		MN-DL-3402	Trailing Arm
	05/01 →	Track Control Arm		MN-DL-8609	Trailing Arm
27.364 DFAK, DFA-KI, DFAK-L	05/01 →	Ball Head, gearshift linkage	CV-ES-2120		
	05/01 →	Centre Rod	MN-DL-12391		for Steering Rod
	05/01 →	Centre Rod	MN-DL-12421		for Steering Rod
	05/01 →	Suspension Arm Repair Kit		MN-SB-5244	for Wishbone (CV)
	05/01 →	Tie Rod End	CV-ES-2146		
	05/01 →	Tie Rod End	CV-ES-14162		for Steering Rod
	05/01 →	Tie Rod End	CV-ES-14163		for Steering Rod
	05/01 →	Track Control Arm		MN-DL-3402	Trailing Arm
05/01 →	Track Control Arm		MN-DL-8609	Trailing Arm	
27.364 DFAS	05/01 →	Ball Head, gearshift linkage	CV-ES-2120		
	05/01 →	Centre Rod	MN-DL-12391		for Steering Rod
	05/01 →	Centre Rod	MN-DL-12421		for Steering Rod
	05/01 →	Suspension Arm Repair Kit		MN-SB-5244	for Wishbone (CV)
	05/01 →	Tie Rod End	CV-ES-2146		
	05/01 →	Tie Rod End	CV-ES-14162		for Steering Rod

CV-ES-2119

Length: 55
Cone Ø: d1 Ø 10 / d2 Ø 10
Thread: M12 x 1,75 LHT
81953016063, 81953016131



CV-ES-2120

Length: 115
Cone Ø: d1 Ø 12,4 / d2 Ø 10,8
Thread: M14 x 1,5 RHT
03008500A, 81953016200, 81953016202,
81953016203, 81953016227



CV-ES-2146

Length: 80
Cone Ø: d1 Ø 30 / d2 Ø 27
Thread: M26 x 1,5 RHT
42533102, 81953016219, 81953016225,
81953016226, 81953016267, 81953016291



CV-ES-2149

Length: 160
Cone Ø: d1 Ø 30 / d2 Ø 27
Thread: M30 x 1,5 RHT
81953016263



CV-ES-2182

Length: 55
Cone Ø: d1 Ø 10 / d2 Ø 10
Thread: M12 x 1,75 RHT
81953016064, 81953016170



CV-ES-14162

Length: 125
Cone Ø: d1 Ø 30 / d2 Ø 27
Thread: M30 x 1,5 LHT
81953010015, 81953010083, 81953010087,
81953016029, 81953016030, 81953016043,
81953016044, 81953016050, 81953016054,
81953016087, 81953016091, 81953016107,
81953016120, 81953016125, 81953016152,
81953016155, 81953016157, 81953016168,
81953016179, 81953016181, 81953016223,
81953016237, 81953016254, 81953016275,
81953016279, 81953016351



CV-ES-14163

Length: 125
Cone Ø: d1 Ø 30 / d2 Ø 27
Thread: M30 x 1,5 RHT
95301.0084, 90804102156, 90804102272,
90804102696, 90804102710, 81953010016,
81953010075, 81953010084, 81953010088,
81953010094, 81953010103, 81953016030,
81953016043, 81953016048, 81953016049,
81953016053, 81953016061, 81953016090,
81953016108, 81953016112, 81953016126,
81953016143, 81953016149, 81953016154,
81953016156, 81953016168, 81953016178,
81953016194, 81953016206, 81953016224,
81953016234, 81953016242, 81953016252,
81953016274, 81953016278, 81953016284,
81953016286, 81953016308, 81953016310,
81953016312, 81953016347, 81953016350,
81953016352, 82953016012, 88953016014,
N2953016001



MN-DL-2160

Length: 1652 Ø: 50
Cone Ø: d1 Ø 30 / d2 Ø 27
81467106112, 81467106163, 81467106165,
81467106198, 81467106353, 81467106354,
81467106361, 81467116725



MN-DL-2176

Length: 1628
Ø: 48
Cone Ø: d1 Ø 30 / d2 Ø 27
81466106779, 81466106780, 81466106782



MN-DL-3402

Length: 590 Ø: 48
Hole Distance: 130 / 130
03307200A, 81432206067, 81432206068,
81432206090, 81432206092, 81432209092



MN-DL-5212

Length: 577 Ø: 48
Hole Distance: 130 / 130
81432206096, 81432206097, 81432206098,
81432206129, 81432209096, 81432209129,
81432306014, 81432306030



MN-DL-8197

Length: 1055
Ø: 42
Cone Ø: d1 Ø 30 / d2 Ø 27
03207500A, 81466116003, 81466116004,
81466116005



MN-DL-8609

Length: 585 Ø: 58
Hole Distance: 130 / 130
81432206070, 81432206071, 81432206072,
81432206091, 81432206093, 81432206119



MN-DL-12391

Length: 1050
Ø: 52
Cone Ø: d1 Ø 30 / d2 Ø 27
82466106057, 82466106147



MN-DL-12421

Length: 1070
Ø: 48
Cone Ø: d1 Ø 30 / d2 Ø 27
Thread: M30 x 1,5 RHT
81466106656, 81466106659, 81466106669,
81466116006, 81466116007



MN-SB-5244

Ø: 65
Hole Distance: 125
Thick/Height: 22
03312000A, 81432710027, 81432710082



MN-SB-10390

Ø: 70
Thick/Height: 85/85
81960200341, 81960200373, 81960200385,
81960200408, 81960200418



MN-VB-5222

Length: 627 Ø: 50
Hole Distance: 152 / 152
81432706030, 81432706034, 81432706054,
81432706055, 81432706056, 81432706057,
81432706067, 81432706068, 81432706074,
81432706075, 81432706076, 81432706077,
81432706078, 81432706081, 81432706082,
81432709034, 81432709076, 81432709078,
8143706054





F 2000 ...

27.364 DFAS ...	05/01→	Tie Rod End	CV-ES-14163		for Steering Rod
	05/01→	Track Control Arm		MN-DL-3402	Trailing Arm
	05/01→	Track Control Arm		MN-DL-8609	Trailing Arm
27.364 DFC	05/01→	Ball Head, gearshift linkage	CV-ES-2120	CV-ES-2120	
	05/01→	Centre Rod	MN-DL-8197		Push Rod
	05/01→	Centre Rod	MN-DL-12391		for Steering Rod
	05/01→	Centre Rod	MN-DL-12421		for Steering Rod
	05/01→	Mounting, stabilizer coupling rod	MN-SB-5246		
	05/01→	Suspension Arm Repair Kit		MN-SB-5244	for Wishbone (CV)
	05/01→	Tie Rod	MN-DL-12284		
	05/01→	Tie Rod End	CV-ES-2149		for Push Rod
	05/01→	Tie Rod End	CV-ES-14162		for Steering Rod
	05/01→	Tie Rod End	CV-ES-14163		for Steering Rod
	05/01→	Track Control Arm		MN-DL-3402	Trailing Arm
	05/01→	Track Control Arm		MN-DL-8544	Trailing Arm
	05/01→	Track Control Arm		MN-DL-8609	Trailing Arm
	05/01→	Track Control Arm		MN-VB-8514	Suspension Rod, Wishbone (CV)
27.364 DFK, DFK-KI, DFK-L, DF-KI	05/01→	Ball Head, gearshift linkage	CV-ES-2120	CV-ES-2120	
	05/01→	Centre Rod	MN-DL-8197		Push Rod
	05/01→	Centre Rod	MN-DL-12391		for Steering Rod
	05/01→	Centre Rod	MN-DL-12421		for Steering Rod
	05/01→	Mounting, stabilizer coupling rod	MN-SB-5246		
	05/01→	Suspension Arm Repair Kit		MN-SB-5244	for Wishbone (CV)
	05/01→	Tie Rod	MN-DL-12284		
	05/01→	Tie Rod End	CV-ES-2149		for Push Rod
	05/01→	Tie Rod End	CV-ES-14162		for Steering Rod
	05/01→	Tie Rod End	CV-ES-14163		for Steering Rod
	05/01→	Track Control Arm		MN-DL-3402	Trailing Arm
	05/01→	Track Control Arm		MN-DL-8544	Trailing Arm
	05/01→	Track Control Arm		MN-DL-8609	Trailing Arm
	05/01→	Track Control Arm		MN-VB-8514	Suspension Rod, Wishbone (CV)
27.364 DFS	05/01→	Ball Head, gearshift linkage	CV-ES-2120	CV-ES-2120	
	05/01→	Centre Rod	MN-DL-8197		Push Rod
	05/01→	Centre Rod	MN-DL-12391		for Steering Rod
	05/01→	Centre Rod	MN-DL-12421		for Steering Rod
	05/01→	Mounting, stabilizer coupling rod	MN-SB-5246		
	05/01→	Suspension Arm Repair Kit		MN-SB-5244	for Wishbone (CV)
	05/01→	Tie Rod	MN-DL-12284		
	05/01→	Tie Rod End	CV-ES-2149		for Push Rod
	05/01→	Tie Rod End	CV-ES-14162		for Steering Rod
	05/01→	Tie Rod End	CV-ES-14163		for Steering Rod
	05/01→	Track Control Arm		MN-DL-3402	Trailing Arm
	05/01→	Track Control Arm		MN-DL-8544	Trailing Arm
	05/01→	Track Control Arm		MN-DL-8609	Trailing Arm
	05/01→	Track Control Arm		MN-VB-8514	Suspension Rod, Wishbone (CV)
27.364 DF-TM	05/01→	Ball Head, gearshift linkage	CV-ES-2120	CV-ES-2120	
	05/01→	Centre Rod	MN-DL-8197		Push Rod
	05/01→	Centre Rod	MN-DL-12391		for Steering Rod
	05/01→	Centre Rod	MN-DL-12421		for Steering Rod
	05/01→	Mounting, stabilizer coupling rod	MN-SB-5246		
	05/01→	Suspension Arm Repair Kit		MN-SB-5244	for Wishbone (CV)
	05/01→	Tie Rod	MN-DL-12284		
	05/01→	Tie Rod End	CV-ES-2149		for Push Rod
	05/01→	Tie Rod End	CV-ES-14162		for Steering Rod
	05/01→	Tie Rod End	CV-ES-14163		for Steering Rod
	05/01→	Track Control Arm		MN-DL-3402	Trailing Arm
	05/01→	Track Control Arm		MN-DL-8544	Trailing Arm
	05/01→	Track Control Arm		MN-DL-8609	Trailing Arm
	05/01→	Track Control Arm		MN-VB-8514	Suspension Rod, Wishbone (CV)
27.364 FVL	06/98→	Ball Head, gearshift linkage	CV-ES-2120		
	06/98→	Centre Rod	MN-DL-8197		Push Rod
	06/98→	Centre Rod	MN-DL-8487		Push Rod
	06/98→	Track Control Arm		MN-DL-5212	Trailing Arm

CV-ES-2120

Length: 115
Cone Ø: d1 Ø 12,4 / d2 Ø 10,8
Thread: M14 x 1,5 RHT
03008500A, 81953016200, 81953016202,
81953016203, 81953016227



CV-ES-2149

Length: 160
Cone Ø: d1 Ø 30 / d2 Ø 27
Thread: M30 x 1,5 RHT
81953016263



CV-ES-14162

Length: 125
Cone Ø: d1 Ø 30 / d2 Ø 27
Thread: M30 x 1,5 LHT
81953010015, 81953010083, 81953010087,
81953016029, 81953016030, 81953016043,
81953016044, 81953016050, 81953016054,
81953016087, 81953016091, 81953016107,
81953016120, 81953016125, 81953016152,
81953016155, 81953016157, 81953016168,
81953016179, 81953016181, 81953016223,
81953016237, 81953016254, 81953016275,
81953016279, 81953016351



CV-ES-14163

Length: 125
Cone Ø: d1 Ø 30 / d2 Ø 27
Thread: M30 x 1,5 RHT
95301.0084, 90804102156, 90804102272,
90804102696, 90804102710, 81953010016,
81953010075, 81953010084, 81953010088,
81953010094, 81953010103, 81953016030,
81953016043, 81953016048, 81953016049,
81953016053, 81953016061, 81953016090,
81953016108, 81953016112, 81953016126,
81953016143, 81953016149, 81953016154,
81953016156, 81953016168, 81953016178,
81953016194, 81953016206, 81953016224,
81953016234, 81953016242, 81953016252,
81953016274, 81953016278, 81953016284,
81953016286, 81953016308, 81953016310,
81953016312, 81953016347, 81953016350,
81953016352, 82953016012, 88953016014,
N2953016001



MN-DL-3402

Length: 590 Ø: 48
Hole Distance: 130 / 130
03307200A, 81432206067, 81432206068,
81432206090, 81432206092, 81432209092



MN-DL-5212

Length: 577 Ø: 48
Hole Distance: 130 / 130
81432206096, 81432206097, 81432206098,
81432206129, 81432209096, 81432209129,
81432306014, 81432306030



MN-DL-8197

Length: 1055
Ø: 42
Cone Ø: d1 Ø 30 / d2 Ø 27
03207500A, 81466116003, 81466116004,
81466116005



MN-DL-8487

Length: 900
Ø: 38
Cone Ø: d1 Ø 30 / d2 Ø 27
81466106767, 81466106768, 81466106774,
81466116014



MN-DL-8544

Length: 596 Ø: 48
Hole Distance: 130 / 130
81432206196, 81432206232, 81432206233



MN-DL-8609

Length: 585 Ø: 58
Hole Distance: 130 / 130
81432206070, 81432206071, 81432206072,
81432206091, 81432206093, 81432206119



MN-DL-12284

Length: 1530 Ø: 50
Cone Ø: d1 Ø 30 / d2 Ø 27
81466106579, 81466106580, 81466106624,
81466116720, 81467116720, 81467116730,
81467116952



MN-DL-12391

Length: 1050
Ø: 52
Cone Ø: d1 Ø 30 / d2 Ø 27
82466106057, 82466106147



MN-DL-12421

Length: 1070
Ø: 48
Cone Ø: d1 Ø 30 / d2 Ø 27
Thread: M30 x 1,5 RHT
81466106656, 81466106659, 81466106669,
81466116006, 81466116007



MN-SB-5244

Ø: 65
Hole Distance: 125
Thick/Height: 22
03312000A, 81432710027, 81432710082



MN-SB-5246

Ø: 45 Thick/Height: 47
81437220022, 81437220038, 81962100450,
81962100469



MN-VB-8514

Length: 627 Ø: 48
Hole Ø 25 / 25 / 25
Hole Distance: 152 / 130 / 130
81432706087, 81432706088, 81432706094,
81432706095, 81432796094



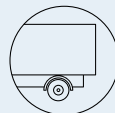

F 2000 ...

27.373 DFAC	01/94 →	Ball Head, gearshift linkage	CV-ES-2119			
	01/94 →	Ball Head, gearshift linkage	CV-ES-2120			
	01/94 →	Ball Head, gearshift linkage	CV-ES-2182			
	01/94 →	Centre Rod	MN-DL-2160		Coupling Rod	
	01/94 →	Centre Rod	MN-DL-2176		Push Rod	
	01/94 →	Centre Rod	MN-DL-12391		for Steering Rod	
	01/94 →	Centre Rod	MN-DL-12421		for Steering Rod	
	01/94 →	Engine Mounting		MN-SB-10390		
	01/94 →	Engine Mounting	MN-SB-10389			
	01/94 →	Suspension Arm Repair Kit		MN-SB-5244	for Wishbone (CV)	
	01/94 →	Suspension Arm Repair Kit		MN-SB-5244	for Wishbone (CV), 1st RA	
	01/94 →	Suspension Arm Repair Kit		MN-SB-5244	for Wishbone (CV), 2nd RA	
	01/94 →	Tie Rod End	CV-ES-2146			
	01/94 →	Tie Rod End	CV-ES-2149		for Push Rod	
	01/94 →	Tie Rod End	CV-ES-14162		for Steering Rod	
	01/94 →	Tie Rod End	CV-ES-14163		for Steering Rod	
	01/94 →	Tie Rod End	SC-ES-8517		for Push Rod	
	01/94 →	Track Control Arm		MN-DL-3402	Trailing Arm, Drive Axle	
	01/94 →	Track Control Arm		MN-DL-8609	Trailing Arm	
	27.373 DFAK, DFA-KI, DFAK-L	01/94 →	Ball Head, gearshift linkage	CV-ES-2119		
		01/94 →	Ball Head, gearshift linkage	CV-ES-2120		
		01/94 →	Ball Head, gearshift linkage	CV-ES-2182		
		01/94 →	Centre Rod	MN-DL-2160		Coupling Rod
		01/94 →	Centre Rod	MN-DL-2176		Push Rod
		01/94 →	Centre Rod	MN-DL-12391		for Steering Rod
		01/94 →	Centre Rod	MN-DL-12421		for Steering Rod
01/94 →		Engine Mounting		MN-SB-10390		
01/94 →		Engine Mounting	MN-SB-10389			
01/94 →		Suspension Arm Repair Kit		MN-SB-5244	for Wishbone (CV)	
01/94 →		Suspension Arm Repair Kit		MN-SB-5244	for Wishbone (CV), 1st RA	
01/94 →		Suspension Arm Repair Kit		MN-SB-5244	for Wishbone (CV), 2nd RA	
01/94 →		Tie Rod End	CV-ES-2146			
01/94 →		Tie Rod End	CV-ES-2149		for Push Rod	
01/94 →		Tie Rod End	CV-ES-14162		for Steering Rod	
01/94 →		Tie Rod End	CV-ES-14163		for Steering Rod	
01/94 →		Tie Rod End	SC-ES-8517		for Push Rod	
01/94 →		Track Control Arm		MN-DL-3402	Trailing Arm, Drive Axle	
01/94 →		Track Control Arm		MN-DL-8609	Trailing Arm	
27.373 DFAS		01/94 →	Ball Head, gearshift linkage	CV-ES-2119		
		01/94 →	Ball Head, gearshift linkage	CV-ES-2120		
		01/94 →	Ball Head, gearshift linkage	CV-ES-2182		
		01/94 →	Centre Rod	MN-DL-2160		Coupling Rod
		01/94 →	Centre Rod	MN-DL-2176		Push Rod
		01/94 →	Centre Rod	MN-DL-12391		for Steering Rod
		01/94 →	Centre Rod	MN-DL-12421		for Steering Rod
	01/94 →	Engine Mounting		MN-SB-10390		
	01/94 →	Engine Mounting	MN-SB-10389			
	01/94 →	Suspension Arm Repair Kit		MN-SB-5244	for Wishbone (CV)	
	01/94 →	Suspension Arm Repair Kit		MN-SB-5244	for Wishbone (CV), 1st RA	
	01/94 →	Suspension Arm Repair Kit		MN-SB-5244	for Wishbone (CV), 2nd RA	
	01/94 →	Tie Rod End	CV-ES-2146			
	01/94 →	Tie Rod End	CV-ES-2149		for Push Rod	
	01/94 →	Tie Rod End	CV-ES-14162		for Steering Rod	
	01/94 →	Tie Rod End	CV-ES-14163		for Steering Rod	
	01/94 →	Tie Rod End	SC-ES-8517		for Push Rod	
	01/94 →	Track Control Arm		MN-DL-3402	Trailing Arm, Drive Axle	
	01/94 →	Track Control Arm		MN-DL-8609	Trailing Arm	
	27.373 DFC	01/94 →	Ball Head, gearshift linkage	CV-ES-2119		
		01/94 →	Ball Head, gearshift linkage	CV-ES-2120	CV-ES-2120	
		01/94 →	Ball Head, gearshift linkage	CV-ES-2182		
		01/94 →	Centre Rod	MN-DL-2160		Coupling Rod
		01/94 →	Centre Rod	MN-DL-2176		Push Rod
		01/94 →	Centre Rod	MN-DL-8197		Push Rod

CV-ES-2119

Length: 55
Cone Ø: d1 Ø 10 / d2 Ø 10
Thread: M12 x 1,75 LHT
81953016063, 81953016131



CV-ES-2120

Length: 115
Cone Ø: d1 Ø 12,4 / d2 Ø 10,8
Thread: M14 x 1,5 RHT
03008500A, 81953016200, 81953016202,
81953016203, 81953016227



CV-ES-2146

Length: 80
Cone Ø: d1 Ø 30 / d2 Ø 27
Thread: M26 x 1,5 RHT
42533102, 81953016219, 81953016225,
81953016226, 81953016267, 81953016291



CV-ES-2149

Length: 160
Cone Ø: d1 Ø 30 / d2 Ø 27
Thread: M30 x 1,5 RHT
81953016263



CV-ES-2182

Length: 55
Cone Ø: d1 Ø 10 / d2 Ø 10
Thread: M12 x 1,75 RHT
81953016064, 81953016170



CV-ES-14162

Length: 125
Cone Ø: d1 Ø 30 / d2 Ø 27
Thread: M30 x 1,5 LHT
81953010015, 81953010083, 81953010087,
81953016029, 81953016030, 81953016043,
81953016044, 81953016050, 81953016054,
81953016087, 81953016091, 81953016107,
81953016120, 81953016125, 81953016152,
81953016155, 81953016157, 81953016168,
81953016179, 81953016181, 81953016223,
81953016237, 81953016254, 81953016275,
81953016279, 81953016351



CV-ES-14163

Length: 125
Cone Ø: d1 Ø 30 / d2 Ø 27
Thread: M30 x 1,5 RHT
95301.0084, 90804102156, 90804102272,
90804102696, 90804102710, 81953010016,
81953010075, 81953010084, 81953010088,
81953010094, 81953010103, 81953016030,
81953016043, 81953016048, 81953016049,
81953016053, 81953016061, 81953016090,
81953016108, 81953016112, 81953016126,
81953016143, 81953016149, 81953016154,
81953016156, 81953016168, 81953016178,
81953016194, 81953016206, 81953016224,
81953016234, 81953016242, 81953016252,
81953016274, 81953016278, 81953016284,
81953016286, 81953016308, 81953016310,
81953016312, 81953016347, 81953016350,
81953016352, 82953016012, 88953016014,
N2953016001



MN-DL-2160

Length: 1652 Ø: 50
Cone Ø: d1 Ø 30 / d2 Ø 27
81467106112, 81467106163, 81467106165,
81467106198, 81467106353, 81467106354,
81467106361, 81467116725



MN-DL-2176

Length: 1628
Ø: 48
Cone Ø: d1 Ø 30 / d2 Ø 27
81466106779, 81466106780, 81466106782



MN-DL-3402

Length: 590 Ø: 48
Hole Distance: 130 / 130
03307200A, 81432206067, 81432206068,
81432206090, 81432206092, 81432209092



MN-DL-8197

Length: 1055
Ø: 42
Cone Ø: d1 Ø 30 / d2 Ø 27
03207500A, 81466116003, 81466116004,
81466116005



MN-DL-8609

Length: 585 Ø: 58
Hole Distance: 130 / 130
81432206070, 81432206071, 81432206072,
81432206091, 81432206093, 81432206119



MN-DL-12391

Length: 1050
Ø: 52
Cone Ø: d1 Ø 30 / d2 Ø 27
82466106057, 82466106147



MN-DL-12421

Length: 1070
Ø: 48
Cone Ø: d1 Ø 30 / d2 Ø 27
Thread: M30 x 1,5 RHT
81466106656, 81466106659, 81466106669,
81466116006, 81466116007



MN-SB-5244

Ø: 65
Hole Distance: 125
Thick/Height: 22
03312000A, 81432710027, 81432710082



MN-SB-10389

Ø: 70
Thick/Height: 72
81960200340



MN-SB-10390

Ø: 70
Thick/Height: 85/85
81960200341, 81960200373, 81960200385,
81960200408, 81960200418



SC-ES-8517

Length: 140
Cone Ø: d1 Ø 30 / d2 Ø 27
Thread: M30 x 1,5 RHT
81953016286





F 2000 ...

27.373 DFC ...

01/94 →	Centre Rod	MN-DL-12391		for Steering Rod
01/94 →	Centre Rod	MN-DL-12421		for Steering Rod
01/94 →	Engine Mounting		MN-SB-10390	
01/94 →	Mounting, stabilizer coupling rod	MN-SB-5246		
01/94 →	Suspension Arm Repair Kit		MN-SB-5244	for Wishbone (CV)
01/94 →	Suspension Arm Repair Kit		MN-SB-5244	for Wishbone (CV), 2nd RA
01/94 →	Suspension Strut Repair Kit		DB-RK-8581	
01/94 →	Tie Rod	MN-DL-12284		
01/94 →	Tie Rod End	CV-ES-2149		for Push Rod
01/94 →	Tie Rod End	CV-ES-14162		for Steering Rod
01/94 →	Tie Rod End	CV-ES-14163		for Steering Rod
01/94 →	Track Control Arm		MN-DL-3402	Trailing Arm, Drive Axle
01/94 →	Track Control Arm		MN-DL-8544	Trailing Arm, Drive Axle;Leaf Spring Axle
01/94 →	Track Control Arm		MN-DL-8609	Trailing Arm
01/94 →	Track Control Arm		MN-VB-8514	Suspension Rod, Wishbone (CV), Drive Axle; Leaf Spring Axle

27.373 DFK, DFK-KI, DFK-L, DF-KI

01/94 →	Ball Head, gearshift linkage	CV-ES-2119		
01/94 →	Ball Head, gearshift linkage	CV-ES-2120	CV-ES-2120	
01/94 →	Ball Head, gearshift linkage	CV-ES-2182		
01/94 →	Centre Rod	MN-DL-2160		Coupling Rod
01/94 →	Centre Rod	MN-DL-2176		Push Rod
01/94 →	Centre Rod	MN-DL-8197		Push Rod
01/94 →	Centre Rod	MN-DL-12391		for Steering Rod
01/94 →	Centre Rod	MN-DL-12421		for Steering Rod
01/94 →	Engine Mounting		MN-SB-10390	
01/94 →	Mounting, stabilizer coupling rod	MN-SB-5246		
01/94 →	Suspension Arm Repair Kit		MN-SB-5244	for Wishbone (CV)
01/94 →	Suspension Arm Repair Kit		MN-SB-5244	for Wishbone (CV), 2nd RA
01/94 →	Suspension Strut Repair Kit		DB-RK-8581	
01/94 →	Tie Rod	MN-DL-12284		
01/94 →	Tie Rod End	CV-ES-2149		for Push Rod
01/94 →	Tie Rod End	CV-ES-14162		for Steering Rod
01/94 →	Tie Rod End	CV-ES-14163		for Steering Rod
01/94 →	Track Control Arm		MN-DL-3402	Trailing Arm, Drive Axle
01/94 →	Track Control Arm		MN-DL-8544	Trailing Arm, Drive Axle;Leaf Spring Axle
01/94 →	Track Control Arm		MN-DL-8609	Trailing Arm
01/94 →	Track Control Arm		MN-VB-8514	Suspension Rod, Wishbone (CV), Drive Axle; Leaf Spring Axle

27.373 DFS

01/94 →	Ball Head, gearshift linkage	CV-ES-2119		
01/94 →	Ball Head, gearshift linkage	CV-ES-2120	CV-ES-2120	
01/94 →	Ball Head, gearshift linkage	CV-ES-2182		
01/94 →	Centre Rod	MN-DL-2160		Coupling Rod
01/94 →	Centre Rod	MN-DL-2176		Push Rod
01/94 →	Centre Rod	MN-DL-8197		Push Rod
01/94 →	Centre Rod	MN-DL-12391		for Steering Rod
01/94 →	Centre Rod	MN-DL-12421		for Steering Rod
01/94 →	Engine Mounting		MN-SB-10390	
01/94 →	Mounting, stabilizer coupling rod	MN-SB-5246		
01/94 →	Suspension Arm Repair Kit		MN-SB-5244	for Wishbone (CV)
01/94 →	Suspension Arm Repair Kit		MN-SB-5244	for Wishbone (CV), 2nd RA
01/94 →	Suspension Strut Repair Kit		DB-RK-8581	
01/94 →	Tie Rod	MN-DL-12284		
01/94 →	Tie Rod End	CV-ES-2149		for Push Rod
01/94 →	Tie Rod End	CV-ES-14162		for Steering Rod
01/94 →	Tie Rod End	CV-ES-14163		for Steering Rod
01/94 →	Track Control Arm		MN-DL-3402	Trailing Arm, Drive Axle
01/94 →	Track Control Arm		MN-DL-8544	Trailing Arm, Drive Axle;Leaf Spring Axle
01/94 →	Track Control Arm		MN-DL-8609	Trailing Arm
01/94 →	Track Control Arm		MN-VB-8514	Suspension Rod, Wishbone (CV), Drive Axle; Leaf Spring Axle

CV-ES-2119

Length: 55
Cone Ø: d1 Ø 10 / d2 Ø 10
Thread: M12 x 1,75 LHT
81953016063, 81953016131



CV-ES-2120

Length: 115
Cone Ø: d1 Ø 12,4 / d2 Ø 10,8
Thread: M14 x 1,5 RHT
03008500A, 81953016200, 81953016202,
81953016203, 81953016227



CV-ES-2149

Length: 160
Cone Ø: d1 Ø 30 / d2 Ø 27
Thread: M30 x 1,5 RHT
81953016263



CV-ES-2182

Length: 55
Cone Ø: d1 Ø 10 / d2 Ø 10
Thread: M12 x 1,75 RHT
81953016064, 81953016170



CV-ES-14162

Length: 125
Cone Ø: d1 Ø 30 / d2 Ø 27
Thread: M30 x 1,5 LHT

81953010015, 81953010083, 81953010087,
81953016029, 81953016030, 81953016043,
81953016044, 81953016050, 81953016054,
81953016087, 81953016091, 81953016107,
81953016120, 81953016125, 81953016152,
81953016155, 81953016157, 81953016168,
81953016179, 81953016181, 81953016223,
81953016237, 81953016254, 81953016275,
81953016279, 81953016351



CV-ES-14163

Length: 125
Cone Ø: d1 Ø 30 / d2 Ø 27
Thread: M30 x 1,5 RHT

95301.0084, 90804102156, 90804102272,
90804102696, 90804102710, 81953010016,
81953010075, 81953010084, 81953010088,
81953010094, 81953010103, 81953016030,
81953016043, 81953016048, 81953016049,
81953016053, 81953016061, 81953016090,
81953016108, 81953016112, 81953016126,
81953016143, 81953016149, 81953016154,
81953016156, 81953016168, 81953016178,
81953016194, 81953016206, 81953016224,
81953016234, 81953016242, 81953016252,
81953016274, 81953016278, 81953016284,
81953016286, 81953016308, 81953016310,
81953016312, 81953016347, 81953016350,
81953016352, 82953016012, 88953016014,
N2953016001



DB-RK-8581

Ø: 85
Hole Distance: 130
Thick/Height: 24
03305800A, 81432706105



MN-DL-2160

Length: 1652 Ø: 50
Cone Ø: d1 Ø 30 / d2 Ø 27
81467106112, 81467106163, 81467106165,
81467106198, 81467106353, 81467106354,
81467106361, 81467116725



MN-DL-2176

Length: 1628
Ø: 48
Cone Ø: d1 Ø 30 / d2 Ø 27
81466106779, 81466106780, 81466106782



MN-DL-3402

Length: 590 Ø: 48
Hole Distance: 130 / 130
03307200A, 81432206067, 81432206068,
81432206090, 81432206092, 81432209092



MN-DL-8197

Length: 1055
Ø: 42
Cone Ø: d1 Ø 30 / d2 Ø 27
03207500A, 81466116003, 81466116004,
81466116005



MN-DL-8544

Length: 596 Ø: 48
Hole Distance: 130 / 130
81432206196, 81432206232, 81432206233



MN-DL-8609

Length: 585 Ø: 58
Hole Distance: 130 / 130
81432206070, 81432206071, 81432206072,
81432206091, 81432206093, 81432206119



MN-DL-12284

Length: 1530 Ø: 50
Cone Ø: d1 Ø 30 / d2 Ø 27
81466106579, 81466106580, 81466106624,
81466116720, 81467116720, 81467116730,
81467116952



MN-DL-12391

Length: 1050
Ø: 52
Cone Ø: d1 Ø 30 / d2 Ø 27
82466106057, 82466106147



MN-DL-12421

Length: 1070
Ø: 48
Cone Ø: d1 Ø 30 / d2 Ø 27
Thread: M30 x 1,5 RHT
81466106656, 81466106659, 81466106669,
81466116006, 81466116007



MN-SB-5244

Ø: 65
Hole Distance: 125
Thick/Height: 22
03312000A, 81432710027, 81432710082



MN-SB-5246

Ø: 45 Thick/Height: 47
81437220022, 81437220038, 81962100450,
81962100469



MN-SB-10390

Ø: 70 Thick/Height: 85/85
81960200341, 81960200373, 81960200385,
81960200408, 81960200418



MN-VB-8514

Length: 627 Ø: 48
Hole Ø 25 / 25 / 25
Hole Distance: 152 / 130 / 130
81432706087, 81432706088, 81432706094,
81432706095, 81432796094





F 2000 ...

27.373 DF-TM	07/00→	Ball Head, gearshift linkage	CV-ES-2120	CV-ES-2120	
	07/00→	Centre Rod	MN-DL-8197		Push Rod
	07/00→	Centre Rod	MN-DL-12391		for Steering Rod
	07/00→	Centre Rod	MN-DL-12421		for Steering Rod
	07/00→	Mounting, stabilizer coupling rod	MN-SB-5246		
	07/00→	Suspension Arm Repair Kit		MN-SB-5244	for Wishbone (CV)
	07/00→	Tie Rod	MN-DL-12284		
	07/00→	Tie Rod End	CV-ES-2149		for Push Rod
	07/00→	Tie Rod End	CV-ES-14162		for Steering Rod
	07/00→	Tie Rod End	CV-ES-14163		for Steering Rod
	07/00→	Track Control Arm		MN-DL-3402	Trailing Arm
	07/00→	Track Control Arm		MN-DL-8544	Trailing Arm
	07/00→	Track Control Arm		MN-DL-8609	Trailing Arm
	07/00→	Track Control Arm		MN-VB-8514	Suspension Rod, Wishbone (CV)
27.403 DFAC	01/94→	Ball Head, gearshift linkage	CV-ES-2119		
	01/94→	Ball Head, gearshift linkage	CV-ES-2120		
	01/94→	Ball Head, gearshift linkage	CV-ES-2182		
	01/94→	Centre Rod	MN-DL-2160		Coupling Rod
	01/94→	Centre Rod	MN-DL-2176		Push Rod
	01/94→	Centre Rod	MN-DL-12391		for Steering Rod
	01/94→	Centre Rod	MN-DL-12421		for Steering Rod
	01/94→	Engine Mounting		MN-SB-10390	
	01/94→	Engine Mounting	MN-SB-10389		
	01/94→	Suspension Arm Repair Kit		MN-SB-5244	for Wishbone (CV)
	01/94→	Suspension Arm Repair Kit		MN-SB-5244	for Wishbone (CV), 1st RA
	01/94→	Suspension Arm Repair Kit		MN-SB-5244	for Wishbone (CV), 2nd RA
	01/94→	Tie Rod End	CV-ES-2146		
	01/94→	Tie Rod End	CV-ES-2149		for Push Rod
	01/94→	Tie Rod End	CV-ES-14162		for Steering Rod
	01/94→	Tie Rod End	CV-ES-14163		for Steering Rod
	01/94→	Tie Rod End	SC-ES-8517		for Push Rod
	01/94→	Track Control Arm		MN-DL-3402	Trailing Arm, Drive Axle
	01/94→	Track Control Arm		MN-DL-8609	Trailing Arm
	27.403 DFAK, DFA-KI, DFAK-L	01/94→	Ball Head, gearshift linkage	CV-ES-2119	
01/94→		Ball Head, gearshift linkage	CV-ES-2120		
01/94→		Ball Head, gearshift linkage	CV-ES-2182		
01/94→		Centre Rod	MN-DL-2160		Coupling Rod
01/94→		Centre Rod	MN-DL-2176		Push Rod
01/94→		Centre Rod	MN-DL-12391		for Steering Rod
01/94→		Centre Rod	MN-DL-12421		for Steering Rod
01/94→		Engine Mounting		MN-SB-10390	
01/94→		Engine Mounting	MN-SB-10389		
01/94→		Suspension Arm Repair Kit		MN-SB-5244	for Wishbone (CV)
01/94→		Suspension Arm Repair Kit		MN-SB-5244	for Wishbone (CV), 1st RA
01/94→		Suspension Arm Repair Kit		MN-SB-5244	for Wishbone (CV), 2nd RA
01/94→		Tie Rod End	CV-ES-2146		
01/94→		Tie Rod End	CV-ES-2149		for Push Rod
01/94→		Tie Rod End	CV-ES-14162		for Steering Rod
01/94→		Tie Rod End	CV-ES-14163		for Steering Rod
01/94→		Tie Rod End	SC-ES-8517		for Push Rod
01/94→		Track Control Arm		MN-DL-3402	Trailing Arm, Drive Axle
01/94→		Track Control Arm		MN-DL-8609	Trailing Arm
27.403 DFAS		01/94→	Ball Head, gearshift linkage	CV-ES-2119	
	01/94→	Ball Head, gearshift linkage	CV-ES-2120		
	01/94→	Ball Head, gearshift linkage	CV-ES-2182		
	01/94→	Centre Rod	MN-DL-2160		Coupling Rod
	01/94→	Centre Rod	MN-DL-2176		Push Rod
	01/94→	Centre Rod	MN-DL-12391		for Steering Rod
	01/94→	Centre Rod	MN-DL-12421		for Steering Rod
	01/94→	Engine Mounting		MN-SB-10390	
	01/94→	Engine Mounting	MN-SB-10389		
	01/94→	Suspension Arm Repair Kit		MN-SB-5244	for Wishbone (CV)
	01/94→	Suspension Arm Repair Kit		MN-SB-5244	for Wishbone (CV), 1st RA

CV-ES-2119

Length: 55
Cone Ø: d1 Ø 10 / d2 Ø 10
Thread: M12 x 1,75 LHT
81953016063, 81953016131



CV-ES-2120

Length: 115
Cone Ø: d1 Ø 12,4 / d2 Ø 10,8
Thread: M14 x 1,5 RHT
03008500A, 81953016200, 81953016202,
81953016203, 81953016227



CV-ES-2146

Length: 80
Cone Ø: d1 Ø 30 / d2 Ø 27
Thread: M26 x 1,5 RHT
42533102, 81953016219, 81953016225,
81953016226, 81953016267, 81953016291



CV-ES-2149

Length: 160
Cone Ø: d1 Ø 30 / d2 Ø 27
Thread: M30 x 1,5 RHT
81953016263



CV-ES-2182

Length: 55
Cone Ø: d1 Ø 10 / d2 Ø 10
Thread: M12 x 1,75 RHT
81953016064, 81953016170



CV-ES-14162

Length: 125
Cone Ø: d1 Ø 30 / d2 Ø 27
Thread: M30 x 1,5 LHT
81953010015, 81953010083, 81953010087,
81953016029, 81953016030, 81953016043,
81953016044, 81953016050, 81953016054,
81953016087, 81953016091, 81953016107,
81953016120, 81953016125, 81953016152,
81953016155, 81953016157, 81953016168,
81953016179, 81953016181, 81953016223,
81953016237, 81953016254, 81953016275,
81953016279, 81953016351



CV-ES-14163

Length: 125
Cone Ø: d1 Ø 30 / d2 Ø 27
Thread: M30 x 1,5 RHT
95301.0084, 90804102156, 90804102272,
90804102696, 90804102710, 81953010016,
81953010075, 81953010084, 81953010088,
81953010094, 81953010103, 81953016030,
81953016043, 81953016048, 81953016049,
81953016053, 81953016061, 81953016090,
81953016108, 81953016112, 81953016126,
81953016143, 81953016149, 81953016154,
81953016156, 81953016168, 81953016178,
81953016194, 81953016206, 81953016224,
81953016234, 81953016242, 81953016252,
81953016274, 81953016278, 81953016284,
81953016286, 81953016308, 81953016310,
81953016312, 81953016347, 81953016350,
81953016352, 82953016012, 88953016014,
N2953016001



MN-DL-2160

Length: 1652 Ø: 50
Cone Ø: d1 Ø 30 / d2 Ø 27
81467106112, 81467106163, 81467106165,
81467106198, 81467106353, 81467106354,
81467106361, 81467116725



MN-DL-2176

Length: 1628 Ø: 48
Cone Ø: d1 Ø 30 / d2 Ø 27
81466106779, 81466106780, 81466106782



MN-DL-3402

Length: 590 Ø: 48
Hole Distance: 130 / 130
03307200A, 81432206067, 81432206068,
81432206090, 81432206092, 81432209092



MN-DL-8197

Length: 1055 Ø: 42
Cone Ø: d1 Ø 30 / d2 Ø 27
03207500A, 81466116003, 81466116004,
81466116005



MN-DL-8544

Length: 596 Ø: 48
Hole Distance: 130 / 130
81432206196, 81432206232, 81432206233



MN-DL-8609

Length: 585 Ø: 58
Hole Distance: 130 / 130
81432206070, 81432206071, 81432206072,
81432206091, 81432206093, 81432206119



MN-DL-12284

Length: 1530 Ø: 50
Cone Ø: d1 Ø 30 / d2 Ø 27
81466106579, 81466106580, 81466106624,
81466116720, 81467116720, 81467116730,
81467116952



MN-DL-12391

Length: 1050 Ø: 52
Cone Ø: d1 Ø 30 / d2 Ø 27
82466106057, 82466106147



MN-DL-12421

Length: 1070
Ø: 48
Cone Ø: d1 Ø 30 / d2 Ø 27
Thread: M30 x 1,5 RHT
81466106656, 81466106659, 81466106669,
81466116006, 81466116007



MN-SB-5244

Ø: 65
Hole Distance: 125
Thick/Height: 22
03312000A, 81432710027, 81432710082



MN-SB-5246

Ø: 45 Thick/Height: 47
81437220022, 81437220038, 81962100450,
81962100469



MN-SB-10389

Ø: 70 Thick/Height: 72
81960200340



MN-SB-10390

Ø: 70 Thick/Height: 85/85
81960200341, 81960200373, 81960200385,
81960200408, 81960200418



MN-VB-8514

Length: 627 Ø: 48
Hole Ø 25 / 25 / 25
Hole Distance: 152 / 130 / 130
81432706087, 81432706088, 81432706094,
81432706095, 81432796094



SC-ES-8517

Length: 140
Cone Ø: d1 Ø 30 / d2 Ø 27
Thread: M30 x 1,5 RHT
81953016286





F 2000 ...

27.403 DFAS ...	01/94 →	Suspension Arm Repair Kit		MN-SB-5244	for Wishbone (CV), 2nd RA
	01/94 →	Tie Rod End	CV-ES-2146		
	01/94 →	Tie Rod End	CV-ES-2149		for Push Rod
	01/94 →	Tie Rod End	CV-ES-14162		for Steering Rod
	01/94 →	Tie Rod End	CV-ES-14163		for Steering Rod
	01/94 →	Tie Rod End	SC-ES-8517		for Push Rod
	01/94 →	Track Control Arm		MN-DL-3402	Trailing Arm, Drive Axle
	01/94 →	Track Control Arm		MN-DL-8609	Trailing Arm
27.403 DFC	01/94 →	Ball Head, gearshift linkage	CV-ES-2119		
	01/94 →	Ball Head, gearshift linkage	CV-ES-2120	CV-ES-2120	
	01/94 →	Ball Head, gearshift linkage	CV-ES-2182		
	01/94 →	Centre Rod	MN-DL-2160		Coupling Rod
	01/94 →	Centre Rod	MN-DL-2176		Push Rod
	01/94 →	Centre Rod	MN-DL-8197		Push Rod
	01/94 →	Centre Rod	MN-DL-12391		for Steering Rod
	01/94 →	Centre Rod	MN-DL-12421		for Steering Rod
	01/94 →	Engine Mounting		MN-SB-10390	
	01/94 →	Mounting, stabilizer coupling rod	MN-SB-5246		
	01/94 →	Suspension Arm Repair Kit		MN-SB-5244	for Wishbone (CV)
	01/94 →	Suspension Arm Repair Kit		MN-SB-5244	for Wishbone (CV), 2nd RA
	01/94 →	Suspension Strut Repair Kit		DB-RK-8581	
	01/94 →	Tie Rod	MN-DL-12284		
	01/94 →	Tie Rod End	CV-ES-2146		
	01/94 →	Tie Rod End	CV-ES-2149		for Push Rod
	01/94 →	Tie Rod End	CV-ES-14162		for Steering Rod
	01/94 →	Tie Rod End	CV-ES-14163		for Steering Rod
	01/94 →	Track Control Arm		MN-DL-3402	Trailing Arm, Drive Axle
	01/94 →	Track Control Arm		MN-DL-8544	Trailing Arm, Drive Axle;Leaf Spring Axle
	01/94 →	Track Control Arm		MN-DL-8609	Trailing Arm
01/94 →	Track Control Arm		MN-VB-8514	Suspension Rod, Wishbone (CV), Drive Axle; Leaf Spring Axle	
27.403 DFK, DFK-KI, DFK-L, DF-KI	01/94 →	Ball Head, gearshift linkage	CV-ES-2119		
	01/94 →	Ball Head, gearshift linkage	CV-ES-2120	CV-ES-2120	
	01/94 →	Ball Head, gearshift linkage	CV-ES-2182		
	01/94 →	Centre Rod	MN-DL-2160		Coupling Rod
	01/94 →	Centre Rod	MN-DL-2176		Push Rod
	01/94 →	Centre Rod	MN-DL-8197		Push Rod
	01/94 →	Centre Rod	MN-DL-12391		for Steering Rod
	01/94 →	Centre Rod	MN-DL-12421		for Steering Rod
	01/94 →	Engine Mounting		MN-SB-10390	
	01/94 →	Mounting, stabilizer coupling rod	MN-SB-5246		
	01/94 →	Suspension Arm Repair Kit		MN-SB-5244	for Wishbone (CV)
	01/94 →	Suspension Arm Repair Kit		MN-SB-5244	for Wishbone (CV), 2nd RA
	01/94 →	Suspension Strut Repair Kit		DB-RK-8581	
	01/94 →	Tie Rod	MN-DL-12284		
	01/94 →	Tie Rod End	CV-ES-2146		
	01/94 →	Tie Rod End	CV-ES-2149		for Push Rod
	01/94 →	Tie Rod End	CV-ES-14162		for Steering Rod
	01/94 →	Tie Rod End	CV-ES-14163		for Steering Rod
	01/94 →	Track Control Arm		MN-DL-3402	Trailing Arm, Drive Axle
	01/94 →	Track Control Arm		MN-DL-8544	Trailing Arm, Drive Axle;Leaf Spring Axle
	01/94 →	Track Control Arm		MN-DL-8609	Trailing Arm
01/94 →	Track Control Arm		MN-VB-8514	Suspension Rod, Wishbone (CV), Drive Axle; Leaf Spring Axle	
27.403 DFS	01/94 →	Ball Head, gearshift linkage	CV-ES-2119		
	01/94 →	Ball Head, gearshift linkage	CV-ES-2120	CV-ES-2120	
	01/94 →	Ball Head, gearshift linkage	CV-ES-2182		
	01/94 →	Centre Rod	MN-DL-2160		Coupling Rod
	01/94 →	Centre Rod	MN-DL-2176		Push Rod
	01/94 →	Centre Rod	MN-DL-8197		Push Rod
	01/94 →	Centre Rod	MN-DL-12391		for Steering Rod
	01/94 →	Centre Rod	MN-DL-12421		for Steering Rod
01/94 →	Engine Mounting		MN-SB-10390		

CV-ES-2119

Length: 55
Cone Ø: d1 Ø 10 / d2 Ø 10
Thread: M12 x 1,75 LHT
81953016063, 81953016131



CV-ES-2120

Length: 115
Cone Ø: d1 Ø 12,4 / d2 Ø 10,8
Thread: M14 x 1,5 RHT
03008500A, 81953016200, 81953016202,
81953016203, 81953016227



CV-ES-2146

Length: 80
Cone Ø: d1 Ø 30 / d2 Ø 27
Thread: M26 x 1,5 RHT
42533102, 81953016219, 81953016225,
81953016226, 81953016267, 81953016291



CV-ES-2149

Length: 160
Cone Ø: d1 Ø 30 / d2 Ø 27
Thread: M30 x 1,5 RHT
81953016263



CV-ES-2182

Length: 55
Cone Ø: d1 Ø 10 / d2 Ø 10
Thread: M12 x 1,75 RHT
81953016064, 81953016170



CV-ES-14162

Length: 125
Cone Ø: d1 Ø 30 / d2 Ø 27
Thread: M30 x 1,5 LHT
81953010015, 81953010083, 81953010087,
81953016029, 81953016030, 81953016043,
81953016044, 81953016050, 81953016054,
81953016087, 81953016091, 81953016107,
81953016120, 81953016125, 81953016152,
81953016155, 81953016157, 81953016168,
81953016179, 81953016181, 81953016223,
81953016237, 81953016254, 81953016275,
81953016279, 81953016351



CV-ES-14163

Length: 125
Cone Ø: d1 Ø 30 / d2 Ø 27
Thread: M30 x 1,5 RHT
95301.0084, 90804102156, 90804102272,
90804102696, 90804102710, 81953010016,
81953010075, 81953010084, 81953010088,
81953010094, 81953010103, 81953016030,
81953016043, 81953016048, 81953016049,
81953016053, 81953016061, 81953016090,
81953016108, 81953016112, 81953016126,
81953016143, 81953016149, 81953016154,
81953016156, 81953016168, 81953016178,
81953016194, 81953016206, 81953016224,
81953016234, 81953016242, 81953016252,
81953016274, 81953016278, 81953016284,
81953016286, 81953016308, 81953016310,
81953016312, 81953016347, 81953016350,
81953016352, 82953016012, 88953016014,
N2953016001



DB-RK-8581

Ø: 85
Hole Distance: 130
Thick/Height: 24
03305800A, 81432706105



MN-DL-2160

Length: 1652 Ø: 50
Cone Ø: d1 Ø 30 / d2 Ø 27
81467106112, 81467106163, 81467106165,
81467106198, 81467106353, 81467106354,
81467106361, 81467116725



MN-DL-2176

Length: 1628 Ø: 48
Cone Ø: d1 Ø 30 / d2 Ø 27
81466106779, 81466106780, 81466106782



MN-DL-3402

Length: 590 Ø: 48
Hole Distance: 130 / 130
03307200A, 81432206067, 81432206068,
81432206090, 81432206092, 81432209092



MN-DL-8197

Length: 1055 Ø: 42
Cone Ø: d1 Ø 30 / d2 Ø 27
03207500A, 81466116003, 81466116004,
81466116005



MN-DL-8544

Length: 596 Ø: 48
Hole Distance: 130 / 130
81432206196, 81432206232, 81432206233



MN-DL-8609

Length: 585 Ø: 58
Hole Distance: 130 / 130
81432206070, 81432206071, 81432206072,
81432206091, 81432206093, 81432206119



MN-DL-12284

Length: 1530 Ø: 50
Cone Ø: d1 Ø 30 / d2 Ø 27
81466106579, 81466106580, 81466106624,
81466116720, 81467116720, 81467116730,
81467116952



MN-DL-12391

Length: 1050 Ø: 52
Cone Ø: d1 Ø 30 / d2 Ø 27
82466106057, 82466106147



MN-DL-12421

Length: 1070 Ø: 48
Cone Ø: d1 Ø 30 / d2 Ø 27
Thread: M30 x 1,5 RHT
81466106656, 81466106659, 81466106669,
81466116006, 81466116007



MN-SB-5244

Ø: 65
Hole Distance: 125
Thick/Height: 22
03312000A, 81432710027, 81432710082



MN-SB-5246

Ø: 45 Thick/Height: 47
81437220022, 81437220038, 81962100450,
81962100469



MN-SB-10390

Ø: 70 Thick/Height: 85/85
81960200341, 81960200373, 81960200385,
81960200408, 81960200418



MN-VB-8514

Length: 627 Ø: 48
Hole Ø 25 / 25 / 25
Hole Distance: 152 / 130 / 130
81432706087, 81432706088, 81432706094,
81432706095, 81432796094



SC-ES-8517

Length: 140
Cone Ø: d1 Ø 30 / d2 Ø 27
Thread: M30 x 1,5 RHT
81953016286





F 2000 ...

27.403 DFS ...	01/94 →	Mounting, stabilizer coupling rod	MN-SB-5246		
	01/94 →	Suspension Arm Repair Kit		MN-SB-5244	for Wishbone (CV)
	01/94 →	Suspension Arm Repair Kit		MN-SB-5244	for Wishbone (CV), 2nd RA
	01/94 →	Suspension Strut Repair Kit		DB-RK-8581	
	01/94 →	Tie Rod	MN-DL-12284		
	01/94 →	Tie Rod End	CV-ES-2146		
	01/94 →	Tie Rod End	CV-ES-2149		for Push Rod
	01/94 →	Tie Rod End	CV-ES-14162		for Steering Rod
	01/94 →	Tie Rod End	CV-ES-14163		for Steering Rod
	01/94 →	Track Control Arm		MN-DL-3402	Trailing Arm, Drive Axle
	01/94 →	Track Control Arm		MN-DL-8544	Trailing Arm, Drive Axle; Leaf Spring Axle
	01/94 →	Track Control Arm		MN-DL-8609	Trailing Arm
	01/94 →	Track Control Arm		MN-VB-8514	Suspension Rod, Wishbone (CV), Drive Axle; Leaf Spring Axle
27.403 DF-TM	07/00 →	Ball Head, gearshift linkage	CV-ES-2120	CV-ES-2120	
	07/00 →	Centre Rod	MN-DL-8197		Push Rod
	07/00 →	Centre Rod	MN-DL-12391		for Steering Rod
	07/00 →	Centre Rod	MN-DL-12421		for Steering Rod
	07/00 →	Mounting, stabilizer coupling rod	MN-SB-5246		
	07/00 →	Suspension Arm Repair Kit		MN-SB-5244	for Wishbone (CV)
	07/00 →	Tie Rod	MN-DL-12284		
	07/00 →	Tie Rod End	CV-ES-2149		for Push Rod
	07/00 →	Tie Rod End	CV-ES-14162		for Steering Rod
	07/00 →	Tie Rod End	CV-ES-14163		for Steering Rod
	07/00 →	Track Control Arm		MN-DL-3402	Trailing Arm
	07/00 →	Track Control Arm		MN-DL-8544	Trailing Arm
	07/00 →	Track Control Arm		MN-DL-8609	Trailing Arm
07/00 →	Track Control Arm		MN-VB-8514	Suspension Rod, Wishbone (CV)	
27.414 DFAC	05/01 →	Ball Head, gearshift linkage	CV-ES-2120		
	05/01 →	Centre Rod	MN-DL-12391		for Steering Rod
	05/01 →	Centre Rod	MN-DL-12421		for Steering Rod
	05/01 →	Suspension Arm Repair Kit		MN-SB-5244	for Wishbone (CV)
	05/01 →	Tie Rod End	CV-ES-2146		
	05/01 →	Tie Rod End	CV-ES-14162		for Steering Rod
	05/01 →	Tie Rod End	CV-ES-14163		for Steering Rod
	05/01 →	Track Control Arm		MN-DL-3402	Trailing Arm
05/01 →	Track Control Arm		MN-DL-8609	Trailing Arm	
27.414 DFAK, DFA-KI, DFAK-L	05/01 →	Ball Head, gearshift linkage	CV-ES-2120		
	05/01 →	Centre Rod	MN-DL-12391		for Steering Rod
	05/01 →	Centre Rod	MN-DL-12421		for Steering Rod
	05/01 →	Suspension Arm Repair Kit		MN-SB-5244	for Wishbone (CV)
	05/01 →	Tie Rod End	CV-ES-2146		
	05/01 →	Tie Rod End	CV-ES-14162		for Steering Rod
	05/01 →	Tie Rod End	CV-ES-14163		for Steering Rod
	05/01 →	Track Control Arm		MN-DL-3402	Trailing Arm
05/01 →	Track Control Arm		MN-DL-8609	Trailing Arm	
27.414 DFAS	05/01 →	Ball Head, gearshift linkage	CV-ES-2120		
	05/01 →	Centre Rod	MN-DL-12391		for Steering Rod
	05/01 →	Centre Rod	MN-DL-12421		for Steering Rod
	05/01 →	Suspension Arm Repair Kit		MN-SB-5244	for Wishbone (CV)
	05/01 →	Tie Rod End	CV-ES-2146		
	05/01 →	Tie Rod End	CV-ES-14162		for Steering Rod
	05/01 →	Tie Rod End	CV-ES-14163		for Steering Rod
	05/01 →	Track Control Arm		MN-DL-3402	Trailing Arm
05/01 →	Track Control Arm		MN-DL-8609	Trailing Arm	
27.414 DFC	05/01 →	Ball Head, gearshift linkage	CV-ES-2120	CV-ES-2120	
	05/01 →	Centre Rod	MN-DL-8197		Push Rod
	05/01 →	Centre Rod	MN-DL-12391		for Steering Rod
	05/01 →	Centre Rod	MN-DL-12421		for Steering Rod
	05/01 →	Mounting, stabilizer coupling rod	MN-SB-5246		
	05/01 →	Suspension Arm Repair Kit		MN-SB-5244	for Wishbone (CV)
	05/01 →	Tie Rod	MN-DL-12284		
	05/01 →	Tie Rod End	CV-ES-2149		for Push Rod

CV-ES-2120

Length: 115
Cone Ø: d1 Ø 12,4 / d2 Ø 10,8
Thread: M14 x 1,5 RHT
03008500A, 81953016200, 81953016202, 81953016203, 81953016227



CV-ES-2146

Length: 80
Cone Ø: d1 Ø 30 / d2 Ø 27
Thread: M26 x 1,5 RHT
42533102, 81953016219, 81953016225, 81953016226, 81953016267, 81953016291



CV-ES-2149

Length: 160
Cone Ø: d1 Ø 30 / d2 Ø 27
Thread: M30 x 1,5 RHT
81953016263



CV-ES-14162

Length: 125
Cone Ø: d1 Ø 30 / d2 Ø 27
Thread: M30 x 1,5 LHT
81953010015, 81953010083, 81953010087, 81953016029, 81953016030, 81953016043, 81953016044, 81953016050, 81953016054, 81953016087, 81953016091, 81953016107, 81953016120, 81953016125, 81953016152, 81953016155, 81953016157, 81953016168, 81953016179, 81953016181, 81953016223, 81953016237, 81953016254, 81953016275, 81953016279, 81953016351



CV-ES-14163

Length: 125
Cone Ø: d1 Ø 30 / d2 Ø 27
Thread: M30 x 1,5 RHT
95301.0084, 90804102156, 90804102272, 90804102696, 90804102710, 81953010016, 81953010075, 81953010084, 81953010088, 81953010094, 81953010103, 81953016030, 81953016043, 81953016048, 81953016049, 81953016053, 81953016061, 81953016090, 81953016108, 81953016112, 81953016126, 81953016143, 81953016149, 81953016154, 81953016156, 81953016168, 81953016178, 81953016194, 81953016206, 81953016224, 81953016234, 81953016242, 81953016252, 81953016274, 81953016278, 81953016284, 81953016286, 81953016308, 81953016310, 81953016312, 81953016347, 81953016350, 81953016352, 82953016012, 88953016014, N2953016001



DB-RK-8581

Ø: 85
Hole Distance: 130
Thick/Height: 24
03305800A, 81432706105



MN-DL-3402

Length: 590 Ø: 48
Hole Distance: 130 / 130
03307200A, 81432206067, 81432206068, 81432206090, 81432206092, 81432209092



MN-DL-8197

Length: 1055 Ø: 42
Cone Ø: d1 Ø 30 / d2 Ø 27
03207500A, 81466116003, 81466116004, 81466116005



MN-DL-8544

Length: 596 Ø: 48
Hole Distance: 130 / 130
81432206196, 81432206232, 81432206233



MN-DL-8609

Length: 585 Ø: 58
Hole Distance: 130 / 130
81432206070, 81432206071, 81432206072, 81432206091, 81432206093, 81432206119



MN-DL-12284

Length: 1530 Ø: 50
Cone Ø: d1 Ø 30 / d2 Ø 27
81466106579, 81466106580, 81466106624, 81466116720, 81467116720, 81467116730, 81467116952



MN-DL-12391

Length: 1050 Ø: 52
Cone Ø: d1 Ø 30 / d2 Ø 27
82466106057, 82466106147



MN-DL-12421

Length: 1070 Ø: 48
Cone Ø: d1 Ø 30 / d2 Ø 27
Thread: M30 x 1,5 RHT
81466106656, 81466106659, 81466106669, 81466116006, 81466116007



MN-SB-5244

Ø: 65
Hole Distance: 125
Thick/Height: 22
03312000A, 81432710027, 81432710082



MN-SB-5246

Ø: 45 Thick/Height: 47
81437220022, 81437220038, 81962100450, 81962100469



MN-VB-8514

Length: 627 Ø: 48
Hole Ø 25 / 25 / 25
Hole Distance: 152 / 130 / 130
81432706087, 81432706088, 81432706094, 81432706095, 81432796094





F 2000 ...

27.414 DFC ...	05/01→	Tie Rod End	CV-ES-14162		for Steering Rod
	05/01→	Tie Rod End	CV-ES-14163		for Steering Rod
	05/01→	Track Control Arm		MN-DL-3402	Trailing Arm
	05/01→	Track Control Arm		MN-DL-8544	Trailing Arm
	05/01→	Track Control Arm		MN-DL-8609	Trailing Arm
	05/01→	Track Control Arm		MN-VB-8514	Suspension Rod, Wishbone (CV)
27.414 DFK, DFK-KI, DFK-L, DF-KI	05/01→	Ball Head, gearshift linkage	CV-ES-2120	CV-ES-2120	
	05/01→	Centre Rod	MN-DL-8197		Push Rod
	05/01→	Centre Rod	MN-DL-12391		for Steering Rod
	05/01→	Centre Rod	MN-DL-12421		for Steering Rod
	05/01→	Mounting, stabilizer coupling rod	MN-SB-5246		
	05/01→	Suspension Arm Repair Kit		MN-SB-5244	for Wishbone (CV)
	05/01→	Tie Rod	MN-DL-12284		
	05/01→	Tie Rod End	CV-ES-2149		for Push Rod
	05/01→	Tie Rod End	CV-ES-14162		for Steering Rod
	05/01→	Tie Rod End	CV-ES-14163		for Steering Rod
	05/01→	Track Control Arm		MN-DL-3402	Trailing Arm
	05/01→	Track Control Arm		MN-DL-8544	Trailing Arm
	05/01→	Track Control Arm		MN-DL-8609	Trailing Arm
	05/01→	Track Control Arm		MN-VB-8514	Suspension Rod, Wishbone (CV)
	27.414 DFS	05/01→	Ball Head, gearshift linkage	CV-ES-2120	CV-ES-2120
05/01→		Centre Rod	MN-DL-8197		Push Rod
05/01→		Centre Rod	MN-DL-12391		for Steering Rod
05/01→		Centre Rod	MN-DL-12421		for Steering Rod
05/01→		Mounting, stabilizer coupling rod	MN-SB-5246		
05/01→		Suspension Arm Repair Kit		MN-SB-5244	for Wishbone (CV)
05/01→		Tie Rod	MN-DL-12284		
05/01→		Tie Rod End	CV-ES-2149		for Push Rod
05/01→		Tie Rod End	CV-ES-14162		for Steering Rod
05/01→		Tie Rod End	CV-ES-14163		for Steering Rod
05/01→		Track Control Arm		MN-DL-3402	Trailing Arm
05/01→		Track Control Arm		MN-DL-8544	Trailing Arm
05/01→		Track Control Arm		MN-DL-8609	Trailing Arm
05/01→		Track Control Arm		MN-VB-8514	Suspension Rod, Wishbone (CV)
27.414 DF-TM		05/01→	Ball Head, gearshift linkage	CV-ES-2120	CV-ES-2120
	05/01→	Centre Rod	MN-DL-8197		Push Rod
	05/01→	Centre Rod	MN-DL-12391		for Steering Rod
	05/01→	Centre Rod	MN-DL-12421		for Steering Rod
	05/01→	Mounting, stabilizer coupling rod	MN-SB-5246		
	05/01→	Suspension Arm Repair Kit		MN-SB-5244	for Wishbone (CV)
	05/01→	Tie Rod	MN-DL-12284		
	05/01→	Tie Rod End	CV-ES-2149		for Push Rod
	05/01→	Tie Rod End	CV-ES-14162		for Steering Rod
	05/01→	Tie Rod End	CV-ES-14163		for Steering Rod
	05/01→	Track Control Arm		MN-DL-3402	Trailing Arm
	05/01→	Track Control Arm		MN-DL-8544	Trailing Arm
	05/01→	Track Control Arm		MN-DL-8609	Trailing Arm
	05/01→	Track Control Arm		MN-VB-8514	Suspension Rod, Wishbone (CV)
	27.414 FVL	06/98→	Ball Head, gearshift linkage	CV-ES-2120	
06/98→		Centre Rod	MN-DL-8197		Push Rod
06/98→		Centre Rod	MN-DL-8487		Push Rod
06/98→		Track Control Arm		MN-DL-5212	Trailing Arm
27.423 DFAC	01/94→	Ball Head, gearshift linkage	CV-ES-2119		
	01/94→	Ball Head, gearshift linkage	CV-ES-2120		
	01/94→	Ball Head, gearshift linkage	CV-ES-2182		
	01/94→	Centre Rod	MN-DL-2160		Coupling Rod
	01/94→	Centre Rod	MN-DL-2176		Push Rod
	01/94→	Centre Rod	MN-DL-12391		for Steering Rod
	01/94→	Centre Rod	MN-DL-12421		for Steering Rod
	01/94→	Engine Mounting		MN-SB-10390	
	01/94→	Engine Mounting	MN-SB-10389		
	01/94→	Suspension Arm Repair Kit		MN-SB-5244	for Wishbone (CV)
01/94→	Suspension Arm Repair Kit		MN-SB-5244	for Wishbone (CV), 1st RA	

CV-ES-2119

Length: 55
Cone Ø: d1 Ø 10 / d2 Ø 10
Thread: M12 x 1,75 LHT
81953016063, 81953016131



CV-ES-2120

Length: 115
Cone Ø: d1 Ø 12,4 / d2 Ø 10,8
Thread: M14 x 1,5 RHT
03008500A, 81953016200, 81953016202,
81953016203, 81953016227



CV-ES-2149

Length: 160
Cone Ø: d1 Ø 30 / d2 Ø 27
Thread: M30 x 1,5 RHT
81953016263



CV-ES-2182

Length: 55
Cone Ø: d1 Ø 10 / d2 Ø 10
Thread: M12 x 1,75 RHT
81953016064, 81953016170



CV-ES-14162

Length: 125
Cone Ø: d1 Ø 30 / d2 Ø 27
Thread: M30 x 1,5 LHT
81953010015, 81953010083, 81953010087,
81953016029, 81953016030, 81953016043,
81953016044, 81953016050, 81953016054,
81953016087, 81953016091, 81953016107,
81953016120, 81953016125, 81953016152,
81953016155, 81953016157, 81953016168,
81953016179, 81953016181, 81953016223,
81953016237, 81953016254, 81953016275,
81953016279, 81953016351



CV-ES-14163

Length: 125
Cone Ø: d1 Ø 30 / d2 Ø 27
Thread: M30 x 1,5 RHT
95301.0084, 90804102156, 90804102272,
90804102696, 90804102710, 81953010016,
81953010075, 81953010084, 81953010088,
81953010094, 81953010103, 81953016030,
81953016043, 81953016048, 81953016049,
81953016053, 81953016061, 81953016090,
81953016108, 81953016112, 81953016126,
81953016143, 81953016149, 81953016154,
81953016156, 81953016168, 81953016178,
81953016194, 81953016206, 81953016224,
81953016234, 81953016242, 81953016252,
81953016274, 81953016278, 81953016284,
81953016286, 81953016308, 81953016310,
81953016312, 81953016347, 81953016350,
81953016352, 82953016012, 88953016014,
N2953016001



MN-DL-2160

Length: 1652 Ø: 50
Cone Ø: d1 Ø 30 / d2 Ø 27
81467106112, 81467106163, 81467106165,
81467106198, 81467106353, 81467106354,
81467106361, 81467116725



MN-DL-2176

Length: 1628
Ø: 48
Cone Ø: d1 Ø 30 / d2 Ø 27
81466106779, 81466106780, 81466106782



MN-DL-3402

Length: 590 Ø: 48
Hole Distance: 130 / 130
03307200A, 81432206067, 81432206068,
81432206090, 81432206092, 81432209092



MN-DL-5212

Length: 577 Ø: 48
Hole Distance: 130 / 130
81432206096, 81432206097, 81432206098,
81432206129, 81432209096, 81432209129,
81432306014, 81432306030



MN-DL-8197

Length: 1055
Ø: 42
Cone Ø: d1 Ø 30 / d2 Ø 27
03207500A, 81466116003, 81466116004,
81466116005



MN-DL-8487

Length: 900
Ø: 38
Cone Ø: d1 Ø 30 / d2 Ø 27
81466106767, 81466106768, 81466106774,
81466116014



MN-DL-8544

Length: 596 Ø: 48
Hole Distance: 130 / 130
81432206196, 81432206232, 81432206233



MN-DL-8609

Length: 585 Ø: 58
Hole Distance: 130 / 130
81432206070, 81432206071, 81432206072,
81432206091, 81432206093, 81432206119



MN-DL-12284

Length: 1530 Ø: 50
Cone Ø: d1 Ø 30 / d2 Ø 27
81466106579, 81466106580, 81466106624,
81466116720, 81467116720, 81467116730,
81467116952



MN-DL-12391

Length: 1050
Ø: 52
Cone Ø: d1 Ø 30 / d2 Ø 27
82466106057, 82466106147



MN-DL-12421

Length: 1070
Ø: 48
Cone Ø: d1 Ø 30 / d2 Ø 27
Thread: M30 x 1,5 RHT
81466106656, 81466106659, 81466106669,
81466116006, 81466116007



MN-SB-5244

Ø: 65
Hole Distance: 125
Thick/Height: 22
03312000A, 81432710027, 81432710082



MN-SB-5246

Ø: 45 Thick/Height: 47
81437220022, 81437220038, 81962100450,
81962100469



MN-SB-10389

Ø: 70
Thick/Height: 72
81960200340



MN-SB-10390

Ø: 70
Thick/Height: 85/85
81960200341, 81960200373, 81960200385,
81960200408, 81960200418



MN-VB-8514

Length: 627 Ø: 48
Hole Ø 25 / 25 / 25
Hole Distance: 152 / 130 / 130
81432706087, 81432706088, 81432706094,
81432706095, 81432796094





F 2000 ...

27.423 DFAC ...	01/94 →	Suspension Arm Repair Kit		MN-SB-5244	for Wishbone (CV), 2nd RA
	01/94 →	Tie Rod End	CV-ES-2146		
	01/94 →	Tie Rod End	CV-ES-2149		for Push Rod
	01/94 →	Tie Rod End	CV-ES-14162		for Steering Rod
	01/94 →	Tie Rod End	CV-ES-14163		for Steering Rod
	01/94 →	Tie Rod End	SC-ES-8517		for Push Rod
	01/94 →	Track Control Arm		MN-DL-3402	Trailing Arm, Drive Axle
	01/94 →	Track Control Arm		MN-DL-8609	Trailing Arm
27.423 DFAK, DFA-KI, DFAK-L	01/94 →	Ball Head, gearshift linkage	CV-ES-2119		
	01/94 →	Ball Head, gearshift linkage	CV-ES-2120		
	01/94 →	Ball Head, gearshift linkage	CV-ES-2182		
	01/94 →	Centre Rod	MN-DL-2160		Coupling Rod
	01/94 →	Centre Rod	MN-DL-2176		Push Rod
	01/94 →	Centre Rod	MN-DL-12391		for Steering Rod
	01/94 →	Centre Rod	MN-DL-12421		for Steering Rod
	01/94 →	Engine Mounting		MN-SB-10390	
	01/94 →	Engine Mounting	MN-SB-10389		
	01/94 →	Suspension Arm Repair Kit		MN-SB-5244	for Wishbone (CV)
	01/94 →	Suspension Arm Repair Kit		MN-SB-5244	for Wishbone (CV), 1st RA
	01/94 →	Suspension Arm Repair Kit		MN-SB-5244	for Wishbone (CV), 2nd RA
	01/94 →	Tie Rod End	CV-ES-2146		
	01/94 →	Tie Rod End	CV-ES-2149		for Push Rod
	01/94 →	Tie Rod End	CV-ES-14162		for Steering Rod
	01/94 →	Tie Rod End	CV-ES-14163		for Steering Rod
	01/94 →	Tie Rod End	SC-ES-8517		for Push Rod
	01/94 →	Track Control Arm		MN-DL-3402	Trailing Arm, Drive Axle
	01/94 →	Track Control Arm		MN-DL-8609	Trailing Arm
	27.423 DFAS	01/94 →12/95	Ball Head, gearshift linkage	CV-ES-2119	
01/94 →12/95		Ball Head, gearshift linkage	CV-ES-2120		
01/94 →12/95		Ball Head, gearshift linkage	CV-ES-2182		
01/94 →12/95		Centre Rod	MN-DL-2160		Coupling Rod
01/94 →12/95		Centre Rod	MN-DL-2176		Push Rod
01/94 →12/95		Centre Rod	MN-DL-12391		for Steering Rod
01/94 →12/95		Centre Rod	MN-DL-12421		for Steering Rod
01/94 →12/95		Engine Mounting		MN-SB-10390	
01/94 →12/95		Engine Mounting	MN-SB-10389		
01/94 →12/95		Suspension Arm Repair Kit		MN-SB-5244	for Wishbone (CV)
01/94 →12/95		Suspension Arm Repair Kit		MN-SB-5244	for Wishbone (CV), 1st RA
01/94 →12/95		Suspension Arm Repair Kit		MN-SB-5244	for Wishbone (CV), 2nd RA
01/94 →12/95		Tie Rod End	CV-ES-2146		
01/94 →12/95		Tie Rod End	CV-ES-2149		for Push Rod
01/94 →12/95		Tie Rod End	CV-ES-14162		for Steering Rod
01/94 →12/95		Tie Rod End	CV-ES-14163		for Steering Rod
01/94 →12/95		Tie Rod End	SC-ES-8517		for Push Rod
01/94 →12/95		Track Control Arm		MN-DL-3402	Trailing Arm, Drive Axle
01/94 →12/95		Track Control Arm		MN-DL-8609	Trailing Arm
27.423 DFC		01/94 →	Ball Head, gearshift linkage	CV-ES-2119	
	01/94 →	Ball Head, gearshift linkage	CV-ES-2120	CV-ES-2120	
	01/94 →	Ball Head, gearshift linkage	CV-ES-2182		
	01/94 →	Centre Rod	MN-DL-2160		Coupling Rod
	01/94 →	Centre Rod	MN-DL-2176		Push Rod
	01/94 →	Centre Rod	MN-DL-8197		Push Rod
	01/94 →	Centre Rod	MN-DL-12391		for Steering Rod
	01/94 →	Centre Rod	MN-DL-12421		for Steering Rod
	01/94 →	Engine Mounting		MN-SB-10390	
	01/94 →	Mounting, stabilizer coupling rod	MN-SB-5246		
	01/94 →	Suspension Arm Repair Kit		MN-SB-5244	for Wishbone (CV)
	01/94 →	Suspension Arm Repair Kit		MN-SB-5244	for Wishbone (CV), 2nd RA
	01/94 →	Suspension Strut Repair Kit		DB-RK-8581	
	01/94 →	Tie Rod	MN-DL-12284		
	01/94 →	Tie Rod End	CV-ES-2149		for Push Rod
	01/94 →	Tie Rod End	CV-ES-14162		for Steering Rod
	01/94 →	Tie Rod End	CV-ES-14163		for Steering Rod

CV-ES-2119

Length: 55
Cone Ø: d1 Ø 10 / d2 Ø 10
Thread: M12 x 1,75 LHT
81953016063, 81953016131



CV-ES-2120

Length: 115
Cone Ø: d1 Ø 12,4 / d2 Ø 10,8
Thread: M14 x 1,5 RHT
03008500A, 81953016200, 81953016202,
81953016203, 81953016227



CV-ES-2146

Length: 80
Cone Ø: d1 Ø 30 / d2 Ø 27
Thread: M26 x 1,5 RHT
42533102, 81953016219, 81953016225,
81953016226, 81953016267, 81953016291



CV-ES-2149

Length: 160
Cone Ø: d1 Ø 30 / d2 Ø 27
Thread: M30 x 1,5 RHT
81953016263



CV-ES-2182

Length: 55
Cone Ø: d1 Ø 10 / d2 Ø 10
Thread: M12 x 1,75 RHT
81953016064, 81953016170



CV-ES-14162

Length: 125
Cone Ø: d1 Ø 30 / d2 Ø 27
Thread: M30 x 1,5 LHT
81953010015, 81953010083, 81953010087,
81953016029, 81953016030, 81953016043,
81953016044, 81953016050, 81953016054,
81953016087, 81953016091, 81953016107,
81953016120, 81953016125, 81953016152,
81953016155, 81953016157, 81953016168,
81953016179, 81953016181, 81953016223,
81953016237, 81953016254, 81953016275,
81953016279, 81953016351



CV-ES-14163

Length: 125
Cone Ø: d1 Ø 30 / d2 Ø 27
Thread: M30 x 1,5 RHT
95301.0084, 90804102156, 90804102272,
90804102696, 90804102710, 81953010016,
81953010075, 81953010084, 81953010088,
81953010094, 81953010103, 81953016030,
81953016043, 81953016048, 81953016049,
81953016053, 81953016061, 81953016090,
81953016108, 81953016112, 81953016126,
81953016143, 81953016149, 81953016154,
81953016156, 81953016168, 81953016178,
81953016194, 81953016206, 81953016224,
81953016234, 81953016242, 81953016252,
81953016274, 81953016278, 81953016284,
81953016286, 81953016308, 81953016310,
81953016312, 81953016347, 81953016350,
81953016352, 82953016012, 88953016014,
N2953016001



DB-RK-8581

Ø: 85
Hole Distance: 130
Thick/Height: 24
03305800A, 81432706105



MN-DL-2160

Length: 1652 Ø: 50
Cone Ø: d1 Ø 30 / d2 Ø 27
81467106112, 81467106163, 81467106165,
81467106198, 81467106353, 81467106354,
81467106361, 81467116725



MN-DL-2176

Length: 1628
Ø: 48
Cone Ø: d1 Ø 30 / d2 Ø 27
81466106779, 81466106780, 81466106782



MN-DL-3402

Length: 590 Ø: 48
Hole Distance: 130 / 130
03307200A, 81432206067, 81432206068,
81432206090, 81432206092, 81432209092



MN-DL-8197

Length: 1055
Ø: 42
Cone Ø: d1 Ø 30 / d2 Ø 27
03207500A, 81466116003, 81466116004,
81466116005



MN-DL-8609

Length: 585 Ø: 58
Hole Distance: 130 / 130
81432206070, 81432206071, 81432206072,
81432206091, 81432206093, 81432206119



MN-DL-12284

Length: 1530 Ø: 50
Cone Ø: d1 Ø 30 / d2 Ø 27
81466106579, 81466106580, 81466106624,
81466116720, 81467116720, 81467116730,
81467116952



MN-DL-12391

Length: 1050
Ø: 52
Cone Ø: d1 Ø 30 / d2 Ø 27
82466106057, 82466106147



MN-DL-12421

Length: 1070
Ø: 48
Cone Ø: d1 Ø 30 / d2 Ø 27
Thread: M30 x 1,5 RHT
81466106656, 81466106659, 81466106669,
81466116006, 81466116007



MN-SB-5244

Ø: 65
Hole Distance: 125
Thick/Height: 22
03312000A, 81432710027, 81432710082



MN-SB-5246

Ø: 45 Thick/Height: 47
81437220022, 81437220038, 81962100450,
81962100469



MN-SB-10389

Ø: 70
Thick/Height: 72
81960200340



MN-SB-10390

Ø: 70
Thick/Height: 85/85
81960200341, 81960200373, 81960200385,
81960200408, 81960200418



SC-ES-8517

Length: 140
Cone Ø: d1 Ø 30 / d2 Ø 27
Thread: M30 x 1,5 RHT
81953016286





F 2000 ...

27.423 DFC ...	01/94 →	Track Control Arm		MN-DL-3402	Trailing Arm, Drive Axle	
	01/94 →	Track Control Arm		MN-DL-8544	Trailing Arm, Drive Axle; Leaf Spring Axle	
	01/94 →	Track Control Arm		MN-DL-8609	Trailing Arm	
	01/94 →	Track Control Arm		MN-VB-8514	Suspension Rod, Wishbone (CV), Drive Axle; Leaf Spring Axle	
27.423 DFK, DFK-KI, DFK-L, DF-KI	01/94 →	Ball Head, gearshift linkage	CV-ES-2119			
	01/94 →	Ball Head, gearshift linkage	CV-ES-2120	CV-ES-2120		
	01/94 →	Ball Head, gearshift linkage	CV-ES-2182			
	01/94 →	Centre Rod	MN-DL-2160		Coupling Rod	
	01/94 →	Centre Rod	MN-DL-2176		Push Rod	
	01/94 →	Centre Rod	MN-DL-8197		Push Rod	
	01/94 →	Centre Rod	MN-DL-12391		for Steering Rod	
	01/94 →	Centre Rod	MN-DL-12421		for Steering Rod	
	01/94 →	Engine Mounting		MN-SB-10390		
	01/94 →	Mounting, stabilizer coupling rod	MN-SB-5246			
	01/94 →	Suspension Arm Repair Kit		MN-SB-5244	for Wishbone (CV)	
	01/94 →	Suspension Arm Repair Kit		MN-SB-5244	for Wishbone (CV), 2nd RA	
	01/94 →	Suspension Strut Repair Kit		DB-RK-8581		
	01/94 →	Tie Rod	MN-DL-12284			
	01/94 →	Tie Rod End	CV-ES-2149		for Push Rod	
	01/94 →	Tie Rod End	CV-ES-14162		for Steering Rod	
	01/94 →	Tie Rod End	CV-ES-14163		for Steering Rod	
	01/94 →	Track Control Arm		MN-DL-3402	Trailing Arm, Drive Axle	
	01/94 →	Track Control Arm		MN-DL-8544	Trailing Arm, Drive Axle; Leaf Spring Axle	
	01/94 →	Track Control Arm		MN-DL-8609	Trailing Arm	
	01/94 →	Track Control Arm		MN-VB-8514	Suspension Rod, Wishbone (CV), Drive Axle; Leaf Spring Axle	
	27.423 DFS	01/94 →	Ball Head, gearshift linkage	CV-ES-2119		
		01/94 →	Ball Head, gearshift linkage	CV-ES-2120	CV-ES-2120	
01/94 →		Ball Head, gearshift linkage	CV-ES-2182			
01/94 →		Centre Rod	MN-DL-2160		Coupling Rod	
01/94 →		Centre Rod	MN-DL-2176		Push Rod	
01/94 →		Centre Rod	MN-DL-8197		Push Rod	
01/94 →		Centre Rod	MN-DL-12391		for Steering Rod	
01/94 →		Centre Rod	MN-DL-12421		for Steering Rod	
01/94 →		Engine Mounting		MN-SB-10390		
01/94 →		Mounting, stabilizer coupling rod	MN-SB-5246			
01/94 →		Suspension Arm Repair Kit		MN-SB-5244	for Wishbone (CV)	
01/94 →		Suspension Arm Repair Kit		MN-SB-5244	for Wishbone (CV), 2nd RA	
01/94 →		Suspension Strut Repair Kit		DB-RK-8581		
01/94 →		Tie Rod	MN-DL-12284			
01/94 →		Tie Rod End	CV-ES-2149		for Push Rod	
01/94 →		Tie Rod End	CV-ES-14162		for Steering Rod	
01/94 →		Tie Rod End	CV-ES-14163		for Steering Rod	
01/94 →		Track Control Arm		MN-DL-3402	Trailing Arm, Drive Axle	
01/94 →		Track Control Arm		MN-DL-8544	Trailing Arm, Drive Axle; Leaf Spring Axle	
01/94 →		Track Control Arm		MN-DL-8609	Trailing Arm	
01/94 →		Track Control Arm		MN-VB-8514	Suspension Rod, Wishbone (CV), Drive Axle; Leaf Spring Axle	
27.423 DF-TM		07/00 →	Ball Head, gearshift linkage	CV-ES-2120	CV-ES-2120	
		07/00 →	Centre Rod	MN-DL-8197		Push Rod
	07/00 →	Centre Rod	MN-DL-12391		for Steering Rod	
	07/00 →	Centre Rod	MN-DL-12421		for Steering Rod	
	07/00 →	Mounting, stabilizer coupling rod	MN-SB-5246			
	07/00 →	Suspension Arm Repair Kit		MN-SB-5244	for Wishbone (CV)	
	07/00 →	Tie Rod	MN-DL-12284			
	07/00 →	Tie Rod End	CV-ES-2149		for Push Rod	
	07/00 →	Tie Rod End	CV-ES-14162		for Steering Rod	
	07/00 →	Tie Rod End	CV-ES-14163		for Steering Rod	
	07/00 →	Track Control Arm		MN-DL-3402	Trailing Arm	
	07/00 →	Track Control Arm		MN-DL-8544	Trailing Arm	
	07/00 →	Track Control Arm		MN-DL-8609	Trailing Arm	
	07/00 →	Track Control Arm		MN-VB-8514	Suspension Rod, Wishbone (CV)	

CV-ES-2119

Length: 55
Cone Ø: d1 Ø 10 / d2 Ø 10
Thread: M12 x 1,75 LHT
81953016063, 81953016131



CV-ES-2120

Length: 115
Cone Ø: d1 Ø 12,4 / d2 Ø 10,8
Thread: M14 x 1,5 RHT
03008500A, 81953016200, 81953016202, 81953016203, 81953016227



CV-ES-2149

Length: 160
Cone Ø: d1 Ø 30 / d2 Ø 27
Thread: M30 x 1,5 RHT
81953016263



CV-ES-2182

Length: 55
Cone Ø: d1 Ø 10 / d2 Ø 10
Thread: M12 x 1,75 RHT
81953016064, 81953016170



CV-ES-14162

Length: 125
Cone Ø: d1 Ø 30 / d2 Ø 27
Thread: M30 x 1,5 LHT

81953010015, 81953010083, 81953010087, 81953016029, 81953016030, 81953016043, 81953016044, 81953016050, 81953016054, 81953016087, 81953016091, 81953016107, 81953016120, 81953016125, 81953016152, 81953016155, 81953016157, 81953016168, 81953016179, 81953016181, 81953016223, 81953016237, 81953016254, 81953016275, 81953016279, 81953016351



CV-ES-14163

Length: 125
Cone Ø: d1 Ø 30 / d2 Ø 27
Thread: M30 x 1,5 RHT

95301.0084, 90804102156, 90804102272, 90804102696, 90804102710, 81953010016, 81953010075, 81953010084, 81953010088, 81953010094, 81953010103, 81953016030, 81953016043, 81953016048, 81953016049, 81953016053, 81953016061, 81953016090, 81953016108, 81953016112, 81953016126, 81953016143, 81953016149, 81953016154, 81953016156, 81953016168, 81953016178, 81953016194, 81953016206, 81953016224, 81953016234, 81953016242, 81953016252, 81953016274, 81953016278, 81953016284, 81953016286, 81953016308, 81953016310, 81953016312, 81953016347, 81953016350, 81953016352, 82953016012, 88953016014, N2953016001



DB-RK-8581

Ø: 85
Hole Distance: 130
Thick/Height: 24
03305800A, 81432706105



MN-DL-2160

Length: 1652 Ø: 50
Cone Ø: d1 Ø 30 / d2 Ø 27
81467106112, 81467106163, 81467106165, 81467106198, 81467106353, 81467106354, 81467106361, 81467116725



MN-DL-2176

Length: 1628
Ø: 48
Cone Ø: d1 Ø 30 / d2 Ø 27
81466106779, 81466106780, 81466106782



MN-DL-3402

Length: 590 Ø: 48
Hole Distance: 130 / 130
03307200A, 81432206067, 81432206068, 81432206090, 81432206092, 81432209092



MN-DL-8197

Length: 1055
Ø: 42
Cone Ø: d1 Ø 30 / d2 Ø 27
03207500A, 81466116003, 81466116004, 81466116005



MN-DL-8544

Length: 596 Ø: 48
Hole Distance: 130 / 130
81432206196, 81432206232, 81432206233



MN-DL-8609

Length: 585 Ø: 58
Hole Distance: 130 / 130
81432206070, 81432206071, 81432206072, 81432206091, 81432206093, 81432206119



MN-DL-12284

Length: 1530 Ø: 50
Cone Ø: d1 Ø 30 / d2 Ø 27
81466106579, 81466106580, 81466106624, 81466116720, 81467116720, 81467116730, 81467116952



MN-DL-12391

Length: 1050
Ø: 52
Cone Ø: d1 Ø 30 / d2 Ø 27
82466106057, 82466106147



MN-DL-12421

Length: 1070
Ø: 48
Cone Ø: d1 Ø 30 / d2 Ø 27
Thread: M30 x 1,5 RHT
81466106656, 81466106659, 81466106669, 81466116006, 81466116007



MN-SB-5244

Ø: 65
Hole Distance: 125
Thick/Height: 22
03312000A, 81432710027, 81432710082



MN-SB-5246

Ø: 45 Thick/Height: 47
81437220022, 81437220038, 81962100450, 81962100469



MN-SB-10390

Ø: 70 Thick/Height: 85/85
81960200341, 81960200373, 81960200385, 81960200408, 81960200418



MN-VB-8514

Length: 627 Ø: 48
Hole Ø 25 / 25 / 25
Hole Distance: 152 / 130 / 130
81432706087, 81432706088, 81432706094, 81432706095, 81432796094



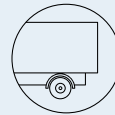

F 2000 ...

27.463 DFAC	01/94 →	Ball Head, gearshift linkage	CV-ES-2119			
	01/94 →	Ball Head, gearshift linkage	CV-ES-2120			
	01/94 →	Ball Head, gearshift linkage	CV-ES-2182			
	01/94 →	Centre Rod	MN-DL-2160		Coupling Rod	
	01/94 →	Centre Rod	MN-DL-2176		Push Rod	
	01/94 →	Centre Rod	MN-DL-12391		for Steering Rod	
	01/94 →	Centre Rod	MN-DL-12421		for Steering Rod	
	01/94 →	Engine Mounting		MN-SB-10390		
	01/94 →	Engine Mounting	MN-SB-10389			
	01/94 →	Suspension Arm Repair Kit		MN-SB-5244	for Wishbone (CV)	
	01/94 →	Suspension Arm Repair Kit		MN-SB-5244	for Wishbone (CV), 1st RA	
	01/94 →	Suspension Arm Repair Kit		MN-SB-5244	for Wishbone (CV), 2nd RA	
	01/94 →	Tie Rod End	CV-ES-2146			
	01/94 →	Tie Rod End	CV-ES-2149		for Push Rod	
	01/94 →	Tie Rod End	CV-ES-14162		for Steering Rod	
	01/94 →	Tie Rod End	CV-ES-14163		for Steering Rod	
	01/94 →	Tie Rod End	SC-ES-8517		for Push Rod	
	01/94 →	Track Control Arm		MN-DL-3402	Trailing Arm, Drive Axle	
	01/94 →	Track Control Arm		MN-DL-8609	Trailing Arm	
	27.463 DFAK, DFA-KI, DFAK-L	01/94 →	Ball Head, gearshift linkage	CV-ES-2119		
		01/94 →	Ball Head, gearshift linkage	CV-ES-2120		
		01/94 →	Ball Head, gearshift linkage	CV-ES-2182		
		01/94 →	Centre Rod	MN-DL-2160		Coupling Rod
		01/94 →	Centre Rod	MN-DL-2176		Push Rod
		01/94 →	Centre Rod	MN-DL-12391		for Steering Rod
01/94 →		Centre Rod	MN-DL-12421		for Steering Rod	
01/94 →		Engine Mounting		MN-SB-10390		
01/94 →		Engine Mounting	MN-SB-10389			
01/94 →		Suspension Arm Repair Kit		MN-SB-5244	for Wishbone (CV)	
01/94 →		Suspension Arm Repair Kit		MN-SB-5244	for Wishbone (CV), 1st RA	
01/94 →		Suspension Arm Repair Kit		MN-SB-5244	for Wishbone (CV), 2nd RA	
01/94 →		Tie Rod End	CV-ES-2146			
01/94 →		Tie Rod End	CV-ES-2149		for Push Rod	
01/94 →		Tie Rod End	CV-ES-14162		for Steering Rod	
01/94 →		Tie Rod End	CV-ES-14163		for Steering Rod	
01/94 →		Tie Rod End	SC-ES-8517		for Push Rod	
01/94 →		Track Control Arm		MN-DL-3402	Trailing Arm, Drive Axle	
01/94 →		Track Control Arm		MN-DL-8609	Trailing Arm	
27.463 DFAS		01/94 →	Ball Head, gearshift linkage	CV-ES-2119		
		01/94 →	Ball Head, gearshift linkage	CV-ES-2120		
		01/94 →	Ball Head, gearshift linkage	CV-ES-2182		
		01/94 →	Centre Rod	MN-DL-2160		Coupling Rod
		01/94 →	Centre Rod	MN-DL-2176		Push Rod
		01/94 →	Centre Rod	MN-DL-12391		for Steering Rod
	01/94 →	Centre Rod	MN-DL-12421		for Steering Rod	
	01/94 →	Engine Mounting		MN-SB-10390		
	01/94 →	Engine Mounting	MN-SB-10389			
	01/94 →	Suspension Arm Repair Kit		MN-SB-5244	for Wishbone (CV)	
	01/94 →	Suspension Arm Repair Kit		MN-SB-5244	for Wishbone (CV), 1st RA	
	01/94 →	Suspension Arm Repair Kit		MN-SB-5244	for Wishbone (CV), 2nd RA	
	01/94 →	Tie Rod End	CV-ES-2146			
	01/94 →	Tie Rod End	CV-ES-2149		for Push Rod	
	01/94 →	Tie Rod End	CV-ES-14162		for Steering Rod	
	01/94 →	Tie Rod End	CV-ES-14163		for Steering Rod	
	01/94 →	Tie Rod End	SC-ES-8517		for Push Rod	
	01/94 →	Track Control Arm		MN-DL-3402	Trailing Arm, Drive Axle	
	01/94 →	Track Control Arm		MN-DL-8609	Trailing Arm	
	27.463 DFC	01/94 →	Ball Head, gearshift linkage	CV-ES-2119		
		01/94 →	Ball Head, gearshift linkage	CV-ES-2120	CV-ES-2120	
		01/94 →	Ball Head, gearshift linkage	CV-ES-2182		
		01/94 →	Centre Rod	MN-DL-2160		Coupling Rod
		01/94 →	Centre Rod	MN-DL-2176		Push Rod
		01/94 →	Centre Rod	MN-DL-8197		Push Rod

CV-ES-2119

Length: 55
Cone Ø: d1 Ø 10 / d2 Ø 10
Thread: M12 x 1,75 LHT
81953016063, 81953016131



CV-ES-2120

Length: 115
Cone Ø: d1 Ø 12,4 / d2 Ø 10,8
Thread: M14 x 1,5 RHT
03008500A, 81953016200, 81953016202,
81953016203, 81953016227



CV-ES-2146

Length: 80
Cone Ø: d1 Ø 30 / d2 Ø 27
Thread: M26 x 1,5 RHT
42533102, 81953016219, 81953016225,
81953016226, 81953016267, 81953016291



CV-ES-2149

Length: 160
Cone Ø: d1 Ø 30 / d2 Ø 27
Thread: M30 x 1,5 RHT
81953016263



CV-ES-2182

Length: 55
Cone Ø: d1 Ø 10 / d2 Ø 10
Thread: M12 x 1,75 RHT
81953016064, 81953016170



CV-ES-14162

Length: 125
Cone Ø: d1 Ø 30 / d2 Ø 27
Thread: M30 x 1,5 LHT
81953010015, 81953010083, 81953010087,
81953016029, 81953016030, 81953016043,
81953016044, 81953016050, 81953016054,
81953016087, 81953016091, 81953016107,
81953016120, 81953016125, 81953016152,
81953016155, 81953016157, 81953016168,
81953016179, 81953016181, 81953016223,
81953016237, 81953016254, 81953016275,
81953016279, 81953016351



CV-ES-14163

Length: 125
Cone Ø: d1 Ø 30 / d2 Ø 27
Thread: M30 x 1,5 RHT
95301.0084, 90804102156, 90804102272,
90804102696, 90804102710, 81953010016,
81953010075, 81953010084, 81953010088,
81953010094, 81953010103, 81953016030,
81953016043, 81953016048, 81953016049,
81953016053, 81953016061, 81953016090,
81953016108, 81953016112, 81953016126,
81953016143, 81953016149, 81953016154,
81953016156, 81953016168, 81953016178,
81953016194, 81953016206, 81953016224,
81953016234, 81953016242, 81953016252,
81953016274, 81953016278, 81953016284,
81953016286, 81953016308, 81953016310,
81953016312, 81953016347, 81953016350,
81953016352, 82953016012, 88953016014,
N2953016001



MN-DL-2160

Length: 1652 Ø: 50
Cone Ø: d1 Ø 30 / d2 Ø 27
81467106112, 81467106163, 81467106165,
81467106198, 81467106353, 81467106354,
81467106361, 81467116725



MN-DL-2176

Length: 1628
Ø: 48
Cone Ø: d1 Ø 30 / d2 Ø 27
81466106779, 81466106780, 81466106782



MN-DL-3402

Length: 590 Ø: 48
Hole Distance: 130 / 130
03307200A, 81432206067, 81432206068,
81432206090, 81432206092, 81432209092



MN-DL-8197

Length: 1055
Ø: 42
Cone Ø: d1 Ø 30 / d2 Ø 27
03207500A, 81466116003, 81466116004,
81466116005



MN-DL-8609

Length: 585 Ø: 58
Hole Distance: 130 / 130
81432206070, 81432206071, 81432206072,
81432206091, 81432206093, 81432206119



MN-DL-12391

Length: 1050
Ø: 52
Cone Ø: d1 Ø 30 / d2 Ø 27
82466106057, 82466106147



MN-DL-12421

Length: 1070
Ø: 48
Cone Ø: d1 Ø 30 / d2 Ø 27
Thread: M30 x 1,5 RHT
81466106656, 81466106659, 81466106669,
81466116006, 81466116007



MN-SB-5244

Ø: 65
Hole Distance: 125
Thick/Height: 22
03312000A, 81432710027, 81432710082



MN-SB-10389

Ø: 70
Thick/Height: 72
81960200340



MN-SB-10390

Ø: 70
Thick/Height: 85/85
81960200341, 81960200373, 81960200385,
81960200408, 81960200418



SC-ES-8517

Length: 140
Cone Ø: d1 Ø 30 / d2 Ø 27
Thread: M30 x 1,5 RHT
81953016286



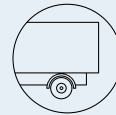

F 2000 ...

27.463 DFC ...	01/94 →	Centre Rod	MN-DL-12391		for Steering Rod
	01/94 →	Centre Rod	MN-DL-12421		for Steering Rod
	01/94 →	Engine Mounting		MN-SB-10390	
	01/94 →	Mounting, stabilizer coupling rod	MN-SB-5246		
	01/94 →	Suspension Arm Repair Kit		MN-SB-5244	for Wishbone (CV)
	01/94 →	Suspension Arm Repair Kit		MN-SB-5244	for Wishbone (CV), 2nd RA
	01/94 →	Suspension Strut Repair Kit		DB-RK-8581	
	01/94 →	Tie Rod	MN-DL-12284		
	01/94 →	Tie Rod End	CV-ES-2146		
	01/94 →	Tie Rod End	CV-ES-2149		for Push Rod
	01/94 →	Tie Rod End	CV-ES-14162		for Steering Rod
	01/94 →	Tie Rod End	CV-ES-14163		for Steering Rod
	01/94 →	Track Control Arm		MN-DL-3402	Trailing Arm, Drive Axle
	01/94 →	Track Control Arm		MN-DL-8544	Trailing Arm, Drive Axle;Leaf Spring Axle
	01/94 →	Track Control Arm		MN-DL-8609	Trailing Arm
	01/94 →	Track Control Arm		MN-VB-8514	Suspension Rod, Wishbone (CV), Drive Axle; Leaf Spring Axle
	27.463 DFK, DFK-KI, DFK-L, DF-KI	01/94 →	Ball Head, gearshift linkage	CV-ES-2119	
01/94 →		Ball Head, gearshift linkage	CV-ES-2120	CV-ES-2120	
01/94 →		Ball Head, gearshift linkage	CV-ES-2182		
01/94 →		Centre Rod	MN-DL-2160		Coupling Rod
01/94 →		Centre Rod	MN-DL-2176		Push Rod
01/94 →		Centre Rod	MN-DL-8197		Push Rod
01/94 →		Centre Rod	MN-DL-12391		for Steering Rod
01/94 →		Centre Rod	MN-DL-12421		for Steering Rod
01/94 →		Engine Mounting		MN-SB-10390	
01/94 →		Mounting, stabilizer coupling rod	MN-SB-5246		
01/94 →		Suspension Arm Repair Kit		MN-SB-5244	for Wishbone (CV)
01/94 →		Suspension Arm Repair Kit		MN-SB-5244	for Wishbone (CV), 2nd RA
01/94 →		Suspension Strut Repair Kit		DB-RK-8581	
01/94 →		Tie Rod	MN-DL-12284		
01/94 →		Tie Rod End	CV-ES-2146		
01/94 →		Tie Rod End	CV-ES-2149		for Push Rod
01/94 →		Tie Rod End	CV-ES-14162		for Steering Rod
01/94 →	Tie Rod End	CV-ES-14163		for Steering Rod	
01/94 →	Track Control Arm		MN-DL-3402	Trailing Arm, Drive Axle	
01/94 →	Track Control Arm		MN-DL-8544	Trailing Arm, Drive Axle;Leaf Spring Axle	
01/94 →	Track Control Arm		MN-DL-8609	Trailing Arm	
01/94 →	Track Control Arm		MN-VB-8514	Suspension Rod, Wishbone (CV), Drive Axle; Leaf Spring Axle	
27.463 DFS	01/94 →	Ball Head, gearshift linkage	CV-ES-2119		
	01/94 →	Ball Head, gearshift linkage	CV-ES-2120	CV-ES-2120	
	01/94 →	Ball Head, gearshift linkage	CV-ES-2182		
	01/94 →	Centre Rod	MN-DL-2160		Coupling Rod
	01/94 →	Centre Rod	MN-DL-2176		Push Rod
	01/94 →	Centre Rod	MN-DL-8197		Push Rod
	01/94 →	Centre Rod	MN-DL-12391		for Steering Rod
	01/94 →	Centre Rod	MN-DL-12421		for Steering Rod
	01/94 →	Engine Mounting		MN-SB-10390	
	01/94 →	Mounting, stabilizer coupling rod	MN-SB-5246		
	01/94 →	Suspension Arm Repair Kit		MN-SB-5244	for Wishbone (CV)
	01/94 →	Suspension Arm Repair Kit		MN-SB-5244	for Wishbone (CV), 2nd RA
	01/94 →	Suspension Strut Repair Kit		DB-RK-8581	
	01/94 →	Tie Rod	MN-DL-12284		
	01/94 →	Tie Rod End	CV-ES-2146		
	01/94 →	Tie Rod End	CV-ES-2149		for Push Rod
	01/94 →	Tie Rod End	CV-ES-14162		for Steering Rod
01/94 →	Tie Rod End	CV-ES-14163		for Steering Rod	
01/94 →	Track Control Arm		MN-DL-3402	Trailing Arm, Drive Axle	
01/94 →	Track Control Arm		MN-DL-8544	Trailing Arm, Drive Axle;Leaf Spring Axle	
01/94 →	Track Control Arm		MN-DL-8609	Trailing Arm	
01/94 →	Track Control Arm		MN-VB-8514	Suspension Rod, Wishbone (CV), Drive Axle; Leaf Spring Axle	

CV-ES-2119

Length: 55
Cone Ø: d1 Ø 10 / d2 Ø 10
Thread: M12 x 1,75 LHT
81953016063, 81953016131



CV-ES-2120

Length: 115
Cone Ø: d1 Ø 12,4 / d2 Ø 10,8
Thread: M14 x 1,5 RHT
03008500A, 81953016200, 81953016202,
81953016203, 81953016227



CV-ES-2146

Length: 80
Cone Ø: d1 Ø 30 / d2 Ø 27
Thread: M26 x 1,5 RHT
42533102, 81953016219, 81953016225,
81953016226, 81953016267, 81953016291



CV-ES-2149

Length: 160
Cone Ø: d1 Ø 30 / d2 Ø 27
Thread: M30 x 1,5 RHT
81953016263



CV-ES-2182

Length: 55
Cone Ø: d1 Ø 10 / d2 Ø 10
Thread: M12 x 1,75 RHT
81953016064, 81953016170



CV-ES-14162

Length: 125
Cone Ø: d1 Ø 30 / d2 Ø 27
Thread: M30 x 1,5 LHT
81953010015, 81953010083, 81953010087,
81953016029, 81953016030, 81953016043,
81953016044, 81953016050, 81953016054,
81953016087, 81953016091, 81953016107,
81953016120, 81953016125, 81953016152,
81953016155, 81953016157, 81953016168,
81953016179, 81953016181, 81953016223,
81953016237, 81953016254, 81953016275,
81953016279, 81953016351



CV-ES-14163

Length: 125
Cone Ø: d1 Ø 30 / d2 Ø 27
Thread: M30 x 1,5 RHT
95301.0084, 90804102156, 90804102272,
90804102696, 90804102710, 81953010016,
81953010075, 81953010084, 81953010088,
81953010094, 81953010103, 81953016030,
81953016043, 81953016048, 81953016049,
81953016053, 81953016061, 81953016090,
81953016108, 81953016112, 81953016126,
81953016143, 81953016149, 81953016154,
81953016156, 81953016168, 81953016178,
81953016194, 81953016206, 81953016224,
81953016234, 81953016242, 81953016252,
81953016274, 81953016278, 81953016284,
81953016286, 81953016308, 81953016310,
81953016312, 81953016347, 81953016350,
81953016352, 82953016012, 88953016014,
N2953016001



DB-RK-8581

Ø: 85
Hole Distance: 130
Thick/Height: 24
03305800A, 81432706105



MN-DL-2160

Length: 1652 Ø: 50
Cone Ø: d1 Ø 30 / d2 Ø 27
81467106112, 81467106163, 81467106165,
81467106198, 81467106353, 81467106354,
81467106361, 81467116725



MN-DL-2176

Length: 1628
Ø: 48
Cone Ø: d1 Ø 30 / d2 Ø 27
81466106779, 81466106780, 81466106782



MN-DL-3402

Length: 590 Ø: 48
Hole Distance: 130 / 130
03307200A, 81432206067, 81432206068,
81432206090, 81432206092, 81432209092



MN-DL-8197

Length: 1055
Ø: 42
Cone Ø: d1 Ø 30 / d2 Ø 27
03207500A, 81466116003, 81466116004,
81466116005



MN-DL-8544

Length: 596 Ø: 48
Hole Distance: 130 / 130
81432206196, 81432206232, 81432206233



MN-DL-8609

Length: 585 Ø: 58
Hole Distance: 130 / 130
81432206070, 81432206071, 81432206072,
81432206091, 81432206093, 81432206119



MN-DL-12284

Length: 1530 Ø: 50
Cone Ø: d1 Ø 30 / d2 Ø 27
81466106579, 81466106580, 81466106624,
81466116720, 81467116720, 81467116730,
81467116952



MN-DL-12391

Length: 1050
Ø: 52
Cone Ø: d1 Ø 30 / d2 Ø 27
82466106057, 82466106147



MN-DL-12421

Length: 1070
Ø: 48
Cone Ø: d1 Ø 30 / d2 Ø 27
Thread: M30 x 1,5 RHT
81466106656, 81466106659, 81466106669,
81466116006, 81466116007



MN-SB-5244

Ø: 65
Hole Distance: 125
Thick/Height: 22
03312000A, 81432710027, 81432710082



MN-SB-5246

Ø: 45 Thick/Height: 47
81437220022, 81437220038, 81962100450,
81962100469



MN-SB-10390

Ø: 70
Thick/Height: 85/85
81960200341, 81960200373, 81960200385,
81960200408, 81960200418



MN-VB-8514

Length: 627 Ø: 48
Hole Ø 25 / 25 / 25
Hole Distance: 152 / 130 / 130
81432706087, 81432706088, 81432706094,
81432706095, 81432796094



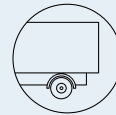

F 2000 ...

27.463 DF-TM	07/00→	Ball Head, gearshift linkage	CV-ES-2120	CV-ES-2120	
	07/00→	Centre Rod	MN-DL-8197		Push Rod
	07/00→	Centre Rod	MN-DL-12391		for Steering Rod
	07/00→	Centre Rod	MN-DL-12421		for Steering Rod
	07/00→	Mounting, stabilizer coupling rod	MN-SB-5246		
	07/00→	Suspension Arm Repair Kit		MN-SB-5244	for Wishbone (CV)
	07/00→	Tie Rod	MN-DL-12284		
	07/00→	Tie Rod End	CV-ES-2149		for Push Rod
	07/00→	Tie Rod End	CV-ES-14162		for Steering Rod
	07/00→	Tie Rod End	CV-ES-14163		for Steering Rod
	07/00→	Track Control Arm		MN-DL-3402	Trailing Arm
	07/00→	Track Control Arm		MN-DL-8544	Trailing Arm
	07/00→	Track Control Arm		MN-DL-8609	Trailing Arm
	07/00→	Track Control Arm		MN-VB-8514	Suspension Rod, Wishbone (CV)
27.464 DFAC	05/01→	Ball Head, gearshift linkage	CV-ES-2120		
	05/01→	Centre Rod	MN-DL-12391		for Steering Rod
	05/01→	Centre Rod	MN-DL-12421		for Steering Rod
	05/01→	Suspension Arm Repair Kit		MN-SB-5244	for Wishbone (CV)
	05/01→	Tie Rod End	CV-ES-2146		
	05/01→	Tie Rod End	CV-ES-14162		for Steering Rod
	05/01→	Tie Rod End	CV-ES-14163		for Steering Rod
	05/01→	Track Control Arm		MN-DL-3402	Trailing Arm
27.464 DFAK, DFA-KI, DFAK-L	05/01→	Ball Head, gearshift linkage	CV-ES-2120		
	05/01→	Centre Rod	MN-DL-12391		for Steering Rod
	05/01→	Centre Rod	MN-DL-12421		for Steering Rod
	05/01→	Suspension Arm Repair Kit		MN-SB-5244	for Wishbone (CV)
	05/01→	Tie Rod End	CV-ES-2146		
	05/01→	Tie Rod End	CV-ES-14162		for Steering Rod
	05/01→	Tie Rod End	CV-ES-14163		for Steering Rod
	05/01→	Track Control Arm		MN-DL-3402	Trailing Arm
27.464 DFAS	05/01→	Ball Head, gearshift linkage	CV-ES-2120		
	05/01→	Centre Rod	MN-DL-12391		for Steering Rod
	05/01→	Centre Rod	MN-DL-12421		for Steering Rod
	05/01→	Suspension Arm Repair Kit		MN-SB-5244	for Wishbone (CV)
	05/01→	Tie Rod End	CV-ES-2146		
	05/01→	Tie Rod End	CV-ES-14162		for Steering Rod
	05/01→	Tie Rod End	CV-ES-14163		for Steering Rod
	05/01→	Track Control Arm		MN-DL-3402	Trailing Arm
27.464 DFC	01/94→	Ball Head, gearshift linkage	CV-ES-2120	CV-ES-2120	
	01/94→	Centre Rod	MN-DL-8197		Push Rod
	01/94→	Centre Rod	MN-DL-12391		for Steering Rod
	01/94→	Centre Rod	MN-DL-12421		for Steering Rod
	01/94→	Mounting, stabilizer coupling rod	MN-SB-5246		
	01/94→	Suspension Arm Repair Kit		MN-SB-5244	for Wishbone (CV)
	01/94→	Tie Rod	MN-DL-12284		
	01/94→	Tie Rod End	CV-ES-2149		for Push Rod
27.464 DFK, DFK-KI, DFK-L, DFK-KI	05/01→	Ball Head, gearshift linkage	CV-ES-2120	CV-ES-2120	
	05/01→	Centre Rod	MN-DL-8197		Push Rod
	05/01→	Centre Rod	MN-DL-12391		for Steering Rod
	05/01→	Centre Rod	MN-DL-12421		for Steering Rod
	05/01→	Mounting, stabilizer coupling rod	MN-SB-5246		
	05/01→	Suspension Arm Repair Kit		MN-SB-5244	for Wishbone (CV)
	05/01→	Tie Rod	MN-DL-12284		
	05/01→	Tie Rod End	CV-ES-2149		for Push Rod

CV-ES-2120

Length: 115
Cone Ø: d1 Ø 12,4 / d2 Ø 10,8
Thread: M14 x 1,5 RHT
03008500A, 81953016200, 81953016202,
81953016203, 81953016227



CV-ES-2146

Length: 80
Cone Ø: d1 Ø 30 / d2 Ø 27
Thread: M26 x 1,5 RHT
42533102, 81953016219, 81953016225,
81953016226, 81953016267, 81953016291



CV-ES-2149

Length: 160
Cone Ø: d1 Ø 30 / d2 Ø 27
Thread: M30 x 1,5 RHT
81953016263



CV-ES-14162

Length: 125
Cone Ø: d1 Ø 30 / d2 Ø 27
Thread: M30 x 1,5 LHT
81953010015, 81953010083, 81953010087,
81953016029, 81953016030, 81953016043,
81953016044, 81953016050, 81953016054,
81953016087, 81953016091, 81953016107,
81953016120, 81953016125, 81953016152,
81953016155, 81953016157, 81953016168,
81953016179, 81953016181, 81953016223,
81953016237, 81953016254, 81953016275,
81953016279, 81953016351



CV-ES-14163

Length: 125
Cone Ø: d1 Ø 30 / d2 Ø 27
Thread: M30 x 1,5 RHT
95301.0084, 90804102156, 90804102272,
90804102696, 90804102710, 81953010016,
81953010075, 81953010084, 81953010088,
81953010094, 81953010103, 81953016030,
81953016043, 81953016048, 81953016049,
81953016053, 81953016061, 81953016090,
81953016108, 81953016112, 81953016126,
81953016143, 81953016149, 81953016154,
81953016156, 81953016168, 81953016178,
81953016194, 81953016206, 81953016224,
81953016234, 81953016242, 81953016252,
81953016274, 81953016278, 81953016284,
81953016286, 81953016308, 81953016310,
81953016312, 81953016347, 81953016350,
81953016352, 82953016012, 88953016014,
N2953016001



MN-DL-3402

Length: 590 Ø: 48
Hole Distance: 130 / 130
03307200A, 81432206067, 81432206068,
81432206090, 81432206092, 81432209092



MN-DL-8197

Length: 1055
Ø: 42
Cone Ø: d1 Ø 30 / d2 Ø 27
03207500A, 81466116003, 81466116004,
81466116005



MN-DL-8544

Length: 596 Ø: 48
Hole Distance: 130 / 130
81432206196, 81432206232, 81432206233



MN-DL-8609

Length: 585 Ø: 58
Hole Distance: 130 / 130
81432206070, 81432206071, 81432206072,
81432206091, 81432206093, 81432206119



MN-DL-12284

Length: 1530 Ø: 50
Cone Ø: d1 Ø 30 / d2 Ø 27
81466106579, 81466106580, 81466106624,
81466116720, 81467116720, 81467116730,
81467116952



MN-DL-12391

Length: 1050
Ø: 52
Cone Ø: d1 Ø 30 / d2 Ø 27
82466106057, 82466106147



MN-DL-12421

Length: 1070
Ø: 48
Cone Ø: d1 Ø 30 / d2 Ø 27
Thread: M30 x 1,5 RHT
81466106656, 81466106659, 81466106669,
81466116006, 81466116007



MN-SB-5244

Ø: 65
Hole Distance: 125
Thick/Height: 22
03312000A, 81432710027, 81432710082



MN-SB-5246

Ø: 45 Thick/Height: 47
81437220022, 81437220038, 81962100450,
81962100469



MN-VB-8514

Length: 627 Ø: 48
Hole Ø 25 / 25 / 25
Hole Distance: 152 / 130 / 130
81432706087, 81432706088, 81432706094,
81432706095, 81432796094





F 2000 ...

27.464 DFK, DFK-KI, DFK-L, DF-KI ...	05/01 →	Tie Rod End	CV-ES-14162		for Steering Rod
	05/01 →	Tie Rod End	CV-ES-14163		for Steering Rod
	05/01 →	Track Control Arm		MN-DL-3402	Trailing Arm
	05/01 →	Track Control Arm		MN-DL-8544	Trailing Arm
	05/01 →	Track Control Arm		MN-DL-8609	Trailing Arm
	05/01 →	Track Control Arm		MN-VB-8514	Suspension Rod, Wishbone (CV)
27.464 DFS	01/94 →	Ball Head, gearshift linkage	CV-ES-2120	CV-ES-2120	
	01/94 →	Centre Rod	MN-DL-8197		Push Rod
	01/94 →	Centre Rod	MN-DL-12391		for Steering Rod
	01/94 →	Centre Rod	MN-DL-12421		for Steering Rod
	01/94 →	Mounting, stabilizer coupling rod	MN-SB-5246		
	01/94 →	Suspension Arm Repair Kit		MN-SB-5244	for Wishbone (CV)
	01/94 →	Tie Rod	MN-DL-12284		
	01/94 →	Tie Rod End	CV-ES-2149		for Push Rod
	01/94 →	Tie Rod End	CV-ES-14162		for Steering Rod
	01/94 →	Tie Rod End	CV-ES-14163		for Steering Rod
	01/94 →	Track Control Arm		MN-DL-3402	Trailing Arm
	01/94 →	Track Control Arm		MN-DL-8544	Trailing Arm
	01/94 →	Track Control Arm		MN-DL-8609	Trailing Arm
	01/94 →	Track Control Arm		MN-VB-8514	Suspension Rod, Wishbone (CV)
	27.464 DF-TM	05/01 →	Ball Head, gearshift linkage	CV-ES-2120	CV-ES-2120
05/01 →		Centre Rod	MN-DL-8197		Push Rod
05/01 →		Centre Rod	MN-DL-12391		for Steering Rod
05/01 →		Centre Rod	MN-DL-12421		for Steering Rod
05/01 →		Mounting, stabilizer coupling rod	MN-SB-5246		
05/01 →		Suspension Arm Repair Kit		MN-SB-5244	for Wishbone (CV)
05/01 →		Tie Rod	MN-DL-12284		
05/01 →		Tie Rod End	CV-ES-2149		for Push Rod
05/01 →		Tie Rod End	CV-ES-14162		for Steering Rod
05/01 →		Tie Rod End	CV-ES-14163		for Steering Rod
05/01 →		Track Control Arm		MN-DL-3402	Trailing Arm
05/01 →		Track Control Arm		MN-DL-8544	Trailing Arm
05/01 →		Track Control Arm		MN-DL-8609	Trailing Arm
05/01 →		Track Control Arm		MN-VB-8514	Suspension Rod, Wishbone (CV)
27.464 FVL		06/98 →	Ball Head, gearshift linkage	CV-ES-2120	
	06/98 →	Centre Rod	MN-DL-8197		Push Rod
	06/98 →	Centre Rod	MN-DL-8487		Push Rod
	06/98 →	Track Control Arm		MN-DL-5212	Trailing Arm
27.603 DFAS	01/96 →	Ball Head, gearshift linkage	CV-ES-2119		
	01/96 →	Ball Head, gearshift linkage	CV-ES-2120		
	01/96 →	Ball Head, gearshift linkage	CV-ES-2182		
	01/96 →	Centre Rod	MN-DL-2160		Coupling Rod
	01/96 →	Centre Rod	MN-DL-2176		Push Rod
	01/96 →	Centre Rod	MN-DL-12421		for Steering Rod
	01/96 →	Suspension Strut Repair Kit		CV-RK-5311	
	01/96 →	Tie Rod End	CV-ES-2149		for Push Rod
	01/96 →	Tie Rod End	CV-ES-14162		for Steering Rod
	01/96 →	Tie Rod End	CV-ES-14163		for Steering Rod
	01/96 →	Tie Rod End	SC-ES-8517		for Push Rod
	01/96 →	Track Control Arm		MN-DL-3402	Trailing Arm, Drive Axle
	01/96 →	Track Control Arm		MN-DL-8609	Trailing Arm, Leaf Spring Axle
27.603 DFS	01/96 →	Ball Head, gearshift linkage	CV-ES-2119		
	01/96 →	Ball Head, gearshift linkage	CV-ES-2120		
	01/96 →	Ball Head, gearshift linkage	CV-ES-2182		
	01/96 →	Centre Rod	MN-DL-2160		Coupling Rod
	01/96 →	Centre Rod	MN-DL-2176		Push Rod
	01/96 →	Centre Rod	MN-DL-8197		Push Rod
	01/96 →	Centre Rod	MN-DL-12421		for Steering Rod
	01/96 →	Engine Mounting	MN-SB-10390		
	01/96 →	Suspension Arm Repair Kit		MN-RK-7280	for Drag Link; for Semi-Trailing Arm; for Wishbone (CV)
	01/96 →	Suspension Arm Repair Kit		MN-SB-5244	for Wishbone (CV)
01/96 →	Suspension Arm Repair Kit		MN-SB-5244	for Wishbone (CV), 2nd RA	

CV-ES-2119

Length: 55
Cone Ø: d1 Ø 10 / d2 Ø 10
Thread: M12 x 1,75 LHT
81953016063, 81953016131



CV-ES-2120

Length: 115
Cone Ø: d1 Ø 12,4 / d2 Ø 10,8
Thread: M14 x 1,5 RHT
03008500A, 81953016200, 81953016202,
81953016203, 81953016227



CV-ES-2149

Length: 160
Cone Ø: d1 Ø 30 / d2 Ø 27
Thread: M30 x 1,5 RHT
81953016263



CV-ES-2182

Length: 55
Cone Ø: d1 Ø 10 / d2 Ø 10
Thread: M12 x 1,75 RHT
81953016064, 81953016170



CV-ES-14162

Length: 125
Cone Ø: d1 Ø 30 / d2 Ø 27
Thread: M30 x 1,5 LHT

81953010015, 81953010083, 81953010087,
81953016029, 81953016030, 81953016043,
81953016044, 81953016050, 81953016054,
81953016087, 81953016091, 81953016107,
81953016120, 81953016125, 81953016152,
81953016155, 81953016157, 81953016168,
81953016179, 81953016181, 81953016223,
81953016237, 81953016254, 81953016275,
81953016279, 81953016351



CV-ES-14163

Length: 125
Cone Ø: d1 Ø 30 / d2 Ø 27
Thread: M30 x 1,5 RHT

95301.0084, 90804102156, 90804102272,
90804102696, 90804102710, 81953010016,
81953010075, 81953010084, 81953010088,
81953010094, 81953010103, 81953016030,
81953016043, 81953016048, 81953016049,
81953016053, 81953016061, 81953016090,
81953016108, 81953016112, 81953016126,
81953016143, 81953016149, 81953016154,
81953016156, 81953016168, 81953016178,
81953016194, 81953016206, 81953016224,
81953016234, 81953016242, 81953016252,
81953016274, 81953016278, 81953016284,
81953016286, 81953016308, 81953016310,
81953016312, 81953016347, 81953016350,
81953016352, 82953016012, 88953016014,
N2953016001



CV-RK-5311

638862, 639287, 938423, 1104335,
1953248, 0003500506, 3500506, 11013547,
42488722, 070550504, 634303610,
81432206055, 81432206073, 82262320660,
5001842823, 7000307001, 8226232066



MN-DL-2160

Length: 1652 Ø: 50
Cone Ø: d1 Ø 30 / d2 Ø 27
81467106112, 81467106163, 81467106165,
81467106198, 81467106353, 81467106354,
81467106361, 81467116725



MN-DL-2176

Length: 1628 Ø: 48
Cone Ø: d1 Ø 30 / d2 Ø 27
81466106779, 81466106780, 81466106782



MN-DL-3402

Length: 590 Ø: 48
Hole Distance: 130 / 130
03307200A, 81432206067, 81432206068,
81432206090, 81432206092, 81432209092



MN-DL-5212

Length: 577 Ø: 48
Hole Distance: 130 / 130
81432206096, 81432206097, 81432206098,
81432206129, 81432209096, 81432209129,
81432306014, 81432306030



MN-DL-8197

Length: 1055 Ø: 42
Cone Ø: d1 Ø 30 / d2 Ø 27
03207500A, 81466116003, 81466116004,
81466116005



MN-DL-8487

Length: 900 Ø: 38
Cone Ø: d1 Ø 30 / d2 Ø 27
81466106767, 81466106768, 81466106774,
81466116014



MN-DL-8544

Length: 596 Ø: 48
Hole Distance: 130 / 130
81432206196, 81432206232, 81432206233



MN-DL-8609

Length: 585 Ø: 58
Hole Distance: 130 / 130
81432206070, 81432206071, 81432206072,
81432206091, 81432206093, 81432206119



MN-DL-12284

Length: 1530 Ø: 50
Cone Ø: d1 Ø 30 / d2 Ø 27
81466106579, 81466106580, 81466106624,
81466116720, 81467116720, 81467116730,
81467116952



MN-DL-12391

Length: 1050 Ø: 52
Cone Ø: d1 Ø 30 / d2 Ø 27
82466106057, 82466106147



MN-DL-12421

Length: 1070 Ø: 48
Cone Ø: d1 Ø 30 / d2 Ø 27
Thread: M30 x 1,5 RHT
81466106656, 81466106659, 81466106669,
81466116006, 81466116007



MN-RK-7280

Ø: 75
Hole Distance: 115
Thick/Height: 24
0550806, 0639370, 689748, 10307400A,
81432306051, 81432306068, 81432706064



MN-SB-5244

Ø: 65
Hole Distance: 125
Thick/Height: 22
03312000A, 81432710027, 81432710082



MN-SB-5246

Ø: 45
Thick/Height: 47
81437220022, 81437220038, 81962100450,
81962100469



MN-SB-10390

Ø: 70
Thick/Height: 85/85
81960200341, 81960200373, 81960200385,
81960200408, 81960200418



MN-VB-8514

Length: 627 Ø: 48
Hole Ø 25 / 25 / 25
Hole Distance: 152 / 130 / 130
81432706087, 81432706088, 81432706094,
81432706095, 81432796094



SC-ES-8517

Length: 140
Cone Ø: d1 Ø 30 / d2 Ø 27
Thread: M30 x 1,5 RHT
81953016286





F 2000 ...

27.603 DFS ...	01/96→	Suspension Strut Repair Kit		DB-RK-8581		
	01/96→	Tie Rod End	CV-ES-2149		for Push Rod	
	01/96→	Tie Rod End	CV-ES-14162		for Steering Rod	
	01/96→	Tie Rod End	CV-ES-14163		for Steering Rod	
	01/96→	Track Control Arm		MN-DL-3402	Trailing Arm, Drive Axle	
	01/96→	Track Control Arm		MN-DL-8544	Trailing Arm, Drive Axle;Leaf Spring Axle	
	01/96→	Track Control Arm		MN-DL-8609	Trailing Arm, Leaf Spring Axle	
	01/96→	Track Control Arm		MN-VB-8514	Suspension Rod, Wishbone (CV), Drive Axle; Leaf Spring Axle	
32.293 VFC	08/95→	Ball Head, gearshift linkage	CV-ES-2119			
	08/95→	Ball Head, gearshift linkage	CV-ES-2120			
	08/95→	Ball Head, gearshift linkage	CV-ES-2182			
	08/95→	Centre Rod	MN-DL-2160		Coupling Rod	
	08/95→	Centre Rod	MN-DL-2162		Push Rod	
	08/95→	Centre Rod	MN-DL-7792		Push Rod	
	08/95→	Centre Rod	MN-DL-8197		Push Rod	
	08/95→	Centre Rod	MN-DL-12421		for Steering Rod	
	08/95→	Engine Mounting		MN-SB-10390		
	08/95→	Suspension Arm Repair Kit		MN-SB-5244	for Wishbone (CV)	
	08/95→	Suspension Arm Repair Kit		MN-SB-5244	for Wishbone (CV), 1st RA	
	08/95→	Tie Rod	MN-DL-12284			
	08/95→	Tie Rod End	CV-ES-2146			
	08/95→	Tie Rod End	CV-ES-2149		for Push Rod	
	08/95→	Tie Rod End	CV-ES-14162		for Steering Rod	
	08/95→	Tie Rod End	CV-ES-14163		for Steering Rod	
	08/95→	Track Control Arm		MN-DL-3402	Trailing Arm	
	08/95→	Track Control Arm		MN-DL-3402	Trailing Arm, Drive Axle	
	08/95→	Track Control Arm		MN-VB-8569	Wishbone (CV)	
	08/95→	Track Control Arm		MN-VB-8569	Wishbone (CV), Drive Axle	
32.314 VF, VFC	05/01→	Ball Head, gearshift linkage	CV-ES-2120			
	05/01→	Centre Rod	MN-DL-7792		Push Rod	
	05/01→	Centre Rod	MN-DL-8197		Push Rod	
	05/01→	Centre Rod	MN-DL-12421		for Steering Rod	
	05/01→	Suspension Arm Repair Kit		MN-SB-5244	for Wishbone (CV)	
	05/01→	Tie Rod	MN-DL-12284			
	05/01→	Tie Rod End	CV-ES-2146			
	05/01→	Tie Rod End	CV-ES-2149		for Push Rod	
	05/01→	Tie Rod End	CV-ES-14162		for Steering Rod	
	05/01→	Tie Rod End	CV-ES-14163		for Steering Rod	
	05/01→	Track Control Arm		MN-DL-3402	Trailing Arm	
	05/01→	Track Control Arm		MN-VB-8569	Wishbone (CV)	
	32.314 VFK, VF-HK	05/01→	Ball Head, gearshift linkage	CV-ES-2120		
		05/01→	Centre Rod	MN-DL-7792		Push Rod
05/01→		Centre Rod	MN-DL-8197		Push Rod	
05/01→		Centre Rod	MN-DL-12421		for Steering Rod	
05/01→		Suspension Arm Repair Kit		MN-SB-5244	for Wishbone (CV)	
05/01→		Tie Rod	MN-DL-12284			
05/01→		Tie Rod End	CV-ES-2146			
05/01→		Tie Rod End	CV-ES-2149		for Push Rod	
05/01→		Tie Rod End	CV-ES-14162		for Steering Rod	
05/01→		Tie Rod End	CV-ES-14163		for Steering Rod	
05/01→		Track Control Arm		MN-DL-3402	Trailing Arm	
05/01→		Track Control Arm		MN-VB-8569	Wishbone (CV)	
32.314 VF-TM		05/01→	Ball Head, gearshift linkage	CV-ES-2120		
		05/01→	Centre Rod	MN-DL-7792		Push Rod
	05/01→	Centre Rod	MN-DL-8197		Push Rod	
	05/01→	Centre Rod	MN-DL-12421		for Steering Rod	
	05/01→	Suspension Arm Repair Kit		MN-SB-5244	for Wishbone (CV)	
	05/01→	Tie Rod	MN-DL-12284			
	05/01→	Tie Rod End	CV-ES-2146			
	05/01→	Tie Rod End	CV-ES-2149		for Push Rod	
	05/01→	Tie Rod End	CV-ES-14162		for Steering Rod	
	05/01→	Tie Rod End	CV-ES-14163		for Steering Rod	

CV-ES-2119

Length: 55
Cone Ø: d1 Ø 10 / d2 Ø 10
Thread: M12 x 1,75 LHT
81953016063, 81953016131



CV-ES-2120

Length: 115
Cone Ø: d1 Ø 12,4 / d2 Ø 10,8
Thread: M14 x 1,5 RHT
03008500A, 81953016200, 81953016202,
81953016203, 81953016227



CV-ES-2146

Length: 80
Cone Ø: d1 Ø 30 / d2 Ø 27
Thread: M26 x 1,5 RHT
42533102, 81953016219, 81953016225,
81953016226, 81953016267, 81953016291



CV-ES-2149

Length: 160
Cone Ø: d1 Ø 30 / d2 Ø 27
Thread: M30 x 1,5 RHT
81953016263



CV-ES-2182

Length: 55
Cone Ø: d1 Ø 10 / d2 Ø 10
Thread: M12 x 1,75 RHT
81953016064, 81953016170



CV-ES-14162

Length: 125
Cone Ø: d1 Ø 30 / d2 Ø 27
Thread: M30 x 1,5 LHT
81953010015, 81953010083, 81953010087,
81953016029, 81953016030, 81953016043,
81953016044, 81953016050, 81953016054,
81953016087, 81953016091, 81953016107,
81953016120, 81953016125, 81953016152,
81953016155, 81953016157, 81953016168,
81953016179, 81953016181, 81953016223,
81953016237, 81953016254, 81953016275,
81953016279, 81953016351



CV-ES-14163

Length: 125
Cone Ø: d1 Ø 30 / d2 Ø 27
Thread: M30 x 1,5 RHT
95301.0084, 90804102156, 90804102272,
90804102696, 90804102710, 81953010016,
81953010075, 81953010084, 81953010088,
81953010094, 81953010103, 81953016030,
81953016043, 81953016048, 81953016049,
81953016053, 81953016061, 81953016090,
81953016108, 81953016112, 81953016126,
81953016143, 81953016149, 81953016154,
81953016156, 81953016168, 81953016178,
81953016194, 81953016206, 81953016224,
81953016234, 81953016242, 81953016252,
81953016274, 81953016278, 81953016284,
81953016286, 81953016308, 81953016310,
81953016312, 81953016347, 81953016350,
81953016352, 82953016012, 88953016014,
N2953016001



DB-RK-8581

Ø: 85
Hole Distance: 130
Thick/Height: 24
03305800A, 81432706105



MN-DL-2160

Length: 1652 Ø: 50
Cone Ø: d1 Ø 30 / d2 Ø 27
81467106112, 81467106163, 81467106165,
81467106198, 81467106353, 81467106354,
81467106361, 81467116725



MN-DL-2162

Length: 755
Ø: 40
Cone Ø: d1 Ø 30 / d2 Ø 27
81466106578, 81466106704, 81466106705,
81466106798, 81466106799



MN-DL-3402

Length: 590 Ø: 48
Hole Distance: 130 / 130
03307200A, 81432206067, 81432206068,
81432206090, 81432206092, 81432209092



MN-DL-7792

Length: 1750
Ø: 52
Cone Ø: d1 Ø 30 / d2 Ø 27
81466106790, 81466106791, 82466106191



MN-DL-8197

Length: 1055
Ø: 42
Cone Ø: d1 Ø 30 / d2 Ø 27
03207500A, 81466116003, 81466116004,
81466116005



MN-DL-8544

Length: 596 Ø: 48
Hole Distance: 130 / 130
81432206196, 81432206232, 81432206233



MN-DL-8609

Length: 585 Ø: 58
Hole Distance: 130 / 130
81432206070, 81432206071, 81432206072,
81432206091, 81432206093, 81432206119



MN-DL-12284

Length: 1530 Ø: 50
Cone Ø: d1 Ø 30 / d2 Ø 27
81466106579, 81466106580, 81466106624,
81466116720, 81467116720, 81467116730,
81467116952



MN-DL-12421

Length: 1070
Ø: 48
Cone Ø: d1 Ø 30 / d2 Ø 27
Thread: M30 x 1,5 RHT
81466106656, 81466106659, 81466106669,
81466116006, 81466116007



MN-SB-5244

Ø: 65
Hole Distance: 125
Thick/Height: 22
03312000A, 81432710027, 81432710082



MN-SB-10390

Ø: 70
Thick/Height: 85/85
81960200341, 81960200373, 81960200385,
81960200408, 81960200418



MN-VB-8514

Length: 627 Ø: 48
Hole Ø 25 / 25 / 25
Hole Distance: 152 / 130 / 130
81432706087, 81432706088, 81432706094,
81432706095, 81432796094



MN-VB-8569

Length: 627
Ø: 58
Hole Distance: 152 / 152
81432706055, 81432706056, 81432706067,
81432706068, 81432706075, 81432706077,
81432706081, 81432709056



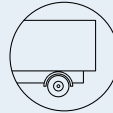

F 2000 ...

32.314 VF-TM ...	05/01→	Track Control Arm		MN-DL-3402	Trailing Arm
	05/01→	Track Control Arm		MN-VB-8569	Wishbone (CV)
32.343 VFC	08/95→	Ball Head, gearshift linkage	CV-ES-2119		
	08/95→	Ball Head, gearshift linkage	CV-ES-2120		
	08/95→	Ball Head, gearshift linkage	CV-ES-2182		
	08/95→	Centre Rod	MN-DL-2160		Coupling Rod
	08/95→	Centre Rod	MN-DL-2162		Push Rod
	08/95→	Centre Rod	MN-DL-7792		Push Rod
	08/95→	Centre Rod	MN-DL-8197		Push Rod
	08/95→	Centre Rod	MN-DL-12421		for Steering Rod
	08/95→	Engine Mounting		MN-SB-10390	
	08/95→	Suspension Arm Repair Kit		MN-SB-5244	for Wishbone (CV)
	08/95→	Suspension Arm Repair Kit		MN-SB-5244	for Wishbone (CV), 1st RA
	08/95→	Tie Rod	MN-DL-12284		
	08/95→	Tie Rod End	CV-ES-2146		
	08/95→	Tie Rod End	CV-ES-2149		for Push Rod
	08/95→	Tie Rod End	CV-ES-14162		for Steering Rod
	08/95→	Tie Rod End	CV-ES-14163		for Steering Rod
	08/95→	Track Control Arm		MN-DL-3402	Trailing Arm
	08/95→	Track Control Arm		MN-DL-3402	Trailing Arm, Drive Axle
	08/95→	Track Control Arm		MN-VB-8569	Wishbone (CV)
	08/95→	Track Control Arm		MN-VB-8569	Wishbone (CV), Drive Axle
32.343 VFK	08/95→	Ball Head, gearshift linkage	CV-ES-2119		
	08/95→	Ball Head, gearshift linkage	CV-ES-2120		
	08/95→	Ball Head, gearshift linkage	CV-ES-2182		
	08/95→	Centre Rod	MN-DL-2160		Coupling Rod
	08/95→	Centre Rod	MN-DL-2162		Push Rod
	08/95→	Centre Rod	MN-DL-7792		Push Rod
	08/95→	Centre Rod	MN-DL-8197		Push Rod
	08/95→	Centre Rod	MN-DL-12421		for Steering Rod
	08/95→	Engine Mounting		MN-SB-10390	
	08/95→	Suspension Arm Repair Kit		MN-SB-5244	for Wishbone (CV)
	08/95→	Suspension Arm Repair Kit		MN-SB-5244	for Wishbone (CV), 1st RA
	08/95→	Tie Rod	MN-DL-12284		
	08/95→	Tie Rod End	CV-ES-2146		
	08/95→	Tie Rod End	CV-ES-2149		for Push Rod
	08/95→	Tie Rod End	CV-ES-14162		for Steering Rod
	08/95→	Tie Rod End	CV-ES-14163		for Steering Rod
	08/95→	Track Control Arm		MN-DL-3402	Trailing Arm
	08/95→	Track Control Arm		MN-DL-3402	Trailing Arm, Drive Axle
	08/95→	Track Control Arm		MN-VB-8569	Wishbone (CV)
	08/95→	Track Control Arm		MN-VB-8569	Wishbone (CV), Drive Axle
32.364 VF, VFC	05/01→	Ball Head, gearshift linkage	CV-ES-2120		
	05/01→	Centre Rod	MN-DL-7792		Push Rod
	05/01→	Centre Rod	MN-DL-8197		Push Rod
	05/01→	Centre Rod	MN-DL-12421		for Steering Rod
	05/01→	Suspension Arm Repair Kit		MN-SB-5244	for Wishbone (CV)
	05/01→	Tie Rod	MN-DL-12284		
	05/01→	Tie Rod End	CV-ES-2146		
	05/01→	Tie Rod End	CV-ES-2149		for Push Rod
	05/01→	Tie Rod End	CV-ES-14162		for Steering Rod
	05/01→	Tie Rod End	CV-ES-14163		for Steering Rod
	05/01→	Track Control Arm		MN-DL-3402	Trailing Arm
	05/01→	Track Control Arm		MN-VB-8569	Wishbone (CV)
32.364 VFK, VF-HK	05/01→	Ball Head, gearshift linkage	CV-ES-2120		
	05/01→	Centre Rod	MN-DL-7792		Push Rod
	05/01→	Centre Rod	MN-DL-8197		Push Rod
	05/01→	Centre Rod	MN-DL-12421		for Steering Rod
	05/01→	Suspension Arm Repair Kit		MN-SB-5244	for Wishbone (CV)
	05/01→	Tie Rod	MN-DL-12284		
	05/01→	Tie Rod End	CV-ES-2146		
	05/01→	Tie Rod End	CV-ES-2149		for Push Rod
05/01→	Tie Rod End	CV-ES-14162		for Steering Rod	

CV-ES-2119

Length: 55
Cone Ø: d1 Ø 10 / d2 Ø 10
Thread: M12 x 1,75 LHT
81953016063, 81953016131



CV-ES-2120

Length: 115
Cone Ø: d1 Ø 12,4 / d2 Ø 10,8
Thread: M14 x 1,5 RHT
03008500A, 81953016200, 81953016202,
81953016203, 81953016227



CV-ES-2146

Length: 80
Cone Ø: d1 Ø 30 / d2 Ø 27
Thread: M26 x 1,5 RHT
42533102, 81953016219, 81953016225,
81953016226, 81953016267, 81953016291



CV-ES-2149

Length: 160
Cone Ø: d1 Ø 30 / d2 Ø 27
Thread: M30 x 1,5 RHT
81953016263



CV-ES-2182

Length: 55
Cone Ø: d1 Ø 10 / d2 Ø 10
Thread: M12 x 1,75 RHT
81953016064, 81953016170



CV-ES-14162

Length: 125
Cone Ø: d1 Ø 30 / d2 Ø 27
Thread: M30 x 1,5 LHT
81953010015, 81953010083, 81953010087,
81953016029, 81953016030, 81953016043,
81953016044, 81953016050, 81953016054,
81953016087, 81953016091, 81953016107,
81953016120, 81953016125, 81953016152,
81953016155, 81953016157, 81953016168,
81953016179, 81953016181, 81953016223,
81953016237, 81953016254, 81953016275,
81953016279, 81953016351



CV-ES-14163

Length: 125
Cone Ø: d1 Ø 30 / d2 Ø 27
Thread: M30 x 1,5 RHT
95301.0084, 90804102156, 90804102272,
90804102696, 90804102710, 81953010016,
81953010075, 81953010084, 81953010088,
81953010094, 81953010103, 81953016030,
81953016043, 81953016048, 81953016049,
81953016053, 81953016061, 81953016090,
81953016108, 81953016112, 81953016126,
81953016143, 81953016149, 81953016154,
81953016156, 81953016168, 81953016178,
81953016194, 81953016206, 81953016224,
81953016234, 81953016242, 81953016252,
81953016274, 81953016278, 81953016284,
81953016286, 81953016308, 81953016310,
81953016312, 81953016347, 81953016350,
81953016352, 82953016012, 88953016014,
N2953016001



MN-DL-2160

Length: 1652 Ø: 50
Cone Ø: d1 Ø 30 / d2 Ø 27
81467106112, 81467106163, 81467106165,
81467106198, 81467106353, 81467106354,
81467106361, 81467116725



MN-DL-2162

Length: 755
Ø: 40
Cone Ø: d1 Ø 30 / d2 Ø 27
81466106578, 81466106704, 81466106705,
81466106798, 81466106799



MN-DL-3402

Length: 590 Ø: 48
Hole Distance: 130 / 130
03307200A, 81432206067, 81432206068,
81432206090, 81432206092, 81432209092



MN-DL-7792

Length: 1750
Ø: 52
Cone Ø: d1 Ø 30 / d2 Ø 27
81466106790, 81466106791, 82466106191



MN-DL-8197

Length: 1055
Ø: 42
Cone Ø: d1 Ø 30 / d2 Ø 27
03207500A, 81466116003, 81466116004,
81466116005



MN-DL-12284

Length: 1530 Ø: 50
Cone Ø: d1 Ø 30 / d2 Ø 27
81466106579, 81466106580, 81466106624,
81466116720, 81467116720, 81467116730,
81467116952



MN-DL-12421

Length: 1070
Ø: 48
Cone Ø: d1 Ø 30 / d2 Ø 27
Thread: M30 x 1,5 RHT
81466106656, 81466106659, 81466106669,
81466116006, 81466116007



MN-SB-5244

Ø: 65
Hole Distance: 125
Thick/Height: 22
03312000A, 81432710027, 81432710082



MN-SB-10390

Ø: 70
Thick/Height: 85/85
81960200341, 81960200373, 81960200385,
81960200408, 81960200418



MN-VB-8569

Length: 627
Ø: 58
Hole Distance: 152 / 152
81432706055, 81432706056, 81432706067,
81432706068, 81432706075, 81432706077,
81432706081, 81432709056





F 2000 ...

32.364 VFK, VF-HK ...	05/01→	Tie Rod End	CV-ES-14163		for Steering Rod	
	05/01→	Track Control Arm		MN-DL-3402	Trailing Arm	
	05/01→	Track Control Arm		MN-VB-8569	Wishbone (CV)	
32.364 VF-TM	05/01→	Ball Head, gearshift linkage	CV-ES-2120			
	05/01→	Centre Rod	MN-DL-7792		Push Rod	
	05/01→	Centre Rod	MN-DL-8197		Push Rod	
	05/01→	Centre Rod	MN-DL-12421		for Steering Rod	
	05/01→	Suspension Arm Repair Kit		MN-SB-5244	for Wishbone (CV)	
	05/01→	Tie Rod	MN-DL-12284			
	05/01→	Tie Rod End	CV-ES-2146			
	05/01→	Tie Rod End	CV-ES-2149		for Push Rod	
	05/01→	Tie Rod End	CV-ES-14162		for Steering Rod	
	05/01→	Tie Rod End	CV-ES-14163		for Steering Rod	
	05/01→	Track Control Arm		MN-DL-3402	Trailing Arm	
	05/01→	Track Control Arm		MN-VB-8569	Wishbone (CV)	
	32.403 VFC	08/95→	Ball Head, gearshift linkage	CV-ES-2119		
08/95→		Ball Head, gearshift linkage	CV-ES-2120			
08/95→		Ball Head, gearshift linkage	CV-ES-2182			
08/95→		Centre Rod	MN-DL-2160		Coupling Rod	
08/95→		Centre Rod	MN-DL-2162		Push Rod	
08/95→		Centre Rod	MN-DL-7792		Push Rod	
08/95→		Centre Rod	MN-DL-8197		Push Rod	
08/95→		Centre Rod	MN-DL-12421		for Steering Rod	
08/95→		Engine Mounting		MN-SB-10390		
08/95→		Suspension Arm Repair Kit		MN-SB-5244	for Wishbone (CV)	
08/95→		Suspension Arm Repair Kit		MN-SB-5244	for Wishbone (CV), 2nd RA	
08/95→		Tie Rod	MN-DL-12284			
08/95→		Tie Rod End	CV-ES-2146			
08/95→		Tie Rod End	CV-ES-2149		for Push Rod	
08/95→		Tie Rod End	CV-ES-14162		for Steering Rod	
08/95→		Tie Rod End	CV-ES-14163		for Steering Rod	
08/95→		Track Control Arm		MN-DL-3402	Trailing Arm, Drive Axle	
08/95→		Track Control Arm		MN-VB-8569	Wishbone (CV), Drive Axle	
32.403 VFK		08/95→	Ball Head, gearshift linkage	CV-ES-2119		
		08/95→	Ball Head, gearshift linkage	CV-ES-2120		
		08/95→	Ball Head, gearshift linkage	CV-ES-2182		
	08/95→	Centre Rod	MN-DL-2160		Coupling Rod	
	08/95→	Centre Rod	MN-DL-2162		Push Rod	
	08/95→	Centre Rod	MN-DL-7792		Push Rod	
	08/95→	Centre Rod	MN-DL-8197		Push Rod	
	08/95→	Centre Rod	MN-DL-12421		for Steering Rod	
	08/95→	Engine Mounting		MN-SB-10390		
	08/95→	Suspension Arm Repair Kit		MN-SB-5244	for Wishbone (CV)	
	08/95→	Suspension Arm Repair Kit		MN-SB-5244	for Wishbone (CV), 2nd RA	
	08/95→	Tie Rod	MN-DL-12284			
	08/95→	Tie Rod End	CV-ES-2146			
	08/95→	Tie Rod End	CV-ES-2149		for Push Rod	
	08/95→	Tie Rod End	CV-ES-14162		for Steering Rod	
	08/95→	Tie Rod End	CV-ES-14163		for Steering Rod	
	08/95→	Track Control Arm		MN-DL-3402	Trailing Arm, Drive Axle	
	08/95→	Track Control Arm		MN-VB-8569	Wishbone (CV), Drive Axle	
	32.414 VF, VFC	05/01→	Ball Head, gearshift linkage	CV-ES-2120		
		05/01→	Centre Rod	MN-DL-7792		Push Rod
		05/01→	Centre Rod	MN-DL-8197		Push Rod
05/01→		Centre Rod	MN-DL-12421		for Steering Rod	
05/01→		Suspension Arm Repair Kit		MN-SB-5244	for Wishbone (CV)	
05/01→		Tie Rod	MN-DL-12284			
05/01→		Tie Rod End	CV-ES-2146			
05/01→		Tie Rod End	CV-ES-2149		for Push Rod	
05/01→		Tie Rod End	CV-ES-14162		for Steering Rod	
05/01→		Tie Rod End	CV-ES-14163		for Steering Rod	
05/01→		Track Control Arm		MN-DL-3402	Trailing Arm	
05/01→		Track Control Arm		MN-VB-8569	Wishbone (CV)	

CV-ES-2119

Length: 55
Cone Ø: d1 Ø 10 / d2 Ø 10
Thread: M12 x 1,75 LHT
81953016063, 81953016131



CV-ES-2120

Length: 115
Cone Ø: d1 Ø 12,4 / d2 Ø 10,8
Thread: M14 x 1,5 RHT
03008500A, 81953016200, 81953016202,
81953016203, 81953016227



CV-ES-2146

Length: 80
Cone Ø: d1 Ø 30 / d2 Ø 27
Thread: M26 x 1,5 RHT
42533102, 81953016219, 81953016225,
81953016226, 81953016267, 81953016291



CV-ES-2149

Length: 160
Cone Ø: d1 Ø 30 / d2 Ø 27
Thread: M30 x 1,5 RHT
81953016263



CV-ES-2182

Length: 55
Cone Ø: d1 Ø 10 / d2 Ø 10
Thread: M12 x 1,75 RHT
81953016064, 81953016170



CV-ES-14162

Length: 125
Cone Ø: d1 Ø 30 / d2 Ø 27
Thread: M30 x 1,5 LHT
81953010015, 81953010083, 81953010087,
81953016029, 81953016030, 81953016043,
81953016044, 81953016050, 81953016054,
81953016087, 81953016091, 81953016107,
81953016120, 81953016125, 81953016152,
81953016155, 81953016157, 81953016168,
81953016179, 81953016181, 81953016223,
81953016237, 81953016254, 81953016275,
81953016279, 81953016351



CV-ES-14163

Length: 125
Cone Ø: d1 Ø 30 / d2 Ø 27
Thread: M30 x 1,5 RHT
95301.0084, 90804102156, 90804102272,
90804102696, 90804102710, 81953010016,
81953010075, 81953010084, 81953010088,
81953010094, 81953010103, 81953016030,
81953016043, 81953016048, 81953016049,
81953016053, 81953016061, 81953016090,
81953016108, 81953016112, 81953016126,
81953016143, 81953016149, 81953016154,
81953016156, 81953016168, 81953016178,
81953016194, 81953016206, 81953016224,
81953016234, 81953016242, 81953016252,
81953016274, 81953016278, 81953016284,
81953016286, 81953016308, 81953016310,
81953016312, 81953016347, 81953016350,
81953016352, 82953016012, 88953016014,
N2953016001



MN-DL-2160

Length: 1652 Ø: 50
Cone Ø: d1 Ø 30 / d2 Ø 27
81467106112, 81467106163, 81467106165,
81467106198, 81467106353, 81467106354,
81467106361, 81467116725



MN-DL-2162

Length: 755
Ø: 40
Cone Ø: d1 Ø 30 / d2 Ø 27
81466106578, 81466106704, 81466106705,
81466106798, 81466106799



MN-DL-3402

Length: 590 Ø: 48
Hole Distance: 130 / 130
03307200A, 81432206067, 81432206068,
81432206090, 81432206092, 81432209092



MN-DL-7792

Length: 1750
Ø: 52
Cone Ø: d1 Ø 30 / d2 Ø 27
81466106790, 81466106791, 82466106191



MN-DL-8197

Length: 1055
Ø: 42
Cone Ø: d1 Ø 30 / d2 Ø 27
03207500A, 81466116003, 81466116004,
81466116005



MN-DL-12284

Length: 1530 Ø: 50
Cone Ø: d1 Ø 30 / d2 Ø 27
81466106579, 81466106580, 81466106624,
81466116720, 81467116720, 81467116730,
81467116952



MN-DL-12421

Length: 1070
Ø: 48
Cone Ø: d1 Ø 30 / d2 Ø 27
Thread: M30 x 1,5 RHT
81466106656, 81466106659, 81466106669,
81466116006, 81466116007



MN-SB-5244

Ø: 65
Hole Distance: 125
Thick/Height: 22
03312000A, 81432710027, 81432710082



MN-SB-10390

Ø: 70
Thick/Height: 85/85
81960200341, 81960200373, 81960200385,
81960200408, 81960200418



MN-VB-8569

Length: 627
Ø: 58
Hole Distance: 152 / 152
81432706055, 81432706056, 81432706067,
81432706068, 81432706075, 81432706077,
81432706081, 81432709056



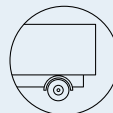

F 2000 ...

32.414 VFK, VF-HK	05/01→	Ball Head, gearshift linkage	CV-ES-2120		
	05/01→	Centre Rod	MN-DL-7792		Push Rod
	05/01→	Centre Rod	MN-DL-8197		Push Rod
	05/01→	Suspension Arm Repair Kit		MN-SB-5244	for Wishbone (CV)
	05/01→	Tie Rod	MN-DL-12284		
	05/01→	Tie Rod End	CV-ES-2146		
	05/01→	Tie Rod End	CV-ES-2149		for Push Rod
	05/01→	Tie Rod End	CV-ES-14162		for Steering Rod
	05/01→	Tie Rod End	CV-ES-14163		for Steering Rod
	05/01→	Track Control Arm		MN-DL-3402	Trailing Arm
	05/01→	Track Control Arm		MN-VB-8569	Wishbone (CV)
32.414 VF-TM	05/01→	Ball Head, gearshift linkage	CV-ES-2120		
	05/01→	Centre Rod	MN-DL-7792		Push Rod
	05/01→	Centre Rod	MN-DL-8197		Push Rod
	05/01→	Suspension Arm Repair Kit		MN-SB-5244	for Wishbone (CV)
	05/01→	Tie Rod	MN-DL-12284		
	05/01→	Tie Rod End	CV-ES-2146		
	05/01→	Tie Rod End	CV-ES-2149		for Push Rod
	05/01→	Tie Rod End	CV-ES-14162		for Steering Rod
	05/01→	Tie Rod End	CV-ES-14163		for Steering Rod
	05/01→	Track Control Arm		MN-DL-3402	Trailing Arm
	05/01→	Track Control Arm		MN-VB-8569	Wishbone (CV)
32.463 VFC	08/95→	Ball Head, gearshift linkage	CV-ES-2119		
	08/95→	Ball Head, gearshift linkage	CV-ES-2120		
	08/95→	Ball Head, gearshift linkage	CV-ES-2182		
	08/95→	Centre Rod	MN-DL-2160		Coupling Rod
	08/95→	Centre Rod	MN-DL-2162		Push Rod
	08/95→	Centre Rod	MN-DL-7792		Push Rod
	08/95→	Centre Rod	MN-DL-8197		Push Rod
	08/95→	Centre Rod	MN-DL-12421		for Steering Rod
	08/95→	Engine Mounting		MN-SB-10390	
	08/95→	Suspension Arm Repair Kit		MN-SB-5244	for Wishbone (CV)
	08/95→	Suspension Arm Repair Kit		MN-SB-5244	for Wishbone (CV), 2nd RA
	08/95→	Tie Rod	MN-DL-12284		
	08/95→	Tie Rod End	CV-ES-2146		
	08/95→	Tie Rod End	CV-ES-2149		for Push Rod
	08/95→	Tie Rod End	CV-ES-14162		for Steering Rod
	08/95→	Tie Rod End	CV-ES-14163		for Steering Rod
	08/95→	Track Control Arm		MN-DL-3402	Trailing Arm, Drive Axle
	08/95→	Track Control Arm		MN-VB-8569	Wishbone (CV), Drive Axle
32.463 VFK	08/95→	Ball Head, gearshift linkage	CV-ES-2119		
	08/95→	Ball Head, gearshift linkage	CV-ES-2120		
	08/95→	Ball Head, gearshift linkage	CV-ES-2182		
	08/95→	Centre Rod	MN-DL-2160		Coupling Rod
	08/95→	Centre Rod	MN-DL-2162		Push Rod
	08/95→	Centre Rod	MN-DL-7792		Push Rod
	08/95→	Centre Rod	MN-DL-8197		Push Rod
	08/95→	Centre Rod	MN-DL-12421		for Steering Rod
	08/95→	Engine Mounting		MN-SB-10390	
	08/95→	Suspension Arm Repair Kit		MN-SB-5244	for Wishbone (CV)
	08/95→	Suspension Arm Repair Kit		MN-SB-5244	for Wishbone (CV), 2nd RA
	08/95→	Tie Rod	MN-DL-12284		
	08/95→	Tie Rod End	CV-ES-2146		
	08/95→	Tie Rod End	CV-ES-2149		for Push Rod
	08/95→	Tie Rod End	CV-ES-14162		for Steering Rod
	08/95→	Tie Rod End	CV-ES-14163		for Steering Rod
	08/95→	Track Control Arm		MN-DL-3402	Trailing Arm, Drive Axle
	08/95→	Track Control Arm		MN-VB-8569	Wishbone (CV), Drive Axle
32.464 VF, VFC	05/01→	Ball Head, gearshift linkage	CV-ES-2120		
	05/01→	Centre Rod	MN-DL-7792		Push Rod
	05/01→	Centre Rod	MN-DL-8197		Push Rod
	05/01→	Centre Rod	MN-DL-12421		for Steering Rod
	05/01→	Suspension Arm Repair Kit		MN-SB-5244	for Wishbone (CV)

CV-ES-2119

Length: 55
Cone Ø: d1 Ø 10 / d2 Ø 10
Thread: M12 x 1,75 LHT
81953016063, 81953016131



CV-ES-2120

Length: 115
Cone Ø: d1 Ø 12,4 / d2 Ø 10,8
Thread: M14 x 1,5 RHT
03008500A, 81953016200, 81953016202,
81953016203, 81953016227



CV-ES-2146

Length: 80
Cone Ø: d1 Ø 30 / d2 Ø 27
Thread: M26 x 1,5 RHT
42533102, 81953016219, 81953016225,
81953016226, 81953016267, 81953016291



CV-ES-2149

Length: 160
Cone Ø: d1 Ø 30 / d2 Ø 27
Thread: M30 x 1,5 RHT
81953016263



CV-ES-2182

Length: 55
Cone Ø: d1 Ø 10 / d2 Ø 10
Thread: M12 x 1,75 RHT
81953016064, 81953016170



CV-ES-14162

Length: 125
Cone Ø: d1 Ø 30 / d2 Ø 27
Thread: M30 x 1,5 LHT
81953010015, 81953010083, 81953010087,
81953016029, 81953016030, 81953016043,
81953016044, 81953016050, 81953016054,
81953016087, 81953016091, 81953016107,
81953016120, 81953016125, 81953016152,
81953016155, 81953016157, 81953016168,
81953016179, 81953016181, 81953016223,
81953016237, 81953016254, 81953016275,
81953016279, 81953016351



CV-ES-14163

Length: 125
Cone Ø: d1 Ø 30 / d2 Ø 27
Thread: M30 x 1,5 RHT
95301.0084, 90804102156, 90804102272,
90804102696, 90804102710, 81953010016,
81953010075, 81953010084, 81953010088,
81953010094, 81953010103, 81953016030,
81953016043, 81953016048, 81953016049,
81953016053, 81953016061, 81953016090,
81953016108, 81953016112, 81953016126,
81953016143, 81953016149, 81953016154,
81953016156, 81953016168, 81953016178,
81953016194, 81953016206, 81953016224,
81953016234, 81953016242, 81953016252,
81953016274, 81953016278, 81953016284,
81953016286, 81953016308, 81953016310,
81953016312, 81953016347, 81953016350,
81953016352, 82953016012, 88953016014,
N2953016001



MN-DL-2160

Length: 1652 Ø: 50
Cone Ø: d1 Ø 30 / d2 Ø 27
81467106112, 81467106163, 81467106165,
81467106198, 81467106353, 81467106354,
81467106361, 81467116725



MN-DL-2162

Length: 755
Ø: 40
Cone Ø: d1 Ø 30 / d2 Ø 27
81466106578, 81466106704, 81466106705,
81466106798, 81466106799



MN-DL-3402

Length: 590 Ø: 48
Hole Distance: 130 / 130
03307200A, 81432206067, 81432206068,
81432206090, 81432206092, 81432209092



MN-DL-7792

Length: 1750
Ø: 52
Cone Ø: d1 Ø 30 / d2 Ø 27
81466106790, 81466106791, 82466106191



MN-DL-8197

Length: 1055
Ø: 42
Cone Ø: d1 Ø 30 / d2 Ø 27
03207500A, 81466116003, 81466116004,
81466116005



MN-DL-12284

Length: 1530 Ø: 50
Cone Ø: d1 Ø 30 / d2 Ø 27
81466106579, 81466106580, 81466106624,
81466116720, 81467116720, 81467116730,
81467116952



MN-DL-12421

Length: 1070
Ø: 48
Cone Ø: d1 Ø 30 / d2 Ø 27
Thread: M30 x 1,5 RHT
81466106656, 81466106659, 81466106669,
81466116006, 81466116007



MN-SB-5244

Ø: 65
Hole Distance: 125
Thick/Height: 22
03312000A, 81432710027, 81432710082



MN-SB-10390

Ø: 70
Thick/Height: 85/85
81960200341, 81960200373, 81960200385,
81960200408, 81960200418



MN-VB-8569

Length: 627
Ø: 58
Hole Distance: 152 / 152
81432706055, 81432706056, 81432706067,
81432706068, 81432706075, 81432706077,
81432706081, 81432709056





F 2000 ...

32.464 VF, VFC ...	05/01→	Tie Rod	MN-DL-12284		
	05/01→	Tie Rod End	CV-ES-2146		
	05/01→	Tie Rod End	CV-ES-2149	for Push Rod	
	05/01→	Tie Rod End	CV-ES-14162	for Steering Rod	
	05/01→	Tie Rod End	CV-ES-14163	for Steering Rod	
	05/01→	Track Control Arm		MN-DL-3402	Trailing Arm
	05/01→	Track Control Arm		MN-VB-8569	Wishbone (CV)
	32.464 VFK, VF-HK	05/01→	Ball Head, gearshift linkage	CV-ES-2120	
05/01→		Centre Rod	MN-DL-7792	Push Rod	
05/01→		Centre Rod	MN-DL-8197	Push Rod	
05/01→		Centre Rod	MN-DL-12421	for Steering Rod	
05/01→		Suspension Arm Repair Kit		MN-SB-5244	for Wishbone (CV)
05/01→		Tie Rod	MN-DL-12284		
05/01→		Tie Rod End	CV-ES-2146		
05/01→		Tie Rod End	CV-ES-2149	for Push Rod	
05/01→		Tie Rod End	CV-ES-14162	for Steering Rod	
05/01→		Tie Rod End	CV-ES-14163	for Steering Rod	
05/01→		Track Control Arm		MN-DL-3402	Trailing Arm
05/01→		Track Control Arm		MN-VB-8569	Wishbone (CV)
32.464 VF-TM		05/01→	Ball Head, gearshift linkage	CV-ES-2120	
		05/01→	Centre Rod	MN-DL-7792	Push Rod
		05/01→	Centre Rod	MN-DL-8197	Push Rod
		05/01→	Centre Rod	MN-DL-12421	for Steering Rod
	05/01→	Suspension Arm Repair Kit		MN-SB-5244	for Wishbone (CV)
	05/01→	Tie Rod	MN-DL-12284		
	05/01→	Tie Rod End	CV-ES-2146		
	05/01→	Tie Rod End	CV-ES-2149	for Push Rod	
	05/01→	Tie Rod End	CV-ES-14162	for Steering Rod	
	05/01→	Tie Rod End	CV-ES-14163	for Steering Rod	
	05/01→	Track Control Arm		MN-DL-3402	Trailing Arm
	05/01→	Track Control Arm		MN-VB-8569	Wishbone (CV)
	33.323 DFAC	01/94→12/95	Ball Head, gearshift linkage	CV-ES-2119	
		01/94→12/95	Ball Head, gearshift linkage	CV-ES-2120	
		01/94→12/95	Ball Head, gearshift linkage	CV-ES-2182	
		01/94→12/95	Centre Rod	MN-DL-2160	Coupling Rod
01/94→12/95		Centre Rod	MN-DL-2176	Push Rod	
01/94→12/95		Centre Rod	MN-DL-12391	for Steering Rod	
01/94→12/95		Centre Rod	MN-DL-12421	for Steering Rod	
01/94→12/95		Engine Mounting		MN-SB-10390	
01/94→12/95		Suspension Arm Repair Kit		MN-SB-5244	for Wishbone (CV)
01/94→12/95		Suspension Arm Repair Kit		MN-SB-5244	for Wishbone (CV), 2nd RA
01/94→12/95		Tie Rod End	CV-ES-2149	for Push Rod	
01/94→12/95		Tie Rod End	CV-ES-14162	for Steering Rod	
01/94→12/95		Tie Rod End	CV-ES-14163	for Steering Rod	
01/94→12/95		Tie Rod End	SC-ES-8517	for Push Rod	
01/94→12/95		Track Control Arm		MN-DL-3402	Trailing Arm
01/94→12/95		Track Control Arm		MN-DL-8609	Trailing Arm, Leaf Spring Axle
33.323 DFAK		01/94→12/95	Ball Head, gearshift linkage	CV-ES-2119	
		01/94→12/95	Ball Head, gearshift linkage	CV-ES-2120	
		01/94→12/95	Ball Head, gearshift linkage	CV-ES-2182	
		01/94→12/95	Centre Rod	MN-DL-2160	Coupling Rod
	01/94→12/95	Centre Rod	MN-DL-2176	Push Rod	
	01/94→12/95	Centre Rod	MN-DL-12391	for Steering Rod	
	01/94→12/95	Centre Rod	MN-DL-12421	for Steering Rod	
	01/94→12/95	Engine Mounting		MN-SB-10390	
	01/94→12/95	Suspension Arm Repair Kit		MN-SB-5244	for Wishbone (CV)
	01/94→12/95	Suspension Arm Repair Kit		MN-SB-5244	for Wishbone (CV), 2nd RA
	01/94→12/95	Tie Rod End	CV-ES-2149	for Push Rod	
	01/94→12/95	Tie Rod End	CV-ES-14162	for Steering Rod	
	01/94→12/95	Tie Rod End	CV-ES-14163	for Steering Rod	
	01/94→12/95	Tie Rod End	SC-ES-8517	for Push Rod	
	01/94→12/95	Track Control Arm		MN-DL-3402	Trailing Arm
	01/94→12/95	Track Control Arm		MN-DL-8609	Trailing Arm, 1st RA;2nd RA, for Leaf-Spring Suspension vehicles

CV-ES-2119

Length: 55
Cone Ø: d1 Ø 10 / d2 Ø 10
Thread: M12 x 1,75 LHT
81953016063, 81953016131



CV-ES-2120

Length: 115
Cone Ø: d1 Ø 12,4 / d2 Ø 10,8
Thread: M14 x 1,5 RHT
03008500A, 81953016200, 81953016202,
81953016203, 81953016227



CV-ES-2146

Length: 80
Cone Ø: d1 Ø 30 / d2 Ø 27
Thread: M26 x 1,5 RHT
42533102, 81953016219, 81953016225,
81953016226, 81953016267, 81953016291



CV-ES-2149

Length: 160
Cone Ø: d1 Ø 30 / d2 Ø 27
Thread: M30 x 1,5 RHT
81953016263



CV-ES-2182

Length: 55
Cone Ø: d1 Ø 10 / d2 Ø 10
Thread: M12 x 1,75 RHT
81953016064, 81953016170



CV-ES-14162

Length: 125
Cone Ø: d1 Ø 30 / d2 Ø 27
Thread: M30 x 1,5 LHT
81953010015, 81953010083, 81953010087,
81953016029, 81953016030, 81953016043,
81953016044, 81953016050, 81953016054,
81953016087, 81953016091, 81953016107,
81953016120, 81953016125, 81953016152,
81953016155, 81953016157, 81953016168,
81953016179, 81953016181, 81953016223,
81953016237, 81953016254, 81953016275,
81953016279, 81953016351



CV-ES-14163

Length: 125
Cone Ø: d1 Ø 30 / d2 Ø 27
Thread: M30 x 1,5 RHT

95301.0084, 90804102156, 90804102272,
90804102696, 90804102710, 81953010016,
81953010075, 81953010084, 81953010088,
81953010094, 81953010103, 81953016030,
81953016043, 81953016048, 81953016049,
81953016053, 81953016061, 81953016090,
81953016108, 81953016112, 81953016126,
81953016143, 81953016149, 81953016154,
81953016156, 81953016168, 81953016178,
81953016194, 81953016206, 81953016224,
81953016234, 81953016242, 81953016252,
81953016274, 81953016278, 81953016284,
81953016286, 81953016308, 81953016310,
81953016312, 81953016347, 81953016350,
81953016352, 82953016012, 88953016014,
N2953016001



MN-DL-2160

Length: 1652 Ø: 50
Cone Ø: d1 Ø 30 / d2 Ø 27
81467106112, 81467106163, 81467106165,
81467106198, 81467106353, 81467106354,
81467106361, 81467116725



MN-DL-2176

Length: 1628
Ø: 48
Cone Ø: d1 Ø 30 / d2 Ø 27
81466106779, 81466106780, 81466106782



MN-DL-3402

Length: 590 Ø: 48
Hole Distance: 130 / 130
03307200A, 81432206067, 81432206068,
81432206090, 81432206092, 81432209092



MN-DL-7792

Length: 1750
Ø: 52
Cone Ø: d1 Ø 30 / d2 Ø 27
81466106790, 81466106791, 82466106191



MN-DL-8197

Length: 1055
Ø: 42
Cone Ø: d1 Ø 30 / d2 Ø 27
03207500A, 81466116003, 81466116004,
81466116005



MN-DL-8609

Length: 585 Ø: 58
Hole Distance: 130 / 130
81432206070, 81432206071, 81432206072,
81432206091, 81432206093, 81432206119



MN-DL-12284

Length: 1530 Ø: 50
Cone Ø: d1 Ø 30 / d2 Ø 27
81466106579, 81466106580, 81466106624,
81466116720, 81467116720, 81467116730,
81467116952



MN-DL-12391

Length: 1050
Ø: 52
Cone Ø: d1 Ø 30 / d2 Ø 27
82466106057, 82466106147



MN-DL-12421

Length: 1070
Ø: 48
Cone Ø: d1 Ø 30 / d2 Ø 27
Thread: M30 x 1,5 RHT
81466106656, 81466106659, 81466106669,
81466116006, 81466116007



MN-SB-5244

Ø: 65
Hole Distance: 125
Thick/Height: 22
03312000A, 81432710027, 81432710082



MN-SB-10390

Ø: 70
Thick/Height: 85/85
81960200341, 81960200373, 81960200385,
81960200408, 81960200418



MN-VB-8569

Length: 627
Ø: 58
Hole Distance: 152 / 152
81432706055, 81432706056, 81432706067,
81432706068, 81432706075, 81432706077,
81432706081, 81432709056



SC-ES-8517

Length: 140
Cone Ø: d1 Ø 30 / d2 Ø 27
Thread: M30 x 1,5 RHT
81953016286





F 2000 ...

33.323 DFAS	01/94 → 12/95	Ball Head, gearshift linkage	CV-ES-2119		
	01/94 → 12/95	Ball Head, gearshift linkage	CV-ES-2120		
	01/94 → 12/95	Ball Head, gearshift linkage	CV-ES-2182		
	01/94 → 12/95	Centre Rod	MN-DL-2160		Coupling Rod
	01/94 → 12/95	Centre Rod	MN-DL-2176		Push Rod
	01/94 → 12/95	Centre Rod	MN-DL-12391		for Steering Rod
	01/94 → 12/95	Centre Rod	MN-DL-12421		for Steering Rod
	01/94 → 12/95	Engine Mounting		MN-SB-10390	
	01/94 → 12/95	Suspension Arm Repair Kit		MN-SB-5244	for Wishbone (CV)
	01/94 → 12/95	Suspension Arm Repair Kit		MN-SB-5244	for Wishbone (CV), 2nd RA
	01/94 → 12/95	Tie Rod End	CV-ES-2149		for Push Rod
	01/94 → 12/95	Tie Rod End	CV-ES-14162		for Steering Rod
	01/94 → 12/95	Tie Rod End	CV-ES-14163		for Steering Rod
	01/94 → 12/95	Tie Rod End	SC-ES-8517		for Push Rod
	01/94 → 12/95	Track Control Arm		MN-DL-3402	Trailing Arm
	01/94 → 12/95	Track Control Arm		MN-DL-8609	Trailing Arm, Leaf Spring Axle
33.323 DFC	01/94 → 12/95	Ball Head, gearshift linkage	CV-ES-2119		
	01/94 → 12/95	Ball Head, gearshift linkage	CV-ES-2120		
	01/94 → 12/95	Ball Head, gearshift linkage	CV-ES-2182		
	01/94 → 12/95	Centre Rod	MN-DL-2160		Coupling Rod
	01/94 → 12/95	Centre Rod	MN-DL-2176		Push Rod
	01/94 → 12/95	Centre Rod	MN-DL-8197		Push Rod
	01/94 → 12/95	Centre Rod	MN-DL-12421		for Steering Rod
	01/94 → 12/95	Engine Mounting		MN-SB-10390	
	01/94 → 12/95	Suspension Arm Repair Kit		MN-SB-5244	for Wishbone (CV)
	01/94 → 12/95	Suspension Arm Repair Kit		MN-SB-5244	for Wishbone (CV), 1st RA
	01/94 → 12/95	Suspension Arm Repair Kit		MN-SB-5244	for Wishbone (CV), 2nd RA
	01/94 → 12/95	Tie Rod End	CV-ES-2149		for Push Rod
	01/94 → 12/95	Tie Rod End	CV-ES-14162		for Steering Rod
	01/94 → 12/95	Tie Rod End	CV-ES-14163		for Steering Rod
	01/94 → 12/95	Track Control Arm		MN-DL-3402	Trailing Arm, Drive Axle
	01/94 → 12/95	Track Control Arm		MN-DL-8609	Trailing Arm, Leaf Spring Axle
33.323 DFK	01/94 → 12/95	Ball Head, gearshift linkage	CV-ES-2119		
	01/94 → 12/95	Ball Head, gearshift linkage	CV-ES-2120		
	01/94 → 12/95	Ball Head, gearshift linkage	CV-ES-2182		
	01/94 → 12/95	Centre Rod	MN-DL-2160		Coupling Rod
	01/94 → 12/95	Centre Rod	MN-DL-2176		Push Rod
	01/94 → 12/95	Centre Rod	MN-DL-8197		Push Rod
	01/94 → 12/95	Centre Rod	MN-DL-12421		for Steering Rod
	01/94 → 12/95	Engine Mounting		MN-SB-10390	
	01/94 → 12/95	Suspension Arm Repair Kit		MN-SB-5244	for Wishbone (CV)
	01/94 → 12/95	Suspension Arm Repair Kit		MN-SB-5244	for Wishbone (CV), 1st RA
	01/94 → 12/95	Suspension Arm Repair Kit		MN-SB-5244	for Wishbone (CV), 2nd RA
	01/94 → 12/95	Tie Rod End	CV-ES-2149		for Push Rod
	01/94 → 12/95	Tie Rod End	CV-ES-14162		for Steering Rod
	01/94 → 12/95	Tie Rod End	CV-ES-14163		for Steering Rod
	01/94 → 12/95	Track Control Arm		MN-DL-3402	Trailing Arm, Drive Axle
	01/94 → 12/95	Track Control Arm		MN-DL-8609	Trailing Arm, Leaf Spring Axle
33.323 DFS	01/94 → 12/95	Ball Head, gearshift linkage	CV-ES-2119		
	01/94 → 12/95	Ball Head, gearshift linkage	CV-ES-2120		
	01/94 → 12/95	Ball Head, gearshift linkage	CV-ES-2182		
	01/94 → 12/95	Centre Rod	MN-DL-2160		Coupling Rod
	01/94 → 12/95	Centre Rod	MN-DL-2176		Push Rod
	01/94 → 12/95	Centre Rod	MN-DL-8197		Push Rod
	01/94 → 12/95	Centre Rod	MN-DL-12421		for Steering Rod
	01/94 → 12/95	Engine Mounting		MN-SB-10390	
	01/94 → 12/95	Suspension Arm Repair Kit		MN-SB-5244	for Wishbone (CV)
	01/94 → 12/95	Suspension Arm Repair Kit		MN-SB-5244	for Wishbone (CV), 1st RA
	01/94 → 12/95	Suspension Arm Repair Kit		MN-SB-5244	for Wishbone (CV), 2nd RA
	01/94 → 12/95	Tie Rod End	CV-ES-2149		for Push Rod
	01/94 → 12/95	Tie Rod End	CV-ES-14162		for Steering Rod
	01/94 → 12/95	Tie Rod End	CV-ES-14163		for Steering Rod
	01/94 → 12/95	Track Control Arm		MN-DL-3402	Trailing Arm, Drive Axle
	01/94 → 12/95	Track Control Arm		MN-DL-8609	Trailing Arm, Leaf Spring Axle

CV-ES-2119

Length: 55
Cone Ø: d1 Ø 10 / d2 Ø 10
Thread: M12 x 1,75 LHT
81953016063, 81953016131



CV-ES-2120

Length: 115
Cone Ø: d1 Ø 12,4 / d2 Ø 10,8
Thread: M14 x 1,5 RHT
03008500A, 81953016200, 81953016202,
81953016203, 81953016227



CV-ES-2149

Length: 160
Cone Ø: d1 Ø 30 / d2 Ø 27
Thread: M30 x 1,5 RHT
81953016263



CV-ES-2182

Length: 55
Cone Ø: d1 Ø 10 / d2 Ø 10
Thread: M12 x 1,75 RHT
81953016064, 81953016170



CV-ES-14162

Length: 125
Cone Ø: d1 Ø 30 / d2 Ø 27
Thread: M30 x 1,5 LHT
81953010015, 81953010083, 81953010087,
81953016029, 81953016030, 81953016043,
81953016044, 81953016050, 81953016054,
81953016087, 81953016091, 81953016107,
81953016120, 81953016125, 81953016152,
81953016155, 81953016157, 81953016168,
81953016179, 81953016181, 81953016223,
81953016237, 81953016254, 81953016275,
81953016279, 81953016351



CV-ES-14163

Length: 125
Cone Ø: d1 Ø 30 / d2 Ø 27
Thread: M30 x 1,5 RHT
95301.0084, 90804102156, 90804102272,
90804102696, 90804102710, 81953010016,
81953010075, 81953010084, 81953010088,
81953010094, 81953010103, 81953016030,
81953016043, 81953016048, 81953016049,
81953016053, 81953016061, 81953016090,
81953016108, 81953016112, 81953016126,
81953016143, 81953016149, 81953016154,
81953016156, 81953016168, 81953016178,
81953016194, 81953016206, 81953016224,
81953016234, 81953016242, 81953016252,
81953016274, 81953016278, 81953016284,
81953016286, 81953016308, 81953016310,
81953016312, 81953016347, 81953016350,
81953016352, 82953016012, 88953016014,
N2953016001



MN-DL-2160

Length: 1652 Ø: 50
Cone Ø: d1 Ø 30 / d2 Ø 27
81467106112, 81467106163, 81467106165,
81467106198, 81467106353, 81467106354,
81467106361, 81467116725



MN-DL-2176

Length: 1628
Ø: 48
Cone Ø: d1 Ø 30 / d2 Ø 27
81466106779, 81466106780, 81466106782



MN-DL-3402

Length: 590 Ø: 48
Hole Distance: 130 / 130
03307200A, 81432206067, 81432206068,
81432206090, 81432206092, 81432209092



MN-DL-8197

Length: 1055
Ø: 42
Cone Ø: d1 Ø 30 / d2 Ø 27
03207500A, 81466116003, 81466116004,
81466116005



MN-DL-8609

Length: 585 Ø: 58
Hole Distance: 130 / 130
81432206070, 81432206071, 81432206072,
81432206091, 81432206093, 81432206119



MN-DL-12391

Length: 1050
Ø: 52
Cone Ø: d1 Ø 30 / d2 Ø 27
82466106057, 82466106147



MN-DL-12421

Length: 1070
Ø: 48
Cone Ø: d1 Ø 30 / d2 Ø 27
Thread: M30 x 1,5 RHT
81466106656, 81466106659, 81466106669,
81466116006, 81466116007



MN-SB-5244

Ø: 65
Hole Distance: 125
Thick/Height: 22
03312000A, 81432710027, 81432710082



MN-SB-10390

Ø: 70
Thick/Height: 85/85
81960200341, 81960200373, 81960200385,
81960200408, 81960200418



SC-ES-8517

Length: 140
Cone Ø: d1 Ø 30 / d2 Ø 27
Thread: M30 x 1,5 RHT
81953016286





F 2000 ...

33.343 DFAC	01/94 →	Ball Head, gearshift linkage	CV-ES-2119			
	01/94 →	Ball Head, gearshift linkage	CV-ES-2120			
	01/94 →	Ball Head, gearshift linkage	CV-ES-2182			
	01/94 →	Centre Rod	MN-DL-2160		Coupling Rod	
	01/94 →	Centre Rod	MN-DL-2176		Push Rod	
	01/94 →	Centre Rod	MN-DL-12391		for Steering Rod	
	01/94 →	Centre Rod	MN-DL-12421		for Steering Rod	
	01/94 →	Engine Mounting		MN-SB-10390		
	01/94 →	Suspension Arm Repair Kit		MN-SB-5244	for Wishbone (CV)	
	01/94 →	Suspension Arm Repair Kit		MN-SB-5244	for Wishbone (CV), 2nd RA	
	01/94 →	Tie Rod End	CV-ES-2146			
	01/94 →	Tie Rod End	CV-ES-2149		for Push Rod	
	01/94 →	Tie Rod End	CV-ES-14162		for Steering Rod	
	01/94 →	Tie Rod End	CV-ES-14163		for Steering Rod	
	01/94 →	Tie Rod End	SC-ES-8517		for Push Rod	
	01/94 →	Track Control Arm		MN-DL-3402	Trailing Arm	
	01/94 →	Track Control Arm		MN-DL-8609	Trailing Arm, Leaf Spring Axle	
	33.343 DFAK	01/94 →	Ball Head, gearshift linkage	CV-ES-2119		
		01/94 →	Ball Head, gearshift linkage	CV-ES-2120		
		01/94 →	Ball Head, gearshift linkage	CV-ES-2182		
01/94 →		Centre Rod	MN-DL-2160		Coupling Rod	
01/94 →		Centre Rod	MN-DL-2176		Push Rod	
01/94 →		Centre Rod	MN-DL-12391		for Steering Rod	
01/94 →		Centre Rod	MN-DL-12421		for Steering Rod	
01/94 →		Engine Mounting		MN-SB-10390		
01/94 →		Suspension Arm Repair Kit		MN-SB-5244	for Wishbone (CV)	
01/94 →		Suspension Arm Repair Kit		MN-SB-5244	for Wishbone (CV), 2nd RA	
01/94 →		Tie Rod End	CV-ES-2146			
01/94 →		Tie Rod End	CV-ES-2149		for Push Rod	
01/94 →		Tie Rod End	CV-ES-14162		for Steering Rod	
01/94 →		Tie Rod End	CV-ES-14163		for Steering Rod	
01/94 →		Tie Rod End	SC-ES-8517		for Push Rod	
01/94 →		Track Control Arm		MN-DL-3402	Trailing Arm	
01/94 →		Track Control Arm		MN-DL-8609	Trailing Arm, Leaf Spring Axle	
33.343 DFAS		01/94 →	Ball Head, gearshift linkage	CV-ES-2119		
		01/94 →	Ball Head, gearshift linkage	CV-ES-2120		
		01/94 →	Ball Head, gearshift linkage	CV-ES-2182		
	01/94 →	Centre Rod	MN-DL-2160		Coupling Rod	
	01/94 →	Centre Rod	MN-DL-2176		Push Rod	
	01/94 →	Centre Rod	MN-DL-12391		for Steering Rod	
	01/94 →	Centre Rod	MN-DL-12421		for Steering Rod	
	01/94 →	Engine Mounting		MN-SB-10390		
	01/94 →	Suspension Arm Repair Kit		MN-SB-5244	for Wishbone (CV)	
	01/94 →	Suspension Arm Repair Kit		MN-SB-5244	for Wishbone (CV), 2nd RA	
	01/94 →	Tie Rod End	CV-ES-2146			
	01/94 →	Tie Rod End	CV-ES-2149		for Push Rod	
	01/94 →	Tie Rod End	CV-ES-14162		for Steering Rod	
	01/94 →	Tie Rod End	CV-ES-14163		for Steering Rod	
	01/94 →	Tie Rod End	SC-ES-8517		for Push Rod	
	01/94 →	Track Control Arm		MN-DL-3402	Trailing Arm	
	01/94 →	Track Control Arm		MN-DL-8609	Trailing Arm, Leaf Spring Axle	
	33.343 DFC	01/94 →	Ball Head, gearshift linkage	CV-ES-2119		
		01/94 →	Ball Head, gearshift linkage	CV-ES-2120		
		01/94 →	Ball Head, gearshift linkage	CV-ES-2182		
01/94 →		Centre Rod	MN-DL-2160		Coupling Rod	
01/94 →		Centre Rod	MN-DL-2176		Push Rod	
01/94 →		Centre Rod	MN-DL-8197		Push Rod	
01/94 →		Centre Rod	MN-DL-12421		for Steering Rod	
01/94 →		Engine Mounting		MN-SB-10390		
01/94 →		Suspension Arm Repair Kit		MN-SB-5244	for Wishbone (CV)	
01/94 →		Suspension Arm Repair Kit		MN-SB-5244	for Wishbone (CV), 1st RA	
01/94 →		Suspension Arm Repair Kit		MN-SB-5244	for Wishbone (CV), 2nd RA	
01/94 →		Tie Rod End	CV-ES-2146			

CV-ES-2119

Length: 55
Cone Ø: d1 Ø 10 / d2 Ø 10
Thread: M12 x 1,75 LHT
81953016063, 81953016131



CV-ES-2120

Length: 115
Cone Ø: d1 Ø 12,4 / d2 Ø 10,8
Thread: M14 x 1,5 RHT
03008500A, 81953016200, 81953016202,
81953016203, 81953016227



CV-ES-2146

Length: 80
Cone Ø: d1 Ø 30 / d2 Ø 27
Thread: M26 x 1,5 RHT
42533102, 81953016219, 81953016225,
81953016226, 81953016267, 81953016291



CV-ES-2149

Length: 160
Cone Ø: d1 Ø 30 / d2 Ø 27
Thread: M30 x 1,5 RHT
81953016263



CV-ES-2182

Length: 55
Cone Ø: d1 Ø 10 / d2 Ø 10
Thread: M12 x 1,75 RHT
81953016064, 81953016170



CV-ES-14162

Length: 125
Cone Ø: d1 Ø 30 / d2 Ø 27
Thread: M30 x 1,5 LHT
81953010015, 81953010083, 81953010087,
81953016029, 81953016030, 81953016043,
81953016044, 81953016050, 81953016054,
81953016087, 81953016091, 81953016107,
81953016120, 81953016125, 81953016152,
81953016155, 81953016157, 81953016168,
81953016179, 81953016181, 81953016223,
81953016237, 81953016254, 81953016275,
81953016279, 81953016351



CV-ES-14163

Length: 125
Cone Ø: d1 Ø 30 / d2 Ø 27
Thread: M30 x 1,5 RHT
95301.0084, 90804102156, 90804102272,
90804102696, 90804102710, 81953010016,
81953010075, 81953010084, 81953010088,
81953010094, 81953010103, 81953016030,
81953016043, 81953016048, 81953016049,
81953016053, 81953016061, 81953016090,
81953016108, 81953016112, 81953016126,
81953016143, 81953016149, 81953016154,
81953016156, 81953016168, 81953016178,
81953016194, 81953016206, 81953016224,
81953016234, 81953016242, 81953016252,
81953016274, 81953016278, 81953016284,
81953016286, 81953016308, 81953016310,
81953016312, 81953016347, 81953016350,
81953016352, 82953016012, 88953016014,
N2953016001



MN-DL-2160

Length: 1652 Ø: 50
Cone Ø: d1 Ø 30 / d2 Ø 27
81467106112, 81467106163, 81467106165,
81467106198, 81467106353, 81467106354,
81467106361, 81467116725



MN-DL-2176

Length: 1628
Ø: 48
Cone Ø: d1 Ø 30 / d2 Ø 27
81466106779, 81466106780, 81466106782



MN-DL-3402

Length: 590 Ø: 48
Hole Distance: 130 / 130
03307200A, 81432206067, 81432206068,
81432206090, 81432206092, 81432209092



MN-DL-8197

Length: 1055
Ø: 42
Cone Ø: d1 Ø 30 / d2 Ø 27
03207500A, 81466116003, 81466116004,
81466116005



MN-DL-8609

Length: 585 Ø: 58
Hole Distance: 130 / 130
81432206070, 81432206071, 81432206072,
81432206091, 81432206093, 81432206119



MN-DL-12391

Length: 1050
Ø: 52
Cone Ø: d1 Ø 30 / d2 Ø 27
82466106057, 82466106147



MN-DL-12421

Length: 1070
Ø: 48
Cone Ø: d1 Ø 30 / d2 Ø 27
Thread: M30 x 1,5 RHT
81466106656, 81466106659, 81466106669,
81466116006, 81466116007



MN-SB-5244

Ø: 65
Hole Distance: 125
Thick/Height: 22
03312000A, 81432710027, 81432710082



MN-SB-10390

Ø: 70
Thick/Height: 85/85
81960200341, 81960200373, 81960200385,
81960200408, 81960200418



SC-ES-8517

Length: 140
Cone Ø: d1 Ø 30 / d2 Ø 27
Thread: M30 x 1,5 RHT
81953016286





F 2000 ...

33.343 DFC ...	01/94 →	Tie Rod End	CV-ES-2149		for Push Rod	
	01/94 →	Tie Rod End	CV-ES-14162		for Steering Rod	
	01/94 →	Tie Rod End	CV-ES-14163		for Steering Rod	
	01/94 →	Track Control Arm		MN-DL-3402	Trailing Arm, Drive Axle	
	01/94 →	Track Control Arm		MN-DL-8609	Trailing Arm, Leaf Spring Axle	
33.343 DFK	01/94 →	Ball Head, gearshift linkage	CV-ES-2119			
	01/94 →	Ball Head, gearshift linkage	CV-ES-2120			
	01/94 →	Ball Head, gearshift linkage	CV-ES-2182			
	01/94 →	Centre Rod	MN-DL-2160		Coupling Rod	
	01/94 →	Centre Rod	MN-DL-2176		Push Rod	
	01/94 →	Centre Rod	MN-DL-8197		Push Rod	
	01/94 →	Centre Rod	MN-DL-12421		for Steering Rod	
	01/94 →	Engine Mounting		MN-SB-10390		
	01/94 →	Suspension Arm Repair Kit		MN-SB-5244	for Wishbone (CV)	
	01/94 →	Suspension Arm Repair Kit		MN-SB-5244	for Wishbone (CV), 1st RA	
	01/94 →	Suspension Arm Repair Kit		MN-SB-5244	for Wishbone (CV), 2nd RA	
	01/94 →	Tie Rod End	CV-ES-2146			
	01/94 →	Tie Rod End	CV-ES-2149		for Push Rod	
	01/94 →	Tie Rod End	CV-ES-14162		for Steering Rod	
	01/94 →	Tie Rod End	CV-ES-14163		for Steering Rod	
	01/94 →	Track Control Arm		MN-DL-3402	Trailing Arm, Drive Axle	
	01/94 →	Track Control Arm		MN-DL-8609	Trailing Arm, Leaf Spring Axle	
	33.343 DFS	01/94 →	Ball Head, gearshift linkage	CV-ES-2119		
		01/94 →	Ball Head, gearshift linkage	CV-ES-2120		
		01/94 →	Ball Head, gearshift linkage	CV-ES-2182		
01/94 →		Centre Rod	MN-DL-2160		Coupling Rod	
01/94 →		Centre Rod	MN-DL-2176		Push Rod	
01/94 →		Centre Rod	MN-DL-8197		Push Rod	
01/94 →		Centre Rod	MN-DL-12421		for Steering Rod	
01/94 →		Engine Mounting		MN-SB-10390		
01/94 →		Suspension Arm Repair Kit		MN-SB-5244	for Wishbone (CV)	
01/94 →		Suspension Arm Repair Kit		MN-SB-5244	for Wishbone (CV), 1st RA	
01/94 →		Suspension Arm Repair Kit		MN-SB-5244	for Wishbone (CV), 2nd RA	
01/94 →		Tie Rod End	CV-ES-2146			
01/94 →		Tie Rod End	CV-ES-2149		for Push Rod	
01/94 →		Tie Rod End	CV-ES-14162		for Steering Rod	
01/94 →		Tie Rod End	CV-ES-14163		for Steering Rod	
01/94 →		Track Control Arm		MN-DL-3402	Trailing Arm, Drive Axle	
01/94 →		Track Control Arm		MN-DL-8609	Trailing Arm, Leaf Spring Axle	
33.364 DFAC		05/01 →	Ball Head, gearshift linkage	CV-ES-2120		
		05/01 →	Centre Rod	MN-DL-12391		for Steering Rod
		05/01 →	Centre Rod	MN-DL-12421		for Steering Rod
	05/01 →	Suspension Arm Repair Kit		MN-SB-5244	for Wishbone (CV)	
	05/01 →	Tie Rod End	CV-ES-2146			
	05/01 →	Tie Rod End	CV-ES-14162		for Steering Rod	
	05/01 →	Tie Rod End	CV-ES-14163		for Steering Rod	
	05/01 →	Track Control Arm		MN-DL-3402	Trailing Arm	
	05/01 →	Track Control Arm		MN-DL-8609	Trailing Arm	
	33.364 DFAK, DFAK-HK, DFA-KI	05/01 →	Ball Head, gearshift linkage	CV-ES-2120		
05/01 →		Centre Rod	MN-DL-12391		for Steering Rod	
05/01 →		Centre Rod	MN-DL-12421		for Steering Rod	
05/01 →		Suspension Arm Repair Kit		MN-SB-5244	for Wishbone (CV)	
05/01 →		Tie Rod End	CV-ES-2146			
05/01 →		Tie Rod End	CV-ES-14162		for Steering Rod	
05/01 →		Tie Rod End	CV-ES-14163		for Steering Rod	
05/01 →		Track Control Arm		MN-DL-3402	Trailing Arm	
05/01 →		Track Control Arm		MN-DL-8609	Trailing Arm	
33.364 DFAS	05/01 →	Ball Head, gearshift linkage	CV-ES-2120			
	05/01 →	Centre Rod	MN-DL-12391		for Steering Rod	
	05/01 →	Centre Rod	MN-DL-12421		for Steering Rod	
	05/01 →	Suspension Arm Repair Kit		MN-SB-5244	for Wishbone (CV)	
	05/01 →	Tie Rod End	CV-ES-2146			
	05/01 →	Tie Rod End	CV-ES-14162		for Steering Rod	

CV-ES-2119

Length: 55
Cone Ø: d1 Ø 10 / d2 Ø 10
Thread: M12 x 1,75 LHT
81953016063, 81953016131



CV-ES-2120

Length: 115
Cone Ø: d1 Ø 12,4 / d2 Ø 10,8
Thread: M14 x 1,5 RHT
03008500A, 81953016200, 81953016202,
81953016203, 81953016227



CV-ES-2146

Length: 80
Cone Ø: d1 Ø 30 / d2 Ø 27
Thread: M26 x 1,5 RHT
42533102, 81953016219, 81953016225,
81953016226, 81953016267, 81953016291



CV-ES-2149

Length: 160
Cone Ø: d1 Ø 30 / d2 Ø 27
Thread: M30 x 1,5 RHT
81953016263



CV-ES-2182

Length: 55
Cone Ø: d1 Ø 10 / d2 Ø 10
Thread: M12 x 1,75 RHT
81953016064, 81953016170



CV-ES-14162

Length: 125
Cone Ø: d1 Ø 30 / d2 Ø 27
Thread: M30 x 1,5 LHT
81953010015, 81953010083, 81953010087,
81953016029, 81953016030, 81953016043,
81953016044, 81953016050, 81953016054,
81953016087, 81953016091, 81953016107,
81953016120, 81953016125, 81953016152,
81953016155, 81953016157, 81953016168,
81953016179, 81953016181, 81953016223,
81953016237, 81953016254, 81953016275,
81953016279, 81953016351



CV-ES-14163

Length: 125
Cone Ø: d1 Ø 30 / d2 Ø 27
Thread: M30 x 1,5 RHT
95301.0084, 90804102156, 90804102272,
90804102696, 90804102710, 81953010016,
81953010075, 81953010084, 81953010088,
81953010094, 81953010103, 81953016030,
81953016043, 81953016048, 81953016049,
81953016053, 81953016061, 81953016090,
81953016108, 81953016112, 81953016126,
81953016143, 81953016149, 81953016154,
81953016156, 81953016168, 81953016178,
81953016194, 81953016206, 81953016224,
81953016234, 81953016242, 81953016252,
81953016274, 81953016278, 81953016284,
81953016286, 81953016308, 81953016310,
81953016312, 81953016347, 81953016350,
81953016352, 82953016012, 88953016014,
N2953016001



MN-DL-2160

Length: 1652 Ø: 50
Cone Ø: d1 Ø 30 / d2 Ø 27
81467106112, 81467106163, 81467106165,
81467106198, 81467106353, 81467106354,
81467106361, 81467116725



MN-DL-2176

Length: 1628
Ø: 48
Cone Ø: d1 Ø 30 / d2 Ø 27
81466106779, 81466106780, 81466106782



MN-DL-3402

Length: 590 Ø: 48
Hole Distance: 130 / 130
03307200A, 81432206067, 81432206068,
81432206090, 81432206092, 81432209092



MN-DL-8197

Length: 1055
Ø: 42
Cone Ø: d1 Ø 30 / d2 Ø 27
03207500A, 81466116003, 81466116004,
81466116005



MN-DL-8609

Length: 585 Ø: 58
Hole Distance: 130 / 130
81432206070, 81432206071, 81432206072,
81432206091, 81432206093, 81432206119



MN-DL-12391

Length: 1050
Ø: 52
Cone Ø: d1 Ø 30 / d2 Ø 27
82466106057, 82466106147



MN-DL-12421

Length: 1070
Ø: 48
Cone Ø: d1 Ø 30 / d2 Ø 27
Thread: M30 x 1,5 RHT
81466106656, 81466106659, 81466106669,
81466116006, 81466116007



MN-SB-5244

Ø: 65
Hole Distance: 125
Thick/Height: 22
03312000A, 81432710027, 81432710082



MN-SB-10390

Ø: 70
Thick/Height: 85/85
81960200341, 81960200373, 81960200385,
81960200408, 81960200418





F 2000 ...

33.364 DFAS ...	05/01→	Tie Rod End	CV-ES-14163		for Steering Rod
	05/01→	Track Control Arm		MN-DL-3402	Trailing Arm
	05/01→	Track Control Arm		MN-DL-8609	Trailing Arm
33.364 DFC	05/01→	Ball Head, gearshift linkage	CV-ES-2120	CV-ES-2120	
	05/01→	Centre Rod	MN-DL-8197		Push Rod
	05/01→	Centre Rod	MN-DL-12391		for Steering Rod
	05/01→	Centre Rod	MN-DL-12421		for Steering Rod
	05/01→	Mounting, stabilizer coupling rod	MN-SB-5246		
	05/01→	Suspension Arm Repair Kit		MN-SB-5244	for Wishbone (CV)
	05/01→	Tie Rod	MN-DL-12284		
	05/01→	Tie Rod End	CV-ES-2149		for Push Rod
	05/01→	Tie Rod End	CV-ES-14162		for Steering Rod
	05/01→	Tie Rod End	CV-ES-14163		for Steering Rod
	05/01→	Track Control Arm		MN-DL-3402	Trailing Arm
	05/01→	Track Control Arm		MN-DL-8544	Trailing Arm
	05/01→	Track Control Arm		MN-DL-8609	Trailing Arm
	05/01→	Track Control Arm		MN-VB-8514	Suspension Rod, Wishbone (CV)
	33.364 DFK, DF-KI	05/01→	Ball Head, gearshift linkage	CV-ES-2120	CV-ES-2120
05/01→		Centre Rod	MN-DL-8197		Push Rod
05/01→		Centre Rod	MN-DL-12391		for Steering Rod
05/01→		Centre Rod	MN-DL-12421		for Steering Rod
05/01→		Mounting, stabilizer coupling rod	MN-SB-5246		
05/01→		Suspension Arm Repair Kit		MN-SB-5244	for Wishbone (CV)
05/01→		Tie Rod	MN-DL-12284		
05/01→		Tie Rod End	CV-ES-2149		for Push Rod
05/01→		Tie Rod End	CV-ES-14162		for Steering Rod
05/01→		Tie Rod End	CV-ES-14163		for Steering Rod
05/01→		Track Control Arm		MN-DL-3402	Trailing Arm
05/01→		Track Control Arm		MN-DL-8544	Trailing Arm
05/01→		Track Control Arm		MN-DL-8609	Trailing Arm
05/01→		Track Control Arm		MN-VB-8514	Suspension Rod, Wishbone (CV)
33.364 DFS, DFRS		05/01→	Ball Head, gearshift linkage	CV-ES-2120	CV-ES-2120
	05/01→	Centre Rod	MN-DL-8197		Push Rod
	05/01→	Centre Rod	MN-DL-12391		for Steering Rod
	05/01→	Centre Rod	MN-DL-12421		for Steering Rod
	05/01→	Mounting, stabilizer coupling rod	MN-SB-5246		
	05/01→	Suspension Arm Repair Kit		MN-SB-5244	for Wishbone (CV)
	05/01→	Tie Rod	MN-DL-12284		
	05/01→	Tie Rod End	CV-ES-2149		for Push Rod
	05/01→	Tie Rod End	CV-ES-14162		for Steering Rod
	05/01→	Tie Rod End	CV-ES-14163		for Steering Rod
	05/01→	Track Control Arm		MN-DL-3402	Trailing Arm
	05/01→	Track Control Arm		MN-DL-8544	Trailing Arm
	05/01→	Track Control Arm		MN-DL-8609	Trailing Arm
	05/01→	Track Control Arm		MN-VB-8514	Suspension Rod, Wishbone (CV)
	33.373 DFAC	01/94→	Ball Head, gearshift linkage	CV-ES-2119	
01/94→		Ball Head, gearshift linkage	CV-ES-2120		
01/94→		Ball Head, gearshift linkage	CV-ES-2182		
01/94→		Centre Rod	MN-DL-2160		Coupling Rod
01/94→		Centre Rod	MN-DL-2176		Push Rod
01/94→		Centre Rod	MN-DL-12391		for Steering Rod
01/94→		Centre Rod	MN-DL-12421		for Steering Rod
01/94→		Engine Mounting		MN-SB-10390	
01/94→		Engine Mounting	MN-SB-10389		
01/94→		Suspension Arm Repair Kit		MN-SB-5244	for Wishbone (CV)
01/94→		Suspension Arm Repair Kit		MN-SB-5244	for Wishbone (CV), 1st RA
01/94→		Suspension Arm Repair Kit		MN-SB-5244	for Wishbone (CV), 2nd RA
01/94→		Tie Rod End	CV-ES-2146		
01/94→		Tie Rod End	CV-ES-2149		for Push Rod
01/94→		Tie Rod End	CV-ES-14162		for Steering Rod
01/94→		Tie Rod End	CV-ES-14163		for Steering Rod
01/94→		Tie Rod End	SC-ES-8517		for Push Rod
01/94→		Track Control Arm		MN-DL-3402	Trailing Arm, Drive Axle
01/94→	Track Control Arm		MN-DL-8609	Trailing Arm, Leaf Spring Axle	

CV-ES-2119

Length: 55
Cone Ø: d1 Ø 10 / d2 Ø 10
Thread: M12 x 1,75 LHT
81953016063, 81953016131



CV-ES-2120

Length: 115
Cone Ø: d1 Ø 12,4 / d2 Ø 10,8
Thread: M14 x 1,5 RHT
03008500A, 81953016200, 81953016202,
81953016203, 81953016227



CV-ES-2146

Length: 80
Cone Ø: d1 Ø 30 / d2 Ø 27
Thread: M26 x 1,5 RHT
42533102, 81953016219, 81953016225,
81953016226, 81953016267, 81953016291



CV-ES-2149

Length: 160
Cone Ø: d1 Ø 30 / d2 Ø 27
Thread: M30 x 1,5 RHT
81953016263



CV-ES-2182

Length: 55
Cone Ø: d1 Ø 10 / d2 Ø 10
Thread: M12 x 1,75 RHT
81953016064, 81953016170



CV-ES-14162

Length: 125
Cone Ø: d1 Ø 30 / d2 Ø 27
Thread: M30 x 1,5 LHT
81953010015, 81953010083, 81953010087,
81953016029, 81953016030, 81953016043,
81953016044, 81953016050, 81953016054,
81953016087, 81953016091, 81953016107,
81953016120, 81953016125, 81953016152,
81953016155, 81953016157, 81953016168,
81953016179, 81953016181, 81953016223,
81953016237, 81953016254, 81953016275,
81953016279, 81953016351



CV-ES-14163

Length: 125
Cone Ø: d1 Ø 30 / d2 Ø 27
Thread: M30 x 1,5 RHT
95301.0084, 90804102156, 90804102272,
90804102696, 90804102710, 81953010016,
81953010075, 81953010084, 81953010088,
81953010094, 81953010103, 81953016030,
81953016043, 81953016048, 81953016049,
81953016053, 81953016061, 81953016090,
81953016108, 81953016112, 81953016126,
81953016143, 81953016149, 81953016154,
81953016156, 81953016168, 81953016178,
81953016194, 81953016206, 81953016224,
81953016234, 81953016242, 81953016252,
81953016274, 81953016278, 81953016284,
81953016286, 81953016308, 81953016310,
81953016312, 81953016347, 81953016350,
81953016352, 82953016012, 88953016014,
N2953016001



MN-DL-2160

Length: 1652 Ø: 50
Cone Ø: d1 Ø 30 / d2 Ø 27
81467106112, 81467106163, 81467106165,
81467106198, 81467106353, 81467106354,
81467106361, 81467116725



MN-DL-2176

Length: 1628 Ø: 48
Cone Ø: d1 Ø 30 / d2 Ø 27
81466106779, 81466106780, 81466106782



MN-DL-3402

Length: 590 Ø: 48
Hole Distance: 130 / 130
03307200A, 81432206067, 81432206068,
81432206090, 81432206092, 81432209092



MN-DL-8197

Length: 1055 Ø: 42
Cone Ø: d1 Ø 30 / d2 Ø 27
03207500A, 81466116003, 81466116004,
81466116005



MN-DL-8544

Length: 596 Ø: 48
Hole Distance: 130 / 130
81432206196, 81432206232, 81432206233



MN-DL-8609

Length: 585 Ø: 58
Hole Distance: 130 / 130
81432206070, 81432206071, 81432206072,
81432206091, 81432206093, 81432206119



MN-DL-12284

Length: 1530 Ø: 50
Cone Ø: d1 Ø 30 / d2 Ø 27
81466106579, 81466106580, 81466106624,
81466116720, 81467116720, 81467116730,
81467116952



MN-DL-12391

Length: 1050 Ø: 52
Cone Ø: d1 Ø 30 / d2 Ø 27
82466106057, 82466106147



MN-DL-12421

Length: 1070 Ø: 48
Cone Ø: d1 Ø 30 / d2 Ø 27
Thread: M30 x 1,5 RHT
81466106656, 81466106659, 81466106669,
81466116006, 81466116007



MN-SB-5244

Ø: 65
Hole Distance: 125
Thick/Height: 22
03312000A, 81432710027, 81432710082



MN-SB-5246

Ø: 45 Thick/Height: 47
81437220022, 81437220038, 81962100450,
81962100469



MN-SB-10389

Ø: 70 Thick/Height: 72
81960200340



MN-SB-10390

Ø: 70 Thick/Height: 85/85
81960200341, 81960200373, 81960200385,
81960200408, 81960200418



MN-VB-8514

Length: 627 Ø: 48
Hole Ø 25 / 25 / 25
Hole Distance: 152 / 130 / 130
81432706087, 81432706088, 81432706094,
81432706095, 81432796094



SC-ES-8517

Length: 140
Cone Ø: d1 Ø 30 / d2 Ø 27
Thread: M30 x 1,5 RHT
81953016286





F 2000 ...

33.373 DFAK, DFAK-HK, DFA-KI	01/94 →	Ball Head, gearshift linkage	CV-ES-2119			
	01/94 →	Ball Head, gearshift linkage	CV-ES-2120			
	01/94 →	Ball Head, gearshift linkage	CV-ES-2182			
	01/94 →	Centre Rod	MN-DL-2160		Coupling Rod	
	01/94 →	Centre Rod	MN-DL-2176		Push Rod	
	01/94 →	Centre Rod	MN-DL-12391		for Steering Rod	
	01/94 →	Centre Rod	MN-DL-12421		for Steering Rod	
	01/94 →	Engine Mounting		MN-SB-10390		
	01/94 →	Engine Mounting	MN-SB-10389			
	01/94 →	Suspension Arm Repair Kit		MN-SB-5244	for Wishbone (CV)	
	01/94 →	Suspension Arm Repair Kit		MN-SB-5244	for Wishbone (CV), 1st RA	
	01/94 →	Suspension Arm Repair Kit		MN-SB-5244	for Wishbone (CV), 2nd RA	
	01/94 →	Tie Rod End	CV-ES-2146			
	01/94 →	Tie Rod End	CV-ES-2149		for Push Rod	
	01/94 →	Tie Rod End	CV-ES-14162		for Steering Rod	
	01/94 →	Tie Rod End	CV-ES-14163		for Steering Rod	
	01/94 →	Tie Rod End	SC-ES-8517		for Push Rod	
	01/94 →	Track Control Arm		MN-DL-3402	Trailing Arm, Drive Axle	
	01/94 →	Track Control Arm		MN-DL-8609	Trailing Arm, Leaf Spring Axle	
	33.373 DFAS	01/94 →	Ball Head, gearshift linkage	CV-ES-2119		
		01/94 →	Ball Head, gearshift linkage	CV-ES-2120		
		01/94 →	Ball Head, gearshift linkage	CV-ES-2182		
		01/94 →	Centre Rod	MN-DL-2160		Coupling Rod
		01/94 →	Centre Rod	MN-DL-2176		Push Rod
		01/94 →	Centre Rod	MN-DL-12391		for Steering Rod
01/94 →		Centre Rod	MN-DL-12421		for Steering Rod	
01/94 →		Engine Mounting		MN-SB-10390		
01/94 →		Engine Mounting	MN-SB-10389			
01/94 →		Suspension Arm Repair Kit		MN-SB-5244	for Wishbone (CV)	
01/94 →		Suspension Arm Repair Kit		MN-SB-5244	for Wishbone (CV), 1st RA	
01/94 →		Suspension Arm Repair Kit		MN-SB-5244	for Wishbone (CV), 2nd RA	
01/94 →		Tie Rod End	CV-ES-2146			
01/94 →		Tie Rod End	CV-ES-2149		for Push Rod	
01/94 →		Tie Rod End	CV-ES-14162		for Steering Rod	
01/94 →		Tie Rod End	CV-ES-14163		for Steering Rod	
01/94 →		Tie Rod End	SC-ES-8517		for Push Rod	
01/94 →		Track Control Arm		MN-DL-3402	Trailing Arm, Drive Axle	
01/94 →		Track Control Arm		MN-DL-8609	Trailing Arm, Leaf Spring Axle	
33.373 DFC		01/94 →	Ball Head, gearshift linkage	CV-ES-2119		
		01/94 →	Ball Head, gearshift linkage	CV-ES-2120	CV-ES-2120	
		01/94 →	Ball Head, gearshift linkage	CV-ES-2182		
		01/94 →	Centre Rod	MN-DL-2160		Coupling Rod
		01/94 →	Centre Rod	MN-DL-2176		Push Rod
		01/94 →	Centre Rod	MN-DL-8197		Push Rod
	01/94 →	Centre Rod	MN-DL-12391		for Steering Rod	
	01/94 →	Centre Rod	MN-DL-12421		for Steering Rod	
	01/94 →	Engine Mounting		MN-SB-10390		
	01/94 →	Mounting, stabilizer coupling rod	MN-SB-5246			
	01/94 →	Suspension Arm Repair Kit		MN-SB-5244	for Wishbone (CV)	
	01/94 →	Suspension Arm Repair Kit		MN-SB-5244	for Wishbone (CV), 2nd RA	
	01/94 →	Suspension Strut Repair Kit		DB-RK-8581		
	01/94 →	Tie Rod	MN-DL-12284			
	01/94 →	Tie Rod End	CV-ES-2149		for Push Rod	
	01/94 →	Tie Rod End	CV-ES-14162		for Steering Rod	
	01/94 →	Tie Rod End	CV-ES-14163		for Steering Rod	
	01/94 →	Track Control Arm		MN-DL-3402	Trailing Arm, Drive Axle	
	01/94 →	Track Control Arm		MN-DL-8544	Trailing Arm, Drive Axle; Leaf Spring Axle	
	01/94 →	Track Control Arm		MN-DL-8609	Trailing Arm, Leaf Spring Axle	
	01/94 →	Track Control Arm		MN-VB-8514	Suspension Rod, Wishbone (CV), Drive Axle; Leaf Spring Axle	

CV-ES-2119

Length: 55
Cone Ø: d1 Ø 10 / d2 Ø 10
Thread: M12 x 1,75 LHT
81953016063, 81953016131



CV-ES-2120

Length: 115
Cone Ø: d1 Ø 12,4 / d2 Ø 10,8
Thread: M14 x 1,5 RHT
03008500A, 81953016200, 81953016202, 81953016203, 81953016227



CV-ES-2146

Length: 80
Cone Ø: d1 Ø 30 / d2 Ø 27
Thread: M26 x 1,5 RHT
42533102, 81953016219, 81953016225, 81953016226, 81953016267, 81953016291



CV-ES-2149

Length: 160
Cone Ø: d1 Ø 30 / d2 Ø 27
Thread: M30 x 1,5 RHT
81953016263



CV-ES-2182

Length: 55
Cone Ø: d1 Ø 10 / d2 Ø 10
Thread: M12 x 1,75 RHT
81953016064, 81953016170



CV-ES-14162

Length: 125
Cone Ø: d1 Ø 30 / d2 Ø 27
Thread: M30 x 1,5 LHT
81953010015, 81953010083, 81953010087, 81953016029, 81953016030, 81953016043, 81953016044, 81953016050, 81953016054, 81953016087, 81953016091, 81953016107, 81953016120, 81953016125, 81953016152, 81953016155, 81953016157, 81953016168, 81953016179, 81953016181, 81953016223, 81953016237, 81953016254, 81953016275, 81953016279, 81953016351



CV-ES-14163

Length: 125
Cone Ø: d1 Ø 30 / d2 Ø 27
Thread: M30 x 1,5 RHT
95301.0084, 90804102156, 90804102272, 90804102696, 90804102710, 81953010016, 81953010075, 81953010084, 81953010088, 81953010094, 81953010103, 81953016030, 81953016043, 81953016048, 81953016049, 81953016053, 81953016061, 81953016090, 81953016108, 81953016112, 81953016126, 81953016143, 81953016149, 81953016154, 81953016156, 81953016168, 81953016178, 81953016194, 81953016206, 81953016224, 81953016234, 81953016242, 81953016252, 81953016274, 81953016278, 81953016284, 81953016286, 81953016308, 81953016310, 81953016312, 81953016347, 81953016350, 81953016352, 82953016012, 88953016014, N2953016001



DB-RK-8581

Ø: 85
Hole Distance: 130
Thick/Height: 24
03305800A, 81432706105



MN-DL-2160

Length: 1652 Ø: 50
Cone Ø: d1 Ø 30 / d2 Ø 27
81467106112, 81467106163, 81467106165, 81467106198, 81467106353, 81467106354, 81467106361, 81467116725



MN-DL-2176

Length: 1628 Ø: 48
Cone Ø: d1 Ø 30 / d2 Ø 27
81466106779, 81466106780, 81466106782



MN-DL-3402

Length: 590 Ø: 48
Hole Distance: 130 / 130
03307200A, 81432206067, 81432206068, 81432206090, 81432206092, 81432209092



MN-DL-8197

Length: 1055 Ø: 42
Cone Ø: d1 Ø 30 / d2 Ø 27
03207500A, 81466116003, 81466116004, 81466116005



MN-DL-8544

Length: 596 Ø: 48
Hole Distance: 130 / 130
81432206196, 81432206232, 81432206233



MN-DL-8609

Length: 585 Ø: 58
Hole Distance: 130 / 130
81432206070, 81432206071, 81432206072, 81432206091, 81432206093, 81432206119



MN-DL-12284

Length: 1530 Ø: 50
Cone Ø: d1 Ø 30 / d2 Ø 27
81466106579, 81466106580, 81466106624, 81466116720, 81467116720, 81467116730, 81467116952



MN-DL-12391

Length: 1050 Ø: 52
Cone Ø: d1 Ø 30 / d2 Ø 27
82466106057, 82466106147



MN-DL-12421

Length: 1070 Ø: 48
Cone Ø: d1 Ø 30 / d2 Ø 27
Thread: M30 x 1,5 RHT
81466106656, 81466106659, 81466106669, 81466116006, 81466116007



MN-SB-5244

Ø: 65
Hole Distance: 125
Thick/Height: 22
03312000A, 81432710027, 81432710082



MN-SB-5246

Ø: 45 Thick/Height: 47
81437220022, 81437220038, 81962100450, 81962100469



MN-SB-10389

Ø: 70 Thick/Height: 72
81960200340



MN-SB-10390

Ø: 70 Thick/Height: 85/85
81960200341, 81960200373, 81960200385, 81960200408, 81960200418



MN-VB-8514

Length: 627 Ø: 48
Hole Ø 25 / 25 / 25
Hole Distance: 152 / 130 / 130
81432706087, 81432706088, 81432706094, 81432706095, 81432796094



SC-ES-8517

Length: 140
Cone Ø: d1 Ø 30 / d2 Ø 27
Thread: M30 x 1,5 RHT
81953016286





F 2000 ...

33.373 DFK, DF-KI	01/94 →	Ball Head, gearshift linkage	CV-ES-2119		
	01/94 →	Ball Head, gearshift linkage	CV-ES-2120	CV-ES-2120	
	01/94 →	Ball Head, gearshift linkage	CV-ES-2182		
	01/94 →	Centre Rod	MN-DL-2160		Coupling Rod
	01/94 →	Centre Rod	MN-DL-2176		Push Rod
	01/94 →	Centre Rod	MN-DL-8197		Push Rod
	01/94 →	Centre Rod	MN-DL-12391		for Steering Rod
	01/94 →	Centre Rod	MN-DL-12421		for Steering Rod
	01/94 →	Engine Mounting		MN-SB-10390	
	01/94 →	Mounting, stabilizer coupling rod	MN-SB-5246		
	01/94 →	Suspension Arm Repair Kit		MN-SB-5244	for Wishbone (CV)
	01/94 →	Suspension Arm Repair Kit		MN-SB-5244	for Wishbone (CV), 2nd RA
	01/94 →	Suspension Strut Repair Kit		DB-RK-8581	
	01/94 →	Tie Rod	MN-DL-12284		
	01/94 →	Tie Rod End	CV-ES-2149		for Push Rod
	01/94 →	Tie Rod End	CV-ES-14162		for Steering Rod
	01/94 →	Tie Rod End	CV-ES-14163		for Steering Rod
	01/94 →	Track Control Arm		MN-DL-3402	Trailing Arm, Drive Axle
	01/94 →	Track Control Arm		MN-DL-8544	Trailing Arm, Drive Axle; Leaf Spring Axle
	01/94 →	Track Control Arm		MN-DL-8609	Trailing Arm, Leaf Spring Axle
01/94 →	Track Control Arm		MN-VB-8514	Suspension Rod, Wishbone (CV), Drive Axle; Leaf Spring Axle	
33.373 DFS, DFRS	01/94 →	Ball Head, gearshift linkage	CV-ES-2119		
	01/94 →	Ball Head, gearshift linkage	CV-ES-2120	CV-ES-2120	
	01/94 →	Ball Head, gearshift linkage	CV-ES-2182		
	01/94 →	Centre Rod	MN-DL-2160		Coupling Rod
	01/94 →	Centre Rod	MN-DL-2176		Push Rod
	01/94 →	Centre Rod	MN-DL-8197		Push Rod
	01/94 →	Centre Rod	MN-DL-12391		for Steering Rod
	01/94 →	Centre Rod	MN-DL-12421		for Steering Rod
	01/94 →	Engine Mounting		MN-SB-10390	
	01/94 →	Mounting, stabilizer coupling rod	MN-SB-5246		
	01/94 →	Suspension Arm Repair Kit		MN-SB-5244	for Wishbone (CV)
	01/94 →	Suspension Arm Repair Kit		MN-SB-5244	for Wishbone (CV), 2nd RA
	01/94 →	Suspension Strut Repair Kit		DB-RK-8581	
	01/94 →	Tie Rod	MN-DL-12284		
	01/94 →	Tie Rod End	CV-ES-2149		for Push Rod
	01/94 →	Tie Rod End	CV-ES-14162		for Steering Rod
	01/94 →	Tie Rod End	CV-ES-14163		for Steering Rod
	01/94 →	Track Control Arm		MN-DL-3402	Trailing Arm, Drive Axle
	01/94 →	Track Control Arm		MN-DL-8544	Trailing Arm, Drive Axle; Leaf Spring Axle
	01/94 →	Track Control Arm		MN-DL-8609	Trailing Arm, Leaf Spring Axle
01/94 →	Track Control Arm		MN-VB-8514	Suspension Rod, Wishbone (CV), Drive Axle; Leaf Spring Axle	
33.403 DFAC	01/94 →	Ball Head, gearshift linkage	CV-ES-2119		
	01/94 →	Ball Head, gearshift linkage	CV-ES-2120		
	01/94 →	Ball Head, gearshift linkage	CV-ES-2182		
	01/94 →	Centre Rod	MN-DL-2160		Coupling Rod
	01/94 →	Centre Rod	MN-DL-2176		Push Rod
	01/94 →	Centre Rod	MN-DL-12391		for Steering Rod
	01/94 →	Centre Rod	MN-DL-12421		for Steering Rod
	01/94 →	Engine Mounting		MN-SB-10390	
	01/94 →	Engine Mounting	MN-SB-10389		
	01/94 →	Suspension Arm Repair Kit		MN-SB-5244	for Wishbone (CV)
	01/94 →	Suspension Arm Repair Kit		MN-SB-5244	for Wishbone (CV), 1st RA
	01/94 →	Suspension Arm Repair Kit		MN-SB-5244	for Wishbone (CV), 2nd RA
	01/94 →	Tie Rod End	CV-ES-2146		
	01/94 →	Tie Rod End	CV-ES-2149		for Push Rod
	01/94 →	Tie Rod End	CV-ES-14162		for Steering Rod
	01/94 →	Tie Rod End	CV-ES-14163		for Steering Rod
	01/94 →	Tie Rod End	SC-ES-8517		for Push Rod
	01/94 →	Track Control Arm		MN-DL-3402	Trailing Arm, Drive Axle
	01/94 →	Track Control Arm		MN-DL-8609	Trailing Arm, Leaf Spring Axle

CV-ES-2119

Length: 55
Cone Ø: d1 Ø 10 / d2 Ø 10
Thread: M12 x 1,75 LHT
81953016063, 81953016131



CV-ES-2120

Length: 115
Cone Ø: d1 Ø 12,4 / d2 Ø 10,8
Thread: M14 x 1,5 RHT
03008500A, 81953016200, 81953016202, 81953016203, 81953016227



CV-ES-2146

Length: 80
Cone Ø: d1 Ø 30 / d2 Ø 27
Thread: M26 x 1,5 RHT
42533102, 81953016219, 81953016225, 81953016226, 81953016267, 81953016291



CV-ES-2149

Length: 160
Cone Ø: d1 Ø 30 / d2 Ø 27
Thread: M30 x 1,5 RHT
81953016263



CV-ES-2182

Length: 55
Cone Ø: d1 Ø 10 / d2 Ø 10
Thread: M12 x 1,75 RHT
81953016064, 81953016170



CV-ES-14162

Length: 125
Cone Ø: d1 Ø 30 / d2 Ø 27
Thread: M30 x 1,5 LHT
81953010015, 81953010083, 81953010087, 81953016029, 81953016030, 81953016043, 81953016044, 81953016050, 81953016054, 81953016087, 81953016091, 81953016107, 81953016120, 81953016125, 81953016152, 81953016155, 81953016157, 81953016168, 81953016179, 81953016181, 81953016223, 81953016237, 81953016254, 81953016275, 81953016279, 81953016351



CV-ES-14163

Length: 125
Cone Ø: d1 Ø 30 / d2 Ø 27
Thread: M30 x 1,5 RHT
95301.0084, 90804102156, 90804102272, 90804102696, 90804102710, 81953010016, 81953010075, 81953010084, 81953010088, 81953010094, 81953010103, 81953016030, 81953016043, 81953016048, 81953016049, 81953016053, 81953016061, 81953016090, 81953016108, 81953016112, 81953016126, 81953016143, 81953016149, 81953016154, 81953016156, 81953016168, 81953016178, 81953016194, 81953016206, 81953016224, 81953016234, 81953016242, 81953016252, 81953016274, 81953016278, 81953016284, 81953016286, 81953016308, 81953016310, 81953016312, 81953016347, 81953016350, 81953016352, 82953016012, 88953016014, N2953016001



DB-RK-8581

Ø: 85
Hole Distance: 130
Thick/Height: 24
03305800A, 81432706105



MN-DL-2160

Length: 1652 Ø: 50
Cone Ø: d1 Ø 30 / d2 Ø 27
81467106112, 81467106163, 81467106165, 81467106198, 81467106353, 81467106354, 81467106361, 81467116725



MN-DL-2176

Length: 1628 Ø: 48
Cone Ø: d1 Ø 30 / d2 Ø 27
81466106779, 81466106780, 81466106782



MN-DL-3402

Length: 590 Ø: 48
Hole Distance: 130 / 130
03307200A, 81432206067, 81432206068, 81432206090, 81432206092, 81432209092



MN-DL-8197

Length: 1055 Ø: 42
Cone Ø: d1 Ø 30 / d2 Ø 27
03207500A, 81466116003, 81466116004, 81466116005



MN-DL-8544

Length: 596 Ø: 48
Hole Distance: 130 / 130
81432206196, 81432206232, 81432206233



MN-DL-8609

Length: 585 Ø: 58
Hole Distance: 130 / 130
81432206070, 81432206071, 81432206072, 81432206091, 81432206093, 81432206119



MN-DL-12284

Length: 1530 Ø: 50
Cone Ø: d1 Ø 30 / d2 Ø 27
81466106579, 81466106580, 81466106624, 81466116720, 81467116720, 81467116730, 81467116952



MN-DL-12391

Length: 1050 Ø: 52
Cone Ø: d1 Ø 30 / d2 Ø 27
82466106057, 82466106147



MN-DL-12421

Length: 1070 Ø: 48
Cone Ø: d1 Ø 30 / d2 Ø 27
Thread: M30 x 1,5 RHT
81466106656, 81466106659, 81466106669, 81466116006, 81466116007



MN-SB-5244

Ø: 65
Hole Distance: 125
Thick/Height: 22
03312000A, 81432710027, 81432710082



MN-SB-5246

Ø: 45 Thick/Height: 47
81437220022, 81437220038, 81962100450, 81962100469



MN-SB-10389

Ø: 70 Thick/Height: 72
81960200340



MN-SB-10390

Ø: 70 Thick/Height: 85/85
81960200341, 81960200373, 81960200385, 81960200408, 81960200418



MN-VB-8514

Length: 627 Ø: 48
Hole Ø 25 / 25 / 25
Hole Distance: 152 / 130 / 130
81432706087, 81432706088, 81432706094, 81432706095, 81432796094



SC-ES-8517

Length: 140
Cone Ø: d1 Ø 30 / d2 Ø 27
Thread: M30 x 1,5 RHT
81953016286





F 2000 ...

33.403 DFAK, DFAK-HK, DFA-KI	01/94 →	Ball Head, gearshift linkage	CV-ES-2119			
	01/94 →	Ball Head, gearshift linkage	CV-ES-2120			
	01/94 →	Ball Head, gearshift linkage	CV-ES-2182			
	01/94 →	Centre Rod	MN-DL-2160		Coupling Rod	
	01/94 →	Centre Rod	MN-DL-2176		Push Rod	
	01/94 →	Centre Rod	MN-DL-12391		for Steering Rod	
	01/94 →	Centre Rod	MN-DL-12421		for Steering Rod	
	01/94 →	Engine Mounting		MN-SB-10390		
	01/94 →	Engine Mounting	MN-SB-10389			
	01/94 →	Suspension Arm Repair Kit		MN-SB-5244	for Wishbone (CV)	
	01/94 →	Suspension Arm Repair Kit		MN-SB-5244	for Wishbone (CV), 1st RA	
	01/94 →	Suspension Arm Repair Kit		MN-SB-5244	for Wishbone (CV), 2nd RA	
	01/94 →	Tie Rod End	CV-ES-2146			
	01/94 →	Tie Rod End	CV-ES-2149		for Push Rod	
	01/94 →	Tie Rod End	CV-ES-14162		for Steering Rod	
	01/94 →	Tie Rod End	CV-ES-14163		for Steering Rod	
	01/94 →	Tie Rod End	SC-ES-8517		for Push Rod	
	01/94 →	Track Control Arm		MN-DL-3402	Trailing Arm, Drive Axle	
	01/94 →	Track Control Arm		MN-DL-8609	Trailing Arm, Leaf Spring Axle	
	33.403 DFAS	01/94 →	Ball Head, gearshift linkage	CV-ES-2119		
		01/94 →	Ball Head, gearshift linkage	CV-ES-2120		
		01/94 →	Ball Head, gearshift linkage	CV-ES-2182		
		01/94 →	Centre Rod	MN-DL-2160		Coupling Rod
		01/94 →	Centre Rod	MN-DL-2176		Push Rod
		01/94 →	Centre Rod	MN-DL-12391		for Steering Rod
		01/94 →	Centre Rod	MN-DL-12421		for Steering Rod
01/94 →		Engine Mounting		MN-SB-10390		
01/94 →		Engine Mounting	MN-SB-10389			
01/94 →		Suspension Arm Repair Kit		MN-SB-5244	for Wishbone (CV)	
01/94 →		Suspension Arm Repair Kit		MN-SB-5244	for Wishbone (CV), 1st RA	
01/94 →		Suspension Arm Repair Kit		MN-SB-5244	for Wishbone (CV), 2nd RA	
01/94 →		Tie Rod End	CV-ES-2146			
01/94 →		Tie Rod End	CV-ES-2149		for Push Rod	
01/94 →		Tie Rod End	CV-ES-14162		for Steering Rod	
01/94 →		Tie Rod End	CV-ES-14163		for Steering Rod	
01/94 →		Tie Rod End	SC-ES-8517		for Push Rod	
01/94 →		Track Control Arm		MN-DL-3402	Trailing Arm, Drive Axle	
01/94 →		Track Control Arm		MN-DL-8609	Trailing Arm, Leaf Spring Axle	
33.403 DFC		01/94 →	Ball Head, gearshift linkage	CV-ES-2119		
		01/94 →	Ball Head, gearshift linkage	CV-ES-2120	CV-ES-2120	
		01/94 →	Ball Head, gearshift linkage	CV-ES-2182		
		01/94 →	Centre Rod	MN-DL-2160		Coupling Rod
		01/94 →	Centre Rod	MN-DL-2176		Push Rod
		01/94 →	Centre Rod	MN-DL-8197		Push Rod
		01/94 →	Centre Rod	MN-DL-12391		for Steering Rod
	01/94 →	Centre Rod	MN-DL-12421		for Steering Rod	
	01/94 →	Engine Mounting		MN-SB-10390		
	01/94 →	Mounting, stabilizer coupling rod	MN-SB-5246			
	01/94 →	Suspension Arm Repair Kit		MN-SB-5244	for Wishbone (CV)	
	01/94 →	Suspension Arm Repair Kit		MN-SB-5244	for Wishbone (CV), 2nd RA	
	01/94 →	Suspension Strut Repair Kit		DB-RK-8581		
	01/94 →	Tie Rod	MN-DL-12284			
	01/94 →	Tie Rod End	CV-ES-2146			
	01/94 →	Tie Rod End	CV-ES-2149		for Push Rod	
	01/94 →	Tie Rod End	CV-ES-14162		for Steering Rod	
	01/94 →	Tie Rod End	CV-ES-14163		for Steering Rod	
	01/94 →	Track Control Arm		MN-DL-3402	Trailing Arm, Drive Axle	
	01/94 →	Track Control Arm		MN-DL-8544	Trailing Arm, Drive Axle; Leaf Spring Axle	
	01/94 →	Track Control Arm		MN-DL-8609	Trailing Arm, Leaf Spring Axle	
	01/94 →	Track Control Arm		MN-VB-8514	Suspension Rod, Wishbone (CV), Drive Axle; Leaf Spring Axle	

CV-ES-2119

Length: 55
Cone Ø: d1 Ø 10 / d2 Ø 10
Thread: M12 x 1,75 LHT
81953016063, 81953016131



CV-ES-2120

Length: 115
Cone Ø: d1 Ø 12,4 / d2 Ø 10,8
Thread: M14 x 1,5 RHT
03008500A, 81953016200, 81953016202, 81953016203, 81953016227



CV-ES-2146

Length: 80
Cone Ø: d1 Ø 30 / d2 Ø 27
Thread: M26 x 1,5 RHT
42533102, 81953016219, 81953016225, 81953016226, 81953016267, 81953016291



CV-ES-2149

Length: 160
Cone Ø: d1 Ø 30 / d2 Ø 27
Thread: M30 x 1,5 RHT
81953016263



CV-ES-2182

Length: 55
Cone Ø: d1 Ø 10 / d2 Ø 10
Thread: M12 x 1,75 RHT
81953016064, 81953016170



CV-ES-14162

Length: 125
Cone Ø: d1 Ø 30 / d2 Ø 27
Thread: M30 x 1,5 LHT
81953010015, 81953010083, 81953010087, 81953016029, 81953016030, 81953016043, 81953016044, 81953016050, 81953016054, 81953016087, 81953016091, 81953016107, 81953016120, 81953016125, 81953016152, 81953016155, 81953016157, 81953016168, 81953016179, 81953016181, 81953016223, 81953016237, 81953016254, 81953016275, 81953016279, 81953016351



CV-ES-14163

Length: 125
Cone Ø: d1 Ø 30 / d2 Ø 27
Thread: M30 x 1,5 RHT
95301.0084, 90804102156, 90804102272, 90804102696, 90804102710, 81953010016, 81953010075, 81953010084, 81953010088, 81953010094, 81953010103, 81953016030, 81953016043, 81953016048, 81953016049, 81953016053, 81953016061, 81953016090, 81953016108, 81953016112, 81953016126, 81953016143, 81953016149, 81953016154, 81953016156, 81953016168, 81953016178, 81953016194, 81953016206, 81953016224, 81953016234, 81953016242, 81953016252, 81953016274, 81953016278, 81953016284, 81953016286, 81953016308, 81953016310, 81953016312, 81953016347, 81953016350, 81953016352, 82953016012, 88953016014, N2953016001



DB-RK-8581

Ø: 85
Hole Distance: 130
Thick/Height: 24
03305800A, 81432706105



MN-DL-2160

Length: 1652 Ø: 50
Cone Ø: d1 Ø 30 / d2 Ø 27
81467106112, 81467106163, 81467106165, 81467106198, 81467106353, 81467106354, 81467106361, 81467116725



MN-DL-2176

Length: 1628 Ø: 48
Cone Ø: d1 Ø 30 / d2 Ø 27
81466106779, 81466106780, 81466106782



MN-DL-3402

Length: 590 Ø: 48
Hole Distance: 130 / 130
03307200A, 81432206067, 81432206068, 81432206090, 81432206092, 81432209092



MN-DL-8197

Length: 1055 Ø: 42
Cone Ø: d1 Ø 30 / d2 Ø 27
03207500A, 81466116003, 81466116004, 81466116005



MN-DL-8544

Length: 596 Ø: 48
Hole Distance: 130 / 130
81432206196, 81432206232, 81432206233



MN-DL-8609

Length: 585 Ø: 58
Hole Distance: 130 / 130
81432206070, 81432206071, 81432206072, 81432206091, 81432206093, 81432206119



MN-DL-12284

Length: 1530 Ø: 50
Cone Ø: d1 Ø 30 / d2 Ø 27
81466106579, 81466106580, 81466106624, 81466116720, 81467116720, 81467116730, 81467116952



MN-DL-12391

Length: 1050 Ø: 52
Cone Ø: d1 Ø 30 / d2 Ø 27
82466106057, 82466106147



MN-DL-12421

Length: 1070 Ø: 48
Cone Ø: d1 Ø 30 / d2 Ø 27
Thread: M30 x 1,5 RHT
81466106656, 81466106659, 81466106669, 81466116006, 81466116007



MN-SB-5244

Ø: 65
Hole Distance: 125
Thick/Height: 22
03312000A, 81432710027, 81432710082



MN-SB-5246

Ø: 45 Thick/Height: 47
81437220022, 81437220038, 81962100450, 81962100469



MN-SB-10389

Ø: 70 Thick/Height: 72
81960200340



MN-SB-10390

Ø: 70 Thick/Height: 85/85
81960200341, 81960200373, 81960200385, 81960200408, 81960200418



MN-VB-8514

Length: 627 Ø: 48
Hole Ø 25 / 25 / 25
Hole Distance: 152 / 130 / 130
81432706087, 81432706088, 81432706094, 81432706095, 81432796094



SC-ES-8517

Length: 140
Cone Ø: d1 Ø 30 / d2 Ø 27
Thread: M30 x 1,5 RHT
81953016286





F 2000 ...

33.403 DFK, DF-KI	01/94 →	Ball Head, gearshift linkage	CV-ES-2119		
	01/94 →	Ball Head, gearshift linkage	CV-ES-2120	CV-ES-2120	
	01/94 →	Ball Head, gearshift linkage	CV-ES-2182		
	01/94 →	Centre Rod	MN-DL-2160		Coupling Rod
	01/94 →	Centre Rod	MN-DL-2176		Push Rod
	01/94 →	Centre Rod	MN-DL-8197		Push Rod
	01/94 →	Centre Rod	MN-DL-12391		for Steering Rod
	01/94 →	Centre Rod	MN-DL-12421		for Steering Rod
	01/94 →	Engine Mounting		MN-SB-10390	
	01/94 →	Mounting, stabilizer coupling rod	MN-SB-5246		
	01/94 →	Suspension Arm Repair Kit		MN-SB-5244	for Wishbone (CV)
	01/94 →	Suspension Arm Repair Kit		MN-SB-5244	for Wishbone (CV), 2nd RA
	01/94 →	Suspension Strut Repair Kit		DB-RK-8581	
	01/94 →	Tie Rod	MN-DL-12284		
	01/94 →	Tie Rod End	CV-ES-2146		
	01/94 →	Tie Rod End	CV-ES-2149		for Push Rod
	01/94 →	Tie Rod End	CV-ES-14162		for Steering Rod
	01/94 →	Tie Rod End	CV-ES-14163		for Steering Rod
	01/94 →	Track Control Arm		MN-DL-3402	Trailing Arm, Drive Axle
	01/94 →	Track Control Arm		MN-DL-8544	Trailing Arm, Drive Axle; Leaf Spring Axle
01/94 →	Track Control Arm		MN-DL-8609	Trailing Arm, Leaf Spring Axle	
01/94 →	Track Control Arm		MN-VB-8514	Suspension Rod, Wishbone (CV), Drive Axle; Leaf Spring Axle	
33.403 DFS, DFRS	01/94 →	Ball Head, gearshift linkage	CV-ES-2119		
	01/94 →	Ball Head, gearshift linkage	CV-ES-2120	CV-ES-2120	
	01/94 →	Ball Head, gearshift linkage	CV-ES-2182		
	01/94 →	Centre Rod	MN-DL-2160		Coupling Rod
	01/94 →	Centre Rod	MN-DL-2176		Push Rod
	01/94 →	Centre Rod	MN-DL-8197		Push Rod
	01/94 →	Centre Rod	MN-DL-12391		for Steering Rod
	01/94 →	Centre Rod	MN-DL-12421		for Steering Rod
	01/94 →	Engine Mounting		MN-SB-10390	
	01/94 →	Mounting, stabilizer coupling rod	MN-SB-5246		
	01/94 →	Suspension Arm Repair Kit		MN-SB-5244	for Wishbone (CV)
	01/94 →	Suspension Arm Repair Kit		MN-SB-5244	for Wishbone (CV), 2nd RA
	01/94 →	Suspension Strut Repair Kit		DB-RK-8581	
	01/94 →	Tie Rod	MN-DL-12284		
	01/94 →	Tie Rod End	CV-ES-2146		
	01/94 →	Tie Rod End	CV-ES-2149		for Push Rod
	01/94 →	Tie Rod End	CV-ES-14162		for Steering Rod
	01/94 →	Tie Rod End	CV-ES-14163		for Steering Rod
	01/94 →	Track Control Arm		MN-DL-3402	Trailing Arm, Drive Axle
	01/94 →	Track Control Arm		MN-DL-8544	Trailing Arm, Drive Axle; Leaf Spring Axle
01/94 →	Track Control Arm		MN-DL-8609	Trailing Arm, Leaf Spring Axle	
01/94 →	Track Control Arm		MN-VB-8514	Suspension Rod, Wishbone (CV), Drive Axle; Leaf Spring Axle	
33.414 DFAC	05/01 →	Ball Head, gearshift linkage	CV-ES-2120		
	05/01 →	Centre Rod	MN-DL-12391		for Steering Rod
	05/01 →	Centre Rod	MN-DL-12421		for Steering Rod
	05/01 →	Suspension Arm Repair Kit		MN-SB-5244	for Wishbone (CV)
	05/01 →	Tie Rod End	CV-ES-2146		
	05/01 →	Tie Rod End	CV-ES-14162		for Steering Rod
	05/01 →	Tie Rod End	CV-ES-14163		for Steering Rod
	05/01 →	Track Control Arm		MN-DL-3402	Trailing Arm
05/01 →	Track Control Arm		MN-DL-8609	Trailing Arm	
33.414 DFAK, DFAK-HK, DFA-KI	05/01 →	Ball Head, gearshift linkage	CV-ES-2120		
	05/01 →	Centre Rod	MN-DL-12391		for Steering Rod
	05/01 →	Centre Rod	MN-DL-12421		for Steering Rod
	05/01 →	Suspension Arm Repair Kit		MN-SB-5244	for Wishbone (CV)
	05/01 →	Tie Rod End	CV-ES-2146		
	05/01 →	Tie Rod End	CV-ES-14162		for Steering Rod
	05/01 →	Tie Rod End	CV-ES-14163		for Steering Rod
	05/01 →	Track Control Arm		MN-DL-3402	Trailing Arm
05/01 →	Track Control Arm		MN-DL-8609	Trailing Arm	

CV-ES-2119

Length: 55
Cone Ø: d1 Ø 10 / d2 Ø 10
Thread: M12 x 1,75 LHT
81953016063, 81953016131



CV-ES-2120

Length: 115
Cone Ø: d1 Ø 12,4 / d2 Ø 10,8
Thread: M14 x 1,5 RHT
03008500A, 81953016200, 81953016202,
81953016203, 81953016227



CV-ES-2146

Length: 80
Cone Ø: d1 Ø 30 / d2 Ø 27
Thread: M26 x 1,5 RHT
42533102, 81953016219, 81953016225,
81953016226, 81953016267, 81953016291



CV-ES-2149

Length: 160
Cone Ø: d1 Ø 30 / d2 Ø 27
Thread: M30 x 1,5 RHT
81953016263



CV-ES-2182

Length: 55
Cone Ø: d1 Ø 10 / d2 Ø 10
Thread: M12 x 1,75 RHT
81953016064, 81953016170



CV-ES-14162

Length: 125
Cone Ø: d1 Ø 30 / d2 Ø 27
Thread: M30 x 1,5 LHT
81953010015, 81953010083, 81953010087,
81953016029, 81953016030, 81953016043,
81953016044, 81953016050, 81953016054,
81953016087, 81953016091, 81953016107,
81953016120, 81953016125, 81953016152,
81953016155, 81953016157, 81953016168,
81953016179, 81953016181, 81953016223,
81953016237, 81953016254, 81953016275,
81953016279, 81953016351



CV-ES-14163

Length: 125
Cone Ø: d1 Ø 30 / d2 Ø 27
Thread: M30 x 1,5 RHT
95301.0084, 90804102156, 90804102272,
90804102696, 90804102710, 81953010016,
81953010075, 81953010084, 81953010088,
81953010094, 81953010103, 81953016030,
81953016043, 81953016048, 81953016049,
81953016053, 81953016061, 81953016090,
81953016108, 81953016112, 81953016126,
81953016143, 81953016149, 81953016154,
81953016156, 81953016168, 81953016178,
81953016194, 81953016206, 81953016224,
81953016234, 81953016242, 81953016252,
81953016274, 81953016278, 81953016284,
81953016286, 81953016308, 81953016310,
81953016312, 81953016347, 81953016350,
81953016352, 82953016012, 88953016014,
N2953016001



DB-RK-8581

Ø: 85
Hole Distance: 130
Thick/Height: 24
03305800A, 81432706105



MN-DL-2160

Length: 1652 Ø: 50
Cone Ø: d1 Ø 30 / d2 Ø 27
81467106112, 81467106163, 81467106165,
81467106198, 81467106353, 81467106354,
81467106361, 81467116725



MN-DL-2176

Length: 1628 Ø: 48
Cone Ø: d1 Ø 30 / d2 Ø 27
81466106779, 81466106780, 81466106782



MN-DL-3402

Length: 590 Ø: 48
Hole Distance: 130 / 130
03307200A, 81432206067, 81432206068,
81432206090, 81432206092, 81432209092



MN-DL-8197

Length: 1055 Ø: 42
Cone Ø: d1 Ø 30 / d2 Ø 27
03207500A, 81466116003, 81466116004,
81466116005



MN-DL-8544

Length: 596 Ø: 48
Hole Distance: 130 / 130
81432206196, 81432206232, 81432206233



MN-DL-8609

Length: 585 Ø: 58
Hole Distance: 130 / 130
81432206070, 81432206071, 81432206072,
81432206091, 81432206093, 81432206119



MN-DL-12284

Length: 1530 Ø: 50
Cone Ø: d1 Ø 30 / d2 Ø 27
81466106579, 81466106580, 81466106624,
81466116720, 81467116720, 81467116730,
81467116952



MN-DL-12391

Length: 1050 Ø: 52
Cone Ø: d1 Ø 30 / d2 Ø 27
82466106057, 82466106147



MN-DL-12421

Length: 1070 Ø: 48
Cone Ø: d1 Ø 30 / d2 Ø 27
Thread: M30 x 1,5 RHT
81466106656, 81466106659, 81466106669,
81466116006, 81466116007



MN-SB-5244

Ø: 65
Hole Distance: 125
Thick/Height: 22
03312000A, 81432710027, 81432710082



MN-SB-5246

Ø: 45 Thick/Height: 47
81437220022, 81437220038, 81962100450,
81962100469



MN-SB-10390

Ø: 70 Thick/Height: 85/85
81960200341, 81960200373, 81960200385,
81960200408, 81960200418



MN-VB-8514

Length: 627 Ø: 48
Hole Ø 25 / 25 / 25
Hole Distance: 152 / 130 / 130
81432706087, 81432706088, 81432706094,
81432706095, 81432796094



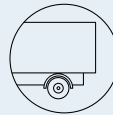

F 2000 ...

33.414 DFAS	05/01→	Ball Head, gearshift linkage	CV-ES-2120		
	05/01→	Centre Rod	MN-DL-12391		for Steering Rod
	05/01→	Centre Rod	MN-DL-12421		for Steering Rod
	05/01→	Suspension Arm Repair Kit		MN-SB-5244	for Wishbone (CV)
	05/01→	Tie Rod End	CV-ES-2146		
	05/01→	Tie Rod End	CV-ES-14162		for Steering Rod
	05/01→	Tie Rod End	CV-ES-14163		for Steering Rod
	05/01→	Track Control Arm		MN-DL-3402	Trailing Arm
	05/01→	Track Control Arm		MN-DL-8609	Trailing Arm
33.414 DFC	05/01→	Ball Head, gearshift linkage	CV-ES-2120	CV-ES-2120	
	05/01→	Centre Rod	MN-DL-8197		Push Rod
	05/01→	Centre Rod	MN-DL-12391		for Steering Rod
	05/01→	Centre Rod	MN-DL-12421		for Steering Rod
	05/01→	Mounting, stabilizer coupling rod	MN-SB-5246		
	05/01→	Suspension Arm Repair Kit		MN-SB-5244	for Wishbone (CV)
	05/01→	Tie Rod	MN-DL-12284		
	05/01→	Tie Rod End	CV-ES-2149		for Push Rod
	05/01→	Tie Rod End	CV-ES-14162		for Steering Rod
	05/01→	Tie Rod End	CV-ES-14163		for Steering Rod
	05/01→	Track Control Arm		MN-DL-3402	Trailing Arm
	05/01→	Track Control Arm		MN-DL-8544	Trailing Arm
	05/01→	Track Control Arm		MN-DL-8609	Trailing Arm
	05/01→	Track Control Arm		MN-VB-8514	Suspension Rod, Wishbone (CV)
	33.414 DFK, DF-KI	05/01→	Ball Head, gearshift linkage	CV-ES-2120	CV-ES-2120
05/01→		Centre Rod	MN-DL-8197		Push Rod
05/01→		Centre Rod	MN-DL-12391		for Steering Rod
05/01→		Centre Rod	MN-DL-12421		for Steering Rod
05/01→		Mounting, stabilizer coupling rod	MN-SB-5246		
05/01→		Suspension Arm Repair Kit		MN-SB-5244	for Wishbone (CV)
05/01→		Tie Rod	MN-DL-12284		
05/01→		Tie Rod End	CV-ES-2149		for Push Rod
05/01→		Tie Rod End	CV-ES-14162		for Steering Rod
05/01→		Tie Rod End	CV-ES-14163		for Steering Rod
05/01→		Track Control Arm		MN-DL-3402	Trailing Arm
05/01→		Track Control Arm		MN-DL-8544	Trailing Arm
05/01→		Track Control Arm		MN-DL-8609	Trailing Arm
05/01→		Track Control Arm		MN-VB-8514	Suspension Rod, Wishbone (CV)
33.414 DFS, DFRS		05/01→	Ball Head, gearshift linkage	CV-ES-2120	CV-ES-2120
	05/01→	Centre Rod	MN-DL-8197		Push Rod
	05/01→	Centre Rod	MN-DL-12391		for Steering Rod
	05/01→	Centre Rod	MN-DL-12421		for Steering Rod
	05/01→	Mounting, stabilizer coupling rod	MN-SB-5246		
	05/01→	Suspension Arm Repair Kit		MN-SB-5244	for Wishbone (CV)
	05/01→	Tie Rod	MN-DL-12284		
	05/01→	Tie Rod End	CV-ES-2149		for Push Rod
	05/01→	Tie Rod End	CV-ES-14162		for Steering Rod
	05/01→	Tie Rod End	CV-ES-14163		for Steering Rod
	05/01→	Track Control Arm		MN-DL-3402	Trailing Arm
	05/01→	Track Control Arm		MN-DL-8544	Trailing Arm
	05/01→	Track Control Arm		MN-DL-8609	Trailing Arm
	05/01→	Track Control Arm		MN-VB-8514	Suspension Rod, Wishbone (CV)
	33.423 DFAC	01/94→	Ball Head, gearshift linkage	CV-ES-2119	
01/94→		Ball Head, gearshift linkage	CV-ES-2120		
01/94→		Ball Head, gearshift linkage	CV-ES-2182		
01/94→		Centre Rod	MN-DL-2160		Coupling Rod
01/94→		Centre Rod	MN-DL-2176		Push Rod
01/94→		Centre Rod	MN-DL-12391		for Steering Rod
01/94→		Centre Rod	MN-DL-12421		for Steering Rod
01/94→		Engine Mounting		MN-SB-10390	
01/94→		Engine Mounting	MN-SB-10389		
01/94→		Suspension Arm Repair Kit		MN-SB-5244	for Wishbone (CV)
01/94→		Suspension Arm Repair Kit		MN-SB-5244	for Wishbone (CV), 1st RA
01/94→		Suspension Arm Repair Kit		MN-SB-5244	for Wishbone (CV), 2nd RA

CV-ES-2119

Length: 55
Cone Ø: d1 Ø 10 / d2 Ø 10
Thread: M12 x 1,75 LHT
81953016063, 81953016131



CV-ES-2120

Length: 115
Cone Ø: d1 Ø 12,4 / d2 Ø 10,8
Thread: M14 x 1,5 RHT
03008500A, 81953016200, 81953016202, 81953016203, 81953016227



CV-ES-2146

Length: 80
Cone Ø: d1 Ø 30 / d2 Ø 27
Thread: M26 x 1,5 RHT
42533102, 81953016219, 81953016225, 81953016226, 81953016267, 81953016291



CV-ES-2149

Length: 160
Cone Ø: d1 Ø 30 / d2 Ø 27
Thread: M30 x 1,5 RHT
81953016263



CV-ES-2182

Length: 55
Cone Ø: d1 Ø 10 / d2 Ø 10
Thread: M12 x 1,75 RHT
81953016064, 81953016170



CV-ES-14162

Length: 125
Cone Ø: d1 Ø 30 / d2 Ø 27
Thread: M30 x 1,5 LHT
81953010015, 81953010083, 81953010087, 81953016029, 81953016030, 81953016043, 81953016044, 81953016050, 81953016054, 81953016087, 81953016091, 81953016107, 81953016120, 81953016125, 81953016152, 81953016155, 81953016157, 81953016168, 81953016179, 81953016181, 81953016223, 81953016237, 81953016254, 81953016275, 81953016279, 81953016351



CV-ES-14163

Length: 125
Cone Ø: d1 Ø 30 / d2 Ø 27
Thread: M30 x 1,5 RHT
95301.0084, 90804102156, 90804102272, 90804102696, 90804102710, 81953010016, 81953010075, 81953010084, 81953010088, 81953010094, 81953010103, 81953016030, 81953016043, 81953016048, 81953016049, 81953016053, 81953016061, 81953016090, 81953016108, 81953016112, 81953016126, 81953016143, 81953016149, 81953016154, 81953016156, 81953016168, 81953016178, 81953016194, 81953016206, 81953016224, 81953016234, 81953016242, 81953016252, 81953016274, 81953016278, 81953016284, 81953016286, 81953016308, 81953016310, 81953016312, 81953016347, 81953016350, 81953016352, 82953016012, 88953016014, N2953016001



MN-DL-2160

Length: 1652 Ø: 50
Cone Ø: d1 Ø 30 / d2 Ø 27
81467106112, 81467106163, 81467106165, 81467106198, 81467106353, 81467106354, 81467106361, 81467116725



MN-DL-2176

Length: 1628 Ø: 48
Cone Ø: d1 Ø 30 / d2 Ø 27
81466106779, 81466106780, 81466106782



MN-DL-3402

Length: 590 Ø: 48
Hole Distance: 130 / 130
03307200A, 81432206067, 81432206068, 81432206090, 81432206092, 81432209092



MN-DL-8197

Length: 1055 Ø: 42
Cone Ø: d1 Ø 30 / d2 Ø 27
03207500A, 81466116003, 81466116004, 81466116005



MN-DL-8544

Length: 596 Ø: 48
Hole Distance: 130 / 130
81432206196, 81432206232, 81432206233



MN-DL-8609

Length: 585 Ø: 58
Hole Distance: 130 / 130
81432206070, 81432206071, 81432206072, 81432206091, 81432206093, 81432206119



MN-DL-12284

Length: 1530 Ø: 50
Cone Ø: d1 Ø 30 / d2 Ø 27
81466106579, 81466106580, 81466106624, 81466116720, 81467116720, 81467116730, 81467116952



MN-DL-12391

Length: 1050 Ø: 52
Cone Ø: d1 Ø 30 / d2 Ø 27
82466106057, 82466106147



MN-DL-12421

Length: 1070 Ø: 48
Cone Ø: d1 Ø 30 / d2 Ø 27
Thread: M30 x 1,5 RHT
81466106656, 81466106659, 81466106669, 81466116006, 81466116007



MN-SB-5244

Ø: 65
Hole Distance: 125
Thick/Height: 22
03312000A, 81432710027, 81432710082



MN-SB-5246

Ø: 45 Thick/Height: 47
81437220022, 81437220038, 81962100450, 81962100469



MN-SB-10389

Ø: 70 Thick/Height: 72
81960200340



MN-SB-10390

Ø: 70 Thick/Height: 85/85
81960200341, 81960200373, 81960200385, 81960200408, 81960200418



MN-VB-8514

Length: 627 Ø: 48
Hole Ø 25 / 25 / 25
Hole Distance: 152 / 130 / 130
81432706087, 81432706088, 81432706094, 81432706095, 81432796094



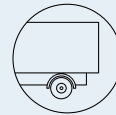

F 2000 ...

33.423 DFAC ...	01/94 →	Tie Rod End	CV-ES-2146		
	01/94 →	Tie Rod End	CV-ES-2149		for Push Rod
	01/94 →	Tie Rod End	CV-ES-14162		for Steering Rod
	01/94 →	Tie Rod End	CV-ES-14163		for Steering Rod
	01/94 →	Tie Rod End	SC-ES-8517		for Push Rod
	01/94 →	Track Control Arm		MN-DL-3402	Trailing Arm, Drive Axle
	01/94 →	Track Control Arm		MN-DL-8609	Trailing Arm, Leaf Spring Axle
	33.423 DFAK, DFAK-HK, DFA-KI	01/94 →	Ball Head, gearshift linkage	CV-ES-2119	
01/94 →		Ball Head, gearshift linkage	CV-ES-2120		
01/94 →		Ball Head, gearshift linkage	CV-ES-2182		
01/94 →		Centre Rod	MN-DL-2160		Coupling Rod
01/94 →		Centre Rod	MN-DL-2176		Push Rod
01/94 →		Centre Rod	MN-DL-12391		for Steering Rod
01/94 →		Centre Rod	MN-DL-12421		for Steering Rod
01/94 →		Engine Mounting		MN-SB-10390	
01/94 →		Engine Mounting	MN-SB-10389		
01/94 →		Suspension Arm Repair Kit		MN-SB-5244	for Wishbone (CV)
01/94 →		Suspension Arm Repair Kit		MN-SB-5244	for Wishbone (CV), 1st RA
01/94 →		Suspension Arm Repair Kit		MN-SB-5244	for Wishbone (CV), 2nd RA
01/94 →		Tie Rod End	CV-ES-2146		
01/94 →		Tie Rod End	CV-ES-2149		for Push Rod
01/94 →		Tie Rod End	CV-ES-14162		for Steering Rod
01/94 →		Tie Rod End	CV-ES-14163		for Steering Rod
01/94 →		Tie Rod End	SC-ES-8517		for Push Rod
01/94 →		Track Control Arm		MN-DL-3402	Trailing Arm, Drive Axle
01/94 →		Track Control Arm		MN-DL-8609	Trailing Arm, Leaf Spring Axle
33.423 DFAS		01/94 →	Ball Head, gearshift linkage	CV-ES-2119	
	01/94 →	Ball Head, gearshift linkage	CV-ES-2120		
	01/94 →	Ball Head, gearshift linkage	CV-ES-2182		
	01/94 →	Centre Rod	MN-DL-2160		Coupling Rod
	01/94 →	Centre Rod	MN-DL-2176		Push Rod
	01/94 →	Centre Rod	MN-DL-12391		for Steering Rod
	01/94 →	Centre Rod	MN-DL-12421		for Steering Rod
	01/94 →	Engine Mounting		MN-SB-10390	
	01/94 →	Engine Mounting	MN-SB-10389		
	01/94 →	Suspension Arm Repair Kit		MN-SB-5244	for Wishbone (CV)
	01/94 →	Suspension Arm Repair Kit		MN-SB-5244	for Wishbone (CV), 1st RA
	01/94 →	Suspension Arm Repair Kit		MN-SB-5244	for Wishbone (CV), 2nd RA
	01/94 →	Tie Rod End	CV-ES-2146		
	01/94 →	Tie Rod End	CV-ES-2149		for Push Rod
	01/94 →	Tie Rod End	CV-ES-14162		for Steering Rod
	01/94 →	Tie Rod End	CV-ES-14163		for Steering Rod
	01/94 →	Tie Rod End	SC-ES-8517		for Push Rod
	01/94 →	Track Control Arm		MN-DL-3402	Trailing Arm, Drive Axle
	01/94 →	Track Control Arm		MN-DL-8609	Trailing Arm, Leaf Spring Axle
	33.423 DFC	01/94 →	Ball Head, gearshift linkage	CV-ES-2119	
01/94 →		Ball Head, gearshift linkage	CV-ES-2120	CV-ES-2120	
01/94 →		Ball Head, gearshift linkage	CV-ES-2182		
01/94 →		Centre Rod	MN-DL-2160		Coupling Rod
01/94 →		Centre Rod	MN-DL-2176		Push Rod
01/94 →		Centre Rod	MN-DL-8197		Push Rod
01/94 →		Centre Rod	MN-DL-12391		for Steering Rod
01/94 →		Centre Rod	MN-DL-12421		for Steering Rod
01/94 →		Engine Mounting		MN-SB-10390	
01/94 →		Mounting, stabilizer coupling rod	MN-SB-5246		
01/94 →		Suspension Arm Repair Kit		MN-SB-5244	for Wishbone (CV)
01/94 →		Suspension Arm Repair Kit		MN-SB-5244	for Wishbone (CV), 2nd RA
01/94 →		Suspension Strut Repair Kit		DB-RK-8581	
01/94 →		Tie Rod	MN-DL-12284		
01/94 →		Tie Rod End	CV-ES-2149		for Push Rod
01/94 →		Tie Rod End	CV-ES-14162		for Steering Rod
01/94 →		Tie Rod End	CV-ES-14163		for Steering Rod
01/94 →		Track Control Arm		MN-DL-3402	Trailing Arm, Drive Axle

CV-ES-2119

Length: 55
Cone Ø: d1 Ø 10 / d2 Ø 10
Thread: M12 x 1,75 LHT
81953016063, 81953016131



CV-ES-2120

Length: 115
Cone Ø: d1 Ø 12,4 / d2 Ø 10,8
Thread: M14 x 1,5 RHT
03008500A, 81953016200, 81953016202,
81953016203, 81953016227



CV-ES-2146

Length: 80
Cone Ø: d1 Ø 30 / d2 Ø 27
Thread: M26 x 1,5 RHT
42533102, 81953016219, 81953016225,
81953016226, 81953016267, 81953016291



CV-ES-2149

Length: 160
Cone Ø: d1 Ø 30 / d2 Ø 27
Thread: M30 x 1,5 RHT
81953016263



CV-ES-2182

Length: 55
Cone Ø: d1 Ø 10 / d2 Ø 10
Thread: M12 x 1,75 RHT
81953016064, 81953016170



CV-ES-14162

Length: 125
Cone Ø: d1 Ø 30 / d2 Ø 27
Thread: M30 x 1,5 LHT
81953010015, 81953010083, 81953010087,
81953016029, 81953016030, 81953016043,
81953016044, 81953016050, 81953016054,
81953016087, 81953016091, 81953016107,
81953016120, 81953016125, 81953016152,
81953016155, 81953016157, 81953016168,
81953016179, 81953016181, 81953016223,
81953016237, 81953016254, 81953016275,
81953016279, 81953016351



CV-ES-14163

Length: 125
Cone Ø: d1 Ø 30 / d2 Ø 27
Thread: M30 x 1,5 RHT
95301.0084, 90804102156, 90804102272,
90804102696, 90804102710, 81953010016,
81953010075, 81953010084, 81953010088,
81953010094, 81953010103, 81953016030,
81953016043, 81953016048, 81953016049,
81953016053, 81953016061, 81953016090,
81953016108, 81953016112, 81953016126,
81953016143, 81953016149, 81953016154,
81953016156, 81953016168, 81953016178,
81953016194, 81953016206, 81953016224,
81953016234, 81953016242, 81953016252,
81953016274, 81953016278, 81953016284,
81953016286, 81953016308, 81953016310,
81953016312, 81953016347, 81953016350,
81953016352, 82953016012, 88953016014,
N2953016001



DB-RK-8581

Ø: 85
Hole Distance: 130
Thick/Height: 24
03305800A, 81432706105



MN-DL-2160

Length: 1652 Ø: 50
Cone Ø: d1 Ø 30 / d2 Ø 27
81467106112, 81467106163, 81467106165,
81467106198, 81467106353, 81467106354,
81467106361, 81467116725



MN-DL-2176

Length: 1628 Ø: 48
Cone Ø: d1 Ø 30 / d2 Ø 27
81466106779, 81466106780, 81466106782



MN-DL-3402

Length: 590 Ø: 48
Hole Distance: 130 / 130
03307200A, 81432206067, 81432206068,
81432206090, 81432206092, 81432209092



MN-DL-8197

Length: 1055 Ø: 42
Cone Ø: d1 Ø 30 / d2 Ø 27
03207500A, 81466116003, 81466116004,
81466116005



MN-DL-8609

Length: 585 Ø: 58
Hole Distance: 130 / 130
81432206070, 81432206071, 81432206072,
81432206091, 81432206093, 81432206119



MN-DL-12284

Length: 1530 Ø: 50
Cone Ø: d1 Ø 30 / d2 Ø 27
81466106579, 81466106580, 81466106624,
81466116720, 81467116720, 81467116730,
81467116952



MN-DL-12391

Length: 1050 Ø: 52
Cone Ø: d1 Ø 30 / d2 Ø 27
82466106057, 82466106147



MN-DL-12421

Length: 1070 Ø: 48
Cone Ø: d1 Ø 30 / d2 Ø 27
Thread: M30 x 1,5 RHT
81466106656, 81466106659, 81466106669,
81466116006, 81466116007



MN-SB-5244

Ø: 65
Hole Distance: 125
Thick/Height: 22
03312000A, 81432710027, 81432710082



MN-SB-5246

Ø: 45 Thick/Height: 47
81437220022, 81437220038, 81962100450,
81962100469



MN-SB-10389

Ø: 70 Thick/Height: 72
81960200340



MN-SB-10390

Ø: 70 Thick/Height: 85/85
81960200341, 81960200373, 81960200385,
81960200408, 81960200418



SC-ES-8517

Length: 140
Cone Ø: d1 Ø 30 / d2 Ø 27
Thread: M30 x 1,5 RHT
81953016286





F 2000 ...

33.423 DFC ...	01/94 →	Track Control Arm		MN-DL-8544	Trailing Arm, Drive Axle;Leaf Spring Axle	
	01/94 →	Track Control Arm		MN-DL-8609	Trailing Arm, Leaf Spring Axle	
	01/94 →	Track Control Arm		MN-VB-8514	Suspension Rod, Wishbone (CV), Drive Axle; Leaf Spring Axle	
33.423 DFK, DF-KI	01/94 →	Ball Head, gearshift linkage	CV-ES-2119			
	01/94 →	Ball Head, gearshift linkage	CV-ES-2120	CV-ES-2120		
	01/94 →	Ball Head, gearshift linkage	CV-ES-2182			
	01/94 →	Centre Rod	MN-DL-2160		Coupling Rod	
	01/94 →	Centre Rod	MN-DL-2176		Push Rod	
	01/94 →	Centre Rod	MN-DL-8197		Push Rod	
	01/94 →	Centre Rod	MN-DL-12391		for Steering Rod	
	01/94 →	Centre Rod	MN-DL-12421		for Steering Rod	
	01/94 →	Engine Mounting		MN-SB-10390		
	01/94 →	Mounting, stabilizer coupling rod	MN-SB-5246			
	01/94 →	Suspension Arm Repair Kit		MN-SB-5244	for Wishbone (CV)	
	01/94 →	Suspension Arm Repair Kit		MN-SB-5244	for Wishbone (CV), 2nd RA	
	01/94 →	Suspension Strut Repair Kit		DB-RK-8581		
	01/94 →	Tie Rod	MN-DL-12284			
	01/94 →	Tie Rod End	CV-ES-2149		for Push Rod	
	01/94 →	Tie Rod End	CV-ES-14162		for Steering Rod	
	01/94 →	Tie Rod End	CV-ES-14163		for Steering Rod	
	01/94 →	Track Control Arm		MN-DL-3402	Trailing Arm, Drive Axle	
	01/94 →	Track Control Arm		MN-DL-8544	Trailing Arm, Drive Axle;Leaf Spring Axle	
	01/94 →	Track Control Arm		MN-DL-8609	Trailing Arm, Leaf Spring Axle	
	01/94 →	Track Control Arm		MN-VB-8514	Suspension Rod, Wishbone (CV), Drive Axle; Leaf Spring Axle	
	33.423 DFS, DFRS	01/94 →	Ball Head, gearshift linkage	CV-ES-2119		
		01/94 →	Ball Head, gearshift linkage	CV-ES-2120	CV-ES-2120	
01/94 →		Ball Head, gearshift linkage	CV-ES-2182			
01/94 →		Centre Rod	MN-DL-2160		Coupling Rod	
01/94 →		Centre Rod	MN-DL-2176		Push Rod	
01/94 →		Centre Rod	MN-DL-8197		Push Rod	
01/94 →		Centre Rod	MN-DL-12391		for Steering Rod	
01/94 →		Centre Rod	MN-DL-12421		for Steering Rod	
01/94 →		Engine Mounting		MN-SB-10390		
01/94 →		Mounting, stabilizer coupling rod	MN-SB-5246			
01/94 →		Suspension Arm Repair Kit		MN-SB-5244	for Wishbone (CV)	
01/94 →		Suspension Arm Repair Kit		MN-SB-5244	for Wishbone (CV), 2nd RA	
01/94 →		Suspension Strut Repair Kit		DB-RK-8581		
01/94 →		Tie Rod	MN-DL-12284			
01/94 →		Tie Rod End	CV-ES-2149		for Push Rod	
01/94 →		Tie Rod End	CV-ES-14162		for Steering Rod	
01/94 →		Tie Rod End	CV-ES-14163		for Steering Rod	
01/94 →		Track Control Arm		MN-DL-3402	Trailing Arm, Drive Axle	
01/94 →		Track Control Arm		MN-DL-8544	Trailing Arm, Drive Axle;Leaf Spring Axle	
01/94 →		Track Control Arm		MN-DL-8609	Trailing Arm, Leaf Spring Axle	
01/94 →		Track Control Arm		MN-VB-8514	Suspension Rod, Wishbone (CV), Drive Axle; Leaf Spring Axle	
33.463 DFAC		01/94 →	Ball Head, gearshift linkage	CV-ES-2119		
		01/94 →	Ball Head, gearshift linkage	CV-ES-2120		
	01/94 →	Ball Head, gearshift linkage	CV-ES-2182			
	01/94 →	Centre Rod	MN-DL-2160		Coupling Rod	
	01/94 →	Centre Rod	MN-DL-2176		Push Rod	
	01/94 →	Centre Rod	MN-DL-12391		for Steering Rod	
	01/94 →	Centre Rod	MN-DL-12421		for Steering Rod	
	01/94 →	Engine Mounting		MN-SB-10390		
	01/94 →	Engine Mounting	MN-SB-10389			
	01/94 →	Suspension Arm Repair Kit		MN-SB-5244	for Wishbone (CV)	
	01/94 →	Suspension Arm Repair Kit		MN-SB-5244	for Wishbone (CV), 1st RA	
	01/94 →	Suspension Arm Repair Kit		MN-SB-5244	for Wishbone (CV), 2nd RA	
	01/94 →	Tie Rod End	CV-ES-2146			
	01/94 →	Tie Rod End	CV-ES-2149		for Push Rod	
	01/94 →	Tie Rod End	CV-ES-14162		for Steering Rod	

CV-ES-2119

Length: 55
Cone Ø: d1 Ø 10 / d2 Ø 10
Thread: M12 x 1,75 LHT
81953016063, 81953016131



CV-ES-2120

Length: 115
Cone Ø: d1 Ø 12,4 / d2 Ø 10,8
Thread: M14 x 1,5 RHT
03008500A, 81953016200, 81953016202,
81953016203, 81953016227



CV-ES-2146

Length: 80
Cone Ø: d1 Ø 30 / d2 Ø 27
Thread: M26 x 1,5 RHT
42533102, 81953016219, 81953016225,
81953016226, 81953016267, 81953016291



CV-ES-2149

Length: 160
Cone Ø: d1 Ø 30 / d2 Ø 27
Thread: M30 x 1,5 RHT
81953016263



CV-ES-2182

Length: 55
Cone Ø: d1 Ø 10 / d2 Ø 10
Thread: M12 x 1,75 RHT
81953016064, 81953016170



CV-ES-14162

Length: 125
Cone Ø: d1 Ø 30 / d2 Ø 27
Thread: M30 x 1,5 LHT
81953010015, 81953010083, 81953010087,
81953016029, 81953016030, 81953016043,
81953016044, 81953016050, 81953016054,
81953016087, 81953016091, 81953016107,
81953016120, 81953016125, 81953016152,
81953016155, 81953016157, 81953016168,
81953016179, 81953016181, 81953016223,
81953016237, 81953016254, 81953016275,
81953016279, 81953016351



CV-ES-14163

Length: 125
Cone Ø: d1 Ø 30 / d2 Ø 27
Thread: M30 x 1,5 RHT
95301.0084, 90804102156, 90804102272,
90804102696, 90804102710, 81953010016,
81953010075, 81953010084, 81953010088,
81953010094, 81953010103, 81953016030,
81953016043, 81953016048, 81953016049,
81953016053, 81953016061, 81953016090,
81953016108, 81953016112, 81953016126,
81953016143, 81953016149, 81953016154,
81953016156, 81953016168, 81953016178,
81953016194, 81953016206, 81953016224,
81953016234, 81953016242, 81953016252,
81953016274, 81953016278, 81953016284,
81953016286, 81953016308, 81953016310,
81953016312, 81953016347, 81953016350,
81953016352, 82953016012, 88953016014,
N2953016001



DB-RK-8581

Ø: 85
Hole Distance: 130
Thick/Height: 24
03305800A, 81432706105



MN-DL-2160

Length: 1652 Ø: 50
Cone Ø: d1 Ø 30 / d2 Ø 27
81467106112, 81467106163, 81467106165,
81467106198, 81467106353, 81467106354,
81467106361, 81467116725



MN-DL-2176

Length: 1628 Ø: 48
Cone Ø: d1 Ø 30 / d2 Ø 27
81466106779, 81466106780, 81466106782



MN-DL-3402

Length: 590 Ø: 48
Hole Distance: 130 / 130
03307200A, 81432206067, 81432206068,
81432206090, 81432206092, 81432209092



MN-DL-8197

Length: 1055 Ø: 42
Cone Ø: d1 Ø 30 / d2 Ø 27
03207500A, 81466116003, 81466116004,
81466116005



MN-DL-8544

Length: 596 Ø: 48
Hole Distance: 130 / 130
81432206196, 81432206232, 81432206233



MN-DL-8609

Length: 585 Ø: 58
Hole Distance: 130 / 130
81432206070, 81432206071, 81432206072,
81432206091, 81432206093, 81432206119



MN-DL-12284

Length: 1530 Ø: 50
Cone Ø: d1 Ø 30 / d2 Ø 27
81466106579, 81466106580, 81466106624,
81466116720, 81467116720, 81467116730,
81467116952



MN-DL-12391

Length: 1050 Ø: 52
Cone Ø: d1 Ø 30 / d2 Ø 27
82466106057, 82466106147



MN-DL-12421

Length: 1070 Ø: 48
Cone Ø: d1 Ø 30 / d2 Ø 27
Thread: M30 x 1,5 RHT
81466106656, 81466106659, 81466106669,
81466116006, 81466116007



MN-SB-5244

Ø: 65
Hole Distance: 125
Thick/Height: 22
03312000A, 81432710027, 81432710082



MN-SB-5246

Ø: 45 Thick/Height: 47
81437220022, 81437220038, 81962100450,
81962100469



MN-SB-10389

Ø: 70 Thick/Height: 72
81960200340



MN-SB-10390

Ø: 70 Thick/Height: 85/85
81960200341, 81960200373, 81960200385,
81960200408, 81960200418



MN-VB-8514

Length: 627 Ø: 48
Hole Ø 25 / 25 / 25
Hole Distance: 152 / 130 / 130
81432706087, 81432706088, 81432706094,
81432706095, 81432796094





F 2000 ...

33.463 DFAC ...	01/94 →	Tie Rod End	CV-ES-14163		for Steering Rod
	01/94 →	Tie Rod End	SC-ES-8517		for Push Rod
	01/94 →	Track Control Arm		MN-DL-3402	Trailing Arm, Drive Axle
	01/94 →	Track Control Arm		MN-DL-8609	Trailing Arm, Leaf Spring Axle
33.463 DFAK, DFAK-HK, DFA-KI	01/94 →	Ball Head, gearshift linkage	CV-ES-2119		
	01/94 →	Ball Head, gearshift linkage	CV-ES-2120		
	01/94 →	Ball Head, gearshift linkage	CV-ES-2182		
	01/94 →	Centre Rod	MN-DL-2160		Coupling Rod
	01/94 →	Centre Rod	MN-DL-2176		Push Rod
	01/94 →	Centre Rod	MN-DL-12391		for Steering Rod
	01/94 →	Centre Rod	MN-DL-12421		for Steering Rod
	01/94 →	Engine Mounting		MN-SB-10390	
	01/94 →	Engine Mounting	MN-SB-10389		
	01/94 →	Suspension Arm Repair Kit		MN-SB-5244	for Wishbone (CV)
	01/94 →	Suspension Arm Repair Kit		MN-SB-5244	for Wishbone (CV), 1st RA
	01/94 →	Suspension Arm Repair Kit		MN-SB-5244	for Wishbone (CV), 2nd RA
	01/94 →	Tie Rod End	CV-ES-2146		
	01/94 →	Tie Rod End	CV-ES-2149		for Push Rod
	01/94 →	Tie Rod End	CV-ES-14162		for Steering Rod
	01/94 →	Tie Rod End	CV-ES-14163		for Steering Rod
	01/94 →	Tie Rod End	SC-ES-8517		for Push Rod
	01/94 →	Track Control Arm		MN-DL-3402	Trailing Arm, Drive Axle
	01/94 →	Track Control Arm		MN-DL-8609	Trailing Arm, Leaf Spring Axle
	33.463 DFAS	01/94 →	Ball Head, gearshift linkage	CV-ES-2119	
01/94 →		Ball Head, gearshift linkage	CV-ES-2120		
01/94 →		Ball Head, gearshift linkage	CV-ES-2182		
01/94 →		Centre Rod	MN-DL-2160		Coupling Rod
01/94 →		Centre Rod	MN-DL-2176		Push Rod
01/94 →		Centre Rod	MN-DL-12391		for Steering Rod
01/94 →		Centre Rod	MN-DL-12421		for Steering Rod
01/94 →		Engine Mounting		MN-SB-10390	
01/94 →		Engine Mounting	MN-SB-10389		
01/94 →		Suspension Arm Repair Kit		MN-SB-5244	for Wishbone (CV)
01/94 →		Suspension Arm Repair Kit		MN-SB-5244	for Wishbone (CV), 1st RA
01/94 →		Suspension Arm Repair Kit		MN-SB-5244	for Wishbone (CV), 2nd RA
01/94 →		Tie Rod End	CV-ES-2146		
01/94 →		Tie Rod End	CV-ES-2149		for Push Rod
01/94 →		Tie Rod End	CV-ES-14162		for Steering Rod
01/94 →		Tie Rod End	CV-ES-14163		for Steering Rod
01/94 →		Tie Rod End	SC-ES-8517		for Push Rod
01/94 →		Track Control Arm		MN-DL-3402	Trailing Arm, Drive Axle
01/94 →		Track Control Arm		MN-DL-8609	Trailing Arm, Leaf Spring Axle
33.463 DFC		01/94 →	Ball Head, gearshift linkage	CV-ES-2119	
	01/94 →	Ball Head, gearshift linkage	CV-ES-2120	CV-ES-2120	
	01/94 →	Ball Head, gearshift linkage	CV-ES-2182		
	01/94 →	Centre Rod	MN-DL-2160		Coupling Rod
	01/94 →	Centre Rod	MN-DL-2176		Push Rod
	01/94 →	Centre Rod	MN-DL-8197		Push Rod
	01/94 →	Centre Rod	MN-DL-12391		for Steering Rod
	01/94 →	Centre Rod	MN-DL-12421		for Steering Rod
	01/94 →	Engine Mounting		MN-SB-10390	
	01/94 →	Mounting, stabilizer coupling rod	MN-SB-5246		
	01/94 →	Suspension Arm Repair Kit		MN-SB-5244	for Wishbone (CV)
	01/94 →	Suspension Arm Repair Kit		MN-SB-5244	for Wishbone (CV), 2nd RA
	01/94 →	Suspension Strut Repair Kit		DB-RK-8581	
	01/94 →	Tie Rod	MN-DL-12284		
	01/94 →	Tie Rod End	CV-ES-2146		
	01/94 →	Tie Rod End	CV-ES-2149		for Push Rod
	01/94 →	Tie Rod End	CV-ES-14162		for Steering Rod
	01/94 →	Tie Rod End	CV-ES-14163		for Steering Rod
	01/94 →	Track Control Arm		MN-DL-3402	Trailing Arm, Drive Axle
	01/94 →	Track Control Arm		MN-DL-8544	Trailing Arm, Drive Axle; Leaf Spring Axle
01/94 →	Track Control Arm		MN-DL-8609	Trailing Arm, Leaf Spring Axle	

CV-ES-2119

Length: 55
Cone Ø: d1 Ø 10 / d2 Ø 10
Thread: M12 x 1,75 LHT
81953016063, 81953016131



CV-ES-2120

Length: 115
Cone Ø: d1 Ø 12,4 / d2 Ø 10,8
Thread: M14 x 1,5 RHT
03008500A, 81953016200, 81953016202,
81953016203, 81953016227



CV-ES-2146

Length: 80
Cone Ø: d1 Ø 30 / d2 Ø 27
Thread: M26 x 1,5 RHT
42533102, 81953016219, 81953016225,
81953016226, 81953016267, 81953016291



CV-ES-2149

Length: 160
Cone Ø: d1 Ø 30 / d2 Ø 27
Thread: M30 x 1,5 RHT
81953016263



CV-ES-2182

Length: 55
Cone Ø: d1 Ø 10 / d2 Ø 10
Thread: M12 x 1,75 RHT
81953016064, 81953016170



CV-ES-14162

Length: 125
Cone Ø: d1 Ø 30 / d2 Ø 27
Thread: M30 x 1,5 LHT
81953010015, 81953010083, 81953010087,
81953016029, 81953016030, 81953016043,
81953016044, 81953016050, 81953016054,
81953016087, 81953016091, 81953016107,
81953016120, 81953016125, 81953016152,
81953016155, 81953016157, 81953016168,
81953016179, 81953016181, 81953016223,
81953016237, 81953016254, 81953016275,
81953016279, 81953016351



CV-ES-14163

Length: 125
Cone Ø: d1 Ø 30 / d2 Ø 27
Thread: M30 x 1,5 RHT
95301.0084, 90804102156, 90804102272,
90804102696, 90804102710, 81953010016,
81953010075, 81953010084, 81953010088,
81953010094, 81953010103, 81953016030,
81953016043, 81953016048, 81953016049,
81953016053, 81953016061, 81953016090,
81953016108, 81953016112, 81953016126,
81953016143, 81953016149, 81953016154,
81953016156, 81953016168, 81953016178,
81953016194, 81953016206, 81953016224,
81953016234, 81953016242, 81953016252,
81953016274, 81953016278, 81953016284,
81953016286, 81953016308, 81953016310,
81953016312, 81953016347, 81953016350,
81953016352, 82953016012, 88953016014,
N2953016001



DB-RK-8581

Ø: 85
Hole Distance: 130
Thick/Height: 24
03305800A, 81432706105



MN-DL-2160

Length: 1652 Ø: 50
Cone Ø: d1 Ø 30 / d2 Ø 27
81467106112, 81467106163, 81467106165,
81467106198, 81467106353, 81467106354,
81467106361, 81467116725



MN-DL-2176

Length: 1628 Ø: 48
Cone Ø: d1 Ø 30 / d2 Ø 27
81466106779, 81466106780, 81466106782



MN-DL-3402

Length: 590 Ø: 48
Hole Distance: 130 / 130
03307200A, 81432206067, 81432206068,
81432206090, 81432206092, 81432209092



MN-DL-8197

Length: 1055 Ø: 42
Cone Ø: d1 Ø 30 / d2 Ø 27
03207500A, 81466116003, 81466116004,
81466116005



MN-DL-8544

Length: 596 Ø: 48
Hole Distance: 130 / 130
81432206196, 81432206232, 81432206233



MN-DL-8609

Length: 585 Ø: 58
Hole Distance: 130 / 130
81432206070, 81432206071, 81432206072,
81432206091, 81432206093, 81432206119



MN-DL-12284

Length: 1530 Ø: 50
Cone Ø: d1 Ø 30 / d2 Ø 27
81466106579, 81466106580, 81466106624,
81466116720, 81467116720, 81467116730,
81467116952



MN-DL-12391

Length: 1050 Ø: 52
Cone Ø: d1 Ø 30 / d2 Ø 27
82466106057, 82466106147



MN-DL-12421

Length: 1070 Ø: 48
Cone Ø: d1 Ø 30 / d2 Ø 27
Thread: M30 x 1,5 RHT
81466106656, 81466106659, 81466106669,
81466116006, 81466116007



MN-SB-5244

Ø: 65
Hole Distance: 125
Thick/Height: 22
03312000A, 81432710027, 81432710082



MN-SB-5246

Ø: 45 Thick/Height: 47
81437220022, 81437220038, 81962100450,
81962100469



MN-SB-10389

Ø: 70 Thick/Height: 72
8196200340



MN-SB-10390

Ø: 70 Thick/Height: 85/85
8196200341, 8196200373, 8196200385,
8196200408, 8196200418



SC-ES-8517

Length: 140
Cone Ø: d1 Ø 30 / d2 Ø 27
Thread: M30 x 1,5 RHT
81953016286





F 2000 ...

33.463 DFC ...	01/94 →	Track Control Arm		MN-VB-8514	Suspension Rod, Wishbone (CV), Drive Axle; Leaf Spring Axle
33.463 DFK, DF-KI	01/94 →	Ball Head, gearshift linkage	CV-ES-2119		
	01/94 →	Ball Head, gearshift linkage	CV-ES-2120	CV-ES-2120	
	01/94 →	Ball Head, gearshift linkage	CV-ES-2182		
	01/94 →	Centre Rod	MN-DL-2160		Coupling Rod
	01/94 →	Centre Rod	MN-DL-2176		Push Rod
	01/94 →	Centre Rod	MN-DL-8197		Push Rod
	01/94 →	Centre Rod	MN-DL-12391		for Steering Rod
	01/94 →	Centre Rod	MN-DL-12421		for Steering Rod
	01/94 →	Engine Mounting		MN-SB-10390	
	01/94 →	Mounting, stabilizer coupling rod	MN-SB-5246		
	01/94 →	Suspension Arm Repair Kit		MN-SB-5244	for Wishbone (CV)
	01/94 →	Suspension Arm Repair Kit		MN-SB-5244	for Wishbone (CV), 2nd RA
	01/94 →	Suspension Strut Repair Kit		DB-RK-8581	
	01/94 →	Tie Rod	MN-DL-12284		
	01/94 →	Tie Rod End	CV-ES-2146		
	01/94 →	Tie Rod End	CV-ES-2149		for Push Rod
	01/94 →	Tie Rod End	CV-ES-14162		for Steering Rod
	01/94 →	Tie Rod End	CV-ES-14163		for Steering Rod
	01/94 →	Track Control Arm		MN-DL-3402	Trailing Arm, Drive Axle
	01/94 →	Track Control Arm		MN-DL-8544	Trailing Arm, Drive Axle; Leaf Spring Axle
	01/94 →	Track Control Arm		MN-DL-8609	Trailing Arm, Leaf Spring Axle
	01/94 →	Track Control Arm		MN-VB-8514	Suspension Rod, Wishbone (CV), Drive Axle; Leaf Spring Axle
	33.463 DFS, DFRS	01/94 →	Ball Head, gearshift linkage	CV-ES-2119	
01/94 →		Ball Head, gearshift linkage	CV-ES-2120	CV-ES-2120	
01/94 →		Ball Head, gearshift linkage	CV-ES-2182		
01/94 →		Centre Rod	MN-DL-2160		Coupling Rod
01/94 →		Centre Rod	MN-DL-2176		Push Rod
01/94 →		Centre Rod	MN-DL-8197		Push Rod
01/94 →		Centre Rod	MN-DL-12391		for Steering Rod
01/94 →		Centre Rod	MN-DL-12421		for Steering Rod
01/94 →		Engine Mounting		MN-SB-10390	
01/94 →		Mounting, stabilizer coupling rod	MN-SB-5246		
01/94 →		Suspension Arm Repair Kit		MN-SB-5244	for Wishbone (CV)
01/94 →		Suspension Arm Repair Kit		MN-SB-5244	for Wishbone (CV), 2nd RA
01/94 →		Suspension Strut Repair Kit		DB-RK-8581	
01/94 →		Tie Rod	MN-DL-12284		
01/94 →		Tie Rod End	CV-ES-2146		
01/94 →		Tie Rod End	CV-ES-2149		for Push Rod
01/94 →		Tie Rod End	CV-ES-14162		for Steering Rod
01/94 →		Tie Rod End	CV-ES-14163		for Steering Rod
01/94 →		Track Control Arm		MN-DL-3402	Trailing Arm, Drive Axle
01/94 →		Track Control Arm		MN-DL-8544	Trailing Arm, Drive Axle; Leaf Spring Axle
01/94 →		Track Control Arm		MN-DL-8609	Trailing Arm, Leaf Spring Axle
01/94 →		Track Control Arm		MN-VB-8514	Suspension Rod, Wishbone (CV), Drive Axle; Leaf Spring Axle
33.464 DFAC		05/01 →	Ball Head, gearshift linkage	CV-ES-2120	
	05/01 →	Centre Rod	MN-DL-12391		for Steering Rod
	05/01 →	Centre Rod	MN-DL-12421		for Steering Rod
	05/01 →	Suspension Arm Repair Kit		MN-SB-5244	for Wishbone (CV)
	05/01 →	Tie Rod End	CV-ES-2146		
	05/01 →	Tie Rod End	CV-ES-14162		for Steering Rod
	05/01 →	Tie Rod End	CV-ES-14163		for Steering Rod
	05/01 →	Track Control Arm		MN-DL-3402	Trailing Arm
	05/01 →	Track Control Arm		MN-DL-8609	Trailing Arm
33.464 DFAK, DFAK-HK, DFA-KI	05/01 →	Ball Head, gearshift linkage	CV-ES-2120		
	05/01 →	Centre Rod	MN-DL-12391		for Steering Rod
	05/01 →	Centre Rod	MN-DL-12421		for Steering Rod
	05/01 →	Suspension Arm Repair Kit		MN-SB-5244	for Wishbone (CV)
	05/01 →	Tie Rod End	CV-ES-2146		
	05/01 →	Tie Rod End	CV-ES-14162		for Steering Rod

CV-ES-2119

Length: 55
Cone Ø: d1 Ø 10 / d2 Ø 10
Thread: M12 x 1,75 LHT
81953016063, 81953016131



CV-ES-2120

Length: 115
Cone Ø: d1 Ø 12,4 / d2 Ø 10,8
Thread: M14 x 1,5 RHT
03008500A, 81953016200, 81953016202,
81953016203, 81953016227



CV-ES-2146

Length: 80
Cone Ø: d1 Ø 30 / d2 Ø 27
Thread: M26 x 1,5 RHT
42533102, 81953016219, 81953016225,
81953016226, 81953016267, 81953016291



CV-ES-2149

Length: 160
Cone Ø: d1 Ø 30 / d2 Ø 27
Thread: M30 x 1,5 RHT
81953016263



CV-ES-2182

Length: 55
Cone Ø: d1 Ø 10 / d2 Ø 10
Thread: M12 x 1,75 RHT
81953016064, 81953016170



CV-ES-14162

Length: 125
Cone Ø: d1 Ø 30 / d2 Ø 27
Thread: M30 x 1,5 LHT
81953010015, 81953010083, 81953010087,
81953016029, 81953016030, 81953016043,
81953016044, 81953016050, 81953016054,
81953016087, 81953016091, 81953016107,
81953016120, 81953016125, 81953016152,
81953016155, 81953016157, 81953016168,
81953016179, 81953016181, 81953016223,
81953016237, 81953016254, 81953016275,
81953016279, 81953016351



CV-ES-14163

Length: 125
Cone Ø: d1 Ø 30 / d2 Ø 27
Thread: M30 x 1,5 RHT
95301.0084, 90804102156, 90804102272,
90804102696, 90804102710, 81953010016,
81953010075, 81953010084, 81953010088,
81953010094, 81953010103, 81953016030,
81953016043, 81953016048, 81953016049,
81953016053, 81953016061, 81953016090,
81953016108, 81953016112, 81953016126,
81953016143, 81953016149, 81953016154,
81953016156, 81953016168, 81953016178,
81953016194, 81953016206, 81953016224,
81953016234, 81953016242, 81953016252,
81953016274, 81953016278, 81953016284,
81953016286, 81953016308, 81953016310,
81953016312, 81953016347, 81953016350,
81953016352, 82953016012, 88953016014,
N2953016001



DB-RK-8581

Ø: 85
Hole Distance: 130
Thick/Height: 24
03305800A, 81432706105



MN-DL-2160

Length: 1652 Ø: 50
Cone Ø: d1 Ø 30 / d2 Ø 27
81467106112, 81467106163, 81467106165,
81467106198, 81467106353, 81467106354,
81467106361, 81467116725



MN-DL-2176

Length: 1628 Ø: 48
Cone Ø: d1 Ø 30 / d2 Ø 27
81466106779, 81466106780, 81466106782



MN-DL-3402

Length: 590 Ø: 48
Hole Distance: 130 / 130
03307200A, 81432206067, 81432206068,
81432206090, 81432206092, 81432209092



MN-DL-8197

Length: 1055 Ø: 42
Cone Ø: d1 Ø 30 / d2 Ø 27
03207500A, 81466116003, 81466116004,
81466116005



MN-DL-8544

Length: 596 Ø: 48
Hole Distance: 130 / 130
81432206196, 81432206232, 81432206233



MN-DL-8609

Length: 585 Ø: 58
Hole Distance: 130 / 130
81432206070, 81432206071, 81432206072,
81432206091, 81432206093, 81432206119



MN-DL-12284

Length: 1530 Ø: 50
Cone Ø: d1 Ø 30 / d2 Ø 27
81466106579, 81466106580, 81466106624,
81466116720, 81467116720, 81467116730,
81467116952



MN-DL-12391

Length: 1050 Ø: 52
Cone Ø: d1 Ø 30 / d2 Ø 27
82466106057, 82466106147



MN-DL-12421

Length: 1070 Ø: 48
Cone Ø: d1 Ø 30 / d2 Ø 27
Thread: M30 x 1,5 RHT
81466106656, 81466106659, 81466106669,
81466116006, 81466116007



MN-SB-5244

Ø: 65
Hole Distance: 125
Thick/Height: 22
03312000A, 81432710027, 81432710082



MN-SB-5246

Ø: 45 Thick/Height: 47
81437220022, 81437220038, 81962100450,
81962100469



MN-SB-10390

Ø: 70 Thick/Height: 85/85
81960200341, 81960200373, 81960200385,
81960200408, 81960200418



MN-VB-8514

Length: 627 Ø: 48
Hole Ø 25 / 25 / 25
Hole Distance: 152 / 130 / 130
81432706087, 81432706088, 81432706094,
81432706095, 81432796094



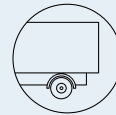

F 2000 ...

33.464 DFAK, DFAK-HK, DFA-KI ...	05/01→	Tie Rod End	CV-ES-14163		for Steering Rod
	05/01→	Track Control Arm		MN-DL-3402	Trailing Arm
	05/01→	Track Control Arm		MN-DL-8609	Trailing Arm
33.464 DFAS	05/01→	Ball Head, gearshift linkage	CV-ES-2120		
	05/01→	Centre Rod	MN-DL-12391		for Steering Rod
	05/01→	Centre Rod	MN-DL-12421		for Steering Rod
	05/01→	Suspension Arm Repair Kit		MN-SB-5244	for Wishbone (CV)
	05/01→	Tie Rod End	CV-ES-2146		
	05/01→	Tie Rod End	CV-ES-14162		for Steering Rod
	05/01→	Tie Rod End	CV-ES-14163		for Steering Rod
	05/01→	Track Control Arm		MN-DL-3402	Trailing Arm
	05/01→	Track Control Arm		MN-DL-8609	Trailing Arm
	33.464 DFC	05/01→	Ball Head, gearshift linkage	CV-ES-2120	CV-ES-2120
05/01→		Centre Rod	MN-DL-8197		Push Rod
05/01→		Centre Rod	MN-DL-12391		for Steering Rod
05/01→		Centre Rod	MN-DL-12421		for Steering Rod
05/01→		Mounting, stabilizer coupling rod	MN-SB-5246		
05/01→		Suspension Arm Repair Kit		MN-SB-5244	for Wishbone (CV)
05/01→		Tie Rod	MN-DL-12284		
05/01→		Tie Rod End	CV-ES-2149		for Push Rod
05/01→		Tie Rod End	CV-ES-14162		for Steering Rod
05/01→		Tie Rod End	CV-ES-14163		for Steering Rod
05/01→		Track Control Arm		MN-DL-3402	Trailing Arm
05/01→		Track Control Arm		MN-DL-8544	Trailing Arm
05/01→		Track Control Arm		MN-DL-8609	Trailing Arm
05/01→		Track Control Arm		MN-VB-8514	Suspension Rod, Wishbone (CV)
33.464 DFK, DF-KI		05/01→	Ball Head, gearshift linkage	CV-ES-2120	CV-ES-2120
	05/01→	Centre Rod	MN-DL-8197		Push Rod
	05/01→	Centre Rod	MN-DL-12391		for Steering Rod
	05/01→	Centre Rod	MN-DL-12421		for Steering Rod
	05/01→	Mounting, stabilizer coupling rod	MN-SB-5246		
	05/01→	Suspension Arm Repair Kit		MN-SB-5244	for Wishbone (CV)
	05/01→	Tie Rod	MN-DL-12284		
	05/01→	Tie Rod End	CV-ES-2149		for Push Rod
	05/01→	Tie Rod End	CV-ES-14162		for Steering Rod
	05/01→	Tie Rod End	CV-ES-14163		for Steering Rod
	05/01→	Track Control Arm		MN-DL-3402	Trailing Arm
	05/01→	Track Control Arm		MN-DL-8544	Trailing Arm
	05/01→	Track Control Arm		MN-DL-8609	Trailing Arm
	05/01→	Track Control Arm		MN-VB-8514	Suspension Rod, Wishbone (CV)
	33.464 DFS, DFRS	05/01→	Ball Head, gearshift linkage	CV-ES-2120	CV-ES-2120
05/01→		Centre Rod	MN-DL-8197		Push Rod
05/01→		Centre Rod	MN-DL-12391		for Steering Rod
05/01→		Centre Rod	MN-DL-12421		for Steering Rod
05/01→		Mounting, stabilizer coupling rod	MN-SB-5246		
05/01→		Suspension Arm Repair Kit		MN-SB-5244	for Wishbone (CV)
05/01→		Tie Rod	MN-DL-12284		
05/01→		Tie Rod End	CV-ES-2149		for Push Rod
05/01→		Tie Rod End	CV-ES-14162		for Steering Rod
05/01→		Tie Rod End	CV-ES-14163		for Steering Rod
05/01→		Track Control Arm		MN-DL-3402	Trailing Arm
05/01→		Track Control Arm		MN-DL-8544	Trailing Arm
05/01→		Track Control Arm		MN-DL-8609	Trailing Arm
05/01→		Track Control Arm		MN-VB-8514	Suspension Rod, Wishbone (CV)
33.603 DFAC		06/96→	Ball Head, gearshift linkage	CV-ES-2119	
	06/96→	Ball Head, gearshift linkage	CV-ES-2120		
	06/96→	Ball Head, gearshift linkage	CV-ES-2182		
	06/96→	Centre Rod	MN-DL-2160		Coupling Rod
	06/96→	Centre Rod	MN-DL-2176		Push Rod
	06/96→	Centre Rod	MN-DL-12421		for Steering Rod
	06/96→	Tie Rod End	CV-ES-2149		for Push Rod
	06/96→	Tie Rod End	CV-ES-14162		for Steering Rod
	06/96→	Tie Rod End	CV-ES-14163		for Steering Rod

CV-ES-2119

Length: 55
Cone Ø: d1 Ø 10 / d2 Ø 10
Thread: M12 x 1,75 LHT
81953016063, 81953016131



CV-ES-2120

Length: 115
Cone Ø: d1 Ø 12,4 / d2 Ø 10,8
Thread: M14 x 1,5 RHT
03008500A, 81953016200, 81953016202,
81953016203, 81953016227



CV-ES-2146

Length: 80
Cone Ø: d1 Ø 30 / d2 Ø 27
Thread: M26 x 1,5 RHT
42533102, 81953016219, 81953016225,
81953016226, 81953016267, 81953016291



CV-ES-2149

Length: 160
Cone Ø: d1 Ø 30 / d2 Ø 27
Thread: M30 x 1,5 RHT
81953016263



CV-ES-2182

Length: 55
Cone Ø: d1 Ø 10 / d2 Ø 10
Thread: M12 x 1,75 RHT
81953016064, 81953016170



CV-ES-14162

Length: 125
Cone Ø: d1 Ø 30 / d2 Ø 27
Thread: M30 x 1,5 LHT
81953010015, 81953010083, 81953010087,
81953016029, 81953016030, 81953016043,
81953016044, 81953016050, 81953016054,
81953016087, 81953016091, 81953016107,
81953016120, 81953016125, 81953016152,
81953016155, 81953016157, 81953016168,
81953016179, 81953016181, 81953016223,
81953016237, 81953016254, 81953016275,
81953016279, 81953016351



CV-ES-14163

Length: 125
Cone Ø: d1 Ø 30 / d2 Ø 27
Thread: M30 x 1,5 RHT

95301.0084, 90804102156, 90804102272,
90804102696, 90804102710, 81953010016,
81953010075, 81953010084, 81953010088,
81953010094, 81953010103, 81953016030,
81953016043, 81953016048, 81953016049,
81953016053, 81953016061, 81953016090,
81953016108, 81953016112, 81953016126,
81953016143, 81953016149, 81953016154,
81953016156, 81953016168, 81953016178,
81953016194, 81953016206, 81953016224,
81953016234, 81953016242, 81953016252,
81953016274, 81953016278, 81953016284,
81953016286, 81953016308, 81953016310,
81953016312, 81953016347, 81953016350,
81953016352, 82953016012, 88953016014,
N2953016001



MN-DL-2160

Length: 1652 Ø: 50
Cone Ø: d1 Ø 30 / d2 Ø 27
81467106112, 81467106163, 81467106165,
81467106198, 81467106353, 81467106354,
81467106361, 81467116725



MN-DL-2176

Length: 1628 Ø: 48
Cone Ø: d1 Ø 30 / d2 Ø 27
81466106779, 81466106780, 81466106782



MN-DL-3402

Length: 590 Ø: 48
Hole Distance: 130 / 130
03307200A, 81432206067, 81432206068,
81432206090, 81432206092, 81432209092



MN-DL-8197

Length: 1055 Ø: 42
Cone Ø: d1 Ø 30 / d2 Ø 27
03207500A, 81466116003, 81466116004,
81466116005



MN-DL-8544

Length: 596 Ø: 48
Hole Distance: 130 / 130
81432206196, 81432206232, 81432206233



MN-DL-8609

Length: 585 Ø: 58
Hole Distance: 130 / 130
81432206070, 81432206071, 81432206072,
81432206091, 81432206093, 81432206119



MN-DL-12284

Length: 1530 Ø: 50
Cone Ø: d1 Ø 30 / d2 Ø 27
81466106579, 81466106580, 81466106624,
81466116720, 81467116720, 81467116730,
81467116952



MN-DL-12391

Length: 1050 Ø: 52
Cone Ø: d1 Ø 30 / d2 Ø 27
82466106057, 82466106147



MN-DL-12421

Length: 1070 Ø: 48
Cone Ø: d1 Ø 30 / d2 Ø 27
Thread: M30 x 1,5 RHT
81466106656, 81466106659, 81466106669,
81466116006, 81466116007



MN-SB-5244

Ø: 65
Hole Distance: 125
Thick/Height: 22
03312000A, 81432710027, 81432710082



MN-SB-5246

Ø: 45 Thick/Height: 47
81437220022, 81437220038, 81962100450,
81962100469



MN-VB-8514

Length: 627 Ø: 48
Hole Ø 25 / 25 / 25
Hole Distance: 152 / 130 / 130
81432706087, 81432706088, 81432706094,
81432706095, 81432796094





F 2000 ...

33.603 DFAC ...	06/96 →	Track Control Arm		MN-DL-3402	Trailing Arm, Drive Axle
	06/96 →	Track Control Arm		MN-DL-8609	Trailing Arm, Leaf Spring Axle
33.603 DFAS	06/96 →	Ball Head, gearshift linkage	CV-ES-2119		
	06/96 →	Ball Head, gearshift linkage	CV-ES-2120		
	06/96 →	Ball Head, gearshift linkage	CV-ES-2182		
	06/96 →	Centre Rod	MN-DL-2160		Coupling Rod
	06/96 →	Centre Rod	MN-DL-2176		Push Rod
	06/96 →	Centre Rod	MN-DL-12421		for Steering Rod
	06/96 →	Tie Rod End	CV-ES-2149		for Push Rod
	06/96 →	Tie Rod End	CV-ES-14162		for Steering Rod
	06/96 →	Tie Rod End	CV-ES-14163		for Steering Rod
	06/96 →	Track Control Arm		MN-DL-3402	Trailing Arm, Drive Axle
	06/96 →	Track Control Arm		MN-DL-8609	Trailing Arm, Leaf Spring Axle
	33.603 DFC	06/96 →	Ball Head, gearshift linkage	CV-ES-2119	
06/96 →		Ball Head, gearshift linkage	CV-ES-2120		
06/96 →		Ball Head, gearshift linkage	CV-ES-2182		
06/96 →		Centre Rod	MN-DL-2160		Coupling Rod
06/96 →		Centre Rod	MN-DL-2176		Push Rod
06/96 →		Centre Rod	MN-DL-8197		Push Rod
06/96 →		Centre Rod	MN-DL-12421		for Steering Rod
06/96 →		Engine Mounting	MN-SB-10390		
06/96 →		Suspension Arm Repair Kit		MN-RK-7280	for Drag Link;for Semi-Trailing Arm; for Wishbone (CV)
06/96 →		Suspension Arm Repair Kit		MN-SB-5244	for Wishbone (CV)
06/96 →		Suspension Arm Repair Kit		MN-SB-5244	for Wishbone (CV), 2nd RA
06/96 →		Suspension Strut Repair Kit		DB-RK-8581	
06/96 →		Tie Rod End	CV-ES-2149		for Push Rod
06/96 →		Tie Rod End	CV-ES-14162		for Steering Rod
06/96 →		Tie Rod End	CV-ES-14163		for Steering Rod
06/96 →		Track Control Arm		MN-DL-3402	Trailing Arm
06/96 →		Track Control Arm		MN-DL-3402	Trailing Arm, Drive Axle
06/96 →		Track Control Arm		MN-DL-8544	Trailing Arm, Drive Axle;Leaf Spring Axle
06/96 →		Track Control Arm		MN-DL-8609	Trailing Arm, Leaf Spring Axle
06/96 →		Track Control Arm		MN-VB-8514	Suspension Rod, Wishbone (CV), Drive Axle; Leaf Spring Axle
33.603 DFS, DFRS	06/96 →	Ball Head, gearshift linkage	CV-ES-2119		
	06/96 →	Ball Head, gearshift linkage	CV-ES-2120		
	06/96 →	Ball Head, gearshift linkage	CV-ES-2182		
	06/96 →	Centre Rod	MN-DL-2160		Coupling Rod
	06/96 →	Centre Rod	MN-DL-2176		Push Rod
	06/96 →	Centre Rod	MN-DL-8197		Push Rod
	06/96 →	Centre Rod	MN-DL-12421		for Steering Rod
	06/96 →	Engine Mounting	MN-SB-10390		
	06/96 →	Suspension Arm Repair Kit		MN-RK-7280	for Drag Link;for Semi-Trailing Arm; for Wishbone (CV)
	06/96 →	Suspension Arm Repair Kit		MN-SB-5244	for Wishbone (CV)
	06/96 →	Suspension Arm Repair Kit		MN-SB-5244	for Wishbone (CV), 2nd RA
	06/96 →	Suspension Strut Repair Kit		DB-RK-8581	
	06/96 →	Tie Rod End	CV-ES-2149		for Push Rod
	06/96 →	Tie Rod End	CV-ES-14162		for Steering Rod
	06/96 →	Tie Rod End	CV-ES-14163		for Steering Rod
	06/96 →	Track Control Arm		MN-DL-3402	Trailing Arm, Drive Axle
	06/96 →	Track Control Arm		MN-DL-8544	Trailing Arm, Drive Axle;Leaf Spring Axle
	06/96 →	Track Control Arm		MN-DL-8609	Trailing Arm, Leaf Spring Axle
	06/96 →	Track Control Arm		MN-VB-8514	Suspension Rod, Wishbone (CV), Drive Axle; Leaf Spring Axle
	33.604 DFAS	04/00 →	Centre Rod	MN-DL-2174	
04/00 →		Centre Rod	MN-DL-12391		for Steering Rod
04/00 →		Centre Rod	MN-DL-12421		for Steering Rod
04/00 →		Suspension Strut Repair Kit		CV-RK-5311	
04/00 →		Tie Rod End	CV-ES-14162		for Steering Rod
04/00 →		Tie Rod End	CV-ES-14163		for Steering Rod
04/00 →	Tie Rod End	SC-ES-8517		for Push Rod	

CV-ES-2119

Length: 55
Cone Ø: d1 Ø 10 / d2 Ø 10
Thread: M12 x 1,75 LHT
81953016063, 81953016131



CV-ES-2120

Length: 115
Cone Ø: d1 Ø 12,4 / d2 Ø 10,8
Thread: M14 x 1,5 RHT
03008500A, 81953016200, 81953016202,
81953016203, 81953016227



CV-ES-2149

Length: 160
Cone Ø: d1 Ø 30 / d2 Ø 27
Thread: M30 x 1,5 RHT
81953016263



CV-ES-2182

Length: 55
Cone Ø: d1 Ø 10 / d2 Ø 10
Thread: M12 x 1,75 RHT
81953016064, 81953016170



CV-ES-14162

Length: 125
Cone Ø: d1 Ø 30 / d2 Ø 27
Thread: M30 x 1,5 LHT
81953010015, 81953010083, 81953010087,
81953016029, 81953016030, 81953016043,
81953016044, 81953016050, 81953016054,
81953016087, 81953016091, 81953016107,
81953016120, 81953016125, 81953016152,
81953016155, 81953016157, 81953016168,
81953016179, 81953016181, 81953016223,
81953016237, 81953016254, 81953016275,
81953016279, 81953016351



CV-ES-14163

Length: 125
Cone Ø: d1 Ø 30 / d2 Ø 27
Thread: M30 x 1,5 RHT
95301.0084, 90804102156, 90804102272,
90804102696, 90804102710, 81953010016,
81953010075, 81953010084, 81953010088,
81953010094, 81953010103, 81953016030,
81953016043, 81953016048, 81953016049,
81953016053, 81953016061, 81953016090,
81953016108, 81953016112, 81953016126,
81953016143, 81953016149, 81953016154,
81953016156, 81953016168, 81953016178,
81953016194, 81953016206, 81953016224,
81953016234, 81953016242, 81953016252,
81953016274, 81953016278, 81953016284,
81953016286, 81953016308, 81953016310,
81953016312, 81953016347, 81953016350,
81953016352, 82953016012, 88953016014,
N2953016001



CV-RK-5311

638862, 639287, 938423, 1104335,
1953248, 0003500506, 3500506, 11013547,
42488722, 070550504, 634303610,
81432206055, 81432206073, 82262320660,
5001842823, 7000307001, 8226232066



DB-RK-8581

Ø: 85
Hole Distance: 130
Thick/Height: 24
03305800A, 81432706105



MN-DL-2160

Length: 1652 Ø: 50
Cone Ø: d1 Ø 30 / d2 Ø 27
81467106112, 81467106163, 81467106165,
81467106198, 81467106353, 81467106354,
81467106361, 81467116725



MN-DL-2174

Length: 1588 Ø: 52
Cone Ø: d1 Ø 30 / d2 Ø 27
81467106378, 81467106912



MN-DL-2176

Length: 1628 Ø: 48
Cone Ø: d1 Ø 30 / d2 Ø 27
81466106779, 81466106780, 81466106782



MN-DL-3402

Length: 590 Ø: 48
Hole Distance: 130 / 130
03307200A, 81432206067, 81432206068,
81432206090, 81432206092, 81432209092



MN-DL-8197

Length: 1055 Ø: 42
Cone Ø: d1 Ø 30 / d2 Ø 27
03207500A, 81466116003, 81466116004,
81466116005



MN-DL-8544

Length: 596 Ø: 48
Hole Distance: 130 / 130
81432206196, 81432206232, 81432206233



MN-DL-8609

Length: 585 Ø: 58
Hole Distance: 130 / 130
81432206070, 81432206071, 81432206072,
81432206091, 81432206093, 81432206119



MN-DL-12391

Length: 1050 Ø: 52
Cone Ø: d1 Ø 30 / d2 Ø 27
82466106057, 82466106147



MN-DL-12421

Length: 1070 Ø: 48
Cone Ø: d1 Ø 30 / d2 Ø 27
Thread: M30 x 1,5 RHT
81466106656, 81466106659, 81466106669,
81466116006, 81466116007



MN-RK-7280

Ø: 75
Hole Distance: 115
Thick/Height: 24
0550806, 0639370, 689748, 10307400A,
81432306051, 81432306068, 81432706064



MN-SB-5244

Ø: 65
Hole Distance: 125
Thick/Height: 22
03312000A, 81432710027, 81432710082



MN-SB-10390

Ø: 70 Thick/Height: 85/85
81960200341, 81960200373, 81960200385,
81960200408, 81960200418



MN-VB-8514

Length: 627 Ø: 48
Hole Ø 25 / 25 / 25
Hole Distance: 152 / 130 / 130
81432706087, 81432706088, 81432706094,
81432706095, 81432796094



SC-ES-8517

Length: 140
Cone Ø: d1 Ø 30 / d2 Ø 27
Thread: M30 x 1,5 RHT
81953016286





F 2000 ...

33.604 DFAS ...	04/00→	Track Control Arm		MN-DL-3402	Trailing Arm
	04/00→	Track Control Arm		MN-DL-8609	Trailing Arm
33.604 DFS	04/00→	Centre Rod	MN-DL-2160		Coupling Rod
	04/00→	Centre Rod	MN-DL-2176		Push Rod
	04/00→	Centre Rod	MN-DL-8197		Push Rod
	04/00→	Tie Rod End	CV-ES-2149		for Push Rod
	04/00→	Tie Rod End	CV-ES-14162		for Steering Rod
	04/00→	Tie Rod End	CV-ES-14163		for Steering Rod
	04/00→	Track Control Arm		MN-DL-3402	Trailing Arm
	04/00→	Track Control Arm		MN-DL-8544	Trailing Arm
	04/00→	Track Control Arm		MN-DL-8609	Trailing Arm
	04/00→	Track Control Arm		MN-VB-8514	Suspension Rod, Wishbone (CV)
	35.314 VF-TM	03/02→	Ball Head, gearshift linkage	CV-ES-2120	
03/02→		Centre Rod	MN-DL-7792		Push Rod
03/02→		Centre Rod	MN-DL-8197		Push Rod
03/02→		Centre Rod	MN-DL-12421		for Steering Rod
03/02→		Mounting, stabilizer coupling rod	MN-SB-5246		
03/02→		Suspension Arm Repair Kit		MN-SB-5244	for Wishbone (CV)
03/02→		Tie Rod	MN-DL-12284		
03/02→		Tie Rod End	CV-ES-2146		
03/02→		Tie Rod End	CV-ES-2149		for Push Rod
03/02→		Tie Rod End	CV-ES-14162		for Steering Rod
03/02→		Tie Rod End	CV-ES-14163		for Steering Rod
03/02→		Track Control Arm		MN-DL-3402	Trailing Arm
03/02→		Track Control Arm		MN-DL-8544	Trailing Arm
03/02→		Track Control Arm		MN-DL-8609	Trailing Arm
03/02→		Track Control Arm		MN-VB-8514	Suspension Rod, Wishbone (CV)
03/02→		Track Control Arm		MN-VB-8669	Suspension Rod, Wishbone (CV)
35.343 VFC		08/95→	Ball Head, gearshift linkage	CV-ES-2119	
	08/95→	Ball Head, gearshift linkage	CV-ES-2120		
	08/95→	Ball Head, gearshift linkage	CV-ES-2182		
	08/95→	Centre Rod	MN-DL-2160		Coupling Rod
	08/95→	Centre Rod	MN-DL-2162		Push Rod
	08/95→	Centre Rod	MN-DL-2176		Push Rod
	08/95→	Centre Rod	MN-DL-7792		Push Rod
	08/95→	Centre Rod	MN-DL-8197		Push Rod
	08/95→	Centre Rod	MN-DL-12421		for Steering Rod
	08/95→	Engine Mounting		MN-SB-10390	
	08/95→	Suspension Arm Repair Kit		MN-SB-5244	for Wishbone (CV)
	08/95→	Suspension Arm Repair Kit		MN-SB-5244	for Wishbone (CV), 1st RA
	08/95→	Suspension Arm Repair Kit		MN-SB-5244	for Wishbone (CV), 2nd RA
	08/95→	Tie Rod End	CV-ES-2146		
	08/95→	Tie Rod End	CV-ES-2149		for Push Rod
	08/95→	Tie Rod End	CV-ES-14162		for Steering Rod
	08/95→	Tie Rod End	CV-ES-14163		for Steering Rod
	08/95→	Track Control Arm		MN-DL-3402	Trailing Arm, Drive Axle
	08/95→	Track Control Arm		MN-DL-8609	Trailing Arm, Leaf Spring Axle
	35.343 VFK	08/95→	Ball Head, gearshift linkage	CV-ES-2119	
08/95→		Ball Head, gearshift linkage	CV-ES-2120		
08/95→		Ball Head, gearshift linkage	CV-ES-2182		
08/95→		Centre Rod	MN-DL-2160		Coupling Rod
08/95→		Centre Rod	MN-DL-2162		Push Rod
08/95→		Centre Rod	MN-DL-2176		Push Rod
08/95→		Centre Rod	MN-DL-7792		Push Rod
08/95→		Centre Rod	MN-DL-8197		Push Rod
08/95→		Centre Rod	MN-DL-12421		for Steering Rod
08/95→		Engine Mounting		MN-SB-10390	
08/95→		Suspension Arm Repair Kit		MN-SB-5244	for Wishbone (CV)
08/95→		Suspension Arm Repair Kit		MN-SB-5244	for Wishbone (CV), 1st RA
08/95→		Suspension Arm Repair Kit		MN-SB-5244	for Wishbone (CV), 2nd RA
08/95→		Tie Rod End	CV-ES-2146		
08/95→		Tie Rod End	CV-ES-2149		for Push Rod
08/95→		Tie Rod End	CV-ES-14162		for Steering Rod

CV-ES-2119

Length: 55
Cone Ø: d1 Ø 10 / d2 Ø 10
Thread: M12 x 1,75 LHT
81953016063, 81953016131



CV-ES-2120

Length: 115
Cone Ø: d1 Ø 12,4 / d2 Ø 10,8
Thread: M14 x 1,5 RHT
03008500A, 81953016200, 81953016202,
81953016203, 81953016227



CV-ES-2146

Length: 80
Cone Ø: d1 Ø 30 / d2 Ø 27
Thread: M26 x 1,5 RHT
42533102, 81953016219, 81953016225,
81953016226, 81953016267, 81953016291



CV-ES-2149

Length: 160
Cone Ø: d1 Ø 30 / d2 Ø 27
Thread: M30 x 1,5 RHT
81953016263



CV-ES-2182

Length: 55
Cone Ø: d1 Ø 10 / d2 Ø 10
Thread: M12 x 1,75 RHT
81953016064, 81953016170



CV-ES-14162

Length: 125
Cone Ø: d1 Ø 30 / d2 Ø 27
Thread: M30 x 1,5 LHT
81953010015, 81953010083, 81953010087,
81953016029, 81953016030, 81953016043,
81953016044, 81953016050, 81953016054,
81953016087, 81953016091, 81953016107,
81953016120, 81953016125, 81953016152,
81953016155, 81953016157, 81953016168,
81953016179, 81953016181, 81953016223,
81953016237, 81953016254, 81953016275,
81953016279, 81953016351



CV-ES-14163

Length: 125
Cone Ø: d1 Ø 30 / d2 Ø 27
Thread: M30 x 1,5 RHT
95301.0084, 90804102156, 90804102272,
90804102696, 90804102710, 81953010016,
81953010075, 81953010084, 81953010088,
81953010094, 81953010103, 81953016030,
81953016043, 81953016048, 81953016049,
81953016053, 81953016061, 81953016090,
81953016108, 81953016112, 81953016126,
81953016143, 81953016149, 81953016154,
81953016156, 81953016168, 81953016178,
81953016194, 81953016206, 81953016224,
81953016234, 81953016242, 81953016252,
81953016274, 81953016278, 81953016284,
81953016286, 81953016308, 81953016310,
81953016312, 81953016347, 81953016350,
81953016352, 82953016012, 88953016014,
N2953016001



MN-DL-2160

Length: 1652 Ø: 50
Cone Ø: d1 Ø 30 / d2 Ø 27
81467106112, 81467106163, 81467106165,
81467106198, 81467106353, 81467106354,
81467106361, 81467116725



MN-DL-2162

Length: 755 Ø: 40
Cone Ø: d1 Ø 30 / d2 Ø 27
81466106578, 81466106704, 81466106705,
81466106798, 81466106799



MN-DL-2176

Length: 1628 Ø: 48
Cone Ø: d1 Ø 30 / d2 Ø 27
81466106779, 81466106780, 81466106782



MN-DL-3402

Length: 590 Ø: 48
Hole Distance: 130 / 130
03307200A, 81432206067, 81432206068,
81432206090, 81432206092, 81432209092



MN-DL-7792

Length: 1750 Ø: 52
Cone Ø: d1 Ø 30 / d2 Ø 27
81466106790, 81466106791, 82466106191



MN-DL-8197

Length: 1055 Ø: 42
Cone Ø: d1 Ø 30 / d2 Ø 27
03207500A, 81466116003, 81466116004,
81466116005



MN-DL-8544

Length: 596 Ø: 48
Hole Distance: 130 / 130
81432206196, 81432206232, 81432206233



MN-DL-8609

Length: 585 Ø: 58
Hole Distance: 130 / 130
81432206070, 81432206071, 81432206072,
81432206091, 81432206093, 81432206119



MN-DL-12284

Length: 1530 Ø: 50
Cone Ø: d1 Ø 30 / d2 Ø 27
81466106579, 81466106580, 81466106624,
81466116720, 81467116720, 81467116730,
81467116952



MN-DL-12421

Length: 1070 Ø: 48
Cone Ø: d1 Ø 30 / d2 Ø 27
Thread: M30 x 1,5 RHT
81466106656, 81466106659, 81466106669,
81466116006, 81466116007



MN-SB-5244

Ø: 65
Hole Distance: 125
Thick/Height: 22
03312000A, 81432710027, 81432710082



MN-SB-5246

Ø: 45 Thick/Height: 47
81437220022, 81437220038, 81962100450,
81962100469



MN-SB-10390

Ø: 70 Thick/Height: 85/85
81960200341, 81960200373, 81960200385,
81960200408, 81960200418



MN-VB-8514

Length: 627 Ø: 48
Hole Ø 25 / 25 / 25
Hole Distance: 152 / 130 / 130
81432706087, 81432706088, 81432706094,
81432706095, 81432796094



MN-VB-8669

Length: 627 Ø: 48
Hole Ø 25 / 25 / 25
Hole Distance: 152 / 130 / 130
81432706116, 81432706137, 81432706150,
81432706151



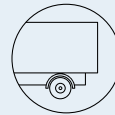

F 2000 ...

35.343 VFK ...	08/95→	Tie Rod End	CV-ES-14163		for Steering Rod
	08/95→	Track Control Arm		MN-DL-3402	Trailing Arm, Drive Axle
	08/95→	Track Control Arm		MN-DL-8609	Trailing Arm, Leaf Spring Axle
35.364 VF, VFC, VFRC	05/01→	Ball Head, gearshift linkage	CV-ES-2120		
	05/01→	Centre Rod	MN-DL-7792		Push Rod
	05/01→	Centre Rod	MN-DL-8197		Push Rod
	05/01→	Centre Rod	MN-DL-12421		for Steering Rod
	05/01→	Mounting, stabilizer coupling rod	MN-SB-5246		
	05/01→	Suspension Arm Repair Kit		MN-SB-5244	for Wishbone (CV)
	05/01→	Tie Rod	MN-DL-12284		
	05/01→	Tie Rod End	CV-ES-2146		
	05/01→	Tie Rod End	CV-ES-2149		for Push Rod
	05/01→	Tie Rod End	CV-ES-14162		for Steering Rod
	05/01→	Tie Rod End	CV-ES-14163		for Steering Rod
	05/01→	Track Control Arm		MN-DL-3402	Trailing Arm
	05/01→	Track Control Arm		MN-DL-8544	Trailing Arm
	05/01→	Track Control Arm		MN-DL-8609	Trailing Arm
	05/01→	Track Control Arm		MN-VB-8514	Suspension Rod, Wishbone (CV)
	05/01→	Track Control Arm		MN-VB-8669	Suspension Rod, Wishbone (CV)
35.364 VFK, VF-HK, VF-KI	03/02→	Ball Head, gearshift linkage	CV-ES-2120		
	03/02→	Centre Rod	MN-DL-7792		Push Rod
	03/02→	Centre Rod	MN-DL-8197		Push Rod
	03/02→	Centre Rod	MN-DL-12421		for Steering Rod
	03/02→	Mounting, stabilizer coupling rod	MN-SB-5246		
	03/02→	Suspension Arm Repair Kit		MN-SB-5244	for Wishbone (CV)
	03/02→	Tie Rod	MN-DL-12284		
	03/02→	Tie Rod End	CV-ES-2146		
	03/02→	Tie Rod End	CV-ES-2149		for Push Rod
	03/02→	Tie Rod End	CV-ES-14162		for Steering Rod
	03/02→	Tie Rod End	CV-ES-14163		for Steering Rod
	03/02→	Track Control Arm		MN-DL-3402	Trailing Arm
	03/02→	Track Control Arm		MN-DL-8544	Trailing Arm
	03/02→	Track Control Arm		MN-DL-8609	Trailing Arm
	03/02→	Track Control Arm		MN-VB-8514	Suspension Rod, Wishbone (CV)
	03/02→	Track Control Arm		MN-VB-8669	Suspension Rod, Wishbone (CV)
35.364 VF-TM	03/02→	Ball Head, gearshift linkage	CV-ES-2120		
	03/02→	Centre Rod	MN-DL-7792		Push Rod
	03/02→	Centre Rod	MN-DL-8197		Push Rod
	03/02→	Centre Rod	MN-DL-12421		for Steering Rod
	03/02→	Mounting, stabilizer coupling rod	MN-SB-5246		
	03/02→	Suspension Arm Repair Kit		MN-SB-5244	for Wishbone (CV)
	03/02→	Tie Rod	MN-DL-12284		
	03/02→	Tie Rod End	CV-ES-2146		
	03/02→	Tie Rod End	CV-ES-2149		for Push Rod
	03/02→	Tie Rod End	CV-ES-14162		for Steering Rod
	03/02→	Tie Rod End	CV-ES-14163		for Steering Rod
	03/02→	Track Control Arm		MN-DL-3402	Trailing Arm
	03/02→	Track Control Arm		MN-DL-8544	Trailing Arm
	03/02→	Track Control Arm		MN-DL-8609	Trailing Arm
	03/02→	Track Control Arm		MN-VB-8514	Suspension Rod, Wishbone (CV)
	03/02→	Track Control Arm		MN-VB-8669	Suspension Rod, Wishbone (CV)
35.373 VF, VFC, VFRC	05/01→	Ball Head, gearshift linkage	CV-ES-2120		
	05/01→	Centre Rod	MN-DL-7792		Push Rod
	05/01→	Centre Rod	MN-DL-8197		Push Rod
	05/01→	Centre Rod	MN-DL-12421		for Steering Rod
	05/01→	Mounting, stabilizer coupling rod	MN-SB-5246		
	05/01→	Suspension Arm Repair Kit		MN-SB-5244	for Wishbone (CV)
	05/01→	Tie Rod	MN-DL-12284		
	05/01→	Tie Rod End	CV-ES-2146		
	05/01→	Tie Rod End	CV-ES-2149		for Push Rod
	05/01→	Tie Rod End	CV-ES-14162		for Steering Rod
	05/01→	Tie Rod End	CV-ES-14163		for Steering Rod
	05/01→	Track Control Arm		MN-DL-3402	Trailing Arm

CV-ES-2120

Length: 115
Cone Ø: d1 Ø 12,4 / d2 Ø 10,8
Thread: M14 x 1,5 RHT
03008500A, 81953016200, 81953016202, 81953016203, 81953016227



CV-ES-2146

Length: 80
Cone Ø: d1 Ø 30 / d2 Ø 27
Thread: M26 x 1,5 RHT
42533102, 81953016219, 81953016225, 81953016226, 81953016267, 81953016291



CV-ES-2149

Length: 160
Cone Ø: d1 Ø 30 / d2 Ø 27
Thread: M30 x 1,5 RHT
81953016263



CV-ES-14162

Length: 125
Cone Ø: d1 Ø 30 / d2 Ø 27
Thread: M30 x 1,5 LHT
81953010015, 81953010083, 81953010087, 81953016029, 81953016030, 81953016043, 81953016044, 81953016050, 81953016054, 81953016087, 81953016091, 81953016107, 81953016120, 81953016125, 81953016152, 81953016155, 81953016157, 81953016168, 81953016179, 81953016181, 81953016223, 81953016237, 81953016254, 81953016275, 81953016279, 81953016351



CV-ES-14163

Length: 125
Cone Ø: d1 Ø 30 / d2 Ø 27
Thread: M30 x 1,5 RHT
95301.0084, 90804102156, 90804102272, 90804102696, 90804102710, 81953010016, 81953010075, 81953010084, 81953010088, 81953010094, 81953010103, 81953016030, 81953016043, 81953016048, 81953016049, 81953016053, 81953016061, 81953016090, 81953016108, 81953016112, 81953016126, 81953016143, 81953016149, 81953016154, 81953016156, 81953016168, 81953016178, 81953016194, 81953016206, 81953016224, 81953016234, 81953016242, 81953016252, 81953016274, 81953016278, 81953016284, 81953016286, 81953016308, 81953016310, 81953016312, 81953016347, 81953016350, 81953016352, 82953016012, 88953016014, N2953016001



MN-DL-3402

Length: 590 Ø: 48
Hole Distance: 130 / 130
03307200A, 81432206067, 81432206068, 81432206090, 81432206092, 81432209092



MN-DL-7792

Length: 1750 Ø: 52
Cone Ø: d1 Ø 30 / d2 Ø 27
81466106790, 81466106791, 82466106191



MN-DL-8197

Length: 1055 Ø: 42
Cone Ø: d1 Ø 30 / d2 Ø 27
03207500A, 81466116003, 81466116004, 81466116005



MN-DL-8544

Length: 596 Ø: 48
Hole Distance: 130 / 130
81432206196, 81432206232, 81432206233



MN-DL-8609

Length: 585 Ø: 58
Hole Distance: 130 / 130
81432206070, 81432206071, 81432206072, 81432206091, 81432206093, 81432206119



MN-DL-12284

Length: 1530 Ø: 50
Cone Ø: d1 Ø 30 / d2 Ø 27
81466106579, 81466106580, 81466106624, 81466116720, 81467116720, 81467116730, 81467116952



MN-DL-12421

Length: 1070 Ø: 48
Cone Ø: d1 Ø 30 / d2 Ø 27
Thread: M30 x 1,5 RHT
81466106656, 81466106659, 81466106669, 81466116006, 81466116007



MN-SB-5244

Ø: 65
Hole Distance: 125
Thick/Height: 22
03312000A, 81432710027, 81432710082



MN-SB-5246

Ø: 45 Thick/Height: 47
81437220022, 81437220038, 81962100450, 81962100469



MN-VB-8514

Length: 627 Ø: 48
Hole Ø 25 / 25 / 25
Hole Distance: 152 / 130 / 130
81432706087, 81432706088, 81432706094, 81432706095, 81432796094



MN-VB-8669

Length: 627 Ø: 48
Hole Ø 25 / 25 / 25
Hole Distance: 152 / 130 / 130
81432706116, 81432706137, 81432706150, 81432706151





F 2000 ...

35.373 VF, VFC, VFRC ...	05/01→	Track Control Arm		MN-DL-8544	Trailing Arm	
	05/01→	Track Control Arm		MN-DL-8609	Trailing Arm	
	05/01→	Track Control Arm		MN-VB-8514	Suspension Rod, Wishbone (CV)	
	05/01→	Track Control Arm		MN-VB-8669	Suspension Rod, Wishbone (CV)	
35.373 VFK, VF-HK, VF-KI	03/02→	Ball Head, gearshift linkage	CV-ES-2120			
	03/02→	Centre Rod	MN-DL-7792		Push Rod	
	03/02→	Centre Rod	MN-DL-8197		Push Rod	
	03/02→	Centre Rod	MN-DL-12421		for Steering Rod	
	03/02→	Mounting, stabilizer coupling rod	MN-SB-5246			
	03/02→	Suspension Arm Repair Kit		MN-SB-5244	for Wishbone (CV)	
	03/02→	Tie Rod	MN-DL-12284			
	03/02→	Tie Rod End	CV-ES-2146			
	03/02→	Tie Rod End	CV-ES-2149		for Push Rod	
	03/02→	Tie Rod End	CV-ES-14162		for Steering Rod	
	03/02→	Tie Rod End	CV-ES-14163		for Steering Rod	
	03/02→	Track Control Arm		MN-DL-3402	Trailing Arm	
	03/02→	Track Control Arm		MN-DL-8544	Trailing Arm	
	03/02→	Track Control Arm		MN-DL-8609	Trailing Arm	
	03/02→	Track Control Arm		MN-VB-8514	Suspension Rod, Wishbone (CV)	
	03/02→	Track Control Arm		MN-VB-8669	Suspension Rod, Wishbone (CV)	
	35.403 VF, VFC, VFRC	08/95→	Ball Head, gearshift linkage	CV-ES-2119		
08/95→		Ball Head, gearshift linkage	CV-ES-2120			
08/95→		Ball Head, gearshift linkage	CV-ES-2182			
08/95→		Centre Rod	MN-DL-2160		Coupling Rod	
08/95→		Centre Rod	MN-DL-2162		Push Rod	
08/95→		Centre Rod	MN-DL-2176		Push Rod	
08/95→		Centre Rod	MN-DL-7792		Push Rod	
08/95→		Centre Rod	MN-DL-8197		Push Rod	
08/95→		Centre Rod	MN-DL-12421		for Steering Rod	
08/95→		Engine Mounting		MN-SB-10390		
08/95→		Mounting, stabilizer coupling rod	MN-SB-5246			
08/95→		Suspension Arm Repair Kit		MN-SB-5244	for Wishbone (CV)	
08/95→		Suspension Arm Repair Kit		MN-SB-5244	for Wishbone (CV), 1st RA	
08/95→		Suspension Strut Repair Kit		DB-RK-8581		
08/95→		Tie Rod	MN-DL-12284			
08/95→		Tie Rod End	CV-ES-2146			
08/95→		Tie Rod End	CV-ES-2149		for Push Rod	
08/95→		Tie Rod End	CV-ES-14162		for Steering Rod	
08/95→		Tie Rod End	CV-ES-14163		for Steering Rod	
08/95→		Track Control Arm		MN-DL-3402	Trailing Arm, Drive Axle	
08/95→		Track Control Arm		MN-DL-8544	Trailing Arm, Drive Axle; Leaf Spring Axle	
08/95→		Track Control Arm		MN-DL-8609	Trailing Arm, Leaf Spring Axle	
08/95→		Track Control Arm		MN-VB-8514	Suspension Rod, Wishbone (CV), Drive Axle; Leaf Spring Axle	
05/02→		Track Control Arm		MN-VB-8669	Suspension Rod, Wishbone (CV), Drive Axle	
35.403 VFK, VF-HK, VF-KI		03/02→	Ball Head, gearshift linkage	CV-ES-2119		
		03/02→	Ball Head, gearshift linkage	CV-ES-2120		
		03/02→	Ball Head, gearshift linkage	CV-ES-2182		
	03/02→	Centre Rod	MN-DL-2160		Coupling Rod	
	03/02→	Centre Rod	MN-DL-2162		Push Rod	
	03/02→	Centre Rod	MN-DL-2176		Push Rod	
	03/02→	Centre Rod	MN-DL-7792		Push Rod	
	03/02→	Centre Rod	MN-DL-8197		Push Rod	
	03/02→	Centre Rod	MN-DL-12421		for Steering Rod	
	03/02→	Engine Mounting		MN-SB-10390		
	03/02→	Mounting, stabilizer coupling rod	MN-SB-5246			
	03/02→	Suspension Arm Repair Kit		MN-SB-5244	for Wishbone (CV)	
	03/02→	Suspension Arm Repair Kit		MN-SB-5244	for Wishbone (CV), 1st RA	
	03/02→	Suspension Strut Repair Kit		DB-RK-8581		
	03/02→	Tie Rod	MN-DL-12284			
	03/02→	Tie Rod End	CV-ES-2146			
	03/02→	Tie Rod End	CV-ES-2149		for Push Rod	
03/02→	Tie Rod End	CV-ES-14162		for Steering Rod		

CV-ES-2119

Length: 55
Cone Ø: d1 Ø 10 / d2 Ø 10
Thread: M12 x 1,75 LHT
81953016063, 81953016131



CV-ES-2120

Length: 115
Cone Ø: d1 Ø 12,4 / d2 Ø 10,8
Thread: M14 x 1,5 RHT
03008500A, 81953016200, 81953016202, 81953016203, 81953016227



CV-ES-2146

Length: 80
Cone Ø: d1 Ø 30 / d2 Ø 27
Thread: M26 x 1,5 RHT
42533102, 81953016219, 81953016225, 81953016226, 81953016267, 81953016291



CV-ES-2149

Length: 160
Cone Ø: d1 Ø 30 / d2 Ø 27
Thread: M30 x 1,5 RHT
81953016263



CV-ES-2182

Length: 55
Cone Ø: d1 Ø 10 / d2 Ø 10
Thread: M12 x 1,75 RHT
81953016064, 81953016170



CV-ES-14162

Length: 125
Cone Ø: d1 Ø 30 / d2 Ø 27
Thread: M30 x 1,5 LHT
81953010015, 81953010083, 81953010087, 81953016029, 81953016030, 81953016043, 81953016044, 81953016050, 81953016054, 81953016087, 81953016091, 81953016107, 81953016120, 81953016125, 81953016152, 81953016155, 81953016157, 81953016168, 81953016179, 81953016181, 81953016223, 81953016237, 81953016254, 81953016275, 81953016279, 81953016351



CV-ES-14163

Length: 125
Cone Ø: d1 Ø 30 / d2 Ø 27
Thread: M30 x 1,5 RHT
95301.0084, 90804102156, 90804102272, 90804102696, 90804102710, 81953010016, 81953010075, 81953010084, 81953010088, 81953010094, 81953010103, 81953016030, 81953016043, 81953016048, 81953016049, 81953016053, 81953016061, 81953016090, 81953016108, 81953016112, 81953016126, 81953016143, 81953016149, 81953016154, 81953016156, 81953016168, 81953016178, 81953016194, 81953016206, 81953016224, 81953016234, 81953016242, 81953016252, 81953016274, 81953016278, 81953016284, 81953016286, 81953016308, 81953016310, 81953016312, 81953016347, 81953016350, 81953016352, 82953016012, 88953016014, N2953016001



DB-RK-8581

Ø: 85
Hole Distance: 130
Thick/Height: 24
03305800A, 81432706105



MN-DL-2160

Length: 1652 Ø: 50
Cone Ø: d1 Ø 30 / d2 Ø 27
81467106112, 81467106163, 81467106165, 81467106198, 81467106353, 81467106354, 81467106361, 81467116725



MN-DL-2162

Length: 755 Ø: 40
Cone Ø: d1 Ø 30 / d2 Ø 27
81466106578, 81466106704, 81466106705, 81466106798, 81466106799



MN-DL-2176

Length: 1628 Ø: 48
Cone Ø: d1 Ø 30 / d2 Ø 27
81466106779, 81466106780, 81466106782



MN-DL-3402

Length: 590 Ø: 48
Hole Distance: 130 / 130
03307200A, 81432206067, 81432206068, 81432206090, 81432206092, 81432209092



MN-DL-7792

Length: 1750 Ø: 52
Cone Ø: d1 Ø 30 / d2 Ø 27
81466106790, 81466106791, 82466106191



MN-DL-8197

Length: 1055 Ø: 42
Cone Ø: d1 Ø 30 / d2 Ø 27
03207500A, 81466116003, 81466116004, 81466116005



MN-DL-8544

Length: 596 Ø: 48
Hole Distance: 130 / 130
81432206196, 81432206232, 81432206233



MN-DL-8609

Length: 585 Ø: 58
Hole Distance: 130 / 130
81432206070, 81432206071, 81432206072, 81432206091, 81432206093, 81432206119



MN-DL-12284

Length: 1530 Ø: 50
Cone Ø: d1 Ø 30 / d2 Ø 27
81466106579, 81466106580, 81466106624, 81466116720, 81467116720, 81467116730, 81467116952



MN-DL-12421

Length: 1070 Ø: 48
Cone Ø: d1 Ø 30 / d2 Ø 27
Thread: M30 x 1,5 RHT
81466106656, 81466106659, 81466106669, 81466116006, 81466116007



MN-SB-5244

Ø: 65
Hole Distance: 125
Thick/Height: 22
03312000A, 81432710027, 81432710082



MN-SB-5246

Ø: 45 Thick/Height: 47
81437220022, 81437220038, 81962100450, 81962100469



MN-SB-10390

Ø: 70 Thick/Height: 85/85
81960200341, 81960200373, 81960200385, 81960200408, 81960200418



MN-VB-8514

Length: 627 Ø: 48
Hole Ø 25 / 25 / 25
Hole Distance: 152 / 130 / 130
81432706087, 81432706088, 81432706094, 81432706095, 81432796094



MN-VB-8669

Length: 627 Ø: 48
Hole Ø 25 / 25 / 25
Hole Distance: 152 / 130 / 130
81432706116, 81432706137, 81432706150, 81432706151





F 2000 ...

35.403 VFK, VF-HK, VF-KI ...	03/02→	Tie Rod End	CV-ES-14163		for Steering Rod
	03/02→	Track Control Arm		MN-DL-3402	Trailing Arm, Drive Axle
	03/02→	Track Control Arm		MN-DL-8544	Trailing Arm, Drive Axle; Leaf Spring Axle
	03/02→	Track Control Arm		MN-DL-8609	Trailing Arm, Leaf Spring Axle
	03/02→	Track Control Arm		MN-VB-8514	Suspension Rod, Wishbone (CV), Drive Axle; Leaf Spring Axle
	05/02→	Track Control Arm		MN-VB-8669	Suspension Rod, Wishbone (CV), Drive Axle
35.414 VF, VFC, VFRC	05/01→	Ball Head, gearshift linkage	CV-ES-2120		
	05/01→	Centre Rod	MN-DL-7792		Push Rod
	05/01→	Centre Rod	MN-DL-8197		Push Rod
	05/01→	Centre Rod	MN-DL-12421		for Steering Rod
	05/01→	Mounting, stabilizer coupling rod	MN-SB-5246		
	05/01→	Suspension Arm Repair Kit		MN-SB-5244	for Wishbone (CV)
	05/01→	Tie Rod	MN-DL-12284		
	05/01→	Tie Rod End	CV-ES-2146		
	05/01→	Tie Rod End	CV-ES-2149		for Push Rod
	05/01→	Tie Rod End	CV-ES-14162		for Steering Rod
	05/01→	Tie Rod End	CV-ES-14163		for Steering Rod
	05/01→	Track Control Arm		MN-DL-3402	Trailing Arm
	05/01→	Track Control Arm		MN-DL-8544	Trailing Arm
	05/01→	Track Control Arm		MN-DL-8609	Trailing Arm
	05/01→	Track Control Arm		MN-VB-8514	Suspension Rod, Wishbone (CV)
	05/01→	Track Control Arm		MN-VB-8669	Suspension Rod, Wishbone (CV)
35.414 VFK, VF-HK, VF-KI	03/02→	Ball Head, gearshift linkage	CV-ES-2120		
	03/02→	Centre Rod	MN-DL-7792		Push Rod
	03/02→	Centre Rod	MN-DL-8197		Push Rod
	03/02→	Centre Rod	MN-DL-12421		for Steering Rod
	03/02→	Mounting, stabilizer coupling rod	MN-SB-5246		
	03/02→	Suspension Arm Repair Kit		MN-SB-5244	for Wishbone (CV)
	03/02→	Tie Rod	MN-DL-12284		
	03/02→	Tie Rod End	CV-ES-2146		
	03/02→	Tie Rod End	CV-ES-2149		for Push Rod
	03/02→	Tie Rod End	CV-ES-14162		for Steering Rod
	03/02→	Tie Rod End	CV-ES-14163		for Steering Rod
	03/02→	Track Control Arm		MN-DL-3402	Trailing Arm
	03/02→	Track Control Arm		MN-DL-8544	Trailing Arm
	03/02→	Track Control Arm		MN-DL-8609	Trailing Arm
	03/02→	Track Control Arm		MN-VB-8514	Suspension Rod, Wishbone (CV)
	03/02→	Track Control Arm		MN-VB-8669	Suspension Rod, Wishbone (CV)
35.414 VF-TM	03/02→	Ball Head, gearshift linkage	CV-ES-2120		
	03/02→	Centre Rod	MN-DL-7792		Push Rod
	03/02→	Centre Rod	MN-DL-8197		Push Rod
	03/02→	Centre Rod	MN-DL-12421		for Steering Rod
	03/02→	Mounting, stabilizer coupling rod	MN-SB-5246		
	03/02→	Suspension Arm Repair Kit		MN-SB-5244	for Wishbone (CV)
	03/02→	Tie Rod	MN-DL-12284		
	03/02→	Tie Rod End	CV-ES-2146		
	03/02→	Tie Rod End	CV-ES-2149		for Push Rod
	03/02→	Tie Rod End	CV-ES-14162		for Steering Rod
	03/02→	Tie Rod End	CV-ES-14163		for Steering Rod
	03/02→	Track Control Arm		MN-DL-3402	Trailing Arm
	03/02→	Track Control Arm		MN-DL-8544	Trailing Arm
	03/02→	Track Control Arm		MN-DL-8609	Trailing Arm
	03/02→	Track Control Arm		MN-VB-8514	Suspension Rod, Wishbone (CV)
	03/02→	Track Control Arm		MN-VB-8669	Suspension Rod, Wishbone (CV)
35.423 VF, VFC, VFRC	05/01→	Ball Head, gearshift linkage	CV-ES-2120		
	05/01→	Centre Rod	MN-DL-7792		Push Rod
	05/01→	Centre Rod	MN-DL-8197		Push Rod
	05/01→	Centre Rod	MN-DL-12421		for Steering Rod
	05/01→	Mounting, stabilizer coupling rod	MN-SB-5246		
	05/01→	Suspension Arm Repair Kit		MN-SB-5244	for Wishbone (CV)
	05/01→	Tie Rod	MN-DL-12284		
	05/01→	Tie Rod End	CV-ES-2146		

CV-ES-2120

Length: 115
Cone Ø: d1 Ø 12,4 / d2 Ø 10,8
Thread: M14 x 1,5 RHT
03008500A, 81953016200, 81953016202,
81953016203, 81953016227



CV-ES-2146

Length: 80
Cone Ø: d1 Ø 30 / d2 Ø 27
Thread: M26 x 1,5 RHT
42533102, 81953016219, 81953016225,
81953016226, 81953016267, 81953016291



CV-ES-2149

Length: 160
Cone Ø: d1 Ø 30 / d2 Ø 27
Thread: M30 x 1,5 RHT
81953016263



CV-ES-14162

Length: 125
Cone Ø: d1 Ø 30 / d2 Ø 27
Thread: M30 x 1,5 LHT
81953010015, 81953010083, 81953010087,
81953016029, 81953016030, 81953016043,
81953016044, 81953016050, 81953016054,
81953016087, 81953016091, 81953016107,
81953016120, 81953016125, 81953016152,
81953016155, 81953016157, 81953016168,
81953016179, 81953016181, 81953016223,
81953016237, 81953016254, 81953016275,
81953016279, 81953016351



CV-ES-14163

Length: 125
Cone Ø: d1 Ø 30 / d2 Ø 27
Thread: M30 x 1,5 RHT
95301.0084, 90804102156, 90804102272,
90804102696, 90804102710, 81953010016,
81953010075, 81953010084, 81953010088,
81953010094, 81953010103, 81953016030,
81953016043, 81953016048, 81953016049,
81953016053, 81953016061, 81953016090,
81953016108, 81953016112, 81953016126,
81953016143, 81953016149, 81953016154,
81953016156, 81953016168, 81953016178,
81953016194, 81953016206, 81953016224,
81953016234, 81953016242, 81953016252,
81953016274, 81953016278, 81953016284,
81953016286, 81953016308, 81953016310,
81953016312, 81953016347, 81953016350,
81953016352, 82953016012, 88953016014,
N2953016001



MN-DL-3402

Length: 590 Ø: 48
Hole Distance: 130 / 130
03307200A, 81432206067, 81432206068,
81432206090, 81432206092, 81432209092



MN-DL-7792

Length: 1750 Ø: 52
Cone Ø: d1 Ø 30 / d2 Ø 27
81466106790, 81466106791, 82466106191



MN-DL-8197

Length: 1055 Ø: 42
Cone Ø: d1 Ø 30 / d2 Ø 27
03207500A, 81466116003, 81466116004,
81466116005



MN-DL-8544

Length: 596 Ø: 48
Hole Distance: 130 / 130
81432206196, 81432206232, 81432206233



MN-DL-8609

Length: 585 Ø: 58
Hole Distance: 130 / 130
81432206070, 81432206071, 81432206072,
81432206091, 81432206093, 81432206119



MN-DL-12284

Length: 1530 Ø: 50
Cone Ø: d1 Ø 30 / d2 Ø 27
81466106579, 81466106580, 81466106624,
81466116720, 81467116720, 81467116730,
81467116952



MN-DL-12421

Length: 1070 Ø: 48
Cone Ø: d1 Ø 30 / d2 Ø 27
Thread: M30 x 1,5 RHT
81466106656, 81466106659, 81466106669,
81466116006, 81466116007



MN-SB-5244

Ø: 65
Hole Distance: 125
Thick/Height: 22
03312000A, 81432710027, 81432710082



MN-SB-5246

Ø: 45 Thick/Height: 47
81437220022, 81437220038, 81962100450,
81962100469



MN-VB-8514

Length: 627 Ø: 48
Hole Ø 25 / 25 / 25
Hole Distance: 152 / 130 / 130
81432706087, 81432706088, 81432706094,
81432706095, 81432796094



MN-VB-8669

Length: 627 Ø: 48
Hole Ø 25 / 25 / 25
Hole Distance: 152 / 130 / 130
81432706116, 81432706137, 81432706150,
81432706151



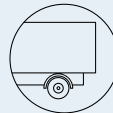

F 2000 ...

35.423 VF, VFC, VFRC ...	05/01→	Tie Rod End	CV-ES-2149		for Push Rod
	05/01→	Tie Rod End	CV-ES-14162		for Steering Rod
	05/01→	Tie Rod End	CV-ES-14163		for Steering Rod
	05/01→	Track Control Arm		MN-DL-3402	Trailing Arm
	05/01→	Track Control Arm		MN-DL-8544	Trailing Arm
	05/01→	Track Control Arm		MN-DL-8609	Trailing Arm
	05/01→	Track Control Arm		MN-VB-8514	Suspension Rod, Wishbone (CV)
	05/01→	Track Control Arm		MN-VB-8669	Suspension Rod, Wishbone (CV)
35.423 VFK, VF-HK, VF-KI	03/02→	Ball Head, gearshift linkage	CV-ES-2120		
	03/02→	Centre Rod	MN-DL-7792		Push Rod
	03/02→	Centre Rod	MN-DL-8197		Push Rod
	03/02→	Centre Rod	MN-DL-12421		for Steering Rod
	03/02→	Mounting, stabilizer coupling rod	MN-SB-5246		
	03/02→	Suspension Arm Repair Kit		MN-SB-5244	for Wishbone (CV)
	03/02→	Tie Rod	MN-DL-12284		
	03/02→	Tie Rod End	CV-ES-2146		
	03/02→	Tie Rod End	CV-ES-2149		for Push Rod
	03/02→	Tie Rod End	CV-ES-14162		for Steering Rod
	03/02→	Tie Rod End	CV-ES-14163		for Steering Rod
	03/02→	Track Control Arm		MN-DL-3402	Trailing Arm
	03/02→	Track Control Arm		MN-DL-8544	Trailing Arm
	03/02→	Track Control Arm		MN-DL-8609	Trailing Arm
	03/02→	Track Control Arm		MN-VB-8514	Suspension Rod, Wishbone (CV)
	03/02→	Track Control Arm		MN-VB-8669	Suspension Rod, Wishbone (CV)
35.463 VF, VFC, VFRC	08/95→	Ball Head, gearshift linkage	CV-ES-2119		
	08/95→	Ball Head, gearshift linkage	CV-ES-2120		
	08/95→	Ball Head, gearshift linkage	CV-ES-2182		
	08/95→	Centre Rod	MN-DL-2160		Coupling Rod
	08/95→	Centre Rod	MN-DL-2162		Push Rod
	08/95→	Centre Rod	MN-DL-2176		Push Rod
	08/95→	Centre Rod	MN-DL-7792		Push Rod
	08/95→	Centre Rod	MN-DL-8197		Push Rod
	08/95→	Centre Rod	MN-DL-12421		for Steering Rod
	08/95→	Engine Mounting		MN-SB-10390	
	08/95→	Mounting, stabilizer coupling rod	MN-SB-5246		
	08/95→	Suspension Arm Repair Kit		MN-SB-5244	for Wishbone (CV)
	08/95→	Suspension Arm Repair Kit		MN-SB-5244	for Wishbone (CV), 1st RA
	08/95→	Suspension Strut Repair Kit		DB-RK-8581	
	08/95→	Tie Rod	MN-DL-12284		
	08/95→	Tie Rod End	CV-ES-2146		
	08/95→	Tie Rod End	CV-ES-2149		for Push Rod
	08/95→	Tie Rod End	CV-ES-14162		for Steering Rod
	08/95→	Tie Rod End	CV-ES-14163		for Steering Rod
	08/95→	Track Control Arm		MN-DL-3402	Trailing Arm, Drive Axle
	08/95→	Track Control Arm		MN-DL-8544	Trailing Arm, Drive Axle; Leaf Spring Axle
	08/95→	Track Control Arm		MN-DL-8609	Trailing Arm, Leaf Spring Axle
	08/95→	Track Control Arm		MN-VB-8514	Suspension Rod, Wishbone (CV), Drive Axle; Leaf Spring Axle
	05/02→	Track Control Arm		MN-VB-8669	Suspension Rod, Wishbone (CV), Drive Axle
35.463 VFK, VF-HK, VF-KI	08/95→	Ball Head, gearshift linkage	CV-ES-2119		
	08/95→	Ball Head, gearshift linkage	CV-ES-2120		
	08/95→	Ball Head, gearshift linkage	CV-ES-2182		
	08/95→	Centre Rod	MN-DL-2160		Coupling Rod
	08/95→	Centre Rod	MN-DL-2162		Push Rod
	08/95→	Centre Rod	MN-DL-2176		Push Rod
	08/95→	Centre Rod	MN-DL-7792		Push Rod
	08/95→	Centre Rod	MN-DL-8197		Push Rod
	08/95→	Centre Rod	MN-DL-12421		for Steering Rod
	08/95→	Engine Mounting		MN-SB-10390	
	08/95→	Mounting, stabilizer coupling rod	MN-SB-5246		
	08/95→	Suspension Arm Repair Kit		MN-SB-5244	for Wishbone (CV)
	08/95→	Suspension Arm Repair Kit		MN-SB-5244	for Wishbone (CV), 1st RA
	08/95→	Suspension Strut Repair Kit		DB-RK-8581	

CV-ES-2119

Length: 55
Cone Ø: d1 Ø 10 / d2 Ø 10
Thread: M12 x 1,75 LHT
81953016063, 81953016131



CV-ES-2120

Length: 115
Cone Ø: d1 Ø 12,4 / d2 Ø 10,8
Thread: M14 x 1,5 RHT
03008500A, 81953016200, 81953016202,
81953016203, 81953016227



CV-ES-2146

Length: 80
Cone Ø: d1 Ø 30 / d2 Ø 27
Thread: M26 x 1,5 RHT
42533102, 81953016219, 81953016225,
81953016226, 81953016267, 81953016291



CV-ES-2149

Length: 160
Cone Ø: d1 Ø 30 / d2 Ø 27
Thread: M30 x 1,5 RHT
81953016263



CV-ES-2182

Length: 55
Cone Ø: d1 Ø 10 / d2 Ø 10
Thread: M12 x 1,75 RHT
81953016064, 81953016170



CV-ES-14162

Length: 125
Cone Ø: d1 Ø 30 / d2 Ø 27
Thread: M30 x 1,5 LHT
81953010015, 81953010083, 81953010087,
81953016029, 81953016030, 81953016043,
81953016044, 81953016050, 81953016054,
81953016087, 81953016091, 81953016107,
81953016120, 81953016125, 81953016152,
81953016155, 81953016157, 81953016168,
81953016179, 81953016181, 81953016223,
81953016237, 81953016254, 81953016275,
81953016279, 81953016351



CV-ES-14163

Length: 125
Cone Ø: d1 Ø 30 / d2 Ø 27
Thread: M30 x 1,5 RHT
95301.0084, 90804102156, 90804102272,
90804102696, 90804102710, 81953010016,
81953010075, 81953010084, 81953010088,
81953010094, 81953010103, 81953016030,
81953016043, 81953016048, 81953016049,
81953016053, 81953016061, 81953016090,
81953016108, 81953016112, 81953016126,
81953016143, 81953016149, 81953016154,
81953016156, 81953016168, 81953016178,
81953016194, 81953016206, 81953016224,
81953016234, 81953016242, 81953016252,
81953016274, 81953016278, 81953016284,
81953016286, 81953016308, 81953016310,
81953016312, 81953016347, 81953016350,
81953016352, 82953016012, 88953016014,
N2953016001



DB-RK-8581

Ø: 85
Hole Distance: 130
Thick/Height: 24
03305800A, 81432706105



MN-DL-2160

Length: 1652 Ø: 50
Cone Ø: d1 Ø 30 / d2 Ø 27
81467106112, 81467106163, 81467106165,
81467106198, 81467106353, 81467106354,
81467106361, 81467116725



MN-DL-2162

Length: 755 Ø: 40
Cone Ø: d1 Ø 30 / d2 Ø 27
81466106578, 81466106704, 81466106705,
81466106798, 81466106799



MN-DL-2176

Length: 1628 Ø: 48
Cone Ø: d1 Ø 30 / d2 Ø 27
81466106779, 81466106780, 81466106782



MN-DL-3402

Length: 590 Ø: 48
Hole Distance: 130 / 130
03307200A, 81432206067, 81432206068,
81432206090, 81432206092, 81432209092



MN-DL-7792

Length: 1750 Ø: 52
Cone Ø: d1 Ø 30 / d2 Ø 27
81466106790, 81466106791, 82466106191



MN-DL-8197

Length: 1055 Ø: 42
Cone Ø: d1 Ø 30 / d2 Ø 27
03207500A, 81466116003, 81466116004,
81466116005



MN-DL-8544

Length: 596 Ø: 48
Hole Distance: 130 / 130
81432206196, 81432206232, 81432206233



MN-DL-8609

Length: 585 Ø: 58
Hole Distance: 130 / 130
81432206070, 81432206071, 81432206072,
81432206091, 81432206093, 81432206119



MN-DL-12284

Length: 1530 Ø: 50
Cone Ø: d1 Ø 30 / d2 Ø 27
81466106579, 81466106580, 81466106624,
81466116720, 81467116720, 81467116730,
81467116952



MN-DL-12421

Length: 1070 Ø: 48
Cone Ø: d1 Ø 30 / d2 Ø 27
Thread: M30 x 1,5 RHT
81466106656, 81466106659, 81466106669,
81466116006, 81466116007



MN-SB-5244

Ø: 65
Hole Distance: 125
Thick/Height: 22
03312000A, 81432710027, 81432710082



MN-SB-5246

Ø: 45 Thick/Height: 47
81437220022, 81437220038, 81962100450,
81962100469



MN-SB-10390

Ø: 70 Thick/Height: 85/85
81960200341, 81960200373, 81960200385,
81960200408, 81960200418



MN-VB-8514

Length: 627 Ø: 48
Hole Ø 25 / 25 / 25
Hole Distance: 152 / 130 / 130
81432706087, 81432706088, 81432706094,
81432706095, 81432796094



MN-VB-8669

Length: 627 Ø: 48
Hole Ø 25 / 25 / 25
Hole Distance: 152 / 130 / 130
81432706116, 81432706137, 81432706150,
81432706151





F 2000 ...

35.463 VFK, VF-HK, VF-KI ...	08/95→	Tie Rod	MN-DL-12284		
	08/95→	Tie Rod End	CV-ES-2146		
	08/95→	Tie Rod End	CV-ES-2149	for Push Rod	
	08/95→	Tie Rod End	CV-ES-14162	for Steering Rod	
	08/95→	Tie Rod End	CV-ES-14163	for Steering Rod	
	08/95→	Track Control Arm		MN-DL-3402	Trailing Arm, Drive Axle
	08/95→	Track Control Arm		MN-DL-8544	Trailing Arm, Drive Axle; Leaf Spring Axle
	08/95→	Track Control Arm		MN-DL-8609	Trailing Arm, Leaf Spring Axle
	08/95→	Track Control Arm		MN-VB-8514	Suspension Rod, Wishbone (CV), Drive Axle; Leaf Spring Axle
	05/02→	Track Control Arm		MN-VB-8669	Suspension Rod, Wishbone (CV), Drive Axle
35.464 VF, VFC, VFRC	05/01→	Ball Head, gearshift linkage	CV-ES-2120		
	05/01→	Centre Rod	MN-DL-7792	Push Rod	
	05/01→	Centre Rod	MN-DL-8197	Push Rod	
	05/01→	Centre Rod	MN-DL-12421	for Steering Rod	
	05/01→	Mounting, stabilizer coupling rod	MN-SB-5246		
	05/01→	Suspension Arm Repair Kit		MN-SB-5244	for Wishbone (CV)
	05/01→	Tie Rod	MN-DL-12284		
	05/01→	Tie Rod End	CV-ES-2146		
	05/01→	Tie Rod End	CV-ES-2149	for Push Rod	
	05/01→	Tie Rod End	CV-ES-14162	for Steering Rod	
	05/01→	Tie Rod End	CV-ES-14163	for Steering Rod	
	05/01→	Track Control Arm		MN-DL-3402	Trailing Arm
	05/01→	Track Control Arm		MN-DL-8544	Trailing Arm
	05/01→	Track Control Arm		MN-DL-8609	Trailing Arm
	05/01→	Track Control Arm		MN-VB-8514	Suspension Rod, Wishbone (CV)
05/01→	Track Control Arm		MN-VB-8669	Suspension Rod, Wishbone (CV)	
35.464 VFK, VF-HK, VF-KI	03/02→	Ball Head, gearshift linkage	CV-ES-2120		
	03/02→	Centre Rod	MN-DL-7792	Push Rod	
	03/02→	Centre Rod	MN-DL-8197	Push Rod	
	03/02→	Centre Rod	MN-DL-12421	for Steering Rod	
	03/02→	Mounting, stabilizer coupling rod	MN-SB-5246		
	03/02→	Suspension Arm Repair Kit		MN-SB-5244	for Wishbone (CV)
	03/02→	Tie Rod	MN-DL-12284		
	03/02→	Tie Rod End	CV-ES-2146		
	03/02→	Tie Rod End	CV-ES-2149	for Push Rod	
	03/02→	Tie Rod End	CV-ES-14162	for Steering Rod	
	03/02→	Tie Rod End	CV-ES-14163	for Steering Rod	
	03/02→	Track Control Arm		MN-DL-3402	Trailing Arm
	03/02→	Track Control Arm		MN-DL-8544	Trailing Arm
	03/02→	Track Control Arm		MN-DL-8609	Trailing Arm
	03/02→	Track Control Arm		MN-VB-8514	Suspension Rod, Wishbone (CV)
	03/02→	Track Control Arm		MN-VB-8669	Suspension Rod, Wishbone (CV)
	35.464 VF-TM	03/02→	Ball Head, gearshift linkage	CV-ES-2120	
		03/02→	Centre Rod	MN-DL-7792	Push Rod
03/02→		Centre Rod	MN-DL-8197	Push Rod	
03/02→		Centre Rod	MN-DL-12421	for Steering Rod	
03/02→		Mounting, stabilizer coupling rod	MN-SB-5246		
03/02→		Suspension Arm Repair Kit		MN-SB-5244	for Wishbone (CV)
03/02→		Tie Rod	MN-DL-12284		
03/02→		Tie Rod End	CV-ES-2146		
03/02→		Tie Rod End	CV-ES-2149	for Push Rod	
03/02→		Tie Rod End	CV-ES-14162	for Steering Rod	
03/02→		Tie Rod End	CV-ES-14163	for Steering Rod	
03/02→		Track Control Arm		MN-DL-3402	Trailing Arm
03/02→		Track Control Arm		MN-DL-8544	Trailing Arm
03/02→		Track Control Arm		MN-DL-8609	Trailing Arm
03/02→		Track Control Arm		MN-VB-8514	Suspension Rod, Wishbone (CV)
37.414 VFA	06/98→	Centre Rod	MN-DL-7792	Push Rod	
	06/98→	Centre Rod	MN-DL-8197	Push Rod	
	06/98→	Centre Rod	MN-DL-12391	for Steering Rod	
	06/98→	Suspension Arm Repair Kit		MN-SB-5244	for Wishbone (CV)

CV-ES-2120

Length: 115
Cone Ø: d1 Ø 12,4 / d2 Ø 10,8
Thread: M14 x 1,5 RHT
03008500A, 81953016200, 81953016202, 81953016203, 81953016227



CV-ES-2146

Length: 80
Cone Ø: d1 Ø 30 / d2 Ø 27
Thread: M26 x 1,5 RHT
42533102, 81953016219, 81953016225, 81953016226, 81953016267, 81953016291



CV-ES-2149

Length: 160
Cone Ø: d1 Ø 30 / d2 Ø 27
Thread: M30 x 1,5 RHT
81953016263



CV-ES-14162

Length: 125
Cone Ø: d1 Ø 30 / d2 Ø 27
Thread: M30 x 1,5 LHT
81953010015, 81953010083, 81953010087, 81953016029, 81953016030, 81953016043, 81953016044, 81953016050, 81953016054, 81953016087, 81953016091, 81953016107, 81953016120, 81953016125, 81953016152, 81953016155, 81953016157, 81953016168, 81953016179, 81953016181, 81953016223, 81953016237, 81953016254, 81953016275, 81953016279, 81953016351



CV-ES-14163

Length: 125
Cone Ø: d1 Ø 30 / d2 Ø 27
Thread: M30 x 1,5 RHT
95301.0084, 90804102156, 90804102272, 90804102696, 90804102710, 81953010016, 81953010075, 81953010084, 81953010088, 81953010094, 81953010103, 81953016030, 81953016043, 81953016048, 81953016049, 81953016053, 81953016061, 81953016090, 81953016108, 81953016112, 81953016126, 81953016143, 81953016149, 81953016154, 81953016156, 81953016168, 81953016178, 81953016194, 81953016206, 81953016224, 81953016234, 81953016242, 81953016252, 81953016274, 81953016278, 81953016284, 81953016286, 81953016308, 81953016310, 81953016312, 81953016347, 81953016350, 81953016352, 82953016012, 88953016014, N2953016001



MN-DL-3402

Length: 590 Ø: 48
Hole Distance: 130 / 130
03307200A, 81432206067, 81432206068, 81432206090, 81432206092, 81432209092



MN-DL-7792

Length: 1750 Ø: 52
Cone Ø: d1 Ø 30 / d2 Ø 27
81466106790, 81466106791, 82466106191



MN-DL-8197

Length: 1055 Ø: 42
Cone Ø: d1 Ø 30 / d2 Ø 27
03207500A, 81466116003, 81466116004, 81466116005



MN-DL-8544

Length: 596 Ø: 48
Hole Distance: 130 / 130
81432206196, 81432206232, 81432206233



MN-DL-8609

Length: 585 Ø: 58
Hole Distance: 130 / 130
81432206070, 81432206071, 81432206072, 81432206091, 81432206093, 81432206119



MN-DL-12284

Length: 1530 Ø: 50
Cone Ø: d1 Ø 30 / d2 Ø 27
81466106579, 81466106580, 81466106624, 81466116720, 81467116720, 81467116730, 81467116952



MN-DL-12391

Length: 1050 Ø: 52
Cone Ø: d1 Ø 30 / d2 Ø 27
82466106057, 82466106147



MN-DL-12421

Length: 1070 Ø: 48
Cone Ø: d1 Ø 30 / d2 Ø 27
Thread: M30 x 1,5 RHT
81466106656, 81466106659, 81466106669, 81466116006, 81466116007



MN-SB-5244

Ø: 65
Hole Distance: 125
Thick/Height: 22
03312000A, 81432710027, 81432710082



MN-SB-5246

Ø: 45 Thick/Height: 47
81437220022, 81437220038, 81962100450, 81962100469



MN-VB-8514

Length: 627 Ø: 48
Hole Ø 25 / 25 / 25
Hole Distance: 152 / 130 / 130
81432706087, 81432706088, 81432706094, 81432706095, 81432796094



MN-VB-8669

Length: 627 Ø: 48
Hole Ø 25 / 25 / 25
Hole Distance: 152 / 130 / 130
81432706116, 81432706137, 81432706150, 81432706151





F 2000 ...

37.414 VFA ...	06/98 →	Tie Rod End	CV-ES-2146		
	06/98 →	Tie Rod End	MN-ES-10333		for Steering Rod
	06/98 →	Track Control Arm		MN-DL-3402	Trailing Arm
	06/98 →	Track Control Arm		MN-DL-8609	Trailing Arm
37.464 VFA	06/98 →	Centre Rod	MN-DL-7792		Push Rod
	06/98 →	Centre Rod	MN-DL-8197		Push Rod
	06/98 →	Centre Rod	MN-DL-12391		for Steering Rod
	06/98 →	Suspension Arm Repair Kit		MN-SB-5244	for Wishbone (CV)
	06/98 →	Tie Rod End	CV-ES-2146		
	06/98 →	Tie Rod End	MN-ES-10333		for Steering Rod
	06/98 →	Track Control Arm		MN-DL-3402	Trailing Arm
	06/98 →	Track Control Arm		MN-DL-8609	Trailing Arm
40.273 DFAK	01/94 →	Ball Head, gearshift linkage	CV-ES-2120		
	01/94 →	Centre Rod	MN-DL-12391		for Steering Rod
	01/94 →	Centre Rod	MN-DL-12421		for Steering Rod
	01/94 →	Suspension Arm Repair Kit		MN-SB-5244	for Wishbone (CV)
	01/94 →	Track Control Arm		MN-DL-8544	Trailing Arm
	01/94 →	Track Control Arm		MN-DL-8609	Trailing Arm
40.273 DFK	01/94 →	Centre Rod	MN-DL-12421		for Steering Rod
40.373 DFAK	05/01 →	Ball Head, gearshift linkage	CV-ES-2120		
	05/01 →	Centre Rod	MN-DL-12391		for Steering Rod
	05/01 →	Centre Rod	MN-DL-12421		for Steering Rod
	05/01 →	Suspension Arm Repair Kit		MN-SB-5244	for Wishbone (CV)
	05/01 →	Tie Rod End	CV-ES-14162		for Steering Rod
	05/01 →	Tie Rod End	CV-ES-14163		for Steering Rod
	05/01 →	Tie Rod End	SC-ES-8517		for Push Rod
	05/01 →	Track Control Arm		MN-DL-8544	Trailing Arm
	05/01 →	Track Control Arm		MN-DL-8609	Trailing Arm
40.373 DFK	05/01 →	Centre Rod	MN-DL-12421		for Steering Rod
	05/01 →	Tie Rod End	CV-ES-2149		for Push Rod
	05/01 →	Tie Rod End	CV-ES-14162		for Steering Rod
	05/01 →	Tie Rod End	CV-ES-14163		for Steering Rod
	05/01 →	Track Control Arm		MN-DL-8609	Trailing Arm
40.403 DFAK	01/94 →	Ball Head, gearshift linkage	CV-ES-2120		
	01/94 →	Centre Rod	MN-DL-12391		for Steering Rod
	01/94 →	Centre Rod	MN-DL-12421		for Steering Rod
	01/94 →	Suspension Arm Repair Kit		MN-SB-5244	for Wishbone (CV)
	01/94 →	Tie Rod End	CV-ES-2146		
	01/94 →	Tie Rod End	CV-ES-14162		for Steering Rod
	01/94 →	Tie Rod End	CV-ES-14163		for Steering Rod
	01/94 →	Track Control Arm		MN-DL-8544	Trailing Arm
	01/94 →	Track Control Arm		MN-DL-8609	Trailing Arm
40.403 DFAS	01/94 →	Centre Rod	MN-DL-12421		for Steering Rod
	01/94 →	Tie Rod End	CV-ES-2146		
	01/94 →	Tie Rod End	CV-ES-14162		for Steering Rod
	01/94 →	Tie Rod End	CV-ES-14163		for Steering Rod
	01/94 →	Track Control Arm		MN-DL-8609	Trailing Arm
40.403 DFK	01/94 →	Centre Rod	MN-DL-12421		for Steering Rod
	01/94 →	Tie Rod End	CV-ES-2146		
	01/94 →	Tie Rod End	CV-ES-2149		for Push Rod
	01/94 →	Tie Rod End	CV-ES-14162		for Steering Rod
	01/94 →	Tie Rod End	CV-ES-14163		for Steering Rod
	01/94 →	Track Control Arm		MN-DL-8609	Trailing Arm
40.403 DFS	01/94 →	Centre Rod	MN-DL-12421		for Steering Rod
	01/94 →	Tie Rod End	CV-ES-2146		
40.414 DFAK	05/01 →	Ball Head, gearshift linkage	CV-ES-2120		
	05/01 →	Centre Rod	MN-DL-12391		for Steering Rod
	05/01 →	Centre Rod	MN-DL-12421		for Steering Rod
	05/01 →	Suspension Arm Repair Kit		MN-SB-5244	for Wishbone (CV)
	05/01 →	Tie Rod End	CV-ES-14162		for Steering Rod
	05/01 →	Tie Rod End	CV-ES-14163		for Steering Rod
	05/01 →	Tie Rod End	SC-ES-8517		for Push Rod
	05/01 →	Track Control Arm		MN-DL-8544	Trailing Arm
05/01 →	Track Control Arm		MN-DL-8609	Trailing Arm	

CV-ES-2120

Length: 115
Cone Ø: d1 Ø 12,4 / d2 Ø 10,8
Thread: M14 x 1,5 RHT
03008500A, 81953016200, 81953016202, 81953016203, 81953016227



CV-ES-2146

Length: 80
Cone Ø: d1 Ø 30 / d2 Ø 27
Thread: M26 x 1,5 RHT
42533102, 81953016219, 81953016225, 81953016226, 81953016267, 81953016291



CV-ES-2149

Length: 160
Cone Ø: d1 Ø 30 / d2 Ø 27
Thread: M30 x 1,5 RHT
81953016263



CV-ES-14162

Length: 125
Cone Ø: d1 Ø 30 / d2 Ø 27
Thread: M30 x 1,5 LHT
81953010015, 81953010083, 81953010087, 81953016029, 81953016030, 81953016043, 81953016044, 81953016050, 81953016054, 81953016087, 81953016091, 81953016107, 81953016120, 81953016125, 81953016152, 81953016155, 81953016157, 81953016168, 81953016179, 81953016181, 81953016223, 81953016237, 81953016254, 81953016275, 81953016279, 81953016351



CV-ES-14163

Length: 125
Cone Ø: d1 Ø 30 / d2 Ø 27
Thread: M30 x 1,5 RHT
95301.0084, 90804102156, 90804102272, 90804102696, 90804102710, 81953010016, 81953010075, 81953010084, 81953010088, 81953010094, 81953010103, 81953016030, 81953016043, 81953016048, 81953016049, 81953016053, 81953016061, 81953016090, 81953016108, 81953016112, 81953016126, 81953016143, 81953016149, 81953016154, 81953016156, 81953016168, 81953016178, 81953016194, 81953016206, 81953016224, 81953016234, 81953016242, 81953016252, 81953016274, 81953016278, 81953016284, 81953016286, 81953016308, 81953016310, 81953016312, 81953016347, 81953016350, 81953016352, 82953016012, 88953016014, N2953016001



MN-DL-3402

Length: 590 Ø: 48
Hole Distance: 130 / 130
03307200A, 81432206067, 81432206068, 81432206090, 81432206092, 81432209092



MN-DL-7792

Length: 1750 Ø: 52
Cone Ø: d1 Ø 30 / d2 Ø 27
81466106790, 81466106791, 82466106191



MN-DL-8197

Length: 1055 Ø: 42
Cone Ø: d1 Ø 30 / d2 Ø 27
03207500A, 81466116003, 81466116004, 81466116005



MN-DL-8544

Length: 596 Ø: 48
Hole Distance: 130 / 130
81432206196, 81432206232, 81432206233



MN-DL-8609

Length: 585 Ø: 58
Hole Distance: 130 / 130
81432206070, 81432206071, 81432206072, 81432206091, 81432206093, 81432206119



MN-DL-12391

Length: 1050 Ø: 52
Cone Ø: d1 Ø 30 / d2 Ø 27
82466106057, 82466106147



MN-DL-12421

Length: 1070 Ø: 48
Cone Ø: d1 Ø 30 / d2 Ø 27
Thread: M30 x 1,5 RHT
81466106656, 81466106659, 81466106669, 81466116006, 81466116007



MN-ES-10333

Length: 90
Cone Ø: d1 Ø 38 / d2 Ø 34,35
Thread: M36 x 1,5 RHT
1271126, 3090291, 3099128, 42538048, 81953016268, 82953016018, 82953016019



MN-SB-5244

Ø: 65
Hole Distance: 125
Thick/Height: 22
03312000A, 81432710027, 81432710082



SC-ES-8517

Length: 140
Cone Ø: d1 Ø 30 / d2 Ø 27
Thread: M30 x 1,5 RHT
81953016286





F 2000 ...

40.414 DFK	05/01→	Centre Rod	MN-DL-12421		for Steering Rod
	05/01→	Tie Rod End	CV-ES-2149		for Push Rod
	05/01→	Tie Rod End	CV-ES-14162		for Steering Rod
	05/01→	Tie Rod End	CV-ES-14163		for Steering Rod
	05/01→	Track Control Arm		MN-DL-8609	Trailing Arm
40.423 DFAK	05/01→	Ball Head, gearshift linkage	CV-ES-2120		
	05/01→	Centre Rod	MN-DL-12391		for Steering Rod
	05/01→	Centre Rod	MN-DL-12421		for Steering Rod
	05/01→	Suspension Arm Repair Kit		MN-SB-5244	for Wishbone (CV)
	05/01→	Tie Rod End	CV-ES-14162		for Steering Rod
	05/01→	Tie Rod End	CV-ES-14163		for Steering Rod
	05/01→	Tie Rod End	SC-ES-8517		for Push Rod
	05/01→	Track Control Arm		MN-DL-8544	Trailing Arm
	05/01→	Track Control Arm		MN-DL-8609	Trailing Arm
40.423 DFK	05/01→	Ball Head, gearshift linkage	CV-ES-2120		
	05/01→	Centre Rod	MN-DL-12391		for Steering Rod
	05/01→	Suspension Arm Repair Kit		MN-SB-5244	for Wishbone (CV)
	05/01→	Tie Rod End	CV-ES-2146		
	05/01→	Tie Rod End	CV-ES-2149		for Push Rod
	05/01→	Tie Rod End	CV-ES-14162		for Steering Rod
	05/01→	Tie Rod End	CV-ES-14163		for Steering Rod
	05/01→	Track Control Arm		MN-DL-3402	Trailing Arm
	05/01→	Track Control Arm		MN-DL-8609	Trailing Arm
40.463 DFAK	01/94→	Ball Head, gearshift linkage	CV-ES-2120		
	01/94→	Centre Rod	MN-DL-12391		for Steering Rod
	01/94→	Centre Rod	MN-DL-12421		for Steering Rod
	01/94→	Suspension Arm Repair Kit		MN-SB-5244	for Wishbone (CV)
	01/94→	Tie Rod End	CV-ES-2146		
	01/94→	Tie Rod End	CV-ES-14162		for Steering Rod
	01/94→	Tie Rod End	CV-ES-14163		for Steering Rod
	01/94→	Track Control Arm		MN-DL-8544	Trailing Arm
	01/94→	Track Control Arm		MN-DL-8609	Trailing Arm
40.463 DFAS	01/94→	Ball Head, gearshift linkage	CV-ES-2120		
	01/94→	Centre Rod	MN-DL-12391		for Steering Rod
	01/94→	Centre Rod	MN-DL-12421		for Steering Rod
	01/94→	Suspension Arm Repair Kit		MN-SB-5244	for Wishbone (CV)
	01/94→	Tie Rod End	CV-ES-2146		
	01/94→	Tie Rod End	CV-ES-14162		for Steering Rod
	01/94→	Tie Rod End	CV-ES-14163		for Steering Rod
	01/94→	Track Control Arm		MN-DL-8544	Trailing Arm
	01/94→	Track Control Arm		MN-DL-8609	Trailing Arm
40.463 DFK	01/94→	Centre Rod	MN-DL-12421		for Steering Rod
	01/94→	Tie Rod End	CV-ES-2146		
	01/94→	Tie Rod End	CV-ES-2149		for Push Rod
	01/94→	Tie Rod End	CV-ES-14162		for Steering Rod
	01/94→	Tie Rod End	CV-ES-14163		for Steering Rod
	01/94→	Track Control Arm		MN-DL-8609	Trailing Arm
40.463 DFS	01/94→	Centre Rod	MN-DL-12421		for Steering Rod
	01/94→	Tie Rod End	CV-ES-2146		
	01/94→	Tie Rod End	CV-ES-14162		for Steering Rod
	01/94→	Tie Rod End	CV-ES-14163		for Steering Rod
	01/94→	Track Control Arm		MN-DL-8609	Trailing Arm
40.464 DFAK	05/01→	Centre Rod	MN-DL-2174		Push Rod
	05/01→	Centre Rod	MN-DL-12391		for Steering Rod
	05/01→	Centre Rod	MN-DL-12421		for Steering Rod
	05/01→	Tie Rod End	CV-ES-14162		for Steering Rod
	05/01→	Tie Rod End	CV-ES-14163		for Steering Rod
	05/01→	Tie Rod End	SC-ES-8517		for Push Rod
40.464 DFAS	05/01→	Track Control Arm		MN-DL-8609	Trailing Arm
	05/01→	Centre Rod	MN-DL-2174		Push Rod
	05/01→	Centre Rod	MN-DL-12391		for Steering Rod
	05/01→	Centre Rod	MN-DL-12421		for Steering Rod
	05/01→	Tie Rod End	CV-ES-14162		for Steering Rod

CV-ES-2120

Length: 115
Cone Ø: d1 Ø 12,4 / d2 Ø 10,8
Thread: M14 x 1,5 RHT
03008500A, 81953016200, 81953016202,
81953016203, 81953016227



CV-ES-2146

Length: 80
Cone Ø: d1 Ø 30 / d2 Ø 27
Thread: M26 x 1,5 RHT
42533102, 81953016219, 81953016225,
81953016226, 81953016267, 81953016291



CV-ES-2149

Length: 160
Cone Ø: d1 Ø 30 / d2 Ø 27
Thread: M30 x 1,5 RHT
81953016263



CV-ES-14162

Length: 125
Cone Ø: d1 Ø 30 / d2 Ø 27
Thread: M30 x 1,5 LHT
81953010015, 81953010083, 81953010087,
81953016029, 81953016030, 81953016043,
81953016044, 81953016050, 81953016054,
81953016087, 81953016091, 81953016107,
81953016120, 81953016125, 81953016152,
81953016155, 81953016157, 81953016168,
81953016179, 81953016181, 81953016223,
81953016237, 81953016254, 81953016275,
81953016279, 81953016351



CV-ES-14163

Length: 125
Cone Ø: d1 Ø 30 / d2 Ø 27
Thread: M30 x 1,5 RHT
95301.0084, 90804102156, 90804102272,
90804102696, 90804102710, 81953010016,
81953010075, 81953010084, 81953010088,
81953010094, 81953010103, 81953016030,
81953016043, 81953016048, 81953016049,
81953016053, 81953016061, 81953016090,
81953016108, 81953016112, 81953016126,
81953016143, 81953016149, 81953016154,
81953016156, 81953016168, 81953016178,
81953016194, 81953016206, 81953016224,
81953016234, 81953016242, 81953016252,
81953016274, 81953016278, 81953016284,
81953016286, 81953016308, 81953016310,
81953016312, 81953016347, 81953016350,
81953016352, 82953016012, 88953016014,
N2953016001



MN-DL-2174

Length: 1588 Ø: 52
Cone Ø: d1 Ø 30 / d2 Ø 27
81467106378, 81467106912



MN-DL-3402

Length: 590 Ø: 48
Hole Distance: 130 / 130
03307200A, 81432206067, 81432206068,
81432206090, 81432206092, 81432209092



MN-DL-8544

Length: 596 Ø: 48
Hole Distance: 130 / 130
81432206196, 81432206232, 81432206233



MN-DL-8609

Length: 585 Ø: 58
Hole Distance: 130 / 130
81432206070, 81432206071, 81432206072,
81432206091, 81432206093, 81432206119



MN-DL-12391

Length: 1050 Ø: 52
Cone Ø: d1 Ø 30 / d2 Ø 27
82466106057, 82466106147



MN-DL-12421

Length: 1070 Ø: 48
Cone Ø: d1 Ø 30 / d2 Ø 27
Thread: M30 x 1,5 RHT
81466106656, 81466106659, 81466106669,
81466116006, 81466116007



MN-SB-5244

Ø: 65
Hole Distance: 125
Thick/Height: 22
03312000A, 81432710027, 81432710082



SC-ES-8517

Length: 140
Cone Ø: d1 Ø 30 / d2 Ø 27
Thread: M30 x 1,5 RHT
81953016286





F 2000 ...

40.464 DFAS ...	05/01→	Tie Rod End	CV-ES-14163		for Steering Rod
	05/01→	Tie Rod End	SC-ES-8517		for Push Rod
	05/01→	Track Control Arm		MN-DL-8609	Trailing Arm
40.464 DFK	05/01→	Centre Rod	MN-DL-2176		Push Rod
	05/01→	Centre Rod	MN-DL-3588		Push Rod
	05/01→	Centre Rod	MN-DL-8197		Push Rod
	05/01→	Centre Rod	MN-DL-12391		for Steering Rod
	05/01→	Tie Rod End	CV-ES-2149		for Push Rod
	05/01→	Tie Rod End	CV-ES-14162		for Steering Rod
	05/01→	Tie Rod End	CV-ES-14163		for Steering Rod
	05/01→	Track Control Arm		MN-DL-8609	Trailing Arm
41.343 VFC	08/95→	Ball Head, gearshift linkage	CV-ES-2119		
	08/95→	Ball Head, gearshift linkage	CV-ES-2120		
	08/95→	Ball Head, gearshift linkage	CV-ES-2182		
	08/95→	Centre Rod	MN-DL-2162		Push Rod
	08/95→	Centre Rod	MN-DL-2176		Push Rod
	08/95→	Centre Rod	MN-DL-7792		Push Rod
	08/95→	Centre Rod	MN-DL-8197		Push Rod
	08/95→	Centre Rod	MN-DL-12421		for Steering Rod
	08/95→	Engine Mounting		MN-SB-10390	
	08/95→	Suspension Arm Repair Kit		MN-SB-5244	for Wishbone (CV)
	08/95→	Suspension Arm Repair Kit		MN-SB-5244	for Wishbone (CV), 1st RA
	08/95→	Suspension Arm Repair Kit		MN-SB-5244	for Wishbone (CV), 2nd RA
	08/95→	Tie Rod End	CV-ES-2146		
	08/95→	Tie Rod End	CV-ES-2149		for Push Rod
	08/95→	Tie Rod End	CV-ES-14162		for Steering Rod
	08/95→	Tie Rod End	CV-ES-14163		for Steering Rod
	08/95→	Track Control Arm		MN-DL-3402	Trailing Arm, Drive Axle
	08/95→	Track Control Arm		MN-DL-8609	Trailing Arm, Leaf Spring Axle
41.343 VFK	08/95→	Ball Head, gearshift linkage	CV-ES-2119		
	08/95→	Ball Head, gearshift linkage	CV-ES-2120		
	08/95→	Ball Head, gearshift linkage	CV-ES-2182		
	08/95→	Centre Rod	MN-DL-2162		Push Rod
	08/95→	Centre Rod	MN-DL-2176		Push Rod
	08/95→	Centre Rod	MN-DL-7792		Push Rod
	08/95→	Centre Rod	MN-DL-8197		Push Rod
	08/95→	Centre Rod	MN-DL-12421		for Steering Rod
	08/95→	Engine Mounting		MN-SB-10390	
	08/95→	Suspension Arm Repair Kit		MN-SB-5244	for Wishbone (CV)
	08/95→	Suspension Arm Repair Kit		MN-SB-5244	for Wishbone (CV), 1st RA
	08/95→	Suspension Arm Repair Kit		MN-SB-5244	for Wishbone (CV), 2nd RA
	08/95→	Tie Rod End	CV-ES-2146		
	08/95→	Tie Rod End	CV-ES-2149		for Push Rod
	08/95→	Tie Rod End	CV-ES-14162		for Steering Rod
	08/95→	Tie Rod End	CV-ES-14163		for Steering Rod
	08/95→	Track Control Arm		MN-DL-3402	Trailing Arm, Drive Axle
	08/95→	Track Control Arm		MN-DL-8609	Trailing Arm, Leaf Spring Axle
41.364 VF, VFC, VFRC	05/01→	Ball Head, gearshift linkage	CV-ES-2120		
	05/01→	Centre Rod	MN-DL-7792		Push Rod
	05/01→	Centre Rod	MN-DL-8197		Push Rod
	05/01→	Centre Rod	MN-DL-12421		for Steering Rod
	05/01→	Mounting, stabilizer coupling rod	MN-SB-5246		
	05/01→	Suspension Arm Repair Kit		MN-SB-5244	for Wishbone (CV)
	05/01→	Tie Rod	MN-DL-12284		
	05/01→	Tie Rod End	CV-ES-2146		
	05/01→	Tie Rod End	CV-ES-2149		for Push Rod
	05/01→	Tie Rod End	CV-ES-14162		for Steering Rod
	05/01→	Tie Rod End	CV-ES-14163		for Steering Rod
	05/01→	Track Control Arm		MN-DL-3402	Trailing Arm
	05/01→	Track Control Arm		MN-DL-8544	Trailing Arm
	05/01→	Track Control Arm		MN-DL-8609	Trailing Arm
	05/01→	Track Control Arm		MN-VB-8514	Suspension Rod, Wishbone (CV)
05/01→	Track Control Arm		MN-VB-8669	Suspension Rod, Wishbone (CV)	

CV-ES-2119

Length: 55
Cone Ø: d1 Ø 10 / d2 Ø 10
Thread: M12 x 1,75 LHT
81953016063, 81953016131



CV-ES-2120

Length: 115
Cone Ø: d1 Ø 12,4 / d2 Ø 10,8
Thread: M14 x 1,5 RHT
03008500A, 81953016200, 81953016202, 81953016203, 81953016227



CV-ES-2146

Length: 80
Cone Ø: d1 Ø 30 / d2 Ø 27
Thread: M26 x 1,5 RHT
42533102, 81953016219, 81953016225, 81953016226, 81953016267, 81953016291



CV-ES-2149

Length: 160
Cone Ø: d1 Ø 30 / d2 Ø 27
Thread: M30 x 1,5 RHT
81953016263



CV-ES-2182

Length: 55
Cone Ø: d1 Ø 10 / d2 Ø 10
Thread: M12 x 1,75 RHT
81953016064, 81953016170



CV-ES-14162

Length: 125
Cone Ø: d1 Ø 30 / d2 Ø 27
Thread: M30 x 1,5 LHT
81953010015, 81953010083, 81953010087, 81953016029, 81953016030, 81953016043, 81953016044, 81953016050, 81953016054, 81953016087, 81953016091, 81953016107, 81953016120, 81953016125, 81953016152, 81953016155, 81953016157, 81953016168, 81953016179, 81953016181, 81953016223, 81953016237, 81953016254, 81953016275, 81953016279, 81953016351



CV-ES-14163

Length: 125
Cone Ø: d1 Ø 30 / d2 Ø 27
Thread: M30 x 1,5 RHT
95301.0084, 90804102156, 90804102272, 90804102696, 90804102710, 81953010016, 81953010075, 81953010084, 81953010088, 81953010094, 81953010103, 81953016030, 81953016043, 81953016048, 81953016049, 81953016053, 81953016061, 81953016090, 81953016108, 81953016112, 81953016126, 81953016143, 81953016149, 81953016154, 81953016156, 81953016168, 81953016178, 81953016194, 81953016206, 81953016224, 81953016234, 81953016242, 81953016252, 81953016274, 81953016278, 81953016284, 81953016286, 81953016308, 81953016310, 81953016312, 81953016347, 81953016350, 81953016352, 82953016012, 88953016014, N2953016001



MN-DL-2162

Length: 755 Ø: 40
Cone Ø: d1 Ø 30 / d2 Ø 27
81466106578, 81466106704, 81466106705, 81466106798, 81466106799



MN-DL-2176

Length: 1628 Ø: 48
Cone Ø: d1 Ø 30 / d2 Ø 27
81466106779, 81466106780, 81466106782



MN-DL-3402

Length: 590 Ø: 48
Hole Distance: 130 / 130
03307200A, 81432206067, 81432206068, 81432206090, 81432206092, 81432209092



MN-DL-3588

Length: 1035 Ø: 48
Cone Ø: d1 Ø 30 / d2 Ø 27
81466106333, 81466106334, 81466106354, 81466106355, 81466106360, 81466106361, 81466106721, 81466106722, 81466106723, 81466116216



MN-DL-7792

Length: 1750 Ø: 52
Cone Ø: d1 Ø 30 / d2 Ø 27
81466106790, 81466106791, 82466106191



MN-DL-8197

Length: 1055 Ø: 42
Cone Ø: d1 Ø 30 / d2 Ø 27
03207500A, 81466116003, 81466116004, 81466116005



MN-DL-8544

Length: 596 Ø: 48
Hole Distance: 130 / 130
81432206196, 81432206232, 81432206233



MN-DL-8609

Length: 585 Ø: 58
Hole Distance: 130 / 130
81432206070, 81432206071, 81432206072, 81432206091, 81432206093, 81432206119



MN-DL-12284

Length: 1530 Ø: 50
Cone Ø: d1 Ø 30 / d2 Ø 27
81466106579, 81466106580, 81466106624, 81466116720, 81467116720, 81467116730, 81467116952



MN-DL-12391

Length: 1050 Ø: 52
Cone Ø: d1 Ø 30 / d2 Ø 27
82466106057, 82466106147



MN-DL-12421

Length: 1070 Ø: 48
Cone Ø: d1 Ø 30 / d2 Ø 27
Thread: M30 x 1,5 RHT
81466106656, 81466106659, 81466106669, 81466116006, 81466116007



MN-SB-5244

Ø: 65
Hole Distance: 125
Thick/Height: 22
03312000A, 81432710027, 81432710082



MN-SB-5246

Ø: 45 Thick/Height: 47
81437220022, 81437220038, 81962100450, 81962100469



MN-SB-10390

Ø: 70 Thick/Height: 85/85
81960200341, 81960200373, 81960200385, 81960200408, 81960200418



MN-VB-8514

Length: 627 Ø: 48
Hole Ø 25 / 25 / 25
Hole Distance: 152 / 130 / 130
81432706087, 81432706088, 81432706094, 81432706095, 81432796094



MN-VB-8669

Length: 627 Ø: 48
Hole Ø 25 / 25 / 25
Hole Distance: 152 / 130 / 130
81432706116, 81432706137, 81432706150, 81432706151



SC-ES-8517

Length: 140
Cone Ø: d1 Ø 30 / d2 Ø 27
Thread: M30 x 1,5 RHT
81953016286



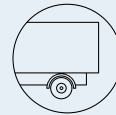

F 2000 ...

41.364 VFK, VF-HK, VF-KI	03/02→	Ball Head, gearshift linkage	CV-ES-2120		
	03/02→	Centre Rod	MN-DL-7792		Push Rod
	03/02→	Centre Rod	MN-DL-8197		Push Rod
	03/02→	Centre Rod	MN-DL-12421		for Steering Rod
	03/02→	Mounting, stabilizer coupling rod	MN-SB-5246		
	03/02→	Suspension Arm Repair Kit		MN-SB-5244	for Wishbone (CV)
	03/02→	Tie Rod	MN-DL-12284		
	03/02→	Tie Rod End	CV-ES-2146		
	03/02→	Tie Rod End	CV-ES-2149		for Push Rod
	03/02→	Tie Rod End	CV-ES-14162		for Steering Rod
	03/02→	Tie Rod End	CV-ES-14163		for Steering Rod
	03/02→	Track Control Arm		MN-DL-3402	Trailing Arm
	03/02→	Track Control Arm		MN-DL-8544	Trailing Arm
	03/02→	Track Control Arm		MN-DL-8609	Trailing Arm
	03/02→	Track Control Arm		MN-VB-8514	Suspension Rod, Wishbone (CV)
03/02→	Track Control Arm		MN-VB-8669	Suspension Rod, Wishbone (CV)	
41.373 VF, VFC, VFRC	05/01→	Ball Head, gearshift linkage	CV-ES-2120		
	05/01→	Centre Rod	MN-DL-7792		Push Rod
	05/01→	Centre Rod	MN-DL-8197		Push Rod
	05/01→	Centre Rod	MN-DL-12421		for Steering Rod
	05/01→	Mounting, stabilizer coupling rod	MN-SB-5246		
	05/01→	Suspension Arm Repair Kit		MN-SB-5244	for Wishbone (CV)
	05/01→	Tie Rod	MN-DL-12284		
	05/01→	Tie Rod End	CV-ES-2146		
	05/01→	Tie Rod End	CV-ES-2149		for Push Rod
	05/01→	Tie Rod End	CV-ES-14162		for Steering Rod
	05/01→	Tie Rod End	CV-ES-14163		for Steering Rod
	05/01→	Track Control Arm		MN-DL-3402	Trailing Arm
	05/01→	Track Control Arm		MN-DL-8544	Trailing Arm
	05/01→	Track Control Arm		MN-DL-8609	Trailing Arm
	05/01→	Track Control Arm		MN-VB-8514	Suspension Rod, Wishbone (CV)
05/01→	Track Control Arm		MN-VB-8669	Suspension Rod, Wishbone (CV)	
41.373 VFK, VF-HK, VF-KI	03/02→	Ball Head, gearshift linkage	CV-ES-2120		
	03/02→	Centre Rod	MN-DL-7792		Push Rod
	03/02→	Centre Rod	MN-DL-8197		Push Rod
	03/02→	Centre Rod	MN-DL-12421		for Steering Rod
	03/02→	Mounting, stabilizer coupling rod	MN-SB-5246		
	03/02→	Suspension Arm Repair Kit		MN-SB-5244	for Wishbone (CV)
	03/02→	Tie Rod	MN-DL-12284		
	03/02→	Tie Rod End	CV-ES-2146		
	03/02→	Tie Rod End	CV-ES-2149		for Push Rod
	03/02→	Tie Rod End	CV-ES-14162		for Steering Rod
	03/02→	Tie Rod End	CV-ES-14163		for Steering Rod
	03/02→	Track Control Arm		MN-DL-3402	Trailing Arm
	03/02→	Track Control Arm		MN-DL-8544	Trailing Arm
	03/02→	Track Control Arm		MN-DL-8609	Trailing Arm
	03/02→	Track Control Arm		MN-VB-8514	Suspension Rod, Wishbone (CV)
03/02→	Track Control Arm		MN-VB-8669	Suspension Rod, Wishbone (CV)	
41.403 VF, VFC, VFRC	08/95→	Ball Head, gearshift linkage	CV-ES-2119		
	08/95→	Ball Head, gearshift linkage	CV-ES-2120		
	08/95→	Ball Head, gearshift linkage	CV-ES-2182		
	08/95→	Centre Rod	MN-DL-2162		Push Rod
	08/95→	Centre Rod	MN-DL-2176		Push Rod
	08/95→	Centre Rod	MN-DL-7792		Push Rod
	08/95→	Centre Rod	MN-DL-8197		Push Rod
	08/95→	Centre Rod	MN-DL-12421		for Steering Rod
	08/95→	Engine Mounting		MN-SB-10390	
	08/95→	Mounting, stabilizer coupling rod	MN-SB-5246		
	08/95→	Suspension Arm Repair Kit		MN-SB-5244	for Wishbone (CV)
	08/95→	Suspension Arm Repair Kit		MN-SB-5244	for Wishbone (CV), 1st RA
	08/95→	Suspension Strut Repair Kit		DB-RK-8581	
	08/95→	Tie Rod	MN-DL-12284		
	08/95→	Tie Rod End	CV-ES-2146		

CV-ES-2119

Length: 55
Cone Ø: d1 Ø 10 / d2 Ø 10
Thread: M12 x 1,75 LHT
81953016063, 81953016131



CV-ES-2120

Length: 115
Cone Ø: d1 Ø 12,4 / d2 Ø 10,8
Thread: M14 x 1,5 RHT
03008500A, 81953016200, 81953016202,
81953016203, 81953016227



CV-ES-2146

Length: 80
Cone Ø: d1 Ø 30 / d2 Ø 27
Thread: M26 x 1,5 RHT
42533102, 81953016219, 81953016225,
81953016226, 81953016267, 81953016291



CV-ES-2149

Length: 160
Cone Ø: d1 Ø 30 / d2 Ø 27
Thread: M30 x 1,5 RHT
81953016263



CV-ES-2182

Length: 55
Cone Ø: d1 Ø 10 / d2 Ø 10
Thread: M12 x 1,75 RHT
81953016064, 81953016170



CV-ES-14162

Length: 125
Cone Ø: d1 Ø 30 / d2 Ø 27
Thread: M30 x 1,5 LHT
81953010015, 81953010083, 81953010087,
81953016029, 81953016030, 81953016043,
81953016044, 81953016050, 81953016054,
81953016087, 81953016091, 81953016107,
81953016120, 81953016125, 81953016152,
81953016155, 81953016157, 81953016168,
81953016179, 81953016181, 81953016223,
81953016237, 81953016254, 81953016275,
81953016279, 81953016351



CV-ES-14163

Length: 125
Cone Ø: d1 Ø 30 / d2 Ø 27
Thread: M30 x 1,5 RHT
95301.0084, 90804102156, 90804102272,
90804102696, 90804102710, 81953010016,
81953010075, 81953010084, 81953010088,
81953010094, 81953010103, 81953016030,
81953016043, 81953016048, 81953016049,
81953016053, 81953016061, 81953016090,
81953016108, 81953016112, 81953016126,
81953016143, 81953016149, 81953016154,
81953016156, 81953016168, 81953016178,
81953016194, 81953016206, 81953016224,
81953016234, 81953016242, 81953016252,
81953016274, 81953016278, 81953016284,
81953016286, 81953016308, 81953016310,
81953016312, 81953016347, 81953016350,
81953016352, 82953016012, 88953016014,
N2953016001



DB-RK-8581

Ø: 85
Hole Distance: 130
Thick/Height: 24
03305800A, 81432706105



MN-DL-2162

Length: 755 Ø: 40
Cone Ø: d1 Ø 30 / d2 Ø 27
81466106578, 81466106704, 81466106705,
81466106798, 81466106799



MN-DL-2176

Length: 1628 Ø: 48
Cone Ø: d1 Ø 30 / d2 Ø 27
81466106779, 81466106780, 81466106782



MN-DL-3402

Length: 590 Ø: 48
Hole Distance: 130 / 130
03307200A, 81432206067, 81432206068,
81432206090, 81432206092, 81432209092



MN-DL-7792

Length: 1750 Ø: 52
Cone Ø: d1 Ø 30 / d2 Ø 27
81466106790, 81466106791, 82466106191



MN-DL-8197

Length: 1055 Ø: 42
Cone Ø: d1 Ø 30 / d2 Ø 27
03207500A, 81466116003, 81466116004,
81466116005



MN-DL-8544

Length: 596 Ø: 48
Hole Distance: 130 / 130
81432206196, 81432206232, 81432206233



MN-DL-8609

Length: 585 Ø: 58
Hole Distance: 130 / 130
81432206070, 81432206071, 81432206072,
81432206091, 81432206093, 81432206119



MN-DL-12284

Length: 1530 Ø: 50
Cone Ø: d1 Ø 30 / d2 Ø 27
81466106579, 81466106580, 81466106624,
81466116720, 81467116720, 81467116730,
81467116952



MN-DL-12421

Length: 1070 Ø: 48
Cone Ø: d1 Ø 30 / d2 Ø 27
Thread: M30 x 1,5 RHT
81466106656, 81466106659, 81466106669,
81466116006, 81466116007



MN-SB-5244

Ø: 65
Hole Distance: 125
Thick/Height: 22
03312000A, 81432710027, 81432710082



MN-SB-5246

Ø: 45 Thick/Height: 47
81437220022, 81437220038, 81962100450,
81962100469



MN-SB-10390

Ø: 70 Thick/Height: 85/85
81960200341, 81960200373, 81960200385,
81960200408, 81960200418



MN-VB-8514

Length: 627 Ø: 48
Hole Ø 25 / 25 / 25
Hole Distance: 152 / 130 / 130
81432706087, 81432706088, 81432706094,
81432706095, 81432796094



MN-VB-8669

Length: 627 Ø: 48
Hole Ø 25 / 25 / 25
Hole Distance: 152 / 130 / 130
81432706116, 81432706137, 81432706150,
81432706151





F 2000 ...

41.403 VF, VFC, VFRC ...	08/95→	Tie Rod End	CV-ES-2149		for Push Rod
	08/95→	Tie Rod End	CV-ES-14162		for Steering Rod
	08/95→	Tie Rod End	CV-ES-14163		for Steering Rod
	08/95→	Track Control Arm		MN-DL-3402	Trailing Arm, Drive Axle
	08/95→	Track Control Arm		MN-DL-8544	Trailing Arm, Drive Axle;Leaf Spring Axle
	08/95→	Track Control Arm		MN-DL-8609	Trailing Arm, Leaf Spring Axle
	08/95→	Track Control Arm		MN-VB-8514	Suspension Rod, Wishbone (CV), Drive Axle; Leaf Spring Axle
	05/02→	Track Control Arm		MN-VB-8669	Suspension Rod, Wishbone (CV), Drive Axle
41.403 VFK, VF-HK, VF-KI	08/95→	Ball Head, gearshift linkage	CV-ES-2119		
	08/95→	Ball Head, gearshift linkage	CV-ES-2120		
	08/95→	Ball Head, gearshift linkage	CV-ES-2182		
	08/95→	Centre Rod	MN-DL-2162		Push Rod
	08/95→	Centre Rod	MN-DL-2176		Push Rod
	08/95→	Centre Rod	MN-DL-7792		Push Rod
	08/95→	Centre Rod	MN-DL-8197		Push Rod
	08/95→	Centre Rod	MN-DL-12421		for Steering Rod
	08/95→	Engine Mounting		MN-SB-10390	
	08/95→	Mounting, stabilizer coupling rod	MN-SB-5246		
	08/95→	Suspension Arm Repair Kit		MN-SB-5244	for Wishbone (CV)
	08/95→	Suspension Arm Repair Kit		MN-SB-5244	for Wishbone (CV), 1st RA
	08/95→	Suspension Strut Repair Kit		DB-RK-8581	
	08/95→	Tie Rod	MN-DL-12284		
	08/95→	Tie Rod End	CV-ES-2146		
	08/95→	Tie Rod End	CV-ES-2149		for Push Rod
	08/95→	Tie Rod End	CV-ES-14162		for Steering Rod
	08/95→	Tie Rod End	CV-ES-14163		for Steering Rod
	08/95→	Track Control Arm		MN-DL-3402	Trailing Arm, Drive Axle
	08/95→	Track Control Arm		MN-DL-8544	Trailing Arm, Drive Axle;Leaf Spring Axle
	08/95→	Track Control Arm		MN-DL-8609	Trailing Arm, Leaf Spring Axle
08/95→	Track Control Arm		MN-VB-8514	Suspension Rod, Wishbone (CV), Drive Axle; Leaf Spring Axle	
05/02→	Track Control Arm		MN-VB-8669	Suspension Rod, Wishbone (CV), Drive Axle	
41.414 VF, VFC, VFRC	05/01→	Ball Head, gearshift linkage	CV-ES-2120		
	05/01→	Centre Rod	MN-DL-7792		Push Rod
	05/01→	Centre Rod	MN-DL-8197		Push Rod
	05/01→	Centre Rod	MN-DL-12421		for Steering Rod
	05/01→	Mounting, stabilizer coupling rod	MN-SB-5246		
	05/01→	Suspension Arm Repair Kit		MN-SB-5244	for Wishbone (CV)
	05/01→	Tie Rod	MN-DL-12284		
	05/01→	Tie Rod End	CV-ES-2146		
	05/01→	Tie Rod End	CV-ES-2149		for Push Rod
	05/01→	Tie Rod End	CV-ES-14162		for Steering Rod
	05/01→	Tie Rod End	CV-ES-14163		for Steering Rod
	05/01→	Track Control Arm		MN-DL-3402	Trailing Arm
	05/01→	Track Control Arm		MN-DL-8544	Trailing Arm
	05/01→	Track Control Arm		MN-DL-8609	Trailing Arm
	05/01→	Track Control Arm		MN-VB-8514	Suspension Rod, Wishbone (CV)
	05/01→	Track Control Arm		MN-VB-8669	Suspension Rod, Wishbone (CV)
	41.414 VFK, VF-HK, VF-KI	03/02→	Ball Head, gearshift linkage	CV-ES-2120	
03/02→		Centre Rod	MN-DL-7792		Push Rod
03/02→		Centre Rod	MN-DL-8197		Push Rod
03/02→		Centre Rod	MN-DL-12421		for Steering Rod
03/02→		Mounting, stabilizer coupling rod	MN-SB-5246		
03/02→		Suspension Arm Repair Kit		MN-SB-5244	for Wishbone (CV)
03/02→		Tie Rod	MN-DL-12284		
03/02→		Tie Rod End	CV-ES-2146		
03/02→		Tie Rod End	CV-ES-2149		for Push Rod
03/02→		Tie Rod End	CV-ES-14162		for Steering Rod
03/02→		Tie Rod End	CV-ES-14163		for Steering Rod
03/02→		Track Control Arm		MN-DL-3402	Trailing Arm
03/02→		Track Control Arm		MN-DL-8544	Trailing Arm
03/02→		Track Control Arm		MN-DL-8609	Trailing Arm

CV-ES-2119

Length: 55
Cone Ø: d1 Ø 10 / d2 Ø 10
Thread: M12 x 1,75 LHT
81953016063, 81953016131



CV-ES-2120

Length: 115
Cone Ø: d1 Ø 12,4 / d2 Ø 10,8
Thread: M14 x 1,5 RHT
03008500A, 81953016200, 81953016202,
81953016203, 81953016227



CV-ES-2146

Length: 80
Cone Ø: d1 Ø 30 / d2 Ø 27
Thread: M26 x 1,5 RHT
42533102, 81953016219, 81953016225,
81953016226, 81953016267, 81953016291



CV-ES-2149

Length: 160
Cone Ø: d1 Ø 30 / d2 Ø 27
Thread: M30 x 1,5 RHT
81953016263



CV-ES-2182

Length: 55
Cone Ø: d1 Ø 10 / d2 Ø 10
Thread: M12 x 1,75 RHT
81953016064, 81953016170



CV-ES-14162

Length: 125
Cone Ø: d1 Ø 30 / d2 Ø 27
Thread: M30 x 1,5 LHT
81953010015, 81953010083, 81953010087,
81953016029, 81953016030, 81953016043,
81953016044, 81953016050, 81953016054,
81953016087, 81953016091, 81953016107,
81953016120, 81953016125, 81953016152,
81953016155, 81953016157, 81953016168,
81953016179, 81953016181, 81953016223,
81953016237, 81953016254, 81953016275,
81953016279, 81953016351



CV-ES-14163

Length: 125
Cone Ø: d1 Ø 30 / d2 Ø 27
Thread: M30 x 1,5 RHT
95301.0084, 90804102156, 90804102272,
90804102696, 90804102710, 81953010016,
81953010075, 81953010084, 81953010088,
81953010094, 81953010103, 81953016030,
81953016043, 81953016048, 81953016049,
81953016053, 81953016061, 81953016090,
81953016108, 81953016112, 81953016126,
81953016143, 81953016149, 81953016154,
81953016156, 81953016168, 81953016178,
81953016194, 81953016206, 81953016224,
81953016234, 81953016242, 81953016252,
81953016274, 81953016278, 81953016284,
81953016286, 81953016308, 81953016310,
81953016312, 81953016347, 81953016350,
81953016352, 82953016012, 88953016014,
N2953016001



DB-RK-8581

Ø: 85
Hole Distance: 130
Thick/Height: 24
03305800A, 81432706105



MN-DL-2162

Length: 755 Ø: 40
Cone Ø: d1 Ø 30 / d2 Ø 27
81466106578, 81466106704, 81466106705,
81466106798, 81466106799



MN-DL-2176

Length: 1628 Ø: 48
Cone Ø: d1 Ø 30 / d2 Ø 27
81466106779, 81466106780, 81466106782



MN-DL-3402

Length: 590 Ø: 48
Hole Distance: 130 / 130
03307200A, 81432206067, 81432206068,
81432206090, 81432206092, 81432209092



MN-DL-7792

Length: 1750 Ø: 52
Cone Ø: d1 Ø 30 / d2 Ø 27
81466106790, 81466106791, 82466106191



MN-DL-8197

Length: 1055 Ø: 42
Cone Ø: d1 Ø 30 / d2 Ø 27
03207500A, 81466116003, 81466116004,
81466116005



MN-DL-8544

Length: 596 Ø: 48
Hole Distance: 130 / 130
81432206196, 81432206232, 81432206233



MN-DL-8609

Length: 585 Ø: 58
Hole Distance: 130 / 130
81432206070, 81432206071, 81432206072,
81432206091, 81432206093, 81432206119



MN-DL-12284

Length: 1530 Ø: 50
Cone Ø: d1 Ø 30 / d2 Ø 27
81466106579, 81466106580, 81466106624,
81466116720, 81467116720, 81467116730,
81467116952



MN-DL-12421

Length: 1070 Ø: 48
Cone Ø: d1 Ø 30 / d2 Ø 27
Thread: M30 x 1,5 RHT
81466106656, 81466106659, 81466106669,
81466116006, 81466116007



MN-SB-5244

Ø: 65
Hole Distance: 125
Thick/Height: 22
03312000A, 81432710027, 81432710082



MN-SB-5246

Ø: 45 Thick/Height: 47
81437220022, 81437220038, 81962100450,
81962100469



MN-SB-10390

Ø: 70 Thick/Height: 85/85
81960200341, 81960200373, 81960200385,
81960200408, 81960200418



MN-VB-8514

Length: 627 Ø: 48
Hole Ø 25 / 25 / 25
Hole Distance: 152 / 130 / 130
81432706087, 81432706088, 81432706094,
81432706095, 81432706094



MN-VB-8669

Length: 627 Ø: 48
Hole Ø 25 / 25 / 25
Hole Distance: 152 / 130 / 130
81432706116, 81432706137, 81432706150,
81432706151



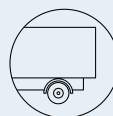

F 2000 ...

41.414 VFK, VF-HK, VF-KI ...	03/02→	Track Control Arm		MN-VB-8514	Suspension Rod, Wishbone (CV)
	03/02→	Track Control Arm		MN-VB-8669	Suspension Rod, Wishbone (CV)
41.423 VF, VFC, VFRC	05/01→	Ball Head, gearshift linkage	CV-ES-2120		
	05/01→	Centre Rod	MN-DL-7792		Push Rod
	05/01→	Centre Rod	MN-DL-8197		Push Rod
	05/01→	Centre Rod	MN-DL-12421		for Steering Rod
	05/01→	Mounting, stabilizer coupling rod	MN-SB-5246		
	05/01→	Suspension Arm Repair Kit		MN-SB-5244	for Wishbone (CV)
	05/01→	Tie Rod	MN-DL-12284		
	05/01→	Tie Rod End	CV-ES-2146		
	05/01→	Tie Rod End	CV-ES-2149		for Push Rod
	05/01→	Tie Rod End	CV-ES-14162		for Steering Rod
	05/01→	Tie Rod End	CV-ES-14163		for Steering Rod
	05/01→	Track Control Arm		MN-DL-3402	Trailing Arm
	05/01→	Track Control Arm		MN-DL-8544	Trailing Arm
	05/01→	Track Control Arm		MN-DL-8609	Trailing Arm
	05/01→	Track Control Arm		MN-VB-8514	Suspension Rod, Wishbone (CV)
	05/01→	Track Control Arm		MN-VB-8669	Suspension Rod, Wishbone (CV)
41.423 VFK, VF-HK, VF-KI	03/02→	Ball Head, gearshift linkage	CV-ES-2120		
	03/02→	Centre Rod	MN-DL-7792		Push Rod
	03/02→	Centre Rod	MN-DL-8197		Push Rod
	03/02→	Centre Rod	MN-DL-12421		for Steering Rod
	03/02→	Mounting, stabilizer coupling rod	MN-SB-5246		
	03/02→	Suspension Arm Repair Kit		MN-SB-5244	for Wishbone (CV)
	03/02→	Tie Rod	MN-DL-12284		
	03/02→	Tie Rod End	CV-ES-2146		
	03/02→	Tie Rod End	CV-ES-2149		for Push Rod
	03/02→	Tie Rod End	CV-ES-14162		for Steering Rod
	03/02→	Tie Rod End	CV-ES-14163		for Steering Rod
	03/02→	Track Control Arm		MN-DL-3402	Trailing Arm
	03/02→	Track Control Arm		MN-DL-8544	Trailing Arm
	03/02→	Track Control Arm		MN-DL-8609	Trailing Arm
	03/02→	Track Control Arm		MN-VB-8514	Suspension Rod, Wishbone (CV)
	03/02→	Track Control Arm		MN-VB-8669	Suspension Rod, Wishbone (CV)
41.463 VF, VFC, VFRC	08/95→	Ball Head, gearshift linkage	CV-ES-2119		
	08/95→	Ball Head, gearshift linkage	CV-ES-2120		
	08/95→	Ball Head, gearshift linkage	CV-ES-2182		
	08/95→	Centre Rod	MN-DL-2162		Push Rod
	08/95→	Centre Rod	MN-DL-2176		Push Rod
	08/95→	Centre Rod	MN-DL-7792		Push Rod
	08/95→	Centre Rod	MN-DL-8197		Push Rod
	08/95→	Centre Rod	MN-DL-12421		for Steering Rod
	08/95→	Engine Mounting		MN-SB-10390	
	08/95→	Mounting, stabilizer coupling rod	MN-SB-5246		
	08/95→	Suspension Arm Repair Kit		MN-SB-5244	for Wishbone (CV)
	08/95→	Suspension Arm Repair Kit		MN-SB-5244	for Wishbone (CV), 1st RA
	08/95→	Suspension Strut Repair Kit		DB-RK-8581	
	08/95→	Tie Rod	MN-DL-12284		
	08/95→	Tie Rod End	CV-ES-2146		
	08/95→	Tie Rod End	CV-ES-2149		for Push Rod
	08/95→	Tie Rod End	CV-ES-14162		for Steering Rod
	08/95→	Tie Rod End	CV-ES-14163		for Steering Rod
	08/95→	Track Control Arm		MN-DL-3402	Trailing Arm, Drive Axle
	08/95→	Track Control Arm		MN-DL-8544	Trailing Arm, Drive Axle; Leaf Spring Axle
08/95→	Track Control Arm		MN-DL-8609	Trailing Arm, Leaf Spring Axle	
08/95→	Track Control Arm		MN-VB-8514	Suspension Rod, Wishbone (CV), Drive Axle; Leaf Spring Axle	
05/02→	Track Control Arm		MN-VB-8669	Suspension Rod, Wishbone (CV), Drive Axle	
41.463 VFK, VF-HK, VF-KI	08/95→	Ball Head, gearshift linkage	CV-ES-2119		
	08/95→	Ball Head, gearshift linkage	CV-ES-2120		
	08/95→	Ball Head, gearshift linkage	CV-ES-2182		
	08/95→	Centre Rod	MN-DL-2162		Push Rod
	08/95→	Centre Rod	MN-DL-2176		Push Rod

CV-ES-2119

Length: 55
Cone Ø: d1 Ø 10 / d2 Ø 10
Thread: M12 x 1,75 LHT
81953016063, 81953016131



CV-ES-2120

Length: 115
Cone Ø: d1 Ø 12,4 / d2 Ø 10,8
Thread: M14 x 1,5 RHT
03008500A, 81953016200, 81953016202,
81953016203, 81953016227



CV-ES-2146

Length: 80
Cone Ø: d1 Ø 30 / d2 Ø 27
Thread: M26 x 1,5 RHT
42533102, 81953016219, 81953016225,
81953016226, 81953016267, 81953016291



CV-ES-2149

Length: 160
Cone Ø: d1 Ø 30 / d2 Ø 27
Thread: M30 x 1,5 RHT
81953016263



CV-ES-2182

Length: 55
Cone Ø: d1 Ø 10 / d2 Ø 10
Thread: M12 x 1,75 RHT
81953016064, 81953016170



CV-ES-14162

Length: 125
Cone Ø: d1 Ø 30 / d2 Ø 27
Thread: M30 x 1,5 LHT
81953010015, 81953010083, 81953010087,
81953016029, 81953016030, 81953016043,
81953016044, 81953016050, 81953016054,
81953016087, 81953016091, 81953016107,
81953016120, 81953016125, 81953016152,
81953016155, 81953016157, 81953016168,
81953016179, 81953016181, 81953016223,
81953016237, 81953016254, 81953016275,
81953016279, 81953016351



CV-ES-14163

Length: 125
Cone Ø: d1 Ø 30 / d2 Ø 27
Thread: M30 x 1,5 RHT
95301.0084, 90804102156, 90804102272,
90804102696, 90804102710, 81953010016,
81953010075, 81953010084, 81953010088,
81953010094, 81953010103, 81953016030,
81953016043, 81953016048, 81953016049,
81953016053, 81953016061, 81953016090,
81953016108, 81953016112, 81953016126,
81953016143, 81953016149, 81953016154,
81953016156, 81953016168, 81953016178,
81953016194, 81953016206, 81953016224,
81953016234, 81953016242, 81953016252,
81953016274, 81953016278, 81953016284,
81953016286, 81953016308, 81953016310,
81953016312, 81953016347, 81953016350,
81953016352, 82953016012, 88953016014,
N2953016001



DB-RK-8581

Ø: 85
Hole Distance: 130
Thick/Height: 24
03305800A, 81432706105



MN-DL-2162

Length: 755 Ø: 40
Cone Ø: d1 Ø 30 / d2 Ø 27
81466106578, 81466106704, 81466106705,
81466106798, 81466106799



MN-DL-2176

Length: 1628 Ø: 48
Cone Ø: d1 Ø 30 / d2 Ø 27
81466106779, 81466106780, 81466106782



MN-DL-3402

Length: 590 Ø: 48
Hole Distance: 130 / 130
03307200A, 81432206067, 81432206068,
81432206090, 81432206092, 81432209092



MN-DL-7792

Length: 1750 Ø: 52
Cone Ø: d1 Ø 30 / d2 Ø 27
81466106790, 81466106791, 82466106191



MN-DL-8197

Length: 1055 Ø: 42
Cone Ø: d1 Ø 30 / d2 Ø 27
03207500A, 81466116003, 81466116004,
81466116005



MN-DL-8544

Length: 596 Ø: 48
Hole Distance: 130 / 130
81432206196, 81432206232, 81432206233



MN-DL-8609

Length: 585 Ø: 58
Hole Distance: 130 / 130
81432206070, 81432206071, 81432206072,
81432206091, 81432206093, 81432206119



MN-DL-12284

Length: 1530 Ø: 50
Cone Ø: d1 Ø 30 / d2 Ø 27
81466106579, 81466106580, 81466106624,
81466116720, 81467116720, 81467116730,
81467116952



MN-DL-12421

Length: 1070 Ø: 48
Cone Ø: d1 Ø 30 / d2 Ø 27
Thread: M30 x 1,5 RHT
81466106656, 81466106659, 81466106669,
81466116006, 81466116007



MN-SB-5244

Ø: 65
Hole Distance: 125
Thick/Height: 22
03312000A, 81432710027, 81432710082



MN-SB-5246

Ø: 45 Thick/Height: 47
81437220022, 81437220038, 81962100450,
81962100469



MN-SB-10390

Ø: 70 Thick/Height: 85/85
81960200341, 81960200373, 81960200385,
81960200408, 81960200418



MN-VB-8514

Length: 627 Ø: 48
Hole Ø 25 / 25 / 25
Hole Distance: 152 / 130 / 130
81432706087, 81432706088, 81432706094,
81432706095, 81432796094



MN-VB-8669

Length: 627 Ø: 48
Hole Ø 25 / 25 / 25
Hole Distance: 152 / 130 / 130
81432706116, 81432706137, 81432706150,
81432706151





F 2000 ...

41.463 VFK, VF-HK, VF-KI ...	08/95→	Centre Rod	MN-DL-7792		Push Rod
	08/95→	Centre Rod	MN-DL-8197		Push Rod
	08/95→	Centre Rod	MN-DL-12421		for Steering Rod
	08/95→	Engine Mounting		MN-SB-10390	
	08/95→	Mounting, stabilizer coupling rod	MN-SB-5246		
	08/95→	Suspension Arm Repair Kit		MN-SB-5244	for Wishbone (CV)
	08/95→	Suspension Arm Repair Kit		MN-SB-5244	for Wishbone (CV), 1st RA
	08/95→	Suspension Strut Repair Kit		DB-RK-8581	
	08/95→	Tie Rod	MN-DL-12284		
	08/95→	Tie Rod End	CV-ES-2146		
	08/95→	Tie Rod End	CV-ES-2149		for Push Rod
	08/95→	Tie Rod End	CV-ES-14162		for Steering Rod
	08/95→	Tie Rod End	CV-ES-14163		for Steering Rod
	08/95→	Track Control Arm		MN-DL-3402	Trailing Arm, Drive Axle
	08/95→	Track Control Arm		MN-DL-8544	Trailing Arm, Drive Axle;Leaf Spring Axle
	08/95→	Track Control Arm		MN-DL-8609	Trailing Arm, Leaf Spring Axle
	08/95→	Track Control Arm		MN-VB-8514	Suspension Rod, Wishbone (CV), Drive Axle; Leaf Spring Axle
05/02→	Track Control Arm		MN-VB-8669	Suspension Rod, Wishbone (CV), Drive Axle	
41.464 VF, VFC, VFRC	06/98→	Ball Head, gearshift linkage	CV-ES-2120		
	06/98→	Centre Rod	MN-DL-7792		Push Rod
	06/98→	Centre Rod	MN-DL-8197		Push Rod
	06/98→	Centre Rod	MN-DL-12421		for Steering Rod
	06/98→	Mounting, stabilizer coupling rod	MN-SB-5246		
	06/98→	Suspension Arm Repair Kit		MN-SB-5244	for Wishbone (CV)
	06/98→	Tie Rod	MN-DL-12284		
	06/98→	Tie Rod End	CV-ES-2146		
	06/98→	Tie Rod End	CV-ES-2149		for Push Rod
	06/98→	Tie Rod End	CV-ES-14162		for Steering Rod
	06/98→	Tie Rod End	CV-ES-14163		for Steering Rod
	06/98→	Track Control Arm		MN-DL-3402	Trailing Arm
	06/98→	Track Control Arm		MN-DL-8544	Trailing Arm
	06/98→	Track Control Arm		MN-DL-8609	Trailing Arm
	06/98→	Track Control Arm		MN-VB-8514	Suspension Rod, Wishbone (CV)
06/98→	Track Control Arm		MN-VB-8669	Suspension Rod, Wishbone (CV)	
41.464 VFK, VF-HK, VF-KI	03/02→	Ball Head, gearshift linkage	CV-ES-2120		
	03/02→	Centre Rod	MN-DL-7792		Push Rod
	03/02→	Centre Rod	MN-DL-8197		Push Rod
	03/02→	Centre Rod	MN-DL-12421		for Steering Rod
	03/02→	Mounting, stabilizer coupling rod	MN-SB-5246		
	03/02→	Suspension Arm Repair Kit		MN-SB-5244	for Wishbone (CV)
	03/02→	Tie Rod	MN-DL-12284		
	03/02→	Tie Rod End	CV-ES-2146		
	03/02→	Tie Rod End	CV-ES-2149		for Push Rod
	03/02→	Tie Rod End	CV-ES-14162		for Steering Rod
	03/02→	Tie Rod End	CV-ES-14163		for Steering Rod
	03/02→	Track Control Arm		MN-DL-3402	Trailing Arm
	03/02→	Track Control Arm		MN-DL-8544	Trailing Arm
	03/02→	Track Control Arm		MN-DL-8609	Trailing Arm
	03/02→	Track Control Arm		MN-VB-8514	Suspension Rod, Wishbone (CV)
03/02→	Track Control Arm		MN-VB-8669	Suspension Rod, Wishbone (CV)	

G

10.136 F,10.136 FL	09/81→09/87	Ball Head, gearshift linkage	CV-ES-2120		
	09/81→09/87	Centre Rod	MN-DL-2131		Push Rod
	09/81→09/87	Tie Rod	MN-DL-7835		
10.136 FK	09/81→09/87	Ball Head, gearshift linkage	CV-ES-2120		
	09/81→09/87	Centre Rod	MN-DL-2131		Push Rod
	09/81→09/87	Tie Rod	MN-DL-7835		
6.90 F	10/79→09/87	Ball Head, gearshift linkage	CV-ES-2120		
	10/79→09/87	Centre Rod	MN-DL-2131		Push Rod
	10/79→09/87	Tie Rod	MN-DL-7835		

CV-ES-2120

Length: 115
Cone Ø: d1 Ø 12,4 / d2 Ø 10,8
Thread: M14 x 1,5 RHT
03008500A, 81953016200, 81953016202, 81953016203, 81953016227



CV-ES-2146

Length: 80
Cone Ø: d1 Ø 30 / d2 Ø 27
Thread: M26 x 1,5 RHT
42533102, 81953016219, 81953016225, 81953016226, 81953016267, 81953016291



CV-ES-2149

Length: 160
Cone Ø: d1 Ø 30 / d2 Ø 27
Thread: M30 x 1,5 RHT
81953016263



CV-ES-14162

Length: 125
Cone Ø: d1 Ø 30 / d2 Ø 27
Thread: M30 x 1,5 LHT
81953010015, 81953010083, 81953010087, 81953016029, 81953016030, 81953016043, 81953016044, 81953016050, 81953016054, 81953016087, 81953016091, 81953016107, 81953016120, 81953016125, 81953016152, 81953016155, 81953016157, 81953016168, 81953016179, 81953016181, 81953016223, 81953016237, 81953016254, 81953016275, 81953016279, 81953016351



CV-ES-14163

Length: 125
Cone Ø: d1 Ø 30 / d2 Ø 27
Thread: M30 x 1,5 RHT
95301.0084, 90804102156, 90804102272, 90804102696, 90804102710, 81953010016, 81953010075, 81953010084, 81953010088, 81953010094, 81953010103, 81953016030, 81953016043, 81953016048, 81953016049, 81953016053, 81953016061, 81953016090, 81953016108, 81953016112, 81953016126, 81953016143, 81953016149, 81953016154, 81953016156, 81953016168, 81953016178, 81953016194, 81953016206, 81953016224, 81953016234, 81953016242, 81953016252, 81953016274, 81953016278, 81953016284, 81953016286, 81953016308, 81953016310, 81953016312, 81953016347, 81953016350, 81953016352, 82953016012, 88953016014, N2953016001



DB-RK-8581

Ø: 85
Hole Distance: 130
Thick/Height: 24
03305800A, 81432706105



MN-DL-2131

Length: 780 Ø: 35
Cone Ø: d1 Ø 22 / d2 Ø 20
81466106301, 81466106305



MN-DL-3402

Length: 590 Ø: 48
Hole Distance: 130 / 130
03307200A, 81432206067, 81432206068, 81432206090, 81432206092, 81432209092



MN-DL-7792

Length: 1750 Ø: 52
Cone Ø: d1 Ø 30 / d2 Ø 27
81466106790, 81466106791, 82466106191



MN-DL-7835

Length: 1455 Ø: 35
Cone Ø: d1 Ø 22 / d2 Ø 20
81467106238, 81467106240, 81467106242, 81467106409, 81467106410, 81467106411



MN-DL-8197

Length: 1055 Ø: 42
Cone Ø: d1 Ø 30 / d2 Ø 27
03207500A, 81466116003, 81466116004, 81466116005



MN-DL-8544

Length: 596 Ø: 48
Hole Distance: 130 / 130
81432206196, 81432206232, 81432206233



MN-DL-8609

Length: 585 Ø: 58
Hole Distance: 130 / 130
81432206070, 81432206071, 81432206072, 81432206091, 81432206093, 81432206119



MN-DL-12284

Length: 1530 Ø: 50
Cone Ø: d1 Ø 30 / d2 Ø 27
81466106579, 81466106580, 81466106624, 81466116720, 81467116720, 81467116730, 81467116952



MN-DL-12421

Length: 1070 Ø: 48
Cone Ø: d1 Ø 30 / d2 Ø 27
Thread: M30 x 1,5 RHT
81466106656, 81466106659, 81466106669, 81466116006, 81466116007



MN-SB-5244

Ø: 65
Hole Distance: 125
Thick/Height: 22
03312000A, 81432710027, 81432710082



MN-SB-5246

Ø: 45 Thick/Height: 47
81437220022, 81437220038, 81962100450, 81962100469



MN-SB-10390

Ø: 70 Thick/Height: 85/85
81960200341, 81960200373, 81960200385, 81960200408, 81960200418



MN-VB-8514

Length: 627 Ø: 48
Hole Ø 25 / 25 / 25
Hole Distance: 152 / 130 / 130
81432706087, 81432706088, 81432706094, 81432706095, 81432796094



MN-VB-8669

Length: 627 Ø: 48
Hole Ø 25 / 25 / 25
Hole Distance: 152 / 130 / 130
81432706116, 81432706137, 81432706150, 81432706151





G ...

6.90 FK	10/79→09/87	Ball Head, gearshift linkage	CV-ES-2120		
	10/79→09/87	Centre Rod	MN-DL-2131		Push Rod
	10/79→09/87	Tie Rod	MN-DL-7835		
8.136 F,8.136 FL	10/79→09/87	Ball Head, gearshift linkage	CV-ES-2119		
	10/79→09/87	Ball Head, gearshift linkage	CV-ES-2120		
	10/79→09/87	Ball Head, gearshift linkage	CV-ES-2182		
	10/79→09/87	Centre Rod	MN-DL-2131		Push Rod
	10/79→09/87	Suspension Arm Repair Kit	MN-RK-8723	MN-RK-8723	for Control Arm
	10/79→09/87	Tie Rod	MN-DL-7835		
	10/79→09/87	Track Control Arm		MN-DL-9381	Control Arm, Air Suspension Axle
8.136 FAE	12/83→08/88	Ball Head, gearshift linkage	CV-ES-2119		
	12/83→08/88	Ball Head, gearshift linkage	CV-ES-2120		
	12/83→08/88	Ball Head, gearshift linkage	CV-ES-2182		
	12/83→08/88	Centre Rod	MN-DL-2131		Push Rod
	12/83→08/88	Centre Rod	MN-DL-12281		for Steering Rod
	12/83→08/88	Tie Rod End	CV-ES-12462		for Steering Rod
8.136 FK	10/79→08/88	Ball Head, gearshift linkage	CV-ES-2119		
	10/79→08/88	Ball Head, gearshift linkage	CV-ES-2120		
	10/79→08/88	Ball Head, gearshift linkage	CV-ES-2182		
	10/79→08/88	Centre Rod	MN-DL-2131		Push Rod
	10/79→08/88	Suspension Arm Repair Kit	MN-RK-8723	MN-RK-8723	for Control Arm
	10/79→08/88	Tie Rod	MN-DL-7835		
8.136 FOC	10/79→08/88	Track Control Arm		MN-DL-9381	Control Arm, Air Suspension Axle
	03/82→07/88	Ball Head, gearshift linkage	CV-ES-2119		
	03/82→07/88	Ball Head, gearshift linkage	CV-ES-2120		
	03/82→07/88	Ball Head, gearshift linkage	CV-ES-2182		
	03/82→07/88	Centre Rod	MN-DL-2131		Push Rod
	03/82→07/88	Suspension Arm Repair Kit	MN-RK-8723	MN-RK-8723	for Control Arm
8.90 F	10/79→09/87	Track Control Arm		MN-DL-9381	Control Arm, Air Suspension Axle
	10/79→09/87	Ball Head, gearshift linkage	CV-ES-2120		
8.90 FK	10/79→09/87	Tie Rod	MN-DL-7835		
	10/79→09/87	Ball Head, gearshift linkage	CV-ES-2120		
9.136 F,9.136 FL	10/79→09/87	Tie Rod	MN-DL-7835		
	10/79→09/87	Ball Head, gearshift linkage	CV-ES-2119		
	10/79→09/87	Ball Head, gearshift linkage	CV-ES-2120		
	10/79→09/87	Ball Head, gearshift linkage	CV-ES-2182		
	10/79→09/87	Centre Rod	MN-DL-2131		Push Rod
	10/79→09/87	Suspension Arm Repair Kit	MN-RK-8723	MN-RK-8723	for Control Arm
	10/79→09/87	Tie Rod	MN-DL-7835		
9.136 FAE	10/79→09/87	Track Control Arm		MN-DL-9381	Control Arm, Air Suspension Axle
	12/83→08/88	Ball Head, gearshift linkage	CV-ES-2119		
	12/83→08/88	Ball Head, gearshift linkage	CV-ES-2120		
	12/83→08/88	Ball Head, gearshift linkage	CV-ES-2182		
	12/83→08/88	Centre Rod	MN-DL-2131		Push Rod
	12/83→08/88	Centre Rod	MN-DL-12281		for Steering Rod
	12/83→08/88	Tie Rod End	CV-ES-12462		for Steering Rod
9.136 FK	10/79→08/88	Ball Head, gearshift linkage	CV-ES-2119		
	10/79→08/88	Ball Head, gearshift linkage	CV-ES-2120		
	10/79→08/88	Ball Head, gearshift linkage	CV-ES-2182		
	10/79→08/88	Centre Rod	MN-DL-2131		Push Rod
	10/79→08/88	Suspension Arm Repair Kit	MN-RK-8723	MN-RK-8723	for Control Arm
	10/79→08/88	Tie Rod	MN-DL-7835		
9.136 FOC	10/79→08/88	Track Control Arm		MN-DL-9381	Control Arm, Air Suspension Axle
	03/82→07/88	Ball Head, gearshift linkage	CV-ES-2119		
	03/82→07/88	Ball Head, gearshift linkage	CV-ES-2120		
	03/82→07/88	Ball Head, gearshift linkage	CV-ES-2182		
	03/82→07/88	Centre Rod	MN-DL-2131		Push Rod
	03/82→07/88	Suspension Arm Repair Kit	MN-RK-8723	MN-RK-8723	for Control Arm
	03/82→07/88	Track Control Arm		MN-DL-9381	Control Arm, Air Suspension Axle

CV-ES-2119

Length: 55
Cone Ø: d1 Ø 10 / d2 Ø 10
Thread: M12 x 1,75 LHT
81953016063, 81953016131



MN-DL-7835

Length: 1455 Ø: 35
Cone Ø: d1 Ø 22 / d2 Ø 20
81467106238, 81467106240, 81467106242,
81467106409, 81467106410, 81467106411



CV-ES-2120

Length: 115
Cone Ø: d1 Ø 12,4 / d2 Ø 10,8
Thread: M14 x 1,5 RHT
03008500A, 81953016200, 81953016202,
81953016203, 81953016227



MN-DL-9381

Length: 840 Ø: 40
81432506007



CV-ES-2182

Length: 55
Cone Ø: d1 Ø 10 / d2 Ø 10
Thread: M12 x 1,75 RHT
81953016064, 81953016170



MN-DL-12281

Length: 850 Ø: 36
Cone Ø: d1 Ø 26/23.5 / d2 Ø 22/20
82466106021



CV-ES-12462

Length: 120
Cone Ø: d1 Ø 26 / d2 Ø 23,5
Thread: M30 x 1,5 RHT
90804102218, 90804153111, 81953010014,
81953010042, 81953010064, 81953010068,
81953016065, 81953016067, 81953016073,
81953016162, 81953016239, 81953016240,
81953016246, 81953016250, 81953016272,
81953016282, 81953016319, 81953016360,
82953016014



MN-RK-8723

Length: 100 Ø: 46
Hole Distance: 60
81432506009



MN-DL-2131

Length: 780
Ø: 35
Cone Ø: d1 Ø 22 / d2 Ø 20
81466106301, 81466106305



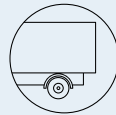

G 90

10.150 F,10.150 FL	09/87→10/93	Ball Head, gearshift linkage	CV-ES-2120		
	09/87→10/93	Centre Rod	MN-DL-2131		Push Rod
	09/87→10/93	Mounting, stabilizer coupling rod	MN-SB-5246	MN-SB-5246	
	09/87→10/93	Stabiliser Mounting		MN-SB-5249	
	09/87→10/93	Stabiliser Mounting		MN-SB-5249	1st RA
	09/87→10/93	Stabiliser Mounting		MN-SB-5252	
	09/87→10/93	Stabiliser Mounting	MN-SB-5278		
	09/87→10/93	Suspension Arm Repair Kit	MN-RK-8723	MN-RK-8723	for Control Arm
	09/87→10/93	Tie Rod	MN-DL-7835		
10.150 FK	09/87→10/93	Track Control Arm		MN-DL-9381	Control Arm, Air Suspension Axle
	09/87→10/93	Ball Head, gearshift linkage	CV-ES-2120		
	09/87→10/93	Centre Rod	MN-DL-2131		Push Rod
	09/87→10/93	Mounting, stabilizer coupling rod	MN-SB-5246	MN-SB-5246	
	09/87→10/93	Stabiliser Mounting		MN-SB-5249	
	09/87→10/93	Stabiliser Mounting		MN-SB-5249	1st RA
	09/87→10/93	Stabiliser Mounting		MN-SB-5252	
	09/87→10/93	Stabiliser Mounting	MN-SB-5278		
	09/87→10/93	Suspension Arm Repair Kit	MN-RK-8723	MN-RK-8723	for Control Arm
6.100 F	09/87→10/93	Tie Rod	MN-DL-7835		
	09/87→10/93	Track Control Arm		MN-DL-9381	Control Arm, Air Suspension Axle
	09/87→10/93	Ball Head, gearshift linkage	CV-ES-2120		
	09/87→10/93	Centre Rod	MN-DL-2131		Push Rod
	09/87→10/93	Stabiliser Mounting		MN-SB-5252	
6.100 FK	09/87→10/93	Stabiliser Mounting	MN-SB-5278		
	09/87→10/93	Ball Head, gearshift linkage	CV-ES-2120		
	09/87→10/93	Centre Rod	MN-DL-2131		Push Rod
	09/87→10/93	Stabiliser Mounting		MN-SB-5252	
	09/87→10/93	Stabiliser Mounting	MN-SB-5278		
8.100 F	09/87→10/93	Tie Rod	MN-DL-7835		
	09/87→10/93	Ball Head, gearshift linkage	CV-ES-2119		
	09/87→10/93	Ball Head, gearshift linkage	CV-ES-2120		
	09/87→10/93	Ball Head, gearshift linkage	CV-ES-2182		
	09/87→10/93	Centre Rod	MN-DL-2131		Push Rod
8.100 FK	09/87→10/93	Stabiliser Mounting		MN-SB-5252	
	09/87→10/93	Stabiliser Mounting	MN-SB-5278		
	09/87→10/93	Ball Head, gearshift linkage	CV-ES-2119		
	09/87→10/93	Ball Head, gearshift linkage	CV-ES-2120		
	09/87→10/93	Ball Head, gearshift linkage	CV-ES-2182		
8.150 F,8.150 FL	09/87→10/93	Centre Rod	MN-DL-2131		Push Rod
	09/87→10/93	Stabiliser Mounting		MN-SB-5252	
	09/87→10/93	Stabiliser Mounting	MN-SB-5278		
	09/87→10/93	Suspension Arm Repair Kit	MN-RK-8723	MN-RK-8723	for Control Arm
	09/87→10/93	Tie Rod	MN-DL-7835		
8.150 FAE	09/87→10/93	Track Control Arm		MN-DL-9381	Control Arm, Air Suspension Axle
	09/87→10/93	Ball Head, gearshift linkage	CV-ES-2119		
	05/88→05/95	Ball Head, gearshift linkage	CV-ES-2120		
	05/88→05/95	Ball Head, gearshift linkage	CV-ES-2182		
	05/88→05/95	Centre Rod	MN-DL-2131		Push Rod
	05/88→05/95	Centre Rod	MN-DL-12281		for Steering Rod
	05/88→05/95	Tie Rod End	CV-ES-12462		for Steering Rod

CV-ES-2119

Length: 55
Cone Ø: d1 Ø 10 / d2 Ø 10
Thread: M12 x 1,75 LHT
81953016063, 81953016131



CV-ES-2120

Length: 115
Cone Ø: d1 Ø 12,4 / d2 Ø 10,8
Thread: M14 x 1,5 RHT
03008500A, 81953016200, 81953016202,
81953016203, 81953016227



CV-ES-2182

Length: 55
Cone Ø: d1 Ø 10 / d2 Ø 10
Thread: M12 x 1,75 RHT
81953016064, 81953016170



CV-ES-12462

Length: 120
Cone Ø: d1 Ø 26 / d2 Ø 23,5
Thread: M30 x 1,5 RHT
90804102218, 90804153111, 81953010014,
81953010042, 81953010064, 81953010068,
81953016065, 81953016067, 81953016073,
81953016162, 81953016239, 81953016240,
81953016246, 81953016250, 81953016272,
81953016282, 81953016319, 81953016360,
82953016014



MN-DL-2131

Length: 780
Ø: 35
Cone Ø: d1 Ø 22 / d2 Ø 20
81466106301, 81466106305



MN-DL-7835

Length: 1455
Ø: 35
Cone Ø: d1 Ø 22 / d2 Ø 20
81467106238, 81467106240, 81467106242,
81467106409, 81467106410, 81467106411



MN-DL-9381

Length: 840 Ø: 40
81432506007



MN-DL-12281

Length: 850
Ø: 36
Cone Ø: d1 Ø 26/23.5 / d2 Ø 22/20
82466106021



MN-RK-8723

Length: 100 Ø: 46
Hole Distance: 60
81432506009



MN-SB-5246

Ø: 45 Thick/Height: 47
81437220022, 81437220038, 81962100450,
81962100469



MN-SB-5249

Length: 55 Ø: 71
Thick/Height: 80
03310200A, 81437040029



MN-SB-5252

Ø: 37,5
Thick/Height: 51
03312200A, 81960200286



MN-SB-5278

Length: 50
Ø: 39
Thick/Height: 50,5
03312700A, 81962100278



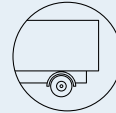
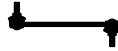

G 90 ...

8.150 FAKO	10/92→05/95	Ball Head, gearshift linkage	CV-ES-2119		
	10/92→05/95	Ball Head, gearshift linkage	CV-ES-2120		
	10/92→05/95	Ball Head, gearshift linkage	CV-ES-2182		
	10/92→05/95	Centre Rod	MN-DL-2131		Push Rod
8.150 FK	09/87→10/93	Ball Head, gearshift linkage	CV-ES-2119		
	09/87→10/93	Ball Head, gearshift linkage	CV-ES-2120		
	09/87→10/93	Ball Head, gearshift linkage	CV-ES-2182		
	09/87→10/93	Centre Rod	MN-DL-2131		Push Rod
	09/87→10/93	Mounting, stabilizer coupling rod	MN-SB-5246	MN-SB-5246	
	09/87→10/93	Stabiliser Mounting		MN-SB-5249	
	09/87→10/93	Stabiliser Mounting		MN-SB-5249	1st RA
	09/87→10/93	Stabiliser Mounting		MN-SB-5252	
	09/87→10/93	Stabiliser Mounting	MN-SB-5278		
	09/87→10/93	Suspension Arm Repair Kit	MN-RK-8723	MN-RK-8723	for Control Arm
	09/87→10/93	Tie Rod	MN-DL-7835		
8.150 FOC	07/88→10/93	Ball Head, gearshift linkage	CV-ES-2119		
	07/88→10/93	Ball Head, gearshift linkage	CV-ES-2120		
	07/88→10/93	Ball Head, gearshift linkage	CV-ES-2182		
	07/88→10/93	Centre Rod	MN-DL-2131		Push Rod
8.150 FS,8.150 FLS	07/88→10/93	Tie Rod	MN-DL-7835		
	09/87→10/93	Ball Head, gearshift linkage	CV-ES-2119		
	09/87→10/93	Ball Head, gearshift linkage	CV-ES-2120		
	09/87→10/93	Ball Head, gearshift linkage	CV-ES-2182		
	09/87→10/93	Centre Rod	MN-DL-2131		Push Rod
	09/87→10/93	Mounting, stabilizer coupling rod	MN-SB-5246	MN-SB-5246	
	09/87→10/93	Stabiliser Mounting		MN-SB-5249	
	09/87→10/93	Stabiliser Mounting		MN-SB-5249	1st RA
	09/87→10/93	Stabiliser Mounting		MN-SB-5252	
	09/87→10/93	Stabiliser Mounting	MN-SB-5278		
	09/87→10/93	Suspension Arm Repair Kit	MN-RK-8723	MN-RK-8723	for Control Arm
8.170 FOC	09/87→10/93	Tie Rod	MN-DL-7835		
	09/87→10/93	Track Control Arm		MN-DL-9381	Control Arm, Air Suspension Axle
	02/89→10/93	Ball Head, gearshift linkage	CV-ES-2119		
	02/89→10/93	Ball Head, gearshift linkage	CV-ES-2120		
	02/89→10/93	Ball Head, gearshift linkage	CV-ES-2182		
	02/89→10/93	Centre Rod	MN-DL-2131		Push Rod
9.150 F,9.150 FL	02/89→10/93	Tie Rod	MN-DL-7835		
	09/87→10/93	Ball Head, gearshift linkage	CV-ES-2119		
	09/87→10/93	Ball Head, gearshift linkage	CV-ES-2120		
	09/87→10/93	Ball Head, gearshift linkage	CV-ES-2182		
	09/87→10/93	Centre Rod	MN-DL-2131		Push Rod
	09/87→10/93	Mounting, stabilizer coupling rod	MN-SB-5246	MN-SB-5246	
	09/87→10/93	Stabiliser Mounting		MN-SB-5249	
	09/87→10/93	Stabiliser Mounting		MN-SB-5249	1st RA
	09/87→10/93	Stabiliser Mounting		MN-SB-5252	
	09/87→10/93	Stabiliser Mounting	MN-SB-5278		
	09/87→10/93	Suspension Arm Repair Kit	MN-RK-8723	MN-RK-8723	for Control Arm
9.150 FAE	09/87→10/93	Tie Rod	MN-DL-7835		
	09/87→10/93	Track Control Arm		MN-DL-9381	Control Arm, Air Suspension Axle
	05/88→05/92	Ball Head, gearshift linkage	CV-ES-2119		
	05/88→05/92	Ball Head, gearshift linkage	CV-ES-2120		
	05/88→05/92	Ball Head, gearshift linkage	CV-ES-2182		
	05/88→05/92	Centre Rod	MN-DL-2131		Push Rod
	05/88→05/92	Centre Rod	MN-DL-12281		for Steering Rod
	05/88→05/92	Tie Rod End	CV-ES-12462		for Steering Rod
9.150 FAKO	10/92→05/95	Ball Head, gearshift linkage	CV-ES-2119		
	10/92→05/95	Ball Head, gearshift linkage	CV-ES-2120		
	10/92→05/95	Ball Head, gearshift linkage	CV-ES-2182		
	10/92→05/95	Centre Rod	MN-DL-2131		Push Rod

CV-ES-2119

Length: 55
Cone Ø: d1 Ø 10 / d2 Ø 10
Thread: M12 x 1,75 LHT
81953016063, 81953016131



CV-ES-2120

Length: 115
Cone Ø: d1 Ø 12,4 / d2 Ø 10,8
Thread: M14 x 1,5 RHT
03008500A, 81953016200, 81953016202,
81953016203, 81953016227



CV-ES-2182

Length: 55
Cone Ø: d1 Ø 10 / d2 Ø 10
Thread: M12 x 1,75 RHT
81953016064, 81953016170



CV-ES-12462

Length: 120
Cone Ø: d1 Ø 26 / d2 Ø 23,5
Thread: M30 x 1,5 RHT
90804102218, 90804153111, 81953010014,
81953010042, 81953010064, 81953010068,
81953016065, 81953016067, 81953016073,
81953016162, 81953016239, 81953016240,
81953016246, 81953016250, 81953016272,
81953016282, 81953016319, 81953016360,
82953016014



MN-DL-2131

Length: 780
Ø: 35
Cone Ø: d1 Ø 22 / d2 Ø 20
81466106301, 81466106305



MN-DL-7835

Length: 1455
Ø: 35
Cone Ø: d1 Ø 22 / d2 Ø 20
81467106238, 81467106240, 81467106242,
81467106409, 81467106410, 81467106411



MN-DL-9381

Length: 840 Ø: 40
81432506007



MN-DL-12281

Length: 850
Ø: 36
Cone Ø: d1 Ø 26/23.5 / d2 Ø 22/20
82466106021



MN-RK-8723

Length: 100 Ø: 46
Hole Distance: 60
81432506009



MN-SB-5246

Ø: 45 Thick/Height: 47
81437220022, 81437220038, 81962100450,
81962100469



MN-SB-5249

Length: 55 Ø: 71
Thick/Height: 80
03310200A, 81437040029



MN-SB-5252

Ø: 37,5
Thick/Height: 51
03312200A, 81960200286



MN-SB-5278

Length: 50
Ø: 39
Thick/Height: 50,5
03312700A, 81962100278





G 90 ...

9.150 FK	09/87→10/93	Ball Head, gearshift linkage	CV-ES-2119		
	09/87→10/93	Ball Head, gearshift linkage	CV-ES-2120		
	09/87→10/93	Ball Head, gearshift linkage	CV-ES-2182		
	09/87→10/93	Centre Rod	MN-DL-2131		Push Rod
	09/87→10/93	Mounting, stabilizer coupling rod	MN-SB-5246	MN-SB-5246	
	09/87→10/93	Stabiliser Mounting		MN-SB-5249	
	09/87→10/93	Stabiliser Mounting		MN-SB-5249	1st RA
	09/87→10/93	Stabiliser Mounting		MN-SB-5252	
	09/87→10/93	Stabiliser Mounting	MN-SB-5278		
	09/87→10/93	Suspension Arm Repair Kit	MN-RK-8723	MN-RK-8723	for Control Arm
9.150 FOC	07/88→10/93	Ball Head, gearshift linkage	CV-ES-2119		
	07/88→10/93	Ball Head, gearshift linkage	CV-ES-2120		
	07/88→10/93	Ball Head, gearshift linkage	CV-ES-2182		
	07/88→10/93	Centre Rod	MN-DL-2131		Push Rod
	07/88→10/93	Tie Rod	MN-DL-7835		
9.150 FS,9.150 FLS	09/87→10/93	Ball Head, gearshift linkage	CV-ES-2119		
	09/87→10/93	Ball Head, gearshift linkage	CV-ES-2120		
	09/87→10/93	Ball Head, gearshift linkage	CV-ES-2182		
	09/87→10/93	Centre Rod	MN-DL-2131		Push Rod
	09/87→10/93	Mounting, stabilizer coupling rod	MN-SB-5246	MN-SB-5246	
	09/87→10/93	Stabiliser Mounting		MN-SB-5249	
	09/87→10/93	Stabiliser Mounting		MN-SB-5249	1st RA
	09/87→10/93	Stabiliser Mounting		MN-SB-5252	
	09/87→10/93	Stabiliser Mounting	MN-SB-5278		
	09/87→10/93	Suspension Arm Repair Kit	MN-RK-8723	MN-RK-8723	for Control Arm
9.170 FOC	02/89→10/93	Ball Head, gearshift linkage	CV-ES-2119		
	02/89→10/93	Ball Head, gearshift linkage	CV-ES-2120		
	02/89→10/93	Ball Head, gearshift linkage	CV-ES-2182		
	02/89→10/93	Centre Rod	MN-DL-2131		Push Rod
	02/89→10/93	Tie Rod	MN-DL-7835		

HOCL

10.150 HOCL	08/87→04/04	Tie Rod End	CV-ES-14163		for Steering Rod
10.190 HOCL	08/87→04/04	Tie Rod End	CV-ES-14163		for Steering Rod
11.150 HOCL	08/87→04/04	Tie Rod End	CV-ES-14163		for Steering Rod
11.190 HOCL	08/87→04/04	Tie Rod End	CV-ES-14163		for Steering Rod
13.220 HOCL/R	09/01→04/04	Tie Rod End	CV-ES-14163		for Steering Rod
14.240 HOCL-NL		Tie Rod End	CV-ES-12462		for Steering Rod
14.250 HOCL-NL		Tie Rod End	CV-ES-12462		for Steering Rod
14.280 HOCL	08/02→12/14	Suspension Arm Repair Kit		MN-RK-7291	for Drag Link
	08/02→12/14	Tie Rod End	CV-ES-12462		for Steering Rod
	08/02→12/14	Track Control Arm		MN-DL-7803	Trailing Arm
	08/02→12/14	Track Control Arm		MN-DL-10283	Trailing Arm
	08/02→12/14	Track Control Arm		MN-TC-12397	Suspension Rod, Control Arm
14.290 HOCL-NL		Tie Rod End	CV-ES-12462		for Steering Rod
18.220 HOCL/R-NL, HOCL/SKD(SL)	08/93→05/01	Tie Rod End	CV-ES-14163		for Steering Rod
18.240 HOCL-NL		Tie Rod End	CV-ES-14163		for Steering Rod
18.250 HOCL-NL, HOCL-SKD(SL)	08/93→05/01	Tie Rod End	CV-ES-14163		for Steering Rod
18.280 HOCL-NL	05/02→08/08	Tie Rod End	CV-ES-14163		for Steering Rod
18.290 HOCL-NL		Tie Rod End	CV-ES-14163		for Steering Rod
18.310 HOCL/R	01/92→	Tie Rod End	CV-ES-14163		for Steering Rod
18.310 HOCL-NL		Tie Rod End	CV-ES-14163		for Steering Rod
18.320 HOCL-NL		Tie Rod End	CV-ES-14163		for Steering Rod
18.360 HOCL	01/06→12/14	Centre Rod	MN-DL-10314		Push Rod
	01/06→12/14	Tie Rod End	CV-ES-14163		for Steering Rod
18.400 HOCL	01/06→12/14	Centre Rod	MN-DL-10314		Push Rod
	01/06→12/14	Tie Rod End	CV-ES-14163		for Steering Rod

CV-ES-2119

Length: 55
Cone Ø: d1 Ø 10 / d2 Ø 10
Thread: M12 x 1,75 LHT
81953016063, 81953016131



CV-ES-2120

Length: 115
Cone Ø: d1 Ø 12,4 / d2 Ø 10,8
Thread: M14 x 1,5 RHT
03008500A, 81953016200, 81953016202,
81953016203, 81953016227



CV-ES-2182

Length: 55
Cone Ø: d1 Ø 10 / d2 Ø 10
Thread: M12 x 1,75 RHT
81953016064, 81953016170



CV-ES-12462

Length: 120
Cone Ø: d1 Ø 26 / d2 Ø 23,5
Thread: M30 x 1,5 RHT
90804102218, 90804153111, 81953010014,
81953010042, 81953010064, 81953010068,
81953016065, 81953016067, 81953016073,
81953016162, 81953016239, 81953016240,
81953016246, 81953016250, 81953016272,
81953016282, 81953016319, 81953016360,
82953016014



CV-ES-14163

Length: 125
Cone Ø: d1 Ø 30 / d2 Ø 27
Thread: M30 x 1,5 RHT
95301.0084, 90804102156, 90804102272,
90804102696, 90804102710, 81953010016,
81953010075, 81953010084, 81953010088,
81953010094, 81953010103, 81953016030,
81953016043, 81953016048, 81953016049,
81953016053, 81953016061, 81953016090,
81953016108, 81953016112, 81953016126,
81953016143, 81953016149, 81953016154,
81953016156, 81953016168, 81953016178,
81953016194, 81953016206, 81953016224,
81953016234, 81953016242, 81953016252,
81953016274, 81953016278, 81953016284,
81953016286, 81953016308, 81953016310,
81953016312, 81953016347, 81953016350,
81953016352, 82953016012, 88953016014,
N2953016001



MN-DL-2131

Length: 780
Ø: 35
Cone Ø: d1 Ø 22 / d2 Ø 20
81466106301, 81466106305



MN-DL-7803

Length: 644
Ø: 50
Hole Distance: 130 / 102
03307300A, 81432206174



MN-DL-7835

Length: 1455
Ø: 35
Cone Ø: d1 Ø 22 / d2 Ø 20
81467106238, 81467106240, 81467106242,
81467106409, 81467106410, 81467106411



MN-DL-9381

Length: 840 Ø: 40
81432506007



MN-DL-10283

Length: 622 Ø: 50
Hole Distance: 130 / 130
81432206258, 81432206264, 81432206275,
81432206278, 81432206279



MN-DL-10314

Length: 1103
Ø: 50
Cone Ø: d1 Ø 30 / d2 Ø 27
81466116217, 83466106001, 83466106501,
36466106012, 36466106040



MN-RK-7291

Ø: 72
Hole Distance: 130
Thick/Height: 30
10307800A, 81432206108, 81432206132



MN-RK-8723

Length: 100 Ø: 46
Hole Distance: 60
81432506009



MN-SB-5246

Ø: 45 Thick/Height: 47
81437220022, 81437220038, 81962100450,
81962100469



MN-SB-5249

Length: 55 Ø: 71
Thick/Height: 80
03310200A, 81437040029



MN-SB-5252

Ø: 37,5
Thick/Height: 51
03312200A, 81960200286



MN-SB-5278

Length: 50
Ø: 39
Thick/Height: 50,5
03312700A, 81962100278



MN-TC-12397

Length: 661
Ø: 40
Hole Distance: 130 / 130
81432206319, 81432206325



MN-VB-8565

Length: 693
Ø: 46
Hole Distance: 115 / 115
81432706053, 81432709053



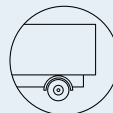

HOCL ...

18.430 HOCL	01/06→10/09	Centre Rod	MN-DL-10314		Push Rod
	01/06→10/09	Tie Rod End	CV-ES-14163		for Steering Rod
18.440 HOCL	01/06→10/09	Centre Rod	MN-DL-10314		Push Rod
	01/06→10/09	Tie Rod End	CV-ES-14163		for Steering Rod
18.460 HOCL	03/06→10/09	Centre Rod	MN-DL-10314		Push Rod
	03/06→10/09	Tie Rod End	CV-ES-14163		for Steering Rod
18.480 HOCL	05/07→12/14	Centre Rod	MN-DL-10314		Push Rod
	05/07→12/14	Tie Rod End	CV-ES-14163		for Steering Rod
24.440 HOCLN	01/06→10/09	Centre Rod	MN-DL-10314		Push Rod
	01/06→10/09	Tie Rod	MN-DL-10268		
	01/06→10/09	Tie Rod	MN-DL-10269		
	01/06→10/09	Track Control Arm		MN-DL-10283	Trailing Arm
	01/06→10/09	Track Control Arm		MN-DL-10286	Trailing Arm
24.460 HOCLN	03/06→12/14	Centre Rod	MN-DL-10314		Push Rod
	03/06→12/14	Tie Rod	MN-DL-10268		
	03/06→12/14	Tie Rod	MN-DL-10269		
	03/06→12/14	Track Control Arm		MN-DL-10283	Trailing Arm
	03/06→12/14	Track Control Arm		MN-DL-10286	Trailing Arm
24.480 HOCLN	05/07→12/14	Centre Rod	MN-DL-10314		Push Rod
	05/07→12/14	Tie Rod	MN-DL-10268		
	05/07→12/14	Tie Rod	MN-DL-10269		
	05/07→12/14	Track Control Arm		MN-DL-10283	Trailing Arm
	05/07→12/14	Track Control Arm		MN-DL-10286	Trailing Arm

L 2000

10.145 LC, 10.145 LLC, LRC, LLRC (LE140C)	09/00→	Ball Head, gearshift linkage	CV-ES-2119		
	09/00→	Ball Head, gearshift linkage	CV-ES-2120		
	09/00→	Ball Head, gearshift linkage	CV-ES-2182		
	09/00→	Centre Rod	MN-DL-0549		Push Rod
	09/00→	Centre Rod	MN-DL-2127		Coupling Rod
	09/00→	Centre Rod	MN-DL-2133		Push Rod
	09/00→	Centre Rod	MN-DL-8378		Push Rod
	09/00→	Stabiliser Mounting		MN-SB-5249	
	09/00→	Stabiliser Mounting		MN-SB-5249	1st RA
	09/00→	Suspension Arm Repair Kit		MN-RK-8723	for Drag Link;for Semi-Trailing Arm
	09/00→	Tie Rod	MN-DL-7781		Guide Rod
	09/00→	Tie Rod End	CV-ES-2774		
	09/00→	Tie Rod End	CV-ES-14163		for Steering Rod
	09/00→	Track Control Arm		MN-DL-9381	Control Arm, Air Suspension Axle
	09/00→	Track Control Arm		MN-TC-12471	Semi-Trailing Arm, 1st Drive Axle, for Pneumatic Suspension vehicles
10.145 LK, L-KI, LRK, LR-KI, LRK-L, LK-L (LE140C)	09/00→	Ball Head, gearshift linkage	CV-ES-2119		
	09/00→	Ball Head, gearshift linkage	CV-ES-2120		
	09/00→	Ball Head, gearshift linkage	CV-ES-2182		
	09/00→	Centre Rod	MN-DL-0549		Push Rod
	09/00→	Centre Rod	MN-DL-2127		Coupling Rod
	09/00→	Centre Rod	MN-DL-2133		Push Rod
	09/00→	Suspension Arm Repair Kit		MN-RK-8723	for Drag Link;for Semi-Trailing Arm
	09/00→	Tie Rod	MN-DL-7781		Guide Rod
	09/00→	Tie Rod End	CV-ES-2774		
10.145 LLS, LLRS (LE140C)	09/00→	Ball Head, gearshift linkage	CV-ES-2119		
	09/00→	Ball Head, gearshift linkage	CV-ES-2120		
	09/00→	Ball Head, gearshift linkage	CV-ES-2182		
	09/00→	Centre Rod	MN-DL-0549		Push Rod
	09/00→	Centre Rod	MN-DL-2127		Coupling Rod
	09/00→	Centre Rod	MN-DL-2133		Push Rod
	09/00→	Stabiliser Mounting		MN-SB-5249	
	09/00→	Stabiliser Mounting		MN-SB-5249	1st RA
	09/00→	Suspension Arm Repair Kit		MN-RK-8723	for Drag Link;for Semi-Trailing Arm
	09/00→	Tie Rod	MN-DL-7781		Guide Rod
	09/00→	Tie Rod End	CV-ES-2774		
	09/00→	Track Control Arm		MN-DL-9381	Control Arm, Air Suspension Axle
09/00→	Track Control Arm		MN-TC-12471	Semi-Trailing Arm, 1st Drive Axle, for Pneumatic Suspension vehicles	

CV-ES-2119

Length: 55
Cone Ø: d1 Ø 10 / d2 Ø 10
Thread: M12 x 1,75 LHT
81953016063, 81953016131



CV-ES-2120

Length: 115
Cone Ø: d1 Ø 12,4 / d2 Ø 10,8
Thread: M14 x 1,5 RHT
03008500A, 81953016200, 81953016202,
81953016203, 81953016227



CV-ES-2182

Length: 55
Cone Ø: d1 Ø 10 / d2 Ø 10
Thread: M12 x 1,75 RHT
81953016064, 81953016170



CV-ES-2774

Length: 95
Cone Ø: d1 Ø 20 / d2 Ø 18
Thread: M24 x 1,5 RHT
81953016134, 81953016142



CV-ES-14163

Length: 125
Cone Ø: d1 Ø 30 / d2 Ø 27
Thread: M30 x 1,5 RHT
95301.0084, 90804102156, 90804102272,
90804102696, 90804102710, 81953010016,
81953010075, 81953010084, 81953010088,
81953010094, 81953010103, 81953016030,
81953016043, 81953016048, 81953016049,
81953016053, 81953016061, 81953016090,
81953016108, 81953016112, 81953016126,
81953016143, 81953016149, 81953016154,
81953016156, 81953016168, 81953016178,
81953016194, 81953016206, 81953016224,
81953016234, 81953016242, 81953016252,
81953016274, 81953016278, 81953016284,
81953016286, 81953016308, 81953016310,
81953016312, 81953016347, 81953016350,
81953016352, 82953016012, 88953016014,
N2953016001



MN-DL-0549

Length: 820
Ø: 32
Cone Ø: d1 Ø 20 / d2 Ø 18
81466106725, 85466106102



MN-DL-2127

Length: 1670 Ø: 30
Cone Ø: d1 Ø 20 / d2 Ø 18
81467106865, 81467106866



MN-DL-2133

Length: 829
Ø: 38
Cone Ø: d1 Ø 22 / d2 Ø 20
81466106753, 81466106754, 85466106104



MN-DL-7781

Length: 1630 Ø: 35
Cone Ø: d1 Ø 22 / d2 Ø 20
81467106395, 81467106851, 81467106852,
81467106853, 81467116719, 81467116729,
81467116841



MN-DL-8378

Length: 882 Ø: 38
Cone Ø: d1 Ø 30 / d2 Ø 26
85466106156



MN-DL-9381

Length: 840 Ø: 40
81432506007



MN-DL-10268

Length: 661 Ø: 38
Cone Ø: d1 Ø 30 / d2 Ø 27
81467116770, 81467116772, 81467116874,
81467116875, 81467116876



MN-DL-10269

Length: 429
Ø: 36
Cone Ø: d1 Ø 30 / d2 Ø 27
81467116886, 81467116897, 81467116898,
81467116899



MN-DL-10283

Length: 622 Ø: 50
Hole Distance: 130 / 130
81432206258, 81432206264, 81432206275,
81432206278, 81432206279



MN-DL-10286

Length: 570 Ø: 48
Hole Distance: 130 / 130
81432206151, 81432206183, 81432206276



MN-DL-10314

Length: 1103
Ø: 50
Cone Ø: d1 Ø 30 / d2 Ø 27
81466116217, 83466106001, 83466106501,
36466106012, 36466106040



MN-RK-8723

Length: 100 Ø: 46
Hole Distance: 60
81432506009



MN-SB-5249

Length: 55 Ø: 71
Thick/Height: 80
03310200A, 81437040029



MN-TC-12471

Length: 840
Ø: 50
81432506014



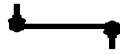

L 2000 ...

10.150 FOC	02/95→01/96	Ball Head, gearshift linkage	CV-ES-2120		
	02/95→01/96	Tie Rod	MN-DL-7781	Guide Rod	
10.153 F	10/93→	Centre Rod	MN-DL-0549	Push Rod	
	10/93→	Centre Rod	MN-DL-2133	Push Rod	
	10/93→	Tie Rod	MN-DL-7781	Guide Rod, 1st Front Axle	
10.153 LAEK	10/93→06/96	Ball Head, gearshift linkage	CV-ES-2119		
	10/93→06/96	Ball Head, gearshift linkage	CV-ES-2120		
	10/93→06/96	Ball Head, gearshift linkage	CV-ES-2182		
	10/93→06/96	Centre Rod	MN-DL-0549	Push Rod	
	10/93→06/96	Centre Rod	MN-DL-2127	Coupling Rod	
	10/93→06/96	Centre Rod	MN-DL-2133	Push Rod	
	10/93→06/96	Centre Rod	MN-DL-12282	for Steering Rod	
	10/93→06/96	Stabiliser Mounting		MN-SB-5249	
	10/93→06/96	Stabiliser Mounting		MN-SB-5249	1st RA
	10/93→06/96	Tie Rod End	CV-ES-2774		
	10/93→06/96	Tie Rod End	CV-ES-12462	for Steering Rod	
	10.153 LC, 10.153 LLC	10/93→06/96	Ball Head, gearshift linkage	CV-ES-2119	
		10/93→06/96	Ball Head, gearshift linkage	CV-ES-2120	
10/93→06/96		Ball Head, gearshift linkage	CV-ES-2182		
10/93→06/96		Centre Rod	MN-DL-0549	Push Rod	
10/93→06/96		Centre Rod	MN-DL-2127	Coupling Rod	
10/93→06/96		Centre Rod	MN-DL-2133	Push Rod	
10/93→06/96		Stabiliser Mounting		MN-SB-5249	
10/93→06/96		Stabiliser Mounting		MN-SB-5249	1st RA
10/93→06/96		Suspension Arm Repair Kit		MN-RK-8723	for Drag Link;for Semi-Trailing Arm
10/93→06/96		Tie Rod	MN-DL-7781		
10/93→06/96		Tie Rod	MN-DL-7835		
10/93→06/96		Tie Rod End	CV-ES-2774		
10/93→06/96		Track Control Arm		MN-DL-9381	Control Arm, Air Suspension Axle
10.153 LK		10/93→06/96	Ball Head, gearshift linkage	CV-ES-2119	
		10/93→06/96	Ball Head, gearshift linkage	CV-ES-2120	
	10/93→06/96	Ball Head, gearshift linkage	CV-ES-2182		
	10/93→06/96	Centre Rod	MN-DL-0549	Push Rod	
	10/93→06/96	Centre Rod	MN-DL-2127	Coupling Rod	
	10/93→06/96	Centre Rod	MN-DL-2133	Push Rod	
	10/93→06/96	Suspension Arm Repair Kit		MN-RK-8723	for Drag Link;for Semi-Trailing Arm
	10/93→06/96	Tie Rod	MN-DL-7781		
	10/93→06/96	Tie Rod	MN-DL-7835		
	10/93→06/96	Tie Rod End	CV-ES-2774		
10.153 LLS	10/93→06/96	Ball Head, gearshift linkage	CV-ES-2119		
	10/93→06/96	Ball Head, gearshift linkage	CV-ES-2120		
	10/93→06/96	Ball Head, gearshift linkage	CV-ES-2182		
	10/93→06/96	Centre Rod	MN-DL-0549	Push Rod	
	10/93→06/96	Centre Rod	MN-DL-2127	Coupling Rod	
	10/93→06/96	Centre Rod	MN-DL-2133	Push Rod	
	10/93→06/96	Stabiliser Mounting		MN-SB-5249	
	10/93→06/96	Stabiliser Mounting		MN-SB-5249	1st RA
	10/93→06/96	Suspension Arm Repair Kit		MN-RK-8723	for Drag Link;for Semi-Trailing Arm
	10/93→06/96	Tie Rod	MN-DL-7781		
	10/93→06/96	Tie Rod End	CV-ES-2774		
10.155 LC, LLC, LLRC, LRC, LLRC	09/00→	Centre Rod	MN-DL-0549	Push Rod	
	09/00→	Centre Rod	MN-DL-2133	Push Rod	
	09/00→	Tie Rod	MN-DL-7781	Guide Rod	
	09/00→	Tie Rod End	CV-ES-2774		
	09/00→	Tie Rod End	CV-ES-2774		
10.155 LK, L-KI, LRK, LR-KI, LK-L	02/04→	Centre Rod	MN-DL-0549	Push Rod	
	02/04→	Centre Rod	MN-DL-2133	Push Rod	
	02/04→	Tie Rod	MN-DL-7781	Guide Rod, 1st Front Axle	
	02/04→	Tie Rod End	CV-ES-2774		
10.163 F	05/94→	Centre Rod	MN-DL-0549	Push Rod	
	05/94→	Centre Rod	MN-DL-2133	Push Rod	
	05/94→	Tie Rod	MN-DL-7781	Guide Rod, 1st Front Axle	

CV-ES-2119

Length: 55
Cone Ø: d1 Ø 10 / d2 Ø 10
Thread: M12 x 1,75 LHT
81953016063, 81953016131



CV-ES-2120

Length: 115
Cone Ø: d1 Ø 12,4 / d2 Ø 10,8
Thread: M14 x 1,5 RHT
03008500A, 81953016200, 81953016202,
81953016203, 81953016227



CV-ES-2182

Length: 55
Cone Ø: d1 Ø 10 / d2 Ø 10
Thread: M12 x 1,75 RHT
81953016064, 81953016170



CV-ES-2774

Length: 95
Cone Ø: d1 Ø 20 / d2 Ø 18
Thread: M24 x 1,5 RHT
81953016134, 81953016142



CV-ES-12462

Length: 120
Cone Ø: d1 Ø 26 / d2 Ø 23,5
Thread: M30 x 1,5 RHT
90804102218, 90804153111, 81953010014,
81953010042, 81953010064, 81953010068,
81953016065, 81953016067, 81953016073,
81953016162, 81953016239, 81953016240,
81953016246, 81953016250, 81953016272,
81953016282, 81953016319, 81953016360,
82953016014



MN-DL-0549

Length: 820
Ø: 32
Cone Ø: d1 Ø 20 / d2 Ø 18
81466106725, 85466106102



MN-DL-2127

Length: 1670 Ø: 30
Cone Ø: d1 Ø 20 / d2 Ø 18
81467106865, 81467106866



MN-DL-2133

Length: 829
Ø: 38
Cone Ø: d1 Ø 22 / d2 Ø 20
81466106753, 81466106754, 85466106104



MN-DL-7781

Length: 1630 Ø: 35
Cone Ø: d1 Ø 22 / d2 Ø 20
81467106395, 81467106851, 81467106852,
81467106853, 81467116719, 81467116729,
81467116841



MN-DL-7835

Length: 1455
Ø: 35
Cone Ø: d1 Ø 22 / d2 Ø 20
81467106238, 81467106240, 81467106242,
81467106409, 81467106410, 81467106411



MN-DL-9381

Length: 840 Ø: 40
81432506007



MN-DL-12282

Length: 874 Ø: 36
Cone Ø: d1 Ø 26 / d2 Ø 23,5
85466106032, 85466106103, 85466106202



MN-RK-8723

Length: 100 Ø: 46
Hole Distance: 60
81432506009



MN-SB-5249

Length: 55 Ø: 71
Thick/Height: 80
03310200A, 81437040029



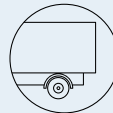

L 2000 ...

10.163 LAC, LAEC, LARC, LAERC	05/94 →	Ball Head, gearshift linkage	CV-ES-2119		
	05/94 →	Ball Head, gearshift linkage	CV-ES-2120		
	05/94 →	Ball Head, gearshift linkage	CV-ES-2182		
	05/94 →	Centre Rod	MN-DL-0549	Push Rod	
	05/94 →	Centre Rod	MN-DL-2127	Coupling Rod	
	05/94 →	Centre Rod	MN-DL-2133	Push Rod	
	05/94 →	Centre Rod	MN-DL-12282	for Steering Rod	
	05/94 →	Stabiliser Mounting		MN-SB-5249	
	05/94 →	Stabiliser Mounting		MN-SB-5249	1st RA
	05/94 →	Tie Rod End	CV-ES-2774		
	05/94 →	Tie Rod End	CV-ES-12462	for Steering Rod	
	10.163 LAEK, LAEK-L, LAERK, LAERK-L, LAK, LAK-L, LARK	01/95 →	Ball Head, gearshift linkage	CV-ES-2119	
01/95 →		Ball Head, gearshift linkage	CV-ES-2120		
01/95 →		Ball Head, gearshift linkage	CV-ES-2182		
01/95 →		Centre Rod	MN-DL-0549	Push Rod	
01/95 →		Centre Rod	MN-DL-2127	Coupling Rod	
01/95 →		Centre Rod	MN-DL-2133	Push Rod	
01/95 →		Centre Rod	MN-DL-12282	for Steering Rod	
01/95 →		Stabiliser Mounting		MN-SB-5249	
01/95 →		Stabiliser Mounting		MN-SB-5249	1st RA
01/95 →		Tie Rod End	CV-ES-2774		
01/95 →		Tie Rod End	CV-ES-12462	for Steering Rod	
10.163 LC, 10.163 LLC		05/94 →	Ball Head, gearshift linkage	CV-ES-2119	
	05/94 →	Ball Head, gearshift linkage	CV-ES-2120		
	05/94 →	Ball Head, gearshift linkage	CV-ES-2182		
	05/94 →	Centre Rod	MN-DL-0549	Push Rod	
	05/94 →	Centre Rod	MN-DL-2127	Coupling Rod	
	05/94 →	Centre Rod	MN-DL-2133	Push Rod	
	05/94 →	Stabiliser Mounting		MN-SB-5249	
	05/94 →	Stabiliser Mounting		MN-SB-5249	1st RA
	05/94 →	Suspension Arm Repair Kit		MN-RK-8723	for Drag Link;for Semi-Trailing Arm
	05/94 →	Tie Rod	MN-DL-7781		
	05/94 →	Tie Rod	MN-DL-7835		
	05/94 →	Tie Rod End	CV-ES-2774		
	05/94 →	Track Control Arm		MN-DL-9381	Control Arm, Air Suspension Axle
	05/94 →	Track Control Arm		MN-TC-12471	Semi-Trailing Arm, 1st Drive Axle, for Pneumatic Suspension vehicles
10.163 LC, 10.163 LLC, LRC, LLRC (LE160C)	09/00 →	Ball Head, gearshift linkage	CV-ES-2119		
	09/00 →	Ball Head, gearshift linkage	CV-ES-2120		
	09/00 →	Ball Head, gearshift linkage	CV-ES-2182		
	09/00 →	Centre Rod	MN-DL-0549	Push Rod	
	09/00 →	Centre Rod	MN-DL-2127	Coupling Rod	
	09/00 →	Centre Rod	MN-DL-2133	Push Rod	
	09/00 →	Stabiliser Mounting		MN-SB-5249	
	09/00 →	Stabiliser Mounting		MN-SB-5249	1st RA
	09/00 →	Suspension Arm Repair Kit		MN-RK-8723	for Drag Link;for Semi-Trailing Arm
	09/00 →	Tie Rod	MN-DL-7781		
	09/00 →	Tie Rod End	CV-ES-2774		
	09/00 →	Track Control Arm		MN-DL-9381	Control Arm, Air Suspension Axle
10.163 LK, L-KI, LRK, LR-KI, LRK-L, LK-L	05/94 →	Ball Head, gearshift linkage	CV-ES-2119		
	05/94 →	Ball Head, gearshift linkage	CV-ES-2120		
	05/94 →	Ball Head, gearshift linkage	CV-ES-2182		
	05/94 →	Centre Rod	MN-DL-0549	Push Rod	
	05/94 →	Centre Rod	MN-DL-2127	Coupling Rod	
	05/94 →	Centre Rod	MN-DL-2133	Push Rod	
	05/94 →	Suspension Arm Repair Kit		MN-RK-8723	for Drag Link;for Semi-Trailing Arm
	05/94 →	Tie Rod	MN-DL-7781		
	05/94 →	Tie Rod	MN-DL-7835		
	05/94 →	Tie Rod End	CV-ES-2774		
	05/94 →	Ball Head, gearshift linkage	CV-ES-2119		
	05/94 →	Ball Head, gearshift linkage	CV-ES-2120		
05/94 →	Ball Head, gearshift linkage	CV-ES-2182			
05/94 →	Centre Rod	MN-DL-0549	Push Rod		

CV-ES-2119

Length: 55
Cone Ø: d1 Ø 10 / d2 Ø 10
Thread: M12 x 1,75 LHT
81953016063, 81953016131



CV-ES-2120

Length: 115
Cone Ø: d1 Ø 12,4 / d2 Ø 10,8
Thread: M14 x 1,5 RHT
03008500A, 81953016200, 81953016202,
81953016203, 81953016227



CV-ES-2182

Length: 55
Cone Ø: d1 Ø 10 / d2 Ø 10
Thread: M12 x 1,75 RHT
81953016064, 81953016170



CV-ES-2774

Length: 95
Cone Ø: d1 Ø 20 / d2 Ø 18
Thread: M24 x 1,5 RHT
81953016134, 81953016142



CV-ES-12462

Length: 120
Cone Ø: d1 Ø 26 / d2 Ø 23,5
Thread: M30 x 1,5 RHT
90804102218, 90804153111, 81953010014,
81953010042, 81953010064, 81953010068,
81953016065, 81953016067, 81953016073,
81953016162, 81953016239, 81953016240,
81953016246, 81953016250, 81953016272,
81953016282, 81953016319, 81953016360,
82953016014



MN-DL-0549

Length: 820
Ø: 32
Cone Ø: d1 Ø 20 / d2 Ø 18
81466106725, 85466106102



MN-DL-2127

Length: 1670 Ø: 30
Cone Ø: d1 Ø 20 / d2 Ø 18
81467106865, 81467106866



MN-DL-2133

Length: 829
Ø: 38
Cone Ø: d1 Ø 22 / d2 Ø 20
81466106753, 81466106754, 85466106104



MN-DL-7781

Length: 1630 Ø: 35
Cone Ø: d1 Ø 22 / d2 Ø 20
81467106395, 81467106851, 81467106852,
81467106853, 81467116719, 81467116729,
81467116841



MN-DL-7835

Length: 1455
Ø: 35
Cone Ø: d1 Ø 22 / d2 Ø 20
81467106238, 81467106240, 81467106242,
81467106409, 81467106410, 81467106411



MN-DL-9381

Length: 840 Ø: 40
81432506007



MN-DL-12282

Length: 874 Ø: 36
Cone Ø: d1 Ø 26 / d2 Ø 23,5
85466106032, 85466106103, 85466106202



MN-RK-8723

Length: 100 Ø: 46
Hole Distance: 60
81432506009



MN-SB-5249

Length: 55 Ø: 71
Thick/Height: 80
03310200A, 81437040029



MN-TC-12471

Length: 840
Ø: 50
81432506014



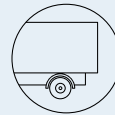

L 2000 ...

10.163 LLS, LLRS ...	05/94 →	Centre Rod	MN-DL-2127		Coupling Rod	
	05/94 →	Centre Rod	MN-DL-2133		Push Rod	
	05/94 →	Stabiliser Mounting		MN-SB-5249		
	05/94 →	Stabiliser Mounting		MN-SB-5249	1st RA	
	05/94 →	Suspension Arm Repair Kit		MN-RK-8723	for Drag Link;for Semi-Trailing Arm	
	05/94 →	Tie Rod	MN-DL-7781		Guide Rod	
	05/94 →	Tie Rod End	CV-ES-2774			
	05/94 →	Track Control Arm		MN-DL-9381	Control Arm, Air Suspension Axle	
	05/94 →	Track Control Arm		MN-TC-12471	Semi-Trailing Arm, 1st Drive Axle, for Pneumatic Suspension vehicles	
10.185 LAC, LAEC, LARC, LAERC, LA-LA (LE180C)	09/00 →	Ball Head, gearshift linkage	CV-ES-2119			
	09/00 →	Ball Head, gearshift linkage	CV-ES-2120			
	09/00 →	Ball Head, gearshift linkage	CV-ES-2182			
	09/00 →	Centre Rod	MN-DL-0549		Push Rod	
	09/00 →	Centre Rod	MN-DL-2127		Coupling Rod	
	09/00 →	Centre Rod	MN-DL-2133		Push Rod	
	09/00 →	Centre Rod	MN-DL-12282		for Steering Rod	
	09/00 →	Stabiliser Mounting		MN-SB-5249		
	09/00 →	Stabiliser Mounting		MN-SB-5249	1st RA	
	09/00 →	Tie Rod End	CV-ES-2774			
	09/00 →	Tie Rod End	CV-ES-12462		for Steering Rod	
	09/00 →	Centre Rod	MN-DL-12282		for Steering Rod	
	09/00 →	Tie Rod End	CV-ES-12462		for Steering Rod	
10.185 LAE-GT, LAE-LF	09/00 →	Centre Rod	MN-DL-12282		for Steering Rod	
09/00 →	Tie Rod End	CV-ES-12462		for Steering Rod		
10.185 LAEK, LAEK-L, LAERK, LAERK-L, LAK, LAK-L, LARK	09/00 →	Ball Head, gearshift linkage	CV-ES-2119			
	09/00 →	Ball Head, gearshift linkage	CV-ES-2120			
	09/00 →	Ball Head, gearshift linkage	CV-ES-2182			
	09/00 →	Centre Rod	MN-DL-0549		Push Rod	
	09/00 →	Centre Rod	MN-DL-2127		Coupling Rod	
	09/00 →	Centre Rod	MN-DL-2133		Push Rod	
	09/00 →	Centre Rod	MN-DL-12282		for Steering Rod	
	09/00 →	Stabiliser Mounting		MN-SB-5249		
	09/00 →	Stabiliser Mounting		MN-SB-5249	1st RA	
	09/00 →	Tie Rod End	CV-ES-2774			
	09/00 →	Tie Rod End	CV-ES-12462		for Steering Rod	
	10.185 LC, 10.185 LLC, LRC, LLRC (LE180C)	09/00 →	Ball Head, gearshift linkage	CV-ES-2119		
		09/00 →	Ball Head, gearshift linkage	CV-ES-2120		
09/00 →		Ball Head, gearshift linkage	CV-ES-2182			
09/00 →		Centre Rod	MN-DL-0549		Push Rod	
09/00 →		Centre Rod	MN-DL-2127		Coupling Rod	
09/00 →		Centre Rod	MN-DL-2133		Push Rod	
09/00 →		Stabiliser Mounting		MN-SB-5249		
09/00 →		Stabiliser Mounting		MN-SB-5249	1st RA	
09/00 →		Suspension Arm Repair Kit		MN-RK-8723	for Drag Link;for Semi-Trailing Arm	
09/00 →		Tie Rod	MN-DL-7781		Guide Rod	
09/00 →		Tie Rod End	CV-ES-2774			
09/00 →		Track Control Arm		MN-DL-9381	Control Arm, Air Suspension Axle	
09/00 →		Track Control Arm		MN-TC-12471	Semi-Trailing Arm, 1st Drive Axle, for Pneumatic Suspension vehicles	
10.185 LK, L-KI, LRK, LR-KI, LRK-L, LK-L (LE180C)	09/00 →	Ball Head, gearshift linkage	CV-ES-2119			
	09/00 →	Ball Head, gearshift linkage	CV-ES-2120			
	09/00 →	Ball Head, gearshift linkage	CV-ES-2182			
	09/00 →	Centre Rod	MN-DL-0549		Push Rod	
	09/00 →	Centre Rod	MN-DL-2127		Coupling Rod	
	09/00 →	Centre Rod	MN-DL-2133		Push Rod	
	09/00 →	Suspension Arm Repair Kit		MN-RK-8723	for Drag Link;for Semi-Trailing Arm	
	09/00 →	Tie Rod	MN-DL-7781		Guide Rod	
	09/00 →	Tie Rod End	CV-ES-2774			
10.185 LLS, LLRS (LE180C)	09/00 →	Ball Head, gearshift linkage	CV-ES-2119			
	09/00 →	Ball Head, gearshift linkage	CV-ES-2120			
	09/00 →	Ball Head, gearshift linkage	CV-ES-2182			
	09/00 →	Centre Rod	MN-DL-0549		Push Rod	
	09/00 →	Centre Rod	MN-DL-2127		Coupling Rod	
	09/00 →	Centre Rod	MN-DL-2133		Push Rod	

CV-ES-2119

Length: 55
Cone Ø: d1 Ø 10 / d2 Ø 10
Thread: M12 x 1,75 LHT
81953016063, 81953016131



CV-ES-2120

Length: 115
Cone Ø: d1 Ø 12,4 / d2 Ø 10,8
Thread: M14 x 1,5 RHT
03008500A, 81953016200, 81953016202,
81953016203, 81953016227



CV-ES-2182

Length: 55
Cone Ø: d1 Ø 10 / d2 Ø 10
Thread: M12 x 1,75 RHT
81953016064, 81953016170



CV-ES-2774

Length: 95
Cone Ø: d1 Ø 20 / d2 Ø 18
Thread: M24 x 1,5 RHT
81953016134, 81953016142



CV-ES-12462

Length: 120
Cone Ø: d1 Ø 26 / d2 Ø 23,5
Thread: M30 x 1,5 RHT
90804102218, 90804153111, 81953010014,
81953010042, 81953010064, 81953010068,
81953016065, 81953016067, 81953016073,
81953016162, 81953016239, 81953016240,
81953016246, 81953016250, 81953016272,
81953016282, 81953016319, 81953016360,
82953016014



MN-DL-0549

Length: 820
Ø: 32
Cone Ø: d1 Ø 20 / d2 Ø 18
81466106725, 85466106102



MN-DL-2127

Length: 1670 Ø: 30
Cone Ø: d1 Ø 20 / d2 Ø 18
81467106865, 81467106866



MN-DL-2133

Length: 829
Ø: 38
Cone Ø: d1 Ø 22 / d2 Ø 20
81466106753, 81466106754, 85466106104



MN-DL-7781

Length: 1630 Ø: 35
Cone Ø: d1 Ø 22 / d2 Ø 20
81467106395, 81467106851, 81467106852,
81467106853, 81467116719, 81467116729,
81467116841



MN-DL-9381

Length: 840 Ø: 40
81432506007



MN-DL-12282

Length: 874 Ø: 36
Cone Ø: d1 Ø 26 / d2 Ø 23,5
85466106032, 85466106103, 85466106202



MN-RK-8723

Length: 100 Ø: 46
Hole Distance: 60
81432506009



MN-SB-5249

Length: 55 Ø: 71
Thick/Height: 80
03310200A, 81437040029



MN-TC-12471

Length: 840 Ø: 50
81432506014





L 2000 ...

10.185 LLS, LLRS (LE180C) ...	09/00→	Stabiliser Mounting		MN-SB-5249	
	09/00→	Stabiliser Mounting		MN-SB-5249	1st RA
	09/00→	Suspension Arm Repair Kit		MN-RK-8723	for Drag Link;for Semi-Trailing Arm
	09/00→	Tie Rod	MN-DL-7781		Guide Rod
	09/00→	Tie Rod End	CV-ES-2774		
	09/00→	Track Control Arm		MN-DL-9381	Control Arm, Air Suspension Axle
	09/00→	Track Control Arm		MN-TC-12471	Semi-Trailing Arm, 1st Drive Axle, for Pneumatic Suspension vehicles
10.220 FOC,10.220 FOCL	02/95→	Ball Head, gearshift linkage	CV-ES-2120		
	02/95→	Stabiliser Mounting		MN-SB-5249	
	02/95→	Stabiliser Mounting		MN-SB-5249	1st RA
	02/95→	Suspension Arm Repair Kit		MN-RK-8723	for Drag Link;for Semi-Trailing Arm
	02/95→	Tie Rod	MN-DL-7781		Guide Rod
10.223 F, 10.223 FL	10/93→06/96	Centre Rod	MN-DL-2133		Push Rod
	10/93→06/96	Suspension Arm Repair Kit		MN-RK-8723	for Drag Link;for Semi-Trailing Arm
	10/93→06/96	Tie Rod	MN-DL-7781		Guide Rod, 1st Front Axle
	10/93→06/96	Track Control Arm		MN-DL-9381	Control Arm, 1st Drive Axle
	10/93→06/96	Track Control Arm		MN-TC-12471	Semi-Trailing Arm, 1st Drive Axle, for Pneumatic Suspension vehicles
10.223 FA	10/93→06/96	Centre Rod	MN-DL-2133		Push Rod
	10/93→06/96	Suspension Arm Repair Kit		MN-RK-8723	for Drag Link;for Semi-Trailing Arm
	10/93→06/96	Tie Rod	MN-DL-7781		Guide Rod, 1st Front Axle
	10/93→06/96	Track Control Arm		MN-DL-9381	Control Arm, 1st Drive Axle
	10/93→06/96	Track Control Arm		MN-TC-12471	Semi-Trailing Arm, 1st Drive Axle, for Pneumatic Suspension vehicles
10.223 LAEC	01/95→06/96	Ball Head, gearshift linkage	CV-ES-2119		
	01/95→06/96	Ball Head, gearshift linkage	CV-ES-2120		
	01/95→06/96	Ball Head, gearshift linkage	CV-ES-2182		
	01/95→06/96	Centre Rod	MN-DL-0549		Push Rod
	01/95→06/96	Centre Rod	MN-DL-2127		Coupling Rod
	01/95→06/96	Centre Rod	MN-DL-2133		Push Rod
	01/95→06/96	Centre Rod	MN-DL-12282		for Steering Rod
	01/95→06/96	Tie Rod End	CV-ES-2774		
	01/95→06/96	Tie Rod End	CV-ES-12462		for Steering Rod
10.223 LC, 10.223 LLC	10/93→06/96	Ball Head, gearshift linkage	CV-ES-2119		
	10/93→06/96	Ball Head, gearshift linkage	CV-ES-2120		
	10/93→06/96	Ball Head, gearshift linkage	CV-ES-2182		
	10/93→06/96	Centre Rod	MN-DL-0549		Push Rod
	10/93→06/96	Centre Rod	MN-DL-2127		Coupling Rod
	10/93→06/96	Centre Rod	MN-DL-2133		Push Rod
	10/93→06/96	Stabiliser Mounting		MN-SB-5249	
	10/93→06/96	Stabiliser Mounting		MN-SB-5249	1st RA
	10/93→06/96	Suspension Arm Repair Kit		MN-RK-8723	for Drag Link;for Semi-Trailing Arm
	10/93→06/96	Tie Rod	MN-DL-7781		Guide Rod
	10/93→06/96	Tie Rod End	CV-ES-2774		
	10/93→06/96	Track Control Arm		MN-DL-9381	Control Arm, Air Suspension Axle
	10/93→06/96	Track Control Arm		MN-TC-12471	Semi-Trailing Arm, 1st Drive Axle, for Pneumatic Suspension vehicles
	10.223 LK	10/93→06/96	Ball Head, gearshift linkage	CV-ES-2119	
10/93→06/96		Ball Head, gearshift linkage	CV-ES-2120		
10/93→06/96		Ball Head, gearshift linkage	CV-ES-2182		
10/93→06/96		Centre Rod	MN-DL-0549		Push Rod
10/93→06/96		Centre Rod	MN-DL-2127		Coupling Rod
10/93→06/96		Centre Rod	MN-DL-2133		Push Rod
10/93→06/96		Suspension Arm Repair Kit		MN-RK-8723	for Drag Link;for Semi-Trailing Arm
10/93→06/96		Tie Rod	MN-DL-7781		Guide Rod
10/93→06/96		Tie Rod End	CV-ES-2774		
10.223 LLS	10/93→06/96	Ball Head, gearshift linkage	CV-ES-2119		
	10/93→06/96	Ball Head, gearshift linkage	CV-ES-2120		
	10/93→06/96	Ball Head, gearshift linkage	CV-ES-2182		
	10/93→06/96	Centre Rod	MN-DL-0549		Push Rod
	10/93→06/96	Centre Rod	MN-DL-2127		Coupling Rod
10/93→06/96	Centre Rod	MN-DL-2133		Push Rod	

CV-ES-2119

Length: 55
Cone Ø: d1 Ø 10 / d2 Ø 10
Thread: M12 x 1,75 LHT
81953016063, 81953016131



CV-ES-2120

Length: 115
Cone Ø: d1 Ø 12,4 / d2 Ø 10,8
Thread: M14 x 1,5 RHT
03008500A, 81953016200, 81953016202,
81953016203, 81953016227



CV-ES-2182

Length: 55
Cone Ø: d1 Ø 10 / d2 Ø 10
Thread: M12 x 1,75 RHT
81953016064, 81953016170



CV-ES-2774

Length: 95
Cone Ø: d1 Ø 20 / d2 Ø 18
Thread: M24 x 1,5 RHT
81953016134, 81953016142



CV-ES-12462

Length: 120
Cone Ø: d1 Ø 26 / d2 Ø 23,5
Thread: M30 x 1,5 RHT
90804102218, 90804153111, 81953010014,
81953010042, 81953010064, 81953010068,
81953016065, 81953016067, 81953016073,
81953016162, 81953016239, 81953016240,
81953016246, 81953016250, 81953016272,
81953016282, 81953016319, 81953016360,
82953016014



MN-DL-0549

Length: 820
Ø: 32
Cone Ø: d1 Ø 20 / d2 Ø 18
81466106725, 85466106102



MN-DL-2127

Length: 1670 Ø: 30
Cone Ø: d1 Ø 20 / d2 Ø 18
81467106865, 81467106866



MN-DL-2133

Length: 829
Ø: 38
Cone Ø: d1 Ø 22 / d2 Ø 20
81466106753, 81466106754, 85466106104



MN-DL-7781

Length: 1630 Ø: 35
Cone Ø: d1 Ø 22 / d2 Ø 20
81467106395, 81467106851, 81467106852,
81467106853, 81467116719, 81467116729,
81467116841



MN-DL-9381

Length: 840 Ø: 40
81432506007



MN-DL-12282

Length: 874 Ø: 36
Cone Ø: d1 Ø 26 / d2 Ø 23,5
85466106032, 85466106103, 85466106202



MN-RK-8723

Length: 100 Ø: 46
Hole Distance: 60
81432506009



MN-SB-5249

Length: 55 Ø: 71
Thick/Height: 80
03310200A, 81437040029



MN-TC-12471

Length: 840
Ø: 50
81432506014





L 2000 ...

10.223 LLS ...	10/93→06/96	Stabiliser Mounting		MN-SB-5249		
	10/93→06/96	Stabiliser Mounting		MN-SB-5249	1st RA	
	10/93→06/96	Suspension Arm Repair Kit		MN-RK-8723	for Drag Link;for Semi-Trailing Arm	
	10/93→06/96	Tie Rod	MN-DL-7781		Guide Rod	
	10/93→06/96	Tie Rod End	CV-ES-2774			
	10/93→06/96	Track Control Arm		MN-DL-9381	Control Arm, Air Suspension Axle	
	10/93→06/96	Track Control Arm		MN-TC-12471	Semi-Trailing Arm, 1st Drive Axle, for Pneumatic Suspension vehicles	
10.224 F, 10.224 FL	05/94→	Centre Rod	MN-DL-2133		Push Rod	
	05/94→	Suspension Arm Repair Kit		MN-RK-8723	for Drag Link;for Semi-Trailing Arm	
	05/94→	Tie Rod	MN-DL-7781		Guide Rod, 1st Front Axle	
	05/94→	Track Control Arm		MN-DL-9381	Control Arm, 1st Drive Axle	
	05/94→	Track Control Arm		MN-TC-12471	Semi-Trailing Arm, 1st Drive Axle, for Pneumatic Suspension vehicles	
10.224 FA	05/94→	Tie Rod End	CV-ES-12462		for Steering Rod	
10.224 LAC, LAEC, LARC, LAERC	01/95→	Ball Head, gearshift linkage	CV-ES-2119			
	01/95→	Ball Head, gearshift linkage	CV-ES-2120			
	01/95→	Ball Head, gearshift linkage	CV-ES-2182			
	01/95→	Centre Rod	MN-DL-0549		Push Rod	
	01/95→	Centre Rod	MN-DL-2127		Coupling Rod	
	01/95→	Centre Rod	MN-DL-2133		Push Rod	
	01/95→	Centre Rod	MN-DL-12282		for Steering Rod	
	01/95→	Tie Rod End	CV-ES-2774			
	01/95→	Tie Rod End	CV-ES-12462		for Steering Rod	
	10.224 LAEK, LAEK-L, LAERK, LAERK-L, LAK, LAK-L, LARK	01/95→	Ball Head, gearshift linkage	CV-ES-2119		
01/95→		Ball Head, gearshift linkage	CV-ES-2120			
01/95→		Ball Head, gearshift linkage	CV-ES-2182			
01/95→		Centre Rod	MN-DL-0549		Push Rod	
01/95→		Centre Rod	MN-DL-2127		Coupling Rod	
01/95→		Centre Rod	MN-DL-2133		Push Rod	
01/95→		Centre Rod	MN-DL-12282		for Steering Rod	
01/95→		Tie Rod End	CV-ES-2774			
01/95→		Tie Rod End	CV-ES-12462		for Steering Rod	
10.224 LC, 10.224 LLC, LRC, LLRC		05/94→	Ball Head, gearshift linkage	CV-ES-2119		
	05/94→	Ball Head, gearshift linkage	CV-ES-2120			
	05/94→	Ball Head, gearshift linkage	CV-ES-2182			
	05/94→	Centre Rod	MN-DL-0549		Push Rod	
	05/94→	Centre Rod	MN-DL-2127		Coupling Rod	
	05/94→	Centre Rod	MN-DL-2133		Push Rod	
	05/94→	Stabiliser Mounting		MN-SB-5249		
	05/94→	Stabiliser Mounting		MN-SB-5249	1st RA	
	05/94→	Suspension Arm Repair Kit		MN-RK-8723	for Drag Link;for Semi-Trailing Arm	
	05/94→	Tie Rod	MN-DL-7781		Guide Rod	
	05/94→	Tie Rod End	CV-ES-2774			
	05/94→	Track Control Arm		MN-DL-9381	Control Arm, Air Suspension Axle	
	05/94→	Track Control Arm		MN-TC-12471	Semi-Trailing Arm, 1st Drive Axle, for Pneumatic Suspension vehicles	
	10.224 LK, L-KI, LRK, LR-KI, LRK-L, LK-L	05/94→	Ball Head, gearshift linkage	CV-ES-2119		
		05/94→	Ball Head, gearshift linkage	CV-ES-2120		
05/94→		Ball Head, gearshift linkage	CV-ES-2182			
05/94→		Centre Rod	MN-DL-0549		Push Rod	
05/94→		Centre Rod	MN-DL-2127		Coupling Rod	
05/94→		Centre Rod	MN-DL-2133		Push Rod	
05/94→		Suspension Arm Repair Kit		MN-RK-8723	for Drag Link;for Semi-Trailing Arm	
05/94→		Tie Rod	MN-DL-7781		Guide Rod	
05/94→		Tie Rod End	CV-ES-2774			
10.224 LLS, LLRS	05/94→	Ball Head, gearshift linkage	CV-ES-2119			
	05/94→	Ball Head, gearshift linkage	CV-ES-2120			
	05/94→	Ball Head, gearshift linkage	CV-ES-2182			
	05/94→	Centre Rod	MN-DL-0549		Push Rod	
	05/94→	Centre Rod	MN-DL-2127		Coupling Rod	
	05/94→	Centre Rod	MN-DL-2133		Push Rod	
	05/94→	Stabiliser Mounting		MN-SB-5249		

CV-ES-2119

Length: 55
Cone Ø: d1 Ø 10 / d2 Ø 10
Thread: M12 x 1,75 LHT
81953016063, 81953016131



CV-ES-2120

Length: 115
Cone Ø: d1 Ø 12,4 / d2 Ø 10,8
Thread: M14 x 1,5 RHT
03008500A, 81953016200, 81953016202,
81953016203, 81953016227



CV-ES-2182

Length: 55
Cone Ø: d1 Ø 10 / d2 Ø 10
Thread: M12 x 1,75 RHT
81953016064, 81953016170



CV-ES-2774

Length: 95
Cone Ø: d1 Ø 20 / d2 Ø 18
Thread: M24 x 1,5 RHT
81953016134, 81953016142



CV-ES-12462

Length: 120
Cone Ø: d1 Ø 26 / d2 Ø 23,5
Thread: M30 x 1,5 RHT
90804102218, 90804153111, 81953010014,
81953010042, 81953010064, 81953010068,
81953016065, 81953016067, 81953016073,
81953016162, 81953016239, 81953016240,
81953016246, 81953016250, 81953016272,
81953016282, 81953016319, 81953016360,
82953016014



MN-DL-0549

Length: 820
Ø: 32
Cone Ø: d1 Ø 20 / d2 Ø 18
81466106725, 85466106102



MN-DL-2127

Length: 1670 Ø: 30
Cone Ø: d1 Ø 20 / d2 Ø 18
81467106865, 81467106866



MN-DL-2133

Length: 829
Ø: 38
Cone Ø: d1 Ø 22 / d2 Ø 20
81466106753, 81466106754, 85466106104



MN-DL-7781

Length: 1630 Ø: 35
Cone Ø: d1 Ø 22 / d2 Ø 20
81467106395, 81467106851, 81467106852,
81467106853, 81467116719, 81467116729,
81467116841



MN-DL-9381

Length: 840 Ø: 40
81432506007



MN-DL-12282

Length: 874 Ø: 36
Cone Ø: d1 Ø 26 / d2 Ø 23,5
85466106032, 85466106103, 85466106202



MN-RK-8723

Length: 100 Ø: 46
Hole Distance: 60
81432506009



MN-SB-5249

Length: 55 Ø: 71
Thick/Height: 80
03310200A, 81437040029



MN-TC-12471

Length: 840
Ø: 50
81432506014





L 2000 ...

10.224 LLS, LLRS ...	05/94 →	Stabiliser Mounting		MN-SB-5249	1st RA
	05/94 →	Suspension Arm Repair Kit		MN-RK-8723	for Drag Link;for Semi-Trailing Arm
	05/94 →	Tie Rod	MN-DL-7781		Guide Rod
	05/94 →	Tie Rod End	CV-ES-2774		
	05/94 →	Track Control Arm		MN-DL-9381	Control Arm, Air Suspension Axle
	05/94 →	Track Control Arm		MN-TC-12471	Semi-Trailing Arm, 1st Drive Axle, for Pneumatic Suspension vehicles
10.225 LAC, LAEC, LARC, LAERC (LE220C)	09/00 →	Ball Head, gearshift linkage	CV-ES-2119		
	09/00 →	Ball Head, gearshift linkage	CV-ES-2120		
	09/00 →	Ball Head, gearshift linkage	CV-ES-2182		
	09/00 →	Centre Rod	MN-DL-0549		Push Rod
	09/00 →	Centre Rod	MN-DL-2127		Coupling Rod
	09/00 →	Centre Rod	MN-DL-2133		Push Rod
	09/00 →	Centre Rod	MN-DL-12282		for Steering Rod
	09/00 →	Tie Rod End	CV-ES-2774		
10.225 LAE-GT, LAE-LF	09/00 →	Centre Rod	MN-DL-12282		for Steering Rod
	09/00 →	Centre Rod	MN-DL-12282		for Steering Rod
10.225 LAEK, LAEK-L, LAERK, LAERK-L, LAK, LAK-L, LARK	09/00 →	Ball Head, gearshift linkage	CV-ES-2119		
	09/00 →	Ball Head, gearshift linkage	CV-ES-2120		
	09/00 →	Ball Head, gearshift linkage	CV-ES-2182		
	09/00 →	Centre Rod	MN-DL-0549		Push Rod
	09/00 →	Centre Rod	MN-DL-2127		Coupling Rod
	09/00 →	Centre Rod	MN-DL-2133		Push Rod
	09/00 →	Centre Rod	MN-DL-12282		for Steering Rod
	09/00 →	Tie Rod End	CV-ES-2774		
10.225 LC, 10.225 LLC, LRC, LLRC	09/00 →	Centre Rod	MN-DL-2133		Push Rod
	09/00 →	Suspension Arm Repair Kit		MN-RK-8723	for Drag Link;for Semi-Trailing Arm
	09/00 →	Tie Rod	MN-DL-7781		Guide Rod, 1st Front Axle
	09/00 →	Track Control Arm		MN-DL-9381	Control Arm
	09/00 →	Track Control Arm		MN-TC-12471	Semi-Trailing Arm, 1st Drive Axle, for Pneumatic Suspension vehicles
10.225 LC, 10.225 LLC, LRC, LLRC (LE220C)	09/00 →	Ball Head, gearshift linkage	CV-ES-2119		
	09/00 →	Ball Head, gearshift linkage	CV-ES-2120		
	09/00 →	Ball Head, gearshift linkage	CV-ES-2182		
	09/00 →	Centre Rod	MN-DL-0549		Push Rod
	09/00 →	Centre Rod	MN-DL-2127		Coupling Rod
	09/00 →	Centre Rod	MN-DL-2133		Push Rod
	09/00 →	Stabiliser Mounting		MN-SB-5249	
	09/00 →	Stabiliser Mounting		MN-SB-5249	1st RA
	09/00 →	Suspension Arm Repair Kit		MN-RK-8723	for Drag Link;for Semi-Trailing Arm
	09/00 →	Tie Rod	MN-DL-7781		Guide Rod
	09/00 →	Tie Rod End	CV-ES-2774		
	09/00 →	Track Control Arm		MN-DL-9381	Control Arm, Air Suspension Axle
	09/00 →	Track Control Arm		MN-TC-12471	Semi-Trailing Arm, 1st Drive Axle, for Pneumatic Suspension vehicles
10.225 LK, L-KI, LRK, LR-KI, LRK-L, LK-L (LE220C)	09/00 →	Ball Head, gearshift linkage	CV-ES-2119		
	09/00 →	Ball Head, gearshift linkage	CV-ES-2120		
	09/00 →	Ball Head, gearshift linkage	CV-ES-2182		
	09/00 →	Centre Rod	MN-DL-0549		Push Rod
	09/00 →	Centre Rod	MN-DL-2127		Coupling Rod
	09/00 →	Centre Rod	MN-DL-2133		Push Rod
	09/00 →	Suspension Arm Repair Kit		MN-RK-8723	for Drag Link;for Semi-Trailing Arm
	09/00 →	Tie Rod	MN-DL-7781		Guide Rod
10.225 LLS, LLRS (LE220C)	09/00 →	Tie Rod End	CV-ES-2774		
	09/00 →	Ball Head, gearshift linkage	CV-ES-2119		
	09/00 →	Ball Head, gearshift linkage	CV-ES-2120		
	09/00 →	Ball Head, gearshift linkage	CV-ES-2182		
	09/00 →	Centre Rod	MN-DL-0549		Push Rod
	09/00 →	Centre Rod	MN-DL-2127		Coupling Rod
	09/00 →	Centre Rod	MN-DL-2133		Push Rod
	09/00 →	Stabiliser Mounting		MN-SB-5249	
09/00 →	Stabiliser Mounting		MN-SB-5249	1st RA	

CV-ES-2119

Length: 55
Cone Ø: d1 Ø 10 / d2 Ø 10
Thread: M12 x 1,75 LHT
81953016063, 81953016131



CV-ES-2120

Length: 115
Cone Ø: d1 Ø 12,4 / d2 Ø 10,8
Thread: M14 x 1,5 RHT
03008500A, 81953016200, 81953016202,
81953016203, 81953016227



CV-ES-2182

Length: 55
Cone Ø: d1 Ø 10 / d2 Ø 10
Thread: M12 x 1,75 RHT
81953016064, 81953016170



CV-ES-2774

Length: 95
Cone Ø: d1 Ø 20 / d2 Ø 18
Thread: M24 x 1,5 RHT
81953016134, 81953016142



CV-ES-12462

Length: 120
Cone Ø: d1 Ø 26 / d2 Ø 23,5
Thread: M30 x 1,5 RHT
90804102218, 90804153111, 81953010014,
81953010042, 81953010064, 81953010068,
81953016065, 81953016067, 81953016073,
81953016162, 81953016239, 81953016240,
81953016246, 81953016250, 81953016272,
81953016282, 81953016319, 81953016360,
82953016014



MN-DL-0549

Length: 820
Ø: 32
Cone Ø: d1 Ø 20 / d2 Ø 18
81466106725, 85466106102



MN-DL-2127

Length: 1670 Ø: 30
Cone Ø: d1 Ø 20 / d2 Ø 18
81467106865, 81467106866



MN-DL-2133

Length: 829
Ø: 38
Cone Ø: d1 Ø 22 / d2 Ø 20
81466106753, 81466106754, 85466106104



MN-DL-7781

Length: 1630 Ø: 35
Cone Ø: d1 Ø 22 / d2 Ø 20
81467106395, 81467106851, 81467106852,
81467106853, 81467116719, 81467116729,
81467116841



MN-DL-9381

Length: 840 Ø: 40
81432506007



MN-DL-12282

Length: 874 Ø: 36
Cone Ø: d1 Ø 26 / d2 Ø 23,5
85466106032, 85466106103, 85466106202



MN-RK-8723

Length: 100 Ø: 46
Hole Distance: 60
81432506009



MN-SB-5249

Length: 55 Ø: 71
Thick/Height: 80
03310200A, 81437040029



MN-TC-12471

Length: 840
Ø: 50
81432506014





L 2000 ...

10.225 LLS, LLRS (LE220C) ...	09/00→	Suspension Arm Repair Kit		MN-RK-8723	for Drag Link;for Semi-Trailing Arm
	09/00→	Tie Rod	MN-DL-7781		Guide Rod
	09/00→	Tie Rod End	CV-ES-2774		
	09/00→	Track Control Arm		MN-DL-9381	Control Arm, Air Suspension Axle
	09/00→	Track Control Arm		MN-TC-12471	Semi-Trailing Arm, 1st Drive Axle, for Pneumatic Suspension vehicles
12.185 LC, LLC (LE180C)	09/99→	Ball Head, gearshift linkage	CV-ES-2120		
	09/99→	Stabiliser Mounting		MN-SB-5249	
	09/99→	Stabiliser Mounting		MN-SB-5249	1st RA
	09/99→	Suspension Arm Repair Kit		MN-RK-9383	for Control Arm
	09/99→	Tie Rod	MN-DL-7781		Guide Rod
12.225 LC, LLC (LE220C)	09/99→	Ball Head, gearshift linkage	CV-ES-2120		
	09/99→	Tie Rod	MN-DL-7781		Guide Rod
	09/99→	Track Control Arm		MN-DL-8714	Trailing Arm, Air Suspension Axle
8.103 LC, 8.103 LLC	10/93→06/96	Ball Head, gearshift linkage	CV-ES-2120		
	10/93→06/96	Centre Rod	MN-DL-0549		Push Rod
	10/93→06/96	Centre Rod	MN-DL-2127		Coupling Rod
	10/93→06/96	Centre Rod	MN-DL-2133		Push Rod
	10/93→06/96	Centre Rod	MN-DL-8378		Push Rod
	10/93→06/96	Stabiliser Mounting		MN-SB-5249	
	10/93→06/96	Stabiliser Mounting		MN-SB-5249	1st RA
	10/93→06/96	Suspension Arm Repair Kit		MN-RK-8723	for Drag Link;for Semi-Trailing Arm
	10/93→06/96	Tie Rod	MN-DL-7781		Guide Rod
	10/93→06/96	Tie Rod	MN-DL-7835		
	10/93→06/96	Tie Rod End	CV-ES-2774		
	10/93→06/96	Tie Rod End	CV-ES-14163		for Steering Rod
	10/93→06/96	Track Control Arm		MN-DL-9381	Control Arm, Air Suspension Axle
	10/93→06/96	Track Control Arm		MN-TC-12471	Semi-Trailing Arm, 1st Drive Axle, for Pneumatic Suspension vehicles
8.103 LK	10/93→06/96	Ball Head, gearshift linkage	CV-ES-2120		
	10/93→06/96	Centre Rod	MN-DL-0549		Push Rod
	10/93→06/96	Centre Rod	MN-DL-2127		Coupling Rod
	10/93→06/96	Centre Rod	MN-DL-2133		Push Rod
	10/93→06/96	Centre Rod	MN-DL-8378		Push Rod
	10/93→06/96	Suspension Arm Repair Kit		MN-RK-8723	for Drag Link;for Semi-Trailing Arm
	10/93→06/96	Tie Rod	MN-DL-7781		Guide Rod
	10/93→06/96	Tie Rod	MN-DL-7835		
	10/93→06/96	Tie Rod End	CV-ES-2774		
	10/93→06/96	Tie Rod End	CV-ES-14163		for Steering Rod
8.113 LC, 8.113 LLC	08/95→	Ball Head, gearshift linkage	CV-ES-2120		
	08/95→	Centre Rod	MN-DL-0549		Push Rod
	08/95→	Centre Rod	MN-DL-2127		Coupling Rod
	08/95→	Centre Rod	MN-DL-2133		Push Rod
	08/95→	Centre Rod	MN-DL-8378		Push Rod
	08/95→	Stabiliser Mounting		MN-SB-5249	
	08/95→	Stabiliser Mounting		MN-SB-5249	1st RA
	08/95→	Suspension Arm Repair Kit		MN-RK-8723	for Drag Link;for Semi-Trailing Arm
	08/95→	Tie Rod	MN-DL-7781		Guide Rod
	08/95→	Tie Rod	MN-DL-7835		
	08/95→	Tie Rod End	CV-ES-2774		
	08/95→	Tie Rod End	CV-ES-14163		for Steering Rod
	08/95→	Track Control Arm		MN-DL-9381	Control Arm, Air Suspension Axle
08/95→	Track Control Arm		MN-TC-12471	Semi-Trailing Arm, 1st Drive Axle, for Pneumatic Suspension vehicles	
8.113 LC,8.113 LLC, LRC, LLRC(LE110C)	09/00→	Ball Head, gearshift linkage	CV-ES-2120		
	09/00→	Centre Rod	MN-DL-0549		Push Rod
	09/00→	Centre Rod	MN-DL-2127		Coupling Rod
	09/00→	Centre Rod	MN-DL-2133		Push Rod
	09/00→	Centre Rod	MN-DL-8378		Push Rod
	09/00→	Stabiliser Mounting		MN-SB-5249	
	09/00→	Suspension Arm Repair Kit		MN-RK-8723	for Drag Link;for Semi-Trailing Arm

CV-ES-2120

Length: 115
Cone Ø: d1 Ø 12,4 / d2 Ø 10,8
Thread: M14 x 1,5 RHT
03008500A, 81953016200, 81953016202,
81953016203, 81953016227



CV-ES-2774

Length: 95
Cone Ø: d1 Ø 20 / d2 Ø 18
Thread: M24 x 1,5 RHT
81953016134, 81953016142



CV-ES-14163

Length: 125
Cone Ø: d1 Ø 30 / d2 Ø 27
Thread: M30 x 1,5 RHT
95301.0084, 90804102156, 90804102272,
90804102696, 90804102710, 81953010016,
81953010075, 81953010084, 81953010088,
81953010094, 81953010103, 81953016030,
81953016043, 81953016048, 81953016049,
81953016053, 81953016061, 81953016090,
81953016108, 81953016112, 81953016126,
81953016143, 81953016149, 81953016154,
81953016156, 81953016168, 81953016178,
81953016194, 81953016206, 81953016224,
81953016234, 81953016242, 81953016252,
81953016274, 81953016278, 81953016284,
81953016286, 81953016308, 81953016310,
81953016312, 81953016347, 81953016350,
81953016352, 82953016012, 88953016014,
N2953016001



MN-DL-0549

Length: 820
Ø: 32
Cone Ø: d1 Ø 20 / d2 Ø 18
81466106725, 85466106102



MN-DL-2127

Length: 1670 Ø: 30
Cone Ø: d1 Ø 20 / d2 Ø 18
81467106865, 81467106866



MN-DL-2133

Length: 829
Ø: 38
Cone Ø: d1 Ø 22 / d2 Ø 20
81466106753, 81466106754, 85466106104



MN-DL-7781

Length: 1630 Ø: 35
Cone Ø: d1 Ø 22 / d2 Ø 20
81467106395, 81467106851, 81467106852,
81467106853, 81467116719, 81467116729,
81467116841



MN-DL-7835

Length: 1455
Ø: 35
Cone Ø: d1 Ø 22 / d2 Ø 20
81467106238, 81467106240, 81467106242,
81467106409, 81467106410, 81467106411



MN-DL-8378

Length: 882 Ø: 38
Cone Ø: d1 Ø 30 / d2 Ø 26
85466106156



MN-DL-8714

Length: 540
Ø: 38
Hole Distance: 100 / 100
81432206216



MN-DL-9381

Length: 840 Ø: 40
81432506007



MN-RK-8723

Length: 100 Ø: 46
Hole Distance: 60
81432506009



MN-RK-9383

Ø: 67
Hole Distance: 100
Thick/Height: 24
81432206202



MN-SB-5249

Length: 55 Ø: 71
Thick/Height: 80
03310200A, 81437040029



MN-TC-12471

Length: 840
Ø: 50
81432506014





L 2000 ...

8.113 LC,8.113 LLC, LRC, LLRC(LE110C) ...	09/00→	Tie Rod	MN-DL-7781		Guide Rod
	09/00→	Tie Rod End	CV-ES-2774		
	09/00→	Tie Rod End	CV-ES-14163		for Steering Rod
	09/00→	Track Control Arm		MN-DL-9381	Control Arm, Air Suspension Axle
	09/00→	Track Control Arm		MN-TC-12471	Semi-Trailing Arm, 1st Drive Axle, for Pneumatic Suspension vehicles
8.113 LK, L-KI, LRK, LR-KI, LRK-L, LK-L	08/95→	Ball Head, gearshift linkage	CV-ES-2120		
	08/95→	Centre Rod	MN-DL-0549		Push Rod
	08/95→	Centre Rod	MN-DL-2127		Coupling Rod
	08/95→	Centre Rod	MN-DL-2133		Push Rod
	08/95→	Centre Rod	MN-DL-8378		Push Rod
	08/95→	Suspension Arm Repair Kit		MN-RK-8723	for Drag Link;for Semi-Trailing Arm
	08/95→	Tie Rod	MN-DL-7781		Guide Rod
	08/95→	Tie Rod	MN-DL-7835		
	08/95→	Tie Rod End	CV-ES-2774		
	08/95→	Tie Rod End	CV-ES-14163		for Steering Rod
	08/95→	Tie Rod End	CV-ES-14163		for Steering Rod
8.145 LA-LF, LAE-LF	07/00→	Centre Rod	MN-DL-12282		for Steering Rod
	07/00→	Tie Rod End	CV-ES-12462		for Steering Rod
8.145 LC, LLC, LLRC, LRC (LE140C)	09/00→	Ball Head, gearshift linkage	CV-ES-2120		
	09/00→	Centre Rod	MN-DL-0549		Push Rod
	09/00→	Centre Rod	MN-DL-2127		Coupling Rod
	09/00→	Centre Rod	MN-DL-2133		Push Rod
	09/00→	Centre Rod	MN-DL-8378		Push Rod
	09/00→	Stabiliser Mounting		MN-SB-5249	
	09/00→	Stabiliser Mounting		MN-SB-5249	1st RA
	09/00→	Suspension Arm Repair Kit		MN-RK-8723	for Drag Link;for Semi-Trailing Arm
	09/00→	Tie Rod	MN-DL-7781		Guide Rod
	09/00→	Tie Rod End	CV-ES-2774		
	09/00→	Tie Rod End	CV-ES-14163		for Steering Rod
	09/00→	Track Control Arm		MN-DL-9381	Control Arm, Air Suspension Axle
	09/00→	Track Control Arm		MN-TC-12471	Semi-Trailing Arm, 1st Drive Axle, for Pneumatic Suspension vehicles
	8.145 LK, LRK, L-KI, LRK-L, LK-L, LR-KILK (LE140C)	09/00→	Ball Head, gearshift linkage	CV-ES-2120	
09/00→		Centre Rod	MN-DL-0549		Push Rod
09/00→		Centre Rod	MN-DL-2127		Coupling Rod
09/00→		Centre Rod	MN-DL-2133		Push Rod
09/00→		Centre Rod	MN-DL-8378		Push Rod
09/00→		Suspension Arm Repair Kit		MN-RK-8723	for Drag Link;for Semi-Trailing Arm
09/00→		Tie Rod	MN-DL-7781		Guide Rod
09/00→		Tie Rod End	CV-ES-2774		
09/00→		Tie Rod End	CV-ES-14163		for Steering Rod
09/00→		Tie Rod End	CV-ES-14163		for Steering Rod
8.145 L-LF	09/00→	Centre Rod	MN-DL-0549		Push Rod
	09/00→	Centre Rod	MN-DL-2127		Coupling Rod
	09/00→	Centre Rod	MN-DL-2133		Push Rod
	09/00→	Suspension Arm Repair Kit		MN-RK-8723	for Drag Link;for Semi-Trailing Arm
	09/00→	Tie Rod	MN-DL-7781		Guide Rod
	09/00→	Track Control Arm		MN-DL-9381	Control Arm, 1st Drive Axle
	09/00→	Track Control Arm		MN-TC-12471	Semi-Trailing Arm, 1st Drive Axle, for Pneumatic Suspension vehicles
8.145 LLS, LLRS (LE140C)	09/00→	Ball Head, gearshift linkage	CV-ES-2120		
	09/00→	Centre Rod	MN-DL-0549		Push Rod
	09/00→	Centre Rod	MN-DL-2127		Coupling Rod
	09/00→	Centre Rod	MN-DL-2133		Push Rod
	09/00→	Stabiliser Mounting		MN-SB-5249	
	09/00→	Stabiliser Mounting		MN-SB-5249	1st RA
	09/00→	Suspension Arm Repair Kit		MN-RK-8723	for Drag Link;for Semi-Trailing Arm
	09/00→	Tie Rod	MN-DL-7781		Guide Rod
	09/00→	Tie Rod End	CV-ES-2774		
	09/00→	Track Control Arm		MN-DL-9381	Control Arm, Air Suspension Axle
09/00→	Track Control Arm		MN-TC-12471	Semi-Trailing Arm, 1st Drive Axle, for Pneumatic Suspension vehicles	
8.145, LA-LF LAE-LF	07/00→	Ball Head, gearshift linkage	CV-ES-2120		
	07/00→	Tie Rod End	CV-ES-12462		for Steering Rod

CV-ES-2120

Length: 115
Cone Ø: d1 Ø 12,4 / d2 Ø 10,8
Thread: M14 x 1,5 RHT
03008500A, 81953016200, 81953016202,
81953016203, 81953016227



CV-ES-2774

Length: 95
Cone Ø: d1 Ø 20 / d2 Ø 18
Thread: M24 x 1,5 RHT
81953016134, 81953016142



CV-ES-12462

Length: 120
Cone Ø: d1 Ø 26 / d2 Ø 23,5
Thread: M30 x 1,5 RHT
90804102218, 90804153111, 81953010014,
81953010042, 81953010064, 81953010068,
81953016065, 81953016067, 81953016073,
81953016162, 81953016239, 81953016240,
81953016246, 81953016250, 81953016272,
81953016282, 81953016319, 81953016360,
82953016014



CV-ES-14163

Length: 125
Cone Ø: d1 Ø 30 / d2 Ø 27
Thread: M30 x 1,5 RHT
95301.0084, 90804102156, 90804102272,
90804102696, 90804102710, 81953010016,
81953010075, 81953010084, 81953010088,
81953010094, 81953010103, 81953016030,
81953016043, 81953016048, 81953016049,
81953016053, 81953016061, 81953016090,
81953016108, 81953016112, 81953016126,
81953016143, 81953016149, 81953016154,
81953016156, 81953016168, 81953016178,
81953016194, 81953016206, 81953016224,
81953016234, 81953016242, 81953016252,
81953016274, 81953016278, 81953016284,
81953016286, 81953016308, 81953016310,
81953016312, 81953016347, 81953016350,
81953016352, 82953016012, 88953016014,
N2953016001



MN-DL-0549

Length: 820
Ø: 32
Cone Ø: d1 Ø 20 / d2 Ø 18
81466106725, 85466106102



MN-DL-2127

Length: 1670 Ø: 30
Cone Ø: d1 Ø 20 / d2 Ø 18
81467106865, 81467106866



MN-DL-2133

Length: 829
Ø: 38
Cone Ø: d1 Ø 22 / d2 Ø 20
81466106753, 81466106754, 85466106104



MN-DL-7781

Length: 1630 Ø: 35
Cone Ø: d1 Ø 22 / d2 Ø 20
81467106395, 81467106851, 81467106852,
81467106853, 81467116719, 81467116729,
81467116841



MN-DL-7835

Length: 1455
Ø: 35
Cone Ø: d1 Ø 22 / d2 Ø 20
81467106238, 81467106240, 81467106242,
81467106409, 81467106410, 81467106411



MN-DL-8378

Length: 882 Ø: 38
Cone Ø: d1 Ø 30 / d2 Ø 26
85466106156



MN-DL-9381

Length: 840 Ø: 40
81432506007



MN-DL-12282

Length: 874 Ø: 36
Cone Ø: d1 Ø 26 / d2 Ø 23,5
85466106032, 85466106103, 85466106202



MN-RK-8723

Length: 100 Ø: 46
Hole Distance: 60
81432506009



MN-SB-5249

Length: 55 Ø: 71
Thick/Height: 80
03310200A, 81437040029



MN-TC-12471

Length: 840
Ø: 50
81432506014





L 2000 ...

8.150 FOC,8.150 FOCL	02/95→	Ball Head, gearshift linkage	CV-ES-2120		
	02/95→	Tie Rod	MN-DL-7781	Guide Rod	
	02/95→	Track Control Arm	MN-DL-9381	Control Arm, Air Suspension Axle	
8.153 LAEC	01/95→06/96	Ball Head, gearshift linkage	CV-ES-2120		
	01/95→06/96	Centre Rod	MN-DL-0549	Push Rod	
	01/95→06/96	Centre Rod	MN-DL-2127	Coupling Rod	
	01/95→06/96	Centre Rod	MN-DL-2133	Push Rod	
	01/95→06/96	Centre Rod	MN-DL-12282	for Steering Rod	
	01/95→06/96	Tie Rod End	CV-ES-2774		
	01/95→06/96	Tie Rod End	CV-ES-12462	for Steering Rod	
	8.153 LAEK	01/95→09/96	Ball Head, gearshift linkage	CV-ES-2120	
01/95→09/96		Centre Rod	MN-DL-0549	Push Rod	
01/95→09/96		Centre Rod	MN-DL-2127	Coupling Rod	
01/95→09/96		Centre Rod	MN-DL-2133	Push Rod	
01/95→09/96		Centre Rod	MN-DL-12282	for Steering Rod	
01/95→09/96		Tie Rod End	CV-ES-2774		
01/95→09/96		Tie Rod End	CV-ES-12462	for Steering Rod	
8.153 LC,8.153 LLC		10/93→07/97	Ball Head, gearshift linkage	CV-ES-2120	
	10/93→07/97	Centre Rod	MN-DL-0549	Push Rod	
	10/93→07/97	Centre Rod	MN-DL-2127	Coupling Rod	
	10/93→07/97	Centre Rod	MN-DL-2133	Push Rod	
	10/93→07/97	Centre Rod	MN-DL-8378	Push Rod	
	10/93→07/97	Stabiliser Mounting		MN-SB-5249	
	10/93→07/97	Stabiliser Mounting		MN-SB-5249	1st RA
	10/93→07/97	Suspension Arm Repair Kit		MN-RK-8723	for Drag Link;for Semi-Trailing Arm
	10/93→07/97	Tie Rod	MN-DL-7781		Guide Rod
	10/93→07/97	Tie Rod	MN-DL-7835		
	10/93→07/97	Tie Rod End	CV-ES-2774		
	10/93→07/97	Tie Rod End	CV-ES-14163		for Steering Rod
	10/93→07/97	Track Control Arm		MN-DL-9381	Control Arm, Air Suspension Axle
	10/93→07/97	Track Control Arm		MN-TC-12471	Semi-Trailing Arm, 1st Drive Axle, for Pneumatic Suspension vehicles
	8.153 LK	10/93→07/97	Ball Head, gearshift linkage	CV-ES-2120	
10/93→07/97		Centre Rod	MN-DL-0549	Push Rod	
10/93→07/97		Centre Rod	MN-DL-2127	Coupling Rod	
10/93→07/97		Centre Rod	MN-DL-2133	Push Rod	
10/93→07/97		Centre Rod	MN-DL-8378	Push Rod	
10/93→07/97		Suspension Arm Repair Kit		MN-RK-8723	for Drag Link;for Semi-Trailing Arm
10/93→07/97		Tie Rod	MN-DL-7781		Guide Rod
10/93→07/97		Tie Rod	MN-DL-7835		
10/93→07/97		Tie Rod End	CV-ES-2774		
10/93→07/97		Tie Rod End	CV-ES-14163		for Steering Rod
8.153 LLS		10/93→06/96	Ball Head, gearshift linkage	CV-ES-2120	
	10/93→06/96	Centre Rod	MN-DL-0549	Push Rod	
	10/93→06/96	Centre Rod	MN-DL-2127	Coupling Rod	
	10/93→06/96	Centre Rod	MN-DL-2133	Push Rod	
	10/93→06/96	Stabiliser Mounting		MN-SB-5249	
	10/93→06/96	Stabiliser Mounting		MN-SB-5249	1st RA
	10/93→06/96	Suspension Arm Repair Kit		MN-RK-8723	for Drag Link;for Semi-Trailing Arm
	10/93→06/96	Tie Rod	MN-DL-7781		Guide Rod
	10/93→06/96	Tie Rod End	CV-ES-2774		
	10/93→06/96	Track Control Arm		MN-DL-9381	Control Arm, Air Suspension Axle
	10/93→06/96	Track Control Arm		MN-TC-12471	Semi-Trailing Arm, 1st Drive Axle, for Pneumatic Suspension vehicles
8.155 L, LR, LC, LLC, LRC, LLRC, L-LF	02/04→	Centre Rod	MN-DL-0549	Push Rod	
	02/04→	Centre Rod	MN-DL-2127	Coupling Rod	
	02/04→	Centre Rod	MN-DL-2133	Push Rod	
	02/04→	Suspension Arm Repair Kit		MN-RK-8723	for Drag Link;for Semi-Trailing Arm
	02/04→	Tie Rod	MN-DL-7781		Guide Rod, 1st Front Axle
	02/04→	Tie Rod End	CV-ES-14163		for Steering Rod
	02/04→	Track Control Arm		MN-DL-9381	Control Arm, 1st Drive Axle
	02/04→	Track Control Arm		MN-TC-12471	Semi-Trailing Arm, 1st Drive Axle, for Pneumatic Suspension vehicles

CV-ES-2120

Length: 115
Cone Ø: d1 Ø 12,4 / d2 Ø 10,8
Thread: M14 x 1,5 RHT
03008500A, 81953016200, 81953016202,
81953016203, 81953016227



CV-ES-2774

Length: 95
Cone Ø: d1 Ø 20 / d2 Ø 18
Thread: M24 x 1,5 RHT
81953016134, 81953016142



CV-ES-12462

Length: 120
Cone Ø: d1 Ø 26 / d2 Ø 23,5
Thread: M30 x 1,5 RHT
90804102218, 90804153111, 81953010014,
81953010042, 81953010064, 81953010068,
81953016065, 81953016067, 81953016073,
81953016162, 81953016239, 81953016240,
81953016246, 81953016250, 81953016272,
81953016282, 81953016319, 81953016360,
82953016014



CV-ES-14163

Length: 125
Cone Ø: d1 Ø 30 / d2 Ø 27
Thread: M30 x 1,5 RHT
95301.0084, 90804102156, 90804102272,
90804102696, 90804102710, 81953010016,
81953010075, 81953010084, 81953010088,
81953010094, 81953010103, 81953016030,
81953016043, 81953016048, 81953016049,
81953016053, 81953016061, 81953016090,
81953016108, 81953016112, 81953016126,
81953016143, 81953016149, 81953016154,
81953016156, 81953016168, 81953016178,
81953016194, 81953016206, 81953016224,
81953016234, 81953016242, 81953016252,
81953016274, 81953016278, 81953016284,
81953016286, 81953016308, 81953016310,
81953016312, 81953016347, 81953016350,
81953016352, 82953016012, 88953016014,
N2953016001



MN-DL-0549

Length: 820
Ø: 32
Cone Ø: d1 Ø 20 / d2 Ø 18
81466106725, 85466106102



MN-DL-2127

Length: 1670 Ø: 30
Cone Ø: d1 Ø 20 / d2 Ø 18
81467106865, 81467106866



MN-DL-2133

Length: 829
Ø: 38
Cone Ø: d1 Ø 22 / d2 Ø 20
81466106753, 81466106754, 85466106104



MN-DL-7781

Length: 1630 Ø: 35
Cone Ø: d1 Ø 22 / d2 Ø 20
81467106395, 81467106851, 81467106852,
81467106853, 81467116719, 81467116729,
81467116841



MN-DL-7835

Length: 1455
Ø: 35
Cone Ø: d1 Ø 22 / d2 Ø 20
81467106238, 81467106240, 81467106242,
81467106409, 81467106410, 81467106411



MN-DL-8378

Length: 882 Ø: 38
Cone Ø: d1 Ø 30 / d2 Ø 26
85466106156



MN-DL-9381

Length: 840 Ø: 40
81432506007



MN-DL-12282

Length: 874 Ø: 36
Cone Ø: d1 Ø 26 / d2 Ø 23,5
85466106032, 85466106103, 85466106202



MN-RK-8723

Length: 100 Ø: 46
Hole Distance: 60
81432506009



MN-SB-5249

Length: 55 Ø: 71
Thick/Height: 80
03310200A, 81437040029



MN-TC-12471

Length: 840
Ø: 50
81432506014



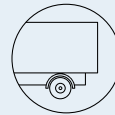

L 2000 ...

8.155 LC, LLC, LRC, LLRC	02/04 →	Centre Rod	MN-DL-0549	Push Rod
	02/04 →	Centre Rod	MN-DL-2127	Coupling Rod
	02/04 →	Centre Rod	MN-DL-2133	Push Rod
	02/04 →	Suspension Arm Repair Kit		MN-RK-8723 for Drag Link;for Semi-Trailing Arm
	02/04 →	Tie Rod	MN-DL-7781	Guide Rod
	02/04 →	Tie Rod End	CV-ES-2774	
	02/04 →	Tie Rod End	DB-ES-0830	
	02/04 →	Track Control Arm		MN-DL-9381 Control Arm, 1st Drive Axle
02/04 →	Track Control Arm		MN-TC-12471 Semi-Trailing Arm, 1st Drive Axle, for Pneumatic Suspension vehicles	
8.155 LK, L-KI, LR-KI, LRK-L, LK-L	02/04 →	Centre Rod	MN-DL-0549	Push Rod
	02/04 →	Centre Rod	MN-DL-2127	Coupling Rod
	02/04 →	Centre Rod	MN-DL-2133	Push Rod
	02/04 →	Tie Rod	MN-DL-7781	Guide Rod
	02/04 →	Tie Rod End	CV-ES-2774	
	02/04 →	Tie Rod End	DB-ES-0830	
8.155 LK, LRK	02/04 →	Centre Rod	MN-DL-0549	Push Rod
	02/04 →	Centre Rod	MN-DL-2127	Coupling Rod
	02/04 →	Centre Rod	MN-DL-2133	Push Rod
	02/04 →	Tie Rod	MN-DL-7781	Guide Rod, 1st Front Axle for Steering Rod
	02/04 →	Tie Rod End	CV-ES-14163	
8.155 L-LF	02/04 →	Centre Rod	MN-DL-0549	Push Rod
	02/04 →	Centre Rod	MN-DL-2127	Coupling Rod
	02/04 →	Centre Rod	MN-DL-2133	Push Rod
	02/04 →	Suspension Arm Repair Kit		MN-RK-8723 for Drag Link;for Semi-Trailing Arm
	02/04 →	Tie Rod	MN-DL-7781	Guide Rod
	02/04 →	Track Control Arm		MN-DL-9381 Control Arm, 1st Drive Axle
	02/04 →	Track Control Arm		MN-TC-12471 Semi-Trailing Arm, 1st Drive Axle, for Pneumatic Suspension vehicles
8.155 LLS, LLRS	02/04 →	Ball Head, gearshift linkage	CV-ES-2120	
	02/04 →	Centre Rod	MN-DL-2127	Coupling Rod
	02/04 →	Centre Rod	MN-DL-2133	Push Rod
	02/04 →	Suspension Arm Repair Kit		MN-RK-8723 for Drag Link;for Semi-Trailing Arm
	02/04 →	Tie Rod	MN-DL-7781	Guide Rod
	02/04 →	Tie Rod End	CV-ES-2774	
	02/04 →	Tie Rod End	DB-ES-0830	
	02/04 →	Track Control Arm		MN-DL-9381 Control Arm, Air Suspension Axle
	02/04 →	Track Control Arm		MN-DL-9381 Control Arm, Drive Axle
02/04 →	Track Control Arm		MN-TC-12471 Semi-Trailing Arm, 1st Drive Axle, for Pneumatic Suspension vehicles	
8.163 LAC, LAEC, LARC, LAERC	01/95 →	Centre Rod	MN-DL-12282	for Steering Rod
	01/95 →	Tie Rod End	CV-ES-12462	for Steering Rod
8.163 LAC, LAEC, LARC, LAERC, LA-LF, LAE-LF	01/95 →	Ball Head, gearshift linkage	CV-ES-2120	
	01/95 →	Centre Rod	MN-DL-0549	Push Rod
	01/95 →	Centre Rod	MN-DL-2127	Coupling Rod
	01/95 →	Centre Rod	MN-DL-2133	Push Rod
	01/95 →	Centre Rod	MN-DL-12282	for Steering Rod
	01/95 →	Tie Rod End	CV-ES-2774	
	01/95 →	Tie Rod End	CV-ES-12462	for Steering Rod
8.163 LAEC	08/95 →03/97	Ball Head, gearshift linkage	CV-ES-2120	
	08/95 →03/97	Centre Rod	MN-DL-0549	Push Rod
	08/95 →03/97	Centre Rod	MN-DL-2127	Coupling Rod
	08/95 →03/97	Centre Rod	MN-DL-2133	Push Rod
	08/95 →03/97	Centre Rod	MN-DL-12282	for Steering Rod
	08/95 →03/97	Tie Rod End	CV-ES-2774	
	08/95 →03/97	Tie Rod End	CV-ES-12462	for Steering Rod
	08/95 →03/97	Tie Rod End	CV-ES-12462	for Steering Rod
8.163 LAEK, LAEK-L, LAERK, LAERK-L, LAK, LAK-L, LARK, LARK-L	04/00 →	Centre Rod	MN-DL-12282	for Steering Rod
	04/00 →	Centre Rod	MN-DL-12282	for Steering Rod
8.163 LAK, LARK, LAEK, LAERK	04/00 →	Ball Head, gearshift linkage	CV-ES-2120	
	04/00 →	Centre Rod	MN-DL-12282	for Steering Rod
	04/00 →	Tie Rod End	CV-ES-12462	for Steering Rod
8.163 LA-LF, LAE-LF	01/95 →	Centre Rod	MN-DL-12282	for Steering Rod

CV-ES-2120

Length: 115
Cone Ø: d1 Ø 12,4 / d2 Ø 10,8
Thread: M14 x 1,5 RHT
03008500A, 81953016200, 81953016202,
81953016203, 81953016227



CV-ES-2774

Length: 95
Cone Ø: d1 Ø 20 / d2 Ø 18
Thread: M24 x 1,5 RHT
81953016134, 81953016142



CV-ES-12462

Length: 120
Cone Ø: d1 Ø 26 / d2 Ø 23,5
Thread: M30 x 1,5 RHT
90804102218, 90804153111, 81953010014,
81953010042, 81953010064, 81953010068,
81953016065, 81953016067, 81953016073,
81953016162, 81953016239, 81953016240,
81953016246, 81953016250, 81953016272,
81953016282, 81953016319, 81953016360,
82953016014



CV-ES-14163

Length: 125
Cone Ø: d1 Ø 30 / d2 Ø 27
Thread: M30 x 1,5 RHT
95301.0084, 90804102156, 90804102272,
90804102696, 90804102710, 81953010016,
81953010075, 81953010084, 81953010088,
81953010094, 81953010103, 81953016030,
81953016043, 81953016048, 81953016049,
81953016053, 81953016061, 81953016090,
81953016108, 81953016112, 81953016126,
81953016143, 81953016149, 81953016154,
81953016156, 81953016168, 81953016178,
81953016194, 81953016206, 81953016224,
81953016234, 81953016242, 81953016252,
81953016274, 81953016278, 81953016284,
81953016286, 81953016308, 81953016310,
81953016312, 81953016347, 81953016350,
81953016352, 82953016012, 88953016014,
N2953016001



DB-ES-0830



MN-DL-0549

Length: 820
Ø: 32
Cone Ø: d1 Ø 20 / d2 Ø 18
81466106725, 85466106102



MN-DL-2127

Length: 1670 Ø: 30
Cone Ø: d1 Ø 20 / d2 Ø 18
81467106865, 81467106866



MN-DL-2133

Length: 829
Ø: 38
Cone Ø: d1 Ø 22 / d2 Ø 20
81466106753, 81466106754, 85466106104



MN-DL-7781

Length: 1630 Ø: 35
Cone Ø: d1 Ø 22 / d2 Ø 20
81467106395, 81467106851, 81467106852,
81467106853, 81467116719, 81467116729,
81467116841



MN-DL-9381

Length: 840 Ø: 40
81432506007



MN-DL-12282

Length: 874 Ø: 36
Cone Ø: d1 Ø 26 / d2 Ø 23,5
85466106032, 85466106103, 85466106202



MN-RK-8723

Length: 100 Ø: 46
Hole Distance: 60
81432506009



MN-TC-12471

Length: 840
Ø: 50
81432506014



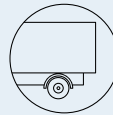

L 2000 ...

8.163 LC, LLC, LLRC, LRC (LE160C)	09/00→	Ball Head, gearshift linkage	CV-ES-2120		
	09/00→	Centre Rod	MN-DL-0549	Push Rod	
	09/00→	Centre Rod	MN-DL-2127	Coupling Rod	
	09/00→	Centre Rod	MN-DL-2133	Push Rod	
	09/00→	Centre Rod	MN-DL-8378	Push Rod	
	09/00→	Stabiliser Mounting		MN-SB-5249	
	09/00→	Stabiliser Mounting		MN-SB-5249	1st RA
	09/00→	Suspension Arm Repair Kit		MN-RK-8723	for Drag Link;for Semi-Trailing Arm
	09/00→	Tie Rod	MN-DL-7781		Guide Rod
	09/00→	Tie Rod End	CV-ES-2774		
	09/00→	Tie Rod End	CV-ES-14163		for Steering Rod
	09/00→	Track Control Arm		MN-DL-9381	Control Arm, Air Suspension Axle
	09/00→	Track Control Arm		MN-TC-12471	Semi-Trailing Arm, 1st Drive Axle, for Pneumatic Suspension vehicles
8.163 LC,8.163 LLC	05/94→	Ball Head, gearshift linkage	CV-ES-2120		
	05/94→	Centre Rod	MN-DL-0549	Push Rod	
	05/94→	Centre Rod	MN-DL-2127	Coupling Rod	
	05/94→	Centre Rod	MN-DL-2133	Push Rod	
	05/94→	Centre Rod	MN-DL-8378	Push Rod	
	05/94→	Stabiliser Mounting		MN-SB-5249	
	05/94→	Stabiliser Mounting		MN-SB-5249	1st RA
	05/94→	Suspension Arm Repair Kit		MN-RK-8723	for Drag Link;for Semi-Trailing Arm
	05/94→	Tie Rod	MN-DL-7781		Guide Rod
	05/94→	Tie Rod	MN-DL-7835		
	05/94→	Tie Rod End	CV-ES-2774		
	05/94→	Tie Rod End	CV-ES-14163		for Steering Rod
	05/94→	Track Control Arm		MN-DL-9381	Control Arm, Air Suspension Axle
05/94→	Track Control Arm		MN-TC-12471	Semi-Trailing Arm, 1st Drive Axle, for Pneumatic Suspension vehicles	
8.163 LC,8.163 LLC, LRC, LLRC, L-LF	08/95→	Ball Head, gearshift linkage	CV-ES-2120		
	08/95→	Centre Rod	MN-DL-0549	Push Rod	
	08/95→	Centre Rod	MN-DL-2127	Coupling Rod	
	08/95→	Centre Rod	MN-DL-2133	Push Rod	
	08/95→	Centre Rod	MN-DL-8378	Push Rod	
	08/95→	Stabiliser Mounting		MN-SB-5249	
	08/95→	Stabiliser Mounting		MN-SB-5249	1st RA
	08/95→	Suspension Arm Repair Kit		MN-RK-8723	for Drag Link;for Semi-Trailing Arm
	08/95→	Tie Rod	MN-DL-7781		Guide Rod
	08/95→	Tie Rod	MN-DL-7835		
	08/95→	Tie Rod End	CV-ES-2774		
	08/95→	Tie Rod End	CV-ES-14163		for Steering Rod
	08/95→	Track Control Arm		MN-DL-9381	Control Arm, Air Suspension Axle
8.163 LK, L-KI, LRK, LR-KI, LRK-L, LK-L	05/94→	Ball Head, gearshift linkage	CV-ES-2120		
	05/94→	Centre Rod	MN-DL-0549	Push Rod	
	05/94→	Centre Rod	MN-DL-2127	Coupling Rod	
	05/94→	Centre Rod	MN-DL-2133	Push Rod	
	05/94→	Centre Rod	MN-DL-8378	Push Rod	
	05/94→	Suspension Arm Repair Kit		MN-RK-8723	for Drag Link;for Semi-Trailing Arm
	05/94→	Tie Rod	MN-DL-7781		Guide Rod
	05/94→	Tie Rod	MN-DL-7835		
	05/94→	Tie Rod End	CV-ES-2774		
	05/94→	Tie Rod End	CV-ES-14163		for Steering Rod
	8.163 L-LF	05/94→	Centre Rod	MN-DL-12282	for Steering Rod
		05/94→	Tie Rod End	CV-ES-12462	for Steering Rod
	8.163 LLS, LLRS	05/94→	Ball Head, gearshift linkage	CV-ES-2120	
05/94→		Centre Rod	MN-DL-0549	Push Rod	
05/94→		Centre Rod	MN-DL-2127	Coupling Rod	
05/94→		Centre Rod	MN-DL-2133	Push Rod	
05/94→		Stabiliser Mounting		MN-SB-5249	
05/94→		Stabiliser Mounting		MN-SB-5249	1st RA
05/94→		Suspension Arm Repair Kit		MN-RK-8723	for Drag Link;for Semi-Trailing Arm
	05/94→	Tie Rod	MN-DL-7781	Guide Rod	
	05/94→	Tie Rod End	CV-ES-2774		

CV-ES-2120

Length: 115
Cone Ø: d1 Ø 12,4 / d2 Ø 10,8
Thread: M14 x 1,5 RHT
03008500A, 81953016200, 81953016202,
81953016203, 81953016227



CV-ES-2774

Length: 95
Cone Ø: d1 Ø 20 / d2 Ø 18
Thread: M24 x 1,5 RHT
81953016134, 81953016142



CV-ES-12462

Length: 120
Cone Ø: d1 Ø 26 / d2 Ø 23,5
Thread: M30 x 1,5 RHT
90804102218, 90804153111, 81953010014,
81953010042, 81953010064, 81953010068,
81953016065, 81953016067, 81953016073,
81953016162, 81953016239, 81953016240,
81953016246, 81953016250, 81953016272,
81953016282, 81953016319, 81953016360,
82953016014



CV-ES-14163

Length: 125
Cone Ø: d1 Ø 30 / d2 Ø 27
Thread: M30 x 1,5 RHT
95301.0084, 90804102156, 90804102272,
90804102696, 90804102710, 81953010016,
81953010075, 81953010084, 81953010088,
81953010094, 81953010103, 81953016030,
81953016043, 81953016048, 81953016049,
81953016053, 81953016061, 81953016090,
81953016108, 81953016112, 81953016126,
81953016143, 81953016149, 81953016154,
81953016156, 81953016168, 81953016178,
81953016194, 81953016206, 81953016224,
81953016234, 81953016242, 81953016252,
81953016274, 81953016278, 81953016284,
81953016286, 81953016308, 81953016310,
81953016312, 81953016347, 81953016350,
81953016352, 82953016012, 88953016014,
N2953016001



MN-DL-0549

Length: 820
Ø: 32
Cone Ø: d1 Ø 20 / d2 Ø 18
81466106725, 85466106102



MN-DL-2127

Length: 1670 Ø: 30
Cone Ø: d1 Ø 20 / d2 Ø 18
81467106865, 81467106866



MN-DL-2133

Length: 829
Ø: 38
Cone Ø: d1 Ø 22 / d2 Ø 20
81466106753, 81466106754, 85466106104



MN-DL-7781

Length: 1630 Ø: 35
Cone Ø: d1 Ø 22 / d2 Ø 20
81467106395, 81467106851, 81467106852,
81467106853, 81467116719, 81467116729,
81467116841



MN-DL-7835

Length: 1455 Ø: 35
Cone Ø: d1 Ø 22 / d2 Ø 20
81467106238, 81467106240, 81467106242,
81467106409, 81467106410, 81467106411



MN-DL-8378

Length: 882 Ø: 38
Cone Ø: d1 Ø 30 / d2 Ø 26
85466106156



MN-DL-9381

Length: 840 Ø: 40
81432506007



MN-DL-12282

Length: 874 Ø: 36
Cone Ø: d1 Ø 26 / d2 Ø 23,5
85466106032, 85466106103, 85466106202



MN-RK-8723

Length: 100 Ø: 46
Hole Distance: 60
81432506009



MN-SB-5249

Length: 55 Ø: 71
Thick/Height: 80
03310200A, 81437040029



MN-TC-12471

Length: 840 Ø: 50
81432506014





L 2000 ...

8.163 LLS, LLRS ...	05/94 →	Tie Rod End	DB-ES-0830		
	05/94 →	Track Control Arm		MN-DL-9381	Control Arm, Air Suspension Axle
	05/94 →	Track Control Arm		MN-DL-9381	Control Arm, Drive Axle
	05/94 →	Track Control Arm		MN-TC-12471	Semi-Trailing Arm, 1st Drive Axle, for Pneumatic Suspension vehicles
8.185 LAC, LAEC, LARC, LAERC, LA-LF, LAE-LF (LE180C)	09/00 →	Ball Head, gearshift linkage	CV-ES-2120		
	09/00 →	Centre Rod	MN-DL-0549		Push Rod
	09/00 →	Centre Rod	MN-DL-2127		Coupling Rod
	09/00 →	Centre Rod	MN-DL-2133		Push Rod
	09/00 →	Centre Rod	MN-DL-12282		for Steering Rod
	09/00 →	Tie Rod End	CV-ES-2774		for Steering Rod
8.185 LAEK, LAEK-L, LAERK, LAERK-L, LAK, LAK-L, LARK, LARK-L	09/00 →	Ball Head, gearshift linkage	CV-ES-2120		
	09/00 →	Centre Rod	MN-DL-0549		Push Rod
	09/00 →	Centre Rod	MN-DL-2127		Coupling Rod
	09/00 →	Centre Rod	MN-DL-2133		Push Rod
	09/00 →	Centre Rod	MN-DL-12282		for Steering Rod
	09/00 →	Tie Rod End	CV-ES-2774		for Steering Rod
8.185 LA-LF, LAE-LF	09/00 →	Centre Rod	MN-DL-12282		for Steering Rod
	09/00 →	Tie Rod End	CV-ES-12462		for Steering Rod
8.185 LC, LLC, LRC, LLRC (LE180C)	09/00 →	Ball Head, gearshift linkage	CV-ES-2120		
	09/00 →	Centre Rod	MN-DL-0549		Push Rod
	09/00 →	Centre Rod	MN-DL-2127		Coupling Rod
	09/00 →	Centre Rod	MN-DL-2133		Push Rod
	09/00 →	Centre Rod	MN-DL-8378		Push Rod
	09/00 →	Stabiliser Mounting		MN-SB-5249	
	09/00 →	Stabiliser Mounting		MN-SB-5249	1st RA
	09/00 →	Suspension Arm Repair Kit		MN-RK-8723	for Drag Link;for Semi-Trailing Arm
	09/00 →	Tie Rod	MN-DL-7781		Guide Rod
	09/00 →	Tie Rod End	CV-ES-2774		for Steering Rod
	09/00 →	Tie Rod End	CV-ES-14163		for Steering Rod
	09/00 →	Track Control Arm		MN-DL-9381	Control Arm, Air Suspension Axle
	09/00 →	Track Control Arm		MN-TC-12471	Semi-Trailing Arm, 1st Drive Axle, for Pneumatic Suspension vehicles
8.185 LK, L-KI, LRK, LR-KI LRK-L, LK-L(LE180C)	09/00 →	Ball Head, gearshift linkage	CV-ES-2120		
	09/00 →	Centre Rod	MN-DL-0549		Push Rod
	09/00 →	Centre Rod	MN-DL-2127		Coupling Rod
	09/00 →	Centre Rod	MN-DL-2133		Push Rod
	09/00 →	Centre Rod	MN-DL-8378		Push Rod
	09/00 →	Suspension Arm Repair Kit		MN-RK-8723	for Drag Link;for Semi-Trailing Arm
	09/00 →	Tie Rod	MN-DL-7781		Guide Rod
	09/00 →	Tie Rod End	CV-ES-2774		for Steering Rod
	09/00 →	Tie Rod End	CV-ES-14163		for Steering Rod
	8.185 L-LF	09/00 →	Centre Rod	MN-DL-0549	
09/00 →		Centre Rod	MN-DL-2127		Coupling Rod
09/00 →		Centre Rod	MN-DL-2133		Push Rod
09/00 →		Suspension Arm Repair Kit		MN-RK-8723	for Drag Link;for Semi-Trailing Arm
09/00 →		Tie Rod	MN-DL-7781		Guide Rod
09/00 →		Track Control Arm		MN-DL-9381	Control Arm, Drive Axle
8.185 LLS, LLRS (LE180C)	09/00 →	Track Control Arm		MN-TC-12471	Semi-Trailing Arm, 1st Drive Axle, for Pneumatic Suspension vehicles
	09/00 →	Ball Head, gearshift linkage	CV-ES-2120		
	09/00 →	Centre Rod	MN-DL-0549		Push Rod
	09/00 →	Centre Rod	MN-DL-2127		Coupling Rod
	09/00 →	Centre Rod	MN-DL-2133		Push Rod
	09/00 →	Stabiliser Mounting		MN-SB-5249	
	09/00 →	Stabiliser Mounting		MN-SB-5249	1st RA
	09/00 →	Suspension Arm Repair Kit		MN-RK-8723	for Drag Link;for Semi-Trailing Arm
	09/00 →	Tie Rod	MN-DL-7781		Guide Rod
	09/00 →	Tie Rod End	CV-ES-2774		for Steering Rod
	09/00 →	Track Control Arm		MN-DL-9381	Control Arm, Air Suspension Axle
	09/00 →	Track Control Arm		MN-TC-12471	Semi-Trailing Arm, 1st Drive Axle, for Pneumatic Suspension vehicles

CV-ES-2120

Length: 115
Cone Ø: d1 Ø 12,4 / d2 Ø 10,8
Thread: M14 x 1,5 RHT
03008500A, 81953016200, 81953016202,
81953016203, 81953016227



CV-ES-2774

Length: 95
Cone Ø: d1 Ø 20 / d2 Ø 18
Thread: M24 x 1,5 RHT
81953016134, 81953016142



CV-ES-12462

Length: 120
Cone Ø: d1 Ø 26 / d2 Ø 23,5
Thread: M30 x 1,5 RHT
90804102218, 90804153111, 81953010014,
81953010042, 81953010064, 81953010068,
81953016065, 81953016067, 81953016073,
81953016162, 81953016239, 81953016240,
81953016246, 81953016250, 81953016272,
81953016282, 81953016319, 81953016360,
82953016014



CV-ES-14163

Length: 125
Cone Ø: d1 Ø 30 / d2 Ø 27
Thread: M30 x 1,5 RHT
95301.0084, 90804102156, 90804102272,
90804102696, 90804102710, 81953010016,
81953010075, 81953010084, 81953010088,
81953010094, 81953010103, 81953016030,
81953016043, 81953016048, 81953016049,
81953016053, 81953016061, 81953016090,
81953016108, 81953016112, 81953016126,
81953016143, 81953016149, 81953016154,
81953016156, 81953016168, 81953016178,
81953016194, 81953016206, 81953016224,
81953016234, 81953016242, 81953016252,
81953016274, 81953016278, 81953016284,
81953016286, 81953016308, 81953016310,
81953016312, 81953016347, 81953016350,
81953016352, 82953016012, 88953016014,
N2953016001



DB-ES-0830



MN-DL-0549

Length: 820
Ø: 32
Cone Ø: d1 Ø 20 / d2 Ø 18
81466106725, 85466106102



MN-DL-2127

Length: 1670 Ø: 30
Cone Ø: d1 Ø 20 / d2 Ø 18
81467106865, 81467106866



MN-DL-2133

Length: 829
Ø: 38
Cone Ø: d1 Ø 22 / d2 Ø 20
81466106753, 81466106754, 85466106104



MN-DL-7781

Length: 1630 Ø: 35
Cone Ø: d1 Ø 22 / d2 Ø 20
81467106395, 81467106851, 81467106852,
81467106853, 81467116719, 81467116729,
81467116841



MN-DL-8378

Length: 882 Ø: 38
Cone Ø: d1 Ø 30 / d2 Ø 26
85466106156



MN-DL-9381

Length: 840 Ø: 40
81432506007



MN-DL-12282

Length: 874 Ø: 36
Cone Ø: d1 Ø 26 / d2 Ø 23,5
85466106032, 85466106103, 85466106202



MN-RK-8723

Length: 100 Ø: 46
Hole Distance: 60
81432506009



MN-SB-5249

Length: 55 Ø: 71
Thick/Height: 80
03310200A, 81437040029



MN-TC-12471

Length: 840
Ø: 50
81432506014





L 2000 ...

8.220 FOC,8.220 FOCL	04/95→	Ball Head, gearshift linkage	CV-ES-2120		
	04/95→	Stabiliser Mounting		MN-SB-5249	
	04/95→	Stabiliser Mounting		MN-SB-5249	1st RA
	04/95→	Suspension Arm Repair Kit		MN-RK-8723	for Drag Link;for Semi-Trailing Arm
	04/95→	Tie Rod	MN-DL-7781		Guide Rod
8.223 LAEC	01/95→06/96	Ball Head, gearshift linkage	CV-ES-2120		
	01/95→06/96	Centre Rod	MN-DL-0549		Push Rod
	01/95→06/96	Centre Rod	MN-DL-2127		Coupling Rod
	01/95→06/96	Centre Rod	MN-DL-2133		Push Rod
	01/95→06/96	Tie Rod End	CV-ES-2774		
	01/95→06/96	Tie Rod End	CV-ES-12462		for Steering Rod
8.223 LC,8.223 LLC	10/93→06/96	Ball Head, gearshift linkage	CV-ES-2120		
	10/93→06/96	Centre Rod	MN-DL-0549		Push Rod
	10/93→06/96	Centre Rod	MN-DL-2127		Coupling Rod
	10/93→06/96	Centre Rod	MN-DL-2133		Push Rod
	10/93→06/96	Stabiliser Mounting		MN-SB-5249	
	10/93→06/96	Stabiliser Mounting		MN-SB-5249	1st RA
	10/93→06/96	Suspension Arm Repair Kit		MN-RK-8723	for Drag Link;for Semi-Trailing Arm
	10/93→06/96	Tie Rod	MN-DL-7781		Guide Rod
	10/93→06/96	Tie Rod	MN-DL-7835		
	10/93→06/96	Tie Rod End	CV-ES-2774		
	10/93→06/96	Track Control Arm		MN-DL-9381	Control Arm, Air Suspension Axle
	10/93→06/96	Track Control Arm		MN-TC-12471	Semi-Trailing Arm, 1st Drive Axle, for Pneumatic Suspension vehicles
	8.223 LK	10/93→06/96	Ball Head, gearshift linkage	CV-ES-2120	
10/93→06/96		Centre Rod	MN-DL-0549		Push Rod
10/93→06/96		Centre Rod	MN-DL-2127		Coupling Rod
10/93→06/96		Centre Rod	MN-DL-2133		Push Rod
10/93→06/96		Tie Rod	MN-DL-7781		Guide Rod
10/93→06/96		Tie Rod End	CV-ES-2774		
8.223 LLS	10/93→06/96	Ball Head, gearshift linkage	CV-ES-2120		
	10/93→06/96	Centre Rod	MN-DL-0549		Push Rod
	10/93→06/96	Centre Rod	MN-DL-2127		Coupling Rod
	10/93→06/96	Centre Rod	MN-DL-2133		Push Rod
	10/93→06/96	Stabiliser Mounting		MN-SB-5249	
	10/93→06/96	Stabiliser Mounting		MN-SB-5249	1st RA
	10/93→06/96	Suspension Arm Repair Kit		MN-RK-8723	for Drag Link;for Semi-Trailing Arm
	10/93→06/96	Tie Rod	MN-DL-7781		Guide Rod
	10/93→06/96	Tie Rod	MN-DL-7835		
	10/93→06/96	Tie Rod End	CV-ES-2774		
8.224 LAC, LAEC, LARC, LAERC	01/95→	Ball Head, gearshift linkage	CV-ES-2120		
	01/95→	Centre Rod	MN-DL-0549		Push Rod
	01/95→	Centre Rod	MN-DL-2127		Coupling Rod
	01/95→	Centre Rod	MN-DL-2133		Push Rod
	01/95→	Centre Rod	MN-DL-12282		for Steering Rod
	01/95→	Tie Rod End	CV-ES-2774		
	01/95→	Tie Rod End	CV-ES-12462		for Steering Rod
8.224 LAEK, LAEK-L, LAERK, LAERK-L, LAK, LAK-L, LARK, LARK-L	01/95→	Centre Rod	MN-DL-12282		for Steering Rod
	01/95→	Tie Rod End	CV-ES-12462		for Steering Rod
8.224 LAK, LAEK, LARK, LAERK	01/95→	Ball Head, gearshift linkage	CV-ES-2120		
	01/95→	Centre Rod	MN-DL-0549		Push Rod
	01/95→	Centre Rod	MN-DL-2127		Coupling Rod
	01/95→	Centre Rod	MN-DL-2133		Push Rod
	01/95→	Centre Rod	MN-DL-12282		for Steering Rod
	01/95→	Tie Rod End	CV-ES-2774		
8.224 LC, LLC, LRC, LLRC	05/94→	Centre Rod	MN-DL-0549		Push Rod
	05/94→	Centre Rod	MN-DL-2127		Coupling Rod
	05/94→	Centre Rod	MN-DL-2133		Push Rod
	05/94→	Suspension Arm Repair Kit		MN-RK-8723	for Drag Link;for Semi-Trailing Arm

CV-ES-2120

Length: 115
Cone Ø: d1 Ø 12,4 / d2 Ø 10,8
Thread: M14 x 1,5 RHT
03008500A, 81953016200, 81953016202,
81953016203, 81953016227



CV-ES-2774

Length: 95
Cone Ø: d1 Ø 20 / d2 Ø 18
Thread: M24 x 1,5 RHT
81953016134, 81953016142



CV-ES-12462

Length: 120
Cone Ø: d1 Ø 26 / d2 Ø 23,5
Thread: M30 x 1,5 RHT
90804102218, 90804153111, 81953010014,
81953010042, 81953010064, 81953010068,
81953016065, 81953016067, 81953016073,
81953016162, 81953016239, 81953016240,
81953016246, 81953016250, 81953016272,
81953016282, 81953016319, 81953016360,
82953016014



MN-DL-0549

Length: 820
Ø: 32
Cone Ø: d1 Ø 20 / d2 Ø 18
81466106725, 85466106102



MN-DL-2127

Length: 1670 Ø: 30
Cone Ø: d1 Ø 20 / d2 Ø 18
81467106865, 81467106866



MN-DL-2133

Length: 829
Ø: 38
Cone Ø: d1 Ø 22 / d2 Ø 20
81466106753, 81466106754, 85466106104



MN-DL-7781

Length: 1630 Ø: 35
Cone Ø: d1 Ø 22 / d2 Ø 20
81467106395, 81467106851, 81467106852,
81467106853, 81467116719, 81467116729,
81467116841



MN-DL-7835

Length: 1455
Ø: 35
Cone Ø: d1 Ø 22 / d2 Ø 20
81467106238, 81467106240, 81467106242,
81467106409, 81467106410, 81467106411



MN-DL-9381

Length: 840 Ø: 40
81432506007



MN-DL-12282

Length: 874 Ø: 36
Cone Ø: d1 Ø 26 / d2 Ø 23,5
85466106032, 85466106103, 85466106202



MN-RK-8723

Length: 100 Ø: 46
Hole Distance: 60
81432506009



MN-SB-5249

Length: 55 Ø: 71
Thick/Height: 80
03310200A, 81437040029



MN-TC-12471

Length: 840
Ø: 50
81432506014





L 2000 ...

8.224 LC, LLC, LRC, LLRC ...	05/94 →	Tie Rod	MN-DL-7781		Guide Rod
	05/94 →	Tie Rod End	CV-ES-2774		
	05/94 →	Tie Rod End	DB-ES-0830		
	05/94 →	Track Control Arm		MN-DL-9381	Control Arm, Drive Axle
	05/94 →	Track Control Arm		MN-TC-12471	Semi-Trailing Arm, 1st Drive Axle, for Pneumatic Suspension vehicles
8.224 LC,8.224 LLC, LRC, LLRC	05/94 →	Ball Head, gearshift linkage	CV-ES-2120		
	05/94 →	Centre Rod	MN-DL-0549		Push Rod
	05/94 →	Centre Rod	MN-DL-2127		Coupling Rod
	05/94 →	Centre Rod	MN-DL-2133		Push Rod
	05/94 →	Stabiliser Mounting		MN-SB-5249	
	05/94 →	Stabiliser Mounting		MN-SB-5249	1st RA
	05/94 →	Suspension Arm Repair Kit		MN-RK-8723	for Drag Link;for Semi-Trailing Arm
	05/94 →	Tie Rod	MN-DL-7781		Guide Rod
	05/94 →	Tie Rod	MN-DL-7835		
	05/94 →	Tie Rod End	CV-ES-2774		
	05/94 →	Track Control Arm		MN-DL-9381	Control Arm, Air Suspension Axle
	05/94 →	Track Control Arm		MN-TC-12471	Semi-Trailing Arm, 1st Drive Axle, for Pneumatic Suspension vehicles
	8.224 LK, LRK, L-KI, LR-KI	05/94 →	Ball Head, gearshift linkage	CV-ES-2120	
05/94 →		Centre Rod	MN-DL-0549		Push Rod
05/94 →		Centre Rod	MN-DL-2127		Coupling Rod
05/94 →		Centre Rod	MN-DL-2133		Push Rod
05/94 →		Tie Rod	MN-DL-7781		Guide Rod
05/94 →		Tie Rod End	CV-ES-2774		
05/94 →		Tie Rod End	DB-ES-0830		
8.224 LLS, LLRS	05/94 →	Ball Head, gearshift linkage	CV-ES-2120		
	05/94 →	Centre Rod	MN-DL-0549		Push Rod
	05/94 →	Centre Rod	MN-DL-2127		Coupling Rod
	05/94 →	Centre Rod	MN-DL-2133		Push Rod
	05/94 →	Stabiliser Mounting		MN-SB-5249	
	05/94 →	Stabiliser Mounting		MN-SB-5249	1st RA
	05/94 →	Suspension Arm Repair Kit		MN-RK-8723	for Drag Link;for Semi-Trailing Arm
	05/94 →	Tie Rod	MN-DL-7781		Guide Rod
	05/94 →	Tie Rod	MN-DL-7835		
	05/94 →	Tie Rod End	CV-ES-2774		
	05/94 →	Tie Rod End	DB-ES-0830		
	05/94 →	Track Control Arm		MN-DL-9381	Control Arm, Air Suspension Axle
	05/94 →	Track Control Arm		MN-DL-9381	Control Arm, Drive Axle
05/94 →	Track Control Arm		MN-TC-12471	Semi-Trailing Arm, 1st Drive Axle, for Pneumatic Suspension vehicles	
8.225 LAC, LAEC, LARC, LAERC (LE220C)	09/00 →	Ball Head, gearshift linkage	CV-ES-2120		
	09/00 →	Centre Rod	MN-DL-0549		Push Rod
	09/00 →	Centre Rod	MN-DL-2127		Coupling Rod
	09/00 →	Centre Rod	MN-DL-2133		Push Rod
	09/00 →	Centre Rod	MN-DL-12282		for Steering Rod
	09/00 →	Tie Rod End	CV-ES-2774		
	09/00 →	Tie Rod End	CV-ES-12462		for Steering Rod
8.225 LAEK, LAEK-L, LAERK, LAERK-L, LAK, LAK-L, LARK, LARK-L	09/00 →	Ball Head, gearshift linkage	CV-ES-2120		
	09/00 →	Centre Rod	MN-DL-0549		Push Rod
	09/00 →	Centre Rod	MN-DL-2127		Coupling Rod
	09/00 →	Centre Rod	MN-DL-2133		Push Rod
	09/00 →	Centre Rod	MN-DL-12282		for Steering Rod
	09/00 →	Tie Rod End	CV-ES-2774		
	09/00 →	Tie Rod End	CV-ES-12462		for Steering Rod
8.225 LC,8.225 LLC, LRC, LLRC (LE220C)	09/00 →	Ball Head, gearshift linkage	CV-ES-2120		
	09/00 →	Centre Rod	MN-DL-0549		Push Rod
	09/00 →	Centre Rod	MN-DL-2127		Coupling Rod
	09/00 →	Centre Rod	MN-DL-2133		Push Rod
	09/00 →	Stabiliser Mounting		MN-SB-5249	
	09/00 →	Stabiliser Mounting		MN-SB-5249	1st RA
	09/00 →	Suspension Arm Repair Kit		MN-RK-8723	for Drag Link;for Semi-Trailing Arm
09/00 →	Tie Rod	MN-DL-7781		Guide Rod	

CV-ES-2120

Length: 115
Cone Ø: d1 Ø 12,4 / d2 Ø 10,8
Thread: M14 x 1,5 RHT
03008500A, 81953016200, 81953016202,
81953016203, 81953016227



CV-ES-2774

Length: 95
Cone Ø: d1 Ø 20 / d2 Ø 18
Thread: M24 x 1,5 RHT
81953016134, 81953016142



CV-ES-12462

Length: 120
Cone Ø: d1 Ø 26 / d2 Ø 23,5
Thread: M30 x 1,5 RHT
90804102218, 90804153111, 81953010014,
81953010042, 81953010064, 81953010068,
81953016065, 81953016067, 81953016073,
81953016162, 81953016239, 81953016240,
81953016246, 81953016250, 81953016272,
81953016282, 81953016319, 81953016360,
82953016014



DB-ES-0830



MN-DL-0549

Length: 820
Ø: 32
Cone Ø: d1 Ø 20 / d2 Ø 18
81466106725, 85466106102



MN-DL-2127

Length: 1670 Ø: 30
Cone Ø: d1 Ø 20 / d2 Ø 18
81467106865, 81467106866



MN-DL-2133

Length: 829
Ø: 38
Cone Ø: d1 Ø 22 / d2 Ø 20
81466106753, 81466106754, 85466106104



MN-DL-7781

Length: 1630 Ø: 35
Cone Ø: d1 Ø 22 / d2 Ø 20
81467106395, 81467106851, 81467106852,
81467106853, 81467116719, 81467116729,
81467116841



MN-DL-7835

Length: 1455
Ø: 35
Cone Ø: d1 Ø 22 / d2 Ø 20
81467106238, 81467106240, 81467106242,
81467106409, 81467106410, 81467106411



MN-DL-9381

Length: 840 Ø: 40
81432506007



MN-DL-12282

Length: 874 Ø: 36
Cone Ø: d1 Ø 26 / d2 Ø 23,5
85466106032, 85466106103, 85466106202



MN-RK-8723

Length: 100 Ø: 46
Hole Distance: 60
81432506009



MN-SB-5249

Length: 55 Ø: 71
Thick/Height: 80
03310200A, 81437040029



MN-TC-12471

Length: 840
Ø: 50
81432506014





L 2000 ...

8.225 LC,8.225 LLC, LRC, LLRC (LE220C) ...	09/00→	Tie Rod End	CV-ES-2774			
	09/00→	Track Control Arm		MN-DL-9381	Control Arm, Air Suspension Axle	
	09/00→	Track Control Arm		MN-TC-12471	Semi-Trailing Arm, 1st Drive Axle, for Pneumatic Suspension vehicles	
8.225 LK, L-KI, LRK, LR-KI, LRK-L, LK-L (LE220C)	09/00→	Ball Head, gearshift linkage	CV-ES-2120			
	09/00→	Centre Rod	MN-DL-0549		Push Rod	
	09/00→	Centre Rod	MN-DL-2127		Coupling Rod	
	09/00→	Centre Rod	MN-DL-2133		Push Rod	
	09/00→	Tie Rod	MN-DL-7781		Guide Rod	
	09/00→	Tie Rod End	CV-ES-2774			
8.225 LLS, LLRS (LE220C)	09/00→	Ball Head, gearshift linkage	CV-ES-2120			
	09/00→	Centre Rod	MN-DL-0549		Push Rod	
	09/00→	Centre Rod	MN-DL-2127		Coupling Rod	
	09/00→	Centre Rod	MN-DL-2133		Push Rod	
	09/00→	Stabiliser Mounting		MN-SB-5249		
	09/00→	Stabiliser Mounting		MN-SB-5249	1st RA	
	09/00→	Suspension Arm Repair Kit		MN-RK-8723	for Drag Link;for Semi-Trailing Arm	
	09/00→	Tie Rod	MN-DL-7781		Guide Rod	
	09/00→	Tie Rod End	CV-ES-2774			
	09/00→	Track Control Arm		MN-DL-9381	Control Arm, Air Suspension Axle	
	09/00→	Track Control Arm		MN-TC-12471	Semi-Trailing Arm, 1st Drive Axle, for Pneumatic Suspension vehicles	
	9.145 LC,9.145 LLC, LRC, LLRC (LE140C)	09/00→	Ball Head, gearshift linkage	CV-ES-2120		
		09/00→	Centre Rod	MN-DL-0549		Push Rod
09/00→		Centre Rod	MN-DL-2127		Coupling Rod	
09/00→		Centre Rod	MN-DL-2133		Push Rod	
09/00→		Centre Rod	MN-DL-8378		Push Rod	
09/00→		Stabiliser Mounting		MN-SB-5249		
09/00→		Stabiliser Mounting		MN-SB-5249	1st RA	
09/00→		Suspension Arm Repair Kit		MN-RK-8723	for Drag Link;for Semi-Trailing Arm	
09/00→		Tie Rod	MN-DL-7781		Guide Rod	
09/00→		Tie Rod End	CV-ES-2774			
09/00→		Tie Rod End	CV-ES-14163		for Steering Rod	
09/00→		Track Control Arm		MN-DL-9381	Control Arm, Air Suspension Axle	
09/00→		Track Control Arm		MN-TC-12471	Semi-Trailing Arm, 1st Drive Axle, for Pneumatic Suspension vehicles	
9.145 LK, L-KI, LRK, LR-KI, LRK-L, LK-L (LE140C)		09/00→	Ball Head, gearshift linkage	CV-ES-2120		
	09/00→	Centre Rod	MN-DL-0549		Push Rod	
	09/00→	Centre Rod	MN-DL-2127		Coupling Rod	
	09/00→	Centre Rod	MN-DL-2133		Push Rod	
	09/00→	Centre Rod	MN-DL-8378		Push Rod	
	09/00→	Tie Rod	MN-DL-7781		Guide Rod	
	09/00→	Tie Rod End	CV-ES-2774			
	09/00→	Tie Rod End	CV-ES-14163		for Steering Rod	
	9.145 LLS, LLRS (LE140C)	09/00→	Ball Head, gearshift linkage	CV-ES-2120		
09/00→		Centre Rod	MN-DL-0549		Push Rod	
09/00→		Centre Rod	MN-DL-2127		Coupling Rod	
09/00→		Centre Rod	MN-DL-2133		Push Rod	
09/00→		Stabiliser Mounting		MN-SB-5249		
09/00→		Stabiliser Mounting		MN-SB-5249	1st RA	
09/00→		Suspension Arm Repair Kit		MN-RK-8723	for Drag Link;for Semi-Trailing Arm	
09/00→		Tie Rod	MN-DL-7781		Guide Rod	
09/00→		Tie Rod End	CV-ES-2774			
09/00→		Track Control Arm		MN-DL-9381	Control Arm, Air Suspension Axle	
09/00→		Track Control Arm		MN-TC-12471	Semi-Trailing Arm, 1st Drive Axle, for Pneumatic Suspension vehicles	
9.153 LC,9.153 LLC		10/93→06/96	Ball Head, gearshift linkage	CV-ES-2120		
		10/93→06/96	Centre Rod	MN-DL-0549		Push Rod
	10/93→06/96	Centre Rod	MN-DL-2127		Coupling Rod	
	10/93→06/96	Centre Rod	MN-DL-2133		Push Rod	
	10/93→06/96	Centre Rod	MN-DL-8378		Push Rod	
	10/93→06/96	Stabiliser Mounting		MN-SB-5249		
	10/93→06/96	Stabiliser Mounting		MN-SB-5249	1st RA	

CV-ES-2120

Length: 115
Cone Ø: d1 Ø 12,4 / d2 Ø 10,8
Thread: M14 x 1,5 RHT
03008500A, 81953016200, 81953016202,
81953016203, 81953016227



CV-ES-2774

Length: 95
Cone Ø: d1 Ø 20 / d2 Ø 18
Thread: M24 x 1,5 RHT
81953016134, 81953016142



CV-ES-14163

Length: 125
Cone Ø: d1 Ø 30 / d2 Ø 27
Thread: M30 x 1,5 RHT
95301.0084, 90804102156, 90804102272,
90804102696, 90804102710, 81953010016,
81953010075, 81953010084, 81953010088,
81953010094, 81953010103, 81953016030,
81953016043, 81953016048, 81953016049,
81953016053, 81953016061, 81953016090,
81953016108, 81953016112, 81953016126,
81953016143, 81953016149, 81953016154,
81953016156, 81953016168, 81953016178,
81953016194, 81953016206, 81953016224,
81953016234, 81953016242, 81953016252,
81953016274, 81953016278, 81953016284,
81953016286, 81953016308, 81953016310,
81953016312, 81953016347, 81953016350,
81953016352, 82953016012, 88953016014,
N2953016001



MN-DL-0549

Length: 820
Ø: 32
Cone Ø: d1 Ø 20 / d2 Ø 18
81466106725, 85466106102



MN-DL-2127

Length: 1670 Ø: 30
Cone Ø: d1 Ø 20 / d2 Ø 18
81467106865, 81467106866



MN-DL-2133

Length: 829
Ø: 38
Cone Ø: d1 Ø 22 / d2 Ø 20
81466106753, 81466106754, 85466106104



MN-DL-7781

Length: 1630 Ø: 35
Cone Ø: d1 Ø 22 / d2 Ø 20
81467106395, 81467106851, 81467106852,
81467106853, 81467116719, 81467116729,
81467116841



MN-DL-8378

Length: 882 Ø: 38
Cone Ø: d1 Ø 30 / d2 Ø 26
85466106156



MN-DL-9381

Length: 840 Ø: 40
81432506007



MN-RK-8723

Length: 100 Ø: 46
Hole Distance: 60
81432506009



MN-SB-5249

Length: 55 Ø: 71
Thick/Height: 80
03310200A, 81437040029



MN-TC-12471

Length: 840
Ø: 50
81432506014





L 2000 ...

9.153 LC,9.153 LLC ...	10/93→06/96	Suspension Arm Repair Kit		MN-RK-8723	for Drag Link;for Semi-Trailing Arm
	10/93→06/96	Tie Rod	MN-DL-7781		Guide Rod
	10/93→06/96	Tie Rod	MN-DL-7835		
	10/93→06/96	Tie Rod End	CV-ES-2774		
	10/93→06/96	Tie Rod End	CV-ES-14163		for Steering Rod
	10/93→06/96	Track Control Arm		MN-DL-9381	Control Arm, Air Suspension Axle
	10/93→06/96	Track Control Arm		MN-TC-12471	Semi-Trailing Arm, 1st Drive Axle, for Pneumatic Suspension vehicles
9.153 LK	10/93→06/96	Ball Head, gearshift linkage	CV-ES-2120		
	10/93→06/96	Centre Rod	MN-DL-0549		Push Rod
	10/93→06/96	Centre Rod	MN-DL-2127		Coupling Rod
	10/93→06/96	Centre Rod	MN-DL-2133		Push Rod
	10/93→06/96	Centre Rod	MN-DL-8378		Push Rod
	10/93→06/96	Suspension Arm Repair Kit		MN-RK-8723	for Drag Link;for Semi-Trailing Arm
	10/93→06/96	Tie Rod	MN-DL-7781		Guide Rod
	10/93→06/96	Tie Rod	MN-DL-7835		
	10/93→06/96	Tie Rod End	CV-ES-2774		
	10/93→06/96	Tie Rod End	CV-ES-14163		for Steering Rod
9.153 LLS	10/93→12/95	Ball Head, gearshift linkage	CV-ES-2120		
	10/93→12/95	Centre Rod	MN-DL-0549		Push Rod
	10/93→12/95	Centre Rod	MN-DL-2127		Coupling Rod
	10/93→12/95	Centre Rod	MN-DL-2133		Push Rod
	10/93→12/95	Stabiliser Mounting		MN-SB-5249	
	10/93→12/95	Stabiliser Mounting		MN-SB-5249	1st RA
	10/93→12/95	Suspension Arm Repair Kit		MN-RK-8723	for Drag Link;for Semi-Trailing Arm
	10/93→12/95	Tie Rod	MN-DL-7781		Guide Rod
	10/93→12/95	Tie Rod End	CV-ES-2774		
	10/93→12/95	Track Control Arm		MN-DL-9381	Control Arm, Air Suspension Axle
10/93→12/95	Track Control Arm		MN-TC-12471	Semi-Trailing Arm, 1st Drive Axle, for Pneumatic Suspension vehicles	
9.155 L, LC, LLC, LRC, LLRC	02/04→	Centre Rod	MN-DL-0549		Push Rod
	02/04→	Centre Rod	MN-DL-2127		Coupling Rod
	02/04→	Centre Rod	MN-DL-2133		Push Rod
	02/04→	Suspension Arm Repair Kit		MN-RK-8723	for Drag Link;for Semi-Trailing Arm
	02/04→	Tie Rod	MN-DL-7781		Guide Rod, 1st Front Axle
	02/04→	Tie Rod End	CV-ES-14163		for Steering Rod
	02/04→	Track Control Arm		MN-DL-9381	Control Arm, 1st Drive Axle
02/04→	Track Control Arm		MN-TC-12471	Semi-Trailing Arm, 1st Drive Axle, for Pneumatic Suspension vehicles	
9.155 LK, L-KI, LRK, LR-KI, LRK-L, LK-L	02/04→	Centre Rod	MN-DL-0549		Push Rod
	02/04→	Centre Rod	MN-DL-2127		Coupling Rod
	02/04→	Centre Rod	MN-DL-2133		Push Rod
	02/04→	Tie Rod	MN-DL-7781		Guide Rod, 1st Front Axle
	02/04→	Tie Rod End	CV-ES-14163		for Steering Rod
9.155 LLS, LLRS	02/04→	Ball Head, gearshift linkage	CV-ES-2120		
	02/04→	Suspension Arm Repair Kit		MN-RK-8723	for Drag Link;for Semi-Trailing Arm
	02/04→	Tie Rod	MN-DL-7781		Guide Rod
	02/04→	Tie Rod End	CV-ES-2774		
	02/04→	Tie Rod End	DB-ES-0830		
	02/04→	Track Control Arm		MN-DL-9381	Control Arm, Air Suspension Axle
	02/04→	Track Control Arm		MN-TC-12471	Semi-Trailing Arm, 1st Drive Axle, for Pneumatic Suspension vehicles
9.163 LC	08/95→03/97	Ball Head, gearshift linkage	CV-ES-2120		
	08/95→03/97	Centre Rod	MN-DL-0549		Push Rod
	08/95→03/97	Centre Rod	MN-DL-2127		Coupling Rod
	08/95→03/97	Centre Rod	MN-DL-2133		Push Rod
	08/95→03/97	Centre Rod	MN-DL-8378		Push Rod
	08/95→03/97	Suspension Arm Repair Kit		MN-RK-8723	for Drag Link;for Semi-Trailing Arm
	08/95→03/97	Tie Rod	MN-DL-7781		Guide Rod
	08/95→03/97	Tie Rod	MN-DL-7835		
	08/95→03/97	Tie Rod End	CV-ES-2774		
08/95→03/97	Tie Rod End	CV-ES-14163		for Steering Rod	

CV-ES-2120

Length: 115
Cone Ø: d1 Ø 12,4 / d2 Ø 10,8
Thread: M14 x 1,5 RHT
03008500A, 81953016200, 81953016202,
81953016203, 81953016227



CV-ES-2774

Length: 95
Cone Ø: d1 Ø 20 / d2 Ø 18
Thread: M24 x 1,5 RHT
81953016134, 81953016142



CV-ES-14163

Length: 125
Cone Ø: d1 Ø 30 / d2 Ø 27
Thread: M30 x 1,5 RHT
95301.0084, 90804102156, 90804102272,
90804102696, 90804102710, 81953010016,
81953010075, 81953010084, 81953010088,
81953010094, 81953010103, 81953016030,
81953016043, 81953016048, 81953016049,
81953016053, 81953016061, 81953016090,
81953016108, 81953016112, 81953016126,
81953016143, 81953016149, 81953016154,
81953016156, 81953016168, 81953016178,
81953016194, 81953016206, 81953016224,
81953016234, 81953016242, 81953016252,
81953016274, 81953016278, 81953016284,
81953016286, 81953016308, 81953016310,
81953016312, 81953016347, 81953016350,
81953016352, 82953016012, 88953016014,
N2953016001



DB-ES-0830



MN-DL-0549

Length: 820
Ø: 32
Cone Ø: d1 Ø 20 / d2 Ø 18
81466106725, 85466106102



MN-DL-2127

Length: 1670 Ø: 30
Cone Ø: d1 Ø 20 / d2 Ø 18
81467106865, 81467106866



MN-DL-2133

Length: 829
Ø: 38
Cone Ø: d1 Ø 22 / d2 Ø 20
81466106753, 81466106754, 85466106104



MN-DL-7781

Length: 1630 Ø: 35
Cone Ø: d1 Ø 22 / d2 Ø 20
81467106395, 81467106851, 81467106852,
81467106853, 81467116719, 81467116729,
81467116841



MN-DL-7835

Length: 1455
Ø: 35
Cone Ø: d1 Ø 22 / d2 Ø 20
81467106238, 81467106240, 81467106242,
81467106409, 81467106410, 81467106411



MN-DL-8378

Length: 882 Ø: 38
Cone Ø: d1 Ø 30 / d2 Ø 26
85466106156



MN-DL-9381

Length: 840 Ø: 40
81432506007



MN-RK-8723

Length: 100 Ø: 46
Hole Distance: 60
81432506009



MN-SB-5249

Length: 55 Ø: 71
Thick/Height: 80
03310200A, 81437040029



MN-TC-12471

Length: 840
Ø: 50
81432506014





L 2000 ...

9.163 LC,9.163 LLC, LRC, LLRC	05/94 →	Ball Head, gearshift linkage	CV-ES-2120		
	05/94 →	Centre Rod	MN-DL-0549	Push Rod	
	05/94 →	Centre Rod	MN-DL-2127	Coupling Rod	
	05/94 →	Centre Rod	MN-DL-2133	Push Rod	
	05/94 →	Centre Rod	MN-DL-8378	Push Rod	
	05/94 →	Stabiliser Mounting		MN-SB-5249	
	05/94 →	Stabiliser Mounting		MN-SB-5249	1st RA
	05/94 →	Suspension Arm Repair Kit		MN-RK-8723	for Drag Link;for Semi-Trailing Arm
	05/94 →	Tie Rod	MN-DL-7781		Guide Rod
	05/94 →	Tie Rod	MN-DL-7835		
	05/94 →	Tie Rod End	CV-ES-2774		
	05/94 →	Tie Rod End	CV-ES-14163		for Steering Rod
	05/94 →	Track Control Arm		MN-DL-9381	Control Arm, Air Suspension Axle
	05/94 →	Track Control Arm		MN-TC-12471	Semi-Trailing Arm, 1st Drive Axle, for Pneumatic Suspension vehicles
9.163 LK	08/95 →03/97	Ball Head, gearshift linkage	CV-ES-2120		
	08/95 →03/97	Centre Rod	MN-DL-0549	Push Rod	
	08/95 →03/97	Centre Rod	MN-DL-2127	Coupling Rod	
	08/95 →03/97	Centre Rod	MN-DL-2133	Push Rod	
	08/95 →03/97	Centre Rod	MN-DL-8378	Push Rod	
	08/95 →03/97	Suspension Arm Repair Kit		MN-RK-8723	for Drag Link;for Semi-Trailing Arm
	08/95 →03/97	Tie Rod	MN-DL-7781		Guide Rod
	08/95 →03/97	Tie Rod	MN-DL-7835		
	08/95 →03/97	Tie Rod End	CV-ES-2774		
08/95 →03/97	Tie Rod End	CV-ES-14163		for Steering Rod	
9.163 LK, L-KI, LRK, LR-KI, LRK-L, LK-L	05/94 →	Ball Head, gearshift linkage	CV-ES-2120		
	05/94 →	Centre Rod	MN-DL-0549	Push Rod	
	05/94 →	Centre Rod	MN-DL-2127	Coupling Rod	
	05/94 →	Centre Rod	MN-DL-2133	Push Rod	
	05/94 →	Centre Rod	MN-DL-8378	Push Rod	
	05/94 →	Suspension Arm Repair Kit		MN-RK-8723	for Drag Link;for Semi-Trailing Arm
	05/94 →	Tie Rod	MN-DL-7781		Guide Rod
	05/94 →	Tie Rod	MN-DL-7835		
	05/94 →	Tie Rod End	CV-ES-2774		
	05/94 →	Tie Rod End	CV-ES-14163		for Steering Rod
9.163 LLS, LLRS	05/94 →	Ball Head, gearshift linkage	CV-ES-2120		
	05/94 →	Centre Rod	MN-DL-0549	Push Rod	
	05/94 →	Centre Rod	MN-DL-2127	Coupling Rod	
	05/94 →	Centre Rod	MN-DL-2133	Push Rod	
	05/94 →	Stabiliser Mounting		MN-SB-5249	
	05/94 →	Stabiliser Mounting		MN-SB-5249	1st RA
	05/94 →	Suspension Arm Repair Kit		MN-RK-8723	for Drag Link;for Semi-Trailing Arm
	05/94 →	Tie Rod	MN-DL-7781		Guide Rod
	05/94 →	Tie Rod End	CV-ES-2774		
	05/94 →	Track Control Arm		MN-DL-9381	Control Arm, Air Suspension Axle
05/94 →	Track Control Arm		MN-TC-12471	Semi-Trailing Arm, 1st Drive Axle, for Pneumatic Suspension vehicles	
9.185 LC,9.185 LLC, LRC, LLRC (LE180C)	09/00 →	Ball Head, gearshift linkage	CV-ES-2120		
	09/00 →	Centre Rod	MN-DL-0549	Push Rod	
	09/00 →	Centre Rod	MN-DL-2127	Coupling Rod	
	09/00 →	Centre Rod	MN-DL-2133	Push Rod	
	09/00 →	Centre Rod	MN-DL-8378	Push Rod	
	09/00 →	Stabiliser Mounting		MN-SB-5249	
	09/00 →	Stabiliser Mounting		MN-SB-5249	1st RA
	09/00 →	Suspension Arm Repair Kit		MN-RK-8723	for Drag Link;for Semi-Trailing Arm
	09/00 →	Tie Rod	MN-DL-7781		Guide Rod
	09/00 →	Tie Rod End	CV-ES-2774		
	09/00 →	Tie Rod End	CV-ES-14163		for Steering Rod
	09/00 →	Track Control Arm		MN-DL-9381	Control Arm, Air Suspension Axle
	09/00 →	Track Control Arm		MN-TC-12471	Semi-Trailing Arm, 1st Drive Axle, for Pneumatic Suspension vehicles

CV-ES-2120

Length: 115
Cone Ø: d1 Ø 12,4 / d2 Ø 10,8
Thread: M14 x 1,5 RHT
03008500A, 81953016200, 81953016202,
81953016203, 81953016227



CV-ES-2774

Length: 95
Cone Ø: d1 Ø 20 / d2 Ø 18
Thread: M24 x 1,5 RHT
81953016134, 81953016142



CV-ES-14163

Length: 125
Cone Ø: d1 Ø 30 / d2 Ø 27
Thread: M30 x 1,5 RHT
95301.0084, 90804102156, 90804102272,
90804102696, 90804102710, 81953010016,
81953010075, 81953010084, 81953010088,
81953010094, 81953010103, 81953016030,
81953016043, 81953016048, 81953016049,
81953016053, 81953016061, 81953016090,
81953016108, 81953016112, 81953016126,
81953016143, 81953016149, 81953016154,
81953016156, 81953016168, 81953016178,
81953016194, 81953016206, 81953016224,
81953016234, 81953016242, 81953016252,
81953016274, 81953016278, 81953016284,
81953016286, 81953016308, 81953016310,
81953016312, 81953016347, 81953016350,
81953016352, 82953016012, 88953016014,
N2953016001



MN-DL-0549

Length: 820
Ø: 32
Cone Ø: d1 Ø 20 / d2 Ø 18
81466106725, 85466106102



MN-DL-2127

Length: 1670 Ø: 30
Cone Ø: d1 Ø 20 / d2 Ø 18
81467106865, 81467106866



MN-DL-2133

Length: 829
Ø: 38
Cone Ø: d1 Ø 22 / d2 Ø 20
81466106753, 81466106754, 85466106104



MN-DL-7781

Length: 1630 Ø: 35
Cone Ø: d1 Ø 22 / d2 Ø 20
81467106395, 81467106851, 81467106852,
81467106853, 81467116719, 81467116729,
81467116841



MN-DL-7835

Length: 1455
Ø: 35
Cone Ø: d1 Ø 22 / d2 Ø 20
81467106238, 81467106240, 81467106242,
81467106409, 81467106410, 81467106411



MN-DL-8378

Length: 882 Ø: 38
Cone Ø: d1 Ø 30 / d2 Ø 26
85466106156



MN-DL-9381

Length: 840 Ø: 40
81432506007



MN-RK-8723

Length: 100 Ø: 46
Hole Distance: 60
81432506009



MN-SB-5249

Length: 55 Ø: 71
Thick/Height: 80
03310200A, 81437040029



MN-TC-12471

Length: 840
Ø: 50
81432506014





L 2000 ...

9.185 LK, L-KI, LRK, LR-KI, LRK-L, LK-L (LE180C)	09/00→	Ball Head, gearshift linkage	CV-ES-2120		
	09/00→	Centre Rod	MN-DL-0549		Push Rod
	09/00→	Centre Rod	MN-DL-2127		Coupling Rod
	09/00→	Centre Rod	MN-DL-2133		Push Rod
	09/00→	Centre Rod	MN-DL-8378		Push Rod
	09/00→	Suspension Arm Repair Kit		MN-RK-8723	for Drag Link;for Semi-Trailing Arm
	09/00→	Tie Rod	MN-DL-7781		Guide Rod
	09/00→	Tie Rod End	CV-ES-2774		
	09/00→	Tie Rod End	CV-ES-14163		for Steering Rod
	9.185 LLS, LLRS (LE 180C)	09/00→	Ball Head, gearshift linkage	CV-ES-2120	
09/00→		Centre Rod	MN-DL-0549		Push Rod
09/00→		Centre Rod	MN-DL-2127		Coupling Rod
09/00→		Centre Rod	MN-DL-2133		Push Rod
09/00→		Stabiliser Mounting		MN-SB-5249	
09/00→		Stabiliser Mounting		MN-SB-5249	1st RA
09/00→		Suspension Arm Repair Kit		MN-RK-8723	for Drag Link;for Semi-Trailing Arm
09/00→		Tie Rod	MN-DL-7781		Guide Rod
09/00→		Tie Rod End	CV-ES-2774		
09/00→		Track Control Arm		MN-DL-9381	Control Arm, Air Suspension Axle
09/00→	Track Control Arm		MN-TC-12471	Semi-Trailing Arm, 1st Drive Axle, for Pneumatic Suspension vehicles	
9.223 LC,9.223 LLC	10/93→06/96	Ball Head, gearshift linkage	CV-ES-2120		
	10/93→06/96	Centre Rod	MN-DL-0549		Push Rod
	10/93→06/96	Centre Rod	MN-DL-2127		Coupling Rod
	10/93→06/96	Centre Rod	MN-DL-2133		Push Rod
	10/93→06/96	Stabiliser Mounting		MN-SB-5249	
	10/93→06/96	Stabiliser Mounting		MN-SB-5249	1st RA
	10/93→06/96	Suspension Arm Repair Kit		MN-RK-8723	for Drag Link;for Semi-Trailing Arm
	10/93→06/96	Tie Rod	MN-DL-7781		Guide Rod
	10/93→06/96	Tie Rod End	CV-ES-2774		
	10/93→06/96	Track Control Arm		MN-DL-9381	Control Arm, Air Suspension Axle
10/93→06/96	Track Control Arm		MN-TC-12471	Semi-Trailing Arm, 1st Drive Axle, for Pneumatic Suspension vehicles	
9.223 LK	10/93→06/96	Ball Head, gearshift linkage	CV-ES-2120		
	10/93→06/96	Centre Rod	MN-DL-0549		Push Rod
	10/93→06/96	Centre Rod	MN-DL-2127		Coupling Rod
	10/93→06/96	Centre Rod	MN-DL-2133		Push Rod
	10/93→06/96	Tie Rod	MN-DL-7781		Guide Rod
	10/93→06/96	Tie Rod End	CV-ES-2774		
9.223 LLS	10/93→06/96	Ball Head, gearshift linkage	CV-ES-2120		
	10/93→06/96	Centre Rod	MN-DL-0549		Push Rod
	10/93→06/96	Centre Rod	MN-DL-2127		Coupling Rod
	10/93→06/96	Centre Rod	MN-DL-2133		Push Rod
	10/93→06/96	Stabiliser Mounting		MN-SB-5249	
	10/93→06/96	Stabiliser Mounting		MN-SB-5249	1st RA
	10/93→06/96	Suspension Arm Repair Kit		MN-RK-8723	for Drag Link;for Semi-Trailing Arm
	10/93→06/96	Tie Rod	MN-DL-7781		Guide Rod
	10/93→06/96	Tie Rod End	CV-ES-2774		
	10/93→06/96	Track Control Arm		MN-DL-9381	Control Arm, Air Suspension Axle
10/93→06/96	Track Control Arm		MN-TC-12471	Semi-Trailing Arm, 1st Drive Axle, for Pneumatic Suspension vehicles	
9.224 LC,9.224 LLC, LRC, LLRC	05/94→	Ball Head, gearshift linkage	CV-ES-2120		
	05/94→	Centre Rod	MN-DL-0549		Push Rod
	05/94→	Centre Rod	MN-DL-2127		Coupling Rod
	05/94→	Centre Rod	MN-DL-2133		Push Rod
	05/94→	Stabiliser Mounting		MN-SB-5249	
	05/94→	Stabiliser Mounting		MN-SB-5249	1st RA
	05/94→	Suspension Arm Repair Kit		MN-RK-8723	for Drag Link;for Semi-Trailing Arm
	05/94→	Tie Rod	MN-DL-7781		Guide Rod
	05/94→	Tie Rod End	CV-ES-2774		
	05/94→	Track Control Arm		MN-DL-9381	Control Arm, Air Suspension Axle
	05/94→	Track Control Arm		MN-TC-12471	Semi-Trailing Arm, 1st Drive Axle, for Pneumatic Suspension vehicles

CV-ES-2120

Length: 115
Cone Ø: d1 Ø 12,4 / d2 Ø 10,8
Thread: M14 x 1,5 RHT
03008500A, 81953016200, 81953016202,
81953016203, 81953016227



CV-ES-2774

Length: 95
Cone Ø: d1 Ø 20 / d2 Ø 18
Thread: M24 x 1,5 RHT
81953016134, 81953016142



CV-ES-14163

Length: 125
Cone Ø: d1 Ø 30 / d2 Ø 27
Thread: M30 x 1,5 RHT
95301.0084, 90804102156, 90804102272,
90804102696, 90804102710, 81953010016,
81953010075, 81953010084, 81953010088,
81953010094, 81953010103, 81953016030,
81953016043, 81953016048, 81953016049,
81953016053, 81953016061, 81953016090,
81953016108, 81953016112, 81953016126,
81953016143, 81953016149, 81953016154,
81953016156, 81953016168, 81953016178,
81953016194, 81953016206, 81953016224,
81953016234, 81953016242, 81953016252,
81953016274, 81953016278, 81953016284,
81953016286, 81953016308, 81953016310,
81953016312, 81953016347, 81953016350,
81953016352, 82953016012, 88953016014,
N2953016001



MN-DL-0549

Length: 820
Ø: 32
Cone Ø: d1 Ø 20 / d2 Ø 18
81466106725, 85466106102



MN-DL-2127

Length: 1670 Ø: 30
Cone Ø: d1 Ø 20 / d2 Ø 18
81467106865, 81467106866



MN-DL-2133

Length: 829
Ø: 38
Cone Ø: d1 Ø 22 / d2 Ø 20
81466106753, 81466106754, 85466106104



MN-DL-7781

Length: 1630 Ø: 35
Cone Ø: d1 Ø 22 / d2 Ø 20
81467106395, 81467106851, 81467106852,
81467106853, 81467116719, 81467116729,
81467116841



MN-DL-8378

Length: 882 Ø: 38
Cone Ø: d1 Ø 30 / d2 Ø 26
85466106156



MN-DL-9381

Length: 840 Ø: 40
81432506007



MN-RK-8723

Length: 100 Ø: 46
Hole Distance: 60
81432506009



MN-SB-5249

Length: 55 Ø: 71
Thick/Height: 80
03310200A, 81437040029



MN-TC-12471

Length: 840
Ø: 50
81432506014



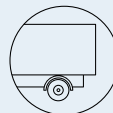

L 2000 ...

9.224 LK, L-KI, LRK, LR-KI, LRK-L, LK-L	05/94 →	Ball Head, gearshift linkage	CV-ES-2120		
	05/94 →	Centre Rod	MN-DL-0549	Push Rod	
	05/94 →	Centre Rod	MN-DL-2127	Coupling Rod	
	05/94 →	Centre Rod	MN-DL-2133	Push Rod	
	05/94 →	Tie Rod	MN-DL-7781	Guide Rod	
	05/94 →	Tie Rod End	CV-ES-2774		
9.224 LLS, LLRS	05/94 →	Ball Head, gearshift linkage	CV-ES-2120		
	05/94 →	Centre Rod	MN-DL-0549	Push Rod	
	05/94 →	Centre Rod	MN-DL-2127	Coupling Rod	
	05/94 →	Centre Rod	MN-DL-2133	Push Rod	
	05/94 →	Stabiliser Mounting		MN-SB-5249	
	05/94 →	Stabiliser Mounting		MN-SB-5249	1st RA
	05/94 →	Suspension Arm Repair Kit		MN-RK-8723	for Drag Link;for Semi-Trailing Arm
	05/94 →	Tie Rod	MN-DL-7781		Guide Rod
	05/94 →	Tie Rod End	CV-ES-2774		
	05/94 →	Track Control Arm		MN-DL-9381	Control Arm, Air Suspension Axle
05/94 →	Track Control Arm		MN-TC-12471	Semi-Trailing Arm, 1st Drive Axle, for Pneumatic Suspension vehicles	
9.225 LC,9.225 LLC, LRC, LLRC (LE220C)	09/00 →	Ball Head, gearshift linkage	CV-ES-2120		
	09/00 →	Centre Rod	MN-DL-0549	Push Rod	
	09/00 →	Centre Rod	MN-DL-2127	Coupling Rod	
	09/00 →	Centre Rod	MN-DL-2133	Push Rod	
	09/00 →	Centre Rod	MN-DL-8378	Push Rod	
	09/00 →	Stabiliser Mounting		MN-SB-5249	
	09/00 →	Stabiliser Mounting		MN-SB-5249	1st RA
	09/00 →	Suspension Arm Repair Kit		MN-RK-8723	for Drag Link;for Semi-Trailing Arm
	09/00 →	Tie Rod	MN-DL-7781		Guide Rod
	09/00 →	Tie Rod End	CV-ES-2774		
	09/00 →	Tie Rod End	CV-ES-14163		for Steering Rod
	09/00 →	Track Control Arm		MN-DL-9381	Control Arm, Air Suspension Axle
	09/00 →	Track Control Arm		MN-TC-12471	Semi-Trailing Arm, 1st Drive Axle, for Pneumatic Suspension vehicles
9.225 LK, L-KI, LRK, LR-KI, LRK-KI, LK-L (LE220C)	09/00 →	Ball Head, gearshift linkage	CV-ES-2120		
	09/00 →	Centre Rod	MN-DL-0549	Push Rod	
	09/00 →	Centre Rod	MN-DL-2127	Coupling Rod	
	09/00 →	Centre Rod	MN-DL-2133	Push Rod	
	09/00 →	Tie Rod	MN-DL-7781	Guide Rod	
	09/00 →	Tie Rod End	CV-ES-2774		
	09/00 →	Track Control Arm		MN-DL-9381	Control Arm, Air Suspension Axle
9.225 LLS, LLRS (LE220C)	09/00 →	Ball Head, gearshift linkage	CV-ES-2120		
	09/00 →	Centre Rod	MN-DL-0549	Push Rod	
	09/00 →	Centre Rod	MN-DL-2127	Coupling Rod	
	09/00 →	Centre Rod	MN-DL-2133	Push Rod	
	09/00 →	Stabiliser Mounting		MN-SB-5249	
	09/00 →	Stabiliser Mounting		MN-SB-5249	1st RA
	09/00 →	Suspension Arm Repair Kit		MN-RK-8723	for Drag Link;for Semi-Trailing Arm
	09/00 →	Tie Rod	MN-DL-7781		Guide Rod
	09/00 →	Tie Rod End	CV-ES-2774		
	09/00 →	Track Control Arm		MN-DL-9381	Control Arm, Air Suspension Axle
09/00 →	Track Control Arm		MN-TC-12471	Semi-Trailing Arm, 1st Drive Axle, for Pneumatic Suspension vehicles	

LION S CITY

A 26	02/98 →	Track Control Arm		MN-TC-12400	Control Arm
A 37	01/02 →10/09	Track Control Arm		MN-TC-12400	Control Arm
A 39	08/04 →	Track Control Arm		MN-TC-12400	Control Arm
A 66	02/09 →	Tie Rod End	CV-ES-12462		for Steering Rod

CV-ES-2120

Length: 115
Cone Ø: d1 Ø 12,4 / d2 Ø 10,8
Thread: M14 x 1,5 RHT
03008500A, 81953016200, 81953016202,
81953016203, 81953016227



CV-ES-2774

Length: 95
Cone Ø: d1 Ø 20 / d2 Ø 18
Thread: M24 x 1,5 RHT
81953016134, 81953016142



CV-ES-12462

Length: 120
Cone Ø: d1 Ø 26 / d2 Ø 23,5
Thread: M30 x 1,5 RHT
90804102218, 90804153111, 81953010014,
81953010042, 81953010064, 81953010068,
81953016065, 81953016067, 81953016073,
81953016162, 81953016239, 81953016240,
81953016246, 81953016250, 81953016272,
81953016282, 81953016319, 81953016360,
82953016014



CV-ES-14163

Length: 125
Cone Ø: d1 Ø 30 / d2 Ø 27
Thread: M30 x 1,5 RHT
95301.0084, 90804102156, 90804102272,
90804102696, 90804102710, 81953010016,
81953010075, 81953010084, 81953010088,
81953010094, 81953010103, 81953016030,
81953016043, 81953016048, 81953016049,
81953016053, 81953016061, 81953016090,
81953016108, 81953016112, 81953016126,
81953016143, 81953016149, 81953016154,
81953016156, 81953016168, 81953016178,
81953016194, 81953016206, 81953016224,
81953016234, 81953016242, 81953016252,
81953016274, 81953016278, 81953016284,
81953016286, 81953016308, 81953016310,
81953016312, 81953016347, 81953016350,
81953016352, 82953016012, 88953016014,
N2953016001



MN-DL-0549

Length: 820
Ø: 32
Cone Ø: d1 Ø 20 / d2 Ø 18
81466106725, 85466106102



MN-DL-2127

Length: 1670 Ø: 30
Cone Ø: d1 Ø 20 / d2 Ø 18
81467106865, 81467106866



MN-DL-2133

Length: 829
Ø: 38
Cone Ø: d1 Ø 22 / d2 Ø 20
81466106753, 81466106754, 85466106104



MN-DL-7781

Length: 1630 Ø: 35
Cone Ø: d1 Ø 22 / d2 Ø 20
81467106395, 81467106851, 81467106852,
81467106853, 81467116719, 81467116729,
81467116841



MN-DL-8378

Length: 882 Ø: 38
Cone Ø: d1 Ø 30 / d2 Ø 26
85466106156



MN-DL-9381

Length: 840 Ø: 40
81432506007



MN-RK-8723

Length: 100 Ø: 46
Hole Distance: 60
81432506009



MN-SB-5249

Length: 55 Ø: 71
Thick/Height: 80
03310200A, 81437040029



MN-TC-12400

Length: 413
Hole Distance: 80 / 80
Thick/Height: 35
81432206164, 81432206165, 81432206166,
81432206215, 81432206227, 81432206228



MN-TC-12471

Length: 840
Ø: 50
81432506014



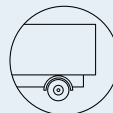

LION S COACH

FRH 352,RH 353	09/95→	Ball Head, gearshift linkage	CV-ES-2120			
	09/95→	Engine Mounting	MN-SB-10387			
	09/95→	Suspension Strut Repair Kit		CV-RK-5311		
	09/95→	Suspension Strut Repair Kit		MN-RK-8558		
	09/95→	Tie Rod	MN-DL-8370			
	09/95→	Tie Rod	MN-DL-8734			
	09/95→	Tie Rod	MN-DL-10268			
	09/95→	Tie Rod End	CV-ES-14163		for Steering Rod	
	09/95→	Track Control Arm		MN-DL-10281	Trailing Arm	
	09/95→	Track Control Arm		MN-DL-10286	Trailing Arm	
	09/95→	Track Control Arm	MN-DL-9368	MN-DL-9368	Trailing Arm	
	09/95→	Track Control Arm	MN-DL-9369		Control Arm	
	FRH 402,RH 403	09/95→	Ball Head, gearshift linkage	CV-ES-2120		
		09/95→	Engine Mounting	MN-SB-10387		
09/95→		Suspension Strut Repair Kit		CV-RK-5311		
09/95→		Suspension Strut Repair Kit		MN-RK-8558		
09/95→		Tie Rod	MN-DL-8370			
09/95→		Tie Rod	MN-DL-8734			
09/95→		Tie Rod	MN-DL-10268			
09/95→		Tie Rod End	CV-ES-14163		for Steering Rod	
09/95→		Track Control Arm		MN-DL-10281	Trailing Arm	
09/95→		Track Control Arm		MN-DL-10286	Trailing Arm	
09/95→		Track Control Arm	MN-DL-9368	MN-DL-9368	Trailing Arm	
09/95→		Track Control Arm	MN-DL-9369		Control Arm	
RH 403		09/98→	Ball Head, gearshift linkage	CV-ES-2120		
		09/98→	Engine Mounting	MN-SB-10387		
	09/98→	Suspension Strut Repair Kit		CV-RK-5311		
	09/98→	Suspension Strut Repair Kit		MN-RK-8558		
	09/98→	Tie Rod	MN-DL-8734			
	09/98→	Tie Rod	MN-DL-10268			
	09/98→	Tie Rod End	CV-ES-2146			
	09/98→	Tie Rod End	CV-ES-14163		for Steering Rod	
	09/98→	Track Control Arm		MN-DL-10284	Trailing Arm	
	09/98→	Track Control Arm		MN-DL-10286	Trailing Arm	
	09/98→	Track Control Arm	MN-DL-9368	MN-DL-9368	Trailing Arm	
	RH 463, RHC 464	01/00→	Ball Head, gearshift linkage	CV-ES-2120		
		01/00→	Engine Mounting	MN-SB-10387		
		01/00→	Suspension Strut Repair Kit		CV-RK-5311	
01/00→		Suspension Strut Repair Kit		MN-RK-8558		
01/00→		Tie Rod	MN-DL-8734			
01/00→		Tie Rod	MN-DL-10268			
01/00→		Tie Rod End	CV-ES-14163		for Steering Rod	
01/00→		Track Control Arm		MN-DL-10283	Trailing Arm	
01/00→		Track Control Arm		MN-DL-10284	Trailing Arm	
01/00→		Track Control Arm		MN-DL-10286	Trailing Arm	
01/00→		Track Control Arm	MN-DL-9368	MN-DL-9368	Trailing Arm	
01/00→		Track Control Arm	MN-DL-9369		Control Arm	
RHC 414		06/02→	Ball Head, gearshift linkage	CV-ES-2120		
		06/02→	Suspension Strut Repair Kit		CV-RK-5311	
	06/02→	Tie Rod	MN-DL-8734			
	06/02→	Tie Rod	MN-DL-10268			
	06/02→	Track Control Arm		MN-DL-10283	Trailing Arm	
	06/02→	Track Control Arm	MN-DL-9368	MN-DL-9368	Trailing Arm	

LION S COMFORT

RN 313	09/96→	Ball Head, gearshift linkage	CV-ES-2120		
RN 353	06/97→	Ball Head, gearshift linkage	CV-ES-2120		

CV-ES-2120

Length: 115
Cone Ø: d1 Ø 12,4 / d2 Ø 10,8
Thread: M14 x 1,5 RHT
03008500A, 81953016200, 81953016202,
81953016203, 81953016227



CV-ES-2146

Length: 80
Cone Ø: d1 Ø 30 / d2 Ø 27
Thread: M26 x 1,5 RHT
42533102, 81953016219, 81953016225,
81953016226, 81953016267, 81953016291



CV-ES-14163

Length: 125
Cone Ø: d1 Ø 30 / d2 Ø 27
Thread: M30 x 1,5 RHT
95301.0084, 90804102156, 90804102272,
90804102696, 90804102710, 81953010016,
81953010075, 81953010084, 81953010088,
81953010094, 81953010103, 81953016030,
81953016043, 81953016048, 81953016049,
81953016053, 81953016061, 81953016090,
81953016108, 81953016112, 81953016126,
81953016143, 81953016149, 81953016154,
81953016156, 81953016168, 81953016178,
81953016194, 81953016206, 81953016224,
81953016234, 81953016242, 81953016252,
81953016274, 81953016278, 81953016284,
81953016286, 81953016308, 81953016310,
81953016312, 81953016347, 81953016350,
81953016352, 82953016012, 88953016014,
N2953016001



CV-RK-5311

638862, 639287, 938423, 1104335,
1953248, 3500506, 0003500506, 11013547,
42488722, 070550504, 634303610,
81432206055, 81432206073, 82262320660,
5001842823, 7000307001, 8226232066



MN-DL-8370

Length: 501 Ø: 40
Cone Ø: d1 Ø 30 / d2 Ø 27
81467106080, 81467106136, 81467106172,
81467106295, 81467106337, 81467106345,
81467106421, 81467106451, 81467106876,
81467116762



MN-DL-8734

Length: 413 Ø: 36
Cone Ø: d1 Ø 30 / d2 Ø 27
81467116771, 81467116877, 81467116878,
81467116879



MN-DL-9368

Length: 330
Ø: 36
Hole Distance: 80
81432206177



MN-DL-9369

Length: 330 Ø: 36
Hole Distance: 80
81432206177, 81432206294



MN-DL-10268

Length: 661 Ø: 38
Cone Ø: d1 Ø 30 / d2 Ø 27
81467116770, 81467116772, 81467116874,
81467116875, 81467116876



MN-DL-10281

Length: 633 Ø: 50
Hole Distance: 130
81432206134, 81432206135, 81432206136,
81432206137, 81432206138, 81432206191



MN-DL-10283

Length: 622 Ø: 50
Hole Distance: 130 / 130
81432206258, 81432206264, 81432206275,
81432206278, 81432206279



MN-DL-10284

Length: 633 Ø: 50
Hole Distance: 130
81432206187



MN-DL-10286

Length: 570 Ø: 48
Hole Distance: 130 / 130
81432206151, 81432206183, 81432206276



MN-RK-8558

Length: 100 Ø: 95
81432206204



MN-SB-10387

Ø: 70
Thick/Height: 85/85
81960200384



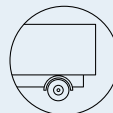

LION S STAR

FRH 352,RH 353	09/95 →	Ball Head, gearshift linkage	CV-ES-2120			
	09/95 →	Centre Rod	MN-DL-12421		for Steering Rod	
	09/95 →	Engine Mounting	MN-SB-10387			
	09/95 →	Suspension Arm Repair Kit		IV-RK-8998	for Wishbone (CV)	
	09/95 →	Suspension Strut Repair Kit		CV-RK-5311		
	09/95 →	Suspension Strut Repair Kit		MN-RK-8558		
	09/95 →	Tie Rod	MN-DL-8370			
	09/95 →	Tie Rod	MN-DL-8734			
	09/95 →	Tie Rod	MN-DL-10268			
	09/95 →	Tie Rod End	CV-ES-14163		for Steering Rod	
	09/95 →	Track Control Arm		MN-DL-10281	Trailing Arm	
	09/95 →	Track Control Arm		MN-DL-10284	Trailing Arm	
	09/95 →	Track Control Arm		MN-DL-10286	Trailing Arm	
	09/95 →	Track Control Arm	MN-DL-9368	MN-DL-9368	Trailing Arm	
	09/95 →	Track Control Arm	MN-DL-9369		Control Arm	
FRH 402,RH 403	09/95 →	Ball Head, gearshift linkage	CV-ES-2120			
	09/95 →	Centre Rod	MN-DL-12421		for Steering Rod	
	09/95 →	Engine Mounting	MN-SB-10387			
	09/95 →	Suspension Arm Repair Kit		IV-RK-8998	for Wishbone (CV)	
	09/95 →	Suspension Strut Repair Kit		CV-RK-5311		
	09/95 →	Suspension Strut Repair Kit		MN-RK-8558		
	09/95 →	Tie Rod	MN-DL-8370			
	09/95 →	Tie Rod	MN-DL-8734			
	09/95 →	Tie Rod	MN-DL-10268			
	09/95 →	Tie Rod End	CV-ES-14163		for Steering Rod	
	09/95 →	Track Control Arm		MN-DL-10281	Trailing Arm	
	09/95 →	Track Control Arm		MN-DL-10284	Trailing Arm	
	09/95 →	Track Control Arm		MN-DL-10286	Trailing Arm	
	09/95 →	Track Control Arm	MN-DL-9368	MN-DL-9368	Trailing Arm	
	09/95 →	Track Control Arm	MN-DL-9369		Control Arm	
FRH 422	01/93 →09/96	Ball Head, gearshift linkage	CV-ES-2120			
	01/93 →09/96	Centre Rod	MN-DL-12421		for Steering Rod	
	01/93 →09/96	Engine Mounting	MN-SB-10387			
	01/93 →09/96	Suspension Arm Repair Kit		IV-RK-8998	for Wishbone (CV)	
	01/93 →09/96	Suspension Strut Repair Kit		CV-RK-5311		
	01/93 →09/96	Suspension Strut Repair Kit		MN-RK-8558		
	01/93 →09/96	Tie Rod	MN-DL-8370			
	01/93 →09/96	Tie Rod	MN-DL-8734			
	01/93 →09/96	Tie Rod	MN-DL-10268			
	01/93 →09/96	Tie Rod End	CV-ES-14163		for Steering Rod	
	01/93 →09/96	Track Control Arm		MN-DL-10281	Trailing Arm	
	01/93 →09/96	Track Control Arm		MN-DL-10284	Trailing Arm	
	01/93 →09/96	Track Control Arm		MN-DL-10286	Trailing Arm	
	01/93 →09/96	Track Control Arm	MN-DL-9368	MN-DL-9368	Trailing Arm	
	01/93 →09/96	Track Control Arm	MN-DL-9369		Control Arm	
RH 414, RHS 414	03/00 →	Ball Head, gearshift linkage	CV-ES-2120			
	03/00 →	Suspension Strut Repair Kit		CV-RK-5311		
	03/00 →	Suspension Strut Repair Kit		MN-RK-8558		
	03/00 →	Tie Rod	MN-DL-8734			
	03/00 →	Tie Rod	MN-DL-10268			
	03/00 →	Track Control Arm		MN-DL-10281	Trailing Arm	
	03/00 →	Track Control Arm		MN-DL-10283	Trailing Arm	
	03/00 →	Track Control Arm		MN-DL-10284	Trailing Arm	
	03/00 →	Track Control Arm		MN-DL-10286	Trailing Arm	
	03/00 →	Track Control Arm	MN-DL-9368	MN-DL-9368	Trailing Arm	
	03/00 →	Track Control Arm	MN-DL-9369		Control Arm	
	RH 464, RHS 464	03/00 →	Ball Head, gearshift linkage	CV-ES-2120		
		03/00 →	Suspension Strut Repair Kit		CV-RK-5311	
		03/00 →	Suspension Strut Repair Kit		MN-RK-8558	
		03/00 →	Tie Rod	MN-DL-8734		
03/00 →		Tie Rod	MN-DL-10268			
03/00 →		Track Control Arm		MN-DL-10281	Trailing Arm	
03/00 →		Track Control Arm		MN-DL-10283	Trailing Arm	

CV-ES-2120

Length: 115
Cone Ø: d1 Ø 12,4 / d2 Ø 10,8
Thread: M14 x 1,5 RHT
03008500A, 81953016200, 81953016202,
81953016203, 81953016227



CV-ES-14163

Length: 125
Cone Ø: d1 Ø 30 / d2 Ø 27
Thread: M30 x 1,5 RHT

95301.0084, 90804102156, 90804102272,
90804102696, 90804102710, 81953010016,
81953010075, 81953010084, 81953010088,
81953010094, 81953010103, 81953016030,
81953016043, 81953016048, 81953016049,
81953016053, 81953016061, 81953016090,
81953016108, 81953016112, 81953016126,
81953016143, 81953016149, 81953016154,
81953016156, 81953016168, 81953016178,
81953016194, 81953016206, 81953016224,
81953016234, 81953016242, 81953016252,
81953016274, 81953016278, 81953016284,
81953016286, 81953016308, 81953016310,
81953016312, 81953016347, 81953016350,
81953016352, 82953016012, 88953016014,
N2953016001



CV-RK-5311

638862, 639287, 938423, 1104335,
1953248, 3500506, 0003500506, 11013547,
42488722, 070550504, 634303610,
81432206055, 81432206073, 82262320660,
5001842823, 7000307001, 8226232066



IV-RK-8998

Ø: 85
Hole Distance: 130
Thick/Height: 30
81432206203



MN-DL-8370

Length: 501 Ø: 40
Cone Ø: d1 Ø 30 / d2 Ø 27
81467106080, 81467106136, 81467106172,
81467106295, 81467106337, 81467106345,
81467106421, 81467106451, 81467106876,
81467116762



MN-DL-8734

Length: 413 Ø: 36
Cone Ø: d1 Ø 30 / d2 Ø 27
81467116771, 81467116877, 81467116878,
81467116879



MN-DL-9368

Length: 330
Ø: 36
Hole Distance: 80
81432206177



MN-DL-9369

Length: 330 Ø: 36
Hole Distance: 80
81432206177, 81432206294



MN-DL-10268

Length: 661 Ø: 38
Cone Ø: d1 Ø 30 / d2 Ø 27
81467116770, 81467116772, 81467116874,
81467116875, 81467116876



MN-DL-10281

Length: 633 Ø: 50
Hole Distance: 130
81432206134, 81432206135, 81432206136,
81432206137, 81432206138, 81432206191



MN-DL-10283

Length: 622 Ø: 50
Hole Distance: 130 / 130
81432206258, 81432206264, 81432206275,
81432206278, 81432206279



MN-DL-10284

Length: 633 Ø: 50
Hole Distance: 130
81432206187



MN-DL-10286

Length: 570 Ø: 48
Hole Distance: 130 / 130
81432206151, 81432206183, 81432206276



MN-DL-12421

Length: 1070
Ø: 48
Cone Ø: d1 Ø 30 / d2 Ø 27
Thread: M30 x 1,5 RHT
81466106656, 81466106659, 81466106669,
81466116006, 81466116007



MN-RK-8558

Length: 100 Ø: 95
81432206204



MN-SB-10387

Ø: 70
Thick/Height: 85/85
81960200384



**LION S STAR ...**

RH 464, RHS 464 ...	03/00→	Track Control Arm		MN-DL-10284	Trailing Arm
	03/00→	Track Control Arm		MN-DL-10286	Trailing Arm
	03/00→	Track Control Arm	MN-DL-9368	MN-DL-9368	Trailing Arm
	03/00→	Track Control Arm	MN-DL-9369		Control Arm

M 90

12.152 F,12.152 FL	12/88→04/93	Track Control Arm		MN-DL-9370	Trailing Arm	
	12/88→05/94	Ball Head, gearshift linkage	CV-ES-2119			
	12/88→05/94	Ball Head, gearshift linkage	CV-ES-2120			
	12/88→05/94	Ball Head, gearshift linkage	CV-ES-2121			
	12/88→05/94	Ball Head, gearshift linkage	CV-ES-2182			
	12/88→05/94	Centre Rod	MN-DL-7833		Push Rod	
	12/88→05/94	Centre Rod	MN-DL-7837		Push Rod	
	12/88→05/94	Stabiliser Mounting		MN-SB-5248		
	12/88→05/94	Stabiliser Mounting		MN-SB-5248	1st RA	
	12/88→05/94	Stabiliser Mounting		MN-SB-5249		
	12/88→05/94	Stabiliser Mounting		MN-SB-5249	1st RA	
	12/88→05/94	Stabiliser Mounting	MN-SB-5249		1st FA	
	12/88→05/94	Suspension Arm Repair Kit		CV-RK-8118	for Control Arm	
	12/88→05/94	Suspension Arm Repair Kit		MN-RK-8523	for Wishbone (CV)	
	12/88→05/94	Tie Rod	MN-DL-8486			
	12/88→05/94	Tie Rod End	CV-ES-12461		for Steering Rod	
	12/88→05/94	Tie Rod End	CV-ES-12462		for Steering Rod	
	12/88→05/94	Track Control Arm		MN-VB-8565	Wishbone (CV)	
	04/93→05/94	Track Control Arm		MN-DL-8590	Trailing Arm, Air Suspension Axle	
	12.152 FK	12/88→05/94	Ball Head, gearshift linkage	CV-ES-2119		
		12/88→05/94	Ball Head, gearshift linkage	CV-ES-2120		
		12/88→05/94	Ball Head, gearshift linkage	CV-ES-2121		
		12/88→05/94	Ball Head, gearshift linkage	CV-ES-2182		
		12/88→05/94	Centre Rod	MN-DL-7833		Push Rod
12/88→05/94		Centre Rod	MN-DL-7837		Push Rod	
12/88→05/94		Stabiliser Mounting		MN-SB-5249		
12/88→05/94		Stabiliser Mounting		MN-SB-5249	1st RA	
12/88→05/94		Stabiliser Mounting	MN-SB-5249		1st FA	
12/88→05/94		Tie Rod	MN-DL-8486			
12/88→05/94		Tie Rod End	CV-ES-12461		for Steering Rod	
12/88→05/94		Tie Rod End	CV-ES-12462		for Steering Rod	
12.152 FS,12.152 FLS	12/88→04/93	Track Control Arm		MN-DL-9370	Trailing Arm	
	12/88→05/94	Ball Head, gearshift linkage	CV-ES-2119			
	12/88→05/94	Ball Head, gearshift linkage	CV-ES-2120			
	12/88→05/94	Ball Head, gearshift linkage	CV-ES-2121			
	12/88→05/94	Ball Head, gearshift linkage	CV-ES-2182			
	12/88→05/94	Centre Rod	MN-DL-7833		Push Rod	
	12/88→05/94	Centre Rod	MN-DL-7837		Push Rod	
	12/88→05/94	Stabiliser Mounting		MN-SB-5248		
	12/88→05/94	Stabiliser Mounting		MN-SB-5248	1st RA	
	12/88→05/94	Stabiliser Mounting		MN-SB-5249		
	12/88→05/94	Stabiliser Mounting		MN-SB-5249	1st RA	
	12/88→05/94	Stabiliser Mounting	MN-SB-5249		1st FA	
	12/88→05/94	Suspension Arm Repair Kit		CV-RK-8118	for Control Arm	
	12/88→05/94	Suspension Arm Repair Kit		MN-RK-8523	for Wishbone (CV)	
	12/88→05/94	Tie Rod	MN-DL-8486			
	12/88→05/94	Tie Rod End	CV-ES-12461		for Steering Rod	
	12/88→05/94	Tie Rod End	CV-ES-12462		for Steering Rod	
	12/88→05/94	Track Control Arm		MN-VB-8565	Wishbone (CV)	
	04/93→05/94	Track Control Arm		MN-DL-8590	Trailing Arm, Air Suspension Axle	
	12.192 F,12.192 FL	07/90→04/93	Track Control Arm		MN-DL-9370	Trailing Arm
		07/90→06/96	Ball Head, gearshift linkage	CV-ES-2119		
		07/90→06/96	Ball Head, gearshift linkage	CV-ES-2120		
07/90→06/96		Ball Head, gearshift linkage	CV-ES-2121			
07/90→06/96		Ball Head, gearshift linkage	CV-ES-2182			
07/90→06/96		Centre Rod	MN-DL-7833		Push Rod	
07/90→06/96		Centre Rod	MN-DL-7837		Push Rod	

CV-ES-2119

Length: 55
Cone Ø: d1 Ø 10 / d2 Ø 10
Thread: M12 x 1,75 LHT
81953016063, 81953016131



CV-ES-2120

Length: 115
Cone Ø: d1 Ø 12,4 / d2 Ø 10,8
Thread: M14 x 1,5 RHT
03008500A, 81953016200, 81953016202, 81953016203, 81953016227



CV-ES-2121

Length: 85
Cone Ø: d1 Ø 12 / d2 Ø 10,8
Thread: M14 x 1,5 RHT
81953010038, 81953010045, 81953016016, 81953016169, 81953016172, 81953016176, 81953016266, 81953016302



CV-ES-2182

Length: 55
Cone Ø: d1 Ø 10 / d2 Ø 10
Thread: M12 x 1,75 RHT
81953016064, 81953016170



CV-ES-12461

Length: 120
Cone Ø: d1 Ø 26 / d2 Ø 23,5
Thread: M30 x 1,5 LHT
90804102216, 90804102612, 90804102720, 90804153107, 90804153113, 81953010013, 81953010074, 81953010082, 81953016068, 81953016074, 81953016163, 81953016273, 81953016283, 81953016320, 81953016361



CV-ES-12462

Length: 120
Cone Ø: d1 Ø 26 / d2 Ø 23,5
Thread: M30 x 1,5 RHT
90804102218, 90804153111, 81953010014, 81953010042, 81953010064, 81953010068, 81953016065, 81953016067, 81953016073, 81953016162, 81953016239, 81953016240, 81953016246, 81953016250, 81953016272, 81953016282, 81953016319, 81953016360, 82953016014



CV-RK-8118

Ø: 85
Hole Distance: 130
Thick/Height: 30
638862, 639287, 775201, 938423, 1104335, 1953248, 0003500506, 3500506, 11013547, 21032592, 42065912, 42488722, 070550504, 93192618, 070400009000, 634303610, 81432206055, 81432206073, 82262320660, 9544171010099, 5001842823, 7000307001, 8226232066



MN-DL-7833

Length: 900 **Ø:** 40
Cone Ø: d1 Ø 26 / d2 Ø 23,5
81467106434, 81467106435, 81467106456



MN-DL-7837

Length: 955 **Ø:** 40
Cone Ø: d1 Ø 26 / d2 Ø 23,5
03206800A, 81467106436, 81467106437, 81467106455



MN-DL-8486

Length: 1545 **Ø:** 38
Cone Ø: d1 Ø 26 / d2 Ø 23,5
81467106314, 81467106315, 81467106316



MN-DL-8590

Length: 596 **Ø:** 50
Hole Distance: 130 / 102
81432206140, 81432209140



MN-DL-9368

Length: 330
Ø: 36
Hole Distance: 80
81432206177



MN-DL-9369

Length: 330 **Ø:** 36
Hole Distance: 80
81432206177, 81432206294



MN-DL-9370

Length: 596 **Ø:** 50
Hole Distance: 130 / 130
81432306015, 81432306031, 81432309031



MN-DL-10284

Length: 633 **Ø:** 50
Hole Distance: 130
81432206187



MN-DL-10286

Length: 570 **Ø:** 48
Hole Distance: 130 / 130
81432206151, 81432206183, 81432206276



MN-RK-8523

Ø: 72
03304900A, 81432706065



MN-SB-5248

Length: 55 **Ø:** 80
Thick/Height: 80
03310100A, 81437040025



MN-SB-5249

Length: 55 **Ø:** 71
Thick/Height: 80
03310200A, 81437040029



MN-VB-8565

Length: 693
Ø: 46
Hole Distance: 115 / 115
81432706053, 81432709053



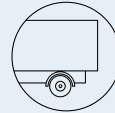
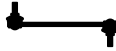

M 90 ...

12.192 F, 12.192 FL ...	07/90→06/96	Stabiliser Mounting		MN-SB-5248		
	07/90→06/96	Stabiliser Mounting		MN-SB-5248	1st RA	
	07/90→06/96	Stabiliser Mounting		MN-SB-5249		
	07/90→06/96	Stabiliser Mounting		MN-SB-5249	1st RA	
	07/90→06/96	Stabiliser Mounting	MN-SB-5249		1st FA	
	07/90→06/96	Suspension Arm Repair Kit		CV-RK-8118	for Control Arm	
	07/90→06/96	Suspension Arm Repair Kit		MN-RK-8523	for Wishbone (CV)	
	07/90→06/96	Tie Rod	MN-DL-8486			
	07/90→06/96	Tie Rod End	CV-ES-12461		for Steering Rod	
	07/90→06/96	Tie Rod End	CV-ES-12462		for Steering Rod	
	07/90→06/96	Track Control Arm		MN-VB-8565	Wishbone (CV)	
	04/93→06/96	Track Control Arm		MN-DL-8590	Trailing Arm, Air Suspension Axle	
12.192 FA	10/92→06/96	Ball Head, gearshift linkage	CV-ES-2119			
	10/92→06/96	Ball Head, gearshift linkage	CV-ES-2120			
	10/92→06/96	Ball Head, gearshift linkage	CV-ES-2121			
	10/92→06/96	Ball Head, gearshift linkage	CV-ES-2182			
	10/92→06/96	Centre Rod	MN-DL-12432		for Steering Rod	
	10/92→06/96	Stabiliser Mounting		MN-SB-5249		
	10/92→06/96	Stabiliser Mounting		MN-SB-5249	1st RA	
	10/92→06/96	Stabiliser Mounting	MN-SB-5249		1st FA	
	10/92→06/96	Tie Rod End	CV-ES-12461		for Steering Rod	
	10/92→06/96	Tie Rod End	CV-ES-12462		for Steering Rod	
12.192 FAK	10/92→06/96	Ball Head, gearshift linkage	CV-ES-2119			
	10/92→06/96	Ball Head, gearshift linkage	CV-ES-2120			
	10/92→06/96	Ball Head, gearshift linkage	CV-ES-2121			
	10/92→06/96	Ball Head, gearshift linkage	CV-ES-2182			
	10/92→06/96	Centre Rod	MN-DL-12432		for Steering Rod	
	10/92→06/96	Stabiliser Mounting		MN-SB-5249		
	10/92→06/96	Stabiliser Mounting		MN-SB-5249	1st RA	
	10/92→06/96	Stabiliser Mounting	MN-SB-5249		1st FA	
	10/92→06/96	Tie Rod End	CV-ES-12461		for Steering Rod	
	10/92→06/96	Tie Rod End	CV-ES-12462		for Steering Rod	
12.192 FK	07/90→06/96	Ball Head, gearshift linkage	CV-ES-2119			
	07/90→06/96	Ball Head, gearshift linkage	CV-ES-2120			
	07/90→06/96	Ball Head, gearshift linkage	CV-ES-2121			
	07/90→06/96	Ball Head, gearshift linkage	CV-ES-2182			
	07/90→06/96	Centre Rod	MN-DL-7833		Push Rod	
	07/90→06/96	Centre Rod	MN-DL-7837		Push Rod	
	07/90→06/96	Stabiliser Mounting		MN-SB-5249		
	07/90→06/96	Stabiliser Mounting		MN-SB-5249	1st RA	
	07/90→06/96	Stabiliser Mounting	MN-SB-5249		1st FA	
	07/90→06/96	Tie Rod	MN-DL-8486			
	07/90→06/96	Tie Rod End	CV-ES-12461		for Steering Rod	
	07/90→06/96	Tie Rod End	CV-ES-12462		for Steering Rod	
	12.192 FS, 12.192 FLS	07/90→04/93	Track Control Arm		MN-DL-9370	Trailing Arm
		07/90→06/96	Ball Head, gearshift linkage	CV-ES-2119		
07/90→06/96		Ball Head, gearshift linkage	CV-ES-2120			
07/90→06/96		Ball Head, gearshift linkage	CV-ES-2121			
07/90→06/96		Ball Head, gearshift linkage	CV-ES-2182			
07/90→06/96		Centre Rod	MN-DL-7833		Push Rod	
07/90→06/96		Centre Rod	MN-DL-7837		Push Rod	
07/90→06/96		Stabiliser Mounting		MN-SB-5248		
07/90→06/96		Stabiliser Mounting		MN-SB-5248	1st RA	
07/90→06/96		Stabiliser Mounting		MN-SB-5249		
07/90→06/96		Stabiliser Mounting		MN-SB-5249	1st RA	
07/90→06/96		Stabiliser Mounting	MN-SB-5249		1st FA	
07/90→06/96		Suspension Arm Repair Kit		CV-RK-8118	for Control Arm	
07/90→06/96		Suspension Arm Repair Kit		MN-RK-8523	for Wishbone (CV)	
07/90→06/96		Tie Rod	MN-DL-8486			
07/90→06/96		Tie Rod End	CV-ES-12461		for Steering Rod	
07/90→06/96		Tie Rod End	CV-ES-12462		for Steering Rod	
07/90→06/96		Track Control Arm		MN-VB-8565	Wishbone (CV)	
04/93→06/96		Track Control Arm		MN-DL-8590	Trailing Arm, Air Suspension Axle	

CV-ES-2119

Length: 55
Cone Ø: d1 Ø 10 / d2 Ø 10
Thread: M12 x 1,75 LHT
81953016063, 81953016131



CV-ES-2120

Length: 115
Cone Ø: d1 Ø 12,4 / d2 Ø 10,8
Thread: M14 x 1,5 RHT
03008500A, 81953016200, 81953016202,
81953016203, 81953016227



CV-ES-2121

Length: 85
Cone Ø: d1 Ø 12 / d2 Ø 10,8
Thread: M14 x 1,5 RHT
81953010038, 81953010045, 81953016016,
81953016169, 81953016172, 81953016176,
81953016266, 81953016302



CV-ES-2182

Length: 55
Cone Ø: d1 Ø 10 / d2 Ø 10
Thread: M12 x 1,75 RHT
81953016064, 81953016170



CV-ES-12461

Length: 120
Cone Ø: d1 Ø 26 / d2 Ø 23,5
Thread: M30 x 1,5 LHT
90804102216, 90804102612, 90804102720,
90804153107, 90804153113, 81953010013,
81953010074, 81953010082, 81953016068,
81953016074, 81953016163, 81953016273,
81953016283, 81953016320, 81953016361



CV-ES-12462

Length: 120
Cone Ø: d1 Ø 26 / d2 Ø 23,5
Thread: M30 x 1,5 RHT
90804102218, 90804153111, 81953010014,
81953010042, 81953010064, 81953010068,
81953016065, 81953016067, 81953016073,
81953016162, 81953016239, 81953016240,
81953016246, 81953016250, 81953016272,
81953016282, 81953016319, 81953016360,
82953016014



CV-RK-8118

Ø: 85
Hole Distance: 130
Thick/Height: 30
638862, 639287, 775201, 938423,
1104335, 1953248, 0003500506, 3500506,
11013547, 21032592, 42065912, 42488722,
070550504, 93192618, 070400009000,
634303610, 81432206055, 81432206073,
82262320660, 9544171010099,
5001842823, 7000307001, 8226232066



MN-DL-7833

Length: 900 Ø: 40
Cone Ø: d1 Ø 26 / d2 Ø 23,5
81467106434, 81467106435, 81467106456



MN-DL-7837

Length: 955 Ø: 40
Cone Ø: d1 Ø 26 / d2 Ø 23,5
03206800A, 81467106436, 81467106437,
81467106455



MN-DL-8486

Length: 1545 Ø: 38
Cone Ø: d1 Ø 26 / d2 Ø 23,5
81467106314, 81467106315, 81467106316



MN-DL-8590

Length: 596 Ø: 50
Hole Distance: 130 / 102
81432206140, 81432209140



MN-DL-9370

Length: 596 Ø: 50
Hole Distance: 130 / 130
81432306015, 81432306031, 81432309031



MN-DL-12432

Length: 975
Ø: 40
Cone Ø: d1 Ø 26 / d2 Ø 23,5
81466106692, 81466106693, 81466106695,
85466106020, 85466106120, 85466106151



MN-RK-8523

Ø: 72
03304900A, 81432706065



MN-SB-5248

Length: 55 Ø: 80
Thick/Height: 80
03310100A, 81437040025



MN-SB-5249

Length: 55 Ø: 71
Thick/Height: 80
03310200A, 81437040029



MN-VB-8565

Length: 693
Ø: 46
Hole Distance: 115 / 115
81432706053, 81432709053



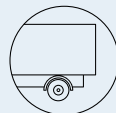

M 90 ...

12.222 F,12.222 FL	05/94 →06/96	Ball Head, gearshift linkage	CV-ES-2119			
	05/94 →06/96	Ball Head, gearshift linkage	CV-ES-2120			
	05/94 →06/96	Ball Head, gearshift linkage	CV-ES-2121			
	05/94 →06/96	Ball Head, gearshift linkage	CV-ES-2182			
	05/94 →06/96	Centre Rod	MN-DL-7833		Push Rod	
	05/94 →06/96	Centre Rod	MN-DL-7837		Push Rod	
	05/94 →06/96	Stabiliser Mounting		MN-SB-5248		
	05/94 →06/96	Stabiliser Mounting		MN-SB-5248	1st RA	
	05/94 →06/96	Stabiliser Mounting		MN-SB-5249		
	05/94 →06/96	Stabiliser Mounting		MN-SB-5249	1st RA	
	05/94 →06/96	Stabiliser Mounting	MN-SB-5249		1st FA	
	05/94 →06/96	Suspension Arm Repair Kit		CV-RK-8118	for Control Arm	
	05/94 →06/96	Suspension Arm Repair Kit		MN-RK-8523	for Wishbone (CV)	
	05/94 →06/96	Tie Rod	MN-DL-8486			
	05/94 →06/96	Tie Rod End	CV-ES-12461		for Steering Rod	
	05/94 →06/96	Tie Rod End	CV-ES-12462		for Steering Rod	
	05/94 →06/96	Track Control Arm		MN-DL-8590	Trailing Arm, Air Suspension Axle	
	05/94 →06/96	Track Control Arm		MN-VB-8565	Wishbone (CV)	
	12.222 FA	05/94 →06/96	Ball Head, gearshift linkage	CV-ES-2119		
		05/94 →06/96	Ball Head, gearshift linkage	CV-ES-2120		
05/94 →06/96		Ball Head, gearshift linkage	CV-ES-2121			
05/94 →06/96		Ball Head, gearshift linkage	CV-ES-2182			
05/94 →06/96		Centre Rod	MN-DL-12432		for Steering Rod	
05/94 →06/96		Stabiliser Mounting		MN-SB-5249		
05/94 →06/96		Stabiliser Mounting		MN-SB-5249	1st RA	
05/94 →06/96		Stabiliser Mounting	MN-SB-5249		1st FA	
05/94 →06/96		Tie Rod End	CV-ES-12461		for Steering Rod	
05/94 →06/96	Tie Rod End	CV-ES-12462		for Steering Rod		
12.222 FAK	05/94 →06/96	Ball Head, gearshift linkage	CV-ES-2119			
	05/94 →06/96	Ball Head, gearshift linkage	CV-ES-2120			
	05/94 →06/96	Ball Head, gearshift linkage	CV-ES-2121			
	05/94 →06/96	Ball Head, gearshift linkage	CV-ES-2182			
	05/94 →06/96	Centre Rod	MN-DL-12432		for Steering Rod	
	05/94 →06/96	Stabiliser Mounting		MN-SB-5249		
	05/94 →06/96	Stabiliser Mounting		MN-SB-5249	1st RA	
	05/94 →06/96	Stabiliser Mounting	MN-SB-5249		1st FA	
	05/94 →06/96	Tie Rod End	CV-ES-12461		for Steering Rod	
05/94 →06/96	Tie Rod End	CV-ES-12462		for Steering Rod		
12.222 FK	05/94 →06/96	Ball Head, gearshift linkage	CV-ES-2119			
	05/94 →06/96	Ball Head, gearshift linkage	CV-ES-2120			
	05/94 →06/96	Ball Head, gearshift linkage	CV-ES-2121			
	05/94 →06/96	Ball Head, gearshift linkage	CV-ES-2182			
	05/94 →06/96	Centre Rod	MN-DL-7833		Push Rod	
	05/94 →06/96	Centre Rod	MN-DL-7837		Push Rod	
	05/94 →06/96	Stabiliser Mounting		MN-SB-5249		
	05/94 →06/96	Stabiliser Mounting		MN-SB-5249	1st RA	
	05/94 →06/96	Stabiliser Mounting	MN-SB-5249		1st FA	
	05/94 →06/96	Tie Rod End	CV-ES-12461		for Steering Rod	
	05/94 →06/96	Tie Rod End	CV-ES-12462		for Steering Rod	
12.222 FLS	05/94 →06/96	Ball Head, gearshift linkage	CV-ES-2119			
	05/94 →06/96	Ball Head, gearshift linkage	CV-ES-2120			
	05/94 →06/96	Ball Head, gearshift linkage	CV-ES-2121			
	05/94 →06/96	Ball Head, gearshift linkage	CV-ES-2182			
	05/94 →06/96	Centre Rod	MN-DL-7833		Push Rod	
	05/94 →06/96	Centre Rod	MN-DL-7837		Push Rod	
	05/94 →06/96	Stabiliser Mounting		MN-SB-5248		
	05/94 →06/96	Stabiliser Mounting		MN-SB-5248	1st RA	
	05/94 →06/96	Stabiliser Mounting	MN-SB-5249		1st FA	
	05/94 →06/96	Stabiliser Mounting	MN-SB-5249		1st FA	
	05/94 →06/96	Suspension Arm Repair Kit		CV-RK-8118	for Control Arm	
05/94 →06/96	Suspension Arm Repair Kit		MN-RK-8523	for Wishbone (CV)		
05/94 →06/96	Tie Rod End	CV-ES-12461		for Steering Rod		

CV-ES-2119

Length: 55
Cone Ø: d1 Ø 10 / d2 Ø 10
Thread: M12 x 1,75 LHT
81953016063, 81953016131



CV-ES-2120

Length: 115
Cone Ø: d1 Ø 12,4 / d2 Ø 10,8
Thread: M14 x 1,5 RHT
03008500A, 81953016200, 81953016202,
81953016203, 81953016227



CV-ES-2121

Length: 85
Cone Ø: d1 Ø 12 / d2 Ø 10,8
Thread: M14 x 1,5 RHT
81953010038, 81953010045, 81953016016,
81953016169, 81953016172, 81953016176,
81953016266, 81953016302



CV-ES-2182

Length: 55
Cone Ø: d1 Ø 10 / d2 Ø 10
Thread: M12 x 1,75 RHT
81953016064, 81953016170



CV-ES-12461

Length: 120
Cone Ø: d1 Ø 26 / d2 Ø 23,5
Thread: M30 x 1,5 LHT
90804102216, 90804102612, 90804102720,
90804153107, 90804153113, 81953010013,
81953010074, 81953010082, 81953016068,
81953016074, 81953016163, 81953016273,
81953016283, 81953016320, 81953016361



CV-ES-12462

Length: 120
Cone Ø: d1 Ø 26 / d2 Ø 23,5
Thread: M30 x 1,5 RHT
90804102218, 90804153111, 81953010014,
81953010042, 81953010064, 81953010068,
81953016065, 81953016067, 81953016073,
81953016162, 81953016239, 81953016240,
81953016246, 81953016250, 81953016272,
81953016282, 81953016319, 81953016360,
82953016014



CV-RK-8118

Ø: 85
Hole Distance: 130
Thick/Height: 30
638862, 639287, 775201, 938423,
1104335, 1953248, 3500506, 0003500506,
11013547, 21032592, 42065912, 42488722,
070550504, 93192618, 070400009000,
634303610, 81432206055, 81432206073,
82262320660, 9544171010099,
5001842823, 7000307001, 8226232066



MN-DL-7833

Length: 900 Ø: 40
Cone Ø: d1 Ø 26 / d2 Ø 23,5
81467106434, 81467106435, 81467106456



MN-DL-7837

Length: 955 Ø: 40
Cone Ø: d1 Ø 26 / d2 Ø 23,5
03206800A, 81467106436, 81467106437,
81467106455



MN-DL-8486

Length: 1545 Ø: 38
Cone Ø: d1 Ø 26 / d2 Ø 23,5
81467106314, 81467106315, 81467106316



MN-DL-8590

Length: 596 Ø: 50
Hole Distance: 130 / 102
81432206140, 81432209140



MN-DL-12432

Length: 975
Ø: 40
Cone Ø: d1 Ø 26 / d2 Ø 23,5
81466106692, 81466106693, 81466106695,
85466106020, 85466106120, 85466106151



MN-RK-8523

Ø: 72
03304900A, 81432706065



MN-SB-5248

Length: 55 Ø: 80
Thick/Height: 80
03310100A, 81437040025



MN-SB-5249

Length: 55 Ø: 71
Thick/Height: 80
03310200A, 81437040029



MN-VB-8565

Length: 693
Ø: 46
Hole Distance: 115 / 115
81432706053, 81432709053



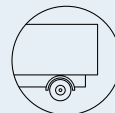

M 90 ...

12.222 FLS ...	05/94 → 06/96	Tie Rod End	CV-ES-12462		for Steering Rod	
	05/94 → 06/96	Track Control Arm		MN-DL-8590	Trailing Arm, Air Suspension Axle	
	05/94 → 06/96	Track Control Arm		MN-VB-8565	Wishbone (CV)	
	05/94 → 06/96	Track Control Arm		MN-DL-9370	Trailing Arm	
12.232 F, 12.232 FL	08/88 → 04/93	Track Control Arm		MN-DL-9370	Trailing Arm	
	08/88 → 06/96	Ball Head, gearshift linkage	CV-ES-2119			
	08/88 → 06/96	Ball Head, gearshift linkage	CV-ES-2120			
	08/88 → 06/96	Ball Head, gearshift linkage	CV-ES-2121			
	08/88 → 06/96	Ball Head, gearshift linkage	CV-ES-2182			
	08/88 → 06/96	Centre Rod	MN-DL-7833		Push Rod	
	08/88 → 06/96	Centre Rod	MN-DL-7837		Push Rod	
	08/88 → 06/96	Stabiliser Mounting		MN-SB-5248		
	08/88 → 06/96	Stabiliser Mounting		MN-SB-5248	1st RA	
	08/88 → 06/96	Stabiliser Mounting		MN-SB-5249		
	08/88 → 06/96	Stabiliser Mounting		MN-SB-5249	1st RA	
	08/88 → 06/96	Stabiliser Mounting	MN-SB-5249		1st FA	
	08/88 → 06/96	Suspension Arm Repair Kit		CV-RK-8118	for Control Arm	
	08/88 → 06/96	Suspension Arm Repair Kit		MN-RK-8523	for Wishbone (CV)	
	08/88 → 06/96	Tie Rod	MN-DL-8486			
	08/88 → 06/96	Tie Rod End	CV-ES-12461		for Steering Rod	
	08/88 → 06/96	Tie Rod End	CV-ES-12462		for Steering Rod	
	08/88 → 06/96	Track Control Arm		MN-VB-8565	Wishbone (CV)	
	08/88 → 06/96	Track Control Arm		MN-DL-8590	Trailing Arm, Air Suspension Axle	
	12.232 FA	05/90 → 06/96	Ball Head, gearshift linkage	CV-ES-2119		
		05/90 → 06/96	Ball Head, gearshift linkage	CV-ES-2120		
05/90 → 06/96		Ball Head, gearshift linkage	CV-ES-2121			
05/90 → 06/96		Ball Head, gearshift linkage	CV-ES-2182			
05/90 → 06/96		Centre Rod	MN-DL-12432		for Steering Rod	
05/90 → 06/96		Stabiliser Mounting		MN-SB-5249		
05/90 → 06/96		Stabiliser Mounting		MN-SB-5249	1st RA	
05/90 → 06/96		Stabiliser Mounting	MN-SB-5249		1st FA	
05/90 → 06/96		Tie Rod End	CV-ES-12461		for Steering Rod	
05/90 → 06/96		Tie Rod End	CV-ES-12462		for Steering Rod	
12.232 FAK		05/90 → 06/96	Ball Head, gearshift linkage	CV-ES-2119		
	05/90 → 06/96	Ball Head, gearshift linkage	CV-ES-2120			
	05/90 → 06/96	Ball Head, gearshift linkage	CV-ES-2121			
	05/90 → 06/96	Ball Head, gearshift linkage	CV-ES-2182			
	05/90 → 06/96	Centre Rod	MN-DL-12432		for Steering Rod	
	05/90 → 06/96	Stabiliser Mounting		MN-SB-5249		
	05/90 → 06/96	Stabiliser Mounting		MN-SB-5249	1st RA	
	05/90 → 06/96	Stabiliser Mounting	MN-SB-5249		1st FA	
	05/90 → 06/96	Tie Rod End	CV-ES-12461		for Steering Rod	
	05/90 → 06/96	Tie Rod End	CV-ES-12462		for Steering Rod	
	12.232 FK	08/88 → 06/96	Ball Head, gearshift linkage	CV-ES-2119		
08/88 → 06/96		Ball Head, gearshift linkage	CV-ES-2120			
08/88 → 06/96		Ball Head, gearshift linkage	CV-ES-2121			
08/88 → 06/96		Ball Head, gearshift linkage	CV-ES-2182			
08/88 → 06/96		Centre Rod	MN-DL-7833		Push Rod	
08/88 → 06/96		Centre Rod	MN-DL-7837		Push Rod	
08/88 → 06/96		Stabiliser Mounting		MN-SB-5249		
08/88 → 06/96		Stabiliser Mounting		MN-SB-5249	1st RA	
08/88 → 06/96		Stabiliser Mounting	MN-SB-5249		1st FA	
08/88 → 06/96		Tie Rod	MN-DL-8486			
08/88 → 06/96		Tie Rod End	CV-ES-12461		for Steering Rod	
08/88 → 06/96	Tie Rod End	CV-ES-12462		for Steering Rod		
12.232 FS, 12.232 FLS	08/88 → 04/93	Track Control Arm		MN-DL-9370	Trailing Arm	
	08/88 → 06/96	Ball Head, gearshift linkage	CV-ES-2119			
	08/88 → 06/96	Ball Head, gearshift linkage	CV-ES-2120			
	08/88 → 06/96	Ball Head, gearshift linkage	CV-ES-2121			
	08/88 → 06/96	Ball Head, gearshift linkage	CV-ES-2182			
	08/88 → 06/96	Centre Rod	MN-DL-7833		Push Rod	
	08/88 → 06/96	Centre Rod	MN-DL-7837		Push Rod	
	08/88 → 06/96	Stabiliser Mounting		MN-SB-5248		
	08/88 → 06/96	Stabiliser Mounting		MN-SB-5248	1st RA	

CV-ES-2119

Length: 55
Cone Ø: d1 Ø 10 / d2 Ø 10
Thread: M12 x 1,75 LHT
81953016063, 81953016131



CV-ES-2120

Length: 115
Cone Ø: d1 Ø 12,4 / d2 Ø 10,8
Thread: M14 x 1,5 RHT
03008500A, 81953016200, 81953016202,
81953016203, 81953016227



CV-ES-2121

Length: 85
Cone Ø: d1 Ø 12 / d2 Ø 10,8
Thread: M14 x 1,5 RHT
81953010038, 81953010045, 81953016016,
81953016169, 81953016172, 81953016176,
81953016266, 81953016302



CV-ES-2182

Length: 55
Cone Ø: d1 Ø 10 / d2 Ø 10
Thread: M12 x 1,75 RHT
81953016064, 81953016170



CV-ES-12461

Length: 120
Cone Ø: d1 Ø 26 / d2 Ø 23,5
Thread: M30 x 1,5 LHT
90804102216, 90804102612, 90804102720,
90804153107, 90804153113, 81953010013,
81953010074, 81953010082, 81953016068,
81953016074, 81953016163, 81953016273,
81953016283, 81953016320, 81953016361



CV-ES-12462

Length: 120
Cone Ø: d1 Ø 26 / d2 Ø 23,5
Thread: M30 x 1,5 RHT
90804102218, 90804153111, 81953010014,
81953010042, 81953010064, 81953010068,
81953016065, 81953016067, 81953016073,
81953016162, 81953016239, 81953016240,
81953016246, 81953016250, 81953016272,
81953016282, 81953016319, 81953016360,
82953016014



CV-RK-8118

Ø: 85
Hole Distance: 130
Thick/Height: 30
638862, 639287, 775201, 938423,
1104335, 1953248, 0003500506, 3500506,
11013547, 21032592, 42065912, 42488722,
070550504, 93192618, 070400009000,
634303610, 81432206055, 81432206073,
82262320660, 9544171010099,
5001842823, 7000307001, 8226232066



MN-DL-7833

Length: 900 Ø: 40
Cone Ø: d1 Ø 26 / d2 Ø 23,5
81467106434, 81467106435, 81467106456



MN-DL-7837

Length: 955 Ø: 40
Cone Ø: d1 Ø 26 / d2 Ø 23,5
03206800A, 81467106436, 81467106437,
81467106455



MN-DL-8486

Length: 1545 Ø: 38
Cone Ø: d1 Ø 26 / d2 Ø 23,5
81467106314, 81467106315, 81467106316



MN-DL-8590

Length: 596 Ø: 50
Hole Distance: 130 / 102
81432206140, 81432209140



MN-DL-9370

Length: 596 Ø: 50
Hole Distance: 130 / 130
81432306015, 81432306031, 81432309031



MN-DL-12432

Length: 975
Ø: 40
Cone Ø: d1 Ø 26 / d2 Ø 23,5
81466106692, 81466106693, 81466106695,
85466106020, 85466106120, 85466106151



MN-RK-8523

Ø: 72
03304900A, 81432706065



MN-SB-5248

Length: 55 Ø: 80
Thick/Height: 80
03310100A, 81437040025



MN-SB-5249

Length: 55 Ø: 71
Thick/Height: 80
03310200A, 81437040029



MN-VB-8565

Length: 693
Ø: 46
Hole Distance: 115 / 115
81432706053, 81432709053



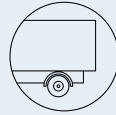
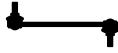

MAN ...

M 90 ...

12.232 FS,12.232 FLS ...	08/88→06/96	Stabiliser Mounting		MN-SB-5249		
	08/88→06/96	Stabiliser Mounting		MN-SB-5249	1st RA	
	08/88→06/96	Stabiliser Mounting	MN-SB-5249		1st FA	
	08/88→06/96	Suspension Arm Repair Kit		CV-RK-8118	for Control Arm	
	08/88→06/96	Suspension Arm Repair Kit		MN-RK-8523	for Wishbone (CV)	
	08/88→06/96	Tie Rod	MN-DL-8486			
	08/88→06/96	Tie Rod End	CV-ES-12461		for Steering Rod	
	08/88→06/96	Tie Rod End	CV-ES-12462		for Steering Rod	
	08/88→06/96	Track Control Arm		MN-VB-8565	Wishbone (CV)	
	04/93→06/96	Track Control Arm		MN-DL-8590	Trailing Arm, Air Suspension Axle	
12.262 F,12.262 FL	08/95→06/96	Ball Head, gearshift linkage	CV-ES-2119			
	08/95→06/96	Ball Head, gearshift linkage	CV-ES-2120			
	08/95→06/96	Ball Head, gearshift linkage	CV-ES-2121			
	08/95→06/96	Ball Head, gearshift linkage	CV-ES-2182			
	08/95→06/96	Centre Rod	MN-DL-7833		Push Rod	
	08/95→06/96	Centre Rod	MN-DL-7837		Push Rod	
	08/95→06/96	Stabiliser Mounting		MN-SB-5248		
	08/95→06/96	Stabiliser Mounting		MN-SB-5248	1st RA	
	08/95→06/96	Stabiliser Mounting		MN-SB-5249		
	08/95→06/96	Stabiliser Mounting		MN-SB-5249	1st RA	
	08/95→06/96	Stabiliser Mounting	MN-SB-5249		1st FA	
	08/95→06/96	Suspension Arm Repair Kit		CV-RK-8118	for Control Arm	
	08/95→06/96	Suspension Arm Repair Kit		MN-RK-8523	for Wishbone (CV)	
	08/95→06/96	Tie Rod	MN-DL-8486			
	08/95→06/96	Tie Rod End	CV-ES-12461		for Steering Rod	
	08/95→06/96	Tie Rod End	CV-ES-12462		for Steering Rod	
	08/95→06/96	Track Control Arm		MN-DL-8590	Trailing Arm, Air Suspension Axle	
	08/95→06/96	Track Control Arm		MN-VB-8565	Wishbone (CV)	
	12.262 FK	08/95→06/96	Ball Head, gearshift linkage	CV-ES-2119		
08/95→06/96		Ball Head, gearshift linkage	CV-ES-2120			
08/95→06/96		Ball Head, gearshift linkage	CV-ES-2121			
08/95→06/96		Ball Head, gearshift linkage	CV-ES-2182			
08/95→06/96		Centre Rod	MN-DL-7833		Push Rod	
08/95→06/96		Centre Rod	MN-DL-7837		Push Rod	
08/95→06/96		Stabiliser Mounting		MN-SB-5249		
08/95→06/96		Stabiliser Mounting		MN-SB-5249	1st RA	
08/95→06/96		Stabiliser Mounting	MN-SB-5249		1st FA	
08/95→06/96		Tie Rod	MN-DL-8486			
08/95→06/96		Tie Rod End	CV-ES-12461		for Steering Rod	
08/95→06/96		Tie Rod End	CV-ES-12462		for Steering Rod	
12.262 FS,12.262 FLS		08/95→06/96	Ball Head, gearshift linkage	CV-ES-2119		
		08/95→06/96	Ball Head, gearshift linkage	CV-ES-2120		
	08/95→06/96	Ball Head, gearshift linkage	CV-ES-2121			
	08/95→06/96	Ball Head, gearshift linkage	CV-ES-2182			
	08/95→06/96	Centre Rod	MN-DL-7833		Push Rod	
	08/95→06/96	Centre Rod	MN-DL-7837		Push Rod	
	08/95→06/96	Stabiliser Mounting		MN-SB-5248		
	08/95→06/96	Stabiliser Mounting		MN-SB-5248	1st RA	
	08/95→06/96	Stabiliser Mounting		MN-SB-5249		
	08/95→06/96	Stabiliser Mounting		MN-SB-5249	1st RA	
	08/95→06/96	Stabiliser Mounting	MN-SB-5249		1st FA	
	08/95→06/96	Suspension Arm Repair Kit		CV-RK-8118	for Control Arm	
	08/95→06/96	Suspension Arm Repair Kit		MN-RK-8523	for Wishbone (CV)	
	08/95→06/96	Tie Rod	MN-DL-8486			
	08/95→06/96	Tie Rod End	CV-ES-12461		for Steering Rod	
	08/95→06/96	Tie Rod End	CV-ES-12462		for Steering Rod	
	08/95→06/96	Track Control Arm		MN-DL-8590	Trailing Arm, Air Suspension Axle	
	08/95→06/96	Track Control Arm		MN-VB-8565	Wishbone (CV)	
	12.272 F,12.272 FL	09/91→10/92	Track Control Arm		MN-DL-8590	Trailing Arm
09/91→04/93		Track Control Arm		MN-DL-9370	Trailing Arm	
09/91→06/96		Ball Head, gearshift linkage	CV-ES-2119			
09/91→06/96		Ball Head, gearshift linkage	CV-ES-2120			
09/91→06/96		Ball Head, gearshift linkage	CV-ES-2121			

CV-ES-2119

Length: 55
Cone Ø: d1 Ø 10 / d2 Ø 10
Thread: M12 x 1,75 LHT
81953016063, 81953016131



CV-ES-2120

Length: 115
Cone Ø: d1 Ø 12,4 / d2 Ø 10,8
Thread: M14 x 1,5 RHT
03008500A, 81953016200, 81953016202,
81953016203, 81953016227



CV-ES-2121

Length: 85
Cone Ø: d1 Ø 12 / d2 Ø 10,8
Thread: M14 x 1,5 RHT
81953010038, 81953010045, 81953016016,
81953016169, 81953016172, 81953016176,
81953016266, 81953016302



CV-ES-2182

Length: 55
Cone Ø: d1 Ø 10 / d2 Ø 10
Thread: M12 x 1,75 RHT
81953016064, 81953016170



CV-ES-12461

Length: 120
Cone Ø: d1 Ø 26 / d2 Ø 23,5
Thread: M30 x 1,5 LHT
90804102216, 90804102612, 90804102720,
90804153107, 90804153113, 81953010013,
81953010074, 81953010082, 81953016068,
81953016074, 81953016163, 81953016273,
81953016283, 81953016320, 81953016361



CV-ES-12462

Length: 120
Cone Ø: d1 Ø 26 / d2 Ø 23,5
Thread: M30 x 1,5 RHT
90804102218, 90804153111, 81953010014,
81953010042, 81953010064, 81953010068,
81953016065, 81953016067, 81953016073,
81953016162, 81953016239, 81953016240,
81953016246, 81953016250, 81953016272,
81953016282, 81953016319, 81953016360,
82953016014



CV-RK-8118

Ø: 85
Hole Distance: 130
Thick/Height: 30
638862, 639287, 775201, 938423,
1104335, 1953248, 0003500506, 3500506,
11013547, 21032592, 42065912, 42488722,
070550504, 93192618, 070400009000,
634303610, 81432206055, 81432206073,
82262320660, 9544171010099,
5001842823, 7000307001, 8226232066



MN-DL-7833

Length: 900 Ø: 40
Cone Ø: d1 Ø 26 / d2 Ø 23,5
81467106434, 81467106435, 81467106456



MN-DL-7837

Length: 955 Ø: 40
Cone Ø: d1 Ø 26 / d2 Ø 23,5
03206800A, 81467106436, 81467106437,
81467106455



MN-DL-8486

Length: 1545 Ø: 38
Cone Ø: d1 Ø 26 / d2 Ø 23,5
81467106314, 81467106315, 81467106316



MN-DL-8590

Length: 596 Ø: 50
Hole Distance: 130 / 102
81432206140, 81432209140



MN-DL-9370

Length: 596 Ø: 50
Hole Distance: 130 / 130
81432306015, 81432306031, 81432309031



MN-RK-8523

Ø: 72
03304900A, 81432706065



MN-SB-5248

Length: 55 Ø: 80
Thick/Height: 80
03310100A, 81437040025



MN-SB-5249

Length: 55 Ø: 71
Thick/Height: 80
03310200A, 81437040029



MN-VB-8565

Length: 693
Ø: 46
Hole Distance: 115 / 115
81432706053, 81432709053



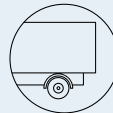

M 90 ...

12.272 F,12.272 FL ...	09/91→06/96	Ball Head, gearshift linkage	CV-ES-2182		
	09/91→06/96	Centre Rod	MN-DL-7833		Push Rod
	09/91→06/96	Centre Rod	MN-DL-7837		Push Rod
	09/91→06/96	Stabiliser Mounting		MN-SB-5248	
	09/91→06/96	Stabiliser Mounting		MN-SB-5248	1st RA
	09/91→06/96	Stabiliser Mounting		MN-SB-5249	
	09/91→06/96	Stabiliser Mounting		MN-SB-5249	1st RA
	09/91→06/96	Stabiliser Mounting	MN-SB-5249		1st FA
	09/91→06/96	Suspension Arm Repair Kit		CV-RK-8118	for Control Arm
	09/91→06/96	Suspension Arm Repair Kit		MN-RK-8523	for Wishbone (CV)
	09/91→06/96	Tie Rod	MN-DL-8486		
	09/91→06/96	Tie Rod End	CV-ES-12461		for Steering Rod
	09/91→06/96	Tie Rod End	CV-ES-12462		for Steering Rod
	09/91→06/96	Track Control Arm		MN-VB-8565	Wishbone (CV)
	04/93→06/96	Track Control Arm		MN-DL-8590	Trailing Arm, Air Suspension Axle
	12.272 FA	10/93→04/95	Ball Head, gearshift linkage	CV-ES-2119	
10/93→04/95		Ball Head, gearshift linkage	CV-ES-2120		
10/93→04/95		Ball Head, gearshift linkage	CV-ES-2121		
10/93→04/95		Ball Head, gearshift linkage	CV-ES-2182		
10/93→04/95		Centre Rod	MN-DL-12432		for Steering Rod
10/93→04/95		Stabiliser Mounting		MN-SB-5249	
10/93→04/95		Stabiliser Mounting		MN-SB-5249	1st RA
10/93→04/95		Stabiliser Mounting	MN-SB-5249		1st FA
12.272 FAK	10/93→04/95	Ball Head, gearshift linkage	CV-ES-2119		
	10/93→04/95	Ball Head, gearshift linkage	CV-ES-2120		
	10/93→04/95	Ball Head, gearshift linkage	CV-ES-2121		
	10/93→04/95	Ball Head, gearshift linkage	CV-ES-2182		
	10/93→04/95	Centre Rod	MN-DL-12432		for Steering Rod
	10/93→04/95	Stabiliser Mounting		MN-SB-5249	
	10/93→04/95	Stabiliser Mounting		MN-SB-5249	1st RA
	10/93→04/95	Stabiliser Mounting	MN-SB-5249		1st FA
12.272 FK	10/93→04/95	Tie Rod End	CV-ES-12461		for Steering Rod
	10/93→04/95	Tie Rod End	CV-ES-12462		for Steering Rod
	09/91→06/96	Ball Head, gearshift linkage	CV-ES-2119		
	09/91→06/96	Ball Head, gearshift linkage	CV-ES-2120		
	09/91→06/96	Ball Head, gearshift linkage	CV-ES-2121		
	09/91→06/96	Ball Head, gearshift linkage	CV-ES-2182		
	09/91→06/96	Centre Rod	MN-DL-7833		Push Rod
	09/91→06/96	Centre Rod	MN-DL-7837		Push Rod
12.272 FS,12.272 FLS	09/91→06/96	Stabiliser Mounting		MN-SB-5249	
	09/91→06/96	Stabiliser Mounting		MN-SB-5249	1st RA
	09/91→06/96	Stabiliser Mounting	MN-SB-5249		1st FA
	09/91→06/96	Tie Rod	MN-DL-8486		
	09/91→06/96	Tie Rod End	CV-ES-12461		for Steering Rod
	09/91→06/96	Tie Rod End	CV-ES-12462		for Steering Rod
	09/91→10/92	Track Control Arm		MN-DL-8590	Trailing Arm
	09/91→04/93	Track Control Arm		MN-DL-9370	Trailing Arm
	09/91→06/96	Ball Head, gearshift linkage	CV-ES-2119		
	09/91→06/96	Ball Head, gearshift linkage	CV-ES-2120		
	09/91→06/96	Ball Head, gearshift linkage	CV-ES-2121		
	09/91→06/96	Ball Head, gearshift linkage	CV-ES-2182		
	09/91→06/96	Centre Rod	MN-DL-7833		Push Rod
	09/91→06/96	Centre Rod	MN-DL-7837		Push Rod
	09/91→06/96	Stabiliser Mounting		MN-SB-5248	
	09/91→06/96	Stabiliser Mounting		MN-SB-5248	1st RA
09/91→06/96	Stabiliser Mounting		MN-SB-5249		
09/91→06/96	Stabiliser Mounting		MN-SB-5249	1st RA	
09/91→06/96	Stabiliser Mounting	MN-SB-5249		1st FA	
09/91→06/96	Suspension Arm Repair Kit		CV-RK-8118	for Control Arm	
09/91→06/96	Suspension Arm Repair Kit		MN-RK-8523	for Wishbone (CV)	
09/91→06/96	Tie Rod	MN-DL-8486			

CV-ES-2119

Length: 55
Cone Ø: d1 Ø 10 / d2 Ø 10
Thread: M12 x 1,75 LHT
81953016063, 81953016131



CV-ES-2120

Length: 115
Cone Ø: d1 Ø 12,4 / d2 Ø 10,8
Thread: M14 x 1,5 RHT
03008500A, 81953016200, 81953016202,
81953016203, 81953016227



CV-ES-2121

Length: 85
Cone Ø: d1 Ø 12 / d2 Ø 10,8
Thread: M14 x 1,5 RHT
81953010038, 81953010045, 81953016016,
81953016169, 81953016172, 81953016176,
81953016266, 81953016302



CV-ES-2182

Length: 55
Cone Ø: d1 Ø 10 / d2 Ø 10
Thread: M12 x 1,75 RHT
81953016064, 81953016170



CV-ES-12461

Length: 120
Cone Ø: d1 Ø 26 / d2 Ø 23,5
Thread: M30 x 1,5 LHT
90804102216, 90804102612, 90804102720,
90804153107, 90804153113, 81953010013,
81953010074, 81953010082, 81953016068,
81953016074, 81953016163, 81953016273,
81953016283, 81953016320, 81953016361



CV-ES-12462

Length: 120
Cone Ø: d1 Ø 26 / d2 Ø 23,5
Thread: M30 x 1,5 RHT
90804102218, 90804153111, 81953010014,
81953010042, 81953010064, 81953010068,
81953016065, 81953016067, 81953016073,
81953016162, 81953016239, 81953016240,
81953016246, 81953016250, 81953016272,
81953016282, 81953016319, 81953016360,
82953016014



CV-RK-8118

Ø: 85
Hole Distance: 130
Thick/Height: 30
638862, 639287, 775201, 938423,
1104335, 1953248, 0003500506, 3500506,
11013547, 21032592, 42065912, 42488722,
070550504, 93192618, 070400009000,
634303610, 81432206055, 81432206073,
82262320660, 9544171010099,
5001842823, 7000307001, 8226232066



MN-DL-7833

Length: 900 Ø: 40
Cone Ø: d1 Ø 26 / d2 Ø 23,5
81467106434, 81467106435, 81467106456



MN-DL-7837

Length: 955 Ø: 40
Cone Ø: d1 Ø 26 / d2 Ø 23,5
03206800A, 81467106436, 81467106437,
81467106455



MN-DL-8486

Length: 1545 Ø: 38
Cone Ø: d1 Ø 26 / d2 Ø 23,5
81467106314, 81467106315, 81467106316



MN-DL-8590

Length: 596 Ø: 50
Hole Distance: 130 / 102
81432206140, 81432209140



MN-DL-9370

Length: 596 Ø: 50
Hole Distance: 130 / 130
81432306015, 81432306031, 81432309031



MN-DL-12432

Length: 975
Ø: 40
Cone Ø: d1 Ø 26 / d2 Ø 23,5
81466106692, 81466106693, 81466106695,
85466106020, 85466106120, 85466106151



MN-RK-8523

Ø: 72
03304900A, 81432706065



MN-SB-5248

Length: 55 Ø: 80
Thick/Height: 80
03310100A, 81437040025



MN-SB-5249

Length: 55 Ø: 71
Thick/Height: 80
03310200A, 81437040029



MN-VB-8565

Length: 693
Ø: 46
Hole Distance: 115 / 115
81432706053, 81432709053





M 90 ...

12.272 FS,12.272 FLS ...	09/91→06/96	Tie Rod End	CV-ES-12461		for Steering Rod	
	09/91→06/96	Tie Rod End	CV-ES-12462		for Steering Rod	
	09/91→06/96	Track Control Arm		MN-VB-8565	Wishbone (CV)	
	04/93→06/96	Track Control Arm		MN-DL-8590	Trailing Arm, Air Suspension Axle	
14.152 F,14.152 FL	12/88→04/93	Track Control Arm		MN-DL-9370	Trailing Arm	
	12/88→06/96	Ball Head, gearshift linkage	CV-ES-2119			
	12/88→06/96	Ball Head, gearshift linkage	CV-ES-2120			
	12/88→06/96	Ball Head, gearshift linkage	CV-ES-2182			
	12/88→06/96	Centre Rod	MN-DL-7833		Push Rod	
	12/88→06/96	Centre Rod	MN-DL-7837		Push Rod	
	12/88→06/96	Stabiliser Mounting		MN-SB-5248		
	12/88→06/96	Stabiliser Mounting		MN-SB-5248	1st RA	
	12/88→06/96	Stabiliser Mounting		MN-SB-5249		
	12/88→06/96	Stabiliser Mounting		MN-SB-5249	1st RA	
	12/88→06/96	Stabiliser Mounting	MN-SB-5249		1st FA	
	12/88→06/96	Suspension Arm Repair Kit		CV-RK-8118	for Control Arm	
	12/88→06/96	Suspension Arm Repair Kit		MN-RK-8523	for Wishbone (CV)	
	12/88→06/96	Tie Rod	MN-DL-8486			
	12/88→06/96	Tie Rod End	CV-ES-12461		for Steering Rod	
	12/88→06/96	Tie Rod End	CV-ES-12462		for Steering Rod	
	12/88→06/96	Track Control Arm		MN-VB-8565	Wishbone (CV)	
	04/93→06/96	Track Control Arm		MN-DL-8590	Trailing Arm, Air Suspension Axle	
	14.152 FK	12/88→06/96	Ball Head, gearshift linkage	CV-ES-2119		
		12/88→06/96	Ball Head, gearshift linkage	CV-ES-2120		
12/88→06/96		Ball Head, gearshift linkage	CV-ES-2182			
12/88→06/96		Centre Rod	MN-DL-7833		Push Rod	
12/88→06/96		Centre Rod	MN-DL-7837		Push Rod	
12/88→06/96		Stabiliser Mounting		MN-SB-5249		
12/88→06/96		Stabiliser Mounting		MN-SB-5249	1st RA	
12/88→06/96		Stabiliser Mounting	MN-SB-5249		1st FA	
12/88→06/96		Tie Rod	MN-DL-8486			
12/88→06/96		Tie Rod End	CV-ES-12461		for Steering Rod	
12/88→06/96		Tie Rod End	CV-ES-12462		for Steering Rod	
14.152 FS,14.152 FLS		12/88→04/93	Track Control Arm		MN-DL-9370	Trailing Arm
	12/88→06/96	Ball Head, gearshift linkage	CV-ES-2119			
	12/88→06/96	Ball Head, gearshift linkage	CV-ES-2120			
	12/88→06/96	Ball Head, gearshift linkage	CV-ES-2182			
	12/88→06/96	Centre Rod	MN-DL-7833		Push Rod	
	12/88→06/96	Centre Rod	MN-DL-7837		Push Rod	
	12/88→06/96	Stabiliser Mounting		MN-SB-5248		
	12/88→06/96	Stabiliser Mounting		MN-SB-5248	1st RA	
	12/88→06/96	Stabiliser Mounting		MN-SB-5249		
	12/88→06/96	Stabiliser Mounting		MN-SB-5249	1st RA	
	12/88→06/96	Stabiliser Mounting	MN-SB-5249		1st FA	
	12/88→06/96	Suspension Arm Repair Kit		CV-RK-8118	for Control Arm	
	12/88→06/96	Suspension Arm Repair Kit		MN-RK-8523	for Wishbone (CV)	
	12/88→06/96	Tie Rod	MN-DL-8486			
	12/88→06/96	Tie Rod End	CV-ES-12461		for Steering Rod	
	12/88→06/96	Tie Rod End	CV-ES-12462		for Steering Rod	
	12/88→06/96	Track Control Arm		MN-VB-8565	Wishbone (CV)	
	04/93→06/96	Track Control Arm		MN-DL-8590	Trailing Arm, Air Suspension Axle	
	14.162 F,14.162 FL	08/95→06/96	Ball Head, gearshift linkage	CV-ES-2119		
		08/95→06/96	Ball Head, gearshift linkage	CV-ES-2120		
08/95→06/96		Ball Head, gearshift linkage	CV-ES-2182			
08/95→06/96		Centre Rod	MN-DL-7833		Push Rod	
08/95→06/96		Centre Rod	MN-DL-7837		Push Rod	
08/95→06/96		Stabiliser Mounting		MN-SB-5248		
08/95→06/96		Stabiliser Mounting		MN-SB-5248	1st RA	
08/95→06/96		Stabiliser Mounting		MN-SB-5249		
08/95→06/96		Stabiliser Mounting		MN-SB-5249	1st RA	
08/95→06/96		Stabiliser Mounting	MN-SB-5249		1st FA	
08/95→06/96		Suspension Arm Repair Kit		CV-RK-8118	for Control Arm	
08/95→06/96		Suspension Arm Repair Kit		MN-RK-8523	for Wishbone (CV)	

CV-ES-2119

Length: 55
Cone Ø: d1 Ø 10 / d2 Ø 10
Thread: M12 x 1,75 LHT
81953016063, 81953016131



CV-ES-2120

Length: 115
Cone Ø: d1 Ø 12,4 / d2 Ø 10,8
Thread: M14 x 1,5 RHT
03008500A, 81953016200, 81953016202,
81953016203, 81953016227



CV-ES-2182

Length: 55
Cone Ø: d1 Ø 10 / d2 Ø 10
Thread: M12 x 1,75 RHT
81953016064, 81953016170



CV-ES-12461

Length: 120
Cone Ø: d1 Ø 26 / d2 Ø 23,5
Thread: M30 x 1,5 LHT
90804102216, 90804102612, 90804102720,
90804153107, 90804153113, 81953010013,
81953010074, 81953010082, 81953016068,
81953016074, 81953016163, 81953016273,
81953016283, 81953016320, 81953016361



CV-ES-12462

Length: 120
Cone Ø: d1 Ø 26 / d2 Ø 23,5
Thread: M30 x 1,5 RHT
90804102218, 90804153111, 81953010014,
81953010042, 81953010064, 81953010068,
81953016065, 81953016067, 81953016073,
81953016162, 81953016239, 81953016240,
81953016246, 81953016250, 81953016272,
81953016282, 81953016319, 81953016360,
82953016014



CV-RK-8118

Ø: 85
Hole Distance: 130
Thick/Height: 30
638862, 639287, 775201, 938423,
1104335, 1953248, 0003500506, 3500506,
11013547, 21032592, 42065912, 42488722,
070550504, 93192618, 070400009000,
634303610, 81432206055, 81432206073,
82262320660, 9544171010099,
5001842823, 7000307001, 8226232066



MN-DL-7833

Length: 900 Ø: 40
Cone Ø: d1 Ø 26 / d2 Ø 23,5
81467106434, 81467106435, 81467106456



MN-DL-7837

Length: 955 Ø: 40
Cone Ø: d1 Ø 26 / d2 Ø 23,5
03206800A, 81467106436, 81467106437,
81467106455



MN-DL-8486

Length: 1545 Ø: 38
Cone Ø: d1 Ø 26 / d2 Ø 23,5
81467106314, 81467106315, 81467106316



MN-DL-8590

Length: 596 Ø: 50
Hole Distance: 130 / 102
81432206140, 81432209140



MN-DL-9370

Length: 596 Ø: 50
Hole Distance: 130 / 130
81432306015, 81432306031, 81432309031



MN-RK-8523

Ø: 72
03304900A, 81432706065



MN-SB-5248

Length: 55 Ø: 80
Thick/Height: 80
03310100A, 81437040025



MN-SB-5249

Length: 55 Ø: 71
Thick/Height: 80
03310200A, 81437040029



MN-VB-8565

Length: 693
Ø: 46
Hole Distance: 115 / 115
81432706053, 81432709053



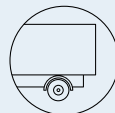

M 90 ...

14.162 F,14.162 FL ...	08/95→06/96	Tie Rod	MN-DL-8486		
	08/95→06/96	Tie Rod End	CV-ES-12461	for Steering Rod	
	08/95→06/96	Tie Rod End	CV-ES-12462	for Steering Rod	
	08/95→06/96	Track Control Arm		MN-DL-8590 Trailing Arm, Air Suspension Axle	
	08/95→06/96	Track Control Arm		MN-VB-8565 Wishbone (CV)	
14.162 FK	08/95→06/96	Ball Head, gearshift linkage	CV-ES-2119		
	08/95→06/96	Ball Head, gearshift linkage	CV-ES-2120		
	08/95→06/96	Ball Head, gearshift linkage	CV-ES-2182		
	08/95→06/96	Centre Rod	MN-DL-7833	Push Rod	
	08/95→06/96	Centre Rod	MN-DL-7837	Push Rod	
	08/95→06/96	Stabiliser Mounting		MN-SB-5249	
	08/95→06/96	Stabiliser Mounting		MN-SB-5249 1st RA	
	08/95→06/96	Stabiliser Mounting	MN-SB-5249	1st FA	
	08/95→06/96	Tie Rod	MN-DL-8486		
	08/95→06/96	Tie Rod End	CV-ES-12461	for Steering Rod	
	08/95→06/96	Tie Rod End	CV-ES-12462	for Steering Rod	
	14.162 FS,14.162 FLS	08/95→06/96	Ball Head, gearshift linkage	CV-ES-2119	
		08/95→06/96	Ball Head, gearshift linkage	CV-ES-2120	
08/95→06/96		Ball Head, gearshift linkage	CV-ES-2182		
08/95→06/96		Centre Rod	MN-DL-7833	Push Rod	
08/95→06/96		Centre Rod	MN-DL-7837	Push Rod	
08/95→06/96		Stabiliser Mounting		MN-SB-5248	
08/95→06/96		Stabiliser Mounting		MN-SB-5248 1st RA	
08/95→06/96		Stabiliser Mounting		MN-SB-5249	
08/95→06/96		Stabiliser Mounting		MN-SB-5249 1st RA	
08/95→06/96		Stabiliser Mounting	MN-SB-5249	1st FA	
08/95→06/96		Suspension Arm Repair Kit		CV-RK-8118 for Control Arm	
08/95→06/96		Suspension Arm Repair Kit		MN-RK-8523 for Wishbone (CV)	
08/95→06/96		Tie Rod	MN-DL-8486		
08/95→06/96		Tie Rod End	CV-ES-12461	for Steering Rod	
08/95→06/96		Tie Rod End	CV-ES-12462	for Steering Rod	
08/95→06/96		Track Control Arm		MN-DL-8590 Trailing Arm, Air Suspension Axle	
08/95→06/96		Track Control Arm		MN-VB-8565 Wishbone (CV)	
14.192 F,14.192 FL		08/88→06/90	Track Control Arm		MN-DL-8590 Trailing Arm
		08/88→04/93	Track Control Arm		MN-DL-9370 Trailing Arm
		08/88→06/96	Ball Head, gearshift linkage	CV-ES-2119	
	08/88→06/96	Ball Head, gearshift linkage	CV-ES-2120		
	08/88→06/96	Ball Head, gearshift linkage	CV-ES-2182		
	08/88→06/96	Centre Rod	MN-DL-7833	Push Rod	
	08/88→06/96	Centre Rod	MN-DL-7837	Push Rod	
	08/88→06/96	Stabiliser Mounting		MN-SB-5248	
	08/88→06/96	Stabiliser Mounting		MN-SB-5248 1st RA	
	08/88→06/96	Stabiliser Mounting		MN-SB-5249	
	08/88→06/96	Stabiliser Mounting		MN-SB-5249 1st RA	
	08/88→06/96	Stabiliser Mounting	MN-SB-5249	1st FA	
	08/88→06/96	Suspension Arm Repair Kit		CV-RK-8118 for Control Arm	
	08/88→06/96	Suspension Arm Repair Kit		MN-RK-8523 for Wishbone (CV)	
	08/88→06/96	Tie Rod	MN-DL-8486		
	08/88→06/96	Tie Rod End	CV-ES-12461	for Steering Rod	
	08/88→06/96	Tie Rod End	CV-ES-12462	for Steering Rod	
	08/88→06/96	Track Control Arm		MN-VB-8565 Wishbone (CV)	
	04/93→06/96	Track Control Arm		MN-DL-8590 Trailing Arm, Air Suspension Axle	
	14.192 FA	08/88→06/90	Ball Head, gearshift linkage	CV-ES-2120	CV-ES-2120
		08/88→06/90	Centre Rod	MN-DL-7833	Push Rod
		08/88→06/90	Centre Rod	MN-DL-7837	Push Rod
		08/88→06/90	Tie Rod	MN-DL-8486	
14.192 FK	08/88→06/96	Ball Head, gearshift linkage	CV-ES-2119		
	08/88→06/96	Ball Head, gearshift linkage	CV-ES-2120		
	08/88→06/96	Ball Head, gearshift linkage	CV-ES-2182		
	08/88→06/96	Centre Rod	MN-DL-7833	Push Rod	
	08/88→06/96	Centre Rod	MN-DL-7837	Push Rod	
	08/88→06/96	Stabiliser Mounting		MN-SB-5249	
	08/88→06/96	Stabiliser Mounting		MN-SB-5249 1st RA	

CV-ES-2119

Length: 55
Cone Ø: d1 Ø 10 / d2 Ø 10
Thread: M12 x 1,75 LHT
81953016063, 81953016131



CV-ES-2120

Length: 115
Cone Ø: d1 Ø 12,4 / d2 Ø 10,8
Thread: M14 x 1,5 RHT
03008500A, 81953016200, 81953016202,
81953016203, 81953016227



CV-ES-2182

Length: 55
Cone Ø: d1 Ø 10 / d2 Ø 10
Thread: M12 x 1,75 RHT
81953016064, 81953016170



CV-ES-12461

Length: 120
Cone Ø: d1 Ø 26 / d2 Ø 23,5
Thread: M30 x 1,5 LHT
90804102216, 90804102612, 90804102720,
90804153107, 90804153113, 81953010013,
81953010074, 81953010082, 81953016068,
81953016074, 81953016163, 81953016273,
81953016283, 81953016320, 81953016361



CV-ES-12462

Length: 120
Cone Ø: d1 Ø 26 / d2 Ø 23,5
Thread: M30 x 1,5 RHT
90804102218, 90804153111, 81953010014,
81953010042, 81953010064, 81953010068,
81953016065, 81953016067, 81953016073,
81953016162, 81953016239, 81953016240,
81953016246, 81953016250, 81953016272,
81953016282, 81953016319, 81953016360,
82953016014



CV-RK-8118

Ø: 85
Hole Distance: 130
Thick/Height: 30
638862, 639287, 775201, 938423,
1104335, 1953248, 0003500506, 3500506,
11013547, 21032592, 42065912, 42488722,
070550504, 93192618, 070400009000,
634303610, 81432206055, 81432206073,
82262320660, 9544171010099,
5001842823, 7000307001, 8226232066



MN-DL-7833

Length: 900 Ø: 40
Cone Ø: d1 Ø 26 / d2 Ø 23,5
81467106434, 81467106435, 81467106456



MN-DL-7837

Length: 955 Ø: 40
Cone Ø: d1 Ø 26 / d2 Ø 23,5
03206800A, 81467106436, 81467106437,
81467106455



MN-DL-8486

Length: 1545 Ø: 38
Cone Ø: d1 Ø 26 / d2 Ø 23,5
81467106314, 81467106315, 81467106316



MN-DL-8590

Length: 596 Ø: 50
Hole Distance: 130 / 102
81432206140, 81432209140



MN-DL-9370

Length: 596 Ø: 50
Hole Distance: 130 / 130
81432306015, 81432306031, 81432309031



MN-RK-8523

Ø: 72
03304900A, 81432706065



MN-SB-5248

Length: 55 Ø: 80
Thick/Height: 80
03310100A, 81437040025



MN-SB-5249

Length: 55 Ø: 71
Thick/Height: 80
03310200A, 81437040029



MN-VB-8565

Length: 693
Ø: 46
Hole Distance: 115 / 115
81432706053, 81432709053





M 90 ...

14.192 FK ...	08/88→06/96	Stabiliser Mounting	MN-SB-5249		1st FA	
	08/88→06/96	Tie Rod	MN-DL-8486			
	08/88→06/96	Tie Rod End	CV-ES-12461		for Steering Rod	
	08/88→06/96	Tie Rod End	CV-ES-12462		for Steering Rod	
14.192 FS,14.192 FLS	08/88→06/90	Track Control Arm		MN-DL-8590	Trailing Arm	
	08/88→04/93	Track Control Arm		MN-DL-9370	Trailing Arm	
	08/88→06/96	Ball Head, gearshift linkage	CV-ES-2119			
	08/88→06/96	Ball Head, gearshift linkage	CV-ES-2120			
	08/88→06/96	Ball Head, gearshift linkage	CV-ES-2182			
	08/88→06/96	Centre Rod	MN-DL-7833		Push Rod	
	08/88→06/96	Centre Rod	MN-DL-7837		Push Rod	
	08/88→06/96	Stabiliser Mounting		MN-SB-5248		
	08/88→06/96	Stabiliser Mounting		MN-SB-5248	1st RA	
	08/88→06/96	Stabiliser Mounting		MN-SB-5249		
	08/88→06/96	Stabiliser Mounting		MN-SB-5249	1st RA	
	08/88→06/96	Stabiliser Mounting	MN-SB-5249		1st FA	
	08/88→06/96	Suspension Arm Repair Kit		CV-RK-8118	for Control Arm	
	08/88→06/96	Suspension Arm Repair Kit		MN-RK-8523	for Wishbone (CV)	
	08/88→06/96	Tie Rod	MN-DL-8486			
	08/88→06/96	Tie Rod End	CV-ES-12461		for Steering Rod	
	08/88→06/96	Tie Rod End	CV-ES-12462		for Steering Rod	
	08/88→06/96	Track Control Arm		MN-VB-8565	Wishbone (CV)	
	04/93→06/96	Track Control Arm		MN-DL-8590	Trailing Arm, Air Suspension Axle	
	14.222 F,14.222 FL	05/94→06/96	Ball Head, gearshift linkage	CV-ES-2119		
05/94→06/96		Ball Head, gearshift linkage	CV-ES-2120			
05/94→06/96		Ball Head, gearshift linkage	CV-ES-2182			
05/94→06/96		Centre Rod	MN-DL-7833		Push Rod	
05/94→06/96		Centre Rod	MN-DL-7837		Push Rod	
05/94→06/96		Stabiliser Mounting		MN-SB-5248		
05/94→06/96		Stabiliser Mounting		MN-SB-5248	1st RA	
05/94→06/96		Stabiliser Mounting		MN-SB-5249		
05/94→06/96		Stabiliser Mounting		MN-SB-5249	1st RA	
05/94→06/96		Stabiliser Mounting	MN-SB-5249		1st FA	
05/94→06/96		Suspension Arm Repair Kit		CV-RK-8118	for Control Arm	
05/94→06/96		Suspension Arm Repair Kit		MN-RK-8523	for Wishbone (CV)	
05/94→06/96		Tie Rod	MN-DL-8486			
05/94→06/96		Tie Rod End	CV-ES-12461		for Steering Rod	
05/94→06/96		Tie Rod End	CV-ES-12462		for Steering Rod	
05/94→06/96		Track Control Arm		MN-DL-8590	Trailing Arm, Air Suspension Axle	
05/94→06/96		Track Control Arm		MN-VB-8565	Wishbone (CV)	
14.222 FK		05/94→06/96	Ball Head, gearshift linkage	CV-ES-2119		
		05/94→06/96	Ball Head, gearshift linkage	CV-ES-2120		
		05/94→06/96	Ball Head, gearshift linkage	CV-ES-2182		
	05/94→06/96	Centre Rod	MN-DL-7833		Push Rod	
	05/94→06/96	Centre Rod	MN-DL-7837		Push Rod	
	05/94→06/96	Stabiliser Mounting		MN-SB-5249		
	05/94→06/96	Stabiliser Mounting		MN-SB-5249	1st RA	
	05/94→06/96	Stabiliser Mounting	MN-SB-5249		1st FA	
	05/94→06/96	Tie Rod	MN-DL-8486			
	05/94→06/96	Tie Rod End	CV-ES-12461		for Steering Rod	
	05/94→06/96	Tie Rod End	CV-ES-12462		for Steering Rod	
	14.222 FLS	05/94→06/96	Ball Head, gearshift linkage	CV-ES-2119		
		05/94→06/96	Ball Head, gearshift linkage	CV-ES-2120		
05/94→06/96		Ball Head, gearshift linkage	CV-ES-2182			
05/94→06/96		Centre Rod	MN-DL-7833		Push Rod	
05/94→06/96		Centre Rod	MN-DL-7837		Suspension Rod	
05/94→06/96		Stabiliser Mounting		MN-SB-5248		
05/94→06/96		Stabiliser Mounting		MN-SB-5248	1st RA	
05/94→06/96		Stabiliser Mounting	MN-SB-5249			
05/94→06/96		Stabiliser Mounting	MN-SB-5249		1st FA	
05/94→06/96		Suspension Arm Repair Kit		CV-RK-8118	for Control Arm	
05/94→06/96		Suspension Arm Repair Kit		MN-RK-8523	for Wishbone (CV)	
05/94→06/96		Tie Rod End	CV-ES-12461		for Steering Rod	

CV-ES-2119

Length: 55
Cone Ø: d1 Ø 10 / d2 Ø 10
Thread: M12 x 1,75 LHT
81953016063, 81953016131



CV-ES-2120

Length: 115
Cone Ø: d1 Ø 12,4 / d2 Ø 10,8
Thread: M14 x 1,5 RHT
03008500A, 81953016200, 81953016202,
81953016203, 81953016227



CV-ES-2182

Length: 55
Cone Ø: d1 Ø 10 / d2 Ø 10
Thread: M12 x 1,75 RHT
81953016064, 81953016170



CV-ES-12461

Length: 120
Cone Ø: d1 Ø 26 / d2 Ø 23,5
Thread: M30 x 1,5 LHT
90804102216, 90804102612, 90804102720,
90804153107, 90804153113, 81953010013,
81953010074, 81953010082, 81953016068,
81953016074, 81953016163, 81953016273,
81953016283, 81953016320, 81953016361



CV-ES-12462

Length: 120
Cone Ø: d1 Ø 26 / d2 Ø 23,5
Thread: M30 x 1,5 RHT
90804102218, 90804153111, 81953010014,
81953010042, 81953010064, 81953010068,
81953016065, 81953016067, 81953016073,
81953016162, 81953016239, 81953016240,
81953016246, 81953016250, 81953016272,
81953016282, 81953016319, 81953016360,
82953016014



CV-RK-8118

Ø: 85
Hole Distance: 130
Thick/Height: 30
638862, 639287, 775201, 938423,
1104335, 1953248, 3500506, 0003500506,
11013547, 21032592, 42065912, 42488722,
070550504, 93192618, 070400009000,
634303610, 81432206055, 81432206073,
82262320660, 9544171010099,
5001842823, 7000307001, 8226232066



MN-DL-7833

Length: 900 Ø: 40
Cone Ø: d1 Ø 26 / d2 Ø 23,5
81467106434, 81467106435, 81467106456



MN-DL-7837

Length: 955 Ø: 40
Cone Ø: d1 Ø 26 / d2 Ø 23,5
03206800A, 81467106436, 81467106437,
81467106455



MN-DL-8486

Length: 1545 Ø: 38
Cone Ø: d1 Ø 26 / d2 Ø 23,5
81467106314, 81467106315, 81467106316



MN-DL-8590

Length: 596 Ø: 50
Hole Distance: 130 / 102
81432206140, 81432209140



MN-DL-9370

Length: 596 Ø: 50
Hole Distance: 130 / 130
81432306015, 81432306031, 81432309031



MN-RK-8523

Ø: 72
03304900A, 81432706065



MN-SB-5248

Length: 55 Ø: 80
Thick/Height: 80
03310100A, 81437040025



MN-SB-5249

Length: 55 Ø: 71
Thick/Height: 80
03310200A, 81437040029



MN-VB-8565

Length: 693
Ø: 46
Hole Distance: 115 / 115
81432706053, 81432709053





M 90 ...

14.222 FLS ...	05/94 → 06/96	Tie Rod End	CV-ES-12462		for Steering Rod
	05/94 → 06/96	Track Control Arm		MN-DL-8590	Trailing Arm, Air Suspension Axle
	05/94 → 06/96	Track Control Arm		MN-VB-8565	Wishbone (CV)
	05/94 → 06/96	Track Control Arm		MN-DL-9370	Trailing Arm
14.232 F, 14.232 FL	08/88 → 04/93	Track Control Arm		MN-DL-9370	Trailing Arm
	08/88 → 06/96	Ball Head, gearshift linkage	CV-ES-2119		
	08/88 → 06/96	Ball Head, gearshift linkage	CV-ES-2120		
	08/88 → 06/96	Ball Head, gearshift linkage	CV-ES-2182		
	08/88 → 06/96	Centre Rod	MN-DL-7833		Push Rod
	08/88 → 06/96	Centre Rod	MN-DL-7837		Push Rod
	08/88 → 06/96	Stabiliser Mounting		MN-SB-5248	
	08/88 → 06/96	Stabiliser Mounting		MN-SB-5248	1st RA
	08/88 → 06/96	Stabiliser Mounting		MN-SB-5249	
	08/88 → 06/96	Stabiliser Mounting		MN-SB-5249	1st RA
	08/88 → 06/96	Stabiliser Mounting	MN-SB-5249		1st FA
	08/88 → 06/96	Suspension Arm Repair Kit		CV-RK-8118	for Control Arm
	08/88 → 06/96	Suspension Arm Repair Kit		MN-RK-8523	for Wishbone (CV)
	08/88 → 06/96	Tie Rod	MN-DL-8486		
	08/88 → 06/96	Tie Rod End	CV-ES-12461		for Steering Rod
	08/88 → 06/96	Tie Rod End	CV-ES-12462		for Steering Rod
	08/88 → 06/96	Track Control Arm		MN-VB-8565	Wishbone (CV)
	04/93 → 06/96	Track Control Arm		MN-DL-8590	Trailing Arm, Air Suspension Axle
	14.232 FK	08/88 → 06/96	Ball Head, gearshift linkage	CV-ES-2119	
08/88 → 06/96		Ball Head, gearshift linkage	CV-ES-2120		
08/88 → 06/96		Ball Head, gearshift linkage	CV-ES-2182		
08/88 → 06/96		Centre Rod	MN-DL-7833		Push Rod
08/88 → 06/96		Centre Rod	MN-DL-7837		Push Rod
08/88 → 06/96		Stabiliser Mounting		MN-SB-5249	
08/88 → 06/96		Stabiliser Mounting		MN-SB-5249	1st RA
08/88 → 06/96		Stabiliser Mounting	MN-SB-5249		1st FA
08/88 → 06/96		Tie Rod	MN-DL-8486		
08/88 → 06/96		Tie Rod End	CV-ES-12461		for Steering Rod
08/88 → 06/96		Tie Rod End	CV-ES-12462		for Steering Rod
08/88 → 06/96		Track Control Arm		MN-DL-9370	Trailing Arm
14.232 FS, 14.232 FLS		08/88 → 04/93	Track Control Arm		MN-DL-9370
	08/88 → 06/96	Ball Head, gearshift linkage	CV-ES-2119		
	08/88 → 06/96	Ball Head, gearshift linkage	CV-ES-2120		
	08/88 → 06/96	Ball Head, gearshift linkage	CV-ES-2182		
	08/88 → 06/96	Centre Rod	MN-DL-7833		Push Rod
	08/88 → 06/96	Centre Rod	MN-DL-7837		Push Rod
	08/88 → 06/96	Stabiliser Mounting		MN-SB-5248	
	08/88 → 06/96	Stabiliser Mounting		MN-SB-5248	1st RA
	08/88 → 06/96	Stabiliser Mounting		MN-SB-5249	
	08/88 → 06/96	Stabiliser Mounting		MN-SB-5249	1st RA
	08/88 → 06/96	Stabiliser Mounting	MN-SB-5249		1st FA
	08/88 → 06/96	Suspension Arm Repair Kit		CV-RK-8118	for Control Arm
	08/88 → 06/96	Suspension Arm Repair Kit		MN-RK-8523	for Wishbone (CV)
	08/88 → 06/96	Tie Rod	MN-DL-8486		
	08/88 → 06/96	Tie Rod End	CV-ES-12461		for Steering Rod
	08/88 → 06/96	Tie Rod End	CV-ES-12462		for Steering Rod
	08/88 → 06/96	Track Control Arm		MN-VB-8565	Wishbone (CV)
	05/90 → 04/95	Track Control Arm		MN-DL-8590	Trailing Arm
	04/93 → 06/96	Track Control Arm		MN-DL-8590	Trailing Arm, Air Suspension Axle
	14.262 F, 14.262 FL	08/95 → 06/96	Ball Head, gearshift linkage	CV-ES-2119	
08/95 → 06/96		Ball Head, gearshift linkage	CV-ES-2120		
08/95 → 06/96		Ball Head, gearshift linkage	CV-ES-2182		
08/95 → 06/96		Centre Rod	MN-DL-7833		Push Rod
08/95 → 06/96		Centre Rod	MN-DL-7837		Push Rod
08/95 → 06/96		Stabiliser Mounting		MN-SB-5248	
08/95 → 06/96		Stabiliser Mounting		MN-SB-5248	1st RA
08/95 → 06/96		Stabiliser Mounting		MN-SB-5249	
08/95 → 06/96		Stabiliser Mounting		MN-SB-5249	1st RA
08/95 → 06/96		Stabiliser Mounting	MN-SB-5249		1st FA
08/95 → 06/96		Suspension Arm Repair Kit		CV-RK-8118	for Control Arm
08/95 → 06/96		Suspension Arm Repair Kit		MN-RK-8523	for Wishbone (CV)

CV-ES-2119

Length: 55
Cone Ø: d1 Ø 10 / d2 Ø 10
Thread: M12 x 1,75 LHT
81953016063, 81953016131



CV-ES-2120

Length: 115
Cone Ø: d1 Ø 12,4 / d2 Ø 10,8
Thread: M14 x 1,5 RHT
03008500A, 81953016200, 81953016202,
81953016203, 81953016227



CV-ES-2182

Length: 55
Cone Ø: d1 Ø 10 / d2 Ø 10
Thread: M12 x 1,75 RHT
81953016064, 81953016170



CV-ES-12461

Length: 120
Cone Ø: d1 Ø 26 / d2 Ø 23,5
Thread: M30 x 1,5 LHT
90804102216, 90804102612, 90804102720,
90804153107, 90804153113, 81953010013,
81953010074, 81953010082, 81953016068,
81953016074, 81953016163, 81953016273,
81953016283, 81953016320, 81953016361



CV-ES-12462

Length: 120
Cone Ø: d1 Ø 26 / d2 Ø 23,5
Thread: M30 x 1,5 RHT
90804102218, 90804153111, 81953010014,
81953010042, 81953010064, 81953010068,
81953016065, 81953016067, 81953016073,
81953016162, 81953016239, 81953016240,
81953016246, 81953016250, 81953016272,
81953016282, 81953016319, 81953016360,
82953016014



CV-RK-8118

Ø: 85
Hole Distance: 130
Thick/Height: 30
638862, 639287, 775201, 938423,
1104335, 1953248, 0003500506, 3500506,
11013547, 21032592, 42065912, 42488722,
070550504, 93192618, 070400009000,
634303610, 81432206055, 81432206073,
82262320660, 9544171010099,
5001842823, 7000307001, 8226232066



MN-DL-7833

Length: 900 Ø: 40
Cone Ø: d1 Ø 26 / d2 Ø 23,5
81467106434, 81467106435, 81467106456



MN-DL-7837

Length: 955 Ø: 40
Cone Ø: d1 Ø 26 / d2 Ø 23,5
03206800A, 81467106436, 81467106437,
81467106455



MN-DL-8486

Length: 1545 Ø: 38
Cone Ø: d1 Ø 26 / d2 Ø 23,5
81467106314, 81467106315, 81467106316



MN-DL-8590

Length: 596 Ø: 50
Hole Distance: 130 / 102
81432206140, 81432209140



MN-DL-9370

Length: 596 Ø: 50
Hole Distance: 130 / 130
81432306015, 81432306031, 81432309031



MN-RK-8523

Ø: 72
03304900A, 81432706065



MN-SB-5248

Length: 55 Ø: 80
Thick/Height: 80
03310100A, 81437040025



MN-SB-5249

Length: 55 Ø: 71
Thick/Height: 80
03310200A, 81437040029



MN-VB-8565

Length: 693
Ø: 46
Hole Distance: 115 / 115
81432706053, 81432709053



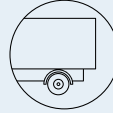
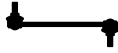

M 90 ...

14.262 F,14.262 FL ...	08/95→06/96	Tie Rod	MN-DL-8486			
	08/95→06/96	Tie Rod End	CV-ES-12461		for Steering Rod	
	08/95→06/96	Tie Rod End	CV-ES-12462		for Steering Rod	
	08/95→06/96	Track Control Arm		MN-DL-8590	Trailing Arm, Air Suspension Axle	
	08/95→06/96	Track Control Arm		MN-VB-8565	Wishbone (CV)	
14.262 FK	08/95→06/96	Ball Head, gearshift linkage	CV-ES-2119			
	08/95→06/96	Ball Head, gearshift linkage	CV-ES-2120			
	08/95→06/96	Ball Head, gearshift linkage	CV-ES-2182			
	08/95→06/96	Centre Rod	MN-DL-7833		Push Rod	
	08/95→06/96	Centre Rod	MN-DL-7837		Push Rod	
	08/95→06/96	Stabiliser Mounting		MN-SB-5249		
	08/95→06/96	Stabiliser Mounting		MN-SB-5249	1st RA	
	08/95→06/96	Stabiliser Mounting	MN-SB-5249		1st FA	
	08/95→06/96	Tie Rod	MN-DL-8486			
	08/95→06/96	Tie Rod End	CV-ES-12461		for Steering Rod	
	08/95→06/96	Tie Rod End	CV-ES-12462		for Steering Rod	
	14.262 FS,14.262 FLS	08/95→06/96	Ball Head, gearshift linkage	CV-ES-2119		
08/95→06/96		Ball Head, gearshift linkage	CV-ES-2120			
08/95→06/96		Ball Head, gearshift linkage	CV-ES-2182			
08/95→06/96		Centre Rod	MN-DL-7833		Push Rod	
08/95→06/96		Centre Rod	MN-DL-7837		Push Rod	
08/95→06/96		Stabiliser Mounting		MN-SB-5248		
08/95→06/96		Stabiliser Mounting		MN-SB-5248	1st RA	
08/95→06/96		Stabiliser Mounting		MN-SB-5249		
08/95→06/96		Stabiliser Mounting		MN-SB-5249	1st RA	
08/95→06/96		Stabiliser Mounting	MN-SB-5249		1st FA	
08/95→06/96		Suspension Arm Repair Kit		CV-RK-8118	for Control Arm	
08/95→06/96		Suspension Arm Repair Kit		MN-RK-8523	for Wishbone (CV)	
08/95→06/96		Tie Rod	MN-DL-8486			
08/95→06/96		Tie Rod End	CV-ES-12461		for Steering Rod	
08/95→06/96		Tie Rod End	CV-ES-12462		for Steering Rod	
08/95→06/96		Track Control Arm		MN-DL-8590	Trailing Arm, Air Suspension Axle	
08/95→06/96		Track Control Arm		MN-VB-8565	Wishbone (CV)	
14.272 F,14.272 FL		09/91→10/92	Track Control Arm		MN-DL-8590	Trailing Arm
	09/91→04/93	Track Control Arm		MN-DL-9370	Trailing Arm	
	09/91→06/96	Ball Head, gearshift linkage	CV-ES-2119			
	09/91→06/96	Ball Head, gearshift linkage	CV-ES-2120			
	09/91→06/96	Ball Head, gearshift linkage	CV-ES-2182			
	09/91→06/96	Centre Rod	MN-DL-7833		Push Rod	
	09/91→06/96	Centre Rod	MN-DL-7837		Push Rod	
	09/91→06/96	Stabiliser Mounting		MN-SB-5248		
	09/91→06/96	Stabiliser Mounting		MN-SB-5248	1st RA	
	09/91→06/96	Stabiliser Mounting		MN-SB-5249		
	09/91→06/96	Stabiliser Mounting		MN-SB-5249	1st RA	
	09/91→06/96	Stabiliser Mounting	MN-SB-5249		1st FA	
	09/91→06/96	Suspension Arm Repair Kit		CV-RK-8118	for Control Arm	
	09/91→06/96	Suspension Arm Repair Kit		MN-RK-8523	for Wishbone (CV)	
	09/91→06/96	Tie Rod	MN-DL-8486			
	09/91→06/96	Tie Rod End	CV-ES-12461		for Steering Rod	
	09/91→06/96	Tie Rod End	CV-ES-12462		for Steering Rod	
	09/91→06/96	Track Control Arm		MN-VB-8565	Wishbone (CV)	
	04/93→06/96	Track Control Arm		MN-DL-8590	Trailing Arm, Air Suspension Axle	
	14.272 FK	09/91→06/96	Ball Head, gearshift linkage	CV-ES-2119		
		09/91→06/96	Ball Head, gearshift linkage	CV-ES-2120		
		09/91→06/96	Ball Head, gearshift linkage	CV-ES-2182		
		09/91→06/96	Centre Rod	MN-DL-7833		Push Rod
		09/91→06/96	Centre Rod	MN-DL-7837		Push Rod
09/91→06/96		Stabiliser Mounting		MN-SB-5249		
09/91→06/96		Stabiliser Mounting		MN-SB-5249	1st RA	
09/91→06/96		Stabiliser Mounting	MN-SB-5249		1st FA	
09/91→06/96		Tie Rod	MN-DL-8486			
09/91→06/96		Tie Rod End	CV-ES-12461		for Steering Rod	
09/91→06/96		Tie Rod End	CV-ES-12462		for Steering Rod	

CV-ES-2119

Length: 55
Cone Ø: d1 Ø 10 / d2 Ø 10
Thread: M12 x 1,75 LHT
81953016063, 81953016131



CV-ES-2120

Length: 115
Cone Ø: d1 Ø 12,4 / d2 Ø 10,8
Thread: M14 x 1,5 RHT
03008500A, 81953016200, 81953016202,
81953016203, 81953016227



CV-ES-2182

Length: 55
Cone Ø: d1 Ø 10 / d2 Ø 10
Thread: M12 x 1,75 RHT
81953016064, 81953016170



CV-ES-12461

Length: 120
Cone Ø: d1 Ø 26 / d2 Ø 23,5
Thread: M30 x 1,5 LHT
90804102216, 90804102612, 90804102720,
90804153107, 90804153113, 81953010013,
81953010074, 81953010082, 81953016068,
81953016074, 81953016163, 81953016273,
81953016283, 81953016320, 81953016361



CV-ES-12462

Length: 120
Cone Ø: d1 Ø 26 / d2 Ø 23,5
Thread: M30 x 1,5 RHT
90804102218, 90804153111, 81953010014,
81953010042, 81953010064, 81953010068,
81953016065, 81953016067, 81953016073,
81953016162, 81953016239, 81953016240,
81953016246, 81953016250, 81953016272,
81953016282, 81953016319, 81953016360,
82953016014



CV-RK-8118

Ø: 85
Hole Distance: 130
Thick/Height: 30
638862, 639287, 775201, 938423,
1104335, 1953248, 0003500506, 3500506,
11013547, 21032592, 42065912, 42488722,
070550504, 93192618, 070400009000,
634303610, 81432206055, 81432206073,
82262320660, 9544171010099,
5001842823, 7000307001, 8226232066



MN-DL-7833

Length: 900 Ø: 40
Cone Ø: d1 Ø 26 / d2 Ø 23,5
81467106434, 81467106435, 81467106456



MN-DL-7837

Length: 955 Ø: 40
Cone Ø: d1 Ø 26 / d2 Ø 23,5
03206800A, 81467106436, 81467106437,
81467106455



MN-DL-8486

Length: 1545 Ø: 38
Cone Ø: d1 Ø 26 / d2 Ø 23,5
81467106314, 81467106315, 81467106316



MN-DL-8590

Length: 596 Ø: 50
Hole Distance: 130 / 102
81432206140, 81432209140



MN-DL-9370

Length: 596 Ø: 50
Hole Distance: 130 / 130
81432306015, 81432306031, 81432309031



MN-RK-8523

Ø: 72
03304900A, 81432706065



MN-SB-5248

Length: 55 Ø: 80
Thick/Height: 80
03310100A, 81437040025



MN-SB-5249

Length: 55 Ø: 71
Thick/Height: 80
03310200A, 81437040029



MN-VB-8565

Length: 693
Ø: 46
Hole Distance: 115 / 115
81432706053, 81432709053



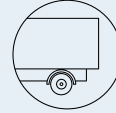
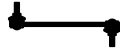

M 90 ...

14.272 FS, 14.272 FLS	09/91 → 10/92	Track Control Arm		MN-DL-8590	Trailing Arm	
	09/91 → 04/93	Track Control Arm		MN-DL-9370	Trailing Arm	
	09/91 → 06/96	Ball Head, gearshift linkage	CV-ES-2119			
	09/91 → 06/96	Ball Head, gearshift linkage	CV-ES-2120			
	09/91 → 06/96	Ball Head, gearshift linkage	CV-ES-2182			
	09/91 → 06/96	Centre Rod	MN-DL-7833		Push Rod	
	09/91 → 06/96	Centre Rod	MN-DL-7837		Push Rod	
	09/91 → 06/96	Stabiliser Mounting		MN-SB-5248		
	09/91 → 06/96	Stabiliser Mounting		MN-SB-5248	1st RA	
	09/91 → 06/96	Stabiliser Mounting		MN-SB-5249		
	09/91 → 06/96	Stabiliser Mounting		MN-SB-5249	1st RA	
	09/91 → 06/96	Stabiliser Mounting	MN-SB-5249		1st FA	
	09/91 → 06/96	Suspension Arm Repair Kit		CV-RK-8118	for Control Arm	
	09/91 → 06/96	Suspension Arm Repair Kit		MN-RK-8523	for Wishbone (CV)	
	09/91 → 06/96	Tie Rod	MN-DL-8486			
	09/91 → 06/96	Tie Rod End	CV-ES-12461		for Steering Rod	
	09/91 → 06/96	Tie Rod End	CV-ES-12462		for Steering Rod	
	09/91 → 06/96	Track Control Arm		MN-VB-8565	Wishbone (CV)	
	04/93 → 06/96	Track Control Arm		MN-DL-8590	Trailing Arm, Air Suspension Axle	
	17.192 F, 17.192 FL	08/88 → 04/95	Ball Head, gearshift linkage	CV-ES-2119		
08/88 → 04/95		Ball Head, gearshift linkage	CV-ES-2120			
08/88 → 04/95		Ball Head, gearshift linkage	CV-ES-2121			
08/88 → 04/95		Ball Head, gearshift linkage	CV-ES-2182			
08/88 → 04/95		Centre Rod	MN-DL-2138		Push Rod	
08/88 → 04/95		Centre Rod	MN-DL-2160		Coupling Rod	
08/88 → 04/95		Centre Rod	MN-DL-2174		Push Rod	
08/88 → 04/95		Centre Rod	MN-DL-7837		Push Rod	
08/88 → 04/95		Stabiliser Mounting		MN-SB-5248		
08/88 → 04/95		Stabiliser Mounting		MN-SB-5248	1st RA	
08/88 → 04/95		Stabiliser Mounting		MN-SB-5249		
08/88 → 04/95		Stabiliser Mounting		MN-SB-5249	1st RA	
08/88 → 04/95		Stabiliser Mounting	MN-SB-5249		1st FA	
08/88 → 04/95		Suspension Arm Repair Kit		CV-RK-8118	for Control Arm	
08/88 → 04/95		Suspension Arm Repair Kit		MN-RK-7280	for Drag Link	
08/88 → 04/95		Suspension Arm Repair Kit		MN-RK-7291	for Drag Link	
08/88 → 04/95		Suspension Arm Repair Kit		MN-RK-8523	for Wishbone (CV)	
08/88 → 04/95		Tie Rod End	CV-ES-12461		for Steering Rod	
08/88 → 04/95		Tie Rod End	CV-ES-12462		for Steering Rod	
08/88 → 04/95		Tie Rod End	CV-ES-14162		for Steering Rod	
08/88 → 04/95		Tie Rod End	CV-ES-14163		for Steering Rod	
08/88 → 04/95		Track Control Arm		MN-DL-5212	Trailing Arm, Drive Axle	
08/88 → 04/95		Track Control Arm		MN-VB-8565	Wishbone (CV)	
05/90 → 04/95		Centre Rod	MN-DL-5232		Push Rod	
17.192 FA		02/89 → 06/96	Ball Head, gearshift linkage	CV-ES-2119		
		02/89 → 06/96	Ball Head, gearshift linkage	CV-ES-2120		
	02/89 → 06/96	Ball Head, gearshift linkage	CV-ES-2121			
	02/89 → 06/96	Ball Head, gearshift linkage	CV-ES-2182			
	02/89 → 06/96	Centre Rod	MN-DL-2138		Push Rod	
	02/89 → 06/96	Centre Rod	MN-DL-2160		Coupling Rod	
	02/89 → 06/96	Centre Rod	MN-DL-2174		Push Rod	
	02/89 → 06/96	Centre Rod	MN-DL-5232		Push Rod	
	02/89 → 06/96	Stabiliser Mounting		MN-SB-5249		
	02/89 → 06/96	Stabiliser Mounting		MN-SB-5249	1st RA	
	02/89 → 06/96	Stabiliser Mounting	MN-SB-5249		1st FA	
	02/89 → 06/96	Tie Rod End	CV-ES-12461		for Steering Rod	
	02/89 → 06/96	Tie Rod End	CV-ES-12462		for Steering Rod	
	02/89 → 06/96	Tie Rod End	CV-ES-14162		for Steering Rod	
	02/89 → 06/96	Tie Rod End	CV-ES-14163		for Steering Rod	
17.192 FAK	02/89 → 06/96	Ball Head, gearshift linkage	CV-ES-2119			
	02/89 → 06/96	Ball Head, gearshift linkage	CV-ES-2120			
	02/89 → 06/96	Ball Head, gearshift linkage	CV-ES-2121			
	02/89 → 06/96	Ball Head, gearshift linkage	CV-ES-2182			
	02/89 → 06/96	Centre Rod	MN-DL-2138		Push Rod	

CV-ES-2119

Length: 55
Cone Ø: d1 Ø 10 / d2 Ø 10
Thread: M12 x 1,75 LHT
81953016063, 81953016131



CV-ES-2120

Length: 115
Cone Ø: d1 Ø 12,4 / d2 Ø 10,8
Thread: M14 x 1,5 RHT
03008500A, 81953016200, 81953016202, 81953016203, 81953016227



CV-ES-2121

Length: 85
Cone Ø: d1 Ø 12 / d2 Ø 10,8
Thread: M14 x 1,5 RHT
81953010038, 81953010045, 81953016016, 81953016169, 81953016172, 81953016176, 81953016266, 81953016302



CV-ES-2182

Length: 55
Cone Ø: d1 Ø 10 / d2 Ø 10
Thread: M12 x 1,75 RHT
81953016064, 81953016170



CV-ES-12461

Length: 120
Cone Ø: d1 Ø 26 / d2 Ø 23,5
Thread: M30 x 1,5 LHT
90804102216, 90804102612, 90804102720, 90804153107, 90804153113, 81953010013, 81953010074, 81953010082, 81953016068, 81953016074, 81953016163, 81953016273, 81953016283, 81953016320, 81953016361



CV-ES-12462

Length: 120
Cone Ø: d1 Ø 26 / d2 Ø 23,5
Thread: M30 x 1,5 RHT
90804102218, 90804153111, 81953010014, 81953010042, 81953010064, 81953010068, 81953016065, 81953016067, 81953016073, 81953016162, 81953016239, 81953016240, 81953016246, 81953016250, 81953016272, 81953016282, 81953016319, 81953016360, 82953016014



CV-ES-14162

Length: 125
Cone Ø: d1 Ø 30 / d2 Ø 27
Thread: M30 x 1,5 LHT
81953010015, 81953010083, 81953010087, 81953016029, 81953016030, 81953016043, 81953016044, 81953016050, 81953016054, 81953016087, 81953016091, 81953016107, 81953016120, 81953016125, 81953016152, 81953016155, 81953016157, 81953016168, 81953016179, 81953016181, 81953016223, 81953016237, 81953016254, 81953016275, 81953016279, 81953016351



CV-ES-14163

Length: 125
Cone Ø: d1 Ø 30 / d2 Ø 27
Thread: M30 x 1,5 RHT
95301.0084, 90804102156, 90804102272, 90804102696, 90804102710, 81953010016, 81953010075, 81953010084, 81953010088, 81953010094, 81953010103, 81953016030, 81953016043, 81953016048, 81953016049, 81953016053, 81953016061, 81953016090, 81953016108, 81953016112, 81953016126, 81953016143, 81953016149, 81953016154, 81953016156, 81953016168, 81953016178, 81953016194, 81953016206, 81953016224, 81953016234, 81953016242, 81953016252, 81953016274, 81953016278, 81953016284, 81953016286, 81953016308, 81953016310, 81953016312, 81953016347, 81953016350, 81953016352, 82953016012, 88953016014, N2953016001



CV-RK-8118

Ø: 85
Hole Distance: 130
Thick/Height: 30
638862, 639287, 775201, 938423, 1104335, 1953248, 0003500506, 3500506, 11013547, 21032592, 42065912, 42488722, 070550504, 93192618, 070400009000, 634303610, 81432206055, 81432206073, 82262320660, 9544171010099, 5001842823, 7000307001, 8226232066



MN-DL-2138

Length: 1000 Ø: 40
Cone Ø: d1 Ø 26 / d2 Ø 23,5
81467106438, 81467106439



MN-DL-2160

Length: 1652 Ø: 50
Cone Ø: d1 Ø 30 / d2 Ø 27
81467106112, 81467106163, 81467106165, 81467106198, 81467106353, 81467106354, 81467106361, 81467116725



MN-DL-2174

Length: 1588 Ø: 52
Cone Ø: d1 Ø 30 / d2 Ø 27
81467106378, 81467106912



MN-DL-5212

Length: 577 Ø: 48
Hole Distance: 130 / 130
81432206096, 81432206097, 81432206098, 81432206129, 81432209096, 81432209129, 81432306014, 81432306030



MN-DL-5232

Length: 1000 Ø: 42
Cone Ø: d1 Ø 30 / d2 Ø 26
03207100A, 81467106442



MN-DL-7833

Length: 900 Ø: 40
Cone Ø: d1 Ø 26 / d2 Ø 23,5
81467106434, 81467106435, 81467106456



MN-DL-7837

Length: 955 Ø: 40
Cone Ø: d1 Ø 26 / d2 Ø 23,5
03206800A, 81467106436, 81467106437, 81467106455



MN-DL-8486

Length: 1545 Ø: 38
Cone Ø: d1 Ø 26 / d2 Ø 23,5
81467106314, 81467106315, 81467106316



MN-DL-8590

Length: 596 Ø: 50
Hole Distance: 130 / 102
81432206140, 81432209140

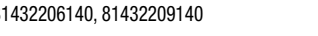

MN-DL-9370

Length: 596 Ø: 50
Hole Distance: 130 / 130
81432306015, 81432306031, 81432309031



MN-RK-7280

Ø: 75
Hole Distance: 115
Thick/Height: 24
0550806, 0639370, 689748, 10307400A, 81432306051, 81432306068, 81432706064



MN-RK-7291

Ø: 72
Hole Distance: 130
Thick/Height: 30
10307800A, 81432206108, 81432206132



MN-RK-8523

Ø: 72
03304900A, 81432706065



MN-SB-5248

Length: 55 Ø: 80
Thick/Height: 80
03310100A, 81437040025



MN-SB-5249

Length: 55 Ø: 71
Thick/Height: 80
03310200A, 81437040029



MN-VB-8565

Length: 693 Ø: 46
Hole Distance: 115 / 115
81432706053, 81432709053



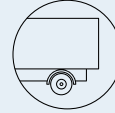
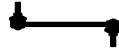

MAN ...

M 90 ...

17.192 FAK ...	02/89→06/96	Centre Rod	MN-DL-2160		Coupling Rod	
	02/89→06/96	Centre Rod	MN-DL-2174		Push Rod	
	02/89→06/96	Centre Rod	MN-DL-5232		Push Rod	
	02/89→06/96	Stabiliser Mounting		MN-SB-5249		
	02/89→06/96	Stabiliser Mounting		MN-SB-5249	1st RA	
	02/89→06/96	Stabiliser Mounting	MN-SB-5249		1st FA	
	02/89→06/96	Tie Rod End	CV-ES-12461		for Steering Rod	
	02/89→06/96	Tie Rod End	CV-ES-12462		for Steering Rod	
	02/89→06/96	Tie Rod End	CV-ES-14162		for Steering Rod	
02/89→06/96	Tie Rod End	CV-ES-14163		for Steering Rod		
17.192 FK	08/88→01/91	Ball Head, gearshift linkage	CV-ES-2119			
	08/88→01/91	Ball Head, gearshift linkage	CV-ES-2120			
	08/88→01/91	Ball Head, gearshift linkage	CV-ES-2121			
	08/88→01/91	Ball Head, gearshift linkage	CV-ES-2182			
	08/88→01/91	Centre Rod	MN-DL-2138		Push Rod	
	08/88→01/91	Centre Rod	MN-DL-2160		Coupling Rod	
	08/88→01/91	Centre Rod	MN-DL-2174		Push Rod	
	08/88→01/91	Centre Rod	MN-DL-7837		Push Rod	
	08/88→01/91	Stabiliser Mounting		MN-SB-5249		
	08/88→01/91	Stabiliser Mounting		MN-SB-5249	1st RA	
	08/88→01/91	Stabiliser Mounting	MN-SB-5249		1st FA	
	08/88→01/91	Suspension Arm Repair Kit		MN-RK-7280	for Drag Link	
	08/88→01/91	Tie Rod End	CV-ES-12461		for Steering Rod	
	08/88→01/91	Tie Rod End	CV-ES-12462		for Steering Rod	
	08/88→01/91	Tie Rod End	CV-ES-14162		for Steering Rod	
	08/88→01/91	Tie Rod End	CV-ES-14163		for Steering Rod	
	05/90→01/91	Centre Rod	MN-DL-5232		Push Rod	
	17.192 FS,17.192 FLS	08/88→04/95	Ball Head, gearshift linkage	CV-ES-2119		
		08/88→04/95	Ball Head, gearshift linkage	CV-ES-2120		
		08/88→04/95	Ball Head, gearshift linkage	CV-ES-2121		
08/88→04/95		Ball Head, gearshift linkage	CV-ES-2182			
08/88→04/95		Centre Rod	MN-DL-2138		Push Rod	
08/88→04/95		Centre Rod	MN-DL-2160		Coupling Rod	
08/88→04/95		Centre Rod	MN-DL-2174		Push Rod	
08/88→04/95		Centre Rod	MN-DL-7837		Push Rod	
08/88→04/95		Stabiliser Mounting		MN-SB-5248		
08/88→04/95		Stabiliser Mounting		MN-SB-5248	1st RA	
08/88→04/95		Stabiliser Mounting		MN-SB-5249	1st RA	
08/88→04/95		Stabiliser Mounting		MN-SB-5249	1st RA	
08/88→04/95		Stabiliser Mounting	MN-SB-5249		1st FA	
08/88→04/95		Suspension Arm Repair Kit		CV-RK-8118	for Control Arm	
08/88→04/95		Suspension Arm Repair Kit		MN-RK-7280	for Drag Link	
08/88→04/95		Suspension Arm Repair Kit		MN-RK-7291	for Drag Link	
08/88→04/95		Suspension Arm Repair Kit		MN-RK-8523	for Wishbone (CV)	
08/88→04/95		Tie Rod End	CV-ES-12461		for Steering Rod	
08/88→04/95		Tie Rod End	CV-ES-12462		for Steering Rod	
08/88→04/95		Tie Rod End	CV-ES-14162		for Steering Rod	
08/88→04/95		Tie Rod End	CV-ES-14163		for Steering Rod	
08/88→04/95		Track Control Arm		MN-DL-5212	Trailing Arm, Drive Axle	
08/88→04/95		Track Control Arm		MN-VB-8565	Wishbone (CV)	
05/90→04/95		Centre Rod	MN-DL-5232		Push Rod	
17.222 FA		05/94→06/96	Ball Head, gearshift linkage	CV-ES-2119		
		05/94→06/96	Ball Head, gearshift linkage	CV-ES-2120		
		05/94→06/96	Ball Head, gearshift linkage	CV-ES-2121		
		05/94→06/96	Ball Head, gearshift linkage	CV-ES-2182		
		05/94→06/96	Centre Rod	MN-DL-2138		Push Rod
		05/94→06/96	Centre Rod	MN-DL-2160		Coupling Rod
		05/94→06/96	Centre Rod	MN-DL-2174		Push Rod
		05/94→06/96	Centre Rod	MN-DL-5232		Push Rod
		05/94→06/96	Stabiliser Mounting		MN-SB-5249	
	05/94→06/96	Stabiliser Mounting		MN-SB-5249	1st RA	
	05/94→06/96	Stabiliser Mounting	MN-SB-5249		1st FA	
	05/94→06/96	Tie Rod End	CV-ES-12461		for Steering Rod	

CV-ES-2119

Length: 55
Cone Ø: d1 Ø 10 / d2 Ø 10
Thread: M12 x 1,75 LHT
81953016063, 81953016131



CV-ES-2120

Length: 115
Cone Ø: d1 Ø 12,4 / d2 Ø 10,8
Thread: M14 x 1,5 RHT
03008500A, 81953016200, 81953016202,
81953016203, 81953016227



CV-ES-2121

Length: 85
Cone Ø: d1 Ø 12 / d2 Ø 10,8
Thread: M14 x 1,5 RHT
81953010038, 81953010045, 81953016016,
81953016169, 81953016172, 81953016176,
81953016266, 81953016302



CV-ES-2182

Length: 55
Cone Ø: d1 Ø 10 / d2 Ø 10
Thread: M12 x 1,75 RHT
81953016064, 81953016170



CV-ES-12461

Length: 120
Cone Ø: d1 Ø 26 / d2 Ø 23,5
Thread: M30 x 1,5 LHT
90804102216, 90804102612, 90804102720,
90804153107, 90804153113, 81953010013,
81953010074, 81953010082, 81953016068,
81953016074, 81953016163, 81953016273,
81953016283, 81953016320, 81953016361



CV-ES-12462

Length: 120
Cone Ø: d1 Ø 26 / d2 Ø 23,5
Thread: M30 x 1,5 RHT
90804102218, 90804153111, 81953010014,
81953010042, 81953010064, 81953010068,
81953016065, 81953016067, 81953016073,
81953016162, 81953016239, 81953016240,
81953016246, 81953016250, 81953016272,
81953016282, 81953016319, 81953016360,
82953016014



CV-ES-14162

Length: 125
Cone Ø: d1 Ø 30 / d2 Ø 27
Thread: M30 x 1,5 LHT
81953010015, 81953010083, 81953010087,
81953016029, 81953016030, 81953016043,
81953016044, 81953016050, 81953016054,
81953016087, 81953016091, 81953016107,
81953016120, 81953016125, 81953016152,
81953016155, 81953016157, 81953016168,
81953016179, 81953016181, 81953016223,
81953016237, 81953016254, 81953016275,
81953016279, 81953016351



CV-ES-14163

Length: 125
Cone Ø: d1 Ø 30 / d2 Ø 27
Thread: M30 x 1,5 RHT
95301.0084, 90804102156, 90804102272,
90804102696, 90804102710, 81953010016,
81953010075, 81953010084, 81953010088,
81953010094, 81953010103, 81953016030,
81953016043, 81953016048, 81953016049,
81953016053, 81953016061, 81953016090,
81953016108, 81953016112, 81953016126,
81953016143, 81953016149, 81953016154,
81953016156, 81953016168, 81953016178,
81953016194, 81953016206, 81953016224,
81953016234, 81953016242, 81953016252,
81953016274, 81953016278, 81953016284,
81953016286, 81953016308, 81953016310,
81953016312, 81953016347, 81953016350,
81953016352, 82953016012, 88953016014,
N2953016001



CV-RK-8118

Ø: 85
Hole Distance: 130
Thick/Height: 30
638862, 639287, 775201, 938423,
1104335, 1953248, 0003500506, 3500506,
11013547, 21032592, 42065912, 42488722,
070550504, 93192618, 070400009000,
634303610, 81432206055, 81432206073,
82262320660, 9544171010099,
5001842823, 7000307001, 8226232066



MN-DL-2138

Length: 1000 Ø: 40
Cone Ø: d1 Ø 26 / d2 Ø 23,5
81467106438, 81467106439



MN-DL-2160

Length: 1652 Ø: 50
Cone Ø: d1 Ø 30 / d2 Ø 27
81467106112, 81467106163, 81467106165,
81467106198, 81467106353, 81467106354,
81467106361, 81467116725



MN-DL-2174

Length: 1588 Ø: 52
Cone Ø: d1 Ø 30 / d2 Ø 27
81467106378, 81467106912



MN-DL-5212

Length: 577 Ø: 48
Hole Distance: 130 / 130
81432206096, 81432206097, 81432206098,
81432206129, 81432209096, 81432209129,
81432306014, 81432306030



MN-DL-5232

Length: 1000 Ø: 42
Cone Ø: d1 Ø 30 / d2 Ø 26
03207100A, 81467106442



MN-DL-7837

Length: 955 Ø: 40
Cone Ø: d1 Ø 26 / d2 Ø 23,5
03206800A, 81467106436, 81467106437,
81467106455



MN-RK-7280

Ø: 75
Hole Distance: 115
Thick/Height: 24
0550806, 0639370, 689748, 10307400A,
81432306051, 81432306068, 81432706064



MN-RK-7291

Ø: 72
Hole Distance: 130
Thick/Height: 30
10307800A, 81432206108, 81432206132



MN-RK-8523

Ø: 72
03304900A, 81432706065



MN-SB-5248

Length: 55 Ø: 80
Thick/Height: 80
03310100A, 81437040025



MN-SB-5249

Length: 55 Ø: 71
Thick/Height: 80
03310200A, 81437040029



MN-VB-8565

Length: 693
Ø: 46
Hole Distance: 115 / 115
81432706053, 81432709053





M 90 ...

17.222 FA ...	05/94 → 06/96	Tie Rod End	CV-ES-12462		for Steering Rod
	05/94 → 06/96	Tie Rod End	CV-ES-14162		for Steering Rod
	05/94 → 06/96	Tie Rod End	CV-ES-14163		for Steering Rod
17.222 FAK	05/94 → 06/96	Ball Head, gearshift linkage	CV-ES-2119		
	05/94 → 06/96	Ball Head, gearshift linkage	CV-ES-2120		
	05/94 → 06/96	Ball Head, gearshift linkage	CV-ES-2121		
	05/94 → 06/96	Ball Head, gearshift linkage	CV-ES-2182		
	05/94 → 06/96	Centre Rod	MN-DL-2138		Push Rod
	05/94 → 06/96	Centre Rod	MN-DL-2160		Coupling Rod
	05/94 → 06/96	Centre Rod	MN-DL-2174		Push Rod
	05/94 → 06/96	Centre Rod	MN-DL-5232		Push Rod
	05/94 → 06/96	Stabiliser Mounting		MN-SB-5249	
	05/94 → 06/96	Stabiliser Mounting		MN-SB-5249	1st RA
	05/94 → 06/96	Stabiliser Mounting	MN-SB-5249		1st FA
	05/94 → 06/96	Tie Rod End	CV-ES-12461		for Steering Rod
	05/94 → 06/96	Tie Rod End	CV-ES-12462		for Steering Rod
	05/94 → 06/96	Tie Rod End	CV-ES-14162		for Steering Rod
05/94 → 06/96	Tie Rod End	CV-ES-14163		for Steering Rod	
17.232 F, 17.232 FL	08/88 → 04/95	Ball Head, gearshift linkage	CV-ES-2119		
	08/88 → 04/95	Ball Head, gearshift linkage	CV-ES-2120		
	08/88 → 04/95	Ball Head, gearshift linkage	CV-ES-2121		
	08/88 → 04/95	Ball Head, gearshift linkage	CV-ES-2182		
	08/88 → 04/95	Centre Rod	MN-DL-2138		Push Rod
	08/88 → 04/95	Centre Rod	MN-DL-2160		Coupling Rod
	08/88 → 04/95	Centre Rod	MN-DL-2174		Push Rod
	08/88 → 04/95	Centre Rod	MN-DL-7837		Push Rod
	08/88 → 04/95	Stabiliser Mounting		MN-SB-5248	
	08/88 → 04/95	Stabiliser Mounting		MN-SB-5248	1st RA
	08/88 → 04/95	Stabiliser Mounting		MN-SB-5249	
	08/88 → 04/95	Stabiliser Mounting		MN-SB-5249	1st RA
	08/88 → 04/95	Stabiliser Mounting	MN-SB-5249		1st FA
	08/88 → 04/95	Suspension Arm Repair Kit		CV-RK-8118	for Control Arm
	08/88 → 04/95	Suspension Arm Repair Kit		MN-RK-7280	for Drag Link
	08/88 → 04/95	Suspension Arm Repair Kit		MN-RK-7291	for Drag Link
	08/88 → 04/95	Suspension Arm Repair Kit		MN-RK-8523	for Wishbone (CV)
	08/88 → 04/95	Tie Rod End	CV-ES-12461		for Steering Rod
	08/88 → 04/95	Tie Rod End	CV-ES-12462		for Steering Rod
	08/88 → 04/95	Tie Rod End	CV-ES-14162		for Steering Rod
	08/88 → 04/95	Tie Rod End	CV-ES-14163		for Steering Rod
	08/88 → 04/95	Track Control Arm		MN-DL-5212	Trailing Arm, Drive Axle
	08/88 → 04/95	Track Control Arm		MN-VB-8565	Wishbone (CV)
	05/90 → 04/95	Centre Rod	MN-DL-5232		Push Rod
17.232 FA	02/89 → 06/96	Ball Head, gearshift linkage	CV-ES-2119		
	02/89 → 06/96	Ball Head, gearshift linkage	CV-ES-2120		
	02/89 → 06/96	Ball Head, gearshift linkage	CV-ES-2121		
	02/89 → 06/96	Ball Head, gearshift linkage	CV-ES-2182		
	02/89 → 06/96	Centre Rod	MN-DL-2138		Push Rod
	02/89 → 06/96	Centre Rod	MN-DL-2160		Coupling Rod
	02/89 → 06/96	Centre Rod	MN-DL-2174		Push Rod
	02/89 → 06/96	Centre Rod	MN-DL-5232		Push Rod
	02/89 → 06/96	Stabiliser Mounting		MN-SB-5249	
	02/89 → 06/96	Stabiliser Mounting		MN-SB-5249	1st RA
	02/89 → 06/96	Stabiliser Mounting	MN-SB-5249		1st FA
	02/89 → 06/96	Tie Rod End	CV-ES-12461		for Steering Rod
	02/89 → 06/96	Tie Rod End	CV-ES-12462		for Steering Rod
	02/89 → 06/96	Tie Rod End	CV-ES-14162		for Steering Rod
02/89 → 06/96	Tie Rod End	CV-ES-14163		for Steering Rod	
17.232 FAK	02/89 → 06/96	Ball Head, gearshift linkage	CV-ES-2119		
	02/89 → 06/96	Ball Head, gearshift linkage	CV-ES-2120		
	02/89 → 06/96	Ball Head, gearshift linkage	CV-ES-2121		
	02/89 → 06/96	Ball Head, gearshift linkage	CV-ES-2182		
	02/89 → 06/96	Centre Rod	MN-DL-2138		Push Rod
	02/89 → 06/96	Centre Rod	MN-DL-2160		Coupling Rod

CV-ES-2119

Length: 55
Cone Ø: d1 Ø 10 / d2 Ø 10
Thread: M12 x 1,75 LHT
81953016063, 81953016131



CV-ES-2120

Length: 115
Cone Ø: d1 Ø 12,4 / d2 Ø 10,8
Thread: M14 x 1,5 RHT
03008500A, 81953016200, 81953016202,
81953016203, 81953016227



CV-ES-2121

Length: 85
Cone Ø: d1 Ø 12 / d2 Ø 10,8
Thread: M14 x 1,5 RHT
81953010038, 81953010045, 81953016016,
81953016169, 81953016172, 81953016176,
81953016266, 81953016302



CV-ES-2182

Length: 55
Cone Ø: d1 Ø 10 / d2 Ø 10
Thread: M12 x 1,75 RHT
81953016064, 81953016170



CV-ES-12461

Length: 120
Cone Ø: d1 Ø 26 / d2 Ø 23,5
Thread: M30 x 1,5 LHT
90804102216, 90804102612, 90804102720,
90804153107, 90804153113, 81953010013,
81953010074, 81953010082, 81953016068,
81953016074, 81953016163, 81953016273,
81953016283, 81953016320, 81953016361



CV-ES-12462

Length: 120
Cone Ø: d1 Ø 26 / d2 Ø 23,5
Thread: M30 x 1,5 RHT
90804102218, 90804153111, 81953010014,
81953010042, 81953010064, 81953010068,
81953016065, 81953016067, 81953016073,
81953016162, 81953016239, 81953016240,
81953016246, 81953016250, 81953016272,
81953016282, 81953016319, 81953016360,
82953016014



CV-ES-14162

Length: 125
Cone Ø: d1 Ø 30 / d2 Ø 27
Thread: M30 x 1,5 LHT
81953010015, 81953010083, 81953010087,
81953016029, 81953016030, 81953016043,
81953016044, 81953016050, 81953016054,
81953016087, 81953016091, 81953016107,
81953016120, 81953016125, 81953016152,
81953016155, 81953016157, 81953016168,
81953016179, 81953016181, 81953016223,
81953016237, 81953016254, 81953016275,
81953016279, 81953016351



CV-ES-14163

Length: 125
Cone Ø: d1 Ø 30 / d2 Ø 27
Thread: M30 x 1,5 RHT
95301.0084, 90804102156, 90804102272,
90804102696, 90804102710, 81953010016,
81953010075, 81953010084, 81953010088,
81953010094, 81953010103, 81953016030,
81953016043, 81953016048, 81953016049,
81953016053, 81953016061, 81953016090,
81953016108, 81953016112, 81953016126,
81953016143, 81953016149, 81953016154,
81953016156, 81953016168, 81953016178,
81953016194, 81953016206, 81953016224,
81953016234, 81953016242, 81953016252,
81953016274, 81953016278, 81953016284,
81953016286, 81953016308, 81953016310,
81953016312, 81953016347, 81953016350,
81953016352, 82953016012, 88953016014,
N2953016001



CV-RK-8118

Ø: 85
Hole Distance: 130
Thick/Height: 30
638862, 639287, 775201, 938423,
1104335, 1953248, 0003500506, 3500506,
11013547, 21032592, 42065912, 42488722,
070550504, 93192618, 070400009000,
634303610, 81432206055, 81432206073,
82262320660, 9544171010099,
5001842823, 7000307001, 8226232066



MN-DL-2138

Length: 1000 Ø: 40
Cone Ø: d1 Ø 26 / d2 Ø 23,5
81467106438, 81467106439



MN-DL-2160

Length: 1652 Ø: 50
Cone Ø: d1 Ø 30 / d2 Ø 27
81467106112, 81467106163, 81467106165,
81467106198, 81467106353, 81467106354,
81467106361, 81467116725



MN-DL-2174

Length: 1588 Ø: 52
Cone Ø: d1 Ø 30 / d2 Ø 27
81467106378, 81467106912



MN-DL-5212

Length: 577 Ø: 48
Hole Distance: 130 / 130
81432206096, 81432206097, 81432206098,
81432206129, 81432209096, 81432209129,
81432306014, 81432306030



MN-DL-5232

Length: 1000 Ø: 42
Cone Ø: d1 Ø 30 / d2 Ø 26
03207100A, 81467106442



MN-DL-7837

Length: 955 Ø: 40
Cone Ø: d1 Ø 26 / d2 Ø 23,5
03206800A, 81467106436, 81467106437,
81467106455



MN-RK-7280

Ø: 75
Hole Distance: 115
Thick/Height: 24
0550806, 0639370, 689748, 10307400A,
81432306051, 81432306068, 81432706064



MN-RK-7291

Ø: 72
Hole Distance: 130
Thick/Height: 30
10307800A, 81432206108, 81432206132



MN-RK-8523

Ø: 72
03304900A, 81432706065



MN-SB-5248

Length: 55 Ø: 80
Thick/Height: 80
03310100A, 81437040025



MN-SB-5249

Length: 55 Ø: 71
Thick/Height: 80
03310200A, 81437040029



MN-VB-8565

Length: 693
Ø: 46
Hole Distance: 115 / 115
81432706053, 81432709053





M 90 ...

17.232 FAK ...	02/89→06/96	Centre Rod	MN-DL-2174		Push Rod	
	02/89→06/96	Centre Rod	MN-DL-5232		Push Rod	
	02/89→06/96	Stabiliser Mounting		MN-SB-5249		
	02/89→06/96	Stabiliser Mounting		MN-SB-5249	1st RA	
	02/89→06/96	Stabiliser Mounting	MN-SB-5249		1st FA	
	02/89→06/96	Tie Rod End	CV-ES-12461		for Steering Rod	
	02/89→06/96	Tie Rod End	CV-ES-12462		for Steering Rod	
	02/89→06/96	Tie Rod End	CV-ES-14162		for Steering Rod	
	02/89→06/96	Tie Rod End	CV-ES-14163		for Steering Rod	
17.232 FK	08/88→01/91	Ball Head, gearshift linkage	CV-ES-2119			
	08/88→01/91	Ball Head, gearshift linkage	CV-ES-2120			
	08/88→01/91	Ball Head, gearshift linkage	CV-ES-2121			
	08/88→01/91	Ball Head, gearshift linkage	CV-ES-2182			
	08/88→01/91	Centre Rod	MN-DL-2138		Push Rod	
	08/88→01/91	Centre Rod	MN-DL-2160		Coupling Rod	
	08/88→01/91	Centre Rod	MN-DL-2174		Push Rod	
	08/88→01/91	Centre Rod	MN-DL-7837		Push Rod	
	08/88→01/91	Stabiliser Mounting		MN-SB-5249		
	08/88→01/91	Stabiliser Mounting		MN-SB-5249	1st RA	
	08/88→01/91	Stabiliser Mounting	MN-SB-5249		1st FA	
	08/88→01/91	Suspension Arm Repair Kit		MN-RK-7280	for Drag Link	
	08/88→01/91	Tie Rod End	CV-ES-12461		for Steering Rod	
	08/88→01/91	Tie Rod End	CV-ES-12462		for Steering Rod	
	08/88→01/91	Tie Rod End	CV-ES-14162		for Steering Rod	
	08/88→01/91	Tie Rod End	CV-ES-14163		for Steering Rod	
	05/90→01/91	Centre Rod	MN-DL-5232		Push Rod	
	17.232 FS,17.232 FLS	08/88→04/95	Ball Head, gearshift linkage	CV-ES-2119		
		08/88→04/95	Ball Head, gearshift linkage	CV-ES-2120		
		08/88→04/95	Ball Head, gearshift linkage	CV-ES-2121		
08/88→04/95		Ball Head, gearshift linkage	CV-ES-2182			
08/88→04/95		Centre Rod	MN-DL-2138		Push Rod	
08/88→04/95		Centre Rod	MN-DL-2160		Coupling Rod	
08/88→04/95		Centre Rod	MN-DL-2174		Push Rod	
08/88→04/95		Centre Rod	MN-DL-7837		Push Rod	
08/88→04/95		Stabiliser Mounting		MN-SB-5248		
08/88→04/95		Stabiliser Mounting		MN-SB-5248	1st RA	
08/88→04/95		Stabiliser Mounting		MN-SB-5249		
08/88→04/95		Stabiliser Mounting		MN-SB-5249	1st RA	
08/88→04/95		Stabiliser Mounting	MN-SB-5249		1st FA	
08/88→04/95		Suspension Arm Repair Kit		CV-RK-8118	for Control Arm	
08/88→04/95		Suspension Arm Repair Kit		MN-RK-7280	for Drag Link	
08/88→04/95		Suspension Arm Repair Kit		MN-RK-7291	for Drag Link	
08/88→04/95		Suspension Arm Repair Kit		MN-RK-8523	for Wishbone (CV)	
08/88→04/95		Tie Rod End	CV-ES-12461		for Steering Rod	
08/88→04/95		Tie Rod End	CV-ES-12462		for Steering Rod	
08/88→04/95		Tie Rod End	CV-ES-14162		for Steering Rod	
08/88→04/95		Tie Rod End	CV-ES-14163		for Steering Rod	
08/88→04/95		Track Control Arm		MN-DL-5212	Trailing Arm, Drive Axle	
08/88→04/95		Track Control Arm		MN-VB-8565	Wishbone (CV)	
05/90→04/95		Centre Rod	MN-DL-5232		Push Rod	
17.272 FLS		09/91→05/95	Ball Head, gearshift linkage	CV-ES-2119		
		09/91→05/95	Ball Head, gearshift linkage	CV-ES-2120		
		09/91→05/95	Ball Head, gearshift linkage	CV-ES-2121		
		09/91→05/95	Ball Head, gearshift linkage	CV-ES-2182		
		09/91→05/95	Centre Rod	MN-DL-2138		Push Rod
		09/91→05/95	Centre Rod	MN-DL-2160		Coupling Rod
	09/91→05/95	Centre Rod	MN-DL-2174		Push Rod	
	09/91→05/95	Centre Rod	MN-DL-5232		Suspension Rod	
	09/91→05/95	Stabiliser Mounting		MN-SB-5248		
	09/91→05/95	Stabiliser Mounting		MN-SB-5248	1st RA	
	09/91→05/95	Stabiliser Mounting	MN-SB-5249			
	09/91→05/95	Stabiliser Mounting	MN-SB-5249		1st FA	
	09/91→05/95	Suspension Arm Repair Kit		CV-RK-8118	for Control Arm	

CV-ES-2119

Length: 55
Cone Ø: d1 Ø 10 / d2 Ø 10
Thread: M12 x 1,75 LHT
81953016063, 81953016131



CV-ES-2120

Length: 115
Cone Ø: d1 Ø 12,4 / d2 Ø 10,8
Thread: M14 x 1,5 RHT
03008500A, 81953016200, 81953016202,
81953016203, 81953016227



CV-ES-2121

Length: 85
Cone Ø: d1 Ø 12 / d2 Ø 10,8
Thread: M14 x 1,5 RHT
81953010038, 81953010045, 81953016016,
81953016169, 81953016172, 81953016176,
81953016266, 81953016302



CV-ES-2182

Length: 55
Cone Ø: d1 Ø 10 / d2 Ø 10
Thread: M12 x 1,75 RHT
81953016064, 81953016170



CV-ES-12461

Length: 120
Cone Ø: d1 Ø 26 / d2 Ø 23,5
Thread: M30 x 1,5 LHT
90804102216, 90804102612, 90804102720,
90804153107, 90804153113, 81953010013,
81953010074, 81953010082, 81953016068,
81953016074, 81953016163, 81953016273,
81953016283, 81953016320, 81953016361



CV-ES-12462

Length: 120
Cone Ø: d1 Ø 26 / d2 Ø 23,5
Thread: M30 x 1,5 RHT
90804102218, 90804153111, 81953010014,
81953010042, 81953010064, 81953010068,
81953016065, 81953016067, 81953016073,
81953016162, 81953016239, 81953016240,
81953016246, 81953016250, 81953016272,
81953016282, 81953016319, 81953016360,
82953016014



CV-ES-14162

Length: 125
Cone Ø: d1 Ø 30 / d2 Ø 27
Thread: M30 x 1,5 LHT
81953010015, 81953010083, 81953010087,
81953016029, 81953016030, 81953016043,
81953016044, 81953016050, 81953016054,
81953016087, 81953016091, 81953016107,
81953016120, 81953016125, 81953016152,
81953016155, 81953016157, 81953016168,
81953016179, 81953016181, 81953016223,
81953016237, 81953016254, 81953016275,
81953016279, 81953016351



CV-ES-14163

Length: 125
Cone Ø: d1 Ø 30 / d2 Ø 27
Thread: M30 x 1,5 RHT
95301.0084, 90804102156, 90804102272,
90804102696, 90804102710, 81953010016,
81953010075, 81953010084, 81953010088,
81953010094, 81953010103, 81953016030,
81953016043, 81953016048, 81953016049,
81953016053, 81953016061, 81953016090,
81953016108, 81953016112, 81953016126,
81953016143, 81953016149, 81953016154,
81953016156, 81953016168, 81953016178,
81953016194, 81953016206, 81953016224,
81953016234, 81953016242, 81953016252,
81953016274, 81953016278, 81953016284,
81953016286, 81953016308, 81953016310,
81953016312, 81953016347, 81953016350,
81953016352, 82953016012, 88953016014,
N2953016001



CV-RK-8118

Ø: 85
Hole Distance: 130
Thick/Height: 30
638862, 639287, 775201, 938423,
1104335, 1953248, 0003500506, 3500506,
11013547, 21032592, 42065912, 42488722,
070550504, 93192618, 070400009000,
634303610, 81432206055, 81432206073,
82262320660, 9544171010099,
5001842823, 7000307001, 8226232066



MN-DL-2138

Length: 1000 Ø: 40
Cone Ø: d1 Ø 26 / d2 Ø 23,5
81467106438, 81467106439



MN-DL-2160

Length: 1652 Ø: 50
Cone Ø: d1 Ø 30 / d2 Ø 27
81467106112, 81467106163, 81467106165,
81467106198, 81467106353, 81467106354,
81467106361, 81467116725



MN-DL-2174

Length: 1588 Ø: 52
Cone Ø: d1 Ø 30 / d2 Ø 27
81467106378, 81467106912



MN-DL-5212

Length: 577 Ø: 48
Hole Distance: 130 / 130
81432206096, 81432206097, 81432206098,
81432206129, 81432209096, 81432209129,
81432306014, 81432306030



MN-DL-5232

Length: 1000 Ø: 42
Cone Ø: d1 Ø 30 / d2 Ø 26
03207100A, 81467106442



MN-DL-7837

Length: 955 Ø: 40
Cone Ø: d1 Ø 26 / d2 Ø 23,5
03206800A, 81467106436, 81467106437,
81467106455



MN-RK-7280

Ø: 75
Hole Distance: 115
Thick/Height: 24
0550806, 0639370, 689748, 10307400A,
81432306051, 81432306068, 81432706064



MN-RK-7291

Ø: 72
Hole Distance: 130
Thick/Height: 30
10307800A, 81432206108, 81432206132



MN-RK-8523

Ø: 72
03304900A, 81432706065



MN-SB-5248

Length: 55 Ø: 80
Thick/Height: 80
03310100A, 81437040025



MN-SB-5249

Length: 55 Ø: 71
Thick/Height: 80
03310200A, 81437040029



MN-VB-8565

Length: 693
Ø: 46
Hole Distance: 115 / 115
81432706053, 81432709053





M 90 ...

17.272 FLS ...	09/91→05/95	Suspension Arm Repair Kit		MN-RK-7280	for Drag Link	
	09/91→05/95	Suspension Arm Repair Kit		MN-RK-7291	for Drag Link	
	09/91→05/95	Suspension Arm Repair Kit		MN-RK-8523	for Wishbone (CV)	
	09/91→05/95	Tie Rod End	CV-ES-12461		for Steering Rod	
	09/91→05/95	Tie Rod End	CV-ES-12462		for Steering Rod	
	09/91→05/95	Tie Rod End	CV-ES-14162		for Steering Rod	
	09/91→05/95	Tie Rod End	CV-ES-14163		for Steering Rod	
	09/91→05/95	Track Control Arm		MN-DL-5212	Trailing Arm, Drive Axle	
	09/91→05/95	Track Control Arm		MN-VB-8565	Wishbone (CV)	
18.192 F,18.192 FL,18.192 FLL	09/90→06/96	Ball Head, gearshift linkage	CV-ES-2119			
	09/90→06/96	Ball Head, gearshift linkage	CV-ES-2120			
	09/90→06/96	Ball Head, gearshift linkage	CV-ES-2182			
	09/90→06/96	Centre Rod	MN-DL-2138		Push Rod	
	09/90→06/96	Centre Rod	MN-DL-2160		Coupling Rod	
	09/90→06/96	Centre Rod	MN-DL-2175		Push Rod	
	09/90→06/96	Centre Rod	MN-DL-5232		Push Rod	
	09/90→06/96	Centre Rod	MN-DL-7837		Push Rod	
	09/90→06/96	Stabiliser Mounting		MN-SB-5248		
	09/90→06/96	Stabiliser Mounting		MN-SB-5248	1st RA	
	09/90→06/96	Stabiliser Mounting		MN-SB-5249		
	09/90→06/96	Stabiliser Mounting		MN-SB-5249	1st RA	
	09/90→06/96	Stabiliser Mounting	MN-SB-5249		1st FA	
	09/90→06/96	Suspension Arm Repair Kit		CV-RK-8118	for Control Arm	
	09/90→06/96	Suspension Arm Repair Kit		MN-RK-7280	for Drag Link	
	09/90→06/96	Suspension Arm Repair Kit		MN-RK-7291	for Drag Link	
	09/90→06/96	Suspension Arm Repair Kit		MN-RK-8523	for Wishbone (CV)	
	09/90→06/96	Tie Rod End	CV-ES-12461		for Steering Rod	
	09/90→06/96	Tie Rod End	CV-ES-12462		for Steering Rod	
	09/90→06/96	Tie Rod End	CV-ES-14162		for Steering Rod	
	09/90→06/96	Tie Rod End	CV-ES-14163		for Steering Rod	
	09/90→06/96	Track Control Arm		MN-DL-5212	Trailing Arm, Drive Axle	
	09/90→06/96	Track Control Arm		MN-VB-8565	Wishbone (CV)	
	18.192 FK	09/90→06/96	Ball Head, gearshift linkage	CV-ES-2119		
		09/90→06/96	Ball Head, gearshift linkage	CV-ES-2120		
		09/90→06/96	Ball Head, gearshift linkage	CV-ES-2182		
		09/90→06/96	Centre Rod	MN-DL-2138		Push Rod
		09/90→06/96	Centre Rod	MN-DL-2160		Coupling Rod
		09/90→06/96	Centre Rod	MN-DL-2175		Push Rod
		09/90→06/96	Centre Rod	MN-DL-5232		Push Rod
09/90→06/96		Centre Rod	MN-DL-7837		Push Rod	
09/90→06/96		Stabiliser Mounting		MN-SB-5249		
09/90→06/96		Stabiliser Mounting		MN-SB-5249	1st RA	
09/90→06/96		Stabiliser Mounting	MN-SB-5249		1st FA	
09/90→06/96		Suspension Arm Repair Kit		MN-RK-7280	for Drag Link	
09/90→06/96		Tie Rod End	CV-ES-12461		for Steering Rod	
09/90→06/96		Tie Rod End	CV-ES-12462		for Steering Rod	
09/90→06/96		Tie Rod End	CV-ES-14162		for Steering Rod	
09/90→06/96		Tie Rod End	CV-ES-14163		for Steering Rod	
18.222 F,18.222 FL,18.222 FLL		05/94→06/96	Ball Head, gearshift linkage	CV-ES-2119		
		05/94→06/96	Ball Head, gearshift linkage	CV-ES-2120		
		05/94→06/96	Ball Head, gearshift linkage	CV-ES-2182		
		05/94→06/96	Centre Rod	MN-DL-2138		Push Rod
		05/94→06/96	Centre Rod	MN-DL-2160		Coupling Rod
		05/94→06/96	Centre Rod	MN-DL-2175		Push Rod
		05/94→06/96	Centre Rod	MN-DL-5232		Push Rod
		05/94→06/96	Centre Rod	MN-DL-7837		Push Rod
		05/94→06/96	Stabiliser Mounting		MN-SB-5248	
		05/94→06/96	Stabiliser Mounting		MN-SB-5248	1st RA
		05/94→06/96	Stabiliser Mounting		MN-SB-5249	
		05/94→06/96	Stabiliser Mounting		MN-SB-5249	1st RA
		05/94→06/96	Stabiliser Mounting	MN-SB-5249		1st FA
		05/94→06/96	Suspension Arm Repair Kit		CV-RK-8118	for Control Arm
	05/94→06/96	Suspension Arm Repair Kit		MN-RK-7280	for Drag Link	

CV-ES-2119

Length: 55
Cone Ø: d1 Ø 10 / d2 Ø 10
Thread: M12 x 1,75 LHT
81953016063, 81953016131



CV-ES-2120

Length: 115
Cone Ø: d1 Ø 12,4 / d2 Ø 10,8
Thread: M14 x 1,5 RHT
03008500A, 81953016200, 81953016202,
81953016203, 81953016227



CV-ES-2182

Length: 55
Cone Ø: d1 Ø 10 / d2 Ø 10
Thread: M12 x 1,75 RHT
81953016064, 81953016170



CV-ES-12461

Length: 120
Cone Ø: d1 Ø 26 / d2 Ø 23,5
Thread: M30 x 1,5 LHT

90804102216, 90804102612, 90804102720,
90804153107, 90804153113, 81953010013,
81953010074, 81953010082, 81953016068,
81953016074, 81953016163, 81953016273,
81953016283, 81953016320, 81953016361



CV-ES-12462

Length: 120
Cone Ø: d1 Ø 26 / d2 Ø 23,5
Thread: M30 x 1,5 RHT

90804102218, 90804153111, 81953010014,
81953010042, 81953010064, 81953010068,
81953016065, 81953016067, 81953016073,
81953016162, 81953016239, 81953016240,
81953016246, 81953016250, 81953016272,
81953016282, 81953016319, 81953016360,
82953016014



CV-ES-14162

Length: 125
Cone Ø: d1 Ø 30 / d2 Ø 27
Thread: M30 x 1,5 LHT

81953010015, 81953010083, 81953010087,
81953016029, 81953016030, 81953016043,
81953016044, 81953016050, 81953016054,
81953016087, 81953016091, 81953016107,
81953016120, 81953016125, 81953016152,
81953016155, 81953016157, 81953016168,
81953016179, 81953016181, 81953016223,
81953016237, 81953016254, 81953016275,
81953016279, 81953016351



CV-ES-14163

Length: 125
Cone Ø: d1 Ø 30 / d2 Ø 27
Thread: M30 x 1,5 RHT

95301.0084, 90804102156, 90804102272,
90804102696, 90804102710, 81953010016,
81953010075, 81953010084, 81953010088,
81953010094, 81953010103, 81953016030,
81953016043, 81953016048, 81953016049,
81953016053, 81953016061, 81953016090,
81953016108, 81953016112, 81953016126,
81953016143, 81953016149, 81953016154,
81953016156, 81953016168, 81953016178,
81953016194, 81953016206, 81953016224,
81953016234, 81953016242, 81953016252,
81953016274, 81953016278, 81953016284,
81953016286, 81953016308, 81953016310,
81953016312, 81953016347, 81953016350,
81953016352, 82953016012, 88953016014,
N2953016001



CV-RK-8118

Ø: 85
Hole Distance: 130
Thick/Height: 30

638862, 639287, 775201, 938423,
1104335, 1953248, 0003500506, 3500506,
11013547, 21032592, 42065912, 42488722,
070550504, 93192618, 070400009000,
634303610, 81432206055, 81432206073,
82262320660, 9544171010099,
5001842823, 7000307001, 8226232066



MN-DL-2138

Length: 1000 Ø: 40
Cone Ø: d1 Ø 26 / d2 Ø 23,5
81467106438, 81467106439



MN-DL-2160

Length: 1652 Ø: 50
Cone Ø: d1 Ø 30 / d2 Ø 27

81467106112, 81467106163, 81467106165,
81467106198, 81467106353, 81467106354,
81467106361, 81467116725



MN-DL-2175

Length: 1628
Ø: 50
Cone Ø: d1 Ø 30 / d2 Ø 27
81467106396, 81467106904



MN-DL-5212

Length: 577 Ø: 48
Hole Distance: 130 / 130

81432206096, 81432206097, 81432206098,
81432206129, 81432209096, 81432209129,
81432306014, 81432306030



MN-DL-5232

Length: 1000 Ø: 42
Cone Ø: d1 Ø 30 / d2 Ø 26

03207100A, 81467106442



MN-DL-7837

Length: 955 Ø: 40
Cone Ø: d1 Ø 26 / d2 Ø 23,5

03206800A, 81467106436, 81467106437,
81467106455



MN-RK-7280

Ø: 75
Hole Distance: 115
Thick/Height: 24

0550806, 0639370, 689748, 10307400A,
81432306051, 81432306068, 81432706064



MN-RK-7291

Ø: 72
Hole Distance: 130
Thick/Height: 30

10307800A, 81432206108, 81432206132



MN-RK-8523

Ø: 72
03304900A, 81432706065



MN-SB-5248

Length: 55 Ø: 80
Thick/Height: 80
03310100A, 81437040025



MN-SB-5249

Length: 55 Ø: 71
Thick/Height: 80
03310200A, 81437040029



MN-VB-8565

Length: 693
Ø: 46
Hole Distance: 115 / 115
81432706053, 81432709053





M 90 ...

18.222 F,18.222 FL,18.222 FLL ...	05/94→06/96	Suspension Arm Repair Kit		MN-RK-7291	for Drag Link	
	05/94→06/96	Suspension Arm Repair Kit		MN-RK-8523	for Wishbone (CV)	
	05/94→06/96	Tie Rod End	CV-ES-12461		for Steering Rod	
	05/94→06/96	Tie Rod End	CV-ES-12462		for Steering Rod	
	05/94→06/96	Tie Rod End	CV-ES-14162		for Steering Rod	
	05/94→06/96	Tie Rod End	CV-ES-14163		for Steering Rod	
	05/94→06/96	Track Control Arm		MN-DL-5212	Trailing Arm, Drive Axle	
	05/94→06/96	Track Control Arm		MN-VB-8565	Wishbone (CV)	
18.222 FK	05/94→06/96	Ball Head, gearshift linkage	CV-ES-2119			
	05/94→06/96	Ball Head, gearshift linkage	CV-ES-2120			
	05/94→06/96	Ball Head, gearshift linkage	CV-ES-2182			
	05/94→06/96	Centre Rod	MN-DL-2138		Push Rod	
	05/94→06/96	Centre Rod	MN-DL-2160		Coupling Rod	
	05/94→06/96	Centre Rod	MN-DL-2175		Push Rod	
	05/94→06/96	Centre Rod	MN-DL-5232		Push Rod	
	05/94→06/96	Centre Rod	MN-DL-7837		Push Rod	
	05/94→06/96	Stabiliser Mounting		MN-SB-5249		
	05/94→06/96	Stabiliser Mounting		MN-SB-5249	1st RA	
	05/94→06/96	Stabiliser Mounting	MN-SB-5249		1st FA	
	05/94→06/96	Suspension Arm Repair Kit		MN-RK-7280	for Drag Link	
	05/94→06/96	Tie Rod End	CV-ES-12461		for Steering Rod	
	05/94→06/96	Tie Rod End	CV-ES-12462		for Steering Rod	
	05/94→06/96	Tie Rod End	CV-ES-14162		for Steering Rod	
	05/94→06/96	Tie Rod End	CV-ES-14163		for Steering Rod	
	18.232 F,18.232 FL,18.232 FLL	09/90→06/96	Ball Head, gearshift linkage	CV-ES-2119		
		09/90→06/96	Ball Head, gearshift linkage	CV-ES-2120		
09/90→06/96		Ball Head, gearshift linkage	CV-ES-2182			
09/90→06/96		Centre Rod	MN-DL-2138		Push Rod	
09/90→06/96		Centre Rod	MN-DL-2160		Coupling Rod	
09/90→06/96		Centre Rod	MN-DL-2175		Push Rod	
09/90→06/96		Centre Rod	MN-DL-5232		Push Rod	
09/90→06/96		Centre Rod	MN-DL-7837		Push Rod	
09/90→06/96		Stabiliser Mounting		MN-SB-5248		
09/90→06/96		Stabiliser Mounting		MN-SB-5248	1st RA	
09/90→06/96		Stabiliser Mounting		MN-SB-5249		
09/90→06/96		Stabiliser Mounting		MN-SB-5249	1st RA	
09/90→06/96		Stabiliser Mounting	MN-SB-5249		1st FA	
09/90→06/96		Suspension Arm Repair Kit		CV-RK-8118	for Control Arm	
09/90→06/96		Suspension Arm Repair Kit		MN-RK-7280	for Drag Link	
09/90→06/96		Suspension Arm Repair Kit		MN-RK-7291	for Drag Link	
09/90→06/96		Suspension Arm Repair Kit		MN-RK-8523	for Wishbone (CV)	
09/90→06/96		Tie Rod End	CV-ES-12461		for Steering Rod	
09/90→06/96		Tie Rod End	CV-ES-12462		for Steering Rod	
09/90→06/96		Tie Rod End	CV-ES-14162		for Steering Rod	
09/90→06/96		Tie Rod End	CV-ES-14163		for Steering Rod	
09/90→06/96		Track Control Arm		MN-DL-5212	Trailing Arm, Drive Axle	
09/90→06/96		Track Control Arm		MN-VB-8565	Wishbone (CV)	
18.232 FK		09/90→06/96	Ball Head, gearshift linkage	CV-ES-2119		
		09/90→06/96	Ball Head, gearshift linkage	CV-ES-2120		
		09/90→06/96	Ball Head, gearshift linkage	CV-ES-2182		
		09/90→06/96	Centre Rod	MN-DL-2138		Push Rod
		09/90→06/96	Centre Rod	MN-DL-2160		Coupling Rod
	09/90→06/96	Centre Rod	MN-DL-2175		Push Rod	
	09/90→06/96	Centre Rod	MN-DL-5232		Push Rod	
	09/90→06/96	Centre Rod	MN-DL-7837		Push Rod	
	09/90→06/96	Stabiliser Mounting		MN-SB-5249		
	09/90→06/96	Stabiliser Mounting		MN-SB-5249	1st RA	
	09/90→06/96	Stabiliser Mounting	MN-SB-5249		1st FA	
	09/90→06/96	Suspension Arm Repair Kit		MN-RK-7280	for Drag Link	
	09/90→06/96	Tie Rod End	CV-ES-12461		for Steering Rod	
	09/90→06/96	Tie Rod End	CV-ES-12462		for Steering Rod	
	09/90→06/96	Tie Rod End	CV-ES-14162		for Steering Rod	
	09/90→06/96	Tie Rod End	CV-ES-14163		for Steering Rod	

CV-ES-2119

Length: 55
Cone Ø: d1 Ø 10 / d2 Ø 10
Thread: M12 x 1,75 LHT
81953016063, 81953016131



CV-ES-2120

Length: 115
Cone Ø: d1 Ø 12,4 / d2 Ø 10,8
Thread: M14 x 1,5 RHT
03008500A, 81953016200, 81953016202,
81953016203, 81953016227



CV-ES-2182

Length: 55
Cone Ø: d1 Ø 10 / d2 Ø 10
Thread: M12 x 1,75 RHT
81953016064, 81953016170



CV-ES-12461

Length: 120
Cone Ø: d1 Ø 26 / d2 Ø 23,5
Thread: M30 x 1,5 LHT
90804102216, 90804102612, 90804102720,
90804153107, 90804153113, 81953010013,
81953010074, 81953010082, 81953016068,
81953016074, 81953016163, 81953016273,
81953016283, 81953016320, 81953016361



CV-ES-12462

Length: 120
Cone Ø: d1 Ø 26 / d2 Ø 23,5
Thread: M30 x 1,5 RHT
90804102218, 90804153111, 81953010014,
81953010042, 81953010064, 81953010068,
81953016065, 81953016067, 81953016073,
81953016162, 81953016239, 81953016240,
81953016246, 81953016250, 81953016272,
81953016282, 81953016319, 81953016360,
82953016014



CV-ES-14162

Length: 125
Cone Ø: d1 Ø 30 / d2 Ø 27
Thread: M30 x 1,5 LHT
81953010015, 81953010083, 81953010087,
81953016029, 81953016030, 81953016043,
81953016044, 81953016050, 81953016054,
81953016087, 81953016091, 81953016107,
81953016120, 81953016125, 81953016152,
81953016155, 81953016157, 81953016168,
81953016179, 81953016181, 81953016223,
81953016237, 81953016254, 81953016275,
81953016279, 81953016351



CV-ES-14163

Length: 125
Cone Ø: d1 Ø 30 / d2 Ø 27
Thread: M30 x 1,5 RHT
95301.0084, 90804102156, 90804102272,
90804102696, 90804102710, 81953010016,
81953010075, 81953010084, 81953010088,
81953010094, 81953010103, 81953016030,
81953016043, 81953016048, 81953016049,
81953016053, 81953016061, 81953016090,
81953016108, 81953016112, 81953016126,
81953016143, 81953016149, 81953016154,
81953016156, 81953016168, 81953016178,
81953016194, 81953016206, 81953016224,
81953016234, 81953016242, 81953016252,
81953016274, 81953016278, 81953016284,
81953016286, 81953016308, 81953016310,
81953016312, 81953016347, 81953016350,
81953016352, 82953016012, 88953016014,
N2953016001



CV-RK-8118

Ø: 85
Hole Distance: 130
Thick/Height: 30
638862, 639287, 775201, 938423,
1104335, 1953248, 0003500506, 3500506,
11013547, 21032592, 42065912, 42488722,
070550504, 93192618, 070400009000,
634303610, 81432206055, 81432206073,
82262320660, 9544171010099,
5001842823, 7000307001, 8226232066



MN-DL-2138

Length: 1000 Ø: 40
Cone Ø: d1 Ø 26 / d2 Ø 23,5
81467106438, 81467106439



MN-DL-2160

Length: 1652 Ø: 50
Cone Ø: d1 Ø 30 / d2 Ø 27
81467106112, 81467106163, 81467106165,
81467106198, 81467106353, 81467106354,
81467106361, 81467116725



MN-DL-2175

Length: 1628
Ø: 50
Cone Ø: d1 Ø 30 / d2 Ø 27
81467106396, 81467106904



MN-DL-5212

Length: 577 Ø: 48
Hole Distance: 130 / 130
81432206096, 81432206097, 81432206098,
81432206129, 81432209096, 81432209129,
81432306014, 81432306030



MN-DL-5232

Length: 1000 Ø: 42
Cone Ø: d1 Ø 30 / d2 Ø 26
03207100A, 81467106442



MN-DL-7837

Length: 955 Ø: 40
Cone Ø: d1 Ø 26 / d2 Ø 23,5
03206800A, 81467106436, 81467106437,
81467106455



MN-RK-7280

Ø: 75
Hole Distance: 115
Thick/Height: 24
0550806, 0639370, 689748, 10307400A,
81432306051, 81432306068, 81432706064



MN-RK-7291

Ø: 72
Hole Distance: 130
Thick/Height: 30
10307800A, 81432206108, 81432206132



MN-RK-8523

Ø: 72
03304900A, 81432706065



MN-SB-5248

Length: 55 Ø: 80
Thick/Height: 80
03310100A, 81437040025



MN-SB-5249

Length: 55 Ø: 71
Thick/Height: 80
03310200A, 81437040029



MN-VB-8565

Length: 693
Ø: 46
Hole Distance: 115 / 115
81432706053, 81432709053





M 90 ...

18.262 F,18.262 FL,18.262 FLL	08/95→06/96	Ball Head, gearshift linkage	CV-ES-2119			
	08/95→06/96	Ball Head, gearshift linkage	CV-ES-2120			
	08/95→06/96	Ball Head, gearshift linkage	CV-ES-2182			
	08/95→06/96	Centre Rod	MN-DL-2138		Push Rod	
	08/95→06/96	Centre Rod	MN-DL-2160		Coupling Rod	
	08/95→06/96	Centre Rod	MN-DL-2175		Push Rod	
	08/95→06/96	Centre Rod	MN-DL-5232		Push Rod	
	08/95→06/96	Centre Rod	MN-DL-7837		Push Rod	
	08/95→06/96	Stabiliser Mounting		MN-SB-5248		
	08/95→06/96	Stabiliser Mounting		MN-SB-5248	1st RA	
	08/95→06/96	Stabiliser Mounting		MN-SB-5249		
	08/95→06/96	Stabiliser Mounting		MN-SB-5249	1st RA	
	08/95→06/96	Stabiliser Mounting	MN-SB-5249		1st FA	
	08/95→06/96	Suspension Arm Repair Kit		CV-RK-8118	for Control Arm	
	08/95→06/96	Suspension Arm Repair Kit		MN-RK-7280	for Drag Link	
	08/95→06/96	Suspension Arm Repair Kit		MN-RK-7291	for Drag Link	
	08/95→06/96	Suspension Arm Repair Kit		MN-RK-8523	for Wishbone (CV)	
	08/95→06/96	Tie Rod End	CV-ES-12461		for Steering Rod	
	08/95→06/96	Tie Rod End	CV-ES-12462		for Steering Rod	
	08/95→06/96	Tie Rod End	CV-ES-14162		for Steering Rod	
	08/95→06/96	Tie Rod End	CV-ES-14163		for Steering Rod	
	08/95→06/96	Track Control Arm		MN-DL-5212	Trailing Arm, Drive Axle	
	08/95→06/96	Track Control Arm		MN-VB-8565	Wishbone (CV)	
	18.262 FK	08/95→06/96	Ball Head, gearshift linkage	CV-ES-2119		
		08/95→06/96	Ball Head, gearshift linkage	CV-ES-2120		
		08/95→06/96	Ball Head, gearshift linkage	CV-ES-2182		
		08/95→06/96	Centre Rod	MN-DL-2138		Push Rod
08/95→06/96		Centre Rod	MN-DL-2160		Coupling Rod	
08/95→06/96		Centre Rod	MN-DL-2175		Push Rod	
08/95→06/96		Centre Rod	MN-DL-5232		Push Rod	
08/95→06/96		Centre Rod	MN-DL-7837		Push Rod	
08/95→06/96		Stabiliser Mounting		MN-SB-5249		
08/95→06/96		Stabiliser Mounting		MN-SB-5249	1st RA	
08/95→06/96		Stabiliser Mounting	MN-SB-5249		1st FA	
08/95→06/96		Suspension Arm Repair Kit		MN-RK-7280	for Drag Link	
08/95→06/96		Tie Rod End	CV-ES-12461		for Steering Rod	
08/95→06/96		Tie Rod End	CV-ES-12462		for Steering Rod	
08/95→06/96		Tie Rod End	CV-ES-14162		for Steering Rod	
08/95→06/96		Tie Rod End	CV-ES-14163		for Steering Rod	
18.272 F,18.272 FL,18.272 FLL		09/91→06/96	Ball Head, gearshift linkage	CV-ES-2119		
	09/91→06/96	Ball Head, gearshift linkage	CV-ES-2120			
	09/91→06/96	Ball Head, gearshift linkage	CV-ES-2182			
	09/91→06/96	Centre Rod	MN-DL-2138		Push Rod	
	09/91→06/96	Centre Rod	MN-DL-2160		Coupling Rod	
	09/91→06/96	Centre Rod	MN-DL-2175		Push Rod	
	09/91→06/96	Centre Rod	MN-DL-5232		Push Rod	
	09/91→06/96	Centre Rod	MN-DL-7837		Push Rod	
	09/91→06/96	Stabiliser Mounting		MN-SB-5248		
	09/91→06/96	Stabiliser Mounting		MN-SB-5248	1st RA	
	09/91→06/96	Stabiliser Mounting		MN-SB-5249		
	09/91→06/96	Stabiliser Mounting		MN-SB-5249	1st RA	
	09/91→06/96	Stabiliser Mounting	MN-SB-5249		1st FA	
	09/91→06/96	Suspension Arm Repair Kit		CV-RK-8118	for Control Arm	
	09/91→06/96	Suspension Arm Repair Kit		MN-RK-7280	for Drag Link	
	09/91→06/96	Suspension Arm Repair Kit		MN-RK-7291	for Drag Link	
	09/91→06/96	Suspension Arm Repair Kit		MN-RK-8523	for Wishbone (CV)	
	09/91→06/96	Tie Rod End	CV-ES-12461		for Steering Rod	
	09/91→06/96	Tie Rod End	CV-ES-12462		for Steering Rod	
	09/91→06/96	Tie Rod End	CV-ES-14162		for Steering Rod	
	09/91→06/96	Tie Rod End	CV-ES-14163		for Steering Rod	
	09/91→06/96	Track Control Arm		MN-DL-5212	Trailing Arm, Drive Axle	
	09/91→06/96	Track Control Arm		MN-VB-8565	Wishbone (CV)	

CV-ES-2119

Length: 55
Cone Ø: d1 Ø 10 / d2 Ø 10
Thread: M12 x 1,75 LHT
81953016063, 81953016131



CV-ES-2120

Length: 115
Cone Ø: d1 Ø 12,4 / d2 Ø 10,8
Thread: M14 x 1,5 RHT
03008500A, 81953016200, 81953016202,
81953016203, 81953016227



CV-ES-2182

Length: 55
Cone Ø: d1 Ø 10 / d2 Ø 10
Thread: M12 x 1,75 RHT
81953016064, 81953016170



CV-ES-12461

Length: 120
Cone Ø: d1 Ø 26 / d2 Ø 23,5
Thread: M30 x 1,5 LHT
90804102216, 90804102612, 90804102720,
90804153107, 90804153113, 81953010013,
81953010074, 81953010082, 81953016068,
81953016074, 81953016163, 81953016273,
81953016283, 81953016320, 81953016361



CV-ES-12462

Length: 120
Cone Ø: d1 Ø 26 / d2 Ø 23,5
Thread: M30 x 1,5 RHT
90804102218, 90804153111, 81953010014,
81953010042, 81953010064, 81953010068,
81953016065, 81953016067, 81953016073,
81953016162, 81953016239, 81953016240,
81953016246, 81953016250, 81953016272,
81953016282, 81953016319, 81953016360,
82953016014



CV-ES-14162

Length: 125
Cone Ø: d1 Ø 30 / d2 Ø 27
Thread: M30 x 1,5 LHT
81953010015, 81953010083, 81953010087,
81953016029, 81953016030, 81953016043,
81953016044, 81953016050, 81953016054,
81953016087, 81953016091, 81953016107,
81953016120, 81953016125, 81953016152,
81953016155, 81953016157, 81953016168,
81953016179, 81953016181, 81953016223,
81953016237, 81953016254, 81953016275,
81953016279, 81953016351



CV-ES-14163

Length: 125
Cone Ø: d1 Ø 30 / d2 Ø 27
Thread: M30 x 1,5 RHT
95301.0084, 90804102156, 90804102272,
90804102696, 90804102710, 81953010016,
81953010075, 81953010084, 81953010088,
81953010094, 81953010103, 81953016030,
81953016043, 81953016048, 81953016049,
81953016053, 81953016061, 81953016090,
81953016108, 81953016112, 81953016126,
81953016143, 81953016149, 81953016154,
81953016156, 81953016168, 81953016178,
81953016194, 81953016206, 81953016224,
81953016234, 81953016242, 81953016252,
81953016274, 81953016278, 81953016284,
81953016286, 81953016308, 81953016310,
81953016312, 81953016347, 81953016350,
81953016352, 82953016012, 88953016014,
N2953016001



CV-RK-8118

Ø: 85
Hole Distance: 130
Thick/Height: 30
638862, 639287, 775201, 938423,
1104335, 1953248, 0003500506, 3500506,
11013547, 21032592, 42065912, 42488722,
070550504, 93192618, 070400009000,
634303610, 81432206055, 81432206073,
82262320660, 9544171010099,
5001842823, 7000307001, 8226232066



MN-DL-2138

Length: 1000 Ø: 40
Cone Ø: d1 Ø 26 / d2 Ø 23,5
81467106438, 81467106439



MN-DL-2160

Length: 1652 Ø: 50
Cone Ø: d1 Ø 30 / d2 Ø 27
81467106112, 81467106163, 81467106165,
81467106198, 81467106353, 81467106354,
81467106361, 81467116725



MN-DL-2175

Length: 1628
Ø: 50
Cone Ø: d1 Ø 30 / d2 Ø 27
81467106396, 81467106904



MN-DL-5212

Length: 577 Ø: 48
Hole Distance: 130 / 130
81432206096, 81432206097, 81432206098,
81432206129, 81432209096, 81432209129,
81432306014, 81432306030



MN-DL-5232

Length: 1000 Ø: 42
Cone Ø: d1 Ø 30 / d2 Ø 26
03207100A, 81467106442



MN-DL-7837

Length: 955 Ø: 40
Cone Ø: d1 Ø 26 / d2 Ø 23,5
03206800A, 81467106436, 81467106437,
81467106455



MN-RK-7280

Ø: 75
Hole Distance: 115
Thick/Height: 24
0550806, 0639370, 689748, 10307400A,
81432306051, 81432306068, 81432706064



MN-RK-7291

Ø: 72
Hole Distance: 130
Thick/Height: 30
10307800A, 81432206108, 81432206132



MN-RK-8523

Ø: 72
03304900A, 81432706065



MN-SB-5248

Length: 55 Ø: 80
Thick/Height: 80
03310100A, 81437040025



MN-SB-5249

Length: 55 Ø: 71
Thick/Height: 80
03310200A, 81437040029



MN-VB-8565

Length: 693
Ø: 46
Hole Distance: 115 / 115
81432706053, 81432709053





M 90 ...

18.272 FK	09/91 → 06/96	Ball Head, gearshift linkage	CV-ES-2119		
	09/91 → 06/96	Ball Head, gearshift linkage	CV-ES-2120		
	09/91 → 06/96	Ball Head, gearshift linkage	CV-ES-2182		
	09/91 → 06/96	Centre Rod	MN-DL-2138		Push Rod
	09/91 → 06/96	Centre Rod	MN-DL-2160		Coupling Rod
	09/91 → 06/96	Centre Rod	MN-DL-2175		Push Rod
	09/91 → 06/96	Centre Rod	MN-DL-5232		Push Rod
	09/91 → 06/96	Centre Rod	MN-DL-7837		Push Rod
	09/91 → 06/96	Stabiliser Mounting		MN-SB-5249	
	09/91 → 06/96	Stabiliser Mounting		MN-SB-5249	1st RA
	09/91 → 06/96	Stabiliser Mounting	MN-SB-5249		1st FA
	09/91 → 06/96	Suspension Arm Repair Kit		MN-RK-7280	for Drag Link
	09/91 → 06/96	Tie Rod End	CV-ES-12461		for Steering Rod
	09/91 → 06/96	Tie Rod End	CV-ES-12462		for Steering Rod
	09/91 → 06/96	Tie Rod End	CV-ES-14162		for Steering Rod
09/91 → 06/96	Tie Rod End	CV-ES-14163		for Steering Rod	
24.192 FNL, 24.192 FNLL, 24.192 FVL	07/89 → 06/96	Ball Head, gearshift linkage	CV-ES-2119		
	07/89 → 06/96	Ball Head, gearshift linkage	CV-ES-2120		
	07/89 → 06/96	Ball Head, gearshift linkage	CV-ES-2121		
	07/89 → 06/96	Ball Head, gearshift linkage	CV-ES-2182		
	07/89 → 06/96	Centre Rod	MN-DL-2138		Push Rod
	07/89 → 06/96	Centre Rod	MN-DL-2160		Coupling Rod
	07/89 → 06/96	Centre Rod	MN-DL-5232		Push Rod
	07/89 → 06/96	Centre Rod	MN-DL-12421		for Steering Rod
	07/89 → 06/96	Mounting, stabilizer coupling rod		MN-SB-5246	
	07/89 → 06/96	Stabiliser Mounting		MN-SB-5248	
	07/89 → 06/96	Stabiliser Mounting		MN-SB-5248	1st RA
	07/89 → 06/96	Stabiliser Mounting	MN-SB-5249		
	07/89 → 06/96	Stabiliser Mounting	MN-SB-5249		2nd FA
	07/89 → 06/96	Suspension Arm Repair Kit		MN-RK-7280	for Drag Link
	07/89 → 06/96	Suspension Arm Repair Kit		MN-RK-7291	for Drag Link
	07/89 → 06/96	Suspension Arm Repair Kit		MN-RK-8523	for Wishbone (CV)
	07/89 → 06/96	Tie Rod End	CV-ES-2149		for Push Rod
	07/89 → 06/96	Tie Rod End	CV-ES-12461		for Steering Rod
	07/89 → 06/96	Tie Rod End	CV-ES-12462		for Steering Rod
	07/89 → 06/96	Tie Rod End	CV-ES-14162		for Steering Rod
	07/89 → 06/96	Tie Rod End	CV-ES-14163		for Steering Rod
	07/89 → 06/96	Track Control Arm		MN-DL-5212	Trailing Arm, Drive Axle; for vehicles with Rigid Trailing Axle
	07/89 → 06/96	Track Control Arm		MN-DL-5212	Trailing Arm, Drive Axle; Tag Axle
	07/89 → 06/96	Track Control Arm		MN-VB-8565	Wishbone (CV), Drive Axle
	07/89 → 06/96	Track Control Arm		MN-VB-8565	Wishbone (CV), Drive Axle; Air Suspension Axle
07/89 → 06/96	Track Control Arm		MN-VB-8565	Wishbone (CV), Tag Axle	
24.222 FNL, 24.222 FNLL, 24.222 FVL	05/94 → 06/96	Ball Head, gearshift linkage	CV-ES-2119		
	05/94 → 06/96	Ball Head, gearshift linkage	CV-ES-2120		
	05/94 → 06/96	Ball Head, gearshift linkage	CV-ES-2121		
	05/94 → 06/96	Ball Head, gearshift linkage	CV-ES-2182		
	05/94 → 06/96	Centre Rod	MN-DL-2138		Push Rod
	05/94 → 06/96	Centre Rod	MN-DL-2160		Coupling Rod
	05/94 → 06/96	Centre Rod	MN-DL-5232		Push Rod
	05/94 → 06/96	Centre Rod	MN-DL-12421		for Steering Rod
	05/94 → 06/96	Mounting, stabilizer coupling rod		MN-SB-5246	
	05/94 → 06/96	Stabiliser Mounting		MN-SB-5248	
	05/94 → 06/96	Stabiliser Mounting		MN-SB-5248	1st RA
	05/94 → 06/96	Stabiliser Mounting	MN-SB-5249		
	05/94 → 06/96	Stabiliser Mounting	MN-SB-5249		2nd FA
	05/94 → 06/96	Suspension Arm Repair Kit		MN-RK-7280	for Drag Link
	05/94 → 06/96	Suspension Arm Repair Kit		MN-RK-7291	for Drag Link
	05/94 → 06/96	Suspension Arm Repair Kit		MN-RK-8523	for Wishbone (CV)
	05/94 → 06/96	Tie Rod End	CV-ES-2149		for Push Rod
	05/94 → 06/96	Tie Rod End	CV-ES-12461		for Steering Rod
05/94 → 06/96	Tie Rod End	CV-ES-12462		for Steering Rod	
05/94 → 06/96	Tie Rod End	CV-ES-14162		for Steering Rod	

CV-ES-2119

Length: 55
 Cone Ø: d1 Ø 10 / d2 Ø 10
 Thread: M12 x 1,75 LHT
 81953016063, 81953016131



CV-ES-2120

Length: 115
 Cone Ø: d1 Ø 12,4 / d2 Ø 10,8
 Thread: M14 x 1,5 RHT
 03008500A, 81953016200, 81953016202,
 81953016203, 81953016227



CV-ES-2121

Length: 85
 Cone Ø: d1 Ø 12 / d2 Ø 10,8
 Thread: M14 x 1,5 RHT
 81953010038, 81953010045, 81953016016,
 81953016169, 81953016172, 81953016176,
 81953016266, 81953016302



CV-ES-2149

Length: 160
 Cone Ø: d1 Ø 30 / d2 Ø 27
 Thread: M30 x 1,5 RHT
 81953016263



CV-ES-2182

Length: 55
 Cone Ø: d1 Ø 10 / d2 Ø 10
 Thread: M12 x 1,75 RHT
 81953016064, 81953016170



CV-ES-12461

Length: 120
 Cone Ø: d1 Ø 26 / d2 Ø 23,5
 Thread: M30 x 1,5 LHT
 90804102216, 90804102612, 90804102720,
 90804153107, 90804153113, 81953010013,
 81953010074, 81953010082, 81953016068,
 81953016074, 81953016163, 81953016273,
 81953016283, 81953016320, 81953016361



CV-ES-12462

Length: 120
 Cone Ø: d1 Ø 26 / d2 Ø 23,5
 Thread: M30 x 1,5 RHT
 90804102218, 90804153111, 81953010014,
 81953010042, 81953010064, 81953010068,
 81953016065, 81953016067, 81953016073,
 81953016162, 81953016239, 81953016240,
 81953016246, 81953016250, 81953016272,
 81953016282, 81953016319, 81953016360,
 82953016014



CV-ES-14162

Length: 125
 Cone Ø: d1 Ø 30 / d2 Ø 27
 Thread: M30 x 1,5 LHT
 81953010015, 81953010083, 81953010087,
 81953016029, 81953016030, 81953016043,
 81953016044, 81953016050, 81953016054,
 81953016087, 81953016091, 81953016107,
 81953016120, 81953016125, 81953016152,
 81953016155, 81953016157, 81953016168,
 81953016179, 81953016181, 81953016223,
 81953016237, 81953016254, 81953016275,
 81953016279, 81953016351



CV-ES-14163

Length: 125
 Cone Ø: d1 Ø 30 / d2 Ø 27
 Thread: M30 x 1,5 RHT
 95301.0084, 90804102156, 90804102272,
 90804102696, 90804102710, 81953010016,
 81953010075, 81953010084, 81953010088,
 81953010094, 81953010103, 81953016030,
 81953016043, 81953016048, 81953016049,
 81953016053, 81953016061, 81953016090,
 81953016108, 81953016112, 81953016126,
 81953016143, 81953016181, 81953016154,
 81953016156, 81953016168, 81953016178,
 81953016194, 81953016206, 81953016224,
 81953016234, 81953016242, 81953016252,
 81953016274, 81953016278, 81953016284,
 81953016286, 81953016308, 81953016310,
 81953016312, 81953016347, 81953016350,
 81953016352, 82953016012, 88953016014,
 N2953016001



MN-DL-2138

Length: 1000 Ø: 40
 Cone Ø: d1 Ø 26 / d2 Ø 23,5
 81467106438, 81467106439



MN-DL-2160

Length: 1652 Ø: 50
 Cone Ø: d1 Ø 30 / d2 Ø 27
 81467106112, 81467106163, 81467106165,
 81467106198, 81467106353, 81467106354,
 81467106361, 81467116725



MN-DL-2175

Length: 1628
 Ø: 50
 Cone Ø: d1 Ø 30 / d2 Ø 27
 81467106396, 81467106904



MN-DL-5212

Length: 577 Ø: 48
 Hole Distance: 130 / 130
 81432206096, 81432206097, 81432206098,
 81432206129, 81432209096, 81432209129,
 81432306014, 81432306030



MN-DL-5232

Length: 1000 Ø: 42
 Cone Ø: d1 Ø 30 / d2 Ø 26
 03207100A, 81467106442



MN-DL-7837

Length: 955 Ø: 40
 Cone Ø: d1 Ø 26 / d2 Ø 23,5
 03206800A, 81467106436, 81467106437,
 81467106455



MN-DL-12421

Length: 1070
 Ø: 48
 Cone Ø: d1 Ø 30 / d2 Ø 27
 Thread: M30 x 1,5 RHT
 81466106656, 81466106659, 81466106669,
 81466116006, 81466116007



MN-RK-7280

Ø: 75
 Hole Distance: 115
 Thick/Height: 24
 0550806, 0639370, 689748, 10307400A,
 81432306051, 81432306068, 81432706064



MN-RK-7291

Ø: 72
 Hole Distance: 130
 Thick/Height: 30
 10307800A, 81432206108, 81432206132



MN-RK-8523

Ø: 72
 03304900A, 81432706065



MN-SB-5246

Ø: 45 Thick/Height: 47
 81437220022, 81437220038, 81962100450,
 81962100469



MN-SB-5248

Length: 55 Ø: 80
 Thick/Height: 80
 03310100A, 81437040025



MN-SB-5249

Length: 55 Ø: 71
 Thick/Height: 80
 03310200A, 81437040029



MN-VB-8565

Length: 693
 Ø: 46
 Hole Distance: 115 / 115
 81432706053, 81432709053





M 90 ...

24.222 FNL,24.222 FNLL, 24.222 FVL ...	05/94 →06/96	Tie Rod End	CV-ES-14163		for Steering Rod
	05/94 →06/96	Track Control Arm		MN-DL-5212	Trailing Arm, Drive Axle;for vehicles with Rigid Trailing Axle
	05/94 →06/96	Track Control Arm		MN-DL-5212	Trailing Arm, Drive Axle;Tag Axle
	05/94 →06/96	Track Control Arm		MN-VB-8565	Wishbone (CV), Drive Axle
	05/94 →06/96	Track Control Arm		MN-VB-8565	Wishbone (CV), Drive Axle;Air Suspension Axle
	05/94 →06/96	Track Control Arm		MN-VB-8565	Wishbone (CV), Tag Axle
24.232 FNL	05/90 →04/95	Ball Head, gearshift linkage	CV-ES-2119		
	05/90 →04/95	Ball Head, gearshift linkage	CV-ES-2120		
	05/90 →04/95	Ball Head, gearshift linkage	CV-ES-2121		
	05/90 →04/95	Ball Head, gearshift linkage	CV-ES-2182		
	05/90 →04/95	Centre Rod	MN-DL-2138		Push Rod
	05/90 →04/95	Centre Rod	MN-DL-2160		Coupling Rod
	05/90 →04/95	Centre Rod	MN-DL-5232		Push Rod
	05/90 →04/95	Centre Rod	MN-DL-12421		for Steering Rod
	05/90 →04/95	Mounting, stabilizer coupling rod		MN-SB-5246	
	05/90 →04/95	Stabiliser Mounting		MN-SB-5242	
	05/90 →04/95	Stabiliser Mounting		MN-SB-5248	
	05/90 →04/95	Stabiliser Mounting		MN-SB-5248	1st RA
	05/90 →04/95	Stabiliser Mounting	MN-SB-5249		
	05/90 →04/95	Stabiliser Mounting	MN-SB-5249		1st FA
	05/90 →04/95	Suspension Arm Repair Kit		MN-RK-7280	for Drag Link
	05/90 →04/95	Suspension Arm Repair Kit		MN-RK-7291	for Drag Link
	05/90 →04/95	Suspension Arm Repair Kit		MN-RK-8523	for Wishbone (CV)
	05/90 →04/95	Tie Rod End	CV-ES-2149		for Push Rod
	05/90 →04/95	Tie Rod End	CV-ES-12461		for Steering Rod
	05/90 →04/95	Tie Rod End	CV-ES-12462		for Steering Rod
	05/90 →04/95	Tie Rod End	CV-ES-14162		for Steering Rod
	05/90 →04/95	Tie Rod End	CV-ES-14163		for Steering Rod
	05/90 →04/95	Track Control Arm		MN-DL-5212	Trailing Arm, Drive Axle;Tag Axle
	05/90 →04/95	Track Control Arm		MN-VB-8565	Wishbone (CV), Drive Axle
	05/90 →04/95	Track Control Arm		MN-VB-8565	Wishbone (CV), Tag Axle
	24.232 FNL,24.232 FNLL, 24.232 FVL	07/89 →06/96	Ball Head, gearshift linkage	CV-ES-2119	
07/89 →06/96		Ball Head, gearshift linkage	CV-ES-2120		
07/89 →06/96		Ball Head, gearshift linkage	CV-ES-2121		
07/89 →06/96		Ball Head, gearshift linkage	CV-ES-2182		
07/89 →06/96		Centre Rod	MN-DL-2138		Push Rod
07/89 →06/96		Centre Rod	MN-DL-2160		Coupling Rod
07/89 →06/96		Centre Rod	MN-DL-5232		Push Rod
07/89 →06/96		Centre Rod	MN-DL-12421		for Steering Rod
07/89 →06/96		Mounting, stabilizer coupling rod		MN-SB-5246	
07/89 →06/96		Stabiliser Mounting		MN-SB-5248	
07/89 →06/96		Stabiliser Mounting		MN-SB-5248	1st RA
07/89 →06/96		Stabiliser Mounting	MN-SB-5249		
07/89 →06/96		Stabiliser Mounting	MN-SB-5249		2nd FA
07/89 →06/96		Suspension Arm Repair Kit		MN-RK-7280	for Drag Link
07/89 →06/96		Suspension Arm Repair Kit		MN-RK-7291	for Drag Link
07/89 →06/96		Suspension Arm Repair Kit		MN-RK-8523	for Wishbone (CV)
07/89 →06/96		Tie Rod End	CV-ES-2149		for Push Rod
07/89 →06/96		Tie Rod End	CV-ES-12461		for Steering Rod
07/89 →06/96		Tie Rod End	CV-ES-12462		for Steering Rod
07/89 →06/96		Tie Rod End	CV-ES-14162		for Steering Rod
07/89 →06/96		Tie Rod End	CV-ES-14163		for Steering Rod
07/89 →06/96		Track Control Arm		MN-DL-5212	Trailing Arm, Drive Axle;for vehicles with Rigid Trailing Axle
07/89 →06/96		Track Control Arm		MN-DL-5212	Trailing Arm, Drive Axle;Tag Axle
07/89 →06/96		Track Control Arm		MN-VB-8565	Wishbone (CV), Drive Axle
07/89 →06/96		Track Control Arm		MN-VB-8565	Wishbone (CV), Drive Axle;Air Suspension Axle
07/89 →06/96		Track Control Arm		MN-VB-8565	Wishbone (CV), Tag Axle
24.262 FNL,24.262 FNLL, 24.262 FVL	08/95 →06/96	Ball Head, gearshift linkage	CV-ES-2119		
	08/95 →06/96	Ball Head, gearshift linkage	CV-ES-2120		
	08/95 →06/96	Ball Head, gearshift linkage	CV-ES-2121		
	08/95 →06/96	Ball Head, gearshift linkage	CV-ES-2182		

CV-ES-2119

Length: 55
Cone Ø: d1 Ø 10 / d2 Ø 10
Thread: M12 x 1,75 LHT
81953016063, 81953016131



CV-ES-2120

Length: 115
Cone Ø: d1 Ø 12,4 / d2 Ø 10,8
Thread: M14 x 1,5 RHT
03008500A, 81953016200, 81953016202,
81953016203, 81953016227



CV-ES-2121

Length: 85
Cone Ø: d1 Ø 12 / d2 Ø 10,8
Thread: M14 x 1,5 RHT
81953010038, 81953010045, 81953016016,
81953016169, 81953016172, 81953016176,
81953016266, 81953016302



CV-ES-2149

Length: 160
Cone Ø: d1 Ø 30 / d2 Ø 27
Thread: M30 x 1,5 RHT
81953016263



CV-ES-2182

Length: 55
Cone Ø: d1 Ø 10 / d2 Ø 10
Thread: M12 x 1,75 RHT
81953016064, 81953016170



CV-ES-12461

Length: 120
Cone Ø: d1 Ø 26 / d2 Ø 23,5
Thread: M30 x 1,5 LHT
90804102216, 90804102612, 90804102720,
90804153107, 90804153113, 81953010013,
81953010074, 81953010082, 81953016068,
81953016074, 81953016163, 81953016273,
81953016283, 81953016320, 81953016361



CV-ES-12462

Length: 120
Cone Ø: d1 Ø 26 / d2 Ø 23,5
Thread: M30 x 1,5 RHT
90804102218, 90804153111, 81953010014,
81953010042, 81953010064, 81953010068,
81953016065, 81953016067, 81953016073,
81953016162, 81953016239, 81953016240,
81953016246, 81953016250, 81953016272,
81953016282, 81953016319, 81953016360,
82953016014



CV-ES-14162

Length: 125
Cone Ø: d1 Ø 30 / d2 Ø 27
Thread: M30 x 1,5 LHT
81953010015, 81953010083, 81953010087,
81953016029, 81953016030, 81953016043,
81953016044, 81953016050, 81953016054,
81953016087, 81953016091, 81953016107,
81953016120, 81953016125, 81953016152,
81953016155, 81953016157, 81953016168,
81953016179, 81953016181, 81953016223,
81953016237, 81953016254, 81953016275,
81953016279, 81953016351



CV-ES-14163

Length: 125
Cone Ø: d1 Ø 30 / d2 Ø 27
Thread: M30 x 1,5 RHT
95301.0084, 90804102156, 90804102272,
90804102696, 90804102710, 81953010016,
81953010075, 81953010084, 81953010088,
81953010094, 81953010103, 81953016030,
81953016043, 81953016048, 81953016049,
81953016053, 81953016061, 81953016090,
81953016108, 81953016112, 81953016126,
81953016143, 81953016149, 81953016154,
81953016156, 81953016168, 81953016178,
81953016194, 81953016206, 81953016224,
81953016234, 81953016242, 81953016252,
81953016274, 81953016278, 81953016284,
81953016286, 81953016308, 81953016310,
81953016312, 81953016347, 81953016350,
81953016352, 82953016012, 88953016014,
N2953016001



MN-DL-2138

Length: 1000 Ø: 40
Cone Ø: d1 Ø 26 / d2 Ø 23,5
81467106438, 81467106439



MN-DL-2160

Length: 1652 Ø: 50
Cone Ø: d1 Ø 30 / d2 Ø 27
81467106112, 81467106163, 81467106165,
81467106198, 81467106353, 81467106354,
81467106361, 81467116725



MN-DL-5212

Length: 577 Ø: 48
Hole Distance: 130 / 130
81432206096, 81432206097, 81432206098,
81432206129, 81432209096, 81432209129,
81432306014, 81432306030



MN-DL-5232

Length: 1000 Ø: 42
Cone Ø: d1 Ø 30 / d2 Ø 26
03207100A, 81467106442



MN-DL-12421

Length: 1070
Ø: 48
Cone Ø: d1 Ø 30 / d2 Ø 27
Thread: M30 x 1,5 RHT
81466106656, 81466106659, 81466106669,
81466116006, 81466116007



MN-RK-7280

Ø: 75
Hole Distance: 115
Thick/Height: 24
0550806, 0639370, 689748, 10307400A,
81432306051, 81432306068, 81432706064



MN-RK-7291

Ø: 72
Hole Distance: 130
Thick/Height: 30
10307800A, 81432206108, 81432206132



MN-RK-8523

Ø: 72
03304900A, 81432706065



MN-SB-5242

Ø: 65
Thick/Height: 62
03310800A, 81437220021, 81437220039,
81437220063



MN-SB-5246

Ø: 45 Thick/Height: 47
81437220022, 81437220038, 81962100450,
81962100469



MN-SB-5248

Length: 55 Ø: 80
Thick/Height: 80
03310100A, 81437040025



MN-SB-5249

Length: 55 Ø: 71
Thick/Height: 80
03310200A, 81437040029



MN-VB-8565

Length: 693
Ø: 46
Hole Distance: 115 / 115
81432706053, 81432709053



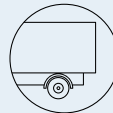

M 90 ...

24.262 FNL,24.262 FNLL, 24.262 FVL ...	08/95→06/96	Centre Rod	MN-DL-2138	Push Rod
	08/95→06/96	Centre Rod	MN-DL-2160	Coupling Rod
	08/95→06/96	Centre Rod	MN-DL-5232	Push Rod
	08/95→06/96	Centre Rod	MN-DL-12421	for Steering Rod
	08/95→06/96	Mounting, stabilizer coupling rod	MN-SB-5246	
	08/95→06/96	Stabiliser Mounting	MN-SB-5242	
	08/95→06/96	Stabiliser Mounting	MN-SB-5248	
	08/95→06/96	Stabiliser Mounting	MN-SB-5248	1st RA
	08/95→06/96	Stabiliser Mounting	MN-SB-5249	
	08/95→06/96	Stabiliser Mounting	MN-SB-5249	2nd FA
	08/95→06/96	Suspension Arm Repair Kit	MN-RK-7280	for Drag Link
	08/95→06/96	Suspension Arm Repair Kit	MN-RK-7291	for Drag Link
	08/95→06/96	Suspension Arm Repair Kit	MN-RK-8523	for Wishbone (CV)
	08/95→06/96	Tie Rod End	CV-ES-2149	for Push Rod
	08/95→06/96	Tie Rod End	CV-ES-12461	for Steering Rod
	08/95→06/96	Tie Rod End	CV-ES-12462	for Steering Rod
	08/95→06/96	Tie Rod End	CV-ES-14162	for Steering Rod
	08/95→06/96	Tie Rod End	CV-ES-14163	for Steering Rod
	08/95→06/96	Track Control Arm	MN-DL-5212	Trailing Arm, Drive Axle;for vehicles with Rigid Trailing Axle
	08/95→06/96	Track Control Arm	MN-DL-5212	Trailing Arm, Drive Axle;Tag Axle
	08/95→06/96	Track Control Arm	MN-VB-8565	Wishbone (CV), Drive Axle
	08/95→06/96	Track Control Arm	MN-VB-8565	Wishbone (CV), Drive Axle;Air Suspension Axle
	08/95→06/96	Track Control Arm	MN-VB-8565	Wishbone (CV), Tag Axle
24.272 FNL,24.272 FNLL, 24.272 FVL	10/92→06/96	Ball Head, gearshift linkage	CV-ES-2119	
	10/92→06/96	Ball Head, gearshift linkage	CV-ES-2120	
	10/92→06/96	Ball Head, gearshift linkage	CV-ES-2121	
	10/92→06/96	Ball Head, gearshift linkage	CV-ES-2182	
	10/92→06/96	Centre Rod	MN-DL-2138	Push Rod
	10/92→06/96	Centre Rod	MN-DL-2160	Coupling Rod
	10/92→06/96	Centre Rod	MN-DL-5232	Push Rod
	10/92→06/96	Centre Rod	MN-DL-12421	for Steering Rod
	10/92→06/96	Mounting, stabilizer coupling rod	MN-SB-5246	
	10/92→06/96	Stabiliser Mounting	MN-SB-5248	
	10/92→06/96	Stabiliser Mounting	MN-SB-5248	1st RA
	10/92→06/96	Stabiliser Mounting	MN-SB-5249	
	10/92→06/96	Stabiliser Mounting	MN-SB-5249	2nd FA
	10/92→06/96	Suspension Arm Repair Kit	MN-RK-7280	for Drag Link
	10/92→06/96	Suspension Arm Repair Kit	MN-RK-7291	for Drag Link
	10/92→06/96	Suspension Arm Repair Kit	MN-RK-8523	for Wishbone (CV)
	10/92→06/96	Tie Rod End	CV-ES-2149	for Push Rod
	10/92→06/96	Tie Rod End	CV-ES-12461	for Steering Rod
	10/92→06/96	Tie Rod End	CV-ES-12462	for Steering Rod
	10/92→06/96	Tie Rod End	CV-ES-14162	for Steering Rod
	10/92→06/96	Tie Rod End	CV-ES-14163	for Steering Rod
	10/92→06/96	Track Control Arm	MN-DL-5212	Trailing Arm, Drive Axle;for vehicles with Rigid Trailing Axle
	10/92→06/96	Track Control Arm	MN-DL-5212	Trailing Arm, Drive Axle;Tag Axle
10/92→06/96	Track Control Arm	MN-VB-8565	Wishbone (CV), Drive Axle	
10/92→06/96	Track Control Arm	MN-VB-8565	Wishbone (CV), Drive Axle;Air Suspension Axle	
10/92→06/96	Track Control Arm	MN-VB-8565	Wishbone (CV), Tag Axle	
24.272 FNL,24.272 FVL	09/91→05/94	Ball Head, gearshift linkage	CV-ES-2119	
	09/91→05/94	Ball Head, gearshift linkage	CV-ES-2120	
	09/91→05/94	Ball Head, gearshift linkage	CV-ES-2121	
	09/91→05/94	Ball Head, gearshift linkage	CV-ES-2182	
	09/91→05/94	Centre Rod	MN-DL-2138	Push Rod
	09/91→05/94	Centre Rod	MN-DL-2160	Coupling Rod
	09/91→05/94	Centre Rod	MN-DL-5232	Push Rod
	09/91→05/94	Centre Rod	MN-DL-12421	for Steering Rod
	09/91→05/94	Mounting, stabilizer coupling rod	MN-SB-5246	
	09/91→05/94	Stabiliser Mounting	MN-SB-5248	
	09/91→05/94	Stabiliser Mounting	MN-SB-5248	1st RA
	09/91→05/94	Stabiliser Mounting	MN-SB-5249	

CV-ES-2119

Length: 55
Cone Ø: d1 Ø 10 / d2 Ø 10
Thread: M12 x 1,75 LHT
81953016063, 81953016131



CV-ES-2120

Length: 115
Cone Ø: d1 Ø 12,4 / d2 Ø 10,8
Thread: M14 x 1,5 RHT
03008500A, 81953016200, 81953016202,
81953016203, 81953016227



CV-ES-2121

Length: 85
Cone Ø: d1 Ø 12 / d2 Ø 10,8
Thread: M14 x 1,5 RHT
81953010038, 81953010045, 81953016016,
81953016169, 81953016172, 81953016176,
81953016266, 81953016302



CV-ES-2149

Length: 160
Cone Ø: d1 Ø 30 / d2 Ø 27
Thread: M30 x 1,5 RHT
81953016263



CV-ES-2182

Length: 55
Cone Ø: d1 Ø 10 / d2 Ø 10
Thread: M12 x 1,75 RHT
81953016064, 81953016170



CV-ES-12461

Length: 120
Cone Ø: d1 Ø 26 / d2 Ø 23,5
Thread: M30 x 1,5 LHT
90804102216, 90804102612, 90804102720,
90804153107, 90804153113, 81953010013,
81953010074, 81953010082, 81953016068,
81953016074, 81953016163, 81953016273,
81953016283, 81953016320, 81953016361



CV-ES-12462

Length: 120
Cone Ø: d1 Ø 26 / d2 Ø 23,5
Thread: M30 x 1,5 RHT
90804102218, 90804153111, 81953010014,
81953010042, 81953010064, 81953010068,
81953016065, 81953016067, 81953016073,
81953016162, 81953016239, 81953016240,
81953016246, 81953016250, 81953016272,
81953016282, 81953016319, 81953016360,
82953016014



CV-ES-14162

Length: 125
Cone Ø: d1 Ø 30 / d2 Ø 27
Thread: M30 x 1,5 LHT
81953010015, 81953010083, 81953010087,
81953016029, 81953016030, 81953016043,
81953016044, 81953016050, 81953016054,
81953016087, 81953016091, 81953016107,
81953016120, 81953016125, 81953016152,
81953016155, 81953016157, 81953016168,
81953016179, 81953016181, 81953016223,
81953016237, 81953016254, 81953016275,
81953016279, 81953016351



CV-ES-14163

Length: 125
Cone Ø: d1 Ø 30 / d2 Ø 27
Thread: M30 x 1,5 RHT
95301.0084, 90804102156, 90804102272,
90804102696, 90804102710, 81953010016,
81953010075, 81953010084, 81953010088,
81953010094, 81953010103, 81953016030,
81953016043, 81953016048, 81953016049,
81953016053, 81953016061, 81953016090,
81953016108, 81953016112, 81953016126,
81953016143, 81953016149, 81953016154,
81953016156, 81953016168, 81953016178,
81953016194, 81953016206, 81953016224,
81953016234, 81953016242, 81953016252,
81953016274, 81953016278, 81953016284,
81953016286, 81953016308, 81953016310,
81953016312, 81953016347, 81953016350,
81953016352, 82953016012, 88953016014,
N2953016001



MN-DL-2138

Length: 1000 Ø: 40
Cone Ø: d1 Ø 26 / d2 Ø 23,5
81467106438, 81467106439



MN-DL-2160

Length: 1652 Ø: 50
Cone Ø: d1 Ø 30 / d2 Ø 27
81467106112, 81467106163, 81467106165,
81467106198, 81467106353, 81467106354,
81467106361, 81467116725



MN-DL-5212

Length: 577 Ø: 48
Hole Distance: 130 / 130
81432206096, 81432206097, 81432206098,
81432206129, 81432209096, 81432209129,
81432306014, 81432306030



MN-DL-5232

Length: 1000 Ø: 42
Cone Ø: d1 Ø 30 / d2 Ø 26
03207100A, 81467106442



MN-DL-12421

Length: 1070
Ø: 48
Cone Ø: d1 Ø 30 / d2 Ø 27
Thread: M30 x 1,5 RHT
81466106656, 81466106659, 81466106669,
81466116006, 81466116007



MN-RK-7280

Ø: 75
Hole Distance: 115
Thick/Height: 24
0550806, 0639370, 689748, 10307400A,
81432306051, 81432306068, 81432706064



MN-RK-7291

Ø: 72
Hole Distance: 130
Thick/Height: 30
10307800A, 81432206108, 81432206132



MN-RK-8523

Ø: 72
03304900A, 81432706065



MN-SB-5242

Ø: 65
Thick/Height: 62
03310800A, 81437220021, 81437220039,
81437220063



MN-SB-5246

Ø: 45 Thick/Height: 47
81437220022, 81437220038, 81962100450,
81962100469



MN-SB-5248

Length: 55 Ø: 80
Thick/Height: 80
03310100A, 81437040025



MN-SB-5249

Length: 55 Ø: 71
Thick/Height: 80
03310200A, 81437040029



MN-VB-8565

Length: 693
Ø: 46
Hole Distance: 115 / 115
81432706053, 81432709053





M 90 ...

24.272 FNL,24.272 FVL ...	09/91→05/94	Stabiliser Mounting	MN-SB-5249		2nd FA
	09/91→05/94	Suspension Arm Repair Kit		MN-RK-7280	for Drag Link
	09/91→05/94	Suspension Arm Repair Kit		MN-RK-7291	for Drag Link
	09/91→05/94	Suspension Arm Repair Kit		MN-RK-8523	for Wishbone (CV)
	09/91→05/94	Tie Rod End	CV-ES-2149		for Push Rod
	09/91→05/94	Tie Rod End	CV-ES-12461		for Steering Rod
	09/91→05/94	Tie Rod End	CV-ES-12462		for Steering Rod
	09/91→05/94	Tie Rod End	CV-ES-14162		for Steering Rod
	09/91→05/94	Tie Rod End	CV-ES-14163		for Steering Rod
	09/91→05/94	Track Control Arm		MN-DL-5212	Trailing Arm, Drive Axle;for vehicles with Rigid Trailing Axle
	09/91→05/94	Track Control Arm		MN-DL-5212	Trailing Arm, Drive Axle;Tag Axle
	09/91→05/94	Track Control Arm		MN-VB-8565	Wishbone (CV), Drive Axle
	09/91→05/94	Track Control Arm		MN-VB-8565	Wishbone (CV), Drive Axle;Air Suspension Axle
	09/91→05/94	Track Control Arm		MN-VB-8565	Wishbone (CV), Tag Axle

M 2000 L

12.163 LC, LLC, LRC, LLRC	08/95→	Ball Head, gearshift linkage	CV-ES-2119		
	08/95→	Ball Head, gearshift linkage	CV-ES-2120		
	08/95→	Ball Head, gearshift linkage	CV-ES-2182		
	08/95→	Centre Rod	MN-DL-2132		Push Rod
	08/95→	Stabiliser Mounting		MN-SB-5249	
	08/95→	Stabiliser Mounting		MN-SB-5249	1st RA
	08/95→	Suspension Arm Repair Kit		MN-RK-9383	for Control Arm
	08/95→	Tie Rod	MN-DL-7781		Guide Rod
	02/99→	Track Control Arm		MN-DL-8714	Trailing Arm, Air Suspension Axle
	12.163 LK, LRK	08/95→	Ball Head, gearshift linkage	CV-ES-2119	
08/95→		Ball Head, gearshift linkage	CV-ES-2120		
08/95→		Ball Head, gearshift linkage	CV-ES-2182		
08/95→		Centre Rod	MN-DL-2132		Push Rod
08/95→		Stabiliser Mounting		MN-SB-5249	
08/95→		Stabiliser Mounting		MN-SB-5249	1st RA
12.224 LC, LLC, LRC, LLRC	08/95→	Ball Head, gearshift linkage	CV-ES-2119		
	08/95→	Ball Head, gearshift linkage	CV-ES-2120		
	08/95→	Ball Head, gearshift linkage	CV-ES-2182		
	08/95→	Centre Rod	MN-DL-2132		Push Rod
	08/95→	Tie Rod	MN-DL-7781		Guide Rod
	02/99→	Track Control Arm		MN-DL-8714	Trailing Arm, Air Suspension Axle
12.224, 12.225, LK, LRK	08/95→	Ball Head, gearshift linkage	CV-ES-2119		
	08/95→	Ball Head, gearshift linkage	CV-ES-2120		
	08/95→	Ball Head, gearshift linkage	CV-ES-2182		
	08/95→	Centre Rod	MN-DL-2132		Push Rod
	08/95→	Tie Rod	MN-DL-7781		Guide Rod
12.225 LC, LLC, LLLC, LRC, LLRC	05/01→	Suspension Arm Repair Kit		MN-RK-7291	for Drag Link
	05/01→	Suspension Arm Repair Kit		MN-RK-8523	for Wishbone (CV)
	05/01→	Tie Rod End	CV-ES-12462		for Steering Rod
12.255 LC, LLC, LLLC, LLRC, LRC	08/02→	Suspension Arm Repair Kit		MN-RK-7291	for Drag Link
	08/02→	Suspension Arm Repair Kit		MN-RK-8523	for Wishbone (CV)
	08/02→	Tie Rod End	CV-ES-12462		for Steering Rod
12.255 LK, LRK	10/03→	Tie Rod End	CV-ES-12462		for Steering Rod
12.285 LC, LLC, LLLC, LLRC, LRC	08/02→	Suspension Arm Repair Kit		MN-RK-7291	for Drag Link
	08/02→	Suspension Arm Repair Kit		MN-RK-8523	for Wishbone (CV)
12.285 LK, LRK	08/02→	Tie Rod End	CV-ES-12462		for Steering Rod
	10/03→	Tie Rod End	CV-ES-12462		for Steering Rod
14.163 LC, LLC, LRC, LLRC	08/95→	Ball Head, gearshift linkage	CV-ES-2119		
	08/95→	Ball Head, gearshift linkage	CV-ES-2120		
	08/95→	Centre Rod	MN-DL-2140		Push Rod
	08/95→	Centre Rod	MN-DL-8377		Push Rod
	08/95→	Centre Rod	MN-DL-8662		Push Rod, for Leaf-Spring Suspension vehicles
	08/95→	Stabiliser Mounting		MN-SB-5249	
	08/95→	Stabiliser Mounting		MN-SB-5249	1st RA
	08/95→	Suspension Arm Repair Kit		MN-RK-7291	for Drag Link

CV-ES-2119

Length: 55
Cone Ø: d1 Ø 10 / d2 Ø 10
Thread: M12 x 1,75 LHT
81953016063, 81953016131



CV-ES-2120

Length: 115
Cone Ø: d1 Ø 12,4 / d2 Ø 10,8
Thread: M14 x 1,5 RHT
03008500A, 81953016200, 81953016202,
81953016203, 81953016227



CV-ES-2149

Length: 160
Cone Ø: d1 Ø 30 / d2 Ø 27
Thread: M30 x 1,5 RHT
81953016263



CV-ES-2182

Length: 55
Cone Ø: d1 Ø 10 / d2 Ø 10
Thread: M12 x 1,75 RHT
81953016064, 81953016170



CV-ES-12461

Length: 120
Cone Ø: d1 Ø 26 / d2 Ø 23,5
Thread: M30 x 1,5 LHT

90804102216, 90804102612, 90804102720,
90804153107, 90804153113, 81953010013,
81953010074, 81953010082, 81953016068,
81953016074, 81953016163, 81953016273,
81953016283, 81953016320, 81953016361



CV-ES-12462

Length: 120
Cone Ø: d1 Ø 26 / d2 Ø 23,5
Thread: M30 x 1,5 RHT

90804102218, 90804153111, 81953010014,
81953010042, 81953010064, 81953010068,
81953016065, 81953016067, 81953016073,
81953016162, 81953016239, 81953016240,
81953016246, 81953016250, 81953016272,
81953016282, 81953016319, 81953016360,
82953016014



CV-ES-14162

Length: 125
Cone Ø: d1 Ø 30 / d2 Ø 27
Thread: M30 x 1,5 LHT

81953010015, 81953010083, 81953010087,
81953016029, 81953016030, 81953016043,
81953016044, 81953016050, 81953016054,
81953016087, 81953016091, 81953016107,
81953016120, 81953016125, 81953016152,
81953016155, 81953016157, 81953016168,
81953016179, 81953016181, 81953016223,
81953016237, 81953016254, 81953016275,
81953016279, 81953016351



CV-ES-14163

Length: 125
Cone Ø: d1 Ø 30 / d2 Ø 27
Thread: M30 x 1,5 RHT

95301.0084, 90804102156, 90804102272,
90804102696, 90804102710, 81953010016,
81953010075, 81953010084, 81953010088,
81953010094, 81953010103, 81953016030,
81953016043, 81953016048, 81953016049,
81953016053, 81953016061, 81953016090,
81953016108, 81953016112, 81953016126,
81953016143, 81953016149, 81953016154,
81953016156, 81953016168, 81953016178,
81953016194, 81953016206, 81953016224,
81953016234, 81953016242, 81953016252,
81953016274, 81953016278, 81953016284,
81953016286, 81953016308, 81953016310,
81953016312, 81953016347, 81953016350,
81953016352, 82953016012, 88953016014,
N2953016001



MN-DL-2132

Length: 840
Ø: 38
Cone Ø: d1 Ø 22 / d2 Ø 20
85466106021, 85466106121, 85466106140



MN-DL-2140

Length: 1650
Ø: 50
Cone Ø: d1 Ø 26 / d2 Ø 23,5
81467106933, 81467116711



MN-DL-5212

Length: 577 Ø: 48
Hole Distance: 130 / 130

81432206096, 81432206097, 81432206098,
81432206129, 81432209096, 81432209129,
81432306014, 81432306030



MN-DL-7781

Length: 1630 Ø: 35
Cone Ø: d1 Ø 22 / d2 Ø 20

81467106395, 81467106851, 81467106852,
81467106853, 81467116719, 81467116729,
81467116841



MN-DL-8377

Length: 795
Ø: 38
Cone Ø: d1 Ø 26 / d2 Ø 23,5

854661106141, 85466106105, 85466106141,
85466106205, 85466106231



MN-DL-8662

Length: 860
Ø: 38
Cone Ø: d1 Ø 26 / d2 Ø 23,5

85466106012, 85466106112, 85466106142,
85466106212



MN-DL-8714

Length: 540
Ø: 38
Hole Distance: 100 / 100
81432206216



MN-RK-7280

Ø: 75
Hole Distance: 115
Thick/Height: 24
0550806, 0639370, 689748, 10307400A,
81432306051, 81432306068, 81432706064



MN-RK-7291

Ø: 72
Hole Distance: 130
Thick/Height: 30
10307800A, 81432206108, 81432206132



MN-RK-8523

Ø: 72
03304900A, 81432706065



MN-RK-9383

Ø: 67
Hole Distance: 100
Thick/Height: 24
81432206202



MN-SB-5249

Length: 55 Ø: 71
Thick/Height: 80
03310200A, 81437040029



MN-VB-8565

Length: 693
Ø: 46
Hole Distance: 115 / 115
81432706053, 81432709053





M 2000 L ...

14.163 LC, LLC, LRC, LLRC ...	08/95→	Suspension Arm Repair Kit		MN-RK-8523	for Wishbone (CV)	
	08/95→	Tie Rod End	CV-ES-12461		for Steering Rod	
	08/95→	Tie Rod End	CV-ES-12462		for Steering Rod	
	08/95→	Track Control Arm		MN-DL-7803	Trailing Arm, Air Suspension Axle	
	08/95→	Track Control Arm		MN-DL-8590	Trailing Arm, Air Suspension Axle	
	08/95→	Track Control Arm		MN-VB-8565	Wishbone (CV)	
14.163 LK, LRK	08/95→	Ball Head, gearshift linkage	CV-ES-2119			
	08/95→	Ball Head, gearshift linkage	CV-ES-2120			
	08/95→	Centre Rod	MN-DL-2140		Push Rod	
	08/95→	Centre Rod	MN-DL-8377		Push Rod	
	08/95→	Centre Rod	MN-DL-8662		Push Rod, for Leaf-Spring Suspension vehicles	
	08/95→	Stabiliser Mounting		MN-SB-5249		
	08/95→	Stabiliser Mounting		MN-SB-5249	1st RA	
	08/95→	Tie Rod End	CV-ES-12461		for Steering Rod	
	08/95→	Tie Rod End	CV-ES-12462		for Steering Rod	
	08/95→	Tie Rod End	CV-ES-12462		for Steering Rod	
14.185 LC, LLC, LRC, LLRC	05/01→	Suspension Arm Repair Kit		MN-RK-7291	for Drag Link	
	05/01→	Suspension Arm Repair Kit		MN-RK-8523	for Wishbone (CV)	
	05/01→	Tie Rod End	CV-ES-12462		for Steering Rod	
14.185 LK, LRK	05/01→	Tie Rod End	CV-ES-12462		for Steering Rod	
14.224 LAC, LARC	08/95→	Ball Head, gearshift linkage	CV-ES-2119			
	08/95→	Ball Head, gearshift linkage	CV-ES-2120			
	08/95→	Ball Head, gearshift linkage	CV-ES-2121			
	08/95→	Centre Rod	MN-DL-2140		Push Rod	
	08/95→	Stabiliser Mounting		MN-SB-5249		
	08/95→	Stabiliser Mounting		MN-SB-5249	1st RA	
	08/95→	Tie Rod End	CV-ES-12461		for Steering Rod	
	08/95→	Tie Rod End	CV-ES-12462		for Steering Rod	
14.224 LAK, LARK, LAK-L	08/95→	Ball Head, gearshift linkage	CV-ES-2119			
	08/95→	Ball Head, gearshift linkage	CV-ES-2120			
	08/95→	Ball Head, gearshift linkage	CV-ES-2121			
	08/95→	Centre Rod	MN-DL-2140		Push Rod	
	08/95→	Stabiliser Mounting		MN-SB-5249		
	08/95→	Stabiliser Mounting		MN-SB-5249	1st RA	
	08/95→	Tie Rod End	CV-ES-12461		for Steering Rod	
	08/95→	Tie Rod End	CV-ES-12462		for Steering Rod	
	08/95→	Tie Rod End	CV-ES-12462		for Steering Rod	
	08/95→	Tie Rod End	CV-ES-12462		for Steering Rod	
14.224 LC, LLC, LLLC, LRC, LLRC, LLLRC	08/95→	Ball Head, gearshift linkage	CV-ES-2119			
	08/95→	Ball Head, gearshift linkage	CV-ES-2120			
	08/95→	Ball Head, gearshift linkage	CV-ES-2121			
	08/95→	Centre Rod	MN-DL-2140		Push Rod	
	08/95→	Centre Rod	MN-DL-8377		Push Rod	
	08/95→	Centre Rod	MN-DL-8662		Push Rod, for Leaf-Spring Suspension vehicles	
	08/95→	Stabiliser Mounting		MN-SB-5249		
	08/95→	Stabiliser Mounting		MN-SB-5249	1st RA	
	08/95→	Suspension Arm Repair Kit		MN-RK-7291	for Drag Link	
	08/95→	Suspension Arm Repair Kit		MN-RK-8523	for Wishbone (CV)	
	08/95→	Tie Rod End	CV-ES-12461		for Steering Rod	
	08/95→	Tie Rod End	CV-ES-12462		for Steering Rod	
	08/95→	Track Control Arm		MN-DL-7803	Trailing Arm, Air Suspension Axle	
	08/95→	Track Control Arm		MN-DL-8590	Trailing Arm, Air Suspension Axle	
	08/95→	Track Control Arm		MN-VB-8565	Wishbone (CV)	
	14.224 LK, LRK	08/95→	Ball Head, gearshift linkage	CV-ES-2119		
		08/95→	Ball Head, gearshift linkage	CV-ES-2120		
		08/95→	Ball Head, gearshift linkage	CV-ES-2121		
08/95→		Centre Rod	MN-DL-2140		Push Rod	
08/95→		Centre Rod	MN-DL-8377		Push Rod	
08/95→		Centre Rod	MN-DL-8662		Push Rod, for Leaf-Spring Suspension vehicles	
08/95→		Stabiliser Mounting		MN-SB-5249		
08/95→		Stabiliser Mounting		MN-SB-5249	1st RA	
08/95→		Tie Rod End	CV-ES-12461		for Steering Rod	
08/95→		Tie Rod End	CV-ES-12462		for Steering Rod	
14.224, 14.225, LA-LF	07/03→	Tie Rod End	CV-ES-12462		for Steering Rod	

CV-ES-2119

Length: 55
Cone Ø: d1 Ø 10 / d2 Ø 10
Thread: M12 x 1,75 LHT
81953016063, 81953016131



CV-ES-2120

Length: 115
Cone Ø: d1 Ø 12,4 / d2 Ø 10,8
Thread: M14 x 1,5 RHT
03008500A, 81953016200, 81953016202,
81953016203, 81953016227



CV-ES-2121

Length: 85
Cone Ø: d1 Ø 12 / d2 Ø 10,8
Thread: M14 x 1,5 RHT
81953010038, 81953010045, 81953016016,
81953016169, 81953016172, 81953016176,
81953016266, 81953016302



CV-ES-12461

Length: 120
Cone Ø: d1 Ø 26 / d2 Ø 23,5
Thread: M30 x 1,5 LHT
90804102216, 90804102612, 90804102720,
90804153107, 90804153113, 81953010013,
81953010074, 81953010082, 81953016068,
81953016074, 81953016163, 81953016273,
81953016283, 81953016320, 81953016361



CV-ES-12462

Length: 120
Cone Ø: d1 Ø 26 / d2 Ø 23,5
Thread: M30 x 1,5 RHT
90804102218, 90804153111, 81953010014,
81953010042, 81953010064, 81953010068,
81953016065, 81953016067, 81953016073,
81953016162, 81953016239, 81953016240,
81953016246, 81953016250, 81953016272,
81953016282, 81953016319, 81953016360,
82953016014



MN-DL-2140

Length: 1650
Ø: 50
Cone Ø: d1 Ø 26 / d2 Ø 23,5
81467106933, 81467116711



MN-DL-7803

Length: 644
Ø: 50
Hole Distance: 130 / 102
03307300A, 81432206174



MN-DL-8377

Length: 795
Ø: 38
Cone Ø: d1 Ø 26 / d2 Ø 23,5
85461106141, 85466106105, 85466106141,
85466106205, 85466106231



MN-DL-8590

Length: 596 Ø: 50
Hole Distance: 130 / 102
81432206140, 81432209140



MN-DL-8662

Length: 860
Ø: 38
Cone Ø: d1 Ø 26 / d2 Ø 23,5
85466106012, 85466106112, 85466106142,
85466106212



MN-RK-8523

Ø: 72
03304900A, 81432706065



MN-SB-5249

Length: 55 Ø: 71
Thick/Height: 80
03310200A, 81437040029



MN-VB-8565

Length: 693
Ø: 46
Hole Distance: 115 / 115
81432706053, 81432709053



MN-RK-7291

Ø: 72
Hole Distance: 130
Thick/Height: 30
10307800A, 81432206108, 81432206132



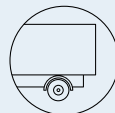

M 2000 L ...

14.225 LAC, LARC, (LE220B)	09/00→	Ball Head, gearshift linkage	CV-ES-2120			
	09/00→	Ball Head, gearshift linkage	CV-ES-2121			
	09/00→	Stabiliser Mounting		MN-SB-5249		
	09/00→	Stabiliser Mounting		MN-SB-5249	1st RA	
	09/00→	Tie Rod End	CV-ES-12462		for Steering Rod	
14.225 LAK, LARK, LAK-L, (LE220B)	09/00→	Ball Head, gearshift linkage	CV-ES-2120			
	09/00→	Ball Head, gearshift linkage	CV-ES-2121			
	09/00→	Stabiliser Mounting		MN-SB-5249		
	09/00→	Stabiliser Mounting		MN-SB-5249	1st RA	
	09/00→	Tie Rod End	CV-ES-12462		for Steering Rod	
14.225 LC, LLC, LLLC, LRC, LLRC, LLLRC (LE220B)	09/00→	Ball Head, gearshift linkage	CV-ES-2120			
	09/00→	Ball Head, gearshift linkage	CV-ES-2121			
	09/00→	Centre Rod	MN-DL-8377		Push Rod	
	09/00→	Centre Rod	MN-DL-8662		Push Rod, for Leaf-Spring Suspension vehicles	
	09/00→	Stabiliser Mounting		MN-SB-5249		
	09/00→	Stabiliser Mounting		MN-SB-5249	1st RA	
	09/00→	Suspension Arm Repair Kit		MN-RK-7291	for Drag Link	
	09/00→	Suspension Arm Repair Kit		MN-RK-8523	for Wishbone (CV)	
	09/00→	Tie Rod End	CV-ES-12462		for Steering Rod	
	09/00→	Track Control Arm		MN-DL-7803	Trailing Arm, Air Suspension Axle	
	09/00→	Track Control Arm		MN-DL-8590	Trailing Arm, Air Suspension Axle	
	09/00→	Track Control Arm		MN-VB-8565	Wishbone (CV)	
	14.225 LK, LRK (LE220B)	09/00→	Ball Head, gearshift linkage	CV-ES-2120		
09/00→		Ball Head, gearshift linkage	CV-ES-2121			
09/00→		Centre Rod	MN-DL-8377		Push Rod	
09/00→		Centre Rod	MN-DL-8662		Push Rod, for Leaf-Spring Suspension vehicles	
09/00→		Stabiliser Mounting		MN-SB-5249		
09/00→		Stabiliser Mounting		MN-SB-5249	1st RA	
09/00→		Tie Rod End	CV-ES-12462		for Steering Rod	
14.255 LAC, LARC	11/02→	Tie Rod End	CV-ES-12462		for Steering Rod	
14.255 LAK, LARK, LAK-L	11/02→	Tie Rod End	CV-ES-12462		for Steering Rod	
14.255 LA-LF	07/03→	Tie Rod End	CV-ES-12462		for Steering Rod	
14.255 LC, LLC, LLLC, LRC, LLRC, LLLRC (LE250B)	09/00→	Ball Head, gearshift linkage	CV-ES-2120			
	09/00→	Ball Head, gearshift linkage	CV-ES-2121			
	09/00→	Centre Rod	MN-DL-8377		Push Rod	
	09/00→	Centre Rod	MN-DL-8662		Push Rod, for Leaf-Spring Suspension vehicles	
	09/00→	Stabiliser Mounting		MN-SB-5249		
	09/00→	Stabiliser Mounting		MN-SB-5249	1st RA	
	09/00→	Suspension Arm Repair Kit		MN-RK-7291	for Drag Link	
	09/00→	Suspension Arm Repair Kit		MN-RK-8523	for Wishbone (CV)	
	09/00→	Tie Rod End	CV-ES-12462		for Steering Rod	
	09/00→	Track Control Arm		MN-DL-7803	Trailing Arm, Air Suspension Axle	
	09/00→	Track Control Arm		MN-DL-8590	Trailing Arm	
	09/00→	Track Control Arm		MN-VB-8565	Wishbone (CV)	
	14.255 LK, LRK	11/02→	Tie Rod End	CV-ES-12462		for Steering Rod
14.263, 14.264 LAC, LARC	08/95→	Ball Head, gearshift linkage	CV-ES-2119			
	08/95→	Ball Head, gearshift linkage	CV-ES-2120			
	08/95→	Ball Head, gearshift linkage	CV-ES-2121			
	08/95→	Centre Rod	MN-DL-2140		Push Rod	
	08/95→	Stabiliser Mounting		MN-SB-5249		
	08/95→	Stabiliser Mounting		MN-SB-5249	1st RA	
	08/95→	Tie Rod End	CV-ES-12461		for Steering Rod	
	08/95→	Tie Rod End	CV-ES-12462		for Steering Rod	
	14.263, 14.264 LAK, LARK, LAK-L	08/95→	Ball Head, gearshift linkage	CV-ES-2119		
		08/95→	Ball Head, gearshift linkage	CV-ES-2120		
08/95→		Ball Head, gearshift linkage	CV-ES-2121			
08/95→		Centre Rod	MN-DL-2140		Push Rod	
08/95→		Stabiliser Mounting		MN-SB-5249		
08/95→		Stabiliser Mounting		MN-SB-5249	1st RA	
08/95→		Tie Rod End	CV-ES-12461		for Steering Rod	
08/95→		Tie Rod End	CV-ES-12462		for Steering Rod	

CV-ES-2119

Length: 55
Cone Ø: d1 Ø 10 / d2 Ø 10
Thread: M12 x 1,75 LHT
81953016063, 81953016131



CV-ES-2120

Length: 115
Cone Ø: d1 Ø 12,4 / d2 Ø 10,8
Thread: M14 x 1,5 RHT
03008500A, 81953016200, 81953016202,
81953016203, 81953016227



CV-ES-2121

Length: 85
Cone Ø: d1 Ø 12 / d2 Ø 10,8
Thread: M14 x 1,5 RHT
81953010038, 81953010045, 81953016016,
81953016169, 81953016172, 81953016176,
81953016266, 81953016302



CV-ES-12461

Length: 120
Cone Ø: d1 Ø 26 / d2 Ø 23,5
Thread: M30 x 1,5 LHT
90804102216, 90804102612, 90804102720,
90804153107, 90804153113, 81953010013,
81953010074, 81953010082, 81953016068,
81953016074, 81953016163, 81953016273,
81953016283, 81953016320, 81953016361



CV-ES-12462

Length: 120
Cone Ø: d1 Ø 26 / d2 Ø 23,5
Thread: M30 x 1,5 RHT
90804102218, 90804153111, 81953010014,
81953010042, 81953010064, 81953010068,
81953016065, 81953016067, 81953016073,
81953016162, 81953016239, 81953016240,
81953016246, 81953016250, 81953016272,
81953016282, 81953016319, 81953016360,
82953016014



MN-DL-2140

Length: 1650
Ø: 50
Cone Ø: d1 Ø 26 / d2 Ø 23,5
81467106933, 81467116711



MN-DL-7803

Length: 644
Ø: 50
Hole Distance: 130 / 102
03307300A, 81432206174



MN-DL-8377

Length: 795
Ø: 38
Cone Ø: d1 Ø 26 / d2 Ø 23,5
85461106141, 85466106105, 85466106141,
85466106205, 85466106231



MN-DL-8590

Length: 596 Ø: 50
Hole Distance: 130 / 102
81432206140, 81432209140



MN-DL-8662

Length: 860
Ø: 38
Cone Ø: d1 Ø 26 / d2 Ø 23,5
85466106012, 85466106112, 85466106142,
85466106212



MN-RK-8523

Ø: 72
03304900A, 81432706065



MN-SB-5249

Length: 55 Ø: 71
Thick/Height: 80
03310200A, 81437040029



MN-VB-8565

Length: 693
Ø: 46
Hole Distance: 115 / 115
81432706053, 81432709053



MN-RK-7291

Ø: 72
Hole Distance: 130
Thick/Height: 30
10307800A, 81432206108, 81432206132





M 2000 L ...

14.263, 14.264 LC, LLC, LLLC, LRC, LLRC, LLLRC	08/95→	Ball Head, gearshift linkage	CV-ES-2119		
	08/95→	Ball Head, gearshift linkage	CV-ES-2120		
	08/95→	Ball Head, gearshift linkage	CV-ES-2121		
	08/95→	Centre Rod	MN-DL-2140	Push Rod	
	08/95→	Centre Rod	MN-DL-8377	Push Rod	
	08/95→	Centre Rod	MN-DL-8662	Push Rod, for Leaf-Spring Suspension vehicles	
	08/95→	Stabiliser Mounting		MN-SB-5249	
	08/95→	Stabiliser Mounting		MN-SB-5249	1st RA
	08/95→	Suspension Arm Repair Kit		MN-RK-7291	for Drag Link
	08/95→	Suspension Arm Repair Kit		MN-RK-8523	for Wishbone (CV)
	08/95→	Tie Rod End	CV-ES-12461		for Steering Rod
	08/95→	Tie Rod End	CV-ES-12462		for Steering Rod
	08/95→	Track Control Arm		MN-DL-7803	Trailing Arm, Air Suspension Axle
	08/95→	Track Control Arm		MN-DL-8590	Trailing Arm, Air Suspension Axle
	08/95→	Track Control Arm		MN-VB-8565	Wishbone (CV)
14.263, 14.264 LK, LRK	08/95→	Ball Head, gearshift linkage	CV-ES-2119		
	08/95→	Ball Head, gearshift linkage	CV-ES-2120		
	08/95→	Ball Head, gearshift linkage	CV-ES-2121		
	08/95→	Centre Rod	MN-DL-2140	Push Rod	
	08/95→	Centre Rod	MN-DL-8377	Push Rod	
	08/95→	Centre Rod	MN-DL-8662	Push Rod, for Leaf-Spring Suspension vehicles	
	08/95→	Stabiliser Mounting		MN-SB-5249	
	08/95→	Stabiliser Mounting		MN-SB-5249	1st RA
	08/95→	Tie Rod End	CV-ES-12461		for Steering Rod
08/95→	Tie Rod End	CV-ES-12462		for Steering Rod	
14.264 LA-LF	07/03→	Tie Rod End	CV-ES-12462	for Steering Rod	
14.284 LC, LLC, LLLC, LRC, LLRC, LLLRC	10/98→	Ball Head, gearshift linkage	CV-ES-2120		
	06/98→	Ball Head, gearshift linkage	CV-ES-2120		
14.284, 14.285, LAC, LARC	06/98→	Ball Head, gearshift linkage	CV-ES-2120		
14.284, 14.285, LAK, LARK, LAK-L	06/98→	Ball Head, gearshift linkage	CV-ES-2120		
14.284, 14.285, LA-LF	06/98→	Ball Head, gearshift linkage	CV-ES-2120		
14.284, 14.285, LK, LRK	10/98→	Ball Head, gearshift linkage	CV-ES-2120		
14.285 LC, LLC, LLLC, LRC, LLRC, LLLRC,(LE280B)	09/00→	Ball Head, gearshift linkage	CV-ES-2120		
	09/00→	Ball Head, gearshift linkage	CV-ES-2121		
	09/00→	Centre Rod	MN-DL-8377	Push Rod	
	09/00→	Centre Rod	MN-DL-8662	Push Rod, for Leaf-Spring Suspension vehicles	
	09/00→	Stabiliser Mounting		MN-SB-5249	
	09/00→	Stabiliser Mounting		MN-SB-5249	1st RA
	09/00→	Suspension Arm Repair Kit		MN-RK-7291	for Drag Link
	09/00→	Suspension Arm Repair Kit		MN-RK-8523	for Wishbone (CV)
	09/00→	Tie Rod End	CV-ES-12462		for Steering Rod
	09/00→	Track Control Arm		MN-DL-7803	Trailing Arm, Air Suspension Axle
	09/00→	Track Control Arm		MN-DL-8590	Trailing Arm, Air Suspension Axle
	09/00→	Track Control Arm		MN-VB-8565	Wishbone (CV)
	15.163 LC, LLC, LLLC, LLLRC, LLRC, LRC	08/95→	Ball Head, gearshift linkage	CV-ES-2119	
		08/95→	Ball Head, gearshift linkage	CV-ES-2120	
		08/95→	Ball Head, gearshift linkage	CV-ES-2182	
08/95→		Centre Rod	MN-DL-2140	Push Rod	
08/95→		Centre Rod	MN-DL-8377	Push Rod	
08/95→		Centre Rod	MN-DL-8662	Push Rod, for Leaf-Spring Suspension vehicles	
08/95→		Stabiliser Mounting		MN-SB-5249	
08/95→		Stabiliser Mounting		MN-SB-5249	1st RA
08/95→		Suspension Arm Repair Kit		MN-RK-7291	for Drag Link
08/95→		Suspension Arm Repair Kit		MN-RK-8523	for Wishbone (CV)
08/95→		Tie Rod End	CV-ES-12462		for Steering Rod
08/95→		Track Control Arm		MN-DL-7803	Trailing Arm, Air Suspension Axle
08/95→		Track Control Arm		MN-DL-8590	Trailing Arm, Air Suspension Axle
08/95→		Track Control Arm		MN-VB-8565	Wishbone (CV)
15.163 LK, LRK, LK-L		08/95→	Ball Head, gearshift linkage	CV-ES-2119	
	08/95→	Ball Head, gearshift linkage	CV-ES-2120		
	08/95→	Ball Head, gearshift linkage	CV-ES-2182		
	08/95→	Centre Rod	MN-DL-2140	Push Rod	
	08/95→	Centre Rod	MN-DL-8377	Push Rod	
	08/95→	Centre Rod	MN-DL-8662	Push Rod, for Leaf-Spring Suspension vehicles	

CV-ES-2119

Length: 55
Cone Ø: d1 Ø 10 / d2 Ø 10
Thread: M12 x 1,75 LHT
81953016063, 81953016131



CV-ES-2120

Length: 115
Cone Ø: d1 Ø 12,4 / d2 Ø 10,8
Thread: M14 x 1,5 RHT
03008500A, 81953016200, 81953016202,
81953016203, 81953016227



CV-ES-2121

Length: 85
Cone Ø: d1 Ø 12 / d2 Ø 10,8
Thread: M14 x 1,5 RHT
81953010038, 81953010045, 81953016016,
81953016169, 81953016172, 81953016176,
81953016266, 81953016302



CV-ES-2182

Length: 55
Cone Ø: d1 Ø 10 / d2 Ø 10
Thread: M12 x 1,75 RHT
81953016064, 81953016170



CV-ES-12461

Length: 120
Cone Ø: d1 Ø 26 / d2 Ø 23,5
Thread: M30 x 1,5 LHT
90804102216, 90804102612, 90804102720,
90804153107, 90804153113, 81953010013,
81953010074, 81953010082, 81953016068,
81953016074, 81953016163, 81953016273,
81953016283, 81953016320, 81953016361



CV-ES-12462

Length: 120
Cone Ø: d1 Ø 26 / d2 Ø 23,5
Thread: M30 x 1,5 RHT
90804102218, 90804153111, 81953010014,
81953010042, 81953010064, 81953010068,
81953016065, 81953016067, 81953016073,
81953016162, 81953016239, 81953016240,
81953016246, 81953016250, 81953016272,
81953016282, 81953016319, 81953016360,
82953016014



MN-DL-2140

Length: 1650
Ø: 50
Cone Ø: d1 Ø 26 / d2 Ø 23,5
81467106933, 81467116711



MN-DL-7803

Length: 644
Ø: 50
Hole Distance: 130 / 102
03307300A, 81432206174



MN-DL-8377

Length: 795
Ø: 38
Cone Ø: d1 Ø 26 / d2 Ø 23,5
854661106141, 85466106105, 85466106141,
85466106205, 85466106231



MN-DL-8590

Length: 596 Ø: 50
Hole Distance: 130 / 102
81432206140, 81432209140



MN-DL-8662

Length: 860
Ø: 38
Cone Ø: d1 Ø 26 / d2 Ø 23,5
85466106012, 85466106112, 85466106142,
85466106212



MN-RK-7291

Ø: 72
Hole Distance: 130
Thick/Height: 30
10307800A, 81432206108, 81432206132



MN-RK-8523

Ø: 72
03304900A, 81432706065



MN-SB-5249

Length: 55 Ø: 71
Thick/Height: 80
03310200A, 81437040029



MN-VB-8565

Length: 693
Ø: 46
Hole Distance: 115 / 115
81432706053, 81432709053





M 2000 L ...

15.163 LK, LRK, LK-L ...	08/95→	Centre Rod	MN-DL-8662		Push Rod, for Leaf-Spring Suspension vehicles	
	08/95→	Stabiliser Mounting		MN-SB-5249		
	08/95→	Stabiliser Mounting		MN-SB-5249	1st RA	
	08/95→	Tie Rod End	CV-ES-12462		for Steering Rod	
15.185 LC, LLC, LLLC, LLLRC, LLRC, LRC	05/01→	Tie Rod End	CV-ES-12462		for Steering Rod	
15.185 LK, LRK, LK-L	11/02→	Tie Rod End	CV-ES-12462		for Steering Rod	
15.224 LC, LLC, LLLC, LRC, LLRC, LLLRC	08/95→	Ball Head, gearshift linkage	CV-ES-2119			
	08/95→	Ball Head, gearshift linkage	CV-ES-2120			
	08/95→	Ball Head, gearshift linkage	CV-ES-2121			
	08/95→	Ball Head, gearshift linkage	CV-ES-2182			
	08/95→	Centre Rod	MN-DL-2140		Push Rod	
	08/95→	Centre Rod	MN-DL-8377		Push Rod	
	08/95→	Centre Rod	MN-DL-8662		Push Rod, for Leaf-Spring Suspension vehicles	
	08/95→	Stabiliser Mounting		MN-SB-5249		
	08/95→	Stabiliser Mounting		MN-SB-5249	1st RA	
	08/95→	Suspension Arm Repair Kit		MN-RK-7291	for Drag Link	
	08/95→	Suspension Arm Repair Kit		MN-RK-8523	for Wishbone (CV)	
	08/95→	Tie Rod		MN-DL-8486	Tag Axle;for vehicles with Hinged Trailing Axle	
	08/95→	Tie Rod End	CV-ES-12462		for Steering Rod	
	08/95→	Track Control Arm		MN-DL-7803	Trailing Arm, Air Suspension Axle	
	08/95→	Track Control Arm		MN-DL-8590	Trailing Arm, Air Suspension Axle	
	08/95→	Track Control Arm		MN-VB-8565	Wishbone (CV)	
	15.224 LK, LRK, LK-L	08/95→	Ball Head, gearshift linkage	CV-ES-2119		
08/95→		Ball Head, gearshift linkage	CV-ES-2120			
08/95→		Ball Head, gearshift linkage	CV-ES-2121			
08/95→		Ball Head, gearshift linkage	CV-ES-2182			
08/95→		Centre Rod	MN-DL-2140		Push Rod	
08/95→		Centre Rod	MN-DL-8377		Push Rod	
08/95→		Centre Rod	MN-DL-8662		Push Rod, for Leaf-Spring Suspension vehicles	
08/95→		Stabiliser Mounting		MN-SB-5249		
08/95→		Stabiliser Mounting		MN-SB-5249	1st RA	
08/95→		Tie Rod End	CV-ES-12462		for Steering Rod	
15.225 LC, LLC, LLLC, LRC, LLRC, LLLRC, (LE220B)		09/99→	Ball Head, gearshift linkage	CV-ES-2120		
		09/99→	Ball Head, gearshift linkage	CV-ES-2121		
		09/99→	Centre Rod	MN-DL-8377		Push Rod
	09/99→	Centre Rod	MN-DL-8662		Push Rod, for Leaf-Spring Suspension vehicles	
	09/99→	Stabiliser Mounting		MN-SB-5249		
	09/99→	Stabiliser Mounting		MN-SB-5249	1st RA	
	09/99→	Suspension Arm Repair Kit		MN-RK-7291	for Drag Link	
	09/99→	Suspension Arm Repair Kit		MN-RK-8523	for Wishbone (CV)	
	09/99→	Tie Rod		MN-DL-8486	Tag Axle;for vehicles with Hinged Trailing Axle	
	09/99→	Tie Rod End	CV-ES-12462		for Steering Rod	
	09/99→	Track Control Arm		MN-DL-7803	Trailing Arm, Air Suspension Axle	
	09/99→	Track Control Arm		MN-DL-8590	Trailing Arm, Air Suspension Axle	
	09/99→	Track Control Arm		MN-VB-8565	Wishbone (CV)	
15.225 LK, LRK, LK-L, (LE220B)	09/99→	Ball Head, gearshift linkage	CV-ES-2120			
	09/99→	Ball Head, gearshift linkage	CV-ES-2121			
	09/99→	Centre Rod	MN-DL-8377		Push Rod	
	09/99→	Centre Rod	MN-DL-8662		Push Rod, for Leaf-Spring Suspension vehicles	
	09/99→	Stabiliser Mounting		MN-SB-5249		
	09/99→	Stabiliser Mounting		MN-SB-5249	1st RA	
	09/99→	Tie Rod End	CV-ES-12462		for Steering Rod	
15.255 LC, LLC, LLLC, LRC, LLRC, LLLRC, (LE250B)	09/99→	Ball Head, gearshift linkage	CV-ES-2120			
	09/99→	Ball Head, gearshift linkage	CV-ES-2121			
	09/99→	Centre Rod	MN-DL-8377		Push Rod	
	09/99→	Centre Rod	MN-DL-8662		Push Rod, for Leaf-Spring Suspension vehicles	
	09/99→	Stabiliser Mounting		MN-SB-5249		
	09/99→	Stabiliser Mounting		MN-SB-5249	1st RA	
	09/99→	Suspension Arm Repair Kit		MN-RK-7291	for Drag Link	
	09/99→	Suspension Arm Repair Kit		MN-RK-8523	for Wishbone (CV)	
	09/99→	Tie Rod		MN-DL-8486	Tag Axle;for vehicles with Hinged Trailing Axle	
	09/99→	Tie Rod End	CV-ES-12462		for Steering Rod	

CV-ES-2119

Length: 55
Cone Ø: d1 Ø 10 / d2 Ø 10
Thread: M12 x 1,75 LHT
81953016063, 81953016131



CV-ES-2120

Length: 115
Cone Ø: d1 Ø 12,4 / d2 Ø 10,8
Thread: M14 x 1,5 RHT
03008500A, 81953016200, 81953016202,
81953016203, 81953016227



CV-ES-2121

Length: 85
Cone Ø: d1 Ø 12 / d2 Ø 10,8
Thread: M14 x 1,5 RHT
81953010038, 81953010045, 81953016016,
81953016169, 81953016172, 81953016176,
81953016266, 81953016302



CV-ES-2182

Length: 55
Cone Ø: d1 Ø 10 / d2 Ø 10
Thread: M12 x 1,75 RHT
81953016064, 81953016170



CV-ES-12462

Length: 120
Cone Ø: d1 Ø 26 / d2 Ø 23,5
Thread: M30 x 1,5 RHT
90804102218, 90804153111, 81953010014,
81953010042, 81953010064, 81953010068,
81953016065, 81953016067, 81953016073,
81953016162, 81953016239, 81953016240,
81953016246, 81953016250, 81953016272,
81953016282, 81953016319, 81953016360,
82953016014



MN-DL-2140

Length: 1650
Ø: 50
Cone Ø: d1 Ø 26 / d2 Ø 23,5
81467106933, 81467116711



MN-DL-7803

Length: 644
Ø: 50
Hole Distance: 130 / 102
03307300A, 81432206174



MN-DL-8377

Length: 795
Ø: 38
Cone Ø: d1 Ø 26 / d2 Ø 23,5
85461106141, 85466106105, 85466106141,
85466106205, 85466106231



MN-DL-8486

Length: 1545 Ø: 38
Cone Ø: d1 Ø 26 / d2 Ø 23,5
81467106314, 81467106315, 81467106316



MN-DL-8590

Length: 596 Ø: 50
Hole Distance: 130 / 102
81432206140, 81432209140



MN-DL-8662

Length: 860
Ø: 38
Cone Ø: d1 Ø 26 / d2 Ø 23,5
85466106012, 85466106112, 85466106142,
85466106212



MN-RK-7291

Ø: 72
Hole Distance: 130
Thick/Height: 30
10307800A, 81432206108, 81432206132



MN-RK-8523

Ø: 72
03304900A, 81432706065



MN-SB-5249

Length: 55 Ø: 71
Thick/Height: 80
03310200A, 81437040029



MN-VB-8565

Length: 693
Ø: 46
Hole Distance: 115 / 115
81432706053, 81432709053





M 2000 L ...

15.255 LC, LLC, LLLC, LRC, LLRC, LLLRC, (LE250B) ...	09/99 →	Track Control Arm		MN-DL-7803	Trailing Arm, Air Suspension Axle
	09/99 →	Track Control Arm		MN-DL-8590	Trailing Arm, Air Suspension Axle
	09/99 →	Track Control Arm		MN-VB-8565	Wishbone (CV)
15.255 LK, LRK, LK-L, (LE250B)	09/99 →	Ball Head, gearshift linkage	CV-ES-2120		
	09/99 →	Ball Head, gearshift linkage	CV-ES-2121		
	09/99 →	Centre Rod	MN-DL-8377		Push Rod
	09/99 →	Centre Rod	MN-DL-8662		Push Rod, for Leaf-Spring Suspension vehicles
	09/99 →	Stabiliser Mounting		MN-SB-5249	
	09/99 →	Stabiliser Mounting		MN-SB-5249	1st RA
	09/99 →	Tie Rod End	CV-ES-12462		for Steering Rod
15.263, 15.264 LC, LLC, LLLC, LRC, LLRC, LLLRC	08/95 →	Ball Head, gearshift linkage	CV-ES-2119		
	08/95 →	Ball Head, gearshift linkage	CV-ES-2120		
	08/95 →	Ball Head, gearshift linkage	CV-ES-2121		
	08/95 →	Ball Head, gearshift linkage	CV-ES-2182		
	08/95 →	Centre Rod	MN-DL-2140		Push Rod
	08/95 →	Centre Rod	MN-DL-8377		Push Rod
	08/95 →	Centre Rod	MN-DL-8662		Push Rod, for Leaf-Spring Suspension vehicles
	08/95 →	Stabiliser Mounting		MN-SB-5249	
	08/95 →	Stabiliser Mounting		MN-SB-5249	1st RA
	08/95 →	Suspension Arm Repair Kit		MN-RK-7291	for Drag Link
	08/95 →	Suspension Arm Repair Kit		MN-RK-8523	for Wishbone (CV)
	08/95 →	Tie Rod		MN-DL-8486	Tag Axle; for vehicles with Hinged Trailing Axle
	08/95 →	Tie Rod End	CV-ES-12462		for Steering Rod
	08/95 →	Track Control Arm		MN-DL-7803	Trailing Arm, Air Suspension Axle
	08/95 →	Track Control Arm		MN-DL-8590	Trailing Arm, Air Suspension Axle
	08/95 →	Track Control Arm		MN-VB-8565	Wishbone (CV)
	15.263, 15.264 LK, LRK, LK-L	08/95 →	Ball Head, gearshift linkage	CV-ES-2119	
08/95 →		Ball Head, gearshift linkage	CV-ES-2120		
08/95 →		Ball Head, gearshift linkage	CV-ES-2121		
08/95 →		Ball Head, gearshift linkage	CV-ES-2182		
08/95 →		Centre Rod	MN-DL-2140		Push Rod
08/95 →		Centre Rod	MN-DL-8377		Push Rod
08/95 →		Centre Rod	MN-DL-8662		Push Rod, for Leaf-Spring Suspension vehicles
08/95 →		Stabiliser Mounting		MN-SB-5249	
08/95 →		Stabiliser Mounting		MN-SB-5249	1st RA
15.284 LC, LLC, LLLC, LRC, LLRC, LLLRC	06/98 →	Ball Head, gearshift linkage	CV-ES-2120		
15.284 LK, LRK, LK-L	06/98 →	Ball Head, gearshift linkage	CV-ES-2120		
15.285 LC, LLC, LLLC, LRC, LLRC, LLLRC, (LE280B)	09/99 →	Ball Head, gearshift linkage	CV-ES-2120		
	09/99 →	Ball Head, gearshift linkage	CV-ES-2121		
	09/99 →	Centre Rod	MN-DL-8377		Push Rod
	09/99 →	Centre Rod	MN-DL-8662		Push Rod, for Leaf-Spring Suspension vehicles
	09/99 →	Stabiliser Mounting		MN-SB-5249	
	09/99 →	Stabiliser Mounting		MN-SB-5249	1st RA
	09/99 →	Suspension Arm Repair Kit		MN-RK-7291	for Drag Link
	09/99 →	Suspension Arm Repair Kit		MN-RK-8523	for Wishbone (CV)
	09/99 →	Tie Rod		MN-DL-8486	Tag Axle; for vehicles with Hinged Trailing Axle
	09/99 →	Tie Rod End	CV-ES-12462		for Steering Rod
	09/99 →	Track Control Arm		MN-DL-7803	Trailing Arm, Air Suspension Axle
	09/99 →	Track Control Arm		MN-DL-8590	Trailing Arm, Air Suspension Axle
	09/99 →	Track Control Arm		MN-VB-8565	Wishbone (CV)
15.285 LK, LRK, LK-L, (LE280B)	09/99 →	Ball Head, gearshift linkage	CV-ES-2120		
	09/99 →	Ball Head, gearshift linkage	CV-ES-2121		
	09/99 →	Centre Rod	MN-DL-8377		Push Rod
	09/99 →	Centre Rod	MN-DL-8662		Push Rod, for Leaf-Spring Suspension vehicles
	09/99 →	Stabiliser Mounting		MN-SB-5249	
	09/99 →	Stabiliser Mounting		MN-SB-5249	1st RA
18.224, 18.225, LAC, LARC	08/95 →	Ball Head, gearshift linkage	CV-ES-2119		
	08/95 →	Ball Head, gearshift linkage	CV-ES-2120		
	08/95 →	Ball Head, gearshift linkage	CV-ES-2121		
	08/95 →	Ball Head, gearshift linkage	CV-ES-2182		
	08/95 →	Ball Head, gearshift linkage	CV-ES-2120		

CV-ES-2119

Length: 55
Cone Ø: d1 Ø 10 / d2 Ø 10
Thread: M12 x 1,75 LHT
81953016063, 81953016131



CV-ES-2120

Length: 115
Cone Ø: d1 Ø 12,4 / d2 Ø 10,8
Thread: M14 x 1,5 RHT
03008500A, 81953016200, 81953016202,
81953016203, 81953016227



CV-ES-2121

Length: 85
Cone Ø: d1 Ø 12 / d2 Ø 10,8
Thread: M14 x 1,5 RHT
81953010038, 81953010045, 81953016016,
81953016169, 81953016172, 81953016176,
81953016266, 81953016302



CV-ES-2182

Length: 55
Cone Ø: d1 Ø 10 / d2 Ø 10
Thread: M12 x 1,75 RHT
81953016064, 81953016170



CV-ES-12462

Length: 120
Cone Ø: d1 Ø 26 / d2 Ø 23,5
Thread: M30 x 1,5 RHT
90804102218, 90804153111, 81953010014,
81953010042, 81953010064, 81953010068,
81953016065, 81953016067, 81953016073,
81953016162, 81953016239, 81953016240,
81953016246, 81953016250, 81953016272,
81953016282, 81953016319, 81953016360,
82953016014



MN-DL-2140

Length: 1650
Ø: 50
Cone Ø: d1 Ø 26 / d2 Ø 23,5
81467106933, 81467116711



MN-DL-7803

Length: 644
Ø: 50
Hole Distance: 130 / 102
03307300A, 81432206174



MN-DL-8377

Length: 795
Ø: 38
Cone Ø: d1 Ø 26 / d2 Ø 23,5
85461106141, 85466106105, 85466106141,
85466106205, 85466106231



MN-DL-8486

Length: 1545 Ø: 38
Cone Ø: d1 Ø 26 / d2 Ø 23,5
81467106314, 81467106315, 81467106316



MN-DL-8590

Length: 596 Ø: 50
Hole Distance: 130 / 102
81432206140, 81432209140



MN-DL-8662

Length: 860
Ø: 38
Cone Ø: d1 Ø 26 / d2 Ø 23,5
85466106012, 85466106112, 85466106142,
85466106212



MN-RK-7291

Ø: 72
Hole Distance: 130
Thick/Height: 30
10307800A, 81432206108, 81432206132



MN-RK-8523

Ø: 72
03304900A, 81432706065



MN-SB-5249

Length: 55 Ø: 71
Thick/Height: 80
03310200A, 81437040029



MN-VB-8565

Length: 693
Ø: 46
Hole Distance: 115 / 115
81432706053, 81432709053



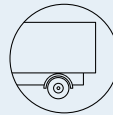

M 2000 L ...

18.224, 18.225, LAC, LARC ...	08/95 →	Centre Rod	MN-DL-2160	Coupling Rod	
	08/95 →	Centre Rod	MN-DL-2174	Push Rod	
	08/95 →	Centre Rod	MN-DL-2175	Push Rod	
	08/95 →	Centre Rod	MN-DL-8374	Push Rod, Leaf Spring Axle	
	08/95 →	Stabiliser Mounting		MN-SB-5249	
	08/95 →	Stabiliser Mounting		MN-SB-5249	
	08/95 →	Tie Rod End	CV-ES-14162	1st RA	
	08/95 →	Tie Rod End	CV-ES-14163	for Steering Rod	
18.224, 18.225, LAK, LARK, LAK-L	08/95 →	Ball Head, gearshift linkage	CV-ES-2119		
	08/95 →	Ball Head, gearshift linkage	CV-ES-2120		
	08/95 →	Ball Head, gearshift linkage	CV-ES-2121		
	08/95 →	Ball Head, gearshift linkage	CV-ES-2182		
	08/95 →	Centre Rod	MN-DL-2160	Coupling Rod	
	08/95 →	Centre Rod	MN-DL-2174	Push Rod	
	08/95 →	Centre Rod	MN-DL-2175	Push Rod	
	08/95 →	Centre Rod	MN-DL-8374	Push Rod, Leaf Spring Axle	
	08/95 →	Stabiliser Mounting		MN-SB-5249	
	08/95 →	Stabiliser Mounting		MN-SB-5249	
	08/95 →	Tie Rod End	CV-ES-14162	1st RA	
	08/95 →	Tie Rod End	CV-ES-14163	for Steering Rod	
	08/95 →	Tie Rod End	CV-ES-14163	for Steering Rod	
	18.224, 18.225, LC, LLC, LLLC, LRC, LLRC, LLLRC	08/95 →	Ball Head, gearshift linkage	CV-ES-2119	
		08/95 →	Ball Head, gearshift linkage	CV-ES-2120	
		08/95 →	Ball Head, gearshift linkage	CV-ES-2121	
08/95 →		Ball Head, gearshift linkage	CV-ES-2182		
08/95 →		Centre Rod	MN-DL-2160	Coupling Rod	
08/95 →		Centre Rod	MN-DL-2174	Push Rod	
08/95 →		Centre Rod	MN-DL-2175	Push Rod	
08/95 →		Centre Rod	MN-DL-8378	Push Rod	
08/95 →		Stabiliser Mounting		MN-SB-5249	
08/95 →		Stabiliser Mounting		MN-SB-5249	
08/95 →		Suspension Arm Repair Kit		MN-RK-8523	
08/95 →		Tie Rod	MN-DL-7802		
08/95 →		Tie Rod	MN-DL-12284		
08/95 →		Tie Rod End	CV-ES-14162	for Steering Rod	
08/95 →		Tie Rod End	CV-ES-14163	for Steering Rod	
08/95 →		Track Control Arm		MN-DL-5212	
08/95 →		Track Control Arm		MN-VB-8565	
01/01 → 04/03		Centre Rod	MN-DL-8374	Trailing Arm, Drive Axle; Air Suspension Axle	
08/95 →		Track Control Arm		MN-VB-8565	
08/95 →		Centre Rod	MN-DL-8374	Wishbone (CV)	
08/95 →		Centre Rod	MN-DL-8374	Push Rod, Air Suspension Axle	
18.224, 18.225, LK, LK-L, LLLK, LLLK-L, LLRK, LRK		08/95 →	Ball Head, gearshift linkage	CV-ES-2119	
		08/95 →	Ball Head, gearshift linkage	CV-ES-2120	
		08/95 →	Ball Head, gearshift linkage	CV-ES-2121	
		08/95 →	Ball Head, gearshift linkage	CV-ES-2182	
		08/95 →	Centre Rod	MN-DL-2160	Coupling Rod
		08/95 →	Centre Rod	MN-DL-2174	Push Rod
		08/95 →	Centre Rod	MN-DL-2175	Push Rod
	08/95 →	Centre Rod	MN-DL-8378	Push Rod	
	08/95 →	Stabiliser Mounting		MN-SB-5249	
	08/95 →	Stabiliser Mounting		MN-SB-5249	
	08/95 →	Suspension Arm Repair Kit		MN-RK-8523	
	08/95 →	Tie Rod	MN-DL-7802		
	08/95 →	Tie Rod	MN-DL-12284		
	08/95 →	Tie Rod End	CV-ES-14162	1st RA	
	08/95 →	Tie Rod End	CV-ES-14163	for Steering Rod	
	08/95 →	Tie Rod End	CV-ES-14163	for Steering Rod	
	08/95 →	Track Control Arm		MN-DL-5212	
	08/95 →	Track Control Arm		MN-VB-8565	
	18.224, 18.225, L-KO, LR-KO	05/01 →	Tie Rod End	CV-ES-14163	Trailing Arm, Drive Axle; Air Suspension Axle
		08/95 →	Tie Rod End	CV-ES-14163	Wishbone (CV)
08/95 →		Tie Rod End	CV-ES-14163	for Steering Rod	
09/99 →		Ball Head, gearshift linkage	CV-ES-2120		
09/99 →		Ball Head, gearshift linkage	CV-ES-2121		
09/99 →		Centre Rod	MN-DL-8378	Push Rod	
09/99 →		Stabiliser Mounting		MN-SB-5249	
09/99 →		Stabiliser Mounting		MN-SB-5249	
09/99 →		Suspension Arm Repair Kit		MN-RK-8523	
09/99 →		Tie Rod	MN-DL-7802	1st RA	
09/99 →		Tie Rod	MN-DL-7802	for Steering Rod	
09/99 →		Tie Rod	MN-DL-7802	for Steering Rod	

CV-ES-2119

Length: 55
Cone Ø: d1 Ø 10 / d2 Ø 10
Thread: M12 x 1,75 LHT
81953016063, 81953016131



CV-ES-2120

Length: 115
Cone Ø: d1 Ø 12,4 / d2 Ø 10,8
Thread: M14 x 1,5 RHT
03008500A, 81953016200, 81953016202, 81953016203, 81953016227



CV-ES-2121

Length: 85
Cone Ø: d1 Ø 12 / d2 Ø 10,8
Thread: M14 x 1,5 RHT
81953010038, 81953010045, 81953016016, 81953016169, 81953016172, 81953016176, 81953016266, 81953016302



CV-ES-2182

Length: 55
Cone Ø: d1 Ø 10 / d2 Ø 10
Thread: M12 x 1,75 RHT
81953016064, 81953016170



CV-ES-14162

Length: 125
Cone Ø: d1 Ø 30 / d2 Ø 27
Thread: M30 x 1,5 LHT

81953010015, 81953010083, 81953010087, 81953016029, 81953016030, 81953016043, 81953016044, 81953016050, 81953016054, 81953016087, 81953016091, 81953016107, 81953016120, 81953016125, 81953016152, 81953016155, 81953016157, 81953016168, 81953016179, 81953016181, 81953016223, 81953016237, 81953016254, 81953016275, 81953016279, 81953016351



CV-ES-14163

Length: 125
Cone Ø: d1 Ø 30 / d2 Ø 27
Thread: M30 x 1,5 RHT

95301.0084, 90804102156, 90804102272, 90804102696, 90804102710, 81953010016, 81953010075, 81953010084, 81953010088, 81953010094, 81953010103, 81953016030, 81953016043, 81953016048, 81953016049, 81953016053, 81953016061, 81953016090, 81953016108, 81953016112, 81953016126, 81953016143, 81953016149, 81953016154, 81953016156, 81953016168, 81953016178, 81953016194, 81953016206, 81953016224, 81953016234, 81953016242, 81953016252, 81953016274, 81953016278, 81953016284, 81953016286, 81953016308, 81953016310, 81953016312, 81953016347, 81953016350, 81953016352, 82953016012, 88953016014, N2953016001



MN-DL-2160

Length: 1652 Ø: 50
Cone Ø: d1 Ø 30 / d2 Ø 27
81467106112, 81467106163, 81467106165, 81467106198, 81467106353, 81467106354, 81467106361, 81467116725



MN-DL-2174

Length: 1588 Ø: 52
Cone Ø: d1 Ø 30 / d2 Ø 27
81467106378, 81467106912



MN-DL-2175

Length: 1628
Ø: 50
Cone Ø: d1 Ø 30 / d2 Ø 27
81467106396, 81467106904



MN-DL-5212

Length: 577 Ø: 48
Hole Distance: 130 / 130
81432206096, 81432206097, 81432206098, 81432206129, 81432209096, 81432209129, 81432306014, 81432306030



MN-DL-7802

Length: 1680 Ø: 52
Cone Ø: d1 Ø 30 / d2 Ø 27
03208300A, 81467116773, 81467116858, 81467116859, 81467116860, 81467116861, 81467116863, 81467116882, 81467116883, 81467116920, 81467116921



MN-DL-8374

Length: 896
Ø: 38
Cone Ø: d1 Ø 30 / d2 Ø 27
85466106108, 85466106144, 85466106208



MN-DL-8378

Length: 882 Ø: 38
Cone Ø: d1 Ø 30 / d2 Ø 26
85466106156



MN-DL-12284

Length: 1530 Ø: 50
Cone Ø: d1 Ø 30 / d2 Ø 27
81466106579, 81466106580, 81466106624, 81466116720, 81467116720, 81467116730, 81467116952



MN-RK-8523

Ø: 72
03304900A, 81432706065



MN-SB-5249

Length: 55 Ø: 71
Thick/Height: 80
03310200A, 81437040029



MN-VB-8565

Length: 693
Ø: 46
Hole Distance: 115 / 115
81432706053, 81432709053



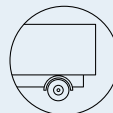

M 2000 L ...

18.255 LC, LLC, LLLC, LRC, LLRC, LLLRC, (LE250B) ...	09/99 →	Tie Rod	MN-DL-12284		
	09/99 →	Tie Rod End	CV-ES-14163	for Steering Rod	
	09/99 →	Track Control Arm		MN-DL-5212 Trailing Arm, Drive Axle; Air Suspension Axle	
	09/99 →	Track Control Arm		MN-VB-8565 Wishbone (CV)	
	01/01 → 04/03	Centre Rod	MN-DL-8374		Push Rod, Air Suspension Axle
18.255 LK, LK-L, LLK, LLK-L, LLRK, LRK	11/02 →	Suspension Arm Repair Kit		MN-RK-8523 for Wishbone (CV)	
	11/02 →	Tie Rod End	CV-ES-14163	for Steering Rod	
18.255 L-KO, LR-KO	05/01 →	Tie Rod End	CV-ES-14163	for Steering Rod	
18.263, 18.264, LAC, LARC	08/95 →	Ball Head, gearshift linkage	CV-ES-2119		
	08/95 →	Ball Head, gearshift linkage	CV-ES-2120		
	08/95 →	Ball Head, gearshift linkage	CV-ES-2121		
	08/95 →	Ball Head, gearshift linkage	CV-ES-2182		
	08/95 →	Centre Rod	MN-DL-2160		Coupling Rod
	08/95 →	Centre Rod	MN-DL-2174		Push Rod
	08/95 →	Centre Rod	MN-DL-2175		Push Rod
	08/95 →	Centre Rod	MN-DL-8374		Push Rod, Leaf Spring Axle
	08/95 →	Stabiliser Mounting		MN-SB-5249	
	08/95 →	Stabiliser Mounting		MN-SB-5249	1st RA
	08/95 →	Tie Rod End	CV-ES-14162		for Steering Rod
	08/95 →	Tie Rod End	CV-ES-14163		for Steering Rod
	18.263, 18.264, LAK, LARK, LAK-L	08/95 →	Ball Head, gearshift linkage	CV-ES-2119	
		08/95 →	Ball Head, gearshift linkage	CV-ES-2120	
		08/95 →	Ball Head, gearshift linkage	CV-ES-2121	
08/95 →		Ball Head, gearshift linkage	CV-ES-2182		
08/95 →		Centre Rod	MN-DL-2160		Coupling Rod
08/95 →		Centre Rod	MN-DL-2174		Push Rod
08/95 →		Centre Rod	MN-DL-2175		Push Rod
08/95 →		Centre Rod	MN-DL-8374		Push Rod, Leaf Spring Axle
08/95 →		Stabiliser Mounting		MN-SB-5249	
08/95 →		Stabiliser Mounting		MN-SB-5249	1st RA
08/95 →		Tie Rod End	CV-ES-14162		for Steering Rod
08/95 →		Tie Rod End	CV-ES-14163		for Steering Rod
18.263, 18.264, LC, LLC, LLLC, LRC, LLRC, LLLRC		08/95 →	Ball Head, gearshift linkage	CV-ES-2119	
		08/95 →	Ball Head, gearshift linkage	CV-ES-2120	
		08/95 →	Ball Head, gearshift linkage	CV-ES-2121	
	08/95 →	Ball Head, gearshift linkage	CV-ES-2182		
	08/95 →	Centre Rod	MN-DL-2160		Coupling Rod
	08/95 →	Centre Rod	MN-DL-2174		Push Rod
	08/95 →	Centre Rod	MN-DL-2175		Push Rod
	08/95 →	Centre Rod	MN-DL-8378		Push Rod
	08/95 →	Stabiliser Mounting		MN-SB-5249	
	08/95 →	Stabiliser Mounting		MN-SB-5249	1st RA
	08/95 →	Suspension Arm Repair Kit		MN-RK-8523	for Wishbone (CV)
	08/95 →	Tie Rod	MN-DL-7802		
	08/95 →	Tie Rod	MN-DL-12284		
	08/95 →	Tie Rod End	CV-ES-14162		for Steering Rod
	08/95 →	Tie Rod End	CV-ES-14163		for Steering Rod
08/95 →	Track Control Arm		MN-DL-5212	Trailing Arm, Drive Axle; Air Suspension Axle	
08/95 →	Track Control Arm		MN-VB-8565	Wishbone (CV)	
01/01 → 04/03	Centre Rod	MN-DL-8374		Push Rod, Air Suspension Axle	
18.263, 18.264, LK, LK-L, LLK, LLK-L, LLRK, LRK	08/95 →	Ball Head, gearshift linkage	CV-ES-2119		
	08/95 →	Ball Head, gearshift linkage	CV-ES-2120		
	08/95 →	Ball Head, gearshift linkage	CV-ES-2121		
	08/95 →	Ball Head, gearshift linkage	CV-ES-2182		
	08/95 →	Centre Rod	MN-DL-2160		Coupling Rod
	08/95 →	Centre Rod	MN-DL-2174		Push Rod
	08/95 →	Centre Rod	MN-DL-2175		Push Rod
	08/95 →	Centre Rod	MN-DL-8378		Push Rod
	08/95 →	Stabiliser Mounting		MN-SB-5249	
	08/95 →	Stabiliser Mounting		MN-SB-5249	1st RA
	08/95 →	Suspension Arm Repair Kit		MN-RK-8523	for Wishbone (CV)
	08/95 →	Tie Rod	MN-DL-7802		
	08/95 →	Tie Rod	MN-DL-12284		

CV-ES-2119

Length: 55
Cone Ø: d1 Ø 10 / d2 Ø 10
Thread: M12 x 1,75 LHT
81953016063, 81953016131



CV-ES-2120

Length: 115
Cone Ø: d1 Ø 12,4 / d2 Ø 10,8
Thread: M14 x 1,5 RHT
03008500A, 81953016200, 81953016202, 81953016203, 81953016227



CV-ES-2121

Length: 85
Cone Ø: d1 Ø 12 / d2 Ø 10,8
Thread: M14 x 1,5 RHT
81953010038, 81953010045, 81953016016, 81953016169, 81953016172, 81953016176, 81953016266, 81953016302



CV-ES-2182

Length: 55
Cone Ø: d1 Ø 10 / d2 Ø 10
Thread: M12 x 1,75 RHT
81953016064, 81953016170



CV-ES-14162

Length: 125
Cone Ø: d1 Ø 30 / d2 Ø 27
Thread: M30 x 1,5 LHT
81953010015, 81953010083, 81953010087, 81953016029, 81953016030, 81953016043, 81953016044, 81953016050, 81953016054, 81953016087, 81953016091, 81953016107, 81953016120, 81953016125, 81953016152, 81953016155, 81953016157, 81953016168, 81953016179, 81953016181, 81953016223, 81953016237, 81953016254, 81953016275, 81953016279, 81953016351



CV-ES-14163

Length: 125
Cone Ø: d1 Ø 30 / d2 Ø 27
Thread: M30 x 1,5 RHT
95301.0084, 90804102156, 90804102272, 90804102696, 90804102710, 81953010016, 81953010075, 81953010084, 81953010088, 81953010094, 81953010103, 81953016030, 81953016043, 81953016048, 81953016049, 81953016053, 81953016061, 81953016090, 81953016108, 81953016112, 81953016126, 81953016143, 81953016149, 81953016154, 81953016156, 81953016168, 81953016178, 81953016194, 81953016206, 81953016224, 81953016234, 81953016242, 81953016252, 81953016274, 81953016278, 81953016284, 81953016286, 81953016308, 81953016310, 81953016312, 81953016347, 81953016350, 81953016352, 82953016012, 88953016014, N2953016001



MN-DL-2160

Length: 1652 Ø: 50
Cone Ø: d1 Ø 30 / d2 Ø 27
81467106112, 81467106163, 81467106165, 81467106198, 81467106353, 81467106354, 81467106361, 81467116725



MN-DL-2174

Length: 1588 Ø: 52
Cone Ø: d1 Ø 30 / d2 Ø 27
81467106378, 81467106912



MN-DL-2175

Length: 1628
Ø: 50
Cone Ø: d1 Ø 30 / d2 Ø 27
81467106396, 81467106904



MN-DL-5212

Length: 577 Ø: 48
Hole Distance: 130 / 130
81432206096, 81432206097, 81432206098, 81432206129, 81432209096, 81432209129, 81432306014, 81432306030



MN-DL-7802

Length: 1680 Ø: 52
Cone Ø: d1 Ø 30 / d2 Ø 27
03208300A, 81467116773, 81467116858, 81467116859, 81467116860, 81467116861, 81467116863, 81467116882, 81467116883, 81467116920, 81467116921



MN-DL-8374

Length: 896
Ø: 38
Cone Ø: d1 Ø 30 / d2 Ø 27
85466106108, 85466106144, 85466106208



MN-DL-8378

Length: 882 Ø: 38
Cone Ø: d1 Ø 30 / d2 Ø 26
85466106156



MN-DL-12284

Length: 1530 Ø: 50
Cone Ø: d1 Ø 30 / d2 Ø 27
81466106579, 81466106580, 81466106624, 81466116720, 81467116720, 81467116730, 81467116952



MN-RK-8523

Ø: 72
03304900A, 81432706065



MN-SB-5249

Length: 55 Ø: 71
Thick/Height: 80
03310200A, 81437040029



MN-VB-8565

Length: 693
Ø: 46
Hole Distance: 115 / 115
81432706053, 81432709053





M 2000 L ...

18.263, 18.264, LK, LK-L, LLK, LLK-L, LLRK, LRK ...	08/95 →	Tie Rod End	CV-ES-14162		for Steering Rod	
	08/95 →	Tie Rod End	CV-ES-14163		for Steering Rod	
	08/95 →	Track Control Arm		MN-DL-5212	Trailing Arm, Drive Axle; Air Suspension Axle	
	08/95 →	Track Control Arm		MN-VB-8565	Wishbone (CV)	
18.263, 18.264, L-KO, LR-KO	05/01 →	Tie Rod End	CV-ES-14163		for Steering Rod	
18.284 LAC, LARC	06/98 →	Ball Head, gearshift linkage	CV-ES-2120			
18.284 LAK, LARK, LAK-L	06/98 →	Ball Head, gearshift linkage	CV-ES-2120			
18.284 LC, LLC, LLLC, LRC, LLRC, LLLRC	06/98 →	Ball Head, gearshift linkage	CV-ES-2120			
18.284, 18.285, LK, LK-L, LLK, LLK-L, LLRK, LRK	06/98 →	Ball Head, gearshift linkage	CV-ES-2120			
18.284, 18.285, L-KO, LR-KO	06/98 →	Ball Head, gearshift linkage	CV-ES-2120			
18.285 LAC, LARC (LE280B)	09/99 →	Ball Head, gearshift linkage	CV-ES-2120			
	09/99 →	Ball Head, gearshift linkage	CV-ES-2121			
	09/99 →	Centre Rod	MN-DL-8374		Push Rod, Leaf Spring Axle	
	09/99 →	Stabiliser Mounting		MN-SB-5249		
	09/99 →	Stabiliser Mounting		MN-SB-5249	1st RA	
18.285 LAK, LARK, LAK-L, (LE280B)	09/99 →	Ball Head, gearshift linkage	CV-ES-2120			
	09/99 →	Ball Head, gearshift linkage	CV-ES-2121			
	09/99 →	Centre Rod	MN-DL-8374		Push Rod, Leaf Spring Axle	
	09/99 →	Stabiliser Mounting		MN-SB-5249		
	09/99 →	Stabiliser Mounting		MN-SB-5249	1st RA	
18.285 LC, LLC, LLLC, LRC, LLRC, LLLRC, (LE280B)	09/99 →	Ball Head, gearshift linkage	CV-ES-2120			
	09/99 →	Ball Head, gearshift linkage	CV-ES-2121			
	09/99 →	Centre Rod	MN-DL-8374		Push Rod	
	09/99 →	Stabiliser Mounting		MN-SB-5249		
	09/99 →	Stabiliser Mounting		MN-SB-5249	1st RA	
	09/99 →	Suspension Arm Repair Kit		MN-RK-8523	for Wishbone (CV)	
	09/99 →	Tie Rod	MN-DL-7802			
	09/99 →	Tie Rod	MN-DL-12284			
	09/99 →	Tie Rod End	CV-ES-14163		for Steering Rod	
	09/99 →	Track Control Arm		MN-DL-5212	Trailing Arm, Drive Axle; Air Suspension Axle	
	09/99 →	Track Control Arm		MN-VB-8565	Wishbone (CV)	
	01/01 → 04/03	Centre Rod	MN-DL-8374		Push Rod, Air Suspension Axle	
	19.224, 19.225, LC, LLC, LLLC, LLLRC, LLRC, LRC	05/01 →	Suspension Arm Repair Kit		MN-RK-8523	for Wishbone (CV)
	19.224, 19.225, LC, LLC, LLLC, LLLRC, LLRC, LRC	05/01 →	Tie Rod End	CV-ES-14163		for Steering Rod
19.255 LC, LLC, LLLC, LLLRC, LLRC, LRC	05/01 →	Suspension Arm Repair Kit		MN-RK-8523	for Wishbone (CV)	
19.255 LC, LLC, LLLC, LLLRC, LLRC, LRC	05/01 →	Tie Rod End	CV-ES-14163		for Steering Rod	
19.264 LC, LLC, LLLC, LLLRC, LLRC, LRC	05/01 →	Suspension Arm Repair Kit		MN-RK-8523	for Wishbone (CV)	
19.264 LC, LLC, LLLC, LLLRC, LLRC, LRC	05/01 →	Tie Rod End	CV-ES-14163		for Steering Rod	
19.284, 19.285, LC, LLC, LLLC, LLLRC, LLRC, LRC	05/01 →	Suspension Arm Repair Kit		MN-RK-8523	for Wishbone (CV)	
19.284, 19.285, LC, LLC, LLLC, LLLRC, LLRC, LRC	05/01 →	Tie Rod End	CV-ES-14163		for Steering Rod	
20.224 LNLC, LNLLC	05/01 →	Suspension Arm Repair Kit		MN-RK-7291	for Drag Link	
	05/01 →	Suspension Arm Repair Kit		MN-RK-8523	for Wishbone (CV)	
	05/01 →	Tie Rod End	CV-ES-12462		for Steering Rod	
20.255 LNLC, LNLLC	05/01 →	Suspension Arm Repair Kit		MN-RK-7291	for Drag Link	
	05/01 →	Suspension Arm Repair Kit		MN-RK-8523	for Wishbone (CV)	
	05/01 →	Tie Rod End	CV-ES-12462		for Steering Rod	
20.264 LNLC, LNLLC	05/01 →	Suspension Arm Repair Kit		MN-RK-7291	for Drag Link	
	05/01 →	Suspension Arm Repair Kit		MN-RK-8523	for Wishbone (CV)	
	05/01 →	Tie Rod End	CV-ES-12462		for Steering Rod	
20.284, 20.285, LNLC, LNLLC	05/01 →	Suspension Arm Repair Kit		MN-RK-7291	for Drag Link	
	05/01 →	Suspension Arm Repair Kit		MN-RK-8523	for Wishbone (CV)	
	05/01 →	Tie Rod End	CV-ES-12462		for Steering Rod	
26.224, 26.225, DL-HK, DLR-HK	11/02 →	Tie Rod End	CV-ES-14163		for Steering Rod	
26.255 DL-HK, DLR-HK	11/02 →	Tie Rod End	CV-ES-14163		for Steering Rod	
26.284 DL-TM, DLR-TM	05/01 →	Tie Rod End	CV-ES-14163		for Steering Rod	
26.284, 26.285, DL-HK, DLR-HK	11/02 →	Tie Rod End	CV-ES-14163		for Steering Rod	

CV-ES-2120

Length: 115
Cone Ø: d1 Ø 12,4 / d2 Ø 10,8
Thread: M14 x 1,5 RHT

03008500A, 81953016200, 81953016202, 81953016203, 81953016227



CV-ES-2121

Length: 85
Cone Ø: d1 Ø 12 / d2 Ø 10,8
Thread: M14 x 1,5 RHT

81953010038, 81953010045, 81953016016, 81953016169, 81953016172, 81953016176, 81953016266, 81953016302



CV-ES-12462

Length: 120
Cone Ø: d1 Ø 26 / d2 Ø 23,5
Thread: M30 x 1,5 RHT

90804102218, 90804153111, 81953010014, 81953010042, 81953010064, 81953010068, 81953016065, 81953016067, 81953016073, 81953016162, 81953016239, 81953016240, 81953016246, 81953016250, 81953016272, 81953016282, 81953016319, 81953016360, 82953016014



CV-ES-14162

Length: 125
Cone Ø: d1 Ø 30 / d2 Ø 27
Thread: M30 x 1,5 LHT

81953010015, 81953010083, 81953010087, 81953016029, 81953016030, 81953016043, 81953016044, 81953016050, 81953016054, 81953016087, 81953016091, 81953016107, 81953016120, 81953016125, 81953016152, 81953016155, 81953016157, 81953016168, 81953016179, 81953016181, 81953016223, 81953016237, 81953016254, 81953016275, 81953016279, 81953016351



CV-ES-14163

Length: 125
Cone Ø: d1 Ø 30 / d2 Ø 27
Thread: M30 x 1,5 RHT

95301.0084, 90804102156, 90804102272, 90804102696, 90804102710, 81953010016, 81953010075, 81953010084, 81953010088, 81953010094, 81953010103, 81953016030, 81953016043, 81953016048, 81953016049, 81953016053, 81953016061, 81953016090, 81953016108, 81953016112, 81953016126, 81953016143, 81953016149, 81953016154, 81953016156, 81953016168, 81953016178, 81953016194, 81953016206, 81953016224, 81953016234, 81953016242, 81953016252, 81953016274, 81953016278, 81953016284, 81953016286, 81953016308, 81953016310, 81953016312, 81953016347, 81953016350, 81953016352, 82953016012, 88953016014, N2953016001



MN-DL-5212

Length: 577 Ø: 48
Hole Distance: 130 / 130

81432206096, 81432206097, 81432206098, 81432206129, 81432209096, 81432209129, 81432306014, 81432306030



MN-DL-7802

Length: 1680 Ø: 52
Cone Ø: d1 Ø 30 / d2 Ø 27

03208300A, 81467116773, 81467116858, 81467116859, 81467116860, 81467116861, 81467116863, 81467116882, 81467116883, 81467116920, 81467116921



MN-DL-8374

Length: 896
Ø: 38
Cone Ø: d1 Ø 30 / d2 Ø 27

85466106108, 85466106144, 85466106208



MN-DL-8378

Length: 882 Ø: 38
Cone Ø: d1 Ø 30 / d2 Ø 26

85466106156



MN-DL-12284

Length: 1530 Ø: 50
Cone Ø: d1 Ø 30 / d2 Ø 27

81466106579, 81466106580, 81466106624, 81466116720, 81467116720, 81467116730, 81467116952



MN-RK-7291

Ø: 72
Hole Distance: 130
Thick/Height: 30

10307800A, 81432206108, 81432206132



MN-RK-8523

Ø: 72
03304900A, 81432706065



MN-SB-5249

Length: 55 Ø: 71
Thick/Height: 80

03310200A, 81437040029



MN-VB-8565

Length: 693
Ø: 46
Hole Distance: 115 / 115

81432706053, 81432709053



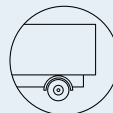

M 2000 M

12.224 MC, MLC, MLLC, MLRC, MRC, MLLRC	02/03→	Suspension Arm Repair Kit		MN-RK-7291	for Drag Link
	02/03→	Suspension Arm Repair Kit		MN-RK-8523	for Wishbone (CV)
	02/03→	Tie Rod End	CV-ES-12462		for Steering Rod
12.224 MLS, MLRS	02/03→	Suspension Arm Repair Kit		MN-RK-7291	for Drag Link
	02/03→	Suspension Arm Repair Kit		MN-RK-8523	for Wishbone (CV)
	02/03→	Tie Rod End	CV-ES-12462		for Steering Rod
12.225 MC, MLC, MLLC, MLRC, MRC, MLLRC	02/03→	Centre Rod	MN-DL-12432		for Steering Rod
12.255 MC, MLC, MLLC, MLRC, MRC, MLLRC	02/03→	Suspension Arm Repair Kit		MN-RK-7291	for Drag Link
	02/03→	Suspension Arm Repair Kit		MN-RK-8523	for Wishbone (CV)
	02/03→	Tie Rod End	CV-ES-12462		for Steering Rod
12.255 MLS	02/03→	Suspension Arm Repair Kit		MN-RK-7291	for Drag Link
	02/03→	Suspension Arm Repair Kit		MN-RK-8523	for Wishbone (CV)
	02/03→	Tie Rod End	CV-ES-12462		for Steering Rod
12.264 MC, MLC, MLLC, MLRC, MRC, MLLRC	02/03→	Suspension Arm Repair Kit		MN-RK-7291	for Drag Link
	02/03→	Suspension Arm Repair Kit		MN-RK-8523	for Wishbone (CV)
	02/03→	Tie Rod End	CV-ES-12462		for Steering Rod
12.264 MLS, MLRS	02/03→	Suspension Arm Repair Kit		MN-RK-7291	for Drag Link
	02/03→	Suspension Arm Repair Kit		MN-RK-8523	for Wishbone (CV)
	02/03→	Tie Rod End	CV-ES-12462		for Steering Rod
12.284 MC, MLC, MLLC, MLRC, MRC, MLLRC	02/00→	Suspension Arm Repair Kit		MN-RK-7291	for Drag Link
	02/00→	Suspension Arm Repair Kit		MN-RK-8523	for Wishbone (CV)
	02/00→	Tie Rod End	CV-ES-12462		for Steering Rod
12.284 MLS, MLRS	02/00→	Suspension Arm Repair Kit		MN-RK-7291	for Drag Link
	02/00→	Suspension Arm Repair Kit		MN-RK-8523	for Wishbone (CV)
	02/00→	Tie Rod End	CV-ES-12462		for Steering Rod
12.285 MC, MLC, MLLC, MLRC, MRC, MLLRC	02/03→	Centre Rod	MN-DL-12432		for Steering Rod
14.224 MAK, MAK-L, MARK	08/95→12/05	Ball Head, gearshift linkage	CV-ES-2119		
	08/95→12/05	Ball Head, gearshift linkage	CV-ES-2120		
	08/95→12/05	Ball Head, gearshift linkage	CV-ES-2182		
	08/95→12/05	Centre Rod	MN-DL-2140		Push Rod
	08/95→12/05	Stabiliser Mounting		MN-SB-5249	
	08/95→12/05	Stabiliser Mounting		MN-SB-5249	1st RA
14.224 MA-KO, MA-LF	11/02→	Tie Rod End	CV-ES-12462		for Steering Rod
14.224 MC, MLC, MLLC, MLRC, MRC, MLLRC	08/95→12/05	Ball Head, gearshift linkage	CV-ES-2119		
	08/95→12/05	Ball Head, gearshift linkage	CV-ES-2120		
	08/95→12/05	Ball Head, gearshift linkage	CV-ES-2182		
	08/95→12/05	Centre Rod	MN-DL-2140		Push Rod
	08/95→12/05	Centre Rod	MN-DL-12432		for Steering Rod
	08/95→12/05	Stabiliser Mounting		MN-SB-5249	
	08/95→12/05	Stabiliser Mounting		MN-SB-5249	1st RA
	08/95→12/05	Suspension Arm Repair Kit		MN-RK-7291	for Drag Link
	08/95→12/05	Suspension Arm Repair Kit		MN-RK-8523	for Wishbone (CV)
	08/95→12/05	Tie Rod End	CV-ES-12462		for Steering Rod
	08/95→12/05	Track Control Arm		MN-DL-7803	Trailing Arm, Air Suspension Axle
08/95→12/05	Track Control Arm		MN-DL-8590	Trailing Arm, Air Suspension Axle	
08/95→12/05	Track Control Arm		MN-VB-8565	Wishbone (CV), Air Suspension Axle	
14.224 MK	08/95→12/05	Ball Head, gearshift linkage	CV-ES-2119		
	08/95→12/05	Ball Head, gearshift linkage	CV-ES-2120		
	08/95→12/05	Ball Head, gearshift linkage	CV-ES-2182		
	08/95→12/05	Centre Rod	MN-DL-2140		Push Rod
	08/95→12/05	Centre Rod	MN-DL-12432		for Steering Rod
	08/95→12/05	Stabiliser Mounting		MN-SB-5249	
14.224 MLS, MLRS	08/95→12/05	Stabiliser Mounting		MN-SB-5249	1st RA
	08/95→12/05	Tie Rod End	CV-ES-12462		for Steering Rod
	08/95→12/05	Ball Head, gearshift linkage	CV-ES-2119		
	08/95→12/05	Ball Head, gearshift linkage	CV-ES-2120		
	08/95→12/05	Ball Head, gearshift linkage	CV-ES-2182		
	08/95→12/05	Centre Rod	MN-DL-2140		Push Rod
14.224 MLRS	08/95→12/05	Centre Rod	MN-DL-12432		for Steering Rod
	08/95→12/05	Suspension Arm Repair Kit		MN-RK-7291	for Drag Link

CV-ES-2119

Length: 55
Cone Ø: d1 Ø 10 / d2 Ø 10
Thread: M12 x 1,75 LHT
81953016063, 81953016131



CV-ES-2120

Length: 115
Cone Ø: d1 Ø 12,4 / d2 Ø 10,8
Thread: M14 x 1,5 RHT
03008500A, 81953016200, 81953016202,
81953016203, 81953016227



CV-ES-2182

Length: 55
Cone Ø: d1 Ø 10 / d2 Ø 10
Thread: M12 x 1,75 RHT
81953016064, 81953016170



CV-ES-12462

Length: 120
Cone Ø: d1 Ø 26 / d2 Ø 23,5
Thread: M30 x 1,5 RHT
90804102218, 90804153111, 81953010014,
81953010042, 81953010064, 81953010068,
81953016065, 81953016067, 81953016073,
81953016162, 81953016239, 81953016240,
81953016246, 81953016250, 81953016272,
81953016282, 81953016319, 81953016360,
82953016014



MN-DL-2140

Length: 1650
Ø: 50
Cone Ø: d1 Ø 26 / d2 Ø 23,5
81467106933, 81467116711



MN-DL-7803

Length: 644
Ø: 50
Hole Distance: 130 / 102
03307300A, 81432206174



MN-DL-8590

Length: 596 Ø: 50
Hole Distance: 130 / 102
81432206140, 81432209140



MN-DL-12432

Length: 975
Ø: 40
Cone Ø: d1 Ø 26 / d2 Ø 23,5
81466106692, 81466106693, 81466106695,
85466106020, 85466106120, 85466106151



MN-RK-7291

Ø: 72
Hole Distance: 130
Thick/Height: 30
10307800A, 81432206108, 81432206132



MN-RK-8523

Ø: 72
03304900A, 81432706065



MN-SB-5249

Length: 55 Ø: 71
Thick/Height: 80
03310200A, 81437040029



MN-VB-8565

Length: 693
Ø: 46
Hole Distance: 115 / 115
81432706053, 81432709053





M 2000 M ...

14.224 MLS, MLRS ...	08/95→12/05	Suspension Arm Repair Kit		MN-RK-8523	for Wishbone (CV)
	08/95→12/05	Tie Rod End	CV-ES-12462		for Steering Rod
	08/95→12/05	Track Control Arm		MN-DL-7803	Trailing Arm, Air Suspension Axle
	08/95→12/05	Track Control Arm		MN-DL-8590	Trailing Arm, Air Suspension Axle
	08/95→12/05	Track Control Arm		MN-VB-8565	Wishbone (CV), Air Suspension Axle
14.225 MC, MLC, MLLC, MLRC, MRC, MLLRC	10/00→	Suspension Arm Repair Kit		MN-RK-7291	for Drag Link
	10/00→	Tie Rod End	CV-ES-12462		for Steering Rod
14.225 MLS, MLRS	02/03→	Suspension Arm Repair Kit		MN-RK-7291	for Drag Link
	02/03→	Tie Rod End	CV-ES-12462		for Steering Rod
14.255 MAK, MAK-L, MARK	11/02→	Tie Rod End	CV-ES-12462		for Steering Rod
14.255 MA-KO, MA-LF	11/02→	Tie Rod End	CV-ES-12462		for Steering Rod
14.255 MC, MLC, MLLC, MLRC, MRC, MLLRC	10/00→	Suspension Arm Repair Kit		MN-RK-7291	for Drag Link
	10/00→	Suspension Arm Repair Kit		MN-RK-8523	for Wishbone (CV)
	10/00→	Tie Rod End	CV-ES-12462		for Steering Rod
14.255 MLS, MLRS	10/00→	Suspension Arm Repair Kit		MN-RK-7291	for Drag Link
	10/00→	Suspension Arm Repair Kit		MN-RK-8523	for Wishbone (CV)
	10/00→	Tie Rod End	CV-ES-12462		for Steering Rod
14.264 MAK, MAK-L, MARK	11/02→	Tie Rod End	CV-ES-12462		for Steering Rod
14.264 MA-KO, MA-LF	11/02→	Tie Rod End	CV-ES-12462		for Steering Rod
14.264 MC, MLC, MLLC, MLRC, MRC, MLLRC	08/95→12/05	Ball Head, gearshift linkage	CV-ES-2119		
	08/95→12/05	Ball Head, gearshift linkage	CV-ES-2120		
	08/95→12/05	Ball Head, gearshift linkage	CV-ES-2182		
	08/95→12/05	Centre Rod	MN-DL-2140		Push Rod
	08/95→12/05	Centre Rod	MN-DL-12432		for Steering Rod
	08/95→12/05	Stabiliser Mounting		MN-SB-5249	
	08/95→12/05	Stabiliser Mounting		MN-SB-5249	1st RA
	08/95→12/05	Suspension Arm Repair Kit		MN-RK-7291	for Drag Link
	08/95→12/05	Suspension Arm Repair Kit		MN-RK-8523	for Wishbone (CV)
	08/95→12/05	Tie Rod End	CV-ES-12462		for Steering Rod
	08/95→12/05	Track Control Arm		MN-DL-7803	Trailing Arm, Air Suspension Axle
	08/95→12/05	Track Control Arm		MN-DL-8590	Trailing Arm, Air Suspension Axle
	08/95→12/05	Track Control Arm		MN-VB-8565	Wishbone (CV), Air Suspension Axle
	14.264 MLS, MLRS	08/95→12/05	Ball Head, gearshift linkage	CV-ES-2119	
08/95→12/05		Ball Head, gearshift linkage	CV-ES-2120		
08/95→12/05		Ball Head, gearshift linkage	CV-ES-2182		
08/95→12/05		Centre Rod	MN-DL-2140		Push Rod
08/95→12/05		Centre Rod	MN-DL-12432		for Steering Rod
08/95→12/05		Suspension Arm Repair Kit		MN-RK-7291	for Drag Link
08/95→12/05		Suspension Arm Repair Kit		MN-RK-8523	for Wishbone (CV)
08/95→12/05		Tie Rod End	CV-ES-12462		for Steering Rod
08/95→12/05		Track Control Arm		MN-DL-7803	Trailing Arm, Air Suspension Axle
08/95→12/05		Track Control Arm		MN-DL-8590	Trailing Arm, Air Suspension Axle
08/95→12/05	Track Control Arm		MN-VB-8565	Wishbone (CV), Air Suspension Axle	
14.284 MAK, MAK-L, MARK	06/98→12/05	Ball Head, gearshift linkage	CV-ES-2120		
14.284 MA-KO, MA-LF	06/98→12/05	Ball Head, gearshift linkage	CV-ES-2120		
14.284 MC, MLC, MLLC, MLRC, MRC, MLLRC	06/98→12/05	Ball Head, gearshift linkage	CV-ES-2120		
14.284 MLS, MLRS	06/98→12/05	Ball Head, gearshift linkage	CV-ES-2120		
14.285 MC, MLC, MLLC, MLRC, MRC, MLLRC (ME280C)	09/99→12/05	Ball Head, gearshift linkage	CV-ES-2120		
	09/99→12/05	Centre Rod	MN-DL-12432		for Steering Rod
	09/99→12/05	Suspension Arm Repair Kit		MN-RK-7291	for Drag Link
	09/99→12/05	Suspension Arm Repair Kit		MN-RK-8523	for Wishbone (CV)
	09/99→12/05	Tie Rod End	CV-ES-12462		for Steering Rod
	09/99→12/05	Track Control Arm		MN-DL-7803	Trailing Arm, Air Suspension Axle
	09/99→12/05	Track Control Arm		MN-DL-8590	Trailing Arm, Air Suspension Axle
	09/99→12/05	Track Control Arm		MN-VB-8565	Wishbone (CV), Air Suspension Axle
14.285 MLS, MLRS	02/03→	Suspension Arm Repair Kit		MN-RK-7291	for Drag Link
	02/03→	Tie Rod End	CV-ES-12462		for Steering Rod
18.224 MAC, MARC	08/95→12/05	Ball Head, gearshift linkage	CV-ES-2119		
	08/95→12/05	Ball Head, gearshift linkage	CV-ES-2120		
	08/95→12/05	Ball Head, gearshift linkage	CV-ES-2182		
	08/95→12/05	Centre Rod	MN-DL-2160		Coupling Rod
	08/95→12/05	Centre Rod	MN-DL-2174		Push Rod

CV-ES-2119

Length: 55
Cone Ø: d1 Ø 10 / d2 Ø 10
Thread: M12 x 1,75 LHT
81953016063, 81953016131



CV-ES-2120

Length: 115
Cone Ø: d1 Ø 12,4 / d2 Ø 10,8
Thread: M14 x 1,5 RHT
03008500A, 81953016200, 81953016202,
81953016203, 81953016227



CV-ES-2182

Length: 55
Cone Ø: d1 Ø 10 / d2 Ø 10
Thread: M12 x 1,75 RHT
81953016064, 81953016170



CV-ES-12462

Length: 120
Cone Ø: d1 Ø 26 / d2 Ø 23,5
Thread: M30 x 1,5 RHT
90804102218, 90804153111, 81953010014,
81953010042, 81953010064, 81953010068,
81953016065, 81953016067, 81953016073,
81953016162, 81953016239, 81953016240,
81953016246, 81953016250, 81953016272,
81953016282, 81953016319, 81953016360,
82953016014



MN-DL-2140

Length: 1650
Ø: 50
Cone Ø: d1 Ø 26 / d2 Ø 23,5
81467106933, 81467116711



MN-DL-2160

Length: 1652 Ø: 50
Cone Ø: d1 Ø 30 / d2 Ø 27
81467106112, 81467106163, 81467106165,
81467106198, 81467106353, 81467106354,
81467106361, 81467116725



MN-DL-2174

Length: 1588 Ø: 52
Cone Ø: d1 Ø 30 / d2 Ø 27
81467106378, 81467106912



MN-DL-7803

Length: 644
Ø: 50
Hole Distance: 130 / 102
03307300A, 81432206174



MN-DL-8590

Length: 596 Ø: 50
Hole Distance: 130 / 102
81432206140, 81432209140



MN-DL-12432

Length: 975
Ø: 40
Cone Ø: d1 Ø 26 / d2 Ø 23,5
81466106692, 81466106693, 81466106695,
85466106020, 85466106120, 85466106151



MN-RK-7291

Ø: 72
Hole Distance: 130
Thick/Height: 30
10307800A, 81432206108, 81432206132



MN-RK-8523

Ø: 72
03304900A, 81432706065



MN-SB-5249

Length: 55 Ø: 71
Thick/Height: 80
03310200A, 81437040029



MN-VB-8565

Length: 693
Ø: 46
Hole Distance: 115 / 115
81432706053, 81432709053





M 2000 M ...

18.224 MAC, MARC ...	08/95→12/05	Centre Rod	MN-DL-12433		Push Rod	
	08/95→12/05	Stabiliser Mounting		MN-SB-5249		
	08/95→12/05	Stabiliser Mounting		MN-SB-5249	1st RA	
	08/95→12/05	Tie Rod End	CV-ES-14162		for Steering Rod	
	08/95→12/05	Tie Rod End	CV-ES-14163		for Steering Rod	
18.224 MAK, MAK-L, MARK	08/95→12/05	Ball Head, gearshift linkage	CV-ES-2119			
	08/95→12/05	Ball Head, gearshift linkage	CV-ES-2120			
	08/95→12/05	Ball Head, gearshift linkage	CV-ES-2182			
	08/95→12/05	Centre Rod	MN-DL-2160		Coupling Rod	
	08/95→12/05	Centre Rod	MN-DL-2174		Push Rod	
	08/95→12/05	Centre Rod	MN-DL-12433		Push Rod	
	08/95→12/05	Stabiliser Mounting		MN-SB-5249		
	08/95→12/05	Stabiliser Mounting		MN-SB-5249	1st RA	
	08/95→12/05	Tie Rod End	CV-ES-14162		for Steering Rod	
	08/95→12/05	Tie Rod End	CV-ES-14163		for Steering Rod	
18.224 MC, MLC, MLLC, MRC, MLRC, MLLRC	08/95→12/05	Ball Head, gearshift linkage	CV-ES-2119			
	08/95→12/05	Ball Head, gearshift linkage	CV-ES-2120			
	08/95→12/05	Ball Head, gearshift linkage	CV-ES-2182			
	08/95→12/05	Centre Rod	MN-DL-2160		Coupling Rod	
	08/95→12/05	Centre Rod	MN-DL-2174		Push Rod	
	08/95→12/05	Centre Rod	MN-DL-8376		Push Rod	
	08/95→12/05	Centre Rod	MN-DL-12433		Push Rod	
	08/95→12/05	Stabiliser Mounting		MN-SB-5249		
	08/95→12/05	Stabiliser Mounting		MN-SB-5249	1st RA	
	08/95→12/05	Suspension Arm Repair Kit		MN-RK-7280	for Drag Link	
	08/95→12/05	Suspension Arm Repair Kit		MN-RK-8523	for Wishbone (CV)	
	08/95→12/05	Tie Rod	MN-DL-7802			
	08/95→12/05	Tie Rod End	CV-ES-14162		for Steering Rod	
	08/95→12/05	Tie Rod End	CV-ES-14163		for Steering Rod	
	08/95→12/05	Track Control Arm		MN-DL-5212	Trailing Arm, Drive Axle;Air Suspension Axle	
	08/95→12/05	Track Control Arm		MN-VB-8565	Wishbone (CV), Air Suspension Axle	
	18.224 MK, MK-L, MLK, MLRK, MRK	08/95→12/05	Ball Head, gearshift linkage	CV-ES-2119		
08/95→12/05		Ball Head, gearshift linkage	CV-ES-2120			
08/95→12/05		Ball Head, gearshift linkage	CV-ES-2182			
08/95→12/05		Centre Rod	MN-DL-2160		Coupling Rod	
08/95→12/05		Centre Rod	MN-DL-2174		Push Rod	
08/95→12/05		Centre Rod	MN-DL-8376		Push Rod	
08/95→12/05		Stabiliser Mounting		MN-SB-5249		
08/95→12/05		Stabiliser Mounting		MN-SB-5249	1st RA	
08/95→12/05		Suspension Arm Repair Kit		MN-RK-7280	for Drag Link	
08/95→12/05		Suspension Arm Repair Kit		MN-RK-8523	for Wishbone (CV)	
08/95→12/05		Tie Rod	MN-DL-7802			
08/95→12/05		Tie Rod End	CV-ES-14162		for Steering Rod	
08/95→12/05		Tie Rod End	CV-ES-14163		for Steering Rod	
08/95→12/05		Track Control Arm		MN-DL-5212	Trailing Arm, Drive Axle;Air Suspension Axle	
08/95→12/05		Track Control Arm		MN-VB-8565	Wishbone (CV), Air Suspension Axle	
18.224 MLS, MLRS		08/95→12/05	Ball Head, gearshift linkage	CV-ES-2119		
		08/95→12/05	Ball Head, gearshift linkage	CV-ES-2120		
	08/95→12/05	Ball Head, gearshift linkage	CV-ES-2182			
	08/95→12/05	Centre Rod	MN-DL-2160		Coupling Rod	
	08/95→12/05	Centre Rod	MN-DL-2174		Push Rod	
	08/95→12/05	Suspension Arm Repair Kit		MN-RK-7280	for Drag Link	
	08/95→12/05	Suspension Arm Repair Kit		MN-RK-8523	for Wishbone (CV)	
	08/95→12/05	Tie Rod	MN-DL-7802			
	08/95→12/05	Tie Rod End	CV-ES-14162		for Steering Rod	
	08/95→12/05	Tie Rod End	CV-ES-14163		for Steering Rod	
	08/95→12/05	Track Control Arm		MN-DL-5212	Trailing Arm, Drive Axle;Air Suspension Axle	
08/95→12/05	Track Control Arm		MN-VB-8565	Wishbone (CV), Air Suspension Axle		
18.225 MAC, MARC	02/03→	Centre Rod	MN-DL-12433		Push Rod	
18.225 MAK, MAK-L, MARK	01/96→07/05	Centre Rod	MN-DL-12433		Push Rod	
18.255 MC, MLC, MLLC, MLRC, MRC, MLLRC	10/00→	Suspension Arm Repair Kit		MN-RK-8523	for Wishbone (CV)	
18.255 MK, MK-L, MLK, MLRK, MRK	11/02→	Suspension Arm Repair Kit		MN-RK-8523	for Wishbone (CV)	

CV-ES-2119

Length: 55
Cone Ø: d1 Ø 10 / d2 Ø 10
Thread: M12 x 1,75 LHT
81953016063, 81953016131

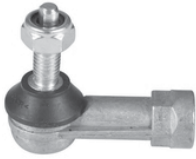

CV-ES-2120

Length: 115
Cone Ø: d1 Ø 12,4 / d2 Ø 10,8
Thread: M14 x 1,5 RHT
03008500A, 81953016200, 81953016202,
81953016203, 81953016227



CV-ES-2182

Length: 55
Cone Ø: d1 Ø 10 / d2 Ø 10
Thread: M12 x 1,75 RHT
81953016064, 81953016170



CV-ES-14162

Length: 125
Cone Ø: d1 Ø 30 / d2 Ø 27
Thread: M30 x 1,5 LHT
81953010015, 81953010083, 81953010087,
81953016029, 81953016030, 81953016043,
81953016044, 81953016050, 81953016054,
81953016087, 81953016091, 81953016107,
81953016120, 81953016125, 81953016152,
81953016155, 81953016157, 81953016168,
81953016179, 81953016181, 81953016223,
81953016237, 81953016254, 81953016275,
81953016279, 81953016351



CV-ES-14163

Length: 125
Cone Ø: d1 Ø 30 / d2 Ø 27
Thread: M30 x 1,5 RHT
95301.0084, 90804102156, 90804102272,
90804102696, 90804102710, 81953010016,
81953010075, 81953010084, 81953010088,
81953010094, 81953010103, 81953016030,
81953016043, 81953016048, 81953016049,
81953016053, 81953016061, 81953016090,
81953016108, 81953016112, 81953016126,
81953016143, 81953016149, 81953016154,
81953016156, 81953016168, 81953016178,
81953016194, 81953016206, 81953016224,
81953016234, 81953016242, 81953016252,
81953016274, 81953016278, 81953016284,
81953016286, 81953016308, 81953016310,
81953016312, 81953016347, 81953016350,
81953016352, 82953016012, 88953016014,
N2953016001



MN-DL-2160

Length: 1652 Ø: 50
Cone Ø: d1 Ø 30 / d2 Ø 27
81467106112, 81467106163, 81467106165,
81467106198, 81467106353, 81467106354,
81467106361, 81467116725



MN-DL-2174

Length: 1588 Ø: 52
Cone Ø: d1 Ø 30 / d2 Ø 27
81467106378, 81467106912



MN-DL-5212

Length: 577 Ø: 48
Hole Distance: 130 / 130
81432206096, 81432206097, 81432206098,
81432206129, 81432209096, 81432209129,
81432306014, 81432306030



MN-DL-7802

Length: 1680 Ø: 52
Cone Ø: d1 Ø 30 / d2 Ø 27
03208300A, 81467116773, 81467116858,
81467116859, 81467116860, 81467116861,
81467116863, 81467116882, 81467116883,
81467116920, 81467116921



MN-DL-8376

Length: 980
Ø: 42
Cone Ø: d1 Ø 30 / d2 Ø 27
85466106018, 85466106118, 85466106152,
85466106218



MN-DL-12433

Length: 1020
Ø: 42
Cone Ø: d1 Ø 30 / d2 Ø 27
85.46610.6022, 85.46610.6122,
85.46610.6155, 85.46610.6222

No Image

MN-RK-7280

Ø: 75
Hole Distance: 115
Thick/Height: 24
0550806, 0639370, 689748, 10307400A,
81432306051, 81432306068, 81432706064



MN-RK-8523

Ø: 72
03304900A, 81432706065



MN-SB-5249

Length: 55 Ø: 71
Thick/Height: 80
03310200A, 81437040029



MN-VB-8565

Length: 693
Ø: 46
Hole Distance: 115 / 115
81432706053, 81432709053



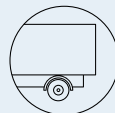

M 2000 M ...

18.255 MLS, MLRS	10/00→	Suspension Arm Repair Kit		MN-RK-8523	for Wishbone (CV)
18.264 MAC, MARC	08/95→12/05	Ball Head, gearshift linkage	CV-ES-2119		
	08/95→12/05	Ball Head, gearshift linkage	CV-ES-2120		
	08/95→12/05	Ball Head, gearshift linkage	CV-ES-2182		
	08/95→12/05	Centre Rod	MN-DL-2160		Coupling Rod
	08/95→12/05	Centre Rod	MN-DL-2174		Push Rod
	08/95→12/05	Centre Rod	MN-DL-12433		Push Rod
	08/95→12/05	Stabiliser Mounting		MN-SB-5249	
	08/95→12/05	Stabiliser Mounting		MN-SB-5249	1st RA
	08/95→12/05	Tie Rod End	CV-ES-14162		for Steering Rod
	08/95→12/05	Tie Rod End	CV-ES-14163		for Steering Rod
18.264 MAK, MAK-L, MARK	08/95→12/05	Ball Head, gearshift linkage	CV-ES-2119		
	08/95→12/05	Ball Head, gearshift linkage	CV-ES-2120		
	08/95→12/05	Ball Head, gearshift linkage	CV-ES-2182		
	08/95→12/05	Centre Rod	MN-DL-2160		Coupling Rod
	08/95→12/05	Centre Rod	MN-DL-2174		Push Rod
	08/95→12/05	Centre Rod	MN-DL-12433		Push Rod
	08/95→12/05	Stabiliser Mounting		MN-SB-5249	
	08/95→12/05	Stabiliser Mounting		MN-SB-5249	1st RA
	08/95→12/05	Tie Rod End	CV-ES-14162		for Steering Rod
	08/95→12/05	Tie Rod End	CV-ES-14163		for Steering Rod
18.264 MC, MLC, MLLC, MRC, MLRC, MLLRC	08/95→12/05	Ball Head, gearshift linkage	CV-ES-2119		
	08/95→12/05	Ball Head, gearshift linkage	CV-ES-2120		
	08/95→12/05	Ball Head, gearshift linkage	CV-ES-2182		
	08/95→12/05	Centre Rod	MN-DL-2160		Coupling Rod
	08/95→12/05	Centre Rod	MN-DL-2174		Push Rod
	08/95→12/05	Centre Rod	MN-DL-8376		Push Rod
	08/95→12/05	Centre Rod	MN-DL-12433		Push Rod
	08/95→12/05	Stabiliser Mounting		MN-SB-5249	
	08/95→12/05	Stabiliser Mounting		MN-SB-5249	1st RA
	08/95→12/05	Suspension Arm Repair Kit		MN-RK-7280	for Drag Link
	08/95→12/05	Suspension Arm Repair Kit		MN-RK-8523	for Wishbone (CV)
	08/95→12/05	Tie Rod	MN-DL-7802		
	08/95→12/05	Tie Rod End	CV-ES-14162		for Steering Rod
	08/95→12/05	Tie Rod End	CV-ES-14163		for Steering Rod
	08/95→12/05	Track Control Arm		MN-DL-5212	Trailing Arm, Drive Axle;Air Suspension Axle
08/95→12/05	Track Control Arm		MN-VB-8565	Wishbone (CV), Air Suspension Axle	
18.264 MK, MK-L, MLK, MLRK, MRK	08/95→12/05	Ball Head, gearshift linkage	CV-ES-2119		
	08/95→12/05	Ball Head, gearshift linkage	CV-ES-2120		
	08/95→12/05	Ball Head, gearshift linkage	CV-ES-2182		
	08/95→12/05	Centre Rod	MN-DL-2160		Coupling Rod
	08/95→12/05	Centre Rod	MN-DL-2174		Push Rod
	08/95→12/05	Centre Rod	MN-DL-8376		Push Rod
	08/95→12/05	Stabiliser Mounting		MN-SB-5249	
	08/95→12/05	Stabiliser Mounting		MN-SB-5249	1st RA
	08/95→12/05	Suspension Arm Repair Kit		MN-RK-7280	for Drag Link
	08/95→12/05	Suspension Arm Repair Kit		MN-RK-8523	for Wishbone (CV)
	08/95→12/05	Tie Rod	MN-DL-7802		
	08/95→12/05	Tie Rod End	CV-ES-14162		for Steering Rod
	08/95→12/05	Tie Rod End	CV-ES-14163		for Steering Rod
	08/95→12/05	Track Control Arm		MN-DL-5212	Trailing Arm, Drive Axle;Air Suspension Axle
	08/95→12/05	Track Control Arm		MN-VB-8565	Wishbone (CV), Air Suspension Axle
18.264 MLS, MLRS	08/95→12/05	Ball Head, gearshift linkage	CV-ES-2119		
	08/95→12/05	Ball Head, gearshift linkage	CV-ES-2120		
	08/95→12/05	Ball Head, gearshift linkage	CV-ES-2182		
	08/95→12/05	Centre Rod	MN-DL-2160		Coupling Rod
	08/95→12/05	Centre Rod	MN-DL-2174		Push Rod
	08/95→12/05	Suspension Arm Repair Kit		MN-RK-7280	for Drag Link
	08/95→12/05	Suspension Arm Repair Kit		MN-RK-8523	for Wishbone (CV)
	08/95→12/05	Tie Rod	MN-DL-7802		
	08/95→12/05	Tie Rod End	CV-ES-14162		for Steering Rod
	08/95→12/05	Tie Rod End	CV-ES-14163		for Steering Rod
	08/95→12/05	Track Control Arm		MN-DL-5212	Trailing Arm, Drive Axle;Air Suspension Axle
	08/95→12/05	Track Control Arm		MN-VB-8565	Wishbone (CV), Air Suspension Axle

CV-ES-2119

Length: 55
Cone Ø: d1 Ø 10 / d2 Ø 10
Thread: M12 x 1,75 LHT
81953016063, 81953016131

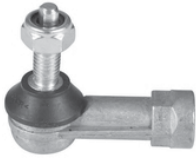

CV-ES-2120

Length: 115
Cone Ø: d1 Ø 12,4 / d2 Ø 10,8
Thread: M14 x 1,5 RHT
03008500A, 81953016200, 81953016202,
81953016203, 81953016227



CV-ES-2182

Length: 55
Cone Ø: d1 Ø 10 / d2 Ø 10
Thread: M12 x 1,75 RHT
81953016064, 81953016170



CV-ES-14162

Length: 125
Cone Ø: d1 Ø 30 / d2 Ø 27
Thread: M30 x 1,5 LHT
81953010015, 81953010083, 81953010087,
81953016029, 81953016030, 81953016043,
81953016044, 81953016050, 81953016054,
81953016087, 81953016091, 81953016107,
81953016120, 81953016125, 81953016152,
81953016155, 81953016157, 81953016168,
81953016179, 81953016181, 81953016223,
81953016237, 81953016254, 81953016275,
81953016279, 81953016351



CV-ES-14163

Length: 125
Cone Ø: d1 Ø 30 / d2 Ø 27
Thread: M30 x 1,5 RHT
95301.0084, 90804102156, 90804102272,
90804102696, 90804102710, 81953010016,
81953010075, 81953010084, 81953010088,
81953010094, 81953010103, 81953016030,
81953016043, 81953016048, 81953016049,
81953016053, 81953016061, 81953016090,
81953016108, 81953016112, 81953016126,
81953016143, 81953016149, 81953016154,
81953016156, 81953016168, 81953016178,
81953016194, 81953016206, 81953016224,
81953016234, 81953016242, 81953016252,
81953016274, 81953016278, 81953016284,
81953016286, 81953016308, 81953016310,
81953016312, 81953016347, 81953016350,
81953016352, 82953016012, 88953016014,
N2953016001



MN-DL-2160

Length: 1652 Ø: 50
Cone Ø: d1 Ø 30 / d2 Ø 27
81467106112, 81467106163, 81467106165,
81467106198, 81467106353, 81467106354,
81467106361, 81467116725



MN-DL-2174

Length: 1588 Ø: 52
Cone Ø: d1 Ø 30 / d2 Ø 27
81467106378, 81467106912



MN-DL-5212

Length: 577 Ø: 48
Hole Distance: 130 / 130
81432206096, 81432206097, 81432206098,
81432206129, 81432209096, 81432209129,
81432306014, 81432306030



MN-DL-7802

Length: 1680 Ø: 52
Cone Ø: d1 Ø 30 / d2 Ø 27
03208300A, 81467116773, 81467116858,
81467116859, 81467116860, 81467116861,
81467116863, 81467116882, 81467116883,
81467116920, 81467116921



MN-DL-8376

Length: 980
Ø: 42
Cone Ø: d1 Ø 30 / d2 Ø 27
85466106018, 85466106118, 85466106152,
85466106218



MN-DL-12433

Length: 1020
Ø: 42
Cone Ø: d1 Ø 30 / d2 Ø 27
85.46610.6022, 85.46610.6122,
85.46610.6155, 85.46610.6222

No Image

MN-RK-7280

Ø: 75
Hole Distance: 115
Thick/Height: 24
0550806, 0639370, 689748, 10307400A,
81432306051, 81432306068, 81432706064



MN-RK-8523

Ø: 72
03304900A, 81432706065



MN-SB-5249

Length: 55 Ø: 71
Thick/Height: 80
03310200A, 81437040029



MN-VB-8565

Length: 693
Ø: 46
Hole Distance: 115 / 115
81432706053, 81432709053





M 2000 M ...

18.284 MAC, MARC	06/98→12/05	Ball Head, gearshift linkage	CV-ES-2120			
18.284 MAK, MAK-L, MARK	06/98→12/05	Ball Head, gearshift linkage	CV-ES-2120			
18.284 MC, MLC, MLLC, MLRC, MRC, MLLRC	06/98→12/05	Ball Head, gearshift linkage	CV-ES-2120			
	06/98→12/05	Suspension Arm Repair Kit		MN-RK-7280	for Drag Link	
18.284 MK, MK-L, MLK, MLRK, MRK	06/98→12/05	Ball Head, gearshift linkage	CV-ES-2120			
	06/98→12/05	Suspension Arm Repair Kit		MN-RK-7280	for Drag Link	
18.284 MLS, MLRS	06/98→12/05	Ball Head, gearshift linkage	CV-ES-2120			
	06/98→12/05	Suspension Arm Repair Kit		MN-RK-7280	for Drag Link	
18.285 MAC, MARC	02/03→	Centre Rod	MN-DL-12433		Push Rod	
18.285 MAK, MAK-L, MARK	01/96→07/05	Centre Rod	MN-DL-12433		Push Rod	
25.224 MNLC, MNLLC, MNLRC, MNLLRC, MVLC	08/95→12/05	Ball Head, gearshift linkage	CV-ES-2120			
	08/95→12/05	Centre Rod	MN-DL-8376		Push Rod	
	08/95→12/05	Centre Rod	MN-DL-12433		Push Rod	
	08/95→12/05	Suspension Arm Repair Kit		MN-RK-7280	for Drag Link	
	08/95→12/05	Suspension Arm Repair Kit		MN-RK-8523	for Wishbone (CV)	
	08/95→12/05	Tie Rod End	CV-ES-14163		for Steering Rod	
	08/95→12/05	Track Control Arm		MN-DL-5212		Trailing Arm, Drive Axle;Air Suspension Axle;for vehicles with Rigid Leading Axle
		Track Control Arm		MN-DL-5212		Trailing Arm, Drive Axle;Air Suspension Axle; Tag Axle
	08/95→12/05	Track Control Arm		MN-VB-8565		Wishbone (CV), Air Suspension Axle;Drive Axle
08/95→12/05	Track Control Arm		MN-VB-8565		Wishbone (CV), Tag Axle	
25.255 MNLC, MNLLC, MNLRC, MNLLRC, MVLC	10/00→	Suspension Arm Repair Kit		MN-RK-8523	for Wishbone (CV)	
25.264 MNLC, MNLLC, MNLRC, MNLLRC, MVLC	08/95→12/05	Ball Head, gearshift linkage	CV-ES-2120			
	08/95→12/05	Centre Rod	MN-DL-8376		Push Rod	
	08/95→12/05	Centre Rod	MN-DL-12433		Push Rod	
	08/95→12/05	Suspension Arm Repair Kit		MN-RK-7280	for Drag Link	
	08/95→12/05	Suspension Arm Repair Kit		MN-RK-8523	for Wishbone (CV)	
	08/95→12/05	Tie Rod End	CV-ES-14163		for Steering Rod	
	08/95→12/05	Track Control Arm		MN-DL-5212		Trailing Arm, Drive Axle;Air Suspension Axle;for vehicles with Rigid Leading Axle
		Track Control Arm		MN-DL-5212		Trailing Arm, Drive Axle;Air Suspension Axle; Tag Axle
	08/95→12/05	Track Control Arm		MN-VB-8565		Wishbone (CV), Air Suspension Axle;Drive Axle
08/95→12/05	Track Control Arm		MN-VB-8565		Wishbone (CV), Tag Axle	
25.284 MNLC, MNLLC, MNLRC, MNLLRC, MVLC	02/00→	Suspension Arm Repair Kit		MN-RK-8523	for Wishbone (CV)	

NG

NG 262	06/97→07/98	Ball Head, gearshift linkage	CV-ES-2119		
	06/97→07/98	Ball Head, gearshift linkage	CV-ES-2120		
	06/97→07/98	Ball Head, gearshift linkage	CV-ES-2182		
	06/97→07/98	Centre Rod	MN-DL-2141		Push Rod
	06/97→07/98	Centre Rod	MN-DL-2172		Push Rod
	06/97→07/98	Centre Rod	MN-DL-7786		Push Rod
	06/97→07/98	Suspension Arm Repair Kit		DF-RK-8503	for Control Arm
	06/97→07/98	Suspension Strut Repair Kit		CV-RK-5311	
	06/97→07/98	Tie Rod End	CV-ES-12462		for Steering Rod
	06/97→07/98	Tie Rod End	CV-ES-14162		for Steering Rod
	06/97→07/98	Tie Rod End	CV-ES-14163		for Steering Rod
	06/97→07/98	Tie Rod End	DF-ES-8362		for Steering Rod
	06/97→07/98	Tie Rod End	MN-ES-8611		
	06/97→07/98	Track Control Arm		MN-DL-7797	
NG 262, NG 263	07/98→	Ball Head, gearshift linkage	CV-ES-2119		
	07/98→	Ball Head, gearshift linkage	CV-ES-2120		
	07/98→	Ball Head, gearshift linkage	CV-ES-2182		
	07/98→	Centre Rod	MN-DL-2141		Push Rod
	07/98→	Centre Rod	MN-DL-2172		Push Rod
	07/98→	Centre Rod	MN-DL-7786		Push Rod
	07/98→	Centre Rod	MN-DL-7804		Push Rod
	07/98→	Centre Rod	MN-DL-7808		Push Rod
	07/98→	Engine Mounting	MN-SB-10387		

CV-ES-2119

Length: 55
Cone Ø: d1 Ø 10 / d2 Ø 10
Thread: M12 x 1,75 LHT
81953016063, 81953016131

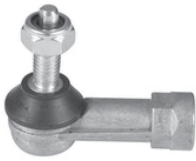

CV-ES-2120

Length: 115
Cone Ø: d1 Ø 12,4 / d2 Ø 10,8
Thread: M14 x 1,5 RHT
03008500A, 81953016200, 81953016202,
81953016203, 81953016227



CV-ES-2182

Length: 55
Cone Ø: d1 Ø 10 / d2 Ø 10
Thread: M12 x 1,75 RHT
81953016064, 81953016170



CV-ES-12462

Length: 120
Cone Ø: d1 Ø 26 / d2 Ø 23,5
Thread: M30 x 1,5 RHT
90804102218, 90804153111, 81953010014,
81953010042, 81953010064, 81953010068,
81953016065, 81953016067, 81953016073,
81953016162, 81953016239, 81953016240,
81953016246, 81953016250, 81953016272,
81953016282, 81953016319, 81953016360,
82953016014



CV-ES-14162

Length: 125
Cone Ø: d1 Ø 30 / d2 Ø 27
Thread: M30 x 1,5 LHT
81953010015, 81953010083, 81953010087,
81953016029, 81953016030, 81953016043,
81953016044, 81953016050, 81953016054,
81953016087, 81953016091, 81953016107,
81953016120, 81953016125, 81953016152,
81953016155, 81953016157, 81953016168,
81953016179, 81953016181, 81953016223,
81953016237, 81953016254, 81953016275,
81953016279, 81953016351



CV-ES-14163

Length: 125
Cone Ø: d1 Ø 30 / d2 Ø 27
Thread: M30 x 1,5 RHT
95301.0084, 90804102156, 90804102272,
90804102696, 90804102710, 81953010016,
81953010075, 81953010084, 81953010088,
81953010094, 81953010103, 81953016030,
81953016043, 81953016048, 81953016049,
81953016053, 81953016061, 81953016090,
81953016108, 81953016112, 81953016126,
81953016143, 81953016149, 81953016154,
81953016156, 81953016168, 81953016178,
81953016194, 81953016206, 81953016224,
81953016234, 81953016242, 81953016252,
81953016274, 81953016278, 81953016284,
81953016286, 81953016308, 81953016310,
81953016312, 81953016347, 81953016350,
81953016352, 82953016012, 88953016014,
N2953016001



CV-RK-5311

638862, 639287, 938423, 1104335,
1953248, 0003500506, 3500506, 11013547,
42488722, 070550504, 634303610,
81432206055, 81432206073, 82262320660,
5001842823, 7000307001, 8226232066

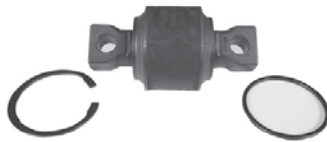

DF-ES-8362

Length: 150
Cone Ø: d1 Ø 26 / d2 Ø 23,5
Thread: M30 x 1,5 RHT
81953016270



DF-RK-8503

Ø: 75
Hole Distance: 130
Thick/Height: 24
81432306061



MN-DL-2141

Length: 1689
Ø: 50
Cone Ø: d1 Ø 26 / d2 Ø 23,5
81467106862, 81467116712



MN-DL-2172

Length: 1050 Ø: 42
Cone Ø: d1 Ø 30 / d2 Ø 27
81466106374, 81466116019, 82466106080,
82466106189, 82466106190



MN-DL-5212

Length: 577 Ø: 48
Hole Distance: 130 / 130
81432206096, 81432206097, 81432206098,
81432206129, 81432209096, 81432209129,
81432306014, 81432306030



MN-DL-7786

Length: 1245 Ø: 60
Cone Ø: d1 Ø 30
81466106375, 81466106684, 81466116016,
3574602005, 3574602305



MN-DL-7797

Length: 750 Ø: 48
Hole Distance: 130 / 130
81432206099, 81432206100, 81432206185,
3573330205



MN-DL-7804

Length: 628
Ø: 40
Cone Ø: d1 Ø 30 / d2 Ø 26
81466116045



MN-DL-7808

Length: 1358
Ø: 52
Cone Ø: d1 Ø 30 / d2 Ø 27
81466106794, 81466116044, 81466116085



MN-DL-8376

Length: 980
Ø: 42
Cone Ø: d1 Ø 30 / d2 Ø 27
85466106018, 85466106118, 85466106152,
85466106218



MN-DL-12433

Length: 1020
Ø: 42
Cone Ø: d1 Ø 30 / d2 Ø 27
85.46610.6022, 85.46610.6122,
85.46610.6155, 85.46610.6222

No Image

MN-ES-8611

Length: 168
Cone Ø: d1 Ø 30 / d2 Ø 27
Thread: M52 x 1,5 RHT
0004606748, 81953016233, 81953016255,
81953016277



MN-RK-7280

Ø: 75
Hole Distance: 115
Thick/Height: 24
0550806, 0639370, 689748, 10307400A,
81432306051, 81432306068, 81432706064



MN-RK-8523

Ø: 72
03304900A, 81432706065



MN-SB-10387

Ø: 70
Thick/Height: 85/85
81960200384



MN-VB-8565

Length: 693
Ø: 46
Hole Distance: 115 / 115
81432706053, 81432709053





NG ...

NG 262, NG 263 ...	07/98 →	Suspension Arm Repair Kit		DF-RK-8503	for Control Arm
	07/98 →	Suspension Strut Repair Kit		CV-RK-5311	
	07/98 →	Tie Rod	MN-DL-8621		
	07/98 →	Tie Rod End	CV-ES-12462		for Steering Rod
	07/98 →	Tie Rod End	CV-ES-14162		for Steering Rod
	07/98 →	Tie Rod End	CV-ES-14163		for Steering Rod
	07/98 →	Tie Rod End	DF-ES-8362		for Steering Rod
	07/98 →	Track Control Arm		MN-DL-7272	Trailing Arm
	07/98 →	Track Control Arm		MN-DL-7797	Suspension Rod, Control Arm;Trailing Arm
NG 262, NG 272	08/92 →07/98	Ball Head, gearshift linkage	CV-ES-2119		
	08/92 →07/98	Ball Head, gearshift linkage	CV-ES-2120		
	08/92 →07/98	Ball Head, gearshift linkage	CV-ES-2182		
	08/92 →07/98	Centre Rod	MN-DL-2141		Push Rod
	08/92 →07/98	Centre Rod	MN-DL-2172		Push Rod
	08/92 →07/98	Centre Rod	MN-DL-7786		Push Rod
	08/92 →07/98	Suspension Arm Repair Kit		DF-RK-8503	for Control Arm
	08/92 →07/98	Suspension Strut Repair Kit		CV-RK-5311	
	08/92 →07/98	Tie Rod End	CV-ES-12462		for Steering Rod
	08/92 →07/98	Tie Rod End	CV-ES-14162		for Steering Rod
	08/92 →07/98	Tie Rod End	CV-ES-14163		for Steering Rod
	08/92 →07/98	Tie Rod End	DF-ES-8362		for Steering Rod
	08/92 →07/98	Track Control Arm		MN-DL-7797	Suspension Rod, Control Arm;Trailing Arm
	NG 312	09/95 →07/98	Ball Head, gearshift linkage	CV-ES-2119	
09/95 →07/98		Ball Head, gearshift linkage	CV-ES-2120		
09/95 →07/98		Ball Head, gearshift linkage	CV-ES-2182		
09/95 →07/98		Centre Rod	MN-DL-2141		Push Rod
09/95 →07/98		Centre Rod	MN-DL-2172		Push Rod
09/95 →07/98		Centre Rod	MN-DL-7786		Push Rod
09/95 →07/98		Suspension Arm Repair Kit		DF-RK-8503	for Control Arm
09/95 →07/98		Suspension Strut Repair Kit		CV-RK-5311	
09/95 →07/98		Tie Rod End	CV-ES-12462		for Steering Rod
09/95 →07/98		Tie Rod End	CV-ES-14162		for Steering Rod
09/95 →07/98		Tie Rod End	CV-ES-14163		for Steering Rod
09/95 →07/98		Tie Rod End	DF-ES-8362		for Steering Rod
09/95 →07/98		Tie Rod End	MN-ES-8611		
09/95 →07/98		Track Control Arm		MN-DL-7797	Suspension Rod, Control Arm;Trailing Arm
NG 312, NG 313	07/98 →	Ball Head, gearshift linkage	CV-ES-2119		
	07/98 →	Ball Head, gearshift linkage	CV-ES-2120		
	07/98 →	Ball Head, gearshift linkage	CV-ES-2182		
	07/98 →	Centre Rod	MN-DL-2141		Push Rod
	07/98 →	Centre Rod	MN-DL-2172		Push Rod
	07/98 →	Centre Rod	MN-DL-7786		Push Rod
	07/98 →	Centre Rod	MN-DL-7804		Push Rod
	07/98 →	Engine Mounting	MN-SB-10387		
	07/98 →	Suspension Arm Repair Kit		DF-RK-8503	for Control Arm
	07/98 →	Suspension Strut Repair Kit		CV-RK-5311	
	07/98 →	Tie Rod	MN-DL-8621		
	07/98 →	Tie Rod End	CV-ES-12462		for Steering Rod
	07/98 →	Tie Rod End	CV-ES-14162		for Steering Rod
	07/98 →	Tie Rod End	CV-ES-14163		for Steering Rod
	07/98 →	Tie Rod End	DF-ES-8362		for Steering Rod
	07/98 →	Tie Rod End	MN-ES-8611		
	07/98 →	Track Control Arm		MN-DL-7797	Suspension Rod, Control Arm;Trailing Arm
07/98 →	Track Control Arm		MN-DL-8733	Trailing Arm, Air Suspension Axle;Drive Axle	
NG 313	01/06 →12/14	Centre Rod	MN-DL-7804		Push Rod
	01/06 →12/14	Centre Rod	MN-DL-7808		Push Rod
	01/06 →12/14	Tie Rod	MN-DL-8621		
	01/06 →12/14	Track Control Arm		MN-DL-7272	Trailing Arm
	01/06 →12/14	Track Control Arm		MN-DL-8733	Trailing Arm
	01/06 →12/14	Track Control Arm		MN-TC-12400	Control Arm

CV-ES-2119

Length: 55
Cone Ø: d1 Ø 10 / d2 Ø 10
Thread: M12 x 1,75 LHT
81953016063, 81953016131



CV-ES-2120

Length: 115
Cone Ø: d1 Ø 12,4 / d2 Ø 10,8
Thread: M14 x 1,5 RHT
03008500A, 81953016200, 81953016202, 81953016203, 81953016227



CV-ES-2182

Length: 55
Cone Ø: d1 Ø 10 / d2 Ø 10
Thread: M12 x 1,75 RHT
81953016064, 81953016170



CV-ES-12462

Length: 120
Cone Ø: d1 Ø 26 / d2 Ø 23,5
Thread: M30 x 1,5 RHT
90804102218, 90804153111, 81953010014, 81953010042, 81953010064, 81953010068, 81953016065, 81953016067, 81953016073, 81953016162, 81953016239, 81953016240, 81953016246, 81953016250, 81953016272, 81953016282, 81953016319, 81953016360, 82953016014



CV-ES-14162

Length: 125
Cone Ø: d1 Ø 30 / d2 Ø 27
Thread: M30 x 1,5 LHT
81953010015, 81953010083, 81953010087, 81953016029, 81953016030, 81953016043, 81953016044, 81953016050, 81953016054, 81953016087, 81953016091, 81953016107, 81953016120, 81953016125, 81953016152, 81953016155, 81953016157, 81953016168, 81953016179, 81953016181, 81953016223, 81953016237, 81953016254, 81953016275, 81953016279, 81953016351



CV-ES-14163

Length: 125
Cone Ø: d1 Ø 30 / d2 Ø 27
Thread: M30 x 1,5 RHT
95301.0084, 90804102156, 90804102272, 90804102696, 90804102710, 81953010016, 81953010075, 81953010084, 81953010088, 81953010094, 81953010103, 81953016030, 81953016043, 81953016048, 81953016049, 81953016053, 81953016061, 81953016090, 81953016108, 81953016112, 81953016126, 81953016143, 81953016149, 81953016154, 81953016156, 81953016168, 81953016178, 81953016194, 81953016206, 81953016224, 81953016234, 81953016242, 81953016252, 81953016274, 81953016278, 81953016284, 81953016286, 81953016308, 81953016310, 81953016312, 81953016347, 81953016350, 81953016352, 82953016012, 88953016014, N2953016001



CV-RK-5311

638862, 639287, 938423, 1104335, 1953248, 0003500506, 3500506, 11013547, 42488722, 070550504, 634303610, 81432206055, 81432206073, 82262320660, 5001842823, 7000307001, 8226232066



DF-ES-8362

Length: 150
Cone Ø: d1 Ø 26 / d2 Ø 23,5
Thread: M30 x 1,5 RHT
81953016270



DF-RK-8503

Ø: 75
Hole Distance: 130
Thick/Height: 24
81432306061



MN-DL-2141

Length: 1689
Ø: 50
Cone Ø: d1 Ø 26 / d2 Ø 23,5
81467106862, 81467116712



MN-DL-2172

Length: 1050 Ø: 42
Cone Ø: d1 Ø 30 / d2 Ø 27
81466106374, 81466116019, 82466106080, 82466106189, 82466106190



MN-DL-7272

Length: 614
Ø: 48
Hole Distance: 130 / 130
03300300A, 81432206189



MN-DL-7786

Length: 1245
Ø: 60
Cone Ø: d1 Ø 30
81466106375, 81466106684, 81466116016, 3574602005, 3574602305



MN-DL-7797

Length: 750 Ø: 48
Hole Distance: 130 / 130
81432206099, 81432206100, 81432206185, 3573330205



MN-DL-7804

Length: 628
Ø: 40
Cone Ø: d1 Ø 30 / d2 Ø 26
81466116045



MN-DL-7808

Length: 1358
Ø: 52
Cone Ø: d1 Ø 30 / d2 Ø 27
81466106794, 81466116044, 81466116085



MN-DL-8621

Length: 1702
Ø: 50
Cone Ø: d1 Ø 30 / d2 Ø 27
81467116715



MN-DL-8733

Length: 530 Ø: 48
Hole Distance: 130 / 130
81432206161, 81432206190, 81432206358, 81432206359



MN-ES-8611

Length: 168
Cone Ø: d1 Ø 30 / d2 Ø 27
Thread: M52 x 1,5 RHT
0004606748, 81953016233, 81953016255, 81953016277



MN-SB-10387

Ø: 70
Thick/Height: 85/85
81960200384



MN-TC-12400

Length: 413
Hole Distance: 80 / 80
Thick/Height: 35
81432206164, 81432206165, 81432206166, 81432206215, 81432206227, 81432206228





NL

NL 202	09/89→04/94	Ball Head, gearshift linkage	CV-ES-2119		
	09/89→04/94	Ball Head, gearshift linkage	CV-ES-2120		
	09/89→04/94	Ball Head, gearshift linkage	CV-ES-2182		
	09/89→04/94	Centre Rod	MN-DL-2141		Push Rod
	09/89→04/94	Centre Rod	MN-DL-2172		Push Rod
	09/89→04/94	Centre Rod	MN-DL-7786		Push Rod
	09/89→04/94	Suspension Arm Repair Kit		DF-RK-8503	for Control Arm
	09/89→04/94	Suspension Strut Repair Kit		CV-RK-5311	
	09/89→04/94	Tie Rod End	CV-ES-12462		for Steering Rod
	09/89→04/94	Tie Rod End	CV-ES-14162		for Steering Rod
	09/89→04/94	Tie Rod End	CV-ES-14163		for Steering Rod
	09/89→04/94	Tie Rod End	DF-ES-8362		for Steering Rod
	09/89→04/94	Track Control Arm		MN-DL-7797	Suspension Rod, Control Arm;Trailing Arm
NL 202, NL 222, NL 223	08/92→	Ball Head, gearshift linkage	CV-ES-2119		
	08/92→	Ball Head, gearshift linkage	CV-ES-2120		
	08/92→	Ball Head, gearshift linkage	CV-ES-2182		
	08/92→	Centre Rod	MN-DL-2141		Push Rod
	08/92→	Centre Rod	MN-DL-2172		Push Rod
	08/92→	Centre Rod	MN-DL-7786		Push Rod
	08/92→	Centre Rod	MN-DL-7804		Push Rod
	08/92→	Centre Rod	MN-DL-7808		Push Rod
	08/92→	Centre Rod	MN-DL-12421		for Steering Rod
	08/92→	Engine Mounting	MN-SB-10387		
	08/92→	Suspension Arm Repair Kit		DF-RK-8503	for Control Arm
	08/92→	Suspension Strut Repair Kit		CV-RK-5311	
	08/92→	Tie Rod	MN-DL-8621		
	08/92→	Tie Rod End	CV-ES-12462		for Steering Rod
	08/92→	Tie Rod End	CV-ES-14162		for Steering Rod
	08/92→	Tie Rod End	CV-ES-14163		for Steering Rod
	08/92→	Tie Rod End	DF-ES-8362		for Steering Rod
	08/92→	Tie Rod End	MN-ES-8611		
	08/92→	Track Control Arm		MN-DL-7272	Trailing Arm
	08/92→	Track Control Arm		MN-DL-7797	Suspension Rod, Control Arm;Trailing Arm
06/98→	Track Control Arm		MN-DL-8733	Trailing Arm, Air Suspension Axle;Drive Axle	
NL 202, NL 262, NL 263	04/91→	Ball Head, gearshift linkage	CV-ES-2119		
	04/91→	Ball Head, gearshift linkage	CV-ES-2120		
	04/91→	Ball Head, gearshift linkage	CV-ES-2182		
	04/91→	Centre Rod	MN-DL-2141		Push Rod
	04/91→	Centre Rod	MN-DL-2172		Push Rod
	04/91→	Centre Rod	MN-DL-7786		Push Rod
	04/91→	Centre Rod	MN-DL-7804		Push Rod
	04/91→	Centre Rod	MN-DL-12421		for Steering Rod
	04/91→	Engine Mounting	MN-SB-10387		
	04/91→	Suspension Arm Repair Kit		DF-RK-8503	for Control Arm
	04/91→	Suspension Strut Repair Kit		CV-RK-5311	
	04/91→	Tie Rod	MN-DL-8621		
	04/91→	Tie Rod End	CV-ES-12462		for Steering Rod
	04/91→	Tie Rod End	CV-ES-14162		for Steering Rod
	04/91→	Tie Rod End	CV-ES-14163		for Steering Rod
	04/91→	Tie Rod End	DF-ES-8362		for Steering Rod
	04/91→	Tie Rod End	MN-ES-8611		
	04/91→	Track Control Arm		MN-DL-7797	Suspension Rod, Control Arm;Trailing Arm
	06/98→	Track Control Arm		MN-DL-8733	Trailing Arm, Air Suspension Axle;Drive Axle
	NL 262	06/97→	Ball Head, gearshift linkage	CV-ES-2119	
06/97→		Ball Head, gearshift linkage	CV-ES-2120		
06/97→		Ball Head, gearshift linkage	CV-ES-2182		
06/97→		Centre Rod	MN-DL-2141		Push Rod
06/97→		Centre Rod	MN-DL-2172		Push Rod
06/97→		Centre Rod	MN-DL-7786		Push Rod
06/97→		Centre Rod	MN-DL-12421		for Steering Rod
06/97→		Suspension Arm Repair Kit		DF-RK-8503	for Control Arm
06/97→		Suspension Strut Repair Kit		CV-RK-5311	
06/97→		Tie Rod End	CV-ES-12462		for Steering Rod

CV-ES-2119

Length: 55
Cone Ø: d1 Ø 10 / d2 Ø 10
Thread: M12 x 1,75 LHT
81953016063, 81953016131



CV-ES-2120

Length: 115
Cone Ø: d1 Ø 12,4 / d2 Ø 10,8
Thread: M14 x 1,5 RHT
03008500A, 81953016200, 81953016202,
81953016203, 81953016227



CV-ES-2182

Length: 55
Cone Ø: d1 Ø 10 / d2 Ø 10
Thread: M12 x 1,75 RHT
81953016064, 81953016170



CV-ES-12462

Length: 120
Cone Ø: d1 Ø 26 / d2 Ø 23,5
Thread: M30 x 1,5 RHT

90804102218, 90804153111, 81953010014,
81953010042, 81953010064, 81953010068,
81953016065, 81953016067, 81953016073,
81953016162, 81953016239, 81953016240,
81953016246, 81953016250, 81953016272,
81953016282, 81953016319, 81953016360,
82953016014



CV-ES-14162

Length: 125
Cone Ø: d1 Ø 30 / d2 Ø 27
Thread: M30 x 1,5 LHT

81953010015, 81953010083, 81953010087,
81953016029, 81953016030, 81953016043,
81953016044, 81953016050, 81953016054,
81953016087, 81953016091, 81953016107,
81953016120, 81953016125, 81953016152,
81953016155, 81953016157, 81953016168,
81953016179, 81953016181, 81953016223,
81953016237, 81953016254, 81953016275,
81953016279, 81953016351



CV-ES-14163

Length: 125
Cone Ø: d1 Ø 30 / d2 Ø 27
Thread: M30 x 1,5 RHT

95301.0084, 90804102156, 90804102272,
90804102696, 90804102710, 81953010016,
81953010075, 81953010084, 81953010088,
81953010094, 81953010103, 81953016030,
81953016043, 81953016048, 81953016049,
81953016053, 81953016061, 81953016090,
81953016108, 81953016112, 81953016126,
81953016143, 81953016149, 81953016154,
81953016156, 81953016168, 81953016178,
81953016194, 81953016206, 81953016224,
81953016234, 81953016242, 81953016252,
81953016274, 81953016278, 81953016284,
81953016286, 81953016308, 81953016310,
81953016312, 81953016347, 81953016350,
81953016352, 82953016012, 88953016014,
N2953016001



CV-RK-5311

638862, 639287, 938423, 1104335,
1953248, 0003500506, 3500506, 11013547,
42488722, 070550504, 634303610,
81432206055, 81432206073, 82262320660,
5001842823, 7000307001, 8226232066



DF-ES-8362

Length: 150
Cone Ø: d1 Ø 26 / d2 Ø 23,5
Thread: M30 x 1,5 RHT
81953016270



DF-RK-8503

Ø: 75
Hole Distance: 130
Thick/Height: 24
81432306061



MN-DL-2141

Length: 1689
Ø: 50
Cone Ø: d1 Ø 26 / d2 Ø 23,5
81467106862, 81467116712



MN-DL-2172

Length: 1050 Ø: 42
Cone Ø: d1 Ø 30 / d2 Ø 27
81466106374, 81466116019, 82466106080,
82466106189, 82466106190



MN-DL-7272

Length: 614
Ø: 48
Hole Distance: 130 / 130
03300300A, 81432206189



MN-DL-7786

Length: 1245
Ø: 60
Cone Ø: d1 Ø 30
81466106375, 81466106684, 81466116016,
3574602005, 3574602305



MN-DL-7797

Length: 750 Ø: 48
Hole Distance: 130 / 130
81432206099, 81432206100, 81432206185,
3573330205



MN-DL-7804

Length: 628
Ø: 40
Cone Ø: d1 Ø 30 / d2 Ø 26
81466116045



MN-DL-7808

Length: 1358
Ø: 52
Cone Ø: d1 Ø 30 / d2 Ø 27
81466106794, 81466116044, 81466116085



MN-DL-8621

Length: 1702
Ø: 50
Cone Ø: d1 Ø 30 / d2 Ø 27
81467116715



MN-DL-8733

Length: 530 Ø: 48
Hole Distance: 130 / 130
81432206161, 81432206190, 81432206358,
81432206359



MN-DL-12421

Length: 1070
Ø: 48
Cone Ø: d1 Ø 30 / d2 Ø 27
Thread: M30 x 1,5 RHT
81466106656, 81466106659, 81466106669,
81466116006, 81466116007



MN-ES-8611

Length: 168
Cone Ø: d1 Ø 30 / d2 Ø 27
Thread: M52 x 1,5 RHT
0004606748, 81953016233, 81953016255,
81953016277



MN-SB-10387

Ø: 70
Thick/Height: 85/85
81960200384





NL ...

NL 262 ...	06/97→	Tie Rod End	CV-ES-14162		for Steering Rod
	06/97→	Tie Rod End	CV-ES-14163		for Steering Rod
	06/97→	Tie Rod End	DF-ES-8362		for Steering Rod
	06/97→	Tie Rod End	MN-ES-8611		
	06/97→	Track Control Arm		MN-DL-7797	Suspension Rod, Control Arm;Trailing Arm
NL 262, NL 263	07/98→	Ball Head, gearshift linkage	CV-ES-2119		
	07/98→	Ball Head, gearshift linkage	CV-ES-2120		
	07/98→	Ball Head, gearshift linkage	CV-ES-2182		
	07/98→	Centre Rod	MN-DL-2141		Push Rod
	07/98→	Centre Rod	MN-DL-2172		Push Rod
	07/98→	Centre Rod	MN-DL-7786		Push Rod
	07/98→	Centre Rod	MN-DL-7804		Push Rod
	07/98→	Centre Rod	MN-DL-7808		Push Rod
	07/98→	Centre Rod	MN-DL-12421		for Steering Rod
	07/98→	Engine Mounting	MN-SB-10387		
	07/98→	Suspension Arm Repair Kit		DF-RK-8503	for Control Arm
	07/98→	Suspension Strut Repair Kit		CV-RK-5311	
	07/98→	Tie Rod	MN-DL-8621		
	07/98→	Tie Rod End	CV-ES-12462		for Steering Rod
	07/98→	Tie Rod End	CV-ES-14162		for Steering Rod
	07/98→	Tie Rod End	CV-ES-14163		for Steering Rod
	07/98→	Tie Rod End	DF-ES-8362		for Steering Rod
	07/98→	Tie Rod End	MN-ES-8611		
	07/98→	Track Control Arm		MN-DL-7272	Trailing Arm
	07/98→	Track Control Arm		MN-DL-7797	Suspension Rod, Control Arm;Trailing Arm
07/98→	Track Control Arm		MN-DL-8733	Trailing Arm, Air Suspension Axle;Drive Axle	
NL 312	11/95→07/98	Ball Head, gearshift linkage	CV-ES-2119		
	11/95→07/98	Ball Head, gearshift linkage	CV-ES-2120		
	11/95→07/98	Ball Head, gearshift linkage	CV-ES-2182		
	11/95→07/98	Centre Rod	MN-DL-2141		Push Rod
	11/95→07/98	Centre Rod	MN-DL-2172		Push Rod
	11/95→07/98	Centre Rod	MN-DL-7786		Push Rod
	11/95→07/98	Centre Rod	MN-DL-12421		for Steering Rod
	11/95→07/98	Suspension Arm Repair Kit		DF-RK-8503	for Control Arm
	11/95→07/98	Suspension Strut Repair Kit		CV-RK-5311	
	11/95→07/98	Tie Rod End	CV-ES-12462		for Steering Rod
	11/95→07/98	Tie Rod End	CV-ES-14162		for Steering Rod
	11/95→07/98	Tie Rod End	CV-ES-14163		for Steering Rod
	11/95→07/98	Tie Rod End	DF-ES-8362		for Steering Rod
	11/95→07/98	Tie Rod End	MN-ES-8611		
11/95→07/98	Track Control Arm		MN-DL-7797	Suspension Rod, Control Arm;Trailing Arm	
NL 313	07/98→	Ball Head, gearshift linkage	CV-ES-2119		
	07/98→	Ball Head, gearshift linkage	CV-ES-2120		
	07/98→	Ball Head, gearshift linkage	CV-ES-2182		
	07/98→	Centre Rod	MN-DL-2141		Push Rod
	07/98→	Centre Rod	MN-DL-2172		Push Rod
	07/98→	Centre Rod	MN-DL-7804		Push Rod
	07/98→	Centre Rod	MN-DL-7808		Push Rod
	07/98→	Engine Mounting	MN-SB-10387		
	07/98→	Suspension Strut Repair Kit		CV-RK-5311	
	07/98→	Tie Rod	MN-DL-8621		
	07/98→	Tie Rod End	CV-ES-14162		for Steering Rod
	07/98→	Tie Rod End	CV-ES-14163		for Steering Rod
	07/98→	Track Control Arm		MN-DL-7272	Trailing Arm
	07/98→	Track Control Arm		MN-DL-8733	Trailing Arm, Air Suspension Axle;Drive Axle
	07/98→	Track Control Arm		MN-TC-12400	Control Arm
01/06→12/14	Track Control Arm		MN-DL-8733	Trailing Arm	

CV-ES-2119

Length: 55
Cone Ø: d1 Ø 10 / d2 Ø 10
Thread: M12 x 1,75 LHT
81953016063, 81953016131



CV-ES-2120

Length: 115
Cone Ø: d1 Ø 12,4 / d2 Ø 10,8
Thread: M14 x 1,5 RHT
03008500A, 81953016200, 81953016202,
81953016203, 81953016227



CV-ES-2182

Length: 55
Cone Ø: d1 Ø 10 / d2 Ø 10
Thread: M12 x 1,75 RHT
81953016064, 81953016170



CV-ES-12462

Length: 120
Cone Ø: d1 Ø 26 / d2 Ø 23,5
Thread: M30 x 1,5 RHT

90804102218, 90804153111, 81953010014,
81953010042, 81953010064, 81953010068,
81953016065, 81953016067, 81953016073,
81953016162, 81953016239, 81953016240,
81953016246, 81953016250, 81953016272,
81953016282, 81953016319, 81953016360,
82953016014



CV-ES-14162

Length: 125
Cone Ø: d1 Ø 30 / d2 Ø 27
Thread: M30 x 1,5 LHT

81953010015, 81953010083, 81953010087,
81953016029, 81953016030, 81953016043,
81953016044, 81953016050, 81953016054,
81953016087, 81953016091, 81953016107,
81953016120, 81953016125, 81953016152,
81953016155, 81953016157, 81953016168,
81953016179, 81953016181, 81953016223,
81953016237, 81953016254, 81953016275,
81953016279, 81953016351



CV-ES-14163

Length: 125
Cone Ø: d1 Ø 30 / d2 Ø 27
Thread: M30 x 1,5 RHT

95301.0084, 90804102156, 90804102272,
90804102696, 90804102710, 81953010016,
81953010075, 81953010084, 81953010088,
81953010094, 81953010103, 81953016030,
81953016043, 81953016048, 81953016049,
81953016053, 81953016061, 81953016090,
81953016108, 81953016112, 81953016126,
81953016143, 81953016149, 81953016154,
81953016156, 81953016168, 81953016178,
81953016194, 81953016206, 81953016224,
81953016234, 81953016242, 81953016252,
81953016274, 81953016278, 81953016284,
81953016286, 81953016308, 81953016310,
81953016312, 81953016347, 81953016350,
81953016352, 82953016012, 88953016014,
N2953016001



CV-RK-5311

638862, 639287, 938423, 1104335,
1953248, 0003500506, 3500506, 11013547,
42488722, 070550504, 634303610,
81432206055, 81432206073, 82262320660,
5001842823, 7000307001, 8226232066



DF-ES-8362

Length: 150
Cone Ø: d1 Ø 26 / d2 Ø 23,5
Thread: M30 x 1,5 RHT
81953016270



DF-RK-8503

Ø: 75
Hole Distance: 130
Thick/Height: 24
81432306061



MN-DL-2141

Length: 1689
Ø: 50
Cone Ø: d1 Ø 26 / d2 Ø 23,5
81467106862, 81467116712



MN-DL-2172

Length: 1050 Ø: 42
Cone Ø: d1 Ø 30 / d2 Ø 27
81466106374, 81466116019, 82466106080,
82466106189, 82466106190



MN-DL-7272

Length: 614
Ø: 48
Hole Distance: 130 / 130
03300300A, 81432206189



MN-DL-7786

Length: 1245
Ø: 60
Cone Ø: d1 Ø 30
81466106375, 81466106684, 81466116016,
3574602005, 3574602305



MN-DL-7797

Length: 750 Ø: 48
Hole Distance: 130 / 130
81432206099, 81432206100, 81432206185,
3573330205



MN-DL-7804

Length: 628
Ø: 40
Cone Ø: d1 Ø 30 / d2 Ø 26
81466116045



MN-DL-7808

Length: 1358
Ø: 52
Cone Ø: d1 Ø 30 / d2 Ø 27
81466106794, 81466116044, 81466116085



MN-DL-8621

Length: 1702
Ø: 50
Cone Ø: d1 Ø 30 / d2 Ø 27
81467116715



MN-DL-8733

Length: 530 Ø: 48
Hole Distance: 130 / 130
81432206161, 81432206190, 81432206358,
81432206359



MN-DL-12421

Length: 1070
Ø: 48
Cone Ø: d1 Ø 30 / d2 Ø 27
Thread: M30 x 1,5 RHT
81466106656, 81466106659, 81466106669,
81466116006, 81466116007



MN-ES-8611

Length: 168
Cone Ø: d1 Ø 30 / d2 Ø 27
Thread: M52 x 1,5 RHT
0004606748, 81953016233, 81953016255,
81953016277



MN-SB-10387

Ø: 70
Thick/Height: 85/85
81960200384



MN-TC-12400

Length: 413
Hole Distance: 80 / 80
Thick/Height: 35
81432206164, 81432206165, 81432206166,
81432206215, 81432206227, 81432206228





NM

NM 152	05/90→03/97	Ball Head, gearshift linkage	CV-ES-2119		
	05/90→03/97	Ball Head, gearshift linkage	CV-ES-2120		
	05/90→03/97	Ball Head, gearshift linkage	CV-ES-2182		
	05/90→03/97	Centre Rod	MN-DL-2141		Push Rod
	05/90→03/97	Centre Rod	MN-DL-2172		Push Rod
	05/90→03/97	Tie Rod End	CV-ES-12462		for Steering Rod
	05/90→03/97	Tie Rod End	CV-ES-14162		for Steering Rod
	05/90→03/97	Tie Rod End	CV-ES-14163		for Steering Rod
	04/92→03/97	Centre Rod	MN-DL-7786		Push Rod
	04/92→03/97	Suspension Arm Repair Kit		DF-RK-8503	for Control Arm
	04/92→03/97	Tie Rod End	DF-ES-8362		for Steering Rod
NM 182, NM 192	05/90→03/97	Ball Head, gearshift linkage	CV-ES-2120		
	05/90→03/97	Tie Rod End	CV-ES-12462		for Steering Rod
	05/90→03/97	Tie Rod End	CV-ES-14163		for Steering Rod
NM 222, NM 223	02/96→	Ball Head, gearshift linkage	CV-ES-2119		
	02/96→	Ball Head, gearshift linkage	CV-ES-2120		
	02/96→	Ball Head, gearshift linkage	CV-ES-2182		
	02/96→	Centre Rod	MN-DL-8686		Push Rod
	02/96→	Tie Rod End	CV-ES-14163		for Steering Rod
NM 223	08/87→	Ball Head, gearshift linkage	CV-ES-2119		
	08/87→	Ball Head, gearshift linkage	CV-ES-2120		
	08/87→	Ball Head, gearshift linkage	CV-ES-2182		
	08/87→	Tie Rod End	CV-ES-12462		for Steering Rod
	08/87→	Tie Rod End	CV-ES-14163		for Steering Rod
NM 283		Centre Rod	MN-DL-7804		Push Rod
		Centre Rod	MN-DL-7808		Push Rod
		Tie Rod	MN-DL-8621		
		Track Control Arm		MN-DL-7272	Trailing Arm
		Track Control Arm		MN-DL-8733	Trailing Arm
			MN-TC-12400	Control Arm	

NÜ

NÜ 263	09/96→	Ball Head, gearshift linkage	CV-ES-2120		
	09/96→	Centre Rod	MN-DL-7804		Push Rod
	09/96→	Centre Rod	MN-DL-7808		Push Rod
	09/96→	Engine Mounting	MN-SB-10387		
	09/96→	Suspension Strut Repair Kit		CV-RK-5311	
	09/96→	Tie Rod	MN-DL-8621		
	09/96→	Tie Rod End	CV-ES-14163		for Steering Rod
	09/96→	Track Control Arm		MN-DL-7272	Trailing Arm
	09/96→	Track Control Arm		MN-TC-12400	Control Arm
	06/98→	Track Control Arm		MN-DL-8733	Trailing Arm, Air Suspension Axle; Drive Axle
	NÜ 313	07/98→	Ball Head, gearshift linkage	CV-ES-2120	
07/98→		Centre Rod	MN-DL-7804		Push Rod
07/98→		Centre Rod	MN-DL-7808		Push Rod
07/98→		Engine Mounting	MN-SB-10387		
07/98→		Suspension Strut Repair Kit		CV-RK-5311	
07/98→		Tie Rod	MN-DL-8621		
07/98→		Tie Rod End	CV-ES-14163		for Steering Rod
07/98→		Track Control Arm		MN-DL-7272	Trailing Arm
07/98→		Track Control Arm		MN-DL-8733	Trailing Arm, Air Suspension Axle; Drive Axle
07/98→		Track Control Arm		MN-TC-12400	Control Arm
NÜ 313 15M	07/98→	Ball Head, gearshift linkage	CV-ES-2120		
	07/98→	Centre Rod	MN-DL-7804		Push Rod
	07/98→	Centre Rod	MN-DL-7808		Push Rod
	07/98→	Suspension Strut Repair Kit		CV-RK-5311	
	07/98→	Tie Rod		MN-DL-7802	Trailing Axle; Tag Axle
	07/98→	Tie Rod	MN-DL-8621		
	07/98→	Tie Rod End		MN-ES-8490	for vehicles with Hinged Trailing Axle
	07/98→	Track Control Arm		MN-DL-7272	Trailing Arm
	07/98→	Track Control Arm		MN-DL-8733	Trailing Arm, Air Suspension Axle; Drive Axle
	07/98→	Track Control Arm		MN-TC-12400	Control Arm

CV-ES-2119

Length: 55
Cone Ø: d1 Ø 10 / d2 Ø 10
Thread: M12 x 1,75 LHT
81953016063, 81953016131



CV-ES-2120

Length: 115
Cone Ø: d1 Ø 12,4 / d2 Ø 10,8
Thread: M14 x 1,5 RHT
03008500A, 81953016200, 81953016202,
81953016203, 81953016227



CV-ES-2182

Length: 55
Cone Ø: d1 Ø 10 / d2 Ø 10
Thread: M12 x 1,75 RHT
81953016064, 81953016170



CV-ES-12462

Length: 120
Cone Ø: d1 Ø 26 / d2 Ø 23,5
Thread: M30 x 1,5 RHT

90804102218, 90804153111, 81953010014,
81953010042, 81953010064, 81953010068,
81953016065, 81953016067, 81953016073,
81953016162, 81953016239, 81953016240,
81953016246, 81953016250, 81953016272,
81953016282, 81953016319, 81953016360,
82953016014



CV-ES-14162

Length: 125
Cone Ø: d1 Ø 30 / d2 Ø 27
Thread: M30 x 1,5 LHT

81953010015, 81953010083, 81953010087,
81953016029, 81953016030, 81953016043,
81953016044, 81953016050, 81953016054,
81953016087, 81953016091, 81953016107,
81953016120, 81953016125, 81953016152,
81953016155, 81953016157, 81953016168,
81953016179, 81953016181, 81953016223,
81953016237, 81953016254, 81953016275,
81953016279, 81953016351



CV-ES-14163

Length: 125
Cone Ø: d1 Ø 30 / d2 Ø 27
Thread: M30 x 1,5 RHT

95301.0084, 90804102156, 90804102272,
90804102696, 90804102710, 81953010016,
81953010075, 81953010084, 81953010088,
81953010094, 81953010103, 81953016030,
81953016043, 81953016048, 81953016049,
81953016053, 81953016061, 81953016090,
81953016108, 81953016112, 81953016126,
81953016143, 81953016149, 81953016154,
81953016156, 81953016168, 81953016178,
81953016194, 81953016206, 81953016224,
81953016234, 81953016242, 81953016252,
81953016274, 81953016278, 81953016284,
81953016286, 81953016308, 81953016310,
81953016312, 81953016347, 81953016350,
81953016352, 82953016012, 88953016014,
N2953016001



CV-RK-5311

638862, 639287, 938423, 1104335,
1953248, 0003500506, 3500506, 11013547,
42488722, 070550504, 634303610,
81432206055, 81432206073, 82262320660,
5001842823, 7000307001, 8226232066



DF-ES-8362

Length: 150
Cone Ø: d1 Ø 26 / d2 Ø 23,5
Thread: M30 x 1,5 RHT
81953016270



DF-RK-8503

Ø: 75
Hole Distance: 130
Thick/Height: 24
81432306061



MN-DL-2141

Length: 1689
Ø: 50
Cone Ø: d1 Ø 26 / d2 Ø 23,5
81467106862, 81467116712



MN-DL-2172

Length: 1050 Ø: 42
Cone Ø: d1 Ø 30 / d2 Ø 27
81466106374, 81466116019, 82466106080,
82466106189, 82466106190



MN-DL-7272

Length: 614
Ø: 48
Hole Distance: 130 / 130
03300300A, 81432206189



MN-DL-7786

Length: 1245
Ø: 60
Cone Ø: d1 Ø 30
81466106375, 81466106684, 81466116016,
3574602005, 3574602305



MN-DL-7802

Length: 1680 Ø: 52
Cone Ø: d1 Ø 30 / d2 Ø 27
03208300A, 81467116773, 81467116858,
81467116859, 81467116860, 81467116861,
81467116863, 81467116882, 81467116883,
81467116920, 81467116921



MN-DL-7804

Length: 628
Ø: 40
Cone Ø: d1 Ø 30 / d2 Ø 26
81466116045



MN-DL-7808

Length: 1358
Ø: 52
Cone Ø: d1 Ø 30 / d2 Ø 27
81466106794, 81466116044, 81466116085



MN-DL-8621

Length: 1702
Ø: 50
Cone Ø: d1 Ø 30 / d2 Ø 27
81467116715



MN-DL-8686

Length: 1375
Ø: 40
Cone Ø: d1 Ø 30 / d2 Ø 26
81466106654, 81466116061



MN-DL-8733

Length: 530 Ø: 48
Hole Distance: 130 / 130
81432206161, 81432206190, 81432206358,
81432206359



MN-ES-8490

Length: 90
Cone Ø: d1 Ø 30 / d2 Ø 27
Thread: M26 x 1,5 RHT
0014606948, 14606948, 81953016281,
81953016337, 82953016016



MN-SB-10387

Ø: 70
Thick/Height: 85/85
81960200384



MN-TC-12400

Length: 413
Hole Distance: 80 / 80
Thick/Height: 35
81432206164, 81432206165, 81432206166,
81432206215, 81432206227, 81432206228





NÜ ...

NÜ 353 15M	07/98→	Ball Head, gearshift linkage	CV-ES-2120		
	07/98→	Centre Rod	MN-DL-7804		Push Rod
	07/98→	Centre Rod	MN-DL-7808		Push Rod
	07/98→	Suspension Strut Repair Kit		CV-RK-5311	
	07/98→	Tie Rod		MN-DL-7802	Trailing Axle; Tag Axle
	07/98→	Tie Rod	MN-DL-8621		
	07/98→	Tie Rod End		MN-ES-8490	for vehicles with Hinged Trailing Axle
	07/98→	Track Control Arm		MN-DL-7272	Trailing Arm
	07/98→	Track Control Arm		MN-DL-8733	Trailing Arm, Air Suspension Axle; Drive Axle
07/98→	Track Control Arm		MN-TC-12400	Control Arm	

R

FRH 362	05/85→12/92	Ball Head, gearshift linkage	CV-ES-2120		
	05/85→12/92	Track Control Arm	MN-DL-9368	MN-DL-9368	Trailing Arm
R 292, FR 292, FRH 292	05/85→01/93	Ball Head, gearshift linkage	CV-ES-2120		

SD

SD 200	10/75→12/86	Ball Head, gearshift linkage	CV-ES-2120		
SD 202	10/85→04/94	Ball Head, gearshift linkage	CV-ES-2120		
	10/85→04/94	Track Control Arm	MN-DL-7272	MN-DL-7272	Trailing Arm

SG

SG 220	07/76→01/85	Ball Head, gearshift linkage	CV-ES-2119			
	07/76→01/85	Ball Head, gearshift linkage	CV-ES-2120			
	07/76→01/85	Ball Head, gearshift linkage	CV-ES-2182			
	07/76→01/85	Centre Rod	MN-DL-2293		Push Rod	
	07/76→01/85	Tie Rod End	CV-ES-14162		for Steering Rod	
	07/76→01/85	Tie Rod End	CV-ES-14163		for Steering Rod	
SG 220, SG 240 HÜ, SG 242 H	05/80→01/86	Control Arm-/Trailing Arm Bush	MN-SB-9399	MN-SB-9399		
	05/80→01/86	Ball Head, gearshift linkage	CV-ES-2119			
	05/80→01/86	Ball Head, gearshift linkage	CV-ES-2120			
	05/80→01/86	Ball Head, gearshift linkage	CV-ES-2182			
	05/80→01/86	Centre Rod	MN-DL-2293		Push Rod	
	05/80→01/86	Control Arm-/Trailing Arm Bush	MN-SB-9399	MN-SB-9399		
SG 240 H, SG 242, SG 242 H	05/80→01/86	Tie Rod End	CV-ES-14162		for Steering Rod	
	05/80→01/86	Tie Rod End	CV-ES-14163		for Steering Rod	
	SG 240 H, SG 292 H	09/85→04/94	Ball Head, gearshift linkage	CV-ES-2119		
		09/85→04/94	Ball Head, gearshift linkage	CV-ES-2120		
		09/85→04/94	Ball Head, gearshift linkage	CV-ES-2182		
		09/85→04/94	Centre Rod	MN-DL-2293		Push Rod
09/85→04/94		Control Arm-/Trailing Arm Bush	MN-SB-9399	MN-SB-9399		
09/85→04/94		Tie Rod End	CV-ES-14162		for Steering Rod	
SG 240 H, SG 292 H	09/85→04/94	Tie Rod End	CV-ES-14163		for Steering Rod	
	11/84→09/89	Ball Head, gearshift linkage	CV-ES-2119			
	11/84→09/89	Ball Head, gearshift linkage	CV-ES-2120			
	11/84→09/89	Ball Head, gearshift linkage	CV-ES-2182			
	11/84→09/89	Centre Rod	MN-DL-2293		Push Rod	
	11/84→09/89	Control Arm-/Trailing Arm Bush	MN-SB-9399	MN-SB-9399		
SG 240 HÜ	11/84→09/89	Tie Rod End	CV-ES-14162		for Steering Rod	
	11/84→09/89	Tie Rod End	CV-ES-14163		for Steering Rod	
	SG 242, SG 292	09/81→01/86	Ball Head, gearshift linkage	CV-ES-2119		
		09/81→01/86	Ball Head, gearshift linkage	CV-ES-2120		
		09/81→01/86	Ball Head, gearshift linkage	CV-ES-2182		
		09/81→01/86	Centre Rod	MN-DL-2293		Push Rod
09/81→01/86		Control Arm-/Trailing Arm Bush	MN-SB-9399	MN-SB-9399		
09/81→01/86		Tie Rod End	CV-ES-14162		for Steering Rod	
SG 242, SG 292	09/81→01/86	Tie Rod End	CV-ES-14163		for Steering Rod	
	09/85→04/94	Ball Head, gearshift linkage	CV-ES-2119			
	09/85→04/94	Ball Head, gearshift linkage	CV-ES-2120			
	09/85→04/94	Ball Head, gearshift linkage	CV-ES-2182			
	09/85→04/94	Centre Rod	MN-DL-2293		Push Rod	
	09/85→04/94	Control Arm-/Trailing Arm Bush	MN-SB-9399			
09/85→04/94	Tie Rod End	CV-ES-14162		for Steering Rod		
09/85→04/94	Tie Rod End	CV-ES-14163		for Steering Rod		

CV-ES-2119

Length: 55
Cone Ø: d1 Ø 10 / d2 Ø 10
Thread: M12 x 1,75 LHT
81953016063, 81953016131



CV-ES-2120

Length: 115
Cone Ø: d1 Ø 12,4 / d2 Ø 10,8
Thread: M14 x 1,5 RHT
03008500A, 81953016200, 81953016202,
81953016203, 81953016227



CV-ES-2182

Length: 55
Cone Ø: d1 Ø 10 / d2 Ø 10
Thread: M12 x 1,75 RHT
81953016064, 81953016170



CV-ES-14162

Length: 125
Cone Ø: d1 Ø 30 / d2 Ø 27
Thread: M30 x 1,5 LHT
81953010015, 81953010083, 81953010087,
81953016029, 81953016030, 81953016043,
81953016044, 81953016050, 81953016054,
81953016087, 81953016091, 81953016107,
81953016120, 81953016125, 81953016152,
81953016155, 81953016157, 81953016168,
81953016179, 81953016181, 81953016223,
81953016237, 81953016254, 81953016275,
81953016279, 81953016351



CV-ES-14163

Length: 125
Cone Ø: d1 Ø 30 / d2 Ø 27
Thread: M30 x 1,5 RHT
95301.0084, 90804102156, 90804102272,
90804102696, 90804102710, 81953010016,
81953010075, 81953010084, 81953010088,
81953010094, 81953010103, 81953016030,
81953016043, 81953016048, 81953016049,
81953016053, 81953016061, 81953016090,
81953016108, 81953016112, 81953016126,
81953016143, 81953016149, 81953016154,
81953016156, 81953016168, 81953016178,
81953016194, 81953016206, 81953016224,
81953016234, 81953016242, 81953016252,
81953016274, 81953016278, 81953016284,
81953016286, 81953016308, 81953016310,
81953016312, 81953016347, 81953016350,
81953016352, 82953016012, 88953016014,
N2953016001



CV-RK-5311

638862, 639287, 938423, 1104335,
1953248, 0003500506, 3500506, 11013547,
42488722, 070550504, 634303610,
81432206055, 81432206073, 82262320660,
5001842823, 7000307001, 8226232066



MN-DL-2293

Length: 729
Ø: 40
Cone Ø: d1 Ø 30 / d2 Ø 27
81467106081, 81467106137



MN-DL-7272

Length: 614
Ø: 48
Hole Distance: 130 / 130
03300300A, 81432206189



MN-DL-7802

Length: 1680 Ø: 52
Cone Ø: d1 Ø 30 / d2 Ø 27
03208300A, 81467116773, 81467116858,
81467116859, 81467116860, 81467116861,
81467116863, 81467116882, 81467116883,
81467116920, 81467116921



MN-DL-7804

Length: 628
Ø: 40
Cone Ø: d1 Ø 30 / d2 Ø 26
81466116045



MN-DL-7808

Length: 1358
Ø: 52
Cone Ø: d1 Ø 30 / d2 Ø 27
81466106794, 81466116044, 81466116085



MN-DL-8621

Length: 1702
Ø: 50
Cone Ø: d1 Ø 30 / d2 Ø 27
81467116715



MN-DL-8733

Length: 530 Ø: 48
Hole Distance: 130 / 130
81432206161, 81432206190, 81432206358,
81432206359



MN-DL-9368

Length: 330
Ø: 36
Hole Distance: 80
81432206177



MN-ES-8490

Length: 90
Cone Ø: d1 Ø 30 / d2 Ø 27
Thread: M26 x 1,5 RHT
0014606948, 14606948, 81953016281,
81953016337, 82953016016



MN-SB-9399

Ø: 75
Thick/Height: 83 / 83
81432710033



MN-TC-12400

Length: 413
Hole Distance: 80 / 80
Thick/Height: 35
81432206164, 81432206165, 81432206166,
81432206215, 81432206227, 81432206228



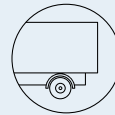

SG ...

SG 312,SG 322	02/94→06/97	Ball Head, gearshift linkage	CV-ES-2119		
	02/94→06/97	Ball Head, gearshift linkage	CV-ES-2120		
	02/94→06/97	Ball Head, gearshift linkage	CV-ES-2182		
	02/94→06/97	Centre Rod	MN-DL-2293		Push Rod
	02/94→06/97	Control Arm-/Trailing Arm Bush	MN-SB-9399		
	02/94→06/97	Tie Rod End	CV-ES-14162		for Steering Rod
	02/94→06/97	Tie Rod End	CV-ES-14163		for Steering Rod

SL

SL 200	05/80→04/87	Ball Head, gearshift linkage	CV-ES-2119		
	05/80→04/87	Ball Head, gearshift linkage	CV-ES-2120		
	05/80→04/87	Ball Head, gearshift linkage	CV-ES-2182		
	05/80→04/87	Centre Rod	MN-DL-2293		Push Rod
	05/80→04/87	Control Arm-/Trailing Arm Bush	MN-SB-9399	MN-SB-9399	
	05/80→04/87	Tie Rod End	CV-ES-14162		for Steering Rod
	05/80→04/87	Tie Rod End	CV-ES-14163		for Steering Rod

SL II

SL 202	06/84→04/94	Ball Head, gearshift linkage	CV-ES-2119		
	06/84→04/94	Ball Head, gearshift linkage	CV-ES-2120		
	06/84→04/94	Ball Head, gearshift linkage	CV-ES-2182		
	06/84→04/94	Centre Rod	MN-DL-2293		Push Rod
	06/84→04/94	Control Arm-/Trailing Arm Bush	MN-SB-9399	MN-SB-9399	
	06/84→04/94	Tie Rod End	CV-ES-14162		for Steering Rod
	06/84→04/94	Tie Rod End	CV-ES-14163		for Steering Rod
SL 283		Tie Rod End	CV-ES-14163		for Steering Rod
SL 353		Tie Rod End	CV-ES-14163		for Steering Rod
SL 363		Tie Rod End	CV-ES-14163		for Steering Rod

SM

SM 152	11/87→04/94	Ball Head, gearshift linkage	CV-ES-2120		
	11/87→04/94	Tie Rod End	CV-ES-12462		for Steering Rod
	11/87→04/94	Tie Rod End	CV-ES-14163		for Steering Rod
SM 182,SM 192	11/87→02/95	Ball Head, gearshift linkage	CV-ES-2120		
	11/87→02/95	Tie Rod End	CV-ES-12462		for Steering Rod
	11/87→02/95	Tie Rod End	CV-ES-14163		for Steering Rod

SR

SR 240	10/75→06/83	Ball Head, gearshift linkage	CV-ES-2119		
	10/75→06/83	Ball Head, gearshift linkage	CV-ES-2120		
	10/75→06/83	Ball Head, gearshift linkage	CV-ES-2182		
	10/75→06/83	Centre Rod	MN-DL-2293		Push Rod
	10/75→06/83	Tie Rod End	CV-ES-14162		for Steering Rod
	10/75→06/83	Tie Rod End	CV-ES-14163		for Steering Rod
SR 280,SR 280 H	01/77→11/86	Ball Head, gearshift linkage	CV-ES-2119		
	01/77→11/86	Ball Head, gearshift linkage	CV-ES-2120		
	01/77→11/86	Ball Head, gearshift linkage	CV-ES-2182		
	01/77→11/86	Centre Rod	MN-DL-2293		Push Rod
	01/77→11/86	Tie Rod End	CV-ES-14162		for Steering Rod
	01/77→11/86	Tie Rod End	CV-ES-14163		for Steering Rod
SR 321 H	03/82→11/86	Ball Head, gearshift linkage	CV-ES-2119		
	03/82→11/86	Ball Head, gearshift linkage	CV-ES-2120		
	03/82→11/86	Ball Head, gearshift linkage	CV-ES-2182		
	03/82→11/86	Centre Rod	MN-DL-2293		Push Rod
	03/82→11/86	Tie Rod End	CV-ES-14162		for Steering Rod
	03/82→11/86	Tie Rod End	CV-ES-14163		for Steering Rod

sü

SÜ 240	10/75→09/89	Ball Head, gearshift linkage	CV-ES-2119		
	10/75→09/89	Ball Head, gearshift linkage	CV-ES-2120		
	10/75→09/89	Ball Head, gearshift linkage	CV-ES-2182		
	10/75→09/89	Centre Rod	MN-DL-2293		Push Rod
	10/75→09/89	Control Arm-/Trailing Arm Bush		MN-SB-9399	
	10/75→09/89	Suspension Arm Repair Kit		DB-RK-7267	for Drag Link
	10/75→09/89	Tie Rod End	CV-ES-14162		for Steering Rod

CV-ES-2119

Length: 55
Cone Ø: d1 Ø 10 / d2 Ø 10
Thread: M12 x 1,75 LHT
81953016063, 81953016131



CV-ES-2120

Length: 115
Cone Ø: d1 Ø 12,4 / d2 Ø 10,8
Thread: M14 x 1,5 RHT
03008500A, 81953016200, 81953016202,
81953016203, 81953016227



CV-ES-2182

Length: 55
Cone Ø: d1 Ø 10 / d2 Ø 10
Thread: M12 x 1,75 RHT
81953016064, 81953016170



CV-ES-12462

Length: 120
Cone Ø: d1 Ø 26 / d2 Ø 23,5
Thread: M30 x 1,5 RHT
90804102218, 90804153111, 81953010014,
81953010042, 81953010064, 81953010068,
81953016065, 81953016067, 81953016073,
81953016162, 81953016239, 81953016240,
81953016246, 81953016250, 81953016272,
81953016282, 81953016319, 81953016360,
82953016014



CV-ES-14162

Length: 125
Cone Ø: d1 Ø 30 / d2 Ø 27
Thread: M30 x 1,5 LHT
81953010015, 81953010083, 81953010087,
81953016029, 81953016030, 81953016043,
81953016044, 81953016050, 81953016054,
81953016087, 81953016091, 81953016107,
81953016120, 81953016125, 81953016152,
81953016155, 81953016157, 81953016168,
81953016179, 81953016181, 81953016223,
81953016237, 81953016254, 81953016275,
81953016279, 81953016351



CV-ES-14163

Length: 125
Cone Ø: d1 Ø 30 / d2 Ø 27
Thread: M30 x 1,5 RHT
95301.0084, 90804102156, 90804102272,
90804102696, 90804102710, 81953010016,
81953010075, 81953010084, 81953010088,
81953010094, 81953010103, 81953016030,
81953016043, 81953016048, 81953016049,
81953016053, 81953016061, 81953016090,
81953016108, 81953016112, 81953016126,
81953016143, 81953016149, 81953016154,
81953016156, 81953016168, 81953016178,
81953016194, 81953016206, 81953016224,
81953016234, 81953016242, 81953016252,
81953016274, 81953016278, 81953016284,
81953016286, 81953016308, 81953016310,
81953016312, 81953016347, 81953016350,
81953016352, 82953016012, 88953016014,
N2953016001



DB-RK-7267

Ø: 95
Hole Distance: 152
Thick/Height: 24
81432706040, 81432706045



MN-DL-2293

Length: 729
Ø: 40
Cone Ø: d1 Ø 30 / d2 Ø 27
81467106081, 81467106137



MN-SB-9399

Ø: 75
Thick/Height: 83 / 83
81432710033



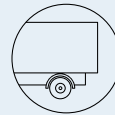

SÜ ...

SÜ 240 ...	10/75→09/89	Tie Rod End	CV-ES-14163		for Steering Rod
	01/86→09/89	Control Arm-/Trailing Arm Bush	MN-SB-9399	MN-SB-9399	
SÜ 242	01/87→04/93	Ball Head, gearshift linkage	CV-ES-2119		
	01/87→04/93	Ball Head, gearshift linkage	CV-ES-2120		
	01/87→04/93	Ball Head, gearshift linkage	CV-ES-2182		
	01/87→04/93	Centre Rod	MN-DL-2293		Push Rod
	01/87→04/93	Tie Rod End	CV-ES-14162		for Steering Rod
	01/87→04/93	Tie Rod End	CV-ES-14163		for Steering Rod
SÜ 243	06/05→10/09	Centre Rod	MN-DL-10314		Push Rod
SÜ 263	09/03→	Tie Rod End	CV-ES-14163		for Steering Rod
	06/05→10/09	Centre Rod	MN-DL-10314		Push Rod
SÜ 272	04/93→05/95	Ball Head, gearshift linkage	CV-ES-2119		
	04/93→05/95	Ball Head, gearshift linkage	CV-ES-2120		
	04/93→05/95	Ball Head, gearshift linkage	CV-ES-2182		
	04/93→05/95	Centre Rod	MN-DL-2293		Push Rod
	04/93→05/95	Tie Rod End	CV-ES-14162		for Steering Rod
	04/93→05/95	Tie Rod End	CV-ES-14163		for Steering Rod
	01/06→10/09	Centre Rod	MN-DL-10314		Push Rod
SÜ 273	01/06→10/09	Tie Rod End	CV-ES-14163		for Steering Rod
	09/03→	Centre Rod	MN-DL-10314		Push Rod
SÜ 283	09/03→	Tie Rod End	CV-ES-14163		for Steering Rod
	04/92→04/93	Ball Head, gearshift linkage	CV-ES-2120		
SÜ 292	09/03→	Centre Rod	MN-DL-10314		Push Rod
SÜ 293	09/03→	Tie Rod End	CV-ES-14163		for Steering Rod
	09/03→	Centre Rod	MN-DL-10314		Push Rod
SÜ 313	09/03→	Tie Rod End	CV-ES-14163		for Steering Rod
	09/03→	Centre Rod	MN-DL-10314		Push Rod
SÜ 320	09/03→	Tie Rod End	CV-ES-14163		for Steering Rod
	09/03→	Centre Rod	MN-DL-10314		Push Rod
SÜ 322	05/95→06/97	Ball Head, gearshift linkage	CV-ES-2119		
	05/95→06/97	Ball Head, gearshift linkage	CV-ES-2120		
	05/95→06/97	Ball Head, gearshift linkage	CV-ES-2182		
	05/95→06/97	Centre Rod	MN-DL-2293		Push Rod
	05/95→06/97	Tie Rod End	CV-ES-14162		for Steering Rod
	05/95→06/97	Tie Rod End	CV-ES-14163		for Steering Rod
	01/06→10/09	Centre Rod	MN-DL-10314		Push Rod
SÜ 353	01/06→10/09	Tie Rod End	CV-ES-14163		for Steering Rod
	05/07→	Centre Rod	MN-DL-10314		Push Rod
SÜ 360	05/07→	Tie Rod End	CV-ES-14163		for Steering Rod

TGA

18.310 FAC, FARC	09/02→	Ball Head, gearshift linkage	CV-ES-2120		
	09/02→	Centre Rod	MN-DL-8646		Push Rod, Leaf Spring Axle
	09/02→	Tie Rod End	CV-ES-14162		for Steering Rod
	09/02→	Tie Rod End	CV-ES-14163		for Steering Rod
	09/02→	Tie Rod End	MN-ES-10333		for Steering Rod
	09/02→	Track Control Arm		MN-DL-5225	Trailing Arm
	18.310 FAK, FAK-L, FALK, FALK-L, FHLK	09/02→	Ball Head, gearshift linkage	CV-ES-2120	
09/02→		Centre Rod	MN-DL-8646		Push Rod, Leaf Spring Axle
09/02→		Tie Rod End	CV-ES-0914		for Steering Rod
09/02→		Tie Rod End	CV-ES-14162		for Steering Rod
09/02→		Tie Rod End	CV-ES-14163		for Steering Rod
09/02→		Tie Rod End	MN-ES-10333		for Steering Rod
09/02→		Tie Rod End	SC-ES-8517		for Push Rod
09/02→		Track Control Arm		MN-DL-5225	Trailing Arm
09/02→		Track Control Arm		MN-DL-8544	Trailing Arm
09/02→		Track Control Arm		MN-VB-8514	Suspension Rod, Wishbone (CV)
18.310 FALS, FARS, FAS	09/02→	Ball Head, gearshift linkage	CV-ES-2120		
	09/02→	Centre Rod	MN-DL-8646		Push Rod, Leaf Spring Axle
	09/02→	Tie Rod End	CV-ES-0914		for Steering Rod
	09/02→	Tie Rod End	CV-ES-14162		for Steering Rod
	09/02→	Tie Rod End	CV-ES-14163		for Steering Rod
	09/02→	Tie Rod End	MN-ES-10333		for Steering Rod
	09/02→	Tie Rod End	SC-ES-8517		for Push Rod

CV-ES-0914

Length: 125
Cone Ø: d1 Ø 30 / d2 Ø 27
Thread: M38 x 1,5 RHT
81953016184, 81953016251, 81953016276



CV-ES-2119

Length: 55
Cone Ø: d1 Ø 10 / d2 Ø 10
Thread: M12 x 1,75 LHT
81953016063, 81953016131



CV-ES-2120

Length: 115
Cone Ø: d1 Ø 12,4 / d2 Ø 10,8
Thread: M14 x 1,5 RHT
03008500A, 81953016200, 81953016202,
81953016203, 81953016227



CV-ES-2182

Length: 55
Cone Ø: d1 Ø 10 / d2 Ø 10
Thread: M12 x 1,75 RHT
81953016064, 81953016170



CV-ES-14162

Length: 125
Cone Ø: d1 Ø 30 / d2 Ø 27
Thread: M30 x 1,5 LHT
81953010015, 81953010083, 81953010087,
81953016029, 81953016030, 81953016043,
81953016044, 81953016050, 81953016054,
81953016087, 81953016091, 81953016107,
81953016120, 81953016125, 81953016152,
81953016155, 81953016157, 81953016168,
81953016179, 81953016181, 81953016223,
81953016237, 81953016254, 81953016275,
81953016279, 81953016351



CV-ES-14163

Length: 125
Cone Ø: d1 Ø 30 / d2 Ø 27
Thread: M30 x 1,5 RHT
95301.0084, 90804102156, 90804102272,
90804102696, 90804102710, 81953010016,
81953010075, 81953010084, 81953010088,
81953010094, 81953010103, 81953016030,
81953016043, 81953016048, 81953016049,
81953016053, 81953016061, 81953016090,
81953016108, 81953016112, 81953016126,
81953016143, 81953016149, 81953016154,
81953016156, 81953016168, 81953016178,
81953016194, 81953016206, 81953016224,
81953016234, 81953016242, 81953016252,
81953016274, 81953016278, 81953016284,
81953016286, 81953016308, 81953016310,
81953016312, 81953016347, 81953016350,
81953016352, 82953016012, 88953016014,
N2953016001



MN-DL-2293

Length: 729
Ø: 40
Cone Ø: d1 Ø 30 / d2 Ø 27
81467106081, 81467106137



MN-DL-5225

Length: 572 Ø: 48
Hole Distance: 130 / 130
03301500A, 81432206229, 81432206236,
81432206267, 81432206270, 81432206272,
81432206304, 81432206305, 81432209236,
81432209267, 81432209272



MN-DL-8544

Length: 596 Ø: 48
Hole Distance: 130 / 130
81432206196, 81432206232, 81432206233



MN-DL-8646

Length: 1021 Ø: 52
Cone Ø: d1 Ø 30 / d2 Ø 27
81466106811, 81466106812, 81466116138,
81466116139, 81466116201, 81466116202



MN-DL-10314

Length: 1103
Ø: 50
Cone Ø: d1 Ø 30 / d2 Ø 27
81466116217, 83466106001, 83466106501,
36466106012, 36466106040



MN-ES-10333

Length: 90
Cone Ø: d1 Ø 38 / d2 Ø 34,35
Thread: M36 x 1,5 RHT
1271126, 3090291, 3099128, 42538048,
81953016268, 82953016018, 82953016019



MN-SB-9399

Ø: 75
Thick/Height: 83 / 83
81432710033



MN-VB-8514

Length: 627 Ø: 48
Hole Ø 25 / 25 / 25
Hole Distance: 152 / 130 / 130
81432706087, 81432706088, 81432706094,
81432706095, 81432796094



SC-ES-8517

Length: 140
Cone Ø: d1 Ø 30 / d2 Ø 27
Thread: M30 x 1,5 RHT
81953016286





TGA ...

18.310 FALS, FARS, FAS ...	09/02→	Track Control Arm		MN-DL-5225	Trailing Arm	
	09/02→	Track Control Arm		MN-DL-8544	Trailing Arm, Drive Axle, for Pneumatic Suspension vehicles	
	09/02→	Track Control Arm		MN-VB-8514	Suspension Rod, Wishbone (CV), 1st Drive Axle, for Pneumatic Suspension vehicles	
18.310 FLLRS, FLLS, FLRS, FLS, FLS-TS	04/00→	Ball Head, gearshift linkage	CV-ES-2120			
	04/00→	Centre Rod	MN-DL-7801		Push Rod, Leaf Spring Axle	
	04/00→	Centre Rod	MN-DL-8560		Push Rod, Air Suspension Axle	
	04/00→	Centre Rod	MN-DL-14107		Push Rod	
	04/00→	Suspension Strut Repair Kit		DB-RK-8581		
	04/00→	Suspension Strut Repair Kit		MN-RK-12436		
	04/00→	Tie Rod	MN-DL-7802			
	04/00→	Tie Rod End		MN-ES-8490	Tag Axle	
	04/00→	Tie Rod End	CV-ES-0914		for Steering Rod	
	04/00→	Tie Rod End	CV-ES-14162		for Steering Rod	
	04/00→	Tie Rod End	CV-ES-14163		for Steering Rod	
	04/00→	Tie Rod End	IV-ES-12272		for Steering Rod	
	04/00→	Tie Rod End	SC-ES-7279		for Steering Rod	
	04/00→	Tie Rod End	SC-ES-8517		for Push Rod	
	04/00→	Tie Rod End	SC-ES-8535		for Guide Rod	
	04/00→	Track Control Arm		MN-DL-5225	Trailing Arm, Drive Axle;Air Suspension Axle	
	04/00→	Track Control Arm		MN-DL-8488	Trailing Arm;for Wishbone (CV), Air Suspension Axle	
	04/00→	Track Control Arm		MN-DL-8544	Trailing Arm, Drive Axle;Air Suspension Axle	
	04/00→	Track Control Arm		MN-DL-8709	Trailing Arm, Drive Axle;Air Suspension Axle	
	04/00→	Track Control Arm		MN-DL-8733	Trailing Arm, Air Suspension Axle;Drive Axle	
	04/00→	Track Control Arm		MN-TC-12399	Control Arm	
	04/00→	Track Control Arm		MN-VB-5238	Wishbone (CV), Drive Axle;Air Suspension Axle	
	04/00→	Track Control Arm		MN-VB-8514	Suspension Rod, Wishbone (CV), Drive Axle; Air Suspension Axle	
	04/00→	Track Control Arm		MN-VB-8514	Suspension Rod, Wishbone (CV), Drive Axle; Leaf Spring Axle	
	04/00→	Track Control Arm	MN-DL-8663		Control Arm, Air Suspension Axle	
	06/02→	Track Control Arm		MN-VB-8669	Suspension Rod, Wishbone (CV), Drive Axle	
	18.310, 18.320 FAC, FARC, FHLC	05/04→	Ball Head, gearshift linkage	CV-ES-2120		
		05/04→	Centre Rod	MN-DL-7801		Push Rod, Leaf Spring Axle
		05/04→	Centre Rod	MN-DL-8646		Push Rod, Leaf Spring Axle
		05/04→	Suspension Strut Repair Kit		DB-RK-8581	
		05/04→	Tie Rod	MN-DL-7802		
		05/04→	Tie Rod End	CV-ES-0914		for Steering Rod
		05/04→	Tie Rod End	CV-ES-14162		for Steering Rod
05/04→		Tie Rod End	CV-ES-14163		for Steering Rod	
05/04→		Tie Rod End	MN-ES-10333		for Steering Rod	
05/04→		Tie Rod End	SC-ES-7279		for Steering Rod	
05/04→		Tie Rod End	SC-ES-8517		for Push Rod	
05/04→		Tie Rod End	SC-ES-8535		for Guide Rod	
05/04→		Track Control Arm		MN-DL-5225	Trailing Arm, Drive Axle;Air Suspension Axle	
05/04→		Track Control Arm		MN-DL-5225	Trailing Arm, Leading Axle;Air Suspension Axle	
05/04→		Track Control Arm		MN-DL-8544	Trailing Arm, Drive Axle;Air Suspension Axle	
05/04→		Track Control Arm		MN-VB-5238	Wishbone (CV), Drive Axle;Air Suspension Axle	
05/04→		Track Control Arm		MN-VB-5238	Wishbone (CV), Leading Axle;Air Suspension Axle	
05/04→		Track Control Arm		MN-VB-8514	Suspension Rod, Wishbone (CV), Drive Axle; Air Suspension Axle	
18.310, 18.320 FAK, FAK-L, FALK, FALK-L, FHLC	05/04→	Ball Head, gearshift linkage	CV-ES-2120			
	05/04→	Centre Rod	MN-DL-7801		Push Rod, Leaf Spring Axle	
	05/04→	Centre Rod	MN-DL-8646		Push Rod, Leaf Spring Axle	
	05/04→	Suspension Strut Repair Kit		DB-RK-8581		
	05/04→	Tie Rod	MN-DL-7802			
	05/04→	Tie Rod End	CV-ES-0914		for Steering Rod	
	05/04→	Tie Rod End	CV-ES-14162		for Steering Rod	
	05/04→	Tie Rod End	CV-ES-14163		for Steering Rod	

CV-ES-0914

Length: 125
Cone Ø: d1 Ø 30 / d2 Ø 27
Thread: M38 x 1,5 RHT
81953016184, 81953016251, 81953016276



CV-ES-2120

Length: 115
Cone Ø: d1 Ø 12,4 / d2 Ø 10,8
Thread: M14 x 1,5 RHT
03008500A, 81953016200, 81953016202,
81953016203, 81953016227



CV-ES-14162

Length: 125
Cone Ø: d1 Ø 30 / d2 Ø 27
Thread: M30 x 1,5 LHT
81953010015, 81953010083, 81953010087,
81953016029, 81953016030, 81953016043,
81953016044, 81953016050, 81953016054,
81953016087, 81953016091, 81953016107,
81953016120, 81953016125, 81953016152,
81953016155, 81953016157, 81953016168,
81953016179, 81953016181, 81953016223,
81953016237, 81953016254, 81953016275,
81953016279, 81953016351



CV-ES-14163

Length: 125
Cone Ø: d1 Ø 30 / d2 Ø 27
Thread: M30 x 1,5 RHT
95301.0084, 90804102156, 90804102272,
90804102696, 90804102710, 81953010016,
81953010075, 81953010084, 81953010088,
81953010094, 81953010103, 81953016030,
81953016043, 81953016048, 81953016049,
81953016053, 81953016061, 81953016090,
81953016108, 81953016112, 81953016126,
81953016143, 81953016149, 81953016154,
81953016156, 81953016168, 81953016178,
81953016194, 81953016206, 81953016224,
81953016234, 81953016242, 81953016252,
81953016274, 81953016278, 81953016284,
81953016286, 81953016308, 81953016310,
81953016312, 81953016347, 81953016350,
81953016352, 82953016012, 88953016014,
N2953016001



DB-RK-8581

Ø: 85
Hole Distance: 130
Thick/Height: 24
03305800A, 81432706105



IV-ES-12272

Length: 75
Cone Ø: d1 Ø 30 / d2 Ø 27
Thread: M26 x 1,5 RHT
81953016280, 82953010010



MN-DL-5225

Length: 572 Ø: 48
Hole Distance: 130 / 130
03301500A, 81432206229, 81432206236,
81432206267, 81432206270, 81432206272,
81432206304, 81432206305, 81432209232,
81432209267, 81432209272



MN-DL-7801

Length: 995 Ø: 52
Cone Ø: d1 Ø 30 / d2 Ø 27
81466106807, 81466106808, 81466116087,
81466116088, 81466116096, 81466116097,
81466116099, 81466116132, 81466116133,
81466116136, 81466116197, 81466116198,
81466116205



MN-DL-7802

Length: 1680 Ø: 52
Cone Ø: d1 Ø 30 / d2 Ø 27
03208300A, 81467116773, 81467116858,
81467116859, 81467116860, 81467116861,
81467116863, 81467116882, 81467116883,
81467116920, 81467116921



MN-DL-8488

Length: 414 Ø: 50
Hole Distance: 130 / 130
81432206247, 81432206341, 81432206342



MN-DL-8544

Length: 596 Ø: 48
Hole Distance: 130 / 130
81432206196, 81432206232, 81432206233



MN-DL-8560

Length: 970 Ø: 52
Cone Ø: d1 Ø 30 / d2 Ø 27
03206900A, 81466106809, 81466106810,
81466106823, 81466106838, 81466106839,
81466116104, 81466116105, 81466116107,
81466116134, 81466116135, 81466116137,
81466116199, 81466116200, 81466116206



MN-DL-8646

Length: 1021 Ø: 52
Cone Ø: d1 Ø 30 / d2 Ø 27
81466106811, 81466106812, 81466116138,
81466116139, 81466116201, 81466116202



MN-DL-8663

Length: 947 Ø: 60
Hole Distance: 115 / 115
03307400A, 81432206222, 81432206260,
81432206283, 81432206284



MN-DL-8709

Length: 572 Ø: 52
Hole Distance: 130 / 130
81432206268, 81432206274, 81432206291,
81432206292, 82432206007



MN-DL-8733

Length: 530 Ø: 48
Hole Distance: 130 / 130
81432206161, 81432206190, 81432206358,
81432206359



MN-DL-14107

Length: 960 Ø: 50
Cone Ø: d1 Ø 30 / d2 Ø 27
81466106813, 81466116146, 81466116147,
81466116148, 81466116204



MN-ES-8490

Length: 90
Cone Ø: d1 Ø 30 / d2 Ø 27
Thread: M26 x 1,5 RHT
0014606948, 14606948, 81953016281,
81953016337, 82953016016



MN-ES-10333

Length: 90
Cone Ø: d1 Ø 38 / d2 Ø 34,35
Thread: M36 x 1,5 RHT
1271126, 3090291, 3099128, 42538048,
81953016268, 82953016018, 82953016019



MN-RK-12436

Ø: 75
Hole Distance: 115
Thick/Height: 24
81432206244



MN-TC-12399

Length: 694 Ø: 50
Hole Distance: 130 / 130
81432206265



MN-VB-5238

Length: 627 Ø: 48
Hole Distance: 130 / 130
81432206221, 81432706096, 81432706114,
81432706116, 81432706121



MN-VB-8514

Length: 627 Ø: 48
Hole Ø 25 / 25 / 25
Hole Distance: 152 / 130 / 130
81432706087, 81432706088, 81432706094,
81432706095, 81432796094



MN-VB-8669

Length: 627 Ø: 48
Hole Ø 25 / 25 / 25
Hole Distance: 152 / 130 / 130
81432706116, 81432706137, 81432706150,
81432706151



SC-ES-7279

Length: 150
Cone Ø: d1 Ø 30 / d2 Ø 27
Thread: M30 x 1,5 RHT
81953016288



SC-ES-8517

Length: 140
Cone Ø: d1 Ø 30 / d2 Ø 27
Thread: M30 x 1,5 RHT
81953016286



SC-ES-8535

Length: 145
Cone Ø: d1 Ø 30 / d2 Ø 27
Thread: M30 x 1,5 RHT
81953016271, 81953016325





TGA ...

18.310, 18.320 FAK, FAK-L, FALK, FALK-L, FHLK ...	05/04 →	Tie Rod End	SC-ES-8517		for Push Rod	
	05/04 →	Tie Rod End	SC-ES-8535		for Guide Rod	
	05/04 →	Track Control Arm		MN-DL-5225	Trailing Arm, Drive Axle; Air Suspension Axle	
	05/04 →	Track Control Arm		MN-DL-5225	Trailing Arm, Leading Axle; Air Suspension Axle	
	05/04 →	Track Control Arm		MN-DL-8544	Trailing Arm, Drive Axle; Air Suspension Axle	
	05/04 →	Track Control Arm		MN-VB-5238	Wishbone (CV), Drive Axle; Air Suspension Axle	
	05/04 →	Track Control Arm		MN-VB-5238	Wishbone (CV), Leading Axle; Air Suspension Axle	
	05/04 →	Track Control Arm		MN-VB-8514	Suspension Rod, Wishbone (CV), Drive Axle; Air Suspension Axle	
18.310, 18.320 FALS, FARS, FAS, FHLS	05/04 →	Ball Head, gearshift linkage	CV-ES-2120			
	05/04 →	Centre Rod	MN-DL-7801		Push Rod, Leaf Spring Axle	
	05/04 →	Centre Rod	MN-DL-8646		Push Rod, Leaf Spring Axle	
	05/04 →	Suspension Strut Repair Kit		DB-RK-8581		
	05/04 →	Tie Rod	MN-DL-7802			
	05/04 →	Tie Rod End	CV-ES-0914		for Steering Rod	
	05/04 →	Tie Rod End	CV-ES-14162		for Steering Rod	
	05/04 →	Tie Rod End	CV-ES-14163		for Steering Rod	
	05/04 →	Tie Rod End	MN-ES-10333		for Steering Rod	
	05/04 →	Tie Rod End	SC-ES-7279		for Steering Rod	
	05/04 →	Tie Rod End	SC-ES-8517		for Push Rod	
	05/04 →	Tie Rod End	SC-ES-8535		for Guide Rod	
	05/04 →	Track Control Arm		MN-DL-5225	Trailing Arm, Drive Axle; Air Suspension Axle	
	05/04 →	Track Control Arm		MN-DL-5225	Trailing Arm, Leading Axle; Air Suspension Axle	
	05/04 →	Track Control Arm		MN-DL-8544	Trailing Arm, Drive Axle; Air Suspension Axle	
	05/04 →	Track Control Arm		MN-VB-5238	Wishbone (CV), Drive Axle; Air Suspension Axle	
	05/04 →	Track Control Arm		MN-VB-5238	Wishbone (CV), Leading Axle; Air Suspension Axle	
	05/04 →	Track Control Arm		MN-VB-8514	Suspension Rod, Wishbone (CV), Drive Axle; Air Suspension Axle	
	18.310, 18.320 FC, FLC, FLLC, FLLRC, FLLRW, FLLW, FLRC, FRC	04/00 →	Ball Head, gearshift linkage	CV-ES-2120		
		04/00 →	Centre Rod	MN-DL-7801		Push Rod, Leaf Spring Axle
04/00 →		Centre Rod	MN-DL-8560		Push Rod, Air Suspension Axle	
04/00 →		Centre Rod	MN-DL-14107		Push Rod	
04/00 →		Suspension Strut Repair Kit		DB-RK-8581		
04/00 →		Suspension Strut Repair Kit		MN-RK-12436		
04/00 →		Tie Rod	MN-DL-7802			
04/00 →		Tie Rod End		MN-ES-8490	for vehicles with Hinged Trailing Axle	
04/00 →		Tie Rod End	CV-ES-0914		for Steering Rod	
04/00 →		Tie Rod End	CV-ES-14162		for Steering Rod	
04/00 →		Tie Rod End	CV-ES-14163		for Steering Rod	
04/00 →		Tie Rod End	IV-ES-12272		for Steering Rod	
04/00 →		Tie Rod End	SC-ES-7279		for Steering Rod	
04/00 →		Tie Rod End	SC-ES-8517		for Push Rod	
04/00 →		Tie Rod End	SC-ES-8535		for Guide Rod	
04/00 →		Track Control Arm		MN-DL-5225	Trailing Arm, Drive Axle; Air Suspension Axle	
04/00 →		Track Control Arm		MN-DL-8544	Trailing Arm, Drive Axle; Air Suspension Axle	
04/00 →		Track Control Arm		MN-DL-8709	Trailing Arm, Drive Axle; Air Suspension Axle	
04/00 →		Track Control Arm		MN-DL-8733	Trailing Arm, Air Suspension Axle; Drive Axle	
04/00 →		Track Control Arm		MN-TC-12399	Control Arm	
04/00 →		Track Control Arm		MN-VB-5238	Wishbone (CV), Drive Axle; Air Suspension Axle	
04/00 →		Track Control Arm		MN-VB-8514	Suspension Rod, Wishbone (CV), Drive Axle; Air Suspension Axle	
04/00 →		Track Control Arm		MN-VB-8514	Suspension Rod, Wishbone (CV), Drive Axle; Leaf Spring Axle	
04/00 →		Track Control Arm	MN-DL-8663		Control Arm, Air Suspension Axle	
06/02 →		Track Control Arm		MN-VB-8669	Suspension Rod, Wishbone (CV), Drive Axle	
18.310, 18.320 FK, FK-L, FLK, FLRK		05/04 →	Centre Rod	MN-DL-7801		Push Rod, Leaf Spring Axle
		05/04 →	Suspension Strut Repair Kit		DB-RK-8581	
		05/04 →	Tie Rod	MN-DL-7802		
		05/04 →	Tie Rod End	CV-ES-0914		for Steering Rod
		05/04 →	Tie Rod End	CV-ES-14162		for Steering Rod
	05/04 →	Tie Rod End	CV-ES-14163		for Steering Rod	
	05/04 →	Tie Rod End	SC-ES-7279		for Steering Rod	
	05/04 →	Tie Rod End	SC-ES-8517		for Push Rod	

CV-ES-0914

Length: 125
Cone Ø: d1 Ø 30 / d2 Ø 27
Thread: M38 x 1,5 RHT
81953016184, 81953016251, 81953016276



CV-ES-2120

Length: 115
Cone Ø: d1 Ø 12,4 / d2 Ø 10,8
Thread: M14 x 1,5 RHT
03008500A, 81953016200, 81953016202,
81953016203, 81953016227



CV-ES-14162

Length: 125
Cone Ø: d1 Ø 30 / d2 Ø 27
Thread: M30 x 1,5 LHT
81953010015, 81953010083, 81953010087,
81953016029, 81953016030, 81953016043,
81953016044, 81953016050, 81953016054,
81953016087, 81953016091, 81953016107,
81953016120, 81953016125, 81953016152,
81953016155, 81953016157, 81953016168,
81953016179, 81953016181, 81953016223,
81953016237, 81953016254, 81953016275,
81953016279, 81953016351



CV-ES-14163

Length: 125
Cone Ø: d1 Ø 30 / d2 Ø 27
Thread: M30 x 1,5 RHT
95301.0084, 90804102156, 90804102272,
90804102696, 90804102710, 81953010016,
81953010075, 81953010084, 81953010088,
81953010094, 81953010103, 81953016030,
81953016043, 81953016048, 81953016049,
81953016053, 81953016061, 81953016090,
81953016108, 81953016112, 81953016126,
81953016143, 81953016149, 81953016154,
81953016156, 81953016168, 81953016178,
81953016194, 81953016206, 81953016224,
81953016234, 81953016242, 81953016252,
81953016274, 81953016278, 81953016284,
81953016286, 81953016308, 81953016310,
81953016312, 81953016347, 81953016350,
81953016352, 82953016012, 88953016014,
N2953016001



DB-RK-8581

Ø: 85
Hole Distance: 130
Thick/Height: 24
03305800A, 81432706105



IV-ES-12272

Length: 75
Cone Ø: d1 Ø 30 / d2 Ø 27
Thread: M26 x 1,5 RHT
81953016280, 82953010010



MN-DL-5225

Length: 572 Ø: 48
Hole Distance: 130 / 130
03301500A, 81432206229, 81432206236,
81432206267, 81432206270, 81432206272,
81432206304, 81432206305, 81432209236,
81432209267, 81432209272



MN-DL-7801

Length: 995 Ø: 52
Cone Ø: d1 Ø 30 / d2 Ø 27
81466106807, 81466106808, 81466116087,
81466116088, 81466116096, 81466116097,
81466116099, 81466116132, 81466116133,
81466116136, 81466116197, 81466116198,
81466116205



MN-DL-7802

Length: 1680 Ø: 52
Cone Ø: d1 Ø 30 / d2 Ø 27
03208300A, 81467116773, 81467116858,
81467116859, 81467116860, 81467116861,
81467116863, 81467116882, 81467116883,
81467116920, 81467116921



MN-DL-8544

Length: 596 Ø: 48
Hole Distance: 130 / 130
81432206196, 81432206232, 81432206233



MN-DL-8560

Length: 970 Ø: 52
Cone Ø: d1 Ø 30 / d2 Ø 27
03206900A, 81466106809, 81466106810,
81466106823, 81466106838, 81466106839,
81466116104, 81466116105, 81466116107,
81466116134, 81466116135, 81466116137,
81466116199, 81466116200, 81466116206



MN-DL-8646

Length: 1021 Ø: 52
Cone Ø: d1 Ø 30 / d2 Ø 27
81466106811, 81466106812, 81466116138,
81466116139, 81466116201, 81466116202



MN-DL-8663

Length: 947 Ø: 60
Hole Distance: 115 / 115
03307400A, 81432206222, 81432206260,
81432206283, 81432206284



MN-DL-8709

Length: 572 Ø: 52
Hole Distance: 130 / 130
81432206268, 81432206274, 81432206291,
81432206292, 82432206007



MN-DL-8733

Length: 530 Ø: 48
Hole Distance: 130 / 130
81432206161, 81432206190, 81432206358,
81432206359



MN-DL-14107

Length: 960 Ø: 50
Cone Ø: d1 Ø 30 / d2 Ø 27
81466106813, 81466116146, 81466116147,
81466116148, 81466116204



MN-ES-8490

Length: 90
Cone Ø: d1 Ø 30 / d2 Ø 27
Thread: M26 x 1,5 RHT
0014606948, 14606948, 81953016281,
81953016337, 82953016016



MN-ES-10333

Length: 90
Cone Ø: d1 Ø 38 / d2 Ø 34,35
Thread: M36 x 1,5 RHT
1271126, 3090291, 3099128, 42538048,
81953016268, 82953016018, 82953016019



MN-RK-12436

Ø: 75
Hole Distance: 115
Thick/Height: 24
81432206244



MN-TC-12399

Length: 694 Ø: 50
Hole Distance: 130 / 130
81432206265



MN-VB-5238

Length: 627 Ø: 48
Hole Distance: 130 / 130
81432206221, 81432706096, 81432706114,
81432706116, 81432706121



MN-VB-8514

Length: 627 Ø: 48
Hole Ø 25 / 25 / 25
Hole Distance: 152 / 130 / 130
81432706087, 81432706088, 81432706094,
81432706095, 81432796094



MN-VB-8669

Length: 627 Ø: 48
Hole Ø 25 / 25 / 25
Hole Distance: 152 / 130 / 130
81432706116, 81432706137, 81432706150,
81432706151



SC-ES-7279

Length: 150
Cone Ø: d1 Ø 30 / d2 Ø 27
Thread: M30 x 1,5 RHT
81953016288



SC-ES-8517

Length: 140
Cone Ø: d1 Ø 30 / d2 Ø 27
Thread: M30 x 1,5 RHT
81953016286



SC-ES-8535

Length: 145
Cone Ø: d1 Ø 30 / d2 Ø 27
Thread: M30 x 1,5 RHT
81953016271, 81953016325





TGA ...

18.310, 18.320 FK, FK-L, FLK, FLRK ...	05/04 →	Tie Rod End	SC-ES-8535		for Guide Rod
	05/04 →	Track Control Arm		MN-DL-5225	Trailing Arm, Drive Axle; Air Suspension Axle
	05/04 →	Track Control Arm		MN-DL-8544	Trailing Arm, Drive Axle; Air Suspension Axle
	05/04 →	Track Control Arm		MN-DL-8709	Trailing Arm, Drive Axle; Air Suspension Axle
	05/04 →	Track Control Arm		MN-DL-8733	Trailing Arm, Air Suspension Axle; Drive Axle
	05/04 →	Track Control Arm		MN-VB-5238	Wishbone (CV), Drive Axle; Air Suspension Axle
	05/04 →	Track Control Arm		MN-VB-8514	Suspension Rod, Wishbone (CV), Drive Axle; Air Suspension Axle
	05/04 →	Track Control Arm		MN-VB-8514	Suspension Rod, Wishbone (CV), Drive Axle; Leaf Spring Axle
	05/04 →	Track Control Arm		MN-VB-8669	Suspension Rod, Wishbone (CV), Drive Axle
18.310, 18.320 FK, FLK, FK-L, FLRK	12/00 →	Ball Head, gearshift linkage	CV-ES-2120		
	12/00 →	Centre Rod	MN-DL-7801		Push Rod, Leaf Spring Axle
	12/00 →	Centre Rod	MN-DL-14107		Push Rod
	12/00 →	Suspension Strut Repair Kit		DB-RK-8581	
	12/00 →	Tie Rod	MN-DL-7802		
	12/00 →	Tie Rod End		MN-ES-8490	for vehicles with Hinged Trailing Axle
	12/00 →	Tie Rod End	CV-ES-0914		for Steering Rod
	12/00 →	Tie Rod End	CV-ES-14162		for Steering Rod
	12/00 →	Tie Rod End	CV-ES-14163		for Steering Rod
	12/00 →	Tie Rod End	IV-ES-12272		for Steering Rod
	12/00 →	Tie Rod End	SC-ES-7279		for Steering Rod
	12/00 →	Tie Rod End	SC-ES-8517		for Push Rod
	12/00 →	Tie Rod End	SC-ES-8535		for Guide Rod
	12/00 →	Track Control Arm		MN-DL-5225	Trailing Arm, Drive Axle; Air Suspension Axle
	12/00 →	Track Control Arm		MN-DL-8544	Trailing Arm, Drive Axle; Air Suspension Axle
	12/00 →	Track Control Arm		MN-DL-8709	Trailing Arm, Drive Axle; Air Suspension Axle
	12/00 →	Track Control Arm		MN-DL-8733	Trailing Arm, Air Suspension Axle; Drive Axle
	12/00 →	Track Control Arm		MN-TC-12399	Control Arm
	12/00 →	Track Control Arm		MN-VB-5238	Wishbone (CV), Drive Axle; Air Suspension Axle
	12/00 →	Track Control Arm		MN-VB-8514	Suspension Rod, Wishbone (CV), Drive Axle; Air Suspension Axle
	12/00 →	Track Control Arm		MN-VB-8514	Suspension Rod, Wishbone (CV), Drive Axle; Leaf Spring Axle
	12/00 →	Track Control Arm		MN-VB-8669	Suspension Rod, Wishbone (CV), Drive Axle
	18.310, 18.320 FLLRS, FLLS, FLRS, FLS, FLS-TS	05/04 →	Ball Head, gearshift linkage	CV-ES-2120	
05/04 →		Centre Rod	MN-DL-7801		Push Rod, Leaf Spring Axle
05/04 →		Centre Rod	MN-DL-8560		Push Rod, Air Suspension Axle
05/04 →		Centre Rod	MN-DL-8560		Push Rod, Air Suspension Axle; Leaf Spring Axle
05/04 →		Centre Rod	MN-DL-14107		Push Rod
05/04 →		Suspension Strut Repair Kit		DB-RK-8581	
05/04 →		Suspension Strut Repair Kit		MN-RK-12436	
05/04 →		Tie Rod	MN-DL-7802		
05/04 →		Tie Rod End	CV-ES-0914		for Steering Rod
05/04 →		Tie Rod End	CV-ES-14162		for Steering Rod
05/04 →		Tie Rod End	CV-ES-14163		for Steering Rod
05/04 →		Tie Rod End	SC-ES-7279		for Steering Rod
05/04 →		Tie Rod End	SC-ES-8517		for Push Rod
05/04 →		Tie Rod End	SC-ES-8535		for Guide Rod
05/04 →		Track Control Arm		MN-DL-5225	Trailing Arm, Drive Axle; Air Suspension Axle
05/04 →		Track Control Arm		MN-DL-8488	Trailing Arm; for Wishbone (CV), Air Suspension Axle
05/04 →		Track Control Arm		MN-DL-8544	Trailing Arm, Drive Axle; Air Suspension Axle
05/04 →		Track Control Arm		MN-DL-8709	Trailing Arm, Drive Axle; Air Suspension Axle
05/04 →		Track Control Arm		MN-DL-8733	Trailing Arm, Air Suspension Axle; Drive Axle
05/04 →		Track Control Arm		MN-VB-5238	Wishbone (CV), Drive Axle; Air Suspension Axle
05/04 →		Track Control Arm		MN-VB-8514	Suspension Rod, Wishbone (CV), Drive Axle; Air Suspension Axle
05/04 →		Track Control Arm		MN-VB-8514	Suspension Rod, Wishbone (CV), Drive Axle; Leaf Spring Axle
05/04 →		Track Control Arm		MN-VB-8669	Suspension Rod, Wishbone (CV), Drive Axle
05/04 →	Track Control Arm	MN-DL-8663		Control Arm, Air Suspension Axle	

CV-ES-0914

Length: 125
Cone Ø: d1 Ø 30 / d2 Ø 27
Thread: M38 x 1,5 RHT
81953016184, 81953016251, 81953016276



CV-ES-2120

Length: 115
Cone Ø: d1 Ø 12,4 / d2 Ø 10,8
Thread: M14 x 1,5 RHT
03008500A, 81953016200, 81953016202, 81953016203, 81953016227



CV-ES-14162

Length: 125
Cone Ø: d1 Ø 30 / d2 Ø 27
Thread: M30 x 1,5 LHT
81953010015, 81953010083, 81953010087, 81953016029, 81953016030, 81953016043, 81953016044, 81953016050, 81953016054, 81953016087, 81953016091, 81953016107, 81953016120, 81953016125, 81953016152, 81953016155, 81953016157, 81953016168, 81953016179, 81953016181, 81953016223, 81953016237, 81953016254, 81953016275, 81953016279, 81953016351



CV-ES-14163

Length: 125
Cone Ø: d1 Ø 30 / d2 Ø 27
Thread: M30 x 1,5 RHT
95301.0084, 90804102156, 90804102272, 90804102696, 90804102710, 81953010016, 81953010075, 81953010084, 81953010088, 81953010094, 81953010103, 81953016030, 81953016043, 81953016048, 81953016049, 81953016053, 81953016061, 81953016090, 81953016108, 81953016112, 81953016126, 81953016143, 81953016149, 81953016154, 81953016156, 81953016168, 81953016178, 81953016194, 81953016206, 81953016224, 81953016234, 81953016242, 81953016252, 81953016274, 81953016278, 81953016284, 81953016286, 81953016308, 81953016310, 81953016312, 81953016347, 81953016350, 81953016352, 82953016012, 88953016014, N2953016001



DB-RK-8581

Ø: 85
Hole Distance: 130
Thick/Height: 24
03305800A, 81432706105



IV-ES-12272

Length: 75
Cone Ø: d1 Ø 30 / d2 Ø 27
Thread: M26 x 1,5 RHT
81953016280, 82953010010



MN-DL-5225

Length: 572 Ø: 48
Hole Distance: 130 / 130
03301500A, 81432206229, 81432206236, 81432206267, 81432206270, 81432206272, 81432206304, 81432206305, 81432209236, 81432209267, 81432209272



MN-DL-7801

Length: 995 Ø: 52
Cone Ø: d1 Ø 30 / d2 Ø 27
81466106807, 81466106808, 81466116087, 81466116088, 81466116096, 81466116097, 81466116099, 81466116132, 81466116133, 81466116136, 81466116197, 81466116198, 81466116205



MN-DL-7802

Length: 1680 Ø: 52
Cone Ø: d1 Ø 30 / d2 Ø 27
03208300A, 81467116773, 81467116858, 81467116859, 81467116860, 81467116861, 81467116863, 81467116882, 81467116883, 81467116920, 81467116921



MN-DL-8488

Length: 414 Ø: 50
Hole Distance: 130 / 130
81432206247, 81432206341, 81432206342



MN-DL-8544

Length: 596 Ø: 48
Hole Distance: 130 / 130
81432206196, 81432206232, 81432206233



MN-DL-8560

Length: 970 Ø: 52
Cone Ø: d1 Ø 30 / d2 Ø 27
03206900A, 81466106809, 81466106810, 81466106823, 81466106838, 81466106839, 81466116104, 81466116105, 81466116107, 81466116134, 81466116135, 81466116137, 81466116199, 81466116200, 81466116206



MN-DL-8663

Length: 947 Ø: 60
Hole Distance: 115 / 115
03307400A, 81432206222, 81432206260, 81432206283, 81432206284



MN-DL-8709

Length: 572 Ø: 52
Hole Distance: 130 / 130
81432206268, 81432206274, 81432206291, 81432206292, 82432206007



MN-DL-8733

Length: 530 Ø: 48
Hole Distance: 130 / 130
81432206161, 81432206190, 81432206358, 81432206359



MN-DL-14107

Length: 960 Ø: 50
Cone Ø: d1 Ø 30 / d2 Ø 27
81466106813, 81466116146, 81466116147, 81466116148, 81466116204



MN-ES-8490

Length: 90
Cone Ø: d1 Ø 30 / d2 Ø 27
Thread: M26 x 1,5 RHT
0014606948, 14606948, 81953016281, 81953016337, 82953016016



MN-RK-12436

Ø: 75
Hole Distance: 115
Thick/Height: 24
81432206244



MN-TC-12399

Length: 694 Ø: 50
Hole Distance: 130 / 130
81432206265



MN-VB-5238

Length: 627 Ø: 48
Hole Distance: 130 / 130
81432206221, 81432706096, 81432706114, 81432706116, 81432706121



MN-VB-8514

Length: 627 Ø: 48
Hole Ø 25 / 25 / 25
Hole Distance: 152 / 130 / 130
81432706087, 81432706088, 81432706094, 81432706095, 81432796094



MN-VB-8669

Length: 627 Ø: 48
Hole Ø 25 / 25 / 25
Hole Distance: 152 / 130 / 130
81432706116, 81432706137, 81432706150, 81432706151



SC-ES-7279

Length: 150
Cone Ø: d1 Ø 30 / d2 Ø 27
Thread: M30 x 1,5 RHT
81953016288



SC-ES-8517

Length: 140
Cone Ø: d1 Ø 30 / d2 Ø 27
Thread: M30 x 1,5 RHT
81953016286



SC-ES-8535

Length: 145
Cone Ø: d1 Ø 30 / d2 Ø 27
Thread: M30 x 1,5 RHT
81953016271, 81953016325





TGA ...

18.350 FLLRS, FLLS, FLRS, FLS, FLS-TS	05/04 →	Ball Head, gearshift linkage	CV-ES-2120		
	05/04 →	Centre Rod	MN-DL-7801		Push Rod, Leaf Spring Axle
	05/04 →	Centre Rod	MN-DL-8560		Push Rod, Air Suspension Axle
	05/04 →	Centre Rod	MN-DL-8560		Push Rod, Air Suspension Axle; Leaf Spring Axle
	05/04 →	Centre Rod	MN-DL-14107		Push Rod
	05/04 →	Suspension Strut Repair Kit		DB-RK-8581	
	05/04 →	Suspension Strut Repair Kit		MN-RK-12436	
	05/04 →	Tie Rod	MN-DL-7802		
	05/04 →	Tie Rod End	CV-ES-0914		for Steering Rod
	05/04 →	Tie Rod End	CV-ES-14162		for Steering Rod
	05/04 →	Tie Rod End	CV-ES-14163		for Steering Rod
	05/04 →	Tie Rod End	SC-ES-7279		for Steering Rod
	05/04 →	Tie Rod End	SC-ES-8517		for Push Rod
	05/04 →	Tie Rod End	SC-ES-8535		for Guide Rod
	05/04 →	Track Control Arm		MN-DL-5225	Trailing Arm, Drive Axle; Air Suspension Axle
	05/04 →	Track Control Arm		MN-DL-8488	Trailing Arm; for Wishbone (CV), Air Suspension Axle
	05/04 →	Track Control Arm		MN-DL-8544	Trailing Arm, Drive Axle; Air Suspension Axle
	05/04 →	Track Control Arm		MN-DL-8709	Trailing Arm, Drive Axle; Air Suspension Axle
	05/04 →	Track Control Arm		MN-DL-8733	Trailing Arm, Air Suspension Axle; Drive Axle
	05/04 →	Track Control Arm		MN-VB-5238	Wishbone (CV), Drive Axle; Air Suspension Axle
	05/04 →	Track Control Arm		MN-VB-8514	Suspension Rod, Wishbone (CV), Drive Axle; Air Suspension Axle
	05/04 →	Track Control Arm		MN-VB-8514	Suspension Rod, Wishbone (CV), Drive Axle; Leaf Spring Axle
	05/04 →	Track Control Arm		MN-VB-8669	Suspension Rod, Wishbone (CV), Drive Axle Control Arm, Air Suspension Axle
18.350, 18.360 FAC, FARC, FHLC	05/04 →	Ball Head, gearshift linkage	CV-ES-2120		
	05/04 →	Centre Rod	MN-DL-7801		Push Rod, Leaf Spring Axle
	05/04 →	Centre Rod	MN-DL-8646		Push Rod, Leaf Spring Axle
	05/04 →	Suspension Strut Repair Kit		DB-RK-8581	
	05/04 →	Tie Rod	MN-DL-7802		
	05/04 →	Tie Rod End	CV-ES-0914		for Steering Rod
	05/04 →	Tie Rod End	CV-ES-14162		for Steering Rod
	05/04 →	Tie Rod End	CV-ES-14163		for Steering Rod
	05/04 →	Tie Rod End	MN-ES-10333		for Steering Rod
	05/04 →	Tie Rod End	SC-ES-7279		for Steering Rod
	05/04 →	Tie Rod End	SC-ES-8517		for Push Rod
	05/04 →	Tie Rod End	SC-ES-8535		for Guide Rod
	05/04 →	Track Control Arm		MN-DL-5225	Trailing Arm, Drive Axle; Air Suspension Axle
	05/04 →	Track Control Arm		MN-DL-5225	Trailing Arm, Leading Axle; Air Suspension Axle
	05/04 →	Track Control Arm		MN-DL-8544	Trailing Arm, Drive Axle; Air Suspension Axle
	05/04 →	Track Control Arm		MN-VB-5238	Wishbone (CV), Drive Axle; Air Suspension Axle
	05/04 →	Track Control Arm		MN-VB-5238	Wishbone (CV), Leading Axle; Air Suspension Axle
05/04 →	Track Control Arm		MN-VB-8514	Suspension Rod, Wishbone (CV), Drive Axle; Air Suspension Axle	
18.350, 18.360 FAK, FAK-L, FALK, FALK-L, FHLK, FHLK/M	05/04 →	Ball Head, gearshift linkage	CV-ES-2120		
	05/04 →	Centre Rod	MN-DL-7801		Push Rod, Leaf Spring Axle
	05/04 →	Centre Rod	MN-DL-8646		Push Rod, Leaf Spring Axle
	05/04 →	Suspension Strut Repair Kit		DB-RK-8581	
	05/04 →	Tie Rod	MN-DL-7802		
	05/04 →	Tie Rod End	CV-ES-0914		for Steering Rod
	05/04 →	Tie Rod End	CV-ES-14162		for Steering Rod
	05/04 →	Tie Rod End	CV-ES-14163		for Steering Rod
	05/04 →	Tie Rod End	MN-ES-10333		for Steering Rod
	05/04 →	Tie Rod End	SC-ES-7279		for Steering Rod
	05/04 →	Tie Rod End	SC-ES-8517		for Push Rod
	05/04 →	Tie Rod End	SC-ES-8535		for Guide Rod
	05/04 →	Track Control Arm		MN-DL-5225	Trailing Arm, Drive Axle; Air Suspension Axle
	05/04 →	Track Control Arm		MN-DL-5225	Trailing Arm, Leading Axle; Air Suspension Axle
05/04 →	Track Control Arm		MN-DL-8544	Trailing Arm, Drive Axle; Air Suspension Axle	
05/04 →	Track Control Arm		MN-VB-5238	Wishbone (CV), Drive Axle; Air Suspension Axle	
05/04 →	Track Control Arm		MN-VB-5238	Wishbone (CV), Leading Axle; Air Suspension Axle	
05/04 →	Track Control Arm		MN-VB-8514	Suspension Rod, Wishbone (CV), Drive Axle; Air Suspension Axle	

CV-ES-0914

Length: 125
Cone Ø: d1 Ø 30 / d2 Ø 27
Thread: M38 x 1,5 RHT
81953016184, 81953016251, 81953016276



CV-ES-2120

Length: 115
Cone Ø: d1 Ø 12,4 / d2 Ø 10,8
Thread: M14 x 1,5 RHT
03008500A, 81953016200, 81953016202,
81953016203, 81953016227



CV-ES-14162

Length: 125
Cone Ø: d1 Ø 30 / d2 Ø 27
Thread: M30 x 1,5 LHT
81953010015, 81953010083, 81953010087,
81953016029, 81953016030, 81953016043,
81953016044, 81953016050, 81953016054,
81953016087, 81953016091, 81953016107,
81953016120, 81953016125, 81953016152,
81953016155, 81953016157, 81953016168,
81953016179, 81953016181, 81953016223,
81953016237, 81953016254, 81953016275,
81953016279, 81953016351



CV-ES-14163

Length: 125
Cone Ø: d1 Ø 30 / d2 Ø 27
Thread: M30 x 1,5 RHT
95301.0084, 90804102156, 90804102272,
90804102696, 90804102710, 81953010016,
81953010075, 81953010084, 81953010088,
81953010094, 81953010103, 81953016030,
81953016043, 81953016048, 81953016049,
81953016053, 81953016061, 81953016090,
81953016108, 81953016112, 81953016126,
81953016143, 81953016149, 81953016154,
81953016156, 81953016168, 81953016178,
81953016194, 81953016206, 81953016224,
81953016234, 81953016242, 81953016252,
81953016274, 81953016278, 81953016284,
81953016286, 81953016308, 81953016310,
81953016312, 81953016347, 81953016350,
81953016352, 82953016012, 88953016014,
N2953016001



DB-RK-8581

Ø: 85
Hole Distance: 130
Thick/Height: 24
03305800A, 81432706105



MN-DL-5225

Length: 572 Ø: 48
Hole Distance: 130 / 130
03301500A, 81432206229, 81432206236,
81432206267, 81432206270, 81432206272,
81432206304, 81432206305, 81432209236,
81432209267, 81432209272



MN-DL-7801

Length: 995 Ø: 52
Cone Ø: d1 Ø 30 / d2 Ø 27
81466106807, 81466106808, 81466116087,
81466116088, 81466116096, 81466116097,
81466116099, 81466116132, 81466116133,
81466116136, 81466116197, 81466116198,
81466116205



MN-DL-7802

Length: 1680 Ø: 52
Cone Ø: d1 Ø 30 / d2 Ø 27
03208300A, 81467116773, 81467116858,
81467116859, 81467116860, 81467116861,
81467116863, 81467116882, 81467116883,
81467116920, 81467116921



MN-DL-8488

Length: 414 Ø: 50
Hole Distance: 130 / 130
81432206247, 81432206341, 81432206342



MN-DL-8544

Length: 596 Ø: 48
Hole Distance: 130 / 130
81432206196, 81432206232, 81432206233



MN-DL-8560

Length: 970 Ø: 52
Cone Ø: d1 Ø 30 / d2 Ø 27
03206900A, 81466106809, 81466106810,
81466106823, 81466106838, 81466106839,
81466116104, 81466116105, 81466116107,
81466116134, 81466116135, 81466116137,
81466116199, 81466116200, 81466116206



MN-DL-8646

Length: 1021 Ø: 52
Cone Ø: d1 Ø 30 / d2 Ø 27
81466106811, 81466106812, 81466116138,
81466116139, 81466116201, 81466116202



MN-DL-8663

Length: 947 Ø: 60
Hole Distance: 115 / 115
03307400A, 81432206222, 81432206260,
81432206283, 81432206284



MN-DL-8709

Length: 572 Ø: 52
Hole Distance: 130 / 130
81432206268, 81432206274, 81432206291,
81432206292, 82432206007



MN-DL-8733

Length: 530 Ø: 48
Hole Distance: 130 / 130
81432206161, 81432206190, 81432206358,
81432206359



MN-DL-14107

Length: 960 Ø: 50
Cone Ø: d1 Ø 30 / d2 Ø 27
81466106813, 81466116146, 81466116147,
81466116148, 81466116204



MN-ES-10333

Length: 90
Cone Ø: d1 Ø 38 / d2 Ø 34,35
Thread: M36 x 1,5 RHT
1271126, 3090291, 3099128, 42538048,
81953016268, 82953016018, 82953016019



MN-RK-12436

Ø: 75
Hole Distance: 115
Thick/Height: 24
81432206244



MN-VB-5238

Length: 627 Ø: 48
Hole Distance: 130 / 130
81432206221, 81432706096, 81432706114,
81432706116, 81432706121



MN-VB-8514

Length: 627 Ø: 48
Hole Ø 25 / 25 / 25
Hole Distance: 152 / 130 / 130
81432706087, 81432706088, 81432706094,
81432706095, 81432796094



MN-VB-8669

Length: 627 Ø: 48
Hole Ø 25 / 25 / 25
Hole Distance: 152 / 130 / 130
81432706116, 81432706137, 81432706150,
81432706151



SC-ES-7279

Length: 150
Cone Ø: d1 Ø 30 / d2 Ø 27
Thread: M30 x 1,5 RHT
81953016288



SC-ES-8517

Length: 140
Cone Ø: d1 Ø 30 / d2 Ø 27
Thread: M30 x 1,5 RHT
81953016286



SC-ES-8535

Length: 145
Cone Ø: d1 Ø 30 / d2 Ø 27
Thread: M30 x 1,5 RHT
81953016271, 81953016325





TGA ...

18.350, 18.360 FALS, FARS,
FAS, FHLS

05/04 →	Ball Head, gearshift linkage	CV-ES-2120		
05/04 →	Centre Rod	MN-DL-7801		Push Rod, Leaf Spring Axle
05/04 →	Centre Rod	MN-DL-8646		Push Rod, Leaf Spring Axle
05/04 →	Suspension Strut Repair Kit		DB-RK-8581	
05/04 →	Tie Rod	MN-DL-7802		
05/04 →	Tie Rod End	CV-ES-0914		for Steering Rod
05/04 →	Tie Rod End	CV-ES-14162		for Steering Rod
05/04 →	Tie Rod End	CV-ES-14163		for Steering Rod
05/04 →	Tie Rod End	MN-ES-10333		for Steering Rod
05/04 →	Tie Rod End	SC-ES-7279		for Steering Rod
05/04 →	Tie Rod End	SC-ES-8517		for Push Rod
05/04 →	Tie Rod End	SC-ES-8535		for Guide Rod
05/04 →	Track Control Arm		MN-DL-5225	Trailing Arm, Drive Axle; Air Suspension Axle
05/04 →	Track Control Arm		MN-DL-5225	Trailing Arm, Leading Axle; Air Suspension Axle
05/04 →	Track Control Arm		MN-DL-8544	Trailing Arm, Drive Axle; Air Suspension Axle
05/04 →	Track Control Arm		MN-VB-5238	Wishbone (CV), Drive Axle; Air Suspension Axle
05/04 →	Track Control Arm		MN-VB-5238	Wishbone (CV), Leading Axle; Air Suspension Axle
05/04 →	Track Control Arm		MN-VB-8514	Suspension Rod, Wishbone (CV), Drive Axle; Air Suspension Axle

18.350, 18.360 FC, FLC, FLLC,
FLLRC, FLLW, FLRC, FLLRW, FRC

05/04 →	Ball Head, gearshift linkage	CV-ES-2120		
05/04 →	Centre Rod	MN-DL-7801		Push Rod, Leaf Spring Axle
05/04 →	Centre Rod	MN-DL-8560		Push Rod, Air Suspension Axle
05/04 →	Suspension Strut Repair Kit		DB-RK-8581	
05/04 →	Suspension Strut Repair Kit		MN-RK-12436	
05/04 →	Tie Rod	MN-DL-7802		
05/04 →	Tie Rod End	CV-ES-0914		for Steering Rod
05/04 →	Tie Rod End	CV-ES-14162		for Steering Rod
05/04 →	Tie Rod End	CV-ES-14163		for Steering Rod
05/04 →	Tie Rod End	SC-ES-7279		for Steering Rod
05/04 →	Tie Rod End	SC-ES-8517		for Push Rod
05/04 →	Tie Rod End	SC-ES-8535		for Guide Rod
05/04 →	Track Control Arm		MN-DL-5225	Trailing Arm, Drive Axle; Air Suspension Axle
05/04 →	Track Control Arm		MN-DL-8544	Trailing Arm, Drive Axle; Air Suspension Axle
05/04 →	Track Control Arm		MN-DL-8709	Trailing Arm, Drive Axle; Air Suspension Axle
05/04 →	Track Control Arm		MN-DL-8733	Trailing Arm, Air Suspension Axle; Drive Axle
05/04 →	Track Control Arm		MN-VB-5238	Wishbone (CV), Drive Axle; Air Suspension Axle
05/04 →	Track Control Arm		MN-VB-8514	Suspension Rod, Wishbone (CV), Drive Axle; Air Suspension Axle
05/04 →	Track Control Arm		MN-VB-8514	Suspension Rod, Wishbone (CV), Drive Axle; Leaf Spring Axle
05/04 →	Track Control Arm		MN-VB-8669	Suspension Rod, Wishbone (CV), Drive Axle Control Arm, Air Suspension Axle

18.350, 18.360 FK, FK-L, FLK, FLRK

05/04 →	Ball Head, gearshift linkage	CV-ES-2120		
05/04 →	Centre Rod	MN-DL-7801		Push Rod, Leaf Spring Axle
05/04 →	Suspension Strut Repair Kit		DB-RK-8581	
05/04 →	Tie Rod	MN-DL-7802		
05/04 →	Tie Rod End	CV-ES-0914		for Steering Rod
05/04 →	Tie Rod End	CV-ES-14162		for Steering Rod
05/04 →	Tie Rod End	CV-ES-14163		for Steering Rod
05/04 →	Tie Rod End	SC-ES-7279		for Steering Rod
05/04 →	Tie Rod End	SC-ES-8517		for Push Rod
05/04 →	Tie Rod End	SC-ES-8535		for Guide Rod
05/04 →	Track Control Arm		MN-DL-5225	Trailing Arm, Drive Axle; Air Suspension Axle
05/04 →	Track Control Arm		MN-DL-8544	Trailing Arm, Drive Axle; Air Suspension Axle
05/04 →	Track Control Arm		MN-DL-8709	Trailing Arm, Drive Axle; Air Suspension Axle
05/04 →	Track Control Arm		MN-DL-8733	Trailing Arm, Air Suspension Axle; Drive Axle
05/04 →	Track Control Arm		MN-VB-5238	Wishbone (CV), Drive Axle; Air Suspension Axle
05/04 →	Track Control Arm		MN-VB-8514	Suspension Rod, Wishbone (CV), Drive Axle; Air Suspension Axle
05/04 →	Track Control Arm		MN-VB-8514	Suspension Rod, Wishbone (CV), Drive Axle; Leaf Spring Axle
05/04 →	Track Control Arm		MN-VB-8669	Suspension Rod, Wishbone (CV), Drive Axle

CV-ES-0914

Length: 125
Cone Ø: d1 Ø 30 / d2 Ø 27
Thread: M38 x 1,5 RHT
81953016184, 81953016251, 81953016276



CV-ES-2120

Length: 115
Cone Ø: d1 Ø 12,4 / d2 Ø 10,8
Thread: M14 x 1,5 RHT
03008500A, 81953016200, 81953016202,
81953016203, 81953016227



CV-ES-14162

Length: 125
Cone Ø: d1 Ø 30 / d2 Ø 27
Thread: M30 x 1,5 LHT
81953010015, 81953010083, 81953010087,
81953016029, 81953016030, 81953016043,
81953016044, 81953016050, 81953016054,
81953016087, 81953016091, 81953016107,
81953016120, 81953016125, 81953016152,
81953016155, 81953016157, 81953016168,
81953016179, 81953016181, 81953016223,
81953016237, 81953016254, 81953016275,
81953016279, 81953016351



CV-ES-14163

Length: 125
Cone Ø: d1 Ø 30 / d2 Ø 27
Thread: M30 x 1,5 RHT
95301.0084, 90804102156, 90804102272,
90804102696, 90804102710, 81953010016,
81953010075, 81953010084, 81953010088,
81953010094, 81953010103, 81953016030,
81953016043, 81953016048, 81953016049,
81953016053, 81953016061, 81953016090,
81953016108, 81953016112, 81953016126,
81953016143, 81953016149, 81953016154,
81953016156, 81953016168, 81953016178,
81953016194, 81953016206, 81953016224,
81953016234, 81953016242, 81953016252,
81953016274, 81953016278, 81953016284,
81953016286, 81953016308, 81953016310,
81953016312, 81953016347, 81953016350,
81953016352, 82953016012, 88953016014,
N2953016001



DB-RK-8581

Ø: 85
Hole Distance: 130
Thick/Height: 24
03305800A, 81432706105



MN-DL-5225

Length: 572 Ø: 48
Hole Distance: 130 / 130
03301500A, 81432206229, 81432206236,
81432206267, 81432206270, 81432206272,
81432206304, 81432206305, 81432209236,
81432209267, 81432209272



MN-DL-7801

Length: 995 Ø: 52
Cone Ø: d1 Ø 30 / d2 Ø 27
81466106807, 81466106808, 81466116087,
81466116088, 81466116096, 81466116097,
81466116099, 81466116132, 81466116133,
81466116136, 81466116197, 81466116198,
81466116205



MN-DL-7802

Length: 1680 Ø: 52
Cone Ø: d1 Ø 30 / d2 Ø 27
03208300A, 81467116773, 81467116858,
81467116859, 81467116860, 81467116861,
81467116863, 81467116882, 81467116883,
81467116920, 81467116921



MN-DL-8544

Length: 596 Ø: 48
Hole Distance: 130 / 130
81432206196, 81432206232, 81432206233



MN-DL-8560

Length: 970 Ø: 52
Cone Ø: d1 Ø 30 / d2 Ø 27
03206900A, 81466106809, 81466106810,
81466106823, 81466106838, 81466106839,
81466116104, 81466116105, 81466116107,
81466116134, 81466116135, 81466116137,
81466116199, 81466116200, 81466116206



MN-DL-8646

Length: 1021 Ø: 52
Cone Ø: d1 Ø 30 / d2 Ø 27
81466106811, 81466106812, 81466116138,
81466116139, 81466116201, 81466116202



MN-DL-8663

Length: 947 Ø: 60
Hole Distance: 115 / 115
03307400A, 81432206222, 81432206260,
81432206283, 81432206284



MN-DL-8709

Length: 572 Ø: 52
Hole Distance: 130 / 130
81432206268, 81432206274, 81432206291,
81432206292, 82432206007



MN-DL-8733

Length: 530 Ø: 48
Hole Distance: 130 / 130
81432206161, 81432206190, 81432206358,
81432206359



MN-ES-10333

Length: 90
Cone Ø: d1 Ø 38 / d2 Ø 34,35
Thread: M36 x 1,5 RHT
1271126, 3090291, 3099128, 42538048,
81953016268, 82953016018, 82953016019



MN-RK-12436

Ø: 75
Hole Distance: 115
Thick/Height: 24
81432206244



MN-VB-5238

Length: 627 Ø: 48
Hole Distance: 130 / 130
81432206221, 81432706096, 81432706114,
81432706116, 81432706121



MN-VB-8514

Length: 627 Ø: 48
Hole Ø 25 / 25 / 25
Hole Distance: 152 / 130 / 130
81432706087, 81432706088, 81432706094,
81432706095, 81432796094



MN-VB-8669

Length: 627 Ø: 48
Hole Ø 25 / 25 / 25
Hole Distance: 152 / 130 / 130
81432706116, 81432706137, 81432706150,
81432706151



SC-ES-7279

Length: 150
Cone Ø: d1 Ø 30 / d2 Ø 27
Thread: M30 x 1,5 RHT
81953016288



SC-ES-8517

Length: 140
Cone Ø: d1 Ø 30 / d2 Ø 27
Thread: M30 x 1,5 RHT
81953016286



SC-ES-8535

Length: 145
Cone Ø: d1 Ø 30 / d2 Ø 27
Thread: M30 x 1,5 RHT
81953016271, 81953016325





TGA ...

18.360 FAC, FARC	09/02→	Ball Head, gearshift linkage	CV-ES-2120			
	09/02→	Centre Rod	MN-DL-8646		Push Rod, Leaf Spring Axle	
	09/02→	Tie Rod End	CV-ES-14162		for Steering Rod	
	09/02→	Tie Rod End	CV-ES-14163		for Steering Rod	
	09/02→	Tie Rod End	MN-ES-10333		for Steering Rod	
	09/02→	Track Control Arm			MN-DL-5225	Trailing Arm
18.360 FAK, FAK-L, FALK, FALK-L, FHLK	09/02→	Ball Head, gearshift linkage	CV-ES-2120			
	09/02→	Centre Rod	MN-DL-8646		Push Rod, Leaf Spring Axle	
	09/02→	Suspension Strut Repair Kit			DB-RK-8581	
	09/02→	Tie Rod End	CV-ES-0914		for Steering Rod	
	09/02→	Tie Rod End	CV-ES-14162		for Steering Rod	
	09/02→	Tie Rod End	CV-ES-14163		for Steering Rod	
	09/02→	Tie Rod End	MN-ES-10333		for Steering Rod	
	09/02→	Tie Rod End	SC-ES-8517		for Push Rod	
	09/02→	Track Control Arm			MN-DL-5225	Trailing Arm
	09/02→	Track Control Arm			MN-DL-8544	Trailing Arm, 1st RA;Air Suspension Axle
	09/02→	Track Control Arm			MN-VB-8514	Suspension Rod, Wishbone (CV), Drive Axle; Air Suspension Axle
	18.360 FALS, FARS, FAS, FHLS	09/02→	Ball Head, gearshift linkage	CV-ES-2120		
09/02→		Centre Rod	MN-DL-8646		Push Rod, Leaf Spring Axle	
09/02→		Suspension Strut Repair Kit			DB-RK-8581	
09/02→		Tie Rod End	CV-ES-0914		for Steering Rod	
09/02→		Tie Rod End	CV-ES-14162		for Steering Rod	
09/02→		Tie Rod End	CV-ES-14163		for Steering Rod	
09/02→		Tie Rod End	MN-ES-10333		for Steering Rod	
09/02→		Tie Rod End	SC-ES-8517		for Push Rod	
09/02→		Track Control Arm			MN-DL-5225	Trailing Arm
09/02→		Track Control Arm			MN-DL-8544	Trailing Arm, 1st RA;Air Suspension Axle
09/02→		Track Control Arm			MN-VB-8514	Suspension Rod, Wishbone (CV), Drive Axle; Air Suspension Axle
18.360 FC, FLC, FLLC, FLLRC, FLLW, FLRC, FLLRW, FRC		04/00→	Ball Head, gearshift linkage	CV-ES-2120		
	04/00→	Centre Rod	MN-DL-7801		Push Rod, Leaf Spring Axle	
	04/00→	Centre Rod	MN-DL-8560		Push Rod, Air Suspension Axle	
	04/00→	Centre Rod	MN-DL-14107		Push Rod	
	04/00→	Suspension Strut Repair Kit			DB-RK-8581	
	04/00→	Suspension Strut Repair Kit			MN-RK-12436	
	04/00→	Tie Rod	MN-DL-7802			
	04/00→	Tie Rod End			MN-ES-8490	for vehicles with Hinged Trailing Axle
	04/00→	Tie Rod End	CV-ES-0914		for Steering Rod	
	04/00→	Tie Rod End	CV-ES-14162		for Steering Rod	
	04/00→	Tie Rod End	CV-ES-14163		for Steering Rod	
	04/00→	Tie Rod End	IV-ES-12272		for Steering Rod	
	04/00→	Tie Rod End	SC-ES-7279		for Steering Rod	
	04/00→	Tie Rod End	SC-ES-8517		for Push Rod	
	04/00→	Tie Rod End	SC-ES-8535		for Guide Rod	
	04/00→	Track Control Arm			MN-DL-5225	Trailing Arm, Drive Axle;Air Suspension Axle
	04/00→	Track Control Arm			MN-DL-8544	Trailing Arm, Drive Axle;Air Suspension Axle
	04/00→	Track Control Arm			MN-DL-8709	Trailing Arm, Drive Axle;Air Suspension Axle
	04/00→	Track Control Arm			MN-DL-8733	Trailing Arm, Air Suspension Axle;Drive Axle
	04/00→	Track Control Arm			MN-TC-12399	Control Arm
	04/00→	Track Control Arm			MN-VB-5238	Wishbone (CV), Drive Axle;Air Suspension Axle
	04/00→	Track Control Arm			MN-VB-8514	Suspension Rod, Wishbone (CV), Drive Axle; Air Suspension Axle
	04/00→	Track Control Arm			MN-VB-8514	Suspension Rod, Wishbone (CV), Drive Axle; Leaf Spring Axle
	04/00→	Track Control Arm	MN-DL-8663			Control Arm, Air Suspension Axle
	06/02→	Track Control Arm			MN-VB-8669	Suspension Rod, Wishbone (CV), Drive Axle
	18.360 FK, FLK, FK-L, FLRK	12/00→	Ball Head, gearshift linkage	CV-ES-2120		
12/00→		Centre Rod	MN-DL-7801		Push Rod, Leaf Spring Axle	
12/00→		Centre Rod	MN-DL-14107		Push Rod	
12/00→		Suspension Strut Repair Kit			DB-RK-8581	
12/00→		Tie Rod	MN-DL-7802			
12/00→		Tie Rod End			MN-ES-8490	for vehicles with Hinged Trailing Axle

CV-ES-0914

Length: 125
Cone Ø: d1 Ø 30 / d2 Ø 27
Thread: M38 x 1,5 RHT
81953016184, 81953016251, 81953016276



CV-ES-2120

Length: 115
Cone Ø: d1 Ø 12,4 / d2 Ø 10,8
Thread: M14 x 1,5 RHT
03008500A, 81953016200, 81953016202, 81953016203, 81953016227



CV-ES-14162

Length: 125
Cone Ø: d1 Ø 30 / d2 Ø 27
Thread: M30 x 1,5 LHT
81953010015, 81953010083, 81953010087, 81953016029, 81953016030, 81953016043, 81953016044, 81953016050, 81953016054, 81953016087, 81953016091, 81953016107, 81953016120, 81953016125, 81953016152, 81953016155, 81953016157, 81953016168, 81953016179, 81953016181, 81953016223, 81953016237, 81953016254, 81953016275, 81953016279, 81953016351



CV-ES-14163

Length: 125
Cone Ø: d1 Ø 30 / d2 Ø 27
Thread: M30 x 1,5 RHT
95301.0084, 90804102156, 90804102272, 90804102696, 90804102710, 81953010016, 81953010075, 81953010084, 81953010088, 81953010094, 81953010103, 81953016030, 81953016043, 81953016048, 81953016049, 81953016053, 81953016061, 81953016090, 81953016108, 81953016112, 81953016126, 81953016143, 81953016149, 81953016154, 81953016156, 81953016168, 81953016178, 81953016194, 81953016206, 81953016224, 81953016234, 81953016242, 81953016252, 81953016274, 81953016278, 81953016284, 81953016286, 81953016308, 81953016310, 81953016312, 81953016347, 81953016350, 81953016352, 82953016012, 88953016014, N2953016001



DB-RK-8581

Ø: 85
Hole Distance: 130
Thick/Height: 24
03305800A, 81432706105



IV-ES-12272

Length: 75
Cone Ø: d1 Ø 30 / d2 Ø 27
Thread: M26 x 1,5 RHT
81953016280, 82953010010



MN-DL-5225

Length: 572 Ø: 48
Hole Distance: 130 / 130
03301500A, 81432206229, 81432206236, 81432206267, 81432206270, 81432206272, 81432206304, 81432206305, 81432209236, 81432209267, 81432209272



MN-DL-7801

Length: 995 Ø: 52
Cone Ø: d1 Ø 30 / d2 Ø 27
81466106807, 81466106808, 81466116087, 81466116088, 81466116096, 81466116097, 81466116099, 81466116132, 81466116133, 81466116136, 81466116197, 81466116198, 81466116205



MN-DL-7802

Length: 1680 Ø: 52
Cone Ø: d1 Ø 30 / d2 Ø 27
03208300A, 81467116773, 81467116858, 81467116859, 81467116860, 81467116861, 81467116863, 81467116882, 81467116883, 81467116920, 81467116921



MN-DL-8544

Length: 596 Ø: 48
Hole Distance: 130 / 130
81432206196, 81432206232, 81432206233



MN-DL-8560

Length: 970 Ø: 52
Cone Ø: d1 Ø 30 / d2 Ø 27
03206900A, 81466106809, 81466106810, 81466106823, 81466106838, 81466106839, 81466116104, 81466116105, 81466116107, 81466116134, 81466116135, 81466116137, 81466116199, 81466116200, 81466116206



MN-DL-8646

Length: 1021 Ø: 52
Cone Ø: d1 Ø 30 / d2 Ø 27
81466106811, 81466106812, 81466116138, 81466116139, 81466116201, 81466116202



MN-DL-8663

Length: 947 Ø: 60
Hole Distance: 115 / 115
03307400A, 81432206222, 81432206260, 81432206283, 81432206284



MN-DL-8709

Length: 572 Ø: 52
Hole Distance: 130 / 130
81432206268, 81432206274, 81432206291, 81432206292, 82432206007



MN-DL-8733

Length: 530 Ø: 48
Hole Distance: 130 / 130
81432206161, 81432206190, 81432206358, 81432206359



MN-DL-14107

Length: 960 Ø: 50
Cone Ø: d1 Ø 30 / d2 Ø 27
81466106813, 81466116146, 81466116147, 81466116148, 81466116204



MN-ES-8490

Length: 90
Cone Ø: d1 Ø 30 / d2 Ø 27
Thread: M26 x 1,5 RHT
14606948, 0014606948, 81953016281, 81953016337, 82953016016



MN-ES-10333

Length: 90
Cone Ø: d1 Ø 38 / d2 Ø 34,35
Thread: M36 x 1,5 RHT
1271126, 3090291, 3099128, 42538048, 81953016268, 82953016018, 82953016019



MN-RK-12436

Ø: 75
Hole Distance: 115
Thick/Height: 24
81432206244



MN-TC-12399

Length: 694 Ø: 50
Hole Distance: 130 / 130
81432206265



MN-VB-5238

Length: 627 Ø: 48
Hole Distance: 130 / 130
81432206221, 81432706096, 81432706114, 81432706116, 81432706121



MN-VB-8514

Length: 627 Ø: 48
Hole Ø 25 / 25 / 25
Hole Distance: 152 / 130 / 130
81432706087, 81432706088, 81432706094, 81432706095, 81432796094



MN-VB-8669

Length: 627 Ø: 48
Hole Ø 25 / 25 / 25
Hole Distance: 152 / 130 / 130
81432706116, 81432706137, 81432706150, 81432706151



SC-ES-7279

Length: 150
Cone Ø: d1 Ø 30 / d2 Ø 27
Thread: M30 x 1,5 RHT
81953016288



SC-ES-8517

Length: 140
Cone Ø: d1 Ø 30 / d2 Ø 27
Thread: M30 x 1,5 RHT
81953016286



SC-ES-8535

Length: 145
Cone Ø: d1 Ø 30 / d2 Ø 27
Thread: M30 x 1,5 RHT
81953016271, 81953016325





TGA ...

18.360 FK, FLK, FK-L, FLRK ...	12/00→	Tie Rod End	CV-ES-0914		for Steering Rod
	12/00→	Tie Rod End	CV-ES-14162		for Steering Rod
	12/00→	Tie Rod End	CV-ES-14163		for Steering Rod
	12/00→	Tie Rod End	IV-ES-12272		for Steering Rod
	12/00→	Tie Rod End	SC-ES-7279		for Steering Rod
	12/00→	Tie Rod End	SC-ES-8517		for Push Rod
	12/00→	Tie Rod End	SC-ES-8535		for Guide Rod
	12/00→	Track Control Arm		MN-DL-5225	Trailing Arm
	12/00→	Track Control Arm		MN-DL-8544	Trailing Arm, Drive Axle;Air Suspension Axle
	12/00→	Track Control Arm		MN-DL-8709	Trailing Arm, Drive Axle;Air Suspension Axle
	12/00→	Track Control Arm		MN-DL-8733	Trailing Arm, Air Suspension Axle;Drive Axle
	12/00→	Track Control Arm		MN-TC-12399	Control Arm
	12/00→	Track Control Arm		MN-VB-5238	Four-Point Steering Arm (CV);Wishbone (CV)
	12/00→	Track Control Arm		MN-VB-8514	Suspension Rod, Wishbone (CV), Drive Axle; Air Suspension Axle
	12/00→	Track Control Arm		MN-VB-8514	Suspension Rod, Wishbone (CV), Drive Axle; Leaf Spring Axle
	18.360 FLLRS, FLLS, FLRS, FLS, FLS-TS	04/00→	Ball Head, gearshift linkage	CV-ES-2120	
04/00→		Centre Rod	MN-DL-7801		Push Rod, Leaf Spring Axle
04/00→		Centre Rod	MN-DL-8560		Push Rod, Air Suspension Axle
04/00→		Centre Rod	MN-DL-14107		Push Rod
04/00→		Suspension Strut Repair Kit		DB-RK-8581	
04/00→		Suspension Strut Repair Kit		MN-RK-12436	
04/00→		Tie Rod	MN-DL-7802		
04/00→		Tie Rod End		MN-ES-8490	Tag Axle
04/00→		Tie Rod End	CV-ES-0914		for Steering Rod
04/00→		Tie Rod End	CV-ES-14162		for Steering Rod
04/00→		Tie Rod End	CV-ES-14163		for Steering Rod
04/00→		Tie Rod End	IV-ES-12272		for Steering Rod
04/00→		Tie Rod End	SC-ES-7279		for Steering Rod
04/00→		Tie Rod End	SC-ES-8517		for Push Rod
04/00→		Tie Rod End	SC-ES-8535		for Guide Rod
04/00→		Track Control Arm		MN-DL-5225	Trailing Arm, Drive Axle;Air Suspension Axle
04/00→		Track Control Arm		MN-DL-8488	Trailing Arm;for Wishbone (CV), Air Suspension Axle
04/00→		Track Control Arm		MN-DL-8544	Trailing Arm, Drive Axle;Air Suspension Axle
04/00→		Track Control Arm		MN-DL-8709	Trailing Arm, Drive Axle;Air Suspension Axle
04/00→		Track Control Arm		MN-DL-8733	Trailing Arm, Air Suspension Axle;Drive Axle
04/00→		Track Control Arm		MN-TC-12399	Control Arm
04/00→		Track Control Arm		MN-VB-5238	Wishbone (CV), Drive Axle;Air Suspension Axle
04/00→		Track Control Arm		MN-VB-8514	Suspension Rod, Wishbone (CV), Drive Axle; Air Suspension Axle
04/00→		Track Control Arm		MN-VB-8514	Suspension Rod, Wishbone (CV), Drive Axle; Leaf Spring Axle
04/00→		Track Control Arm	MN-DL-8663		Control Arm, Air Suspension Axle
06/02→		Track Control Arm		MN-VB-8669	Suspension Rod, Wishbone (CV), Drive Axle
01/06→		Centre Rod	MN-DL-8560		Push Rod, Air Suspension Axle;Leaf Spring Axle
01/06→		Track Control Arm		MN-DL-5225	Trailing Arm
01/06→		Track Control Arm		MN-DL-8488	Wishbone (CV), Drive Axle, for Pneumatic Suspension vehicles
01/06→		Track Control Arm		MN-DL-8544	Trailing Arm, Drive Axle, for Pneumatic Suspension vehicles, →MHB Chassis
01/06→		Track Control Arm		MN-DL-8733	Trailing Arm, 1st Drive Axle, for Pneumatic Suspension vehicles, →Type_RHFN
01/06→		Track Control Arm		MN-VB-5238	Wishbone (CV), 1st Drive Axle, for Pneumatic Suspension vehicles
01/06→	Track Control Arm		MN-VB-8514	Suspension Rod, Wishbone (CV)	
01/06→	Track Control Arm	MN-DL-8663		Control Arm	
18.390 FLS, FLS-TS, FLLS, FLLRS	05/04→	Ball Head, gearshift linkage	CV-ES-2120		
	05/04→	Centre Rod	MN-DL-7801		Push Rod, Leaf Spring Axle
	05/04→	Centre Rod	MN-DL-8560		Push Rod, Air Suspension Axle
	05/04→	Centre Rod	MN-DL-8560		Push Rod, Air Suspension Axle;Leaf Spring Axle
	05/04→	Centre Rod	MN-DL-14107		Push Rod

CV-ES-0914

Length: 125
Cone Ø: d1 Ø 30 / d2 Ø 27
Thread: M38 x 1,5 RHT
81953016184, 81953016251, 81953016276



CV-ES-2120

Length: 115
Cone Ø: d1 Ø 12,4 / d2 Ø 10,8
Thread: M14 x 1,5 RHT
03008500A, 81953016200, 81953016202,
81953016203, 81953016227



CV-ES-14162

Length: 125
Cone Ø: d1 Ø 30 / d2 Ø 27
Thread: M30 x 1,5 LHT
81953010015, 81953010083, 81953010087,
81953016029, 81953016030, 81953016043,
81953016044, 81953016050, 81953016054,
81953016087, 81953016091, 81953016107,
81953016120, 81953016125, 81953016152,
81953016155, 81953016157, 81953016168,
81953016179, 81953016181, 81953016223,
81953016237, 81953016254, 81953016275,
81953016279, 81953016351



CV-ES-14163

Length: 125
Cone Ø: d1 Ø 30 / d2 Ø 27
Thread: M30 x 1,5 RHT
95301.0084, 90804102156, 90804102272,
90804102696, 90804102710, 81953010016,
81953010075, 81953010084, 81953010088,
81953010094, 81953010103, 81953016030,
81953016043, 81953016048, 81953016049,
81953016053, 81953016061, 81953016090,
81953016108, 81953016112, 81953016126,
81953016143, 81953016149, 81953016154,
81953016156, 81953016168, 81953016178,
81953016194, 81953016206, 81953016224,
81953016234, 81953016242, 81953016252,
81953016274, 81953016278, 81953016284,
81953016286, 81953016308, 81953016310,
81953016312, 81953016347, 81953016350,
81953016352, 82953016012, 88953016014,
N2953016001



DB-RK-8581

Ø: 85
Hole Distance: 130
Thick/Height: 24
03305800A, 81432706105



IV-ES-12272

Length: 75
Cone Ø: d1 Ø 30 / d2 Ø 27
Thread: M26 x 1,5 RHT
81953016280, 82953010010



MN-DL-5225

Length: 572 Ø: 48
Hole Distance: 130 / 130
03301500A, 81432206229, 81432206236,
81432206267, 81432206270, 81432206272,
81432206304, 81432206305, 81432209238,
81432209267, 81432209272



MN-DL-7801

Length: 995 Ø: 52
Cone Ø: d1 Ø 30 / d2 Ø 27
81466106807, 81466106808, 81466116087,
81466116088, 81466116096, 81466116097,
81466116099, 81466116132, 81466116133,
81466116136, 81466116197, 81466116198,
81466116205



MN-DL-7802

Length: 1680 Ø: 52
Cone Ø: d1 Ø 30 / d2 Ø 27
03208300A, 81467116773, 81467116858,
81467116859, 81467116860, 81467116861,
81467116863, 81467116882, 81467116883,
81467116920, 81467116921



MN-DL-8488

Length: 414 Ø: 50
Hole Distance: 130 / 130
81432206247, 81432206341, 81432206342



MN-DL-8544

Length: 596 Ø: 48
Hole Distance: 130 / 130
81432206196, 81432206232, 81432206233



MN-DL-8560

Length: 970 Ø: 52
Cone Ø: d1 Ø 30 / d2 Ø 27
03206900A, 81466106809, 81466106810,
81466106823, 81466106838, 81466106839,
81466116104, 81466116105, 81466116107,
81466116134, 81466116135, 81466116137,
81466116199, 81466116200, 81466116206



MN-DL-8663

Length: 947 Ø: 60
Hole Distance: 115 / 115
03307400A, 81432206222, 81432206260,
81432206283, 81432206284



MN-DL-8709

Length: 572 Ø: 52
Hole Distance: 130 / 130
81432206268, 81432206274, 81432206291,
81432206292, 82432206007



MN-DL-8733

Length: 530 Ø: 48
Hole Distance: 130 / 130
81432206161, 81432206190, 81432206358,
81432206359



MN-DL-14107

Length: 960 Ø: 50
Cone Ø: d1 Ø 30 / d2 Ø 27
81466106813, 81466116146, 81466116147,
81466116148, 81466116204



MN-ES-8490

Length: 90
Cone Ø: d1 Ø 30 / d2 Ø 27
Thread: M26 x 1,5 RHT
14606948, 0014606948, 81953016281,
81953016337, 82953016016



MN-RK-12436

Ø: 75
Hole Distance: 115
Thick/Height: 24
81432206244



MN-TC-12399

Length: 694 Ø: 50
Hole Distance: 130 / 130
81432206265



MN-VB-5238

Length: 627 Ø: 48
Hole Distance: 130 / 130
81432206221, 81432706096, 81432706114,
81432706116, 81432706121



MN-VB-8514

Length: 627 Ø: 48
Hole Ø 25 / 25 / 25
Hole Distance: 152 / 130 / 130
81432706087, 81432706088, 81432706094,
81432706095, 81432796094



MN-VB-8669

Length: 627 Ø: 48
Hole Ø 25 / 25 / 25
Hole Distance: 152 / 130 / 130
81432706116, 81432706137, 81432706150,
81432706151



SC-ES-7279

Length: 150
Cone Ø: d1 Ø 30 / d2 Ø 27
Thread: M30 x 1,5 RHT
81953016288



SC-ES-8517

Length: 140
Cone Ø: d1 Ø 30 / d2 Ø 27
Thread: M30 x 1,5 RHT
81953016286



SC-ES-8535

Length: 145
Cone Ø: d1 Ø 30 / d2 Ø 27
Thread: M30 x 1,5 RHT
81953016271, 81953016325





TGA ...

18.390 FLS, FLS-TS, FLLS, FLLRS ...	05/04 →	Suspension Strut Repair Kit		DB-RK-8581		
	05/04 →	Suspension Strut Repair Kit		MN-RK-12436		
	05/04 →	Tie Rod	MN-DL-7802			
	05/04 →	Tie Rod End		MN-ES-8490	for vehicles with Hinged Trailing Axle	
	05/04 →	Tie Rod End	CV-ES-0914		for Steering Rod	
	05/04 →	Tie Rod End	CV-ES-14162		for Steering Rod	
	05/04 →	Tie Rod End	CV-ES-14163		for Steering Rod	
	05/04 →	Tie Rod End	IV-ES-12272		for Steering Rod	
	05/04 →	Tie Rod End	SC-ES-7279		for Steering Rod	
	05/04 →	Tie Rod End	SC-ES-8517		for Push Rod	
	05/04 →	Tie Rod End	SC-ES-8535		for Guide Rod	
	05/04 →	Track Control Arm		MN-DL-5225	Trailing Arm, Drive Axle; Air Suspension Axle	
	05/04 →	Track Control Arm		MN-DL-8488	Trailing Arm; for Wishbone (CV), Air Suspension Axle	
	05/04 →	Track Control Arm		MN-DL-8544	Trailing Arm, Drive Axle; Air Suspension Axle	
	05/04 →	Track Control Arm		MN-DL-8709	Trailing Arm, Drive Axle; Air Suspension Axle	
	05/04 →	Track Control Arm		MN-DL-8733	Trailing Arm, Air Suspension Axle; Drive Axle	
	05/04 →	Track Control Arm		MN-VB-5238	Wishbone (CV), Drive Axle; Air Suspension Axle	
	05/04 →	Track Control Arm		MN-VB-8514	Suspension Rod, Wishbone (CV), Drive Axle; Air Suspension Axle	
	05/04 →	Track Control Arm		MN-VB-8514	Suspension Rod, Wishbone (CV), Drive Axle; Leaf Spring Axle	
	05/04 →	Track Control Arm		MN-VB-8669	Suspension Rod, Wishbone (CV), Drive Axle	
	05/04 →	Track Control Arm	MN-DL-8663		Control Arm, Air Suspension Axle	
	18.390, 18.400 FAC, FARC, FHLC	05/04 →	Ball Head, gearshift linkage	CV-ES-2120		
		05/04 →	Centre Rod	MN-DL-7801		Push Rod, Leaf Spring Axle
05/04 →		Centre Rod	MN-DL-8646		Push Rod, Leaf Spring Axle	
05/04 →		Suspension Strut Repair Kit		DB-RK-8581		
05/04 →		Tie Rod	MN-DL-7802			
05/04 →		Tie Rod End	CV-ES-0914		for Steering Rod	
05/04 →		Tie Rod End	CV-ES-14162		for Steering Rod	
05/04 →		Tie Rod End	CV-ES-14163		for Steering Rod	
05/04 →		Tie Rod End	MN-ES-10333		for Steering Rod	
05/04 →		Tie Rod End	SC-ES-7279		for Steering Rod	
05/04 →		Tie Rod End	SC-ES-8517		for Push Rod	
05/04 →		Tie Rod End	SC-ES-8535		for Guide Rod	
05/04 →		Track Control Arm		MN-DL-5225	Trailing Arm, Drive Axle; Air Suspension Axle	
05/04 →		Track Control Arm		MN-DL-5225	Trailing Arm, Leading Axle; Air Suspension Axle	
05/04 →		Track Control Arm		MN-DL-8544	Trailing Arm, Drive Axle; Air Suspension Axle	
05/04 →		Track Control Arm		MN-VB-5238	Wishbone (CV), Drive Axle; Air Suspension Axle	
05/04 →		Track Control Arm		MN-VB-5238	Wishbone (CV), Leading Axle; Air Suspension Axle	
05/04 →	Track Control Arm		MN-VB-8514	Suspension Rod, Wishbone (CV), Drive Axle; Air Suspension Axle		
18.390, 18.400 FAK, FAK-L, FALK, FALK-L, FHLK, FHLK/M	05/04 →	Ball Head, gearshift linkage	CV-ES-2120			
	05/04 →	Centre Rod	MN-DL-7801		Push Rod, Leaf Spring Axle	
	05/04 →	Centre Rod	MN-DL-8646		Push Rod, Leaf Spring Axle	
	05/04 →	Suspension Strut Repair Kit		DB-RK-8581		
	05/04 →	Tie Rod	MN-DL-7802			
	05/04 →	Tie Rod End	CV-ES-0914		for Steering Rod	
	05/04 →	Tie Rod End	CV-ES-14162		for Steering Rod	
	05/04 →	Tie Rod End	CV-ES-14163		for Steering Rod	
	05/04 →	Tie Rod End	MN-ES-10333		for Steering Rod	
	05/04 →	Tie Rod End	SC-ES-7279		for Steering Rod	
	05/04 →	Tie Rod End	SC-ES-8517		for Push Rod	
	05/04 →	Tie Rod End	SC-ES-8535		for Guide Rod	
	05/04 →	Track Control Arm		MN-DL-5225	Trailing Arm, Drive Axle; Air Suspension Axle	
	05/04 →	Track Control Arm		MN-DL-5225	Trailing Arm, Leading Axle; Air Suspension Axle	
	05/04 →	Track Control Arm		MN-DL-8544	Trailing Arm, Drive Axle; Air Suspension Axle	
	05/04 →	Track Control Arm		MN-VB-5238	Wishbone (CV), Drive Axle; Air Suspension Axle	
	05/04 →	Track Control Arm		MN-VB-5238	Wishbone (CV), Leading Axle; Air Suspension Axle	
05/04 →	Track Control Arm		MN-VB-8514	Suspension Rod, Wishbone (CV), Drive Axle; Air Suspension Axle		

CV-ES-0914

Length: 125
Cone Ø: d1 Ø 30 / d2 Ø 27
Thread: M38 x 1,5 RHT
81953016184, 81953016251, 81953016276



CV-ES-2120

Length: 115
Cone Ø: d1 Ø 12,4 / d2 Ø 10,8
Thread: M14 x 1,5 RHT
03008500A, 81953016200, 81953016202,
81953016203, 81953016227



CV-ES-14162

Length: 125
Cone Ø: d1 Ø 30 / d2 Ø 27
Thread: M30 x 1,5 LHT
81953010015, 81953010083, 81953010087,
81953016029, 81953016030, 81953016043,
81953016044, 81953016050, 81953016054,
81953016087, 81953016091, 81953016107,
81953016120, 81953016125, 81953016152,
81953016155, 81953016157, 81953016168,
81953016179, 81953016181, 81953016223,
81953016237, 81953016254, 81953016275,
81953016279, 81953016351



CV-ES-14163

Length: 125
Cone Ø: d1 Ø 30 / d2 Ø 27
Thread: M30 x 1,5 RHT
95301.0084, 90804102156, 90804102272,
90804102696, 90804102710, 81953010016,
81953010075, 81953010084, 81953010088,
81953010094, 81953010103, 81953016030,
81953016043, 81953016048, 81953016049,
81953016053, 81953016061, 81953016090,
81953016108, 81953016112, 81953016126,
81953016143, 81953016149, 81953016154,
81953016156, 81953016168, 81953016178,
81953016194, 81953016206, 81953016224,
81953016234, 81953016242, 81953016252,
81953016274, 81953016278, 81953016284,
81953016286, 81953016308, 81953016310,
81953016312, 81953016347, 81953016350,
81953016352, 82953016012, 88953016014,
N2953016001



DB-RK-8581

Ø: 85
Hole Distance: 130
Thick/Height: 24
03305800A, 81432706105



IV-ES-12272

Length: 75
Cone Ø: d1 Ø 30 / d2 Ø 27
Thread: M26 x 1,5 RHT
81953016280, 82953010010



MN-DL-5225

Length: 572 Ø: 48
Hole Distance: 130 / 130
03301500A, 81432206229, 81432206236,
81432206267, 81432206270, 81432206272,
81432206304, 81432206305, 81432209236,
81432209267, 81432209272



MN-DL-7801

Length: 995 Ø: 52
Cone Ø: d1 Ø 30 / d2 Ø 27
81466106807, 81466106808, 81466116087,
81466116088, 81466116096, 81466116097,
81466116099, 81466116132, 81466116133,
81466116136, 81466116197, 81466116198,
81466116205



MN-DL-7802

Length: 1680 Ø: 52
Cone Ø: d1 Ø 30 / d2 Ø 27
03208300A, 81467116773, 81467116858,
81467116859, 81467116860, 81467116861,
81467116863, 81467116882, 81467116883,
81467116920, 81467116921



MN-DL-8488

Length: 414 Ø: 50
Hole Distance: 130 / 130
81432206247, 81432206341, 81432206342



MN-DL-8544

Length: 596 Ø: 48
Hole Distance: 130 / 130
81432206196, 81432206232, 81432206233



MN-DL-8646

Length: 1021 Ø: 52
Cone Ø: d1 Ø 30 / d2 Ø 27
81466106811, 81466106812, 81466116138,
81466116139, 81466116201, 81466116202



MN-DL-8663

Length: 947 Ø: 60
Hole Distance: 115 / 115
03307400A, 81432206222, 81432206260,
81432206283, 81432206284



MN-DL-8709

Length: 572 Ø: 52
Hole Distance: 130 / 130
81432206268, 81432206274, 81432206291,
81432206292, 82432206007



MN-DL-8733

Length: 530 Ø: 48
Hole Distance: 130 / 130
81432206161, 81432206190, 81432206358,
81432206359



MN-ES-8490

Length: 90
Cone Ø: d1 Ø 30 / d2 Ø 27
Thread: M26 x 1,5 RHT
0014606948, 14606948, 81953016281,
81953016337, 82953016016



MN-ES-10333

Length: 90
Cone Ø: d1 Ø 38 / d2 Ø 34,35
Thread: M36 x 1,5 RHT
1271126, 3090291, 3099128, 42538048,
81953016268, 82953016018, 82953016019



MN-RK-12436

Ø: 75
Hole Distance: 115
Thick/Height: 24
81432206244



MN-VB-5238

Length: 627 Ø: 48
Hole Distance: 130 / 130
81432206221, 81432706096, 81432706114,
81432706116, 81432706121



MN-VB-8514

Length: 627 Ø: 48
Hole Ø 25 / 25 / 25
Hole Distance: 152 / 130 / 130
81432706087, 81432706088, 81432706094,
81432706095, 81432796094



MN-VB-8669

Length: 627 Ø: 48
Hole Ø 25 / 25 / 25
Hole Distance: 152 / 130 / 130
81432706116, 81432706137, 81432706150,
81432706151



SC-ES-7279

Length: 150
Cone Ø: d1 Ø 30 / d2 Ø 27
Thread: M30 x 1,5 RHT
81953016288



SC-ES-8517

Length: 140
Cone Ø: d1 Ø 30 / d2 Ø 27
Thread: M30 x 1,5 RHT
81953016286



SC-ES-8535

Length: 145
Cone Ø: d1 Ø 30 / d2 Ø 27
Thread: M30 x 1,5 RHT
81953016271, 81953016325





TGA ...

18.390, 18.400 FALS, FAS, FHLS	05/04 →	Ball Head, gearshift linkage	CV-ES-2120		
	05/04 →	Centre Rod	MN-DL-7801		Push Rod, Leaf Spring Axle
	05/04 →	Centre Rod	MN-DL-8646		Push Rod, Leaf Spring Axle
	05/04 →	Suspension Strut Repair Kit		DB-RK-8581	
	05/04 →	Tie Rod	MN-DL-7802		
	05/04 →	Tie Rod End	CV-ES-0914		for Steering Rod
	05/04 →	Tie Rod End	CV-ES-14162		for Steering Rod
	05/04 →	Tie Rod End	CV-ES-14163		for Steering Rod
	05/04 →	Tie Rod End	MN-ES-10333		for Steering Rod
	05/04 →	Tie Rod End	SC-ES-7279		for Steering Rod
	05/04 →	Tie Rod End	SC-ES-8517		for Push Rod
	05/04 →	Tie Rod End	SC-ES-8535		for Guide Rod
	05/04 →	Track Control Arm		MN-DL-5225	Trailing Arm, Drive Axle; Air Suspension Axle
	05/04 →	Track Control Arm		MN-DL-5225	Trailing Arm, Leading Axle; Air Suspension Axle
	05/04 →	Track Control Arm		MN-DL-8544	Trailing Arm, Drive Axle; Air Suspension Axle
	05/04 →	Track Control Arm		MN-VB-5238	Wishbone (CV), Drive Axle; Air Suspension Axle
05/04 →	Track Control Arm		MN-VB-5238	Wishbone (CV), Leading Axle; Air Suspension Axle	
05/04 →	Track Control Arm		MN-VB-8514	Suspension Rod, Wishbone (CV), Drive Axle; Air Suspension Axle	
18.390, 18.400 FC, FLC, FLLC, FLLRC, FLLRW, FLLW, FLRC	05/04 →	Ball Head, gearshift linkage	CV-ES-2120		
	05/04 →	Centre Rod	MN-DL-7801		Push Rod, Leaf Spring Axle
	05/04 →	Centre Rod	MN-DL-8560		Push Rod, Air Suspension Axle
	05/04 →	Suspension Strut Repair Kit		DB-RK-8581	
	05/04 →	Suspension Strut Repair Kit		MN-RK-12436	
	05/04 →	Tie Rod	MN-DL-7802		
	05/04 →	Tie Rod End		MN-ES-8490	for vehicles with Hinged Trailing Axle
	05/04 →	Tie Rod End	CV-ES-0914		for Steering Rod
	05/04 →	Tie Rod End	CV-ES-14162		for Steering Rod
	05/04 →	Tie Rod End	CV-ES-14163		for Steering Rod
	05/04 →	Tie Rod End	IV-ES-12272		for Steering Rod
	05/04 →	Tie Rod End	SC-ES-7279		for Steering Rod
	05/04 →	Tie Rod End	SC-ES-8517		for Push Rod
	05/04 →	Tie Rod End	SC-ES-8535		for Guide Rod
	05/04 →	Track Control Arm		MN-DL-5225	Trailing Arm, Drive Axle; Air Suspension Axle
	05/04 →	Track Control Arm		MN-DL-8544	Trailing Arm, Drive Axle; Air Suspension Axle
	05/04 →	Track Control Arm		MN-DL-8709	Trailing Arm, Drive Axle; Air Suspension Axle
	05/04 →	Track Control Arm		MN-DL-8733	Trailing Arm, Air Suspension Axle; Drive Axle
	05/04 →	Track Control Arm		MN-VB-5238	Wishbone (CV), Drive Axle; Air Suspension Axle
	05/04 →	Track Control Arm		MN-VB-8514	Suspension Rod, Wishbone (CV), Drive Axle; Air Suspension Axle
05/04 →	Track Control Arm		MN-VB-8514	Suspension Rod, Wishbone (CV), Drive Axle; Leaf Spring Axle	
05/04 →	Track Control Arm		MN-VB-8669	Suspension Rod, Wishbone (CV), Drive Axle Control Arm, Air Suspension Axle	
05/04 →	Track Control Arm	MN-DL-8663			
18.390, 18.400 FK, FK-L, FLK, FLRK	05/04 →	Ball Head, gearshift linkage	CV-ES-2120		
	05/04 →	Centre Rod	MN-DL-7801		Push Rod, Leaf Spring Axle
	05/04 →	Suspension Strut Repair Kit		DB-RK-8581	
	05/04 →	Tie Rod	MN-DL-7802		
	05/04 →	Tie Rod End		MN-ES-8490	for vehicles with Hinged Trailing Axle
	05/04 →	Tie Rod End	CV-ES-0914		for Steering Rod
	05/04 →	Tie Rod End	CV-ES-14162		for Steering Rod
	05/04 →	Tie Rod End	CV-ES-14163		for Steering Rod
	05/04 →	Tie Rod End	IV-ES-12272		for Steering Rod
	05/04 →	Tie Rod End	SC-ES-7279		for Steering Rod
	05/04 →	Tie Rod End	SC-ES-8517		for Push Rod
	05/04 →	Tie Rod End	SC-ES-8535		for Guide Rod
	05/04 →	Track Control Arm		MN-DL-5225	Trailing Arm, Drive Axle; Air Suspension Axle
	05/04 →	Track Control Arm		MN-DL-8544	Trailing Arm, Drive Axle; Air Suspension Axle
	05/04 →	Track Control Arm		MN-DL-8709	Trailing Arm, Drive Axle; Air Suspension Axle
	05/04 →	Track Control Arm		MN-DL-8733	Trailing Arm, Air Suspension Axle; Drive Axle
05/04 →	Track Control Arm		MN-VB-5238	Wishbone (CV), Drive Axle; Air Suspension Axle	
05/04 →	Track Control Arm		MN-VB-8514	Suspension Rod, Wishbone (CV), Drive Axle; Air Suspension Axle	

CV-ES-0914

Length: 125
Cone Ø: d1 Ø 30 / d2 Ø 27
Thread: M38 x 1,5 RHT
81953016184, 81953016251, 81953016276



CV-ES-2120

Length: 115
Cone Ø: d1 Ø 12,4 / d2 Ø 10,8
Thread: M14 x 1,5 RHT
03008500A, 81953016200, 81953016202,
81953016203, 81953016227



CV-ES-14162

Length: 125
Cone Ø: d1 Ø 30 / d2 Ø 27
Thread: M30 x 1,5 LHT
81953010015, 81953010083, 81953010087,
81953016029, 81953016030, 81953016043,
81953016044, 81953016050, 81953016054,
81953016087, 81953016091, 81953016107,
81953016120, 81953016125, 81953016152,
81953016155, 81953016157, 81953016168,
81953016179, 81953016181, 81953016223,
81953016237, 81953016254, 81953016275,
81953016279, 81953016351



CV-ES-14163

Length: 125
Cone Ø: d1 Ø 30 / d2 Ø 27
Thread: M30 x 1,5 RHT
95301.0084, 90804102156, 90804102272,
90804102696, 90804102710, 81953010016,
81953010075, 81953010084, 81953010088,
81953010094, 81953010103, 81953016030,
81953016043, 81953016048, 81953016049,
81953016053, 81953016061, 81953016090,
81953016108, 81953016112, 81953016126,
81953016143, 81953016149, 81953016154,
81953016156, 81953016168, 81953016178,
81953016194, 81953016206, 81953016224,
81953016234, 81953016242, 81953016252,
81953016274, 81953016278, 81953016284,
81953016286, 81953016308, 81953016310,
81953016312, 81953016347, 81953016350,
81953016352, 82953016012, 88953016014,
N2953016001



DB-RK-8581

Ø: 85
Hole Distance: 130
Thick/Height: 24
03305800A, 81432706105



IV-ES-12272

Length: 75
Cone Ø: d1 Ø 30 / d2 Ø 27
Thread: M26 x 1,5 RHT
81953016280, 82953010010



MN-DL-5225

Length: 572 Ø: 48
Hole Distance: 130 / 130
03301500A, 81432206229, 81432206236,
81432206267, 81432206270, 81432206272,
81432206304, 81432206305, 81432209236,
81432209267, 81432209272



MN-DL-7801

Length: 995 Ø: 52
Cone Ø: d1 Ø 30 / d2 Ø 27
81466106807, 81466106808, 81466116087,
81466116088, 81466116096, 81466116097,
81466116099, 81466116132, 81466116133,
81466116136, 81466116197, 81466116198,
81466116205



MN-DL-7802

Length: 1680 Ø: 52
Cone Ø: d1 Ø 30 / d2 Ø 27
03208300A, 81467116773, 81467116858,
81467116859, 81467116860, 81467116861,
81467116863, 81467116882, 81467116883,
81467116920, 81467116921



MN-DL-8544

Length: 596 Ø: 48
Hole Distance: 130 / 130
81432206196, 81432206232, 81432206233



MN-DL-8560

Length: 970 Ø: 52
Cone Ø: d1 Ø 30 / d2 Ø 27
03206900A, 81466106809, 81466106810,
81466106823, 81466106838, 81466106839,
81466116104, 81466116105, 81466116107,
81466116134, 81466116135, 81466116137,
81466116199, 81466116200, 81466116206



MN-DL-8646

Length: 1021 Ø: 52
Cone Ø: d1 Ø 30 / d2 Ø 27
81466106811, 81466106812, 81466116138,
81466116139, 81466116201, 81466116202



MN-DL-8663

Length: 947 Ø: 60
Hole Distance: 115 / 115
03307400A, 81432206222, 81432206260,
81432206283, 81432206284



MN-DL-8709

Length: 572 Ø: 52
Hole Distance: 130 / 130
81432206268, 81432206274, 81432206291,
81432206292, 82432206007



MN-DL-8733

Length: 530 Ø: 48
Hole Distance: 130 / 130
81432206161, 81432206190, 81432206358,
81432206359



MN-ES-8490

Length: 90
Cone Ø: d1 Ø 30 / d2 Ø 27
Thread: M26 x 1,5 RHT
0014606948, 14606948, 81953016281,
81953016337, 82953016016



MN-ES-10333

Length: 90
Cone Ø: d1 Ø 38 / d2 Ø 34,35
Thread: M36 x 1,5 RHT
1271126, 3090291, 3099128, 42538048,
81953016268, 82953016018, 82953016019



MN-RK-12436

Ø: 75
Hole Distance: 115
Thick/Height: 24
81432206244



MN-VB-5238

Length: 627 Ø: 48
Hole Distance: 130 / 130
81432206221, 81432706096, 81432706114,
81432706116, 81432706121



MN-VB-8514

Length: 627 Ø: 48
Hole Ø 25 / 25 / 25
Hole Distance: 152 / 130 / 130
81432706087, 81432706088, 81432706094,
81432706095, 81432796094



MN-VB-8669

Length: 627 Ø: 48
Hole Ø 25 / 25 / 25
Hole Distance: 152 / 130 / 130
81432706116, 81432706137, 81432706150,
81432706151



SC-ES-7279

Length: 150
Cone Ø: d1 Ø 30 / d2 Ø 27
Thread: M30 x 1,5 RHT
81953016288



SC-ES-8517

Length: 140
Cone Ø: d1 Ø 30 / d2 Ø 27
Thread: M30 x 1,5 RHT
81953016286



SC-ES-8535

Length: 145
Cone Ø: d1 Ø 30 / d2 Ø 27
Thread: M30 x 1,5 RHT
81953016271, 81953016325



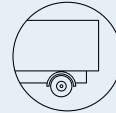

TGA ...

18.390, 18.400 FK, FK-L, FLK, FLRK ...	05/04 →	Track Control Arm		MN-VB-8514	Suspension Rod, Wishbone (CV), Drive Axle; Leaf Spring Axle
	05/04 →	Track Control Arm		MN-VB-8669	Suspension Rod, Wishbone (CV), Drive Axle
18.400 FLS, FLLS, FLRS, FLLRS, FLS-TS	10/05 →	Centre Rod	MN-DL-7801		Push Rod, Leaf Spring Axle
	10/05 →	Centre Rod	MN-DL-8560		Push Rod, Air Suspension Axle
	10/05 →	Centre Rod	MN-DL-8560		Push Rod, Air Suspension Axle; Leaf Spring Axle
	10/05 →	Centre Rod	MN-DL-14107		Push Rod
	10/05 →	Suspension Strut Repair Kit		MN-RK-12436	
	10/05 →	Tie Rod	MN-DL-7802		
	10/05 →	Tie Rod End	CV-ES-0914		for Steering Rod
	10/05 →	Tie Rod End	CV-ES-14162		for Steering Rod
	10/05 →	Tie Rod End	CV-ES-14163		for Steering Rod
	10/05 →	Tie Rod End	SC-ES-7279		for Steering Rod
	10/05 →	Tie Rod End	SC-ES-8517		for Push Rod
	10/05 →	Tie Rod End	SC-ES-8535		for Guide Rod
	10/05 →	Track Control Arm		MN-DL-5225	Trailing Arm
	10/05 →	Track Control Arm		MN-DL-8488	Wishbone (CV), Drive Axle, for Pneumatic Suspension vehicles
	10/05 →	Track Control Arm		MN-DL-8544	Trailing Arm, Drive Axle, for Pneumatic Suspension vehicles, →MHB Chassis
	10/05 →	Track Control Arm		MN-DL-8733	Trailing Arm, 1st Drive Axle, for Pneumatic Suspension vehicles, →Type_RHFN
	10/05 →	Track Control Arm		MN-VB-5238	Wishbone (CV), 1st Drive Axle, for Pneumatic Suspension vehicles
	10/05 →	Track Control Arm		MN-VB-8514	Suspension Rod, Wishbone (CV)
	10/05 →	Track Control Arm	MN-DL-8663		Control Arm
	18.410 FAC, FARC	09/02 →	Ball Head, gearshift linkage	CV-ES-2120	
09/02 →		Centre Rod	MN-DL-8646		Push Rod, Leaf Spring Axle
09/02 →		Tie Rod End	CV-ES-14162		for Steering Rod
09/02 →		Tie Rod End	CV-ES-14163		for Steering Rod
09/02 →		Tie Rod End	MN-ES-10333		for Steering Rod
09/02 →		Track Control Arm		MN-DL-5225	Trailing Arm
18.410 FAS, FALS, FARS	09/02 →	Ball Head, gearshift linkage	CV-ES-2120		
	09/02 →	Centre Rod	MN-DL-8646		Push Rod, Leaf Spring Axle
	09/02 →	Tie Rod End	CV-ES-0914		for Steering Rod
	09/02 →	Tie Rod End	CV-ES-14162		for Steering Rod
	09/02 →	Tie Rod End	CV-ES-14163		for Steering Rod
	09/02 →	Tie Rod End	MN-ES-10333		for Steering Rod
	09/02 →	Tie Rod End	SC-ES-8517		for Push Rod
	09/02 →	Track Control Arm		MN-DL-5225	Trailing Arm
	09/02 →	Track Control Arm		MN-DL-8544	Trailing Arm, Drive Axle, for Pneumatic Suspension vehicles
	09/02 →	Track Control Arm		MN-VB-8514	Suspension Rod, Wishbone (CV)
18.410 FLLRS, FLLS, FLRS, FLS, FLS-TS	04/00 →	Ball Head, gearshift linkage	CV-ES-2120		
	04/00 →	Centre Rod	MN-DL-7801		Push Rod, Leaf Spring Axle
	04/00 →	Centre Rod	MN-DL-8560		Push Rod, Air Suspension Axle
	04/00 →	Centre Rod	MN-DL-14107		Push Rod
	04/00 →	Suspension Strut Repair Kit		DB-RK-8581	
	04/00 →	Suspension Strut Repair Kit		MN-RK-8537	
	04/00 →	Suspension Strut Repair Kit		MN-RK-12436	
	04/00 →	Tie Rod	MN-DL-7802		
	04/00 →	Tie Rod End		MN-ES-8490	for vehicles with Hinged Trailing Axle
	04/00 →	Tie Rod End	CV-ES-0914		for Steering Rod
	04/00 →	Tie Rod End	CV-ES-14162		for Steering Rod
	04/00 →	Tie Rod End	CV-ES-14163		for Steering Rod
	04/00 →	Tie Rod End	IV-ES-12272		for Steering Rod
	04/00 →	Tie Rod End	SC-ES-7279		for Steering Rod
	04/00 →	Tie Rod End	SC-ES-8517		for Push Rod
	04/00 →	Tie Rod End	SC-ES-8535		for Guide Rod
	04/00 →	Track Control Arm		MN-DL-5225	Trailing Arm, Drive Axle; Air Suspension Axle
	04/00 →	Track Control Arm		MN-DL-8488	Trailing Arm; for Wishbone (CV), Air Suspension Axle
	04/00 →	Track Control Arm		MN-DL-8544	Trailing Arm, Drive Axle; Air Suspension Axle

CV-ES-0914

Length: 125
Cone Ø: d1 Ø 30 / d2 Ø 27
Thread: M38 x 1,5 RHT
81953016184, 81953016251, 81953016276



CV-ES-2120

Length: 115
Cone Ø: d1 Ø 12,4 / d2 Ø 10,8
Thread: M14 x 1,5 RHT
03008500A, 81953016200, 81953016202, 81953016203, 81953016227



CV-ES-14162

Length: 125
Cone Ø: d1 Ø 30 / d2 Ø 27
Thread: M30 x 1,5 LHT
81953010015, 81953010083, 81953010087, 81953016029, 81953016030, 81953016043, 81953016044, 81953016050, 81953016054, 81953016087, 81953016091, 81953016107, 81953016120, 81953016125, 81953016152, 81953016155, 81953016157, 81953016168, 81953016179, 81953016181, 81953016223, 81953016237, 81953016254, 81953016275, 81953016279, 81953016351



CV-ES-14163

Length: 125
Cone Ø: d1 Ø 30 / d2 Ø 27
Thread: M30 x 1,5 RHT
95301.0084, 90804102156, 90804102272, 90804102696, 90804102710, 81953010016, 81953010075, 81953010084, 81953010088, 81953010094, 81953010103, 81953016030, 81953016043, 81953016048, 81953016049, 81953016053, 81953016061, 81953016090, 81953016108, 81953016112, 81953016126, 81953016143, 81953016149, 81953016154, 81953016156, 81953016168, 81953016178, 81953016194, 81953016206, 81953016224, 81953016234, 81953016242, 81953016252, 81953016274, 81953016278, 81953016284, 81953016286, 81953016308, 81953016310, 81953016312, 81953016347, 81953016350, 81953016352, 82953016012, 88953016014, N2953016001



DB-RK-8581

Ø: 85
Hole Distance: 130
Thick/Height: 24
03305800A, 81432706105



IV-ES-12272

Length: 75
Cone Ø: d1 Ø 30 / d2 Ø 27
Thread: M26 x 1,5 RHT
81953016280, 82953010010



MN-DL-5225

Length: 572 Ø: 48
Hole Distance: 130 / 130
03301500A, 81432206229, 81432206236, 81432206267, 81432206270, 81432206272, 81432206304, 81432206305, 81432209232, 81432209267, 81432209272



MN-DL-7801

Length: 995 Ø: 52
Cone Ø: d1 Ø 30 / d2 Ø 27
81466106807, 81466106808, 81466116087, 81466116088, 81466116096, 81466116097, 81466116099, 81466116132, 81466116133, 81466116136, 81466116197, 81466116198, 81466116205



MN-DL-7802

Length: 1680 Ø: 52
Cone Ø: d1 Ø 30 / d2 Ø 27
03208300A, 81467116773, 81467116858, 81467116859, 81467116860, 81467116861, 81467116863, 81467116882, 81467116883, 81467116920, 81467116921



MN-DL-8488

Length: 414 Ø: 50
Hole Distance: 130 / 130
81432206247, 81432206341, 81432206342



MN-DL-8544

Length: 596 Ø: 48
Hole Distance: 130 / 130
81432206196, 81432206232, 81432206233



MN-DL-8560

Length: 970 Ø: 52
Cone Ø: d1 Ø 30 / d2 Ø 27
03206900A, 81466106809, 81466106810, 81466106823, 81466106838, 81466106839, 81466116104, 81466116105, 81466116107, 81466116134, 81466116135, 81466116137, 81466116199, 81466116200, 81466116206



MN-DL-8646

Length: 1021 Ø: 52
Cone Ø: d1 Ø 30 / d2 Ø 27
81466106811, 81466106812, 81466116138, 81466116139, 81466116201, 81466116202



MN-DL-8663

Length: 947 Ø: 60
Hole Distance: 115 / 115
03307400A, 81432206222, 81432206260, 81432206283, 81432206284



MN-DL-8733

Length: 530 Ø: 48
Hole Distance: 130 / 130
81432206161, 81432206190, 81432206358, 81432206359



MN-DL-14107

Length: 960 Ø: 50
Cone Ø: d1 Ø 30 / d2 Ø 27
81466106813, 81466116146, 81466116147, 81466116148, 81466116204



MN-ES-8490

Length: 90
Cone Ø: d1 Ø 30 / d2 Ø 27
Thread: M26 x 1,5 RHT
0014606948, 14606948, 81953016281, 81953016337, 82953016016



MN-ES-10333

Length: 90
Cone Ø: d1 Ø 38 / d2 Ø 34,35
Thread: M36 x 1,5 RHT
1271126, 3090291, 3099128, 42538048, 81953016268, 82953016018, 82953016019



MN-RK-8537

Ø: 95
Hole Distance: 152
Thick/Height: 24
696321, 03306600A, 81432706079, 81432706099



MN-RK-12436

Ø: 75
Hole Distance: 115
Thick/Height: 24
81432206244



MN-VB-5238

Length: 627 Ø: 48
Hole Distance: 130 / 130
81432206221, 81432706096, 81432706114, 81432706116, 81432706121



MN-VB-8514

Length: 627 Ø: 48
Hole Ø 25 / 25 / 25
Hole Distance: 152 / 130 / 130
81432706087, 81432706088, 81432706094, 81432706095, 81432796094



MN-VB-8669

Length: 627 Ø: 48
Hole Ø 25 / 25 / 25
Hole Distance: 152 / 130 / 130
81432706116, 81432706137, 81432706150, 81432706151



SC-ES-7279

Length: 150
Cone Ø: d1 Ø 30 / d2 Ø 27
Thread: M30 x 1,5 RHT
81953016288



SC-ES-8517

Length: 140
Cone Ø: d1 Ø 30 / d2 Ø 27
Thread: M30 x 1,5 RHT
81953016286



SC-ES-8535

Length: 145
Cone Ø: d1 Ø 30 / d2 Ø 27
Thread: M30 x 1,5 RHT
81953016271, 81953016325





TGA ...

18.410 FLLRS, FLLS, FLRS, FLS, FLS-TS ...	04/00→	Track Control Arm		MN-DL-8709	Trailing Arm, Drive Axle;Air Suspension Axle	
	04/00→	Track Control Arm		MN-DL-8733	Trailing Arm, Air Suspension Axle;Drive Axle	
	04/00→	Track Control Arm		MN-TC-12399	Control Arm	
	04/00→	Track Control Arm		MN-VB-5238	Wishbone (CV), Drive Axle;Air Suspension Axle	
	04/00→	Track Control Arm		MN-VB-8514	Suspension Rod, Wishbone (CV), Drive Axle; Air Suspension Axle	
	04/00→	Track Control Arm		MN-VB-8514	Suspension Rod, Wishbone (CV), Drive Axle; Leaf Spring Axle	
	04/00→	Track Control Arm	MN-DL-8663		Control Arm, Air Suspension Axle	
18.410, 18.420 FAK, FAK-L, FALK, FALK-L	06/02→	Track Control Arm		MN-VB-8669	Suspension Rod, Wishbone (CV), Drive Axle	
	09/02→	Ball Head, gearshift linkage	CV-ES-2120			
	09/02→	Centre Rod	MN-DL-8646		Push Rod, Leaf Spring Axle	
	09/02→	Tie Rod End	CV-ES-0914		for Steering Rod	
	09/02→	Tie Rod End	CV-ES-14162		for Steering Rod	
	09/02→	Tie Rod End	CV-ES-14163		for Steering Rod	
	09/02→	Tie Rod End	MN-ES-10333		for Steering Rod	
	09/02→	Tie Rod End	SC-ES-8517		for Push Rod	
	09/02→	Track Control Arm		MN-DL-5225	Trailing Arm	
	09/02→	Track Control Arm		MN-DL-8544	Trailing Arm	
	09/02→	Track Control Arm		MN-VB-8514	Suspension Rod, Wishbone (CV)	
	18.410, 18.420 FC, FRC, FLC, FLRC, FLLC, FLLW, FLLRC, FLLRW	04/00→	Ball Head, gearshift linkage	CV-ES-2120		
		04/00→	Centre Rod	MN-DL-7801		Push Rod, Leaf Spring Axle
		04/00→	Centre Rod	MN-DL-8560		Push Rod, Air Suspension Axle
04/00→		Centre Rod	MN-DL-14107		Push Rod	
04/00→		Suspension Strut Repair Kit		DB-RK-8581		
04/00→		Suspension Strut Repair Kit		MN-RK-8537		
04/00→		Suspension Strut Repair Kit		MN-RK-12436		
04/00→		Tie Rod	MN-DL-7802			
04/00→		Tie Rod End		MN-ES-8490	for vehicles with Hinged Trailing Axle	
04/00→		Tie Rod End	CV-ES-0914		for Steering Rod	
04/00→		Tie Rod End	CV-ES-14162		for Steering Rod	
04/00→		Tie Rod End	CV-ES-14163		for Steering Rod	
04/00→		Tie Rod End	IV-ES-12272		for Steering Rod	
04/00→		Tie Rod End	SC-ES-7279		for Steering Rod	
04/00→		Tie Rod End	SC-ES-8517		for Push Rod	
04/00→		Tie Rod End	SC-ES-8535		for Guide Rod	
04/00→		Track Control Arm		MN-DL-5225	Trailing Arm, Drive Axle;Air Suspension Axle	
04/00→		Track Control Arm		MN-DL-8544	Trailing Arm, Drive Axle;Air Suspension Axle	
04/00→		Track Control Arm		MN-DL-8709	Trailing Arm, Drive Axle;Air Suspension Axle	
04/00→		Track Control Arm		MN-DL-8733	Trailing Arm, Air Suspension Axle;Drive Axle	
04/00→		Track Control Arm		MN-TC-12399	Control Arm	
04/00→		Track Control Arm		MN-VB-5238	Wishbone (CV), Drive Axle;Air Suspension Axle	
04/00→		Track Control Arm		MN-VB-8514	Suspension Rod, Wishbone (CV), Drive Axle; Air Suspension Axle	
04/00→		Track Control Arm		MN-VB-8514	Suspension Rod, Wishbone (CV), Drive Axle; Leaf Spring Axle	
04/00→		Track Control Arm	MN-DL-8663		Control Arm, Air Suspension Axle	
06/02→		Track Control Arm		MN-VB-8669	Suspension Rod, Wishbone (CV), Drive Axle	
18.410, 18.420 FK, FK-L, FLK, FLRK		12/00→	Ball Head, gearshift linkage	CV-ES-2120		
		12/00→	Centre Rod	MN-DL-7801		Push Rod, Leaf Spring Axle
		12/00→	Centre Rod	MN-DL-14107		Push Rod
		12/00→	Suspension Strut Repair Kit		DB-RK-8581	
		12/00→	Tie Rod	MN-DL-7802		
		12/00→	Tie Rod End		MN-ES-8490	for vehicles with Hinged Trailing Axle
	12/00→	Tie Rod End	CV-ES-0914		for Steering Rod	
	12/00→	Tie Rod End	CV-ES-14162		for Steering Rod	
	12/00→	Tie Rod End	CV-ES-14163		for Steering Rod	
	12/00→	Tie Rod End	IV-ES-12272		for Steering Rod	
	12/00→	Tie Rod End	SC-ES-7279		for Steering Rod	
	12/00→	Tie Rod End	SC-ES-8517		for Push Rod	
	12/00→	Tie Rod End	SC-ES-8535		for Guide Rod	
	12/00→	Track Control Arm		MN-DL-5225	Trailing Arm, Drive Axle;Air Suspension Axle	
12/00→	Track Control Arm		MN-DL-8544	Trailing Arm, Drive Axle;Air Suspension Axle		

CV-ES-0914

Length: 125
Cone Ø: d1 Ø 30 / d2 Ø 27
Thread: M38 x 1,5 RHT
81953016184, 81953016251, 81953016276



CV-ES-2120

Length: 115
Cone Ø: d1 Ø 12,4 / d2 Ø 10,8
Thread: M14 x 1,5 RHT
03008500A, 81953016200, 81953016202, 81953016203, 81953016227



CV-ES-14162

Length: 125
Cone Ø: d1 Ø 30 / d2 Ø 27
Thread: M30 x 1,5 LHT
81953010015, 81953010083, 81953010087, 81953016029, 81953016030, 81953016043, 81953016044, 81953016050, 81953016054, 81953016087, 81953016091, 81953016107, 81953016120, 81953016125, 81953016152, 81953016155, 81953016157, 81953016168, 81953016179, 81953016181, 81953016223, 81953016237, 81953016254, 81953016275, 81953016279, 81953016351



CV-ES-14163

Length: 125
Cone Ø: d1 Ø 30 / d2 Ø 27
Thread: M30 x 1,5 RHT
95301.0084, 90804102156, 90804102272, 90804102696, 90804102710, 81953010016, 81953010075, 81953010084, 81953010088, 81953010094, 81953010103, 81953016030, 81953016043, 81953016048, 81953016049, 81953016053, 81953016061, 81953016090, 81953016108, 81953016112, 81953016126, 81953016143, 81953016149, 81953016154, 81953016156, 81953016168, 81953016178, 81953016194, 81953016206, 81953016224, 81953016234, 81953016242, 81953016252, 81953016274, 81953016278, 81953016284, 81953016286, 81953016308, 81953016310, 81953016312, 81953016347, 81953016350, 81953016352, 82953016012, 88953016014, N2953016001



DB-RK-8581

Ø: 85
Hole Distance: 130
Thick/Height: 24
03305800A, 81432706105



IV-ES-12272

Length: 75
Cone Ø: d1 Ø 30 / d2 Ø 27
Thread: M26 x 1,5 RHT
81953016280, 82953010010



MN-DL-5225

Length: 572 Ø: 48
Hole Distance: 130 / 130
03301500A, 81432206229, 81432206236, 81432206267, 81432206270, 81432206272, 81432206304, 81432206305, 81432209230, 81432209267, 81432209272



MN-DL-7801

Length: 995 Ø: 52
Cone Ø: d1 Ø 30 / d2 Ø 27
81466106807, 81466106808, 81466116087, 81466116088, 81466116096, 81466116097, 81466116099, 81466116132, 81466116133, 81466116136, 81466116197, 81466116198, 81466116205



MN-DL-7802

Length: 1680 Ø: 52
Cone Ø: d1 Ø 30 / d2 Ø 27
03208300A, 81467116773, 81467116858, 81467116859, 81467116860, 81467116861, 81467116863, 81467116882, 81467116883, 81467116920, 81467116921



MN-DL-8544

Length: 596 Ø: 48
Hole Distance: 130 / 130
81432206196, 81432206232, 81432206233



MN-DL-8560

Length: 970 Ø: 52
Cone Ø: d1 Ø 30 / d2 Ø 27
03206900A, 81466106809, 81466106810, 81466106823, 81466106838, 81466106839, 81466116104, 81466116105, 81466116107, 81466116134, 81466116135, 81466116137, 81466116199, 81466116200, 81466116206



MN-DL-8646

Length: 1021 Ø: 52
Cone Ø: d1 Ø 30 / d2 Ø 27
81466106811, 81466106812, 81466116138, 81466116139, 81466116201, 81466116202



MN-DL-8663

Length: 947 Ø: 60
Hole Distance: 115 / 115
03307400A, 81432206222, 81432206260, 81432206283, 81432206284



MN-DL-8709

Length: 572 Ø: 52
Hole Distance: 130 / 130
81432206268, 81432206274, 81432206291, 81432206292, 82432206007

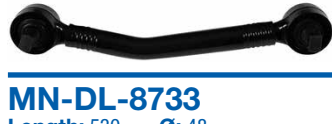

MN-DL-8733

Length: 530 Ø: 48
Hole Distance: 130 / 130
81432206161, 81432206190, 81432206358, 81432206359



MN-DL-14107

Length: 960 Ø: 50
Cone Ø: d1 Ø 30 / d2 Ø 27
81466106813, 81466116146, 81466116147, 81466116148, 81466116204



MN-ES-8490

Length: 90
Cone Ø: d1 Ø 30 / d2 Ø 27
Thread: M26 x 1,5 RHT
14606948, 0014606948, 81953016281, 81953016337, 82953016016



MN-ES-10333

Length: 90
Cone Ø: d1 Ø 38 / d2 Ø 34,35
Thread: M36 x 1,5 RHT
1271126, 3090291, 3099128, 42538048, 81953016268, 82953016018, 82953016019



MN-RK-8537

Ø: 95
Hole Distance: 152
Thick/Height: 24
696321, 03306600A, 81432706079, 81432706099



MN-RK-12436

Ø: 75
Hole Distance: 115
Thick/Height: 24
81432206244



MN-TC-12399

Length: 694 Ø: 50
Hole Distance: 130 / 130
81432206265



MN-VB-5238

Length: 627 Ø: 48
Hole Distance: 130 / 130
81432206221, 81432706096, 81432706114, 81432706116, 81432706121



MN-VB-8514

Length: 627 Ø: 48
Hole Ø 25 / 25 / 25
Hole Distance: 152 / 130 / 130
81432706087, 81432706088, 81432706094, 81432706095, 81432706094



MN-VB-8669

Length: 627 Ø: 48
Hole Ø 25 / 25 / 25
Hole Distance: 152 / 130 / 130
81432706116, 81432706137, 81432706150, 81432706151



SC-ES-7279

Length: 150
Cone Ø: d1 Ø 30 / d2 Ø 27
Thread: M30 x 1,5 RHT
81953016288



SC-ES-8517

Length: 140
Cone Ø: d1 Ø 30 / d2 Ø 27
Thread: M30 x 1,5 RHT
81953016286



SC-ES-8535

Length: 145
Cone Ø: d1 Ø 30 / d2 Ø 27
Thread: M30 x 1,5 RHT
81953016271, 81953016325





TGA ...

18.410, 18.420 FK, FK-L, FLK, FLRK ...	12/00 →	Track Control Arm		MN-DL-8709	Trailing Arm, Drive Axle; Air Suspension Axle
	12/00 →	Track Control Arm		MN-DL-8733	Trailing Arm, Air Suspension Axle; Drive Axle
	12/00 →	Track Control Arm		MN-TC-12399	Control Arm
	12/00 →	Track Control Arm		MN-VB-5238	Wishbone (CV), Drive Axle; Air Suspension Axle
	12/00 →	Track Control Arm		MN-VB-8514	Suspension Rod, Wishbone (CV), Drive Axle; Air Suspension Axle
	12/00 →	Track Control Arm		MN-VB-8514	Suspension Rod, Wishbone (CV), Drive Axle; Leaf Spring Axle
	06/02 →	Track Control Arm		MN-VB-8669	Suspension Rod, Wishbone (CV), Drive Axle
18.430 FLLRS, FLLS, FLRS, FLS, FLS-TS	05/04 →	Ball Head, gearshift linkage	CV-ES-2120		
	05/04 →	Centre Rod	MN-DL-7801		Push Rod, Leaf Spring Axle
	05/04 →	Centre Rod	MN-DL-8560		Push Rod, Air Suspension Axle
	05/04 →	Centre Rod	MN-DL-8560		Push Rod, Air Suspension Axle; Leaf Spring Axle
	05/04 →	Centre Rod	MN-DL-14107		Push Rod
	05/04 →	Suspension Strut Repair Kit		DB-RK-8581	
	05/04 →	Suspension Strut Repair Kit		MN-RK-12436	
	05/04 →	Tie Rod	MN-DL-7802		
	05/04 →	Tie Rod End		MN-ES-8490	for vehicles with Hinged Trailing Axle
	05/04 →	Tie Rod End	CV-ES-0914		for Steering Rod
	05/04 →	Tie Rod End	CV-ES-14162		for Steering Rod
	05/04 →	Tie Rod End	CV-ES-14163		for Steering Rod
	05/04 →	Tie Rod End	IV-ES-12272		for Steering Rod
	05/04 →	Tie Rod End	SC-ES-7279		for Steering Rod
	05/04 →	Tie Rod End	SC-ES-8517		for Push Rod
	05/04 →	Tie Rod End	SC-ES-8535		for Guide Rod
	05/04 →	Track Control Arm		MN-DL-5225	Trailing Arm, Drive Axle; Air Suspension Axle
	05/04 →	Track Control Arm		MN-DL-8488	Trailing Arm; for Wishbone (CV), Air Suspension Axle
	05/04 →	Track Control Arm		MN-DL-8544	Trailing Arm, Drive Axle; Air Suspension Axle
	05/04 →	Track Control Arm		MN-DL-8709	Trailing Arm, Drive Axle; Air Suspension Axle
	05/04 →	Track Control Arm		MN-DL-8733	Trailing Arm, Air Suspension Axle; Drive Axle
	05/04 →	Track Control Arm		MN-VB-5238	Wishbone (CV), Drive Axle; Air Suspension Axle
	05/04 →	Track Control Arm		MN-VB-8514	Suspension Rod, Wishbone (CV), Drive Axle; Air Suspension Axle
	05/04 →	Track Control Arm		MN-VB-8514	Suspension Rod, Wishbone (CV), Drive Axle; Leaf Spring Axle
	05/04 →	Track Control Arm		MN-VB-8669	Suspension Rod, Wishbone (CV), Drive Axle
	05/04 →	Track Control Arm	MN-DL-8663		Control Arm, Air Suspension Axle
	18.430, 18.440 FAC, FARC, FHLC	05/04 →	Ball Head, gearshift linkage	CV-ES-2120	
05/04 →		Centre Rod	MN-DL-7801		Push Rod, Leaf Spring Axle
05/04 →		Centre Rod	MN-DL-8646		Push Rod, Leaf Spring Axle
05/04 →		Suspension Strut Repair Kit		DB-RK-8581	
05/04 →		Tie Rod	MN-DL-7802		
05/04 →		Tie Rod End	CV-ES-0914		for Steering Rod
05/04 →		Tie Rod End	CV-ES-14162		for Steering Rod
05/04 →		Tie Rod End	CV-ES-14163		for Steering Rod
05/04 →		Tie Rod End	MN-ES-10333		for Steering Rod
05/04 →		Tie Rod End	SC-ES-7279		for Steering Rod
05/04 →		Tie Rod End	SC-ES-8517		for Push Rod
05/04 →		Tie Rod End	SC-ES-8535		for Guide Rod
05/04 →		Track Control Arm		MN-DL-5225	Trailing Arm, Drive Axle; Air Suspension Axle
05/04 →		Track Control Arm		MN-DL-5225	Trailing Arm, Leading Axle; Air Suspension Axle
05/04 →		Track Control Arm		MN-DL-8544	Trailing Arm, Drive Axle; Air Suspension Axle
05/04 →		Track Control Arm		MN-VB-5238	Wishbone (CV), Drive Axle; Air Suspension Axle
05/04 →		Track Control Arm		MN-VB-5238	Wishbone (CV), Leading Axle; Air Suspension Axle
05/04 →	Track Control Arm		MN-VB-8514	Suspension Rod, Wishbone (CV), Drive Axle; Air Suspension Axle	
18.430, 18.440 FAK, FALK, FALK-L, FHLK, FHLK/M	05/04 →	Ball Head, gearshift linkage	CV-ES-2120		
	05/04 →	Centre Rod	MN-DL-7801		Push Rod, Leaf Spring Axle
	05/04 →	Centre Rod	MN-DL-8646		Push Rod, Leaf Spring Axle
	05/04 →	Suspension Strut Repair Kit		DB-RK-8581	
	05/04 →	Tie Rod	MN-DL-7802		
	05/04 →	Tie Rod End	CV-ES-0914		for Steering Rod

CV-ES-0914

Length: 125
Cone Ø: d1 Ø 30 / d2 Ø 27
Thread: M38 x 1,5 RHT
81953016184, 81953016251, 81953016276



CV-ES-2120

Length: 115
Cone Ø: d1 Ø 12,4 / d2 Ø 10,8
Thread: M14 x 1,5 RHT
03008500A, 81953016200, 81953016202, 81953016203, 81953016227



CV-ES-14162

Length: 125
Cone Ø: d1 Ø 30 / d2 Ø 27
Thread: M30 x 1,5 LHT
81953010015, 81953010083, 81953010087, 81953016029, 81953016030, 81953016043, 81953016044, 81953016050, 81953016054, 81953016087, 81953016091, 81953016107, 81953016120, 81953016125, 81953016152, 81953016155, 81953016157, 81953016168, 81953016179, 81953016181, 81953016223, 81953016237, 81953016254, 81953016275, 81953016279, 81953016351



CV-ES-14163

Length: 125
Cone Ø: d1 Ø 30 / d2 Ø 27
Thread: M30 x 1,5 RHT
95301.0084, 90804102156, 90804102272, 90804102696, 90804102710, 81953010016, 81953010075, 81953010084, 81953010088, 81953010094, 81953010103, 81953016030, 81953016043, 81953016048, 81953016049, 81953016053, 81953016061, 81953016090, 81953016108, 81953016112, 81953016126, 81953016143, 81953016149, 81953016154, 81953016156, 81953016168, 81953016178, 81953016194, 81953016206, 81953016224, 81953016234, 81953016242, 81953016252, 81953016274, 81953016278, 81953016284, 81953016286, 81953016308, 81953016310, 81953016312, 81953016347, 81953016350, 81953016352, 82953016012, 88953016014, N2953016001



DB-RK-8581

Ø: 85
Hole Distance: 130
Thick/Height: 24
03305800A, 81432706105



IV-ES-12272

Length: 75
Cone Ø: d1 Ø 30 / d2 Ø 27
Thread: M26 x 1,5 RHT
81953016280, 82953010010



MN-DL-5225

Length: 572 Ø: 48
Hole Distance: 130 / 130
03301500A, 81432206229, 81432206236, 81432206267, 81432206270, 81432206272, 81432206304, 81432206305, 81432209236, 81432209267, 81432209272



MN-DL-7801

Length: 995 Ø: 52
Cone Ø: d1 Ø 30 / d2 Ø 27
81466106807, 81466106808, 81466116087, 81466116088, 81466116096, 81466116097, 81466116099, 81466116132, 81466116133, 81466116136, 81466116197, 81466116198, 81466116205



MN-DL-7802

Length: 1680 Ø: 52
Cone Ø: d1 Ø 30 / d2 Ø 27
03208300A, 81467116773, 81467116858, 81467116859, 81467116860, 81467116861, 81467116863, 81467116882, 81467116883, 81467116920, 81467116921



MN-DL-8488

Length: 414 Ø: 50
Hole Distance: 130 / 130
81432206247, 81432206341, 81432206342



MN-DL-8544

Length: 596 Ø: 48
Hole Distance: 130 / 130
81432206196, 81432206232, 81432206233



MN-DL-8560

Length: 970 Ø: 52
Cone Ø: d1 Ø 30 / d2 Ø 27
03206900A, 81466106809, 81466106810, 81466106823, 81466106838, 81466106839, 81466116104, 81466116105, 81466116107, 81466116134, 81466116135, 81466116137, 81466116199, 81466116200, 81466116206



MN-DL-8646

Length: 1021 Ø: 52
Cone Ø: d1 Ø 30 / d2 Ø 27
81466106811, 81466106812, 81466116138, 81466116139, 81466116201, 81466116202



MN-DL-8663

Length: 947 Ø: 60
Hole Distance: 115 / 115
03307400A, 81432206222, 81432206260, 81432206283, 81432206284



MN-DL-8709

Length: 572 Ø: 52
Hole Distance: 130 / 130
81432206268, 81432206274, 81432206291, 81432206292, 82432206007



MN-DL-8733

Length: 530 Ø: 48
Hole Distance: 130 / 130
81432206161, 81432206190, 81432206358, 81432206359



MN-DL-14107

Length: 960 Ø: 50
Cone Ø: d1 Ø 30 / d2 Ø 27
81466106813, 81466116146, 81466116147, 81466116148, 81466116204



MN-ES-8490

Length: 90
Cone Ø: d1 Ø 30 / d2 Ø 27
Thread: M26 x 1,5 RHT
0014606948, 14606948, 81953016281, 81953016337, 82953016016



MN-ES-10333

Length: 90
Cone Ø: d1 Ø 38 / d2 Ø 34,35
Thread: M36 x 1,5 RHT
1271126, 3090291, 3099128, 42538048, 81953016268, 82953016018, 82953016019



MN-RK-12436

Ø: 75
Hole Distance: 115
Thick/Height: 24
81432206244



MN-TC-12399

Length: 694 Ø: 50
Hole Distance: 130 / 130
81432206265



MN-VB-5238

Length: 627 Ø: 48
Hole Distance: 130 / 130
81432206221, 81432706096, 81432706114, 81432706116, 81432706121



MN-VB-8514

Length: 627 Ø: 48
Hole Ø 25 / 25 / 25
Hole Distance: 152 / 130 / 130
81432706087, 81432706088, 81432706094, 81432706095, 81432706094



MN-VB-8669

Length: 627 Ø: 48
Hole Ø 25 / 25 / 25
Hole Distance: 152 / 130 / 130
81432706116, 81432706137, 81432706150, 81432706151



SC-ES-7279

Length: 150
Cone Ø: d1 Ø 30 / d2 Ø 27
Thread: M30 x 1,5 RHT
81953016288



SC-ES-8517

Length: 140
Cone Ø: d1 Ø 30 / d2 Ø 27
Thread: M30 x 1,5 RHT
81953016286



SC-ES-8535

Length: 145
Cone Ø: d1 Ø 30 / d2 Ø 27
Thread: M30 x 1,5 RHT
81953016271, 81953016325





TGA ...

18.430, 18.440 FAK, FALK, FALK-L, FHLK, FHLK/M ...	05/04 →	Tie Rod End	CV-ES-14162		for Steering Rod
	05/04 →	Tie Rod End	CV-ES-14163		for Steering Rod
	05/04 →	Tie Rod End	MN-ES-10333		for Steering Rod
	05/04 →	Tie Rod End	SC-ES-7279		for Steering Rod
	05/04 →	Tie Rod End	SC-ES-8517		for Push Rod
	05/04 →	Tie Rod End	SC-ES-8535		for Guide Rod
	05/04 →	Track Control Arm		MN-DL-5225	Trailing Arm, Drive Axle; Air Suspension Axle
	05/04 →	Track Control Arm		MN-DL-5225	Trailing Arm, Leading Axle; Air Suspension Axle
	05/04 →	Track Control Arm		MN-DL-8544	Trailing Arm, Drive Axle; Air Suspension Axle
	05/04 →	Track Control Arm		MN-VB-5238	Wishbone (CV), Drive Axle; Air Suspension Axle
	05/04 →	Track Control Arm		MN-VB-5238	Wishbone (CV), Leading Axle; Air Suspension Axle
	05/04 →	Track Control Arm		MN-VB-8514	Suspension Rod, Wishbone (CV), Drive Axle; Air Suspension Axle
	18.430, 18.440 FALS, FAS, FHLS	05/04 →	Ball Head, gearshift linkage	CV-ES-2120	
05/04 →		Centre Rod	MN-DL-7801		Push Rod, Leaf Spring Axle
05/04 →		Centre Rod	MN-DL-8646		Push Rod, Leaf Spring Axle
05/04 →		Suspension Strut Repair Kit		DB-RK-8581	
05/04 →		Tie Rod	MN-DL-7802		
05/04 →		Tie Rod End	CV-ES-0914		for Steering Rod
05/04 →		Tie Rod End	CV-ES-14162		for Steering Rod
05/04 →		Tie Rod End	CV-ES-14163		for Steering Rod
05/04 →		Tie Rod End	MN-ES-10333		for Steering Rod
05/04 →		Tie Rod End	SC-ES-7279		for Steering Rod
05/04 →		Tie Rod End	SC-ES-8517		for Push Rod
05/04 →		Tie Rod End	SC-ES-8535		for Guide Rod
05/04 →		Track Control Arm		MN-DL-5225	Trailing Arm, Drive Axle; Air Suspension Axle
05/04 →		Track Control Arm		MN-DL-5225	Trailing Arm, Leading Axle; Air Suspension Axle
05/04 →		Track Control Arm		MN-DL-8544	Trailing Arm, Drive Axle; Air Suspension Axle
05/04 →		Track Control Arm		MN-VB-5238	Wishbone (CV), Drive Axle; Air Suspension Axle
05/04 →		Track Control Arm		MN-VB-5238	Wishbone (CV), Leading Axle; Air Suspension Axle
05/04 →		Track Control Arm		MN-VB-8514	Suspension Rod, Wishbone (CV), Drive Axle; Air Suspension Axle
18.430, 18.440 FC, FLC, FLLC, FLLRC, FLLRW, FLLW, FLRC	05/04 →	Ball Head, gearshift linkage	CV-ES-2120		
	05/04 →	Centre Rod	MN-DL-7801		Push Rod, Leaf Spring Axle
	05/04 →	Centre Rod	MN-DL-8560		Push Rod, Air Suspension Axle
	05/04 →	Suspension Strut Repair Kit		DB-RK-8581	
	05/04 →	Suspension Strut Repair Kit		MN-RK-12436	
	05/04 →	Tie Rod	MN-DL-7802		
	05/04 →	Tie Rod End		MN-ES-8490	for vehicles with Hinged Trailing Axle
	05/04 →	Tie Rod End	CV-ES-0914		for Steering Rod
	05/04 →	Tie Rod End	CV-ES-14162		for Steering Rod
	05/04 →	Tie Rod End	CV-ES-14163		for Steering Rod
	05/04 →	Tie Rod End	IV-ES-12272		for Steering Rod
	05/04 →	Tie Rod End	SC-ES-7279		for Steering Rod
	05/04 →	Tie Rod End	SC-ES-8517		for Push Rod
	05/04 →	Tie Rod End	SC-ES-8535		for Guide Rod
	05/04 →	Track Control Arm		MN-DL-5225	Trailing Arm, Drive Axle; Air Suspension Axle
	05/04 →	Track Control Arm		MN-DL-8544	Trailing Arm, Drive Axle; Air Suspension Axle
	05/04 →	Track Control Arm		MN-DL-8709	Trailing Arm, Drive Axle; Air Suspension Axle
	05/04 →	Track Control Arm		MN-DL-8733	Trailing Arm, Air Suspension Axle; Drive Axle
	05/04 →	Track Control Arm		MN-VB-5238	Wishbone (CV), Drive Axle; Air Suspension Axle
	05/04 →	Track Control Arm		MN-VB-8514	Suspension Rod, Wishbone (CV), Drive Axle; Air Suspension Axle
	05/04 →	Track Control Arm		MN-VB-8514	Suspension Rod, Wishbone (CV), Drive Axle; Leaf Spring Axle
	05/04 →	Track Control Arm		MN-VB-8669	Suspension Rod, Wishbone (CV), Drive Axle Control Arm, Air Suspension Axle
	05/04 →	Track Control Arm	MN-DL-8663		
18.430, 18.440 FK, FK-L, FLK, FLRK	05/04 →	Ball Head, gearshift linkage	CV-ES-2120		
	05/04 →	Centre Rod	MN-DL-7801		Push Rod, Leaf Spring Axle
	05/04 →	Suspension Strut Repair Kit		DB-RK-8581	
	05/04 →	Tie Rod	MN-DL-7802		
	05/04 →	Tie Rod End		MN-ES-8490	for vehicles with Hinged Trailing Axle
05/04 →	Tie Rod End	CV-ES-0914		for Steering Rod	

CV-ES-0914

Length: 125
Cone Ø: d1 Ø 30 / d2 Ø 27
Thread: M38 x 1,5 RHT
81953016184, 81953016251, 81953016276



CV-ES-2120

Length: 115
Cone Ø: d1 Ø 12,4 / d2 Ø 10,8
Thread: M14 x 1,5 RHT
03008500A, 81953016200, 81953016202,
81953016203, 81953016227



CV-ES-14162

Length: 125
Cone Ø: d1 Ø 30 / d2 Ø 27
Thread: M30 x 1,5 LHT
81953010015, 81953010083, 81953010087,
81953016029, 81953016030, 81953016043,
81953016044, 81953016050, 81953016054,
81953016087, 81953016091, 81953016107,
81953016120, 81953016125, 81953016152,
81953016155, 81953016157, 81953016168,
81953016179, 81953016181, 81953016223,
81953016237, 81953016254, 81953016275,
81953016279, 81953016351



CV-ES-14163

Length: 125
Cone Ø: d1 Ø 30 / d2 Ø 27
Thread: M30 x 1,5 RHT
95301.0084, 90804102156, 90804102272,
90804102696, 90804102710, 81953010016,
81953010075, 81953010084, 81953010088,
81953010094, 81953010103, 81953016030,
81953016043, 81953016048, 81953016049,
81953016053, 81953016061, 81953016090,
81953016108, 81953016112, 81953016126,
81953016143, 81953016149, 81953016154,
81953016156, 81953016168, 81953016178,
81953016194, 81953016206, 81953016224,
81953016234, 81953016242, 81953016252,
81953016274, 81953016278, 81953016284,
81953016286, 81953016308, 81953016310,
81953016312, 81953016347, 81953016350,
81953016352, 82953016012, 88953016014,
N2953016001



DB-RK-8581

Ø: 85
Hole Distance: 130
Thick/Height: 24
03305800A, 81432706105



IV-ES-12272

Length: 75
Cone Ø: d1 Ø 30 / d2 Ø 27
Thread: M26 x 1,5 RHT
81953016280, 82953010010



MN-DL-5225

Length: 572 Ø: 48
Hole Distance: 130 / 130
03301500A, 81432206229, 81432206236,
81432206267, 81432206270, 81432206272,
81432206304, 81432206305, 81432209236,
81432209267, 81432209272



MN-DL-7801

Length: 995 Ø: 52
Cone Ø: d1 Ø 30 / d2 Ø 27
81466106807, 81466106808, 81466116087,
81466116088, 81466116096, 81466116097,
81466116099, 81466116132, 81466116133,
81466116136, 81466116197, 81466116198,
81466116205



MN-DL-7802

Length: 1680 Ø: 52
Cone Ø: d1 Ø 30 / d2 Ø 27
03208300A, 81467116773, 81467116858,
81467116859, 81467116860, 81467116861,
81467116863, 81467116882, 81467116883,
81467116920, 81467116921



MN-DL-8544

Length: 596 Ø: 48
Hole Distance: 130 / 130
81432206196, 81432206232, 81432206233



MN-DL-8560

Length: 970 Ø: 52
Cone Ø: d1 Ø 30 / d2 Ø 27
03206900A, 81466106809, 81466106810,
81466106823, 81466106838, 81466106839,
81466116104, 81466116105, 81466116107,
81466116134, 81466116135, 81466116137,
81466116199, 81466116200, 81466116206



MN-DL-8646

Length: 1021 Ø: 52
Cone Ø: d1 Ø 30 / d2 Ø 27
81466106811, 81466106812, 81466116138,
81466116139, 81466116201, 81466116202



MN-DL-8663

Length: 947 Ø: 60
Hole Distance: 115 / 115
03307400A, 81432206222, 81432206260,
81432206283, 81432206284



MN-DL-8709

Length: 572 Ø: 52
Hole Distance: 130 / 130
81432206268, 81432206274, 81432206291,
81432206292, 82432206007



MN-DL-8733

Length: 530 Ø: 48
Hole Distance: 130 / 130
81432206161, 81432206190, 81432206358,
81432206359



MN-ES-8490

Length: 90
Cone Ø: d1 Ø 30 / d2 Ø 27
Thread: M26 x 1,5 RHT
0014606948, 14606948, 81953016281,
81953016337, 82953016016



MN-ES-10333

Length: 90
Cone Ø: d1 Ø 38 / d2 Ø 34,35
Thread: M36 x 1,5 RHT
1271126, 3090291, 3099128, 42538048,
81953016268, 82953016018, 82953016019



MN-RK-12436

Ø: 75
Hole Distance: 115
Thick/Height: 24
81432206244



MN-VB-5238

Length: 627 Ø: 48
Hole Distance: 130 / 130
81432206221, 81432706096, 81432706114,
81432706116, 81432706121



MN-VB-8514

Length: 627 Ø: 48
Hole Ø 25 / 25 / 25
Hole Distance: 152 / 130 / 130
81432706087, 81432706088, 81432706094,
81432706095, 81432796094



MN-VB-8669

Length: 627 Ø: 48
Hole Ø 25 / 25 / 25
Hole Distance: 152 / 130 / 130
81432706116, 81432706137, 81432706150,
81432706151



SC-ES-7279

Length: 150
Cone Ø: d1 Ø 30 / d2 Ø 27
Thread: M30 x 1,5 RHT
81953016288



SC-ES-8517

Length: 140
Cone Ø: d1 Ø 30 / d2 Ø 27
Thread: M30 x 1,5 RHT
81953016286



SC-ES-8535

Length: 145
Cone Ø: d1 Ø 30 / d2 Ø 27
Thread: M30 x 1,5 RHT
81953016271, 81953016325





TGA ...

18.430, 18.440 FK, FK-L, FLK, FLRK ...	05/04 →	Tie Rod End	CV-ES-14162		for Steering Rod
	05/04 →	Tie Rod End	CV-ES-14163		for Steering Rod
	05/04 →	Tie Rod End	IV-ES-12272		for Steering Rod
	05/04 →	Tie Rod End	SC-ES-7279		for Steering Rod
	05/04 →	Tie Rod End	SC-ES-8517		for Push Rod
	05/04 →	Tie Rod End	SC-ES-8535		for Guide Rod
	05/04 →	Track Control Arm		MN-DL-5225	Trailing Arm, Drive Axle; Air Suspension Axle
	05/04 →	Track Control Arm		MN-DL-8544	Trailing Arm, Drive Axle; Air Suspension Axle
	05/04 →	Track Control Arm		MN-DL-8709	Trailing Arm, Drive Axle; Air Suspension Axle
	05/04 →	Track Control Arm		MN-DL-8733	Trailing Arm, Air Suspension Axle; Drive Axle
	05/04 →	Track Control Arm		MN-VB-5238	Wishbone (CV), Drive Axle; Air Suspension Axle
	05/04 →	Track Control Arm		MN-VB-8514	Suspension Rod, Wishbone (CV), Drive Axle; Air Suspension Axle
	05/04 →	Track Control Arm		MN-VB-8514	Suspension Rod, Wishbone (CV), Drive Axle; Leaf Spring Axle
	05/04 →	Track Control Arm		MN-VB-8669	Suspension Rod, Wishbone (CV), Drive Axle
18.440 FLLRS, FLLS, FLRS, FLS, FLS-TS	09/05 →	Centre Rod	MN-DL-7801		Push Rod, Leaf Spring Axle
	09/05 →	Centre Rod	MN-DL-8560		Push Rod, Air Suspension Axle
	09/05 →	Centre Rod	MN-DL-8560		Push Rod, Air Suspension Axle; Leaf Spring Axle
	09/05 →	Centre Rod	MN-DL-14107		Push Rod
	09/05 →	Suspension Strut Repair Kit		MN-RK-12436	
	09/05 →	Tie Rod	MN-DL-7802		
	09/05 →	Tie Rod End	CV-ES-0914		for Steering Rod
	09/05 →	Tie Rod End	CV-ES-14162		for Steering Rod
	09/05 →	Tie Rod End	CV-ES-14163		for Steering Rod
	09/05 →	Tie Rod End	SC-ES-7279		for Steering Rod
	09/05 →	Tie Rod End	SC-ES-8517		for Push Rod
	09/05 →	Tie Rod End	SC-ES-8535		for Guide Rod
	09/05 →	Track Control Arm		MN-DL-5225	Trailing Arm
	09/05 →	Track Control Arm		MN-DL-8488	Wishbone (CV), Drive Axle, for Pneumatic Suspension vehicles
	09/05 →	Track Control Arm		MN-DL-8544	Trailing Arm, Drive Axle, for Pneumatic Suspension vehicles, →MHB Chassis
	09/05 →	Track Control Arm		MN-DL-8733	Trailing Arm, 1st Drive Axle, for Pneumatic Suspension vehicles, →Type_RHFN
	09/05 →	Track Control Arm		MN-VB-5238	Wishbone (CV), 1st Drive Axle, for Pneumatic Suspension vehicles
	09/05 →	Track Control Arm		MN-VB-8514	Suspension Rod, Wishbone (CV)
	09/05 →	Track Control Arm	MN-DL-8663		Control Arm
	18.460 FAK	12/00 →	Centre Rod	MN-DL-8646	
12/00 →		Track Control Arm		MN-DL-8544	Trailing Arm
12/00 →		Track Control Arm		MN-VB-8514	Suspension Rod, Wishbone (CV)
18.460 FC, FLC, FLLC, FLLRC, FLLRW, FLLW, FLRC, FRC	04/00 →	Ball Head, gearshift linkage	CV-ES-2120		
	04/00 →	Centre Rod	MN-DL-7801		Push Rod, Leaf Spring Axle
	04/00 →	Centre Rod	MN-DL-8560		Push Rod, Air Suspension Axle
	04/00 →	Centre Rod	MN-DL-14107		Push Rod
	04/00 →	Suspension Strut Repair Kit		DB-RK-8581	
	04/00 →	Suspension Strut Repair Kit		MN-RK-8537	
	04/00 →	Suspension Strut Repair Kit		MN-RK-12436	
	04/00 →	Tie Rod	MN-DL-7802		
	04/00 →	Tie Rod End		MN-ES-8490	for vehicles with Hinged Trailing Axle
	04/00 →	Tie Rod End	CV-ES-0914		for Steering Rod
	04/00 →	Tie Rod End	CV-ES-14162		for Steering Rod
	04/00 →	Tie Rod End	CV-ES-14163		for Steering Rod
	04/00 →	Tie Rod End	IV-ES-12272		for Steering Rod
	04/00 →	Tie Rod End	SC-ES-7279		for Steering Rod
	04/00 →	Tie Rod End	SC-ES-8517		for Push Rod
	04/00 →	Tie Rod End	SC-ES-8535		for Guide Rod
	04/00 →	Track Control Arm		MN-DL-5225	Trailing Arm, Drive Axle; Air Suspension Axle
	04/00 →	Track Control Arm		MN-DL-8544	Trailing Arm, Drive Axle; Air Suspension Axle
	04/00 →	Track Control Arm		MN-DL-8709	Trailing Arm, Drive Axle; Air Suspension Axle
	04/00 →	Track Control Arm		MN-DL-8733	Trailing Arm, Air Suspension Axle; Drive Axle
	04/00 →	Track Control Arm		MN-TC-12399	Control Arm

CV-ES-0914

Length: 125
Cone Ø: d1 Ø 30 / d2 Ø 27
Thread: M38 x 1,5 RHT
81953016184, 81953016251, 81953016276



CV-ES-2120

Length: 115
Cone Ø: d1 Ø 12,4 / d2 Ø 10,8
Thread: M14 x 1,5 RHT
03008500A, 81953016200, 81953016202, 81953016203, 81953016227



CV-ES-14162

Length: 125
Cone Ø: d1 Ø 30 / d2 Ø 27
Thread: M30 x 1,5 LHT
81953010015, 81953010083, 81953010087, 81953016029, 81953016030, 81953016043, 81953016044, 81953016050, 81953016054, 81953016087, 81953016091, 81953016107, 81953016120, 81953016125, 81953016152, 81953016155, 81953016157, 81953016168, 81953016179, 81953016181, 81953016223, 81953016237, 81953016254, 81953016275, 81953016279, 81953016351



CV-ES-14163

Length: 125
Cone Ø: d1 Ø 30 / d2 Ø 27
Thread: M30 x 1,5 RHT
95301.0084, 90804102156, 90804102272, 90804102696, 90804102710, 81953010016, 81953010075, 81953010084, 81953010088, 81953010094, 81953010103, 81953016030, 81953016043, 81953016048, 81953016049, 81953016053, 81953016061, 81953016090, 81953016108, 81953016112, 81953016126, 81953016143, 81953016149, 81953016154, 81953016156, 81953016168, 81953016178, 81953016194, 81953016206, 81953016224, 81953016234, 81953016242, 81953016252, 81953016274, 81953016278, 81953016284, 81953016286, 81953016308, 81953016310, 81953016312, 81953016347, 81953016350, 81953016352, 82953016012, 88953016014, N2953016001



DB-RK-8581

Ø: 85
Hole Distance: 130
Thick/Height: 24
03305800A, 81432706105



IV-ES-12272

Length: 75
Cone Ø: d1 Ø 30 / d2 Ø 27
Thread: M26 x 1,5 RHT
81953016280, 82953010010



MN-DL-5225

Length: 572 Ø: 48
Hole Distance: 130 / 130
03301500A, 81432206229, 81432206236, 81432206267, 81432206270, 81432206272, 81432206304, 81432206305, 81432209236, 81432209267, 81432209272



MN-DL-7801

Length: 995 Ø: 52
Cone Ø: d1 Ø 30 / d2 Ø 27
81466106807, 81466106808, 81466116087, 81466116088, 81466116096, 81466116097, 81466116099, 81466116132, 81466116133, 81466116136, 81466116197, 81466116198, 81466116205



MN-DL-7802

Length: 1680 Ø: 52
Cone Ø: d1 Ø 30 / d2 Ø 27
03208300A, 81467116773, 81467116858, 81467116859, 81467116860, 81467116861, 81467116863, 81467116882, 81467116883, 81467116920, 81467116921



MN-DL-8488

Length: 414 Ø: 50
Hole Distance: 130 / 130
81432206247, 81432206341, 81432206342



MN-DL-8544

Length: 596 Ø: 48
Hole Distance: 130 / 130
81432206196, 81432206232, 81432206233



MN-DL-8560

Length: 970 Ø: 52
Cone Ø: d1 Ø 30 / d2 Ø 27
03206900A, 81466106809, 81466106810, 81466106823, 81466106838, 81466106839, 81466116104, 81466116105, 81466116107, 81466116134, 81466116135, 81466116137, 81466116199, 81466116200, 81466116206



MN-DL-8646

Length: 1021 Ø: 52
Cone Ø: d1 Ø 30 / d2 Ø 27
81466106811, 81466106812, 81466116138, 81466116139, 81466116201, 81466116202



MN-DL-8663

Length: 947 Ø: 60
Hole Distance: 115 / 115
03307400A, 81432206222, 81432206260, 81432206283, 81432206284



MN-DL-8709

Length: 572 Ø: 52
Hole Distance: 130 / 130
81432206268, 81432206274, 81432206291, 81432206292, 82432206007



MN-DL-8733

Length: 530 Ø: 48
Hole Distance: 130 / 130
81432206161, 81432206190, 81432206358, 81432206359



MN-DL-14107

Length: 960 Ø: 50
Cone Ø: d1 Ø 30 / d2 Ø 27
81466106813, 81466116146, 81466116147, 81466116148, 81466116204



MN-ES-8490

Length: 90
Cone Ø: d1 Ø 30 / d2 Ø 27
Thread: M26 x 1,5 RHT
0014606948, 14606948, 81953016281, 81953016337, 82953016016



MN-RK-8537

Ø: 95
Hole Distance: 152
Thick/Height: 24
696321, 03306600A, 81432706079, 81432706099



MN-RK-12436

Ø: 75
Hole Distance: 115
Thick/Height: 24
81432206244



MN-TC-12399

Length: 694 Ø: 50
Hole Distance: 130 / 130
81432206265



MN-VB-5238

Length: 627 Ø: 48
Hole Distance: 130 / 130
81432206221, 81432706096, 81432706114, 81432706116, 81432706121



MN-VB-8514

Length: 627 Ø: 48
Hole Ø 25 / 25 / 25
Hole Distance: 152 / 130 / 130
81432706087, 81432706088, 81432706094, 81432706095, 81432706094



MN-VB-8669

Length: 627 Ø: 48
Hole Ø 25 / 25 / 25
Hole Distance: 152 / 130 / 130
81432706116, 81432706137, 81432706150, 81432706151



SC-ES-7279

Length: 150
Cone Ø: d1 Ø 30 / d2 Ø 27
Thread: M30 x 1,5 RHT
81953016288



SC-ES-8517

Length: 140
Cone Ø: d1 Ø 30 / d2 Ø 27
Thread: M30 x 1,5 RHT
81953016286



SC-ES-8535

Length: 145
Cone Ø: d1 Ø 30 / d2 Ø 27
Thread: M30 x 1,5 RHT
81953016271, 81953016325





TGA ...

18.460 FC, FLC, FLLC, FLLRC, FLLRW, FLLW, FLRC, FRC ...	04/00→	Track Control Arm		MN-VB-5238	Wishbone (CV), Drive Axle;Air Suspension Axle	
	04/00→	Track Control Arm		MN-VB-8514	Suspension Rod, Wishbone (CV), Drive Axle; Air Suspension Axle	
	04/00→	Track Control Arm		MN-VB-8514	Suspension Rod, Wishbone (CV), Drive Axle; Leaf Spring Axle	
	04/00→	Track Control Arm	MN-DL-8663		Control Arm, Air Suspension Axle	
	06/02→	Track Control Arm		MN-VB-8669	Suspension Rod, Wishbone (CV), Drive Axle	
	18.460 FK, FK-L, FLK, FLRK	12/00→	Ball Head, gearshift linkage	CV-ES-2120		
12/00→		Centre Rod	MN-DL-7801		Push Rod, Leaf Spring Axle	
12/00→		Centre Rod	MN-DL-14107		Push Rod	
12/00→		Suspension Strut Repair Kit		DB-RK-8581		
12/00→		Tie Rod	MN-DL-7802			
12/00→		Tie Rod End		MN-ES-8490	for vehicles with Hinged Trailing Axle	
12/00→		Tie Rod End	CV-ES-0914		for Steering Rod	
12/00→		Tie Rod End	CV-ES-14162		for Steering Rod	
12/00→		Tie Rod End	CV-ES-14163		for Steering Rod	
12/00→		Tie Rod End	IV-ES-12272		for Steering Rod	
12/00→		Tie Rod End	SC-ES-7279		for Steering Rod	
12/00→		Tie Rod End	SC-ES-8517		for Push Rod	
12/00→		Tie Rod End	SC-ES-8535		for Guide Rod	
12/00→		Track Control Arm		MN-DL-5225	Trailing Arm, Drive Axle;Air Suspension Axle	
12/00→		Track Control Arm		MN-DL-8544	Trailing Arm, Drive Axle;Air Suspension Axle	
12/00→		Track Control Arm		MN-DL-8709	Trailing Arm, Drive Axle;Air Suspension Axle	
12/00→		Track Control Arm		MN-DL-8733	Trailing Arm, Air Suspension Axle;Drive Axle	
12/00→		Track Control Arm		MN-TC-12399	Control Arm	
12/00→		Track Control Arm		MN-VB-5238	Wishbone (CV), Drive Axle;Air Suspension Axle	
12/00→		Track Control Arm		MN-VB-8514	Suspension Rod, Wishbone (CV), Drive Axle; Air Suspension Axle	
12/00→		Track Control Arm		MN-VB-8514	Suspension Rod, Wishbone (CV), Drive Axle; Leaf Spring Axle	
06/02→		Track Control Arm		MN-VB-8669	Suspension Rod, Wishbone (CV), Drive Axle	
18.460 FLLRS, FLLS, FLRS, FLS, FLS-TS		04/00→	Ball Head, gearshift linkage	CV-ES-2120		
		04/00→	Centre Rod	MN-DL-7801		Push Rod, Leaf Spring Axle
		04/00→	Centre Rod	MN-DL-8560		Push Rod, Air Suspension Axle
		04/00→	Centre Rod	MN-DL-14107		Push Rod
		04/00→	Suspension Strut Repair Kit		DB-RK-8581	
		04/00→	Suspension Strut Repair Kit		MN-RK-8537	
	04/00→	Suspension Strut Repair Kit		MN-RK-12436		
	04/00→	Tie Rod	MN-DL-7802			
	04/00→	Tie Rod End		MN-ES-8490	for vehicles with Hinged Trailing Axle	
	04/00→	Tie Rod End	CV-ES-0914		for Steering Rod	
	04/00→	Tie Rod End	CV-ES-14162		for Steering Rod	
	04/00→	Tie Rod End	CV-ES-14163		for Steering Rod	
	04/00→	Tie Rod End	IV-ES-12272		for Steering Rod	
	04/00→	Tie Rod End	SC-ES-7279		for Steering Rod	
	04/00→	Tie Rod End	SC-ES-8517		for Push Rod	
	04/00→	Tie Rod End	SC-ES-8535		for Guide Rod	
	04/00→	Track Control Arm		MN-DL-5225	Trailing Arm, Drive Axle;Air Suspension Axle	
	04/00→	Track Control Arm		MN-DL-8488	Trailing Arm;for Wishbone (CV), Air Suspension Axle	
	04/00→	Track Control Arm		MN-DL-8544	Trailing Arm, Drive Axle;Air Suspension Axle	
	04/00→	Track Control Arm		MN-DL-8709	Trailing Arm, Drive Axle;Air Suspension Axle	
	04/00→	Track Control Arm		MN-DL-8733	Trailing Arm, Air Suspension Axle;Drive Axle	
	04/00→	Track Control Arm		MN-TC-12399	Control Arm	
	04/00→	Track Control Arm		MN-VB-5238	Wishbone (CV), Drive Axle;Air Suspension Axle	
	04/00→	Track Control Arm		MN-VB-8514	Suspension Rod, Wishbone (CV), Drive Axle; Air Suspension Axle	
	04/00→	Track Control Arm		MN-VB-8514	Suspension Rod, Wishbone (CV), Drive Axle; Leaf Spring Axle	
	04/00→	Track Control Arm	MN-DL-8663		Control Arm, Air Suspension Axle	
	06/02→	Track Control Arm		MN-VB-8669	Suspension Rod, Wishbone (CV), Drive Axle	

CV-ES-0914

Length: 125
Cone Ø: d1 Ø 30 / d2 Ø 27
Thread: M38 x 1,5 RHT
81953016184, 81953016251, 81953016276



CV-ES-2120

Length: 115
Cone Ø: d1 Ø 12,4 / d2 Ø 10,8
Thread: M14 x 1,5 RHT
03008500A, 81953016200, 81953016202, 81953016203, 81953016227



CV-ES-14162

Length: 125
Cone Ø: d1 Ø 30 / d2 Ø 27
Thread: M30 x 1,5 LHT
81953010015, 81953010083, 81953010087, 81953016029, 81953016030, 81953016043, 81953016044, 81953016050, 81953016054, 81953016087, 81953016091, 81953016107, 81953016120, 81953016125, 81953016152, 81953016155, 81953016157, 81953016168, 81953016179, 81953016181, 81953016223, 81953016237, 81953016254, 81953016275, 81953016279, 81953016351



CV-ES-14163

Length: 125
Cone Ø: d1 Ø 30 / d2 Ø 27
Thread: M30 x 1,5 RHT
95301.0084, 90804102156, 90804102272, 90804102696, 90804102710, 81953010016, 81953010075, 81953010084, 81953010088, 81953010094, 81953010103, 81953016030, 81953016043, 81953016048, 81953016049, 81953016053, 81953016061, 81953016090, 81953016108, 81953016112, 81953016126, 81953016143, 81953016149, 81953016154, 81953016156, 81953016168, 81953016178, 81953016194, 81953016206, 81953016224, 81953016234, 81953016242, 81953016252, 81953016274, 81953016278, 81953016284, 81953016286, 81953016308, 81953016310, 81953016312, 81953016347, 81953016350, 81953016352, 82953016012, 88953016014, N2953016001



DB-RK-8581

Ø: 85
Hole Distance: 130
Thick/Height: 24
03305800A, 81432706105



IV-ES-12272

Length: 75
Cone Ø: d1 Ø 30 / d2 Ø 27
Thread: M26 x 1,5 RHT
81953016280, 82953010010



MN-DL-5225

Length: 572 Ø: 48
Hole Distance: 130 / 130
03301500A, 81432206229, 81432206236, 81432206267, 81432206270, 81432206272, 81432206304, 81432206305, 81432209236, 81432209267, 81432209272



MN-DL-7801

Length: 995 Ø: 52
Cone Ø: d1 Ø 30 / d2 Ø 27
81466106807, 81466106808, 81466116087, 81466116088, 81466116096, 81466116097, 81466116099, 81466116132, 81466116133, 81466116136, 81466116197, 81466116198, 81466116205



MN-DL-7802

Length: 1680 Ø: 52
Cone Ø: d1 Ø 30 / d2 Ø 27
03208300A, 81467116773, 81467116858, 81467116859, 81467116860, 81467116861, 81467116863, 81467116882, 81467116883, 81467116920, 81467116921



MN-DL-8488

Length: 414 Ø: 50
Hole Distance: 130 / 130
81432206247, 81432206341, 81432206342



MN-DL-8544

Length: 596 Ø: 48
Hole Distance: 130 / 130
81432206196, 81432206232, 81432206233



MN-DL-8560

Length: 970 Ø: 52
Cone Ø: d1 Ø 30 / d2 Ø 27
03206900A, 81466106809, 81466106810, 81466106823, 81466106838, 81466106839, 81466116104, 81466116105, 81466116107, 81466116134, 81466116135, 81466116137, 81466116199, 81466116200, 81466116206



MN-DL-8663

Length: 947 Ø: 60
Hole Distance: 115 / 115
03307400A, 81432206222, 81432206260, 81432206283, 81432206284



MN-DL-8709

Length: 572 Ø: 52
Hole Distance: 130 / 130
81432206268, 81432206274, 81432206291, 81432206292, 82432206007



MN-DL-8733

Length: 530 Ø: 48
Hole Distance: 130 / 130
81432206161, 81432206190, 81432206358, 81432206359



MN-DL-14107

Length: 960 Ø: 50
Cone Ø: d1 Ø 30 / d2 Ø 27
81466106813, 81466116146, 81466116147, 81466116148, 81466116204



MN-ES-8490

Length: 90
Cone Ø: d1 Ø 30 / d2 Ø 27
Thread: M26 x 1,5 RHT
0014606948, 14606948, 81953016281, 81953016337, 82953016016



MN-RK-8537

Ø: 95
Hole Distance: 152
Thick/Height: 24
696321, 03306600A, 81432706079, 81432706099



MN-RK-12436

Ø: 75
Hole Distance: 115
Thick/Height: 24
81432206244



MN-TC-12399

Length: 694 Ø: 50
Hole Distance: 130 / 130
81432206265



MN-VB-5238

Length: 627 Ø: 48
Hole Distance: 130 / 130
81432206221, 81432706096, 81432706114, 81432706116, 81432706121



MN-VB-8514

Length: 627 Ø: 48
Hole Ø 25 / 25 / 25
Hole Distance: 152 / 130 / 130
81432706087, 81432706088, 81432706094, 81432706095, 81432796094



MN-VB-8669

Length: 627 Ø: 48
Hole Ø 25 / 25 / 25
Hole Distance: 152 / 130 / 130
81432706116, 81432706137, 81432706150, 81432706151



SC-ES-7279

Length: 150
Cone Ø: d1 Ø 30 / d2 Ø 27
Thread: M30 x 1,5 RHT
81953016288



SC-ES-8517

Length: 140
Cone Ø: d1 Ø 30 / d2 Ø 27
Thread: M30 x 1,5 RHT
81953016286



SC-ES-8535

Length: 145
Cone Ø: d1 Ø 30 / d2 Ø 27
Thread: M30 x 1,5 RHT
81953016271, 81953016325





TGA ...

18.480 FAC, FARC	09/02→	Ball Head, gearshift linkage	CV-ES-2120			
	09/02→	Centre Rod	MN-DL-8646		Push Rod, Leaf Spring Axle	
	09/02→	Tie Rod End	CV-ES-14162		for Steering Rod	
	09/02→	Tie Rod End	CV-ES-14163		for Steering Rod	
	09/02→	Tie Rod End	MN-ES-10333		for Steering Rod	
	09/02→	Track Control Arm		MN-DL-5225	Trailing Arm	
	02/06→	Centre Rod	MN-DL-2160		Coupling Rod	
	02/06→	Centre Rod	MN-DL-2174		Push Rod	
	02/06→	Suspension Arm Repair Kit		CV-RK-5313	for Wishbone (CV)	
	02/06→	Suspension Arm Repair Kit	DB-RK-9300	DB-RK-9300	for Drag Link	
	02/06→	Tie Rod End	CV-ES-0914		for Steering Rod	
	02/06→	Tie Rod End	SC-ES-7279		for Steering Rod	
	02/06→	Tie Rod End	SC-ES-8517		for Push Rod	
	02/06→	Tie Rod End	SC-ES-8535		for Guide Rod	
	02/06→	Track Control Arm		MN-DL-5225	for Control Arm	
	02/06→	Track Control Arm		MN-DL-8544	Trailing Arm	
	02/06→	Track Control Arm		MN-VB-5238	Wishbone (CV), 1st Drive Axle	
	02/06→	Track Control Arm		MN-VB-8514	Suspension Rod, Wishbone (CV)	
	18.480 FAK, FAK-L, FALK, FALK-L, FHLL	09/02→	Ball Head, gearshift linkage	CV-ES-2120		
		09/02→	Centre Rod	MN-DL-8646		Push Rod, Leaf Spring Axle
09/02→		Tie Rod End	CV-ES-0914		for Steering Rod	
09/02→		Tie Rod End	CV-ES-14162		for Steering Rod	
09/02→		Tie Rod End	CV-ES-14163		for Steering Rod	
09/02→		Tie Rod End	MN-ES-10333		for Steering Rod	
09/02→		Tie Rod End	SC-ES-8517		for Push Rod	
09/02→		Track Control Arm		MN-DL-5225	Trailing Arm	
09/02→		Track Control Arm		MN-DL-8544	Trailing Arm	
09/02→		Track Control Arm		MN-VB-8514	Suspension Rod, Wishbone (CV)	
02/06→		Centre Rod	MN-DL-2160		Coupling Rod	
02/06→		Centre Rod	MN-DL-2174		Push Rod	
02/06→		Suspension Arm Repair Kit		CV-RK-5313	for Wishbone (CV)	
02/06→		Suspension Arm Repair Kit	DB-RK-9300	DB-RK-9300	for Drag Link	
02/06→		Tie Rod End	SC-ES-7279		for Steering Rod	
02/06→		Tie Rod End	SC-ES-8535		for Guide Rod	
02/06→		Track Control Arm		MN-DL-5225	for Control Arm	
02/06→		Track Control Arm		MN-VB-5238	Wishbone (CV)	
18.480 FALS, FARS, FAS, FHLS		02/06→	Centre Rod	MN-DL-2160		Coupling Rod
		02/06→	Centre Rod	MN-DL-2174		Push Rod
	02/06→	Suspension Arm Repair Kit		CV-RK-5313	for Wishbone (CV)	
	02/06→	Suspension Arm Repair Kit	DB-RK-9300	DB-RK-9300	for Drag Link	
	02/06→	Tie Rod End	CV-ES-0914		for Steering Rod	
	02/06→	Tie Rod End	CV-ES-14162		for Steering Rod	
	02/06→	Tie Rod End	CV-ES-14163		for Steering Rod	
	02/06→	Tie Rod End	MN-ES-10333		for Steering Rod	
	02/06→	Tie Rod End	SC-ES-7279		for Steering Rod	
	02/06→	Tie Rod End	SC-ES-8517		for Push Rod	
	02/06→	Tie Rod End	SC-ES-8535		for Guide Rod	
	02/06→	Track Control Arm		MN-VB-8514	Suspension Rod, Wishbone (CV)	
	18.480 FAS, FALS, FARS	09/02→	Ball Head, gearshift linkage	CV-ES-2120		
09/02→		Centre Rod	MN-DL-7801		Push Rod, Leaf Spring Axle	
09/02→		Tie Rod End	CV-ES-0914		for Steering Rod	
09/02→		Tie Rod End	CV-ES-14162		for Steering Rod	
09/02→		Tie Rod End	CV-ES-14163		for Steering Rod	
09/02→		Tie Rod End	MN-ES-10333		for Steering Rod	
09/02→		Tie Rod End	SC-ES-8517		for Push Rod	
09/02→		Track Control Arm		MN-DL-5225	Trailing Arm	
09/02→		Track Control Arm		MN-DL-8544	Trailing Arm, Drive Axle, for Pneumatic Suspension vehicles	
09/02→		Track Control Arm		MN-VB-8514	Suspension Rod, Wishbone (CV)	
18.480 FC, FLC, FLLC, FLLRC, FLLRW, FLLW, FLRC	09/02→	Ball Head, gearshift linkage	CV-ES-2120			
	09/02→	Centre Rod	MN-DL-7801		Push Rod, Leaf Spring Axle	
	09/02→	Centre Rod	MN-DL-8560		Push Rod, Air Suspension Axle	
	09/02→	Centre Rod	MN-DL-14107		Push Rod	

CV-ES-0914

Length: 125
Cone Ø: d1 Ø 30 / d2 Ø 27
Thread: M38 x 1,5 RHT
81953016184, 81953016251, 81953016276



CV-ES-2120

Length: 115
Cone Ø: d1 Ø 12,4 / d2 Ø 10,8
Thread: M14 x 1,5 RHT
03008500A, 81953016200, 81953016202, 81953016203, 81953016227



CV-ES-14162

Length: 125
Cone Ø: d1 Ø 30 / d2 Ø 27
Thread: M30 x 1,5 LHT
81953010015, 81953010083, 81953010087, 81953016029, 81953016030, 81953016043, 81953016044, 81953016050, 81953016054, 81953016087, 81953016091, 81953016107, 81953016120, 81953016125, 81953016152, 81953016155, 81953016157, 81953016168, 81953016179, 81953016181, 81953016223, 81953016237, 81953016254, 81953016275, 81953016279, 81953016351



CV-ES-14163

Length: 125
Cone Ø: d1 Ø 30 / d2 Ø 27
Thread: M30 x 1,5 RHT
95301.0084, 90804102156, 90804102272, 90804102696, 90804102710, 81953010016, 81953010075, 81953010084, 81953010088, 81953010094, 81953010103, 81953016030, 81953016043, 81953016048, 81953016049, 81953016053, 81953016061, 81953016090, 81953016108, 81953016112, 81953016126, 81953016143, 81953016149, 81953016154, 81953016156, 81953016168, 81953016178, 81953016194, 81953016206, 81953016224, 81953016234, 81953016242, 81953016252, 81953016274, 81953016278, 81953016284, 81953016286, 81953016308, 81953016310, 81953016312, 81953016347, 81953016350, 81953016352, 82953016012, 88953016014, N2953016001



CV-RK-5313

Ø: 90
03304800A, 81953016132



DB-RK-9300

Ø: 75
Hole Distance: 130
Thickness/Height: 24
85432206002



MN-DL-2160

Length: 1652 Ø: 50
Cone Ø: d1 Ø 30 / d2 Ø 27
81467106112, 81467106163, 81467106165, 81467106198, 81467106353, 81467106354, 81467106361, 81467116725



MN-DL-2174

Length: 1588 Ø: 52
Cone Ø: d1 Ø 30 / d2 Ø 27
81467106378, 81467106912



MN-DL-5225

Length: 572 Ø: 48
Hole Distance: 130 / 130
03301500A, 81432206229, 81432206236, 81432206267, 81432206270, 81432206272, 81432206304, 81432206305, 81432209236, 81432209267, 81432209272



MN-DL-7801

Length: 995 Ø: 52
Cone Ø: d1 Ø 30 / d2 Ø 27
81466106807, 81466106808, 81466116087, 81466116088, 81466116096, 81466116097, 81466116099, 81466116132, 81466116133, 81466116136, 81466116197, 81466116198, 81466116205



MN-DL-8544

Length: 596 Ø: 48
Hole Distance: 130 / 130
81432206196, 81432206232, 81432206233



MN-DL-8560

Length: 970 Ø: 52
Cone Ø: d1 Ø 30 / d2 Ø 27
03206900A, 81466106809, 81466106810, 81466106823, 81466106838, 81466106839, 81466116104, 81466116105, 81466116107, 81466116134, 81466116135, 81466116137, 81466116199, 81466116200, 81466116206



MN-DL-8646

Length: 1021 Ø: 52
Cone Ø: d1 Ø 30 / d2 Ø 27
81466106811, 81466106812, 81466116138, 81466116139, 81466116201, 81466116202



MN-DL-14107

Length: 960 Ø: 50
Cone Ø: d1 Ø 30 / d2 Ø 27
81466106813, 81466116146, 81466116147, 81466116148, 81466116204



MN-ES-10333

Length: 90
Cone Ø: d1 Ø 38 / d2 Ø 34,35
Thread: M36 x 1,5 RHT
1271126, 3090291, 3099128, 42538048, 81953016268, 82953016018, 82953016019



MN-VB-5238

Length: 627 Ø: 48
Hole Distance: 130 / 130
81432206221, 81432706096, 81432706114, 81432706116, 81432706121



MN-VB-8514

Length: 627 Ø: 48
Hole Ø 25 / 25 / 25
Hole Distance: 152 / 130 / 130
81432706087, 81432706088, 81432706094, 81432706095, 81432796094



SC-ES-7279

Length: 150
Cone Ø: d1 Ø 30 / d2 Ø 27
Thread: M30 x 1,5 RHT
81953016288



SC-ES-8517

Length: 140
Cone Ø: d1 Ø 30 / d2 Ø 27
Thread: M30 x 1,5 RHT
81953016286



SC-ES-8535

Length: 145
Cone Ø: d1 Ø 30 / d2 Ø 27
Thread: M30 x 1,5 RHT
81953016271, 81953016325



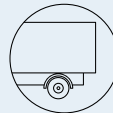

TGA ...

18.480 FC, FLC, FLLC, FLLRC,
FLLRW, FLLW, FLRC ...

09/02→	Suspension Strut Repair Kit		DB-RK-8581	
09/02→	Suspension Strut Repair Kit		MN-RK-12436	
09/02→	Tie Rod	MN-DL-7802		
09/02→	Tie Rod End		MN-ES-8490	for vehicles with Hinged Trailing Axle
09/02→	Tie Rod End	CV-ES-0914		for Steering Rod
09/02→	Tie Rod End	CV-ES-14162		for Steering Rod
09/02→	Tie Rod End	CV-ES-14163		for Steering Rod
09/02→	Tie Rod End	IV-ES-12272		for Steering Rod
09/02→	Tie Rod End	SC-ES-7279		for Steering Rod
09/02→	Tie Rod End	SC-ES-8517		for Push Rod
09/02→	Tie Rod End	SC-ES-8535		for Guide Rod
09/02→	Track Control Arm		MN-DL-5225	Trailing Arm, Drive Axle;Air Suspension Axle
09/02→	Track Control Arm		MN-DL-8544	Trailing Arm, Drive Axle;Air Suspension Axle
09/02→	Track Control Arm		MN-DL-8709	Trailing Arm, Drive Axle;Air Suspension Axle
09/02→	Track Control Arm		MN-DL-8733	Trailing Arm, Air Suspension Axle;Drive Axle
09/02→	Track Control Arm		MN-TC-12399	Control Arm
09/02→	Track Control Arm		MN-VB-5238	Wishbone (CV), Drive Axle;Air Suspension Axle
09/02→	Track Control Arm		MN-VB-8514	Suspension Rod, Wishbone (CV), Drive Axle; Air Suspension Axle
09/02→	Track Control Arm		MN-VB-8514	Suspension Rod, Wishbone (CV), Drive Axle; Leaf Spring Axle
09/02→	Track Control Arm		MN-VB-8669	Suspension Rod, Wishbone (CV), Drive Axle
09/02→	Track Control Arm	MN-DL-8663		Control Arm, Air Suspension Axle
01/06→	Track Control Arm		MN-DL-5225	Trailing Arm
01/06→	Track Control Arm		MN-DL-8544	Trailing Arm, Drive Axle, for Pneumatic Suspension vehicles
01/06→	Track Control Arm		MN-DL-8733	Trailing Arm, 1st Drive Axle, for Pneumatic Suspension vehicles, →Type_RHFN
01/06→	Track Control Arm		MN-VB-5238	Wishbone (CV), 1st Drive Axle, for Pneumatic Suspension vehicles
01/06→	Track Control Arm		MN-VB-8514	Suspension Rod, Wishbone (CV)

18.480 FHLC

04/06→	Centre Rod	MN-DL-7801		Push Rod, Leaf Spring Axle
04/06→	Suspension Strut Repair Kit		DB-RK-8581	
04/06→	Tie Rod	MN-DL-7802		
04/06→	Tie Rod End	CV-ES-0914		for Steering Rod
04/06→	Tie Rod End	CV-ES-14162		for Steering Rod
04/06→	Tie Rod End	CV-ES-14163		for Steering Rod
04/06→	Tie Rod End	MN-ES-10333		for Steering Rod
04/06→	Tie Rod End	SC-ES-7279		for Steering Rod
04/06→	Tie Rod End	SC-ES-8517		for Push Rod
04/06→	Tie Rod End	SC-ES-8535		for Guide Rod
04/06→	Track Control Arm		MN-DL-5225	Trailing Arm, Drive Axle;Air Suspension Axle
04/06→	Track Control Arm		MN-DL-5225	Trailing Arm, Leading Axle;Air Suspension Axle
04/06→	Track Control Arm		MN-DL-8544	Trailing Arm, Drive Axle;Air Suspension Axle
04/06→	Track Control Arm		MN-VB-5238	Wishbone (CV), Drive Axle;Air Suspension Axle
04/06→	Track Control Arm		MN-VB-5238	Wishbone (CV), Leading Axle;Air Suspension Axle
04/06→	Track Control Arm		MN-VB-8514	Suspension Rod, Wishbone (CV), Drive Axle; Air Suspension Axle

18.480 FHLK, FHLK/M

04/06→	Centre Rod	MN-DL-7801		Push Rod, Leaf Spring Axle
04/06→	Suspension Strut Repair Kit		DB-RK-8581	
04/06→	Tie Rod	MN-DL-7802		
04/06→	Tie Rod End	CV-ES-0914		for Steering Rod
04/06→	Tie Rod End	CV-ES-14162		for Steering Rod
04/06→	Tie Rod End	CV-ES-14163		for Steering Rod
04/06→	Tie Rod End	MN-ES-10333		for Steering Rod
04/06→	Tie Rod End	SC-ES-7279		for Steering Rod
04/06→	Tie Rod End	SC-ES-8517		for Push Rod
04/06→	Tie Rod End	SC-ES-8535		for Guide Rod
04/06→	Track Control Arm		MN-DL-5225	Trailing Arm, Drive Axle;Air Suspension Axle
04/06→	Track Control Arm		MN-DL-5225	Trailing Arm, Leading Axle;Air Suspension Axle
04/06→	Track Control Arm		MN-DL-8544	Trailing Arm, Drive Axle;Air Suspension Axle
04/06→	Track Control Arm		MN-VB-5238	Wishbone (CV), Drive Axle;Air Suspension Axle

CV-ES-0914

Length: 125
Cone Ø: d1 Ø 30 / d2 Ø 27
Thread: M38 x 1,5 RHT
81953016184, 81953016251, 81953016276



CV-ES-14162

Length: 125
Cone Ø: d1 Ø 30 / d2 Ø 27
Thread: M30 x 1,5 LHT
81953010015, 81953010083, 81953010087, 81953016029, 81953016030, 81953016043, 81953016044, 81953016050, 81953016054, 81953016087, 81953016091, 81953016107, 81953016120, 81953016125, 81953016152, 81953016155, 81953016157, 81953016168, 81953016179, 81953016181, 81953016223, 81953016237, 81953016254, 81953016275, 81953016279, 81953016351



CV-ES-14163

Length: 125
Cone Ø: d1 Ø 30 / d2 Ø 27
Thread: M30 x 1,5 RHT
95301.0084, 90804102156, 90804102272, 90804102696, 90804102710, 81953010016, 81953010075, 81953010084, 81953010088, 81953010094, 81953010103, 81953016030, 81953016043, 81953016048, 81953016049, 81953016053, 81953016061, 81953016090, 81953016108, 81953016112, 81953016126, 81953016143, 81953016149, 81953016154, 81953016156, 81953016168, 81953016178, 81953016194, 81953016206, 81953016224, 81953016234, 81953016242, 81953016252, 81953016274, 81953016278, 81953016284, 81953016286, 81953016308, 81953016310, 81953016312, 81953016347, 81953016350, 81953016352, 82953016012, 88953016014, N2953016001



DB-RK-8581

Ø: 85
Hole Distance: 130
Thick/Height: 24
03305800A, 81432706105



IV-ES-12272

Length: 75
Cone Ø: d1 Ø 30 / d2 Ø 27
Thread: M26 x 1,5 RHT
81953016280, 82953010010



MN-DL-5225

Length: 572 Ø: 48
Hole Distance: 130 / 130
03301500A, 81432206229, 81432206236, 81432206267, 81432206270, 81432206272, 81432206304, 81432206305, 81432209235, 81432209267, 81432209272



MN-DL-7801

Length: 995 Ø: 52
Cone Ø: d1 Ø 30 / d2 Ø 27
81466106807, 81466106808, 81466116087, 81466116088, 81466116096, 81466116097, 81466116099, 81466116132, 81466116133, 81466116136, 81466116197, 81466116198, 81466116205



MN-DL-7802

Length: 1680 Ø: 52
Cone Ø: d1 Ø 30 / d2 Ø 27
03208300A, 81467116773, 81467116858, 81467116859, 81467116860, 81467116861, 81467116863, 81467116882, 81467116883, 81467116920, 81467116921



MN-DL-8544

Length: 596 Ø: 48
Hole Distance: 130 / 130
81432206196, 81432206232, 81432206233



MN-DL-8663

Length: 947 Ø: 60
Hole Distance: 115 / 115
03307400A, 81432206222, 81432206260, 81432206283, 81432206284



MN-DL-8709

Length: 572 Ø: 52
Hole Distance: 130 / 130
81432206268, 81432206274, 81432206291, 81432206292, 82432206007



MN-DL-8733

Length: 530 Ø: 48
Hole Distance: 130 / 130
81432206161, 81432206190, 81432206358, 81432206359



MN-ES-8490

Length: 90
Cone Ø: d1 Ø 30 / d2 Ø 27
Thread: M26 x 1,5 RHT
0014606948, 14606948, 81953016281, 81953016337, 82953016016



MN-ES-10333

Length: 90
Cone Ø: d1 Ø 38 / d2 Ø 34,35
Thread: M36 x 1,5 RHT
1271126, 3090291, 3099128, 42538048, 81953016268, 82953016018, 82953016019



MN-RK-12436

Ø: 75
Hole Distance: 115
Thick/Height: 24
81432206244



MN-TC-12399

Length: 694 Ø: 50
Hole Distance: 130 / 130
81432206265



MN-VB-5238

Length: 627 Ø: 48
Hole Distance: 130 / 130
81432206221, 81432706096, 81432706114, 81432706116, 81432706121



MN-VB-8514

Length: 627 Ø: 48
Hole Ø 25 / 25 / 25
Hole Distance: 152 / 130 / 130
81432706087, 81432706088, 81432706094, 81432706095, 81432796094



MN-VB-8669

Length: 627 Ø: 48
Hole Ø 25 / 25 / 25
Hole Distance: 152 / 130 / 130
81432706116, 81432706137, 81432706150, 81432706151



SC-ES-7279

Length: 150
Cone Ø: d1 Ø 30 / d2 Ø 27
Thread: M30 x 1,5 RHT
81953016288



SC-ES-8517

Length: 140
Cone Ø: d1 Ø 30 / d2 Ø 27
Thread: M30 x 1,5 RHT
81953016286



SC-ES-8535

Length: 145
Cone Ø: d1 Ø 30 / d2 Ø 27
Thread: M30 x 1,5 RHT
81953016271, 81953016325





TGA ...

18.480 FHLK, FHLK/M ...	04/06→	Track Control Arm		MN-VB-5238	Wishbone (CV), Leading Axle;Air Suspension Axle
	04/06→	Track Control Arm		MN-VB-8514	Suspension Rod, Wishbone (CV), Drive Axle; Air Suspension Axle
18.480 FHLS, FHLS/M	04/06→	Centre Rod	MN-DL-7801		Push Rod, Leaf Spring Axle
	04/06→	Suspension Strut Repair Kit		DB-RK-8581	
	04/06→	Tie Rod	MN-DL-7802		
	04/06→	Tie Rod End	CV-ES-0914		for Steering Rod
	04/06→	Tie Rod End	CV-ES-14162		for Steering Rod
	04/06→	Tie Rod End	CV-ES-14163		for Steering Rod
	04/06→	Tie Rod End	MN-ES-10333		for Steering Rod
	04/06→	Tie Rod End	SC-ES-7279		for Steering Rod
	04/06→	Tie Rod End	SC-ES-8517		for Push Rod
	04/06→	Tie Rod End	SC-ES-8535		for Guide Rod
	04/06→	Track Control Arm		MN-DL-5225	Trailing Arm, Drive Axle;Air Suspension Axle
	04/06→	Track Control Arm		MN-DL-5225	Trailing Arm, Leading Axle;Air Suspension Axle
	04/06→	Track Control Arm		MN-DL-8544	Trailing Arm, Drive Axle;Air Suspension Axle
	04/06→	Track Control Arm		MN-VB-5238	Wishbone (CV), Drive Axle;Air Suspension Axle
	04/06→	Track Control Arm		MN-VB-5238	Wishbone (CV), Leading Axle;Air Suspension Axle
	04/06→	Track Control Arm		MN-VB-8514	Suspension Rod, Wishbone (CV), Drive Axle; Air Suspension Axle
	18.480 FK, FK-L, FLK, FLRK	01/06→	Centre Rod	MN-DL-7801	
01/06→		Suspension Arm Repair Kit		CV-RK-5313	for Wishbone (CV)
01/06→		Suspension Arm Repair Kit	DB-RK-9300	DB-RK-9300	for Drag Link
01/06→		Suspension Strut Repair Kit		CV-RK-5311	
01/06→		Tie Rod	MN-DL-7802		
01/06→		Tie Rod End	CV-ES-0914		for Steering Rod
01/06→		Tie Rod End	CV-ES-14162		for Steering Rod
01/06→		Tie Rod End	CV-ES-14163		for Steering Rod
01/06→		Tie Rod End	SC-ES-7279		for Steering Rod
01/06→		Tie Rod End	SC-ES-8517		for Push Rod
01/06→		Tie Rod End	SC-ES-8535		for Guide Rod
01/06→		Track Control Arm		MN-DL-5225	Trailing Arm
01/06→		Track Control Arm		MN-DL-8544	Trailing Arm, Drive Axle, for Pneumatic Suspension vehicles
01/06→		Track Control Arm		MN-DL-8733	Trailing Arm, 1st Drive Axle, for Pneumatic Suspension vehicles, →Type_RHFN
01/06→		Track Control Arm		MN-TC-12399	Control Arm
01/06→		Track Control Arm		MN-VB-5238	Wishbone (CV), 1st Drive Axle, for Pneumatic Suspension vehicles
01/06→		Track Control Arm		MN-VB-8514	Suspension Rod, Wishbone (CV)
18.480 FK, FLK, FK-L, FLRK	09/02→	Ball Head, gearshift linkage	CV-ES-2120		
	09/02→	Centre Rod	MN-DL-7801		Push Rod, Leaf Spring Axle
	09/02→	Centre Rod	MN-DL-14107		Push Rod
	09/02→	Suspension Strut Repair Kit		DB-RK-8581	
	09/02→	Tie Rod	MN-DL-7802		
	09/02→	Tie Rod End		MN-ES-8490	for vehicles with Hinged Trailing Axle
	09/02→	Tie Rod End	CV-ES-0914		for Steering Rod
	09/02→	Tie Rod End	CV-ES-14162		for Steering Rod
	09/02→	Tie Rod End	CV-ES-14163		for Steering Rod
	09/02→	Tie Rod End	IV-ES-12272		for Steering Rod
	09/02→	Tie Rod End	SC-ES-7279		for Steering Rod
	09/02→	Tie Rod End	SC-ES-8517		for Push Rod
	09/02→	Tie Rod End	SC-ES-8535		for Guide Rod
	09/02→	Track Control Arm		MN-DL-5225	Trailing Arm, Drive Axle;Air Suspension Axle
	09/02→	Track Control Arm		MN-DL-8544	Trailing Arm, Drive Axle;Air Suspension Axle
	09/02→	Track Control Arm		MN-DL-8709	Trailing Arm, Drive Axle;Air Suspension Axle
	09/02→	Track Control Arm		MN-DL-8733	Trailing Arm, Air Suspension Axle;Drive Axle
	09/02→	Track Control Arm		MN-TC-12399	Control Arm
	09/02→	Track Control Arm		MN-VB-5238	Wishbone (CV), Drive Axle;Air Suspension Axle
	09/02→	Track Control Arm		MN-VB-8514	Suspension Rod, Wishbone (CV), Drive Axle; Air Suspension Axle
	09/02→	Track Control Arm		MN-VB-8514	Suspension Rod, Wishbone (CV), Drive Axle; Leaf Spring Axle
	09/02→	Track Control Arm		MN-VB-8669	Suspension Rod, Wishbone (CV), Drive Axle

CV-ES-0914

Length: 125
Cone Ø: d1 Ø 30 / d2 Ø 27
Thread: M38 x 1,5 RHT
81953016184, 81953016251, 81953016276



CV-ES-2120

Length: 115
Cone Ø: d1 Ø 12,4 / d2 Ø 10,8
Thread: M14 x 1,5 RHT
03008500A, 81953016200, 81953016202,
81953016203, 81953016227



CV-ES-14162

Length: 125
Cone Ø: d1 Ø 30 / d2 Ø 27
Thread: M30 x 1,5 LHT
81953010015, 81953010083, 81953010087,
81953016029, 81953016030, 81953016043,
81953016044, 81953016050, 81953016054,
81953016087, 81953016091, 81953016107,
81953016120, 81953016125, 81953016152,
81953016155, 81953016157, 81953016168,
81953016179, 81953016181, 81953016223,
81953016237, 81953016254, 81953016275,
81953016279, 81953016351



CV-ES-14163

Length: 125
Cone Ø: d1 Ø 30 / d2 Ø 27
Thread: M30 x 1,5 RHT
95301.0084, 90804102156, 90804102272,
90804102696, 90804102710, 81953010016,
81953010075, 81953010084, 81953010088,
81953010094, 81953010103, 81953016030,
81953016043, 81953016048, 81953016049,
81953016053, 81953016061, 81953016090,
81953016108, 81953016112, 81953016126,
81953016143, 81953016149, 81953016154,
81953016156, 81953016168, 81953016178,
81953016194, 81953016206, 81953016224,
81953016234, 81953016242, 81953016252,
81953016274, 81953016278, 81953016284,
81953016286, 81953016308, 81953016310,
81953016312, 81953016347, 81953016350,
81953016352, 82953016012, 88953016014,
N2953016001



CV-RK-5311

638862, 639287, 938423, 1104335,
1953248, 0003500506, 3500506, 11013547,
42488722, 070550504, 634303610,
81432206055, 81432206073, 82262320660,
5001842823, 7000307001, 8226232066



CV-RK-5313

Ø: 90
03304800A, 81953016132



DB-RK-8581

Ø: 85
Hole Distance: 130
Thick/Height: 24
03305800A, 81432706105



DB-RK-9300

Ø: 75
Hole Distance: 130
Thick/Height: 24
85432206002



IV-ES-12272

Length: 75
Cone Ø: d1 Ø 30 / d2 Ø 27
Thread: M26 x 1,5 RHT
81953016280, 82953010010



MN-DL-5225

Length: 572 Ø: 48
Hole Distance: 130 / 130
03301500A, 81432206229, 81432206236,
81432206267, 81432206270, 81432206272,
81432206304, 81432206305, 81432209236,
81432209267, 81432209272



MN-DL-7801

Length: 995 Ø: 52
Cone Ø: d1 Ø 30 / d2 Ø 27
81466106807, 81466106808, 81466116087,
81466116088, 81466116096, 81466116097,
81466116099, 81466116132, 81466116133,
81466116136, 81466116197, 81466116198,
81466116205



MN-DL-7802

Length: 1680 Ø: 52
Cone Ø: d1 Ø 30 / d2 Ø 27
03208300A, 81467116773, 81467116858,
81467116859, 81467116860, 81467116861,
81467116863, 81467116882, 81467116883,
81467116920, 81467116921



MN-DL-8544

Length: 596 Ø: 48
Hole Distance: 130 / 130
81432206196, 81432206232, 81432206233



MN-DL-8709

Length: 572 Ø: 52
Hole Distance: 130 / 130
81432206268, 81432206274, 81432206291,
81432206292, 82432206007



MN-DL-8733

Length: 530 Ø: 48
Hole Distance: 130 / 130
81432206161, 81432206190, 81432206358,
81432206359



MN-DL-14107

Length: 960 Ø: 50
Cone Ø: d1 Ø 30 / d2 Ø 27
81466106813, 81466116146, 81466116147,
81466116148, 81466116204



MN-ES-8490

Length: 90
Cone Ø: d1 Ø 30 / d2 Ø 27
Thread: M26 x 1,5 RHT
0014606948, 14606948, 81953016281,
81953016337, 82953016016



MN-ES-10333

Length: 90
Cone Ø: d1 Ø 38 / d2 Ø 34,35
Thread: M36 x 1,5 RHT
1271126, 3090291, 3099128, 42538048,
81953016268, 82953016018, 82953016019



MN-TC-12399

Length: 694 Ø: 50
Hole Distance: 130 / 130
81432206265



MN-VB-5238

Length: 627 Ø: 48
Hole Distance: 130 / 130
81432206221, 81432706096, 81432706114,
81432706116, 81432706121



MN-VB-8514

Length: 627 Ø: 48
Hole Ø 25 / 25 / 25
Hole Distance: 152 / 130 / 130
81432706087, 81432706088, 81432706094,
81432706095, 81432796094



MN-VB-8669

Length: 627 Ø: 48
Hole Ø 25 / 25 / 25
Hole Distance: 152 / 130 / 130
81432706116, 81432706137, 81432706150,
81432706151



SC-ES-7279

Length: 150
Cone Ø: d1 Ø 30 / d2 Ø 27
Thread: M30 x 1,5 RHT
81953016288



SC-ES-8517

Length: 140
Cone Ø: d1 Ø 30 / d2 Ø 27
Thread: M30 x 1,5 RHT
81953016286



SC-ES-8535

Length: 145
Cone Ø: d1 Ø 30 / d2 Ø 27
Thread: M30 x 1,5 RHT
81953016271, 81953016325



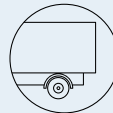

TGA ...

18.480 FLLRS, FLLS, FLRS,
FLS, FLS-TS

09/02→	Ball Head, gearshift linkage	CV-ES-2120		
09/02→	Centre Rod	MN-DL-7801		Push Rod, Leaf Spring Axle
09/02→	Centre Rod	MN-DL-8560		Push Rod, Air Suspension Axle
09/02→	Centre Rod	MN-DL-14107		Push Rod
09/02→	Suspension Strut Repair Kit		DB-RK-8581	
09/02→	Suspension Strut Repair Kit		MN-RK-12436	
09/02→	Tie Rod	MN-DL-7802		
09/02→	Tie Rod End		MN-ES-8490	for vehicles with Hinged Trailing Axle
09/02→	Tie Rod End	CV-ES-0914		for Steering Rod
09/02→	Tie Rod End	CV-ES-14162		for Steering Rod
09/02→	Tie Rod End	CV-ES-14163		for Steering Rod
09/02→	Tie Rod End	IV-ES-12272		for Steering Rod
09/02→	Tie Rod End	SC-ES-7279		for Steering Rod
09/02→	Tie Rod End	SC-ES-8517		for Push Rod
09/02→	Tie Rod End	SC-ES-8535		for Guide Rod
09/02→	Track Control Arm		MN-DL-5225	Trailing Arm, Drive Axle;Air Suspension Axle
09/02→	Track Control Arm		MN-DL-8488	Trailing Arm;for Wishbone (CV), Air Suspension Axle
09/02→	Track Control Arm		MN-DL-8544	Trailing Arm, Drive Axle;Air Suspension Axle
09/02→	Track Control Arm		MN-DL-8709	Trailing Arm, Drive Axle;Air Suspension Axle
09/02→	Track Control Arm		MN-DL-8733	Trailing Arm, Air Suspension Axle;Drive Axle
09/02→	Track Control Arm		MN-TC-12399	Control Arm
09/02→	Track Control Arm		MN-VB-5238	Wishbone (CV), Drive Axle;Air Suspension Axle
09/02→	Track Control Arm		MN-VB-8514	Suspension Rod, Wishbone (CV), Drive Axle; Air Suspension Axle
09/02→	Track Control Arm		MN-VB-8514	Suspension Rod, Wishbone (CV), Drive Axle; Leaf Spring Axle
09/02→	Track Control Arm		MN-VB-8669	Suspension Rod, Wishbone (CV), Drive Axle
09/02→	Track Control Arm	MN-DL-8663		Control Arm, Air Suspension Axle
01/06→	Centre Rod	MN-DL-8560		Push Rod, Air Suspension Axle;Leaf Spring Axle
01/06→	Track Control Arm		MN-DL-5225	Trailing Arm
01/06→	Track Control Arm		MN-DL-8488	Wishbone (CV), Drive Axle, for Pneumatic Suspension vehicles
01/06→	Track Control Arm		MN-DL-8544	Trailing Arm, Drive Axle, for Pneumatic Suspension vehicles, →MHB Chassis
01/06→	Track Control Arm		MN-DL-8733	Trailing Arm, 1st Drive Axle, for Pneumatic Suspension vehicles, →Type_RHFN
01/06→	Track Control Arm		MN-VB-5238	Wishbone (CV), 1st Drive Axle, for Pneumatic Suspension vehicles
01/06→	Track Control Arm		MN-VB-8514	Suspension Rod, Wishbone (CV)
01/06→	Track Control Arm	MN-DL-8663		Control Arm

18.510 FC, FLC, FLLC, FLLRC,
FLLRW, FLLW, FLRC, FRC

09/00→	Ball Head, gearshift linkage	CV-ES-2120		
09/00→	Centre Rod	MN-DL-7801		Push Rod, Leaf Spring Axle
09/00→	Centre Rod	MN-DL-8560		Push Rod, Air Suspension Axle
09/00→	Centre Rod	MN-DL-14107		Push Rod
09/00→	Suspension Strut Repair Kit		DB-RK-8581	
09/00→	Suspension Strut Repair Kit		MN-RK-12436	
09/00→	Tie Rod	MN-DL-7802		
09/00→	Tie Rod End		MN-ES-8490	for vehicles with Hinged Trailing Axle
09/00→	Tie Rod End	CV-ES-0914		for Steering Rod
09/00→	Tie Rod End	CV-ES-14162		for Steering Rod
09/00→	Tie Rod End	CV-ES-14163		for Steering Rod
09/00→	Tie Rod End	IV-ES-12272		for Steering Rod
09/00→	Tie Rod End	SC-ES-7279		for Steering Rod
09/00→	Tie Rod End	SC-ES-8517		for Push Rod
09/00→	Tie Rod End	SC-ES-8535		for Guide Rod
09/00→	Track Control Arm		MN-DL-5225	Trailing Arm, Drive Axle;Air Suspension Axle
09/00→	Track Control Arm		MN-DL-8544	Trailing Arm, Drive Axle;Air Suspension Axle
09/00→	Track Control Arm		MN-DL-8709	Trailing Arm, Drive Axle;Air Suspension Axle
09/00→	Track Control Arm		MN-DL-8733	Trailing Arm, Air Suspension Axle;Drive Axle
09/00→	Track Control Arm		MN-TC-12399	Control Arm
09/00→	Track Control Arm		MN-VB-5238	Wishbone (CV), Drive Axle;Air Suspension Axle

CV-ES-0914

Length: 125
Cone Ø: d1 Ø 30 / d2 Ø 27
Thread: M38 x 1,5 RHT
81953016184, 81953016251, 81953016276



CV-ES-2120

Length: 115
Cone Ø: d1 Ø 12,4 / d2 Ø 10,8
Thread: M14 x 1,5 RHT
03008500A, 81953016200, 81953016202,
81953016203, 81953016227



CV-ES-14162

Length: 125
Cone Ø: d1 Ø 30 / d2 Ø 27
Thread: M30 x 1,5 LHT
81953010015, 81953010083, 81953010087,
81953016029, 81953016030, 81953016043,
81953016044, 81953016050, 81953016054,
81953016087, 81953016091, 81953016107,
81953016120, 81953016125, 81953016152,
81953016155, 81953016157, 81953016168,
81953016179, 81953016181, 81953016223,
81953016237, 81953016254, 81953016275,
81953016279, 81953016351



CV-ES-14163

Length: 125
Cone Ø: d1 Ø 30 / d2 Ø 27
Thread: M30 x 1,5 RHT
95301.0084, 90804102156, 90804102272,
90804102696, 90804102710, 81953010016,
81953010075, 81953010084, 81953010088,
81953010094, 81953010103, 81953016030,
81953016043, 81953016048, 81953016049,
81953016053, 81953016061, 81953016090,
81953016108, 81953016112, 81953016126,
81953016143, 81953016149, 81953016154,
81953016156, 81953016168, 81953016178,
81953016194, 81953016206, 81953016224,
81953016234, 81953016242, 81953016252,
81953016274, 81953016278, 81953016284,
81953016286, 81953016308, 81953016310,
81953016312, 81953016347, 81953016350,
81953016352, 82953016012, 88953016014,
N2953016001



DB-RK-8581

Ø: 85
Hole Distance: 130
Thick/Height: 24
03305800A, 81432706105



IV-ES-12272

Length: 75
Cone Ø: d1 Ø 30 / d2 Ø 27
Thread: M26 x 1,5 RHT
81953016280, 82953010010



MN-DL-5225

Length: 572 Ø: 48
Hole Distance: 130 / 130
03301500A, 81432206229, 81432206236,
81432206267, 81432206270, 81432206272,
81432206304, 81432206305, 81432209236,
81432209267, 81432209272



MN-DL-7801

Length: 995 Ø: 52
Cone Ø: d1 Ø 30 / d2 Ø 27
81466106807, 81466106808, 81466116087,
81466116088, 81466116096, 81466116097,
81466116099, 81466116132, 81466116133,
81466116136, 81466116197, 81466116198,
81466116205



MN-DL-7802

Length: 1680 Ø: 52
Cone Ø: d1 Ø 30 / d2 Ø 27
03208300A, 81467116773, 81467116858,
81467116859, 81467116860, 81467116861,
81467116863, 81467116882, 81467116883,
81467116920, 81467116921



MN-DL-8488

Length: 414 Ø: 50
Hole Distance: 130 / 130
81432206247, 81432206341, 81432206342



MN-DL-8544

Length: 596 Ø: 48
Hole Distance: 130 / 130
81432206196, 81432206232, 81432206233



MN-DL-8560

Length: 970 Ø: 52
Cone Ø: d1 Ø 30 / d2 Ø 27
03206900A, 81466106809, 81466106810,
81466106823, 81466106838, 81466106839,
81466116104, 81466116105, 81466116107,
81466116134, 81466116135, 81466116137,
81466116199, 81466116200, 81466116206



MN-DL-8663

Length: 947 Ø: 60
Hole Distance: 115 / 115
03307400A, 81432206222, 81432206260,
81432206283, 81432206284



MN-DL-8709

Length: 572 Ø: 52
Hole Distance: 130 / 130
81432206268, 81432206274, 81432206291,
81432206292, 82432206007



MN-DL-8733

Length: 530 Ø: 48
Hole Distance: 130 / 130
81432206161, 81432206190, 81432206358,
81432206359



MN-DL-14107

Length: 960 Ø: 50
Cone Ø: d1 Ø 30 / d2 Ø 27
81466106813, 81466116146, 81466116147,
81466116148, 81466116204



MN-ES-8490

Length: 90
Cone Ø: d1 Ø 30 / d2 Ø 27
Thread: M26 x 1,5 RHT
0014606948, 14606948, 81953016281,
81953016337, 82953016016



MN-RK-12436

Ø: 75
Hole Distance: 115
Thick/Height: 24
81432206244



MN-TC-12399

Length: 694 Ø: 50
Hole Distance: 130 / 130
81432206265



MN-VB-5238

Length: 627 Ø: 48
Hole Distance: 130 / 130
81432206221, 81432706096, 81432706114,
81432706116, 81432706121



MN-VB-8514

Length: 627 Ø: 48
Hole Ø 25 / 25 / 25
Hole Distance: 152 / 130 / 130
81432706087, 81432706088, 81432706094,
81432706095, 81432796094



MN-VB-8669

Length: 627 Ø: 48
Hole Ø 25 / 25 / 25
Hole Distance: 152 / 130 / 130
81432706116, 81432706137, 81432706150,
81432706151



SC-ES-7279

Length: 150
Cone Ø: d1 Ø 30 / d2 Ø 27
Thread: M30 x 1,5 RHT
81953016288



SC-ES-8517

Length: 140
Cone Ø: d1 Ø 30 / d2 Ø 27
Thread: M30 x 1,5 RHT
81953016286



SC-ES-8535

Length: 145
Cone Ø: d1 Ø 30 / d2 Ø 27
Thread: M30 x 1,5 RHT
81953016271, 81953016325





TGA ...

18.510 FC, FLC, FLLC, FLLRC, FLLRW, FLLW, FLRC, FRC ...	09/00 →	Track Control Arm		MN-VB-8514	Suspension Rod, Wishbone (CV), Drive Axle; Air Suspension Axle	
	09/00 →	Track Control Arm		MN-VB-8514	Suspension Rod, Wishbone (CV), Drive Axle; Leaf Spring Axle	
	09/00 →	Track Control Arm	MN-DL-8663		Control Arm, Air Suspension Axle	
	06/02 →	Track Control Arm		MN-VB-8669	Suspension Rod, Wishbone (CV), Drive Axle	
18.510 FLLRS, FLLS, FLRS, FLS	04/00 →	Ball Head, gearshift linkage	CV-ES-2120			
	04/00 →	Centre Rod	MN-DL-7801		Push Rod, Leaf Spring Axle	
	04/00 →	Centre Rod	MN-DL-8560		Push Rod, Air Suspension Axle	
	04/00 →	Centre Rod	MN-DL-14107		Push Rod	
	04/00 →	Suspension Strut Repair Kit		DB-RK-8581		
	04/00 →	Suspension Strut Repair Kit		MN-RK-12436		
	04/00 →	Tie Rod	MN-DL-7802			
	04/00 →	Tie Rod End		MN-ES-8490	Tag Axle	
	04/00 →	Tie Rod End	CV-ES-0914		for Steering Rod	
	04/00 →	Tie Rod End	CV-ES-14162		for Steering Rod	
	04/00 →	Tie Rod End	CV-ES-14163		for Steering Rod	
	04/00 →	Tie Rod End	IV-ES-12272		for Steering Rod	
	04/00 →	Tie Rod End	SC-ES-7279		for Steering Rod	
	04/00 →	Tie Rod End	SC-ES-8517		for Push Rod	
	04/00 →	Tie Rod End	SC-ES-8535		for Guide Rod	
	04/00 →	Track Control Arm		MN-DL-5225	Trailing Arm, Drive Axle; Air Suspension Axle	
	04/00 →	Track Control Arm		MN-DL-8488	Trailing Arm; for Wishbone (CV), Air Suspension Axle	
	04/00 →	Track Control Arm		MN-DL-8544	Trailing Arm, Drive Axle; Air Suspension Axle	
	04/00 →	Track Control Arm		MN-DL-8709	Trailing Arm, Drive Axle; Air Suspension Axle	
	04/00 →	Track Control Arm		MN-DL-8733	Trailing Arm, Air Suspension Axle; Drive Axle	
	04/00 →	Track Control Arm		MN-TC-12399	Control Arm	
	04/00 →	Track Control Arm		MN-VB-5238	Wishbone (CV), Drive Axle; Air Suspension Axle	
	04/00 →	Track Control Arm		MN-VB-8514	Suspension Rod, Wishbone (CV), Drive Axle; Air Suspension Axle	
	04/00 →	Track Control Arm		MN-VB-8514	Suspension Rod, Wishbone (CV), Drive Axle; Leaf Spring Axle	
	04/00 →	Track Control Arm	MN-DL-8663		Control Arm, Air Suspension Axle	
	06/02 →	Track Control Arm		MN-VB-8669	Suspension Rod, Wishbone (CV), Drive Axle	
	18.530 FAC, FARC	04/04 →	Centre Rod	MN-DL-2174		Push Rod
		04/04 →	Tie Rod End	CV-ES-14162		for Steering Rod
		04/04 →	Tie Rod End	CV-ES-14163		for Steering Rod
		04/04 →	Tie Rod End	MN-ES-10333		for Steering Rod
	18.530 FAK, FAK-L, FALK, FALK-L	04/04 →	Centre Rod	MN-DL-8646		Push Rod
		04/04 →	Tie Rod End	CV-ES-0914		for Steering Rod
04/04 →		Tie Rod End	CV-ES-14162		for Steering Rod	
04/04 →		Tie Rod End	CV-ES-14163		for Steering Rod	
04/04 →		Tie Rod End	MN-ES-10333		for Steering Rod	
04/04 →		Tie Rod End	SC-ES-8517		for Push Rod	
04/04 →		Track Control Arm		MN-DL-8544	Trailing Arm	
04/04 →		Track Control Arm		MN-VB-8514	Suspension Rod, Wishbone (CV)	
18.530 FAS, FALS		04/04 →	Centre Rod	MN-DL-2174		Push Rod
		04/04 →	Tie Rod End	CV-ES-0914		for Steering Rod
	04/04 →	Tie Rod End	CV-ES-14162		for Steering Rod	
	04/04 →	Tie Rod End	CV-ES-14163		for Steering Rod	
	04/04 →	Tie Rod End	MN-ES-10333		for Steering Rod	
	04/04 →	Tie Rod End	SC-ES-8517		for Push Rod	
	04/04 →	Track Control Arm		MN-DL-8544	Trailing Arm, Drive Axle, for Pneumatic Suspension vehicles	
	04/04 →	Track Control Arm		MN-VB-8514	Suspension Rod, Wishbone (CV)	
18.530 FC, FLC, FLLC, FLLRC, FLLRW, FLLW, FLRC	09/02 →	Ball Head, gearshift linkage	CV-ES-2120			
	09/02 →	Centre Rod	MN-DL-7801		Push Rod, Leaf Spring Axle	
	09/02 →	Centre Rod	MN-DL-8560		Push Rod, Air Suspension Axle	
	09/02 →	Centre Rod	MN-DL-14107		Push Rod	
	09/02 →	Suspension Strut Repair Kit		DB-RK-8581		
	09/02 →	Suspension Strut Repair Kit		MN-RK-12436		
	09/02 →	Tie Rod	MN-DL-7802			

CV-ES-0914

Length: 125
Cone Ø: d1 Ø 30 / d2 Ø 27
Thread: M38 x 1,5 RHT
81953016184, 81953016251, 81953016276



CV-ES-2120

Length: 115
Cone Ø: d1 Ø 12,4 / d2 Ø 10,8
Thread: M14 x 1,5 RHT
03008500A, 81953016200, 81953016202, 81953016203, 81953016227



CV-ES-14162

Length: 125
Cone Ø: d1 Ø 30 / d2 Ø 27
Thread: M30 x 1,5 LHT
81953010015, 81953010083, 81953010087, 81953016029, 81953016030, 81953016043, 81953016044, 81953016050, 81953016054, 81953016087, 81953016091, 81953016107, 81953016120, 81953016125, 81953016152, 81953016155, 81953016157, 81953016168, 81953016179, 81953016181, 81953016223, 81953016237, 81953016254, 81953016275, 81953016279, 81953016351



CV-ES-14163

Length: 125
Cone Ø: d1 Ø 30 / d2 Ø 27
Thread: M30 x 1,5 RHT
95301.0084, 90804102156, 90804102272, 90804102696, 90804102710, 81953010016, 81953010075, 81953010084, 81953010088, 81953010094, 81953010103, 81953016030, 81953016043, 81953016048, 81953016049, 81953016053, 81953016061, 81953016090, 81953016108, 81953016112, 81953016126, 81953016143, 81953016149, 81953016154, 81953016156, 81953016168, 81953016178, 81953016194, 81953016206, 81953016224, 81953016234, 81953016242, 81953016252, 81953016274, 81953016278, 81953016284, 81953016286, 81953016308, 81953016310, 81953016312, 81953016347, 81953016350, 81953016352, 82953016012, 88953016014, N2953016001



DB-RK-8581

Ø: 85
Hole Distance: 130
Thick/Height: 24
03305800A, 81432706105



IV-ES-12272

Length: 75
Cone Ø: d1 Ø 30 / d2 Ø 27
Thread: M26 x 1,5 RHT
81953016280, 82953010010



MN-DL-2174

Length: 1588 Ø: 52
Cone Ø: d1 Ø 30 / d2 Ø 27
81467106378, 81467106912



MN-DL-5225

Length: 572 Ø: 48
Hole Distance: 130 / 130
03301500A, 81432206229, 81432206236, 81432206267, 81432206270, 81432206272, 81432206304, 81432206305, 81432209226, 81432209267, 81432209272



MN-DL-7801

Length: 995 Ø: 52
Cone Ø: d1 Ø 30 / d2 Ø 27
81466106807, 81466106808, 81466116087, 81466116088, 81466116096, 81466116097, 81466116099, 81466116132, 81466116133, 81466116136, 81466116197, 81466116198, 81466116205



MN-DL-7802

Length: 1680 Ø: 52
Cone Ø: d1 Ø 30 / d2 Ø 27
03208300A, 81467116773, 81467116858, 81467116859, 81467116860, 81467116861, 81467116863, 81467116882, 81467116883, 81467116920, 81467116921



MN-DL-8488

Length: 414 Ø: 50
Hole Distance: 130 / 130
81432206247, 81432206341, 81432206342



MN-DL-8544

Length: 596 Ø: 48
Hole Distance: 130 / 130
81432206196, 81432206232, 81432206233



MN-DL-8560

Length: 970 Ø: 52
Cone Ø: d1 Ø 30 / d2 Ø 27
03206900A, 81466106809, 81466106810, 81466106823, 81466106838, 81466106839, 81466116104, 81466116105, 81466116107, 81466116134, 81466116135, 81466116137, 81466116199, 81466116200, 81466116206



MN-DL-8646

Length: 1021 Ø: 52
Cone Ø: d1 Ø 30 / d2 Ø 27
81466106811, 81466106812, 81466116138, 81466116139, 81466116201, 81466116202



MN-DL-8663

Length: 947 Ø: 60
Hole Distance: 115 / 115
03307400A, 81432206222, 81432206260, 81432206283, 81432206284



MN-DL-8709

Length: 572 Ø: 52
Hole Distance: 130 / 130
81432206268, 81432206274, 81432206291, 81432206292, 82432206007



MN-DL-8733

Length: 530 Ø: 48
Hole Distance: 130 / 130
81432206161, 81432206190, 81432206358, 81432206359



MN-DL-14107

Length: 960 Ø: 50
Cone Ø: d1 Ø 30 / d2 Ø 27
81466106813, 81466116146, 81466116147, 81466116148, 81466116204



MN-ES-8490

Length: 90
Cone Ø: d1 Ø 30 / d2 Ø 27
Thread: M26 x 1,5 RHT
0014606948, 14606948, 81953016281, 81953016337, 82953016016



MN-ES-10333

Length: 90
Cone Ø: d1 Ø 38 / d2 Ø 34,35
Thread: M36 x 1,5 RHT
1271126, 3090291, 3099128, 42538048, 81953016268, 82953016018, 82953016019



MN-RK-12436

Ø: 75
Hole Distance: 115
Thick/Height: 24
81432206244



MN-TC-12399

Length: 694 Ø: 50
Hole Distance: 130 / 130
81432206265



MN-VB-5238

Length: 627 Ø: 48
Hole Distance: 130 / 130
81432206221, 81432706096, 81432706114, 81432706116, 81432706121



MN-VB-8514

Length: 627 Ø: 48
Hole Ø 25 / 25 / 25
Hole Distance: 152 / 130 / 130
81432706087, 81432706088, 81432706094, 81432706095, 81432796094



MN-VB-8669

Length: 627 Ø: 48
Hole Ø 25 / 25 / 25
Hole Distance: 152 / 130 / 130
81432706116, 81432706137, 81432706150, 81432706151



SC-ES-7279

Length: 150
Cone Ø: d1 Ø 30 / d2 Ø 27
Thread: M30 x 1,5 RHT
81953016288



SC-ES-8517

Length: 140
Cone Ø: d1 Ø 30 / d2 Ø 27
Thread: M30 x 1,5 RHT
81953016286



SC-ES-8535

Length: 145
Cone Ø: d1 Ø 30 / d2 Ø 27
Thread: M30 x 1,5 RHT
81953016271, 81953016325



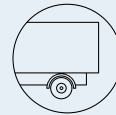

TGA ...

18.530 FC, FLC, FLLC, FLLRC, FLLRW, FLLW, FLRC ...	09/02→	Tie Rod End		MN-ES-8490	for vehicles with Hinged Trailing Axle	
	09/02→	Tie Rod End	CV-ES-0914		for Steering Rod	
	09/02→	Tie Rod End	CV-ES-14162		for Steering Rod	
	09/02→	Tie Rod End	CV-ES-14163		for Steering Rod	
	09/02→	Tie Rod End	IV-ES-12272		for Steering Rod	
	09/02→	Tie Rod End	SC-ES-7279		for Steering Rod	
	09/02→	Tie Rod End	SC-ES-8517		for Push Rod	
	09/02→	Tie Rod End	SC-ES-8535		for Guide Rod	
	09/02→	Track Control Arm		MN-DL-5225	Trailing Arm, Drive Axle;Air Suspension Axle	
	09/02→	Track Control Arm		MN-DL-8544	Trailing Arm, Drive Axle;Air Suspension Axle	
	09/02→	Track Control Arm		MN-DL-8709	Trailing Arm, Drive Axle;Air Suspension Axle	
	09/02→	Track Control Arm		MN-DL-8733	Trailing Arm, Air Suspension Axle;Drive Axle	
	09/02→	Track Control Arm		MN-TC-12399	Control Arm	
	09/02→	Track Control Arm		MN-VB-5238	Wishbone (CV), Drive Axle;Air Suspension Axle	
	09/02→	Track Control Arm		MN-VB-8514	Suspension Rod, Wishbone (CV), Drive Axle; Air Suspension Axle	
	09/02→	Track Control Arm		MN-VB-8514	Suspension Rod, Wishbone (CV), Drive Axle; Leaf Spring Axle	
	09/02→	Track Control Arm		MN-VB-8669	Suspension Rod, Wishbone (CV), Drive Axle	
	09/02→	Track Control Arm	MN-DL-8663		Control Arm, Air Suspension Axle	
	18.530 FLLRS, FLLS, FLRS, FLS	09/02→	Ball Head, gearshift linkage	CV-ES-2120		
		09/02→	Centre Rod	MN-DL-7801		Push Rod
		09/02→	Centre Rod	MN-DL-8560		Push Rod, Air Suspension Axle
		09/02→	Centre Rod	MN-DL-14107		Push Rod
		09/02→	Suspension Strut Repair Kit		DB-RK-8581	
		09/02→	Suspension Strut Repair Kit		MN-RK-12436	
		09/02→	Tie Rod	MN-DL-7802		
		09/02→	Tie Rod End		MN-ES-8490	for vehicles with Hinged Trailing Axle
		09/02→	Tie Rod End	CV-ES-0914		for Steering Rod
09/02→		Tie Rod End	CV-ES-14162		for Steering Rod	
09/02→		Tie Rod End	CV-ES-14163		for Steering Rod	
09/02→		Tie Rod End	IV-ES-12272		for Steering Rod	
09/02→		Tie Rod End	SC-ES-7279		for Steering Rod	
09/02→		Tie Rod End	SC-ES-8517		for Push Rod	
09/02→		Tie Rod End	SC-ES-8535		for Guide Rod	
09/02→		Track Control Arm		MN-DL-5225	Trailing Arm, Drive Axle;Air Suspension Axle	
09/02→		Track Control Arm		MN-DL-8488	Trailing Arm;for Wishbone (CV), Air Suspension Axle	
09/02→		Track Control Arm		MN-DL-8544	Trailing Arm, Drive Axle;Air Suspension Axle	
09/02→		Track Control Arm		MN-DL-8709	Trailing Arm, Drive Axle;Air Suspension Axle	
09/02→		Track Control Arm		MN-DL-8733	Trailing Arm, Air Suspension Axle;Drive Axle	
09/02→		Track Control Arm		MN-TC-12399	Control Arm	
09/02→		Track Control Arm		MN-VB-5238	Wishbone (CV), Drive Axle;Air Suspension Axle	
09/02→		Track Control Arm		MN-VB-8514	Suspension Rod, Wishbone (CV), Drive Axle; Air Suspension Axle	
09/02→		Track Control Arm		MN-VB-8514	Suspension Rod, Wishbone (CV), Drive Axle; Leaf Spring Axle	
09/02→		Track Control Arm		MN-VB-8669	Suspension Rod, Wishbone (CV), Drive Axle	
09/02→		Track Control Arm	MN-DL-8663		Control Arm, Air Suspension Axle	
18.540 FLC, FLLC, FLLRC, FLLW, FLRC		08/06→	Centre Rod	MN-DL-7801		Push Rod, Leaf Spring Axle
	08/06→	Suspension Strut Repair Kit		MN-RK-12436		
	08/06→	Tie Rod	MN-DL-7802			
	08/06→	Tie Rod End	CV-ES-0914		for Steering Rod	
	08/06→	Tie Rod End	CV-ES-14162		for Steering Rod	
	08/06→	Tie Rod End	CV-ES-14163		for Steering Rod	
	08/06→	Tie Rod End	SC-ES-7279		for Steering Rod	
	08/06→	Tie Rod End	SC-ES-8517		for Push Rod	
	08/06→	Tie Rod End	SC-ES-8535		for Guide Rod	
	08/06→	Track Control Arm		MN-DL-5225	Trailing Arm	
	08/06→	Track Control Arm		MN-DL-8544	Trailing Arm, Drive Axle, for Pneumatic Suspension vehicles, →MHB Chassis	
	08/06→	Track Control Arm		MN-DL-8733	Trailing Arm, 1st Drive Axle, for Pneumatic Suspension vehicles, →Type_RHFN	

CV-ES-0914

Length: 125
Cone Ø: d1 Ø 30 / d2 Ø 27
Thread: M38 x 1,5 RHT
81953016184, 81953016251, 81953016276



CV-ES-2120

Length: 115
Cone Ø: d1 Ø 12,4 / d2 Ø 10,8
Thread: M14 x 1,5 RHT
03008500A, 81953016200, 81953016202,
81953016203, 81953016227



CV-ES-14162

Length: 125
Cone Ø: d1 Ø 30 / d2 Ø 27
Thread: M30 x 1,5 LHT
81953010015, 81953010083, 81953010087,
81953016029, 81953016030, 81953016043,
81953016044, 81953016050, 81953016054,
81953016087, 81953016091, 81953016107,
81953016120, 81953016125, 81953016152,
81953016155, 81953016157, 81953016168,
81953016179, 81953016181, 81953016223,
81953016237, 81953016254, 81953016275,
81953016279, 81953016351



CV-ES-14163

Length: 125
Cone Ø: d1 Ø 30 / d2 Ø 27
Thread: M30 x 1,5 RHT
95301.0084, 90804102156, 90804102272,
90804102696, 90804102710, 81953010016,
81953010075, 81953010084, 81953010088,
81953010094, 81953010103, 81953016030,
81953016043, 81953016048, 81953016049,
81953016053, 81953016061, 81953016090,
81953016108, 81953016112, 81953016126,
81953016143, 81953016149, 81953016154,
81953016156, 81953016168, 81953016178,
81953016194, 81953016206, 81953016224,
81953016234, 81953016242, 81953016252,
81953016274, 81953016278, 81953016284,
81953016286, 81953016308, 81953016310,
81953016312, 81953016347, 81953016350,
81953016352, 82953016012, 88953016014,
N2953016001



DB-RK-8581

Ø: 85
Hole Distance: 130
Thick/Height: 24
03305800A, 81432706105



IV-ES-12272

Length: 75
Cone Ø: d1 Ø 30 / d2 Ø 27
Thread: M26 x 1,5 RHT
81953016280, 82953010010



MN-DL-5225

Length: 572 Ø: 48
Hole Distance: 130 / 130
03301500A, 81432206229, 81432206236,
81432206267, 81432206270, 81432206272,
81432206304, 81432206305, 81432209236,
81432209267, 81432209272



MN-DL-7801

Length: 995 Ø: 52
Cone Ø: d1 Ø 30 / d2 Ø 27
81466106807, 81466106808, 81466116087,
81466116088, 81466116096, 81466116097,
81466116099, 81466116132, 81466116133,
81466116136, 81466116197, 81466116198,
81466116205



MN-DL-7802

Length: 1680 Ø: 52
Cone Ø: d1 Ø 30 / d2 Ø 27
03208300A, 81467116773, 81467116858,
81467116859, 81467116860, 81467116861,
81467116863, 81467116882, 81467116883,
81467116920, 81467116921



MN-DL-8488

Length: 414 Ø: 50
Hole Distance: 130 / 130
81432206247, 81432206341, 81432206342



MN-DL-8544

Length: 596 Ø: 48
Hole Distance: 130 / 130
81432206196, 81432206232, 81432206233



MN-DL-8560

Length: 970 Ø: 52
Cone Ø: d1 Ø 30 / d2 Ø 27
03206900A, 81466106809, 81466106810,
81466106823, 81466106838, 81466106839,
81466116104, 81466116105, 81466116107,
81466116134, 81466116135, 81466116137,
81466116199, 81466116200, 81466116206



MN-DL-8663

Length: 947 Ø: 60
Hole Distance: 115 / 115
03307400A, 81432206222, 81432206260,
81432206283, 81432206284



MN-DL-8709

Length: 572 Ø: 52
Hole Distance: 130 / 130
81432206268, 81432206274, 81432206291,
81432206292, 82432206007



MN-DL-8733

Length: 530 Ø: 48
Hole Distance: 130 / 130
81432206161, 81432206190, 81432206358,
81432206359



MN-DL-14107

Length: 960 Ø: 50
Cone Ø: d1 Ø 30 / d2 Ø 27
81466106813, 81466116146, 81466116147,
81466116148, 81466116204



MN-ES-8490

Length: 90
Cone Ø: d1 Ø 30 / d2 Ø 27
Thread: M26 x 1,5 RHT
0014606948, 14606948, 81953016281,
81953016337, 82953016016



MN-RK-12436

Ø: 75
Hole Distance: 115
Thick/Height: 24
81432206244



MN-TC-12399

Length: 694 Ø: 50
Hole Distance: 130 / 130
81432206265



MN-VB-5238

Length: 627 Ø: 48
Hole Distance: 130 / 130
81432206221, 81432706096, 81432706114,
81432706116, 81432706121



MN-VB-8514

Length: 627 Ø: 48
Hole Ø 25 / 25 / 25
Hole Distance: 152 / 130 / 130
81432706087, 81432706088, 81432706094,
81432706095, 81432796094



MN-VB-8669

Length: 627 Ø: 48
Hole Ø 25 / 25 / 25
Hole Distance: 152 / 130 / 130
81432706116, 81432706137, 81432706150,
81432706151



SC-ES-7279

Length: 150
Cone Ø: d1 Ø 30 / d2 Ø 27
Thread: M30 x 1,5 RHT
81953016288



SC-ES-8517

Length: 140
Cone Ø: d1 Ø 30 / d2 Ø 27
Thread: M30 x 1,5 RHT
81953016286



SC-ES-8535

Length: 145
Cone Ø: d1 Ø 30 / d2 Ø 27
Thread: M30 x 1,5 RHT
81953016271, 81953016325





TGA ...

18.540 FLC, FLLC, FLLRC, FLLW, FLRC ...	08/06 →	Track Control Arm		MN-VB-5238	Wishbone (CV), 1st Drive Axle, for Pneumatic Suspension vehicles	
	08/06 →	Track Control Arm		MN-VB-8514	Suspension Rod, Wishbone (CV)	
	08/06 →	Track Control Arm	MN-DL-8663		Control Arm	
	18.540 FLLRS, FLLS, FLRS, FLS	08/06 →	Centre Rod	MN-DL-7801		Push Rod
		08/06 →	Suspension Strut Repair Kit		MN-RK-12436	
		08/06 →	Tie Rod	MN-DL-7802		
		08/06 →	Tie Rod End	CV-ES-0914		for Steering Rod
		08/06 →	Tie Rod End	CV-ES-14162		for Steering Rod
		08/06 →	Tie Rod End	CV-ES-14163		for Steering Rod
		08/06 →	Tie Rod End	SC-ES-7279		for Steering Rod
		08/06 →	Tie Rod End	SC-ES-8517		for Push Rod
		08/06 →	Tie Rod End	SC-ES-8535		for Guide Rod
		08/06 →	Track Control Arm		MN-DL-5225	Trailing Arm
		08/06 →	Track Control Arm		MN-DL-8488	Wishbone (CV), Drive Axle, for Pneumatic Suspension vehicles
		08/06 →	Track Control Arm		MN-DL-8544	Trailing Arm, Drive Axle, for Pneumatic Suspension vehicles, →MHB Chassis
08/06 →	Track Control Arm		MN-DL-8733	Trailing Arm, 1st Drive Axle, for Pneumatic Suspension vehicles, →Type_RHFN		
08/06 →	Track Control Arm		MN-VB-5238	Wishbone (CV), 1st Drive Axle, for Pneumatic Suspension vehicles		
08/06 →	Track Control Arm		MN-VB-8514	Suspension Rod, Wishbone (CV)		
08/06 →	Track Control Arm	MN-DL-8663		Control Arm		
19.350 FLRS, FLS, FRS, FS	05/04 →	Centre Rod	MN-DL-7801		Push Rod, Leaf Spring Axle	
	05/04 →	Tie Rod	MN-DL-7802			
	05/04 →	Tie Rod	MN-DL-12293			
	05/04 →	Tie Rod End	CV-ES-0914		for Steering Rod	
	05/04 →	Tie Rod End	CV-ES-14162		for Steering Rod	
	05/04 →	Tie Rod End	CV-ES-14163		for Steering Rod	
	05/04 →	Tie Rod End	SC-ES-7279		for Steering Rod	
	05/04 →	Tie Rod End	SC-ES-8517		for Push Rod	
	05/04 →	Tie Rod End	SC-ES-8535		for Guide Rod	
	05/04 →	Track Control Arm		MN-DL-5225	Trailing Arm, Drive Axle;Air Suspension Axle	
	19.360 FLRS, FLS, FRS, FS	05/04 →	Centre Rod	MN-DL-7801		Push Rod, Leaf Spring Axle
		05/04 →	Suspension Arm Repair Kit		CV-RK-5313	for Wishbone (CV)
		05/04 →	Tie Rod	MN-DL-7802		
		05/04 →	Tie Rod	MN-DL-12293		
05/04 →		Tie Rod End	CV-ES-0914		for Steering Rod	
05/04 →		Tie Rod End	CV-ES-14162		for Steering Rod	
05/04 →		Tie Rod End	CV-ES-14163		for Steering Rod	
05/04 →		Tie Rod End	SC-ES-7279		for Steering Rod	
05/04 →		Tie Rod End	SC-ES-8517		for Push Rod	
05/04 →		Tie Rod End	SC-ES-8535		for Guide Rod	
05/04 →		Track Control Arm		MN-DL-5225	Trailing Arm	
05/04 →		Track Control Arm		MN-DL-5225	Trailing Arm, Drive Axle;Air Suspension Axle	
05/04 →		Track Control Arm		MN-VB-5238	Wishbone (CV), 1st Drive Axle, for Pneumatic Suspension vehicles	
19.390 FLRS, FLS, FRS, FS		05/04 →	Centre Rod	MN-DL-7801		Push Rod, Leaf Spring Axle
	05/04 →	Tie Rod	MN-DL-7802			
	05/04 →	Tie Rod	MN-DL-12293			
	05/04 →	Tie Rod End	CV-ES-0914		for Steering Rod	
	05/04 →	Tie Rod End	CV-ES-14162		for Steering Rod	
	05/04 →	Tie Rod End	CV-ES-14163		for Steering Rod	
	05/04 →	Tie Rod End	SC-ES-7279		for Steering Rod	
	05/04 →	Tie Rod End	SC-ES-8517		for Push Rod	
	05/04 →	Tie Rod End	SC-ES-8535		for Guide Rod	
	05/04 →	Track Control Arm		MN-DL-5225	Trailing Arm, Drive Axle;Air Suspension Axle	
	19.400 FLRS, FLS, FRS, FS	05/04 →	Centre Rod	MN-DL-7801		Push Rod, Leaf Spring Axle
05/04 →		Suspension Arm Repair Kit		CV-RK-5313	for Wishbone (CV)	
05/04 →		Tie Rod	MN-DL-7802			
05/04 →		Tie Rod	MN-DL-12293			
05/04 →		Tie Rod End	CV-ES-0914		for Steering Rod	

CV-ES-0914

Length: 125
Cone Ø: d1 Ø 30 / d2 Ø 27
Thread: M38 x 1,5 RHT
81953016184, 81953016251, 81953016276



CV-ES-14162

Length: 125
Cone Ø: d1 Ø 30 / d2 Ø 27
Thread: M30 x 1,5 LHT
81953010015, 81953010083, 81953010087, 81953016029, 81953016030, 81953016043, 81953016044, 81953016050, 81953016054, 81953016087, 81953016091, 81953016107, 81953016120, 81953016125, 81953016152, 81953016155, 81953016157, 81953016168, 81953016179, 81953016181, 81953016223, 81953016237, 81953016254, 81953016275, 81953016279, 81953016351



CV-ES-14163

Length: 125
Cone Ø: d1 Ø 30 / d2 Ø 27
Thread: M30 x 1,5 RHT
95301.0084, 90804102156, 90804102272, 90804102696, 90804102710, 81953010016, 81953010075, 81953010084, 81953010088, 81953010094, 81953010103, 81953016030, 81953016043, 81953016048, 81953016049, 81953016053, 81953016061, 81953016090, 81953016108, 81953016112, 81953016126, 81953016143, 81953016149, 81953016154, 81953016156, 81953016168, 81953016178, 81953016194, 81953016206, 81953016224, 81953016234, 81953016242, 81953016252, 81953016274, 81953016278, 81953016284, 81953016286, 81953016308, 81953016310, 81953016312, 81953016347, 81953016350, 81953016352, 82953016012, 88953016014, N2953016001



CV-RK-5313

Ø: 90
03304800A, 81953016132



MN-DL-5225

Length: 572 Ø: 48
Hole Distance: 130 / 130
03301500A, 81432206229, 81432206236, 81432206267, 81432206270, 81432206272, 81432206304, 81432206305, 81432209236, 81432209267, 81432209272



MN-DL-7801

Length: 995 Ø: 52
Cone Ø: d1 Ø 30 / d2 Ø 27
81466106807, 81466106808, 81466116087, 81466116088, 81466116096, 81466116097, 81466116099, 81466116132, 81466116133, 81466116136, 81466116197, 81466116198, 81466116205



MN-DL-7802

Length: 1680 Ø: 52
Cone Ø: d1 Ø 30 / d2 Ø 27
03208300A, 81467116773, 81467116858, 81467116859, 81467116860, 81467116861, 81467116863, 81467116882, 81467116883, 81467116920, 81467116921



MN-DL-8488

Length: 414 Ø: 50
Hole Distance: 130 / 130
81432206247, 81432206341, 81432206342



MN-DL-8544

Length: 596 Ø: 48
Hole Distance: 130 / 130
81432206196, 81432206232, 81432206233



MN-DL-8663

Length: 947 Ø: 60
Hole Distance: 115 / 115
03307400A, 81432206222, 81432206260, 81432206283, 81432206284



MN-DL-8733

Length: 530 Ø: 48
Hole Distance: 130 / 130
81432206161, 81432206190, 81432206358, 81432206359



MN-DL-12293

Length: 1680 Ø: 42
Cone Ø: d1 Ø 30 / d2 Ø 27
81467106236, 81467106268, 81467106356, 81467116356, 81467116723, 81467116794, 81467116933, 81467116934, 81467116966



MN-RK-12436

Ø: 75
Hole Distance: 115
Thick/Height: 24
81432206244



MN-VB-5238

Length: 627 Ø: 48
Hole Distance: 130 / 130
81432206221, 81432706096, 81432706114, 81432706116, 81432706121



MN-VB-8514

Length: 627 Ø: 48
Hole Ø 25 / 25 / 25
Hole Distance: 152 / 130 / 130
81432706087, 81432706088, 81432706094, 81432706095, 81432796094



SC-ES-7279

Length: 150
Cone Ø: d1 Ø 30 / d2 Ø 27
Thread: M30 x 1,5 RHT
81953016288



SC-ES-8517

Length: 140
Cone Ø: d1 Ø 30 / d2 Ø 27
Thread: M30 x 1,5 RHT
81953016286



SC-ES-8535

Length: 145
Cone Ø: d1 Ø 30 / d2 Ø 27
Thread: M30 x 1,5 RHT
81953016271, 81953016325





TGA ...

19.400 FLRS, FLS, FRS, FS ...	05/04 →	Tie Rod End	CV-ES-14162		for Steering Rod
	05/04 →	Tie Rod End	CV-ES-14163		for Steering Rod
	05/04 →	Tie Rod End	SC-ES-7279		for Steering Rod
	05/04 →	Tie Rod End	SC-ES-8517		for Push Rod
	05/04 →	Tie Rod End	SC-ES-8535		for Guide Rod
	05/04 →	Track Control Arm		MN-DL-5225	Trailing Arm, Drive Axle; Air Suspension Axle
	05/04 →	Track Control Arm		MN-VB-5238	Wishbone (CV), 1st Drive Axle, for Pneumatic Suspension vehicles
19.410 FRS, FS	05/04 →	Centre Rod	MN-DL-7801		Push Rod, Leaf Spring Axle
	05/04 →	Tie Rod End	CV-ES-0914		for Steering Rod
	05/04 →	Tie Rod End	CV-ES-14162		for Steering Rod
	05/04 →	Tie Rod End	CV-ES-14163		for Steering Rod
	05/04 →	Tie Rod End	SC-ES-8517		for Push Rod
19.430 FLRS, FLS, FRS, FS	05/04 →	Track Control Arm		MN-DL-5225	Trailing Arm
	05/04 →	Centre Rod	MN-DL-7801		Push Rod, Leaf Spring Axle
	05/04 →	Tie Rod	MN-DL-7802		
	05/04 →	Tie Rod	MN-DL-12293		
19.440 FLRS, FLS, FRS, FS	05/04 →	Track Control Arm		MN-DL-5225	Trailing Arm, Drive Axle; Air Suspension Axle
	02/06 →	Centre Rod	MN-DL-7801		Push Rod, Leaf Spring Axle
	02/06 →	Tie Rod	MN-DL-7802		
	02/06 →	Tie Rod	MN-DL-12293		
19.460 FRS, FS	02/06 →	Track Control Arm		MN-DL-5225	Trailing Arm, Drive Axle; Air Suspension Axle
	05/04 →	Centre Rod	MN-DL-7801		Push Rod, Leaf Spring Axle
	05/04 →	Tie Rod End	CV-ES-0914		for Steering Rod
	05/04 →	Tie Rod End	CV-ES-14162		for Steering Rod
	05/04 →	Tie Rod End	CV-ES-14163		for Steering Rod
	05/04 →	Tie Rod End	SC-ES-8517		for Push Rod
19.480 FLRS, FLS, FRS, FS	05/04 →	Track Control Arm		MN-DL-5225	Trailing Arm
	02/06 →	Centre Rod	MN-DL-7801		Push Rod, Leaf Spring Axle
	02/06 →	Suspension Arm Repair Kit		CV-RK-5313	for Wishbone (CV)
	02/06 →	Tie Rod	MN-DL-7802		
	02/06 →	Tie Rod	MN-DL-12293		
	02/06 →	Tie Rod End	CV-ES-0914		for Steering Rod
	02/06 →	Tie Rod End	CV-ES-14162		for Steering Rod
	02/06 →	Tie Rod End	CV-ES-14163		for Steering Rod
	02/06 →	Tie Rod End	SC-ES-7279		for Steering Rod
	02/06 →	Tie Rod End	SC-ES-8517		for Push Rod
	02/06 →	Tie Rod End	SC-ES-8535		for Guide Rod
	02/06 →	Track Control Arm		MN-DL-5225	Trailing Arm, Drive Axle; Air Suspension Axle
	02/06 →	Track Control Arm		MN-VB-5238	Wishbone (CV), 1st Drive Axle, for Pneumatic Suspension vehicles
19.480 FRS, FS	05/04 →	Track Control Arm		MN-DL-5225	Trailing Arm
	05/04 →	Centre Rod	MN-DL-7801		Push Rod, Leaf Spring Axle
	05/04 →	Tie Rod End	CV-ES-0914		for Steering Rod
	05/04 →	Tie Rod End	CV-ES-14162		for Steering Rod
	05/04 →	Tie Rod End	CV-ES-14163		for Steering Rod
	05/04 →	Tie Rod End	SC-ES-8517		for Push Rod
19.480 FS/M, FRS/M-WW	05/04 →	Track Control Arm		MN-DL-5225	Trailing Arm
	02/06 →	Centre Rod	MN-DL-7801		Push Rod, Leaf Spring Axle
	02/06 →	Suspension Arm Repair Kit		CV-RK-5313	for Wishbone (CV)
	02/06 →	Tie Rod	MN-DL-12293		
	02/06 →	Tie Rod End	CV-ES-0914		for Steering Rod
	02/06 →	Tie Rod End	CV-ES-14162		for Steering Rod
	02/06 →	Tie Rod End	CV-ES-14163		for Steering Rod
	02/06 →	Tie Rod End	SC-ES-7279		for Steering Rod
	02/06 →	Tie Rod End	SC-ES-8517		for Push Rod
	02/06 →	Tie Rod End	SC-ES-8535		for Guide Rod
	02/06 →	Track Control Arm		MN-DL-5225	for Control Arm
	02/06 →	Track Control Arm		MN-VB-5238	Wishbone (CV), 1st Drive Axle
	24.350, 24.360 FLLRW, FNLLC, FNLLRC, FNLLRW, FNLLW	05/04 → 01/05	Track Control Arm		MN-DL-5212
05/04 →		Centre Rod	MN-DL-8560		Push Rod, Air Suspension Axle
05/04 →		Suspension Strut Repair Kit		DB-RK-8581	
05/04 →		Suspension Strut Repair Kit		MN-RK-12436	
05/04 →		Tie Rod	MN-DL-7802		

CV-ES-0914

Length: 125
Cone Ø: d1 Ø 30 / d2 Ø 27
Thread: M38 x 1,5 RHT
81953016184, 81953016251, 81953016276



CV-ES-14162

Length: 125
Cone Ø: d1 Ø 30 / d2 Ø 27
Thread: M30 x 1,5 LHT
81953010015, 81953010083, 81953010087, 81953016029, 81953016030, 81953016043, 81953016044, 81953016050, 81953016054, 81953016087, 81953016091, 81953016107, 81953016120, 81953016125, 81953016152, 81953016155, 81953016157, 81953016168, 81953016179, 81953016181, 81953016223, 81953016237, 81953016254, 81953016275, 81953016279, 81953016351



CV-ES-14163

Length: 125
Cone Ø: d1 Ø 30 / d2 Ø 27
Thread: M30 x 1,5 RHT
95301.0084, 90804102156, 90804102272, 90804102696, 90804102710, 81953010016, 81953010075, 81953010084, 81953010088, 81953010094, 81953010103, 81953016030, 81953016043, 81953016048, 81953016049, 81953016053, 81953016061, 81953016090, 81953016108, 81953016112, 81953016126, 81953016143, 81953016149, 81953016154, 81953016156, 81953016168, 81953016178, 81953016194, 81953016206, 81953016224, 81953016234, 81953016242, 81953016252, 81953016274, 81953016278, 81953016284, 81953016286, 81953016308, 81953016310, 81953016312, 81953016347, 81953016350, 81953016352, 82953016012, 88953016014, N2953016001



CV-RK-5313

Ø: 90
03304800A, 81953016132



DB-RK-8581

Ø: 85
Hole Distance: 130
Thick/Height: 24
03305800A, 81432706105



MN-DL-5212

Length: 577 Ø: 48
Hole Distance: 130 / 130
81432206096, 81432206097, 81432206098, 81432206129, 81432209096, 81432209129, 81432306014, 81432306030



MN-DL-5225

Length: 572 Ø: 48
Hole Distance: 130 / 130
03301500A, 81432206229, 81432206236, 81432206267, 81432206270, 81432206272, 81432206304, 81432206305, 81432209236, 81432209267, 81432209272



MN-DL-7801

Length: 995 Ø: 52
Cone Ø: d1 Ø 30 / d2 Ø 27
81466106807, 81466106808, 81466116087, 81466116088, 81466116096, 81466116097, 81466116099, 81466116132, 81466116133, 81466116136, 81466116197, 81466116198, 81466116205



MN-DL-7802

Length: 1680 Ø: 52
Cone Ø: d1 Ø 30 / d2 Ø 27
03208300A, 81467116773, 81467116858, 81467116859, 81467116860, 81467116861, 81467116863, 81467116882, 81467116883, 81467116920, 81467116921



MN-DL-8560

Length: 970 Ø: 52
Cone Ø: d1 Ø 30 / d2 Ø 27
03206900A, 81466106809, 81466106810, 81466106823, 81466106838, 81466106839, 81466116104, 81466116105, 81466116107, 81466116134, 81466116135, 81466116137, 81466116199, 81466116200, 81466116206



MN-DL-12293

Length: 1680 Ø: 42
Cone Ø: d1 Ø 30 / d2 Ø 27
81467106236, 81467106268, 81467106356, 81467116356, 81467116723, 81467116794, 81467116933, 81467116934, 81467116966



MN-RK-12436

Ø: 75
Hole Distance: 115
Thick/Height: 24
81432206244



MN-VB-5238

Length: 627 Ø: 48
Hole Distance: 130 / 130
81432206221, 81432706096, 81432706114, 81432706116, 81432706121



SC-ES-7279

Length: 150
Cone Ø: d1 Ø 30 / d2 Ø 27
Thread: M30 x 1,5 RHT
81953016288



SC-ES-8517

Length: 140
Cone Ø: d1 Ø 30 / d2 Ø 27
Thread: M30 x 1,5 RHT
81953016286



SC-ES-8535

Length: 145
Cone Ø: d1 Ø 30 / d2 Ø 27
Thread: M30 x 1,5 RHT
81953016271, 81953016325





TGA ...

24.350, 24.360 FLLRW, FNLLC, FNLLRC, FNLLRW, FNLLW ...	05/04 →	Tie Rod	MN-DL-12284			
	05/04 →	Tie Rod End	CV-ES-0914		for Steering Rod	
	05/04 →	Tie Rod End	CV-ES-14163		for Steering Rod	
	05/04 →	Tie Rod End	SC-ES-7279		for Steering Rod	
	05/04 →	Tie Rod End	SC-ES-8517		for Push Rod	
	05/04 →	Tie Rod End	SC-ES-8535		for Guide Rod	
	05/04 →	Track Control Arm		MN-DL-5225	Trailing Arm, Drive Axle; Air Suspension Axle; for vehicles with Rigid Trailing Axle	
	05/04 →	Track Control Arm		MN-DL-5225	Trailing Arm, Tag Axle; Air Suspension Axle; for vehicles with Hinged Trailing Axle	
	05/04 →	Track Control Arm		MN-DL-8709	Trailing Arm, Air Suspension Axle; for vehicles with Hinged Trailing Axle	
	05/04 →	Track Control Arm		MN-DL-8733	Trailing Arm, 1st Drive Axle, for Pneumatic Suspension vehicles	
	05/04 →	Track Control Arm		MN-VB-5238	Wishbone (CV), Drive Axle; Air Suspension Axle	
	05/04 →	Track Control Arm		MN-VB-9403	Wishbone (CV), Air Suspension Axle	
	05/04 →	Track Control Arm	MN-DL-8663		Control Arm, Air Suspension Axle	
	01/05 →	Track Control Arm		MN-DL-5225	Trailing Arm, Tag Axle; Air Suspension Axle; for vehicles with Rigid Trailing Axle	
	24.350, 24.360 FPLS, FPLRS	02/04 →	Centre Rod	MN-DL-7801		Push Rod, Leaf Spring Axle
02/04 →		Suspension Strut Repair Kit		DB-RK-8581		
02/04 →		Tie Rod	MN-DL-7802			
02/04 →		Tie Rod End	CV-ES-0914		for Steering Rod	
02/04 →		Tie Rod End	CV-ES-14163		for Steering Rod	
02/04 →		Tie Rod End	SC-ES-7279		for Steering Rod	
02/04 →		Tie Rod End	SC-ES-8517		for Push Rod	
02/04 →		Tie Rod End	SC-ES-8535		for Guide Rod	
02/04 →		Track Control Arm		MN-DL-5225	Trailing Arm, Drive Axle; Air Suspension Axle	
02/04 →		Track Control Arm		MN-DL-5225	Trailing Arm, Leading Axle; Air Suspension Axle	
02/04 →		Track Control Arm		MN-DL-8733	Trailing Arm, Air Suspension Axle; Drive Axle	
02/04 →		Track Control Arm		MN-VB-5238	Wishbone (CV), Drive Axle; Air Suspension Axle	
02/04 →		Track Control Arm		MN-VB-5238	Wishbone (CV), Leading Axle; Air Suspension Axle	
24.360 FNLLC/N, FNLLW, FNLLRW, FNLLRC	09/01 → 01/05	Track Control Arm		MN-DL-5212	Trailing Arm, Tag Axle; Air Suspension Axle	
	09/01 →	Ball Head, gearshift linkage	CV-ES-2120			
	09/01 →	Centre Rod	MN-DL-8560		Push Rod, Air Suspension Axle	
	09/01 →	Suspension Strut Repair Kit		DB-RK-8581		
	09/01 →	Suspension Strut Repair Kit		MN-RK-12436		
	09/01 →	Tie Rod	MN-DL-7802			
	09/01 →	Tie Rod	MN-DL-12284			
	09/01 →	Tie Rod End	CV-ES-0914		for Steering Rod	
	09/01 →	Tie Rod End	CV-ES-14163		for Steering Rod	
	09/01 →	Tie Rod End	SC-ES-7279		for Steering Rod	
	09/01 →	Tie Rod End	SC-ES-8517		for Push Rod	
	09/01 →	Tie Rod End	SC-ES-8535		for Guide Rod	
	09/01 →	Track Control Arm		MN-DL-5225	Trailing Arm, Drive Axle; Air Suspension Axle	
	09/01 →	Track Control Arm		MN-VB-5238	Wishbone (CV), Drive Axle; Air Suspension Axle	
	09/01 →	Track Control Arm		MN-VB-9403	Wishbone (CV), Air Suspension Axle	
	09/01 →	Track Control Arm		MN-VB-9404	Wishbone (CV), Drive Axle	
	09/01 →	Track Control Arm	MN-DL-8663		Control Arm, Air Suspension Axle	
	01/05 →	Track Control Arm		MN-DL-5225	Trailing Arm, Tag Axle; Air Suspension Axle; for vehicles with Rigid Trailing Axle	
	24.390, 24.400 FLLRW, FNLLC, FNLLRC, FNLLW, FNLLRC	05/04 → 01/05	Track Control Arm		MN-DL-5212	Trailing Arm, Tag Axle; Air Suspension Axle
		05/04 →	Centre Rod	MN-DL-8560		Push Rod, Air Suspension Axle
05/04 →		Suspension Strut Repair Kit		DB-RK-8581		
05/04 →		Suspension Strut Repair Kit		MN-RK-12436		
05/04 →		Tie Rod	MN-DL-7802			
05/04 →		Tie Rod	MN-DL-12284			
05/04 →		Tie Rod End	CV-ES-0914		for Steering Rod	
05/04 →		Tie Rod End	CV-ES-14163		for Steering Rod	
05/04 →		Tie Rod End	SC-ES-7279		for Steering Rod	
05/04 →		Tie Rod End	SC-ES-8517		for Push Rod	
05/04 →		Tie Rod End	SC-ES-8535		for Guide Rod	

CV-ES-0914

Length: 125
Cone Ø: d1 Ø 30 / d2 Ø 27
Thread: M38 x 1,5 RHT
81953016184, 81953016251, 81953016276



CV-ES-2120

Length: 115
Cone Ø: d1 Ø 12,4 / d2 Ø 10,8
Thread: M14 x 1,5 RHT
03008500A, 81953016200, 81953016202,
81953016203, 81953016227



CV-ES-14163

Length: 125
Cone Ø: d1 Ø 30 / d2 Ø 27
Thread: M30 x 1,5 RHT
95301.0084, 90804102156, 90804102272,
90804102696, 90804102710, 81953010016,
81953010075, 81953010084, 81953010088,
81953010094, 81953010103, 81953016030,
81953016043, 81953016048, 81953016049,
81953016053, 81953016061, 81953016090,
81953016108, 81953016112, 81953016126,
81953016143, 81953016149, 81953016154,
81953016156, 81953016168, 81953016178,
81953016194, 81953016206, 81953016224,
81953016234, 81953016242, 81953016252,
81953016274, 81953016278, 81953016284,
81953016286, 81953016308, 81953016310,
81953016312, 81953016347, 81953016350,
81953016352, 82953016012, 88953016014,
N2953016001



DB-RK-8581

Ø: 85
Hole Distance: 130
Thick/Height: 24
03305800A, 81432706105



MN-DL-5212

Length: 577 Ø: 48
Hole Distance: 130 / 130
81432206096, 81432206097, 81432206098,
81432206129, 81432209096, 81432209129,
81432306014, 81432306030



MN-DL-5225

Length: 572 Ø: 48
Hole Distance: 130 / 130
03301500A, 81432206229, 81432206236,
81432206267, 81432206270, 81432206272,
81432206304, 81432206305, 81432209236,
81432209267, 81432209272



MN-DL-7801

Length: 995 Ø: 52
Cone Ø: d1 Ø 30 / d2 Ø 27
81466106807, 81466106808, 81466116087,
81466116088, 81466116096, 81466116097,
81466116099, 81466116132, 81466116133,
81466116136, 81466116197, 81466116198,
81466116205



MN-DL-7802

Length: 1680 Ø: 52
Cone Ø: d1 Ø 30 / d2 Ø 27
03208300A, 81467116773, 81467116858,
81467116859, 81467116860, 81467116861,
81467116863, 81467116882, 81467116883,
81467116920, 81467116921



MN-DL-8560

Length: 970 Ø: 52
Cone Ø: d1 Ø 30 / d2 Ø 27
03206900A, 81466106809, 81466106810,
81466106823, 81466106838, 81466106839,
81466116104, 81466116105, 81466116107,
81466116134, 81466116135, 81466116137,
81466116199, 81466116200, 81466116206



MN-DL-8663

Length: 947 Ø: 60
Hole Distance: 115 / 115
03307400A, 81432206222, 81432206260,
81432206283, 81432206284



MN-DL-8709

Length: 572 Ø: 52
Hole Distance: 130 / 130
81432206268, 81432206274, 81432206291,
81432206292, 82432206007



MN-DL-8733

Length: 530 Ø: 48
Hole Distance: 130 / 130
81432206161, 81432206190, 81432206358,
81432206359



MN-DL-12284

Length: 1530 Ø: 50
Cone Ø: d1 Ø 30 / d2 Ø 27
81466106579, 81466106580, 81466106624,
81466116720, 81467116720, 81467116730,
81467116952



MN-RK-12436

Ø: 75
Hole Distance: 115
Thick/Height: 24
81432206244



MN-VB-5238

Length: 627 Ø: 48
Hole Distance: 130 / 130
81432206221, 81432706096, 81432706114,
81432706116, 81432706121



MN-VB-9403

Length: 627 Ø: 48
Hole Ø 25 / 23 / 23
Hole Distance: 152 / 130 / 130
81432706097, 81432706113, 81432706135,
81432706160, 81432706161



MN-VB-9404

Length: 627 Ø: 58
Hole Distance: 130 / 130
81432706117, 81432706152, 81432706153



SC-ES-7279

Length: 150
Cone Ø: d1 Ø 30 / d2 Ø 27
Thread: M30 x 1,5 RHT
81953016288



SC-ES-8517

Length: 140
Cone Ø: d1 Ø 30 / d2 Ø 27
Thread: M30 x 1,5 RHT
81953016286



SC-ES-8535

Length: 145
Cone Ø: d1 Ø 30 / d2 Ø 27
Thread: M30 x 1,5 RHT
81953016271, 81953016325





TGA ...

24.390, 24.400 FLLRW, FNLLC, FNLLRC, FNLLW, FNLLRC ...	05/04 →	Track Control Arm		MN-DL-5225	Trailing Arm, Drive Axle; Air Suspension Axle; for vehicles with Rigid Trailing Axle	
	05/04 →	Track Control Arm		MN-DL-5225	Trailing Arm, Tag Axle; Air Suspension Axle; for vehicles with Hinged Trailing Axle	
	05/04 →	Track Control Arm		MN-DL-8709	Trailing Arm, Air Suspension Axle; for vehicles with Hinged Trailing Axle	
	05/04 →	Track Control Arm		MN-DL-8733	Trailing Arm, 1st Drive Axle, for Pneumatic Suspension vehicles	
	05/04 →	Track Control Arm		MN-VB-5238	Wishbone (CV), Drive Axle; Air Suspension Axle	
	05/04 →	Track Control Arm		MN-VB-9403	Wishbone (CV), Air Suspension Axle	
	05/04 →	Track Control Arm	MN-DL-8663		Control Arm, Air Suspension Axle	
	01/05 →	Track Control Arm		MN-DL-5225	Trailing Arm, Tag Axle; Air Suspension Axle; for vehicles with Rigid Trailing Axle	
24.390, 24.400 FPLS, FPLRS	05/04 →	Centre Rod	MN-DL-7801		Push Rod, Leaf Spring Axle	
	05/04 →	Suspension Strut Repair Kit		DB-RK-8581		
	05/04 →	Tie Rod	MN-DL-7802			
	05/04 →	Tie Rod End	CV-ES-0914		for Steering Rod	
	05/04 →	Tie Rod End	CV-ES-14163		for Steering Rod	
	05/04 →	Tie Rod End	SC-ES-7279		for Steering Rod	
	05/04 →	Tie Rod End	SC-ES-8517		for Push Rod	
	05/04 →	Tie Rod End	SC-ES-8535		for Guide Rod	
	05/04 →	Track Control Arm		MN-DL-5225	Trailing Arm, Drive Axle; Air Suspension Axle	
	05/04 →	Track Control Arm		MN-DL-5225	Trailing Arm, Leading Axle; Air Suspension Axle	
	05/04 →	Track Control Arm		MN-DL-8733	Trailing Arm, Air Suspension Axle; Drive Axle	
	05/04 →	Track Control Arm		MN-VB-5238	Wishbone (CV), Drive Axle; Air Suspension Axle	
	05/04 →	Track Control Arm		MN-VB-5238	Wishbone (CV), Leading Axle; Air Suspension Axle	
	24.410 FNLLC, FNLLW, FNLLRW, FNLLRC	09/01 → 01/05	Track Control Arm		MN-DL-5212	Trailing Arm, Tag Axle; Air Suspension Axle
09/01 →		Ball Head, gearshift linkage	CV-ES-2120			
09/01 →		Centre Rod	MN-DL-8560		Push Rod, Air Suspension Axle	
09/01 →		Suspension Strut Repair Kit		DB-RK-8581		
09/01 →		Suspension Strut Repair Kit		MN-RK-12436		
09/01 →		Tie Rod	MN-DL-7802			
09/01 →		Tie Rod	MN-DL-12284			
09/01 →		Tie Rod End	CV-ES-0914		for Steering Rod	
09/01 →		Tie Rod End	CV-ES-14163		for Steering Rod	
09/01 →		Tie Rod End	SC-ES-7279		for Steering Rod	
09/01 →		Tie Rod End	SC-ES-8517		for Push Rod	
09/01 →		Tie Rod End	SC-ES-8535		for Guide Rod	
09/01 →		Track Control Arm		MN-DL-5225	Trailing Arm, Drive Axle; Air Suspension Axle	
09/01 →		Track Control Arm		MN-VB-5238	Wishbone (CV), Drive Axle; Air Suspension Axle	
09/01 →		Track Control Arm		MN-VB-9403	Wishbone (CV), Air Suspension Axle	
09/01 →		Track Control Arm	MN-DL-8663		Control Arm, Air Suspension Axle	
01/05 →		Track Control Arm		MN-DL-5225	Trailing Arm, Tag Axle; Air Suspension Axle; for vehicles with Rigid Trailing Axle	
24.430, 24.440 FNLLC, FNLLRC, FNLLW, FNLLRC, FNLLRW		05/04 → 01/05	Track Control Arm		MN-DL-5212	Trailing Arm, Tag Axle; Air Suspension Axle
		05/04 →	Centre Rod	MN-DL-8560		Push Rod, Air Suspension Axle
		05/04 →	Suspension Strut Repair Kit		DB-RK-8581	
	05/04 →	Suspension Strut Repair Kit		MN-RK-12436		
	05/04 →	Tie Rod	MN-DL-7802			
	05/04 →	Tie Rod	MN-DL-12284			
	05/04 →	Tie Rod End	CV-ES-0914		for Steering Rod	
	05/04 →	Tie Rod End	CV-ES-14163		for Steering Rod	
	05/04 →	Tie Rod End	SC-ES-7279		for Steering Rod	
	05/04 →	Tie Rod End	SC-ES-8517		for Push Rod	
	05/04 →	Tie Rod End	SC-ES-8535		for Guide Rod	
	05/04 →	Track Control Arm		MN-DL-5225	Trailing Arm, Drive Axle; Air Suspension Axle; for vehicles with Rigid Trailing Axle	
	05/04 →	Track Control Arm		MN-DL-5225	Trailing Arm, Tag Axle; Air Suspension Axle; for vehicles with Hinged Trailing Axle	
	05/04 →	Track Control Arm		MN-DL-8709	Trailing Arm, Air Suspension Axle; for vehicles with Hinged Trailing Axle	
	05/04 →	Track Control Arm		MN-DL-8733	Trailing Arm, 1st Drive Axle, for Pneumatic Suspension vehicles	

CV-ES-0914

Length: 125
Cone Ø: d1 Ø 30 / d2 Ø 27
Thread: M38 x 1,5 RHT
81953016184, 81953016251, 81953016276



CV-ES-2120

Length: 115
Cone Ø: d1 Ø 12,4 / d2 Ø 10,8
Thread: M14 x 1,5 RHT
03008500A, 81953016200, 81953016202,
81953016203, 81953016227



CV-ES-14163

Length: 125
Cone Ø: d1 Ø 30 / d2 Ø 27
Thread: M30 x 1,5 RHT
95301.0084, 90804102156, 90804102272,
90804102696, 90804102710, 81953010016,
81953010075, 81953010084, 81953010088,
81953010094, 81953010103, 81953016030,
81953016043, 81953016048, 81953016049,
81953016053, 81953016061, 81953016090,
81953016108, 81953016112, 81953016126,
81953016143, 81953016149, 81953016154,
81953016156, 81953016168, 81953016178,
81953016194, 81953016206, 81953016224,
81953016234, 81953016242, 81953016252,
81953016274, 81953016278, 81953016284,
81953016286, 81953016308, 81953016310,
81953016312, 81953016347, 81953016350,
81953016352, 82953016012, 88953016014,
N2953016001



DB-RK-8581

Ø: 85
Hole Distance: 130
Thick/Height: 24
03305800A, 81432706105



MN-DL-5212

Length: 577 Ø: 48
Hole Distance: 130 / 130
81432206096, 81432206097, 81432206098,
81432206129, 81432209096, 81432209129,
81432306014, 81432306030



MN-DL-5225

Length: 572 Ø: 48
Hole Distance: 130 / 130
03301500A, 81432206229, 81432206236,
81432206267, 81432206270, 81432206272,
81432206304, 81432206305, 81432209236,
81432209267, 81432209272



MN-DL-7801

Length: 995 Ø: 52
Cone Ø: d1 Ø 30 / d2 Ø 27
81466106807, 81466106808, 81466116087,
81466116088, 81466116096, 81466116097,
81466116099, 81466116132, 81466116133,
81466116136, 81466116197, 81466116198,
81466116205



MN-DL-7802

Length: 1680 Ø: 52
Cone Ø: d1 Ø 30 / d2 Ø 27
03208300A, 81467116773, 81467116858,
81467116859, 81467116860, 81467116861,
81467116863, 81467116882, 81467116883,
81467116920, 81467116921



MN-DL-8560

Length: 970 Ø: 52
Cone Ø: d1 Ø 30 / d2 Ø 27
03206900A, 81466106809, 81466106810,
81466106823, 81466106838, 81466106839,
81466116104, 81466116105, 81466116107,
81466116134, 81466116135, 81466116137,
81466116199, 81466116200, 81466116206



MN-DL-8663

Length: 947 Ø: 60
Hole Distance: 115 / 115
03307400A, 81432206222, 81432206260,
81432206283, 81432206284



MN-DL-8709

Length: 572 Ø: 52
Hole Distance: 130 / 130
81432206268, 81432206274, 81432206291,
81432206292, 82432206007



MN-DL-8733

Length: 530 Ø: 48
Hole Distance: 130 / 130
81432206161, 81432206190, 81432206358,
81432206359



MN-DL-12284

Length: 1530 Ø: 50
Cone Ø: d1 Ø 30 / d2 Ø 27
81466106579, 81466106580, 81466106624,
81466116720, 81467116720, 81467116730,
81467116952



MN-RK-12436

Ø: 75
Hole Distance: 115
Thick/Height: 24
81432206244



MN-VB-5238

Length: 627 Ø: 48
Hole Distance: 130 / 130
81432206221, 81432706096, 81432706114,
81432706116, 81432706121



MN-VB-9403

Length: 627 Ø: 48
Hole Ø 25 / 23 / 23
Hole Distance: 152 / 130 / 130
81432706097, 81432706113, 81432706135,
81432706160, 81432706161



SC-ES-7279

Length: 150
Cone Ø: d1 Ø 30 / d2 Ø 27
Thread: M30 x 1,5 RHT
81953016288



SC-ES-8517

Length: 140
Cone Ø: d1 Ø 30 / d2 Ø 27
Thread: M30 x 1,5 RHT
81953016286



SC-ES-8535

Length: 145
Cone Ø: d1 Ø 30 / d2 Ø 27
Thread: M30 x 1,5 RHT
81953016271, 81953016325





TGA ...

24.430, 24.440 FNLLC, FNLCR, FNLLW, FNLLRC, FNLLRW ...	05/04 →	Track Control Arm		MN-VB-5238	Wishbone (CV), Drive Axle; Air Suspension Axle	
	05/04 →	Track Control Arm		MN-VB-9403	Wishbone (CV), Air Suspension Axle	
	05/04 →	Track Control Arm	MN-DL-8663		Control Arm, Air Suspension Axle	
	01/05 →	Track Control Arm		MN-DL-5225	Trailing Arm, Tag Axle; Air Suspension Axle; for vehicles with Rigid Trailing Axle	
24.430, 24.440 FPLS, FPLRS	05/04 →	Centre Rod	MN-DL-7801		Push Rod, Leaf Spring Axle	
	05/04 →	Suspension Strut Repair Kit		DB-RK-8581		
	05/04 →	Tie Rod	MN-DL-7802			
	05/04 →	Tie Rod End	CV-ES-0914		for Steering Rod	
	05/04 →	Tie Rod End	CV-ES-14163		for Steering Rod	
	05/04 →	Tie Rod End	SC-ES-7279		for Steering Rod	
	05/04 →	Tie Rod End	SC-ES-8517		for Push Rod	
	05/04 →	Tie Rod End	SC-ES-8535		for Guide Rod	
	05/04 →	Track Control Arm		MN-DL-5225	Trailing Arm, Drive Axle; Air Suspension Axle	
	05/04 →	Track Control Arm		MN-DL-5225	Trailing Arm, Leading Axle; Air Suspension Axle	
	05/04 →	Track Control Arm		MN-DL-8733	Trailing Arm, Air Suspension Axle; Drive Axle	
	05/04 →	Track Control Arm		MN-VB-5238	Wishbone (CV), Drive Axle; Air Suspension Axle	
	05/04 →	Track Control Arm		MN-VB-5238	Wishbone (CV), Leading Axle; Air Suspension Axle	
	24.460 FNLLC, FNLLRC, FNLLRW, FNLLW	09/01 → 01/05	Track Control Arm		MN-DL-5212	Trailing Arm, Tag Axle; Air Suspension Axle
09/01 →		Ball Head, gearshift linkage	CV-ES-2120			
09/01 →		Centre Rod	MN-DL-8560		Push Rod, Air Suspension Axle	
09/01 →		Suspension Strut Repair Kit		DB-RK-8581		
09/01 →		Suspension Strut Repair Kit		MN-RK-12436		
09/01 →		Tie Rod	MN-DL-7802			
09/01 →		Tie Rod	MN-DL-12284			
09/01 →		Tie Rod End	CV-ES-0914		for Steering Rod	
09/01 →		Tie Rod End	CV-ES-14163		for Steering Rod	
09/01 →		Tie Rod End	SC-ES-7279		for Steering Rod	
09/01 →		Tie Rod End	SC-ES-8517		for Push Rod	
09/01 →		Tie Rod End	SC-ES-8535		for Guide Rod	
09/01 →		Track Control Arm		MN-DL-5225	Trailing Arm, Drive Axle; Air Suspension Axle	
09/01 →		Track Control Arm		MN-VB-5238	Wishbone (CV), Drive Axle; Air Suspension Axle	
09/01 →		Track Control Arm		MN-VB-9403	Wishbone (CV), Air Suspension Axle	
09/01 →		Track Control Arm	MN-DL-8663		Control Arm, Air Suspension Axle	
01/05 →		Track Control Arm		MN-DL-5225	Trailing Arm, Tag Axle; Air Suspension Axle; for vehicles with Rigid Trailing Axle	
24.480 FNLLC, FNLLRC, FNLLRW, FNLLW		09/02 → 01/05	Track Control Arm		MN-DL-5212	Trailing Arm, Tag Axle; Air Suspension Axle
		09/02 →	Ball Head, gearshift linkage	CV-ES-2120		
		09/02 →	Centre Rod	MN-DL-8560		Push Rod, Air Suspension Axle
	09/02 →	Suspension Strut Repair Kit		DB-RK-8581		
	09/02 →	Suspension Strut Repair Kit		MN-RK-12436		
	09/02 →	Tie Rod	MN-DL-7802			
	09/02 →	Tie Rod	MN-DL-12284			
	09/02 →	Tie Rod End	CV-ES-0914		for Steering Rod	
	09/02 →	Tie Rod End	CV-ES-14163		for Steering Rod	
	09/02 →	Tie Rod End	SC-ES-7279		for Steering Rod	
	09/02 →	Tie Rod End	SC-ES-8517		for Push Rod	
	09/02 →	Tie Rod End	SC-ES-8535		for Guide Rod	
	09/02 →	Track Control Arm		MN-DL-5225	Trailing Arm, Drive Axle; Air Suspension Axle	
	09/02 →	Track Control Arm		MN-DL-8733	Trailing Arm, 1st Drive Axle, for Pneumatic Suspension vehicles	
	09/02 →	Track Control Arm		MN-VB-5238	Wishbone (CV), Drive Axle; Air Suspension Axle	
	09/02 →	Track Control Arm		MN-VB-9403	Wishbone (CV), Air Suspension Axle	
	09/02 →	Track Control Arm	MN-DL-8663		Control Arm, Air Suspension Axle	
	01/05 →	Track Control Arm		MN-DL-5225	Trailing Arm, Tag Axle; Air Suspension Axle; for vehicles with Rigid Trailing Axle	
	01/06 →	Track Control Arm		MN-DL-5212	Trailing Arm, Trailing Axle not Steered, for Pneumatic Suspension vehicles	
	01/06 →	Track Control Arm		MN-DL-5225	Trailing Arm	
	01/06 →	Track Control Arm		MN-DL-8709	Trailing Arm, Air Suspension Axle; for vehicles with Hinged Trailing Axle	
	01/06 →	Track Control Arm		MN-VB-5238	Wishbone (CV), 1st Drive Axle, for Pneumatic Suspension vehicles	
	01/06 →	Track Control Arm	MN-DL-8663		Control Arm	

CV-ES-0914

Length: 125
Cone Ø: d1 Ø 30 / d2 Ø 27
Thread: M38 x 1,5 RHT
81953016184, 81953016251, 81953016276



CV-ES-2120

Length: 115
Cone Ø: d1 Ø 12,4 / d2 Ø 10,8
Thread: M14 x 1,5 RHT
03008500A, 81953016200, 81953016202,
81953016203, 81953016227



CV-ES-14163

Length: 125
Cone Ø: d1 Ø 30 / d2 Ø 27
Thread: M30 x 1,5 RHT
95301.0084, 90804102156, 90804102272,
90804102696, 90804102710, 81953010016,
81953010075, 81953010084, 81953010088,
81953010094, 81953010103, 81953016030,
81953016043, 81953016048, 81953016049,
81953016053, 81953016061, 81953016090,
81953016108, 81953016112, 81953016126,
81953016143, 81953016149, 81953016154,
81953016156, 81953016168, 81953016178,
81953016194, 81953016206, 81953016224,
81953016234, 81953016242, 81953016252,
81953016274, 81953016278, 81953016284,
81953016286, 81953016308, 81953016310,
81953016312, 81953016347, 81953016350,
81953016352, 82953016012, 88953016014,
N2953016001



DB-RK-8581

Ø: 85
Hole Distance: 130
Thick/Height: 24
03305800A, 81432706105



MN-DL-5212

Length: 577 Ø: 48
Hole Distance: 130 / 130
81432206096, 81432206097, 81432206098,
81432206129, 81432209096, 81432209129,
81432306014, 81432306030



MN-DL-5225

Length: 572 Ø: 48
Hole Distance: 130 / 130
03301500A, 81432206229, 81432206236,
81432206267, 81432206270, 81432206272,
81432206304, 81432206305, 81432209236,
81432209267, 81432209272



MN-DL-7801

Length: 995 Ø: 52
Cone Ø: d1 Ø 30 / d2 Ø 27
81466106807, 81466106808, 81466116087,
81466116088, 81466116096, 81466116097,
81466116099, 81466116132, 81466116133,
81466116136, 81466116197, 81466116198,
81466116205



MN-DL-7802

Length: 1680 Ø: 52
Cone Ø: d1 Ø 30 / d2 Ø 27
03208300A, 81467116773, 81467116858,
81467116859, 81467116860, 81467116861,
81467116863, 81467116882, 81467116883,
81467116920, 81467116921



MN-DL-8560

Length: 970 Ø: 52
Cone Ø: d1 Ø 30 / d2 Ø 27
03206900A, 81466106809, 81466106810,
81466106823, 81466106838, 81466106839,
81466116104, 81466116105, 81466116107,
81466116134, 81466116135, 81466116137,
81466116199, 81466116200, 81466116206



MN-DL-8663

Length: 947 Ø: 60
Hole Distance: 115 / 115
03307400A, 81432206222, 81432206260,
81432206283, 81432206284



MN-DL-8709

Length: 572 Ø: 52
Hole Distance: 130 / 130
81432206268, 81432206274, 81432206291,
81432206292, 82432206007



MN-DL-8733

Length: 530 Ø: 48
Hole Distance: 130 / 130
81432206161, 81432206190, 81432206358,
81432206359



MN-DL-12284

Length: 1530 Ø: 50
Cone Ø: d1 Ø 30 / d2 Ø 27
81466106579, 81466106580, 81466106624,
81466116720, 81467116720, 81467116730,
81467116952



MN-RK-12436

Ø: 75
Hole Distance: 115
Thick/Height: 24
81432206244



MN-VB-5238

Length: 627 Ø: 48
Hole Distance: 130 / 130
81432206221, 81432706096, 81432706114,
81432706116, 81432706121



MN-VB-9403

Length: 627 Ø: 48
Hole Ø 25 / 23 / 23
Hole Distance: 152 / 130 / 130
81432706097, 81432706113, 81432706135,
81432706160, 81432706161



SC-ES-7279

Length: 150
Cone Ø: d1 Ø 30 / d2 Ø 27
Thread: M30 x 1,5 RHT
81953016288



SC-ES-8517

Length: 140
Cone Ø: d1 Ø 30 / d2 Ø 27
Thread: M30 x 1,5 RHT
81953016286



SC-ES-8535

Length: 145
Cone Ø: d1 Ø 30 / d2 Ø 27
Thread: M30 x 1,5 RHT
81953016271, 81953016325



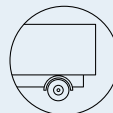

TGA ...

24.480 FPLS, FPLRS	07/05→	Centre Rod	MN-DL-7801		Push Rod	
	07/05→	Suspension Arm Repair Kit		CV-RK-5313	for Wishbone (CV)	
	07/05→	Suspension Arm Repair Kit	DB-RK-9300	DB-RK-9300	for Drag Link	
	07/05→	Suspension Strut Repair Kit		CV-RK-5311		
	07/05→	Tie Rod	MN-DL-7802			
	07/05→	Tie Rod End	CV-ES-0914		for Steering Rod	
	07/05→	Tie Rod End	CV-ES-14163		for Steering Rod	
	07/05→	Tie Rod End	SC-ES-7279		for Steering Rod	
	07/05→	Tie Rod End	SC-ES-8517		for Push Rod	
	07/05→	Tie Rod End	SC-ES-8535		for Guide Rod	
	07/05→	Track Control Arm		MN-DL-5225	Trailing Arm	
	07/05→	Track Control Arm		MN-DL-8733	Trailing Arm, 1st Drive Axle, for Pneumatic Suspension vehicles	
	07/05→	Track Control Arm		MN-VB-5238	Wishbone (CV), 1st Drive Axle, for Pneumatic Suspension vehicles	
	01/06→	Centre Rod	MN-DL-7801		Push Rod, Leaf Spring Axle	
	01/06→	Suspension Strut Repair Kit		DB-RK-8581		
	01/06→	Track Control Arm		MN-DL-5225	Trailing Arm, Drive Axle;Air Suspension Axle	
	01/06→	Track Control Arm		MN-DL-5225	Trailing Arm, Leading Axle;Air Suspension Axle	
	01/06→	Track Control Arm		MN-DL-8733	Trailing Arm, Air Suspension Axle;Drive Axle	
	01/06→	Track Control Arm		MN-VB-5238	Wishbone (CV), Drive Axle;Air Suspension Axle	
	01/06→	Track Control Arm		MN-VB-5238	Wishbone (CV), Leading Axle;Air Suspension Axle	
24.510 FNLLC/N, FNLLW, FNLLRW	09/01→01/05	Track Control Arm		MN-DL-5212	Trailing Arm, Tag Axle;Air Suspension Axle	
	09/01→	Ball Head, gearshift linkage	CV-ES-2120			
	09/01→	Centre Rod	MN-DL-8560		Push Rod, Air Suspension Axle	
	09/01→	Suspension Strut Repair Kit		DB-RK-8581		
	09/01→	Suspension Strut Repair Kit		MN-RK-12436		
	09/01→	Tie Rod	MN-DL-7802			
	09/01→	Tie Rod	MN-DL-12284			
	09/01→	Tie Rod End	CV-ES-0914		for Steering Rod	
	09/01→	Tie Rod End	CV-ES-14163		for Steering Rod	
	09/01→	Tie Rod End	SC-ES-7279		for Steering Rod	
	09/01→	Tie Rod End	SC-ES-8517		for Push Rod	
	09/01→	Tie Rod End	SC-ES-8535		for Guide Rod	
	09/01→	Track Control Arm		MN-DL-5225	Trailing Arm, Drive Axle;Air Suspension Axle	
	09/01→	Track Control Arm		MN-VB-5238	Wishbone (CV), Drive Axle;Air Suspension Axle	
	09/01→	Track Control Arm		MN-VB-9403	Wishbone (CV), Air Suspension Axle	
	09/01→	Track Control Arm	MN-DL-8663		Control Arm	
	01/05→	Track Control Arm		MN-DL-5225	Trailing Arm, Tag Axle;Air Suspension Axle; for vehicles with Rigid Trailing Axle	
	24.530 FNLLC, FNLLRC, FNLLRW, FNLLW	09/01→01/05	Track Control Arm		MN-DL-5212	Trailing Arm, Tag Axle;Air Suspension Axle
		09/01→	Ball Head, gearshift linkage	CV-ES-2120		
		09/01→	Centre Rod	MN-DL-8560		Push Rod, Air Suspension Axle
09/01→		Suspension Strut Repair Kit		DB-RK-8581		
09/01→		Suspension Strut Repair Kit		MN-RK-12436		
09/01→		Tie Rod	MN-DL-7802			
09/01→		Tie Rod	MN-DL-12284			
09/01→		Tie Rod End	CV-ES-0914		for Steering Rod	
09/01→		Tie Rod End	CV-ES-14163		for Steering Rod	
09/01→		Tie Rod End	SC-ES-7279		for Steering Rod	
09/01→		Tie Rod End	SC-ES-8517		for Push Rod	
09/01→		Tie Rod End	SC-ES-8535		for Guide Rod	
09/01→		Track Control Arm		MN-DL-5225	Trailing Arm, Drive Axle;Air Suspension Axle	
09/01→		Track Control Arm		MN-DL-8733	Trailing Arm, 1st Drive Axle, for Pneumatic Suspension vehicles	
09/01→		Track Control Arm		MN-VB-5238	Wishbone (CV), Drive Axle;Air Suspension Axle	
09/01→		Track Control Arm		MN-VB-9403	Wishbone (CV), Air Suspension Axle	
09/01→		Track Control Arm	MN-DL-8663		Control Arm, Air Suspension Axle	
01/05→		Track Control Arm		MN-DL-5225	Trailing Arm, Tag Axle;Air Suspension Axle; for vehicles with Rigid Trailing Axle	

CV-ES-0914

Length: 125
Cone Ø: d1 Ø 30 / d2 Ø 27
Thread: M38 x 1,5 RHT
81953016184, 81953016251, 81953016276



CV-ES-2120

Length: 115
Cone Ø: d1 Ø 12,4 / d2 Ø 10,8
Thread: M14 x 1,5 RHT
03008500A, 81953016200, 81953016202,
81953016203, 81953016227



CV-ES-14163

Length: 125
Cone Ø: d1 Ø 30 / d2 Ø 27
Thread: M30 x 1,5 RHT
95301.0084, 90804102156, 90804102272,
90804102696, 90804102710, 81953010016,
81953010075, 81953010084, 81953010088,
81953010094, 81953010103, 81953016030,
81953016043, 81953016048, 81953016049,
81953016053, 81953016061, 81953016090,
81953016108, 81953016112, 81953016126,
81953016143, 81953016149, 81953016154,
81953016156, 81953016168, 81953016178,
81953016194, 81953016206, 81953016224,
81953016234, 81953016242, 81953016252,
81953016274, 81953016278, 81953016284,
81953016286, 81953016308, 81953016310,
81953016312, 81953016347, 81953016350,
81953016352, 82953016012, 88953016014,
N2953016001



CV-RK-5311

638862, 639287, 938423, 1104335,
1953248, 3500506, 0003500506, 11013547,
42488722, 070550504, 634303610,
81432206055, 81432206073, 82262320660,
5001842823, 7000307001, 8226232066



CV-RK-5313

Ø: 90
03304800A, 81953016132



DB-RK-8581

Ø: 85
Hole Distance: 130
Thick/Height: 24
03305800A, 81432706105



DB-RK-9300

Ø: 75
Hole Distance: 130
Thick/Height: 24
85432206002



MN-DL-5212

Length: 577 Ø: 48
Hole Distance: 130 / 130
81432206096, 81432206097, 81432206098,
81432206129, 81432209096, 81432209129,
81432306014, 81432306030



MN-DL-5225

Length: 572 Ø: 48
Hole Distance: 130 / 130
03301500A, 81432206229, 81432206236,
81432206267, 81432206270, 81432206272,
81432206304, 81432206305, 81432209236,
81432209267, 81432209272



MN-DL-7801

Length: 995 Ø: 52
Cone Ø: d1 Ø 30 / d2 Ø 27
81466106807, 81466106808, 81466116087,
81466116088, 81466116096, 81466116097,
81466116099, 81466116132, 81466116133,
81466116136, 81466116197, 81466116198,
81466116205



MN-DL-7802

Length: 1680 Ø: 52
Cone Ø: d1 Ø 30 / d2 Ø 27
03208300A, 81467116773, 81467116858,
81467116859, 81467116860, 81467116861,
81467116863, 81467116882, 81467116883,
81467116920, 81467116921



MN-DL-8560

Length: 970 Ø: 52
Cone Ø: d1 Ø 30 / d2 Ø 27
03206900A, 81466106809, 81466106810,
81466106823, 81466106838, 81466106839,
81466116104, 81466116105, 81466116107,
81466116134, 81466116135, 81466116137,
81466116199, 81466116200, 81466116206



MN-DL-8663

Length: 947 Ø: 60
Hole Distance: 115 / 115
03307400A, 81432206222, 81432206260,
81432206283, 81432206284



MN-DL-8733

Length: 530 Ø: 48
Hole Distance: 130 / 130
81432206161, 81432206190, 81432206358,
81432206359



MN-DL-12284

Length: 1530 Ø: 50
Cone Ø: d1 Ø 30 / d2 Ø 27
81466106579, 81466106580, 81466106624,
81466116720, 81467116720, 81467116730,
81467116952



MN-RK-12436

Ø: 75
Hole Distance: 115
Thick/Height: 24
81432206244



MN-VB-5238

Length: 627 Ø: 48
Hole Distance: 130 / 130
81432206221, 81432706096, 81432706114,
81432706116, 81432706121



MN-VB-9403

Length: 627 Ø: 48
Hole Ø 25 / 23 / 23
Hole Distance: 152 / 130 / 130
81432706097, 81432706113, 81432706135,
81432706160, 81432706161



SC-ES-7279

Length: 150
Cone Ø: d1 Ø 30 / d2 Ø 27
Thread: M30 x 1,5 RHT
81953016288



SC-ES-8517

Length: 140
Cone Ø: d1 Ø 30 / d2 Ø 27
Thread: M30 x 1,5 RHT
81953016286



SC-ES-8535

Length: 145
Cone Ø: d1 Ø 30 / d2 Ø 27
Thread: M30 x 1,5 RHT
81953016271, 81953016325





TGA ...

24.530 FPLS, FPLRS	07/05→	Centre Rod	MN-DL-7801		Push Rod
	07/05→	Suspension Arm Repair Kit		CV-RK-5313	for Wishbone (CV)
	07/05→	Suspension Arm Repair Kit	DB-RK-9300	DB-RK-9300	for Drag Link
	07/05→	Suspension Strut Repair Kit		CV-RK-5311	
	07/05→	Tie Rod	MN-DL-7802		
	07/05→	Tie Rod End	CV-ES-0914		for Steering Rod
	07/05→	Tie Rod End	CV-ES-14163		for Steering Rod
	07/05→	Tie Rod End	SC-ES-7279		for Steering Rod
	07/05→	Tie Rod End	SC-ES-8517		for Push Rod
	07/05→	Tie Rod End	SC-ES-8535		for Guide Rod
	07/05→	Track Control Arm		MN-DL-5225	Trailing Arm
	07/05→	Track Control Arm		MN-DL-8733	Trailing Arm, 1st Drive Axle, for Pneumatic Suspension vehicles
	07/05→	Track Control Arm		MN-VB-5238	Wishbone (CV), 1st Drive Axle, for Pneumatic Suspension vehicles
24.540 FNLLC, FNLLW	01/06→	Centre Rod	MN-DL-8560		Push Rod, Air Suspension Axle
	01/06→	Suspension Strut Repair Kit		DB-RK-8581	
	01/06→	Suspension Strut Repair Kit		MN-RK-12436	
	01/06→	Tie Rod	MN-DL-7802		
	01/06→	Tie Rod End	CV-ES-0914		for Steering Rod
	01/06→	Tie Rod End	CV-ES-14163		for Steering Rod
	01/06→	Tie Rod End	SC-ES-7279		for Steering Rod
	01/06→	Tie Rod End	SC-ES-8517		for Push Rod
	01/06→	Tie Rod End	SC-ES-8535		for Guide Rod
	01/06→	Track Control Arm		MN-DL-5212	Trailing Arm, Trailing Axle not Steered, for Pneumatic Suspension vehicles
	01/06→	Track Control Arm		MN-DL-5225	Trailing Arm, Drive Axle;Air Suspension Axle; for vehicles with Rigid Trailing Axle
	01/06→	Track Control Arm		MN-DL-5225	Trailing Arm, Tag Axle;Air Suspension Axle; for vehicles with Hinged Trailing Axle
	01/06→	Track Control Arm		MN-DL-5225	Trailing Arm, Tag Axle;Air Suspension Axle; for vehicles with Rigid Trailing Axle
	01/06→	Track Control Arm		MN-DL-8709	Trailing Arm, Air Suspension Axle; for vehicles with Hinged Trailing Axle
	01/06→	Track Control Arm		MN-VB-5238	Wishbone (CV), Drive Axle;Air Suspension Axle
	01/06→	Track Control Arm		MN-VB-9403	Wishbone (CV), Air Suspension Axle
	01/06→	Track Control Arm	MN-DL-8663		Control Arm, Air Suspension Axle
26.280 FNLC, FNLLC, FNLLW	11/02→	Ball Head, gearshift linkage	CV-ES-2120		
	11/02→	Centre Rod	MN-DL-7801		Push Rod, Leaf Spring Axle
	11/02→	Centre Rod	MN-DL-8560		Push Rod, Air Suspension Axle
	11/02→	Suspension Strut Repair Kit		DB-RK-8581	
	11/02→	Suspension Strut Repair Kit		MN-RK-12436	
	11/02→	Tie Rod	MN-DL-7802		
	11/02→	Tie Rod	MN-DL-12284		
	11/02→	Tie Rod End	CV-ES-0914		for Steering Rod
	11/02→	Tie Rod End	CV-ES-14162	CV-ES-14162	for Steering Rod
	11/02→	Tie Rod End	CV-ES-14163		for Steering Rod
	11/02→	Tie Rod End	SC-ES-7279		for Steering Rod
	11/02→	Tie Rod End	SC-ES-8517		for Push Rod
	11/02→	Tie Rod End	SC-ES-8535		for Guide Rod
	11/02→	Track Control Arm		MN-DL-5212	Trailing Arm, Tag Axle;Air Suspension Axle
	11/02→	Track Control Arm		MN-DL-5225	Trailing Arm, Drive Axle;Air Suspension Axle
	11/02→	Track Control Arm		MN-DL-5225	Trailing Arm, Leading Axle;Air Suspension Axle
	11/02→	Track Control Arm		MN-DL-8709	Trailing Arm, Air Suspension Axle; for vehicles with Hinged Trailing Axle
	11/02→	Track Control Arm		MN-VB-5238	Wishbone (CV), Drive Axle;Leading Axle; Air Suspension Axle
	11/02→	Track Control Arm		MN-VB-9403	Wishbone (CV), Air Suspension Axle
	11/02→	Track Control Arm	MN-DL-8663		Control Arm, Air Suspension Axle
26.310 FDAC, FDARC, FDH, FDHC	01/04→	Centre Rod	MN-DL-2160		Coupling Rod
	01/04→	Centre Rod	MN-DL-2174		Push Rod
	01/04→	Suspension Arm Repair Kit		CV-RK-5313	for Wishbone (CV)
	01/04→	Tie Rod End	CV-ES-0914		for Steering Rod

CV-ES-0914

Length: 125
Cone Ø: d1 Ø 30 / d2 Ø 27
Thread: M38 x 1,5 RHT
81953016184, 81953016251, 81953016276



CV-ES-2120

Length: 115
Cone Ø: d1 Ø 12,4 / d2 Ø 10,8
Thread: M14 x 1,5 RHT
03008500A, 81953016200, 81953016202, 81953016203, 81953016227



CV-ES-14162

Length: 125
Cone Ø: d1 Ø 30 / d2 Ø 27
Thread: M30 x 1,5 LHT
81953010015, 81953010083, 81953010087, 81953016029, 81953016030, 81953016043, 81953016044, 81953016050, 81953016054, 81953016087, 81953016091, 81953016107, 81953016120, 81953016125, 81953016152, 81953016155, 81953016157, 81953016168, 81953016179, 81953016181, 81953016223, 81953016237, 81953016254, 81953016275, 81953016279, 81953016351



CV-ES-14163

Length: 125
Cone Ø: d1 Ø 30 / d2 Ø 27
Thread: M30 x 1,5 RHT
95301.0084, 90804102156, 90804102272, 90804102696, 90804102710, 81953010016, 81953010075, 81953010084, 81953010088, 81953010094, 81953010103, 81953016030, 81953016043, 81953016048, 81953016049, 81953016053, 81953016061, 81953016090, 81953016108, 81953016112, 81953016126, 81953016143, 81953016149, 81953016154, 81953016156, 81953016168, 81953016178, 81953016194, 81953016206, 81953016224, 81953016234, 81953016242, 81953016252, 81953016274, 81953016278, 81953016284, 81953016286, 81953016308, 81953016310, 81953016312, 81953016347, 81953016350, 81953016352, 82953016012, 88953016014, N2953016001



CV-RK-5311

638862, 639287, 938423, 1104335, 1953248, 0003500506, 3500506, 11013547, 42488722, 070550504, 634303610, 81432206055, 81432206073, 82262320660, 5001842823, 7000307001, 8226232066



CV-RK-5313

Ø: 90
03304800A, 81953016132



DB-RK-8581

Ø: 85
Hole Distance: 130
Thick/Height: 24
03305800A, 81432706105



DB-RK-9300

Ø: 75
Hole Distance: 130
Thick/Height: 24
85432206002



MN-DL-2160

Length: 1652 Ø: 50
Cone Ø: d1 Ø 30 / d2 Ø 27
81467106112, 81467106163, 81467106165, 81467106198, 81467106353, 81467106354, 81467106361, 81467116725



MN-DL-2174

Length: 1588 Ø: 52
Cone Ø: d1 Ø 30 / d2 Ø 27
81467106378, 81467106912



MN-DL-5212

Length: 577 Ø: 48
Hole Distance: 130 / 130
81432206096, 81432206097, 81432206098, 81432206129, 81432209096, 81432209129, 81432306014, 81432306030



MN-DL-5225

Length: 572 Ø: 48
Hole Distance: 130 / 130
03301500A, 81432206229, 81432206236, 81432206267, 81432206270, 81432206272, 81432206304, 81432206305, 81432209236, 81432209267, 81432209272



MN-DL-7801

Length: 995 Ø: 52
Cone Ø: d1 Ø 30 / d2 Ø 27
81466106807, 81466106808, 81466116087, 81466116088, 81466116096, 81466116097, 81466116099, 81466116132, 81466116133, 81466116136, 81466116197, 81466116198, 81466116205



MN-DL-7802

Length: 1680 Ø: 52
Cone Ø: d1 Ø 30 / d2 Ø 27
03208300A, 81467116773, 81467116858, 81467116859, 81467116860, 81467116861, 81467116863, 81467116882, 81467116883, 81467116920, 81467116921



MN-DL-8560

Length: 970 Ø: 52
Cone Ø: d1 Ø 30 / d2 Ø 27
03206900A, 81466106809, 81466106810, 81466106823, 81466106838, 81466106839, 81466116104, 81466116105, 81466116107, 81466116134, 81466116135, 81466116137, 81466116199, 81466116200, 81466116206



MN-DL-8663

Length: 947 Ø: 60
Hole Distance: 115 / 115
03307400A, 81432206222, 81432206260, 81432206283, 81432206284



MN-DL-8709

Length: 572 Ø: 52
Hole Distance: 130 / 130
81432206268, 81432206274, 81432206291, 81432206292, 82432206007



MN-DL-8733

Length: 530 Ø: 48
Hole Distance: 130 / 130
81432206161, 81432206190, 81432206358, 81432206359



MN-DL-12284

Length: 1530 Ø: 50
Cone Ø: d1 Ø 30 / d2 Ø 27
81466106579, 81466106580, 81466106624, 81466116720, 81467116720, 81467116730, 81467116952



MN-RK-12436

Ø: 75
Hole Distance: 115
Thick/Height: 24
81432206244



MN-VB-5238

Length: 627 Ø: 48
Hole Distance: 130 / 130
81432206221, 81432706096, 81432706114, 81432706116, 81432706121



MN-VB-9403

Length: 627 Ø: 48
Hole Ø 25 / 23 / 23
Hole Distance: 152 / 130 / 130
81432706097, 81432706113, 81432706135, 81432706160, 81432706161



SC-ES-7279

Length: 150
Cone Ø: d1 Ø 30 / d2 Ø 27
Thread: M30 x 1,5 RHT
81953016288



SC-ES-8517

Length: 140
Cone Ø: d1 Ø 30 / d2 Ø 27
Thread: M30 x 1,5 RHT
81953016286



SC-ES-8535

Length: 145
Cone Ø: d1 Ø 30 / d2 Ø 27
Thread: M30 x 1,5 RHT
81953016271, 81953016325





TGA ...

26.310 FDAC, FDARC, FDH, FDHC ...	01/04→	Tie Rod End	CV-ES-14162		for Steering Rod	
	01/04→	Tie Rod End	CV-ES-14163		for Steering Rod	
	01/04→	Tie Rod End	MN-ES-10333		for Steering Rod	
	01/04→	Tie Rod End	SC-ES-7279		for Steering Rod	
	01/04→	Tie Rod End	SC-ES-8517		for Push Rod	
	01/04→	Tie Rod End	SC-ES-8535		for Guide Rod	
	01/04→	Track Control Arm		MN-DL-8544	Trailing Arm, 1st RA;2nd RA, for Leaf-Spring Suspension vehicles	
	01/04→	Track Control Arm		MN-DL-8609	Trailing Arm, 1st RA;2nd RA, for Leaf-Spring Suspension vehicles, →Type_HB Chassis	
	01/04→	Track control arm		MN-DL-10288	Trailing Arm, 1st RA;2nd RA, for Leaf-Spring Suspension vehicles, →Type HB	
	01/04→	Track control arm		MN-DL-12288	Trailing Arm	
	01/04→	Track Control Arm		MN-VB-8514	Suspension Rod, Wishbone (CV)	
	01/04→	Track Control Arm		MN-VB-8669	Suspension Rod, Wishbone (CV), 1st RA; 2nd RA, for Leaf-Spring Suspension vehicles, →Type_MHB Chassis	
	01/04→	Track Control Arm		MN-VB-9404	Wishbone (CV), 1st RA;2nd RA, for Leaf-Spring Suspension vehicles, →Type_HB Chassis	
	26.310 FDAC, FDARC, FDHC	02/02→	Ball Head, gearshift linkage	CV-ES-2120		
		02/02→	Centre Rod	MN-DL-7801		Push Rod
02/02→		Suspension Strut Repair Kit		DB-RK-8581		
02/02→		Tie Rod End	CV-ES-0914		for Steering Rod	
02/02→		Tie Rod End	CV-ES-14163		for Steering Rod	
02/02→		Tie Rod End	MN-ES-10333		for Steering Rod	
02/02→		Tie Rod End	SC-ES-8517		for Push Rod	
02/02→		Track Control Arm		MN-DL-5225	Trailing Arm	
02/02→		Track Control Arm		MN-DL-8544	Trailing Arm, 1st RA;2nd RA;Leaf Spring Axle	
02/02→		Track Control Arm		MN-DL-8609	Trailing Arm, 1st RA;2nd RA, for Leaf-Spring Suspension vehicles, →Type_HB Chassis	
02/02→		Track Control Arm		MN-VB-8514	Suspension Rod, Wishbone (CV), Drive Axle; Leaf Spring Axle	
02/02→	Track Control Arm		MN-VB-9404	Wishbone (CV), Drive Axle		
26.310 FDAK, FDHK	02/02→	Ball Head, gearshift linkage	CV-ES-2120			
	02/02→	Centre Rod	MN-DL-7801		Push Rod	
	02/02→	Suspension Strut Repair Kit		DB-RK-8581		
	02/02→	Tie Rod End	CV-ES-0914		for Steering Rod	
	02/02→	Tie Rod End	CV-ES-14163		for Steering Rod	
	02/02→	Tie Rod End	MN-ES-10333		for Steering Rod	
	02/02→	Tie Rod End	SC-ES-8517		for Push Rod	
	02/02→	Track Control Arm		MN-DL-5225	Trailing Arm	
	02/02→	Track Control Arm		MN-DL-8544	Trailing Arm, 1st RA;2nd RA;Leaf Spring Axle	
	02/02→	Track Control Arm		MN-DL-8609	Trailing Arm, 1st RA;2nd RA, for Leaf-Spring Suspension vehicles, →Type_HB Chassis	
	02/02→	Track Control Arm		MN-VB-8514	Suspension Rod, Wishbone (CV), Drive Axle; Leaf Spring Axle	
	02/02→	Track Control Arm		MN-VB-9404	Wishbone (CV), Drive Axle	
	01/04→	Centre Rod	MN-DL-2160		Coupling Rod	
	01/04→	Centre Rod	MN-DL-2174		Push Rod	
	01/04→	Suspension Arm Repair Kit		CV-RK-5313	for Wishbone (CV)	
	01/04→	Tie Rod End	CV-ES-14162		for Steering Rod	
	01/04→	Tie Rod End	SC-ES-7279		for Steering Rod	
	01/04→	Tie Rod End	SC-ES-8535		for Guide Rod	
	01/04→	Track control arm		MN-DL-10288	Trailing Arm, 1st RA;2nd RA, for Leaf-Spring Suspension vehicles, →Type HB	
	01/04→	Track control arm		MN-DL-12288	Trailing Arm	
	01/04→	Track Control Arm		MN-VB-8514	Suspension Rod, Wishbone (CV)	
	01/04→	Track Control Arm		MN-VB-8669	Suspension Rod, Wishbone (CV), 1st RA; 2nd RA, for Leaf-Spring Suspension vehicles, →Type_MHB Chassis	
	01/04→	Track Control Arm		MN-VB-9404	Wishbone (CV), 1st RA;2nd RA, for Leaf-Spring Suspension vehicles, →Type_HB	

CV-ES-0914

Length: 125
Cone Ø: d1 Ø 30 / d2 Ø 27
Thread: M38 x 1,5 RHT
81953016184, 81953016251, 81953016276



CV-ES-2120

Length: 115
Cone Ø: d1 Ø 12,4 / d2 Ø 10,8
Thread: M14 x 1,5 RHT
03008500A, 81953016200, 81953016202,
81953016203, 81953016227



CV-ES-14162

Length: 125
Cone Ø: d1 Ø 30 / d2 Ø 27
Thread: M30 x 1,5 LHT
81953010015, 81953010083, 81953010087,
81953016029, 81953016030, 81953016043,
81953016044, 81953016050, 81953016054,
81953016087, 81953016091, 81953016107,
81953016120, 81953016125, 81953016152,
81953016155, 81953016157, 81953016168,
81953016179, 81953016181, 81953016223,
81953016237, 81953016254, 81953016275,
81953016279, 81953016351



CV-ES-14163

Length: 125
Cone Ø: d1 Ø 30 / d2 Ø 27
Thread: M30 x 1,5 RHT
95301.0084, 90804102156, 90804102272,
90804102696, 90804102710, 81953010016,
81953010075, 81953010084, 81953010088,
81953010094, 81953010103, 81953016030,
81953016043, 81953016048, 81953016049,
81953016053, 81953016061, 81953016090,
81953016108, 81953016112, 81953016126,
81953016143, 81953016149, 81953016154,
81953016156, 81953016168, 81953016178,
81953016194, 81953016206, 81953016224,
81953016234, 81953016242, 81953016252,
81953016274, 81953016278, 81953016284,
81953016286, 81953016308, 81953016310,
81953016312, 81953016347, 81953016350,
81953016352, 82953016012, 88953016014,
N2953016001



CV-RK-5313

Ø: 90
03304800A, 81953016132



DB-RK-8581

Ø: 85
Hole Distance: 130
Thick/Height: 24
03305800A, 81432706105



MN-DL-2160

Length: 1652 Ø: 50
Cone Ø: d1 Ø 30 / d2 Ø 27
81467106112, 81467106163, 81467106165,
81467106198, 81467106353, 81467106354,
81467106361, 81467116725



MN-DL-2174

Length: 1588 Ø: 52
Cone Ø: d1 Ø 30 / d2 Ø 27
81467106378, 81467106912



MN-DL-5225

Length: 572 Ø: 48
Hole Distance: 130 / 130
03301500A, 81432206229, 81432206236,
81432206267, 81432206270, 81432206272,
81432206304, 81432206305, 81432209236,
81432209267, 81432209272



MN-DL-7801

Length: 995 Ø: 52
Cone Ø: d1 Ø 30 / d2 Ø 27
81466106807, 81466106808, 81466116087,
81466116088, 81466116096, 81466116097,
81466116099, 81466116132, 81466116133,
81466116136, 81466116197, 81466116198,
81466116205



MN-DL-8544

Length: 596 Ø: 48
Hole Distance: 130 / 130
81432206196, 81432206232, 81432206233



MN-DL-8609

Length: 585 Ø: 58
Hole Distance: 130 / 130
81432206070, 81432206071, 81432206072,
81432206091, 81432206093, 81432206119



MN-DL-10288

81432206386, 82432206008, 82432209008

No Image

MN-DL-12288

Length: 585 Ø: 58
Hole Distance: 130 / 130
81432206386, 82432206008, 82432209008

No Image

MN-ES-10333

Length: 90
Cone Ø: d1 Ø 38 / d2 Ø 34,35
Thread: M36 x 1,5 RHT
1271126, 3090291, 3099128, 42538048,
81953016268, 82953016018, 82953016019



MN-VB-8514

Length: 627 Ø: 48
Hole Ø 25 / 25 / 25
Hole Distance: 152 / 130 / 130
81432706087, 81432706088, 81432706094,
81432706095, 81432796094



MN-VB-8669

Length: 627 Ø: 48
Hole Ø 25 / 25 / 25
Hole Distance: 152 / 130 / 130
81432706116, 81432706137, 81432706150,
81432706151



MN-VB-9404

Length: 627 Ø: 58
Hole Distance: 130 / 130
81432706117, 81432706152, 81432706153



SC-ES-7279

Length: 150
Cone Ø: d1 Ø 30 / d2 Ø 27
Thread: M30 x 1,5 RHT
81953016288



SC-ES-8517

Length: 140
Cone Ø: d1 Ø 30 / d2 Ø 27
Thread: M30 x 1,5 RHT
81953016286



SC-ES-8535

Length: 145
Cone Ø: d1 Ø 30 / d2 Ø 27
Thread: M30 x 1,5 RHT
81953016271, 81953016325





TGA ...

26.310 FDARS, FDAS, FDHS	02/02→	Ball Head, gearshift linkage	CV-ES-2120			
	02/02→	Centre Rod	MN-DL-7801		Push Rod	
	02/02→	Suspension Strut Repair Kit		DB-RK-8581		
	02/02→	Tie Rod End	CV-ES-0914		for Steering Rod	
	02/02→	Tie Rod End	CV-ES-14163		for Steering Rod	
	02/02→	Tie Rod End	MN-ES-10333		for Steering Rod	
	02/02→	Tie Rod End	SC-ES-8517		for Push Rod	
	02/02→	Track Control Arm		MN-DL-5225	Trailing Arm	
	02/02→	Track Control Arm		MN-DL-8544	Trailing Arm, 1st RA;2nd RA;Leaf Spring Axle	
	02/02→	Track Control Arm		MN-DL-8609	Trailing Arm, 1st RA;2nd RA, for Leaf-Spring Suspension vehicles, →Type_HB Chassis	
	02/02→	Track Control Arm		MN-VB-8514	Suspension Rod, Wishbone (CV), Drive Axle; Leaf Spring Axle	
	02/02→	Track Control Arm		MN-VB-9404	Wishbone (CV), Drive Axle	
	01/04→	Centre Rod	MN-DL-2160		Coupling Rod	
	01/04→	Centre Rod	MN-DL-2174		Push Rod	
	01/04→	Suspension Arm Repair Kit		CV-RK-5313	for Wishbone (CV)	
	01/04→	Tie Rod End	CV-ES-14162		for Steering Rod	
	01/04→	Tie Rod End	SC-ES-7279		for Steering Rod	
	01/04→	Tie Rod End	SC-ES-8535		for Guide Rod	
	01/04→	Track Control Arm		MN-DL-8544	Trailing Arm, 1st RA;2nd RA, for Leaf-Spring Suspension vehicles	
	01/04→	Track control arm		MN-DL-10288	Trailing Arm, 1st RA;2nd RA, for Leaf-Spring Suspension vehicles, →Type HB	
	01/04→	Track control arm		MN-DL-12288	Trailing Arm	
	01/04→	Track Control Arm		MN-VB-8514	Suspension Rod, Wishbone (CV)	
	01/04→	Track Control Arm		MN-VB-8669	Suspension Rod, Wishbone (CV), 1st RA; 2nd RA, for Leaf-Spring Suspension vehicles, →Type_MHB Chassis	
	01/04→	Track Control Arm		MN-VB-9404	Wishbone (CV), 1st RA;2nd RA, for Leaf-Spring Suspension vehicles, →Type_HB	
	26.310 FDC, FDLC, FDLRC, F DRC, FNHLC, FVHLC	01/01→	Ball Head, gearshift linkage	CV-ES-2120		
		01/01→	Centre Rod	MN-DL-7801		Push Rod, Leaf Spring Axle
01/01→		Centre Rod	MN-DL-8560		Push Rod, Air Suspension Axle	
01/01→		Suspension Strut Repair Kit		DB-RK-8581		
01/01→		Suspension Strut Repair Kit		MN-RK-12436		
01/01→		Tie Rod	MN-DL-7802			
01/01→		Tie Rod End	CV-ES-0914		for Steering Rod	
01/01→		Tie Rod End	CV-ES-14162		for Steering Rod	
01/01→		Tie Rod End	CV-ES-14163		for Steering Rod	
01/01→		Tie Rod End	SC-ES-7279		for Steering Rod	
01/01→		Tie Rod End	SC-ES-8517		for Push Rod	
01/01→		Tie Rod End	SC-ES-8535		for Guide Rod	
01/01→		Track Control Arm		MN-DL-3402	Trailing Arm, Air Suspension Axle;Drive Axle	
01/01→		Track Control Arm		MN-DL-5225	Trailing Arm, Drive Axle;Air Suspension Axle	
01/01→		Track Control Arm		MN-DL-8544	Trailing Arm, Drive Axle;Air Suspension Axle	
01/01→		Track Control Arm		MN-DL-8544	Trailing Arm, Drive Axle;Leaf Spring Axle	
01/01→		Track control arm		MN-DL-10288	Trailing Arm, 1st RA;2nd RA, for Leaf-Spring Suspension vehicles	
01/01→		Track control arm		MN-DL-12288	Trailing Arm	
01/01→		Track Control Arm		MN-VB-5222	Wishbone (CV), 1st RA;2nd RA, for Pneumatic Suspension vehicles	
01/01→		Track Control Arm		MN-VB-5238	Wishbone (CV), Drive Axle;Air Suspension Axle	
01/01→		Track Control Arm		MN-VB-8514	Suspension Rod, Wishbone (CV), Drive Axle; Leaf Spring Axle	
01/01→		Track Control Arm		MN-VB-8669	Suspension Rod, Wishbone (CV), Drive Axle	
01/01→		Track Control Arm		MN-VB-8669	Suspension Rod, Wishbone (CV), Drive Axle; Leaf Spring Axle	
01/01→		Track Control Arm		MN-VB-9404	Wishbone (CV), Drive Axle	
01/01→		Track Control Arm		MN-VB-9404	Wishbone (CV), Drive Axle;Air Suspension Axle	
01/01→		Track Control Arm	MN-DL-8663		Control Arm, Air Suspension Axle	

CV-ES-0914

Length: 125
Cone Ø: d1 Ø 30 / d2 Ø 27
Thread: M38 x 1,5 RHT
81953016184, 81953016251, 81953016276



CV-ES-2120

Length: 115
Cone Ø: d1 Ø 12,4 / d2 Ø 10,8
Thread: M14 x 1,5 RHT
03008500A, 81953016200, 81953016202, 81953016203, 81953016227



CV-ES-14162

Length: 125
Cone Ø: d1 Ø 30 / d2 Ø 27
Thread: M30 x 1,5 LHT
81953010015, 81953010083, 81953010087, 81953016029, 81953016030, 81953016043, 81953016044, 81953016050, 81953016054, 81953016087, 81953016091, 81953016107, 81953016120, 81953016125, 81953016152, 81953016155, 81953016157, 81953016168, 81953016179, 81953016181, 81953016223, 81953016237, 81953016254, 81953016275, 81953016279, 81953016351



CV-ES-14163

Length: 125
Cone Ø: d1 Ø 30 / d2 Ø 27
Thread: M30 x 1,5 RHT
95301.0084, 90804102156, 90804102272, 90804102696, 90804102710, 81953010016, 81953010075, 81953010084, 81953010088, 81953010094, 81953010103, 81953016030, 81953016043, 81953016048, 81953016049, 81953016053, 81953016061, 81953016090, 81953016108, 81953016112, 81953016126, 81953016143, 81953016149, 81953016154, 81953016156, 81953016168, 81953016178, 81953016194, 81953016206, 81953016224, 81953016234, 81953016242, 81953016252, 81953016274, 81953016278, 81953016284, 81953016286, 81953016308, 81953016310, 81953016312, 81953016347, 81953016350, 81953016352, 82953016012, 88953016014, N2953016001



CV-RK-5313

Ø: 90
03304800A, 81953016132



DB-RK-8581

Ø: 85
Hole Distance: 130
Thick/Height: 24
03305800A, 81432706105



MN-DL-2160

Length: 1652 Ø: 50
Cone Ø: d1 Ø 30 / d2 Ø 27
81467106112, 81467106163, 81467106165, 81467106198, 81467106353, 81467106354, 81467106361, 81467116725



MN-DL-2174

Length: 1588 Ø: 52
Cone Ø: d1 Ø 30 / d2 Ø 27
81467106378, 81467106912



MN-DL-3402

Length: 590 Ø: 48
Hole Distance: 130 / 130
03307200A, 81432206067, 81432206068, 81432206090, 81432206092, 81432209092



MN-DL-5225

Length: 572 Ø: 48
Hole Distance: 130 / 130
03301500A, 81432206229, 81432206236, 81432206267, 81432206270, 81432206272, 81432206304, 81432206305, 81432209236, 81432209267, 81432209272



MN-DL-7801

Length: 995 Ø: 52
Cone Ø: d1 Ø 30 / d2 Ø 27
81466106807, 81466106808, 81466116087, 81466116088, 81466116096, 81466116097, 81466116099, 81466116132, 81466116133, 81466116136, 81466116197, 81466116198, 81466116205

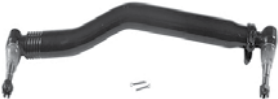

MN-DL-7802

Length: 1680 Ø: 52
Cone Ø: d1 Ø 30 / d2 Ø 27
03208300A, 81467116773, 81467116858, 81467116859, 81467116860, 81467116861, 81467116863, 81467116882, 81467116883, 81467116920, 81467116921



MN-DL-8544

Length: 596 Ø: 48
Hole Distance: 130 / 130
81432206196, 81432206232, 81432206233



MN-DL-8560

Length: 970 Ø: 52
Cone Ø: d1 Ø 30 / d2 Ø 27
03206900A, 81466106809, 81466106810, 81466106823, 81466106838, 81466106839, 81466116104, 81466116105, 81466116107, 81466116134, 81466116135, 81466116137, 81466116199, 81466116200, 81466116206



MN-DL-8609

Length: 585 Ø: 58
Hole Distance: 130 / 130
81432206070, 81432206071, 81432206072, 81432206091, 81432206093, 81432206119



MN-DL-8663

Length: 947 Ø: 60
Hole Distance: 115 / 115
03307400A, 81432206222, 81432206260, 81432206283, 81432206284



MN-DL-10288

81432206386, 82432206008, 82432209008

No Image

MN-DL-12288

Length: 585 Ø: 58
Hole Distance: 130 / 130
81432206386, 82432206008, 82432209008

No Image

MN-ES-10333

Length: 90
Cone Ø: d1 Ø 38 / d2 Ø 34,35
Thread: M36 x 1,5 RHT
1271126, 3090291, 3099128, 42538048, 81953016268, 82953016018, 82953016019



MN-RK-12436

Ø: 75
Hole Distance: 115
Thick/Height: 24
81432206244



MN-VB-5222

Length: 627 Ø: 50
Hole Distance: 152 / 152
81432706030, 81432706034, 81432706054, 81432706055, 81432706056, 81432706057, 81432706067, 81432706068, 81432706074, 81432706075, 81432706076, 81432706077, 81432706078, 81432706081, 81432706082, 81432709034, 81432709076, 81432709078, 8143706054



MN-VB-5238

Length: 627 Ø: 48
Hole Distance: 130 / 130
81432206221, 81432706096, 81432706114, 81432706116, 81432706121



MN-VB-8514

Length: 627 Ø: 48
Hole Ø 25 / 25 / 25
Hole Distance: 152 / 130 / 130
81432706087, 81432706088, 81432706094, 81432706095, 81432796094



MN-VB-8669

Length: 627 Ø: 48
Hole Ø 25 / 25 / 25
Hole Distance: 152 / 130 / 130
81432706116, 81432706137, 81432706150, 81432706151



MN-VB-9404

Length: 627 Ø: 58
Hole Distance: 130 / 130
81432706117, 81432706152, 81432706153



SC-ES-7279

Length: 150
Cone Ø: d1 Ø 30 / d2 Ø 27
Thread: M30 x 1,5 RHT
81953016288



SC-ES-8517

Length: 140
Cone Ø: d1 Ø 30 / d2 Ø 27
Thread: M30 x 1,5 RHT
81953016286



SC-ES-8535

Length: 145
Cone Ø: d1 Ø 30 / d2 Ø 27
Thread: M30 x 1,5 RHT
81953016271, 81953016325





TGA ...

26.310 FDK, FDLK, FDLRK, FDRK	09/02→	Ball Head, gearshift linkage	CV-ES-2120		
	09/02→	Centre Rod	MN-DL-7801	Push Rod, Leaf Spring Axle	
	09/02→	Centre Rod	MN-DL-8560	Push Rod, Air Suspension Axle	
	09/02→	Suspension Strut Repair Kit		DB-RK-8581	
	09/02→	Suspension Strut Repair Kit		MN-RK-12436	
	09/02→	Tie Rod	MN-DL-7802		
	09/02→	Tie Rod End	CV-ES-0914	for Steering Rod	
	09/02→	Tie Rod End	CV-ES-14162	for Steering Rod	
	09/02→	Tie Rod End	CV-ES-14163	for Steering Rod	
	09/02→	Tie Rod End	SC-ES-7279	for Steering Rod	
	09/02→	Tie Rod End	SC-ES-8517	for Push Rod	
	09/02→	Tie Rod End	SC-ES-8535	for Guide Rod	
	09/02→	Track Control Arm		MN-DL-3402	Trailing Arm, Air Suspension Axle; Drive Axle
	09/02→	Track Control Arm		MN-DL-5225	Trailing Arm, Drive Axle; Air Suspension Axle
	09/02→	Track Control Arm		MN-DL-8544	Trailing Arm, Drive Axle; Air Suspension Axle
	09/02→	Track Control Arm		MN-DL-8544	Trailing Arm, Drive Axle; Leaf Spring Axle
	09/02→	Track control arm		MN-DL-10288	Trailing Arm, 1st RA; 2nd RA, for Leaf-Spring Suspension vehicles
	09/02→	Track control arm		MN-DL-12288	Trailing Arm
	09/02→	Track Control Arm		MN-VB-5222	Wishbone (CV), 1st RA; 2nd RA, for Pneumatic Suspension vehicles
	09/02→	Track Control Arm		MN-VB-5238	Wishbone (CV), Drive Axle; Air Suspension Axle
09/02→	Track Control Arm		MN-VB-8514	Suspension Rod, Wishbone (CV), Drive Axle; Leaf Spring Axle	
09/02→	Track Control Arm		MN-VB-8669	Suspension Rod, Wishbone (CV), Drive Axle	
09/02→	Track Control Arm		MN-VB-8669	Suspension Rod, Wishbone (CV), Drive Axle; Leaf Spring Axle	
09/02→	Track Control Arm		MN-VB-9404	Wishbone (CV), Drive Axle	
09/02→	Track Control Arm		MN-VB-9404	Wishbone (CV), Drive Axle; Air Suspension Axle	
09/02→	Track Control Arm	MN-DL-8663		Control Arm, Air Suspension Axle	
26.310 FDS, FDLS, FDRS, FDLRS, FNHLS	01/01→	Ball Head, gearshift linkage	CV-ES-2120		
	01/01→	Centre Rod	MN-DL-7801	Push Rod, Leaf Spring Axle	
	01/01→	Centre Rod	MN-DL-8560	Push Rod, Air Suspension Axle	
	01/01→	Suspension Strut Repair Kit		DB-RK-8581	
	01/01→	Suspension Strut Repair Kit		MN-RK-12436	
	01/01→	Tie Rod	MN-DL-7802		
	01/01→	Tie Rod End	CV-ES-0914	for Steering Rod	
	01/01→	Tie Rod End	CV-ES-14162	for Steering Rod	
	01/01→	Tie Rod End	CV-ES-14163	for Steering Rod	
	01/01→	Tie Rod End	SC-ES-7279	for Steering Rod	
	01/01→	Tie Rod End	SC-ES-8517	for Push Rod	
	01/01→	Tie Rod End	SC-ES-8535	for Guide Rod	
	01/01→	Track Control Arm		MN-DL-3402	Trailing Arm, Air Suspension Axle; Drive Axle
	01/01→	Track Control Arm		MN-DL-5225	Trailing Arm, Drive Axle; Air Suspension Axle
	01/01→	Track Control Arm		MN-DL-8544	Trailing Arm, Drive Axle; Air Suspension Axle
	01/01→	Track Control Arm		MN-DL-8544	Trailing Arm, Drive Axle; Leaf Spring Axle
	01/01→	Track control arm		MN-DL-10288	Trailing Arm, 1st RA; 2nd RA, for Leaf-Spring Suspension vehicles
	01/01→	Track control arm		MN-DL-12288	Trailing Arm
	01/01→	Track Control Arm		MN-VB-5222	Wishbone (CV), 1st RA; 2nd RA, for Pneumatic Suspension vehicles
	01/01→	Track Control Arm		MN-VB-5238	Four-Point Steering Arm (CV); Wishbone (CV)
01/01→	Track Control Arm		MN-VB-8514	Suspension Rod, Wishbone (CV), Drive Axle; Leaf Spring Axle	
01/01→	Track Control Arm		MN-VB-8669	Suspension Rod, Wishbone (CV), Drive Axle	
01/01→	Track Control Arm		MN-VB-8669	Suspension Rod, Wishbone (CV), Drive Axle; Leaf Spring Axle	
01/01→	Track Control Arm		MN-VB-9404	Wishbone (CV), Drive Axle	
01/01→	Track Control Arm		MN-VB-9404	Wishbone (CV), Drive Axle; Air Suspension Axle	
01/01→	Track Control Arm	MN-DL-8663		Control Arm, Air Suspension Axle	

CV-ES-0914

Length: 125
Cone Ø: d1 Ø 30 / d2 Ø 27
Thread: M38 x 1,5 RHT
81953016184, 81953016251, 81953016276



CV-ES-2120

Length: 115
Cone Ø: d1 Ø 12,4 / d2 Ø 10,8
Thread: M14 x 1,5 RHT
03008500A, 81953016200, 81953016202, 81953016203, 81953016227



CV-ES-14162

Length: 125
Cone Ø: d1 Ø 30 / d2 Ø 27
Thread: M30 x 1,5 LHT
81953010015, 81953010083, 81953010087, 81953016029, 81953016030, 81953016043, 81953016044, 81953016050, 81953016054, 81953016087, 81953016091, 81953016107, 81953016120, 81953016125, 81953016152, 81953016155, 81953016157, 81953016168, 81953016179, 81953016181, 81953016223, 81953016237, 81953016254, 81953016275, 81953016279, 81953016351



CV-ES-14163

Length: 125
Cone Ø: d1 Ø 30 / d2 Ø 27
Thread: M30 x 1,5 RHT
95301.0084, 90804102156, 90804102272, 90804102696, 90804102710, 81953010016, 81953010075, 81953010084, 81953010088, 81953010094, 81953010103, 81953016030, 81953016043, 81953016048, 81953016049, 81953016053, 81953016061, 81953016090, 81953016108, 81953016112, 81953016126, 81953016143, 81953016149, 81953016154, 81953016156, 81953016168, 81953016178, 81953016194, 81953016206, 81953016224, 81953016234, 81953016242, 81953016252, 81953016274, 81953016278, 81953016284, 81953016286, 81953016308, 81953016310, 81953016312, 81953016347, 81953016350, 81953016352, 82953016012, 88953016014, N2953016001



DB-RK-8581

Ø: 85
Hole Distance: 130
Thick/Height: 24
03305800A, 81432706105



MN-DL-3402

Length: 590 Ø: 48
Hole Distance: 130 / 130
03307200A, 81432206067, 81432206068, 81432206090, 81432206092, 81432209092



MN-DL-5225

Length: 572 Ø: 48
Hole Distance: 130 / 130
03301500A, 81432206229, 81432206236, 81432206267, 81432206270, 81432206272, 81432206304, 81432206305, 81432209236, 81432209267, 81432209272



MN-DL-7801

Length: 995 Ø: 52
Cone Ø: d1 Ø 30 / d2 Ø 27
81466106807, 81466106808, 81466116087, 81466116088, 81466116096, 81466116097, 81466116099, 81466116132, 81466116133, 81466116136, 81466116197, 81466116198, 81466116205

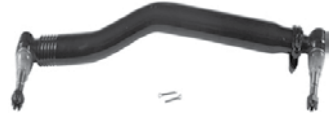

MN-DL-7802

Length: 1680 Ø: 52
Cone Ø: d1 Ø 30 / d2 Ø 27
03208300A, 81467116773, 81467116858, 81467116859, 81467116860, 81467116861, 81467116863, 81467116882, 81467116883, 81467116920, 81467116921



MN-DL-8544

Length: 596 Ø: 48
Hole Distance: 130 / 130
81432206196, 81432206232, 81432206233



MN-DL-8560

Length: 970 Ø: 52
Cone Ø: d1 Ø 30 / d2 Ø 27
03206900A, 81466106809, 81466106810, 81466106823, 81466106838, 81466106839, 81466116104, 81466116105, 81466116107, 81466116134, 81466116135, 81466116137, 81466116199, 81466116200, 81466116206



MN-DL-8663

Length: 947 Ø: 60
Hole Distance: 115 / 115
03307400A, 81432206222, 81432206260, 81432206283, 81432206284



MN-DL-10288

81432206386, 82432206008, 82432209008

No Image

MN-DL-12288

Length: 585 Ø: 58
Hole Distance: 130 / 130
81432206386, 82432206008, 82432209008

No Image

MN-RK-12436

Ø: 75
Hole Distance: 115
Thick/Height: 24
81432206244



MN-VB-5222

Length: 627 Ø: 50
Hole Distance: 152 / 152
81432706030, 81432706034, 81432706054, 81432706055, 81432706056, 81432706057, 81432706067, 81432706068, 81432706074, 81432706075, 81432706076, 81432706077, 81432706078, 81432706081, 81432706082, 81432709034, 81432709076, 81432709078, 8143706054



MN-VB-5238

Length: 627 Ø: 48
Hole Distance: 130 / 130
81432206221, 81432706096, 81432706114, 81432706116, 81432706121



MN-VB-8514

Length: 627 Ø: 48
Hole Ø 25 / 25 / 25
Hole Distance: 152 / 130 / 130
81432706087, 81432706088, 81432706094, 81432706095, 81432796094



MN-VB-8669

Length: 627 Ø: 48
Hole Ø 25 / 25 / 25
Hole Distance: 152 / 130 / 130
81432706116, 81432706137, 81432706150, 81432706151



MN-VB-9404

Length: 627 Ø: 58
Hole Distance: 130 / 130
81432706117, 81432706152, 81432706153



SC-ES-7279

Length: 150
Cone Ø: d1 Ø 30 / d2 Ø 27
Thread: M30 x 1,5 RHT
81953016288



SC-ES-8517

Length: 140
Cone Ø: d1 Ø 30 / d2 Ø 27
Thread: M30 x 1,5 RHT
81953016286



SC-ES-8535

Length: 145
Cone Ø: d1 Ø 30 / d2 Ø 27
Thread: M30 x 1,5 RHT
81953016271, 81953016325





TGA ...

26.310 FD-TM, FDR-TM	10/00→	Ball Head, gearshift linkage	CV-ES-2120			
	10/00→	Centre Rod	MN-DL-7801		Push Rod, Leaf Spring Axle	
	10/00→	Suspension Strut Repair Kit		DB-RK-8581		
	10/00→	Tie Rod	MN-DL-7802			
	10/00→	Tie Rod End	CV-ES-0914		for Steering Rod	
	10/00→	Tie Rod End	CV-ES-14162		for Steering Rod	
	10/00→	Tie Rod End	CV-ES-14163		for Steering Rod	
	10/00→	Tie Rod End	SC-ES-7279		for Steering Rod	
	10/00→	Tie Rod End	SC-ES-8517		for Push Rod	
	10/00→	Tie Rod End	SC-ES-8535		for Guide Rod	
	10/00→	Track Control Arm		MN-DL-5225	Trailing Arm	
	10/00→	Track Control Arm		MN-DL-8544	Trailing Arm, Drive Axle;Leaf Spring Axle	
	10/00→	Track control arm		MN-DL-10288	Trailing Arm, 1st RA;2nd RA, for Leaf-Spring Suspension vehicles	
	10/00→	Track control arm		MN-DL-12288	Trailing Arm	
	10/00→	Track Control Arm		MN-VB-8514	Suspension Rod, Wishbone (CV), Drive Axle; Leaf Spring Axle	
	10/00→	Track Control Arm		MN-VB-8669	Suspension Rod, Wishbone (CV), Drive Axle; Leaf Spring Axle	
	10/00→	Track Control Arm		MN-VB-9404	Wishbone (CV), Drive Axle	
26.310 FNLC, FNLLC, FNLLRC, FNLLRW, FNLLW, FNLRC, FVLC	09/00→01/05	Track Control Arm		MN-DL-5212	Trailing Arm, Tag Axle;Air Suspension Axle	
	09/00→	Ball Head, gearshift linkage	CV-ES-2120			
	09/00→	Centre Rod	MN-DL-7801		Push Rod, Leaf Spring Axle	
	09/00→	Centre Rod	MN-DL-8560		Push Rod, Air Suspension Axle	
	09/00→	Suspension Strut Repair Kit		CV-RK-5311		
	09/00→	Suspension Strut Repair Kit		DB-RK-8581		
	09/00→	Suspension Strut Repair Kit		MN-RK-12436		
	09/00→	Tie Rod	MN-DL-7802			
	09/00→	Tie Rod	MN-DL-12284			
	09/00→	Tie Rod End		IV-ES-8507	Tag Axle	
	09/00→	Tie Rod End		MN-ES-8490	Tag Axle	
	09/00→	Tie Rod End		SC-ES-8517	for Push Rod	
	09/00→	Tie Rod End	CV-ES-0914		for Steering Rod	
	09/00→	Tie Rod End	CV-ES-14162	CV-ES-14162	for Steering Rod	
	09/00→	Tie Rod End	CV-ES-14163		for Steering Rod	
	09/00→	Tie Rod End	IV-ES-12272		for Steering Rod	
	09/00→	Tie Rod End	SC-ES-7279		for Steering Rod	
	09/00→	Tie Rod End	SC-ES-8535		for Guide Rod	
	09/00→	Track Control Arm		MN-DL-5225	Trailing Arm, Drive Axle;Air Suspension Axle	
	09/00→	Track Control Arm		MN-DL-5225	Trailing Arm, Leading Axle;Air Suspension Axle	
	09/00→	Track Control Arm		MN-DL-8709	Trailing Arm, Air Suspension Axle; for vehicles with Hinged Trailing Axle	
	09/00→	Track Control Arm		MN-DL-8733	Trailing Arm, Air Suspension Axle;Drive Axle	
	09/00→	Track Control Arm		MN-TC-12399	Control Arm	
	09/00→	Track Control Arm		MN-VB-5238	Wishbone (CV), Drive Axle;Leading Axle; Air Suspension Axle	
	09/00→	Track Control Arm		MN-VB-9403	Wishbone (CV), Air Suspension Axle	
	09/00→	Track Control Arm	MN-DL-8663		Control Arm, Air Suspension Axle	
	03/04→	Track Control Arm		MN-DL-5225	Trailing Arm, Tag Axle;Air Suspension Axle; for vehicles with Hinged Trailing Axle	
	26.310 FPLS, FVLS, FNLS, FNLLS, FPLRS, FNLRS, FVLRS	12/00→01/05	Track Control Arm		MN-DL-5212	Trailing Arm, Tag Axle;Air Suspension Axle
		12/00→	Ball Head, gearshift linkage	CV-ES-2120		
		12/00→	Centre Rod	MN-DL-7801		Push Rod, Leaf Spring Axle
		12/00→	Centre Rod	MN-DL-8560		Push Rod, Air Suspension Axle
12/00→		Suspension Strut Repair Kit		CV-RK-5311		
12/00→		Suspension Strut Repair Kit		DB-RK-8581		
12/00→		Suspension Strut Repair Kit		MN-RK-12436		
12/00→		Tie Rod	MN-DL-7802			
12/00→		Tie Rod	MN-DL-12284			
12/00→		Tie Rod End		IV-ES-8507	Tag Axle	
12/00→		Tie Rod End		MN-ES-8490	Tag Axle	
12/00→		Tie Rod End		SC-ES-8517	for Push Rod	
12/00→		Tie Rod End	CV-ES-0914		for Steering Rod	

CV-ES-0914

Length: 125
Cone Ø: d1 Ø 30 / d2 Ø 27
Thread: M38 x 1,5 RHT
81953016184, 81953016251, 81953016276



CV-ES-2120

Length: 115
Cone Ø: d1 Ø 12,4 / d2 Ø 10,8
Thread: M14 x 1,5 RHT
03008500A, 81953016200, 81953016202,
81953016203, 81953016227



CV-ES-14162

Length: 125
Cone Ø: d1 Ø 30 / d2 Ø 27
Thread: M30 x 1,5 LHT
81953010015, 81953010083, 81953010087,
81953016029, 81953016030, 81953016043,
81953016044, 81953016050, 81953016054,
81953016087, 81953016091, 81953016107,
81953016120, 81953016125, 81953016152,
81953016155, 81953016157, 81953016168,
81953016179, 81953016181, 81953016223,
81953016237, 81953016254, 81953016275,
81953016279, 81953016351



CV-ES-14163

Length: 125
Cone Ø: d1 Ø 30 / d2 Ø 27
Thread: M30 x 1,5 RHT
95301.0084, 90804102156, 90804102272,
90804102696, 90804102710, 81953010016,
81953010075, 81953010084, 81953010088,
81953010094, 81953010103, 81953016030,
81953016043, 81953016048, 81953016049,
81953016053, 81953016061, 81953016090,
81953016108, 81953016112, 81953016126,
81953016143, 81953016149, 81953016154,
81953016156, 81953016168, 81953016178,
81953016194, 81953016206, 81953016224,
81953016234, 81953016242, 81953016252,
81953016274, 81953016278, 81953016284,
81953016286, 81953016308, 81953016310,
81953016312, 81953016347, 81953016350,
81953016352, 82953016012, 88953016014,
N2953016001



CV-RK-5311

638862, 639287, 938423, 1104335,
1953248, 0003500506, 3500506, 11013547,
42488722, 070550504, 634303610,
81432206055, 81432206073, 82262320660,
5001842823, 7000307001, 8226232066



DB-RK-8581

Ø: 85
Hole Distance: 130
Thick/Height: 24
03305800A, 81432706105



IV-ES-8507

Length: 80
Cone Ø: d1 Ø 30 / d2 Ø 27
Thread: M30 x 1,5 RHT
11019869, 12216380, 55175540,
81953016238



IV-ES-12272

Length: 75
Cone Ø: d1 Ø 30 / d2 Ø 27
Thread: M26 x 1,5 RHT
81953016280, 82953010010



MN-DL-5212

Length: 577 Ø: 48
Hole Distance: 130 / 130
81432206096, 81432206097, 81432206098,
81432206129, 81432209096, 81432209129,
81432306014, 81432306030



MN-DL-5225

Length: 572 Ø: 48
Hole Distance: 130 / 130
03301500A, 81432206229, 81432206236,
81432206267, 81432206270, 81432206272,
81432206304, 81432206305, 81432209236,
81432209267, 81432209272



MN-DL-7801

Length: 995 Ø: 52
Cone Ø: d1 Ø 30 / d2 Ø 27
81466106807, 81466106808, 81466116087,
81466116088, 81466116096, 81466116097,
81466116099, 81466116132, 81466116133,
81466116136, 81466116197, 81466116198,
81466116205

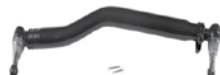

MN-DL-7802

Length: 1680 Ø: 52
Cone Ø: d1 Ø 30 / d2 Ø 27
03208300A, 81467116773, 81467116858,
81467116859, 81467116860, 81467116861,
81467116863, 81467116882, 81467116883,
81467116920, 81467116921



MN-DL-8544

Length: 596 Ø: 48
Hole Distance: 130 / 130
81432206196, 81432206232, 81432206233



MN-DL-8560

Length: 970 Ø: 52
Cone Ø: d1 Ø 30 / d2 Ø 27
03206900A, 81466106809, 81466106810,
81466106823, 81466106838, 81466106839,
81466116104, 81466116105, 81466116107,
81466116134, 81466116135, 81466116137,
81466116199, 81466116200, 81466116206



MN-DL-8663

Length: 947 Ø: 60
Hole Distance: 115 / 115
03307400A, 81432206222, 81432206260,
81432206283, 81432206284



MN-DL-8709

Length: 572 Ø: 52
Hole Distance: 130 / 130
81432206268, 81432206274, 81432206291,
81432206292, 82432206007



MN-DL-8733

Length: 530 Ø: 48
Hole Distance: 130 / 130
81432206161, 81432206190, 81432206358,
81432206359



MN-DL-10288

81432206386, 82432206008, 82432209008

No Image

MN-DL-12284

Length: 1530 Ø: 50
Cone Ø: d1 Ø 30 / d2 Ø 27
81466106579, 81466106580, 81466106624,
81466116720, 81467116720, 81467116730,
81467116952



MN-DL-12288

Length: 585 Ø: 58
Hole Distance: 130 / 130
81432206386, 82432206008, 82432209008

No Image

MN-ES-8490

Length: 90
Cone Ø: d1 Ø 30 / d2 Ø 27
Thread: M26 x 1,5 RHT
0014606948, 14606948, 81953016281,
81953016337, 82953016016



MN-RK-12436

Ø: 75
Hole Distance: 115
Thick/Height: 24
81432206244



MN-TC-12399

Length: 694 Ø: 50
Hole Distance: 130 / 130
81432206265



MN-VB-5238

Length: 627 Ø: 48
Hole Distance: 130 / 130
81432206221, 81432706096, 81432706114,
81432706116, 81432706121



MN-VB-8514

Length: 627 Ø: 48
Hole Ø 25 / 25 / 25
Hole Distance: 152 / 130 / 130
81432706087, 81432706088, 81432706094,
81432706095, 81432796094



MN-VB-8669

Length: 627 Ø: 48
Hole Ø 25 / 25 / 25
Hole Distance: 152 / 130 / 130
81432706116, 81432706137, 81432706150,
81432706151



MN-VB-9403

Length: 627 Ø: 48
Hole Ø 25 / 23 / 23
Hole Distance: 152 / 130 / 130
81432706097, 81432706113, 81432706135,
81432706160, 81432706161



MN-VB-9404

Length: 627 Ø: 58
Hole Distance: 130 / 130
81432706117, 81432706152, 81432706153



SC-ES-7279

Length: 150
Cone Ø: d1 Ø 30 / d2 Ø 27
Thread: M30 x 1,5 RHT
81953016288



SC-ES-8517

Length: 140
Cone Ø: d1 Ø 30 / d2 Ø 27
Thread: M30 x 1,5 RHT
81953016286



SC-ES-8535

Length: 145
Cone Ø: d1 Ø 30 / d2 Ø 27
Thread: M30 x 1,5 RHT
81953016271, 81953016325





TGA ...

26.310 FPLS, FVLS, FNLS, FNLLS, FPLRS, FNLRS, FVLRs ...	12/00→	Tie Rod End	CV-ES-14162	CV-ES-14162	for Steering Rod
	12/00→	Tie Rod End	CV-ES-14163		for Steering Rod
	12/00→	Tie Rod End	IV-ES-12272		for Steering Rod
	12/00→	Tie Rod End	SC-ES-7279		for Steering Rod
	12/00→	Tie Rod End	SC-ES-8535		for Guide Rod
	12/00→	Track Control Arm		MN-DL-5225	Trailing Arm, Drive Axle;Air Suspension Axle
	12/00→	Track Control Arm		MN-DL-5225	Trailing Arm, Leading Axle;Air Suspension Axle
	12/00→	Track Control Arm		MN-DL-8709	Trailing Arm, Air Suspension Axle; for vehicles with Hinged Trailing Axle
	12/00→	Track Control Arm		MN-DL-8733	Trailing Arm, Air Suspension Axle;Drive Axle
	12/00→	Track Control Arm		MN-TC-12399	Control Arm
	12/00→	Track Control Arm		MN-VB-5238	Wishbone (CV), Drive Axle;Leading Axle; Air Suspension Axle
	12/00→	Track Control Arm		MN-VB-9403	Wishbone (CV), Air Suspension Axle
	12/00→	Track Control Arm	MN-DL-8663		Control Arm, Air Suspension Axle
	03/04→	Track Control Arm		MN-DL-5225	Trailing Arm, Tag Axle;Air Suspension Axle; for vehicles with Hinged Trailing Axle
	01/05→	Track Control Arm		MN-DL-5225	Trailing Arm, Tag Axle;Air Suspension Axle; for vehicles with Rigid Trailing Axle
26.310 FVLC	09/03→	Centre Rod	MN-DL-7801		Push Rod
	09/03→	Tie Rod	MN-DL-7802		
	09/03→	Track Control Arm		MN-DL-5225	Trailing Arm
26.310 FVL-KO	12/00→	Ball Head, gearshift linkage	CV-ES-2120		
	12/00→	Centre Rod	MN-DL-7801		Push Rod, Leaf Spring Axle
	12/00→	Centre Rod	MN-DL-8560		Push Rod, Air Suspension Axle
	12/00→	Suspension Strut Repair Kit		DB-RK-8581	
	12/00→	Suspension Strut Repair Kit		MN-RK-12436	
	12/00→	Tie Rod	MN-DL-7802		
	12/00→	Tie Rod End	CV-ES-0914		for Steering Rod
	12/00→	Tie Rod End	CV-ES-14163		for Steering Rod
	12/00→	Tie Rod End	SC-ES-7279		for Steering Rod
	12/00→	Tie Rod End	SC-ES-8517		for Push Rod
	12/00→	Tie Rod End	SC-ES-8535		for Guide Rod
	12/00→	Track Control Arm		MN-DL-5225	Trailing Arm
	12/00→	Track Control Arm		MN-DL-8733	Trailing Arm, Air Suspension Axle;Drive Axle
	12/00→	Track Control Arm		MN-VB-5238	Four-Point Steering Arm (CV);Wishbone (CV)
	26.310, 26.320 FDAK, FDHK	06/05→	Centre Rod	MN-DL-7801	
06/05→		Suspension Strut Repair Kit		DB-RK-8581	
06/05→		Tie Rod	MN-DL-7802		
06/05→		Tie Rod End	CV-ES-0914		for Steering Rod
06/05→		Tie Rod End	CV-ES-14162		for Steering Rod
06/05→		Tie Rod End	CV-ES-14163		for Steering Rod
06/05→		Tie Rod End	MN-ES-10333		for Steering Rod
06/05→		Tie Rod End	SC-ES-7279		for Steering Rod
06/05→		Tie Rod End	SC-ES-8517		for Push Rod
06/05→		Tie Rod End	SC-ES-8535		for Guide Rod
06/05→		Track Control Arm		MN-DL-5225	Trailing Arm
06/05→		Track Control Arm		MN-DL-8544	Trailing Arm, 1st RA;2nd RA;Leaf Spring Axle
06/05→		Track Control Arm		MN-DL-8609	Trailing Arm, 1st RA;2nd RA, for Leaf-Spring Suspension vehicles, →Type_HB Chassis
06/05→		Track Control Arm		MN-VB-8514	Suspension Rod, Wishbone (CV), Drive Axle; Leaf Spring Axle
06/05→		Track Control Arm		MN-VB-8669	Suspension Rod, Wishbone (CV), Drive Axle; Leaf Spring Axle
06/05→	Track Control Arm		MN-VB-9404	Wishbone (CV), 1st RA;2nd RA, for Leaf-Spring Suspension vehicles, →Type_HB	
26.310, 26.320 FDAS, FDHS	06/05→	Centre Rod	MN-DL-7801		Push Rod, Leaf Spring Axle
	06/05→	Suspension Strut Repair Kit		DB-RK-8581	
	06/05→	Tie Rod	MN-DL-7802		
	06/05→	Tie Rod End	CV-ES-0914		for Steering Rod
	06/05→	Tie Rod End	CV-ES-14162		for Steering Rod
	06/05→	Tie Rod End	CV-ES-14163		for Steering Rod

CV-ES-0914

Length: 125
Cone Ø: d1 Ø 30 / d2 Ø 27
Thread: M38 x 1,5 RHT
81953016184, 81953016251, 81953016276



CV-ES-2120

Length: 115
Cone Ø: d1 Ø 12,4 / d2 Ø 10,8
Thread: M14 x 1,5 RHT
03008500A, 81953016200, 81953016202, 81953016203, 81953016227



CV-ES-14162

Length: 125
Cone Ø: d1 Ø 30 / d2 Ø 27
Thread: M30 x 1,5 LHT
81953010015, 81953010083, 81953010087, 81953016029, 81953016030, 81953016043, 81953016044, 81953016050, 81953016054, 81953016087, 81953016091, 81953016107, 81953016120, 81953016125, 81953016152, 81953016155, 81953016157, 81953016168, 81953016179, 81953016181, 81953016223, 81953016237, 81953016254, 81953016275, 81953016279, 81953016351



CV-ES-14163

Length: 125
Cone Ø: d1 Ø 30 / d2 Ø 27
Thread: M30 x 1,5 RHT
95301.0084, 90804102156, 90804102272, 90804102696, 90804102710, 81953010016, 81953010075, 81953010084, 81953010088, 81953010094, 81953010103, 81953016030, 81953016043, 81953016048, 81953016049, 81953016053, 81953016061, 81953016090, 81953016108, 81953016112, 81953016126, 81953016143, 81953016149, 81953016154, 81953016156, 81953016168, 81953016178, 81953016194, 81953016206, 81953016224, 81953016234, 81953016242, 81953016252, 81953016274, 81953016278, 81953016284, 81953016286, 81953016308, 81953016310, 81953016312, 81953016347, 81953016350, 81953016352, 82953016012, 88953016014, N2953016001



DB-RK-8581

Ø: 85
Hole Distance: 130
Thick/Height: 24
03305800A, 81432706105



IV-ES-12272

Length: 75
Cone Ø: d1 Ø 30 / d2 Ø 27
Thread: M26 x 1,5 RHT
81953016280, 82953010010



MN-DL-5225

Length: 572 Ø: 48
Hole Distance: 130 / 130
03301500A, 81432206229, 81432206236, 81432206267, 81432206270, 81432206272, 81432206304, 81432206305, 81432209236, 81432209267, 81432209272



MN-DL-7801

Length: 995 Ø: 52
Cone Ø: d1 Ø 30 / d2 Ø 27
81466106807, 81466106808, 81466116087, 81466116088, 81466116096, 81466116097, 81466116099, 81466116132, 81466116133, 81466116136, 81466116197, 81466116198, 81466116205



MN-DL-7802

Length: 1680 Ø: 52
Cone Ø: d1 Ø 30 / d2 Ø 27
03208300A, 81467116773, 81467116858, 81467116859, 81467116860, 81467116861, 81467116863, 81467116882, 81467116883, 81467116920, 81467116921



MN-DL-8544

Length: 596 Ø: 48
Hole Distance: 130 / 130
81432206196, 81432206232, 81432206233



MN-DL-8560

Length: 970 Ø: 52
Cone Ø: d1 Ø 30 / d2 Ø 27
03206900A, 81466106809, 81466106810, 81466106823, 81466106838, 81466106839, 81466116104, 81466116105, 81466116107, 81466116134, 81466116135, 81466116137, 81466116199, 81466116200, 81466116206



MN-DL-8609

Length: 585 Ø: 58
Hole Distance: 130 / 130
81432206070, 81432206071, 81432206072, 81432206091, 81432206093, 81432206119



MN-DL-8663

Length: 947 Ø: 60
Hole Distance: 115 / 115
03307400A, 81432206222, 81432206260, 81432206283, 81432206284



MN-DL-8709

Length: 572 Ø: 52
Hole Distance: 130 / 130
81432206268, 81432206274, 81432206291, 81432206292, 82432206007



MN-DL-8733

Length: 530 Ø: 48
Hole Distance: 130 / 130
81432206161, 81432206190, 81432206358, 81432206359



MN-ES-10333

Length: 90
Cone Ø: d1 Ø 38 / d2 Ø 34,35
Thread: M36 x 1,5 RHT
1271126, 3090291, 3099128, 42538048, 81953016268, 82953016018, 82953016019



MN-RK-12436

Ø: 75
Hole Distance: 115
Thick/Height: 24
81432206244



MN-TC-12399

Length: 694 Ø: 50
Hole Distance: 130 / 130
81432206265



MN-VB-5238

Length: 627 Ø: 48
Hole Distance: 130 / 130
81432206221, 81432706096, 81432706114, 81432706116, 81432706121



MN-VB-8514

Length: 627 Ø: 48
Hole Ø 25 / 25 / 25
Hole Distance: 152 / 130 / 130
81432706087, 81432706088, 81432706094, 81432706095, 81432796094



MN-VB-8669

Length: 627 Ø: 48
Hole Ø 25 / 25 / 25
Hole Distance: 152 / 130 / 130
81432706116, 81432706137, 81432706150, 81432706151



MN-VB-9403

Length: 627 Ø: 48
Hole Ø 25 / 23 / 23
Hole Distance: 152 / 130 / 130
81432706097, 81432706113, 81432706135, 81432706160, 81432706161



MN-VB-9404

Length: 627 Ø: 58
Hole Distance: 130 / 130
81432706117, 81432706152, 81432706153



SC-ES-7279

Length: 150
Cone Ø: d1 Ø 30 / d2 Ø 27
Thread: M30 x 1,5 RHT
81953016288



SC-ES-8517

Length: 140
Cone Ø: d1 Ø 30 / d2 Ø 27
Thread: M30 x 1,5 RHT
81953016286



SC-ES-8535

Length: 145
Cone Ø: d1 Ø 30 / d2 Ø 27
Thread: M30 x 1,5 RHT
81953016271, 81953016325





TGA ...

26.310, 26.320 FDAS, FDHS ...	06/05→	Tie Rod End	MN-ES-10333		for Steering Rod
	06/05→	Tie Rod End	SC-ES-7279		for Steering Rod
	06/05→	Tie Rod End	SC-ES-8517		for Push Rod
	06/05→	Tie Rod End	SC-ES-8535		for Guide Rod
	06/05→	Track Control Arm		MN-DL-5225	Trailing Arm
	06/05→	Track Control Arm		MN-DL-8544	Trailing Arm, 1st RA;2nd RA;Leaf Spring Axle
	06/05→	Track Control Arm		MN-DL-8609	Trailing Arm, 1st RA;2nd RA, for Leaf-Spring Suspension vehicles, →Type_HB Chassis
	06/05→	Track Control Arm		MN-VB-8514	Suspension Rod, Wishbone (CV), Drive Axle; Leaf Spring Axle
	06/05→	Track Control Arm		MN-VB-8669	Suspension Rod, Wishbone (CV), Drive Axle; Leaf Spring Axle
	06/05→	Track Control Arm		MN-VB-9404	Wishbone (CV), 1st RA;2nd RA, for Leaf-Spring Suspension vehicles, →Type_HB
26.310, 26.320 FDC, FDL, FDLRC, FDRC, FNHLC, FVHLC	05/04→01/05	Track Control Arm		MN-DL-5212	Trailing Arm, Tag Axle;Air Suspension Axle
	05/04→	Centre Rod	MN-DL-7801		Push Rod, Leaf Spring Axle
	05/04→	Centre Rod	MN-DL-8560		Push Rod, Air Suspension Axle
	05/04→	Suspension Strut Repair Kit		DB-RK-8581	
	05/04→	Suspension Strut Repair Kit		MN-RK-12436	
	05/04→	Tie Rod	MN-DL-7802		
	05/04→	Tie Rod	MN-DL-12284		
	05/04→	Tie Rod End		IV-ES-8507	Tag Axle
	05/04→	Tie Rod End		MN-ES-8490	for vehicles with Hinged Trailing Axle
	05/04→	Tie Rod End		SC-ES-8517	for Push Rod
	05/04→	Tie Rod End	CV-ES-0914		for Steering Rod
	05/04→	Tie Rod End	CV-ES-14162	CV-ES-14162	for Steering Rod
	05/04→	Tie Rod End	CV-ES-14163		for Steering Rod
	05/04→	Tie Rod End	IV-ES-12272		for Steering Rod
	05/04→	Tie Rod End	SC-ES-7279		for Steering Rod
	05/04→	Tie Rod End	SC-ES-8535		for Guide Rod
	05/04→	Track Control Arm		MN-DL-3402	Trailing Arm, Air Suspension Axle;Drive Axle
	05/04→	Track Control Arm		MN-DL-5225	Trailing Arm, Drive Axle;Air Suspension Axle
	05/04→	Track Control Arm		MN-DL-5225	Trailing Arm, Tag Axle;Air Suspension Axle; for vehicles with Hinged Trailing Axle
	05/04→	Track Control Arm		MN-DL-8544	Trailing Arm, Drive Axle;Air Suspension Axle
	05/04→	Track Control Arm		MN-DL-8544	Trailing Arm, Drive Axle;Leaf Spring Axle
	05/04→	Track Control Arm		MN-DL-8709	Trailing Arm, Air Suspension Axle; for vehicles with Hinged Trailing Axle
	05/04→	Track Control Arm		MN-DL-8733	Trailing Arm, 1st Drive Axle, for Pneumatic Suspension vehicles
	05/04→	Track control arm		MN-DL-10288	Trailing Arm, 1st RA;2nd RA, for Leaf-Spring Suspension vehicles
	05/04→	Track control arm		MN-DL-12288	Trailing Arm
	05/04→	Track Control Arm		MN-TC-12399	Control Arm
	05/04→	Track Control Arm		MN-VB-5222	Wishbone (CV), 1st RA;2nd RA, for Pneumatic Suspension vehicles
	05/04→	Track Control Arm		MN-VB-5238	Wishbone (CV), Drive Axle;Air Suspension Axle
	05/04→	Track Control Arm		MN-VB-5238	Wishbone (CV), Drive Axle;Leading Axle; Air Suspension Axle
	05/04→	Track Control Arm		MN-VB-8514	Suspension Rod, Wishbone (CV), Drive Axle; Air Suspension Axle
	05/04→	Track Control Arm		MN-VB-8514	Suspension Rod, Wishbone (CV), Drive Axle; Leaf Spring Axle
	05/04→	Track Control Arm		MN-VB-8669	Suspension Rod, Wishbone (CV), Drive Axle
	05/04→	Track Control Arm		MN-VB-8669	Suspension Rod, Wishbone (CV), Drive Axle; Leaf Spring Axle
	05/04→	Track Control Arm		MN-VB-9403	Wishbone (CV), Air Suspension Axle
	05/04→	Track Control Arm		MN-VB-9404	Wishbone (CV), Drive Axle
	05/04→	Track Control Arm		MN-VB-9404	Wishbone (CV), Drive Axle;Air Suspension Axle
	05/04→	Track Control Arm	MN-DL-8663		Control Arm, Air Suspension Axle
	01/05→	Track Control Arm		MN-DL-5225	Trailing Arm, Leading Axle;Air Suspension Axle
	01/05→	Track Control Arm		MN-DL-5225	Trailing Arm, Tag Axle;Air Suspension Axle; for vehicles with Rigid Trailing Axle

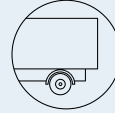

TGA ...

26.310, 26.320 FDH, FDHC, FDHC/M	06/05 →	Centre Rod	MN-DL-7801		Push Rod, Leaf Spring Axle	
	06/05 →	Suspension Strut Repair Kit		DB-RK-8581		
	06/05 →	Tie Rod	MN-DL-7802			
	06/05 →	Tie Rod End	CV-ES-0914		for Steering Rod	
	06/05 →	Tie Rod End	CV-ES-14162		for Steering Rod	
	06/05 →	Tie Rod End	CV-ES-14163		for Steering Rod	
	06/05 →	Tie Rod End	MN-ES-10333		for Steering Rod	
	06/05 →	Tie Rod End	SC-ES-7279		for Steering Rod	
	06/05 →	Tie Rod End	SC-ES-8517		for Push Rod	
	06/05 →	Tie Rod End	SC-ES-8535		for Guide Rod	
	06/05 →	Track Control Arm		MN-DL-5225	Trailing Arm	
	06/05 →	Track Control Arm		MN-DL-8544	Trailing Arm, 1st RA;2nd RA;Leaf Spring Axle	
	06/05 →	Track Control Arm		MN-DL-8609	Trailing Arm, 1st RA;2nd RA, for Leaf-Spring Suspension vehicles, →Type_HB Chassis	
	06/05 →	Track Control Arm		MN-VB-8514	Suspension Rod, Wishbone (CV), Drive Axle; Leaf Spring Axle	
	06/05 →	Track Control Arm		MN-VB-8669	Suspension Rod, Wishbone (CV), Drive Axle; Leaf Spring Axle	
	06/05 →	Track Control Arm		MN-VB-9404	Wishbone (CV), 1st RA;2nd RA, for Leaf-Spring Suspension vehicles, →Type_HB Chassis	
26.310, 26.320 FDH-TM	06/05 →	Centre Rod	MN-DL-7801		Push Rod, Leaf Spring Axle	
	06/05 →	Suspension Strut Repair Kit		DB-RK-8581		
	06/05 →	Tie Rod	MN-DL-7802			
	06/05 →	Tie Rod End	CV-ES-0914		for Steering Rod	
	06/05 →	Tie Rod End	CV-ES-14162		for Steering Rod	
	06/05 →	Tie Rod End	CV-ES-14163		for Steering Rod	
	06/05 →	Tie Rod End	SC-ES-7279		for Steering Rod	
	06/05 →	Tie Rod End	SC-ES-8517		for Push Rod	
	06/05 →	Tie Rod End	SC-ES-8535		for Guide Rod	
	06/05 →	Track Control Arm		MN-DL-5225	Trailing Arm	
	06/05 →	Track Control Arm		MN-DL-8544	Trailing Arm, 1st RA;2nd RA;Leaf Spring Axle	
	06/05 →	Track Control Arm		MN-VB-8514	Suspension Rod, Wishbone (CV), Drive Axle; Leaf Spring Axle	
	06/05 →	Track Control Arm		MN-VB-8669	Suspension Rod, Wishbone (CV), Drive Axle; Leaf Spring Axle	
	26.310, 26.320 FDK, FDLK, FDLRK, FDRK	05/04 →	Centre Rod	MN-DL-7801		Push Rod, Leaf Spring Axle
		05/04 →	Centre Rod	MN-DL-8560		Push Rod, Air Suspension Axle
		05/04 →	Suspension Strut Repair Kit		DB-RK-8581	
05/04 →		Suspension Strut Repair Kit		MN-RK-12436		
05/04 →		Tie Rod	MN-DL-7802			
05/04 →		Tie Rod End	CV-ES-0914		for Steering Rod	
05/04 →		Tie Rod End	CV-ES-14162		for Steering Rod	
05/04 →		Tie Rod End	CV-ES-14163		for Steering Rod	
05/04 →		Tie Rod End	SC-ES-7279		for Steering Rod	
05/04 →		Tie Rod End	SC-ES-8517		for Push Rod	
05/04 →		Tie Rod End	SC-ES-8535		for Guide Rod	
05/04 →		Track Control Arm		MN-DL-3402	Trailing Arm, Air Suspension Axle;Drive Axle	
05/04 →		Track Control Arm		MN-DL-5225	Trailing Arm, Drive Axle;Air Suspension Axle	
05/04 →		Track Control Arm		MN-DL-8544	Trailing Arm, Drive Axle;Air Suspension Axle	
05/04 →		Track Control Arm		MN-DL-8544	Trailing Arm, Drive Axle;Leaf Spring Axle	
05/04 →		Track control arm		MN-DL-10288	Trailing Arm, 1st RA;2nd RA, for Leaf-Spring Suspension vehicles	
05/04 →		Track control arm		MN-DL-12288	Trailing Arm	
05/04 →		Track Control Arm		MN-VB-5222	Wishbone (CV), 1st RA;2nd RA, for Pneumatic Suspension vehicles	
05/04 →		Track Control Arm		MN-VB-5238	Wishbone (CV), Drive Axle;Air Suspension Axle	
05/04 →		Track Control Arm		MN-VB-8514	Suspension Rod, Wishbone (CV), Drive Axle; Air Suspension Axle	
05/04 →		Track Control Arm		MN-VB-8514	Suspension Rod, Wishbone (CV), Drive Axle; Leaf Spring Axle	
05/04 →		Track Control Arm		MN-VB-8669	Suspension Rod, Wishbone (CV), Drive Axle	
05/04 →		Track Control Arm		MN-VB-8669	Suspension Rod, Wishbone (CV), Drive Axle; Leaf Spring Axle	

CV-ES-0914

Length: 125
Cone Ø: d1 Ø 30 / d2 Ø 27
Thread: M38 x 1,5 RHT
81953016184, 81953016251, 81953016276



CV-ES-14162

Length: 125
Cone Ø: d1 Ø 30 / d2 Ø 27
Thread: M30 x 1,5 LHT
81953010015, 81953010083, 81953010087, 81953016029, 81953016030, 81953016043, 81953016044, 81953016050, 81953016054, 81953016087, 81953016091, 81953016107, 81953016120, 81953016125, 81953016152, 81953016155, 81953016157, 81953016168, 81953016179, 81953016181, 81953016223, 81953016237, 81953016254, 81953016275, 81953016279, 81953016351



CV-ES-14163

Length: 125
Cone Ø: d1 Ø 30 / d2 Ø 27
Thread: M30 x 1,5 RHT
95301.0084, 90804102156, 90804102272, 90804102696, 90804102710, 81953010016, 81953010075, 81953010084, 81953010088, 81953010094, 81953010103, 81953016030, 81953016043, 81953016048, 81953016049, 81953016053, 81953016061, 81953016090, 81953016108, 81953016112, 81953016126, 81953016143, 81953016149, 81953016154, 81953016156, 81953016168, 81953016178, 81953016194, 81953016206, 81953016224, 81953016234, 81953016242, 81953016252, 81953016274, 81953016278, 81953016284, 81953016286, 81953016308, 81953016310, 81953016312, 81953016347, 81953016350, 81953016352, 82953016012, 88953016014, N2953016001



DB-RK-8581

Ø: 85
Hole Distance: 130
Thick/Height: 24
03305800A, 81432706105



MN-DL-3402

Length: 590 Ø: 48
Hole Distance: 130 / 130
03307200A, 81432206067, 81432206068, 81432206090, 81432206092, 81432209092



MN-DL-5225

Length: 572 Ø: 48
Hole Distance: 130 / 130
03301500A, 81432206229, 81432206236, 81432206267, 81432206270, 81432206272, 81432206304, 81432206305, 81432209236, 81432209267, 81432209272



MN-DL-7801

Length: 995 Ø: 52
Cone Ø: d1 Ø 30 / d2 Ø 27
81466106807, 81466106808, 81466116087, 81466116088, 81466116096, 81466116097, 81466116099, 81466116132, 81466116133, 81466116136, 81466116197, 81466116198, 81466116205

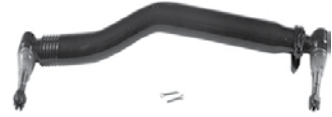

MN-DL-7802

Length: 1680 Ø: 52
Cone Ø: d1 Ø 30 / d2 Ø 27
03208300A, 81467116773, 81467116858, 81467116859, 81467116860, 81467116861, 81467116863, 81467116882, 81467116883, 81467116920, 81467116921



MN-DL-8544

Length: 596 Ø: 48
Hole Distance: 130 / 130
81432206196, 81432206232, 81432206233



MN-DL-8560

Length: 970 Ø: 52
Cone Ø: d1 Ø 30 / d2 Ø 27
03206900A, 81466106809, 81466106810, 81466106823, 81466106838, 81466106839, 81466116104, 81466116105, 81466116107, 81466116134, 81466116135, 81466116137, 81466116199, 81466116200, 81466116206



MN-DL-8609

Length: 585 Ø: 58
Hole Distance: 130 / 130
81432206070, 81432206071, 81432206072, 81432206091, 81432206093, 81432206119



MN-DL-10288

81432206386, 82432206008, 82432209008

No Image

MN-DL-12288

Length: 585 Ø: 58
Hole Distance: 130 / 130
81432206386, 82432206008, 82432209008

No Image

MN-ES-10333

Length: 90
Cone Ø: d1 Ø 38 / d2 Ø 34,35
Thread: M36 x 1,5 RHT
1271126, 3090291, 3099128, 42538048, 81953016268, 82953016018, 82953016019



MN-RK-12436

Ø: 75
Hole Distance: 115
Thick/Height: 24
81432206244



MN-VB-5222

Length: 627 Ø: 50
Hole Distance: 152 / 152
81432706030, 81432706034, 81432706054, 81432706055, 81432706056, 81432706057, 81432706067, 81432706068, 81432706074, 81432706075, 81432706076, 81432706077, 81432706078, 81432706081, 81432706082, 81432709034, 81432709076, 81432709078, 8143706054



MN-VB-5238

Length: 627 Ø: 48
Hole Distance: 130 / 130
81432206221, 81432706096, 81432706114, 81432706116, 81432706121



MN-VB-8514

Length: 627 Ø: 48
Hole Ø 25 / 25 / 25
Hole Distance: 152 / 130 / 130
81432706087, 81432706088, 81432706094, 81432706095, 81432796094



MN-VB-8669

Length: 627 Ø: 48
Hole Ø 25 / 25 / 25
Hole Distance: 152 / 130 / 130
81432706116, 81432706137, 81432706150, 81432706151



MN-VB-9404

Length: 627 Ø: 58
Hole Distance: 130 / 130
81432706117, 81432706152, 81432706153



SC-ES-7279

Length: 150
Cone Ø: d1 Ø 30 / d2 Ø 27
Thread: M30 x 1,5 RHT
81953016288



SC-ES-8517

Length: 140
Cone Ø: d1 Ø 30 / d2 Ø 27
Thread: M30 x 1,5 RHT
81953016286



SC-ES-8535

Length: 145
Cone Ø: d1 Ø 30 / d2 Ø 27
Thread: M30 x 1,5 RHT
81953016271, 81953016325





TGA ...

26.310, 26.320 FDK, FDLK, FDLRK, FDRK ...	05/04 →	Track Control Arm		MN-VB-9404	Wishbone (CV), Drive Axle
	05/04 →	Track Control Arm		MN-VB-9404	Wishbone (CV), Drive Axle; Air Suspension Axle
	05/04 →	Track Control Arm	MN-DL-8663		Control Arm, Air Suspension Axle
26.310, 26.320 FDS, FDLs, FDRS, FNHLS, FDLRS	05/04 → 01/05	Track Control Arm		MN-DL-5212	Trailing Arm, Tag Axle; Air Suspension Axle
	05/04 →	Centre Rod	MN-DL-7801		Push Rod, Leaf Spring Axle
	05/04 →	Centre Rod	MN-DL-8560		Push Rod, Air Suspension Axle
	05/04 →	Suspension Strut Repair Kit		DB-RK-8581	
	05/04 →	Suspension Strut Repair Kit		MN-RK-12436	
	05/04 →	Tie Rod	MN-DL-7802		
	05/04 →	Tie Rod	MN-DL-12284		
	05/04 →	Tie Rod End		IV-ES-8507	Tag Axle
	05/04 →	Tie Rod End		MN-ES-8490	for vehicles with Hinged Trailing Axle
	05/04 →	Tie Rod End		SC-ES-8517	for Push Rod
	05/04 →	Tie Rod End	CV-ES-0914		for Steering Rod
	05/04 →	Tie Rod End	CV-ES-14162	CV-ES-14162	for Steering Rod
	05/04 →	Tie Rod End	CV-ES-14163		for Steering Rod
	05/04 →	Tie Rod End	IV-ES-12272		for Steering Rod
	05/04 →	Tie Rod End	SC-ES-7279		for Steering Rod
	05/04 →	Tie Rod End	SC-ES-8535		for Guide Rod
	05/04 →	Track Control Arm		MN-DL-3402	Trailing Arm, Air Suspension Axle; Drive Axle
	05/04 →	Track Control Arm		MN-DL-5225	Trailing Arm, Drive Axle; Air Suspension Axle
	05/04 →	Track Control Arm		MN-DL-5225	Trailing Arm, Tag Axle; Air Suspension Axle; for vehicles with Hinged Trailing Axle
	05/04 →	Track Control Arm		MN-DL-8544	Trailing Arm, Drive Axle; Air Suspension Axle
	05/04 →	Track Control Arm		MN-DL-8544	Trailing Arm, Drive Axle; Leaf Spring Axle
	05/04 →	Track Control Arm		MN-DL-8709	Trailing Arm, Air Suspension Axle; for vehicles with Hinged Trailing Axle
	05/04 →	Track Control Arm		MN-DL-8733	Trailing Arm, 1st Drive Axle, for Pneumatic Suspension vehicles
	05/04 →	Track control arm		MN-DL-10288	Trailing Arm, 1st RA; 2nd RA, for Leaf-Spring Suspension vehicles
	05/04 →	Track control arm		MN-DL-12288	Trailing Arm
	05/04 →	Track Control Arm		MN-TC-12399	Control Arm
	05/04 →	Track Control Arm		MN-VB-5222	Wishbone (CV), 1st RA; 2nd RA, for Pneumatic Suspension vehicles
	05/04 →	Track Control Arm		MN-VB-5238	Wishbone (CV), Drive Axle; Air Suspension Axle
	05/04 →	Track Control Arm		MN-VB-5238	Wishbone (CV), Drive Axle; Leading Axle; Air Suspension Axle
	05/04 →	Track Control Arm		MN-VB-8514	Suspension Rod, Wishbone (CV), Drive Axle; Air Suspension Axle
	05/04 →	Track Control Arm		MN-VB-8514	Suspension Rod, Wishbone (CV), Drive Axle; Leaf Spring Axle
	05/04 →	Track Control Arm		MN-VB-8669	Suspension Rod, Wishbone (CV), Drive Axle
	05/04 →	Track Control Arm		MN-VB-8669	Suspension Rod, Wishbone (CV), Drive Axle; Leaf Spring Axle
05/04 →	Track Control Arm		MN-VB-9403	Wishbone (CV), Air Suspension Axle	
05/04 →	Track Control Arm		MN-VB-9404	Wishbone (CV), Drive Axle	
05/04 →	Track Control Arm		MN-VB-9404	Wishbone (CV), Drive Axle; Air Suspension Axle	
05/04 →	Track Control Arm	MN-DL-8663		Control Arm, Air Suspension Axle	
01/05 →	Track Control Arm		MN-DL-5225	Trailing Arm, Tag Axle; Air Suspension Axle; for vehicles with Rigid Trailing Axle	
26.310, 26.320 FD-TM, FDR-TM	06/05 →	Centre Rod	MN-DL-7801		Push Rod, Leaf Spring Axle
	06/05 →	Suspension Strut Repair Kit		DB-RK-8581	
	06/05 →	Tie Rod	MN-DL-7802		
	06/05 →	Tie Rod End	CV-ES-0914		for Steering Rod
	06/05 →	Tie Rod End	CV-ES-14162		for Steering Rod
	06/05 →	Tie Rod End	CV-ES-14163		for Steering Rod
	06/05 →	Tie Rod End	SC-ES-7279		for Steering Rod
	06/05 →	Tie Rod End	SC-ES-8517		for Push Rod
	06/05 →	Tie Rod End	SC-ES-8535		for Guide Rod
	06/05 →	Track Control Arm		MN-DL-5225	Trailing Arm
06/05 →	Track Control Arm		MN-DL-8544	Trailing Arm, Drive Axle; Leaf Spring Axle	

CV-ES-0914

Length: 125
Cone Ø: d1 Ø 30 / d2 Ø 27
Thread: M38 x 1,5 RHT
81953016184, 81953016251, 81953016276



CV-ES-14162

Length: 125
Cone Ø: d1 Ø 30 / d2 Ø 27
Thread: M30 x 1,5 LHT
81953010015, 81953010083, 81953010087, 81953016029, 81953016030, 81953016043, 81953016044, 81953016050, 81953016054, 81953016087, 81953016091, 81953016107, 81953016120, 81953016125, 81953016152, 81953016155, 81953016157, 81953016168, 81953016179, 81953016181, 81953016223, 81953016237, 81953016254, 81953016275, 81953016279, 81953016351



CV-ES-14163

Length: 125
Cone Ø: d1 Ø 30 / d2 Ø 27
Thread: M30 x 1,5 RHT
95301.0084, 90804102156, 90804102272, 90804102696, 90804102710, 81953010016, 81953010075, 81953010084, 81953010088, 81953010094, 81953010103, 81953016030, 81953016043, 81953016048, 81953016049, 81953016053, 81953016061, 81953016090, 81953016108, 81953016112, 81953016126, 81953016143, 81953016149, 81953016154, 81953016156, 81953016168, 81953016178, 81953016194, 81953016206, 81953016224, 81953016234, 81953016242, 81953016252, 81953016274, 81953016278, 81953016284, 81953016286, 81953016308, 81953016310, 81953016312, 81953016347, 81953016350, 81953016352, 82953016012, 88953016014, N2953016001



DB-RK-8581

Ø: 85
Hole Distance: 130
Thick/Height: 24
03305800A, 81432706105



IV-ES-8507

Length: 80
Cone Ø: d1 Ø 30 / d2 Ø 27
Thread: M30 x 1,5 RHT
11019869, 12216380, 55175540, 81953016238



IV-ES-12272

Length: 75
Cone Ø: d1 Ø 30 / d2 Ø 27
Thread: M26 x 1,5 RHT
81953016280, 82953010010



MN-DL-3402

Length: 590 Ø: 48
Hole Distance: 130 / 130
03307200A, 81432206067, 81432206068, 81432206090, 81432206092, 81432209092



MN-DL-5212

Length: 577 Ø: 48
Hole Distance: 130 / 130
81432206096, 81432206097, 81432206098, 81432206129, 81432209096, 81432209129, 81432306014, 81432306030



MN-DL-5225

Length: 572 Ø: 48
Hole Distance: 130 / 130
03301500A, 81432206229, 81432206236, 81432206267, 81432206270, 81432206272, 81432206304, 81432206305, 81432209236, 81432209267, 81432209272



MN-DL-7801

Length: 995 Ø: 52
Cone Ø: d1 Ø 30 / d2 Ø 27
81466106807, 81466106808, 81466116087, 81466116088, 81466116096, 81466116097, 81466116099, 81466116132, 81466116133, 81466116136, 81466116197, 81466116198, 81466116205

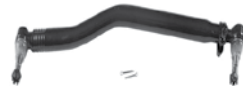

MN-DL-7802

Length: 1680 Ø: 52
Cone Ø: d1 Ø 30 / d2 Ø 27
03208300A, 81467116773, 81467116858, 81467116859, 81467116860, 81467116861, 81467116863, 81467116882, 81467116883, 81467116920, 81467116921



MN-DL-8544

Length: 596 Ø: 48
Hole Distance: 130 / 130
81432206196, 81432206232, 81432206233



MN-DL-8560

Length: 970 Ø: 52
Cone Ø: d1 Ø 30 / d2 Ø 27
03206900A, 81466106809, 81466106810, 81466106823, 81466106838, 81466106839, 81466116104, 81466116105, 81466116107, 81466116134, 81466116135, 81466116137, 81466116199, 81466116200, 81466116206



MN-DL-8663

Length: 947 Ø: 60
Hole Distance: 115 / 115
03307400A, 81432206222, 81432206260, 81432206283, 81432206284



MN-DL-8709

Length: 572 Ø: 52
Hole Distance: 130 / 130
81432206268, 81432206274, 81432206291, 81432206292, 82432206007



MN-DL-8733

Length: 530 Ø: 48
Hole Distance: 130 / 130
81432206161, 81432206190, 81432206358, 81432206359



MN-DL-10288

81432206386, 82432206008, 82432209008

No Image

MN-DL-12284

Length: 1530 Ø: 50
Cone Ø: d1 Ø 30 / d2 Ø 27
81466106579, 81466106580, 81466106624, 81466116720, 81467116720, 81467116730, 81467116952



MN-DL-12288

Length: 585 Ø: 58
Hole Distance: 130 / 130
81432206386, 82432206008, 82432209008

No Image

MN-ES-8490

Length: 90
Cone Ø: d1 Ø 30 / d2 Ø 27
Thread: M26 x 1,5 RHT
14606948, 0014606948, 81953016281, 81953016337, 82953016016



MN-RK-12436

Ø: 75
Hole Distance: 115
Thick/Height: 24
81432206244



MN-TC-12399

Length: 694 Ø: 50
Hole Distance: 130 / 130
81432206265



MN-VB-5222

Length: 627 Ø: 50
Hole Distance: 152 / 152
81432706030, 81432706034, 81432706054, 81432706055, 81432706056, 81432706057, 81432706067, 81432706068, 81432706074, 81432706075, 81432706076, 81432706077, 81432706078, 81432706081, 81432706082, 81432709034, 81432709076, 81432709078, 8143706054



MN-VB-5238

Length: 627 Ø: 48
Hole Distance: 130 / 130
81432206221, 81432706096, 81432706114, 81432706116, 81432706121



MN-VB-8514

Length: 627 Ø: 48
Hole Ø 25 / 25 / 25
Hole Distance: 152 / 130 / 130
81432706087, 81432706088, 81432706094, 81432706095, 81432796094



MN-VB-8669

Length: 627 Ø: 48
Hole Ø 25 / 25 / 25
Hole Distance: 152 / 130 / 130
81432706116, 81432706137, 81432706150, 81432706151



MN-VB-9403

Length: 627 Ø: 48
Hole Ø 25 / 23 / 23
Hole Distance: 152 / 130 / 130
81432706097, 81432706113, 81432706135, 81432706160, 81432706161



MN-VB-9404

Length: 627 Ø: 58
Hole Distance: 130 / 130
81432706117, 81432706152, 81432706153



SC-ES-7279

Length: 150
Cone Ø: d1 Ø 30 / d2 Ø 27
Thread: M30 x 1,5 RHT
81953016288



SC-ES-8517

Length: 140
Cone Ø: d1 Ø 30 / d2 Ø 27
Thread: M30 x 1,5 RHT
81953016286



SC-ES-8535

Length: 145
Cone Ø: d1 Ø 30 / d2 Ø 27
Thread: M30 x 1,5 RHT
81953016271, 81953016325



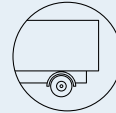

TGA ...

26.310, 26.320 FD-TM, FDR-TM ...	06/05 →	Track control arm		MN-DL-10288	Trailing Arm, 1st RA;2nd RA, for Leaf-Spring Suspension vehicles	
	06/05 →	Track control arm		MN-DL-12288	Trailing Arm	
	06/05 →	Track Control Arm		MN-VB-8514	Suspension Rod, Wishbone (CV), Drive Axle; Leaf Spring Axle	
	06/05 →	Track Control Arm		MN-VB-8669	Suspension Rod, Wishbone (CV), Drive Axle; Leaf Spring Axle	
	06/05 →	Track Control Arm		MN-VB-9404	Wishbone (CV), Drive Axle	
26.310, 26.320 FNLC, FNLLC, FNLLRC, FNLLRW, FNLLW, FNLR	05/04 →01/05	Track Control Arm		MN-DL-5212	Trailing Arm, Tag Axle;Air Suspension Axle	
	05/04 →	Centre Rod	MN-DL-7801		Push Rod	
	05/04 →	Centre Rod	MN-DL-8560		Push Rod, Air Suspension Axle	
	05/04 →	Suspension Strut Repair Kit		CV-RK-5311		
	05/04 →	Suspension Strut Repair Kit		DB-RK-8581		
	05/04 →	Suspension Strut Repair Kit		MN-RK-12436		
	05/04 →	Tie Rod	MN-DL-7802			
	05/04 →	Tie Rod	MN-DL-12284			
	05/04 →	Tie Rod End		IV-ES-8507	Tag Axle	
	05/04 →	Tie Rod End		MN-ES-8490	for vehicles with Hinged Trailing Axle	
	05/04 →	Tie Rod End	CV-ES-0914		for Steering Rod	
	05/04 →	Tie Rod End	CV-ES-14163		for Steering Rod	
	05/04 →	Tie Rod End	IV-ES-12272		for Steering Rod	
	05/04 →	Tie Rod End	SC-ES-7279		for Steering Rod	
	05/04 →	Tie Rod End	SC-ES-8517		for Push Rod	
	05/04 →	Tie Rod End	SC-ES-8535		for Guide Rod	
	05/04 →	Track Control Arm		MN-DL-5225	Trailing Arm, Drive Axle;Air Suspension Axle	
	05/04 →	Track Control Arm		MN-DL-5225	Trailing Arm, Tag Axle;Air Suspension Axle; for vehicles with Hinged Trailing Axle	
	05/04 →	Track Control Arm		MN-DL-8709	Trailing Arm, Air Suspension Axle; for vehicles with Hinged Trailing Axle	
	05/04 →	Track Control Arm		MN-DL-8733	Trailing Arm	
	05/04 →	Track Control Arm		MN-TC-12399	Control Arm	
	05/04 →	Track Control Arm		MN-VB-5238	Wishbone (CV), Drive Axle;Leading Axle; Air Suspension Axle	
	05/04 →	Track Control Arm		MN-VB-9403	Wishbone (CV), Air Suspension Axle	
	05/04 →	Track Control Arm	MN-DL-8663		Control Arm, Air Suspension Axle	
	01/05 →	Track Control Arm		MN-DL-5225	Trailing Arm, Tag Axle;Air Suspension Axle; for vehicles with Rigid Trailing Axle	
	26.310, 26.320 FNLS, FNLLS, FNLLRS, FNLLRS, FPLRS, FPLS	05/04 →01/05	Track Control Arm		MN-DL-5212	Trailing Arm, Tag Axle;Air Suspension Axle
		05/04 →	Centre Rod	MN-DL-7801		Push Rod
05/04 →		Centre Rod	MN-DL-8560		Push Rod, Air Suspension Axle	
05/04 →		Suspension Strut Repair Kit		CV-RK-5311		
05/04 →		Suspension Strut Repair Kit		DB-RK-8581		
05/04 →		Suspension Strut Repair Kit		MN-RK-12436		
05/04 →		Tie Rod	MN-DL-7802			
05/04 →		Tie Rod	MN-DL-12284			
05/04 →		Tie Rod End		IV-ES-8507	Tag Axle	
05/04 →		Tie Rod End		MN-ES-8490	for vehicles with Hinged Trailing Axle	
05/04 →		Tie Rod End	CV-ES-0914		for Steering Rod	
05/04 →		Tie Rod End	CV-ES-14163		for Steering Rod	
05/04 →		Tie Rod End	IV-ES-12272		for Steering Rod	
05/04 →		Tie Rod End	SC-ES-7279		for Steering Rod	
05/04 →		Tie Rod End	SC-ES-8517		for Push Rod	
05/04 →		Tie Rod End	SC-ES-8535		for Guide Rod	
05/04 →		Track Control Arm		MN-DL-5225	Trailing Arm, Drive Axle;Air Suspension Axle	
05/04 →		Track Control Arm		MN-DL-5225	Trailing Arm, Tag Axle;Air Suspension Axle; for vehicles with Hinged Trailing Axle	
05/04 →		Track Control Arm		MN-DL-8709	Trailing Arm, Air Suspension Axle; for vehicles with Hinged Trailing Axle	
05/04 →		Track Control Arm		MN-DL-8733	Trailing Arm	
05/04 →		Track Control Arm		MN-TC-12399	Control Arm	
05/04 →		Track Control Arm		MN-VB-5238	Wishbone (CV), Drive Axle;Leading Axle; Air Suspension Axle	
05/04 →		Track Control Arm		MN-VB-9403	Wishbone (CV), Air Suspension Axle	

CV-ES-0914

Length: 125
Cone Ø: d1 Ø 30 / d2 Ø 27
Thread: M38 x 1,5 RHT
81953016184, 81953016251, 81953016276



CV-ES-14163

Length: 125
Cone Ø: d1 Ø 30 / d2 Ø 27
Thread: M30 x 1,5 RHT
95301.0084, 90804102156, 90804102272, 90804102696, 90804102710, 81953010016, 81953010075, 81953010084, 81953010088, 81953010094, 81953010103, 81953016030, 81953016043, 81953016048, 81953016049, 81953016053, 81953016061, 81953016090, 81953016108, 81953016112, 81953016126, 81953016143, 81953016149, 81953016154, 81953016156, 81953016168, 81953016178, 81953016194, 81953016206, 81953016224, 81953016234, 81953016242, 81953016252, 81953016274, 81953016278, 81953016284, 81953016286, 81953016308, 81953016310, 81953016312, 81953016347, 81953016350, 81953016352, 82953016012, 88953016014, N2953016001



CV-RK-5311

638862, 639287, 938423, 1104335, 1953248, 0003500506, 3500506, 11013547, 42488722, 070550504, 634303610, 81432206055, 81432206073, 82262320660, 5001842823, 7000307001, 8226232066



DB-RK-8581

Ø: 85
Hole Distance: 130
Thick/Height: 24
03305800A, 81432706105



IV-ES-8507

Length: 80
Cone Ø: d1 Ø 30 / d2 Ø 27
Thread: M30 x 1,5 RHT
11019869, 12216380, 55175540, 81953016238



IV-ES-12272

Length: 75
Cone Ø: d1 Ø 30 / d2 Ø 27
Thread: M26 x 1,5 RHT
81953016280, 82953010010



MN-DL-5212

Length: 577 Ø: 48
Hole Distance: 130 / 130
81432206096, 81432206097, 81432206098, 81432206129, 81432209096, 81432209129, 81432306014, 81432306030



MN-DL-5225

Length: 572 Ø: 48
Hole Distance: 130 / 130
03301500A, 81432206229, 81432206236, 81432206267, 81432206270, 81432206272, 81432206304, 81432206305, 81432209236, 81432209267, 81432209272



MN-DL-7801

Length: 995 Ø: 52
Cone Ø: d1 Ø 30 / d2 Ø 27
81466106807, 81466106808, 81466116087, 81466116088, 81466116096, 81466116097, 81466116099, 81466116132, 81466116133, 81466116136, 81466116197, 81466116198, 81466116205

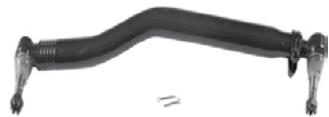

MN-DL-7802

Length: 1680 Ø: 52
Cone Ø: d1 Ø 30 / d2 Ø 27
03208300A, 81467116773, 81467116858, 81467116859, 81467116860, 81467116861, 81467116863, 81467116882, 81467116883, 81467116920, 81467116921



MN-DL-8560

Length: 970 Ø: 52
Cone Ø: d1 Ø 30 / d2 Ø 27
03206900A, 81466106809, 81466106810, 81466106823, 81466106838, 81466106839, 81466116104, 81466116105, 81466116107, 81466116134, 81466116135, 81466116137, 81466116199, 81466116200, 81466116206



MN-DL-8663

Length: 947 Ø: 60
Hole Distance: 115 / 115
03307400A, 81432206222, 81432206260, 81432206283, 81432206284



MN-DL-8709

Length: 572 Ø: 52
Hole Distance: 130 / 130
81432206268, 81432206274, 81432206291, 81432206292, 82432206007



MN-DL-8733

Length: 530 Ø: 48
Hole Distance: 130 / 130
81432206161, 81432206190, 81432206358, 81432206359



MN-DL-10288

81432206386, 82432206008, 82432209008

No Image

MN-DL-12284

Length: 1530 Ø: 50
Cone Ø: d1 Ø 30 / d2 Ø 27
81466106579, 81466106580, 81466106624, 81466116720, 81467116720, 81467116730, 81467116952



MN-DL-12288

Length: 585 Ø: 58
Hole Distance: 130 / 130
81432206386, 82432206008, 82432209008

No Image

MN-ES-8490

Length: 90
Cone Ø: d1 Ø 30 / d2 Ø 27
Thread: M26 x 1,5 RHT
0014606948, 14606948, 81953016281, 81953016337, 82953016016



MN-RK-12436

Ø: 75
Hole Distance: 115
Thick/Height: 24
81432206244



MN-TC-12399

Length: 694 Ø: 50
Hole Distance: 130 / 130
81432206265



MN-VB-5238

Length: 627 Ø: 48
Hole Distance: 130 / 130
81432206221, 81432706096, 81432706114, 81432706116, 81432706121



MN-VB-8514

Length: 627 Ø: 48
Hole Ø 25 / 25 / 25
Hole Distance: 152 / 130 / 130
81432706087, 81432706088, 81432706094, 81432706095, 81432796094



MN-VB-8669

Length: 627 Ø: 48
Hole Ø 25 / 25 / 25
Hole Distance: 152 / 130 / 130
81432706116, 81432706137, 81432706150, 81432706151



MN-VB-9403

Length: 627 Ø: 48
Hole Ø 25 / 23 / 23
Hole Distance: 152 / 130 / 130
81432706097, 81432706113, 81432706135, 81432706160, 81432706161



MN-VB-9404

Length: 627 Ø: 58
Hole Distance: 130 / 130
81432706117, 81432706152, 81432706153



SC-ES-7279

Length: 150
Cone Ø: d1 Ø 30 / d2 Ø 27
Thread: M30 x 1,5 RHT
81953016288



SC-ES-8517

Length: 140
Cone Ø: d1 Ø 30 / d2 Ø 27
Thread: M30 x 1,5 RHT
81953016286



SC-ES-8535

Length: 145
Cone Ø: d1 Ø 30 / d2 Ø 27
Thread: M30 x 1,5 RHT
81953016271, 81953016325





TGA ...

26.310, 26.320 FNLS, FNLLS, FNLRS, FNLLRS, FPLRS, FPLS ...	05/04 →	Track Control Arm	MN-DL-8663		Control Arm, Air Suspension Axle
	01/05 →	Track Control Arm		MN-DL-5225	Trailing Arm, Tag Axle; Air Suspension Axle; for vehicles with Rigid Trailing Axle
26.310, 26.320 FVHL-KO	06/05 →	Centre Rod	MN-DL-7801		Push Rod, Leaf Spring Axle
	06/05 →	Suspension Strut Repair Kit		DB-RK-8581	
	06/05 →	Tie Rod	MN-DL-7802		
	06/05 →	Tie Rod End		SC-ES-8517	for Push Rod
	06/05 →	Tie Rod End	CV-ES-0914		for Steering Rod
	06/05 →	Tie Rod End	CV-ES-14163		for Steering Rod
	06/05 →	Tie Rod End	SC-ES-7279		for Steering Rod
	06/05 →	Tie Rod End	SC-ES-8535		for Guide Rod
	06/05 →	Track Control Arm		MN-DL-5225	Trailing Arm, Drive Axle; Air Suspension Axle
	06/05 →	Track Control Arm		MN-DL-5225	Trailing Arm, Leading Axle; Air Suspension Axle
	06/05 →	Track Control Arm		MN-VB-5238	Wishbone (CV), Drive Axle; Leading Axle; Air Suspension Axle
26.310, 26.320 FVLC	02/04 →	Centre Rod	MN-DL-7801		Push Rod, Leaf Spring Axle
	02/04 →	Suspension Strut Repair Kit		DB-RK-8581	
	02/04 →	Suspension Strut Repair Kit		MN-RK-12436	
	02/04 →	Tie Rod	MN-DL-7802		
	02/04 →	Tie Rod End		SC-ES-8517	for Push Rod
	02/04 →	Tie Rod End	CV-ES-0914		for Steering Rod
	02/04 →	Tie Rod End	CV-ES-14162	CV-ES-14162	for Steering Rod
	02/04 →	Tie Rod End	CV-ES-14163		for Steering Rod
	02/04 →	Tie Rod End	SC-ES-7279		for Steering Rod
	02/04 →	Tie Rod End	SC-ES-8535		for Guide Rod
	02/04 →	Track Control Arm		MN-DL-5212	Trailing Arm, Trailing Axle Steered, for Pneumatic Suspension vehicles
	02/04 →	Track Control Arm		MN-DL-5225	Trailing Arm, Drive Axle; Air Suspension Axle
	02/04 →	Track Control Arm		MN-DL-5225	Trailing Arm, Leading Axle; Air Suspension Axle
	02/04 →	Track Control Arm		MN-DL-8709	Trailing Arm, 1st Drive Axle, for Pneumatic Suspension vehicles
	02/04 →	Track Control Arm		MN-DL-8709	Trailing Arm, Trailing Axle Steered, for Pneumatic Suspension vehicles
	02/04 →	Track Control Arm		MN-DL-8733	Trailing Arm, Air Suspension Axle; Drive Axle
	02/04 →	Track Control Arm		MN-VB-5238	Wishbone (CV), Drive Axle; Air Suspension Axle
	02/04 →	Track Control Arm		MN-VB-5238	Wishbone (CV), Leading Axle; Air Suspension Axle
	02/04 →	Track Control Arm		MN-VB-9403	Wishbone (CV), Trailing Axle Steered, for Pneumatic Suspension vehicles
	26.310, 26.320 FVL-KO	02/04 →	Track Control Arm	MN-DL-8663	
02/04 →		Centre Rod	MN-DL-7801		Push Rod, Leaf Spring Axle
26.320 FDAC, FDH, FDHC	02/04 →	Suspension Strut Repair Kit		DB-RK-8581	
	02/04 →	Tie Rod	MN-DL-7802		
	02/04 →	Tie Rod End		SC-ES-8517	for Push Rod
	02/04 →	Tie Rod End	CV-ES-0914		for Steering Rod
	02/04 →	Tie Rod End	CV-ES-14163		for Steering Rod
	02/04 →	Tie Rod End	SC-ES-7279		for Steering Rod
	02/04 →	Tie Rod End	SC-ES-8535		for Guide Rod
	02/04 →	Track Control Arm		MN-DL-5225	Trailing Arm, Drive Axle; Air Suspension Axle
	02/04 →	Track Control Arm		MN-DL-5225	Trailing Arm, Leading Axle; Air Suspension Axle
	02/04 →	Track Control Arm		MN-DL-8733	Trailing Arm, Air Suspension Axle; Drive Axle
	02/04 →	Track Control Arm		MN-VB-5238	Wishbone (CV), Drive Axle; Air Suspension Axle
	02/04 →	Track Control Arm		MN-VB-5238	Wishbone (CV), Leading Axle; Air Suspension Axle
	06/05 →	Centre Rod	MN-DL-2160		Coupling Rod
	06/05 →	Centre Rod	MN-DL-2174		Push Rod
06/05 →	Suspension Arm Repair Kit		CV-RK-5313	for Wishbone (CV)	
06/05 →	Tie Rod End	CV-ES-0914		for Steering Rod	
06/05 →	Tie Rod End	CV-ES-14162		for Steering Rod	
06/05 →	Tie Rod End	CV-ES-14163		for Steering Rod	
06/05 →	Tie Rod End	MN-ES-10333		for Steering Rod	
06/05 →	Tie Rod End	SC-ES-7279		for Steering Rod	
06/05 →	Tie Rod End	SC-ES-8517		for Push Rod	
06/05 →	Tie Rod End	SC-ES-8535		for Guide Rod	

CV-ES-0914

Length: 125
Cone Ø: d1 Ø 30 / d2 Ø 27
Thread: M38 x 1,5 RHT
81953016184, 81953016251, 81953016276



CV-ES-14162

Length: 125
Cone Ø: d1 Ø 30 / d2 Ø 27
Thread: M30 x 1,5 LHT
81953010015, 81953010083, 81953010087, 81953016029, 81953016030, 81953016043, 81953016044, 81953016050, 81953016054, 81953016087, 81953016091, 81953016107, 81953016120, 81953016125, 81953016152, 81953016155, 81953016157, 81953016168, 81953016179, 81953016181, 81953016223, 81953016237, 81953016254, 81953016275, 81953016279, 81953016351



CV-ES-14163

Length: 125
Cone Ø: d1 Ø 30 / d2 Ø 27
Thread: M30 x 1,5 RHT
95301.0084, 90804102156, 90804102272, 90804102696, 90804102710, 81953010016, 81953010075, 81953010084, 81953010088, 81953010094, 81953010103, 81953016030, 81953016043, 81953016048, 81953016049, 81953016053, 81953016061, 81953016090, 81953016108, 81953016112, 81953016126, 81953016143, 81953016149, 81953016154, 81953016156, 81953016168, 81953016178, 81953016194, 81953016206, 81953016224, 81953016234, 81953016242, 81953016252, 81953016274, 81953016278, 81953016284, 81953016286, 81953016308, 81953016310, 81953016312, 81953016347, 81953016350, 81953016352, 82953016012, 88953016014, N2953016001



CV-RK-5313

Ø: 90
03304800A, 81953016132



DB-RK-8581

Ø: 85
Hole Distance: 130
Thick/Height: 24
03305800A, 81432706105



MN-DL-2160

Length: 1652 Ø: 50
Cone Ø: d1 Ø 30 / d2 Ø 27
81467106112, 81467106163, 81467106165, 81467106198, 81467106353, 81467106354, 81467106361, 81467116725



MN-DL-2174

Length: 1588 Ø: 52
Cone Ø: d1 Ø 30 / d2 Ø 27
81467106378, 81467106912



MN-DL-5212

Length: 577 Ø: 48
Hole Distance: 130 / 130
81432206096, 81432206097, 81432206098, 81432206129, 81432209096, 81432209129, 81432306014, 81432306030



MN-DL-5225

Length: 572 Ø: 48
Hole Distance: 130 / 130
03301500A, 81432206229, 81432206236, 81432206267, 81432206270, 81432206272, 81432206304, 81432206305, 81432209236, 81432209267, 81432209272



MN-DL-7801

Length: 995 Ø: 52
Cone Ø: d1 Ø 30 / d2 Ø 27
81466106807, 81466106808, 81466116087, 81466116088, 81466116096, 81466116097, 81466116099, 81466116132, 81466116133, 81466116136, 81466116197, 81466116198, 81466116205



MN-DL-7802

Length: 1680 Ø: 52
Cone Ø: d1 Ø 30 / d2 Ø 27
03208300A, 81467116773, 81467116858, 81467116859, 81467116860, 81467116861, 81467116863, 81467116882, 81467116883, 81467116920, 81467116921



MN-DL-8663

Length: 947 Ø: 60
Hole Distance: 115 / 115
03307400A, 81432206222, 81432206260, 81432206283, 81432206284



MN-DL-8709

Length: 572 Ø: 52
Hole Distance: 130 / 130
81432206268, 81432206274, 81432206291, 81432206292, 82432206007



MN-DL-8733

Length: 530 Ø: 48
Hole Distance: 130 / 130
81432206161, 81432206190, 81432206358, 81432206359



MN-ES-10333

Length: 90
Cone Ø: d1 Ø 38 / d2 Ø 34,35
Thread: M36 x 1,5 RHT
1271126, 3090291, 3099128, 42538048, 81953016268, 82953016018, 82953016019



MN-RK-12436

Ø: 75
Hole Distance: 115
Thick/Height: 24
81432206244



MN-VB-5238

Length: 627 Ø: 48
Hole Distance: 130 / 130
81432206221, 81432706096, 81432706114, 81432706116, 81432706121



MN-VB-9403

Length: 627 Ø: 48
Hole Ø 25 / 23 / 23
Hole Distance: 152 / 130 / 130
81432706097, 81432706113, 81432706135, 81432706160, 81432706161



SC-ES-7279

Length: 150
Cone Ø: d1 Ø 30 / d2 Ø 27
Thread: M30 x 1,5 RHT
81953016288



SC-ES-8517

Length: 140
Cone Ø: d1 Ø 30 / d2 Ø 27
Thread: M30 x 1,5 RHT
81953016286



SC-ES-8535

Length: 145
Cone Ø: d1 Ø 30 / d2 Ø 27
Thread: M30 x 1,5 RHT
81953016271, 81953016325





TGA ...

26.320 FDAK, FDH, FDHC ...	06/05→	Track Control Arm		MN-DL-8609	Trailing Arm, 1st RA;2nd RA, for Leaf-Spring Suspension vehicles, →Type_HB Chassis
	06/05→	Track control arm		MN-DL-10288	Trailing Arm, 1st RA;2nd RA, for Leaf-Spring Suspension vehicles, →Type HB
	06/05→	Track control arm		MN-DL-12288	Trailing Arm
	06/05→	Track Control Arm		MN-VB-8514	Suspension Rod, Wishbone (CV)
	06/05→	Track Control Arm		MN-VB-8669	Suspension Rod, Wishbone (CV), 1st RA; 2nd RA, for Leaf-Spring Suspension vehicles, →Type_MHB Chassis
	06/05→	Track Control Arm		MN-VB-9404	Wishbone (CV), 1st RA;2nd RA, for Leaf-Spring Suspension vehicles, →Type_HB Chassis
26.320 FDAK, FDHK	04/06→	Centre Rod	MN-DL-2160		Coupling Rod
	04/06→	Centre Rod	MN-DL-2174		Push Rod
	04/06→	Suspension Arm Repair Kit		CV-RK-5313	for Wishbone (CV)
	04/06→	Tie Rod End	CV-ES-0914		for Steering Rod
	04/06→	Tie Rod End	CV-ES-14162		for Steering Rod
	04/06→	Tie Rod End	CV-ES-14163		for Steering Rod
	04/06→	Tie Rod End	MN-ES-10333		for Steering Rod
	04/06→	Tie Rod End	SC-ES-7279		for Steering Rod
	04/06→	Tie Rod End	SC-ES-8517		for Push Rod
	04/06→	Tie Rod End	SC-ES-8535		for Guide Rod
	04/06→	Track Control Arm		MN-DL-8609	Trailing Arm, 1st RA;2nd RA, for Leaf-Spring Suspension vehicles, →Type_HB Chassis
	04/06→	Track control arm		MN-DL-10288	Trailing Arm, 1st RA;2nd RA, for Leaf-Spring Suspension vehicles, →Type HB
	04/06→	Track control arm		MN-DL-12288	Trailing Arm
	04/06→	Track Control Arm		MN-VB-8514	Suspension Rod, Wishbone (CV)
	04/06→	Track Control Arm		MN-VB-8669	Suspension Rod, Wishbone (CV), 1st RA; 2nd RA, for Leaf-Spring Suspension vehicles, →Type_MHB Chassis
	04/06→	Track Control Arm		MN-VB-9404	Wishbone (CV), 1st RA;2nd RA, for Leaf-Spring Suspension vehicles, →Type_HB
26.320 FDAS, FDHS	04/06→	Centre Rod	MN-DL-2160		Coupling Rod
	04/06→	Centre Rod	MN-DL-2174		Push Rod
	04/06→	Suspension Arm Repair Kit		CV-RK-5313	for Wishbone (CV)
	04/06→	Tie Rod End	CV-ES-0914		for Steering Rod
	04/06→	Tie Rod End	CV-ES-14162		for Steering Rod
	04/06→	Tie Rod End	CV-ES-14163		for Steering Rod
	04/06→	Tie Rod End	MN-ES-10333		for Steering Rod
	04/06→	Tie Rod End	SC-ES-7279		for Steering Rod
	04/06→	Tie Rod End	SC-ES-8517		for Push Rod
	04/06→	Tie Rod End	SC-ES-8535		for Guide Rod
	04/06→	Track Control Arm		MN-DL-8609	Trailing Arm, 1st RA;2nd RA, for Leaf-Spring Suspension vehicles, →Type_HB Chassis
	04/06→	Track control arm		MN-DL-10288	Trailing Arm, 1st RA;2nd RA, for Leaf-Spring Suspension vehicles, →Type HB
	04/06→	Track control arm		MN-DL-12288	Trailing Arm
	04/06→	Track Control Arm		MN-VB-8514	Suspension Rod, Wishbone (CV)
	04/06→	Track Control Arm		MN-VB-8669	Suspension Rod, Wishbone (CV), 1st RA; 2nd RA, for Leaf-Spring Suspension vehicles, →Type_MHB Chassis
	04/06→	Track Control Arm		MN-VB-9404	Wishbone (CV), 1st RA;2nd RA, for Leaf-Spring Suspension vehicles, →Type_HB
26.330 FNLC, FNLLC, FNLLW	11/02→	Ball Head, gearshift linkage	CV-ES-2120		
	11/02→	Centre Rod	MN-DL-7801		Push Rod, Leaf Spring Axle
	11/02→	Centre Rod	MN-DL-8560		Push Rod, Air Suspension Axle
	11/02→	Suspension Strut Repair Kit		DB-RK-8581	
	11/02→	Suspension Strut Repair Kit		MN-RK-12436	
	11/02→	Tie Rod	MN-DL-7802		
	11/02→	Tie Rod	MN-DL-12284		
	11/02→	Tie Rod End	CV-ES-0914		for Steering Rod
	11/02→	Tie Rod End	CV-ES-14162	CV-ES-14162	for Steering Rod
	11/02→	Tie Rod End	CV-ES-14163		for Steering Rod
	11/02→	Tie Rod End	CV-ES-14163		for Steering Rod

CV-ES-0914

Length: 125
Cone Ø: d1 Ø 30 / d2 Ø 27
Thread: M38 x 1,5 RHT
81953016184, 81953016251, 81953016276



CV-ES-2120

Length: 115
Cone Ø: d1 Ø 12,4 / d2 Ø 10,8
Thread: M14 x 1,5 RHT
03008500A, 81953016200, 81953016202,
81953016203, 81953016227



CV-ES-14162

Length: 125
Cone Ø: d1 Ø 30 / d2 Ø 27
Thread: M30 x 1,5 LHT
81953010015, 81953010083, 81953010087,
81953016029, 81953016030, 81953016043,
81953016044, 81953016050, 81953016054,
81953016087, 81953016091, 81953016107,
81953016120, 81953016125, 81953016152,
81953016155, 81953016157, 81953016168,
81953016179, 81953016181, 81953016223,
81953016237, 81953016254, 81953016275,
81953016279, 81953016351

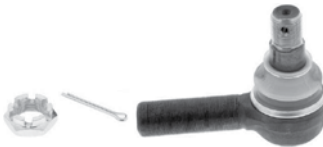

CV-ES-14163

Length: 125
Cone Ø: d1 Ø 30 / d2 Ø 27
Thread: M30 x 1,5 RHT
95301.0084, 90804102156, 90804102272,
90804102696, 90804102710, 81953010016,
81953010075, 81953010084, 81953010088,
81953010094, 81953010103, 81953016030,
81953016043, 81953016048, 81953016049,
81953016053, 81953016061, 81953016090,
81953016108, 81953016112, 81953016126,
81953016143, 81953016149, 81953016154,
81953016156, 81953016168, 81953016178,
81953016194, 81953016206, 81953016224,
81953016234, 81953016242, 81953016252,
81953016274, 81953016278, 81953016284,
81953016286, 81953016308, 81953016310,
81953016312, 81953016347, 81953016350,
81953016352, 82953016012, 88953016014,
N2953016001



CV-RK-5313

Ø: 90
03304800A, 81953016132



DB-RK-8581

Ø: 85
Hole Distance: 130
Thick/Height: 24
03305800A, 81432706105



MN-DL-2160

Length: 1652 Ø: 50
Cone Ø: d1 Ø 30 / d2 Ø 27
81467106112, 81467106163, 81467106165,
81467106198, 81467106353, 81467106354,
81467106361, 81467116725



MN-DL-2174

Length: 1588 Ø: 52
Cone Ø: d1 Ø 30 / d2 Ø 27
81467106378, 81467106912



MN-DL-7801

Length: 995 Ø: 52
Cone Ø: d1 Ø 30 / d2 Ø 27
81466106807, 81466106808, 81466116087,
81466116088, 81466116096, 81466116097,
81466116099, 81466116132, 81466116133,
81466116136, 81466116197, 81466116198,
81466116205

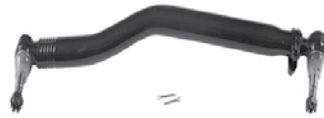

MN-DL-7802

Length: 1680 Ø: 52
Cone Ø: d1 Ø 30 / d2 Ø 27
03208300A, 81467116773, 81467116858,
81467116859, 81467116860, 81467116861,
81467116863, 81467116882, 81467116883,
81467116920, 81467116921



MN-DL-8560

Length: 970 Ø: 52
Cone Ø: d1 Ø 30 / d2 Ø 27
03206900A, 81466106809, 81466106810,
81466106823, 81466106838, 81466106839,
81466116104, 81466116105, 81466116107,
81466116134, 81466116135, 81466116137,
81466116199, 81466116200, 81466116206



MN-DL-8609

Length: 585 Ø: 58
Hole Distance: 130 / 130
81432206070, 81432206071, 81432206072,
81432206091, 81432206093, 81432206119



MN-DL-10288

81432206386, 82432206008, 82432209008

No Image

MN-DL-12284

Length: 1530 Ø: 50
Cone Ø: d1 Ø 30 / d2 Ø 27
81466106579, 81466106580, 81466106624,
81466116720, 81467116720, 81467116730,
81467116952



MN-DL-12288

Length: 585 Ø: 58
Hole Distance: 130 / 130
81432206386, 82432206008, 82432209008

No Image

MN-ES-10333

Length: 90
Cone Ø: d1 Ø 38 / d2 Ø 34,35
Thread: M36 x 1,5 RHT
1271126, 3090291, 3099128, 42538048,
81953016268, 82953016018, 82953016019



MN-RK-12436

Ø: 75
Hole Distance: 115
Thick/Height: 24
81432206244



MN-VB-8514

Length: 627 Ø: 48
Hole Ø 25 / 25 / 25
Hole Distance: 152 / 130 / 130
81432706087, 81432706088, 81432706094,
81432706095, 81432796094



MN-VB-8669

Length: 627 Ø: 48
Hole Ø 25 / 25 / 25
Hole Distance: 152 / 130 / 130
81432706116, 81432706137, 81432706150,
81432706151



MN-VB-9404

Length: 627 Ø: 58
Hole Distance: 130 / 130
81432706117, 81432706152, 81432706153



SC-ES-7279

Length: 150
Cone Ø: d1 Ø 30 / d2 Ø 27
Thread: M30 x 1,5 RHT
81953016288



SC-ES-8517

Length: 140
Cone Ø: d1 Ø 30 / d2 Ø 27
Thread: M30 x 1,5 RHT
81953016286



SC-ES-8535

Length: 145
Cone Ø: d1 Ø 30 / d2 Ø 27
Thread: M30 x 1,5 RHT
81953016271, 81953016325





TGA ...

26.330 FNLC, FNLLC, FNLLW ...	11/02→	Tie Rod End	SC-ES-7279		for Steering Rod	
	11/02→	Tie Rod End	SC-ES-8517		for Push Rod	
	11/02→	Tie Rod End	SC-ES-8535		for Guide Rod	
	11/02→	Track Control Arm		MN-DL-5212	Trailing Arm, Tag Axle;Air Suspension Axle	
	11/02→	Track Control Arm		MN-DL-5225	Trailing Arm, Drive Axle;Air Suspension Axle	
	11/02→	Track Control Arm		MN-DL-5225	Trailing Arm, Leading Axle;Air Suspension Axle	
	11/02→	Track Control Arm		MN-DL-8709	Trailing Arm, Air Suspension Axle; for vehicles with Hinged Trailing Axle	
	11/02→	Track Control Arm		MN-VB-5238	Wishbone (CV), Drive Axle;Leading Axle; Air Suspension Axle	
	11/02→	Track Control Arm		MN-VB-9403	Wishbone (CV), Air Suspension Axle	
	11/02→	Track Control Arm	MN-DL-8663		Control Arm, Air Suspension Axle	
	26.350 FDAC, FDHC	02/04→	Centre Rod	MN-DL-2160		Coupling Rod
		02/04→	Centre Rod	MN-DL-2174		Push Rod
		02/04→	Suspension Arm Repair Kit		CV-RK-5313	for Wishbone (CV)
		02/04→	Tie Rod End	CV-ES-0914		for Steering Rod
		02/04→	Tie Rod End	CV-ES-14162		for Steering Rod
02/04→		Tie Rod End	CV-ES-14163		for Steering Rod	
02/04→		Tie Rod End	MN-ES-10333		for Steering Rod	
02/04→		Tie Rod End	SC-ES-7279		for Steering Rod	
02/04→		Tie Rod End	SC-ES-8517		for Push Rod	
02/04→		Tie Rod End	SC-ES-8535		for Guide Rod	
02/04→		Track Control Arm		MN-DL-8609	Trailing Arm, 1st RA;2nd RA, for Leaf-Spring Suspension vehicles, →Type_HB Chassis	
02/04→		Track control arm		MN-DL-10288	Trailing Arm, 1st RA;2nd RA, for Leaf-Spring Suspension vehicles, →Type HB	
02/04→		Track control arm		MN-DL-12288	Trailing Arm	
02/04→		Track Control Arm		MN-VB-8514	Suspension Rod, Wishbone (CV)	
02/04→		Track Control Arm		MN-VB-8669	Suspension Rod, Wishbone (CV), 1st RA; 2nd RA, for Leaf-Spring Suspension vehicles, →Type_MHB Chassis	
26.350 FDAK	02/04→	Centre Rod	MN-DL-2160		Coupling Rod	
	02/04→	Centre Rod	MN-DL-2174		Push Rod	
	02/04→	Suspension Arm Repair Kit		CV-RK-5313	for Wishbone (CV)	
	02/04→	Tie Rod End	CV-ES-0914		for Steering Rod	
	02/04→	Tie Rod End	CV-ES-14162		for Steering Rod	
	02/04→	Tie Rod End	CV-ES-14163		for Steering Rod	
	02/04→	Tie Rod End	MN-ES-10333		for Steering Rod	
	02/04→	Tie Rod End	SC-ES-7279		for Steering Rod	
	02/04→	Tie Rod End	SC-ES-8517		for Push Rod	
	02/04→	Tie Rod End	SC-ES-8535		for Guide Rod	
	02/04→	Track Control Arm		MN-DL-8609	Trailing Arm, 1st RA;2nd RA, for Leaf-Spring Suspension vehicles, →Type_HB Chassis	
	02/04→	Track control arm		MN-DL-10288	Trailing Arm, 1st RA;2nd RA, for Leaf-Spring Suspension vehicles, →Type HB	
	02/04→	Track control arm		MN-DL-12288	Trailing Arm	
	02/04→	Track Control Arm		MN-VB-8514	Suspension Rod, Wishbone (CV)	
	02/04→	Track Control Arm		MN-VB-8669	Suspension Rod, Wishbone (CV), 1st RA; 2nd RA, for Leaf-Spring Suspension vehicles, →Type_MHB Chassis	
26.350 FDAS, FDHS	02/04→	Centre Rod	MN-DL-2160		Coupling Rod	
	02/04→	Centre Rod	MN-DL-2174		Push Rod	
	02/04→	Suspension Arm Repair Kit		CV-RK-5313	for Wishbone (CV)	
	02/04→	Tie Rod End	CV-ES-0914		for Steering Rod	
	02/04→	Tie Rod End	CV-ES-14162		for Steering Rod	
	02/04→	Tie Rod End	CV-ES-14163		for Steering Rod	
	02/04→	Tie Rod End	MN-ES-10333		for Steering Rod	
	02/04→	Tie Rod End	SC-ES-7279		for Steering Rod	
	02/04→	Tie Rod End	SC-ES-8517		for Push Rod	

CV-ES-0914

Length: 125
Cone Ø: d1 Ø 30 / d2 Ø 27
Thread: M38 x 1,5 RHT
81953016184, 81953016251, 81953016276



CV-ES-14162

Length: 125
Cone Ø: d1 Ø 30 / d2 Ø 27
Thread: M30 x 1,5 LHT
81953010015, 81953010083, 81953010087, 81953016029, 81953016030, 81953016043, 81953016044, 81953016050, 81953016054, 81953016087, 81953016091, 81953016107, 81953016120, 81953016125, 81953016152, 81953016155, 81953016157, 81953016168, 81953016179, 81953016181, 81953016223, 81953016237, 81953016254, 81953016275, 81953016279, 81953016351



CV-ES-14163

Length: 125
Cone Ø: d1 Ø 30 / d2 Ø 27
Thread: M30 x 1,5 RHT
95301.0084, 90804102156, 90804102272, 90804102696, 90804102710, 81953010016, 81953010075, 81953010084, 81953010088, 81953010094, 81953010103, 81953016030, 81953016043, 81953016048, 81953016049, 81953016053, 81953016061, 81953016090, 81953016108, 81953016112, 81953016126, 81953016143, 81953016149, 81953016154, 81953016156, 81953016168, 81953016178, 81953016194, 81953016206, 81953016224, 81953016234, 81953016242, 81953016252, 81953016274, 81953016278, 81953016284, 81953016286, 81953016308, 81953016310, 81953016312, 81953016347, 81953016350, 81953016352, 82953016012, 88953016014, N2953016001



CV-RK-5313

Ø: 90
03304800A, 81953016132



MN-DL-2160

Length: 1652 Ø: 50
Cone Ø: d1 Ø 30 / d2 Ø 27
81467106112, 81467106163, 81467106165, 81467106198, 81467106353, 81467106354, 81467106361, 81467116725



MN-DL-2174

Length: 1588 Ø: 52
Cone Ø: d1 Ø 30 / d2 Ø 27
81467106378, 81467106912



MN-DL-5212

Length: 577 Ø: 48
Hole Distance: 130 / 130
81432206096, 81432206097, 81432206098, 81432206129, 81432209096, 81432209129, 81432306014, 81432306030



MN-DL-5225

Length: 572 Ø: 48
Hole Distance: 130 / 130
03301500A, 81432206229, 81432206236, 81432206267, 81432206270, 81432206272, 81432206304, 81432206305, 81432209236, 81432209267, 81432209272



MN-DL-8609

Length: 585 Ø: 58
Hole Distance: 130 / 130
81432206070, 81432206071, 81432206072, 81432206091, 81432206093, 81432206119



MN-DL-8663

Length: 947 Ø: 60
Hole Distance: 115 / 115
03307400A, 81432206222, 81432206260, 81432206283, 81432206284



MN-DL-8709

Length: 572 Ø: 52
Hole Distance: 130 / 130
81432206268, 81432206274, 81432206291, 81432206292, 82432206007



MN-DL-10288

81432206386, 82432206008, 82432209008

No Image

MN-DL-12288

Length: 585 Ø: 58
Hole Distance: 130 / 130
81432206386, 82432206008, 82432209008

No Image

MN-ES-10333

Length: 90
Cone Ø: d1 Ø 38 / d2 Ø 34,35
Thread: M36 x 1,5 RHT
1271126, 3090291, 3099128, 42538048, 81953016268, 82953016018, 82953016019



MN-VB-5238

Length: 627 Ø: 48
Hole Distance: 130 / 130
81432206221, 81432706096, 81432706114, 81432706116, 81432706121



MN-VB-8514

Length: 627 Ø: 48
Hole Ø 25 / 25 / 25
Hole Distance: 152 / 130 / 130
81432706087, 81432706088, 81432706094, 81432706095, 81432796094



MN-VB-8669

Length: 627 Ø: 48
Hole Ø 25 / 25 / 25
Hole Distance: 152 / 130 / 130
81432706116, 81432706137, 81432706150, 81432706151



MN-VB-9403

Length: 627 Ø: 48
Hole Ø 25 / 23 / 23
Hole Distance: 152 / 130 / 130
81432706097, 81432706113, 81432706135, 81432706160, 81432706161



MN-VB-9404

Length: 627 Ø: 58
Hole Distance: 130 / 130
81432706117, 81432706152, 81432706153



SC-ES-7279

Length: 150
Cone Ø: d1 Ø 30 / d2 Ø 27
Thread: M30 x 1,5 RHT
81953016288



SC-ES-8517

Length: 140
Cone Ø: d1 Ø 30 / d2 Ø 27
Thread: M30 x 1,5 RHT
81953016286



SC-ES-8535

Length: 145
Cone Ø: d1 Ø 30 / d2 Ø 27
Thread: M30 x 1,5 RHT
81953016271, 81953016325



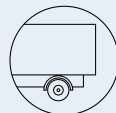

TGA ...

26.350 FDAS, FDHS ...	02/04 →	Tie Rod End	SC-ES-8535		for Guide Rod	
	02/04 →	Track Control Arm		MN-DL-8609	Trailing Arm, 1st RA;2nd RA, for Leaf-Spring Suspension vehicles, →Type_HB Chassis	
	02/04 →	Track control arm		MN-DL-10288	Trailing Arm, 1st RA;2nd RA, for Leaf-Spring Suspension vehicles, →Type HB	
	02/04 →	Track control arm		MN-DL-12288	Trailing Arm	
	02/04 →	Track Control Arm		MN-VB-8514	Suspension Rod, Wishbone (CV)	
	02/04 →	Track Control Arm		MN-VB-8669	Suspension Rod, Wishbone (CV), 1st RA; 2nd RA, for Leaf-Spring Suspension vehicles, →Type_MHB Chassis	
	02/04 →	Track Control Arm		MN-VB-9404	Wishbone (CV), 1st RA;2nd RA, for Leaf-Spring Suspension vehicles, →Type_HB	
26.350 FDHC, FDHC/M	04/05 →	Centre Rod	MN-DL-7801		Push Rod, Leaf Spring Axle	
	04/05 →	Suspension Strut Repair Kit		DB-RK-8581		
	04/05 →	Tie Rod	MN-DL-7802			
	04/05 →	Tie Rod End	CV-ES-0914		for Steering Rod	
	04/05 →	Tie Rod End	CV-ES-14162		for Steering Rod	
	04/05 →	Tie Rod End	CV-ES-14163		for Steering Rod	
	04/05 →	Tie Rod End	MN-ES-10333		for Steering Rod	
	04/05 →	Tie Rod End	SC-ES-7279		for Steering Rod	
	04/05 →	Tie Rod End	SC-ES-8517		for Push Rod	
	04/05 →	Tie Rod End	SC-ES-8535		for Guide Rod	
	04/05 →	Track Control Arm		MN-DL-5225	Trailing Arm	
	04/05 →	Track Control Arm		MN-DL-8544	Trailing Arm, 1st RA;2nd RA;Leaf Spring Axle	
	04/05 →	Track Control Arm		MN-DL-8609	Trailing Arm, 1st RA;2nd RA, for Leaf-Spring Suspension vehicles, →Type_HB Chassis	
	04/05 →	Track Control Arm		MN-VB-8514	Suspension Rod, Wishbone (CV), Drive Axle; Leaf Spring Axle	
	04/05 →	Track Control Arm		MN-VB-8669	Suspension Rod, Wishbone (CV), Drive Axle; Leaf Spring Axle	
04/05 →	Track Control Arm		MN-VB-9404	Wishbone (CV), 1st RA;2nd RA, for Leaf-Spring Suspension vehicles, →Type_HB Chassis		
26.350 FDLRC-WW	05/04 →	Centre Rod	MN-DL-7801		Push Rod, Leaf Spring Axle	
	05/04 →	Suspension Strut Repair Kit		DB-RK-8581		
	05/04 →	Tie Rod	MN-DL-7802			
	05/04 →	Tie Rod End	CV-ES-0914		for Steering Rod	
	05/04 →	Tie Rod End	CV-ES-14162		for Steering Rod	
	05/04 →	Tie Rod End	CV-ES-14163		for Steering Rod	
	05/04 →	Tie Rod End	SC-ES-7279		for Steering Rod	
	05/04 →	Tie Rod End	SC-ES-8517		for Push Rod	
	05/04 →	Tie Rod End	SC-ES-8535		for Guide Rod	
	05/04 →	Track Control Arm		MN-DL-5225	Trailing Arm	
	05/04 →	Track Control Arm		MN-DL-8733	Trailing Arm, 1st Drive Axle, for Pneumatic Suspension vehicles	
	05/04 →	Track Control Arm		MN-VB-5222	Wishbone (CV), 1st RA;2nd RA, for Pneumatic Suspension vehicles	
	05/04 →	Track Control Arm		MN-VB-8669	Suspension Rod, Wishbone (CV), 1st RA; 2nd RA, for Leaf-Spring Suspension vehicles, →Type_MHB Chassis	
	26.350 FDLs, FDLRS, FDLRS/M, FDLRS-WW	05/04 →	Centre Rod	MN-DL-7801		Push Rod, Leaf Spring Axle
		05/04 →	Suspension Strut Repair Kit		DB-RK-8581	
05/04 →		Tie Rod	MN-DL-7802			
05/04 →		Tie Rod	MN-DL-12293			
05/04 →		Tie Rod End	CV-ES-0914		for Steering Rod	
05/04 →		Tie Rod End	CV-ES-14162		for Steering Rod	
05/04 →		Tie Rod End	CV-ES-14163		for Steering Rod	
05/04 →		Tie Rod End	SC-ES-7279		for Steering Rod	
05/04 →		Tie Rod End	SC-ES-8517		for Push Rod	
05/04 →		Tie Rod End	SC-ES-8535		for Guide Rod	
05/04 →		Track Control Arm		MN-DL-5225	Trailing Arm	
05/04 →		Track Control Arm		MN-DL-8733	Trailing Arm, 1st Drive Axle, for Pneumatic Suspension vehicles	

CV-ES-0914

Length: 125
Cone Ø: d1 Ø 30 / d2 Ø 27
Thread: M38 x 1,5 RHT
81953016184, 81953016251, 81953016276



CV-ES-14162

Length: 125
Cone Ø: d1 Ø 30 / d2 Ø 27
Thread: M30 x 1,5 LHT
81953010015, 81953010083, 81953010087, 81953016029, 81953016030, 81953016043, 81953016044, 81953016050, 81953016054, 81953016087, 81953016091, 81953016107, 81953016120, 81953016125, 81953016152, 81953016155, 81953016157, 81953016168, 81953016179, 81953016181, 81953016223, 81953016237, 81953016254, 81953016275, 81953016279, 81953016351

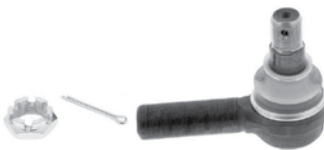

CV-ES-14163

Length: 125
Cone Ø: d1 Ø 30 / d2 Ø 27
Thread: M30 x 1,5 RHT
95301.0084, 90804102156, 90804102272, 90804102696, 90804102710, 81953010016, 81953010075, 81953010084, 81953010088, 81953010094, 81953010103, 81953016030, 81953016043, 81953016048, 81953016049, 81953016053, 81953016061, 81953016090, 81953016108, 81953016112, 81953016126, 81953016143, 81953016149, 81953016154, 81953016156, 81953016168, 81953016178, 81953016194, 81953016206, 81953016224, 81953016234, 81953016242, 81953016252, 81953016274, 81953016278, 81953016284, 81953016286, 81953016308, 81953016310, 81953016312, 81953016347, 81953016350, 81953016352, 82953016012, 88953016014, N2953016001



DB-RK-8581

Ø: 85
Hole Distance: 130
Thick/Height: 24
03305800A, 81432706105



MN-DL-5225

Length: 572 Ø: 48
Hole Distance: 130 / 130
03301500A, 81432206229, 81432206236, 81432206267, 81432206270, 81432206272, 81432206304, 81432206305, 81432209236, 81432209267, 81432209272



MN-DL-7801

Length: 995 Ø: 52
Cone Ø: d1 Ø 30 / d2 Ø 27
81466106807, 81466106808, 81466116087, 81466116088, 81466116096, 81466116097, 81466116099, 81466116132, 81466116133, 81466116136, 81466116197, 81466116198, 81466116205

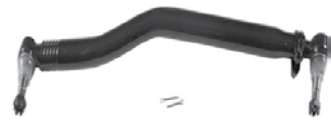

MN-DL-7802

Length: 1680 Ø: 52
Cone Ø: d1 Ø 30 / d2 Ø 27
03208300A, 81467116773, 81467116858, 81467116859, 81467116860, 81467116861, 81467116863, 81467116882, 81467116883, 81467116920, 81467116921



MN-DL-8544

Length: 596 Ø: 48
Hole Distance: 130 / 130
81432206196, 81432206232, 81432206233



MN-DL-8609

Length: 585 Ø: 58
Hole Distance: 130 / 130
81432206070, 81432206071, 81432206072, 81432206091, 81432206093, 81432206119



MN-DL-8733

Length: 530 Ø: 48
Hole Distance: 130 / 130
81432206161, 81432206190, 81432206358, 81432206359



MN-DL-10288

81432206386, 82432206008, 82432209008

No Image

MN-DL-12288

Length: 585 Ø: 58
Hole Distance: 130 / 130
81432206386, 82432206008, 82432209008

No Image

MN-DL-12293

Length: 1680 Ø: 42
Cone Ø: d1 Ø 30 / d2 Ø 27
81467106236, 81467106268, 81467106356, 81467116356, 81467116723, 81467116794, 81467116933, 81467116934, 81467116966



MN-ES-10333

Length: 90
Cone Ø: d1 Ø 38 / d2 Ø 34,35
Thread: M36 x 1,5 RHT
1271126, 3090291, 3099128, 42538048, 81953016268, 82953016018, 82953016019



MN-VB-5222

Length: 627 Ø: 50
Hole Distance: 152 / 152
81432706030, 81432706034, 81432706054, 81432706055, 81432706056, 81432706057, 81432706067, 81432706068, 81432706074, 81432706075, 81432706076, 81432706077, 81432706078, 81432706081, 81432706082, 81432709034, 81432709076, 81432709078, 8143706054



MN-VB-8514

Length: 627 Ø: 48
Hole Ø 25 / 25 / 25
Hole Distance: 152 / 130 / 130
81432706087, 81432706088, 81432706094, 81432706095, 81432796094



MN-VB-8669

Length: 627 Ø: 48
Hole Ø 25 / 25 / 25
Hole Distance: 152 / 130 / 130
81432706116, 81432706137, 81432706150, 81432706151



MN-VB-9404

Length: 627 Ø: 58
Hole Distance: 130 / 130
81432706117, 81432706152, 81432706153



SC-ES-7279

Length: 150
Cone Ø: d1 Ø 30 / d2 Ø 27
Thread: M30 x 1,5 RHT
81953016288



SC-ES-8517

Length: 140
Cone Ø: d1 Ø 30 / d2 Ø 27
Thread: M30 x 1,5 RHT
81953016286



SC-ES-8535

Length: 145
Cone Ø: d1 Ø 30 / d2 Ø 27
Thread: M30 x 1,5 RHT
81953016271, 81953016325



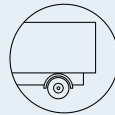

TGA ...

26.350 FDL5, FDLRS, FDLRS/M, FDLRS-WW ...	05/04 →	Track Control Arm		MN-VB-5222	Wishbone (CV), 1st RA;2nd RA, for Pneumatic Suspension vehicles
	05/04 →	Track Control Arm		MN-VB-8514	Suspension Rod, Wishbone (CV)
	05/04 →	Track Control Arm		MN-VB-8669	Suspension Rod, Wishbone (CV), 1st RA; 2nd RA, for Leaf-Spring Suspension vehicles, →Type_MHB Chassis
26.350 FVHLC	06/05 →	Centre Rod	MN-DL-7801		Push Rod
	06/05 →	Suspension Arm Repair Kit		CV-RK-5313	for Wishbone (CV)
	06/05 →	Suspension Arm Repair Kit		MN-RK-7291	for Drag Link
	06/05 →	Suspension Arm Repair Kit	DB-RK-9300	DB-RK-9300	for Drag Link
	06/05 →	Suspension Strut Repair Kit		CV-RK-5311	
	06/05 →	Tie Rod	MN-DL-7802		
	06/05 →	Tie Rod End		SC-ES-8517	for Push Rod
	06/05 →	Tie Rod End	CV-ES-0914		for Steering Rod
	06/05 →	Tie Rod End	CV-ES-14162	CV-ES-14162	for Steering Rod
	06/05 →	Tie Rod End	CV-ES-14163		for Steering Rod
	06/05 →	Tie Rod End	SC-ES-7279		for Steering Rod
	06/05 →	Tie Rod End	SC-ES-8535		for Guide Rod
	06/05 →	Track Control Arm		MN-DL-5225	Trailing Arm
	06/05 →	Track Control Arm		MN-DL-8733	Trailing Arm, 1st Drive Axle, for Pneumatic Suspension vehicles
	06/05 →	Track Control Arm		MN-VB-5222	Wishbone (CV), 1st RA;2nd RA, for Pneumatic Suspension vehicles
	06/05 →	Track Control Arm		MN-VB-8669	Suspension Rod, Wishbone (CV), 1st RA; 2nd RA, for Leaf-Spring Suspension vehicles, →Type_MHB Chassis
26.350 FVHLS	07/05 →	Centre Rod	MN-DL-7801		Push Rod
	07/05 →	Suspension Arm Repair Kit		CV-RK-5313	for Wishbone (CV)
	07/05 →	Suspension Arm Repair Kit		MN-RK-7291	for Drag Link
	07/05 →	Suspension Arm Repair Kit	DB-RK-9300	DB-RK-9300	for Drag Link
	07/05 →	Suspension Strut Repair Kit		CV-RK-5311	
	07/05 →	Tie Rod	MN-DL-7802		
	07/05 →	Tie Rod End		SC-ES-8517	for Push Rod
	07/05 →	Tie Rod End	CV-ES-0914		for Steering Rod
	07/05 →	Tie Rod End	CV-ES-14162	CV-ES-14162	for Steering Rod
	07/05 →	Tie Rod End	CV-ES-14163		for Steering Rod
	07/05 →	Tie Rod End	SC-ES-7279		for Steering Rod
	07/05 →	Tie Rod End	SC-ES-8535		for Guide Rod
	07/05 →	Track Control Arm		MN-DL-5225	Trailing Arm
	07/05 →	Track Control Arm		MN-DL-8733	Trailing Arm, 1st Drive Axle, for Pneumatic Suspension vehicles
	07/05 →	Track Control Arm		MN-VB-5222	Wishbone (CV), 1st RA;2nd RA, for Pneumatic Suspension vehicles
	07/05 →	Track Control Arm		MN-VB-8669	Suspension Rod, Wishbone (CV), 1st RA; 2nd RA, for Leaf-Spring Suspension vehicles, →Type_MHB Chassis
26.350 FVLC	01/04 →	Centre Rod	MN-DL-7801		Push Rod
	01/04 →	Suspension Strut Repair Kit		MN-RK-12436	
	01/04 →	Tie Rod	MN-DL-7802		
	01/04 →	Tie Rod	MN-DL-12284		
	01/04 →	Tie Rod End		SC-ES-8517	for Push Rod
	01/04 →	Tie Rod End	CV-ES-0914		for Steering Rod
	01/04 →	Tie Rod End	CV-ES-14162	CV-ES-14162	for Steering Rod
	01/04 →	Tie Rod End	CV-ES-14163		for Steering Rod
	01/04 →	Tie Rod End	SC-ES-7279		for Steering Rod
	01/04 →	Tie Rod End	SC-ES-8535		for Guide Rod
	01/04 →	Track Control Arm		MN-DL-5212	Trailing Arm, Trailing Axle not Steered, for Pneumatic Suspension vehicles
	01/04 →	Track Control Arm		MN-DL-5225	Trailing Arm
	01/04 →	Track Control Arm		MN-DL-8709	Trailing Arm, 1st Drive Axle, for Pneumatic Suspension vehicles
	01/04 →	Track Control Arm		MN-DL-8709	Trailing Arm, Trailing Axle not Steered, for Pneumatic Suspension vehicles

CV-ES-0914

Length: 125
Cone Ø: d1 Ø 30 / d2 Ø 27
Thread: M38 x 1,5 RHT
81953016184, 81953016251, 81953016276



CV-ES-14162

Length: 125
Cone Ø: d1 Ø 30 / d2 Ø 27
Thread: M30 x 1,5 LHT
81953010015, 81953010083, 81953010087, 81953016029, 81953016030, 81953016043, 81953016044, 81953016050, 81953016054, 81953016087, 81953016091, 81953016107, 81953016120, 81953016125, 81953016152, 81953016155, 81953016157, 81953016168, 81953016179, 81953016181, 81953016223, 81953016237, 81953016254, 81953016275, 81953016279, 81953016351



CV-ES-14163

Length: 125
Cone Ø: d1 Ø 30 / d2 Ø 27
Thread: M30 x 1,5 RHT
95301.0084, 90804102156, 90804102272, 90804102696, 90804102710, 81953010016, 81953010075, 81953010084, 81953010088, 81953010094, 81953010103, 81953016030, 81953016043, 81953016048, 81953016049, 81953016053, 81953016061, 81953016090, 81953016108, 81953016112, 81953016126, 81953016143, 81953016149, 81953016154, 81953016156, 81953016168, 81953016178, 81953016194, 81953016206, 81953016224, 81953016234, 81953016242, 81953016252, 81953016274, 81953016278, 81953016284, 81953016286, 81953016308, 81953016310, 81953016312, 81953016347, 81953016350, 81953016352, 82953016012, 88953016014, N2953016001



CV-RK-5311

638862, 639287, 938423, 1104335, 1953248, 0003500506, 3500506, 11013547, 42488722, 070550504, 634303610, 81432206055, 81432206073, 82262320660, 5001842823, 7000307001, 8226232066



CV-RK-5313

Ø: 90
03304800A, 81953016132



DB-RK-9300

Ø: 75
Hole Distance: 130
Thick/Height: 24
85432206002



MN-DL-5212

Length: 577 Ø: 48
Hole Distance: 130 / 130
81432206096, 81432206097, 81432206098, 81432206129, 81432209096, 81432209129, 81432306014, 81432306030



MN-DL-5225

Length: 572 Ø: 48
Hole Distance: 130 / 130
03301500A, 81432206229, 81432206236, 81432206267, 81432206270, 81432206272, 81432206304, 81432206305, 81432209236, 81432209267, 81432209272



MN-DL-7801

Length: 995 Ø: 52
Cone Ø: d1 Ø 30 / d2 Ø 27
81466106807, 81466106808, 81466116087, 81466116088, 81466116096, 81466116097, 81466116099, 81466116132, 81466116133, 81466116136, 81466116197, 81466116198, 81466116205



MN-DL-7802

Length: 1680 Ø: 52
Cone Ø: d1 Ø 30 / d2 Ø 27
03208300A, 81467116773, 81467116858, 81467116859, 81467116860, 81467116861, 81467116863, 81467116882, 81467116883, 81467116920, 81467116921



MN-DL-8709

Length: 572 Ø: 52
Hole Distance: 130 / 130
81432206268, 81432206274, 81432206291, 81432206292, 82432206007



MN-DL-8733

Length: 530 Ø: 48
Hole Distance: 130 / 130
81432206161, 81432206190, 81432206358, 81432206359



MN-DL-12284

Length: 1530 Ø: 50
Cone Ø: d1 Ø 30 / d2 Ø 27
81466106579, 81466106580, 81466106624, 81466116720, 81467116720, 81467116730, 81467116952



MN-RK-7291

Ø: 72
Hole Distance: 130
Thick/Height: 30
10307800A, 81432206108, 81432206132



MN-RK-12436

Ø: 75
Hole Distance: 115
Thick/Height: 24
81432206244



MN-VB-5222

Length: 627 Ø: 50
Hole Distance: 152 / 152
81432706030, 81432706034, 81432706054, 81432706055, 81432706056, 81432706057, 81432706067, 81432706068, 81432706074, 81432706075, 81432706076, 81432706077, 81432706078, 81432706081, 81432706082, 81432709034, 81432709076, 81432709078, 8143706054



MN-VB-8514

Length: 627 Ø: 48
Hole Ø 25 / 25 / 25
Hole Distance: 152 / 130 / 130
81432706087, 81432706088, 81432706094, 81432706095, 81432796094



MN-VB-8669

Length: 627 Ø: 48
Hole Ø 25 / 25 / 25
Hole Distance: 152 / 130 / 130
81432706116, 81432706137, 81432706150, 81432706151



SC-ES-7279

Length: 150
Cone Ø: d1 Ø 30 / d2 Ø 27
Thread: M30 x 1,5 RHT
81953016288



SC-ES-8517

Length: 140
Cone Ø: d1 Ø 30 / d2 Ø 27
Thread: M30 x 1,5 RHT
81953016286



SC-ES-8535

Length: 145
Cone Ø: d1 Ø 30 / d2 Ø 27
Thread: M30 x 1,5 RHT
81953016271, 81953016325



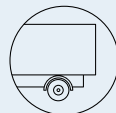

TGA ...

26.350 FVLC ...	01/04 →	Track Control Arm		MN-DL-8733	Trailing Arm, 1st Drive Axle, for Pneumatic Suspension vehicles
	01/04 →	Track Control Arm		MN-VB-5238	Wishbone (CV), 1st Drive Axle, for Pneumatic Suspension vehicles
	01/04 →	Track Control Arm		MN-VB-9403	Wishbone (CV), Trailing Axle not Steered, for Pneumatic Suspension vehicles
	01/04 →	Track Control Arm	MN-DL-8663		Control Arm
26.350 FVLS, FVLRS	07/05 →	Centre Rod	MN-DL-7801		Push Rod
	07/05 →	Suspension Strut Repair Kit		MN-RK-12436	
	07/05 →	Tie Rod	MN-DL-7802		
	07/05 →	Tie Rod	MN-DL-12284		
	07/05 →	Tie Rod End		SC-ES-8517	for Push Rod
	07/05 →	Tie Rod End	CV-ES-0914		for Steering Rod
	07/05 →	Tie Rod End	CV-ES-14162	CV-ES-14162	for Steering Rod
	07/05 →	Tie Rod End	CV-ES-14163		for Steering Rod
	07/05 →	Tie Rod End	SC-ES-7279		for Steering Rod
	07/05 →	Tie Rod End	SC-ES-8535		for Guide Rod
	07/05 →	Track Control Arm		MN-DL-5212	Trailing Arm, Trailing Axle Steered, for Pneumatic Suspension vehicles
	07/05 →	Track Control Arm		MN-DL-5225	Trailing Arm
	07/05 →	Track Control Arm		MN-DL-8709	Trailing Arm, 1st Drive Axle, for Pneumatic Suspension vehicles
	07/05 →	Track Control Arm		MN-DL-8709	Trailing Arm, Trailing Axle Steered, for Pneumatic Suspension vehicles
	07/05 →	Track Control Arm		MN-DL-8733	Trailing Arm, 1st Drive Axle, for Pneumatic Suspension vehicles
	07/05 →	Track Control Arm		MN-VB-5238	Wishbone (CV), 1st Drive Axle, for Pneumatic Suspension vehicles
	07/05 →	Track Control Arm		MN-VB-9403	Wishbone (CV), Trailing Axle Steered, for Pneumatic Suspension vehicles
07/05 →	Track Control Arm	MN-DL-8663		Control Arm	
26.350, 26.360 FDAK, FDALK, FDHK, FDHLK	05/04 →	Centre Rod	MN-DL-7801		Push Rod, Leaf Spring Axle
	05/04 →	Suspension Strut Repair Kit		DB-RK-8581	
	05/04 →	Tie Rod	MN-DL-7802		
	05/04 →	Tie Rod End	CV-ES-0914		for Steering Rod
	05/04 →	Tie Rod End	CV-ES-14162		for Steering Rod
	05/04 →	Tie Rod End	CV-ES-14163		for Steering Rod
	05/04 →	Tie Rod End	MN-ES-10333		for Steering Rod
	05/04 →	Tie Rod End	SC-ES-7279		for Steering Rod
	05/04 →	Tie Rod End	SC-ES-8517		for Push Rod
	05/04 →	Tie Rod End	SC-ES-8535		for Guide Rod
	05/04 →	Track Control Arm		MN-DL-5225	Trailing Arm
	05/04 →	Track Control Arm		MN-DL-8544	Trailing Arm, 1st RA;2nd RA;Leaf Spring Axle
	05/04 →	Track Control Arm		MN-DL-8609	Trailing Arm, 1st RA;2nd RA, for Leaf-Spring Suspension vehicles, →Type_HB Chassis
	05/04 →	Track Control Arm		MN-VB-5238	Wishbone (CV), 1st RA;2nd RA, for Pneumatic Suspension vehicles, →Type_NBA Chassis
	05/04 →	Track Control Arm		MN-VB-8514	Suspension Rod, Wishbone (CV), Drive Axle; Leaf Spring Axle
	05/04 →	Track Control Arm		MN-VB-8669	Suspension Rod, Wishbone (CV), Drive Axle; Leaf Spring Axle
	05/04 →	Track Control Arm		MN-VB-9404	Wishbone (CV), 1st RA;2nd RA, for Leaf-Spring Suspension vehicles, →Type_HB
26.350, 26.360 FDARS, FDAS, FDHLS, FDHS	05/04 →	Centre Rod	MN-DL-7801		Push Rod, Leaf Spring Axle
	05/04 →	Suspension Strut Repair Kit		DB-RK-8581	
	05/04 →	Tie Rod	MN-DL-7802		
	05/04 →	Tie Rod End	CV-ES-0914		for Steering Rod
	05/04 →	Tie Rod End	CV-ES-14162		for Steering Rod
	05/04 →	Tie Rod End	CV-ES-14163		for Steering Rod
	05/04 →	Tie Rod End	MN-ES-10333		for Steering Rod
	05/04 →	Tie Rod End	SC-ES-7279		for Steering Rod
	05/04 →	Tie Rod End	SC-ES-8517		for Push Rod
05/04 →	Tie Rod End	SC-ES-8535		for Guide Rod	

CV-ES-0914

Length: 125
Cone Ø: d1 Ø 30 / d2 Ø 27
Thread: M38 x 1,5 RHT
81953016184, 81953016251, 81953016276



CV-ES-14162

Length: 125
Cone Ø: d1 Ø 30 / d2 Ø 27
Thread: M30 x 1,5 LHT
81953010015, 81953010083, 81953010087, 81953016029, 81953016030, 81953016043, 81953016044, 81953016050, 81953016054, 81953016087, 81953016091, 81953016107, 81953016120, 81953016125, 81953016152, 81953016155, 81953016157, 81953016168, 81953016179, 81953016181, 81953016223, 81953016237, 81953016254, 81953016275, 81953016279, 81953016351



CV-ES-14163

Length: 125
Cone Ø: d1 Ø 30 / d2 Ø 27
Thread: M30 x 1,5 RHT
95301.0084, 90804102156, 90804102272, 90804102696, 90804102710, 81953010016, 81953010075, 81953010084, 81953010088, 81953010094, 81953010103, 81953016030, 81953016043, 81953016048, 81953016049, 81953016053, 81953016061, 81953016090, 81953016108, 81953016112, 81953016126, 81953016143, 81953016149, 81953016154, 81953016156, 81953016168, 81953016178, 81953016194, 81953016206, 81953016224, 81953016234, 81953016242, 81953016252, 81953016274, 81953016278, 81953016284, 81953016286, 81953016308, 81953016310, 81953016312, 81953016347, 81953016350, 81953016352, 82953016012, 88953016014, N2953016001



DB-RK-8581

Ø: 85
Hole Distance: 130
Thick/Height: 24
03305800A, 81432706105



MN-DL-5212

Length: 577 Ø: 48
Hole Distance: 130 / 130
81432206096, 81432206097, 81432206098, 81432206129, 81432209096, 81432209129, 81432306014, 81432306030



MN-DL-5225

Length: 572 Ø: 48
Hole Distance: 130 / 130
03301500A, 81432206229, 81432206236, 81432206267, 81432206270, 81432206272, 81432206304, 81432206305, 81432209236, 81432209267, 81432209272



MN-DL-7801

Length: 995 Ø: 52
Cone Ø: d1 Ø 30 / d2 Ø 27
81466106807, 81466106808, 81466116087, 81466116088, 81466116096, 81466116097, 81466116099, 81466116132, 81466116133, 81466116136, 81466116197, 81466116198, 81466116205



MN-DL-7802

Length: 1680 Ø: 52
Cone Ø: d1 Ø 30 / d2 Ø 27
03208300A, 81467116773, 81467116858, 81467116859, 81467116860, 81467116861, 81467116863, 81467116882, 81467116883, 81467116920, 81467116921



MN-DL-8544

Length: 596 Ø: 48
Hole Distance: 130 / 130
81432206196, 81432206232, 81432206233



MN-DL-8609

Length: 585 Ø: 58
Hole Distance: 130 / 130
81432206070, 81432206071, 81432206072, 81432206091, 81432206093, 81432206119



MN-DL-8663

Length: 947 Ø: 60
Hole Distance: 115 / 115
03307400A, 81432206222, 81432206260, 81432206283, 81432206284



MN-DL-8709

Length: 572 Ø: 52
Hole Distance: 130 / 130
81432206268, 81432206274, 81432206291, 81432206292, 82432206007



MN-DL-8733

Length: 530 Ø: 48
Hole Distance: 130 / 130
81432206161, 81432206190, 81432206358, 81432206359



MN-DL-12284

Length: 1530 Ø: 50
Cone Ø: d1 Ø 30 / d2 Ø 27
81466106579, 81466106580, 81466106624, 81466116720, 81467116720, 81467116730, 81467116952



MN-ES-10333

Length: 90
Cone Ø: d1 Ø 38 / d2 Ø 34,35
Thread: M36 x 1,5 RHT
1271126, 3090291, 3099128, 42538048, 81953016268, 82953016018, 82953016019



MN-RK-12436

Ø: 75
Hole Distance: 115
Thick/Height: 24
81432206244



MN-VB-5238

Length: 627 Ø: 48
Hole Distance: 130 / 130
81432206221, 81432706096, 81432706114, 81432706116, 81432706121



MN-VB-8514

Length: 627 Ø: 48
Hole Ø 25 / 25 / 25
Hole Distance: 152 / 130 / 130
81432706087, 81432706088, 81432706094, 81432706095, 81432796094



MN-VB-8669

Length: 627 Ø: 48
Hole Ø 25 / 25 / 25
Hole Distance: 152 / 130 / 130
81432706116, 81432706137, 81432706150, 81432706151



MN-VB-9403

Length: 627 Ø: 48
Hole Ø 25 / 23 / 23
Hole Distance: 152 / 130 / 130
81432706097, 81432706113, 81432706135, 81432706160, 81432706161



MN-VB-9404

Length: 627 Ø: 58
Hole Distance: 130 / 130
81432706117, 81432706152, 81432706153



SC-ES-7279

Length: 150
Cone Ø: d1 Ø 30 / d2 Ø 27
Thread: M30 x 1,5 RHT
81953016288



SC-ES-8517

Length: 140
Cone Ø: d1 Ø 30 / d2 Ø 27
Thread: M30 x 1,5 RHT
81953016286



SC-ES-8535

Length: 145
Cone Ø: d1 Ø 30 / d2 Ø 27
Thread: M30 x 1,5 RHT
81953016271, 81953016325





TGA ...

26.350, 26.360 FDARS, FDAS, FDHLS, FDHS ...	05/04 →	Track Control Arm		MN-DL-5225	Trailing Arm
	05/04 →	Track Control Arm		MN-DL-8544	Trailing Arm, 1st RA;2nd RA;Leaf Spring Axle
	05/04 →	Track Control Arm		MN-DL-8609	Trailing Arm, 1st RA;2nd RA, for Leaf-Spring Suspension vehicles, →Type_HB Chassis
	05/04 →	Track Control Arm		MN-VB-5238	Wishbone (CV), 1st RA;2nd RA, for Pneumatic Suspension vehicles, →Type_NBA Chassis
	05/04 →	Track Control Arm		MN-VB-8514	Suspension Rod, Wishbone (CV), Drive Axle; Leaf Spring Axle
	05/04 →	Track Control Arm		MN-VB-8669	Suspension Rod, Wishbone (CV), Drive Axle; Leaf Spring Axle
	05/04 →	Track Control Arm		MN-VB-9404	Wishbone (CV), 1st RA;2nd RA, for Leaf-Spring Suspension vehicles, →Type_HB
26.350, 26.360 FDC, FDLC, FDLRC, FDRC, FNHLC, FVHLC	05/04 →01/05	Track Control Arm		MN-DL-5212	Trailing Arm, Tag Axle;Air Suspension Axle
	05/04 →	Centre Rod	MN-DL-7801		Push Rod, Leaf Spring Axle
	05/04 →	Centre Rod	MN-DL-8560		Push Rod, Air Suspension Axle
	05/04 →	Suspension Strut Repair Kit		DB-RK-8581	
	05/04 →	Suspension Strut Repair Kit		MN-RK-12436	
	05/04 →	Tie Rod	MN-DL-7802		
	05/04 →	Tie Rod	MN-DL-12284		
	05/04 →	Tie Rod End		IV-ES-8507	Tag Axle
	05/04 →	Tie Rod End		MN-ES-8490	for vehicles with Hinged Trailing Axle
	05/04 →	Tie Rod End		SC-ES-8517	for Push Rod
	05/04 →	Tie Rod End	CV-ES-0914		for Steering Rod
	05/04 →	Tie Rod End	CV-ES-14162	CV-ES-14162	for Steering Rod
	05/04 →	Tie Rod End	CV-ES-14163		for Steering Rod
	05/04 →	Tie Rod End	IV-ES-12272		for Steering Rod
	05/04 →	Tie Rod End	SC-ES-7279		for Steering Rod
	05/04 →	Tie Rod End	SC-ES-8535		for Guide Rod
	05/04 →	Track Control Arm		MN-DL-3402	Trailing Arm, Air Suspension Axle;Drive Axle
	05/04 →	Track Control Arm		MN-DL-5225	Trailing Arm, Drive Axle;Air Suspension Axle
	05/04 →	Track Control Arm		MN-DL-5225	Trailing Arm, Tag Axle;Air Suspension Axle; for vehicles with Hinged Trailing Axle
	05/04 →	Track Control Arm		MN-DL-8544	Trailing Arm, Drive Axle;Air Suspension Axle
	05/04 →	Track Control Arm		MN-DL-8544	Trailing Arm, Drive Axle;Leaf Spring Axle
	05/04 →	Track Control Arm		MN-DL-8709	Trailing Arm, Air Suspension Axle; for vehicles with Hinged Trailing Axle
	05/04 →	Track Control Arm		MN-DL-8733	Trailing Arm, 1st Drive Axle, for Pneumatic Suspension vehicles
	05/04 →	Track control arm		MN-DL-10288	Trailing Arm, 1st RA;2nd RA, for Leaf-Spring Suspension vehicles
	05/04 →	Track control arm		MN-DL-12288	Trailing Arm
	05/04 →	Track Control Arm		MN-TC-12399	Control Arm
	05/04 →	Track Control Arm		MN-VB-5222	Wishbone (CV), 1st RA;2nd RA, for Pneumatic Suspension vehicles
	05/04 →	Track Control Arm		MN-VB-5238	Wishbone (CV), Drive Axle;Air Suspension Axle
	05/04 →	Track Control Arm		MN-VB-5238	Wishbone (CV), Drive Axle;Leading Axle; Air Suspension Axle
	05/04 →	Track Control Arm		MN-VB-8514	Suspension Rod, Wishbone (CV), Drive Axle; Air Suspension Axle
	05/04 →	Track Control Arm		MN-VB-8514	Suspension Rod, Wishbone (CV), Drive Axle; Leaf Spring Axle
	05/04 →	Track Control Arm		MN-VB-8669	Suspension Rod, Wishbone (CV), Drive Axle
	05/04 →	Track Control Arm		MN-VB-8669	Suspension Rod, Wishbone (CV), Drive Axle; Leaf Spring Axle
	05/04 →	Track Control Arm		MN-VB-9403	Wishbone (CV), Air Suspension Axle
	05/04 →	Track Control Arm		MN-VB-9404	Wishbone (CV), Drive Axle
	05/04 →	Track Control Arm		MN-VB-9404	Wishbone (CV), Drive Axle;Air Suspension Axle
	05/04 →	Track Control Arm	MN-DL-8663		Control Arm, Air Suspension Axle
	01/05 →	Track Control Arm		MN-DL-5225	Trailing Arm, Leading Axle;Air Suspension Axle
	01/05 →	Track Control Arm		MN-DL-5225	Trailing Arm, Tag Axle;Air Suspension Axle; for vehicles with Rigid Trailing Axle

CV-ES-0914

Length: 125
Cone Ø: d1 Ø 30 / d2 Ø 27
Thread: M38 x 1,5 RHT
81953016184, 81953016251, 81953016276



CV-ES-14162

Length: 125
Cone Ø: d1 Ø 30 / d2 Ø 27
Thread: M30 x 1,5 LHT
81953010015, 81953010083, 81953010087, 81953016029, 81953016030, 81953016043, 81953016044, 81953016050, 81953016054, 81953016087, 81953016091, 81953016107, 81953016120, 81953016125, 81953016152, 81953016155, 81953016157, 81953016168, 81953016179, 81953016181, 81953016223, 81953016237, 81953016254, 81953016275, 81953016279, 81953016351



CV-ES-14163

Length: 125
Cone Ø: d1 Ø 30 / d2 Ø 27
Thread: M30 x 1,5 RHT
95301.0084, 90804102156, 90804102272, 90804102696, 90804102710, 81953010016, 81953010075, 81953010084, 81953010088, 81953010094, 81953010103, 81953016030, 81953016043, 81953016048, 81953016049, 81953016053, 81953016061, 81953016090, 81953016108, 81953016112, 81953016126, 81953016143, 81953016149, 81953016154, 81953016156, 81953016168, 81953016178, 81953016194, 81953016206, 81953016224, 81953016234, 81953016242, 81953016252, 81953016274, 81953016278, 81953016284, 81953016286, 81953016308, 81953016310, 81953016312, 81953016347, 81953016350, 81953016352, 82953016012, 88953016014, N2953016001



DB-RK-8581

Ø: 85
Hole Distance: 130
Thick/Height: 24
03305800A, 81432706105



IV-ES-8507

Length: 80
Cone Ø: d1 Ø 30 / d2 Ø 27
Thread: M30 x 1,5 RHT
11019869, 12216380, 55175540, 81953016238



IV-ES-12272

Length: 75
Cone Ø: d1 Ø 30 / d2 Ø 27
Thread: M26 x 1,5 RHT
81953016280, 82953010010



MN-DL-3402

Length: 590 Ø: 48
Hole Distance: 130 / 130
03307200A, 81432206067, 81432206068, 81432206090, 81432206092, 81432209092



MN-DL-5212

Length: 577 Ø: 48
Hole Distance: 130 / 130
81432206096, 81432206097, 81432206098, 81432206129, 81432209096, 81432209129, 81432306014, 81432306030



MN-DL-5225

Length: 572 Ø: 48
Hole Distance: 130 / 130
03301500A, 81432206229, 81432206236, 81432206267, 81432206270, 81432206272, 81432206304, 81432206305, 81432209236, 81432209267, 81432209272



MN-DL-7801

Length: 995 Ø: 52
Cone Ø: d1 Ø 30 / d2 Ø 27
81466106807, 81466106808, 81466116087, 81466116088, 81466116096, 81466116097, 81466116099, 81466116132, 81466116133, 81466116136, 81466116197, 81466116198, 81466116205

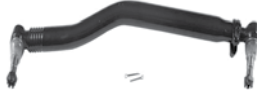

MN-DL-7802

Length: 1680 Ø: 52
Cone Ø: d1 Ø 30 / d2 Ø 27
03208300A, 81467116773, 81467116858, 81467116859, 81467116860, 81467116861, 81467116863, 81467116882, 81467116883, 81467116920, 81467116921



MN-DL-8544

Length: 596 Ø: 48
Hole Distance: 130 / 130
81432206196, 81432206232, 81432206233



MN-DL-8560

Length: 970 Ø: 52
Cone Ø: d1 Ø 30 / d2 Ø 27
03206900A, 81466106809, 81466106810, 81466106823, 81466106838, 81466106839, 81466116104, 81466116105, 81466116107, 81466116134, 81466116135, 81466116137, 81466116199, 81466116200, 81466116206



MN-DL-8609

Length: 585 Ø: 58
Hole Distance: 130 / 130
81432206070, 81432206071, 81432206072, 81432206091, 81432206093, 81432206119



MN-DL-8663

Length: 947 Ø: 60
Hole Distance: 115 / 115
03307400A, 81432206222, 81432206260, 81432206283, 81432206284



MN-DL-8709

Length: 572 Ø: 52
Hole Distance: 130 / 130
81432206268, 81432206274, 81432206291, 81432206292, 82432206007



MN-DL-8733

Length: 530 Ø: 48
Hole Distance: 130 / 130
81432206161, 81432206190, 81432206358, 81432206359



MN-DL-10288

81432206386, 82432206008, 82432209008

No Image

MN-DL-12284

Length: 1530 Ø: 50
Cone Ø: d1 Ø 30 / d2 Ø 27
81466106579, 81466106580, 81466106624, 81466116720, 81467116720, 81467116730, 81467116952



MN-DL-12288

Length: 585 Ø: 58
Hole Distance: 130 / 130
81432206386, 82432206008, 82432209008

No Image

MN-ES-8490

Length: 90
Cone Ø: d1 Ø 30 / d2 Ø 27
Thread: M26 x 1,5 RHT
0014606948, 14606948, 81953016281, 81953016337, 82953016016



MN-RK-12436

Ø: 75
Hole Distance: 115
Thick/Height: 24
81432206244



MN-TC-12399

Length: 694 Ø: 50
Hole Distance: 130 / 130
81432206265



MN-VB-5222

Length: 627 Ø: 50
Hole Distance: 152 / 152
81432706030, 81432706034, 81432706054, 81432706055, 81432706056, 81432706057, 81432706067, 81432706068, 81432706074, 81432706075, 81432706076, 81432706077, 81432706078, 81432706081, 81432706082, 81432709034, 81432709076, 81432709078, 8143706054



MN-VB-5238

Length: 627 Ø: 48
Hole Distance: 130 / 130
81432206221, 81432706096, 81432706114, 81432706116, 81432706121



MN-VB-8514

Length: 627 Ø: 48
Hole Ø 25 / 25 / 25
Hole Distance: 152 / 130 / 130
81432706087, 81432706088, 81432706094, 81432706095, 81432796094



MN-VB-8669

Length: 627 Ø: 48
Hole Ø 25 / 25 / 25
Hole Distance: 152 / 130 / 130
81432706116, 81432706137, 81432706150, 81432706151



MN-VB-9403

Length: 627 Ø: 48
Hole Ø 25 / 23 / 23
Hole Distance: 152 / 130 / 130
81432706097, 81432706113, 81432706135, 81432706160, 81432706161



MN-VB-9404

Length: 627 Ø: 58
Hole Distance: 130 / 130
81432706117, 81432706152, 81432706153



SC-ES-7279

Length: 150
Cone Ø: d1 Ø 30 / d2 Ø 27
Thread: M30 x 1,5 RHT
81953016288



SC-ES-8517

Length: 140
Cone Ø: d1 Ø 30 / d2 Ø 27
Thread: M30 x 1,5 RHT
81953016286



SC-ES-8535

Length: 145
Cone Ø: d1 Ø 30 / d2 Ø 27
Thread: M30 x 1,5 RHT
81953016271, 81953016325



Tuesday
21

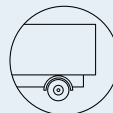

MAN ...

TGA ...

26.350, 26.360 FDH-TM	05/04→	Centre Rod	MN-DL-7801		Push Rod, Leaf Spring Axle	
	05/04→	Suspension Strut Repair Kit		DB-RK-8581		
	05/04→	Tie Rod	MN-DL-7802			
	05/04→	Tie Rod End	CV-ES-0914		for Steering Rod	
	05/04→	Tie Rod End	CV-ES-14162		for Steering Rod	
	05/04→	Tie Rod End	CV-ES-14163		for Steering Rod	
	05/04→	Tie Rod End	SC-ES-7279		for Steering Rod	
	05/04→	Tie Rod End	SC-ES-8517		for Push Rod	
	05/04→	Tie Rod End	SC-ES-8535		for Guide Rod	
	05/04→	Track Control Arm		MN-DL-5225	Trailing Arm	
	05/04→	Track Control Arm		MN-DL-8544	Trailing Arm, 1st RA;2nd RA;Leaf Spring Axle	
	05/04→	Track Control Arm		MN-VB-8514	Suspension Rod, Wishbone (CV), Drive Axle; Leaf Spring Axle	
	26.350, 26.360 FDK, FDLK, FDLRK, FDRK	05/04→	Centre Rod	MN-DL-7801		Push Rod, Leaf Spring Axle
05/04→		Centre Rod	MN-DL-8560		Push Rod, Air Suspension Axle	
05/04→		Suspension Strut Repair Kit		DB-RK-8581		
05/04→		Suspension Strut Repair Kit		MN-RK-12436		
05/04→		Tie Rod	MN-DL-7802			
05/04→		Tie Rod End	CV-ES-0914		for Steering Rod	
05/04→		Tie Rod End	CV-ES-14162		for Steering Rod	
05/04→		Tie Rod End	CV-ES-14163		for Steering Rod	
05/04→		Tie Rod End	SC-ES-7279		for Steering Rod	
05/04→		Tie Rod End	SC-ES-8517		for Push Rod	
05/04→		Tie Rod End	SC-ES-8535		for Guide Rod	
05/04→		Track Control Arm		MN-DL-3402	Trailing Arm, Air Suspension Axle;Drive Axle	
05/04→		Track Control Arm		MN-DL-5225	Trailing Arm, Drive Axle;Air Suspension Axle	
05/04→		Track Control Arm		MN-DL-8544	Trailing Arm, Drive Axle;Air Suspension Axle	
05/04→		Track Control Arm		MN-DL-8544	Trailing Arm, Drive Axle;Leaf Spring Axle	
05/04→		Track control arm		MN-DL-10288	Trailing Arm, 1st RA;2nd RA, for Leaf-Spring Suspension vehicles	
05/04→		Track control arm		MN-DL-12288	Trailing Arm	
05/04→		Track Control Arm		MN-VB-5222	Wishbone (CV), 1st RA;2nd RA, for Pneumatic Suspension vehicles	
05/04→		Track Control Arm		MN-VB-5238	Wishbone (CV), Drive Axle;Air Suspension Axle	
05/04→		Track Control Arm		MN-VB-8514	Suspension Rod, Wishbone (CV), Drive Axle; Air Suspension Axle	
05/04→		Track Control Arm		MN-VB-8514	Suspension Rod, Wishbone (CV), Drive Axle; Leaf Spring Axle	
05/04→		Track Control Arm		MN-VB-8669	Suspension Rod, Wishbone (CV), Drive Axle	
05/04→		Track Control Arm		MN-VB-8669	Suspension Rod, Wishbone (CV), Drive Axle; Leaf Spring Axle	
05/04→		Track Control Arm		MN-VB-9404	Wishbone (CV), Drive Axle	
05/04→		Track Control Arm		MN-VB-9404	Wishbone (CV), Drive Axle;Air Suspension Axle	
05/04→		Track Control Arm	MN-DL-8663		Control Arm, Air Suspension Axle	
26.350, 26.360 FDLRS, FDLS, FDRS, FDS, FNHLS, FPHLS, FVHLS		05/04→01/05	Track Control Arm		MN-DL-5212	Trailing Arm, Tag Axle;Air Suspension Axle
		05/04→	Centre Rod	MN-DL-7801		Push Rod, Leaf Spring Axle
		05/04→	Centre Rod	MN-DL-8560		Push Rod, Air Suspension Axle
		05/04→	Suspension Strut Repair Kit		DB-RK-8581	
		05/04→	Suspension Strut Repair Kit		MN-RK-12436	
		05/04→	Tie Rod	MN-DL-7802		
		05/04→	Tie Rod	MN-DL-12284		
	05/04→	Tie Rod	MN-DL-12293			
	05/04→	Tie Rod End		IV-ES-8507	Tag Axle	
	05/04→	Tie Rod End		MN-ES-8490	for vehicles with Hinged Trailing Axle	
	05/04→	Tie Rod End		SC-ES-8517	for Push Rod	
	05/04→	Tie Rod End	CV-ES-0914		for Steering Rod	
	05/04→	Tie Rod End	CV-ES-14162	CV-ES-14162	for Steering Rod	
	05/04→	Tie Rod End	CV-ES-14163		for Steering Rod	
	05/04→	Tie Rod End	IV-ES-12272		for Steering Rod	
	05/04→	Tie Rod End	SC-ES-7279		for Steering Rod	
	05/04→	Tie Rod End	SC-ES-8535		for Guide Rod	

MAN

CV-ES-0914

Length: 125
Cone Ø: d1 Ø 30 / d2 Ø 27
Thread: M38 x 1,5 RHT
81953016184, 81953016251, 81953016276



CV-ES-14162

Length: 125
Cone Ø: d1 Ø 30 / d2 Ø 27
Thread: M30 x 1,5 LHT
81953010015, 81953010083, 81953010087, 81953016029, 81953016030, 81953016043, 81953016044, 81953016050, 81953016054, 81953016087, 81953016091, 81953016107, 81953016120, 81953016125, 81953016152, 81953016155, 81953016157, 81953016168, 81953016179, 81953016181, 81953016223, 81953016237, 81953016254, 81953016275, 81953016279, 81953016351



CV-ES-14163

Length: 125
Cone Ø: d1 Ø 30 / d2 Ø 27
Thread: M30 x 1,5 RHT
95301.0084, 90804102156, 90804102272, 90804102696, 90804102710, 81953010016, 81953010075, 81953010084, 81953010088, 81953010094, 81953010103, 81953016030, 81953016043, 81953016048, 81953016049, 81953016053, 81953016061, 81953016090, 81953016108, 81953016112, 81953016126, 81953016143, 81953016149, 81953016154, 81953016156, 81953016168, 81953016178, 81953016194, 81953016206, 81953016224, 81953016234, 81953016242, 81953016252, 81953016274, 81953016278, 81953016284, 81953016286, 81953016308, 81953016310, 81953016312, 81953016347, 81953016350, 81953016352, 82953016012, 88953016014, N2953016001



DB-RK-8581

Ø: 85
Hole Distance: 130
Thick/Height: 24
03305800A, 81432706105



IV-ES-8507

Length: 80
Cone Ø: d1 Ø 30 / d2 Ø 27
Thread: M30 x 1,5 RHT
11019869, 12216380, 55175540, 81953016238



IV-ES-12272

Length: 75
Cone Ø: d1 Ø 30 / d2 Ø 27
Thread: M26 x 1,5 RHT
81953016280, 82953010010



MN-DL-3402

Length: 590 Ø: 48
Hole Distance: 130 / 130
03307200A, 81432206067, 81432206068, 81432206090, 81432206092, 81432209092



MN-DL-5212

Length: 577 Ø: 48
Hole Distance: 130 / 130
81432206096, 81432206097, 81432206098, 81432206129, 81432209096, 81432209129, 81432306014, 81432306030



MN-DL-5225

Length: 572 Ø: 48
Hole Distance: 130 / 130
03301500A, 81432206229, 81432206236, 81432206267, 81432206270, 81432206272, 81432206304, 81432206305, 81432209236, 81432209267, 81432209272



MN-DL-7801

Length: 995 Ø: 52
Cone Ø: d1 Ø 30 / d2 Ø 27
81466106807, 81466106808, 81466106807, 81466106888, 81466106906, 81466106907, 81466106909, 81466116132, 81466116133, 81466116136, 81466116197, 81466116198, 81466116205

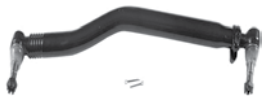

MN-DL-7802

Length: 1680 Ø: 52
Cone Ø: d1 Ø 30 / d2 Ø 27
03208300A, 81467116773, 81467116858, 81467116859, 81467116860, 81467116861, 81467116863, 81467116882, 81467116883, 81467116920, 81467116921



MN-DL-8544

Length: 596 Ø: 48
Hole Distance: 130 / 130
81432206196, 81432206232, 81432206233



MN-DL-8560

Length: 970 Ø: 52
Cone Ø: d1 Ø 30 / d2 Ø 27
03206900A, 81466106809, 81466106810, 81466106823, 81466106838, 81466106839, 81466116104, 81466116105, 81466116107, 81466116134, 81466116135, 81466116137, 81466116199, 81466116200, 81466116206



MN-DL-8663

Length: 947 Ø: 60
Hole Distance: 115 / 115
03307400A, 81432206222, 81432206260, 81432206283, 81432206284



MN-DL-10288

81432206386, 82432206008, 82432209008

No Image

MN-DL-12284

Length: 1530 Ø: 50
Cone Ø: d1 Ø 30 / d2 Ø 27
81466106579, 81466106580, 81466106624, 81466116720, 81467116720, 81467116730, 81467116952



MN-DL-12288

Length: 585 Ø: 58
Hole Distance: 130 / 130
81432206386, 82432206008, 82432209008

No Image

MN-DL-12293

Length: 1680 Ø: 42
Cone Ø: d1 Ø 30 / d2 Ø 27
81467106236, 81467106268, 81467106356, 81467116356, 81467116723, 81467116794, 81467116933, 81467116934, 81467116966



MN-ES-8490

Length: 90
Cone Ø: d1 Ø 30 / d2 Ø 27
Thread: M26 x 1,5 RHT
0014606948, 14606948, 81953016281, 81953016337, 82953016016



MN-RK-12436

Ø: 75
Hole Distance: 115
Thick/Height: 24
81432206244



MN-VB-5222

Length: 627 Ø: 50
Hole Distance: 152 / 152
81432706030, 81432706034, 81432706054, 81432706055, 81432706056, 81432706057, 81432706067, 81432706068, 81432706074, 81432706075, 81432706076, 81432706077, 81432706078, 81432706081, 81432706082, 81432709034, 81432709076, 81432709078, 8143706054



MN-VB-5238

Length: 627 Ø: 48
Hole Distance: 130 / 130
81432206221, 81432706096, 81432706114, 81432706116, 81432706121



MN-VB-8514

Length: 627 Ø: 48
Hole Ø 25 / 25 / 25
Hole Distance: 152 / 130 / 130
81432706087, 81432706088, 81432706094, 81432706095, 81432796094



MN-VB-8669

Length: 627 Ø: 48
Hole Ø 25 / 25 / 25
Hole Distance: 152 / 130 / 130
81432706116, 81432706137, 81432706150, 81432706151



MN-VB-9404

Length: 627 Ø: 58
Hole Distance: 130 / 130
81432706117, 81432706152, 81432706153



SC-ES-7279

Length: 150
Cone Ø: d1 Ø 30 / d2 Ø 27
Thread: M30 x 1,5 RHT
81953016288



SC-ES-8517

Length: 140
Cone Ø: d1 Ø 30 / d2 Ø 27
Thread: M30 x 1,5 RHT
81953016286



SC-ES-8535

Length: 145
Cone Ø: d1 Ø 30 / d2 Ø 27
Thread: M30 x 1,5 RHT
81953016271, 81953016325





TGA ...

26.350, 26.360 FDLRS, FDLS, FDRS, FDS, FNHLS, FPHLS, FVHLS ...	05/04 →	Track Control Arm		MN-DL-3402	Trailing Arm, Air Suspension Axle; Drive Axle	
	05/04 →	Track Control Arm		MN-DL-5225	Trailing Arm, Drive Axle; Air Suspension Axle	
	05/04 →	Track Control Arm		MN-DL-5225	Trailing Arm, Tag Axle; Air Suspension Axle; for vehicles with Hinged Trailing Axle	
	05/04 →	Track Control Arm		MN-DL-8544	Trailing Arm, Drive Axle; Air Suspension Axle	
	05/04 →	Track Control Arm		MN-DL-8544	Trailing Arm, Drive Axle; Leaf Spring Axle	
	05/04 →	Track Control Arm		MN-DL-8709	Trailing Arm, Air Suspension Axle; for vehicles with Hinged Trailing Axle	
	05/04 →	Track Control Arm		MN-DL-8733	Trailing Arm, 1st Drive Axle, for Pneumatic Suspension vehicles	
	05/04 →	Track control arm		MN-DL-10288	Trailing Arm, 1st RA; 2nd RA, for Leaf-Spring Suspension vehicles	
	05/04 →	Track control arm		MN-DL-12288	Trailing Arm	
	05/04 →	Track Control Arm		MN-TC-12399	Control Arm	
	05/04 →	Track Control Arm		MN-VB-5222	Wishbone (CV), 1st RA; 2nd RA, for Pneumatic Suspension vehicles	
	05/04 →	Track Control Arm		MN-VB-5238	Wishbone (CV), Drive Axle; Air Suspension Axle	
	05/04 →	Track Control Arm		MN-VB-5238	Wishbone (CV), Drive Axle; Leading Axle; Air Suspension Axle	
	05/04 →	Track Control Arm		MN-VB-8514	Suspension Rod, Wishbone (CV), Drive Axle; Air Suspension Axle	
	05/04 →	Track Control Arm		MN-VB-8514	Suspension Rod, Wishbone (CV), Drive Axle; Leaf Spring Axle	
	05/04 →	Track Control Arm		MN-VB-8669	Suspension Rod, Wishbone (CV), Drive Axle	
	05/04 →	Track Control Arm		MN-VB-8669	Suspension Rod, Wishbone (CV), Drive Axle; Leaf Spring Axle	
	05/04 →	Track Control Arm		MN-VB-9403	Wishbone (CV), Air Suspension Axle	
	05/04 →	Track Control Arm		MN-VB-9404	Wishbone (CV), Drive Axle	
	05/04 →	Track Control Arm		MN-VB-9404	Wishbone (CV), Drive Axle; Air Suspension Axle	
	05/04 →	Track Control Arm	MN-DL-8663		Control Arm, Air Suspension Axle	
	01/05 →	Track Control Arm		MN-DL-5225	Trailing Arm, Leading Axle; Air Suspension Axle	
	01/05 →	Track Control Arm		MN-DL-5225	Trailing Arm, Tag Axle; Air Suspension Axle; for vehicles with Rigid Trailing Axle	
	26.350, 26.360 FD-TM, FDR-TM	02/04 →	Centre Rod	MN-DL-7801		Push Rod, Leaf Spring Axle
		02/04 →	Suspension Strut Repair Kit		DB-RK-8581	
		02/04 →	Tie Rod	MN-DL-7802		
		02/04 →	Tie Rod End	CV-ES-0914		for Steering Rod
		02/04 →	Tie Rod End	CV-ES-14162		for Steering Rod
02/04 →		Tie Rod End	CV-ES-14163		for Steering Rod	
02/04 →		Tie Rod End	SC-ES-7279		for Steering Rod	
02/04 →		Tie Rod End	SC-ES-8517		for Push Rod	
02/04 →		Tie Rod End	SC-ES-8535		for Guide Rod	
02/04 →		Track Control Arm		MN-DL-5225	Trailing Arm	
02/04 →		Track Control Arm		MN-DL-8544	Trailing Arm, Drive Axle; Leaf Spring Axle	
02/04 →		Track control arm		MN-DL-10288	Trailing Arm, 1st RA; 2nd RA, for Leaf-Spring Suspension vehicles	
02/04 →		Track control arm		MN-DL-12288	Trailing Arm	
02/04 →		Track Control Arm		MN-VB-8514	Suspension Rod, Wishbone (CV), Drive Axle; Leaf Spring Axle	
02/04 →		Track Control Arm		MN-VB-8669	Suspension Rod, Wishbone (CV), Drive Axle; Leaf Spring Axle	
02/04 →		Track Control Arm		MN-VB-9404	Wishbone (CV), Drive Axle	
26.350, 26.360 FNLC, FNLLC, FNLLRC, FNLLRW, FNLLW, FNLCR		05/04 → 01/05	Track Control Arm		MN-DL-5212	Trailing Arm, Tag Axle; Air Suspension Axle
	05/04 →	Centre Rod	MN-DL-7801		Push Rod	
	05/04 →	Centre Rod	MN-DL-8560		Push Rod, Air Suspension Axle	
	05/04 →	Suspension Strut Repair Kit		CV-RK-5311		
	05/04 →	Suspension Strut Repair Kit		DB-RK-8581		
	05/04 →	Suspension Strut Repair Kit		MN-RK-12436		
	05/04 →	Tie Rod	MN-DL-7802			
	05/04 →	Tie Rod	MN-DL-12284			
	05/04 →	Tie Rod End		IV-ES-8507	Tag Axle	
	05/04 →	Tie Rod End		MN-ES-8490	for vehicles with Hinged Trailing Axle	
	05/04 →	Tie Rod End	CV-ES-0914		for Steering Rod	



TGA ...

26.350, 26.360 FNLC, FNLLC, FNLLRC, FNLLRW, FNLLW, FNLCRC ...	05/04 →	Tie Rod End	CV-ES-14163		for Steering Rod	
	05/04 →	Tie Rod End	IV-ES-12272		for Steering Rod	
	05/04 →	Tie Rod End	SC-ES-7279		for Steering Rod	
	05/04 →	Tie Rod End	SC-ES-8517		for Push Rod	
	05/04 →	Tie Rod End	SC-ES-8535		for Guide Rod	
	05/04 →	Track Control Arm		MN-DL-5225	Trailing Arm, Drive Axle;Air Suspension Axle	
	05/04 →	Track Control Arm		MN-DL-5225	Trailing Arm, Drive Axle;Air Suspension Axle; for vehicles with Rigid Trailing Axle	
	05/04 →	Track Control Arm		MN-DL-5225	Trailing Arm, Tag Axle;Air Suspension Axle; for vehicles with Hinged Trailing Axle	
	05/04 →	Track Control Arm		MN-DL-8709	Trailing Arm, Air Suspension Axle; for vehicles with Hinged Trailing Axle	
	05/04 →	Track Control Arm		MN-DL-8733	Trailing Arm	
	05/04 →	Track Control Arm		MN-TC-12399	Control Arm	
	05/04 →	Track Control Arm		MN-VB-5238	Wishbone (CV), Drive Axle;Air Suspension Axle	
	05/04 →	Track Control Arm		MN-VB-5238	Wishbone (CV), Drive Axle;Leading Axle; Air Suspension Axle	
	05/04 →	Track Control Arm		MN-VB-9403	Wishbone (CV), Air Suspension Axle	
	05/04 →	Track Control Arm	MN-DL-8663		Control Arm, Air Suspension Axle	
	01/05 →	Track Control Arm		MN-DL-5225	Trailing Arm, Tag Axle;Air Suspension Axle; for vehicles with Rigid Trailing Axle	
	26.350, 26.360 FNLS, FNLLS, FNLLRS, FNLLRS, FPLS, FPLRS	05/04 →01/05	Track Control Arm		MN-DL-5212	Trailing Arm, Tag Axle;Air Suspension Axle
		05/04 →	Centre Rod	MN-DL-7801		Push Rod, Leaf Spring Axle
		05/04 →	Centre Rod	MN-DL-8560		Push Rod, Air Suspension Axle
		05/04 →	Suspension Strut Repair Kit		CV-RK-5311	
05/04 →		Suspension Strut Repair Kit		DB-RK-8581		
05/04 →		Suspension Strut Repair Kit		MN-RK-12436		
05/04 →		Tie Rod	MN-DL-7802			
05/04 →		Tie Rod	MN-DL-12284			
05/04 →		Tie Rod End		IV-ES-8507	Tag Axle	
05/04 →		Tie Rod End		MN-ES-8490	for vehicles with Hinged Trailing Axle	
05/04 →		Tie Rod End	CV-ES-0914		for Steering Rod	
05/04 →		Tie Rod End	CV-ES-14163		for Steering Rod	
05/04 →		Tie Rod End	IV-ES-12272		for Steering Rod	
05/04 →		Tie Rod End	SC-ES-7279		for Steering Rod	
05/04 →		Tie Rod End	SC-ES-8517		for Push Rod	
05/04 →		Tie Rod End	SC-ES-8535		for Guide Rod	
05/04 →		Track Control Arm		MN-DL-5225	Trailing Arm, Drive Axle;Air Suspension Axle	
05/04 →		Track Control Arm		MN-DL-5225	Trailing Arm, Leading Axle;Air Suspension Axle	
05/04 →		Track Control Arm		MN-DL-5225	Trailing Arm, Tag Axle;Air Suspension Axle; for vehicles with Hinged Trailing Axle	
05/04 →		Track Control Arm		MN-DL-8709	Trailing Arm, Air Suspension Axle; for vehicles with Hinged Trailing Axle	
05/04 →		Track Control Arm		MN-DL-8733	Trailing Arm, Air Suspension Axle;Drive Axle	
05/04 →		Track Control Arm		MN-TC-12399	Control Arm	
05/04 →		Track Control Arm		MN-VB-5238	Wishbone (CV), Drive Axle;Air Suspension Axle	
05/04 →		Track Control Arm		MN-VB-5238	Wishbone (CV), Drive Axle;Leading Axle; Air Suspension Axle	
05/04 →		Track Control Arm		MN-VB-5238	Wishbone (CV), Leading Axle;Air Suspension Axle	
05/04 →		Track Control Arm		MN-VB-9403	Wishbone (CV), Air Suspension Axle	
05/04 →		Track Control Arm	MN-DL-8663		Control Arm, Air Suspension Axle	
01/05 →		Track Control Arm		MN-DL-5225	Trailing Arm, Tag Axle;Air Suspension Axle; for vehicles with Rigid Trailing Axle	
26.350, 26.360 FVHL-KO		06/05 →	Centre Rod	MN-DL-7801		Push Rod, Leaf Spring Axle
		06/05 →	Suspension Strut Repair Kit		DB-RK-8581	
		06/05 →	Tie Rod	MN-DL-7802		
		06/05 →	Tie Rod End		SC-ES-8517	for Push Rod
		06/05 →	Tie Rod End	CV-ES-0914		for Steering Rod
	06/05 →	Tie Rod End	CV-ES-14163		for Steering Rod	
	06/05 →	Tie Rod End	SC-ES-7279		for Steering Rod	
	06/05 →	Tie Rod End	SC-ES-8535		for Guide Rod	
	06/05 →	Track Control Arm		MN-DL-5225	Trailing Arm, Drive Axle;Air Suspension Axle	
	06/05 →	Track Control Arm		MN-DL-5225	Trailing Arm, Leading Axle;Air Suspension Axle	

CV-ES-0914

Length: 125
Cone Ø: d1 Ø 30 / d2 Ø 27
Thread: M38 x 1,5 RHT
81953016184, 81953016251, 81953016276



CV-ES-14163

Length: 125
Cone Ø: d1 Ø 30 / d2 Ø 27
Thread: M30 x 1,5 RHT
95301.0084, 90804102156, 90804102272, 90804102696, 90804102710, 81953010016, 81953010075, 81953010084, 81953010088, 81953010094, 81953010103, 81953016030, 81953016043, 81953016048, 81953016049, 81953016053, 81953016061, 81953016090, 81953016108, 81953016112, 81953016126, 81953016143, 81953016149, 81953016154, 81953016156, 81953016168, 81953016178, 81953016194, 81953016206, 81953016224, 81953016234, 81953016242, 81953016252, 81953016274, 81953016278, 81953016284, 81953016286, 81953016308, 81953016310, 81953016312, 81953016347, 81953016350, 81953016352, 82953016012, 88953016014, N2953016001



CV-RK-5311

638862, 639287, 938423, 1104335, 1953248, 3500506, 0003500506, 11013547, 42488722, 070550504, 634303610, 81432206055, 81432206073, 82262320660, 5001842823, 7000307001, 8226232066



DB-RK-8581

Ø: 85
Hole Distance: 130
Thick/Height: 24
03305800A, 81432706105



IV-ES-8507

Length: 80
Cone Ø: d1 Ø 30 / d2 Ø 27
Thread: M30 x 1,5 RHT
11019869, 12216380, 55175540, 81953016238



IV-ES-12272

Length: 75
Cone Ø: d1 Ø 30 / d2 Ø 27
Thread: M26 x 1,5 RHT
81953016280, 82953010010



MN-DL-5212

Length: 577 Ø: 48
Hole Distance: 130 / 130
81432206096, 81432206097, 81432206098, 81432206129, 81432209096, 81432209129, 81432306014, 81432306030



MN-DL-5225

Length: 572 Ø: 48
Hole Distance: 130 / 130
03301500A, 81432206229, 81432206236, 81432206267, 81432206270, 81432206272, 81432206304, 81432206305, 81432209236, 81432209267, 81432209272



MN-DL-7801

Length: 995 Ø: 52
Cone Ø: d1 Ø 30 / d2 Ø 27
81466106807, 81466106808, 81466116087, 81466116088, 81466116096, 81466116097, 81466116099, 81466116132, 81466116133, 81466116136, 81466116197, 81466116198, 81466116205



MN-DL-7802

Length: 1680 Ø: 52
Cone Ø: d1 Ø 30 / d2 Ø 27
03208300A, 81467116773, 81467116858, 81467116859, 81467116860, 81467116861, 81467116863, 81467116882, 81467116883, 81467116920, 81467116921



MN-DL-8560

Length: 970 Ø: 52
Cone Ø: d1 Ø 30 / d2 Ø 27
03206900A, 81466106809, 81466106810, 81466106823, 81466106838, 81466106839, 81466116104, 81466116105, 81466116107, 81466116134, 81466116135, 81466116137, 81466116199, 81466116200, 81466116206



MN-DL-8663

Length: 947 Ø: 60
Hole Distance: 115 / 115
03307400A, 81432206222, 81432206260, 81432206283, 81432206284



MN-DL-8709

Length: 572 Ø: 52
Hole Distance: 130 / 130
81432206268, 81432206274, 81432206291, 81432206292, 82432206007



MN-DL-8733

Length: 530 Ø: 48
Hole Distance: 130 / 130
81432206161, 81432206190, 81432206358, 81432206359



MN-DL-12284

Length: 1530 Ø: 50
Cone Ø: d1 Ø 30 / d2 Ø 27
81466106579, 81466106580, 81466106624, 81466116720, 81467116720, 81467116730, 81467116952



MN-ES-8490

Length: 90
Cone Ø: d1 Ø 30 / d2 Ø 27
Thread: M26 x 1,5 RHT
0014606948, 14606948, 81953016281, 81953016337, 82953016016



MN-RK-12436

Ø: 75
Hole Distance: 115
Thick/Height: 24
81432206244



MN-TC-12399

Length: 694 Ø: 50
Hole Distance: 130 / 130
81432206265



MN-VB-5238

Length: 627 Ø: 48
Hole Distance: 130 / 130
81432206221, 81432706096, 81432706114, 81432706116, 81432706121



MN-VB-9403

Length: 627 Ø: 48
Hole Ø 25 / 23 / 23
Hole Distance: 152 / 130 / 130
81432706097, 81432706113, 81432706135, 81432706160, 81432706161



SC-ES-7279

Length: 150
Cone Ø: d1 Ø 30 / d2 Ø 27
Thread: M30 x 1,5 RHT
81953016286



SC-ES-8517

Length: 140
Cone Ø: d1 Ø 30 / d2 Ø 27
Thread: M30 x 1,5 RHT
81953016286



SC-ES-8535

Length: 145
Cone Ø: d1 Ø 30 / d2 Ø 27
Thread: M30 x 1,5 RHT
81953016271, 81953016325





TGA ...

26.350, 26.360 FVHL-KO ...	06/05 →	Track Control Arm		MN-VB-5238	Wishbone (CV), Drive Axle;Leading Axle; Air Suspension Axle	
26.350, 26.360 FVL-KO	01/04 →	Centre Rod	MN-DL-7801		Push Rod, Leaf Spring Axle	
	01/04 →	Suspension Strut Repair Kit		DB-RK-8581		
	01/04 →	Tie Rod	MN-DL-7802			
	01/04 →	Tie Rod End		SC-ES-8517	for Push Rod	
	01/04 →	Tie Rod End	CV-ES-0914		for Steering Rod	
	01/04 →	Tie Rod End	CV-ES-14163		for Steering Rod	
	01/04 →	Tie Rod End	SC-ES-7279		for Steering Rod	
	01/04 →	Tie Rod End	SC-ES-8535		for Guide Rod	
	01/04 →	Track Control Arm		MN-DL-5225	Trailing Arm, Drive Axle;Air Suspension Axle	
	01/04 →	Track Control Arm		MN-DL-5225	Trailing Arm, Leading Axle;Air Suspension Axle	
	01/04 →	Track Control Arm		MN-DL-8733	Trailing Arm, Air Suspension Axle;Drive Axle	
	01/04 →	Track Control Arm		MN-VB-5238	Wishbone (CV), Drive Axle;Air Suspension Axle	
	01/04 →	Track Control Arm		MN-VB-5238	Wishbone (CV), Leading Axle;Air Suspension Axle	
26.360 FDAC, FDARC, FDHC, FDHLC	02/02 →	Ball Head, gearshift linkage	CV-ES-2120			
	02/02 →	Centre Rod	MN-DL-7801		Push Rod	
	02/02 →	Suspension Strut Repair Kit		DB-RK-8581		
	02/02 →	Tie Rod End	CV-ES-0914		for Steering Rod	
	02/02 →	Tie Rod End	CV-ES-14163		for Steering Rod	
	02/02 →	Tie Rod End	MN-ES-10333		for Steering Rod	
	02/02 →	Tie Rod End	SC-ES-8517		for Push Rod	
	02/02 →	Track Control Arm		MN-DL-5225	Trailing Arm	
	02/02 →	Track Control Arm		MN-DL-8544	Trailing Arm, 1st RA;2nd RA;Leaf Spring Axle	
	02/02 →	Track Control Arm		MN-DL-8609	Trailing Arm, 1st RA;2nd RA, for Leaf-Spring Suspension vehicles, →Type_HB Chassis	
	02/02 →	Track Control Arm		MN-VB-8514	Suspension Rod, Wishbone (CV), Drive Axle; Leaf Spring Axle	
	02/02 →	Track Control Arm		MN-VB-9404	Wishbone (CV), Drive Axle	
	06/04 →	Centre Rod	MN-DL-2160		Coupling Rod	
	06/04 →	Centre Rod	MN-DL-2174		Push Rod	
	06/04 →	Suspension Arm Repair Kit		CV-RK-5313	for Wishbone (CV)	
	06/04 →	Tie Rod End	CV-ES-14162		for Steering Rod	
	06/04 →	Tie Rod End	SC-ES-7279		for Steering Rod	
	06/04 →	Tie Rod End	SC-ES-8535		for Guide Rod	
	06/04 →	Track Control Arm		MN-DL-8544	Trailing Arm, 1st RA;2nd RA, for Leaf-Spring Suspension vehicles	
	06/04 →	Track control arm		MN-DL-10288	Trailing Arm, 1st RA;2nd RA, for Leaf-Spring Suspension vehicles, →Type HB	
	06/04 →	Track control arm		MN-DL-12288	Trailing Arm	
	06/04 →	Track Control Arm		MN-VB-5238	Wishbone (CV), 1st RA;2nd RA, for Pneumatic Suspension vehicles, →Type_NBA Chassis	
	06/04 →	Track Control Arm		MN-VB-8514	Suspension Rod, Wishbone (CV)	
	06/04 →	Track Control Arm		MN-VB-8669	Suspension Rod, Wishbone (CV), 1st RA; 2nd RA, for Leaf-Spring Suspension vehicles, →Type_MHB Chassis	
	06/04 →	Track Control Arm		MN-VB-9404	Wishbone (CV), 1st RA;2nd RA, for Leaf-Spring Suspension vehicles, →Type_HB Chassis	
	26.360 FDAK, FDALK, FDHK, FDHLC	02/02 →	Ball Head, gearshift linkage	CV-ES-2120		
		02/02 →	Centre Rod	MN-DL-7801		Push Rod
02/02 →		Suspension Strut Repair Kit		DB-RK-8581		
02/02 →		Tie Rod End	CV-ES-0914		for Steering Rod	
02/02 →		Tie Rod End	CV-ES-14163		for Steering Rod	
02/02 →		Tie Rod End	MN-ES-10333		for Steering Rod	
02/02 →		Tie Rod End	SC-ES-8517		for Push Rod	
02/02 →		Track Control Arm		MN-DL-5225	Trailing Arm	
02/02 →		Track Control Arm		MN-DL-8544	Trailing Arm, 1st RA;2nd RA;Leaf Spring Axle	
02/02 →		Track Control Arm		MN-DL-8544	Trailing Arm, Drive Axle;Air Suspension Axle	
02/02 →		Track Control Arm		MN-DL-8609	Trailing Arm, 1st RA;2nd RA, for Leaf-Spring Suspension vehicles, →Type_HB Chassis	
02/02 →		Track Control Arm		MN-VB-8514	Suspension Rod, Wishbone (CV), Drive Axle; Air Suspension Axle	

CV-ES-0914

Length: 125
Cone Ø: d1 Ø 30 / d2 Ø 27
Thread: M38 x 1,5 RHT
81953016184, 81953016251, 81953016276



CV-ES-2120

Length: 115
Cone Ø: d1 Ø 12,4 / d2 Ø 10,8
Thread: M14 x 1,5 RHT
03008500A, 81953016200, 81953016202,
81953016203, 81953016227



CV-ES-14162

Length: 125
Cone Ø: d1 Ø 30 / d2 Ø 27
Thread: M30 x 1,5 LHT
81953010015, 81953010083, 81953010087,
81953016029, 81953016030, 81953016043,
81953016044, 81953016050, 81953016054,
81953016087, 81953016091, 81953016107,
81953016120, 81953016125, 81953016152,
81953016155, 81953016157, 81953016168,
81953016179, 81953016181, 81953016223,
81953016237, 81953016254, 81953016275,
81953016279, 81953016351



CV-ES-14163

Length: 125
Cone Ø: d1 Ø 30 / d2 Ø 27
Thread: M30 x 1,5 RHT
95301.0084, 90804102156, 90804102272,
90804102696, 90804102710, 81953010016,
81953010075, 81953010084, 81953010088,
81953010094, 81953010103, 81953016030,
81953016043, 81953016048, 81953016049,
81953016053, 81953016061, 81953016090,
81953016108, 81953016112, 81953016126,
81953016143, 81953016149, 81953016154,
81953016156, 81953016168, 81953016178,
81953016194, 81953016206, 81953016224,
81953016234, 81953016242, 81953016252,
81953016274, 81953016278, 81953016284,
81953016286, 81953016308, 81953016310,
81953016312, 81953016347, 81953016350,
81953016352, 82953016012, 88953016014,
N2953016001



CV-RK-5313

Ø: 90
03304800A, 81953016132



DB-RK-8581

Ø: 85
Hole Distance: 130
Thick/Height: 24
03305800A, 81432706105



MN-DL-2160

Length: 1652 Ø: 50
Cone Ø: d1 Ø 30 / d2 Ø 27
81467106112, 81467106163, 81467106165,
81467106198, 81467106353, 81467106354,
81467106361, 81467116725



MN-DL-2174

Length: 1588 Ø: 52
Cone Ø: d1 Ø 30 / d2 Ø 27
81467106378, 81467106912



MN-DL-5225

Length: 572 Ø: 48
Hole Distance: 130 / 130
03301500A, 81432206229, 81432206236,
81432206267, 81432206270, 81432206272,
81432206304, 81432206305, 81432209236,
81432209267, 81432209272



MN-DL-7801

Length: 995 Ø: 52
Cone Ø: d1 Ø 30 / d2 Ø 27
81466106807, 81466106808, 81466116087,
81466116088, 81466116096, 81466116097,
81466116099, 81466116132, 81466116133,
81466116136, 81466116197, 81466116198,
81466116205

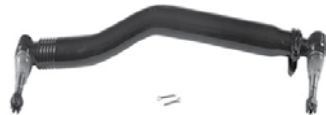

MN-DL-7802

Length: 1680 Ø: 52
Cone Ø: d1 Ø 30 / d2 Ø 27
03208300A, 81467116773, 81467116858,
81467116859, 81467116860, 81467116861,
81467116863, 81467116882, 81467116883,
81467116920, 81467116921



MN-DL-8544

Length: 596 Ø: 48
Hole Distance: 130 / 130
81432206196, 81432206232, 81432206233



MN-DL-8609

Length: 585 Ø: 58
Hole Distance: 130 / 130
81432206070, 81432206071, 81432206072,
81432206091, 81432206093, 81432206119



MN-DL-8733

Length: 530 Ø: 48
Hole Distance: 130 / 130
81432206161, 81432206190, 81432206358,
81432206359



MN-DL-10288

81432206386, 82432206008, 82432209008

No Image

MN-DL-12288

Length: 585 Ø: 58
Hole Distance: 130 / 130
81432206386, 82432206008, 82432209008

No Image

MN-ES-10333

Length: 90
Cone Ø: d1 Ø 38 / d2 Ø 34,35
Thread: M36 x 1,5 RHT
1271126, 3090291, 3099128, 42538048,
81953016268, 82953016018, 82953016019



MN-VB-5238

Length: 627 Ø: 48
Hole Distance: 130 / 130
81432206221, 81432706096, 81432706114,
81432706116, 81432706121



MN-VB-8514

Length: 627 Ø: 48
Hole Ø 25 / 25 / 25
Hole Distance: 152 / 130 / 130
81432706087, 81432706088, 81432706094,
81432706095, 81432796094



MN-VB-8669

Length: 627 Ø: 48
Hole Ø 25 / 25 / 25
Hole Distance: 152 / 130 / 130
81432706116, 81432706137, 81432706150,
81432706151



MN-VB-9404

Length: 627 Ø: 58
Hole Distance: 130 / 130
81432706117, 81432706152, 81432706153



SC-ES-7279

Length: 150
Cone Ø: d1 Ø 30 / d2 Ø 27
Thread: M30 x 1,5 RHT
81953016288



SC-ES-8517

Length: 140
Cone Ø: d1 Ø 30 / d2 Ø 27
Thread: M30 x 1,5 RHT
81953016286



SC-ES-8535

Length: 145
Cone Ø: d1 Ø 30 / d2 Ø 27
Thread: M30 x 1,5 RHT
81953016271, 81953016325





TGA ...

26.360 FDAK, FDALK, FDHK, FDHLK ...	02/02→	Track Control Arm		MN-VB-8514	Suspension Rod, Wishbone (CV), Drive Axle; Leaf Spring Axle	
	02/02→	Track Control Arm		MN-VB-9404	Wishbone (CV)	
26.360 FDAK, FDARK	06/04→	Centre Rod	MN-DL-2160		Coupling Rod	
	06/04→	Centre Rod	MN-DL-2174		Push Rod	
	06/04→	Suspension Arm Repair Kit		CV-RK-5313	for Wishbone (CV)	
	06/04→	Tie Rod End	CV-ES-0914		for Steering Rod	
	06/04→	Tie Rod End	CV-ES-14162		for Steering Rod	
	06/04→	Tie Rod End	CV-ES-14163		for Steering Rod	
	06/04→	Tie Rod End	MN-ES-10333		for Steering Rod	
	06/04→	Tie Rod End	SC-ES-7279		for Steering Rod	
	06/04→	Tie Rod End	SC-ES-8517		for Push Rod	
	06/04→	Tie Rod End	SC-ES-8535		for Guide Rod	
	06/04→	Track Control Arm		MN-DL-8609	Trailing Arm, 1st RA;2nd RA, for Leaf-Spring Suspension vehicles, →Type_HB Chassis	
	06/04→	Track control arm		MN-DL-10288	Trailing Arm, 1st RA;2nd RA, for Leaf-Spring Suspension vehicles, →Type HB	
	06/04→	Track control arm		MN-DL-12288	Trailing Arm	
	06/04→	Track Control Arm		MN-VB-5238	Wishbone (CV), 1st RA;2nd RA, for Pneumatic Suspension vehicles, →Type_NBA Chassis	
	06/04→	Track Control Arm		MN-VB-8514	Suspension Rod, Wishbone (CV)	
		Track Control Arm		MN-VB-8669	Suspension Rod, Wishbone (CV), 1st RA; 2nd RA, for Leaf-Spring Suspension vehicles, →Type_MHB Chassis	
06/04→	Track Control Arm		MN-VB-9404	Wishbone (CV), 1st RA;2nd RA, for Leaf-Spring Suspension vehicles, →Type_HB		
26.360 FDARS, FDAS, FDHLS, FDHS	02/02→	Ball Head, gearshift linkage	CV-ES-2120			
	02/02→	Centre Rod	MN-DL-7801		Push Rod	
	02/02→	Suspension Strut Repair Kit		DB-RK-8581		
	02/02→	Tie Rod End	CV-ES-0914		for Steering Rod	
	02/02→	Tie Rod End	CV-ES-14163		for Steering Rod	
	02/02→	Tie Rod End	MN-ES-10333		for Steering Rod	
	02/02→	Tie Rod End	SC-ES-8517		for Push Rod	
	02/02→	Track Control Arm		MN-DL-5225	Trailing Arm	
	02/02→	Track Control Arm		MN-DL-8544	Trailing Arm, 1st RA;2nd RA;Leaf Spring Axle	
	02/02→	Track Control Arm		MN-DL-8609	Trailing Arm, 1st RA;2nd RA, for Leaf-Spring Suspension vehicles, →Type_HB Chassis	
	02/02→	Track Control Arm		MN-VB-8514	Suspension Rod, Wishbone (CV), Drive Axle; Leaf Spring Axle	
		Track Control Arm		MN-VB-9404	Wishbone (CV), Drive Axle	
	06/04→	Centre Rod	MN-DL-2160		Coupling Rod	
	06/04→	Centre Rod	MN-DL-2174		Push Rod	
	06/04→	Suspension Arm Repair Kit		CV-RK-5313	for Wishbone (CV)	
	06/04→	Tie Rod End	CV-ES-14162		for Steering Rod	
	06/04→	Tie Rod End	SC-ES-7279		for Steering Rod	
	06/04→	Tie Rod End	SC-ES-8535		for Guide Rod	
	06/04→	Track control arm		MN-DL-10288	Trailing Arm, 1st RA;2nd RA, for Leaf-Spring Suspension vehicles, →Type HB	
	06/04→	Track control arm		MN-DL-12288	Trailing Arm	
	06/04→	Track Control Arm		MN-VB-5238	Wishbone (CV), 1st RA;2nd RA, for Pneumatic Suspension vehicles, →Type_NBA Chassis	
	06/04→	Track Control Arm		MN-VB-8514	Suspension Rod, Wishbone (CV)	
	06/04→	Track Control Arm		MN-VB-8669	Suspension Rod, Wishbone (CV), 1st RA; 2nd RA, for Leaf-Spring Suspension vehicles, →Type_MHB Chassis	
	06/04→	Track Control Arm		MN-VB-9404	Wishbone (CV), 1st RA;2nd RA, for Leaf-Spring Suspension vehicles, →Type_HB	
	26.360 FDC, FDLC, FDLRC, FDRC, FNHLC, FVHLC	01/01→	Ball Head, gearshift linkage	CV-ES-2120		
		01/01→	Centre Rod	MN-DL-7801		Push Rod, Leaf Spring Axle
		01/01→	Centre Rod	MN-DL-8560		Push Rod, Air Suspension Axle
		01/01→	Suspension Strut Repair Kit		DB-RK-8581	
		01/01→	Suspension Strut Repair Kit		MN-RK-12436	
		01/01→	Tie Rod	MN-DL-7802		

CV-ES-0914

Length: 125
Cone Ø: d1 Ø 30 / d2 Ø 27
Thread: M38 x 1,5 RHT
81953016184, 81953016251, 81953016276



CV-ES-2120

Length: 115
Cone Ø: d1 Ø 12,4 / d2 Ø 10,8
Thread: M14 x 1,5 RHT
03008500A, 81953016200, 81953016202,
81953016203, 81953016227



CV-ES-14162

Length: 125
Cone Ø: d1 Ø 30 / d2 Ø 27
Thread: M30 x 1,5 LHT
81953010015, 81953010083, 81953010087,
81953016029, 81953016030, 81953016043,
81953016044, 81953016050, 81953016054,
81953016087, 81953016091, 81953016107,
81953016120, 81953016125, 81953016152,
81953016155, 81953016157, 81953016168,
81953016179, 81953016181, 81953016223,
81953016237, 81953016254, 81953016275,
81953016279, 81953016351



CV-ES-14163

Length: 125
Cone Ø: d1 Ø 30 / d2 Ø 27
Thread: M30 x 1,5 RHT
95301.0084, 90804102156, 90804102272,
90804102696, 90804102710, 81953010016,
81953010075, 81953010084, 81953010088,
81953010094, 81953010103, 81953016030,
81953016043, 81953016048, 81953016049,
81953016053, 81953016061, 81953016090,
81953016108, 81953016112, 81953016126,
81953016143, 81953016149, 81953016154,
81953016156, 81953016168, 81953016178,
81953016194, 81953016206, 81953016224,
81953016234, 81953016242, 81953016252,
81953016274, 81953016278, 81953016284,
81953016286, 81953016308, 81953016310,
81953016312, 81953016347, 81953016350,
81953016352, 82953016012, 88953016014,
N2953016001



CV-RK-5313

Ø: 90
03304800A, 81953016132



DB-RK-8581

Ø: 85
Hole Distance: 130
Thick/Height: 24
03305800A, 81432706105



MN-DL-2160

Length: 1652 Ø: 50
Cone Ø: d1 Ø 30 / d2 Ø 27
81467106112, 81467106163, 81467106165,
81467106198, 81467106353, 81467106354,
81467106361, 81467116725



MN-DL-2174

Length: 1588 Ø: 52
Cone Ø: d1 Ø 30 / d2 Ø 27
81467106378, 81467106912



MN-DL-5225

Length: 572 Ø: 48
Hole Distance: 130 / 130
03301500A, 81432206229, 81432206236,
81432206267, 81432206270, 81432206272,
81432206304, 81432206305, 81432209236,
81432209267, 81432209272



MN-DL-7801

Length: 995 Ø: 52
Cone Ø: d1 Ø 30 / d2 Ø 27
81466106807, 81466106808, 81466116087,
81466116088, 81466116096, 81466116097,
81466116099, 81466116132, 81466116133,
81466116136, 81466116197, 81466116198,
81466116205

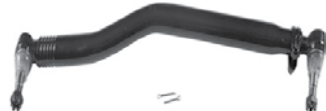

MN-DL-7802

Length: 1680 Ø: 52
Cone Ø: d1 Ø 30 / d2 Ø 27
03208300A, 81467116773, 81467116858,
81467116859, 81467116860, 81467116861,
81467116863, 81467116882, 81467116883,
81467116920, 81467116921



MN-DL-8544

Length: 596 Ø: 48
Hole Distance: 130 / 130
81432206196, 81432206232, 81432206233



MN-DL-8560

Length: 970 Ø: 52
Cone Ø: d1 Ø 30 / d2 Ø 27
03206900A, 81466106809, 81466106810,
81466106823, 81466106838, 81466106839,
81466116104, 81466116105, 81466116107,
81466116134, 81466116135, 81466116137,
81466116199, 81466116200, 81466116206



MN-DL-8609

Length: 585 Ø: 58
Hole Distance: 130 / 130
81432206070, 81432206071, 81432206072,
81432206091, 81432206093, 81432206119



MN-DL-10288

81432206386, 82432206008, 82432209008

No Image

MN-DL-12288

Length: 585 Ø: 58
Hole Distance: 130 / 130
81432206386, 82432206008, 82432209008

No Image

MN-ES-10333

Length: 90
Cone Ø: d1 Ø 38 / d2 Ø 34,35
Thread: M36 x 1,5 RHT
1271126, 3090291, 3099128, 42538048,
81953016268, 82953016018, 82953016019



MN-RK-12436

Ø: 75
Hole Distance: 115
Thick/Height: 24
81432206244



MN-VB-5238

Length: 627 Ø: 48
Hole Distance: 130 / 130
81432206221, 81432706096, 81432706114,
81432706116, 81432706121



MN-VB-8514

Length: 627 Ø: 48
Hole Ø 25 / 25 / 25
Hole Distance: 152 / 130 / 130
81432706087, 81432706088, 81432706094,
81432706095, 81432796094



MN-VB-8669

Length: 627 Ø: 48
Hole Ø 25 / 25 / 25
Hole Distance: 152 / 130 / 130
81432706116, 81432706137, 81432706150,
81432706151



MN-VB-9404

Length: 627 Ø: 58
Hole Distance: 130 / 130
81432706117, 81432706152, 81432706153



SC-ES-7279

Length: 150
Cone Ø: d1 Ø 30 / d2 Ø 27
Thread: M30 x 1,5 RHT
81953016288



SC-ES-8517

Length: 140
Cone Ø: d1 Ø 30 / d2 Ø 27
Thread: M30 x 1,5 RHT
81953016286



SC-ES-8535

Length: 145
Cone Ø: d1 Ø 30 / d2 Ø 27
Thread: M30 x 1,5 RHT
81953016271, 81953016325





TGA ...

26.360 FDC, FDLC, FDLRC, FDRC,
FNHLC, FVHLC ...

01/01→	Tie Rod End	CV-ES-0914		for Steering Rod
01/01→	Tie Rod End	CV-ES-14162		for Steering Rod
01/01→	Tie Rod End	CV-ES-14163		for Steering Rod
01/01→	Tie Rod End	SC-ES-7279		for Steering Rod
01/01→	Tie Rod End	SC-ES-8517		for Push Rod
01/01→	Tie Rod End	SC-ES-8535		for Guide Rod
01/01→	Track Control Arm		MN-DL-3402	Trailing Arm, Air Suspension Axle; Drive Axle
01/01→	Track Control Arm		MN-DL-5225	Trailing Arm, Drive Axle; Air Suspension Axle
01/01→	Track Control Arm		MN-DL-8544	Trailing Arm, Drive Axle; Air Suspension Axle
01/01→	Track Control Arm		MN-DL-8544	Trailing Arm, Drive Axle; Leaf Spring Axle
01/01→	Track control arm		MN-DL-10288	Trailing Arm, 1st RA; 2nd RA, for Leaf-Spring Suspension vehicles
01/01→	Track control arm		MN-DL-12288	Trailing Arm
01/01→	Track Control Arm		MN-VB-5222	Wishbone (CV), 1st RA; 2nd RA, for Pneumatic Suspension vehicles
01/01→	Track Control Arm		MN-VB-5238	Wishbone (CV), Drive Axle; Air Suspension Axle
01/01→	Track Control Arm		MN-VB-8514	Suspension Rod, Wishbone (CV), Drive Axle; Leaf Spring Axle
01/01→	Track Control Arm		MN-VB-8669	Suspension Rod, Wishbone (CV), Drive Axle
01/01→	Track Control Arm		MN-VB-8669	Suspension Rod, Wishbone (CV), Drive Axle; Leaf Spring Axle
01/01→	Track Control Arm		MN-VB-9404	Wishbone (CV), Drive Axle
01/01→	Track Control Arm		MN-VB-9404	Wishbone (CV), Drive Axle; Air Suspension Axle
01/01→	Track Control Arm	MN-DL-8663		Control Arm, Air Suspension Axle

26.360 FDHC, FDHLC

05/04→	Centre Rod	MN-DL-7801		Push Rod
05/04→	Suspension Arm Repair Kit		CV-RK-5313	for Wishbone (CV)
05/04→	Tie Rod	MN-DL-7802		
05/04→	Tie Rod End	CV-ES-0914		for Steering Rod
05/04→	Tie Rod End	CV-ES-14162		for Steering Rod
05/04→	Tie Rod End	CV-ES-14163		for Steering Rod
05/04→	Tie Rod End	MN-ES-10333		for Steering Rod
05/04→	Tie Rod End	SC-ES-7279		for Steering Rod
05/04→	Tie Rod End	SC-ES-8517		for Push Rod
05/04→	Tie Rod End	SC-ES-8535		for Guide Rod
05/04→	Track Control Arm		MN-DL-5225	Trailing Arm
05/04→	Track Control Arm		MN-DL-8544	Trailing Arm, 1st RA; 2nd RA, for Leaf-Spring Suspension vehicles
05/04→	Track Control Arm		MN-DL-8609	Trailing Arm, 1st RA; 2nd RA, for Leaf-Spring Suspension vehicles, →Type_HB Chassis
05/04→	Track Control Arm		MN-VB-5238	Wishbone (CV), 1st RA; 2nd RA, for Pneumatic Suspension vehicles, →Type_NBA Chassis
05/04→	Track Control Arm		MN-VB-8514	Suspension Rod, Wishbone (CV)
05/04→	Track Control Arm		MN-VB-8669	Suspension Rod, Wishbone (CV), 1st RA; 2nd RA, for Leaf-Spring Suspension vehicles, →Type_MHB Chassis
05/04→	Track Control Arm		MN-VB-9404	Wishbone (CV), 1st RA; 2nd RA, for Leaf-Spring Suspension vehicles, →Type_HB Chassis

26.360 FDK, FDLK, FDRK, FDLRK

09/02→	Ball Head, gearshift linkage	CV-ES-2120		
09/02→	Centre Rod	MN-DL-7801		Push Rod, Leaf Spring Axle
09/02→	Centre Rod	MN-DL-8560		Push Rod, Air Suspension Axle
09/02→	Suspension Strut Repair Kit		DB-RK-8581	
09/02→	Suspension Strut Repair Kit		MN-RK-12436	
09/02→	Tie Rod	MN-DL-7802		
09/02→	Tie Rod End	CV-ES-0914		for Steering Rod
09/02→	Tie Rod End	CV-ES-14162		for Steering Rod
09/02→	Tie Rod End	CV-ES-14163		for Steering Rod
09/02→	Tie Rod End	SC-ES-7279		for Steering Rod
09/02→	Tie Rod End	SC-ES-8517		for Push Rod
09/02→	Tie Rod End	SC-ES-8535		for Guide Rod
09/02→	Track Control Arm		MN-DL-3402	Trailing Arm, Air Suspension Axle; Drive Axle
09/02→	Track Control Arm		MN-DL-5225	Trailing Arm, Drive Axle; Air Suspension Axle
09/02→	Track Control Arm		MN-DL-8544	Trailing Arm, Drive Axle; Air Suspension Axle
09/02→	Track Control Arm		MN-DL-8544	Trailing Arm, Drive Axle; Leaf Spring Axle

CV-ES-0914

Length: 125
Cone Ø: d1 Ø 30 / d2 Ø 27
Thread: M38 x 1,5 RHT
81953016184, 81953016251, 81953016276



CV-ES-2120

Length: 115
Cone Ø: d1 Ø 12,4 / d2 Ø 10,8
Thread: M14 x 1,5 RHT
03008500A, 81953016200, 81953016202,
81953016203, 81953016227



CV-ES-14162

Length: 125
Cone Ø: d1 Ø 30 / d2 Ø 27
Thread: M30 x 1,5 LHT
81953010015, 81953010083, 81953010087,
81953016029, 81953016030, 81953016043,
81953016044, 81953016050, 81953016054,
81953016087, 81953016091, 81953016107,
81953016120, 81953016125, 81953016152,
81953016155, 81953016157, 81953016168,
81953016179, 81953016181, 81953016223,
81953016237, 81953016254, 81953016275,
81953016279, 81953016351



CV-ES-14163

Length: 125
Cone Ø: d1 Ø 30 / d2 Ø 27
Thread: M30 x 1,5 RHT
95301.0084, 90804102156, 90804102272,
90804102696, 90804102710, 81953010016,
81953010075, 81953010084, 81953010088,
81953010094, 81953010103, 81953016030,
81953016043, 81953016048, 81953016049,
81953016053, 81953016061, 81953016090,
81953016108, 81953016112, 81953016126,
81953016143, 81953016149, 81953016154,
81953016156, 81953016168, 81953016178,
81953016194, 81953016206, 81953016224,
81953016234, 81953016242, 81953016252,
81953016274, 81953016278, 81953016284,
81953016286, 81953016308, 81953016310,
81953016312, 81953016347, 81953016350,
81953016352, 82953016012, 88953016014,
N2953016001



CV-RK-5313

Ø: 90
03304800A, 81953016132



DB-RK-8581

Ø: 85
Hole Distance: 130
Thick/Height: 24
03305800A, 81432706105



MN-DL-3402

Length: 590 Ø: 48
Hole Distance: 130 / 130
03307200A, 81432206067, 81432206068,
81432206090, 81432206092, 81432209092



MN-DL-5225

Length: 572 Ø: 48
Hole Distance: 130 / 130
03301500A, 81432206229, 81432206236,
81432206267, 81432206270, 81432206272,
81432206304, 81432206305, 81432209236,
81432209267, 81432209272



MN-DL-7801

Length: 995 Ø: 52
Cone Ø: d1 Ø 30 / d2 Ø 27
81466106807, 81466106808, 81466116087,
81466116088, 81466116096, 81466116097,
81466116099, 81466116132, 81466116133,
81466116136, 81466116197, 81466116198,
81466116205

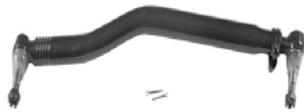

MN-DL-7802

Length: 1680 Ø: 52
Cone Ø: d1 Ø 30 / d2 Ø 27
03208300A, 81467116773, 81467116858,
81467116859, 81467116860, 81467116861,
81467116863, 81467116882, 81467116883,
81467116920, 81467116921



MN-DL-8544

Length: 596 Ø: 48
Hole Distance: 130 / 130
81432206196, 81432206232, 81432206233



MN-DL-8560

Length: 970 Ø: 52
Cone Ø: d1 Ø 30 / d2 Ø 27
03206900A, 81466106809, 81466106810,
81466106823, 81466106838, 81466106839,
81466116104, 81466116105, 81466116107,
81466116134, 81466116135, 81466116137,
81466116199, 81466116200, 81466116206



MN-DL-8609

Length: 585 Ø: 58
Hole Distance: 130 / 130
81432206070, 81432206071, 81432206072,
81432206091, 81432206093, 81432206119



MN-DL-8663

Length: 947 Ø: 60
Hole Distance: 115 / 115
03307400A, 81432206222, 81432206260,
81432206283, 81432206284



MN-DL-10288

81432206386, 82432206008, 82432209008

No Image

MN-DL-12288

Length: 585 Ø: 58
Hole Distance: 130 / 130
81432206386, 82432206008, 82432209008

No Image

MN-ES-10333

Length: 90
Cone Ø: d1 Ø 38 / d2 Ø 34,35
Thread: M36 x 1,5 RHT
1271126, 3090291, 3099128, 42538048,
81953016268, 82953016018, 82953016019



MN-RK-12436

Ø: 75
Hole Distance: 115
Thick/Height: 24
81432206244



MN-VB-5222

Length: 627 Ø: 50
Hole Distance: 152 / 152
81432706030, 81432706034, 81432706054,
81432706055, 81432706056, 81432706057,
81432706067, 81432706068, 81432706074,
81432706075, 81432706076, 81432706077,
81432706078, 81432706081, 81432706082,
81432709034, 81432709076, 81432709078,
8143706054



MN-VB-5238

Length: 627 Ø: 48
Hole Distance: 130 / 130
81432206221, 81432706096, 81432706114,
81432706116, 81432706121



MN-VB-8514

Length: 627 Ø: 48
Hole Ø 25 / 25 / 25
Hole Distance: 152 / 130 / 130
81432706087, 81432706088, 81432706094,
81432706095, 81432796094



MN-VB-8669

Length: 627 Ø: 48
Hole Ø 25 / 25 / 25
Hole Distance: 152 / 130 / 130
81432706116, 81432706137, 81432706150,
81432706151



MN-VB-9404

Length: 627 Ø: 58
Hole Distance: 130 / 130
81432706117, 81432706152, 81432706153



SC-ES-7279

Length: 150
Cone Ø: d1 Ø 30 / d2 Ø 27
Thread: M30 x 1,5 RHT
81953016288



SC-ES-8517

Length: 140
Cone Ø: d1 Ø 30 / d2 Ø 27
Thread: M30 x 1,5 RHT
81953016286



SC-ES-8535

Length: 145
Cone Ø: d1 Ø 30 / d2 Ø 27
Thread: M30 x 1,5 RHT
81953016271, 81953016325





TGA ...

26.360 FDK, FDLK, FDRK, FDLRK ...	09/02→	Track control arm		MN-DL-10288	Trailing Arm, 1st RA;2nd RA, for Leaf-Spring Suspension vehicles
	09/02→	Track control arm		MN-DL-12288	Trailing Arm
	09/02→	Track Control Arm		MN-VB-5222	Wishbone (CV), 1st RA;2nd RA, for Pneumatic Suspension vehicles
	09/02→	Track Control Arm		MN-VB-5238	Wishbone (CV), Drive Axle;Air Suspension Axle
	09/02→	Track Control Arm		MN-VB-8514	Suspension Rod, Wishbone (CV), Drive Axle; Leaf Spring Axle
	09/02→	Track Control Arm		MN-VB-8669	Suspension Rod, Wishbone (CV), Drive Axle
	09/02→	Track Control Arm		MN-VB-8669	Suspension Rod, Wishbone (CV), Drive Axle; Leaf Spring Axle
	09/02→	Track Control Arm		MN-VB-9404	Wishbone (CV), Drive Axle
	09/02→	Track Control Arm		MN-VB-9404	Wishbone (CV), Drive Axle;Air Suspension Axle
	09/02→	Track Control Arm	MN-DL-8663		Control Arm, Air Suspension Axle
26.360 FDLK-WW, FDLRC	05/04→	Centre Rod	MN-DL-7801		Push Rod, Leaf Spring Axle
	05/04→	Suspension Strut Repair Kit		DB-RK-8581	
	05/04→	Tie Rod	MN-DL-7802		
	05/04→	Tie Rod End	CV-ES-0914		for Steering Rod
	05/04→	Tie Rod End	CV-ES-14162		for Steering Rod
	05/04→	Tie Rod End	CV-ES-14163		for Steering Rod
	05/04→	Tie Rod End	SC-ES-7279		for Steering Rod
	05/04→	Tie Rod End	SC-ES-8517		for Push Rod
	05/04→	Tie Rod End	SC-ES-8535		for Guide Rod
	05/04→	Track Control Arm		MN-DL-5225	Trailing Arm
	05/04→	Track Control Arm		MN-DL-8733	Trailing Arm, 1st Drive Axle, for Pneumatic Suspension vehicles
	05/04→	Track Control Arm		MN-VB-5222	Wishbone (CV), 1st RA;2nd RA, for Pneumatic Suspension vehicles
	05/04→	Track Control Arm		MN-VB-8669	Suspension Rod, Wishbone (CV), 1st RA; 2nd RA, for Leaf-Spring Suspension vehicles, →Type_MHB Chassis
	26.360 FDLK, FDLRS-WW, FNHLS	05/04→	Centre Rod	MN-DL-7801	
05/04→		Suspension Strut Repair Kit		DB-RK-8581	
05/04→		Tie Rod	MN-DL-7802		
05/04→		Tie Rod End		SC-ES-8517	for Push Rod
05/04→		Tie Rod End	CV-ES-0914		for Steering Rod
05/04→		Tie Rod End	CV-ES-14162	CV-ES-14162	for Steering Rod
05/04→		Tie Rod End	CV-ES-14163		for Steering Rod
05/04→		Tie Rod End	SC-ES-7279		for Steering Rod
05/04→		Tie Rod End	SC-ES-8535		for Guide Rod
05/04→		Track Control Arm		MN-DL-5225	Trailing Arm
05/04→		Track Control Arm		MN-DL-8733	Trailing Arm, 1st Drive Axle, for Pneumatic Suspension vehicles
05/04→		Track Control Arm		MN-VB-5222	Wishbone (CV), 1st RA;2nd RA, for Pneumatic Suspension vehicles
05/04→		Track Control Arm		MN-VB-8669	Suspension Rod, Wishbone (CV), 1st RA; 2nd RA, for Leaf-Spring Suspension vehicles, →Type_MHB Chassis
26.360 FDLK, FDLK/M, FDLRS, FDLRS/M, FDLRS-WW, FDRS		09/03→	Centre Rod	MN-DL-7801	
	09/03→	Centre Rod	MN-DL-8560		Push Rod, Air Suspension Axle
	09/03→	Suspension Strut Repair Kit		DB-RK-8581	
	09/03→	Suspension Strut Repair Kit		MN-RK-12436	
	09/03→	Tie Rod	MN-DL-7802		
	09/03→	Tie Rod End	CV-ES-0914		for Steering Rod
	09/03→	Tie Rod End	CV-ES-14162		for Steering Rod
	09/03→	Tie Rod End	CV-ES-14163		for Steering Rod
	09/03→	Tie Rod End	SC-ES-7279		for Steering Rod
	09/03→	Tie Rod End	SC-ES-8517		for Push Rod
	09/03→	Tie Rod End	SC-ES-8535		for Guide Rod
	09/03→	Track Control Arm		MN-DL-3402	Trailing Arm, Air Suspension Axle;Drive Axle
	09/03→	Track Control Arm		MN-DL-5225	Trailing Arm, Drive Axle;Air Suspension Axle
	09/03→	Track Control Arm		MN-DL-8544	Trailing Arm, 1st RA;2nd RA, for Leaf-Spring Suspension vehicles

CV-ES-0914

Length: 125
Cone Ø: d1 Ø 30 / d2 Ø 27
Thread: M38 x 1,5 RHT
81953016184, 81953016251, 81953016276



CV-ES-14162

Length: 125
Cone Ø: d1 Ø 30 / d2 Ø 27
Thread: M30 x 1,5 LHT
81953010015, 81953010083, 81953010087, 81953016029, 81953016030, 81953016043, 81953016044, 81953016050, 81953016054, 81953016087, 81953016091, 81953016107, 81953016120, 81953016125, 81953016152, 81953016155, 81953016157, 81953016168, 81953016179, 81953016181, 81953016223, 81953016237, 81953016254, 81953016275, 81953016279, 81953016351

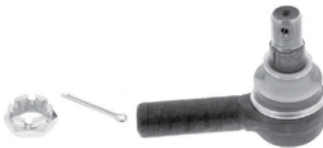

CV-ES-14163

Length: 125
Cone Ø: d1 Ø 30 / d2 Ø 27
Thread: M30 x 1,5 RHT
95301.0084, 90804102156, 90804102272, 90804102696, 90804102710, 81953010016, 81953010075, 81953010084, 81953010088, 81953010094, 81953010103, 81953016030, 81953016043, 81953016048, 81953016049, 81953016053, 81953016061, 81953016090, 81953016108, 81953016112, 81953016126, 81953016143, 81953016149, 81953016154, 81953016156, 81953016168, 81953016178, 81953016194, 81953016206, 81953016224, 81953016234, 81953016242, 81953016252, 81953016274, 81953016278, 81953016284, 81953016286, 81953016308, 81953016310, 81953016312, 81953016347, 81953016350, 81953016352, 82953016012, 88953016014, N2953016001



DB-RK-8581

Ø: 85
Hole Distance: 130
Thick/Height: 24
03305800A, 81432706105



MN-DL-3402

Length: 590 Ø: 48
Hole Distance: 130 / 130
03307200A, 81432206067, 81432206068, 81432206090, 81432206092, 81432209092



MN-DL-5225

Length: 572 Ø: 48
Hole Distance: 130 / 130
03301500A, 81432206229, 81432206236, 81432206267, 81432206270, 81432206272, 81432206304, 81432206305, 81432209236, 81432209267, 81432209272



MN-DL-7801

Length: 995 Ø: 52
Cone Ø: d1 Ø 30 / d2 Ø 27
81466106807, 81466106808, 81466116087, 81466116088, 81466116096, 81466116097, 81466116099, 81466116132, 81466116133, 81466116136, 81466116197, 81466116198, 81466116205

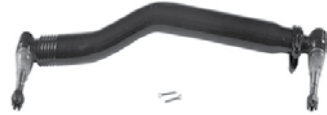

MN-DL-7802

Length: 1680 Ø: 52
Cone Ø: d1 Ø 30 / d2 Ø 27
03208300A, 81467116773, 81467116858, 81467116859, 81467116860, 81467116861, 81467116863, 81467116882, 81467116883, 81467116920, 81467116921



MN-DL-8544

Length: 596 Ø: 48
Hole Distance: 130 / 130
81432206196, 81432206232, 81432206233



MN-DL-8560

Length: 970 Ø: 52
Cone Ø: d1 Ø 30 / d2 Ø 27
03206900A, 81466106809, 81466106810, 81466106823, 81466106838, 81466106839, 81466116104, 81466116105, 81466116107, 81466116134, 81466116135, 81466116137, 81466116199, 81466116200, 81466116206



MN-DL-8663

Length: 947 Ø: 60
Hole Distance: 115 / 115
03307400A, 81432206222, 81432206260, 81432206283, 81432206284



MN-DL-8733

Length: 530 Ø: 48
Hole Distance: 130 / 130
81432206161, 81432206190, 81432206358, 81432206359



MN-DL-10288

81432206386, 82432206008, 82432209008

No Image

MN-DL-12288

Length: 585 Ø: 58
Hole Distance: 130 / 130
81432206386, 82432206008, 82432209008

No Image

MN-RK-12436

Ø: 75
Hole Distance: 115
Thick/Height: 24
81432206244



MN-VB-5222

Length: 627 Ø: 50
Hole Distance: 152 / 152
81432706030, 81432706034, 81432706054, 81432706055, 81432706056, 81432706057, 81432706067, 81432706068, 81432706074, 81432706075, 81432706076, 81432706077, 81432706078, 81432706081, 81432706082, 81432709034, 81432709076, 81432709078, 8143706054



MN-VB-5238

Length: 627 Ø: 48
Hole Distance: 130 / 130
81432206221, 81432706096, 81432706114, 81432706116, 81432706121



MN-VB-8514

Length: 627 Ø: 48
Hole Ø 25 / 25 / 25
Hole Distance: 152 / 130 / 130
81432706087, 81432706088, 81432706094, 81432706095, 81432796094



MN-VB-8669

Length: 627 Ø: 48
Hole Ø 25 / 25 / 25
Hole Distance: 152 / 130 / 130
81432706116, 81432706137, 81432706150, 81432706151



MN-VB-9404

Length: 627 Ø: 58
Hole Distance: 130 / 130
81432706117, 81432706152, 81432706153



SC-ES-7279

Length: 150
Cone Ø: d1 Ø 30 / d2 Ø 27
Thread: M30 x 1,5 RHT
81953016288



SC-ES-8517

Length: 140
Cone Ø: d1 Ø 30 / d2 Ø 27
Thread: M30 x 1,5 RHT
81953016286



SC-ES-8535

Length: 145
Cone Ø: d1 Ø 30 / d2 Ø 27
Thread: M30 x 1,5 RHT
81953016271, 81953016325





TGA ...

26.360 FDLs, FDLs/M, FDLRS,
FDLRS/M, FDLRS-WW , FDRS ...

09/03→	Track Control Arm		MN-DL-8544	Trailing Arm, 1st RA;2nd RA, for Pneumatic Suspension vehicles
09/03→	Track control arm		MN-DL-10288	Trailing Arm, 1st RA;2nd RA, for Leaf-Spring Suspension vehicles
09/03→	Track control arm		MN-DL-12288	Trailing Arm
09/03→	Track Control Arm		MN-VB-5222	Wishbone (CV), 1st RA;2nd RA, for Pneumatic Suspension vehicles
09/03→	Track Control Arm		MN-VB-5238	Wishbone (CV), Drive Axle;Air Suspension Axle
09/03→	Track Control Arm		MN-VB-8514	Suspension Rod, Wishbone (CV)
09/03→	Track Control Arm		MN-VB-8669	Suspension Rod, Wishbone (CV), 1st RA; 2nd RA, for Leaf-Spring Suspension vehicles, →Type_MHB Chassis
09/03→	Track Control Arm		MN-VB-9404	Wishbone (CV), Drive Axle;Air Suspension Axle
09/03→	Track Control Arm	MN-DL-8663		Control Arm, Air Suspension Axle

26.360 FDS, FDLS, FNLS, FNLRS,
FPLS, FPLRS, FVLS, FVLRS

12/00→01/05	Track Control Arm		MN-DL-5212	Trailing Arm, Tag Axle;Air Suspension Axle
12/00→	Ball Head, gearshift linkage	CV-ES-2120		
12/00→	Centre Rod	MN-DL-7801		Push Rod, Leaf Spring Axle
12/00→	Centre Rod	MN-DL-8560		Push Rod, Air Suspension Axle
12/00→	Suspension Strut Repair Kit		CV-RK-5311	
12/00→	Suspension Strut Repair Kit		DB-RK-8581	
12/00→	Suspension Strut Repair Kit		MN-RK-12436	
12/00→	Tie Rod	MN-DL-7802		
12/00→	Tie Rod	MN-DL-12284		
12/00→	Tie Rod End		IV-ES-8507	Tag Axle
12/00→	Tie Rod End		MN-ES-8490	Tag Axle
12/00→	Tie Rod End		SC-ES-8517	for Push Rod
12/00→	Tie Rod End	CV-ES-0914		for Steering Rod
12/00→	Tie Rod End	CV-ES-14162	CV-ES-14162	for Steering Rod
12/00→	Tie Rod End	CV-ES-14163		for Steering Rod
12/00→	Tie Rod End	IV-ES-12272		for Steering Rod
12/00→	Tie Rod End	SC-ES-7279		for Steering Rod
12/00→	Tie Rod End	SC-ES-8535		for Guide Rod
12/00→	Track Control Arm		MN-DL-5225	Trailing Arm, Drive Axle;Air Suspension Axle
12/00→	Track Control Arm		MN-DL-5225	Trailing Arm, Leading Axle;Air Suspension Axle
12/00→	Track Control Arm		MN-DL-8544	Trailing Arm, Drive Axle;Leaf Spring Axle
12/00→	Track Control Arm		MN-DL-8709	Trailing Arm, Air Suspension Axle; for vehicles with Hinged Trailing Axle
12/00→	Track Control Arm		MN-DL-8733	Trailing Arm, Air Suspension Axle;Drive Axle
12/00→	Track control arm		MN-DL-12288	Trailing Arm
12/00→	Track Control Arm		MN-TC-12399	Control Arm
12/00→	Track Control Arm		MN-VB-5238	Wishbone (CV), Drive Axle;Leading Axle; Air Suspension Axle
12/00→	Track Control Arm		MN-VB-8514	Suspension Rod, Wishbone (CV), Drive Axle; Leaf Spring Axle
12/00→	Track Control Arm		MN-VB-8669	Suspension Rod, Wishbone (CV), Drive Axle; Leaf Spring Axle
12/00→	Track Control Arm		MN-VB-9403	Wishbone (CV), Air Suspension Axle
12/00→	Track Control Arm		MN-VB-9404	Wishbone (CV), Drive Axle
12/00→	Track Control Arm	MN-DL-8663		Control Arm, Air Suspension Axle
03/04→	Track Control Arm		MN-DL-5225	Trailing Arm, Tag Axle;Air Suspension Axle; for vehicles with Hinged Trailing Axle
01/05→	Track Control Arm		MN-DL-5225	Trailing Arm, Tag Axle;Air Suspension Axle; for vehicles with Rigid Trailing Axle

26.360 FD-TM, FDR-TM

01/01→	Ball Head, gearshift linkage	CV-ES-2120		
01/01→	Centre Rod	MN-DL-7801		Push Rod, Leaf Spring Axle
01/01→	Suspension Strut Repair Kit		DB-RK-8581	
01/01→	Tie Rod	MN-DL-7802		
01/01→	Tie Rod End	CV-ES-0914		for Steering Rod
01/01→	Tie Rod End	CV-ES-14162		for Steering Rod
01/01→	Tie Rod End	CV-ES-14163		for Steering Rod
01/01→	Tie Rod End	SC-ES-7279		for Steering Rod
01/01→	Tie Rod End	SC-ES-8517		for Push Rod
01/01→	Tie Rod End	SC-ES-8535		for Guide Rod

CV-ES-0914

Length: 125
Cone Ø: d1 Ø 30 / d2 Ø 27
Thread: M38 x 1,5 RHT
81953016184, 81953016251, 81953016276



CV-ES-2120

Length: 115
Cone Ø: d1 Ø 12,4 / d2 Ø 10,8
Thread: M14 x 1,5 RHT
03008500A, 81953016200, 81953016202,
81953016203, 81953016227



CV-ES-14162

Length: 125
Cone Ø: d1 Ø 30 / d2 Ø 27
Thread: M30 x 1,5 LHT
81953010015, 81953010083, 81953010087,
81953016029, 81953016030, 81953016043,
81953016044, 81953016050, 81953016054,
81953016087, 81953016091, 81953016107,
81953016120, 81953016125, 81953016152,
81953016155, 81953016157, 81953016168,
81953016179, 81953016181, 81953016223,
81953016237, 81953016254, 81953016275,
81953016279, 81953016351



CV-ES-14163

Length: 125
Cone Ø: d1 Ø 30 / d2 Ø 27
Thread: M30 x 1,5 RHT
95301.0084, 90804102156, 90804102272,
90804102696, 90804102710, 81953010016,
81953010075, 81953010084, 81953010088,
81953010094, 81953010103, 81953016030,
81953016043, 81953016048, 81953016049,
81953016053, 81953016061, 81953016090,
81953016108, 81953016112, 81953016126,
81953016143, 81953016149, 81953016154,
81953016156, 81953016168, 81953016178,
81953016194, 81953016206, 81953016224,
81953016234, 81953016242, 81953016252,
81953016274, 81953016278, 81953016284,
81953016286, 81953016308, 81953016310,
81953016312, 81953016347, 81953016350,
81953016352, 82953016012, 88953016014,
N2953016001



CV-RK-5311

638862, 639287, 938423, 1104335,
1953248, 3500506, 0003500506, 11013547,
42488722, 070550504, 634303610,
81432206055, 81432206073, 82262320660,
5001842823, 7000307001, 8226232066



DB-RK-8581

Ø: 85 Hole Distance: 130
Thick/Height: 24
03305800A, 81432706105



IV-ES-8507

Length: 80
Cone Ø: d1 Ø 30 / d2 Ø 27
Thread: M30 x 1,5 RHT
11019869, 12216380, 55175540,
81953016238



IV-ES-12272

Length: 75
Cone Ø: d1 Ø 30 / d2 Ø 27
Thread: M26 x 1,5 RHT
81953016280, 82953010010



MN-DL-5212

Length: 577 Ø: 48
Hole Distance: 130 / 130
81432206096, 81432206097, 81432206098,
81432206129, 81432209096, 81432209129,
81432306014, 81432306030



MN-DL-5225

Length: 572 Ø: 48
Hole Distance: 130 / 130
03301500A, 81432206229, 81432206236,
81432206267, 81432206270, 81432206272,
81432206304, 81432206305, 81432209236,
81432209267, 81432209272



MN-DL-7801

Length: 995 Ø: 52
Cone Ø: d1 Ø 30 / d2 Ø 27
81466106807, 81466106808, 81466116087,
81466116088, 81466116096, 81466116097,
81466116099, 81466116132, 81466116133,
81466116136, 81466116197, 81466116198,
81466116205

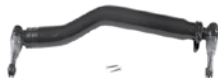

MN-DL-7802

Length: 1680 Ø: 52
Cone Ø: d1 Ø 30 / d2 Ø 27
03208300A, 81467116773, 81467116858,
81467116859, 81467116860, 81467116861,
81467116863, 81467116882, 81467116883,
81467116920, 81467116921



MN-DL-8544

Length: 596 Ø: 48
Hole Distance: 130 / 130
81432206196, 81432206232, 81432206233



MN-DL-8560

Length: 970 Ø: 52
Cone Ø: d1 Ø 30 / d2 Ø 27
03206900A, 81466106809, 81466106810,
81466106823, 81466106838, 81466106839,
81466116104, 81466116105, 81466116107,
81466116134, 81466116135, 81466116137,
81466116199, 81466116200, 81466116206



MN-DL-8663

Length: 947 Ø: 60
Hole Distance: 115 / 115
03307400A, 81432206222, 81432206260,
81432206283, 81432206284



MN-DL-8709

Length: 572 Ø: 52
Hole Distance: 130 / 130
81432206268, 81432206274, 81432206291,
81432206292, 82432206007



MN-DL-8733

Length: 530 Ø: 48
Hole Distance: 130 / 130
81432206161, 81432206190, 81432206358,
81432206359



MN-DL-10288

81432206386, 82432206008, 82432209008

No Image

MN-DL-12284

Length: 1530 Ø: 50
Cone Ø: d1 Ø 30 / d2 Ø 27
81466106579, 81466106580, 81466106624,
81466116720, 81467116720, 81467116730,
81467116952



MN-DL-12288

Length: 585 Ø: 58
Hole Distance: 130 / 130
81432206386, 82432206008, 82432209008

No Image

MN-ES-8490

Length: 90
Cone Ø: d1 Ø 30 / d2 Ø 27
Thread: M26 x 1,5 RHT
14606948, 0014606948, 81953016281,
81953016337, 82953016016



MN-RK-12436

Ø: 75 Hole Distance: 115
Thick/Height: 24
81432206244



MN-TC-12399

Length: 694 Ø: 50
Hole Distance: 130 / 130
81432206265



MN-VB-5222

Length: 627 Ø: 50
Hole Distance: 152 / 152
81432706030, 81432706034, 81432706054,
81432706055, 81432706056, 81432706057,
81432706067, 81432706068, 81432706074,
81432706075, 81432706076, 81432706077,
81432706078, 81432706081, 81432706082,
81432709034, 81432709076, 81432709078,
8143706054



MN-VB-5238

Length: 627 Ø: 48
Hole Distance: 130 / 130
81432206221, 81432706096, 81432706114,
81432706116, 81432706121



MN-VB-8514

Length: 627 Ø: 48
Hole Ø 25 / 25 / 25
Hole Distance: 152 / 130 / 130
81432706087, 81432706088, 81432706094,
81432706095, 81432796094



MN-VB-8669

Length: 627 Ø: 48
Hole Ø 25 / 25 / 25
Hole Distance: 152 / 130 / 130
81432706116, 81432706137, 81432706150,
81432706151



MN-VB-9403

Length: 627 Ø: 48
Hole Ø 25 / 23 / 23
Hole Distance: 152 / 130 / 130
81432706097, 81432706113, 81432706135,
81432706160, 81432706161



MN-VB-9404

Length: 627 Ø: 58
Hole Distance: 130 / 130
81432706117, 81432706152, 81432706153



SC-ES-7279

Length: 150
Cone Ø: d1 Ø 30 / d2 Ø 27
Thread: M30 x 1,5 RHT
81953016288



SC-ES-8517

Length: 140
Cone Ø: d1 Ø 30 / d2 Ø 27
Thread: M30 x 1,5 RHT
81953016286



SC-ES-8535

Length: 145
Cone Ø: d1 Ø 30 / d2 Ø 27
Thread: M30 x 1,5 RHT
81953016271, 81953016325





TGA ...

26.360 FD-TM, FDR-TM ...	01/01→	Track Control Arm		MN-DL-5225	Trailing Arm	
	01/01→	Track Control Arm		MN-DL-8544	Trailing Arm, Drive Axle;Leaf Spring Axle	
	01/01→	Track control arm		MN-DL-10288	Trailing Arm, 1st RA;2nd RA, for Leaf-Spring Suspension vehicles	
	01/01→	Track control arm		MN-DL-12288	Trailing Arm	
	01/01→	Track Control Arm		MN-VB-8514	Suspension Rod, Wishbone (CV), Drive Axle; Leaf Spring Axle	
	01/01→	Track Control Arm		MN-VB-8669	Suspension Rod, Wishbone (CV), Drive Axle; Leaf Spring Axle	
	01/01→	Track Control Arm		MN-VB-9404	Wishbone (CV), Drive Axle	
26.360 FNLC, FNLLC, FNLLRC, FNLLRW, FNLLW, FNLRC, FVLC	09/00→01/05	Track Control Arm		MN-DL-5212	Trailing Arm, Tag Axle;Air Suspension Axle	
	09/00→	Ball Head, gearshift linkage	CV-ES-2120			
	09/00→	Centre Rod	MN-DL-7801		Push Rod, Leaf Spring Axle	
	09/00→	Centre Rod	MN-DL-8560		Push Rod, Air Suspension Axle	
	09/00→	Suspension Strut Repair Kit		CV-RK-5311		
	09/00→	Suspension Strut Repair Kit		DB-RK-8581		
	09/00→	Suspension Strut Repair Kit		MN-RK-12436		
	09/00→	Tie Rod	MN-DL-7802			
	09/00→	Tie Rod	MN-DL-12284			
	09/00→	Tie Rod End		IV-ES-8507	Tag Axle	
	09/00→	Tie Rod End		MN-ES-8490	Tag Axle	
	09/00→	Tie Rod End		SC-ES-8517	for Push Rod	
	09/00→	Tie Rod End	CV-ES-0914		for Steering Rod	
	09/00→	Tie Rod End	CV-ES-14162	CV-ES-14162	for Steering Rod	
	09/00→	Tie Rod End	CV-ES-14163		for Steering Rod	
	09/00→	Tie Rod End	IV-ES-12272		for Steering Rod	
	09/00→	Tie Rod End	SC-ES-7279		for Steering Rod	
	09/00→	Tie Rod End	SC-ES-8535		for Guide Rod	
	09/00→	Track Control Arm		MN-DL-5225	Trailing Arm, Drive Axle;Air Suspension Axle	
	09/00→	Track Control Arm		MN-DL-5225	Trailing Arm, Leading Axle;Air Suspension Axle	
	09/00→	Track Control Arm		MN-DL-8709	Trailing Arm, Air Suspension Axle; for vehicles with Hinged Trailing Axle	
	09/00→	Track Control Arm		MN-DL-8733	Trailing Arm, Air Suspension Axle;Drive Axle	
	09/00→	Track Control Arm		MN-TC-12399	Control Arm	
	09/00→	Track Control Arm		MN-VB-5238	Wishbone (CV), Drive Axle;Leading Axle; Air Suspension Axle	
	09/00→	Track Control Arm		MN-VB-9403	Wishbone (CV), Air Suspension Axle	
	09/00→	Track Control Arm	MN-DL-8663		Control Arm, Air Suspension Axle	
	03/04→	Track Control Arm		MN-DL-5225	Trailing Arm, Tag Axle;Air Suspension Axle; for vehicles with Hinged Trailing Axle	
	01/05→	Track Control Arm		MN-DL-5225	Trailing Arm, Tag Axle;Air Suspension Axle; for vehicles with Rigid Trailing Axle	
	26.360 FVHLC	04/06→	Centre Rod	MN-DL-7801		Push Rod
		04/06→	Suspension Arm Repair Kit		CV-RK-5313	for Wishbone (CV)
		04/06→	Suspension Arm Repair Kit		MN-RK-7291	for Drag Link
		04/06→	Suspension Arm Repair Kit	DB-RK-9300	DB-RK-9300	for Drag Link
04/06→		Suspension Strut Repair Kit		CV-RK-5311		
04/06→		Tie Rod	MN-DL-7802			
04/06→		Tie Rod End	CV-ES-0914		for Steering Rod	
04/06→		Tie Rod End	CV-ES-14162	CV-ES-14162	for Steering Rod	
04/06→		Tie Rod End	SC-ES-7279		for Steering Rod	
04/06→		Tie Rod End	SC-ES-8535		for Guide Rod	
04/06→		Track Control Arm		MN-DL-5225	Trailing Arm	
04/06→		Track Control Arm		MN-DL-8733	Trailing Arm, 1st Drive Axle, for Pneumatic Suspension vehicles	
04/06→		Track Control Arm		MN-VB-5222	Wishbone (CV), 1st RA;2nd RA, for Pneumatic Suspension vehicles	
04/06→		Track Control Arm		MN-VB-8669	Suspension Rod, Wishbone (CV), 1st RA; 2nd RA, for Leaf-Spring Suspension vehicles, →Type_MHB Chassis	

CV-ES-0914

Length: 125
Cone Ø: d1 Ø 30 / d2 Ø 27
Thread: M38 x 1,5 RHT
81953016184, 81953016251, 81953016276



CV-ES-2120

Length: 115
Cone Ø: d1 Ø 12,4 / d2 Ø 10,8
Thread: M14 x 1,5 RHT
03008500A, 81953016200, 81953016202, 81953016203, 81953016227



CV-ES-14162

Length: 125
Cone Ø: d1 Ø 30 / d2 Ø 27
Thread: M30 x 1,5 LHT
81953010015, 81953010083, 81953010087, 81953016029, 81953016030, 81953016043, 81953016044, 81953016050, 81953016054, 81953016087, 81953016091, 81953016107, 81953016120, 81953016125, 81953016152, 81953016155, 81953016157, 81953016168, 81953016179, 81953016181, 81953016223, 81953016237, 81953016254, 81953016275, 81953016279, 81953016351



CV-ES-14163

Length: 125
Cone Ø: d1 Ø 30 / d2 Ø 27
Thread: M30 x 1,5 RHT
95301,0084, 90804102156, 90804102272, 90804102696, 90804102710, 81953010016, 81953010075, 81953010084, 81953010088, 81953010094, 81953010103, 81953016030, 81953016043, 81953016048, 81953016049, 81953016053, 81953016061, 81953016090, 81953016108, 81953016112, 81953016126, 81953016143, 81953016149, 81953016154, 81953016156, 81953016168, 81953016178, 81953016194, 81953016206, 81953016224, 81953016234, 81953016242, 81953016252, 81953016274, 81953016278, 81953016284, 81953016286, 81953016308, 81953016310, 81953016312, 81953016347, 81953016350, 81953016352, 82953016012, 88953016014, N2953016001



CV-RK-5311

638862, 639287, 938423, 1104335, 1953248, 0003500506, 3500506, 11013547, 42488722, 070550504, 634303610, 81432206055, 81432206073, 82262320660, 5001842823, 7000307001, 8226232066



CV-RK-5313

Ø: 90
03304800A, 81953016132



DB-RK-8581

Ø: 85 Hole Distance: 130
Thick/Height: 24
03305800A, 81432706105



DB-RK-9300

Ø: 75 Hole Distance: 130
Thick/Height: 24
85432206002



IV-ES-8507

Length: 80
Cone Ø: d1 Ø 30 / d2 Ø 27
Thread: M30 x 1,5 RHT
11019869, 12216380, 55175540, 81953016238



IV-ES-12272

Length: 75
Cone Ø: d1 Ø 30 / d2 Ø 27
Thread: M26 x 1,5 RHT
81953016280, 82953010010



MN-DL-5212

Length: 577 Ø: 48
Hole Distance: 130 / 130
81432206096, 81432206097, 81432206098, 81432206129, 81432209096, 81432209129, 81432306014, 81432306030



MN-DL-5225

Length: 572 Ø: 48
Hole Distance: 130 / 130
03301500A, 81432206229, 81432206236, 81432206267, 81432206270, 81432206272, 81432206304, 81432206305, 81432209236, 81432209267, 81432209272



MN-DL-7801

Length: 995 Ø: 52
Cone Ø: d1 Ø 30 / d2 Ø 27
81466106807, 81466106808, 81466116087, 81466116088, 81466116096, 81466116097, 81466116099, 81466116132, 81466116133, 81466116136, 81466116197, 81466116198, 81466116205



MN-DL-7802

Length: 1680 Ø: 52
Cone Ø: d1 Ø 30 / d2 Ø 27
03208300A, 81467116773, 81467116858, 81467116859, 81467116860, 81467116861, 81467116863, 81467116882, 81467116883, 81467116920, 81467116921



MN-DL-8544

Length: 596 Ø: 48
Hole Distance: 130 / 130
81432206196, 81432206232, 81432206233



MN-DL-8560

Length: 970 Ø: 52
Cone Ø: d1 Ø 30 / d2 Ø 27
03206900A, 81466106809, 81466106810, 81466106823, 81466106838, 81466106839, 81466116104, 81466116105, 81466116107, 81466116134, 81466116135, 81466116137, 81466116199, 81466116200, 81466116206



MN-DL-8663

Length: 947 Ø: 60
Hole Distance: 115 / 115
03307400A, 81432206222, 81432206260, 81432206283, 81432206284



MN-DL-8709

Length: 572 Ø: 52
Hole Distance: 130 / 130
81432206268, 81432206274, 81432206291, 81432206292, 82432206007



MN-DL-8733

Length: 530 Ø: 48
Hole Distance: 130 / 130
81432206161, 81432206190, 81432206358, 81432206359



MN-DL-10288

81432206386, 82432206008, 82432209008

No Image

MN-DL-12284

Length: 1530 Ø: 50
Cone Ø: d1 Ø 30 / d2 Ø 27
81466106579, 81466106580, 81466106624, 81466116720, 81467116720, 81467116730, 81467116952



MN-DL-12288

Length: 585 Ø: 58
Hole Distance: 130 / 130
81432206386, 82432206008, 82432209008

No Image

MN-ES-8490

Length: 90
Cone Ø: d1 Ø 30 / d2 Ø 27
Thread: M26 x 1,5 RHT
14606948, 0014606948, 81953016281, 81953016337, 82953016016



MN-RK-7291

Ø: 72 Hole Distance: 130
Thick/Height: 30
10307800A, 81432206108, 81432206132



MN-RK-12436

Ø: 75 Hole Distance: 115
Thick/Height: 24
81432206244



MN-TC-12399

Length: 694 Ø: 50
Hole Distance: 130 / 130
81432206265



MN-VB-5222

Length: 627 Ø: 50
Hole Distance: 152 / 152
81432706030, 81432706034, 81432706054, 81432706055, 81432706056, 81432706057, 81432706067, 81432706068, 81432706074, 81432706075, 81432706076, 81432706077, 81432706078, 81432706081, 81432706082, 81432709034, 81432709076, 81432709078, 8143706054



MN-VB-5238

Length: 627 Ø: 48
Hole Distance: 130 / 130
81432206221, 81432706096, 81432706114, 81432706116, 81432706121



MN-VB-8514

Length: 627 Ø: 48
Hole Ø 25 / 25 / 25
Hole Distance: 152 / 130 / 130
81432706087, 81432706088, 81432706094, 81432706095, 81432796094



MN-VB-8669

Length: 627 Ø: 48
Hole Ø 25 / 25 / 25
Hole Distance: 152 / 130 / 130
81432706116, 81432706137, 81432706150, 81432706151



MN-VB-9403

Length: 627 Ø: 48
Hole Ø 25 / 23 / 23
Hole Distance: 152 / 130 / 130
81432706097, 81432706113, 81432706135, 81432706160, 81432706161



MN-VB-9404

Length: 627 Ø: 58
Hole Distance: 130 / 130
81432706117, 81432706152, 81432706153



SC-ES-7279

Length: 150
Cone Ø: d1 Ø 30 / d2 Ø 27
Thread: M30 x 1,5 RHT
81953016288



SC-ES-8517

Length: 140
Cone Ø: d1 Ø 30 / d2 Ø 27
Thread: M30 x 1,5 RHT
81953016286



SC-ES-8535

Length: 145
Cone Ø: d1 Ø 30 / d2 Ø 27
Thread: M30 x 1,5 RHT
81953016271, 81953016325





TGA ...

26.360 FVHLS	04/06→	Centre Rod	MN-DL-7801		Push Rod
	04/06→	Suspension Arm Repair Kit		CV-RK-5313	for Wishbone (CV)
	04/06→	Suspension Arm Repair Kit		MN-RK-7291	for Drag Link
	04/06→	Suspension Arm Repair Kit	DB-RK-9300	DB-RK-9300	for Drag Link
	04/06→	Suspension Strut Repair Kit		CV-RK-5311	
	04/06→	Tie Rod	MN-DL-7802		
	04/06→	Tie Rod End	CV-ES-0914		for Steering Rod
	04/06→	Tie Rod End	CV-ES-14162	CV-ES-14162	for Steering Rod
	04/06→	Tie Rod End	SC-ES-7279		for Steering Rod
	04/06→	Tie Rod End	SC-ES-8535		for Guide Rod
	04/06→	Track Control Arm		MN-DL-5225	Trailing Arm
	04/06→	Track Control Arm		MN-DL-8733	Trailing Arm, 1st Drive Axle, for Pneumatic Suspension vehicles
	04/06→	Track Control Arm		MN-VB-5222	Wishbone (CV), 1st RA;2nd RA, for Pneumatic Suspension vehicles
	04/06→	Track Control Arm		MN-VB-8669	Suspension Rod, Wishbone (CV), 1st RA; 2nd RA, for Leaf-Spring Suspension vehicles, →Type_MHB Chassis
	26.360 FVLC	04/06→	Centre Rod	MN-DL-7801	
04/06→		Suspension Strut Repair Kit		MN-RK-12436	
04/06→		Tie Rod	MN-DL-7802		
04/06→		Tie Rod	MN-DL-12284		
04/06→		Tie Rod End		SC-ES-8517	for Push Rod
04/06→		Tie Rod End	CV-ES-0914		for Steering Rod
04/06→		Tie Rod End	CV-ES-14162	CV-ES-14162	for Steering Rod
04/06→		Tie Rod End	CV-ES-14163		for Steering Rod
04/06→		Tie Rod End	SC-ES-7279		for Steering Rod
04/06→		Tie Rod End	SC-ES-8535		for Guide Rod
04/06→		Track Control Arm		MN-DL-5212	Trailing Arm, Trailing Axle Steered, for Pneumatic Suspension vehicles
04/06→		Track Control Arm		MN-DL-5225	Trailing Arm
04/06→		Track Control Arm		MN-DL-8709	Trailing Arm, 1st Drive Axle, for Pneumatic Suspension vehicles
04/06→		Track Control Arm		MN-DL-8709	Trailing Arm, Trailing Axle Steered, for Pneumatic Suspension vehicles
04/06→		Track Control Arm		MN-DL-8733	Trailing Arm, 1st Drive Axle, for Pneumatic Suspension vehicles
04/06→	Track Control Arm		MN-VB-5238	Wishbone (CV), 1st Drive Axle, for Pneumatic Suspension vehicles	
04/06→	Track Control Arm		MN-VB-9403	Wishbone (CV), Trailing Axle Steered, for Pneumatic Suspension vehicles	
26.360 FVL-KO	04/06→	Track Control Arm	MN-DL-8663		Control Arm
	12/00→	Ball Head, gearshift linkage	CV-ES-2120		
	12/00→	Centre Rod	MN-DL-7801		Push Rod, Leaf Spring Axle
	12/00→	Centre Rod	MN-DL-8560		Push Rod, Air Suspension Axle
	12/00→	Suspension Strut Repair Kit		DB-RK-8581	
	12/00→	Suspension Strut Repair Kit		MN-RK-12436	
	12/00→	Tie Rod	MN-DL-7802		
	12/00→	Tie Rod End	CV-ES-0914		for Steering Rod
	12/00→	Tie Rod End	CV-ES-14163		for Steering Rod
	12/00→	Tie Rod End	SC-ES-7279		for Steering Rod
	12/00→	Tie Rod End	SC-ES-8517		for Push Rod
	12/00→	Tie Rod End	SC-ES-8535		for Guide Rod
	12/00→	Track Control Arm		MN-DL-5225	Trailing Arm, Drive Axle;Air Suspension Axle
	12/00→	Track Control Arm		MN-DL-5225	Trailing Arm, Leading Axle;Air Suspension Axle
	12/00→	Track Control Arm		MN-DL-8733	Trailing Arm, Air Suspension Axle;Drive Axle
12/00→	Track Control Arm		MN-VB-5238	Wishbone (CV), Drive Axle;Leading Axle; Air Suspension Axle	
12/00→	Track Control Arm	MN-DL-8663		Control Arm, Air Suspension Axle	
26.360 FVLS, FVLRS	04/06→	Centre Rod	MN-DL-7801		Push Rod
	04/06→	Suspension Strut Repair Kit		MN-RK-12436	
	04/06→	Tie Rod	MN-DL-7802		
	04/06→	Tie Rod	MN-DL-12284		

CV-ES-0914

Length: 125
Cone Ø: d1 Ø 30 / d2 Ø 27
Thread: M38 x 1,5 RHT
81953016184, 81953016251, 81953016276



CV-ES-2120

Length: 115
Cone Ø: d1 Ø 12,4 / d2 Ø 10,8
Thread: M14 x 1,5 RHT
03008500A, 81953016200, 81953016202, 81953016203, 81953016227



CV-ES-14162

Length: 125
Cone Ø: d1 Ø 30 / d2 Ø 27
Thread: M30 x 1,5 LHT
81953010015, 81953010083, 81953010087, 81953016029, 81953016030, 81953016043, 81953016044, 81953016050, 81953016054, 81953016087, 81953016091, 81953016107, 81953016120, 81953016125, 81953016152, 81953016155, 81953016157, 81953016168, 81953016179, 81953016181, 81953016223, 81953016237, 81953016254, 81953016275, 81953016279, 81953016351



CV-ES-14163

Length: 125
Cone Ø: d1 Ø 30 / d2 Ø 27
Thread: M30 x 1,5 RHT
95301.0084, 90804102156, 90804102272, 90804102696, 90804102710, 81953010016, 81953010075, 81953010084, 81953010088, 81953010094, 81953010103, 81953016030, 81953016043, 81953016048, 81953016049, 81953016053, 81953016061, 81953016090, 81953016108, 81953016112, 81953016126, 81953016143, 81953016149, 81953016154, 81953016156, 81953016168, 81953016178, 81953016194, 81953016206, 81953016224, 81953016234, 81953016242, 81953016252, 81953016274, 81953016278, 81953016284, 81953016286, 81953016308, 81953016310, 81953016312, 81953016347, 81953016350, 81953016352, 82953016012, 88953016014, N2953016001



CV-RK-5311

638862, 639287, 938423, 1104335, 1953248, 3500506, 0003500506, 11013547, 42488722, 070550504, 634303610, 81432206055, 81432206073, 82262320660, 5001842823, 7000307001, 8226232066



CV-RK-5313

Ø: 90
03304800A, 81953016132



DB-RK-8581

Ø: 85
Hole Distance: 130
Thick/Height: 24
03305800A, 81432706105



DB-RK-9300

Ø: 75
Hole Distance: 130
Thick/Height: 24
85432206002



MN-DL-5212

Length: 577 Ø: 48
Hole Distance: 130 / 130
81432206096, 81432206097, 81432206098, 81432206129, 81432209096, 81432209129, 81432306014, 81432306030



MN-DL-5225

Length: 572 Ø: 48
Hole Distance: 130 / 130
03301500A, 81432206229, 81432206236, 81432206267, 81432206270, 81432206272, 81432206304, 81432206305, 81432209236, 81432209267, 81432209272



MN-DL-7801

Length: 995 Ø: 52
Cone Ø: d1 Ø 30 / d2 Ø 27
81466106807, 81466106808, 81466116087, 81466116088, 81466116096, 81466116097, 81466116099, 81466116132, 81466116133, 81466116136, 81466116197, 81466116198, 81466116205



MN-DL-7802

Length: 1680 Ø: 52
Cone Ø: d1 Ø 30 / d2 Ø 27
03208300A, 81467116773, 81467116858, 81467116859, 81467116860, 81467116861, 81467116863, 81467116882, 81467116883, 81467116920, 81467116921



MN-DL-8560

Length: 970 Ø: 52
Cone Ø: d1 Ø 30 / d2 Ø 27
03206900A, 81466106809, 81466106810, 81466106823, 81466106838, 81466106839, 81466116104, 81466116105, 81466116107, 81466116134, 81466116135, 81466116137, 81466116199, 81466116200, 81466116206



MN-DL-8663

Length: 947 Ø: 60
Hole Distance: 115 / 115
03307400A, 81432206222, 81432206260, 81432206283, 81432206284



MN-DL-8709

Length: 572 Ø: 52
Hole Distance: 130 / 130
81432206268, 81432206274, 81432206291, 81432206292, 82432206007



MN-DL-8733

Length: 530 Ø: 48
Hole Distance: 130 / 130
81432206161, 81432206190, 81432206358, 81432206359



MN-DL-12284

Length: 1530 Ø: 50
Cone Ø: d1 Ø 30 / d2 Ø 27
81466106579, 81466106580, 81466106624, 81466116720, 81467116720, 81467116730, 81467116952



MN-RK-7291

Ø: 72 Hole Distance: 130
Thick/Height: 30
10307800A, 81432206108, 81432206132



MN-RK-12436

Ø: 75 Hole Distance: 115
Thick/Height: 24
81432206244



MN-VB-5222

Length: 627 Ø: 50
Hole Distance: 152 / 152
81432706030, 81432706034, 81432706054, 81432706055, 81432706056, 81432706057, 81432706067, 81432706068, 81432706074, 81432706075, 81432706076, 81432706077, 81432706078, 81432706081, 81432706082, 81432709034, 81432709076, 81432709078, 8143706054



MN-VB-5238

Length: 627 Ø: 48
Hole Distance: 130 / 130
81432206221, 81432706096, 81432706114, 81432706116, 81432706121



MN-VB-8669

Length: 627 Ø: 48
Hole Ø 25 / 25 / 25
Hole Distance: 152 / 130 / 130
81432706116, 81432706137, 81432706150, 81432706151



MN-VB-9403

Length: 627 Ø: 48
Hole Ø 25 / 23 / 23
Hole Distance: 152 / 130 / 130
81432706097, 81432706113, 81432706135, 81432706160, 81432706161



SC-ES-7279

Length: 150
Cone Ø: d1 Ø 30 / d2 Ø 27
Thread: M30 x 1,5 RHT
81953016288



SC-ES-8517

Length: 140
Cone Ø: d1 Ø 30 / d2 Ø 27
Thread: M30 x 1,5 RHT
81953016286



SC-ES-8535

Length: 145
Cone Ø: d1 Ø 30 / d2 Ø 27
Thread: M30 x 1,5 RHT
81953016271, 81953016325





TGA ...

26.360 FVLS, FVLSR ...	04/06 →	Tie Rod End		SC-ES-8517	for Push Rod	
	04/06 →	Tie Rod End	CV-ES-0914		for Steering Rod	
	04/06 →	Tie Rod End	CV-ES-14162	CV-ES-14162	for Steering Rod	
	04/06 →	Tie Rod End	CV-ES-14163		for Steering Rod	
	04/06 →	Tie Rod End	SC-ES-7279		for Steering Rod	
	04/06 →	Tie Rod End	SC-ES-8535		for Guide Rod	
	04/06 →	Track Control Arm		MN-DL-5212	Trailing Arm, Trailing Axle Steered, for Pneumatic Suspension vehicles	
	04/06 →	Track Control Arm		MN-DL-5225	Trailing Arm	
	04/06 →	Track Control Arm		MN-DL-8709	Trailing Arm, 1st Drive Axle, for Pneumatic Suspension vehicles	
	04/06 →	Track Control Arm		MN-DL-8709	Trailing Arm, Trailing Axle Steered, for Pneumatic Suspension vehicles	
	04/06 →	Track Control Arm		MN-DL-8733	Trailing Arm, 1st Drive Axle, for Pneumatic Suspension vehicles	
	04/06 →	Track Control Arm		MN-VB-5238	Wishbone (CV), 1st Drive Axle, for Pneumatic Suspension vehicles	
	04/06 →	Track Control Arm		MN-VB-9403	Wishbone (CV), Trailing Axle Steered, for Pneumatic Suspension vehicles	
	26.390 FDAC, FDALC, FDHC	04/06 →	Track Control Arm	MN-DL-8663		Control Arm
		01/04 →	Centre Rod	MN-DL-2160		Coupling Rod
01/04 →		Centre Rod	MN-DL-2174		Push Rod	
01/04 →		Suspension Arm Repair Kit		CV-RK-5313	for Wishbone (CV)	
01/04 →		Tie Rod End	CV-ES-0914		for Steering Rod	
01/04 →		Tie Rod End	CV-ES-14162		for Steering Rod	
01/04 →		Tie Rod End	CV-ES-14163		for Steering Rod	
01/04 →		Tie Rod End	MN-ES-10333		for Steering Rod	
01/04 →		Tie Rod End	SC-ES-7279		for Steering Rod	
01/04 →		Tie Rod End	SC-ES-8517		for Push Rod	
01/04 →		Tie Rod End	SC-ES-8535		for Guide Rod	
01/04 →		Track Control Arm		MN-DL-8544	Trailing Arm, 1st RA;2nd RA, for Leaf-Spring Suspension vehicles	
01/04 →		Track Control Arm		MN-DL-8544	Trailing Arm, 1st RA;2nd RA, for Pneumatic Suspension vehicles	
01/04 →		Track Control Arm		MN-DL-8609	Trailing Arm, 1st RA;2nd RA, for Leaf-Spring Suspension vehicles, →Type_HB Chassis	
26.390 FDAK, FDALK, FDHK		02/04 →	Centre Rod	MN-DL-2160		Coupling Rod
	02/04 →	Centre Rod	MN-DL-2174		Push Rod	
	02/04 →	Suspension Arm Repair Kit		CV-RK-5313	for Wishbone (CV)	
	02/04 →	Tie Rod End	CV-ES-0914		for Steering Rod	
	02/04 →	Tie Rod End	CV-ES-14162		for Steering Rod	
	02/04 →	Tie Rod End	CV-ES-14163		for Steering Rod	
	02/04 →	Tie Rod End	MN-ES-10333		for Steering Rod	
	02/04 →	Tie Rod End	SC-ES-7279		for Steering Rod	
	02/04 →	Tie Rod End	SC-ES-8517		for Push Rod	
	02/04 →	Tie Rod End	SC-ES-8535		for Guide Rod	
	02/04 →	Track Control Arm		MN-DL-8609	Trailing Arm, 1st RA;2nd RA, for Leaf-Spring Suspension vehicles, →Type_HB Chassis	
	02/04 →	Track Control Arm		MN-VB-8514	Suspension Rod, Wishbone (CV)	
	02/04 →	Track Control Arm		MN-VB-8669	Suspension Rod, Wishbone (CV), 1st RA; 2nd RA, for Leaf-Spring Suspension vehicles, →Type_MHB Chassis	
	02/04 →	Track Control Arm		MN-VB-9404	Wishbone (CV), 1st RA;2nd RA, for Leaf-Spring Suspension vehicles, →Type_HB Chassis	

CV-ES-0914

Length: 125
Cone Ø: d1 Ø 30 / d2 Ø 27
Thread: M38 x 1,5 RHT
81953016184, 81953016251, 81953016276



CV-ES-14162

Length: 125
Cone Ø: d1 Ø 30 / d2 Ø 27
Thread: M30 x 1,5 LHT
81953010015, 81953010083, 81953010087,
81953016029, 81953016030, 81953016043,
81953016044, 81953016050, 81953016054,
81953016087, 81953016091, 81953016107,
81953016120, 81953016125, 81953016152,
81953016155, 81953016157, 81953016168,
81953016179, 81953016181, 81953016223,
81953016237, 81953016254, 81953016275,
81953016279, 81953016351



CV-ES-14163

Length: 125
Cone Ø: d1 Ø 30 / d2 Ø 27
Thread: M30 x 1,5 RHT
95301.0084, 90804102156, 90804102272,
90804102696, 90804102710, 81953010016,
81953010075, 81953010084, 81953010088,
81953010094, 81953010103, 81953016030,
81953016043, 81953016048, 81953016049,
81953016053, 81953016061, 81953016090,
81953016108, 81953016112, 81953016126,
81953016143, 81953016149, 81953016154,
81953016156, 81953016168, 81953016178,
81953016194, 81953016206, 81953016224,
81953016234, 81953016242, 81953016252,
81953016274, 81953016278, 81953016284,
81953016286, 81953016308, 81953016310,
81953016312, 81953016347, 81953016350,
81953016352, 82953016012, 88953016014,
N2953016001



CV-RK-5313

Ø: 90
03304800A, 81953016132



MN-DL-2160

Length: 1652 Ø: 50
Cone Ø: d1 Ø 30 / d2 Ø 27
81467106112, 81467106163, 81467106165,
81467106198, 81467106353, 81467106354,
81467106361, 81467116725



MN-DL-2174

Length: 1588 Ø: 52
Cone Ø: d1 Ø 30 / d2 Ø 27
81467106378, 81467106912



MN-DL-5212

Length: 577 Ø: 48
Hole Distance: 130 / 130
81432206096, 81432206097, 81432206098,
81432206129, 81432209096, 81432209129,
81432306014, 81432306030



MN-DL-5225

Length: 572 Ø: 48
Hole Distance: 130 / 130
03301500A, 81432206229, 81432206236,
81432206267, 81432206270, 81432206272,
81432206304, 81432206305, 81432209236,
81432209267, 81432209272



MN-DL-8544

Length: 596 Ø: 48
Hole Distance: 130 / 130
81432206196, 81432206232, 81432206233



MN-DL-8609

Length: 585 Ø: 58
Hole Distance: 130 / 130
81432206070, 81432206071, 81432206072,
81432206091, 81432206093, 81432206119



MN-DL-8663

Length: 947 Ø: 60
Hole Distance: 115 / 115
03307400A, 81432206222, 81432206260,
81432206283, 81432206284



MN-DL-8709

Length: 572 Ø: 52
Hole Distance: 130 / 130
81432206268, 81432206274, 81432206291,
81432206292, 82432206007



MN-DL-8733

Length: 530 Ø: 48
Hole Distance: 130 / 130
81432206161, 81432206190, 81432206358,
81432206359



MN-ES-10333

Length: 90
Cone Ø: d1 Ø 38 / d2 Ø 34,35
Thread: M36 x 1,5 RHT
1271126, 3090291, 3099128, 42538048,
81953016268, 82953016018, 82953016019



MN-VB-5238

Length: 627 Ø: 48
Hole Distance: 130 / 130
81432206221, 81432706096, 81432706114,
81432706116, 81432706121



MN-VB-8514

Length: 627 Ø: 48
Hole Ø 25 / 25 / 25
Hole Distance: 152 / 130 / 130
81432706087, 81432706088, 81432706094,
81432706095, 81432796094



MN-VB-8669

Length: 627 Ø: 48
Hole Ø 25 / 25 / 25
Hole Distance: 152 / 130 / 130
81432706116, 81432706137, 81432706150,
81432706151



MN-VB-9403

Length: 627 Ø: 48
Hole Ø 25 / 23 / 23
Hole Distance: 152 / 130 / 130
81432706097, 81432706113, 81432706135,
81432706160, 81432706161



MN-VB-9404

Length: 627 Ø: 58
Hole Distance: 130 / 130
81432706117, 81432706152, 81432706153



SC-ES-7279

Length: 150
Cone Ø: d1 Ø 30 / d2 Ø 27
Thread: M30 x 1,5 RHT
81953016288



SC-ES-8517

Length: 140
Cone Ø: d1 Ø 30 / d2 Ø 27
Thread: M30 x 1,5 RHT
81953016286



SC-ES-8535

Length: 145
Cone Ø: d1 Ø 30 / d2 Ø 27
Thread: M30 x 1,5 RHT
81953016271, 81953016325





TGA ...

26.390 FDALS, FDAS, FDALS, FDHS	02/04 →	Centre Rod	MN-DL-2160		Coupling Rod
	02/04 →	Centre Rod	MN-DL-2174		Push Rod
	02/04 →	Suspension Arm Repair Kit		CV-RK-5313	for Wishbone (CV)
	02/04 →	Tie Rod End	CV-ES-0914		for Steering Rod
	02/04 →	Tie Rod End	CV-ES-14162		for Steering Rod
	02/04 →	Tie Rod End	CV-ES-14163		for Steering Rod
	02/04 →	Tie Rod End	MN-ES-10333		for Steering Rod
	02/04 →	Tie Rod End	SC-ES-7279		for Steering Rod
	02/04 →	Tie Rod End	SC-ES-8517		for Push Rod
	02/04 →	Tie Rod End	SC-ES-8535		for Guide Rod
	02/04 →	Track Control Arm		MN-DL-8609	Trailing Arm, 1st RA;2nd RA, for Leaf-Spring Suspension vehicles, →Type_HB Chassis
	02/04 →	Track Control Arm		MN-VB-8514	Suspension Rod, Wishbone (CV)
	02/04 →	Track Control Arm		MN-VB-8669	Suspension Rod, Wishbone (CV), 1st RA; 2nd RA, for Leaf-Spring Suspension vehicles, →Type_MHB Chassis
	02/04 →	Track Control Arm		MN-VB-9404	Wishbone (CV), 1st RA;2nd RA, for Leaf-Spring Suspension vehicles, →Type_HB
26.390 FDH-TM	06/05 →	Centre Rod	MN-DL-7801		Push Rod
	06/05 →	Tie Rod	MN-DL-7802		
	06/05 →	Tie Rod End	CV-ES-0914		for Steering Rod
	06/05 →	Tie Rod End	CV-ES-14162		for Steering Rod
	06/05 →	Tie Rod End	CV-ES-14163		for Steering Rod
	06/05 →	Tie Rod End	SC-ES-7279		for Steering Rod
	06/05 →	Tie Rod End	SC-ES-8517		for Push Rod
	06/05 →	Tie Rod End	SC-ES-8535		for Guide Rod
26.390 FVLC	02/04 →	Centre Rod	MN-DL-7801		Push Rod
	02/04 →	Suspension Strut Repair Kit		MN-RK-12436	
	02/04 →	Tie Rod	MN-DL-7802		
26.390 FVLS, FVLRS	02/04 →	Tie Rod	MN-DL-12284		
	02/04 →	Tie Rod End		SC-ES-8517	for Push Rod
	02/04 →	Tie Rod End	CV-ES-0914		for Steering Rod
	02/04 →	Tie Rod End	CV-ES-14162	CV-ES-14162	for Steering Rod
	02/04 →	Tie Rod End	CV-ES-14163		for Steering Rod
	02/04 →	Tie Rod End	SC-ES-7279		for Steering Rod
	02/04 →	Tie Rod End	SC-ES-8535		for Guide Rod
	02/04 →	Track Control Arm		MN-DL-5212	Trailing Arm, Trailing Axle not Steered, for Pneumatic Suspension vehicles
	02/04 →	Track Control Arm		MN-DL-5225	Trailing Arm
	02/04 →	Track Control Arm		MN-DL-8709	Trailing Arm, 1st Drive Axle, for Pneumatic Suspension vehicles
	02/04 →	Track Control Arm		MN-DL-8709	Trailing Arm, Trailing Axle not Steered, for Pneumatic Suspension vehicles
	02/04 →	Track Control Arm		MN-DL-8733	Trailing Arm, 1st Drive Axle, for Pneumatic Suspension vehicles
	02/04 →	Track Control Arm		MN-VB-5238	Wishbone (CV), 1st Drive Axle, for Pneumatic Suspension vehicles
	02/04 →	Track Control Arm		MN-VB-9403	Wishbone (CV), Trailing Axle not Steered, for Pneumatic Suspension vehicles
	02/04 →	Track Control Arm	MN-DL-8663		Control Arm
	26.390 FVLS, FVLRS	07/05 →	Centre Rod	MN-DL-7801	
07/05 →		Suspension Strut Repair Kit		MN-RK-12436	
07/05 →		Tie Rod	MN-DL-7802		
07/05 →		Tie Rod	MN-DL-12284		
07/05 →		Tie Rod End		SC-ES-8517	for Push Rod
07/05 →		Tie Rod End	CV-ES-0914		for Steering Rod
07/05 →	Tie Rod End	CV-ES-14162	CV-ES-14162	for Steering Rod	

CV-ES-0914

Length: 125
Cone Ø: d1 Ø 30 / d2 Ø 27
Thread: M38 x 1,5 RHT
81953016184, 81953016251, 81953016276



CV-ES-14162

Length: 125
Cone Ø: d1 Ø 30 / d2 Ø 27
Thread: M30 x 1,5 LHT
81953010015, 81953010083, 81953010087, 81953016029, 81953016030, 81953016043, 81953016044, 81953016050, 81953016054, 81953016087, 81953016091, 81953016107, 81953016120, 81953016125, 81953016152, 81953016155, 81953016157, 81953016168, 81953016179, 81953016181, 81953016223, 81953016237, 81953016254, 81953016275, 81953016279, 81953016351



CV-ES-14163

Length: 125
Cone Ø: d1 Ø 30 / d2 Ø 27
Thread: M30 x 1,5 RHT
95301.0084, 90804102156, 90804102272, 90804102696, 90804102710, 81953010016, 81953010075, 81953010084, 81953010088, 81953010094, 81953010103, 81953016030, 81953016043, 81953016048, 81953016049, 81953016053, 81953016061, 81953016090, 81953016108, 81953016112, 81953016126, 81953016143, 81953016149, 81953016154, 81953016156, 81953016168, 81953016178, 81953016194, 81953016206, 81953016224, 81953016234, 81953016242, 81953016252, 81953016274, 81953016278, 81953016284, 81953016286, 81953016308, 81953016310, 81953016312, 81953016347, 81953016350, 81953016352, 82953016012, 88953016014, N2953016001



CV-RK-5313

Ø: 90
03304800A, 81953016132



MN-DL-2160

Length: 1652 Ø: 50
Cone Ø: d1 Ø 30 / d2 Ø 27
81467106112, 81467106163, 81467106165, 81467106198, 81467106353, 81467106354, 81467106361, 81467116725



MN-DL-2174

Length: 1588 Ø: 52
Cone Ø: d1 Ø 30 / d2 Ø 27
81467106378, 81467106912



MN-DL-5212

Length: 577 Ø: 48
Hole Distance: 130 / 130
81432206096, 81432206097, 81432206098, 81432206129, 81432209096, 81432209129, 81432306014, 81432306030



MN-DL-5225

Length: 572 Ø: 48
Hole Distance: 130 / 130
03301500A, 81432206229, 81432206236, 81432206267, 81432206270, 81432206272, 81432206304, 81432206305, 81432209236, 81432209267, 81432209272



MN-DL-7801

Length: 995 Ø: 52
Cone Ø: d1 Ø 30 / d2 Ø 27
81466106807, 81466106808, 81466116087, 81466116088, 81466116096, 81466116097, 81466116099, 81466116132, 81466116133, 81466116136, 81466116197, 81466116198, 81466116205



MN-DL-7802

Length: 1680 Ø: 52
Cone Ø: d1 Ø 30 / d2 Ø 27
03208300A, 81467116773, 81467116858, 81467116859, 81467116860, 81467116861, 81467116863, 81467116882, 81467116883, 81467116920, 81467116921



MN-DL-8544

Length: 596 Ø: 48
Hole Distance: 130 / 130
81432206196, 81432206232, 81432206233



MN-DL-8609

Length: 585 Ø: 58
Hole Distance: 130 / 130
81432206070, 81432206071, 81432206072, 81432206091, 81432206093, 81432206119



MN-DL-8663

Length: 947 Ø: 60
Hole Distance: 115 / 115
03307400A, 81432206222, 81432206260, 81432206283, 81432206284



MN-DL-8709

Length: 572 Ø: 52
Hole Distance: 130 / 130
81432206268, 81432206274, 81432206291, 81432206292, 82432206007



MN-DL-8733

Length: 530 Ø: 48
Hole Distance: 130 / 130
81432206161, 81432206190, 81432206358, 81432206359



MN-DL-12284

Length: 1530 Ø: 50
Cone Ø: d1 Ø 30 / d2 Ø 27
81466106579, 81466106580, 81466106624, 81466116720, 81467116720, 81467116730, 81467116952



MN-ES-10333

Length: 90
Cone Ø: d1 Ø 38 / d2 Ø 34,35
Thread: M36 x 1,5 RHT
1271126, 3090291, 3099128, 42538048, 81953016268, 82953016018, 82953016019



MN-RK-12436

Ø: 75
Hole Distance: 115
Thick/Height: 24
81432206244



MN-VB-5238

Length: 627 Ø: 48
Hole Distance: 130 / 130
81432206221, 81432706096, 81432706114, 81432706116, 81432706121



MN-VB-8514

Length: 627 Ø: 48
Hole Ø 25 / 25 / 25
Hole Distance: 152 / 130 / 130
81432706087, 81432706088, 81432706094, 81432706095, 81432796094



MN-VB-8669

Length: 627 Ø: 48
Hole Ø 25 / 25 / 25
Hole Distance: 152 / 130 / 130
81432706116, 81432706137, 81432706150, 81432706151



MN-VB-9403

Length: 627 Ø: 48
Hole Ø 25 / 23 / 23
Hole Distance: 152 / 130 / 130
81432706097, 81432706113, 81432706135, 81432706160, 81432706161



MN-VB-9404

Length: 627 Ø: 58
Hole Distance: 130 / 130
81432706117, 81432706152, 81432706153



SC-ES-7279

Length: 150
Cone Ø: d1 Ø 30 / d2 Ø 27
Thread: M30 x 1,5 RHT
81953016288



SC-ES-8517

Length: 140
Cone Ø: d1 Ø 30 / d2 Ø 27
Thread: M30 x 1,5 RHT
81953016286



SC-ES-8535

Length: 145
Cone Ø: d1 Ø 30 / d2 Ø 27
Thread: M30 x 1,5 RHT
81953016271, 81953016325





TGA ...

26.390 FVLS, FVLSR ...	07/05→	Tie Rod End	CV-ES-14163		for Steering Rod
	07/05→	Tie Rod End	SC-ES-7279		for Steering Rod
	07/05→	Tie Rod End	SC-ES-8535		for Guide Rod
	07/05→	Track Control Arm		MN-DL-5212	Trailing Arm, Trailing Axle Steered, for Pneumatic Suspension vehicles
	07/05→	Track Control Arm		MN-DL-5225	Trailing Arm
	07/05→	Track Control Arm		MN-DL-8709	Trailing Arm, 1st Drive Axle, for Pneumatic Suspension vehicles
	07/05→	Track Control Arm		MN-DL-8709	Trailing Arm, Trailing Axle Steered, for Pneumatic Suspension vehicles
	07/05→	Track Control Arm		MN-DL-8733	Trailing Arm, 1st Drive Axle, for Pneumatic Suspension vehicles
	07/05→	Track Control Arm		MN-VB-5238	Wishbone (CV), 1st Drive Axle, for Pneumatic Suspension vehicles
	07/05→	Track Control Arm		MN-VB-9403	Wishbone (CV), Trailing Axle Steered, for Pneumatic Suspension vehicles
26.390, 26.400 FDAK, FDALK, FDHK, FDHLK	07/05→	Track Control Arm	MN-DL-8663		Control Arm
	06/05→	Centre Rod	MN-DL-7801		Push Rod, Leaf Spring Axle
	06/05→	Suspension Strut Repair Kit		DB-RK-8581	
	06/05→	Tie Rod	MN-DL-7802		
	06/05→	Tie Rod End	CV-ES-0914		for Steering Rod
	06/05→	Tie Rod End	CV-ES-14162		for Steering Rod
	06/05→	Tie Rod End	CV-ES-14163		for Steering Rod
	06/05→	Tie Rod End	MN-ES-10333		for Steering Rod
	06/05→	Tie Rod End	SC-ES-7279		for Steering Rod
	06/05→	Tie Rod End	SC-ES-8517		for Push Rod
	06/05→	Tie Rod End	SC-ES-8535		for Guide Rod
	06/05→	Track Control Arm		MN-DL-5225	Trailing Arm
	06/05→	Track Control Arm		MN-DL-8544	Trailing Arm, 1st RA;2nd RA;Leaf Spring Axle
	06/05→	Track Control Arm		MN-DL-8609	Trailing Arm, 1st RA;2nd RA, for Leaf-Spring Suspension vehicles, →Type_HB Chassis
	06/05→	Track Control Arm		MN-VB-5238	Wishbone (CV), 1st RA;2nd RA, for Pneumatic Suspension vehicles, →Type_NBA Chassis
	06/05→	Track Control Arm		MN-VB-8514	Suspension Rod, Wishbone (CV), Drive Axle; Leaf Spring Axle
	06/05→	Track Control Arm		MN-VB-8669	Suspension Rod, Wishbone (CV), Drive Axle; Leaf Spring Axle
	06/05→	Track Control Arm		MN-VB-9404	Wishbone (CV), 1st RA;2nd RA, for Leaf-Spring Suspension vehicles, →Type_HB
26.390, 26.400 FDALS, FDAS, FDHLS, FDHS	06/05→	Centre Rod	MN-DL-7801		Push Rod, Leaf Spring Axle
	06/05→	Suspension Strut Repair Kit		DB-RK-8581	
	06/05→	Tie Rod	MN-DL-7802		
	06/05→	Tie Rod End	CV-ES-0914		for Steering Rod
	06/05→	Tie Rod End	CV-ES-14162		for Steering Rod
	06/05→	Tie Rod End	CV-ES-14163		for Steering Rod
	06/05→	Tie Rod End	MN-ES-10333		for Steering Rod
	06/05→	Tie Rod End	SC-ES-7279		for Steering Rod
	06/05→	Tie Rod End	SC-ES-8517		for Push Rod
	06/05→	Tie Rod End	SC-ES-8535		for Guide Rod
	06/05→	Track Control Arm		MN-DL-5225	Trailing Arm
	06/05→	Track Control Arm		MN-DL-8544	Trailing Arm, 1st RA;2nd RA;Leaf Spring Axle
	06/05→	Track Control Arm		MN-DL-8609	Trailing Arm, 1st RA;2nd RA, for Leaf-Spring Suspension vehicles, →Type_HB Chassis
	06/05→	Track Control Arm		MN-VB-5238	Wishbone (CV), 1st RA;2nd RA, for Pneumatic Suspension vehicles, →Type_NBA Chassis
	06/05→	Track Control Arm		MN-VB-8514	Suspension Rod, Wishbone (CV), Drive Axle; Leaf Spring Axle
	06/05→	Track Control Arm		MN-VB-8669	Suspension Rod, Wishbone (CV), Drive Axle; Leaf Spring Axle
	06/05→	Track Control Arm		MN-VB-9404	Wishbone (CV), 1st RA;2nd RA, for Leaf-Spring Suspension vehicles, →Type_HB

CV-ES-0914

Length: 125
Cone Ø: d1 Ø 30 / d2 Ø 27
Thread: M38 x 1,5 RHT
81953016184, 81953016251, 81953016276



CV-ES-14162

Length: 125
Cone Ø: d1 Ø 30 / d2 Ø 27
Thread: M30 x 1,5 LHT
81953010015, 81953010083, 81953010087, 81953016029, 81953016030, 81953016043, 81953016044, 81953016050, 81953016054, 81953016087, 81953016091, 81953016107, 81953016120, 81953016125, 81953016152, 81953016155, 81953016157, 81953016168, 81953016179, 81953016181, 81953016223, 81953016237, 81953016254, 81953016275, 81953016279, 81953016351



CV-ES-14163

Length: 125
Cone Ø: d1 Ø 30 / d2 Ø 27
Thread: M30 x 1,5 RHT
95301.0084, 90804102156, 90804102272, 90804102696, 90804102710, 81953010016, 81953010075, 81953010084, 81953010088, 81953010094, 81953010103, 81953016030, 81953016043, 81953016048, 81953016049, 81953016053, 81953016061, 81953016090, 81953016108, 81953016112, 81953016126, 81953016143, 81953016149, 81953016154, 81953016156, 81953016168, 81953016178, 81953016194, 81953016206, 81953016224, 81953016234, 81953016242, 81953016252, 81953016274, 81953016278, 81953016284, 81953016286, 81953016308, 81953016310, 81953016312, 81953016347, 81953016350, 81953016352, 82953016012, 88953016014, N2953016001



DB-RK-8581

Ø: 85
Hole Distance: 130
Thick/Height: 24
03305800A, 81432706105



MN-DL-5212

Length: 577 Ø: 48
Hole Distance: 130 / 130
81432206096, 81432206097, 81432206098, 81432206129, 81432209096, 81432209129, 81432306014, 81432306030



MN-DL-5225

Length: 572 Ø: 48
Hole Distance: 130 / 130
03301500A, 81432206229, 81432206236, 81432206267, 81432206270, 81432206272, 81432206304, 81432206305, 81432209236, 81432209267, 81432209272



MN-DL-7801

Length: 995 Ø: 52
Cone Ø: d1 Ø 30 / d2 Ø 27
81466106807, 81466106808, 81466116087, 81466116088, 81466116096, 81466116097, 81466116099, 81466116132, 81466116133, 81466116136, 81466116197, 81466116198, 81466116205



MN-DL-7802

Length: 1680 Ø: 52
Cone Ø: d1 Ø 30 / d2 Ø 27
03208300A, 81467116773, 81467116858, 81467116859, 81467116860, 81467116861, 81467116863, 81467116882, 81467116883, 81467116920, 81467116921



MN-DL-8544

Length: 596 Ø: 48
Hole Distance: 130 / 130
81432206196, 81432206232, 81432206233



MN-DL-8609

Length: 585 Ø: 58
Hole Distance: 130 / 130
81432206070, 81432206071, 81432206072, 81432206091, 81432206093, 81432206119



MN-DL-8663

Length: 947 Ø: 60
Hole Distance: 115 / 115
03307400A, 81432206222, 81432206260, 81432206283, 81432206284



MN-DL-8709

Length: 572 Ø: 52
Hole Distance: 130 / 130
81432206268, 81432206274, 81432206291, 81432206292, 82432206007



MN-DL-8733

Length: 530 Ø: 48
Hole Distance: 130 / 130
81432206161, 81432206190, 81432206358, 81432206359



MN-ES-10333

Length: 90
Cone Ø: d1 Ø 38 / d2 Ø 34,35
Thread: M36 x 1,5 RHT
1271126, 3090291, 3099128, 42538048, 81953016268, 82953016018, 82953016019



MN-VB-5238

Length: 627 Ø: 48
Hole Distance: 130 / 130
81432206221, 81432706096, 81432706114, 81432706116, 81432706121



MN-VB-8514

Length: 627 Ø: 48
Hole Ø 25 / 25 / 25
Hole Distance: 152 / 130 / 130
81432706087, 81432706088, 81432706094, 81432706095, 81432796094



MN-VB-8669

Length: 627 Ø: 48
Hole Ø 25 / 25 / 25
Hole Distance: 152 / 130 / 130
81432706116, 81432706137, 81432706150, 81432706151



MN-VB-9403

Length: 627 Ø: 48
Hole Ø 25 / 23 / 23
Hole Distance: 152 / 130 / 130
81432706097, 81432706113, 81432706135, 81432706160, 81432706161



MN-VB-9404

Length: 627 Ø: 58
Hole Distance: 130 / 130
81432706117, 81432706152, 81432706153



SC-ES-7279

Length: 150
Cone Ø: d1 Ø 30 / d2 Ø 27
Thread: M30 x 1,5 RHT
81953016288



SC-ES-8517

Length: 140
Cone Ø: d1 Ø 30 / d2 Ø 27
Thread: M30 x 1,5 RHT
81953016286



SC-ES-8535

Length: 145
Cone Ø: d1 Ø 30 / d2 Ø 27
Thread: M30 x 1,5 RHT
81953016271, 81953016325



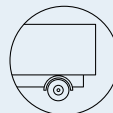

TGA ...

26.390, 26.400 FDC, FDLC,
FDLRC, FDR, FNHLC, FVHLC

05/04→01/05	Track Control Arm		MN-DL-5212	Trailing Arm, Tag Axle;Air Suspension Axle
05/04→	Centre Rod	MN-DL-7801		Push Rod, Leaf Spring Axle
05/04→	Centre Rod	MN-DL-8560		Push Rod, Air Suspension Axle
05/04→	Suspension Strut Repair Kit		DB-RK-8581	
05/04→	Suspension Strut Repair Kit		MN-RK-12436	
05/04→	Tie Rod	MN-DL-7802		
05/04→	Tie Rod	MN-DL-12284		
05/04→	Tie Rod End		IV-ES-8507	Tag Axle
05/04→	Tie Rod End		MN-ES-8490	for vehicles with Hinged Trailing Axle
05/04→	Tie Rod End		SC-ES-8517	for Push Rod
05/04→	Tie Rod End	CV-ES-0914		for Steering Rod
05/04→	Tie Rod End	CV-ES-14162	CV-ES-14162	for Steering Rod
05/04→	Tie Rod End	CV-ES-14163		for Steering Rod
05/04→	Tie Rod End	IV-ES-12272		for Steering Rod
05/04→	Tie Rod End	SC-ES-7279		for Steering Rod
05/04→	Tie Rod End	SC-ES-8535		for Guide Rod
05/04→	Track Control Arm		MN-DL-3402	Trailing Arm, Air Suspension Axle;Drive Axle
05/04→	Track Control Arm		MN-DL-5225	Trailing Arm, Drive Axle;Air Suspension Axle
05/04→	Track Control Arm		MN-DL-5225	Trailing Arm, Tag Axle;Air Suspension Axle; for vehicles with Hinged Trailing Axle
05/04→	Track Control Arm		MN-DL-8544	Trailing Arm, Drive Axle;Air Suspension Axle
05/04→	Track Control Arm		MN-DL-8544	Trailing Arm, Drive Axle;Leaf Spring Axle
05/04→	Track Control Arm		MN-DL-8709	Trailing Arm, Air Suspension Axle; for vehicles with Hinged Trailing Axle
05/04→	Track Control Arm		MN-DL-8733	Trailing Arm, 1st Drive Axle, for Pneumatic Suspension vehicles
05/04→	Track control arm		MN-DL-10288	Trailing Arm, 1st RA;2nd RA, for Leaf-Spring Suspension vehicles
05/04→	Track control arm		MN-DL-12288	Trailing Arm
05/04→	Track Control Arm		MN-TC-12399	Control Arm
05/04→	Track Control Arm		MN-VB-5222	Wishbone (CV), 1st RA;2nd RA, for Pneumatic Suspension vehicles
05/04→	Track Control Arm		MN-VB-5238	Wishbone (CV), Drive Axle;Air Suspension Axle
05/04→	Track Control Arm		MN-VB-5238	Wishbone (CV), Drive Axle;Leading Axle; Air Suspension Axle
05/04→	Track Control Arm		MN-VB-8514	Suspension Rod, Wishbone (CV), Drive Axle; Air Suspension Axle
05/04→	Track Control Arm		MN-VB-8514	Suspension Rod, Wishbone (CV), Drive Axle; Leaf Spring Axle
05/04→	Track Control Arm		MN-VB-8669	Suspension Rod, Wishbone (CV), Drive Axle
05/04→	Track Control Arm		MN-VB-8669	Suspension Rod, Wishbone (CV), Drive Axle; Leaf Spring Axle
05/04→	Track Control Arm		MN-VB-9403	Wishbone (CV), Air Suspension Axle
05/04→	Track Control Arm		MN-VB-9404	Wishbone (CV), Drive Axle
05/04→	Track Control Arm		MN-VB-9404	Wishbone (CV), Drive Axle;Air Suspension Axle
05/04→	Track Control Arm	MN-DL-8663		Control Arm, Air Suspension Axle
01/05→	Track Control Arm		MN-DL-5225	Trailing Arm, Leading Axle;Air Suspension Axle
01/05→	Track Control Arm		MN-DL-5225	Trailing Arm, Tag Axle;Air Suspension Axle; for vehicles with Rigid Trailing Axle
06/05→	Centre Rod	MN-DL-7801		Push Rod, Leaf Spring Axle
06/05→	Suspension Strut Repair Kit		DB-RK-8581	
06/05→	Tie Rod	MN-DL-7802		
06/05→	Tie Rod End	CV-ES-0914		for Steering Rod
06/05→	Tie Rod End	CV-ES-14162		for Steering Rod
06/05→	Tie Rod End	CV-ES-14163		for Steering Rod
06/05→	Tie Rod End	MN-ES-10333		for Steering Rod
06/05→	Tie Rod End	SC-ES-7279		for Steering Rod
06/05→	Tie Rod End	SC-ES-8517		for Push Rod
06/05→	Tie Rod End	SC-ES-8535		for Guide Rod
06/05→	Track Control Arm		MN-DL-5225	Trailing Arm
06/05→	Track Control Arm		MN-DL-8544	Trailing Arm, 1st RA;2nd RA;Leaf Spring Axle
06/05→	Track Control Arm		MN-DL-8609	Trailing Arm, 1st RA;2nd RA, for Leaf-Spring Suspension vehicles, →Type_HB Chassis

26.390, 26.400 FDHC, FDHC/M,
FDHLC

CV-ES-0914

Length: 125
Cone Ø: d1 Ø 30 / d2 Ø 27
Thread: M38 x 1,5 RHT
81953016184, 81953016251, 81953016276



CV-ES-14162

Length: 125
Cone Ø: d1 Ø 30 / d2 Ø 27
Thread: M30 x 1,5 LHT
81953010015, 81953010083, 81953010087,
81953016029, 81953016030, 81953016043,
81953016044, 81953016050, 81953016054,
81953016087, 81953016091, 81953016107,
81953016120, 81953016125, 81953016152,
81953016155, 81953016157, 81953016168,
81953016179, 81953016181, 81953016223,
81953016237, 81953016254, 81953016275,
81953016279, 81953016351



CV-ES-14163

Length: 125
Cone Ø: d1 Ø 30 / d2 Ø 27
Thread: M30 x 1,5 RHT
95301.0084, 90804102156, 90804102272,
90804102696, 90804102710, 81953010016,
81953010075, 81953010084, 81953010088,
81953010094, 81953010103, 81953016030,
81953016043, 81953016048, 81953016049,
81953016053, 81953016061, 81953016090,
81953016108, 81953016112, 81953016126,
81953016143, 81953016149, 81953016154,
81953016156, 81953016168, 81953016178,
81953016194, 81953016206, 81953016224,
81953016234, 81953016242, 81953016252,
81953016274, 81953016278, 81953016284,
81953016286, 81953016308, 81953016310,
81953016312, 81953016347, 81953016350,
81953016352, 82953016012, 88953016014,
N2953016001



DB-RK-8581

Ø: 85 **Hole Distance:** 130
Thick/Height: 24
03305800A, 81432706105



IV-ES-8507

Length: 80
Cone Ø: d1 Ø 30 / d2 Ø 27
Thread: M30 x 1,5 RHT
11019869, 12216380, 55175540,
81953016238



IV-ES-12272

Length: 75
Cone Ø: d1 Ø 30 / d2 Ø 27
Thread: M26 x 1,5 RHT
81953016280, 82953010010



MN-DL-3402

Length: 590 **Ø:** 48
Hole Distance: 130 / 130
03307200A, 81432206067, 81432206068,
81432206090, 81432206092, 81432209092



MN-DL-5212

Length: 577 **Ø:** 48
Hole Distance: 130 / 130
81432206096, 81432206097, 81432206098,
81432206129, 81432209096, 81432209129,
81432306014, 81432306030



MN-DL-5225

Length: 572 **Ø:** 48
Hole Distance: 130 / 130
03301500A, 81432206229, 81432206236,
81432206267, 81432206270, 81432206272,
81432206304, 81432206305, 81432209236,
81432209267, 81432209272



MN-DL-7801

Length: 995 **Ø:** 52
Cone Ø: d1 Ø 30 / d2 Ø 27
81466106807, 81466106808, 81466116087,
81466116088, 81466116096, 81466116097,
81466116099, 81466116132, 81466116133,
81466116136, 81466116197, 81466116198,
81466116205

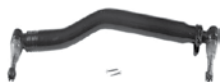

MN-DL-7802

Length: 1680 **Ø:** 52
Cone Ø: d1 Ø 30 / d2 Ø 27
03208300A, 81467116773, 81467116858,
81467116859, 81467116860, 81467116861,
81467116863, 81467116882, 81467116883,
81467116920, 81467116921



MN-DL-8544

Length: 596 **Ø:** 48
Hole Distance: 130 / 130
81432206196, 81432206232, 81432206233



MN-DL-8560

Length: 970 **Ø:** 52
Cone Ø: d1 Ø 30 / d2 Ø 27
03206900A, 81466106809, 81466106810,
81466106823, 81466106838, 81466106839,
81466116104, 81466116105, 81466116107,
81466116134, 81466116135, 81466116137,
81466116199, 81466116200, 81466116206



MN-DL-8609

Length: 585 **Ø:** 58
Hole Distance: 130 / 130
81432206070, 81432206071, 81432206072,
81432206091, 81432206093, 81432206119



MN-DL-8663

Length: 947 **Ø:** 60
Hole Distance: 115 / 115
03307400A, 81432206222, 81432206260,
81432206283, 81432206284



MN-DL-8709

Length: 572 **Ø:** 52
Hole Distance: 130 / 130
81432206268, 81432206274, 81432206291,
81432206292, 82432206007



MN-DL-8733

Length: 530 **Ø:** 48
Hole Distance: 130 / 130
81432206161, 81432206190, 81432206358,
81432206359



MN-DL-10288

81432206386, 82432206008, 82432209008

No Image

MN-DL-12284

Length: 1530 **Ø:** 50
Cone Ø: d1 Ø 30 / d2 Ø 27
81466106579, 81466106580, 81466106624,
81466116720, 81467116720, 81467116730,
81467116952

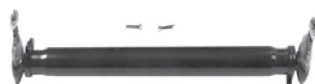

MN-DL-12288

Length: 585 **Ø:** 58
Hole Distance: 130 / 130
81432206386, 82432206008, 82432209008

No Image

MN-ES-8490

Length: 90
Cone Ø: d1 Ø 30 / d2 Ø 27
Thread: M26 x 1,5 RHT
0014606948, 14606948, 81953016281,
81953016337, 82953016016



MN-ES-10333

Length: 90
Cone Ø: d1 Ø 38 / d2 Ø 34,35
Thread: M36 x 1,5 RHT
1271126, 3090291, 3099128, 42538048,
81953016268, 82953016018, 82953016019



MN-RK-12436

Ø: 75 **Hole Distance:** 115
Thick/Height: 24
81432206244



MN-TC-12399

Length: 694 **Ø:** 50
Hole Distance: 130 / 130
81432206265



MN-VB-5222

Length: 627 **Ø:** 50
Hole Distance: 152 / 152
81432706030, 81432706034, 81432706054,
81432706055, 81432706056, 81432706057,
81432706067, 81432706068, 81432706074,
81432706075, 81432706076, 81432706077,
81432706078, 81432706081, 81432706082,
81432709034, 81432709076, 81432709078,
8143706054



MN-VB-5238

Length: 627 **Ø:** 48
Hole Distance: 130 / 130
81432206221, 81432706096, 81432706114,
81432706116, 81432706121



MN-VB-8514

Length: 627 **Ø:** 48
Hole Ø: 25 / 25 / 25
Hole Distance: 152 / 130 / 130
81432706087, 81432706088, 81432706094,
81432706095, 81432796094



MN-VB-8669

Length: 627 **Ø:** 48
Hole Ø: 25 / 25 / 25
Hole Distance: 152 / 130 / 130
81432706116, 81432706137, 81432706150,
81432706151



MN-VB-9403

Length: 627 **Ø:** 48
Hole Ø: 25 / 23 / 23
Hole Distance: 152 / 130 / 130
81432706097, 81432706113, 81432706135,
81432706160, 81432706161



MN-VB-9404

Length: 627 **Ø:** 58
Hole Distance: 130 / 130
81432706117, 81432706152, 81432706153



SC-ES-7279

Length: 150
Cone Ø: d1 Ø 30 / d2 Ø 27
Thread: M30 x 1,5 RHT
81953016288



SC-ES-8517

Length: 140
Cone Ø: d1 Ø 30 / d2 Ø 27
Thread: M30 x 1,5 RHT
81953016286



SC-ES-8535

Length: 145
Cone Ø: d1 Ø 30 / d2 Ø 27
Thread: M30 x 1,5 RHT
81953016271, 81953016325





TGA ...

26.390, 26.400 FDHC, FDHC/M, FDHLC ...	06/05 →	Track Control Arm		MN-VB-5238	Wishbone (CV), 1st RA;2nd RA, for Pneumatic Suspension vehicles, →Type_NBA Chassis	
	06/05 →	Track Control Arm		MN-VB-8514	Suspension Rod, Wishbone (CV), Drive Axle; Leaf Spring Axle	
	06/05 →	Track Control Arm		MN-VB-8669	Suspension Rod, Wishbone (CV), Drive Axle; Leaf Spring Axle	
	06/05 →	Track Control Arm		MN-VB-9404	Wishbone (CV), 1st RA;2nd RA, for Leaf-Spring Suspension vehicles, →Type_HB Chassis	
26.390, 26.400 FDK, FDLK	05/04 →	Centre Rod	MN-DL-7801		Push Rod, Leaf Spring Axle	
	05/04 →	Centre Rod	MN-DL-8560		Push Rod, Air Suspension Axle	
	05/04 →	Suspension Strut Repair Kit		DB-RK-8581		
	05/04 →	Suspension Strut Repair Kit		MN-RK-12436		
	05/04 →	Tie Rod	MN-DL-7802			
	05/04 →	Tie Rod	MN-DL-12284			
	05/04 →	Tie Rod End	CV-ES-0914			for Steering Rod
	05/04 →	Tie Rod End	CV-ES-14162			for Steering Rod
	05/04 →	Tie Rod End	CV-ES-14163			for Steering Rod
	05/04 →	Tie Rod End	SC-ES-7279			for Steering Rod
	05/04 →	Tie Rod End	SC-ES-8517			for Push Rod
	05/04 →	Tie Rod End	SC-ES-8535			for Guide Rod
	05/04 →	Track Control Arm		MN-DL-3402		Trailing Arm, Air Suspension Axle;Drive Axle
	05/04 →	Track Control Arm		MN-DL-5225		Trailing Arm, Drive Axle;Air Suspension Axle
	05/04 →	Track Control Arm		MN-DL-8544		Trailing Arm, Drive Axle;Air Suspension Axle
	05/04 →	Track Control Arm		MN-DL-8544		Trailing Arm, Drive Axle;Leaf Spring Axle
	05/04 →	Track control arm		MN-DL-10288		Trailing Arm, 1st RA;2nd RA, for Leaf-Spring Suspension vehicles
	05/04 →	Track control arm		MN-DL-12288		Trailing Arm
	05/04 →	Track Control Arm		MN-VB-5222		Wishbone (CV), 1st RA;2nd RA, for Pneumatic Suspension vehicles
	05/04 →	Track Control Arm		MN-VB-5238		Wishbone (CV), Drive Axle;Air Suspension Axle
	05/04 →	Track Control Arm		MN-VB-8514		Suspension Rod, Wishbone (CV), Drive Axle; Air Suspension Axle
	05/04 →	Track Control Arm		MN-VB-8514		Suspension Rod, Wishbone (CV), Drive Axle; Leaf Spring Axle
	05/04 →	Track Control Arm		MN-VB-8669		Suspension Rod, Wishbone (CV), Drive Axle
	05/04 →	Track Control Arm		MN-VB-8669		Suspension Rod, Wishbone (CV), Drive Axle; Leaf Spring Axle
	05/04 →	Track Control Arm		MN-VB-9404		Wishbone (CV), Drive Axle
	05/04 →	Track Control Arm		MN-VB-9404		Wishbone (CV), Drive Axle;Air Suspension Axle
	05/04 →	Track Control Arm	MN-DL-8663			Control Arm, Air Suspension Axle
	26.390, 26.400 FDLRS, FDLS, FDRS, FDS, FNHLS, FPMLS, FVHLS	05/04 →01/05	Track Control Arm		MN-DL-5212	Trailing Arm, Tag Axle;Air Suspension Axle
		05/04 →	Centre Rod	MN-DL-7801		Push Rod, Leaf Spring Axle
		05/04 →	Centre Rod	MN-DL-8560		Push Rod, Air Suspension Axle
		05/04 →	Suspension Strut Repair Kit		DB-RK-8581	
		05/04 →	Suspension Strut Repair Kit		MN-RK-12436	
		05/04 →	Tie Rod	MN-DL-7802		
05/04 →		Tie Rod	MN-DL-12284			
05/04 →		Tie Rod End		IV-ES-8507		Tag Axle
05/04 →		Tie Rod End		MN-ES-8490		for vehicles with Hinged Trailing Axle
05/04 →		Tie Rod End		SC-ES-8517		for Push Rod
05/04 →		Tie Rod End	CV-ES-0914			for Steering Rod
05/04 →		Tie Rod End	CV-ES-14162	CV-ES-14162		for Steering Rod
05/04 →		Tie Rod End	CV-ES-14163			for Steering Rod
05/04 →		Tie Rod End	IV-ES-12272			for Steering Rod
05/04 →		Tie Rod End	SC-ES-7279			for Steering Rod
05/04 →		Tie Rod End	SC-ES-8535			for Guide Rod
05/04 →		Track Control Arm		MN-DL-3402		Trailing Arm, Air Suspension Axle;Drive Axle
05/04 →		Track Control Arm		MN-DL-5225		Trailing Arm, Drive Axle;Air Suspension Axle
05/04 →		Track Control Arm		MN-DL-5225		Trailing Arm, Tag Axle;Air Suspension Axle; for vehicles with Hinged Trailing Axle
05/04 →		Track Control Arm		MN-DL-8544		Trailing Arm, Drive Axle;Air Suspension Axle
05/04 →		Track Control Arm		MN-DL-8544		Trailing Arm, Drive Axle;Leaf Spring Axle

CV-ES-0914

Length: 125
Cone Ø: d1 Ø 30 / d2 Ø 27
Thread: M38 x 1,5 RHT
81953016184, 81953016251, 81953016276



CV-ES-14162

Length: 125
Cone Ø: d1 Ø 30 / d2 Ø 27
Thread: M30 x 1,5 LHT
81953010015, 81953010083, 81953010087, 81953016029, 81953016030, 81953016043, 81953016044, 81953016050, 81953016054, 81953016087, 81953016091, 81953016107, 81953016120, 81953016125, 81953016152, 81953016155, 81953016157, 81953016168, 81953016179, 81953016181, 81953016223, 81953016237, 81953016254, 81953016275, 81953016279, 81953016351



CV-ES-14163

Length: 125
Cone Ø: d1 Ø 30 / d2 Ø 27
Thread: M30 x 1,5 RHT
95301.0084, 90804102156, 90804102272, 90804102696, 90804102710, 81953010016, 81953010075, 81953010084, 81953010088, 81953010094, 81953010103, 81953016030, 81953016043, 81953016048, 81953016049, 81953016053, 81953016061, 81953016090, 81953016108, 81953016112, 81953016126, 81953016143, 81953016149, 81953016154, 81953016156, 81953016168, 81953016178, 81953016194, 81953016206, 81953016224, 81953016234, 81953016242, 81953016252, 81953016274, 81953016278, 81953016284, 81953016286, 81953016308, 81953016310, 81953016312, 81953016347, 81953016350, 81953016352, 82953016012, 88953016014, N2953016001



DB-RK-8581

Ø: 85
Hole Distance: 130
Thick/Height: 24
03305800A, 81432706105



IV-ES-8507

Length: 80
Cone Ø: d1 Ø 30 / d2 Ø 27
Thread: M30 x 1,5 RHT
11019869, 12216380, 55175540, 81953016238



IV-ES-12272

Length: 75
Cone Ø: d1 Ø 30 / d2 Ø 27
Thread: M26 x 1,5 RHT
81953016280, 82953010010



MN-DL-3402

Length: 590 Ø: 48
Hole Distance: 130 / 130
03307200A, 81432206067, 81432206068, 81432206090, 81432206092, 81432209092



MN-DL-5212

Length: 577 Ø: 48
Hole Distance: 130 / 130
81432206096, 81432206097, 81432206098, 81432206129, 81432209096, 81432209129, 81432306014, 81432306030



MN-DL-5225

Length: 572 Ø: 48
Hole Distance: 130 / 130
03301500A, 81432206229, 81432206236, 81432206267, 81432206270, 81432206272, 81432206304, 81432206305, 81432209236, 81432209267, 81432209272



MN-DL-7801

Length: 995 Ø: 52
Cone Ø: d1 Ø 30 / d2 Ø 27
81466106807, 81466106808, 81466116087, 81466116088, 81466116096, 81466116097, 81466116099, 81466116132, 81466116133, 81466116136, 81466116197, 81466116198, 81466116205



MN-DL-7802

Length: 1680 Ø: 52
Cone Ø: d1 Ø 30 / d2 Ø 27
03208300A, 81467116773, 81467116858, 81467116859, 81467116860, 81467116861, 81467116863, 81467116882, 81467116883, 81467116920, 81467116921



MN-DL-8544

Length: 596 Ø: 48
Hole Distance: 130 / 130
81432206196, 81432206232, 81432206233



MN-DL-8560

Length: 970 Ø: 52
Cone Ø: d1 Ø 30 / d2 Ø 27
03206900A, 81466106809, 81466106810, 81466106823, 81466106838, 81466106839, 81466116104, 81466116105, 81466116107, 81466116134, 81466116135, 81466116137, 81466116199, 81466116200, 81466116206



MN-DL-8663

Length: 947 Ø: 60
Hole Distance: 115 / 115
03307400A, 81432206222, 81432206260, 81432206283, 81432206284



MN-DL-10288

81432206386, 82432206008, 82432209008

No Image

MN-DL-12284

Length: 1530 Ø: 50
Cone Ø: d1 Ø 30 / d2 Ø 27
81466106579, 81466106580, 81466106624, 81466116720, 81467116720, 81467116730, 81467116952



MN-DL-12288

Length: 585 Ø: 58
Hole Distance: 130 / 130
81432206386, 82432206008, 82432209008

No Image

MN-ES-8490

Length: 90
Cone Ø: d1 Ø 30 / d2 Ø 27
Thread: M26 x 1,5 RHT
14606948, 0014606948, 81953016281, 81953016337, 82953016016



MN-RK-12436

Ø: 75
Hole Distance: 115
Thick/Height: 24
81432206244



MN-VB-5222

Length: 627 Ø: 50
Hole Distance: 152 / 152
81432706030, 81432706034, 81432706054, 81432706055, 81432706056, 81432706057, 81432706067, 81432706068, 81432706074, 81432706075, 81432706076, 81432706077, 81432706078, 81432706081, 81432706082, 81432709034, 81432709076, 81432709078, 8143706054



MN-VB-5238

Length: 627 Ø: 48
Hole Distance: 130 / 130
81432206221, 81432706096, 81432706114, 81432706116, 81432706121



MN-VB-8514

Length: 627 Ø: 48
Hole Ø 25 / 25 / 25
Hole Distance: 152 / 130 / 130
81432706087, 81432706088, 81432706094, 81432706095, 81432796094



MN-VB-8669

Length: 627 Ø: 48
Hole Ø 25 / 25 / 25
Hole Distance: 152 / 130 / 130
81432706116, 81432706137, 81432706150, 81432706151



MN-VB-9404

Length: 627 Ø: 58
Hole Distance: 130 / 130
81432706117, 81432706152, 81432706153



SC-ES-7279

Length: 150
Cone Ø: d1 Ø 30 / d2 Ø 27
Thread: M30 x 1,5 RHT
81953016288



SC-ES-8517

Length: 140
Cone Ø: d1 Ø 30 / d2 Ø 27
Thread: M30 x 1,5 RHT
81953016286



SC-ES-8535

Length: 145
Cone Ø: d1 Ø 30 / d2 Ø 27
Thread: M30 x 1,5 RHT
81953016271, 81953016325





TGA ...

26.390, 26.400 FDLRS, FDLS, FDRS, FDS, FNHLS, FPHLS, FVHLS ...	05/04 →	Track Control Arm		MN-DL-8709	Trailing Arm, Air Suspension Axle; for vehicles with Hinged Trailing Axle
	05/04 →	Track Control Arm		MN-DL-8733	Trailing Arm, 1st Drive Axle, for Pneumatic Suspension vehicles
	05/04 →	Track control arm		MN-DL-10288	Trailing Arm, 1st RA;2nd RA, for Leaf-Spring Suspension vehicles
	05/04 →	Track control arm		MN-DL-12288	Trailing Arm
	05/04 →	Track Control Arm		MN-TC-12399	Control Arm
	05/04 →	Track Control Arm		MN-VB-5222	Wishbone (CV), 1st RA;2nd RA, for Pneumatic Suspension vehicles
	05/04 →	Track Control Arm		MN-VB-5238	Wishbone (CV), Drive Axle;Air Suspension Axle
	05/04 →	Track Control Arm		MN-VB-5238	Wishbone (CV), Drive Axle;Leading Axle; Air Suspension Axle
	05/04 →	Track Control Arm		MN-VB-8514	Suspension Rod, Wishbone (CV), Drive Axle; Air Suspension Axle
	05/04 →	Track Control Arm		MN-VB-8514	Suspension Rod, Wishbone (CV), Drive Axle; Leaf Spring Axle
	05/04 →	Track Control Arm		MN-VB-8669	Suspension Rod, Wishbone (CV), Drive Axle
	05/04 →	Track Control Arm		MN-VB-8669	Suspension Rod, Wishbone (CV), Drive Axle; Leaf Spring Axle
	05/04 →	Track Control Arm		MN-VB-9403	Wishbone (CV), Air Suspension Axle
	05/04 →	Track Control Arm		MN-VB-9404	Wishbone (CV), Drive Axle
	05/04 →	Track Control Arm		MN-VB-9404	Wishbone (CV), Drive Axle;Air Suspension Axle
	05/04 →	Track Control Arm	MN-DL-8663		Control Arm, Air Suspension Axle
	01/05 →	Track Control Arm		MN-DL-5225	Trailing Arm, Leading Axle;Air Suspension Axle
01/05 →	Track Control Arm		MN-DL-5225	Trailing Arm, Tag Axle;Air Suspension Axle; for vehicles with Rigid Trailing Axle	
26.390, 26.400 FD-TM	05/04 →	Centre Rod	MN-DL-7801		Push Rod, Leaf Spring Axle
	05/04 →	Suspension Strut Repair Kit		DB-RK-8581	
	05/04 →	Tie Rod	MN-DL-7802		
	05/04 →	Tie Rod End	CV-ES-0914		for Steering Rod
	05/04 →	Tie Rod End	CV-ES-14162		for Steering Rod
	05/04 →	Tie Rod End	CV-ES-14163		for Steering Rod
	05/04 →	Tie Rod End	SC-ES-7279		for Steering Rod
	05/04 →	Tie Rod End	SC-ES-8517		for Push Rod
	05/04 →	Tie Rod End	SC-ES-8535		for Guide Rod
	05/04 →	Track Control Arm		MN-DL-5225	Trailing Arm
	05/04 →	Track Control Arm		MN-DL-8544	Trailing Arm, Drive Axle;Leaf Spring Axle
	05/04 →	Track control arm		MN-DL-10288	Trailing Arm, 1st RA;2nd RA, for Leaf-Spring Suspension vehicles
	05/04 →	Track control arm		MN-DL-12288	Trailing Arm
	05/04 →	Track Control Arm		MN-VB-8514	Suspension Rod, Wishbone (CV), Drive Axle; Leaf Spring Axle
	05/04 →	Track Control Arm		MN-VB-8669	Suspension Rod, Wishbone (CV), Drive Axle; Leaf Spring Axle
	05/04 →	Track Control Arm		MN-VB-9404	Wishbone (CV), Drive Axle
	26.390, 26.400 FNLC, FNLLC, FNLLRC, FNLLRW, FNLLW, FNLR	05/04 →01/05	Track Control Arm		MN-DL-5212
05/04 →		Centre Rod	MN-DL-7801		Push Rod
05/04 →		Centre Rod	MN-DL-8560		Push Rod, Air Suspension Axle
05/04 →		Suspension Strut Repair Kit		CV-RK-5311	
05/04 →		Suspension Strut Repair Kit		DB-RK-8581	
05/04 →		Suspension Strut Repair Kit		MN-RK-12436	
05/04 →		Tie Rod	MN-DL-7802		
05/04 →		Tie Rod End		IV-ES-8507	Tag Axle
05/04 →		Tie Rod End		MN-ES-8490	for vehicles with Hinged Trailing Axle
05/04 →		Tie Rod End	CV-ES-0914		for Steering Rod
05/04 →		Tie Rod End	CV-ES-14163		for Steering Rod
05/04 →		Tie Rod End	IV-ES-12272		for Steering Rod
05/04 →		Tie Rod End	SC-ES-7279		for Steering Rod
05/04 →		Tie Rod End	SC-ES-8517		for Push Rod
05/04 →		Tie Rod End	SC-ES-8535		for Guide Rod
05/04 →		Track Control Arm		MN-DL-5225	Trailing Arm, Drive Axle;Air Suspension Axle

CV-ES-0914

Length: 125
Cone Ø: d1 Ø 30 / d2 Ø 27
Thread: M38 x 1,5 RHT
81953016184, 81953016251, 81953016276



CV-ES-14162

Length: 125
Cone Ø: d1 Ø 30 / d2 Ø 27
Thread: M30 x 1,5 LHT
81953010015, 81953010083, 81953010087, 81953016029, 81953016030, 81953016043, 81953016044, 81953016050, 81953016054, 81953016087, 81953016091, 81953016107, 81953016120, 81953016125, 81953016152, 81953016155, 81953016157, 81953016168, 81953016179, 81953016181, 81953016223, 81953016237, 81953016254, 81953016275, 81953016279, 81953016351



CV-ES-14163

Length: 125
Cone Ø: d1 Ø 30 / d2 Ø 27
Thread: M30 x 1,5 RHT
95301.0084, 90804102156, 90804102272, 90804102696, 90804102710, 81953010016, 81953010075, 81953010084, 81953010088, 81953010094, 81953010103, 81953016030, 81953016043, 81953016048, 81953016049, 81953016053, 81953016061, 81953016090, 81953016108, 81953016112, 81953016126, 81953016143, 81953016149, 81953016154, 81953016156, 81953016168, 81953016178, 81953016194, 81953016206, 81953016224, 81953016234, 81953016242, 81953016252, 81953016274, 81953016278, 81953016284, 81953016286, 81953016308, 81953016310, 81953016312, 81953016347, 81953016350, 81953016352, 82953016012, 88953016014, N2953016001



CV-RK-5311

638862, 639287, 938423, 1104335, 1953248, 3500506, 0003500506, 11013547, 42488722, 070550504, 634303610, 81432206055, 81432206073, 82262320660, 5001842823, 7000307001, 8226232066



DB-RK-8581

Ø: 85 Hole Distance: 130
Thick/Height: 24
03305800A, 81432706105



IV-ES-8507

Length: 80
Cone Ø: d1 Ø 30 / d2 Ø 27
Thread: M30 x 1,5 RHT
11019869, 12216380, 55175540, 81953016238



IV-ES-12272

Length: 75
Cone Ø: d1 Ø 30 / d2 Ø 27
Thread: M26 x 1,5 RHT
81953016280, 82953010010



MN-DL-5212

Length: 577 Ø: 48
Hole Distance: 130 / 130
81432206096, 81432206097, 81432206098, 81432206129, 81432209096, 81432209129, 81432306014, 81432306030



MN-DL-5225

Length: 572 Ø: 48
Hole Distance: 130 / 130
03301500A, 81432206229, 81432206236, 81432206267, 81432206270, 81432206272, 81432206304, 81432206305, 81432209236, 81432209267, 81432209272



MN-DL-7801

Length: 995 Ø: 52
Cone Ø: d1 Ø 30 / d2 Ø 27
81466106807, 81466106808, 81466116087, 81466116088, 81466116096, 81466116097, 81466116099, 81466116132, 81466116133, 81466116136, 81466116197, 81466116198, 81466116205

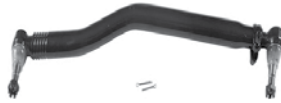

MN-DL-7802

Length: 1680 Ø: 52
Cone Ø: d1 Ø 30 / d2 Ø 27
03208300A, 81467116773, 81467116858, 81467116859, 81467116860, 81467116861, 81467116863, 81467116882, 81467116883, 81467116920, 81467116921



MN-DL-8544

Length: 596 Ø: 48
Hole Distance: 130 / 130
81432206196, 81432206232, 81432206233



MN-DL-8560

Length: 970 Ø: 52
Cone Ø: d1 Ø 30 / d2 Ø 27
03206900A, 81466106809, 81466106810, 81466106823, 81466106838, 81466106839, 81466116104, 81466116105, 81466116107, 81466116134, 81466116135, 81466116137, 81466116199, 81466116200, 81466116206



MN-DL-8663

Length: 947 Ø: 60
Hole Distance: 115 / 115
03307400A, 81432206222, 81432206260, 81432206283, 81432206284



MN-DL-8709

Length: 572 Ø: 52
Hole Distance: 130 / 130
81432206268, 81432206274, 81432206291, 81432206292, 82432206007



MN-DL-8733

Length: 530 Ø: 48
Hole Distance: 130 / 130
81432206161, 81432206190, 81432206358, 81432206359



MN-DL-10288

81432206386, 82432206008, 82432209008

No Image

MN-DL-12288

Length: 585 Ø: 58
Hole Distance: 130 / 130
81432206386, 82432206008, 82432209008

No Image

MN-ES-8490

Length: 90
Cone Ø: d1 Ø 30 / d2 Ø 27
Thread: M26 x 1,5 RHT
0014606948, 14606948, 81953016281, 81953016337, 82953016016



MN-RK-12436

Ø: 75 Hole Distance: 115
Thick/Height: 24
81432206244



MN-TC-12399

Length: 694 Ø: 50
Hole Distance: 130 / 130
81432206265



MN-VB-5222

Length: 627 Ø: 50
Hole Distance: 152 / 152
81432706030, 81432706034, 81432706054, 81432706055, 81432706056, 81432706057, 81432706067, 81432706068, 81432706074, 81432706075, 81432706076, 81432706077, 81432706078, 81432706081, 81432706082, 81432709034, 81432709076, 81432709078, 8143706054



MN-VB-5238

Length: 627 Ø: 48
Hole Distance: 130 / 130
81432206221, 81432706096, 81432706114, 81432706116, 81432706121



MN-VB-8514

Length: 627 Ø: 48
Hole Ø 25 / 25 / 25
Hole Distance: 152 / 130 / 130
81432706087, 81432706088, 81432706094, 81432706095, 81432796094



MN-VB-8669

Length: 627 Ø: 48
Hole Ø 25 / 25 / 25
Hole Distance: 152 / 130 / 130
81432706116, 81432706137, 81432706150, 81432706151



MN-VB-9403

Length: 627 Ø: 48
Hole Ø 25 / 23 / 23
Hole Distance: 152 / 130 / 130
81432706097, 81432706113, 81432706135, 81432706160, 81432706161



MN-VB-9404

Length: 627 Ø: 58
Hole Distance: 130 / 130
81432706117, 81432706152, 81432706153



SC-ES-7279

Length: 150
Cone Ø: d1 Ø 30 / d2 Ø 27
Thread: M30 x 1,5 RHT
81953016288



SC-ES-8517

Length: 140
Cone Ø: d1 Ø 30 / d2 Ø 27
Thread: M30 x 1,5 RHT
81953016286



SC-ES-8535

Length: 145
Cone Ø: d1 Ø 30 / d2 Ø 27
Thread: M30 x 1,5 RHT
81953016271, 81953016325





TGA ...

26.390, 26.400 FNLC, FNLLC, FNLLRC, FNLLRW, FNLLW, FNLCR ...	05/04 →	Track Control Arm		MN-DL-5225	Trailing Arm, Tag Axle; Air Suspension Axle; for vehicles with Hinged Trailing Axle	
	05/04 →	Track Control Arm		MN-DL-8709	Trailing Arm, Air Suspension Axle; for vehicles with Hinged Trailing Axle	
	05/04 →	Track Control Arm		MN-DL-8733	Trailing Arm	
	05/04 →	Track Control Arm		MN-TC-12399	Control Arm	
	05/04 →	Track Control Arm		MN-VB-5238	Wishbone (CV), Drive Axle; Leading Axle; Air Suspension Axle	
	05/04 →	Track Control Arm		MN-VB-9403	Wishbone (CV), Air Suspension Axle	
	05/04 →	Track Control Arm	MN-DL-8663		Control Arm, Air Suspension Axle	
	01/05 →	Track Control Arm		MN-DL-5225	Trailing Arm, Tag Axle; Air Suspension Axle; for vehicles with Rigid Trailing Axle	
26.390, 26.400 FNLS, FNLLS, FNLLRS, FNLLRS, FPLS, FPLRS	05/04 → 01/05	Track Control Arm		MN-DL-5212	Trailing Arm, Tag Axle; Air Suspension Axle	
	05/04 →	Centre Rod	MN-DL-7801		Push Rod, Leaf Spring Axle	
	05/04 →	Centre Rod	MN-DL-8560		Push Rod, Air Suspension Axle	
	05/04 →	Suspension Strut Repair Kit		CV-RK-5311		
	05/04 →	Suspension Strut Repair Kit		DB-RK-8581		
	05/04 →	Suspension Strut Repair Kit		MN-RK-12436		
	05/04 →	Tie Rod	MN-DL-7802			
	05/04 →	Tie Rod	MN-DL-12284			
	05/04 →	Tie Rod End		IV-ES-8507	Tag Axle	
	05/04 →	Tie Rod End		MN-ES-8490	for vehicles with Hinged Trailing Axle	
	05/04 →	Tie Rod End	CV-ES-0914		for Steering Rod	
	05/04 →	Tie Rod End	CV-ES-14163		for Steering Rod	
	05/04 →	Tie Rod End	IV-ES-12272		for Steering Rod	
	05/04 →	Tie Rod End	SC-ES-7279		for Steering Rod	
	05/04 →	Tie Rod End	SC-ES-8517		for Push Rod	
	05/04 →	Tie Rod End	SC-ES-8535		for Guide Rod	
	05/04 →	Track Control Arm		MN-DL-5225	Trailing Arm, Drive Axle; Air Suspension Axle	
	05/04 →	Track Control Arm		MN-DL-5225	Trailing Arm, Leading Axle; Air Suspension Axle	
	05/04 →	Track Control Arm		MN-DL-5225	Trailing Arm, Tag Axle; Air Suspension Axle; for vehicles with Hinged Trailing Axle	
	05/04 →	Track Control Arm		MN-DL-8709	Trailing Arm, Air Suspension Axle; for vehicles with Hinged Trailing Axle	
	05/04 →	Track Control Arm		MN-DL-8733	Trailing Arm, Air Suspension Axle; Drive Axle	
	05/04 →	Track Control Arm		MN-TC-12399	Control Arm	
	05/04 →	Track Control Arm		MN-VB-5238	Wishbone (CV), Drive Axle; Air Suspension Axle	
	05/04 →	Track Control Arm		MN-VB-5238	Wishbone (CV), Drive Axle; Leading Axle; Air Suspension Axle	
	05/04 →	Track Control Arm		MN-VB-5238	Wishbone (CV), Leading Axle; Air Suspension Axle	
	05/04 →	Track Control Arm		MN-VB-9403	Wishbone (CV), Air Suspension Axle	
	05/04 →	Track Control Arm	MN-DL-8663		Control Arm, Air Suspension Axle	
	01/05 →	Track Control Arm		MN-DL-5225	Trailing Arm, Tag Axle; Air Suspension Axle; for vehicles with Rigid Trailing Axle	
	26.390, 26.400 FVHL-KO	06/05 →	Centre Rod	MN-DL-7801		Push Rod, Leaf Spring Axle
		06/05 →	Suspension Strut Repair Kit		DB-RK-8581	
06/05 →		Tie Rod	MN-DL-7802			
06/05 →		Tie Rod End		SC-ES-8517	for Push Rod	
06/05 →		Tie Rod End	CV-ES-0914		for Steering Rod	
06/05 →		Tie Rod End	CV-ES-14163		for Steering Rod	
06/05 →		Tie Rod End	SC-ES-7279		for Steering Rod	
06/05 →		Tie Rod End	SC-ES-8535		for Guide Rod	
06/05 →		Track Control Arm		MN-DL-5225	Trailing Arm, Drive Axle; Air Suspension Axle	
06/05 →		Track Control Arm		MN-DL-5225	Trailing Arm, Leading Axle; Air Suspension Axle	
06/05 →		Track Control Arm		MN-VB-5238	Wishbone (CV), Drive Axle; Leading Axle; Air Suspension Axle	
26.390, 26.400 FVL-KO		02/04 →	Centre Rod	MN-DL-7801		Push Rod, Leaf Spring Axle
	02/04 →	Suspension Strut Repair Kit		DB-RK-8581		
	02/04 →	Tie Rod	MN-DL-7802			
	02/04 →	Tie Rod End		SC-ES-8517	for Push Rod	
	02/04 →	Tie Rod End	CV-ES-0914		for Steering Rod	
	02/04 →	Tie Rod End	CV-ES-14163		for Steering Rod	
	02/04 →	Tie Rod End	SC-ES-7279		for Steering Rod	

CV-ES-0914

Length: 125
Cone Ø: d1 Ø 30 / d2 Ø 27
Thread: M38 x 1,5 RHT
81953016184, 81953016251, 81953016276



CV-ES-14163

Length: 125
Cone Ø: d1 Ø 30 / d2 Ø 27
Thread: M30 x 1,5 RHT
95301.0084, 90804102156, 90804102272, 90804102696, 90804102710, 81953010016, 81953010075, 81953010084, 81953010088, 81953010094, 81953010103, 81953016030, 81953016043, 81953016048, 81953016049, 81953016053, 81953016061, 81953016090, 81953016108, 81953016112, 81953016126, 81953016143, 81953016149, 81953016154, 81953016156, 81953016168, 81953016178, 81953016194, 81953016206, 81953016224, 81953016234, 81953016242, 81953016252, 81953016274, 81953016278, 81953016284, 81953016286, 81953016308, 81953016310, 81953016312, 81953016347, 81953016350, 81953016352, 82953016012, 88953016014, N2953016001



CV-RK-5311

638862, 639287, 938423, 1104335, 1953248, 0003500506, 3500506, 11013547, 42488722, 070550504, 634303610, 81432206055, 81432206073, 82262320660, 5001842823, 7000307001, 8226232066



DB-RK-8581

Ø: 85
Hole Distance: 130
Thick/Height: 24
03305800A, 81432706105



IV-ES-8507

Length: 80
Cone Ø: d1 Ø 30 / d2 Ø 27
Thread: M30 x 1,5 RHT
11019869, 12216380, 55175540, 81953016238



IV-ES-12272

Length: 75
Cone Ø: d1 Ø 30 / d2 Ø 27
Thread: M26 x 1,5 RHT
81953016280, 82953010010



MN-DL-5212

Length: 577 Ø: 48
Hole Distance: 130 / 130
81432206096, 81432206097, 81432206098, 81432206129, 81432209096, 81432209129, 81432306014, 81432306030



MN-DL-5225

Length: 572 Ø: 48
Hole Distance: 130 / 130
03301500A, 81432206229, 81432206236, 81432206267, 81432206270, 81432206272, 81432206304, 81432206305, 81432209236, 81432209267, 81432209272



MN-DL-7801

Length: 995 Ø: 52
Cone Ø: d1 Ø 30 / d2 Ø 27
81466106807, 81466106808, 81466116087, 81466116088, 81466116096, 81466116097, 81466116099, 81466116132, 81466116133, 81466116136, 81466116197, 81466116198, 81466116205



MN-DL-7802

Length: 1680 Ø: 52
Cone Ø: d1 Ø 30 / d2 Ø 27
03208300A, 81467116773, 81467116858, 81467116859, 81467116860, 81467116861, 81467116863, 81467116882, 81467116883, 81467116920, 81467116921



MN-DL-8560

Length: 970 Ø: 52
Cone Ø: d1 Ø 30 / d2 Ø 27
03206900A, 81466106809, 81466106810, 81466106823, 81466106838, 81466106839, 81466116104, 81466116105, 81466116107, 81466116134, 81466116135, 81466116137, 81466116199, 81466116200, 81466116206



MN-DL-8663

Length: 947 Ø: 60
Hole Distance: 115 / 115
03307400A, 81432206222, 81432206260, 81432206283, 81432206284



MN-DL-8709

Length: 572 Ø: 52
Hole Distance: 130 / 130
81432206268, 81432206274, 81432206291, 81432206292, 82432206007



MN-DL-8733

Length: 530 Ø: 48
Hole Distance: 130 / 130
81432206161, 81432206190, 81432206358, 81432206359



MN-DL-12284

Length: 1530 Ø: 50
Cone Ø: d1 Ø 30 / d2 Ø 27
81466106579, 81466106580, 81466106624, 81466116720, 81467116720, 81467116730, 81467116952



MN-ES-8490

Length: 90
Cone Ø: d1 Ø 30 / d2 Ø 27
Thread: M26 x 1,5 RHT
0014606948, 14606948, 81953016281, 81953016337, 82953016016



MN-RK-12436

Ø: 75
Hole Distance: 115
Thick/Height: 24
81432206244



MN-TC-12399

Length: 694 Ø: 50
Hole Distance: 130 / 130
81432206265



MN-VB-5238

Length: 627 Ø: 48
Hole Distance: 130 / 130
81432206221, 81432706096, 81432706114, 81432706116, 81432706121



MN-VB-9403

Length: 627 Ø: 48
Hole Ø 25 / 23 / 23
Hole Distance: 152 / 130 / 130
81432706097, 81432706113, 81432706135, 81432706160, 81432706161



SC-ES-7279

Length: 150
Cone Ø: d1 Ø 30 / d2 Ø 27
Thread: M30 x 1,5 RHT
81953016288



SC-ES-8517

Length: 140
Cone Ø: d1 Ø 30 / d2 Ø 27
Thread: M30 x 1,5 RHT
81953016286



SC-ES-8535

Length: 145
Cone Ø: d1 Ø 30 / d2 Ø 27
Thread: M30 x 1,5 RHT
81953016271, 81953016325





TGA ...

26.390, 26.400 FVL-K0 ...	02/04 →	Tie Rod End	SC-ES-8535		for Guide Rod
	02/04 →	Track Control Arm		MN-DL-5225	Trailing Arm, Drive Axle;Air Suspension Axle
	02/04 →	Track Control Arm		MN-DL-5225	Trailing Arm, Leading Axle;Air Suspension Axle
	02/04 →	Track Control Arm		MN-DL-8733	Trailing Arm, Air Suspension Axle;Drive Axle
	02/04 →	Track Control Arm		MN-VB-5238	Wishbone (CV), Drive Axle;Air Suspension Axle
	02/04 →	Track Control Arm		MN-VB-5238	Wishbone (CV), Leading Axle;Air Suspension Axle
26.400 FDAC, FDALC, FDHC, FDHLC	01/04 →	Centre Rod	MN-DL-2160		Coupling Rod
	01/04 →	Centre Rod	MN-DL-2174		Push Rod
	01/04 →	Suspension Arm Repair Kit		CV-RK-5313	for Wishbone (CV)
	01/04 →	Tie Rod End	CV-ES-0914		for Steering Rod
	01/04 →	Tie Rod End	CV-ES-14162		for Steering Rod
	01/04 →	Tie Rod End	CV-ES-14163		for Steering Rod
	01/04 →	Tie Rod End	MN-ES-10333		for Steering Rod
	01/04 →	Tie Rod End	SC-ES-7279		for Steering Rod
	01/04 →	Tie Rod End	SC-ES-8517		for Push Rod
	01/04 →	Tie Rod End	SC-ES-8535		for Guide Rod
	01/04 →	Track Control Arm		MN-DL-8609	Trailing Arm, 1st RA;2nd RA, for Leaf-Spring Suspension vehicles, →Type_HB Chassis
	01/04 →	Track Control Arm		MN-VB-5238	Wishbone (CV), 1st RA;2nd RA, for Pneumatic Suspension vehicles, →Type_NBA Chassis
	01/04 →	Track Control Arm		MN-VB-8514	Suspension Rod, Wishbone (CV)
	01/04 →	Track Control Arm		MN-VB-8669	Suspension Rod, Wishbone (CV), 1st RA; 2nd RA, for Leaf-Spring Suspension vehicles, →Type_MHB Chassis
	01/04 →	Track Control Arm		MN-VB-9404	Wishbone (CV), 1st RA;2nd RA, for Leaf-Spring Suspension vehicles, →Type_HB Chassis
26.400 FDAK, FDALK, FDHK, FDHLC	01/04 →	Centre Rod	MN-DL-2160		Coupling Rod
	01/04 →	Centre Rod	MN-DL-2174		Push Rod
	01/04 →	Suspension Arm Repair Kit		CV-RK-5313	for Wishbone (CV)
	01/04 →	Tie Rod End	CV-ES-0914		for Steering Rod
	01/04 →	Tie Rod End	CV-ES-14162		for Steering Rod
	01/04 →	Tie Rod End	CV-ES-14163		for Steering Rod
	01/04 →	Tie Rod End	MN-ES-10333		for Steering Rod
	01/04 →	Tie Rod End	SC-ES-7279		for Steering Rod
	01/04 →	Tie Rod End	SC-ES-8517		for Push Rod
	01/04 →	Tie Rod End	SC-ES-8535		for Guide Rod
	01/04 →	Track Control Arm		MN-DL-8609	Trailing Arm, 1st RA;2nd RA, for Leaf-Spring Suspension vehicles, →Type_HB Chassis
	01/04 →	Track Control Arm		MN-VB-5238	Wishbone (CV), 1st RA;2nd RA, for Pneumatic Suspension vehicles, →Type_NBA Chassis
	01/04 →	Track Control Arm		MN-VB-8514	Suspension Rod, Wishbone (CV)
	01/04 →	Track Control Arm		MN-VB-8669	Suspension Rod, Wishbone (CV), 1st RA; 2nd RA, for Leaf-Spring Suspension vehicles, →Type_MHB Chassis
	01/04 →	Track Control Arm		MN-VB-9404	Wishbone (CV), 1st RA;2nd RA, for Leaf-Spring Suspension vehicles, →Type_HB
26.400 FDALS, FDAS, FDHLS, FDHS	01/04 →	Centre Rod	MN-DL-2160		Coupling Rod
	01/04 →	Centre Rod	MN-DL-2174		Push Rod
	01/04 →	Suspension Arm Repair Kit		CV-RK-5313	for Wishbone (CV)
	01/04 →	Tie Rod End	CV-ES-0914		for Steering Rod
	01/04 →	Tie Rod End	CV-ES-14162		for Steering Rod
	01/04 →	Tie Rod End	CV-ES-14163		for Steering Rod
	01/04 →	Tie Rod End	MN-ES-10333		for Steering Rod
	01/04 →	Tie Rod End	SC-ES-7279		for Steering Rod
	01/04 →	Tie Rod End	SC-ES-8517		for Push Rod
	01/04 →	Tie Rod End	SC-ES-8535		for Guide Rod
	01/04 →	Track Control Arm		MN-DL-8609	Trailing Arm, 1st RA;2nd RA, for Leaf-Spring Suspension vehicles, →Type_HB Chassis
	01/04 →	Track Control Arm		MN-VB-5238	Wishbone (CV), 1st RA;2nd RA, for Pneumatic Suspension vehicles, →Type_NBA Chassis
	01/04 →	Track Control Arm		MN-VB-8514	Suspension Rod, Wishbone (CV)

CV-ES-0914

Length: 125
Cone Ø: d1 Ø 30 / d2 Ø 27
Thread: M38 x 1,5 RHT
81953016184, 81953016251, 81953016276



CV-ES-14162

Length: 125
Cone Ø: d1 Ø 30 / d2 Ø 27
Thread: M30 x 1,5 LHT
81953010015, 81953010083, 81953010087, 81953016029, 81953016030, 81953016043, 81953016044, 81953016050, 81953016054, 81953016087, 81953016091, 81953016107, 81953016120, 81953016125, 81953016152, 81953016155, 81953016157, 81953016168, 81953016179, 81953016181, 81953016223, 81953016237, 81953016254, 81953016275, 81953016279, 81953016351



CV-ES-14163

Length: 125
Cone Ø: d1 Ø 30 / d2 Ø 27
Thread: M30 x 1,5 RHT
95301.0084, 90804102156, 90804102272, 90804102696, 90804102710, 81953010016, 81953010075, 81953010084, 81953010088, 81953010094, 81953010103, 81953016030, 81953016043, 81953016048, 81953016049, 81953016053, 81953016061, 81953016090, 81953016108, 81953016112, 81953016126, 81953016143, 81953016149, 81953016154, 81953016156, 81953016168, 81953016178, 81953016194, 81953016206, 81953016224, 81953016234, 81953016242, 81953016252, 81953016274, 81953016278, 81953016284, 81953016286, 81953016308, 81953016310, 81953016312, 81953016347, 81953016350, 81953016352, 82953016012, 88953016014, N2953016001



CV-RK-5313

Ø: 90
03304800A, 81953016132



MN-DL-2160

Length: 1652 Ø: 50
Cone Ø: d1 Ø 30 / d2 Ø 27
81467106112, 81467106163, 81467106165, 81467106198, 81467106353, 81467106354, 81467106361, 81467116725



MN-DL-2174

Length: 1588 Ø: 52
Cone Ø: d1 Ø 30 / d2 Ø 27
81467106378, 81467106912



MN-DL-5225

Length: 572 Ø: 48
Hole Distance: 130 / 130
03301500A, 81432206229, 81432206236, 81432206267, 81432206270, 81432206272, 81432206304, 81432206305, 81432209236, 81432209267, 81432209272



MN-DL-8609

Length: 585 Ø: 58
Hole Distance: 130 / 130
81432206070, 81432206071, 81432206072, 81432206091, 81432206093, 81432206119



MN-DL-8733

Length: 530 Ø: 48
Hole Distance: 130 / 130
81432206161, 81432206190, 81432206358, 81432206359



MN-ES-10333

Length: 90
Cone Ø: d1 Ø 38 / d2 Ø 34,35
Thread: M36 x 1,5 RHT
1271126, 3090291, 3099128, 42538048, 81953016268, 82953016018, 82953016019



MN-VB-5238

Length: 627 Ø: 48
Hole Distance: 130 / 130
81432206221, 81432706096, 81432706114, 81432706116, 81432706121



MN-VB-8514

Length: 627 Ø: 48
Hole Ø 25 / 25 / 25
Hole Distance: 152 / 130 / 130
81432706087, 81432706088, 81432706094, 81432706095, 81432796094



MN-VB-8669

Length: 627 Ø: 48
Hole Ø 25 / 25 / 25
Hole Distance: 152 / 130 / 130
81432706116, 81432706137, 81432706150, 81432706151



MN-VB-9404

Length: 627 Ø: 58
Hole Distance: 130 / 130
81432706117, 81432706152, 81432706153



SC-ES-7279

Length: 150
Cone Ø: d1 Ø 30 / d2 Ø 27
Thread: M30 x 1,5 RHT
81953016288



SC-ES-8517

Length: 140
Cone Ø: d1 Ø 30 / d2 Ø 27
Thread: M30 x 1,5 RHT
81953016286



SC-ES-8535

Length: 145
Cone Ø: d1 Ø 30 / d2 Ø 27
Thread: M30 x 1,5 RHT
81953016271, 81953016325





TGA ...

26.400 FDALS, FDAS, FDHLS, FDHS ...	01/04 →	Track Control Arm		MN-VB-8669	Suspension Rod, Wishbone (CV), 1st RA; 2nd RA, for Leaf-Spring Suspension vehicles, →Type_MHB Chassis
	01/04 →	Track Control Arm		MN-VB-9404	Wishbone (CV), 1st RA; 2nd RA, for Leaf-Spring Suspension vehicles, →Type_HB
26.400 FDH-TM	04/06 →	Centre Rod	MN-DL-7801		Push Rod
	04/06 →	Tie Rod	MN-DL-7802		
	04/06 →	Tie Rod End	CV-ES-0914		for Steering Rod
	04/06 →	Tie Rod End	CV-ES-14162		for Steering Rod
	04/06 →	Tie Rod End	CV-ES-14163		for Steering Rod
	04/06 →	Tie Rod End	SC-ES-7279		for Steering Rod
	04/06 →	Tie Rod End	SC-ES-8517		for Push Rod
	04/06 →	Tie Rod End	SC-ES-8535		for Guide Rod
	04/06 →	Track Control Arm		MN-DL-8544	Trailing Arm, 1st RA; 2nd RA, for Leaf-Spring Suspension vehicles
	04/06 →	Track Control Arm		MN-VB-8514	Suspension Rod, Wishbone (CV)
	04/06 →	Track Control Arm		MN-VB-8669	Suspension Rod, Wishbone (CV), 1st RA; 2nd RA, for Leaf-Spring Suspension vehicles, →Type_MHB Chassis
26.400 FVLC	04/06 →	Centre Rod	MN-DL-7801		Push Rod
	04/06 →	Suspension Strut Repair Kit		MN-RK-12436	
	04/06 →	Tie Rod	MN-DL-7802		
	04/06 →	Tie Rod	MN-DL-12284		
	04/06 →	Tie Rod End		SC-ES-8517	for Push Rod
	04/06 →	Tie Rod End	CV-ES-0914		for Steering Rod
	04/06 →	Tie Rod End	CV-ES-14162	CV-ES-14162	for Steering Rod
	04/06 →	Tie Rod End	CV-ES-14163		for Steering Rod
	04/06 →	Tie Rod End	SC-ES-7279		for Steering Rod
	04/06 →	Tie Rod End	SC-ES-8535		for Guide Rod
	04/06 →	Track Control Arm		MN-DL-5212	Trailing Arm, Trailing Axle Steered, for Pneumatic Suspension vehicles
	04/06 →	Track Control Arm		MN-DL-5225	Trailing Arm
	04/06 →	Track Control Arm		MN-DL-8709	Trailing Arm, 1st Drive Axle, for Pneumatic Suspension vehicles
	04/06 →	Track Control Arm		MN-DL-8709	Trailing Arm, Trailing Axle Steered, for Pneumatic Suspension vehicles
	04/06 →	Track Control Arm		MN-DL-8733	Trailing Arm, 1st Drive Axle, for Pneumatic Suspension vehicles
	04/06 →	Track Control Arm		MN-VB-5238	Wishbone (CV), 1st Drive Axle, for Pneumatic Suspension vehicles
	04/06 →	Track Control Arm		MN-VB-9403	Wishbone (CV), Trailing Axle Steered, for Pneumatic Suspension vehicles
	26.400 FVLS, FVLRS	04/06 →	Track Control Arm	MN-DL-8663	
04/06 →		Centre Rod	MN-DL-7801		Push Rod
04/06 →		Suspension Strut Repair Kit		MN-RK-12436	
04/06 →		Tie Rod	MN-DL-7802		
04/06 →		Tie Rod	MN-DL-12284		
04/06 →		Tie Rod End		SC-ES-8517	for Push Rod
04/06 →		Tie Rod End	CV-ES-0914		for Steering Rod
04/06 →		Tie Rod End	CV-ES-14162	CV-ES-14162	for Steering Rod
04/06 →		Tie Rod End	CV-ES-14163		for Steering Rod
04/06 →		Tie Rod End	SC-ES-7279		for Steering Rod
04/06 →		Tie Rod End	SC-ES-8535		for Guide Rod
04/06 →		Track Control Arm		MN-DL-5212	Trailing Arm, Trailing Axle Steered, for Pneumatic Suspension vehicles
04/06 →		Track Control Arm		MN-DL-5225	Trailing Arm
04/06 →		Track Control Arm		MN-DL-8709	Trailing Arm, 1st Drive Axle, for Pneumatic Suspension vehicles
04/06 →		Track Control Arm		MN-DL-8709	Trailing Arm, Trailing Axle Steered, for Pneumatic Suspension vehicles
04/06 →		Track Control Arm		MN-DL-8733	Trailing Arm, 1st Drive Axle, for Pneumatic Suspension vehicles

CV-ES-0914

Length: 125
Cone Ø: d1 Ø 30 / d2 Ø 27
Thread: M38 x 1,5 RHT
81953016184, 81953016251, 81953016276



CV-ES-14162

Length: 125
Cone Ø: d1 Ø 30 / d2 Ø 27
Thread: M30 x 1,5 LHT
81953010015, 81953010083, 81953010087, 81953016029, 81953016030, 81953016043, 81953016044, 81953016050, 81953016054, 81953016087, 81953016091, 81953016107, 81953016120, 81953016125, 81953016152, 81953016155, 81953016157, 81953016168, 81953016179, 81953016181, 81953016223, 81953016237, 81953016254, 81953016275, 81953016279, 81953016351



CV-ES-14163

Length: 125
Cone Ø: d1 Ø 30 / d2 Ø 27
Thread: M30 x 1,5 RHT
95301.0084, 90804102156, 90804102272, 90804102696, 90804102710, 81953010016, 81953010075, 81953010084, 81953010088, 81953010094, 81953010103, 81953016030, 81953016043, 81953016048, 81953016049, 81953016053, 81953016061, 81953016090, 81953016108, 81953016112, 81953016126, 81953016143, 81953016149, 81953016154, 81953016156, 81953016168, 81953016178, 81953016194, 81953016206, 81953016224, 81953016234, 81953016242, 81953016252, 81953016274, 81953016278, 81953016284, 81953016286, 81953016308, 81953016310, 81953016312, 81953016347, 81953016350, 81953016352, 82953016012, 88953016014, N2953016001



MN-DL-5212

Length: 577 Ø: 48
Hole Distance: 130 / 130
81432206096, 81432206097, 81432206098, 81432206129, 81432209096, 81432209129, 81432306014, 81432306030



MN-DL-5225

Length: 572 Ø: 48
Hole Distance: 130 / 130
03301500A, 81432206229, 81432206236, 81432206267, 81432206270, 81432206272, 81432206304, 81432206305, 81432209236, 81432209267, 81432209272



MN-DL-7801

Length: 995 Ø: 52
Cone Ø: d1 Ø 30 / d2 Ø 27
81466106807, 81466106808, 81466116087, 81466116088, 81466116096, 81466116097, 81466116099, 81466116132, 81466116133, 81466116136, 81466116197, 81466116198, 81466116205



MN-DL-7802

Length: 1680 Ø: 52
Cone Ø: d1 Ø 30 / d2 Ø 27
03208300A, 81467116773, 81467116858, 81467116859, 81467116860, 81467116861, 81467116863, 81467116882, 81467116883, 81467116920, 81467116921



MN-DL-8544

Length: 596 Ø: 48
Hole Distance: 130 / 130
81432206196, 81432206232, 81432206233



MN-DL-8663

Length: 947 Ø: 60
Hole Distance: 115 / 115
03307400A, 81432206222, 81432206260, 81432206283, 81432206284



MN-DL-8709

Length: 572 Ø: 52
Hole Distance: 130 / 130
81432206268, 81432206274, 81432206291, 81432206292, 82432206007



MN-DL-8733

Length: 530 Ø: 48
Hole Distance: 130 / 130
81432206161, 81432206190, 81432206358, 81432206359



MN-DL-12284

Length: 1530 Ø: 50
Cone Ø: d1 Ø 30 / d2 Ø 27
81466106579, 81466106580, 81466106624, 81466116720, 81467116720, 81467116730, 81467116952



MN-RK-12436

Ø: 75
Hole Distance: 115
Thick/Height: 24
81432206244



MN-VB-5238

Length: 627 Ø: 48
Hole Distance: 130 / 130
81432206221, 81432706096, 81432706114, 81432706116, 81432706121



MN-VB-8514

Length: 627 Ø: 48
Hole Ø 25 / 25 / 25
Hole Distance: 152 / 130 / 130
81432706087, 81432706088, 81432706094, 81432706095, 81432796094



MN-VB-8669

Length: 627 Ø: 48
Hole Ø 25 / 25 / 25
Hole Distance: 152 / 130 / 130
81432706116, 81432706137, 81432706150, 81432706151



MN-VB-9403

Length: 627 Ø: 48
Hole Ø 25 / 23 / 23
Hole Distance: 152 / 130 / 130
81432706097, 81432706113, 81432706135, 81432706160, 81432706161



MN-VB-9404

Length: 627 Ø: 58
Hole Distance: 130 / 130
81432706117, 81432706152, 81432706153



SC-ES-7279

Length: 150
Cone Ø: d1 Ø 30 / d2 Ø 27
Thread: M30 x 1,5 RHT
81953016288



SC-ES-8517

Length: 140
Cone Ø: d1 Ø 30 / d2 Ø 27
Thread: M30 x 1,5 RHT
81953016286



SC-ES-8535

Length: 145
Cone Ø: d1 Ø 30 / d2 Ø 27
Thread: M30 x 1,5 RHT
81953016271, 81953016325





TGA ...

26.400 FVLS, FVLSR ...	04/06→	Track Control Arm		MN-VB-5238	Wishbone (CV), 1st Drive Axle, for Pneumatic Suspension vehicles
	04/06→	Track Control Arm		MN-VB-9403	Wishbone (CV), Trailing Axle Steered, for Pneumatic Suspension vehicles
	04/06→	Track Control Arm	MN-DL-8663		Control Arm
26.410 FDAC, FDARC	02/02→	Ball Head, gearshift linkage	CV-ES-2120		
	02/02→	Centre Rod	MN-DL-7801		Push Rod
	02/02→	Suspension Strut Repair Kit		DB-RK-8581	
	02/02→	Tie Rod End	CV-ES-0914		for Steering Rod
	02/02→	Tie Rod End	CV-ES-14163		for Steering Rod
	02/02→	Tie Rod End	MN-ES-10333		for Steering Rod
	02/02→	Tie Rod End	SC-ES-8517		for Push Rod
	02/02→	Track Control Arm		MN-DL-5225	Trailing Arm
	02/02→	Track Control Arm		MN-DL-8544	Trailing Arm, 1st RA;2nd RA;Leaf Spring Axle
	02/02→	Track Control Arm		MN-DL-8609	Trailing Arm, 1st RA;2nd RA, for Leaf-Spring Suspension vehicles, →Type_HB Chassis
	02/02→	Track Control Arm		MN-VB-8514	Suspension Rod, Wishbone (CV), Drive Axle; Leaf Spring Axle
	02/02→	Track Control Arm		MN-VB-9404	Wishbone (CV), Drive Axle
	26.410 FDAK, FDALK	02/02→	Ball Head, gearshift linkage	CV-ES-2120	
02/02→		Centre Rod	MN-DL-7801		Push Rod
02/02→		Suspension Strut Repair Kit		DB-RK-8581	
02/02→		Tie Rod End	CV-ES-0914		for Steering Rod
02/02→		Tie Rod End	CV-ES-14163		for Steering Rod
02/02→		Tie Rod End	MN-ES-10333		for Steering Rod
02/02→		Tie Rod End	SC-ES-8517		for Push Rod
02/02→		Track Control Arm		MN-DL-5225	Trailing Arm
02/02→		Track Control Arm		MN-DL-8544	Trailing Arm, 1st RA;2nd RA;Leaf Spring Axle
02/02→		Track Control Arm		MN-DL-8544	Trailing Arm, Drive Axle;Air Suspension Axle
02/02→		Track Control Arm		MN-DL-8609	Trailing Arm, 1st RA;2nd RA, for Leaf-Spring Suspension vehicles, →Type_HB Chassis
02/02→		Track Control Arm		MN-VB-8514	Suspension Rod, Wishbone (CV), Drive Axle; Air Suspension Axle
02/02→		Track Control Arm		MN-VB-8514	Suspension Rod, Wishbone (CV), Drive Axle; Leaf Spring Axle
02/02→	Track Control Arm		MN-VB-9404	Wishbone (CV), Drive Axle	
26.410 FDALS, FDARS, FDAS	02/02→	Ball Head, gearshift linkage	CV-ES-2120		
	02/02→	Centre Rod	MN-DL-7801		Push Rod
	02/02→	Suspension Strut Repair Kit		DB-RK-8581	
	02/02→	Tie Rod End	CV-ES-0914		for Steering Rod
	02/02→	Tie Rod End	CV-ES-14163		for Steering Rod
	02/02→	Tie Rod End	MN-ES-10333		for Steering Rod
	02/02→	Tie Rod End	SC-ES-8517		for Push Rod
	02/02→	Track Control Arm		MN-DL-5225	Trailing Arm
	02/02→	Track Control Arm		MN-DL-8544	Trailing Arm, 1st RA;2nd RA;Leaf Spring Axle
	02/02→	Track Control Arm		MN-DL-8544	Trailing Arm, Drive Axle;Air Suspension Axle
	02/02→	Track Control Arm		MN-DL-8609	Trailing Arm, 1st RA;2nd RA, for Leaf-Spring Suspension vehicles, →Type_HB Chassis
	02/02→	Track Control Arm		MN-VB-8514	Suspension Rod, Wishbone (CV), Drive Axle; Air Suspension Axle
	02/02→	Track Control Arm		MN-VB-8514	Suspension Rod, Wishbone (CV), Drive Axle; Leaf Spring Axle
02/02→	Track Control Arm		MN-VB-9404	Wishbone (CV), Drive Axle	
26.410 FDC, FDL, FDLRC, FDR	01/01→	Ball Head, gearshift linkage	CV-ES-2120		
	01/01→	Centre Rod	MN-DL-7801		Push Rod, Leaf Spring Axle
	01/01→	Centre Rod	MN-DL-8560		Push Rod, Air Suspension Axle
	01/01→	Suspension Strut Repair Kit		DB-RK-8581	
	01/01→	Suspension Strut Repair Kit		MN-RK-12436	
	01/01→	Tie Rod	MN-DL-7802		
	01/01→	Tie Rod End	CV-ES-0914		for Steering Rod
	01/01→	Tie Rod End	CV-ES-14162		for Steering Rod
	01/01→	Tie Rod End	CV-ES-14163		for Steering Rod
	01/01→	Tie Rod End	SC-ES-7279		for Steering Rod

CV-ES-0914

Length: 125
Cone Ø: d1 Ø 30 / d2 Ø 27
Thread: M38 x 1,5 RHT
81953016184, 81953016251, 81953016276



CV-ES-2120

Length: 115
Cone Ø: d1 Ø 12,4 / d2 Ø 10,8
Thread: M14 x 1,5 RHT
03008500A, 81953016200, 81953016202, 81953016203, 81953016227



CV-ES-14162

Length: 125
Cone Ø: d1 Ø 30 / d2 Ø 27
Thread: M30 x 1,5 LHT
81953010015, 81953010083, 81953010087, 81953016029, 81953016030, 81953016043, 81953016044, 81953016050, 81953016054, 81953016087, 81953016091, 81953016107, 81953016120, 81953016125, 81953016152, 81953016155, 81953016157, 81953016168, 81953016179, 81953016181, 81953016223, 81953016237, 81953016254, 81953016275, 81953016279, 81953016351



CV-ES-14163

Length: 125
Cone Ø: d1 Ø 30 / d2 Ø 27
Thread: M30 x 1,5 RHT
95301.0084, 90804102156, 90804102272, 90804102696, 90804102710, 81953010016, 81953010075, 81953010084, 81953010088, 81953010094, 81953010103, 81953016030, 81953016043, 81953016048, 81953016049, 81953016053, 81953016061, 81953016090, 81953016108, 81953016112, 81953016126, 81953016143, 81953016149, 81953016154, 81953016156, 81953016168, 81953016178, 81953016194, 81953016206, 81953016224, 81953016234, 81953016242, 81953016252, 81953016274, 81953016278, 81953016284, 81953016286, 81953016308, 81953016310, 81953016312, 81953016347, 81953016350, 81953016352, 82953016012, 88953016014, N2953016001



DB-RK-8581

Ø: 85
Hole Distance: 130
Thick/Height: 24
03305800A, 81432706105



MN-DL-5225

Length: 572 Ø: 48
Hole Distance: 130 / 130
03301500A, 81432206229, 81432206236, 81432206267, 81432206270, 81432206272, 81432206304, 81432206305, 81432209236, 81432209267, 81432209272



MN-DL-7801

Length: 995 Ø: 52
Cone Ø: d1 Ø 30 / d2 Ø 27
81466106807, 81466106808, 81466116087, 81466116088, 81466116096, 81466116097, 81466116099, 81466116132, 81466116133, 81466116136, 81466116197, 81466116198, 81466116205



MN-DL-7802

Length: 1680 Ø: 52
Cone Ø: d1 Ø 30 / d2 Ø 27
03208300A, 81467116773, 81467116858, 81467116859, 81467116860, 81467116861, 81467116863, 81467116882, 81467116883, 81467116920, 81467116921



MN-DL-8544

Length: 596 Ø: 48
Hole Distance: 130 / 130
81432206196, 81432206232, 81432206233



MN-DL-8560

Length: 970 Ø: 52
Cone Ø: d1 Ø 30 / d2 Ø 27
03206900A, 81466106809, 81466106810, 81466106823, 81466106838, 81466106839, 81466116104, 81466116105, 81466116107, 81466116134, 81466116135, 81466116137, 81466116199, 81466116200, 81466116206



MN-DL-8609

Length: 585 Ø: 58
Hole Distance: 130 / 130
81432206070, 81432206071, 81432206072, 81432206091, 81432206093, 81432206119



MN-DL-8663

Length: 947 Ø: 60
Hole Distance: 115 / 115
03307400A, 81432206222, 81432206260, 81432206283, 81432206284



MN-ES-10333

Length: 90
Cone Ø: d1 Ø 38 / d2 Ø 34,35
Thread: M36 x 1,5 RHT
1271126, 3090291, 3099128, 42538048, 81953016268, 82953016018, 82953016019



MN-RK-12436

Ø: 75
Hole Distance: 115
Thick/Height: 24
81432206244



MN-VB-5238

Length: 627 Ø: 48
Hole Distance: 130 / 130
81432206221, 81432706096, 81432706114, 81432706116, 81432706121



MN-VB-8514

Length: 627 Ø: 48
Hole Ø 25 / 25 / 25
Hole Distance: 152 / 130 / 130
81432706087, 81432706088, 81432706094, 81432706095, 81432796094



MN-VB-9403

Length: 627 Ø: 48
Hole Ø 25 / 23 / 23
Hole Distance: 152 / 130 / 130
81432706097, 81432706113, 81432706135, 81432706160, 81432706161



MN-VB-9404

Length: 627 Ø: 58
Hole Distance: 130 / 130
81432706117, 81432706152, 81432706153



SC-ES-7279

Length: 150
Cone Ø: d1 Ø 30 / d2 Ø 27
Thread: M30 x 1,5 RHT
81953016288



SC-ES-8517

Length: 140
Cone Ø: d1 Ø 30 / d2 Ø 27
Thread: M30 x 1,5 RHT
81953016286





TGA ...

26.410 FDC, FDLC, FDLRC, FDRC ...	01/01→	Tie Rod End	SC-ES-8517		for Push Rod	
	01/01→	Tie Rod End	SC-ES-8535		for Guide Rod	
	01/01→	Track Control Arm		MN-DL-3402	Trailing Arm, Air Suspension Axle; Drive Axle	
	01/01→	Track Control Arm		MN-DL-5225	Trailing Arm, Drive Axle; Air Suspension Axle	
	01/01→	Track Control Arm		MN-DL-8544	Trailing Arm, Drive Axle; Air Suspension Axle	
	01/01→	Track Control Arm		MN-DL-8544	Trailing Arm, Drive Axle; Leaf Spring Axle	
	01/01→	Track control arm		MN-DL-10288	Trailing Arm, 1st RA; 2nd RA, for Leaf-Spring Suspension vehicles	
	01/01→	Track control arm		MN-DL-12288	Trailing Arm	
	01/01→	Track Control Arm		MN-VB-5222	Wishbone (CV), 1st RA; 2nd RA, for Pneumatic Suspension vehicles	
	01/01→	Track Control Arm		MN-VB-5238	Wishbone (CV), Drive Axle; Air Suspension Axle	
	01/01→	Track Control Arm		MN-VB-8514	Suspension Rod, Wishbone (CV), Drive Axle; Leaf Spring Axle	
	01/01→	Track Control Arm		MN-VB-8669	Suspension Rod, Wishbone (CV), Drive Axle	
	01/01→	Track Control Arm		MN-VB-8669	Suspension Rod, Wishbone (CV), Drive Axle; Leaf Spring Axle	
	01/01→	Track Control Arm		MN-VB-9404	Wishbone (CV), Drive Axle	
	01/01→	Track Control Arm		MN-VB-9404	Wishbone (CV), Drive Axle; Air Suspension Axle	
	26.410 FDK, FDRK, FDLK, FDLRK	01/01→	Track Control Arm	MN-DL-8663		Control Arm, Air Suspension Axle
		09/01→	Ball Head, gearshift linkage	CV-ES-2120		
09/01→		Centre Rod	MN-DL-7801		Push Rod, Leaf Spring Axle	
09/01→		Centre Rod	MN-DL-8560		Push Rod, Air Suspension Axle	
09/01→		Suspension Strut Repair Kit		DB-RK-8581		
09/01→		Suspension Strut Repair Kit		MN-RK-12436		
09/01→		Tie Rod	MN-DL-7802			
09/01→		Tie Rod End	CV-ES-0914		for Steering Rod	
09/01→		Tie Rod End	CV-ES-14162		for Steering Rod	
09/01→		Tie Rod End	CV-ES-14163		for Steering Rod	
09/01→		Tie Rod End	SC-ES-7279		for Steering Rod	
09/01→		Tie Rod End	SC-ES-8517		for Push Rod	
09/01→		Tie Rod End	SC-ES-8535		for Guide Rod	
09/01→		Track Control Arm		MN-DL-3402	Trailing Arm, Air Suspension Axle; Drive Axle	
09/01→		Track Control Arm		MN-DL-5225	Trailing Arm, Drive Axle; Air Suspension Axle	
09/01→		Track Control Arm		MN-DL-8544	Trailing Arm, Drive Axle; Air Suspension Axle	
09/01→		Track Control Arm		MN-DL-8544	Trailing Arm, Drive Axle; Leaf Spring Axle	
09/01→		Track control arm		MN-DL-10288	Trailing Arm, 1st RA; 2nd RA, for Leaf-Spring Suspension vehicles	
09/01→		Track control arm		MN-DL-12288	Trailing Arm	
09/01→		Track Control Arm		MN-VB-5222	Wishbone (CV), 1st RA; 2nd RA, for Pneumatic Suspension vehicles	
09/01→		Track Control Arm		MN-VB-5238	Wishbone (CV), Drive Axle; Air Suspension Axle	
09/01→		Track Control Arm		MN-VB-8514	Suspension Rod, Wishbone (CV), Drive Axle; Leaf Spring Axle	
09/01→		Track Control Arm		MN-VB-8669	Suspension Rod, Wishbone (CV), Drive Axle	
09/01→		Track Control Arm		MN-VB-8669	Suspension Rod, Wishbone (CV), Drive Axle; Leaf Spring Axle	
09/01→		Track Control Arm		MN-VB-9404	Wishbone (CV), Drive Axle	
09/01→		Track Control Arm		MN-VB-9404	Wishbone (CV), Drive Axle; Air Suspension Axle	
09/01→		Track Control Arm	MN-DL-8663		Control Arm, Air Suspension Axle	
26.410 FDLRS, FDLS, FDRS, FDS		06/01→	Ball Head, gearshift linkage	CV-ES-2120		
		06/01→	Centre Rod	MN-DL-7801		Push Rod, Leaf Spring Axle
		06/01→	Centre Rod	MN-DL-8560		Push Rod, Air Suspension Axle
		06/01→	Suspension Strut Repair Kit		DB-RK-8581	
		06/01→	Suspension Strut Repair Kit		MN-RK-12436	
		06/01→	Tie Rod	MN-DL-7802		
	06/01→	Tie Rod End	CV-ES-0914		for Steering Rod	
	06/01→	Tie Rod End	CV-ES-14162		for Steering Rod	
	06/01→	Tie Rod End	CV-ES-14163		for Steering Rod	
	06/01→	Tie Rod End	SC-ES-7279		for Steering Rod	
	06/01→	Tie Rod End	SC-ES-8517		for Push Rod	
	06/01→	Tie Rod End	SC-ES-8535		for Guide Rod	
	06/01→	Track Control Arm		MN-DL-3402	Trailing Arm, Air Suspension Axle; Drive Axle	

CV-ES-0914

Length: 125
Cone Ø: d1 Ø 30 / d2 Ø 27
Thread: M38 x 1,5 RHT
81953016184, 81953016251, 81953016276



CV-ES-2120

Length: 115
Cone Ø: d1 Ø 12,4 / d2 Ø 10,8
Thread: M14 x 1,5 RHT
03008500A, 81953016200, 81953016202, 81953016203, 81953016227



CV-ES-14162

Length: 125
Cone Ø: d1 Ø 30 / d2 Ø 27
Thread: M30 x 1,5 LHT
81953010015, 81953010083, 81953010087, 81953016029, 81953016030, 81953016043, 81953016044, 81953016050, 81953016054, 81953016087, 81953016091, 81953016107, 81953016120, 81953016125, 81953016152, 81953016155, 81953016157, 81953016168, 81953016179, 81953016181, 81953016223, 81953016237, 81953016254, 81953016275, 81953016279, 81953016351



CV-ES-14163

Length: 125
Cone Ø: d1 Ø 30 / d2 Ø 27
Thread: M30 x 1,5 RHT
95301.0084, 90804102156, 90804102272, 90804102696, 90804102710, 81953010016, 81953010075, 81953010084, 81953010088, 81953010094, 81953010103, 81953016030, 81953016043, 81953016048, 81953016049, 81953016053, 81953016061, 81953016090, 81953016108, 81953016112, 81953016126, 81953016143, 81953016149, 81953016154, 81953016156, 81953016168, 81953016178, 81953016194, 81953016206, 81953016224, 81953016234, 81953016242, 81953016252, 81953016274, 81953016278, 81953016284, 81953016286, 81953016308, 81953016310, 81953016312, 81953016347, 81953016350, 81953016352, 82953016012, 88953016014, N2953016001



DB-RK-8581

Ø: 85
Hole Distance: 130
Thick/Height: 24
03305800A, 81432706105



MN-DL-3402

Length: 590 Ø: 48
Hole Distance: 130 / 130
03307200A, 81432206067, 81432206068, 81432206090, 81432206092, 81432209092



MN-DL-5225

Length: 572 Ø: 48
Hole Distance: 130 / 130
03301500A, 81432206229, 81432206236, 81432206267, 81432206270, 81432206272, 81432206304, 81432206305, 81432209236, 81432209267, 81432209272



MN-DL-7801

Length: 995 Ø: 52
Cone Ø: d1 Ø 30 / d2 Ø 27
81466106807, 81466106808, 81466116087, 81466116088, 81466116096, 81466116097, 81466116099, 81466116132, 81466116133, 81466116136, 81466116197, 81466116198, 81466116205

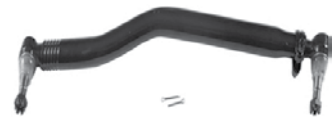

MN-DL-7802

Length: 1680 Ø: 52
Cone Ø: d1 Ø 30 / d2 Ø 27
03208300A, 81467116773, 81467116858, 81467116859, 81467116860, 81467116861, 81467116863, 81467116882, 81467116883, 81467116920, 81467116921



MN-DL-8544

Length: 596 Ø: 48
Hole Distance: 130 / 130
81432206196, 81432206232, 81432206233



MN-DL-8560

Length: 970 Ø: 52
Cone Ø: d1 Ø 30 / d2 Ø 27
03206900A, 81466106809, 81466106810, 81466106823, 81466106838, 81466106839, 81466116104, 81466116105, 81466116107, 81466116134, 81466116135, 81466116137, 81466116199, 81466116200, 81466116206



MN-DL-8663

Length: 947 Ø: 60
Hole Distance: 115 / 115
03307400A, 81432206222, 81432206260, 81432206283, 81432206284



MN-DL-10288

81432206386, 82432206008, 82432209008

No Image

MN-DL-12288

Length: 585 Ø: 58
Hole Distance: 130 / 130
81432206386, 82432206008, 82432209008

No Image

MN-RK-12436

Ø: 75
Hole Distance: 115
Thick/Height: 24
81432206244

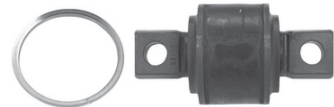

MN-VB-5222

Length: 627 Ø: 50
Hole Distance: 152 / 152
81432706030, 81432706034, 81432706054, 81432706055, 81432706056, 81432706057, 81432706067, 81432706068, 81432706074, 81432706075, 81432706076, 81432706077, 81432706078, 81432706081, 81432706082, 81432709034, 81432709076, 81432709078, 8143706054



MN-VB-5238

Length: 627 Ø: 48
Hole Distance: 130 / 130
81432206221, 81432706096, 81432706114, 81432706116, 81432706121



MN-VB-8514

Length: 627 Ø: 48
Hole Ø 25 / 25 / 25
Hole Distance: 152 / 130 / 130
81432706087, 81432706088, 81432706094, 81432706095, 81432796094



MN-VB-8669

Length: 627 Ø: 48
Hole Ø 25 / 25 / 25
Hole Distance: 152 / 130 / 130
81432706116, 81432706137, 81432706150, 81432706151



MN-VB-9404

Length: 627 Ø: 58
Hole Distance: 130 / 130
81432706117, 81432706152, 81432706153



SC-ES-7279

Length: 150
Cone Ø: d1 Ø 30 / d2 Ø 27
Thread: M30 x 1,5 RHT
81953016288



SC-ES-8517

Length: 140
Cone Ø: d1 Ø 30 / d2 Ø 27
Thread: M30 x 1,5 RHT
81953016286



SC-ES-8535

Length: 145
Cone Ø: d1 Ø 30 / d2 Ø 27
Thread: M30 x 1,5 RHT
81953016271, 81953016325





TGA ...

26.410 FDLRS, FDLS, FDRS, FDS ...	06/01→	Track Control Arm		MN-DL-5225	Trailing Arm, Drive Axle;Air Suspension Axle
	06/01→	Track Control Arm		MN-DL-8544	Trailing Arm, Drive Axle;Air Suspension Axle
	06/01→	Track Control Arm		MN-DL-8544	Trailing Arm, Drive Axle;Leaf Spring Axle
	06/01→	Track control arm		MN-DL-10288	Trailing Arm, 1st RA;2nd RA, for Leaf-Spring Suspension vehicles
	06/01→	Track control arm		MN-DL-12288	Trailing Arm
	06/01→	Track Control Arm		MN-VB-5222	Wishbone (CV), 1st RA;2nd RA, for Pneumatic Suspension vehicles
	06/01→	Track Control Arm		MN-VB-5238	Wishbone (CV), Drive Axle;Air Suspension Axle
	06/01→	Track Control Arm		MN-VB-8514	Suspension Rod, Wishbone (CV), Drive Axle; Leaf Spring Axle
	06/01→	Track Control Arm		MN-VB-8669	Suspension Rod, Wishbone (CV), Drive Axle
	06/01→	Track Control Arm		MN-VB-8669	Suspension Rod, Wishbone (CV), Drive Axle; Leaf Spring Axle
	06/01→	Track Control Arm		MN-VB-9404	Wishbone (CV), Drive Axle
	06/01→	Track Control Arm		MN-VB-9404	Wishbone (CV), Drive Axle;Air Suspension Axle
	06/01→	Track Control Arm	MN-DL-8663		Control Arm, Air Suspension Axle
	26.410 FD-TM, FDR-TM	01/01→	Ball Head, gearshift linkage	CV-ES-2120	
01/01→		Centre Rod	MN-DL-7801		Push Rod, Leaf Spring Axle
01/01→		Suspension Strut Repair Kit		DB-RK-8581	
01/01→		Tie Rod	MN-DL-7802		
01/01→		Tie Rod End	CV-ES-0914		for Steering Rod
01/01→		Tie Rod End	CV-ES-14162		for Steering Rod
01/01→		Tie Rod End	CV-ES-14163		for Steering Rod
01/01→		Tie Rod End	SC-ES-7279		for Steering Rod
01/01→		Tie Rod End	SC-ES-8517		for Push Rod
01/01→		Tie Rod End	SC-ES-8535		for Guide Rod
01/01→		Track Control Arm		MN-DL-5225	Trailing Arm
01/01→		Track Control Arm		MN-DL-8544	Trailing Arm, Drive Axle;Leaf Spring Axle
01/01→		Track control arm		MN-DL-10288	Trailing Arm, 1st RA;2nd RA, for Leaf-Spring Suspension vehicles
01/01→		Track control arm		MN-DL-12288	Trailing Arm
01/01→		Track Control Arm		MN-VB-8514	Suspension Rod, Wishbone (CV), Drive Axle; Leaf Spring Axle
01/01→		Track Control Arm		MN-VB-8669	Suspension Rod, Wishbone (CV), Drive Axle; Leaf Spring Axle
01/01→		Track Control Arm		MN-VB-9404	Wishbone (CV), Drive Axle
26.410 FNLC, FNLLC, FNLLRC, FNLLRW, FNLLW, FNLR, FVLC	04/00→01/05	Track Control Arm		MN-DL-5212	Trailing Arm, Tag Axle;Air Suspension Axle
	04/00→	Ball Head, gearshift linkage	CV-ES-2120		
	04/00→	Centre Rod	MN-DL-7801		Push Rod, Leaf Spring Axle
	04/00→	Centre Rod	MN-DL-8560		Push Rod, Air Suspension Axle
	04/00→	Suspension Strut Repair Kit		CV-RK-5311	
	04/00→	Suspension Strut Repair Kit		DB-RK-8581	
	04/00→	Suspension Strut Repair Kit		MN-RK-8537	
	04/00→	Suspension Strut Repair Kit		MN-RK-12436	
	04/00→	Tie Rod	MN-DL-7802		
	04/00→	Tie Rod	MN-DL-12284		
	04/00→	Tie Rod End		IV-ES-8507	Tag Axle
	04/00→	Tie Rod End		MN-ES-8490	for vehicles with Hinged Trailing Axle
	04/00→	Tie Rod End	CV-ES-0914		for Steering Rod
	04/00→	Tie Rod End	CV-ES-14162		for Steering Rod
	04/00→	Tie Rod End	CV-ES-14163		for Steering Rod
	04/00→	Tie Rod End	IV-ES-12272		for Steering Rod
	04/00→	Tie Rod End	SC-ES-7279		for Steering Rod
	04/00→	Tie Rod End	SC-ES-8517		for Push Rod
	04/00→	Tie Rod End	SC-ES-8535		for Guide Rod
	04/00→	Track Control Arm		MN-DL-5225	Trailing Arm, Drive Axle;Air Suspension Axle
	04/00→	Track Control Arm		MN-DL-5225	Trailing Arm, Leading Axle;Air Suspension Axle
	04/00→	Track Control Arm		MN-DL-8709	Trailing Arm, Air Suspension Axle; for vehicles with Hinged Trailing Axle
	04/00→	Track Control Arm		MN-DL-8733	Trailing Arm, Air Suspension Axle;Drive Axle
	04/00→	Track Control Arm		MN-TC-12399	Control Arm

CV-ES-0914

Length: 125
Cone Ø: d1 Ø 30 / d2 Ø 27
Thread: M38 x 1,5 RHT
81953016184, 81953016251, 81953016276



CV-ES-2120

Length: 115
Cone Ø: d1 Ø 12,4 / d2 Ø 10,8
Thread: M14 x 1,5 RHT
03008500A, 81953016200, 81953016202, 81953016203, 81953016227



CV-ES-14162

Length: 125
Cone Ø: d1 Ø 30 / d2 Ø 27
Thread: M30 x 1,5 LHT
81953010015, 81953010083, 81953010087, 81953016029, 81953016030, 81953016043, 81953016044, 81953016050, 81953016054, 81953016087, 81953016091, 81953016107, 81953016120, 81953016125, 81953016152, 81953016155, 81953016157, 81953016168, 81953016179, 81953016181, 81953016223, 81953016237, 81953016254, 81953016275, 81953016279, 81953016351



CV-ES-14163

Length: 125
Cone Ø: d1 Ø 30 / d2 Ø 27
Thread: M30 x 1,5 RHT
95301.0084, 90804102156, 90804102272, 90804102696, 90804102710, 81953010016, 81953010075, 81953010084, 81953010088, 81953010094, 81953010103, 81953016030, 81953016043, 81953016048, 81953016049, 81953016053, 81953016061, 81953016090, 81953016108, 81953016112, 81953016126, 81953016143, 81953016149, 81953016154, 81953016156, 81953016168, 81953016178, 81953016194, 81953016206, 81953016224, 81953016234, 81953016242, 81953016252, 81953016274, 81953016278, 81953016284, 81953016286, 81953016308, 81953016310, 81953016312, 81953016347, 81953016350, 81953016352, 82953016012, 88953016014, N2953016001



CV-RK-5311

638862, 639287, 938423, 1104335, 1953248, 0003500506, 3500506, 11013547, 42488722, 070550504, 634303610, 81432206055, 81432206073, 82262320660, 5001842823, 7000307001, 8226232066



DB-RK-8581

Ø: 85
Hole Distance: 130
Thick/Height: 24
03305800A, 81432706105



IV-ES-8507

Length: 80
Cone Ø: d1 Ø 30 / d2 Ø 27
Thread: M30 x 1,5 RHT
11019869, 12216380, 55175540, 81953016238



IV-ES-12272

Length: 75
Cone Ø: d1 Ø 30 / d2 Ø 27
Thread: M26 x 1,5 RHT
81953016280, 82953010010



MN-DL-5212

Length: 577 Ø: 48
Hole Distance: 130 / 130
81432206096, 81432206097, 81432206098, 81432206129, 81432209096, 81432209129, 81432306014, 81432306030



MN-DL-5225

Length: 572 Ø: 48
Hole Distance: 130 / 130
03301500A, 81432206229, 81432206236, 81432206267, 81432206270, 81432206272, 81432206304, 81432206305, 81432209236, 81432209267, 81432209272



MN-DL-7801

Length: 995 Ø: 52
Cone Ø: d1 Ø 30 / d2 Ø 27
81466106807, 81466106808, 81466116087, 81466116088, 81466116096, 81466116097, 81466116099, 81466116132, 81466116133, 81466116136, 81466116197, 81466116198, 81466116205

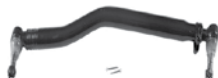

MN-DL-7802

Length: 1680 Ø: 52
Cone Ø: d1 Ø 30 / d2 Ø 27
03208300A, 81467116773, 81467116858, 81467116859, 81467116860, 81467116861, 81467116863, 81467116882, 81467116883, 81467116920, 81467116921



MN-DL-8544

Length: 596 Ø: 48
Hole Distance: 130 / 130
81432206196, 81432206232, 81432206233



MN-DL-8560

Length: 970 Ø: 52
Cone Ø: d1 Ø 30 / d2 Ø 27
03206900A, 81466106809, 81466106810, 81466106823, 81466106838, 81466106839, 81466116104, 81466116105, 81466116107, 81466116134, 81466116135, 81466116137, 81466116199, 81466116200, 81466116206



MN-DL-8663

Length: 947 Ø: 60
Hole Distance: 115 / 115
03307400A, 81432206222, 81432206260, 81432206283, 81432206284



MN-DL-8709

Length: 572 Ø: 52
Hole Distance: 130 / 130
81432206268, 81432206274, 81432206291, 81432206292, 82432206007



MN-DL-8733

Length: 530 Ø: 48
Hole Distance: 130 / 130
81432206161, 81432206190, 81432206358, 81432206359



MN-DL-10288

81432206386, 82432206008, 82432209008

No Image

MN-DL-12284

Length: 1530 Ø: 50
Cone Ø: d1 Ø 30 / d2 Ø 27
81466106579, 81466106580, 81466106624, 81466116720, 81467116720, 81467116730, 81467116952



MN-DL-12288

Length: 585 Ø: 58
Hole Distance: 130 / 130
81432206386, 82432206008, 82432209008

No Image

MN-ES-8490

Length: 90
Cone Ø: d1 Ø 30 / d2 Ø 27
Thread: M26 x 1,5 RHT
0014606948, 14606948, 81953016281, 81953016337, 82953016016



MN-RK-8537

Ø: 95
Hole Distance: 152
Thick/Height: 24
696321, 03306600A, 81432706079, 81432706099



MN-RK-12436

Ø: 75 Hole Distance: 115
Thick/Height: 24
81432206244



MN-TC-12399

Length: 694 Ø: 50
Hole Distance: 130 / 130
81432206265



MN-VB-5222

Length: 627 Ø: 50
Hole Distance: 152 / 152
81432706030, 81432706034, 81432706054, 81432706055, 81432706056, 81432706057, 81432706067, 81432706068, 81432706074, 81432706075, 81432706076, 81432706077, 81432706078, 81432706081, 81432706082, 81432709034, 81432709076, 81432709078, 81432706054



MN-VB-5238

Length: 627 Ø: 48
Hole Distance: 130 / 130
81432206221, 81432706096, 81432706114, 81432706116, 81432706121



MN-VB-8514

Length: 627 Ø: 48
Hole Ø 25 / 25 / 25
Hole Distance: 152 / 130 / 130
81432706087, 81432706088, 81432706094, 81432706095, 81432796094



MN-VB-8669

Length: 627 Ø: 48
Hole Ø 25 / 25 / 25
Hole Distance: 152 / 130 / 130
81432706116, 81432706137, 81432706150, 81432706151



MN-VB-9404

Length: 627 Ø: 58
Hole Distance: 130 / 130
81432706117, 81432706152, 81432706153



SC-ES-7279

Length: 150
Cone Ø: d1 Ø 30 / d2 Ø 27
Thread: M30 x 1,5 RHT
81953016288



SC-ES-8517

Length: 140
Cone Ø: d1 Ø 30 / d2 Ø 27
Thread: M30 x 1,5 RHT
81953016286



SC-ES-8535

Length: 145
Cone Ø: d1 Ø 30 / d2 Ø 27
Thread: M30 x 1,5 RHT
81953016271, 81953016325





TGA ...

26.410 FNLC, FNLLC, FNLLRC, FNLLRW, FNLLW, FNLR, FVLC ...	04/00→	Track Control Arm		MN-VB-5238	Wishbone (CV), Drive Axle;Leading Axle; Air Suspension Axle	
	04/00→	Track Control Arm		MN-VB-9403	Wishbone (CV), Air Suspension Axle	
	04/00→	Track Control Arm	MN-DL-8663		Control Arm, Air Suspension Axle	
	03/04→	Track Control Arm		MN-DL-5225	Trailing Arm, Tag Axle;Air Suspension Axle; for vehicles with Hinged Trailing Axle	
	01/05→	Track Control Arm		MN-DL-5225	Trailing Arm, Tag Axle;Air Suspension Axle; for vehicles with Rigid Trailing Axle	
26.410 FPLS, FPLRS, FVLS, FNLS, FNLLS, FNLRS	12/00→01/05	Track Control Arm		MN-DL-5212	Trailing Arm, Tag Axle;Air Suspension Axle	
	12/00→	Ball Head, gearshift linkage	CV-ES-2120			
	12/00→	Centre Rod	MN-DL-7801		Push Rod, Leaf Spring Axle	
	12/00→	Centre Rod	MN-DL-8560		Push Rod, Air Suspension Axle	
	12/00→	Suspension Strut Repair Kit		CV-RK-5311		
	12/00→	Suspension Strut Repair Kit		DB-RK-8581		
	12/00→	Suspension Strut Repair Kit		MN-RK-12436		
	12/00→	Tie Rod	MN-DL-7802			
	12/00→	Tie Rod	MN-DL-12284			
	12/00→	Tie Rod End		IV-ES-8507	Tag Axle	
	12/00→	Tie Rod End		MN-ES-8490	for vehicles with Hinged Trailing Axle	
	12/00→	Tie Rod End		SC-ES-8517	for Push Rod	
	12/00→	Tie Rod End	CV-ES-0914		for Steering Rod	
	12/00→	Tie Rod End	CV-ES-14162	CV-ES-14162	for Steering Rod	
	12/00→	Tie Rod End	CV-ES-14163		for Steering Rod	
	12/00→	Tie Rod End	IV-ES-12272		for Steering Rod	
	12/00→	Tie Rod End	SC-ES-7279		for Steering Rod	
	12/00→	Tie Rod End	SC-ES-8535		for Guide Rod	
	12/00→	Track Control Arm		MN-DL-5225	Trailing Arm, Drive Axle;Air Suspension Axle	
	12/00→	Track Control Arm		MN-DL-5225	Trailing Arm, Leading Axle;Air Suspension Axle	
	12/00→	Track Control Arm		MN-DL-8709	Trailing Arm, Air Suspension Axle; for vehicles with Hinged Trailing Axle	
	12/00→	Track Control Arm		MN-DL-8733	Trailing Arm, Air Suspension Axle;Drive Axle	
	12/00→	Track Control Arm		MN-TC-12399	Control Arm	
	12/00→	Track Control Arm		MN-VB-5238	Wishbone (CV), Drive Axle;Leading Axle; Air Suspension Axle	
	12/00→	Track Control Arm		MN-VB-9403	Wishbone (CV), Air Suspension Axle	
	12/00→	Track Control Arm	MN-DL-8663		Control Arm, Air Suspension Axle	
	03/04→	Track Control Arm		MN-DL-5225	Trailing Arm, Tag Axle;Air Suspension Axle; for vehicles with Hinged Trailing Axle	
	01/05→	Track Control Arm		MN-DL-5225	Trailing Arm, Tag Axle;Air Suspension Axle; for vehicles with Rigid Trailing Axle	
	26.410 FVLC	09/03→	Centre Rod	MN-DL-7801		Push Rod
		09/03→	Suspension Strut Repair Kit		MN-RK-12436	
09/03→		Tie Rod	MN-DL-7802			
09/03→		Tie Rod End		SC-ES-8517	for Push Rod	
09/03→		Tie Rod End	CV-ES-0914		for Steering Rod	
09/03→		Tie Rod End	CV-ES-14162	CV-ES-14162	for Steering Rod	
09/03→		Tie Rod End	CV-ES-14163		for Steering Rod	
09/03→		Tie Rod End	SC-ES-7279		for Steering Rod	
09/03→		Tie Rod End	SC-ES-8535		for Guide Rod	
09/03→		Track Control Arm		MN-DL-5212	Trailing Arm, Trailing Axle Steered, for Pneumatic Suspension vehicles	
09/03→		Track Control Arm		MN-DL-5225	Trailing Arm	
09/03→		Track Control Arm		MN-DL-8709	Trailing Arm, 1st Drive Axle, for Pneumatic Suspension vehicles	
09/03→		Track Control Arm		MN-DL-8709	Trailing Arm, Trailing Axle Steered, for Pneumatic Suspension vehicles	
09/03→		Track Control Arm		MN-DL-8733	Trailing Arm, 1st Drive Axle, for Pneumatic Suspension vehicles	
09/03→		Track Control Arm		MN-VB-5238	Wishbone (CV), 1st Drive Axle, for Pneumatic Suspension vehicles	
09/03→	Track Control Arm		MN-VB-9403	Wishbone (CV), Trailing Axle Steered, for Pneumatic Suspension vehicles		
09/03→	Track Control Arm	MN-DL-8663		Control Arm		

CV-ES-0914

Length: 125
Cone Ø: d1 Ø 30 / d2 Ø 27
Thread: M38 x 1,5 RHT
81953016184, 81953016251, 81953016276



CV-ES-2120

Length: 115
Cone Ø: d1 Ø 12,4 / d2 Ø 10,8
Thread: M14 x 1,5 RHT
03008500A, 81953016200, 81953016202,
81953016203, 81953016227



CV-ES-14162

Length: 125
Cone Ø: d1 Ø 30 / d2 Ø 27
Thread: M30 x 1,5 LHT
81953010015, 81953010083, 81953010087,
81953016029, 81953016030, 81953016043,
81953016044, 81953016050, 81953016054,
81953016087, 81953016091, 81953016107,
81953016120, 81953016125, 81953016152,
81953016155, 81953016157, 81953016168,
81953016179, 81953016181, 81953016223,
81953016237, 81953016254, 81953016275,
81953016279, 81953016351



CV-ES-14163

Length: 125
Cone Ø: d1 Ø 30 / d2 Ø 27
Thread: M30 x 1,5 RHT
95301.0084, 90804102156, 90804102272,
90804102696, 90804102710, 81953010016,
81953010075, 81953010084, 81953010088,
81953010094, 81953010103, 81953016030,
81953016043, 81953016048, 81953016049,
81953016053, 81953016061, 81953016090,
81953016108, 81953016112, 81953016126,
81953016143, 81953016149, 81953016154,
81953016156, 81953016168, 81953016178,
81953016194, 81953016206, 81953016224,
81953016234, 81953016242, 81953016252,
81953016274, 81953016278, 81953016284,
81953016286, 81953016308, 81953016310,
81953016312, 81953016347, 81953016350,
81953016352, 82953016012, 88953016014,
N2953016001



CV-RK-5311

638862, 639287, 938423, 1104335,
1953248, 0003500506, 3500506, 11013547,
42488722, 070550504, 634303610,
81432206055, 81432206073, 82262320660,
5001842823, 7000307001, 8226232066



DB-RK-8581

Ø: 85
Hole Distance: 130
Thick/Height: 24
03305800A, 81432706105



IV-ES-8507

Length: 80
Cone Ø: d1 Ø 30 / d2 Ø 27
Thread: M30 x 1,5 RHT
11019869, 12216380, 55175540,
81953016238



IV-ES-12272

Length: 75
Cone Ø: d1 Ø 30 / d2 Ø 27
Thread: M26 x 1,5 RHT
81953016280, 82953010010



MN-DL-5212

Length: 577 Ø: 48
Hole Distance: 130 / 130
81432206096, 81432206097, 81432206098,
81432206129, 81432209096, 81432209129,
81432306014, 81432306030



MN-DL-5225

Length: 572 Ø: 48
Hole Distance: 130 / 130
03301500A, 81432206229, 81432206236,
81432206267, 81432206270, 81432206272,
81432206304, 81432206305, 81432209236,
81432209267, 81432209272



MN-DL-7801

Length: 995 Ø: 52
Cone Ø: d1 Ø 30 / d2 Ø 27
81466106807, 81466106808, 81466116087,
81466116088, 81466116096, 81466116097,
81466116099, 81466116132, 81466116133,
81466116136, 81466116197, 81466116198,
81466116205



MN-DL-7802

Length: 1680 Ø: 52
Cone Ø: d1 Ø 30 / d2 Ø 27
03208300A, 81467116773, 81467116858,
81467116859, 81467116860, 81467116861,
81467116863, 81467116882, 81467116883,
81467116920, 81467116921



MN-DL-8560

Length: 970 Ø: 52
Cone Ø: d1 Ø 30 / d2 Ø 27
03206900A, 81466106809, 81466106810,
81466106823, 81466106838, 81466106839,
81466116104, 81466116105, 81466116107,
81466116134, 81466116135, 81466116137,
81466116199, 81466116200, 81466116206



MN-DL-8663

Length: 947 Ø: 60
Hole Distance: 115 / 115
03307400A, 81432206222, 81432206260,
81432206283, 81432206284



MN-DL-8709

Length: 572 Ø: 52
Hole Distance: 130 / 130
81432206268, 81432206274, 81432206291,
81432206292, 82432206007



MN-DL-8733

Length: 530 Ø: 48
Hole Distance: 130 / 130
81432206161, 81432206190, 81432206358,
81432206359



MN-DL-12284

Length: 1530 Ø: 50
Cone Ø: d1 Ø 30 / d2 Ø 27
81466106579, 81466106580, 81466106624,
81466116720, 81467116720, 81467116730,
81467116952



MN-ES-8490

Length: 90
Cone Ø: d1 Ø 30 / d2 Ø 27
Thread: M26 x 1,5 RHT
0014606948, 14606948, 81953016281,
81953016337, 82953016016



MN-RK-12436

Ø: 75
Hole Distance: 115
Thick/Height: 24
81432206244



MN-TC-12399

Length: 694 Ø: 50
Hole Distance: 130 / 130
81432206265



MN-VB-5238

Length: 627 Ø: 48
Hole Distance: 130 / 130
81432206221, 81432706096, 81432706114,
81432706116, 81432706121



MN-VB-9403

Length: 627 Ø: 48
Hole Ø 25 / 23 / 23
Hole Distance: 152 / 130 / 130
81432706097, 81432706113, 81432706135,
81432706160, 81432706161



SC-ES-7279

Length: 150
Cone Ø: d1 Ø 30 / d2 Ø 27
Thread: M30 x 1,5 RHT
81953016288



SC-ES-8517

Length: 140
Cone Ø: d1 Ø 30 / d2 Ø 27
Thread: M30 x 1,5 RHT
81953016286



SC-ES-8535

Length: 145
Cone Ø: d1 Ø 30 / d2 Ø 27
Thread: M30 x 1,5 RHT
81953016271, 81953016325





TGA ...

26.410 FVL-KO	12/00→	Ball Head, gearshift linkage	CV-ES-2120		
	12/00→	Centre Rod	MN-DL-7801		Push Rod, Leaf Spring Axle
	12/00→	Centre Rod	MN-DL-8560		Push Rod, Air Suspension Axle
	12/00→	Suspension Strut Repair Kit		DB-RK-8581	
	12/00→	Suspension Strut Repair Kit		MN-RK-12436	
	12/00→	Tie Rod	MN-DL-7802		
	12/00→	Tie Rod End	CV-ES-0914		for Steering Rod
	12/00→	Tie Rod End	CV-ES-14163		for Steering Rod
	12/00→	Tie Rod End	SC-ES-7279		for Steering Rod
	12/00→	Tie Rod End	SC-ES-8517		for Push Rod
	12/00→	Tie Rod End	SC-ES-8535		for Guide Rod
	12/00→	Track Control Arm		MN-DL-5225	Trailing Arm, Drive Axle;Air Suspension Axle
	12/00→	Track Control Arm		MN-DL-5225	Trailing Arm, Leading Axle;Air Suspension Axle
	12/00→	Track Control Arm		MN-DL-8733	Trailing Arm, Air Suspension Axle;Drive Axle
	12/00→	Track Control Arm		MN-VB-5238	Wishbone (CV), Drive Axle;Leading Axle; Air Suspension Axle
12/00→	Track Control Arm	MN-DL-8663		Control Arm, Air Suspension Axle	
26.410 FVLS, FVLRS	07/05→	Centre Rod	MN-DL-7801		Push Rod
	07/05→	Tie Rod	MN-DL-7802		
	07/05→	Track Control Arm		MN-DL-5225	Trailing Arm
26.430 FDAC, FDALC, FDHC	01/04→	Centre Rod	MN-DL-2160		Coupling Rod
	01/04→	Centre Rod	MN-DL-2174		Push Rod
	01/04→	Suspension Arm Repair Kit		CV-RK-5313	for Wishbone (CV)
	01/04→	Tie Rod End	CV-ES-0914		for Steering Rod
	01/04→	Tie Rod End	CV-ES-14162		for Steering Rod
	01/04→	Tie Rod End	CV-ES-14163		for Steering Rod
	01/04→	Tie Rod End	MN-ES-10333		for Steering Rod
	01/04→	Tie Rod End	SC-ES-7279		for Steering Rod
	01/04→	Tie Rod End	SC-ES-8517		for Push Rod
	01/04→	Tie Rod End	SC-ES-8535		for Guide Rod
	01/04→	Track Control Arm		MN-DL-8544	Trailing Arm, 1st RA;2nd RA, for Leaf-Spring Suspension vehicles
	01/04→	Track Control Arm		MN-DL-8544	Trailing Arm, 1st RA;2nd RA, for Pneumatic Suspension vehicles
	01/04→	Track Control Arm		MN-DL-8609	Trailing Arm, 1st RA;2nd RA, for Leaf-Spring Suspension vehicles, →Type_HB Chassis
	01/04→	Track Control Arm		MN-VB-8514	Suspension Rod, Wishbone (CV)
	01/04→	Track Control Arm		MN-VB-8669	Suspension Rod, Wishbone (CV), 1st RA; 2nd RA, for Leaf-Spring Suspension vehicles, →Type_MHB Chassis
01/04→	Track Control Arm		MN-VB-9404	Wishbone (CV), 1st RA;2nd RA, for Leaf-Spring Suspension vehicles, →Type_HB Chassis	
26.430 FDAK, FDALK, FDHK	01/04→	Centre Rod	MN-DL-2160		Coupling Rod
	01/04→	Centre Rod	MN-DL-2174		Push Rod
	01/04→	Suspension Arm Repair Kit		CV-RK-5313	for Wishbone (CV)
	01/04→	Tie Rod End	CV-ES-0914		for Steering Rod
	01/04→	Tie Rod End	CV-ES-14162		for Steering Rod
	01/04→	Tie Rod End	CV-ES-14163		for Steering Rod
	01/04→	Tie Rod End	MN-ES-10333		for Steering Rod
	01/04→	Tie Rod End	SC-ES-7279		for Steering Rod
	01/04→	Tie Rod End	SC-ES-8517		for Push Rod
	01/04→	Tie Rod End	SC-ES-8535		for Guide Rod
	01/04→	Track Control Arm		MN-DL-8609	Trailing Arm, 1st RA;2nd RA, for Leaf-Spring Suspension vehicles, →Type_HB Chassis
	01/04→	Track Control Arm		MN-VB-8514	Suspension Rod, Wishbone (CV)
	01/04→	Track Control Arm		MN-VB-8669	Suspension Rod, Wishbone (CV), 1st RA; 2nd RA, for Leaf-Spring Suspension vehicles, →Type_MHB Chassis
01/04→	Track Control Arm		MN-VB-9404	Wishbone (CV), 1st RA;2nd RA, for Leaf-Spring Suspension vehicles, →Type_HB	

CV-ES-0914

Length: 125
Cone Ø: d1 Ø 30 / d2 Ø 27
Thread: M38 x 1,5 RHT
81953016184, 81953016251, 81953016276



CV-ES-2120

Length: 115
Cone Ø: d1 Ø 12,4 / d2 Ø 10,8
Thread: M14 x 1,5 RHT
03008500A, 81953016200, 81953016202, 81953016203, 81953016227



CV-ES-14162

Length: 125
Cone Ø: d1 Ø 30 / d2 Ø 27
Thread: M30 x 1,5 LHT
81953010015, 81953010083, 81953010087, 81953016029, 81953016030, 81953016043, 81953016044, 81953016050, 81953016054, 81953016087, 81953016091, 81953016107, 81953016120, 81953016125, 81953016152, 81953016155, 81953016157, 81953016168, 81953016179, 81953016181, 81953016223, 81953016237, 81953016254, 81953016275, 81953016279, 81953016351



CV-ES-14163

Length: 125
Cone Ø: d1 Ø 30 / d2 Ø 27
Thread: M30 x 1,5 RHT
95301.0084, 90804102156, 90804102272, 90804102696, 90804102710, 81953010016, 81953010075, 81953010084, 81953010088, 81953010094, 81953010103, 81953016030, 81953016043, 81953016048, 81953016049, 81953016053, 81953016061, 81953016090, 81953016108, 81953016112, 81953016126, 81953016143, 81953016149, 81953016154, 81953016156, 81953016168, 81953016178, 81953016194, 81953016206, 81953016224, 81953016234, 81953016242, 81953016252, 81953016274, 81953016278, 81953016284, 81953016286, 81953016308, 81953016310, 81953016312, 81953016347, 81953016350, 81953016352, 82953016012, 88953016014, N2953016001



CV-RK-5313

Ø: 90
03304800A, 81953016132



DB-RK-8581

Ø: 85
Hole Distance: 130
Thick/Height: 24
03305800A, 81432706105



MN-DL-2160

Length: 1652 Ø: 50
Cone Ø: d1 Ø 30 / d2 Ø 27
81467106112, 81467106163, 81467106165, 81467106198, 81467106353, 81467106354, 81467106361, 81467116725



MN-DL-2174

Length: 1588 Ø: 52
Cone Ø: d1 Ø 30 / d2 Ø 27
81467106378, 81467106912



MN-DL-5225

Length: 572 Ø: 48
Hole Distance: 130 / 130
03301500A, 81432206229, 81432206236, 81432206267, 81432206270, 81432206272, 81432206304, 81432206305, 81432209236, 81432209267, 81432209272



MN-DL-7801

Length: 995 Ø: 52
Cone Ø: d1 Ø 30 / d2 Ø 27
81466106807, 81466106808, 81466116087, 81466116088, 81466116096, 81466116097, 81466116099, 81466116132, 81466116133, 81466116136, 81466116197, 81466116198, 81466116205



MN-DL-7802

Length: 1680 Ø: 52
Cone Ø: d1 Ø 30 / d2 Ø 27
03208300A, 81467116773, 81467116858, 81467116859, 81467116860, 81467116861, 81467116863, 81467116882, 81467116883, 81467116920, 81467116921



MN-DL-8544

Length: 596 Ø: 48
Hole Distance: 130 / 130
81432206196, 81432206232, 81432206233



MN-DL-8560

Length: 970 Ø: 52
Cone Ø: d1 Ø 30 / d2 Ø 27
03206900A, 81466106809, 81466106810, 81466106823, 81466106838, 81466106839, 81466116104, 81466116105, 81466116107, 81466116134, 81466116135, 81466116137, 81466116199, 81466116200, 81466116206



MN-DL-8609

Length: 585 Ø: 58
Hole Distance: 130 / 130
81432206070, 81432206071, 81432206072, 81432206091, 81432206093, 81432206119



MN-DL-8663

Length: 947 Ø: 60
Hole Distance: 115 / 115
03307400A, 81432206222, 81432206260, 81432206283, 81432206284



MN-DL-8733

Length: 530 Ø: 48
Hole Distance: 130 / 130
81432206161, 81432206190, 81432206358, 81432206359



MN-ES-10333

Length: 90
Cone Ø: d1 Ø 38 / d2 Ø 34,35
Thread: M36 x 1,5 RHT
1271126, 3090291, 3099128, 42538048, 81953016268, 82953016018, 82953016019



MN-RK-12436

Ø: 75
Hole Distance: 115
Thick/Height: 24
81432206244



MN-VB-5238

Length: 627 Ø: 48
Hole Distance: 130 / 130
81432206221, 81432706096, 81432706114, 81432706116, 81432706121



MN-VB-8514

Length: 627 Ø: 48
Hole Ø 25 / 25 / 25
Hole Distance: 152 / 130 / 130
81432706087, 81432706088, 81432706094, 81432706095, 81432796094



MN-VB-8669

Length: 627 Ø: 48
Hole Ø 25 / 25 / 25
Hole Distance: 152 / 130 / 130
81432706116, 81432706137, 81432706150, 81432706151



MN-VB-9404

Length: 627 Ø: 58
Hole Distance: 130 / 130
81432706117, 81432706152, 81432706153



SC-ES-7279

Length: 150
Cone Ø: d1 Ø 30 / d2 Ø 27
Thread: M30 x 1,5 RHT
81953016288



SC-ES-8517

Length: 140
Cone Ø: d1 Ø 30 / d2 Ø 27
Thread: M30 x 1,5 RHT
81953016286



SC-ES-8535

Length: 145
Cone Ø: d1 Ø 30 / d2 Ø 27
Thread: M30 x 1,5 RHT
81953016271, 81953016325





TGA ...

26.430 FDALS, FDAS, FDHLS, FDHS	01/04 →	Centre Rod	MN-DL-2160		Coupling Rod
	01/04 →	Centre Rod	MN-DL-2174		Push Rod
	01/04 →	Suspension Arm Repair Kit		CV-RK-5313	for Wishbone (CV)
	01/04 →	Tie Rod End	CV-ES-0914		for Steering Rod
	01/04 →	Tie Rod End	CV-ES-14162		for Steering Rod
	01/04 →	Tie Rod End	CV-ES-14163		for Steering Rod
	01/04 →	Tie Rod End	MN-ES-10333		for Steering Rod
	01/04 →	Tie Rod End	SC-ES-7279		for Steering Rod
	01/04 →	Tie Rod End	SC-ES-8517		for Push Rod
	01/04 →	Tie Rod End	SC-ES-8535		for Guide Rod
	01/04 →	Track Control Arm		MN-DL-8609	Trailing Arm, 1st RA;2nd RA, for Leaf-Spring Suspension vehicles, →Type_HB Chassis
	01/04 →	Track Control Arm		MN-VB-8514	Suspension Rod, Wishbone (CV)
	01/04 →	Track Control Arm		MN-VB-8669	Suspension Rod, Wishbone (CV), 1st RA; 2nd RA, for Leaf-Spring Suspension vehicles, →Type_MHB Chassis
	01/04 →	Track Control Arm		MN-VB-9404	Wishbone (CV), 1st RA;2nd RA, for Leaf-Spring Suspension vehicles, →Type_HB
26.430 FDLS, FDLS/M, FDLRS-WW	02/04 →	Centre Rod	MN-DL-7801		Push Rod, Leaf Spring Axle
	02/04 →	Suspension Strut Repair Kit		DB-RK-8581	
	02/04 →	Tie Rod	MN-DL-7802		
	02/04 →	Tie Rod	MN-DL-12293		
	02/04 →	Tie Rod End	CV-ES-0914		for Steering Rod
	02/04 →	Tie Rod End	CV-ES-14162		for Steering Rod
	02/04 →	Tie Rod End	CV-ES-14163		for Steering Rod
	02/04 →	Tie Rod End	SC-ES-7279		for Steering Rod
	02/04 →	Tie Rod End	SC-ES-8517		for Push Rod
	02/04 →	Tie Rod End	SC-ES-8535		for Guide Rod
	02/04 →	Track Control Arm		MN-DL-5225	Trailing Arm
	02/04 →	Track Control Arm		MN-DL-8733	Trailing Arm, 1st Drive Axle, for Pneumatic Suspension vehicles
	02/04 →	Track Control Arm		MN-VB-5222	Wishbone (CV), 1st RA;2nd RA, for Pneumatic Suspension vehicles
	02/04 →	Track Control Arm		MN-VB-8514	Suspension Rod, Wishbone (CV)
02/04 →	Track Control Arm		MN-VB-8669	Suspension Rod, Wishbone (CV), 1st RA; 2nd RA, for Leaf-Spring Suspension vehicles, →Type_MHB Chassis	
26.430 FVL-KO	12/00 →	Centre Rod	MN-DL-7801		Push Rod
	12/00 →	Suspension Arm Repair Kit		CV-RK-5313	for Wishbone (CV)
	12/00 →	Suspension Arm Repair Kit	DB-RK-9300	DB-RK-9300	for Drag Link
	12/00 →	Suspension Strut Repair Kit		CV-RK-5311	
	12/00 →	Tie Rod	MN-DL-7802		
	12/00 →	Tie Rod End		SC-ES-8517	for Push Rod
	12/00 →	Tie Rod End	CV-ES-0914		for Steering Rod
	12/00 →	Tie Rod End	CV-ES-14163		for Steering Rod
	12/00 →	Tie Rod End	SC-ES-7279		for Steering Rod
	12/00 →	Tie Rod End	SC-ES-8535		for Guide Rod
	12/00 →	Track Control Arm		MN-DL-5225	Trailing Arm
	12/00 →	Track Control Arm		MN-DL-8733	Trailing Arm, 1st Drive Axle, for Pneumatic Suspension vehicles
	12/00 →	Track Control Arm		MN-VB-5238	Wishbone (CV), 1st Drive Axle, for Pneumatic Suspension vehicles
	26.430 FVLS, FVLRS	07/05 →	Centre Rod	MN-DL-7801	
07/05 →		Suspension Strut Repair Kit		MN-RK-12436	
07/05 →		Tie Rod	MN-DL-7802		
07/05 →		Tie Rod	MN-DL-12284		
07/05 →		Tie Rod End		SC-ES-8517	for Push Rod
07/05 →		Tie Rod End	CV-ES-0914		for Steering Rod
07/05 →		Tie Rod End	CV-ES-14162	CV-ES-14162	for Steering Rod
07/05 →		Tie Rod End	CV-ES-14163		for Steering Rod
07/05 →		Tie Rod End	SC-ES-7279		for Steering Rod
07/05 →		Tie Rod End	SC-ES-8535		for Guide Rod
07/05 →		Tie Rod End			

CV-ES-0914

Length: 125
Cone Ø: d1 Ø 30 / d2 Ø 27
Thread: M38 x 1,5 RHT
81953016184, 81953016251, 81953016276



CV-ES-14162

Length: 125
Cone Ø: d1 Ø 30 / d2 Ø 27
Thread: M30 x 1,5 LHT
81953010015, 81953010083, 81953010087, 81953016029, 81953016030, 81953016043, 81953016044, 81953016050, 81953016054, 81953016087, 81953016091, 81953016107, 81953016120, 81953016125, 81953016152, 81953016155, 81953016157, 81953016168, 81953016179, 81953016181, 81953016223, 81953016237, 81953016254, 81953016275, 81953016279, 81953016351



CV-ES-14163

Length: 125
Cone Ø: d1 Ø 30 / d2 Ø 27
Thread: M30 x 1,5 RHT
95301.0084, 90804102156, 90804102272, 90804102696, 90804102710, 81953010016, 81953010075, 81953010084, 81953010088, 81953010094, 81953010103, 81953016030, 81953016043, 81953016048, 81953016049, 81953016053, 81953016061, 81953016090, 81953016108, 81953016112, 81953016126, 81953016143, 81953016149, 81953016154, 81953016156, 81953016168, 81953016178, 81953016194, 81953016206, 81953016224, 81953016234, 81953016242, 81953016252, 81953016274, 81953016278, 81953016284, 81953016286, 81953016308, 81953016310, 81953016312, 81953016347, 81953016350, 81953016352, 82953016012, 88953016014, N2953016001



CV-RK-5311

638862, 639287, 938423, 1104335, 1953248, 3500506, 0003500506, 11013547, 42488722, 070550504, 634303610, 81432206055, 81432206073, 82262320660, 5001842823, 7000307001, 8226232066



CV-RK-5313

Ø: 90
03304800A, 81953016132



DB-RK-8581

Ø: 85
Hole Distance: 130
Thick/Height: 24
03305800A, 81432706105



DB-RK-9300

Ø: 75
Hole Distance: 130
Thick/Height: 24
85432206002



MN-DL-2160

Length: 1652 Ø: 50
Cone Ø: d1 Ø 30 / d2 Ø 27
81467106112, 81467106163, 81467106165, 81467106198, 81467106353, 81467106354, 81467106361, 81467116725



MN-DL-2174

Length: 1588 Ø: 52
Cone Ø: d1 Ø 30 / d2 Ø 27
81467106378, 81467106912



MN-DL-5225

Length: 572 Ø: 48
Hole Distance: 130 / 130
03301500A, 81432206229, 81432206236, 81432206267, 81432206270, 81432206272, 81432206304, 81432206305, 81432209236, 81432209267, 81432209272



MN-DL-7801

Length: 995 Ø: 52
Cone Ø: d1 Ø 30 / d2 Ø 27
81466106807, 81466106808, 81466116087, 81466116088, 81466116096, 81466116097, 81466116099, 81466116132, 81466116133, 81466116136, 81466116197, 81466116198, 81466116205



MN-DL-7802

Length: 1680 Ø: 52
Cone Ø: d1 Ø 30 / d2 Ø 27
03208300A, 81467116773, 81467116858, 81467116859, 81467116860, 81467116861, 81467116863, 81467116882, 81467116883, 81467116920, 81467116921



MN-DL-8609

Length: 585 Ø: 58
Hole Distance: 130 / 130
81432206070, 81432206071, 81432206072, 81432206091, 81432206093, 81432206119



MN-DL-8733

Length: 530 Ø: 48
Hole Distance: 130 / 130
81432206161, 81432206190, 81432206358, 81432206359



MN-DL-12284

Length: 1530 Ø: 50
Cone Ø: d1 Ø 30 / d2 Ø 27
81466106579, 81466106580, 81466106624, 81466116720, 81467116720, 81467116730, 81467116952



MN-DL-12293

Length: 1680 Ø: 42
Cone Ø: d1 Ø 30 / d2 Ø 27
81467106236, 81467106268, 81467106356, 81467116356, 81467116723, 81467116794, 81467116933, 81467116934, 81467116966



MN-ES-10333

Length: 90
Cone Ø: d1 Ø 38 / d2 Ø 34,35
Thread: M36 x 1,5 RHT
1271126, 3090291, 3099128, 42538048, 81953016268, 82953016018, 82953016019



MN-RK-12436

Ø: 75
Hole Distance: 115
Thick/Height: 24
81432206244



MN-VB-5222

Length: 627 Ø: 50
Hole Distance: 152 / 152
81432706030, 81432706034, 81432706054, 81432706055, 81432706056, 81432706057, 81432706067, 81432706068, 81432706074, 81432706075, 81432706076, 81432706077, 81432706078, 81432706081, 81432706082, 81432709034, 81432709076, 81432709078, 8143706054



MN-VB-5238

Length: 627 Ø: 48
Hole Distance: 130 / 130
81432206221, 81432706096, 81432706114, 81432706116, 81432706121



MN-VB-8514

Length: 627 Ø: 48
Hole Ø 25 / 25 / 25
Hole Distance: 152 / 130 / 130
81432706087, 81432706088, 81432706094, 81432706095, 81432796094



MN-VB-8669

Length: 627 Ø: 48
Hole Ø 25 / 25 / 25
Hole Distance: 152 / 130 / 130
81432706116, 81432706137, 81432706150, 81432706151



MN-VB-9404

Length: 627 Ø: 58
Hole Distance: 130 / 130
81432706117, 81432706152, 81432706153



SC-ES-7279

Length: 150
Cone Ø: d1 Ø 30 / d2 Ø 27
Thread: M30 x 1,5 RHT
81953016288



SC-ES-8517

Length: 140
Cone Ø: d1 Ø 30 / d2 Ø 27
Thread: M30 x 1,5 RHT
81953016286



SC-ES-8535

Length: 145
Cone Ø: d1 Ø 30 / d2 Ø 27
Thread: M30 x 1,5 RHT
81953016271, 81953016325





TGA ...

26.430 FVLS, FVLSR ...	07/05→	Track Control Arm		MN-DL-5212	Trailing Arm, Trailing Axle Steered, for Pneumatic Suspension vehicles	
	07/05→	Track Control Arm		MN-DL-5225	Trailing Arm	
	07/05→	Track Control Arm		MN-DL-8709	Trailing Arm, 1st Drive Axle, for Pneumatic Suspension vehicles	
	07/05→	Track Control Arm		MN-DL-8709	Trailing Arm, Trailing Axle Steered, for Pneumatic Suspension vehicles	
	07/05→	Track Control Arm		MN-DL-8733	Trailing Arm, 1st Drive Axle, for Pneumatic Suspension vehicles	
	07/05→	Track Control Arm		MN-VB-5238	Wishbone (CV), 1st Drive Axle, for Pneumatic Suspension vehicles	
	07/05→	Track Control Arm		MN-VB-9403	Wishbone (CV), Trailing Axle Steered, for Pneumatic Suspension vehicles	
26.430, 26.440 FDAK, FDALK, FDHK, FDHLK	07/05→	Track Control Arm	MN-DL-8663		Control Arm	
	06/05→	Centre Rod	MN-DL-7801		Push Rod, Leaf Spring Axle	
	06/05→	Suspension Strut Repair Kit		DB-RK-8581		
	06/05→	Tie Rod	MN-DL-7802			
	06/05→	Tie Rod End	CV-ES-0914		for Steering Rod	
	06/05→	Tie Rod End	CV-ES-14162		for Steering Rod	
	06/05→	Tie Rod End	CV-ES-14163		for Steering Rod	
	06/05→	Tie Rod End	MN-ES-10333		for Steering Rod	
	06/05→	Tie Rod End	SC-ES-7279		for Steering Rod	
	06/05→	Tie Rod End	SC-ES-8517		for Push Rod	
	06/05→	Tie Rod End	SC-ES-8535		for Guide Rod	
	06/05→	Track Control Arm		MN-DL-5225	Trailing Arm	
	06/05→	Track Control Arm		MN-DL-8544	Trailing Arm, 1st RA;2nd RA;Leaf Spring Axle	
	06/05→	Track Control Arm		MN-DL-8609	Trailing Arm, 1st RA;2nd RA, for Leaf-Spring Suspension vehicles, →Type_HB Chassis	
	06/05→	Track Control Arm		MN-VB-5238	Wishbone (CV), 1st RA;2nd RA, for Pneumatic Suspension vehicles, →Type_NBA Chassis	
	06/05→	Track Control Arm		MN-VB-8514	Suspension Rod, Wishbone (CV), Drive Axle; Leaf Spring Axle	
	06/05→	Track Control Arm		MN-VB-8669	Suspension Rod, Wishbone (CV), Drive Axle; Leaf Spring Axle	
	06/05→	Track Control Arm		MN-VB-9404	Wishbone (CV), 1st RA;2nd RA, for Leaf-Spring Suspension vehicles, →Type_HB	
	26.430, 26.440 FDALS, FDAS, FDHLS, FDHS	06/05→	Centre Rod	MN-DL-7801		Push Rod, Leaf Spring Axle
		06/05→	Suspension Strut Repair Kit		DB-RK-8581	
06/05→		Tie Rod	MN-DL-7802			
06/05→		Tie Rod End	CV-ES-0914		for Steering Rod	
06/05→		Tie Rod End	CV-ES-14162		for Steering Rod	
06/05→		Tie Rod End	CV-ES-14163		for Steering Rod	
06/05→		Tie Rod End	MN-ES-10333		for Steering Rod	
06/05→		Tie Rod End	SC-ES-7279		for Steering Rod	
06/05→		Tie Rod End	SC-ES-8517		for Push Rod	
06/05→		Tie Rod End	SC-ES-8535		for Guide Rod	
06/05→		Track Control Arm		MN-DL-5225	Trailing Arm	
06/05→		Track Control Arm		MN-DL-8544	Trailing Arm, 1st RA;2nd RA;Leaf Spring Axle	
06/05→		Track Control Arm		MN-DL-8609	Trailing Arm, 1st RA;2nd RA, for Leaf-Spring Suspension vehicles, →Type_HB Chassis	
06/05→		Track Control Arm		MN-VB-5238	Wishbone (CV), 1st RA;2nd RA, for Pneumatic Suspension vehicles, →Type_NBA Chassis	
06/05→		Track Control Arm		MN-VB-8514	Suspension Rod, Wishbone (CV), Drive Axle; Leaf Spring Axle	
06/05→		Track Control Arm		MN-VB-8669	Suspension Rod, Wishbone (CV), Drive Axle; Leaf Spring Axle	
06/05→		Track Control Arm		MN-VB-9404	Wishbone (CV), 1st RA;2nd RA, for Leaf-Spring Suspension vehicles, →Type_HB	
26.430, 26.440 FDC, FDLC, FDLRC, FDRC, FNHLK, FVHLK	05/04→01/05	Track Control Arm		MN-DL-5212	Trailing Arm, Tag Axle;Air Suspension Axle	
	05/04→	Centre Rod	MN-DL-7801		Push Rod, Leaf Spring Axle	
	05/04→	Centre Rod	MN-DL-8560		Push Rod, Air Suspension Axle	
	05/04→	Suspension Strut Repair Kit		DB-RK-8581		
	05/04→	Suspension Strut Repair Kit		MN-RK-12436		

CV-ES-0914

Length: 125
Cone Ø: d1 Ø 30 / d2 Ø 27
Thread: M38 x 1,5 RHT
81953016184, 81953016251, 81953016276



CV-ES-14162

Length: 125
Cone Ø: d1 Ø 30 / d2 Ø 27
Thread: M30 x 1,5 LHT
81953010015, 81953010083, 81953010087, 81953016029, 81953016030, 81953016043, 81953016044, 81953016050, 81953016054, 81953016087, 81953016091, 81953016107, 81953016120, 81953016125, 81953016152, 81953016155, 81953016157, 81953016168, 81953016179, 81953016181, 81953016223, 81953016237, 81953016254, 81953016275, 81953016279, 81953016351



CV-ES-14163

Length: 125
Cone Ø: d1 Ø 30 / d2 Ø 27
Thread: M30 x 1,5 RHT
95301.0084, 90804102156, 90804102272, 90804102696, 90804102710, 81953010016, 81953010075, 81953010084, 81953010088, 81953010094, 81953010103, 81953016030, 81953016043, 81953016048, 81953016049, 81953016053, 81953016061, 81953016090, 81953016108, 81953016112, 81953016126, 81953016143, 81953016149, 81953016154, 81953016156, 81953016168, 81953016178, 81953016194, 81953016206, 81953016224, 81953016234, 81953016242, 81953016252, 81953016274, 81953016278, 81953016284, 81953016286, 81953016308, 81953016310, 81953016312, 81953016347, 81953016350, 81953016352, 82953016012, 88953016014, N2953016001



DB-RK-8581

Ø: 85
Hole Distance: 130
Thick/Height: 24
03305800A, 81432706105



MN-DL-5212

Length: 577 Ø: 48
Hole Distance: 130 / 130
81432206096, 81432206097, 81432206098, 81432206129, 81432209096, 81432209129, 81432306014, 81432306030



MN-DL-5225

Length: 572 Ø: 48
Hole Distance: 130 / 130
03301500A, 81432206229, 81432206236, 81432206267, 81432206270, 81432206272, 81432206304, 81432206305, 81432209236, 81432209267, 81432209272



MN-DL-7801

Length: 995 Ø: 52
Cone Ø: d1 Ø 30 / d2 Ø 27
81466106807, 81466106808, 81466116087, 81466116088, 81466116096, 81466116097, 81466116099, 81466116132, 81466116133, 81466116136, 81466116197, 81466116198, 81466116205



MN-DL-7802

Length: 1680 Ø: 52
Cone Ø: d1 Ø 30 / d2 Ø 27
03208300A, 81467116773, 81467116858, 81467116859, 81467116860, 81467116861, 81467116863, 81467116882, 81467116883, 81467116920, 81467116921



MN-DL-8544

Length: 596 Ø: 48
Hole Distance: 130 / 130
81432206196, 81432206232, 81432206233



MN-DL-8560

Length: 970 Ø: 52
Cone Ø: d1 Ø 30 / d2 Ø 27
03206900A, 81466106809, 81466106810, 81466106823, 81466106838, 81466106839, 81466116104, 81466116105, 81466116107, 81466116134, 81466116135, 81466116137, 81466116199, 81466116200, 81466116206



MN-DL-8609

Length: 585 Ø: 58
Hole Distance: 130 / 130
81432206070, 81432206071, 81432206072, 81432206091, 81432206093, 81432206119



MN-DL-8663

Length: 947 Ø: 60
Hole Distance: 115 / 115
03307400A, 81432206222, 81432206260, 81432206283, 81432206284



MN-DL-8709

Length: 572 Ø: 52
Hole Distance: 130 / 130
81432206268, 81432206274, 81432206291, 81432206292, 82432206007



MN-DL-8733

Length: 530 Ø: 48
Hole Distance: 130 / 130
81432206161, 81432206190, 81432206358, 81432206359



MN-ES-10333

Length: 90
Cone Ø: d1 Ø 38 / d2 Ø 34,35
Thread: M36 x 1,5 RHT
1271126, 3090291, 3099128, 42538048, 81953016268, 82953016018, 82953016019



MN-RK-12436

Ø: 75
Hole Distance: 115
Thick/Height: 24
81432206244



MN-VB-5238

Length: 627 Ø: 48
Hole Distance: 130 / 130
81432206221, 81432706096, 81432706114, 81432706116, 81432706121



MN-VB-8514

Length: 627 Ø: 48
Hole Ø 25 / 25 / 25
Hole Distance: 152 / 130 / 130
81432706087, 81432706088, 81432706094, 81432706095, 81432796094



MN-VB-8669

Length: 627 Ø: 48
Hole Ø 25 / 25 / 25
Hole Distance: 152 / 130 / 130
81432706116, 81432706137, 81432706150, 81432706151



MN-VB-9403

Length: 627 Ø: 48
Hole Ø 25 / 23 / 23
Hole Distance: 152 / 130 / 130
81432706097, 81432706113, 81432706135, 81432706160, 81432706161



MN-VB-9404

Length: 627 Ø: 58
Hole Distance: 130 / 130
81432706117, 81432706152, 81432706153



SC-ES-7279

Length: 150
Cone Ø: d1 Ø 30 / d2 Ø 27
Thread: M30 x 1,5 RHT
81953016288



SC-ES-8517

Length: 140
Cone Ø: d1 Ø 30 / d2 Ø 27
Thread: M30 x 1,5 RHT
81953016286



SC-ES-8535

Length: 145
Cone Ø: d1 Ø 30 / d2 Ø 27
Thread: M30 x 1,5 RHT
81953016271, 81953016325





TGA ...

26.430, 26.440 FDC, FDLC, FDLRC,
FDRC, FNHLC, FVHLC ...

05/04 →	Tie Rod	MN-DL-7802		
05/04 →	Tie Rod	MN-DL-12284		
05/04 →	Tie Rod End		IV-ES-8507	Tag Axle
05/04 →	Tie Rod End		MN-ES-8490	for vehicles with Hinged Trailing Axle
05/04 →	Tie Rod End		SC-ES-8517	for Push Rod
05/04 →	Tie Rod End	CV-ES-0914		for Steering Rod
05/04 →	Tie Rod End	CV-ES-14162	CV-ES-14162	for Steering Rod
05/04 →	Tie Rod End	CV-ES-14163		for Steering Rod
05/04 →	Tie Rod End	IV-ES-12272		for Steering Rod
05/04 →	Tie Rod End	SC-ES-7279		for Steering Rod
05/04 →	Tie Rod End	SC-ES-8535		for Guide Rod
05/04 →	Track Control Arm		MN-DL-3402	Trailing Arm, Air Suspension Axle; Drive Axle
05/04 →	Track Control Arm		MN-DL-5225	Trailing Arm, Drive Axle; Air Suspension Axle
05/04 →	Track Control Arm		MN-DL-5225	Trailing Arm, Tag Axle; Air Suspension Axle; for vehicles with Hinged Trailing Axle
05/04 →	Track Control Arm		MN-DL-8544	Trailing Arm, Drive Axle; Air Suspension Axle
05/04 →	Track Control Arm		MN-DL-8544	Trailing Arm, Drive Axle; Leaf Spring Axle
05/04 →	Track Control Arm		MN-DL-8709	Trailing Arm, Air Suspension Axle; for vehicles with Hinged Trailing Axle
05/04 →	Track Control Arm		MN-DL-8733	Trailing Arm, 1st Drive Axle, for Pneumatic Suspension vehicles
05/04 →	Track control arm		MN-DL-10288	Trailing Arm, 1st RA; 2nd RA, for Leaf-Spring Suspension vehicles
05/04 →	Track control arm		MN-DL-12288	Trailing Arm
05/04 →	Track Control Arm		MN-TC-12399	Control Arm
05/04 →	Track Control Arm		MN-VB-5222	Wishbone (CV), 1st RA; 2nd RA, for Pneumatic Suspension vehicles
05/04 →	Track Control Arm		MN-VB-5238	Wishbone (CV), Drive Axle; Air Suspension Axle
05/04 →	Track Control Arm		MN-VB-5238	Wishbone (CV), Drive Axle; Leading Axle; Air Suspension Axle
05/04 →	Track Control Arm		MN-VB-8514	Suspension Rod, Wishbone (CV), Drive Axle; Air Suspension Axle
05/04 →	Track Control Arm		MN-VB-8514	Suspension Rod, Wishbone (CV), Drive Axle; Leaf Spring Axle
05/04 →	Track Control Arm		MN-VB-8669	Suspension Rod, Wishbone (CV), Drive Axle
05/04 →	Track Control Arm		MN-VB-8669	Suspension Rod, Wishbone (CV), Drive Axle; Leaf Spring Axle
05/04 →	Track Control Arm		MN-VB-9403	Wishbone (CV), Air Suspension Axle
05/04 →	Track Control Arm		MN-VB-9404	Wishbone (CV), Drive Axle
05/04 →	Track Control Arm		MN-VB-9404	Wishbone (CV), Drive Axle; Air Suspension Axle
05/04 →	Track Control Arm	MN-DL-8663		Control Arm, Air Suspension Axle
01/05 →	Track Control Arm		MN-DL-5225	Trailing Arm, Leading Axle; Air Suspension Axle
01/05 →	Track Control Arm		MN-DL-5225	Trailing Arm, Tag Axle; Air Suspension Axle; for vehicles with Rigid Trailing Axle

26.430, 26.440 FDHC, FDHC/M,
FDHLC

06/05 →	Centre Rod	MN-DL-7801		Push Rod, Leaf Spring Axle
06/05 →	Suspension Strut Repair Kit		DB-RK-8581	
06/05 →	Tie Rod	MN-DL-7802		
06/05 →	Tie Rod End	CV-ES-0914		for Steering Rod
06/05 →	Tie Rod End	CV-ES-14162		for Steering Rod
06/05 →	Tie Rod End	CV-ES-14163		for Steering Rod
06/05 →	Tie Rod End	MN-ES-10333		for Steering Rod
06/05 →	Tie Rod End	SC-ES-7279		for Steering Rod
06/05 →	Tie Rod End	SC-ES-8517		for Push Rod
06/05 →	Tie Rod End	SC-ES-8535		for Guide Rod
06/05 →	Track Control Arm		MN-DL-5225	Trailing Arm
06/05 →	Track Control Arm		MN-DL-8544	Trailing Arm, 1st RA; 2nd RA; Leaf Spring Axle
06/05 →	Track Control Arm		MN-DL-8609	Trailing Arm, 1st RA; 2nd RA, for Leaf-Spring Suspension vehicles, →Type_HB Chassis
06/05 →	Track Control Arm		MN-VB-5238	Wishbone (CV), 1st RA; 2nd RA, for Pneumatic Suspension vehicles, →Type_NBA Chassis
06/05 →	Track Control Arm		MN-VB-8514	Suspension Rod, Wishbone (CV), Drive Axle; Leaf Spring Axle

CV-ES-0914

Length: 125
Cone Ø: d1 Ø 30 / d2 Ø 27
Thread: M38 x 1,5 RHT
81953016184, 81953016251, 81953016276



CV-ES-14162

Length: 125
Cone Ø: d1 Ø 30 / d2 Ø 27
Thread: M30 x 1,5 LHT
81953010015, 81953010083, 81953010087, 81953016029, 81953016030, 81953016043, 81953016044, 81953016050, 81953016054, 81953016087, 81953016091, 81953016107, 81953016120, 81953016125, 81953016152, 81953016155, 81953016157, 81953016168, 81953016179, 81953016181, 81953016223, 81953016237, 81953016254, 81953016275, 81953016279, 81953016351



CV-ES-14163

Length: 125
Cone Ø: d1 Ø 30 / d2 Ø 27
Thread: M30 x 1,5 RHT
95301.0084, 90804102156, 90804102272, 90804102696, 90804102710, 81953010016, 81953010075, 81953010084, 81953010088, 81953010094, 81953010103, 81953016030, 81953016043, 81953016048, 81953016049, 81953016053, 81953016061, 81953016090, 81953016108, 81953016112, 81953016126, 81953016143, 81953016149, 81953016154, 81953016156, 81953016168, 81953016178, 81953016194, 81953016206, 81953016224, 81953016234, 81953016242, 81953016252, 81953016274, 81953016278, 81953016284, 81953016286, 81953016308, 81953016310, 81953016312, 81953016347, 81953016350, 81953016352, 82953016012, 88953016014, N2953016001



DB-RK-8581

Ø: 85 Hole Distance: 130
Thick/Height: 24
03305800A, 81432706105



IV-ES-8507

Length: 80
Cone Ø: d1 Ø 30 / d2 Ø 27
Thread: M30 x 1,5 RHT
11019869, 12216380, 55175540, 81953016238



IV-ES-12272

Length: 75
Cone Ø: d1 Ø 30 / d2 Ø 27
Thread: M26 x 1,5 RHT
81953016280, 82953010010



MN-DL-3402

Length: 590 Ø: 48
Hole Distance: 130 / 130
03307200A, 81432206067, 81432206068, 81432206090, 81432206092, 81432209092



MN-DL-5225

Length: 572 Ø: 48
Hole Distance: 130 / 130
03301500A, 81432206229, 81432206236, 81432206267, 81432206270, 81432206272, 81432206304, 81432206305, 81432209236, 81432209267, 81432209272



MN-DL-7801

Length: 995 Ø: 52
Cone Ø: d1 Ø 30 / d2 Ø 27
81466106807, 81466106808, 81466116087, 81466116088, 81466116096, 81466116097, 81466116099, 81466116132, 81466116133, 81466116136, 81466116197, 81466116198, 81466116205

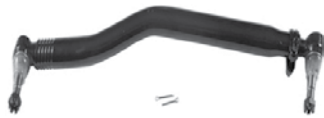

MN-DL-7802

Length: 1680 Ø: 52
Cone Ø: d1 Ø 30 / d2 Ø 27
03208300A, 81467116773, 81467116858, 81467116859, 81467116860, 81467116861, 81467116863, 81467116882, 81467116883, 81467116920, 81467116921



MN-DL-8544

Length: 596 Ø: 48
Hole Distance: 130 / 130
81432206196, 81432206232, 81432206233



MN-DL-8609

Length: 585 Ø: 58
Hole Distance: 130 / 130
81432206070, 81432206071, 81432206072, 81432206091, 81432206093, 81432206119



MN-DL-8663

Length: 947 Ø: 60
Hole Distance: 115 / 115
03307400A, 81432206222, 81432206260, 81432206283, 81432206284



MN-DL-8709

Length: 572 Ø: 52
Hole Distance: 130 / 130
81432206268, 81432206274, 81432206291, 81432206292, 82432206007



MN-DL-8733

Length: 530 Ø: 48
Hole Distance: 130 / 130
81432206161, 81432206190, 81432206358, 81432206359



MN-DL-10288

81432206386, 82432206008, 82432209008

No Image

MN-DL-12284

Length: 1530 Ø: 50
Cone Ø: d1 Ø 30 / d2 Ø 27
81466106579, 81466106580, 81466106624, 81466116720, 81467116720, 81467116730, 81467116952

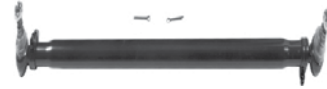

MN-DL-12288

Length: 585 Ø: 58
Hole Distance: 130 / 130
81432206386, 82432206008, 82432209008

No Image

MN-ES-8490

Length: 90
Cone Ø: d1 Ø 30 / d2 Ø 27
Thread: M26 x 1,5 RHT
0014606948, 14606948, 81953016281, 81953016337, 82953016016



MN-ES-10333

Length: 90
Cone Ø: d1 Ø 38 / d2 Ø 34,35
Thread: M36 x 1,5 RHT
1271126, 3090291, 3099128, 42538048, 81953016268, 82953016018, 82953016019



MN-TC-12399

Length: 694 Ø: 50
Hole Distance: 130 / 130
81432206265



MN-VB-5222

Length: 627 Ø: 50
Hole Distance: 152 / 152
81432706030, 81432706034, 81432706054, 81432706055, 81432706056, 81432706057, 81432706067, 81432706068, 81432706074, 81432706075, 81432706076, 81432706077, 81432706078, 81432706081, 81432706082, 81432709034, 81432709076, 81432709078, 8143706054



MN-VB-5238

Length: 627 Ø: 48
Hole Distance: 130 / 130
81432206221, 81432706096, 81432706114, 81432706116, 81432706121



MN-VB-8514

Length: 627 Ø: 48
Hole Ø 25 / 25 / 25
Hole Distance: 152 / 130 / 130
81432706087, 81432706088, 81432706094, 81432706095, 81432796094



MN-VB-8669

Length: 627 Ø: 48
Hole Ø 25 / 25 / 25
Hole Distance: 152 / 130 / 130
81432706116, 81432706137, 81432706150, 81432706151



MN-VB-9403

Length: 627 Ø: 48
Hole Ø 25 / 23 / 23
Hole Distance: 152 / 130 / 130
81432706097, 81432706113, 81432706135, 81432706160, 81432706161



MN-VB-9404

Length: 627 Ø: 58
Hole Distance: 130 / 130
81432706117, 81432706152, 81432706153



SC-ES-7279

Length: 150
Cone Ø: d1 Ø 30 / d2 Ø 27
Thread: M30 x 1,5 RHT
81953016288



SC-ES-8517

Length: 140
Cone Ø: d1 Ø 30 / d2 Ø 27
Thread: M30 x 1,5 RHT
81953016286



SC-ES-8535

Length: 145
Cone Ø: d1 Ø 30 / d2 Ø 27
Thread: M30 x 1,5 RHT
81953016271, 81953016325



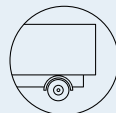

TGA ...

26.430, 26.440 FDHC, FDHC/M, FDHLC ...	06/05 →	Track Control Arm		MN-VB-8669	Suspension Rod, Wishbone (CV), Drive Axle; Leaf Spring Axle	
	06/05 →	Track Control Arm		MN-VB-9404	Wishbone (CV), 1st RA;2nd RA, for Leaf-Spring Suspension vehicles, →Type_HB Chassis	
26.430, 26.440 FDH-TM	06/05 →	Centre Rod	MN-DL-7801		Push Rod, Leaf Spring Axle	
	06/05 →	Suspension Strut Repair Kit		DB-RK-8581		
	06/05 →	Tie Rod	MN-DL-7802			
	06/05 →	Tie Rod End	CV-ES-0914		for Steering Rod	
	06/05 →	Tie Rod End	CV-ES-14162		for Steering Rod	
	06/05 →	Tie Rod End	CV-ES-14163		for Steering Rod	
	06/05 →	Tie Rod End	SC-ES-7279		for Steering Rod	
	06/05 →	Tie Rod End	SC-ES-8517		for Push Rod	
	06/05 →	Tie Rod End	SC-ES-8535		for Guide Rod	
	06/05 →	Track Control Arm		MN-DL-5225	Trailing Arm	
	06/05 →	Track Control Arm		MN-DL-8544	Trailing Arm, 1st RA;2nd RA;Leaf Spring Axle	
	06/05 →	Track Control Arm		MN-VB-8514	Suspension Rod, Wishbone (CV), Drive Axle; Leaf Spring Axle	
	06/05 →	Track Control Arm		MN-VB-8669	Suspension Rod, Wishbone (CV), Drive Axle; Leaf Spring Axle	
	26.430, 26.440 FDK, FDLK	05/04 →	Centre Rod	MN-DL-7801		Push Rod, Leaf Spring Axle
05/04 →		Centre Rod	MN-DL-8560		Push Rod, Air Suspension Axle	
05/04 →		Suspension Strut Repair Kit		DB-RK-8581		
05/04 →		Suspension Strut Repair Kit		MN-RK-12436		
05/04 →		Tie Rod	MN-DL-7802			
05/04 →		Tie Rod End	CV-ES-0914		for Steering Rod	
05/04 →		Tie Rod End	CV-ES-14162		for Steering Rod	
05/04 →		Tie Rod End	CV-ES-14163		for Steering Rod	
05/04 →		Tie Rod End	SC-ES-7279		for Steering Rod	
05/04 →		Tie Rod End	SC-ES-8517		for Push Rod	
05/04 →		Tie Rod End	SC-ES-8535		for Guide Rod	
05/04 →		Track Control Arm		MN-DL-3402	Trailing Arm, Air Suspension Axle;Drive Axle	
05/04 →		Track Control Arm		MN-DL-5225	Trailing Arm, Drive Axle;Air Suspension Axle	
05/04 →		Track Control Arm		MN-DL-8544	Trailing Arm, Drive Axle;Air Suspension Axle	
05/04 →		Track Control Arm		MN-DL-8544	Trailing Arm, Drive Axle;Leaf Spring Axle	
05/04 →		Track control arm		MN-DL-10288	Trailing Arm, 1st RA;2nd RA, for Leaf-Spring Suspension vehicles	
05/04 →		Track control arm		MN-DL-12288	Trailing Arm	
05/04 →		Track Control Arm		MN-VB-5222	Wishbone (CV), 1st RA;2nd RA, for Pneumatic Suspension vehicles	
05/04 →		Track Control Arm		MN-VB-5238	Wishbone (CV), Drive Axle;Air Suspension Axle	
05/04 →		Track Control Arm		MN-VB-8514	Suspension Rod, Wishbone (CV), Drive Axle; Air Suspension Axle	
05/04 →		Track Control Arm		MN-VB-8514	Suspension Rod, Wishbone (CV), Drive Axle; Leaf Spring Axle	
05/04 →		Track Control Arm		MN-VB-8669	Suspension Rod, Wishbone (CV), Drive Axle	
05/04 →		Track Control Arm		MN-VB-8669	Suspension Rod, Wishbone (CV), Drive Axle; Leaf Spring Axle	
05/04 →		Track Control Arm		MN-VB-9404	Wishbone (CV), Drive Axle	
05/04 →		Track Control Arm		MN-VB-9404	Wishbone (CV), Drive Axle;Air Suspension Axle	
05/04 →		Track Control Arm	MN-DL-8663		Control Arm, Air Suspension Axle	
26.430, 26.440 FDLRS, FDLS, FDRS, FDS, FNHLS, FPHLS, FVHLS		02/04 →01/05	Track Control Arm		MN-DL-5212	Trailing Arm, Tag Axle;Air Suspension Axle
		02/04 →	Centre Rod	MN-DL-7801		Push Rod, Leaf Spring Axle
		02/04 →	Centre Rod	MN-DL-8560		Push Rod, Air Suspension Axle
		02/04 →	Suspension Strut Repair Kit		DB-RK-8581	
	02/04 →	Suspension Strut Repair Kit		MN-RK-12436		
	02/04 →	Tie Rod	MN-DL-7802			
	02/04 →	Tie Rod	MN-DL-12284			
	02/04 →	Tie Rod End		IV-ES-8507	Tag Axle	
	02/04 →	Tie Rod End		MN-ES-8490	for vehicles with Hinged Trailing Axle	
	02/04 →	Tie Rod End		SC-ES-8517	for Push Rod	
	02/04 →	Tie Rod End	CV-ES-0914		for Steering Rod	
	02/04 →	Tie Rod End	CV-ES-14162	CV-ES-14162	for Steering Rod	
	02/04 →	Tie Rod End	CV-ES-14163		for Steering Rod	

CV-ES-0914

Length: 125
Cone Ø: d1 Ø 30 / d2 Ø 27
Thread: M38 x 1,5 RHT
81953016184, 81953016251, 81953016276



CV-ES-14162

Length: 125
Cone Ø: d1 Ø 30 / d2 Ø 27
Thread: M30 x 1,5 LHT
81953010015, 81953010083, 81953010087, 81953016029, 81953016030, 81953016043, 81953016044, 81953016050, 81953016054, 81953016087, 81953016091, 81953016107, 81953016120, 81953016125, 81953016152, 81953016155, 81953016157, 81953016168, 81953016179, 81953016181, 81953016223, 81953016237, 81953016254, 81953016275, 81953016279, 81953016351



CV-ES-14163

Length: 125
Cone Ø: d1 Ø 30 / d2 Ø 27
Thread: M30 x 1,5 RHT
95301.0084, 90804102156, 90804102272, 90804102696, 90804102710, 81953010016, 81953010075, 81953010084, 81953010088, 81953010094, 81953010103, 81953016030, 81953016043, 81953016048, 81953016049, 81953016053, 81953016061, 81953016090, 81953016108, 81953016112, 81953016126, 81953016143, 81953016149, 81953016154, 81953016156, 81953016168, 81953016178, 81953016194, 81953016206, 81953016224, 81953016234, 81953016242, 81953016252, 81953016274, 81953016278, 81953016284, 81953016286, 81953016308, 81953016310, 81953016312, 81953016347, 81953016350, 81953016352, 82953016012, 88953016014, N2953016001



DB-RK-8581

Ø: 85
Hole Distance: 130
Thick/Height: 24
03305800A, 81432706105



IV-ES-8507

Length: 80
Cone Ø: d1 Ø 30 / d2 Ø 27
Thread: M30 x 1,5 RHT
11019869, 12216380, 55175540, 81953016238



MN-DL-3402

Length: 590 Ø: 48
Hole Distance: 130 / 130
03307200A, 81432206067, 81432206068, 81432206090, 81432206092, 81432209092



MN-DL-5212

Length: 577 Ø: 48
Hole Distance: 130 / 130
81432206096, 81432206097, 81432206098, 81432206129, 81432209096, 81432209129, 81432306014, 81432306030



MN-DL-5225

Length: 572 Ø: 48
Hole Distance: 130 / 130
03301500A, 81432206229, 81432206236, 81432206267, 81432206270, 81432206272, 81432206304, 81432206305, 81432209236, 81432209267, 81432209272



MN-DL-7801

Length: 995 Ø: 52
Cone Ø: d1 Ø 30 / d2 Ø 27
81466106807, 81466106808, 81466116087, 81466116088, 81466116096, 81466116097, 81466116099, 81466116132, 81466116133, 81466116136, 81466116197, 81466116198, 81466116205



MN-DL-7802

Length: 1680 Ø: 52
Cone Ø: d1 Ø 30 / d2 Ø 27
03208300A, 81467116773, 81467116858, 81467116859, 81467116860, 81467116861, 81467116863, 81467116882, 81467116883, 81467116920, 81467116921



MN-DL-8544

Length: 596 Ø: 48
Hole Distance: 130 / 130
81432206196, 81432206232, 81432206233



MN-DL-8560

Length: 970 Ø: 52
Cone Ø: d1 Ø 30 / d2 Ø 27
03206900A, 81466106809, 81466106810, 81466106823, 81466106838, 81466106839, 81466116104, 81466116105, 81466116107, 81466116134, 81466116135, 81466116137, 81466116199, 81466116200, 81466116206



MN-DL-8663

Length: 947 Ø: 60
Hole Distance: 115 / 115
03307400A, 81432206222, 81432206260, 81432206283, 81432206284



MN-DL-10288

81432206386, 82432206008, 82432209008

No Image

MN-DL-12284

Length: 1530 Ø: 50
Cone Ø: d1 Ø 30 / d2 Ø 27
81466106579, 81466106580, 81466106624, 81466116720, 81467116720, 81467116730, 81467116952



MN-DL-12288

Length: 585 Ø: 58
Hole Distance: 130 / 130
81432206386, 82432206008, 82432209008

No Image

MN-ES-8490

Length: 90
Cone Ø: d1 Ø 30 / d2 Ø 27
Thread: M26 x 1,5 RHT
0014606948, 14606948, 81953016281, 81953016337, 82953016016



MN-RK-12436

Ø: 75
Hole Distance: 115
Thick/Height: 24
81432206244



MN-VB-5222

Length: 627 Ø: 50
Hole Distance: 152 / 152
81432706030, 81432706034, 81432706054, 81432706055, 81432706056, 81432706057, 81432706067, 81432706068, 81432706074, 81432706075, 81432706076, 81432706077, 81432706078, 81432706081, 81432706082, 81432709034, 81432709076, 81432709078, 8143706054



MN-VB-5238

Length: 627 Ø: 48
Hole Distance: 130 / 130
81432206221, 81432706096, 81432706114, 81432706116, 81432706121



MN-VB-8514

Length: 627 Ø: 48
Hole Ø 25 / 25 / 25
Hole Distance: 152 / 130 / 130
81432706087, 81432706088, 81432706094, 81432706095, 81432796094



MN-VB-8669

Length: 627 Ø: 48
Hole Ø 25 / 25 / 25
Hole Distance: 152 / 130 / 130
81432706116, 81432706137, 81432706150, 81432706151



MN-VB-9404

Length: 627 Ø: 58
Hole Distance: 130 / 130
81432706117, 81432706152, 81432706153



SC-ES-7279

Length: 150
Cone Ø: d1 Ø 30 / d2 Ø 27
Thread: M30 x 1,5 RHT
81953016288



SC-ES-8517

Length: 140
Cone Ø: d1 Ø 30 / d2 Ø 27
Thread: M30 x 1,5 RHT
81953016286



SC-ES-8535

Length: 145
Cone Ø: d1 Ø 30 / d2 Ø 27
Thread: M30 x 1,5 RHT
81953016271, 81953016325





TGA ...

26.430, 26.440 FDLRS, FDLS, FDRS, FDS, FNHLS, FPHLS, FVHLS ...	02/04 →	Tie Rod End	IV-ES-12272		for Steering Rod
	02/04 →	Tie Rod End	SC-ES-7279		for Steering Rod
	02/04 →	Tie Rod End	SC-ES-8535		for Guide Rod
	02/04 →	Track Control Arm		MN-DL-3402	Trailing Arm, Air Suspension Axle; Drive Axle
	02/04 →	Track Control Arm		MN-DL-5225	Trailing Arm, Drive Axle; Air Suspension Axle
	02/04 →	Track Control Arm		MN-DL-5225	Trailing Arm, Tag Axle; Air Suspension Axle; for vehicles with Hinged Trailing Axle
	02/04 →	Track Control Arm		MN-DL-8544	Trailing Arm, Drive Axle; Air Suspension Axle
	02/04 →	Track Control Arm		MN-DL-8544	Trailing Arm, Drive Axle; Leaf Spring Axle
	02/04 →	Track Control Arm		MN-DL-8709	Trailing Arm, Air Suspension Axle; for vehicles with Hinged Trailing Axle
	02/04 →	Track Control Arm		MN-DL-8733	Trailing Arm, 1st Drive Axle, for Pneumatic Suspension vehicles
	02/04 →	Track control arm		MN-DL-10288	Trailing Arm, 1st RA; 2nd RA, for Leaf-Spring Suspension vehicles
	02/04 →	Track control arm		MN-DL-12288	Trailing Arm
	02/04 →	Track Control Arm		MN-TC-12399	Control Arm
	02/04 →	Track Control Arm		MN-VB-5222	Wishbone (CV), 1st RA; 2nd RA, for Pneumatic Suspension vehicles
	02/04 →	Track Control Arm		MN-VB-5238	Wishbone (CV), Drive Axle; Air Suspension Axle
	02/04 →	Track Control Arm		MN-VB-5238	Wishbone (CV), Drive Axle; Leading Axle; Air Suspension Axle
	02/04 →	Track Control Arm		MN-VB-8514	Suspension Rod, Wishbone (CV), Drive Axle; Air Suspension Axle
	02/04 →	Track Control Arm		MN-VB-8514	Suspension Rod, Wishbone (CV), Drive Axle; Leaf Spring Axle
	02/04 →	Track Control Arm		MN-VB-8669	Suspension Rod, Wishbone (CV), Drive Axle
	02/04 →	Track Control Arm		MN-VB-8669	Suspension Rod, Wishbone (CV), Drive Axle; Leaf Spring Axle
	02/04 →	Track Control Arm		MN-VB-9403	Wishbone (CV), Air Suspension Axle
	02/04 →	Track Control Arm		MN-VB-9404	Wishbone (CV), Drive Axle
	02/04 →	Track Control Arm		MN-VB-9404	Wishbone (CV), Drive Axle; Air Suspension Axle
	02/04 →	Track Control Arm	MN-DL-8663		Control Arm, Air Suspension Axle
	01/05 →	Track Control Arm		MN-DL-5225	Trailing Arm, Leading Axle; Air Suspension Axle
	01/05 →	Track Control Arm		MN-DL-5225	Trailing Arm, Tag Axle; Air Suspension Axle; for vehicles with Rigid Trailing Axle
	26.430, 26.440 FD-TM, FDR-TM	05/04 →	Centre Rod	MN-DL-7801	
05/04 →		Suspension Strut Repair Kit		DB-RK-8581	
05/04 →		Tie Rod	MN-DL-7802		
05/04 →		Tie Rod End	CV-ES-0914		for Steering Rod
05/04 →		Tie Rod End	CV-ES-14162		for Steering Rod
05/04 →		Tie Rod End	CV-ES-14163		for Steering Rod
05/04 →		Tie Rod End	SC-ES-7279		for Steering Rod
05/04 →		Tie Rod End	SC-ES-8517		for Push Rod
05/04 →		Tie Rod End	SC-ES-8535		for Guide Rod
05/04 →		Track Control Arm		MN-DL-5225	Trailing Arm
05/04 →		Track Control Arm		MN-DL-8544	Trailing Arm, Drive Axle; Leaf Spring Axle
05/04 →		Track control arm		MN-DL-10288	Trailing Arm, 1st RA; 2nd RA, for Leaf-Spring Suspension vehicles
05/04 →		Track control arm		MN-DL-12288	Trailing Arm
05/04 →		Track Control Arm		MN-VB-8514	Suspension Rod, Wishbone (CV), Drive Axle; Leaf Spring Axle
05/04 →		Track Control Arm		MN-VB-8669	Suspension Rod, Wishbone (CV), Drive Axle; Leaf Spring Axle
05/04 →	Track Control Arm		MN-VB-9404	Wishbone (CV), Drive Axle	
26.430, 26.440 FVLH-KO	06/05 →	Centre Rod	MN-DL-7801		Push Rod, Leaf Spring Axle
	06/05 →	Suspension Arm Repair Kit		CV-RK-5313	for Wishbone (CV)
	06/05 →	Suspension Arm Repair Kit	DB-RK-9300	DB-RK-9300	for Drag Link
	06/05 →	Suspension Strut Repair Kit		DB-RK-8581	
	06/05 →	Tie Rod	MN-DL-7802		
	06/05 →	Tie Rod End		SC-ES-8517	for Push Rod
	06/05 →	Tie Rod End	CV-ES-0914		for Steering Rod
	06/05 →	Tie Rod End	CV-ES-14162	CV-ES-14162	for Steering Rod

CV-ES-0914

Length: 125
Cone Ø: d1 Ø 30 / d2 Ø 27
Thread: M38 x 1,5 RHT
81953016184, 81953016251, 81953016276



CV-ES-14162

Length: 125
Cone Ø: d1 Ø 30 / d2 Ø 27
Thread: M30 x 1,5 LHT
81953010015, 81953010083, 81953010087, 81953016029, 81953016030, 81953016043, 81953016044, 81953016050, 81953016054, 81953016087, 81953016091, 81953016107, 81953016120, 81953016125, 81953016152, 81953016155, 81953016157, 81953016168, 81953016179, 81953016181, 81953016223, 81953016237, 81953016254, 81953016275, 81953016279, 81953016351

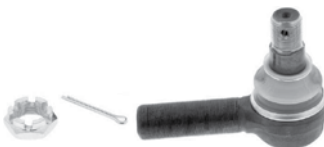

CV-ES-14163

Length: 125
Cone Ø: d1 Ø 30 / d2 Ø 27
Thread: M30 x 1,5 RHT
95301.0084, 90804102156, 90804102272, 90804102696, 90804102710, 81953010016, 81953010075, 81953010084, 81953010088, 81953010094, 81953010103, 81953016030, 81953016043, 81953016048, 81953016049, 81953016053, 81953016061, 81953016090, 81953016108, 81953016112, 81953016126, 81953016143, 81953016149, 81953016154, 81953016156, 81953016168, 81953016178, 81953016194, 81953016206, 81953016224, 81953016234, 81953016242, 81953016252, 81953016274, 81953016278, 81953016284, 81953016286, 81953016308, 81953016310, 81953016312, 81953016347, 81953016350, 81953016352, 82953016012, 88953016014, N2953016001



CV-RK-5313

Ø: 90
03304800A, 81953016132



DB-RK-8581

Ø: 85
Hole Distance: 130
Thick/Height: 24
03305800A, 81432706105



DB-RK-9300

Ø: 75
Hole Distance: 130
Thick/Height: 24
85432206002

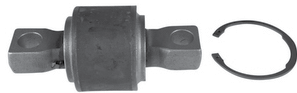

IV-ES-12272

Length: 75
Cone Ø: d1 Ø 30 / d2 Ø 27
Thread: M26 x 1,5 RHT
81953016280, 82953010010



MN-DL-3402

Length: 590 Ø: 48
Hole Distance: 130 / 130
03307200A, 81432206067, 81432206068, 81432206090, 81432206092, 81432209092



MN-DL-5225

Length: 572 Ø: 48
Hole Distance: 130 / 130
03301500A, 81432206229, 81432206236, 81432206267, 81432206270, 81432206272, 81432206304, 81432206305, 81432209230, 81432209267, 81432209272



MN-DL-7801

Length: 995 Ø: 52
Cone Ø: d1 Ø 30 / d2 Ø 27
81466106807, 81466106808, 81466116087, 81466116088, 81466116096, 81466116097, 81466116099, 81466116132, 81466116133, 81466116136, 81466116197, 81466116198, 81466116205

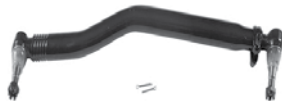

MN-DL-7802

Length: 1680 Ø: 52
Cone Ø: d1 Ø 30 / d2 Ø 27
03208300A, 81467116773, 81467116858, 81467116859, 81467116860, 81467116861, 81467116863, 81467116882, 81467116883, 81467116920, 81467116921



MN-DL-8544

Length: 596 Ø: 48
Hole Distance: 130 / 130
81432206196, 81432206232, 81432206233



MN-DL-8663

Length: 947 Ø: 60
Hole Distance: 115 / 115
03307400A, 81432206222, 81432206260, 81432206283, 81432206284



MN-DL-8709

Length: 572 Ø: 52
Hole Distance: 130 / 130
81432206268, 81432206274, 81432206291, 81432206292, 82432206007



MN-DL-8733

Length: 530 Ø: 48
Hole Distance: 130 / 130
81432206161, 81432206190, 81432206358, 81432206359



MN-DL-10288

81432206386, 82432206008, 82432209008

No Image

MN-DL-12288

Length: 585 Ø: 58
Hole Distance: 130 / 130
81432206386, 82432206008, 82432209008

No Image

MN-TC-12399

Length: 694 Ø: 50
Hole Distance: 130 / 130
81432206265



MN-VB-5222

Length: 627 Ø: 50
Hole Distance: 152 / 152
81432706030, 81432706034, 81432706054, 81432706055, 81432706056, 81432706057, 81432706067, 81432706068, 81432706074, 81432706075, 81432706076, 81432706077, 81432706078, 81432706081, 81432706082, 81432709034, 81432709076, 81432709078, 8143706054



MN-VB-5238

Length: 627 Ø: 48
Hole Distance: 130 / 130
81432206221, 81432706096, 81432706114, 81432706116, 81432706121



MN-VB-8514

Length: 627 Ø: 48
Hole Ø 25 / 25 / 25
Hole Distance: 152 / 130 / 130
81432706087, 81432706088, 81432706094, 81432706095, 81432796094



MN-VB-8669

Length: 627 Ø: 48
Hole Ø 25 / 25 / 25
Hole Distance: 152 / 130 / 130
81432706116, 81432706137, 81432706150, 81432706151



MN-VB-9403

Length: 627 Ø: 48
Hole Ø 25 / 23 / 23
Hole Distance: 152 / 130 / 130
81432706097, 81432706113, 81432706135, 81432706160, 81432706161



MN-VB-9404

Length: 627 Ø: 58
Hole Distance: 130 / 130
81432706117, 81432706152, 81432706153



SC-ES-7279

Length: 150
Cone Ø: d1 Ø 30 / d2 Ø 27
Thread: M30 x 1,5 RHT
81953016288



SC-ES-8517

Length: 140
Cone Ø: d1 Ø 30 / d2 Ø 27
Thread: M30 x 1,5 RHT
81953016286



SC-ES-8535

Length: 145
Cone Ø: d1 Ø 30 / d2 Ø 27
Thread: M30 x 1,5 RHT
81953016271, 81953016325





TGA ...

26.430, 26.440 FVLH-KO ...	06/05→	Tie Rod End	CV-ES-14163		for Steering Rod
	06/05→	Tie Rod End	SC-ES-7279		for Steering Rod
	06/05→	Tie Rod End	SC-ES-8535		for Guide Rod
	06/05→	Track Control Arm		MN-DL-5225	Trailing Arm, Drive Axle;Air Suspension Axle
	06/05→	Track Control Arm		MN-DL-5225	Trailing Arm, Leading Axle Steered/not Steered, for Pneumatic Suspension vehicles
	06/05→	Track Control Arm		MN-DL-5225	Trailing Arm, Leading Axle;Air Suspension Axle
	06/05→	Track Control Arm		MN-DL-8733	Trailing Arm, 1st Drive Axle, for Pneumatic Suspension vehicles
	06/05→	Track Control Arm		MN-VB-5222	Wishbone (CV), 1st RA;2nd RA, for Pneumatic Suspension vehicles
	06/05→	Track Control Arm		MN-VB-5238	Wishbone (CV), 1st Drive Axle, for Pneumatic Suspension vehicles
	06/05→	Track Control Arm		MN-VB-5238	Wishbone (CV), Drive Axle;Leading Axle; Air Suspension Axle
	06/05→	Track Control Arm		MN-VB-8669	Suspension Rod, Wishbone (CV), 1st RA; 2nd RA, for Leaf-Spring Suspension vehicles, →Type_MHB Chassis
26.430, 26.440, FNLC, FNLLC, FNLLW, FNLLRC, FNLLRC, FVLC	05/04→01/05	Track Control Arm		MN-DL-5212	Trailing Arm, Tag Axle;Air Suspension Axle
	05/04→	Centre Rod	MN-DL-7801		Push Rod
	05/04→	Centre Rod	MN-DL-8560		Push Rod, Air Suspension Axle
	05/04→	Suspension Strut Repair Kit		CV-RK-5311	
	05/04→	Suspension Strut Repair Kit		DB-RK-8581	
	05/04→	Suspension Strut Repair Kit		MN-RK-12436	
	05/04→	Tie Rod	MN-DL-7802		
	05/04→	Tie Rod	MN-DL-12284		
	05/04→	Tie Rod End		IV-ES-8507	Tag Axle
	05/04→	Tie Rod End		MN-ES-8490	for vehicles with Hinged Trailing Axle
	05/04→	Tie Rod End		SC-ES-8517	for Push Rod
	05/04→	Tie Rod End	CV-ES-0914		for Steering Rod
	05/04→	Tie Rod End	CV-ES-14162	CV-ES-14162	for Steering Rod
	05/04→	Tie Rod End	CV-ES-14163		for Steering Rod
	05/04→	Tie Rod End	IV-ES-12272		for Steering Rod
	05/04→	Tie Rod End	SC-ES-7279		for Steering Rod
	05/04→	Tie Rod End	SC-ES-8535		for Guide Rod
	05/04→	Track Control Arm		MN-DL-5225	Trailing Arm, Drive Axle;Air Suspension Axle
	05/04→	Track Control Arm		MN-DL-5225	Trailing Arm, Tag Axle;Air Suspension Axle; for vehicles with Hinged Trailing Axle
	05/04→	Track Control Arm		MN-DL-8709	Trailing Arm, Air Suspension Axle; for vehicles with Hinged Trailing Axle
	05/04→	Track Control Arm		MN-DL-8733	Trailing Arm
	05/04→	Track Control Arm		MN-TC-12399	Control Arm
	05/04→	Track Control Arm		MN-VB-5238	Wishbone (CV), Drive Axle;Leading Axle; Air Suspension Axle
	05/04→	Track Control Arm		MN-VB-9403	Wishbone (CV), Air Suspension Axle
	05/04→	Track Control Arm	MN-DL-8663		Control Arm, Air Suspension Axle
	01/05→	Track Control Arm		MN-DL-5225	Trailing Arm, Tag Axle;Air Suspension Axle; for vehicles with Rigid Trailing Axle
	26.430, 26.440, FNLS, FNLLS, FNLLRS, FNLLRS, FPLS, FPLRS	05/04→01/05	Track Control Arm		MN-DL-5212
05/04→		Centre Rod	MN-DL-7801		Push Rod, Leaf Spring Axle
05/04→		Centre Rod	MN-DL-8560		Push Rod, Air Suspension Axle
05/04→		Suspension Strut Repair Kit		CV-RK-5311	
05/04→		Suspension Strut Repair Kit		DB-RK-8581	
05/04→		Suspension Strut Repair Kit		MN-RK-12436	
05/04→		Tie Rod	MN-DL-7802		
05/04→		Tie Rod	MN-DL-12284		
05/04→		Tie Rod End		IV-ES-8507	Tag Axle
05/04→		Tie Rod End		MN-ES-8490	for vehicles with Hinged Trailing Axle
05/04→		Tie Rod End	CV-ES-0914		for Steering Rod
05/04→		Tie Rod End	CV-ES-14163		for Steering Rod
05/04→		Tie Rod End	IV-ES-12272		for Steering Rod
05/04→		Tie Rod End	SC-ES-7279		for Steering Rod
05/04→		Tie Rod End	SC-ES-8517		for Push Rod

CV-ES-0914

Length: 125
Cone Ø: d1 Ø 30 / d2 Ø 27
Thread: M38 x 1,5 RHT
81953016184, 81953016251, 81953016276



CV-ES-14162

Length: 125
Cone Ø: d1 Ø 30 / d2 Ø 27
Thread: M30 x 1,5 LHT
81953010015, 81953010083, 81953010087, 81953016029, 81953016030, 81953016043, 81953016044, 81953016050, 81953016054, 81953016087, 81953016091, 81953016107, 81953016120, 81953016125, 81953016152, 81953016155, 81953016157, 81953016168, 81953016179, 81953016181, 81953016223, 81953016237, 81953016254, 81953016275, 81953016279, 81953016351



CV-ES-14163

Length: 125
Cone Ø: d1 Ø 30 / d2 Ø 27
Thread: M30 x 1,5 RHT
95301.0084, 90804102156, 90804102272, 90804102696, 90804102710, 81953010016, 81953010075, 81953010084, 81953010088, 81953010094, 81953010103, 81953016030, 81953016043, 81953016048, 81953016049, 81953016053, 81953016061, 81953016090, 81953016108, 81953016112, 81953016126, 81953016143, 81953016149, 81953016154, 81953016156, 81953016168, 81953016178, 81953016194, 81953016206, 81953016224, 81953016234, 81953016242, 81953016252, 81953016274, 81953016278, 81953016284, 81953016286, 81953016308, 81953016310, 81953016312, 81953016347, 81953016350, 81953016352, 82953016012, 88953016014, N2953016001



CV-RK-5311

638862, 639287, 938423, 1104335, 1953248, 0003500506, 3500506, 11013547, 42488722, 070550504, 634303610, 81432206055, 81432206073, 82262320660, 5001842823, 7000307001, 8226232066



DB-RK-8581

Ø: 85
Hole Distance: 130
Thick/Height: 24
03305800A, 81432706105



IV-ES-8507

Length: 80
Cone Ø: d1 Ø 30 / d2 Ø 27
Thread: M30 x 1,5 RHT
11019869, 12216380, 55175540, 81953016238



IV-ES-12272

Length: 75
Cone Ø: d1 Ø 30 / d2 Ø 27
Thread: M26 x 1,5 RHT
81953016280, 82953010010



MN-DL-5212

Length: 577 Ø: 48
Hole Distance: 130 / 130
81432206096, 81432206097, 81432206098, 81432206129, 81432209096, 81432209129, 81432306014, 81432306030



MN-DL-5225

Length: 572 Ø: 48
Hole Distance: 130 / 130
03301500A, 81432206229, 81432206236, 81432206267, 81432206270, 81432206272, 81432206304, 81432206305, 81432209236, 81432209267, 81432209272



MN-DL-7801

Length: 995 Ø: 52
Cone Ø: d1 Ø 30 / d2 Ø 27
81466106807, 81466106808, 81466116087, 81466116088, 81466116096, 81466116097, 81466116099, 81466116132, 81466116133, 81466116136, 81466116197, 81466116198, 81466116205



MN-DL-7802

Length: 1680 Ø: 52
Cone Ø: d1 Ø 30 / d2 Ø 27
03208300A, 81467116773, 81467116858, 81467116859, 81467116860, 81467116861, 81467116863, 81467116882, 81467116883, 81467116920, 81467116921



MN-DL-8560

Length: 970 Ø: 52
Cone Ø: d1 Ø 30 / d2 Ø 27
03206900A, 81466106809, 81466106810, 81466106823, 81466106838, 81466106839, 81466116104, 81466116105, 81466116107, 81466116134, 81466116135, 81466116137, 81466116199, 81466116200, 81466116206



MN-DL-8663

Length: 947 Ø: 60
Hole Distance: 115 / 115
03307400A, 81432206222, 81432206260, 81432206283, 81432206284



MN-DL-8709

Length: 572 Ø: 52
Hole Distance: 130 / 130
81432206268, 81432206274, 81432206291, 81432206292, 82432206007



MN-DL-8733

Length: 530 Ø: 48
Hole Distance: 130 / 130
81432206161, 81432206190, 81432206358, 81432206359



MN-DL-12284

Length: 1530 Ø: 50
Cone Ø: d1 Ø 30 / d2 Ø 27
81466106579, 81466106580, 81466106624, 81466116720, 81467116720, 81467116730, 81467116952



MN-ES-8490

Length: 90
Cone Ø: d1 Ø 30 / d2 Ø 27
Thread: M26 x 1,5 RHT
0014606948, 14606948, 81953016281, 81953016337, 82953016016



MN-RK-12436

Ø: 75
Hole Distance: 115
Thick/Height: 24
81432206244



MN-TC-12399

Length: 694 Ø: 50
Hole Distance: 130 / 130
81432206265



MN-VB-5222

Length: 627 Ø: 50
Hole Distance: 152 / 152
81432706030, 81432706034, 81432706054, 81432706055, 81432706056, 81432706057, 81432706067, 81432706068, 81432706074, 81432706075, 81432706076, 81432706077, 81432706078, 81432706081, 81432706082, 81432709034, 81432709076, 81432709078, 8143706054



MN-VB-5238

Length: 627 Ø: 48
Hole Distance: 130 / 130
81432206221, 81432706096, 81432706114, 81432706116, 81432706121



MN-VB-8669

Length: 627 Ø: 48
Hole Ø 25 / 25 / 25
Hole Distance: 152 / 130 / 130
81432706116, 81432706137, 81432706150, 81432706151



MN-VB-9403

Length: 627 Ø: 48
Hole Ø 25 / 23 / 23
Hole Distance: 152 / 130 / 130
81432706097, 81432706113, 81432706135, 81432706160, 81432706161



SC-ES-7279

Length: 150
Cone Ø: d1 Ø 30 / d2 Ø 27
Thread: M30 x 1,5 RHT
81953016288



SC-ES-8517

Length: 140
Cone Ø: d1 Ø 30 / d2 Ø 27
Thread: M30 x 1,5 RHT
81953016286



SC-ES-8535

Length: 145
Cone Ø: d1 Ø 30 / d2 Ø 27
Thread: M30 x 1,5 RHT
81953016271, 81953016325





TGA ...

26.430, 26.440, FNLS, FNLLS, FNLRS, FNLLRS, FPLS, FPLRS ...	05/04 →	Tie Rod End	SC-ES-8535		for Guide Rod
	05/04 →	Track Control Arm		MN-DL-5225	Trailing Arm, Drive Axle; Air Suspension Axle
	05/04 →	Track Control Arm		MN-DL-5225	Trailing Arm, Leading Axle; Air Suspension Axle
	05/04 →	Track Control Arm		MN-DL-5225	Trailing Arm, Tag Axle; Air Suspension Axle; for vehicles with Hinged Trailing Axle
	05/04 →	Track Control Arm		MN-DL-8709	Trailing Arm, Air Suspension Axle; for vehicles with Hinged Trailing Axle
	05/04 →	Track Control Arm		MN-DL-8733	Trailing Arm, Air Suspension Axle; Drive Axle
	05/04 →	Track Control Arm		MN-TC-12399	Control Arm
	05/04 →	Track Control Arm		MN-VB-5238	Wishbone (CV), Drive Axle; Air Suspension Axle
	05/04 →	Track Control Arm		MN-VB-5238	Wishbone (CV), Drive Axle; Leading Axle; Air Suspension Axle
	05/04 →	Track Control Arm		MN-VB-5238	Wishbone (CV), Leading Axle; Air Suspension Axle
	05/04 →	Track Control Arm		MN-VB-9403	Wishbone (CV), Air Suspension Axle
	05/04 →	Track Control Arm	MN-DL-8663		Control Arm, Air Suspension Axle
	26.440 FDAC, FDALC, FDHC, FDHLC	01/05 →	Track Control Arm		MN-DL-5225
09/05 →		Centre Rod	MN-DL-2160		Coupling Rod
09/05 →		Centre Rod	MN-DL-2174		Push Rod
09/05 →		Suspension Arm Repair Kit		CV-RK-5313	for Wishbone (CV)
09/05 →		Tie Rod End	CV-ES-0914		for Steering Rod
09/05 →		Tie Rod End	CV-ES-14162		for Steering Rod
09/05 →		Tie Rod End	CV-ES-14163		for Steering Rod
09/05 →		Tie Rod End	MN-ES-10333		for Steering Rod
09/05 →		Tie Rod End	SC-ES-7279		for Steering Rod
09/05 →		Tie Rod End	SC-ES-8517		for Push Rod
09/05 →		Tie Rod End	SC-ES-8535		for Guide Rod
09/05 →		Track Control Arm		MN-DL-8609	Trailing Arm, 1st RA; 2nd RA, for Leaf-Spring Suspension vehicles, →Type_HB Chassis
09/05 →		Track Control Arm		MN-VB-5238	Wishbone (CV), 1st RA; 2nd RA, for Pneumatic Suspension vehicles, →Type_NBA Chassis
09/05 →		Track Control Arm		MN-VB-8514	Suspension Rod, Wishbone (CV)
09/05 →		Track Control Arm		MN-VB-8669	Suspension Rod, Wishbone (CV), 1st RA; 2nd RA, for Leaf-Spring Suspension vehicles, →Type_MHB Chassis
09/05 →		Track Control Arm		MN-VB-9404	Wishbone (CV), 1st RA; 2nd RA, for Leaf-Spring Suspension vehicles, →Type_HB Chassis
26.440 FDAK, FDALK		01/04 →	Centre Rod	MN-DL-2160	
	01/04 →	Centre Rod	MN-DL-2174		Push Rod
	01/04 →	Suspension Arm Repair Kit		CV-RK-5313	for Wishbone (CV)
	01/04 →	Tie Rod End	CV-ES-0914		for Steering Rod
	01/04 →	Tie Rod End	CV-ES-14162		for Steering Rod
	01/04 →	Tie Rod End	CV-ES-14163		for Steering Rod
	01/04 →	Tie Rod End	MN-ES-10333		for Steering Rod
	01/04 →	Tie Rod End	SC-ES-7279		for Steering Rod
	01/04 →	Tie Rod End	SC-ES-8517		for Push Rod
	01/04 →	Tie Rod End	SC-ES-8535		for Guide Rod
	01/04 →	Track Control Arm		MN-DL-8609	Trailing Arm, 1st RA; 2nd RA, for Leaf-Spring Suspension vehicles, →Type_HB Chassis
	01/04 →	Track Control Arm		MN-VB-5238	Wishbone (CV), 1st RA; 2nd RA, for Pneumatic Suspension vehicles, →Type_NBA Chassis
	01/04 →	Track Control Arm		MN-VB-8514	Suspension Rod, Wishbone (CV)
	01/04 →	Track Control Arm		MN-VB-8669	Suspension Rod, Wishbone (CV), 1st RA; 2nd RA, for Leaf-Spring Suspension vehicles, →Type_MHB Chassis
	01/04 →	Track Control Arm		MN-VB-9404	Wishbone (CV), 1st RA; 2nd RA, for Leaf-Spring Suspension vehicles, →Type_HB
26.440 FDALS, FDAS, FDHLS, FDHS	01/04 →	Centre Rod	MN-DL-2160		Coupling Rod
	01/04 →	Centre Rod	MN-DL-2174		Push Rod
	01/04 →	Suspension Arm Repair Kit		CV-RK-5313	for Wishbone (CV)
	01/04 →	Tie Rod End	CV-ES-0914		for Steering Rod
	01/04 →	Tie Rod End	CV-ES-14162		for Steering Rod
	01/04 →	Tie Rod End	CV-ES-14163		for Steering Rod

CV-ES-0914

Length: 125
Cone Ø: d1 Ø 30 / d2 Ø 27
Thread: M38 x 1,5 RHT
81953016184, 81953016251, 81953016276



CV-ES-14162

Length: 125
Cone Ø: d1 Ø 30 / d2 Ø 27
Thread: M30 x 1,5 LHT
81953010015, 81953010083, 81953010087, 81953016029, 81953016030, 81953016043, 81953016044, 81953016050, 81953016054, 81953016087, 81953016091, 81953016107, 81953016120, 81953016125, 81953016152, 81953016155, 81953016157, 81953016168, 81953016179, 81953016181, 81953016223, 81953016237, 81953016254, 81953016275, 81953016279, 81953016351



CV-ES-14163

Length: 125
Cone Ø: d1 Ø 30 / d2 Ø 27
Thread: M30 x 1,5 RHT
95301.0084, 90804102156, 90804102272, 90804102696, 90804102710, 81953010016, 81953010075, 81953010084, 81953010088, 81953010094, 81953010103, 81953016030, 81953016043, 81953016048, 81953016049, 81953016053, 81953016061, 81953016090, 81953016108, 81953016112, 81953016126, 81953016143, 81953016149, 81953016154, 81953016156, 81953016168, 81953016178, 81953016194, 81953016206, 81953016224, 81953016234, 81953016242, 81953016252, 81953016274, 81953016278, 81953016284, 81953016286, 81953016308, 81953016310, 81953016312, 81953016347, 81953016350, 81953016352, 82953016012, 88953016014, N2953016001



CV-RK-5313

Ø: 90
03304800A, 81953016132



MN-DL-2160

Length: 1652 Ø: 50
Cone Ø: d1 Ø 30 / d2 Ø 27
81467106112, 81467106163, 81467106165, 81467106198, 81467106353, 81467106354, 81467106361, 81467116725



MN-DL-2174

Length: 1588 Ø: 52
Cone Ø: d1 Ø 30 / d2 Ø 27
81467106378, 81467106912



MN-DL-5225

Length: 572 Ø: 48
Hole Distance: 130 / 130
03301500A, 81432206229, 81432206236, 81432206267, 81432206270, 81432206272, 81432206304, 81432206305, 81432209236, 81432209267, 81432209272



MN-DL-8609

Length: 585 Ø: 58
Hole Distance: 130 / 130
81432206070, 81432206071, 81432206072, 81432206091, 81432206093, 81432206119



MN-DL-8663

Length: 947 Ø: 60
Hole Distance: 115 / 115
03307400A, 81432206222, 81432206260, 81432206283, 81432206284



MN-DL-8709

Length: 572 Ø: 52
Hole Distance: 130 / 130
81432206268, 81432206274, 81432206291, 81432206292, 82432206007



MN-DL-8733

Length: 530 Ø: 48
Hole Distance: 130 / 130
81432206161, 81432206190, 81432206358, 81432206359



MN-ES-10333

Length: 90
Cone Ø: d1 Ø 38 / d2 Ø 34,35
Thread: M36 x 1,5 RHT
1271126, 3090291, 3099128, 42538048, 81953016268, 82953016018, 82953016019



MN-TC-12399

Length: 694 Ø: 50
Hole Distance: 130 / 130
81432206265



MN-VB-5238

Length: 627 Ø: 48
Hole Distance: 130 / 130
81432206221, 81432706096, 81432706114, 81432706116, 81432706121



MN-VB-8514

Length: 627 Ø: 48
Hole Ø 25 / 25 / 25
Hole Distance: 152 / 130 / 130
81432706087, 81432706088, 81432706094, 81432706095, 81432796094



MN-VB-8669

Length: 627 Ø: 48
Hole Ø 25 / 25 / 25
Hole Distance: 152 / 130 / 130
81432706116, 81432706137, 81432706150, 81432706151



MN-VB-9403

Length: 627 Ø: 48
Hole Ø 25 / 23 / 23
Hole Distance: 152 / 130 / 130
81432706097, 81432706113, 81432706135, 81432706160, 81432706161



MN-VB-9404

Length: 627 Ø: 58
Hole Distance: 130 / 130
81432706117, 81432706152, 81432706153



SC-ES-7279

Length: 150
Cone Ø: d1 Ø 30 / d2 Ø 27
Thread: M30 x 1,5 RHT
81953016288



SC-ES-8517

Length: 140
Cone Ø: d1 Ø 30 / d2 Ø 27
Thread: M30 x 1,5 RHT
81953016286



SC-ES-8535

Length: 145
Cone Ø: d1 Ø 30 / d2 Ø 27
Thread: M30 x 1,5 RHT
81953016271, 81953016325





TGA ...

26.440 FDALS, FDAS, FDHLS, FDHS ...	01/04 →	Tie Rod End	MN-ES-10333		for Steering Rod	
	01/04 →	Tie Rod End	SC-ES-7279		for Steering Rod	
	01/04 →	Tie Rod End	SC-ES-8517		for Push Rod	
	01/04 →	Tie Rod End	SC-ES-8535		for Guide Rod	
	01/04 →	Track Control Arm		MN-DL-8609	Trailing Arm, 1st RA;2nd RA, for Leaf-Spring Suspension vehicles, →Type_HB Chassis	
	01/04 →	Track Control Arm		MN-VB-5238	Wishbone (CV), 1st RA;2nd RA, for Pneumatic Suspension vehicles, →Type_NBA Chassis	
	01/04 →	Track Control Arm		MN-VB-8514	Suspension Rod, Wishbone (CV)	
	01/04 →	Track Control Arm		MN-VB-8669	Suspension Rod, Wishbone (CV), 1st RA; 2nd RA, for Leaf-Spring Suspension vehicles, →Type_MHB Chassis	
	01/04 →	Track Control Arm		MN-VB-9404	Wishbone (CV), 1st RA;2nd RA, for Leaf-Spring Suspension vehicles, →Type_HB	
26.440 FDC, FDLC, FDLRC, FDRC, FNHLC	02/06 →	Centre Rod	MN-DL-7801		Push Rod, Leaf Spring Axle	
	02/06 →	Suspension Strut Repair Kit		DB-RK-8581		
	02/06 →	Tie Rod	MN-DL-7802			
	02/06 →	Track Control Arm		MN-DL-5225	Trailing Arm	
26.440 FDLRS, FDLS, FDRS, FDS, FNHLS, FPHLS, FVHLS	02/06 →	Centre Rod	MN-DL-7801		Push Rod, Leaf Spring Axle	
	02/06 →	Suspension Strut Repair Kit		DB-RK-8581		
	02/06 →	Tie Rod	MN-DL-7802			
	02/06 →	Track Control Arm		MN-DL-5225	Trailing Arm	
26.440 FVL-KO	09/05 →	Centre Rod	MN-DL-7801		Push Rod	
	09/05 →	Suspension Arm Repair Kit		CV-RK-5313	for Wishbone (CV)	
	09/05 →	Suspension Arm Repair Kit	DB-RK-9300	DB-RK-9300	for Drag Link	
	09/05 →	Suspension Strut Repair Kit		CV-RK-5311		
	09/05 →	Tie Rod	MN-DL-7802			
	09/05 →	Tie Rod End		SC-ES-8517	for Push Rod	
	09/05 →	Tie Rod End	CV-ES-0914		for Steering Rod	
	09/05 →	Tie Rod End	CV-ES-14163		for Steering Rod	
	09/05 →	Tie Rod End	SC-ES-7279		for Steering Rod	
	09/05 →	Tie Rod End	SC-ES-8535		for Guide Rod	
	09/05 →	Track Control Arm		MN-DL-5225	Trailing Arm	
	09/05 →	Track Control Arm		MN-DL-8733	Trailing Arm, 1st Drive Axle, for Pneumatic Suspension vehicles	
	09/05 →	Track Control Arm		MN-VB-5238	Wishbone (CV), 1st Drive Axle, for Pneumatic Suspension vehicles	
	26.440 FVLS, FVLRS	09/05 →	Centre Rod	MN-DL-7801		Push Rod
		09/05 →	Suspension Strut Repair Kit		MN-RK-12436	
09/05 →		Tie Rod	MN-DL-7802			
09/05 →		Tie Rod	MN-DL-12284			
09/05 →		Tie Rod End		SC-ES-8517	for Push Rod	
09/05 →		Tie Rod End	CV-ES-0914		for Steering Rod	
09/05 →		Tie Rod End	CV-ES-14162	CV-ES-14162	for Steering Rod	
09/05 →		Tie Rod End	CV-ES-14163		for Steering Rod	
09/05 →		Tie Rod End	SC-ES-7279		for Steering Rod	
09/05 →		Tie Rod End	SC-ES-8535		for Guide Rod	
09/05 →		Track Control Arm		MN-DL-5212	Trailing Arm, Trailing Axle Steered, for Pneumatic Suspension vehicles	
09/05 →		Track Control Arm		MN-DL-5225	Trailing Arm	
09/05 →		Track Control Arm		MN-DL-8709	Trailing Arm, 1st Drive Axle, for Pneumatic Suspension vehicles	
09/05 →		Track Control Arm		MN-DL-8709	Trailing Arm, Trailing Axle Steered, for Pneumatic Suspension vehicles	
09/05 →		Track Control Arm		MN-DL-8733	Trailing Arm, 1st Drive Axle, for Pneumatic Suspension vehicles	
09/05 →		Track Control Arm		MN-VB-5238	Wishbone (CV), 1st Drive Axle, for Pneumatic Suspension vehicles	
09/05 →		Track Control Arm		MN-VB-9403	Wishbone (CV), Trailing Axle Steered, for Pneumatic Suspension vehicles	
09/05 →		Track Control Arm	MN-DL-8663		Control Arm	

CV-ES-0914

Length: 125
Cone Ø: d1 Ø 30 / d2 Ø 27
Thread: M38 x 1,5 RHT
81953016184, 81953016251, 81953016276



CV-ES-14162

Length: 125
Cone Ø: d1 Ø 30 / d2 Ø 27
Thread: M30 x 1,5 LHT
81953010015, 81953010083, 81953010087, 81953016029, 81953016030, 81953016043, 81953016044, 81953016050, 81953016054, 81953016087, 81953016091, 81953016107, 81953016120, 81953016125, 81953016152, 81953016155, 81953016157, 81953016168, 81953016179, 81953016181, 81953016223, 81953016237, 81953016254, 81953016275, 81953016279, 81953016351



CV-ES-14163

Length: 125
Cone Ø: d1 Ø 30 / d2 Ø 27
Thread: M30 x 1,5 RHT
95301.0084, 90804102156, 90804102272, 90804102696, 90804102710, 81953010016, 81953010075, 81953010084, 81953010088, 81953010094, 81953010103, 81953016030, 81953016043, 81953016048, 81953016049, 81953016053, 81953016061, 81953016090, 81953016108, 81953016112, 81953016126, 81953016143, 81953016149, 81953016154, 81953016156, 81953016168, 81953016178, 81953016194, 81953016206, 81953016224, 81953016234, 81953016242, 81953016252, 81953016274, 81953016278, 81953016284, 81953016286, 81953016308, 81953016310, 81953016312, 81953016347, 81953016350, 81953016352, 82953016012, 88953016014, N2953016001



CV-RK-5311

638862, 639287, 938423, 1104335, 1953248, 0003500506, 3500506, 11013547, 42488722, 070550504, 634303610, 81432206055, 81432206073, 82262320660, 5001842823, 7000307001, 8226232066



CV-RK-5313

Ø: 90
03304800A, 81953016132



DB-RK-8581

Ø: 85 Hole Distance: 130
Thick/Height: 24
03305800A, 81432706105



DB-RK-9300

Ø: 75 Hole Distance: 130
Thick/Height: 24
85432206002



MN-DL-5212

Length: 577 Ø: 48
Hole Distance: 130 / 130
81432206096, 81432206097, 81432206098, 81432206129, 81432209096, 81432209129, 81432306014, 81432306030



MN-DL-5225

Length: 572 Ø: 48
Hole Distance: 130 / 130
03301500A, 81432206229, 81432206236, 81432206267, 81432206270, 81432206272, 81432206304, 81432206305, 81432209236, 81432209267, 81432209272



MN-DL-7801

Length: 995 Ø: 52
Cone Ø: d1 Ø 30 / d2 Ø 27
81466106807, 81466106808, 81466116087, 81466116088, 81466116096, 81466116097, 81466116099, 81466116132, 81466116133, 81466116136, 81466116197, 81466116198, 81466116205



MN-DL-7802

Length: 1680 Ø: 52
Cone Ø: d1 Ø 30 / d2 Ø 27
03208300A, 81467116773, 81467116858, 81467116859, 81467116860, 81467116861, 81467116863, 81467116882, 81467116883, 81467116920, 81467116921



MN-DL-8609

Length: 585 Ø: 58
Hole Distance: 130 / 130
81432206070, 81432206071, 81432206072, 81432206091, 81432206093, 81432206119



MN-DL-8663

Length: 947 Ø: 60
Hole Distance: 115 / 115
03307400A, 81432206222, 81432206260, 81432206283, 81432206284



MN-DL-8709

Length: 572 Ø: 52
Hole Distance: 130 / 130
81432206268, 81432206274, 81432206291, 81432206292, 82432206007



MN-DL-8733

Length: 530 Ø: 48
Hole Distance: 130 / 130
81432206161, 81432206190, 81432206358, 81432206359



MN-DL-12284

Length: 1530 Ø: 50
Cone Ø: d1 Ø 30 / d2 Ø 27
81466106579, 81466106580, 81466106624, 81466116720, 81467116720, 81467116730, 81467116952



MN-ES-10333

Length: 90
Cone Ø: d1 Ø 38 / d2 Ø 34,35
Thread: M36 x 1,5 RHT
1271126, 3090291, 3099128, 42538048, 81953016268, 82953016018, 82953016019



MN-RK-12436

Ø: 75
Hole Distance: 115
Thick/Height: 24
81432206244



MN-VB-5238

Length: 627 Ø: 48
Hole Distance: 130 / 130
81432206221, 81432706096, 81432706114, 81432706116, 81432706121



MN-VB-8514

Length: 627 Ø: 48
Hole Ø 25 / 25 / 25
Hole Distance: 152 / 130 / 130
81432706087, 81432706088, 81432706094, 81432706095, 81432796094



MN-VB-8669

Length: 627 Ø: 48
Hole Ø 25 / 25 / 25
Hole Distance: 152 / 130 / 130
81432706116, 81432706137, 81432706150, 81432706151



MN-VB-9403

Length: 627 Ø: 48
Hole Ø 25 / 23 / 23
Hole Distance: 152 / 130 / 130
81432706097, 81432706113, 81432706135, 81432706160, 81432706161



MN-VB-9404

Length: 627 Ø: 58
Hole Distance: 130 / 130
81432706117, 81432706152, 81432706153



SC-ES-7279

Length: 150
Cone Ø: d1 Ø 30 / d2 Ø 27
Thread: M30 x 1,5 RHT
81953016288



SC-ES-8517

Length: 140
Cone Ø: d1 Ø 30 / d2 Ø 27
Thread: M30 x 1,5 RHT
81953016286



SC-ES-8535

Length: 145
Cone Ø: d1 Ø 30 / d2 Ø 27
Thread: M30 x 1,5 RHT
81953016271, 81953016325





TGA ...

26.460 FDC, FDLK, FDLRC, FDRK	01/01→	Ball Head, gearshift linkage	CV-ES-2120		
	01/01→	Centre Rod	MN-DL-7801	Push Rod, Leaf Spring Axle	
	01/01→	Centre Rod	MN-DL-8560	Push Rod, Air Suspension Axle	
	01/01→	Suspension Strut Repair Kit		DB-RK-8581	
	01/01→	Suspension Strut Repair Kit		MN-RK-12436	
	01/01→	Tie Rod	MN-DL-7802		
	01/01→	Tie Rod End	CV-ES-0914	for Steering Rod	
	01/01→	Tie Rod End	CV-ES-14162	for Steering Rod	
	01/01→	Tie Rod End	CV-ES-14163	for Steering Rod	
	01/01→	Tie Rod End	SC-ES-7279	for Steering Rod	
	01/01→	Tie Rod End	SC-ES-8517	for Push Rod	
	01/01→	Tie Rod End	SC-ES-8535	for Guide Rod	
	01/01→	Track Control Arm		MN-DL-3402	Trailing Arm, Air Suspension Axle; Drive Axle
	01/01→	Track Control Arm		MN-DL-5225	Trailing Arm, Drive Axle; Air Suspension Axle
	01/01→	Track Control Arm		MN-DL-8544	Trailing Arm, Drive Axle; Air Suspension Axle
	01/01→	Track Control Arm		MN-DL-8544	Trailing Arm, Drive Axle; Leaf Spring Axle
	01/01→	Track control arm		MN-DL-10288	Trailing Arm, 1st RA; 2nd RA, for Leaf-Spring Suspension vehicles
	01/01→	Track control arm		MN-DL-12288	Trailing Arm
	01/01→	Track Control Arm		MN-VB-5222	Wishbone (CV), 1st RA; 2nd RA, for Pneumatic Suspension vehicles
	01/01→	Track Control Arm		MN-VB-5238	Wishbone (CV), Drive Axle; Air Suspension Axle
	01/01→	Track Control Arm		MN-VB-8514	Suspension Rod, Wishbone (CV), Drive Axle; Leaf Spring Axle
	01/01→	Track Control Arm		MN-VB-8669	Suspension Rod, Wishbone (CV), Drive Axle
	01/01→	Track Control Arm		MN-VB-8669	Suspension Rod, Wishbone (CV), Drive Axle; Leaf Spring Axle
	01/01→	Track Control Arm		MN-VB-9404	Wishbone (CV), Drive Axle
	01/01→	Track Control Arm		MN-VB-9404	Wishbone (CV), Drive Axle; Air Suspension Axle
01/01→	Track Control Arm	MN-DL-8663		Control Arm, Air Suspension Axle	
26.460 FDK, FDLK, FDLRK, FDRK	01/01→	Ball Head, gearshift linkage	CV-ES-2120		
	01/01→	Centre Rod	MN-DL-7801	Push Rod, Leaf Spring Axle	
	01/01→	Centre Rod	MN-DL-8560	Push Rod, Air Suspension Axle	
	01/01→	Suspension Strut Repair Kit		DB-RK-8581	
	01/01→	Suspension Strut Repair Kit		MN-RK-12436	
	01/01→	Tie Rod	MN-DL-7802		
	01/01→	Tie Rod End	CV-ES-0914	for Steering Rod	
	01/01→	Tie Rod End	CV-ES-14162	for Steering Rod	
	01/01→	Tie Rod End	CV-ES-14163	for Steering Rod	
	01/01→	Tie Rod End	SC-ES-7279	for Steering Rod	
	01/01→	Tie Rod End	SC-ES-8517	for Push Rod	
	01/01→	Tie Rod End	SC-ES-8535	for Guide Rod	
	01/01→	Track Control Arm		MN-DL-3402	Trailing Arm, Air Suspension Axle; Drive Axle
	01/01→	Track Control Arm		MN-DL-5225	Trailing Arm, Drive Axle; Air Suspension Axle
	01/01→	Track Control Arm		MN-DL-8544	Trailing Arm, Drive Axle; Air Suspension Axle
	01/01→	Track Control Arm		MN-DL-8544	Trailing Arm, Drive Axle; Leaf Spring Axle
	01/01→	Track control arm		MN-DL-10288	Trailing Arm, 1st RA; 2nd RA, for Leaf-Spring Suspension vehicles
	01/01→	Track control arm		MN-DL-12288	Trailing Arm
	01/01→	Track Control Arm		MN-VB-5222	Wishbone (CV), 1st RA; 2nd RA, for Pneumatic Suspension vehicles
	01/01→	Track Control Arm		MN-VB-5238	Wishbone (CV), Drive Axle; Air Suspension Axle
	01/01→	Track Control Arm		MN-VB-8514	Suspension Rod, Wishbone (CV), Drive Axle; Leaf Spring Axle
	01/01→	Track Control Arm		MN-VB-8669	Suspension Rod, Wishbone (CV), Drive Axle
	01/01→	Track Control Arm		MN-VB-8669	Suspension Rod, Wishbone (CV), Drive Axle; Leaf Spring Axle
	01/01→	Track Control Arm		MN-VB-9404	Wishbone (CV), Drive Axle
	01/01→	Track Control Arm		MN-VB-9404	Wishbone (CV), Drive Axle; Air Suspension Axle
01/01→	Track Control Arm	MN-DL-8663		Control Arm, Air Suspension Axle	

CV-ES-0914

Length: 125
Cone Ø: d1 Ø 30 / d2 Ø 27
Thread: M38 x 1,5 RHT
81953016184, 81953016251, 81953016276



CV-ES-2120

Length: 115
Cone Ø: d1 Ø 12,4 / d2 Ø 10,8
Thread: M14 x 1,5 RHT
03008500A, 81953016200, 81953016202, 81953016203, 81953016227



CV-ES-14162

Length: 125
Cone Ø: d1 Ø 30 / d2 Ø 27
Thread: M30 x 1,5 LHT
81953010015, 81953010083, 81953010087, 81953016029, 81953016030, 81953016043, 81953016044, 81953016050, 81953016054, 81953016087, 81953016091, 81953016107, 81953016120, 81953016125, 81953016152, 81953016155, 81953016157, 81953016168, 81953016179, 81953016181, 81953016223, 81953016237, 81953016254, 81953016275, 81953016279, 81953016351



CV-ES-14163

Length: 125
Cone Ø: d1 Ø 30 / d2 Ø 27
Thread: M30 x 1,5 RHT
95301.0084, 90804102156, 90804102272, 90804102696, 90804102710, 81953010016, 81953010075, 81953010084, 81953010088, 81953010094, 81953010103, 81953016030, 81953016043, 81953016048, 81953016049, 81953016053, 81953016061, 81953016090, 81953016108, 81953016112, 81953016126, 81953016143, 81953016149, 81953016154, 81953016156, 81953016168, 81953016178, 81953016194, 81953016206, 81953016224, 81953016234, 81953016242, 81953016252, 81953016274, 81953016278, 81953016284, 81953016286, 81953016308, 81953016310, 81953016312, 81953016347, 81953016350, 81953016352, 82953016012, 88953016014, N2953016001



DB-RK-8581

Ø: 85
Hole Distance: 130
Thick/Height: 24
03305800A, 81432706105



MN-DL-3402

Length: 590 Ø: 48
Hole Distance: 130 / 130
03307200A, 81432206067, 81432206068, 81432206090, 81432206092, 81432209092



MN-DL-5225

Length: 572 Ø: 48
Hole Distance: 130 / 130
03301500A, 81432206229, 81432206236, 81432206267, 81432206270, 81432206272, 81432206304, 81432206305, 81432209236, 81432209267, 81432209272



MN-DL-7801

Length: 995 Ø: 52
Cone Ø: d1 Ø 30 / d2 Ø 27
81466106807, 81466106808, 81466116087, 81466116088, 81466116096, 81466116097, 81466116099, 81466116132, 81466116133, 81466116136, 81466116197, 81466116198, 81466116205

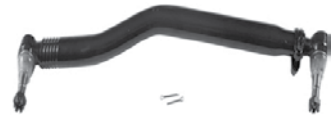

MN-DL-7802

Length: 1680 Ø: 52
Cone Ø: d1 Ø 30 / d2 Ø 27
03208300A, 81467116773, 81467116858, 81467116859, 81467116860, 81467116861, 81467116863, 81467116882, 81467116883, 81467116920, 81467116921



MN-DL-8544

Length: 596 Ø: 48
Hole Distance: 130 / 130
81432206196, 81432206232, 81432206233



MN-DL-8560

Length: 970 Ø: 52
Cone Ø: d1 Ø 30 / d2 Ø 27
03206900A, 81466106809, 81466106810, 81466106823, 81466106838, 81466106839, 81466116104, 81466116105, 81466116107, 81466116134, 81466116135, 81466116137, 81466116199, 81466116200, 81466116206



MN-DL-8663

Length: 947 Ø: 60
Hole Distance: 115 / 115
03307400A, 81432206222, 81432206260, 81432206283, 81432206284



MN-DL-10288

81432206386, 82432206008, 82432209008

No Image

MN-DL-12288

Length: 585 Ø: 58
Hole Distance: 130 / 130
81432206386, 82432206008, 82432209008

No Image

MN-RK-12436

Ø: 75
Hole Distance: 115
Thick/Height: 24
81432206244



MN-VB-5222

Length: 627 Ø: 50
Hole Distance: 152 / 152
81432706030, 81432706034, 81432706054, 81432706055, 81432706056, 81432706057, 81432706067, 81432706068, 81432706074, 81432706075, 81432706076, 81432706077, 81432706078, 81432706081, 81432706082, 81432709034, 81432709076, 81432709078, 8143706054



MN-VB-5238

Length: 627 Ø: 48
Hole Distance: 130 / 130
81432206221, 81432706096, 81432706114, 81432706116, 81432706121



MN-VB-8514

Length: 627 Ø: 48
Hole Ø 25 / 25 / 25
Hole Distance: 152 / 130 / 130
81432706087, 81432706088, 81432706094, 81432706095, 81432796094



MN-VB-8669

Length: 627 Ø: 48
Hole Ø 25 / 25 / 25
Hole Distance: 152 / 130 / 130
81432706116, 81432706137, 81432706150, 81432706151



MN-VB-9404

Length: 627 Ø: 58
Hole Distance: 130 / 130
81432706117, 81432706152, 81432706153



SC-ES-7279

Length: 150
Cone Ø: d1 Ø 30 / d2 Ø 27
Thread: M30 x 1,5 RHT
81953016288



SC-ES-8517

Length: 140
Cone Ø: d1 Ø 30 / d2 Ø 27
Thread: M30 x 1,5 RHT
81953016286



SC-ES-8535

Length: 145
Cone Ø: d1 Ø 30 / d2 Ø 27
Thread: M30 x 1,5 RHT
81953016271, 81953016325





TGA ...

26.460 FDLRS, FDLS, FDRS, FDS	06/01→	Ball Head, gearshift linkage	CV-ES-2120		
	06/01→	Centre Rod	MN-DL-7801		Push Rod, Leaf Spring Axle
	06/01→	Centre Rod	MN-DL-8560		Push Rod, Air Suspension Axle
	06/01→	Suspension Strut Repair Kit		DB-RK-8581	
	06/01→	Suspension Strut Repair Kit		MN-RK-12436	
	06/01→	Tie Rod	MN-DL-7802		
	06/01→	Tie Rod End	CV-ES-0914		for Steering Rod
	06/01→	Tie Rod End	CV-ES-14162		for Steering Rod
	06/01→	Tie Rod End	CV-ES-14163		for Steering Rod
	06/01→	Tie Rod End	SC-ES-7279		for Steering Rod
	06/01→	Tie Rod End	SC-ES-8517		for Steering Rod
	06/01→	Tie Rod End	SC-ES-8535		for Guide Rod
	06/01→	Track Control Arm		MN-DL-3402	Trailing Arm, Air Suspension Axle; Drive Axle
	06/01→	Track Control Arm		MN-DL-5225	Trailing Arm, Drive Axle; Air Suspension Axle
	06/01→	Track Control Arm		MN-DL-8544	Trailing Arm, Drive Axle; Air Suspension Axle
	06/01→	Track Control Arm		MN-DL-8544	Trailing Arm, Drive Axle; Leaf Spring Axle
	06/01→	Track control arm		MN-DL-10288	Trailing Arm, 1st RA; 2nd RA, for Leaf-Spring Suspension vehicles
	06/01→	Track control arm		MN-DL-12288	Trailing Arm
	06/01→	Track Control Arm		MN-VB-5222	Wishbone (CV), 1st RA; 2nd RA, for Pneumatic Suspension vehicles
	06/01→	Track Control Arm		MN-VB-5238	Wishbone (CV), Drive Axle; Air Suspension Axle
	06/01→	Track Control Arm		MN-VB-8514	Suspension Rod, Wishbone (CV), Drive Axle; Leaf Spring Axle
	06/01→	Track Control Arm		MN-VB-8669	Suspension Rod, Wishbone (CV), Drive Axle
	06/01→	Track Control Arm		MN-VB-8669	Suspension Rod, Wishbone (CV), Drive Axle; Leaf Spring Axle
	06/01→	Track Control Arm		MN-VB-9404	Wishbone (CV), Drive Axle
	06/01→	Track Control Arm		MN-VB-9404	Wishbone (CV), Drive Axle; Air Suspension Axle
06/01→	Track Control Arm	MN-DL-8663		Control Arm, Air Suspension Axle	
26.460 FD-TM, FDR-TM	01/01→	Ball Head, gearshift linkage	CV-ES-2120		
	01/01→	Centre Rod	MN-DL-7801		Push Rod, Leaf Spring Axle
	01/01→	Suspension Strut Repair Kit		DB-RK-8581	
	01/01→	Tie Rod	MN-DL-7802		
	01/01→	Tie Rod End	CV-ES-0914		for Steering Rod
	01/01→	Tie Rod End	CV-ES-14162		for Steering Rod
	01/01→	Tie Rod End	CV-ES-14163		for Steering Rod
	01/01→	Tie Rod End	SC-ES-7279		for Steering Rod
	01/01→	Tie Rod End	SC-ES-8517		for Push Rod
	01/01→	Tie Rod End	SC-ES-8535		for Guide Rod
	01/01→	Track Control Arm		MN-DL-5225	Trailing Arm
	01/01→	Track Control Arm		MN-DL-8544	Trailing Arm, Drive Axle; Leaf Spring Axle
	01/01→	Track control arm		MN-DL-10288	Trailing Arm, 1st RA; 2nd RA, for Leaf-Spring Suspension vehicles
	01/01→	Track control arm		MN-DL-12288	Trailing Arm
	01/01→	Track Control Arm		MN-VB-8514	Suspension Rod, Wishbone (CV), Drive Axle; Leaf Spring Axle
	01/01→	Track Control Arm		MN-VB-8669	Suspension Rod, Wishbone (CV), Drive Axle; Leaf Spring Axle
	01/01→	Track Control Arm		MN-VB-9404	Wishbone (CV), Drive Axle
26.460 FNLC, FNLLC, FNLLRC, FNLLRW, FNLLW, FNLLRC	04/00→01/05	Track Control Arm		MN-DL-5212	Trailing Arm, Tag Axle; Air Suspension Axle
	04/00→	Ball Head, gearshift linkage	CV-ES-2120		
	04/00→	Centre Rod	MN-DL-7801		Push Rod, Leaf Spring Axle
	04/00→	Centre Rod	MN-DL-8560		Push Rod, Air Suspension Axle
	04/00→	Suspension Strut Repair Kit		CV-RK-5311	
	04/00→	Suspension Strut Repair Kit		DB-RK-8581	
	04/00→	Suspension Strut Repair Kit		MN-RK-8537	
	04/00→	Suspension Strut Repair Kit		MN-RK-12436	
	04/00→	Tie Rod	MN-DL-7802		
	04/00→	Tie Rod	MN-DL-12284		
	04/00→	Tie Rod End		IV-ES-8507	Tag Axle
	04/00→	Tie Rod End		MN-ES-8490	for vehicles with Hinged Trailing Axle
	04/00→	Tie Rod End	CV-ES-0914		for Steering Rod

CV-ES-0914

Length: 125
Cone Ø: d1 Ø 30 / d2 Ø 27
Thread: M38 x 1,5 RHT
81953016184, 81953016251, 81953016276



CV-ES-2120

Length: 115
Cone Ø: d1 Ø 12,4 / d2 Ø 10,8
Thread: M14 x 1,5 RHT
03008500A, 81953016200, 81953016202, 81953016203, 81953016227



CV-ES-14162

Length: 125
Cone Ø: d1 Ø 30 / d2 Ø 27
Thread: M30 x 1,5 LHT
81953010015, 81953010083, 81953010087, 81953016029, 81953016030, 81953016043, 81953016044, 81953016050, 81953016054, 81953016087, 81953016091, 81953016107, 81953016120, 81953016125, 81953016152, 81953016155, 81953016157, 81953016168, 81953016179, 81953016181, 81953016223, 81953016237, 81953016254, 81953016275, 81953016279, 81953016351



CV-ES-14163

Length: 125
Cone Ø: d1 Ø 30 / d2 Ø 27
Thread: M30 x 1,5 RHT
95301.0084, 90804102156, 90804102272, 90804102696, 90804102710, 81953010016, 81953010075, 81953010084, 81953010088, 81953010094, 81953010103, 81953016030, 81953016043, 81953016048, 81953016049, 81953016053, 81953016061, 81953016090, 81953016108, 81953016112, 81953016126, 81953016143, 81953016149, 81953016154, 81953016156, 81953016168, 81953016178, 81953016194, 81953016206, 81953016224, 81953016234, 81953016242, 81953016252, 81953016274, 81953016278, 81953016284, 81953016286, 81953016308, 81953016310, 81953016312, 81953016347, 81953016350, 81953016352, 82953016012, 88953016014, N2953016001



CV-RK-5311

638862, 639287, 938423, 1104335, 1953248, 0003500506, 3500506, 11013547, 42488722, 070550504, 634303610, 81432206055, 81432206073, 82262320660, 5001842823, 7000307001, 8226232066



DB-RK-8581

Ø: 85 Hole Distance: 130
Thick/Height: 24
03305800A, 81432706105



IV-ES-8507

Length: 80
Cone Ø: d1 Ø 30 / d2 Ø 27
Thread: M30 x 1,5 RHT
11019869, 12216380, 55175540, 81953016238



MN-DL-3402

Length: 590 Ø: 48
Hole Distance: 130 / 130
03307200A, 81432206067, 81432206068, 81432206090, 81432206092, 81432209092



MN-DL-5212

Length: 577 Ø: 48
Hole Distance: 130 / 130
81432206096, 81432206097, 81432206098, 81432206129, 81432209096, 81432209129, 81432306014, 81432306030



MN-DL-5225

Length: 572 Ø: 48
Hole Distance: 130 / 130
03301500A, 81432206229, 81432206236, 81432206267, 81432206270, 81432206272, 81432206304, 81432206305, 81432209236, 81432209267, 81432209272



MN-DL-7801

Length: 995 Ø: 52
Cone Ø: d1 Ø 30 / d2 Ø 27
81466106807, 81466106808, 81466116087, 81466116088, 81466116096, 81466116097, 81466116099, 81466116132, 81466116133, 81466116136, 81466116197, 81466116198, 81466116205

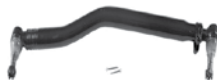

MN-DL-7802

Length: 1680 Ø: 52
Cone Ø: d1 Ø 30 / d2 Ø 27
03208300A, 81467116773, 81467116858, 81467116859, 81467116860, 81467116861, 81467116863, 81467116882, 81467116883, 81467116920, 81467116921



MN-DL-8544

Length: 596 Ø: 48
Hole Distance: 130 / 130
81432206196, 81432206232, 81432206233



MN-DL-8560

Length: 970 Ø: 52
Cone Ø: d1 Ø 30 / d2 Ø 27
03206900A, 81466106809, 81466106810, 81466106823, 81466106838, 81466106839, 81466116104, 81466116105, 81466116107, 81466116134, 81466116135, 81466116137, 81466116199, 81466116200, 81466116206



MN-DL-8663

Length: 947 Ø: 60
Hole Distance: 115 / 115
03307400A, 81432206222, 81432206260, 81432206283, 81432206284



MN-DL-10288

81432206386, 82432206008, 82432209008

No Image

MN-DL-12284

Length: 1530 Ø: 50
Cone Ø: d1 Ø 30 / d2 Ø 27
81466106579, 81466106580, 81466106624, 81466116720, 81467116720, 81467116730, 81467116952



MN-DL-12288

Length: 585 Ø: 58
Hole Distance: 130 / 130
81432206386, 82432206008, 82432209008

No Image

MN-ES-8490

Length: 90
Cone Ø: d1 Ø 30 / d2 Ø 27
Thread: M26 x 1,5 RHT
0014606948, 14606948, 81953016281, 81953016337, 82953016016



MN-RK-8537

Ø: 95 Hole Distance: 152
Thick/Height: 24
696321, 03306600A, 81432706079, 81432706099



MN-RK-12436

Ø: 75 Hole Distance: 115
Thick/Height: 24
81432206244



MN-VB-5222

Length: 627 Ø: 50
Hole Distance: 152 / 152
81432706030, 81432706034, 81432706054, 81432706055, 81432706056, 81432706057, 81432706067, 81432706068, 81432706074, 81432706075, 81432706076, 81432706077, 81432706078, 81432706081, 81432706082, 81432709034, 81432709076, 81432709078, 8143706054



MN-VB-5238

Length: 627 Ø: 48
Hole Distance: 130 / 130
81432206221, 81432706096, 81432706114, 81432706116, 81432706121



MN-VB-8514

Length: 627 Ø: 48
Hole Ø 25 / 25 / 25
Hole Distance: 152 / 130 / 130
81432706087, 81432706088, 81432706094, 81432706095, 81432796094



MN-VB-8669

Length: 627 Ø: 48
Hole Ø 25 / 25 / 25
Hole Distance: 152 / 130 / 130
81432706116, 81432706137, 81432706150, 81432706151



MN-VB-9404

Length: 627 Ø: 58
Hole Distance: 130 / 130
81432706117, 81432706152, 81432706153



SC-ES-7279

Length: 150
Cone Ø: d1 Ø 30 / d2 Ø 27
Thread: M30 x 1,5 RHT
81953016288



SC-ES-8517

Length: 140
Cone Ø: d1 Ø 30 / d2 Ø 27
Thread: M30 x 1,5 RHT
81953016286



SC-ES-8535

Length: 145
Cone Ø: d1 Ø 30 / d2 Ø 27
Thread: M30 x 1,5 RHT
81953016271, 81953016325





TGA ...

26.460 FNLC, FNLLC, FNLLRC, FNLLRW, FNLLW, FNLR ...	04/00→	Tie Rod End	CV-ES-14162		for Steering Rod	
	04/00→	Tie Rod End	CV-ES-14163		for Steering Rod	
	04/00→	Tie Rod End	IV-ES-12272		for Steering Rod	
	04/00→	Tie Rod End	SC-ES-7279		for Steering Rod	
	04/00→	Tie Rod End	SC-ES-8517		for Push Rod	
	04/00→	Tie Rod End	SC-ES-8535		for Guide Rod	
	04/00→	Track Control Arm		MN-DL-5225	Trailing Arm, Drive Axle;Air Suspension Axle	
	04/00→	Track Control Arm		MN-DL-5225	Trailing Arm, Leading Axle;Air Suspension Axle	
	04/00→	Track Control Arm		MN-DL-8709	Trailing Arm, Air Suspension Axle; for vehicles with Hinged Trailing Axle	
	04/00→	Track Control Arm		MN-DL-8733	Trailing Arm, Air Suspension Axle;Drive Axle	
	04/00→	Track Control Arm		MN-TC-12399	Control Arm	
	04/00→	Track Control Arm		MN-VB-5238	Wishbone (CV), Drive Axle;Leading Axle; Air Suspension Axle	
	04/00→	Track Control Arm		MN-VB-9403	Wishbone (CV), Air Suspension Axle	
	04/00→	Track Control Arm	MN-DL-8663		Control Arm, Air Suspension Axle	
	03/04→	Track Control Arm		MN-DL-5225	Trailing Arm, Tag Axle;Air Suspension Axle; for vehicles with Hinged Trailing Axle	
	01/05→	Track Control Arm		MN-DL-5225	Trailing Arm, Tag Axle;Air Suspension Axle; for vehicles with Rigid Trailing Axle	
26.460 FPLS, FPLRS, FVLS, FVLRS, FNLS, FNLLS, FNLRS	12/00→01/05	Track Control Arm		MN-DL-5212	Trailing Arm, Tag Axle;Air Suspension Axle	
	12/00→	Ball Head, gearshift linkage	CV-ES-2120			
	12/00→	Centre Rod	MN-DL-7801		Push Rod, Leaf Spring Axle	
	12/00→	Centre Rod	MN-DL-8560		Push Rod, Air Suspension Axle	
	12/00→	Suspension Strut Repair Kit		CV-RK-5311		
	12/00→	Suspension Strut Repair Kit		DB-RK-8581		
	12/00→	Suspension Strut Repair Kit		MN-RK-12436		
	12/00→	Tie Rod	MN-DL-7802			
	12/00→	Tie Rod	MN-DL-12284			
	12/00→	Tie Rod End		IV-ES-8507	Tag Axle	
	12/00→	Tie Rod End		MN-ES-8490	for vehicles with Hinged Trailing Axle	
	12/00→	Tie Rod End		SC-ES-8517	for Push Rod	
	12/00→	Tie Rod End	CV-ES-0914		for Steering Rod	
	12/00→	Tie Rod End	CV-ES-14162	CV-ES-14162	for Steering Rod	
	12/00→	Tie Rod End	CV-ES-14163		for Steering Rod	
	12/00→	Tie Rod End	IV-ES-12272		for Steering Rod	
	12/00→	Tie Rod End	SC-ES-7279		for Steering Rod	
	12/00→	Tie Rod End	SC-ES-8535		for Guide Rod	
	12/00→	Track Control Arm		MN-DL-5225	Trailing Arm, Drive Axle;Air Suspension Axle	
	12/00→	Track Control Arm		MN-DL-5225	Trailing Arm, Leading Axle;Air Suspension Axle	
	12/00→	Track Control Arm		MN-DL-8709	Trailing Arm, Air Suspension Axle; for vehicles with Hinged Trailing Axle	
	12/00→	Track Control Arm		MN-DL-8733	Trailing Arm, Air Suspension Axle;Drive Axle	
	12/00→	Track Control Arm		MN-TC-12399	Control Arm	
	12/00→	Track Control Arm		MN-VB-5238	Wishbone (CV), Drive Axle;Leading Axle; Air Suspension Axle	
	12/00→	Track Control Arm		MN-VB-9403	Wishbone (CV), Air Suspension Axle	
	12/00→	Track Control Arm	MN-DL-8663		Control Arm, Air Suspension Axle	
	03/04→	Track Control Arm		MN-DL-5225	Trailing Arm, Tag Axle;Air Suspension Axle; for vehicles with Hinged Trailing Axle	
	01/05→	Track Control Arm		MN-DL-5225	Trailing Arm, Tag Axle;Air Suspension Axle; for vehicles with Rigid Trailing Axle	
	26.460 FVLC	02/01→	Ball Head, gearshift linkage	CV-ES-2120		
		02/01→	Centre Rod	MN-DL-7801		Push Rod, Leaf Spring Axle
		02/01→	Centre Rod	MN-DL-8560		Push Rod, Air Suspension Axle
		02/01→	Suspension Strut Repair Kit		DB-RK-8581	
		02/01→	Suspension Strut Repair Kit		MN-RK-12436	
02/01→		Tie Rod	MN-DL-7802			
02/01→		Tie Rod End		SC-ES-8517	for Push Rod	
02/01→		Tie Rod End	CV-ES-0914		for Steering Rod	
02/01→		Tie Rod End	CV-ES-14162	CV-ES-14162	for Steering Rod	
02/01→		Tie Rod End	CV-ES-14163		for Steering Rod	
02/01→	Tie Rod End	SC-ES-7279		for Steering Rod		

CV-ES-0914

Length: 125
Cone Ø: d1 Ø 30 / d2 Ø 27
Thread: M38 x 1,5 RHT
81953016184, 81953016251, 81953016276



CV-ES-2120

Length: 115
Cone Ø: d1 Ø 12,4 / d2 Ø 10,8
Thread: M14 x 1,5 RHT
03008500A, 81953016200, 81953016202, 81953016203, 81953016227



CV-ES-14162

Length: 125
Cone Ø: d1 Ø 30 / d2 Ø 27
Thread: M30 x 1,5 LHT
81953010015, 81953010083, 81953010087, 81953016029, 81953016030, 81953016043, 81953016044, 81953016050, 81953016054, 81953016087, 81953016091, 81953016107, 81953016120, 81953016125, 81953016152, 81953016155, 81953016157, 81953016168, 81953016179, 81953016181, 81953016223, 81953016237, 81953016254, 81953016275, 81953016279, 81953016351



CV-ES-14163

Length: 125
Cone Ø: d1 Ø 30 / d2 Ø 27
Thread: M30 x 1,5 RHT
95301.0084, 90804102156, 90804102272, 90804102696, 90804102710, 81953010016, 81953010075, 81953010084, 81953010088, 81953010094, 81953010103, 81953016030, 81953016043, 81953016048, 81953016049, 81953016053, 81953016061, 81953016090, 81953016108, 81953016112, 81953016126, 81953016143, 81953016149, 81953016154, 81953016156, 81953016168, 81953016178, 81953016194, 81953016206, 81953016224, 81953016234, 81953016242, 81953016252, 81953016274, 81953016278, 81953016284, 81953016286, 81953016308, 81953016310, 81953016312, 81953016347, 81953016350, 81953016352, 82953016012, 88953016014, N2953016001



CV-RK-5311

638862, 639287, 938423, 1104335, 1953248, 0003500506, 3500506, 11013547, 42488722, 070550504, 634303610, 81432206055, 81432206073, 82262320660, 5001842823, 7000307001, 8226232066



DB-RK-8581

Ø: 85
Hole Distance: 130
Thick/Height: 24
03305800A, 81432706105



IV-ES-8507

Length: 80
Cone Ø: d1 Ø 30 / d2 Ø 27
Thread: M30 x 1,5 RHT
11019869, 12216380, 55175540, 81953016238



IV-ES-12272

Length: 75
Cone Ø: d1 Ø 30 / d2 Ø 27
Thread: M26 x 1,5 RHT
81953016280, 82953010010



MN-DL-5212

Length: 577 Ø: 48
Hole Distance: 130 / 130
81432206096, 81432206097, 81432206098, 81432206129, 81432209096, 81432209129, 81432306014, 81432306030



MN-DL-5225

Length: 572 Ø: 48
Hole Distance: 130 / 130
03301500A, 81432206229, 81432206236, 81432206267, 81432206270, 81432206272, 81432206304, 81432206305, 81432209236, 81432209267, 81432209272



MN-DL-7801

Length: 995 Ø: 52
Cone Ø: d1 Ø 30 / d2 Ø 27
81466106807, 81466106808, 81466116087, 81466116088, 81466116096, 81466116097, 81466116099, 81466116132, 81466116133, 81466116136, 81466116197, 81466116198, 81466116205



MN-DL-7802

Length: 1680 Ø: 52
Cone Ø: d1 Ø 30 / d2 Ø 27
03208300A, 81467116773, 81467116858, 81467116859, 81467116860, 81467116861, 81467116863, 81467116882, 81467116883, 81467116920, 81467116921



MN-DL-8560

Length: 970 Ø: 52
Cone Ø: d1 Ø 30 / d2 Ø 27
03206900A, 81466106809, 81466106810, 81466106823, 81466106838, 81466106839, 81466116104, 81466116105, 81466116107, 81466116134, 81466116135, 81466116137, 81466116199, 81466116200, 81466116206



MN-DL-8663

Length: 947 Ø: 60
Hole Distance: 115 / 115
03307400A, 81432206222, 81432206260, 81432206283, 81432206284



MN-DL-8709

Length: 572 Ø: 52
Hole Distance: 130 / 130
81432206268, 81432206274, 81432206291, 81432206292, 82432206007



MN-DL-8733

Length: 530 Ø: 48
Hole Distance: 130 / 130
81432206161, 81432206190, 81432206358, 81432206359



MN-DL-12284

Length: 1530 Ø: 50
Cone Ø: d1 Ø 30 / d2 Ø 27
81466106579, 81466106580, 81466106624, 81466116720, 81467116720, 81467116730, 81467116952



MN-ES-8490

Length: 90
Cone Ø: d1 Ø 30 / d2 Ø 27
Thread: M26 x 1,5 RHT
14606948, 0014606948, 81953016281, 81953016337, 82953016016



MN-RK-12436

Ø: 75
Hole Distance: 115
Thick/Height: 24
81432206244



MN-TC-12399

Length: 694 Ø: 50
Hole Distance: 130 / 130
81432206265



MN-VB-5238

Length: 627 Ø: 48
Hole Distance: 130 / 130
81432206221, 81432706096, 81432706114, 81432706116, 81432706121



MN-VB-9403

Length: 627 Ø: 48
Hole Ø 25 / 23 / 23
Hole Distance: 152 / 130 / 130
81432706097, 81432706113, 81432706135, 81432706160, 81432706161



SC-ES-7279

Length: 150
Cone Ø: d1 Ø 30 / d2 Ø 27
Thread: M30 x 1,5 RHT
81953016288



SC-ES-8517

Length: 140
Cone Ø: d1 Ø 30 / d2 Ø 27
Thread: M30 x 1,5 RHT
81953016286



SC-ES-8535

Length: 145
Cone Ø: d1 Ø 30 / d2 Ø 27
Thread: M30 x 1,5 RHT
81953016271, 81953016325





TGA ...

26.460 FVLC ...	02/01→	Tie Rod End	SC-ES-8535		for Guide Rod
	02/01→	Track Control Arm		MN-DL-5212	Trailing Arm, Trailing Axle Steered, for Pneumatic Suspension vehicles
	02/01→	Track Control Arm		MN-DL-5225	Trailing Arm, Drive Axle;Air Suspension Axle
	02/01→	Track Control Arm		MN-DL-5225	Trailing Arm, Leading Axle;Air Suspension Axle
	02/01→	Track Control Arm		MN-DL-8709	Trailing Arm, 1st Drive Axle, for Pneumatic Suspension vehicles
	02/01→	Track Control Arm		MN-DL-8709	Trailing Arm, Trailing Axle Steered,, for Pneumatic Suspension vehicles
	02/01→	Track Control Arm		MN-DL-8733	Trailing Arm, Air Suspension Axle;Drive Axle
	02/01→	Track Control Arm		MN-VB-5238	Wishbone (CV), Drive Axle;Leading Axle; Air Suspension Axle
	02/01→	Track Control Arm		MN-VB-9403	Wishbone (CV), Trailing Axle Steered, for Pneumatic Suspension vehicles
26.460 FVL-K0	02/01→	Track Control Arm	MN-DL-8663		Control Arm, Air Suspension Axle
	12/00→	Ball Head, gearshift linkage	CV-ES-2120		
	12/00→	Centre Rod	MN-DL-7801		Push Rod, Leaf Spring Axle
	12/00→	Centre Rod	MN-DL-8560		Push Rod, Air Suspension Axle
	12/00→	Suspension Strut Repair Kit		DB-RK-8581	
	12/00→	Suspension Strut Repair Kit		MN-RK-12436	
	12/00→	Tie Rod	MN-DL-7802		
	12/00→	Tie Rod End	CV-ES-0914		for Steering Rod
	12/00→	Tie Rod End	CV-ES-14163		for Steering Rod
	12/00→	Tie Rod End	SC-ES-7279		for Steering Rod
	12/00→	Tie Rod End	SC-ES-8517		for Push Rod
	12/00→	Tie Rod End	SC-ES-8535		for Guide Rod
	12/00→	Track Control Arm		MN-DL-5225	Trailing Arm, Drive Axle;Air Suspension Axle
	12/00→	Track Control Arm		MN-DL-5225	Trailing Arm, Leading Axle;Air Suspension Axle
	12/00→	Track Control Arm		MN-DL-8733	Trailing Arm, Air Suspension Axle;Drive Axle
	12/00→	Track Control Arm		MN-VB-5238	Wishbone (CV), Drive Axle;Leading Axle; Air Suspension Axle
12/00→	Track Control Arm	MN-DL-8663		Control Arm, Air Suspension Axle	
26.480 FDAC, FDALC, FDARC, FDHC, FDHLC	09/02→	Ball Head, gearshift linkage	CV-ES-2120		
	09/02→	Centre Rod	MN-DL-7801		Push Rod
	09/02→	Suspension Strut Repair Kit		DB-RK-8581	
	09/02→	Tie Rod End	CV-ES-0914		for Steering Rod
	09/02→	Tie Rod End	CV-ES-14163		for Steering Rod
	09/02→	Tie Rod End	MN-ES-10333		for Steering Rod
	09/02→	Tie Rod End	SC-ES-8517		for Push Rod
	09/02→	Track Control Arm		MN-DL-5225	Trailing Arm
	09/02→	Track Control Arm		MN-DL-8544	Trailing Arm, 1st RA;2nd RA;Leaf Spring Axle
	09/02→	Track Control Arm		MN-DL-8544	Trailing Arm, Drive Axle;Air Suspension Axle
	09/02→	Track Control Arm		MN-DL-8609	Trailing Arm, 1st RA;2nd RA, for Leaf-Spring Suspension vehicles, →Type_HB Chassis
	09/02→	Track Control Arm		MN-VB-8514	Suspension Rod, Wishbone (CV), Drive Axle; Air Suspension Axle
	09/02→	Track Control Arm		MN-VB-8514	Suspension Rod, Wishbone (CV), Drive Axle; Leaf Spring Axle
	09/02→	Track Control Arm		MN-VB-9404	Wishbone (CV), Drive Axle
	02/06→	Centre Rod	MN-DL-2160		Coupling Rod
	02/06→	Centre Rod	MN-DL-2174		Push Rod
	02/06→	Suspension Arm Repair Kit		CV-RK-5313	for Wishbone (CV)
	02/06→	Tie Rod End	CV-ES-14162		for Steering Rod
	02/06→	Tie Rod End	SC-ES-7279		for Steering Rod
	02/06→	Tie Rod End	SC-ES-8535		for Guide Rod
	02/06→	Track Control Arm		MN-VB-5238	Wishbone (CV), 1st RA;2nd RA, for Pneumatic Suspension vehicles, →Type_NBA Chassis
	02/06→	Track Control Arm		MN-VB-8514	Suspension Rod, Wishbone (CV)
	02/06→	Track Control Arm		MN-VB-8669	Suspension Rod, Wishbone (CV), 1st RA; 2nd RA, for Leaf-Spring Suspension vehicles, →Type_MHB Chassis
	02/06→	Track Control Arm		MN-VB-9404	Wishbone (CV), 1st RA;2nd RA, for Leaf-Spring Suspension vehicles, →Type_HB Chassis

CV-ES-0914

Length: 125
Cone Ø: d1 Ø 30 / d2 Ø 27
Thread: M38 x 1,5 RHT
81953016184, 81953016251, 81953016276



CV-ES-2120

Length: 115
Cone Ø: d1 Ø 12,4 / d2 Ø 10,8
Thread: M14 x 1,5 RHT
03008500A, 81953016200, 81953016202, 81953016203, 81953016227



CV-ES-14162

Length: 125
Cone Ø: d1 Ø 30 / d2 Ø 27
Thread: M30 x 1,5 LHT
81953010015, 81953010083, 81953010087, 81953016029, 81953016030, 81953016043, 81953016044, 81953016050, 81953016054, 81953016087, 81953016091, 81953016107, 81953016120, 81953016125, 81953016152, 81953016155, 81953016157, 81953016168, 81953016179, 81953016181, 81953016223, 81953016237, 81953016254, 81953016275, 81953016279, 81953016351



CV-ES-14163

Length: 125
Cone Ø: d1 Ø 30 / d2 Ø 27
Thread: M30 x 1,5 RHT
95301.0084, 90804102156, 90804102272, 90804102696, 90804102710, 81953010016, 81953010075, 81953010084, 81953010088, 81953010094, 81953010103, 81953016030, 81953016043, 81953016048, 81953016049, 81953016053, 81953016061, 81953016090, 81953016108, 81953016112, 81953016126, 81953016143, 81953016149, 81953016154, 81953016156, 81953016168, 81953016178, 81953016194, 81953016206, 81953016224, 81953016234, 81953016242, 81953016252, 81953016274, 81953016278, 81953016284, 81953016286, 81953016308, 81953016310, 81953016312, 81953016347, 81953016350, 81953016352, 82953016012, 88953016014, N2953016001



CV-RK-5313

Ø: 90
03304800A, 81953016132



DB-RK-8581

Ø: 85
Hole Distance: 130
Thick/Height: 24
03305800A, 81432706105



MN-DL-2160

Length: 1652 Ø: 50
Cone Ø: d1 Ø 30 / d2 Ø 27
81467106112, 81467106163, 81467106165, 81467106198, 81467106353, 81467106354, 81467106361, 81467116725



MN-DL-2174

Length: 1588 Ø: 52
Cone Ø: d1 Ø 30 / d2 Ø 27
81467106378, 81467106912



MN-DL-5212

Length: 577 Ø: 48
Hole Distance: 130 / 130
81432206096, 81432206097, 81432206098, 81432206129, 81432209096, 81432209129, 81432306014, 81432306030



MN-DL-5225

Length: 572 Ø: 48
Hole Distance: 130 / 130
03301500A, 81432206229, 81432206236, 81432206267, 81432206270, 81432206272, 81432206304, 81432206305, 81432209236, 81432209267, 81432209272



MN-DL-7801

Length: 995 Ø: 52
Cone Ø: d1 Ø 30 / d2 Ø 27
81466106807, 81466106808, 81466116087, 81466116088, 81466116096, 81466116097, 81466116099, 81466116132, 81466116133, 81466116136, 81466116197, 81466116198, 81466116205



MN-DL-7802

Length: 1680 Ø: 52
Cone Ø: d1 Ø 30 / d2 Ø 27
03208300A, 81467116773, 81467116858, 81467116859, 81467116860, 81467116861, 81467116863, 81467116882, 81467116883, 81467116920, 81467116921



MN-DL-8544

Length: 596 Ø: 48
Hole Distance: 130 / 130
81432206196, 81432206232, 81432206233



MN-DL-8560

Length: 970 Ø: 52
Cone Ø: d1 Ø 30 / d2 Ø 27
03206900A, 81466106809, 81466106810, 81466106823, 81466106838, 81466106839, 81466116104, 81466116105, 81466116107, 81466116134, 81466116135, 81466116137, 81466116199, 81466116200, 81466116206



MN-DL-8609

Length: 585 Ø: 58
Hole Distance: 130 / 130
81432206070, 81432206071, 81432206072, 81432206091, 81432206093, 81432206119



MN-DL-8663

Length: 947 Ø: 60
Hole Distance: 115 / 115
03307400A, 81432206222, 81432206260, 81432206283, 81432206284



MN-DL-8709

Length: 572 Ø: 52
Hole Distance: 130 / 130
81432206268, 81432206274, 81432206291, 81432206292, 82432206007



MN-DL-8733

Length: 530 Ø: 48
Hole Distance: 130 / 130
81432206161, 81432206190, 81432206358, 81432206359



MN-ES-10333

Length: 90
Cone Ø: d1 Ø 38 / d2 Ø 34,35
Thread: M36 x 1,5 RHT
1271126, 3090291, 3099128, 42538048, 81953016268, 82953016018, 82953016019



MN-RK-12436

Ø: 75
Hole Distance: 115
Thick/Height: 24
81432206244



MN-VB-5238

Length: 627 Ø: 48
Hole Distance: 130 / 130
81432206221, 81432706096, 81432706114, 81432706116, 81432706121



MN-VB-8514

Length: 627 Ø: 48
Hole Ø 25 / 25 / 25
Hole Distance: 152 / 130 / 130
81432706087, 81432706088, 81432706094, 81432706095, 81432796094



MN-VB-8669

Length: 627 Ø: 48
Hole Ø 25 / 25 / 25
Hole Distance: 152 / 130 / 130
81432706116, 81432706137, 81432706150, 81432706151



MN-VB-9403

Length: 627 Ø: 48
Hole Ø 25 / 23 / 23
Hole Distance: 152 / 130 / 130
81432706097, 81432706113, 81432706135, 81432706160, 81432706161



MN-VB-9404

Length: 627 Ø: 58
Hole Distance: 130 / 130
81432706117, 81432706152, 81432706153



SC-ES-7279

Length: 150
Cone Ø: d1 Ø 30 / d2 Ø 27
Thread: M30 x 1,5 RHT
81953016288



SC-ES-8517

Length: 140
Cone Ø: d1 Ø 30 / d2 Ø 27
Thread: M30 x 1,5 RHT
81953016286



SC-ES-8535

Length: 145
Cone Ø: d1 Ø 30 / d2 Ø 27
Thread: M30 x 1,5 RHT
81953016271, 81953016325



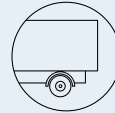

TGA ...

26.480 FDAK, FDALK	02/06→	Centre Rod	MN-DL-2160		Coupling Rod	
	02/06→	Centre Rod	MN-DL-2174		Push Rod	
	02/06→	Suspension Arm Repair Kit		CV-RK-5313	for Wishbone (CV)	
	02/06→	Tie Rod End	CV-ES-0914		for Steering Rod	
	02/06→	Tie Rod End	CV-ES-14162		for Steering Rod	
	02/06→	Tie Rod End	CV-ES-14163		for Steering Rod	
	02/06→	Tie Rod End	MN-ES-10333		for Steering Rod	
	02/06→	Tie Rod End	SC-ES-7279		for Steering Rod	
	02/06→	Tie Rod End	SC-ES-8517		for Push Rod	
	02/06→	Tie Rod End	SC-ES-8535		for Guide Rod	
	02/06→	Track Control Arm		MN-DL-8609	Trailing Arm, 1st RA;2nd RA, for Leaf-Spring Suspension vehicles, →Type_HB Chassis	
	02/06→	Track Control Arm		MN-VB-5238	Wishbone (CV), 1st RA;2nd RA, for Pneumatic Suspension vehicles, →Type_NBA Chassis	
	02/06→	Track Control Arm		MN-VB-8514	Suspension Rod, Wishbone (CV)	
	02/06→	Track Control Arm		MN-VB-8669	Suspension Rod, Wishbone (CV), 1st RA; 2nd RA, for Leaf-Spring Suspension vehicles, →Type_MHB Chassis	
	02/06→	Track Control Arm		MN-VB-9404	Wishbone (CV), 1st RA;2nd RA, for Leaf-Spring Suspension vehicles, →Type_HB	
26.480 FDAK, FDALK, FDHK, FDHLK	09/02→	Ball Head, gearshift linkage	CV-ES-2120			
	09/02→	Centre Rod	MN-DL-7801		Push Rod	
	09/02→	Suspension Strut Repair Kit		DB-RK-8581		
	09/02→	Tie Rod End	CV-ES-0914		for Steering Rod	
	09/02→	Tie Rod End	CV-ES-14163		for Steering Rod	
	09/02→	Tie Rod End	MN-ES-10333		for Steering Rod	
	09/02→	Tie Rod End	SC-ES-8517		for Push Rod	
	09/02→	Track Control Arm		MN-DL-5225	Trailing Arm	
	09/02→	Track Control Arm		MN-DL-8544	Trailing Arm, 1st RA;2nd RA;Leaf Spring Axle	
	09/02→	Track Control Arm		MN-DL-8544	Trailing Arm, Drive Axle;Air Suspension Axle	
	09/02→	Track Control Arm		MN-DL-8609	Trailing Arm, 1st RA;2nd RA, for Leaf-Spring Suspension vehicles, →Type_HB Chassis	
	09/02→	Track Control Arm		MN-VB-8514	Suspension Rod, Wishbone (CV), Drive Axle; Air Suspension Axle	
	09/02→	Track Control Arm		MN-VB-8514	Suspension Rod, Wishbone (CV), Drive Axle; Leaf Spring Axle	
	09/02→	Track Control Arm		MN-VB-9404	Wishbone (CV), Drive Axle	
	02/06→	Centre Rod	MN-DL-7801		Push Rod, Leaf Spring Axle	
	02/06→	Tie Rod	MN-DL-7802			
	02/06→	Tie Rod End	CV-ES-14162		for Steering Rod	
	02/06→	Tie Rod End	SC-ES-7279		for Steering Rod	
	02/06→	Tie Rod End	SC-ES-8535		for Guide Rod	
	02/06→	Track Control Arm		MN-VB-5238	Wishbone (CV), 1st RA;2nd RA, for Pneumatic Suspension vehicles, →Type_NBA Chassis	
	02/06→	Track Control Arm		MN-VB-8669	Suspension Rod, Wishbone (CV), Drive Axle; Leaf Spring Axle	
	02/06→	Track Control Arm		MN-VB-9404	Wishbone (CV), 1st RA;2nd RA, for Leaf-Spring Suspension vehicles, →Type_HB	
	26.480 FDALS, FDARS, FDAS, FDHLS, FDHS	09/02→	Ball Head, gearshift linkage	CV-ES-2120		
		09/02→	Centre Rod	MN-DL-7801		Push Rod
		09/02→	Suspension Strut Repair Kit		DB-RK-8581	
		09/02→	Tie Rod End	CV-ES-0914		for Steering Rod
		09/02→	Tie Rod End	CV-ES-14163		for Steering Rod
09/02→		Tie Rod End	MN-ES-10333		for Steering Rod	
09/02→		Tie Rod End	SC-ES-8517		for Push Rod	
09/02→		Track Control Arm		MN-DL-5225	Trailing Arm	
09/02→		Track Control Arm		MN-DL-8544	Trailing Arm, 1st RA;2nd RA;Leaf Spring Axle	
09/02→		Track Control Arm		MN-DL-8544	Trailing Arm, Drive Axle;Air Suspension Axle	
09/02→		Track Control Arm		MN-DL-8609	Trailing Arm, 1st RA;2nd RA, for Leaf-Spring Suspension vehicles, →Type_HB Chassis	
09/02→		Track Control Arm		MN-VB-8514	Suspension Rod, Wishbone (CV), Drive Axle; Air Suspension Axle	

CV-ES-0914

Length: 125
Cone Ø: d1 Ø 30 / d2 Ø 27
Thread: M38 x 1,5 RHT
81953016184, 81953016251, 81953016276



CV-ES-2120

Length: 115
Cone Ø: d1 Ø 12,4 / d2 Ø 10,8
Thread: M14 x 1,5 RHT
03008500A, 81953016200, 81953016202,
81953016203, 81953016227



CV-ES-14162

Length: 125
Cone Ø: d1 Ø 30 / d2 Ø 27
Thread: M30 x 1,5 LHT
81953010015, 81953010083, 81953010087,
81953016029, 81953016030, 81953016043,
81953016044, 81953016050, 81953016054,
81953016087, 81953016091, 81953016107,
81953016120, 81953016125, 81953016152,
81953016155, 81953016157, 81953016168,
81953016179, 81953016181, 81953016223,
81953016237, 81953016254, 81953016275,
81953016279, 81953016351



CV-ES-14163

Length: 125
Cone Ø: d1 Ø 30 / d2 Ø 27
Thread: M30 x 1,5 RHT
95301.0084, 90804102156, 90804102272,
90804102696, 90804102710, 81953010016,
81953010075, 81953010084, 81953010088,
81953010094, 81953010103, 81953016030,
81953016043, 81953016048, 81953016049,
81953016053, 81953016061, 81953016090,
81953016108, 81953016112, 81953016126,
81953016143, 81953016149, 81953016154,
81953016156, 81953016168, 81953016178,
81953016194, 81953016206, 81953016224,
81953016234, 81953016242, 81953016252,
81953016274, 81953016278, 81953016284,
81953016286, 81953016308, 81953016310,
81953016312, 81953016347, 81953016350,
81953016352, 82953016012, 88953016014,
N2953016001



CV-RK-5313

Ø: 90
03304800A, 81953016132



DB-RK-8581

Ø: 85
Hole Distance: 130
Thick/Height: 24
03305800A, 81432706105



MN-DL-2160

Length: 1652 Ø: 50
Cone Ø: d1 Ø 30 / d2 Ø 27
81467106112, 81467106163, 81467106165,
81467106198, 81467106353, 81467106354,
81467106361, 81467116725



MN-DL-2174

Length: 1588 Ø: 52
Cone Ø: d1 Ø 30 / d2 Ø 27
81467106378, 81467106912



MN-DL-5225

Length: 572 Ø: 48
Hole Distance: 130 / 130
03301500A, 81432206229, 81432206236,
81432206267, 81432206270, 81432206272,
81432206304, 81432206305, 81432209236,
81432209267, 81432209272



MN-DL-7801

Length: 995 Ø: 52
Cone Ø: d1 Ø 30 / d2 Ø 27
81466106807, 81466106808, 81466116087,
81466116088, 81466116096, 81466116097,
81466116099, 81466116132, 81466116133,
81466116136, 81466116197, 81466116198,
81466116205



MN-DL-7802

Length: 1680 Ø: 52
Cone Ø: d1 Ø 30 / d2 Ø 27
03208300A, 81467116773, 81467116858,
81467116859, 81467116860, 81467116861,
81467116863, 81467116882, 81467116883,
81467116920, 81467116921



MN-DL-8544

Length: 596 Ø: 48
Hole Distance: 130 / 130
81432206196, 81432206232, 81432206233



MN-DL-8609

Length: 585 Ø: 58
Hole Distance: 130 / 130
81432206070, 81432206071, 81432206072,
81432206091, 81432206093, 81432206119



MN-ES-10333

Length: 90
Cone Ø: d1 Ø 38 / d2 Ø 34,35
Thread: M36 x 1,5 RHT
1271126, 3090291, 3099128, 42538048,
81953016268, 82953016018, 82953016019



MN-VB-5238

Length: 627 Ø: 48
Hole Distance: 130 / 130
81432206221, 81432706096, 81432706114,
81432706116, 81432706121



MN-VB-8514

Length: 627 Ø: 48
Hole Ø 25 / 25 / 25
Hole Distance: 152 / 130 / 130
81432706087, 81432706088, 81432706094,
81432706095, 81432796094



MN-VB-8669

Length: 627 Ø: 48
Hole Ø 25 / 25 / 25
Hole Distance: 152 / 130 / 130
81432706116, 81432706137, 81432706150,
81432706151



MN-VB-9404

Length: 627 Ø: 58
Hole Distance: 130 / 130
81432706117, 81432706152, 81432706153



SC-ES-7279

Length: 150
Cone Ø: d1 Ø 30 / d2 Ø 27
Thread: M30 x 1,5 RHT
81953016288



SC-ES-8517

Length: 140
Cone Ø: d1 Ø 30 / d2 Ø 27
Thread: M30 x 1,5 RHT
81953016286



SC-ES-8535

Length: 145
Cone Ø: d1 Ø 30 / d2 Ø 27
Thread: M30 x 1,5 RHT
81953016271, 81953016325



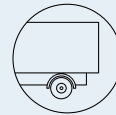

TGA ...

26.480 FDALS, FDARS, FDAS,
FDHLS, FDHS ...

09/02→	Track Control Arm		MN-VB-8514	Suspension Rod, Wishbone (CV), Drive Axle; Leaf Spring Axle
09/02→	Track Control Arm		MN-VB-9404	Wishbone (CV), Drive Axle
02/06→	Centre Rod	MN-DL-2160		Coupling Rod
02/06→	Centre Rod	MN-DL-2174		Push Rod
02/06→	Centre Rod	MN-DL-7801		Push Rod, Leaf Spring Axle
02/06→	Suspension Arm Repair Kit		CV-RK-5313	for Wishbone (CV)
02/06→	Tie Rod	MN-DL-7802		
02/06→	Tie Rod End	CV-ES-14162		for Steering Rod
02/06→	Tie Rod End	SC-ES-7279		for Steering Rod
02/06→	Tie Rod End	SC-ES-8535		for Guide Rod
02/06→	Track Control Arm		MN-VB-5238	Wishbone (CV), 1st RA;2nd RA, for Pneumatic Suspension vehicles, →Type_NBA Chassis
02/06→	Track Control Arm		MN-VB-8514	Suspension Rod, Wishbone (CV)
02/06→	Track Control Arm		MN-VB-8669	Suspension Rod, Wishbone (CV), 1st RA; 2nd RA, for Leaf-Spring Suspension vehicles, →Type_MHB Chassis
02/06→	Track Control Arm		MN-VB-8669	Suspension Rod, Wishbone (CV), Drive Axle; Leaf Spring Axle
02/06→	Track Control Arm		MN-VB-9404	Wishbone (CV), 1st RA;2nd RA, for Leaf- Spring Suspension vehicles, →Type_HB

26.480 FDC, FDLC, FDLRC, FDRC,
FNHLC, FVHLC

09/02→	Ball Head, gearshift linkage	CV-ES-2120		
09/02→	Centre Rod	MN-DL-7801		Push Rod, Leaf Spring Axle
09/02→	Centre Rod	MN-DL-8560		Push Rod, Air Suspension Axle
09/02→	Suspension Strut Repair Kit		DB-RK-8581	
09/02→	Suspension Strut Repair Kit		MN-RK-12436	
09/02→	Tie Rod	MN-DL-7802		
09/02→	Tie Rod End	CV-ES-0914		for Steering Rod
09/02→	Tie Rod End	CV-ES-14162		for Steering Rod
09/02→	Tie Rod End	CV-ES-14163		for Steering Rod
09/02→	Tie Rod End	SC-ES-7279		for Steering Rod
09/02→	Tie Rod End	SC-ES-8517		for Push Rod
09/02→	Tie Rod End	SC-ES-8535		for Guide Rod
09/02→	Track Control Arm		MN-DL-3402	Trailing Arm, Air Suspension Axle;Drive Axle
09/02→	Track Control Arm		MN-DL-5225	Trailing Arm, Drive Axle;Air Suspension Axle
09/02→	Track Control Arm		MN-DL-8544	Trailing Arm, Drive Axle;Air Suspension Axle
09/02→	Track Control Arm		MN-DL-8544	Trailing Arm, Drive Axle;Leaf Spring Axle
09/02→	Track control arm		MN-DL-10288	Trailing Arm, 1st RA;2nd RA, for Leaf-Spring Suspension vehicles
09/02→	Track control arm		MN-DL-12288	Trailing Arm
09/02→	Track Control Arm		MN-VB-5222	Wishbone (CV), 1st RA;2nd RA, for Pneumatic Suspension vehicles
09/02→	Track Control Arm		MN-VB-5238	Wishbone (CV), Drive Axle;Air Suspension Axle
09/02→	Track Control Arm		MN-VB-8514	Suspension Rod, Wishbone (CV), Drive Axle; Leaf Spring Axle
09/02→	Track Control Arm		MN-VB-8669	Suspension Rod, Wishbone (CV), Drive Axle
09/02→	Track Control Arm		MN-VB-8669	Suspension Rod, Wishbone (CV), Drive Axle; Leaf Spring Axle
09/02→	Track Control Arm		MN-VB-9404	Wishbone (CV), Drive Axle
09/02→	Track Control Arm		MN-VB-9404	Wishbone (CV), Drive Axle;Air Suspension Axle
09/02→	Track Control Arm	MN-DL-8663		Control Arm, Air Suspension Axle
02/06→	Tie Rod	MN-DL-12284		
02/06→	Tie Rod End		IV-ES-8507	Tag Axle
02/06→	Tie Rod End		MN-ES-8490	for vehicles with Hinged Trailing Axle
02/06→	Tie Rod End	CV-ES-14162	CV-ES-14162	for Steering Rod
02/06→	Tie Rod End	IV-ES-12272		for Steering Rod
02/06→	Track Control Arm		MN-DL-5212	Trailing Arm, Trailing Axle Steered/not Steered, for Pneumatic Suspension vehicles
02/06→	Track Control Arm		MN-DL-5225	Trailing Arm, Leading Axle;Air Suspension Axle
02/06→	Track Control Arm		MN-DL-5225	Trailing Arm, Tag Axle;Air Suspension Axle; for vehicles with Hinged Trailing Axle
02/06→	Track Control Arm		MN-DL-5225	Trailing Arm, Tag Axle;Air Suspension Axle; for vehicles with Rigid Trailing Axle

CV-ES-0914

Length: 125
Cone Ø: d1 Ø 30 / d2 Ø 27
Thread: M38 x 1,5 RHT
81953016184, 81953016251, 81953016276



CV-ES-2120

Length: 115
Cone Ø: d1 Ø 12,4 / d2 Ø 10,8
Thread: M14 x 1,5 RHT
03008500A, 81953016200, 81953016202, 81953016203, 81953016227



CV-ES-14162

Length: 125
Cone Ø: d1 Ø 30 / d2 Ø 27
Thread: M30 x 1,5 LHT
81953010015, 81953010083, 81953010087, 81953016029, 81953016030, 81953016043, 81953016044, 81953016050, 81953016054, 81953016087, 81953016091, 81953016107, 81953016120, 81953016125, 81953016152, 81953016155, 81953016157, 81953016168, 81953016179, 81953016181, 81953016223, 81953016237, 81953016254, 81953016275, 81953016279, 81953016351



CV-ES-14163

Length: 125
Cone Ø: d1 Ø 30 / d2 Ø 27
Thread: M30 x 1,5 RHT
95301.0084, 90804102156, 90804102272, 90804102696, 90804102710, 81953010016, 81953010075, 81953010084, 81953010088, 81953010094, 81953010103, 81953016030, 81953016043, 81953016048, 81953016049, 81953016053, 81953016061, 81953016090, 81953016108, 81953016112, 81953016126, 81953016143, 81953016149, 81953016154, 81953016156, 81953016168, 81953016178, 81953016194, 81953016206, 81953016224, 81953016234, 81953016242, 81953016252, 81953016274, 81953016278, 81953016284, 81953016286, 81953016308, 81953016310, 81953016312, 81953016347, 81953016350, 81953016352, 82953016012, 88953016014, N2953016001



CV-RK-5313

Ø: 90
03304800A, 81953016132



DB-RK-8581

Ø: 85 Hole Distance: 130
Thick/Height: 24
03305800A, 81432706105



IV-ES-8507

Length: 80
Cone Ø: d1 Ø 30 / d2 Ø 27
Thread: M30 x 1,5 RHT
11019869, 12216380, 55175540, 81953016238



IV-ES-12272

Length: 75
Cone Ø: d1 Ø 30 / d2 Ø 27
Thread: M26 x 1,5 RHT
81953016280, 82953010010



MN-DL-2160

Length: 1652 Ø: 50
Cone Ø: d1 Ø 30 / d2 Ø 27
81467106112, 81467106163, 81467106165, 81467106198, 81467106353, 81467106354, 81467106361, 81467116725



MN-DL-2174

Length: 1588 Ø: 52
Cone Ø: d1 Ø 30 / d2 Ø 27
81467106378, 81467106912



MN-DL-3402

Length: 590 Ø: 48
Hole Distance: 130 / 130
03307200A, 81432206067, 81432206068, 81432206090, 81432206092, 81432209092



MN-DL-5212

Length: 577 Ø: 48
Hole Distance: 130 / 130
81432206096, 81432206097, 81432206098, 81432206129, 81432209096, 81432209129, 81432306014, 81432306030



MN-DL-5225

Length: 572 Ø: 48
Hole Distance: 130 / 130
03301500A, 81432206229, 81432206236, 81432206267, 81432206270, 81432206272, 81432206304, 81432206305, 81432209236, 81432209267, 81432209272



MN-DL-7801

Length: 995 Ø: 52
Cone Ø: d1 Ø 30 / d2 Ø 27
81466106807, 81466106808, 81466116087, 81466116088, 81466116096, 81466116097, 81466116099, 81466116132, 81466116133, 81466116136, 81466116197, 81466116198, 81466116205

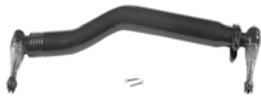

MN-DL-7802

Length: 1680 Ø: 52
Cone Ø: d1 Ø 30 / d2 Ø 27
03208300A, 81467116773, 81467116858, 81467116859, 81467116860, 81467116861, 81467116863, 81467116882, 81467116883, 81467116920, 81467116921



MN-DL-8544

Length: 596 Ø: 48
Hole Distance: 130 / 130
81432206196, 81432206232, 81432206233



MN-DL-8560

Length: 970 Ø: 52
Cone Ø: d1 Ø 30 / d2 Ø 27
03206900A, 81466106809, 81466106810, 81466106823, 81466106838, 81466106839, 81466116104, 81466116105, 81466116107, 81466116134, 81466116135, 81466116137, 81466116199, 81466116200, 81466116206



MN-DL-8663

Length: 947 Ø: 60
Hole Distance: 115 / 115
03307400A, 81432206222, 81432206260, 81432206283, 81432206284



MN-DL-10288

81432206386, 82432206008, 82432209008

No Image

MN-DL-12284

Length: 1530 Ø: 50
Cone Ø: d1 Ø 30 / d2 Ø 27
81466106579, 81466106580, 81466106624, 81466116720, 81467116720, 81467116730, 81467116952



MN-DL-12288

Length: 585 Ø: 58
Hole Distance: 130 / 130
81432206386, 82432206008, 82432209008

No Image

MN-ES-8490

Length: 90
Cone Ø: d1 Ø 30 / d2 Ø 27
Thread: M26 x 1,5 RHT
0014606948, 14606948, 81953016281, 81953016337, 82953016016



MN-RK-12436

Ø: 75
Hole Distance: 115
Thick/Height: 24
81432206244



MN-VB-5222

Length: 627 Ø: 50
Hole Distance: 152 / 152
81432706030, 81432706034, 81432706054, 81432706055, 81432706056, 81432706057, 81432706067, 81432706068, 81432706074, 81432706075, 81432706076, 81432706077, 81432706078, 81432706081, 81432706082, 81432709034, 81432709076, 81432709078, 8143706054



MN-VB-5238

Length: 627 Ø: 48
Hole Distance: 130 / 130
81432206221, 81432706096, 81432706114, 81432706116, 81432706099



MN-VB-8514

Length: 627 Ø: 48
Hole Ø 25 / 25 / 25
Hole Distance: 152 / 130 / 130
81432706087, 81432706088, 81432706094, 81432706095, 81432796094



MN-VB-8669

Length: 627 Ø: 48
Hole Ø 25 / 25 / 25
Hole Distance: 152 / 130 / 130
81432706116, 81432706137, 81432706150, 81432706151



MN-VB-9404

Length: 627 Ø: 58
Hole Distance: 130 / 130
81432706117, 81432706152, 81432706153



SC-ES-7279

Length: 150
Cone Ø: d1 Ø 30 / d2 Ø 27
Thread: M30 x 1,5 RHT
81953016288



SC-ES-8517

Length: 140
Cone Ø: d1 Ø 30 / d2 Ø 27
Thread: M30 x 1,5 RHT
81953016286



SC-ES-8535

Length: 145
Cone Ø: d1 Ø 30 / d2 Ø 27
Thread: M30 x 1,5 RHT
81953016271, 81953016325





TGA ...

26.480 FDC, FDLC, FDLRC, FDRC, FNHLC, FVHLC ...	02/06 →	Track Control Arm		MN-DL-8709	Trailing Arm, Air Suspension Axle; for vehicles with Hinged Trailing Axle	
	02/06 →	Track Control Arm		MN-DL-8733	Trailing Arm, 1st Drive Axle, for Pneumatic Suspension vehicles	
	02/06 →	Track Control Arm		MN-TC-12399	Control Arm	
	02/06 →	Track Control Arm		MN-VB-5238	Wishbone (CV), Drive Axle; Leading Axle; Air Suspension Axle	
	02/06 →	Track Control Arm		MN-VB-8514	Suspension Rod, Wishbone (CV), Drive Axle; Air Suspension Axle	
	02/06 →	Track Control Arm		MN-VB-9403	Wishbone (CV), Air Suspension Axle	
26.480 FDHC, FDHC/M, FDHLC	02/06 →	Centre Rod	MN-DL-7801		Push Rod, Leaf Spring Axle	
	02/06 →	Suspension Strut Repair Kit		DB-RK-8581		
	02/06 →	Tie Rod	MN-DL-7802			
	02/06 →	Tie Rod End	CV-ES-0914		for Steering Rod	
	02/06 →	Tie Rod End	CV-ES-14162		for Steering Rod	
	02/06 →	Tie Rod End	CV-ES-14163		for Steering Rod	
	02/06 →	Tie Rod End	MN-ES-10333		for Steering Rod	
	02/06 →	Tie Rod End	SC-ES-7279		for Steering Rod	
	02/06 →	Tie Rod End	SC-ES-8517		for Push Rod	
	02/06 →	Tie Rod End	SC-ES-8535		for Guide Rod	
	02/06 →	Track Control Arm		MN-DL-5225	Trailing Arm	
	02/06 →	Track Control Arm		MN-DL-8544	Trailing Arm, 1st RA; 2nd RA; Leaf Spring Axle	
	02/06 →	Track Control Arm		MN-DL-8609	Trailing Arm, 1st RA; 2nd RA, for Leaf-Spring Suspension vehicles, →Type_HB Chassis	
	02/06 →	Track Control Arm		MN-VB-5238	Wishbone (CV), 1st RA; 2nd RA, for Pneumatic Suspension vehicles, →Type_NBA Chassis	
	02/06 →	Track Control Arm		MN-VB-8514	Suspension Rod, Wishbone (CV), Drive Axle; Leaf Spring Axle	
	02/06 →	Track Control Arm		MN-VB-8669	Suspension Rod, Wishbone (CV), Drive Axle; Leaf Spring Axle	
	02/06 →	Track Control Arm		MN-VB-9404	Wishbone (CV), 1st RA; 2nd RA, for Leaf-Spring Suspension vehicles, →Type_HB Chassis	
	26.480 FDH-TM	02/06 →	Centre Rod	MN-DL-7801		Push Rod, Leaf Spring Axle
		02/06 →	Suspension Strut Repair Kit		DB-RK-8581	
		02/06 →	Tie Rod	MN-DL-7802		
02/06 →		Tie Rod End	CV-ES-0914		for Steering Rod	
02/06 →		Tie Rod End	CV-ES-14162		for Steering Rod	
02/06 →		Tie Rod End	CV-ES-14163		for Steering Rod	
02/06 →		Tie Rod End	SC-ES-7279		for Steering Rod	
02/06 →		Tie Rod End	SC-ES-8517		for Push Rod	
02/06 →		Tie Rod End	SC-ES-8535		for Guide Rod	
02/06 →		Track Control Arm		MN-DL-5225	Trailing Arm	
02/06 →		Track Control Arm		MN-DL-8544	Trailing Arm, 1st RA; 2nd RA; Leaf Spring Axle	
02/06 →		Track Control Arm		MN-VB-8514	Suspension Rod, Wishbone (CV), Drive Axle; Leaf Spring Axle	
02/06 →		Track Control Arm		MN-VB-8669	Suspension Rod, Wishbone (CV), Drive Axle; Leaf Spring Axle	
26.480 FDK, FDLK, FDLRK		09/02 →	Ball Head, gearshift linkage	CV-ES-2120		
	09/02 →	Centre Rod	MN-DL-7801		Push Rod, Leaf Spring Axle	
	09/02 →	Centre Rod	MN-DL-8560		Push Rod, Air Suspension Axle	
	09/02 →	Suspension Strut Repair Kit		DB-RK-8581		
	09/02 →	Suspension Strut Repair Kit		MN-RK-12436		
	09/02 →	Tie Rod	MN-DL-7802			
	09/02 →	Tie Rod End	CV-ES-0914		for Steering Rod	
	09/02 →	Tie Rod End	CV-ES-14162		for Steering Rod	
	09/02 →	Tie Rod End	CV-ES-14163		for Steering Rod	
	09/02 →	Tie Rod End	SC-ES-7279		for Steering Rod	
	09/02 →	Tie Rod End	SC-ES-8517		for Push Rod	
	09/02 →	Tie Rod End	SC-ES-8535		for Guide Rod	
	09/02 →	Track Control Arm		MN-DL-3402	Trailing Arm, Air Suspension Axle; Drive Axle	
	09/02 →	Track Control Arm		MN-DL-5225	Trailing Arm, Drive Axle; Air Suspension Axle	
09/02 →	Track Control Arm		MN-DL-8544	Trailing Arm, Drive Axle; Air Suspension Axle		
09/02 →	Track Control Arm		MN-DL-8544	Trailing Arm, Drive Axle; Leaf Spring Axle		

CV-ES-0914

Length: 125
 Cone Ø: d1 Ø 30 / d2 Ø 27
 Thread: M38 x 1,5 RHT
 81953016184, 81953016251, 81953016276

**CV-ES-2120**

Length: 115
 Cone Ø: d1 Ø 12,4 / d2 Ø 10,8
 Thread: M14 x 1,5 RHT
 03008500A, 81953016200, 81953016202,
 81953016203, 81953016227

**CV-ES-14162**

Length: 125
 Cone Ø: d1 Ø 30 / d2 Ø 27
 Thread: M30 x 1,5 LHT
 81953010015, 81953010083, 81953010087,
 81953016029, 81953016030, 81953016043,
 81953016044, 81953016050, 81953016054,
 81953016087, 81953016091, 81953016107,
 81953016120, 81953016125, 81953016152,
 81953016155, 81953016157, 81953016168,
 81953016179, 81953016181, 81953016223,
 81953016237, 81953016254, 81953016275,
 81953016279, 81953016351

**CV-ES-14163**

Length: 125
 Cone Ø: d1 Ø 30 / d2 Ø 27
 Thread: M30 x 1,5 RHT
 95301.0084, 90804102156, 90804102272,
 90804102696, 90804102710, 81953010016,
 81953010075, 81953010084, 81953010088,
 81953010094, 81953010103, 81953016030,
 81953016043, 81953016048, 81953016049,
 81953016053, 81953016061, 81953016090,
 81953016108, 81953016112, 81953016126,
 81953016143, 81953016149, 81953016154,
 81953016156, 81953016168, 81953016178,
 81953016194, 81953016206, 81953016224,
 81953016234, 81953016242, 81953016252,
 81953016274, 81953016278, 81953016284,
 81953016286, 81953016308, 81953016310,
 81953016312, 81953016347, 81953016350,
 81953016352, 82953016012, 88953016014,
 N2953016001

**DB-RK-8581**

Ø: 85
 Hole Distance: 130
 Thick/Height: 24
 03305800A, 81432706105

**MN-DL-3402**

Length: 590 Ø: 48
 Hole Distance: 130 / 130
 03307200A, 81432206067, 81432206068,
 81432206090, 81432206092, 81432209099

**MN-DL-5225**

Length: 572 Ø: 48
 Hole Distance: 130 / 130
 03301500A, 81432206229, 81432206236,
 81432206267, 81432206270, 81432206272,
 81432206304, 81432206305, 81432209236,
 81432209267, 81432209272

**MN-DL-7801**

Length: 995 Ø: 52
 Cone Ø: d1 Ø 30 / d2 Ø 27
 81466106807, 81466106808, 81466116087,
 81466116088, 81466116096, 81466116097,
 81466116099, 81466116132, 81466116133,
 81466116136, 81466116197, 81466116198,
 81466116205

**MN-DL-7802**

Length: 1680 Ø: 52
 Cone Ø: d1 Ø 30 / d2 Ø 27
 03208300A, 81467116773, 81467116858,
 81467116859, 81467116860, 81467116861,
 81467116863, 81467116882, 81467116883,
 81467116920, 81467116921

**MN-DL-8544**

Length: 596 Ø: 48
 Hole Distance: 130 / 130
 81432206196, 81432206232, 81432206233

**MN-DL-8560**

Length: 970 Ø: 52
 Cone Ø: d1 Ø 30 / d2 Ø 27
 03206900A, 81466106809, 81466106810,
 81466106823, 81466106838, 81466106839,
 81466116104, 81466116105, 81466116107,
 81466116134, 81466116135, 81466116137,
 81466116199, 81466116200, 81466116206

**MN-DL-8609**

Length: 585 Ø: 58
 Hole Distance: 130 / 130
 81432206070, 81432206071, 81432206072,
 81432206091, 81432206093, 81432206119

**MN-DL-8709**

Length: 572 Ø: 52
 Hole Distance: 130 / 130
 81432206268, 81432206274, 81432206291,
 81432206292, 82432206007

**MN-DL-8733**

Length: 530 Ø: 48
 Hole Distance: 130 / 130
 81432206161, 81432206190, 81432206358,
 81432206359

**MN-ES-10333**

Length: 90
 Cone Ø: d1 Ø 38 / d2 Ø 34,35
 Thread: M36 x 1,5 RHT
 1271126, 3090291, 3099128, 42538048,
 81953016268, 82953016018, 82953016019

**MN-RK-12436**

Ø: 75
 Hole Distance: 115
 Thick/Height: 24
 81432206244

**MN-TC-12399**

Length: 694 Ø: 50
 Hole Distance: 130 / 130
 81432206265

**MN-VB-5238**

Length: 627 Ø: 48
 Hole Distance: 130 / 130
 81432206221, 81432706096, 81432706114,
 81432706116, 81432706121

**MN-VB-8514**

Length: 627 Ø: 48
 Hole Ø 25 / 25 / 25
 Hole Distance: 152 / 130 / 130
 81432706087, 81432706088, 81432706094,
 81432706095, 81432796094

**MN-VB-8669**

Length: 627 Ø: 48
 Hole Ø 25 / 25 / 25
 Hole Distance: 152 / 130 / 130
 81432706116, 81432706137, 81432706150,
 81432706151

**MN-VB-9403**

Length: 627 Ø: 48
 Hole Ø 25 / 23 / 23
 Hole Distance: 152 / 130 / 130
 81432706097, 81432706113, 81432706135,
 81432706160, 81432706161

**MN-VB-9404**

Length: 627 Ø: 58
 Hole Distance: 130 / 130
 81432706117, 81432706152, 81432706153

**SC-ES-7279**

Length: 150
 Cone Ø: d1 Ø 30 / d2 Ø 27
 Thread: M30 x 1,5 RHT
 81953016288

**SC-ES-8517**

Length: 140
 Cone Ø: d1 Ø 30 / d2 Ø 27
 Thread: M30 x 1,5 RHT
 81953016286

**SC-ES-8535**

Length: 145
 Cone Ø: d1 Ø 30 / d2 Ø 27
 Thread: M30 x 1,5 RHT
 81953016271, 81953016325





TGA ...

26.480 FDK, FDLK, FDLRK ...	09/02→	Track control arm		MN-DL-10288	Trailing Arm, 1st RA;2nd RA, for Leaf-Spring Suspension vehicles
	09/02→	Track control arm		MN-DL-12288	Trailing Arm
	09/02→	Track Control Arm		MN-VB-5222	Wishbone (CV), 1st RA;2nd RA, for Pneumatic Suspension vehicles
	09/02→	Track Control Arm		MN-VB-5238	Wishbone (CV), Drive Axle;Air Suspension Axle
	09/02→	Track Control Arm		MN-VB-8514	Suspension Rod, Wishbone (CV), Drive Axle; Leaf Spring Axle
	09/02→	Track Control Arm		MN-VB-8669	Suspension Rod, Wishbone (CV), Drive Axle
	09/02→	Track Control Arm		MN-VB-8669	Suspension Rod, Wishbone (CV), Drive Axle; Leaf Spring Axle
	09/02→	Track Control Arm		MN-VB-9404	Wishbone (CV), Drive Axle
	09/02→	Track Control Arm		MN-VB-9404	Wishbone (CV), Drive Axle;Air Suspension Axle
	09/02→	Track Control Arm	MN-DL-8663		Control Arm, Air Suspension Axle
	02/06→	Track Control Arm		MN-VB-8514	Suspension Rod, Wishbone (CV), Drive Axle; Air Suspension Axle
26.480 FDLRS, FDLS, FDRS, FDS, FNHLS, FPHLS, FVHLS	09/02→	Ball Head, gearshift linkage	CV-ES-2120		
	09/02→	Centre Rod	MN-DL-7801		Push Rod, Leaf Spring Axle
	09/02→	Centre Rod	MN-DL-8560		Push Rod, Air Suspension Axle
	09/02→	Suspension Strut Repair Kit		DB-RK-8581	
	09/02→	Suspension Strut Repair Kit		MN-RK-12436	
	09/02→	Tie Rod	MN-DL-7802		
	09/02→	Tie Rod End	CV-ES-0914		for Steering Rod
	09/02→	Tie Rod End	CV-ES-14162		for Steering Rod
	09/02→	Tie Rod End	CV-ES-14163		for Steering Rod
	09/02→	Tie Rod End	SC-ES-7279		for Steering Rod
	09/02→	Tie Rod End	SC-ES-8517		for Push Rod
	09/02→	Tie Rod End	SC-ES-8535		for Guide Rod
	09/02→	Track Control Arm		MN-DL-3402	Trailing Arm, Air Suspension Axle;Drive Axle
	09/02→	Track Control Arm		MN-DL-5225	Trailing Arm, Drive Axle;Air Suspension Axle
	09/02→	Track Control Arm		MN-DL-8544	Trailing Arm, Drive Axle;Air Suspension Axle
	09/02→	Track Control Arm		MN-DL-8544	Trailing Arm, Drive Axle;Leaf Spring Axle
	09/02→	Track control arm		MN-DL-10288	Trailing Arm, 1st RA;2nd RA, for Leaf-Spring Suspension vehicles
	09/02→	Track control arm		MN-DL-12288	Trailing Arm
	09/02→	Track Control Arm		MN-VB-5222	Wishbone (CV), 1st RA;2nd RA, for Pneumatic Suspension vehicles
	09/02→	Track Control Arm		MN-VB-5238	Wishbone (CV), Drive Axle;Air Suspension Axle
	09/02→	Track Control Arm		MN-VB-8514	Suspension Rod, Wishbone (CV), Drive Axle; Leaf Spring Axle
	09/02→	Track Control Arm		MN-VB-8669	Suspension Rod, Wishbone (CV), Drive Axle
	09/02→	Track Control Arm		MN-VB-8669	Suspension Rod, Wishbone (CV), Drive Axle; Leaf Spring Axle
	09/02→	Track Control Arm		MN-VB-9404	Wishbone (CV), Drive Axle;Air Suspension Axle
	09/02→	Track Control Arm	MN-DL-8663		Control Arm, Air Suspension Axle
	02/06→	Tie Rod	MN-DL-12284		
	02/06→	Tie Rod	MN-DL-12293		
	02/06→	Tie Rod End		IV-ES-8507	Tag Axle
	02/06→	Tie Rod End		MN-ES-8490	for vehicles with Hinged Trailing Axle
	02/06→	Tie Rod End	CV-ES-14162	CV-ES-14162	for Steering Rod
	02/06→	Tie Rod End	IV-ES-12272		for Steering Rod
	02/06→	Track Control Arm		MN-DL-5212	Trailing Arm, Trailing Axle Steered/not Steered, for Pneumatic Suspension vehicles
	02/06→	Track Control Arm		MN-DL-5225	Trailing Arm, Leading Axle;Air Suspension Axle
	02/06→	Track Control Arm		MN-DL-5225	Trailing Arm, Tag Axle;Air Suspension Axle; for vehicles with Hinged Trailing Axle
	02/06→	Track Control Arm		MN-DL-5225	Trailing Arm, Tag Axle;Air Suspension Axle; for vehicles with Rigid Trailing Axle
	02/06→	Track Control Arm		MN-DL-8709	Trailing Arm, Air Suspension Axle; for vehicles with Hinged Trailing Axle
02/06→	Track Control Arm		MN-DL-8733	Trailing Arm, 1st Drive Axle, for Pneumatic Suspension vehicles	
02/06→	Track Control Arm		MN-TC-12399	Control Arm	

CV-ES-0914

Length: 125
Cone Ø: d1 Ø 30 / d2 Ø 27
Thread: M38 x 1,5 RHT
81953016184, 81953016251, 81953016276



CV-ES-2120

Length: 115
Cone Ø: d1 Ø 12,4 / d2 Ø 10,8
Thread: M14 x 1,5 RHT
03008500A, 81953016200, 81953016202,
81953016203, 81953016227



CV-ES-14162

Length: 125
Cone Ø: d1 Ø 30 / d2 Ø 27
Thread: M30 x 1,5 LHT
81953010015, 81953010083, 81953010087,
81953016029, 81953016030, 81953016043,
81953016044, 81953016050, 81953016054,
81953016087, 81953016091, 81953016107,
81953016120, 81953016125, 81953016152,
81953016155, 81953016157, 81953016168,
81953016179, 81953016181, 81953016223,
81953016237, 81953016254, 81953016275,
81953016279, 81953016351



CV-ES-14163

Length: 125
Cone Ø: d1 Ø 30 / d2 Ø 27
Thread: M30 x 1,5 RHT
95301.0084, 90804102156, 90804102272,
90804102696, 90804102710, 81953010016,
81953010075, 81953010084, 81953010088,
81953010094, 81953010103, 81953016030,
81953016043, 81953016048, 81953016049,
81953016053, 81953016061, 81953016090,
81953016108, 81953016112, 81953016126,
81953016143, 81953016149, 81953016154,
81953016156, 81953016168, 81953016178,
81953016194, 81953016206, 81953016224,
81953016234, 81953016242, 81953016252,
81953016274, 81953016278, 81953016284,
81953016286, 81953016308, 81953016310,
81953016312, 81953016347, 81953016350,
81953016352, 82953016012, 88953016014,
N2953016001



DB-RK-8581

Ø: 85 Hole Distance: 130
Thick/Height: 24
03305800A, 81432706105



IV-ES-8507

Length: 80
Cone Ø: d1 Ø 30 / d2 Ø 27
Thread: M30 x 1,5 RHT
11019869, 12216380, 55175540,
81953016238



IV-ES-12272

Length: 75
Cone Ø: d1 Ø 30 / d2 Ø 27
Thread: M26 x 1,5 RHT
81953016280, 82953010010



MN-DL-3402

Length: 590 Ø: 48
Hole Distance: 130 / 130
03307200A, 81432206067, 81432206068,
81432206090, 81432206092, 81432209092



MN-DL-5212

Length: 577 Ø: 48
Hole Distance: 130 / 130
81432206096, 81432206097, 81432206098,
81432206129, 81432209096, 81432209129,
81432306014, 81432306030



MN-DL-5225

Length: 572 Ø: 48
Hole Distance: 130 / 130
03301500A, 81432206229, 81432206236,
81432206267, 81432206270, 81432206272,
81432206304, 81432206305, 81432209236,
81432209267, 81432209272



MN-DL-7801

Length: 995 Ø: 52
Cone Ø: d1 Ø 30 / d2 Ø 27
81466106807, 81466106808, 81466116087,
81466116088, 81466116096, 81466116097,
81466116099, 81466116132, 81466116133,
81466116136, 81466116197, 81466116198,
81466116205

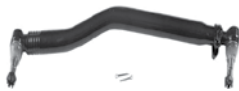

MN-DL-7802

Length: 1680 Ø: 52
Cone Ø: d1 Ø 30 / d2 Ø 27
03208300A, 81467116773, 81467116858,
81467116859, 81467116860, 81467116861,
81467116863, 81467116882, 81467116883,
81467116920, 81467116921



MN-DL-8544

Length: 596 Ø: 48
Hole Distance: 130 / 130
81432206196, 81432206232, 81432206233



MN-DL-8560

Length: 970 Ø: 52
Cone Ø: d1 Ø 30 / d2 Ø 27
03206900A, 81466106809, 81466106810,
81466106823, 81466106838, 81466106839,
81466116104, 81466116105, 81466116107,
81466116134, 81466116135, 81466116137,
81466116199, 81466116200, 81466116206



MN-DL-8663

Length: 947 Ø: 60
Hole Distance: 115 / 115
03307400A, 81432206222, 81432206260,
81432206283, 81432206284



MN-DL-8709

Length: 572 Ø: 52
Hole Distance: 130 / 130
81432206268, 81432206274, 81432206291,
81432206292, 82432206007



MN-DL-8733

Length: 530 Ø: 48
Hole Distance: 130 / 130
81432206161, 81432206190, 81432206358,
81432206359



MN-DL-10288

81432206386, 82432206008, 82432209008

No Image

MN-DL-12284

Length: 1530 Ø: 50
Cone Ø: d1 Ø 30 / d2 Ø 27
81466106579, 81466106580, 81466106624,
81466116720, 81467116720, 81467116730,
81467116952



MN-DL-12288

Length: 585 Ø: 58
Hole Distance: 130 / 130
81432206386, 82432206008, 82432209008



MN-DL-12293

Length: 1680 Ø: 42
Cone Ø: d1 Ø 30 / d2 Ø 27
81467106236, 81467106268, 81467106356,
81467116356, 81467116723, 81467116794,
81467116933, 81467116934, 81467116966



MN-ES-8490

Length: 90
Cone Ø: d1 Ø 30 / d2 Ø 27
Thread: M26 x 1,5 RHT
0014606948, 14606948, 81953016281,
81953016337, 82953016016



MN-RK-12436

Ø: 75
Hole Distance: 115
Thick/Height: 24
81432206244



MN-TC-12399

Length: 694 Ø: 50
Hole Distance: 130 / 130
81432206265



MN-VB-5222

Length: 627 Ø: 50
Hole Distance: 152 / 152
81432706030, 81432706034, 81432706054,
81432706055, 81432706056, 81432706057,
81432706067, 81432706068, 81432706074,
81432706075, 81432706076, 81432706077,
81432706078, 81432706081, 81432706082,
81432709034, 81432709076, 81432709078,
8143706054



MN-VB-5238

Length: 627 Ø: 48
Hole Distance: 130 / 130
81432206221, 81432706096, 81432706114,
81432706116, 81432706121



MN-VB-8514

Length: 627 Ø: 48
Hole Ø 25 / 25 / 25
Hole Distance: 152 / 130 / 130
81432706087, 81432706088, 81432706094,
81432706095, 81432796094



MN-VB-8669

Length: 627 Ø: 48
Hole Ø 25 / 25 / 25
Hole Distance: 152 / 130 / 130
81432706116, 81432706137, 81432706150,
81432706151



MN-VB-9404

Length: 627 Ø: 58
Hole Distance: 130 / 130
81432706117, 81432706152, 81432706153



SC-ES-7279

Length: 150
Cone Ø: d1 Ø 30 / d2 Ø 27
Thread: M30 x 1,5 RHT
81953016288



SC-ES-8517

Length: 140
Cone Ø: d1 Ø 30 / d2 Ø 27
Thread: M30 x 1,5 RHT
81953016286



SC-ES-8535

Length: 145
Cone Ø: d1 Ø 30 / d2 Ø 27
Thread: M30 x 1,5 RHT
81953016271, 81953016325





TGA ...

26.480 FDLRS, FDLS, FDRS, FDS, FNHLS, FPHLS, FVHLS ...	02/06 →	Track Control Arm		MN-VB-5238	Wishbone (CV), Drive Axle;Leading Axle; Air Suspension Axle
	02/06 →	Track Control Arm		MN-VB-8514	Suspension Rod, Wishbone (CV), Drive Axle; Air Suspension Axle
	02/06 →	Track Control Arm		MN-VB-9403	Wishbone (CV), Air Suspension Axle
	02/06 →	Track Control Arm		MN-VB-9404	Wishbone (CV), Drive Axle
26.480 FD-TM	09/02 →	Ball Head, gearshift linkage	CV-ES-2120		
	09/02 →	Centre Rod	MN-DL-7801		Push Rod, Leaf Spring Axle
	09/02 →	Suspension Strut Repair Kit		DB-RK-8581	
	09/02 →	Tie Rod	MN-DL-7802		
	09/02 →	Tie Rod End	CV-ES-0914		for Steering Rod
	09/02 →	Tie Rod End	CV-ES-14162		for Steering Rod
	09/02 →	Tie Rod End	CV-ES-14163		for Steering Rod
	09/02 →	Tie Rod End	SC-ES-7279		for Steering Rod
	09/02 →	Tie Rod End	SC-ES-8517		for Push Rod
	09/02 →	Tie Rod End	SC-ES-8535		for Guide Rod
	09/02 →	Track Control Arm		MN-DL-5225	Trailing Arm, Drive Axle;Air Suspension Axle
	09/02 →	Track Control Arm		MN-DL-8544	Trailing Arm, Drive Axle;Leaf Spring Axle
	09/02 →	Track control arm		MN-DL-10288	Trailing Arm, 1st RA;2nd RA, for Leaf-Spring Suspension vehicles
	09/02 →	Track control arm		MN-DL-12288	Trailing Arm
	09/02 →	Track Control Arm		MN-VB-5238	Wishbone (CV), Drive Axle;Air Suspension Axle
	09/02 →	Track Control Arm		MN-VB-8514	Suspension Rod, Wishbone (CV), Drive Axle; Leaf Spring Axle
	09/02 →	Track Control Arm		MN-VB-8669	Suspension Rod, Wishbone (CV), Drive Axle; Leaf Spring Axle
	09/02 →	Track Control Arm		MN-VB-9404	Wishbone (CV), Drive Axle
	02/06 →	Track Control Arm		MN-DL-5225	Trailing Arm
	26.480 FNLC, FNLLC, FNLLRC, FNLLW, FNLRC, FVLC	09/02 →01/05	Track Control Arm		MN-DL-5212
09/02 →		Ball Head, gearshift linkage	CV-ES-2120		
09/02 →		Centre Rod	MN-DL-7801		Push Rod, Leaf Spring Axle
09/02 →		Centre Rod	MN-DL-8560		Push Rod, Air Suspension Axle
09/02 →		Suspension Strut Repair Kit		CV-RK-5311	
09/02 →		Suspension Strut Repair Kit		DB-RK-8581	
09/02 →		Suspension Strut Repair Kit		MN-RK-12436	
09/02 →		Tie Rod	MN-DL-7802		
09/02 →		Tie Rod	MN-DL-12284		
09/02 →		Tie Rod End		IV-ES-8507	Tag Axle
09/02 →		Tie Rod End		MN-ES-8490	for vehicles with Hinged Trailing Axle
09/02 →		Tie Rod End		SC-ES-8517	for Push Rod
09/02 →		Tie Rod End	CV-ES-0914		for Steering Rod
09/02 →		Tie Rod End	CV-ES-14162	CV-ES-14162	for Steering Rod
09/02 →		Tie Rod End	CV-ES-14163		for Steering Rod
09/02 →		Tie Rod End	IV-ES-12272		for Steering Rod
09/02 →		Tie Rod End	SC-ES-7279		for Steering Rod
09/02 →		Tie Rod End	SC-ES-8535		for Guide Rod
09/02 →		Track Control Arm		MN-DL-5225	Trailing Arm, Drive Axle;Air Suspension Axle
09/02 →		Track Control Arm		MN-DL-5225	Trailing Arm, Leading Axle;Air Suspension Axle
09/02 →		Track Control Arm		MN-DL-8709	Trailing Arm, Air Suspension Axle; for vehicles with Hinged Trailing Axle
09/02 →		Track Control Arm		MN-DL-8733	Trailing Arm, Air Suspension Axle;Drive Axle
09/02 →		Track Control Arm		MN-TC-12399	Control Arm
09/02 →		Track Control Arm		MN-VB-5238	Wishbone (CV), Drive Axle;Leading Axle; Air Suspension Axle
09/02 →		Track Control Arm		MN-VB-9403	Wishbone (CV), Air Suspension Axle
09/02 →		Track Control Arm	MN-DL-8663		Control Arm, Air Suspension Axle
03/04 →		Track Control Arm		MN-DL-5225	Trailing Arm, Tag Axle;Air Suspension Axle; for vehicles with Hinged Trailing Axle
01/05 →		Track Control Arm		MN-DL-5225	Trailing Arm, Tag Axle;Air Suspension Axle; for vehicles with Rigid Trailing Axle
02/06 →		Centre Rod	MN-DL-7801		Push Rod
02/06 →		Track Control Arm		MN-DL-5212	Trailing Arm, Trailing Axle not Steered, for Pneumatic Suspension vehicles

CV-ES-0914

Length: 125
 Cone Ø: d1 Ø 30 / d2 Ø 27
 Thread: M38 x 1,5 RHT
 81953016184, 81953016251, 81953016276



CV-ES-2120

Length: 115
 Cone Ø: d1 Ø 12,4 / d2 Ø 10,8
 Thread: M14 x 1,5 RHT
 03008500A, 81953016200, 81953016202,
 81953016203, 81953016227



CV-ES-14162

Length: 125
 Cone Ø: d1 Ø 30 / d2 Ø 27
 Thread: M30 x 1,5 LHT
 81953010015, 81953010083, 81953010087,
 81953016029, 81953016030, 81953016043,
 81953016044, 81953016050, 81953016054,
 81953016087, 81953016091, 81953016107,
 81953016120, 81953016125, 81953016152,
 81953016155, 81953016157, 81953016168,
 81953016179, 81953016181, 81953016223,
 81953016237, 81953016254, 81953016275,
 81953016279, 81953016351



CV-ES-14163

Length: 125
 Cone Ø: d1 Ø 30 / d2 Ø 27
 Thread: M30 x 1,5 RHT
 95301.0084, 90804102156, 90804102272,
 90804102696, 90804102710, 81953010016,
 81953010075, 81953010084, 81953010088,
 81953010094, 81953010103, 81953016030,
 81953016043, 81953016048, 81953016049,
 81953016053, 81953016061, 81953016090,
 81953016108, 81953016112, 81953016126,
 81953016143, 81953016149, 81953016154,
 81953016156, 81953016168, 81953016178,
 81953016194, 81953016206, 81953016224,
 81953016234, 81953016242, 81953016252,
 81953016274, 81953016278, 81953016284,
 81953016286, 81953016308, 81953016310,
 81953016312, 81953016347, 81953016350,
 81953016352, 82953016012, 88953016014,
 N2953016001



CV-RK-5311

638862, 639287, 938423, 1104335,
 1953248, 0003500506, 3500506, 11013547,
 42488722, 070550504, 634303610,
 81432206055, 81432206073, 82262320660,
 5001842823, 7000307001, 8226232066



DB-RK-8581

Ø: 85
 Hole Distance: 130
 Thick/Height: 24
 03305800A, 81432706105



IV-ES-8507

Length: 80
 Cone Ø: d1 Ø 30 / d2 Ø 27
 Thread: M30 x 1,5 RHT
 11019869, 12216380, 55175540,
 81953016238



IV-ES-12272

Length: 75
 Cone Ø: d1 Ø 30 / d2 Ø 27
 Thread: M26 x 1,5 RHT
 81953016280, 82953010010



MN-DL-5212

Length: 577 Ø: 48
 Hole Distance: 130 / 130
 81432206096, 81432206097, 81432206098,
 81432206129, 81432209096, 81432209129,
 81432306014, 81432306030



MN-DL-5225

Length: 572 Ø: 48
 Hole Distance: 130 / 130
 03301500A, 81432206229, 81432206236,
 81432206267, 81432206270, 81432206272,
 81432206304, 81432206305, 81432209236,
 81432209267, 81432209272



MN-DL-7801

Length: 995 Ø: 52
 Cone Ø: d1 Ø 30 / d2 Ø 27
 81466106807, 81466106808, 81466116087,
 81466116088, 81466116096, 81466116097,
 81466116099, 81466116132, 81466116133,
 81466116136, 81466116197, 81466116198,
 81466116205

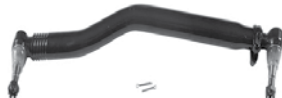

MN-DL-7802

Length: 1680 Ø: 52
 Cone Ø: d1 Ø 30 / d2 Ø 27
 03208300A, 81467116773, 81467116858,
 81467116859, 81467116860, 81467116861,
 81467116863, 81467116882, 81467116883,
 81467116920, 81467116921



MN-DL-8544

Length: 596 Ø: 48
 Hole Distance: 130 / 130
 81432206196, 81432206232, 81432206233



MN-DL-8560

Length: 970 Ø: 52
 Cone Ø: d1 Ø 30 / d2 Ø 27
 03206900A, 81466106809, 81466106810,
 81466106823, 81466106838, 81466106839,
 81466116104, 81466116105, 81466116107,
 81466116134, 81466116135, 81466116137,
 81466116199, 81466116200, 81466116206



MN-DL-8663

Length: 947 Ø: 60
 Hole Distance: 115 / 115
 03307400A, 81432206222, 81432206260,
 81432206283, 81432206284



MN-DL-8709

Length: 572 Ø: 52
 Hole Distance: 130 / 130
 81432206268, 81432206274, 81432206291,
 81432206292, 82432206007



MN-DL-8733

Length: 530 Ø: 48
 Hole Distance: 130 / 130
 81432206161, 81432206190, 81432206358,
 81432206359



MN-DL-10288

81432206386, 82432206008, 82432209008

No Image

MN-DL-12284

Length: 1530 Ø: 50
 Cone Ø: d1 Ø 30 / d2 Ø 27
 81466106579, 81466106580, 81466106624,
 81466116720, 81467116720, 81467116730,
 81467116952



MN-DL-12288

Length: 585 Ø: 58
 Hole Distance: 130 / 130
 81432206386, 82432206008, 82432209008

No Image

MN-ES-8490

Length: 90
 Cone Ø: d1 Ø 30 / d2 Ø 27
 Thread: M26 x 1,5 RHT
 0014606948, 14606948, 81953016281,
 81953016337, 82953016016



MN-RK-12436

Ø: 75
 Hole Distance: 115
 Thick/Height: 24
 81432206244



MN-TC-12399

Length: 694 Ø: 50
 Hole Distance: 130 / 130
 81432206265



MN-VB-5238

Length: 627 Ø: 48
 Hole Distance: 130 / 130
 81432206221, 81432706096, 81432706114,
 81432706116, 81432706121



MN-VB-8514

Length: 627 Ø: 48
 Hole Ø 25 / 25 / 25
 Hole Distance: 152 / 130 / 130
 81432706087, 81432706088, 81432706094,
 81432706095, 81432796094



MN-VB-8669

Length: 627 Ø: 48
 Hole Ø 25 / 25 / 25
 Hole Distance: 152 / 130 / 130
 81432706116, 81432706137, 81432706150,
 81432706151



MN-VB-9403

Length: 627 Ø: 48
 Hole Ø 25 / 23 / 23
 Hole Distance: 152 / 130 / 130
 81432706097, 81432706113, 81432706135,
 81432706160, 81432706161



MN-VB-9404

Length: 627 Ø: 58
 Hole Distance: 130 / 130
 81432706117, 81432706152, 81432706153



SC-ES-7279

Length: 150
 Cone Ø: d1 Ø 30 / d2 Ø 27
 Thread: M30 x 1,5 RHT
 81953016288



SC-ES-8517

Length: 140
 Cone Ø: d1 Ø 30 / d2 Ø 27
 Thread: M30 x 1,5 RHT
 81953016286



SC-ES-8535

Length: 145
 Cone Ø: d1 Ø 30 / d2 Ø 27
 Thread: M30 x 1,5 RHT
 81953016271, 81953016325





TGA ...

26.480 FNLC, FNLLC, FNLLRC, FNLLW, FNLRC, FVLC ...	02/06 →	Track Control Arm		MN-DL-8733	Trailing Arm, 1st Drive Axle, for Pneumatic Suspension vehicles	
	02/06 →	Track Control Arm	MN-DL-8663		Control Arm, 1st FA, for Pneumatic Suspension vehicles	
26.480 FNLS, FNLLS, FNLRS, FPLS, FVLS, FVLRS	09/02 →01/05	Track Control Arm		MN-DL-5212	Trailing Arm, Tag Axle;Air Suspension Axle	
	09/02 →	Ball Head, gearshift linkage	CV-ES-2120			
	09/02 →	Centre Rod	MN-DL-7801		Push Rod, Leaf Spring Axle	
	09/02 →	Centre Rod	MN-DL-8560		Push Rod, Air Suspension Axle	
	09/02 →	Suspension Strut Repair Kit		DB-RK-8581		
	09/02 →	Suspension Strut Repair Kit		MN-RK-12436		
	09/02 →	Tie Rod	MN-DL-7802			
	09/02 →	Tie Rod	MN-DL-12284			
	09/02 →	Tie Rod End		SC-ES-8517	for Push Rod	
	09/02 →	Tie Rod End	CV-ES-0914		for Steering Rod	
	09/02 →	Tie Rod End	CV-ES-14162	CV-ES-14162	for Steering Rod	
	09/02 →	Tie Rod End	CV-ES-14163		for Steering Rod	
	09/02 →	Tie Rod End	SC-ES-7279		for Steering Rod	
	09/02 →	Tie Rod End	SC-ES-8535		for Guide Rod	
	09/02 →	Track Control Arm		MN-DL-5225	Trailing Arm, Drive Axle;Air Suspension Axle	
	09/02 →	Track Control Arm		MN-DL-5225	Trailing Arm, Leading Axle;Air Suspension Axle	
	09/02 →	Track Control Arm		MN-DL-8709	Trailing Arm, Air Suspension Axle; for vehicles with Hinged Trailing Axle	
	09/02 →	Track Control Arm		MN-DL-8733	Trailing Arm, Air Suspension Axle;Drive Axle	
	09/02 →	Track Control Arm		MN-TC-12399	Control Arm	
	09/02 →	Track Control Arm		MN-VB-5238	Wishbone (CV), Drive Axle;Leading Axle; Air Suspension Axle	
	09/02 →	Track Control Arm		MN-VB-9403	Wishbone (CV), Air Suspension Axle	
	09/02 →	Track Control Arm	MN-DL-8663		Control Arm, Air Suspension Axle	
	03/04 →	Track Control Arm		MN-DL-5225	Trailing Arm, Tag Axle;Air Suspension Axle; for vehicles with Hinged Trailing Axle	
	01/05 →	Track Control Arm		MN-DL-5225	Trailing Arm, Tag Axle;Air Suspension Axle; for vehicles with Rigid Trailing Axle	
	02/06 →	Tie Rod End		IV-ES-8507	Tag Axle	
	02/06 →	Tie Rod End		MN-ES-8490	for vehicles with Hinged Trailing Axle	
	02/06 →	Tie Rod End	IV-ES-12272		for Steering Rod	
	02/06 →	Track Control Arm		MN-DL-5212	Trailing Arm, Trailing Axle not Steered, for Pneumatic Suspension vehicles	
	02/06 →	Track Control Arm		MN-VB-5238	Wishbone (CV), Drive Axle;Air Suspension Axle	
	02/06 →	Track Control Arm		MN-VB-5238	Wishbone (CV), Leading Axle;Air Suspension Axle	
	02/06 →	Track Control Arm	MN-DL-8663		Control Arm, 1st FA, for Pneumatic Suspension vehicles	
	26.480 FVHL-KO	02/06 →	Centre Rod	MN-DL-7801		Push Rod, Leaf Spring Axle
		02/06 →	Suspension Strut Repair Kit		DB-RK-8581	
02/06 →		Tie Rod	MN-DL-7802			
02/06 →		Tie Rod End		SC-ES-8517	for Push Rod	
02/06 →		Tie Rod End	CV-ES-0914		for Steering Rod	
02/06 →		Tie Rod End	CV-ES-14163		for Steering Rod	
02/06 →		Tie Rod End	SC-ES-7279		for Steering Rod	
02/06 →		Tie Rod End	SC-ES-8535		for Guide Rod	
02/06 →		Track Control Arm		MN-DL-5225	Trailing Arm, Drive Axle;Air Suspension Axle	
02/06 →		Track Control Arm		MN-DL-5225	Trailing Arm, Leading Axle;Air Suspension Axle	
02/06 →	Track Control Arm		MN-VB-5238	Wishbone (CV), Drive Axle;Leading Axle; Air Suspension Axle		
26.480 FVL-KO	09/02 →	Ball Head, gearshift linkage	CV-ES-2120			
	09/02 →	Centre Rod	MN-DL-7801		Push Rod, Leaf Spring Axle	
	09/02 →	Centre Rod	MN-DL-8560		Push Rod, Air Suspension Axle	
	09/02 →	Suspension Strut Repair Kit		DB-RK-8581		
	09/02 →	Suspension Strut Repair Kit		MN-RK-12436		
	09/02 →	Tie Rod	MN-DL-7802			
	09/02 →	Tie Rod End	CV-ES-0914		for Steering Rod	
	09/02 →	Tie Rod End	CV-ES-14163		for Steering Rod	
	09/02 →	Tie Rod End	SC-ES-7279		for Steering Rod	
	09/02 →	Tie Rod End	SC-ES-8517		for Push Rod	

CV-ES-0914

Length: 125
Cone Ø: d1 Ø 30 / d2 Ø 27
Thread: M38 x 1,5 RHT
81953016184, 81953016251, 81953016276



CV-ES-2120

Length: 115
Cone Ø: d1 Ø 12,4 / d2 Ø 10,8
Thread: M14 x 1,5 RHT
03008500A, 81953016200, 81953016202,
81953016203, 81953016227



CV-ES-14162

Length: 125
Cone Ø: d1 Ø 30 / d2 Ø 27
Thread: M30 x 1,5 LHT
81953010015, 81953010083, 81953010087,
81953016029, 81953016030, 81953016043,
81953016044, 81953016050, 81953016054,
81953016087, 81953016091, 81953016107,
81953016120, 81953016125, 81953016152,
81953016155, 81953016157, 81953016168,
81953016179, 81953016181, 81953016223,
81953016237, 81953016254, 81953016275,
81953016279, 81953016351



CV-ES-14163

Length: 125
Cone Ø: d1 Ø 30 / d2 Ø 27
Thread: M30 x 1,5 RHT
95301.0084, 90804102156, 90804102272,
90804102696, 90804102710, 81953010016,
81953010075, 81953010084, 81953010088,
81953010094, 81953010103, 81953016030,
81953016043, 81953016048, 81953016049,
81953016053, 81953016061, 81953016090,
81953016108, 81953016112, 81953016126,
81953016143, 81953016149, 81953016154,
81953016156, 81953016168, 81953016178,
81953016194, 81953016206, 81953016224,
81953016234, 81953016242, 81953016252,
81953016274, 81953016278, 81953016284,
81953016286, 81953016308, 81953016310,
81953016312, 81953016347, 81953016350,
81953016352, 82953016012, 88953016014,
N2953016001



DB-RK-8581

Ø: 85
Hole Distance: 130
Thick/Height: 24
03305800A, 81432706105



IV-ES-8507

Length: 80
Cone Ø: d1 Ø 30 / d2 Ø 27
Thread: M30 x 1,5 RHT
11019869, 12216380, 55175540,
81953016238



IV-ES-12272

Length: 75
Cone Ø: d1 Ø 30 / d2 Ø 27
Thread: M26 x 1,5 RHT
81953016280, 82953010010



MN-DL-5212

Length: 577 Ø: 48
Hole Distance: 130 / 130
81432206096, 81432206097, 81432206098,
81432206129, 81432209096, 81432209129,
81432306014, 81432306030



MN-DL-5225

Length: 572 Ø: 48
Hole Distance: 130 / 130
03301500A, 81432206229, 81432206236,
81432206267, 81432206270, 81432206272,
81432206304, 81432206305, 81432209236,
81432209267, 81432209272



MN-DL-7801

Length: 995 Ø: 52
Cone Ø: d1 Ø 30 / d2 Ø 27
81466106807, 81466106808, 81466116087,
81466116088, 81466116096, 81466116097,
81466116099, 81466116132, 81466116133,
81466116136, 81466116197, 81466116198,
81466116205



MN-DL-7802

Length: 1680 Ø: 52
Cone Ø: d1 Ø 30 / d2 Ø 27
03208300A, 81467116773, 81467116858,
81467116859, 81467116860, 81467116861,
81467116863, 81467116882, 81467116883,
81467116920, 81467116921



MN-DL-8560

Length: 970 Ø: 52
Cone Ø: d1 Ø 30 / d2 Ø 27
03206900A, 81466106809, 81466106810,
81466106823, 81466106838, 81466106839,
81466116104, 81466116105, 81466116107,
81466116134, 81466116135, 81466116137,
81466116199, 81466116200, 81466116206



MN-DL-8663

Length: 947 Ø: 60
Hole Distance: 115 / 115
03307400A, 81432206222, 81432206260,
81432206283, 81432206284



MN-DL-8709

Length: 572 Ø: 52
Hole Distance: 130 / 130
81432206268, 81432206274, 81432206291,
81432206292, 82432206007



MN-DL-8733

Length: 530 Ø: 48
Hole Distance: 130 / 130
81432206161, 81432206190, 81432206358,
81432206359



MN-DL-12284

Length: 1530 Ø: 50
Cone Ø: d1 Ø 30 / d2 Ø 27
81466106579, 81466106580, 81466106624,
81466116720, 81467116720, 81467116730,
81467116952



MN-ES-8490

Length: 90
Cone Ø: d1 Ø 30 / d2 Ø 27
Thread: M26 x 1,5 RHT
0014606948, 14606948, 81953016281,
81953016337, 82953016016



MN-RK-12436

Ø: 75
Hole Distance: 115
Thick/Height: 24
81432206244



MN-TC-12399

Length: 694 Ø: 50
Hole Distance: 130 / 130
81432206265



MN-VB-5238

Length: 627 Ø: 48
Hole Distance: 130 / 130
81432206221, 81432706096, 81432706114,
81432706116, 81432706121



MN-VB-9403

Length: 627 Ø: 48
Hole Ø 25 / 23 / 23
Hole Distance: 152 / 130 / 130
81432706097, 81432706113, 81432706135,
81432706160, 81432706161



SC-ES-7279

Length: 150
Cone Ø: d1 Ø 30 / d2 Ø 27
Thread: M30 x 1,5 RHT
81953016288



SC-ES-8517

Length: 140
Cone Ø: d1 Ø 30 / d2 Ø 27
Thread: M30 x 1,5 RHT
81953016286



SC-ES-8535

Length: 145
Cone Ø: d1 Ø 30 / d2 Ø 27
Thread: M30 x 1,5 RHT
81953016271, 81953016325





TGA ...

26.480 FVL-KO ...	09/02→	Tie Rod End	SC-ES-8535		for Guide Rod	
	09/02→	Track Control Arm		MN-DL-5225	Trailing Arm, Drive Axle;Air Suspension Axle	
	09/02→	Track Control Arm		MN-DL-5225	Trailing Arm, Leading Axle;Air Suspension Axle	
	09/02→	Track Control Arm		MN-DL-8733	Trailing Arm, Air Suspension Axle;Drive Axle	
	09/02→	Track Control Arm		MN-VB-5238	Wishbone (CV), Drive Axle;Leading Axle; Air Suspension Axle	
	09/02→	Track Control Arm	MN-DL-8663		Control Arm, Air Suspension Axle	
	01/06→	Centre Rod	MN-DL-7801		Push Rod	
	01/06→	Suspension Arm Repair Kit		CV-RK-5313	for Wishbone (CV)	
	01/06→	Suspension Arm Repair Kit	DB-RK-9300	DB-RK-9300	for Drag Link	
	01/06→	Suspension Strut Repair Kit		CV-RK-5311		
	01/06→	Track Control Arm		MN-DL-5225	Trailing Arm	
	01/06→	Track Control Arm		MN-DL-8733	Trailing Arm, 1st Drive Axle, for Pneumatic Suspension vehicles	
	01/06→	Track Control Arm		MN-VB-5238	Wishbone (CV), 1st Drive Axle, for Pneumatic Suspension vehicles	
	26.510 FDC, FDLC, FDLRC, FDRC	01/01→	Ball Head, gearshift linkage	CV-ES-2120		
01/01→		Centre Rod	MN-DL-7801		Push Rod, Leaf Spring Axle	
01/01→		Centre Rod	MN-DL-8560		Push Rod, Air Suspension Axle	
01/01→		Suspension Strut Repair Kit		DB-RK-8581		
01/01→		Suspension Strut Repair Kit		MN-RK-12436		
01/01→		Tie Rod	MN-DL-7802			
01/01→		Tie Rod End	CV-ES-0914		for Steering Rod	
01/01→		Tie Rod End	CV-ES-14162		for Steering Rod	
01/01→		Tie Rod End	CV-ES-14163		for Steering Rod	
01/01→		Tie Rod End	SC-ES-7279		for Steering Rod	
01/01→		Tie Rod End	SC-ES-8517		for Push Rod	
01/01→		Tie Rod End	SC-ES-8535		for Guide Rod	
01/01→		Track Control Arm		MN-DL-3402	Trailing Arm, Air Suspension Axle;Drive Axle	
01/01→		Track Control Arm		MN-DL-5225	Trailing Arm, Drive Axle;Air Suspension Axle	
01/01→		Track Control Arm		MN-DL-8544	Trailing Arm, Drive Axle;Air Suspension Axle	
01/01→		Track Control Arm		MN-DL-8544	Trailing Arm, Drive Axle;Leaf Spring Axle	
01/01→		Track control arm		MN-DL-10288	Trailing Arm, 1st RA;2nd RA, for Leaf-Spring Suspension vehicles	
01/01→		Track control arm		MN-DL-12288	Trailing Arm	
01/01→		Track Control Arm		MN-VB-5222	Wishbone (CV), 1st RA;2nd RA, for Pneumatic Suspension vehicles	
01/01→		Track Control Arm		MN-VB-5238	Wishbone (CV), Drive Axle;Air Suspension Axle	
01/01→		Track Control Arm		MN-VB-8514	Suspension Rod, Wishbone (CV), Drive Axle; Leaf Spring Axle	
01/01→		Track Control Arm		MN-VB-8669	Suspension Rod, Wishbone (CV), Drive Axle	
01/01→		Track Control Arm		MN-VB-8669	Suspension Rod, Wishbone (CV), Drive Axle; Leaf Spring Axle	
01/01→		Track Control Arm		MN-VB-9404	Wishbone (CV), Drive Axle	
01/01→		Track Control Arm		MN-VB-9404	Wishbone (CV), Drive Axle;Air Suspension Axle	
01/01→		Track Control Arm	MN-DL-8663		Control Arm, Air Suspension Axle	
26.510 FDS, FDLS, FDLS/M, FDRS, FDLRS		01/01→	Ball Head, gearshift linkage	CV-ES-2120		
		01/01→	Centre Rod	MN-DL-7801		Push Rod, Leaf Spring Axle
		01/01→	Centre Rod	MN-DL-8560		Push Rod, Air Suspension Axle
		01/01→	Suspension Strut Repair Kit		DB-RK-8581	
	01/01→	Suspension Strut Repair Kit		MN-RK-12436		
	01/01→	Tie Rod	MN-DL-7802			
	01/01→	Tie Rod End	CV-ES-0914		for Steering Rod	
	01/01→	Tie Rod End	CV-ES-14162		for Steering Rod	
	01/01→	Tie Rod End	CV-ES-14163		for Steering Rod	
	01/01→	Tie Rod End	SC-ES-7279		for Steering Rod	
	01/01→	Tie Rod End	SC-ES-8517		for Push Rod	
	01/01→	Tie Rod End	SC-ES-8535		for Guide Rod	
	01/01→	Track Control Arm		MN-DL-3402	Trailing Arm, Air Suspension Axle;Drive Axle	
	01/01→	Track Control Arm		MN-DL-5225	Trailing Arm, Drive Axle;Air Suspension Axle	
	01/01→	Track Control Arm		MN-DL-8544	Trailing Arm, Drive Axle;Air Suspension Axle	
	01/01→	Track Control Arm		MN-DL-8544	Trailing Arm, Drive Axle;Leaf Spring Axle	

CV-ES-0914

Length: 125
Cone Ø: d1 Ø 30 / d2 Ø 27
Thread: M38 x 1,5 RHT
81953016184, 81953016251, 81953016276

**CV-ES-2120**

Length: 115
Cone Ø: d1 Ø 12,4 / d2 Ø 10,8
Thread: M14 x 1,5 RHT
03008500A, 81953016200, 81953016202, 81953016203, 81953016227

**CV-ES-14162**

Length: 125
Cone Ø: d1 Ø 30 / d2 Ø 27
Thread: M30 x 1,5 LHT
81953010015, 81953010083, 81953010087, 81953016029, 81953016030, 81953016043, 81953016044, 81953016050, 81953016054, 81953016087, 81953016091, 81953016107, 81953016120, 81953016125, 81953016152, 81953016155, 81953016157, 81953016168, 81953016179, 81953016181, 81953016223, 81953016237, 81953016254, 81953016275, 81953016279, 81953016351

**CV-ES-14163**

Length: 125
Cone Ø: d1 Ø 30 / d2 Ø 27
Thread: M30 x 1,5 RHT
95301.0084, 90804102156, 90804102272, 90804102696, 90804102710, 81953010016, 81953010075, 81953010084, 81953010088, 81953010094, 81953010103, 81953016030, 81953016043, 81953016048, 81953016049, 81953016053, 81953016061, 81953016090, 81953016108, 81953016112, 81953016126, 81953016143, 81953016149, 81953016154, 81953016156, 81953016168, 81953016178, 81953016194, 81953016206, 81953016224, 81953016234, 81953016242, 81953016252, 81953016274, 81953016278, 81953016284, 81953016286, 81953016308, 81953016310, 81953016312, 81953016347, 81953016350, 81953016352, 82953016012, 88953016014, N2953016001

**CV-RK-5311**

638862, 639287, 938423, 1104335, 1953248, 0003500506, 3500506, 11013547, 42488722, 070550504, 634303610, 81432206055, 81432206073, 82262320660, 5001842823, 7000307001, 8226232066

**CV-RK-5313**

Ø: 90
03304800A, 81953016132

**DB-RK-8581**

Ø: 85
Hole Distance: 130
Thick/Height: 24
03305800A, 81432706105

**DB-RK-9300**

Ø: 75
Hole Distance: 130
Thick/Height: 24
85432206002

**MN-DL-3402**

Length: 590 Ø: 48
Hole Distance: 130 / 130
03307200A, 81432206067, 81432206068, 81432206090, 81432206092, 81432209092

**MN-DL-5225**

Length: 572 Ø: 48
Hole Distance: 130 / 130
03301500A, 81432206229, 81432206236, 81432206267, 81432206270, 81432206272, 81432206304, 81432206305, 81432209235, 81432209267, 81432209272

**MN-DL-7801**

Length: 995 Ø: 52
Cone Ø: d1 Ø 30 / d2 Ø 27
81466106807, 81466106808, 81466116087, 81466116088, 81466116096, 81466116097, 81466116099, 81466116132, 81466116133, 81466116136, 81466116197, 81466116198, 81466116205

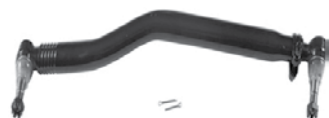
**MN-DL-7802**

Length: 1680 Ø: 52
Cone Ø: d1 Ø 30 / d2 Ø 27
03208300A, 81467116773, 81467116858, 81467116859, 81467116860, 81467116861, 81467116863, 81467116882, 81467116883, 81467116920, 81467116921

**MN-DL-8544**

Length: 596 Ø: 48
Hole Distance: 130 / 130
81432206196, 81432206232, 81432206233

**MN-DL-8560**

Length: 970 Ø: 52
Cone Ø: d1 Ø 30 / d2 Ø 27
03206900A, 81466106809, 81466106810, 81466106823, 81466106838, 81466106839, 81466116104, 81466116105, 81466116107, 81466116134, 81466116135, 81466116137, 81466116199, 81466116200, 81466116206

**MN-DL-8663**

Length: 947 Ø: 60
Hole Distance: 115 / 115
03307400A, 81432206222, 81432206260, 81432206283, 81432206284

**MN-DL-8733**

Length: 530 Ø: 48
Hole Distance: 130 / 130
81432206161, 81432206190, 81432206358, 81432206359

**MN-DL-10288**

81432206386, 82432206008, 82432209008

No Image

MN-DL-12288

Length: 585 Ø: 58
Hole Distance: 130 / 130
81432206386, 82432206008, 82432209008

No Image

MN-RK-12436

Ø: 75
Hole Distance: 115
Thick/Height: 24
81432206244

**MN-VB-5222**

Length: 627 Ø: 50
Hole Distance: 152 / 152
81432706030, 81432706034, 81432706054, 81432706055, 81432706056, 81432706057, 81432706067, 81432706068, 81432706074, 81432706075, 81432706076, 81432706077, 81432706078, 81432706081, 81432706082, 81432709034, 81432709076, 81432709078, 8143706054

**MN-VB-5238**

Length: 627 Ø: 48
Hole Distance: 130 / 130
81432206221, 81432706096, 81432706114, 81432706116, 81432706121

**MN-VB-8514**

Length: 627 Ø: 48
Hole Ø 25 / 25 / 25
Hole Distance: 152 / 130 / 130
81432706087, 81432706088, 81432706094, 81432706095, 81432706094

**MN-VB-8669**

Length: 627 Ø: 48
Hole Ø 25 / 25 / 25
Hole Distance: 152 / 130 / 130
81432706116, 81432706137, 81432706150, 81432706151

**MN-VB-9404**

Length: 627 Ø: 58
Hole Distance: 130 / 130
81432706117, 81432706152, 81432706153

**SC-ES-7279**

Length: 150
Cone Ø: d1 Ø 30 / d2 Ø 27
Thread: M30 x 1,5 RHT
81953016288

**SC-ES-8517**

Length: 140
Cone Ø: d1 Ø 30 / d2 Ø 27
Thread: M30 x 1,5 RHT
81953016286

**SC-ES-8535**

Length: 145
Cone Ø: d1 Ø 30 / d2 Ø 27
Thread: M30 x 1,5 RHT
81953016271, 81953016325





TGA ...

26.510 FDS, FDLS, FDLS/M,
FDRS, FDLRS ...

01/01→	Track control arm		MN-DL-10288	Trailing Arm, 1st RA;2nd RA, for Leaf-Spring Suspension vehicles
01/01→	Track control arm		MN-DL-12288	Trailing Arm
01/01→	Track Control Arm		MN-VB-5222	Wishbone (CV), 1st RA;2nd RA, for Pneumatic Suspension vehicles
01/01→	Track Control Arm		MN-VB-5238	Wishbone (CV), Drive Axle;Air Suspension Axle
01/01→	Track Control Arm		MN-VB-8514	Suspension Rod, Wishbone (CV), Drive Axle; Leaf Spring Axle
01/01→	Track Control Arm		MN-VB-8669	Suspension Rod, Wishbone (CV), Drive Axle
01/01→	Track Control Arm		MN-VB-8669	Suspension Rod, Wishbone (CV), Drive Axle; Leaf Spring Axle
01/01→	Track Control Arm		MN-VB-9404	Wishbone (CV), Drive Axle
01/01→	Track Control Arm		MN-VB-9404	Wishbone (CV), Drive Axle;Air Suspension Axle
01/01→	Track Control Arm	MN-DL-8663		Control Arm, Air Suspension Axle

26.510 FNLC, FNLLC, FNLLRC, F
NLLRW, FNLLW, FNLRC, FVLC

12/00→	Ball Head, gearshift linkage	CV-ES-2120		
12/00→	Centre Rod	MN-DL-7801		Push Rod, Leaf Spring Axle
12/00→	Centre Rod	MN-DL-8560		Push Rod, Air Suspension Axle
12/00→	Suspension Strut Repair Kit		CV-RK-5311	
12/00→	Suspension Strut Repair Kit		DB-RK-8581	
12/00→	Suspension Strut Repair Kit		MN-RK-12436	
12/00→	Tie Rod	MN-DL-7802		
12/00→	Tie Rod	MN-DL-12284		
12/00→	Tie Rod End		IV-ES-8507	Tag Axle
12/00→	Tie Rod End		MN-ES-8490	Tag Axle
12/00→	Tie Rod End		SC-ES-8517	for Push Rod
12/00→	Tie Rod End	CV-ES-0914		for Steering Rod
12/00→	Tie Rod End	CV-ES-14162	CV-ES-14162	for Steering Rod
12/00→	Tie Rod End	CV-ES-14163		for Steering Rod
12/00→	Tie Rod End	IV-ES-12272		for Steering Rod
12/00→	Tie Rod End	SC-ES-7279		for Steering Rod
12/00→	Tie Rod End	SC-ES-8535		for Guide Rod
12/00→	Track Control Arm		MN-DL-5212	Trailing Arm, Trailing Axle Steered/not Steered, for Pneumatic Suspension vehicles
12/00→	Track Control Arm		MN-DL-5225	Trailing Arm, Drive Axle;Air Suspension Axle
12/00→	Track Control Arm		MN-DL-5225	Trailing Arm, Leading Axle;Air Suspension Axle
12/00→	Track Control Arm		MN-DL-8709	Trailing Arm, Air Suspension Axle; for vehicles with Hinged Trailing Axle
12/00→	Track Control Arm		MN-DL-8733	Trailing Arm, Air Suspension Axle;Drive Axle
12/00→	Track Control Arm		MN-TC-12399	Control Arm
12/00→	Track Control Arm		MN-VB-5238	Wishbone (CV), Drive Axle;Leading Axle; Air Suspension Axle
12/00→	Track Control Arm		MN-VB-9403	Wishbone (CV), Air Suspension Axle
12/00→	Track Control Arm	MN-DL-8663		Control Arm, Air Suspension Axle
03/04→	Track Control Arm		MN-DL-5225	Trailing Arm, Tag Axle;Air Suspension Axle; for vehicles with Hinged Trailing Axle
01/05→	Track Control Arm		MN-DL-5225	Trailing Arm, Tag Axle;Air Suspension Axle; for vehicles with Rigid Trailing Axle

26.510 FNLS, FNLLS, FNLLRS,
FPLS, FVLS, FVLLRS

12/00→01/05	Track Control Arm		MN-DL-5212	Trailing Arm, Tag Axle;Air Suspension Axle
12/00→	Ball Head, gearshift linkage	CV-ES-2120		
12/00→	Centre Rod	MN-DL-7801		Push Rod, Leaf Spring Axle
12/00→	Centre Rod	MN-DL-8560		Push Rod, Air Suspension Axle
12/00→	Suspension Strut Repair Kit		CV-RK-5311	
12/00→	Suspension Strut Repair Kit		DB-RK-8581	
12/00→	Suspension Strut Repair Kit		MN-RK-12436	
12/00→	Tie Rod	MN-DL-7802		
12/00→	Tie Rod	MN-DL-12284		
12/00→	Tie Rod End		IV-ES-8507	Tag Axle
12/00→	Tie Rod End		MN-ES-8490	for vehicles with Hinged Trailing Axle
12/00→	Tie Rod End		SC-ES-8517	for Push Rod
12/00→	Tie Rod End	CV-ES-0914		for Steering Rod
12/00→	Tie Rod End	CV-ES-14162	CV-ES-14162	for Steering Rod
12/00→	Tie Rod End	CV-ES-14163		for Steering Rod
12/00→	Tie Rod End	IV-ES-12272		for Steering Rod

CV-ES-0914

Length: 125
Cone Ø: d1 Ø 30 / d2 Ø 27
Thread: M38 x 1,5 RHT
81953016184, 81953016251, 81953016276

**CV-ES-2120**

Length: 115
Cone Ø: d1 Ø 12,4 / d2 Ø 10,8
Thread: M14 x 1,5 RHT
03008500A, 81953016200, 81953016202, 81953016203, 81953016227

**CV-ES-14162**

Length: 125
Cone Ø: d1 Ø 30 / d2 Ø 27
Thread: M30 x 1,5 LHT
81953010015, 81953010083, 81953010087, 81953016029, 81953016030, 81953016043, 81953016044, 81953016050, 81953016054, 81953016087, 81953016091, 81953016107, 81953016120, 81953016125, 81953016152, 81953016155, 81953016157, 81953016168, 81953016179, 81953016181, 81953016223, 81953016237, 81953016254, 81953016275, 81953016279, 81953016351

**CV-ES-14163**

Length: 125
Cone Ø: d1 Ø 30 / d2 Ø 27
Thread: M30 x 1,5 RHT
95301.0084, 90804102156, 90804102272, 90804102696, 90804102710, 81953010016, 81953010075, 81953010084, 81953010088, 81953010094, 81953010103, 81953016030, 81953016043, 81953016048, 81953016049, 81953016053, 81953016061, 81953016090, 81953016108, 81953016112, 81953016126, 81953016143, 81953016149, 81953016154, 81953016156, 81953016168, 81953016178, 81953016194, 81953016206, 81953016224, 81953016234, 81953016242, 81953016252, 81953016274, 81953016278, 81953016284, 81953016286, 81953016308, 81953016310, 81953016312, 81953016347, 81953016350, 81953016352, 82953016012, 88953016014, N2953016001

**CV-RK-5311**

638862, 639287, 938423, 1104335, 1953248, 3500506, 0003500506, 11013547, 42488722, 070550504, 634303610, 81432206055, 81432206073, 82262320660, 5001842823, 7000307001, 82262320666

**DB-RK-8581**

Ø: 85
Hole Distance: 130
Thick/Height: 24
03305800A, 81432706105

**IV-ES-8507**

Length: 80
Cone Ø: d1 Ø 30 / d2 Ø 27
Thread: M30 x 1,5 RHT
11019869, 12216380, 55175540, 81953016238

**IV-ES-12272**

Length: 75
Cone Ø: d1 Ø 30 / d2 Ø 27
Thread: M26 x 1,5 RHT
81953016280, 82953010010

**MN-DL-5212**

Length: 577 Ø: 48
Hole Distance: 130 / 130
81432206096, 81432206097, 81432206098, 81432206129, 81432209096, 81432209129, 81432306014, 81432306030

**MN-DL-5225**

Length: 572 Ø: 48
Hole Distance: 130 / 130
03301500A, 81432206229, 81432206236, 81432206267, 81432206270, 81432206272, 81432206304, 81432206305, 81432209236, 81432209267, 81432209272

**MN-DL-7801**

Length: 995 Ø: 52
Cone Ø: d1 Ø 30 / d2 Ø 27
81466106807, 81466106808, 81466116087, 81466116088, 81466116096, 81466116097, 81466116099, 81466116132, 81466116133, 81466116136, 81466116197, 81466116198, 81466116205

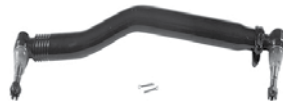
**MN-DL-7802**

Length: 1680 Ø: 52
Cone Ø: d1 Ø 30 / d2 Ø 27
03208300A, 81467116773, 81467116858, 81467116859, 81467116860, 81467116861, 81467116863, 81467116882, 81467116883, 81467116920, 81467116921

**MN-DL-8560**

Length: 970 Ø: 52
Cone Ø: d1 Ø 30 / d2 Ø 27
03206900A, 81466106809, 81466106810, 81466106823, 81466106838, 81466106839, 81466116104, 81466116105, 81466116107, 81466116134, 81466116135, 81466116137, 81466116199, 81466116200, 81466116206

**MN-DL-8663**

Length: 947 Ø: 60
Hole Distance: 115 / 115
03307400A, 81432206222, 81432206260, 81432206283, 81432206284

**MN-DL-8709**

Length: 572 Ø: 52
Hole Distance: 130 / 130
81432206268, 81432206274, 81432206291, 81432206292, 82432206007

**MN-DL-8733**

Length: 530 Ø: 48
Hole Distance: 130 / 130
81432206161, 81432206190, 81432206358, 81432206359

**MN-DL-10288**

81432206386, 82432206008, 82432209008

No Image

MN-DL-12284

Length: 1530 Ø: 50
Cone Ø: d1 Ø 30 / d2 Ø 27
81466106579, 81466106580, 81466106624, 81466116720, 81467116720, 81467116730, 81467116952

**MN-DL-12288**

Length: 585 Ø: 58
Hole Distance: 130 / 130
81432206386, 82432206008, 82432209008

No Image

MN-ES-8490

Length: 90
Cone Ø: d1 Ø 30 / d2 Ø 27
Thread: M26 x 1,5 RHT
0014606948, 14606948, 81953016281, 81953016337, 82953016016

**MN-RK-12436**

Ø: 75
Hole Distance: 115
Thick/Height: 24
81432206244

**MN-TC-12399**

Length: 694 Ø: 50
Hole Distance: 130 / 130
81432206265

**MN-VB-5222**

Length: 627 Ø: 50
Hole Distance: 152 / 152
81432706030, 81432706034, 81432706054, 81432706055, 81432706056, 81432706057, 81432706067, 81432706068, 81432706074, 81432706075, 81432706076, 81432706077, 81432706078, 81432706081, 81432706082, 81432709034, 81432709076, 81432709078, 8143706054

**MN-VB-5238**

Length: 627 Ø: 48
Hole Distance: 130 / 130
81432206221, 81432706096, 81432706114, 81432706116, 81432706121

**MN-VB-8514**

Length: 627 Ø: 48
Hole Ø 25 / 25 / 25
Hole Distance: 152 / 130 / 130
81432706087, 81432706088, 81432706094, 81432706095, 81432796094

**MN-VB-8669**

Length: 627 Ø: 48
Hole Ø 25 / 25 / 25
Hole Distance: 152 / 130 / 130
81432706116, 81432706137, 81432706150, 81432706151

**MN-VB-9403**

Length: 627 Ø: 48
Hole Ø 25 / 23 / 23
Hole Distance: 152 / 130 / 130
81432706097, 81432706113, 81432706135, 81432706160, 81432706161

**MN-VB-9404**

Length: 627 Ø: 58
Hole Distance: 130 / 130
81432706117, 81432706152, 81432706153

**SC-ES-7279**

Length: 150
Cone Ø: d1 Ø 30 / d2 Ø 27
Thread: M30 x 1,5 RHT
81953016288

**SC-ES-8517**

Length: 140
Cone Ø: d1 Ø 30 / d2 Ø 27
Thread: M30 x 1,5 RHT
81953016286

**SC-ES-8535**

Length: 145
Cone Ø: d1 Ø 30 / d2 Ø 27
Thread: M30 x 1,5 RHT
81953016271, 81953016325



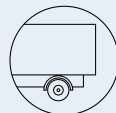

TGA ...

26.510 FNLS, FNLLS, FNLRS, FPLS, FVLS, FVLRS ...	12/00→	Tie Rod End	SC-ES-7279		for Steering Rod
	12/00→	Tie Rod End	SC-ES-8535		for Guide Rod
	12/00→	Track Control Arm		MN-DL-5225	Trailing Arm, Drive Axle;Air Suspension Axle
	12/00→	Track Control Arm		MN-DL-5225	Trailing Arm, Leading Axle;Air Suspension Axle
	12/00→	Track Control Arm		MN-DL-8709	Trailing Arm, Air Suspension Axle; for vehicles with Hinged Trailing Axle
	12/00→	Track Control Arm		MN-DL-8733	Trailing Arm, Air Suspension Axle;Drive Axle
	12/00→	Track Control Arm		MN-TC-12399	Control Arm
	12/00→	Track Control Arm		MN-VB-5238	Wishbone (CV), Drive Axle;Leading Axle; Air Suspension Axle
	12/00→	Track Control Arm		MN-VB-9403	Wishbone (CV), Air Suspension Axle
	12/00→	Track Control Arm	MN-DL-8663		Control Arm, Air Suspension Axle
	03/04→	Track Control Arm		MN-DL-5225	Trailing Arm, Tag Axle;Air Suspension Axle; for vehicles with Hinged Trailing Axle
	01/05→	Track Control Arm		MN-DL-5225	Trailing Arm, Tag Axle;Air Suspension Axle; for vehicles with Rigid Trailing Axle
26.530 FDAC, FDALC	07/06→	Centre Rod	MN-DL-7801		Push Rod
	07/06→	Suspension Strut Repair Kit		DB-RK-8581	
	07/06→	Tie Rod End	CV-ES-0914		for Steering Rod
	07/06→	Tie Rod End	CV-ES-14163		for Steering Rod
	07/06→	Tie Rod End	MN-ES-10333		for Steering Rod
	07/06→	Tie Rod End	SC-ES-8517		for Push Rod
	07/06→	Track Control Arm		MN-DL-5225	Trailing Arm
	07/06→	Track Control Arm		MN-DL-8544	Trailing Arm, Drive Axle;Air Suspension Axle
	07/06→	Track Control Arm		MN-DL-8609	Trailing Arm, 1st RA;2nd RA, for Leaf-Spring Suspension vehicles, →Type_HB Chassis
	07/06→	Track Control Arm		MN-VB-8514	Suspension Rod, Wishbone (CV), Drive Axle; Air Suspension Axle
26.530 FDAK, FDALK	09/02→	Centre Rod	MN-DL-7801		Push Rod
	09/02→	Suspension Strut Repair Kit		DB-RK-8581	
	09/02→	Tie Rod End	CV-ES-0914		for Steering Rod
	09/02→	Tie Rod End	CV-ES-14163		for Steering Rod
	09/02→	Tie Rod End	MN-ES-10333		for Steering Rod
	09/02→	Tie Rod End	SC-ES-8517		for Push Rod
	09/02→	Track Control Arm		MN-DL-5225	Trailing Arm
	09/02→	Track Control Arm		MN-DL-8544	Trailing Arm, 1st RA;2nd RA;Leaf Spring Axle
	09/02→	Track Control Arm		MN-DL-8544	Trailing Arm, Drive Axle;Air Suspension Axle
	09/02→	Track Control Arm		MN-DL-8609	Trailing Arm, 1st RA;2nd RA, for Leaf-Spring Suspension vehicles, →Type_HB Chassis
26.530 FDAS, FDALS	09/02→	Track Control Arm		MN-VB-8514	Suspension Rod, Wishbone (CV), Drive Axle; Leaf Spring Axle
	09/02→	Track Control Arm		MN-VB-9404	Wishbone (CV), Drive Axle
	07/06→	Centre Rod	MN-DL-7801		Push Rod
	07/06→	Suspension Strut Repair Kit		DB-RK-8581	
	07/06→	Tie Rod End	CV-ES-0914		for Steering Rod
	07/06→	Tie Rod End	CV-ES-14163		for Steering Rod
	07/06→	Tie Rod End	MN-ES-10333		for Steering Rod
	07/06→	Tie Rod End	SC-ES-8517		for Push Rod
	07/06→	Track Control Arm		MN-DL-5225	Trailing Arm
	07/06→	Track Control Arm		MN-DL-8544	Trailing Arm, Drive Axle;Air Suspension Axle
26.530 FDC, FDLC, FDLRC, FDRC	07/06→	Track Control Arm		MN-DL-8609	Trailing Arm, 1st RA;2nd RA, for Leaf-Spring Suspension vehicles, →Type_HB Chassis
	07/06→	Track Control Arm		MN-VB-8514	Suspension Rod, Wishbone (CV), Drive Axle; Air Suspension Axle
	07/06→	Track Control Arm		MN-VB-9404	Wishbone (CV), 1st RA;2nd RA, for Leaf-Spring Suspension vehicles, →Type_HB Chassis
	01/01→	Ball Head, gearshift linkage	CV-ES-2120		
	01/01→	Centre Rod	MN-DL-7801		Push Rod, Leaf Spring Axle
	01/01→	Centre Rod	MN-DL-8560		Push Rod, Air Suspension Axle
	01/01→	Suspension Strut Repair Kit		DB-RK-8581	
	01/01→	Suspension Strut Repair Kit		MN-RK-12436	

CV-ES-0914

Length: 125
Cone Ø: d1 Ø 30 / d2 Ø 27
Thread: M38 x 1,5 RHT
81953016184, 81953016251, 81953016276



CV-ES-2120

Length: 115
Cone Ø: d1 Ø 12,4 / d2 Ø 10,8
Thread: M14 x 1,5 RHT
03008500A, 81953016200, 81953016202,
81953016203, 81953016227



CV-ES-14163

Length: 125
Cone Ø: d1 Ø 30 / d2 Ø 27
Thread: M30 x 1,5 RHT
95301.0084, 90804102156, 90804102272,
90804102696, 90804102710, 81953010016,
81953010075, 81953010084, 81953010088,
81953010094, 81953010103, 81953016030,
81953016043, 81953016048, 81953016049,
81953016053, 81953016061, 81953016090,
81953016108, 81953016112, 81953016126,
81953016143, 81953016149, 81953016154,
81953016156, 81953016168, 81953016178,
81953016194, 81953016206, 81953016224,
81953016234, 81953016242, 81953016252,
81953016274, 81953016278, 81953016284,
81953016286, 81953016308, 81953016310,
81953016312, 81953016347, 81953016350,
81953016352, 82953016012, 88953016014,
N2953016001



DB-RK-8581

Ø: 85
Hole Distance: 130
Thick/Height: 24
03305800A, 81432706105



MN-DL-5225

Length: 572 Ø: 48
Hole Distance: 130 / 130
03301500A, 81432206229, 81432206236,
81432206267, 81432206270, 81432206272,
81432206304, 81432206305, 81432209236,
81432209267, 81432209272



MN-DL-7801

Length: 995 Ø: 52
Cone Ø: d1 Ø 30 / d2 Ø 27
81466106807, 81466106808, 81466116087,
81466116088, 81466116096, 81466116097,
81466116099, 81466116132, 81466116133,
81466116136, 81466116197, 81466116198,
81466116205



MN-DL-8544

Length: 596 Ø: 48
Hole Distance: 130 / 130
81432206196, 81432206232, 81432206233



MN-DL-8560

Length: 970 Ø: 52
Cone Ø: d1 Ø 30 / d2 Ø 27
03206900A, 81466106809, 81466106810,
81466106823, 81466106838, 81466106839,
81466116104, 81466116105, 81466116107,
81466116134, 81466116135, 81466116137,
81466116199, 81466116200, 81466116206



MN-DL-8609

Length: 585 Ø: 58
Hole Distance: 130 / 130
81432206070, 81432206071, 81432206072,
81432206091, 81432206093, 81432206119



MN-DL-8663

Length: 947 Ø: 60
Hole Distance: 115 / 115
03307400A, 81432206222, 81432206260,
81432206283, 81432206284



MN-DL-8709

Length: 572 Ø: 52
Hole Distance: 130 / 130
81432206268, 81432206274, 81432206291,
81432206292, 82432206007



MN-DL-8733

Length: 530 Ø: 48
Hole Distance: 130 / 130
81432206161, 81432206190, 81432206358,
81432206359



MN-ES-10333

Length: 90
Cone Ø: d1 Ø 38 / d2 Ø 34,35
Thread: M36 x 1,5 RHT
1271126, 3090291, 3099128, 42538048,
81953016268, 82953016018, 82953016019



MN-RK-12436

Ø: 75
Hole Distance: 115
Thick/Height: 24
81432206244



MN-TC-12399

Length: 694 Ø: 50
Hole Distance: 130 / 130
81432206265



MN-VB-5238

Length: 627 Ø: 48
Hole Distance: 130 / 130
81432206221, 81432706096, 81432706114,
81432706116, 81432706121



MN-VB-8514

Length: 627 Ø: 48
Hole Ø 25 / 25 / 25
Hole Distance: 152 / 130 / 130
81432706087, 81432706088, 81432706094,
81432706095, 81432796094



MN-VB-9403

Length: 627 Ø: 48
Hole Ø 25 / 23 / 23
Hole Distance: 152 / 130 / 130
81432706097, 81432706113, 81432706135,
81432706160, 81432706161



MN-VB-9404

Length: 627 Ø: 58
Hole Distance: 130 / 130
81432706117, 81432706152, 81432706153



SC-ES-7279

Length: 150
Cone Ø: d1 Ø 30 / d2 Ø 27
Thread: M30 x 1,5 RHT
81953016288



SC-ES-8517

Length: 140
Cone Ø: d1 Ø 30 / d2 Ø 27
Thread: M30 x 1,5 RHT
81953016286



SC-ES-8535

Length: 145
Cone Ø: d1 Ø 30 / d2 Ø 27
Thread: M30 x 1,5 RHT
81953016271, 81953016325





TGA ...

26.530 FDC, FDLC, FDLRC, FDRC ...	01/01→	Tie Rod	MN-DL-7802		
	01/01→	Tie Rod End	CV-ES-0914	for Steering Rod	
	01/01→	Tie Rod End	CV-ES-14162	for Steering Rod	
	01/01→	Tie Rod End	CV-ES-14163	for Steering Rod	
	01/01→	Tie Rod End	SC-ES-7279	for Steering Rod	
	01/01→	Tie Rod End	SC-ES-8517	for Push Rod	
	01/01→	Tie Rod End	SC-ES-8535	for Guide Rod	
	01/01→	Track Control Arm		MN-DL-3402	Trailing Arm, Air Suspension Axle; Drive Axle
	01/01→	Track Control Arm		MN-DL-5225	Trailing Arm, Drive Axle; Air Suspension Axle
	01/01→	Track Control Arm		MN-DL-8544	Trailing Arm, Drive Axle; Air Suspension Axle
	01/01→	Track Control Arm		MN-DL-8544	Trailing Arm, Drive Axle; Leaf Spring Axle
	01/01→	Track control arm		MN-DL-10288	Trailing Arm, 1st RA; 2nd RA, for Leaf-Spring Suspension vehicles
	01/01→	Track control arm		MN-DL-12288	Trailing Arm
	01/01→	Track Control Arm		MN-VB-5222	Wishbone (CV), 1st RA; 2nd RA, for Pneumatic Suspension vehicles
	01/01→	Track Control Arm		MN-VB-5238	Wishbone (CV), Drive Axle; Air Suspension Axle
	01/01→	Track Control Arm		MN-VB-8514	Suspension Rod, Wishbone (CV), Drive Axle; Leaf Spring Axle
	01/01→	Track Control Arm		MN-VB-8669	Suspension Rod, Wishbone (CV), Drive Axle
	01/01→	Track Control Arm		MN-VB-8669	Suspension Rod, Wishbone (CV), Drive Axle; Leaf Spring Axle
	01/01→	Track Control Arm		MN-VB-9404	Wishbone (CV), Drive Axle
	01/01→	Track Control Arm		MN-VB-9404	Wishbone (CV), Drive Axle; Air Suspension Axle
	01/01→	Track Control Arm	MN-DL-8663		Control Arm, Air Suspension Axle
	26.530 FDK, FDLK, FDLRK	09/02→	Ball Head, gearshift linkage	CV-ES-2120	
		09/02→	Centre Rod	MN-DL-7801	Push Rod, Leaf Spring Axle
09/02→		Centre Rod	MN-DL-8560	Push Rod, Air Suspension Axle	
09/02→		Suspension Strut Repair Kit		DB-RK-8581	
09/02→		Suspension Strut Repair Kit		MN-RK-12436	
09/02→		Tie Rod	MN-DL-7802		
09/02→		Tie Rod End	CV-ES-0914	for Steering Rod	
09/02→		Tie Rod End	CV-ES-14162	for Steering Rod	
09/02→		Tie Rod End	CV-ES-14163	for Steering Rod	
09/02→		Tie Rod End	SC-ES-7279	for Steering Rod	
09/02→		Tie Rod End	SC-ES-8517	for Push Rod	
09/02→		Tie Rod End	SC-ES-8535	for Guide Rod	
09/02→		Track Control Arm		MN-DL-3402	Trailing Arm, Air Suspension Axle; Drive Axle
09/02→		Track Control Arm		MN-DL-5225	Trailing Arm, Drive Axle; Air Suspension Axle
09/02→		Track Control Arm		MN-DL-8544	Trailing Arm, Drive Axle; Air Suspension Axle
09/02→		Track Control Arm		MN-DL-8544	Trailing Arm, Drive Axle; Leaf Spring Axle
09/02→		Track control arm		MN-DL-10288	Trailing Arm, 1st RA; 2nd RA, for Leaf-Spring Suspension vehicles
09/02→		Track control arm		MN-DL-12288	Trailing Arm
09/02→		Track Control Arm		MN-VB-5222	Wishbone (CV), 1st RA; 2nd RA, for Pneumatic Suspension vehicles
09/02→		Track Control Arm		MN-VB-5238	Wishbone (CV), Drive Axle; Air Suspension Axle
09/02→		Track Control Arm		MN-VB-8514	Suspension Rod, Wishbone (CV), Drive Axle; Leaf Spring Axle
09/02→		Track Control Arm		MN-VB-8669	Suspension Rod, Wishbone (CV), Drive Axle
09/02→		Track Control Arm		MN-VB-8669	Suspension Rod, Wishbone (CV), Drive Axle; Leaf Spring Axle
09/02→	Track Control Arm		MN-VB-9404	Wishbone (CV), Drive Axle	
09/02→	Track Control Arm		MN-VB-9404	Wishbone (CV), Drive Axle; Air Suspension Axle	
09/02→	Track Control Arm	MN-DL-8663		Control Arm, Air Suspension Axle	
26.530 FDLRS, FDLs, FDRS, FDS	01/01→	Ball Head, gearshift linkage	CV-ES-2120		
	01/01→	Centre Rod	MN-DL-7801	Push Rod, Leaf Spring Axle	
	01/01→	Centre Rod	MN-DL-8560	Push Rod, Air Suspension Axle	
	01/01→	Suspension Strut Repair Kit		DB-RK-8581	
	01/01→	Suspension Strut Repair Kit		MN-RK-12436	
	01/01→	Tie Rod	MN-DL-7802		
	01/01→	Tie Rod End	CV-ES-0914	for Steering Rod	
01/01→	Tie Rod End	CV-ES-14162	for Steering Rod		

CV-ES-0914

Length: 125
Cone Ø: d1 Ø 30 / d2 Ø 27
Thread: M38 x 1,5 RHT
81953016184, 81953016251, 81953016276



CV-ES-2120

Length: 115
Cone Ø: d1 Ø 12,4 / d2 Ø 10,8
Thread: M14 x 1,5 RHT
03008500A, 81953016200, 81953016202,
81953016203, 81953016227



CV-ES-14162

Length: 125
Cone Ø: d1 Ø 30 / d2 Ø 27
Thread: M30 x 1,5 LHT
81953010015, 81953010083, 81953010087,
81953016029, 81953016030, 81953016043,
81953016044, 81953016050, 81953016054,
81953016087, 81953016091, 81953016107,
81953016120, 81953016125, 81953016152,
81953016155, 81953016157, 81953016168,
81953016179, 81953016181, 81953016223,
81953016237, 81953016254, 81953016275,
81953016279, 81953016351



CV-ES-14163

Length: 125
Cone Ø: d1 Ø 30 / d2 Ø 27
Thread: M30 x 1,5 RHT
95301.0084, 90804102156, 90804102272,
90804102696, 90804102710, 81953010016,
81953010075, 81953010084, 81953010088,
81953010094, 81953010103, 81953016030,
81953016043, 81953016048, 81953016049,
81953016053, 81953016061, 81953016090,
81953016108, 81953016112, 81953016126,
81953016143, 81953016149, 81953016154,
81953016156, 81953016168, 81953016178,
81953016194, 81953016206, 81953016224,
81953016234, 81953016242, 81953016252,
81953016274, 81953016278, 81953016284,
81953016286, 81953016308, 81953016310,
81953016312, 81953016347, 81953016350,
81953016352, 82953016012, 88953016014,
N2953016001



DB-RK-8581

Ø: 85
Hole Distance: 130
Thick/Height: 24
03305800A, 81432706105



MN-DL-3402

Length: 590 Ø: 48
Hole Distance: 130 / 130
03307200A, 81432206067, 81432206068,
81432206090, 81432206092, 81432209092



MN-DL-5225

Length: 572 Ø: 48
Hole Distance: 130 / 130
03301500A, 81432206229, 81432206236,
81432206267, 81432206270, 81432206272,
81432206304, 81432206305, 81432209236,
81432209267, 81432209272



MN-DL-7801

Length: 995 Ø: 52
Cone Ø: d1 Ø 30 / d2 Ø 27
81466106807, 81466106808, 81466116087,
81466116088, 81466116096, 81466116097,
81466116099, 81466116132, 81466116133,
81466116136, 81466116197, 81466116198,
81466116205

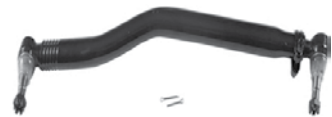

MN-DL-7802

Length: 1680 Ø: 52
Cone Ø: d1 Ø 30 / d2 Ø 27
03208300A, 81467116773, 81467116858,
81467116859, 81467116860, 81467116861,
81467116863, 81467116882, 81467116883,
81467116920, 81467116921



MN-DL-8544

Length: 596 Ø: 48
Hole Distance: 130 / 130
81432206196, 81432206232, 81432206233



MN-DL-8560

Length: 970 Ø: 52
Cone Ø: d1 Ø 30 / d2 Ø 27
03206900A, 81466106809, 81466106810,
81466106823, 81466106838, 81466106839,
81466116104, 81466116105, 81466116107,
81466116134, 81466116135, 81466116137,
81466116199, 81466116200, 81466116206



MN-DL-8663

Length: 947 Ø: 60
Hole Distance: 115 / 115
03307400A, 81432206222, 81432206260,
81432206283, 81432206284



MN-DL-10288

81432206386, 82432206008, 82432209008

No Image

MN-DL-12288

Length: 585 Ø: 58
Hole Distance: 130 / 130
81432206386, 82432206008, 82432209008

No Image

MN-RK-12436

Ø: 75
Hole Distance: 115
Thick/Height: 24
81432206244

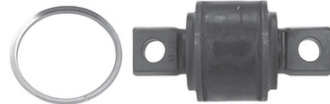

MN-VB-5222

Length: 627 Ø: 50
Hole Distance: 152 / 152
81432706030, 81432706034, 81432706054,
81432706055, 81432706056, 81432706057,
81432706067, 81432706068, 81432706074,
81432706075, 81432706076, 81432706077,
81432706078, 81432706081, 81432706082,
81432709034, 81432709076, 81432709078,
8143706054



MN-VB-5238

Length: 627 Ø: 48
Hole Distance: 130 / 130
81432206221, 81432706096, 81432706114,
81432706116, 81432706121



MN-VB-8514

Length: 627 Ø: 48
Hole Ø 25 / 25 / 25
Hole Distance: 152 / 130 / 130
81432706087, 81432706088, 81432706094,
81432706095, 81432796094



MN-VB-8669

Length: 627 Ø: 48
Hole Ø 25 / 25 / 25
Hole Distance: 152 / 130 / 130
81432706116, 81432706137, 81432706150,
81432706151



MN-VB-9404

Length: 627 Ø: 58
Hole Distance: 130 / 130
81432706117, 81432706152, 81432706153



SC-ES-7279

Length: 150
Cone Ø: d1 Ø 30 / d2 Ø 27
Thread: M30 x 1,5 RHT
81953016288



SC-ES-8517

Length: 140
Cone Ø: d1 Ø 30 / d2 Ø 27
Thread: M30 x 1,5 RHT
81953016286



SC-ES-8535

Length: 145
Cone Ø: d1 Ø 30 / d2 Ø 27
Thread: M30 x 1,5 RHT
81953016271, 81953016325





TGA ...

26.530 FDLRS, FDLS, FDRS, FDS ...	01/01→	Tie Rod End	CV-ES-14163		for Steering Rod	
	01/01→	Tie Rod End	SC-ES-7279		for Steering Rod	
	01/01→	Tie Rod End	SC-ES-8517		for Push Rod	
	01/01→	Tie Rod End	SC-ES-8535		for Guide Rod	
	01/01→	Track Control Arm		MN-DL-3402	Trailing Arm, Air Suspension Axle; Drive Axle	
	01/01→	Track Control Arm		MN-DL-5225	Trailing Arm, Drive Axle; Air Suspension Axle	
	01/01→	Track Control Arm		MN-DL-8544	Trailing Arm, Drive Axle; Air Suspension Axle	
	01/01→	Track Control Arm		MN-DL-8544	Trailing Arm, Drive Axle; Leaf Spring Axle	
	01/01→	Track control arm		MN-DL-10288	Trailing Arm, 1st RA; 2nd RA, for Leaf-Spring Suspension vehicles	
	01/01→	Track control arm		MN-DL-12288	Trailing Arm	
	01/01→	Track Control Arm		MN-VB-5222	Wishbone (CV), 1st RA; 2nd RA, for Pneumatic Suspension vehicles	
	01/01→	Track Control Arm		MN-VB-5238	Wishbone (CV), Drive Axle; Air Suspension Axle	
	01/01→	Track Control Arm		MN-VB-8514	Suspension Rod, Wishbone (CV), Drive Axle; Leaf Spring Axle	
	01/01→	Track Control Arm		MN-VB-8669	Suspension Rod, Wishbone (CV), Drive Axle	
	01/01→	Track Control Arm		MN-VB-8669	Suspension Rod, Wishbone (CV), Drive Axle; Leaf Spring Axle	
	01/01→	Track Control Arm		MN-VB-9404	Wishbone (CV), Drive Axle	
	01/01→	Track Control Arm		MN-VB-9404	Wishbone (CV), Drive Axle; Air Suspension Axle	
	01/01→	Track Control Arm	MN-DL-8663		Control Arm, Air Suspension Axle	
	26.530 FNLC, FNLLC, FNLLRC, FNLLRW, FNLLW, FNLRC, FVLC, FVLR	09/02→01/05	Track Control Arm		MN-DL-5212	Trailing Arm, Tag Axle; Air Suspension Axle
		09/02→	Ball Head, gearshift linkage	CV-ES-2120		
09/02→		Centre Rod	MN-DL-7801		Push Rod, Leaf Spring Axle	
09/02→		Centre Rod	MN-DL-8560		Push Rod, Air Suspension Axle	
09/02→		Suspension Strut Repair Kit		CV-RK-5311		
09/02→		Suspension Strut Repair Kit		DB-RK-8581		
09/02→		Suspension Strut Repair Kit		MN-RK-12436		
09/02→		Tie Rod	MN-DL-7802			
09/02→		Tie Rod	MN-DL-12284			
09/02→		Tie Rod End		IV-ES-8507	Tag Axle	
09/02→		Tie Rod End		MN-ES-8490	for vehicles with Hinged Trailing Axle	
09/02→		Tie Rod End		SC-ES-8517	for Push Rod	
09/02→		Tie Rod End	CV-ES-0914		for Steering Rod	
09/02→		Tie Rod End	CV-ES-14162	CV-ES-14162	for Steering Rod	
09/02→		Tie Rod End	CV-ES-14163		for Steering Rod	
09/02→		Tie Rod End	IV-ES-12272		for Steering Rod	
09/02→		Tie Rod End	SC-ES-7279		for Steering Rod	
09/02→		Tie Rod End	SC-ES-8535		for Guide Rod	
09/02→		Track Control Arm		MN-DL-5225	Trailing Arm, Drive Axle; Air Suspension Axle	
09/02→		Track Control Arm		MN-DL-5225	Trailing Arm, Leading Axle; Air Suspension Axle	
09/02→		Track Control Arm		MN-DL-8709	Trailing Arm, Air Suspension Axle; for vehicles with Hinged Trailing Axle	
09/02→		Track Control Arm		MN-DL-8733	Trailing Arm, Air Suspension Axle; Drive Axle	
09/02→		Track Control Arm		MN-TC-12399	Control Arm	
09/02→		Track Control Arm		MN-VB-5238	Wishbone (CV), Drive Axle; Leading Axle; Air Suspension Axle	
09/02→		Track Control Arm		MN-VB-9403	Wishbone (CV), Air Suspension Axle	
09/02→		Track Control Arm	MN-DL-8663		Control Arm, Air Suspension Axle	
03/04→		Track Control Arm		MN-DL-5225	Trailing Arm, Tag Axle; Air Suspension Axle; for vehicles with Hinged Trailing Axle	
01/05→		Track Control Arm		MN-DL-5225	Trailing Arm, Tag Axle; Air Suspension Axle; for vehicles with Rigid Trailing Axle	
26.530 FNLS, FNLLS, FNLRS, FPLS, FVLS, FVLRS		09/02→01/05	Track Control Arm		MN-DL-5212	Trailing Arm, Tag Axle; Air Suspension Axle
		09/02→	Ball Head, gearshift linkage	CV-ES-2120		
	09/02→	Centre Rod	MN-DL-7801		Push Rod, Leaf Spring Axle	
	09/02→	Centre Rod	MN-DL-8560		Push Rod, Air Suspension Axle	
	09/02→	Suspension Strut Repair Kit		CV-RK-5311		
	09/02→	Suspension Strut Repair Kit		DB-RK-8581		
	09/02→	Suspension Strut Repair Kit		MN-RK-12436		
	09/02→	Tie Rod	MN-DL-7802			
	09/02→	Tie Rod	MN-DL-12284			

CV-ES-0914

Length: 125
Cone Ø: d1 Ø 30 / d2 Ø 27
Thread: M38 x 1,5 RHT
81953016184, 81953016251, 81953016276



CV-ES-2120

Length: 115
Cone Ø: d1 Ø 12,4 / d2 Ø 10,8
Thread: M14 x 1,5 RHT
03008500A, 81953016200, 81953016202, 81953016203, 81953016227



CV-ES-14162

Length: 125
Cone Ø: d1 Ø 30 / d2 Ø 27
Thread: M30 x 1,5 LHT
81953010015, 81953010083, 81953010087, 81953016029, 81953016030, 81953016043, 81953016044, 81953016050, 81953016054, 81953016087, 81953016091, 81953016107, 81953016120, 81953016125, 81953016152, 81953016155, 81953016157, 81953016168, 81953016179, 81953016181, 81953016223, 81953016237, 81953016254, 81953016275, 81953016279, 81953016351



CV-ES-14163

Length: 125
Cone Ø: d1 Ø 30 / d2 Ø 27
Thread: M30 x 1,5 RHT
95301.0084, 90804102156, 90804102272, 90804102696, 90804102710, 81953010016, 81953010075, 81953010084, 81953010088, 81953010094, 81953010103, 81953016030, 81953016043, 81953016048, 81953016049, 81953016053, 81953016061, 81953016090, 81953016108, 81953016112, 81953016126, 81953016143, 81953016149, 81953016154, 81953016156, 81953016168, 81953016178, 81953016194, 81953016206, 81953016224, 81953016234, 81953016242, 81953016252, 81953016274, 81953016278, 81953016284, 81953016286, 81953016308, 81953016310, 81953016312, 81953016347, 81953016350, 81953016352, 82953016012, 88953016014, N2953016001



CV-RK-5311

638862, 639287, 938423, 1104335, 1953248, 0003500506, 3500506, 11013547, 42488722, 070550504, 634303610, 81432206055, 81432206073, 82262320660, 5001842823, 7000307001, 8226232066



DB-RK-8581

Ø: 85 Hole Distance: 130
Thick/Height: 24
03305800A, 81432706105



IV-ES-8507

Length: 80
Cone Ø: d1 Ø 30 / d2 Ø 27
Thread: M30 x 1,5 RHT
11019869, 12216380, 55175540, 81953016238



IV-ES-12272

Length: 75
Cone Ø: d1 Ø 30 / d2 Ø 27
Thread: M26 x 1,5 RHT
81953016280, 82953010010



MN-DL-3402

Length: 590 Ø: 48
Hole Distance: 130 / 130
03307200A, 81432206067, 81432206068, 81432206090, 81432206092, 81432209092



MN-DL-5212

Length: 577 Ø: 48
Hole Distance: 130 / 130
81432206096, 81432206097, 81432206098, 81432206129, 81432209096, 81432209129, 81432306014, 81432306030



MN-DL-5225

Length: 572 Ø: 48
Hole Distance: 130 / 130
03301500A, 81432206229, 81432206236, 81432206267, 81432206270, 81432206272, 81432206304, 81432206305, 81432209236, 81432209267, 81432209272



MN-DL-7801

Length: 995 Ø: 52
Cone Ø: d1 Ø 30 / d2 Ø 27
81466106807, 81466106808, 81466116087, 81466116088, 81466116096, 81466116097, 81466116099, 81466116132, 81466116133, 81466116136, 81466116197, 81466116198, 81466116205

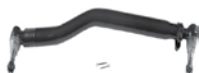

MN-DL-7802

Length: 1680 Ø: 52
Cone Ø: d1 Ø 30 / d2 Ø 27
03208300A, 81467116773, 81467116858, 81467116859, 81467116860, 81467116861, 81467116863, 81467116882, 81467116883, 81467116920, 81467116921



MN-DL-8544

Length: 596 Ø: 48
Hole Distance: 130 / 130
81432206196, 81432206232, 81432206233



MN-DL-8560

Length: 970 Ø: 52
Cone Ø: d1 Ø 30 / d2 Ø 27
03206900A, 81466106809, 81466106810, 81466106823, 81466106838, 81466106839, 81466116104, 81466116105, 81466116107, 81466116134, 81466116135, 81466116137, 81466116199, 81466116200, 81466116206



MN-DL-8663

Length: 947 Ø: 60
Hole Distance: 115 / 115
03307400A, 81432206222, 81432206260, 81432206283, 81432206284



MN-DL-8709

Length: 572 Ø: 52
Hole Distance: 130 / 130
81432206268, 81432206274, 81432206291, 81432206292, 82432206007



MN-DL-8733

Length: 530 Ø: 48
Hole Distance: 130 / 130
81432206161, 81432206190, 81432206358, 81432206359



MN-DL-10288

81432206386, 82432206008, 82432209008

No Image

MN-DL-12284

Length: 1530 Ø: 50
Cone Ø: d1 Ø 30 / d2 Ø 27
81466106579, 81466106580, 81466106624, 81466116720, 81467116720, 81467116730, 81467116952



MN-DL-12288

Length: 585 Ø: 58
Hole Distance: 130 / 130
81432206386, 82432206008, 82432209008

No Image

MN-ES-8490

Length: 90
Cone Ø: d1 Ø 30 / d2 Ø 27
Thread: M26 x 1,5 RHT
14606948, 0014606948, 81953016281, 81953016337, 82953016016



MN-RK-12436

Ø: 75 Hole Distance: 115
Thick/Height: 24
81432206244



MN-TC-12399

Length: 694 Ø: 50
Hole Distance: 130 / 130
81432206265



MN-VB-5222

Length: 627 Ø: 50
Hole Distance: 152 / 152
81432706030, 81432706034, 81432706054, 81432706055, 81432706056, 81432706057, 81432706067, 81432706068, 81432706074, 81432706075, 81432706076, 81432706077, 81432706078, 81432706081, 81432706082, 81432709034, 81432709076, 81432709078, 8143706054



MN-VB-5238

Length: 627 Ø: 48
Hole Distance: 130 / 130
81432206221, 81432706096, 81432706114, 81432706116, 81432706121



MN-VB-8514

Length: 627 Ø: 48
Hole Ø 25 / 25 / 25
Hole Distance: 152 / 130 / 130
81432706087, 81432706088, 81432706094, 81432706095, 81432796094



MN-VB-8669

Length: 627 Ø: 48
Hole Ø 25 / 25 / 25
Hole Distance: 152 / 130 / 130
81432706116, 81432706137, 81432706150, 81432706151



MN-VB-9403

Length: 627 Ø: 48
Hole Ø 25 / 23 / 23
Hole Distance: 152 / 130 / 130
81432706097, 81432706113, 81432706135, 81432706160, 81432706161



MN-VB-9404

Length: 627 Ø: 58
Hole Distance: 130 / 130
81432706117, 81432706152, 81432706153



SC-ES-7279

Length: 150
Cone Ø: d1 Ø 30 / d2 Ø 27
Thread: M30 x 1,5 RHT
81953016288



SC-ES-8517

Length: 140
Cone Ø: d1 Ø 30 / d2 Ø 27
Thread: M30 x 1,5 RHT
81953016286



SC-ES-8535

Length: 145
Cone Ø: d1 Ø 30 / d2 Ø 27
Thread: M30 x 1,5 RHT
81953016271, 81953016325





TGA ...

26.530 FNLS, FNLLS, FNLRS, FPLS, FVLS, FVLRS ...	09/02→	Tie Rod End		IV-ES-8507	Tag Axle
	09/02→	Tie Rod End		MN-ES-8490	for vehicles with Hinged Trailing Axle
	09/02→	Tie Rod End		SC-ES-8517	for Push Rod
	09/02→	Tie Rod End	CV-ES-0914		for Steering Rod
	09/02→	Tie Rod End	CV-ES-14162	CV-ES-14162	for Steering Rod
	09/02→	Tie Rod End	CV-ES-14163		for Steering Rod
	09/02→	Tie Rod End	IV-ES-12272		for Steering Rod
	09/02→	Tie Rod End	SC-ES-7279		for Steering Rod
	09/02→	Tie Rod End	SC-ES-8535		for Guide Rod
	09/02→	Track Control Arm		MN-DL-5225	Trailing Arm, Drive Axle;Air Suspension Axle
	09/02→	Track Control Arm		MN-DL-5225	Trailing Arm, Leading Axle;Air Suspension Axle
	09/02→	Track Control Arm		MN-DL-8709	Trailing Arm, Air Suspension Axle; for vehicles with Hinged Trailing Axle
	09/02→	Track Control Arm		MN-DL-8733	Trailing Arm, Air Suspension Axle;Drive Axle
	09/02→	Track Control Arm		MN-TC-12399	Control Arm
	09/02→	Track Control Arm		MN-VB-5238	Wishbone (CV), Drive Axle;Leading Axle; Air Suspension Axle
	09/02→	Track Control Arm		MN-VB-9403	Wishbone (CV), Air Suspension Axle
	09/02→	Track Control Arm	MN-DL-8663		Control Arm, Air Suspension Axle
	03/04→	Track Control Arm		MN-DL-5225	Trailing Arm, Tag Axle;Air Suspension Axle; for vehicles with Hinged Trailing Axle
	01/05→	Track Control Arm		MN-DL-5225	Trailing Arm, Tag Axle;Air Suspension Axle; for vehicles with Rigid Trailing Axle
	26.540 FNLC, FNLLC, FNLLRC, FNLLW, FNLCR	08/06→	Centre Rod	MN-DL-7801	
08/06→		Suspension Strut Repair Kit		MN-RK-12436	
08/06→		Tie Rod	MN-DL-7802		
08/06→		Tie Rod	MN-DL-12284		
08/06→		Tie Rod End	CV-ES-0914		for Steering Rod
08/06→		Tie Rod End	CV-ES-14162	CV-ES-14162	for Steering Rod
08/06→		Tie Rod End	CV-ES-14163		for Steering Rod
08/06→		Tie Rod End	SC-ES-7279		for Steering Rod
08/06→		Tie Rod End	SC-ES-8517		for Push Rod
08/06→		Tie Rod End	SC-ES-8535		for Guide Rod
08/06→		Track Control Arm		MN-DL-5212	Trailing Arm, Trailing Axle Steered/not Steered, for Pneumatic Suspension vehicles
08/06→		Track Control Arm		MN-DL-5225	Trailing Arm
08/06→		Track Control Arm		MN-DL-8709	Trailing Arm, 1st Drive Axle, for Pneumatic Suspension vehicles
08/06→		Track Control Arm		MN-DL-8709	Trailing Arm, Trailing Axle Steered/not Steered, for Pneumatic Suspension vehicles
08/06→		Track Control Arm		MN-DL-8733	Trailing Arm, 1st Drive Axle, for Pneumatic Suspension vehicles
08/06→		Track Control Arm		MN-VB-5238	Wishbone (CV), 1st Drive Axle, for Pneumatic Suspension vehicles
08/06→		Track Control Arm		MN-VB-9403	Wishbone (CV), Trailing Axle Steered/not Steered, for Pneumatic Suspension vehicles
08/06→		Track Control Arm	MN-DL-8663		Control Arm
28.310 FNLC, FNLLC	09/02→	Centre Rod	MN-DL-7801		Push Rod
	09/02→	Centre Rod	MN-DL-8560		Push Rod, Air Suspension Axle
	09/02→	Suspension Strut Repair Kit		DB-RK-8581	
	09/02→	Suspension Strut Repair Kit		MN-RK-12436	
	09/02→	Tie Rod	MN-DL-7802		
	09/02→	Tie Rod	MN-DL-12284		
	09/02→	Tie Rod End	CV-ES-0914		for Steering Rod
	09/02→	Tie Rod End	CV-ES-14162	CV-ES-14162	for Steering Rod
	09/02→	Tie Rod End	CV-ES-14163		for Steering Rod
	09/02→	Tie Rod End	SC-ES-7279		for Steering Rod
	09/02→	Tie Rod End	SC-ES-8517		for Push Rod
	09/02→	Tie Rod End	SC-ES-8535		for Guide Rod
	09/02→	Track Control Arm		MN-DL-5212	Trailing Arm, Trailing Axle Steered, for Pneumatic Suspension vehicles
	09/02→	Track Control Arm		MN-DL-5225	Trailing Arm

CV-ES-0914

Length: 125
Cone Ø: d1 Ø 30 / d2 Ø 27
Thread: M38 x 1,5 RHT
81953016184, 81953016251, 81953016276



CV-ES-14162

Length: 125
Cone Ø: d1 Ø 30 / d2 Ø 27
Thread: M30 x 1,5 LHT
81953010015, 81953010083, 81953010087, 81953016029, 81953016030, 81953016043, 81953016044, 81953016050, 81953016054, 81953016087, 81953016091, 81953016107, 81953016120, 81953016125, 81953016152, 81953016155, 81953016157, 81953016168, 81953016179, 81953016181, 81953016223, 81953016237, 81953016254, 81953016275, 81953016279, 81953016351



CV-ES-14163

Length: 125
Cone Ø: d1 Ø 30 / d2 Ø 27
Thread: M30 x 1,5 RHT
95301.0084, 90804102156, 90804102272, 90804102696, 90804102710, 81953010016, 81953010075, 81953010084, 81953010088, 81953010094, 81953010103, 81953016030, 81953016043, 81953016048, 81953016049, 81953016053, 81953016061, 81953016090, 81953016108, 81953016112, 81953016126, 81953016143, 81953016149, 81953016154, 81953016156, 81953016168, 81953016178, 81953016194, 81953016206, 81953016224, 81953016234, 81953016242, 81953016252, 81953016274, 81953016278, 81953016284, 81953016286, 81953016308, 81953016310, 81953016312, 81953016347, 81953016350, 81953016352, 82953016012, 88953016014, N2953016001



DB-RK-8581

Ø: 85
Hole Distance: 130
Thick/Height: 24
03305800A, 81432706105



IV-ES-8507

Length: 80
Cone Ø: d1 Ø 30 / d2 Ø 27
Thread: M30 x 1,5 RHT
11019869, 12216380, 55175540, 81953016238



IV-ES-12272

Length: 75
Cone Ø: d1 Ø 30 / d2 Ø 27
Thread: M26 x 1,5 RHT
81953016280, 82953010010



MN-DL-5212

Length: 577 Ø: 48
Hole Distance: 130 / 130
81432206096, 81432206097, 81432206098, 81432206129, 81432209096, 81432209129, 81432306014, 81432306030



MN-DL-5225

Length: 572 Ø: 48
Hole Distance: 130 / 130
03301500A, 81432206229, 81432206236, 81432206267, 81432206270, 81432206272, 81432206304, 81432206305, 81432209236, 81432209267, 81432209272



MN-DL-7801

Length: 995 Ø: 52
Cone Ø: d1 Ø 30 / d2 Ø 27
81466106807, 81466106808, 81466116087, 81466116088, 81466116096, 81466116097, 81466116099, 81466116132, 81466116133, 81466116136, 81466116197, 81466116198, 81466116205



MN-DL-7802

Length: 1680 Ø: 52
Cone Ø: d1 Ø 30 / d2 Ø 27
03208300A, 81467116773, 81467116858, 81467116859, 81467116860, 81467116861, 81467116863, 81467116882, 81467116883, 81467116920, 81467116921



MN-DL-8560

Length: 970 Ø: 52
Cone Ø: d1 Ø 30 / d2 Ø 27
03206900A, 81466106809, 81466106810, 81466106823, 81466106838, 81466106839, 81466116104, 81466116105, 81466116107, 81466116134, 81466116135, 81466116137, 81466116199, 81466116200, 81466116206



MN-DL-8663

Length: 947 Ø: 60
Hole Distance: 115 / 115
03307400A, 81432206222, 81432206260, 81432206283, 81432206284



MN-DL-8709

Length: 572 Ø: 52
Hole Distance: 130 / 130
81432206268, 81432206274, 81432206291, 81432206292, 82432206007



MN-DL-8733

Length: 530 Ø: 48
Hole Distance: 130 / 130
81432206161, 81432206190, 81432206358, 81432206359



MN-DL-12284

Length: 1530 Ø: 50
Cone Ø: d1 Ø 30 / d2 Ø 27
81466106579, 81466106580, 81466106624, 81466116720, 81467116720, 81467116730, 81467116952



MN-ES-8490

Length: 90
Cone Ø: d1 Ø 30 / d2 Ø 27
Thread: M26 x 1,5 RHT
0014606948, 14606948, 81953016281, 81953016337, 82953016016



MN-RK-12436

Ø: 75
Hole Distance: 115
Thick/Height: 24
81432206244



MN-TC-12399

Length: 694 Ø: 50
Hole Distance: 130 / 130
81432206265



MN-VB-5238

Length: 627 Ø: 48
Hole Distance: 130 / 130
81432206221, 81432706096, 81432706114, 81432706116, 81432706121



MN-VB-9403

Length: 627 Ø: 48
Hole Ø 25 / 23 / 23
Hole Distance: 152 / 130 / 130
81432706097, 81432706113, 81432706135, 81432706160, 81432706161



SC-ES-7279

Length: 150
Cone Ø: d1 Ø 30 / d2 Ø 27
Thread: M30 x 1,5 RHT
81953016288



SC-ES-8517

Length: 140
Cone Ø: d1 Ø 30 / d2 Ø 27
Thread: M30 x 1,5 RHT
81953016286



SC-ES-8535

Length: 145
Cone Ø: d1 Ø 30 / d2 Ø 27
Thread: M30 x 1,5 RHT
81953016271, 81953016325





TGA ...

28.310 FNLC, FNLLC ...	09/02→	Track Control Arm		MN-DL-8709	Trailing Arm, Trailing Axle Steered, for Pneumatic Suspension vehicles	
	09/02→	Track Control Arm		MN-DL-8733	Trailing Arm, 1st Drive Axle, for Pneumatic Suspension vehicles	
	09/02→	Track Control Arm		MN-TC-12399	Control Arm	
	09/02→	Track Control Arm		MN-VB-5238	Wishbone (CV), 1st Drive Axle, for Pneumatic Suspension vehicles	
	09/02→	Track Control Arm		MN-VB-9403	Wishbone (CV), Trailing Axle Steered, for Pneumatic Suspension vehicles	
	09/02→	Track Control Arm	MN-DL-8663		Control Arm, 1st FA, for Pneumatic Suspension vehicles	
	07/06→	Centre Rod	MN-DL-8560		Push Rod	
	07/06→	Track Control Arm		MN-DL-5225	for Control Arm	
	07/06→	Track Control Arm		MN-DL-8709	Trailing Arm	
	07/06→	Track Control Arm		MN-DL-8733	Trailing Arm	
	07/06→	Track Control Arm		MN-VB-5238	Wishbone (CV)	
	07/06→	Track Control Arm		MN-VB-5238	Wishbone (CV), Drive Axle	
	07/06→	Track Control Arm		MN-VB-9403	Wishbone (CV)	
	07/06→	Track Control Arm	MN-DL-8663		Control Arm	
	28.310 FNLC, FNLLC, FNLRC	09/02→	Ball Head, gearshift linkage	CV-ES-2120		
		09/02→	Centre Rod	MN-DL-7801		Push Rod
		09/02→	Centre Rod	MN-DL-7801		Push Rod, Leaf Spring Axle
09/02→		Centre Rod	MN-DL-8560		Push Rod, Air Suspension Axle	
09/02→		Suspension Strut Repair Kit		DB-RK-8581		
09/02→		Suspension Strut Repair Kit		MN-RK-12436		
09/02→		Tie Rod	MN-DL-7802			
09/02→		Tie Rod	MN-DL-12284			
09/02→		Tie Rod End		IV-ES-8507	Tag Axle	
09/02→		Tie Rod End	CV-ES-0914		for Steering Rod	
09/02→		Tie Rod End	CV-ES-14163		for Steering Rod	
09/02→		Tie Rod End	SC-ES-7279		for Steering Rod	
09/02→		Tie Rod End	SC-ES-8517		for Push Rod	
09/02→		Tie Rod End	SC-ES-8535		for Guide Rod	
09/02→		Track Control Arm		MN-DL-5212	Trailing Arm, Tag Axle;Air Suspension Axle	
09/02→		Track Control Arm		MN-DL-5225	Trailing Arm	
09/02→		Track Control Arm		MN-DL-5225	Trailing Arm, Drive Axle;Air Suspension Axle	
09/02→		Track Control Arm		MN-DL-5225	Trailing Arm, Leading Axle;Air Suspension Axle	
09/02→		Track Control Arm		MN-DL-5225	Trailing Arm, Tag Axle;Air Suspension Axle	
09/02→		Track Control Arm		MN-DL-8709	Trailing Arm, Air Suspension Axle; for vehicles with Hinged Trailing Axle	
09/02→		Track Control Arm		MN-DL-8709	Trailing Arm, Trailing Axle not Steered, for Pneumatic Suspension vehicles	
09/02→		Track Control Arm		MN-VB-5238	Wishbone (CV), 1st Drive Axle, for Pneumatic Suspension vehicles	
09/02→		Track Control Arm		MN-VB-5238	Wishbone (CV), Drive Axle;Air Suspension Axle	
09/02→		Track Control Arm		MN-VB-5238	Wishbone (CV), Drive Axle;Leading Axle; Air Suspension Axle	
09/02→		Track Control Arm		MN-VB-9403	Wishbone (CV), Air Suspension Axle	
09/02→		Track Control Arm	MN-DL-8663		Control Arm	
09/02→		Track Control Arm	MN-DL-8663		Control Arm, Air Suspension Axle	
28.310 FNLS, FNLRS	09/02→	Ball Head, gearshift linkage	CV-ES-2120			
	09/02→	Centre Rod	MN-DL-7801		Push Rod, Leaf Spring Axle	
	09/02→	Centre Rod	MN-DL-8560		Push Rod, Air Suspension Axle	
	09/02→	Suspension Strut Repair Kit		DB-RK-8581		
	09/02→	Suspension Strut Repair Kit		MN-RK-12436		
	09/02→	Tie Rod	MN-DL-7802			
	09/02→	Tie Rod End	CV-ES-0914		for Steering Rod	
	09/02→	Tie Rod End	CV-ES-14163		for Steering Rod	
	09/02→	Tie Rod End	SC-ES-7279		for Steering Rod	
	09/02→	Tie Rod End	SC-ES-8517		for Push Rod	
	09/02→	Tie Rod End	SC-ES-8535		for Guide Rod	
	09/02→	Track Control Arm		MN-DL-5212	Trailing Arm, Tag Axle;Air Suspension Axle	
	09/02→	Track Control Arm		MN-DL-5225	Trailing Arm, Drive Axle;Air Suspension Axle	

CV-ES-0914

Length: 125
Cone Ø: d1 Ø 30 / d2 Ø 27
Thread: M38 x 1,5 RHT
81953016184, 81953016251, 81953016276



CV-ES-2120

Length: 115
Cone Ø: d1 Ø 12,4 / d2 Ø 10,8
Thread: M14 x 1,5 RHT
03008500A, 81953016200, 81953016202, 81953016203, 81953016227



CV-ES-14163

Length: 125
Cone Ø: d1 Ø 30 / d2 Ø 27
Thread: M30 x 1,5 RHT
95301.0084, 90804102156, 90804102272, 90804102696, 90804102710, 81953010016, 81953010075, 81953010084, 81953010088, 81953010094, 81953010103, 81953016030, 81953016043, 81953016048, 81953016049, 81953016053, 81953016061, 81953016090, 81953016108, 81953016112, 81953016126, 81953016143, 81953016149, 81953016154, 81953016156, 81953016168, 81953016178, 81953016194, 81953016206, 81953016224, 81953016234, 81953016242, 81953016252, 81953016274, 81953016278, 81953016284, 81953016286, 81953016308, 81953016310, 81953016312, 81953016347, 81953016350, 81953016352, 82953016012, 88953016014, N2953016001



DB-RK-8581

Ø: 85
Hole Distance: 130
Thick/Height: 24
03305800A, 81432706105



IV-ES-8507

Length: 80
Cone Ø: d1 Ø 30 / d2 Ø 27
Thread: M30 x 1,5 RHT
11019869, 12216380, 55175540, 81953016238



MN-DL-5212

Length: 577 Ø: 48
Hole Distance: 130 / 130
81432206096, 81432206097, 81432206098, 81432206129, 81432209096, 81432209129, 81432306014, 81432306030



MN-DL-5225

Length: 572 Ø: 48
Hole Distance: 130 / 130
03301500A, 81432206229, 81432206236, 81432206267, 81432206270, 81432206272, 81432206304, 81432206305, 81432209236, 81432209267, 81432209272



MN-DL-7801

Length: 995 Ø: 52
Cone Ø: d1 Ø 30 / d2 Ø 27
81466106807, 81466106808, 81466116087, 81466116088, 81466116096, 81466116097, 81466116099, 81466116132, 81466116133, 81466116136, 81466116197, 81466116198, 81466116205



MN-DL-7802

Length: 1680 Ø: 52
Cone Ø: d1 Ø 30 / d2 Ø 27
03208300A, 81467116773, 81467116858, 81467116859, 81467116860, 81467116861, 81467116863, 81467116882, 81467116883, 81467116920, 81467116921



MN-DL-8560

Length: 970 Ø: 52
Cone Ø: d1 Ø 30 / d2 Ø 27
03206900A, 81466106809, 81466106810, 81466106823, 81466106838, 81466106839, 81466116104, 81466116105, 81466116107, 81466116134, 81466116135, 81466116137, 81466116199, 81466116200, 81466116206



MN-DL-8663

Length: 947 Ø: 60
Hole Distance: 115 / 115
03307400A, 81432206222, 81432206260, 81432206283, 81432206284



MN-DL-8709

Length: 572 Ø: 52
Hole Distance: 130 / 130
81432206268, 81432206274, 81432206291, 81432206292, 82432206007



MN-DL-8733

Length: 530 Ø: 48
Hole Distance: 130 / 130
81432206161, 81432206190, 81432206358, 81432206359



MN-DL-12284

Length: 1530 Ø: 50
Cone Ø: d1 Ø 30 / d2 Ø 27
81466106579, 81466106580, 81466106624, 81466116720, 81467116720, 81467116730, 81467116952



MN-RK-12436

Ø: 75
Hole Distance: 115
Thick/Height: 24
81432206244



MN-TC-12399

Length: 694 Ø: 50
Hole Distance: 130 / 130
81432206265



MN-VB-5238

Length: 627 Ø: 48
Hole Distance: 130 / 130
81432206221, 81432706096, 81432706114, 81432706116, 81432706121



MN-VB-9403

Length: 627 Ø: 48
Hole Ø 25 / 23 / 23
Hole Distance: 152 / 130 / 130
81432706097, 81432706113, 81432706135, 81432706160, 81432706161



SC-ES-7279

Length: 150
Cone Ø: d1 Ø 30 / d2 Ø 27
Thread: M30 x 1,5 RHT
81953016288



SC-ES-8517

Length: 140
Cone Ø: d1 Ø 30 / d2 Ø 27
Thread: M30 x 1,5 RHT
81953016286



SC-ES-8535

Length: 145
Cone Ø: d1 Ø 30 / d2 Ø 27
Thread: M30 x 1,5 RHT
81953016271, 81953016325





TGA ...

28.310 FNLS, FNLSR ...	09/02→	Track Control Arm		MN-DL-5225	Trailing Arm, Leading Axle;Air Suspension Axle	
	09/02→	Track Control Arm		MN-DL-8709	Trailing Arm, Trailing Axle not Steered, for Pneumatic Suspension vehicles	
	09/02→	Track Control Arm		MN-VB-5238	Wishbone (CV), Drive Axle;Leading Axle; Air Suspension Axle	
	09/02→	Track Control Arm		MN-VB-9403	Wishbone (CV), Air Suspension Axle	
	09/02→	Track Control Arm	MN-DL-8663		Control Arm, Air Suspension Axle	
	06/04→	Centre Rod	MN-DL-7801		Push Rod	
	06/04→	Suspension Arm Repair Kit		CV-RK-5313	for Wishbone (CV)	
	06/04→	Suspension Arm Repair Kit	DB-RK-9300	DB-RK-9300	for Drag Link	
	06/04→	Track Control Arm		MN-DL-5225	Trailing Arm	
06/04→	Track Control Arm		MN-VB-5238	Wishbone (CV), 1st Drive Axle, for Pneumatic Suspension vehicles		
28.310, 28.320 FNLC, FNLLC, FNLLR-LE, FNLLR-LE	07/06→	Centre Rod	MN-DL-7801		Push Rod	
	07/06→	Centre Rod	MN-DL-8560		Push Rod, Air Suspension Axle	
	07/06→	Suspension Strut Repair Kit		CV-RK-5311		
	07/06→	Suspension Strut Repair Kit		DB-RK-8581		
	07/06→	Suspension Strut Repair Kit		MN-RK-12436		
	07/06→	Tie Rod	MN-DL-7802			
	07/06→	Tie Rod	MN-DL-12284			
	07/06→	Tie Rod End		IV-ES-8507	Tag Axle	
	07/06→	Tie Rod End		MN-ES-8490	for vehicles with Hinged Trailing Axle	
	07/06→	Tie Rod End	CV-ES-0914		for Steering Rod	
	07/06→	Tie Rod End	CV-ES-14162	CV-ES-14162	for Steering Rod	
	07/06→	Tie Rod End	CV-ES-14163		for Steering Rod	
	07/06→	Tie Rod End	IV-ES-12272		for Steering Rod	
	07/06→	Tie Rod End	SC-ES-7279		for Steering Rod	
	07/06→	Tie Rod End	SC-ES-8517		for Push Rod	
	07/06→	Tie Rod End	SC-ES-8535		for Guide Rod	
	07/06→	Track Control Arm		MN-DL-5212	Trailing Arm, Tag Axle;Air Suspension Axle	
	07/06→	Track Control Arm		MN-DL-5225	Trailing Arm, Drive Axle;Air Suspension Axle	
	07/06→	Track Control Arm		MN-DL-5225	Trailing Arm, Drive Axle;Air Suspension Axle; for vehicles with Rigid Trailing Axle	
	07/06→	Track Control Arm		MN-DL-5225	Trailing Arm, Tag Axle;Air Suspension Axle	
	07/06→	Track Control Arm		MN-DL-5225	Trailing Arm, Tag Axle;Air Suspension Axle; for vehicles with Hinged Trailing Axle	
	07/06→	Track Control Arm		MN-DL-5225	Trailing Arm, Tag Axle;Air Suspension Axle; for vehicles with Rigid Trailing Axle	
	07/06→	Track Control Arm		MN-DL-8709	Trailing Arm, Air Suspension Axle; for vehicles with Hinged Trailing Axle	
	07/06→	Track Control Arm		MN-DL-8733	Trailing Arm, 1st Drive Axle, for Pneumatic Suspension vehicles	
	07/06→	Track Control Arm		MN-TC-12399	Control Arm	
	07/06→	Track Control Arm		MN-VB-5238	Wishbone (CV), Drive Axle;Air Suspension Axle	
	07/06→	Track Control Arm		MN-VB-5238	Wishbone (CV), Drive Axle;Leading Axle; Air Suspension Axle	
	07/06→	Track Control Arm		MN-VB-9403	Wishbone (CV), Air Suspension Axle	
	07/06→	Track Control Arm	MN-DL-8663		Control Arm, Air Suspension Axle	
	28.320 FNLC, FNLLC, FNLLRC, FNLLR-LE	07/06→	Centre Rod	MN-DL-7801		Push Rod, Leaf Spring Axle
		07/06→	Suspension Strut Repair Kit		CV-RK-5311	
		07/06→	Suspension Strut Repair Kit		DB-RK-8581	
		07/06→	Suspension Strut Repair Kit		MN-RK-12436	
07/06→		Tie Rod	MN-DL-7802			
07/06→		Tie Rod	MN-DL-12284			
07/06→		Tie Rod End		IV-ES-8507	Tag Axle	
07/06→		Tie Rod End		MN-ES-8490	for vehicles with Hinged Trailing Axle	
07/06→		Tie Rod End	CV-ES-0914		for Steering Rod	
07/06→		Tie Rod End	CV-ES-14162	CV-ES-14162	for Steering Rod	
07/06→		Tie Rod End	CV-ES-14163		for Steering Rod	
07/06→		Tie Rod End	SC-ES-7279		for Steering Rod	
07/06→		Tie Rod End	SC-ES-8517		for Push Rod	
07/06→		Tie Rod End	SC-ES-8535		for Guide Rod	
07/06→		Track Control Arm		MN-DL-5212	Trailing Arm, Tag Axle;Air Suspension Axle	

CV-ES-0914

Length: 125
Cone Ø: d1 Ø 30 / d2 Ø 27
Thread: M38 x 1,5 RHT
81953016184, 81953016251, 81953016276



CV-ES-14162

Length: 125
Cone Ø: d1 Ø 30 / d2 Ø 27
Thread: M30 x 1,5 LHT
81953010015, 81953010083, 81953010087, 81953016029, 81953016030, 81953016043, 81953016044, 81953016050, 81953016054, 81953016087, 81953016091, 81953016107, 81953016120, 81953016125, 81953016152, 81953016155, 81953016157, 81953016168, 81953016179, 81953016181, 81953016223, 81953016237, 81953016254, 81953016275, 81953016279, 81953016351



CV-ES-14163

Length: 125
Cone Ø: d1 Ø 30 / d2 Ø 27
Thread: M30 x 1,5 RHT
95301.0084, 90804102156, 90804102272, 90804102696, 90804102710, 81953010016, 81953010075, 81953010084, 81953010088, 81953010094, 81953010103, 81953016030, 81953016043, 81953016048, 81953016049, 81953016053, 81953016061, 81953016090, 81953016108, 81953016112, 81953016126, 81953016143, 81953016149, 81953016154, 81953016156, 81953016168, 81953016178, 81953016194, 81953016206, 81953016224, 81953016234, 81953016242, 81953016252, 81953016274, 81953016278, 81953016284, 81953016286, 81953016308, 81953016310, 81953016312, 81953016347, 81953016350, 81953016352, 82953016012, 88953016014, N2953016001



CV-RK-5311

638862, 639287, 938423, 1104335, 1953248, 0003500506, 3500506, 11013547, 42488722, 070550504, 634303610, 81432206055, 81432206073, 82262320660, 5001842823, 7000307001, 8226232066



CV-RK-5313

Ø: 90
03304800A, 81953016132



DB-RK-8581

Ø: 85
Hole Distance: 130
Thick/Height: 24
03305800A, 81432706105



DB-RK-9300

Ø: 75
Hole Distance: 130
Thick/Height: 24
85432206002



IV-ES-8507

Length: 80
Cone Ø: d1 Ø 30 / d2 Ø 27
Thread: M30 x 1,5 RHT
11019869, 12216380, 55175540, 81953016238



IV-ES-12272

Length: 75
Cone Ø: d1 Ø 30 / d2 Ø 27
Thread: M26 x 1,5 RHT
81953016280, 82953010010



MN-DL-5212

Length: 577 Ø: 48
Hole Distance: 130 / 130
81432206096, 81432206097, 81432206098, 81432206129, 81432209096, 81432209129, 81432306014, 81432306030



MN-DL-5225

Length: 572 Ø: 48
Hole Distance: 130 / 130
03301500A, 81432206229, 81432206236, 81432206267, 81432206270, 81432206272, 81432206304, 81432206305, 81432209236, 81432209267, 81432209272



MN-DL-7801

Length: 995 Ø: 52
Cone Ø: d1 Ø 30 / d2 Ø 27
81466106807, 81466106808, 81466116087, 81466116088, 81466116096, 81466116097, 81466116099, 81466116132, 81466116133, 81466116136, 81466116197, 81466116198, 81466116205



MN-DL-7802

Length: 1680 Ø: 52
Cone Ø: d1 Ø 30 / d2 Ø 27
03208300A, 81467116773, 81467116858, 81467116859, 81467116860, 81467116861, 81467116863, 81467116882, 81467116883, 81467116920, 81467116921



MN-DL-8560

Length: 970 Ø: 52
Cone Ø: d1 Ø 30 / d2 Ø 27
03206900A, 81466106809, 81466106810, 81466106823, 81466106838, 81466106839, 81466116104, 81466116105, 81466116107, 81466116134, 81466116135, 81466116137, 81466116199, 81466116200, 81466116206



MN-DL-8663

Length: 947 Ø: 60
Hole Distance: 115 / 115
03307400A, 81432206222, 81432206260, 81432206283, 81432206284



MN-DL-8709

Length: 572 Ø: 52
Hole Distance: 130 / 130
81432206268, 81432206274, 81432206291, 81432206292, 82432206007



MN-DL-8733

Length: 530 Ø: 48
Hole Distance: 130 / 130
81432206161, 81432206190, 81432206358, 81432206359



MN-DL-12284

Length: 1530 Ø: 50
Cone Ø: d1 Ø 30 / d2 Ø 27
81466106579, 81466106580, 81466106624, 81466116720, 81467116720, 81467116730, 81467116952



MN-ES-8490

Length: 90
Cone Ø: d1 Ø 30 / d2 Ø 27
Thread: M26 x 1,5 RHT
0014606948, 14606948, 81953016281, 81953016337, 82953016016



MN-RK-12436

Ø: 75
Hole Distance: 115
Thick/Height: 24
81432206244



MN-TC-12399

Length: 694 Ø: 50
Hole Distance: 130 / 130
81432206265



MN-VB-5238

Length: 627 Ø: 48
Hole Distance: 130 / 130
81432206221, 81432706096, 81432706114, 81432706116, 81432706121



MN-VB-9403

Length: 627 Ø: 48
Hole Ø 25 / 23 / 23
Hole Distance: 152 / 130 / 130
81432706097, 81432706113, 81432706135, 81432706160, 81432706161



SC-ES-7279

Length: 150
Cone Ø: d1 Ø 30 / d2 Ø 27
Thread: M30 x 1,5 RHT
81953016288



SC-ES-8517

Length: 140
Cone Ø: d1 Ø 30 / d2 Ø 27
Thread: M30 x 1,5 RHT
81953016286



SC-ES-8535

Length: 145
Cone Ø: d1 Ø 30 / d2 Ø 27
Thread: M30 x 1,5 RHT
81953016271, 81953016325





TGA ...

28.320 FNLC, FNLLC, FNLLRC, FNLLR-LE ...	07/06 →	Track Control Arm		MN-DL-5225	Trailing Arm, Drive Axle; Air Suspension Axle	
	07/06 →	Track Control Arm		MN-DL-5225	Trailing Arm, Drive Axle; Air Suspension Axle; for vehicles with Rigid Trailing Axle	
	07/06 →	Track Control Arm		MN-DL-8709	Trailing Arm, Air Suspension Axle; for vehicles with Hinged Trailing Axle	
	07/06 →	Track Control Arm		MN-DL-8733	Trailing Arm, 1st Drive Axle, for Pneumatic Suspension vehicles	
	07/06 →	Track Control Arm		MN-TC-12399	Control Arm	
	07/06 →	Track Control Arm		MN-VB-5238	Wishbone (CV), Drive Axle; Air Suspension Axle	
	07/06 →	Track Control Arm		MN-VB-5238	Wishbone (CV), Drive Axle; Leading Axle; Air Suspension Axle	
	07/06 →	Track Control Arm		MN-VB-9403	Wishbone (CV), Air Suspension Axle	
	07/06 →	Track Control Arm	MN-DL-8663		Control Arm, Air Suspension Axle	
	28.320 FNLC, FNLLC, FNLR	06/04 →	Centre Rod	MN-DL-7801		Push Rod
06/04 →		Suspension Strut Repair Kit		MN-RK-12436		
06/04 →		Tie Rod	MN-DL-7802			
06/04 →		Tie Rod End	CV-ES-0914		for Steering Rod	
06/04 →		Tie Rod End	CV-ES-14163		for Steering Rod	
06/04 →		Tie Rod End	SC-ES-7279		for Steering Rod	
06/04 →		Tie Rod End	SC-ES-8517		for Push Rod	
06/04 →		Tie Rod End	SC-ES-8535		for Guide Rod	
06/04 →		Track Control Arm		MN-DL-5225	Trailing Arm	
06/04 →		Track Control Arm		MN-DL-8709	Trailing Arm, Trailing Axle not Steered, for Pneumatic Suspension vehicles	
06/04 →		Track Control Arm		MN-VB-5238	Wishbone (CV), 1st Drive Axle, for Pneumatic Suspension vehicles	
06/04 →		Track Control Arm	MN-DL-8663		Control Arm	
28.320 FNLS, FNLRS		06/04 →	Centre Rod	MN-DL-7801		Push Rod
		06/04 →	Suspension Arm Repair Kit		CV-RK-5313	for Wishbone (CV)
		06/04 →	Suspension Arm Repair Kit	DB-RK-9300	DB-RK-9300	for Drag Link
	06/04 →	Tie Rod	MN-DL-7802			
	06/04 →	Tie Rod End	CV-ES-0914		for Steering Rod	
	06/04 →	Tie Rod End	CV-ES-14163		for Steering Rod	
	06/04 →	Tie Rod End	SC-ES-7279		for Steering Rod	
	06/04 →	Tie Rod End	SC-ES-8517		for Push Rod	
	06/04 →	Tie Rod End	SC-ES-8535		for Guide Rod	
	06/04 →	Track Control Arm		MN-DL-5225	Trailing Arm	
	06/04 →	Track Control Arm		MN-DL-8709	Trailing Arm, Trailing Axle not Steered, for Pneumatic Suspension vehicles	
	06/04 →	Track Control Arm		MN-VB-5238	Wishbone (CV), 1st Drive Axle, for Pneumatic Suspension vehicles	
	28.350 FANLC	07/06 →	Suspension Arm Repair Kit	DB-RK-9300	DB-RK-9300	for Drag Link
		07/06 →	Tie Rod	MN-DL-12284		
		07/06 →	Tie Rod End	CV-ES-14162	CV-ES-14162	for Steering Rod
07/06 →		Tie Rod End	CV-ES-14163		for Steering Rod	
07/06 →		Tie Rod End	MN-ES-10333		for Steering Rod	
07/06 →		Track Control Arm		MN-DL-5225	Trailing Arm	
07/06 →		Track Control Arm		MN-DL-8544	Trailing Arm, 1st RA; 2nd RA, for Pneumatic Suspension vehicles	
07/06 →		Track Control Arm		MN-DL-8709	Trailing Arm, Trailing Axle Steered, for Pneumatic Suspension vehicles	
07/06 →		Track Control Arm		MN-VB-8514	Suspension Rod, Wishbone (CV)	
07/06 →		Track Control Arm		MN-VB-9403	Wishbone (CV), Trailing Axle Steered, for Pneumatic Suspension vehicles	
28.350 FANLK	07/06 →	Suspension Arm Repair Kit	DB-RK-9300	DB-RK-9300	for Drag Link	
	07/06 →	Tie Rod	MN-DL-12284			
	07/06 →	Tie Rod End	CV-ES-14162	CV-ES-14162	for Steering Rod	
	07/06 →	Tie Rod End	CV-ES-14163		for Steering Rod	
	07/06 →	Tie Rod End	MN-ES-10333		for Steering Rod	
	07/06 →	Track Control Arm		MN-DL-5225	Trailing Arm	
	07/06 →	Track Control Arm		MN-DL-8544	Trailing Arm, 1st RA; 2nd RA, for Pneumatic Suspension vehicles	

CV-ES-0914

Length: 125
Cone Ø: d1 Ø 30 / d2 Ø 27
Thread: M38 x 1,5 RHT
81953016184, 81953016251, 81953016276



CV-ES-14162

Length: 125
Cone Ø: d1 Ø 30 / d2 Ø 27
Thread: M30 x 1,5 LHT
81953010015, 81953010083, 81953010087, 81953016029, 81953016030, 81953016043, 81953016044, 81953016050, 81953016054, 81953016087, 81953016091, 81953016107, 81953016120, 81953016125, 81953016152, 81953016155, 81953016157, 81953016168, 81953016179, 81953016181, 81953016223, 81953016237, 81953016254, 81953016275, 81953016279, 81953016351



CV-ES-14163

Length: 125
Cone Ø: d1 Ø 30 / d2 Ø 27
Thread: M30 x 1,5 RHT
95301.0084, 90804102156, 90804102272, 90804102696, 90804102710, 81953010016, 81953010075, 81953010084, 81953010088, 81953010094, 81953010103, 81953016030, 81953016043, 81953016048, 81953016049, 81953016053, 81953016061, 81953016090, 81953016108, 81953016112, 81953016126, 81953016143, 81953016149, 81953016154, 81953016156, 81953016168, 81953016178, 81953016194, 81953016206, 81953016224, 81953016234, 81953016242, 81953016252, 81953016274, 81953016278, 81953016284, 81953016286, 81953016308, 81953016310, 81953016312, 81953016347, 81953016350, 81953016352, 82953016012, 88953016014, N2953016001



CV-RK-5313

Ø: 90
03304800A, 81953016132



DB-RK-9300

Ø: 75
Hole Distance: 130
Thick/Height: 24
85432206002



MN-DL-5225

Length: 572 Ø: 48
Hole Distance: 130 / 130
03301500A, 81432206229, 81432206236, 81432206267, 81432206270, 81432206272, 81432206304, 81432206305, 81432209236, 81432209267, 81432209272



MN-DL-7801

Length: 995 Ø: 52
Cone Ø: d1 Ø 30 / d2 Ø 27
81466106807, 81466106808, 81466116087, 81466116088, 81466116096, 81466116097, 81466116099, 81466116132, 81466116133, 81466116136, 81466116197, 81466116198, 81466116205



MN-DL-7802

Length: 1680 Ø: 52
Cone Ø: d1 Ø 30 / d2 Ø 27
03208300A, 81467116773, 81467116858, 81467116859, 81467116860, 81467116861, 81467116863, 81467116882, 81467116883, 81467116920, 81467116921



MN-DL-8544

Length: 596 Ø: 48
Hole Distance: 130 / 130
81432206196, 81432206232, 81432206233



MN-DL-8663

Length: 947 Ø: 60
Hole Distance: 115 / 115
03307400A, 81432206222, 81432206260, 81432206283, 81432206284



MN-DL-8709

Length: 572 Ø: 52
Hole Distance: 130 / 130
81432206268, 81432206274, 81432206291, 81432206292, 82432206007



MN-DL-8733

Length: 530 Ø: 48
Hole Distance: 130 / 130
81432206161, 81432206190, 81432206358, 81432206359



MN-DL-12284

Length: 1530 Ø: 50
Cone Ø: d1 Ø 30 / d2 Ø 27
81466106579, 81466106580, 81466106624, 81466116720, 81467116720, 81467116730, 81467116952



MN-ES-10333

Length: 90
Cone Ø: d1 Ø 38 / d2 Ø 34,35
Thread: M36 x 1,5 RHT
1271126, 3090291, 3099128, 42538048, 81953016268, 82953016018, 82953016019



MN-RK-12436

Ø: 75
Hole Distance: 115
Thick/Height: 24
81432206244



MN-TC-12399

Length: 694 Ø: 50
Hole Distance: 130 / 130
81432206265



MN-VB-5238

Length: 627 Ø: 48
Hole Distance: 130 / 130
81432206221, 81432706096, 81432706114, 81432706116, 81432706121



MN-VB-8514

Length: 627 Ø: 48
Hole Ø 25 / 25 / 25
Hole Distance: 152 / 130 / 130
81432706087, 81432706088, 81432706094, 81432706095, 81432796094



MN-VB-9403

Length: 627 Ø: 48
Hole Ø 25 / 23 / 23
Hole Distance: 152 / 130 / 130
81432706097, 81432706113, 81432706135, 81432706160, 81432706161



SC-ES-7279

Length: 150
Cone Ø: d1 Ø 30 / d2 Ø 27
Thread: M30 x 1,5 RHT
81953016288



SC-ES-8517

Length: 140
Cone Ø: d1 Ø 30 / d2 Ø 27
Thread: M30 x 1,5 RHT
81953016286



SC-ES-8535

Length: 145
Cone Ø: d1 Ø 30 / d2 Ø 27
Thread: M30 x 1,5 RHT
81953016271, 81953016325





TGA ...

28.350 FANLK ...	07/06 →	Track Control Arm		MN-DL-8709	Trailing Arm, Trailing Axle Steered, for Pneumatic Suspension vehicles	
	07/06 →	Track Control Arm		MN-VB-8514	Suspension Rod, Wishbone (CV)	
	07/06 →	Track Control Arm		MN-VB-9403	Wishbone (CV), Trailing Axle Steered, for Pneumatic Suspension vehicles	
28.350 FNLS, FNLRS	02/04 →	Centre Rod	MN-DL-7801		Push Rod	
	02/04 →	Suspension Arm Repair Kit		CV-RK-5313	for Wishbone (CV)	
	02/04 →	Suspension Arm Repair Kit	DB-RK-9300	DB-RK-9300	for Drag Link	
	02/04 →	Tie Rod	MN-DL-7802			
	02/04 →	Tie Rod End	CV-ES-0914		for Steering Rod	
	02/04 →	Tie Rod End	CV-ES-14163		for Steering Rod	
	02/04 →	Tie Rod End	SC-ES-7279		for Steering Rod	
	02/04 →	Tie Rod End	SC-ES-8517		for Push Rod	
	02/04 →	Tie Rod End	SC-ES-8535		for Guide Rod	
	02/04 →	Track Control Arm		MN-DL-5225	Trailing Arm	
	02/04 →	Track Control Arm		MN-DL-8709	Trailing Arm, Trailing Axle not Steered, for Pneumatic Suspension vehicles	
	02/04 →	Track Control Arm		MN-VB-5238	Wishbone (CV), 1st Drive Axle, for Pneumatic Suspension vehicles	
28.350, 28.360 FNLC, FNLLC, FNLL-LE, FNLLR-LE	07/06 →	Centre Rod	MN-DL-7801		Push Rod, Leaf Spring Axle	
	07/06 →	Centre Rod	MN-DL-8560		Push Rod, Air Suspension Axle	
	07/06 →	Suspension Strut Repair Kit		CV-RK-5311		
	07/06 →	Suspension Strut Repair Kit		DB-RK-8581		
	07/06 →	Suspension Strut Repair Kit		MN-RK-12436		
	07/06 →	Tie Rod	MN-DL-7802			
	07/06 →	Tie Rod	MN-DL-12284			
	07/06 →	Tie Rod End		IV-ES-8507	Tag Axle	
	07/06 →	Tie Rod End		MN-ES-8490	for vehicles with Hinged Trailing Axle	
	07/06 →	Tie Rod End	CV-ES-0914		for Steering Rod	
	07/06 →	Tie Rod End	CV-ES-14162	CV-ES-14162	for Steering Rod	
	07/06 →	Tie Rod End	CV-ES-14163		for Steering Rod	
	07/06 →	Tie Rod End	SC-ES-7279		for Steering Rod	
	07/06 →	Tie Rod End	SC-ES-8517		for Push Rod	
	07/06 →	Tie Rod End	SC-ES-8535		for Guide Rod	
	07/06 →	Track Control Arm		MN-DL-5212	Trailing Arm, Tag Axle; Air Suspension Axle	
	07/06 →	Track Control Arm		MN-DL-5225	Trailing Arm, Drive Axle; Air Suspension Axle	
	07/06 →	Track Control Arm		MN-DL-5225	Trailing Arm, Drive Axle; Air Suspension Axle; for vehicles with Rigid Trailing Axle	
	07/06 →	Track Control Arm		MN-DL-5225	Trailing Arm, Tag Axle; Air Suspension Axle	
	07/06 →	Track Control Arm		MN-DL-5225	Trailing Arm, Tag Axle; Air Suspension Axle; for vehicles with Hinged Trailing Axle	
	07/06 →	Track Control Arm		MN-DL-5225	Trailing Arm, Tag Axle; Air Suspension Axle; for vehicles with Rigid Trailing Axle	
	07/06 →	Track Control Arm		MN-DL-8709	Trailing Arm, Air Suspension Axle; for vehicles with Hinged Trailing Axle	
	07/06 →	Track Control Arm		MN-DL-8733	Trailing Arm, 1st Drive Axle, for Pneumatic Suspension vehicles	
	07/06 →	Track Control Arm		MN-TC-12399	Control Arm	
	07/06 →	Track Control Arm		MN-VB-5238	Wishbone (CV), Drive Axle; Air Suspension Axle	
	07/06 →	Track Control Arm		MN-VB-5238	Wishbone (CV), Drive Axle; Leading Axle; Air Suspension Axle	
	07/06 →	Track Control Arm		MN-VB-9403	Wishbone (CV), Air Suspension Axle	
	07/06 →	Track Control Arm	MN-DL-8663		Control Arm, Air Suspension Axle	
	28.350, 28.360 FNLC, FNLLC, FNLLR-LE, FNLLR-LE	06/04 →	Centre Rod	MN-DL-7801		Push Rod, Leaf Spring Axle
		06/04 →	Centre Rod	MN-DL-8560		Push Rod, Air Suspension Axle
06/04 →		Suspension Strut Repair Kit		CV-RK-5311		
06/04 →		Suspension Strut Repair Kit		DB-RK-8581		
06/04 →		Suspension Strut Repair Kit		MN-RK-12436		
06/04 →		Tie Rod	MN-DL-7802			
06/04 →		Tie Rod	MN-DL-12284			
06/04 →		Tie Rod End		IV-ES-8507	Tag Axle	
06/04 →		Tie Rod End		MN-ES-8490	for vehicles with Hinged Trailing Axle	
06/04 →		Tie Rod End	CV-ES-0914		for Steering Rod	

CV-ES-0914

Length: 125
Cone Ø: d1 Ø 30 / d2 Ø 27
Thread: M38 x 1,5 RHT
81953016184, 81953016251, 81953016276



CV-ES-14162

Length: 125
Cone Ø: d1 Ø 30 / d2 Ø 27
Thread: M30 x 1,5 LHT
81953010015, 81953010083, 81953010087, 81953016029, 81953016030, 81953016043, 81953016044, 81953016050, 81953016054, 81953016087, 81953016091, 81953016107, 81953016120, 81953016125, 81953016152, 81953016155, 81953016157, 81953016168, 81953016179, 81953016181, 81953016223, 81953016237, 81953016254, 81953016275, 81953016279, 81953016351



CV-ES-14163

Length: 125
Cone Ø: d1 Ø 30 / d2 Ø 27
Thread: M30 x 1,5 RHT
95301.0084, 90804102156, 90804102272, 90804102696, 90804102710, 81953010016, 81953010075, 81953010084, 81953010088, 81953010094, 81953010103, 81953016030, 81953016043, 81953016048, 81953016049, 81953016053, 81953016061, 81953016090, 81953016108, 81953016112, 81953016126, 81953016143, 81953016149, 81953016154, 81953016156, 81953016168, 81953016178, 81953016194, 81953016206, 81953016224, 81953016234, 81953016242, 81953016252, 81953016274, 81953016278, 81953016284, 81953016286, 81953016308, 81953016310, 81953016312, 81953016347, 81953016350, 81953016352, 82953016012, 88953016014, N2953016001



CV-RK-5311

638862, 639287, 938423, 1104335, 1953248, 0003500506, 3500506, 11013547, 42488722, 070550504, 634303610, 81432206055, 81432206073, 82262320660, 5001842823, 7000307001, 8226232066



CV-RK-5313

Ø: 90
03304800A, 81953016132



DB-RK-8581

Ø: 85
Hole Distance: 130
Thick/Height: 24
03305800A, 81432706105



DB-RK-9300

Ø: 75
Hole Distance: 130
Thick/Height: 24
85432206002



IV-ES-8507

Length: 80
Cone Ø: d1 Ø 30 / d2 Ø 27
Thread: M30 x 1,5 RHT
11019869, 12216380, 55175540, 81953016238



MN-DL-5212

Length: 577 Ø: 48
Hole Distance: 130 / 130
81432206096, 81432206097, 81432206098, 81432206129, 81432209096, 81432209129, 81432306014, 81432306030



MN-DL-5225

Length: 572 Ø: 48
Hole Distance: 130 / 130
03301500A, 81432206229, 81432206236, 81432206267, 81432206270, 81432206272, 81432206304, 81432206305, 81432209236, 81432209267, 81432209272



MN-DL-7801

Length: 995 Ø: 52
Cone Ø: d1 Ø 30 / d2 Ø 27
81466106807, 81466106808, 81466116087, 81466116088, 81466116096, 81466116097, 81466116099, 81466116132, 81466116133, 81466116136, 81466116197, 81466116198, 81466116205



MN-DL-7802

Length: 1680 Ø: 52
Cone Ø: d1 Ø 30 / d2 Ø 27
03208300A, 81467116773, 81467116858, 81467116859, 81467116860, 81467116861, 81467116863, 81467116882, 81467116883, 81467116920, 81467116921



MN-DL-8560

Length: 970 Ø: 52
Cone Ø: d1 Ø 30 / d2 Ø 27
03206900A, 81466106809, 81466106810, 81466106823, 81466106838, 81466106839, 81466116104, 81466116105, 81466116107, 81466116134, 81466116135, 81466116137, 81466116199, 81466116200, 81466116206



MN-DL-8663

Length: 947 Ø: 60
Hole Distance: 115 / 115
03307400A, 81432206222, 81432206260, 81432206283, 81432206284



MN-DL-8709

Length: 572 Ø: 52
Hole Distance: 130 / 130
81432206268, 81432206274, 81432206291, 81432206292, 82432206007



MN-DL-8733

Length: 530 Ø: 48
Hole Distance: 130 / 130
81432206161, 81432206190, 81432206358, 81432206359



MN-DL-12284

Length: 1530 Ø: 50
Cone Ø: d1 Ø 30 / d2 Ø 27
81466106579, 81466106580, 81466106624, 81466116720, 81467116720, 81467116730, 81467116952



MN-ES-8490

Length: 90
Cone Ø: d1 Ø 30 / d2 Ø 27
Thread: M26 x 1,5 RHT
0014606948, 14606948, 81953016281, 81953016337, 82953016016



MN-RK-12436

Ø: 75
Hole Distance: 115
Thick/Height: 24
81432206244



MN-TC-12399

Length: 694 Ø: 50
Hole Distance: 130 / 130
81432206265



MN-VB-5238

Length: 627 Ø: 48
Hole Distance: 130 / 130
81432206221, 81432706096, 81432706114, 81432706116, 81432706121



MN-VB-8514

Length: 627 Ø: 48
Hole Ø 25 / 25 / 25
Hole Distance: 152 / 130 / 130
81432706087, 81432706088, 81432706094, 81432706095, 81432796094



MN-VB-9403

Length: 627 Ø: 48
Hole Ø 25 / 23 / 23
Hole Distance: 152 / 130 / 130
81432706097, 81432706113, 81432706135, 81432706160, 81432706161



SC-ES-7279

Length: 150
Cone Ø: d1 Ø 30 / d2 Ø 27
Thread: M30 x 1,5 RHT
81953016288



SC-ES-8517

Length: 140
Cone Ø: d1 Ø 30 / d2 Ø 27
Thread: M30 x 1,5 RHT
81953016286



SC-ES-8535

Length: 145
Cone Ø: d1 Ø 30 / d2 Ø 27
Thread: M30 x 1,5 RHT
81953016271, 81953016325



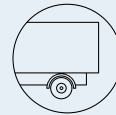

TGA ...

28.350, 28.360 FNLC, FNLLC, FNLR, FNLL-LE, FNLLR-LE ...	06/04 →	Tie Rod End	CV-ES-14162	CV-ES-14162	for Steering Rod	
	06/04 →	Tie Rod End	CV-ES-14163		for Steering Rod	
	06/04 →	Tie Rod End	IV-ES-12272		for Steering Rod	
	06/04 →	Tie Rod End	SC-ES-7279		for Steering Rod	
	06/04 →	Tie Rod End	SC-ES-8517		for Push Rod	
	06/04 →	Tie Rod End	SC-ES-8535		for Guide Rod	
	06/04 →	Track Control Arm		MN-DL-5212	Trailing Arm, Tag Axle; Air Suspension Axle	
	06/04 →	Track Control Arm		MN-DL-5225	Trailing Arm, Drive Axle; Air Suspension Axle	
	06/04 →	Track Control Arm		MN-DL-5225	Trailing Arm, Drive Axle; Air Suspension Axle; for vehicles with Rigid Trailing Axle	
	06/04 →	Track Control Arm		MN-DL-8709	Trailing Arm, Air Suspension Axle; for vehicles with Hinged Trailing Axle	
	06/04 →	Track Control Arm		MN-DL-8733	Trailing Arm, 1st Drive Axle, for Pneumatic Suspension vehicles	
	06/04 →	Track Control Arm		MN-TC-12399	Control Arm	
	06/04 →	Track Control Arm		MN-VB-5238	Wishbone (CV), Drive Axle; Air Suspension Axle	
	06/04 →	Track Control Arm		MN-VB-5238	Wishbone (CV), Drive Axle; Leading Axle; Air Suspension Axle	
	06/04 →	Track Control Arm		MN-VB-9403	Wishbone (CV), Air Suspension Axle	
	28.360 FANLC	06/04 →	Track Control Arm	MN-DL-8663		Control Arm, Air Suspension Axle
		07/06 →	Suspension Arm Repair Kit	DB-RK-9300	DB-RK-9300	for Drag Link
07/06 →		Suspension Strut Repair Kit		DB-RK-8581		
07/06 →		Tie Rod	MN-DL-12284			
07/06 →		Tie Rod End		IV-ES-8507	Tag Axle	
07/06 →		Tie Rod End	CV-ES-14162	CV-ES-14162	for Steering Rod	
07/06 →		Tie Rod End	CV-ES-14163		for Steering Rod	
07/06 →		Tie Rod End	MN-ES-10333		for Steering Rod	
07/06 →		Track Control Arm		MN-DL-5225	Trailing Arm	
07/06 →		Track Control Arm		MN-DL-8544	Trailing Arm, 1st RA; 2nd RA, for Pneumatic Suspension vehicles	
07/06 →		Track Control Arm		MN-DL-8544	Trailing Arm, 1st RA; Air Suspension Axle; for vehicles with Hinged Trailing Axle	
07/06 →		Track Control Arm		MN-DL-8709	Trailing Arm, Air Suspension Axle; for vehicles with Hinged Trailing Axle	
07/06 →		Track Control Arm		MN-DL-8709	Trailing Arm, Trailing Axle Steered, for Pneumatic Suspension vehicles	
07/06 →		Track Control Arm		MN-VB-8514	Suspension Rod, Wishbone (CV)	
07/06 →		Track Control Arm		MN-VB-9403	Wishbone (CV), Air Suspension Axle; for vehicles with Hinged Trailing Axle	
07/06 →		Track Control Arm		MN-VB-9403	Wishbone (CV), Trailing Axle Steered, for Pneumatic Suspension vehicles	
28.360 FANLK		07/06 →	Suspension Arm Repair Kit	DB-RK-9300	DB-RK-9300	for Drag Link
	07/06 →	Suspension Strut Repair Kit		DB-RK-8581		
	07/06 →	Tie Rod	MN-DL-12284			
	07/06 →	Tie Rod End		IV-ES-8507	Tag Axle	
	07/06 →	Tie Rod End	CV-ES-14162	CV-ES-14162	for Steering Rod	
	07/06 →	Tie Rod End	CV-ES-14163		for Steering Rod	
	07/06 →	Tie Rod End	MN-ES-10333		for Steering Rod	
	07/06 →	Track Control Arm		MN-DL-5225	Trailing Arm	
	07/06 →	Track Control Arm		MN-DL-8544	Trailing Arm, 1st RA; 2nd RA, for Pneumatic Suspension vehicles	
	07/06 →	Track Control Arm		MN-DL-8544	Trailing Arm, 1st RA; Air Suspension Axle; for vehicles with Hinged Trailing Axle	
	07/06 →	Track Control Arm		MN-DL-8709	Trailing Arm, Air Suspension Axle; for vehicles with Hinged Trailing Axle	
	07/06 →	Track Control Arm		MN-DL-8709	Trailing Arm, Trailing Axle Steered, for Pneumatic Suspension vehicles	
	07/06 →	Track Control Arm		MN-VB-8514	Suspension Rod, Wishbone (CV)	
	07/06 →	Track Control Arm		MN-VB-9403	Wishbone (CV), Air Suspension Axle; for vehicles with Hinged Trailing Axle	
	07/06 →	Track Control Arm		MN-VB-9403	Wishbone (CV), Trailing Axle Steered, for Pneumatic Suspension vehicles	

CV-ES-14162

Length: 125
Cone Ø: d1 Ø 30 / d2 Ø 27
Thread: M30 x 1,5 LHT

81953010015, 81953010083, 81953010087, 81953016029, 81953016030, 81953016043, 81953016044, 81953016050, 81953016054, 81953016087, 81953016091, 81953016107, 81953016120, 81953016125, 81953016152, 81953016155, 81953016157, 81953016168, 81953016179, 81953016181, 81953016223, 81953016237, 81953016254, 81953016275, 81953016279, 81953016351



CV-ES-14163

Length: 125
Cone Ø: d1 Ø 30 / d2 Ø 27
Thread: M30 x 1,5 RHT

95301.0084, 90804102156, 90804102272, 90804102696, 90804102710, 81953010016, 81953010075, 81953010084, 81953010088, 81953010094, 81953010103, 81953016030, 81953016043, 81953016048, 81953016049, 81953016053, 81953016061, 81953016090, 81953016108, 81953016112, 81953016126, 81953016143, 81953016149, 81953016154, 81953016156, 81953016168, 81953016178, 81953016194, 81953016206, 81953016224, 81953016234, 81953016242, 81953016252, 81953016274, 81953016278, 81953016284, 81953016286, 81953016308, 81953016310, 81953016312, 81953016347, 81953016350, 81953016352, 82953016012, 88953016014, N2953016001



DB-RK-8581

Ø: 85
Hole Distance: 130
Thick/Height: 24
03305800A, 81432706105



DB-RK-9300

Ø: 75
Hole Distance: 130
Thick/Height: 24
85432206002



IV-ES-8507

Length: 80
Cone Ø: d1 Ø 30 / d2 Ø 27
Thread: M30 x 1,5 RHT
11019869, 12216380, 55175540, 81953016238



IV-ES-12272

Length: 75
Cone Ø: d1 Ø 30 / d2 Ø 27
Thread: M26 x 1,5 RHT
81953016280, 82953010010



MN-DL-5212

Length: 577 Ø: 48
Hole Distance: 130 / 130
81432206096, 81432206097, 81432206098, 81432206129, 81432209096, 81432209129, 81432306014, 81432306030



MN-DL-5225

Length: 572 Ø: 48
Hole Distance: 130 / 130
03301500A, 81432206229, 81432206236, 81432206267, 81432206270, 81432206272, 81432206304, 81432206305, 81432209236, 81432209267, 81432209272



MN-DL-8544

Length: 596 Ø: 48
Hole Distance: 130 / 130
81432206196, 81432206232, 81432206233



MN-DL-8663

Length: 947 Ø: 60
Hole Distance: 115 / 115
03307400A, 81432206222, 81432206260, 81432206283, 81432206284



MN-DL-8709

Length: 572 Ø: 52
Hole Distance: 130 / 130
81432206268, 81432206274, 81432206291, 81432206292, 82432206007



MN-DL-8733

Length: 530 Ø: 48
Hole Distance: 130 / 130
81432206161, 81432206190, 81432206358, 81432206359



MN-DL-12284

Length: 1530 Ø: 50
Cone Ø: d1 Ø 30 / d2 Ø 27
81466106579, 81466106580, 81466106624, 81466116720, 81467116720, 81467116730, 81467116952



MN-ES-10333

Length: 90
Cone Ø: d1 Ø 38 / d2 Ø 34,35
Thread: M36 x 1,5 RHT
1271126, 3090291, 3099128, 42538048, 81953016268, 82953016018, 82953016019



MN-TC-12399

Length: 694 Ø: 50
Hole Distance: 130 / 130
81432206265



MN-VB-5238

Length: 627 Ø: 48
Hole Distance: 130 / 130
81432206221, 81432706096, 81432706114, 81432706116, 81432706121



MN-VB-8514

Length: 627 Ø: 48
Hole Ø 25 / 25 / 25
Hole Distance: 152 / 130 / 130
81432706087, 81432706088, 81432706094, 81432706095, 81432796094



MN-VB-9403

Length: 627 Ø: 48
Hole Ø 25 / 23 / 23
Hole Distance: 152 / 130 / 130
81432706097, 81432706113, 81432706135, 81432706160, 81432706161



SC-ES-7279

Length: 150
Cone Ø: d1 Ø 30 / d2 Ø 27
Thread: M30 x 1,5 RHT
81953016288



SC-ES-8517

Length: 140
Cone Ø: d1 Ø 30 / d2 Ø 27
Thread: M30 x 1,5 RHT
81953016286



SC-ES-8535

Length: 145
Cone Ø: d1 Ø 30 / d2 Ø 27
Thread: M30 x 1,5 RHT
81953016271, 81953016325





TGA ...

28.360 FNLC, FNLLC	09/02→	Centre Rod	MN-DL-7801		Push Rod
	09/02→	Centre Rod	MN-DL-8560		Push Rod, Air Suspension Axle
	09/02→	Suspension Strut Repair Kit		DB-RK-8581	
	09/02→	Suspension Strut Repair Kit		MN-RK-12436	
	09/02→	Tie Rod	MN-DL-7802		
	09/02→	Tie Rod	MN-DL-12284		
	09/02→	Tie Rod End	CV-ES-0914		for Steering Rod
	09/02→	Tie Rod End	CV-ES-14162	CV-ES-14162	for Steering Rod
	09/02→	Tie Rod End	CV-ES-14163		for Steering Rod
	09/02→	Tie Rod End	SC-ES-7279		for Steering Rod
	09/02→	Tie Rod End	SC-ES-8517		for Push Rod
	09/02→	Tie Rod End	SC-ES-8535		for Guide Rod
	09/02→	Track Control Arm		MN-DL-5212	Trailing Arm, Trailing Axle Steered, for Pneumatic Suspension vehicles
	09/02→	Track Control Arm		MN-DL-5225	Trailing Arm
	09/02→	Track Control Arm		MN-DL-8709	Trailing Arm, Trailing Axle Steered, for Pneumatic Suspension vehicles
	09/02→	Track Control Arm		MN-DL-8733	Trailing Arm, 1st Drive Axle, for Pneumatic Suspension vehicles
	09/02→	Track Control Arm		MN-VB-5238	Wishbone (CV), 1st Drive Axle, for Pneumatic Suspension vehicles
	09/02→	Track Control Arm		MN-VB-9403	Wishbone (CV), Trailing Axle Steered, for Pneumatic Suspension vehicles
	09/02→	Track Control Arm	MN-DL-8663		Control Arm
	07/06→	Centre Rod	MN-DL-8560		Push Rod
	07/06→	Track Control Arm		MN-DL-5225	for Control Arm
	07/06→	Track Control Arm		MN-DL-8709	Trailing Arm
	07/06→	Track Control Arm		MN-DL-8733	Trailing Arm
	07/06→	Track Control Arm		MN-VB-5238	Wishbone (CV), Drive Axle
	07/06→	Track Control Arm		MN-VB-9403	Wishbone (CV)
28.360 FNLC, FNLLC, FNLR	09/02→	Ball Head, gearshift linkage	CV-ES-2120		
	09/02→	Centre Rod	MN-DL-7801		Push Rod, Leaf Spring Axle
	09/02→	Centre Rod	MN-DL-8560		Push Rod, Air Suspension Axle
	09/02→	Suspension Strut Repair Kit		DB-RK-8581	
	09/02→	Suspension Strut Repair Kit		MN-RK-12436	
	09/02→	Tie Rod	MN-DL-7802		
	09/02→	Tie Rod End	CV-ES-0914		for Steering Rod
	09/02→	Tie Rod End	CV-ES-14163		for Steering Rod
	09/02→	Tie Rod End	SC-ES-7279		for Steering Rod
	09/02→	Tie Rod End	SC-ES-8517		for Push Rod
	09/02→	Tie Rod End	SC-ES-8535		for Guide Rod
	09/02→	Track Control Arm		MN-DL-5212	Trailing Arm, Tag Axle;Air Suspension Axle
	09/02→	Track Control Arm		MN-DL-5225	Trailing Arm, Drive Axle;Air Suspension Axle
	09/02→	Track Control Arm		MN-DL-5225	Trailing Arm, Leading Axle;Air Suspension Axle
	09/02→	Track Control Arm		MN-DL-8709	Trailing Arm, Trailing Axle not Steered, for Pneumatic Suspension vehicles
	09/02→	Track Control Arm		MN-TC-12399	Control Arm
	09/02→	Track Control Arm		MN-VB-5238	Wishbone (CV), Drive Axle;Leading Axle; Air Suspension Axle
	09/02→	Track Control Arm		MN-VB-9403	Wishbone (CV), Air Suspension Axle
	09/02→	Track Control Arm	MN-DL-8663		Control Arm, Air Suspension Axle
	28.360 FNLS, FNLR	09/02→	Ball Head, gearshift linkage	CV-ES-2120	
09/02→		Centre Rod	MN-DL-7801		Push Rod, Leaf Spring Axle
09/02→		Centre Rod	MN-DL-8560		Push Rod, Air Suspension Axle
09/02→		Suspension Strut Repair Kit		DB-RK-8581	
09/02→		Suspension Strut Repair Kit		MN-RK-12436	
09/02→		Tie Rod	MN-DL-7802		
09/02→		Tie Rod End	CV-ES-0914		for Steering Rod
09/02→		Tie Rod End	CV-ES-14163		for Steering Rod
09/02→		Tie Rod End	SC-ES-7279		for Steering Rod
09/02→		Tie Rod End	SC-ES-8517		for Push Rod
09/02→		Tie Rod End	SC-ES-8535		for Guide Rod
09/02→		Track Control Arm		MN-DL-5212	Trailing Arm, Tag Axle;Air Suspension Axle

CV-ES-0914

Length: 125
Cone Ø: d1 Ø 30 / d2 Ø 27
Thread: M38 x 1,5 RHT
81953016184, 81953016251, 81953016276



CV-ES-2120

Length: 115
Cone Ø: d1 Ø 12,4 / d2 Ø 10,8
Thread: M14 x 1,5 RHT
03008500A, 81953016200, 81953016202, 81953016203, 81953016227



CV-ES-14162

Length: 125
Cone Ø: d1 Ø 30 / d2 Ø 27
Thread: M30 x 1,5 LHT
81953010015, 81953010083, 81953010087, 81953016029, 81953016030, 81953016043, 81953016044, 81953016050, 81953016054, 81953016087, 81953016091, 81953016107, 81953016120, 81953016125, 81953016152, 81953016155, 81953016157, 81953016168, 81953016179, 81953016181, 81953016223, 81953016237, 81953016254, 81953016275, 81953016279, 81953016351



CV-ES-14163

Length: 125
Cone Ø: d1 Ø 30 / d2 Ø 27
Thread: M30 x 1,5 RHT
95301.0084, 90804102156, 90804102272, 90804102696, 90804102710, 81953010016, 81953010075, 81953010084, 81953010088, 81953010094, 81953010103, 81953016030, 81953016043, 81953016048, 81953016049, 81953016053, 81953016061, 81953016090, 81953016108, 81953016112, 81953016126, 81953016143, 81953016149, 81953016154, 81953016156, 81953016168, 81953016178, 81953016194, 81953016206, 81953016224, 81953016234, 81953016242, 81953016252, 81953016274, 81953016278, 81953016284, 81953016286, 81953016308, 81953016310, 81953016312, 81953016347, 81953016350, 81953016352, 82953016012, 88953016014, N2953016001



DB-RK-8581

Ø: 85
Hole Distance: 130
Thick/Height: 24
03305800A, 81432706105



MN-DL-5212

Length: 577 Ø: 48
Hole Distance: 130 / 130
81432206096, 81432206097, 81432206098, 81432206129, 81432209096, 81432209129, 81432306014, 81432306030



MN-DL-5225

Length: 572 Ø: 48
Hole Distance: 130 / 130
03301500A, 81432206229, 81432206236, 81432206267, 81432206270, 81432206272, 81432206304, 81432206305, 81432209236, 81432209267, 81432209272



MN-DL-7801

Length: 995 Ø: 52
Cone Ø: d1 Ø 30 / d2 Ø 27
81466106807, 81466106808, 81466116087, 81466116088, 81466116096, 81466116097, 81466116099, 81466116132, 81466116133, 81466116136, 81466116197, 81466116198, 81466116205



MN-DL-7802

Length: 1680 Ø: 52
Cone Ø: d1 Ø 30 / d2 Ø 27
03208300A, 81467116773, 81467116858, 81467116859, 81467116860, 81467116861, 81467116863, 81467116882, 81467116883, 81467116920, 81467116921



MN-DL-8560

Length: 970 Ø: 52
Cone Ø: d1 Ø 30 / d2 Ø 27
03206900A, 81466106809, 81466106810, 81466106823, 81466106838, 81466106839, 81466116104, 81466116105, 81466116107, 81466116134, 81466116135, 81466116137, 81466116199, 81466116200, 81466116206



MN-DL-8663

Length: 947 Ø: 60
Hole Distance: 115 / 115
03307400A, 81432206222, 81432206260, 81432206283, 81432206284



MN-DL-8709

Length: 572 Ø: 52
Hole Distance: 130 / 130
81432206268, 81432206274, 81432206291, 81432206292, 82432206007



MN-DL-8733

Length: 530 Ø: 48
Hole Distance: 130 / 130
81432206161, 81432206190, 81432206358, 81432206359



MN-DL-12284

Length: 1530 Ø: 50
Cone Ø: d1 Ø 30 / d2 Ø 27
81466106579, 81466106580, 81466106624, 81466116720, 81467116720, 81467116730, 81467116952



MN-RK-12436

Ø: 75
Hole Distance: 115
Thick/Height: 24
81432206244



MN-TC-12399

Length: 694 Ø: 50
Hole Distance: 130 / 130
81432206265



MN-VB-5238

Length: 627 Ø: 48
Hole Distance: 130 / 130
81432206221, 81432706096, 81432706114, 81432706116, 81432706121



MN-VB-9403

Length: 627 Ø: 48
Hole Ø 25 / 23 / 23
Hole Distance: 152 / 130 / 130
81432706097, 81432706113, 81432706135, 81432706160, 81432706161



SC-ES-7279

Length: 150
Cone Ø: d1 Ø 30 / d2 Ø 27
Thread: M30 x 1,5 RHT
81953016288



SC-ES-8517

Length: 140
Cone Ø: d1 Ø 30 / d2 Ø 27
Thread: M30 x 1,5 RHT
81953016286



SC-ES-8535

Length: 145
Cone Ø: d1 Ø 30 / d2 Ø 27
Thread: M30 x 1,5 RHT
81953016271, 81953016325





TGA ...

28.360 FNLS, FNLSR ...	09/02→	Track Control Arm		MN-DL-5225	Trailing Arm, Drive Axle;Air Suspension Axle
	09/02→	Track Control Arm		MN-DL-5225	Trailing Arm, Leading Axle;Air Suspension Axle
	09/02→	Track Control Arm		MN-DL-8709	Trailing Arm, Trailing Axle not Steered, for Pneumatic Suspension vehicles
	09/02→	Track Control Arm		MN-VB-5238	Wishbone (CV), Drive Axle;Leading Axle; Air Suspension Axle
	09/02→	Track Control Arm		MN-VB-9403	Wishbone (CV), Air Suspension Axle
	09/02→	Track Control Arm	MN-DL-8663		Control Arm, Air Suspension Axle
	04/06→	Centre Rod	MN-DL-7801		Push Rod
	04/06→	Suspension Arm Repair Kit		CV-RK-5313	for Wishbone (CV)
	04/06→	Suspension Arm Repair Kit	DB-RK-9300	DB-RK-9300	for Drag Link
	04/06→	Track Control Arm		MN-DL-5225	Trailing Arm
04/06→	Track Control Arm		MN-VB-5238	Wishbone (CV), 1st Drive Axle, for Pneumatic Suspension vehicles	
28.390 FANLC	07/06→	Suspension Arm Repair Kit	DB-RK-9300	DB-RK-9300	for Drag Link
	07/06→	Tie Rod	MN-DL-12284		
	07/06→	Tie Rod End	CV-ES-14162	CV-ES-14162	for Steering Rod
	07/06→	Tie Rod End	CV-ES-14163		for Steering Rod
	07/06→	Tie Rod End	MN-ES-10333		for Steering Rod
	07/06→	Track Control Arm		MN-DL-5225	Trailing Arm
	07/06→	Track Control Arm		MN-DL-8544	Trailing Arm, 1st RA;2nd RA, for Pneumatic Suspension vehicles
	07/06→	Track Control Arm		MN-DL-8709	Trailing Arm, Trailing Axle Steered, for Pneumatic Suspension vehicles
	07/06→	Track Control Arm		MN-VB-8514	Suspension Rod, Wishbone (CV)
	07/06→	Track Control Arm		MN-VB-9403	Wishbone (CV), Trailing Axle Steered, for Pneumatic Suspension vehicles
28.390 FANLK	07/06→	Suspension Arm Repair Kit	DB-RK-9300	DB-RK-9300	for Drag Link
	07/06→	Tie Rod	MN-DL-12284		
	07/06→	Tie Rod End	CV-ES-14162	CV-ES-14162	for Steering Rod
	07/06→	Tie Rod End	CV-ES-14163		for Steering Rod
	07/06→	Tie Rod End	MN-ES-10333		for Steering Rod
	07/06→	Track Control Arm		MN-DL-5225	Trailing Arm
	07/06→	Track Control Arm		MN-DL-8544	Trailing Arm, 1st RA;2nd RA, for Pneumatic Suspension vehicles
	07/06→	Track Control Arm		MN-DL-8709	Trailing Arm, Trailing Axle Steered, for Pneumatic Suspension vehicles
	07/06→	Track Control Arm		MN-VB-8514	Suspension Rod, Wishbone (CV)
	07/06→	Track Control Arm		MN-VB-9403	Wishbone (CV), Trailing Axle Steered, for Pneumatic Suspension vehicles
28.390 FNLC, FNLLC	07/06→	Centre Rod	MN-DL-8560		Push Rod
	07/06→	Suspension Strut Repair Kit		MN-RK-12436	
	07/06→	Tie Rod End	CV-ES-0914		for Steering Rod
	07/06→	Tie Rod End	CV-ES-14162		for Steering Rod
	07/06→	Tie Rod End	CV-ES-14163		for Steering Rod
	07/06→	Tie Rod End	SC-ES-7279		for Steering Rod
	07/06→	Tie Rod End	SC-ES-8517		for Push Rod
	07/06→	Tie Rod End	SC-ES-8535		for Guide Rod
	07/06→	Track Control Arm		MN-DL-5225	for Control Arm
	07/06→	Track Control Arm		MN-DL-8709	Trailing Arm
	07/06→	Track Control Arm		MN-DL-8733	Trailing Arm
	07/06→	Track Control Arm		MN-VB-5238	Wishbone (CV), Drive Axle
	07/06→	Track Control Arm		MN-VB-9403	Wishbone (CV)
	07/06→	Track Control Arm	MN-DL-8663		Control Arm
	28.390 FNLLC	07/06→	Suspension Strut Repair Kit		DB-RK-8581
07/06→		Tie Rod	MN-DL-12284		
07/06→		Tie Rod End		IV-ES-8507	Tag Axle
07/06→		Track Control Arm		MN-DL-5225	Trailing Arm
07/06→		Track Control Arm		MN-DL-8544	Trailing Arm, 1st RA;Air Suspension Axle; for vehicles with Hinged Trailing Axle
07/06→		Track Control Arm		MN-DL-8709	Trailing Arm, Air Suspension Axle; for vehicles with Hinged Trailing Axle

CV-ES-0914

Length: 125
Cone Ø: d1 Ø 30 / d2 Ø 27
Thread: M38 x 1,5 RHT
81953016184, 81953016251, 81953016276



CV-ES-14162

Length: 125
Cone Ø: d1 Ø 30 / d2 Ø 27
Thread: M30 x 1,5 LHT
81953010015, 81953010083, 81953010087, 81953016029, 81953016030, 81953016043, 81953016044, 81953016050, 81953016054, 81953016087, 81953016091, 81953016107, 81953016120, 81953016125, 81953016152, 81953016155, 81953016157, 81953016168, 81953016179, 81953016181, 81953016223, 81953016237, 81953016254, 81953016275, 81953016279, 81953016351



CV-ES-14163

Length: 125
Cone Ø: d1 Ø 30 / d2 Ø 27
Thread: M30 x 1,5 RHT
95301.0084, 90804102156, 90804102272, 90804102696, 90804102710, 81953010016, 81953010075, 81953010084, 81953010088, 81953010094, 81953010103, 81953016030, 81953016043, 81953016048, 81953016049, 81953016053, 81953016061, 81953016090, 81953016108, 81953016112, 81953016126, 81953016143, 81953016149, 81953016154, 81953016156, 81953016168, 81953016178, 81953016194, 81953016206, 81953016224, 81953016234, 81953016242, 81953016252, 81953016274, 81953016278, 81953016284, 81953016286, 81953016308, 81953016310, 81953016312, 81953016347, 81953016350, 81953016352, 82953016012, 88953016014, N2953016001



CV-RK-5313

Ø: 90
03304800A, 81953016132



DB-RK-8581

Ø: 85
Hole Distance: 130
Thick/Height: 24
03305800A, 81432706105



DB-RK-9300

Ø: 75
Hole Distance: 130
Thick/Height: 24
85432206002



IV-ES-8507

Length: 80
Cone Ø: d1 Ø 30 / d2 Ø 27
Thread: M30 x 1,5 RHT
11019869, 12216380, 55175540, 81953016238



MN-DL-5225

Length: 572 Ø: 48
Hole Distance: 130 / 130
03301500A, 81432206229, 81432206236, 81432206267, 81432206270, 81432206272, 81432206304, 81432206305, 81432209236, 81432209267, 81432209272



MN-DL-7801

Length: 995 Ø: 52
Cone Ø: d1 Ø 30 / d2 Ø 27
81466106807, 81466106808, 81466116087, 81466116088, 81466116096, 81466116097, 81466116099, 81466116132, 81466116133, 81466116136, 81466116197, 81466116198, 81466116205



MN-DL-8544

Length: 596 Ø: 48
Hole Distance: 130 / 130
81432206196, 81432206232, 81432206233



MN-DL-8560

Length: 970 Ø: 52
Cone Ø: d1 Ø 30 / d2 Ø 27
03206900A, 81466106809, 81466106810, 81466106823, 81466106838, 81466106839, 81466116104, 81466116105, 81466116107, 81466116134, 81466116135, 81466116137, 81466116199, 81466116200, 81466116206



MN-DL-8663

Length: 947 Ø: 60
Hole Distance: 115 / 115
03307400A, 81432206222, 81432206260, 81432206283, 81432206284



MN-DL-8709

Length: 572 Ø: 52
Hole Distance: 130 / 130
81432206268, 81432206274, 81432206291, 81432206292, 82432206007



MN-DL-8733

Length: 530 Ø: 48
Hole Distance: 130 / 130
81432206161, 81432206190, 81432206358, 81432206359



MN-DL-12284

Length: 1530 Ø: 50
Cone Ø: d1 Ø 30 / d2 Ø 27
81466106579, 81466106580, 81466106624, 81466116720, 81467116720, 81467116730, 81467116952



MN-ES-10333

Length: 90
Cone Ø: d1 Ø 38 / d2 Ø 34,35
Thread: M36 x 1,5 RHT
1271126, 3090291, 3099128, 42538048, 81953016268, 82953016018, 82953016019



MN-RK-12436

Ø: 75
Hole Distance: 115
Thick/Height: 24
81432206244



MN-VB-5238

Length: 627 Ø: 48
Hole Distance: 130 / 130
81432206221, 81432706096, 81432706114, 81432706116, 81432706121



MN-VB-8514

Length: 627 Ø: 48
Hole Ø 25 / 25 / 25
Hole Distance: 152 / 130 / 130
81432706087, 81432706088, 81432706094, 81432706095, 81432796094



MN-VB-9403

Length: 627 Ø: 48
Hole Ø 25 / 23 / 23
Hole Distance: 152 / 130 / 130
81432706097, 81432706113, 81432706135, 81432706160, 81432706161



SC-ES-7279

Length: 150
Cone Ø: d1 Ø 30 / d2 Ø 27
Thread: M30 x 1,5 RHT
81953016288



SC-ES-8517

Length: 140
Cone Ø: d1 Ø 30 / d2 Ø 27
Thread: M30 x 1,5 RHT
81953016286



SC-ES-8535

Length: 145
Cone Ø: d1 Ø 30 / d2 Ø 27
Thread: M30 x 1,5 RHT
81953016271, 81953016325





TGA ...

28.390 FNLLC ...	07/06 →	Track Control Arm		MN-VB-8514	Suspension Rod, Wishbone (CV), Drive Axle; Air Suspension Axle; for vehicles with Hinged Trailing Axle	
	07/06 →	Track Control Arm		MN-VB-9403	Wishbone (CV), Air Suspension Axle; for vehicles with Hinged Trailing Axle	
28.390 FNLS, FNLRS	05/04 →	Centre Rod	MN-DL-7801		Push Rod	
	05/04 →	Suspension Arm Repair Kit		CV-RK-5313	for Wishbone (CV)	
	05/04 →	Suspension Arm Repair Kit	DB-RK-9300	DB-RK-9300	for Drag Link	
	05/04 →	Tie Rod	MN-DL-7802			
	05/04 →	Tie Rod End	CV-ES-0914		for Steering Rod	
	05/04 →	Tie Rod End	CV-ES-14163		for Steering Rod	
	05/04 →	Tie Rod End	SC-ES-7279		for Steering Rod	
	05/04 →	Tie Rod End	SC-ES-8517		for Push Rod	
	05/04 →	Tie Rod End	SC-ES-8535		for Guide Rod	
	05/04 →	Track Control Arm		MN-DL-5225	Trailing Arm	
	05/04 →	Track Control Arm		MN-DL-8709	Trailing Arm, Trailing Axle not Steered, for Pneumatic Suspension vehicles	
	05/04 →	Track Control Arm		MN-VB-5238	Wishbone (CV), 1st Drive Axle, for Pneumatic Suspension vehicles	
	28.390, 28.400 FNLC, FNLLC, FNLR	06/04 →	Centre Rod	MN-DL-7801		Push Rod, Leaf Spring Axle
06/04 →		Centre Rod	MN-DL-8560		Push Rod, Air Suspension Axle	
06/04 →		Suspension Strut Repair Kit		CV-RK-5311		
06/04 →		Suspension Strut Repair Kit		DB-RK-8581		
06/04 →		Suspension Strut Repair Kit		MN-RK-12436		
06/04 →		Tie Rod	MN-DL-7802			
06/04 →		Tie Rod	MN-DL-12284			
06/04 →		Tie Rod End		IV-ES-8507	Tag Axle	
06/04 →		Tie Rod End		MN-ES-8490	for vehicles with Hinged Trailing Axle	
06/04 →		Tie Rod End	CV-ES-0914		for Steering Rod	
06/04 →		Tie Rod End	CV-ES-14162	CV-ES-14162	for Steering Rod	
06/04 →		Tie Rod End	CV-ES-14163		for Steering Rod	
06/04 →		Tie Rod End	IV-ES-12272		for Steering Rod	
06/04 →		Tie Rod End	SC-ES-7279		for Steering Rod	
06/04 →		Tie Rod End	SC-ES-8517		for Push Rod	
06/04 →		Tie Rod End	SC-ES-8535		for Guide Rod	
06/04 →		Track Control Arm		MN-DL-5212	Trailing Arm, Tag Axle; Air Suspension Axle	
06/04 →		Track Control Arm		MN-DL-5225	Trailing Arm, Drive Axle; Air Suspension Axle	
06/04 →		Track Control Arm		MN-DL-5225	Trailing Arm, Drive Axle; Air Suspension Axle; for vehicles with Rigid Trailing Axle	
06/04 →		Track Control Arm		MN-DL-5225	Trailing Arm, Tag Axle; Air Suspension Axle; for vehicles with Hinged Trailing Axle	
06/04 →		Track Control Arm		MN-DL-8709	Trailing Arm, Air Suspension Axle; for vehicles with Hinged Trailing Axle	
06/04 →		Track Control Arm		MN-DL-8733	Trailing Arm, 1st Drive Axle, for Pneumatic Suspension vehicles	
06/04 →		Track Control Arm		MN-TC-12399	Control Arm	
06/04 →		Track Control Arm		MN-VB-5238	Wishbone (CV), Drive Axle; Air Suspension Axle	
06/04 →		Track Control Arm		MN-VB-5238	Wishbone (CV), Drive Axle; Leading Axle; Air Suspension Axle	
06/04 →		Track Control Arm		MN-VB-9403	Wishbone (CV), Air Suspension Axle	
06/04 →		Track Control Arm	MN-DL-8663		Control Arm, Air Suspension Axle	
01/05 →		Track Control Arm		MN-DL-5225	Trailing Arm, Tag Axle; Air Suspension Axle; for vehicles with Rigid Trailing Axle	
28.400 FANLC		07/06 →	Suspension Arm Repair Kit	DB-RK-9300	DB-RK-9300	for Drag Link
		07/06 →	Tie Rod	MN-DL-12284		
		07/06 →	Tie Rod End	CV-ES-14162	CV-ES-14162	for Steering Rod
	07/06 →	Tie Rod End	CV-ES-14163		for Steering Rod	
	07/06 →	Tie Rod End	MN-ES-10333		for Steering Rod	
	07/06 →	Track Control Arm		MN-DL-5225	Trailing Arm	
	07/06 →	Track Control Arm		MN-DL-8544	Trailing Arm, 1st RA; 2nd RA, for Pneumatic Suspension vehicles	
07/06 →	Track Control Arm		MN-DL-8709	Trailing Arm, Trailing Axle Steered, for Pneumatic Suspension vehicles		

CV-ES-0914

Length: 125
Cone Ø: d1 Ø 30 / d2 Ø 27
Thread: M38 x 1,5 RHT
81953016184, 81953016251, 81953016276



CV-ES-14162

Length: 125
Cone Ø: d1 Ø 30 / d2 Ø 27
Thread: M30 x 1,5 LHT
81953010015, 81953010083, 81953010087, 81953016029, 81953016030, 81953016043, 81953016044, 81953016050, 81953016054, 81953016087, 81953016091, 81953016107, 81953016120, 81953016125, 81953016152, 81953016155, 81953016157, 81953016168, 81953016179, 81953016181, 81953016223, 81953016237, 81953016254, 81953016275, 81953016279, 81953016351



CV-ES-14163

Length: 125
Cone Ø: d1 Ø 30 / d2 Ø 27
Thread: M30 x 1,5 RHT
95301.0084, 90804102156, 90804102272, 90804102696, 90804102710, 81953010016, 81953010075, 81953010084, 81953010088, 81953010094, 81953010103, 81953016030, 81953016043, 81953016048, 81953016049, 81953016053, 81953016061, 81953016090, 81953016108, 81953016112, 81953016126, 81953016143, 81953016149, 81953016154, 81953016156, 81953016168, 81953016178, 81953016194, 81953016206, 81953016224, 81953016234, 81953016242, 81953016252, 81953016274, 81953016278, 81953016284, 81953016286, 81953016308, 81953016310, 81953016312, 81953016347, 81953016350, 81953016352, 82953016012, 88953016014, N2953016001



CV-RK-5311

638862, 639287, 938423, 1104335, 1953248, 0003500506, 3500506, 11013547, 42488722, 070550504, 634303610, 81432206055, 81432206073, 82262320660, 5001842823, 7000307001, 8226232066



CV-RK-5313

Ø: 90
03304800A, 81953016132



DB-RK-8581

Ø: 85
Hole Distance: 130
Thick/Height: 24
03305800A, 81432706105



DB-RK-9300

Ø: 75
Hole Distance: 130
Thick/Height: 24
85432206002



IV-ES-8507

Length: 80
Cone Ø: d1 Ø 30 / d2 Ø 27
Thread: M30 x 1,5 RHT
11019869, 12216380, 55175540, 81953016238



IV-ES-12272

Length: 75
Cone Ø: d1 Ø 30 / d2 Ø 27
Thread: M26 x 1,5 RHT
81953016280, 82953010010



MN-DL-5212

Length: 577 Ø: 48
Hole Distance: 130 / 130
81432206096, 81432206097, 81432206098, 81432206129, 81432209096, 81432209129, 81432306014, 81432306030



MN-DL-5225

Length: 572 Ø: 48
Hole Distance: 130 / 130
03301500A, 81432206229, 81432206236, 81432206267, 81432206270, 81432206272, 81432206304, 81432206305, 81432209235, 81432209267, 81432209272



MN-DL-7801

Length: 995 Ø: 52
Cone Ø: d1 Ø 30 / d2 Ø 27
81466106807, 81466106808, 81466116087, 81466116088, 81466116096, 81466116097, 81466116099, 81466116132, 81466116133, 81466116136, 81466116197, 81466116198, 81466116205



MN-DL-7802

Length: 1680 Ø: 52
Cone Ø: d1 Ø 30 / d2 Ø 27
03208300A, 81467116773, 81467116858, 81467116859, 81467116860, 81467116861, 81467116863, 81467116882, 81467116883, 81467116920, 81467116921



MN-DL-8544

Length: 596 Ø: 48
Hole Distance: 130 / 130
81432206196, 81432206232, 81432206233



MN-DL-8560

Length: 970 Ø: 52
Cone Ø: d1 Ø 30 / d2 Ø 27
03206900A, 81466106809, 81466106810, 81466106823, 81466106838, 81466106839, 81466116104, 81466116105, 81466116107, 81466116134, 81466116135, 81466116137, 81466116199, 81466116200, 81466116206



MN-DL-8663

Length: 947 Ø: 60
Hole Distance: 115 / 115
03307400A, 81432206222, 81432206260, 81432206283, 81432206284



MN-DL-8709

Length: 572 Ø: 52
Hole Distance: 130 / 130
81432206268, 81432206274, 81432206291, 81432206292, 82432206007



MN-DL-8733

Length: 530 Ø: 48
Hole Distance: 130 / 130
81432206161, 81432206190, 81432206358, 81432206359



MN-DL-12284

Length: 1530 Ø: 50
Cone Ø: d1 Ø 30 / d2 Ø 27
81466106579, 81466106580, 81466106624, 81466116720, 81467116720, 81467116730, 81467116952



MN-ES-8490

Length: 90
Cone Ø: d1 Ø 30 / d2 Ø 27
Thread: M26 x 1,5 RHT
0014606948, 14606948, 81953016281, 81953016337, 82953016016



MN-ES-10333

Length: 90
Cone Ø: d1 Ø 38 / d2 Ø 34,35
Thread: M36 x 1,5 RHT
1271126, 3090291, 3099128, 42538048, 81953016268, 82953016018, 82953016019



MN-RK-12436

Ø: 75
Hole Distance: 115
Thick/Height: 24
81432206244



MN-TC-12399

Length: 694 Ø: 50
Hole Distance: 130 / 130
81432206265



MN-VB-5238

Length: 627 Ø: 48
Hole Distance: 130 / 130
81432206221, 81432706096, 81432706114, 81432706116, 81432706121



MN-VB-8514

Length: 627 Ø: 48
Hole Ø 25 / 25 / 25
Hole Distance: 152 / 130 / 130
81432706087, 81432706088, 81432706094, 81432706095, 81432796094



MN-VB-9403

Length: 627 Ø: 48
Hole Ø 25 / 23 / 23
Hole Distance: 152 / 130 / 130
81432706097, 81432706113, 81432706135, 81432706160, 81432706161



SC-ES-7279

Length: 150
Cone Ø: d1 Ø 30 / d2 Ø 27
Thread: M30 x 1,5 RHT
81953016288



SC-ES-8517

Length: 140
Cone Ø: d1 Ø 30 / d2 Ø 27
Thread: M30 x 1,5 RHT
81953016286



SC-ES-8535

Length: 145
Cone Ø: d1 Ø 30 / d2 Ø 27
Thread: M30 x 1,5 RHT
81953016271, 81953016325





TGA ...

28.400 FANLC ...	07/06→	Track Control Arm		MN-VB-8514	Suspension Rod, Wishbone (CV)	
	07/06→	Track Control Arm		MN-VB-9403	Wishbone (CV), Trailing Axle Steered, for Pneumatic Suspension vehicles	
28.400 FANLK	07/06→	Centre Rod	MN-DL-7801		Push Rod	
	07/06→	Tie Rod	MN-DL-7802			
	07/06→	Track Control Arm		MN-DL-5225	Trailing Arm	
28.400 FNLC, FNLLC	07/06→	Centre Rod	MN-DL-8560		Push Rod	
	07/06→	Suspension Strut Repair Kit		MN-RK-12436		
	07/06→	Tie Rod End	CV-ES-0914		for Steering Rod	
	07/06→	Tie Rod End	CV-ES-14162		for Steering Rod	
	07/06→	Tie Rod End	CV-ES-14163		for Steering Rod	
	07/06→	Tie Rod End	SC-ES-7279		for Steering Rod	
	07/06→	Tie Rod End	SC-ES-8517		for Push Rod	
	07/06→	Tie Rod End	SC-ES-8535		for Guide Rod	
	07/06→	Track Control Arm		MN-DL-5225	for Control Arm	
	07/06→	Track Control Arm		MN-DL-8709	Trailing Arm	
	07/06→	Track Control Arm		MN-DL-8733	Trailing Arm	
	07/06→	Track Control Arm		MN-VB-5238	Wishbone (CV), Drive Axle	
	07/06→	Track Control Arm		MN-VB-9403	Wishbone (CV)	
	07/06→	Track Control Arm	MN-DL-8663		Control Arm	
	28.400 FNLS, FNLRS	04/06→	Centre Rod	MN-DL-7801		Push Rod
04/06→		Suspension Arm Repair Kit		CV-RK-5313	for Wishbone (CV)	
04/06→		Suspension Arm Repair Kit	DB-RK-9300	DB-RK-9300	for Drag Link	
04/06→		Tie Rod	MN-DL-7802			
04/06→		Tie Rod End	CV-ES-0914		for Steering Rod	
04/06→		Tie Rod End	CV-ES-14163		for Steering Rod	
04/06→		Tie Rod End	SC-ES-7279		for Steering Rod	
04/06→		Tie Rod End	SC-ES-8517		for Push Rod	
04/06→		Tie Rod End	SC-ES-8535		for Guide Rod	
04/06→		Track Control Arm		MN-DL-5225	Trailing Arm	
04/06→		Track Control Arm		MN-DL-8709	Trailing Arm, Trailing Axle not Steered, for Pneumatic Suspension vehicles	
04/06→		Track Control Arm		MN-VB-5238	Wishbone (CV), 1st Drive Axle, for Pneumatic Suspension vehicles	
28.410 FANLC		07/06→	Suspension Strut Repair Kit		DB-RK-8581	
		07/06→	Tie Rod	MN-DL-12284		
		07/06→	Tie Rod End		IV-ES-8507	Tag Axle
	07/06→	Tie Rod End	CV-ES-14162	CV-ES-14162	for Steering Rod	
	07/06→	Tie Rod End	CV-ES-14163		for Steering Rod	
	07/06→	Tie Rod End	MN-ES-10333		for Steering Rod	
	07/06→	Track Control Arm		MN-DL-5225	Trailing Arm	
	07/06→	Track Control Arm		MN-DL-8544	Trailing Arm, 1st RA; Air Suspension Axle; for vehicles with Hinged Trailing Axle	
	07/06→	Track Control Arm		MN-DL-8709	Trailing Arm, Air Suspension Axle; for vehicles with Hinged Trailing Axle	
	07/06→	Track Control Arm		MN-VB-8514	Suspension Rod, Wishbone (CV)	
	07/06→	Track Control Arm		MN-VB-9403	Wishbone (CV), Air Suspension Axle; for vehicles with Hinged Trailing Axle	
28.410 FANLK	07/06→	Suspension Strut Repair Kit		DB-RK-8581		
	07/06→	Tie Rod	MN-DL-12284			
	07/06→	Tie Rod End		IV-ES-8507	Tag Axle	
	07/06→	Tie Rod End	CV-ES-14162	CV-ES-14162	for Steering Rod	
	07/06→	Tie Rod End	CV-ES-14163		for Steering Rod	
	07/06→	Tie Rod End	MN-ES-10333		for Steering Rod	
	07/06→	Track Control Arm		MN-DL-5225	Trailing Arm	
	07/06→	Track Control Arm		MN-DL-8544	Trailing Arm, 1st RA; Air Suspension Axle; for vehicles with Hinged Trailing Axle	
	07/06→	Track Control Arm		MN-DL-8709	Trailing Arm, Air Suspension Axle; for vehicles with Hinged Trailing Axle	
	07/06→	Track Control Arm		MN-VB-8514	Suspension Rod, Wishbone (CV)	
	07/06→	Track Control Arm		MN-VB-9403	Wishbone (CV), Air Suspension Axle; for vehicles with Hinged Trailing Axle	

CV-ES-0914

Length: 125
Cone Ø: d1 Ø 30 / d2 Ø 27
Thread: M38 x 1,5 RHT
81953016184, 81953016251, 81953016276



CV-ES-14162

Length: 125
Cone Ø: d1 Ø 30 / d2 Ø 27
Thread: M30 x 1,5 LHT
81953010015, 81953010083, 81953010087, 81953016029, 81953016030, 81953016043, 81953016044, 81953016050, 81953016054, 81953016087, 81953016091, 81953016107, 81953016120, 81953016125, 81953016152, 81953016155, 81953016157, 81953016168, 81953016179, 81953016181, 81953016223, 81953016237, 81953016254, 81953016275, 81953016279, 81953016351



CV-ES-14163

Length: 125
Cone Ø: d1 Ø 30 / d2 Ø 27
Thread: M30 x 1,5 RHT
95301.0084, 90804102156, 90804102272, 90804102696, 90804102710, 81953010016, 81953010075, 81953010084, 81953010088, 81953010094, 81953010103, 81953016030, 81953016043, 81953016048, 81953016049, 81953016053, 81953016061, 81953016090, 81953016108, 81953016112, 81953016126, 81953016143, 81953016149, 81953016154, 81953016156, 81953016168, 81953016178, 81953016194, 81953016206, 81953016224, 81953016234, 81953016242, 81953016252, 81953016274, 81953016278, 81953016284, 81953016286, 81953016308, 81953016310, 81953016312, 81953016347, 81953016350, 81953016352, 82953016012, 88953016014, N2953016001



CV-RK-5313

Ø: 90
03304800A, 81953016132



DB-RK-8581

Ø: 85
Hole Distance: 130
Thick/Height: 24
03305800A, 81432706105



DB-RK-9300

Ø: 75
Hole Distance: 130
Thick/Height: 24
85432206002



IV-ES-8507

Length: 80
Cone Ø: d1 Ø 30 / d2 Ø 27
Thread: M30 x 1,5 RHT
11019869, 12216380, 55175540, 81953016238



MN-DL-5225

Length: 572 Ø: 48
Hole Distance: 130 / 130
03301500A, 81432206229, 81432206236, 81432206267, 81432206270, 81432206272, 81432206304, 81432206305, 81432209236, 81432209267, 81432209272



MN-DL-7801

Length: 995 Ø: 52
Cone Ø: d1 Ø 30 / d2 Ø 27
81466106807, 81466106808, 81466116087, 81466116088, 81466116096, 81466116097, 81466116099, 81466116132, 81466116133, 81466116136, 81466116197, 81466116198, 81466116205



MN-DL-7802

Length: 1680 Ø: 52
Cone Ø: d1 Ø 30 / d2 Ø 27
03208300A, 81467116773, 81467116858, 81467116859, 81467116860, 81467116861, 81467116863, 81467116882, 81467116883, 81467116920, 81467116921



MN-DL-8544

Length: 596 Ø: 48
Hole Distance: 130 / 130
81432206196, 81432206232, 81432206233



MN-DL-8560

Length: 970 Ø: 52
Cone Ø: d1 Ø 30 / d2 Ø 27
03206900A, 81466106809, 81466106810, 81466106823, 81466106838, 81466106839, 81466116104, 81466116105, 81466116107, 81466116134, 81466116135, 81466116137, 81466116199, 81466116200, 81466116206



MN-DL-8663

Length: 947 Ø: 60
Hole Distance: 115 / 115
03307400A, 81432206222, 81432206260, 81432206283, 81432206284



MN-DL-8709

Length: 572 Ø: 52
Hole Distance: 130 / 130
81432206268, 81432206274, 81432206291, 81432206292, 82432206007



MN-DL-8733

Length: 530 Ø: 48
Hole Distance: 130 / 130
81432206161, 81432206190, 81432206358, 81432206359



MN-DL-12284

Length: 1530 Ø: 50
Cone Ø: d1 Ø 30 / d2 Ø 27
81466106579, 81466106580, 81466106624, 81466116720, 81467116720, 81467116730, 81467116952



MN-ES-10333

Length: 90
Cone Ø: d1 Ø 38 / d2 Ø 34,35
Thread: M36 x 1,5 RHT
1271126, 3090291, 3099128, 42538048, 81953016268, 82953016018, 82953016019



MN-RK-12436

Ø: 75
Hole Distance: 115
Thick/Height: 24
81432206244



MN-VB-5238

Length: 627 Ø: 48
Hole Distance: 130 / 130
81432206221, 81432706096, 81432706114, 81432706116, 81432706121



MN-VB-8514

Length: 627 Ø: 48
Hole Ø 25 / 25 / 25
Hole Distance: 152 / 130 / 130
81432706087, 81432706088, 81432706094, 81432706095, 81432796094



MN-VB-9403

Length: 627 Ø: 48
Hole Ø 25 / 23 / 23
Hole Distance: 152 / 130 / 130
81432706097, 81432706113, 81432706135, 81432706160, 81432706161



SC-ES-7279

Length: 150
Cone Ø: d1 Ø 30 / d2 Ø 27
Thread: M30 x 1,5 RHT
81953016288



SC-ES-8517

Length: 140
Cone Ø: d1 Ø 30 / d2 Ø 27
Thread: M30 x 1,5 RHT
81953016286



SC-ES-8535

Length: 145
Cone Ø: d1 Ø 30 / d2 Ø 27
Thread: M30 x 1,5 RHT
81953016271, 81953016325





TGA ...

28.410 FNLC, FNLLC	09/02→	Centre Rod	MN-DL-7801		Push Rod	
	09/02→	Centre Rod	MN-DL-8560		Push Rod, Air Suspension Axle	
	09/02→	Suspension Strut Repair Kit		DB-RK-8581		
	09/02→	Suspension Strut Repair Kit		MN-RK-12436		
	09/02→	Tie Rod	MN-DL-7802			
	09/02→	Tie Rod End	CV-ES-0914		for Steering Rod	
	09/02→	Tie Rod End	CV-ES-14162	CV-ES-14162	for Steering Rod	
	09/02→	Tie Rod End	CV-ES-14163		for Steering Rod	
	09/02→	Tie Rod End	SC-ES-7279		for Steering Rod	
	09/02→	Tie Rod End	SC-ES-8517		for Push Rod	
	09/02→	Tie Rod End	SC-ES-8535		for Guide Rod	
	09/02→	Track Control Arm		MN-DL-5225	Trailing Arm	
	09/02→	Track Control Arm		MN-DL-8709	Trailing Arm, Trailing Axle Steered, for Pneumatic Suspension vehicles	
	09/02→	Track Control Arm		MN-DL-8733	Trailing Arm, 1st Drive Axle, for Pneumatic Suspension vehicles	
	09/02→	Track Control Arm		MN-TC-12399	Control Arm	
	09/02→	Track Control Arm		MN-VB-5238	Wishbone (CV), 1st Drive Axle, for Pneumatic Suspension vehicles	
	09/02→	Track Control Arm		MN-VB-9403	Wishbone (CV), Trailing Axle Steered, for Pneumatic Suspension vehicles	
	09/02→	Track Control Arm	MN-DL-8663		Control Arm, 1st FA, for Pneumatic Suspension vehicles	
	07/06→	Centre Rod	MN-DL-8560		Push Rod	
	07/06→	Track Control Arm		MN-DL-5225	for Control Arm	
	07/06→	Track Control Arm		MN-DL-8709	Trailing Arm	
	07/06→	Track Control Arm		MN-DL-8733	Trailing Arm	
	07/06→	Track Control Arm		MN-VB-5238	Wishbone (CV)	
	07/06→	Track Control Arm		MN-VB-9403	Wishbone (CV)	
	07/06→	Track Control Arm	MN-DL-8663		Control Arm	
	28.410 FNLC, FNLLC, FNLR	09/02→	Ball Head, gearshift linkage	CV-ES-2120		
		09/02→	Centre Rod	MN-DL-7801		Push Rod, Leaf Spring Axle
		09/02→	Centre Rod	MN-DL-8560		Push Rod, Air Suspension Axle
		09/02→	Suspension Strut Repair Kit		DB-RK-8581	
		09/02→	Suspension Strut Repair Kit		MN-RK-12436	
09/02→		Tie Rod	MN-DL-7802			
09/02→		Tie Rod	MN-DL-12284			
09/02→		Tie Rod End		IV-ES-8507	Tag Axle	
09/02→		Tie Rod End	CV-ES-0914		for Steering Rod	
09/02→		Tie Rod End	CV-ES-14163		for Steering Rod	
09/02→		Tie Rod End	SC-ES-7279		for Steering Rod	
09/02→		Tie Rod End	SC-ES-8517		for Push Rod	
09/02→		Tie Rod End	SC-ES-8535		for Guide Rod	
09/02→		Track Control Arm		MN-DL-5212	Trailing Arm, Tag Axle;Air Suspension Axle	
09/02→		Track Control Arm		MN-DL-5225	Trailing Arm, Drive Axle;Air Suspension Axle	
09/02→		Track Control Arm		MN-DL-5225	Trailing Arm, Leading Axle;Air Suspension Axle	
09/02→		Track Control Arm		MN-DL-5225	Trailing Arm, Tag Axle;Air Suspension Axle	
09/02→		Track Control Arm		MN-DL-8709	Trailing Arm, Air Suspension Axle; for vehicles with Hinged Trailing Axle	
09/02→		Track Control Arm		MN-VB-5238	Wishbone (CV), Drive Axle;Air Suspension Axle	
09/02→		Track Control Arm		MN-VB-5238	Wishbone (CV), Drive Axle;Leading Axle; Air Suspension Axle	
09/02→		Track Control Arm		MN-VB-9403	Wishbone (CV), Air Suspension Axle	
09/02→		Track Control Arm	MN-DL-8663		Control Arm, Air Suspension Axle	
28.410 FNLS, FNLR		09/02→	Ball Head, gearshift linkage	CV-ES-2120		
		09/02→	Centre Rod	MN-DL-7801		Push Rod, Leaf Spring Axle
		09/02→	Centre Rod	MN-DL-8560		Push Rod, Air Suspension Axle
		09/02→	Suspension Strut Repair Kit		DB-RK-8581	
		09/02→	Suspension Strut Repair Kit		MN-RK-12436	
	09/02→	Tie Rod	MN-DL-7802			
	09/02→	Tie Rod End	CV-ES-0914		for Steering Rod	
	09/02→	Tie Rod End	CV-ES-14163		for Steering Rod	
	09/02→	Tie Rod End	SC-ES-7279		for Steering Rod	

CV-ES-0914

Length: 125
Cone Ø: d1 Ø 30 / d2 Ø 27
Thread: M38 x 1,5 RHT
81953016184, 81953016251, 81953016276



CV-ES-2120

Length: 115
Cone Ø: d1 Ø 12,4 / d2 Ø 10,8
Thread: M14 x 1,5 RHT
03008500A, 81953016200, 81953016202, 81953016203, 81953016227



CV-ES-14162

Length: 125
Cone Ø: d1 Ø 30 / d2 Ø 27
Thread: M30 x 1,5 LHT
81953010015, 81953010083, 81953010087, 81953016029, 81953016030, 81953016043, 81953016044, 81953016050, 81953016054, 81953016087, 81953016091, 81953016107, 81953016120, 81953016125, 81953016152, 81953016155, 81953016157, 81953016168, 81953016179, 81953016181, 81953016223, 81953016237, 81953016254, 81953016275, 81953016279, 81953016351



CV-ES-14163

Length: 125
Cone Ø: d1 Ø 30 / d2 Ø 27
Thread: M30 x 1,5 RHT
95301.0084, 90804102156, 90804102272, 90804102696, 90804102710, 81953010016, 81953010075, 81953010084, 81953010088, 81953010094, 81953010103, 81953016030, 81953016043, 81953016048, 81953016049, 81953016053, 81953016061, 81953016090, 81953016108, 81953016112, 81953016126, 81953016143, 81953016149, 81953016154, 81953016156, 81953016168, 81953016178, 81953016194, 81953016206, 81953016224, 81953016234, 81953016242, 81953016252, 81953016274, 81953016278, 81953016284, 81953016286, 81953016308, 81953016310, 81953016312, 81953016347, 81953016350, 81953016352, 82953016012, 88953016014, N2953016001



DB-RK-8581

Ø: 85
Hole Distance: 130
Thick/Height: 24
03305800A, 81432706105



IV-ES-8507

Length: 80
Cone Ø: d1 Ø 30 / d2 Ø 27
Thread: M30 x 1,5 RHT
11019869, 12216380, 55175540, 81953016238



MN-DL-5212

Length: 577 Ø: 48
Hole Distance: 130 / 130
81432206096, 81432206097, 81432206098, 81432206129, 81432209096, 81432209129, 81432306014, 81432306030



MN-DL-5225

Length: 572 Ø: 48
Hole Distance: 130 / 130
03301500A, 81432206229, 81432206236, 81432206267, 81432206270, 81432206272, 81432206304, 81432206305, 81432209235, 81432209267, 81432209272



MN-DL-7801

Length: 995 Ø: 52
Cone Ø: d1 Ø 30 / d2 Ø 27
81466106807, 81466106808, 81466116087, 81466116088, 81466116096, 81466116097, 81466116099, 81466116132, 81466116133, 81466116136, 81466116197, 81466116198, 81466116205



MN-DL-7802

Length: 1680 Ø: 52
Cone Ø: d1 Ø 30 / d2 Ø 27
03208300A, 81467116773, 81467116858, 81467116859, 81467116860, 81467116861, 81467116863, 81467116882, 81467116883, 81467116920, 81467116921



MN-DL-8560

Length: 970 Ø: 52
Cone Ø: d1 Ø 30 / d2 Ø 27
03206900A, 81466106809, 81466106810, 81466106823, 81466106838, 81466106839, 81466116104, 81466116105, 81466116107, 81466116134, 81466116135, 81466116137, 81466116199, 81466116200, 81466116206



MN-DL-8663

Length: 947 Ø: 60
Hole Distance: 115 / 115
03307400A, 81432206222, 81432206260, 81432206283, 81432206284



MN-DL-8709

Length: 572 Ø: 52
Hole Distance: 130 / 130
81432206268, 81432206274, 81432206291, 81432206292, 82432206007



MN-DL-8733

Length: 530 Ø: 48
Hole Distance: 130 / 130
81432206161, 81432206190, 81432206358, 81432206359



MN-DL-12284

Length: 1530 Ø: 50
Cone Ø: d1 Ø 30 / d2 Ø 27
81466106579, 81466106580, 81466106624, 81466116720, 81467116720, 81467116730, 81467116952



MN-RK-12436

Ø: 75
Hole Distance: 115
Thick/Height: 24
81432206244



MN-TC-12399

Length: 694 Ø: 50
Hole Distance: 130 / 130
81432206265



MN-VB-5238

Length: 627 Ø: 48
Hole Distance: 130 / 130
81432206221, 81432706096, 81432706114, 81432706116, 81432706121



MN-VB-9403

Length: 627 Ø: 48
Hole Ø 25 / 23 / 23
Hole Distance: 152 / 130 / 130
81432706097, 81432706113, 81432706135, 81432706160, 81432706161



SC-ES-7279

Length: 150
Cone Ø: d1 Ø 30 / d2 Ø 27
Thread: M30 x 1,5 RHT
81953016288



SC-ES-8517

Length: 140
Cone Ø: d1 Ø 30 / d2 Ø 27
Thread: M30 x 1,5 RHT
81953016286



SC-ES-8535

Length: 145
Cone Ø: d1 Ø 30 / d2 Ø 27
Thread: M30 x 1,5 RHT
81953016271, 81953016325





TGA ...

28.410 FNLS, FNLRS ...	09/02→	Tie Rod End	SC-ES-8517		for Push Rod
	09/02→	Tie Rod End	SC-ES-8535		for Guide Rod
	09/02→	Track Control Arm		MN-DL-5212	Trailing Arm, Tag Axle;Air Suspension Axle
	09/02→	Track Control Arm		MN-DL-5225	Trailing Arm, Drive Axle;Air Suspension Axle
	09/02→	Track Control Arm		MN-DL-5225	Trailing Arm, Leading Axle;Air Suspension Axle
	09/02→	Track Control Arm		MN-DL-8709	Trailing Arm, Trailing Axle not Steered, for Pneumatic Suspension vehicles
	09/02→	Track Control Arm		MN-VB-5238	Wishbone (CV), Drive Axle;Leading Axle; Air Suspension Axle
	09/02→	Track Control Arm		MN-VB-9403	Wishbone (CV), Air Suspension Axle
	09/02→	Track Control Arm	MN-DL-8663		Control Arm, Air Suspension Axle
	28.430 FANLC	07/06→	Suspension Arm Repair Kit	DB-RK-9300	DB-RK-9300
07/06→		Tie Rod	MN-DL-12284		
07/06→		Tie Rod End	CV-ES-14162	CV-ES-14162	for Steering Rod
07/06→		Tie Rod End	CV-ES-14163		for Steering Rod
07/06→		Tie Rod End	MN-ES-10333		for Steering Rod
07/06→		Track Control Arm		MN-DL-5225	Trailing Arm
07/06→		Track Control Arm		MN-DL-8544	Trailing Arm, 1st RA;2nd RA, for Pneumatic Suspension vehicles
07/06→		Track Control Arm		MN-DL-8709	Trailing Arm, Trailing Axle Steered, for Pneumatic Suspension vehicles
07/06→		Track Control Arm		MN-VB-8514	Suspension Rod, Wishbone (CV)
07/06→		Track Control Arm		MN-VB-9403	Wishbone (CV), Trailing Axle Steered, for Pneumatic Suspension vehicles
28.430 FANLK	07/06→	Suspension Arm Repair Kit	DB-RK-9300	DB-RK-9300	for Drag Link
	07/06→	Tie Rod	MN-DL-12284		
	07/06→	Tie Rod End	CV-ES-14162	CV-ES-14162	for Steering Rod
	07/06→	Tie Rod End	CV-ES-14163		for Steering Rod
	07/06→	Tie Rod End	MN-ES-10333		for Steering Rod
	07/06→	Track Control Arm		MN-DL-5225	Trailing Arm
	07/06→	Track Control Arm		MN-DL-8544	Trailing Arm, 1st RA;2nd RA, for Pneumatic Suspension vehicles
	07/06→	Track Control Arm		MN-DL-8709	Trailing Arm, Trailing Axle Steered, for Pneumatic Suspension vehicles
	07/06→	Track Control Arm		MN-VB-8514	Suspension Rod, Wishbone (CV)
	07/06→	Track Control Arm		MN-VB-9403	Wishbone (CV), Trailing Axle Steered, for Pneumatic Suspension vehicles
28.430 FNLC, FNLLC	07/06→	Centre Rod	MN-DL-8560		Push Rod
	07/06→	Suspension Strut Repair Kit		MN-RK-12436	
	07/06→	Tie Rod End	CV-ES-0914		for Steering Rod
	07/06→	Tie Rod End	CV-ES-14162		for Steering Rod
	07/06→	Tie Rod End	CV-ES-14163		for Steering Rod
	07/06→	Tie Rod End	SC-ES-7279		for Steering Rod
	07/06→	Tie Rod End	SC-ES-8517		for Push Rod
	07/06→	Tie Rod End	SC-ES-8535		for Guide Rod
	07/06→	Track Control Arm		MN-DL-5225	for Control Arm
	07/06→	Track Control Arm		MN-DL-8709	Trailing Arm
	07/06→	Track Control Arm		MN-DL-8733	Trailing Arm
	07/06→	Track Control Arm		MN-VB-5238	Wishbone (CV), Drive Axle
	07/06→	Track Control Arm		MN-VB-9403	Wishbone (CV)
	07/06→	Track Control Arm	MN-DL-8663		Control Arm
	28.430 FNLS, FNLRS	05/04→	Centre Rod	MN-DL-7801	
05/04→		Suspension Arm Repair Kit		CV-RK-5313	for Wishbone (CV)
05/04→		Suspension Arm Repair Kit	DB-RK-9300	DB-RK-9300	for Drag Link
05/04→		Tie Rod	MN-DL-7802		
05/04→		Tie Rod End	CV-ES-0914		for Steering Rod
05/04→		Tie Rod End	CV-ES-14163		for Steering Rod
05/04→		Tie Rod End	SC-ES-7279		for Steering Rod
05/04→		Tie Rod End	SC-ES-8517		for Push Rod
05/04→		Tie Rod End	SC-ES-8535		for Guide Rod
05/04→		Track Control Arm		MN-DL-5225	Trailing Arm
05/04→	Track Control Arm		MN-DL-8709	Trailing Arm, Trailing Axle not Steered, for Pneumatic Suspension vehicles	

CV-ES-0914

Length: 125
Cone Ø: d1 Ø 30 / d2 Ø 27
Thread: M38 x 1,5 RHT
81953016184, 81953016251, 81953016276



CV-ES-14162

Length: 125
Cone Ø: d1 Ø 30 / d2 Ø 27
Thread: M30 x 1,5 LHT
81953010015, 81953010083, 81953010087, 81953016029, 81953016030, 81953016043, 81953016044, 81953016050, 81953016054, 81953016087, 81953016091, 81953016107, 81953016120, 81953016125, 81953016152, 81953016155, 81953016157, 81953016168, 81953016179, 81953016181, 81953016223, 81953016237, 81953016254, 81953016275, 81953016279, 81953016351



CV-ES-14163

Length: 125
Cone Ø: d1 Ø 30 / d2 Ø 27
Thread: M30 x 1,5 RHT
95301.0084, 90804102156, 90804102272, 90804102696, 90804102710, 81953010016, 81953010075, 81953010084, 81953010088, 81953010094, 81953010103, 81953016030, 81953016043, 81953016048, 81953016049, 81953016053, 81953016061, 81953016090, 81953016108, 81953016112, 81953016126, 81953016143, 81953016149, 81953016154, 81953016156, 81953016168, 81953016178, 81953016194, 81953016206, 81953016224, 81953016234, 81953016242, 81953016252, 81953016274, 81953016278, 81953016284, 81953016286, 81953016308, 81953016310, 81953016312, 81953016347, 81953016350, 81953016352, 82953016012, 88953016014, N2953016001



CV-RK-5313

Ø: 90
03304800A, 81953016132



DB-RK-9300

Ø: 75
Hole Distance: 130
Thick/Height: 24
85432206002



MN-DL-5212

Length: 577 Ø: 48
Hole Distance: 130 / 130
81432206096, 81432206097, 81432206098, 81432206129, 81432209096, 81432209129, 81432306014, 81432306030



MN-DL-5225

Length: 572 Ø: 48
Hole Distance: 130 / 130
03301500A, 81432206229, 81432206236, 81432206267, 81432206270, 81432206272, 81432206304, 81432206305, 81432209236, 81432209267, 81432209272



MN-DL-7801

Length: 995 Ø: 52
Cone Ø: d1 Ø 30 / d2 Ø 27
81466106807, 81466106808, 81466116087, 81466116088, 81466116096, 81466116097, 81466116099, 81466116132, 81466116133, 81466116136, 81466116197, 81466116198, 81466116205



MN-DL-7802

Length: 1680 Ø: 52
Cone Ø: d1 Ø 30 / d2 Ø 27
03208300A, 81467116773, 81467116858, 81467116859, 81467116860, 81467116861, 81467116863, 81467116882, 81467116883, 81467116920, 81467116921



MN-DL-8544

Length: 596 Ø: 48
Hole Distance: 130 / 130
81432206196, 81432206232, 81432206233



MN-DL-8560

Length: 970 Ø: 52
Cone Ø: d1 Ø 30 / d2 Ø 27
03206900A, 81466106809, 81466106810, 81466106823, 81466106838, 81466106839, 81466116104, 81466116105, 81466116107, 81466116134, 81466116135, 81466116137, 81466116199, 81466116200, 81466116206



MN-DL-8663

Length: 947 Ø: 60
Hole Distance: 115 / 115
03307400A, 81432206222, 81432206260, 81432206283, 81432206284



MN-DL-8709

Length: 572 Ø: 52
Hole Distance: 130 / 130
81432206268, 81432206274, 81432206291, 81432206292, 82432206007



MN-DL-8733

Length: 530 Ø: 48
Hole Distance: 130 / 130
81432206161, 81432206190, 81432206358, 81432206359



MN-DL-12284

Length: 1530 Ø: 50
Cone Ø: d1 Ø 30 / d2 Ø 27
81466106579, 81466106580, 81466106624, 81466116720, 81467116720, 81467116730, 81467116952



MN-ES-10333

Length: 90
Cone Ø: d1 Ø 38 / d2 Ø 34,35
Thread: M36 x 1,5 RHT
1271126, 3090291, 3099128, 42538048, 81953016268, 82953016018, 82953016019



MN-RK-12436

Ø: 75
Hole Distance: 115
Thick/Height: 24
81432206244



MN-VB-5238

Length: 627 Ø: 48
Hole Distance: 130 / 130
81432206221, 81432706096, 81432706114, 81432706116, 81432706121



MN-VB-8514

Length: 627 Ø: 48
Hole Ø 25 / 25 / 25
Hole Distance: 152 / 130 / 130
81432706087, 81432706088, 81432706094, 81432706095, 81432796094



MN-VB-9403

Length: 627 Ø: 48
Hole Ø 25 / 23 / 23
Hole Distance: 152 / 130 / 130
81432706097, 81432706113, 81432706135, 81432706160, 81432706161



SC-ES-7279

Length: 150
Cone Ø: d1 Ø 30 / d2 Ø 27
Thread: M30 x 1,5 RHT
81953016288



SC-ES-8517

Length: 140
Cone Ø: d1 Ø 30 / d2 Ø 27
Thread: M30 x 1,5 RHT
81953016286



SC-ES-8535

Length: 145
Cone Ø: d1 Ø 30 / d2 Ø 27
Thread: M30 x 1,5 RHT
81953016271, 81953016325





TGA ...

28.430 FNLS, FNLSR ...	05/04 →	Track Control Arm		MN-VB-5238	Wishbone (CV), 1st Drive Axle, for Pneumatic Suspension vehicles
28.430, 28.440 FNLC, FNLLC, FNLR	06/04 →	Centre Rod	MN-DL-7801		Push Rod, Leaf Spring Axle
	06/04 →	Centre Rod	MN-DL-8560		Push Rod, Air Suspension Axle
	06/04 →	Suspension Strut Repair Kit		CV-RK-5311	
	06/04 →	Suspension Strut Repair Kit		DB-RK-8581	
	06/04 →	Suspension Strut Repair Kit		MN-RK-12436	
	06/04 →	Tie Rod	MN-DL-7802		
	06/04 →	Tie Rod	MN-DL-12284		
	06/04 →	Tie Rod End		IV-ES-8507	Tag Axle
	06/04 →	Tie Rod End		MN-ES-8490	for vehicles with Hinged Trailing Axle
	06/04 →	Tie Rod End	CV-ES-0914		for Steering Rod
	06/04 →	Tie Rod End	CV-ES-14162	CV-ES-14162	for Steering Rod
	06/04 →	Tie Rod End	CV-ES-14163		for Steering Rod
	06/04 →	Tie Rod End	IV-ES-12272		for Steering Rod
	06/04 →	Tie Rod End	SC-ES-7279		for Steering Rod
	06/04 →	Tie Rod End	SC-ES-8517		for Push Rod
	06/04 →	Tie Rod End	SC-ES-8535		for Guide Rod
	06/04 →	Track Control Arm		MN-DL-5212	Trailing Arm, Tag Axle; Air Suspension Axle
	06/04 →	Track Control Arm		MN-DL-5225	Trailing Arm, Drive Axle; Air Suspension Axle
	06/04 →	Track Control Arm		MN-DL-5225	Trailing Arm, Drive Axle; Air Suspension Axle; for vehicles with Rigid Trailing Axle
	06/04 →	Track Control Arm		MN-DL-5225	Trailing Arm, Tag Axle; Air Suspension Axle; for vehicles with Hinged Trailing Axle
	06/04 →	Track Control Arm		MN-DL-8709	Trailing Arm, Air Suspension Axle; for vehicles with Hinged Trailing Axle
	06/04 →	Track Control Arm		MN-DL-8733	Trailing Arm, 1st Drive Axle, for Pneumatic Suspension vehicles
	06/04 →	Track Control Arm		MN-TC-12399	Control Arm
	06/04 →	Track Control Arm		MN-VB-5238	Wishbone (CV), Drive Axle; Air Suspension Axle
	06/04 →	Track Control Arm		MN-VB-5238	Wishbone (CV), Drive Axle; Leading Axle; Air Suspension Axle
	06/04 →	Track Control Arm		MN-VB-9403	Wishbone (CV), Air Suspension Axle
	06/04 →	Track Control Arm	MN-DL-8663		Control Arm, Air Suspension Axle
01/05 →	Track Control Arm		MN-DL-5225	Trailing Arm, Tag Axle; Air Suspension Axle; for vehicles with Rigid Trailing Axle	
28.440 FANLC	07/06 →	Suspension Arm Repair Kit	DB-RK-9300	DB-RK-9300	for Drag Link
	07/06 →	Tie Rod	MN-DL-12284		
	07/06 →	Tie Rod End	CV-ES-14162	CV-ES-14162	for Steering Rod
	07/06 →	Tie Rod End	CV-ES-14163		for Steering Rod
	07/06 →	Tie Rod End	MN-ES-10333		for Steering Rod
	07/06 →	Track Control Arm		MN-DL-5225	Trailing Arm
	07/06 →	Track Control Arm		MN-DL-8544	Trailing Arm, 1st RA; 2nd RA, for Pneumatic Suspension vehicles
	07/06 →	Track Control Arm		MN-DL-8709	Trailing Arm, Trailing Axle Steered, for Pneumatic Suspension vehicles
	07/06 →	Track Control Arm		MN-VB-8514	Suspension Rod, Wishbone (CV)
	07/06 →	Track Control Arm		MN-VB-9403	Wishbone (CV), Trailing Axle Steered, for Pneumatic Suspension vehicles
28.440 FANLK	07/06 →	Suspension Arm Repair Kit	DB-RK-9300	DB-RK-9300	for Drag Link
	07/06 →	Tie Rod	MN-DL-12284		
	07/06 →	Tie Rod End	CV-ES-14162	CV-ES-14162	for Steering Rod
	07/06 →	Tie Rod End	CV-ES-14163		for Steering Rod
	07/06 →	Tie Rod End	MN-ES-10333		for Steering Rod
	07/06 →	Track Control Arm		MN-DL-5225	Trailing Arm
	07/06 →	Track Control Arm		MN-DL-8544	Trailing Arm, 1st RA; 2nd RA, for Pneumatic Suspension vehicles
	07/06 →	Track Control Arm		MN-DL-8709	Trailing Arm, Trailing Axle Steered, for Pneumatic Suspension vehicles
	07/06 →	Track Control Arm		MN-VB-8514	Suspension Rod, Wishbone (CV)
	07/06 →	Track Control Arm		MN-VB-9403	Wishbone (CV), Trailing Axle Steered, for Pneumatic Suspension vehicles

CV-ES-0914

Length: 125
Cone Ø: d1 Ø 30 / d2 Ø 27
Thread: M38 x 1,5 RHT
81953016184, 81953016251, 81953016276



CV-ES-14162

Length: 125
Cone Ø: d1 Ø 30 / d2 Ø 27
Thread: M30 x 1,5 LHT
81953010015, 81953010083, 81953010087, 81953016029, 81953016030, 81953016043, 81953016044, 81953016050, 81953016054, 81953016087, 81953016091, 81953016107, 81953016120, 81953016125, 81953016152, 81953016155, 81953016157, 81953016168, 81953016179, 81953016181, 81953016223, 81953016237, 81953016254, 81953016275, 81953016279, 81953016351



CV-ES-14163

Length: 125
Cone Ø: d1 Ø 30 / d2 Ø 27
Thread: M30 x 1,5 RHT
95301.0084, 90804102156, 90804102272, 90804102696, 90804102710, 81953010016, 81953010075, 81953010084, 81953010088, 81953010094, 81953010103, 81953016030, 81953016043, 81953016048, 81953016049, 81953016053, 81953016061, 81953016090, 81953016108, 81953016112, 81953016126, 81953016143, 81953016149, 81953016154, 81953016156, 81953016168, 81953016178, 81953016194, 81953016206, 81953016224, 81953016234, 81953016242, 81953016252, 81953016274, 81953016278, 81953016284, 81953016286, 81953016308, 81953016310, 81953016312, 81953016347, 81953016350, 81953016352, 82953016012, 88953016014, N2953016001



CV-RK-5311

638862, 639287, 938423, 1104335, 1953248, 3500506, 0003500506, 11013547, 42488722, 070550504, 634303610, 81432206055, 81432206073, 82262320660, 5001842823, 7000307001, 8226232066



DB-RK-8581

Ø: 85
Hole Distance: 130
Thick/Height: 24
03305800A, 81432706105



DB-RK-9300

Ø: 75
Hole Distance: 130
Thick/Height: 24
85432206002



IV-ES-8507

Length: 80
Cone Ø: d1 Ø 30 / d2 Ø 27
Thread: M30 x 1,5 RHT
11019869, 12216380, 55175540, 81953016238



IV-ES-12272

Length: 75
Cone Ø: d1 Ø 30 / d2 Ø 27
Thread: M26 x 1,5 RHT
81953016280, 82953010010



MN-DL-5212

Length: 577 Ø: 48
Hole Distance: 130 / 130
81432206096, 81432206097, 81432206098, 81432206129, 81432209096, 81432209129, 81432306014, 81432306030



MN-DL-5225

Length: 572 Ø: 48
Hole Distance: 130 / 130
03301500A, 81432206229, 81432206236, 81432206267, 81432206270, 81432206272, 81432206304, 81432206305, 81432209236, 81432209267, 81432209272



MN-DL-7801

Length: 995 Ø: 52
Cone Ø: d1 Ø 30 / d2 Ø 27
81466106807, 81466106808, 81466116087, 81466116088, 81466116096, 81466116097, 81466116099, 81466116132, 81466116133, 81466116136, 81466116197, 81466116198, 81466116205



MN-DL-7802

Length: 1680 Ø: 52
Cone Ø: d1 Ø 30 / d2 Ø 27
03208300A, 81467116773, 81467116858, 81467116859, 81467116860, 81467116861, 81467116863, 81467116882, 81467116883, 81467116920, 81467116921



MN-DL-8544

Length: 596 Ø: 48
Hole Distance: 130 / 130
81432206196, 81432206232, 81432206233



MN-DL-8560

Length: 970 Ø: 52
Cone Ø: d1 Ø 30 / d2 Ø 27
03206900A, 81466106809, 81466106810, 81466106823, 81466106838, 81466106839, 81466116104, 81466116105, 81466116107, 81466116134, 81466116135, 81466116137, 81466116199, 81466116200, 81466116206



MN-DL-8663

Length: 947 Ø: 60
Hole Distance: 115 / 115
03307400A, 81432206222, 81432206260, 81432206283, 81432206284



MN-DL-8709

Length: 572 Ø: 52
Hole Distance: 130 / 130
81432206268, 81432206274, 81432206291, 81432206292, 82432206007



MN-DL-8733

Length: 530 Ø: 48
Hole Distance: 130 / 130
81432206161, 81432206190, 81432206358, 81432206359



MN-DL-12284

Length: 1530 Ø: 50
Cone Ø: d1 Ø 30 / d2 Ø 27
81466106579, 81466106580, 81466106624, 81466116720, 81467116720, 81467116730, 81467116952



MN-ES-8490

Length: 90
Cone Ø: d1 Ø 30 / d2 Ø 27
Thread: M26 x 1,5 RHT
0014606948, 14606948, 81953016281, 81953016337, 82953016016



MN-ES-10333

Length: 90
Cone Ø: d1 Ø 38 / d2 Ø 34,35
Thread: M36 x 1,5 RHT
1271126, 3090291, 3099128, 42538048, 81953016268, 82953016018, 82953016019



MN-RK-12436

Ø: 75
Hole Distance: 115
Thick/Height: 24
81432206244



MN-TC-12399

Length: 694 Ø: 50
Hole Distance: 130 / 130
81432206265



MN-VB-5238

Length: 627 Ø: 48
Hole Distance: 130 / 130
81432206221, 81432706096, 81432706114, 81432706116, 81432706121



MN-VB-8514

Length: 627 Ø: 48
Hole Ø 25 / 25 / 25
Hole Distance: 152 / 130 / 130
81432706087, 81432706098, 81432706099, 81432706095, 81432796094



MN-VB-9403

Length: 627 Ø: 48
Hole Ø 25 / 23 / 23
Hole Distance: 152 / 130 / 130
81432706097, 81432706113, 81432706135, 81432706160, 81432706161



SC-ES-7279

Length: 150
Cone Ø: d1 Ø 30 / d2 Ø 27
Thread: M30 x 1,5 RHT
81953016288



SC-ES-8517

Length: 140
Cone Ø: d1 Ø 30 / d2 Ø 27
Thread: M30 x 1,5 RHT
81953016286



SC-ES-8535

Length: 145
Cone Ø: d1 Ø 30 / d2 Ø 27
Thread: M30 x 1,5 RHT
81953016271, 81953016325





TGA ...

28.440 FNLC, FNLLC	07/06→	Centre Rod	MN-DL-8560		Push Rod
	07/06→	Suspension Strut Repair Kit		MN-RK-12436	
	07/06→	Tie Rod End	CV-ES-0914		for Steering Rod
	07/06→	Tie Rod End	CV-ES-14162		for Steering Rod
	07/06→	Tie Rod End	CV-ES-14163		for Steering Rod
	07/06→	Tie Rod End	SC-ES-7279		for Steering Rod
	07/06→	Tie Rod End	SC-ES-8517		for Push Rod
	07/06→	Tie Rod End	SC-ES-8535		for Guide Rod
	07/06→	Track Control Arm		MN-DL-5225	for Control Arm
	07/06→	Track Control Arm		MN-DL-8709	Trailing Arm
	07/06→	Track Control Arm		MN-DL-8733	Trailing Arm
	07/06→	Track Control Arm		MN-VB-5238	Wishbone (CV), Drive Axle
	07/06→	Track Control Arm		MN-VB-9403	Wishbone (CV)
	07/06→	Track Control Arm	MN-DL-8663		Control Arm
	28.440 FNLS, FNLSR	09/05→	Centre Rod	MN-DL-7801	
09/05→		Suspension Arm Repair Kit		CV-RK-5313	for Wishbone (CV)
09/05→		Suspension Arm Repair Kit	DB-RK-9300	DB-RK-9300	for Drag Link
09/05→		Tie Rod	MN-DL-7802		
09/05→		Tie Rod End	CV-ES-0914		for Steering Rod
09/05→		Tie Rod End	CV-ES-14163		for Steering Rod
09/05→		Tie Rod End	SC-ES-7279		for Steering Rod
09/05→		Tie Rod End	SC-ES-8517		for Push Rod
09/05→		Tie Rod End	SC-ES-8535		for Guide Rod
09/05→		Track Control Arm		MN-DL-5225	Trailing Arm
09/05→		Track Control Arm		MN-DL-8709	Trailing Arm, Trailing Axle not Steered, for Pneumatic Suspension vehicles
09/05→		Track Control Arm		MN-VB-5238	Wishbone (CV), 1st Drive Axle, for Pneumatic Suspension vehicles
28.460 FNLC, FNLLC, FNLCR		09/02→	Ball Head, gearshift linkage	CV-ES-2120	
	09/02→	Centre Rod	MN-DL-7801		Push Rod, Leaf Spring Axle
	09/02→	Centre Rod	MN-DL-8560		Push Rod, Air Suspension Axle
	09/02→	Suspension Strut Repair Kit		DB-RK-8581	
	09/02→	Suspension Strut Repair Kit		MN-RK-12436	
	09/02→	Tie Rod	MN-DL-7802		
	09/02→	Tie Rod End	CV-ES-0914		for Steering Rod
	09/02→	Tie Rod End	CV-ES-14163		for Steering Rod
	09/02→	Tie Rod End	SC-ES-7279		for Steering Rod
	09/02→	Tie Rod End	SC-ES-8517		for Push Rod
	09/02→	Tie Rod End	SC-ES-8535		for Guide Rod
	09/02→	Track Control Arm		MN-DL-5212	Trailing Arm, Tag Axle;Air Suspension Axle
	09/02→	Track Control Arm		MN-DL-5225	Trailing Arm, Drive Axle;Air Suspension Axle
	09/02→	Track Control Arm		MN-DL-5225	Trailing Arm, Leading Axle;Air Suspension Axle
	09/02→	Track Control Arm		MN-DL-8709	Trailing Arm, Trailing Axle not Steered, for Pneumatic Suspension vehicles
	09/02→	Track Control Arm		MN-VB-5238	Wishbone (CV), Drive Axle;Leading Axle; Air Suspension Axle
	09/02→	Track Control Arm		MN-VB-9403	Wishbone (CV), Air Suspension Axle
	09/02→	Track Control Arm	MN-DL-8663		Control Arm, Air Suspension Axle
	28.460 FNLS, FNLSR	09/02→	Ball Head, gearshift linkage	CV-ES-2120	
09/02→		Centre Rod	MN-DL-7801		Push Rod, Leaf Spring Axle
09/02→		Centre Rod	MN-DL-8560		Push Rod, Air Suspension Axle
09/02→		Suspension Strut Repair Kit		DB-RK-8581	
09/02→		Suspension Strut Repair Kit		MN-RK-12436	
09/02→		Tie Rod	MN-DL-7802		
09/02→		Tie Rod End	CV-ES-0914		for Steering Rod
09/02→		Tie Rod End	CV-ES-14163		for Steering Rod
09/02→		Tie Rod End	SC-ES-7279		for Steering Rod
09/02→		Tie Rod End	SC-ES-8517		for Push Rod
09/02→		Tie Rod End	SC-ES-8535		for Guide Rod
09/02→		Track Control Arm		MN-DL-5212	Trailing Arm, Tag Axle;Air Suspension Axle
09/02→		Track Control Arm		MN-DL-5225	Trailing Arm, Drive Axle;Air Suspension Axle
09/02→		Track Control Arm		MN-DL-5225	Trailing Arm, Leading Axle;Air Suspension Axle

CV-ES-0914

Length: 125
Cone Ø: d1 Ø 30 / d2 Ø 27
Thread: M38 x 1,5 RHT
81953016184, 81953016251, 81953016276



CV-ES-2120

Length: 115
Cone Ø: d1 Ø 12,4 / d2 Ø 10,8
Thread: M14 x 1,5 RHT
03008500A, 81953016200, 81953016202, 81953016203, 81953016227



CV-ES-14162

Length: 125
Cone Ø: d1 Ø 30 / d2 Ø 27
Thread: M30 x 1,5 LHT
81953010015, 81953010083, 81953010087, 81953016029, 81953016030, 81953016043, 81953016044, 81953016050, 81953016054, 81953016087, 81953016091, 81953016107, 81953016120, 81953016125, 81953016152, 81953016155, 81953016157, 81953016168, 81953016179, 81953016181, 81953016223, 81953016237, 81953016254, 81953016275, 81953016279, 81953016351



CV-ES-14163

Length: 125
Cone Ø: d1 Ø 30 / d2 Ø 27
Thread: M30 x 1,5 RHT
95301.0084, 90804102156, 90804102272, 90804102696, 90804102710, 81953010016, 81953010075, 81953010084, 81953010088, 81953010094, 81953010103, 81953016030, 81953016043, 81953016048, 81953016049, 81953016053, 81953016061, 81953016090, 81953016108, 81953016112, 81953016126, 81953016143, 81953016149, 81953016154, 81953016156, 81953016168, 81953016178, 81953016194, 81953016206, 81953016224, 81953016234, 81953016242, 81953016252, 81953016274, 81953016278, 81953016284, 81953016286, 81953016308, 81953016310, 81953016312, 81953016347, 81953016350, 81953016352, 82953016012, 88953016014, N2953016001



CV-RK-5313

Ø: 90
03304800A, 81953016132



DB-RK-8581

Ø: 85
Hole Distance: 130
Thick/Height: 24
03305800A, 81432706105



DB-RK-9300

Ø: 75
Hole Distance: 130
Thick/Height: 24
85432206002



MN-DL-5212

Length: 577 Ø: 48
Hole Distance: 130 / 130
81432206096, 81432206097, 81432206098, 81432206129, 81432209096, 81432209129, 81432306014, 81432306030



MN-DL-5225

Length: 572 Ø: 48
Hole Distance: 130 / 130
03301500A, 81432206229, 81432206236, 81432206267, 81432206270, 81432206272, 81432206304, 81432206305, 81432209236, 81432209267, 81432209272



MN-DL-7801

Length: 995 Ø: 52
Cone Ø: d1 Ø 30 / d2 Ø 27
81466106807, 81466106808, 81466116087, 81466116088, 81466116096, 81466116097, 81466116099, 81466116132, 81466116133, 81466116136, 81466116197, 81466116198, 81466116205



MN-DL-7802

Length: 1680 Ø: 52
Cone Ø: d1 Ø 30 / d2 Ø 27
03208300A, 81467116773, 81467116858, 81467116859, 81467116860, 81467116861, 81467116863, 81467116882, 81467116883, 81467116920, 81467116921



MN-DL-8560

Length: 970 Ø: 52
Cone Ø: d1 Ø 30 / d2 Ø 27
03206900A, 81466106809, 81466106810, 81466106823, 81466106838, 81466106839, 81466116104, 81466116105, 81466116107, 81466116134, 81466116135, 81466116137, 81466116199, 81466116200, 81466116206



MN-DL-8663

Length: 947 Ø: 60
Hole Distance: 115 / 115
03307400A, 81432206222, 81432206260, 81432206283, 81432206284



MN-DL-8709

Length: 572 Ø: 52
Hole Distance: 130 / 130
81432206268, 81432206274, 81432206291, 81432206292, 82432206007



MN-DL-8733

Length: 530 Ø: 48
Hole Distance: 130 / 130
81432206161, 81432206190, 81432206358, 81432206359



MN-RK-12436

Ø: 75
Hole Distance: 115
Thick/Height: 24
81432206244



MN-VB-5238

Length: 627 Ø: 48
Hole Distance: 130 / 130
81432206221, 81432706096, 81432706114, 81432706116, 81432706121



MN-VB-9403

Length: 627 Ø: 48
Hole Ø 25 / 23 / 23
Hole Distance: 152 / 130 / 130
81432706097, 81432706113, 81432706135, 81432706160, 81432706161



SC-ES-7279

Length: 150
Cone Ø: d1 Ø 30 / d2 Ø 27
Thread: M30 x 1,5 RHT
81953016288



SC-ES-8517

Length: 140
Cone Ø: d1 Ø 30 / d2 Ø 27
Thread: M30 x 1,5 RHT
81953016286



SC-ES-8535

Length: 145
Cone Ø: d1 Ø 30 / d2 Ø 27
Thread: M30 x 1,5 RHT
81953016271, 81953016325





TGA ...

28.460 FNLS, FNLRs ...	09/02→	Track Control Arm		MN-DL-8709	Trailing Arm, Trailing Axle not Steered, for Pneumatic Suspension vehicles
	09/02→	Track Control Arm		MN-VB-5238	Wishbone (CV), Drive Axle;Leading Axle; Air Suspension Axle
	09/02→	Track Control Arm		MN-VB-9403	Wishbone (CV), Air Suspension Axle
	09/02→	Track Control Arm	MN-DL-8663		Control Arm, Air Suspension Axle
28.480 FANLC	07/06→	Suspension Arm Repair Kit	DB-RK-9300	DB-RK-9300	for Drag Link
	07/06→	Tie Rod	MN-DL-12284		
	07/06→	Tie Rod End	CV-ES-14162	CV-ES-14162	for Steering Rod
	07/06→	Tie Rod End	CV-ES-14163		for Steering Rod
	07/06→	Tie Rod End	MN-ES-10333		for Steering Rod
	07/06→	Track Control Arm		MN-DL-5225	Trailing Arm
	07/06→	Track Control Arm		MN-DL-8544	Trailing Arm, 1st RA;2nd RA, for Pneumatic Suspension vehicles
	07/06→	Track Control Arm		MN-DL-8709	Trailing Arm, Trailing Axle Steered, for Pneumatic Suspension vehicles
	07/06→	Track Control Arm		MN-VB-8514	Suspension Rod, Wishbone (CV)
	07/06→	Track Control Arm		MN-VB-9403	Wishbone (CV), Trailing Axle Steered, for Pneumatic Suspension vehicles
28.480 FANLK	07/06→	Suspension Arm Repair Kit	DB-RK-9300	DB-RK-9300	for Drag Link
	07/06→	Suspension Strut Repair Kit		DB-RK-8581	
	07/06→	Tie Rod	MN-DL-12284		
	07/06→	Tie Rod End		IV-ES-8507	Tag Axle
	07/06→	Tie Rod End	CV-ES-14162	CV-ES-14162	for Steering Rod
	07/06→	Tie Rod End	CV-ES-14163		for Steering Rod
	07/06→	Tie Rod End	MN-ES-10333		for Steering Rod
	07/06→	Track Control Arm		MN-DL-5225	Trailing Arm
	07/06→	Track Control Arm		MN-DL-8544	Trailing Arm, 1st RA;2nd RA, for Pneumatic Suspension vehicles
	07/06→	Track Control Arm		MN-DL-8544	Trailing Arm, 1st RA;Air Suspension Axle; for vehicles with Hinged Trailing Axle
	07/06→	Track Control Arm		MN-DL-8709	Trailing Arm, Air Suspension Axle; for vehicles with Hinged Trailing Axle
	07/06→	Track Control Arm		MN-DL-8709	Trailing Arm, Trailing Axle Steered, for Pneumatic Suspension vehicles
	07/06→	Track Control Arm		MN-VB-8514	Suspension Rod, Wishbone (CV)
	07/06→	Track Control Arm		MN-VB-9403	Wishbone (CV), Air Suspension Axle; for vehicles with Hinged Trailing Axle
	07/06→	Track Control Arm		MN-VB-9403	Wishbone (CV), Trailing Axle Steered, for Pneumatic Suspension vehicles
	28.480 FNLC, FNLLC, FNLRc	09/02→	Ball Head, gearshift linkage	CV-ES-2120	
09/02→		Centre Rod	MN-DL-7801		Push Rod, Leaf Spring Axle
09/02→		Centre Rod	MN-DL-8560		Push Rod, Air Suspension Axle
09/02→		Suspension Strut Repair Kit		DB-RK-8581	
09/02→		Suspension Strut Repair Kit		MN-RK-12436	
09/02→		Tie Rod	MN-DL-7802		
09/02→		Tie Rod End	CV-ES-0914		for Steering Rod
09/02→		Tie Rod End	CV-ES-14163		for Steering Rod
09/02→		Tie Rod End	SC-ES-7279		for Steering Rod
09/02→		Tie Rod End	SC-ES-8517		for Push Rod
09/02→		Tie Rod End	SC-ES-8535		for Guide Rod
09/02→		Track Control Arm		MN-DL-5212	Trailing Arm, Tag Axle;Air Suspension Axle
09/02→		Track Control Arm		MN-DL-5225	Trailing Arm, Drive Axle;Air Suspension Axle
09/02→		Track Control Arm		MN-DL-5225	Trailing Arm, Leading Axle;Air Suspension Axle
09/02→		Track Control Arm		MN-DL-8709	Trailing Arm, Trailing Axle not Steered, for Pneumatic Suspension vehicles
09/02→		Track Control Arm		MN-VB-5238	Wishbone (CV), Drive Axle;Leading Axle; Air Suspension Axle
09/02→		Track Control Arm		MN-VB-9403	Wishbone (CV), Air Suspension Axle
09/02→		Track Control Arm	MN-DL-8663		Control Arm, Air Suspension Axle

CV-ES-0914

Length: 125
Cone Ø: d1 Ø 30 / d2 Ø 27
Thread: M38 x 1,5 RHT
81953016184, 81953016251, 81953016276



CV-ES-2120

Length: 115
Cone Ø: d1 Ø 12,4 / d2 Ø 10,8
Thread: M14 x 1,5 RHT
03008500A, 81953016200, 81953016202, 81953016203, 81953016227



CV-ES-14162

Length: 125
Cone Ø: d1 Ø 30 / d2 Ø 27
Thread: M30 x 1,5 LHT
81953010015, 81953010083, 81953010087, 81953016029, 81953016030, 81953016043, 81953016044, 81953016050, 81953016054, 81953016087, 81953016091, 81953016107, 81953016120, 81953016125, 81953016152, 81953016155, 81953016157, 81953016168, 81953016179, 81953016181, 81953016223, 81953016237, 81953016254, 81953016275, 81953016279, 81953016351



CV-ES-14163

Length: 125
Cone Ø: d1 Ø 30 / d2 Ø 27
Thread: M30 x 1,5 RHT
95301.0084, 90804102156, 90804102272, 90804102696, 90804102710, 81953010016, 81953010075, 81953010084, 81953010088, 81953010094, 81953010103, 81953016030, 81953016043, 81953016048, 81953016049, 81953016053, 81953016061, 81953016090, 81953016108, 81953016112, 81953016126, 81953016143, 81953016149, 81953016154, 81953016156, 81953016168, 81953016178, 81953016194, 81953016206, 81953016224, 81953016234, 81953016242, 81953016252, 81953016274, 81953016278, 81953016284, 81953016286, 81953016308, 81953016310, 81953016312, 81953016347, 81953016350, 81953016352, 82953016012, 88953016014, N2953016001



DB-RK-8581

Ø: 85
Hole Distance: 130
Thick/Height: 24
03305800A, 81432706105



DB-RK-9300

Ø: 75
Hole Distance: 130
Thick/Height: 24
85432206002



IV-ES-8507

Length: 80
Cone Ø: d1 Ø 30 / d2 Ø 27
Thread: M30 x 1,5 RHT
11019869, 12216380, 55175540, 81953016238



MN-DL-5212

Length: 577 Ø: 48
Hole Distance: 130 / 130
81432206096, 81432206097, 81432206098, 81432206129, 81432209096, 81432209129, 81432306014, 81432306030



MN-DL-5225

Length: 572 Ø: 48
Hole Distance: 130 / 130
03301500A, 81432206229, 81432206236, 81432206267, 81432206270, 81432206272, 81432206304, 81432206305, 81432209236, 81432209267, 81432209272



MN-DL-7801

Length: 995 Ø: 52
Cone Ø: d1 Ø 30 / d2 Ø 27
81466106807, 81466106808, 81466116087, 81466116088, 81466116096, 81466116097, 81466116099, 81466116132, 81466116133, 81466116136, 81466116197, 81466116198, 81466116205



MN-DL-7802

Length: 1680 Ø: 52
Cone Ø: d1 Ø 30 / d2 Ø 27
03208300A, 81467116773, 81467116858, 81467116859, 81467116860, 81467116861, 81467116863, 81467116882, 81467116883, 81467116920, 81467116921



MN-DL-8544

Length: 596 Ø: 48
Hole Distance: 130 / 130
81432206196, 81432206232, 81432206233



MN-DL-8560

Length: 970 Ø: 52
Cone Ø: d1 Ø 30 / d2 Ø 27
03206900A, 81466106809, 81466106810, 81466106823, 81466106838, 81466106839, 81466116104, 81466116105, 81466116107, 81466116134, 81466116135, 81466116137, 81466116199, 81466116200, 81466116206



MN-DL-8663

Length: 947 Ø: 60
Hole Distance: 115 / 115
03307400A, 81432206222, 81432206260, 81432206283, 81432206284



MN-DL-8709

Length: 572 Ø: 52
Hole Distance: 130 / 130
81432206268, 81432206274, 81432206291, 81432206292, 82432206007



MN-DL-12284

Length: 1530 Ø: 50
Cone Ø: d1 Ø 30 / d2 Ø 27
81466106579, 81466106580, 81466106624, 81466116720, 81467116720, 81467116730, 81467116952



MN-ES-10333

Length: 90
Cone Ø: d1 Ø 38 / d2 Ø 34,35
Thread: M36 x 1,5 RHT
1271126, 3090291, 3099128, 42538048, 81953016268, 82953016018, 82953016019



MN-RK-12436

Ø: 75
Hole Distance: 115
Thick/Height: 24
81432206244



MN-VB-5238

Length: 627 Ø: 48
Hole Distance: 130 / 130
81432206221, 81432706096, 81432706114, 81432706116, 81432706121



MN-VB-8514

Length: 627 Ø: 48
Hole Ø 25 / 25 / 25
Hole Distance: 152 / 130 / 130
81432706087, 81432706088, 81432706094, 81432706095, 81432796094



MN-VB-9403

Length: 627 Ø: 48
Hole Ø 25 / 23 / 23
Hole Distance: 152 / 130 / 130
81432706097, 81432706113, 81432706135, 81432706160, 81432706161



SC-ES-7279

Length: 150
Cone Ø: d1 Ø 30 / d2 Ø 27
Thread: M30 x 1,5 RHT
81953016288



SC-ES-8517

Length: 140
Cone Ø: d1 Ø 30 / d2 Ø 27
Thread: M30 x 1,5 RHT
81953016286



SC-ES-8535

Length: 145
Cone Ø: d1 Ø 30 / d2 Ø 27
Thread: M30 x 1,5 RHT
81953016271, 81953016325



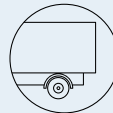

TGA ...

28.480 FNLG, FNLRC, FNLLC	02/06→	Centre Rod	MN-DL-7801		Push Rod	
	02/06→	Suspension Strut Repair Kit		MN-RK-12436		
	02/06→	Tie Rod	MN-DL-7802			
	02/06→	Tie Rod End	CV-ES-0914		for Steering Rod	
	02/06→	Tie Rod End	CV-ES-14163		for Steering Rod	
	02/06→	Tie Rod End	SC-ES-7279		for Steering Rod	
	02/06→	Tie Rod End	SC-ES-8517		for Push Rod	
	02/06→	Tie Rod End	SC-ES-8535		for Guide Rod	
	02/06→	Track Control Arm		MN-DL-5225	Trailing Arm	
	02/06→	Track Control Arm		MN-DL-8709	Trailing Arm, Trailing Axle not Steered, for Pneumatic Suspension vehicles	
	02/06→	Track Control Arm		MN-VB-5238	Wishbone (CV), 1st Drive Axle, for Pneumatic Suspension vehicles	
	02/06→	Track Control Arm	MN-DL-8663		Control Arm	
	28.480 FNLS, FNLSR	09/02→	Ball Head, gearshift linkage	CV-ES-2120		
09/02→		Centre Rod	MN-DL-7801		Push Rod, Leaf Spring Axle	
09/02→		Centre Rod	MN-DL-8560		Push Rod, Air Suspension Axle	
09/02→		Suspension Strut Repair Kit		DB-RK-8581		
09/02→		Suspension Strut Repair Kit		MN-RK-12436		
09/02→		Tie Rod	MN-DL-7802			
09/02→		Tie Rod End	CV-ES-0914		for Steering Rod	
09/02→		Tie Rod End	CV-ES-14163		for Steering Rod	
09/02→		Tie Rod End	SC-ES-7279		for Steering Rod	
09/02→		Tie Rod End	SC-ES-8517		for Push Rod	
09/02→		Tie Rod End	SC-ES-8535		for Guide Rod	
09/02→		Track Control Arm		MN-DL-5212	Trailing Arm, Tag Axle;Air Suspension Axle	
09/02→		Track Control Arm		MN-DL-5225	Trailing Arm, Drive Axle;Air Suspension Axle	
09/02→		Track Control Arm		MN-DL-5225	Trailing Arm, Leading Axle;Air Suspension Axle	
09/02→		Track Control Arm		MN-DL-8709	Trailing Arm, Trailing Axle not Steered, for Pneumatic Suspension vehicles	
09/02→		Track Control Arm		MN-VB-5238	Wishbone (CV), Drive Axle;Leading Axle; Air Suspension Axle	
09/02→		Track Control Arm		MN-VB-9403	Wishbone (CV), Air Suspension Axle	
09/02→		Track Control Arm	MN-DL-8663		Control Arm, Air Suspension Axle	
02/06→		Centre Rod	MN-DL-7801		Push Rod	
02/06→		Suspension Arm Repair Kit		CV-RK-5313	for Wishbone (CV)	
02/06→		Suspension Arm Repair Kit	DB-RK-9300	DB-RK-9300	for Drag Link	
02/06→		Track Control Arm		MN-DL-5225	Trailing Arm	
02/06→		Track Control Arm		MN-VB-5238	Wishbone (CV), 1st Drive Axle, for Pneumatic Suspension vehicles	
28.510 FNLC, FNLLC, FNLSR		09/02→	Ball Head, gearshift linkage	CV-ES-2120		
		09/02→	Centre Rod	MN-DL-7801		Push Rod, Leaf Spring Axle
		09/02→	Centre Rod	MN-DL-8560		Push Rod, Air Suspension Axle
	09/02→	Suspension Strut Repair Kit		DB-RK-8581		
	09/02→	Suspension Strut Repair Kit		MN-RK-12436		
	09/02→	Tie Rod	MN-DL-7802			
	09/02→	Tie Rod End	CV-ES-0914		for Steering Rod	
	09/02→	Tie Rod End	CV-ES-14163		for Steering Rod	
	09/02→	Tie Rod End	SC-ES-7279		for Steering Rod	
	09/02→	Tie Rod End	SC-ES-8517		for Push Rod	
	09/02→	Tie Rod End	SC-ES-8535		for Guide Rod	
	09/02→	Track Control Arm		MN-DL-5212	Trailing Arm, Tag Axle;Air Suspension Axle	
	09/02→	Track Control Arm		MN-DL-5225	Trailing Arm, Drive Axle;Air Suspension Axle	
	09/02→	Track Control Arm		MN-DL-5225	Trailing Arm, Leading Axle;Air Suspension Axle	
	09/02→	Track Control Arm		MN-DL-8709	Trailing Arm, Trailing Axle not Steered, for Pneumatic Suspension vehicles	
	09/02→	Track Control Arm		MN-VB-5238	Wishbone (CV), Drive Axle;Leading Axle; Air Suspension Axle	
	09/02→	Track Control Arm		MN-VB-9403	Wishbone (CV), Air Suspension Axle	
	09/02→	Track Control Arm	MN-DL-8663		Control Arm, Air Suspension Axle	

CV-ES-0914

Length: 125
Cone Ø: d1 Ø 30 / d2 Ø 27
Thread: M38 x 1,5 RHT
81953016184, 81953016251, 81953016276



CV-ES-2120

Length: 115
Cone Ø: d1 Ø 12,4 / d2 Ø 10,8
Thread: M14 x 1,5 RHT
03008500A, 81953016200, 81953016202, 81953016203, 81953016227



CV-ES-14163

Length: 125
Cone Ø: d1 Ø 30 / d2 Ø 27
Thread: M30 x 1,5 RHT
95301.0084, 90804102156, 90804102272, 90804102696, 90804102710, 81953010016, 81953010075, 81953010084, 81953010088, 81953010094, 81953010103, 81953016030, 81953016043, 81953016048, 81953016049, 81953016053, 81953016061, 81953016090, 81953016108, 81953016112, 81953016126, 81953016143, 81953016149, 81953016154, 81953016156, 81953016168, 81953016178, 81953016194, 81953016206, 81953016224, 81953016234, 81953016242, 81953016252, 81953016274, 81953016278, 81953016284, 81953016286, 81953016308, 81953016310, 81953016312, 81953016347, 81953016350, 81953016352, 82953016012, 88953016014, N2953016001



CV-RK-5313

Ø: 90
03304800A, 81953016132



DB-RK-8581

Ø: 85
Hole Distance: 130
Thick/Height: 24
03305800A, 81432706105



DB-RK-9300

Ø: 75
Hole Distance: 130
Thick/Height: 24
85432206002



MN-DL-5212

Length: 577 Ø: 48
Hole Distance: 130 / 130
81432206096, 81432206097, 81432206098, 81432206129, 81432209096, 81432209129, 81432306014, 81432306030



MN-DL-5225

Length: 572 Ø: 48
Hole Distance: 130 / 130
03301500A, 81432206229, 81432206236, 81432206267, 81432206270, 81432206272, 81432206304, 81432206305, 81432209236, 81432209267, 81432209272



MN-DL-7801

Length: 995 Ø: 52
Cone Ø: d1 Ø 30 / d2 Ø 27
81466106807, 81466106808, 81466116087, 81466116088, 81466116096, 81466116097, 81466116099, 81466116132, 81466116133, 81466116136, 81466116197, 81466116198, 81466116205



MN-DL-7802

Length: 1680 Ø: 52
Cone Ø: d1 Ø 30 / d2 Ø 27
03208300A, 81467116773, 81467116858, 81467116859, 81467116860, 81467116861, 81467116863, 81467116882, 81467116883, 81467116920, 81467116921



MN-DL-8560

Length: 970 Ø: 52
Cone Ø: d1 Ø 30 / d2 Ø 27
03206900A, 81466106809, 81466106810, 81466106823, 81466106838, 81466106839, 81466116104, 81466116105, 81466116107, 81466116134, 81466116135, 81466116137, 81466116199, 81466116200, 81466116206



MN-DL-8663

Length: 947 Ø: 60
Hole Distance: 115 / 115
03307400A, 81432206222, 81432206260, 81432206283, 81432206284



MN-DL-8709

Length: 572 Ø: 52
Hole Distance: 130 / 130
81432206268, 81432206274, 81432206291, 81432206292, 82432206007



MN-RK-12436

Ø: 75
Hole Distance: 115
Thick/Height: 24
81432206244



MN-VB-5238

Length: 627 Ø: 48
Hole Distance: 130 / 130
81432206221, 81432706096, 81432706114, 81432706116, 81432706121



MN-VB-9403

Length: 627 Ø: 48
Hole Ø 25 / 23 / 23
Hole Distance: 152 / 130 / 130
81432706097, 81432706113, 81432706135, 81432706160, 81432706161



SC-ES-7279

Length: 150
Cone Ø: d1 Ø 30 / d2 Ø 27
Thread: M30 x 1,5 RHT
81953016288



SC-ES-8517

Length: 140
Cone Ø: d1 Ø 30 / d2 Ø 27
Thread: M30 x 1,5 RHT
81953016286



SC-ES-8535

Length: 145
Cone Ø: d1 Ø 30 / d2 Ø 27
Thread: M30 x 1,5 RHT
81953016271, 81953016325





TGA ...

28.510 FNLS, FNLRs	09/02→	Ball Head, gearshift linkage	CV-ES-2120			
	09/02→	Centre Rod	MN-DL-7801		Push Rod, Leaf Spring Axle	
	09/02→	Centre Rod	MN-DL-8560		Push Rod, Air Suspension Axle	
	09/02→	Suspension Strut Repair Kit		DB-RK-8581		
	09/02→	Suspension Strut Repair Kit		MN-RK-12436		
	09/02→	Tie Rod	MN-DL-7802			
	09/02→	Tie Rod End	CV-ES-0914		for Steering Rod	
	09/02→	Tie Rod End	CV-ES-14163		for Steering Rod	
	09/02→	Tie Rod End	SC-ES-7279		for Steering Rod	
	09/02→	Tie Rod End	SC-ES-8517		for Push Rod	
	09/02→	Tie Rod End	SC-ES-8535		for Guide Rod	
	09/02→	Track Control Arm		MN-DL-5212	Trailing Arm, Trailing Axle not Steered, for Pneumatic Suspension vehicles	
	09/02→	Track Control Arm		MN-DL-5225	Trailing Arm, Drive Axle;Air Suspension Axle	
	09/02→	Track Control Arm		MN-DL-5225	Trailing Arm, Leading Axle;Air Suspension Axle	
	09/02→	Track Control Arm		MN-DL-8709	Trailing Arm, Trailing Axle not Steered, for Pneumatic Suspension vehicles	
	09/02→	Track Control Arm		MN-VB-5238	Wishbone (CV), Drive Axle;Leading Axle; Air Suspension Axle	
	09/02→	Track Control Arm		MN-VB-9403	Wishbone (CV), Air Suspension Axle	
	28.530 FANLC	09/02→	Track Control Arm	MN-DL-8663		Control Arm, Air Suspension Axle
		07/06→	Suspension Strut Repair Kit		DB-RK-8581	
07/06→		Tie Rod	MN-DL-12284			
07/06→		Tie Rod End		IV-ES-8507	Tag Axle	
07/06→		Tie Rod End	CV-ES-14162	CV-ES-14162	for Steering Rod	
07/06→		Tie Rod End	CV-ES-14163		for Steering Rod	
07/06→		Tie Rod End	MN-ES-10333		for Steering Rod	
07/06→		Track Control Arm		MN-DL-5225	Trailing Arm	
07/06→		Track Control Arm		MN-DL-8544	Trailing Arm, 1st RA;Air Suspension Axle; for vehicles with Hinged Trailing Axle	
07/06→		Track Control Arm		MN-DL-8709	Trailing Arm, Air Suspension Axle; for vehicles with Hinged Trailing Axle	
07/06→		Track Control Arm		MN-VB-8514	Suspension Rod, Wishbone (CV)	
28.530 FANLK	07/06→	Track Control Arm		MN-VB-9403	Wishbone (CV), Air Suspension Axle; for vehicles with Hinged Trailing Axle	
	07/06→	Suspension Strut Repair Kit		DB-RK-8581		
	07/06→	Tie Rod	MN-DL-12284			
	07/06→	Tie Rod End		IV-ES-8507	Tag Axle	
	07/06→	Tie Rod End	CV-ES-14162	CV-ES-14162	for Steering Rod	
	07/06→	Tie Rod End	CV-ES-14163		for Steering Rod	
	07/06→	Tie Rod End	MN-ES-10333		for Steering Rod	
	07/06→	Track Control Arm		MN-DL-5225	Trailing Arm	
	07/06→	Track Control Arm		MN-DL-8544	Trailing Arm, 1st RA;Air Suspension Axle; for vehicles with Hinged Trailing Axle	
	07/06→	Track Control Arm		MN-DL-8709	Trailing Arm, Air Suspension Axle; for vehicles with Hinged Trailing Axle	
	07/06→	Track Control Arm		MN-VB-8514	Suspension Rod, Wishbone (CV)	
28.530 FNLC, FNLLC, FNLRc	07/06→	Track Control Arm		MN-VB-9403	Wishbone (CV), Air Suspension Axle; for vehicles with Hinged Trailing Axle	
	09/02→	Ball Head, gearshift linkage	CV-ES-2120			
	09/02→	Centre Rod	MN-DL-7801		Push Rod, Leaf Spring Axle	
	09/02→	Centre Rod	MN-DL-8560		Push Rod, Air Suspension Axle	
	09/02→	Suspension Strut Repair Kit		DB-RK-8581		
	09/02→	Suspension Strut Repair Kit		MN-RK-12436		
	09/02→	Tie Rod	MN-DL-7802			
	09/02→	Tie Rod End	CV-ES-0914		for Steering Rod	
	09/02→	Tie Rod End	CV-ES-14163		for Steering Rod	
	09/02→	Tie Rod End	SC-ES-7279		for Steering Rod	
	09/02→	Tie Rod End	SC-ES-8517		for Push Rod	
	09/02→	Tie Rod End	SC-ES-8535		for Guide Rod	
	09/02→	Track Control Arm		MN-DL-5212	Trailing Arm, Trailing Axle not Steered, for Pneumatic Suspension vehicles	
	09/02→	Track Control Arm		MN-DL-5225	Trailing Arm, Drive Axle;Air Suspension Axle	

CV-ES-0914

Length: 125
Cone Ø: d1 Ø 30 / d2 Ø 27
Thread: M38 x 1,5 RHT
81953016184, 81953016251, 81953016276



CV-ES-2120

Length: 115
Cone Ø: d1 Ø 12,4 / d2 Ø 10,8
Thread: M14 x 1,5 RHT
03008500A, 81953016200, 81953016202, 81953016203, 81953016227



CV-ES-14162

Length: 125
Cone Ø: d1 Ø 30 / d2 Ø 27
Thread: M30 x 1,5 LHT
81953010015, 81953010083, 81953010087, 81953016029, 81953016030, 81953016043, 81953016044, 81953016050, 81953016054, 81953016087, 81953016091, 81953016107, 81953016120, 81953016125, 81953016152, 81953016155, 81953016157, 81953016168, 81953016179, 81953016181, 81953016223, 81953016237, 81953016254, 81953016275, 81953016279, 81953016351



CV-ES-14163

Length: 125
Cone Ø: d1 Ø 30 / d2 Ø 27
Thread: M30 x 1,5 RHT
95301.0084, 90804102156, 90804102272, 90804102696, 90804102710, 81953010016, 81953010075, 81953010084, 81953010088, 81953010094, 81953010103, 81953016030, 81953016043, 81953016048, 81953016049, 81953016053, 81953016061, 81953016090, 81953016108, 81953016112, 81953016126, 81953016143, 81953016149, 81953016154, 81953016156, 81953016168, 81953016178, 81953016194, 81953016206, 81953016224, 81953016234, 81953016242, 81953016252, 81953016274, 81953016278, 81953016284, 81953016286, 81953016308, 81953016310, 81953016312, 81953016347, 81953016350, 81953016352, 82953016012, 88953016014, N2953016001



DB-RK-8581

Ø: 85
Hole Distance: 130
Thick/Height: 24
03305800A, 81432706105



IV-ES-8507

Length: 80
Cone Ø: d1 Ø 30 / d2 Ø 27
Thread: M30 x 1,5 RHT
11019869, 12216380, 55175540, 81953016238



MN-DL-5212

Length: 577 Ø: 48
Hole Distance: 130 / 130
81432206096, 81432206097, 81432206098, 81432206129, 81432209096, 81432209129, 81432306014, 81432306030



MN-DL-5225

Length: 572 Ø: 48
Hole Distance: 130 / 130
03301500A, 81432206229, 81432206236, 81432206267, 81432206270, 81432206272, 81432206304, 81432206305, 81432209235, 81432209267, 81432209272



MN-DL-7801

Length: 995 Ø: 52
Cone Ø: d1 Ø 30 / d2 Ø 27
81466106807, 81466106808, 81466116087, 81466116088, 81466116096, 81466116097, 81466116099, 81466116132, 81466116133, 81466116136, 81466116197, 81466116198, 81466116205



MN-DL-7802

Length: 1680 Ø: 52
Cone Ø: d1 Ø 30 / d2 Ø 27
03208300A, 81467116773, 81467116858, 81467116859, 81467116860, 81467116861, 81467116863, 81467116882, 81467116883, 81467116920, 81467116921



MN-DL-8544

Length: 596 Ø: 48
Hole Distance: 130 / 130
81432206196, 81432206232, 81432206233



MN-DL-8560

Length: 970 Ø: 52
Cone Ø: d1 Ø 30 / d2 Ø 27
03206900A, 81466106809, 81466106810, 81466106823, 81466106838, 81466106839, 81466116104, 81466116105, 81466116107, 81466116134, 81466116135, 81466116137, 81466116199, 81466116200, 81466116206



MN-DL-8663

Length: 947 Ø: 60
Hole Distance: 115 / 115
03307400A, 81432206222, 81432206260, 81432206283, 81432206284



MN-DL-8709

Length: 572 Ø: 52
Hole Distance: 130 / 130
81432206268, 81432206274, 81432206291, 81432206292, 82432206007



MN-DL-12284

Length: 1530 Ø: 50
Cone Ø: d1 Ø 30 / d2 Ø 27
81466106579, 81466106580, 81466106624, 81466116720, 81467116720, 81467116730, 81467116952



MN-ES-10333

Length: 90
Cone Ø: d1 Ø 38 / d2 Ø 34,35
Thread: M36 x 1,5 RHT
1271126, 3090291, 3099128, 42538048, 81953016268, 82953016018, 82953016019



MN-RK-12436

Ø: 75
Hole Distance: 115
Thick/Height: 24
81432206244



MN-VB-5238

Length: 627 Ø: 48
Hole Distance: 130 / 130
81432206221, 81432706096, 81432706114, 81432706116, 81432706121



MN-VB-8514

Length: 627 Ø: 48
Hole Ø 25 / 25 / 25
Hole Distance: 152 / 130 / 130
81432706087, 81432706088, 81432706094, 81432706095, 81432796094



MN-VB-9403

Length: 627 Ø: 48
Hole Ø 25 / 23 / 23
Hole Distance: 152 / 130 / 130
81432706097, 81432706113, 81432706135, 81432706160, 81432706161



SC-ES-7279

Length: 150
Cone Ø: d1 Ø 30 / d2 Ø 27
Thread: M30 x 1,5 RHT
81953016288



SC-ES-8517

Length: 140
Cone Ø: d1 Ø 30 / d2 Ø 27
Thread: M30 x 1,5 RHT
81953016286



SC-ES-8535

Length: 145
Cone Ø: d1 Ø 30 / d2 Ø 27
Thread: M30 x 1,5 RHT
81953016271, 81953016325





TGA ...

28.530 FNLC, FNLLC, FNLRC ...	09/02→	Track Control Arm		MN-DL-5225	Trailing Arm, Leading Axle;Air Suspension Axle
	09/02→	Track Control Arm		MN-DL-8709	Trailing Arm, Trailing Axle not Steered, for Pneumatic Suspension vehicles
	09/02→	Track Control Arm		MN-VB-5238	Wishbone (CV), Drive Axle;Leading Axle; Air Suspension Axle
	09/02→	Track Control Arm		MN-VB-9403	Wishbone (CV), Air Suspension Axle
	09/02→	Track Control Arm	MN-DL-8663		Control Arm, Air Suspension Axle
28.530 FNLS, FNLSR	09/02→	Ball Head, gearshift linkage	CV-ES-2120		
	09/02→	Centre Rod	MN-DL-7801		Push Rod, Leaf Spring Axle
	09/02→	Centre Rod	MN-DL-8560		Push Rod, Air Suspension Axle
	09/02→	Suspension Strut Repair Kit		DB-RK-8581	
	09/02→	Suspension Strut Repair Kit		MN-RK-12436	
	09/02→	Tie Rod	MN-DL-7802		
	09/02→	Tie Rod End	CV-ES-0914		for Steering Rod
	09/02→	Tie Rod End	CV-ES-14163		for Steering Rod
	09/02→	Tie Rod End	SC-ES-7279		for Steering Rod
	09/02→	Tie Rod End	SC-ES-8517		for Push Rod
	09/02→	Tie Rod End	SC-ES-8535		for Guide Rod
	09/02→	Track Control Arm		MN-DL-5212	Trailing Arm, Trailing Axle not Steered, for Pneumatic Suspension vehicles
	09/02→	Track Control Arm		MN-DL-5225	Trailing Arm, Drive Axle;Air Suspension Axle
	09/02→	Track Control Arm		MN-DL-5225	Trailing Arm, Leading Axle;Air Suspension Axle
	09/02→	Track Control Arm		MN-DL-8709	Trailing Arm, Trailing Axle not Steered, for Pneumatic Suspension vehicles
	09/02→	Track Control Arm		MN-VB-5238	Wishbone (CV), Drive Axle;Leading Axle; Air Suspension Axle
	09/02→	Track Control Arm		MN-VB-9403	Wishbone (CV), Air Suspension Axle
	09/02→	Track Control Arm	MN-DL-8663		Control Arm, Air Suspension Axle
28.540 FNLC, FNLLC	08/06→	Centre Rod	MN-DL-7801		Push Rod
	08/06→	Suspension Strut Repair Kit		MN-RK-12436	
	08/06→	Tie Rod	MN-DL-7802		
	08/06→	Tie Rod End	CV-ES-0914		for Steering Rod
	08/06→	Tie Rod End	CV-ES-14163		for Steering Rod
	08/06→	Tie Rod End	SC-ES-7279		for Steering Rod
	08/06→	Tie Rod End	SC-ES-8517		for Push Rod
	08/06→	Tie Rod End	SC-ES-8535		for Guide Rod
	08/06→	Track Control Arm		MN-DL-5225	Trailing Arm
	08/06→	Track Control Arm		MN-DL-8709	Trailing Arm, Trailing Axle not Steered, for Pneumatic Suspension vehicles
	08/06→	Track Control Arm		MN-VB-5238	Wishbone (CV), 1st Drive Axle, for Pneumatic Suspension vehicles
	08/06→	Track Control Arm	MN-DL-8663		Control Arm
	28.540 FNLS	08/06→	Centre Rod	MN-DL-7801	
08/06→		Suspension Arm Repair Kit		CV-RK-5313	for Wishbone (CV)
08/06→		Suspension Arm Repair Kit	DB-RK-9300	DB-RK-9300	for Drag Link
08/06→		Tie Rod	MN-DL-7802		
08/06→		Tie Rod End	CV-ES-0914		for Steering Rod
08/06→		Tie Rod End	CV-ES-14163		for Steering Rod
08/06→		Tie Rod End	SC-ES-7279		for Steering Rod
08/06→		Tie Rod End	SC-ES-8517		for Push Rod
08/06→		Tie Rod End	SC-ES-8535		for Guide Rod
08/06→		Track Control Arm		MN-DL-5225	Trailing Arm
08/06→		Track Control Arm		MN-DL-8709	Trailing Arm, Trailing Axle not Steered, for Pneumatic Suspension vehicles
08/06→		Track Control Arm		MN-VB-5238	Wishbone (CV), 1st Drive Axle, for Pneumatic Suspension vehicles
32.310 FFDLC, FFDLC, FFDLRC, FFDRC		01/02→	Ball Head, gearshift linkage	CV-ES-2120	
	01/02→	Centre Rod	MN-DL-7801		Push Rod, Leaf Spring Axle
	01/02→	Centre Rod	MN-DL-8599		Push Rod
	01/02→	Centre Rod	MN-DL-12285		for Steering Rod
	01/02→	Centre Rod	MN-DL-12393		for Steering Rod
	01/02→	Suspension Strut Repair Kit		DB-RK-8581	
01/02→	Tie Rod	MN-DL-7802			

CV-ES-0914

Length: 125
Cone Ø: d1 Ø 30 / d2 Ø 27
Thread: M38 x 1,5 RHT
81953016184, 81953016251, 81953016276



CV-ES-2120

Length: 115
Cone Ø: d1 Ø 12,4 / d2 Ø 10,8
Thread: M14 x 1,5 RHT
03008500A, 81953016200, 81953016202, 81953016203, 81953016227



CV-ES-14163

Length: 125
Cone Ø: d1 Ø 30 / d2 Ø 27
Thread: M30 x 1,5 RHT
95301.0084, 90804102156, 90804102272, 90804102696, 90804102710, 81953010016, 81953010075, 81953010084, 81953010088, 81953010094, 81953010103, 81953016030, 81953016043, 81953016048, 81953016049, 81953016053, 81953016061, 81953016090, 81953016108, 81953016112, 81953016126, 81953016143, 81953016149, 81953016154, 81953016156, 81953016168, 81953016178, 81953016194, 81953016206, 81953016224, 81953016234, 81953016242, 81953016252, 81953016274, 81953016278, 81953016284, 81953016286, 81953016308, 81953016310, 81953016312, 81953016347, 81953016350, 81953016352, 82953016012, 88953016014, N2953016001



CV-RK-5313

Ø: 90
03304800A, 81953016132



DB-RK-8581

Ø: 85
Hole Distance: 130
Thick/Height: 24
03305800A, 81432706105



DB-RK-9300

Ø: 75
Hole Distance: 130
Thick/Height: 24
85432206002



MN-DL-5212

Length: 577 Ø: 48
Hole Distance: 130 / 130
81432206096, 81432206097, 81432206098, 81432206129, 81432209096, 81432209129, 81432306014, 81432306030



MN-DL-5225

Length: 572 Ø: 48
Hole Distance: 130 / 130
03301500A, 81432206229, 81432206236, 81432206267, 81432206270, 81432206272, 81432206304, 81432206305, 81432209236, 81432209267, 81432209272



MN-DL-7801

Length: 995 Ø: 52
Cone Ø: d1 Ø 30 / d2 Ø 27
81466106807, 81466106808, 81466116087, 81466116088, 81466116096, 81466116097, 81466116099, 81466116132, 81466116133, 81466116136, 81466116197, 81466116198, 81466116205



MN-DL-7802

Length: 1680 Ø: 52
Cone Ø: d1 Ø 30 / d2 Ø 27
03208300A, 81467116773, 81467116858, 81467116859, 81467116860, 81467116861, 81467116863, 81467116882, 81467116883, 81467116920, 81467116921



MN-DL-8560

Length: 970 Ø: 52
Cone Ø: d1 Ø 30 / d2 Ø 27
03206900A, 81466106809, 81466106810, 81466106823, 81466106838, 81466106839, 81466116104, 81466116105, 81466116107, 81466116134, 81466116135, 81466116137, 81466116199, 81466116200, 81466116206



MN-DL-8599

Length: 1800 Ø: 62
Cone Ø: d1 Ø 30 / d2 Ø 27
81466116161, 81466116162, 82466106183, 82466106186, 82466106187



MN-DL-8663

Length: 947 Ø: 60
Hole Distance: 115 / 115
03307400A, 81432206222, 81432206260, 81432206283, 81432206284



MN-DL-8709

Length: 572 Ø: 52
Hole Distance: 130 / 130
81432206268, 81432206274, 81432206291, 81432206292, 82432206007



MN-DL-12285

Length: 993 Ø: 40
Cone Ø: d1 Ø 30 / d2 Ø 27
81466106816, 81466106826, 81466116151, 82466106184, 82466106185



MN-DL-12393

Length: 1796 Ø: 62
Cone Ø: d1 Ø 30 / d2 Ø 27
81466116154, 81466116155, 81466116156



MN-RK-12436

Ø: 75
Hole Distance: 115
Thick/Height: 24
81432206244



MN-VB-5238

Length: 627 Ø: 48
Hole Distance: 130 / 130
81432206221, 81432706096, 81432706114, 81432706116, 81432706121



MN-VB-9403

Length: 627 Ø: 48
Hole Ø 25 / 23 / 23
Hole Distance: 152 / 130 / 130
81432706097, 81432706113, 81432706135, 81432706160, 81432706161



SC-ES-7279

Length: 150
Cone Ø: d1 Ø 30 / d2 Ø 27
Thread: M30 x 1,5 RHT
81953016288



SC-ES-8517

Length: 140
Cone Ø: d1 Ø 30 / d2 Ø 27
Thread: M30 x 1,5 RHT
81953016286



SC-ES-8535

Length: 145
Cone Ø: d1 Ø 30 / d2 Ø 27
Thread: M30 x 1,5 RHT
81953016271, 81953016325





TGA ...

32.310 FFDK, FFDLC, FFDLRC, FFDRC ...	01/02→	Tie Rod End	CV-ES-0914		for Steering Rod
	01/02→	Tie Rod End	CV-ES-14162		for Steering Rod
	01/02→	Tie Rod End	CV-ES-14163		for Steering Rod
	01/02→	Tie Rod End	SC-ES-7279		for Steering Rod
	01/02→	Tie Rod End	SC-ES-8517		for Push Rod
	01/02→	Tie Rod End	SC-ES-8535		for Guide Rod
	01/02→	Track Control Arm		MN-DL-5225	Trailing Arm, Drive Axle;Air Suspension Axle
	01/02→	Track Control Arm		MN-DL-8544	Trailing Arm, Drive Axle;Air Suspension Axle
	01/02→	Track Control Arm		MN-DL-8544	Trailing Arm, Drive Axle;Leaf Spring Axle
	01/02→	Track Control Arm		MN-VB-5238	Wishbone (CV), Drive Axle;Air Suspension Axle
	01/02→	Track Control Arm		MN-VB-8514	Suspension Rod, Wishbone (CV), Drive Axle; Air Suspension Axle
	01/02→	Track Control Arm		MN-VB-8514	Suspension Rod, Wishbone (CV), Drive Axle; Leaf Spring Axle
	01/02→	Track Control Arm		MN-VB-8669	Suspension Rod, Wishbone (CV), Drive Axle; Leaf Spring Axle
	08/04→	Track Control Arm		MN-VB-9404	Wishbone (CV), Drive Axle;Air Suspension Axle
	32.310 FFDK, FFDLK	01/02→	Ball Head, gearshift linkage	CV-ES-2120	
01/02→		Centre Rod	MN-DL-7801		Push Rod, Leaf Spring Axle
01/02→		Centre Rod	MN-DL-8599		Push Rod
01/02→		Centre Rod	MN-DL-12285		for Steering Rod
01/02→		Centre Rod	MN-DL-12393		for Steering Rod
01/02→		Suspension Strut Repair Kit		DB-RK-8581	
01/02→		Tie Rod	MN-DL-7802		
01/02→		Tie Rod End	CV-ES-0914		for Steering Rod
01/02→		Tie Rod End	CV-ES-14162		for Steering Rod
01/02→		Tie Rod End	CV-ES-14163		for Steering Rod
01/02→		Tie Rod End	SC-ES-7279		for Steering Rod
01/02→		Tie Rod End	SC-ES-8517		for Push Rod
01/02→		Tie Rod End	SC-ES-8535		for Guide Rod
01/02→		Track Control Arm		MN-DL-5225	Trailing Arm, Drive Axle;Air Suspension Axle
01/02→		Track Control Arm		MN-DL-8544	Trailing Arm, Drive Axle;Air Suspension Axle
01/02→	Track Control Arm		MN-DL-8544	Trailing Arm, Drive Axle;Leaf Spring Axle	
01/02→	Track Control Arm		MN-VB-5238	Wishbone (CV), Drive Axle;Air Suspension Axle	
01/02→	Track Control Arm		MN-VB-8514	Suspension Rod, Wishbone (CV), Drive Axle; Leaf Spring Axle	
01/02→	Track Control Arm		MN-VB-8669	Suspension Rod, Wishbone (CV), Drive Axle; Leaf Spring Axle	
08/04→	Track Control Arm		MN-VB-9404	Wishbone (CV), Drive Axle;Air Suspension Axle	
32.310 FFD-TM, FFDR-TM	01/02→	Ball Head, gearshift linkage	CV-ES-2120		
	01/02→	Centre Rod	MN-DL-7801		Push Rod, Leaf Spring Axle
	01/02→	Centre Rod	MN-DL-8599		Push Rod
	01/02→	Centre Rod	MN-DL-12285		for Steering Rod
	01/02→	Centre Rod	MN-DL-12393		for Steering Rod
	01/02→	Suspension Strut Repair Kit		DB-RK-8581	
	01/02→	Tie Rod	MN-DL-7802		
	01/02→	Tie Rod End	CV-ES-0914		for Steering Rod
	01/02→	Tie Rod End	CV-ES-14162		for Steering Rod
	01/02→	Tie Rod End	CV-ES-14163		for Steering Rod
	01/02→	Tie Rod End	SC-ES-7279		for Steering Rod
	01/02→	Tie Rod End	SC-ES-8517		for Push Rod
	01/02→	Tie Rod End	SC-ES-8535		for Guide Rod
	01/02→	Track Control Arm		MN-DL-5225	Trailing Arm
	01/02→	Track Control Arm		MN-DL-8544	Trailing Arm, Drive Axle;Leaf Spring Axle
01/02→	Track Control Arm		MN-VB-8514	Suspension Rod, Wishbone (CV), Drive Axle; Air Suspension Axle	
01/02→	Track Control Arm		MN-VB-8514	Suspension Rod, Wishbone (CV), Drive Axle; Leaf Spring Axle	
01/02→	Track Control Arm		MN-VB-8669	Suspension Rod, Wishbone (CV), Drive Axle; Leaf Spring Axle	

CV-ES-0914

Length: 125
Cone Ø: d1 Ø 30 / d2 Ø 27
Thread: M38 x 1,5 RHT
81953016184, 81953016251, 81953016276



CV-ES-2120

Length: 115
Cone Ø: d1 Ø 12,4 / d2 Ø 10,8
Thread: M14 x 1,5 RHT
03008500A, 81953016200, 81953016202, 81953016203, 81953016227



CV-ES-14162

Length: 125
Cone Ø: d1 Ø 30 / d2 Ø 27
Thread: M30 x 1,5 LHT
81953010015, 81953010083, 81953010087, 81953016029, 81953016030, 81953016043, 81953016044, 81953016050, 81953016054, 81953016087, 81953016091, 81953016107, 81953016120, 81953016125, 81953016152, 81953016155, 81953016157, 81953016168, 81953016179, 81953016181, 81953016223, 81953016237, 81953016254, 81953016275, 81953016279, 81953016351



CV-ES-14163

Length: 125
Cone Ø: d1 Ø 30 / d2 Ø 27
Thread: M30 x 1,5 RHT
95301.0084, 90804102156, 90804102272, 90804102696, 90804102710, 81953010016, 81953010075, 81953010084, 81953010088, 81953010094, 81953010103, 81953016030, 81953016043, 81953016048, 81953016049, 81953016053, 81953016061, 81953016090, 81953016108, 81953016112, 81953016126, 81953016143, 81953016149, 81953016154, 81953016156, 81953016168, 81953016178, 81953016194, 81953016206, 81953016224, 81953016234, 81953016242, 81953016252, 81953016274, 81953016278, 81953016284, 81953016286, 81953016308, 81953016310, 81953016312, 81953016347, 81953016350, 81953016352, 82953016012, 88953016014, N2953016001



DB-RK-8581

Ø: 85
Hole Distance: 130
Thick/Height: 24
03305800A, 81432706105



MN-DL-5225

Length: 572 Ø: 48
Hole Distance: 130 / 130
03301500A, 81432206229, 81432206236, 81432206267, 81432206270, 81432206272, 81432206304, 81432206305, 81432209236, 81432209267, 81432209272



MN-DL-7801

Length: 995 Ø: 52
Cone Ø: d1 Ø 30 / d2 Ø 27
81466106807, 81466106808, 81466116087, 81466116088, 81466116096, 81466116097, 81466116099, 81466116132, 81466116133, 81466116136, 81466116197, 81466116198, 81466116205



MN-DL-7802

Length: 1680 Ø: 52
Cone Ø: d1 Ø 30 / d2 Ø 27
03208300A, 81467116773, 81467116858, 81467116859, 81467116860, 81467116861, 81467116863, 81467116882, 81467116883, 81467116920, 81467116921



MN-DL-8544

Length: 596 Ø: 48
Hole Distance: 130 / 130
81432206196, 81432206232, 81432206233



MN-DL-8599

Length: 1800 Ø: 62
Cone Ø: d1 Ø 30 / d2 Ø 27
81466116161, 81466116162, 82466106183, 82466106186, 82466106187



MN-DL-12285

Length: 993 Ø: 40
Cone Ø: d1 Ø 30 / d2 Ø 27
81466106816, 81466106826, 81466116151, 82466106184, 82466106185



MN-DL-12393

Length: 1796 Ø: 62
Cone Ø: d1 Ø 30 / d2 Ø 27
81466116154, 81466116155, 81466116156



MN-VB-5238

Length: 627 Ø: 48
Hole Distance: 130 / 130
81432206221, 81432706096, 81432706114, 81432706116, 81432706121



MN-VB-8514

Length: 627 Ø: 48
Hole Ø 25 / 25 / 25
Hole Distance: 152 / 130 / 130
81432706087, 81432706088, 81432706094, 81432706095, 81432796094



MN-VB-8669

Length: 627 Ø: 48
Hole Ø 25 / 25 / 25
Hole Distance: 152 / 130 / 130
81432706116, 81432706137, 81432706150, 81432706151



MN-VB-9404

Length: 627 Ø: 58
Hole Distance: 130 / 130
81432706117, 81432706152, 81432706153



SC-ES-7279

Length: 150
Cone Ø: d1 Ø 30 / d2 Ø 27
Thread: M30 x 1,5 RHT
81953016288



SC-ES-8517

Length: 140
Cone Ø: d1 Ø 30 / d2 Ø 27
Thread: M30 x 1,5 RHT
81953016286



SC-ES-8535

Length: 145
Cone Ø: d1 Ø 30 / d2 Ø 27
Thread: M30 x 1,5 RHT
81953016271, 81953016325





TGA ...

32.350, 32.360 FFDC, FFDLC, FFDLRC, FFDR	05/04→	Centre Rod	MN-DL-7801		Push Rod, Leaf Spring Axle
	05/04→	Centre Rod	MN-DL-12289		Push Rod
	05/04→	Centre Rod	MN-DL-12393		for Steering Rod
	05/04→	Suspension Strut Repair Kit		DB-RK-8581	
	05/04→	Tie Rod	MN-DL-7802		
	05/04→	Tie Rod End	CV-ES-0914		for Steering Rod
	05/04→	Tie Rod End	CV-ES-14162		for Steering Rod
	05/04→	Tie Rod End	CV-ES-14163		for Steering Rod
	05/04→	Tie Rod End	SC-ES-7279		for Steering Rod
	05/04→	Tie Rod End	SC-ES-8517		for Push Rod
	05/04→	Tie Rod End	SC-ES-8535		for Guide Rod
	05/04→	Track Control Arm		MN-DL-5225	Trailing Arm
	05/04→	Track Control Arm		MN-DL-8544	Trailing Arm, 1st RA;2nd RA, for Leaf-Spring Suspension vehicles
	05/04→	Track Control Arm		MN-VB-8514	Suspension Rod, Wishbone (CV), Drive Axle; Leaf Spring Axle
32.350, 32.360 FFD-TM, FFDR-TM	02/04→	Centre Rod	MN-DL-7801		Push Rod, Leaf Spring Axle
	02/04→	Centre Rod	MN-DL-12289		Push Rod
	02/04→	Centre Rod	MN-DL-12393		for Steering Rod
	02/04→	Suspension Strut Repair Kit		DB-RK-8581	
	02/04→	Tie Rod	MN-DL-7802		
	02/04→	Tie Rod End	CV-ES-0914		for Steering Rod
	02/04→	Tie Rod End	CV-ES-14162		for Steering Rod
	02/04→	Tie Rod End	CV-ES-14163		for Steering Rod
	02/04→	Tie Rod End	SC-ES-7279		for Steering Rod
	02/04→	Tie Rod End	SC-ES-8517		for Push Rod
	02/04→	Tie Rod End	SC-ES-8535		for Guide Rod
	02/04→	Track Control Arm		MN-DL-5225	Trailing Arm
	02/04→	Track Control Arm		MN-DL-8544	Trailing Arm, 1st RA;2nd RA, for Leaf-Spring Suspension vehicles
	02/04→	Track Control Arm		MN-VB-8514	Suspension Rod, Wishbone (CV), Drive Axle; Leaf Spring Axle
32.360 FFDC, FFDLC, FFDLRC, FFDR	01/02→	Ball Head, gearshift linkage	CV-ES-2120		
	01/02→	Centre Rod	MN-DL-7801		Push Rod, Leaf Spring Axle
	01/02→	Centre Rod	MN-DL-8599		Push Rod
	01/02→	Centre Rod	MN-DL-12285		for Steering Rod
	01/02→	Centre Rod	MN-DL-12393		for Steering Rod
	01/02→	Suspension Strut Repair Kit		DB-RK-8581	
	01/02→	Tie Rod	MN-DL-7802		
	01/02→	Tie Rod End	CV-ES-0914		for Steering Rod
	01/02→	Tie Rod End	CV-ES-14162		for Steering Rod
	01/02→	Tie Rod End	CV-ES-14163		for Steering Rod
	01/02→	Tie Rod End	SC-ES-7279		for Steering Rod
	01/02→	Tie Rod End	SC-ES-8517		for Push Rod
	01/02→	Tie Rod End	SC-ES-8535		for Guide Rod
	01/02→	Track Control Arm		MN-DL-5225	Trailing Arm, Drive Axle;Air Suspension Axle
	01/02→	Track Control Arm		MN-DL-8544	Trailing Arm, Drive Axle;Air Suspension Axle
	01/02→	Track Control Arm		MN-DL-8544	Trailing Arm, Drive Axle;Leaf Spring Axle
	01/02→	Track Control Arm		MN-VB-5238	Wishbone (CV), Drive Axle;Air Suspension Axle
	01/02→	Track Control Arm		MN-VB-8514	Suspension Rod, Wishbone (CV), Drive Axle; Air Suspension Axle
	01/02→	Track Control Arm		MN-VB-8514	Suspension Rod, Wishbone (CV), Drive Axle; Leaf Spring Axle
	01/02→	Track Control Arm		MN-VB-8669	Suspension Rod, Wishbone (CV), Drive Axle; Leaf Spring Axle
08/04→	Track Control Arm		MN-VB-9404	Wishbone (CV), Drive Axle;Air Suspension Axle	
32.360 FFDK, FFDLK	01/02→	Ball Head, gearshift linkage	CV-ES-2120		
	01/02→	Centre Rod	MN-DL-7801		Push Rod, Leaf Spring Axle
	01/02→	Centre Rod	MN-DL-8599		Push Rod
	01/02→	Centre Rod	MN-DL-12285		for Steering Rod
	01/02→	Centre Rod	MN-DL-12393		for Steering Rod
	01/02→	Suspension Strut Repair Kit		DB-RK-8581	
	01/02→	Tie Rod	MN-DL-7802		

CV-ES-0914

Length: 125
Cone Ø: d1 Ø 30 / d2 Ø 27
Thread: M38 x 1,5 RHT
81953016184, 81953016251, 81953016276



CV-ES-2120

Length: 115
Cone Ø: d1 Ø 12,4 / d2 Ø 10,8
Thread: M14 x 1,5 RHT
03008500A, 81953016200, 81953016202, 81953016203, 81953016227



CV-ES-14162

Length: 125
Cone Ø: d1 Ø 30 / d2 Ø 27
Thread: M30 x 1,5 LHT
81953010015, 81953010083, 81953010087, 81953016029, 81953016030, 81953016043, 81953016044, 81953016050, 81953016054, 81953016087, 81953016091, 81953016107, 81953016120, 81953016125, 81953016152, 81953016155, 81953016157, 81953016168, 81953016179, 81953016181, 81953016223, 81953016237, 81953016254, 81953016275, 81953016279, 81953016351



CV-ES-14163

Length: 125
Cone Ø: d1 Ø 30 / d2 Ø 27
Thread: M30 x 1,5 RHT
95301.0084, 90804102156, 90804102272, 90804102696, 90804102710, 81953010016, 81953010075, 81953010084, 81953010088, 81953010094, 81953010103, 81953016030, 81953016043, 81953016048, 81953016049, 81953016053, 81953016061, 81953016090, 81953016108, 81953016112, 81953016126, 81953016143, 81953016149, 81953016154, 81953016156, 81953016168, 81953016178, 81953016194, 81953016206, 81953016224, 81953016234, 81953016242, 81953016252, 81953016274, 81953016278, 81953016284, 81953016286, 81953016308, 81953016310, 81953016312, 81953016347, 81953016350, 81953016352, 82953016012, 88953016014, N2953016001



DB-RK-8581

Ø: 85
Hole Distance: 130
Thick/Height: 24
03305800A, 81432706105



MN-DL-5225

Length: 572 Ø: 48
Hole Distance: 130 / 130
03301500A, 81432206229, 81432206236, 81432206267, 81432206270, 81432206272, 81432206304, 81432206305, 81432209236, 81432209267, 81432209272



MN-DL-7801

Length: 995 Ø: 52
Cone Ø: d1 Ø 30 / d2 Ø 27
81466106807, 81466106808, 81466116087, 81466116088, 81466116096, 81466116097, 81466116099, 81466116132, 81466116133, 81466116136, 81466116197, 81466116198, 81466116205

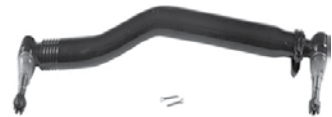

MN-DL-7802

Length: 1680 Ø: 52
Cone Ø: d1 Ø 30 / d2 Ø 27
03208300A, 81467116773, 81467116858, 81467116859, 81467116860, 81467116861, 81467116863, 81467116882, 81467116883, 81467116920, 81467116921



MN-DL-8544

Length: 596 Ø: 48
Hole Distance: 130 / 130
81432206196, 81432206232, 81432206233



MN-DL-8599

Length: 1800 Ø: 62
Cone Ø: d1 Ø 30 / d2 Ø 27
81466116161, 81466116162, 82466106183, 82466106186, 82466106187



MN-DL-12285

Length: 993 Ø: 40
Cone Ø: d1 Ø 30 / d2 Ø 27
81466106816, 81466106826, 81466116151, 82466106184, 82466106185



MN-DL-12289

Length: 1796 Ø: 62
Cone Ø: d1 Ø 30 / d2 Ø 27
81466116174, 81466116175, 81466116176, 81466116244

No Image

MN-DL-12393

Length: 1796 Ø: 62
Cone Ø: d1 Ø 30 / d2 Ø 27
81466116154, 81466116155, 81466116156



MN-VB-5238

Length: 627 Ø: 48
Hole Distance: 130 / 130
81432206221, 81432706096, 81432706114, 81432706116, 81432706121



MN-VB-8514

Length: 627 Ø: 48
Hole Ø 25 / 25 / 25
Hole Distance: 152 / 130 / 130
81432706087, 81432706088, 81432706094, 81432706095, 81432796094



MN-VB-8669

Length: 627 Ø: 48
Hole Ø 25 / 25 / 25
Hole Distance: 152 / 130 / 130
81432706116, 81432706137, 81432706150, 81432706151



MN-VB-9404

Length: 627 Ø: 58
Hole Distance: 130 / 130
81432706117, 81432706152, 81432706153



SC-ES-7279

Length: 150
Cone Ø: d1 Ø 30 / d2 Ø 27
Thread: M30 x 1,5 RHT
81953016288



SC-ES-8517

Length: 140
Cone Ø: d1 Ø 30 / d2 Ø 27
Thread: M30 x 1,5 RHT
81953016286



SC-ES-8535

Length: 145
Cone Ø: d1 Ø 30 / d2 Ø 27
Thread: M30 x 1,5 RHT
81953016271, 81953016325





TGA ...

32.360 FFDK, FFDLK ...	01/02→	Tie Rod End	CV-ES-0914		for Steering Rod
	01/02→	Tie Rod End	CV-ES-14162		for Steering Rod
	01/02→	Tie Rod End	CV-ES-14163		for Steering Rod
	01/02→	Tie Rod End	SC-ES-7279		for Steering Rod
	01/02→	Tie Rod End	SC-ES-8517		for Push Rod
	01/02→	Tie Rod End	SC-ES-8535		for Guide Rod
	01/02→	Track Control Arm		MN-DL-5225	Trailing Arm, Drive Axle;Air Suspension Axle
	01/02→	Track Control Arm		MN-DL-8544	Trailing Arm, Drive Axle;Air Suspension Axle
	01/02→	Track Control Arm		MN-DL-8544	Trailing Arm, Drive Axle;Leaf Spring Axle
	01/02→	Track Control Arm		MN-VB-5238	Wishbone (CV), Drive Axle;Air Suspension Axle
	01/02→	Track Control Arm		MN-VB-8514	Suspension Rod, Wishbone (CV), Drive Axle; Air Suspension Axle
	01/02→	Track Control Arm		MN-VB-8514	Suspension Rod, Wishbone (CV), Drive Axle; Leaf Spring Axle
	01/02→	Track Control Arm		MN-VB-8669	Suspension Rod, Wishbone (CV), Drive Axle; Leaf Spring Axle
	08/04→	Track Control Arm		MN-VB-9404	Wishbone (CV), Drive Axle;Air Suspension Axle
32.360 FFD-TM, FFFDR-TM	01/02→	Ball Head, gearshift linkage	CV-ES-2120		
	01/02→	Centre Rod	MN-DL-7801		Push Rod, Leaf Spring Axle
	01/02→	Centre Rod	MN-DL-8599		Push Rod
	01/02→	Centre Rod	MN-DL-12285		for Steering Rod
	01/02→	Centre Rod	MN-DL-12289		Push Rod
	01/02→	Centre Rod	MN-DL-12393		for Steering Rod
	01/02→	Suspension Strut Repair Kit		DB-RK-8581	
	01/02→	Tie Rod	MN-DL-7802		
	01/02→	Tie Rod End	CV-ES-0914		for Steering Rod
	01/02→	Tie Rod End	CV-ES-14162		for Steering Rod
	01/02→	Tie Rod End	CV-ES-14163		for Steering Rod
	01/02→	Tie Rod End	MN-ES-10333		for Steering Rod
	01/02→	Tie Rod End	SC-ES-7279		for Steering Rod
	01/02→	Tie Rod End	SC-ES-8517		for Push Rod
	01/02→	Tie Rod End	SC-ES-8535		for Guide Rod
	01/02→	Track Control Arm		MN-DL-5225	Trailing Arm
	01/02→	Track Control Arm		MN-DL-8544	Trailing Arm, Drive Axle;Leaf Spring Axle
	01/02→	Track Control Arm		MN-VB-8514	Suspension Rod, Wishbone (CV), Drive Axle; Leaf Spring Axle
01/02→	Track Control Arm		MN-VB-8669	Suspension Rod, Wishbone (CV), Drive Axle; Leaf Spring Axle	
32.390, 32.400 FFDRC	05/04→	Centre Rod	MN-DL-7801		Push Rod, Leaf Spring Axle
	05/04→	Centre Rod	MN-DL-12289		Push Rod
	05/04→	Centre Rod	MN-DL-12393		for Steering Rod
	05/04→	Suspension Strut Repair Kit		DB-RK-8581	
	05/04→	Tie Rod	MN-DL-7802		
	05/04→	Tie Rod End	CV-ES-0914		for Steering Rod
	05/04→	Tie Rod End	CV-ES-14162		for Steering Rod
	05/04→	Tie Rod End	CV-ES-14163		for Steering Rod
	05/04→	Tie Rod End	SC-ES-7279		for Steering Rod
	05/04→	Tie Rod End	SC-ES-8517		for Push Rod
	05/04→	Tie Rod End	SC-ES-8535		for Guide Rod
	05/04→	Track Control Arm		MN-DL-5225	Trailing Arm
	05/04→	Track Control Arm		MN-DL-8544	Trailing Arm, 1st RA;2nd RA, for Leaf-Spring Suspension vehicles
	05/04→	Track Control Arm		MN-VB-8514	Suspension Rod, Wishbone (CV), Drive Axle; Leaf Spring Axle
32.390, 32.400 FFD-TM, FFDR-TM	05/04→	Centre Rod	MN-DL-7801		Push Rod, Leaf Spring Axle
	05/04→	Centre Rod	MN-DL-12289		Push Rod
	05/04→	Centre Rod	MN-DL-12393		for Steering Rod
	05/04→	Suspension Strut Repair Kit		DB-RK-8581	
	05/04→	Tie Rod	MN-DL-7802		
	05/04→	Tie Rod End	CV-ES-0914		for Steering Rod
	05/04→	Tie Rod End	CV-ES-14162		for Steering Rod
	05/04→	Tie Rod End	CV-ES-14163		for Steering Rod
05/04→	Tie Rod End	SC-ES-7279		for Steering Rod	

CV-ES-0914

Length: 125
Cone Ø: d1 Ø 30 / d2 Ø 27
Thread: M38 x 1,5 RHT
81953016184, 81953016251, 81953016276



CV-ES-2120

Length: 115
Cone Ø: d1 Ø 12,4 / d2 Ø 10,8
Thread: M14 x 1,5 RHT
03008500A, 81953016200, 81953016202, 81953016203, 81953016227



CV-ES-14162

Length: 125
Cone Ø: d1 Ø 30 / d2 Ø 27
Thread: M30 x 1,5 LHT
81953010015, 81953010083, 81953010087, 81953016029, 81953016030, 81953016043, 81953016044, 81953016050, 81953016054, 81953016087, 81953016091, 81953016107, 81953016120, 81953016125, 81953016152, 81953016155, 81953016157, 81953016168, 81953016179, 81953016181, 81953016223, 81953016237, 81953016254, 81953016275, 81953016279, 81953016351

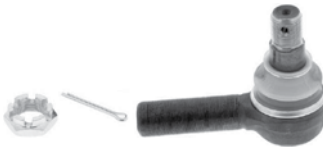

CV-ES-14163

Length: 125
Cone Ø: d1 Ø 30 / d2 Ø 27
Thread: M30 x 1,5 RHT
95301.0084, 90804102156, 90804102272, 90804102696, 90804102710, 81953010016, 81953010075, 81953010084, 81953010088, 81953010094, 81953010103, 81953016030, 81953016043, 81953016048, 81953016049, 81953016053, 81953016061, 81953016090, 81953016108, 81953016112, 81953016126, 81953016143, 81953016149, 81953016154, 81953016156, 81953016168, 81953016178, 81953016194, 81953016206, 81953016224, 81953016234, 81953016242, 81953016252, 81953016274, 81953016278, 81953016284, 81953016286, 81953016308, 81953016310, 81953016312, 81953016347, 81953016350, 81953016352, 82953016012, 88953016014, N2953016001



DB-RK-8581

Ø: 85
Hole Distance: 130
Thick/Height: 24
03305800A, 81432706105



MN-DL-5225

Length: 572 Ø: 48
Hole Distance: 130 / 130
03301500A, 81432206229, 81432206236, 81432206267, 81432206270, 81432206272, 81432206304, 81432206305, 81432209236, 81432209267, 81432209272



MN-DL-7801

Length: 995 Ø: 52
Cone Ø: d1 Ø 30 / d2 Ø 27
81466106807, 81466106808, 81466116087, 81466116088, 81466116096, 81466116097, 81466116099, 81466116132, 81466116133, 81466116136, 81466116197, 81466116198, 81466116205

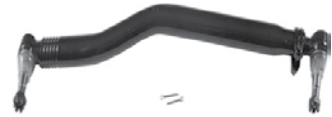

MN-DL-7802

Length: 1680 Ø: 52
Cone Ø: d1 Ø 30 / d2 Ø 27
03208300A, 81467116773, 81467116858, 81467116859, 81467116860, 81467116861, 81467116863, 81467116882, 81467116883, 81467116920, 81467116921



MN-DL-8544

Length: 596 Ø: 48
Hole Distance: 130 / 130
81432206196, 81432206232, 81432206233



MN-DL-8599

Length: 1800 Ø: 62
Cone Ø: d1 Ø 30 / d2 Ø 27
81466116161, 81466116162, 82466106183, 82466106186, 82466106187



MN-DL-12285

Length: 993 Ø: 40
Cone Ø: d1 Ø 30 / d2 Ø 27
81466106816, 81466106826, 81466116151, 82466106184, 82466106185



MN-DL-12289

Length: 1796 Ø: 62
Cone Ø: d1 Ø 30 / d2 Ø 27
81466116174, 81466116175, 81466116176, 81466116244

No Image

MN-DL-12393

Length: 1796 Ø: 62
Cone Ø: d1 Ø 30 / d2 Ø 27
81466116154, 81466116155, 81466116156



MN-ES-10333

Length: 90
Cone Ø: d1 Ø 38 / d2 Ø 34,35
Thread: M36 x 1,5 RHT
1271126, 3090291, 3099128, 42538048, 81953016268, 82953016018, 82953016019



MN-VB-5238

Length: 627 Ø: 48
Hole Distance: 130 / 130
81432206221, 81432706096, 81432706114, 81432706116, 81432706121



MN-VB-8514

Length: 627 Ø: 48
Hole Ø 25 / 25 / 25
Hole Distance: 152 / 130 / 130
81432706087, 81432706088, 81432706094, 81432706095, 81432796094



MN-VB-8669

Length: 627 Ø: 48
Hole Ø 25 / 25 / 25
Hole Distance: 152 / 130 / 130
81432706116, 81432706137, 81432706150, 81432706151



MN-VB-9404

Length: 627 Ø: 58
Hole Distance: 130 / 130
81432706117, 81432706152, 81432706153



SC-ES-7279

Length: 150
Cone Ø: d1 Ø 30 / d2 Ø 27
Thread: M30 x 1,5 RHT
81953016288



SC-ES-8517

Length: 140
Cone Ø: d1 Ø 30 / d2 Ø 27
Thread: M30 x 1,5 RHT
81953016286



SC-ES-8535

Length: 145
Cone Ø: d1 Ø 30 / d2 Ø 27
Thread: M30 x 1,5 RHT
81953016271, 81953016325





TGA ...

32.390, 32.400 FFD-TM, FFDR-TM ...	05/04 →	Tie Rod End	SC-ES-8517		for Push Rod	
	05/04 →	Tie Rod End	SC-ES-8535		for Guide Rod	
	05/04 →	Track Control Arm		MN-DL-5225	Trailing Arm	
	05/04 →	Track Control Arm		MN-DL-8544	Trailing Arm, 1st RA;2nd RA, for Leaf-Spring Suspension vehicles	
	05/04 →	Track Control Arm		MN-VB-8514	Suspension Rod, Wishbone (CV), Drive Axle; Leaf Spring Axle	
32.410 FFDC, FFDLC, FFDR, FFDLRC	01/02 →	Ball Head, gearshift linkage	CV-ES-2120			
	01/02 →	Centre Rod	MN-DL-7801		Push Rod, Leaf Spring Axle	
	01/02 →	Centre Rod	MN-DL-8599		Push Rod	
	01/02 →	Centre Rod	MN-DL-12285		for Steering Rod	
	01/02 →	Centre Rod	MN-DL-12393		for Steering Rod	
	01/02 →	Suspension Strut Repair Kit		DB-RK-8581		
	01/02 →	Tie Rod	MN-DL-7802			
	01/02 →	Tie Rod End	CV-ES-0914		for Steering Rod	
	01/02 →	Tie Rod End	CV-ES-14162		for Steering Rod	
	01/02 →	Tie Rod End	CV-ES-14163		for Steering Rod	
	01/02 →	Tie Rod End	SC-ES-7279		for Steering Rod	
	01/02 →	Tie Rod End	SC-ES-8517		for Push Rod	
	01/02 →	Tie Rod End	SC-ES-8535		for Guide Rod	
	01/02 →	Track Control Arm		MN-DL-5225	Trailing Arm, Drive Axle;Air Suspension Axle	
	01/02 →	Track Control Arm		MN-DL-8544	Trailing Arm, Drive Axle;Air Suspension Axle	
	01/02 →	Track Control Arm		MN-DL-8544	Trailing Arm, Drive Axle;Leaf Spring Axle	
	01/02 →	Track Control Arm		MN-VB-5238	Wishbone (CV), Drive Axle;Air Suspension Axle	
	01/02 →	Track Control Arm		MN-VB-8514	Suspension Rod, Wishbone (CV), Drive Axle; Air Suspension Axle	
	01/02 →	Track Control Arm		MN-VB-8514	Suspension Rod, Wishbone (CV), Drive Axle; Leaf Spring Axle	
	01/02 →	Track Control Arm		MN-VB-8669	Suspension Rod, Wishbone (CV), Drive Axle; Leaf Spring Axle	
	08/04 →	Track Control Arm		MN-VB-9404	Wishbone (CV), Drive Axle;Air Suspension Axle	
	32.410 FFDK, FFDLK	01/02 →	Ball Head, gearshift linkage	CV-ES-2120		
		01/02 →	Centre Rod	MN-DL-7801		Push Rod, Leaf Spring Axle
01/02 →		Centre Rod	MN-DL-8599		Push Rod	
01/02 →		Centre Rod	MN-DL-12285		for Steering Rod	
01/02 →		Centre Rod	MN-DL-12393		for Steering Rod	
01/02 →		Suspension Strut Repair Kit		DB-RK-8581		
01/02 →		Tie Rod	MN-DL-7802			
01/02 →		Tie Rod End	CV-ES-0914		for Steering Rod	
01/02 →		Tie Rod End	CV-ES-14162		for Steering Rod	
01/02 →		Tie Rod End	CV-ES-14163		for Steering Rod	
01/02 →		Tie Rod End	SC-ES-7279		for Steering Rod	
01/02 →		Tie Rod End	SC-ES-8517		for Push Rod	
01/02 →		Tie Rod End	SC-ES-8535		for Guide Rod	
01/02 →		Track Control Arm		MN-DL-5225	Trailing Arm, Drive Axle;Air Suspension Axle	
01/02 →		Track Control Arm		MN-DL-8544	Trailing Arm, Drive Axle;Air Suspension Axle	
01/02 →		Track Control Arm		MN-DL-8544	Trailing Arm, Drive Axle;Leaf Spring Axle	
01/02 →		Track Control Arm		MN-VB-5238	Wishbone (CV), Drive Axle;Air Suspension Axle	
01/02 →		Track Control Arm		MN-VB-8514	Suspension Rod, Wishbone (CV), Drive Axle; Air Suspension Axle	
01/02 →		Track Control Arm		MN-VB-8514	Suspension Rod, Wishbone (CV), Drive Axle; Leaf Spring Axle	
01/02 →		Track Control Arm		MN-VB-8669	Suspension Rod, Wishbone (CV), Drive Axle; Leaf Spring Axle	
08/04 →		Track Control Arm		MN-VB-9404	Wishbone (CV), Drive Axle;Air Suspension Axle	
32.410 FFD-TM, FFDR-TM		01/02 →	Ball Head, gearshift linkage	CV-ES-2120		
		01/02 →	Centre Rod	MN-DL-7801		Push Rod, Leaf Spring Axle
	01/02 →	Centre Rod	MN-DL-8599		Push Rod	
	01/02 →	Centre Rod	MN-DL-12285		for Steering Rod	
	01/02 →	Centre Rod	MN-DL-12289		Push Rod	
	01/02 →	Centre Rod	MN-DL-12393		for Steering Rod	
	01/02 →	Suspension Strut Repair Kit		DB-RK-8581		
	01/02 →	Tie Rod	MN-DL-7802			

CV-ES-0914

Length: 125
Cone Ø: d1 Ø 30 / d2 Ø 27
Thread: M38 x 1,5 RHT
81953016184, 81953016251, 81953016276



CV-ES-2120

Length: 115
Cone Ø: d1 Ø 12,4 / d2 Ø 10,8
Thread: M14 x 1,5 RHT
03008500A, 81953016200, 81953016202, 81953016203, 81953016227



CV-ES-14162

Length: 125
Cone Ø: d1 Ø 30 / d2 Ø 27
Thread: M30 x 1,5 LHT
81953010015, 81953010083, 81953010087, 81953016029, 81953016030, 81953016043, 81953016044, 81953016050, 81953016054, 81953016087, 81953016091, 81953016107, 81953016120, 81953016125, 81953016152, 81953016155, 81953016157, 81953016168, 81953016179, 81953016181, 81953016223, 81953016237, 81953016254, 81953016275, 81953016279, 81953016351



CV-ES-14163

Length: 125
Cone Ø: d1 Ø 30 / d2 Ø 27
Thread: M30 x 1,5 RHT
95301.0084, 90804102156, 90804102272, 90804102696, 90804102710, 81953010016, 81953010075, 81953010084, 81953010088, 81953010094, 81953010103, 81953016030, 81953016043, 81953016048, 81953016049, 81953016053, 81953016061, 81953016090, 81953016108, 81953016112, 81953016126, 81953016143, 81953016149, 81953016154, 81953016156, 81953016168, 81953016178, 81953016194, 81953016206, 81953016224, 81953016234, 81953016242, 81953016252, 81953016274, 81953016278, 81953016284, 81953016286, 81953016308, 81953016310, 81953016312, 81953016347, 81953016350, 81953016352, 82953016012, 88953016014, N2953016001



DB-RK-8581

Ø: 85
Hole Distance: 130
Thick/Height: 24
03305800A, 81432706105



MN-DL-5225

Length: 572 Ø: 48
Hole Distance: 130 / 130
03301500A, 81432206229, 81432206236, 81432206267, 81432206270, 81432206272, 81432206304, 81432206305, 81432209236, 81432209267, 81432209272



MN-DL-7801

Length: 995 Ø: 52
Cone Ø: d1 Ø 30 / d2 Ø 27
81466106807, 81466106808, 81466116087, 81466116088, 81466116096, 81466116097, 81466116099, 81466116132, 81466116133, 81466116136, 81466116197, 81466116198, 81466116205

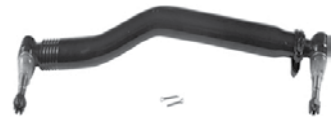

MN-DL-7802

Length: 1680 Ø: 52
Cone Ø: d1 Ø 30 / d2 Ø 27
03208300A, 81467116773, 81467116858, 81467116859, 81467116860, 81467116861, 81467116863, 81467116882, 81467116883, 81467116920, 81467116921



MN-DL-8544

Length: 596 Ø: 48
Hole Distance: 130 / 130
81432206196, 81432206232, 81432206233



MN-DL-8599

Length: 1800 Ø: 62
Cone Ø: d1 Ø 30 / d2 Ø 27
81466116161, 81466116162, 82466106183, 82466106186, 82466106187



MN-DL-12285

Length: 993 Ø: 40
Cone Ø: d1 Ø 30 / d2 Ø 27
81466106816, 81466106826, 81466116151, 82466106184, 82466106185



MN-DL-12289

Length: 1796 Ø: 62
Cone Ø: d1 Ø 30 / d2 Ø 27
81466116174, 81466116175, 81466116176, 81466116244

No Image

MN-DL-12393

Length: 1796 Ø: 62
Cone Ø: d1 Ø 30 / d2 Ø 27
81466116154, 81466116155, 81466116156



MN-VB-5238

Length: 627 Ø: 48
Hole Distance: 130 / 130
81432206221, 81432706096, 81432706114, 81432706116, 81432706121



MN-VB-8514

Length: 627 Ø: 48
Hole Ø 25 / 25 / 25
Hole Distance: 152 / 130 / 130
81432706087, 81432706088, 81432706094, 81432706095, 81432796094



MN-VB-8669

Length: 627 Ø: 48
Hole Ø 25 / 25 / 25
Hole Distance: 152 / 130 / 130
81432706116, 81432706137, 81432706150, 81432706151



MN-VB-9404

Length: 627 Ø: 58
Hole Distance: 130 / 130
81432706117, 81432706152, 81432706153



SC-ES-7279

Length: 150
Cone Ø: d1 Ø 30 / d2 Ø 27
Thread: M30 x 1,5 RHT
81953016288



SC-ES-8517

Length: 140
Cone Ø: d1 Ø 30 / d2 Ø 27
Thread: M30 x 1,5 RHT
81953016286



SC-ES-8535

Length: 145
Cone Ø: d1 Ø 30 / d2 Ø 27
Thread: M30 x 1,5 RHT
81953016271, 81953016325





TGA ...

32.410 FFD-TM, FFDR-TM ...	01/02→	Tie Rod End	CV-ES-0914		for Steering Rod
	01/02→	Tie Rod End	CV-ES-14162		for Steering Rod
	01/02→	Tie Rod End	CV-ES-14163		for Steering Rod
	01/02→	Tie Rod End	MN-ES-10333		for Steering Rod
	01/02→	Tie Rod End	SC-ES-7279		for Steering Rod
	01/02→	Tie Rod End	SC-ES-8517		for Push Rod
	01/02→	Tie Rod End	SC-ES-8535		for Guide Rod
	01/02→	Track Control Arm		MN-DL-5225	Trailing Arm
	01/02→	Track Control Arm		MN-DL-8544	Trailing Arm, Drive Axle;Leaf Spring Axle
	01/02→	Track Control Arm		MN-VB-8514	Suspension Rod, Wishbone (CV), Drive Axle; Leaf Spring Axle
32.430, 32.440 FFDR	01/02→	Track Control Arm		MN-VB-8669	Suspension Rod, Wishbone (CV), Drive Axle; Leaf Spring Axle
	05/04→	Centre Rod	MN-DL-7801		Push Rod, Leaf Spring Axle
	05/04→	Centre Rod	MN-DL-12289		Push Rod
	05/04→	Centre Rod	MN-DL-12393		for Steering Rod
	05/04→	Suspension Strut Repair Kit		DB-RK-8581	
	05/04→	Tie Rod	MN-DL-7802		
	05/04→	Tie Rod End	CV-ES-0914		for Steering Rod
	05/04→	Tie Rod End	CV-ES-14162		for Steering Rod
	05/04→	Tie Rod End	CV-ES-14163		for Steering Rod
	05/04→	Tie Rod End	SC-ES-7279		for Steering Rod
	05/04→	Tie Rod End	SC-ES-8517		for Push Rod
	05/04→	Tie Rod End	SC-ES-8535		for Guide Rod
	05/04→	Track Control Arm		MN-DL-5225	Trailing Arm
	05/04→	Track Control Arm		MN-DL-8544	Trailing Arm, 1st RA;2nd RA, for Leaf-Spring Suspension vehicles
05/04→	Track Control Arm		MN-VB-8514	Suspension Rod, Wishbone (CV), Drive Axle; Leaf Spring Axle	
32.430, 32.440 FFD-TM, FFDR-TM	05/04→	Centre Rod	MN-DL-7801		Push Rod, Leaf Spring Axle
	05/04→	Centre Rod	MN-DL-12289		Push Rod
	05/04→	Centre Rod	MN-DL-12393		for Steering Rod
	05/04→	Suspension Strut Repair Kit		DB-RK-8581	
	05/04→	Tie Rod	MN-DL-7802		
	05/04→	Tie Rod End	CV-ES-0914		for Steering Rod
	05/04→	Tie Rod End	CV-ES-14162		for Steering Rod
	05/04→	Tie Rod End	CV-ES-14163		for Steering Rod
	05/04→	Tie Rod End	SC-ES-7279		for Steering Rod
	05/04→	Tie Rod End	SC-ES-8517		for Push Rod
	05/04→	Tie Rod End	SC-ES-8535		for Guide Rod
	05/04→	Track Control Arm		MN-DL-5225	Trailing Arm
	05/04→	Track Control Arm		MN-DL-8544	Trailing Arm, 1st RA;2nd RA, for Leaf-Spring Suspension vehicles
	05/04→	Track Control Arm		MN-VB-8514	Suspension Rod, Wishbone (CV), Drive Axle; Leaf Spring Axle
32.460 FFDC, FFDLC, FFDLRC, FFDR	01/02→	Ball Head, gearshift linkage	CV-ES-2120		
	01/02→	Centre Rod	MN-DL-7801		Push Rod, Leaf Spring Axle
	01/02→	Centre Rod	MN-DL-8599		Push Rod
	01/02→	Centre Rod	MN-DL-12285		for Steering Rod
	01/02→	Centre Rod	MN-DL-12393		for Steering Rod
	01/02→	Suspension Strut Repair Kit		DB-RK-8581	
	01/02→	Tie Rod	MN-DL-7802		
	01/02→	Tie Rod End	CV-ES-0914		for Steering Rod
	01/02→	Tie Rod End	CV-ES-14162		for Steering Rod
	01/02→	Tie Rod End	CV-ES-14163		for Steering Rod
	01/02→	Tie Rod End	SC-ES-7279		for Steering Rod
	01/02→	Tie Rod End	SC-ES-8517		for Push Rod
	01/02→	Tie Rod End	SC-ES-8535		for Guide Rod
	01/02→	Track Control Arm		MN-DL-5225	Trailing Arm, Drive Axle;Air Suspension Axle
	01/02→	Track Control Arm		MN-DL-8544	Trailing Arm, Drive Axle;Air Suspension Axle
	01/02→	Track Control Arm		MN-DL-8544	Trailing Arm, Drive Axle;Leaf Spring Axle
01/02→	Track Control Arm		MN-VB-5238	Wishbone (CV), Drive Axle;Air Suspension Axle	

CV-ES-0914

Length: 125
Cone Ø: d1 Ø 30 / d2 Ø 27
Thread: M38 x 1,5 RHT
81953016184, 81953016251, 81953016276



CV-ES-2120

Length: 115
Cone Ø: d1 Ø 12,4 / d2 Ø 10,8
Thread: M14 x 1,5 RHT
03008500A, 81953016200, 81953016202, 81953016203, 81953016227



CV-ES-14162

Length: 125
Cone Ø: d1 Ø 30 / d2 Ø 27
Thread: M30 x 1,5 LHT
81953010015, 81953010083, 81953010087, 81953016029, 81953016030, 81953016043, 81953016044, 81953016050, 81953016054, 81953016087, 81953016091, 81953016107, 81953016120, 81953016125, 81953016152, 81953016155, 81953016157, 81953016168, 81953016179, 81953016181, 81953016223, 81953016237, 81953016254, 81953016275, 81953016279, 81953016351



CV-ES-14163

Length: 125
Cone Ø: d1 Ø 30 / d2 Ø 27
Thread: M30 x 1,5 RHT
95301.0084, 90804102156, 90804102272, 90804102696, 90804102710, 81953010016, 81953010075, 81953010084, 81953010088, 81953010094, 81953010103, 81953016030, 81953016043, 81953016048, 81953016049, 81953016053, 81953016061, 81953016090, 81953016108, 81953016112, 81953016126, 81953016143, 81953016149, 81953016154, 81953016156, 81953016168, 81953016178, 81953016194, 81953016206, 81953016224, 81953016234, 81953016242, 81953016252, 81953016274, 81953016278, 81953016284, 81953016286, 81953016308, 81953016310, 81953016312, 81953016347, 81953016350, 81953016352, 82953016012, 88953016014, N2953016001



DB-RK-8581

Ø: 85
Hole Distance: 130
Thick/Height: 24
03305800A, 81432706105



MN-DL-5225

Length: 572 Ø: 48
Hole Distance: 130 / 130
03301500A, 81432206229, 81432206236, 81432206267, 81432206270, 81432206272, 81432206304, 81432206305, 81432209236, 81432209267, 81432209272



MN-DL-7801

Length: 995 Ø: 52
Cone Ø: d1 Ø 30 / d2 Ø 27
81466106807, 81466106808, 81466116087, 81466116088, 81466116096, 81466116097, 81466116099, 81466116132, 81466116133, 81466116136, 81466116197, 81466116198, 81466116205

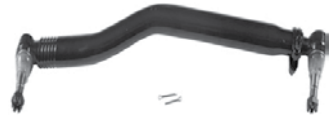

MN-DL-7802

Length: 1680 Ø: 52
Cone Ø: d1 Ø 30 / d2 Ø 27
03208300A, 81467116773, 81467116858, 81467116859, 81467116860, 81467116861, 81467116863, 81467116882, 81467116883, 81467116920, 81467116921



MN-DL-8544

Length: 596 Ø: 48
Hole Distance: 130 / 130
81432206196, 81432206232, 81432206233



MN-DL-8599

Length: 1800 Ø: 62
Cone Ø: d1 Ø 30 / d2 Ø 27
81466116161, 81466116162, 82466106183, 82466106186, 82466106187



MN-DL-12285

Length: 993 Ø: 40
Cone Ø: d1 Ø 30 / d2 Ø 27
81466106816, 81466106826, 81466116151, 82466106184, 82466106185



MN-DL-12289

Length: 1796 Ø: 62
Cone Ø: d1 Ø 30 / d2 Ø 27
81466116174, 81466116175, 81466116176, 81466116244

No Image

MN-DL-12393

Length: 1796 Ø: 62
Cone Ø: d1 Ø 30 / d2 Ø 27
81466116154, 81466116155, 81466116156



MN-ES-10333

Length: 90
Cone Ø: d1 Ø 38 / d2 Ø 34,35
Thread: M36 x 1,5 RHT
1271126, 3090291, 3099128, 42538048, 81953016268, 82953016018, 82953016019



MN-VB-5238

Length: 627 Ø: 48
Hole Distance: 130 / 130
81432206221, 81432706096, 81432706114, 81432706116, 81432706121



MN-VB-8514

Length: 627 Ø: 48
Hole Ø 25 / 25 / 25
Hole Distance: 152 / 130 / 130
81432706087, 81432706088, 81432706094, 81432706095, 81432796094



MN-VB-8669

Length: 627 Ø: 48
Hole Ø 25 / 25 / 25
Hole Distance: 152 / 130 / 130
81432706116, 81432706137, 81432706150, 81432706151



SC-ES-7279

Length: 150
Cone Ø: d1 Ø 30 / d2 Ø 27
Thread: M30 x 1,5 RHT
81953016288



SC-ES-8517

Length: 140
Cone Ø: d1 Ø 30 / d2 Ø 27
Thread: M30 x 1,5 RHT
81953016286



SC-ES-8535

Length: 145
Cone Ø: d1 Ø 30 / d2 Ø 27
Thread: M30 x 1,5 RHT
81953016271, 81953016325





TGA ...

32.460 FFDLC, FFDLRC, FFDLRC, FFDRC ...	01/02 →	Track Control Arm		MN-VB-8514	Suspension Rod, Wishbone (CV), Drive Axle; Air Suspension Axle
	01/02 →	Track Control Arm		MN-VB-8514	Suspension Rod, Wishbone (CV), Drive Axle; Leaf Spring Axle
	01/02 →	Track Control Arm		MN-VB-8669	Suspension Rod, Wishbone (CV), Drive Axle; Leaf Spring Axle
	08/04 →	Track Control Arm		MN-VB-9404	Wishbone (CV), Drive Axle; Air Suspension Axle
32.460 FFDK, FFDLK	01/02 →	Ball Head, gearshift linkage	CV-ES-2120		
	01/02 →	Centre Rod	MN-DL-7801		Push Rod, Leaf Spring Axle
	01/02 →	Centre Rod	MN-DL-8599		Push Rod
	01/02 →	Centre Rod	MN-DL-12285		for Steering Rod
	01/02 →	Centre Rod	MN-DL-12393		for Steering Rod
	01/02 →	Suspension Strut Repair Kit		DB-RK-8581	
	01/02 →	Tie Rod	MN-DL-7802		
	01/02 →	Tie Rod End	CV-ES-0914		for Steering Rod
	01/02 →	Tie Rod End	CV-ES-14162		for Steering Rod
	01/02 →	Tie Rod End	CV-ES-14163		for Steering Rod
	01/02 →	Tie Rod End	SC-ES-7279		for Steering Rod
	01/02 →	Tie Rod End	SC-ES-8517		for Push Rod
	01/02 →	Tie Rod End	SC-ES-8535		for Guide Rod
	01/02 →	Track Control Arm		MN-DL-5225	Trailing Arm, Drive Axle; Air Suspension Axle
	01/02 →	Track Control Arm		MN-DL-8544	Trailing Arm, Drive Axle; Air Suspension Axle
	01/02 →	Track Control Arm		MN-DL-8544	Trailing Arm, Drive Axle; Leaf Spring Axle
	01/02 →	Track Control Arm		MN-VB-5238	Wishbone (CV), Drive Axle; Air Suspension Axle
	01/02 →	Track Control Arm		MN-VB-8514	Suspension Rod, Wishbone (CV), Drive Axle; Air Suspension Axle
	01/02 →	Track Control Arm		MN-VB-8514	Suspension Rod, Wishbone (CV), Drive Axle; Leaf Spring Axle
	01/02 →	Track Control Arm		MN-VB-8669	Suspension Rod, Wishbone (CV), Drive Axle; Leaf Spring Axle
08/04 →	Track Control Arm		MN-VB-9404	Wishbone (CV), Drive Axle; Air Suspension Axle	
32.460 FFD-TM, FFDR-TM	01/02 →	Ball Head, gearshift linkage	CV-ES-2120		
	01/02 →	Centre Rod	MN-DL-7801		Push Rod, Leaf Spring Axle
	01/02 →	Centre Rod	MN-DL-8599		Push Rod
	01/02 →	Centre Rod	MN-DL-12285		for Steering Rod
	01/02 →	Centre Rod	MN-DL-12289		Push Rod
	01/02 →	Centre Rod	MN-DL-12393		for Steering Rod
	01/02 →	Suspension Strut Repair Kit		DB-RK-8581	
	01/02 →	Tie Rod	MN-DL-7802		
	01/02 →	Tie Rod End	CV-ES-0914		for Steering Rod
	01/02 →	Tie Rod End	CV-ES-14162		for Steering Rod
	01/02 →	Tie Rod End	CV-ES-14163		for Steering Rod
	01/02 →	Tie Rod End	MN-ES-10333		for Steering Rod
	01/02 →	Tie Rod End	SC-ES-7279		for Steering Rod
	01/02 →	Tie Rod End	SC-ES-8517		for Push Rod
	01/02 →	Tie Rod End	SC-ES-8535		for Guide Rod
	01/02 →	Track Control Arm		MN-DL-5225	Trailing Arm
	01/02 →	Track Control Arm		MN-DL-8544	Trailing Arm, Drive Axle; Leaf Spring Axle
	01/02 →	Track Control Arm		MN-VB-8514	Suspension Rod, Wishbone (CV), Drive Axle; Leaf Spring Axle
	01/02 →	Track Control Arm		MN-VB-8669	Suspension Rod, Wishbone (CV), Drive Axle; Leaf Spring Axle
	32.480 FFDLC, FFDLRC, FFDRC	09/02 →	Ball Head, gearshift linkage	CV-ES-2120	
09/02 →		Centre Rod	MN-DL-7801		Push Rod, Leaf Spring Axle
09/02 →		Centre Rod	MN-DL-8599		Push Rod
09/02 →		Centre Rod	MN-DL-12285		for Steering Rod
09/02 →		Centre Rod	MN-DL-12393		for Steering Rod
09/02 →		Suspension Strut Repair Kit		DB-RK-8581	
09/02 →		Tie Rod	MN-DL-7802		
09/02 →		Tie Rod End	CV-ES-0914		for Steering Rod
09/02 →		Tie Rod End	CV-ES-14162		for Steering Rod
09/02 →		Tie Rod End	CV-ES-14163		for Steering Rod
09/02 →	Tie Rod End	SC-ES-7279		for Steering Rod	

CV-ES-0914

Length: 125
Cone Ø: d1 Ø 30 / d2 Ø 27
Thread: M38 x 1,5 RHT
81953016184, 81953016251, 81953016276



CV-ES-2120

Length: 115
Cone Ø: d1 Ø 12,4 / d2 Ø 10,8
Thread: M14 x 1,5 RHT
03008500A, 81953016200, 81953016202,
81953016203, 81953016227



CV-ES-14162

Length: 125
Cone Ø: d1 Ø 30 / d2 Ø 27
Thread: M30 x 1,5 LHT
81953010015, 81953010083, 81953010087,
81953016029, 81953016030, 81953016043,
81953016044, 81953016050, 81953016054,
81953016087, 81953016091, 81953016107,
81953016120, 81953016125, 81953016152,
81953016155, 81953016157, 81953016168,
81953016179, 81953016181, 81953016223,
81953016237, 81953016254, 81953016275,
81953016279, 81953016351



CV-ES-14163

Length: 125
Cone Ø: d1 Ø 30 / d2 Ø 27
Thread: M30 x 1,5 RHT
95301.0084, 90804102156, 90804102272,
90804102696, 90804102710, 81953010016,
81953010075, 81953010084, 81953010088,
81953010094, 81953010103, 81953016030,
81953016043, 81953016048, 81953016049,
81953016053, 81953016061, 81953016090,
81953016108, 81953016112, 81953016126,
81953016143, 81953016149, 81953016154,
81953016156, 81953016168, 81953016178,
81953016194, 81953016206, 81953016224,
81953016234, 81953016242, 81953016252,
81953016274, 81953016278, 81953016284,
81953016286, 81953016308, 81953016310,
81953016312, 81953016347, 81953016350,
81953016352, 82953016012, 88953016014,
N2953016001



DB-RK-8581

Ø: 85
Hole Distance: 130
Thick/Height: 24
03305800A, 81432706105



MN-DL-5225

Length: 572 Ø: 48
Hole Distance: 130 / 130
03301500A, 81432206229, 81432206236,
81432206267, 81432206270, 81432206272,
81432206304, 81432206305, 81432209236,
81432209267, 81432209272



MN-DL-7801

Length: 995 Ø: 52
Cone Ø: d1 Ø 30 / d2 Ø 27
81466106807, 81466106808, 81466116087,
81466116088, 81466116096, 81466116097,
81466116099, 81466116132, 81466116133,
81466116136, 81466116197, 81466116198,
81466116205

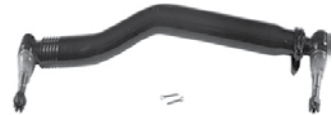

MN-DL-7802

Length: 1680 Ø: 52
Cone Ø: d1 Ø 30 / d2 Ø 27
03208300A, 81467116773, 81467116858,
81467116859, 81467116860, 81467116861,
81467116863, 81467116882, 81467116883,
81467116920, 81467116921



MN-DL-8544

Length: 596 Ø: 48
Hole Distance: 130 / 130
81432206196, 81432206232, 81432206233



MN-DL-8599

Length: 1800 Ø: 62
Cone Ø: d1 Ø 30 / d2 Ø 27
81466116161, 81466116162, 82466106183,
82466106186, 82466106187



MN-DL-12285

Length: 993 Ø: 40
Cone Ø: d1 Ø 30 / d2 Ø 27
81466106816, 81466106826, 81466116151,
82466106184, 82466106185



MN-DL-12289

Length: 1796 Ø: 62
Cone Ø: d1 Ø 30 / d2 Ø 27
81466116174, 81466116175, 81466116176,
81466116244

No Image

MN-DL-12393

Length: 1796 Ø: 62
Cone Ø: d1 Ø 30 / d2 Ø 27
81466116154, 81466116155, 81466116156



MN-ES-10333

Length: 90
Cone Ø: d1 Ø 38 / d2 Ø 34,35
Thread: M36 x 1,5 RHT
1271126, 3090291, 3099128, 42538048,
81953016268, 82953016018, 82953016019



MN-VB-5238

Length: 627 Ø: 48
Hole Distance: 130 / 130
81432206221, 81432706096, 81432706114,
81432706116, 81432706121



MN-VB-8514

Length: 627 Ø: 48
Hole Ø 25 / 25 / 25
Hole Distance: 152 / 130 / 130
81432706087, 81432706088, 81432706094,
81432706095, 81432796094



MN-VB-8669

Length: 627 Ø: 48
Hole Ø 25 / 25 / 25
Hole Distance: 152 / 130 / 130
81432706116, 81432706137, 81432706150,
81432706151



MN-VB-9404

Length: 627 Ø: 58
Hole Distance: 130 / 130
81432706117, 81432706152, 81432706153



SC-ES-7279

Length: 150
Cone Ø: d1 Ø 30 / d2 Ø 27
Thread: M30 x 1,5 RHT
81953016288



SC-ES-8517

Length: 140
Cone Ø: d1 Ø 30 / d2 Ø 27
Thread: M30 x 1,5 RHT
81953016286



SC-ES-8535

Length: 145
Cone Ø: d1 Ø 30 / d2 Ø 27
Thread: M30 x 1,5 RHT
81953016271, 81953016325





TGA ...

32.480 FFDLC, FFDLRC, FFDRC ...	09/02→	Tie Rod End	SC-ES-8517		for Push Rod
	09/02→	Tie Rod End	SC-ES-8535		for Guide Rod
	09/02→	Track Control Arm		MN-DL-5225	Trailing Arm, Drive Axle;Air Suspension Axle
	09/02→	Track Control Arm		MN-DL-8544	Trailing Arm, Drive Axle;Air Suspension Axle
	09/02→	Track Control Arm		MN-DL-8544	Trailing Arm, Drive Axle;Leaf Spring Axle
	09/02→	Track Control Arm		MN-VB-5238	Wishbone (CV), Drive Axle;Air Suspension Axle
	09/02→	Track Control Arm		MN-VB-8514	Suspension Rod, Wishbone (CV), Drive Axle; Air Suspension Axle
	09/02→	Track Control Arm		MN-VB-8514	Suspension Rod, Wishbone (CV), Drive Axle; Leaf Spring Axle
	09/02→	Track Control Arm		MN-VB-8669	Suspension Rod, Wishbone (CV), Drive Axle; Leaf Spring Axle
32.480 FFDK, FFDLK	08/04→	Track Control Arm		MN-VB-9404	Wishbone (CV), Drive Axle;Air Suspension Axle
	09/02→	Ball Head, gearshift linkage	CV-ES-2120		
	09/02→	Centre Rod	MN-DL-7801		Push Rod, Leaf Spring Axle
	09/02→	Centre Rod	MN-DL-8599		Push Rod
	09/02→	Centre Rod	MN-DL-12285		for Steering Rod
	09/02→	Centre Rod	MN-DL-12393		for Steering Rod
	09/02→	Suspension Strut Repair Kit		DB-RK-8581	
	09/02→	Tie Rod	MN-DL-7802		
	09/02→	Tie Rod End	CV-ES-0914		for Steering Rod
	09/02→	Tie Rod End	CV-ES-14162		for Steering Rod
	09/02→	Tie Rod End	CV-ES-14163		for Steering Rod
	09/02→	Tie Rod End	SC-ES-7279		for Steering Rod
	09/02→	Tie Rod End	SC-ES-8517		for Push Rod
	09/02→	Tie Rod End	SC-ES-8535		for Guide Rod
	09/02→	Track Control Arm		MN-DL-5225	Trailing Arm, Drive Axle;Air Suspension Axle
	09/02→	Track Control Arm		MN-DL-8544	Trailing Arm, Drive Axle;Air Suspension Axle
	09/02→	Track Control Arm		MN-DL-8544	Trailing Arm, Drive Axle;Leaf Spring Axle
	09/02→	Track Control Arm		MN-VB-5238	Wishbone (CV), Drive Axle;Air Suspension Axle
	09/02→	Track Control Arm		MN-VB-8514	Suspension Rod, Wishbone (CV), Drive Axle; Air Suspension Axle
	09/02→	Track Control Arm		MN-VB-8514	Suspension Rod, Wishbone (CV), Drive Axle; Leaf Spring Axle
09/02→	Track Control Arm		MN-VB-8669	Suspension Rod, Wishbone (CV), Drive Axle; Leaf Spring Axle	
08/04→	Track Control Arm		MN-VB-9404	Wishbone (CV), Drive Axle;Air Suspension Axle	
32.480 FFDRC	02/06→	Centre Rod	MN-DL-7801		Push Rod, Leaf Spring Axle
	02/06→	Centre Rod	MN-DL-12289		Push Rod
	02/06→	Centre Rod	MN-DL-12393		for Steering Rod
	02/06→	Suspension Strut Repair Kit		DB-RK-8581	
	02/06→	Tie Rod	MN-DL-7802		
	02/06→	Tie Rod End	CV-ES-0914		for Steering Rod
	02/06→	Tie Rod End	CV-ES-14162		for Steering Rod
	02/06→	Tie Rod End	CV-ES-14163		for Steering Rod
	02/06→	Tie Rod End	SC-ES-7279		for Steering Rod
	02/06→	Tie Rod End	SC-ES-8517		for Push Rod
	02/06→	Tie Rod End	SC-ES-8535		for Guide Rod
	02/06→	Track Control Arm		MN-DL-5225	Trailing Arm
	02/06→	Track Control Arm		MN-DL-8544	Trailing Arm, 1st RA;2nd RA, for Leaf-Spring Suspension vehicles
	02/06→	Track Control Arm		MN-VB-8514	Suspension Rod, Wishbone (CV), Drive Axle; Leaf Spring Axle
32.480 FFD-TM, FFDR-TM	09/02→	Ball Head, gearshift linkage	CV-ES-2120		
	09/02→	Centre Rod	MN-DL-7801		Push Rod, Leaf Spring Axle
	09/02→	Centre Rod	MN-DL-8599		Push Rod
	09/02→	Centre Rod	MN-DL-12285		for Steering Rod
	09/02→	Centre Rod	MN-DL-12289		Push Rod
	09/02→	Centre Rod	MN-DL-12393		for Steering Rod
	09/02→	Suspension Strut Repair Kit		DB-RK-8581	
	09/02→	Tie Rod	MN-DL-7802		
	09/02→	Tie Rod End	CV-ES-0914		for Steering Rod
	09/02→	Tie Rod End	CV-ES-14162		for Steering Rod

CV-ES-0914

Length: 125
Cone Ø: d1 Ø 30 / d2 Ø 27
Thread: M38 x 1,5 RHT
81953016184, 81953016251, 81953016276



CV-ES-2120

Length: 115
Cone Ø: d1 Ø 12,4 / d2 Ø 10,8
Thread: M14 x 1,5 RHT
03008500A, 81953016200, 81953016202, 81953016203, 81953016227



CV-ES-14162

Length: 125
Cone Ø: d1 Ø 30 / d2 Ø 27
Thread: M30 x 1,5 LHT
81953010015, 81953010083, 81953010087, 81953016029, 81953016030, 81953016043, 81953016044, 81953016050, 81953016054, 81953016087, 81953016091, 81953016107, 81953016120, 81953016125, 81953016152, 81953016155, 81953016157, 81953016168, 81953016179, 81953016181, 81953016223, 81953016237, 81953016254, 81953016275, 81953016279, 81953016351



CV-ES-14163

Length: 125
Cone Ø: d1 Ø 30 / d2 Ø 27
Thread: M30 x 1,5 RHT
95301.0084, 90804102156, 90804102272, 90804102696, 90804102710, 81953010016, 81953010075, 81953010084, 81953010088, 81953010094, 81953010103, 81953016030, 81953016043, 81953016048, 81953016049, 81953016053, 81953016061, 81953016090, 81953016108, 81953016112, 81953016126, 81953016143, 81953016149, 81953016154, 81953016156, 81953016168, 81953016178, 81953016194, 81953016206, 81953016224, 81953016234, 81953016242, 81953016252, 81953016274, 81953016278, 81953016284, 81953016286, 81953016308, 81953016310, 81953016312, 81953016347, 81953016350, 81953016352, 82953016012, 88953016014, N2953016001



DB-RK-8581

Ø: 85
Hole Distance: 130
Thick/Height: 24
03305800A, 81432706105



MN-DL-5225

Length: 572 Ø: 48
Hole Distance: 130 / 130
03301500A, 81432206229, 81432206236, 81432206267, 81432206270, 81432206272, 81432206304, 81432206305, 81432209236, 81432209267, 81432209272



MN-DL-7801

Length: 995 Ø: 52
Cone Ø: d1 Ø 30 / d2 Ø 27
81466106807, 81466106808, 81466116087, 81466116088, 81466116096, 81466116097, 81466116099, 81466116132, 81466116133, 81466116136, 81466116197, 81466116198, 81466116205

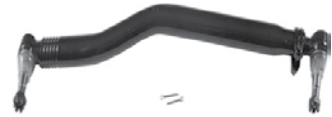

MN-DL-7802

Length: 1680 Ø: 52
Cone Ø: d1 Ø 30 / d2 Ø 27
03208300A, 81467116773, 81467116858, 81467116859, 81467116860, 81467116861, 81467116863, 81467116882, 81467116883, 81467116920, 81467116921



MN-DL-8544

Length: 596 Ø: 48
Hole Distance: 130 / 130
81432206196, 81432206232, 81432206233



MN-DL-8599

Length: 1800 Ø: 62
Cone Ø: d1 Ø 30 / d2 Ø 27
81466116161, 81466116162, 82466106183, 82466106186, 82466106187



MN-DL-12285

Length: 993 Ø: 40
Cone Ø: d1 Ø 30 / d2 Ø 27
81466106816, 81466106826, 81466116151, 82466106184, 82466106185



MN-DL-12289

Length: 1796 Ø: 62
Cone Ø: d1 Ø 30 / d2 Ø 27
81466116174, 81466116175, 81466116176, 81466116244

No Image

MN-DL-12393

Length: 1796 Ø: 62
Cone Ø: d1 Ø 30 / d2 Ø 27
81466116154, 81466116155, 81466116156



MN-VB-5238

Length: 627 Ø: 48
Hole Distance: 130 / 130
81432206221, 81432706096, 81432706114, 81432706116, 81432706121



MN-VB-8514

Length: 627 Ø: 48
Hole Ø 25 / 25 / 25
Hole Distance: 152 / 130 / 130
81432706087, 81432706088, 81432706094, 81432706095, 81432796094



MN-VB-8669

Length: 627 Ø: 48
Hole Ø 25 / 25 / 25
Hole Distance: 152 / 130 / 130
81432706116, 81432706137, 81432706150, 81432706151



MN-VB-9404

Length: 627 Ø: 58
Hole Distance: 130 / 130
81432706117, 81432706152, 81432706153



SC-ES-7279

Length: 150
Cone Ø: d1 Ø 30 / d2 Ø 27
Thread: M30 x 1,5 RHT
81953016288



SC-ES-8517

Length: 140
Cone Ø: d1 Ø 30 / d2 Ø 27
Thread: M30 x 1,5 RHT
81953016286



SC-ES-8535

Length: 145
Cone Ø: d1 Ø 30 / d2 Ø 27
Thread: M30 x 1,5 RHT
81953016271, 81953016325





TGA ...

32.480 FFD-TM, FFDR-TM ...	09/02→	Tie Rod End	CV-ES-14163	for Steering Rod	
	09/02→	Tie Rod End	MN-ES-10333	for Steering Rod	
	09/02→	Tie Rod End	SC-ES-7279	for Steering Rod	
	09/02→	Tie Rod End	SC-ES-8517	for Push Rod	
	09/02→	Tie Rod End	SC-ES-8535	for Guide Rod	
	09/02→	Track Control Arm		MN-DL-5225	Trailing Arm
	09/02→	Track Control Arm		MN-DL-8544	Trailing Arm, Drive Axle;Leaf Spring Axle
	09/02→	Track Control Arm		MN-VB-8514	Suspension Rod, Wishbone (CV), Drive Axle; Leaf Spring Axle
	09/02→	Track Control Arm		MN-VB-8669	Suspension Rod, Wishbone (CV), Drive Axle; Leaf Spring Axle
	02/06→	Track Control Arm		MN-DL-8544	Trailing Arm, 1st RA;2nd RA, for Leaf-Spring Suspension vehicles
33.350 FDC-TM, FDRC-TM	09/07→	Centre Rod	MN-DL-7801	Push Rod	
	09/07→	Suspension Arm Repair Kit		CV-RK-5313	for Wishbone (CV)
	09/07→	Tie Rod	MN-DL-7802		
	09/07→	Tie Rod End	CV-ES-0914	for Steering Rod	
	09/07→	Tie Rod End	CV-ES-14162	for Steering Rod	
	09/07→	Tie Rod End	CV-ES-14163	for Steering Rod	
	09/07→	Tie Rod End	SC-ES-7279	for Steering Rod	
	09/07→	Tie Rod End	SC-ES-8517	for Push Rod	
	09/07→	Tie Rod End	SC-ES-8535	for Guide Rod	
	09/07→	Track Control Arm		MN-DL-8544	Trailing Arm
	09/07→	Track Control Arm		MN-VB-8514	Suspension Rod, Wishbone (CV)
	09/07→	Track Control Arm		MN-VB-8669	Suspension Rod, Wishbone (CV)
	09/07→	Track Control Arm		MN-VB-9404	Wishbone (CV)
33.350, 33.360 FDAC, FDARC, FDHC	06/05→	Centre Rod	MN-DL-7801	Push Rod, Leaf Spring Axle	
	06/05→	Suspension Strut Repair Kit		DB-RK-8581	
	06/05→	Tie Rod	MN-DL-7802		
	06/05→	Tie Rod End	CV-ES-0914	for Steering Rod	
	06/05→	Tie Rod End	CV-ES-14162	for Steering Rod	
	06/05→	Tie Rod End	CV-ES-14163	for Steering Rod	
	06/05→	Tie Rod End	MN-ES-10333	for Steering Rod	
	06/05→	Tie Rod End	SC-ES-7279	for Steering Rod	
	06/05→	Tie Rod End	SC-ES-8517	for Push Rod	
	06/05→	Tie Rod End	SC-ES-8535	for Guide Rod	
	06/05→	Track Control Arm		MN-DL-5225	Trailing Arm
	06/05→	Track Control Arm		MN-DL-8544	Trailing Arm, 1st RA;2nd RA;Leaf Spring Axle
	06/05→	Track Control Arm		MN-DL-8544	Trailing Arm, Drive Axle;Leaf Spring Axle
	06/05→	Track Control Arm		MN-DL-8609	Trailing Arm, 1st RA;2nd RA, for Leaf-Spring Suspension vehicles, →Type_HB Chassis
	06/05→	Track control arm		MN-DL-10288	Trailing Arm, 1st RA;2nd RA, for Leaf-Spring Suspension vehicles, →Type HB
	06/05→	Track control arm		MN-DL-12288	Trailing Arm
	06/05→	Track Control Arm		MN-VB-8514	Suspension Rod, Wishbone (CV), Drive Axle; Leaf Spring Axle
	06/05→	Track Control Arm		MN-VB-8669	Suspension Rod, Wishbone (CV), Drive Axle; Leaf Spring Axle
	06/05→	Track Control Arm		MN-VB-9404	Wishbone (CV), Drive Axle
	33.350, 33.360 FDAK, FDARK, FDHK	06/05→	Centre Rod	MN-DL-7801	Push Rod, Leaf Spring Axle
06/05→		Suspension Strut Repair Kit		DB-RK-8581	
06/05→		Tie Rod	MN-DL-7802		
06/05→		Tie Rod End	CV-ES-0914	for Steering Rod	
06/05→		Tie Rod End	CV-ES-14162	for Steering Rod	
06/05→		Tie Rod End	CV-ES-14163	for Steering Rod	
06/05→		Tie Rod End	MN-ES-10333	for Steering Rod	
06/05→		Tie Rod End	SC-ES-7279	for Steering Rod	
06/05→		Tie Rod End	SC-ES-8517	for Push Rod	
06/05→		Tie Rod End	SC-ES-8535	for Guide Rod	
06/05→		Track Control Arm		MN-DL-5225	Trailing Arm
06/05→		Track Control Arm		MN-DL-8544	Trailing Arm, 1st RA;2nd RA;Leaf Spring Axle
06/05→		Track Control Arm		MN-DL-8544	Trailing Arm, Drive Axle;Leaf Spring Axle

CV-ES-0914

Length: 125
Cone Ø: d1 Ø 30 / d2 Ø 27
Thread: M38 x 1,5 RHT
81953016184, 81953016251, 81953016276



CV-ES-14162

Length: 125
Cone Ø: d1 Ø 30 / d2 Ø 27
Thread: M30 x 1,5 LHT
81953010015, 81953010083, 81953010087, 81953016029, 81953016030, 81953016043, 81953016044, 81953016050, 81953016054, 81953016087, 81953016091, 81953016107, 81953016120, 81953016125, 81953016152, 81953016155, 81953016157, 81953016168, 81953016179, 81953016181, 81953016223, 81953016237, 81953016254, 81953016275, 81953016279, 81953016351



CV-ES-14163

Length: 125
Cone Ø: d1 Ø 30 / d2 Ø 27
Thread: M30 x 1,5 RHT
95301.0084, 90804102156, 90804102272, 90804102696, 90804102710, 81953010016, 81953010075, 81953010084, 81953010088, 81953010094, 81953010103, 81953016030, 81953016043, 81953016048, 81953016049, 81953016053, 81953016061, 81953016090, 81953016108, 81953016112, 81953016126, 81953016143, 81953016149, 81953016154, 81953016156, 81953016168, 81953016178, 81953016194, 81953016206, 81953016224, 81953016234, 81953016242, 81953016252, 81953016274, 81953016278, 81953016284, 81953016286, 81953016308, 81953016310, 81953016312, 81953016347, 81953016350, 81953016352, 82953016012, 88953016014, N2953016001



CV-RK-5313

Ø: 90
03304800A, 81953016132



DB-RK-8581

Ø: 85
Hole Distance: 130
Thick/Height: 24
03305800A, 81432706105



MN-DL-5225

Length: 572 Ø: 48
Hole Distance: 130 / 130
03301500A, 81432206229, 81432206236, 81432206267, 81432206270, 81432206272, 81432206304, 81432206305, 81432209236, 81432209267, 81432209272



MN-DL-7801

Length: 995 Ø: 52
Cone Ø: d1 Ø 30 / d2 Ø 27
81466106807, 81466106808, 81466116087, 81466116088, 81466116096, 81466116097, 81466116099, 81466116132, 81466116133, 81466116136, 81466116197, 81466116198, 81466116205

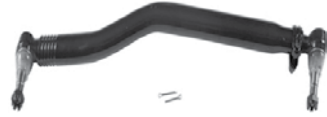

MN-DL-7802

Length: 1680 Ø: 52
Cone Ø: d1 Ø 30 / d2 Ø 27
03208300A, 81467116773, 81467116858, 81467116859, 81467116860, 81467116861, 81467116863, 81467116882, 81467116883, 81467116920, 81467116921



MN-DL-8544

Length: 596 Ø: 48
Hole Distance: 130 / 130
81432206196, 81432206232, 81432206233



MN-DL-8609

Length: 585 Ø: 58
Hole Distance: 130 / 130
81432206070, 81432206071, 81432206072, 81432206091, 81432206093, 81432206119



MN-DL-10288

81432206386, 82432206008, 82432209008

No Image

MN-DL-12288

Length: 585 Ø: 58
Hole Distance: 130 / 130
81432206386, 82432206008, 82432209008

No Image

MN-ES-10333

Length: 90
Cone Ø: d1 Ø 38 / d2 Ø 34,35
Thread: M36 x 1,5 RHT
1271126, 3090291, 3099128, 42538048, 81953016268, 82953016018, 82953016019



MN-VB-8514

Length: 627 Ø: 48
Hole Ø 25 / 25 / 25
Hole Distance: 152 / 130 / 130
81432706087, 81432706088, 81432706094, 81432706095, 81432796094



MN-VB-8669

Length: 627 Ø: 48
Hole Ø 25 / 25 / 25
Hole Distance: 152 / 130 / 130
81432706116, 81432706137, 81432706150, 81432706151



MN-VB-9404

Length: 627 Ø: 58
Hole Distance: 130 / 130
81432706117, 81432706152, 81432706153



SC-ES-7279

Length: 150
Cone Ø: d1 Ø 30 / d2 Ø 27
Thread: M30 x 1,5 RHT
81953016288



SC-ES-8517

Length: 140
Cone Ø: d1 Ø 30 / d2 Ø 27
Thread: M30 x 1,5 RHT
81953016286



SC-ES-8535

Length: 145
Cone Ø: d1 Ø 30 / d2 Ø 27
Thread: M30 x 1,5 RHT
81953016271, 81953016325



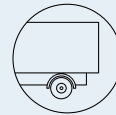

TGA ...

33.350, 33.360 FDAK, FDARK, FDHK ...	06/05 →	Track Control Arm		MN-DL-8609	Trailing Arm, 1st RA;2nd RA, for Leaf-Spring Suspension vehicles, →Type_HB Chassis	
	06/05 →	Track control arm		MN-DL-10288	Trailing Arm, 1st RA;2nd RA, for Leaf-Spring Suspension vehicles, →Type HB	
	06/05 →	Track control arm		MN-DL-12288	Trailing Arm	
	06/05 →	Track Control Arm		MN-VB-8514	Suspension Rod, Wishbone (CV)	
	06/05 →	Track Control Arm		MN-VB-8669	Suspension Rod, Wishbone (CV), Drive Axle; Leaf Spring Axle	
	06/05 →	Track Control Arm		MN-VB-9404	Wishbone (CV), Drive Axle	
33.350, 33.360 FDARS, FDAS, FDHS	06/05 →	Centre Rod	MN-DL-7801		Push Rod, Leaf Spring Axle	
	06/05 →	Suspension Strut Repair Kit		DB-RK-8581		
	06/05 →	Tie Rod	MN-DL-7802			
	06/05 →	Tie Rod End	CV-ES-0914		for Steering Rod	
	06/05 →	Tie Rod End	CV-ES-14162		for Steering Rod	
	06/05 →	Tie Rod End	CV-ES-14163		for Steering Rod	
	06/05 →	Tie Rod End	MN-ES-10333		for Steering Rod	
	06/05 →	Tie Rod End	SC-ES-7279		for Steering Rod	
	06/05 →	Tie Rod End	SC-ES-8517		for Push Rod	
	06/05 →	Tie Rod End	SC-ES-8535		for Guide Rod	
	06/05 →	Track Control Arm		MN-DL-5225	Trailing Arm	
	06/05 →	Track Control Arm		MN-DL-8544	Trailing Arm, 1st RA;2nd RA;Leaf Spring Axle	
	06/05 →	Track Control Arm		MN-DL-8544	Trailing Arm, Drive Axle;Leaf Spring Axle	
	06/05 →	Track Control Arm		MN-DL-8609	Trailing Arm, 1st RA;2nd RA, for Leaf-Spring Suspension vehicles, →Type_HB Chassis	
	06/05 →	Track control arm		MN-DL-10288	Trailing Arm, 1st RA;2nd RA, for Leaf-Spring Suspension vehicles, →Type HB	
	06/05 →	Track control arm		MN-DL-12288	Trailing Arm	
	06/05 →	Track Control Arm		MN-VB-8514	Suspension Rod, Wishbone (CV), Drive Axle; Leaf Spring Axle	
	06/05 →	Track Control Arm		MN-VB-8669	Suspension Rod, Wishbone (CV), Drive Axle; Leaf Spring Axle	
	06/05 →	Track Control Arm		MN-VB-9404	Wishbone (CV), Drive Axle	
	33.350, 33.360 FDC, FDLK, FDRK	05/04 →	Centre Rod	MN-DL-7801		Push Rod, Leaf Spring Axle
		05/04 →	Suspension Strut Repair Kit		DB-RK-8581	
		05/04 →	Tie Rod	MN-DL-7802		
		05/04 →	Tie Rod	MN-DL-12293		
05/04 →		Tie Rod End	CV-ES-0914		for Steering Rod	
05/04 →		Tie Rod End	CV-ES-14162		for Steering Rod	
05/04 →		Tie Rod End	CV-ES-14163		for Steering Rod	
05/04 →		Tie Rod End	SC-ES-7279		for Steering Rod	
05/04 →		Tie Rod End	SC-ES-8517		for Push Rod	
05/04 →		Tie Rod End	SC-ES-8535		for Guide Rod	
05/04 →		Track Control Arm		MN-DL-3402	Trailing Arm, 1st RA;2nd RA, for Pneumatic Suspension vehicles	
05/04 →		Track Control Arm		MN-DL-5225	Trailing Arm	
05/04 →		Track Control Arm		MN-DL-8544	Trailing Arm, Drive Axle;Leaf Spring Axle	
05/04 →		Track control arm		MN-DL-10288	Trailing Arm, 1st RA;2nd RA, for Leaf-Spring Suspension vehicles	
05/04 →		Track control arm		MN-DL-12288	Trailing Arm	
05/04 →		Track Control Arm		MN-VB-5222	Wishbone (CV), 1st RA;2nd RA, for Pneumatic Suspension vehicles	
05/04 →		Track Control Arm		MN-VB-5238	Wishbone (CV), 1st RA;2nd RA, for Pneumatic Suspension vehicles, →Type_NBA Chassis	
05/04 →		Track Control Arm		MN-VB-8514	Suspension Rod, Wishbone (CV), Drive Axle; Leaf Spring Axle	
05/04 →		Track Control Arm		MN-VB-8669	Suspension Rod, Wishbone (CV), Drive Axle; Leaf Spring Axle	
05/04 →		Track Control Arm		MN-VB-9404	Wishbone (CV), Drive Axle	
33.350, 33.360 FDK, FDLK, FDRK	05/04 →	Centre Rod	MN-DL-7801		Push Rod, Leaf Spring Axle	
	05/04 →	Suspension Strut Repair Kit		DB-RK-8581		
	05/04 →	Tie Rod	MN-DL-7802			
	05/04 →	Tie Rod	MN-DL-12293			
	05/04 →	Tie Rod End	CV-ES-0914		for Steering Rod	

CV-ES-0914

Length: 125
Cone Ø: d1 Ø 30 / d2 Ø 27
Thread: M38 x 1,5 RHT
81953016184, 81953016251, 81953016276



CV-ES-14162

Length: 125
Cone Ø: d1 Ø 30 / d2 Ø 27
Thread: M30 x 1,5 LHT
81953010015, 81953010083, 81953010087,
81953016029, 81953016030, 81953016043,
81953016044, 81953016050, 81953016054,
81953016087, 81953016091, 81953016107,
81953016120, 81953016125, 81953016152,
81953016155, 81953016157, 81953016168,
81953016179, 81953016181, 81953016223,
81953016237, 81953016254, 81953016275,
81953016279, 81953016351



CV-ES-14163

Length: 125
Cone Ø: d1 Ø 30 / d2 Ø 27
Thread: M30 x 1,5 RHT
95301.0084, 90804102156, 90804102272,
90804102696, 90804102710, 81953010016,
81953010075, 81953010084, 81953010088,
81953010094, 81953010103, 81953016030,
81953016043, 81953016048, 81953016049,
81953016053, 81953016061, 81953016090,
81953016108, 81953016112, 81953016126,
81953016143, 81953016149, 81953016154,
81953016156, 81953016168, 81953016178,
81953016194, 81953016206, 81953016224,
81953016234, 81953016242, 81953016252,
81953016274, 81953016278, 81953016284,
81953016286, 81953016308, 81953016310,
81953016312, 81953016347, 81953016350,
81953016352, 82953016012, 88953016014,
N2953016001



DB-RK-8581

Ø: 85
Hole Distance: 130
Thick/Height: 24
03305800A, 81432706105



MN-DL-3402

Length: 590 Ø: 48
Hole Distance: 130 / 130
03307200A, 81432206067, 81432206068,
81432206090, 81432206092



MN-DL-5225

Length: 572 Ø: 48
Hole Distance: 130 / 130
03301500A, 81432206229, 81432206236,
81432206267, 81432206270, 81432206272,
81432206304, 81432206305, 81432209236,
81432209267, 81432209272



MN-DL-7801

Length: 995 Ø: 52
Cone Ø: d1 Ø 30 / d2 Ø 27
81466106807, 81466106808, 81466116087,
81466116088, 81466116096, 81466116097,
81466116099, 81466116132, 81466116133,
81466116136, 81466116197, 81466116198,
81466116205

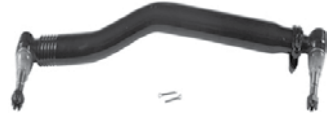

MN-DL-7802

Length: 1680 Ø: 52
Cone Ø: d1 Ø 30 / d2 Ø 27
03208300A, 81467116773, 81467116858,
81467116859, 81467116860, 81467116861,
81467116863, 81467116882, 81467116883,
81467116920, 81467116921



MN-DL-8544

Length: 596 Ø: 48
Hole Distance: 130 / 130
81432206196, 81432206232, 81432206233



MN-DL-8609

Length: 585 Ø: 58
Hole Distance: 130 / 130
81432206070, 81432206071, 81432206072,
81432206091, 81432206093, 81432206119



MN-DL-10288

81432206386, 82432206008, 82432209008

No Image

MN-DL-12288

Length: 585 Ø: 58
Hole Distance: 130 / 130
81432206386, 82432206008, 82432209008

No Image

MN-DL-12293

Length: 1680 Ø: 42
Cone Ø: d1 Ø 30 / d2 Ø 27
81467106236, 81467106268, 81467106356,
81467116356, 81467116723, 81467116794,
81467116933, 81467116934, 81467116966



MN-ES-10333

Length: 90
Cone Ø: d1 Ø 38 / d2 Ø 34,35
Thread: M36 x 1,5 RHT
1271126, 3090291, 3099128, 42538048,
81953016268, 82953016018, 82953016019



MN-VB-5222

Length: 627 Ø: 50
Hole Distance: 152 / 152
81432706030, 81432706034, 81432706054,
81432706055, 81432706056, 81432706057,
81432706067, 81432706068, 81432706074,
81432706075, 81432706076, 81432706077,
81432706078, 81432706081, 81432706082,
81432709034, 81432709076, 81432709078,
8143706054



MN-VB-5238

Length: 627 Ø: 48
Hole Distance: 130 / 130
81432206221, 81432706096, 81432706114,
81432706116, 81432706121



MN-VB-8514

Length: 627 Ø: 48
Hole Ø 25 / 25 / 25
Hole Distance: 152 / 130 / 130
81432706087, 81432706088, 81432706094,
81432706095, 81432796094



MN-VB-8669

Length: 627 Ø: 48
Hole Ø 25 / 25 / 25
Hole Distance: 152 / 130 / 130
81432706116, 81432706137, 81432706150,
81432706151



MN-VB-9404

Length: 627 Ø: 58
Hole Distance: 130 / 130
81432706117, 81432706152, 81432706153



SC-ES-7279

Length: 150
Cone Ø: d1 Ø 30 / d2 Ø 27
Thread: M30 x 1,5 RHT
81953016288



SC-ES-8517

Length: 140
Cone Ø: d1 Ø 30 / d2 Ø 27
Thread: M30 x 1,5 RHT
81953016286



SC-ES-8535

Length: 145
Cone Ø: d1 Ø 30 / d2 Ø 27
Thread: M30 x 1,5 RHT
81953016271, 81953016325





TGA ...

33.350, 33.360 FDK, FDLK, FDRK ...	05/04→	Tie Rod End	CV-ES-14162		for Steering Rod	
	05/04→	Tie Rod End	CV-ES-14163		for Steering Rod	
	05/04→	Tie Rod End	SC-ES-7279		for Steering Rod	
	05/04→	Tie Rod End	SC-ES-8517		for Push Rod	
	05/04→	Tie Rod End	SC-ES-8535		for Guide Rod	
	05/04→	Track Control Arm		MN-DL-3402	Trailing Arm, 1st RA;2nd RA, for Pneumatic Suspension vehicles	
	05/04→	Track Control Arm		MN-DL-5225	Trailing Arm	
	05/04→	Track Control Arm		MN-DL-8544	Trailing Arm, Drive Axle;Leaf Spring Axle	
	05/04→	Track control arm		MN-DL-10288	Trailing Arm, 1st RA;2nd RA, for Leaf-Spring Suspension vehicles	
	05/04→	Track control arm		MN-DL-12288	Trailing Arm	
	05/04→	Track Control Arm		MN-VB-5222	Wishbone (CV), 1st RA;2nd RA, for Pneumatic Suspension vehicles	
	05/04→	Track Control Arm		MN-VB-5238	Wishbone (CV), 1st RA;2nd RA, for Pneumatic Suspension vehicles, →Type_NBA Chassis	
	05/04→	Track Control Arm		MN-VB-8514	Suspension Rod, Wishbone (CV), Drive Axle; Leaf Spring Axle	
	05/04→	Track Control Arm		MN-VB-8669	Suspension Rod, Wishbone (CV), Drive Axle; Leaf Spring Axle	
	33.350, 33.360 FDLRS, FDLS, FDRS, FDS	05/04→	Track Control Arm		MN-VB-9404	Wishbone (CV), Drive Axle
05/04→		Centre Rod	MN-DL-7801		Push Rod, Leaf Spring Axle	
05/04→		Suspension Strut Repair Kit		DB-RK-8581		
05/04→		Tie Rod	MN-DL-7802			
05/04→		Tie Rod	MN-DL-12293			
05/04→		Tie Rod End	CV-ES-0914		for Steering Rod	
05/04→		Tie Rod End	CV-ES-14162		for Steering Rod	
05/04→		Tie Rod End	CV-ES-14163		for Steering Rod	
05/04→		Tie Rod End	SC-ES-7279		for Steering Rod	
05/04→		Tie Rod End	SC-ES-8517		for Push Rod	
05/04→		Tie Rod End	SC-ES-8535		for Guide Rod	
05/04→		Track Control Arm		MN-DL-3402	Trailing Arm, 1st RA;2nd RA, for Pneumatic Suspension vehicles	
05/04→		Track Control Arm		MN-DL-5225	Trailing Arm	
05/04→		Track Control Arm		MN-DL-8544	Trailing Arm, Drive Axle;Leaf Spring Axle	
05/04→		Track control arm		MN-DL-10288	Trailing Arm, 1st RA;2nd RA, for Leaf-Spring Suspension vehicles	
05/04→		Track control arm		MN-DL-12288	Trailing Arm	
05/04→		Track Control Arm		MN-VB-5222	Wishbone (CV), 1st RA;2nd RA, for Pneumatic Suspension vehicles	
05/04→		Track Control Arm		MN-VB-5238	Wishbone (CV), 1st RA;2nd RA, for Pneumatic Suspension vehicles, →Type_NBA Chassis	
05/04→		Track Control Arm		MN-VB-8514	Suspension Rod, Wishbone (CV), Drive Axle; Leaf Spring Axle	
05/04→		Track Control Arm		MN-VB-8669	Suspension Rod, Wishbone (CV), Drive Axle; Leaf Spring Axle	
05/04→		Track Control Arm		MN-VB-9404	Wishbone (CV), Drive Axle	
33.360 FDAC, FDARC, FDHC		09/02→	Ball Head, gearshift linkage	CV-ES-2120		
		09/02→	Centre Rod	MN-DL-7801		Push Rod
		09/02→	Suspension Strut Repair Kit		DB-RK-8581	
		09/02→	Tie Rod End	CV-ES-0914		for Steering Rod
	09/02→	Tie Rod End	CV-ES-14163		for Steering Rod	
	09/02→	Tie Rod End	MN-ES-10333		for Steering Rod	
	09/02→	Tie Rod End	SC-ES-8517		for Push Rod	
	09/02→	Track Control Arm		MN-DL-5225	Trailing Arm	
	09/02→	Track Control Arm		MN-DL-8544	Trailing Arm, 1st RA;2nd RA;Leaf Spring Axle	
	09/02→	Track Control Arm		MN-DL-8609	Trailing Arm, 1st RA;2nd RA, for Leaf-Spring Suspension vehicles, →Type_HB Chassis	
	09/02→	Track Control Arm		MN-VB-8514	Suspension Rod, Wishbone (CV), Drive Axle; Leaf Spring Axle	
	09/02→	Track Control Arm		MN-VB-9404	Wishbone (CV), Drive Axle	
	09/02→	Track Control Arm		MN-VB-9404	Wishbone (CV), Drive Axle;Leaf Spring Axle	

CV-ES-0914

Length: 125
Cone Ø: d1 Ø 30 / d2 Ø 27
Thread: M38 x 1,5 RHT
81953016184, 81953016251, 81953016276



CV-ES-2120

Length: 115
Cone Ø: d1 Ø 12,4 / d2 Ø 10,8
Thread: M14 x 1,5 RHT
03008500A, 81953016200, 81953016202, 81953016203, 81953016227



CV-ES-14162

Length: 125
Cone Ø: d1 Ø 30 / d2 Ø 27
Thread: M30 x 1,5 LHT
81953010015, 81953010083, 81953010087, 81953016029, 81953016030, 81953016043, 81953016044, 81953016050, 81953016054, 81953016087, 81953016091, 81953016107, 81953016120, 81953016125, 81953016152, 81953016155, 81953016157, 81953016168, 81953016179, 81953016181, 81953016223, 81953016237, 81953016254, 81953016275, 81953016279, 81953016351



CV-ES-14163

Length: 125
Cone Ø: d1 Ø 30 / d2 Ø 27
Thread: M30 x 1,5 RHT
95301.0084, 90804102156, 90804102272, 90804102696, 90804102710, 81953010016, 81953010075, 81953010084, 81953010088, 81953010094, 81953010103, 81953016030, 81953016043, 81953016048, 81953016049, 81953016053, 81953016061, 81953016090, 81953016108, 81953016112, 81953016126, 81953016143, 81953016149, 81953016154, 81953016156, 81953016168, 81953016178, 81953016194, 81953016206, 81953016224, 81953016234, 81953016242, 81953016252, 81953016274, 81953016278, 81953016284, 81953016286, 81953016308, 81953016310, 81953016312, 81953016347, 81953016350, 81953016352, 82953016012, 88953016014, N2953016001



DB-RK-8581

Ø: 85
Hole Distance: 130
Thick/Height: 24
03305800A, 81432706105



MN-DL-3402

Length: 590 Ø: 48
Hole Distance: 130 / 130
03307200A, 81432206067, 81432206068, 81432206090, 81432206092, 81432209092



MN-DL-5225

Length: 572 Ø: 48
Hole Distance: 130 / 130
03301500A, 81432206229, 81432206236, 81432206267, 81432206270, 81432206272, 81432206304, 81432206305, 81432209236, 81432209267, 81432209272



MN-DL-7801

Length: 995 Ø: 52
Cone Ø: d1 Ø 30 / d2 Ø 27
81466106807, 81466106808, 81466116087, 81466116088, 81466116096, 81466116097, 81466116099, 81466116132, 81466116133, 81466116136, 81466116197, 81466116198, 81466116205

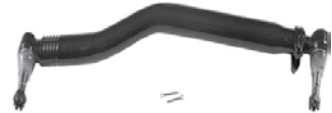

MN-DL-7802

Length: 1680 Ø: 52
Cone Ø: d1 Ø 30 / d2 Ø 27
03208300A, 81467116773, 81467116858, 81467116859, 81467116860, 81467116861, 81467116863, 81467116882, 81467116883, 81467116920, 81467116921



MN-DL-8544

Length: 596 Ø: 48
Hole Distance: 130 / 130
81432206196, 81432206232, 81432206233



MN-DL-8609

Length: 585 Ø: 58
Hole Distance: 130 / 130
81432206070, 81432206071, 81432206072, 81432206091, 81432206093, 81432206119



MN-DL-10288

81432206386, 82432206008, 82432209008

No Image

MN-DL-12288

Length: 585 Ø: 58
Hole Distance: 130 / 130
81432206386, 82432206008, 82432209008

No Image

MN-DL-12293

Length: 1680 Ø: 42
Cone Ø: d1 Ø 30 / d2 Ø 27
81467106236, 81467106268, 81467106356, 81467116356, 81467116723, 81467116794, 81467116933, 81467116934, 81467116966



MN-ES-10333

Length: 90
Cone Ø: d1 Ø 38 / d2 Ø 34,35
Thread: M36 x 1,5 RHT
1271126, 3090291, 3099128, 42538048, 81953016268, 82953016018, 82953016019



MN-VB-5222

Length: 627 Ø: 50
Hole Distance: 152 / 152
81432706030, 81432706034, 81432706054, 81432706055, 81432706056, 81432706057, 81432706067, 81432706068, 81432706074, 81432706075, 81432706076, 81432706077, 81432706078, 81432706081, 81432706082, 81432709034, 81432709076, 81432709078, 8143706054



MN-VB-5238

Length: 627 Ø: 48
Hole Distance: 130 / 130
81432206221, 81432706096, 81432706114, 81432706116, 81432706121



MN-VB-8514

Length: 627 Ø: 48
Hole Ø 25 / 25 / 25
Hole Distance: 152 / 130 / 130
81432706087, 81432706088, 81432706094, 81432706095, 81432796094



MN-VB-8669

Length: 627 Ø: 48
Hole Ø 25 / 25 / 25
Hole Distance: 152 / 130 / 130
81432706116, 81432706137, 81432706150, 81432706151



MN-VB-9404

Length: 627 Ø: 58
Hole Distance: 130 / 130
81432706117, 81432706152, 81432706153



SC-ES-7279

Length: 150
Cone Ø: d1 Ø 30 / d2 Ø 27
Thread: M30 x 1,5 RHT
81953016288



SC-ES-8517

Length: 140
Cone Ø: d1 Ø 30 / d2 Ø 27
Thread: M30 x 1,5 RHT
81953016286



SC-ES-8535

Length: 145
Cone Ø: d1 Ø 30 / d2 Ø 27
Thread: M30 x 1,5 RHT
81953016271, 81953016325





TGA ...

33.360 FDAK, FDARK, FDHK	09/02→	Ball Head, gearshift linkage	CV-ES-2120		
	09/02→	Centre Rod	MN-DL-7801		Push Rod
	09/02→	Suspension Strut Repair Kit		DB-RK-8581	
	09/02→	Tie Rod End	CV-ES-0914		for Steering Rod
	09/02→	Tie Rod End	CV-ES-14163		for Steering Rod
	09/02→	Tie Rod End	MN-ES-10333		for Steering Rod
	09/02→	Tie Rod End	SC-ES-8517		for Push Rod
	09/02→	Track Control Arm		MN-DL-5225	Trailing Arm
	09/02→	Track Control Arm		MN-DL-8544	Trailing Arm, 1st RA;2nd RA;Leaf Spring Axle
	09/02→	Track Control Arm		MN-DL-8609	Trailing Arm, 1st RA;2nd RA, for Leaf-Spring Suspension vehicles, →Type_HB Chassis
	09/02→	Track Control Arm		MN-VB-8514	Suspension Rod, Wishbone (CV), Drive Axle; Leaf Spring Axle
	09/02→	Track Control Arm		MN-VB-9404	Wishbone (CV), Drive Axle
	09/02→	Track Control Arm		MN-VB-9404	Wishbone (CV), Drive Axle;Leaf Spring Axle
	33.360 FDARS, FDAS, FDHS	09/02→	Ball Head, gearshift linkage	CV-ES-2120	
09/02→		Centre Rod	MN-DL-7801		Push Rod
09/02→		Suspension Strut Repair Kit		DB-RK-8581	
09/02→		Tie Rod End	CV-ES-0914		for Steering Rod
09/02→		Tie Rod End	CV-ES-14163		for Steering Rod
09/02→		Tie Rod End	MN-ES-10333		for Steering Rod
09/02→		Tie Rod End	SC-ES-8517		for Push Rod
09/02→		Track Control Arm		MN-DL-5225	Trailing Arm
09/02→		Track Control Arm		MN-DL-8544	Trailing Arm, 1st RA;2nd RA;Leaf Spring Axle
09/02→		Track Control Arm		MN-DL-8609	Trailing Arm, 1st RA;2nd RA, for Leaf-Spring Suspension vehicles, →Type_HB Chassis
09/02→		Track Control Arm		MN-VB-8514	Suspension Rod, Wishbone (CV), Drive Axle; Leaf Spring Axle
09/02→		Track Control Arm		MN-VB-9404	Wishbone (CV), Drive Axle
09/02→		Track Control Arm		MN-VB-9404	Wishbone (CV), Drive Axle;Leaf Spring Axle
33.360 FDC, FDLC, FDRC, FDLRC		10/00→03/03	Track Control Arm		MN-DL-8609
	10/00→	Ball Head, gearshift linkage	CV-ES-2120		
	10/00→	Centre Rod	MN-DL-7801		Push Rod, Leaf Spring Axle
	10/00→	Centre Rod	MN-DL-8560		Push Rod, Air Suspension Axle
	10/00→	Suspension Strut Repair Kit		DB-RK-8581	
	10/00→	Suspension Strut Repair Kit		MN-RK-12436	
	10/00→	Tie Rod	MN-DL-7802		
	10/00→	Tie Rod End	CV-ES-0914		for Steering Rod
	10/00→	Tie Rod End	CV-ES-14162		for Steering Rod
	10/00→	Tie Rod End	CV-ES-14163		for Steering Rod
	10/00→	Tie Rod End	SC-ES-7279		for Steering Rod
	10/00→	Tie Rod End	SC-ES-8517		for Push Rod
	10/00→	Tie Rod End	SC-ES-8535		for Guide Rod
	10/00→	Track Control Arm		MN-DL-3402	Trailing Arm, Air Suspension Axle;Drive Axle
	10/00→	Track Control Arm		MN-DL-5225	Trailing Arm, Drive Axle;Air Suspension Axle
	10/00→	Track Control Arm		MN-DL-8544	Trailing Arm, Drive Axle;Air Suspension Axle
	10/00→	Track Control Arm		MN-DL-8544	Trailing Arm, Drive Axle;Leaf Spring Axle
	10/00→	Track control arm		MN-DL-10288	Trailing Arm, 1st RA;2nd RA, for Leaf-Spring Suspension vehicles
	10/00→	Track control arm		MN-DL-12288	Trailing Arm
	10/00→	Track Control Arm		MN-VB-5222	Wishbone (CV), 1st RA;2nd RA, for Pneumatic Suspension vehicles
	10/00→	Track Control Arm		MN-VB-5238	Wishbone (CV), Drive Axle;Air Suspension Axle
	10/00→	Track Control Arm		MN-VB-8514	Suspension Rod, Wishbone (CV), Drive Axle; Leaf Spring Axle
	10/00→	Track Control Arm		MN-VB-8669	Suspension Rod, Wishbone (CV), Drive Axle
	10/00→	Track Control Arm		MN-VB-8669	Suspension Rod, Wishbone (CV), Drive Axle; Leaf Spring Axle
	10/00→	Track Control Arm		MN-VB-9404	Wishbone (CV), Drive Axle
	10/00→	Track Control Arm		MN-VB-9404	Wishbone (CV), Drive Axle;Air Suspension Axle
	10/00→	Track Control Arm		MN-VB-9404	Wishbone (CV), Drive Axle;Leaf Spring Axle
	10/00→	Track Control Arm	MN-DL-8663		Control Arm, Air Suspension Axle

CV-ES-0914

Length: 125
Cone Ø: d1 Ø 30 / d2 Ø 27
Thread: M38 x 1,5 RHT
81953016184, 81953016251, 81953016276



CV-ES-2120

Length: 115
Cone Ø: d1 Ø 12,4 / d2 Ø 10,8
Thread: M14 x 1,5 RHT
03008500A, 81953016200, 81953016202, 81953016203, 81953016227



CV-ES-14162

Length: 125
Cone Ø: d1 Ø 30 / d2 Ø 27
Thread: M30 x 1,5 LHT
81953010015, 81953010083, 81953010087, 81953016029, 81953016030, 81953016043, 81953016044, 81953016050, 81953016054, 81953016087, 81953016091, 81953016107, 81953016120, 81953016125, 81953016152, 81953016155, 81953016157, 81953016168, 81953016179, 81953016181, 81953016223, 81953016237, 81953016254, 81953016275, 81953016279, 81953016351



CV-ES-14163

Length: 125
Cone Ø: d1 Ø 30 / d2 Ø 27
Thread: M30 x 1,5 RHT
95301.0084, 90804102156, 90804102272, 90804102696, 90804102710, 81953010016, 81953010075, 81953010084, 81953010088, 81953010094, 81953010103, 81953016030, 81953016043, 81953016048, 81953016049, 81953016053, 81953016061, 81953016090, 81953016108, 81953016112, 81953016126, 81953016143, 81953016149, 81953016154, 81953016156, 81953016168, 81953016178, 81953016194, 81953016206, 81953016224, 81953016234, 81953016242, 81953016252, 81953016274, 81953016278, 81953016284, 81953016286, 81953016308, 81953016310, 81953016312, 81953016347, 81953016350, 81953016352, 82953016012, 88953016014, N2953016001



DB-RK-8581

Ø: 85
Hole Distance: 130
Thick/Height: 24
03305800A, 81432706105



MN-DL-3402

Length: 590 Ø: 48
Hole Distance: 130 / 130
03307200A, 81432206067, 81432206068, 81432206090, 81432206092, 81432209099



MN-DL-5225

Length: 572 Ø: 48
Hole Distance: 130 / 130
03301500A, 81432206229, 81432206236, 81432206267, 81432206270, 81432206272, 81432206304, 81432206305, 81432209236, 81432209267, 81432209272



MN-DL-7801

Length: 995 Ø: 52
Cone Ø: d1 Ø 30 / d2 Ø 27
81466106807, 81466106808, 81466116087, 81466116088, 81466116096, 81466116097, 81466116099, 81466116132, 81466116133, 81466116136, 81466116197, 81466116198, 81466116205

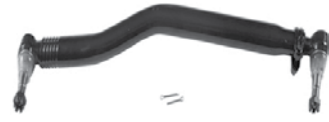

MN-DL-7802

Length: 1680 Ø: 52
Cone Ø: d1 Ø 30 / d2 Ø 27
03208300A, 81467116773, 81467116858, 81467116859, 81467116860, 81467116861, 81467116863, 81467116882, 81467116883, 81467116920, 81467116921



MN-DL-8544

Length: 596 Ø: 48
Hole Distance: 130 / 130
81432206196, 81432206232, 81432206233



MN-DL-8560

Length: 970 Ø: 52
Cone Ø: d1 Ø 30 / d2 Ø 27
03206900A, 81466106809, 81466106810, 81466106823, 81466106838, 81466106839, 81466116104, 81466116105, 81466116107, 81466116134, 81466116135, 81466116137, 81466116199, 81466116200, 81466116206



MN-DL-8609

Length: 585 Ø: 58
Hole Distance: 130 / 130
81432206070, 81432206071, 81432206072, 81432206091, 81432206093, 81432206119



MN-DL-8663

Length: 947 Ø: 60
Hole Distance: 115 / 115
03307400A, 81432206222, 81432206260, 81432206283, 81432206284



MN-DL-10288

81432206386, 82432206008, 82432209008

No Image

MN-DL-12288

Length: 585 Ø: 58
Hole Distance: 130 / 130
81432206386, 82432206008, 82432209008

No Image

MN-ES-10333

Length: 90
Cone Ø: d1 Ø 38 / d2 Ø 34,35
Thread: M36 x 1,5 RHT
1271126, 3090291, 3099128, 42538048, 81953016268, 82953016018, 82953016019



MN-RK-12436

Ø: 75
Hole Distance: 115
Thick/Height: 24
81432206244



MN-VB-5222

Length: 627 Ø: 50
Hole Distance: 152 / 152
81432706030, 81432706034, 81432706054, 81432706055, 81432706056, 81432706057, 81432706067, 81432706068, 81432706074, 81432706075, 81432706076, 81432706077, 81432706078, 81432706081, 81432706082, 81432709034, 81432709076, 81432709078, 8143706054



MN-VB-5238

Length: 627 Ø: 48
Hole Distance: 130 / 130
81432206221, 81432706096, 81432706114, 81432706116, 81432706121



MN-VB-8514

Length: 627 Ø: 48
Hole Ø 25 / 25 / 25
Hole Distance: 152 / 130 / 130
81432706087, 81432706088, 81432706094, 81432706095, 81432796094



MN-VB-8669

Length: 627 Ø: 48
Hole Ø 25 / 25 / 25
Hole Distance: 152 / 130 / 130
81432706116, 81432706137, 81432706150, 81432706151



MN-VB-9404

Length: 627 Ø: 58
Hole Distance: 130 / 130
81432706117, 81432706152, 81432706153



SC-ES-7279

Length: 150
Cone Ø: d1 Ø 30 / d2 Ø 27
Thread: M30 x 1,5 RHT
81953016288



SC-ES-8517

Length: 140
Cone Ø: d1 Ø 30 / d2 Ø 27
Thread: M30 x 1,5 RHT
81953016286



SC-ES-8535

Length: 145
Cone Ø: d1 Ø 30 / d2 Ø 27
Thread: M30 x 1,5 RHT
81953016271, 81953016325



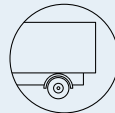

TGA ...

33.360 FDC-TM, FDRM-TM, FDR-TM, FD-TM	09/07→	Centre Rod	MN-DL-7801		Push Rod	
	09/07→	Suspension Arm Repair Kit		CV-RK-5313	for Wishbone (CV)	
	09/07→	Tie Rod	MN-DL-7802			
	09/07→	Tie Rod End	CV-ES-0914		for Steering Rod	
	09/07→	Tie Rod End	CV-ES-14162		for Steering Rod	
	09/07→	Tie Rod End	CV-ES-14163		for Steering Rod	
	09/07→	Tie Rod End	SC-ES-7279		for Steering Rod	
	09/07→	Tie Rod End	SC-ES-8517		for Push Rod	
	09/07→	Tie Rod End	SC-ES-8535		for Guide Rod	
	09/07→	Track Control Arm		MN-DL-8544	Trailing Arm	
	09/07→	Track Control Arm		MN-VB-8514	Suspension Rod, Wishbone (CV)	
	09/07→	Track Control Arm		MN-VB-8669	Suspension Rod, Wishbone (CV)	
	09/07→	Track Control Arm		MN-VB-9404	Wishbone (CV)	
	33.360 FDK, FDK-WW, FDLK, FDRK-WW	01/01→03/03	Track Control Arm		MN-DL-8609	Trailing Arm, Leaf Spring Axle; Double Axle with two Driven Axles
		01/01→	Ball Head, gearshift linkage	CV-ES-2120		
01/01→		Centre Rod	MN-DL-7801		Push Rod, Leaf Spring Axle	
01/01→		Centre Rod	MN-DL-8560		Push Rod, Air Suspension Axle	
01/01→		Suspension Strut Repair Kit		DB-RK-8581		
01/01→		Suspension Strut Repair Kit		MN-RK-12436		
01/01→		Tie Rod	MN-DL-7802			
01/01→		Tie Rod End	CV-ES-0914		for Steering Rod	
01/01→		Tie Rod End	CV-ES-14162		for Steering Rod	
01/01→		Tie Rod End	CV-ES-14163		for Steering Rod	
01/01→		Tie Rod End	SC-ES-7279		for Steering Rod	
01/01→		Tie Rod End	SC-ES-8517		for Push Rod	
01/01→		Tie Rod End	SC-ES-8535		for Guide Rod	
01/01→		Track Control Arm		MN-DL-3402	Trailing Arm, Air Suspension Axle; Drive Axle	
01/01→		Track Control Arm		MN-DL-5225	Trailing Arm, Drive Axle; Air Suspension Axle	
01/01→		Track Control Arm		MN-DL-8544	Trailing Arm, Drive Axle; Air Suspension Axle	
01/01→		Track Control Arm		MN-DL-8544	Trailing Arm, Drive Axle; Leaf Spring Axle	
01/01→		Track control arm		MN-DL-10288	Trailing Arm, 1st RA; 2nd RA, for Leaf-Spring Suspension vehicles	
01/01→		Track control arm		MN-DL-12288	Trailing Arm	
01/01→		Track Control Arm		MN-VB-5222	Wishbone (CV), 1st RA; 2nd RA, for Pneumatic Suspension vehicles	
01/01→		Track Control Arm		MN-VB-5238	Wishbone (CV), Drive Axle; Air Suspension Axle	
01/01→		Track Control Arm		MN-VB-8514	Suspension Rod, Wishbone (CV), Drive Axle; Leaf Spring Axle	
01/01→		Track Control Arm		MN-VB-8669	Suspension Rod, Wishbone (CV), Drive Axle	
01/01→		Track Control Arm		MN-VB-8669	Suspension Rod, Wishbone (CV), Drive Axle; Leaf Spring Axle	
01/01→		Track Control Arm		MN-VB-9404	Wishbone (CV), Drive Axle	
01/01→		Track Control Arm		MN-VB-9404	Wishbone (CV), Drive Axle; Air Suspension Axle	
01/01→		Track Control Arm		MN-VB-9404	Wishbone (CV), Drive Axle; Leaf Spring Axle	
01/01→		Track Control Arm	MN-DL-8663		Control Arm, Air Suspension Axle	
33.360 FDLRS, FDLS, FDRS, FDS		10/00→03/03	Track Control Arm		MN-DL-8609	Trailing Arm, Leaf Spring Axle; Double Axle with two Driven Axles
		10/00→	Ball Head, gearshift linkage	CV-ES-2120		
	10/00→	Centre Rod	MN-DL-7801		Push Rod, Leaf Spring Axle	
	10/00→	Centre Rod	MN-DL-8560		Push Rod, Air Suspension Axle	
	10/00→	Suspension Strut Repair Kit		DB-RK-8581		
	10/00→	Suspension Strut Repair Kit		MN-RK-12436		
	10/00→	Tie Rod	MN-DL-7802			
	10/00→	Tie Rod End	CV-ES-0914		for Steering Rod	
	10/00→	Tie Rod End	CV-ES-14162		for Steering Rod	
	10/00→	Tie Rod End	CV-ES-14163		for Steering Rod	
	10/00→	Tie Rod End	SC-ES-7279		for Steering Rod	
	10/00→	Tie Rod End	SC-ES-8517		for Push Rod	
	10/00→	Tie Rod End	SC-ES-8535		for Guide Rod	
	10/00→	Track Control Arm		MN-DL-3402	Trailing Arm, Air Suspension Axle; Drive Axle	
	10/00→	Track Control Arm		MN-DL-5225	Trailing Arm, Drive Axle; Air Suspension Axle	
10/00→	Track Control Arm		MN-DL-8544	Trailing Arm, Drive Axle; Air Suspension Axle		

CV-ES-0914

Length: 125
Cone Ø: d1 Ø 30 / d2 Ø 27
Thread: M38 x 1,5 RHT
81953016184, 81953016251, 81953016276



CV-ES-2120

Length: 115
Cone Ø: d1 Ø 12,4 / d2 Ø 10,8
Thread: M14 x 1,5 RHT
03008500A, 81953016200, 81953016202,
81953016203, 81953016227



CV-ES-14162

Length: 125
Cone Ø: d1 Ø 30 / d2 Ø 27
Thread: M30 x 1,5 LHT
81953010015, 81953010083, 81953010087,
81953016029, 81953016030, 81953016043,
81953016044, 81953016050, 81953016054,
81953016087, 81953016091, 81953016107,
81953016120, 81953016125, 81953016152,
81953016155, 81953016157, 81953016168,
81953016179, 81953016181, 81953016223,
81953016237, 81953016254, 81953016275,
81953016279, 81953016351



CV-ES-14163

Length: 125
Cone Ø: d1 Ø 30 / d2 Ø 27
Thread: M30 x 1,5 RHT
95301.0084, 90804102156, 90804102272,
90804102696, 90804102710, 81953010016,
81953010075, 81953010084, 81953010088,
81953010094, 81953010103, 81953016030,
81953016043, 81953016048, 81953016049,
81953016053, 81953016061, 81953016090,
81953016108, 81953016112, 81953016126,
81953016143, 81953016149, 81953016154,
81953016156, 81953016168, 81953016178,
81953016194, 81953016206, 81953016224,
81953016234, 81953016242, 81953016252,
81953016274, 81953016278, 81953016284,
81953016286, 81953016308, 81953016310,
81953016312, 81953016347, 81953016350,
81953016352, 82953016012, 88953016014,
N2953016001



CV-RK-5313

Ø: 90
03304800A, 81953016132



DB-RK-8581

Ø: 85
Hole Distance: 130
Thick/Height: 24
03305800A, 81432706105



MN-DL-3402

Length: 590 Ø: 48
Hole Distance: 130 / 130
03307200A, 81432206067, 81432206068,
81432206090, 81432206092, 81432209092



MN-DL-5225

Length: 572 Ø: 48
Hole Distance: 130 / 130
03301500A, 81432206229, 81432206236,
81432206267, 81432206270, 81432206272,
81432206304, 81432206305, 81432209236,
81432209267, 81432209272



MN-DL-7801

Length: 995 Ø: 52
Cone Ø: d1 Ø 30 / d2 Ø 27
81466106807, 81466106808, 81466116087,
81466116088, 81466116096, 81466116097,
81466116099, 81466116132, 81466116133,
81466116136, 81466116197, 81466116198,
81466116205

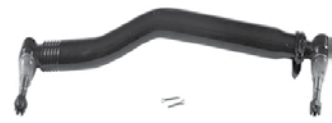

MN-DL-7802

Length: 1680 Ø: 52
Cone Ø: d1 Ø 30 / d2 Ø 27
03208300A, 81467116773, 81467116858,
81467116859, 81467116860, 81467116861,
81467116863, 81467116882, 81467116883,
81467116920, 81467116921



MN-DL-8544

Length: 596 Ø: 48
Hole Distance: 130 / 130
81432206196, 81432206232, 81432206233



MN-DL-8560

Length: 970 Ø: 52
Cone Ø: d1 Ø 30 / d2 Ø 27
03206900A, 81466106809, 81466106810,
81466106823, 81466106838, 81466106839,
81466116104, 81466116105, 81466116107,
81466116134, 81466116135, 81466116137,
81466116199, 81466116200, 81466116206



MN-DL-8609

Length: 585 Ø: 58
Hole Distance: 130 / 130
81432206070, 81432206071, 81432206072,
81432206091, 81432206093, 81432206119



MN-DL-8663

Length: 947 Ø: 60
Hole Distance: 115 / 115
03307400A, 81432206222, 81432206260,
81432206283, 81432206284



MN-DL-10288

81432206386, 82432206008, 82432209008

No Image

MN-DL-12288

Length: 585 Ø: 58
Hole Distance: 130 / 130
81432206386, 82432206008, 82432209008

No Image

MN-RK-12436

Ø: 75
Hole Distance: 115
Thick/Height: 24
81432206244



MN-VB-5222

Length: 627 Ø: 50
Hole Distance: 152 / 152
81432706030, 81432706034, 81432706054,
81432706055, 81432706056, 81432706057,
81432706067, 81432706068, 81432706074,
81432706075, 81432706076, 81432706077,
81432706078, 81432706081, 81432706082,
81432709034, 81432709076, 81432709078,
8143706054



MN-VB-5238

Length: 627 Ø: 48
Hole Distance: 130 / 130
81432206221, 81432706096, 81432706114,
81432706116, 81432706121



MN-VB-8514

Length: 627 Ø: 48
Hole Ø 25 / 25 / 25
Hole Distance: 152 / 130 / 130
81432706087, 81432706088, 81432706094,
81432706095, 81432796094



MN-VB-8669

Length: 627 Ø: 48
Hole Ø 25 / 25 / 25
Hole Distance: 152 / 130 / 130
81432706116, 81432706137, 81432706150,
81432706151



MN-VB-9404

Length: 627 Ø: 58
Hole Distance: 130 / 130
81432706117, 81432706152, 81432706153



SC-ES-7279

Length: 150
Cone Ø: d1 Ø 30 / d2 Ø 27
Thread: M30 x 1,5 RHT
81953016288



SC-ES-8517

Length: 140
Cone Ø: d1 Ø 30 / d2 Ø 27
Thread: M30 x 1,5 RHT
81953016286



SC-ES-8535

Length: 145
Cone Ø: d1 Ø 30 / d2 Ø 27
Thread: M30 x 1,5 RHT
81953016271, 81953016325





TGA ...

33.360 FDLRS, FDLS, FDRS, FDS ...	10/00→	Track Control Arm		MN-DL-8544	Trailing Arm, Drive Axle;Leaf Spring Axle
	10/00→	Track control arm		MN-DL-10288	Trailing Arm, 1st RA;2nd RA, for Leaf-Spring Suspension vehicles
	10/00→	Track control arm		MN-DL-12288	Trailing Arm
	10/00→	Track Control Arm		MN-VB-5222	Wishbone (CV), 1st RA;2nd RA, for Pneumatic Suspension vehicles
	10/00→	Track Control Arm		MN-VB-5238	Wishbone (CV), Drive Axle;Air Suspension Axle
	10/00→	Track Control Arm		MN-VB-8514	Suspension Rod, Wishbone (CV), Drive Axle; Leaf Spring Axle
	10/00→	Track Control Arm		MN-VB-8669	Suspension Rod, Wishbone (CV), Drive Axle
	10/00→	Track Control Arm		MN-VB-8669	Suspension Rod, Wishbone (CV), Drive Axle; Leaf Spring Axle
	10/00→	Track Control Arm		MN-VB-9404	Wishbone (CV), Drive Axle
	10/00→	Track Control Arm		MN-VB-9404	Wishbone (CV), Drive Axle;Air Suspension Axle
	10/00→	Track Control Arm		MN-VB-9404	Wishbone (CV), Drive Axle;Leaf Spring Axle
	10/00→	Track Control Arm	MN-DL-8663		Control Arm, Air Suspension Axle
	33.360 FD-TM, FDR-TM, FDC-TM, FDRS-TM	01/01→	Ball Head, gearshift linkage	CV-ES-2120	
01/01→		Centre Rod	MN-DL-7801		Push Rod, Leaf Spring Axle
01/01→		Suspension Strut Repair Kit		DB-RK-8581	
01/01→		Tie Rod	MN-DL-7802		
01/01→		Tie Rod End	CV-ES-0914		for Steering Rod
01/01→		Tie Rod End	CV-ES-14162		for Steering Rod
01/01→		Tie Rod End	CV-ES-14163		for Steering Rod
01/01→		Tie Rod End	SC-ES-7279		for Steering Rod
01/01→		Tie Rod End	SC-ES-8517		for Push Rod
01/01→		Tie Rod End	SC-ES-8535		for Guide Rod
01/01→		Track Control Arm		MN-DL-5225	Trailing Arm
01/01→		Track Control Arm		MN-DL-8544	Trailing Arm, 1st RA;2nd RA, for Leaf-Spring Suspension vehicles
01/01→		Track control arm		MN-DL-10288	Trailing Arm, 1st RA;2nd RA, for Leaf-Spring Suspension vehicles
01/01→		Track control arm		MN-DL-12288	Trailing Arm
01/01→		Track Control Arm		MN-VB-8514	Suspension Rod, Wishbone (CV), Drive Axle; Leaf Spring Axle
01/01→		Track Control Arm		MN-VB-8669	Suspension Rod, Wishbone (CV), Drive Axle; Leaf Spring Axle
01/01→		Track Control Arm		MN-VB-9404	Wishbone (CV), Drive Axle
33.390, 33.400 FDAC, FDHC	06/05→	Centre Rod	MN-DL-7801		Push Rod, Leaf Spring Axle
	06/05→	Suspension Strut Repair Kit		DB-RK-8581	
	06/05→	Tie Rod	MN-DL-7802		
	06/05→	Tie Rod End	CV-ES-0914		for Steering Rod
	06/05→	Tie Rod End	CV-ES-14162		for Steering Rod
	06/05→	Tie Rod End	CV-ES-14163		for Steering Rod
	06/05→	Tie Rod End	MN-ES-10333		for Steering Rod
	06/05→	Tie Rod End	SC-ES-7279		for Steering Rod
	06/05→	Tie Rod End	SC-ES-8517		for Push Rod
	06/05→	Tie Rod End	SC-ES-8535		for Guide Rod
	06/05→	Track Control Arm		MN-DL-5225	Trailing Arm
	06/05→	Track Control Arm		MN-DL-8544	Trailing Arm, 1st RA;2nd RA;Leaf Spring Axle
	06/05→	Track Control Arm		MN-DL-8544	Trailing Arm, Drive Axle;Leaf Spring Axle
	06/05→	Track Control Arm		MN-DL-8609	Trailing Arm, 1st RA;2nd RA, for Leaf-Spring Suspension vehicles, →Type_HB Chassis
	06/05→	Track control arm		MN-DL-10288	Trailing Arm, 1st RA;2nd RA, for Leaf-Spring Suspension vehicles, →Type HB
	06/05→	Track control arm		MN-DL-12288	Trailing Arm
	06/05→	Track Control Arm		MN-VB-8514	Suspension Rod, Wishbone (CV), Drive Axle; Leaf Spring Axle
	06/05→	Track Control Arm		MN-VB-8669	Suspension Rod, Wishbone (CV), Drive Axle; Leaf Spring Axle
	06/05→	Track Control Arm		MN-VB-9404	Wishbone (CV), Drive Axle

CV-ES-0914

Length: 125
Cone Ø: d1 Ø 30 / d2 Ø 27
Thread: M38 x 1,5 RHT
81953016184, 81953016251, 81953016276



CV-ES-2120

Length: 115
Cone Ø: d1 Ø 12,4 / d2 Ø 10,8
Thread: M14 x 1,5 RHT
03008500A, 81953016200, 81953016202, 81953016203, 81953016227



CV-ES-14162

Length: 125
Cone Ø: d1 Ø 30 / d2 Ø 27
Thread: M30 x 1,5 LHT
81953010015, 81953010083, 81953010087, 81953016029, 81953016030, 81953016043, 81953016044, 81953016050, 81953016054, 81953016087, 81953016091, 81953016107, 81953016120, 81953016125, 81953016152, 81953016155, 81953016157, 81953016168, 81953016179, 81953016181, 81953016223, 81953016237, 81953016254, 81953016275, 81953016279, 81953016351



CV-ES-14163

Length: 125
Cone Ø: d1 Ø 30 / d2 Ø 27
Thread: M30 x 1,5 RHT
95301.0084, 90804102156, 90804102272, 90804102696, 90804102710, 81953010016, 81953010075, 81953010084, 81953010088, 81953010094, 81953010103, 81953016030, 81953016043, 81953016048, 81953016049, 81953016053, 81953016061, 81953016090, 81953016108, 81953016112, 81953016126, 81953016143, 81953016149, 81953016154, 81953016156, 81953016168, 81953016178, 81953016194, 81953016206, 81953016224, 81953016234, 81953016242, 81953016252, 81953016274, 81953016278, 81953016284, 81953016286, 81953016308, 81953016310, 81953016312, 81953016347, 81953016350, 81953016352, 82953016012, 88953016014, N2953016001



DB-RK-8581

Ø: 85
Hole Distance: 130
Thick/Height: 24
03305800A, 81432706105



MN-DL-5225

Length: 572 Ø: 48
Hole Distance: 130 / 130
03301500A, 81432206229, 81432206236, 81432206267, 81432206270, 81432206272, 81432206304, 81432206305, 81432209236, 81432209267, 81432209272



MN-DL-7801

Length: 995 Ø: 52
Cone Ø: d1 Ø 30 / d2 Ø 27
81466106807, 81466106808, 81466116087, 81466116088, 81466116096, 81466116097, 81466116099, 81466116132, 81466116133, 81466116136, 81466116197, 81466116198, 81466116205

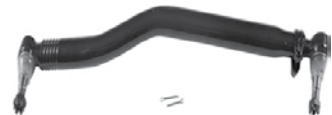

MN-DL-7802

Length: 1680 Ø: 52
Cone Ø: d1 Ø 30 / d2 Ø 27
03208300A, 81467116773, 81467116858, 81467116859, 81467116860, 81467116861, 81467116863, 81467116882, 81467116883, 81467116920, 81467116921



MN-DL-8544

Length: 596 Ø: 48
Hole Distance: 130 / 130
81432206196, 81432206232, 81432206233



MN-DL-8609

Length: 585 Ø: 58
Hole Distance: 130 / 130
81432206070, 81432206071, 81432206072, 81432206091, 81432206093, 81432206119



MN-DL-8663

Length: 947 Ø: 60
Hole Distance: 115 / 115
03307400A, 81432206222, 81432206260, 81432206283, 81432206284



MN-DL-10288

81432206386, 82432206008, 82432209008



MN-DL-12288

Length: 585 Ø: 58
Hole Distance: 130 / 130
81432206386, 82432206008, 82432209008



MN-ES-10333

Length: 90
Cone Ø: d1 Ø 38 / d2 Ø 34,35
Thread: M36 x 1,5 RHT
1271126, 3090291, 3099128, 42538048, 81953016268, 82953016018, 82953016019



MN-VB-5222

Length: 627 Ø: 50
Hole Distance: 152 / 152
81432706030, 81432706034, 81432706054, 81432706055, 81432706056, 81432706057, 81432706067, 81432706068, 81432706074, 81432706075, 81432706076, 81432706077, 81432706078, 81432706081, 81432706082, 81432709034, 81432709076, 81432709078, 8143706054



MN-VB-5238

Length: 627 Ø: 48
Hole Distance: 130 / 130
81432206221, 81432706096, 81432706114, 81432706116, 81432706121



MN-VB-8514

Length: 627 Ø: 48
Hole Ø 25 / 25 / 25
Hole Distance: 152 / 130 / 130
81432706087, 81432706088, 81432706094, 81432706095, 81432796094



MN-VB-8669

Length: 627 Ø: 48
Hole Ø 25 / 25 / 25
Hole Distance: 152 / 130 / 130
81432706116, 81432706137, 81432706150, 81432706151



MN-VB-9404

Length: 627 Ø: 58
Hole Distance: 130 / 130
81432706117, 81432706152, 81432706153



SC-ES-7279

Length: 150
Cone Ø: d1 Ø 30 / d2 Ø 27
Thread: M30 x 1,5 RHT
81953016288



SC-ES-8517

Length: 140
Cone Ø: d1 Ø 30 / d2 Ø 27
Thread: M30 x 1,5 RHT
81953016286



SC-ES-8535

Length: 145
Cone Ø: d1 Ø 30 / d2 Ø 27
Thread: M30 x 1,5 RHT
81953016271, 81953016325



No Image





TGA ...

33.390, 33.400 FDAK, FDARK, FDHK	06/05→	Centre Rod	MN-DL-7801		Push Rod, Leaf Spring Axle
	06/05→	Suspension Strut Repair Kit		DB-RK-8581	
	06/05→	Tie Rod	MN-DL-7802		
	06/05→	Tie Rod End	CV-ES-0914		for Steering Rod
	06/05→	Tie Rod End	CV-ES-14162		for Steering Rod
	06/05→	Tie Rod End	CV-ES-14163		for Steering Rod
	06/05→	Tie Rod End	MN-ES-10333		for Steering Rod
	06/05→	Tie Rod End	SC-ES-7279		for Steering Rod
	06/05→	Tie Rod End	SC-ES-8517		for Push Rod
	06/05→	Tie Rod End	SC-ES-8535		for Guide Rod
	06/05→	Track Control Arm		MN-DL-5225	Trailing Arm
	06/05→	Track Control Arm		MN-DL-8544	Trailing Arm, 1st RA;2nd RA;Leaf Spring Axle
	06/05→	Track Control Arm		MN-DL-8544	Trailing Arm, Drive Axle;Leaf Spring Axle
	06/05→	Track Control Arm		MN-DL-8609	Trailing Arm, 1st RA;2nd RA, for Leaf-Spring Suspension vehicles, →Type_HB Chassis
	06/05→	Track control arm		MN-DL-10288	Trailing Arm, 1st RA;2nd RA, for Leaf-Spring Suspension vehicles, →Type HB
	06/05→	Track control arm		MN-DL-12288	Trailing Arm
	06/05→	Track Control Arm		MN-VB-8514	Suspension Rod, Wishbone (CV), Drive Axle; Leaf Spring Axle
	06/05→	Track Control Arm		MN-VB-8669	Suspension Rod, Wishbone (CV), Drive Axle; Leaf Spring Axle
	06/05→	Track Control Arm		MN-VB-9404	Wishbone (CV), Drive Axle
	33.390, 33.400 FDARS, FDAS, FDHS	06/05→	Centre Rod	MN-DL-7801	
06/05→		Suspension Strut Repair Kit		DB-RK-8581	
06/05→		Tie Rod	MN-DL-7802		
06/05→		Tie Rod End	CV-ES-0914		for Steering Rod
06/05→		Tie Rod End	CV-ES-14162		for Steering Rod
06/05→		Tie Rod End	CV-ES-14163		for Steering Rod
06/05→		Tie Rod End	MN-ES-10333		for Steering Rod
06/05→		Tie Rod End	SC-ES-7279		for Steering Rod
06/05→		Tie Rod End	SC-ES-8517		for Push Rod
06/05→		Tie Rod End	SC-ES-8535		for Guide Rod
06/05→		Track Control Arm		MN-DL-5225	Trailing Arm
06/05→		Track Control Arm		MN-DL-8544	Trailing Arm, 1st RA;2nd RA;Leaf Spring Axle
06/05→		Track Control Arm		MN-DL-8544	Trailing Arm, Drive Axle;Leaf Spring Axle
06/05→		Track Control Arm		MN-DL-8609	Trailing Arm, 1st RA;2nd RA, for Leaf-Spring Suspension vehicles, →Type_HB Chassis
06/05→		Track control arm		MN-DL-10288	Trailing Arm, 1st RA;2nd RA, for Leaf-Spring Suspension vehicles, →Type HB
06/05→		Track control arm		MN-DL-12288	Trailing Arm
06/05→		Track Control Arm		MN-VB-8514	Suspension Rod, Wishbone (CV), Drive Axle; Leaf Spring Axle
06/05→		Track Control Arm		MN-VB-8669	Suspension Rod, Wishbone (CV), Drive Axle; Leaf Spring Axle
06/05→		Track Control Arm		MN-VB-9404	Wishbone (CV), Drive Axle
33.390, 33.400 FDC, FDLC, FDRC, FDLRC		05/04→	Centre Rod	MN-DL-7801	
	05/04→	Suspension Strut Repair Kit		DB-RK-8581	
	05/04→	Tie Rod	MN-DL-7802		
	05/04→	Tie Rod	MN-DL-12293		
	05/04→	Tie Rod End	CV-ES-0914		for Steering Rod
	05/04→	Tie Rod End	CV-ES-14162		for Steering Rod
	05/04→	Tie Rod End	CV-ES-14163		for Steering Rod
	05/04→	Tie Rod End	SC-ES-7279		for Steering Rod
	05/04→	Tie Rod End	SC-ES-8517		for Push Rod
	05/04→	Tie Rod End	SC-ES-8535		for Guide Rod
	05/04→	Track Control Arm		MN-DL-3402	Trailing Arm, 1st RA;2nd RA, for Pneumatic Suspension vehicles
	05/04→	Track Control Arm		MN-DL-5225	Trailing Arm
	05/04→	Track Control Arm		MN-DL-8544	Trailing Arm, Drive Axle;Leaf Spring Axle
	05/04→	Track control arm		MN-DL-10288	Trailing Arm, 1st RA;2nd RA, for Leaf-Spring Suspension vehicles
	05/04→	Track control arm		MN-DL-12288	Trailing Arm

CV-ES-0914

Length: 125
Cone Ø: d1 Ø 30 / d2 Ø 27
Thread: M38 x 1,5 RHT
81953016184, 81953016251, 81953016276



CV-ES-14162

Length: 125
Cone Ø: d1 Ø 30 / d2 Ø 27
Thread: M30 x 1,5 LHT
81953010015, 81953010083, 81953010087, 81953016029, 81953016030, 81953016043, 81953016044, 81953016050, 81953016054, 81953016087, 81953016091, 81953016107, 81953016120, 81953016125, 81953016152, 81953016155, 81953016157, 81953016168, 81953016179, 81953016181, 81953016223, 81953016237, 81953016254, 81953016275, 81953016279, 81953016351

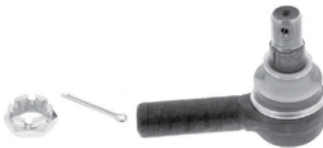

CV-ES-14163

Length: 125
Cone Ø: d1 Ø 30 / d2 Ø 27
Thread: M30 x 1,5 RHT
95301.0084, 90804102156, 90804102272, 90804102696, 90804102710, 81953010016, 81953010075, 81953010084, 81953010088, 81953010094, 81953010103, 81953016030, 81953016043, 81953016048, 81953016049, 81953016053, 81953016061, 81953016090, 81953016108, 81953016112, 81953016126, 81953016143, 81953016149, 81953016154, 81953016156, 81953016168, 81953016178, 81953016194, 81953016206, 81953016224, 81953016234, 81953016242, 81953016252, 81953016274, 81953016278, 81953016284, 81953016286, 81953016308, 81953016310, 81953016312, 81953016347, 81953016350, 81953016352, 82953016012, 88953016014, N2953016001



DB-RK-8581

Ø: 85
Hole Distance: 130
Thick/Height: 24
03305800A, 81432706105



MN-DL-3402

Length: 590 Ø: 48
Hole Distance: 130 / 130
03307200A, 81432206067, 81432206068, 81432206090, 81432206092, 81432209092



MN-DL-5225

Length: 572 Ø: 48
Hole Distance: 130 / 130
03301500A, 81432206229, 81432206236, 81432206267, 81432206270, 81432206272, 81432206304, 81432206305, 81432209236, 81432209267, 81432209272



MN-DL-7801

Length: 995 Ø: 52
Cone Ø: d1 Ø 30 / d2 Ø 27
81466106807, 81466106808, 81466116087, 81466116088, 81466116096, 81466116097, 81466116099, 81466116132, 81466116133, 81466116136, 81466116197, 81466116198, 81466116205

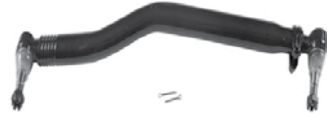

MN-DL-7802

Length: 1680 Ø: 52
Cone Ø: d1 Ø 30 / d2 Ø 27
03208300A, 81467116773, 81467116858, 81467116859, 81467116860, 81467116861, 81467116863, 81467116882, 81467116883, 81467116920, 81467116921



MN-DL-8544

Length: 596 Ø: 48
Hole Distance: 130 / 130
81432206196, 81432206232, 81432206233



MN-DL-8609

Length: 585 Ø: 58
Hole Distance: 130 / 130
81432206070, 81432206071, 81432206072, 81432206091, 81432206093, 81432206119



MN-DL-10288

81432206386, 82432206008, 82432209008

No Image

MN-DL-12288

Length: 585 Ø: 58
Hole Distance: 130 / 130
81432206386, 82432206008, 82432209008

No Image

MN-DL-12293

Length: 1680 Ø: 42
Cone Ø: d1 Ø 30 / d2 Ø 27
81467106236, 81467106268, 81467106356, 81467116356, 81467116723, 81467116794, 81467116933, 81467116934, 81467116966



MN-ES-10333

Length: 90
Cone Ø: d1 Ø 38 / d2 Ø 34,35
Thread: M36 x 1,5 RHT
1271126, 3090291, 3099128, 42538048, 81953016268, 82953016018, 82953016019



MN-VB-8514

Length: 627 Ø: 48
Hole Ø 25 / 25 / 25
Hole Distance: 152 / 130 / 130
81432706087, 81432706088, 81432706094, 81432706095, 81432796094



MN-VB-8669

Length: 627 Ø: 48
Hole Ø 25 / 25 / 25
Hole Distance: 152 / 130 / 130
81432706116, 81432706137, 81432706150, 81432706151



MN-VB-9404

Length: 627 Ø: 58
Hole Distance: 130 / 130
81432706117, 81432706152, 81432706153



SC-ES-7279

Length: 150
Cone Ø: d1 Ø 30 / d2 Ø 27
Thread: M30 x 1,5 RHT
81953016288



SC-ES-8517

Length: 140
Cone Ø: d1 Ø 30 / d2 Ø 27
Thread: M30 x 1,5 RHT
81953016286



SC-ES-8535

Length: 145
Cone Ø: d1 Ø 30 / d2 Ø 27
Thread: M30 x 1,5 RHT
81953016271, 81953016325



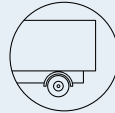

TGA ...

33.390, 33.400 FDC, FDLC, FDRC, FDLRC ...	05/04 →	Track Control Arm		MN-VB-5222	Wishbone (CV), 1st RA;2nd RA, for Pneumatic Suspension vehicles	
	05/04 →	Track Control Arm		MN-VB-5238	Wishbone (CV), 1st RA;2nd RA, for Pneumatic Suspension vehicles, →Type_NBA Chassis	
	05/04 →	Track Control Arm		MN-VB-8514	Suspension Rod, Wishbone (CV), Drive Axle; Leaf Spring Axle	
	05/04 →	Track Control Arm		MN-VB-8669	Suspension Rod, Wishbone (CV), Drive Axle; Leaf Spring Axle	
	05/04 →	Track Control Arm		MN-VB-9404	Wishbone (CV), Drive Axle	
33.390, 33.400 FDC-TM, FDRC-TM	09/07 →	Centre Rod	MN-DL-7801		Push Rod	
	09/07 →	Suspension Arm Repair Kit		CV-RK-5313	for Wishbone (CV)	
	09/07 →	Tie Rod	MN-DL-7802			
	09/07 →	Tie Rod End	CV-ES-0914		for Steering Rod	
	09/07 →	Tie Rod End	CV-ES-14162		for Steering Rod	
	09/07 →	Tie Rod End	CV-ES-14163		for Steering Rod	
	09/07 →	Tie Rod End	SC-ES-7279		for Steering Rod	
	09/07 →	Tie Rod End	SC-ES-8517		for Push Rod	
	09/07 →	Tie Rod End	SC-ES-8535		for Guide Rod	
	09/07 →	Track Control Arm		MN-DL-8544	Trailing Arm	
	09/07 →	Track Control Arm		MN-VB-8514	Suspension Rod, Wishbone (CV)	
	09/07 →	Track Control Arm		MN-VB-8669	Suspension Rod, Wishbone (CV)	
	33.390, 33.400 FDK, FDLK, FDRK	05/04 →	Centre Rod	MN-DL-7801		Push Rod, Leaf Spring Axle
05/04 →		Suspension Strut Repair Kit		DB-RK-8581		
05/04 →		Tie Rod	MN-DL-7802			
05/04 →		Tie Rod	MN-DL-12293			
05/04 →		Tie Rod End	CV-ES-0914		for Steering Rod	
05/04 →		Tie Rod End	CV-ES-14162		for Steering Rod	
05/04 →		Tie Rod End	CV-ES-14163		for Steering Rod	
05/04 →		Tie Rod End	SC-ES-7279		for Steering Rod	
05/04 →		Tie Rod End	SC-ES-8517		for Push Rod	
05/04 →		Tie Rod End	SC-ES-8535		for Guide Rod	
05/04 →		Track Control Arm		MN-DL-3402	Trailing Arm, 1st RA;2nd RA, for Pneumatic Suspension vehicles	
05/04 →		Track Control Arm		MN-DL-5225	Trailing Arm	
05/04 →		Track Control Arm		MN-DL-8544	Trailing Arm, Drive Axle;Leaf Spring Axle	
05/04 →		Track control arm		MN-DL-10288	Trailing Arm, 1st RA;2nd RA, for Leaf-Spring Suspension vehicles	
05/04 →		Track control arm		MN-DL-12288	Trailing Arm	
05/04 →		Track Control Arm		MN-VB-5222	Wishbone (CV), 1st RA;2nd RA, for Pneumatic Suspension vehicles	
05/04 →		Track Control Arm		MN-VB-5238	Wishbone (CV), 1st RA;2nd RA, for Pneumatic Suspension vehicles, →Type_NBA Chassis	
05/04 →		Track Control Arm		MN-VB-8514	Suspension Rod, Wishbone (CV), Drive Axle; Leaf Spring Axle	
05/04 →		Track Control Arm		MN-VB-8669	Suspension Rod, Wishbone (CV), Drive Axle; Leaf Spring Axle	
05/04 →		Track Control Arm		MN-VB-9404	Wishbone (CV), Drive Axle	
33.390, 33.400 FDS, FDLS, FDLRS, FDRS		05/04 →	Centre Rod	MN-DL-7801		Push Rod, Leaf Spring Axle
		05/04 →	Suspension Strut Repair Kit		DB-RK-8581	
		05/04 →	Tie Rod	MN-DL-7802		
		05/04 →	Tie Rod	MN-DL-12293		
		05/04 →	Tie Rod End	CV-ES-0914		for Steering Rod
		05/04 →	Tie Rod End	CV-ES-14162		for Steering Rod
		05/04 →	Tie Rod End	CV-ES-14163		for Steering Rod
	05/04 →	Tie Rod End	SC-ES-7279		for Steering Rod	
	05/04 →	Tie Rod End	SC-ES-8517		for Push Rod	
	05/04 →	Tie Rod End	SC-ES-8535		for Guide Rod	
	05/04 →	Track Control Arm		MN-DL-3402	Trailing Arm, 1st RA;2nd RA, for Pneumatic Suspension vehicles	
	05/04 →	Track Control Arm		MN-DL-5225	Trailing Arm	
	05/04 →	Track Control Arm		MN-DL-8544	Trailing Arm, Drive Axle;Leaf Spring Axle	

CV-ES-0914

Length: 125
Cone Ø: d1 Ø 30 / d2 Ø 27
Thread: M38 x 1,5 RHT
81953016184, 81953016251, 81953016276



CV-ES-14162

Length: 125
Cone Ø: d1 Ø 30 / d2 Ø 27
Thread: M30 x 1,5 LHT
81953010015, 81953010083, 81953010087, 81953016029, 81953016030, 81953016043, 81953016044, 81953016050, 81953016054, 81953016087, 81953016091, 81953016107, 81953016120, 81953016125, 81953016152, 81953016155, 81953016157, 81953016168, 81953016179, 81953016181, 81953016223, 81953016237, 81953016254, 81953016275, 81953016279, 81953016351



CV-ES-14163

Length: 125
Cone Ø: d1 Ø 30 / d2 Ø 27
Thread: M30 x 1,5 RHT
95301.0084, 90804102156, 90804102272, 90804102696, 90804102710, 81953010016, 81953010075, 81953010084, 81953010088, 81953010094, 81953010103, 81953016030, 81953016043, 81953016048, 81953016049, 81953016053, 81953016061, 81953016090, 81953016108, 81953016112, 81953016126, 81953016143, 81953016149, 81953016154, 81953016156, 81953016168, 81953016178, 81953016194, 81953016206, 81953016224, 81953016234, 81953016242, 81953016252, 81953016274, 81953016278, 81953016284, 81953016286, 81953016308, 81953016310, 81953016312, 81953016347, 81953016350, 81953016352, 82953016012, 88953016014, N2953016001



CV-RK-5313

Ø: 90
03304800A, 81953016132



DB-RK-8581

Ø: 85
Hole Distance: 130
Thick/Height: 24
03305800A, 81432706105



MN-DL-3402

Length: 590 Ø: 48
Hole Distance: 130 / 130
03307200A, 81432206067, 81432206068, 81432206090, 81432206092, 81432209099



MN-DL-5225

Length: 572 Ø: 48
Hole Distance: 130 / 130
03301500A, 81432206229, 81432206236, 81432206267, 81432206270, 81432206272, 81432206304, 81432206305, 81432209236, 81432209267, 81432209272



MN-DL-7801

Length: 995 Ø: 52
Cone Ø: d1 Ø 30 / d2 Ø 27
81466106807, 81466106808, 81466116087, 81466116088, 81466116096, 81466116097, 81466116099, 81466116132, 81466116133, 81466116136, 81466116197, 81466116198, 81466116205

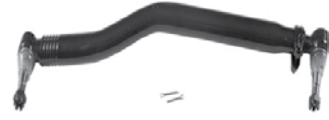

MN-DL-7802

Length: 1680 Ø: 52
Cone Ø: d1 Ø 30 / d2 Ø 27
03208300A, 81467116773, 81467116858, 81467116859, 81467116860, 81467116861, 81467116863, 81467116882, 81467116883, 81467116920, 81467116921



MN-DL-8544

Length: 596 Ø: 48
Hole Distance: 130 / 130
81432206196, 81432206232, 81432206233



MN-DL-10288

81432206386, 82432206008, 82432209008

No Image

MN-DL-12288

Length: 585 Ø: 58
Hole Distance: 130 / 130
81432206386, 82432206008, 82432209008

No Image

MN-DL-12293

Length: 1680 Ø: 42
Cone Ø: d1 Ø 30 / d2 Ø 27
81467106236, 81467106268, 81467106356, 81467116356, 81467116723, 81467116794, 81467116933, 81467116934, 81467116966



MN-VB-5222

Length: 627 Ø: 50
Hole Distance: 152 / 152
81432706030, 81432706034, 81432706054, 81432706055, 81432706056, 81432706057, 81432706067, 81432706068, 81432706074, 81432706075, 81432706076, 81432706077, 81432706078, 81432706081, 81432706082, 81432709034, 81432709076, 81432709078, 8143706054



MN-VB-5238

Length: 627 Ø: 48
Hole Distance: 130 / 130
81432206221, 81432706096, 81432706114, 81432706116, 81432706121



MN-VB-8514

Length: 627 Ø: 48
Hole Ø 25 / 25 / 25
Hole Distance: 152 / 130 / 130
81432706087, 81432706088, 81432706094, 81432706095, 81432796094



MN-VB-8669

Length: 627 Ø: 48
Hole Ø 25 / 25 / 25
Hole Distance: 152 / 130 / 130
81432706116, 81432706137, 81432706150, 81432706151



MN-VB-9404

Length: 627 Ø: 58
Hole Distance: 130 / 130
81432706117, 81432706152, 81432706153



SC-ES-7279

Length: 150
Cone Ø: d1 Ø 30 / d2 Ø 27
Thread: M30 x 1,5 RHT
81953016288



SC-ES-8517

Length: 140
Cone Ø: d1 Ø 30 / d2 Ø 27
Thread: M30 x 1,5 RHT
81953016286



SC-ES-8535

Length: 145
Cone Ø: d1 Ø 30 / d2 Ø 27
Thread: M30 x 1,5 RHT
81953016271, 81953016325





TGA ...

33.390, 33.400 FDS, FDLS, FDLRS, FDRS ...	05/04 →	Track control arm		MN-DL-10288	Trailing Arm, 1st RA;2nd RA, for Leaf-Spring Suspension vehicles
	05/04 →	Track control arm		MN-DL-12288	Trailing Arm
	05/04 →	Track Control Arm		MN-VB-5222	Wishbone (CV), 1st RA;2nd RA, for Pneumatic Suspension vehicles
	05/04 →	Track Control Arm		MN-VB-5238	Wishbone (CV), 1st RA;2nd RA, for Pneumatic Suspension vehicles, →Type_NBA Chassis
	05/04 →	Track Control Arm		MN-VB-8514	Suspension Rod, Wishbone (CV), Drive Axle; Leaf Spring Axle
	05/04 →	Track Control Arm		MN-VB-8669	Suspension Rod, Wishbone (CV), Drive Axle; Leaf Spring Axle
	05/04 →	Track Control Arm		MN-VB-9404	Wishbone (CV), Drive Axle
33.410 FDAC, FDALC, FDARC	09/02 →	Ball Head, gearshift linkage	CV-ES-2120		
	09/02 →	Centre Rod	MN-DL-7801		Push Rod
	09/02 →	Suspension Strut Repair Kit		DB-RK-8581	
	09/02 →	Tie Rod End	CV-ES-0914		for Steering Rod
	09/02 →	Tie Rod End	CV-ES-14163		for Steering Rod
	09/02 →	Tie Rod End	MN-ES-10333		for Steering Rod
	09/02 →	Tie Rod End	SC-ES-8517		for Push Rod
	09/02 →	Track Control Arm		MN-DL-5225	Trailing Arm
	09/02 →	Track Control Arm		MN-DL-8544	Trailing Arm, 1st RA;2nd RA;Leaf Spring Axle
	09/02 →	Track Control Arm		MN-DL-8544	Trailing Arm, Drive Axle;Air Suspension Axle
	09/02 →	Track Control Arm		MN-DL-8609	Trailing Arm, 1st RA;2nd RA, for Leaf-Spring Suspension vehicles, →Type_HB Chassis
	09/02 →	Track Control Arm		MN-VB-8514	Suspension Rod, Wishbone (CV), Drive Axle; Air Suspension Axle
	09/02 →	Track Control Arm		MN-VB-8514	Suspension Rod, Wishbone (CV), Drive Axle; Leaf Spring Axle
	09/02 →	Track Control Arm		MN-VB-9404	Wishbone (CV), Drive Axle
	09/02 →	Track Control Arm		MN-VB-9404	Wishbone (CV), Drive Axle;Leaf Spring Axle
33.410 FDAK, FDALK	09/02 →	Ball Head, gearshift linkage	CV-ES-2120		
	09/02 →	Centre Rod	MN-DL-7801		Push Rod
	09/02 →	Suspension Strut Repair Kit		DB-RK-8581	
	09/02 →	Tie Rod End	CV-ES-0914		for Steering Rod
	09/02 →	Tie Rod End	CV-ES-14163		for Steering Rod
	09/02 →	Tie Rod End	MN-ES-10333		for Steering Rod
	09/02 →	Tie Rod End	SC-ES-8517		for Push Rod
	09/02 →	Track Control Arm		MN-DL-5225	Trailing Arm
	09/02 →	Track Control Arm		MN-DL-8544	Trailing Arm, 1st RA;2nd RA;Leaf Spring Axle
	09/02 →	Track Control Arm		MN-DL-8544	Trailing Arm, Drive Axle;Air Suspension Axle
	09/02 →	Track Control Arm		MN-DL-8609	Trailing Arm, 1st RA;2nd RA, for Leaf-Spring Suspension vehicles, →Type_HB Chassis
	09/02 →	Track Control Arm		MN-VB-8514	Suspension Rod, Wishbone (CV), Drive Axle; Air Suspension Axle
	09/02 →	Track Control Arm		MN-VB-8514	Suspension Rod, Wishbone (CV), Drive Axle; Leaf Spring Axle
	09/02 →	Track Control Arm		MN-VB-9404	Wishbone (CV), Drive Axle
	09/02 →	Track Control Arm		MN-VB-9404	Wishbone (CV), Drive Axle;Leaf Spring Axle
33.410 FDALS, FDARS, FDAS	09/02 →	Ball Head, gearshift linkage	CV-ES-2120		
	09/02 →	Centre Rod	MN-DL-7801		Push Rod
	09/02 →	Suspension Strut Repair Kit		DB-RK-8581	
	09/02 →	Tie Rod End	CV-ES-0914		for Steering Rod
	09/02 →	Tie Rod End	CV-ES-14163		for Steering Rod
	09/02 →	Tie Rod End	MN-ES-10333		for Steering Rod
	09/02 →	Tie Rod End	SC-ES-8517		for Push Rod
	09/02 →	Track Control Arm		MN-DL-5225	Trailing Arm
	09/02 →	Track Control Arm		MN-DL-8544	Trailing Arm, 1st RA;2nd RA;Leaf Spring Axle
	09/02 →	Track Control Arm		MN-DL-8544	Trailing Arm, Drive Axle;Air Suspension Axle
	09/02 →	Track Control Arm		MN-DL-8609	Trailing Arm, 1st RA;2nd RA, for Leaf-Spring Suspension vehicles, →Type_HB Chassis
	09/02 →	Track Control Arm		MN-VB-8514	Suspension Rod, Wishbone (CV), Drive Axle; Air Suspension Axle

CV-ES-0914

Length: 125
Cone Ø: d1 Ø 30 / d2 Ø 27
Thread: M38 x 1,5 RHT
81953016184, 81953016251, 81953016276



CV-ES-2120

Length: 115
Cone Ø: d1 Ø 12,4 / d2 Ø 10,8
Thread: M14 x 1,5 RHT
03008500A, 81953016200, 81953016202, 81953016203, 81953016227



CV-ES-14163

Length: 125
Cone Ø: d1 Ø 30 / d2 Ø 27
Thread: M30 x 1,5 RHT
95301.0084, 90804102156, 90804102272, 90804102696, 90804102710, 81953010016, 81953010075, 81953010084, 81953010088, 81953010094, 81953010103, 81953016030, 81953016043, 81953016048, 81953016049, 81953016053, 81953016061, 81953016090, 81953016108, 81953016112, 81953016126, 81953016143, 81953016149, 81953016154, 81953016156, 81953016168, 81953016178, 81953016194, 81953016206, 81953016224, 81953016234, 81953016242, 81953016252, 81953016274, 81953016278, 81953016284, 81953016286, 81953016308, 81953016310, 81953016312, 81953016347, 81953016350, 81953016352, 82953016012, 88953016014, N2953016001



DB-RK-8581

Ø: 85
Hole Distance: 130
Thick/Height: 24
03305800A, 81432706105



MN-DL-5225

Length: 572 Ø: 48
Hole Distance: 130 / 130
03301500A, 81432206229, 81432206236, 81432206267, 81432206270, 81432206272, 81432206304, 81432206305, 81432209236, 81432209267, 81432209272



MN-DL-7801

Length: 995 Ø: 52
Cone Ø: d1 Ø 30 / d2 Ø 27
81466106807, 81466106808, 81466116087, 81466116088, 81466116096, 81466116097, 81466116099, 81466116132, 81466116133, 81466116136, 81466116197, 81466116198, 81466116205

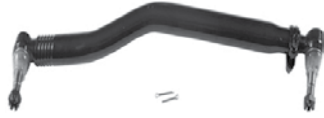

MN-DL-8544

Length: 596 Ø: 48
Hole Distance: 130 / 130
81432206196, 81432206232, 81432206233



MN-DL-8609

Length: 585 Ø: 58
Hole Distance: 130 / 130
81432206070, 81432206071, 81432206072, 81432206091, 81432206093, 81432206119



MN-DL-10288

81432206386, 82432206008, 82432209008

No Image

MN-DL-12288

Length: 585 Ø: 58
Hole Distance: 130 / 130
81432206386, 82432206008, 82432209008

No Image

MN-ES-10333

Length: 90
Cone Ø: d1 Ø 38 / d2 Ø 34,35
Thread: M36 x 1,5 RHT
1271126, 3090291, 3099128, 42538048, 81953016268, 82953016018, 82953016019



MN-VB-5222

Length: 627 Ø: 50
Hole Distance: 152 / 152
81432706030, 81432706034, 81432706054, 81432706055, 81432706056, 81432706057, 81432706067, 81432706068, 81432706074, 81432706075, 81432706076, 81432706077, 81432706078, 81432706081, 81432706082, 81432709034, 81432709076, 81432709078, 8143706054



MN-VB-5238

Length: 627 Ø: 48
Hole Distance: 130 / 130
81432206221, 81432706096, 81432706114, 81432706116, 81432706121



MN-VB-8514

Length: 627 Ø: 48
Hole Ø 25 / 25 / 25
Hole Distance: 152 / 130 / 130
81432706087, 81432706088, 81432706094, 81432706095, 81432796094



MN-VB-8669

Length: 627 Ø: 48
Hole Ø 25 / 25 / 25
Hole Distance: 152 / 130 / 130
81432706116, 81432706137, 81432706150, 81432706151



MN-VB-9404

Length: 627 Ø: 58
Hole Distance: 130 / 130
81432706117, 81432706152, 81432706153



SC-ES-8517

Length: 140
Cone Ø: d1 Ø 30 / d2 Ø 27
Thread: M30 x 1,5 RHT
81953016286





TGA ...

33.410 FDALS, FDARS, FDAS ...	09/02→	Track Control Arm		MN-VB-8514	Suspension Rod, Wishbone (CV), Drive Axle; Leaf Spring Axle	
	09/02→	Track Control Arm		MN-VB-9404	Wishbone (CV), Drive Axle	
	09/02→	Track Control Arm		MN-VB-9404	Wishbone (CV), Drive Axle;Leaf Spring Axle	
33.410 FDC, FDLC, FDLRC, FDRC	10/00→03/03	Track Control Arm		MN-DL-8609	Trailing Arm, Leaf Spring Axle;Double Axle with two Driven Axles	
	10/00→	Ball Head, gearshift linkage	CV-ES-2120			
	10/00→	Centre Rod	MN-DL-7801		Push Rod, Leaf Spring Axle	
	10/00→	Centre Rod	MN-DL-8560		Push Rod, Air Suspension Axle	
	10/00→	Suspension Strut Repair Kit		DB-RK-8581		
	10/00→	Suspension Strut Repair Kit		MN-RK-12436		
	10/00→	Tie Rod	MN-DL-7802			
	10/00→	Tie Rod End	CV-ES-0914		for Steering Rod	
	10/00→	Tie Rod End	CV-ES-14162		for Steering Rod	
	10/00→	Tie Rod End	CV-ES-14163		for Steering Rod	
	10/00→	Tie Rod End	SC-ES-7279		for Steering Rod	
	10/00→	Tie Rod End	SC-ES-8517		for Push Rod	
	10/00→	Tie Rod End	SC-ES-8535		for Guide Rod	
	10/00→	Track Control Arm		MN-DL-3402	Trailing Arm, Air Suspension Axle;Drive Axle	
	10/00→	Track Control Arm		MN-DL-5225	Trailing Arm, Drive Axle;Air Suspension Axle	
	10/00→	Track Control Arm		MN-DL-8544	Trailing Arm, Drive Axle;Air Suspension Axle	
	10/00→	Track Control Arm		MN-DL-8544	Trailing Arm, Drive Axle;Leaf Spring Axle	
	10/00→	Track control arm		MN-DL-10288	Trailing Arm, 1st RA;2nd RA, for Leaf-Spring Suspension vehicles	
	10/00→	Track control arm		MN-DL-12288	Trailing Arm	
	10/00→	Track Control Arm		MN-VB-5222	Wishbone (CV), 1st RA;2nd RA, for Pneumatic Suspension vehicles	
	10/00→	Track Control Arm		MN-VB-5238	Wishbone (CV), Drive Axle;Air Suspension Axle	
	10/00→	Track Control Arm		MN-VB-8514	Suspension Rod, Wishbone (CV), Drive Axle; Leaf Spring Axle	
	10/00→	Track Control Arm		MN-VB-8669	Suspension Rod, Wishbone (CV), Drive Axle	
	10/00→	Track Control Arm		MN-VB-8669	Suspension Rod, Wishbone (CV), Drive Axle; Leaf Spring Axle	
	10/00→	Track Control Arm		MN-VB-9404	Wishbone (CV), Drive Axle	
	10/00→	Track Control Arm		MN-VB-9404	Wishbone (CV), Drive Axle;Air Suspension Axle	
	10/00→	Track Control Arm		MN-VB-9404	Wishbone (CV), Drive Axle;Leaf Spring Axle	
	10/00→	Track Control Arm	MN-DL-8663		Control Arm, Air Suspension Axle	
	33.410 FDK, FDK-WW, FDLK, FDRK-WW	10/00→03/03	Track Control Arm		MN-DL-8609	Trailing Arm, Leaf Spring Axle;Double Axle with two Driven Axles
		10/00→	Ball Head, gearshift linkage	CV-ES-2120		
		10/00→	Centre Rod	MN-DL-7801		Push Rod, Leaf Spring Axle
		10/00→	Centre Rod	MN-DL-8560		Push Rod, Air Suspension Axle
		10/00→	Suspension Strut Repair Kit		DB-RK-8581	
10/00→		Suspension Strut Repair Kit		MN-RK-12436		
10/00→		Tie Rod	MN-DL-7802			
10/00→		Tie Rod End	CV-ES-0914		for Steering Rod	
10/00→		Tie Rod End	CV-ES-14162		for Steering Rod	
10/00→		Tie Rod End	CV-ES-14163		for Steering Rod	
10/00→		Tie Rod End	SC-ES-7279		for Steering Rod	
10/00→		Tie Rod End	SC-ES-8517		for Push Rod	
10/00→		Tie Rod End	SC-ES-8535		for Guide Rod	
10/00→		Track Control Arm		MN-DL-3402	Trailing Arm, Air Suspension Axle;Drive Axle	
10/00→		Track Control Arm		MN-DL-5225	Trailing Arm, Drive Axle;Air Suspension Axle	
10/00→		Track Control Arm		MN-DL-8544	Trailing Arm, Drive Axle;Air Suspension Axle	
10/00→		Track Control Arm		MN-DL-8544	Trailing Arm, Drive Axle;Leaf Spring Axle	
10/00→		Track control arm		MN-DL-10288	Trailing Arm, 1st RA;2nd RA, for Leaf-Spring Suspension vehicles	
10/00→		Track control arm		MN-DL-12288	Trailing Arm	
10/00→		Track Control Arm		MN-VB-5222	Wishbone (CV), 1st RA;2nd RA, for Pneumatic Suspension vehicles	
10/00→		Track Control Arm		MN-VB-5238	Wishbone (CV), Drive Axle;Air Suspension Axle	
10/00→		Track Control Arm		MN-VB-8514	Suspension Rod, Wishbone (CV), Drive Axle; Leaf Spring Axle	

CV-ES-0914

Length: 125
Cone Ø: d1 Ø 30 / d2 Ø 27
Thread: M38 x 1,5 RHT
81953016184, 81953016251, 81953016276



CV-ES-2120

Length: 115
Cone Ø: d1 Ø 12,4 / d2 Ø 10,8
Thread: M14 x 1,5 RHT
03008500A, 81953016200, 81953016202, 81953016203, 81953016227



CV-ES-14162

Length: 125
Cone Ø: d1 Ø 30 / d2 Ø 27
Thread: M30 x 1,5 LHT
81953010015, 81953010083, 81953010087, 81953016029, 81953016030, 81953016043, 81953016044, 81953016050, 81953016054, 81953016087, 81953016091, 81953016107, 81953016120, 81953016125, 81953016152, 81953016155, 81953016157, 81953016168, 81953016179, 81953016181, 81953016223, 81953016237, 81953016254, 81953016275, 81953016279, 81953016351



CV-ES-14163

Length: 125
Cone Ø: d1 Ø 30 / d2 Ø 27
Thread: M30 x 1,5 RHT
95301.0084, 90804102156, 90804102272, 90804102696, 90804102710, 81953010016, 81953010075, 81953010084, 81953010088, 81953010094, 81953010103, 81953016030, 81953016043, 81953016048, 81953016049, 81953016053, 81953016061, 81953016090, 81953016108, 81953016112, 81953016126, 81953016143, 81953016149, 81953016154, 81953016156, 81953016168, 81953016178, 81953016194, 81953016206, 81953016224, 81953016234, 81953016242, 81953016252, 81953016274, 81953016278, 81953016284, 81953016286, 81953016308, 81953016310, 81953016312, 81953016347, 81953016350, 81953016352, 82953016012, 88953016014, N2953016001



DB-RK-8581

Ø: 85
Hole Distance: 130
Thick/Height: 24
03305800A, 81432706105



MN-DL-3402

Length: 590 Ø: 48
Hole Distance: 130 / 130
03307200A, 81432206067, 81432206068, 81432206090, 81432206092, 81432209099



MN-DL-5225

Length: 572 Ø: 48
Hole Distance: 130 / 130
03301500A, 81432206229, 81432206236, 81432206267, 81432206270, 81432206272, 81432206304, 81432206305, 81432209236, 81432209267, 81432209272



MN-DL-7801

Length: 995 Ø: 52
Cone Ø: d1 Ø 30 / d2 Ø 27
81466106807, 81466106808, 81466116087, 81466116088, 81466116096, 81466116097, 81466116099, 81466116132, 81466116133, 81466116136, 81466116197, 81466116198, 81466116205

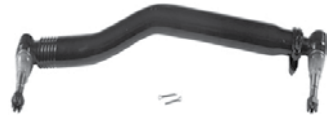

MN-DL-7802

Length: 1680 Ø: 52
Cone Ø: d1 Ø 30 / d2 Ø 27
03208300A, 81467116773, 81467116858, 81467116859, 81467116860, 81467116861, 81467116863, 81467116882, 81467116883, 81467116920, 81467116921



MN-DL-8544

Length: 596 Ø: 48
Hole Distance: 130 / 130
81432206196, 81432206232, 81432206233



MN-DL-8560

Length: 970 Ø: 52
Cone Ø: d1 Ø 30 / d2 Ø 27
03206900A, 81466106809, 81466106810, 81466106823, 81466106838, 81466106839, 81466116104, 81466116105, 81466116107, 81466116134, 81466116135, 81466116137, 81466116199, 81466116200, 81466116206



MN-DL-8609

Length: 585 Ø: 58
Hole Distance: 130 / 130
81432206070, 81432206071, 81432206072, 81432206091, 81432206093, 81432206119



MN-DL-8663

Length: 947 Ø: 60
Hole Distance: 115 / 115
03307400A, 81432206222, 81432206260, 81432206283, 81432206284



MN-DL-10288

81432206386, 82432206008, 82432209008

No Image

MN-DL-12288

Length: 585 Ø: 58
Hole Distance: 130 / 130
81432206386, 82432206008, 82432209008

No Image

MN-RK-12436

Ø: 75
Hole Distance: 115
Thick/Height: 24
81432206244



MN-VB-5222

Length: 627 Ø: 50
Hole Distance: 152 / 152
81432706030, 81432706034, 81432706054, 81432706055, 81432706056, 81432706057, 81432706067, 81432706068, 81432706074, 81432706075, 81432706076, 81432706077, 81432706078, 81432706081, 81432706082, 81432709034, 81432709076, 81432709078, 8143706054



MN-VB-5238

Length: 627 Ø: 48
Hole Distance: 130 / 130
81432206221, 81432706096, 81432706114, 81432706116, 81432706121



MN-VB-8514

Length: 627 Ø: 48
Hole Ø 25 / 25 / 25
Hole Distance: 152 / 130 / 130
81432706087, 81432706088, 81432706094, 81432706095, 81432796094



MN-VB-8669

Length: 627 Ø: 48
Hole Ø 25 / 25 / 25
Hole Distance: 152 / 130 / 130
81432706116, 81432706137, 81432706150, 81432706151



MN-VB-9404

Length: 627 Ø: 58
Hole Distance: 130 / 130
81432706117, 81432706152, 81432706153



SC-ES-7279

Length: 150
Cone Ø: d1 Ø 30 / d2 Ø 27
Thread: M30 x 1,5 RHT
81953016288



SC-ES-8517

Length: 140
Cone Ø: d1 Ø 30 / d2 Ø 27
Thread: M30 x 1,5 RHT
81953016286



SC-ES-8535

Length: 145
Cone Ø: d1 Ø 30 / d2 Ø 27
Thread: M30 x 1,5 RHT
81953016271, 81953016325





TGA ...

33.410 FDK, FDK-WW, FDLK, FDRK-WW ...	10/00→	Track Control Arm		MN-VB-8669	Suspension Rod, Wishbone (CV), Drive Axle	
	10/00→	Track Control Arm		MN-VB-8669	Suspension Rod, Wishbone (CV), Drive Axle; Leaf Spring Axle	
	10/00→	Track Control Arm		MN-VB-9404	Wishbone (CV), Drive Axle	
	10/00→	Track Control Arm		MN-VB-9404	Wishbone (CV), Drive Axle;Air Suspension Axle	
	10/00→	Track Control Arm		MN-VB-9404	Wishbone (CV), Drive Axle;Leaf Spring Axle	
	10/00→	Track Control Arm	MN-DL-8663		Control Arm, Air Suspension Axle	
33.410 FDLRS, FDLS, FDRS, FDS	10/00→03/03	Track Control Arm		MN-DL-8609	Trailing Arm, Leaf Spring Axle;Double Axle with two Driven Axles	
	10/00→	Ball Head, gearshift linkage	CV-ES-2120			
	10/00→	Centre Rod	MN-DL-7801		Push Rod, Leaf Spring Axle	
	10/00→	Centre Rod	MN-DL-8560		Push Rod, Air Suspension Axle	
	10/00→	Suspension Strut Repair Kit		DB-RK-8581		
	10/00→	Suspension Strut Repair Kit		MN-RK-12436		
	10/00→	Tie Rod	MN-DL-7802			
	10/00→	Tie Rod End	CV-ES-0914		for Steering Rod	
	10/00→	Tie Rod End	CV-ES-14162		for Steering Rod	
	10/00→	Tie Rod End	CV-ES-14163		for Steering Rod	
	10/00→	Tie Rod End	SC-ES-7279		for Steering Rod	
	10/00→	Tie Rod End	SC-ES-8517		for Push Rod	
	10/00→	Tie Rod End	SC-ES-8535		for Guide Rod	
	10/00→	Track Control Arm		MN-DL-3402	Trailing Arm, Air Suspension Axle;Drive Axle	
	10/00→	Track Control Arm		MN-DL-5225	Trailing Arm, Drive Axle;Air Suspension Axle	
	10/00→	Track Control Arm		MN-DL-8544	Trailing Arm, Drive Axle;Air Suspension Axle	
	10/00→	Track Control Arm		MN-DL-8544	Trailing Arm, Drive Axle;Leaf Spring Axle	
	10/00→	Track control arm		MN-DL-10288	Trailing Arm, 1st RA;2nd RA, for Leaf-Spring Suspension vehicles	
	10/00→	Track control arm		MN-DL-12288	Trailing Arm	
	10/00→	Track Control Arm		MN-VB-5222	Wishbone (CV), 1st RA;2nd RA, for Pneumatic Suspension vehicles	
	10/00→	Track Control Arm		MN-VB-5238	Wishbone (CV), Drive Axle;Air Suspension Axle	
	10/00→	Track Control Arm		MN-VB-8514	Suspension Rod, Wishbone (CV), Drive Axle; Leaf Spring Axle	
	10/00→	Track Control Arm		MN-VB-8669	Suspension Rod, Wishbone (CV), Drive Axle	
	10/00→	Track Control Arm		MN-VB-8669	Suspension Rod, Wishbone (CV), Drive Axle; Leaf Spring Axle	
	10/00→	Track Control Arm		MN-VB-9404	Wishbone (CV), Drive Axle	
	10/00→	Track Control Arm		MN-VB-9404	Wishbone (CV), Drive Axle;Air Suspension Axle	
	10/00→	Track Control Arm		MN-VB-9404	Wishbone (CV), Drive Axle;Leaf Spring Axle	
	10/00→	Track Control Arm	MN-DL-8663		Control Arm, Air Suspension Axle	
	33.410 FD-TM, FDR-TM	10/00→	Ball Head, gearshift linkage	CV-ES-2120		
		10/00→	Centre Rod	MN-DL-7801		Push Rod, Leaf Spring Axle
		10/00→	Suspension Strut Repair Kit		DB-RK-8581	
		10/00→	Tie Rod	MN-DL-7802		
10/00→		Tie Rod End	CV-ES-0914		for Steering Rod	
10/00→		Tie Rod End	CV-ES-14162		for Steering Rod	
10/00→		Tie Rod End	CV-ES-14163		for Steering Rod	
10/00→		Tie Rod End	SC-ES-7279		for Steering Rod	
10/00→		Tie Rod End	SC-ES-8517		for Push Rod	
10/00→		Tie Rod End	SC-ES-8535		for Guide Rod	
10/00→		Track Control Arm		MN-DL-5225	Trailing Arm	
10/00→		Track Control Arm		MN-DL-8544	Trailing Arm, Drive Axle;Leaf Spring Axle	
10/00→		Track control arm		MN-DL-10288	Trailing Arm, 1st RA;2nd RA, for Leaf-Spring Suspension vehicles	
10/00→		Track control arm		MN-DL-12288	Trailing Arm	
10/00→		Track Control Arm		MN-VB-8514	Suspension Rod, Wishbone (CV), Drive Axle; Leaf Spring Axle	
10/00→		Track Control Arm		MN-VB-8669	Suspension Rod, Wishbone (CV), Drive Axle; Leaf Spring Axle	
10/00→		Track Control Arm		MN-VB-9404	Wishbone (CV), Drive Axle	

CV-ES-0914

Length: 125
Cone Ø: d1 Ø 30 / d2 Ø 27
Thread: M38 x 1,5 RHT
81953016184, 81953016251, 81953016276



CV-ES-2120

Length: 115
Cone Ø: d1 Ø 12,4 / d2 Ø 10,8
Thread: M14 x 1,5 RHT
03008500A, 81953016200, 81953016202, 81953016203, 81953016227



CV-ES-14162

Length: 125
Cone Ø: d1 Ø 30 / d2 Ø 27
Thread: M30 x 1,5 LHT
81953010015, 81953010083, 81953010087, 81953016029, 81953016030, 81953016043, 81953016044, 81953016050, 81953016054, 81953016087, 81953016091, 81953016107, 81953016120, 81953016125, 81953016152, 81953016155, 81953016157, 81953016168, 81953016179, 81953016181, 81953016223, 81953016237, 81953016254, 81953016275, 81953016279, 81953016351

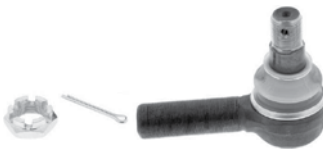

CV-ES-14163

Length: 125
Cone Ø: d1 Ø 30 / d2 Ø 27
Thread: M30 x 1,5 RHT
95301.0084, 90804102156, 90804102272, 90804102696, 90804102710, 81953010016, 81953010075, 81953010084, 81953010088, 81953010094, 81953010103, 81953016030, 81953016043, 81953016048, 81953016049, 81953016053, 81953016061, 81953016090, 81953016108, 81953016112, 81953016126, 81953016143, 81953016149, 81953016154, 81953016156, 81953016168, 81953016178, 81953016194, 81953016206, 81953016224, 81953016234, 81953016242, 81953016252, 81953016274, 81953016278, 81953016284, 81953016286, 81953016308, 81953016310, 81953016312, 81953016347, 81953016350, 81953016352, 82953016012, 88953016014, N2953016001



DB-RK-8581

Ø: 85
Hole Distance: 130
Thick/Height: 24
03305800A, 81432706105



MN-DL-3402

Length: 590 Ø: 48
Hole Distance: 130 / 130
03307200A, 81432206067, 81432206068, 81432206090, 81432206092, 81432209099



MN-DL-5225

Length: 572 Ø: 48
Hole Distance: 130 / 130
03301500A, 81432206229, 81432206236, 81432206267, 81432206270, 81432206272, 81432206304, 81432206305, 81432209236, 81432209267, 81432209272



MN-DL-7801

Length: 995 Ø: 52
Cone Ø: d1 Ø 30 / d2 Ø 27
81466106807, 81466106808, 81466116087, 81466116088, 81466116096, 81466116097, 81466116099, 81466116132, 81466116133, 81466116136, 81466116197, 81466116198, 81466116205

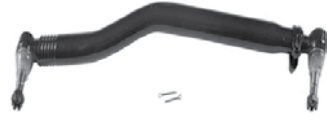

MN-DL-7802

Length: 1680 Ø: 52
Cone Ø: d1 Ø 30 / d2 Ø 27
03208300A, 81467116773, 81467116858, 81467116859, 81467116860, 81467116861, 81467116863, 81467116882, 81467116883, 81467116920, 81467116921



MN-DL-8544

Length: 596 Ø: 48
Hole Distance: 130 / 130
81432206196, 81432206232, 81432206233



MN-DL-8560

Length: 970 Ø: 52
Cone Ø: d1 Ø 30 / d2 Ø 27
03206900A, 81466106809, 81466106810, 81466106823, 81466106838, 81466106839, 81466116104, 81466116105, 81466116107, 81466116134, 81466116135, 81466116137, 81466116199, 81466116200, 81466116206



MN-DL-8609

Length: 585 Ø: 58
Hole Distance: 130 / 130
81432206070, 81432206071, 81432206072, 81432206091, 81432206093, 81432206119



MN-DL-8663

Length: 947 Ø: 60
Hole Distance: 115 / 115
03307400A, 81432206222, 81432206260, 81432206283, 81432206284



MN-DL-10288

81432206386, 82432206008, 82432209008

No Image

MN-DL-12288

Length: 585 Ø: 58
Hole Distance: 130 / 130
81432206386, 82432206008, 82432209008

No Image

MN-RK-12436

Ø: 75
Hole Distance: 115
Thick/Height: 24
81432206244



MN-VB-5222

Length: 627 Ø: 50
Hole Distance: 152 / 152
81432706030, 81432706034, 81432706054, 81432706055, 81432706056, 81432706057, 81432706067, 81432706068, 81432706074, 81432706075, 81432706076, 81432706077, 81432706078, 81432706081, 81432706082, 81432709034, 81432709076, 81432709078, 8143706054



MN-VB-5238

Length: 627 Ø: 48
Hole Distance: 130 / 130
81432206221, 81432706096, 81432706114, 81432706116, 81432706121



MN-VB-8514

Length: 627 Ø: 48
Hole Ø 25 / 25 / 25
Hole Distance: 152 / 130 / 130
81432706087, 81432706088, 81432706094, 81432706095, 81432796094



MN-VB-8669

Length: 627 Ø: 48
Hole Ø 25 / 25 / 25
Hole Distance: 152 / 130 / 130
81432706116, 81432706137, 81432706150, 81432706151



MN-VB-9404

Length: 627 Ø: 58
Hole Distance: 130 / 130
81432706117, 81432706152, 81432706153



SC-ES-7279

Length: 150
Cone Ø: d1 Ø 30 / d2 Ø 27
Thread: M30 x 1,5 RHT
81953016288



SC-ES-8517

Length: 140
Cone Ø: d1 Ø 30 / d2 Ø 27
Thread: M30 x 1,5 RHT
81953016286



SC-ES-8535

Length: 145
Cone Ø: d1 Ø 30 / d2 Ø 27
Thread: M30 x 1,5 RHT
81953016271, 81953016325





TGA ...

33.430 FDC-TM, FDRC-TM	09/07→	Centre Rod	MN-DL-2160		Coupling Rod
	09/07→	Suspension Arm Repair Kit		CV-RK-5313	for Wishbone (CV)
	09/07→	Tie Rod End	CV-ES-0914		for Steering Rod
	09/07→	Tie Rod End	CV-ES-14162		for Steering Rod
	09/07→	Tie Rod End	CV-ES-14163		for Steering Rod
	09/07→	Tie Rod End	SC-ES-8517		for Push Rod
	09/07→	Tie Rod End	SC-ES-8535		for Guide Rod
	09/07→	Track Control Arm		MN-DL-8544	Trailing Arm
	09/07→	Track Control Arm		MN-VB-8514	Suspension Rod, Wishbone (CV)
	09/07→	Track Control Arm		MN-VB-8669	Suspension Rod, Wishbone (CV)
09/07→	Track Control Arm		MN-VB-9404	Wishbone (CV)	
33.430, 33.440 FDAC, FDALC, FDHC	06/05→	Centre Rod	MN-DL-7801		Push Rod, Leaf Spring Axle
	06/05→	Suspension Strut Repair Kit		DB-RK-8581	
	06/05→	Tie Rod	MN-DL-7802		
	06/05→	Tie Rod End	CV-ES-0914		for Steering Rod
	06/05→	Tie Rod End	CV-ES-14162		for Steering Rod
	06/05→	Tie Rod End	CV-ES-14163		for Steering Rod
	06/05→	Tie Rod End	MN-ES-10333		for Steering Rod
	06/05→	Tie Rod End	SC-ES-7279		for Steering Rod
	06/05→	Tie Rod End	SC-ES-8517		for Push Rod
	06/05→	Tie Rod End	SC-ES-8535		for Guide Rod
	06/05→	Track Control Arm		MN-DL-5225	Trailing Arm
	06/05→	Track Control Arm		MN-DL-8544	Trailing Arm, 1st RA;2nd RA;Leaf Spring Axle
	06/05→	Track Control Arm		MN-DL-8544	Trailing Arm, Drive Axle;Leaf Spring Axle
	06/05→	Track Control Arm		MN-DL-8609	Trailing Arm, 1st RA;2nd RA, for Leaf-Spring Suspension vehicles, →Type_HB Chassis
	06/05→	Track control arm		MN-DL-10288	Trailing Arm, 1st RA;2nd RA, for Leaf-Spring Suspension vehicles, →Type HB
	06/05→	Track control arm		MN-DL-12288	Trailing Arm
	06/05→	Track Control Arm		MN-VB-8514	Suspension Rod, Wishbone (CV), Drive Axle; Leaf Spring Axle
	06/05→	Track Control Arm		MN-VB-8669	Suspension Rod, Wishbone (CV), Drive Axle; Leaf Spring Axle
	06/05→	Track Control Arm		MN-VB-9404	Wishbone (CV), Drive Axle
	33.430, 33.440 FDAK, FDALK, FDARK, FDHK	06/05→	Centre Rod	MN-DL-7801	
06/05→		Suspension Strut Repair Kit		DB-RK-8581	
06/05→		Tie Rod	MN-DL-7802		
06/05→		Tie Rod End	CV-ES-0914		for Steering Rod
06/05→		Tie Rod End	CV-ES-14162		for Steering Rod
06/05→		Tie Rod End	CV-ES-14163		for Steering Rod
06/05→		Tie Rod End	MN-ES-10333		for Steering Rod
06/05→		Tie Rod End	SC-ES-7279		for Steering Rod
06/05→		Tie Rod End	SC-ES-8517		for Push Rod
06/05→		Tie Rod End	SC-ES-8535		for Guide Rod
06/05→		Track Control Arm		MN-DL-5225	Trailing Arm
06/05→		Track Control Arm		MN-DL-8544	Trailing Arm, 1st RA;2nd RA;Leaf Spring Axle
06/05→		Track Control Arm		MN-DL-8544	Trailing Arm, Drive Axle;Leaf Spring Axle
06/05→		Track Control Arm		MN-DL-8609	Trailing Arm, 1st RA;2nd RA, for Leaf-Spring Suspension vehicles, →Type_HB Chassis
06/05→		Track control arm		MN-DL-10288	Trailing Arm, 1st RA;2nd RA, for Leaf-Spring Suspension vehicles, →Type HB
06/05→		Track control arm		MN-DL-12288	Trailing Arm
06/05→		Track Control Arm		MN-VB-8514	Suspension Rod, Wishbone (CV), Drive Axle; Leaf Spring Axle
06/05→		Track Control Arm		MN-VB-8669	Suspension Rod, Wishbone (CV), Drive Axle; Leaf Spring Axle
06/05→		Track Control Arm		MN-VB-9404	Wishbone (CV), Drive Axle
33.430, 33.440 FDALS, FDARS, FDAS, FDHS		06/05→	Centre Rod	MN-DL-7801	
	06/05→	Suspension Strut Repair Kit		DB-RK-8581	
	06/05→	Tie Rod	MN-DL-7802		
	06/05→	Tie Rod End	CV-ES-0914		for Steering Rod
	06/05→	Tie Rod End	CV-ES-14162		for Steering Rod
	06/05→	Tie Rod End	CV-ES-14163		for Steering Rod

CV-ES-0914

Length: 125
Cone Ø: d1 Ø 30 / d2 Ø 27
Thread: M38 x 1,5 RHT
81953016184, 81953016251, 81953016276



CV-ES-14162

Length: 125
Cone Ø: d1 Ø 30 / d2 Ø 27
Thread: M30 x 1,5 LHT
81953010015, 81953010083, 81953010087, 81953016029, 81953016030, 81953016043, 81953016044, 81953016050, 81953016054, 81953016087, 81953016091, 81953016107, 81953016120, 81953016125, 81953016152, 81953016155, 81953016157, 81953016168, 81953016179, 81953016181, 81953016223, 81953016237, 81953016254, 81953016275, 81953016279, 81953016351



CV-ES-14163

Length: 125
Cone Ø: d1 Ø 30 / d2 Ø 27
Thread: M30 x 1,5 RHT
95301.0084, 90804102156, 90804102272, 90804102696, 90804102710, 81953010016, 81953010075, 81953010084, 81953010088, 81953010094, 81953010103, 81953016030, 81953016043, 81953016048, 81953016049, 81953016053, 81953016061, 81953016090, 81953016108, 81953016112, 81953016126, 81953016143, 81953016149, 81953016154, 81953016156, 81953016168, 81953016178, 81953016194, 81953016206, 81953016224, 81953016234, 81953016242, 81953016252, 81953016274, 81953016278, 81953016284, 81953016286, 81953016308, 81953016310, 81953016312, 81953016347, 81953016350, 81953016352, 82953016012, 88953016014, N2953016001



CV-RK-5313

Ø: 90
03304800A, 81953016132



DB-RK-8581

Ø: 85
Hole Distance: 130
Thick/Height: 24
03305800A, 81432706105



MN-DL-2160

Length: 1652 Ø: 50
Cone Ø: d1 Ø 30 / d2 Ø 27
81467106112, 81467106163, 81467106165, 81467106198, 81467106353, 81467106354, 81467106361, 81467116725



MN-DL-5225

Length: 572 Ø: 48
Hole Distance: 130 / 130
03301500A, 81432206229, 81432206236, 81432206267, 81432206270, 81432206272, 81432206304, 81432206305, 81432209236, 81432209267, 81432209272



MN-DL-7801

Length: 995 Ø: 52
Cone Ø: d1 Ø 30 / d2 Ø 27
81466106807, 81466106808, 81466116087, 81466116088, 81466116096, 81466116097, 81466116099, 81466116132, 81466116133, 81466116136, 81466116197, 81466116198, 81466116205

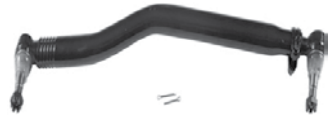

MN-DL-7802

Length: 1680 Ø: 52
Cone Ø: d1 Ø 30 / d2 Ø 27
03208300A, 81467116773, 81467116858, 81467116859, 81467116860, 81467116861, 81467116863, 81467116882, 81467116883, 81467116920, 81467116921



MN-DL-8544

Length: 596 Ø: 48
Hole Distance: 130 / 130
81432206196, 81432206232, 81432206233



MN-DL-8609

Length: 585 Ø: 58
Hole Distance: 130 / 130
81432206070, 81432206071, 81432206072, 81432206091, 81432206093, 81432206119



MN-DL-10288

81432206386, 82432206008, 82432209008

No Image

MN-DL-12288

Length: 585 Ø: 58
Hole Distance: 130 / 130
81432206386, 82432206008, 82432209008

No Image

MN-ES-10333

Length: 90
Cone Ø: d1 Ø 38 / d2 Ø 34,35
Thread: M36 x 1,5 RHT
1271126, 3090291, 3099128, 42538048, 81953016268, 82953016018, 82953016019



MN-VB-8514

Length: 627 Ø: 48
Hole Ø 25 / 25 / 25
Hole Distance: 152 / 130 / 130
81432706087, 81432706088, 81432706094, 81432706095, 81432796094



MN-VB-8669

Length: 627 Ø: 48
Hole Ø 25 / 25 / 25
Hole Distance: 152 / 130 / 130
81432706116, 81432706137, 81432706150, 81432706151



MN-VB-9404

Length: 627 Ø: 58
Hole Distance: 130 / 130
81432706117, 81432706152, 81432706153



SC-ES-7279

Length: 150
Cone Ø: d1 Ø 30 / d2 Ø 27
Thread: M30 x 1,5 RHT
81953016288



SC-ES-8517

Length: 140
Cone Ø: d1 Ø 30 / d2 Ø 27
Thread: M30 x 1,5 RHT
81953016286



SC-ES-8535

Length: 145
Cone Ø: d1 Ø 30 / d2 Ø 27
Thread: M30 x 1,5 RHT
81953016271, 81953016325





TGA ...

33.430, 33.440 FDALS, FDARS,
FDAS, FDHS ...

06/05 →	Tie Rod End	MN-ES-10333		for Steering Rod
06/05 →	Tie Rod End	SC-ES-7279		for Steering Rod
06/05 →	Tie Rod End	SC-ES-8517		for Push Rod
06/05 →	Tie Rod End	SC-ES-8535		for Guide Rod
06/05 →	Track Control Arm		MN-DL-5225	Trailing Arm
06/05 →	Track Control Arm		MN-DL-8544	Trailing Arm, 1st RA;2nd RA;Leaf Spring Axle
06/05 →	Track Control Arm		MN-DL-8544	Trailing Arm, Drive Axle;Leaf Spring Axle
06/05 →	Track Control Arm		MN-DL-8609	Trailing Arm, 1st RA;2nd RA, for Leaf-Spring Suspension vehicles, →Type_HB Chassis
06/05 →	Track control arm		MN-DL-10288	Trailing Arm, 1st RA;2nd RA, for Leaf-Spring Suspension vehicles, →Type HB
06/05 →	Track control arm		MN-DL-12288	Trailing Arm
06/05 →	Track Control Arm		MN-VB-8514	Suspension Rod, Wishbone (CV), Drive Axle; Leaf Spring Axle
06/05 →	Track Control Arm		MN-VB-8669	Suspension Rod, Wishbone (CV), Drive Axle; Leaf Spring Axle
06/05 →	Track Control Arm		MN-VB-9404	Wishbone (CV), Drive Axle

33.430, 33.440 FDC, FDLC,
FDRC, FDLRC

05/04 →	Centre Rod	MN-DL-7801		Push Rod
05/04 →	Suspension Strut Repair Kit		DB-RK-8581	
05/04 →	Tie Rod	MN-DL-7802		
05/04 →	Tie Rod	MN-DL-12293		
05/04 →	Tie Rod End	CV-ES-0914		for Steering Rod
05/04 →	Tie Rod End	CV-ES-14162		for Steering Rod
05/04 →	Tie Rod End	CV-ES-14163		for Steering Rod
05/04 →	Tie Rod End	SC-ES-7279		for Steering Rod
05/04 →	Tie Rod End	SC-ES-8517		for Push Rod
05/04 →	Tie Rod End	SC-ES-8535		for Guide Rod
05/04 →	Track Control Arm		MN-DL-3402	Trailing Arm, 1st RA;2nd RA, for Pneumatic Suspension vehicles
05/04 →	Track Control Arm		MN-DL-5225	Trailing Arm
05/04 →	Track Control Arm		MN-DL-8544	Trailing Arm, Drive Axle;Leaf Spring Axle
05/04 →	Track control arm		MN-DL-10288	Trailing Arm, 1st RA;2nd RA, for Leaf-Spring Suspension vehicles
05/04 →	Track control arm		MN-DL-12288	Trailing Arm
05/04 →	Track Control Arm		MN-VB-5222	Wishbone (CV), 1st RA;2nd RA, for Pneumatic Suspension vehicles
05/04 →	Track Control Arm		MN-VB-5238	Wishbone (CV), 1st RA;2nd RA, for Pneumatic Suspension vehicles, →Type_NBA Chassis
05/04 →	Track Control Arm		MN-VB-8514	Suspension Rod, Wishbone (CV), Drive Axle; Leaf Spring Axle
05/04 →	Track Control Arm		MN-VB-8669	Suspension Rod, Wishbone (CV), Drive Axle; Leaf Spring Axle
05/04 →	Track Control Arm		MN-VB-9404	Wishbone (CV), Drive Axle

33.430, 33.440 FDK, FDLK, FDRK

05/04 →	Centre Rod	MN-DL-7801		Push Rod, Leaf Spring Axle
05/04 →	Suspension Strut Repair Kit		DB-RK-8581	
05/04 →	Tie Rod	MN-DL-7802		
05/04 →	Tie Rod	MN-DL-12293		
05/04 →	Tie Rod End	CV-ES-0914		for Steering Rod
05/04 →	Tie Rod End	CV-ES-14162		for Steering Rod
05/04 →	Tie Rod End	CV-ES-14163		for Steering Rod
05/04 →	Tie Rod End	SC-ES-7279		for Steering Rod
05/04 →	Tie Rod End	SC-ES-8517		for Push Rod
05/04 →	Tie Rod End	SC-ES-8535		for Guide Rod
05/04 →	Track Control Arm		MN-DL-3402	Trailing Arm, 1st RA;2nd RA, for Pneumatic Suspension vehicles
05/04 →	Track Control Arm		MN-DL-5225	Trailing Arm
05/04 →	Track Control Arm		MN-DL-8544	Trailing Arm, Drive Axle;Leaf Spring Axle
05/04 →	Track control arm		MN-DL-10288	Trailing Arm, 1st RA;2nd RA, for Leaf-Spring Suspension vehicles
05/04 →	Track control arm		MN-DL-12288	Trailing Arm
05/04 →	Track Control Arm		MN-VB-5222	Wishbone (CV), 1st RA;2nd RA, for Pneumatic Suspension vehicles

CV-ES-0914

Length: 125
Cone Ø: d1 Ø 30 / d2 Ø 27
Thread: M38 x 1,5 RHT
81953016184, 81953016251, 81953016276



CV-ES-14162

Length: 125
Cone Ø: d1 Ø 30 / d2 Ø 27
Thread: M30 x 1,5 LHT
81953010015, 81953010083, 81953010087, 81953016029, 81953016030, 81953016043, 81953016044, 81953016050, 81953016054, 81953016087, 81953016091, 81953016107, 81953016120, 81953016125, 81953016152, 81953016155, 81953016157, 81953016168, 81953016179, 81953016181, 81953016223, 81953016237, 81953016254, 81953016275, 81953016279, 81953016351



CV-ES-14163

Length: 125
Cone Ø: d1 Ø 30 / d2 Ø 27
Thread: M30 x 1,5 RHT
95301.0084, 90804102156, 90804102272, 90804102696, 90804102710, 81953010016, 81953010075, 81953010084, 81953010088, 81953010094, 81953010103, 81953016030, 81953016043, 81953016048, 81953016049, 81953016053, 81953016061, 81953016090, 81953016108, 81953016112, 81953016126, 81953016143, 81953016149, 81953016154, 81953016156, 81953016168, 81953016178, 81953016194, 81953016206, 81953016224, 81953016234, 81953016242, 81953016252, 81953016274, 81953016278, 81953016284, 81953016286, 81953016308, 81953016310, 81953016312, 81953016347, 81953016350, 81953016352, 82953016012, 88953016014, N2953016001



DB-RK-8581

Ø: 85
Hole Distance: 130
Thick/Height: 24
03305800A, 81432706105



MN-DL-3402

Length: 590 Ø: 48
Hole Distance: 130 / 130
03307200A, 81432206067, 81432206068, 81432206090, 81432206092



MN-DL-5225

Length: 572 Ø: 48
Hole Distance: 130 / 130
03301500A, 81432206229, 81432206236, 81432206267, 81432206270, 81432206272, 81432206304, 81432206305, 81432209236, 81432209267, 81432209272



MN-DL-7801

Length: 995 Ø: 52
Cone Ø: d1 Ø 30 / d2 Ø 27
81466106807, 81466106808, 81466116087, 81466116088, 81466116096, 81466116097, 81466116099, 81466116132, 81466116133, 81466116136, 81466116197, 81466116198, 81466116205

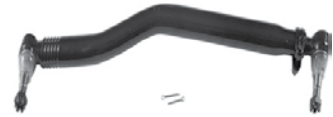

MN-DL-7802

Length: 1680 Ø: 52
Cone Ø: d1 Ø 30 / d2 Ø 27
03208300A, 81467116773, 81467116858, 81467116859, 81467116860, 81467116861, 81467116863, 81467116882, 81467116883, 81467116920, 81467116921



MN-DL-8544

Length: 596 Ø: 48
Hole Distance: 130 / 130
81432206196, 81432206232, 81432206233



MN-DL-8609

Length: 585 Ø: 58
Hole Distance: 130 / 130
81432206070, 81432206071, 81432206072, 81432206091, 81432206093, 81432206119



MN-DL-10288

81432206386, 82432206008, 82432209008

No Image

MN-DL-12288

Length: 585 Ø: 58
Hole Distance: 130 / 130
81432206386, 82432206008, 82432209008

No Image

MN-DL-12293

Length: 1680 Ø: 42
Cone Ø: d1 Ø 30 / d2 Ø 27
81467106236, 81467106268, 81467106356, 81467116356, 81467116723, 81467116794, 81467116933, 81467116934, 81467116966



MN-ES-10333

Length: 90
Cone Ø: d1 Ø 38 / d2 Ø 34,35
Thread: M36 x 1,5 RHT
1271126, 3090291, 3099128, 42538048, 81953016268, 82953016018, 82953016019



MN-VB-5222

Length: 627 Ø: 50
Hole Distance: 152 / 152
81432706030, 81432706034, 81432706054, 81432706055, 81432706056, 81432706057, 81432706067, 81432706068, 81432706074, 81432706075, 81432706076, 81432706077, 81432706078, 81432706081, 81432706082, 81432709034, 81432709076, 81432709078, 8143706054



MN-VB-5238

Length: 627 Ø: 48
Hole Distance: 130 / 130
81432206221, 81432706096, 81432706114, 81432706116, 81432706121



MN-VB-8514

Length: 627 Ø: 48
Hole Ø 25 / 25 / 25
Hole Distance: 152 / 130 / 130
81432706087, 81432706088, 81432706094, 81432706095, 81432796094



MN-VB-8669

Length: 627 Ø: 48
Hole Ø 25 / 25 / 25
Hole Distance: 152 / 130 / 130
81432706116, 81432706137, 81432706150, 81432706151



MN-VB-9404

Length: 627 Ø: 58
Hole Distance: 130 / 130
81432706117, 81432706152, 81432706153



SC-ES-7279

Length: 150
Cone Ø: d1 Ø 30 / d2 Ø 27
Thread: M30 x 1,5 RHT
81953016288



SC-ES-8517

Length: 140
Cone Ø: d1 Ø 30 / d2 Ø 27
Thread: M30 x 1,5 RHT
81953016286



SC-ES-8535

Length: 145
Cone Ø: d1 Ø 30 / d2 Ø 27
Thread: M30 x 1,5 RHT
81953016271, 81953016325





TGA ...

33.430, 33.440 FDK, FDLK, FDRK ...	05/04 →	Track Control Arm		MN-VB-5238	Wishbone (CV), 1st RA;2nd RA, for Pneumatic Suspension vehicles, →Type_NBA Chassis
	05/04 →	Track Control Arm		MN-VB-8514	Suspension Rod, Wishbone (CV), Drive Axle; Leaf Spring Axle
	05/04 →	Track Control Arm		MN-VB-8669	Suspension Rod, Wishbone (CV), Drive Axle; Leaf Spring Axle
	05/04 →	Track Control Arm		MN-VB-9404	Wishbone (CV), Drive Axle
33.430, 33.440 FDLRS, FDLS, FDRS, FDS	05/04 →	Centre Rod	MN-DL-7801		Push Rod, Leaf Spring Axle
	05/04 →	Suspension Strut Repair Kit		DB-RK-8581	
	05/04 →	Tie Rod	MN-DL-7802		
	05/04 →	Tie Rod	MN-DL-12293		
	05/04 →	Tie Rod End	CV-ES-0914		for Steering Rod
	05/04 →	Tie Rod End	CV-ES-14162		for Steering Rod
	05/04 →	Tie Rod End	CV-ES-14163		for Steering Rod
	05/04 →	Tie Rod End	SC-ES-7279		for Steering Rod
	05/04 →	Tie Rod End	SC-ES-8517		for Push Rod
	05/04 →	Tie Rod End	SC-ES-8535		for Guide Rod
	05/04 →	Track Control Arm		MN-DL-3402	Trailing Arm, 1st RA;2nd RA, for Pneumatic Suspension vehicles
	05/04 →	Track Control Arm		MN-DL-5225	Trailing Arm
	05/04 →	Track Control Arm		MN-DL-8544	Trailing Arm, Drive Axle;Leaf Spring Axle
	05/04 →	Track control arm		MN-DL-10288	Trailing Arm, 1st RA;2nd RA, for Leaf-Spring Suspension vehicles
	05/04 →	Track control arm		MN-DL-12288	Trailing Arm
	05/04 →	Track Control Arm		MN-VB-5222	Wishbone (CV), 1st RA;2nd RA, for Pneumatic Suspension vehicles
	05/04 →	Track Control Arm		MN-VB-5238	Wishbone (CV), 1st RA;2nd RA, for Pneumatic Suspension vehicles, →Type_NBA Chassis
	05/04 →	Track Control Arm		MN-VB-8514	Suspension Rod, Wishbone (CV), Drive Axle; Leaf Spring Axle
	05/04 →	Track Control Arm		MN-VB-8669	Suspension Rod, Wishbone (CV), Drive Axle; Leaf Spring Axle
05/04 →	Track Control Arm		MN-VB-9404	Wishbone (CV), Drive Axle	
33.440 FDAC, FDALC, FDHC	06/05 →	Centre Rod	MN-DL-7801		Push Rod
	06/05 →	Suspension Arm Repair Kit		CV-RK-5313	for Wishbone (CV)
	06/05 →	Tie Rod End	CV-ES-14163		for Steering Rod
	06/05 →	Tie Rod End	MN-ES-10333		for Steering Rod
	06/05 →	Track Control Arm		MN-DL-8544	Trailing Arm, 1st RA;2nd RA;Leaf Spring Axle
	06/05 →	Track control arm		MN-DL-10288	Trailing Arm, 1st RA;2nd RA, for Leaf-Spring Suspension vehicles, →Type HB
	06/05 →	Track control arm		MN-DL-12288	Trailing Arm
	06/05 →	Track Control Arm		MN-VB-8514	Suspension Rod, Wishbone (CV), 1st RA;2nd RA, for Leaf-Spring Suspension vehicles
	06/05 →	Track Control Arm		MN-VB-9404	Wishbone (CV), 1st RA;2nd RA, for Leaf-Spring Suspension vehicles, →Type_HB Chassis
33.440 FDAK, FDALK, FDARK, FDHK	06/05 →	Centre Rod	MN-DL-7801		Push Rod
	06/05 →	Suspension Arm Repair Kit		CV-RK-5313	for Wishbone (CV)
	06/05 →	Tie Rod End	CV-ES-14163		for Steering Rod
	06/05 →	Tie Rod End	MN-ES-10333		for Steering Rod
	06/05 →	Track Control Arm		MN-DL-8544	Trailing Arm, 1st RA;2nd RA;Leaf Spring Axle
	06/05 →	Track control arm		MN-DL-10288	Trailing Arm, 1st RA;2nd RA, for Leaf-Spring Suspension vehicles, →Type HB
	06/05 →	Track control arm		MN-DL-12288	Trailing Arm
	06/05 →	Track Control Arm		MN-VB-8514	Suspension Rod, Wishbone (CV), 1st RA; 2nd RA, for Leaf-Spring Suspension vehicles
	06/05 →	Track Control Arm		MN-VB-9404	Wishbone (CV), 1st RA;2nd RA, for Leaf-Spring Suspension vehicles, →Type_HB Chassis
33.440 FDALS, FDARS, FDAS, FDHS	06/05 →	Centre Rod	MN-DL-7801		Push Rod
	06/05 →	Suspension Arm Repair Kit		CV-RK-5313	for Wishbone (CV)
	06/05 →	Tie Rod End	CV-ES-14163		for Steering Rod
	06/05 →	Tie Rod End	MN-ES-10333		for Steering Rod
	06/05 →	Track Control Arm		MN-DL-8544	Trailing Arm, 1st RA;2nd RA;Leaf Spring Axle

CV-ES-0914

Length: 125
Cone Ø: d1 Ø 30 / d2 Ø 27
Thread: M38 x 1,5 RHT
81953016184, 81953016251, 81953016276



CV-ES-14162

Length: 125
Cone Ø: d1 Ø 30 / d2 Ø 27
Thread: M30 x 1,5 LHT
81953010015, 81953010083, 81953010087, 81953016029, 81953016030, 81953016043, 81953016044, 81953016050, 81953016054, 81953016087, 81953016091, 81953016107, 81953016120, 81953016125, 81953016152, 81953016155, 81953016157, 81953016168, 81953016179, 81953016181, 81953016223, 81953016237, 81953016254, 81953016275, 81953016279, 81953016351

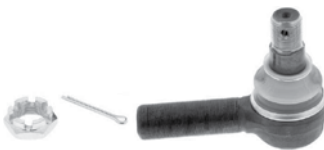

CV-ES-14163

Length: 125
Cone Ø: d1 Ø 30 / d2 Ø 27
Thread: M30 x 1,5 RHT
95301.0084, 90804102156, 90804102272, 90804102696, 90804102710, 81953010016, 81953010075, 81953010084, 81953010088, 81953010094, 81953010103, 81953016030, 81953016043, 81953016048, 81953016049, 81953016053, 81953016061, 81953016090, 81953016108, 81953016112, 81953016126, 81953016143, 81953016149, 81953016154, 81953016156, 81953016168, 81953016178, 81953016194, 81953016206, 81953016224, 81953016234, 81953016242, 81953016252, 81953016274, 81953016278, 81953016284, 81953016286, 81953016308, 81953016310, 81953016312, 81953016347, 81953016350, 81953016352, 82953016012, 88953016014, N2953016001



CV-RK-5313

Ø: 90
03304800A, 81953016132



DB-RK-8581

Ø: 85
Hole Distance: 130
Thick/Height: 24
03305800A, 81432706105



MN-DL-3402

Length: 590 Ø: 48
Hole Distance: 130 / 130
03307200A, 81432206067, 81432206068, 81432206090, 81432206092, 81432209092



MN-DL-5225

Length: 572 Ø: 48
Hole Distance: 130 / 130
03301500A, 81432206229, 81432206236, 81432206267, 81432206270, 81432206272, 81432206304, 81432206305, 81432209236, 81432209267, 81432209272



MN-DL-7801

Length: 995 Ø: 52
Cone Ø: d1 Ø 30 / d2 Ø 27
81466106807, 81466106808, 81466116087, 81466116088, 81466116096, 81466116097, 81466116099, 81466116132, 81466116133, 81466116136, 81466116197, 81466116198, 81466116205

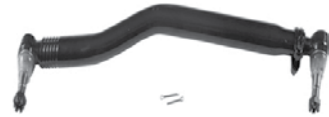

MN-DL-7802

Length: 1680 Ø: 52
Cone Ø: d1 Ø 30 / d2 Ø 27
03208300A, 81467116773, 81467116858, 81467116859, 81467116860, 81467116861, 81467116863, 81467116882, 81467116883, 81467116920, 81467116921



MN-DL-8544

Length: 596 Ø: 48
Hole Distance: 130 / 130
81432206196, 81432206232, 81432206233



MN-DL-10288

81432206386, 82432206008, 82432209008

No Image

MN-DL-12288

Length: 585 Ø: 58
Hole Distance: 130 / 130
81432206386, 82432206008, 82432209008

No Image

MN-DL-12293

Length: 1680 Ø: 42
Cone Ø: d1 Ø 30 / d2 Ø 27
81467106236, 81467106268, 81467106356, 81467116356, 81467116723, 81467116794, 81467116933, 81467116934, 81467116966



MN-ES-10333

Length: 90
Cone Ø: d1 Ø 38 / d2 Ø 34,35
Thread: M36 x 1,5 RHT
1271126, 3090291, 3099128, 42538048, 81953016268, 82953016018, 82953016019



MN-VB-5222

Length: 627 Ø: 50
Hole Distance: 152 / 152
81432706030, 81432706034, 81432706054, 81432706055, 81432706056, 81432706057, 81432706067, 81432706068, 81432706074, 81432706075, 81432706076, 81432706077, 81432706078, 81432706081, 81432706082, 81432709034, 81432709076, 81432709078, 8143706054



MN-VB-5238

Length: 627 Ø: 48
Hole Distance: 130 / 130
81432206221, 81432706096, 81432706114, 81432706116, 81432706121



MN-VB-8514

Length: 627 Ø: 48
Hole Ø 25 / 25 / 25
Hole Distance: 152 / 130 / 130
81432706087, 81432706088, 81432706094, 81432706095, 81432796094



MN-VB-8669

Length: 627 Ø: 48
Hole Ø 25 / 25 / 25
Hole Distance: 152 / 130 / 130
81432706116, 81432706137, 81432706150, 81432706151



MN-VB-9404

Length: 627 Ø: 58
Hole Distance: 130 / 130
81432706117, 81432706152, 81432706153



SC-ES-7279

Length: 150
Cone Ø: d1 Ø 30 / d2 Ø 27
Thread: M30 x 1,5 RHT
81953016288



SC-ES-8517

Length: 140
Cone Ø: d1 Ø 30 / d2 Ø 27
Thread: M30 x 1,5 RHT
81953016286



SC-ES-8535

Length: 145
Cone Ø: d1 Ø 30 / d2 Ø 27
Thread: M30 x 1,5 RHT
81953016271, 81953016325





TGA ...

33.440 FDALS, FDARS, FDAS, FDHS ...	06/05 →	Track control arm		MN-DL-10288	Trailing Arm, 1st RA;2nd RA, for Leaf-Spring Suspension vehicles, →Type HB	
	06/05 →	Track control arm		MN-DL-12288	Trailing Arm	
	06/05 →	Track Control Arm		MN-VB-8514	Suspension Rod, Wishbone (CV), 1st RA; 2nd RA, for Leaf-Spring Suspension vehicles	
	06/05 →	Track Control Arm		MN-VB-9404	Wishbone (CV), 1st RA;2nd RA, for Leaf-Spring Suspension vehicles, →Type_HB Chassis	
33.440 FDC, FDLC, FDRC	06/05 →	Centre Rod	MN-DL-7801		Push Rod, Leaf Spring Axle	
	06/05 →	Suspension Arm Repair Kit		CV-RK-5313	for Wishbone (CV)	
	06/05 →	Tie Rod	MN-DL-7802			
	06/05 →	Tie Rod	MN-DL-12293			
	06/05 →	Tie Rod End	CV-ES-0914		for Steering Rod	
	06/05 →	Tie Rod End	CV-ES-14162		for Steering Rod	
	06/05 →	Tie Rod End	CV-ES-14163		for Steering Rod	
	06/05 →	Tie Rod End	SC-ES-7279		for Steering Rod	
	06/05 →	Tie Rod End	SC-ES-8517		for Push Rod	
	06/05 →	Tie Rod End	SC-ES-8535		for Guide Rod	
	06/05 →	Track Control Arm		MN-DL-8544	Trailing Arm, Drive Axle;Leaf Spring Axle	
	06/05 →	Track Control Arm		MN-VB-9404	Wishbone (CV), Drive Axle	
33.440 FDC-TM, FDRC-TM	09/07 →	Centre Rod	MN-DL-2160		Coupling Rod	
	09/07 →	Suspension Arm Repair Kit		CV-RK-5313	for Wishbone (CV)	
	09/07 →	Tie Rod End	CV-ES-0914		for Steering Rod	
	09/07 →	Tie Rod End	CV-ES-14162		for Steering Rod	
	09/07 →	Tie Rod End	CV-ES-14163		for Steering Rod	
	09/07 →	Tie Rod End	SC-ES-7279		for Steering Rod	
	09/07 →	Tie Rod End	SC-ES-8517		for Push Rod	
	09/07 →	Tie Rod End	SC-ES-8535		for Guide Rod	
	09/07 →	Track Control Arm		MN-DL-8544	Trailing Arm	
	09/07 →	Track Control Arm		MN-VB-9404	Wishbone (CV)	
33.440 FDK, FDLK, FDRK	06/05 →	Centre Rod	MN-DL-7801		Push Rod, Leaf Spring Axle	
	06/05 →	Suspension Arm Repair Kit		CV-RK-5313	for Wishbone (CV)	
	06/05 →	Tie Rod	MN-DL-7802			
	06/05 →	Tie Rod	MN-DL-12293			
	06/05 →	Tie Rod End	CV-ES-0914		for Steering Rod	
	06/05 →	Tie Rod End	CV-ES-14162		for Steering Rod	
	06/05 →	Tie Rod End	CV-ES-14163		for Steering Rod	
	06/05 →	Tie Rod End	SC-ES-7279		for Steering Rod	
	06/05 →	Tie Rod End	SC-ES-8517		for Push Rod	
	06/05 →	Tie Rod End	SC-ES-8535		for Guide Rod	
	06/05 →	Track Control Arm		MN-DL-8544	Trailing Arm, Drive Axle;Leaf Spring Axle	
	06/05 →	Track Control Arm		MN-VB-9404	Wishbone (CV), Drive Axle	
	33.440 FDLS, FDRS, FDS	06/05 →	Centre Rod	MN-DL-2160		Coupling Rod
		06/05 →	Centre Rod	MN-DL-7801		Push Rod, Leaf Spring Axle
06/05 →		Suspension Arm Repair Kit		CV-RK-5313	for Wishbone (CV)	
06/05 →		Suspension Strut Repair Kit		DB-RK-8581		
06/05 →		Tie Rod	MN-DL-7802			
06/05 →		Tie Rod	MN-DL-12293			
06/05 →		Tie Rod End	CV-ES-14162		for Steering Rod	
06/05 →		Tie Rod End	CV-ES-14163		for Steering Rod	
06/05 →		Tie Rod End	SC-ES-7279		for Steering Rod	
06/05 →		Tie Rod End	SC-ES-8535		for Guide Rod	
06/05 →		Track Control Arm		MN-DL-8544	Trailing Arm	
06/05 →		Track Control Arm		MN-DL-8544	Trailing Arm, Drive Axle;Leaf Spring Axle	
06/05 →		Track Control Arm		MN-VB-8514	Suspension Rod, Wishbone (CV)	
06/05 →		Track Control Arm		MN-VB-9404	Wishbone (CV)	
06/05 →		Track Control Arm		MN-VB-9404	Wishbone (CV), Drive Axle	
33.460 FDAC		09/02 →	Centre Rod	MN-DL-7801		Push Rod
		09/02 →	Suspension Strut Repair Kit		DB-RK-8581	
		09/02 →	Tie Rod End	CV-ES-0914		for Steering Rod
	09/02 →	Tie Rod End	CV-ES-14163		for Steering Rod	
	09/02 →	Tie Rod End	MN-ES-10333		for Steering Rod	
	09/02 →	Tie Rod End	SC-ES-8517		for Push Rod	
	09/02 →	Track Control Arm		MN-DL-5225	Trailing Arm	

CV-ES-0914

Length: 125
Cone Ø: d1 Ø 30 / d2 Ø 27
Thread: M38 x 1,5 RHT
81953016184, 81953016251, 81953016276



CV-ES-14162

Length: 125
Cone Ø: d1 Ø 30 / d2 Ø 27
Thread: M30 x 1,5 LHT
81953010015, 81953010083, 81953010087, 81953016029, 81953016030, 81953016043, 81953016044, 81953016050, 81953016054, 81953016087, 81953016091, 81953016107, 81953016120, 81953016125, 81953016152, 81953016155, 81953016157, 81953016168, 81953016179, 81953016181, 81953016223, 81953016237, 81953016254, 81953016275, 81953016279, 81953016351



CV-ES-14163

Length: 125
Cone Ø: d1 Ø 30 / d2 Ø 27
Thread: M30 x 1,5 RHT
95301.0084, 90804102156, 90804102272, 90804102696, 90804102710, 81953010016, 81953010075, 81953010084, 81953010088, 81953010094, 81953010103, 81953016030, 81953016043, 81953016048, 81953016049, 81953016053, 81953016061, 81953016090, 81953016108, 81953016112, 81953016126, 81953016143, 81953016149, 81953016154, 81953016156, 81953016168, 81953016178, 81953016194, 81953016206, 81953016224, 81953016234, 81953016242, 81953016252, 81953016274, 81953016278, 81953016284, 81953016286, 81953016308, 81953016310, 81953016312, 81953016347, 81953016350, 81953016352, 82953016012, 88953016014, N2953016001



CV-RK-5313

Ø: 90
03304800A, 81953016132



DB-RK-8581

Ø: 85
Hole Distance: 130
Thick/Height: 24
03305800A, 81432706105



MN-DL-2160

Length: 1652 Ø: 50
Cone Ø: d1 Ø 30 / d2 Ø 27
81467106112, 81467106163, 81467106165, 81467106198, 81467106353, 81467106354, 81467106361, 81467116725



MN-DL-5225

Length: 572 Ø: 48
Hole Distance: 130 / 130
03301500A, 81432206229, 81432206236, 81432206267, 81432206270, 81432206272, 81432206304, 81432206305, 81432209236, 81432209267, 81432209272



MN-DL-7801

Length: 995 Ø: 52
Cone Ø: d1 Ø 30 / d2 Ø 27
81466106807, 81466106808, 81466116087, 81466116088, 81466116096, 81466116097, 81466116099, 81466116132, 81466116133, 81466116136, 81466116197, 81466116198, 81466116205

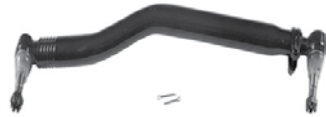

MN-DL-7802

Length: 1680 Ø: 52
Cone Ø: d1 Ø 30 / d2 Ø 27
03208300A, 81467116773, 81467116858, 81467116859, 81467116860, 81467116861, 81467116863, 81467116882, 81467116883, 81467116920, 81467116921



MN-DL-8544

Length: 596 Ø: 48
Hole Distance: 130 / 130
81432206196, 81432206232, 81432206233



MN-DL-10288

81432206386, 82432206008, 82432209008

No Image

MN-DL-12288

Length: 585 Ø: 58
Hole Distance: 130 / 130
81432206386, 82432206008, 82432209008

No Image

MN-DL-12293

Length: 1680 Ø: 42
Cone Ø: d1 Ø 30 / d2 Ø 27
81467106236, 81467106268, 81467106356, 81467116356, 81467116723, 81467116794, 81467116933, 81467116934, 81467116966



MN-ES-10333

Length: 90
Cone Ø: d1 Ø 38 / d2 Ø 34,35
Thread: M36 x 1,5 RHT
1271126, 3090291, 3099128, 42538048, 81953016268, 82953016018, 82953016019



MN-VB-8514

Length: 627 Ø: 48
Hole Ø 25 / 25 / 25
Hole Distance: 152 / 130 / 130
81432706087, 81432706088, 81432706094, 81432706095, 81432796094



MN-VB-9404

Length: 627 Ø: 58
Hole Distance: 130 / 130
81432706117, 81432706152, 81432706153



SC-ES-7279

Length: 150
Cone Ø: d1 Ø 30 / d2 Ø 27
Thread: M30 x 1,5 RHT
81953016288



SC-ES-8517

Length: 140
Cone Ø: d1 Ø 30 / d2 Ø 27
Thread: M30 x 1,5 RHT
81953016286



SC-ES-8535

Length: 145
Cone Ø: d1 Ø 30 / d2 Ø 27
Thread: M30 x 1,5 RHT
81953016271, 81953016325





TGA ...

33.460 FDAC ...	09/02→	Track Control Arm		MN-DL-8544	Trailing Arm, 1st RA;2nd RA;Leaf Spring Axle	
	09/02→	Track Control Arm		MN-DL-8609	Trailing Arm, 1st RA;2nd RA, for Leaf-Spring Suspension vehicles, →Type_HB Chassis	
	09/02→	Track Control Arm		MN-VB-8514	Suspension Rod, Wishbone (CV), Drive Axle; Leaf Spring Axle	
	09/02→	Track Control Arm		MN-VB-9404	Wishbone (CV), Drive Axle	
	09/02→	Track Control Arm		MN-VB-9404	Wishbone (CV), Drive Axle;Leaf Spring Axle	
	33.460 FDAK	09/02→	Centre Rod	MN-DL-7801		Push Rod
09/02→		Suspension Strut Repair Kit		DB-RK-8581		
09/02→		Tie Rod End	CV-ES-0914		for Steering Rod	
09/02→		Tie Rod End	CV-ES-14163		for Steering Rod	
09/02→		Tie Rod End	MN-ES-10333		for Steering Rod	
09/02→		Tie Rod End	SC-ES-8517		for Push Rod	
09/02→		Track Control Arm		MN-DL-5225	Trailing Arm	
09/02→		Track Control Arm		MN-DL-8544	Trailing Arm, 1st RA;2nd RA;Leaf Spring Axle	
09/02→		Track Control Arm		MN-DL-8609	Trailing Arm, 1st RA;2nd RA, for Leaf-Spring Suspension vehicles, →Type_HB Chassis	
09/02→		Track Control Arm		MN-VB-8514	Suspension Rod, Wishbone (CV), Drive Axle; Leaf Spring Axle	
09/02→		Track Control Arm		MN-VB-9404	Wishbone (CV), Drive Axle	
09/02→		Track Control Arm		MN-VB-9404	Wishbone (CV), Drive Axle;Leaf Spring Axle	
33.460 FDAS		09/02→	Centre Rod	MN-DL-7801		Push Rod
		09/02→	Suspension Strut Repair Kit		DB-RK-8581	
	09/02→	Tie Rod End	CV-ES-0914		for Steering Rod	
	09/02→	Tie Rod End	CV-ES-14163		for Steering Rod	
	09/02→	Tie Rod End	MN-ES-10333		for Steering Rod	
	09/02→	Tie Rod End	SC-ES-8517		for Push Rod	
	09/02→	Track Control Arm		MN-DL-5225	Trailing Arm	
	09/02→	Track Control Arm		MN-DL-8544	Trailing Arm, 1st RA;2nd RA;Leaf Spring Axle	
	09/02→	Track Control Arm		MN-DL-8609	Trailing Arm, 1st RA;2nd RA, for Leaf-Spring Suspension vehicles, →Type_HB Chassis	
	09/02→	Track Control Arm		MN-VB-8514	Suspension Rod, Wishbone (CV), Drive Axle; Leaf Spring Axle	
	09/02→	Track Control Arm		MN-VB-9404	Wishbone (CV), Drive Axle	
	09/02→	Track Control Arm		MN-VB-9404	Wishbone (CV), Drive Axle;Leaf Spring Axle	
	33.460 FDC, FDLC, FDLRC, FDRC	09/02→03/03	Track Control Arm		MN-DL-8609	Trailing Arm, Leaf Spring Axle;Double Axle with two Driven Axles
		09/02→	Ball Head, gearshift linkage	CV-ES-2120		
09/02→		Centre Rod	MN-DL-7801		Push Rod, Leaf Spring Axle	
09/02→		Centre Rod	MN-DL-8560		Push Rod, Air Suspension Axle	
09/02→		Suspension Strut Repair Kit		DB-RK-8581		
09/02→		Suspension Strut Repair Kit		MN-RK-12436		
09/02→		Tie Rod	MN-DL-7802			
09/02→		Tie Rod End	CV-ES-0914		for Steering Rod	
09/02→		Tie Rod End	CV-ES-14162		for Steering Rod	
09/02→		Tie Rod End	CV-ES-14163		for Steering Rod	
09/02→		Tie Rod End	SC-ES-7279		for Steering Rod	
09/02→		Tie Rod End	SC-ES-8517		for Push Rod	
09/02→		Tie Rod End	SC-ES-8535		for Guide Rod	
09/02→		Track Control Arm		MN-DL-3402	Trailing Arm, Air Suspension Axle;Drive Axle	
09/02→		Track Control Arm		MN-DL-5225	Trailing Arm, Drive Axle;Air Suspension Axle	
09/02→		Track Control Arm		MN-DL-8544	Trailing Arm, Drive Axle;Air Suspension Axle	
09/02→		Track Control Arm		MN-DL-8544	Trailing Arm, Drive Axle;Leaf Spring Axle	
09/02→		Track control arm		MN-DL-10288	Trailing Arm, 1st RA;2nd RA, for Leaf-Spring Suspension vehicles	
09/02→		Track control arm		MN-DL-12288	Trailing Arm	
09/02→		Track Control Arm		MN-VB-5222	Wishbone (CV), 1st RA;2nd RA, for Pneumatic Suspension vehicles	
09/02→		Track Control Arm		MN-VB-5238	Wishbone (CV), Drive Axle;Air Suspension Axle	
09/02→		Track Control Arm		MN-VB-8514	Suspension Rod, Wishbone (CV), Drive Axle; Leaf Spring Axle	
09/02→		Track Control Arm		MN-VB-8669	Suspension Rod, Wishbone (CV), Drive Axle	

CV-ES-0914

Length: 125
Cone Ø: d1 Ø 30 / d2 Ø 27
Thread: M38 x 1,5 RHT
81953016184, 81953016251, 81953016276



CV-ES-2120

Length: 115
Cone Ø: d1 Ø 12,4 / d2 Ø 10,8
Thread: M14 x 1,5 RHT
03008500A, 81953016200, 81953016202, 81953016203, 81953016227



CV-ES-14162

Length: 125
Cone Ø: d1 Ø 30 / d2 Ø 27
Thread: M30 x 1,5 LHT
81953010015, 81953010083, 81953010087, 81953016029, 81953016030, 81953016043, 81953016044, 81953016050, 81953016054, 81953016087, 81953016091, 81953016107, 81953016120, 81953016125, 81953016152, 81953016155, 81953016157, 81953016168, 81953016179, 81953016181, 81953016223, 81953016237, 81953016254, 81953016275, 81953016279, 81953016351



CV-ES-14163

Length: 125
Cone Ø: d1 Ø 30 / d2 Ø 27
Thread: M30 x 1,5 RHT
95301.0084, 90804102156, 90804102272, 90804102696, 90804102710, 81953010016, 81953010075, 81953010084, 81953010088, 81953010094, 81953010103, 81953016030, 81953016043, 81953016048, 81953016049, 81953016053, 81953016061, 81953016090, 81953016108, 81953016112, 81953016126, 81953016143, 81953016149, 81953016154, 81953016156, 81953016168, 81953016178, 81953016194, 81953016206, 81953016224, 81953016234, 81953016242, 81953016252, 81953016274, 81953016278, 81953016284, 81953016286, 81953016308, 81953016310, 81953016312, 81953016347, 81953016350, 81953016352, 82953016012, 88953016014, N2953016001



DB-RK-8581

Ø: 85
Hole Distance: 130
Thick/Height: 24
03305800A, 81432706105



MN-DL-3402

Length: 590 Ø: 48
Hole Distance: 130 / 130
03307200A, 81432206067, 81432206068, 81432206090, 81432206092, 81432209099



MN-DL-5225

Length: 572 Ø: 48
Hole Distance: 130 / 130
03301500A, 81432206229, 81432206236, 81432206267, 81432206270, 81432206272, 81432206304, 81432206305, 81432209236, 81432209267, 81432209272



MN-DL-7801

Length: 995 Ø: 52
Cone Ø: d1 Ø 30 / d2 Ø 27
81466106807, 81466106808, 81466116087, 81466116088, 81466116096, 81466116097, 81466116099, 81466116132, 81466116133, 81466116136, 81466116197, 81466116198, 81466116205

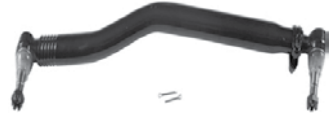

MN-DL-7802

Length: 1680 Ø: 52
Cone Ø: d1 Ø 30 / d2 Ø 27
03208300A, 81467116773, 81467116858, 81467116859, 81467116860, 81467116861, 81467116863, 81467116882, 81467116883, 81467116920, 81467116921



MN-DL-8544

Length: 596 Ø: 48
Hole Distance: 130 / 130
81432206196, 81432206232, 81432206233



MN-DL-8560

Length: 970 Ø: 52
Cone Ø: d1 Ø 30 / d2 Ø 27
03206900A, 81466106809, 81466106810, 81466106823, 81466106838, 81466106839, 81466116104, 81466116105, 81466116107, 81466116134, 81466116135, 81466116137, 81466116199, 81466116200, 81466116206



MN-DL-8609

Length: 585 Ø: 58
Hole Distance: 130 / 130
81432206070, 81432206071, 81432206072, 81432206091, 81432206093, 81432206119



MN-DL-10288

81432206386, 82432206008, 82432209008

No Image

MN-DL-12288

Length: 585 Ø: 58
Hole Distance: 130 / 130
81432206386, 82432206008, 82432209008

No Image

MN-ES-10333

Length: 90
Cone Ø: d1 Ø 38 / d2 Ø 34,35
Thread: M36 x 1,5 RHT
1271126, 3090291, 3099128, 42538048, 81953016268, 82953016018, 82953016019



MN-RK-12436

Ø: 75
Hole Distance: 115
Thick/Height: 24
81432206244



MN-VB-5222

Length: 627 Ø: 50
Hole Distance: 152 / 152
81432706030, 81432706034, 81432706054, 81432706055, 81432706056, 81432706057, 81432706067, 81432706068, 81432706074, 81432706075, 81432706076, 81432706077, 81432706078, 81432706081, 81432706082, 81432709034, 81432709076, 81432709078, 8143706054



MN-VB-5238

Length: 627 Ø: 48
Hole Distance: 130 / 130
81432206221, 81432706096, 81432706114, 81432706116, 81432706121



MN-VB-8514

Length: 627 Ø: 48
Hole Ø 25 / 25 / 25
Hole Distance: 152 / 130 / 130
81432706087, 81432706088, 81432706094, 81432706095, 81432796094



MN-VB-8669

Length: 627 Ø: 48
Hole Ø 25 / 25 / 25
Hole Distance: 152 / 130 / 130
81432706116, 81432706137, 81432706150, 81432706151



MN-VB-9404

Length: 627 Ø: 58
Hole Distance: 130 / 130
81432706117, 81432706152, 81432706153



SC-ES-7279

Length: 150
Cone Ø: d1 Ø 30 / d2 Ø 27
Thread: M30 x 1,5 RHT
81953016288



SC-ES-8517

Length: 140
Cone Ø: d1 Ø 30 / d2 Ø 27
Thread: M30 x 1,5 RHT
81953016286



SC-ES-8535

Length: 145
Cone Ø: d1 Ø 30 / d2 Ø 27
Thread: M30 x 1,5 RHT
81953016271, 81953016325





TGA ...

33.460 FDC, FDLC, FDLRC, FDRC ...	09/02→	Track Control Arm		MN-VB-8669	Suspension Rod, Wishbone (CV), Drive Axle; Leaf Spring Axle
	09/02→	Track Control Arm		MN-VB-9404	Wishbone (CV), Drive Axle
	09/02→	Track Control Arm		MN-VB-9404	Wishbone (CV), Drive Axle;Air Suspension Axle
	09/02→	Track Control Arm		MN-VB-9404	Wishbone (CV), Drive Axle;Leaf Spring Axle
	09/02→	Track Control Arm	MN-DL-8663		Control Arm, Air Suspension Axle
33.460 FDK, FDLK, FDRK	09/02→03/03	Track Control Arm		MN-DL-8609	Trailing Arm, Leaf Spring Axle;Double Axle with two Driven Axles
	09/02→	Ball Head, gearshift linkage	CV-ES-2120		
	09/02→	Centre Rod	MN-DL-7801		Push Rod, Leaf Spring Axle
	09/02→	Centre Rod	MN-DL-8560		Push Rod, Air Suspension Axle
	09/02→	Suspension Strut Repair Kit		DB-RK-8581	
	09/02→	Suspension Strut Repair Kit		MN-RK-12436	
	09/02→	Tie Rod	MN-DL-7802		
	09/02→	Tie Rod End	CV-ES-0914		for Steering Rod
	09/02→	Tie Rod End	CV-ES-14162		for Steering Rod
	09/02→	Tie Rod End	CV-ES-14163		for Steering Rod
	09/02→	Tie Rod End	SC-ES-7279		for Steering Rod
	09/02→	Tie Rod End	SC-ES-8517		for Push Rod
	09/02→	Tie Rod End	SC-ES-8535		for Guide Rod
	09/02→	Track Control Arm		MN-DL-3402	Trailing Arm, Air Suspension Axle;Drive Axle
	09/02→	Track Control Arm		MN-DL-5225	Trailing Arm, Drive Axle;Air Suspension Axle
	09/02→	Track Control Arm		MN-DL-8544	Trailing Arm, Drive Axle;Air Suspension Axle
	09/02→	Track Control Arm		MN-DL-8544	Trailing Arm, Drive Axle;Leaf Spring Axle
	09/02→	Track control arm		MN-DL-10288	Trailing Arm, 1st RA;2nd RA, for Leaf-Spring Suspension vehicles
	09/02→	Track control arm		MN-DL-12288	Trailing Arm
	09/02→	Track Control Arm		MN-VB-5222	Wishbone (CV), 1st RA;2nd RA, for Pneumatic Suspension vehicles
	09/02→	Track Control Arm		MN-VB-5238	Wishbone (CV), Drive Axle;Air Suspension Axle
	09/02→	Track Control Arm		MN-VB-8514	Suspension Rod, Wishbone (CV), Drive Axle; Leaf Spring Axle
	09/02→	Track Control Arm		MN-VB-8669	Suspension Rod, Wishbone (CV), Drive Axle
	09/02→	Track Control Arm		MN-VB-8669	Suspension Rod, Wishbone (CV), Drive Axle; Leaf Spring Axle
	09/02→	Track Control Arm		MN-VB-9404	Wishbone (CV), Drive Axle
	09/02→	Track Control Arm		MN-VB-9404	Wishbone (CV), Drive Axle;Air Suspension Axle
	09/02→	Track Control Arm		MN-VB-9404	Wishbone (CV), Drive Axle;Leaf Spring Axle
09/02→	Track Control Arm	MN-DL-8663		Control Arm, Air Suspension Axle	
33.460 FDLRS, FDLS, FDRS, FDS	09/02→03/03	Track Control Arm		MN-DL-8609	Trailing Arm, Leaf Spring Axle;Double Axle with two Driven Axles
	09/02→	Ball Head, gearshift linkage	CV-ES-2120		
	09/02→	Centre Rod	MN-DL-7801		Push Rod, Leaf Spring Axle
	09/02→	Centre Rod	MN-DL-8560		Push Rod, Air Suspension Axle
	09/02→	Suspension Strut Repair Kit		DB-RK-8581	
	09/02→	Suspension Strut Repair Kit		MN-RK-12436	
	09/02→	Tie Rod	MN-DL-7802		
	09/02→	Tie Rod End	CV-ES-0914		for Steering Rod
	09/02→	Tie Rod End	CV-ES-14162		for Steering Rod
	09/02→	Tie Rod End	CV-ES-14163		for Steering Rod
	09/02→	Tie Rod End	SC-ES-7279		for Steering Rod
	09/02→	Tie Rod End	SC-ES-8517		for Push Rod
	09/02→	Tie Rod End	SC-ES-8535		for Guide Rod
	09/02→	Track Control Arm		MN-DL-3402	Trailing Arm, Air Suspension Axle;Drive Axle
	09/02→	Track Control Arm		MN-DL-5225	Trailing Arm, Drive Axle;Air Suspension Axle
	09/02→	Track Control Arm		MN-DL-8544	Trailing Arm, Drive Axle;Air Suspension Axle
	09/02→	Track Control Arm		MN-DL-8544	Trailing Arm, Drive Axle;Leaf Spring Axle
	09/02→	Track control arm		MN-DL-10288	Trailing Arm, 1st RA;2nd RA, for Leaf-Spring Suspension vehicles
	09/02→	Track control arm		MN-DL-12288	Trailing Arm
	09/02→	Track Control Arm		MN-VB-5222	Wishbone (CV), 1st RA;2nd RA, for Pneumatic Suspension vehicles
	09/02→	Track Control Arm		MN-VB-5238	Wishbone (CV), Drive Axle;Air Suspension Axle

CV-ES-0914

Length: 125
Cone Ø: d1 Ø 30 / d2 Ø 27
Thread: M38 x 1,5 RHT
81953016184, 81953016251, 81953016276



CV-ES-2120

Length: 115
Cone Ø: d1 Ø 12,4 / d2 Ø 10,8
Thread: M14 x 1,5 RHT
03008500A, 81953016200, 81953016202, 81953016203, 81953016227



CV-ES-14162

Length: 125
Cone Ø: d1 Ø 30 / d2 Ø 27
Thread: M30 x 1,5 LHT
81953010015, 81953010083, 81953010087, 81953016029, 81953016030, 81953016043, 81953016044, 81953016050, 81953016054, 81953016087, 81953016091, 81953016107, 81953016120, 81953016125, 81953016152, 81953016155, 81953016157, 81953016168, 81953016179, 81953016181, 81953016223, 81953016237, 81953016254, 81953016275, 81953016279, 81953016351

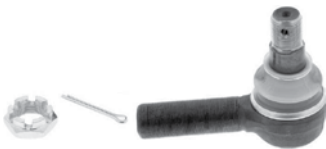

CV-ES-14163

Length: 125
Cone Ø: d1 Ø 30 / d2 Ø 27
Thread: M30 x 1,5 RHT
95301.0084, 90804102156, 90804102272, 90804102696, 90804102710, 81953010016, 81953010075, 81953010084, 81953010088, 81953010094, 81953010103, 81953016030, 81953016043, 81953016048, 81953016049, 81953016053, 81953016061, 81953016090, 81953016108, 81953016112, 81953016126, 81953016143, 81953016149, 81953016154, 81953016156, 81953016168, 81953016178, 81953016194, 81953016206, 81953016224, 81953016234, 81953016242, 81953016252, 81953016274, 81953016278, 81953016284, 81953016286, 81953016308, 81953016310, 81953016312, 81953016347, 81953016350, 81953016352, 82953016012, 88953016014, N2953016001



DB-RK-8581

Ø: 85
Hole Distance: 130
Thick/Height: 24
03305800A, 81432706105



MN-DL-3402

Length: 590 Ø: 48
Hole Distance: 130 / 130
03307200A, 81432206067, 81432206068, 81432206090, 81432206092, 81432209099



MN-DL-5225

Length: 572 Ø: 48
Hole Distance: 130 / 130
03301500A, 81432206229, 81432206236, 81432206267, 81432206270, 81432206272, 81432206304, 81432206305, 81432209236, 81432209267, 81432209272



MN-DL-7801

Length: 995 Ø: 52
Cone Ø: d1 Ø 30 / d2 Ø 27
81466106807, 81466106808, 81466116087, 81466116088, 81466116096, 81466116097, 81466116099, 81466116132, 81466116133, 81466116136, 81466116197, 81466116198, 81466116205

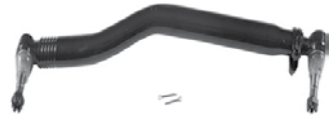

MN-DL-7802

Length: 1680 Ø: 52
Cone Ø: d1 Ø 30 / d2 Ø 27
03208300A, 81467116773, 81467116858, 81467116859, 81467116860, 81467116861, 81467116863, 81467116882, 81467116883, 81467116920, 81467116921



MN-DL-8544

Length: 596 Ø: 48
Hole Distance: 130 / 130
81432206196, 81432206232, 81432206233



MN-DL-8560

Length: 970 Ø: 52
Cone Ø: d1 Ø 30 / d2 Ø 27
03206900A, 81466106809, 81466106810, 81466106823, 81466106838, 81466106839, 81466116104, 81466116105, 81466116107, 81466116134, 81466116135, 81466116137, 81466116199, 81466116200, 81466116206



MN-DL-8609

Length: 585 Ø: 58
Hole Distance: 130 / 130
81432206070, 81432206071, 81432206072, 81432206091, 81432206093, 81432206119



MN-DL-8663

Length: 947 Ø: 60
Hole Distance: 115 / 115
03307400A, 81432206222, 81432206260, 81432206283, 81432206284



MN-DL-10288

81432206386, 82432206008, 82432209008

No Image

MN-DL-12288

Length: 585 Ø: 58
Hole Distance: 130 / 130
81432206386, 82432206008, 82432209008

No Image

MN-RK-12436

Ø: 75
Hole Distance: 115
Thick/Height: 24
81432206244



MN-VB-5222

Length: 627 Ø: 50
Hole Distance: 152 / 152
81432706030, 81432706034, 81432706054, 81432706055, 81432706056, 81432706057, 81432706067, 81432706068, 81432706074, 81432706075, 81432706076, 81432706077, 81432706078, 81432706081, 81432706082, 81432709034, 81432709076, 81432709078, 8143706054



MN-VB-5238

Length: 627 Ø: 48
Hole Distance: 130 / 130
81432206221, 81432706096, 81432706114, 81432706116, 81432706121



MN-VB-8514

Length: 627 Ø: 48
Hole Ø 25 / 25 / 25
Hole Distance: 152 / 130 / 130
81432706087, 81432706088, 81432706094, 81432706095, 81432796094



MN-VB-8669

Length: 627 Ø: 48
Hole Ø 25 / 25 / 25
Hole Distance: 152 / 130 / 130
81432706116, 81432706137, 81432706150, 81432706151



MN-VB-9404

Length: 627 Ø: 58
Hole Distance: 130 / 130
81432706117, 81432706152, 81432706153



SC-ES-7279

Length: 150
Cone Ø: d1 Ø 30 / d2 Ø 27
Thread: M30 x 1,5 RHT
81953016288



SC-ES-8517

Length: 140
Cone Ø: d1 Ø 30 / d2 Ø 27
Thread: M30 x 1,5 RHT
81953016286



SC-ES-8535

Length: 145
Cone Ø: d1 Ø 30 / d2 Ø 27
Thread: M30 x 1,5 RHT
81953016271, 81953016325





TGA ...

33.460 FDLRS, FDLS, FDRS, FDS ...	09/02→	Track Control Arm		MN-VB-8514	Suspension Rod, Wishbone (CV), Drive Axle; Leaf Spring Axle	
	09/02→	Track Control Arm		MN-VB-8669	Suspension Rod, Wishbone (CV), Drive Axle	
	09/02→	Track Control Arm		MN-VB-8669	Suspension Rod, Wishbone (CV), Drive Axle; Leaf Spring Axle	
	09/02→	Track Control Arm		MN-VB-9404	Wishbone (CV), Drive Axle	
	09/02→	Track Control Arm		MN-VB-9404	Wishbone (CV), Drive Axle;Air Suspension Axle	
	09/02→	Track Control Arm		MN-VB-9404	Wishbone (CV), Drive Axle;Leaf Spring Axle	
	09/02→	Track Control Arm	MN-DL-8663		Control Arm, Air Suspension Axle	
	33.460 FD-TM, FDR-TM	09/02→	Ball Head, gearshift linkage	CV-ES-2120		
		09/02→	Centre Rod	MN-DL-7801		Push Rod, Leaf Spring Axle
09/02→		Suspension Strut Repair Kit		DB-RK-8581		
09/02→		Tie Rod	MN-DL-7802			
09/02→		Tie Rod End	CV-ES-0914		for Steering Rod	
09/02→		Tie Rod End	CV-ES-14162		for Steering Rod	
09/02→		Tie Rod End	CV-ES-14163		for Steering Rod	
09/02→		Tie Rod End	SC-ES-7279		for Steering Rod	
09/02→		Tie Rod End	SC-ES-8517		for Push Rod	
09/02→		Tie Rod End	SC-ES-8535		for Guide Rod	
09/02→		Track Control Arm		MN-DL-5225	Trailing Arm	
09/02→		Track Control Arm		MN-DL-8544	Trailing Arm, Drive Axle;Leaf Spring Axle	
09/02→		Track control arm		MN-DL-10288	Trailing Arm, 1st RA;2nd RA, for Leaf-Spring Suspension vehicles	
09/02→		Track control arm		MN-DL-12288	Trailing Arm	
09/02→		Track Control Arm		MN-VB-8514	Suspension Rod, Wishbone (CV), Drive Axle; Leaf Spring Axle	
09/02→		Track Control Arm		MN-VB-8669	Suspension Rod, Wishbone (CV), Drive Axle; Leaf Spring Axle	
09/02→		Track Control Arm		MN-VB-9404	Wishbone (CV), Drive Axle	
33.480 FDAC, FDAC-WW, FDALC, FDARC		09/02→	Ball Head, gearshift linkage	CV-ES-2120		
		09/02→	Centre Rod	MN-DL-7801		Push Rod
		09/02→	Suspension Strut Repair Kit		DB-RK-8581	
	09/02→	Tie Rod End	CV-ES-0914		for Steering Rod	
	09/02→	Tie Rod End	CV-ES-14163		for Steering Rod	
	09/02→	Tie Rod End	MN-ES-10333		for Steering Rod	
	09/02→	Tie Rod End	SC-ES-8517		for Push Rod	
	09/02→	Track Control Arm		MN-DL-5225	Trailing Arm	
	09/02→	Track Control Arm		MN-DL-8544	Trailing Arm, 1st RA;2nd RA;Leaf Spring Axle	
	09/02→	Track Control Arm		MN-DL-8609	Trailing Arm, 1st RA;2nd RA, for Leaf-Spring Suspension vehicles, →Type_HB Chassis	
	09/02→	Track Control Arm		MN-VB-8514	Suspension Rod, Wishbone (CV), Drive Axle; Leaf Spring Axle	
	09/02→	Track Control Arm		MN-VB-9404	Wishbone (CV), Drive Axle	
	33.480 FDAC, FDALC, FDARC, FDHC	02/06→	Centre Rod	MN-DL-7801		Push Rod, Leaf Spring Axle
02/06→		Suspension Strut Repair Kit		DB-RK-8581		
02/06→		Tie Rod	MN-DL-7802			
02/06→		Tie Rod End	CV-ES-0914		for Steering Rod	
02/06→		Tie Rod End	CV-ES-14162		for Steering Rod	
02/06→		Tie Rod End	CV-ES-14163		for Steering Rod	
02/06→		Tie Rod End	MN-ES-10333		for Steering Rod	
02/06→		Tie Rod End	SC-ES-7279		for Steering Rod	
02/06→		Tie Rod End	SC-ES-8517		for Push Rod	
02/06→		Tie Rod End	SC-ES-8535		for Guide Rod	
02/06→		Track Control Arm		MN-DL-5225	Trailing Arm	
02/06→		Track Control Arm		MN-DL-8544	Trailing Arm, 1st RA;2nd RA;Leaf Spring Axle	
02/06→		Track Control Arm		MN-DL-8544	Trailing Arm, Drive Axle;Leaf Spring Axle	
02/06→		Track Control Arm		MN-DL-8609	Trailing Arm, 1st RA;2nd RA, for Leaf-Spring Suspension vehicles, →Type_HB Chassis	
02/06→		Track control arm		MN-DL-10288	Trailing Arm, 1st RA;2nd RA, for Leaf-Spring Suspension vehicles, →Type HB	
02/06→		Track control arm		MN-DL-12288	Trailing Arm	
02/06→		Track Control Arm		MN-VB-8514	Suspension Rod, Wishbone (CV), Drive Axle; Leaf Spring Axle	

CV-ES-0914

Length: 125
Cone Ø: d1 Ø 30 / d2 Ø 27
Thread: M38 x 1,5 RHT
81953016184, 81953016251, 81953016276



CV-ES-2120

Length: 115
Cone Ø: d1 Ø 12,4 / d2 Ø 10,8
Thread: M14 x 1,5 RHT
03008500A, 81953016200, 81953016202,
81953016203, 81953016227



CV-ES-14162

Length: 125
Cone Ø: d1 Ø 30 / d2 Ø 27
Thread: M30 x 1,5 LHT
81953010015, 81953010083, 81953010087,
81953016029, 81953016030, 81953016043,
81953016044, 81953016050, 81953016054,
81953016087, 81953016091, 81953016107,
81953016120, 81953016125, 81953016152,
81953016155, 81953016157, 81953016168,
81953016179, 81953016181, 81953016223,
81953016237, 81953016254, 81953016275,
81953016279, 81953016351



CV-ES-14163

Length: 125
Cone Ø: d1 Ø 30 / d2 Ø 27
Thread: M30 x 1,5 RHT
95301.0084, 90804102156, 90804102272,
90804102696, 90804102710, 81953010016,
81953010075, 81953010084, 81953010088,
81953010094, 81953010103, 81953016030,
81953016043, 81953016048, 81953016049,
81953016053, 81953016061, 81953016090,
81953016108, 81953016112, 81953016126,
81953016143, 81953016149, 81953016154,
81953016156, 81953016168, 81953016178,
81953016194, 81953016206, 81953016224,
81953016234, 81953016242, 81953016252,
81953016274, 81953016278, 81953016284,
81953016286, 81953016308, 81953016310,
81953016312, 81953016347, 81953016350,
81953016352, 82953016012, 88953016014,
N2953016001



DB-RK-8581

Ø: 85
Hole Distance: 130
Thick/Height: 24
03305800A, 81432706105



MN-DL-5225

Length: 572 Ø: 48
Hole Distance: 130 / 130
03301500A, 81432206229, 81432206236,
81432206267, 81432206270, 81432206272,
81432206304, 81432206305, 81432209236,
81432209267, 81432209272



MN-DL-7801

Length: 995 Ø: 52
Cone Ø: d1 Ø 30 / d2 Ø 27
81466106807, 81466106808, 81466116087,
81466116088, 81466116096, 81466116097,
81466116099, 81466116132, 81466116133,
81466116136, 81466116197, 81466116198,
81466116205

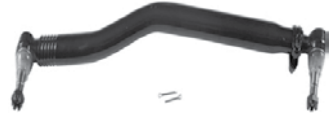

MN-DL-7802

Length: 1680 Ø: 52
Cone Ø: d1 Ø 30 / d2 Ø 27
03208300A, 81467116773, 81467116858,
81467116859, 81467116860, 81467116861,
81467116863, 81467116882, 81467116883,
81467116920, 81467116921



MN-DL-8544

Length: 596 Ø: 48
Hole Distance: 130 / 130
81432206196, 81432206232, 81432206233



MN-DL-8609

Length: 585 Ø: 58
Hole Distance: 130 / 130
81432206070, 81432206071, 81432206072,
81432206091, 81432206093, 81432206119



MN-DL-8663

Length: 947 Ø: 60
Hole Distance: 115 / 115
03307400A, 81432206222, 81432206260,
81432206283, 81432206284



MN-DL-10288

81432206386, 82432206008, 82432209008

No Image

MN-DL-12288

Length: 585 Ø: 58
Hole Distance: 130 / 130
81432206386, 82432206008, 82432209008

No Image

MN-ES-10333

Length: 90
Cone Ø: d1 Ø 38 / d2 Ø 34,35
Thread: M36 x 1,5 RHT
1271126, 3090291, 3099128, 42538048,
81953016268, 82953016018, 82953016019



MN-VB-8514

Length: 627 Ø: 48
Hole Ø 25 / 25 / 25
Hole Distance: 152 / 130 / 130
81432706087, 81432706088, 81432706094,
81432706095, 81432796094



MN-VB-8669

Length: 627 Ø: 48
Hole Ø 25 / 25 / 25
Hole Distance: 152 / 130 / 130
81432706116, 81432706137, 81432706150,
81432706151



MN-VB-9404

Length: 627 Ø: 58
Hole Distance: 130 / 130
81432706117, 81432706152, 81432706153



SC-ES-7279

Length: 150
Cone Ø: d1 Ø 30 / d2 Ø 27
Thread: M30 x 1,5 RHT
81953016288



SC-ES-8517

Length: 140
Cone Ø: d1 Ø 30 / d2 Ø 27
Thread: M30 x 1,5 RHT
81953016286



SC-ES-8535

Length: 145
Cone Ø: d1 Ø 30 / d2 Ø 27
Thread: M30 x 1,5 RHT
81953016271, 81953016325



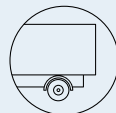

TGA ...

33.480 FDAC, FDALC, FDARC, FDHC ...	02/06 →	Track Control Arm		MN-VB-8669	Suspension Rod, Wishbone (CV), Drive Axle; Leaf Spring Axle	
	02/06 →	Track Control Arm		MN-VB-9404	Wishbone (CV), Drive Axle	
33.480 FDAK, FDALK, FDARK, FDHK	09/02 →	Ball Head, gearshift linkage	CV-ES-2120			
	09/02 →	Centre Rod	MN-DL-7801		Push Rod	
	09/02 →	Suspension Strut Repair Kit		DB-RK-8581		
	09/02 →	Tie Rod End	CV-ES-0914		for Steering Rod	
	09/02 →	Tie Rod End	CV-ES-14163		for Steering Rod	
	09/02 →	Tie Rod End	MN-ES-10333		for Steering Rod	
	09/02 →	Tie Rod End	SC-ES-8517		for Push Rod	
	09/02 →	Track Control Arm		MN-DL-5225	Trailing Arm	
	09/02 →	Track Control Arm		MN-DL-8544	Trailing Arm, 1st RA;2nd RA;Leaf Spring Axle	
	09/02 →	Track Control Arm		MN-DL-8544	Trailing Arm, Drive Axle;Air Suspension Axle	
	09/02 →	Track Control Arm		MN-DL-8609	Trailing Arm, 1st RA;2nd RA, for Leaf-Spring Suspension vehicles, →Type_HB Chassis	
	09/02 →	Track Control Arm		MN-VB-8514	Suspension Rod, Wishbone (CV), Drive Axle; Air Suspension Axle	
	09/02 →	Track Control Arm		MN-VB-8514	Suspension Rod, Wishbone (CV), Drive Axle; Leaf Spring Axle	
	09/02 →	Track Control Arm		MN-VB-9404	Wishbone (CV), Drive Axle	
	09/02 →	Track Control Arm		MN-VB-9404	Wishbone (CV), Drive Axle;Leaf Spring Axle	
	02/06 →	Centre Rod	MN-DL-7801		Push Rod, Leaf Spring Axle	
	02/06 →	Tie Rod	MN-DL-7802			
	02/06 →	Tie Rod End	CV-ES-14162		for Steering Rod	
	02/06 →	Tie Rod End	SC-ES-7279		for Steering Rod	
	02/06 →	Tie Rod End	SC-ES-8535		for Guide Rod	
	02/06 →	Track Control Arm		MN-DL-8544	Trailing Arm, Drive Axle;Leaf Spring Axle	
	02/06 →	Track control arm		MN-DL-10288	Trailing Arm, 1st RA;2nd RA, for Leaf-Spring Suspension vehicles, →Type HB	
	02/06 →	Track control arm		MN-DL-12288	Trailing Arm	
	02/06 →	Track Control Arm		MN-VB-8669	Suspension Rod, Wishbone (CV), Drive Axle; Leaf Spring Axle	
	33.480 FDALS, FDARS, FDAS, FDHS	09/02 →	Ball Head, gearshift linkage	CV-ES-2120		
		09/02 →	Centre Rod	MN-DL-7801		Push Rod
		09/02 →	Suspension Strut Repair Kit		DB-RK-8581	
09/02 →		Tie Rod End	CV-ES-0914		for Steering Rod	
09/02 →		Tie Rod End	CV-ES-14163		for Steering Rod	
09/02 →		Tie Rod End	MN-ES-10333		for Steering Rod	
09/02 →		Tie Rod End	SC-ES-8517		for Push Rod	
09/02 →		Track Control Arm		MN-DL-5225	Trailing Arm	
09/02 →		Track Control Arm		MN-DL-8544	Trailing Arm, 1st RA;2nd RA;Leaf Spring Axle	
09/02 →		Track Control Arm		MN-DL-8609	Trailing Arm, 1st RA;2nd RA, for Leaf-Spring Suspension vehicles, →Type_HB Chassis	
09/02 →		Track Control Arm		MN-VB-8514	Suspension Rod, Wishbone (CV), Drive Axle; Air Suspension Axle	
09/02 →		Track Control Arm		MN-VB-8514	Suspension Rod, Wishbone (CV), Drive Axle; Leaf Spring Axle	
09/02 →		Track Control Arm		MN-VB-9404	Wishbone (CV), Drive Axle	
09/02 →		Track Control Arm		MN-VB-9404	Wishbone (CV), Drive Axle;Leaf Spring Axle	
02/06 →		Centre Rod	MN-DL-7801		Push Rod, Leaf Spring Axle	
02/06 →		Tie Rod	MN-DL-7802			
02/06 →		Tie Rod End	CV-ES-14162		for Steering Rod	
02/06 →		Tie Rod End	SC-ES-7279		for Steering Rod	
02/06 →		Tie Rod End	SC-ES-8535		for Guide Rod	
02/06 →		Track Control Arm		MN-DL-8544	Trailing Arm, Drive Axle;Leaf Spring Axle	
02/06 →		Track control arm		MN-DL-10288	Trailing Arm, 1st RA;2nd RA, for Leaf-Spring Suspension vehicles, →Type HB	
02/06 →		Track control arm		MN-DL-12288	Trailing Arm	
02/06 →		Track Control Arm		MN-VB-8669	Suspension Rod, Wishbone (CV), Drive Axle; Leaf Spring Axle	

CV-ES-0914

Length: 125
Cone Ø: d1 Ø 30 / d2 Ø 27
Thread: M38 x 1,5 RHT
81953016184, 81953016251, 81953016276



CV-ES-2120

Length: 115
Cone Ø: d1 Ø 12,4 / d2 Ø 10,8
Thread: M14 x 1,5 RHT
03008500A, 81953016200, 81953016202, 81953016203, 81953016227



CV-ES-14162

Length: 125
Cone Ø: d1 Ø 30 / d2 Ø 27
Thread: M30 x 1,5 LHT
81953010015, 81953010083, 81953010087, 81953016029, 81953016030, 81953016043, 81953016044, 81953016050, 81953016054, 81953016087, 81953016091, 81953016107, 81953016120, 81953016125, 81953016152, 81953016155, 81953016157, 81953016168, 81953016179, 81953016181, 81953016223, 81953016237, 81953016254, 81953016275, 81953016279, 81953016351



CV-ES-14163

Length: 125
Cone Ø: d1 Ø 30 / d2 Ø 27
Thread: M30 x 1,5 RHT
95301.0084, 90804102156, 90804102272, 90804102696, 90804102710, 81953010016, 81953010075, 81953010084, 81953010088, 81953010094, 81953010103, 81953016030, 81953016043, 81953016048, 81953016049, 81953016053, 81953016061, 81953016090, 81953016108, 81953016112, 81953016126, 81953016143, 81953016149, 81953016154, 81953016156, 81953016168, 81953016178, 81953016194, 81953016206, 81953016224, 81953016234, 81953016242, 81953016252, 81953016274, 81953016278, 81953016284, 81953016286, 81953016308, 81953016310, 81953016312, 81953016347, 81953016350, 81953016352, 82953016012, 88953016014, N2953016001



DB-RK-8581

Ø: 85
Hole Distance: 130
Thick/Height: 24
03305800A, 81432706105



MN-DL-5225

Length: 572 Ø: 48
Hole Distance: 130 / 130
03301500A, 81432206229, 81432206236, 81432206267, 81432206270, 81432206272, 81432206304, 81432206305, 81432209236, 81432209267, 81432209272



MN-DL-7801

Length: 995 Ø: 52
Cone Ø: d1 Ø 30 / d2 Ø 27
81466106807, 81466106808, 81466116087, 81466116088, 81466116096, 81466116097, 81466116099, 81466116132, 81466116133, 81466116136, 81466116197, 81466116198, 81466116205

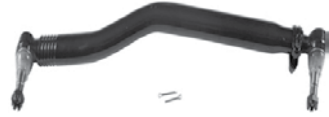

MN-DL-7802

Length: 1680 Ø: 52
Cone Ø: d1 Ø 30 / d2 Ø 27
03208300A, 81467116773, 81467116858, 81467116859, 81467116860, 81467116861, 81467116863, 81467116882, 81467116883, 81467116920, 81467116921



MN-DL-8544

Length: 596 Ø: 48
Hole Distance: 130 / 130
81432206196, 81432206232, 81432206233



MN-DL-8609

Length: 585 Ø: 58
Hole Distance: 130 / 130
81432206070, 81432206071, 81432206072, 81432206091, 81432206093, 81432206119



MN-DL-10288

81432206386, 82432206008, 82432209008

No Image

MN-DL-12288

Length: 585 Ø: 58
Hole Distance: 130 / 130
81432206386, 82432206008, 82432209008

No Image

MN-ES-10333

Length: 90
Cone Ø: d1 Ø 38 / d2 Ø 34,35
Thread: M36 x 1,5 RHT
1271126, 3090291, 3099128, 42538048, 81953016268, 82953016018, 82953016019



MN-VB-8514

Length: 627 Ø: 48
Hole Ø 25 / 25 / 25
Hole Distance: 152 / 130 / 130
81432706087, 81432706088, 81432706094, 81432706095, 81432796094



MN-VB-8669

Length: 627 Ø: 48
Hole Ø 25 / 25 / 25
Hole Distance: 152 / 130 / 130
81432706116, 81432706137, 81432706150, 81432706151



MN-VB-9404

Length: 627 Ø: 58
Hole Distance: 130 / 130
81432706117, 81432706152, 81432706153



SC-ES-7279

Length: 150
Cone Ø: d1 Ø 30 / d2 Ø 27
Thread: M30 x 1,5 RHT
81953016288



SC-ES-8517

Length: 140
Cone Ø: d1 Ø 30 / d2 Ø 27
Thread: M30 x 1,5 RHT
81953016286



SC-ES-8535

Length: 145
Cone Ø: d1 Ø 30 / d2 Ø 27
Thread: M30 x 1,5 RHT
81953016271, 81953016325





TGA ...

33.480 FDC, FDLC, FDRC	01/06→	Centre Rod	MN-DL-7801		Push Rod, Leaf Spring Axle	
	01/06→	Suspension Strut Repair Kit		DB-RK-8581		
	01/06→	Tie Rod	MN-DL-7802			
	01/06→	Tie Rod	MN-DL-12293			
	01/06→	Tie Rod End	CV-ES-0914		for Steering Rod	
	01/06→	Tie Rod End	CV-ES-14162		for Steering Rod	
	01/06→	Tie Rod End	CV-ES-14163		for Steering Rod	
	01/06→	Tie Rod End	SC-ES-7279		for Steering Rod	
	01/06→	Tie Rod End	SC-ES-8517		for Push Rod	
	01/06→	Tie Rod End	SC-ES-8535		for Guide Rod	
	01/06→	Track Control Arm		MN-DL-3402	Trailing Arm, 1st RA;2nd RA, for Pneumatic Suspension vehicles	
	01/06→	Track Control Arm		MN-DL-5225	Trailing Arm	
	01/06→	Track Control Arm		MN-DL-8544	Trailing Arm, Drive Axle;Leaf Spring Axle	
	01/06→	Track control arm		MN-DL-10288	Trailing Arm, 1st RA;2nd RA, for Leaf-Spring Suspension vehicles	
	01/06→	Track control arm		MN-DL-12288	Trailing Arm	
	01/06→	Track Control Arm		MN-VB-5222	Wishbone (CV), 1st RA;2nd RA, for Pneumatic Suspension vehicles	
	01/06→	Track Control Arm		MN-VB-5238	Wishbone (CV), 1st RA;2nd RA, for Pneumatic Suspension vehicles, →Type_NBA Chassis	
	01/06→	Track Control Arm		MN-VB-8514	Suspension Rod, Wishbone (CV), Drive Axle; Leaf Spring Axle	
	01/06→	Track Control Arm		MN-VB-8669	Suspension Rod, Wishbone (CV), Drive Axle; Leaf Spring Axle	
	01/06→	Track Control Arm		MN-VB-9404	Wishbone (CV), Drive Axle	
33.480 FDC, FDLC, FDRC, FDLRC	09/02→03/03	Track Control Arm		MN-DL-8609	Trailing Arm, Leaf Spring Axle;Double Axle with two Driven Axles	
	09/02→	Ball Head, gearshift linkage	CV-ES-2120			
	09/02→	Centre Rod	MN-DL-7801		Push Rod, Leaf Spring Axle	
	09/02→	Centre Rod	MN-DL-8560		Push Rod, Air Suspension Axle	
	09/02→	Suspension Strut Repair Kit		DB-RK-8581		
	09/02→	Suspension Strut Repair Kit		MN-RK-12436		
	09/02→	Tie Rod	MN-DL-7802			
	09/02→	Tie Rod End	CV-ES-0914		for Steering Rod	
	09/02→	Tie Rod End	CV-ES-14162		for Steering Rod	
	09/02→	Tie Rod End	CV-ES-14163		for Steering Rod	
	09/02→	Tie Rod End	SC-ES-7279		for Steering Rod	
	09/02→	Tie Rod End	SC-ES-8517		for Push Rod	
	09/02→	Tie Rod End	SC-ES-8535		for Guide Rod	
	09/02→	Track Control Arm		MN-DL-3402	Trailing Arm, Air Suspension Axle;Drive Axle	
	09/02→	Track Control Arm		MN-DL-5225	Trailing Arm, Drive Axle;Air Suspension Axle	
	09/02→	Track Control Arm		MN-DL-8544	Trailing Arm, Drive Axle;Air Suspension Axle	
	09/02→	Track Control Arm		MN-DL-8544	Trailing Arm, Drive Axle;Leaf Spring Axle	
	09/02→	Track control arm		MN-DL-10288	Trailing Arm, 1st RA;2nd RA, for Leaf-Spring Suspension vehicles	
	09/02→	Track control arm		MN-DL-12288	Trailing Arm	
	09/02→	Track Control Arm		MN-VB-5222	Wishbone (CV), 1st RA;2nd RA, for Pneumatic Suspension vehicles	
	09/02→	Track Control Arm		MN-VB-5238	Wishbone (CV), Drive Axle;Air Suspension Axle	
	09/02→	Track Control Arm		MN-VB-8514	Suspension Rod, Wishbone (CV), Drive Axle; Leaf Spring Axle	
	09/02→	Track Control Arm		MN-VB-8669	Suspension Rod, Wishbone (CV), Drive Axle	
	09/02→	Track Control Arm		MN-VB-8669	Suspension Rod, Wishbone (CV), Drive Axle; Leaf Spring Axle	
	09/02→	Track Control Arm		MN-VB-9404	Wishbone (CV), Drive Axle	
	09/02→	Track Control Arm		MN-VB-9404	Wishbone (CV), Drive Axle;Air Suspension Axle	
	09/02→	Track Control Arm		MN-VB-9404	Wishbone (CV), Drive Axle;Leaf Spring Axle	
	09/02→	Track Control Arm	MN-DL-8663		Control Arm, Air Suspension Axle	
	33.480 FDC-TM, FDRC-TM, FD-TM	09/02→	Ball Head, gearshift linkage	CV-ES-2120		
		09/02→	Centre Rod	MN-DL-7801		Push Rod, Leaf Spring Axle
		09/02→	Suspension Strut Repair Kit		DB-RK-8581	
		09/02→	Tie Rod	MN-DL-7802		

CV-ES-0914

Length: 125
Cone Ø: d1 Ø 30 / d2 Ø 27
Thread: M38 x 1,5 RHT
81953016184, 81953016251, 81953016276



CV-ES-2120

Length: 115
Cone Ø: d1 Ø 12,4 / d2 Ø 10,8
Thread: M14 x 1,5 RHT
03008500A, 81953016200, 81953016202, 81953016203, 81953016227



CV-ES-14162

Length: 125
Cone Ø: d1 Ø 30 / d2 Ø 27
Thread: M30 x 1,5 LHT
81953010015, 81953010083, 81953010087, 81953016029, 81953016030, 81953016043, 81953016044, 81953016050, 81953016054, 81953016087, 81953016091, 81953016107, 81953016120, 81953016125, 81953016152, 81953016155, 81953016157, 81953016168, 81953016179, 81953016181, 81953016223, 81953016237, 81953016254, 81953016275, 81953016279, 81953016351



CV-ES-14163

Length: 125
Cone Ø: d1 Ø 30 / d2 Ø 27
Thread: M30 x 1,5 RHT
95301.0084, 90804102156, 90804102272, 90804102696, 90804102710, 81953010016, 81953010075, 81953010084, 81953010088, 81953010094, 81953010103, 81953016030, 81953016043, 81953016048, 81953016049, 81953016053, 81953016061, 81953016090, 81953016108, 81953016112, 81953016126, 81953016143, 81953016149, 81953016154, 81953016156, 81953016168, 81953016178, 81953016194, 81953016206, 81953016224, 81953016234, 81953016242, 81953016252, 81953016274, 81953016278, 81953016284, 81953016286, 81953016308, 81953016310, 81953016312, 81953016347, 81953016350, 81953016352, 82953016012, 88953016014, N2953016001



DB-RK-8581

Ø: 85
Hole Distance: 130
Thick/Height: 24
03305800A, 81432706105



MN-DL-3402

Length: 590 Ø: 48
Hole Distance: 130 / 130
03307200A, 81432206067, 81432206068, 81432206090, 81432206092, 81432209099



MN-DL-5225

Length: 572 Ø: 48
Hole Distance: 130 / 130
03301500A, 81432206229, 81432206236, 81432206267, 81432206270, 81432206272, 81432206304, 81432206305, 81432209236, 81432209267, 81432209272



MN-DL-7801

Length: 995 Ø: 52
Cone Ø: d1 Ø 30 / d2 Ø 27
81466106807, 81466106808, 81466116087, 81466116088, 81466116096, 81466116097, 81466116099, 81466116132, 81466116133, 81466116136, 81466116197, 81466116198, 81466116205



MN-DL-7802

Length: 1680 Ø: 52
Cone Ø: d1 Ø 30 / d2 Ø 27
03208300A, 81467116773, 81467116858, 81467116859, 81467116860, 81467116861, 81467116863, 81467116882, 81467116883, 81467116920, 81467116921



MN-DL-8544

Length: 596 Ø: 48
Hole Distance: 130 / 130
81432206196, 81432206232, 81432206233



MN-DL-8560

Length: 970 Ø: 52
Cone Ø: d1 Ø 30 / d2 Ø 27
03206900A, 81466106809, 81466106810, 81466106823, 81466106838, 81466106839, 81466116104, 81466116105, 81466116107, 81466116134, 81466116135, 81466116137, 81466116199, 81466116200, 81466116206



MN-DL-8609

Length: 585 Ø: 58
Hole Distance: 130 / 130
81432206070, 81432206071, 81432206072, 81432206091, 81432206093, 81432206119



MN-DL-8663

Length: 947 Ø: 60
Hole Distance: 115 / 115
03307400A, 81432206222, 81432206260, 81432206283, 81432206284



MN-DL-10288

81432206386, 82432206008, 82432209008

No Image

MN-DL-12288

Length: 585 Ø: 58
Hole Distance: 130 / 130
81432206386, 82432206008, 82432209008

No Image

MN-DL-12293

Length: 1680 Ø: 42
Cone Ø: d1 Ø 30 / d2 Ø 27
81467106236, 81467106268, 81467106356, 81467116356, 81467116723, 81467116794, 81467116933, 81467116934, 81467116966



MN-RK-12436

Ø: 75
Hole Distance: 115
Thick/Height: 24
81432206244



MN-VB-5222

Length: 627 Ø: 50
Hole Distance: 152 / 152
81432706030, 81432706034, 81432706054, 81432706055, 81432706056, 81432706057, 81432706067, 81432706068, 81432706074, 81432706075, 81432706076, 81432706077, 81432706078, 81432706081, 81432706082, 81432709034, 81432709076, 81432709078, 8143706054



MN-VB-5238

Length: 627 Ø: 48
Hole Distance: 130 / 130
81432206221, 81432706096, 81432706114, 81432706116, 81432706121



MN-VB-8514

Length: 627 Ø: 48
Hole Ø 25 / 25 / 25
Hole Distance: 152 / 130 / 130
81432706087, 81432706088, 81432706094, 81432706095, 81432796094



MN-VB-8669

Length: 627 Ø: 48
Hole Ø 25 / 25 / 25
Hole Distance: 152 / 130 / 130
81432706116, 81432706137, 81432706150, 81432706151



MN-VB-9404

Length: 627 Ø: 58
Hole Distance: 130 / 130
81432706117, 81432706152, 81432706153



SC-ES-7279

Length: 150
Cone Ø: d1 Ø 30 / d2 Ø 27
Thread: M30 x 1,5 RHT
81953016288



SC-ES-8517

Length: 140
Cone Ø: d1 Ø 30 / d2 Ø 27
Thread: M30 x 1,5 RHT
81953016286



SC-ES-8535

Length: 145
Cone Ø: d1 Ø 30 / d2 Ø 27
Thread: M30 x 1,5 RHT
81953016271, 81953016325





TGA ...

33.480 FDC-TM, FDRC-TM, FD-TM ...	09/02→	Tie Rod End	CV-ES-0914		for Steering Rod
	09/02→	Tie Rod End	CV-ES-14162		for Steering Rod
	09/02→	Tie Rod End	CV-ES-14163		for Steering Rod
	09/02→	Tie Rod End	SC-ES-7279		for Steering Rod
	09/02→	Tie Rod End	SC-ES-8517		for Push Rod
	09/02→	Tie Rod End	SC-ES-8535		for Guide Rod
	09/02→	Track Control Arm		MN-DL-5225	Trailing Arm
	09/02→	Track Control Arm		MN-DL-8544	Trailing Arm, Drive Axle;Leaf Spring Axle
	09/02→	Track control arm		MN-DL-10288	Trailing Arm, 1st RA;2nd RA, for Leaf-Spring Suspension vehicles
	09/02→	Track control arm		MN-DL-12288	Trailing Arm
	09/02→	Track Control Arm		MN-VB-8514	Suspension Rod, Wishbone (CV), Drive Axle; Leaf Spring Axle
	09/02→	Track Control Arm		MN-VB-8669	Suspension Rod, Wishbone (CV), Drive Axle; Leaf Spring Axle
	09/02→	Track Control Arm		MN-VB-9404	Wishbone (CV), Drive Axle
	09/07→	Centre Rod	MN-DL-2160		Coupling Rod
	09/07→	Suspension Arm Repair Kit		CV-RK-5313	for Wishbone (CV)
	09/07→	Track Control Arm		MN-DL-8544	Trailing Arm
	09/07→	Track Control Arm		MN-VB-8514	Suspension Rod, Wishbone (CV)
	09/07→	Track Control Arm		MN-VB-8669	Suspension Rod, Wishbone (CV)
	09/07→	Track Control Arm		MN-VB-9404	Wishbone (CV)
	33.480 FDK, FDLK, FDRK	09/02→03/03	Track Control Arm		MN-DL-8609
09/02→		Ball Head, gearshift linkage	CV-ES-2120		
09/02→		Centre Rod	MN-DL-7801		Push Rod, Leaf Spring Axle
09/02→		Centre Rod	MN-DL-8560		Push Rod, Air Suspension Axle
09/02→		Suspension Strut Repair Kit		DB-RK-8581	
09/02→		Suspension Strut Repair Kit		MN-RK-12436	
09/02→		Tie Rod	MN-DL-7802		
09/02→		Tie Rod End	CV-ES-0914		for Steering Rod
09/02→		Tie Rod End	CV-ES-14162		for Steering Rod
09/02→		Tie Rod End	CV-ES-14163		for Steering Rod
09/02→		Tie Rod End	SC-ES-7279		for Steering Rod
09/02→		Tie Rod End	SC-ES-8517		for Push Rod
09/02→		Tie Rod End	SC-ES-8535		for Guide Rod
09/02→		Track Control Arm		MN-DL-3402	Trailing Arm, Air Suspension Axle;Drive Axle
09/02→		Track Control Arm		MN-DL-5225	Trailing Arm, Drive Axle;Air Suspension Axle
09/02→		Track Control Arm		MN-DL-8544	Trailing Arm, Drive Axle;Air Suspension Axle
09/02→		Track Control Arm		MN-DL-8544	Trailing Arm, Drive Axle;Leaf Spring Axle
09/02→		Track control arm		MN-DL-10288	Trailing Arm, 1st RA;2nd RA, for Leaf-Spring Suspension vehicles
09/02→		Track control arm		MN-DL-12288	Trailing Arm
09/02→		Track Control Arm		MN-VB-5222	Wishbone (CV), 1st RA;2nd RA, for Pneumatic Suspension vehicles
09/02→		Track Control Arm		MN-VB-5238	Wishbone (CV), Drive Axle;Air Suspension Axle
09/02→		Track Control Arm		MN-VB-8514	Suspension Rod, Wishbone (CV), Drive Axle; Leaf Spring Axle
09/02→		Track Control Arm		MN-VB-8669	Suspension Rod, Wishbone (CV), Drive Axle
09/02→		Track Control Arm		MN-VB-8669	Suspension Rod, Wishbone (CV), Drive Axle; Leaf Spring Axle
09/02→		Track Control Arm		MN-VB-9404	Wishbone (CV), Drive Axle
09/02→		Track Control Arm		MN-VB-9404	Wishbone (CV), Drive Axle;Air Suspension Axle
09/02→		Track Control Arm		MN-VB-9404	Wishbone (CV), Drive Axle;Leaf Spring Axle
09/02→		Track Control Arm	MN-DL-8663		Control Arm, Air Suspension Axle
01/06→		Tie Rod	MN-DL-12293		
01/06→		Track Control Arm		MN-DL-3402	Trailing Arm, 1st RA;2nd RA, for Pneumatic Suspension vehicles
01/06→		Track Control Arm		MN-DL-5225	Trailing Arm
01/06→		Track Control Arm		MN-VB-5238	Wishbone (CV), 1st RA;2nd RA, for Pneumatic Suspension vehicles, →Type_NBA Chassis

CV-ES-0914

Length: 125
Cone Ø: d1 Ø 30 / d2 Ø 27
Thread: M38 x 1,5 RHT
81953016184, 81953016251, 81953016276



CV-ES-2120

Length: 115
Cone Ø: d1 Ø 12,4 / d2 Ø 10,8
Thread: M14 x 1,5 RHT
03008500A, 81953016200, 81953016202, 81953016203, 81953016227



CV-ES-14162

Length: 125
Cone Ø: d1 Ø 30 / d2 Ø 27
Thread: M30 x 1,5 LHT
81953010015, 81953010083, 81953010087, 81953016029, 81953016030, 81953016043, 81953016044, 81953016050, 81953016054, 81953016087, 81953016091, 81953016107, 81953016120, 81953016125, 81953016152, 81953016155, 81953016157, 81953016168, 81953016179, 81953016181, 81953016223, 81953016237, 81953016254, 81953016275, 81953016279, 81953016351



CV-ES-14163

Length: 125
Cone Ø: d1 Ø 30 / d2 Ø 27
Thread: M30 x 1,5 RHT
95301.0084, 90804102156, 90804102272, 90804102696, 90804102710, 81953010016, 81953010075, 81953010084, 81953010088, 81953010094, 81953010103, 81953016030, 81953016043, 81953016048, 81953016049, 81953016053, 81953016061, 81953016090, 81953016108, 81953016112, 81953016126, 81953016143, 81953016149, 81953016154, 81953016156, 81953016168, 81953016178, 81953016194, 81953016206, 81953016224, 81953016234, 81953016242, 81953016252, 81953016274, 81953016278, 81953016284, 81953016286, 81953016308, 81953016310, 81953016312, 81953016347, 81953016350, 81953016352, 82953016012, 88953016014, N2953016001



CV-RK-5313

Ø: 90
03304800A, 81953016132



DB-RK-8581

Ø: 85
Hole Distance: 130
Thick/Height: 24
03305800A, 81432706105



MN-DL-2160

Length: 1652 Ø: 50
Cone Ø: d1 Ø 30 / d2 Ø 27
81467106112, 81467106163, 81467106165, 81467106198, 81467106353, 81467106354, 81467106361, 81467116725



MN-DL-3402

Length: 590 Ø: 48
Hole Distance: 130 / 130
03307200A, 81432206067, 81432206068, 81432206090, 81432206092, 81432209092



MN-DL-5225

Length: 572 Ø: 48
Hole Distance: 130 / 130
03301500A, 81432206229, 81432206236, 81432206267, 81432206270, 81432206272, 81432206304, 81432206305, 81432209236, 81432209267, 81432209272



MN-DL-7801

Length: 995 Ø: 52
Cone Ø: d1 Ø 30 / d2 Ø 27
81466106807, 81466106808, 81466116087, 81466116088, 81466116096, 81466116097, 81466116099, 81466116132, 81466116133, 81466116136, 81466116197, 81466116198, 81466116205

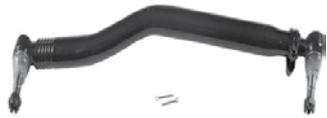

MN-DL-7802

Length: 1680 Ø: 52
Cone Ø: d1 Ø 30 / d2 Ø 27
03208300A, 81467116773, 81467116858, 81467116859, 81467116860, 81467116861, 81467116863, 81467116882, 81467116883, 81467116920, 81467116921



MN-DL-8544

Length: 596 Ø: 48
Hole Distance: 130 / 130
81432206196, 81432206232, 81432206233



MN-DL-8560

Length: 970 Ø: 52
Cone Ø: d1 Ø 30 / d2 Ø 27
03206900A, 81466106809, 81466106810, 81466106823, 81466106838, 81466106839, 81466116104, 81466116105, 81466116107, 81466116134, 81466116135, 81466116137, 81466116199, 81466116200, 81466116206



MN-DL-8609

Length: 585 Ø: 58
Hole Distance: 130 / 130
81432206070, 81432206071, 81432206072, 81432206091, 81432206093, 81432206119



MN-DL-8663

Length: 947 Ø: 60
Hole Distance: 115 / 115
03307400A, 81432206222, 81432206260, 81432206283, 81432206284



MN-DL-10288

81432206386, 82432206008, 82432209008

No Image

MN-DL-12288

Length: 585 Ø: 58
Hole Distance: 130 / 130
81432206386, 82432206008, 82432209008

No Image

MN-DL-12293

Length: 1680 Ø: 42
Cone Ø: d1 Ø 30 / d2 Ø 27
81467106236, 81467106268, 81467106356, 81467116356, 81467116723, 81467116794, 81467116933, 81467116934, 81467116966



MN-RK-12436

Ø: 75
Hole Distance: 115
Thick/Height: 24
81432206244



MN-VB-5222

Length: 627 Ø: 50
Hole Distance: 152 / 152
81432706030, 81432706034, 81432706054, 81432706055, 81432706056, 81432706057, 81432706067, 81432706068, 81432706074, 81432706075, 81432706076, 81432706077, 81432706078, 81432706081, 81432706082, 81432709034, 81432709076, 81432709078, 8143706054



MN-VB-5238

Length: 627 Ø: 48
Hole Distance: 130 / 130
81432206221, 81432706096, 81432706114, 81432706116, 81432706121



MN-VB-8514

Length: 627 Ø: 48
Hole Ø 25 / 25 / 25
Hole Distance: 152 / 130 / 130
81432706087, 81432706088, 81432706094, 81432706095, 81432796094



MN-VB-8669

Length: 627 Ø: 48
Hole Ø 25 / 25 / 25
Hole Distance: 152 / 130 / 130
81432706116, 81432706137, 81432706150, 81432706151



MN-VB-9404

Length: 627 Ø: 58
Hole Distance: 130 / 130
81432706117, 81432706152, 81432706153



SC-ES-7279

Length: 150
Cone Ø: d1 Ø 30 / d2 Ø 27
Thread: M30 x 1,5 RHT
81953016288



SC-ES-8517

Length: 140
Cone Ø: d1 Ø 30 / d2 Ø 27
Thread: M30 x 1,5 RHT
81953016286



SC-ES-8535

Length: 145
Cone Ø: d1 Ø 30 / d2 Ø 27
Thread: M30 x 1,5 RHT
81953016271, 81953016325





TGA ...

33.480 FDLRS, FDLS, FDRS, FDS	09/02→03/03	Track Control Arm		MN-DL-8609	Trailing Arm, Leaf Spring Axle;Double Axle with two Driven Axles
	09/02→	Ball Head, gearshift linkage	CV-ES-2120		
	09/02→	Centre Rod	MN-DL-7801		Push Rod, Leaf Spring Axle
	09/02→	Centre Rod	MN-DL-8560		Push Rod, Air Suspension Axle
	09/02→	Suspension Strut Repair Kit		DB-RK-8581	
	09/02→	Suspension Strut Repair Kit		MN-RK-12436	
	09/02→	Tie Rod	MN-DL-7802		
	09/02→	Tie Rod End	CV-ES-0914		for Steering Rod
	09/02→	Tie Rod End	CV-ES-14162		for Steering Rod
	09/02→	Tie Rod End	CV-ES-14163		for Steering Rod
	09/02→	Tie Rod End	SC-ES-7279		for Steering Rod
	09/02→	Tie Rod End	SC-ES-8517		for Push Rod
	09/02→	Tie Rod End	SC-ES-8535		for Guide Rod
	09/02→	Track Control Arm		MN-DL-3402	Trailing Arm, Air Suspension Axle;Drive Axle
	09/02→	Track Control Arm		MN-DL-5225	Trailing Arm, Drive Axle;Air Suspension Axle
	09/02→	Track Control Arm		MN-DL-8544	Trailing Arm, Drive Axle;Air Suspension Axle
	09/02→	Track Control Arm		MN-DL-8544	Trailing Arm, Drive Axle;Leaf Spring Axle
	09/02→	Track control arm		MN-DL-10288	Trailing Arm, 1st RA;2nd RA, for Leaf-Spring Suspension vehicles
	09/02→	Track control arm		MN-DL-12288	Trailing Arm
	09/02→	Track Control Arm		MN-VB-5222	Wishbone (CV), 1st RA;2nd RA, for Pneumatic Suspension vehicles
	09/02→	Track Control Arm		MN-VB-5238	Wishbone (CV), Drive Axle;Air Suspension Axle
	09/02→	Track Control Arm		MN-VB-8514	Suspension Rod, Wishbone (CV), Drive Axle; Leaf Spring Axle
	09/02→	Track Control Arm		MN-VB-8669	Suspension Rod, Wishbone (CV), Drive Axle
	09/02→	Track Control Arm		MN-VB-8669	Suspension Rod, Wishbone (CV), Drive Axle; Leaf Spring Axle
	09/02→	Track Control Arm		MN-VB-9404	Wishbone (CV), Drive Axle
	09/02→	Track Control Arm		MN-VB-9404	Wishbone (CV), Drive Axle;Air Suspension Axle
	09/02→	Track Control Arm		MN-VB-9404	Wishbone (CV), Drive Axle;Leaf Spring Axle
	09/02→	Track Control Arm	MN-DL-8663		Control Arm, Air Suspension Axle
	01/06→	Tie Rod	MN-DL-12293		
	01/06→	Track Control Arm		MN-DL-3402	Trailing Arm, 1st RA;2nd RA, for Pneumatic Suspension vehicles
	01/06→	Track Control Arm		MN-DL-5225	Trailing Arm
	01/06→	Track Control Arm		MN-VB-5238	Wishbone (CV), 1st RA;2nd RA, for Pneumatic Suspension vehicles, →Type_NBA Chassis
33.510 FDC, FDLC, FDRC, FDLRC	09/02→	Ball Head, gearshift linkage	CV-ES-2120		
	09/02→	Centre Rod	MN-DL-7801		Push Rod, Leaf Spring Axle
	09/02→	Centre Rod	MN-DL-8560		Push Rod, Air Suspension Axle
	09/02→	Suspension Strut Repair Kit		DB-RK-8581	
	09/02→	Suspension Strut Repair Kit		MN-RK-12436	
	09/02→	Tie Rod	MN-DL-7802		
	09/02→	Tie Rod End	CV-ES-0914		for Steering Rod
	09/02→	Tie Rod End	CV-ES-14162		for Steering Rod
	09/02→	Tie Rod End	CV-ES-14163		for Steering Rod
	09/02→	Tie Rod End	SC-ES-7279		for Steering Rod
	09/02→	Tie Rod End	SC-ES-8517		for Push Rod
	09/02→	Tie Rod End	SC-ES-8535		for Guide Rod
	09/02→	Track Control Arm		MN-DL-3402	Trailing Arm, Air Suspension Axle;Drive Axle
	09/02→	Track Control Arm		MN-DL-5225	Trailing Arm, Drive Axle;Air Suspension Axle
	09/02→	Track Control Arm		MN-DL-8544	Trailing Arm, Drive Axle;Air Suspension Axle
	09/02→	Track Control Arm		MN-DL-8544	Trailing Arm, Drive Axle;Leaf Spring Axle
	09/02→	Track control arm		MN-DL-10288	Trailing Arm, 1st RA;2nd RA, for Leaf-Spring Suspension vehicles
	09/02→	Track control arm		MN-DL-12288	Trailing Arm
	09/02→	Track Control Arm		MN-VB-5222	Wishbone (CV), 1st RA;2nd RA, for Pneumatic Suspension vehicles
	09/02→	Track Control Arm		MN-VB-5238	Wishbone (CV), Drive Axle;Air Suspension Axle
	09/02→	Track Control Arm		MN-VB-8514	Suspension Rod, Wishbone (CV), Drive Axle; Leaf Spring Axle

CV-ES-0914

Length: 125
Cone Ø: d1 Ø 30 / d2 Ø 27
Thread: M38 x 1,5 RHT
81953016184, 81953016251, 81953016276



CV-ES-2120

Length: 115
Cone Ø: d1 Ø 12,4 / d2 Ø 10,8
Thread: M14 x 1,5 RHT
03008500A, 81953016200, 81953016202, 81953016203, 81953016227



CV-ES-14162

Length: 125
Cone Ø: d1 Ø 30 / d2 Ø 27
Thread: M30 x 1,5 LHT
81953010015, 81953010083, 81953010087, 81953016029, 81953016030, 81953016043, 81953016044, 81953016050, 81953016054, 81953016087, 81953016091, 81953016107, 81953016120, 81953016125, 81953016152, 81953016155, 81953016157, 81953016168, 81953016179, 81953016181, 81953016223, 81953016237, 81953016254, 81953016275, 81953016279, 81953016351

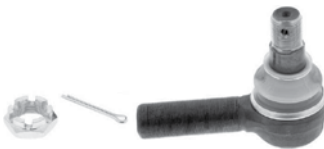

CV-ES-14163

Length: 125
Cone Ø: d1 Ø 30 / d2 Ø 27
Thread: M30 x 1,5 RHT
95301.0084, 90804102156, 90804102272, 90804102696, 90804102710, 81953010016, 81953010075, 81953010084, 81953010088, 81953010094, 81953010103, 81953016030, 81953016043, 81953016048, 81953016049, 81953016053, 81953016061, 81953016090, 81953016108, 81953016112, 81953016126, 81953016143, 81953016149, 81953016154, 81953016156, 81953016168, 81953016178, 81953016194, 81953016206, 81953016224, 81953016234, 81953016242, 81953016252, 81953016274, 81953016278, 81953016284, 81953016286, 81953016308, 81953016310, 81953016312, 81953016347, 81953016350, 81953016352, 82953016012, 88953016014, N2953016001



DB-RK-8581

Ø: 85
Hole Distance: 130
Thick/Height: 24
03305800A, 81432706105



MN-DL-3402

Length: 590 Ø: 48
Hole Distance: 130 / 130
03307200A, 81432206067, 81432206068, 81432206090, 81432206092, 81432209099



MN-DL-5225

Length: 572 Ø: 48
Hole Distance: 130 / 130
03301500A, 81432206229, 81432206236, 81432206267, 81432206270, 81432206272, 81432206304, 81432206305, 81432209236, 81432209267, 81432209272



MN-DL-7801

Length: 995 Ø: 52
Cone Ø: d1 Ø 30 / d2 Ø 27
81466106807, 81466106808, 81466116087, 81466116088, 81466116096, 81466116097, 81466116099, 81466116132, 81466116133, 81466116136, 81466116197, 81466116198, 81466116205

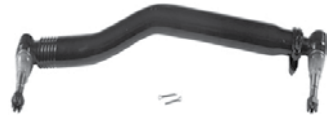

MN-DL-7802

Length: 1680 Ø: 52
Cone Ø: d1 Ø 30 / d2 Ø 27
03208300A, 81467116773, 81467116858, 81467116859, 81467116860, 81467116861, 81467116863, 81467116882, 81467116883, 81467116920, 81467116921



MN-DL-8544

Length: 596 Ø: 48
Hole Distance: 130 / 130
81432206196, 81432206232, 81432206233



MN-DL-8560

Length: 970 Ø: 52
Cone Ø: d1 Ø 30 / d2 Ø 27
03206900A, 81466106809, 81466106810, 81466106823, 81466106838, 81466106839, 81466116104, 81466116105, 81466116107, 81466116134, 81466116135, 81466116137, 81466116199, 81466116200, 81466116206



MN-DL-8609

Length: 585 Ø: 58
Hole Distance: 130 / 130
81432206070, 81432206071, 81432206072, 81432206091, 81432206093, 81432206119



MN-DL-8663

Length: 947 Ø: 60
Hole Distance: 115 / 115
03307400A, 81432206222, 81432206260, 81432206283, 81432206284



MN-DL-10288

81432206386, 82432206008, 82432209008

No Image

MN-DL-12288

Length: 585 Ø: 58
Hole Distance: 130 / 130
81432206386, 82432206008, 82432209008

No Image

MN-DL-12293

Length: 1680 Ø: 42
Cone Ø: d1 Ø 30 / d2 Ø 27
81467106236, 81467106268, 81467106356, 81467116356, 81467116723, 81467116794, 81467116933, 81467116934, 81467116966



MN-RK-12436

Ø: 75
Hole Distance: 115
Thick/Height: 24
81432206244



MN-VB-5222

Length: 627 Ø: 50
Hole Distance: 152 / 152
81432706030, 81432706034, 81432706054, 81432706055, 81432706056, 81432706057, 81432706067, 81432706068, 81432706074, 81432706075, 81432706076, 81432706077, 81432706078, 81432706081, 81432706082, 81432709034, 81432709076, 81432709078, 8143706054



MN-VB-5238

Length: 627 Ø: 48
Hole Distance: 130 / 130
81432206221, 81432706096, 81432706114, 81432706116, 81432706121



MN-VB-8514

Length: 627 Ø: 48
Hole Ø 25 / 25 / 25
Hole Distance: 152 / 130 / 130
81432706087, 81432706088, 81432706094, 81432706095, 81432796094



MN-VB-8669

Length: 627 Ø: 48
Hole Ø 25 / 25 / 25
Hole Distance: 152 / 130 / 130
81432706116, 81432706137, 81432706150, 81432706151



MN-VB-9404

Length: 627 Ø: 58
Hole Distance: 130 / 130
81432706117, 81432706152, 81432706153



SC-ES-7279

Length: 150
Cone Ø: d1 Ø 30 / d2 Ø 27
Thread: M30 x 1,5 RHT
81953016288



SC-ES-8517

Length: 140
Cone Ø: d1 Ø 30 / d2 Ø 27
Thread: M30 x 1,5 RHT
81953016286



SC-ES-8535

Length: 145
Cone Ø: d1 Ø 30 / d2 Ø 27
Thread: M30 x 1,5 RHT
81953016271, 81953016325





TGA ...

33.510 FDC, FDLC, FDRC, FDLRC ...	09/02→	Track Control Arm		MN-VB-8669	Suspension Rod, Wishbone (CV), Drive Axle	
	09/02→	Track Control Arm		MN-VB-8669	Suspension Rod, Wishbone (CV), Drive Axle; Leaf Spring Axle	
	09/02→	Track Control Arm		MN-VB-9404	Wishbone (CV), Drive Axle	
	09/02→	Track Control Arm		MN-VB-9404	Wishbone (CV), Drive Axle; Air Suspension Axle	
	09/02→	Track Control Arm	MN-DL-8663		Control Arm, Air Suspension Axle	
33.510 FDLRS, FDLS, FDRS, FDS	09/02→	Ball Head, gearshift linkage	CV-ES-2120			
	09/02→	Centre Rod	MN-DL-7801		Push Rod, Leaf Spring Axle	
	09/02→	Centre Rod	MN-DL-8560		Push Rod, Air Suspension Axle	
	09/02→	Suspension Strut Repair Kit		DB-RK-8581		
	09/02→	Suspension Strut Repair Kit		MN-RK-12436		
	09/02→	Tie Rod	MN-DL-7802			
	09/02→	Tie Rod End	CV-ES-0914		for Steering Rod	
	09/02→	Tie Rod End	CV-ES-14162		for Steering Rod	
	09/02→	Tie Rod End	CV-ES-14163		for Steering Rod	
	09/02→	Tie Rod End	SC-ES-7279		for Steering Rod	
	09/02→	Tie Rod End	SC-ES-8517		for Push Rod	
	09/02→	Tie Rod End	SC-ES-8535		for Guide Rod	
	09/02→	Track Control Arm		MN-DL-3402	Trailing Arm, Air Suspension Axle; Drive Axle	
	09/02→	Track Control Arm		MN-DL-5225	Trailing Arm, Drive Axle; Air Suspension Axle	
	09/02→	Track Control Arm		MN-DL-8544	Trailing Arm, Drive Axle; Air Suspension Axle	
	09/02→	Track Control Arm		MN-DL-8544	Trailing Arm, Drive Axle; Leaf Spring Axle	
	09/02→	Track control arm		MN-DL-10288	Trailing Arm, 1st RA; 2nd RA, for Leaf-Spring Suspension vehicles	
	09/02→	Track control arm		MN-DL-12288	Trailing Arm	
	09/02→	Track Control Arm		MN-VB-5222	Wishbone (CV), 1st RA; 2nd RA, for Pneumatic Suspension vehicles	
	09/02→	Track Control Arm		MN-VB-5238	Wishbone (CV), Drive Axle; Air Suspension Axle	
	09/02→	Track Control Arm		MN-VB-8514	Suspension Rod, Wishbone (CV), Drive Axle; Leaf Spring Axle	
	09/02→	Track Control Arm		MN-VB-8669	Suspension Rod, Wishbone (CV), Drive Axle	
	09/02→	Track Control Arm		MN-VB-8669	Suspension Rod, Wishbone (CV), Drive Axle; Leaf Spring Axle	
	09/02→	Track Control Arm		MN-VB-9404	Wishbone (CV), Drive Axle	
	09/02→	Track Control Arm		MN-VB-9404	Wishbone (CV), Drive Axle; Air Suspension Axle	
	09/02→	Track Control Arm	MN-DL-8663		Control Arm, Air Suspension Axle	
33.530 FDAC, FDALC	09/02→	Centre Rod	MN-DL-2174		Push Rod	
	09/02→	Suspension Strut Repair Kit		DB-RK-8581		
	09/02→	Tie Rod End	CV-ES-0914		for Steering Rod	
	09/02→	Tie Rod End	CV-ES-14163		for Steering Rod	
	09/02→	Tie Rod End	MN-ES-10333		for Steering Rod	
	09/02→	Tie Rod End	SC-ES-8517		for Push Rod	
	09/02→	Track Control Arm		MN-DL-8544	Trailing Arm, 1st RA; 2nd RA, for Leaf-Spring Suspension vehicles, →Type_HB Chassis	
	09/02→	Track Control Arm		MN-DL-8544	Trailing Arm, 1st RA; 2nd RA, for Pneumatic Suspension vehicles, →Type_HB Chassis	
	09/02→	Track Control Arm		MN-DL-8609	Trailing Arm, 1st RA; 2nd RA, for Leaf-Spring Suspension vehicles, →Type_HB Chassis	
	09/02→	Track Control Arm		MN-VB-8514	Suspension Rod, Wishbone (CV)	
	09/02→	Track Control Arm		MN-VB-9404	Wishbone (CV), 1st RA; 2nd RA, for Leaf-Spring Suspension vehicles, →Type_HB Chassis	
	33.530 FDAK, FDALK	09/02→	Ball Head, gearshift linkage	CV-ES-2120		
		09/02→	Centre Rod	MN-DL-7801		Push Rod
09/02→		Suspension Strut Repair Kit		DB-RK-8581		
09/02→		Tie Rod End	CV-ES-0914		for Steering Rod	
09/02→		Tie Rod End	CV-ES-14163		for Steering Rod	
09/02→		Tie Rod End	MN-ES-10333		for Steering Rod	
09/02→		Tie Rod End	SC-ES-8517		for Push Rod	
09/02→		Track Control Arm		MN-DL-5225	Trailing Arm	
09/02→		Track Control Arm		MN-DL-8544	Trailing Arm, 1st RA; 2nd RA; Leaf Spring Axle	
09/02→		Track Control Arm		MN-DL-8544	Trailing Arm, Drive Axle; Air Suspension Axle	
09/02→	Track Control Arm		MN-DL-8609	Trailing Arm, 1st RA; 2nd RA, for Leaf-Spring Suspension vehicles, →Type_HB Chassis		

CV-ES-0914

Length: 125
Cone Ø: d1 Ø 30 / d2 Ø 27
Thread: M38 x 1,5 RHT
81953016184, 81953016251, 81953016276



CV-ES-2120

Length: 115
Cone Ø: d1 Ø 12,4 / d2 Ø 10,8
Thread: M14 x 1,5 RHT
03008500A, 81953016200, 81953016202, 81953016203, 81953016227



CV-ES-14162

Length: 125
Cone Ø: d1 Ø 30 / d2 Ø 27
Thread: M30 x 1,5 LHT
81953010015, 81953010083, 81953010087, 81953016029, 81953016030, 81953016043, 81953016044, 81953016050, 81953016054, 81953016087, 81953016091, 81953016107, 81953016120, 81953016125, 81953016152, 81953016155, 81953016157, 81953016168, 81953016179, 81953016181, 81953016223, 81953016237, 81953016254, 81953016275, 81953016279, 81953016351



CV-ES-14163

Length: 125
Cone Ø: d1 Ø 30 / d2 Ø 27
Thread: M30 x 1,5 RHT
95301.0084, 90804102156, 90804102272, 90804102696, 90804102710, 81953010016, 81953010075, 81953010084, 81953010088, 81953010094, 81953010103, 81953016030, 81953016043, 81953016048, 81953016049, 81953016053, 81953016061, 81953016090, 81953016108, 81953016112, 81953016126, 81953016143, 81953016149, 81953016154, 81953016156, 81953016168, 81953016178, 81953016194, 81953016206, 81953016224, 81953016234, 81953016242, 81953016252, 81953016274, 81953016278, 81953016284, 81953016286, 81953016308, 81953016310, 81953016312, 81953016347, 81953016350, 81953016352, 82953016012, 88953016014, N2953016001



DB-RK-8581

Ø: 85
Hole Distance: 130
Thick/Height: 24
03305800A, 81432706105



MN-DL-2174

Length: 1588 Ø: 52
Cone Ø: d1 Ø 30 / d2 Ø 27
81467106378, 81467106912



MN-DL-3402

Length: 590 Ø: 48
Hole Distance: 130 / 130
03307200A, 81432206067, 81432206068, 81432206090, 81432206092, 81432209092



MN-DL-5225

Length: 572 Ø: 48
Hole Distance: 130 / 130
03301500A, 81432206229, 81432206236, 81432206267, 81432206270, 81432206272, 81432206304, 81432206305, 81432209236, 81432209267, 81432209272



MN-DL-7801

Length: 995 Ø: 52
Cone Ø: d1 Ø 30 / d2 Ø 27
81466106807, 81466106808, 81466116087, 81466116088, 81466116096, 81466116097, 81466116099, 81466116132, 81466116133, 81466116136, 81466116197, 81466116198, 81466116205

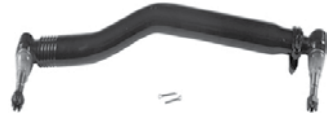

MN-DL-7802

Length: 1680 Ø: 52
Cone Ø: d1 Ø 30 / d2 Ø 27
03208300A, 81467116773, 81467116858, 81467116859, 81467116860, 81467116861, 81467116863, 81467116882, 81467116883, 81467116920, 81467116921



MN-DL-8544

Length: 596 Ø: 48
Hole Distance: 130 / 130
81432206196, 81432206232, 81432206233



MN-DL-8560

Length: 970 Ø: 52
Cone Ø: d1 Ø 30 / d2 Ø 27
03206900A, 81466106809, 81466106810, 81466106823, 81466106838, 81466106839, 81466116104, 81466116105, 81466116107, 81466116134, 81466116135, 81466116137, 81466116199, 81466116200, 81466116206



MN-DL-8609

Length: 585 Ø: 58
Hole Distance: 130 / 130
81432206070, 81432206071, 81432206072, 81432206091, 81432206093, 81432206119



MN-DL-8663

Length: 947 Ø: 60
Hole Distance: 115 / 115
03307400A, 81432206222, 81432206260, 81432206283, 81432206284



MN-DL-10288

81432206386, 82432206008, 82432209008

No Image

MN-DL-12288

Length: 585 Ø: 58
Hole Distance: 130 / 130
81432206386, 82432206008, 82432209008

No Image

MN-ES-10333

Length: 90
Cone Ø: d1 Ø 38 / d2 Ø 34,35
Thread: M36 x 1,5 RHT
1271126, 3090291, 3099128, 42538048, 81953016268, 82953016018, 82953016019



MN-RK-12436

Ø: 75
Hole Distance: 115
Thick/Height: 24
81432206244



MN-VB-5222

Length: 627 Ø: 50
Hole Distance: 152 / 152
81432706030, 81432706034, 81432706054, 81432706055, 81432706056, 81432706057, 81432706067, 81432706068, 81432706074, 81432706075, 81432706076, 81432706077, 81432706078, 81432706081, 81432706082, 81432709034, 81432709076, 81432709078, 8143706054



MN-VB-5238

Length: 627 Ø: 48
Hole Distance: 130 / 130
81432206221, 81432706096, 81432706114, 81432706116, 81432706121



MN-VB-8514

Length: 627 Ø: 48
Hole Ø 25 / 25 / 25
Hole Distance: 152 / 130 / 130
81432706087, 81432706088, 81432706094, 81432706095, 81432796094



MN-VB-8669

Length: 627 Ø: 48
Hole Ø 25 / 25 / 25
Hole Distance: 152 / 130 / 130
81432706116, 81432706137, 81432706150, 81432706151



MN-VB-9404

Length: 627 Ø: 58
Hole Distance: 130 / 130
81432706117, 81432706152, 81432706153



SC-ES-7279

Length: 150
Cone Ø: d1 Ø 30 / d2 Ø 27
Thread: M30 x 1,5 RHT
81953016286



SC-ES-8517

Length: 140
Cone Ø: d1 Ø 30 / d2 Ø 27
Thread: M30 x 1,5 RHT
81953016286



SC-ES-8535

Length: 145
Cone Ø: d1 Ø 30 / d2 Ø 27
Thread: M30 x 1,5 RHT
81953016271, 81953016325





TGA ...

33.530 FDAK, FDALK ...	09/02→	Track Control Arm		MN-VB-8514	Suspension Rod, Wishbone (CV), Drive Axle; Air Suspension Axle
	09/02→	Track Control Arm		MN-VB-8514	Suspension Rod, Wishbone (CV), Drive Axle; Leaf Spring Axle
	09/02→	Track Control Arm		MN-VB-9404	Wishbone (CV)
33.530 FDAS, FDALS	09/02→	Ball Head, gearshift linkage	CV-ES-2120		
	09/02→	Centre Rod	MN-DL-7801		Push Rod
	09/02→	Suspension Strut Repair Kit		DB-RK-8581	
	09/02→	Tie Rod End	CV-ES-0914		for Steering Rod
	09/02→	Tie Rod End	CV-ES-14163		for Steering Rod
	09/02→	Tie Rod End	MN-ES-10333		for Steering Rod
	09/02→	Tie Rod End	SC-ES-8517		for Push Rod
	09/02→	Track Control Arm		MN-DL-5225	Trailing Arm
	09/02→	Track Control Arm		MN-DL-8544	Trailing Arm, 1st RA;2nd RA;Leaf Spring Axle
	09/02→	Track Control Arm		MN-DL-8609	Trailing Arm, 1st RA;2nd RA, for Leaf-Spring Suspension vehicles, →Type_HB Chassis
	09/02→	Track Control Arm		MN-VB-8514	Suspension Rod, Wishbone (CV), Drive Axle; Air Suspension Axle
	09/02→	Track Control Arm		MN-VB-8514	Suspension Rod, Wishbone (CV), Drive Axle; Leaf Spring Axle
	09/02→	Track Control Arm		MN-VB-9404	Wishbone (CV)
33.530 FDC, FDLK, FDRC, FDLRC	09/02→	Ball Head, gearshift linkage	CV-ES-2120		
	09/02→	Centre Rod	MN-DL-7801		Push Rod, Leaf Spring Axle
	09/02→	Suspension Strut Repair Kit		DB-RK-8581	
	09/02→	Tie Rod	MN-DL-7802		
	09/02→	Tie Rod End	CV-ES-0914		for Steering Rod
	09/02→	Tie Rod End	CV-ES-14162		for Steering Rod
	09/02→	Tie Rod End	CV-ES-14163		for Steering Rod
	09/02→	Tie Rod End	SC-ES-7279		for Steering Rod
	09/02→	Tie Rod End	SC-ES-8517		for Push Rod
	09/02→	Tie Rod End	SC-ES-8535		for Guide Rod
	09/02→	Track Control Arm		MN-DL-3402	Trailing Arm, 1st RA;2nd RA, for Pneumatic Suspension vehicles
	09/02→	Track Control Arm		MN-DL-5225	Trailing Arm
	09/02→	Track Control Arm		MN-DL-8544	Trailing Arm, Drive Axle;Leaf Spring Axle
	09/02→	Track control arm		MN-DL-10288	Trailing Arm, 1st RA;2nd RA, for Leaf-Spring Suspension vehicles
	09/02→	Track control arm		MN-DL-12288	Trailing Arm
	09/02→	Track Control Arm		MN-VB-5222	Wishbone (CV), 1st RA;2nd RA, for Pneumatic Suspension vehicles
	09/02→	Track Control Arm		MN-VB-5238	Wishbone (CV), 1st RA;2nd RA, for Pneumatic Suspension vehicles
	09/02→	Track Control Arm		MN-VB-8514	Suspension Rod, Wishbone (CV), Drive Axle; Leaf Spring Axle
	09/02→	Track Control Arm		MN-VB-8669	Suspension Rod, Wishbone (CV), Drive Axle; Leaf Spring Axle
	09/02→	Track Control Arm		MN-VB-9404	Wishbone (CV), Drive Axle
33.530 FDK, FDLK	07/03→	Centre Rod	MN-DL-7801		Push Rod
	07/03→	Centre Rod	MN-DL-8560		Push Rod, Air Suspension Axle
	07/03→	Suspension Strut Repair Kit		DB-RK-8581	
	07/03→	Suspension Strut Repair Kit		MN-RK-12436	
	07/03→	Tie Rod	MN-DL-7802		
	07/03→	Tie Rod End	CV-ES-0914		for Steering Rod
	07/03→	Tie Rod End	CV-ES-14162		for Steering Rod
	07/03→	Tie Rod End	CV-ES-14163		for Steering Rod
	07/03→	Tie Rod End	SC-ES-7279		for Steering Rod
	07/03→	Tie Rod End	SC-ES-8517		for Push Rod
	07/03→	Tie Rod End	SC-ES-8535		for Guide Rod
	07/03→	Track Control Arm		MN-DL-3402	Trailing Arm, Air Suspension Axle;Drive Axle
	07/03→	Track Control Arm		MN-DL-5225	Trailing Arm, Drive Axle;Air Suspension Axle
07/03→	Track Control Arm		MN-DL-8544	Trailing Arm, 1st RA;2nd RA, for Leaf-Spring Suspension vehicles	

CV-ES-0914

Length: 125
Cone Ø: d1 Ø 30 / d2 Ø 27
Thread: M38 x 1,5 RHT
81953016184, 81953016251, 81953016276



CV-ES-2120

Length: 115
Cone Ø: d1 Ø 12,4 / d2 Ø 10,8
Thread: M14 x 1,5 RHT
03008500A, 81953016200, 81953016202, 81953016203, 81953016227



CV-ES-14162

Length: 125
Cone Ø: d1 Ø 30 / d2 Ø 27
Thread: M30 x 1,5 LHT
81953010015, 81953010083, 81953010087, 81953016029, 81953016030, 81953016043, 81953016044, 81953016050, 81953016054, 81953016087, 81953016091, 81953016107, 81953016120, 81953016125, 81953016152, 81953016155, 81953016157, 81953016168, 81953016179, 81953016181, 81953016223, 81953016237, 81953016254, 81953016275, 81953016279, 81953016351

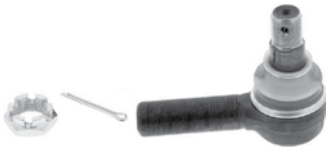

CV-ES-14163

Length: 125
Cone Ø: d1 Ø 30 / d2 Ø 27
Thread: M30 x 1,5 RHT
95301.0084, 90804102156, 90804102272, 90804102696, 90804102710, 81953010016, 81953010075, 81953010084, 81953010088, 81953010094, 81953010103, 81953016030, 81953016043, 81953016048, 81953016049, 81953016053, 81953016061, 81953016090, 81953016108, 81953016112, 81953016126, 81953016143, 81953016149, 81953016154, 81953016156, 81953016168, 81953016178, 81953016194, 81953016206, 81953016224, 81953016234, 81953016242, 81953016252, 81953016274, 81953016278, 81953016284, 81953016286, 81953016308, 81953016310, 81953016312, 81953016347, 81953016350, 81953016352, 82953016012, 88953016014, N2953016001



DB-RK-8581

Ø: 85
Hole Distance: 130
Thick/Height: 24
03305800A, 81432706105



MN-DL-3402

Length: 590 Ø: 48
Hole Distance: 130 / 130
03307200A, 81432206067, 81432206068, 81432206090, 81432206092, 81432209099



MN-DL-5225

Length: 572 Ø: 48
Hole Distance: 130 / 130
03301500A, 81432206229, 81432206236, 81432206267, 81432206270, 81432206272, 81432206304, 81432206305, 81432209236, 81432209267, 81432209272



MN-DL-7801

Length: 995 Ø: 52
Cone Ø: d1 Ø 30 / d2 Ø 27
81466106807, 81466106808, 81466116087, 81466116088, 81466116096, 81466116097, 81466116099, 81466116132, 81466116133, 81466116136, 81466116197, 81466116198, 81466116205

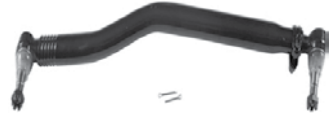

MN-DL-7802

Length: 1680 Ø: 52
Cone Ø: d1 Ø 30 / d2 Ø 27
03208300A, 81467116773, 81467116858, 81467116859, 81467116860, 81467116861, 81467116863, 81467116882, 81467116883, 81467116920, 81467116921



MN-DL-8544

Length: 596 Ø: 48
Hole Distance: 130 / 130
81432206196, 81432206232, 81432206233



MN-DL-8560

Length: 970 Ø: 52
Cone Ø: d1 Ø 30 / d2 Ø 27
03206900A, 81466106809, 81466106810, 81466106823, 81466106838, 81466106839, 81466116104, 81466116105, 81466116107, 81466116134, 81466116135, 81466116137, 81466116199, 81466116200, 81466116206



MN-DL-8609

Length: 585 Ø: 58
Hole Distance: 130 / 130
81432206070, 81432206071, 81432206072, 81432206091, 81432206093, 81432206119



MN-DL-10288

81432206386, 82432206008, 82432209008

No Image

MN-DL-12288

Length: 585 Ø: 58
Hole Distance: 130 / 130
81432206386, 82432206008, 82432209008

No Image

MN-ES-10333

Length: 90
Cone Ø: d1 Ø 38 / d2 Ø 34,35
Thread: M36 x 1,5 RHT
1271126, 3090291, 3099128, 42538048, 81953016268, 82953016018, 82953016019



MN-RK-12436

Ø: 75
Hole Distance: 115
Thick/Height: 24
81432206244



MN-VB-5222

Length: 627 Ø: 50
Hole Distance: 152 / 152
81432706030, 81432706034, 81432706054, 81432706055, 81432706056, 81432706057, 81432706067, 81432706068, 81432706074, 81432706075, 81432706076, 81432706077, 81432706078, 81432706081, 81432706082, 81432709034, 81432709076, 81432709078, 8143706054



MN-VB-5238

Length: 627 Ø: 48
Hole Distance: 130 / 130
81432206221, 81432706096, 81432706114, 81432706116, 81432706121



MN-VB-8514

Length: 627 Ø: 48
Hole Ø 25 / 25 / 25
Hole Distance: 152 / 130 / 130
81432706087, 81432706088, 81432706094, 81432706095, 81432796094



MN-VB-8669

Length: 627 Ø: 48
Hole Ø 25 / 25 / 25
Hole Distance: 152 / 130 / 130
81432706116, 81432706137, 81432706150, 81432706151



MN-VB-9404

Length: 627 Ø: 58
Hole Distance: 130 / 130
81432706117, 81432706152, 81432706153



SC-ES-7279

Length: 150
Cone Ø: d1 Ø 30 / d2 Ø 27
Thread: M30 x 1,5 RHT
81953016288



SC-ES-8517

Length: 140
Cone Ø: d1 Ø 30 / d2 Ø 27
Thread: M30 x 1,5 RHT
81953016286



SC-ES-8535

Length: 145
Cone Ø: d1 Ø 30 / d2 Ø 27
Thread: M30 x 1,5 RHT
81953016271, 81953016325





TGA ...

33.530 FDK, FDLK ...	07/03 →	Track Control Arm		MN-DL-8544	Trailing Arm, 1st RA;2nd RA, for Pneumatic Suspension vehicles
	07/03 →	Track control arm		MN-DL-10288	Trailing Arm, 1st RA;2nd RA, for Leaf-Spring Suspension vehicles
	07/03 →	Track control arm		MN-DL-12288	Trailing Arm
	07/03 →	Track Control Arm		MN-VB-5222	Wishbone (CV), 1st RA;2nd RA, for Pneumatic Suspension vehicles
	07/03 →	Track Control Arm		MN-VB-5238	Wishbone (CV), Drive Axle;Air Suspension Axle
	07/03 →	Track Control Arm		MN-VB-8514	Suspension Rod, Wishbone (CV)
	07/03 →	Track Control Arm		MN-VB-8669	Suspension Rod, Wishbone (CV), Drive Axle
	07/03 →	Track Control Arm		MN-VB-9404	Wishbone (CV), Drive Axle;Air Suspension Axle
	07/03 →	Track Control Arm	MN-DL-8663		Control Arm, Air Suspension Axle
	33.530 FDLRS, FDLs, FDRS, FDS	07/03 →	Centre Rod	MN-DL-7801	
07/03 →		Centre Rod	MN-DL-8560		Push Rod, Air Suspension Axle
07/03 →		Suspension Strut Repair Kit		DB-RK-8581	
07/03 →		Suspension Strut Repair Kit		MN-RK-12436	
07/03 →		Tie Rod	MN-DL-7802		
07/03 →		Tie Rod End	CV-ES-0914		for Steering Rod
07/03 →		Tie Rod End	CV-ES-14162		for Steering Rod
07/03 →		Tie Rod End	CV-ES-14163		for Steering Rod
07/03 →		Tie Rod End	SC-ES-7279		for Steering Rod
07/03 →		Tie Rod End	SC-ES-8517		for Push Rod
07/03 →		Tie Rod End	SC-ES-8535		for Guide Rod
07/03 →		Track Control Arm		MN-DL-3402	Trailing Arm, Air Suspension Axle;Drive Axle
07/03 →		Track Control Arm		MN-DL-5225	Trailing Arm, Drive Axle;Air Suspension Axle
07/03 →		Track Control Arm		MN-DL-8544	Trailing Arm, 1st RA;2nd RA, for Leaf-Spring Suspension vehicles
07/03 →		Track Control Arm		MN-DL-8544	Trailing Arm, 1st RA;2nd RA, for Pneumatic Suspension vehicles
07/03 →		Track control arm		MN-DL-10288	Trailing Arm, 1st RA;2nd RA, for Leaf-Spring Suspension vehicles
07/03 →		Track control arm		MN-DL-12288	Trailing Arm
07/03 →		Track Control Arm		MN-VB-5222	Wishbone (CV), 1st RA;2nd RA, for Pneumatic Suspension vehicles
07/03 →		Track Control Arm		MN-VB-5238	Wishbone (CV), Drive Axle;Air Suspension Axle
07/03 →		Track Control Arm		MN-VB-8514	Suspension Rod, Wishbone (CV)
07/03 →	Track Control Arm		MN-VB-8669	Suspension Rod, Wishbone (CV), Drive Axle	
07/03 →	Track Control Arm		MN-VB-9404	Wishbone (CV), Drive Axle;Air Suspension Axle	
07/03 →	Track Control Arm	MN-DL-8663		Control Arm, Air Suspension Axle	
35.310 FFDC, FFDLC	06/03 →	Centre Rod	MN-DL-7801		Push Rod, Leaf Spring Axle
	06/03 →	Centre Rod	MN-DL-8599		Push Rod
	06/03 →	Centre Rod	MN-DL-12285		for Steering Rod
	06/03 →	Centre Rod	MN-DL-12393		for Steering Rod
	06/03 →	Suspension Strut Repair Kit		DB-RK-8581	
	06/03 →	Tie Rod	MN-DL-7802		
	06/03 →	Tie Rod End	CV-ES-0914		for Steering Rod
	06/03 →	Tie Rod End	CV-ES-14162		for Steering Rod
	06/03 →	Tie Rod End	CV-ES-14163		for Steering Rod
	06/03 →	Tie Rod End	MN-ES-10333		for Steering Rod
	06/03 →	Tie Rod End	SC-ES-7279		for Steering Rod
	06/03 →	Tie Rod End	SC-ES-8517		for Push Rod
	06/03 →	Tie Rod End	SC-ES-8535		for Guide Rod
	06/03 →	Track Control Arm		MN-DL-5225	Trailing Arm
	06/03 →	Track Control Arm		MN-DL-8544	Trailing Arm, Drive Axle;Leaf Spring Axle
	06/03 →	Track Control Arm		MN-VB-5238	Wishbone (CV), 1st RA;2nd RA, for Pneumatic Suspension vehicles, →Type_NBA Chassis
	06/03 →	Track Control Arm		MN-VB-8514	Suspension Rod, Wishbone (CV), Drive Axle; Leaf Spring Axle
	06/03 →	Track Control Arm		MN-VB-8669	Suspension Rod, Wishbone (CV), Drive Axle; Leaf Spring Axle
	06/03 →	Track Control Arm		MN-VB-9404	Wishbone (CV), 1st RA;2nd RA, for Pneumatic Suspension vehicles

CV-ES-0914

Length: 125
Cone Ø: d1 Ø 30 / d2 Ø 27
Thread: M38 x 1,5 RHT
81953016184, 81953016251, 81953016276



CV-ES-14162

Length: 125
Cone Ø: d1 Ø 30 / d2 Ø 27
Thread: M30 x 1,5 LHT
81953010015, 81953010083, 81953010087, 81953016029, 81953016030, 81953016043, 81953016044, 81953016050, 81953016054, 81953016087, 81953016091, 81953016107, 81953016120, 81953016125, 81953016152, 81953016155, 81953016157, 81953016168, 81953016179, 81953016181, 81953016223, 81953016237, 81953016254, 81953016275, 81953016279, 81953016351



CV-ES-14163

Length: 125
Cone Ø: d1 Ø 30 / d2 Ø 27
Thread: M30 x 1,5 RHT
95301.0084, 90804102156, 90804102272, 90804102696, 90804102710, 81953010016, 81953010075, 81953010084, 81953010088, 81953010094, 81953010103, 81953016030, 81953016043, 81953016048, 81953016049, 81953016053, 81953016061, 81953016090, 81953016108, 81953016112, 81953016126, 81953016143, 81953016149, 81953016154, 81953016156, 81953016168, 81953016178, 81953016194, 81953016206, 81953016224, 81953016234, 81953016242, 81953016252, 81953016274, 81953016278, 81953016284, 81953016286, 81953016308, 81953016310, 81953016312, 81953016347, 81953016350, 81953016352, 82953016012, 88953016014, N2953016001



DB-RK-8581

Ø: 85
Hole Distance: 130
Thick/Height: 24
03305800A, 81432706105



MN-DL-3402

Length: 590 Ø: 48
Hole Distance: 130 / 130
03307200A, 81432206067, 81432206068, 81432206090, 81432206092, 81432209092



MN-DL-5225

Length: 572 Ø: 48
Hole Distance: 130 / 130
03301500A, 81432206229, 81432206236, 81432206267, 81432206270, 81432206272, 81432206304, 81432206305, 81432209236, 81432209267, 81432209272



MN-DL-7801

Length: 995 Ø: 52
Cone Ø: d1 Ø 30 / d2 Ø 27
81466106807, 81466106808, 81466116087, 81466116088, 81466116096, 81466116097, 81466116099, 81466116132, 81466116133, 81466116136, 81466116197, 81466116198, 81466116205

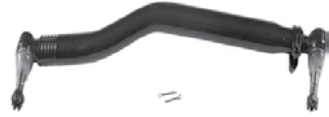

MN-DL-7802

Length: 1680 Ø: 52
Cone Ø: d1 Ø 30 / d2 Ø 27
03208300A, 81467116773, 81467116858, 81467116859, 81467116860, 81467116861, 81467116863, 81467116882, 81467116883, 81467116920, 81467116921



MN-DL-8544

Length: 596 Ø: 48
Hole Distance: 130 / 130
81432206196, 81432206232, 81432206233



MN-DL-8560

Length: 970 Ø: 52
Cone Ø: d1 Ø 30 / d2 Ø 27
03206900A, 81466106809, 81466106810, 81466106823, 81466106838, 81466106839, 81466116104, 81466116105, 81466116107, 81466116134, 81466116135, 81466116137, 81466116199, 81466116200, 81466116206



MN-DL-8599

Length: 1800 Ø: 62
Cone Ø: d1 Ø 30 / d2 Ø 27
81466116161, 81466116162, 82466106183, 82466106186, 82466106187



MN-DL-8663

Length: 947 Ø: 60
Hole Distance: 115 / 115
03307400A, 81432206222, 81432206260, 81432206283, 81432206284



MN-DL-10288

81432206386, 82432206008, 82432209008

No Image

MN-DL-12285

Length: 993 Ø: 40
Cone Ø: d1 Ø 30 / d2 Ø 27
81466106816, 81466106826, 81466116151, 82466106184, 82466106185



MN-DL-12288

Length: 585 Ø: 58
Hole Distance: 130 / 130
81432206386, 82432206008, 82432209008

No Image

MN-DL-12393

Length: 1796 Ø: 62
Cone Ø: d1 Ø 30 / d2 Ø 27
81466116154, 81466116155, 81466116156



MN-ES-10333

Length: 90
Cone Ø: d1 Ø 38 / d2 Ø 34,35
Thread: M36 x 1,5 RHT
1271126, 3090291, 3099128, 42538048, 81953016268, 82953016018, 82953016019



MN-RK-12436

Ø: 75
Hole Distance: 115
Thick/Height: 24
81432206244



MN-VB-5222

Length: 627 Ø: 50
Hole Distance: 152 / 152
81432706030, 81432706034, 81432706054, 81432706055, 81432706056, 81432706057, 81432706067, 81432706068, 81432706074, 81432706075, 81432706076, 81432706077, 81432706078, 81432706081, 81432706082, 81432709034, 81432709076, 81432709078, 8143706054



MN-VB-5238

Length: 627 Ø: 48
Hole Distance: 130 / 130
81432206221, 81432706096, 81432706114, 81432706116, 81432706121



MN-VB-8514

Length: 627 Ø: 48
Hole Ø 25 / 25 / 25
Hole Distance: 152 / 130 / 130
81432706087, 81432706088, 81432706094, 81432706095, 81432796094



MN-VB-8669

Length: 627 Ø: 48
Hole Ø 25 / 25 / 25
Hole Distance: 152 / 130 / 130
81432706116, 81432706137, 81432706150, 81432706151



MN-VB-9404

Length: 627 Ø: 58
Hole Distance: 130 / 130
81432706117, 81432706152, 81432706153



SC-ES-7279

Length: 150
Cone Ø: d1 Ø 30 / d2 Ø 27
Thread: M30 x 1,5 RHT
81953016288



SC-ES-8517

Length: 140
Cone Ø: d1 Ø 30 / d2 Ø 27
Thread: M30 x 1,5 RHT
81953016286



SC-ES-8535

Length: 145
Cone Ø: d1 Ø 30 / d2 Ø 27
Thread: M30 x 1,5 RHT
81953016271, 81953016325





TGA ...

35.310 FFDK, FFDLK	06/03→	Centre Rod	MN-DL-7801		Push Rod, Leaf Spring Axle
	06/03→	Centre Rod	MN-DL-8599		Push Rod
	06/03→	Centre Rod	MN-DL-12285		for Steering Rod
	06/03→	Centre Rod	MN-DL-12393		for Steering Rod
	06/03→	Suspension Strut Repair Kit		DB-RK-8581	
	06/03→	Tie Rod	MN-DL-7802		
	06/03→	Tie Rod End	CV-ES-0914		for Steering Rod
	06/03→	Tie Rod End	CV-ES-14162		for Steering Rod
	06/03→	Tie Rod End	CV-ES-14163		for Steering Rod
	06/03→	Tie Rod End	MN-ES-10333		for Steering Rod
	06/03→	Tie Rod End	SC-ES-7279		for Steering Rod
	06/03→	Tie Rod End	SC-ES-8517		for Push Rod
	06/03→	Tie Rod End	SC-ES-8535		for Guide Rod
	06/03→	Track Control Arm		MN-DL-5225	Trailing Arm, Drive Axle;Air Suspension Axle
	06/03→	Track Control Arm		MN-DL-8544	Trailing Arm, Drive Axle;Air Suspension Axle
	06/03→	Track Control Arm		MN-DL-8544	Trailing Arm, Drive Axle;Leaf Spring Axle
	06/03→	Track Control Arm		MN-VB-5238	Wishbone (CV), Drive Axle;Air Suspension Axle
	06/03→	Track Control Arm		MN-VB-8514	Suspension Rod, Wishbone (CV), Drive Axle; Air Suspension Axle
	06/03→	Track Control Arm		MN-VB-8514	Suspension Rod, Wishbone (CV), Drive Axle; Leaf Spring Axle
	06/03→	Track Control Arm		MN-VB-8669	Suspension Rod, Wishbone (CV), Drive Axle; Leaf Spring Axle
08/04→	Track Control Arm		MN-VB-9404	Wishbone (CV), Drive Axle;Air Suspension Axle	
35.310 FFD-TM	11/03→	Tie Rod End	CV-ES-0914		for Steering Rod
	11/03→	Tie Rod End	CV-ES-14162		for Steering Rod
	11/03→	Tie Rod End	CV-ES-14163		for Steering Rod
	11/03→	Tie Rod End	SC-ES-7279		for Steering Rod
	11/03→	Tie Rod End	SC-ES-8517		for Push Rod
	11/03→	Tie Rod End	SC-ES-8535		for Guide Rod
	11/03→	Track Control Arm		MN-DL-8544	Trailing Arm, 1st RA;2nd RA, for Leaf-Spring Suspension vehicles
	11/03→	Track Control Arm		MN-VB-8514	Suspension Rod, Wishbone (CV)
11/03→	Track Control Arm		MN-VB-8669	Suspension Rod, Wishbone (CV), 1st RA; 2nd RA, for Leaf-Spring Suspension vehicles, →Type_MHB Chassis	
35.310, 35.320 FFDC, FFDLC	02/04→	Centre Rod	MN-DL-7801		Push Rod, Leaf Spring Axle
	02/04→	Centre Rod	MN-DL-8599		Push Rod
	02/04→	Centre Rod	MN-DL-12285		for Steering Rod
	02/04→	Centre Rod	MN-DL-12289		Push Rod
	02/04→	Centre Rod	MN-DL-12393		for Steering Rod
	02/04→	Suspension Strut Repair Kit		DB-RK-8581	
	02/04→	Tie Rod	MN-DL-7802		
	02/04→	Tie Rod End	CV-ES-0914		for Steering Rod
	02/04→	Tie Rod End	CV-ES-14162		for Steering Rod
	02/04→	Tie Rod End	CV-ES-14163		for Steering Rod
	02/04→	Tie Rod End	MN-ES-10333		for Steering Rod
	02/04→	Tie Rod End	SC-ES-7279		for Steering Rod
	02/04→	Tie Rod End	SC-ES-8517		for Push Rod
	02/04→	Tie Rod End	SC-ES-8535		for Guide Rod
	02/04→	Track Control Arm		MN-DL-5225	Trailing Arm, Drive Axle;Air Suspension Axle
	02/04→	Track Control Arm		MN-DL-8544	Trailing Arm, Drive Axle;Air Suspension Axle
	02/04→	Track Control Arm		MN-DL-8544	Trailing Arm, Drive Axle;Leaf Spring Axle
	02/04→	Track Control Arm		MN-VB-5238	Wishbone (CV), Drive Axle;Air Suspension Axle
	02/04→	Track Control Arm		MN-VB-8514	Suspension Rod, Wishbone (CV), Drive Axle; Air Suspension Axle
	02/04→	Track Control Arm		MN-VB-8514	Suspension Rod, Wishbone (CV), Drive Axle; Leaf Spring Axle
	02/04→	Track Control Arm		MN-VB-8669	Suspension Rod, Wishbone (CV), Drive Axle; Leaf Spring Axle
	08/04→	Track Control Arm		MN-VB-9404	Wishbone (CV), Drive Axle;Air Suspension Axle

CV-ES-0914

Length: 125
Cone Ø: d1 Ø 30 / d2 Ø 27
Thread: M38 x 1,5 RHT
81953016184, 81953016251, 81953016276



CV-ES-14162

Length: 125
Cone Ø: d1 Ø 30 / d2 Ø 27
Thread: M30 x 1,5 LHT
81953010015, 81953010083, 81953010087, 81953016029, 81953016030, 81953016043, 81953016044, 81953016050, 81953016054, 81953016087, 81953016091, 81953016107, 81953016120, 81953016125, 81953016152, 81953016155, 81953016157, 81953016168, 81953016179, 81953016181, 81953016223, 81953016237, 81953016254, 81953016275, 81953016279, 81953016351



CV-ES-14163

Length: 125
Cone Ø: d1 Ø 30 / d2 Ø 27
Thread: M30 x 1,5 RHT
95301.0084, 90804102156, 90804102272, 90804102696, 90804102710, 81953010016, 81953010075, 81953010084, 81953010088, 81953010094, 81953010103, 81953016030, 81953016043, 81953016048, 81953016049, 81953016053, 81953016061, 81953016090, 81953016108, 81953016112, 81953016126, 81953016143, 81953016149, 81953016154, 81953016156, 81953016168, 81953016178, 81953016194, 81953016206, 81953016224, 81953016234, 81953016242, 81953016252, 81953016274, 81953016278, 81953016284, 81953016286, 81953016308, 81953016310, 81953016312, 81953016347, 81953016350, 81953016352, 82953016012, 88953016014, N2953016001



DB-RK-8581

Ø: 85
Hole Distance: 130
Thick/Height: 24
03305800A, 81432706105



MN-DL-5225

Length: 572 Ø: 48
Hole Distance: 130 / 130
03301500A, 81432206229, 81432206236, 81432206267, 81432206270, 81432206272, 81432206304, 81432206305, 81432209236, 81432209267, 81432209272



MN-DL-7801

Length: 995 Ø: 52
Cone Ø: d1 Ø 30 / d2 Ø 27
81466106807, 81466106808, 81466116087, 81466116088, 81466116096, 81466116097, 81466116099, 81466116132, 81466116133, 81466116136, 81466116197, 81466116198, 81466116205

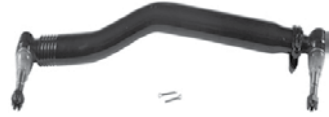

MN-DL-7802

Length: 1680 Ø: 52
Cone Ø: d1 Ø 30 / d2 Ø 27
03208300A, 81467116773, 81467116858, 81467116859, 81467116860, 81467116861, 81467116863, 81467116882, 81467116883, 81467116920, 81467116921



MN-DL-8544

Length: 596 Ø: 48
Hole Distance: 130 / 130
81432206196, 81432206232, 81432206233



MN-DL-8599

Length: 1800 Ø: 62
Cone Ø: d1 Ø 30 / d2 Ø 27
81466116161, 81466116162, 82466106183, 82466106186, 82466106187



MN-DL-12285

Length: 993 Ø: 40
Cone Ø: d1 Ø 30 / d2 Ø 27
81466106816, 81466106826, 81466116151, 82466106184, 82466106185



MN-DL-12289

Length: 1796 Ø: 62
Cone Ø: d1 Ø 30 / d2 Ø 27
81466116174, 81466116175, 81466116176, 81466116244

No Image

MN-DL-12393

Length: 1796 Ø: 62
Cone Ø: d1 Ø 30 / d2 Ø 27
81466116154, 81466116155, 81466116156



MN-ES-10333

Length: 90
Cone Ø: d1 Ø 38 / d2 Ø 34,35
Thread: M36 x 1,5 RHT
1271126, 3090291, 3099128, 42538048, 81953016268, 82953016018, 82953016019



MN-VB-5238

Length: 627 Ø: 48
Hole Distance: 130 / 130
81432206221, 81432706096, 81432706114, 81432706116, 81432706121



MN-VB-8514

Length: 627 Ø: 48
Hole Ø 25 / 25 / 25
Hole Distance: 152 / 130 / 130
81432706087, 81432706088, 81432706094, 81432706095, 81432796094



MN-VB-8669

Length: 627 Ø: 48
Hole Ø 25 / 25 / 25
Hole Distance: 152 / 130 / 130
81432706116, 81432706137, 81432706150, 81432706151



MN-VB-9404

Length: 627 Ø: 58
Hole Distance: 130 / 130
81432706117, 81432706152, 81432706153



SC-ES-7279

Length: 150
Cone Ø: d1 Ø 30 / d2 Ø 27
Thread: M30 x 1,5 RHT
81953016288



SC-ES-8517

Length: 140
Cone Ø: d1 Ø 30 / d2 Ø 27
Thread: M30 x 1,5 RHT
81953016286



SC-ES-8535

Length: 145
Cone Ø: d1 Ø 30 / d2 Ø 27
Thread: M30 x 1,5 RHT
81953016271, 81953016325





TGA ...

35.310, 35.320 FFDK, FFDLK	02/04 →	Centre Rod	MN-DL-7801		Push Rod, Leaf Spring Axle	
	02/04 →	Centre Rod	MN-DL-8599		Push Rod	
	02/04 →	Centre Rod	MN-DL-12285		for Steering Rod	
	02/04 →	Centre Rod	MN-DL-12289		Push Rod	
	02/04 →	Centre Rod	MN-DL-12393		for Steering Rod	
	02/04 →	Suspension Strut Repair Kit		DB-RK-8581		
	02/04 →	Tie Rod	MN-DL-7802			
	02/04 →	Tie Rod End	CV-ES-0914		for Steering Rod	
	02/04 →	Tie Rod End	CV-ES-14162		for Steering Rod	
	02/04 →	Tie Rod End	CV-ES-14163		for Steering Rod	
	02/04 →	Tie Rod End	MN-ES-10333		for Steering Rod	
	02/04 →	Tie Rod End	SC-ES-7279		for Steering Rod	
	02/04 →	Tie Rod End	SC-ES-8517		for Push Rod	
	02/04 →	Tie Rod End	SC-ES-8535		for Guide Rod	
	02/04 →	Track Control Arm		MN-DL-5225	Trailing Arm, Drive Axle; Air Suspension Axle	
	02/04 →	Track Control Arm		MN-DL-8544	Trailing Arm, Drive Axle; Air Suspension Axle	
	02/04 →	Track Control Arm		MN-DL-8544	Trailing Arm, Drive Axle; Leaf Spring Axle	
	02/04 →	Track Control Arm		MN-VB-5238	Wishbone (CV), Drive Axle; Air Suspension Axle	
	02/04 →	Track Control Arm		MN-VB-8514	Suspension Rod, Wishbone (CV), Drive Axle; Air Suspension Axle	
	02/04 →	Track Control Arm		MN-VB-8514	Suspension Rod, Wishbone (CV), Drive Axle; Leaf Spring Axle	
	02/04 →	Track Control Arm		MN-VB-8669	Suspension Rod, Wishbone (CV), Drive Axle; Leaf Spring Axle	
	08/04 →	Track Control Arm		MN-VB-9404	Wishbone (CV), Drive Axle; Air Suspension Axle	
	35.310, 35.320 FFD-TM	02/04 →	Centre Rod	MN-DL-7801		Push Rod, Leaf Spring Axle
		02/04 →	Centre Rod	MN-DL-8599		Push Rod
02/04 →		Centre Rod	MN-DL-12285		for Steering Rod	
02/04 →		Centre Rod	MN-DL-12289		Push Rod	
02/04 →		Centre Rod	MN-DL-12393		for Steering Rod	
02/04 →		Suspension Strut Repair Kit		DB-RK-8581		
02/04 →		Tie Rod	MN-DL-7802			
02/04 →		Tie Rod End	CV-ES-0914		for Steering Rod	
02/04 →		Tie Rod End	CV-ES-14162		for Steering Rod	
02/04 →		Tie Rod End	CV-ES-14163		for Steering Rod	
02/04 →		Tie Rod End	MN-ES-10333		for Steering Rod	
02/04 →		Tie Rod End	SC-ES-7279		for Steering Rod	
02/04 →		Tie Rod End	SC-ES-8517		for Push Rod	
02/04 →		Tie Rod End	SC-ES-8535		for Guide Rod	
02/04 →		Track Control Arm		MN-DL-5225	Trailing Arm	
02/04 →		Track Control Arm		MN-DL-8544	Trailing Arm, Drive Axle; Leaf Spring Axle	
02/04 →		Track Control Arm		MN-VB-8514	Suspension Rod, Wishbone (CV), Drive Axle; Leaf Spring Axle	
02/04 →		Track Control Arm		MN-VB-8669	Suspension Rod, Wishbone (CV), Drive Axle; Leaf Spring Axle	
35.350 FFDHK, FFDHLK		07/06 →	Centre Rod	MN-DL-7801		Push Rod
		07/06 →	Centre Rod	MN-DL-8599		Push Rod
	07/06 →	Centre Rod	MN-DL-12285		for Steering Rod	
	07/06 →	Centre Rod	MN-DL-12393		for Steering Rod	
	07/06 →	Tie Rod	MN-DL-7802			
	07/06 →	Tie Rod End	CV-ES-0914		for Steering Rod	
	07/06 →	Tie Rod End	CV-ES-14162		for Steering Rod	
	07/06 →	Tie Rod End	CV-ES-14163		for Steering Rod	
	07/06 →	Tie Rod End	SC-ES-7279		for Steering Rod	
	07/06 →	Tie Rod End	SC-ES-8517		for Push Rod	
	07/06 →	Tie Rod End	SC-ES-8535		for Guide Rod	
	07/06 →	Track Control Arm		MN-DL-8544	Trailing Arm, Drive Axle	
	07/06 →	Track Control Arm		MN-DL-8544	Trailing Arm, Drive Axle, for Leaf-Spring Suspension vehicles	
	07/06 →	Track Control Arm		MN-VB-8514	Suspension Rod, Wishbone (CV), Drive Axle	
	07/06 →	Track Control Arm		MN-VB-8669	Suspension Rod, Wishbone (CV), 1st RA; 2nd RA, for Leaf-Spring Suspension vehicles, →Type_MHB Chassis	

CV-ES-0914

Length: 125
Cone Ø: d1 Ø 30 / d2 Ø 27
Thread: M38 x 1,5 RHT
81953016184, 81953016251, 81953016276



CV-ES-14162

Length: 125
Cone Ø: d1 Ø 30 / d2 Ø 27
Thread: M30 x 1,5 LHT
81953010015, 81953010083, 81953010087, 81953016029, 81953016030, 81953016043, 81953016044, 81953016050, 81953016054, 81953016087, 81953016091, 81953016107, 81953016120, 81953016125, 81953016152, 81953016155, 81953016157, 81953016168, 81953016179, 81953016181, 81953016223, 81953016237, 81953016254, 81953016275, 81953016279, 81953016351



CV-ES-14163

Length: 125
Cone Ø: d1 Ø 30 / d2 Ø 27
Thread: M30 x 1,5 RHT
95301.0084, 90804102156, 90804102272, 90804102696, 90804102710, 81953010016, 81953010075, 81953010084, 81953010088, 81953010094, 81953010103, 81953016030, 81953016043, 81953016048, 81953016049, 81953016053, 81953016061, 81953016090, 81953016108, 81953016112, 81953016126, 81953016143, 81953016149, 81953016154, 81953016156, 81953016168, 81953016178, 81953016194, 81953016206, 81953016224, 81953016234, 81953016242, 81953016252, 81953016274, 81953016278, 81953016284, 81953016286, 81953016308, 81953016310, 81953016312, 81953016347, 81953016350, 81953016352, 82953016012, 88953016014, N2953016001



DB-RK-8581

Ø: 85
Hole Distance: 130
Thick/Height: 24
03305800A, 81432706105



MN-DL-5225

Length: 572 Ø: 48
Hole Distance: 130 / 130
03301500A, 81432206229, 81432206236, 81432206267, 81432206270, 81432206272, 81432206304, 81432206305, 81432209236, 81432209267, 81432209272



MN-DL-7801

Length: 995 Ø: 52
Cone Ø: d1 Ø 30 / d2 Ø 27
81466106807, 81466106808, 81466116087, 81466116088, 81466116096, 81466116097, 81466116099, 81466116132, 81466116133, 81466116136, 81466116197, 81466116198, 81466116205

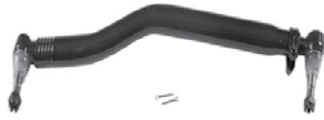

MN-DL-7802

Length: 1680 Ø: 52
Cone Ø: d1 Ø 30 / d2 Ø 27
03208300A, 81467116773, 81467116858, 81467116859, 81467116860, 81467116861, 81467116863, 81467116882, 81467116883, 81467116920, 81467116921



MN-DL-8544

Length: 596 Ø: 48
Hole Distance: 130 / 130
81432206196, 81432206232, 81432206233



MN-DL-8599

Length: 1800 Ø: 62
Cone Ø: d1 Ø 30 / d2 Ø 27
81466116161, 81466116162, 82466106183, 82466106186, 82466106187



MN-DL-12285

Length: 993 Ø: 40
Cone Ø: d1 Ø 30 / d2 Ø 27
81466106816, 81466106826, 81466116151, 82466106184, 82466106185



MN-DL-12289

Length: 1796 Ø: 62
Cone Ø: d1 Ø 30 / d2 Ø 27
81466116174, 81466116175, 81466116176, 81466116244



No Image

MN-DL-12393

Length: 1796 Ø: 62
Cone Ø: d1 Ø 30 / d2 Ø 27
81466116154, 81466116155, 81466116156



MN-ES-10333

Length: 90
Cone Ø: d1 Ø 38 / d2 Ø 34,35
Thread: M36 x 1,5 RHT
1271126, 3090291, 3099128, 42538048, 81953016268, 82953016018, 82953016019



MN-VB-5238

Length: 627 Ø: 48
Hole Distance: 130 / 130
81432206221, 81432706096, 81432706114, 81432706116, 81432706121



MN-VB-8514

Length: 627 Ø: 48
Hole Ø 25 / 25 / 25
Hole Distance: 152 / 130 / 130
81432706087, 81432706088, 81432706094, 81432706095, 81432796094



MN-VB-8669

Length: 627 Ø: 48
Hole Ø 25 / 25 / 25
Hole Distance: 152 / 130 / 130
81432706116, 81432706137, 81432706150, 81432706151



MN-VB-9404

Length: 627 Ø: 58
Hole Distance: 130 / 130
81432706117, 81432706152, 81432706153



SC-ES-7279

Length: 150
Cone Ø: d1 Ø 30 / d2 Ø 27
Thread: M30 x 1,5 RHT
81953016288



SC-ES-8517

Length: 140
Cone Ø: d1 Ø 30 / d2 Ø 27
Thread: M30 x 1,5 RHT
81953016286



SC-ES-8535

Length: 145
Cone Ø: d1 Ø 30 / d2 Ø 27
Thread: M30 x 1,5 RHT
81953016271, 81953016325





TGA ...

35.350 FFDH-TM	07/06→	Centre Rod	MN-DL-7801		Push Rod
	07/06→	Centre Rod	MN-DL-12393		for Steering Rod
	07/06→	Tie Rod	MN-DL-7802		
	07/06→	Tie Rod End	CV-ES-0914		for Steering Rod
	07/06→	Tie Rod End	CV-ES-14162		for Steering Rod
	07/06→	Tie Rod End	CV-ES-14163		for Steering Rod
	07/06→	Tie Rod End	SC-ES-7279		for Steering Rod
	07/06→	Tie Rod End	SC-ES-8517		for Push Rod
	07/06→	Tie Rod End	SC-ES-8535		for Guide Rod
	07/06→	Track Control Arm		MN-DL-8544	Trailing Arm, Drive Axle, for Leaf-Spring Suspension vehicles
	07/06→	Track Control Arm		MN-VB-8514	Suspension Rod, Wishbone (CV), Drive Axle
	07/06→	Track Control Arm		MN-VB-8669	Suspension Rod, Wishbone (CV), 1st RA; 2nd RA, for Leaf-Spring Suspension vehicles, →Type_MHB Chassis
	35.350 FFNLC	07/06→	Centre Rod	MN-DL-12393	
07/06→		Suspension Arm Repair Kit		CV-RK-5313	for Wishbone (CV)
07/06→		Suspension Arm Repair Kit		MN-RK-7291	for Drag Link
07/06→		Suspension Arm Repair Kit	DB-RK-9300	DB-RK-9300	for Drag Link
07/06→		Tie Rod	MN-DL-12284		
07/06→		Tie Rod End	CV-ES-0914		for Steering Rod
07/06→		Tie Rod End	CV-ES-14162	CV-ES-14162	for Steering Rod
07/06→		Tie Rod End	CV-ES-14163		for Steering Rod
07/06→		Tie Rod End	SC-ES-7279		for Steering Rod
07/06→		Tie Rod End	SC-ES-8517		for Push Rod
07/06→		Tie Rod End	SC-ES-8535		for Guide Rod
07/06→		Track Control Arm		MN-DL-5212	Trailing Arm, Trailing Axle not Steered, for Pneumatic Suspension vehicles
07/06→		Track Control Arm		MN-DL-5225	Trailing Arm
07/06→		Track Control Arm		MN-DL-8709	Trailing Arm, Trailing Axle Steered/not Steered, for Pneumatic Suspension vehicles
07/06→		Track Control Arm		MN-VB-5238	Wishbone (CV), 1st Drive Axle, for Pneumatic Suspension vehicles
07/06→		Track Control Arm		MN-VB-9403	Wishbone (CV), Trailing Axle Steered/not Steered, for Pneumatic Suspension vehicles
35.350, 35.360 FFDC, FFDC, FFDC	02/04→	Centre Rod	MN-DL-7801		Push Rod, Leaf Spring Axle
	02/04→	Centre Rod	MN-DL-8599		Push Rod
	02/04→	Centre Rod	MN-DL-12285		for Steering Rod
	02/04→	Centre Rod	MN-DL-12289		Push Rod
	02/04→	Centre Rod	MN-DL-12393		for Steering Rod
	02/04→	Suspension Strut Repair Kit		DB-RK-8581	
	02/04→	Tie Rod	MN-DL-7802		
	02/04→	Tie Rod	MN-DL-12284		
	02/04→	Tie Rod End	CV-ES-0914		for Steering Rod
	02/04→	Tie Rod End	CV-ES-14162	CV-ES-14162	for Steering Rod
	02/04→	Tie Rod End	CV-ES-14163		for Steering Rod
	02/04→	Tie Rod End	MN-ES-10333		for Steering Rod
	02/04→	Tie Rod End	SC-ES-7279		for Steering Rod
	02/04→	Tie Rod End	SC-ES-8517		for Push Rod
	02/04→	Tie Rod End	SC-ES-8535		for Guide Rod
	02/04→	Track Control Arm		MN-DL-5225	Trailing Arm, Drive Axle;Air Suspension Axle
	02/04→	Track Control Arm		MN-DL-8544	Trailing Arm, Drive Axle;Air Suspension Axle
	02/04→	Track Control Arm		MN-DL-8544	Trailing Arm, Drive Axle;Leaf Spring Axle
	02/04→	Track Control Arm		MN-DL-8709	Trailing Arm, Trailing Axle Steered/not Steered, for Pneumatic Suspension vehicles
	02/04→	Track Control Arm		MN-VB-5238	Wishbone (CV), Drive Axle;Air Suspension Axle
	02/04→	Track Control Arm		MN-VB-8514	Suspension Rod, Wishbone (CV), Drive Axle; Air Suspension Axle
	02/04→	Track Control Arm		MN-VB-8514	Suspension Rod, Wishbone (CV), Drive Axle; Leaf Spring Axle
	02/04→	Track Control Arm		MN-VB-8669	Suspension Rod, Wishbone (CV), Drive Axle; Leaf Spring Axle

CV-ES-0914

Length: 125
Cone Ø: d1 Ø 30 / d2 Ø 27
Thread: M38 x 1,5 RHT
81953016184, 81953016251, 81953016276



CV-ES-14162

Length: 125
Cone Ø: d1 Ø 30 / d2 Ø 27
Thread: M30 x 1,5 LHT
81953010015, 81953010083, 81953010087, 81953016029, 81953016030, 81953016043, 81953016044, 81953016050, 81953016054, 81953016087, 81953016091, 81953016107, 81953016120, 81953016125, 81953016152, 81953016155, 81953016157, 81953016168, 81953016179, 81953016181, 81953016223, 81953016237, 81953016254, 81953016275, 81953016279, 81953016351



CV-ES-14163

Length: 125
Cone Ø: d1 Ø 30 / d2 Ø 27
Thread: M30 x 1,5 RHT
95301.0084, 90804102156, 90804102272, 90804102696, 90804102710, 81953010016, 81953010075, 81953010084, 81953010088, 81953010094, 81953010103, 81953016030, 81953016043, 81953016048, 81953016049, 81953016053, 81953016061, 81953016090, 81953016108, 81953016112, 81953016126, 81953016143, 81953016149, 81953016154, 81953016156, 81953016168, 81953016178, 81953016194, 81953016206, 81953016224, 81953016234, 81953016242, 81953016252, 81953016274, 81953016278, 81953016284, 81953016286, 81953016308, 81953016310, 81953016312, 81953016347, 81953016350, 81953016352, 82953016012, 88953016014, N2953016001



CV-RK-5313

Ø: 90
03304800A, 81953016132



DB-RK-8581

Ø: 85
Hole Distance: 130
Thick/Height: 24
03305800A, 81432706105



DB-RK-9300

Ø: 75
Hole Distance: 130
Thick/Height: 24
85432206002



MN-DL-5212

Length: 577 Ø: 48
Hole Distance: 130 / 130
81432206096, 81432206097, 81432206098, 81432206129, 81432209096, 81432209129, 81432306014, 81432306030



MN-DL-5225

Length: 572 Ø: 48
Hole Distance: 130 / 130
03301500A, 81432206229, 81432206236, 81432206267, 81432206270, 81432206272, 81432206304, 81432206305, 81432209236, 81432209267, 81432209272



MN-DL-7801

Length: 995 Ø: 52
Cone Ø: d1 Ø 30 / d2 Ø 27
81466106807, 81466106808, 81466116087, 81466116088, 81466116096, 81466116097, 81466116099, 81466116132, 81466116133, 81466116136, 81466116197, 81466116198, 81466116205

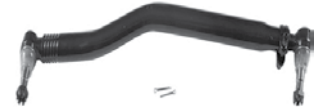

MN-DL-7802

Length: 1680 Ø: 52
Cone Ø: d1 Ø 30 / d2 Ø 27
03208300A, 81467116773, 81467116858, 81467116859, 81467116860, 81467116861, 81467116863, 81467116882, 81467116883, 81467116920, 81467116921



MN-DL-8544

Length: 596 Ø: 48
Hole Distance: 130 / 130
81432206196, 81432206232, 81432206233



MN-DL-8599

Length: 1800 Ø: 62
Cone Ø: d1 Ø 30 / d2 Ø 27
81466116161, 81466116162, 82466106183, 82466106186, 82466106187



MN-DL-8709

Length: 572 Ø: 52
Hole Distance: 130 / 130
81432206268, 81432206274, 81432206291, 81432206292, 82432206007



MN-DL-12284

Length: 1530 Ø: 50
Cone Ø: d1 Ø 30 / d2 Ø 27
81466106579, 81466106580, 81466106624, 81466116720, 81467116720, 81467116730, 81467116952



MN-DL-12285

Length: 993 Ø: 40
Cone Ø: d1 Ø 30 / d2 Ø 27
81466106816, 81466106826, 81466116151, 82466106184, 82466106185



MN-DL-12289

Length: 1796 Ø: 62
Cone Ø: d1 Ø 30 / d2 Ø 27
81466116174, 81466116175, 81466116176, 81466116244



No Image

MN-DL-12393

Length: 1796 Ø: 62
Cone Ø: d1 Ø 30 / d2 Ø 27
81466116154, 81466116155, 81466116156



MN-ES-10333

Length: 90
Cone Ø: d1 Ø 38 / d2 Ø 34,35
Thread: M36 x 1,5 RHT
1271126, 3090291, 3099128, 42538048, 81953016268, 82953016018, 82953016019



MN-RK-7291

Ø: 72
Hole Distance: 130
Thick/Height: 30
10307800A, 81432206108, 81432206132



MN-VB-5238

Length: 627 Ø: 48
Hole Distance: 130 / 130
81432206221, 81432706096, 81432706114, 81432706116, 81432706121



MN-VB-8514

Length: 627 Ø: 48
Hole Ø 25 / 25 / 25
Hole Distance: 152 / 130 / 130
81432706087, 81432706088, 81432706094, 81432706095, 81432796094



MN-VB-8669

Length: 627 Ø: 48
Hole Ø 25 / 25 / 25
Hole Distance: 152 / 130 / 130
81432706116, 81432706137, 81432706150, 81432706151



MN-VB-9403

Length: 627 Ø: 48
Hole Ø 25 / 23 / 23
Hole Distance: 152 / 130 / 130
81432706097, 81432706113, 81432706135, 81432706160, 81432706161



SC-ES-7279

Length: 150
Cone Ø: d1 Ø 30 / d2 Ø 27
Thread: M30 x 1,5 RHT
81953016288



SC-ES-8517

Length: 140
Cone Ø: d1 Ø 30 / d2 Ø 27
Thread: M30 x 1,5 RHT
81953016286



SC-ES-8535

Length: 145
Cone Ø: d1 Ø 30 / d2 Ø 27
Thread: M30 x 1,5 RHT
81953016271, 81953016325





TGA ...

35.350, 35.360 FFDC, FFDRK, FFDLC ...	02/04 →	Track Control Arm		MN-VB-9403	Wishbone (CV), Trailing Axle Steered/not Steered, for Pneumatic Suspension vehicles	
	08/04 →	Track Control Arm		MN-VB-9404	Wishbone (CV), Drive Axle;Air Suspension Axle	
35.350, 35.360 FFDK, FFDRK, FFDLK	02/04 →	Centre Rod	MN-DL-7801		Push Rod, Leaf Spring Axle	
	02/04 →	Centre Rod	MN-DL-8599		Push Rod	
	02/04 →	Centre Rod	MN-DL-12285		for Steering Rod	
	02/04 →	Centre Rod	MN-DL-12289		Push Rod	
	02/04 →	Centre Rod	MN-DL-12393		for Steering Rod	
	02/04 →	Suspension Strut Repair Kit		DB-RK-8581		
	02/04 →	Tie Rod	MN-DL-7802			
	02/04 →	Tie Rod End	CV-ES-0914		for Steering Rod	
	02/04 →	Tie Rod End	CV-ES-14162		for Steering Rod	
	02/04 →	Tie Rod End	CV-ES-14163		for Steering Rod	
	02/04 →	Tie Rod End	MN-ES-10333		for Steering Rod	
	02/04 →	Tie Rod End	SC-ES-7279		for Steering Rod	
	02/04 →	Tie Rod End	SC-ES-8517		for Push Rod	
	02/04 →	Tie Rod End	SC-ES-8535		for Guide Rod	
	02/04 →	Track Control Arm		MN-DL-5225	Trailing Arm, Drive Axle;Air Suspension Axle	
	02/04 →	Track Control Arm		MN-DL-8544	Trailing Arm, Drive Axle;Air Suspension Axle	
	02/04 →	Track Control Arm		MN-DL-8544	Trailing Arm, Drive Axle;Leaf Spring Axle	
	02/04 →	Track Control Arm		MN-VB-5238	Wishbone (CV), Drive Axle;Air Suspension Axle	
	02/04 →	Track Control Arm		MN-VB-8514	Suspension Rod, Wishbone (CV), Drive Axle; Air Suspension Axle	
	02/04 →	Track Control Arm		MN-VB-8514	Suspension Rod, Wishbone (CV), Drive Axle; Leaf Spring Axle	
	02/04 →	Track Control Arm		MN-VB-8669	Suspension Rod, Wishbone (CV), Drive Axle; Leaf Spring Axle	
	08/04 →	Track Control Arm		MN-VB-9404	Wishbone (CV), Drive Axle;Air Suspension Axle	
	35.350, 35.360 FFD-TM	02/04 →	Centre Rod	MN-DL-7801		Push Rod, Leaf Spring Axle
		02/04 →	Centre Rod	MN-DL-8599		Push Rod
		02/04 →	Centre Rod	MN-DL-12285		for Steering Rod
		02/04 →	Centre Rod	MN-DL-12289		Push Rod
02/04 →		Centre Rod	MN-DL-12393		for Steering Rod	
02/04 →		Suspension Strut Repair Kit		DB-RK-8581		
02/04 →		Tie Rod	MN-DL-7802			
02/04 →		Tie Rod End	CV-ES-0914		for Steering Rod	
02/04 →		Tie Rod End	CV-ES-14162		for Steering Rod	
02/04 →		Tie Rod End	CV-ES-14163		for Steering Rod	
02/04 →		Tie Rod End	MN-ES-10333		for Steering Rod	
02/04 →		Tie Rod End	SC-ES-7279		for Steering Rod	
02/04 →		Tie Rod End	SC-ES-8517		for Push Rod	
02/04 →		Tie Rod End	SC-ES-8535		for Guide Rod	
02/04 →		Track Control Arm		MN-DL-5225	Trailing Arm	
02/04 →		Track Control Arm		MN-DL-8544	Trailing Arm, Drive Axle;Leaf Spring Axle	
02/04 →		Track Control Arm		MN-VB-8514	Suspension Rod, Wishbone (CV), Drive Axle; Leaf Spring Axle	
02/04 →		Track Control Arm		MN-VB-8669	Suspension Rod, Wishbone (CV), Drive Axle; Leaf Spring Axle	
35.360 FFDAK, FFDHK, FFDHLK		07/06 →	Centre Rod	MN-DL-7801		Push Rod
		07/06 →	Centre Rod	MN-DL-8599		Push Rod
	07/06 →	Centre Rod	MN-DL-12285		for Steering Rod	
	07/06 →	Centre Rod	MN-DL-12393		for Steering Rod	
	07/06 →	Tie Rod	MN-DL-7802			
	07/06 →	Tie Rod End	CV-ES-0914		for Steering Rod	
	07/06 →	Tie Rod End	CV-ES-14162		for Steering Rod	
	07/06 →	Tie Rod End	CV-ES-14163		for Steering Rod	
	07/06 →	Tie Rod End	SC-ES-7279		for Steering Rod	
	07/06 →	Tie Rod End	SC-ES-8517		for Push Rod	
	07/06 →	Tie Rod End	SC-ES-8535		for Guide Rod	
	07/06 →	Track Control Arm		MN-DL-8544	Trailing Arm, Drive Axle	
	07/06 →	Track Control Arm		MN-DL-8544	Trailing Arm, Drive Axle, for Leaf-Spring Suspension vehicles	
	07/06 →	Track Control Arm		MN-VB-8514	Suspension Rod, Wishbone (CV), Drive Axle	

CV-ES-0914

Length: 125
Cone Ø: d1 Ø 30 / d2 Ø 27
Thread: M38 x 1,5 RHT
81953016184, 81953016251, 81953016276



CV-ES-14162

Length: 125
Cone Ø: d1 Ø 30 / d2 Ø 27
Thread: M30 x 1,5 LHT
81953010015, 81953010083, 81953010087, 81953016029, 81953016030, 81953016043, 81953016044, 81953016050, 81953016054, 81953016087, 81953016091, 81953016107, 81953016120, 81953016125, 81953016152, 81953016155, 81953016157, 81953016168, 81953016179, 81953016181, 81953016223, 81953016237, 81953016254, 81953016275, 81953016279, 81953016351



CV-ES-14163

Length: 125
Cone Ø: d1 Ø 30 / d2 Ø 27
Thread: M30 x 1,5 RHT
95301.0084, 90804102156, 90804102272, 90804102696, 90804102710, 81953010016, 81953010075, 81953010084, 81953010088, 81953010094, 81953010103, 81953016030, 81953016043, 81953016048, 81953016049, 81953016053, 81953016061, 81953016090, 81953016108, 81953016112, 81953016126, 81953016143, 81953016149, 81953016154, 81953016156, 81953016168, 81953016178, 81953016194, 81953016206, 81953016224, 81953016234, 81953016242, 81953016252, 81953016274, 81953016278, 81953016284, 81953016286, 81953016308, 81953016310, 81953016312, 81953016347, 81953016350, 81953016352, 82953016012, 88953016014, N2953016001



DB-RK-8581

Ø: 85
Hole Distance: 130
Thick/Height: 24
03305800A, 81432706105



MN-DL-5225

Length: 572 Ø: 48
Hole Distance: 130 / 130
03301500A, 81432206229, 81432206236, 81432206267, 81432206270, 81432206272, 81432206304, 81432206305, 81432209236, 81432209267, 81432209272



MN-DL-7801

Length: 995 Ø: 52
Cone Ø: d1 Ø 30 / d2 Ø 27
81466106807, 81466106808, 81466116087, 81466116088, 81466116096, 81466116097, 81466116099, 81466116132, 81466116133, 81466116136, 81466116197, 81466116198, 81466116205

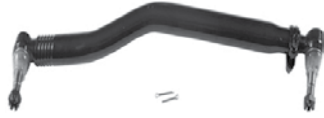

MN-DL-7802

Length: 1680 Ø: 52
Cone Ø: d1 Ø 30 / d2 Ø 27
03208300A, 81467116773, 81467116858, 81467116859, 81467116860, 81467116861, 81467116863, 81467116882, 81467116883, 81467116920, 81467116921



MN-DL-8544

Length: 596 Ø: 48
Hole Distance: 130 / 130
81432206196, 81432206232, 81432206233



MN-DL-8599

Length: 1800 Ø: 62
Cone Ø: d1 Ø 30 / d2 Ø 27
81466116161, 81466116162, 82466106183, 82466106186, 82466106187



MN-DL-12285

Length: 993 Ø: 40
Cone Ø: d1 Ø 30 / d2 Ø 27
81466106816, 81466106826, 81466116151, 82466106184, 82466106185



MN-DL-12289

Length: 1796 Ø: 62
Cone Ø: d1 Ø 30 / d2 Ø 27
81466116174, 81466116175, 81466116176, 81466116244



No Image

MN-DL-12393

Length: 1796 Ø: 62
Cone Ø: d1 Ø 30 / d2 Ø 27
81466116154, 81466116155, 81466116156



MN-ES-10333

Length: 90
Cone Ø: d1 Ø 38 / d2 Ø 34,35
Thread: M36 x 1,5 RHT
1271126, 3090291, 3099128, 42538048, 81953016268, 82953016018, 82953016019



MN-VB-5238

Length: 627 Ø: 48
Hole Distance: 130 / 130
81432206221, 81432706096, 81432706114, 81432706116, 81432706121



MN-VB-8514

Length: 627 Ø: 48
Hole Ø 25 / 25 / 25
Hole Distance: 152 / 130 / 130
81432706087, 81432706088, 81432706094, 81432706095, 81432796094



MN-VB-8669

Length: 627 Ø: 48
Hole Ø 25 / 25 / 25
Hole Distance: 152 / 130 / 130
81432706116, 81432706137, 81432706150, 81432706151



MN-VB-9403

Length: 627 Ø: 48
Hole Ø 25 / 23 / 23
Hole Distance: 152 / 130 / 130
81432706097, 81432706113, 81432706135, 81432706160, 81432706161



MN-VB-9404

Length: 627 Ø: 58
Hole Distance: 130 / 130
81432706117, 81432706152, 81432706153



SC-ES-7279

Length: 150
Cone Ø: d1 Ø 30 / d2 Ø 27
Thread: M30 x 1,5 RHT
81953016288



SC-ES-8517

Length: 140
Cone Ø: d1 Ø 30 / d2 Ø 27
Thread: M30 x 1,5 RHT
81953016286



SC-ES-8535

Length: 145
Cone Ø: d1 Ø 30 / d2 Ø 27
Thread: M30 x 1,5 RHT
81953016271, 81953016325





TGA ...

35.360 FFDK, FFDHK, FFDHLK ...	07/06→	Track Control Arm		MN-VB-8669	Suspension Rod, Wishbone (CV), 1st RA; 2nd RA, for Leaf-Spring Suspension vehicles, →Type_MHB Chassis
35.360 FFDC, FFDLC, FFDRC	10/03→	Centre Rod	MN-DL-7801		Push Rod, Leaf Spring Axle
	10/03→	Centre Rod	MN-DL-8599		Push Rod
	10/03→	Centre Rod	MN-DL-12285		for Steering Rod
	10/03→	Centre Rod	MN-DL-12393		for Steering Rod
	10/03→	Suspension Strut Repair Kit		DB-RK-8581	
	10/03→	Tie Rod	MN-DL-7802		
	10/03→	Tie Rod End	CV-ES-0914		for Steering Rod
	10/03→	Tie Rod End	CV-ES-14162		for Steering Rod
	10/03→	Tie Rod End	CV-ES-14163		for Steering Rod
	10/03→	Tie Rod End	MN-ES-10333		for Steering Rod
	10/03→	Tie Rod End	SC-ES-7279		for Steering Rod
	10/03→	Tie Rod End	SC-ES-8517		for Push Rod
	10/03→	Tie Rod End	SC-ES-8535		for Guide Rod
	10/03→	Track Control Arm		MN-DL-5225	Trailing Arm, Drive Axle;Air Suspension Axle
	10/03→	Track Control Arm		MN-DL-8544	Trailing Arm, Drive Axle;Air Suspension Axle
	10/03→	Track Control Arm		MN-DL-8544	Trailing Arm, Drive Axle;Leaf Spring Axle
	10/03→	Track Control Arm		MN-VB-5238	Wishbone (CV), Drive Axle;Air Suspension Axle
	10/03→	Track Control Arm		MN-VB-8514	Suspension Rod, Wishbone (CV), Drive Axle; Air Suspension Axle
	10/03→	Track Control Arm		MN-VB-8514	Suspension Rod, Wishbone (CV), Drive Axle; Leaf Spring Axle
	10/03→	Track Control Arm		MN-VB-8669	Suspension Rod, Wishbone (CV), Drive Axle; Leaf Spring Axle
08/04→	Track Control Arm		MN-VB-9404	Wishbone (CV), Drive Axle;Air Suspension Axle	
35.360 FFDH-TM	07/06→	Centre Rod	MN-DL-7801		Push Rod
	07/06→	Centre Rod	MN-DL-12393		for Steering Rod
	07/06→	Tie Rod	MN-DL-7802		
	07/06→	Tie Rod End	CV-ES-0914		for Steering Rod
	07/06→	Tie Rod End	CV-ES-14162		for Steering Rod
	07/06→	Tie Rod End	CV-ES-14163		for Steering Rod
	07/06→	Tie Rod End	SC-ES-7279		for Steering Rod
	07/06→	Tie Rod End	SC-ES-8517		for Push Rod
	07/06→	Tie Rod End	SC-ES-8535		for Guide Rod
	07/06→	Track Control Arm		MN-DL-8544	Trailing Arm, Drive Axle, for Leaf-Spring Suspension vehicles
07/06→	Track Control Arm		MN-VB-8514	Suspension Rod, Wishbone (CV), Drive Axle	
07/06→	Track Control Arm		MN-VB-8669	Suspension Rod, Wishbone (CV), 1st RA; 2nd RA, for Leaf-Spring Suspension vehicles, →Type_MHB Chassis	
35.360 FFDK, FFDLK, FFDRC	10/03→	Centre Rod	MN-DL-7801		Push Rod, Leaf Spring Axle
	10/03→	Centre Rod	MN-DL-8599		Push Rod
	10/03→	Centre Rod	MN-DL-12285		for Steering Rod
	10/03→	Centre Rod	MN-DL-12393		for Steering Rod
	10/03→	Suspension Strut Repair Kit		DB-RK-8581	
	10/03→	Tie Rod	MN-DL-7802		
	10/03→	Tie Rod End	CV-ES-0914		for Steering Rod
	10/03→	Tie Rod End	CV-ES-14162		for Steering Rod
	10/03→	Tie Rod End	CV-ES-14163		for Steering Rod
	10/03→	Tie Rod End	MN-ES-10333		for Steering Rod
	10/03→	Tie Rod End	SC-ES-7279		for Steering Rod
	10/03→	Tie Rod End	SC-ES-8517		for Push Rod
	10/03→	Tie Rod End	SC-ES-8535		for Guide Rod
	10/03→	Track Control Arm		MN-DL-5225	Trailing Arm, Drive Axle;Air Suspension Axle
	10/03→	Track Control Arm		MN-DL-8544	Trailing Arm, Drive Axle;Air Suspension Axle
	10/03→	Track Control Arm		MN-DL-8544	Trailing Arm, Drive Axle;Leaf Spring Axle
	10/03→	Track Control Arm		MN-VB-5238	Wishbone (CV), Drive Axle;Air Suspension Axle
	10/03→	Track Control Arm		MN-VB-8514	Suspension Rod, Wishbone (CV), Drive Axle; Air Suspension Axle
	10/03→	Track Control Arm		MN-VB-8514	Suspension Rod, Wishbone (CV), Drive Axle; Leaf Spring Axle

CV-ES-0914

Length: 125
Cone Ø: d1 Ø 30 / d2 Ø 27
Thread: M38 x 1,5 RHT
81953016184, 81953016251, 81953016276



CV-ES-14162

Length: 125
Cone Ø: d1 Ø 30 / d2 Ø 27
Thread: M30 x 1,5 LHT
81953010015, 81953010083, 81953010087, 81953016029, 81953016030, 81953016043, 81953016044, 81953016050, 81953016054, 81953016087, 81953016091, 81953016107, 81953016120, 81953016125, 81953016152, 81953016155, 81953016157, 81953016168, 81953016179, 81953016181, 81953016223, 81953016237, 81953016254, 81953016275, 81953016279, 81953016351



CV-ES-14163

Length: 125
Cone Ø: d1 Ø 30 / d2 Ø 27
Thread: M30 x 1,5 RHT
95301.0084, 90804102156, 90804102272, 90804102696, 90804102710, 81953010016, 81953010075, 81953010084, 81953010088, 81953010094, 81953010103, 81953016030, 81953016043, 81953016048, 81953016049, 81953016053, 81953016061, 81953016090, 81953016108, 81953016112, 81953016126, 81953016143, 81953016149, 81953016154, 81953016156, 81953016168, 81953016178, 81953016194, 81953016206, 81953016224, 81953016234, 81953016242, 81953016252, 81953016274, 81953016278, 81953016284, 81953016286, 81953016308, 81953016310, 81953016312, 81953016347, 81953016350, 81953016352, 82953016012, 88953016014, N2953016001



DB-RK-8581

Ø: 85
Hole Distance: 130
Thick/Height: 24
03305800A, 81432706105



MN-DL-5225

Length: 572 Ø: 48
Hole Distance: 130 / 130
03301500A, 81432206229, 81432206236, 81432206267, 81432206270, 81432206272, 81432206304, 81432206305, 81432209236, 81432209267, 81432209272



MN-DL-7801

Length: 995 Ø: 52
Cone Ø: d1 Ø 30 / d2 Ø 27
81466106807, 81466106808, 81466116087, 81466116088, 81466116096, 81466116097, 81466116099, 81466116132, 81466116133, 81466116136, 81466116197, 81466116198, 81466116205



MN-DL-7802

Length: 1680 Ø: 52
Cone Ø: d1 Ø 30 / d2 Ø 27
03208300A, 81467116773, 81467116858, 81467116859, 81467116860, 81467116861, 81467116863, 81467116882, 81467116883, 81467116920, 81467116921



MN-DL-8544

Length: 596 Ø: 48
Hole Distance: 130 / 130
81432206196, 81432206232, 81432206233



MN-DL-8599

Length: 1800 Ø: 62
Cone Ø: d1 Ø 30 / d2 Ø 27
81466116161, 81466116162, 82466106183, 82466106186, 82466106187



MN-DL-12285

Length: 993 Ø: 40
Cone Ø: d1 Ø 30 / d2 Ø 27
81466106816, 81466106826, 81466116151, 82466106184, 82466106185



MN-DL-12393

Length: 1796 Ø: 62
Cone Ø: d1 Ø 30 / d2 Ø 27
81466116154, 81466116155, 81466116156



MN-ES-10333

Length: 90
Cone Ø: d1 Ø 38 / d2 Ø 34,35
Thread: M36 x 1,5 RHT
1271126, 3090291, 3099128, 42538048, 81953016268, 82953016018, 82953016019



MN-VB-5238

Length: 627 Ø: 48
Hole Distance: 130 / 130
81432206221, 81432706096, 81432706114, 81432706116, 81432706121



MN-VB-8514

Length: 627 Ø: 48
Hole Ø 25 / 25 / 25
Hole Distance: 152 / 130 / 130
81432706087, 81432706088, 81432706094, 81432706095, 81432796094



MN-VB-8669

Length: 627 Ø: 48
Hole Ø 25 / 25 / 25
Hole Distance: 152 / 130 / 130
81432706116, 81432706137, 81432706150, 81432706151



MN-VB-9404

Length: 627 Ø: 58
Hole Distance: 130 / 130
81432706117, 81432706152, 81432706153



SC-ES-7279

Length: 150
Cone Ø: d1 Ø 30 / d2 Ø 27
Thread: M30 x 1,5 RHT
81953016288



SC-ES-8517

Length: 140
Cone Ø: d1 Ø 30 / d2 Ø 27
Thread: M30 x 1,5 RHT
81953016286



SC-ES-8535

Length: 145
Cone Ø: d1 Ø 30 / d2 Ø 27
Thread: M30 x 1,5 RHT
81953016271, 81953016325





TGA ...

35.360 FFDK, FFDLK, FFDRK ...	10/03 →	Track Control Arm		MN-VB-8669	Suspension Rod, Wishbone (CV), Drive Axle; Leaf Spring Axle
	08/04 →	Track Control Arm		MN-VB-9404	Wishbone (CV), Drive Axle; Air Suspension Axle
35.360 FFD-TM	11/03 →	Tie Rod End	CV-ES-0914		for Steering Rod
	11/03 →	Tie Rod End	CV-ES-14162		for Steering Rod
	11/03 →	Tie Rod End	CV-ES-14163		for Steering Rod
	11/03 →	Tie Rod End	SC-ES-7279		for Steering Rod
	11/03 →	Tie Rod End	SC-ES-8517		for Push Rod
	11/03 →	Tie Rod End	SC-ES-8535		for Guide Rod
	11/03 →	Track Control Arm		MN-DL-8544	Trailing Arm, 1st RA; 2nd RA, for Leaf-Spring Suspension vehicles
	11/03 →	Track Control Arm		MN-VB-8514	Suspension Rod, Wishbone (CV)
	11/03 →	Track Control Arm		MN-VB-8669	Suspension Rod, Wishbone (CV), 1st RA; 2nd RA, for Leaf-Spring Suspension vehicles, →Type_MHB Chassis
35.360 FFHLC	07/06 →	Centre Rod	MN-DL-12393		for Steering Rod
	07/06 →	Suspension Arm Repair Kit		CV-RK-5313	for Wishbone (CV)
	07/06 →	Suspension Arm Repair Kit	DB-RK-9300	DB-RK-9300	for Drag Link
	07/06 →	Tie Rod	MN-DL-12284		
	07/06 →	Tie Rod End	CV-ES-0914		for Steering Rod
	07/06 →	Tie Rod End	CV-ES-14162	CV-ES-14162	for Steering Rod
	07/06 →	Tie Rod End	CV-ES-14163		for Steering Rod
	07/06 →	Tie Rod End	SC-ES-7279		for Steering Rod
	07/06 →	Tie Rod End	SC-ES-8517		for Push Rod
	07/06 →	Tie Rod End	SC-ES-8535		for Guide Rod
	07/06 →	Track Control Arm		MN-DL-5225	for Control Arm
	07/06 →	Track Control Arm		MN-DL-5225	Trailing Arm
	07/06 →	Track Control Arm		MN-DL-8709	Trailing Arm
	07/06 →	Track Control Arm		MN-DL-8709	Trailing Arm, Trailing Axle Steered/not Steered, for Pneumatic Suspension vehicles
	07/06 →	Track Control Arm		MN-VB-5238	Wishbone (CV), 1st RA; 2nd RA, for Pneumatic Suspension vehicles
	07/06 →	Track Control Arm		MN-VB-5238	Wishbone (CV), Drive Axle
	07/06 →	Track Control Arm		MN-VB-9403	Wishbone (CV)
	07/06 →	Track Control Arm		MN-VB-9403	Wishbone (CV), Trailing Axle Steered/not Steered, for Pneumatic Suspension vehicles
	35.360 FFNLC	07/06 →	Suspension Arm Repair Kit		CV-RK-5313
07/06 →		Suspension Arm Repair Kit		MN-RK-7291	for Drag Link
07/06 →		Suspension Arm Repair Kit	DB-RK-9300	DB-RK-9300	for Drag Link
07/06 →		Tie Rod	MN-DL-12284		
07/06 →		Tie Rod End	CV-ES-0914		for Steering Rod
07/06 →		Tie Rod End	CV-ES-14162	CV-ES-14162	for Steering Rod
07/06 →		Tie Rod End	CV-ES-14163		for Steering Rod
07/06 →		Tie Rod End	SC-ES-7279		for Steering Rod
07/06 →		Tie Rod End	SC-ES-8517		for Push Rod
07/06 →		Tie Rod End	SC-ES-8535		for Guide Rod
07/06 →		Track Control Arm		MN-DL-5212	Trailing Arm, Trailing Axle not Steered, for Pneumatic Suspension vehicles
07/06 →		Track Control Arm		MN-DL-5225	Trailing Arm
07/06 →		Track Control Arm		MN-DL-8709	Trailing Arm, Trailing Axle Steered/not Steered, for Pneumatic Suspension vehicles
07/06 →		Track Control Arm		MN-VB-5238	Wishbone (CV), 1st Drive Axle, for Pneumatic Suspension vehicles
07/06 →		Track Control Arm		MN-VB-9403	Wishbone (CV), Trailing Axle Steered/not Steered, for Pneumatic Suspension vehicles
35.390 FDNLC	07/06 →	Centre Rod	MN-DL-12393		for Steering Rod
	07/06 →	Suspension Arm Repair Kit		CV-RK-5313	for Wishbone (CV)
	07/06 →	Suspension Arm Repair Kit	DB-RK-9300	DB-RK-9300	for Drag Link
	07/06 →	Tie Rod	MN-DL-12284		
	07/06 →	Tie Rod End	CV-ES-0914		for Steering Rod
	07/06 →	Tie Rod End	CV-ES-14162	CV-ES-14162	for Steering Rod
	07/06 →	Tie Rod End	CV-ES-14163		for Steering Rod
	07/06 →	Tie Rod End	SC-ES-7279		for Steering Rod

CV-ES-0914

Length: 125
Cone Ø: d1 Ø 30 / d2 Ø 27
Thread: M38 x 1,5 RHT
81953016184, 81953016251, 81953016276



CV-ES-14162

Length: 125
Cone Ø: d1 Ø 30 / d2 Ø 27
Thread: M30 x 1,5 LHT
81953010015, 81953010083, 81953010087, 81953016029, 81953016030, 81953016043, 81953016044, 81953016050, 81953016054, 81953016087, 81953016091, 81953016107, 81953016120, 81953016125, 81953016152, 81953016155, 81953016157, 81953016168, 81953016179, 81953016181, 81953016223, 81953016237, 81953016254, 81953016275, 81953016279, 81953016351



CV-ES-14163

Length: 125
Cone Ø: d1 Ø 30 / d2 Ø 27
Thread: M30 x 1,5 RHT
95301.0084, 90804102156, 90804102272, 90804102696, 90804102710, 81953010016, 81953010075, 81953010084, 81953010088, 81953010094, 81953010103, 81953016030, 81953016043, 81953016048, 81953016049, 81953016053, 81953016061, 81953016090, 81953016108, 81953016112, 81953016126, 81953016143, 81953016149, 81953016154, 81953016156, 81953016168, 81953016178, 81953016194, 81953016206, 81953016224, 81953016234, 81953016242, 81953016252, 81953016274, 81953016278, 81953016284, 81953016286, 81953016308, 81953016310, 81953016312, 81953016347, 81953016350, 81953016352, 82953016012, 88953016014, N2953016001



CV-RK-5313

Ø: 90
03304800A, 81953016132



DB-RK-9300

Ø: 75
Hole Distance: 130
Thick/Height: 24
85432206002



MN-DL-5212

Length: 577 Ø: 48
Hole Distance: 130 / 130
81432206096, 81432206097, 81432206098, 81432206129, 81432209096, 81432209129, 81432306014, 81432306030



MN-DL-5225

Length: 572 Ø: 48
Hole Distance: 130 / 130
03301500A, 81432206229, 81432206236, 81432206267, 81432206270, 81432206272, 81432206304, 81432206305, 81432209236, 81432209267, 81432209272



MN-DL-8544

Length: 596 Ø: 48
Hole Distance: 130 / 130
81432206196, 81432206232, 81432206233



MN-DL-8709

Length: 572 Ø: 52
Hole Distance: 130 / 130
81432206268, 81432206274, 81432206291, 81432206292, 82432206007



MN-DL-12284

Length: 1530 Ø: 50
Cone Ø: d1 Ø 30 / d2 Ø 27
81466106579, 81466106580, 81466106624, 81466116720, 81467116720, 81467116730, 81467116952



MN-DL-12393

Length: 1796 Ø: 62
Cone Ø: d1 Ø 30 / d2 Ø 27
81466116154, 81466116155, 81466116156



MN-RK-7291

Ø: 72
Hole Distance: 130
Thick/Height: 30
10307800A, 81432206108, 81432206132



MN-VB-5238

Length: 627 Ø: 48
Hole Distance: 130 / 130
81432206221, 81432706096, 81432706114, 81432706116, 81432706121



MN-VB-8514

Length: 627 Ø: 48
Hole Ø 25 / 25 / 25
Hole Distance: 152 / 130 / 130
81432706087, 81432706088, 81432706094, 81432706095, 81432796094



MN-VB-8669

Length: 627 Ø: 48
Hole Ø 25 / 25 / 25
Hole Distance: 152 / 130 / 130
81432706116, 81432706137, 81432706150, 81432706151



MN-VB-9403

Length: 627 Ø: 48
Hole Ø 25 / 23 / 23
Hole Distance: 152 / 130 / 130
81432706097, 81432706113, 81432706135, 81432706160, 81432706161



MN-VB-9404

Length: 627 Ø: 58
Hole Distance: 130 / 130
81432706117, 81432706152, 81432706153



SC-ES-7279

Length: 150
Cone Ø: d1 Ø 30 / d2 Ø 27
Thread: M30 x 1,5 RHT
81953016288



SC-ES-8517

Length: 140
Cone Ø: d1 Ø 30 / d2 Ø 27
Thread: M30 x 1,5 RHT
81953016286



SC-ES-8535

Length: 145
Cone Ø: d1 Ø 30 / d2 Ø 27
Thread: M30 x 1,5 RHT
81953016271, 81953016325



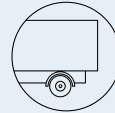

TGA ...

35.390 FDNLC ...	07/06→	Tie Rod End	SC-ES-8517		for Push Rod	
	07/06→	Tie Rod End	SC-ES-8535		for Guide Rod	
	07/06→	Track Control Arm		MN-DL-5225	Trailing Arm	
	07/06→	Track Control Arm		MN-DL-8709	Trailing Arm, Trailing Axle Steered/not Steered, for Pneumatic Suspension vehicles	
	07/06→	Track Control Arm		MN-VB-8669	Suspension Rod, Wishbone (CV), 1st RA; 2nd RA, for Leaf-Spring Suspension vehicles, →Type_MHB Chassis	
	07/06→	Track Control Arm		MN-VB-9403	Wishbone (CV), Trailing Axle Steered/not Steered, for Pneumatic Suspension vehicles Push Rod, for Leaf-Spring Suspension vehicles	
35.390 FFDK	02/04→	Centre Rod	MN-DL-8646			
	02/04→	Suspension Strut Repair Kit		DB-RK-8581		
	02/04→	Tie Rod	MN-DL-12287			
	02/04→	Tie Rod End	CV-ES-14162		for Steering Rod	
	02/04→	Tie Rod End	CV-ES-14163		for Steering Rod	
	02/04→	Tie Rod End	MN-ES-10333		for Steering Rod	
	02/04→	Track Control Arm		MN-DL-8544	Trailing Arm, Drive Axle	
	02/04→	Track Control Arm		MN-DL-8609	Trailing Arm, 1st RA;2nd RA, for Leaf-Spring Suspension vehicles, →Type_HB Chassis	
	02/04→	Track control arm		MN-DL-10288	Trailing Arm, 1st RA;2nd RA, for Leaf-Spring Suspension vehicles, →Type HB	
	02/04→	Track control arm		MN-DL-12288	Trailing Arm	
	02/04→	Track Control Arm		MN-VB-8514	Suspension Rod, Wishbone (CV), Drive Axle	
	02/04→	Track Control Arm		MN-VB-9404	Wishbone (CV), 1st RA;2nd RA, for Leaf-Spring Suspension vehicles, →Type_HB Chassis	
35.390 FFDK, FFDHK, FFDHLK	07/06→	Centre Rod	MN-DL-7801		Push Rod	
	07/06→	Centre Rod	MN-DL-8599		Push Rod	
	07/06→	Centre Rod	MN-DL-8646		Push Rod, for Leaf-Spring Suspension vehicles	
	07/06→	Centre Rod	MN-DL-12285		for Steering Rod	
	07/06→	Centre Rod	MN-DL-12393		for Steering Rod	
	07/06→	Tie Rod	MN-DL-7802			
	07/06→	Tie Rod End	CV-ES-0914		for Steering Rod	
	07/06→	Tie Rod End	CV-ES-14162		for Steering Rod	
	07/06→	Tie Rod End	CV-ES-14163		for Steering Rod	
	07/06→	Tie Rod End	MN-ES-10333		for Steering Rod	
	07/06→	Tie Rod End	SC-ES-7279		for Steering Rod	
	07/06→	Tie Rod End	SC-ES-8517		for Push Rod	
	07/06→	Tie Rod End	SC-ES-8535		for Guide Rod	
	07/06→	Track Control Arm		MN-DL-8544	Trailing Arm, Drive Axle	
	07/06→	Track Control Arm		MN-DL-8544	Trailing Arm, Drive Axle, for Leaf-Spring Suspension vehicles	
	07/06→	Track control arm		MN-DL-12288	Trailing Arm	
	07/06→	Track Control Arm		MN-VB-8514	Suspension Rod, Wishbone (CV), Drive Axle	
	07/06→	Track Control Arm		MN-VB-8669	Suspension Rod, Wishbone (CV), 1st RA; 2nd RA, for Leaf-Spring Suspension vehicles, →Type_MHB Chassis	
	35.390 FFDH-TM	07/06→	Centre Rod	MN-DL-7801		Push Rod
		07/06→	Centre Rod	MN-DL-12393		for Steering Rod
07/06→		Tie Rod	MN-DL-7802			
07/06→		Tie Rod End	CV-ES-0914		for Steering Rod	
07/06→		Tie Rod End	CV-ES-14162		for Steering Rod	
07/06→		Tie Rod End	CV-ES-14163		for Steering Rod	
07/06→		Tie Rod End	SC-ES-7279		for Steering Rod	
07/06→		Tie Rod End	SC-ES-8517		for Push Rod	
07/06→		Tie Rod End	SC-ES-8535		for Guide Rod	
07/06→		Track Control Arm		MN-DL-8544	Trailing Arm, Drive Axle, for Leaf-Spring Suspension vehicles	
07/06→		Track Control Arm		MN-VB-8514	Suspension Rod, Wishbone (CV), Drive Axle	
07/06→		Track Control Arm		MN-VB-8669	Suspension Rod, Wishbone (CV), 1st RA; 2nd RA, for Leaf-Spring Suspension vehicles, →Type_MHB Chassis	

CV-ES-0914

Length: 125
Cone Ø: d1 Ø 30 / d2 Ø 27
Thread: M38 x 1,5 RHT
81953016184, 81953016251, 81953016276



CV-ES-14162

Length: 125
Cone Ø: d1 Ø 30 / d2 Ø 27
Thread: M30 x 1,5 LHT
81953010015, 81953010083, 81953010087, 81953016029, 81953016030, 81953016043, 81953016044, 81953016050, 81953016054, 81953016087, 81953016091, 81953016107, 81953016120, 81953016125, 81953016152, 81953016155, 81953016157, 81953016168, 81953016179, 81953016181, 81953016223, 81953016237, 81953016254, 81953016275, 81953016279, 81953016351



CV-ES-14163

Length: 125
Cone Ø: d1 Ø 30 / d2 Ø 27
Thread: M30 x 1,5 RHT
95301.0084, 90804102156, 90804102272, 90804102696, 90804102710, 81953010016, 81953010075, 81953010084, 81953010088, 81953010094, 81953010103, 81953016030, 81953016043, 81953016048, 81953016049, 81953016053, 81953016061, 81953016090, 81953016108, 81953016112, 81953016126, 81953016143, 81953016149, 81953016154, 81953016156, 81953016168, 81953016178, 81953016194, 81953016206, 81953016224, 81953016234, 81953016242, 81953016252, 81953016274, 81953016278, 81953016284, 81953016286, 81953016308, 81953016310, 81953016312, 81953016347, 81953016350, 81953016352, 82953016012, 88953016014, N2953016001



DB-RK-8581

Ø: 85
Hole Distance: 130
Thick/Height: 24
03305800A, 81432706105



MN-DL-5225

Length: 572 Ø: 48
Hole Distance: 130 / 130
03301500A, 81432206229, 81432206236, 81432206267, 81432206270, 81432206272, 81432206304, 81432206305, 81432209236, 81432209267, 81432209272



MN-DL-7801

Length: 995 Ø: 52
Cone Ø: d1 Ø 30 / d2 Ø 27
81466106807, 81466106808, 81466116087, 81466116088, 81466116096, 81466116097, 81466116099, 81466116132, 81466116133, 81466116136, 81466116197, 81466116198, 81466116205

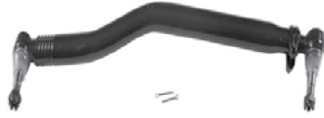

MN-DL-7802

Length: 1680 Ø: 52
Cone Ø: d1 Ø 30 / d2 Ø 27
03208300A, 81467116773, 81467116858, 81467116859, 81467116860, 81467116861, 81467116863, 81467116882, 81467116883, 81467116920, 81467116921



MN-DL-8544

Length: 596 Ø: 48
Hole Distance: 130 / 130
81432206196, 81432206232, 81432206233



MN-DL-8599

Length: 1800 Ø: 62
Cone Ø: d1 Ø 30 / d2 Ø 27
81466116161, 81466116162, 82466106183, 82466106186, 82466106187



MN-DL-8609

Length: 585 Ø: 58
Hole Distance: 130 / 130
81432206070, 81432206071, 81432206072, 81432206091, 81432206093, 81432206119



MN-DL-8646

Length: 1021 Ø: 52
Cone Ø: d1 Ø 30 / d2 Ø 27
81466106811, 81466106812, 81466116138, 81466116139, 81466116201, 81466116202

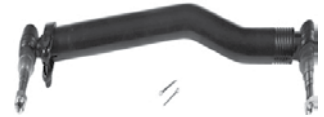

MN-DL-8709

Length: 572 Ø: 52
Hole Distance: 130 / 130
81432206268, 81432206274, 81432206291, 81432206292, 82432206007



MN-DL-10288

81432206386, 82432206008, 82432209008

No Image

MN-DL-12285

Length: 993 Ø: 40
Cone Ø: d1 Ø 30 / d2 Ø 27
81466106816, 81466106826, 81466116151, 82466106184, 82466106185



MN-DL-12287

Length: 1531 Ø: 42
Cone Ø: d1 Ø 30 / d2 Ø 27
81467116855, 81467116856, 81467116857



MN-DL-12288

Length: 585 Ø: 58
Hole Distance: 130 / 130
81432206386, 82432206008, 82432209008

No Image

MN-DL-12393

Length: 1796 Ø: 62
Cone Ø: d1 Ø 30 / d2 Ø 27
81466116154, 81466116155, 81466116156



MN-ES-10333

Length: 90
Cone Ø: d1 Ø 38 / d2 Ø 34,35
Thread: M36 x 1,5 RHT
1271126, 3090291, 3099128, 42538048, 81953016268, 82953016018, 82953016019



MN-VB-8514

Length: 627 Ø: 48
Hole Ø 25 / 25 / 25
Hole Distance: 152 / 130 / 130
81432706087, 81432706088, 81432706094, 81432706095, 81432796094



MN-VB-8669

Length: 627 Ø: 48
Hole Ø 25 / 25 / 25
Hole Distance: 152 / 130 / 130
81432706116, 81432706137, 81432706150, 81432706151



MN-VB-9403

Length: 627 Ø: 48
Hole Ø 25 / 23 / 23
Hole Distance: 152 / 130 / 130
81432706097, 81432706113, 81432706135, 81432706160, 81432706161



MN-VB-9404

Length: 627 Ø: 58
Hole Distance: 130 / 130
81432706117, 81432706152, 81432706153



SC-ES-7279

Length: 150
Cone Ø: d1 Ø 30 / d2 Ø 27
Thread: M30 x 1,5 RHT
81953016288



SC-ES-8517

Length: 140
Cone Ø: d1 Ø 30 / d2 Ø 27
Thread: M30 x 1,5 RHT
81953016286



SC-ES-8535

Length: 145
Cone Ø: d1 Ø 30 / d2 Ø 27
Thread: M30 x 1,5 RHT
81953016271, 81953016325



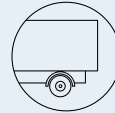

TGA ...

35.390 FFNLC	07/06→	Centre Rod	MN-DL-12393		for Steering Rod
	07/06→	Suspension Arm Repair Kit		CV-RK-5313	for Wishbone (CV)
	07/06→	Suspension Arm Repair Kit		MN-RK-7291	for Drag Link
	07/06→	Suspension Arm Repair Kit	DB-RK-9300	DB-RK-9300	for Drag Link
	07/06→	Tie Rod	MN-DL-12284		
	07/06→	Tie Rod End	CV-ES-0914		for Steering Rod
	07/06→	Tie Rod End	CV-ES-14162	CV-ES-14162	for Steering Rod
	07/06→	Tie Rod End	CV-ES-14163		for Steering Rod
	07/06→	Tie Rod End	SC-ES-7279		for Steering Rod
	07/06→	Tie Rod End	SC-ES-8517		for Push Rod
	07/06→	Tie Rod End	SC-ES-8535		for Guide Rod
	07/06→	Track Control Arm		MN-DL-5212	Trailing Arm, Trailing Axle not Steered, for Pneumatic Suspension vehicles
	07/06→	Track Control Arm		MN-DL-5225	Trailing Arm
	07/06→	Track Control Arm		MN-DL-8709	Trailing Arm, Trailing Axle Steered/not Steered, for Pneumatic Suspension vehicles
	07/06→	Track Control Arm		MN-VB-5238	Wishbone (CV), 1st Drive Axle, for Pneumatic Suspension vehicles
	07/06→	Track Control Arm		MN-VB-9403	Wishbone (CV), Trailing Axle Steered/not Steered, for Pneumatic Suspension vehicles
	35.390, 35.400 FFDC, FFDRK, FFDLC	02/04→	Centre Rod	MN-DL-7801	
02/04→		Centre Rod	MN-DL-8599		Push Rod
02/04→		Centre Rod	MN-DL-12285		for Steering Rod
02/04→		Centre Rod	MN-DL-12289		Push Rod
02/04→		Centre Rod	MN-DL-12393		for Steering Rod
02/04→		Suspension Strut Repair Kit		DB-RK-8581	
02/04→		Tie Rod	MN-DL-7802		
02/04→		Tie Rod	MN-DL-12284		
02/04→		Tie Rod End	CV-ES-0914		for Steering Rod
02/04→		Tie Rod End	CV-ES-14162	CV-ES-14162	for Steering Rod
02/04→		Tie Rod End	CV-ES-14163		for Steering Rod
02/04→		Tie Rod End	MN-ES-10333		for Steering Rod
02/04→		Tie Rod End	SC-ES-7279		for Steering Rod
02/04→		Tie Rod End	SC-ES-8517		for Push Rod
02/04→		Tie Rod End	SC-ES-8535		for Guide Rod
02/04→		Track Control Arm		MN-DL-5225	Trailing Arm, Drive Axle;Air Suspension Axle
02/04→		Track Control Arm		MN-DL-8544	Trailing Arm, Drive Axle;Air Suspension Axle
02/04→		Track Control Arm		MN-DL-8544	Trailing Arm, Drive Axle;Leaf Spring Axle
02/04→		Track Control Arm		MN-DL-8709	Trailing Arm, Trailing Axle Steered/not Steered, for Pneumatic Suspension vehicles
02/04→		Track control arm		MN-DL-12288	Trailing Arm
02/04→		Track Control Arm		MN-VB-5238	Wishbone (CV), Drive Axle;Air Suspension Axle
02/04→		Track Control Arm		MN-VB-8514	Suspension Rod, Wishbone (CV), Drive Axle; Air Suspension Axle
02/04→		Track Control Arm		MN-VB-8514	Suspension Rod, Wishbone (CV), Drive Axle; Leaf Spring Axle
02/04→		Track Control Arm		MN-VB-8669	Suspension Rod, Wishbone (CV), Drive Axle; Leaf Spring Axle
02/04→		Track Control Arm		MN-VB-9403	Wishbone (CV), Trailing Axle Steered/not Steered, for Pneumatic Suspension vehicles
08/04→		Track Control Arm		MN-VB-9404	Wishbone (CV), Drive Axle;Air Suspension Axle
35.390, 35.400 FFDK, FFDRK, FFDLK		02/04→	Centre Rod	MN-DL-7801	
	02/04→	Centre Rod	MN-DL-8599		Push Rod
	02/04→	Centre Rod	MN-DL-12285		for Steering Rod
	02/04→	Centre Rod	MN-DL-12289		Push Rod
	02/04→	Centre Rod	MN-DL-12393		for Steering Rod
	02/04→	Suspension Strut Repair Kit		DB-RK-8581	
	02/04→	Tie Rod	MN-DL-7802		
	02/04→	Tie Rod End	CV-ES-0914		for Steering Rod
	02/04→	Tie Rod End	CV-ES-14162		for Steering Rod
	02/04→	Tie Rod End	CV-ES-14163		for Steering Rod
	02/04→	Tie Rod End	MN-ES-10333		for Steering Rod
	02/04→	Tie Rod End	SC-ES-7279		for Steering Rod

CV-ES-0914

Length: 125
Cone Ø: d1 Ø 30 / d2 Ø 27
Thread: M38 x 1,5 RHT
81953016184, 81953016251, 81953016276



CV-ES-14162

Length: 125
Cone Ø: d1 Ø 30 / d2 Ø 27
Thread: M30 x 1,5 LHT
81953010015, 81953010083, 81953010087, 81953016029, 81953016030, 81953016043, 81953016044, 81953016050, 81953016054, 81953016087, 81953016091, 81953016107, 81953016120, 81953016125, 81953016152, 81953016155, 81953016157, 81953016168, 81953016179, 81953016181, 81953016223, 81953016237, 81953016254, 81953016275, 81953016279, 81953016351



CV-ES-14163

Length: 125
Cone Ø: d1 Ø 30 / d2 Ø 27
Thread: M30 x 1,5 RHT
95301.0084, 90804102156, 90804102272, 90804102696, 90804102710, 81953010016, 81953010075, 81953010084, 81953010088, 81953010094, 81953010103, 81953016030, 81953016043, 81953016048, 81953016049, 81953016053, 81953016061, 81953016090, 81953016108, 81953016112, 81953016126, 81953016143, 81953016149, 81953016154, 81953016156, 81953016168, 81953016178, 81953016194, 81953016206, 81953016224, 81953016234, 81953016242, 81953016252, 81953016274, 81953016278, 81953016284, 81953016286, 81953016308, 81953016310, 81953016312, 81953016347, 81953016350, 81953016352, 82953016012, 88953016014, N2953016001



CV-RK-5313

Ø: 90
03304800A, 81953016132



DB-RK-8581

Ø: 85
Hole Distance: 130
Thick/Height: 24
03305800A, 81432706105



DB-RK-9300

Ø: 75
Hole Distance: 130
Thick/Height: 24
85432206002



MN-DL-5212

Length: 577 Ø: 48
Hole Distance: 130 / 130
81432206096, 81432206097, 81432206098, 81432206129, 81432209096, 81432209129, 81432306014, 81432306030



MN-DL-5225

Length: 572 Ø: 48
Hole Distance: 130 / 130
03301500A, 81432206229, 81432206236, 81432206267, 81432206270, 81432206272, 81432206304, 81432206305, 81432209236, 81432209267, 81432209272



MN-DL-7801

Length: 995 Ø: 52
Cone Ø: d1 Ø 30 / d2 Ø 27
81466106807, 81466106808, 81466116087, 81466116088, 81466116096, 81466116097, 81466116099, 81466116132, 81466116133, 81466116136, 81466116197, 81466116198, 81466116205

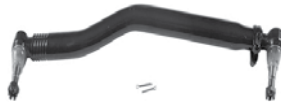

MN-DL-7802

Length: 1680 Ø: 52
Cone Ø: d1 Ø 30 / d2 Ø 27
03208300A, 81467116773, 81467116858, 81467116859, 81467116860, 81467116861, 81467116863, 81467116882, 81467116883, 81467116920, 81467116921



MN-DL-8544

Length: 596 Ø: 48
Hole Distance: 130 / 130
81432206196, 81432206232, 81432206233



MN-DL-8599

Length: 1800 Ø: 62
Cone Ø: d1 Ø 30 / d2 Ø 27
81466116161, 81466116162, 82466106183, 82466106186, 82466106187



MN-DL-8709

Length: 572 Ø: 52
Hole Distance: 130 / 130
81432206268, 81432206274, 81432206291, 81432206292, 82432206007



MN-DL-12284

Length: 1530 Ø: 50
Cone Ø: d1 Ø 30 / d2 Ø 27
81466106579, 81466106580, 81466106624, 81466116720, 81467116720, 81467116730, 81467116952



MN-DL-12285

Length: 993 Ø: 40
Cone Ø: d1 Ø 30 / d2 Ø 27
81466106816, 81466106826, 81466116151, 82466106184, 82466106185



MN-DL-12288

Length: 585 Ø: 58
Hole Distance: 130 / 130
81432206386, 82432206008, 82432209008

No Image

MN-DL-12289

Length: 1796 Ø: 62
Cone Ø: d1 Ø 30 / d2 Ø 27
81466116174, 81466116175, 81466116176, 81466116244

No Image

MN-DL-12393

Length: 1796 Ø: 62
Cone Ø: d1 Ø 30 / d2 Ø 27
81466116154, 81466116155, 81466116156



MN-ES-10333

Length: 90
Cone Ø: d1 Ø 38 / d2 Ø 34,35
Thread: M36 x 1,5 RHT
1271126, 3090291, 3099128, 42538048, 81953016268, 82953016018, 82953016019



MN-RK-7291

Ø: 72
Hole Distance: 130
Thick/Height: 30
10307800A, 81432206108, 81432206132



MN-VB-5238

Length: 627 Ø: 48
Hole Distance: 130 / 130
81432206221, 81432706096, 81432706114, 81432706116, 81432706121



MN-VB-8514

Length: 627 Ø: 48
Hole Ø 25 / 25 / 25
Hole Distance: 152 / 130 / 130
81432706087, 81432706088, 81432706094, 81432706095, 81432796094



MN-VB-8669

Length: 627 Ø: 48
Hole Ø 25 / 25 / 25
Hole Distance: 152 / 130 / 130
81432706116, 81432706137, 81432706150, 81432706151



MN-VB-9403

Length: 627 Ø: 48
Hole Ø 25 / 23 / 23
Hole Distance: 152 / 130 / 130
81432706097, 81432706113, 81432706135, 81432706160, 81432706161



MN-VB-9404

Length: 627 Ø: 58
Hole Distance: 130 / 130
81432706117, 81432706152, 81432706153



SC-ES-7279

Length: 150
Cone Ø: d1 Ø 30 / d2 Ø 27
Thread: M30 x 1,5 RHT
81953016288



SC-ES-8517

Length: 140
Cone Ø: d1 Ø 30 / d2 Ø 27
Thread: M30 x 1,5 RHT
81953016286



SC-ES-8535

Length: 145
Cone Ø: d1 Ø 30 / d2 Ø 27
Thread: M30 x 1,5 RHT
81953016271, 81953016325





TGA ...

35.390, 35.400 FFDK, FFDK, FFDLK ...	02/04 →	Tie Rod End	SC-ES-8517		for Push Rod
	02/04 →	Tie Rod End	SC-ES-8535		for Guide Rod
	02/04 →	Track Control Arm		MN-DL-5225	Trailing Arm, Drive Axle; Air Suspension Axle
	02/04 →	Track Control Arm		MN-DL-8544	Trailing Arm, Drive Axle; Air Suspension Axle
	02/04 →	Track Control Arm		MN-DL-8544	Trailing Arm, Drive Axle; Leaf Spring Axle
	02/04 →	Track Control Arm		MN-VB-5238	Wishbone (CV), Drive Axle; Air Suspension Axle
	02/04 →	Track Control Arm		MN-VB-8514	Suspension Rod, Wishbone (CV), Drive Axle; Air Suspension Axle
	02/04 →	Track Control Arm		MN-VB-8514	Suspension Rod, Wishbone (CV), Drive Axle; Leaf Spring Axle
	02/04 →	Track Control Arm		MN-VB-8669	Suspension Rod, Wishbone (CV), Drive Axle; Leaf Spring Axle
35.390, 35.400 FFD-TM	08/04 →	Track Control Arm		MN-VB-9404	Wishbone (CV), Drive Axle; Air Suspension Axle
	02/04 →	Centre Rod	MN-DL-7801		Push Rod, Leaf Spring Axle
	02/04 →	Centre Rod	MN-DL-8599		Push Rod
	02/04 →	Centre Rod	MN-DL-12285		for Steering Rod
	02/04 →	Centre Rod	MN-DL-12289		Push Rod
	02/04 →	Centre Rod	MN-DL-12393		for Steering Rod
	02/04 →	Suspension Strut Repair Kit		DB-RK-8581	
	02/04 →	Tie Rod	MN-DL-7802		
	02/04 →	Tie Rod End	CV-ES-0914		for Steering Rod
	02/04 →	Tie Rod End	CV-ES-14162		for Steering Rod
	02/04 →	Tie Rod End	CV-ES-14163		for Steering Rod
	02/04 →	Tie Rod End	MN-ES-10333		for Steering Rod
	02/04 →	Tie Rod End	SC-ES-7279		for Steering Rod
	02/04 →	Tie Rod End	SC-ES-8517		for Push Rod
	02/04 →	Tie Rod End	SC-ES-8535		for Guide Rod
	02/04 →	Track Control Arm		MN-DL-5225	Trailing Arm
	02/04 →	Track Control Arm		MN-DL-8544	Trailing Arm, Drive Axle; Leaf Spring Axle
	02/04 →	Track Control Arm		MN-VB-8514	Suspension Rod, Wishbone (CV), Drive Axle; Leaf Spring Axle
	02/04 →	Track Control Arm		MN-VB-8669	Suspension Rod, Wishbone (CV), Drive Axle; Leaf Spring Axle
35.400 FDNLC	07/06 →	Centre Rod	MN-DL-12393		for Steering Rod
	07/06 →	Suspension Arm Repair Kit		CV-RK-5313	for Wishbone (CV)
	07/06 →	Suspension Arm Repair Kit	DB-RK-9300	DB-RK-9300	for Drag Link
	07/06 →	Tie Rod End	CV-ES-0914		for Steering Rod
	07/06 →	Tie Rod End	CV-ES-14162	CV-ES-14162	for Steering Rod
	07/06 →	Tie Rod End	CV-ES-14163		for Steering Rod
	07/06 →	Tie Rod End	SC-ES-7279		for Steering Rod
	07/06 →	Tie Rod End	SC-ES-8517		for Push Rod
	07/06 →	Tie Rod End	SC-ES-8535		for Guide Rod
	07/06 →	Track Control Arm		MN-DL-5225	Trailing Arm
	07/06 →	Track Control Arm		MN-DL-8709	Trailing Arm, Trailing Axle Steered/not Steered, for Pneumatic Suspension vehicles
	07/06 →	Track Control Arm		MN-VB-8669	Suspension Rod, Wishbone (CV), 1st RA; 2nd RA, for Leaf-Spring Suspension vehicles, →Type_MHB Chassis
	07/06 →	Track Control Arm		MN-VB-9403	Wishbone (CV), Trailing Axle Steered/not Steered, for Pneumatic Suspension vehicles
	35.400 FFDK	02/04 →	Centre Rod	MN-DL-8646	
02/04 →		Suspension Arm Repair Kit		CV-RK-5313	for Wishbone (CV)
02/04 →		Tie Rod	MN-DL-12287		
02/04 →		Tie Rod End	CV-ES-14162		for Steering Rod
02/04 →		Tie Rod End	CV-ES-14163		for Steering Rod
02/04 →		Tie Rod End	MN-ES-10333		for Steering Rod
02/04 →		Track Control Arm		MN-DL-8544	Trailing Arm, Drive Axle
02/04 →		Track Control Arm		MN-DL-8609	Trailing Arm, 1st RA; 2nd RA, for Leaf-Spring Suspension vehicles, →Type_HB Chassis
02/04 →		Track control arm		MN-DL-10288	Trailing Arm, 1st RA; 2nd RA, for Leaf-Spring Suspension vehicles, →Type_HB
02/04 →		Track control arm		MN-DL-12288	Trailing Arm
02/04 →	Track Control Arm		MN-VB-8514	Suspension Rod, Wishbone (CV), Drive Axle	

CV-ES-0914

Length: 125
Cone Ø: d1 Ø 30 / d2 Ø 27
Thread: M38 x 1,5 RHT
81953016184, 81953016251, 81953016276



CV-ES-14162

Length: 125
Cone Ø: d1 Ø 30 / d2 Ø 27
Thread: M30 x 1,5 LHT
81953010015, 81953010083, 81953010087,
81953016029, 81953016030, 81953016043,
81953016044, 81953016050, 81953016054,
81953016087, 81953016091, 81953016107,
81953016120, 81953016125, 81953016152,
81953016155, 81953016157, 81953016168,
81953016179, 81953016181, 81953016223,
81953016237, 81953016254, 81953016275,
81953016279, 81953016351



CV-ES-14163

Length: 125
Cone Ø: d1 Ø 30 / d2 Ø 27
Thread: M30 x 1,5 RHT
95301.0084, 90804102156, 90804102272,
90804102696, 90804102710, 81953010016,
81953010075, 81953010084, 81953010088,
81953010094, 81953010103, 81953016030,
81953016043, 81953016048, 81953016049,
81953016053, 81953016061, 81953016090,
81953016108, 81953016112, 81953016126,
81953016143, 81953016149, 81953016154,
81953016156, 81953016168, 81953016178,
81953016194, 81953016206, 81953016224,
81953016234, 81953016242, 81953016252,
81953016274, 81953016278, 81953016284,
81953016286, 81953016308, 81953016310,
81953016312, 81953016347, 81953016350,
81953016352, 82953016012, 88953016014,
N2953016001



CV-RK-5313

Ø: 90
03304800A, 81953016132



DB-RK-8581

Ø: 85
Hole Distance: 130
Thick/Height: 24
03305800A, 81432706105



DB-RK-9300

Ø: 75
Hole Distance: 130
Thick/Height: 24
85432206002



MN-DL-5225

Length: 572 Ø: 48
Hole Distance: 130 / 130
03301500A, 81432206229, 81432206236,
81432206267, 81432206270, 81432206272,
81432206304, 81432206305, 81432209236,
81432209267, 81432209272



MN-DL-7801

Length: 995 Ø: 52
Cone Ø: d1 Ø 30 / d2 Ø 27
81466106807, 81466106808, 81466116087,
81466116088, 81466116096, 81466116097,
81466116099, 81466116132, 81466116133,
81466116136, 81466116197, 81466116198,
81466116205



MN-DL-7802

Length: 1680 Ø: 52
Cone Ø: d1 Ø 30 / d2 Ø 27
03208300A, 81467116773, 81467116858,
81467116859, 81467116860, 81467116861,
81467116863, 81467116882, 81467116883,
81467116920, 81467116921



MN-DL-8544

Length: 596 Ø: 48
Hole Distance: 130 / 130
81432206196, 81432206232, 81432206233



MN-DL-8599

Length: 1800 Ø: 62
Cone Ø: d1 Ø 30 / d2 Ø 27
81466116161, 81466116162, 82466106183,
82466106186, 82466106187



MN-DL-8609

Length: 585 Ø: 58
Hole Distance: 130 / 130
81432206070, 81432206071, 81432206072,
81432206091, 81432206093, 81432206119



MN-DL-8646

Length: 1021 Ø: 52
Cone Ø: d1 Ø 30 / d2 Ø 27
81466106811, 81466106812, 81466116138,
81466116139, 81466116201, 81466116202

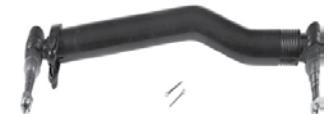

MN-DL-8709

Length: 572 Ø: 52
Hole Distance: 130 / 130
81432206268, 81432206274, 81432206291,
81432206292, 82432206007



MN-DL-10288

81432206386, 82432206008, 82432209008

No Image

MN-DL-12285

Length: 993 Ø: 40
Cone Ø: d1 Ø 30 / d2 Ø 27
81466106816, 81466106826, 81466116151,
82466106184, 82466106185



MN-DL-12287

Length: 1531 Ø: 42
Cone Ø: d1 Ø 30 / d2 Ø 27
81467116855, 81467116856, 81467116857



MN-DL-12288

Length: 585 Ø: 58
Hole Distance: 130 / 130
81432206386, 82432206008, 82432209008

No Image

MN-DL-12289

Length: 1796 Ø: 62
Cone Ø: d1 Ø 30 / d2 Ø 27
81466116174, 81466116175, 81466116176,
81466116244

No Image

MN-DL-12393

Length: 1796 Ø: 62
Cone Ø: d1 Ø 30 / d2 Ø 27
81466116154, 81466116155, 81466116156



MN-ES-10333

Length: 90
Cone Ø: d1 Ø 38 / d2 Ø 34,35
Thread: M36 x 1,5 RHT
1271126, 3090291, 3099128, 42538048,
81953016268, 82953016018, 82953016019



MN-VB-5238

Length: 627 Ø: 48
Hole Distance: 130 / 130
81432206221, 81432706096, 81432706114,
81432706116, 81432706121



MN-VB-8514

Length: 627 Ø: 48
Hole Ø 25 / 25 / 25
Hole Distance: 152 / 130 / 130
81432706087, 81432706088, 81432706094,
81432706095, 81432796094



MN-VB-8669

Length: 627 Ø: 48
Hole Ø 25 / 25 / 25
Hole Distance: 152 / 130 / 130
81432706116, 81432706137, 81432706150,
81432706151



MN-VB-9403

Length: 627 Ø: 48
Hole Ø 25 / 23 / 23
Hole Distance: 152 / 130 / 130
81432706097, 81432706113, 81432706135,
81432706160, 81432706161



MN-VB-9404

Length: 627 Ø: 58
Hole Distance: 130 / 130
81432706117, 81432706152, 81432706153



SC-ES-7279

Length: 150
Cone Ø: d1 Ø 30 / d2 Ø 27
Thread: M30 x 1,5 RHT
81953016288



SC-ES-8517

Length: 140
Cone Ø: d1 Ø 30 / d2 Ø 27
Thread: M30 x 1,5 RHT
81953016286



SC-ES-8535

Length: 145
Cone Ø: d1 Ø 30 / d2 Ø 27
Thread: M30 x 1,5 RHT
81953016271, 81953016325





TGA ...

35.400 FFDK ...	02/04 →	Track Control Arm		MN-VB-9404	Wishbone (CV), 1st RA;2nd RA, for Leaf-Spring Suspension vehicles, →Type_HB Chassis
35.400 FFDK, FFDHK, FFDHLK	07/06 →	Centre Rod	MN-DL-7801		Push Rod
	07/06 →	Centre Rod	MN-DL-8599		Push Rod
	07/06 →	Centre Rod	MN-DL-8646		Push Rod, for Leaf-Spring Suspension vehicles
	07/06 →	Centre Rod	MN-DL-12285		for Steering Rod
	07/06 →	Centre Rod	MN-DL-12393		for Steering Rod
	07/06 →	Tie Rod	MN-DL-7802		
	07/06 →	Tie Rod End	CV-ES-0914		for Steering Rod
	07/06 →	Tie Rod End	CV-ES-14162		for Steering Rod
	07/06 →	Tie Rod End	CV-ES-14163		for Steering Rod
	07/06 →	Tie Rod End	MN-ES-10333		for Steering Rod
	07/06 →	Tie Rod End	SC-ES-7279		for Steering Rod
	07/06 →	Tie Rod End	SC-ES-8517		for Push Rod
	07/06 →	Tie Rod End	SC-ES-8535		for Guide Rod
	07/06 →	Track Control Arm		MN-DL-8544	Trailing Arm, Drive Axle
	07/06 →	Track Control Arm		MN-DL-8544	Trailing Arm, Drive Axle, for Leaf-Spring Suspension vehicles
	07/06 →	Track control arm		MN-DL-12288	Trailing Arm
07/06 →	Track Control Arm		MN-VB-8514	Suspension Rod, Wishbone (CV), Drive Axle	
07/06 →	Track Control Arm		MN-VB-8669	Suspension Rod, Wishbone (CV), 1st RA; 2nd RA, for Leaf-Spring Suspension vehicles, →Type_MHB Chassis	
35.400 FFDH-TM	07/06 →	Centre Rod	MN-DL-7801		Push Rod
	07/06 →	Centre Rod	MN-DL-12393		for Steering Rod
	07/06 →	Tie Rod	MN-DL-7802		
	07/06 →	Tie Rod End	CV-ES-0914		for Steering Rod
	07/06 →	Tie Rod End	CV-ES-14162		for Steering Rod
	07/06 →	Tie Rod End	CV-ES-14163		for Steering Rod
	07/06 →	Tie Rod End	SC-ES-7279		for Steering Rod
	07/06 →	Tie Rod End	SC-ES-8517		for Push Rod
	07/06 →	Tie Rod End	SC-ES-8535		for Guide Rod
	07/06 →	Track Control Arm		MN-DL-8544	Trailing Arm, Drive Axle, for Leaf-Spring Suspension vehicles
	07/06 →	Track Control Arm		MN-VB-8514	Suspension Rod, Wishbone (CV), Drive Axle
07/06 →	Track Control Arm		MN-VB-8669	Suspension Rod, Wishbone (CV), 1st RA; 2nd RA, for Leaf-Spring Suspension vehicles, →Type_MHB Chassis	
35.400 FFNHLC	11/06 →	Centre Rod	MN-DL-12393		for Steering Rod
	11/06 →	Suspension Arm Repair Kit		CV-RK-5313	for Wishbone (CV)
	11/06 →	Suspension Arm Repair Kit	DB-RK-9300	DB-RK-9300	for Drag Link
	11/06 →	Tie Rod	MN-DL-12284		
	11/06 →	Tie Rod End	CV-ES-0914		for Steering Rod
	11/06 →	Tie Rod End	CV-ES-14162	CV-ES-14162	for Steering Rod
	11/06 →	Tie Rod End	CV-ES-14163		for Steering Rod
	11/06 →	Tie Rod End	SC-ES-7279		for Steering Rod
	11/06 →	Tie Rod End	SC-ES-8517		for Push Rod
	11/06 →	Tie Rod End	SC-ES-8535		for Guide Rod
	11/06 →	Track Control Arm		MN-DL-5225	for Control Arm
	11/06 →	Track Control Arm		MN-DL-5225	Trailing Arm
	11/06 →	Track Control Arm		MN-DL-8709	Trailing Arm
	11/06 →	Track Control Arm		MN-DL-8709	Trailing Arm, Trailing Axle Steered/not Steered, for Pneumatic Suspension vehicles
	11/06 →	Track Control Arm		MN-VB-5238	Wishbone (CV), 1st RA;2nd RA, for Pneumatic Suspension vehicles
	11/06 →	Track Control Arm		MN-VB-5238	Wishbone (CV), Drive Axle
	11/06 →	Track Control Arm		MN-VB-9403	Wishbone (CV)
	11/06 →	Track Control Arm		MN-VB-9403	Wishbone (CV), Trailing Axle Steered/not Steered, for Pneumatic Suspension vehicles
35.400 FFNLC	07/06 →	Suspension Arm Repair Kit		CV-RK-5313	for Wishbone (CV)
	07/06 →	Suspension Arm Repair Kit		MN-RK-7291	for Drag Link
	07/06 →	Suspension Arm Repair Kit	DB-RK-9300	DB-RK-9300	for Drag Link
	07/06 →	Tie Rod End	CV-ES-0914		for Steering Rod

CV-ES-0914

Length: 125
Cone Ø: d1 Ø 30 / d2 Ø 27
Thread: M38 x 1,5 RHT
81953016184, 81953016251, 81953016276



CV-ES-14162

Length: 125
Cone Ø: d1 Ø 30 / d2 Ø 27
Thread: M30 x 1,5 LHT
81953010015, 81953010083, 81953010087, 81953016029, 81953016030, 81953016043, 81953016044, 81953016050, 81953016054, 81953016087, 81953016091, 81953016107, 81953016120, 81953016125, 81953016152, 81953016155, 81953016157, 81953016168, 81953016179, 81953016181, 81953016223, 81953016237, 81953016254, 81953016275, 81953016279, 81953016351



CV-ES-14163

Length: 125
Cone Ø: d1 Ø 30 / d2 Ø 27
Thread: M30 x 1,5 RHT
95301.0084, 90804102156, 90804102272, 90804102696, 90804102710, 81953010016, 81953010075, 81953010084, 81953010088, 81953010094, 81953010103, 81953016030, 81953016043, 81953016048, 81953016049, 81953016053, 81953016061, 81953016090, 81953016108, 81953016112, 81953016126, 81953016143, 81953016149, 81953016154, 81953016156, 81953016168, 81953016178, 81953016194, 81953016206, 81953016224, 81953016234, 81953016242, 81953016252, 81953016274, 81953016278, 81953016284, 81953016286, 81953016308, 81953016310, 81953016312, 81953016347, 81953016350, 81953016352, 82953016012, 88953016014, N2953016001



CV-RK-5313

Ø: 90
03304800A, 81953016132



DB-RK-9300

Ø: 75
Hole Distance: 130
Thick/Height: 24
85432206002



MN-DL-5225

Length: 572 Ø: 48
Hole Distance: 130 / 130
03301500A, 81432206229, 81432206236, 81432206267, 81432206270, 81432206272, 81432206304, 81432206305, 81432209235, 81432209267, 81432209272



MN-DL-7801

Length: 995 Ø: 52
Cone Ø: d1 Ø 30 / d2 Ø 27
81466106807, 81466106808, 81466116087, 81466116088, 81466116096, 81466116097, 81466116099, 81466116132, 81466116133, 81466116136, 81466116197, 81466116198, 81466116205

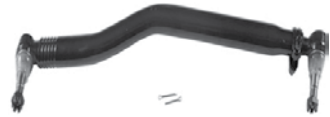

MN-DL-7802

Length: 1680 Ø: 52
Cone Ø: d1 Ø 30 / d2 Ø 27
03208300A, 81467116773, 81467116858, 81467116859, 81467116860, 81467116861, 81467116863, 81467116882, 81467116883, 81467116920, 81467116921



MN-DL-8544

Length: 596 Ø: 48
Hole Distance: 130 / 130
81432206196, 81432206232, 81432206233



MN-DL-8599

Length: 1800 Ø: 62
Cone Ø: d1 Ø 30 / d2 Ø 27
81466116161, 81466116162, 82466106183, 82466106186, 82466106187



MN-DL-8646

Length: 1021 Ø: 52
Cone Ø: d1 Ø 30 / d2 Ø 27
81466106811, 81466106812, 81466116138, 81466116139, 81466116201, 81466116202

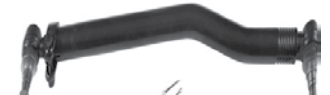

MN-DL-8709

Length: 572 Ø: 52
Hole Distance: 130 / 130
81432206268, 81432206274, 81432206291, 81432206292, 82432206007



MN-DL-12284

Length: 1530 Ø: 50
Cone Ø: d1 Ø 30 / d2 Ø 27
81466106579, 81466106580, 81466106624, 81466116720, 81467116720, 81467116730, 81467116952



MN-DL-12285

Length: 993 Ø: 40
Cone Ø: d1 Ø 30 / d2 Ø 27
81466106816, 81466106826, 81466116151, 82466106184, 82466106185



MN-DL-12288

Length: 585 Ø: 58
Hole Distance: 130 / 130
81432206386, 82432206008, 82432209008

No Image

MN-DL-12393

Length: 1796 Ø: 62
Cone Ø: d1 Ø 30 / d2 Ø 27
81466116154, 81466116155, 81466116156



MN-ES-10333

Length: 90
Cone Ø: d1 Ø 38 / d2 Ø 34,35
Thread: M36 x 1,5 RHT
1271126, 3090291, 3099128, 42538048, 81953016268, 82953016018, 82953016019



MN-RK-7291

Ø: 72
Hole Distance: 130
Thick/Height: 30
10307800A, 81432206108, 81432206132



MN-VB-5238

Length: 627 Ø: 48
Hole Distance: 130 / 130
81432206221, 81432706096, 81432706114, 81432706116, 81432706121



MN-VB-8514

Length: 627 Ø: 48
Hole Ø 25 / 25 / 25
Hole Distance: 152 / 130 / 130
81432706087, 81432706088, 81432706094, 81432706095, 81432796094



MN-VB-8669

Length: 627 Ø: 48
Hole Ø 25 / 25 / 25
Hole Distance: 152 / 130 / 130
81432706116, 81432706137, 81432706150, 81432706151



MN-VB-9403

Length: 627 Ø: 48
Hole Ø 25 / 23 / 23
Hole Distance: 152 / 130 / 130
81432706097, 81432706113, 81432706135, 81432706160, 81432706161



MN-VB-9404

Length: 627 Ø: 58
Hole Distance: 130 / 130
81432706117, 81432706152, 81432706153



SC-ES-7279

Length: 150
Cone Ø: d1 Ø 30 / d2 Ø 27
Thread: M30 x 1,5 RHT
81953016288



SC-ES-8517

Length: 140
Cone Ø: d1 Ø 30 / d2 Ø 27
Thread: M30 x 1,5 RHT
81953016286



SC-ES-8535

Length: 145
Cone Ø: d1 Ø 30 / d2 Ø 27
Thread: M30 x 1,5 RHT
81953016271, 81953016325





TGA ...

35.400 FFNLC ...	07/06→	Tie Rod End	CV-ES-14162	CV-ES-14162	for Steering Rod
	07/06→	Tie Rod End	CV-ES-14163		for Steering Rod
	07/06→	Tie Rod End	SC-ES-7279		for Steering Rod
	07/06→	Tie Rod End	SC-ES-8517		for Push Rod
	07/06→	Tie Rod End	SC-ES-8535		for Guide Rod
	07/06→	Track Control Arm		MN-DL-5212	Trailing Arm, Trailing Axle not Steered, for Pneumatic Suspension vehicles
	07/06→	Track Control Arm		MN-DL-5225	Trailing Arm
	07/06→	Track Control Arm		MN-DL-8709	Trailing Arm, Trailing Axle Steered/not Steered, for Pneumatic Suspension vehicles
	07/06→	Track Control Arm		MN-VB-5238	Wishbone (CV), 1st Drive Axle, for Pneumatic Suspension vehicles
35.410 FDNLC	07/06→	Centre Rod	MN-DL-12393		for Steering Rod
	07/06→	Suspension Arm Repair Kit		CV-RK-5313	for Wishbone (CV)
	07/06→	Suspension Arm Repair Kit	DB-RK-9300	DB-RK-9300	for Drag Link
	07/06→	Tie Rod	MN-DL-12284		
	07/06→	Tie Rod End	CV-ES-0914		for Steering Rod
	07/06→	Tie Rod End	CV-ES-14162	CV-ES-14162	for Steering Rod
	07/06→	Tie Rod End	CV-ES-14163		for Steering Rod
	07/06→	Tie Rod End	SC-ES-7279		for Steering Rod
	07/06→	Tie Rod End	SC-ES-8517		for Push Rod
	07/06→	Tie Rod End	SC-ES-8535		for Guide Rod
	07/06→	Track Control Arm		MN-DL-5225	Trailing Arm
	07/06→	Track Control Arm		MN-DL-8709	Trailing Arm, Trailing Axle Steered/not Steered, for Pneumatic Suspension vehicles
	07/06→	Track Control Arm		MN-VB-8669	Suspension Rod, Wishbone (CV), 1st RA; 2nd RA, for Leaf-Spring Suspension vehicles, →Type_MHB Chassis
	07/06→	Track Control Arm		MN-VB-9403	Wishbone (CV), Trailing Axle Steered/not Steered, for Pneumatic Suspension vehicles
35.410 FFDK	07/06→	Centre Rod	MN-DL-7801		Push Rod
	07/06→	Centre Rod	MN-DL-8599		Push Rod
	07/06→	Centre Rod	MN-DL-12285		for Steering Rod
	07/06→	Suspension Strut Repair Kit		DB-RK-8581	
	07/06→	Tie Rod	MN-DL-12287		
	07/06→	Tie Rod End	CV-ES-0914		for Steering Rod
	07/06→	Tie Rod End	CV-ES-14162		for Steering Rod
	07/06→	Tie Rod End	CV-ES-14163		for Steering Rod
	07/06→	Tie Rod End	MN-ES-10333		for Steering Rod
	07/06→	Tie Rod End	SC-ES-8517		for Push Rod
	07/06→	Track Control Arm		MN-DL-5225	Trailing Arm
	07/06→	Track Control Arm		MN-DL-8544	Trailing Arm, 1st RA;2nd RA;Leaf Spring Axle
	07/06→	Track Control Arm		MN-DL-8544	Trailing Arm, Drive Axle;Air Suspension Axle
	07/06→	Track Control Arm		MN-DL-8609	Trailing Arm, 1st RA;2nd RA, for Leaf-Spring Suspension vehicles, →Type_HB Chassis
	07/06→	Track Control Arm		MN-VB-8514	Suspension Rod, Wishbone (CV), Drive Axle; Air Suspension Axle
	07/06→	Track Control Arm		MN-VB-8514	Suspension Rod, Wishbone (CV), Drive Axle; Leaf Spring Axle
	07/06→	Track Control Arm		MN-VB-9404	Wishbone (CV)
35.410 FFDC, FFDLC	10/03→	Centre Rod	MN-DL-7801		Push Rod, Leaf Spring Axle
	10/03→	Centre Rod	MN-DL-8599		Push Rod
	10/03→	Centre Rod	MN-DL-12393		for Steering Rod
	10/03→	Suspension Strut Repair Kit		DB-RK-8581	
	10/03→	Tie Rod	MN-DL-7802		
	10/03→	Tie Rod	MN-DL-12284		
	10/03→	Tie Rod End	CV-ES-0914		for Steering Rod
	10/03→	Tie Rod End	CV-ES-14162	CV-ES-14162	for Steering Rod
	10/03→	Tie Rod End	CV-ES-14163		for Steering Rod
	10/03→	Tie Rod End	MN-ES-10333		for Steering Rod
	10/03→	Tie Rod End	SC-ES-7279		for Steering Rod

CV-ES-0914

Length: 125
Cone Ø: d1 Ø 30 / d2 Ø 27
Thread: M38 x 1,5 RHT
81953016184, 81953016251, 81953016276



CV-ES-14162

Length: 125
Cone Ø: d1 Ø 30 / d2 Ø 27
Thread: M30 x 1,5 LHT
81953010015, 81953010083, 81953010087, 81953016029, 81953016030, 81953016043, 81953016044, 81953016050, 81953016054, 81953016087, 81953016091, 81953016107, 81953016120, 81953016125, 81953016152, 81953016155, 81953016157, 81953016168, 81953016179, 81953016181, 81953016223, 81953016237, 81953016254, 81953016275, 81953016279, 81953016351



CV-ES-14163

Length: 125
Cone Ø: d1 Ø 30 / d2 Ø 27
Thread: M30 x 1,5 RHT
95301.0084, 90804102156, 90804102272, 90804102696, 90804102710, 81953010016, 81953010075, 81953010084, 81953010088, 81953010094, 81953010103, 81953016030, 81953016043, 81953016048, 81953016049, 81953016053, 81953016061, 81953016090, 81953016108, 81953016112, 81953016126, 81953016143, 81953016149, 81953016154, 81953016156, 81953016168, 81953016178, 81953016194, 81953016206, 81953016224, 81953016234, 81953016242, 81953016252, 81953016274, 81953016278, 81953016284, 81953016286, 81953016308, 81953016310, 81953016312, 81953016347, 81953016350, 81953016352, 82953016012, 88953016014, N2953016001



CV-RK-5313

Ø: 90
03304800A, 81953016132



DB-RK-8581

Ø: 85
Hole Distance: 130
Thick/Height: 24
03305800A, 81432706105



DB-RK-9300

Ø: 75
Hole Distance: 130
Thick/Height: 24
85432206002



MN-DL-5212

Length: 577 Ø: 48
Hole Distance: 130 / 130
81432206096, 81432206097, 81432206098, 81432206129, 81432209096, 81432209129, 81432306014, 81432306030



MN-DL-5225

Length: 572 Ø: 48
Hole Distance: 130 / 130
03301500A, 81432206229, 81432206236, 81432206267, 81432206270, 81432206272, 81432206304, 81432206305, 81432209236, 81432209267, 81432209272



MN-DL-7801

Length: 995 Ø: 52
Cone Ø: d1 Ø 30 / d2 Ø 27
81466106807, 81466106808, 81466116087, 81466116088, 81466116096, 81466116097, 81466116099, 81466116132, 81466116133, 81466116136, 81466116197, 81466116198, 81466116205



MN-DL-7802

Length: 1680 Ø: 52
Cone Ø: d1 Ø 30 / d2 Ø 27
03208300A, 81467116773, 81467116858, 81467116859, 81467116860, 81467116861, 81467116863, 81467116882, 81467116883, 81467116920, 81467116921



MN-DL-8544

Length: 596 Ø: 48
Hole Distance: 130 / 130
81432206196, 81432206232, 81432206233



MN-DL-8599

Length: 1800 Ø: 62
Cone Ø: d1 Ø 30 / d2 Ø 27
81466116161, 81466116162, 82466106183, 82466106186, 82466106187



MN-DL-8609

Length: 585 Ø: 58
Hole Distance: 130 / 130
81432206070, 81432206071, 81432206072, 81432206091, 81432206093, 81432206119



MN-DL-8709

Length: 572 Ø: 52
Hole Distance: 130 / 130
81432206268, 81432206274, 81432206291, 81432206292, 82432206007



MN-DL-12284

Length: 1530 Ø: 50
Cone Ø: d1 Ø 30 / d2 Ø 27
81466106579, 81466106580, 81466106624, 81466116720, 81467116720, 81467116730, 81467116952



MN-DL-12285

Length: 993 Ø: 40
Cone Ø: d1 Ø 30 / d2 Ø 27
81466106816, 81466106826, 81466116151, 82466106184, 82466106185



MN-DL-12287

Length: 1531 Ø: 42
Cone Ø: d1 Ø 30 / d2 Ø 27
81467116855, 81467116856, 81467116857



MN-DL-12393

Length: 1796 Ø: 62
Cone Ø: d1 Ø 30 / d2 Ø 27
81466116154, 81466116155, 81466116156



MN-ES-10333

Length: 90
Cone Ø: d1 Ø 38 / d2 Ø 34,35
Thread: M36 x 1,5 RHT
1271126, 3090291, 3099128, 42538048, 81953016268, 82953016018, 82953016019



MN-VB-5238

Length: 627 Ø: 48
Hole Distance: 130 / 130
81432206221, 81432706096, 81432706114, 81432706116, 81432706121



MN-VB-8514

Length: 627 Ø: 48
Hole Ø 25 / 25 / 25
Hole Distance: 152 / 130 / 130
81432706087, 81432706088, 81432706094, 81432706095, 81432796094



MN-VB-8669

Length: 627 Ø: 48
Hole Ø 25 / 25 / 25
Hole Distance: 152 / 130 / 130
81432706116, 81432706137, 81432706150, 81432706151



MN-VB-9403

Length: 627 Ø: 48
Hole Ø 25 / 23 / 23
Hole Distance: 152 / 130 / 130
81432706097, 81432706113, 81432706135, 81432706160, 81432706161



MN-VB-9404

Length: 627 Ø: 58
Hole Distance: 130 / 130
81432706117, 81432706152, 81432706153



SC-ES-7279

Length: 150
Cone Ø: d1 Ø 30 / d2 Ø 27
Thread: M30 x 1,5 RHT
81953016288



SC-ES-8517

Length: 140
Cone Ø: d1 Ø 30 / d2 Ø 27
Thread: M30 x 1,5 RHT
81953016286



SC-ES-8535

Length: 145
Cone Ø: d1 Ø 30 / d2 Ø 27
Thread: M30 x 1,5 RHT
81953016271, 81953016325





TGA ...

35.410 FFDK, FFDLC ...	10/03→	Tie Rod End	SC-ES-8517		for Push Rod	
	10/03→	Tie Rod End	SC-ES-8535		for Guide Rod	
	10/03→	Track Control Arm		MN-DL-5225	Trailing Arm, Drive Axle;Air Suspension Axle	
	10/03→	Track Control Arm		MN-DL-8544	Trailing Arm, Drive Axle;Air Suspension Axle	
	10/03→	Track Control Arm		MN-DL-8544	Trailing Arm, Drive Axle;Leaf Spring Axle	
	10/03→	Track Control Arm		MN-DL-8709	Trailing Arm, Trailing Axle Steered/not Steered, for Pneumatic Suspension vehicles	
	10/03→	Track Control Arm		MN-VB-5238	Wishbone (CV), Drive Axle;Air Suspension Axle	
	10/03→	Track Control Arm		MN-VB-8514	Suspension Rod, Wishbone (CV), Drive Axle; Air Suspension Axle	
	10/03→	Track Control Arm		MN-VB-8514	Suspension Rod, Wishbone (CV), Drive Axle; Leaf Spring Axle	
	10/03→	Track Control Arm		MN-VB-8669	Suspension Rod, Wishbone (CV), Drive Axle; Leaf Spring Axle	
	10/03→	Track Control Arm		MN-VB-9403	Wishbone (CV), Trailing Axle Steered/not Steered, for Pneumatic Suspension vehicles	
	08/04→	Track Control Arm		MN-VB-9404	Wishbone (CV), Drive Axle;Air Suspension Axle	
35.410 FFDK, FFDLK	10/03→	Centre Rod	MN-DL-7801		Push Rod, Leaf Spring Axle	
	10/03→	Centre Rod	MN-DL-8599		Push Rod	
	10/03→	Centre Rod	MN-DL-12285		for Steering Rod	
	10/03→	Centre Rod	MN-DL-12393		for Steering Rod	
	10/03→	Suspension Strut Repair Kit		DB-RK-8581		
	10/03→	Tie Rod	MN-DL-7802			
	10/03→	Tie Rod End	CV-ES-0914		for Steering Rod	
	10/03→	Tie Rod End	CV-ES-14162		for Steering Rod	
	10/03→	Tie Rod End	CV-ES-14163		for Steering Rod	
	10/03→	Tie Rod End	MN-ES-10333		for Steering Rod	
	10/03→	Tie Rod End	SC-ES-7279		for Steering Rod	
	10/03→	Tie Rod End	SC-ES-8517		for Push Rod	
	10/03→	Tie Rod End	SC-ES-8535		for Guide Rod	
	10/03→	Track Control Arm		MN-DL-5225	Trailing Arm, Drive Axle;Air Suspension Axle	
	10/03→	Track Control Arm		MN-DL-8544	Trailing Arm, Drive Axle;Air Suspension Axle	
	10/03→	Track Control Arm		MN-DL-8544	Trailing Arm, Drive Axle;Leaf Spring Axle	
	10/03→	Track Control Arm		MN-VB-5238	Wishbone (CV), Drive Axle;Air Suspension Axle	
	10/03→	Track Control Arm		MN-VB-8514	Suspension Rod, Wishbone (CV), Drive Axle; Air Suspension Axle	
	10/03→	Track Control Arm		MN-VB-8514	Suspension Rod, Wishbone (CV), Drive Axle; Leaf Spring Axle	
	10/03→	Track Control Arm		MN-VB-8669	Suspension Rod, Wishbone (CV), Drive Axle; Leaf Spring Axle	
	08/04→	Track Control Arm		MN-VB-9404	Wishbone (CV), Drive Axle;Air Suspension Axle	
	35.410 FFD-TM	11/03→	Tie Rod End	CV-ES-0914		for Steering Rod
		11/03→	Tie Rod End	CV-ES-14162		for Steering Rod
11/03→		Tie Rod End	CV-ES-14163		for Steering Rod	
11/03→		Tie Rod End	SC-ES-7279		for Steering Rod	
11/03→		Tie Rod End	SC-ES-8517		for Push Rod	
11/03→		Tie Rod End	SC-ES-8535		for Guide Rod	
11/03→		Track Control Arm		MN-DL-8544	Trailing Arm, 1st RA;2nd RA, for Leaf-Spring Suspension vehicles	
11/03→		Track Control Arm		MN-VB-8514	Suspension Rod, Wishbone (CV)	
11/03→		Track Control Arm		MN-VB-8669	Suspension Rod, Wishbone (CV), 1st RA; 2nd RA, for Leaf-Spring Suspension vehicles, →Type_MHB Chassis	
35.410 FFNLC	07/06→	Suspension Arm Repair Kit		CV-RK-5313	for Wishbone (CV)	
	07/06→	Suspension Arm Repair Kit		MN-RK-7291	for Drag Link	
	07/06→	Suspension Arm Repair Kit	DB-RK-9300	DB-RK-9300	for Drag Link	
	07/06→	Tie Rod	MN-DL-12284			
	07/06→	Tie Rod End	CV-ES-0914		for Steering Rod	
	07/06→	Tie Rod End	CV-ES-14162	CV-ES-14162	for Steering Rod	
	07/06→	Tie Rod End	CV-ES-14163		for Steering Rod	
	07/06→	Tie Rod End	SC-ES-7279		for Steering Rod	
	07/06→	Tie Rod End	SC-ES-8517		for Push Rod	
07/06→	Tie Rod End	SC-ES-8535		for Guide Rod		

CV-ES-0914

Length: 125
Cone Ø: d1 Ø 30 / d2 Ø 27
Thread: M38 x 1,5 RHT
81953016184, 81953016251, 81953016276



CV-ES-14162

Length: 125
Cone Ø: d1 Ø 30 / d2 Ø 27
Thread: M30 x 1,5 LHT
81953010015, 81953010083, 81953010087, 81953016029, 81953016030, 81953016043, 81953016044, 81953016050, 81953016054, 81953016087, 81953016091, 81953016107, 81953016120, 81953016125, 81953016152, 81953016155, 81953016157, 81953016168, 81953016179, 81953016181, 81953016223, 81953016237, 81953016254, 81953016275, 81953016279, 81953016351



CV-ES-14163

Length: 125
Cone Ø: d1 Ø 30 / d2 Ø 27
Thread: M30 x 1,5 RHT
95301.0084, 90804102156, 90804102272, 90804102696, 90804102710, 81953010016, 81953010075, 81953010084, 81953010088, 81953010094, 81953010103, 81953016030, 81953016043, 81953016048, 81953016049, 81953016053, 81953016061, 81953016090, 81953016108, 81953016112, 81953016126, 81953016143, 81953016149, 81953016154, 81953016156, 81953016168, 81953016178, 81953016194, 81953016206, 81953016224, 81953016234, 81953016242, 81953016252, 81953016274, 81953016278, 81953016284, 81953016286, 81953016308, 81953016310, 81953016312, 81953016347, 81953016350, 81953016352, 82953016012, 88953016014, N2953016001



CV-RK-5313

Ø: 90
03304800A, 81953016132



DB-RK-8581

Ø: 85
Hole Distance: 130
Thick/Height: 24
03305800A, 81432706105



DB-RK-9300

Ø: 75
Hole Distance: 130
Thick/Height: 24
85432206002



MN-DL-5225

Length: 572 Ø: 48
Hole Distance: 130 / 130
03301500A, 81432206229, 81432206236, 81432206267, 81432206270, 81432206272, 81432206304, 81432206305, 81432209235, 81432209267, 81432209272



MN-DL-7801

Length: 995 Ø: 52
Cone Ø: d1 Ø 30 / d2 Ø 27
81466106807, 81466106808, 81466116087, 81466116088, 81466116096, 81466116097, 81466116099, 81466116132, 81466116133, 81466116136, 81466116197, 81466116198, 81466116205



MN-DL-7802

Length: 1680 Ø: 52
Cone Ø: d1 Ø 30 / d2 Ø 27
03208300A, 81467116773, 81467116858, 81467116859, 81467116860, 81467116861, 81467116863, 81467116882, 81467116883, 81467116920, 81467116921



MN-DL-8544

Length: 596 Ø: 48
Hole Distance: 130 / 130
81432206196, 81432206232, 81432206233



MN-DL-8599

Length: 1800 Ø: 62
Cone Ø: d1 Ø 30 / d2 Ø 27
81466116161, 81466116162, 82466106183, 82466106186, 82466106187



MN-DL-8709

Length: 572 Ø: 52
Hole Distance: 130 / 130
81432206268, 81432206274, 81432206291, 81432206292, 82432206007



MN-DL-12284

Length: 1530 Ø: 50
Cone Ø: d1 Ø 30 / d2 Ø 27
81466106579, 81466106580, 81466106624, 81466116720, 81467116720, 81467116730, 81467116952



MN-DL-12285

Length: 993 Ø: 40
Cone Ø: d1 Ø 30 / d2 Ø 27
81466106816, 81466106826, 81466116151, 82466106184, 82466106185



MN-DL-12393

Length: 1796 Ø: 62
Cone Ø: d1 Ø 30 / d2 Ø 27
81466116154, 81466116155, 81466116156



MN-ES-10333

Length: 90
Cone Ø: d1 Ø 38 / d2 Ø 34,35
Thread: M36 x 1,5 RHT
1271126, 3090291, 3099128, 42538048, 81953016268, 82953016018, 82953016019



MN-RK-7291

Ø: 72
Hole Distance: 130
Thick/Height: 30
10307800A, 81432206108, 81432206132



MN-VB-5238

Length: 627 Ø: 48
Hole Distance: 130 / 130
81432206221, 81432706096, 81432706114, 81432706116, 81432706121



MN-VB-8514

Length: 627 Ø: 48
Hole Ø 25 / 25 / 25
Hole Distance: 152 / 130 / 130
81432706087, 81432706088, 81432706094, 81432706095, 81432796094



MN-VB-8669

Length: 627 Ø: 48
Hole Ø 25 / 25 / 25
Hole Distance: 152 / 130 / 130
81432706116, 81432706137, 81432706150, 81432706151



MN-VB-9403

Length: 627 Ø: 48
Hole Ø 25 / 23 / 23
Hole Distance: 152 / 130 / 130
81432706097, 81432706113, 81432706135, 81432706160, 81432706161



MN-VB-9404

Length: 627 Ø: 58
Hole Distance: 130 / 130
81432706117, 81432706152, 81432706153



SC-ES-7279

Length: 150
Cone Ø: d1 Ø 30 / d2 Ø 27
Thread: M30 x 1,5 RHT
81953016288



SC-ES-8517

Length: 140
Cone Ø: d1 Ø 30 / d2 Ø 27
Thread: M30 x 1,5 RHT
81953016286



SC-ES-8535

Length: 145
Cone Ø: d1 Ø 30 / d2 Ø 27
Thread: M30 x 1,5 RHT
81953016271, 81953016325





TGA ...

35.410 FFNLC ...	07/06 →	Track Control Arm		MN-DL-5212	Trailing Arm, Trailing Axle not Steered, for Pneumatic Suspension vehicles
	07/06 →	Track Control Arm		MN-DL-5225	Trailing Arm
	07/06 →	Track Control Arm		MN-DL-8709	Trailing Arm, Trailing Axle Steered/not Steered, for Pneumatic Suspension vehicles
	07/06 →	Track Control Arm		MN-VB-5238	Wishbone (CV), 1st Drive Axle, for Pneumatic Suspension vehicles
	07/06 →	Track Control Arm		MN-VB-9403	Wishbone (CV), Trailing Axle Steered/not Steered, for Pneumatic Suspension vehicles
35.430 FDNLC	07/06 →	Centre Rod	MN-DL-12393		for Steering Rod
	07/06 →	Suspension Arm Repair Kit		CV-RK-5313	for Wishbone (CV)
	07/06 →	Suspension Arm Repair Kit	DB-RK-9300	DB-RK-9300	for Drag Link
	07/06 →	Tie Rod	MN-DL-12284		
	07/06 →	Tie Rod End	CV-ES-0914		for Steering Rod
	07/06 →	Tie Rod End	CV-ES-14162	CV-ES-14162	for Steering Rod
	07/06 →	Tie Rod End	CV-ES-14163		for Steering Rod
	07/06 →	Tie Rod End	SC-ES-7279		for Steering Rod
	07/06 →	Tie Rod End	SC-ES-8517		for Push Rod
	07/06 →	Tie Rod End	SC-ES-8535		for Guide Rod
	07/06 →	Track Control Arm		MN-DL-5225	Trailing Arm
	07/06 →	Track Control Arm		MN-DL-8709	Trailing Arm, Trailing Axle Steered/not Steered, for Pneumatic Suspension vehicles
	07/06 →	Track Control Arm		MN-VB-8669	Suspension Rod, Wishbone (CV), 1st RA; 2nd RA, for Leaf-Spring Suspension vehicles, →Type_MHB Chassis
	07/06 →	Track Control Arm		MN-VB-9403	Wishbone (CV), Trailing Axle Steered/not Steered, for Pneumatic Suspension vehicles
35.430 FFDK, FFDHK, FFDHLK	07/06 →	Centre Rod	MN-DL-7801		Push Rod
	07/06 →	Centre Rod	MN-DL-8599		Push Rod
	07/06 →	Centre Rod	MN-DL-8646		Push Rod, for Leaf-Spring Suspension vehicles
	07/06 →	Centre Rod	MN-DL-12285		for Steering Rod
	07/06 →	Centre Rod	MN-DL-12393		for Steering Rod
	07/06 →	Suspension Arm Repair Kit		CV-RK-5313	for Wishbone (CV)
	07/06 →	Tie Rod	MN-DL-7802		
	07/06 →	Tie Rod	MN-DL-12287		
	07/06 →	Tie Rod End	CV-ES-0914		for Steering Rod
	07/06 →	Tie Rod End	CV-ES-14162		for Steering Rod
	07/06 →	Tie Rod End	CV-ES-14163		for Steering Rod
	07/06 →	Tie Rod End	MN-ES-10333		for Steering Rod
	07/06 →	Tie Rod End	SC-ES-7279		for Steering Rod
	07/06 →	Tie Rod End	SC-ES-8517		for Push Rod
	07/06 →	Tie Rod End	SC-ES-8535		for Guide Rod
	07/06 →	Track Control Arm		MN-DL-8544	Trailing Arm, Drive Axle
	07/06 →	Track Control Arm		MN-DL-8544	Trailing Arm, Drive Axle, for Leaf-Spring Suspension vehicles
	07/06 →	Track Control Arm		MN-DL-8609	Trailing Arm, 1st RA;2nd RA, for Leaf-Spring Suspension vehicles, →Type_HB Chassis
	07/06 →	Track control arm		MN-DL-10288	Trailing Arm, 1st RA;2nd RA, for Leaf-Spring Suspension vehicles, →Type_HB
	07/06 →	Track control arm		MN-DL-12288	Trailing Arm
	07/06 →	Track Control Arm		MN-VB-8514	Suspension Rod, Wishbone (CV), Drive Axle
	07/06 →	Track Control Arm		MN-VB-8669	Suspension Rod, Wishbone (CV), 1st RA; 2nd RA, for Leaf-Spring Suspension vehicles, →Type_MHB Chassis
	07/06 →	Track Control Arm		MN-VB-9404	Wishbone (CV), 1st RA;2nd RA, for Leaf-Spring Suspension vehicles, →Type_HB Chassis
35.430 FFDH-TM	07/06 →	Centre Rod	MN-DL-7801		Push Rod
	07/06 →	Centre Rod	MN-DL-12393		for Steering Rod
	07/06 →	Tie Rod	MN-DL-7802		
	07/06 →	Tie Rod End	CV-ES-0914		for Steering Rod
	07/06 →	Tie Rod End	CV-ES-14162		for Steering Rod
	07/06 →	Tie Rod End	SC-ES-7279		for Steering Rod

CV-ES-0914

Length: 125
Cone Ø: d1 Ø 30 / d2 Ø 27
Thread: M38 x 1,5 RHT
81953016184, 81953016251, 81953016276



CV-ES-14162

Length: 125
Cone Ø: d1 Ø 30 / d2 Ø 27
Thread: M30 x 1,5 LHT
81953010015, 81953010083, 81953010087, 81953016029, 81953016030, 81953016043, 81953016044, 81953016050, 81953016054, 81953016087, 81953016091, 81953016107, 81953016120, 81953016125, 81953016152, 81953016155, 81953016157, 81953016168, 81953016179, 81953016181, 81953016223, 81953016237, 81953016254, 81953016275, 81953016279, 81953016351



CV-ES-14163

Length: 125
Cone Ø: d1 Ø 30 / d2 Ø 27
Thread: M30 x 1,5 RHT
95301.0084, 90804102156, 90804102272, 90804102696, 90804102710, 81953010016, 81953010075, 81953010084, 81953010088, 81953010094, 81953010103, 81953016030, 81953016043, 81953016048, 81953016049, 81953016053, 81953016061, 81953016090, 81953016108, 81953016112, 81953016126, 81953016143, 81953016149, 81953016154, 81953016156, 81953016168, 81953016178, 81953016194, 81953016206, 81953016224, 81953016234, 81953016242, 81953016252, 81953016274, 81953016278, 81953016284, 81953016286, 81953016308, 81953016310, 81953016312, 81953016347, 81953016350, 81953016352, 82953016012, 88953016014, N2953016001



CV-RK-5313

Ø: 90
03304800A, 81953016132



DB-RK-9300

Ø: 75
Hole Distance: 130
Thick/Height: 24
85432206002



MN-DL-5212

Length: 577 Ø: 48
Hole Distance: 130 / 130
81432206096, 81432206097, 81432206098, 81432206129, 81432209096, 81432209129, 81432306014, 81432306030



MN-DL-5225

Length: 572 Ø: 48
Hole Distance: 130 / 130
03301500A, 81432206229, 81432206236, 81432206267, 81432206270, 81432206272, 81432206304, 81432206305, 81432209226, 81432209267, 81432209272



MN-DL-7801

Length: 995 Ø: 52
Cone Ø: d1 Ø 30 / d2 Ø 27
81466106807, 81466106808, 81466116087, 81466116088, 81466116096, 81466116097, 81466116099, 81466116132, 81466116133, 81466116136, 81466116197, 81466116198, 81466116205

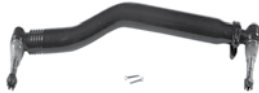

MN-DL-7802

Length: 1680 Ø: 52
Cone Ø: d1 Ø 30 / d2 Ø 27
03208300A, 81467116773, 81467116858, 81467116859, 81467116860, 81467116861, 81467116863, 81467116882, 81467116883, 81467116920, 81467116921



MN-DL-8544

Length: 596 Ø: 48
Hole Distance: 130 / 130
81432206196, 81432206232, 81432206233



MN-DL-8599

Length: 1800 Ø: 62
Cone Ø: d1 Ø 30 / d2 Ø 27
81466116161, 81466116162, 82466106183, 82466106186, 82466106187



MN-DL-8609

Length: 585 Ø: 58
Hole Distance: 130 / 130
81432206070, 81432206071, 81432206072, 81432206091, 81432206093, 81432206119



MN-DL-8646

Length: 1021 Ø: 52
Cone Ø: d1 Ø 30 / d2 Ø 27
81466106811, 81466106812, 81466116138, 81466116139, 81466116201, 81466116202

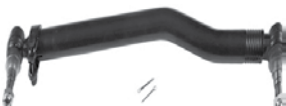

MN-DL-8709

Length: 572 Ø: 52
Hole Distance: 130 / 130
81432206268, 81432206274, 81432206291, 81432206292, 82432206007



MN-DL-10288

81432206386, 82432206008, 82432209008

No Image

MN-DL-12284

Length: 1530 Ø: 50
Cone Ø: d1 Ø 30 / d2 Ø 27
81466106579, 81466106580, 81466106624, 81466116720, 81467116720, 81467116730, 81467116952



MN-DL-12285

Length: 993 Ø: 40
Cone Ø: d1 Ø 30 / d2 Ø 27
81466106816, 81466106826, 81466116151, 82466106184, 82466106185



MN-DL-12287

Length: 1531 Ø: 42
Cone Ø: d1 Ø 30 / d2 Ø 27
81467116855, 81467116856, 81467116857



MN-DL-12288

Length: 585 Ø: 58
Hole Distance: 130 / 130
81432206386, 82432206008, 82432209008



No Image

MN-DL-12393

Length: 1796 Ø: 62
Cone Ø: d1 Ø 30 / d2 Ø 27
81466116154, 81466116155, 81466116156



MN-ES-10333

Length: 90
Cone Ø: d1 Ø 38 / d2 Ø 34,35
Thread: M36 x 1,5 RHT
1271126, 3090291, 3099128, 42538048, 81953016268, 82953016018, 82953016019



MN-VB-5238

Length: 627 Ø: 48
Hole Distance: 130 / 130
81432206221, 81432706096, 81432706114, 81432706116, 81432706121



MN-VB-8514

Length: 627 Ø: 48
Hole Ø 25 / 25 / 25
Hole Distance: 152 / 130 / 130
81432706087, 81432706088, 81432706094, 81432706095, 81432796094



MN-VB-8669

Length: 627 Ø: 48
Hole Ø 25 / 25 / 25
Hole Distance: 152 / 130 / 130
81432706116, 81432706137, 81432706150, 81432706151



MN-VB-9403

Length: 627 Ø: 48
Hole Ø 25 / 23 / 23
Hole Distance: 152 / 130 / 130
81432706097, 81432706113, 81432706135, 81432706160, 81432706161



MN-VB-9404

Length: 627 Ø: 58
Hole Distance: 130 / 130
81432706117, 81432706152, 81432706153



SC-ES-7279

Length: 150
Cone Ø: d1 Ø 30 / d2 Ø 27
Thread: M30 x 1,5 RHT
81953016288



SC-ES-8517

Length: 140
Cone Ø: d1 Ø 30 / d2 Ø 27
Thread: M30 x 1,5 RHT
81953016286



SC-ES-8535

Length: 145
Cone Ø: d1 Ø 30 / d2 Ø 27
Thread: M30 x 1,5 RHT
81953016271, 81953016325





TGA ...

35.430 FFDH-TM ...	07/06→	Tie Rod End	SC-ES-8517		for Push Rod	
	07/06→	Tie Rod End	SC-ES-8535		for Guide Rod	
	07/06→	Track Control Arm		MN-DL-8544	Trailing Arm, Drive Axle, for Leaf-Spring Suspension vehicles	
	07/06→	Track Control Arm		MN-VB-8514	Suspension Rod, Wishbone (CV), Drive Axle	
	07/06→	Track Control Arm		MN-VB-8669	Suspension Rod, Wishbone (CV), 1st RA; 2nd RA, for Leaf-Spring Suspension vehicles, →Type_MHB Chassis	
35.430 FFNLC	07/06→	Centre Rod	MN-DL-12393		for Steering Rod	
	07/06→	Suspension Arm Repair Kit		CV-RK-5313	for Wishbone (CV)	
	07/06→	Suspension Arm Repair Kit		MN-RK-7291	for Drag Link	
	07/06→	Suspension Arm Repair Kit	DB-RK-9300	DB-RK-9300	for Drag Link	
	07/06→	Tie Rod	MN-DL-12284			
	07/06→	Tie Rod End	CV-ES-0914		for Steering Rod	
	07/06→	Tie Rod End	CV-ES-14162	CV-ES-14162	for Steering Rod	
	07/06→	Tie Rod End	CV-ES-14163		for Steering Rod	
	07/06→	Tie Rod End	SC-ES-7279		for Steering Rod	
	07/06→	Tie Rod End	SC-ES-8517		for Push Rod	
	07/06→	Tie Rod End	SC-ES-8535		for Guide Rod	
	07/06→	Track Control Arm		MN-DL-5212	Trailing Arm, Trailing Axle not Steered, for Pneumatic Suspension vehicles	
	07/06→	Track Control Arm		MN-DL-5225	Trailing Arm	
	07/06→	Track Control Arm		MN-DL-8709	Trailing Arm, Trailing Axle Steered/not Steered, for Pneumatic Suspension vehicles	
	07/06→	Track Control Arm		MN-VB-5238	Wishbone (CV), 1st Drive Axle, for Pneumatic Suspension vehicles	
07/06→	Track Control Arm		MN-VB-9403	Wishbone (CV), Trailing Axle Steered/not Steered, for Pneumatic Suspension vehicles		
35.430, 35.440 FFDC, FFDRC, FFDLC	02/04→	Centre Rod	MN-DL-7801		Push Rod, Leaf Spring Axle	
	02/04→	Centre Rod	MN-DL-8599		Push Rod	
	02/04→	Centre Rod	MN-DL-12285		for Steering Rod	
	02/04→	Centre Rod	MN-DL-12289		Push Rod	
	02/04→	Centre Rod	MN-DL-12393		for Steering Rod	
	02/04→	Suspension Strut Repair Kit		DB-RK-8581		
	02/04→	Tie Rod	MN-DL-7802			
	02/04→	Tie Rod	MN-DL-12284			
	02/04→	Tie Rod End	CV-ES-0914		for Steering Rod	
	02/04→	Tie Rod End	CV-ES-14162	CV-ES-14162	for Steering Rod	
	02/04→	Tie Rod End	CV-ES-14163		for Steering Rod	
	02/04→	Tie Rod End	MN-ES-10333		for Steering Rod	
	02/04→	Tie Rod End	SC-ES-7279		for Steering Rod	
	02/04→	Tie Rod End	SC-ES-8517		for Push Rod	
	02/04→	Tie Rod End	SC-ES-8535		for Guide Rod	
	02/04→	Track Control Arm		MN-DL-5225	Trailing Arm, Drive Axle;Air Suspension Axle	
	02/04→	Track Control Arm		MN-DL-8544	Trailing Arm, Drive Axle;Air Suspension Axle	
	02/04→	Track Control Arm		MN-DL-8544	Trailing Arm, Drive Axle;Leaf Spring Axle	
	02/04→	Track Control Arm		MN-DL-8709	Trailing Arm, Trailing Axle Steered/not Steered, for Pneumatic Suspension vehicles	
	02/04→	Track Control Arm		MN-VB-5238	Wishbone (CV), Drive Axle;Air Suspension Axle	
	02/04→	Track Control Arm		MN-VB-8514	Suspension Rod, Wishbone (CV), Drive Axle; Air Suspension Axle	
	02/04→	Track Control Arm		MN-VB-8514	Suspension Rod, Wishbone (CV), Drive Axle; Leaf Spring Axle	
	02/04→	Track Control Arm		MN-VB-8669	Suspension Rod, Wishbone (CV), Drive Axle; Leaf Spring Axle	
	02/04→	Track Control Arm		MN-VB-9403	Wishbone (CV), Trailing Axle Steered/not Steered, for Pneumatic Suspension vehicles	
	08/04→	Track Control Arm		MN-VB-9404	Wishbone (CV), Drive Axle;Air Suspension Axle	
	35.430, 35.440 FFDK, FFDRC, FFDLK	02/04→	Centre Rod	MN-DL-7801		Push Rod, Leaf Spring Axle
		02/04→	Centre Rod	MN-DL-8599		Push Rod
02/04→		Centre Rod	MN-DL-12285		for Steering Rod	
02/04→		Centre Rod	MN-DL-12289		Push Rod	
02/04→		Centre Rod	MN-DL-12393		for Steering Rod	

CV-ES-0914

Length: 125
Cone Ø: d1 Ø 30 / d2 Ø 27
Thread: M38 x 1,5 RHT
81953016184, 81953016251, 81953016276



CV-ES-14162

Length: 125
Cone Ø: d1 Ø 30 / d2 Ø 27
Thread: M30 x 1,5 LHT
81953010015, 81953010083, 81953010087,
81953016029, 81953016030, 81953016043,
81953016044, 81953016050, 81953016054,
81953016087, 81953016091, 81953016107,
81953016120, 81953016125, 81953016152,
81953016155, 81953016157, 81953016168,
81953016179, 81953016181, 81953016223,
81953016237, 81953016254, 81953016275,
81953016279, 81953016351



CV-ES-14163

Length: 125
Cone Ø: d1 Ø 30 / d2 Ø 27
Thread: M30 x 1,5 RHT
95301.0084, 90804102156, 90804102272,
90804102696, 90804102710, 81953010016,
81953010075, 81953010084, 81953010088,
81953010094, 81953010103, 81953016030,
81953016043, 81953016048, 81953016049,
81953016053, 81953016061, 81953016090,
81953016108, 81953016112, 81953016126,
81953016143, 81953016149, 81953016154,
81953016156, 81953016168, 81953016178,
81953016194, 81953016206, 81953016224,
81953016234, 81953016242, 81953016252,
81953016274, 81953016278, 81953016284,
81953016286, 81953016308, 81953016310,
81953016312, 81953016347, 81953016350,
81953016352, 82953016012, 88953016014,
N2953016001



CV-RK-5313

Ø: 90
03304800A, 81953016132



DB-RK-8581

Ø: 85
Hole Distance: 130
Thick/Height: 24
03305800A, 81432706105



DB-RK-9300

Ø: 75
Hole Distance: 130
Thick/Height: 24
85432206002



MN-DL-5212

Length: 577 Ø: 48
Hole Distance: 130 / 130
81432206096, 81432206097, 81432206098,
81432206129, 81432209096, 81432209129,
81432306014, 81432306030



MN-DL-5225

Length: 572 Ø: 48
Hole Distance: 130 / 130
03301500A, 81432206229, 81432206236,
81432206267, 81432206270, 81432206272,
81432206304, 81432206305, 81432209236,
81432209267, 81432209272



MN-DL-7801

Length: 995 Ø: 52
Cone Ø: d1 Ø 30 / d2 Ø 27
81466106807, 81466106808, 81466116087,
81466116088, 81466116096, 81466116097,
81466116099, 81466116132, 81466116133,
81466116136, 81466116197, 81466116198,
81466116205



MN-DL-7802

Length: 1680 Ø: 52
Cone Ø: d1 Ø 30 / d2 Ø 27
03208300A, 81467116773, 81467116858,
81467116859, 81467116860, 81467116861,
81467116863, 81467116882, 81467116883,
81467116920, 81467116921



MN-DL-8544

Length: 596 Ø: 48
Hole Distance: 130 / 130
81432206196, 81432206232, 81432206233



MN-DL-8599

Length: 1800 Ø: 62
Cone Ø: d1 Ø 30 / d2 Ø 27
81466116161, 81466116162, 82466106183,
82466106186, 82466106187



MN-DL-8709

Length: 572 Ø: 52
Hole Distance: 130 / 130
81432206268, 81432206274, 81432206291,
81432206292, 82432206007



MN-DL-12284

Length: 1530 Ø: 50
Cone Ø: d1 Ø 30 / d2 Ø 27
81466106579, 81466106580, 81466106624,
81466116720, 81467116720, 81467116730,
81467116952

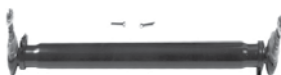

MN-DL-12285

Length: 993 Ø: 40
Cone Ø: d1 Ø 30 / d2 Ø 27
81466106816, 81466106826, 81466116151,
82466106184, 82466106185



MN-DL-12289

Length: 1796 Ø: 62
Cone Ø: d1 Ø 30 / d2 Ø 27
81466116174, 81466116175, 81466116176,
81466116244

No Image

MN-DL-12393

Length: 1796 Ø: 62
Cone Ø: d1 Ø 30 / d2 Ø 27
81466116154, 81466116155, 81466116156



MN-ES-10333

Length: 90
Cone Ø: d1 Ø 38 / d2 Ø 34,35
Thread: M36 x 1,5 RHT
1271126, 3090291, 3099128, 42538048,
81953016268, 82953016018, 82953016019



MN-RK-7291

Ø: 72
Hole Distance: 130
Thick/Height: 30
10307800A, 81432206108, 81432206132



MN-VB-5238

Length: 627 Ø: 48
Hole Distance: 130 / 130
81432206221, 81432706096, 81432706114,
81432706116, 81432706121



MN-VB-8514

Length: 627 Ø: 48
Hole Ø 25 / 25 / 25
Hole Distance: 152 / 130 / 130
81432706087, 81432706088, 81432706094,
81432706095, 81432796094



MN-VB-8669

Length: 627 Ø: 48
Hole Ø 25 / 25 / 25
Hole Distance: 152 / 130 / 130
81432706116, 81432706137, 81432706150,
81432706151



MN-VB-9403

Length: 627 Ø: 48
Hole Ø 25 / 23 / 23
Hole Distance: 152 / 130 / 130
81432706097, 81432706113, 81432706135,
81432706160, 81432706161



MN-VB-9404

Length: 627 Ø: 58
Hole Distance: 130 / 130
81432706117, 81432706152, 81432706153



SC-ES-7279

Length: 150
Cone Ø: d1 Ø 30 / d2 Ø 27
Thread: M30 x 1,5 RHT
81953016288



SC-ES-8517

Length: 140
Cone Ø: d1 Ø 30 / d2 Ø 27
Thread: M30 x 1,5 RHT
81953016286



SC-ES-8535

Length: 145
Cone Ø: d1 Ø 30 / d2 Ø 27
Thread: M30 x 1,5 RHT
81953016271, 81953016325





TGA ...

35.430, 35.440 FFDK, FFDRK, FFDLK ...	02/04 →	Suspension Strut Repair Kit		DB-RK-8581		
	02/04 →	Tie Rod	MN-DL-7802			
	02/04 →	Tie Rod End	CV-ES-0914		for Steering Rod	
	02/04 →	Tie Rod End	CV-ES-14162		for Steering Rod	
	02/04 →	Tie Rod End	CV-ES-14163		for Steering Rod	
	02/04 →	Tie Rod End	MN-ES-10333		for Steering Rod	
	02/04 →	Tie Rod End	SC-ES-7279		for Steering Rod	
	02/04 →	Tie Rod End	SC-ES-8517		for Push Rod	
	02/04 →	Tie Rod End	SC-ES-8535		for Guide Rod	
	02/04 →	Track Control Arm		MN-DL-5225	Trailing Arm, Drive Axle; Air Suspension Axle	
	02/04 →	Track Control Arm		MN-DL-8544	Trailing Arm, Drive Axle; Air Suspension Axle	
	02/04 →	Track Control Arm		MN-DL-8544	Trailing Arm, Drive Axle; Leaf Spring Axle	
	02/04 →	Track Control Arm		MN-VB-5238	Wishbone (CV), Drive Axle; Air Suspension Axle	
	02/04 →	Track Control Arm		MN-VB-8514	Suspension Rod, Wishbone (CV), Drive Axle; Air Suspension Axle	
	02/04 →	Track Control Arm		MN-VB-8514	Suspension Rod, Wishbone (CV), Drive Axle; Leaf Spring Axle	
	02/04 →	Track Control Arm		MN-VB-8669	Suspension Rod, Wishbone (CV), Drive Axle; Leaf Spring Axle	
	35.430, 35.440 FFD-TM	08/04 →	Track Control Arm		MN-VB-9404	Wishbone (CV), Drive Axle; Air Suspension Axle
		02/04 →	Centre Rod	MN-DL-7801		Push Rod, Leaf Spring Axle
02/04 →		Centre Rod	MN-DL-8599		Push Rod	
02/04 →		Centre Rod	MN-DL-12285		for Steering Rod	
02/04 →		Centre Rod	MN-DL-12289		Push Rod	
02/04 →		Centre Rod	MN-DL-12393		for Steering Rod	
02/04 →		Suspension Strut Repair Kit		DB-RK-8581		
02/04 →		Tie Rod	MN-DL-7802			
02/04 →		Tie Rod End	CV-ES-0914		for Steering Rod	
02/04 →		Tie Rod End	CV-ES-14162		for Steering Rod	
02/04 →		Tie Rod End	CV-ES-14163		for Steering Rod	
02/04 →		Tie Rod End	MN-ES-10333		for Steering Rod	
02/04 →		Tie Rod End	SC-ES-7279		for Steering Rod	
02/04 →		Tie Rod End	SC-ES-8517		for Push Rod	
02/04 →		Tie Rod End	SC-ES-8535		for Guide Rod	
02/04 →	Track Control Arm		MN-DL-5225	Trailing Arm		
02/04 →	Track Control Arm		MN-DL-8544	Trailing Arm, Drive Axle; Leaf Spring Axle		
02/04 →	Track Control Arm		MN-VB-8514	Suspension Rod, Wishbone (CV), Drive Axle; Leaf Spring Axle		
02/04 →	Track Control Arm		MN-VB-8669	Suspension Rod, Wishbone (CV), Drive Axle; Leaf Spring Axle		
35.440 FDNLC	07/06 →	Centre Rod	MN-DL-12393		for Steering Rod	
	07/06 →	Suspension Arm Repair Kit		CV-RK-5313	for Wishbone (CV)	
	07/06 →	Suspension Arm Repair Kit	DB-RK-9300	DB-RK-9300	for Drag Link	
	07/06 →	Tie Rod End	CV-ES-0914		for Steering Rod	
	07/06 →	Tie Rod End	CV-ES-14162	CV-ES-14162	for Steering Rod	
	07/06 →	Tie Rod End	CV-ES-14163		for Steering Rod	
	07/06 →	Tie Rod End	SC-ES-7279		for Steering Rod	
	07/06 →	Tie Rod End	SC-ES-8517		for Push Rod	
	07/06 →	Tie Rod End	SC-ES-8535		for Guide Rod	
	07/06 →	Track Control Arm		MN-DL-5225	Trailing Arm	
	07/06 →	Track Control Arm		MN-DL-8709	Trailing Arm, Trailing Axle Steered/not Steered, for Pneumatic Suspension vehicles	
	07/06 →	Track Control Arm		MN-VB-8669	Suspension Rod, Wishbone (CV), 1st RA; 2nd RA, for Leaf-Spring Suspension vehicles, →Type_MHB Chassis	
	07/06 →	Track Control Arm		MN-VB-9403	Wishbone (CV), Trailing Axle Steered/not Steered, for Pneumatic Suspension vehicles	
	35.440 FFDK, FFDHK, FFDHLK	07/06 →	Centre Rod	MN-DL-2160		Coupling Rod
07/06 →		Centre Rod	MN-DL-7801		Push Rod	
07/06 →		Centre Rod	MN-DL-8599		Push Rod	
07/06 →		Centre Rod	MN-DL-8646		Push Rod, for Leaf-Spring Suspension vehicles	
07/06 →		Centre Rod	MN-DL-12285		for Steering Rod	
07/06 →		Centre Rod	MN-DL-12393		for Steering Rod	

CV-ES-0914

Length: 125
Cone Ø: d1 Ø 30 / d2 Ø 27
Thread: M38 x 1,5 RHT
81953016184, 81953016251, 81953016276



CV-ES-14162

Length: 125
Cone Ø: d1 Ø 30 / d2 Ø 27
Thread: M30 x 1,5 LHT
81953010015, 81953010083, 81953010087, 81953016029, 81953016030, 81953016043, 81953016044, 81953016050, 81953016054, 81953016087, 81953016091, 81953016107, 81953016120, 81953016125, 81953016152, 81953016155, 81953016157, 81953016168, 81953016179, 81953016181, 81953016223, 81953016237, 81953016254, 81953016275, 81953016279, 81953016351



CV-ES-14163

Length: 125
Cone Ø: d1 Ø 30 / d2 Ø 27
Thread: M30 x 1,5 RHT
95301.0084, 90804102156, 90804102272, 90804102696, 90804102710, 81953010016, 81953010075, 81953010084, 81953010088, 81953010094, 81953010103, 81953016030, 81953016043, 81953016048, 81953016049, 81953016053, 81953016061, 81953016090, 81953016108, 81953016112, 81953016126, 81953016143, 81953016149, 81953016154, 81953016156, 81953016168, 81953016178, 81953016194, 81953016206, 81953016224, 81953016234, 81953016242, 81953016252, 81953016274, 81953016278, 81953016284, 81953016286, 81953016308, 81953016310, 81953016312, 81953016347, 81953016350, 81953016352, 82953016012, 88953016014, N2953016001



CV-RK-5313

Ø: 90
03304800A, 81953016132



DB-RK-8581

Ø: 85
Hole Distance: 130
Thick/Height: 24
03305800A, 81432706105



DB-RK-9300

Ø: 75
Hole Distance: 130
Thick/Height: 24
85432206002



MN-DL-2160

Length: 1652 Ø: 50
Cone Ø: d1 Ø 30 / d2 Ø 27
81467106112, 81467106163, 81467106165, 81467106198, 81467106353, 81467106354, 81467106361, 81467116725



MN-DL-5225

Length: 572 Ø: 48
Hole Distance: 130 / 130
03301500A, 81432206229, 81432206236, 81432206267, 81432206270, 81432206272, 81432206304, 81432206305, 81432209236, 81432209267, 81432209272



MN-DL-7801

Length: 995 Ø: 52
Cone Ø: d1 Ø 30 / d2 Ø 27
81466106807, 81466106808, 81466116087, 81466116088, 81466116096, 81466116097, 81466116099, 81466116132, 81466116133, 81466116136, 81466116197, 81466116198, 81466116205

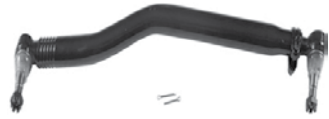

MN-DL-7802

Length: 1680 Ø: 52
Cone Ø: d1 Ø 30 / d2 Ø 27
03208300A, 81467116773, 81467116858, 81467116859, 81467116860, 81467116861, 81467116863, 81467116882, 81467116883, 81467116920, 81467116921



MN-DL-8544

Length: 596 Ø: 48
Hole Distance: 130 / 130
81432206196, 81432206232, 81432206233



MN-DL-8599

Length: 1800 Ø: 62
Cone Ø: d1 Ø 30 / d2 Ø 27
81466116161, 81466116162, 82466106183, 82466106186, 82466106187



MN-DL-8646

Length: 1021 Ø: 52
Cone Ø: d1 Ø 30 / d2 Ø 27
81466106811, 81466106812, 81466116138, 81466116139, 81466116201, 81466116202

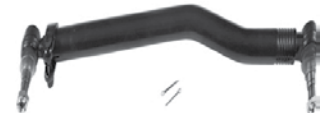

MN-DL-8709

Length: 572 Ø: 52
Hole Distance: 130 / 130
81432206268, 81432206274, 81432206291, 81432206292, 82432206007



MN-DL-12285

Length: 993 Ø: 40
Cone Ø: d1 Ø 30 / d2 Ø 27
81466106816, 81466106826, 81466116151, 82466106184, 82466106185



MN-DL-12289

Length: 1796 Ø: 62
Cone Ø: d1 Ø 30 / d2 Ø 27
81466116174, 81466116175, 81466116176, 81466116244



No Image

MN-DL-12393

Length: 1796 Ø: 62
Cone Ø: d1 Ø 30 / d2 Ø 27
81466116154, 81466116155, 81466116156



MN-ES-10333

Length: 90
Cone Ø: d1 Ø 38 / d2 Ø 34,35
Thread: M36 x 1,5 RHT
1271126, 3090291, 3099128, 42538048, 81953016268, 82953016018, 82953016019



MN-VB-5238

Length: 627 Ø: 48
Hole Distance: 130 / 130
81432206221, 81432706096, 81432706114, 81432706116, 81432706121



MN-VB-8514

Length: 627 Ø: 48
Hole Ø 25 / 25 / 25
Hole Distance: 152 / 130 / 130
81432706087, 81432706088, 81432706094, 81432706095, 81432796094



MN-VB-8669

Length: 627 Ø: 48
Hole Ø 25 / 25 / 25
Hole Distance: 152 / 130 / 130
81432706116, 81432706137, 81432706150, 81432706151



MN-VB-9403

Length: 627 Ø: 48
Hole Ø 25 / 23 / 23
Hole Distance: 152 / 130 / 130
81432706097, 81432706113, 81432706135, 81432706160, 81432706161



MN-VB-9404

Length: 627 Ø: 58
Hole Distance: 130 / 130
81432706117, 81432706152, 81432706153



SC-ES-7279

Length: 150
Cone Ø: d1 Ø 30 / d2 Ø 27
Thread: M30 x 1,5 RHT
81953016288



SC-ES-8517

Length: 140
Cone Ø: d1 Ø 30 / d2 Ø 27
Thread: M30 x 1,5 RHT
81953016286



SC-ES-8535

Length: 145
Cone Ø: d1 Ø 30 / d2 Ø 27
Thread: M30 x 1,5 RHT
81953016271, 81953016325





TGA ...

35.440 FFDK, FFDHK, FFDHLK ...	07/06→	Suspension Arm Repair Kit		CV-RK-5313	for Wishbone (CV)
	07/06→	Tie Rod	MN-DL-7802		
	07/06→	Tie Rod	MN-DL-12287		
	07/06→	Tie Rod End	CV-ES-0914		for Steering Rod
	07/06→	Tie Rod End	CV-ES-14162		for Steering Rod
	07/06→	Tie Rod End	CV-ES-14163		for Steering Rod
	07/06→	Tie Rod End	MN-ES-10333		for Steering Rod
	07/06→	Tie Rod End	SC-ES-8517		for Push Rod
	07/06→	Tie Rod End	SC-ES-8535		for Guide Rod
	07/06→	Track Control Arm		MN-DL-8544	Trailing Arm
	07/06→	Track Control Arm		MN-DL-8544	Trailing Arm, Drive Axle
	07/06→	Track Control Arm		MN-DL-8544	Trailing Arm, Drive Axle, for Leaf-Spring Suspension vehicles
	07/06→	Track Control Arm		MN-DL-8609	Trailing Arm, 1st RA;2nd RA, for Leaf-Spring Suspension vehicles, →Type_HB Chassis
	07/06→	Track control arm		MN-DL-10288	Trailing Arm, 1st RA;2nd RA, for Leaf-Spring Suspension vehicles, →Type HB
	07/06→	Track control arm		MN-DL-12288	Trailing Arm
	07/06→	Track Control Arm		MN-VB-8514	Suspension Rod, Wishbone (CV)
	07/06→	Track Control Arm		MN-VB-8514	Suspension Rod, Wishbone (CV), Drive Axle
	07/06→	Track Control Arm		MN-VB-8669	Suspension Rod, Wishbone (CV)
	07/06→	Track Control Arm		MN-VB-9404	Wishbone (CV), 1st RA;2nd RA, for Leaf-Spring Suspension vehicles, →Type_HB Chassis
	35.440 FFDH-TM	07/06→	Centre Rod	MN-DL-7801	
07/06→		Centre Rod	MN-DL-12393		for Steering Rod
07/06→		Tie Rod	MN-DL-7802		
07/06→		Tie Rod End	CV-ES-0914		for Steering Rod
07/06→		Tie Rod End	CV-ES-14162		for Steering Rod
07/06→		Tie Rod End	CV-ES-14163		for Steering Rod
07/06→		Tie Rod End	SC-ES-7279		for Steering Rod
07/06→		Tie Rod End	SC-ES-8517		for Push Rod
07/06→		Tie Rod End	SC-ES-8535		for Guide Rod
07/06→		Track Control Arm		MN-DL-8544	Trailing Arm, Drive Axle, for Leaf-Spring Suspension vehicles
07/06→		Track Control Arm		MN-VB-8514	Suspension Rod, Wishbone (CV), Drive Axle
07/06→		Track Control Arm		MN-VB-8669	Suspension Rod, Wishbone (CV), 1st RA; 2nd RA, for Leaf-Spring Suspension vehicles, →Type_MHB Chassis
35.440 FFNHL	11/06→	Centre Rod	MN-DL-12393		for Steering Rod
	11/06→	Suspension Arm Repair Kit		CV-RK-5313	for Wishbone (CV)
	11/06→	Suspension Arm Repair Kit	DB-RK-9300	DB-RK-9300	for Drag Link
	11/06→	Tie Rod	MN-DL-12284		
	11/06→	Tie Rod End	CV-ES-0914		for Steering Rod
	11/06→	Tie Rod End	CV-ES-14162	CV-ES-14162	for Steering Rod
	11/06→	Tie Rod End	CV-ES-14163		for Steering Rod
	11/06→	Tie Rod End	SC-ES-7279		for Steering Rod
	11/06→	Tie Rod End	SC-ES-8517		for Push Rod
	11/06→	Tie Rod End	SC-ES-8535		for Guide Rod
	11/06→	Track Control Arm		MN-DL-5225	for Control Arm
	11/06→	Track Control Arm		MN-DL-5225	Trailing Arm
	11/06→	Track Control Arm		MN-DL-8709	Trailing Arm
	11/06→	Track Control Arm		MN-DL-8709	Trailing Arm, Trailing Axle Steered/not Steered, for Pneumatic Suspension vehicles
	11/06→	Track Control Arm		MN-VB-5238	Wishbone (CV), 1st RA;2nd RA, for Pneumatic Suspension vehicles
	11/06→	Track Control Arm		MN-VB-5238	Wishbone (CV), Drive Axle
	11/06→	Track Control Arm		MN-VB-9403	Wishbone (CV)
	11/06→	Track Control Arm		MN-VB-9403	Wishbone (CV), Trailing Axle Steered/not Steered, for Pneumatic Suspension vehicles
35.440 FFNLC	07/06→	Suspension Arm Repair Kit		CV-RK-5313	for Wishbone (CV)
	07/06→	Suspension Arm Repair Kit		MN-RK-7291	for Drag Link
	07/06→	Suspension Arm Repair Kit	DB-RK-9300	DB-RK-9300	for Drag Link
	07/06→	Tie Rod End	CV-ES-0914		for Steering Rod

CV-ES-0914

Length: 125
Cone Ø: d1 Ø 30 / d2 Ø 27
Thread: M38 x 1,5 RHT
81953016184, 81953016251, 81953016276



CV-ES-14162

Length: 125
Cone Ø: d1 Ø 30 / d2 Ø 27
Thread: M30 x 1,5 LHT
81953010015, 81953010083, 81953010087, 81953016029, 81953016030, 81953016043, 81953016044, 81953016050, 81953016054, 81953016087, 81953016091, 81953016107, 81953016120, 81953016125, 81953016152, 81953016155, 81953016157, 81953016168, 81953016179, 81953016181, 81953016223, 81953016237, 81953016254, 81953016275, 81953016279, 81953016351



CV-ES-14163

Length: 125
Cone Ø: d1 Ø 30 / d2 Ø 27
Thread: M30 x 1,5 RHT
95301.0084, 90804102156, 90804102272, 90804102696, 90804102710, 81953010016, 81953010075, 81953010084, 81953010088, 81953010094, 81953010103, 81953016030, 81953016043, 81953016048, 81953016049, 81953016053, 81953016061, 81953016090, 81953016108, 81953016112, 81953016126, 81953016143, 81953016149, 81953016154, 81953016156, 81953016168, 81953016178, 81953016194, 81953016206, 81953016224, 81953016234, 81953016242, 81953016252, 81953016274, 81953016278, 81953016284, 81953016286, 81953016308, 81953016310, 81953016312, 81953016347, 81953016350, 81953016352, 82953016012, 88953016014, N2953016001



CV-RK-5313

Ø: 90
03304800A, 81953016132



DB-RK-9300

Ø: 75
Hole Distance: 130
Thick/Height: 24
85432206002



MN-DL-5225

Length: 572 Ø: 48
Hole Distance: 130 / 130
03301500A, 81432206229, 81432206236, 81432206267, 81432206270, 81432206272, 81432206304, 81432206305, 81432209226, 81432209267, 81432209272



MN-DL-7801

Length: 995 Ø: 52
Cone Ø: d1 Ø 30 / d2 Ø 27
81466106807, 81466106808, 81466116087, 81466116088, 81466116096, 81466116097, 81466116099, 81466116132, 81466116133, 81466116136, 81466116197, 81466116198, 81466116205

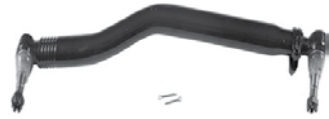

MN-DL-7802

Length: 1680 Ø: 52
Cone Ø: d1 Ø 30 / d2 Ø 27
03208300A, 81467116773, 81467116858, 81467116859, 81467116860, 81467116861, 81467116863, 81467116882, 81467116883, 81467116920, 81467116921



MN-DL-8544

Length: 596 Ø: 48
Hole Distance: 130 / 130
81432206196, 81432206232, 81432206233



MN-DL-8609

Length: 585 Ø: 58
Hole Distance: 130 / 130
81432206070, 81432206071, 81432206072, 81432206091, 81432206093, 81432206119



MN-DL-8709

Length: 572 Ø: 52
Hole Distance: 130 / 130
81432206268, 81432206274, 81432206291, 81432206292, 82432206007



MN-DL-10288

81432206386, 82432206008, 82432209008

No Image

MN-DL-12284

Length: 1530 Ø: 50
Cone Ø: d1 Ø 30 / d2 Ø 27
81466106579, 81466106580, 81466106624, 81466116720, 81467116720, 81467116730, 81467116952



MN-DL-12287

Length: 1531 Ø: 42
Cone Ø: d1 Ø 30 / d2 Ø 27
81467116855, 81467116856, 81467116857



MN-DL-12288

Length: 585 Ø: 58
Hole Distance: 130 / 130
81432206386, 82432206008, 82432209008

No Image

MN-DL-12393

Length: 1796 Ø: 62
Cone Ø: d1 Ø 30 / d2 Ø 27
81466116154, 81466116155, 81466116156



MN-ES-10333

Length: 90
Cone Ø: d1 Ø 38 / d2 Ø 34,35
Thread: M36 x 1,5 RHT
1271126, 3090291, 3099128, 42538048, 81953016268, 82953016018, 82953016019



MN-RK-7291

Ø: 72
Hole Distance: 130
Thick/Height: 30
10307800A, 81432206108, 81432206132



MN-VB-5238

Length: 627 Ø: 48
Hole Distance: 130 / 130
81432206221, 81432706096, 81432706114, 81432706116, 81432706121



MN-VB-8514

Length: 627 Ø: 48
Hole Ø 25 / 25 / 25
Hole Distance: 152 / 130 / 130
81432706087, 81432706088, 81432706094, 81432706095, 81432796094



MN-VB-8669

Length: 627 Ø: 48
Hole Ø 25 / 25 / 25
Hole Distance: 152 / 130 / 130
81432706116, 81432706137, 81432706150, 81432706151



MN-VB-9403

Length: 627 Ø: 48
Hole Ø 25 / 23 / 23
Hole Distance: 152 / 130 / 130
81432706097, 81432706113, 81432706135, 81432706160, 81432706161



MN-VB-9404

Length: 627 Ø: 58
Hole Distance: 130 / 130
81432706117, 81432706152, 81432706153



SC-ES-7279

Length: 150
Cone Ø: d1 Ø 30 / d2 Ø 27
Thread: M30 x 1,5 RHT
81953016288



SC-ES-8517

Length: 140
Cone Ø: d1 Ø 30 / d2 Ø 27
Thread: M30 x 1,5 RHT
81953016286



SC-ES-8535

Length: 145
Cone Ø: d1 Ø 30 / d2 Ø 27
Thread: M30 x 1,5 RHT
81953016271, 81953016325





TGA ...

35.440 FFNLC ...	07/06→	Tie Rod End	CV-ES-14162	CV-ES-14162	for Steering Rod
	07/06→	Tie Rod End	CV-ES-14163		for Steering Rod
	07/06→	Tie Rod End	SC-ES-7279		for Steering Rod
	07/06→	Tie Rod End	SC-ES-8517		for Push Rod
	07/06→	Tie Rod End	SC-ES-8535		for Guide Rod
	07/06→	Track Control Arm		MN-DL-5212	Trailing Arm, Trailing Axle not Steered, for Pneumatic Suspension vehicles
	07/06→	Track Control Arm		MN-DL-5225	Trailing Arm
	07/06→	Track Control Arm		MN-DL-8709	Trailing Arm, Trailing Axle Steered/not Steered, for Pneumatic Suspension vehicles
	07/06→	Track Control Arm		MN-VB-5238	Wishbone (CV), 1st Drive Axle, for Pneumatic Suspension vehicles
07/06→	Track Control Arm		MN-VB-9403	Wishbone (CV), Trailing Axle Steered/not Steered, for Pneumatic Suspension vehicles	
35.460 FFDC, FFDLC	10/03→	Centre Rod	MN-DL-7801		Push Rod, Leaf Spring Axle
	10/03→	Centre Rod	MN-DL-8599		Push Rod
	10/03→	Centre Rod	MN-DL-12285		for Steering Rod
	10/03→	Centre Rod	MN-DL-12393		for Steering Rod
	10/03→	Suspension Strut Repair Kit		DB-RK-8581	
	10/03→	Tie Rod	MN-DL-7802		
	10/03→	Tie Rod End	CV-ES-0914		for Steering Rod
	10/03→	Tie Rod End	CV-ES-14162		for Steering Rod
	10/03→	Tie Rod End	CV-ES-14163		for Steering Rod
	10/03→	Tie Rod End	MN-ES-10333		for Steering Rod
	10/03→	Tie Rod End	SC-ES-7279		for Steering Rod
	10/03→	Tie Rod End	SC-ES-8517		for Push Rod
	10/03→	Tie Rod End	SC-ES-8535		for Guide Rod
	10/03→	Track Control Arm		MN-DL-5225	Trailing Arm, Drive Axle;Air Suspension Axle
	10/03→	Track Control Arm		MN-DL-8544	Trailing Arm, Drive Axle;Air Suspension Axle
	10/03→	Track Control Arm		MN-DL-8544	Trailing Arm, Drive Axle;Leaf Spring Axle
	10/03→	Track Control Arm		MN-VB-5238	Wishbone (CV), Drive Axle;Air Suspension Axle
	10/03→	Track Control Arm		MN-VB-8514	Suspension Rod, Wishbone (CV), Drive Axle; Air Suspension Axle
	10/03→	Track Control Arm		MN-VB-8514	Suspension Rod, Wishbone (CV), Drive Axle; Leaf Spring Axle
	10/03→	Track Control Arm		MN-VB-8669	Suspension Rod, Wishbone (CV), Drive Axle; Leaf Spring Axle
08/04→	Track Control Arm		MN-VB-9404	Wishbone (CV), Drive Axle;Air Suspension Axle	
35.460 FFDK, FFDLK	10/03→	Centre Rod	MN-DL-7801		Push Rod, Leaf Spring Axle
	10/03→	Centre Rod	MN-DL-8599		Push Rod
	10/03→	Centre Rod	MN-DL-12285		for Steering Rod
	10/03→	Centre Rod	MN-DL-12393		for Steering Rod
	10/03→	Suspension Strut Repair Kit		DB-RK-8581	
	10/03→	Tie Rod	MN-DL-7802		
	10/03→	Tie Rod End	CV-ES-0914		for Steering Rod
	10/03→	Tie Rod End	CV-ES-14162		for Steering Rod
	10/03→	Tie Rod End	CV-ES-14163		for Steering Rod
	10/03→	Tie Rod End	MN-ES-10333		for Steering Rod
	10/03→	Tie Rod End	SC-ES-7279		for Steering Rod
	10/03→	Tie Rod End	SC-ES-8517		for Push Rod
	10/03→	Tie Rod End	SC-ES-8535		for Guide Rod
	10/03→	Track Control Arm		MN-DL-5225	Trailing Arm, Drive Axle;Air Suspension Axle
	10/03→	Track Control Arm		MN-DL-8544	Trailing Arm, Drive Axle;Air Suspension Axle
	10/03→	Track Control Arm		MN-DL-8544	Trailing Arm, Drive Axle;Leaf Spring Axle
	10/03→	Track Control Arm		MN-VB-5238	Wishbone (CV), Drive Axle;Air Suspension Axle
	10/03→	Track Control Arm		MN-VB-8514	Suspension Rod, Wishbone (CV), Drive Axle; Air Suspension Axle
	10/03→	Track Control Arm		MN-VB-8514	Suspension Rod, Wishbone (CV), Drive Axle; Leaf Spring Axle
	10/03→	Track Control Arm		MN-VB-8669	Suspension Rod, Wishbone (CV), Drive Axle; Leaf Spring Axle
08/04→	Track Control Arm		MN-VB-9404	Wishbone (CV), Drive Axle;Air Suspension Axle	

CV-ES-0914

Length: 125
Cone Ø: d1 Ø 30 / d2 Ø 27
Thread: M38 x 1,5 RHT
81953016184, 81953016251, 81953016276



CV-ES-14162

Length: 125
Cone Ø: d1 Ø 30 / d2 Ø 27
Thread: M30 x 1,5 LHT
81953010015, 81953010083, 81953010087, 81953016029, 81953016030, 81953016043, 81953016044, 81953016050, 81953016054, 81953016087, 81953016091, 81953016107, 81953016120, 81953016125, 81953016152, 81953016155, 81953016157, 81953016168, 81953016179, 81953016181, 81953016223, 81953016237, 81953016254, 81953016275, 81953016279, 81953016351



CV-ES-14163

Length: 125
Cone Ø: d1 Ø 30 / d2 Ø 27
Thread: M30 x 1,5 RHT
95301.0084, 90804102156, 90804102272, 90804102696, 90804102710, 81953010016, 81953010075, 81953010084, 81953010088, 81953010094, 81953010103, 81953016030, 81953016043, 81953016048, 81953016049, 81953016053, 81953016061, 81953016090, 81953016108, 81953016112, 81953016126, 81953016143, 81953016149, 81953016154, 81953016156, 81953016168, 81953016178, 81953016194, 81953016206, 81953016224, 81953016234, 81953016242, 81953016252, 81953016274, 81953016278, 81953016284, 81953016286, 81953016308, 81953016310, 81953016312, 81953016347, 81953016350, 81953016352, 82953016012, 88953016014, N2953016001



DB-RK-8581

Ø: 85
Hole Distance: 130
Thick/Height: 24
03305800A, 81432706105



MN-DL-5212

Length: 577 Ø: 48
Hole Distance: 130 / 130
81432206096, 81432206097, 81432206098, 81432206129, 81432209096, 81432209129, 81432306014, 81432306030



MN-DL-5225

Length: 572 Ø: 48
Hole Distance: 130 / 130
03301500A, 81432206229, 81432206236, 81432206267, 81432206270, 81432206272, 81432206304, 81432206305, 81432209236, 81432209267, 81432209272



MN-DL-7801

Length: 995 Ø: 52
Cone Ø: d1 Ø 30 / d2 Ø 27
81466106807, 81466106808, 81466116087, 81466116088, 81466116096, 81466116097, 81466116099, 81466116132, 81466116133, 81466116136, 81466116197, 81466116198, 81466116205



MN-DL-7802

Length: 1680 Ø: 52
Cone Ø: d1 Ø 30 / d2 Ø 27
03208300A, 81467116773, 81467116858, 81467116859, 81467116860, 81467116861, 81467116863, 81467116882, 81467116883, 81467116920, 81467116921



MN-DL-8544

Length: 596 Ø: 48
Hole Distance: 130 / 130
81432206196, 81432206232, 81432206233



MN-DL-8599

Length: 1800 Ø: 62
Cone Ø: d1 Ø 30 / d2 Ø 27
81466116161, 81466116162, 82466106183, 82466106186, 82466106187



MN-DL-8709

Length: 572 Ø: 52
Hole Distance: 130 / 130
81432206268, 81432206274, 81432206291, 81432206292, 82432206007



MN-DL-12285

Length: 993 Ø: 40
Cone Ø: d1 Ø 30 / d2 Ø 27
81466106816, 81466106826, 81466116151, 82466106184, 82466106185



MN-DL-12393

Length: 1796 Ø: 62
Cone Ø: d1 Ø 30 / d2 Ø 27
81466116154, 81466116155, 81466116156



MN-ES-10333

Length: 90
Cone Ø: d1 Ø 38 / d2 Ø 34,35
Thread: M36 x 1,5 RHT
1271126, 3090291, 3099128, 42538048, 81953016268, 82953016018, 82953016019



MN-VB-5238

Length: 627 Ø: 48
Hole Distance: 130 / 130
81432206221, 81432706096, 81432706114, 81432706116, 81432706121



MN-VB-8514

Length: 627 Ø: 48
Hole Ø 25 / 25 / 25
Hole Distance: 152 / 130 / 130
81432706087, 81432706088, 81432706094, 81432706095, 81432796094



MN-VB-8669

Length: 627 Ø: 48
Hole Ø 25 / 25 / 25
Hole Distance: 152 / 130 / 130
81432706116, 81432706137, 81432706150, 81432706151



MN-VB-9403

Length: 627 Ø: 48
Hole Ø 25 / 23 / 23
Hole Distance: 152 / 130 / 130
81432706097, 81432706113, 81432706135, 81432706160, 81432706161



MN-VB-9404

Length: 627 Ø: 58
Hole Distance: 130 / 130
81432706117, 81432706152, 81432706153



SC-ES-7279

Length: 150
Cone Ø: d1 Ø 30 / d2 Ø 27
Thread: M30 x 1,5 RHT
81953016288



SC-ES-8517

Length: 140
Cone Ø: d1 Ø 30 / d2 Ø 27
Thread: M30 x 1,5 RHT
81953016286



SC-ES-8535

Length: 145
Cone Ø: d1 Ø 30 / d2 Ø 27
Thread: M30 x 1,5 RHT
81953016271, 81953016325





TGA ...

35.460 FFD-TM	11/03→	Tie Rod End	CV-ES-0914		for Steering Rod
	11/03→	Tie Rod End	CV-ES-14162		for Steering Rod
	11/03→	Tie Rod End	CV-ES-14163		for Steering Rod
	11/03→	Tie Rod End	SC-ES-7279		for Steering Rod
	11/03→	Tie Rod End	SC-ES-8517		for Push Rod
	11/03→	Tie Rod End	SC-ES-8535		for Guide Rod
	11/03→	Track Control Arm		MN-DL-8544	Trailing Arm, 1st RA;2nd RA, for Leaf-Spring Suspension vehicles
	11/03→	Track Control Arm		MN-VB-8514	Suspension Rod, Wishbone (CV)
	11/03→	Track Control Arm		MN-VB-8669	Suspension Rod, Wishbone (CV), 1st RA; 2nd RA, for Leaf-Spring Suspension vehicles, →Type_MHB Chassis
35.460 FFNLC	07/06→	Centre Rod	MN-DL-12393		for Steering Rod
	07/06→	Suspension Arm Repair Kit		CV-RK-5313	for Wishbone (CV)
	07/06→	Suspension Arm Repair Kit		MN-RK-7291	for Drag Link
	07/06→	Suspension Arm Repair Kit	DB-RK-9300	DB-RK-9300	for Drag Link
	07/06→	Tie Rod	MN-DL-12284		
	07/06→	Tie Rod End	CV-ES-0914		for Steering Rod
	07/06→	Tie Rod End	CV-ES-14162	CV-ES-14162	for Steering Rod
	07/06→	Tie Rod End	CV-ES-14163		for Steering Rod
	07/06→	Tie Rod End	SC-ES-7279		for Steering Rod
	07/06→	Tie Rod End	SC-ES-8517		for Push Rod
	07/06→	Tie Rod End	SC-ES-8535		for Guide Rod
	07/06→	Track Control Arm		MN-DL-5212	Trailing Arm, Trailing Axle not Steered, for Pneumatic Suspension vehicles
	07/06→	Track Control Arm		MN-DL-5225	Trailing Arm
	07/06→	Track Control Arm		MN-DL-8709	Trailing Arm, Trailing Axle Steered/not Steered, for Pneumatic Suspension vehicles
	07/06→	Track Control Arm		MN-VB-5238	Wishbone (CV), 1st Drive Axle, for Pneumatic Suspension vehicles
07/06→	Track Control Arm		MN-VB-9403	Wishbone (CV), Trailing Axle Steered/not Steered, for Pneumatic Suspension vehicles	
35.480 FDNLC	07/06→	Centre Rod	MN-DL-12393		for Steering Rod
	07/06→	Suspension Arm Repair Kit		CV-RK-5313	for Wishbone (CV)
	07/06→	Suspension Arm Repair Kit	DB-RK-9300	DB-RK-9300	for Drag Link
	07/06→	Tie Rod	MN-DL-12284		
	07/06→	Tie Rod End	CV-ES-0914		for Steering Rod
	07/06→	Tie Rod End	CV-ES-14162	CV-ES-14162	for Steering Rod
	07/06→	Tie Rod End	CV-ES-14163		for Steering Rod
	07/06→	Tie Rod End	SC-ES-7279		for Steering Rod
	07/06→	Tie Rod End	SC-ES-8517		for Push Rod
	07/06→	Tie Rod End	SC-ES-8535		for Guide Rod
	07/06→	Track Control Arm		MN-DL-5225	Trailing Arm
	07/06→	Track Control Arm		MN-DL-8709	Trailing Arm, Trailing Axle Steered/not Steered, for Pneumatic Suspension vehicles
	07/06→	Track Control Arm		MN-VB-8669	Suspension Rod, Wishbone (CV), 1st RA; 2nd RA, for Leaf-Spring Suspension vehicles, →Type_MHB Chassis
	07/06→	Track Control Arm		MN-VB-9403	Wishbone (CV), Trailing Axle Steered/not Steered, for Pneumatic Suspension vehicles
	35.480 FFDK	07/06→	Centre Rod	MN-DL-7801	
07/06→		Centre Rod	MN-DL-8599		Push Rod
07/06→		Centre Rod	MN-DL-8646		Push Rod, for Leaf-Spring Suspension vehicles
07/06→		Centre Rod	MN-DL-12285		for Steering Rod
07/06→		Suspension Arm Repair Kit		CV-RK-5313	for Wishbone (CV)
07/06→		Suspension Strut Repair Kit		DB-RK-8581	
07/06→		Tie Rod	MN-DL-12287		
07/06→		Tie Rod End	CV-ES-0914		for Steering Rod
07/06→		Tie Rod End	CV-ES-14162		for Steering Rod
07/06→		Tie Rod End	CV-ES-14163		for Steering Rod
07/06→		Tie Rod End	MN-ES-10333		for Steering Rod
07/06→		Tie Rod End	SC-ES-8517		for Push Rod
07/06→		Track Control Arm		MN-DL-5225	Trailing Arm

CV-ES-0914

Length: 125
Cone Ø: d1 Ø 30 / d2 Ø 27
Thread: M38 x 1,5 RHT
81953016184, 81953016251, 81953016276



CV-ES-14162

Length: 125
Cone Ø: d1 Ø 30 / d2 Ø 27
Thread: M30 x 1,5 LHT
81953010015, 81953010083, 81953010087, 81953016029, 81953016030, 81953016043, 81953016044, 81953016050, 81953016054, 81953016087, 81953016091, 81953016107, 81953016120, 81953016125, 81953016152, 81953016155, 81953016157, 81953016168, 81953016179, 81953016181, 81953016223, 81953016237, 81953016254, 81953016275, 81953016279, 81953016351



CV-ES-14163

Length: 125
Cone Ø: d1 Ø 30 / d2 Ø 27
Thread: M30 x 1,5 RHT
95301.0084, 90804102156, 90804102272, 90804102696, 90804102710, 81953010016, 81953010075, 81953010084, 81953010088, 81953010094, 81953010103, 81953016030, 81953016043, 81953016048, 81953016049, 81953016053, 81953016061, 81953016090, 81953016108, 81953016112, 81953016126, 81953016143, 81953016149, 81953016154, 81953016156, 81953016168, 81953016178, 81953016194, 81953016206, 81953016224, 81953016234, 81953016242, 81953016252, 81953016274, 81953016278, 81953016284, 81953016286, 81953016308, 81953016310, 81953016312, 81953016347, 81953016350, 81953016352, 82953016012, 88953016014, N2953016001



CV-RK-5313

Ø: 90
03304800A, 81953016132



DB-RK-8581

Ø: 85
Hole Distance: 130
Thick/Height: 24
03305800A, 81432706105



DB-RK-9300

Ø: 75
Hole Distance: 130
Thick/Height: 24
85432206002



MN-DL-5212

Length: 577 Ø: 48
Hole Distance: 130 / 130
81432206096, 81432206097, 81432206098, 81432206129, 81432209096, 81432209129, 81432306014, 81432306030



MN-DL-5225

Length: 572 Ø: 48
Hole Distance: 130 / 130
03301500A, 81432206229, 81432206236, 81432206267, 81432206270, 81432206272, 81432206304, 81432206305, 81432209236, 81432209267, 81432209272



MN-DL-7801

Length: 995 Ø: 52
Cone Ø: d1 Ø 30 / d2 Ø 27
81466106807, 81466106808, 81466116087, 81466116088, 81466116096, 81466116097, 81466116099, 81466116132, 81466116133, 81466116136, 81466116197, 81466116198, 81466116205



MN-DL-8544

Length: 596 Ø: 48
Hole Distance: 130 / 130
81432206196, 81432206232, 81432206233



MN-DL-8599

Length: 1800 Ø: 62
Cone Ø: d1 Ø 30 / d2 Ø 27
81466116161, 81466116162, 82466106183, 82466106186, 82466106187



MN-DL-8646

Length: 1021 Ø: 52
Cone Ø: d1 Ø 30 / d2 Ø 27
81466106811, 81466106812, 81466116138, 81466116139, 81466116201, 81466116202



MN-DL-8709

Length: 572 Ø: 52
Hole Distance: 130 / 130
81432206268, 81432206274, 81432206291, 81432206292, 82432206007



MN-DL-12284

Length: 1530 Ø: 50
Cone Ø: d1 Ø 30 / d2 Ø 27
81466106579, 81466106580, 81466106624, 81466116720, 81467116720, 81467116730, 81467116952



MN-DL-12285

Length: 993 Ø: 40
Cone Ø: d1 Ø 30 / d2 Ø 27
81466106816, 81466106826, 81466116151, 82466106184, 82466106185



MN-DL-12287

Length: 1531 Ø: 42
Cone Ø: d1 Ø 30 / d2 Ø 27
81467116855, 81467116856, 81467116857



MN-DL-12393

Length: 1796 Ø: 62
Cone Ø: d1 Ø 30 / d2 Ø 27
81466116154, 81466116155, 81466116156



MN-ES-10333

Length: 90
Cone Ø: d1 Ø 38 / d2 Ø 34,35
Thread: M36 x 1,5 RHT
1271126, 3090291, 3099128, 42538048, 81953016268, 82953016018, 82953016019



MN-RK-7291

Ø: 72
Hole Distance: 130
Thick/Height: 30
10307800A, 81432206108, 81432206132



MN-VB-5238

Length: 627 Ø: 48
Hole Distance: 130 / 130
81432206221, 81432706096, 81432706114, 81432706116, 81432706121



MN-VB-8514

Length: 627 Ø: 48
Hole Ø 25 / 25 / 25
Hole Distance: 152 / 130 / 130
81432706087, 81432706088, 81432706094, 81432706095, 81432796094



MN-VB-8669

Length: 627 Ø: 48
Hole Ø 25 / 25 / 25
Hole Distance: 152 / 130 / 130
81432706116, 81432706137, 81432706150, 81432706151



MN-VB-9403

Length: 627 Ø: 48
Hole Ø 25 / 23 / 23
Hole Distance: 152 / 130 / 130
81432706097, 81432706113, 81432706135, 81432706160, 81432706161



SC-ES-7279

Length: 150
Cone Ø: d1 Ø 30 / d2 Ø 27
Thread: M30 x 1,5 RHT
81953016288



SC-ES-8517

Length: 140
Cone Ø: d1 Ø 30 / d2 Ø 27
Thread: M30 x 1,5 RHT
81953016286



SC-ES-8535

Length: 145
Cone Ø: d1 Ø 30 / d2 Ø 27
Thread: M30 x 1,5 RHT
81953016271, 81953016325





TGA ...

35.480 FFDPAK ...	07/06→	Track Control Arm		MN-DL-8544	Trailing Arm, 1st RA;2nd RA;Leaf Spring Axle
	07/06→	Track Control Arm		MN-DL-8544	Trailing Arm, Drive Axle
	07/06→	Track Control Arm		MN-DL-8544	Trailing Arm, Drive Axle;Air Suspension Axle
	07/06→	Track Control Arm		MN-DL-8609	Trailing Arm, 1st RA;2nd RA, for Leaf-Spring Suspension vehicles, →Type_HB Chassis
	07/06→	Track control arm		MN-DL-10288	Trailing Arm, 1st RA;2nd RA, for Leaf-Spring Suspension vehicles, →Type HB
	07/06→	Track control arm		MN-DL-12288	Trailing Arm
	07/06→	Track Control Arm		MN-VB-8514	Suspension Rod, Wishbone (CV), Drive Axle
	07/06→	Track Control Arm		MN-VB-8514	Suspension Rod, Wishbone (CV), Drive Axle; Air Suspension Axle
	07/06→	Track Control Arm		MN-VB-8514	Suspension Rod, Wishbone (CV), Drive Axle; Leaf Spring Axle
	07/06→	Track Control Arm		MN-VB-9404	Wishbone (CV)
	07/06→	Track Control Arm		MN-VB-9404	Wishbone (CV), 1st RA;2nd RA, for Leaf-Spring Suspension vehicles, →Type_HB Chassis
35.480 FFDPAK, FFDHK, FFDHLK	07/06→	Centre Rod	MN-DL-7801		Push Rod
	07/06→	Centre Rod	MN-DL-8599		Push Rod
	07/06→	Centre Rod	MN-DL-8646		Push Rod, for Leaf-Spring Suspension vehicles
	07/06→	Centre Rod	MN-DL-12285		for Steering Rod
	07/06→	Centre Rod	MN-DL-12393		for Steering Rod
	07/06→	Suspension Strut Repair Kit		DB-RK-8581	
	07/06→	Tie Rod	MN-DL-7802		
	07/06→	Tie Rod End	CV-ES-0914		for Steering Rod
	07/06→	Tie Rod End	CV-ES-14162		for Steering Rod
	07/06→	Tie Rod End	CV-ES-14163		for Steering Rod
	07/06→	Tie Rod End	MN-ES-10333		for Steering Rod
	07/06→	Tie Rod End	SC-ES-7279		for Steering Rod
	07/06→	Tie Rod End	SC-ES-8517		for Push Rod
	07/06→	Tie Rod End	SC-ES-8535		for Guide Rod
	07/06→	Track Control Arm		MN-DL-5225	Trailing Arm
	07/06→	Track Control Arm		MN-DL-8544	Trailing Arm, 1st RA;2nd RA;Leaf Spring Axle
	07/06→	Track Control Arm		MN-DL-8544	Trailing Arm, Drive Axle
	07/06→	Track Control Arm		MN-DL-8544	Trailing Arm, Drive Axle, for Leaf-Spring Suspension vehicles
	07/06→	Track Control Arm		MN-DL-8609	Trailing Arm, 1st RA;2nd RA, for Leaf-Spring Suspension vehicles, →Type_HB Chassis
	07/06→	Track control arm		MN-DL-12288	Trailing Arm
	07/06→	Track Control Arm		MN-VB-8514	Suspension Rod, Wishbone (CV), Drive Axle
	07/06→	Track Control Arm		MN-VB-8514	Suspension Rod, Wishbone (CV), Drive Axle; Leaf Spring Axle
	07/06→	Track Control Arm		MN-VB-8669	Suspension Rod, Wishbone (CV), 1st RA; 2nd RA, for Leaf-Spring Suspension vehicles, →Type_MHB Chassis
07/06→	Track Control Arm		MN-VB-9404	Wishbone (CV)	
35.480 FFDARS	07/06→	Centre Rod	MN-DL-12285		for Steering Rod
	07/06→	Suspension Arm Repair Kit		CV-RK-5313	for Wishbone (CV)
	07/06→	Tie Rod	MN-DL-12287		
	07/06→	Tie Rod End	CV-ES-0914		for Steering Rod
	07/06→	Tie Rod End	CV-ES-14162		for Steering Rod
	07/06→	Tie Rod End	CV-ES-14163		for Steering Rod
	07/06→	Tie Rod End	MN-ES-10333		for Steering Rod
	07/06→	Tie Rod End	SC-ES-8517		for Push Rod
	07/06→	Track Control Arm		MN-DL-8544	Trailing Arm, 1st RA;2nd RA, for Leaf-Spring Suspension vehicles, →Type_HB Chassis
	07/06→	Track Control Arm		MN-DL-8609	Trailing Arm, 1st RA;2nd RA, for Leaf-Spring Suspension vehicles, →Type_HB Chassis
	07/06→	Track Control Arm		MN-VB-8514	Suspension Rod, Wishbone (CV)
	07/06→	Track Control Arm		MN-VB-9404	Wishbone (CV), 1st RA;2nd RA, for Leaf-Spring Suspension vehicles, →Type_HB Chassis

CV-ES-0914

Length: 125
Cone Ø: d1 Ø 30 / d2 Ø 27
Thread: M38 x 1,5 RHT
81953016184, 81953016251, 81953016276



CV-ES-14162

Length: 125
Cone Ø: d1 Ø 30 / d2 Ø 27
Thread: M30 x 1,5 LHT
81953010015, 81953010083, 81953010087, 81953016029, 81953016030, 81953016043, 81953016044, 81953016050, 81953016054, 81953016087, 81953016091, 81953016107, 81953016120, 81953016125, 81953016152, 81953016155, 81953016157, 81953016168, 81953016179, 81953016181, 81953016223, 81953016237, 81953016254, 81953016275, 81953016279, 81953016351



CV-ES-14163

Length: 125
Cone Ø: d1 Ø 30 / d2 Ø 27
Thread: M30 x 1,5 RHT
95301.0084, 90804102156, 90804102272, 90804102696, 90804102710, 81953010016, 81953010075, 81953010084, 81953010088, 81953010094, 81953010103, 81953016030, 81953016043, 81953016048, 81953016049, 81953016053, 81953016061, 81953016090, 81953016108, 81953016112, 81953016126, 81953016143, 81953016149, 81953016154, 81953016156, 81953016168, 81953016178, 81953016194, 81953016206, 81953016224, 81953016234, 81953016242, 81953016252, 81953016274, 81953016278, 81953016284, 81953016286, 81953016308, 81953016310, 81953016312, 81953016347, 81953016350, 81953016352, 82953016012, 88953016014, N2953016001



CV-RK-5313

Ø: 90
03304800A, 81953016132



DB-RK-8581

Ø: 85
Hole Distance: 130
Thick/Height: 24
03305800A, 81432706105



MN-DL-5225

Length: 572 Ø: 48
Hole Distance: 130 / 130
03301500A, 81432206229, 81432206236, 81432206267, 81432206270, 81432206272, 81432206304, 81432206305, 81432209226, 81432209267, 81432209272



MN-DL-7801

Length: 995 Ø: 52
Cone Ø: d1 Ø 30 / d2 Ø 27
81466106807, 81466106808, 81466116087, 81466116088, 81466116096, 81466116097, 81466116099, 81466116132, 81466116133, 81466116136, 81466116197, 81466116198, 81466116205

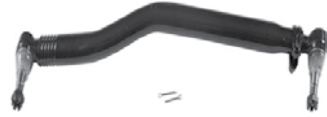

MN-DL-7802

Length: 1680 Ø: 52
Cone Ø: d1 Ø 30 / d2 Ø 27
03208300A, 81467116773, 81467116858, 81467116859, 81467116860, 81467116861, 81467116863, 81467116882, 81467116883, 81467116920, 81467116921



MN-DL-8544

Length: 596 Ø: 48
Hole Distance: 130 / 130
81432206196, 81432206232, 81432206233



MN-DL-8599

Length: 1800 Ø: 62
Cone Ø: d1 Ø 30 / d2 Ø 27
81466116161, 81466116162, 82466106183, 82466106186, 82466106187



MN-DL-8609

Length: 585 Ø: 58
Hole Distance: 130 / 130
81432206070, 81432206071, 81432206072, 81432206091, 81432206093, 81432206119



MN-DL-8646

Length: 1021 Ø: 52
Cone Ø: d1 Ø 30 / d2 Ø 27
81466106811, 81466106812, 81466116138, 81466116139, 81466116201, 81466116202

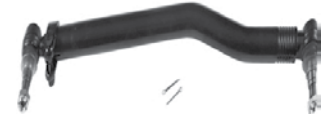

MN-DL-10288

81432206386, 82432206008, 82432209008

No Image

MN-DL-12285

Length: 993 Ø: 40
Cone Ø: d1 Ø 30 / d2 Ø 27
81466106816, 81466106826, 81466116151, 82466106184, 82466106185



MN-DL-12287

Length: 1531 Ø: 42
Cone Ø: d1 Ø 30 / d2 Ø 27
81467116855, 81467116856, 81467116857



MN-DL-12288

Length: 585 Ø: 58
Hole Distance: 130 / 130
81432206386, 82432206008, 82432209008

No Image

MN-DL-12393

Length: 1796 Ø: 62
Cone Ø: d1 Ø 30 / d2 Ø 27
81466116154, 81466116155, 81466116156



MN-ES-10333

Length: 90
Cone Ø: d1 Ø 38 / d2 Ø 34,35
Thread: M36 x 1,5 RHT
1271126, 3090291, 3099128, 42538048, 81953016268, 82953016018, 82953016019



MN-VB-8514

Length: 627 Ø: 48
Hole Ø 25 / 25 / 25
Hole Distance: 152 / 130 / 130
81432706087, 81432706088, 81432706094, 81432706095, 81432796094



MN-VB-8669

Length: 627 Ø: 48
Hole Ø 25 / 25 / 25
Hole Distance: 152 / 130 / 130
81432706116, 81432706137, 81432706150, 81432706151



MN-VB-9404

Length: 627 Ø: 58
Hole Distance: 130 / 130
81432706117, 81432706152, 81432706153



SC-ES-7279

Length: 150
Cone Ø: d1 Ø 30 / d2 Ø 27
Thread: M30 x 1,5 RHT
81953016288



SC-ES-8517

Length: 140
Cone Ø: d1 Ø 30 / d2 Ø 27
Thread: M30 x 1,5 RHT
81953016286



SC-ES-8535

Length: 145
Cone Ø: d1 Ø 30 / d2 Ø 27
Thread: M30 x 1,5 RHT
81953016271, 81953016325





TGA ...

35.480 FFDK, FFDLC	10/03→	Centre Rod	MN-DL-7801		Push Rod, Leaf Spring Axle	
	10/03→	Centre Rod	MN-DL-8599		Push Rod	
	10/03→	Centre Rod	MN-DL-12285		for Steering Rod	
	10/03→	Centre Rod	MN-DL-12393		for Steering Rod	
	10/03→	Suspension Strut Repair Kit		DB-RK-8581		
	10/03→	Tie Rod	MN-DL-7802			
	10/03→	Tie Rod	MN-DL-12284			
	10/03→	Tie Rod End	CV-ES-0914		for Steering Rod	
	10/03→	Tie Rod End	CV-ES-14162	CV-ES-14162	for Steering Rod	
	10/03→	Tie Rod End	CV-ES-14163		for Steering Rod	
	10/03→	Tie Rod End	MN-ES-10333		for Steering Rod	
	10/03→	Tie Rod End	SC-ES-7279		for Steering Rod	
	10/03→	Tie Rod End	SC-ES-8517		for Push Rod	
	10/03→	Tie Rod End	SC-ES-8535		for Guide Rod	
	10/03→	Track Control Arm		MN-DL-5225	Trailing Arm, Drive Axle;Air Suspension Axle	
	10/03→	Track Control Arm		MN-DL-8544	Trailing Arm, Drive Axle;Air Suspension Axle	
	10/03→	Track Control Arm		MN-DL-8544	Trailing Arm, Drive Axle;Leaf Spring Axle	
	10/03→	Track Control Arm		MN-DL-8709	Trailing Arm, Trailing Axle Steered/not Steered, for Pneumatic Suspension vehicles	
	10/03→	Track Control Arm		MN-VB-5238	Wishbone (CV), Drive Axle;Air Suspension Axle	
	10/03→	Track Control Arm		MN-VB-8514	Suspension Rod, Wishbone (CV), Drive Axle; Air Suspension Axle	
	10/03→	Track Control Arm		MN-VB-8514	Suspension Rod, Wishbone (CV), Drive Axle; Leaf Spring Axle	
	10/03→	Track Control Arm		MN-VB-8669	Suspension Rod, Wishbone (CV), Drive Axle; Leaf Spring Axle	
	10/03→	Track Control Arm		MN-VB-9403	Wishbone (CV), Trailing Axle Steered/not Steered, for Pneumatic Suspension vehicles	
	02/04→	Centre Rod	MN-DL-12289		Push Rod	
	08/04→	Track Control Arm		MN-VB-9404	Wishbone (CV), Drive Axle;Air Suspension Axle	
	35.480 FFDH-TM	07/06→	Centre Rod	MN-DL-7801		Push Rod
		07/06→	Centre Rod	MN-DL-12393		for Steering Rod
07/06→		Tie Rod	MN-DL-7802			
07/06→		Tie Rod End	CV-ES-0914		for Steering Rod	
07/06→		Tie Rod End	CV-ES-14162		for Steering Rod	
07/06→		Tie Rod End	CV-ES-14163		for Steering Rod	
07/06→		Tie Rod End	SC-ES-7279		for Steering Rod	
07/06→		Tie Rod End	SC-ES-8517		for Push Rod	
07/06→		Tie Rod End	SC-ES-8535		for Guide Rod	
07/06→		Track Control Arm		MN-DL-8544	Trailing Arm, Drive Axle, for Leaf-Spring Suspension vehicles	
07/06→	Track Control Arm		MN-VB-8514	Suspension Rod, Wishbone (CV), Drive Axle		
07/06→	Track Control Arm		MN-VB-8669	Suspension Rod, Wishbone (CV), 1st RA; 2nd RA, for Leaf-Spring Suspension vehicles, →Type_MHB Chassis		
35.480 FFDK, FFDLK	10/03→	Centre Rod	MN-DL-7801		Push Rod, Leaf Spring Axle	
	10/03→	Centre Rod	MN-DL-8599		Push Rod	
	10/03→	Centre Rod	MN-DL-12285		for Steering Rod	
	10/03→	Centre Rod	MN-DL-12393		for Steering Rod	
	10/03→	Suspension Strut Repair Kit		DB-RK-8581		
	10/03→	Tie Rod	MN-DL-7802			
	10/03→	Tie Rod End	CV-ES-0914		for Steering Rod	
	10/03→	Tie Rod End	CV-ES-14162		for Steering Rod	
	10/03→	Tie Rod End	CV-ES-14163		for Steering Rod	
	10/03→	Tie Rod End	MN-ES-10333		for Steering Rod	
	10/03→	Tie Rod End	SC-ES-7279		for Steering Rod	
	10/03→	Tie Rod End	SC-ES-8517		for Push Rod	
	10/03→	Tie Rod End	SC-ES-8535		for Guide Rod	
	10/03→	Track Control Arm		MN-DL-5225	Trailing Arm, Drive Axle;Air Suspension Axle	
	10/03→	Track Control Arm		MN-DL-8544	Trailing Arm, Drive Axle;Air Suspension Axle	
10/03→	Track Control Arm		MN-DL-8544	Trailing Arm, Drive Axle;Leaf Spring Axle		
10/03→	Track Control Arm		MN-VB-5238	Wishbone (CV), Drive Axle;Air Suspension Axle		

CV-ES-0914

Length: 125
Cone Ø: d1 Ø 30 / d2 Ø 27
Thread: M38 x 1,5 RHT
81953016184, 81953016251, 81953016276



CV-ES-14162

Length: 125
Cone Ø: d1 Ø 30 / d2 Ø 27
Thread: M30 x 1,5 LHT
81953010015, 81953010083, 81953010087, 81953016029, 81953016030, 81953016043, 81953016044, 81953016050, 81953016054, 81953016087, 81953016091, 81953016107, 81953016120, 81953016125, 81953016152, 81953016155, 81953016157, 81953016168, 81953016179, 81953016181, 81953016223, 81953016237, 81953016254, 81953016275, 81953016279, 81953016351



CV-ES-14163

Length: 125
Cone Ø: d1 Ø 30 / d2 Ø 27
Thread: M30 x 1,5 RHT
95301.0084, 90804102156, 90804102272, 90804102696, 90804102710, 81953010016, 81953010075, 81953010084, 81953010088, 81953010094, 81953010103, 81953016030, 81953016043, 81953016048, 81953016049, 81953016053, 81953016061, 81953016090, 81953016108, 81953016112, 81953016126, 81953016143, 81953016149, 81953016154, 81953016156, 81953016168, 81953016178, 81953016194, 81953016206, 81953016224, 81953016234, 81953016242, 81953016252, 81953016274, 81953016278, 81953016284, 81953016286, 81953016308, 81953016310, 81953016312, 81953016347, 81953016350, 81953016352, 82953016012, 88953016014, N2953016001



DB-RK-8581

Ø: 85
Hole Distance: 130
Thick/Height: 24
03305800A, 81432706105



MN-DL-5225

Length: 572 Ø: 48
Hole Distance: 130 / 130
03301500A, 81432206229, 81432206236, 81432206267, 81432206270, 81432206272, 81432206304, 81432206305, 81432209226, 81432209267, 81432209272



MN-DL-7801

Length: 995 Ø: 52
Cone Ø: d1 Ø 30 / d2 Ø 27
81466106807, 81466106808, 81466116087, 81466116088, 81466116096, 81466116097, 81466116099, 81466116132, 81466116133, 81466116136, 81466116197, 81466116198, 81466116205

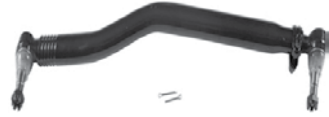

MN-DL-7802

Length: 1680 Ø: 52
Cone Ø: d1 Ø 30 / d2 Ø 27
03208300A, 81467116773, 81467116858, 81467116859, 81467116860, 81467116861, 81467116863, 81467116882, 81467116883, 81467116920, 81467116921



MN-DL-8544

Length: 596 Ø: 48
Hole Distance: 130 / 130
81432206196, 81432206232, 81432206233



MN-DL-8599

Length: 1800 Ø: 62
Cone Ø: d1 Ø 30 / d2 Ø 27
81466116161, 81466116162, 82466106183, 82466106186, 82466106187



MN-DL-8709

Length: 572 Ø: 52
Hole Distance: 130 / 130
81432206268, 81432206274, 81432206291, 81432206292, 82432206007



MN-DL-12284

Length: 1530 Ø: 50
Cone Ø: d1 Ø 30 / d2 Ø 27
81466106579, 81466106580, 81466106624, 81466116720, 81467116720, 81467116730, 81467116952



MN-DL-12285

Length: 993 Ø: 40
Cone Ø: d1 Ø 30 / d2 Ø 27
81466106816, 81466106826, 81466116151, 82466106184, 82466106185



MN-DL-12289

Length: 1796 Ø: 62
Cone Ø: d1 Ø 30 / d2 Ø 27
81466116174, 81466116175, 81466116176, 81466116244

No Image

MN-DL-12393

Length: 1796 Ø: 62
Cone Ø: d1 Ø 30 / d2 Ø 27
81466116154, 81466116155, 81466116156



MN-ES-10333

Length: 90
Cone Ø: d1 Ø 38 / d2 Ø 34,35
Thread: M36 x 1,5 RHT
1271126, 3090291, 3099128, 42538048, 81953016268, 82953016018, 82953016019



MN-VB-5238

Length: 627 Ø: 48
Hole Distance: 130 / 130
81432206221, 81432706096, 81432706114, 81432706116, 81432706121



MN-VB-8514

Length: 627 Ø: 48
Hole Ø 25 / 25 / 25
Hole Distance: 152 / 130 / 130
81432706087, 81432706088, 81432706094, 81432706095, 81432796094



MN-VB-8669

Length: 627 Ø: 48
Hole Ø 25 / 25 / 25
Hole Distance: 152 / 130 / 130
81432706116, 81432706137, 81432706150, 81432706151



MN-VB-9403

Length: 627 Ø: 48
Hole Ø 25 / 23 / 23
Hole Distance: 152 / 130 / 130
81432706097, 81432706113, 81432706135, 81432706160, 81432706161



MN-VB-9404

Length: 627 Ø: 58
Hole Distance: 130 / 130
81432706117, 81432706152, 81432706153



SC-ES-7279

Length: 150
Cone Ø: d1 Ø 30 / d2 Ø 27
Thread: M30 x 1,5 RHT
81953016288



SC-ES-8517

Length: 140
Cone Ø: d1 Ø 30 / d2 Ø 27
Thread: M30 x 1,5 RHT
81953016286



SC-ES-8535

Length: 145
Cone Ø: d1 Ø 30 / d2 Ø 27
Thread: M30 x 1,5 RHT
81953016271, 81953016325





TGA ...

35.480 FFDK, FFDLK ...	10/03→	Track Control Arm		MN-VB-8514	Suspension Rod, Wishbone (CV), Drive Axle; Air Suspension Axle	
	10/03→	Track Control Arm		MN-VB-8514	Suspension Rod, Wishbone (CV), Drive Axle; Leaf Spring Axle	
	10/03→	Track Control Arm		MN-VB-8669	Suspension Rod, Wishbone (CV), Drive Axle; Leaf Spring Axle	
	02/04→	Centre Rod	MN-DL-12289		Push Rod	
	08/04→	Track Control Arm		MN-VB-9404	Wishbone (CV), Drive Axle; Air Suspension Axle	
35.480 FFD-TM	11/03→	Centre Rod	MN-DL-12285		for Steering Rod	
	11/03→	Centre Rod	MN-DL-12393		for Steering Rod	
	11/03→	Tie Rod End	CV-ES-0914		for Steering Rod	
	11/03→	Tie Rod End	CV-ES-14162		for Steering Rod	
	11/03→	Tie Rod End	CV-ES-14163		for Steering Rod	
	11/03→	Tie Rod End	SC-ES-7279		for Steering Rod	
	11/03→	Tie Rod End	SC-ES-8517		for Push Rod	
	11/03→	Tie Rod End	SC-ES-8535		for Guide Rod	
	11/03→	Track Control Arm		MN-DL-8544	Trailing Arm, 1st RA; 2nd RA, for Leaf-Spring Suspension vehicles	
	11/03→	Track Control Arm		MN-VB-8514	Suspension Rod, Wishbone (CV)	
	11/03→	Track Control Arm		MN-VB-8669	Suspension Rod, Wishbone (CV), 1st RA; 2nd RA, for Leaf-Spring Suspension vehicles, →Type_MHB Chassis	
	02/04→	Centre Rod	MN-DL-7801		Push Rod, Leaf Spring Axle	
	02/04→	Centre Rod	MN-DL-8599		Push Rod	
	02/04→	Centre Rod	MN-DL-12289		Push Rod	
	02/04→	Suspension Strut Repair Kit		DB-RK-8581		
	02/04→	Tie Rod	MN-DL-7802			
	02/04→	Tie Rod End	MN-ES-10333		for Steering Rod	
	02/04→	Track Control Arm		MN-DL-5225	Trailing Arm	
	02/04→	Track Control Arm		MN-DL-8544	Trailing Arm, Drive Axle; Leaf Spring Axle	
	02/04→	Track Control Arm		MN-VB-8514	Suspension Rod, Wishbone (CV), Drive Axle; Leaf Spring Axle	
	02/04→	Track Control Arm		MN-VB-8669	Suspension Rod, Wishbone (CV), Drive Axle; Leaf Spring Axle	
	35.480 FFNHLC	11/06→	Centre Rod	MN-DL-12393		for Steering Rod
		11/06→	Suspension Arm Repair Kit		CV-RK-5313	for Wishbone (CV)
11/06→		Suspension Arm Repair Kit	DB-RK-9300	DB-RK-9300	for Drag Link	
11/06→		Tie Rod	MN-DL-12284			
11/06→		Tie Rod End	CV-ES-0914		for Steering Rod	
11/06→		Tie Rod End	CV-ES-14162	CV-ES-14162	for Steering Rod	
11/06→		Tie Rod End	CV-ES-14163		for Steering Rod	
11/06→		Tie Rod End	SC-ES-7279		for Steering Rod	
11/06→		Tie Rod End	SC-ES-8517		for Push Rod	
11/06→		Tie Rod End	SC-ES-8535		for Guide Rod	
11/06→		Track Control Arm		MN-DL-5225	for Control Arm	
11/06→		Track Control Arm		MN-DL-5225	Trailing Arm	
11/06→		Track Control Arm		MN-DL-8709	Trailing Arm	
11/06→		Track Control Arm		MN-DL-8709	Trailing Arm, Trailing Axle Steered/not Steered, for Pneumatic Suspension vehicles	
11/06→		Track Control Arm		MN-VB-5238	Wishbone (CV), 1st RA; 2nd RA, for Pneumatic Suspension vehicles	
11/06→		Track Control Arm		MN-VB-5238	Wishbone (CV), Drive Axle	
11/06→		Track Control Arm		MN-VB-9403	Wishbone (CV)	
11/06→	Track Control Arm		MN-VB-9403	Wishbone (CV), Trailing Axle Steered/not Steered, for Pneumatic Suspension vehicles		
35.480 FFNLC	07/06→	Suspension Arm Repair Kit		CV-RK-5313	for Wishbone (CV)	
	07/06→	Suspension Arm Repair Kit		MN-RK-7291	for Drag Link	
	07/06→	Suspension Arm Repair Kit	DB-RK-9300	DB-RK-9300	for Drag Link	
	07/06→	Tie Rod	MN-DL-12284			
	07/06→	Tie Rod End	CV-ES-0914		for Steering Rod	
	07/06→	Tie Rod End	CV-ES-14162	CV-ES-14162	for Steering Rod	
	07/06→	Tie Rod End	CV-ES-14163		for Steering Rod	
07/06→	Tie Rod End	SC-ES-7279		for Steering Rod		

CV-ES-0914

Length: 125
Cone Ø: d1 Ø 30 / d2 Ø 27
Thread: M38 x 1,5 RHT
81953016184, 81953016251, 81953016276



CV-ES-14162

Length: 125
Cone Ø: d1 Ø 30 / d2 Ø 27
Thread: M30 x 1,5 LHT
81953010015, 81953010083, 81953010087, 81953016029, 81953016030, 81953016043, 81953016044, 81953016050, 81953016054, 81953016087, 81953016091, 81953016107, 81953016120, 81953016125, 81953016152, 81953016155, 81953016157, 81953016168, 81953016179, 81953016181, 81953016223, 81953016237, 81953016254, 81953016275, 81953016279, 81953016351



CV-ES-14163

Length: 125
Cone Ø: d1 Ø 30 / d2 Ø 27
Thread: M30 x 1,5 RHT
95301.0084, 90804102156, 90804102272, 90804102696, 90804102710, 81953010016, 81953010075, 81953010084, 81953010088, 81953010094, 81953010103, 81953016030, 81953016043, 81953016048, 81953016049, 81953016053, 81953016061, 81953016090, 81953016108, 81953016112, 81953016126, 81953016143, 81953016149, 81953016154, 81953016156, 81953016168, 81953016178, 81953016194, 81953016206, 81953016224, 81953016234, 81953016242, 81953016252, 81953016274, 81953016278, 81953016284, 81953016286, 81953016308, 81953016310, 81953016312, 81953016347, 81953016350, 81953016352, 82953016012, 88953016014, N2953016001



CV-RK-5313

Ø: 90
03304800A, 81953016132



DB-RK-8581

Ø: 85
Hole Distance: 130
Thick/Height: 24
03305800A, 81432706105



DB-RK-9300

Ø: 75
Hole Distance: 130
Thick/Height: 24
85432206002



MN-DL-5225

Length: 572 Ø: 48
Hole Distance: 130 / 130
03301500A, 81432206229, 81432206236, 81432206267, 81432206270, 81432206272, 81432206304, 81432206305, 81432209236, 81432209267, 81432209272



MN-DL-7801

Length: 995 Ø: 52
Cone Ø: d1 Ø 30 / d2 Ø 27
81466106807, 81466106808, 81466116087, 81466116088, 81466116096, 81466116097, 81466116099, 81466116132, 81466116133, 81466116136, 81466116197, 81466116198, 81466116205

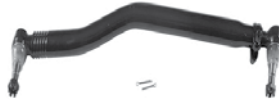

MN-DL-7802

Length: 1680 Ø: 52
Cone Ø: d1 Ø 30 / d2 Ø 27
03208300A, 81467116773, 81467116858, 81467116859, 81467116860, 81467116861, 81467116863, 81467116882, 81467116883, 81467116920, 81467116921



MN-DL-8544

Length: 596 Ø: 48
Hole Distance: 130 / 130
81432206196, 81432206232, 81432206233



MN-DL-8599

Length: 1800 Ø: 62
Cone Ø: d1 Ø 30 / d2 Ø 27
81466116161, 81466116162, 82466106183, 82466106186, 82466106187



MN-DL-8709

Length: 572 Ø: 52
Hole Distance: 130 / 130
81432206268, 81432206274, 81432206291, 81432206292, 82432206007



MN-DL-12284

Length: 1530 Ø: 50
Cone Ø: d1 Ø 30 / d2 Ø 27
81466106579, 81466106580, 81466106624, 81466116720, 81467116720, 81467116730, 81467116952



MN-DL-12285

Length: 993 Ø: 40
Cone Ø: d1 Ø 30 / d2 Ø 27
81466106816, 81466106826, 81466116151, 82466106184, 82466106185



MN-DL-12289

Length: 1796 Ø: 62
Cone Ø: d1 Ø 30 / d2 Ø 27
81466116174, 81466116175, 81466116176, 81466116244

No Image

MN-DL-12393

Length: 1796 Ø: 62
Cone Ø: d1 Ø 30 / d2 Ø 27
81466116154, 81466116155, 81466116156



MN-ES-10333

Length: 90
Cone Ø: d1 Ø 38 / d2 Ø 34,35
Thread: M36 x 1,5 RHT
1271126, 3090291, 3099128, 42538048, 81953016268, 82953016018, 82953016019



MN-RK-7291

Ø: 72
Hole Distance: 130
Thick/Height: 30
10307800A, 81432206108, 81432206132



MN-VB-5238

Length: 627 Ø: 48
Hole Distance: 130 / 130
81432206221, 81432706096, 81432706114, 81432706116, 81432706121



MN-VB-8514

Length: 627 Ø: 48
Hole Ø 25 / 25 / 25
Hole Distance: 152 / 130 / 130
81432706087, 81432706088, 81432706094, 81432706095, 81432796094



MN-VB-8669

Length: 627 Ø: 48
Hole Ø 25 / 25 / 25
Hole Distance: 152 / 130 / 130
81432706116, 81432706137, 81432706150, 81432706151



MN-VB-9403

Length: 627 Ø: 48
Hole Ø 25 / 23 / 23
Hole Distance: 152 / 130 / 130
81432706097, 81432706113, 81432706135, 81432706160, 81432706161



MN-VB-9404

Length: 627 Ø: 58
Hole Distance: 130 / 130
81432706117, 81432706152, 81432706153



SC-ES-7279

Length: 150
Cone Ø: d1 Ø 30 / d2 Ø 27
Thread: M30 x 1,5 RHT
81953016288



SC-ES-8517

Length: 140
Cone Ø: d1 Ø 30 / d2 Ø 27
Thread: M30 x 1,5 RHT
81953016286



SC-ES-8535

Length: 145
Cone Ø: d1 Ø 30 / d2 Ø 27
Thread: M30 x 1,5 RHT
81953016271, 81953016325



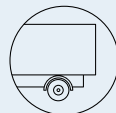

TGA ...

35.480 FFNLC ...	07/06→	Tie Rod End	SC-ES-8517		for Push Rod
	07/06→	Tie Rod End	SC-ES-8535		for Guide Rod
	07/06→	Track Control Arm		MN-DL-5212	Trailing Arm, Trailing Axle not Steered, for Pneumatic Suspension vehicles
	07/06→	Track Control Arm		MN-DL-5225	Trailing Arm
	07/06→	Track Control Arm		MN-DL-8709	Trailing Arm, Trailing Axle Steered/not Steered, for Pneumatic Suspension vehicles
	07/06→	Track Control Arm		MN-VB-5238	Wishbone (CV), 1st Drive Axle, for Pneumatic Suspension vehicles
	07/06→	Track Control Arm		MN-VB-9403	Wishbone (CV), Trailing Axle Steered/not Steered, for Pneumatic Suspension vehicles
35.530 FDNLC	04/04→	Centre Rod	MN-DL-12393		for Steering Rod
	04/04→	Suspension Arm Repair Kit		CV-RK-5313	for Wishbone (CV)
	04/04→	Suspension Arm Repair Kit	DB-RK-9300	DB-RK-9300	for Drag Link
	04/04→	Tie Rod	MN-DL-12284		
	04/04→	Tie Rod End	CV-ES-0914		for Steering Rod
	04/04→	Tie Rod End	CV-ES-14162	CV-ES-14162	for Steering Rod
	04/04→	Tie Rod End	CV-ES-14163		for Steering Rod
	04/04→	Tie Rod End	SC-ES-7279		for Steering Rod
	04/04→	Tie Rod End	SC-ES-8517		for Push Rod
	04/04→	Tie Rod End	SC-ES-8535		for Guide Rod
	04/04→	Track Control Arm		MN-DL-5225	Trailing Arm
	04/04→	Track Control Arm		MN-DL-8709	Trailing Arm, Trailing Axle Steered/not Steered, for Pneumatic Suspension vehicles
	04/04→	Track Control Arm		MN-VB-8669	Suspension Rod, Wishbone (CV), 1st RA; 2nd RA, for Leaf-Spring Suspension vehicles, →Type_MHB Chassis
	04/04→	Track Control Arm		MN-VB-9403	Wishbone (CV), Trailing Axle Steered/not Steered, for Pneumatic Suspension vehicles
35.530 FFDAK	07/06→	Centre Rod	MN-DL-7801		Push Rod
	07/06→	Centre Rod	MN-DL-8599		Push Rod
	07/06→	Centre Rod	MN-DL-12285		for Steering Rod
	07/06→	Suspension Strut Repair Kit		DB-RK-8581	
	07/06→	Tie Rod	MN-DL-12287		
	07/06→	Tie Rod End	CV-ES-0914		for Steering Rod
	07/06→	Tie Rod End	CV-ES-14162		for Steering Rod
	07/06→	Tie Rod End	CV-ES-14163		for Steering Rod
	07/06→	Tie Rod End	MN-ES-10333		for Steering Rod
	07/06→	Tie Rod End	SC-ES-8517		for Push Rod
	07/06→	Track Control Arm		MN-DL-5225	Trailing Arm
	07/06→	Track Control Arm		MN-DL-8544	Trailing Arm, 1st RA;2nd RA;Leaf Spring Axle
	07/06→	Track Control Arm		MN-DL-8544	Trailing Arm, Drive Axle;Air Suspension Axle
	07/06→	Track Control Arm		MN-DL-8609	Trailing Arm, 1st RA;2nd RA, for Leaf-Spring Suspension vehicles, →Type_HB Chassis
	07/06→	Track Control Arm		MN-VB-8514	Suspension Rod, Wishbone (CV), Drive Axle; Air Suspension Axle
	07/06→	Track Control Arm		MN-VB-8514	Suspension Rod, Wishbone (CV), Drive Axle; Leaf Spring Axle
	07/06→	Track Control Arm		MN-VB-9404	Wishbone (CV)
35.530 FFDC, FFDLC	04/04→	Centre Rod	MN-DL-7801		Push Rod, Leaf Spring Axle
	04/04→	Centre Rod	MN-DL-8599		Push Rod
	04/04→	Centre Rod	MN-DL-12285		for Steering Rod
	04/04→	Centre Rod	MN-DL-12393		for Steering Rod
	04/04→	Suspension Strut Repair Kit		DB-RK-8581	
	04/04→	Tie Rod	MN-DL-7802		
	04/04→	Tie Rod	MN-DL-12284		
	04/04→	Tie Rod End	CV-ES-0914		for Steering Rod
	04/04→	Tie Rod End	CV-ES-14162	CV-ES-14162	for Steering Rod
	04/04→	Tie Rod End	CV-ES-14163		for Steering Rod
	04/04→	Tie Rod End	MN-ES-10333		for Steering Rod
	04/04→	Tie Rod End	SC-ES-7279		for Steering Rod
	04/04→	Tie Rod End	SC-ES-8517		for Push Rod
	04/04→	Tie Rod End	SC-ES-8535		for Guide Rod

CV-ES-0914

Length: 125
Cone Ø: d1 Ø 30 / d2 Ø 27
Thread: M38 x 1,5 RHT
81953016184, 81953016251, 81953016276



CV-ES-14162

Length: 125
Cone Ø: d1 Ø 30 / d2 Ø 27
Thread: M30 x 1,5 LHT
81953010015, 81953010083, 81953010087,
81953016029, 81953016030, 81953016043,
81953016044, 81953016050, 81953016054,
81953016087, 81953016091, 81953016107,
81953016120, 81953016125, 81953016152,
81953016155, 81953016157, 81953016168,
81953016179, 81953016181, 81953016223,
81953016237, 81953016254, 81953016275,
81953016279, 81953016351



CV-ES-14163

Length: 125
Cone Ø: d1 Ø 30 / d2 Ø 27
Thread: M30 x 1,5 RHT
95301.0084, 90804102156, 90804102272,
90804102696, 90804102710, 81953010016,
81953010075, 81953010084, 81953010088,
81953010094, 81953010103, 81953016030,
81953016043, 81953016048, 81953016049,
81953016053, 81953016061, 81953016090,
81953016108, 81953016112, 81953016126,
81953016143, 81953016149, 81953016154,
81953016156, 81953016168, 81953016178,
81953016194, 81953016206, 81953016224,
81953016234, 81953016242, 81953016252,
81953016274, 81953016278, 81953016284,
81953016286, 81953016308, 81953016310,
81953016312, 81953016347, 81953016350,
81953016352, 82953016012, 88953016014,
N2953016001



CV-RK-5313

Ø: 90
03304800A, 81953016132



DB-RK-8581

Ø: 85
Hole Distance: 130
Thick/Height: 24
03305800A, 81432706105



DB-RK-9300

Ø: 75
Hole Distance: 130
Thick/Height: 24
85432206002



MN-DL-5212

Length: 577 Ø: 48
Hole Distance: 130 / 130
81432206096, 81432206097, 81432206098,
81432206129, 81432209096, 81432209129,
81432306014, 81432306030



MN-DL-5225

Length: 572 Ø: 48
Hole Distance: 130 / 130
03301500A, 81432206229, 81432206236,
81432206267, 81432206270, 81432206272,
81432206304, 81432206305, 81432209236,
81432209267, 81432209272



MN-DL-7801

Length: 995 Ø: 52
Cone Ø: d1 Ø 30 / d2 Ø 27
81466106807, 81466106808, 81466116087,
81466116088, 81466116096, 81466116097,
81466116099, 81466116132, 81466116133,
81466116136, 81466116197, 81466116198,
81466116205



MN-DL-7802

Length: 1680 Ø: 52
Cone Ø: d1 Ø 30 / d2 Ø 27
03208300A, 81467116773, 81467116858,
81467116859, 81467116860, 81467116861,
81467116863, 81467116882, 81467116883,
81467116920, 81467116921



MN-DL-8544

Length: 596 Ø: 48
Hole Distance: 130 / 130
81432206196, 81432206232, 81432206233



MN-DL-8599

Length: 1800 Ø: 62
Cone Ø: d1 Ø 30 / d2 Ø 27
81466116161, 81466116162, 82466106183,
82466106186, 82466106187



MN-DL-8609

Length: 585 Ø: 58
Hole Distance: 130 / 130
81432206070, 81432206071, 81432206072,
81432206091, 81432206093, 81432206119



MN-DL-8709

Length: 572 Ø: 52
Hole Distance: 130 / 130
81432206268, 81432206274, 81432206291,
81432206292, 82432206007



MN-DL-12284

Length: 1530 Ø: 50
Cone Ø: d1 Ø 30 / d2 Ø 27
81466106579, 81466106580, 81466106624,
81466116720, 81467116720, 81467116730,
81467116952



MN-DL-12285

Length: 993 Ø: 40
Cone Ø: d1 Ø 30 / d2 Ø 27
81466106816, 81466106826, 81466116151,
82466106184, 82466106185



MN-DL-12287

Length: 1531 Ø: 42
Cone Ø: d1 Ø 30 / d2 Ø 27
81467116855, 81467116856, 81467116857



MN-DL-12393

Length: 1796 Ø: 62
Cone Ø: d1 Ø 30 / d2 Ø 27
81466116154, 81466116155, 81466116156



MN-ES-10333

Length: 90
Cone Ø: d1 Ø 38 / d2 Ø 34,35
Thread: M36 x 1,5 RHT
1271126, 3090291, 3099128, 42538048,
81953016268, 82953016018, 82953016019



MN-VB-5238

Length: 627 Ø: 48
Hole Distance: 130 / 130
81432206221, 81432706096, 81432706114,
81432706116, 81432706121



MN-VB-8514

Length: 627 Ø: 48
Hole Ø 25 / 25 / 25
Hole Distance: 152 / 130 / 130
81432706087, 81432706088, 81432706094,
81432706095, 81432796094



MN-VB-8669

Length: 627 Ø: 48
Hole Ø 25 / 25 / 25
Hole Distance: 152 / 130 / 130
81432706116, 81432706137, 81432706150,
81432706151



MN-VB-9403

Length: 627 Ø: 48
Hole Ø 25 / 23 / 23
Hole Distance: 152 / 130 / 130
81432706097, 81432706113, 81432706135,
81432706160, 81432706161



MN-VB-9404

Length: 627 Ø: 58
Hole Distance: 130 / 130
81432706117, 81432706152, 81432706153



SC-ES-7279

Length: 150
Cone Ø: d1 Ø 30 / d2 Ø 27
Thread: M30 x 1,5 RHT
81953016288



SC-ES-8517

Length: 140
Cone Ø: d1 Ø 30 / d2 Ø 27
Thread: M30 x 1,5 RHT
81953016286



SC-ES-8535

Length: 145
Cone Ø: d1 Ø 30 / d2 Ø 27
Thread: M30 x 1,5 RHT
81953016271, 81953016325





TGA ...

35.530 FFDK, FFDLC ...	04/04 →	Track Control Arm		MN-DL-5225	Trailing Arm, Drive Axle; Air Suspension Axle
	04/04 →	Track Control Arm		MN-DL-8544	Trailing Arm, Drive Axle; Air Suspension Axle
	04/04 →	Track Control Arm		MN-DL-8544	Trailing Arm, Drive Axle; Leaf Spring Axle
	04/04 →	Track Control Arm		MN-DL-8709	Trailing Arm, Trailing Axle Steered/not Steered, for Pneumatic Suspension vehicles
	04/04 →	Track Control Arm		MN-VB-5238	Wishbone (CV), Drive Axle; Air Suspension Axle
	04/04 →	Track Control Arm		MN-VB-8514	Suspension Rod, Wishbone (CV), Drive Axle; Air Suspension Axle
	04/04 →	Track Control Arm		MN-VB-8514	Suspension Rod, Wishbone (CV), Drive Axle; Leaf Spring Axle
	04/04 →	Track Control Arm		MN-VB-8669	Suspension Rod, Wishbone (CV), Drive Axle; Leaf Spring Axle
	04/04 →	Track Control Arm		MN-VB-9403	Wishbone (CV), Trailing Axle Steered/not Steered, for Pneumatic Suspension vehicles
	08/04 →	Track Control Arm		MN-VB-9404	Wishbone (CV), Drive Axle; Air Suspension Axle
35.530 FFDK, FFDLK	04/04 →	Centre Rod	MN-DL-7801		Push Rod, Leaf Spring Axle
	04/04 →	Centre Rod	MN-DL-8599		Push Rod
	04/04 →	Centre Rod	MN-DL-12285		for Steering Rod
	04/04 →	Centre Rod	MN-DL-12393		for Steering Rod
	04/04 →	Suspension Strut Repair Kit		DB-RK-8581	
	04/04 →	Tie Rod	MN-DL-7802		
	04/04 →	Tie Rod End	CV-ES-0914		for Steering Rod
	04/04 →	Tie Rod End	CV-ES-14162		for Steering Rod
	04/04 →	Tie Rod End	CV-ES-14163		for Steering Rod
	04/04 →	Tie Rod End	MN-ES-10333		for Steering Rod
	04/04 →	Tie Rod End	SC-ES-7279		for Steering Rod
	04/04 →	Tie Rod End	SC-ES-8517		for Push Rod
	04/04 →	Tie Rod End	SC-ES-8535		for Guide Rod
	04/04 →	Track Control Arm		MN-DL-5225	Trailing Arm, Drive Axle; Air Suspension Axle
	04/04 →	Track Control Arm		MN-DL-8544	Trailing Arm, Drive Axle; Air Suspension Axle
	04/04 →	Track Control Arm		MN-DL-8544	Trailing Arm, Drive Axle; Leaf Spring Axle
	04/04 →	Track Control Arm		MN-VB-5238	Wishbone (CV), Drive Axle; Air Suspension Axle
	04/04 →	Track Control Arm		MN-VB-8514	Suspension Rod, Wishbone (CV), Drive Axle; Air Suspension Axle
	04/04 →	Track Control Arm		MN-VB-8514	Suspension Rod, Wishbone (CV), Drive Axle; Leaf Spring Axle
	04/04 →	Track Control Arm		MN-VB-8669	Suspension Rod, Wishbone (CV), Drive Axle; Leaf Spring Axle
08/04 →	Track Control Arm		MN-VB-9404	Wishbone (CV), Drive Axle; Air Suspension Axle	
35.530 FFD-TM	04/04 →	Tie Rod End	CV-ES-0914		for Steering Rod
	04/04 →	Tie Rod End	CV-ES-14162		for Steering Rod
	04/04 →	Tie Rod End	CV-ES-14163		for Steering Rod
	04/04 →	Tie Rod End	SC-ES-7279		for Steering Rod
	04/04 →	Tie Rod End	SC-ES-8517		for Push Rod
	04/04 →	Tie Rod End	SC-ES-8535		for Guide Rod
	04/04 →	Track Control Arm		MN-DL-8544	Trailing Arm, 1st RA; 2nd RA, for Leaf-Spring Suspension vehicles
	04/04 →	Track Control Arm		MN-VB-8514	Suspension Rod, Wishbone (CV)
04/04 →	Track Control Arm		MN-VB-8669	Suspension Rod, Wishbone (CV), 1st RA; 2nd RA, for Leaf-Spring Suspension vehicles, →Type_MHB Chassis	
35.530 FFNLC	07/06 →	Centre Rod	MN-DL-12393		for Steering Rod
	07/06 →	Suspension Arm Repair Kit		CV-RK-5313	for Wishbone (CV)
	07/06 →	Suspension Arm Repair Kit		MN-RK-7291	for Drag Link
	07/06 →	Suspension Arm Repair Kit	DB-RK-9300	DB-RK-9300	for Drag Link
	07/06 →	Tie Rod	MN-DL-12284		
	07/06 →	Tie Rod End	CV-ES-0914		for Steering Rod
	07/06 →	Tie Rod End	CV-ES-14162	CV-ES-14162	for Steering Rod
	07/06 →	Tie Rod End	CV-ES-14163		for Steering Rod
	07/06 →	Tie Rod End	SC-ES-7279		for Steering Rod
	07/06 →	Tie Rod End	SC-ES-8517		for Push Rod
	07/06 →	Tie Rod End	SC-ES-8535		for Guide Rod

CV-ES-0914

Length: 125
Cone Ø: d1 Ø 30 / d2 Ø 27
Thread: M38 x 1,5 RHT
81953016184, 81953016251, 81953016276



CV-ES-14162

Length: 125
Cone Ø: d1 Ø 30 / d2 Ø 27
Thread: M30 x 1,5 LHT
81953010015, 81953010083, 81953010087, 81953016029, 81953016030, 81953016043, 81953016044, 81953016050, 81953016054, 81953016087, 81953016091, 81953016107, 81953016120, 81953016125, 81953016152, 81953016155, 81953016157, 81953016168, 81953016179, 81953016181, 81953016223, 81953016237, 81953016254, 81953016275, 81953016279, 81953016351



CV-ES-14163

Length: 125
Cone Ø: d1 Ø 30 / d2 Ø 27
Thread: M30 x 1,5 RHT
95301.0084, 90804102156, 90804102272, 90804102696, 90804102710, 81953010016, 81953010075, 81953010084, 81953010088, 81953010094, 81953010103, 81953016030, 81953016043, 81953016048, 81953016049, 81953016053, 81953016061, 81953016090, 81953016108, 81953016112, 81953016126, 81953016143, 81953016149, 81953016154, 81953016156, 81953016168, 81953016178, 81953016194, 81953016206, 81953016224, 81953016234, 81953016242, 81953016252, 81953016274, 81953016278, 81953016284, 81953016286, 81953016308, 81953016310, 81953016312, 81953016347, 81953016350, 81953016352, 82953016012, 88953016014, N2953016001



CV-RK-5313

Ø: 90
03304800A, 81953016132



DB-RK-8581

Ø: 85
Hole Distance: 130
Thick/Height: 24
03305800A, 81432706105



DB-RK-9300

Ø: 75
Hole Distance: 130
Thick/Height: 24
85432206002



MN-DL-5225

Length: 572 Ø: 48
Hole Distance: 130 / 130
03301500A, 81432206229, 81432206236, 81432206267, 81432206270, 81432206272, 81432206304, 81432206305, 81432209236, 81432209267, 81432209272



MN-DL-7801

Length: 995 Ø: 52
Cone Ø: d1 Ø 30 / d2 Ø 27
81466106807, 81466106808, 81466116087, 81466116088, 81466116096, 81466116097, 81466116099, 81466116132, 81466116133, 81466116136, 81466116197, 81466116198, 81466116205



MN-DL-7802

Length: 1680 Ø: 52
Cone Ø: d1 Ø 30 / d2 Ø 27
03208300A, 81467116773, 81467116858, 81467116859, 81467116860, 81467116861, 81467116863, 81467116882, 81467116883, 81467116920, 81467116921



MN-DL-8544

Length: 596 Ø: 48
Hole Distance: 130 / 130
81432206196, 81432206232, 81432206233



MN-DL-8599

Length: 1800 Ø: 62
Cone Ø: d1 Ø 30 / d2 Ø 27
81466116161, 81466116162, 82466106183, 82466106186, 82466106187



MN-DL-8709

Length: 572 Ø: 52
Hole Distance: 130 / 130
81432206268, 81432206274, 81432206291, 81432206292, 82432206007



MN-DL-12284

Length: 1530 Ø: 50
Cone Ø: d1 Ø 30 / d2 Ø 27
81466106579, 81466106580, 81466106624, 81466116720, 81467116720, 81467116730, 81467116952



MN-DL-12285

Length: 993 Ø: 40
Cone Ø: d1 Ø 30 / d2 Ø 27
81466106816, 81466106826, 81466116151, 82466106184, 82466106185



MN-DL-12393

Length: 1796 Ø: 62
Cone Ø: d1 Ø 30 / d2 Ø 27
81466116154, 81466116155, 81466116156



MN-ES-10333

Length: 90
Cone Ø: d1 Ø 38 / d2 Ø 34,35
Thread: M36 x 1,5 RHT
1271126, 3090291, 3099128, 42538048, 81953016268, 82953016018, 82953016019



MN-RK-7291

Ø: 72
Hole Distance: 130
Thick/Height: 30
10307800A, 81432206108, 81432206132



MN-VB-5238

Length: 627 Ø: 48
Hole Distance: 130 / 130
81432206221, 81432706096, 81432706114, 81432706116, 81432706121



MN-VB-8514

Length: 627 Ø: 48
Hole Ø 25 / 25 / 25
Hole Distance: 152 / 130 / 130
81432706087, 81432706088, 81432706094, 81432706095, 81432796094



MN-VB-8669

Length: 627 Ø: 48
Hole Ø 25 / 25 / 25
Hole Distance: 152 / 130 / 130
81432706116, 81432706137, 81432706150, 81432706151



MN-VB-9403

Length: 627 Ø: 48
Hole Ø 25 / 23 / 23
Hole Distance: 152 / 130 / 130
81432706097, 81432706113, 81432706135, 81432706160, 81432706161



MN-VB-9404

Length: 627 Ø: 58
Hole Distance: 130 / 130
81432706117, 81432706152, 81432706153



SC-ES-7279

Length: 150
Cone Ø: d1 Ø 30 / d2 Ø 27
Thread: M30 x 1,5 RHT
81953016288



SC-ES-8517

Length: 140
Cone Ø: d1 Ø 30 / d2 Ø 27
Thread: M30 x 1,5 RHT
81953016286



SC-ES-8535

Length: 145
Cone Ø: d1 Ø 30 / d2 Ø 27
Thread: M30 x 1,5 RHT
81953016271, 81953016325





TGA ...

35.530 FFNLC ...	07/06 →	Track Control Arm		MN-DL-5212	Trailing Arm, Trailing Axle not Steered, for Pneumatic Suspension vehicles
	07/06 →	Track Control Arm		MN-DL-5225	Trailing Arm
	07/06 →	Track Control Arm		MN-DL-8709	Trailing Arm, Trailing Axle Steered/not Steered, for Pneumatic Suspension vehicles
	07/06 →	Track Control Arm		MN-VB-5238	Wishbone (CV), 1st Drive Axle, for Pneumatic Suspension vehicles
	07/06 →	Track Control Arm		MN-VB-9403	Wishbone (CV), Trailing Axle Steered/not Steered, for Pneumatic Suspension vehicles
37.310 FFDC	12/04 →	Centre Rod	MN-DL-2160		Coupling Rod
	12/04 →	Suspension Arm Repair Kit		CV-RK-5313	for Wishbone (CV)
	12/04 →	Tie Rod End	CV-ES-0914		for Steering Rod
	12/04 →	Tie Rod End	CV-ES-14162		for Steering Rod
	12/04 →	Tie Rod End	CV-ES-14163		for Steering Rod
	12/04 →	Tie Rod End	SC-ES-7279		for Steering Rod
	12/04 →	Tie Rod End	SC-ES-8517		for Push Rod
	12/04 →	Tie Rod End	SC-ES-8535		for Guide Rod
	12/04 →	Track Control Arm		MN-DL-5225	Trailing Arm
	12/04 →	Track Control Arm		MN-DL-8544	Trailing Arm, 1st RA;2nd RA, for Leaf-Spring Suspension vehicles
	12/04 →	Track control arm		MN-DL-10288	Trailing Arm, 1st RA;2nd RA, for Leaf-Spring Suspension vehicles, →Type MHB
	12/04 →	Track control arm		MN-DL-12288	Trailing Arm
	12/04 →	Track Control Arm		MN-VB-8514	Suspension Rod, Wishbone (CV)
	12/04 →	Track Control Arm		MN-VB-8669	Suspension Rod, Wishbone (CV), 1st RA; 2nd RA, for Leaf-Spring Suspension vehicles, →Type_MHB Chassis
	12/04 →	Track Control Arm		MN-VB-9404	Wishbone (CV), 1st RA;2nd RA, for Leaf-Spring Suspension vehicles, →Type_MHB Chassis
37.310 FFDK	12/04 →	Centre Rod	MN-DL-2160		Coupling Rod
	12/04 →	Suspension Arm Repair Kit		CV-RK-5313	for Wishbone (CV)
	12/04 →	Tie Rod End	CV-ES-0914		for Steering Rod
	12/04 →	Tie Rod End	CV-ES-14162		for Steering Rod
	12/04 →	Tie Rod End	CV-ES-14163		for Steering Rod
	12/04 →	Tie Rod End	SC-ES-7279		for Steering Rod
	12/04 →	Tie Rod End	SC-ES-8517		for Push Rod
	12/04 →	Tie Rod End	SC-ES-8535		for Guide Rod
	12/04 →	Track Control Arm		MN-DL-5225	Trailing Arm
	12/04 →	Track Control Arm		MN-DL-8544	Trailing Arm, 1st RA;2nd RA, for Leaf-Spring Suspension vehicles
	12/04 →	Track control arm		MN-DL-10288	Trailing Arm, 1st RA;2nd RA, for Leaf-Spring Suspension vehicles, →Type MHB
	12/04 →	Track control arm		MN-DL-12288	Trailing Arm
	12/04 →	Track Control Arm		MN-VB-8514	Suspension Rod, Wishbone (CV)
	12/04 →	Track Control Arm		MN-VB-8669	Suspension Rod, Wishbone (CV), 1st RA; 2nd RA, for Leaf-Spring Suspension vehicles, →Type_MHB Chassis
	12/04 →	Track Control Arm		MN-VB-9404	Wishbone (CV), 1st RA;2nd RA, for Leaf-Spring Suspension vehicles, →Type_MHB Chassis
37.310 FFD-TM	12/04 →	Centre Rod	MN-DL-2160		Coupling Rod
	12/04 →	Suspension Arm Repair Kit		CV-RK-5313	for Wishbone (CV)
	12/04 →	Tie Rod End	CV-ES-0914		for Steering Rod
	12/04 →	Tie Rod End	CV-ES-14162		for Steering Rod
	12/04 →	Tie Rod End	CV-ES-14163		for Steering Rod
	12/04 →	Tie Rod End	SC-ES-7279		for Steering Rod
	12/04 →	Tie Rod End	SC-ES-8517		for Push Rod
	12/04 →	Tie Rod End	SC-ES-8535		for Guide Rod
	12/04 →	Track Control Arm		MN-DL-5225	Trailing Arm
12/04 →	Track Control Arm		MN-DL-8544	Trailing Arm, 1st RA;2nd RA, for Leaf-Spring Suspension vehicles	

CV-ES-0914

Length: 125
Cone Ø: d1 Ø 30 / d2 Ø 27
Thread: M38 x 1,5 RHT
81953016184, 81953016251, 81953016276



CV-ES-14162

Length: 125
Cone Ø: d1 Ø 30 / d2 Ø 27
Thread: M30 x 1,5 LHT
81953010015, 81953010083, 81953010087, 81953016029, 81953016030, 81953016043, 81953016044, 81953016050, 81953016054, 81953016087, 81953016091, 81953016107, 81953016120, 81953016125, 81953016152, 81953016155, 81953016157, 81953016168, 81953016179, 81953016181, 81953016223, 81953016237, 81953016254, 81953016275, 81953016279, 81953016351

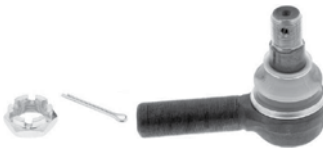

CV-ES-14163

Length: 125
Cone Ø: d1 Ø 30 / d2 Ø 27
Thread: M30 x 1,5 RHT
95301.0084, 90804102156, 90804102272, 90804102696, 90804102710, 81953010016, 81953010075, 81953010084, 81953010088, 81953010094, 81953010103, 81953016030, 81953016043, 81953016048, 81953016049, 81953016053, 81953016061, 81953016090, 81953016108, 81953016112, 81953016126, 81953016143, 81953016149, 81953016154, 81953016156, 81953016168, 81953016178, 81953016194, 81953016206, 81953016224, 81953016234, 81953016242, 81953016252, 81953016274, 81953016278, 81953016284, 81953016286, 81953016308, 81953016310, 81953016312, 81953016347, 81953016350, 81953016352, 82953016012, 88953016014, N2953016001



CV-RK-5313

Ø: 90
03304800A, 81953016132



MN-DL-2160

Length: 1652 Ø: 50
Cone Ø: d1 Ø 30 / d2 Ø 27
81467106112, 81467106163, 81467106165, 81467106198, 81467106353, 81467106354, 81467106361, 81467116725



MN-DL-5212

Length: 577 Ø: 48
Hole Distance: 130 / 130
81432206096, 81432206097, 81432206098, 81432206129, 81432209096, 81432209129, 81432306014, 81432306030



MN-DL-5225

Length: 572 Ø: 48
Hole Distance: 130 / 130
03301500A, 81432206229, 81432206236, 81432206267, 81432206270, 81432206272, 81432206304, 81432206305, 81432209236, 81432209267, 81432209272



MN-DL-8544

Length: 596 Ø: 48
Hole Distance: 130 / 130
81432206196, 81432206232, 81432206233



MN-DL-8709

Length: 572 Ø: 52
Hole Distance: 130 / 130
81432206268, 81432206274, 81432206291, 81432206292, 82432206007



MN-DL-10288

81432206386, 82432206008, 82432209008

No Image

MN-DL-12288

Length: 585 Ø: 58
Hole Distance: 130 / 130
81432206386, 82432206008, 82432209008

No Image

MN-VB-5238

Length: 627 Ø: 48
Hole Distance: 130 / 130
81432206221, 81432706096, 81432706114, 81432706116, 81432706121



MN-VB-8514

Length: 627 Ø: 48
Hole Ø 25 / 25 / 25
Hole Distance: 152 / 130 / 130
81432706087, 81432706088, 81432706094, 81432706095, 81432796094



MN-VB-8669

Length: 627 Ø: 48
Hole Ø 25 / 25 / 25
Hole Distance: 152 / 130 / 130
81432706116, 81432706137, 81432706150, 81432706151



MN-VB-9403

Length: 627 Ø: 48
Hole Ø 25 / 23 / 23
Hole Distance: 152 / 130 / 130
81432706097, 81432706113, 81432706135, 81432706160, 81432706161



MN-VB-9404

Length: 627 Ø: 58
Hole Distance: 130 / 130
81432706117, 81432706152, 81432706153



SC-ES-7279

Length: 150
Cone Ø: d1 Ø 30 / d2 Ø 27
Thread: M30 x 1,5 RHT
81953016288



SC-ES-8517

Length: 140
Cone Ø: d1 Ø 30 / d2 Ø 27
Thread: M30 x 1,5 RHT
81953016286



SC-ES-8535

Length: 145
Cone Ø: d1 Ø 30 / d2 Ø 27
Thread: M30 x 1,5 RHT
81953016271, 81953016325



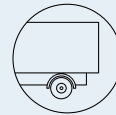

TGA ...

37.310 FFD-TM ...	12/04 →	Track control arm		MN-DL-10288	Trailing Arm, 1st RA;2nd RA, for Leaf-Spring Suspension vehicles, →Type MHB
	12/04 →	Track control arm		MN-DL-12288	Trailing Arm
	12/04 →	Track Control Arm		MN-VB-8514	Suspension Rod, Wishbone (CV)
	12/04 →	Track Control Arm		MN-VB-8669	Suspension Rod, Wishbone (CV), 1st RA; 2nd RA, for Leaf-Spring Suspension vehicles, →Type_MHB Chassis
	12/04 →	Track Control Arm		MN-VB-9404	Wishbone (CV), 1st RA;2nd RA, for Leaf-Spring Suspension vehicles, →Type_MHB Chassis
37.310, 37.320 FFDK	12/04 →	Centre Rod	MN-DL-7801		Push Rod, Leaf Spring Axle
	12/04 →	Centre Rod	MN-DL-8599		Push Rod
	12/04 →	Centre Rod	MN-DL-12285		for Steering Rod
	12/04 →	Suspension Strut Repair Kit		DB-RK-8581	
	12/04 →	Tie Rod	MN-DL-7802		
	12/04 →	Tie Rod End	CV-ES-0914		for Steering Rod
	12/04 →	Tie Rod End	CV-ES-14162		for Steering Rod
	12/04 →	Tie Rod End	CV-ES-14163		for Steering Rod
	12/04 →	Tie Rod End	MN-ES-10333		for Steering Rod
	12/04 →	Tie Rod End	SC-ES-7279		for Steering Rod
	12/04 →	Tie Rod End	SC-ES-8517		for Push Rod
	12/04 →	Tie Rod End	SC-ES-8535		for Guide Rod
	12/04 →	Track Control Arm		MN-DL-5225	Trailing Arm
	12/04 →	Track Control Arm		MN-DL-8544	Trailing Arm, 1st RA;2nd RA, for Leaf-Spring Suspension vehicles
	12/04 →	Track control arm		MN-DL-10288	Trailing Arm, 1st RA;2nd RA, for Leaf-Spring Suspension vehicles, →Type MHB
	12/04 →	Track control arm		MN-DL-12288	Trailing Arm
	12/04 →	Track Control Arm		MN-VB-8514	Suspension Rod, Wishbone (CV), Drive Axle; Leaf Spring Axle
	12/04 →	Track Control Arm		MN-VB-8669	Suspension Rod, Wishbone (CV), Drive Axle; Leaf Spring Axle
	12/04 →	Track Control Arm		MN-VB-9404	Wishbone (CV), Drive Axle;Leaf Spring Axle
	37.310, 37.320 FFDK	12/04 →	Centre Rod	MN-DL-7801	
12/04 →		Centre Rod	MN-DL-8599		Push Rod
12/04 →		Centre Rod	MN-DL-12285		for Steering Rod
12/04 →		Suspension Strut Repair Kit		DB-RK-8581	
12/04 →		Tie Rod	MN-DL-7802		
12/04 →		Tie Rod End	CV-ES-0914		for Steering Rod
12/04 →		Tie Rod End	CV-ES-14162		for Steering Rod
12/04 →		Tie Rod End	CV-ES-14163		for Steering Rod
12/04 →		Tie Rod End	MN-ES-10333		for Steering Rod
12/04 →		Tie Rod End	SC-ES-7279		for Steering Rod
12/04 →		Tie Rod End	SC-ES-8517		for Push Rod
12/04 →		Tie Rod End	SC-ES-8535		for Guide Rod
12/04 →		Track Control Arm		MN-DL-5225	Trailing Arm
12/04 →		Track Control Arm		MN-DL-8544	Trailing Arm, Drive Axle;Leaf Spring Axle
12/04 →		Track control arm		MN-DL-10288	Trailing Arm, 1st RA;2nd RA, for Leaf-Spring Suspension vehicles, →Type MHB
12/04 →		Track control arm		MN-DL-12288	Trailing Arm
12/04 →		Track Control Arm		MN-VB-8514	Suspension Rod, Wishbone (CV), Drive Axle; Leaf Spring Axle
12/04 →		Track Control Arm		MN-VB-8669	Suspension Rod, Wishbone (CV), Drive Axle; Leaf Spring Axle
12/04 →		Track Control Arm		MN-VB-9404	Wishbone (CV), Drive Axle;Leaf Spring Axle
37.310, 37.320 FFD-TM		12/04 →	Centre Rod	MN-DL-7801	
	12/04 →	Centre Rod	MN-DL-8599		Push Rod
	12/04 →	Centre Rod	MN-DL-12285		for Steering Rod
	12/04 →	Suspension Strut Repair Kit		DB-RK-8581	
	12/04 →	Tie Rod	MN-DL-7802		
	12/04 →	Tie Rod End	CV-ES-0914		for Steering Rod
	12/04 →	Tie Rod End	CV-ES-14162		for Steering Rod

CV-ES-0914

Length: 125
Cone Ø: d1 Ø 30 / d2 Ø 27
Thread: M38 x 1,5 RHT
81953016184, 81953016251, 81953016276



CV-ES-14162

Length: 125
Cone Ø: d1 Ø 30 / d2 Ø 27
Thread: M30 x 1,5 LHT
81953010015, 81953010083, 81953010087, 81953016029, 81953016030, 81953016043, 81953016044, 81953016050, 81953016054, 81953016087, 81953016091, 81953016107, 81953016120, 81953016125, 81953016152, 81953016155, 81953016157, 81953016168, 81953016179, 81953016181, 81953016223, 81953016237, 81953016254, 81953016275, 81953016279, 81953016351



CV-ES-14163

Length: 125
Cone Ø: d1 Ø 30 / d2 Ø 27
Thread: M30 x 1,5 RHT
95301.0084, 90804102156, 90804102272, 90804102696, 90804102710, 81953010016, 81953010075, 81953010084, 81953010088, 81953010094, 81953010103, 81953016030, 81953016043, 81953016048, 81953016049, 81953016053, 81953016061, 81953016090, 81953016108, 81953016112, 81953016126, 81953016143, 81953016149, 81953016154, 81953016156, 81953016168, 81953016178, 81953016194, 81953016206, 81953016224, 81953016234, 81953016242, 81953016252, 81953016274, 81953016278, 81953016284, 81953016286, 81953016308, 81953016310, 81953016312, 81953016347, 81953016350, 81953016352, 82953016012, 88953016014, N2953016001



DB-RK-8581

Ø: 85
Hole Distance: 130
Thick/Height: 24
03305800A, 81432706105



MN-DL-5225

Length: 572 Ø: 48
Hole Distance: 130 / 130
03301500A, 81432206229, 81432206236, 81432206267, 81432206270, 81432206272, 81432206304, 81432206305, 81432209236, 81432209267, 81432209272



MN-DL-7801

Length: 995 Ø: 52
Cone Ø: d1 Ø 30 / d2 Ø 27
81466106807, 81466106808, 81466116087, 81466116088, 81466116096, 81466116097, 81466116099, 81466116132, 81466116133, 81466116136, 81466116197, 81466116198, 81466116205

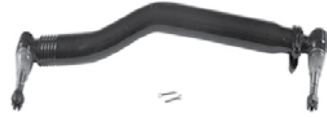

MN-DL-7802

Length: 1680 Ø: 52
Cone Ø: d1 Ø 30 / d2 Ø 27
03208300A, 81467116773, 81467116858, 81467116859, 81467116860, 81467116861, 81467116863, 81467116882, 81467116883, 81467116920, 81467116921



MN-DL-8544

Length: 596 Ø: 48
Hole Distance: 130 / 130
81432206196, 81432206232, 81432206233



MN-DL-8599

Length: 1800 Ø: 62
Cone Ø: d1 Ø 30 / d2 Ø 27
81466116161, 81466116162, 82466106183, 82466106186, 82466106187



MN-DL-10288

81432206386, 82432206008, 82432209008

No Image

MN-DL-12285

Length: 993 Ø: 40
Cone Ø: d1 Ø 30 / d2 Ø 27
81466106816, 81466106826, 81466116151, 82466106184, 82466106185



MN-DL-12288

Length: 585 Ø: 58
Hole Distance: 130 / 130
81432206386, 82432206008, 82432209008

No Image

MN-ES-10333

Length: 90
Cone Ø: d1 Ø 38 / d2 Ø 34,35
Thread: M36 x 1,5 RHT
1271126, 3090291, 3099128, 42538048, 81953016268, 82953016018, 82953016019



MN-VB-8514

Length: 627 Ø: 48
Hole Ø 25 / 25 / 25
Hole Distance: 152 / 130 / 130
81432706087, 81432706088, 81432706094, 81432706095, 81432796094



MN-VB-8669

Length: 627 Ø: 48
Hole Ø 25 / 25 / 25
Hole Distance: 152 / 130 / 130
81432706116, 81432706137, 81432706150, 81432706151



MN-VB-9404

Length: 627 Ø: 58
Hole Distance: 130 / 130
81432706117, 81432706152, 81432706153



SC-ES-7279

Length: 150
Cone Ø: d1 Ø 30 / d2 Ø 27
Thread: M30 x 1,5 RHT
81953016288



SC-ES-8517

Length: 140
Cone Ø: d1 Ø 30 / d2 Ø 27
Thread: M30 x 1,5 RHT
81953016286



SC-ES-8535

Length: 145
Cone Ø: d1 Ø 30 / d2 Ø 27
Thread: M30 x 1,5 RHT
81953016271, 81953016325





TGA ...

37.310, 37.320 FFD-TM ...	12/04 →	Tie Rod End	MN-ES-10333		for Steering Rod
	12/04 →	Tie Rod End	SC-ES-7279		for Steering Rod
	12/04 →	Tie Rod End	SC-ES-8517		for Push Rod
	12/04 →	Tie Rod End	SC-ES-8535		for Guide Rod
	12/04 →	Track Control Arm		MN-DL-5225	Trailing Arm
	12/04 →	Track Control Arm		MN-DL-8544	Trailing Arm, Drive Axle;Leaf Spring Axle
	12/04 →	Track control arm		MN-DL-10288	Trailing Arm, 1st RA;2nd RA, for Leaf-Spring Suspension vehicles, →Type MHB
	12/04 →	Track control arm		MN-DL-12288	Trailing Arm
	12/04 →	Track Control Arm		MN-VB-8514	Suspension Rod, Wishbone (CV), Drive Axle; Leaf Spring Axle
	12/04 →	Track Control Arm		MN-VB-8669	Suspension Rod, Wishbone (CV), Drive Axle; Leaf Spring Axle
37.350, 37.360 FFD-C	12/04 →	Track Control Arm		MN-VB-9404	Wishbone (CV), Drive Axle;Leaf Spring Axle
	12/04 →	Centre Rod	MN-DL-7801		Push Rod, Leaf Spring Axle
	12/04 →	Centre Rod	MN-DL-8599		Push Rod
	12/04 →	Centre Rod	MN-DL-12285		for Steering Rod
	12/04 →	Suspension Strut Repair Kit		DB-RK-8581	
	12/04 →	Tie Rod	MN-DL-7802		
	12/04 →	Tie Rod End	CV-ES-0914		for Steering Rod
	12/04 →	Tie Rod End	CV-ES-14162		for Steering Rod
	12/04 →	Tie Rod End	CV-ES-14163		for Steering Rod
	12/04 →	Tie Rod End	MN-ES-10333		for Steering Rod
37.350, 37.360 FFD-K	12/04 →	Tie Rod End	SC-ES-7279		for Steering Rod
	12/04 →	Tie Rod End	SC-ES-8517		for Push Rod
	12/04 →	Tie Rod End	SC-ES-8535		for Guide Rod
	12/04 →	Track Control Arm		MN-DL-5225	Trailing Arm
	12/04 →	Track Control Arm		MN-DL-8544	Trailing Arm, Drive Axle;Leaf Spring Axle
	12/04 →	Track control arm		MN-DL-10288	Trailing Arm, 1st RA;2nd RA, for Leaf-Spring Suspension vehicles, →Type MHB
	12/04 →	Track control arm		MN-DL-12288	Trailing Arm
	12/04 →	Track Control Arm		MN-VB-8514	Suspension Rod, Wishbone (CV), Drive Axle; Leaf Spring Axle
	12/04 →	Track Control Arm		MN-VB-8669	Suspension Rod, Wishbone (CV), Drive Axle; Leaf Spring Axle
	12/04 →	Track Control Arm		MN-VB-9404	Wishbone (CV), Drive Axle;Leaf Spring Axle
37.350, 37.360 FFD-K	12/04 →	Centre Rod	MN-DL-7801		Push Rod, Leaf Spring Axle
	12/04 →	Centre Rod	MN-DL-8599		Push Rod
	12/04 →	Centre Rod	MN-DL-12285		for Steering Rod
	12/04 →	Suspension Strut Repair Kit		DB-RK-8581	
	12/04 →	Tie Rod	MN-DL-7802		
	12/04 →	Tie Rod End	CV-ES-0914		for Steering Rod
	12/04 →	Tie Rod End	CV-ES-14162		for Steering Rod
	12/04 →	Tie Rod End	CV-ES-14163		for Steering Rod
	12/04 →	Tie Rod End	MN-ES-10333		for Steering Rod
	12/04 →	Tie Rod End	SC-ES-7279		for Steering Rod
37.350, 37.360 FFD-TM	12/04 →	Tie Rod End	SC-ES-8517		for Push Rod
	12/04 →	Tie Rod End	SC-ES-8535		for Guide Rod
	12/04 →	Track Control Arm		MN-DL-5225	Trailing Arm
	12/04 →	Track Control Arm		MN-DL-8544	Trailing Arm, Drive Axle;Leaf Spring Axle
	12/04 →	Track control arm		MN-DL-10288	Trailing Arm, 1st RA;2nd RA, for Leaf-Spring Suspension vehicles, →Type MHB
	12/04 →	Track control arm		MN-DL-12288	Trailing Arm
	12/04 →	Track Control Arm		MN-VB-8514	Suspension Rod, Wishbone (CV), Drive Axle; Leaf Spring Axle
	12/04 →	Track Control Arm		MN-VB-8669	Suspension Rod, Wishbone (CV), Drive Axle; Leaf Spring Axle
	12/04 →	Track Control Arm		MN-VB-9404	Wishbone (CV), Drive Axle;Leaf Spring Axle
	12/04 →	Centre Rod	MN-DL-7801		Push Rod, Leaf Spring Axle
37.350, 37.360 FFD-TM	12/04 →	Centre Rod	MN-DL-8599		Push Rod
	12/04 →	Centre Rod	MN-DL-12285		for Steering Rod
	12/04 →	Suspension Strut Repair Kit		DB-RK-8581	
	12/04 →	Tie Rod	MN-DL-7802		

CV-ES-0914

Length: 125
Cone Ø: d1 Ø 30 / d2 Ø 27
Thread: M38 x 1,5 RHT
81953016184, 81953016251, 81953016276



CV-ES-14162

Length: 125
Cone Ø: d1 Ø 30 / d2 Ø 27
Thread: M30 x 1,5 LHT
81953010015, 81953010083, 81953010087,
81953016029, 81953016030, 81953016043,
81953016044, 81953016050, 81953016054,
81953016087, 81953016091, 81953016107,
81953016120, 81953016125, 81953016152,
81953016155, 81953016157, 81953016168,
81953016179, 81953016181, 81953016223,
81953016237, 81953016254, 81953016275,
81953016279, 81953016351



CV-ES-14163

Length: 125
Cone Ø: d1 Ø 30 / d2 Ø 27
Thread: M30 x 1,5 RHT
95301.0084, 90804102156, 90804102272,
90804102696, 90804102710, 81953010016,
81953010075, 81953010084, 81953010088,
81953010094, 81953010103, 81953016030,
81953016043, 81953016048, 81953016049,
81953016053, 81953016061, 81953016090,
81953016108, 81953016112, 81953016126,
81953016143, 81953016149, 81953016154,
81953016156, 81953016168, 81953016178,
81953016194, 81953016206, 81953016224,
81953016234, 81953016242, 81953016252,
81953016274, 81953016278, 81953016284,
81953016286, 81953016308, 81953016310,
81953016312, 81953016347, 81953016350,
81953016352, 82953016012, 88953016014,
N2953016001



DB-RK-8581

Ø: 85
Hole Distance: 130
Thick/Height: 24
03305800A, 81432706105



MN-DL-5225

Length: 572 Ø: 48
Hole Distance: 130 / 130
03301500A, 81432206229, 81432206236,
81432206267, 81432206270, 81432206272,
81432206304, 81432206305, 81432209236,
81432209267, 81432209272



MN-DL-7801

Length: 995 Ø: 52
Cone Ø: d1 Ø 30 / d2 Ø 27
81466106807, 81466106808, 81466116087,
81466116088, 81466116096, 81466116097,
81466116099, 81466116132, 81466116133,
81466116136, 81466116197, 81466116198,
81466116205

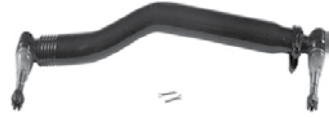

MN-DL-7802

Length: 1680 Ø: 52
Cone Ø: d1 Ø 30 / d2 Ø 27
03208300A, 81467116773, 81467116858,
81467116859, 81467116860, 81467116861,
81467116863, 81467116882, 81467116883,
81467116920, 81467116921



MN-DL-8544

Length: 596 Ø: 48
Hole Distance: 130 / 130
81432206196, 81432206232, 81432206233



MN-DL-8599

Length: 1800 Ø: 62
Cone Ø: d1 Ø 30 / d2 Ø 27
81466116161, 81466116162, 82466106183,
82466106186, 82466106187



MN-DL-10288

81432206386, 82432206008, 82432209008

No Image

MN-DL-12285

Length: 993 Ø: 40
Cone Ø: d1 Ø 30 / d2 Ø 27
81466106816, 81466106826, 81466116151,
82466106184, 82466106185



MN-DL-12288

Length: 585 Ø: 58
Hole Distance: 130 / 130
81432206386, 82432206008, 82432209008

No Image

MN-ES-10333

Length: 90
Cone Ø: d1 Ø 38 / d2 Ø 34,35
Thread: M36 x 1,5 RHT
1271126, 3090291, 3099128, 42538048,
81953016268, 82953016018, 82953016019



MN-VB-8514

Length: 627 Ø: 48
Hole Ø 25 / 25 / 25
Hole Distance: 152 / 130 / 130
81432706087, 81432706088, 81432706094,
81432706095, 81432796094



MN-VB-8669

Length: 627 Ø: 48
Hole Ø 25 / 25 / 25
Hole Distance: 152 / 130 / 130
81432706116, 81432706137, 81432706150,
81432706151



MN-VB-9404

Length: 627 Ø: 58
Hole Distance: 130 / 130
81432706117, 81432706152, 81432706153



SC-ES-7279

Length: 150
Cone Ø: d1 Ø 30 / d2 Ø 27
Thread: M30 x 1,5 RHT
81953016288



SC-ES-8517

Length: 140
Cone Ø: d1 Ø 30 / d2 Ø 27
Thread: M30 x 1,5 RHT
81953016286



SC-ES-8535

Length: 145
Cone Ø: d1 Ø 30 / d2 Ø 27
Thread: M30 x 1,5 RHT
81953016271, 81953016325





TGA ...

37.350, 37.360 FFD-TM ...	12/04 →	Tie Rod End	CV-ES-0914	for Steering Rod
	12/04 →	Tie Rod End	CV-ES-14162	for Steering Rod
	12/04 →	Tie Rod End	CV-ES-14163	for Steering Rod
	12/04 →	Tie Rod End	MN-ES-10333	for Steering Rod
	12/04 →	Tie Rod End	SC-ES-7279	for Steering Rod
	12/04 →	Tie Rod End	SC-ES-8517	for Push Rod
	12/04 →	Tie Rod End	SC-ES-8535	for Guide Rod
	12/04 →	Track Control Arm	MN-DL-5225	Trailing Arm
	12/04 →	Track Control Arm	MN-DL-8544	Trailing Arm, Drive Axle;Leaf Spring Axle
	12/04 →	Track control arm	MN-DL-10288	Trailing Arm, 1st RA;2nd RA, for Leaf-Spring Suspension vehicles, →Type MHB
	12/04 →	Track control arm	MN-DL-12288	Trailing Arm
	12/04 →	Track Control Arm	MN-VB-8514	Suspension Rod, Wishbone (CV), Drive Axle; Leaf Spring Axle
	12/04 →	Track Control Arm	MN-VB-8669	Suspension Rod, Wishbone (CV), Drive Axle; Leaf Spring Axle
	37.360 FFDC	12/04 →	Track Control Arm	MN-VB-9404
12/04 →		Centre Rod	MN-DL-2160	Coupling Rod
12/04 →		Suspension Arm Repair Kit	CV-RK-5313	for Wishbone (CV)
12/04 →		Tie Rod End	CV-ES-0914	for Steering Rod
12/04 →		Tie Rod End	CV-ES-14162	for Steering Rod
12/04 →		Tie Rod End	CV-ES-14163	for Steering Rod
12/04 →		Tie Rod End	SC-ES-7279	for Steering Rod
12/04 →		Tie Rod End	SC-ES-8517	for Push Rod
12/04 →		Tie Rod End	SC-ES-8535	for Guide Rod
12/04 →		Track Control Arm	MN-DL-5225	Trailing Arm
12/04 →		Track Control Arm	MN-DL-8544	Trailing Arm, 1st RA;2nd RA, for Leaf-Spring Suspension vehicles
12/04 →		Track control arm	MN-DL-10288	Trailing Arm, 1st RA;2nd RA, for Leaf-Spring Suspension vehicles, →Type MHB
12/04 →		Track control arm	MN-DL-12288	Trailing Arm
12/04 →		Track Control Arm	MN-VB-8514	Suspension Rod, Wishbone (CV)
12/04 →	Track Control Arm	MN-VB-8669	Suspension Rod, Wishbone (CV), 1st RA; 2nd RA, for Leaf-Spring Suspension vehicles, →Type_MHB Chassis	
37.360 FFDK	12/04 →	Track Control Arm	MN-VB-9404	Wishbone (CV), 1st RA;2nd RA, for Leaf-Spring Suspension vehicles, →Type_MHB Chassis
	12/04 →	Centre Rod	MN-DL-2160	Coupling Rod
	12/04 →	Suspension Arm Repair Kit	CV-RK-5313	for Wishbone (CV)
	12/04 →	Tie Rod End	CV-ES-0914	for Steering Rod
	12/04 →	Tie Rod End	CV-ES-14162	for Steering Rod
	12/04 →	Tie Rod End	CV-ES-14163	for Steering Rod
	12/04 →	Tie Rod End	SC-ES-7279	for Steering Rod
	12/04 →	Tie Rod End	SC-ES-8517	for Push Rod
	12/04 →	Tie Rod End	SC-ES-8535	for Guide Rod
	12/04 →	Track Control Arm	MN-DL-5225	Trailing Arm
	12/04 →	Track Control Arm	MN-DL-8544	Trailing Arm, 1st RA;2nd RA, for Leaf-Spring Suspension vehicles
	12/04 →	Track control arm	MN-DL-10288	Trailing Arm, 1st RA;2nd RA, for Leaf-Spring Suspension vehicles, →Type MHB
	12/04 →	Track control arm	MN-DL-12288	Trailing Arm
	12/04 →	Track Control Arm	MN-VB-8514	Suspension Rod, Wishbone (CV)
12/04 →	Track Control Arm	MN-VB-8669	Suspension Rod, Wishbone (CV), 1st RA; 2nd RA, for Leaf-Spring Suspension vehicles, →Type_MHB Chassis	
37.360 FFD-TM	12/04 →	Track Control Arm	MN-VB-9404	Wishbone (CV), 1st RA;2nd RA, for Leaf-Spring Suspension vehicles, →Type_MHB Chassis
	12/04 →	Centre Rod	MN-DL-2160	Coupling Rod
	12/04 →	Suspension Arm Repair Kit	CV-RK-5313	for Wishbone (CV)
	12/04 →	Tie Rod End	CV-ES-14162	for Steering Rod

CV-ES-0914

Length: 125
Cone Ø: d1 Ø 30 / d2 Ø 27
Thread: M38 x 1,5 RHT
81953016184, 81953016251, 81953016276



CV-ES-14162

Length: 125
Cone Ø: d1 Ø 30 / d2 Ø 27
Thread: M30 x 1,5 LHT
81953010015, 81953010083, 81953010087, 81953016029, 81953016030, 81953016043, 81953016044, 81953016050, 81953016054, 81953016087, 81953016091, 81953016107, 81953016120, 81953016125, 81953016152, 81953016155, 81953016157, 81953016168, 81953016179, 81953016181, 81953016223, 81953016237, 81953016254, 81953016275, 81953016279, 81953016351



CV-ES-14163

Length: 125
Cone Ø: d1 Ø 30 / d2 Ø 27
Thread: M30 x 1,5 RHT
95301.0084, 90804102156, 90804102272, 90804102696, 90804102710, 81953010016, 81953010075, 81953010084, 81953010088, 81953010094, 81953010103, 81953016030, 81953016043, 81953016048, 81953016049, 81953016053, 81953016061, 81953016090, 81953016108, 81953016112, 81953016126, 81953016143, 81953016149, 81953016154, 81953016156, 81953016168, 81953016178, 81953016194, 81953016206, 81953016224, 81953016234, 81953016242, 81953016252, 81953016274, 81953016278, 81953016284, 81953016286, 81953016308, 81953016310, 81953016312, 81953016347, 81953016350, 81953016352, 82953016012, 88953016014, N2953016001



CV-RK-5313

Ø: 90
03304800A, 81953016132



MN-DL-2160

Length: 1652 Ø: 50
Cone Ø: d1 Ø 30 / d2 Ø 27
81467106112, 81467106163, 81467106165, 81467106198, 81467106353, 81467106354, 81467106361, 81467116725



MN-DL-5225

Length: 572 Ø: 48
Hole Distance: 130 / 130
03301500A, 81432206229, 81432206236, 81432206267, 81432206270, 81432206272, 81432206304, 81432206305, 81432209236, 81432209267, 81432209272



MN-DL-8544

Length: 596 Ø: 48
Hole Distance: 130 / 130
81432206196, 81432206232, 81432206233



MN-DL-10288

81432206386, 82432206008, 82432209008

No Image

MN-DL-12288

Length: 585 Ø: 58
Hole Distance: 130 / 130
81432206386, 82432206008, 82432209008

No Image

MN-ES-10333

Length: 90
Cone Ø: d1 Ø 38 / d2 Ø 34,35
Thread: M36 x 1,5 RHT
1271126, 3090291, 3099128, 42538048, 81953016268, 82953016018, 82953016019



MN-VB-8514

Length: 627 Ø: 48
Hole Ø 25 / 25 / 25
Hole Distance: 152 / 130 / 130
81432706087, 81432706088, 81432706094, 81432706095, 81432796094



MN-VB-8669

Length: 627 Ø: 48
Hole Ø 25 / 25 / 25
Hole Distance: 152 / 130 / 130
81432706116, 81432706137, 81432706150, 81432706151



MN-VB-9404

Length: 627 Ø: 58
Hole Distance: 130 / 130
81432706117, 81432706152, 81432706153



SC-ES-7279

Length: 150
Cone Ø: d1 Ø 30 / d2 Ø 27
Thread: M30 x 1,5 RHT
81953016288



SC-ES-8517

Length: 140
Cone Ø: d1 Ø 30 / d2 Ø 27
Thread: M30 x 1,5 RHT
81953016286



SC-ES-8535

Length: 145
Cone Ø: d1 Ø 30 / d2 Ø 27
Thread: M30 x 1,5 RHT
81953016271, 81953016325





TGA ...

37.360 FFD-TM ...	12/04 →	Tie Rod End	CV-ES-14163		for Steering Rod	
	12/04 →	Tie Rod End	SC-ES-7279		for Steering Rod	
	12/04 →	Tie Rod End	SC-ES-8517		for Push Rod	
	12/04 →	Tie Rod End	SC-ES-8535		for Guide Rod	
	12/04 →	Track Control Arm		MN-DL-5225	Trailing Arm	
	12/04 →	Track Control Arm		MN-DL-8544	Trailing Arm, 1st RA;2nd RA, for Leaf-Spring Suspension vehicles	
	12/04 →	Track control arm		MN-DL-10288	Trailing Arm, 1st RA;2nd RA, for Leaf-Spring Suspension vehicles, →Type MHB	
	12/04 →	Track control arm		MN-DL-12288	Trailing Arm	
	12/04 →	Track Control Arm		MN-VB-8514	Suspension Rod, Wishbone (CV)	
	12/04 →	Track Control Arm		MN-VB-8669	Suspension Rod, Wishbone (CV), 1st RA; 2nd RA, for Leaf-Spring Suspension vehicles, →Type_MHB Chassis	
	12/04 →	Track Control Arm		MN-VB-9404	Wishbone (CV), 1st RA;2nd RA, for Leaf-Spring Suspension vehicles, →Type_MHB Chassis	
	37.390, 37.400 FFDC	12/04 →	Centre Rod	MN-DL-7801		Push Rod, Leaf Spring Axle
		12/04 →	Centre Rod	MN-DL-8599		Push Rod
		12/04 →	Centre Rod	MN-DL-12285		for Steering Rod
12/04 →		Suspension Strut Repair Kit		DB-RK-8581		
12/04 →		Tie Rod	MN-DL-7802			
12/04 →		Tie Rod End	CV-ES-0914		for Steering Rod	
12/04 →		Tie Rod End	CV-ES-14162		for Steering Rod	
12/04 →		Tie Rod End	CV-ES-14163		for Steering Rod	
12/04 →		Tie Rod End	MN-ES-10333		for Steering Rod	
12/04 →		Tie Rod End	SC-ES-7279		for Steering Rod	
12/04 →		Tie Rod End	SC-ES-8517		for Push Rod	
12/04 →		Tie Rod End	SC-ES-8535		for Guide Rod	
12/04 →		Track Control Arm		MN-DL-5225	Trailing Arm	
12/04 →		Track Control Arm		MN-DL-8544	Trailing Arm, Drive Axle;Leaf Spring Axle	
12/04 →		Track control arm		MN-DL-10288	Trailing Arm, 1st RA;2nd RA, for Leaf-Spring Suspension vehicles, →Type MHB	
12/04 →		Track control arm		MN-DL-12288	Trailing Arm	
12/04 →		Track Control Arm		MN-VB-8514	Suspension Rod, Wishbone (CV), Drive Axle; Leaf Spring Axle	
12/04 →		Track Control Arm		MN-VB-8669	Suspension Rod, Wishbone (CV), Drive Axle; Leaf Spring Axle	
12/04 →		Track Control Arm		MN-VB-9404	Wishbone (CV), Drive Axle;Leaf Spring Axle	
37.390, 37.400 FFDK	12/04 →	Centre Rod	MN-DL-7801		Push Rod, Leaf Spring Axle	
	12/04 →	Centre Rod	MN-DL-8599		Push Rod	
	12/04 →	Centre Rod	MN-DL-12285		for Steering Rod	
	12/04 →	Suspension Strut Repair Kit		DB-RK-8581		
	12/04 →	Tie Rod	MN-DL-7802			
	12/04 →	Tie Rod End	CV-ES-0914		for Steering Rod	
	12/04 →	Tie Rod End	CV-ES-14162		for Steering Rod	
	12/04 →	Tie Rod End	CV-ES-14163		for Steering Rod	
	12/04 →	Tie Rod End	MN-ES-10333		for Steering Rod	
	12/04 →	Tie Rod End	SC-ES-7279		for Steering Rod	
	12/04 →	Tie Rod End	SC-ES-8517		for Push Rod	
	12/04 →	Tie Rod End	SC-ES-8535		for Guide Rod	
	12/04 →	Track Control Arm		MN-DL-5225	Trailing Arm	
	12/04 →	Track Control Arm		MN-DL-8544	Trailing Arm, Drive Axle;Leaf Spring Axle	
	12/04 →	Track control arm		MN-DL-10288	Trailing Arm, 1st RA;2nd RA, for Leaf-Spring Suspension vehicles, →Type MHB	
	12/04 →	Track control arm		MN-DL-12288	Trailing Arm	
	12/04 →	Track Control Arm		MN-VB-8514	Suspension Rod, Wishbone (CV), Drive Axle; Leaf Spring Axle	
	12/04 →	Track Control Arm		MN-VB-8669	Suspension Rod, Wishbone (CV), Drive Axle; Leaf Spring Axle	
	12/04 →	Track Control Arm		MN-VB-9404	Wishbone (CV), Drive Axle;Leaf Spring Axle	

CV-ES-0914

Length: 125
Cone Ø: d1 Ø 30 / d2 Ø 27
Thread: M38 x 1,5 RHT
81953016184, 81953016251, 81953016276



CV-ES-14162

Length: 125
Cone Ø: d1 Ø 30 / d2 Ø 27
Thread: M30 x 1,5 LHT
81953010015, 81953010083, 81953010087,
81953016029, 81953016030, 81953016043,
81953016044, 81953016050, 81953016054,
81953016087, 81953016091, 81953016107,
81953016120, 81953016125, 81953016152,
81953016155, 81953016157, 81953016168,
81953016179, 81953016181, 81953016223,
81953016237, 81953016254, 81953016275,
81953016279, 81953016351

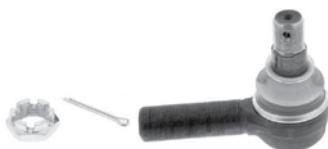

CV-ES-14163

Length: 125
Cone Ø: d1 Ø 30 / d2 Ø 27
Thread: M30 x 1,5 RHT
95301.0084, 90804102156, 90804102272,
90804102696, 90804102710, 81953010016,
81953010075, 81953010084, 81953010088,
81953010094, 81953010103, 81953016030,
81953016043, 81953016048, 81953016049,
81953016053, 81953016061, 81953016090,
81953016108, 81953016112, 81953016126,
81953016143, 81953016149, 81953016154,
81953016156, 81953016168, 81953016178,
81953016194, 81953016206, 81953016224,
81953016234, 81953016242, 81953016252,
81953016274, 81953016278, 81953016284,
81953016286, 81953016308, 81953016310,
81953016312, 81953016347, 81953016350,
81953016352, 82953016012, 88953016014,
N2953016001



DB-RK-8581

Ø: 85
Hole Distance: 130
Thick/Height: 24
03305800A, 81432706105



MN-DL-5225

Length: 572 Ø: 48
Hole Distance: 130 / 130
03301500A, 81432206229, 81432206236,
81432206267, 81432206270, 81432206272,
81432206304, 81432206305, 81432209236,
81432209267, 81432209272



MN-DL-7801

Length: 995 Ø: 52
Cone Ø: d1 Ø 30 / d2 Ø 27
81466106807, 81466106808, 81466116087,
81466116088, 81466116096, 81466116097,
81466116099, 81466116132, 81466116133,
81466116136, 81466116197, 81466116198,
81466116205



MN-DL-7802

Length: 1680 Ø: 52
Cone Ø: d1 Ø 30 / d2 Ø 27
03208300A, 81467116773, 81467116858,
81467116859, 81467116860, 81467116861,
81467116863, 81467116882, 81467116883,
81467116920, 81467116921



MN-DL-8544

Length: 596 Ø: 48
Hole Distance: 130 / 130
81432206196, 81432206232, 81432206233



MN-DL-8599

Length: 1800 Ø: 62
Cone Ø: d1 Ø 30 / d2 Ø 27
81466116161, 81466116162, 82466106183,
82466106186, 82466106187



MN-DL-10288

81432206386, 82432206008, 82432209008

No Image

MN-DL-12285

Length: 993 Ø: 40
Cone Ø: d1 Ø 30 / d2 Ø 27
81466106816, 81466106826, 81466116151,
82466106184, 82466106185



MN-DL-12288

Length: 585 Ø: 58
Hole Distance: 130 / 130
81432206386, 82432206008, 82432209008

No Image

MN-ES-10333

Length: 90
Cone Ø: d1 Ø 38 / d2 Ø 34,35
Thread: M36 x 1,5 RHT
1271126, 3090291, 3099128, 42538048,
81953016268, 82953016018, 82953016019



MN-VB-8514

Length: 627 Ø: 48
Hole Ø 25 / 25 / 25
Hole Distance: 152 / 130 / 130
81432706087, 81432706088, 81432706094,
81432706095, 81432796094



MN-VB-8669

Length: 627 Ø: 48
Hole Ø 25 / 25 / 25
Hole Distance: 152 / 130 / 130
81432706116, 81432706137, 81432706150,
81432706151



MN-VB-9404

Length: 627 Ø: 58
Hole Distance: 130 / 130
81432706117, 81432706152, 81432706153



SC-ES-7279

Length: 150
Cone Ø: d1 Ø 30 / d2 Ø 27
Thread: M30 x 1,5 RHT
81953016288



SC-ES-8517

Length: 140
Cone Ø: d1 Ø 30 / d2 Ø 27
Thread: M30 x 1,5 RHT
81953016286



SC-ES-8535

Length: 145
Cone Ø: d1 Ø 30 / d2 Ø 27
Thread: M30 x 1,5 RHT
81953016271, 81953016325



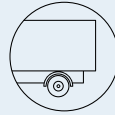

TGA ...

37.390, 37.400 FFD-TM	12/04 →	Centre Rod	MN-DL-7801		Push Rod, Leaf Spring Axle	
	12/04 →	Centre Rod	MN-DL-8599		Push Rod	
	12/04 →	Centre Rod	MN-DL-12285		for Steering Rod	
	12/04 →	Suspension Strut Repair Kit		DB-RK-8581		
	12/04 →	Tie Rod	MN-DL-7802			
	12/04 →	Tie Rod End	CV-ES-0914		for Steering Rod	
	12/04 →	Tie Rod End	CV-ES-14162		for Steering Rod	
	12/04 →	Tie Rod End	CV-ES-14163		for Steering Rod	
	12/04 →	Tie Rod End	MN-ES-10333		for Steering Rod	
	12/04 →	Tie Rod End	SC-ES-7279		for Steering Rod	
	12/04 →	Tie Rod End	SC-ES-8517		for Push Rod	
	12/04 →	Tie Rod End	SC-ES-8535		for Guide Rod	
	12/04 →	Track Control Arm		MN-DL-5225	Trailing Arm	
	12/04 →	Track Control Arm		MN-DL-8544	Trailing Arm, Drive Axle; Leaf Spring Axle	
	12/04 →	Track control arm		MN-DL-10288	Trailing Arm, 1st RA; 2nd RA, for Leaf-Spring Suspension vehicles, →Type MHB	
	12/04 →	Track control arm		MN-DL-12288	Trailing Arm	
	12/04 →	Track Control Arm		MN-VB-8514	Suspension Rod, Wishbone (CV), Drive Axle; Leaf Spring Axle	
	12/04 →	Track Control Arm		MN-VB-8669	Suspension Rod, Wishbone (CV), Drive Axle; Leaf Spring Axle	
	37.410 FFDK	12/04 →	Track Control Arm		MN-VB-9404	Wishbone (CV), Drive Axle; Leaf Spring Axle
		12/04 →	Centre Rod	MN-DL-2160		Coupling Rod
12/04 →		Suspension Arm Repair Kit		CV-RK-5313	for Wishbone (CV)	
12/04 →		Tie Rod End	CV-ES-0914		for Steering Rod	
12/04 →		Tie Rod End	CV-ES-14162		for Steering Rod	
12/04 →		Tie Rod End	CV-ES-14163		for Steering Rod	
12/04 →		Tie Rod End	SC-ES-7279		for Steering Rod	
12/04 →		Tie Rod End	SC-ES-8517		for Push Rod	
12/04 →		Tie Rod End	SC-ES-8535		for Guide Rod	
12/04 →		Track Control Arm		MN-DL-5225	Trailing Arm	
12/04 →		Track Control Arm		MN-DL-8544	Trailing Arm, 1st RA; 2nd RA, for Leaf-Spring Suspension vehicles	
12/04 →		Track control arm		MN-DL-10288	Trailing Arm, 1st RA; 2nd RA, for Leaf-Spring Suspension vehicles, →Type MHB	
12/04 →		Track control arm		MN-DL-12288	Trailing Arm	
12/04 →		Track Control Arm		MN-VB-8514	Suspension Rod, Wishbone (CV)	
12/04 →		Track Control Arm		MN-VB-8669	Suspension Rod, Wishbone (CV), 1st RA; 2nd RA, for Leaf-Spring Suspension vehicles, →Type_MHB Chassis	
37.410 FFDK	12/04 →	Track Control Arm		MN-VB-9404	Wishbone (CV), 1st RA; 2nd RA, for Leaf-Spring Suspension vehicles, →Type_MHB Chassis	
	12/04 →	Centre Rod	MN-DL-2160		Coupling Rod	
	12/04 →	Suspension Arm Repair Kit		CV-RK-5313	for Wishbone (CV)	
	12/04 →	Tie Rod End	CV-ES-0914		for Steering Rod	
	12/04 →	Tie Rod End	CV-ES-14162		for Steering Rod	
	12/04 →	Tie Rod End	CV-ES-14163		for Steering Rod	
	12/04 →	Tie Rod End	SC-ES-7279		for Steering Rod	
	12/04 →	Tie Rod End	SC-ES-8517		for Push Rod	
	12/04 →	Tie Rod End	SC-ES-8535		for Guide Rod	
	12/04 →	Track Control Arm		MN-DL-5225	Trailing Arm	
	12/04 →	Track Control Arm		MN-DL-8544	Trailing Arm, 1st RA; 2nd RA, for Leaf-Spring Suspension vehicles	
	12/04 →	Track control arm		MN-DL-10288	Trailing Arm, 1st RA; 2nd RA, for Leaf-Spring Suspension vehicles, →Type MHB	
	12/04 →	Track control arm		MN-DL-12288	Trailing Arm	
	12/04 →	Track Control Arm		MN-VB-8514	Suspension Rod, Wishbone (CV)	
	12/04 →	Track Control Arm		MN-VB-8669	Suspension Rod, Wishbone (CV), 1st RA; 2nd RA, for Leaf-Spring Suspension vehicles, →Type_MHB Chassis	
12/04 →	Track Control Arm		MN-VB-9404	Wishbone (CV), 1st RA; 2nd RA, for Leaf-Spring Suspension vehicles, →Type_MHB Chassis		

CV-ES-0914

Length: 125
Cone Ø: d1 Ø 30 / d2 Ø 27
Thread: M38 x 1,5 RHT
81953016184, 81953016251, 81953016276



CV-ES-14162

Length: 125
Cone Ø: d1 Ø 30 / d2 Ø 27
Thread: M30 x 1,5 LHT
81953010015, 81953010083, 81953010087, 81953016029, 81953016030, 81953016043, 81953016044, 81953016050, 81953016054, 81953016087, 81953016091, 81953016107, 81953016120, 81953016125, 81953016152, 81953016155, 81953016157, 81953016168, 81953016179, 81953016181, 81953016223, 81953016237, 81953016254, 81953016275, 81953016279, 81953016351



CV-ES-14163

Length: 125
Cone Ø: d1 Ø 30 / d2 Ø 27
Thread: M30 x 1,5 RHT
95301.0084, 90804102156, 90804102272, 90804102696, 90804102710, 81953010016, 81953010075, 81953010084, 81953010088, 81953010094, 81953010103, 81953016030, 81953016043, 81953016048, 81953016049, 81953016053, 81953016061, 81953016090, 81953016108, 81953016112, 81953016126, 81953016143, 81953016149, 81953016154, 81953016156, 81953016168, 81953016178, 81953016194, 81953016206, 81953016224, 81953016234, 81953016242, 81953016252, 81953016274, 81953016278, 81953016284, 81953016286, 81953016308, 81953016310, 81953016312, 81953016347, 81953016350, 81953016352, 82953016012, 88953016014, N2953016001



CV-RK-5313

Ø: 90
03304800A, 81953016132



DB-RK-8581

Ø: 85
Hole Distance: 130
Thick/Height: 24
03305800A, 81432706105



MN-DL-2160

Length: 1652 Ø: 50
Cone Ø: d1 Ø 30 / d2 Ø 27
81467106112, 81467106163, 81467106165, 81467106198, 81467106353, 81467106354, 81467106361, 81467116725



MN-DL-5225

Length: 572 Ø: 48
Hole Distance: 130 / 130
03301500A, 81432206229, 81432206236, 81432206267, 81432206270, 81432206272, 81432206304, 81432206305, 81432209236, 81432209267, 81432209272



MN-DL-7801

Length: 995 Ø: 52
Cone Ø: d1 Ø 30 / d2 Ø 27
81466106807, 81466106808, 81466116087, 81466116088, 81466116096, 81466116097, 81466116099, 81466116132, 81466116133, 81466116136, 81466116197, 81466116198, 81466116205

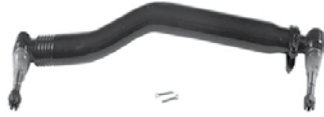

MN-DL-7802

Length: 1680 Ø: 52
Cone Ø: d1 Ø 30 / d2 Ø 27
03208300A, 81467116773, 81467116858, 81467116859, 81467116860, 81467116861, 81467116863, 81467116882, 81467116883, 81467116920, 81467116921



MN-DL-8544

Length: 596 Ø: 48
Hole Distance: 130 / 130
81432206196, 81432206232, 81432206233



MN-DL-8599

Length: 1800 Ø: 62
Cone Ø: d1 Ø 30 / d2 Ø 27
81466116161, 81466116162, 82466106183, 82466106186, 82466106187



MN-DL-10288

81432206386, 82432206008, 82432209008

No Image

MN-DL-12285

Length: 993 Ø: 40
Cone Ø: d1 Ø 30 / d2 Ø 27
81466106816, 81466106826, 81466116151, 82466106184, 82466106185



MN-DL-12288

Length: 585 Ø: 58
Hole Distance: 130 / 130
81432206386, 82432206008, 82432209008

No Image

MN-ES-10333

Length: 90
Cone Ø: d1 Ø 38 / d2 Ø 34,35
Thread: M36 x 1,5 RHT
1271126, 3090291, 3099128, 42538048, 81953016268, 82953016018, 82953016019



MN-VB-8514

Length: 627 Ø: 48
Hole Ø 25 / 25 / 25
Hole Distance: 152 / 130 / 130
81432706087, 81432706088, 81432706094, 81432706095, 81432796094



MN-VB-8669

Length: 627 Ø: 48
Hole Ø 25 / 25 / 25
Hole Distance: 152 / 130 / 130
81432706116, 81432706137, 81432706150, 81432706151



MN-VB-9404

Length: 627 Ø: 58
Hole Distance: 130 / 130
81432706117, 81432706152, 81432706153



SC-ES-7279

Length: 150
Cone Ø: d1 Ø 30 / d2 Ø 27
Thread: M30 x 1,5 RHT
81953016288



SC-ES-8517

Length: 140
Cone Ø: d1 Ø 30 / d2 Ø 27
Thread: M30 x 1,5 RHT
81953016286



SC-ES-8535

Length: 145
Cone Ø: d1 Ø 30 / d2 Ø 27
Thread: M30 x 1,5 RHT
81953016271, 81953016325





TGA ...

37.410 FFD-TM	12/04 →	Centre Rod	MN-DL-2160		Coupling Rod	
	12/04 →	Suspension Arm Repair Kit		CV-RK-5313	for Wishbone (CV)	
	12/04 →	Tie Rod End	CV-ES-0914		for Steering Rod	
	12/04 →	Tie Rod End	CV-ES-14162		for Steering Rod	
	12/04 →	Tie Rod End	CV-ES-14163		for Steering Rod	
	12/04 →	Tie Rod End	SC-ES-7279		for Steering Rod	
	12/04 →	Tie Rod End	SC-ES-8517		for Push Rod	
	12/04 →	Tie Rod End	SC-ES-8535		for Guide Rod	
	12/04 →	Track Control Arm		MN-DL-5225	Trailing Arm	
	12/04 →	Track Control Arm		MN-DL-8544	Trailing Arm, 1st RA;2nd RA, for Leaf-Spring Suspension vehicles	
	12/04 →	Track control arm		MN-DL-10288	Trailing Arm, 1st RA;2nd RA, for Leaf-Spring Suspension vehicles, →Type MHB	
	12/04 →	Track control arm		MN-DL-12288	Trailing Arm	
	12/04 →	Track Control Arm		MN-VB-8514	Suspension Rod, Wishbone (CV)	
	12/04 →	Track Control Arm		MN-VB-8669	Suspension Rod, Wishbone (CV), 1st RA; 2nd RA, for Leaf-Spring Suspension vehicles, →Type_MHB Chassis	
	37.430, 37.440 FFDC	12/04 →	Centre Rod	MN-DL-7801		Push Rod, Leaf Spring Axle
		12/04 →	Centre Rod	MN-DL-8599		Push Rod
12/04 →		Centre Rod	MN-DL-12285		for Steering Rod	
12/04 →		Suspension Strut Repair Kit		DB-RK-8581		
12/04 →		Tie Rod	MN-DL-7802			
12/04 →		Tie Rod End	CV-ES-0914		for Steering Rod	
12/04 →		Tie Rod End	CV-ES-14162		for Steering Rod	
12/04 →		Tie Rod End	CV-ES-14163		for Steering Rod	
12/04 →		Tie Rod End	MN-ES-10333		for Steering Rod	
12/04 →		Tie Rod End	SC-ES-7279		for Steering Rod	
12/04 →		Tie Rod End	SC-ES-8517		for Push Rod	
12/04 →		Tie Rod End	SC-ES-8535		for Guide Rod	
12/04 →		Track Control Arm		MN-DL-5225	Trailing Arm	
12/04 →		Track Control Arm		MN-DL-8544	Trailing Arm, Drive Axle;Leaf Spring Axle	
12/04 →		Track control arm		MN-DL-10288	Trailing Arm, 1st RA;2nd RA, for Leaf-Spring Suspension vehicles, →Type MHB	
12/04 →		Track control arm		MN-DL-12288	Trailing Arm	
12/04 →	Track Control Arm		MN-VB-8514	Suspension Rod, Wishbone (CV), Drive Axle; Leaf Spring Axle		
12/04 →	Track Control Arm		MN-VB-8669	Suspension Rod, Wishbone (CV), Drive Axle; Leaf Spring Axle		
12/04 →	Track Control Arm		MN-VB-9404	Wishbone (CV), Drive Axle;Leaf Spring Axle		
37.430, 37.440 FFDK	12/04 →	Centre Rod	MN-DL-7801		Push Rod, Leaf Spring Axle	
	12/04 →	Centre Rod	MN-DL-8599		Push Rod	
	12/04 →	Centre Rod	MN-DL-12285		for Steering Rod	
	12/04 →	Suspension Strut Repair Kit		DB-RK-8581		
	12/04 →	Tie Rod	MN-DL-7802			
	12/04 →	Tie Rod End	CV-ES-0914		for Steering Rod	
	12/04 →	Tie Rod End	CV-ES-14162		for Steering Rod	
	12/04 →	Tie Rod End	CV-ES-14163		for Steering Rod	
	12/04 →	Tie Rod End	MN-ES-10333		for Steering Rod	
	12/04 →	Tie Rod End	SC-ES-7279		for Steering Rod	
	12/04 →	Tie Rod End	SC-ES-8517		for Push Rod	
	12/04 →	Tie Rod End	SC-ES-8535		for Guide Rod	
	12/04 →	Track Control Arm		MN-DL-5225	Trailing Arm	
	12/04 →	Track Control Arm		MN-DL-8544	Trailing Arm, Drive Axle;Leaf Spring Axle	
	12/04 →	Track control arm		MN-DL-10288	Trailing Arm, 1st RA;2nd RA, for Leaf-Spring Suspension vehicles, →Type MHB	
	12/04 →	Track control arm		MN-DL-12288	Trailing Arm	
12/04 →	Track Control Arm		MN-VB-8514	Suspension Rod, Wishbone (CV), Drive Axle; Leaf Spring Axle		

CV-ES-0914

Length: 125
Cone Ø: d1 Ø 30 / d2 Ø 27
Thread: M38 x 1,5 RHT
81953016184, 81953016251, 81953016276



CV-ES-14162

Length: 125
Cone Ø: d1 Ø 30 / d2 Ø 27
Thread: M30 x 1,5 LHT
81953010015, 81953010083, 81953010087, 81953016029, 81953016030, 81953016043, 81953016044, 81953016050, 81953016054, 81953016087, 81953016091, 81953016107, 81953016120, 81953016125, 81953016152, 81953016155, 81953016157, 81953016168, 81953016179, 81953016181, 81953016223, 81953016237, 81953016254, 81953016275, 81953016279, 81953016351

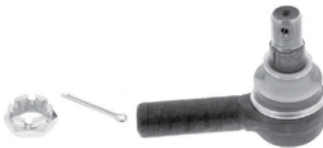

CV-ES-14163

Length: 125
Cone Ø: d1 Ø 30 / d2 Ø 27
Thread: M30 x 1,5 RHT
95301.0084, 90804102156, 90804102272, 90804102696, 90804102710, 81953010016, 81953010075, 81953010084, 81953010088, 81953010094, 81953010103, 81953016030, 81953016043, 81953016048, 81953016049, 81953016053, 81953016061, 81953016090, 81953016108, 81953016112, 81953016126, 81953016143, 81953016149, 81953016154, 81953016156, 81953016168, 81953016178, 81953016194, 81953016206, 81953016224, 81953016234, 81953016242, 81953016252, 81953016274, 81953016278, 81953016284, 81953016286, 81953016308, 81953016310, 81953016312, 81953016347, 81953016350, 81953016352, 82953016012, 88953016014, N2953016001



CV-RK-5313

Ø: 90
03304800A, 81953016132



DB-RK-8581

Ø: 85
Hole Distance: 130
Thick/Height: 24
03305800A, 81432706105



MN-DL-2160

Length: 1652 Ø: 50
Cone Ø: d1 Ø 30 / d2 Ø 27
81467106112, 81467106163, 81467106165, 81467106198, 81467106353, 81467106354, 81467106361, 81467116725



MN-DL-5225

Length: 572 Ø: 48
Hole Distance: 130 / 130
03301500A, 81432206229, 81432206236, 81432206267, 81432206270, 81432206272, 81432206304, 81432206305, 81432209236, 81432209267, 81432209272



MN-DL-7801

Length: 995 Ø: 52
Cone Ø: d1 Ø 30 / d2 Ø 27
81466106807, 81466106808, 81466116087, 81466116088, 81466116096, 81466116097, 81466116099, 81466116132, 81466116133, 81466116136, 81466116197, 81466116198, 81466116205

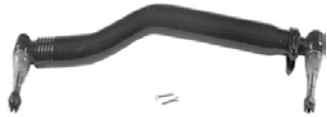

MN-DL-7802

Length: 1680 Ø: 52
Cone Ø: d1 Ø 30 / d2 Ø 27
03208300A, 81467116773, 81467116858, 81467116859, 81467116860, 81467116861, 81467116863, 81467116882, 81467116883, 81467116920, 81467116921



MN-DL-8544

Length: 596 Ø: 48
Hole Distance: 130 / 130
81432206196, 81432206232, 81432206233



MN-DL-8599

Length: 1800 Ø: 62
Cone Ø: d1 Ø 30 / d2 Ø 27
81466116161, 81466116162, 82466106183, 82466106186, 82466106187



MN-DL-10288

81432206386, 82432206008, 82432209008

No Image

MN-DL-12285

Length: 993 Ø: 40
Cone Ø: d1 Ø 30 / d2 Ø 27
81466106816, 81466106826, 81466116151, 82466106184, 82466106185



MN-DL-12288

Length: 585 Ø: 58
Hole Distance: 130 / 130
81432206386, 82432206008, 82432209008

No Image

MN-ES-10333

Length: 90
Cone Ø: d1 Ø 38 / d2 Ø 34,35
Thread: M36 x 1,5 RHT
1271126, 3090291, 3099128, 42538048, 81953016268, 82953016018, 82953016019



MN-VB-8514

Length: 627 Ø: 48
Hole Ø 25 / 25 / 25
Hole Distance: 152 / 130 / 130
81432706087, 81432706088, 81432706094, 81432706095, 81432796094



MN-VB-8669

Length: 627 Ø: 48
Hole Ø 25 / 25 / 25
Hole Distance: 152 / 130 / 130
81432706116, 81432706137, 81432706150, 81432706151



MN-VB-9404

Length: 627 Ø: 58
Hole Distance: 130 / 130
81432706117, 81432706152, 81432706153



SC-ES-7279

Length: 150
Cone Ø: d1 Ø 30 / d2 Ø 27
Thread: M30 x 1,5 RHT
81953016288



SC-ES-8517

Length: 140
Cone Ø: d1 Ø 30 / d2 Ø 27
Thread: M30 x 1,5 RHT
81953016286



SC-ES-8535

Length: 145
Cone Ø: d1 Ø 30 / d2 Ø 27
Thread: M30 x 1,5 RHT
81953016271, 81953016325





TGA ...

37.430, 37.440 FFDK ...	12/04 →	Track Control Arm		MN-VB-8669	Suspension Rod, Wishbone (CV), Drive Axle; Leaf Spring Axle
	12/04 →	Track Control Arm		MN-VB-9404	Wishbone (CV), Drive Axle; Leaf Spring Axle
37.430, 37.440 FFD-TM	12/04 →	Centre Rod	MN-DL-7801		Push Rod, Leaf Spring Axle
	12/04 →	Centre Rod	MN-DL-8599		Push Rod
	12/04 →	Centre Rod	MN-DL-12285		for Steering Rod
	12/04 →	Suspension Strut Repair Kit		DB-RK-8581	
	12/04 →	Tie Rod	MN-DL-7802		
	12/04 →	Tie Rod End	CV-ES-0914		for Steering Rod
	12/04 →	Tie Rod End	CV-ES-14162		for Steering Rod
	12/04 →	Tie Rod End	CV-ES-14163		for Steering Rod
	12/04 →	Tie Rod End	MN-ES-10333		for Steering Rod
	12/04 →	Tie Rod End	SC-ES-7279		for Steering Rod
	12/04 →	Tie Rod End	SC-ES-8517		for Push Rod
	12/04 →	Tie Rod End	SC-ES-8535		for Guide Rod
	12/04 →	Track Control Arm		MN-DL-5225	Trailing Arm
	12/04 →	Track Control Arm		MN-DL-8544	Trailing Arm, Drive Axle; Leaf Spring Axle
	12/04 →	Track control arm		MN-DL-10288	Trailing Arm, 1st RA; 2nd RA, for Leaf-Spring Suspension vehicles, →Type MHB
	12/04 →	Track control arm		MN-DL-12288	Trailing Arm
	12/04 →	Track Control Arm		MN-VB-8514	Suspension Rod, Wishbone (CV), Drive Axle; Leaf Spring Axle
	12/04 →	Track Control Arm		MN-VB-8669	Suspension Rod, Wishbone (CV), Drive Axle; Leaf Spring Axle
	12/04 →	Track Control Arm		MN-VB-9404	Wishbone (CV), Drive Axle; Leaf Spring Axle
	37.460 FFDK	12/04 →	Centre Rod	MN-DL-2160	
12/04 →		Suspension Arm Repair Kit		CV-RK-5313	for Wishbone (CV)
12/04 →		Tie Rod End	CV-ES-0914		for Steering Rod
12/04 →		Tie Rod End	CV-ES-14162		for Steering Rod
12/04 →		Tie Rod End	CV-ES-14163		for Steering Rod
12/04 →		Tie Rod End	SC-ES-7279		for Steering Rod
12/04 →		Tie Rod End	SC-ES-8517		for Push Rod
12/04 →		Tie Rod End	SC-ES-8535		for Guide Rod
12/04 →		Track Control Arm		MN-DL-5225	Trailing Arm
12/04 →		Track Control Arm		MN-DL-8544	Trailing Arm, 1st RA; 2nd RA, for Leaf-Spring Suspension vehicles
12/04 →		Track control arm		MN-DL-10288	Trailing Arm, 1st RA; 2nd RA, for Leaf-Spring Suspension vehicles, →Type MHB
12/04 →		Track control arm		MN-DL-12288	Trailing Arm
12/04 →		Track Control Arm		MN-VB-8514	Suspension Rod, Wishbone (CV)
12/04 →		Track Control Arm		MN-VB-8669	Suspension Rod, Wishbone (CV), 1st RA; 2nd RA, for Leaf-Spring Suspension vehicles, →Type_MHB Chassis
12/04 →		Track Control Arm		MN-VB-9404	Wishbone (CV), 1st RA; 2nd RA, for Leaf-Spring Suspension vehicles, →Type_MHB Chassis
37.460 FFDK		12/04 →	Centre Rod	MN-DL-2160	
	12/04 →	Suspension Arm Repair Kit		CV-RK-5313	for Wishbone (CV)
	12/04 →	Tie Rod End	CV-ES-0914		for Steering Rod
	12/04 →	Tie Rod End	CV-ES-14162		for Steering Rod
	12/04 →	Tie Rod End	CV-ES-14163		for Steering Rod
	12/04 →	Tie Rod End	SC-ES-7279		for Steering Rod
	12/04 →	Tie Rod End	SC-ES-8517		for Push Rod
	12/04 →	Tie Rod End	SC-ES-8535		for Guide Rod
	12/04 →	Track Control Arm		MN-DL-5225	Trailing Arm
	12/04 →	Track Control Arm		MN-DL-8544	Trailing Arm, 1st RA; 2nd RA, for Leaf-Spring Suspension vehicles
	12/04 →	Track control arm		MN-DL-10288	Trailing Arm, 1st RA; 2nd RA, for Leaf-Spring Suspension vehicles, →Type MHB
	12/04 →	Track control arm		MN-DL-12288	Trailing Arm
	12/04 →	Track Control Arm		MN-VB-8514	Suspension Rod, Wishbone (CV)

CV-ES-0914

Length: 125
Cone Ø: d1 Ø 30 / d2 Ø 27
Thread: M38 x 1,5 RHT
81953016184, 81953016251, 81953016276



CV-ES-14162

Length: 125
Cone Ø: d1 Ø 30 / d2 Ø 27
Thread: M30 x 1,5 LHT
81953010015, 81953010083, 81953010087, 81953016029, 81953016030, 81953016043, 81953016044, 81953016050, 81953016054, 81953016087, 81953016091, 81953016107, 81953016120, 81953016125, 81953016152, 81953016155, 81953016157, 81953016168, 81953016179, 81953016181, 81953016223, 81953016237, 81953016254, 81953016275, 81953016279, 81953016351



CV-ES-14163

Length: 125
Cone Ø: d1 Ø 30 / d2 Ø 27
Thread: M30 x 1,5 RHT
95301.0084, 90804102156, 90804102272, 90804102696, 90804102710, 81953010016, 81953010075, 81953010084, 81953010088, 81953010094, 81953010103, 81953016030, 81953016043, 81953016048, 81953016049, 81953016053, 81953016061, 81953016090, 81953016108, 81953016112, 81953016126, 81953016143, 81953016149, 81953016154, 81953016156, 81953016168, 81953016178, 81953016194, 81953016206, 81953016224, 81953016234, 81953016242, 81953016252, 81953016274, 81953016278, 81953016284, 81953016286, 81953016308, 81953016310, 81953016312, 81953016347, 81953016350, 81953016352, 82953016012, 88953016014, N2953016001



CV-RK-5313

Ø: 90
03304800A, 81953016132



DB-RK-8581

Ø: 85
Hole Distance: 130
Thick/Height: 24
03305800A, 81432706105



MN-DL-2160

Length: 1652 Ø: 50
Cone Ø: d1 Ø 30 / d2 Ø 27
81467106112, 81467106163, 81467106165, 81467106198, 81467106353, 81467106354, 81467106361, 81467116725



MN-DL-5225

Length: 572 Ø: 48
Hole Distance: 130 / 130
03301500A, 81432206229, 81432206236, 81432206267, 81432206270, 81432206272, 81432206304, 81432206305, 81432209236, 81432209267, 81432209272



MN-DL-7801

Length: 995 Ø: 52
Cone Ø: d1 Ø 30 / d2 Ø 27
81466106807, 81466106808, 81466116087, 81466116088, 81466116096, 81466116097, 81466116099, 81466116132, 81466116133, 81466116136, 81466116197, 81466116198, 81466116205

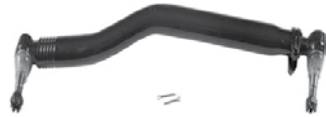

MN-DL-7802

Length: 1680 Ø: 52
Cone Ø: d1 Ø 30 / d2 Ø 27
03208300A, 81467116773, 81467116858, 81467116859, 81467116860, 81467116861, 81467116863, 81467116882, 81467116883, 81467116920, 81467116921



MN-DL-8544

Length: 596 Ø: 48
Hole Distance: 130 / 130
81432206196, 81432206232, 81432206233



MN-DL-8599

Length: 1800 Ø: 62
Cone Ø: d1 Ø 30 / d2 Ø 27
81466116161, 81466116162, 82466106183, 82466106186, 82466106187



MN-DL-10288

81432206386, 82432206008, 82432209008

No Image

MN-DL-12285

Length: 993 Ø: 40
Cone Ø: d1 Ø 30 / d2 Ø 27
81466106816, 81466106826, 81466116151, 82466106184, 82466106185



MN-DL-12288

Length: 585 Ø: 58
Hole Distance: 130 / 130
81432206386, 82432206008, 82432209008

No Image

MN-ES-10333

Length: 90
Cone Ø: d1 Ø 38 / d2 Ø 34,35
Thread: M36 x 1,5 RHT
1271126, 3090291, 3099128, 42538048, 81953016268, 82953016018, 82953016019



MN-VB-8514

Length: 627 Ø: 48
Hole Ø 25 / 25 / 25
Hole Distance: 152 / 130 / 130
81432706087, 81432706088, 81432706094, 81432706095, 81432796094



MN-VB-8669

Length: 627 Ø: 48
Hole Ø 25 / 25 / 25
Hole Distance: 152 / 130 / 130
81432706116, 81432706137, 81432706150, 81432706151



MN-VB-9404

Length: 627 Ø: 58
Hole Distance: 130 / 130
81432706117, 81432706152, 81432706153



SC-ES-7279

Length: 150
Cone Ø: d1 Ø 30 / d2 Ø 27
Thread: M30 x 1,5 RHT
81953016288



SC-ES-8517

Length: 140
Cone Ø: d1 Ø 30 / d2 Ø 27
Thread: M30 x 1,5 RHT
81953016286



SC-ES-8535

Length: 145
Cone Ø: d1 Ø 30 / d2 Ø 27
Thread: M30 x 1,5 RHT
81953016271, 81953016325



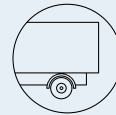

TGA ...

37.460 FFDK ...	12/04 →	Track Control Arm		MN-VB-8669	Suspension Rod, Wishbone (CV), 1st RA; 2nd RA, for Leaf-Spring Suspension vehicles, →Type_MHB Chassis
	12/04 →	Track Control Arm		MN-VB-9404	Wishbone (CV), 1st RA;2nd RA, for Leaf-Spring Suspension vehicles, →Type_MHB Chassis
37.460 FFD-TM	12/04 →	Centre Rod	MN-DL-2160		Coupling Rod
	12/04 →	Suspension Arm Repair Kit		CV-RK-5313	for Wishbone (CV)
	12/04 →	Tie Rod End	CV-ES-0914		for Steering Rod
	12/04 →	Tie Rod End	CV-ES-14162		for Steering Rod
	12/04 →	Tie Rod End	CV-ES-14163		for Steering Rod
	12/04 →	Tie Rod End	SC-ES-7279		for Steering Rod
	12/04 →	Tie Rod End	SC-ES-8517		for Push Rod
	12/04 →	Tie Rod End	SC-ES-8535		for Guide Rod
	12/04 →	Track Control Arm		MN-DL-5225	Trailing Arm
	12/04 →	Track Control Arm		MN-DL-8544	Trailing Arm, 1st RA;2nd RA, for Leaf-Spring Suspension vehicles
	12/04 →	Track control arm		MN-DL-10288	Trailing Arm, 1st RA;2nd RA, for Leaf-Spring Suspension vehicles, →Type MHB
	12/04 →	Track control arm		MN-DL-12288	Trailing Arm
	12/04 →	Track Control Arm		MN-VB-8514	Suspension Rod, Wishbone (CV)
	12/04 →	Track Control Arm		MN-VB-8669	Suspension Rod, Wishbone (CV), 1st RA; 2nd RA, for Leaf-Spring Suspension vehicles, →Type_MHB Chassis
	12/04 →	Track Control Arm		MN-VB-9404	Wishbone (CV), 1st RA;2nd RA, for Leaf-Spring Suspension vehicles, →Type_MHB Chassis
	37.480 FFDC	12/04 →	Centre Rod	MN-DL-12285	
12/04 →		Suspension Arm Repair Kit		CV-RK-5313	for Wishbone (CV)
12/04 →		Tie Rod End	CV-ES-0914		for Steering Rod
12/04 →		Tie Rod End	CV-ES-14162		for Steering Rod
12/04 →		Tie Rod End	CV-ES-14163		for Steering Rod
12/04 →		Tie Rod End	SC-ES-7279		for Steering Rod
12/04 →		Tie Rod End	SC-ES-8517		for Push Rod
12/04 →		Tie Rod End	SC-ES-8535		for Guide Rod
12/04 →		Track Control Arm		MN-DL-5225	Trailing Arm
12/04 →		Track Control Arm		MN-DL-8544	Trailing Arm, 1st RA;2nd RA, for Leaf-Spring Suspension vehicles
12/04 →		Track control arm		MN-DL-10288	Trailing Arm, 1st RA;2nd RA, for Leaf-Spring Suspension vehicles, →Type MHB
12/04 →		Track control arm		MN-DL-12288	Trailing Arm
12/04 →		Track Control Arm		MN-VB-8514	Suspension Rod, Wishbone (CV)
12/04 →		Track Control Arm		MN-VB-8669	Suspension Rod, Wishbone (CV), 1st RA; 2nd RA, for Leaf-Spring Suspension vehicles, →Type_MHB Chassis
12/04 →		Track Control Arm		MN-VB-9404	Wishbone (CV), 1st RA;2nd RA, for Leaf-Spring Suspension vehicles, →Type_MHB Chassis
02/06 →		Centre Rod	MN-DL-7801		Push Rod, Leaf Spring Axle
02/06 →		Centre Rod	MN-DL-8599		Push Rod
02/06 →		Suspension Strut Repair Kit		DB-RK-8581	
02/06 →		Tie Rod	MN-DL-7802		
02/06 →		Tie Rod End	MN-ES-10333		for Steering Rod
02/06 →		Track Control Arm		MN-DL-8544	Trailing Arm, Drive Axle;Leaf Spring Axle
02/06 →		Track Control Arm		MN-VB-8514	Suspension Rod, Wishbone (CV), Drive Axle; Leaf Spring Axle
02/06 →	Track Control Arm		MN-VB-8669	Suspension Rod, Wishbone (CV), Drive Axle; Leaf Spring Axle	
02/06 →	Track Control Arm		MN-VB-9404	Wishbone (CV), Drive Axle;Leaf Spring Axle	

CV-ES-0914

Length: 125
Cone Ø: d1 Ø 30 / d2 Ø 27
Thread: M38 x 1,5 RHT
81953016184, 81953016251, 81953016276



CV-ES-14162

Length: 125
Cone Ø: d1 Ø 30 / d2 Ø 27
Thread: M30 x 1,5 LHT
81953010015, 81953010083, 81953010087, 81953016029, 81953016030, 81953016043, 81953016044, 81953016050, 81953016054, 81953016087, 81953016091, 81953016107, 81953016120, 81953016125, 81953016152, 81953016155, 81953016157, 81953016168, 81953016179, 81953016181, 81953016223, 81953016237, 81953016254, 81953016275, 81953016279, 81953016351

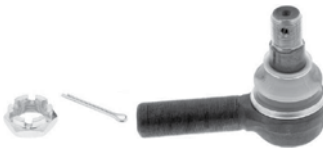

CV-ES-14163

Length: 125
Cone Ø: d1 Ø 30 / d2 Ø 27
Thread: M30 x 1,5 RHT
95301.0084, 90804102156, 90804102272, 90804102696, 90804102710, 81953010016, 81953010075, 81953010084, 81953010088, 81953010094, 81953010103, 81953016030, 81953016043, 81953016048, 81953016049, 81953016053, 81953016061, 81953016090, 81953016108, 81953016112, 81953016126, 81953016143, 81953016149, 81953016154, 81953016156, 81953016168, 81953016178, 81953016194, 81953016206, 81953016224, 81953016234, 81953016242, 81953016252, 81953016274, 81953016278, 81953016284, 81953016286, 81953016308, 81953016310, 81953016312, 81953016347, 81953016350, 81953016352, 82953016012, 88953016014, N2953016001



CV-RK-5313

Ø: 90
03304800A, 81953016132



DB-RK-8581

Ø: 85
Hole Distance: 130
Thick/Height: 24
03305800A, 81432706105



MN-DL-2160

Length: 1652 Ø: 50
Cone Ø: d1 Ø 30 / d2 Ø 27
81467106112, 81467106163, 81467106165, 81467106198, 81467106353, 81467106354, 81467106361, 81467116725



MN-DL-5225

Length: 572 Ø: 48
Hole Distance: 130 / 130
03301500A, 81432206229, 81432206236, 81432206267, 81432206270, 81432206272, 81432206304, 81432206305, 81432209236, 81432209267, 81432209272



MN-DL-7801

Length: 995 Ø: 52
Cone Ø: d1 Ø 30 / d2 Ø 27
81466106807, 81466106808, 81466116087, 81466116088, 81466116096, 81466116097, 81466116099, 81466116132, 81466116133, 81466116136, 81466116197, 81466116198, 81466116205

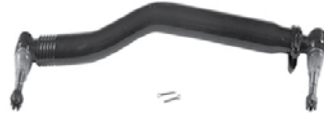

MN-DL-7802

Length: 1680 Ø: 52
Cone Ø: d1 Ø 30 / d2 Ø 27
03208300A, 81467116773, 81467116858, 81467116859, 81467116860, 81467116861, 81467116863, 81467116882, 81467116883, 81467116920, 81467116921



MN-DL-8544

Length: 596 Ø: 48
Hole Distance: 130 / 130
81432206196, 81432206232, 81432206233



MN-DL-8599

Length: 1800 Ø: 62
Cone Ø: d1 Ø 30 / d2 Ø 27
81466116161, 81466116162, 82466106183, 82466106186, 82466106187



MN-DL-10288

81432206386, 82432206008, 82432209008

No Image

MN-DL-12285

Length: 993 Ø: 40
Cone Ø: d1 Ø 30 / d2 Ø 27
81466106816, 81466106826, 81466116151, 82466106184, 82466106185



MN-DL-12288

Length: 585 Ø: 58
Hole Distance: 130 / 130
81432206386, 82432206008, 82432209008

No Image

MN-ES-10333

Length: 90
Cone Ø: d1 Ø 38 / d2 Ø 34,35
Thread: M36 x 1,5 RHT
1271126, 3090291, 3099128, 42538048, 81953016268, 82953016018, 82953016019



MN-VB-8514

Length: 627 Ø: 48
Hole Ø 25 / 25 / 25
Hole Distance: 152 / 130 / 130
81432706087, 81432706088, 81432706094, 81432706095, 81432796094



MN-VB-8669

Length: 627 Ø: 48
Hole Ø 25 / 25 / 25
Hole Distance: 152 / 130 / 130
81432706116, 81432706137, 81432706150, 81432706151



MN-VB-9404

Length: 627 Ø: 58
Hole Distance: 130 / 130
81432706117, 81432706152, 81432706153



SC-ES-7279

Length: 150
Cone Ø: d1 Ø 30 / d2 Ø 27
Thread: M30 x 1,5 RHT
81953016288



SC-ES-8517

Length: 140
Cone Ø: d1 Ø 30 / d2 Ø 27
Thread: M30 x 1,5 RHT
81953016286



SC-ES-8535

Length: 145
Cone Ø: d1 Ø 30 / d2 Ø 27
Thread: M30 x 1,5 RHT
81953016271, 81953016325





TGA ...

37.480 FFDK

12/04 →	Centre Rod	MN-DL-12285		for Steering Rod
12/04 →	Suspension Arm Repair Kit		CV-RK-5313	for Wishbone (CV)
12/04 →	Tie Rod End	CV-ES-0914		for Steering Rod
12/04 →	Tie Rod End	CV-ES-14162		for Steering Rod
12/04 →	Tie Rod End	CV-ES-14163		for Steering Rod
12/04 →	Tie Rod End	SC-ES-7279		for Steering Rod
12/04 →	Tie Rod End	SC-ES-8517		for Push Rod
12/04 →	Tie Rod End	SC-ES-8535		for Guide Rod
12/04 →	Track Control Arm		MN-DL-5225	Trailing Arm
12/04 →	Track Control Arm		MN-DL-8544	Trailing Arm, 1st RA;2nd RA, for Leaf-Spring Suspension vehicles
12/04 →	Track control arm		MN-DL-10288	Trailing Arm, 1st RA;2nd RA, for Leaf-Spring Suspension vehicles, →Type MHB
12/04 →	Track control arm		MN-DL-12288	Trailing Arm
12/04 →	Track Control Arm		MN-VB-8514	Suspension Rod, Wishbone (CV)
12/04 →	Track Control Arm		MN-VB-8669	Suspension Rod, Wishbone (CV), 1st RA; 2nd RA, for Leaf-Spring Suspension vehicles, →Type_MHB Chassis
12/04 →	Track Control Arm		MN-VB-9404	Wishbone (CV), 1st RA;2nd RA, for Leaf-Spring Suspension vehicles, →Type_MHB Chassis
02/06 →	Centre Rod	MN-DL-7801		Push Rod, Leaf Spring Axle
02/06 →	Centre Rod	MN-DL-8599		Push Rod
02/06 →	Suspension Strut Repair Kit		DB-RK-8581	
02/06 →	Tie Rod	MN-DL-7802		
02/06 →	Tie Rod End	MN-ES-10333		for Steering Rod
02/06 →	Track Control Arm		MN-DL-8544	Trailing Arm, Drive Axle;Leaf Spring Axle
02/06 →	Track Control Arm		MN-VB-8514	Suspension Rod, Wishbone (CV), Drive Axle; Leaf Spring Axle
02/06 →	Track Control Arm		MN-VB-8669	Suspension Rod, Wishbone (CV), Drive Axle; Leaf Spring Axle
02/06 →	Track Control Arm		MN-VB-9404	Wishbone (CV), Drive Axle;Leaf Spring Axle

37.480 FFD-TM

12/04 →	Centre Rod	MN-DL-12285		for Steering Rod
12/04 →	Suspension Arm Repair Kit		CV-RK-5313	for Wishbone (CV)
12/04 →	Tie Rod End	CV-ES-0914		for Steering Rod
12/04 →	Tie Rod End	CV-ES-14162		for Steering Rod
12/04 →	Tie Rod End	CV-ES-14163		for Steering Rod
12/04 →	Tie Rod End	SC-ES-7279		for Steering Rod
12/04 →	Tie Rod End	SC-ES-8517		for Push Rod
12/04 →	Tie Rod End	SC-ES-8535		for Guide Rod
12/04 →	Track Control Arm		MN-DL-5225	Trailing Arm
12/04 →	Track Control Arm		MN-DL-8544	Trailing Arm, 1st RA;2nd RA, for Leaf-Spring Suspension vehicles
12/04 →	Track control arm		MN-DL-10288	Trailing Arm, 1st RA;2nd RA, for Leaf-Spring Suspension vehicles, →Type MHB
12/04 →	Track control arm		MN-DL-12288	Trailing Arm
12/04 →	Track Control Arm		MN-VB-8514	Suspension Rod, Wishbone (CV)
12/04 →	Track Control Arm		MN-VB-8669	Suspension Rod, Wishbone (CV), 1st RA; 2nd RA, for Leaf-Spring Suspension vehicles, →Type_MHB Chassis
12/04 →	Track Control Arm		MN-VB-9404	Wishbone (CV), 1st RA;2nd RA, for Leaf-Spring Suspension vehicles, →Type_MHB Chassis
02/06 →	Centre Rod	MN-DL-7801		Push Rod, Leaf Spring Axle
02/06 →	Centre Rod	MN-DL-8599		Push Rod
02/06 →	Suspension Strut Repair Kit		DB-RK-8581	
02/06 →	Tie Rod	MN-DL-7802		
02/06 →	Tie Rod End	MN-ES-10333		for Steering Rod
02/06 →	Track Control Arm		MN-DL-8544	Trailing Arm, Drive Axle;Leaf Spring Axle
02/06 →	Track Control Arm		MN-VB-8514	Suspension Rod, Wishbone (CV), Drive Axle; Leaf Spring Axle
02/06 →	Track Control Arm		MN-VB-8669	Suspension Rod, Wishbone (CV), Drive Axle; Leaf Spring Axle
02/06 →	Track Control Arm		MN-VB-9404	Wishbone (CV), Drive Axle;Leaf Spring Axle

CV-ES-0914

Length: 125
Cone Ø: d1 Ø 30 / d2 Ø 27
Thread: M38 x 1,5 RHT
81953016184, 81953016251, 81953016276



CV-ES-14162

Length: 125
Cone Ø: d1 Ø 30 / d2 Ø 27
Thread: M30 x 1,5 LHT
81953010015, 81953010083, 81953010087, 81953016029, 81953016030, 81953016043, 81953016044, 81953016050, 81953016054, 81953016087, 81953016091, 81953016107, 81953016120, 81953016125, 81953016152, 81953016155, 81953016157, 81953016168, 81953016179, 81953016181, 81953016223, 81953016237, 81953016254, 81953016275, 81953016279, 81953016351



CV-ES-14163

Length: 125
Cone Ø: d1 Ø 30 / d2 Ø 27
Thread: M30 x 1,5 RHT
95301.0084, 90804102156, 90804102272, 90804102696, 90804102710, 81953010016, 81953010075, 81953010084, 81953010088, 81953010094, 81953010103, 81953016030, 81953016043, 81953016048, 81953016049, 81953016053, 81953016061, 81953016090, 81953016108, 81953016112, 81953016126, 81953016143, 81953016149, 81953016154, 81953016156, 81953016168, 81953016178, 81953016194, 81953016206, 81953016224, 81953016234, 81953016242, 81953016252, 81953016274, 81953016278, 81953016284, 81953016286, 81953016308, 81953016310, 81953016312, 81953016347, 81953016350, 81953016352, 82953016012, 88953016014, N2953016001



CV-RK-5313

Ø: 90
03304800A, 81953016132



DB-RK-8581

Ø: 85
Hole Distance: 130
Thick/Height: 24
03305800A, 81432706105



MN-DL-5225

Length: 572 Ø: 48
Hole Distance: 130 / 130
03301500A, 81432206229, 81432206236, 81432206267, 81432206270, 81432206272, 81432206304, 81432206305, 81432209236, 81432209267, 81432209272



MN-DL-7801

Length: 995 Ø: 52
Cone Ø: d1 Ø 30 / d2 Ø 27
81466106807, 81466106808, 81466116087, 81466116088, 81466116096, 81466116097, 81466116099, 81466116132, 81466116133, 81466116136, 81466116197, 81466116198, 81466116205

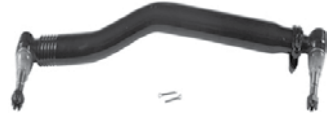

MN-DL-7802

Length: 1680 Ø: 52
Cone Ø: d1 Ø 30 / d2 Ø 27
03208300A, 81467116773, 81467116858, 81467116859, 81467116860, 81467116861, 81467116863, 81467116882, 81467116883, 81467116920, 81467116921



MN-DL-8544

Length: 596 Ø: 48
Hole Distance: 130 / 130
81432206196, 81432206232, 81432206233



MN-DL-8599

Length: 1800 Ø: 62
Cone Ø: d1 Ø 30 / d2 Ø 27
81466116161, 81466116162, 82466106183, 82466106186, 82466106187



MN-DL-10288

81432206386, 82432206008, 82432209008

No Image

MN-DL-12285

Length: 993 Ø: 40
Cone Ø: d1 Ø 30 / d2 Ø 27
81466106816, 81466106826, 81466116151, 82466106184, 82466106185



MN-DL-12288

Length: 585 Ø: 58
Hole Distance: 130 / 130
81432206386, 82432206008, 82432209008

No Image

MN-ES-10333

Length: 90
Cone Ø: d1 Ø 38 / d2 Ø 34,35
Thread: M36 x 1,5 RHT
1271126, 3090291, 3099128, 42538048, 81953016268, 82953016018, 82953016019



MN-VB-8514

Length: 627 Ø: 48
Hole Ø 25 / 25 / 25
Hole Distance: 152 / 130 / 130
81432706087, 81432706088, 81432706094, 81432706095, 81432796094



MN-VB-8669

Length: 627 Ø: 48
Hole Ø 25 / 25 / 25
Hole Distance: 152 / 130 / 130
81432706116, 81432706137, 81432706150, 81432706151



MN-VB-9404

Length: 627 Ø: 58
Hole Distance: 130 / 130
81432706117, 81432706152, 81432706153



SC-ES-7279

Length: 150
Cone Ø: d1 Ø 30 / d2 Ø 27
Thread: M30 x 1,5 RHT
81953016288



SC-ES-8517

Length: 140
Cone Ø: d1 Ø 30 / d2 Ø 27
Thread: M30 x 1,5 RHT
81953016286



SC-ES-8535

Length: 145
Cone Ø: d1 Ø 30 / d2 Ø 27
Thread: M30 x 1,5 RHT
81953016271, 81953016325





TGA ...

37.530 FFDK	12/04 →	Centre Rod	MN-DL-2160		Coupling Rod
	12/04 →	Suspension Arm Repair Kit		CV-RK-5313	for Wishbone (CV)
	12/04 →	Tie Rod End	CV-ES-0914		for Steering Rod
	12/04 →	Tie Rod End	CV-ES-14162		for Steering Rod
	12/04 →	Tie Rod End	CV-ES-14163		for Steering Rod
	12/04 →	Tie Rod End	SC-ES-7279		for Steering Rod
	12/04 →	Tie Rod End	SC-ES-8517		for Push Rod
	12/04 →	Tie Rod End	SC-ES-8535		for Guide Rod
	12/04 →	Track Control Arm		MN-DL-5225	Trailing Arm
	12/04 →	Track Control Arm		MN-DL-8544	Trailing Arm, 1st RA;2nd RA, for Leaf-Spring Suspension vehicles
	12/04 →	Track control arm		MN-DL-10288	Trailing Arm, 1st RA;2nd RA, for Leaf-Spring Suspension vehicles, →Type MHB
	12/04 →	Track control arm		MN-DL-12288	Trailing Arm
	12/04 →	Track Control Arm		MN-VB-8514	Suspension Rod, Wishbone (CV)
	12/04 →	Track Control Arm		MN-VB-8669	Suspension Rod, Wishbone (CV), 1st RA; 2nd RA, for Leaf-Spring Suspension vehicles, →Type_MHB Chassis
	12/04 →	Track Control Arm		MN-VB-9404	Wishbone (CV), 1st RA;2nd RA, for Leaf-Spring Suspension vehicles, →Type_MHB Chassis
	37.530 FFDK	12/04 →	Centre Rod	MN-DL-2160	
12/04 →		Suspension Arm Repair Kit		CV-RK-5313	for Wishbone (CV)
12/04 →		Tie Rod End	CV-ES-0914		for Steering Rod
12/04 →		Tie Rod End	CV-ES-14162		for Steering Rod
12/04 →		Tie Rod End	CV-ES-14163		for Steering Rod
12/04 →		Tie Rod End	SC-ES-7279		for Steering Rod
12/04 →		Tie Rod End	SC-ES-8517		for Push Rod
12/04 →		Tie Rod End	SC-ES-8535		for Guide Rod
12/04 →		Track Control Arm		MN-DL-5225	Trailing Arm
12/04 →		Track Control Arm		MN-DL-8544	Trailing Arm, 1st RA;2nd RA, for Leaf-Spring Suspension vehicles
12/04 →		Track control arm		MN-DL-10288	Trailing Arm, 1st RA;2nd RA, for Leaf-Spring Suspension vehicles, →Type MHB
12/04 →		Track control arm		MN-DL-12288	Trailing Arm
12/04 →		Track Control Arm		MN-VB-8514	Suspension Rod, Wishbone (CV)
12/04 →		Track Control Arm		MN-VB-8669	Suspension Rod, Wishbone (CV), 1st RA; 2nd RA, for Leaf-Spring Suspension vehicles, →Type_MHB Chassis
12/04 →		Track Control Arm		MN-VB-9404	Wishbone (CV), 1st RA;2nd RA, for Leaf-Spring Suspension vehicles, →Type_MHB Chassis
37.530 FFD-TM		12/04 →	Centre Rod	MN-DL-2160	
	12/04 →	Suspension Arm Repair Kit		CV-RK-5313	for Wishbone (CV)
	12/04 →	Tie Rod End	CV-ES-0914		for Steering Rod
	12/04 →	Tie Rod End	CV-ES-14162		for Steering Rod
	12/04 →	Tie Rod End	CV-ES-14163		for Steering Rod
	12/04 →	Tie Rod End	SC-ES-7279		for Steering Rod
	12/04 →	Tie Rod End	SC-ES-8517		for Push Rod
	12/04 →	Tie Rod End	SC-ES-8535		for Guide Rod
	12/04 →	Track Control Arm		MN-DL-5225	Trailing Arm
	12/04 →	Track Control Arm		MN-DL-8544	Trailing Arm, 1st RA;2nd RA, for Leaf-Spring Suspension vehicles
	12/04 →	Track control arm		MN-DL-10288	Trailing Arm, 1st RA;2nd RA, for Leaf-Spring Suspension vehicles, →Type MHB
	12/04 →	Track control arm		MN-DL-12288	Trailing Arm
	12/04 →	Track Control Arm		MN-VB-8514	Suspension Rod, Wishbone (CV)
	12/04 →	Track Control Arm		MN-VB-8669	Suspension Rod, Wishbone (CV), 1st RA; 2nd RA, for Leaf-Spring Suspension vehicles, →Type_MHB Chassis
	12/04 →	Track Control Arm		MN-VB-9404	Wishbone (CV), 1st RA;2nd RA, for Leaf-Spring Suspension vehicles, →Type_MHB Chassis

CV-ES-0914

Length: 125
Cone Ø: d1 Ø 30 / d2 Ø 27
Thread: M38 x 1,5 RHT
81953016184, 81953016251, 81953016276



CV-ES-14162

Length: 125
Cone Ø: d1 Ø 30 / d2 Ø 27
Thread: M30 x 1,5 LHT
81953010015, 81953010083, 81953010087, 81953016029, 81953016030, 81953016043, 81953016044, 81953016050, 81953016054, 81953016087, 81953016091, 81953016107, 81953016120, 81953016125, 81953016152, 81953016155, 81953016157, 81953016168, 81953016179, 81953016181, 81953016223, 81953016237, 81953016254, 81953016275, 81953016279, 81953016351



CV-ES-14163

Length: 125
Cone Ø: d1 Ø 30 / d2 Ø 27
Thread: M30 x 1,5 RHT
95301.0084, 90804102156, 90804102272, 90804102696, 90804102710, 81953010016, 81953010075, 81953010084, 81953010088, 81953010094, 81953010103, 81953016030, 81953016043, 81953016048, 81953016049, 81953016053, 81953016061, 81953016090, 81953016108, 81953016112, 81953016126, 81953016143, 81953016149, 81953016154, 81953016156, 81953016168, 81953016178, 81953016194, 81953016206, 81953016224, 81953016234, 81953016242, 81953016252, 81953016274, 81953016278, 81953016284, 81953016286, 81953016308, 81953016310, 81953016312, 81953016347, 81953016350, 81953016352, 82953016012, 88953016014, N2953016001



CV-RK-5313

Ø: 90
03304800A, 81953016132



MN-DL-2160

Length: 1652 Ø: 50
Cone Ø: d1 Ø 30 / d2 Ø 27
81467106112, 81467106163, 81467106165, 81467106198, 81467106353, 81467106354, 81467106361, 81467116725



MN-DL-5225

Length: 572 Ø: 48
Hole Distance: 130 / 130
03301500A, 81432206229, 81432206236, 81432206267, 81432206270, 81432206272, 81432206304, 81432206305, 81432209236, 81432209267, 81432209272



MN-DL-8544

Length: 596 Ø: 48
Hole Distance: 130 / 130
81432206196, 81432206232, 81432206233



MN-DL-10288

81432206386, 82432206008, 82432209008

No Image

MN-DL-12288

Length: 585 Ø: 58
Hole Distance: 130 / 130
81432206386, 82432206008, 82432209008

No Image

MN-VB-8514

Length: 627 Ø: 48
Hole Ø 25 / 25 / 25
Hole Distance: 152 / 130 / 130
81432706087, 81432706088, 81432706094, 81432706095, 81432796094



MN-VB-8669

Length: 627 Ø: 48
Hole Ø 25 / 25 / 25
Hole Distance: 152 / 130 / 130
81432706116, 81432706137, 81432706150, 81432706151



MN-VB-9404

Length: 627 Ø: 58
Hole Distance: 130 / 130
81432706117, 81432706152, 81432706153



SC-ES-7279

Length: 150
Cone Ø: d1 Ø 30 / d2 Ø 27
Thread: M30 x 1,5 RHT
81953016288



SC-ES-8517

Length: 140
Cone Ø: d1 Ø 30 / d2 Ø 27
Thread: M30 x 1,5 RHT
81953016286



SC-ES-8535

Length: 145
Cone Ø: d1 Ø 30 / d2 Ø 27
Thread: M30 x 1,5 RHT
81953016271, 81953016325





TGA ...

39.390 FVNLC	07/06→	Suspension Arm Repair Kit		CV-RK-5313	for Wishbone (CV)
	07/06→	Suspension Arm Repair Kit	DB-RK-9300	DB-RK-9300	for Drag Link
	07/06→	Tie Rod End		SC-ES-8517	for Push Rod
	07/06→	Tie Rod End	CV-ES-0914		for Steering Rod
	07/06→	Tie Rod End	CV-ES-14163		for Steering Rod
	07/06→	Tie Rod End	SC-ES-7279		for Steering Rod
	07/06→	Tie Rod End	SC-ES-8535		for Guide Rod
	07/06→	Track Control Arm		MN-DL-5225	Trailing Arm
	07/06→	Track Control Arm		MN-DL-8709	Trailing Arm, Trailing Axle Steered/not Steered, for Pneumatic Suspension vehicles
39.400 FVNLC	07/06→	Suspension Arm Repair Kit		CV-RK-5313	for Wishbone (CV)
	07/06→	Suspension Arm Repair Kit	DB-RK-9300	DB-RK-9300	for Drag Link
	07/06→	Tie Rod End		SC-ES-8517	for Push Rod
	07/06→	Tie Rod End	CV-ES-0914		for Steering Rod
	07/06→	Tie Rod End	CV-ES-14163		for Steering Rod
	07/06→	Tie Rod End	SC-ES-7279		for Steering Rod
	07/06→	Tie Rod End	SC-ES-8535		for Guide Rod
	07/06→	Track Control Arm		MN-DL-5225	Trailing Arm
	07/06→	Track Control Arm		MN-DL-8709	Trailing Arm, Trailing Axle Steered/not Steered, for Pneumatic Suspension vehicles
39.430 FVNLC	07/06→	Suspension Arm Repair Kit		CV-RK-5313	for Wishbone (CV)
	07/06→	Suspension Arm Repair Kit	DB-RK-9300	DB-RK-9300	for Drag Link
	07/06→	Tie Rod End		SC-ES-8517	for Push Rod
	07/06→	Tie Rod End	CV-ES-0914		for Steering Rod
	07/06→	Tie Rod End	CV-ES-14163		for Steering Rod
	07/06→	Tie Rod End	SC-ES-7279		for Steering Rod
	07/06→	Tie Rod End	SC-ES-8535		for Guide Rod
	07/06→	Track Control Arm		MN-DL-5225	Trailing Arm
	07/06→	Track Control Arm		MN-DL-8709	Trailing Arm, Trailing Axle Steered/not Steered, for Pneumatic Suspension vehicles
39.440 FVNLC	07/06→	Centre Rod	MN-DL-7801		Push Rod, Leaf Spring Axle
	07/06→	Suspension Arm Repair Kit		CV-RK-5313	for Wishbone (CV)
	07/06→	Suspension Arm Repair Kit	DB-RK-9300	DB-RK-9300	for Drag Link
	07/06→	Tie Rod	MN-DL-7802		
	07/06→	Tie Rod End		SC-ES-8517	for Push Rod
	07/06→	Tie Rod End	CV-ES-0914		for Steering Rod
	07/06→	Tie Rod End	CV-ES-14163		for Steering Rod
	07/06→	Tie Rod End	SC-ES-7279		for Steering Rod
	07/06→	Tie Rod End	SC-ES-8535		for Guide Rod
39.480 FVNLC	07/06→	Track Control Arm		MN-DL-5225	Trailing Arm, Leading Axle; Drive Axle; Trailing Axle
	07/06→	Track Control Arm		MN-DL-8709	Trailing Arm, Trailing Axle
	07/06→	Track Control Arm		MN-VB-5238	Wishbone (CV), Drive Axle; Trailing Axle
	07/06→	Centre Rod	MN-DL-7801		Push Rod, Leaf Spring Axle
	07/06→	Suspension Arm Repair Kit		CV-RK-5313	for Wishbone (CV)
	07/06→	Suspension Arm Repair Kit	DB-RK-9300	DB-RK-9300	for Drag Link
	07/06→	Tie Rod	MN-DL-7802		
	07/06→	Tie Rod End		SC-ES-8517	for Push Rod
	07/06→	Tie Rod End	CV-ES-0914		for Steering Rod
07/06→	Tie Rod End	CV-ES-14163		for Steering Rod	
07/06→	Tie Rod End	SC-ES-7279		for Steering Rod	
07/06→	Tie Rod End	SC-ES-8535		for Guide Rod	
07/06→	Track Control Arm		MN-DL-5225	Trailing Arm, Leading Axle; Drive Axle; Trailing Axle	
07/06→	Track Control Arm		MN-DL-8709	Trailing Arm, Trailing Axle	
07/06→	Track Control Arm		MN-VB-5238	Wishbone (CV), Drive Axle; Trailing Axle	

CV-ES-0914

Length: 125
Cone Ø: d1 Ø 30 / d2 Ø 27
Thread: M38 x 1,5 RHT
81953016184, 81953016251, 81953016276



CV-ES-14163

Length: 125
Cone Ø: d1 Ø 30 / d2 Ø 27
Thread: M30 x 1,5 RHT
95301.0084, 90804102156, 90804102272, 90804102696, 90804102710, 81953010016, 81953010075, 81953010084, 81953010088, 81953010094, 81953010103, 81953016030, 81953016043, 81953016048, 81953016049, 81953016053, 81953016061, 81953016090, 81953016108, 81953016112, 81953016126, 81953016143, 81953016149, 81953016154, 81953016156, 81953016168, 81953016178, 81953016194, 81953016206, 81953016224, 81953016234, 81953016242, 81953016252, 81953016274, 81953016278, 81953016284, 81953016286, 81953016308, 81953016310, 81953016312, 81953016347, 81953016350, 81953016352, 82953016012, 88953016014, N2953016001



CV-RK-5313

Ø: 90
03304800A, 81953016132



DB-RK-9300

Ø: 75
Hole Distance: 130
Thick/Height: 24
85432206002



MN-DL-5225

Length: 572 Ø: 48
Hole Distance: 130 / 130
03301500A, 81432206229, 81432206236, 81432206267, 81432206270, 81432206272, 81432206304, 81432206305, 81432209236, 81432209267, 81432209272



MN-DL-7801

Length: 995 Ø: 52
Cone Ø: d1 Ø 30 / d2 Ø 27
81466106807, 81466106808, 81466116087, 81466116088, 81466116096, 81466116097, 81466116099, 81466116132, 81466116133, 81466116136, 81466116197, 81466116198, 81466116205



MN-DL-7802

Length: 1680 Ø: 52
Cone Ø: d1 Ø 30 / d2 Ø 27
03208300A, 81467116773, 81467116858, 81467116859, 81467116860, 81467116861, 81467116863, 81467116882, 81467116883, 81467116920, 81467116921



MN-DL-8709

Length: 572 Ø: 52
Hole Distance: 130 / 130
81432206268, 81432206274, 81432206291, 81432206292, 82432206007



MN-VB-5238

Length: 627 Ø: 48
Hole Distance: 130 / 130
81432206221, 81432706096, 81432706114, 81432706116, 81432706121



SC-ES-7279

Length: 150
Cone Ø: d1 Ø 30 / d2 Ø 27
Thread: M30 x 1,5 RHT
81953016288



SC-ES-8517

Length: 140
Cone Ø: d1 Ø 30 / d2 Ø 27
Thread: M30 x 1,5 RHT
81953016286



SC-ES-8535

Length: 145
Cone Ø: d1 Ø 30 / d2 Ø 27
Thread: M30 x 1,5 RHT
81953016271, 81953016325





TGA ...

40.390, 40.400 FDAK, FDARK	06/05→	Centre Rod	MN-DL-7801	Push Rod
	06/05→	Centre Rod	MN-DL-8646	Push Rod
	06/05→	Tie Rod End	CV-ES-0914	for Steering Rod
	06/05→	Tie Rod End	CV-ES-14163	for Steering Rod
	06/05→	Tie Rod End	MN-ES-10333	for Steering Rod
	06/05→	Tie Rod End	SC-ES-8517	for Push Rod
	06/05→	Track Control Arm		MN-DL-5225 Trailing Arm
	06/05→	Track Control Arm		MN-DL-8544 Trailing Arm, 1st RA;2nd RA, for Leaf-Spring Suspension vehicles, →Type_HB Chassis
	06/05→	Track control arm		MN-DL-10288 Trailing Arm, 1st RA;2nd RA, for Leaf-Spring Suspension vehicles, →Type HB
	06/05→	Track control arm		MN-DL-12288 Trailing Arm
40.390, 40.400 FDARS, FDAS	06/05→	Centre Rod	MN-DL-7801	Push Rod
	06/05→	Centre Rod	MN-DL-8646	Push Rod
	06/05→	Tie Rod End	CV-ES-0914	for Steering Rod
	06/05→	Tie Rod End	CV-ES-14163	for Steering Rod
	06/05→	Tie Rod End	MN-ES-10333	for Steering Rod
	06/05→	Tie Rod End	SC-ES-8517	for Push Rod
	06/05→	Track Control Arm		MN-DL-5225 Trailing Arm
	06/05→	Track Control Arm		MN-DL-8544 Trailing Arm, 1st RA;2nd RA, for Leaf-Spring Suspension vehicles, →Type_HB Chassis
	06/05→	Track control arm		MN-DL-10288 Trailing Arm, 1st RA;2nd RA, for Leaf-Spring Suspension vehicles, →Type HB
	06/05→	Track control arm		MN-DL-12288 Trailing Arm
40.390, 40.400 FDK, FDRK	06/05→	Centre Rod	MN-DL-2160	Coupling Rod
	06/05→	Suspension Strut Repair Kit		DB-RK-8581
	06/05→	Tie Rod End	CV-ES-14162	for Steering Rod
	06/05→	Tie Rod End	CV-ES-14163	for Steering Rod
	06/05→	Track Control Arm		MN-DL-5225 Trailing Arm
	06/05→	Track Control Arm		MN-DL-8544 Trailing Arm, 1st RA;2nd RA, for Leaf-Spring Suspension vehicles
	06/05→	Track control arm		MN-DL-10288 Trailing Arm, 1st RA;2nd RA, for Leaf-Spring Suspension vehicles
	06/05→	Track control arm		MN-DL-12288 Trailing Arm
	06/05→	Track Control Arm		MN-VB-9404 Wishbone (CV)
	40.390, 40.400 FDRS, FDS	06/05→	Centre Rod	MN-DL-2160
06/05→		Suspension Strut Repair Kit		DB-RK-8581
06/05→		Tie Rod End	CV-ES-14162	for Steering Rod
06/05→		Tie Rod End	CV-ES-14163	for Steering Rod
06/05→		Track Control Arm		MN-DL-5225 Trailing Arm
06/05→		Track Control Arm		MN-DL-8544 Trailing Arm, 1st RA;2nd RA, for Leaf-Spring Suspension vehicles
06/05→		Track control arm		MN-DL-10288 Trailing Arm, 1st RA;2nd RA, for Leaf-Spring Suspension vehicles
06/05→		Track control arm		MN-DL-12288 Trailing Arm
06/05→		Track Control Arm		MN-VB-9404 Wishbone (CV)
40.410 FDAK		04/04→	Centre Rod	MN-DL-7801
	04/04→	Centre Rod	MN-DL-8646	Push Rod
	04/04→	Suspension Arm Repair Kit		CV-RK-5313 for Wishbone (CV)
	04/04→	Tie Rod End	CV-ES-0914	for Steering Rod
	04/04→	Tie Rod End	CV-ES-14163	for Steering Rod
	04/04→	Tie Rod End	MN-ES-10333	for Steering Rod
	04/04→	Tie Rod End	SC-ES-8517	for Push Rod
	04/04→	Track Control Arm		MN-DL-5225 Trailing Arm
	04/04→	Track Control Arm		MN-DL-8544 Trailing Arm, 1st RA;2nd RA;Leaf Spring Axle
	04/04→	Track Control Arm		MN-DL-8609 Trailing Arm, 1st RA;2nd RA, for Leaf-Spring Suspension vehicles, →Type_HB Chassis
04/04→	Track Control Arm		MN-VB-8514 Suspension Rod, Wishbone (CV), 1st RA; 2nd RA, for Leaf-Spring Suspension vehicles	
04/04→	Track Control Arm		MN-VB-9404 Wishbone (CV)	

CV-ES-0914

Length: 125
Cone Ø: d1 Ø 30 / d2 Ø 27
Thread: M38 x 1,5 RHT
81953016184, 81953016251, 81953016276



CV-ES-14162

Length: 125
Cone Ø: d1 Ø 30 / d2 Ø 27
Thread: M30 x 1,5 LHT
81953010015, 81953010083, 81953010087, 81953016029, 81953016030, 81953016043, 81953016044, 81953016050, 81953016054, 81953016087, 81953016091, 81953016107, 81953016120, 81953016125, 81953016152, 81953016155, 81953016157, 81953016168, 81953016179, 81953016181, 81953016223, 81953016237, 81953016254, 81953016275, 81953016279, 81953016351

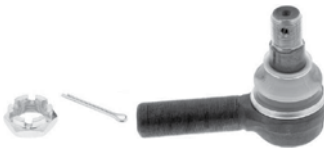

CV-ES-14163

Length: 125
Cone Ø: d1 Ø 30 / d2 Ø 27
Thread: M30 x 1,5 RHT
95301.0084, 90804102156, 90804102272, 90804102696, 90804102710, 81953010016, 81953010075, 81953010084, 81953010088, 81953010094, 81953010103, 81953016030, 81953016043, 81953016048, 81953016049, 81953016053, 81953016061, 81953016090, 81953016108, 81953016112, 81953016126, 81953016143, 81953016149, 81953016154, 81953016156, 81953016168, 81953016178, 81953016194, 81953016206, 81953016224, 81953016234, 81953016242, 81953016252, 81953016274, 81953016278, 81953016284, 81953016286, 81953016308, 81953016310, 81953016312, 81953016347, 81953016350, 81953016352, 82953016012, 88953016014, N2953016001



CV-RK-5313

Ø: 90
03304800A, 81953016132



DB-RK-8581

Ø: 85
Hole Distance: 130
Thick/Height: 24
03305800A, 81432706105



MN-DL-2160

Length: 1652 Ø: 50
Cone Ø: d1 Ø 30 / d2 Ø 27
81467106112, 81467106163, 81467106165, 81467106198, 81467106353, 81467106354, 81467106361, 81467116725



MN-DL-5225

Length: 572 Ø: 48
Hole Distance: 130 / 130
03301500A, 81432206229, 81432206236, 81432206267, 81432206270, 81432206272, 81432206304, 81432206305, 81432209236, 81432209267, 81432209272



MN-DL-7801

Length: 995 Ø: 52
Cone Ø: d1 Ø 30 / d2 Ø 27
81466106807, 81466106808, 81466116087, 81466116088, 81466116096, 81466116097, 81466116099, 81466116132, 81466116133, 81466116136, 81466116197, 81466116198, 81466116205

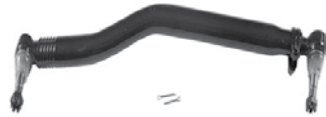

MN-DL-8544

Length: 596 Ø: 48
Hole Distance: 130 / 130
81432206196, 81432206232, 81432206233



MN-DL-8609

Length: 585 Ø: 58
Hole Distance: 130 / 130
81432206070, 81432206071, 81432206072, 81432206091, 81432206093, 81432206119



MN-DL-8646

Length: 1021 Ø: 52
Cone Ø: d1 Ø 30 / d2 Ø 27
81466106811, 81466106812, 81466116138, 81466116139, 81466116201, 81466116202

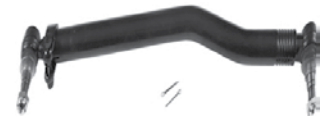

MN-DL-10288

81432206386, 82432206008, 82432209008

No Image

MN-DL-12288

Length: 585 Ø: 58
Hole Distance: 130 / 130
81432206386, 82432206008, 82432209008

No Image

MN-ES-10333

Length: 90
Cone Ø: d1 Ø 38 / d2 Ø 34,35
Thread: M36 x 1,5 RHT
1271126, 3090291, 3099128, 42538048, 81953016268, 82953016018, 82953016019



MN-VB-8514

Length: 627 Ø: 48
Hole Ø 25 / 25 / 25
Hole Distance: 152 / 130 / 130
81432706087, 81432706088, 81432706094, 81432706095, 81432796094



MN-VB-9404

Length: 627 Ø: 58
Hole Distance: 130 / 130
81432706117, 81432706152, 81432706153



SC-ES-8517

Length: 140
Cone Ø: d1 Ø 30 / d2 Ø 27
Thread: M30 x 1,5 RHT
81953016286





TGA ...

40.410 FDAS	04/04 →	Centre Rod	MN-DL-7801		Push Rod
	04/04 →	Centre Rod	MN-DL-8646		Push Rod
	04/04 →	Suspension Arm Repair Kit		CV-RK-5313	for Wishbone (CV)
	04/04 →	Tie Rod End	CV-ES-0914		for Steering Rod
	04/04 →	Tie Rod End	CV-ES-14163		for Steering Rod
	04/04 →	Tie Rod End	MN-ES-10333		for Steering Rod
	04/04 →	Tie Rod End	SC-ES-8517		for Push Rod
	04/04 →	Track Control Arm		MN-DL-5225	Trailing Arm
	04/04 →	Track Control Arm		MN-DL-8544	Trailing Arm, 1st RA;2nd RA;Leaf Spring Axle
	04/04 →	Track Control Arm		MN-DL-8609	Trailing Arm, 1st RA;2nd RA, for Leaf-Spring Suspension vehicles, →Type_HB Chassis
	04/04 →	Track Control Arm		MN-VB-8514	Suspension Rod, Wishbone (CV), 1st RA; 2nd RA, for Leaf-Spring Suspension vehicles
	04/04 →	Track Control Arm		MN-VB-9404	Wishbone (CV)
	40.410 FDK	04/04 →	Centre Rod	MN-DL-7801	
04/04 →		Suspension Strut Repair Kit		DB-RK-8581	
04/04 →		Tie Rod End	CV-ES-0914		for Steering Rod
04/04 →		Tie Rod End	CV-ES-14162		for Steering Rod
04/04 →		Tie Rod End	CV-ES-14163		for Steering Rod
04/04 →		Tie Rod End	SC-ES-8517		for Push Rod
04/04 →		Track Control Arm		MN-DL-5225	Trailing Arm
04/04 →		Track Control Arm		MN-DL-8544	Trailing Arm, 1st RA;2nd RA, for Leaf-Spring Suspension vehicles, →Type_HB Chassis
04/04 →		Track Control Arm		MN-DL-8609	Trailing Arm, 1st RA;2nd RA, for Leaf-Spring Suspension vehicles, →Type_HB Chassis
04/04 →		Track control arm		MN-DL-10288	Trailing Arm, 1st RA;2nd RA, for Leaf-Spring Suspension vehicles, →Type HB
04/04 →		Track control arm		MN-DL-12288	Trailing Arm
04/04 →		Track Control Arm		MN-VB-8514	Suspension Rod, Wishbone (CV), Drive Axle; Leaf Spring Axle
04/04 →		Track Control Arm		MN-VB-9404	Wishbone (CV), Drive Axle
40.410 FDS	04/04 →	Centre Rod	MN-DL-7801		Push Rod, Leaf Spring Axle
	04/04 →	Suspension Strut Repair Kit		DB-RK-8581	
	04/04 →	Tie Rod End	CV-ES-0914		for Steering Rod
	04/04 →	Tie Rod End	CV-ES-14162		for Steering Rod
	04/04 →	Tie Rod End	CV-ES-14163		for Steering Rod
	04/04 →	Tie Rod End	SC-ES-8517		for Push Rod
	04/04 →	Track Control Arm		MN-DL-5225	Trailing Arm
	04/04 →	Track Control Arm		MN-DL-8544	Trailing Arm, 1st RA;2nd RA, for Leaf-Spring Suspension vehicles, →Type_HB Chassis
	04/04 →	Track Control Arm		MN-DL-8609	Trailing Arm, 1st RA;2nd RA, for Leaf-Spring Suspension vehicles, →Type_HB Chassis
	04/04 →	Track control arm		MN-DL-10288	Trailing Arm, 1st RA;2nd RA, for Leaf-Spring Suspension vehicles, →Type HB
	04/04 →	Track control arm		MN-DL-12288	Trailing Arm
	04/04 →	Track Control Arm		MN-VB-8514	Suspension Rod, Wishbone (CV), Drive Axle; Leaf Spring Axle
	04/04 →	Track Control Arm		MN-VB-9404	Wishbone (CV), Drive Axle
40.430 FDK, FDRK	06/05 →	Centre Rod	MN-DL-2160		Coupling Rod
	06/05 →	Suspension Strut Repair Kit		DB-RK-8581	
	06/05 →	Tie Rod End	CV-ES-14162		for Steering Rod
	06/05 →	Tie Rod End	CV-ES-14163		for Steering Rod
	06/05 →	Track Control Arm		MN-DL-5225	Trailing Arm
	06/05 →	Track Control Arm		MN-DL-8544	Trailing Arm, 1st RA;2nd RA, for Leaf-Spring Suspension vehicles
	06/05 →	Track control arm		MN-DL-10288	Trailing Arm, 1st RA;2nd RA, for Leaf-Spring Suspension vehicles
	06/05 →	Track control arm		MN-DL-12288	Trailing Arm
40.430 FDRS, FDS	06/05 →	Centre Rod	MN-DL-2160		Coupling Rod
	06/05 →	Suspension Strut Repair Kit		DB-RK-8581	
	06/05 →	Tie Rod End	CV-ES-14162		for Steering Rod
	06/05 →	Tie Rod End	CV-ES-14163		for Steering Rod

CV-ES-0914

Length: 125
Cone Ø: d1 Ø 30 / d2 Ø 27
Thread: M38 x 1,5 RHT
81953016184, 81953016251, 81953016276



CV-ES-14162

Length: 125
Cone Ø: d1 Ø 30 / d2 Ø 27
Thread: M30 x 1,5 LHT
81953010015, 81953010083, 81953010087, 81953016029, 81953016030, 81953016043, 81953016044, 81953016050, 81953016054, 81953016087, 81953016091, 81953016107, 81953016120, 81953016125, 81953016152, 81953016155, 81953016157, 81953016168, 81953016179, 81953016181, 81953016223, 81953016237, 81953016254, 81953016275, 81953016279, 81953016351



CV-ES-14163

Length: 125
Cone Ø: d1 Ø 30 / d2 Ø 27
Thread: M30 x 1,5 RHT
95301.0084, 90804102156, 90804102272, 90804102696, 90804102710, 81953010016, 81953010075, 81953010084, 81953010088, 81953010094, 81953010103, 81953016030, 81953016043, 81953016048, 81953016049, 81953016053, 81953016061, 81953016090, 81953016108, 81953016112, 81953016126, 81953016143, 81953016149, 81953016154, 81953016156, 81953016168, 81953016178, 81953016194, 81953016206, 81953016224, 81953016234, 81953016242, 81953016252, 81953016274, 81953016278, 81953016284, 81953016286, 81953016308, 81953016310, 81953016312, 81953016347, 81953016350, 81953016352, 82953016012, 88953016014, N2953016001



CV-RK-5313

Ø: 90
03304800A, 81953016132



DB-RK-8581

Ø: 85
Hole Distance: 130
Thick/Height: 24
03305800A, 81432706105



MN-DL-2160

Length: 1652 Ø: 50
Cone Ø: d1 Ø 30 / d2 Ø 27
81467106112, 81467106163, 81467106165, 81467106198, 81467106353, 81467106354, 81467106361, 81467116725



MN-DL-5225

Length: 572 Ø: 48
Hole Distance: 130 / 130
03301500A, 81432206229, 81432206236, 81432206267, 81432206270, 81432206272, 81432206304, 81432206305, 81432209236, 81432209267, 81432209272



MN-DL-7801

Length: 995 Ø: 52
Cone Ø: d1 Ø 30 / d2 Ø 27
81466106807, 81466106808, 81466116087, 81466116088, 81466116096, 81466116097, 81466116099, 81466116132, 81466116133, 81466116136, 81466116197, 81466116198, 81466116205

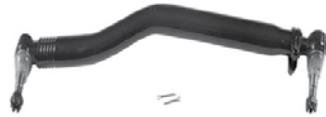

MN-DL-8544

Length: 596 Ø: 48
Hole Distance: 130 / 130
81432206196, 81432206232, 81432206233



MN-DL-8609

Length: 585 Ø: 58
Hole Distance: 130 / 130
81432206070, 81432206071, 81432206072, 81432206091, 81432206093, 81432206119



MN-DL-8646

Length: 1021 Ø: 52
Cone Ø: d1 Ø 30 / d2 Ø 27
81466106811, 81466106812, 81466116138, 81466116139, 81466116201, 81466116202

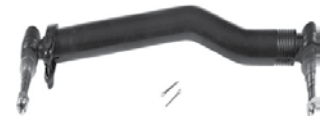

MN-DL-10288

81432206386, 82432206008, 82432209008

No Image

MN-DL-12288

Length: 585 Ø: 58
Hole Distance: 130 / 130
81432206386, 82432206008, 82432209008

No Image

MN-ES-10333

Length: 90
Cone Ø: d1 Ø 38 / d2 Ø 34,35
Thread: M36 x 1,5 RHT
1271126, 3090291, 3099128, 42538048, 81953016268, 82953016018, 82953016019



MN-VB-8514

Length: 627 Ø: 48
Hole Ø 25 / 25 / 25
Hole Distance: 152 / 130 / 130
81432706087, 81432706088, 81432706094, 81432706095, 81432796094



MN-VB-9404

Length: 627 Ø: 58
Hole Distance: 130 / 130
81432706117, 81432706152, 81432706153



SC-ES-8517

Length: 140
Cone Ø: d1 Ø 30 / d2 Ø 27
Thread: M30 x 1,5 RHT
81953016286





TGA ...

40.430 FDRS, FDS ...	06/05→	Track Control Arm		MN-DL-5225	Trailing Arm	
	06/05→	Track Control Arm		MN-DL-8544	Trailing Arm, 1st RA;2nd RA, for Leaf-Spring Suspension vehicles	
	06/05→	Track control arm		MN-DL-10288	Trailing Arm, 1st RA;2nd RA, for Leaf-Spring Suspension vehicles	
	06/05→	Track control arm		MN-DL-12288	Trailing Arm	
	06/05→	Track Control Arm		MN-VB-9404	Wishbone (CV)	
	40.430, 40.440 FDAK, FDARK	06/05→	Centre Rod	MN-DL-7801		Push Rod
06/05→		Centre Rod	MN-DL-8646		Push Rod	
06/05→		Tie Rod End	CV-ES-0914		for Steering Rod	
06/05→		Tie Rod End	CV-ES-14163		for Steering Rod	
06/05→		Tie Rod End	MN-ES-10333		for Steering Rod	
06/05→		Tie Rod End	SC-ES-8517		for Push Rod	
06/05→		Track Control Arm		MN-DL-5225	Trailing Arm	
06/05→		Track Control Arm		MN-DL-8544	Trailing Arm, 1st RA;2nd RA, for Leaf-Spring Suspension vehicles, →Type_HB Chassis	
06/05→		Track control arm		MN-DL-10288	Trailing Arm, 1st RA;2nd RA, for Leaf-Spring Suspension vehicles, →Type HB	
06/05→		Track control arm		MN-DL-12288	Trailing Arm	
06/05→		Track Control Arm		MN-VB-9404	Wishbone (CV)	
40.430, 40.440 FDARS, FDAS		06/05→	Centre Rod	MN-DL-7801		Push Rod
		06/05→	Centre Rod	MN-DL-8646		Push Rod
		06/05→	Tie Rod End	CV-ES-0914		for Steering Rod
	06/05→	Tie Rod End	CV-ES-14163		for Steering Rod	
	06/05→	Tie Rod End	MN-ES-10333		for Steering Rod	
	06/05→	Tie Rod End	SC-ES-8517		for Push Rod	
	06/05→	Track Control Arm		MN-DL-5225	Trailing Arm	
	06/05→	Track Control Arm		MN-DL-8544	Trailing Arm, 1st RA;2nd RA, for Leaf-Spring Suspension vehicles, →Type_HB Chassis	
	06/05→	Track control arm		MN-DL-10288	Trailing Arm, 1st RA;2nd RA, for Leaf-Spring Suspension vehicles, →Type HB	
	06/05→	Track control arm		MN-DL-12288	Trailing Arm	
	06/05→	Track Control Arm		MN-VB-9404	Wishbone (CV)	
	40.440 FDAK, FDARK	06/05→	Centre Rod	MN-DL-7801		Push Rod
		06/05→	Centre Rod	MN-DL-8646		Push Rod
		06/05→	Tie Rod End	CV-ES-0914		for Steering Rod
06/05→		Tie Rod End	CV-ES-14163		for Steering Rod	
06/05→		Tie Rod End	MN-ES-10333		for Steering Rod	
06/05→		Tie Rod End	SC-ES-8517		for Push Rod	
06/05→		Track Control Arm		MN-DL-8544	Trailing Arm, 1st RA;2nd RA, for Leaf-Spring Suspension vehicles, →Type_HB Chassis	
06/05→		Track control arm		MN-DL-10288	Trailing Arm, 1st RA;2nd RA, for Leaf-Spring Suspension vehicles, →Type HB	
06/05→		Track control arm		MN-DL-12288	Trailing Arm	
40.440 FDARS, FDAS		06/05→	Centre Rod	MN-DL-7801		Push Rod
		06/05→	Centre Rod	MN-DL-8646		Push Rod
		06/05→	Tie Rod End	CV-ES-0914		for Steering Rod
		06/05→	Tie Rod End	CV-ES-14163		for Steering Rod
		06/05→	Tie Rod End	MN-ES-10333		for Steering Rod
	06/05→	Tie Rod End	SC-ES-8517		for Push Rod	
	06/05→	Track Control Arm		MN-DL-8544	Trailing Arm, 1st RA;2nd RA, for Leaf-Spring Suspension vehicles, →Type_HB Chassis	
	06/05→	Track control arm		MN-DL-10288	Trailing Arm, 1st RA;2nd RA, for Leaf-Spring Suspension vehicles, →Type HB	
	06/05→	Track control arm		MN-DL-12288	Trailing Arm	
	40.440 FDK, FDRK	06/05→	Centre Rod	MN-DL-2160		Coupling Rod
		06/05→	Suspension Strut Repair Kit		DB-RK-8581	
		06/05→	Tie Rod End	CV-ES-14162		for Steering Rod
		06/05→	Tie Rod End	CV-ES-14163		for Steering Rod
		06/05→	Track Control Arm		MN-DL-8544	Trailing Arm, 1st RA;2nd RA, for Leaf-Spring Suspension vehicles
06/05→		Track control arm		MN-DL-10288	Trailing Arm, 1st RA;2nd RA, for Leaf-Spring Suspension vehicles	
06/05→		Track control arm		MN-DL-12288	Trailing Arm	

CV-ES-0914

Length: 125
Cone Ø: d1 Ø 30 / d2 Ø 27
Thread: M38 x 1,5 RHT
81953016184, 81953016251, 81953016276



CV-ES-14162

Length: 125
Cone Ø: d1 Ø 30 / d2 Ø 27
Thread: M30 x 1,5 LHT
81953010015, 81953010083, 81953010087, 81953016029, 81953016030, 81953016043, 81953016044, 81953016050, 81953016054, 81953016087, 81953016091, 81953016107, 81953016120, 81953016125, 81953016152, 81953016155, 81953016157, 81953016168, 81953016179, 81953016181, 81953016223, 81953016237, 81953016254, 81953016275, 81953016279, 81953016351



CV-ES-14163

Length: 125
Cone Ø: d1 Ø 30 / d2 Ø 27
Thread: M30 x 1,5 RHT
95301.0084, 90804102156, 90804102272, 90804102696, 90804102710, 81953010016, 81953010075, 81953010084, 81953010088, 81953010094, 81953010103, 81953016030, 81953016043, 81953016048, 81953016049, 81953016053, 81953016061, 81953016090, 81953016108, 81953016112, 81953016126, 81953016143, 81953016149, 81953016154, 81953016156, 81953016168, 81953016178, 81953016194, 81953016206, 81953016224, 81953016234, 81953016242, 81953016252, 81953016274, 81953016278, 81953016284, 81953016286, 81953016308, 81953016310, 81953016312, 81953016347, 81953016350, 81953016352, 82953016012, 88953016014, N2953016001



DB-RK-8581

Ø: 85
Hole Distance: 130
Thick/Height: 24
03305800A, 81432706105



MN-DL-2160

Length: 1652 Ø: 50
Cone Ø: d1 Ø 30 / d2 Ø 27
81467106112, 81467106163, 81467106165, 81467106198, 81467106353, 81467106354, 81467106361, 81467116725



MN-DL-5225

Length: 572 Ø: 48
Hole Distance: 130 / 130
03301500A, 81432206229, 81432206236, 81432206267, 81432206270, 81432206272, 81432206304, 81432206305, 81432209236, 81432209267, 81432209272



MN-DL-7801

Length: 995 Ø: 52
Cone Ø: d1 Ø 30 / d2 Ø 27
81466106807, 81466106808, 81466116087, 81466116088, 81466116096, 81466116097, 81466116099, 81466116132, 81466116133, 81466116136, 81466116197, 81466116198, 81466116205

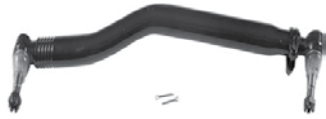

MN-DL-8544

Length: 596 Ø: 48
Hole Distance: 130 / 130
81432206196, 81432206232, 81432206233



MN-DL-8646

Length: 1021 Ø: 52
Cone Ø: d1 Ø 30 / d2 Ø 27
81466106811, 81466106812, 81466116138, 81466116139, 81466116201, 81466116202

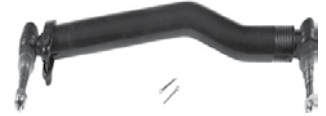

MN-DL-10288

81432206386, 82432206008, 82432209008

No Image

MN-DL-12288

Length: 585 Ø: 58
Hole Distance: 130 / 130
81432206386, 82432206008, 82432209008

No Image

MN-ES-10333

Length: 90
Cone Ø: d1 Ø 38 / d2 Ø 34,35
Thread: M36 x 1,5 RHT
1271126, 3090291, 3099128, 42538048, 81953016268, 82953016018, 82953016019



MN-VB-9404

Length: 627 Ø: 58
Hole Distance: 130 / 130
81432706117, 81432706152, 81432706153



SC-ES-8517

Length: 140
Cone Ø: d1 Ø 30 / d2 Ø 27
Thread: M30 x 1,5 RHT
81953016286





TGA ...

40.440 FDRS, FDS	06/05→	Centre Rod	MN-DL-2160		Coupling Rod	
	06/05→	Suspension Strut Repair Kit		DB-RK-8581		
	06/05→	Tie Rod End	CV-ES-14162		for Steering Rod	
	06/05→	Tie Rod End	CV-ES-14163		for Steering Rod	
	06/05→	Track Control Arm		MN-DL-8544	Trailing Arm, 1st RA;2nd RA, for Leaf-Spring Suspension vehicles	
	06/05→	Track control arm		MN-DL-10288	Trailing Arm, 1st RA;2nd RA, for Leaf-Spring Suspension vehicles	
	06/05→	Track control arm		MN-DL-12288	Trailing Arm	
40.460 FDAK	04/04→	Centre Rod	MN-DL-7801		Push Rod	
	04/04→	Centre Rod	MN-DL-8646		Push Rod	
	04/04→	Suspension Arm Repair Kit		CV-RK-5313	for Wishbone (CV)	
	04/04→	Tie Rod End	CV-ES-0914		for Steering Rod	
	04/04→	Tie Rod End	CV-ES-14163		for Steering Rod	
	04/04→	Tie Rod End	MN-ES-10333		for Steering Rod	
	04/04→	Tie Rod End	SC-ES-8517		for Push Rod	
	04/04→	Track Control Arm		MN-DL-5225	Trailing Arm	
	04/04→	Track Control Arm		MN-DL-8544	Trailing Arm, 1st RA;2nd RA;Leaf Spring Axle	
	04/04→	Track Control Arm		MN-DL-8609	Trailing Arm, 1st RA;2nd RA, for Leaf-Spring Suspension vehicles, →Type_HB Chassis	
	04/04→	Track Control Arm		MN-VB-8514	Suspension Rod, Wishbone (CV), 1st RA; 2nd RA, for Leaf-Spring Suspension vehicles	
	04/04→	Track Control Arm		MN-VB-9404	Wishbone (CV)	
	40.460 FDAS	04/04→	Centre Rod	MN-DL-7801		Push Rod
04/04→		Centre Rod	MN-DL-8646		Push Rod	
04/04→		Suspension Arm Repair Kit		CV-RK-5313	for Wishbone (CV)	
04/04→		Tie Rod End	CV-ES-0914		for Steering Rod	
04/04→		Tie Rod End	CV-ES-14163		for Steering Rod	
04/04→		Tie Rod End	MN-ES-10333		for Steering Rod	
04/04→		Tie Rod End	SC-ES-8517		for Push Rod	
04/04→		Track Control Arm		MN-DL-5225	Trailing Arm	
04/04→		Track Control Arm		MN-DL-8544	Trailing Arm, 1st RA;2nd RA;Leaf Spring Axle	
04/04→		Track Control Arm		MN-DL-8609	Trailing Arm, 1st RA;2nd RA, for Leaf-Spring Suspension vehicles, →Type_HB Chassis	
04/04→		Track Control Arm		MN-VB-8514	Suspension Rod, Wishbone (CV), 1st RA; 2nd RA, for Leaf-Spring Suspension vehicles	
04/04→		Track Control Arm		MN-VB-9404	Wishbone (CV)	
40.460 FDK		04/04→	Centre Rod	MN-DL-7801		Push Rod, Leaf Spring Axle
	04/04→	Suspension Strut Repair Kit		DB-RK-8581		
	04/04→	Tie Rod End	CV-ES-0914		for Steering Rod	
	04/04→	Tie Rod End	CV-ES-14162		for Steering Rod	
	04/04→	Tie Rod End	CV-ES-14163		for Steering Rod	
	04/04→	Tie Rod End	SC-ES-8517		for Push Rod	
	04/04→	Track Control Arm		MN-DL-5225	Trailing Arm	
	04/04→	Track Control Arm		MN-DL-8544	Trailing Arm, 1st RA;2nd RA, for Leaf-Spring Suspension vehicles, →Type_HB Chassis	
	04/04→	Track Control Arm		MN-DL-8609	Trailing Arm, 1st RA;2nd RA, for Leaf-Spring Suspension vehicles, →Type_HB Chassis	
	04/04→	Track control arm		MN-DL-10288	Trailing Arm, 1st RA;2nd RA, for Leaf-Spring Suspension vehicles, →Type HB	
	04/04→	Track control arm		MN-DL-12288	Trailing Arm	
	04/04→	Track Control Arm		MN-VB-8514	Suspension Rod, Wishbone (CV), Drive Axle; Leaf Spring Axle	
	04/04→	Track Control Arm		MN-VB-9404	Wishbone (CV), Drive Axle	
	40.460 FDS	04/04→	Centre Rod	MN-DL-7801		Push Rod, Leaf Spring Axle
		04/04→	Suspension Strut Repair Kit		DB-RK-8581	
04/04→		Tie Rod End	CV-ES-0914		for Steering Rod	
04/04→		Tie Rod End	CV-ES-14162		for Steering Rod	
04/04→		Tie Rod End	CV-ES-14163		for Steering Rod	
04/04→		Tie Rod End	SC-ES-8517		for Push Rod	
04/04→		Track Control Arm		MN-DL-5225	Trailing Arm	
04/04→		Track Control Arm		MN-DL-8544	Trailing Arm, 1st RA;2nd RA, for Leaf-Spring Suspension vehicles, →Type_HB Chassis	

CV-ES-0914

Length: 125
Cone Ø: d1 Ø 30 / d2 Ø 27
Thread: M38 x 1,5 RHT
81953016184, 81953016251, 81953016276



CV-ES-14162

Length: 125
Cone Ø: d1 Ø 30 / d2 Ø 27
Thread: M30 x 1,5 LHT
81953010015, 81953010083, 81953010087, 81953016029, 81953016030, 81953016043, 81953016044, 81953016050, 81953016054, 81953016087, 81953016091, 81953016107, 81953016120, 81953016125, 81953016152, 81953016155, 81953016157, 81953016168, 81953016179, 81953016181, 81953016223, 81953016237, 81953016254, 81953016275, 81953016279, 81953016351



CV-ES-14163

Length: 125
Cone Ø: d1 Ø 30 / d2 Ø 27
Thread: M30 x 1,5 RHT
95301.0084, 90804102156, 90804102272, 90804102696, 90804102710, 81953010016, 81953010075, 81953010084, 81953010088, 81953010094, 81953010103, 81953016030, 81953016043, 81953016048, 81953016049, 81953016053, 81953016061, 81953016090, 81953016108, 81953016112, 81953016126, 81953016143, 81953016149, 81953016154, 81953016156, 81953016168, 81953016178, 81953016194, 81953016206, 81953016224, 81953016234, 81953016242, 81953016252, 81953016274, 81953016278, 81953016284, 81953016286, 81953016308, 81953016310, 81953016312, 81953016347, 81953016350, 81953016352, 82953016012, 88953016014, N2953016001



CV-RK-5313

Ø: 90
03304800A, 81953016132



DB-RK-8581

Ø: 85
Hole Distance: 130
Thick/Height: 24
03305800A, 81432706105



MN-DL-2160

Length: 1652 Ø: 50
Cone Ø: d1 Ø 30 / d2 Ø 27
81467106112, 81467106163, 81467106165, 81467106198, 81467106353, 81467106354, 81467106361, 81467116725



MN-DL-5225

Length: 572 Ø: 48
Hole Distance: 130 / 130
03301500A, 81432206229, 81432206236, 81432206267, 81432206270, 81432206272, 81432206304, 81432206305, 81432209236, 81432209267, 81432209272



MN-DL-7801

Length: 995 Ø: 52
Cone Ø: d1 Ø 30 / d2 Ø 27
81466106807, 81466106808, 81466116087, 81466116088, 81466116096, 81466116097, 81466116099, 81466116132, 81466116133, 81466116136, 81466116197, 81466116198, 81466116205

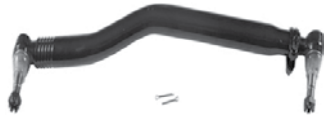

MN-DL-8544

Length: 596 Ø: 48
Hole Distance: 130 / 130
81432206196, 81432206232, 81432206233



MN-DL-8609

Length: 585 Ø: 58
Hole Distance: 130 / 130
81432206070, 81432206071, 81432206072, 81432206091, 81432206093, 81432206119



MN-DL-8646

Length: 1021 Ø: 52
Cone Ø: d1 Ø 30 / d2 Ø 27
81466106811, 81466106812, 81466116138, 81466116139, 81466116201, 81466116202

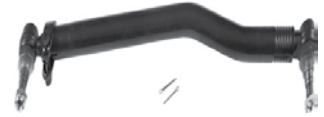

MN-DL-10288

81432206386, 82432206008, 82432209008

No Image

MN-DL-12288

Length: 585 Ø: 58
Hole Distance: 130 / 130
81432206386, 82432206008, 82432209008

No Image

MN-ES-10333

Length: 90
Cone Ø: d1 Ø 38 / d2 Ø 34,35
Thread: M36 x 1,5 RHT
1271126, 3090291, 3099128, 42538048, 81953016268, 82953016018, 82953016019



MN-VB-8514

Length: 627 Ø: 48
Hole Ø 25 / 25 / 25
Hole Distance: 152 / 130 / 130
81432706087, 81432706088, 81432706094, 81432706095, 81432796094



MN-VB-9404

Length: 627 Ø: 58
Hole Distance: 130 / 130
81432706117, 81432706152, 81432706153



SC-ES-8517

Length: 140
Cone Ø: d1 Ø 30 / d2 Ø 27
Thread: M30 x 1,5 RHT
81953016286





TGA ...

40.460 FDS ...	04/04 →	Track Control Arm		MN-DL-8609	Trailing Arm, 1st RA;2nd RA, for Leaf-Spring Suspension vehicles, →Type_HB Chassis
	04/04 →	Track control arm		MN-DL-10288	Trailing Arm, 1st RA;2nd RA, for Leaf-Spring Suspension vehicles, →Type HB
	04/04 →	Track control arm		MN-DL-12288	Trailing Arm
	04/04 →	Track Control Arm		MN-VB-8514	Suspension Rod, Wishbone (CV), Drive Axle; Leaf Spring Axle
	04/04 →	Track Control Arm		MN-VB-9404	Wishbone (CV), Drive Axle
40.480 FDAK, FDARK	04/04 →	Centre Rod	MN-DL-7801		Push Rod
	04/04 →	Centre Rod	MN-DL-8646		Push Rod
	04/04 →	Suspension Arm Repair Kit		CV-RK-5313	for Wishbone (CV)
	04/04 →	Tie Rod End	CV-ES-0914		for Steering Rod
	04/04 →	Tie Rod End	CV-ES-14163		for Steering Rod
	04/04 →	Tie Rod End	MN-ES-10333		for Steering Rod
	04/04 →	Tie Rod End	SC-ES-8517		for Push Rod
	04/04 →	Track Control Arm		MN-DL-5225	Trailing Arm
	04/04 →	Track Control Arm		MN-DL-8544	Trailing Arm, 1st RA;2nd RA;Leaf Spring Axle
	04/04 →	Track Control Arm		MN-DL-8609	Trailing Arm, 1st RA;2nd RA, for Leaf-Spring Suspension vehicles, →Type_HB Chassis
	04/04 →	Track Control Arm		MN-VB-8514	Suspension Rod, Wishbone (CV), 1st RA; 2nd RA, for Leaf-Spring Suspension vehicles
	04/04 →	Track Control Arm		MN-VB-9404	Wishbone (CV)
	06/05 →	Track Control Arm		MN-DL-8544	Trailing Arm, 1st RA;2nd RA, for Leaf-Spring Suspension vehicles, →Type_HB Chassis
	06/05 →	Track control arm		MN-DL-10288	Trailing Arm, 1st RA;2nd RA, for Leaf-Spring Suspension vehicles, →Type HB
	06/05 →	Track control arm		MN-DL-12288	Trailing Arm
40.480 FDARS, FDAS	04/04 →	Centre Rod	MN-DL-7801		Push Rod
	04/04 →	Centre Rod	MN-DL-8646		Push Rod
	04/04 →	Suspension Arm Repair Kit		CV-RK-5313	for Wishbone (CV)
	04/04 →	Tie Rod End	CV-ES-0914		for Steering Rod
	04/04 →	Tie Rod End	CV-ES-14163		for Steering Rod
	04/04 →	Tie Rod End	MN-ES-10333		for Steering Rod
	04/04 →	Tie Rod End	SC-ES-8517		for Push Rod
	04/04 →	Track Control Arm		MN-DL-5225	Trailing Arm
	04/04 →	Track Control Arm		MN-DL-8544	Trailing Arm, 1st RA;2nd RA, for Leaf-Spring Suspension vehicles, →Type_HB Chassis
	04/04 →	Track Control Arm		MN-DL-8609	Trailing Arm, 1st RA;2nd RA, for Leaf-Spring Suspension vehicles, →Type_HB Chassis
	04/04 →	Track control arm		MN-DL-10288	Trailing Arm, 1st RA;2nd RA, for Leaf-Spring Suspension vehicles, →Type HB
	04/04 →	Track control arm		MN-DL-12288	Trailing Arm
	04/04 →	Track Control Arm		MN-VB-8514	Suspension Rod, Wishbone (CV), 1st RA; 2nd RA, for Leaf-Spring Suspension vehicles
	04/04 →	Track Control Arm		MN-VB-9404	Wishbone (CV)
	40.480 FDK, FDRK	04/04 →	Centre Rod	MN-DL-7801	
04/04 →		Suspension Strut Repair Kit		DB-RK-8581	
04/04 →		Tie Rod End	CV-ES-0914		for Steering Rod
04/04 →		Tie Rod End	CV-ES-14162		for Steering Rod
04/04 →		Tie Rod End	CV-ES-14163		for Steering Rod
04/04 →		Tie Rod End	SC-ES-8517		for Push Rod
04/04 →		Track Control Arm		MN-DL-5225	Trailing Arm
04/04 →		Track Control Arm		MN-DL-8544	Trailing Arm, 1st RA;2nd RA, for Leaf-Spring Suspension vehicles, →Type_HB Chassis
04/04 →		Track Control Arm		MN-DL-8609	Trailing Arm, 1st RA;2nd RA, for Leaf-Spring Suspension vehicles, →Type_HB Chassis
04/04 →		Track control arm		MN-DL-10288	Trailing Arm, 1st RA;2nd RA, for Leaf-Spring Suspension vehicles, →Type HB
04/04 →		Track control arm		MN-DL-12288	Trailing Arm
04/04 →		Track Control Arm		MN-VB-8514	Suspension Rod, Wishbone (CV), Drive Axle; Leaf Spring Axle
04/04 →		Track Control Arm		MN-VB-9404	Wishbone (CV), Drive Axle
06/05 →		Centre Rod	MN-DL-2160		Coupling Rod

CV-ES-0914

Length: 125
Cone Ø: d1 Ø 30 / d2 Ø 27
Thread: M38 x 1,5 RHT
81953016184, 81953016251, 81953016276



CV-ES-14162

Length: 125
Cone Ø: d1 Ø 30 / d2 Ø 27
Thread: M30 x 1,5 LHT
81953010015, 81953010083, 81953010087, 81953016029, 81953016030, 81953016043, 81953016044, 81953016050, 81953016054, 81953016087, 81953016091, 81953016107, 81953016120, 81953016125, 81953016152, 81953016155, 81953016157, 81953016168, 81953016179, 81953016181, 81953016223, 81953016237, 81953016254, 81953016275, 81953016279, 81953016351



CV-ES-14163

Length: 125
Cone Ø: d1 Ø 30 / d2 Ø 27
Thread: M30 x 1,5 RHT
95301.0084, 90804102156, 90804102272, 90804102696, 90804102710, 81953010016, 81953010075, 81953010084, 81953010088, 81953010094, 81953010103, 81953016030, 81953016043, 81953016048, 81953016049, 81953016053, 81953016061, 81953016090, 81953016108, 81953016112, 81953016126, 81953016143, 81953016149, 81953016154, 81953016156, 81953016168, 81953016178, 81953016194, 81953016206, 81953016224, 81953016234, 81953016242, 81953016252, 81953016274, 81953016278, 81953016284, 81953016286, 81953016308, 81953016310, 81953016312, 81953016347, 81953016350, 81953016352, 82953016012, 88953016014, N2953016001



CV-RK-5313

Ø: 90
03304800A, 81953016132



DB-RK-8581

Ø: 85
Hole Distance: 130
Thick/Height: 24
03305800A, 81432706105



MN-DL-2160

Length: 1652 Ø: 50
Cone Ø: d1 Ø 30 / d2 Ø 27
81467106112, 81467106163, 81467106165, 81467106198, 81467106353, 81467106354, 81467106361, 81467116725



MN-DL-5225

Length: 572 Ø: 48
Hole Distance: 130 / 130
03301500A, 81432206229, 81432206236, 81432206267, 81432206270, 81432206272, 81432206304, 81432206305, 81432209236, 81432209267, 81432209272



MN-DL-7801

Length: 995 Ø: 52
Cone Ø: d1 Ø 30 / d2 Ø 27
81466106807, 81466106808, 81466116087, 81466116088, 81466116096, 81466116097, 81466116099, 81466116132, 81466116133, 81466116136, 81466116197, 81466116198, 81466116205

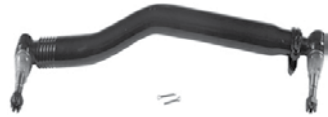

MN-DL-8544

Length: 596 Ø: 48
Hole Distance: 130 / 130
81432206196, 81432206232, 81432206233



MN-DL-8609

Length: 585 Ø: 58
Hole Distance: 130 / 130
81432206070, 81432206071, 81432206072, 81432206091, 81432206093, 81432206119



MN-DL-8646

Length: 1021 Ø: 52
Cone Ø: d1 Ø 30 / d2 Ø 27
81466106811, 81466106812, 81466116138, 81466116139, 81466116201, 81466116202

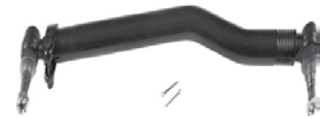

MN-DL-10288

81432206386, 82432206008, 82432209008

No Image

MN-DL-12288

Length: 585 Ø: 58
Hole Distance: 130 / 130
81432206386, 82432206008, 82432209008

No Image

MN-ES-10333

Length: 90
Cone Ø: d1 Ø 38 / d2 Ø 34,35
Thread: M36 x 1,5 RHT
1271126, 3090291, 3099128, 42538048, 81953016268, 82953016018, 82953016019



MN-VB-8514

Length: 627 Ø: 48
Hole Ø 25 / 25 / 25
Hole Distance: 152 / 130 / 130
81432706087, 81432706088, 81432706094, 81432706095, 81432796094



MN-VB-9404

Length: 627 Ø: 58
Hole Distance: 130 / 130
81432706117, 81432706152, 81432706153



SC-ES-8517

Length: 140
Cone Ø: d1 Ø 30 / d2 Ø 27
Thread: M30 x 1,5 RHT
81953016286





TGA ...

40.480 FDK, FDRK ...	06/05 →	Track Control Arm		MN-DL-8544	Trailing Arm, 1st RA;2nd RA, for Leaf-Spring Suspension vehicles	
	06/05 →	Track control arm		MN-DL-10288	Trailing Arm, 1st RA;2nd RA, for Leaf-Spring Suspension vehicles	
40.480 FDRS, FDAS	06/05 →	Centre Rod	MN-DL-7801		Push Rod	
	06/05 →	Centre Rod	MN-DL-8646		Push Rod	
	06/05 →	Tie Rod End	CV-ES-0914		for Steering Rod	
	06/05 →	Tie Rod End	CV-ES-14163		for Steering Rod	
	06/05 →	Tie Rod End	MN-ES-10333		for Steering Rod	
	06/05 →	Tie Rod End	SC-ES-8517		for Push Rod	
	06/05 →	Track Control Arm		MN-DL-5225	Trailing Arm	
	06/05 →	Track Control Arm		MN-DL-8544	Trailing Arm, 1st RA;2nd RA, for Leaf-Spring Suspension vehicles, →Type_HB Chassis	
	06/05 →	Track control arm		MN-DL-10288	Trailing Arm, 1st RA;2nd RA, for Leaf-Spring Suspension vehicles, →Type HB	
	06/05 →	Track control arm		MN-DL-12288	Trailing Arm	
40.480 FDRS, FDS	06/05 →	Track Control Arm		MN-VB-9404	Wishbone (CV)	
	04/04 →	Centre Rod	MN-DL-7801		Push Rod, Leaf Spring Axle	
	04/04 →	Suspension Strut Repair Kit		DB-RK-8581		
	04/04 →	Tie Rod End	CV-ES-0914		for Steering Rod	
	04/04 →	Tie Rod End	CV-ES-14162		for Steering Rod	
	04/04 →	Tie Rod End	CV-ES-14163		for Steering Rod	
	04/04 →	Tie Rod End	SC-ES-8517		for Push Rod	
	04/04 →	Track Control Arm		MN-DL-5225	Trailing Arm	
	04/04 →	Track Control Arm		MN-DL-8544	Trailing Arm, 1st RA;2nd RA, for Leaf-Spring Suspension vehicles, →Type_HB Chassis	
	04/04 →	Track Control Arm		MN-DL-8609	Trailing Arm, 1st RA;2nd RA, for Leaf-Spring Suspension vehicles, →Type_HB Chassis	
	04/04 →	Track control arm		MN-DL-10288	Trailing Arm, 1st RA;2nd RA, for Leaf-Spring Suspension vehicles, →Type HB	
	04/04 →	Track control arm		MN-DL-12288	Trailing Arm	
	04/04 →	Track Control Arm		MN-VB-8514	Suspension Rod, Wishbone (CV), Drive Axle; Leaf Spring Axle	
	04/04 →	Track Control Arm		MN-VB-9404	Wishbone (CV), Drive Axle	
	06/05 →	Centre Rod	MN-DL-2160		Coupling Rod	
	06/05 →	Track Control Arm		MN-DL-8544	Trailing Arm, 1st RA;2nd RA, for Leaf-Spring Suspension vehicles	
	06/05 →	Track control arm		MN-DL-10288	Trailing Arm, 1st RA;2nd RA, for Leaf-Spring Suspension vehicles	
	06/05 →	Track Control Arm		MN-VB-8514	Suspension Rod, Wishbone (CV)	
	41.350 FFDC-TM, FFDRS-TM	09/07 →	Centre Rod	MN-DL-8599		Push Rod
		09/07 →	Suspension Arm Repair Kit		CV-RK-5313	for Wishbone (CV)
09/07 →		Tie Rod End	CV-ES-0914		for Steering Rod	
09/07 →		Tie Rod End	CV-ES-14162		for Steering Rod	
09/07 →		Tie Rod End	CV-ES-14163		for Steering Rod	
09/07 →		Tie Rod End	SC-ES-7279		for Steering Rod	
09/07 →		Tie Rod End	SC-ES-8517		for Push Rod	
09/07 →		Tie Rod End	SC-ES-8535		for Guide Rod	
09/07 →		Track Control Arm		MN-DL-8544	Trailing Arm	
09/07 →		Track control arm		MN-DL-10288	Trailing Arm, 1st RA;2nd RA, for Leaf-Spring Suspension vehicles, →Type MHB	
09/07 →		Track control arm		MN-DL-12288	Trailing Arm	
09/07 →		Track Control Arm		MN-VB-8514	Suspension Rod, Wishbone (CV)	
41.350, 41.360 FFD, FFDC, FFDRS		09/07 →	Track Control Arm		MN-VB-8669	Suspension Rod, Wishbone (CV)
	09/07 →	Track Control Arm		MN-VB-9404	Wishbone (CV)	
	12/04 →	Centre Rod	MN-DL-7801		Push Rod, Leaf Spring Axle	
	12/04 →	Centre Rod	MN-DL-8599		Push Rod	
	12/04 →	Centre Rod	MN-DL-12285		for Steering Rod	
	12/04 →	Suspension Strut Repair Kit		DB-RK-8581		
	12/04 →	Tie Rod	MN-DL-7802			
	12/04 →	Tie Rod	MN-DL-12293			
	12/04 →	Tie Rod End	CV-ES-0914		for Steering Rod	
	12/04 →	Tie Rod End	CV-ES-14162		for Steering Rod	

CV-ES-0914

Length: 125
Cone Ø: d1 Ø 30 / d2 Ø 27
Thread: M38 x 1,5 RHT
81953016184, 81953016251, 81953016276



CV-ES-14162

Length: 125
Cone Ø: d1 Ø 30 / d2 Ø 27
Thread: M30 x 1,5 LHT
81953010015, 81953010083, 81953010087, 81953016029, 81953016030, 81953016043, 81953016044, 81953016050, 81953016054, 81953016087, 81953016091, 81953016107, 81953016120, 81953016125, 81953016152, 81953016155, 81953016157, 81953016168, 81953016179, 81953016181, 81953016223, 81953016237, 81953016254, 81953016275, 81953016279, 81953016351



CV-ES-14163

Length: 125
Cone Ø: d1 Ø 30 / d2 Ø 27
Thread: M30 x 1,5 RHT
95301.0084, 90804102156, 90804102272, 90804102696, 90804102710, 81953010016, 81953010075, 81953010084, 81953010088, 81953010094, 81953010103, 81953016030, 81953016043, 81953016048, 81953016049, 81953016053, 81953016061, 81953016090, 81953016108, 81953016112, 81953016126, 81953016143, 81953016149, 81953016154, 81953016156, 81953016168, 81953016178, 81953016194, 81953016206, 81953016224, 81953016234, 81953016242, 81953016252, 81953016274, 81953016278, 81953016284, 81953016286, 81953016308, 81953016310, 81953016312, 81953016347, 81953016350, 81953016352, 82953016012, 88953016014, N2953016001



CV-RK-5313

Ø: 90
03304800A, 81953016132



DB-RK-8581

Ø: 85
Hole Distance: 130
Thick/Height: 24
03305800A, 81432706105



MN-DL-2160

Length: 1652 Ø: 50
Cone Ø: d1 Ø 30 / d2 Ø 27
81467106112, 81467106163, 81467106165, 81467106198, 81467106353, 81467106354, 81467106361, 81467116725



MN-DL-5225

Length: 572 Ø: 48
Hole Distance: 130 / 130
03301500A, 81432206229, 81432206236, 81432206267, 81432206270, 81432206272, 81432206304, 81432206305, 81432209236, 81432209267, 81432209272



MN-DL-7801

Length: 995 Ø: 52
Cone Ø: d1 Ø 30 / d2 Ø 27
81466106807, 81466106808, 81466116087, 81466116088, 81466116096, 81466116097, 81466116099, 81466116132, 81466116133, 81466116136, 81466116197, 81466116198, 81466116205

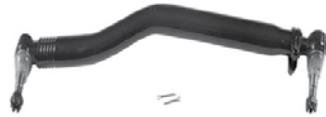

MN-DL-7802

Length: 1680 Ø: 52
Cone Ø: d1 Ø 30 / d2 Ø 27
03208300A, 81467116773, 81467116858, 81467116859, 81467116860, 81467116861, 81467116863, 81467116882, 81467116883, 81467116920, 81467116921



MN-DL-8544

Length: 596 Ø: 48
Hole Distance: 130 / 130
81432206196, 81432206232, 81432206233



MN-DL-8599

Length: 1800 Ø: 62
Cone Ø: d1 Ø 30 / d2 Ø 27
81466116161, 81466116162, 82466106183, 82466106186, 82466106187



MN-DL-8609

Length: 585 Ø: 58
Hole Distance: 130 / 130
81432206070, 81432206071, 81432206072, 81432206091, 81432206093, 81432206119



MN-DL-8646

Length: 1021 Ø: 52
Cone Ø: d1 Ø 30 / d2 Ø 27
81466106811, 81466106812, 81466116138, 81466116139, 81466116201, 81466116202



MN-DL-10288

81432206386, 82432206008, 82432209008

No Image

MN-DL-12285

Length: 993 Ø: 40
Cone Ø: d1 Ø 30 / d2 Ø 27
81466106816, 81466106826, 81466116151, 82466106184, 82466106185



MN-DL-12288

Length: 585 Ø: 58
Hole Distance: 130 / 130
81432206386, 82432206008, 82432209008

No Image

MN-DL-12293

Length: 1680 Ø: 42
Cone Ø: d1 Ø 30 / d2 Ø 27
81467106236, 81467106268, 81467106356, 81467116356, 81467116723, 81467116794, 81467116933, 81467116934, 81467116966



MN-ES-10333

Length: 90
Cone Ø: d1 Ø 38 / d2 Ø 34,35
Thread: M36 x 1,5 RHT
1271126, 3090291, 3099128, 42538048, 81953016268, 82953016018, 82953016019



MN-VB-8514

Length: 627 Ø: 48
Hole Ø 25 / 25 / 25
Hole Distance: 152 / 130 / 130
81432706087, 81432706088, 81432706094, 81432706095, 81432796094



MN-VB-8669

Length: 627 Ø: 48
Hole Ø 25 / 25 / 25
Hole Distance: 152 / 130 / 130
81432706116, 81432706137, 81432706150, 81432706151



MN-VB-9404

Length: 627 Ø: 58
Hole Distance: 130 / 130
81432706117, 81432706152, 81432706153



SC-ES-7279

Length: 150
Cone Ø: d1 Ø 30 / d2 Ø 27
Thread: M30 x 1,5 RHT
81953016288



SC-ES-8517

Length: 140
Cone Ø: d1 Ø 30 / d2 Ø 27
Thread: M30 x 1,5 RHT
81953016286



SC-ES-8535

Length: 145
Cone Ø: d1 Ø 30 / d2 Ø 27
Thread: M30 x 1,5 RHT
81953016271, 81953016325





TGA ...

41.350, 41.360 FFD, FFDC, FFDRK ...	12/04 →	Tie Rod End	CV-ES-14163		for Steering Rod	
	12/04 →	Tie Rod End	MN-ES-10333		for Steering Rod	
	12/04 →	Tie Rod End	SC-ES-7279		for Steering Rod	
	12/04 →	Tie Rod End	SC-ES-8517		for Push Rod	
	12/04 →	Tie Rod End	SC-ES-8535		for Guide Rod	
	12/04 →	Track Control Arm		MN-DL-5225	Trailing Arm	
	12/04 →	Track Control Arm		MN-DL-8544	Trailing Arm, Drive Axle;Leaf Spring Axle	
	12/04 →	Track control arm		MN-DL-10288	Trailing Arm, 1st RA;2nd RA, for Leaf-Spring Suspension vehicles, →Type MHB	
	12/04 →	Track control arm		MN-DL-12288	Trailing Arm	
	12/04 →	Track Control Arm		MN-VB-8514	Suspension Rod, Wishbone (CV), Drive Axle; Leaf Spring Axle	
	12/04 →	Track Control Arm		MN-VB-8669	Suspension Rod, Wishbone (CV), Drive Axle; Leaf Spring Axle	
	12/04 →	Track Control Arm		MN-VB-9404	Wishbone (CV), Drive Axle;Leaf Spring Axle	
	41.350, 41.360 FFDC-TM, FFDRK-TM, FFD-TM	12/04 →	Centre Rod	MN-DL-7801		Push Rod, Leaf Spring Axle
		12/04 →	Centre Rod	MN-DL-8599		Push Rod
12/04 →		Centre Rod	MN-DL-12285		for Steering Rod	
12/04 →		Suspension Strut Repair Kit		DB-RK-8581		
12/04 →		Tie Rod	MN-DL-7802			
12/04 →		Tie Rod	MN-DL-12293			
12/04 →		Tie Rod End	CV-ES-0914		for Steering Rod	
12/04 →		Tie Rod End	CV-ES-14162		for Steering Rod	
12/04 →		Tie Rod End	CV-ES-14163		for Steering Rod	
12/04 →		Tie Rod End	MN-ES-10333		for Steering Rod	
12/04 →		Tie Rod End	SC-ES-7279		for Steering Rod	
12/04 →		Tie Rod End	SC-ES-8517		for Push Rod	
12/04 →		Tie Rod End	SC-ES-8535		for Guide Rod	
41.350, 41.360 FFDK, FFDRK		12/04 →	Track Control Arm		MN-DL-5225	Trailing Arm
	12/04 →	Track Control Arm		MN-DL-8544	Trailing Arm, Drive Axle;Leaf Spring Axle	
	12/04 →	Track control arm		MN-DL-10288	Trailing Arm, 1st RA;2nd RA, for Leaf-Spring Suspension vehicles, →Type MHB	
	12/04 →	Track control arm		MN-DL-12288	Trailing Arm	
	12/04 →	Track Control Arm		MN-VB-8514	Suspension Rod, Wishbone (CV), Drive Axle; Leaf Spring Axle	
	12/04 →	Track Control Arm		MN-VB-8669	Suspension Rod, Wishbone (CV), Drive Axle; Leaf Spring Axle	
	12/04 →	Track Control Arm		MN-VB-9404	Wishbone (CV), Drive Axle;Leaf Spring Axle	
	12/04 →	Centre Rod	MN-DL-7801		Push Rod, Leaf Spring Axle	
	12/04 →	Centre Rod	MN-DL-8599		Push Rod	
	12/04 →	Centre Rod	MN-DL-12285		for Steering Rod	
	12/04 →	Suspension Strut Repair Kit		DB-RK-8581		
	12/04 →	Tie Rod	MN-DL-7802			
	12/04 →	Tie Rod	MN-DL-12293			
	12/04 →	Tie Rod End	CV-ES-0914		for Steering Rod	
12/04 →	Tie Rod End	CV-ES-14162		for Steering Rod		
12/04 →	Tie Rod End	CV-ES-14163		for Steering Rod		
12/04 →	Tie Rod End	MN-ES-10333		for Steering Rod		
12/04 →	Tie Rod End	SC-ES-7279		for Steering Rod		
12/04 →	Tie Rod End	SC-ES-8517		for Push Rod		
12/04 →	Tie Rod End	SC-ES-8535		for Guide Rod		
12/04 →	Track Control Arm		MN-DL-5225	Trailing Arm		
12/04 →	Track Control Arm		MN-DL-8544	Trailing Arm, Drive Axle;Leaf Spring Axle		
12/04 →	Track control arm		MN-DL-10288	Trailing Arm, 1st RA;2nd RA, for Leaf-Spring Suspension vehicles, →Type MHB		
12/04 →	Track control arm		MN-DL-12288	Trailing Arm		
12/04 →	Track Control Arm		MN-VB-8514	Suspension Rod, Wishbone (CV), Drive Axle; Leaf Spring Axle		
12/04 →	Track Control Arm		MN-VB-8669	Suspension Rod, Wishbone (CV), Drive Axle; Leaf Spring Axle		
12/04 →	Track Control Arm		MN-VB-9404	Wishbone (CV), Drive Axle;Leaf Spring Axle		

CV-ES-0914

Length: 125
Cone Ø: d1 Ø 30 / d2 Ø 27
Thread: M38 x 1,5 RHT
81953016184, 81953016251, 81953016276



CV-ES-14162

Length: 125
Cone Ø: d1 Ø 30 / d2 Ø 27
Thread: M30 x 1,5 LHT
81953010015, 81953010083, 81953010087, 81953016029, 81953016030, 81953016043, 81953016044, 81953016050, 81953016054, 81953016087, 81953016091, 81953016107, 81953016120, 81953016125, 81953016152, 81953016155, 81953016157, 81953016168, 81953016179, 81953016181, 81953016223, 81953016237, 81953016254, 81953016275, 81953016279, 81953016351

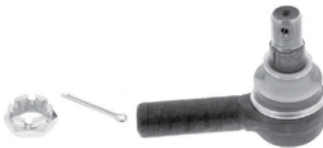

CV-ES-14163

Length: 125
Cone Ø: d1 Ø 30 / d2 Ø 27
Thread: M30 x 1,5 RHT
95301.0084, 90804102156, 90804102272, 90804102696, 90804102710, 81953010016, 81953010075, 81953010084, 81953010088, 81953010094, 81953010103, 81953016030, 81953016043, 81953016048, 81953016049, 81953016053, 81953016061, 81953016090, 81953016108, 81953016112, 81953016126, 81953016143, 81953016149, 81953016154, 81953016156, 81953016168, 81953016178, 81953016194, 81953016206, 81953016224, 81953016234, 81953016242, 81953016252, 81953016274, 81953016278, 81953016284, 81953016286, 81953016308, 81953016310, 81953016312, 81953016347, 81953016350, 81953016352, 82953016012, 88953016014, N2953016001



DB-RK-8581

Ø: 85
Hole Distance: 130
Thick/Height: 24
03305800A, 81432706105



MN-DL-5225

Length: 572 Ø: 48
Hole Distance: 130 / 130
03301500A, 81432206229, 81432206236, 81432206267, 81432206270, 81432206272, 81432206304, 81432206305, 81432209236, 81432209267, 81432209272



MN-DL-7801

Length: 995 Ø: 52
Cone Ø: d1 Ø 30 / d2 Ø 27
81466106807, 81466106808, 81466116087, 81466116088, 81466116096, 81466116097, 81466116099, 81466116132, 81466116133, 81466116136, 81466116197, 81466116198, 81466116205

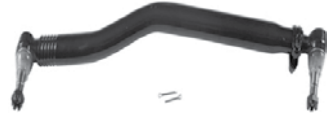

MN-DL-7802

Length: 1680 Ø: 52
Cone Ø: d1 Ø 30 / d2 Ø 27
03208300A, 81467116773, 81467116858, 81467116859, 81467116860, 81467116861, 81467116863, 81467116882, 81467116883, 81467116920, 81467116921



MN-DL-8544

Length: 596 Ø: 48
Hole Distance: 130 / 130
81432206196, 81432206232, 81432206233



MN-DL-8599

Length: 1800 Ø: 62
Cone Ø: d1 Ø 30 / d2 Ø 27
81466116161, 81466116162, 82466106183, 82466106186, 82466106187



MN-DL-10288

81432206386, 82432206008, 82432209008

No Image

MN-DL-12285

Length: 993 Ø: 40
Cone Ø: d1 Ø 30 / d2 Ø 27
81466106816, 81466106826, 81466116151, 82466106184, 82466106185



MN-DL-12288

Length: 585 Ø: 58
Hole Distance: 130 / 130
81432206386, 82432206008, 82432209008

No Image

MN-DL-12293

Length: 1680 Ø: 42
Cone Ø: d1 Ø 30 / d2 Ø 27
81467106236, 81467106268, 81467106356, 81467116356, 81467116723, 81467116794, 81467116933, 81467116934, 81467116966



MN-ES-10333

Length: 90
Cone Ø: d1 Ø 38 / d2 Ø 34,35
Thread: M36 x 1,5 RHT
1271126, 3090291, 3099128, 42538048, 81953016268, 82953016018, 82953016019



MN-VB-8514

Length: 627 Ø: 48
Hole Ø 25 / 25 / 25
Hole Distance: 152 / 130 / 130
81432706087, 81432706088, 81432706094, 81432706095, 81432796094



MN-VB-8669

Length: 627 Ø: 48
Hole Ø 25 / 25 / 25
Hole Distance: 152 / 130 / 130
81432706116, 81432706137, 81432706150, 81432706151



MN-VB-9404

Length: 627 Ø: 58
Hole Distance: 130 / 130
81432706117, 81432706152, 81432706153



SC-ES-7279

Length: 150
Cone Ø: d1 Ø 30 / d2 Ø 27
Thread: M30 x 1,5 RHT
81953016288



SC-ES-8517

Length: 140
Cone Ø: d1 Ø 30 / d2 Ø 27
Thread: M30 x 1,5 RHT
81953016286



SC-ES-8535

Length: 145
Cone Ø: d1 Ø 30 / d2 Ø 27
Thread: M30 x 1,5 RHT
81953016271, 81953016325



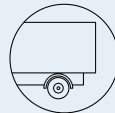

TGA ...

41.360 FFD	12/08→	Centre Rod	MN-DL-8599		Push Rod	
	12/08→	Suspension Arm Repair Kit		CV-RK-5313	for Wishbone (CV)	
	12/08→	Tie Rod End	CV-ES-0914		for Steering Rod	
	12/08→	Tie Rod End	CV-ES-14162		for Steering Rod	
	12/08→	Tie Rod End	CV-ES-14163		for Steering Rod	
	12/08→	Tie Rod End	SC-ES-7279		for Steering Rod	
	12/08→	Tie Rod End	SC-ES-8517		for Push Rod	
	12/08→	Tie Rod End	SC-ES-8535		for Guide Rod	
	12/08→	Track Control Arm		MN-DL-8544	Trailing Arm	
	12/08→	Track Control Arm		MN-VB-8514	Suspension Rod, Wishbone (CV)	
	12/08→	Track Control Arm		MN-VB-8669	Suspension Rod, Wishbone (CV)	
	12/08→	Track Control Arm		MN-VB-9404	Wishbone (CV)	
	41.360 FFDC, FFDC/M, FFDC/M-WW, FFDC	01/03→03/03	Track Control Arm		MN-DL-8609	Trailing Arm, Leaf Spring Axle; Double Axle with two Driven Axles
01/03→		Ball Head, gearshift linkage	CV-ES-2120			
01/03→		Centre Rod	MN-DL-7801		Push Rod, Leaf Spring Axle	
01/03→		Centre Rod	MN-DL-8599		Push Rod	
01/03→		Centre Rod	MN-DL-12285		for Steering Rod	
01/03→		Suspension Strut Repair Kit		DB-RK-8581		
01/03→		Tie Rod	MN-DL-7802			
01/03→		Tie Rod End	CV-ES-0914		for Steering Rod	
01/03→		Tie Rod End	CV-ES-14162		for Steering Rod	
01/03→		Tie Rod End	CV-ES-14163		for Steering Rod	
01/03→		Tie Rod End	MN-ES-10333		for Steering Rod	
01/03→		Tie Rod End	SC-ES-7279		for Steering Rod	
01/03→		Tie Rod End	SC-ES-8517		for Push Rod	
01/03→		Tie Rod End	SC-ES-8535		for Guide Rod	
01/03→		Track Control Arm		MN-DL-5225	Trailing Arm	
01/03→		Track Control Arm		MN-DL-8544	Trailing Arm, Drive Axle; Leaf Spring Axle	
01/03→		Track control arm		MN-DL-10288	Trailing Arm, 1st RA; 2nd RA, for Leaf-Spring Suspension vehicles, →Type MHB	
01/03→		Track control arm		MN-DL-12288	Trailing Arm	
01/03→		Track Control Arm		MN-TC-12399	Control Arm	
01/03→		Track Control Arm		MN-VB-8514	Suspension Rod, Wishbone (CV), Drive Axle; Leaf Spring Axle	
01/03→		Track Control Arm		MN-VB-8669	Suspension Rod, Wishbone (CV), Drive Axle; Leaf Spring Axle	
01/03→		Track Control Arm		MN-VB-9404	Wishbone (CV), Drive Axle	
01/03→		Track Control Arm		MN-VB-9404	Wishbone (CV), Drive Axle; Leaf Spring Axle	
41.360 FFDC-TM, FDRC-TM		09/07→	Centre Rod	MN-DL-8599		Push Rod
		09/07→	Suspension Arm Repair Kit		CV-RK-5313	for Wishbone (CV)
		09/07→	Tie Rod End	CV-ES-0914		for Steering Rod
		09/07→	Tie Rod End	CV-ES-14162		for Steering Rod
	09/07→	Tie Rod End	CV-ES-14163		for Steering Rod	
	09/07→	Tie Rod End	SC-ES-7279		for Steering Rod	
	09/07→	Tie Rod End	SC-ES-8517		for Push Rod	
	09/07→	Tie Rod End	SC-ES-8535		for Guide Rod	
	09/07→	Track Control Arm		MN-DL-8544	Trailing Arm	
	09/07→	Track control arm		MN-DL-10288	Trailing Arm, 1st RA; 2nd RA, for Leaf-Spring Suspension vehicles, →Type MHB	
	09/07→	Track control arm		MN-DL-12288	Trailing Arm	
	09/07→	Track Control Arm		MN-VB-8514	Suspension Rod, Wishbone (CV)	
	09/07→	Track Control Arm		MN-VB-8669	Suspension Rod, Wishbone (CV)	
09/07→	Track Control Arm		MN-VB-9404	Wishbone (CV)		
41.360 FFDC-TM, FFDC-TM, FFD-TM	12/04→	Centre Rod	MN-DL-2160		Coupling Rod	
	12/04→	Suspension Arm Repair Kit		CV-RK-5313	for Wishbone (CV)	
	12/04→	Tie Rod End	CV-ES-0914		for Steering Rod	
	12/04→	Tie Rod End	CV-ES-14162		for Steering Rod	
	12/04→	Tie Rod End	CV-ES-14163		for Steering Rod	
	12/04→	Tie Rod End	SC-ES-7279		for Steering Rod	
	12/04→	Tie Rod End	SC-ES-8517		for Push Rod	
	12/04→	Tie Rod End	SC-ES-8535		for Guide Rod	
	12/04→	Track Control Arm		MN-DL-5225	Trailing Arm	

CV-ES-0914

Length: 125
Cone Ø: d1 Ø 30 / d2 Ø 27
Thread: M38 x 1,5 RHT
81953016184, 81953016251, 81953016276



CV-ES-2120

Length: 115
Cone Ø: d1 Ø 12,4 / d2 Ø 10,8
Thread: M14 x 1,5 RHT
03008500A, 81953016200, 81953016202, 81953016203, 81953016227



CV-ES-14162

Length: 125
Cone Ø: d1 Ø 30 / d2 Ø 27
Thread: M30 x 1,5 LHT
81953010015, 81953010083, 81953010087, 81953016029, 81953016030, 81953016043, 81953016044, 81953016050, 81953016054, 81953016087, 81953016091, 81953016107, 81953016120, 81953016125, 81953016152, 81953016155, 81953016157, 81953016168, 81953016179, 81953016181, 81953016223, 81953016237, 81953016254, 81953016275, 81953016279, 81953016351



CV-ES-14163

Length: 125
Cone Ø: d1 Ø 30 / d2 Ø 27
Thread: M30 x 1,5 RHT
95301.0084, 90804102156, 90804102272, 90804102696, 90804102710, 81953010016, 81953010075, 81953010084, 81953010088, 81953010094, 81953010103, 81953016030, 81953016043, 81953016048, 81953016049, 81953016053, 81953016061, 81953016090, 81953016108, 81953016112, 81953016126, 81953016143, 81953016149, 81953016154, 81953016156, 81953016168, 81953016178, 81953016194, 81953016206, 81953016224, 81953016234, 81953016242, 81953016252, 81953016274, 81953016278, 81953016284, 81953016286, 81953016308, 81953016310, 81953016312, 81953016347, 81953016350, 81953016352, 82953016012, 88953016014, N2953016001



CV-RK-5313

Ø: 90
03304800A, 81953016132



DB-RK-8581

Ø: 85
Hole Distance: 130
Thick/Height: 24
03305800A, 81432706105



MN-DL-2160

Length: 1652 Ø: 50
Cone Ø: d1 Ø 30 / d2 Ø 27
81467106112, 81467106163, 81467106165, 81467106198, 81467106353, 81467106354, 81467106361, 81467116725



MN-DL-5225

Length: 572 Ø: 48
Hole Distance: 130 / 130
03301500A, 81432206229, 81432206236, 81432206267, 81432206270, 81432206272, 81432206304, 81432206305, 81432209236, 81432209267, 81432209272



MN-DL-7801

Length: 995 Ø: 52
Cone Ø: d1 Ø 30 / d2 Ø 27
81466106807, 81466106808, 81466116087, 81466116088, 81466116096, 81466116097, 81466116099, 81466116132, 81466116133, 81466116136, 81466116197, 81466116198, 81466116205

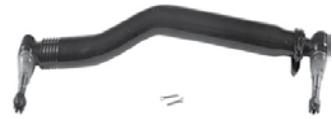

MN-DL-7802

Length: 1680 Ø: 52
Cone Ø: d1 Ø 30 / d2 Ø 27
03208300A, 81467116773, 81467116858, 81467116859, 81467116860, 81467116861, 81467116863, 81467116882, 81467116883, 81467116920, 81467116921



MN-DL-8544

Length: 596 Ø: 48
Hole Distance: 130 / 130
81432206196, 81432206232, 81432206233



MN-DL-8599

Length: 1800 Ø: 62
Cone Ø: d1 Ø 30 / d2 Ø 27
81466116161, 81466116162, 82466106183, 82466106186, 82466106187



MN-DL-8609

Length: 585 Ø: 58
Hole Distance: 130 / 130
81432206070, 81432206071, 81432206072, 81432206091, 81432206093, 81432206119



MN-DL-10288

81432206386, 82432206008, 82432209008

No Image

MN-DL-12285

Length: 993 Ø: 40
Cone Ø: d1 Ø 30 / d2 Ø 27
81466106816, 81466106826, 81466116151, 82466106184, 82466106185



MN-DL-12288

Length: 585 Ø: 58
Hole Distance: 130 / 130
81432206386, 82432206008, 82432209008

No Image

MN-ES-10333

Length: 90
Cone Ø: d1 Ø 38 / d2 Ø 34,35
Thread: M36 x 1,5 RHT
1271126, 3090291, 3099128, 42538048, 81953016268, 82953016018, 82953016019



MN-TC-12399

Length: 694 Ø: 50
Hole Distance: 130 / 130
81432206265



MN-VB-8514

Length: 627 Ø: 48
Hole Ø 25 / 25 / 25
Hole Distance: 152 / 130 / 130
81432706087, 81432706088, 81432706094, 81432706095, 81432796094



MN-VB-8669

Length: 627 Ø: 48
Hole Ø 25 / 25 / 25
Hole Distance: 152 / 130 / 130
81432706116, 81432706137, 81432706150, 81432706151



MN-VB-9404

Length: 627 Ø: 58
Hole Distance: 130 / 130
81432706117, 81432706152, 81432706153



SC-ES-7279

Length: 150
Cone Ø: d1 Ø 30 / d2 Ø 27
Thread: M30 x 1,5 RHT
81953016288



SC-ES-8517

Length: 140
Cone Ø: d1 Ø 30 / d2 Ø 27
Thread: M30 x 1,5 RHT
81953016286



SC-ES-8535

Length: 145
Cone Ø: d1 Ø 30 / d2 Ø 27
Thread: M30 x 1,5 RHT
81953016271, 81953016325





TGA ...

41.360 FFDC-TM, FFDCR-TM, FFD-TM ...	12/04 →	Track Control Arm		MN-DL-8544	Trailing Arm, 1st RA;2nd RA, for Leaf-Spring Suspension vehicles
	12/04 →	Track control arm		MN-DL-10288	Trailing Arm, 1st RA;2nd RA, for Leaf-Spring Suspension vehicles, →Type MHB
	12/04 →	Track control arm		MN-DL-12288	Trailing Arm
	12/04 →	Track Control Arm		MN-VB-8514	Suspension Rod, Wishbone (CV)
	12/04 →	Track Control Arm		MN-VB-8669	Suspension Rod, Wishbone (CV), 1st RA; 2nd RA, for Leaf-Spring Suspension vehicles, →Type_MHB Chassis
	12/04 →	Track Control Arm		MN-VB-9404	Wishbone (CV), 1st RA;2nd RA, for Leaf-Spring Suspension vehicles, →Type_MHB Chassis
41.360 FFDK, FFDRK	09/03 →	Centre Rod	MN-DL-7801		Push Rod, Leaf Spring Axle
	09/03 →	Centre Rod	MN-DL-8599		Push Rod
	09/03 →	Suspension Arm Repair Kit		CV-RK-5313	for Wishbone (CV)
	09/03 →	Tie Rod	MN-DL-7802		
	09/03 →	Tie Rod End	CV-ES-0914		for Steering Rod
	09/03 →	Tie Rod End	CV-ES-14162		for Steering Rod
	09/03 →	Tie Rod End	CV-ES-14163		for Steering Rod
	09/03 →	Tie Rod End	SC-ES-7279		for Steering Rod
	09/03 →	Tie Rod End	SC-ES-8517		for Push Rod
	09/03 →	Tie Rod End	SC-ES-8535		for Guide Rod
	09/03 →	Track Control Arm		MN-DL-5225	Trailing Arm
	09/03 →	Track Control Arm		MN-DL-8544	Trailing Arm, Drive Axle;Leaf Spring Axle
	09/03 →	Track control arm		MN-DL-10288	Trailing Arm, 1st RA;2nd RA, for Leaf-Spring Suspension vehicles, →Type MHB
	09/03 →	Track control arm		MN-DL-12288	Trailing Arm
	09/03 →	Track Control Arm		MN-VB-8514	Suspension Rod, Wishbone (CV)
	09/03 →	Track Control Arm		MN-VB-8669	Suspension Rod, Wishbone (CV), 1st RA; 2nd RA, for Leaf-Spring Suspension vehicles, →Type_MHB Chassis
09/03 →	Track Control Arm		MN-VB-9404	Wishbone (CV)	
41.390 FFDK	12/04 →	Suspension Strut Repair Kit		DB-RK-8581	
	12/04 →	Tie Rod	MN-DL-12287		
	12/04 →	Tie Rod End	CV-ES-14162		for Steering Rod
	12/04 →	Tie Rod End	CV-ES-14163		for Steering Rod
	12/04 →	Tie Rod End	MN-ES-10333		for Steering Rod
	12/04 →	Track Control Arm		MN-DL-8544	Trailing Arm, 1st RA;2nd RA, for Leaf-Spring Suspension vehicles, →Type_HB Chassis
	12/04 →	Track Control Arm		MN-VB-8514	Suspension Rod, Wishbone (CV)
12/04 →	Track Control Arm		MN-VB-9404	Wishbone (CV), 1st RA;2nd RA, for Leaf-Spring Suspension vehicles, →Type_HB Chassis	
41.390 FFDC-TM, FDRC-TM	09/07 →	Centre Rod	MN-DL-8599		Push Rod
	09/07 →	Suspension Arm Repair Kit		CV-RK-5313	for Wishbone (CV)
	09/07 →	Tie Rod End	CV-ES-0914		for Steering Rod
	09/07 →	Tie Rod End	CV-ES-14162		for Steering Rod
	09/07 →	Tie Rod End	CV-ES-14163		for Steering Rod
	09/07 →	Tie Rod End	SC-ES-7279		for Steering Rod
	09/07 →	Tie Rod End	SC-ES-8517		for Push Rod
	09/07 →	Tie Rod End	SC-ES-8535		for Guide Rod
	09/07 →	Track Control Arm		MN-DL-8544	Trailing Arm
	09/07 →	Track control arm		MN-DL-10288	Trailing Arm, 1st RA;2nd RA, for Leaf-Spring Suspension vehicles, →Type MHB
	09/07 →	Track control arm		MN-DL-12288	Trailing Arm
09/07 →	Track Control Arm		MN-VB-8514	Suspension Rod, Wishbone (CV)	
09/07 →	Track Control Arm		MN-VB-8669	Suspension Rod, Wishbone (CV)	
09/07 →	Track Control Arm		MN-VB-9404	Wishbone (CV)	
41.390, 41.400 FFD, FFDC, FFDRK	12/04 →	Centre Rod	MN-DL-7801		Push Rod, Leaf Spring Axle
	12/04 →	Centre Rod	MN-DL-8599		Push Rod
	12/04 →	Centre Rod	MN-DL-12285		for Steering Rod
	12/04 →	Suspension Strut Repair Kit		DB-RK-8581	
	12/04 →	Tie Rod	MN-DL-7802		
	12/04 →	Tie Rod	MN-DL-12293		

CV-ES-0914

Length: 125
Cone Ø: d1 Ø 30 / d2 Ø 27
Thread: M38 x 1,5 RHT
81953016184, 81953016251, 81953016276



CV-ES-14162

Length: 125
Cone Ø: d1 Ø 30 / d2 Ø 27
Thread: M30 x 1,5 LHT
81953010015, 81953010083, 81953010087, 81953016029, 81953016030, 81953016043, 81953016044, 81953016050, 81953016054, 81953016087, 81953016091, 81953016107, 81953016120, 81953016125, 81953016152, 81953016155, 81953016157, 81953016168, 81953016179, 81953016181, 81953016223, 81953016237, 81953016254, 81953016275, 81953016279, 81953016351

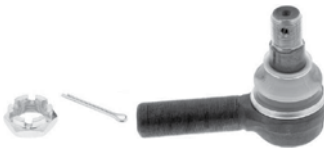

CV-ES-14163

Length: 125
Cone Ø: d1 Ø 30 / d2 Ø 27
Thread: M30 x 1,5 RHT
95301.0084, 90804102156, 90804102272, 90804102696, 90804102710, 81953010016, 81953010075, 81953010084, 81953010088, 81953010094, 81953010103, 81953016030, 81953016043, 81953016048, 81953016049, 81953016053, 81953016061, 81953016090, 81953016108, 81953016112, 81953016126, 81953016143, 81953016149, 81953016154, 81953016156, 81953016168, 81953016178, 81953016194, 81953016206, 81953016224, 81953016234, 81953016242, 81953016252, 81953016274, 81953016278, 81953016284, 81953016286, 81953016308, 81953016310, 81953016312, 81953016347, 81953016350, 81953016352, 82953016012, 88953016014, N2953016001



CV-RK-5313

Ø: 90
03304800A, 81953016132



DB-RK-8581

Ø: 85
Hole Distance: 130
Thick/Height: 24
03305800A, 81432706105



MN-DL-5225

Length: 572 Ø: 48
Hole Distance: 130 / 130
03301500A, 81432206229, 81432206236, 81432206267, 81432206270, 81432206272, 81432206304, 81432206305, 81432209236, 81432209267, 81432209272



MN-DL-7801

Length: 995 Ø: 52
Cone Ø: d1 Ø 30 / d2 Ø 27
81466106807, 81466106808, 81466116087, 81466116088, 81466116096, 81466116097, 81466116099, 81466116132, 81466116133, 81466116136, 81466116197, 81466116198, 81466116205

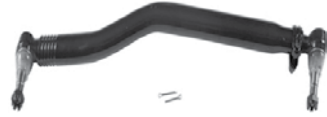

MN-DL-7802

Length: 1680 Ø: 52
Cone Ø: d1 Ø 30 / d2 Ø 27
03208300A, 81467116773, 81467116858, 81467116859, 81467116860, 81467116861, 81467116863, 81467116882, 81467116883, 81467116920, 81467116921



MN-DL-8544

Length: 596 Ø: 48
Hole Distance: 130 / 130
81432206196, 81432206232, 81432206233



MN-DL-8599

Length: 1800 Ø: 62
Cone Ø: d1 Ø 30 / d2 Ø 27
81466116161, 81466116162, 82466106183, 82466106186, 82466106187



MN-DL-10288

81432206386, 82432206008, 82432209008

No Image

MN-DL-12285

Length: 993 Ø: 40
Cone Ø: d1 Ø 30 / d2 Ø 27
81466106816, 81466106826, 81466116151, 82466106184, 82466106185



MN-DL-12287

Length: 1531 Ø: 42
Cone Ø: d1 Ø 30 / d2 Ø 27
81467116855, 81467116856, 81467116857



MN-DL-12288

Length: 585 Ø: 58
Hole Distance: 130 / 130
81432206386, 82432206008, 82432209008

No Image

MN-DL-12293

Length: 1680 Ø: 42
Cone Ø: d1 Ø 30 / d2 Ø 27
81467106236, 81467106268, 81467106356, 81467116356, 81467116723, 81467116794, 81467116933, 81467116934, 81467116966



MN-ES-10333

Length: 90
Cone Ø: d1 Ø 38 / d2 Ø 34,35
Thread: M36 x 1,5 RHT
1271126, 3090291, 3099128, 42538048, 81953016268, 82953016018, 82953016019



MN-VB-8514

Length: 627 Ø: 48
Hole Ø 25 / 25 / 25
Hole Distance: 152 / 130 / 130
81432706087, 81432706088, 81432706094, 81432706095, 81432796094



MN-VB-8669

Length: 627 Ø: 48
Hole Ø 25 / 25 / 25
Hole Distance: 152 / 130 / 130
81432706116, 81432706137, 81432706150, 81432706151



MN-VB-9404

Length: 627 Ø: 58
Hole Distance: 130 / 130
81432706117, 81432706152, 81432706153



SC-ES-7279

Length: 150
Cone Ø: d1 Ø 30 / d2 Ø 27
Thread: M30 x 1,5 RHT
81953016288



SC-ES-8517

Length: 140
Cone Ø: d1 Ø 30 / d2 Ø 27
Thread: M30 x 1,5 RHT
81953016286



SC-ES-8535

Length: 145
Cone Ø: d1 Ø 30 / d2 Ø 27
Thread: M30 x 1,5 RHT
81953016271, 81953016325





TGA ...

41.390, 41.400 FFD, FFDC, FFDRC ...	12/04 →	Tie Rod End	CV-ES-0914		for Steering Rod
	12/04 →	Tie Rod End	CV-ES-14162		for Steering Rod
	12/04 →	Tie Rod End	CV-ES-14163		for Steering Rod
	12/04 →	Tie Rod End	MN-ES-10333		for Steering Rod
	12/04 →	Tie Rod End	SC-ES-7279		for Steering Rod
	12/04 →	Tie Rod End	SC-ES-8517		for Push Rod
	12/04 →	Tie Rod End	SC-ES-8535		for Guide Rod
	12/04 →	Track Control Arm		MN-DL-5225	Trailing Arm
	12/04 →	Track Control Arm		MN-DL-8544	Trailing Arm, Drive Axle;Leaf Spring Axle
	12/04 →	Track control arm		MN-DL-10288	Trailing Arm, 1st RA;2nd RA, for Leaf-Spring Suspension vehicles, →Type MHB
	12/04 →	Track control arm		MN-DL-12288	Trailing Arm
	12/04 →	Track Control Arm		MN-VB-8514	Suspension Rod, Wishbone (CV), Drive Axle; Leaf Spring Axle
	12/04 →	Track Control Arm		MN-VB-8669	Suspension Rod, Wishbone (CV), Drive Axle; Leaf Spring Axle
	12/04 →	Track Control Arm		MN-VB-9404	Wishbone (CV), Drive Axle;Leaf Spring Axle
	41.390, 41.400 FFDC-TM, FFDRC-TM, FFD-TM	12/04 →	Centre Rod	MN-DL-7801	
12/04 →		Centre Rod	MN-DL-8599		Push Rod
12/04 →		Centre Rod	MN-DL-12285		for Steering Rod
12/04 →		Suspension Strut Repair Kit		DB-RK-8581	
12/04 →		Tie Rod	MN-DL-7802		
12/04 →		Tie Rod	MN-DL-12293		
12/04 →		Tie Rod End	CV-ES-0914		for Steering Rod
12/04 →		Tie Rod End	CV-ES-14162		for Steering Rod
12/04 →		Tie Rod End	CV-ES-14163		for Steering Rod
12/04 →		Tie Rod End	MN-ES-10333		for Steering Rod
12/04 →		Tie Rod End	SC-ES-7279		for Steering Rod
12/04 →		Tie Rod End	SC-ES-8517		for Push Rod
12/04 →		Tie Rod End	SC-ES-8535		for Guide Rod
12/04 →		Track Control Arm		MN-DL-5225	Trailing Arm
12/04 →		Track Control Arm		MN-DL-8544	Trailing Arm, Drive Axle;Leaf Spring Axle
12/04 →	Track control arm		MN-DL-10288	Trailing Arm, 1st RA;2nd RA, for Leaf-Spring Suspension vehicles, →Type MHB	
12/04 →	Track control arm		MN-DL-12288	Trailing Arm	
12/04 →	Track Control Arm		MN-VB-8514	Suspension Rod, Wishbone (CV), Drive Axle; Leaf Spring Axle	
12/04 →	Track Control Arm		MN-VB-8669	Suspension Rod, Wishbone (CV), Drive Axle; Leaf Spring Axle	
12/04 →	Track Control Arm		MN-VB-9404	Wishbone (CV), Drive Axle;Leaf Spring Axle	
41.390, 41.400 FFDK, FFDK	12/04 →	Centre Rod	MN-DL-7801		Push Rod, Leaf Spring Axle
	12/04 →	Centre Rod	MN-DL-8599		Push Rod
	12/04 →	Centre Rod	MN-DL-12285		for Steering Rod
	12/04 →	Suspension Strut Repair Kit		DB-RK-8581	
	12/04 →	Tie Rod	MN-DL-7802		
	12/04 →	Tie Rod	MN-DL-12293		
	12/04 →	Tie Rod End	CV-ES-0914		for Steering Rod
	12/04 →	Tie Rod End	CV-ES-14162		for Steering Rod
	12/04 →	Tie Rod End	CV-ES-14163		for Steering Rod
	12/04 →	Tie Rod End	MN-ES-10333		for Steering Rod
	12/04 →	Tie Rod End	SC-ES-7279		for Steering Rod
	12/04 →	Tie Rod End	SC-ES-8517		for Push Rod
	12/04 →	Tie Rod End	SC-ES-8535		for Guide Rod
	12/04 →	Track Control Arm		MN-DL-5225	Trailing Arm
	12/04 →	Track Control Arm		MN-DL-8544	Trailing Arm, Drive Axle;Leaf Spring Axle
12/04 →	Track control arm		MN-DL-10288	Trailing Arm, 1st RA;2nd RA, for Leaf-Spring Suspension vehicles, →Type MHB	
12/04 →	Track control arm		MN-DL-12288	Trailing Arm	
12/04 →	Track Control Arm		MN-VB-8514	Suspension Rod, Wishbone (CV), Drive Axle; Leaf Spring Axle	
12/04 →	Track Control Arm		MN-VB-8669	Suspension Rod, Wishbone (CV), Drive Axle; Leaf Spring Axle	
12/04 →	Track Control Arm		MN-VB-9404	Wishbone (CV), Drive Axle;Leaf Spring Axle	

CV-ES-0914

Length: 125
Cone Ø: d1 Ø 30 / d2 Ø 27
Thread: M38 x 1,5 RHT
81953016184, 81953016251, 81953016276



CV-ES-14162

Length: 125
Cone Ø: d1 Ø 30 / d2 Ø 27
Thread: M30 x 1,5 LHT
81953010015, 81953010083, 81953010087, 81953016029, 81953016030, 81953016043, 81953016044, 81953016050, 81953016054, 81953016087, 81953016091, 81953016107, 81953016120, 81953016125, 81953016152, 81953016155, 81953016157, 81953016168, 81953016179, 81953016181, 81953016223, 81953016237, 81953016254, 81953016275, 81953016279, 81953016351



CV-ES-14163

Length: 125
Cone Ø: d1 Ø 30 / d2 Ø 27
Thread: M30 x 1,5 RHT
95301.0084, 90804102156, 90804102272, 90804102696, 90804102710, 81953010016, 81953010075, 81953010084, 81953010088, 81953010094, 81953010103, 81953016030, 81953016043, 81953016048, 81953016049, 81953016053, 81953016061, 81953016090, 81953016108, 81953016112, 81953016126, 81953016143, 81953016149, 81953016154, 81953016156, 81953016168, 81953016178, 81953016194, 81953016206, 81953016224, 81953016234, 81953016242, 81953016252, 81953016274, 81953016278, 81953016284, 81953016286, 81953016308, 81953016310, 81953016312, 81953016347, 81953016350, 81953016352, 82953016012, 88953016014, N2953016001



DB-RK-8581

Ø: 85
Hole Distance: 130
Thick/Height: 24
03305800A, 81432706105



MN-DL-5225

Length: 572 Ø: 48
Hole Distance: 130 / 130
03301500A, 81432206229, 81432206236, 81432206267, 81432206270, 81432206272, 81432206304, 81432206305, 81432209236, 81432209267, 81432209272



MN-DL-7801

Length: 995 Ø: 52
Cone Ø: d1 Ø 30 / d2 Ø 27
81466106807, 81466106808, 81466116087, 81466116088, 81466116096, 81466116097, 81466116099, 81466116132, 81466116133, 81466116136, 81466116197, 81466116198, 81466116205

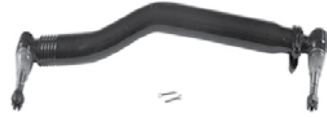

MN-DL-7802

Length: 1680 Ø: 52
Cone Ø: d1 Ø 30 / d2 Ø 27
03208300A, 81467116773, 81467116858, 81467116859, 81467116860, 81467116861, 81467116863, 81467116882, 81467116883, 81467116920, 81467116921



MN-DL-8544

Length: 596 Ø: 48
Hole Distance: 130 / 130
81432206196, 81432206232, 81432206233



MN-DL-8599

Length: 1800 Ø: 62
Cone Ø: d1 Ø 30 / d2 Ø 27
81466116161, 81466116162, 82466106183, 82466106186, 82466106187



MN-DL-10288

81432206386, 82432206008, 82432209008

No Image

MN-DL-12285

Length: 993 Ø: 40
Cone Ø: d1 Ø 30 / d2 Ø 27
81466106816, 81466106826, 81466116151, 82466106184, 82466106185



MN-DL-12288

Length: 585 Ø: 58
Hole Distance: 130 / 130
81432206386, 82432206008, 82432209008

No Image

MN-DL-12293

Length: 1680 Ø: 42
Cone Ø: d1 Ø 30 / d2 Ø 27
81467106236, 81467106268, 81467106356, 81467116356, 81467116723, 81467116794, 81467116933, 81467116934, 81467116966



MN-ES-10333

Length: 90
Cone Ø: d1 Ø 38 / d2 Ø 34,35
Thread: M36 x 1,5 RHT
1271126, 3090291, 3099128, 42538048, 81953016268, 82953016018, 82953016019



MN-VB-8514

Length: 627 Ø: 48
Hole Ø 25 / 25 / 25
Hole Distance: 152 / 130 / 130
81432706087, 81432706088, 81432706094, 81432706095, 81432796094



MN-VB-8669

Length: 627 Ø: 48
Hole Ø 25 / 25 / 25
Hole Distance: 152 / 130 / 130
81432706116, 81432706137, 81432706150, 81432706151



MN-VB-9404

Length: 627 Ø: 58
Hole Distance: 130 / 130
81432706117, 81432706152, 81432706153



SC-ES-7279

Length: 150
Cone Ø: d1 Ø 30 / d2 Ø 27
Thread: M30 x 1,5 RHT
81953016288



SC-ES-8517

Length: 140
Cone Ø: d1 Ø 30 / d2 Ø 27
Thread: M30 x 1,5 RHT
81953016286



SC-ES-8535

Length: 145
Cone Ø: d1 Ø 30 / d2 Ø 27
Thread: M30 x 1,5 RHT
81953016271, 81953016325



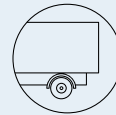

TGA ...

41.400 FFD	12/08→	Centre Rod	MN-DL-8599		Push Rod	
	12/08→	Suspension Arm Repair Kit		CV-RK-5313	for Wishbone (CV)	
	12/08→	Tie Rod End	CV-ES-0914		for Steering Rod	
	12/08→	Tie Rod End	CV-ES-14162		for Steering Rod	
	12/08→	Tie Rod End	CV-ES-14163		for Steering Rod	
	12/08→	Tie Rod End	SC-ES-7279		for Steering Rod	
	12/08→	Tie Rod End	SC-ES-8517		for Push Rod	
	12/08→	Tie Rod End	SC-ES-8535		for Guide Rod	
	12/08→	Track Control Arm		MN-DL-8544	Trailing Arm	
	12/08→	Track Control Arm		MN-VB-8514	Suspension Rod, Wishbone (CV)	
	12/08→	Track Control Arm		MN-VB-8669	Suspension Rod, Wishbone (CV)	
	12/08→	Track Control Arm		MN-VB-9404	Wishbone (CV)	
	41.400 FFDC-TM, FDRC-TM	09/07→	Centre Rod	MN-DL-8599		Push Rod
		09/07→	Suspension Arm Repair Kit		CV-RK-5313	for Wishbone (CV)
09/07→		Tie Rod End	CV-ES-0914		for Steering Rod	
09/07→		Tie Rod End	CV-ES-14162		for Steering Rod	
09/07→		Tie Rod End	CV-ES-14163		for Steering Rod	
09/07→		Tie Rod End	SC-ES-7279		for Steering Rod	
09/07→		Tie Rod End	SC-ES-8517		for Push Rod	
09/07→		Tie Rod End	SC-ES-8535		for Guide Rod	
09/07→		Track Control Arm		MN-DL-8544	Trailing Arm	
09/07→		Track control arm		MN-DL-10288	Trailing Arm, 1st RA;2nd RA, for Leaf-Spring Suspension vehicles, →Type MHB	
09/07→		Track control arm		MN-DL-12288	Trailing Arm	
09/07→		Track Control Arm		MN-VB-8514	Suspension Rod, Wishbone (CV)	
09/07→		Track Control Arm		MN-VB-8669	Suspension Rod, Wishbone (CV)	
09/07→		Track Control Arm		MN-VB-9404	Wishbone (CV)	
41.410 FFDAK		07/06→	Centre Rod	MN-DL-7801		Push Rod
		07/06→	Centre Rod	MN-DL-8599		Push Rod
	07/06→	Centre Rod	MN-DL-12285		for Steering Rod	
	07/06→	Suspension Strut Repair Kit		DB-RK-8581		
	07/06→	Tie Rod	MN-DL-12287			
	07/06→	Tie Rod End	CV-ES-0914		for Steering Rod	
	07/06→	Tie Rod End	CV-ES-14162		for Steering Rod	
	07/06→	Tie Rod End	CV-ES-14163		for Steering Rod	
	07/06→	Tie Rod End	MN-ES-10333		for Steering Rod	
	07/06→	Tie Rod End	SC-ES-8517		for Push Rod	
	07/06→	Track Control Arm		MN-DL-5225	Trailing Arm	
	07/06→	Track Control Arm		MN-DL-8544	Trailing Arm, 1st RA;2nd RA;Leaf Spring Axle	
	07/06→	Track Control Arm		MN-DL-8544	Trailing Arm, Drive Axle;Air Suspension Axle	
	07/06→	Track Control Arm		MN-DL-8609	Trailing Arm, 1st RA;2nd RA, for Leaf-Spring Suspension vehicles, →Type_HB Chassis	
	07/06→	Track Control Arm		MN-VB-8514	Suspension Rod, Wishbone (CV), Drive Axle; Air Suspension Axle	
	07/06→	Track Control Arm		MN-VB-8514	Suspension Rod, Wishbone (CV), Drive Axle; Leaf Spring Axle	
	07/06→	Track Control Arm		MN-VB-9404	Wishbone (CV)	
	41.410 FFDC, FFDC, FDRC	09/03→	Centre Rod	MN-DL-7801		Push Rod, Leaf Spring Axle
		09/03→	Centre Rod	MN-DL-8599		Push Rod
		09/03→	Centre Rod	MN-DL-12285		for Steering Rod
09/03→		Suspension Arm Repair Kit		CV-RK-5313	for Wishbone (CV)	
09/03→		Tie Rod	MN-DL-7802			
09/03→		Tie Rod End	CV-ES-0914		for Steering Rod	
09/03→		Tie Rod End	CV-ES-14162		for Steering Rod	
09/03→		Tie Rod End	CV-ES-14163		for Steering Rod	
09/03→		Tie Rod End	SC-ES-7279		for Steering Rod	
09/03→		Tie Rod End	SC-ES-8517		for Push Rod	
09/03→		Tie Rod End	SC-ES-8535		for Guide Rod	
09/03→		Track Control Arm		MN-DL-5225	Trailing Arm	
09/03→		Track Control Arm		MN-DL-8544	Trailing Arm, Drive Axle;Leaf Spring Axle	
09/03→		Track control arm		MN-DL-10288	Trailing Arm, 1st RA;2nd RA, for Leaf-Spring Suspension vehicles, →Type MHB	
09/03→		Track control arm		MN-DL-12288	Trailing Arm	

CV-ES-0914

Length: 125
 Cone Ø: d1 Ø 30 / d2 Ø 27
 Thread: M38 x 1,5 RHT
 81953016184, 81953016251, 81953016276

**CV-ES-14162**

Length: 125
 Cone Ø: d1 Ø 30 / d2 Ø 27
 Thread: M30 x 1,5 LHT
 81953010015, 81953010083, 81953010087,
 81953016029, 81953016030, 81953016043,
 81953016044, 81953016050, 81953016054,
 81953016087, 81953016091, 81953016107,
 81953016120, 81953016125, 81953016152,
 81953016155, 81953016157, 81953016168,
 81953016179, 81953016181, 81953016223,
 81953016237, 81953016254, 81953016275,
 81953016279, 81953016351

**CV-ES-14163**

Length: 125
 Cone Ø: d1 Ø 30 / d2 Ø 27
 Thread: M30 x 1,5 RHT
 95301.0084, 90804102156, 90804102272,
 90804102696, 90804102710, 81953010016,
 81953010075, 81953010084, 81953010088,
 81953010094, 81953010103, 81953016030,
 81953016043, 81953016048, 81953016049,
 81953016053, 81953016061, 81953016090,
 81953016108, 81953016112, 81953016126,
 81953016143, 81953016149, 81953016154,
 81953016156, 81953016168, 81953016178,
 81953016194, 81953016206, 81953016224,
 81953016234, 81953016242, 81953016252,
 81953016274, 81953016278, 81953016284,
 81953016286, 81953016308, 81953016310,
 81953016312, 81953016347, 81953016350,
 81953016352, 82953016012, 88953016014,
 N2953016001

**CV-RK-5313**

Ø: 90
 03304800A, 81953016132

**DB-RK-8581**

Ø: 85
 Hole Distance: 130
 Thick/Height: 24
 03305800A, 81432706105

**MN-DL-5225**

Length: 572 Ø: 48
 Hole Distance: 130 / 130
 03301500A, 81432206229, 81432206236,
 81432206267, 81432206270, 81432206272,
 81432206304, 81432206305, 81432209236,
 81432209267, 81432209272

**MN-DL-7801**

Length: 995 Ø: 52
 Cone Ø: d1 Ø 30 / d2 Ø 27
 81466106807, 81466106808, 81466116087,
 81466116088, 81466116096, 81466116097,
 81466116099, 81466116132, 81466116133,
 81466116136, 81466116197, 81466116198,
 81466116205

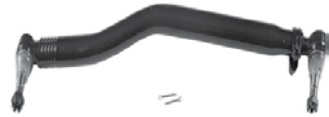
**MN-DL-7802**

Length: 1680 Ø: 52
 Cone Ø: d1 Ø 30 / d2 Ø 27
 03208300A, 81467116773, 81467116858,
 81467116859, 81467116860, 81467116861,
 81467116863, 81467116882, 81467116883,
 81467116920, 81467116921

**MN-DL-8544**

Length: 596 Ø: 48
 Hole Distance: 130 / 130
 81432206196, 81432206232, 81432206233

**MN-DL-8599**

Length: 1800 Ø: 62
 Cone Ø: d1 Ø 30 / d2 Ø 27
 81466116161, 81466116162, 82466106183,
 82466106186, 82466106187

**MN-DL-8609**

Length: 585 Ø: 58
 Hole Distance: 130 / 130
 81432206070, 81432206071, 81432206072,
 81432206091, 81432206093, 81432206119

**MN-DL-10288**

81432206386, 82432206008, 82432209008

No Image

MN-DL-12285

Length: 993 Ø: 40
 Cone Ø: d1 Ø 30 / d2 Ø 27
 81466106816, 81466106826, 81466116151,
 82466106184, 82466106185

**MN-DL-12287**

Length: 1531 Ø: 42
 Cone Ø: d1 Ø 30 / d2 Ø 27
 81467116855, 81467116856, 81467116857

**MN-DL-12288**

Length: 585 Ø: 58
 Hole Distance: 130 / 130
 81432206386, 82432206008, 82432209008

No Image

MN-ES-10333

Length: 90
 Cone Ø: d1 Ø 38 / d2 Ø 34,35
 Thread: M36 x 1,5 RHT
 1271126, 3090291, 3099128, 42538048,
 81953016268, 82953016018, 82953016019

**MN-VB-8514**

Length: 627 Ø: 48
 Hole Ø 25 / 25 / 25
 Hole Distance: 152 / 130 / 130
 81432706087, 81432706088, 81432706094,
 81432706095, 81432796094

**MN-VB-8669**

Length: 627 Ø: 48
 Hole Ø 25 / 25 / 25
 Hole Distance: 152 / 130 / 130
 81432706116, 81432706137, 81432706150,
 81432706151

**MN-VB-9404**

Length: 627 Ø: 58
 Hole Distance: 130 / 130
 81432706117, 81432706152, 81432706153

**SC-ES-7279**

Length: 150
 Cone Ø: d1 Ø 30 / d2 Ø 27
 Thread: M30 x 1,5 RHT
 81953016288

**SC-ES-8517**

Length: 140
 Cone Ø: d1 Ø 30 / d2 Ø 27
 Thread: M30 x 1,5 RHT
 81953016286

**SC-ES-8535**

Length: 145
 Cone Ø: d1 Ø 30 / d2 Ø 27
 Thread: M30 x 1,5 RHT
 81953016271, 81953016325



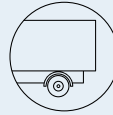
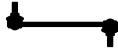

TGA ...

41.410 FFDC, FFDC, FDRC ...	09/03→	Track Control Arm		MN-VB-8514	Suspension Rod, Wishbone (CV)
	09/03→	Track Control Arm		MN-VB-8669	Suspension Rod, Wishbone (CV), 1st RA; 2nd RA, for Leaf-Spring Suspension vehicles, →Type_MHB Chassis
	09/03→	Track Control Arm		MN-VB-9404	Wishbone (CV)
41.410 FFDC-TM, FFDC-TM, FFD-TM	12/04→	Centre Rod	MN-DL-2160		Coupling Rod
	12/04→	Suspension Arm Repair Kit		CV-RK-5313	for Wishbone (CV)
	12/04→	Tie Rod End	CV-ES-0914		for Steering Rod
	12/04→	Tie Rod End	CV-ES-14162		for Steering Rod
	12/04→	Tie Rod End	CV-ES-14163		for Steering Rod
	12/04→	Tie Rod End	SC-ES-7279		for Steering Rod
	12/04→	Tie Rod End	SC-ES-8517		for Push Rod
	12/04→	Tie Rod End	SC-ES-8535		for Guide Rod
	12/04→	Track Control Arm		MN-DL-5225	Trailing Arm
	12/04→	Track Control Arm		MN-DL-8544	Trailing Arm, 1st RA;2nd RA, for Leaf-Spring Suspension vehicles
	12/04→	Track control arm		MN-DL-10288	Trailing Arm, 1st RA;2nd RA, for Leaf-Spring Suspension vehicles, →Type MHB
	12/04→	Track control arm		MN-DL-12288	Trailing Arm
	12/04→	Track Control Arm		MN-VB-8514	Suspension Rod, Wishbone (CV)
	12/04→	Track Control Arm		MN-VB-8669	Suspension Rod, Wishbone (CV), 1st RA; 2nd RA, for Leaf-Spring Suspension vehicles, →Type_MHB Chassis
	12/04→	Track Control Arm		MN-VB-9404	Wishbone (CV), 1st RA;2nd RA, for Leaf-Spring Suspension vehicles, →Type_MHB Chassis
41.410 FFDK, FFDK	09/03→	Centre Rod	MN-DL-7801		Push Rod, Leaf Spring Axle
	09/03→	Centre Rod	MN-DL-8599		Push Rod
	09/03→	Suspension Arm Repair Kit		CV-RK-5313	for Wishbone (CV)
	09/03→	Tie Rod	MN-DL-7802		
	09/03→	Tie Rod End	CV-ES-0914		for Steering Rod
	09/03→	Tie Rod End	CV-ES-14162		for Steering Rod
	09/03→	Tie Rod End	CV-ES-14163		for Steering Rod
	09/03→	Tie Rod End	SC-ES-7279		for Steering Rod
	09/03→	Tie Rod End	SC-ES-8517		for Push Rod
	09/03→	Tie Rod End	SC-ES-8535		for Guide Rod
	09/03→	Track Control Arm		MN-DL-5225	Trailing Arm
	09/03→	Track Control Arm		MN-DL-8544	Trailing Arm, Drive Axle;Leaf Spring Axle
	09/03→	Track control arm		MN-DL-10288	Trailing Arm, 1st RA;2nd RA, for Leaf-Spring Suspension vehicles, →Type MHB
	09/03→	Track control arm		MN-DL-12288	Trailing Arm
	09/03→	Track Control Arm		MN-VB-8514	Suspension Rod, Wishbone (CV)
09/03→	Track Control Arm		MN-VB-8669	Suspension Rod, Wishbone (CV), 1st RA; 2nd RA, for Leaf-Spring Suspension vehicles, →Type_MHB Chassis	
09/03→	Track Control Arm		MN-VB-9404	Wishbone (CV)	
41.430 FFDK	12/04→	Centre Rod	MN-DL-8646		Push Rod, for Leaf-Spring Suspension vehicles
	12/04→	Suspension Strut Repair Kit		DB-RK-8581	
	12/04→	Tie Rod	MN-DL-12287		
	12/04→	Tie Rod End	CV-ES-14162		for Steering Rod
	12/04→	Tie Rod End	CV-ES-14163		for Steering Rod
	12/04→	Tie Rod End	MN-ES-10333		for Steering Rod
	12/04→	Track Control Arm		MN-DL-8544	Trailing Arm, Drive Axle
	12/04→	Track Control Arm		MN-DL-8609	Trailing Arm, 1st RA;2nd RA, for Leaf-Spring Suspension vehicles, →Type_HB Chassis
	12/04→	Track control arm		MN-DL-10288	Trailing Arm, 1st RA;2nd RA, for Leaf-Spring Suspension vehicles, →Type HB
	12/04→	Track control arm		MN-DL-12288	Trailing Arm
	12/04→	Track Control Arm		MN-VB-8514	Suspension Rod, Wishbone (CV), Drive Axle
12/04→	Track Control Arm		MN-VB-9404	Wishbone (CV), 1st RA;2nd RA, for Leaf-Spring Suspension vehicles, →Type_HB Chassis	

CV-ES-0914

Length: 125
Cone Ø: d1 Ø 30 / d2 Ø 27
Thread: M38 x 1,5 RHT
81953016184, 81953016251, 81953016276



CV-ES-14162

Length: 125
Cone Ø: d1 Ø 30 / d2 Ø 27
Thread: M30 x 1,5 LHT
81953010015, 81953010083, 81953010087, 81953016029, 81953016030, 81953016043, 81953016044, 81953016050, 81953016054, 81953016087, 81953016091, 81953016107, 81953016120, 81953016125, 81953016152, 81953016155, 81953016157, 81953016168, 81953016179, 81953016181, 81953016223, 81953016237, 81953016254, 81953016275, 81953016279, 81953016351



CV-ES-14163

Length: 125
Cone Ø: d1 Ø 30 / d2 Ø 27
Thread: M30 x 1,5 RHT
95301.0084, 90804102156, 90804102272, 90804102696, 90804102710, 81953010016, 81953010075, 81953010084, 81953010088, 81953010094, 81953010103, 81953016030, 81953016043, 81953016048, 81953016049, 81953016053, 81953016061, 81953016090, 81953016108, 81953016112, 81953016126, 81953016143, 81953016149, 81953016154, 81953016156, 81953016168, 81953016178, 81953016194, 81953016206, 81953016224, 81953016234, 81953016242, 81953016252, 81953016274, 81953016278, 81953016284, 81953016286, 81953016308, 81953016310, 81953016312, 81953016347, 81953016350, 81953016352, 82953016012, 88953016014, N2953016001



CV-RK-5313

Ø: 90
03304800A, 81953016132



DB-RK-8581

Ø: 85
Hole Distance: 130
Thick/Height: 24
03305800A, 81432706105



MN-DL-2160

Length: 1652 Ø: 50
Cone Ø: d1 Ø 30 / d2 Ø 27
81467106112, 81467106163, 81467106165, 81467106198, 81467106353, 81467106354, 81467106361, 81467116725



MN-DL-5225

Length: 572 Ø: 48
Hole Distance: 130 / 130
03301500A, 81432206229, 81432206236, 81432206267, 81432206270, 81432206272, 81432206304, 81432206305, 81432209236, 81432209267, 81432209272



MN-DL-7801

Length: 995 Ø: 52
Cone Ø: d1 Ø 30 / d2 Ø 27
81466106807, 81466106808, 81466116087, 81466116088, 81466116096, 81466116097, 81466116099, 81466116132, 81466116133, 81466116136, 81466116197, 81466116198, 81466116205

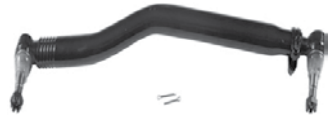

MN-DL-7802

Length: 1680 Ø: 52
Cone Ø: d1 Ø 30 / d2 Ø 27
03208300A, 81467116773, 81467116858, 81467116859, 81467116860, 81467116861, 81467116863, 81467116882, 81467116883, 81467116920, 81467116921



MN-DL-8544

Length: 596 Ø: 48
Hole Distance: 130 / 130
81432206196, 81432206232, 81432206233



MN-DL-8599

Length: 1800 Ø: 62
Cone Ø: d1 Ø 30 / d2 Ø 27
81466116161, 81466116162, 82466106183, 82466106186, 82466106187



MN-DL-8609

Length: 585 Ø: 58
Hole Distance: 130 / 130
81432206070, 81432206071, 81432206072, 81432206091, 81432206093, 81432206119



MN-DL-8646

Length: 1021 Ø: 52
Cone Ø: d1 Ø 30 / d2 Ø 27
81466106811, 81466106812, 81466116138, 81466116139, 81466116201, 81466116202

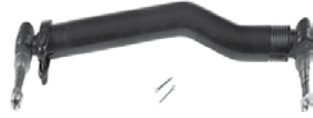

MN-DL-10288

81432206386, 82432206008, 82432209008

No Image

MN-DL-12287

Length: 1531 Ø: 42
Cone Ø: d1 Ø 30 / d2 Ø 27
81467116855, 81467116856, 81467116857



MN-DL-12288

Length: 585 Ø: 58
Hole Distance: 130 / 130
81432206386, 82432206008, 82432209008

No Image

MN-ES-10333

Length: 90
Cone Ø: d1 Ø 38 / d2 Ø 34,35
Thread: M36 x 1,5 RHT
1271126, 3090291, 3099128, 42538048, 81953016268, 82953016018, 82953016019



MN-VB-8514

Length: 627 Ø: 48
Hole Ø 25 / 25 / 25
Hole Distance: 152 / 130 / 130
81432706087, 81432706088, 81432706094, 81432706095, 81432796094



MN-VB-8669

Length: 627 Ø: 48
Hole Ø 25 / 25 / 25
Hole Distance: 152 / 130 / 130
81432706116, 81432706137, 81432706150, 81432706151



MN-VB-9404

Length: 627 Ø: 58
Hole Distance: 130 / 130
81432706117, 81432706152, 81432706153



SC-ES-7279

Length: 150
Cone Ø: d1 Ø 30 / d2 Ø 27
Thread: M30 x 1,5 RHT
81953016288



SC-ES-8517

Length: 140
Cone Ø: d1 Ø 30 / d2 Ø 27
Thread: M30 x 1,5 RHT
81953016288



SC-ES-8535

Length: 145
Cone Ø: d1 Ø 30 / d2 Ø 27
Thread: M30 x 1,5 RHT
81953016271, 81953016325



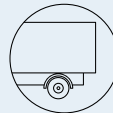

TGA ...

41.430 FFDC-TM, FFDC	09/07→	Centre Rod	MN-DL-8599		Push Rod
	09/07→	Suspension Arm Repair Kit		CV-RK-5313	for Wishbone (CV)
	09/07→	Tie Rod End	CV-ES-0914		for Steering Rod
	09/07→	Tie Rod End	CV-ES-14162		for Steering Rod
	09/07→	Tie Rod End	CV-ES-14163		for Steering Rod
	09/07→	Tie Rod End	SC-ES-7279		for Steering Rod
	09/07→	Tie Rod End	SC-ES-8517		for Push Rod
	09/07→	Tie Rod End	SC-ES-8535		for Guide Rod
	09/07→	Track Control Arm		MN-DL-8544	Trailing Arm
	09/07→	Track control arm		MN-DL-10288	Trailing Arm, 1st RA;2nd RA, for Leaf-Spring Suspension vehicles, →Type MHB
	09/07→	Track control arm		MN-DL-12288	Trailing Arm
	09/07→	Track Control Arm		MN-VB-8514	Suspension Rod, Wishbone (CV)
	09/07→	Track Control Arm		MN-VB-8669	Suspension Rod, Wishbone (CV)
	09/07→	Track Control Arm		MN-VB-9404	Wishbone (CV)
	41.430, 41.440 FFD, FFDC, FFDC	12/04→	Centre Rod	MN-DL-7801	
12/04→		Centre Rod	MN-DL-8599		Push Rod
12/04→		Centre Rod	MN-DL-12285		for Steering Rod
12/04→		Suspension Strut Repair Kit		DB-RK-8581	
12/04→		Tie Rod	MN-DL-7802		
12/04→		Tie Rod	MN-DL-12293		
12/04→		Tie Rod End	CV-ES-0914		for Steering Rod
12/04→		Tie Rod End	CV-ES-14162		for Steering Rod
12/04→		Tie Rod End	CV-ES-14163		for Steering Rod
12/04→		Tie Rod End	MN-ES-10333		for Steering Rod
12/04→		Tie Rod End	SC-ES-7279		for Steering Rod
12/04→		Tie Rod End	SC-ES-8517		for Push Rod
12/04→		Tie Rod End	SC-ES-8535		for Guide Rod
12/04→		Track Control Arm		MN-DL-5225	Trailing Arm
12/04→		Track Control Arm		MN-DL-8544	Trailing Arm, Drive Axle;Leaf Spring Axle
12/04→		Track control arm		MN-DL-10288	Trailing Arm, 1st RA;2nd RA, for Leaf-Spring Suspension vehicles, →Type MHB
12/04→		Track control arm		MN-DL-12288	Trailing Arm
12/04→		Track Control Arm		MN-VB-8514	Suspension Rod, Wishbone (CV), Drive Axle; Leaf Spring Axle
12/04→		Track Control Arm		MN-VB-8669	Suspension Rod, Wishbone (CV), Drive Axle; Leaf Spring Axle
12/04→		Track Control Arm		MN-VB-9404	Wishbone (CV), Drive Axle;Leaf Spring Axle
41.430, 41.440 FFDC-TM, FFDC-TM, FFD-TM		12/04→	Centre Rod	MN-DL-7801	
	12/04→	Centre Rod	MN-DL-8599		Push Rod
	12/04→	Centre Rod	MN-DL-12285		for Steering Rod
	12/04→	Suspension Strut Repair Kit		DB-RK-8581	
	12/04→	Tie Rod	MN-DL-7802		
	12/04→	Tie Rod End	CV-ES-0914		for Steering Rod
	12/04→	Tie Rod End	CV-ES-14162		for Steering Rod
	12/04→	Tie Rod End	CV-ES-14163		for Steering Rod
	12/04→	Tie Rod End	MN-ES-10333		for Steering Rod
	12/04→	Tie Rod End	SC-ES-7279		for Steering Rod
	12/04→	Tie Rod End	SC-ES-8517		for Push Rod
	12/04→	Tie Rod End	SC-ES-8535		for Guide Rod
	12/04→	Track Control Arm		MN-DL-5225	Trailing Arm
	12/04→	Track Control Arm		MN-DL-8544	Trailing Arm, Drive Axle;Leaf Spring Axle
	12/04→	Track control arm		MN-DL-10288	Trailing Arm, 1st RA;2nd RA, for Leaf-Spring Suspension vehicles, →Type MHB
	12/04→	Track control arm		MN-DL-12288	Trailing Arm
	12/04→	Track Control Arm		MN-VB-8514	Suspension Rod, Wishbone (CV), Drive Axle; Leaf Spring Axle
	12/04→	Track Control Arm		MN-VB-8669	Suspension Rod, Wishbone (CV), Drive Axle; Leaf Spring Axle
	12/04→	Track Control Arm		MN-VB-9404	Wishbone (CV), Drive Axle;Leaf Spring Axle

CV-ES-0914

Length: 125
Cone Ø: d1 Ø 30 / d2 Ø 27
Thread: M38 x 1,5 RHT
81953016184, 81953016251, 81953016276



CV-ES-14162

Length: 125
Cone Ø: d1 Ø 30 / d2 Ø 27
Thread: M30 x 1,5 LHT
81953010015, 81953010083, 81953010087, 81953016029, 81953016030, 81953016043, 81953016044, 81953016050, 81953016054, 81953016087, 81953016091, 81953016107, 81953016120, 81953016125, 81953016152, 81953016155, 81953016157, 81953016168, 81953016179, 81953016181, 81953016223, 81953016237, 81953016254, 81953016275, 81953016279, 81953016351



CV-ES-14163

Length: 125
Cone Ø: d1 Ø 30 / d2 Ø 27
Thread: M30 x 1,5 RHT
95301.0084, 90804102156, 90804102272, 90804102696, 90804102710, 81953010016, 81953010075, 81953010084, 81953010088, 81953010094, 81953010103, 81953016030, 81953016043, 81953016048, 81953016049, 81953016053, 81953016061, 81953016090, 81953016108, 81953016112, 81953016126, 81953016143, 81953016149, 81953016154, 81953016156, 81953016168, 81953016178, 81953016194, 81953016206, 81953016224, 81953016234, 81953016242, 81953016252, 81953016274, 81953016278, 81953016284, 81953016286, 81953016308, 81953016310, 81953016312, 81953016347, 81953016350, 81953016352, 82953016012, 88953016014, N2953016001



CV-RK-5313

Ø: 90
03304800A, 81953016132



DB-RK-8581

Ø: 85
Hole Distance: 130
Thick/Height: 24
03305800A, 81432706105



MN-DL-5225

Length: 572 Ø: 48
Hole Distance: 130 / 130
03301500A, 81432206229, 81432206236, 81432206267, 81432206270, 81432206272, 81432206304, 81432206305, 81432209236, 81432209267, 81432209272



MN-DL-7801

Length: 995 Ø: 52
Cone Ø: d1 Ø 30 / d2 Ø 27
81466106807, 81466106808, 81466116087, 81466116088, 81466116096, 81466116097, 81466116099, 81466116132, 81466116133, 81466116136, 81466116197, 81466116198, 81466116205

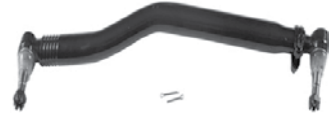

MN-DL-7802

Length: 1680 Ø: 52
Cone Ø: d1 Ø 30 / d2 Ø 27
03208300A, 81467116773, 81467116858, 81467116859, 81467116860, 81467116861, 81467116863, 81467116882, 81467116883, 81467116920, 81467116921



MN-DL-8544

Length: 596 Ø: 48
Hole Distance: 130 / 130
81432206196, 81432206232, 81432206233



MN-DL-8599

Length: 1800 Ø: 62
Cone Ø: d1 Ø 30 / d2 Ø 27
81466116161, 81466116162, 82466106183, 82466106186, 82466106187



MN-DL-10288

81432206386, 82432206008, 82432209008

No Image

MN-DL-12285

Length: 993 Ø: 40
Cone Ø: d1 Ø 30 / d2 Ø 27
81466106816, 81466106826, 81466116151, 82466106184, 82466106185



MN-DL-12288

Length: 585 Ø: 58
Hole Distance: 130 / 130
81432206386, 82432206008, 82432209008

No Image

MN-DL-12293

Length: 1680 Ø: 42
Cone Ø: d1 Ø 30 / d2 Ø 27
81467106236, 81467106268, 81467106356, 81467116356, 81467116723, 81467116794, 81467116933, 81467116934, 81467116966



MN-ES-10333

Length: 90
Cone Ø: d1 Ø 38 / d2 Ø 34,35
Thread: M36 x 1,5 RHT
1271126, 3090291, 3099128, 42538048, 81953016268, 82953016018, 82953016019



MN-VB-8514

Length: 627 Ø: 48
Hole Ø 25 / 25 / 25
Hole Distance: 152 / 130 / 130
81432706087, 81432706088, 81432706094, 81432706095, 81432796094



MN-VB-8669

Length: 627 Ø: 48
Hole Ø 25 / 25 / 25
Hole Distance: 152 / 130 / 130
81432706116, 81432706137, 81432706150, 81432706151



MN-VB-9404

Length: 627 Ø: 58
Hole Distance: 130 / 130
81432706117, 81432706152, 81432706153



SC-ES-7279

Length: 150
Cone Ø: d1 Ø 30 / d2 Ø 27
Thread: M30 x 1,5 RHT
81953016288



SC-ES-8517

Length: 140
Cone Ø: d1 Ø 30 / d2 Ø 27
Thread: M30 x 1,5 RHT
81953016286



SC-ES-8535

Length: 145
Cone Ø: d1 Ø 30 / d2 Ø 27
Thread: M30 x 1,5 RHT
81953016271, 81953016325



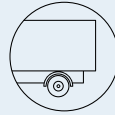

TGA ...

41.430, 41.440 FFDK, FFDRC	12/04→	Centre Rod	MN-DL-7801	Push Rod, Leaf Spring Axle
	12/04→	Centre Rod	MN-DL-8599	Push Rod
	12/04→	Centre Rod	MN-DL-12285	for Steering Rod
	12/04→	Suspension Strut Repair Kit		DB-RK-8581
	12/04→	Tie Rod	MN-DL-7802	
	12/04→	Tie Rod	MN-DL-12293	
	12/04→	Tie Rod End	CV-ES-0914	for Steering Rod
	12/04→	Tie Rod End	CV-ES-14162	for Steering Rod
	12/04→	Tie Rod End	CV-ES-14163	for Steering Rod
	12/04→	Tie Rod End	MN-ES-10333	for Steering Rod
	12/04→	Tie Rod End	SC-ES-7279	for Steering Rod
	12/04→	Tie Rod End	SC-ES-8517	for Push Rod
	12/04→	Tie Rod End	SC-ES-8535	for Guide Rod
	12/04→	Track Control Arm		MN-DL-5225 Trailing Arm
	12/04→	Track Control Arm		MN-DL-8544 Trailing Arm, Drive Axle;Leaf Spring Axle
	12/04→	Track control arm		MN-DL-10288 Trailing Arm, 1st RA;2nd RA, for Leaf-Spring Suspension vehicles, →Type MHB
	12/04→	Track control arm		MN-DL-12288 Trailing Arm
	12/04→	Track Control Arm		MN-VB-8514 Suspension Rod, Wishbone (CV), Drive Axle; Leaf Spring Axle
	12/04→	Track Control Arm		MN-VB-8669 Suspension Rod, Wishbone (CV), Drive Axle; Leaf Spring Axle
	12/04→	Track Control Arm		MN-VB-9404 Wishbone (CV), Drive Axle;Leaf Spring Axle
41.440 FFD, FFDC, FFDRC	12/04→	Centre Rod	MN-DL-7801	Push Rod, Leaf Spring Axle
	12/04→	Centre Rod	MN-DL-8599	Push Rod
	12/04→	Centre Rod	MN-DL-12285	for Steering Rod
	12/04→	Suspension Arm Repair Kit		CV-RK-5313 for Wishbone (CV)
	12/04→	Tie Rod	MN-DL-7802	
	12/04→	Tie Rod	MN-DL-12293	
	12/04→	Tie Rod End	CV-ES-0914	for Steering Rod
	12/04→	Tie Rod End	CV-ES-14162	for Steering Rod
	12/04→	Tie Rod End	CV-ES-14163	for Steering Rod
	12/04→	Tie Rod End	SC-ES-7279	for Steering Rod
	12/04→	Tie Rod End	SC-ES-8517	for Push Rod
	12/04→	Tie Rod End	SC-ES-8535	for Guide Rod
	12/04→	Track Control Arm		MN-DL-8544 Trailing Arm, Drive Axle;Leaf Spring Axle
	12/04→	Track control arm		MN-DL-10288 Trailing Arm, 1st RA;2nd RA, for Leaf-Spring Suspension vehicles, →Type MHB
12/04→	Track control arm		MN-DL-12288 Trailing Arm	
12/04→	Track Control Arm		MN-VB-9404 Wishbone (CV), Drive Axle;Leaf Spring Axle	
41.440 FFD/M	12/04→	Centre Rod	MN-DL-7801	Push Rod, Leaf Spring Axle
	12/04→	Centre Rod	MN-DL-8599	Push Rod
	12/04→	Centre Rod	MN-DL-12285	for Steering Rod
	12/04→	Suspension Arm Repair Kit		CV-RK-5313 for Wishbone (CV)
	12/04→	Tie Rod	MN-DL-7802	
	12/04→	Tie Rod	MN-DL-12293	
	12/04→	Tie Rod End	CV-ES-0914	for Steering Rod
	12/04→	Tie Rod End	CV-ES-14162	for Steering Rod
	12/04→	Tie Rod End	CV-ES-14163	for Steering Rod
	12/04→	Tie Rod End	SC-ES-7279	for Steering Rod
	12/04→	Tie Rod End	SC-ES-8517	for Push Rod
	12/04→	Tie Rod End	SC-ES-8535	for Guide Rod
	12/04→	Track Control Arm		MN-DL-8544 Trailing Arm, Drive Axle;Leaf Spring Axle
	12/04→	Track Control Arm		MN-VB-9404 Wishbone (CV), Drive Axle;Leaf Spring Axle
41.440 FFD/DAK	07/06→	Centre Rod	MN-DL-8646	Push Rod, for Leaf-Spring Suspension vehicles
	07/06→	Suspension Arm Repair Kit		CV-RK-5313 for Wishbone (CV)
	07/06→	Tie Rod	MN-DL-12287	
	07/06→	Tie Rod End	CV-ES-14162	for Steering Rod
	07/06→	Tie Rod End	CV-ES-14163	for Steering Rod
	07/06→	Tie Rod End	MN-ES-10333	for Steering Rod
	07/06→	Track Control Arm		MN-DL-8544 Trailing Arm, Drive Axle
	07/06→	Track Control Arm		MN-DL-8609 Trailing Arm, 1st RA;2nd RA, for Leaf-Spring Suspension vehicles, →Type_HB Chassis

CV-ES-0914

Length: 125
Cone Ø: d1 Ø 30 / d2 Ø 27
Thread: M38 x 1,5 RHT
81953016184, 81953016251, 81953016276



CV-ES-14162

Length: 125
Cone Ø: d1 Ø 30 / d2 Ø 27
Thread: M30 x 1,5 LHT
81953010015, 81953010083, 81953010087, 81953016029, 81953016030, 81953016043, 81953016044, 81953016050, 81953016054, 81953016087, 81953016091, 81953016107, 81953016120, 81953016125, 81953016152, 81953016155, 81953016157, 81953016168, 81953016179, 81953016181, 81953016223, 81953016237, 81953016254, 81953016275, 81953016279, 81953016351

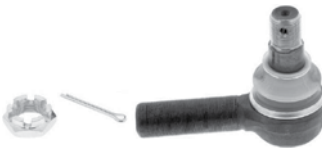

CV-ES-14163

Length: 125
Cone Ø: d1 Ø 30 / d2 Ø 27
Thread: M30 x 1,5 RHT
95301.0084, 90804102156, 90804102272, 90804102696, 90804102710, 81953010016, 81953010075, 81953010084, 81953010088, 81953010094, 81953010103, 81953016030, 81953016043, 81953016048, 81953016049, 81953016053, 81953016061, 81953016090, 81953016108, 81953016112, 81953016126, 81953016143, 81953016149, 81953016154, 81953016156, 81953016168, 81953016178, 81953016194, 81953016206, 81953016224, 81953016234, 81953016242, 81953016252, 81953016274, 81953016278, 81953016284, 81953016286, 81953016308, 81953016310, 81953016312, 81953016347, 81953016350, 81953016352, 82953016012, 88953016014, N2953016001



CV-RK-5313

Ø: 90
03304800A, 81953016132



DB-RK-8581

Ø: 85
Hole Distance: 130
Thick/Height: 24
03305800A, 81432706105



MN-DL-5225

Length: 572 Ø: 48
Hole Distance: 130 / 130
03301500A, 81432206229, 81432206236, 81432206267, 81432206270, 81432206272, 81432206304, 81432206305, 81432209226, 81432209267, 81432209272



MN-DL-7801

Length: 995 Ø: 52
Cone Ø: d1 Ø 30 / d2 Ø 27
81466106807, 81466106808, 81466116087, 81466116088, 81466116096, 81466116097, 81466116099, 81466116132, 81466116133, 81466116136, 81466116197, 81466116198, 81466116205

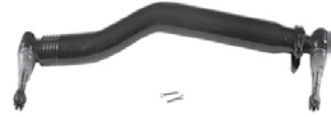

MN-DL-7802

Length: 1680 Ø: 52
Cone Ø: d1 Ø 30 / d2 Ø 27
03208300A, 81467116773, 81467116858, 81467116859, 81467116860, 81467116861, 81467116863, 81467116882, 81467116883, 81467116920, 81467116921



MN-DL-8544

Length: 596 Ø: 48
Hole Distance: 130 / 130
81432206196, 81432206232, 81432206233



MN-DL-8599

Length: 1800 Ø: 62
Cone Ø: d1 Ø 30 / d2 Ø 27
81466116161, 81466116162, 82466106183, 82466106186, 82466106187



MN-DL-8609

Length: 585 Ø: 58
Hole Distance: 130 / 130
81432206070, 81432206071, 81432206072, 81432206091, 81432206093, 81432206119



MN-DL-8646

Length: 1021 Ø: 52
Cone Ø: d1 Ø 30 / d2 Ø 27
81466106811, 81466106812, 81466116138, 81466116139, 81466116201, 81466116202

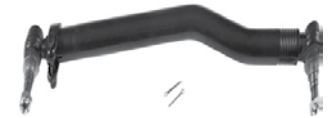

MN-DL-10288

81432206386, 82432206008, 82432209008

No Image

MN-DL-12285

Length: 993 Ø: 40
Cone Ø: d1 Ø 30 / d2 Ø 27
81466106816, 81466106826, 81466116151, 82466106184, 82466106185



MN-DL-12287

Length: 1531 Ø: 42
Cone Ø: d1 Ø 30 / d2 Ø 27
81467116855, 81467116856, 81467116857



MN-DL-12288

Length: 585 Ø: 58
Hole Distance: 130 / 130
81432206386, 82432206008, 82432209008

No Image

MN-DL-12293

Length: 1680 Ø: 42
Cone Ø: d1 Ø 30 / d2 Ø 27
81467106236, 81467106268, 81467106356, 81467116356, 81467116723, 81467116794, 81467116933, 81467116934, 81467116966



MN-ES-10333

Length: 90
Cone Ø: d1 Ø 38 / d2 Ø 34,35
Thread: M36 x 1,5 RHT
1271126, 3090291, 3099128, 42538048, 81953016268, 82953016018, 82953016019



MN-VB-8514

Length: 627 Ø: 48
Hole Ø 25 / 25 / 25
Hole Distance: 152 / 130 / 130
81432706087, 81432706088, 81432706094, 81432706095, 81432796094



MN-VB-8669

Length: 627 Ø: 48
Hole Ø 25 / 25 / 25
Hole Distance: 152 / 130 / 130
81432706116, 81432706137, 81432706150, 81432706151



MN-VB-9404

Length: 627 Ø: 58
Hole Distance: 130 / 130
81432706117, 81432706152, 81432706153



SC-ES-7279

Length: 150
Cone Ø: d1 Ø 30 / d2 Ø 27
Thread: M30 x 1,5 RHT
81953016288



SC-ES-8517

Length: 140
Cone Ø: d1 Ø 30 / d2 Ø 27
Thread: M30 x 1,5 RHT
81953016286



SC-ES-8535

Length: 145
Cone Ø: d1 Ø 30 / d2 Ø 27
Thread: M30 x 1,5 RHT
81953016271, 81953016325



Tuesday
21

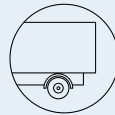
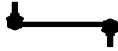

MAN ...

TGA ...

41.440 FFDK ...	07/06→	Track control arm		MN-DL-10288	Trailing Arm, 1st RA;2nd RA, for Leaf-Spring Suspension vehicles, →Type HB	
	07/06→	Track control arm		MN-DL-12288	Trailing Arm	
	07/06→	Track Control Arm		MN-VB-8514	Suspension Rod, Wishbone (CV), Drive Axle	
	07/06→	Track Control Arm		MN-VB-9404	Wishbone (CV), 1st RA;2nd RA, for Leaf-Spring Suspension vehicles, →Type_HB Chassis	
41.440 FFDC-TM, FFDRK-TM, FFD-TM	09/07→	Centre Rod	MN-DL-8599		Push Rod	
	09/07→	Suspension Arm Repair Kit		CV-RK-5313	for Wishbone (CV)	
	09/07→	Tie Rod End	CV-ES-0914		for Steering Rod	
	09/07→	Tie Rod End	CV-ES-14162		for Steering Rod	
	09/07→	Tie Rod End	CV-ES-14163		for Steering Rod	
	09/07→	Tie Rod End	SC-ES-7279		for Steering Rod	
	09/07→	Tie Rod End	SC-ES-8517		for Push Rod	
	09/07→	Tie Rod End	SC-ES-8535		for Guide Rod	
	09/07→	Track Control Arm		MN-DL-8544	Trailing Arm	
	09/07→	Track control arm		MN-DL-10288	Trailing Arm, 1st RA;2nd RA, for Leaf-Spring Suspension vehicles, →Type MHB	
	09/07→	Track control arm		MN-DL-12288	Trailing Arm	
	41.440 FFDK, FFDRK	12/04→	Centre Rod	MN-DL-7801		Push Rod, Leaf Spring Axle
12/04→		Centre Rod	MN-DL-8599		Push Rod	
12/04→		Centre Rod	MN-DL-12285		for Steering Rod	
12/04→		Suspension Arm Repair Kit		CV-RK-5313	for Wishbone (CV)	
12/04→		Tie Rod	MN-DL-7802			
12/04→		Tie Rod	MN-DL-12293			
12/04→		Tie Rod End	CV-ES-0914		for Steering Rod	
12/04→		Tie Rod End	CV-ES-14162		for Steering Rod	
12/04→		Tie Rod End	CV-ES-14163		for Steering Rod	
12/04→		Tie Rod End	SC-ES-7279		for Steering Rod	
12/04→		Tie Rod End	SC-ES-8517		for Push Rod	
12/04→		Tie Rod End	SC-ES-8535		for Guide Rod	
12/04→		Track Control Arm		MN-DL-8544	Trailing Arm, Drive Axle;Leaf Spring Axle	
12/04→		Track control arm		MN-DL-10288	Trailing Arm, 1st RA;2nd RA, for Leaf-Spring Suspension vehicles, →Type MHB	
12/04→		Track control arm		MN-DL-12288	Trailing Arm	
12/04→		Track Control Arm		MN-VB-9404	Wishbone (CV), Drive Axle;Leaf Spring Axle	
41.460 FFDC, FFDRK		09/03→	Centre Rod	MN-DL-7801		Push Rod, Leaf Spring Axle
		09/03→	Centre Rod	MN-DL-8599		Push Rod
		09/03→	Centre Rod	MN-DL-12285		for Steering Rod
		09/03→	Suspension Arm Repair Kit		CV-RK-5313	for Wishbone (CV)
	09/03→	Tie Rod	MN-DL-7802			
	09/03→	Tie Rod End	CV-ES-0914		for Steering Rod	
	09/03→	Tie Rod End	CV-ES-14162		for Steering Rod	
	09/03→	Tie Rod End	CV-ES-14163		for Steering Rod	
	09/03→	Tie Rod End	SC-ES-7279		for Steering Rod	
	09/03→	Tie Rod End	SC-ES-8517		for Push Rod	
	09/03→	Tie Rod End	SC-ES-8535		for Guide Rod	
	09/03→	Track Control Arm		MN-DL-5225	Trailing Arm	
	09/03→	Track Control Arm		MN-DL-8544	Trailing Arm, Drive Axle;Leaf Spring Axle	
	09/03→	Track control arm		MN-DL-10288	Trailing Arm, 1st RA;2nd RA, for Leaf-Spring Suspension vehicles, →Type MHB	
	09/03→	Track control arm		MN-DL-12288	Trailing Arm	
	09/03→	Track Control Arm		MN-VB-8514	Suspension Rod, Wishbone (CV)	
	09/03→	Track Control Arm		MN-VB-8669	Suspension Rod, Wishbone (CV), 1st RA; 2nd RA, for Leaf-Spring Suspension vehicles, →Type_MHB Chassis	
	09/03→	Track Control Arm		MN-VB-9404	Wishbone (CV)	
	41.460 FFDC-TM, FFDRK-TM, FFD-TM	12/04→	Centre Rod	MN-DL-2160		Coupling Rod
		12/04→	Suspension Arm Repair Kit		CV-RK-5313	for Wishbone (CV)
12/04→		Tie Rod End	CV-ES-0914		for Steering Rod	
12/04→		Tie Rod End	CV-ES-14162		for Steering Rod	
12/04→		Tie Rod End	CV-ES-14163		for Steering Rod	
12/04→		Tie Rod End	SC-ES-7279		for Steering Rod	

MAN

CV-ES-0914

Length: 125
Cone Ø: d1 Ø 30 / d2 Ø 27
Thread: M38 x 1,5 RHT
81953016184, 81953016251, 81953016276



CV-ES-14162

Length: 125
Cone Ø: d1 Ø 30 / d2 Ø 27
Thread: M30 x 1,5 LHT
81953010015, 81953010083, 81953010087, 81953016029, 81953016030, 81953016043, 81953016044, 81953016050, 81953016054, 81953016087, 81953016091, 81953016107, 81953016120, 81953016125, 81953016152, 81953016155, 81953016157, 81953016168, 81953016179, 81953016181, 81953016223, 81953016237, 81953016254, 81953016275, 81953016279, 81953016351



CV-ES-14163

Length: 125
Cone Ø: d1 Ø 30 / d2 Ø 27
Thread: M30 x 1,5 RHT
95301.0084, 90804102156, 90804102272, 90804102696, 90804102710, 81953010016, 81953010075, 81953010084, 81953010088, 81953010094, 81953010103, 81953016030, 81953016043, 81953016048, 81953016049, 81953016053, 81953016061, 81953016090, 81953016108, 81953016112, 81953016126, 81953016143, 81953016149, 81953016154, 81953016156, 81953016168, 81953016178, 81953016194, 81953016206, 81953016224, 81953016234, 81953016242, 81953016252, 81953016274, 81953016278, 81953016284, 81953016286, 81953016308, 81953016310, 81953016312, 81953016347, 81953016350, 81953016352, 82953016012, 88953016014, N2953016001



CV-RK-5313

Ø: 90
03304800A, 81953016132



MN-DL-2160

Length: 1652 Ø: 50
Cone Ø: d1 Ø 30 / d2 Ø 27
81467106112, 81467106163, 81467106165, 81467106198, 81467106353, 81467106354, 81467106361, 81467116725



MN-DL-5225

Length: 572 Ø: 48
Hole Distance: 130 / 130
03301500A, 81432206229, 81432206236, 81432206267, 81432206270, 81432206272, 81432206304, 81432206305, 81432209236, 81432209267, 81432209272



MN-DL-7801

Length: 995 Ø: 52
Cone Ø: d1 Ø 30 / d2 Ø 27
81466106807, 81466106808, 81466116087, 81466116088, 81466116096, 81466116097, 81466116099, 81466116132, 81466116133, 81466116136, 81466116197, 81466116198, 81466116205

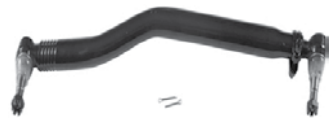

MN-DL-7802

Length: 1680 Ø: 52
Cone Ø: d1 Ø 30 / d2 Ø 27
03208300A, 81467116773, 81467116858, 81467116859, 81467116860, 81467116861, 81467116863, 81467116882, 81467116883, 81467116920, 81467116921



MN-DL-8544

Length: 596 Ø: 48
Hole Distance: 130 / 130
81432206196, 81432206232, 81432206233



MN-DL-8599

Length: 1800 Ø: 62
Cone Ø: d1 Ø 30 / d2 Ø 27
81466116161, 81466116162, 82466106183, 82466106186, 82466106187



MN-DL-10288

81432206386, 82432206008, 82432209008

No Image

MN-DL-12285

Length: 993 Ø: 40
Cone Ø: d1 Ø 30 / d2 Ø 27
81466106816, 81466106826, 81466116151, 82466106184, 82466106185



MN-DL-12288

Length: 585 Ø: 58
Hole Distance: 130 / 130
81432206386, 82432206008, 82432209008

No Image

MN-DL-12293

Length: 1680 Ø: 42
Cone Ø: d1 Ø 30 / d2 Ø 27
81467106236, 81467106268, 81467106356, 81467116356, 81467116723, 81467116794, 81467116933, 81467116934, 81467116966



MN-VB-8514

Length: 627 Ø: 48
Hole Ø 25 / 25 / 25
Hole Distance: 152 / 130 / 130
81432706087, 81432706088, 81432706094, 81432706095, 81432796094



MN-VB-8669

Length: 627 Ø: 48
Hole Ø 25 / 25 / 25
Hole Distance: 152 / 130 / 130
81432706116, 81432706137, 81432706150, 81432706151



MN-VB-9404

Length: 627 Ø: 58
Hole Distance: 130 / 130
81432706117, 81432706152, 81432706153



SC-ES-7279

Length: 150
Cone Ø: d1 Ø 30 / d2 Ø 27
Thread: M30 x 1,5 RHT
81953016288



SC-ES-8517

Length: 140
Cone Ø: d1 Ø 30 / d2 Ø 27
Thread: M30 x 1,5 RHT
81953016286



SC-ES-8535

Length: 145
Cone Ø: d1 Ø 30 / d2 Ø 27
Thread: M30 x 1,5 RHT
81953016271, 81953016325





TGA ...

41.460 FFDC-TM, FFDCR-TM, FFD-TM ...	12/04 →	Tie Rod End	SC-ES-8517		for Push Rod
	12/04 →	Tie Rod End	SC-ES-8535		for Guide Rod
	12/04 →	Track Control Arm		MN-DL-5225	Trailing Arm
	12/04 →	Track Control Arm		MN-DL-8544	Trailing Arm, 1st RA;2nd RA, for Leaf-Spring Suspension vehicles
	12/04 →	Track control arm		MN-DL-10288	Trailing Arm, 1st RA;2nd RA, for Leaf-Spring Suspension vehicles, →Type MHB
	12/04 →	Track control arm		MN-DL-12288	Trailing Arm
	12/04 →	Track Control Arm		MN-VB-8514	Suspension Rod, Wishbone (CV)
	12/04 →	Track Control Arm		MN-VB-8669	Suspension Rod, Wishbone (CV), 1st RA; 2nd RA, for Leaf-Spring Suspension vehicles, →Type_MHB Chassis
41.460 FFDK, FFDRK	09/03 →	Centre Rod	MN-DL-7801		Push Rod, Leaf Spring Axle
	09/03 →	Centre Rod	MN-DL-8599		Push Rod
	09/03 →	Suspension Arm Repair Kit		CV-RK-5313	for Wishbone (CV)
	09/03 →	Tie Rod	MN-DL-7802		
	09/03 →	Tie Rod End	CV-ES-0914		for Steering Rod
	09/03 →	Tie Rod End	CV-ES-14162		for Steering Rod
	09/03 →	Tie Rod End	CV-ES-14163		for Steering Rod
	09/03 →	Tie Rod End	SC-ES-7279		for Steering Rod
	09/03 →	Tie Rod End	SC-ES-8517		for Push Rod
	09/03 →	Tie Rod End	SC-ES-8535		for Guide Rod
	09/03 →	Track Control Arm		MN-DL-5225	Trailing Arm
	09/03 →	Track Control Arm		MN-DL-8544	Trailing Arm, Drive Axle;Leaf Spring Axle
	09/03 →	Track control arm		MN-DL-10288	Trailing Arm, 1st RA;2nd RA, for Leaf-Spring Suspension vehicles, →Type MHB
	09/03 →	Track control arm		MN-DL-12288	Trailing Arm
	09/03 →	Track Control Arm		MN-VB-8514	Suspension Rod, Wishbone (CV)
	09/03 →	Track Control Arm		MN-VB-8669	Suspension Rod, Wishbone (CV), 1st RA; 2nd RA, for Leaf-Spring Suspension vehicles, →Type_MHB Chassis
41.480 FFD, FFDC, FFDRK	06/05 →	Centre Rod	MN-DL-7801		Push Rod, Leaf Spring Axle
	06/05 →	Centre Rod	MN-DL-8599		Push Rod
	06/05 →	Centre Rod	MN-DL-12285		for Steering Rod
	06/05 →	Suspension Arm Repair Kit		CV-RK-5313	for Wishbone (CV)
	06/05 →	Tie Rod	MN-DL-7802		
	06/05 →	Tie Rod End	CV-ES-0914		for Steering Rod
	06/05 →	Tie Rod End	CV-ES-14162		for Steering Rod
	06/05 →	Tie Rod End	CV-ES-14163		for Steering Rod
	06/05 →	Tie Rod End	SC-ES-7279		for Steering Rod
	06/05 →	Tie Rod End	SC-ES-8517		for Push Rod
	06/05 →	Tie Rod End	SC-ES-8535		for Guide Rod
	06/05 →	Track Control Arm		MN-DL-5225	Trailing Arm
	06/05 →	Track Control Arm		MN-DL-8544	Trailing Arm, Drive Axle;Leaf Spring Axle
	06/05 →	Track control arm		MN-DL-10288	Trailing Arm, 1st RA;2nd RA, for Leaf-Spring Suspension vehicles, →Type MHB
	06/05 →	Track control arm		MN-DL-12288	Trailing Arm
	06/05 →	Track Control Arm		MN-VB-8514	Suspension Rod, Wishbone (CV)
	06/05 →	Track Control Arm		MN-VB-8669	Suspension Rod, Wishbone (CV), 1st RA; 2nd RA, for Leaf-Spring Suspension vehicles, →Type_MHB Chassis
	06/05 →	Track Control Arm		MN-VB-9404	Wishbone (CV)
	02/06 →	Suspension Strut Repair Kit		DB-RK-8581	
	02/06 →	Tie Rod	MN-DL-12293		
	02/06 →	Tie Rod End	MN-ES-10333		for Steering Rod
	02/06 →	Track Control Arm		MN-VB-8514	Suspension Rod, Wishbone (CV), Drive Axle; Leaf Spring Axle
	02/06 →	Track Control Arm		MN-VB-8669	Suspension Rod, Wishbone (CV), Drive Axle; Leaf Spring Axle
	02/06 →	Track Control Arm		MN-VB-9404	Wishbone (CV), Drive Axle;Leaf Spring Axle

CV-ES-0914

Length: 125
Cone Ø: d1 Ø 30 / d2 Ø 27
Thread: M38 x 1,5 RHT
81953016184, 81953016251, 81953016276



CV-ES-14162

Length: 125
Cone Ø: d1 Ø 30 / d2 Ø 27
Thread: M30 x 1,5 LHT
81953010015, 81953010083, 81953010087, 81953016029, 81953016030, 81953016043, 81953016044, 81953016050, 81953016054, 81953016087, 81953016091, 81953016107, 81953016120, 81953016125, 81953016152, 81953016155, 81953016157, 81953016168, 81953016179, 81953016181, 81953016223, 81953016237, 81953016254, 81953016275, 81953016279, 81953016351

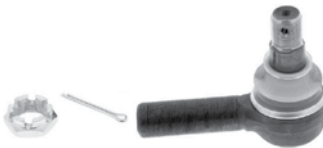

CV-ES-14163

Length: 125
Cone Ø: d1 Ø 30 / d2 Ø 27
Thread: M30 x 1,5 RHT
95301.0084, 90804102156, 90804102272, 90804102696, 90804102710, 81953010016, 81953010075, 81953010084, 81953010088, 81953010094, 81953010103, 81953016030, 81953016043, 81953016048, 81953016049, 81953016053, 81953016061, 81953016090, 81953016108, 81953016112, 81953016126, 81953016143, 81953016149, 81953016154, 81953016156, 81953016168, 81953016178, 81953016194, 81953016206, 81953016224, 81953016234, 81953016242, 81953016252, 81953016274, 81953016278, 81953016284, 81953016286, 81953016308, 81953016310, 81953016312, 81953016347, 81953016350, 81953016352, 82953016012, 88953016014, N2953016001



CV-RK-5313

Ø: 90
03304800A, 81953016132



DB-RK-8581

Ø: 85
Hole Distance: 130
Thick/Height: 24
03305800A, 81432706105



MN-DL-5225

Length: 572 Ø: 48
Hole Distance: 130 / 130
03301500A, 81432206229, 81432206236, 81432206267, 81432206270, 81432206272, 81432206304, 81432206305, 81432209236, 81432209267, 81432209272



MN-DL-7801

Length: 995 Ø: 52
Cone Ø: d1 Ø 30 / d2 Ø 27
81466106807, 81466106808, 81466116087, 81466116088, 81466116096, 81466116097, 81466116099, 81466116132, 81466116133, 81466116136, 81466116197, 81466116198, 81466116205

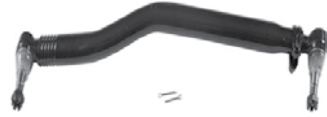

MN-DL-7802

Length: 1680 Ø: 52
Cone Ø: d1 Ø 30 / d2 Ø 27
03208300A, 81467116773, 81467116858, 81467116859, 81467116860, 81467116861, 81467116863, 81467116882, 81467116883, 81467116920, 81467116921



MN-DL-8544

Length: 596 Ø: 48
Hole Distance: 130 / 130
81432206196, 81432206232, 81432206233



MN-DL-8599

Length: 1800 Ø: 62
Cone Ø: d1 Ø 30 / d2 Ø 27
81466116161, 81466116162, 82466106183, 82466106186, 82466106187



MN-DL-10288

81432206386, 82432206008, 82432209008

No Image

MN-DL-12285

Length: 993 Ø: 40
Cone Ø: d1 Ø 30 / d2 Ø 27
81466106816, 81466106826, 81466116151, 82466106184, 82466106185



MN-DL-12288

Length: 585 Ø: 58
Hole Distance: 130 / 130
81432206386, 82432206008, 82432209008

No Image

MN-DL-12293

Length: 1680 Ø: 42
Cone Ø: d1 Ø 30 / d2 Ø 27
81467106236, 81467106268, 81467106356, 81467116356, 81467116723, 81467116794, 81467116933, 81467116934, 81467116966



MN-ES-10333

Length: 90
Cone Ø: d1 Ø 38 / d2 Ø 34,35
Thread: M36 x 1,5 RHT
1271126, 3090291, 3099128, 42538048, 81953016268, 82953016018, 82953016019



MN-VB-8514

Length: 627 Ø: 48
Hole Ø 25 / 25 / 25
Hole Distance: 152 / 130 / 130
81432706087, 81432706088, 81432706094, 81432706095, 81432796094



MN-VB-8669

Length: 627 Ø: 48
Hole Ø 25 / 25 / 25
Hole Distance: 152 / 130 / 130
81432706116, 81432706137, 81432706150, 81432706151



MN-VB-9404

Length: 627 Ø: 58
Hole Distance: 130 / 130
81432706117, 81432706152, 81432706153



SC-ES-7279

Length: 150
Cone Ø: d1 Ø 30 / d2 Ø 27
Thread: M30 x 1,5 RHT
81953016288



SC-ES-8517

Length: 140
Cone Ø: d1 Ø 30 / d2 Ø 27
Thread: M30 x 1,5 RHT
81953016286



SC-ES-8535

Length: 145
Cone Ø: d1 Ø 30 / d2 Ø 27
Thread: M30 x 1,5 RHT
81953016271, 81953016325





TGA ...

41.480 FFDKAK	07/06→	Centre Rod	MN-DL-8646		Push Rod, for Leaf-Spring Suspension vehicles
	07/06→	Centre Rod	MN-DL-12285		for Steering Rod
	07/06→	Suspension Strut Repair Kit		DB-RK-8581	
	07/06→	Tie Rod	MN-DL-12287		
	07/06→	Tie Rod End	CV-ES-14162		for Steering Rod
	07/06→	Tie Rod End	CV-ES-14163		for Steering Rod
	07/06→	Tie Rod End	MN-ES-10333		for Steering Rod
	07/06→	Track Control Arm		MN-DL-5225	Trailing Arm
	07/06→	Track Control Arm		MN-DL-8544	Trailing Arm, 1st RA;2nd RA;Leaf Spring Axle
	07/06→	Track Control Arm		MN-DL-8544	Trailing Arm, Drive Axle
	07/06→	Track Control Arm		MN-DL-8609	Trailing Arm, 1st RA;2nd RA, for Leaf-Spring Suspension vehicles, →Type_HB Chassis
	07/06→	Track control arm		MN-DL-10288	Trailing Arm, 1st RA;2nd RA, for Leaf-Spring Suspension vehicles, →Type HB
	07/06→	Track control arm		MN-DL-12288	Trailing Arm
	07/06→	Track Control Arm		MN-VB-8514	Suspension Rod, Wishbone (CV), Drive Axle
	07/06→	Track Control Arm		MN-VB-8514	Suspension Rod, Wishbone (CV), Drive Axle; Leaf Spring Axle
	07/06→	Track Control Arm		MN-VB-9404	Wishbone (CV)
	07/06→	Track Control Arm		MN-VB-9404	Wishbone (CV), 1st RA;2nd RA, for Leaf-Spring Suspension vehicles, →Type_HB Chassis
	41.480 FFDKAK, FFDRK	07/06→	Centre Rod	MN-DL-7801	
07/06→		Centre Rod	MN-DL-8599		Push Rod
07/06→		Centre Rod	MN-DL-12285		for Steering Rod
07/06→		Suspension Strut Repair Kit		DB-RK-8581	
07/06→		Tie Rod End	CV-ES-0914		for Steering Rod
07/06→		Tie Rod End	CV-ES-14162		for Steering Rod
07/06→		Tie Rod End	CV-ES-14163		for Steering Rod
07/06→		Tie Rod End	MN-ES-10333		for Steering Rod
07/06→		Tie Rod End	SC-ES-8517		for Push Rod
07/06→		Track Control Arm		MN-DL-5225	Trailing Arm
07/06→		Track Control Arm		MN-DL-8544	Trailing Arm, 1st RA;2nd RA;Leaf Spring Axle
07/06→		Track Control Arm		MN-DL-8544	Trailing Arm, Drive Axle;Air Suspension Axle
07/06→		Track Control Arm		MN-DL-8609	Trailing Arm, 1st RA;2nd RA, for Leaf-Spring Suspension vehicles, →Type_HB Chassis
07/06→		Track Control Arm		MN-VB-8514	Suspension Rod, Wishbone (CV), Drive Axle; Air Suspension Axle
07/06→		Track Control Arm		MN-VB-8514	Suspension Rod, Wishbone (CV), Drive Axle; Leaf Spring Axle
07/06→	Track Control Arm		MN-VB-9404	Wishbone (CV)	
41.480 FFDARC	07/06→	Centre Rod	MN-DL-12285		for Steering Rod
	07/06→	Suspension Arm Repair Kit		CV-RK-5313	for Wishbone (CV)
	07/06→	Tie Rod	MN-DL-12287		
	07/06→	Tie Rod End	CV-ES-0914		for Steering Rod
	07/06→	Tie Rod End	CV-ES-14162		for Steering Rod
	07/06→	Tie Rod End	CV-ES-14163		for Steering Rod
	07/06→	Tie Rod End	SC-ES-8517		for Push Rod
	07/06→	Track Control Arm		MN-DL-8609	Trailing Arm, 1st RA;2nd RA, for Leaf-Spring Suspension vehicles, →Type_HB Chassis
07/06→	Track Control Arm		MN-VB-8514	Suspension Rod, Wishbone (CV)	
41.480 FFDC-TM, FFDRC-TM	09/07→	Centre Rod	MN-DL-8599		Push Rod
	09/07→	Suspension Arm Repair Kit		CV-RK-5313	for Wishbone (CV)
	09/07→	Tie Rod End	CV-ES-0914		for Steering Rod
	09/07→	Tie Rod End	CV-ES-14162		for Steering Rod
	09/07→	Tie Rod End	CV-ES-14163		for Steering Rod
	09/07→	Tie Rod End	SC-ES-7279		for Steering Rod
	09/07→	Tie Rod End	SC-ES-8517		for Push Rod
	09/07→	Tie Rod End	SC-ES-8535		for Guide Rod
	09/07→	Track Control Arm		MN-DL-8544	Trailing Arm
	09/07→	Track control arm		MN-DL-10288	Trailing Arm, 1st RA;2nd RA, for Leaf-Spring Suspension vehicles, →Type MHB
	09/07→	Track control arm		MN-DL-12288	Trailing Arm
	09/07→	Track Control Arm		MN-VB-8514	Suspension Rod, Wishbone (CV)

CV-ES-0914

Length: 125
Cone Ø: d1 Ø 30 / d2 Ø 27
Thread: M38 x 1,5 RHT
81953016184, 81953016251, 81953016276



CV-ES-14162

Length: 125
Cone Ø: d1 Ø 30 / d2 Ø 27
Thread: M30 x 1,5 LHT
81953010015, 81953010083, 81953010087, 81953016029, 81953016030, 81953016043, 81953016044, 81953016050, 81953016054, 81953016087, 81953016091, 81953016107, 81953016120, 81953016125, 81953016152, 81953016155, 81953016157, 81953016168, 81953016179, 81953016181, 81953016223, 81953016237, 81953016254, 81953016275, 81953016279, 81953016351



CV-ES-14163

Length: 125
Cone Ø: d1 Ø 30 / d2 Ø 27
Thread: M30 x 1,5 RHT
95301.0084, 90804102156, 90804102272, 90804102696, 90804102710, 81953010016, 81953010075, 81953010084, 81953010088, 81953010094, 81953010103, 81953016030, 81953016043, 81953016048, 81953016049, 81953016053, 81953016061, 81953016090, 81953016108, 81953016112, 81953016126, 81953016143, 81953016149, 81953016154, 81953016156, 81953016168, 81953016178, 81953016194, 81953016206, 81953016224, 81953016234, 81953016242, 81953016252, 81953016274, 81953016278, 81953016284, 81953016286, 81953016308, 81953016310, 81953016312, 81953016347, 81953016350, 81953016352, 82953016012, 88953016014, N2953016001



CV-RK-5313

Ø: 90
03304800A, 81953016132



DB-RK-8581

Ø: 85
Hole Distance: 130
Thick/Height: 24
03305800A, 81432706105



MN-DL-5225

Length: 572 Ø: 48
Hole Distance: 130 / 130
03301500A, 81432206229, 81432206236, 81432206267, 81432206270, 81432206272, 81432206304, 81432206305, 81432209236, 81432209267, 81432209272



MN-DL-7801

Length: 995 Ø: 52
Cone Ø: d1 Ø 30 / d2 Ø 27
81466106807, 81466106808, 81466116087, 81466116088, 81466116096, 81466116097, 81466116099, 81466116132, 81466116133, 81466116136, 81466116197, 81466116198, 81466116205

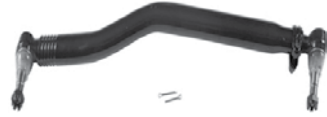

MN-DL-8544

Length: 596 Ø: 48
Hole Distance: 130 / 130
81432206196, 81432206232, 81432206233



MN-DL-8599

Length: 1800 Ø: 62
Cone Ø: d1 Ø 30 / d2 Ø 27
81466116161, 81466116162, 82466106183, 82466106186, 82466106187



MN-DL-8609

Length: 585 Ø: 58
Hole Distance: 130 / 130
81432206070, 81432206071, 81432206072, 81432206091, 81432206093, 81432206119



MN-DL-8646

Length: 1021 Ø: 52
Cone Ø: d1 Ø 30 / d2 Ø 27
81466106811, 81466106812, 81466116138, 81466116139, 81466116201, 81466116202

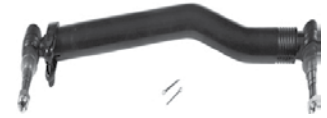

MN-DL-10288

81432206386, 82432206008, 82432209008

No Image

MN-DL-12285

Length: 993 Ø: 40
Cone Ø: d1 Ø 30 / d2 Ø 27
81466106816, 81466106826, 81466116151, 82466106184, 82466106185



MN-DL-12287

Length: 1531 Ø: 42
Cone Ø: d1 Ø 30 / d2 Ø 27
81467116855, 81467116856, 81467116857



MN-DL-12288

Length: 585 Ø: 58
Hole Distance: 130 / 130
81432206386, 82432206008, 82432209008

No Image

MN-ES-10333

Length: 90
Cone Ø: d1 Ø 38 / d2 Ø 34,35
Thread: M36 x 1,5 RHT
1271126, 3090291, 3099128, 42538048, 81953016268, 82953016018, 82953016019



MN-VB-8514

Length: 627 Ø: 48
Hole Ø 25 / 25 / 25
Hole Distance: 152 / 130 / 130
81432706087, 81432706088, 81432706094, 81432706095, 81432796094



MN-VB-9404

Length: 627 Ø: 58
Hole Distance: 130 / 130
81432706117, 81432706152, 81432706153



SC-ES-7279

Length: 150
Cone Ø: d1 Ø 30 / d2 Ø 27
Thread: M30 x 1,5 RHT
81953016288



SC-ES-8517

Length: 140
Cone Ø: d1 Ø 30 / d2 Ø 27
Thread: M30 x 1,5 RHT
81953016286



SC-ES-8535

Length: 145
Cone Ø: d1 Ø 30 / d2 Ø 27
Thread: M30 x 1,5 RHT
81953016271, 81953016325





TGA ...

41.480 FFDC-TM, FFDCR-TM ...	09/07→	Track Control Arm		MN-VB-8669	Suspension Rod, Wishbone (CV)	
	09/07→	Track Control Arm		MN-VB-9404	Wishbone (CV)	
41.480 FFDC-TM, FFDCR-TM, FFD-TM	12/04→	Centre Rod	MN-DL-12285		for Steering Rod	
	12/04→	Suspension Arm Repair Kit		CV-RK-5313	for Wishbone (CV)	
	12/04→	Tie Rod End	CV-ES-0914		for Steering Rod	
	12/04→	Tie Rod End	CV-ES-14162		for Steering Rod	
	12/04→	Tie Rod End	CV-ES-14163		for Steering Rod	
	12/04→	Tie Rod End	SC-ES-7279		for Steering Rod	
	12/04→	Tie Rod End	SC-ES-8517		for Push Rod	
	12/04→	Tie Rod End	SC-ES-8535		for Guide Rod	
	12/04→	Track Control Arm		MN-DL-5225	Trailing Arm	
	12/04→	Track Control Arm		MN-DL-8544	Trailing Arm, 1st RA;2nd RA, for Leaf-Spring Suspension vehicles	
	12/04→	Track control arm		MN-DL-10288	Trailing Arm, 1st RA;2nd RA, for Leaf-Spring Suspension vehicles, →Type MHB	
	12/04→	Track control arm		MN-DL-12288	Trailing Arm	
	12/04→	Track Control Arm		MN-VB-8514	Suspension Rod, Wishbone (CV)	
	12/04→	Track Control Arm		MN-VB-8669	Suspension Rod, Wishbone (CV), 1st RA; 2nd RA, for Leaf-Spring Suspension vehicles, →Type_MHB Chassis	
	12/04→	Track Control Arm		MN-VB-9404	Wishbone (CV), 1st RA;2nd RA, for Leaf-Spring Suspension vehicles, →Type_MHB Chassis	
	02/06→	Centre Rod	MN-DL-7801		Push Rod, Leaf Spring Axle	
	02/06→	Centre Rod	MN-DL-8599		Push Rod	
	02/06→	Suspension Strut Repair Kit		DB-RK-8581		
	02/06→	Tie Rod	MN-DL-7802			
	02/06→	Tie Rod	MN-DL-12293			
	02/06→	Tie Rod End	MN-ES-10333		for Steering Rod	
	02/06→	Track Control Arm		MN-DL-8544	Trailing Arm, Drive Axle;Leaf Spring Axle	
	02/06→	Track Control Arm		MN-VB-8514	Suspension Rod, Wishbone (CV), Drive Axle; Leaf Spring Axle	
	02/06→	Track Control Arm		MN-VB-8669	Suspension Rod, Wishbone (CV), Drive Axle; Leaf Spring Axle	
	02/06→	Track Control Arm		MN-VB-9404	Wishbone (CV), Drive Axle;Leaf Spring Axle	
	41.480 FFDK	12/08→	Centre Rod	MN-DL-8599		Push Rod
		12/08→	Suspension Arm Repair Kit		CV-RK-5313	for Wishbone (CV)
12/08→		Tie Rod End	CV-ES-0914		for Steering Rod	
12/08→		Tie Rod End	CV-ES-14162		for Steering Rod	
12/08→		Tie Rod End	CV-ES-14163		for Steering Rod	
12/08→		Tie Rod End	SC-ES-7279		for Steering Rod	
12/08→		Tie Rod End	SC-ES-8517		for Push Rod	
12/08→		Tie Rod End	SC-ES-8535		for Guide Rod	
12/08→		Track Control Arm		MN-DL-8544	Trailing Arm	
12/08→		Track Control Arm		MN-VB-8514	Suspension Rod, Wishbone (CV)	
12/08→		Track Control Arm		MN-VB-8669	Suspension Rod, Wishbone (CV)	
12/08→		Track Control Arm		MN-VB-9404	Wishbone (CV)	
41.480 FFDK, FFDRK	06/05→	Centre Rod	MN-DL-7801		Push Rod, Leaf Spring Axle	
	06/05→	Centre Rod	MN-DL-8599		Push Rod	
	06/05→	Centre Rod	MN-DL-12285		for Steering Rod	
	06/05→	Suspension Arm Repair Kit		CV-RK-5313	for Wishbone (CV)	
	06/05→	Tie Rod	MN-DL-7802			
	06/05→	Tie Rod End	CV-ES-0914		for Steering Rod	
	06/05→	Tie Rod End	CV-ES-14162		for Steering Rod	
	06/05→	Tie Rod End	CV-ES-14163		for Steering Rod	
	06/05→	Tie Rod End	SC-ES-7279		for Steering Rod	
	06/05→	Tie Rod End	SC-ES-8517		for Push Rod	
	06/05→	Tie Rod End	SC-ES-8535		for Guide Rod	
	06/05→	Track Control Arm		MN-DL-5225	Trailing Arm	
	06/05→	Track Control Arm		MN-DL-8544	Trailing Arm, Drive Axle;Leaf Spring Axle	
	06/05→	Track control arm		MN-DL-10288	Trailing Arm, 1st RA;2nd RA, for Leaf-Spring Suspension vehicles, →Type MHB	
	06/05→	Track control arm		MN-DL-12288	Trailing Arm	

CV-ES-0914

Length: 125
Cone Ø: d1 Ø 30 / d2 Ø 27
Thread: M38 x 1,5 RHT
81953016184, 81953016251, 81953016276



CV-ES-14162

Length: 125
Cone Ø: d1 Ø 30 / d2 Ø 27
Thread: M30 x 1,5 LHT
81953010015, 81953010083, 81953010087, 81953016029, 81953016030, 81953016043, 81953016044, 81953016050, 81953016054, 81953016087, 81953016091, 81953016107, 81953016120, 81953016125, 81953016152, 81953016155, 81953016157, 81953016168, 81953016179, 81953016181, 81953016223, 81953016237, 81953016254, 81953016275, 81953016279, 81953016351



CV-ES-14163

Length: 125
Cone Ø: d1 Ø 30 / d2 Ø 27
Thread: M30 x 1,5 RHT
95301.0084, 90804102156, 90804102272, 90804102696, 90804102710, 81953010016, 81953010075, 81953010084, 81953010088, 81953010094, 81953010103, 81953016030, 81953016043, 81953016048, 81953016049, 81953016053, 81953016061, 81953016090, 81953016108, 81953016112, 81953016126, 81953016143, 81953016149, 81953016154, 81953016156, 81953016168, 81953016178, 81953016194, 81953016206, 81953016224, 81953016234, 81953016242, 81953016252, 81953016274, 81953016278, 81953016284, 81953016286, 81953016308, 81953016310, 81953016312, 81953016347, 81953016350, 81953016352, 82953016012, 88953016014, N2953016001



CV-RK-5313

Ø: 90
03304800A, 81953016132



DB-RK-8581

Ø: 85
Hole Distance: 130
Thick/Height: 24
03305800A, 81432706105



MN-DL-5225

Length: 572 Ø: 48
Hole Distance: 130 / 130
03301500A, 81432206229, 81432206236, 81432206267, 81432206270, 81432206272, 81432206304, 81432206305, 81432209236, 81432209267, 81432209272



MN-DL-7801

Length: 995 Ø: 52
Cone Ø: d1 Ø 30 / d2 Ø 27
81466106807, 81466106808, 81466116087, 81466116088, 81466116096, 81466116097, 81466116099, 81466116132, 81466116133, 81466116136, 81466116197, 81466116198, 81466116205

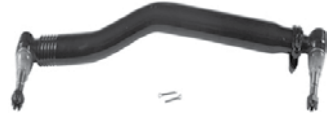

MN-DL-7802

Length: 1680 Ø: 52
Cone Ø: d1 Ø 30 / d2 Ø 27
03208300A, 81467116773, 81467116858, 81467116859, 81467116860, 81467116861, 81467116863, 81467116882, 81467116883, 81467116920, 81467116921



MN-DL-8544

Length: 596 Ø: 48
Hole Distance: 130 / 130
81432206196, 81432206232, 81432206233



MN-DL-8599

Length: 1800 Ø: 62
Cone Ø: d1 Ø 30 / d2 Ø 27
81466116161, 81466116162, 82466106183, 82466106186, 82466106187



MN-DL-10288

81432206386, 82432206008, 82432209008

No Image

MN-DL-12285

Length: 993 Ø: 40
Cone Ø: d1 Ø 30 / d2 Ø 27
81466106816, 81466106826, 81466116151, 82466106184, 82466106185



MN-DL-12288

Length: 585 Ø: 58
Hole Distance: 130 / 130
81432206386, 82432206008, 82432209008

No Image

MN-DL-12293

Length: 1680 Ø: 42
Cone Ø: d1 Ø 30 / d2 Ø 27
81467106236, 81467106268, 81467106356, 81467116356, 81467116723, 81467116794, 81467116933, 81467116934, 81467116966



MN-ES-10333

Length: 90
Cone Ø: d1 Ø 38 / d2 Ø 34,35
Thread: M36 x 1,5 RHT
1271126, 3090291, 3099128, 42538048, 81953016268, 82953016018, 82953016019



MN-VB-8514

Length: 627 Ø: 48
Hole Ø 25 / 25 / 25
Hole Distance: 152 / 130 / 130
81432706087, 81432706088, 81432706094, 81432706095, 81432796094



MN-VB-8669

Length: 627 Ø: 48
Hole Ø 25 / 25 / 25
Hole Distance: 152 / 130 / 130
81432706116, 81432706137, 81432706150, 81432706151



MN-VB-9404

Length: 627 Ø: 58
Hole Distance: 130 / 130
81432706117, 81432706152, 81432706153



SC-ES-7279

Length: 150
Cone Ø: d1 Ø 30 / d2 Ø 27
Thread: M30 x 1,5 RHT
81953016288



SC-ES-8517

Length: 140
Cone Ø: d1 Ø 30 / d2 Ø 27
Thread: M30 x 1,5 RHT
81953016286



SC-ES-8535

Length: 145
Cone Ø: d1 Ø 30 / d2 Ø 27
Thread: M30 x 1,5 RHT
81953016271, 81953016325



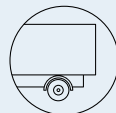

TGA ...

41.480 FFDK, FFDRK ...	06/05→	Track Control Arm		MN-VB-8514	Suspension Rod, Wishbone (CV)
	06/05→	Track Control Arm		MN-VB-8669	Suspension Rod, Wishbone (CV), 1st RA; 2nd RA, for Leaf-Spring Suspension vehicles, →Type_MHB Chassis
	06/05→	Track Control Arm		MN-VB-9404	Wishbone (CV)
	02/06→	Suspension Strut Repair Kit		DB-RK-8581	
	02/06→	Tie Rod	MN-DL-12293		
	02/06→	Tie Rod End	MN-ES-10333		for Steering Rod
	02/06→	Track Control Arm		MN-VB-8514	Suspension Rod, Wishbone (CV), Drive Axle; Leaf Spring Axle
	02/06→	Track Control Arm		MN-VB-8669	Suspension Rod, Wishbone (CV), Drive Axle; Leaf Spring Axle
41.480 FVDS, FVDLS	07/06→	Suspension Arm Repair Kit		CV-RK-5313	for Wishbone (CV)
	07/06→	Suspension Strut Repair Kit		CV-RK-5311	
	07/06→	Tie Rod End		SC-ES-8517	for Push Rod
	07/06→	Tie Rod End	CV-ES-0914		for Steering Rod
	07/06→	Tie Rod End	CV-ES-14163		for Steering Rod
	07/06→	Tie Rod End	SC-ES-7279		for Steering Rod
	07/06→	Tie Rod End	SC-ES-8535		for Guide Rod
	07/06→	Track Control Arm		MN-DL-3402	Trailing Arm, 1st RA;2nd RA, for Pneumatic Suspension vehicles
	07/06→	Track Control Arm		MN-DL-5225	Trailing Arm
	07/06→	Track Control Arm		MN-DL-8544	Trailing Arm, 1st RA;2nd RA, for Leaf-Spring Suspension vehicles
	07/06→	Track Control Arm		MN-VB-5222	Wishbone (CV), 1st RA;2nd RA, for Pneumatic Suspension vehicles
	07/06→	Track Control Arm		MN-VB-8514	Suspension Rod, Wishbone (CV), 1st RA;2nd RA, for Pneumatic Suspension vehicles
	07/06→	Track Control Arm		MN-VB-9404	Wishbone (CV), 1st RA;2nd RA, for Pneumatic Suspension vehicles
	41.530 FFDK	07/06→	Centre Rod	MN-DL-7801	
07/06→		Centre Rod	MN-DL-8599		Push Rod
07/06→		Centre Rod	MN-DL-12285		for Steering Rod
07/06→		Suspension Arm Repair Kit		CV-RK-5313	for Wishbone (CV)
07/06→		Suspension Strut Repair Kit		DB-RK-8581	
07/06→		Tie Rod	MN-DL-12287		
07/06→		Tie Rod End	CV-ES-0914		for Steering Rod
07/06→		Tie Rod End	CV-ES-14162		for Steering Rod
07/06→		Tie Rod End	CV-ES-14163		for Steering Rod
07/06→		Tie Rod End	MN-ES-10333		for Steering Rod
07/06→		Tie Rod End	SC-ES-8517		for Push Rod
07/06→		Track Control Arm		MN-DL-5225	Trailing Arm
07/06→		Track Control Arm		MN-DL-8544	Trailing Arm, 1st RA;2nd RA, for Leaf-Spring Suspension vehicles, →Type_HB Chassis
07/06→		Track Control Arm		MN-DL-8544	Trailing Arm, 1st RA;2nd RA;Leaf Spring Axle
07/06→		Track Control Arm		MN-DL-8544	Trailing Arm, Drive Axle;Air Suspension Axle
07/06→		Track Control Arm		MN-DL-8609	Trailing Arm, 1st RA;2nd RA, for Leaf-Spring Suspension vehicles, →Type_HB Chassis
07/06→		Track Control Arm		MN-VB-8514	Suspension Rod, Wishbone (CV)
07/06→		Track Control Arm		MN-VB-8514	Suspension Rod, Wishbone (CV), Drive Axle; Air Suspension Axle
07/06→		Track Control Arm		MN-VB-8514	Suspension Rod, Wishbone (CV), Drive Axle; Leaf Spring Axle
07/06→		Track Control Arm		MN-VB-9404	Wishbone (CV)
07/06→		Track Control Arm		MN-VB-9404	Wishbone (CV), 1st RA;2nd RA, for Leaf-Spring Suspension vehicles, →Type_HB Chassis
41.530 FFDC	12/04→	Centre Rod	MN-DL-2160		Coupling Rod
	12/04→	Suspension Arm Repair Kit		CV-RK-5313	for Wishbone (CV)
	12/04→	Tie Rod End	CV-ES-0914		for Steering Rod
	12/04→	Tie Rod End	CV-ES-14162		for Steering Rod
	12/04→	Tie Rod End	CV-ES-14163		for Steering Rod
	12/04→	Tie Rod End	SC-ES-7279		for Steering Rod

CV-ES-0914

Length: 125
Cone Ø: d1 Ø 30 / d2 Ø 27
Thread: M38 x 1,5 RHT
81953016184, 81953016251, 81953016276



CV-ES-14162

Length: 125
Cone Ø: d1 Ø 30 / d2 Ø 27
Thread: M30 x 1,5 LHT
81953010015, 81953010083, 81953010087, 81953016029, 81953016030, 81953016043, 81953016044, 81953016050, 81953016054, 81953016087, 81953016091, 81953016107, 81953016120, 81953016125, 81953016152, 81953016155, 81953016157, 81953016168, 81953016179, 81953016181, 81953016223, 81953016237, 81953016254, 81953016275, 81953016279, 81953016351



CV-ES-14163

Length: 125
Cone Ø: d1 Ø 30 / d2 Ø 27
Thread: M30 x 1,5 RHT
95301.0084, 90804102156, 90804102272, 90804102696, 90804102710, 81953010016, 81953010075, 81953010084, 81953010088, 81953010094, 81953010103, 81953016030, 81953016043, 81953016048, 81953016049, 81953016053, 81953016061, 81953016090, 81953016108, 81953016112, 81953016126, 81953016143, 81953016149, 81953016154, 81953016156, 81953016168, 81953016178, 81953016194, 81953016206, 81953016224, 81953016234, 81953016242, 81953016252, 81953016274, 81953016278, 81953016284, 81953016286, 81953016308, 81953016310, 81953016312, 81953016347, 81953016350, 81953016352, 82953016012, 88953016014, N2953016001



CV-RK-5311

638862, 639287, 938423, 1104335, 1953248, 0003500506, 3500506, 11013547, 42488722, 070550504, 634303610, 81432206055, 81432206073, 82262320660, 5001842823, 7000307001, 8226232066



CV-RK-5313

Ø: 90
03304800A, 81953016132



DB-RK-8581

Ø: 85
Hole Distance: 130
Thick/Height: 24
03305800A, 81432706105



MN-DL-2160

Length: 1652 Ø: 50
Cone Ø: d1 Ø 30 / d2 Ø 27
81467106112, 81467106163, 81467106165, 81467106198, 81467106353, 81467106354, 81467106361, 81467116725



MN-DL-3402

Length: 590 Ø: 48
Hole Distance: 130 / 130
03307200A, 81432206067, 81432206068, 81432206090, 81432206092, 81432206099



MN-DL-5225

Length: 572 Ø: 48
Hole Distance: 130 / 130
03301500A, 81432206229, 81432206236, 81432206267, 81432206270, 81432206272, 81432206304, 81432206305, 81432209236, 81432209267, 81432209272



MN-DL-7801

Length: 995 Ø: 52
Cone Ø: d1 Ø 30 / d2 Ø 27
81466106807, 81466106808, 81466116087, 81466116088, 81466116096, 81466116097, 81466116099, 81466116132, 81466116133, 81466116136, 81466116197, 81466116198, 81466116205



MN-DL-8544

Length: 596 Ø: 48
Hole Distance: 130 / 130
81432206196, 81432206232, 81432206233



MN-DL-8599

Length: 1800 Ø: 62
Cone Ø: d1 Ø 30 / d2 Ø 27
81466116161, 81466116162, 82466106183, 82466106186, 82466106187



MN-DL-8609

Length: 585 Ø: 58
Hole Distance: 130 / 130
81432206070, 81432206071, 81432206072, 81432206091, 81432206093, 81432206119



MN-DL-12285

Length: 993 Ø: 40
Cone Ø: d1 Ø 30 / d2 Ø 27
81466106816, 81466106826, 81466116151, 82466106184, 82466106185



MN-DL-12287

Length: 1531 Ø: 42
Cone Ø: d1 Ø 30 / d2 Ø 27
81467116855, 81467116856, 81467116857



MN-DL-12293

Length: 1680 Ø: 42
Cone Ø: d1 Ø 30 / d2 Ø 27
81467106236, 81467106268, 81467106356, 81467116356, 81467116723, 81467116794, 81467116933, 81467116934, 81467116966



MN-ES-10333

Length: 90
Cone Ø: d1 Ø 38 / d2 Ø 34,35
Thread: M36 x 1,5 RHT
1271126, 3090291, 3099128, 42538048, 81953016268, 82953016018, 82953016019



MN-VB-5222

Length: 627 Ø: 50
Hole Distance: 152 / 152
81432706030, 81432706034, 81432706054, 81432706055, 81432706056, 81432706057, 81432706067, 81432706068, 81432706074, 81432706075, 81432706076, 81432706077, 81432706078, 81432706081, 81432706082, 81432709034, 81432709076, 81432709078, 8143706054



MN-VB-8514

Length: 627 Ø: 48
Hole Ø 25 / 25 / 25
Hole Distance: 152 / 130 / 130
81432706087, 81432706088, 81432706094, 81432706095, 81432796094



MN-VB-8669

Length: 627 Ø: 48
Hole Ø 25 / 25 / 25
Hole Distance: 152 / 130 / 130
81432706116, 81432706137, 81432706150, 81432706151



MN-VB-9404

Length: 627 Ø: 58
Hole Distance: 130 / 130
81432706117, 81432706152, 81432706153



SC-ES-7279

Length: 150
Cone Ø: d1 Ø 30 / d2 Ø 27
Thread: M30 x 1,5 RHT
81953016288



SC-ES-8517

Length: 140
Cone Ø: d1 Ø 30 / d2 Ø 27
Thread: M30 x 1,5 RHT
81953016286



SC-ES-8535

Length: 145
Cone Ø: d1 Ø 30 / d2 Ø 27
Thread: M30 x 1,5 RHT
81953016271, 81953016325





TGA ...

41.530 FFDC ...	12/04→	Tie Rod End	SC-ES-8517		for Push Rod
	12/04→	Tie Rod End	SC-ES-8535		for Guide Rod
	12/04→	Track Control Arm		MN-DL-5225	Trailing Arm
	12/04→	Track Control Arm		MN-DL-8544	Trailing Arm, 1st RA;2nd RA, for Leaf-Spring Suspension vehicles
	12/04→	Track control arm		MN-DL-10288	Trailing Arm, 1st RA;2nd RA, for Leaf-Spring Suspension vehicles, →Type MHB
	12/04→	Track control arm		MN-DL-12288	Trailing Arm
	12/04→	Track Control Arm		MN-VB-8514	Suspension Rod, Wishbone (CV)
	12/04→	Track Control Arm		MN-VB-8669	Suspension Rod, Wishbone (CV), 1st RA; 2nd RA, for Leaf-Spring Suspension vehicles, →Type_MHB Chassis
	12/04→	Track Control Arm		MN-VB-9404	Wishbone (CV), 1st RA;2nd RA, for Leaf-Spring Suspension vehicles, →Type_MHB Chassis
41.530 FFDC-TM, FFDC-TM, FFD-TM	12/04→	Centre Rod	MN-DL-2160		Coupling Rod
	12/04→	Suspension Arm Repair Kit		CV-RK-5313	for Wishbone (CV)
	12/04→	Tie Rod End	CV-ES-0914		for Steering Rod
	12/04→	Tie Rod End	CV-ES-14162		for Steering Rod
	12/04→	Tie Rod End	CV-ES-14163		for Steering Rod
	12/04→	Tie Rod End	SC-ES-7279		for Steering Rod
	12/04→	Tie Rod End	SC-ES-8517		for Push Rod
	12/04→	Tie Rod End	SC-ES-8535		for Guide Rod
	12/04→	Track Control Arm		MN-DL-5225	Trailing Arm
	12/04→	Track Control Arm		MN-DL-8544	Trailing Arm, 1st RA;2nd RA, for Leaf-Spring Suspension vehicles
	12/04→	Track control arm		MN-DL-10288	Trailing Arm, 1st RA;2nd RA, for Leaf-Spring Suspension vehicles, →Type MHB
	12/04→	Track control arm		MN-DL-12288	Trailing Arm
	12/04→	Track Control Arm		MN-VB-8514	Suspension Rod, Wishbone (CV)
	12/04→	Track Control Arm		MN-VB-8669	Suspension Rod, Wishbone (CV), 1st RA; 2nd RA, for Leaf-Spring Suspension vehicles, →Type_MHB Chassis
	12/04→	Track Control Arm		MN-VB-9404	Wishbone (CV), 1st RA;2nd RA, for Leaf-Spring Suspension vehicles, →Type_MHB Chassis
41.530 FFDK, FFDK	12/04→	Centre Rod	MN-DL-2160		Coupling Rod
	12/04→	Suspension Arm Repair Kit		CV-RK-5313	for Wishbone (CV)
	12/04→	Tie Rod End	CV-ES-0914		for Steering Rod
	12/04→	Tie Rod End	CV-ES-14162		for Steering Rod
	12/04→	Tie Rod End	CV-ES-14163		for Steering Rod
	12/04→	Tie Rod End	SC-ES-7279		for Steering Rod
	12/04→	Tie Rod End	SC-ES-8517		for Push Rod
	12/04→	Tie Rod End	SC-ES-8535		for Guide Rod
	12/04→	Track Control Arm		MN-DL-5225	Trailing Arm
	12/04→	Track Control Arm		MN-DL-8544	Trailing Arm, 1st RA;2nd RA, for Leaf-Spring Suspension vehicles
	12/04→	Track control arm		MN-DL-10288	Trailing Arm, 1st RA;2nd RA, for Leaf-Spring Suspension vehicles, →Type MHB
	12/04→	Track control arm		MN-DL-12288	Trailing Arm
	12/04→	Track Control Arm		MN-VB-8514	Suspension Rod, Wishbone (CV), 1st RA;2nd RA
	12/04→	Track Control Arm		MN-VB-8669	Suspension Rod, Wishbone (CV), 1st RA; 2nd RA, for Leaf-Spring Suspension vehicles, →Type_MHB Chassis
	12/04→	Track Control Arm		MN-VB-9404	Wishbone (CV), 1st RA;2nd RA, for Leaf-Spring Suspension vehicles, →Type_MHB Chassis
41.530 FVD5, FVDLS	09/02→05/04	Track Control Arm		MN-VB-8514	Suspension Rod, Wishbone (CV), Drive Axle; Air Suspension Axle;for vehicles with Hinged Trailing Axle
	09/02→	Ball Head, gearshift linkage	CV-ES-2120		
	09/02→	Centre Rod	MN-DL-7801		Push Rod, Leaf Spring Axle
	09/02→	Suspension Strut Repair Kit		DB-RK-8581	

CV-ES-0914

Length: 125
Cone Ø: d1 Ø 30 / d2 Ø 27
Thread: M38 x 1,5 RHT
81953016184, 81953016251, 81953016276



CV-ES-2120

Length: 115
Cone Ø: d1 Ø 12,4 / d2 Ø 10,8
Thread: M14 x 1,5 RHT
03008500A, 81953016200, 81953016202, 81953016203, 81953016227



CV-ES-14162

Length: 125
Cone Ø: d1 Ø 30 / d2 Ø 27
Thread: M30 x 1,5 LHT
81953010015, 81953010083, 81953010087, 81953016029, 81953016030, 81953016043, 81953016044, 81953016050, 81953016054, 81953016087, 81953016091, 81953016107, 81953016120, 81953016125, 81953016152, 81953016155, 81953016157, 81953016168, 81953016179, 81953016181, 81953016223, 81953016237, 81953016254, 81953016275, 81953016279, 81953016351

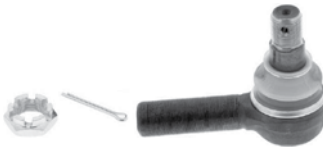

CV-ES-14163

Length: 125
Cone Ø: d1 Ø 30 / d2 Ø 27
Thread: M30 x 1,5 RHT
95301.0084, 90804102156, 90804102272, 90804102696, 90804102710, 81953010016, 81953010075, 81953010084, 81953010088, 81953010094, 81953010103, 81953016030, 81953016043, 81953016048, 81953016049, 81953016053, 81953016061, 81953016090, 81953016108, 81953016112, 81953016126, 81953016143, 81953016149, 81953016154, 81953016156, 81953016168, 81953016178, 81953016194, 81953016206, 81953016224, 81953016234, 81953016242, 81953016252, 81953016274, 81953016278, 81953016284, 81953016286, 81953016308, 81953016310, 81953016312, 81953016347, 81953016350, 81953016352, 82953016012, 88953016014, N2953016001



CV-RK-5313

Ø: 90
03304800A, 81953016132



DB-RK-8581

Ø: 85
Hole Distance: 130
Thick/Height: 24
03305800A, 81432706105



MN-DL-2160

Length: 1652 Ø: 50
Cone Ø: d1 Ø 30 / d2 Ø 27
81467106112, 81467106163, 81467106165, 81467106198, 81467106353, 81467106354, 81467106361, 81467116725



MN-DL-5225

Length: 572 Ø: 48
Hole Distance: 130 / 130
03301500A, 81432206229, 81432206236, 81432206267, 81432206270, 81432206272, 81432206304, 81432206305, 81432209236, 81432209267, 81432209272



MN-DL-7801

Length: 995 Ø: 52
Cone Ø: d1 Ø 30 / d2 Ø 27
81466106807, 81466106808, 81466116087, 81466116088, 81466116096, 81466116097, 81466116099, 81466116132, 81466116133, 81466116136, 81466116197, 81466116198, 81466116205

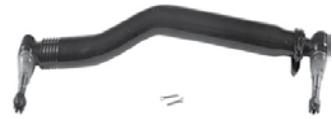

MN-DL-8544

Length: 596 Ø: 48
Hole Distance: 130 / 130
81432206196, 81432206232, 81432206233



MN-DL-10288

81432206386, 82432206008, 82432209008

No Image

MN-DL-12288

Length: 585 Ø: 58
Hole Distance: 130 / 130
81432206386, 82432206008, 82432209008

No Image

MN-VB-8514

Length: 627 Ø: 48
Hole Ø 25 / 25 / 25
Hole Distance: 152 / 130 / 130
81432706087, 81432706088, 81432706094, 81432706095, 81432796094



MN-VB-8669

Length: 627 Ø: 48
Hole Ø 25 / 25 / 25
Hole Distance: 152 / 130 / 130
81432706116, 81432706137, 81432706150, 81432706151



MN-VB-9404

Length: 627 Ø: 58
Hole Distance: 130 / 130
81432706117, 81432706152, 81432706153



SC-ES-7279

Length: 150
Cone Ø: d1 Ø 30 / d2 Ø 27
Thread: M30 x 1,5 RHT
81953016288



SC-ES-8517

Length: 140
Cone Ø: d1 Ø 30 / d2 Ø 27
Thread: M30 x 1,5 RHT
81953016286



SC-ES-8535

Length: 145
Cone Ø: d1 Ø 30 / d2 Ø 27
Thread: M30 x 1,5 RHT
81953016271, 81953016325





TGA ...

41.530 FVDS, FVDLS ...	09/02→	Tie Rod	MN-DL-7802		
	09/02→	Tie Rod End		SC-ES-8517	for Push Rod
	09/02→	Tie Rod End	CV-ES-0914		for Steering Rod
	09/02→	Tie Rod End	CV-ES-14163		for Steering Rod
	09/02→	Tie Rod End	SC-ES-7279		for Steering Rod
	09/02→	Tie Rod End	SC-ES-8535		for Guide Rod
	09/02→	Track Control Arm		MN-DL-3402	Trailing Arm, Air Suspension Axle; Drive Axle; for vehicles with Hinged Leading Axle
	09/02→	Track Control Arm		MN-DL-5225	Trailing Arm, Leading Axle; Air Suspension Axle
	09/02→	Track Control Arm		MN-DL-8544	Trailing Arm, Drive Axle; Air Suspension Axle
	09/02→	Track Control Arm		MN-DL-8544	Trailing Arm, Drive Axle; Leaf Spring Axle
	09/02→	Track Control Arm		MN-VB-5222	Wishbone (CV), 1st RA; 2nd RA, for Pneumatic Suspension vehicles
	09/02→	Track Control Arm		MN-VB-8514	Suspension Rod, Wishbone (CV), Drive Axle; Leaf Spring Axle; for vehicles with Hinged Trailing Axle
	41.540 FVDS, FVDLS	05/04→	Track Control Arm		MN-VB-9404
11/06→		Centre Rod	MN-DL-7801		Push Rod, Leaf Spring Axle
11/06→		Suspension Arm Repair Kit		CV-RK-5313	for Wishbone (CV)
11/06→		Suspension Strut Repair Kit		CV-RK-5311	
11/06→		Tie Rod	MN-DL-7802		
11/06→		Tie Rod End		SC-ES-8517	for Push Rod
11/06→		Tie Rod End	CV-ES-0914		for Steering Rod
11/06→		Tie Rod End	CV-ES-14163		for Steering Rod
11/06→		Tie Rod End	SC-ES-7279		for Steering Rod
11/06→		Tie Rod End	SC-ES-8535		for Guide Rod
11/06→		Track Control Arm		MN-DL-3402	Trailing Arm, 1st RA; 2nd RA, for Pneumatic Suspension vehicles
11/06→		Track Control Arm		MN-DL-5225	Trailing Arm
11/06→		Track Control Arm		MN-DL-8544	Trailing Arm, 1st RA; 2nd RA, for Leaf-Spring Suspension vehicles
11/06→		Track Control Arm		MN-VB-5222	Wishbone (CV), 1st RA; 2nd RA, for Pneumatic Suspension vehicles
11/06→		Track Control Arm		MN-VB-8514	Suspension Rod, Wishbone (CV), 1st RA; 2nd RA, for Pneumatic Suspension vehicles
11/06→	Track Control Arm		MN-VB-9404	Wishbone (CV), 1st RA; 2nd RA, for Pneumatic Suspension vehicles	
41.660 FVDS, FVDLS	09/02→05/04	Track Control Arm		MN-VB-8514	Suspension Rod, Wishbone (CV), Drive Axle; Air Suspension Axle
	09/02→	Ball Head, gearshift linkage	CV-ES-2120		
	09/02→	Centre Rod	MN-DL-7801		Push Rod, Leaf Spring Axle
	09/02→	Suspension Strut Repair Kit		DB-RK-8581	
	09/02→	Tie Rod	MN-DL-7802		
	09/02→	Tie Rod End		SC-ES-8517	for Push Rod
	09/02→	Tie Rod End	CV-ES-0914		for Steering Rod
	09/02→	Tie Rod End	CV-ES-14163		for Steering Rod
	09/02→	Tie Rod End	SC-ES-7279		for Steering Rod
	09/02→	Tie Rod End	SC-ES-8535		for Guide Rod
	09/02→	Track Control Arm		MN-DL-3402	Trailing Arm, Air Suspension Axle; Drive Axle; for vehicles with Hinged Leading Axle
	09/02→	Track Control Arm		MN-DL-5225	Trailing Arm, Leading Axle; Air Suspension Axle
	09/02→	Track Control Arm		MN-DL-8544	Trailing Arm, Drive Axle; Air Suspension Axle
	09/02→	Track Control Arm		MN-DL-8544	Trailing Arm, Drive Axle; Leaf Spring Axle
	09/02→	Track Control Arm		MN-VB-5222	Wishbone (CV), 1st RA; 2nd RA, for Pneumatic Suspension vehicles
	09/02→	Track Control Arm		MN-VB-8514	Suspension Rod, Wishbone (CV), Drive Axle; Leaf Spring Axle
	05/04→	Track Control Arm		MN-VB-9404	Wishbone (CV), Drive Axle; Air Suspension Axle

CV-ES-0914

Length: 125
Cone Ø: d1 Ø 30 / d2 Ø 27
Thread: M38 x 1,5 RHT
81953016184, 81953016251, 81953016276



CV-ES-2120

Length: 115
Cone Ø: d1 Ø 12,4 / d2 Ø 10,8
Thread: M14 x 1,5 RHT
03008500A, 81953016200, 81953016202, 81953016203, 81953016227



CV-ES-14163

Length: 125
Cone Ø: d1 Ø 30 / d2 Ø 27
Thread: M30 x 1,5 RHT
95301.0084, 90804102156, 90804102272, 90804102696, 90804102710, 81953010016, 81953010075, 81953010084, 81953010088, 81953010094, 81953010103, 81953016030, 81953016043, 81953016048, 81953016049, 81953016053, 81953016061, 81953016090, 81953016108, 81953016112, 81953016126, 81953016143, 81953016149, 81953016154, 81953016156, 81953016168, 81953016178, 81953016194, 81953016206, 81953016224, 81953016234, 81953016242, 81953016252, 81953016274, 81953016278, 81953016284, 81953016286, 81953016308, 81953016310, 81953016312, 81953016347, 81953016350, 81953016352, 82953016012, 88953016014, N2953016001



CV-RK-5311

638862, 639287, 938423, 1104335, 1953248, 0003500506, 3500506, 11013547, 42488722, 070550504, 634303610, 81432206055, 81432206073, 82262320660, 5001842823, 7000307001, 8226232066



CV-RK-5313

Ø: 90
03304800A, 81953016132



DB-RK-8581

Ø: 85
Hole Distance: 130
Thick/Height: 24
03305800A, 81432706105



MN-DL-3402

Length: 590 Ø: 48
Hole Distance: 130 / 130
03307200A, 81432206067, 81432206068, 81432206090, 81432206092, 81432209092



MN-DL-5225

Length: 572 Ø: 48
Hole Distance: 130 / 130
03301500A, 81432206229, 81432206236, 81432206267, 81432206270, 81432206272, 81432206304, 81432206305, 81432209236, 81432209267, 81432209272



MN-DL-7801

Length: 995 Ø: 52
Cone Ø: d1 Ø 30 / d2 Ø 27
81466106807, 81466106808, 81466116087, 81466116088, 81466116096, 81466116097, 81466116099, 81466116132, 81466116133, 81466116136, 81466116197, 81466116198, 81466116205



MN-DL-7802

Length: 1680 Ø: 52
Cone Ø: d1 Ø 30 / d2 Ø 27
03208300A, 81467116773, 81467116858, 81467116859, 81467116860, 81467116861, 81467116863, 81467116882, 81467116883, 81467116920, 81467116921



MN-DL-8544

Length: 596 Ø: 48
Hole Distance: 130 / 130
81432206196, 81432206232, 81432206233



MN-VB-5222

Length: 627 Ø: 50
Hole Distance: 152 / 152
81432706030, 81432706034, 81432706054, 81432706055, 81432706056, 81432706057, 81432706067, 81432706068, 81432706074, 81432706075, 81432706076, 81432706077, 81432706078, 81432706081, 81432706082, 81432709034, 81432709076, 81432709078, 8143706054



MN-VB-8514

Length: 627 Ø: 48
Hole Ø 25 / 25 / 25
Hole Distance: 152 / 130 / 130
81432706087, 81432706088, 81432706094, 81432706095, 81432796094



MN-VB-9404

Length: 627 Ø: 58
Hole Distance: 130 / 130
81432706117, 81432706152, 81432706153



SC-ES-7279

Length: 150
Cone Ø: d1 Ø 30 / d2 Ø 27
Thread: M30 x 1,5 RHT
81953016288



SC-ES-8517

Length: 140
Cone Ø: d1 Ø 30 / d2 Ø 27
Thread: M30 x 1,5 RHT
81953016286



SC-ES-8535

Length: 145
Cone Ø: d1 Ø 30 / d2 Ø 27
Thread: M30 x 1,5 RHT
81953016271, 81953016325





TGL

10.180 FC, FRC, FLC, FLRC	04/05→	Ball Head, gearshift linkage	CV-ES-2120		
	04/05→	Centre Rod	MN-DL-9379		Push Rod
	04/05→	Suspension Arm Repair Kit		MN-RK-8723	for Drag Link;for Semi-Trailing Arm
	04/05→	Tie Rod	MN-DL-9380		Leaf Spring Axle
	04/05→	Track Control Arm		MN-TC-12471	Semi-Trailing Arm, 1st Drive Axle, for Pneumatic Suspension vehicles
10.180 FK, FLK, FLRK, FRK	04/05→	Ball Head, gearshift linkage	CV-ES-2120		
	04/05→	Centre Rod	MN-DL-9379		Push Rod
	04/05→	Suspension Arm Repair Kit		MN-RK-8723	for Drag Link;for Semi-Trailing Arm
	04/05→	Tie Rod	MN-DL-9380		Leaf Spring Axle
	04/05→	Track Control Arm		MN-TC-12471	Semi-Trailing Arm, 1st Drive Axle, for Pneumatic Suspension vehicles
10.210 FC, FRC, FLC, FLRC	04/05→	Ball Head, gearshift linkage	CV-ES-2120		
	04/05→	Centre Rod	MN-DL-9379		Push Rod
	04/05→	Suspension Arm Repair Kit		MN-RK-8723	for Drag Link;for Semi-Trailing Arm
	04/05→	Tie Rod	MN-DL-9380		Leaf Spring Axle
	04/05→	Track Control Arm		MN-TC-12471	Semi-Trailing Arm, 1st Drive Axle, for Pneumatic Suspension vehicles
10.210 FK, FLK, FLRK, FRK	04/05→	Ball Head, gearshift linkage	CV-ES-2120		
	04/05→	Centre Rod	MN-DL-9379		Push Rod
	04/05→	Tie Rod	MN-DL-9380		Leaf Spring Axle
	04/05→	Track Control Arm		MN-TC-12471	Semi-Trailing Arm, 1st Drive Axle, for Pneumatic Suspension vehicles
	10.220 FC, FLC, FRC, FLRC	04/05→	Ball Head, gearshift linkage	CV-ES-2120	
04/05→		Centre Rod	MN-DL-9379		Push Rod
04/05→		Track Control Arm		MN-TC-12471	Semi-Trailing Arm, 1st Drive Axle, for Pneumatic Suspension vehicles
10.220 FK, FLK, FLRK, FRK	04/05→	Ball Head, gearshift linkage	CV-ES-2120		
	04/05→	Centre Rod	MN-DL-9379		Push Rod
	04/05→	Track Control Arm		MN-TC-12471	Semi-Trailing Arm, 1st Drive Axle, for Pneumatic Suspension vehicles
10.240 FC, FRC, FLC, FLRC	04/05→	Ball Head, gearshift linkage	CV-ES-2120		
	04/05→	Centre Rod	MN-DL-9379		Push Rod
	04/05→	Suspension Arm Repair Kit		MN-RK-8723	for Drag Link;for Semi-Trailing Arm
	04/05→	Tie Rod	MN-DL-9380		Leaf Spring Axle
	04/05→	Track Control Arm		MN-TC-12471	Semi-Trailing Arm, 1st Drive Axle, for Pneumatic Suspension vehicles
10.240 FK, FLK, FLRK, FRK	04/05→	Ball Head, gearshift linkage	CV-ES-2120		
	04/05→	Centre Rod	MN-DL-9379		Push Rod
	04/05→	Suspension Arm Repair Kit		MN-RK-8723	for Drag Link;for Semi-Trailing Arm
	04/05→	Tie Rod	MN-DL-9380		Leaf Spring Axle
	04/05→	Track Control Arm		MN-TC-12471	Semi-Trailing Arm, 1st Drive Axle, for Pneumatic Suspension vehicles
10.250 FC, FLC, FRC, FLRC	04/05→	Ball Head, gearshift linkage	CV-ES-2120		
	04/05→	Centre Rod	MN-DL-9379		Push Rod
	04/05→	Suspension Arm Repair Kit		MN-RK-8723	for Drag Link;for Semi-Trailing Arm
	04/05→	Track Control Arm		MN-TC-12471	Semi-Trailing Arm, 1st Drive Axle, for Pneumatic Suspension vehicles
	10.250 FK, FLK, FLRK, FRK	04/05→	Ball Head, gearshift linkage	CV-ES-2120	
04/05→		Centre Rod	MN-DL-9379		Push Rod
04/05→		Suspension Arm Repair Kit		MN-RK-8723	for Drag Link;for Semi-Trailing Arm
04/05→		Track Control Arm		MN-TC-12471	Semi-Trailing Arm, 1st Drive Axle, for Pneumatic Suspension vehicles
12.180 FC, FRC, FLC, FLRC		04/05→	Ball Head, gearshift linkage	CV-ES-2120	
	04/05→	Centre Rod	MN-DL-9379		Push Rod
	04/05→	Suspension Arm Repair Kit		MN-RK-8723	for Drag Link;for Semi-Trailing Arm
	04/05→	Tie Rod	MN-DL-9380		Leaf Spring Axle
	04/05→	Track Control Arm		MN-TC-12471	Semi-Trailing Arm, 1st Drive Axle, for Pneumatic Suspension vehicles
12.180 FK, FLK, FLRK, FRK	04/05→	Ball Head, gearshift linkage	CV-ES-2120		
	04/05→	Centre Rod	MN-DL-9379		Push Rod
	04/05→	Tie Rod	MN-DL-9380		Leaf Spring Axle
	04/05→	Track Control Arm		MN-TC-12471	Semi-Trailing Arm, 1st Drive Axle, for Pneumatic Suspension vehicles

CV-ES-2120

Length: 115

Cone Ø: d1 Ø 12,4 / d2 Ø 10,8

Thread: M14 x 1,5 RHT

03008500A, 81953016200, 81953016202,
81953016203, 81953016227



MN-DL-9379

Length: 820

Ø: 38

Cone Ø: d1 Ø 22 / d2 Ø 20

85466106162



MN-DL-9380

Length: 1632

Ø: 38

Cone Ø: d1 Ø 22 / d2 Ø 20

81467116803, 81467116893, 81467116894,
81467116896



MN-RK-8723

Length: 100 Ø: 46

Hole Distance: 60

81432506009



MN-TC-12471

Length: 840

Ø: 50

81432506014



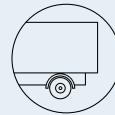

TGL ...

12.210 FC, FRC, FLC, FLRC	04/05 →	Ball Head, gearshift linkage	CV-ES-2120		
	04/05 →	Centre Rod	MN-DL-9379		Push Rod
	04/05 →	Suspension Arm Repair Kit		MN-RK-8723	for Drag Link;for Semi-Trailing Arm
	04/05 →	Tie Rod	MN-DL-9380		Leaf Spring Axle
	04/05 →	Track Control Arm		MN-TC-12471	Semi-Trailing Arm, 1st Drive Axle, for Pneumatic Suspension vehicles
12.210 FK, FLK, FLRK, FRK	04/05 →	Ball Head, gearshift linkage	CV-ES-2120		
	04/05 →	Centre Rod	MN-DL-9379		Push Rod
	04/05 →	Tie Rod	MN-DL-9380		Leaf Spring Axle
	04/05 →	Track Control Arm		MN-TC-12471	Semi-Trailing Arm, 1st Drive Axle, for Pneumatic Suspension vehicles
12.220 FC, FRC, FLC, FLRC	04/05 →	Ball Head, gearshift linkage	CV-ES-2120		
	04/05 →	Centre Rod	MN-DL-9379		Push Rod
	04/05 →	Track Control Arm		MN-TC-12471	Semi-Trailing Arm, 1st Drive Axle, for Pneumatic Suspension vehicles
12.220 FK, FLK, FLRK, FRK	04/05 →	Ball Head, gearshift linkage	CV-ES-2120		
	04/05 →	Centre Rod	MN-DL-9379		Push Rod
	04/05 →	Track Control Arm		MN-TC-12471	Semi-Trailing Arm, 1st Drive Axle, for Pneumatic Suspension vehicles
12.240 FC, FRC, FLC, FLRC	04/05 →	Ball Head, gearshift linkage	CV-ES-2120		
	04/05 →	Centre Rod	MN-DL-9379		Push Rod
	04/05 →	Suspension Arm Repair Kit		MN-RK-8723	for Drag Link;for Semi-Trailing Arm
	04/05 →	Tie Rod	MN-DL-9380		Leaf Spring Axle
	04/05 →	Track Control Arm		MN-TC-12471	Semi-Trailing Arm, 1st Drive Axle, for Pneumatic Suspension vehicles
12.240 FK, FLK, FLRK, FRK	04/05 →	Ball Head, gearshift linkage	CV-ES-2120		
	04/05 →	Centre Rod	MN-DL-9379		Push Rod
	04/05 →	Suspension Arm Repair Kit		MN-RK-8723	for Drag Link;for Semi-Trailing Arm
	04/05 →	Tie Rod	MN-DL-9380		Leaf Spring Axle
	04/05 →	Track Control Arm		MN-TC-12471	Semi-Trailing Arm, 1st Drive Axle, for Pneumatic Suspension vehicles
12.250 FC, FLC, FRC, FLRC	04/05 →	Ball Head, gearshift linkage	CV-ES-2120		
	04/05 →	Centre Rod	MN-DL-9379		Push Rod
	04/05 →	Suspension Arm Repair Kit		MN-RK-8723	for Drag Link;for Semi-Trailing Arm
	04/05 →	Track Control Arm		MN-TC-12471	Semi-Trailing Arm, 1st Drive Axle, for Pneumatic Suspension vehicles
12.250 FK, FLK, FLRK, FRK	04/05 →	Ball Head, gearshift linkage	CV-ES-2120		
	04/05 →	Centre Rod	MN-DL-9379		Push Rod
	04/05 →	Suspension Arm Repair Kit		MN-RK-8723	for Drag Link;for Semi-Trailing Arm
	04/05 →	Track Control Arm		MN-TC-12471	Semi-Trailing Arm, 1st Drive Axle, for Pneumatic Suspension vehicles
7.150, 8.150 FC, FRC, FLC, FLRC	04/05 →	Ball Head, gearshift linkage	CV-ES-2120		
	04/05 →	Centre Rod	MN-DL-8377		Push Rod
	04/05 →	Centre Rod	MN-DL-8662		Push Rod, for Leaf-Spring Suspension vehicles
	04/05 →	Centre Rod	MN-DL-12394		for Steering Rod
	04/05 →	Suspension Arm Repair Kit		MN-RK-8723	for Drag Link;for Semi-Trailing Arm
	04/05 →	Tie Rod End	CV-ES-12462		for Steering Rod
7.180, 8.180 FC, FLC, FRC, FLRC	04/05 →	Track Control Arm		MN-DL-9381	Control Arm, Air Suspension Axle
	04/05 →	Centre Rod	MN-DL-8377		Push Rod
	04/05 →	Centre Rod	MN-DL-8662		Push Rod, for Leaf-Spring Suspension vehicles
	04/05 →	Centre Rod	MN-DL-12394		for Steering Rod
	04/05 →	Suspension Arm Repair Kit		MN-RK-8723	for Drag Link;for Semi-Trailing Arm
	04/05 →	Tie Rod	MN-DL-9380		Leaf Spring Axle
8.150 FK, FK-L, FLK, FLK-L, FLRK, FLRK-L, FRK, FRK-L	04/05 →	Tie Rod End	CV-ES-12462		for Steering Rod
	04/05 →	Track Control Arm		MN-DL-9381	Control Arm, Air Suspension Axle
	10/06 →	Ball Head, gearshift linkage	CV-ES-2120		
	10/06 →	Centre Rod	MN-DL-8377		Push Rod
	10/06 →	Centre Rod	MN-DL-8662		Push Rod, for Leaf-Spring Suspension vehicles
	10/06 →	Centre Rod	MN-DL-12394		for Steering Rod
	10/06 →	Suspension Arm Repair Kit		MN-RK-8723	for Drag Link;for Semi-Trailing Arm
	10/06 →	Tie Rod	MN-DL-9380		Leaf Spring Axle
	10/06 →	Tie Rod End	CV-ES-12462		for Steering Rod
	10/06 →	Track Control Arm		MN-DL-9381	Control Arm

CV-ES-2120

Length: 115
Cone Ø: d1 Ø 12,4 / d2 Ø 10,8
Thread: M14 x 1,5 RHT
03008500A, 81953016200, 81953016202,
81953016203, 81953016227



MN-DL-9380

Length: 1632
Ø: 38
Cone Ø: d1 Ø 22 / d2 Ø 20
81467116803, 81467116893, 81467116894,
81467116896



CV-ES-12462

Length: 120
Cone Ø: d1 Ø 26 / d2 Ø 23,5
Thread: M30 x 1,5 RHT
90804102218, 90804153111, 81953010014,
81953010042, 81953010064, 81953010068,
81953016065, 81953016067, 81953016073,
81953016162, 81953016239, 81953016240,
81953016246, 81953016250, 81953016272,
81953016282, 81953016319, 81953016360,
82953016014



MN-DL-9381

Length: 840 Ø: 40
81432506007



MN-DL-12394

Length: 864
Ø: 38
Cone Ø: d1 Ø 22 / d2 Ø 20
85466106160, 85466106246



MN-DL-8377

Length: 795
Ø: 38
Cone Ø: d1 Ø 26 / d2 Ø 23,5
85461106141, 85466106105, 85466106141,
85466106205, 85466106231



MN-RK-8723

Length: 100 Ø: 46
Hole Distance: 60
81432506009



MN-DL-8662

Length: 860
Ø: 38
Cone Ø: d1 Ø 26 / d2 Ø 23,5
85466106012, 85466106112, 85466106142,
85466106212



MN-TC-12471

Length: 840
Ø: 50
81432506014



MN-DL-9379

Length: 820
Ø: 38
Cone Ø: d1 Ø 22 / d2 Ø 20
85466106162





TGL ...

8.180 FC, FRC, FLC, FLRC	04/05 →	Ball Head, gearshift linkage	CV-ES-2120		
	04/05 →	Centre Rod	MN-DL-8377		Push Rod
	04/05 →	Centre Rod	MN-DL-8662		Push Rod, for Leaf-Spring Suspension vehicles
	04/05 →	Centre Rod	MN-DL-12394		for Steering Rod
	04/05 →	Suspension Arm Repair Kit		MN-RK-8723	for Drag Link;for Semi-Trailing Arm
	04/05 →	Tie Rod	MN-DL-9380		Leaf Spring Axle
	04/05 →	Tie Rod End	CV-ES-12462		for Steering Rod
	04/05 →	Track Control Arm		MN-DL-9381	Control Arm, Air Suspension Axle
8.180 FK, FK-L, FLK, FLK-L, FLRK, FLRK-L, FRK, FRK-L	04/05 →	Ball Head, gearshift linkage	CV-ES-2120		
	04/05 →	Centre Rod	MN-DL-8377		Push Rod
	04/05 →	Centre Rod	MN-DL-8662		Push Rod, for Leaf-Spring Suspension vehicles
	04/05 →	Centre Rod	MN-DL-12394		for Steering Rod
	04/05 →	Suspension Arm Repair Kit		MN-RK-8723	for Drag Link;for Semi-Trailing Arm
	04/05 →	Tie Rod	MN-DL-9380		Leaf Spring Axle
	04/05 →	Tie Rod End	CV-ES-12462		for Steering Rod
	04/05 →	Track Control Arm		MN-DL-9381	Control Arm
8.210 FC, FRC, FLC, FLRC	04/05 →	Ball Head, gearshift linkage	CV-ES-2120		
	04/05 →	Centre Rod	MN-DL-8377		Push Rod
	04/05 →	Centre Rod	MN-DL-8662		Push Rod, for Leaf-Spring Suspension vehicles
	04/05 →	Centre Rod	MN-DL-12394		for Steering Rod
	04/05 →	Suspension Arm Repair Kit		MN-RK-8723	for Drag Link;for Semi-Trailing Arm
	04/05 →	Tie Rod	MN-DL-9380		Leaf Spring Axle
	04/05 →	Tie Rod End	CV-ES-12462		for Steering Rod
	04/05 →	Track Control Arm		MN-DL-9381	Control Arm, Air Suspension Axle
8.210 FK, FK-L, FLK, FLK-L, FLRK, FLRK-L, FRK, FRK-L	04/05 →	Ball Head, gearshift linkage	CV-ES-2120		
	04/05 →	Centre Rod	MN-DL-8377		Push Rod
	04/05 →	Centre Rod	MN-DL-8662		Push Rod, for Leaf-Spring Suspension vehicles
	04/05 →	Centre Rod	MN-DL-12394		for Steering Rod
	04/05 →	Suspension Arm Repair Kit		MN-RK-8723	for Drag Link;for Semi-Trailing Arm
	04/05 →	Tie Rod	MN-DL-9380		Leaf Spring Axle
	04/05 →	Tie Rod End	CV-ES-12462		for Steering Rod
	04/05 →	Track Control Arm		MN-DL-9381	Control Arm
8.220 FC, FLC, FRC, FLRC	04/05 →	Ball Head, gearshift linkage	CV-ES-2120		
	04/05 →	Centre Rod	MN-DL-12394		for Steering Rod
	04/05 →	Suspension Arm Repair Kit		MN-RK-8723	for Drag Link;for Semi-Trailing Arm
	04/05 →	Tie Rod End	CV-ES-12462		for Steering Rod
	04/05 →	Track Control Arm		MN-DL-9381	Control Arm
8.220 FK, FK-L, FLK, FLK-L, FLRK, FLRK-L, FRK, FRK-L	04/05 →	Ball Head, gearshift linkage	CV-ES-2120		
	04/05 →	Centre Rod	MN-DL-12394		for Steering Rod
	04/05 →	Suspension Arm Repair Kit		MN-RK-8723	for Drag Link;for Semi-Trailing Arm
	04/05 →	Tie Rod End	CV-ES-12462		for Steering Rod
	04/05 →	Track Control Arm		MN-DL-9381	Control Arm
8.240 FC, FRC, FLC, FLRC	04/05 →	Ball Head, gearshift linkage	CV-ES-2120		
	04/05 →	Centre Rod	MN-DL-8377		Push Rod
	04/05 →	Centre Rod	MN-DL-8662		Push Rod, for Leaf-Spring Suspension vehicles
	04/05 →	Centre Rod	MN-DL-12394		for Steering Rod
	04/05 →	Suspension Arm Repair Kit		MN-RK-8723	for Drag Link;for Semi-Trailing Arm
	04/05 →	Tie Rod	MN-DL-9380		Leaf Spring Axle
	04/05 →	Tie Rod End	CV-ES-12462		for Steering Rod
	04/05 →	Track Control Arm		MN-DL-9381	Control Arm, Air Suspension Axle
	04/05 →	Track Control Arm		MN-TC-12471	Semi-Trailing Arm, 1st Drive Axle, for Pneumatic Suspension vehicles
8.240 FK, FK-L, FLK, FLK-L, FLRK, FLRK-L, FRK, FRK-L	04/05 →	Ball Head, gearshift linkage	CV-ES-2120		
	04/05 →	Centre Rod	MN-DL-8377		Push Rod
	04/05 →	Centre Rod	MN-DL-8662		Push Rod, for Leaf-Spring Suspension vehicles
	04/05 →	Centre Rod	MN-DL-12394		for Steering Rod
	04/05 →	Suspension Arm Repair Kit		MN-RK-8723	for Drag Link;for Semi-Trailing Arm
	04/05 →	Tie Rod	MN-DL-9380		Leaf Spring Axle
	04/05 →	Tie Rod End	CV-ES-12462		for Steering Rod
	04/05 →	Track Control Arm		MN-DL-9381	Control Arm
	04/05 →	Track Control Arm		MN-TC-12471	Semi-Trailing Arm, 1st Drive Axle, for Pneumatic Suspension vehicles

CV-ES-2120

Length: 115
Cone Ø: d1 Ø 12,4 / d2 Ø 10,8
Thread: M14 x 1,5 RHT
03008500A, 81953016200, 81953016202,
81953016203, 81953016227



MN-DL-12394

Length: 864
Ø: 38
Cone Ø: d1 Ø 22 / d2 Ø 20
85466106160, 85466106246



CV-ES-12462

Length: 120
Cone Ø: d1 Ø 26 / d2 Ø 23,5
Thread: M30 x 1,5 RHT
90804102218, 90804153111, 81953010014,
81953010042, 81953010064, 81953010068,
81953016065, 81953016067, 81953016073,
81953016162, 81953016239, 81953016240,
81953016246, 81953016250, 81953016272,
81953016282, 81953016319, 81953016360,
82953016014



MN-RK-8723

Length: 100 Ø: 46
Hole Distance: 60
81432506009



MN-TC-12471

Length: 840
Ø: 50
81432506014



MN-DL-8377

Length: 795
Ø: 38
Cone Ø: d1 Ø 26 / d2 Ø 23,5
85461106141, 85466106105, 85466106141,
85466106205, 85466106231



MN-DL-8662

Length: 860
Ø: 38
Cone Ø: d1 Ø 26 / d2 Ø 23,5
85466106012, 85466106112, 85466106142,
85466106212



MN-DL-9380

Length: 1632
Ø: 38
Cone Ø: d1 Ø 22 / d2 Ø 20
81467116803, 81467116893, 81467116894,
81467116896



MN-DL-9381

Length: 840 Ø: 40
81432506007





TGL ...

8.250 FC, FLC, FLRC, FRC	04/05→	Ball Head, gearshift linkage	CV-ES-2120	
	04/05→	Centre Rod	MN-DL-8377	Push Rod
	04/05→	Centre Rod	MN-DL-8662	Push Rod
	04/05→	Centre Rod	MN-DL-12394	for Steering Rod
	04/05→	Suspension Arm Repair Kit		MN-RK-8723 for Drag Link;for Semi-Trailing Arm
	04/05→	Tie Rod	MN-DL-9380	
	04/05→	Tie Rod End	CV-ES-12462	for Steering Rod
	04/05→	Track Control Arm		MN-DL-9381 Control Arm
	04/05→	Track Control Arm		MN-TC-12471 Semi-Trailing Arm, 1st Drive Axle, for Pneumatic Suspension vehicles
8.250 FK, FK-L, FLK, FLK-L, FLRK, FLRK-L, FRK, FRK-L	04/05→	Ball Head, gearshift linkage	CV-ES-2120	
	04/05→	Centre Rod	MN-DL-8377	Push Rod
	04/05→	Centre Rod	MN-DL-8662	Push Rod
	04/05→	Centre Rod	MN-DL-12394	for Steering Rod
	04/05→	Suspension Arm Repair Kit		MN-RK-8723 for Drag Link;for Semi-Trailing Arm
	04/05→	Tie Rod	MN-DL-9380	
	04/05→	Tie Rod End	CV-ES-12462	for Steering Rod
	04/05→	Track Control Arm		MN-DL-9381 Control Arm
	04/05→	Track Control Arm		MN-TC-12471 Semi-Trailing Arm, 1st Drive Axle, for Pneumatic Suspension vehicles

TGM

12.240 FLC, FLLC	10/05→	Ball Head, gearshift linkage	CV-ES-2120	
	10/05→	Centre Rod	MN-DL-12291	Push Rod
	10/05→	Tie Rod	MN-DL-9380	Leaf Spring Axle
	10/05→	Tie Rod	MN-DL-12365	
	10/05→	Track Control Arm		MN-TC-12397 Suspension Rod, Control Arm
12.250 FLC, FLLC	10/05→	Ball Head, gearshift linkage	CV-ES-2120	
	10/05→	Centre Rod	MN-DL-12291	Push Rod
	10/05→	Tie Rod	MN-DL-12365	
12.280 FC, FLC, FLLC	10/05→	Ball Head, gearshift linkage	CV-ES-2120	
	10/05→	Centre Rod	MN-DL-12291	Push Rod
	10/05→	Tie Rod	MN-DL-9380	Leaf Spring Axle
	10/05→	Tie Rod	MN-DL-12365	
	10/05→	Track Control Arm		MN-TC-12397 Suspension Rod, Control Arm
12.290 FLC, FLLC	10/05→	Ball Head, gearshift linkage	CV-ES-2120	
	10/05→	Centre Rod	MN-DL-12291	Push Rod
	10/05→	Tie Rod	MN-DL-12365	
13.240 FAL, FALC, FALRC, FAEC, FAERC, FALR	04/06→	Ball Head, gearshift linkage	CV-ES-2120	
	04/06→	Track Control Arm		MN-TC-12397 Suspension Rod, Control Arm
13.240 FALK, FALRK, FALK-L, FALRK-L	04/06→	Ball Head, gearshift linkage	CV-ES-2120	
13.250 FAEC, FAERC, FALC, FAL, FALRC, FALR	10/05→	Ball Head, gearshift linkage	CV-ES-2120	
	10/05→	Ball Head, gearshift linkage	CV-ES-2120	
13.280 FAEC, FAERC, FAL, FALC, FALRC	04/06→	Ball Head, gearshift linkage	CV-ES-2120	
	04/06→	Track Control Arm		MN-TC-12397 Suspension Rod, Control Arm
13.280 FALK, FALRK, FALK-L, FALRK-L	04/06→	Ball Head, gearshift linkage	CV-ES-2120	
13.290 FAEC, FAERC, FAL, FALR, FALC, FALRC	10/05→	Ball Head, gearshift linkage	CV-ES-2120	
	10/05→	Ball Head, gearshift linkage	CV-ES-2120	
15.240 FC, FLC, FLLC, FLRC, FLLRC	10/05→	Ball Head, gearshift linkage	CV-ES-2120	
	10/05→	Centre Rod	MN-DL-10203	Push Rod
	10/05→	Centre Rod	MN-DL-12291	Push Rod
	10/05→	Tie Rod	MN-DL-7802	
	10/05→	Tie Rod	MN-DL-9380	Leaf Spring Axle
	10/05→	Tie Rod	MN-DL-12365	
	10/05→	Track Control Arm		MN-TC-12397 Suspension Rod, Control Arm
15.240 FLK, FLRK	10/05→	Ball Head, gearshift linkage	CV-ES-2120	
	10/05→	Centre Rod	MN-DL-10203	Push Rod
	10/05→	Tie Rod	MN-DL-7802	

CV-ES-2120

Length: 115
Cone Ø: d1 Ø 12,4 / d2 Ø 10,8
Thread: M14 x 1,5 RHT
03008500A, 81953016200, 81953016202,
81953016203, 81953016227



CV-ES-12462

Length: 120
Cone Ø: d1 Ø 26 / d2 Ø 23,5
Thread: M30 x 1,5 RHT
90804102218, 90804153111, 81953010014,
81953010042, 81953010064, 81953010068,
81953016065, 81953016067, 81953016073,
81953016162, 81953016239, 81953016240,
81953016246, 81953016250, 81953016272,
81953016282, 81953016319, 81953016360,
82953016014



MN-DL-7802

Length: 1680 Ø: 52
Cone Ø: d1 Ø 30 / d2 Ø 27
03208300A, 81467116773, 81467116858,
81467116859, 81467116860, 81467116861,
81467116863, 81467116882, 81467116883,
81467116920, 81467116921



MN-DL-8377

Length: 795
Ø: 38
Cone Ø: d1 Ø 26 / d2 Ø 23,5
85461106141, 85466106105, 85466106141,
85466106205, 85466106231



MN-DL-8662

Length: 860
Ø: 38
Cone Ø: d1 Ø 26 / d2 Ø 23,5
85466106012, 85466106112, 85466106142,
85466106212



MN-DL-9380

Length: 1632
Ø: 38
Cone Ø: d1 Ø 22 / d2 Ø 20
81467116803, 81467116893, 81467116894,
81467116896



MN-DL-9381

Length: 840 Ø: 40
81432506007



MN-DL-10203

Length: 882
Ø: 42
Cone Ø: d1 Ø 30 / d2 Ø 26
85466106163



MN-DL-12291

Length: 926
Ø: 38
Cone Ø: d1 Ø 26 / d2 Ø 23,5
85.46610.6056

No Image

MN-DL-12365

Length: 1680
Ø: 50
Cone Ø: d1 Ø 26 / d2 Ø 23,5
81467116818, 81467116819, 81467116887



MN-DL-12394

Length: 864
Ø: 38
Cone Ø: d1 Ø 22 / d2 Ø 20
85466106160, 85466106246



MN-RK-8723

Length: 100 Ø: 46
Hole Distance: 60
81432506009



MN-TC-12397

Length: 661
Ø: 40
Hole Distance: 130 / 130
81432206319, 81432206325



MN-TC-12471

Length: 840
Ø: 50
81432506014



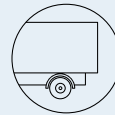

TGM ...

15.250 FC, FLC, FLRC, FLLC, FLLRC	10/05→	Ball Head, gearshift linkage	CV-ES-2120		
	10/05→	Centre Rod	MN-DL-10203		Push Rod
	10/05→	Centre Rod	MN-DL-12291		Push Rod
	10/05→	Tie Rod	MN-DL-7802		
	10/05→	Tie Rod	MN-DL-12365		
15.250 FK, FK-L, FLK, FLK-L, FLRK	10/05→	Ball Head, gearshift linkage	CV-ES-2120		
	10/05→	Centre Rod	MN-DL-10203		Push Rod
	10/05→	Tie Rod	MN-DL-7802		
15.280 FC, FLC, FLLC, FLRC, FLLRC	10/05→	Ball Head, gearshift linkage	CV-ES-2120		
	10/05→	Centre Rod	MN-DL-12291		Push Rod
	10/05→	Tie Rod	MN-DL-9380		Leaf Spring Axle
	10/05→	Tie Rod	MN-DL-12365		
	10/05→	Track Control Arm		MN-TC-12397	Suspension Rod, Control Arm
15.280 FLK, FLRK	10/05→	Ball Head, gearshift linkage	CV-ES-2120		
	10/05→	Centre Rod	MN-DL-10203		Push Rod
	10/05→	Tie Rod	MN-DL-7802		
15.290 FC, FLC, FLRC, FLLC, FLLRC	10/05→	Ball Head, gearshift linkage	CV-ES-2120		
	10/05→	Centre Rod	MN-DL-10203		Push Rod
	10/05→	Centre Rod	MN-DL-12291		Push Rod
	10/05→	Tie Rod	MN-DL-7802		
	10/05→	Tie Rod	MN-DL-12365		
15.290 FK, FK-L, FLK, FLK-L, FLRK	10/05→	Ball Head, gearshift linkage	CV-ES-2120		
	10/05→	Centre Rod	MN-DL-10203		Push Rod
	10/05→	Tie Rod	MN-DL-7802		
15.330 FC, FLC, FRC, FLRC	10/05→	Ball Head, gearshift linkage	CV-ES-2120		
	10/05→	Centre Rod	MN-DL-10203		Push Rod
	10/05→	Tie Rod	MN-DL-7802		
15.330 FLK, FLRK	10/05→	Ball Head, gearshift linkage	CV-ES-2120		
	10/05→	Centre Rod	MN-DL-10203		Push Rod
	10/05→	Tie Rod	MN-DL-7802		
15.340 FC, FLC, FLRC	10/05→	Ball Head, gearshift linkage	CV-ES-2120		
	10/05→	Centre Rod	MN-DL-10203		Push Rod
	10/05→	Tie Rod	MN-DL-7802		
15.340 FK, FK-L, FLK, FLK-L, FLRK	10/05→	Ball Head, gearshift linkage	CV-ES-2120		
	10/05→	Centre Rod	MN-DL-10203		Push Rod
	10/05→	Tie Rod	MN-DL-7802		
18.240 FAC, FARC	10/05→	Ball Head, gearshift linkage	CV-ES-2120		
18.240 FAK, FARK, FAK-L, FARK-L	05/06→	Ball Head, gearshift linkage	CV-ES-2120		
18.240 FC, FRC, FLC, FLRC, FLLC, FLLRC	10/05→	Centre Rod	MN-DL-10203		Push Rod
	10/05→	Tie Rod	MN-DL-7802		
	10/05→	Tie Rod	MN-DL-9380		Leaf Spring Axle
	10/05→	Track Control Arm		MN-TC-12397	Suspension Rod, Control Arm
18.240 FK, FK-L, FLK, FLK-L, FLRK, FLRK-L, FRK, FRK-L	10/05→	Ball Head, gearshift linkage	CV-ES-2120		
	10/05→	Centre Rod	MN-DL-10203		Push Rod
	10/05→	Tie Rod	MN-DL-7802		
	10/05→	Tie Rod	MN-DL-9380		Leaf Spring Axle
18.250 FAC, FARC	10/05→	Ball Head, gearshift linkage	CV-ES-2120		
18.250 FAK, FARK, FAK-L, FARK-L	10/05→	Ball Head, gearshift linkage	CV-ES-2120		
18.250 FC, FLC, FLLC, FRC, FLRC, FLLRC	0/05→	Ball Head, gearshift linkage	CV-ES-2120		
	10/05→	Centre Rod	MN-DL-10203		Push Rod
	10/05→	Tie Rod	MN-DL-7802		
18.250 FK, FK-L, FLK, FLK-L, FLRK, FLRK-L, FRK, FRK-L	10/05→	Ball Head, gearshift linkage	CV-ES-2120		
	10/05→	Centre Rod	MN-DL-10203		Push Rod
	10/05→	Tie Rod	MN-DL-7802		
18.280 FAC, FARC	10/05→	Ball Head, gearshift linkage	CV-ES-2120		
18.280 FAK, FARK, FAK-L, FARK-L	10/05→	Ball Head, gearshift linkage	CV-ES-2120		
18.280 FC, FRC, FLC, FLRC, FLLC, FLLRC	10/05→	Ball Head, gearshift linkage	CV-ES-2120		
	10/05→	Centre Rod	MN-DL-10203		Push Rod
	10/05→	Tie Rod	MN-DL-7802		
	10/05→	Tie Rod	MN-DL-9380		Leaf Spring Axle
	10/05→	Track Control Arm		MN-TC-12397	Suspension Rod, Control Arm

CV-ES-2120

Length: 115

Cone Ø: d1 Ø 12,4 / d2 Ø 10,8

Thread: M14 x 1,5 RHT

03008500A, 81953016200, 81953016202,
81953016203, 81953016227



MN-TC-12397

Length: 661

Ø: 40

Hole Distance: 130 / 130

81432206319, 81432206325



MN-DL-7802

Length: 1680 Ø: 52

Cone Ø: d1 Ø 30 / d2 Ø 27

03208300A, 81467116773, 81467116858,
81467116859, 81467116860, 81467116861,
81467116863, 81467116882, 81467116883,
81467116920, 81467116921



MN-DL-9380

Length: 1632

Ø: 38

Cone Ø: d1 Ø 22 / d2 Ø 20

81467116803, 81467116893, 81467116894,
81467116896



MN-DL-10203

Length: 882

Ø: 42

Cone Ø: d1 Ø 30 / d2 Ø 26

85466106163



MN-DL-12291

Length: 926

Ø: 38

Cone Ø: d1 Ø 26 / d2 Ø 23,5

85.46610.6056

No Image

MN-DL-12365

Length: 1680

Ø: 50

Cone Ø: d1 Ø 26 / d2 Ø 23,5

81467116818, 81467116819, 81467116887





TGM ...

18.280 FK, FK-L, FLK, FLK-L, FLRK, FLRK-L, FRK, FRK-L	10/05 →	Ball Head, gearshift linkage	CV-ES-2120	
	10/05 →	Centre Rod	MN-DL-10203	Push Rod
	10/05 →	Tie Rod	MN-DL-7802	
	10/05 →	Tie Rod	MN-DL-9380	Leaf Spring Axle
18.290 FAC, FARC	10/05 →	Ball Head, gearshift linkage	CV-ES-2120	
18.290 FAK, FARK, FAK-L, FARK-L	10/05 →	Ball Head, gearshift linkage	CV-ES-2120	
	10/05 →	Ball Head, gearshift linkage	CV-ES-2120	
	10/05 →	Centre Rod	MN-DL-10203	Push Rod
18.290 FC, FLC, FRC, FLRC, FLLC, FLLRC	10/05 →	Ball Head, gearshift linkage	CV-ES-2120	
	10/05 →	Centre Rod	MN-DL-10203	Push Rod
	10/05 →	Tie Rod	MN-DL-7802	
18.290 FK, FK-L, FLK, FLK-L, FLRK, FLRK-L, FRK, FRK-L	10/05 →	Ball Head, gearshift linkage	CV-ES-2120	
	10/05 →	Centre Rod	MN-DL-10203	Push Rod
	10/05 →	Tie Rod	MN-DL-7802	
18.330 FAC, FARC	10/05 →	Ball Head, gearshift linkage	CV-ES-2120	
18.330 FAK, FARK, FAK-L, FARK-L	10/05 →	Ball Head, gearshift linkage	CV-ES-2120	
	10/05 →	Ball Head, gearshift linkage	CV-ES-2120	
	10/05 →	Centre Rod	MN-DL-10203	Push Rod
18.330 FC, FRC, FLC, FLRC, FLLC, FLLRC	10/05 →	Ball Head, gearshift linkage	CV-ES-2120	
	10/05 →	Centre Rod	MN-DL-10203	Push Rod
	10/05 →	Tie Rod	MN-DL-7802	
18.330 FK, FK-L, FLK, FLK-L, FLRK, FLRK-L, FRK, FRK-L	10/05 →	Ball Head, gearshift linkage	CV-ES-2120	
	10/05 →	Centre Rod	MN-DL-10203	Push Rod
	10/05 →	Tie Rod	MN-DL-7802	
18.340 FAC, FARC	10/05 →	Ball Head, gearshift linkage	CV-ES-2120	
	10/05 →	Ball Head, gearshift linkage	CV-ES-2120	
	10/05 →	Ball Head, gearshift linkage	CV-ES-2120	
	10/05 →	Centre Rod	MN-DL-10203	Push Rod
18.340 FAK, FARK, FAK-L, FARK-L	10/05 →	Ball Head, gearshift linkage	CV-ES-2120	
	10/05 →	Ball Head, gearshift linkage	CV-ES-2120	
	10/05 →	Centre Rod	MN-DL-10203	Push Rod
18.340 FC, FLC, FLRC, FLLC, FLLRC, FRC	10/05 →	Ball Head, gearshift linkage	CV-ES-2120	
	10/05 →	Centre Rod	MN-DL-10203	Push Rod
	10/05 →	Tie Rod	MN-DL-7802	
18.340 FK, FK-L, FLK, FLK-L, FLRK, FLRK-L, FRK, FRK-L	10/05 →	Ball Head, gearshift linkage	CV-ES-2120	
	10/05 →	Centre Rod	MN-DL-10203	Push Rod
	10/05 →	Tie Rod	MN-DL-7802	
22.240 FNLLC	10/05 →	Ball Head, gearshift linkage	CV-ES-2120	
	10/05 →	Centre Rod	MN-DL-12291	Push Rod
	10/05 →	Tie Rod	MN-DL-12365	
22.250 FNLLC	10/05 →	Ball Head, gearshift linkage	CV-ES-2120	
	10/05 →	Centre Rod	MN-DL-12291	Push Rod
	10/05 →	Tie Rod	MN-DL-12365	
22.280 FNLC, FNLLC, FNLLRC, FNLRC	10/05 →	Ball Head, gearshift linkage	CV-ES-2120	
	10/05 →	Centre Rod	MN-DL-12291	Push Rod
	10/05 →	Tie Rod	MN-DL-12365	
22.290 FNLC, 22.290 FNLLC	10/05 →	Ball Head, gearshift linkage	CV-ES-2120	
	10/05 →	Centre Rod	MN-DL-12291	Push Rod
	10/05 →	Tie Rod	MN-DL-12365	
26.280 FD	10/05 →	Ball Head, gearshift linkage	CV-ES-2120	
	10/05 →	Centre Rod	MN-DL-10203	Push Rod
	10/05 →	Suspension Strut Repair Kit		DB-RK-8581
	10/05 →	Tie Rod	MN-DL-7802	
	10/05 →	Track Control Arm		MN-VB-8514
26.280 FDK-HK, FDRK-HK	04/06 →	Ball Head, gearshift linkage	CV-ES-2120	
	04/06 →	Centre Rod	MN-DL-10203	Push Rod
	04/06 →	Suspension Strut Repair Kit		DB-RK-8581
	04/06 →	Tie Rod	MN-DL-7802	
	04/06 →	Track Control Arm		MN-VB-8514
26.280 FD-TM, FDR-TM	04/06 →	Ball Head, gearshift linkage	CV-ES-2120	
	04/06 →	Centre Rod	MN-DL-10203	Push Rod
	04/06 →	Suspension Strut Repair Kit		DB-RK-8581
	04/06 →	Tie Rod	MN-DL-7802	
	04/06 →	Track Control Arm		MN-VB-8514
26.280 FNLC, FNLLC, FNLRC, FNLLRC	10/05 →	Ball Head, gearshift linkage	CV-ES-2120	

CV-ES-2120

Length: 115

Cone Ø: d1 Ø 12,4 / d2 Ø 10,8

Thread: M14 x 1,5 RHT

03008500A, 81953016200, 81953016202,
81953016203, 81953016227



MN-DL-12365

Length: 1680

Ø: 50

Cone Ø: d1 Ø 26 / d2 Ø 23,5

81467116818, 81467116819, 81467116887



DB-RK-8581

Ø: 85

Hole Distance: 130

Thick/Height: 24

03305800A, 81432706105



MN-VB-8514

Length: 627 Ø: 48

Hole Ø 25 / 25 / 25

Hole Distance: 152 / 130 / 130

81432706087, 81432706088, 81432706094,
81432706095, 81432796094



MN-DL-7802

Length: 1680 Ø: 52

Cone Ø: d1 Ø 30 / d2 Ø 27

03208300A, 81467116773, 81467116858,
81467116859, 81467116860, 81467116861,
81467116863, 81467116882, 81467116883,
81467116920, 81467116921



MN-DL-9380

Length: 1632

Ø: 38

Cone Ø: d1 Ø 22 / d2 Ø 20

81467116803, 81467116893, 81467116894,
81467116896



MN-DL-10203

Length: 882

Ø: 42

Cone Ø: d1 Ø 30 / d2 Ø 26

85466106163



MN-DL-12291

Length: 926

Ø: 38

Cone Ø: d1 Ø 26 / d2 Ø 23,5

85.46610.6056

No Image



TGM ...

26.290 FD, FDR	10/05→	Ball Head, gearshift linkage	CV-ES-2120		
	10/05→	Centre Rod	MN-DL-10203		Push Rod
	10/05→	Suspension Strut Repair Kit		DB-RK-8581	
	10/05→	Tie Rod	MN-DL-7802		
	10/05→	Track Control Arm		MN-VB-8514	Suspension Rod, Wishbone (CV)
26.290 FDK-HK, FDRK-HK	10/05→	Ball Head, gearshift linkage	CV-ES-2120		
	10/05→	Centre Rod	MN-DL-10203		Push Rod
	10/05→	Suspension Strut Repair Kit		DB-RK-8581	
	10/05→	Tie Rod	MN-DL-7802		
	10/05→	Track Control Arm		MN-VB-8514	Suspension Rod, Wishbone (CV)
26.290 FD-TM, FDR-TM	07/08→	Ball Head, gearshift linkage	CV-ES-2120		
	07/08→	Track Control Arm		MN-VB-8514	Suspension Rod, Wishbone (CV)
26.290 FNLC, FNLLC, FNLRC, FNLLRC, FVL	10/05→	Ball Head, gearshift linkage	CV-ES-2120		
26.330 FD, FDR	10/05→	Ball Head, gearshift linkage	CV-ES-2120		
	10/05→	Centre Rod	MN-DL-10203		Push Rod
	10/05→	Suspension Strut Repair Kit		DB-RK-8581	
	10/05→	Tie Rod	MN-DL-7802		
	10/05→	Track Control Arm		MN-VB-8514	Suspension Rod, Wishbone (CV)
26.330 FDK-HK, FDRK-HK	04/06→	Ball Head, gearshift linkage	CV-ES-2120		
	04/06→	Centre Rod	MN-DL-10203		Push Rod
	04/06→	Suspension Strut Repair Kit		DB-RK-8581	
	04/06→	Tie Rod	MN-DL-7802		
26.330 FD-TM, FDR-TM	04/06→	Ball Head, gearshift linkage	CV-ES-2120		
	04/06→	Centre Rod	MN-DL-10203		Push Rod
	04/06→	Suspension Strut Repair Kit		DB-RK-8581	
	04/06→	Tie Rod	MN-DL-7802		
	04/06→	Track Control Arm		MN-VB-8514	Suspension Rod, Wishbone (CV), Drive Axle; Leaf Spring Axle
26.330 FNLC, FNLLC, FNLRC, FNLLRC, FVL	10/05→	Ball Head, gearshift linkage	CV-ES-2120		
26.340 FD, FDR	10/05→	Ball Head, gearshift linkage	CV-ES-2120		
	10/05→	Centre Rod	MN-DL-10203		Push Rod
	10/05→	Suspension Strut Repair Kit		DB-RK-8581	
	10/05→	Tie Rod	MN-DL-7802		
	10/05→	Track Control Arm		MN-VB-8514	Suspension Rod, Wishbone (CV)
26.340 FDK-HK, FDRK-HK	10/05→	Ball Head, gearshift linkage	CV-ES-2120		
	10/05→	Centre Rod	MN-DL-10203		Push Rod
	10/05→	Suspension Strut Repair Kit		DB-RK-8581	
	10/05→	Tie Rod	MN-DL-7802		
26.340 FD-TM, FDR-TM	07/08→	Ball Head, gearshift linkage	CV-ES-2120		
	07/08→	Track Control Arm		MN-VB-8514	Suspension Rod, Wishbone (CV)
	07/08→	Track Control Arm		MN-VB-8514	Suspension Rod, Wishbone (CV)
	07/08→	Track Control Arm		MN-VB-8514	Suspension Rod, Wishbone (CV)
26.340 FNLC, FNLLC, FNLRC, FNLLRC	10/05→	Ball Head, gearshift linkage	CV-ES-2120		

TGS

18.320 FAC, FHLC	10/07→	Centre Rod	MN-DL-7801		Push Rod, Leaf Spring Axle
	10/07→	Centre Rod	MN-DL-8646		Push Rod, Leaf Spring Axle
	10/07→	Suspension Strut Repair Kit		DB-RK-8581	
	10/07→	Tie Rod	MN-DL-7802		
	10/07→	Tie Rod	MN-DL-12293		
	10/07→	Track Control Arm		MN-DL-5225	Trailing Arm, Drive Axle; Air Suspension Axle
	10/07→	Track Control Arm		MN-DL-8544	Trailing Arm, Drive Axle; Air Suspension Axle
	10/07→	Track Control Arm		MN-VB-5238	Wishbone (CV), Drive Axle; Air Suspension Axle
	10/07→	Track Control Arm		MN-VB-8514	Suspension Rod, Wishbone (CV), Drive Axle; Air Suspension Axle
18.320 FAK, FAK-L, FALK, FALK-L, FHLC, FHLC/M	10/07→	Centre Rod	MN-DL-7801		Push Rod, Leaf Spring Axle
	10/07→	Centre Rod	MN-DL-8646		Push Rod, Leaf Spring Axle
	10/07→	Suspension Strut Repair Kit		DB-RK-8581	
	10/07→	Tie Rod	MN-DL-7802		

CV-ES-2120

Length: 115
Cone Ø: d1 Ø 12,4 / d2 Ø 10,8
Thread: M14 x 1,5 RHT
03008500A, 81953016200, 81953016202,
81953016203, 81953016227



DB-RK-8581

Ø: 85
Hole Distance: 130
Thick/Height: 24
03305800A, 81432706105



MN-DL-5225

Length: 572 Ø: 48
Hole Distance: 130 / 130
03301500A, 81432206229, 81432206236,
81432206267, 81432206270, 81432206272,
81432206304, 81432206305, 81432209236,
81432209267, 81432209272



MN-DL-7801

Length: 995 Ø: 52
Cone Ø: d1 Ø 30 / d2 Ø 27
81466106807, 81466106808, 81466116087,
81466116088, 81466116096, 81466116097,
81466116099, 81466116132, 81466116133,
81466116136, 81466116197, 81466116198,
81466116205



MN-DL-7802

Length: 1680 Ø: 52
Cone Ø: d1 Ø 30 / d2 Ø 27
03208300A, 81467116773, 81467116858,
81467116859, 81467116860, 81467116861,
81467116863, 81467116882, 81467116883,
81467116920, 81467116921



MN-DL-8544

Length: 596 Ø: 48
Hole Distance: 130 / 130
81432206196, 81432206232, 81432206233



MN-DL-8646

Length: 1021 Ø: 52
Cone Ø: d1 Ø 30 / d2 Ø 27
81466106811, 81466106812, 81466116138,
81466116139, 81466116201, 81466116202



MN-DL-10203

Length: 882
Ø: 42
Cone Ø: d1 Ø 30 / d2 Ø 26
85466106163



MN-DL-12293

Length: 1680 Ø: 42
Cone Ø: d1 Ø 30 / d2 Ø 27
81467106236, 81467106268, 81467106356,
81467116356, 81467116723, 81467116794,
81467116933, 81467116934, 81467116966



MN-VB-5238

Length: 627 Ø: 48
Hole Distance: 130 / 130
81432206221, 81432706096, 81432706114,
81432706116, 81432706121



MN-VB-8514

Length: 627 Ø: 48
Hole Ø 25 / 25 / 25
Hole Distance: 152 / 130 / 130
81432706087, 81432706088, 81432706094,
81432706095, 81432796094





TGS ...

18.320 FAK, FAK-L, FALK, FALK-L, FHLK, FHLK/M ...	10/07→	Tie Rod	MN-DL-12293		
	10/07→	Track Control Arm		MN-DL-5225	Trailing Arm, Drive Axle;Air Suspension Axle
	10/07→	Track Control Arm		MN-DL-8544	Trailing Arm, Drive Axle;Air Suspension Axle
	10/07→	Track Control Arm		MN-VB-5238	Wishbone (CV), Drive Axle;Air Suspension Axle
	10/07→	Track Control Arm		MN-VB-8514	Suspension Rod, Wishbone (CV)
18.320 FAS, FHLS, FHLS/M, FALS	10/07→	Centre Rod	MN-DL-7801		Push Rod, Leaf Spring Axle
	10/07→	Centre Rod	MN-DL-8646		Push Rod, Leaf Spring Axle
	10/07→	Suspension Strut Repair Kit		DB-RK-8581	
	10/07→	Tie Rod	MN-DL-7802		
	10/07→	Tie Rod	MN-DL-12293		
	10/07→	Track Control Arm		MN-DL-5225	Trailing Arm, Drive Axle;Air Suspension Axle
	10/07→	Track Control Arm		MN-DL-8544	Trailing Arm, Drive Axle;Air Suspension Axle
	10/07→	Track Control Arm		MN-VB-5238	Wishbone (CV), Drive Axle;Air Suspension Axle
	10/07→	Track Control Arm		MN-VB-8514	Suspension Rod, Wishbone (CV), Drive Axle; Air Suspension Axle
	18.320 FC, FLC, FLRC, FLLC, FLLRC, FLLW, FLLW/N	10/07→	Centre Rod	MN-DL-7801	
10/07→		Centre Rod	MN-DL-8560		Push Rod, Air Suspension Axle
10/07→		Suspension Strut Repair Kit		DB-RK-8581	
10/07→		Suspension Strut Repair Kit		MN-RK-12436	
10/07→		Tie Rod	MN-DL-7802		
10/07→		Tie Rod	MN-DL-12293		
10/07→		Track Control Arm		MN-DL-5225	Trailing Arm, Drive Axle;Air Suspension Axle
10/07→		Track Control Arm		MN-DL-8544	Trailing Arm, Drive Axle;Air Suspension Axle
10/07→		Track Control Arm		MN-VB-5238	Wishbone (CV), 1st RA;Air Suspension Axle
10/07→		Track Control Arm		MN-VB-8514	Suspension Rod, Wishbone (CV), Drive Axle; Air Suspension Axle
18.320 FK, FK-L, FLK, FLK/M	10/07→	Track Control Arm	MN-DL-8663		Control Arm, Air Suspension Axle
	10/07→	Centre Rod	MN-DL-7801		Push Rod, Leaf Spring Axle
	10/07→	Suspension Strut Repair Kit		DB-RK-8581	
	10/07→	Tie Rod	MN-DL-7802		
	10/07→	Tie Rod	MN-DL-12293		
	10/07→	Track Control Arm		MN-DL-5225	Trailing Arm, Drive Axle;Air Suspension Axle
	10/07→	Track Control Arm		MN-DL-8544	Trailing Arm, Drive Axle;Air Suspension Axle
	10/07→	Track Control Arm		MN-VB-5238	Wishbone (CV), 1st RA;Air Suspension Axle
18.320 FLS, FLS/M, FLS-TS, FLRS, FLRS/M, FLLS, FLLS/N,FLLRS	10/07→	Track Control Arm		MN-VB-8514	Suspension Rod, Wishbone (CV), Drive Axle; Air Suspension Axle
	10/07→	Centre Rod	MN-DL-7801		Push Rod
	10/07→	Centre Rod	MN-DL-8560		Push Rod, Air Suspension Axle
	10/07→	Centre Rod	MN-DL-14107		Push Rod
	10/07→	Suspension Strut Repair Kit		DB-RK-8581	
	10/07→	Suspension Strut Repair Kit		MN-RK-12436	
	10/07→	Tie Rod	MN-DL-7802		
	10/07→	Track Control Arm		MN-DL-5225	Trailing Arm, Drive Axle;Air Suspension Axle
	10/07→	Track Control Arm		MN-DL-8488	Trailing Arm;for Wishbone (CV), Air Suspension Axle
	10/07→	Track Control Arm		MN-VB-5238	Wishbone (CV), 1st RA;Air Suspension Axle
18.360 FAC, FHLC	10/07→	Track Control Arm		MN-VB-8514	Suspension Rod, Wishbone (CV)
	10/07→	Track Control Arm	MN-DL-8663		Control Arm, Air Suspension Axle
	10/07→	Centre Rod	MN-DL-7801		Push Rod, Leaf Spring Axle
	10/07→	Centre Rod	MN-DL-8646		Push Rod, Leaf Spring Axle
	10/07→	Suspension Strut Repair Kit		DB-RK-8581	
	10/07→	Tie Rod	MN-DL-7802		
	10/07→	Tie Rod	MN-DL-12293		
	10/07→	Track Control Arm		MN-DL-5225	Trailing Arm, Drive Axle;Air Suspension Axle
	10/07→	Track Control Arm		MN-DL-8544	Trailing Arm, Drive Axle;Air Suspension Axle
	10/07→	Track Control Arm		MN-VB-5238	Wishbone (CV), Drive Axle;Air Suspension Axle
18.360 FAK, FAK-L, FALK, FALK-L, FHLK, FHLK/M	10/07→	Track Control Arm		MN-VB-8514	Suspension Rod, Wishbone (CV), Drive Axle; Air Suspension Axle
	10/07→	Centre Rod	MN-DL-7801		Push Rod, Leaf Spring Axle
	10/07→	Centre Rod	MN-DL-8646		Push Rod, Leaf Spring Axle
	10/07→	Suspension Strut Repair Kit		DB-RK-8581	
	10/07→	Tie Rod	MN-DL-7802		

DB-RK-8581

Ø: 85
Hole Distance: 130
Thick/Height: 24
03305800A, 81432706105



MN-DL-5225

Length: 572 Ø: 48
Hole Distance: 130 / 130

03301500A, 81432206229, 81432206236, 81432206267, 81432206270, 81432206272, 81432206304, 81432206305, 81432209236, 81432209267, 81432209272



MN-DL-7801

Length: 995 Ø: 52
Cone Ø: d1 Ø 30 / d2 Ø 27

81466106807, 81466106808, 81466116087, 81466116088, 81466116096, 81466116097, 81466116099, 81466116132, 81466116133, 81466116136, 81466116197, 81466116198, 81466116205



MN-DL-7802

Length: 1680 Ø: 52
Cone Ø: d1 Ø 30 / d2 Ø 27

03208300A, 81467116773, 81467116858, 81467116859, 81467116860, 81467116861, 81467116863, 81467116882, 81467116883, 81467116920, 81467116921



MN-DL-8488

Length: 414 Ø: 50
Hole Distance: 130 / 130

81432206247, 81432206341, 81432206342



MN-DL-8544

Length: 596 Ø: 48
Hole Distance: 130 / 130

81432206196, 81432206232, 81432206233



MN-DL-8560

Length: 970 Ø: 52
Cone Ø: d1 Ø 30 / d2 Ø 27

03206900A, 81466106809, 81466106810, 81466106823, 81466106838, 81466106839, 81466116104, 81466116105, 81466116107, 81466116134, 81466116135, 81466116137, 81466116199, 81466116200, 81466116206



MN-DL-8646

Length: 1021 Ø: 52
Cone Ø: d1 Ø 30 / d2 Ø 27

81466106811, 81466106812, 81466116138, 81466116139, 81466116201, 81466116202



MN-DL-8663

Length: 947 Ø: 60
Hole Distance: 115 / 115

03307400A, 81432206222, 81432206260, 81432206283, 81432206284



MN-DL-12293

Length: 1680 Ø: 42
Cone Ø: d1 Ø 30 / d2 Ø 27

81467106236, 81467106268, 81467106356, 81467116356, 81467116723, 81467116794, 81467116933, 81467116934, 81467116966



MN-DL-14107

Length: 960 Ø: 50
Cone Ø: d1 Ø 30 / d2 Ø 27

81466106813, 81466116146, 81466116147, 81466116148, 81466116204



MN-RK-12436

Ø: 75
Hole Distance: 115
Thick/Height: 24
81432206244



MN-VB-5238

Length: 627 Ø: 48
Hole Distance: 130 / 130

81432206221, 81432706096, 81432706114, 81432706116, 81432706121



MN-VB-8514

Length: 627 Ø: 48
Hole Ø 25 / 25 / 25
Hole Distance: 152 / 130 / 130

81432706087, 81432706088, 81432706094, 81432706095, 81432796094





TGS ...

18.360 FAK, FAK-L, FALK, FALK-L, FHLK, FHLK/M ...	10/07→	Track Control Arm		MN-DL-5225	Trailing Arm, Drive Axle;Air Suspension Axle
	10/07→	Track Control Arm		MN-DL-8544	Trailing Arm, Drive Axle;Air Suspension Axle
	10/07→	Track Control Arm		MN-VB-5238	Wishbone (CV), Drive Axle;Air Suspension Axle
	10/07→	Track Control Arm		MN-VB-8514	Suspension Rod, Wishbone (CV), Drive Axle; Air Suspension Axle
18.360 FAS, FALS, FHLS, FHLS/M	10/07→	Centre Rod	MN-DL-7801		Push Rod, Leaf Spring Axle
	10/07→	Centre Rod	MN-DL-8646		Push Rod, Leaf Spring Axle
	10/07→	Suspension Strut Repair Kit		DB-RK-8581	
	10/07→	Tie Rod	MN-DL-7802		
	10/07→	Tie Rod	MN-DL-12293		
	10/07→	Track Control Arm		MN-DL-5225	Trailing Arm, Drive Axle;Air Suspension Axle
	10/07→	Track Control Arm		MN-DL-8544	Trailing Arm, Drive Axle;Air Suspension Axle
	10/07→	Track Control Arm		MN-VB-5238	Wishbone (CV), Drive Axle;Air Suspension Axle
	10/07→	Track Control Arm		MN-VB-8514	Suspension Rod, Wishbone (CV), Drive Axle; Air Suspension Axle
18.360 FC, FLC, FLRC, FLLC, FLLRC, FLLW, FLLW/N	10/07→	Centre Rod	MN-DL-7801		Push Rod, Leaf Spring Axle
	10/07→	Centre Rod	MN-DL-8560		Push Rod, Air Suspension Axle
	10/07→	Suspension Strut Repair Kit		DB-RK-8581	
	10/07→	Suspension Strut Repair Kit		MN-RK-12436	
	10/07→	Tie Rod	MN-DL-7802		
	10/07→	Tie Rod	MN-DL-12293		
	10/07→	Track Control Arm		MN-DL-5225	Trailing Arm, Drive Axle;Air Suspension Axle
	10/07→	Track Control Arm		MN-DL-8544	Trailing Arm, Drive Axle;Air Suspension Axle
	10/07→	Track Control Arm		MN-VB-5238	Wishbone (CV), 1st RA;Air Suspension Axle
	10/07→	Track Control Arm		MN-VB-8514	Suspension Rod, Wishbone (CV), Drive Axle; Air Suspension Axle
18.360 FK, FK-L, FLK, FLK/M	10/07→	Track Control Arm	MN-DL-8663		Control Arm, Air Suspension Axle
	10/07→	Centre Rod	MN-DL-7801		Push Rod, Leaf Spring Axle
	10/07→	Suspension Strut Repair Kit		DB-RK-8581	
	10/07→	Tie Rod	MN-DL-7802		
	10/07→	Tie Rod	MN-DL-12293		
	10/07→	Track Control Arm		MN-DL-5225	Trailing Arm, Drive Axle;Air Suspension Axle
	10/07→	Track Control Arm		MN-DL-8544	Trailing Arm, Drive Axle;Air Suspension Axle
	10/07→	Track Control Arm		MN-VB-5238	Wishbone (CV), 1st RA;Air Suspension Axle
18.360 FLS, FLS/M, FLS-TS, FLRS, FLRS/M, FLLS, FLLS/N, FLLRS	10/07→	Centre Rod	MN-DL-8560		Push Rod, Air Suspension Axle
	10/07→	Suspension Strut Repair Kit		DB-RK-8581	
	10/07→	Suspension Strut Repair Kit		MN-RK-12436	
	10/07→	Tie Rod	MN-DL-7802		
	10/07→	Track Control Arm		MN-DL-5225	Trailing Arm, Drive Axle;Air Suspension Axle
	10/07→	Track Control Arm		MN-VB-5238	Wishbone (CV), 1st RA;Air Suspension Axle
	10/07→	Track Control Arm		MN-VB-8514	Suspension Rod, Wishbone (CV)
	10/07→	Track Control Arm	MN-DL-8663		Control Arm, Air Suspension Axle
18.400 FAC, FHLC	10/07→	Centre Rod	MN-DL-7801		Push Rod, Leaf Spring Axle
	10/07→	Centre Rod	MN-DL-8646		Push Rod, Leaf Spring Axle
	10/07→	Suspension Strut Repair Kit		DB-RK-8581	
	10/07→	Tie Rod	MN-DL-7802		
	10/07→	Tie Rod	MN-DL-12293		
	10/07→	Track Control Arm		MN-DL-5225	Trailing Arm, Drive Axle;Air Suspension Axle
	10/07→	Track Control Arm		MN-DL-8544	Trailing Arm, Drive Axle;Air Suspension Axle
	10/07→	Track Control Arm		MN-VB-5238	Wishbone (CV), Drive Axle;Air Suspension Axle
	10/07→	Track Control Arm		MN-VB-8514	Suspension Rod, Wishbone (CV), Drive Axle; Air Suspension Axle
18.400 FAK, FAK-L, FALK, FALK-L, FHLK, FHLK/M	10/07→	Centre Rod	MN-DL-7801		Push Rod, Leaf Spring Axle
	10/07→	Centre Rod	MN-DL-8646		Push Rod, Leaf Spring Axle
	10/07→	Suspension Strut Repair Kit		DB-RK-8581	
	10/07→	Tie Rod	MN-DL-7802		
	10/07→	Tie Rod	MN-DL-12293		
	10/07→	Track Control Arm		MN-DL-5225	Trailing Arm, Drive Axle;Air Suspension Axle
	10/07→	Track Control Arm		MN-DL-8544	Trailing Arm, Drive Axle;Air Suspension Axle
	10/07→	Track Control Arm		MN-VB-5238	Wishbone (CV), Drive Axle;Air Suspension Axle
10/07→	Track Control Arm		MN-VB-8514	Suspension Rod, Wishbone (CV), Drive Axle; Air Suspension Axle	

DB-RK-8581

Ø: 85
Hole Distance: 130
Thick/Height: 24
03305800A, 81432706105



MN-DL-5225

Length: 572 Ø: 48
Hole Distance: 130 / 130

03301500A, 81432206229, 81432206236,
81432206267, 81432206270, 81432206272,
81432206304, 81432206305, 81432209236,
81432209267, 81432209272



MN-DL-7801

Length: 995 Ø: 52
Cone Ø: d1 Ø 30 / d2 Ø 27

81466106807, 81466106808, 81466116087,
81466116088, 81466116096, 81466116097,
81466116099, 81466116132, 81466116133,
81466116136, 81466116197, 81466116198,
81466116205



MN-DL-7802

Length: 1680 Ø: 52
Cone Ø: d1 Ø 30 / d2 Ø 27

03208300A, 81467116773, 81467116858,
81467116859, 81467116860, 81467116861,
81467116863, 81467116882, 81467116883,
81467116920, 81467116921



MN-DL-8544

Length: 596 Ø: 48
Hole Distance: 130 / 130

81432206196, 81432206232, 81432206233



MN-DL-8560

Length: 970 Ø: 52
Cone Ø: d1 Ø 30 / d2 Ø 27

03206900A, 81466106809, 81466106810,
81466106823, 81466106838, 81466106839,
81466116104, 81466116105, 81466116107,
81466116134, 81466116135, 81466116137,
81466116199, 81466116200, 81466116206



MN-DL-8646

Length: 1021 Ø: 52
Cone Ø: d1 Ø 30 / d2 Ø 27

81466106811, 81466106812, 81466116138,
81466116139, 81466116201, 81466116202



MN-DL-8663

Length: 947 Ø: 60
Hole Distance: 115 / 115

03307400A, 81432206222, 81432206260,
81432206283, 81432206284



MN-DL-12293

Length: 1680 Ø: 42
Cone Ø: d1 Ø 30 / d2 Ø 27

81467106236, 81467106268, 81467106356,
81467116356, 81467116723, 81467116794,
81467116933, 81467116934, 81467116966



MN-RK-12436

Ø: 75
Hole Distance: 115
Thick/Height: 24

81432206244



MN-VB-5238

Length: 627 Ø: 48
Hole Distance: 130 / 130

81432206221, 81432706096, 81432706114,
81432706116, 81432706121



MN-VB-8514

Length: 627 Ø: 48
Hole Ø 25 / 25 / 25
Hole Distance: 152 / 130 / 130

81432706087, 81432706088, 81432706094,
81432706095, 81432796094





TGS ...

18.400 FAS, FALS, FHLS, FHLS/M	10/07→	Centre Rod	MN-DL-7801		Push Rod, Leaf Spring Axle
	10/07→	Centre Rod	MN-DL-8646		Push Rod, Leaf Spring Axle
	10/07→	Suspension Strut Repair Kit		DB-RK-8581	
	10/07→	Tie Rod	MN-DL-7802		
	10/07→	Tie Rod	MN-DL-12293		
	10/07→	Track Control Arm		MN-DL-5225	Trailing Arm, Drive Axle;Air Suspension Axle
	10/07→	Track Control Arm		MN-DL-8544	Trailing Arm, Drive Axle;Air Suspension Axle
	10/07→	Track Control Arm		MN-VB-5238	Wishbone (CV), Drive Axle;Air Suspension Axle
18.400 FC, FLC, FLRC, FLLC, FLLRC, FLLW, FLLW/N	10/07→	Centre Rod	MN-DL-7801		Push Rod, Leaf Spring Axle
	10/07→	Centre Rod	MN-DL-8560		Push Rod, Air Suspension Axle
	10/07→	Suspension Strut Repair Kit		DB-RK-8581	
	10/07→	Suspension Strut Repair Kit		MN-RK-12436	
	10/07→	Tie Rod	MN-DL-7802		
	10/07→	Tie Rod	MN-DL-12293		
	10/07→	Track Control Arm		MN-DL-5225	Trailing Arm, Drive Axle;Air Suspension Axle
	10/07→	Track Control Arm		MN-DL-8544	Trailing Arm, Drive Axle;Air Suspension Axle
	10/07→	Track Control Arm		MN-VB-5238	Wishbone (CV), 1st RA;Air Suspension Axle
	10/07→	Track Control Arm		MN-VB-8514	Suspension Rod, Wishbone (CV), Drive Axle; Air Suspension Axle
18.400 FK, FK-L, FLK, FLK/M	10/07→	Centre Rod	MN-DL-7801		Push Rod, Leaf Spring Axle
	10/07→	Suspension Strut Repair Kit		DB-RK-8581	
	10/07→	Tie Rod	MN-DL-7802		
	10/07→	Tie Rod	MN-DL-12293		
	10/07→	Track Control Arm		MN-DL-5225	Trailing Arm, Drive Axle;Air Suspension Axle
	10/07→	Track Control Arm		MN-DL-8544	Trailing Arm, Drive Axle;Air Suspension Axle
	10/07→	Track Control Arm		MN-VB-5238	Wishbone (CV), 1st RA;Air Suspension Axle
	10/07→	Track Control Arm		MN-VB-8514	Suspension Rod, Wishbone (CV), Drive Axle; Air Suspension Axle
18.400 FLS, FLS/M, FLS-TS, FLRS, FLRS/M, FLLS, FLLS/N, FLLRS	10/07→	Centre Rod	MN-DL-7801		Push Rod, Leaf Spring Axle
	10/07→	Centre Rod	MN-DL-8560		Push Rod, Air Suspension Axle
	10/07→	Suspension Strut Repair Kit		DB-RK-8581	
	10/07→	Suspension Strut Repair Kit		MN-RK-12436	
	10/07→	Tie Rod	MN-DL-7802		
	10/07→	Tie Rod	MN-DL-12293		
	10/07→	Track Control Arm		MN-DL-5225	Trailing Arm, Drive Axle;Air Suspension Axle
	10/07→	Track Control Arm		MN-DL-8488	Trailing Arm;for Wishbone (CV), Air Suspension Axle
	10/07→	Track Control Arm		MN-DL-8544	Trailing Arm, Drive Axle;Air Suspension Axle
	10/07→	Track Control Arm		MN-VB-5238	Wishbone (CV), 1st RA;Air Suspension Axle
18.440 FAC, FHLC	10/07→	Centre Rod	MN-DL-7801		Push Rod, Leaf Spring Axle
	10/07→	Centre Rod	MN-DL-8646		Push Rod, Leaf Spring Axle
	10/07→	Suspension Strut Repair Kit		DB-RK-8581	
	10/07→	Tie Rod	MN-DL-7802		
	10/07→	Tie Rod	MN-DL-12293		
	10/07→	Track Control Arm		MN-DL-5225	Trailing Arm, Drive Axle;Air Suspension Axle
	10/07→	Track Control Arm		MN-DL-8544	Trailing Arm, Drive Axle;Air Suspension Axle
	10/07→	Track Control Arm		MN-VB-5238	Wishbone (CV), Drive Axle;Air Suspension Axle
	10/07→	Track Control Arm		MN-VB-8514	Suspension Rod, Wishbone (CV), Drive Axle; Air Suspension Axle
	18.440 FAK, FAK-L, FALK, FALK-L, FHLK, FHLK/M	10/07→	Centre Rod	MN-DL-7801	
10/07→		Centre Rod	MN-DL-8646		Push Rod, Leaf Spring Axle
10/07→		Suspension Strut Repair Kit		DB-RK-8581	
10/07→		Tie Rod	MN-DL-7802		
10/07→		Tie Rod	MN-DL-12293		
10/07→		Track Control Arm		MN-DL-5225	Trailing Arm, Drive Axle;Air Suspension Axle
10/07→		Track Control Arm		MN-VB-5238	Wishbone (CV), Drive Axle;Air Suspension Axle

DB-RK-8581

Ø: 85
Hole Distance: 130
Thick/Height: 24
03305800A, 81432706105



MN-DL-5225

Length: 572 Ø: 48
Hole Distance: 130 / 130

03301500A, 81432206229, 81432206236,
81432206267, 81432206270, 81432206272,
81432206304, 81432206305, 81432209236,
81432209267, 81432209272



MN-DL-7801

Length: 995 Ø: 52
Cone Ø: d1 Ø 30 / d2 Ø 27

81466106807, 81466106808, 81466116087,
81466116088, 81466116096, 81466116097,
81466116099, 81466116132, 81466116133,
81466116136, 81466116197, 81466116198,
81466116205



MN-DL-7802

Length: 1680 Ø: 52
Cone Ø: d1 Ø 30 / d2 Ø 27

03208300A, 81467116773, 81467116858,
81467116859, 81467116860, 81467116861,
81467116863, 81467116882, 81467116883,
81467116920, 81467116921



MN-DL-8488

Length: 414 Ø: 50
Hole Distance: 130 / 130

81432206247, 81432206341, 81432206342



MN-DL-8544

Length: 596 Ø: 48
Hole Distance: 130 / 130

81432206196, 81432206232, 81432206233



MN-DL-8560

Length: 970 Ø: 52
Cone Ø: d1 Ø 30 / d2 Ø 27

03206900A, 81466106809, 81466106810,
81466106823, 81466106838, 81466106839,
81466116104, 81466116105, 81466116107,
81466116134, 81466116135, 81466116137,
81466116199, 81466116200, 81466116206



MN-DL-8646

Length: 1021 Ø: 52
Cone Ø: d1 Ø 30 / d2 Ø 27

81466106811, 81466106812, 81466116138,
81466116139, 81466116201, 81466116202



MN-DL-8663

Length: 947 Ø: 60
Hole Distance: 115 / 115

03307400A, 81432206222, 81432206260,
81432206283, 81432206284



MN-DL-12293

Length: 1680 Ø: 42
Cone Ø: d1 Ø 30 / d2 Ø 27

81467106236, 81467106268, 81467106356,
81467116356, 81467116723, 81467116794,
81467116933, 81467116934, 81467116966



MN-RK-12436

Ø: 75
Hole Distance: 115
Thick/Height: 24

81432206244



MN-VB-5238

Length: 627 Ø: 48
Hole Distance: 130 / 130

81432206221, 81432706096, 81432706114,
81432706116, 81432706121



MN-VB-8514

Length: 627 Ø: 48
Hole Ø 25 / 25 / 25
Hole Distance: 152 / 130 / 130

81432706087, 81432706088, 81432706094,
81432706095, 81432796094





TGS ...

18.440 FAK, FAK-L, FALK, FALK-L, FHLK, FHLK/M ...	10/07→	Track Control Arm		MN-VB-8514	Suspension Rod, Wishbone (CV), Drive Axle; Air Suspension Axle
18.440 FAS, FALS, FHLS	10/07→	Tie Rod	MN-DL-12293		
18.440 FAS, FALS, FHLS, FHLS/M	10/07→	Centre Rod	MN-DL-7801		Push Rod, Leaf Spring Axle
	10/07→	Centre Rod	MN-DL-8646		Push Rod, Leaf Spring Axle
	10/07→	Suspension Strut Repair Kit		DB-RK-8581	
	10/07→	Tie Rod	MN-DL-7802		
	10/07→	Tie Rod	MN-DL-12293		
	10/07→	Track Control Arm		MN-DL-5225	Trailing Arm, Drive Axle; Air Suspension Axle
	10/07→	Track Control Arm		MN-DL-8544	Trailing Arm, Drive Axle; Air Suspension Axle
	10/07→	Track Control Arm		MN-VB-5238	Wishbone (CV), Drive Axle; Air Suspension Axle
	10/07→	Track Control Arm		MN-VB-8514	Suspension Rod, Wishbone (CV), Drive Axle; Air Suspension Axle
18.440 FC, FLC, FLRC, FLLC, FLLRC, FLLW, FLLW/N	10/07→	Centre Rod	MN-DL-7801		Push Rod, Leaf Spring Axle
	10/07→	Centre Rod	MN-DL-8560		Push Rod
	10/07→	Centre Rod	MN-DL-8560		Push Rod, Air Suspension Axle
	10/07→	Suspension Strut Repair Kit		DB-RK-8581	
	10/07→	Suspension Strut Repair Kit		MN-RK-12436	
	10/07→	Tie Rod	MN-DL-7802		
	10/07→	Tie Rod	MN-DL-12293		
	10/07→	Track Control Arm		MN-DL-5225	Trailing Arm, Drive Axle; Air Suspension Axle
	10/07→	Track Control Arm		MN-DL-8544	Trailing Arm, Drive Axle; Air Suspension Axle
	10/07→	Track Control Arm		MN-VB-5238	Wishbone (CV), 1st RA; Air Suspension Axle
	10/07→	Track Control Arm		MN-VB-8514	Suspension Rod, Wishbone (CV), Drive Axle; Air Suspension Axle
	10/07→	Track Control Arm	MN-DL-8663		Control Arm, Air Suspension Axle
18.440 FK, FK-L, FLK	10/07→	Tie Rod	MN-DL-12293		
18.440 FK, FK-L, FLK, FLK/M	10/07→	Centre Rod	MN-DL-7801		Push Rod, Leaf Spring Axle
	10/07→	Suspension Strut Repair Kit		DB-RK-8581	
	10/07→	Tie Rod	MN-DL-7802		
	10/07→	Tie Rod	MN-DL-12293		
	10/07→	Track Control Arm		MN-DL-5225	Trailing Arm, Drive Axle; Air Suspension Axle
	10/07→	Track Control Arm		MN-DL-8544	Trailing Arm, Drive Axle; Air Suspension Axle
	10/07→	Track Control Arm		MN-VB-5238	Wishbone (CV), 1st RA; Air Suspension Axle
	10/07→	Track Control Arm		MN-VB-8514	Suspension Rod, Wishbone (CV), Drive Axle; Air Suspension Axle
18.440 FLS, FLS/M, FLS-TS, FLRS, FLRS/M, FLLS, FLLS/N, FLLRS	10/07→	Centre Rod	MN-DL-7801		Push Rod, Leaf Spring Axle
	10/07→	Centre Rod	MN-DL-8560		Push Rod
	10/07→	Centre Rod	MN-DL-8560		Push Rod, Air Suspension Axle
	10/07→	Suspension Strut Repair Kit		DB-RK-8581	
	10/07→	Suspension Strut Repair Kit		MN-RK-12436	
	10/07→	Tie Rod	MN-DL-7802		
	10/07→	Tie Rod	MN-DL-12293		
	10/07→	Track Control Arm		MN-DL-5225	Trailing Arm, Drive Axle; Air Suspension Axle
	10/07→	Track Control Arm		MN-DL-8488	Trailing Arm; for Wishbone (CV), Air Suspension Axle
	10/07→	Track Control Arm		MN-DL-8544	Trailing Arm, Drive Axle; Air Suspension Axle
	10/07→	Track Control Arm		MN-VB-5238	Wishbone (CV), 1st RA; Air Suspension Axle
	10/07→	Track Control Arm		MN-VB-8514	Suspension Rod, Wishbone (CV), Drive Axle; Air Suspension Axle
	10/07→	Track Control Arm	MN-DL-8663		Control Arm, Air Suspension Axle
18.480 FAC, FHLC	10/07→	Track Control Arm		MN-DL-5225	Trailing Arm
	10/07→	Track Control Arm		MN-VB-8514	Suspension Rod, Wishbone (CV)
18.480 FAK, FAK-L, FALK, FALK-L, FHLK, FHLK/M	10/07→	Track Control Arm		MN-DL-5225	Trailing Arm
	10/07→	Track Control Arm		MN-VB-8514	Suspension Rod, Wishbone (CV)
18.480 FAS, FALS, FHLS	10/07→	Track Control Arm		MN-DL-5225	Trailing Arm
	10/07→	Track Control Arm		MN-VB-8514	Suspension Rod, Wishbone (CV)
18.480 FC, FLC, FLRC, FLLC, FLLRC, FLLW, FLLW/N	10/07→	Centre Rod	MN-DL-7801		Push Rod, Leaf Spring Axle
	10/07→	Centre Rod	MN-DL-8560		Push Rod, Air Suspension Axle
	10/07→	Suspension Strut Repair Kit		DB-RK-8581	
	10/07→	Suspension Strut Repair Kit		MN-RK-12436	
	10/07→	Tie Rod	MN-DL-7802		
	10/07→	Tie Rod	MN-DL-12293		

DB-RK-8581

Ø: 85
Hole Distance: 130
Thick/Height: 24
03305800A, 81432706105



MN-DL-8646

Length: 1021 Ø: 52
Cone Ø: d1 Ø 30 / d2 Ø 27
81466106811, 81466106812, 81466116138,
81466116139, 81466116201, 81466116202



MN-DL-5225

Length: 572 Ø: 48
Hole Distance: 130 / 130

03301500A, 81432206229, 81432206236,
81432206267, 81432206270, 81432206272,
81432206304, 81432206305, 81432209236,
81432209267, 81432209272



MN-DL-8663

Length: 947 Ø: 60
Hole Distance: 115 / 115

03307400A, 81432206222, 81432206260,
81432206283, 81432206284



MN-DL-12293

Length: 1680 Ø: 42
Cone Ø: d1 Ø 30 / d2 Ø 27

81467106236, 81467106268, 81467106356,
81467116356, 81467116723, 81467116794,
81467116933, 81467116934, 81467116966



MN-DL-7801

Length: 995 Ø: 52
Cone Ø: d1 Ø 30 / d2 Ø 27

81466106807, 81466106808, 81466116087,
81466116088, 81466116096, 81466116097,
81466116099, 81466116132, 81466116133,
81466116136, 81466116197, 81466116198,
81466116205



MN-RK-12436

Ø: 75
Hole Distance: 115
Thick/Height: 24

81432206244



MN-DL-7802

Length: 1680 Ø: 52
Cone Ø: d1 Ø 30 / d2 Ø 27

03208300A, 81467116773, 81467116858,
81467116859, 81467116860, 81467116861,
81467116863, 81467116882, 81467116883,
81467116920, 81467116921



MN-VB-5238

Length: 627 Ø: 48
Hole Distance: 130 / 130

81432206221, 81432706096, 81432706114,
81432706116, 81432706121



MN-DL-8488

Length: 414 Ø: 50
Hole Distance: 130 / 130

81432206247, 81432206341, 81432206342



MN-VB-8514

Length: 627 Ø: 48
Hole Ø 25 / 25 / 25
Hole Distance: 152 / 130 / 130

81432706087, 81432706088, 81432706094,
81432706095, 81432796094



MN-DL-8544

Length: 596 Ø: 48
Hole Distance: 130 / 130

81432206196, 81432206232, 81432206233



MN-DL-8560

Length: 970 Ø: 52
Cone Ø: d1 Ø 30 / d2 Ø 27

03206900A, 81466106809, 81466106810,
81466106823, 81466106838, 81466106839,
81466116104, 81466116105, 81466116107,
81466116134, 81466116135, 81466116137,
81466116199, 81466116200, 81466116206





TGS ...

18.480 FC, FLC, FLRC, FLLC, FLLRC, FLLW, FLLW/N ...	10/07→	Track Control Arm		MN-DL-5225	Trailing Arm, Drive Axle;Air Suspension Axle
	10/07→	Track Control Arm		MN-DL-8544	Trailing Arm, Drive Axle;Air Suspension Axle
	10/07→	Track Control Arm		MN-VB-5238	Wishbone (CV), 1st RA;Air Suspension Axle
	10/07→	Track Control Arm		MN-VB-8514	Suspension Rod, Wishbone (CV), Drive Axle; Air Suspension Axle
	10/07→	Track Control Arm	MN-DL-8663		Control Arm, Air Suspension Axle
18.480 FK, FK-L, FLK, FLK/M	10/07→	Centre Rod	MN-DL-7801		Push Rod, Leaf Spring Axle
	10/07→	Suspension Strut Repair Kit		DB-RK-8581	
	10/07→	Tie Rod	MN-DL-7802		
	10/07→	Tie Rod	MN-DL-12293		
	10/07→	Track Control Arm		MN-DL-5225	Trailing Arm, Drive Axle;Air Suspension Axle
	10/07→	Track Control Arm		MN-DL-8544	Trailing Arm, Drive Axle;Air Suspension Axle
	10/07→	Track Control Arm		MN-VB-5238	Wishbone (CV), 1st RA;Air Suspension Axle
	10/07→	Track Control Arm		MN-VB-8514	Suspension Rod, Wishbone (CV), Drive Axle; Air Suspension Axle
18.480 FLS, FLS/M, FLS-TS, FLRS, FLRS/M, FLLS, FLLS/N, FLLRS	10/07→	Centre Rod	MN-DL-7801		Push Rod, Leaf Spring Axle
	10/07→	Centre Rod	MN-DL-8560		Push Rod, Air Suspension Axle
	10/07→	Centre Rod	MN-DL-14107		Push Rod
	10/07→	Suspension Strut Repair Kit		DB-RK-8581	
	10/07→	Suspension Strut Repair Kit		MN-RK-12436	
	10/07→	Tie Rod	MN-DL-7802		
	10/07→	Tie Rod	MN-DL-12293		
	10/07→	Track Control Arm		MN-DL-5225	Trailing Arm, Drive Axle;Air Suspension Axle
	10/07→	Track Control Arm		MN-DL-8544	Trailing Arm, Drive Axle;Air Suspension Axle
	10/07→	Track Control Arm		MN-VB-5238	Wishbone (CV), 1st RA;Air Suspension Axle
	10/07→	Track Control Arm		MN-VB-8514	Suspension Rod, Wishbone (CV), Drive Axle; Air Suspension Axle
	10/07→	Track Control Arm	MN-DL-8663		Control Arm, Air Suspension Axle
18.540 FAC, FHLC	10/07→	Centre Rod	MN-DL-7801		Push Rod, Leaf Spring Axle
	10/07→	Centre Rod	MN-DL-8646		Push Rod, Leaf Spring Axle
	10/07→	Suspension Strut Repair Kit		DB-RK-8581	
	10/07→	Tie Rod	MN-DL-7802		
	10/07→	Tie Rod	MN-DL-12293		
	10/07→	Track Control Arm		MN-DL-5225	Trailing Arm, Drive Axle;Air Suspension Axle
	10/07→	Track Control Arm		MN-DL-8544	Trailing Arm, Drive Axle;Air Suspension Axle
	10/07→	Track Control Arm		MN-VB-5238	Wishbone (CV), Drive Axle;Air Suspension Axle
	10/07→	Track Control Arm		MN-VB-8514	Suspension Rod, Wishbone (CV), Drive Axle; Air Suspension Axle
	10/07→	Track Control Arm	MN-DL-8663		Control Arm, Air Suspension Axle
18.540 FAK, FAK-L, FALK, FALK-L, FHLK, FHLK/M	10/07→	Centre Rod	MN-DL-7801		Push Rod, Leaf Spring Axle
	10/07→	Centre Rod	MN-DL-8646		Push Rod, Leaf Spring Axle
	10/07→	Suspension Strut Repair Kit		DB-RK-8581	
	10/07→	Tie Rod	MN-DL-7802		
	10/07→	Tie Rod	MN-DL-12293		
	10/07→	Track Control Arm		MN-DL-5225	Trailing Arm, Drive Axle;Air Suspension Axle
	10/07→	Track Control Arm		MN-DL-8544	Trailing Arm, Drive Axle;Air Suspension Axle
	10/07→	Track Control Arm		MN-VB-5238	Wishbone (CV), Drive Axle;Air Suspension Axle
10/07→	Track Control Arm		MN-VB-8514	Suspension Rod, Wishbone (CV), Drive Axle; Air Suspension Axle	
18.540 FAS, FALS, FHLS, FHLS/M	10/07→	Centre Rod	MN-DL-7801		Push Rod, Leaf Spring Axle
	10/07→	Centre Rod	MN-DL-8646		Push Rod, Leaf Spring Axle
	10/07→	Suspension Strut Repair Kit		DB-RK-8581	
	10/07→	Tie Rod	MN-DL-7802		
	10/07→	Tie Rod	MN-DL-12293		
	10/07→	Track Control Arm		MN-DL-5225	Trailing Arm, Drive Axle;Air Suspension Axle
	10/07→	Track Control Arm		MN-DL-8544	Trailing Arm, Drive Axle;Air Suspension Axle
	10/07→	Track Control Arm		MN-VB-5238	Wishbone (CV), Drive Axle;Air Suspension Axle
	10/07→	Track Control Arm		MN-VB-8514	Suspension Rod, Wishbone (CV), Drive Axle; Air Suspension Axle
18.540 FC, FLC, FLRC, FLLC, FLLRC, FLLW, FLLW/N	10/07→	Centre Rod	MN-DL-7801		Push Rod, Leaf Spring Axle
	10/07→	Centre Rod	MN-DL-8560		Push Rod, Air Suspension Axle
	10/07→	Suspension Strut Repair Kit		DB-RK-8581	
	10/07→	Suspension Strut Repair Kit		MN-RK-12436	
	10/07→	Tie Rod	MN-DL-7802		
	10/07→	Tie Rod	MN-DL-12293		

DB-RK-8581

Ø: 85
Hole Distance: 130
Thick/Height: 24
03305800A, 81432706105



MN-DL-5225

Length: 572 Ø: 48
Hole Distance: 130 / 130

03301500A, 81432206229, 81432206236,
81432206267, 81432206270, 81432206272,
81432206304, 81432206305, 81432209236,
81432209267, 81432209272



MN-DL-7801

Length: 995 Ø: 52
Cone Ø: d1 Ø 30 / d2 Ø 27

81466106807, 81466106808, 81466116087,
81466116088, 81466116096, 81466116097,
81466116099, 81466116132, 81466116133,
81466116136, 81466116197, 81466116198,
81466116205



MN-DL-7802

Length: 1680 Ø: 52
Cone Ø: d1 Ø 30 / d2 Ø 27

03208300A, 81467116773, 81467116858,
81467116859, 81467116860, 81467116861,
81467116863, 81467116882, 81467116883,
81467116920, 81467116921



MN-DL-8544

Length: 596 Ø: 48
Hole Distance: 130 / 130

81432206196, 81432206232, 81432206233



MN-DL-8560

Length: 970 Ø: 52
Cone Ø: d1 Ø 30 / d2 Ø 27

03206900A, 81466106809, 81466106810,
81466106823, 81466106838, 81466106839,
81466116104, 81466116105, 81466116107,
81466116134, 81466116135, 81466116137,
81466116199, 81466116200, 81466116206



MN-DL-8646

Length: 1021 Ø: 52
Cone Ø: d1 Ø 30 / d2 Ø 27

81466106811, 81466106812, 81466116138,
81466116139, 81466116201, 81466116202



MN-DL-8663

Length: 947 Ø: 60
Hole Distance: 115 / 115

03307400A, 81432206222, 81432206260,
81432206283, 81432206284



MN-DL-12293

Length: 1680 Ø: 42
Cone Ø: d1 Ø 30 / d2 Ø 27

81467106236, 81467106268, 81467106356,
81467116356, 81467116723, 81467116794,
81467116933, 81467116934, 81467116966



MN-DL-14107

Length: 960 Ø: 50
Cone Ø: d1 Ø 30 / d2 Ø 27

81466106813, 81466116146, 81466116147,
81466116148, 81466116204



MN-RK-12436

Ø: 75
Hole Distance: 115
Thick/Height: 24

81432206244



MN-VB-5238

Length: 627 Ø: 48
Hole Distance: 130 / 130

81432206221, 81432706096, 81432706114,
81432706116, 81432706121



MN-VB-8514

Length: 627 Ø: 48
Hole Ø 25 / 25 / 25
Hole Distance: 152 / 130 / 130

81432706087, 81432706088, 81432706094,
81432706095, 81432796094





TGS ...

18.540 FC, FLC, FLRC, FLLC, FLLRC, FLLW, FLLW/N ...	10/07→	Tie Rod	MN-DL-12293		
	10/07→	Track Control Arm		MN-DL-5225	Trailing Arm, Drive Axle;Air Suspension Axle
	10/07→	Track Control Arm		MN-DL-8544	Trailing Arm, Drive Axle;Air Suspension Axle
	10/07→	Track Control Arm		MN-VB-5238	Wishbone (CV), 1st RA;Air Suspension Axle
	10/07→	Track Control Arm		MN-VB-8514	Suspension Rod, Wishbone (CV), Drive Axle; Air Suspension Axle
	10/07→	Track Control Arm	MN-DL-8663		Control Arm, Air Suspension Axle
18.540 FK, FK-L, FLK, FLK/M	10/07→	Centre Rod	MN-DL-7801		Push Rod, Leaf Spring Axle
	10/07→	Suspension Strut Repair Kit		DB-RK-8581	
	10/07→	Tie Rod	MN-DL-7802		
	10/07→	Tie Rod	MN-DL-12293		
	10/07→	Track Control Arm		MN-DL-5225	Trailing Arm, Drive Axle;Air Suspension Axle
	10/07→	Track Control Arm		MN-DL-8544	Trailing Arm, Drive Axle;Air Suspension Axle
	10/07→	Track Control Arm		MN-VB-5238	Wishbone (CV), 1st RA;Air Suspension Axle
	10/07→	Track Control Arm		MN-VB-8514	Suspension Rod, Wishbone (CV), Drive Axle; Air Suspension Axle
18.540 FLS, FLS/M, FLRS, FLRS/M, FLLS, FLLS/N, FLLRS	10/07→	Centre Rod	MN-DL-7801		Push Rod, Leaf Spring Axle
	10/07→	Centre Rod	MN-DL-8560		Push Rod, Air Suspension Axle
	10/07→	Centre Rod	MN-DL-14107		Push Rod
	10/07→	Suspension Strut Repair Kit		DB-RK-8581	
	10/07→	Suspension Strut Repair Kit		MN-RK-12436	
	10/07→	Tie Rod	MN-DL-7802		
	10/07→	Tie Rod	MN-DL-12293		
	10/07→	Track Control Arm		MN-DL-5225	Trailing Arm, Drive Axle;Air Suspension Axle
	10/07→	Track Control Arm		MN-DL-8544	Trailing Arm, Drive Axle;Air Suspension Axle
	10/07→	Track Control Arm		MN-VB-5238	Wishbone (CV), 1st RA;Air Suspension Axle
	10/07→	Track Control Arm		MN-VB-8514	Suspension Rod, Wishbone (CV)
	10/07→	Track Control Arm	MN-DL-8663		Control Arm, Air Suspension Axle
19.360 FS, FLS, FRS, FLRS	02/11→	Centre Rod	MN-DL-7801		Push Rod
	02/11→	Mounting, stabilizer coupling rod	MN-SB-5246		
	02/11→	Tie Rod	MN-DL-7802		
	02/11→	Track Control Arm		MN-DL-5225	Trailing Arm
	02/11→	Track Control Arm	MN-VB-5238	MN-VB-5238	Wishbone (CV);Control Arm
	02/11→	Centre Rod	MN-DL-7801		Push Rod
19.400 FS/M-WW, FLS/M-WW, FRS/M-WW, FLRS/M-WW	02/11→	Mounting, stabilizer coupling rod	MN-SB-5246		
	02/11→	Tie Rod	MN-DL-7802		
	02/11→	Tie Rod	MN-DL-12293		
	02/11→	Track Control Arm		MN-DL-5225	Trailing Arm
	02/11→	Track Control Arm	MN-VB-5238	MN-VB-5238	Wishbone (CV);Control Arm
	02/11→	Centre Rod	MN-DL-7801		Push Rod
19.440 FS-WW, FRS-WW, FLS-WW, FLRS-WW	02/11→	Mounting, stabilizer coupling rod	MN-SB-5246		
	02/11→	Tie Rod	MN-DL-7802		
	02/11→	Tie Rod	MN-DL-12293		
	02/11→	Track Control Arm		MN-DL-5225	Trailing Arm
	02/11→	Track Control Arm	MN-VB-5238	MN-VB-5238	Wishbone (CV);Control Arm
	02/11→	Centre Rod	MN-DL-7801		Push Rod
19.480 FS/M-WW, FRS/M-WW, FLS/M-WW, FLRS/M-WW	02/11→	Mounting, stabilizer coupling rod	MN-SB-5246		
	02/11→	Tie Rod	MN-DL-7802		
	02/11→	Tie Rod	MN-DL-12293		
	02/11→	Track Control Arm		MN-DL-5225	Trailing Arm
	02/11→	Track Control Arm	MN-VB-5238	MN-VB-5238	Wishbone (CV);Control Arm
	02/11→	Centre Rod	MN-DL-8560		Push Rod, Air Suspension Axle
24.320 FNLLW/N	10/07→	Suspension Strut Repair Kit		DB-RK-8581	
	10/07→	Suspension Strut Repair Kit		MN-RK-12436	
	10/07→	Tie Rod	MN-DL-7802		
	10/07→	Track Control Arm		MN-DL-5225	Trailing Arm, Drive Axle;Tag Axle; Air Suspension Axle
	10/07→	Track Control Arm		MN-VB-5238	Wishbone (CV), Drive Axle;Air Suspension Axle
	10/07→	Track Control Arm		MN-VB-9403	Wishbone (CV), Air Suspension Axle
	10/07→	Track Control Arm	MN-DL-8663		Control Arm, Air Suspension Axle

DB-RK-8581

Ø: 85
Hole Distance: 130
Thick/Height: 24
03305800A, 81432706105



MN-DL-5225

Length: 572 Ø: 48
Hole Distance: 130 / 130
03301500A, 81432206229, 81432206236,
81432206267, 81432206270, 81432206272,
81432206304, 81432206305, 81432209236,
81432209267, 81432209272



MN-DL-7801

Length: 995 Ø: 52
Cone Ø: d1 Ø 30 / d2 Ø 27
81466106807, 81466106808, 81466116087,
81466116088, 81466116096, 81466116097,
81466116099, 81466116132, 81466116133,
81466116136, 81466116197, 81466116198,
81466116205



MN-DL-7802

Length: 1680 Ø: 52
Cone Ø: d1 Ø 30 / d2 Ø 27
03208300A, 81467116773, 81467116858,
81467116859, 81467116860, 81467116861,
81467116863, 81467116882, 81467116883,
81467116920, 81467116921



MN-DL-8544

Length: 596 Ø: 48
Hole Distance: 130 / 130
81432206196, 81432206232, 81432206233



MN-DL-8560

Length: 970 Ø: 52
Cone Ø: d1 Ø 30 / d2 Ø 27
03206900A, 81466106809, 81466106810,
81466106823, 81466106838, 81466106839,
81466116104, 81466116105, 81466116107,
81466116134, 81466116135, 81466116137,
81466116199, 81466116200, 81466116206



MN-DL-8663

Length: 947 Ø: 60
Hole Distance: 115 / 115
03307400A, 81432206222, 81432206260,
81432206283, 81432206284



MN-DL-12293

Length: 1680 Ø: 42
Cone Ø: d1 Ø 30 / d2 Ø 27
81467106236, 81467106268, 81467106356,
81467116356, 81467116723, 81467116794,
81467116933, 81467116934, 81467116966



MN-DL-14107

Length: 960 Ø: 50
Cone Ø: d1 Ø 30 / d2 Ø 27
81466106813, 81466116146, 81466116147,
81466116148, 81466116204



MN-RK-12436

Ø: 75
Hole Distance: 115
Thick/Height: 24
81432206244



MN-SB-5246

Ø: 45 Thick/Height: 47
81437220022, 81437220038, 81962100450,
81962100469



MN-VB-5238

Length: 627 Ø: 48
Hole Distance: 130 / 130
81432206221, 81432706096, 81432706114,
81432706116, 81432706121



MN-VB-8514

Length: 627 Ø: 48
Hole Ø 25 / 25 / 25
Hole Distance: 152 / 130 / 130
81432706087, 81432706088, 81432706094,
81432706095, 81432796094



MN-VB-9403

Length: 627 Ø: 48
Hole Ø 25 / 23 / 23
Hole Distance: 152 / 130 / 130
81432706097, 81432706113, 81432706135,
81432706160, 81432706161





TGS ...

24.360 FNLLW/N	10/07→	Centre Rod	MN-DL-8560		Push Rod, Air Suspension Axle
	10/07→	Suspension Strut Repair Kit		DB-RK-8581	
	10/07→	Suspension Strut Repair Kit		MN-RK-12436	
	10/07→	Tie Rod	MN-DL-7802		
	10/07→	Track Control Arm		MN-DL-5225	Trailing Arm, Drive Axle;Tag Axle; Air Suspension Axle
	10/07→	Track Control Arm		MN-VB-5238	Wishbone (CV), Drive Axle;Air Suspension Axle
	10/07→	Track Control Arm		MN-VB-9403	Wishbone (CV), Air Suspension Axle
	10/07→	Track Control Arm	MN-DL-8663		Control Arm, Air Suspension Axle
24.360 FPLS, FPLRS	10/07→	Centre Rod	MN-DL-7801		Push Rod, Leaf Spring Axle
	10/07→	Suspension Strut Repair Kit		DB-RK-8581	
	10/07→	Tie Rod	MN-DL-7802		
	10/07→	Track Control Arm		MN-DL-5225	Trailing Arm, Drive Axle;Leading Axle; Air Suspension Axle
24.400 FNLLW/N	10/07→	Track Control Arm		MN-VB-5238	Wishbone (CV), Drive Axle;Air Suspension Axle
	10/07→	Track Control Arm		MN-VB-9403	Wishbone (CV), Air Suspension Axle
	10/07→	Track Control Arm	MN-DL-8663		Control Arm, Air Suspension Axle
	10/07→	Centre Rod	MN-DL-8560		Push Rod, Air Suspension Axle
	10/07→	Suspension Strut Repair Kit		DB-RK-8581	
	10/07→	Suspension Strut Repair Kit		MN-RK-12436	
	10/07→	Tie Rod	MN-DL-7802		
	10/07→	Track Control Arm		MN-DL-5225	Trailing Arm, Drive Axle;Tag Axle; Air Suspension Axle
24.400 FPLS, FPLRS	10/07→	Track Control Arm		MN-VB-5238	Wishbone (CV), Drive Axle;Air Suspension Axle
	10/07→	Track Control Arm		MN-VB-9403	Wishbone (CV), Air Suspension Axle
	10/07→	Track Control Arm	MN-DL-8663		Control Arm, Air Suspension Axle
	10/07→	Centre Rod	MN-DL-7801		Push Rod, Leaf Spring Axle
24.440 FNLLW/N	10/07→	Suspension Strut Repair Kit		DB-RK-8581	
	10/07→	Suspension Strut Repair Kit		MN-RK-12436	
	10/07→	Tie Rod	MN-DL-7802		
	10/07→	Track Control Arm		MN-DL-5225	Trailing Arm, Drive Axle;Tag Axle; Air Suspension Axle
	10/07→	Track Control Arm		MN-VB-5238	Wishbone (CV), Drive Axle;Air Suspension Axle
	10/07→	Track Control Arm		MN-VB-9403	Wishbone (CV), Air Suspension Axle
	10/07→	Centre Rod	MN-DL-7801		Push Rod, Leaf Spring Axle
	10/07→	Suspension Strut Repair Kit		DB-RK-8581	
24.440 FPLS, FPLRS	10/07→	Tie Rod	MN-DL-7802		
	10/07→	Track Control Arm		MN-DL-5225	Trailing Arm, Drive Axle;Leading Axle; Air Suspension Axle
	10/07→	Track Control Arm		MN-VB-5238	Wishbone (CV), Leading Axle;Drive Axle; Air Suspension Axle
	10/07→	Track Control Arm		MN-VB-9403	Wishbone (CV), Air Suspension Axle
24.480 FNLLW/N	10/07→	Centre Rod	MN-DL-8560		Push Rod
24.480 FPLS, FPLRS	10/07→	Centre Rod	MN-DL-7801		Push Rod, Leaf Spring Axle
	10/07→	Suspension Strut Repair Kit		DB-RK-8581	
	10/07→	Tie Rod	MN-DL-7802		
	10/07→	Track Control Arm		MN-DL-5225	Trailing Arm, Drive Axle;Leading Axle; Air Suspension Axle
	10/07→	Track Control Arm		MN-VB-5238	Wishbone (CV), Leading Axle;Drive Axle; Air Suspension Axle
24.540 FPLS, FPLRS	10/07→	Track Control Arm		MN-VB-9403	Wishbone (CV), Air Suspension Axle
	10/07→	Centre Rod	MN-DL-7801		Push Rod, Leaf Spring Axle
	10/07→	Suspension Strut Repair Kit		DB-RK-8581	
	10/07→	Tie Rod	MN-DL-7802		
	10/07→	Track Control Arm		MN-DL-5225	Trailing Arm, Drive Axle;Leading Axle; Air Suspension Axle
10/07→	Track Control Arm		MN-VB-5238	Wishbone (CV), Leading Axle;Drive Axle; Air Suspension Axle	

DB-RK-8581

Ø: 85
Hole Distance: 130
Thick/Height: 24
03305800A, 81432706105



MN-VB-5238

Length: 627 Ø: 48
Hole Distance: 130 / 130
81432206221, 81432706096, 81432706114,
81432706116, 81432706121



MN-DL-5225

Length: 572 Ø: 48
Hole Distance: 130 / 130
03301500A, 81432206229, 81432206236,
81432206267, 81432206270, 81432206272,
81432206304, 81432206305, 81432209236,
81432209267, 81432209272



MN-VB-9403

Length: 627 Ø: 48
Hole Ø 25 / 23 / 23
Hole Distance: 152 / 130 / 130
81432706097, 81432706113, 81432706135,
81432706160, 81432706161



MN-DL-7801

Length: 995 Ø: 52
Cone Ø: d1 Ø 30 / d2 Ø 27
81466106807, 81466106808, 81466116087,
81466116088, 81466116096, 81466116097,
81466116099, 81466116132, 81466116133,
81466116136, 81466116197, 81466116198,
81466116205



MN-DL-7802

Length: 1680 Ø: 52
Cone Ø: d1 Ø 30 / d2 Ø 27
03208300A, 81467116773, 81467116858,
81467116859, 81467116860, 81467116861,
81467116863, 81467116882, 81467116883,
81467116920, 81467116921



MN-DL-8560

Length: 970 Ø: 52
Cone Ø: d1 Ø 30 / d2 Ø 27
03206900A, 81466106809, 81466106810,
81466106823, 81466106838, 81466106839,
81466116104, 81466116105, 81466116107,
81466116134, 81466116135, 81466116137,
81466116199, 81466116200, 81466116206



MN-DL-8663

Length: 947 Ø: 60
Hole Distance: 115 / 115
03307400A, 81432206222, 81432206260,
81432206283, 81432206284



MN-RK-12436

Ø: 75
Hole Distance: 115
Thick/Height: 24
81432206244



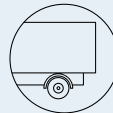

TGS ...

26.320 FDAC, FDALC, FDHLC, FDHLC/M	07/08→	Centre Rod	MN-DL-7801		Push Rod, Leaf Spring Axle
	07/08→	Centre Rod	MN-DL-8646		Push Rod, Drive Axle
	07/08→	Tie Rod	MN-DL-7802		
	07/08→	Tie Rod	MN-DL-12293		
	07/08→	Track Control Arm		MN-DL-5225	Trailing Arm, Drive Axle;Air Suspension Axle
	07/08→	Track Control Arm		MN-DL-8544	Trailing Arm, Drive Axle;Air Suspension Axle
	07/08→	Track Control Arm		MN-DL-8544	Trailing Arm, Drive Axle;Leaf Spring Axle
	07/08→	Track control arm		MN-DL-12288	Trailing Arm
	07/08→	Track Control Arm		MN-VB-5238	Wishbone (CV), Drive Axle;Air Suspension Axle
	07/08→	Track Control Arm		MN-VB-8514	Suspension Rod, Wishbone (CV), Drive Axle; Air Suspension Axle
26.320 FDAK, FDALK, FDHK, FDHLK	07/08→	Centre Rod	MN-DL-7801		Push Rod, Leaf Spring Axle
	07/08→	Centre Rod	MN-DL-8646		Push Rod, Drive Axle
	07/08→	Tie Rod	MN-DL-7802		
	07/08→	Tie Rod	MN-DL-12293		
	07/08→	Track Control Arm		MN-DL-5225	Trailing Arm, Drive Axle;Air Suspension Axle
	07/08→	Track Control Arm		MN-DL-8544	Trailing Arm, Drive Axle;Air Suspension Axle
	07/08→	Track Control Arm		MN-DL-8544	Trailing Arm, Drive Axle;Leaf Spring Axle
	07/08→	Track control arm		MN-DL-12288	Trailing Arm
	07/08→	Track Control Arm		MN-VB-5238	Wishbone (CV), Drive Axle;Air Suspension Axle
	07/08→	Track Control Arm		MN-VB-8514	Suspension Rod, Wishbone (CV), Drive Axle; Air Suspension Axle
26.320 FDAS, FDALS, FDHS, FDHLS, FDHLS/M	07/08→	Centre Rod	MN-DL-7801		Push Rod, Leaf Spring Axle
	07/08→	Centre Rod	MN-DL-8646		Push Rod, Drive Axle
	07/08→	Tie Rod	MN-DL-7802		
	07/08→	Tie Rod	MN-DL-12293		
	07/08→	Track Control Arm		MN-DL-5225	Trailing Arm, Drive Axle;Air Suspension Axle
	07/08→	Track Control Arm		MN-DL-8544	Trailing Arm, Drive Axle;Air Suspension Axle
	07/08→	Track Control Arm		MN-DL-8544	Trailing Arm, Drive Axle;Leaf Spring Axle
	07/08→	Track control arm		MN-DL-12288	Trailing Arm
	07/08→	Track Control Arm		MN-VB-5238	Wishbone (CV), Drive Axle;Air Suspension Axle
	07/08→	Track Control Arm		MN-VB-8514	Suspension Rod, Wishbone (CV), Drive Axle; Air Suspension Axle
26.320 FDC, FDRC, FDLC, FDLK/M, FDLRC, FDLRC/M, FNHLC, FVHLC	07/08→	Centre Rod	MN-DL-7801		Push Rod, Leaf Spring Axle
	07/08→	Tie Rod	MN-DL-7802		
	07/08→	Tie Rod	MN-DL-12284		
	07/08→	Tie Rod	MN-DL-12293		
	07/08→	Tie Rod End		MN-ES-8490	for vehicles with Hinged Trailing Axle
	07/08→	Track Control Arm		MN-DL-5225	Trailing Arm, Drive Axle
	07/08→	Track Control Arm		MN-DL-5225	Trailing Arm, Tag Axle;Air Suspension Axle; for vehicles with Hinged Trailing Axle
	07/08→	Track Control Arm		MN-DL-5225	Trailing Arm, Tag Axle;Air Suspension Axle; not for vehicles with Hinged Trailing Axle
	07/08→	Track Control Arm		MN-DL-8544	Trailing Arm, Drive Axle
	07/08→	Track Control Arm		MN-DL-8709	Trailing Arm, Air Suspension Axle; for vehicles with Hinged Trailing Axle
	07/08→	Track Control Arm		MN-TC-12399	Control Arm
	07/08→	Track Control Arm		MN-VB-5238	Wishbone (CV), Drive Axle;Air Suspension Axle
	07/08→	Track Control Arm		MN-VB-8514	Suspension Rod, Wishbone (CV), Drive Axle; Air Suspension Axle
	07/08→	Track Control Arm		MN-VB-8514	Suspension Rod, Wishbone (CV), Drive Axle; Leaf Spring Axle
	26.320 FDK, FDLK	07/08→	Track Control Arm		MN-VB-9403
07/08→		Centre Rod	MN-DL-7801		Push Rod, Leaf Spring Axle
07/08→		Tie Rod	MN-DL-7802		
07/08→		Track Control Arm		MN-DL-12293	
07/08→	Track Control Arm		MN-DL-5225	Trailing Arm, Drive Axle	

MN-DL-5225

Length: 572 Ø: 48
Hole Distance: 130 / 130

03301500A, 81432206229, 81432206236,
81432206267, 81432206270, 81432206272,
81432206304, 81432206305, 81432209236,
81432209267, 81432209272



MN-DL-7801

Length: 995 Ø: 52
Cone Ø: d1 Ø 30 / d2 Ø 27

81466106807, 81466106808, 81466116087,
81466116088, 81466116096, 81466116097,
81466116099, 81466116132, 81466116133,
81466116136, 81466116197, 81466116198,
81466116205

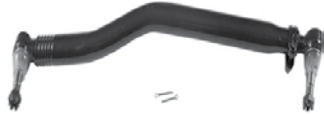

MN-DL-7802

Length: 1680 Ø: 52
Cone Ø: d1 Ø 30 / d2 Ø 27

03208300A, 81467116773, 81467116858,
81467116859, 81467116860, 81467116861,
81467116863, 81467116882, 81467116883,
81467116920, 81467116921



MN-DL-8544

Length: 596 Ø: 48
Hole Distance: 130 / 130

81432206196, 81432206232, 81432206233



MN-DL-8646

Length: 1021 Ø: 52
Cone Ø: d1 Ø 30 / d2 Ø 27

81466106811, 81466106812, 81466116138,
81466116139, 81466116201, 81466116202

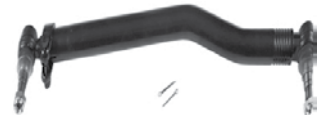

MN-DL-8709

Length: 572 Ø: 52
Hole Distance: 130 / 130

81432206268, 81432206274, 81432206291,
81432206292, 82432206007



MN-DL-12284

Length: 1530 Ø: 50
Cone Ø: d1 Ø 30 / d2 Ø 27

81466106579, 81466106580, 81466106624,
81466116720, 81467116720, 81467116730,
81467116952



MN-DL-12288

Length: 585 Ø: 58
Hole Distance: 130 / 130

81432206386, 82432206008, 82432209008

No Image

MN-DL-12293

Length: 1680 Ø: 42
Cone Ø: d1 Ø 30 / d2 Ø 27

81467106236, 81467106268, 81467106356,
81467116356, 81467116723, 81467116794,
81467116933, 81467116934, 81467116966



MN-ES-8490

Length: 90
Cone Ø: d1 Ø 30 / d2 Ø 27
Thread: M26 x 1,5 RHT

0014606948, 14606948, 81953016281,
81953016337, 82953016016



MN-TC-12399

Length: 694 Ø: 50
Hole Distance: 130 / 130

81432206265



MN-VB-5238

Length: 627 Ø: 48
Hole Distance: 130 / 130

81432206221, 81432706096, 81432706114,
81432706116, 81432706121



MN-VB-8514

Length: 627 Ø: 48
Hole Ø 25 / 25 / 25
Hole Distance: 152 / 130 / 130

81432706087, 81432706088, 81432706094,
81432706095, 81432796094



MN-VB-9403

Length: 627 Ø: 48
Hole Ø 25 / 23 / 23
Hole Distance: 152 / 130 / 130

81432706097, 81432706113, 81432706135,
81432706160, 81432706161





TGS ...

26.320 FDK, FDLK ...	07/08→	Track Control Arm		MN-DL-8544	Trailing Arm, Drive Axle	
	07/08→	Track Control Arm		MN-VB-5238	Wishbone (CV), Drive Axle;Air Suspension Axle	
	07/08→	Track Control Arm		MN-VB-8514	Suspension Rod, Wishbone (CV), Drive Axle; Air Suspension Axle	
	07/08→	Track Control Arm		MN-VB-8514	Suspension Rod, Wishbone (CV), Drive Axle; Leaf Spring Axle	
26.320 FDS, FDLS, FDRS, FDLRS, FNHLS, FPHLS, FVHLS	07/08→	Centre Rod	MN-DL-7801		Push Rod, Leaf Spring Axle	
	07/08→	Tie Rod	MN-DL-7802			
	07/08→	Tie Rod	MN-DL-12293			
	07/08→	Track Control Arm		MN-DL-5225	Trailing Arm, Drive Axle	
	07/08→	Track Control Arm		MN-DL-8544	Trailing Arm, Drive Axle	
	07/08→	Track Control Arm		MN-VB-5238	Wishbone (CV), Drive Axle;Air Suspension Axle	
	07/08→	Track Control Arm		MN-VB-8514	Suspension Rod, Wishbone (CV), Drive Axle; Air Suspension Axle	
	07/08→	Track Control Arm		MN-VB-8514	Suspension Rod, Wishbone (CV), Drive Axle; Leaf Spring Axle	
26.320 FD-TM	07/08→	Tie Rod	MN-DL-12293			
	07/08→	Track Control Arm		MN-VB-8514	Suspension Rod, Wishbone (CV)	
26.320 FNLC, FNLRC, FNLLC, FNLLRC, FNLLW, FVLC, FVL-KO	10/07→	Centre Rod	MN-DL-7801		Push Rod, Leaf Spring Axle	
	10/07→	Centre Rod	MN-DL-8560		Push Rod, Air Suspension Axle	
	10/07→	Tie Rod	MN-DL-7802			
	10/07→	Tie Rod	MN-DL-12284			
	10/07→	Tie Rod End		MN-ES-8490	for vehicles with Hinged Trailing Axle	
	10/07→	Track Control Arm		MN-DL-5225	Trailing Arm, Drive Axle	
	10/07→	Track Control Arm		MN-DL-5225	Trailing Arm, Trailing Axle;for vehicles with Hinged Trailing Axle	
	10/07→	Track Control Arm		MN-DL-5225	Trailing Arm, Trailing Axle;for vehicles with Rigid Trailing Axle	
	10/07→	Track Control Arm		MN-DL-8709	Trailing Arm, Trailing Axle;for vehicles with Hinged Trailing Axle	
	10/07→	Track Control Arm		MN-TC-12399	Control Arm	
	10/07→	Track Control Arm		MN-VB-9403	Wishbone (CV)	
	10/07→	Track Control Arm	MN-DL-8663		Control Arm, Air Suspension Axle	
	26.320 FNLS, FNLRS, FNLLS, FPLS, FVLS, FPLRS	07/08→	Centre Rod	MN-DL-7801		Push Rod, Leaf Spring Axle
		07/08→	Centre Rod	MN-DL-8560		Push Rod, Air Suspension Axle
07/08→		Tie Rod	MN-DL-7802			
07/08→		Tie Rod	MN-DL-12284			
07/08→		Tie Rod End		MN-ES-8490	for vehicles with Hinged Trailing Axle	
07/08→		Track Control Arm		MN-DL-5225	Trailing Arm, Drive Axle	
07/08→		Track Control Arm		MN-DL-5225	Trailing Arm, Trailing Axle;for vehicles with Hinged Trailing Axle	
07/08→		Track Control Arm		MN-DL-5225	Trailing Arm, Trailing Axle;for vehicles with Rigid Trailing Axle	
07/08→		Track Control Arm		MN-DL-8709	Trailing Arm, Trailing Axle;for vehicles with Hinged Trailing Axle	
07/08→		Track Control Arm		MN-TC-12399	Control Arm	
07/08→		Track Control Arm		MN-VB-5238	Wishbone (CV), Drive Axle	
07/08→		Track Control Arm		MN-VB-9403	Wishbone (CV)	
07/08→		Track Control Arm	MN-DL-8663		Control Arm, Air Suspension Axle	
26.320 FVHLC		10/07→	Track Control Arm		MN-DL-5225	Trailing Arm
26.360 FDAC, FDALC, FDHLC, FDHLC/M		08/08→	Centre Rod	MN-DL-7801		Push Rod, Leaf Spring Axle
		08/08→	Centre Rod	MN-DL-8646		Push Rod, Drive Axle
		08/08→	Tie Rod	MN-DL-7802		
		08/08→	Tie Rod	MN-DL-12293		
	08/08→	Track Control Arm		MN-DL-5225	Trailing Arm, Drive Axle;Air Suspension Axle	
	08/08→	Track Control Arm		MN-DL-8544	Trailing Arm, Drive Axle;Air Suspension Axle	
	08/08→	Track Control Arm		MN-DL-8544	Trailing Arm, Drive Axle;Leaf Spring Axle	
	08/08→	Track control arm		MN-DL-12288	Trailing Arm	
	08/08→	Track Control Arm		MN-VB-5238	Wishbone (CV), Drive Axle;Air Suspension Axle	
	08/08→	Track Control Arm		MN-VB-8514	Suspension Rod, Wishbone (CV), Drive Axle; Air Suspension Axle	
	08/08→	Track Control Arm		MN-VB-8514	Suspension Rod, Wishbone (CV), Drive Axle; Leaf Spring Axle	

MN-DL-5225

Length: 572 Ø: 48
Hole Distance: 130 / 130

03301500A, 81432206229, 81432206236,
81432206267, 81432206270, 81432206272,
81432206304, 81432206305, 81432209236,
81432209267, 81432209272



MN-DL-7801

Length: 995 Ø: 52
Cone Ø: d1 Ø 30 / d2 Ø 27

81466106807, 81466106808, 81466116087,
81466116088, 81466116096, 81466116097,
81466116099, 81466116132, 81466116133,
81466116136, 81466116197, 81466116198,
81466116205



MN-DL-7802

Length: 1680 Ø: 52
Cone Ø: d1 Ø 30 / d2 Ø 27

03208300A, 81467116773, 81467116858,
81467116859, 81467116860, 81467116861,
81467116863, 81467116882, 81467116883,
81467116920, 81467116921



MN-DL-8544

Length: 596 Ø: 48
Hole Distance: 130 / 130

81432206196, 81432206232, 81432206233



MN-DL-8560

Length: 970 Ø: 52
Cone Ø: d1 Ø 30 / d2 Ø 27

03206900A, 81466106809, 81466106810,
81466106823, 81466106838, 81466106839,
81466116104, 81466116105, 81466116107,
81466116134, 81466116135, 81466116137,
81466116199, 81466116200, 81466116206



MN-DL-8646

Length: 1021 Ø: 52
Cone Ø: d1 Ø 30 / d2 Ø 27

81466106811, 81466106812, 81466116138,
81466116139, 81466116201, 81466116202

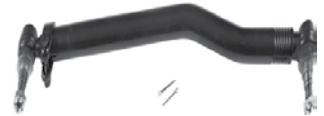

MN-DL-8663

Length: 947 Ø: 60
Hole Distance: 115 / 115

03307400A, 81432206222, 81432206260,
81432206283, 81432206284



MN-DL-8709

Length: 572 Ø: 52
Hole Distance: 130 / 130

81432206268, 81432206274, 81432206291,
81432206292, 82432206007



MN-DL-12284

Length: 1530 Ø: 50
Cone Ø: d1 Ø 30 / d2 Ø 27

81466106579, 81466106580, 81466106624,
81466116720, 81467116720, 81467116730,
81467116952



MN-DL-12288

Length: 585 Ø: 58
Hole Distance: 130 / 130

81432206386, 82432206008, 82432209008

No Image

MN-DL-12293

Length: 1680 Ø: 42
Cone Ø: d1 Ø 30 / d2 Ø 27

81467106236, 81467106268, 81467106356,
81467116356, 81467116723, 81467116794,
81467116933, 81467116934, 81467116966



MN-ES-8490

Length: 90
Cone Ø: d1 Ø 30 / d2 Ø 27
Thread: M26 x 1,5 RHT

0014606948, 14606948, 81953016281,
81953016337, 82953016016



MN-TC-12399

Length: 694 Ø: 50
Hole Distance: 130 / 130

81432206265



MN-VB-5238

Length: 627 Ø: 48
Hole Distance: 130 / 130

81432206221, 81432706096, 81432706114,
81432706116, 81432706121



MN-VB-8514

Length: 627 Ø: 48
Hole Ø 25 / 25 / 25
Hole Distance: 152 / 130 / 130

81432706087, 81432706088, 81432706094,
81432706095, 81432796094



MN-VB-9403

Length: 627 Ø: 48
Hole Ø 25 / 23 / 23
Hole Distance: 152 / 130 / 130

81432706097, 81432706113, 81432706135,
81432706160, 81432706161





TGS ...

26.360 FDAK, FDALK, FDHK, FDHLK	08/08→	Centre Rod	MN-DL-7801		Push Rod, Leaf Spring Axle	
	08/08→	Centre Rod	MN-DL-8646		Push Rod, Drive Axle	
	08/08→	Tie Rod	MN-DL-7802			
	08/08→	Tie Rod	MN-DL-12293			
	08/08→	Track Control Arm		MN-DL-5225	for Control Arm	
	08/08→	Track Control Arm		MN-DL-8544	Trailing Arm, Drive Axle;Air Suspension Axle	
	08/08→	Track Control Arm		MN-DL-8544	Trailing Arm, Drive Axle;Leaf Spring Axle	
	08/08→	Track control arm		MN-DL-12288	Trailing Arm	
	08/08→	Track Control Arm		MN-VB-5238	Wishbone (CV), Drive Axle;Air Suspension Axle	
	08/08→	Track Control Arm		MN-VB-8514	Suspension Rod, Wishbone (CV), Drive Axle; Air Suspension Axle	
	08/08→	Track Control Arm		MN-VB-8514	Suspension Rod, Wishbone (CV), Drive Axle; Leaf Spring Axle	
26.360 FDAS, FDALS, FDHS, FDHLS, FDHLS/M	08/08→	Centre Rod	MN-DL-7801		Push Rod, Leaf Spring Axle	
	08/08→	Centre Rod	MN-DL-8646		Push Rod, Drive Axle	
	08/08→	Tie Rod	MN-DL-7802			
	08/08→	Tie Rod	MN-DL-12293			
	08/08→	Track Control Arm		MN-DL-5225	Trailing Arm, Drive Axle;Air Suspension Axle	
	08/08→	Track Control Arm		MN-DL-8544	Trailing Arm, Drive Axle;Air Suspension Axle	
	08/08→	Track Control Arm		MN-DL-8544	Trailing Arm, Drive Axle;Leaf Spring Axle	
	08/08→	Track control arm		MN-DL-12288	Trailing Arm	
	08/08→	Track Control Arm		MN-VB-5238	Wishbone (CV), Drive Axle;Air Suspension Axle	
	08/08→	Track Control Arm		MN-VB-8514	Suspension Rod, Wishbone (CV), Drive Axle; Air Suspension Axle	
	08/08→	Track Control Arm		MN-VB-8514	Suspension Rod, Wishbone (CV), Drive Axle; Leaf Spring Axle	
26.360 FDC, FDRC, FDRC/M, FDLK, FDLRC, FNHLC	08/08→	Centre Rod	MN-DL-7801		Push Rod, Leaf Spring Axle	
	08/08→	Tie Rod	MN-DL-7802			
	08/08→	Tie Rod	MN-DL-12284			
	08/08→	Tie Rod	MN-DL-12293			
	08/08→	Tie Rod End		MN-ES-8490	for vehicles with Hinged Trailing Axle	
	08/08→	Track Control Arm		MN-DL-5225	Trailing Arm, Drive Axle	
	08/08→	Track Control Arm		MN-DL-5225	Trailing Arm, Tag Axle;Air Suspension Axle; for vehicles with Hinged Trailing Axle	
	08/08→	Track Control Arm		MN-DL-5225	Trailing Arm, Tag Axle;Air Suspension Axle; not for vehicles with Hinged Trailing Axle	
	08/08→	Track Control Arm		MN-DL-8544	Trailing Arm, Drive Axle	
	08/08→	Track Control Arm		MN-DL-8709	Trailing Arm, for vehicles with Hinged Trailing Axle;Air Suspension Axle	
	08/08→	Track Control Arm		MN-TC-12399	Control Arm	
	08/08→	Track Control Arm		MN-VB-5238	Wishbone (CV), Drive Axle;Air Suspension Axle	
	08/08→	Track Control Arm		MN-VB-8514	Suspension Rod, Wishbone (CV), Drive Axle; Air Suspension Axle	
	08/08→	Track Control Arm		MN-VB-8514	Suspension Rod, Wishbone (CV), Drive Axle; Leaf Spring Axle	
	08/08→	Track Control Arm		MN-VB-9403	Wishbone (CV), Air Suspension Axle	
	26.360 FDK, FDLK, FDRK	08/08→	Centre Rod	MN-DL-7801		Push Rod, Leaf Spring Axle
		08/08→	Tie Rod	MN-DL-7802		
08/08→		Tie Rod	MN-DL-12293			
08/08→		Track Control Arm		MN-DL-5225	Trailing Arm, Drive Axle	
08/08→		Track Control Arm		MN-DL-8544	Trailing Arm, Drive Axle	
08/08→		Track Control Arm		MN-VB-5238	Wishbone (CV), Drive Axle;Air Suspension Axle	
08/08→		Track Control Arm		MN-VB-8514	Suspension Rod, Wishbone (CV), Drive Axle; Air Suspension Axle	
08/08→		Track Control Arm		MN-VB-8514	Suspension Rod, Wishbone (CV), Drive Axle; Leaf Spring Axle	
26.360 FDS, FDRS, FDLS, FDLRS, FNHLS, FPHLS, FVHLS	08/08→	Centre Rod	MN-DL-7801		Push Rod, Leaf Spring Axle	
	08/08→	Tie Rod	MN-DL-7802			
	08/08→	Tie Rod	MN-DL-12284			
	08/08→	Tie Rod	MN-DL-12293			
	08/08→	Tie Rod End		MN-ES-8490	for vehicles with Hinged Trailing Axle	
	08/08→	Track Control Arm		MN-DL-5225	Trailing Arm, Drive Axle	

MN-DL-5225

Length: 572 Ø: 48
Hole Distance: 130 / 130

03301500A, 81432206229, 81432206236,
81432206267, 81432206270, 81432206272,
81432206304, 81432206305, 81432209236,
81432209267, 81432209272



MN-DL-7801

Length: 995 Ø: 52
Cone Ø: d1 Ø 30 / d2 Ø 27

81466106807, 81466106808, 81466116087,
81466116088, 81466116096, 81466116097,
81466116099, 81466116132, 81466116133,
81466116136, 81466116197, 81466116198,
81466116205



MN-DL-7802

Length: 1680 Ø: 52
Cone Ø: d1 Ø 30 / d2 Ø 27

03208300A, 81467116773, 81467116858,
81467116859, 81467116860, 81467116861,
81467116863, 81467116882, 81467116883,
81467116920, 81467116921



MN-DL-8544

Length: 596 Ø: 48
Hole Distance: 130 / 130

81432206196, 81432206232, 81432206233



MN-DL-8646

Length: 1021 Ø: 52
Cone Ø: d1 Ø 30 / d2 Ø 27

81466106811, 81466106812, 81466116138,
81466116139, 81466116201, 81466116202

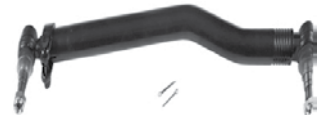

MN-DL-8709

Length: 572 Ø: 52
Hole Distance: 130 / 130

81432206268, 81432206274, 81432206291,
81432206292, 82432206007



MN-DL-12284

Length: 1530 Ø: 50
Cone Ø: d1 Ø 30 / d2 Ø 27

81466106579, 81466106580, 81466106624,
81466116720, 81467116720, 81467116730,
81467116952



MN-DL-12288

Length: 585 Ø: 58
Hole Distance: 130 / 130

81432206386, 82432206008, 82432209008

No Image

MN-DL-12293

Length: 1680 Ø: 42
Cone Ø: d1 Ø 30 / d2 Ø 27

81467106236, 81467106268, 81467106356,
81467116356, 81467116723, 81467116794,
81467116933, 81467116934, 81467116966



MN-ES-8490

Length: 90
Cone Ø: d1 Ø 30 / d2 Ø 27
Thread: M26 x 1,5 RHT

0014606948, 14606948, 81953016281,
81953016337, 82953016016



MN-TC-12399

Length: 694 Ø: 50
Hole Distance: 130 / 130

81432206265



MN-VB-5238

Length: 627 Ø: 48
Hole Distance: 130 / 130

81432206221, 81432706096, 81432706114,
81432706116, 81432706121



MN-VB-8514

Length: 627 Ø: 48
Hole Ø 25 / 25 / 25
Hole Distance: 152 / 130 / 130

81432706087, 81432706088, 81432706094,
81432706095, 81432796094



MN-VB-9403

Length: 627 Ø: 48
Hole Ø 25 / 23 / 23
Hole Distance: 152 / 130 / 130

81432706097, 81432706113, 81432706135,
81432706160, 81432706161





TGS ...

26.360 FDS, FDRS, FDLS, FDLRS, FNHLS, FPHLS, FVHLS ...	08/08 →	Track Control Arm		MN-DL-5225	Trailing Arm, Tag Axle; Air Suspension Axle; for vehicles with Hinged Trailing Axle
	08/08 →	Track Control Arm		MN-DL-5225	Trailing Arm, Tag Axle; Air Suspension Axle; not for vehicles with Hinged Trailing Axle
	08/08 →	Track Control Arm		MN-DL-8544	Trailing Arm, Drive Axle
	08/08 →	Track Control Arm		MN-DL-8709	Trailing Arm, Air Suspension Axle; for vehicles with Hinged Trailing Axle
	08/08 →	Track Control Arm		MN-TC-12399	Control Arm
	08/08 →	Track Control Arm		MN-VB-5238	Wishbone (CV), Drive Axle; Air Suspension Axle
	08/08 →	Track Control Arm		MN-VB-8514	Suspension Rod, Wishbone (CV), Drive Axle; Air Suspension Axle
	08/08 →	Track Control Arm		MN-VB-8514	Suspension Rod, Wishbone (CV), Drive Axle; Leaf Spring Axle
26.360 FD-TM	07/08 →	Tie Rod	MN-DL-12293		
	07/08 →	Track Control Arm		MN-VB-8514	Suspension Rod, Wishbone (CV)
26.360 FNLC, FNLRC, FNLLC, FNLLRC, FVLC, FVL-KO	10/07 →	Centre Rod	MN-DL-7801		Push Rod, Leaf Spring Axle
	10/07 →	Centre Rod	MN-DL-8560		Push Rod, Air Suspension Axle
	10/07 →	Tie Rod	MN-DL-7802		
	10/07 →	Tie Rod	MN-DL-12284		
	10/07 →	Tie Rod End		MN-ES-8490	for vehicles with Hinged Trailing Axle
	10/07 →	Track Control Arm		MN-DL-5225	for Control Arm
	10/07 →	Track Control Arm		MN-DL-5225	Trailing Arm, Drive Axle
	10/07 →	Track Control Arm		MN-DL-5225	Trailing Arm, Trailing Axle; for vehicles with Hinged Trailing Axle
	10/07 →	Track Control Arm		MN-DL-8709	Trailing Arm, Trailing Axle; for vehicles with Hinged Trailing Axle
	10/07 →	Track Control Arm		MN-TC-12399	Control Arm
	10/07 →	Track Control Arm		MN-VB-5238	Wishbone (CV), Drive Axle
	10/07 →	Track Control Arm		MN-VB-9403	Wishbone (CV)
	10/07 →	Track Control Arm	MN-DL-8663		Control Arm, Air Suspension Axle
	26.360 FNLLW	04/08 →	Tie Rod	MN-DL-12284	
04/08 →		Track Control Arm		MN-DL-5225	Trailing Arm
04/08 →		Track Control Arm		MN-TC-12399	Control Arm
26.360 FNLS, FNLLS, FNLRS, FPLS, FPLRS, FVLS	08/08 →	Centre Rod	MN-DL-7801		Push Rod, Leaf Spring Axle
	08/08 →	Centre Rod	MN-DL-8560		Push Rod, Air Suspension Axle
	08/08 →	Tie Rod	MN-DL-7802		
	08/08 →	Tie Rod	MN-DL-12284		
	08/08 →	Tie Rod End		MN-ES-8490	for vehicles with Hinged Trailing Axle
	08/08 →	Track Control Arm		MN-DL-5225	Trailing Arm, Drive Axle
	08/08 →	Track Control Arm		MN-DL-5225	Trailing Arm, Trailing Axle; for vehicles with Hinged Trailing Axle
	08/08 →	Track Control Arm		MN-DL-5225	Trailing Arm, Trailing Axle; for vehicles with Rigid Trailing Axle
	08/08 →	Track Control Arm		MN-DL-8709	Trailing Arm, Trailing Axle; for vehicles with Hinged Trailing Axle
	08/08 →	Track Control Arm		MN-TC-12399	Control Arm
	08/08 →	Track Control Arm		MN-VB-5238	Wishbone (CV), Drive Axle
	08/08 →	Track Control Arm		MN-VB-9403	Wishbone (CV)
	08/08 →	Track Control Arm	MN-DL-8663		Control Arm, Air Suspension Axle
	26.360 FPHLS	05/08 →	Centre Rod	MN-DL-8560	
05/08 →		Track Control Arm		MN-DL-5225	Trailing Arm
26.360 FVHLC	10/07 →	Centre Rod	MN-DL-8560		Push Rod
26.360 FVHLS	10/07 →	Track Control Arm		MN-DL-5225	Trailing Arm
	05/08 →	Centre Rod	MN-DL-8560		Push Rod
26.400	05/08 →	Track Control Arm		MN-DL-5225	Trailing Arm
	11/07 →	Centre Rod	MN-DL-8646		Push Rod, Drive Axle
26.400	11/07 →	Track Control Arm		MN-DL-5225	Trailing Arm
	11/07 →	Track Control Arm		MN-DL-8544	Trailing Arm, Drive Axle; Air Suspension Axle
	11/07 →	Track Control Arm		MN-DL-8544	Trailing Arm, Drive Axle; Leaf Spring Axle
	11/07 →	Track control arm		MN-DL-12288	Trailing Arm
	11/07 →	Track Control Arm		MN-VB-8514	Suspension Rod, Wishbone (CV), Drive Axle; Air Suspension Axle

MN-DL-5225

Length: 572 Ø: 48
Hole Distance: 130 / 130

03301500A, 81432206229, 81432206236,
81432206267, 81432206270, 81432206272,
81432206304, 81432206305, 81432209236,
81432209267, 81432209272



MN-DL-7801

Length: 995 Ø: 52
Cone Ø: d1 Ø 30 / d2 Ø 27

81466106807, 81466106808, 81466116087,
81466116088, 81466116096, 81466116097,
81466116099, 81466116132, 81466116133,
81466116136, 81466116197, 81466116198,
81466116205

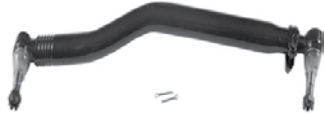

MN-DL-7802

Length: 1680 Ø: 52
Cone Ø: d1 Ø 30 / d2 Ø 27

03208300A, 81467116773, 81467116858,
81467116859, 81467116860, 81467116861,
81467116863, 81467116882, 81467116883,
81467116920, 81467116921



MN-DL-8544

Length: 596 Ø: 48
Hole Distance: 130 / 130

81432206196, 81432206232, 81432206233



MN-DL-8560

Length: 970 Ø: 52
Cone Ø: d1 Ø 30 / d2 Ø 27

03206900A, 81466106809, 81466106810,
81466106823, 81466106838, 81466106839,
81466116104, 81466116105, 81466116107,
81466116134, 81466116135, 81466116137,
81466116199, 81466116200, 81466116206



MN-DL-8646

Length: 1021 Ø: 52
Cone Ø: d1 Ø 30 / d2 Ø 27

81466106811, 81466106812, 81466116138,
81466116139, 81466116201, 81466116202

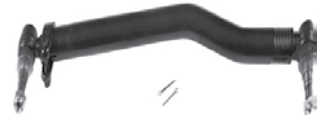

MN-DL-8663

Length: 947 Ø: 60
Hole Distance: 115 / 115

03307400A, 81432206222, 81432206260,
81432206283, 81432206284



MN-DL-8709

Length: 572 Ø: 52
Hole Distance: 130 / 130

81432206268, 81432206274, 81432206291,
81432206292, 82432206007



MN-DL-12284

Length: 1530 Ø: 50
Cone Ø: d1 Ø 30 / d2 Ø 27

81466106579, 81466106580, 81466106624,
81466116720, 81467116720, 81467116730,
81467116952



MN-DL-12288

Length: 585 Ø: 58
Hole Distance: 130 / 130

81432206386, 82432206008, 82432209008

No Image

MN-DL-12293

Length: 1680 Ø: 42
Cone Ø: d1 Ø 30 / d2 Ø 27

81467106236, 81467106268, 81467106356,
81467116356, 81467116723, 81467116794,
81467116933, 81467116934, 81467116966



MN-ES-8490

Length: 90
Cone Ø: d1 Ø 30 / d2 Ø 27
Thread: M26 x 1,5 RHT

0014606948, 14606948, 81953016281,
81953016337, 82953016016



MN-TC-12399

Length: 694 Ø: 50
Hole Distance: 130 / 130

81432206265



MN-VB-5238

Length: 627 Ø: 48
Hole Distance: 130 / 130

81432206221, 81432706096, 81432706114,
81432706116, 81432706121



MN-VB-8514

Length: 627 Ø: 48
Hole Ø 25 / 25 / 25
Hole Distance: 152 / 130 / 130

81432706087, 81432706088, 81432706094,
81432706095, 81432796094



MN-VB-9403

Length: 627 Ø: 48
Hole Ø 25 / 23 / 23
Hole Distance: 152 / 130 / 130

81432706097, 81432706113, 81432706135,
81432706160, 81432706161





TGS ...

26.400 ...	11/07→	Track Control Arm		MN-VB-8514	Suspension Rod, Wishbone (CV), Drive Axle; Leaf Spring Axle
26.400 FDAC, FDALC, FDHLC, FDHLC/M	02/09→	Centre Rod	MN-DL-8646		Push Rod, Drive Axle
	02/09→	Track Control Arm		MN-DL-5225	Trailing Arm
	02/09→	Track Control Arm		MN-DL-8544	Trailing Arm, Drive Axle;Air Suspension Axle
	02/09→	Track Control Arm		MN-DL-8544	Trailing Arm, Drive Axle;Leaf Spring Axle
	02/09→	Track control arm		MN-DL-12288	Trailing Arm
	02/09→	Track Control Arm		MN-VB-8514	Suspension Rod, Wishbone (CV), Drive Axle; Air Suspension Axle
	02/09→	Track Control Arm		MN-VB-8514	Suspension Rod, Wishbone (CV), Drive Axle; Leaf Spring Axle
26.400 FDAS, FDALS, FDHS, FDHLS, FDHLS/M	09/07→	Centre Rod	MN-DL-8646		Push Rod, Drive Axle
	09/07→	Track Control Arm		MN-DL-5225	Trailing Arm
	09/07→	Track Control Arm		MN-DL-8544	Trailing Arm, Drive Axle;Air Suspension Axle
	09/07→	Track Control Arm		MN-DL-8544	Trailing Arm, Drive Axle;Leaf Spring Axle
	09/07→	Track control arm		MN-DL-12288	Trailing Arm
	09/07→	Track Control Arm		MN-VB-8514	Suspension Rod, Wishbone (CV), Drive Axle; Air Suspension Axle
	09/07→	Track Control Arm		MN-VB-8514	Suspension Rod, Wishbone (CV), Drive Axle; Leaf Spring Axle
26.400 FDC, FDRC, FDC/M, FDLC, FDLC/M, FDLRC, FDLRC/M, FNHLC	08/08→	Centre Rod	MN-DL-7801		Push Rod, Leaf Spring Axle
	08/08→	Tie Rod	MN-DL-7802		
	08/08→	Tie Rod	MN-DL-12293		
	08/08→	Track Control Arm		MN-DL-5225	Trailing Arm, Drive Axle
	08/08→	Track Control Arm		MN-DL-8544	Trailing Arm, Drive Axle
	08/08→	Track Control Arm		MN-VB-5238	Wishbone (CV), Drive Axle;Air Suspension Axle
	08/08→	Track Control Arm		MN-VB-8514	Suspension Rod, Wishbone (CV), Drive Axle; Air Suspension Axle
	08/08→	Track Control Arm		MN-VB-8514	Suspension Rod, Wishbone (CV), Drive Axle; Leaf Spring Axle
26.400 FDK, FDLK	02/09→	Centre Rod	MN-DL-7801		Push Rod, Leaf Spring Axle
	02/09→	Tie Rod	MN-DL-7802		
	02/09→	Tie Rod	MN-DL-12293		
	02/09→	Track Control Arm		MN-DL-5225	Trailing Arm, Drive Axle
	02/09→	Track Control Arm		MN-DL-8544	Trailing Arm, Drive Axle
	02/09→	Track Control Arm		MN-VB-5238	Wishbone (CV), Drive Axle;Air Suspension Axle
	02/09→	Track Control Arm		MN-VB-8514	Suspension Rod, Wishbone (CV), Drive Axle; Air Suspension Axle
	02/09→	Track Control Arm		MN-VB-8514	Suspension Rod, Wishbone (CV), Drive Axle; Leaf Spring Axle
26.400 FDS, FDLS, FDRS, FDLRS, FNHLS, FPHLS, FVHLS	05/08→	Centre Rod	MN-DL-7801		Push Rod, Leaf Spring Axle
	05/08→	Tie Rod	MN-DL-7802		
	05/08→	Tie Rod	MN-DL-12284		
	05/08→	Tie Rod	MN-DL-12293		
	05/08→	Tie Rod End		MN-ES-8490	for vehicles with Hinged Trailing Axle
	05/08→	Track Control Arm		MN-DL-5225	Trailing Arm, Drive Axle
	05/08→	Track Control Arm		MN-DL-5225	Trailing Arm, Tag Axle;Air Suspension Axle; for vehicles with Hinged Trailing Axle
	05/08→	Track Control Arm		MN-DL-5225	Trailing Arm, Tag Axle;Air Suspension Axle; not for vehicles with Hinged Trailing Axle
	05/08→	Track Control Arm		MN-DL-8544	Trailing Arm, Drive Axle
	05/08→	Track Control Arm		MN-DL-8709	Trailing Arm, Air Suspension Axle; for vehicles with Hinged Trailing Axle
	05/08→	Track Control Arm		MN-TC-12399	Control Arm
	05/08→	Track Control Arm		MN-VB-5238	Wishbone (CV), Drive Axle;Air Suspension Axle
	05/08→	Track Control Arm		MN-VB-8514	Suspension Rod, Wishbone (CV), Drive Axle; Air Suspension Axle
	05/08→	Track Control Arm		MN-VB-8514	Suspension Rod, Wishbone (CV), Drive Axle; Leaf Spring Axle
	26.400 FD-TM	07/08→	Tie Rod	MN-DL-12293	
07/08→		Track Control Arm		MN-VB-8514	Suspension Rod, Wishbone (CV)

MN-DL-5225

Length: 572 Ø: 48
Hole Distance: 130 / 130

03301500A, 81432206229, 81432206236,
81432206267, 81432206270, 81432206272,
81432206304, 81432206305, 81432209236,
81432209267, 81432209272



MN-DL-7801

Length: 995 Ø: 52
Cone Ø: d1 Ø 30 / d2 Ø 27

81466106807, 81466106808, 81466116087,
81466116088, 81466116096, 81466116097,
81466116099, 81466116132, 81466116133,
81466116136, 81466116197, 81466116198,
81466116205

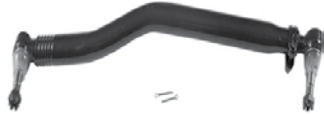

MN-DL-7802

Length: 1680 Ø: 52
Cone Ø: d1 Ø 30 / d2 Ø 27

03208300A, 81467116773, 81467116858,
81467116859, 81467116860, 81467116861,
81467116863, 81467116882, 81467116883,
81467116920, 81467116921



MN-DL-8544

Length: 596 Ø: 48
Hole Distance: 130 / 130

81432206196, 81432206232, 81432206233



MN-DL-8646

Length: 1021 Ø: 52
Cone Ø: d1 Ø 30 / d2 Ø 27

81466106811, 81466106812, 81466116138,
81466116139, 81466116201, 81466116202

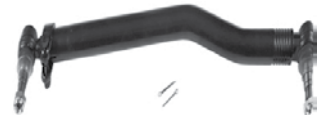

MN-DL-8709

Length: 572 Ø: 52
Hole Distance: 130 / 130

81432206268, 81432206274, 81432206291,
81432206292, 82432206007



MN-DL-12284

Length: 1530 Ø: 50
Cone Ø: d1 Ø 30 / d2 Ø 27

81466106579, 81466106580, 81466106624,
81466116720, 81467116720, 81467116730,
81467116952



MN-DL-12288

Length: 585 Ø: 58
Hole Distance: 130 / 130

81432206386, 82432206008, 82432209008

No Image

MN-DL-12293

Length: 1680 Ø: 42
Cone Ø: d1 Ø 30 / d2 Ø 27

81467106236, 81467106268, 81467106356,
81467116356, 81467116723, 81467116794,
81467116933, 81467116934, 81467116966



MN-ES-8490

Length: 90
Cone Ø: d1 Ø 30 / d2 Ø 27
Thread: M26 x 1,5 RHT

0014606948, 14606948, 81953016281,
81953016337, 82953016016



MN-TC-12399

Length: 694 Ø: 50
Hole Distance: 130 / 130

81432206265



MN-VB-5238

Length: 627 Ø: 48
Hole Distance: 130 / 130

81432206221, 81432706096, 81432706114,
81432706116, 81432706121



MN-VB-8514

Length: 627 Ø: 48
Hole Ø 25 / 25 / 25
Hole Distance: 152 / 130 / 130

81432706087, 81432706088, 81432706094,
81432706095, 81432796094



MN-VB-9403

Length: 627 Ø: 48
Hole Ø 25 / 23 / 23
Hole Distance: 152 / 130 / 130

81432706097, 81432706113, 81432706135,
81432706160, 81432706161





TGS ...

26.400 FNLC, FNLRC, FNLLC, FNLLRC, FVLC, FVL-KO, FNLLW	10/07→	Centre Rod	MN-DL-7801		Push Rod, Leaf Spring Axle
	10/07→	Centre Rod	MN-DL-8560		Push Rod, Air Suspension Axle
	10/07→	Tie Rod	MN-DL-7802		
	10/07→	Tie Rod	MN-DL-12284		
	10/07→	Tie Rod End		MN-ES-8490	for vehicles with Hinged Trailing Axle
	10/07→	Track Control Arm		MN-DL-5225	Trailing Arm, Drive Axle
	10/07→	Track Control Arm		MN-DL-5225	Trailing Arm, Trailing Axle;for vehicles with Hinged Trailing Axle
	10/07→	Track Control Arm		MN-DL-5225	Trailing Arm, Trailing Axle;for vehicles with Rigid Trailing Axle
	10/07→	Track Control Arm		MN-DL-8709	Trailing Arm, Trailing Axle;for vehicles with Hinged Trailing Axle
	10/07→	Track Control Arm		MN-TC-12399	Control Arm
	10/07→	Track Control Arm		MN-VB-5238	Wishbone (CV), Drive Axle
	10/07→	Track Control Arm		MN-VB-9403	Wishbone (CV)
	10/07→	Track Control Arm	MN-DL-8663		Control Arm, Air Suspension Axle
	26.400 FNLS, FNLRS, FNLLS, FNLLRS, FPLS, FPLRS, FVLS	02/09→	Centre Rod	MN-DL-7801	
02/09→		Centre Rod	MN-DL-8560		Push Rod, Air Suspension Axle
02/09→		Tie Rod	MN-DL-7802		
02/09→		Tie Rod	MN-DL-12284		
02/09→		Tie Rod End		MN-ES-8490	for vehicles with Hinged Trailing Axle
02/09→		Track Control Arm		MN-DL-5225	Trailing Arm, Drive Axle
02/09→		Track Control Arm		MN-DL-5225	Trailing Arm, Trailing Axle;for vehicles with Hinged Trailing Axle
02/09→		Track Control Arm		MN-DL-5225	Trailing Arm, Trailing Axle;for vehicles with Rigid Trailing Axle
02/09→		Track Control Arm		MN-DL-8709	Trailing Arm, Trailing Axle;for vehicles with Hinged Trailing Axle
02/09→		Track Control Arm		MN-TC-12399	Control Arm
02/09→		Track Control Arm		MN-VB-5238	Wishbone (CV), Drive Axle
02/09→		Track Control Arm		MN-VB-9403	Wishbone (CV)
02/09→		Track Control Arm	MN-DL-8663		Control Arm, Air Suspension Axle
26.400 FP HLS		05/08→	Centre Rod	MN-DL-8560	
	05/08→	Track Control Arm		MN-DL-5225	Trailing Arm
26.400 FVHLC	10/07→	Centre Rod	MN-DL-8560		Push Rod
	10/07→	Track Control Arm		MN-DL-5225	Trailing Arm
26.400 FVHLS	05/08→	Centre Rod	MN-DL-8560		Push Rod
	05/08→	Track Control Arm		MN-DL-5225	Trailing Arm
26.440 FDAC, FDALC, FDHLC, FDHLC/M	02/09→	Centre Rod	MN-DL-8646		Push Rod, Drive Axle
	02/09→	Track Control Arm		MN-DL-5225	Trailing Arm
	02/09→	Track Control Arm		MN-DL-8544	Trailing Arm, Drive Axle;Air Suspension Axle
	02/09→	Track Control Arm		MN-DL-8544	Trailing Arm, Drive Axle;Leaf Spring Axle
	02/09→	Track control arm		MN-DL-12288	Trailing Arm
	02/09→	Track Control Arm		MN-VB-8514	Suspension Rod, Wishbone (CV), Drive Axle; Air Suspension Axle
26.440 FDAK, FDALK, FDHK, FDHKL	11/07→	Centre Rod	MN-DL-7801		Push Rod, Leaf Spring Axle
	11/07→	Centre Rod	MN-DL-8646		Push Rod, Drive Axle
	11/07→	Tie Rod	MN-DL-7802		
	11/07→	Tie Rod	MN-DL-12293		
	11/07→	Track Control Arm		MN-DL-5225	Trailing Arm, Drive Axle;Air Suspension Axle
	11/07→	Track Control Arm		MN-DL-8544	Trailing Arm, Drive Axle;Air Suspension Axle
	11/07→	Track Control Arm		MN-DL-8544	Trailing Arm, Drive Axle;Leaf Spring Axle
	11/07→	Track control arm		MN-DL-12288	Trailing Arm
	11/07→	Track Control Arm		MN-VB-5238	Wishbone (CV), Drive Axle;Air Suspension Axle
	11/07→	Track Control Arm		MN-VB-8514	Suspension Rod, Wishbone (CV), Drive Axle; Air Suspension Axle
26.440 FDAS, FDALS, FDHS, FDHLS	02/09→	Tie Rod	MN-DL-12293		
	02/09→	Track control arm		MN-DL-12288	Trailing Arm

MN-DL-5225

Length: 572 Ø: 48
Hole Distance: 130 / 130

03301500A, 81432206229, 81432206236,
81432206267, 81432206270, 81432206272,
81432206304, 81432206305, 81432209236,
81432209267, 81432209272



MN-DL-7801

Length: 995 Ø: 52
Cone Ø: d1 Ø 30 / d2 Ø 27

81466106807, 81466106808, 81466116087,
81466116088, 81466116096, 81466116097,
81466116099, 81466116132, 81466116133,
81466116136, 81466116197, 81466116198,
81466116205



MN-DL-7802

Length: 1680 Ø: 52
Cone Ø: d1 Ø 30 / d2 Ø 27

03208300A, 81467116773, 81467116858,
81467116859, 81467116860, 81467116861,
81467116863, 81467116882, 81467116883,
81467116920, 81467116921



MN-DL-8544

Length: 596 Ø: 48
Hole Distance: 130 / 130

81432206196, 81432206232, 81432206233



MN-DL-8560

Length: 970 Ø: 52
Cone Ø: d1 Ø 30 / d2 Ø 27

03206900A, 81466106809, 81466106810,
81466106823, 81466106838, 81466106839,
81466116104, 81466116105, 81466116107,
81466116134, 81466116135, 81466116137,
81466116199, 81466116200, 81466116206



MN-DL-8646

Length: 1021 Ø: 52
Cone Ø: d1 Ø 30 / d2 Ø 27

81466106811, 81466106812, 81466116138,
81466116139, 81466116201, 81466116202

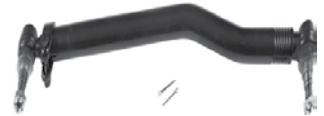

MN-DL-8663

Length: 947 Ø: 60
Hole Distance: 115 / 115

03307400A, 81432206222, 81432206260,
81432206283, 81432206284



MN-DL-8709

Length: 572 Ø: 52
Hole Distance: 130 / 130

81432206268, 81432206274, 81432206291,
81432206292, 82432206007



MN-DL-12284

Length: 1530 Ø: 50
Cone Ø: d1 Ø 30 / d2 Ø 27

81466106579, 81466106580, 81466106624,
81466116720, 81467116720, 81467116730,
81467116952

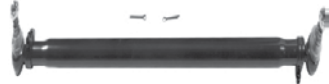

MN-DL-12288

Length: 585 Ø: 58
Hole Distance: 130 / 130

81432206386, 82432206008, 82432209008

No Image

MN-DL-12293

Length: 1680 Ø: 42
Cone Ø: d1 Ø 30 / d2 Ø 27

81467106236, 81467106268, 81467106356,
81467116356, 81467116723, 81467116794,
81467116933, 81467116934, 81467116966



MN-ES-8490

Length: 90
Cone Ø: d1 Ø 30 / d2 Ø 27
Thread: M26 x 1,5 RHT

0014606948, 14606948, 81953016281,
81953016337, 82953016016



MN-TC-12399

Length: 694 Ø: 50
Hole Distance: 130 / 130

81432206265



MN-VB-5238

Length: 627 Ø: 48
Hole Distance: 130 / 130

81432206221, 81432706096, 81432706114,
81432706116, 81432706121



MN-VB-8514

Length: 627 Ø: 48
Hole Ø 25 / 25 / 25
Hole Distance: 152 / 130 / 130

81432706087, 81432706088, 81432706094,
81432706095, 81432796094



MN-VB-9403

Length: 627 Ø: 48
Hole Ø 25 / 23 / 23
Hole Distance: 152 / 130 / 130

81432706097, 81432706113, 81432706135,
81432706160, 81432706161





TGS ...

26.440 FDAS, FDALS, FDHS, FDHLS, FDHLS/M	02/09→	Centre Rod	MN-DL-8646		Push Rod, Drive Axle
	02/09→	Track Control Arm		MN-DL-5225	Trailing Arm
	02/09→	Track Control Arm		MN-DL-8544	Trailing Arm, Drive Axle;Air Suspension Axle
	02/09→	Track Control Arm		MN-DL-8544	Trailing Arm, Drive Axle;Leaf Spring Axle
	02/09→	Track control arm		MN-DL-12288	Trailing Arm
	02/09→	Track Control Arm		MN-VB-8514	Suspension Rod, Wishbone (CV), Drive Axle; Air Suspension Axle
	02/09→	Track Control Arm		MN-VB-8514	Suspension Rod, Wishbone (CV), Drive Axle; Leaf Spring Axle
26.440 FDC, FDRC, FDC/M, FDLC, FDL/M, FDLRC, FNHLC, FVHLC	02/09→	Centre Rod	MN-DL-7801		Push Rod, Leaf Spring Axle
	02/09→	Tie Rod	MN-DL-7802		
	02/09→	Tie Rod	MN-DL-12284		
	02/09→	Tie Rod	MN-DL-12293		
	02/09→	Tie Rod End		MN-ES-8490	for vehicles with Hinged Trailing Axle
	02/09→	Track Control Arm		MN-DL-5225	Trailing Arm, Drive Axle
	02/09→	Track Control Arm		MN-DL-5225	Trailing Arm, Tag Axle;Air Suspension Axle; for vehicles with Hinged Trailing Axle
	02/09→	Track Control Arm		MN-DL-5225	Trailing Arm, Tag Axle;Air Suspension Axle; not for vehicles with Hinged Trailing Axle
	02/09→	Track Control Arm		MN-DL-8544	Trailing Arm, Drive Axle
	02/09→	Track Control Arm		MN-DL-8709	Trailing Arm, Air Suspension Axle; for vehicles with Hinged Trailing Axle
	02/09→	Track Control Arm		MN-TC-12399	Control Arm
	02/09→	Track Control Arm		MN-VB-5238	Wishbone (CV), Drive Axle;Air Suspension Axle
	02/09→	Track Control Arm		MN-VB-8514	Suspension Rod, Wishbone (CV), Drive Axle; Air Suspension Axle
	02/09→	Track Control Arm		MN-VB-8514	Suspension Rod, Wishbone (CV), Drive Axle; Leaf Spring Axle
	02/09→	Track Control Arm		MN-VB-9403	Wishbone (CV), Air Suspension Axle
	26.440 FDC, FDRC, FDLC, FDLRC, FNHLC, FVHLC	02/09→	Centre Rod	MN-DL-8560	
26.440 FDK, FDLK	07/08→	Centre Rod	MN-DL-7801		Push Rod, Leaf Spring Axle
	07/08→	Centre Rod	MN-DL-8560		Push Rod
	07/08→	Tie Rod	MN-DL-7802		
	07/08→	Tie Rod	MN-DL-12293		
	07/08→	Track Control Arm		MN-DL-5225	Trailing Arm, Drive Axle
	07/08→	Track Control Arm		MN-DL-8544	Trailing Arm, Drive Axle
	07/08→	Track Control Arm		MN-VB-5238	Wishbone (CV), Drive Axle;Air Suspension Axle
	07/08→	Track Control Arm		MN-VB-8514	Suspension Rod, Wishbone (CV), Drive Axle; Air Suspension Axle
07/08→	Track Control Arm		MN-VB-8514	Suspension Rod, Wishbone (CV), Drive Axle; Leaf Spring Axle	
26.440 FDS, FDRS, FDLS, FDLRS, FNHLS, FPHLS, FVHLS	05/08→	Centre Rod	MN-DL-7801		Push Rod, Leaf Spring Axle
	05/08→	Centre Rod	MN-DL-8560		Push Rod
	05/08→	Tie Rod	MN-DL-7802		
	05/08→	Tie Rod	MN-DL-12284		
	05/08→	Tie Rod	MN-DL-12293		
	05/08→	Tie Rod End		MN-ES-8490	for vehicles with Hinged Trailing Axle
	05/08→	Track Control Arm		MN-DL-5225	Trailing Arm, Drive Axle
	05/08→	Track Control Arm		MN-DL-5225	Trailing Arm, Tag Axle;Air Suspension Axle; for vehicles with Hinged Trailing Axle
	05/08→	Track Control Arm		MN-DL-5225	Trailing Arm, Tag Axle;Air Suspension Axle; not for vehicles with Hinged Trailing Axle
	05/08→	Track Control Arm		MN-DL-8544	Trailing Arm, Drive Axle
	05/08→	Track Control Arm		MN-DL-8709	Trailing Arm, Air Suspension Axle; for vehicles with Hinged Trailing Axle
	05/08→	Track Control Arm		MN-TC-12399	Control Arm
	05/08→	Track Control Arm		MN-VB-5238	Wishbone (CV), Drive Axle;Air Suspension Axle
	05/08→	Track Control Arm		MN-VB-8514	Suspension Rod, Wishbone (CV), Drive Axle; Air Suspension Axle
05/08→	Track Control Arm		MN-VB-8514	Suspension Rod, Wishbone (CV), Drive Axle; Leaf Spring Axle	
05/08→	Track Control Arm		MN-VB-9403	Wishbone (CV), Air Suspension Axle	

MN-DL-5225

Length: 572 Ø: 48
Hole Distance: 130 / 130

03301500A, 81432206229, 81432206236,
81432206267, 81432206270, 81432206272,
81432206304, 81432206305, 81432209236,
81432209267, 81432209272



MN-DL-7801

Length: 995 Ø: 52
Cone Ø: d1 Ø 30 / d2 Ø 27

81466106807, 81466106808, 81466116087,
81466116088, 81466116096, 81466116097,
81466116099, 81466116132, 81466116133,
81466116136, 81466116197, 81466116198,
81466116205

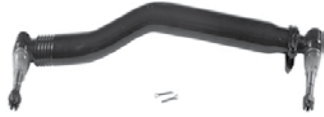

MN-DL-7802

Length: 1680 Ø: 52
Cone Ø: d1 Ø 30 / d2 Ø 27

03208300A, 81467116773, 81467116858,
81467116859, 81467116860, 81467116861,
81467116863, 81467116882, 81467116883,
81467116920, 81467116921



MN-DL-8544

Length: 596 Ø: 48
Hole Distance: 130 / 130

81432206196, 81432206232, 81432206233



MN-DL-8560

Length: 970 Ø: 52
Cone Ø: d1 Ø 30 / d2 Ø 27

03206900A, 81466106809, 81466106810,
81466106823, 81466106838, 81466106839,
81466116104, 81466116105, 81466116107,
81466116134, 81466116135, 81466116137,
81466116199, 81466116200, 81466116206



MN-DL-8646

Length: 1021 Ø: 52
Cone Ø: d1 Ø 30 / d2 Ø 27

81466106811, 81466106812, 81466116138,
81466116139, 81466116201, 81466116202

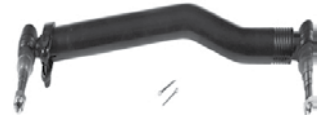

MN-DL-8709

Length: 572 Ø: 52
Hole Distance: 130 / 130

81432206268, 81432206274, 81432206291,
81432206292, 82432206007



MN-DL-12284

Length: 1530 Ø: 50
Cone Ø: d1 Ø 30 / d2 Ø 27

81466106579, 81466106580, 81466106624,
81466116720, 81467116720, 81467116730,
81467116952

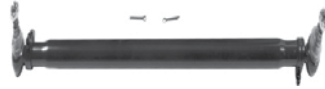

MN-DL-12288

Length: 585 Ø: 58
Hole Distance: 130 / 130

81432206386, 82432206008, 82432209008

No Image

MN-DL-12293

Length: 1680 Ø: 42
Cone Ø: d1 Ø 30 / d2 Ø 27

81467106236, 81467106268, 81467106356,
81467116356, 81467116723, 81467116794,
81467116933, 81467116934, 81467116966



MN-ES-8490

Length: 90
Cone Ø: d1 Ø 30 / d2 Ø 27
Thread: M26 x 1,5 RHT

0014606948, 14606948, 81953016281,
81953016337, 82953016016



MN-TC-12399

Length: 694 Ø: 50
Hole Distance: 130 / 130

81432206265



MN-VB-5238

Length: 627 Ø: 48
Hole Distance: 130 / 130

81432206221, 81432706096, 81432706114,
81432706116, 81432706121



MN-VB-8514

Length: 627 Ø: 48
Hole Ø 25 / 25 / 25
Hole Distance: 152 / 130 / 130

81432706087, 81432706088, 81432706094,
81432706095, 81432796094



MN-VB-9403

Length: 627 Ø: 48
Hole Ø 25 / 23 / 23

Hole Distance: 152 / 130 / 130
81432706097, 81432706113, 81432706135,
81432706160, 81432706161





TGS ...

26.440 FD-TM	07/08→	Tie Rod	MN-DL-12293			
	07/08→	Track Control Arm		MN-VB-8514	Suspension Rod, Wishbone (CV)	
26.440 FNLC, FNLLC, FNLLW, FNLR, FNLLRC, FVLC, FVL-KO	10/07→	Centre Rod	MN-DL-7801		Push Rod, Leaf Spring Axle	
	10/07→	Centre Rod	MN-DL-8560		Push Rod, Air Suspension Axle	
	10/07→	Tie Rod	MN-DL-7802			
	10/07→	Tie Rod	MN-DL-12284			
	10/07→	Tie Rod End		MN-ES-8490	for vehicles with Hinged Trailing Axle	
	10/07→	Track Control Arm		MN-DL-5225	Trailing Arm, Drive Axle	
	10/07→	Track Control Arm		MN-DL-5225	Trailing Arm, Trailing Axle;for vehicles with Rigid Trailing Axle	
	10/07→	Track Control Arm		MN-DL-8709	Trailing Arm, Trailing Axle;for vehicles with Hinged Trailing Axle	
	10/07→	Track Control Arm		MN-TC-12399	Control Arm	
	10/07→	Track Control Arm		MN-VB-5238	Wishbone (CV), Drive Axle	
	10/07→	Track Control Arm		MN-VB-9403	Wishbone (CV)	
	10/07→	Track Control Arm	MN-DL-8663		Control Arm, Air Suspension Axle	
	26.440 FNLS, FNLLS, FNLR, FPLS, FPLRS, FVLS	02/09→	Centre Rod	MN-DL-7801		Push Rod, Leaf Spring Axle
02/09→		Centre Rod	MN-DL-8560		Push Rod, Air Suspension Axle	
02/09→		Tie Rod	MN-DL-7802			
02/09→		Tie Rod	MN-DL-12284			
02/09→		Tie Rod End		MN-ES-8490	for vehicles with Hinged Trailing Axle	
02/09→		Track Control Arm		MN-DL-5225	Trailing Arm, Drive Axle	
02/09→		Track Control Arm		MN-DL-5225	Trailing Arm, Trailing Axle;for vehicles with Hinged Trailing Axle	
02/09→		Track Control Arm		MN-DL-5225	Trailing Arm, Trailing Axle;for vehicles with Rigid Trailing Axle	
02/09→		Track Control Arm		MN-DL-8709	Trailing Arm, Trailing Axle;for vehicles with Hinged Trailing Axle	
02/09→		Track Control Arm		MN-TC-12399	Control Arm	
02/09→		Track Control Arm		MN-VB-5238	Wishbone (CV), Drive Axle	
02/09→		Track Control Arm		MN-VB-9403	Wishbone (CV)	
02/09→		Track Control Arm	MN-DL-8663		Control Arm, Air Suspension Axle	
26.440 FPHLS		05/08→	Centre Rod	MN-DL-8560		Push Rod
		05/08→	Track Control Arm		MN-DL-5225	Trailing Arm
26.440 FVHLC	10/07→	Track Control Arm		MN-DL-5225	Trailing Arm	
26.440 FVHLS	05/08→	Centre Rod	MN-DL-8560		Push Rod	
	05/08→	Track Control Arm		MN-DL-5225	Trailing Arm	
26.480 FDAC, FDALC, FDHLC, FDHLC/M	02/09→	Centre Rod	MN-DL-7801		Push Rod, Leaf Spring Axle	
	02/09→	Centre Rod	MN-DL-8646		Push Rod, Drive Axle	
	02/09→	Tie Rod	MN-DL-7802			
	02/09→	Track Control Arm		MN-DL-5225	Trailing Arm, Drive Axle;Air Suspension Axle	
	02/09→	Track Control Arm		MN-DL-8544	Trailing Arm, Drive Axle;Air Suspension Axle	
	02/09→	Track Control Arm		MN-DL-8544	Trailing Arm, Drive Axle;Leaf Spring Axle	
	02/09→	Track Control Arm		MN-VB-5238	Wishbone (CV), Drive Axle;Air Suspension Axle	
	02/09→	Track Control Arm		MN-VB-8514	Suspension Rod, Wishbone (CV), Drive Axle; Air Suspension Axle	
	02/09→	Track Control Arm		MN-VB-8514	Suspension Rod, Wishbone (CV), Drive Axle; Leaf Spring Axle	
	02/09→	Track Control Arm		MN-VB-8514	Suspension Rod, Wishbone (CV), Drive Axle; Leaf Spring Axle	
26.480 FDAK, FDALK, FDHK, FDHLK	02/09→	Centre Rod	MN-DL-7801		Push Rod, Leaf Spring Axle	
	02/09→	Centre Rod	MN-DL-8646		Push Rod, Drive Axle	
	02/09→	Tie Rod	MN-DL-7802			
	02/09→	Tie Rod	MN-DL-12293			
	02/09→	Track Control Arm		MN-DL-5225	Trailing Arm, Drive Axle;Air Suspension Axle	
	02/09→	Track Control Arm		MN-DL-8544	Trailing Arm, Drive Axle;Air Suspension Axle	
	02/09→	Track Control Arm		MN-DL-8544	Trailing Arm, Drive Axle;Leaf Spring Axle	
	02/09→	Track control arm		MN-DL-12288	Trailing Arm	
	02/09→	Track Control Arm		MN-VB-5238	Wishbone (CV), Drive Axle;Air Suspension Axle	
	02/09→	Track Control Arm		MN-VB-8514	Suspension Rod, Wishbone (CV), Drive Axle; Air Suspension Axle	
	02/09→	Track Control Arm		MN-VB-8514	Suspension Rod, Wishbone (CV), Drive Axle; Leaf Spring Axle	
	02/09→	Track Control Arm		MN-VB-8514	Suspension Rod, Wishbone (CV), Drive Axle; Leaf Spring Axle	

MN-DL-5225

Length: 572 Ø: 48
Hole Distance: 130 / 130

03301500A, 81432206229, 81432206236,
81432206267, 81432206270, 81432206272,
81432206304, 81432206305, 81432209236,
81432209267, 81432209272



MN-DL-7801

Length: 995 Ø: 52
Cone Ø: d1 Ø 30 / d2 Ø 27

81466106807, 81466106808, 81466116087,
81466116088, 81466116096, 81466116097,
81466116099, 81466116132, 81466116133,
81466116136, 81466116197, 81466116198,
81466116205

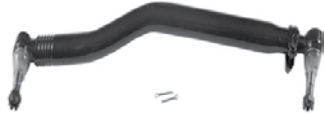

MN-DL-7802

Length: 1680 Ø: 52
Cone Ø: d1 Ø 30 / d2 Ø 27

03208300A, 81467116773, 81467116858,
81467116859, 81467116860, 81467116861,
81467116863, 81467116882, 81467116883,
81467116920, 81467116921



MN-DL-8544

Length: 596 Ø: 48
Hole Distance: 130 / 130

81432206196, 81432206232, 81432206233



MN-DL-8560

Length: 970 Ø: 52
Cone Ø: d1 Ø 30 / d2 Ø 27

03206900A, 81466106809, 81466106810,
81466106823, 81466106838, 81466106839,
81466116104, 81466116105, 81466116107,
81466116134, 81466116135, 81466116137,
81466116199, 81466116200, 81466116206



MN-DL-8646

Length: 1021 Ø: 52
Cone Ø: d1 Ø 30 / d2 Ø 27

81466106811, 81466106812, 81466116138,
81466116139, 81466116201, 81466116202

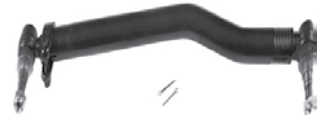

MN-DL-8663

Length: 947 Ø: 60
Hole Distance: 115 / 115

03307400A, 81432206222, 81432206260,
81432206283, 81432206284



MN-DL-8709

Length: 572 Ø: 52
Hole Distance: 130 / 130

81432206268, 81432206274, 81432206291,
81432206292, 82432206007



MN-DL-12284

Length: 1530 Ø: 50
Cone Ø: d1 Ø 30 / d2 Ø 27

81466106579, 81466106580, 81466106624,
81466116720, 81467116720, 81467116730,
81467116952



MN-DL-12288

Length: 585 Ø: 58
Hole Distance: 130 / 130

81432206386, 82432206008, 82432209008

No Image

MN-DL-12293

Length: 1680 Ø: 42
Cone Ø: d1 Ø 30 / d2 Ø 27

81467106236, 81467106268, 81467106356,
81467116356, 81467116723, 81467116794,
81467116933, 81467116934, 81467116966



MN-ES-8490

Length: 90
Cone Ø: d1 Ø 30 / d2 Ø 27
Thread: M26 x 1,5 RHT

0014606948, 14606948, 81953016281,
81953016337, 82953016016



MN-TC-12399

Length: 694 Ø: 50
Hole Distance: 130 / 130

81432206265



MN-VB-5238

Length: 627 Ø: 48
Hole Distance: 130 / 130

81432206221, 81432706096, 81432706114,
81432706116, 81432706121



MN-VB-8514

Length: 627 Ø: 48
Hole Ø 25 / 25 / 25
Hole Distance: 152 / 130 / 130

81432706087, 81432706088, 81432706094,
81432706095, 81432796094



MN-VB-9403

Length: 627 Ø: 48
Hole Ø 25 / 23 / 23
Hole Distance: 152 / 130 / 130

81432706097, 81432706113, 81432706135,
81432706160, 81432706161





TGS ...

26.480 FDAS, FDALS, FDHS, FDHLS	02/09→	Centre Rod	MN-DL-7801		Push Rod, Leaf Spring Axle
	02/09→	Centre Rod	MN-DL-8646		Push Rod, Drive Axle
	02/09→	Tie Rod	MN-DL-7802		
	02/09→	Tie Rod	MN-DL-12293		
	02/09→	Track Control Arm		MN-DL-5225	Trailing Arm, Drive Axle;Air Suspension Axle
	02/09→	Track Control Arm		MN-DL-8544	Trailing Arm, Drive Axle;Air Suspension Axle
	02/09→	Track Control Arm		MN-DL-8544	Trailing Arm, Drive Axle;Leaf Spring Axle
	02/09→	Track control arm		MN-DL-12288	Trailing Arm
	02/09→	Track Control Arm		MN-VB-5238	Wishbone (CV), Drive Axle;Air Suspension Axle
	02/09→	Track Control Arm		MN-VB-8514	Suspension Rod, Wishbone (CV), Drive Axle; Air Suspension Axle
	02/09→	Track Control Arm		MN-VB-8514	Suspension Rod, Wishbone (CV), Drive Axle; Leaf Spring Axle
26.480 FDC, FDC/M, FDLC, FDRC, FDLRC, FNLHC, FVHLC	02/09→	Centre Rod	MN-DL-7801		Push Rod, Leaf Spring Axle
	02/09→	Tie Rod	MN-DL-7802		
	02/09→	Tie Rod	MN-DL-12284		
	02/09→	Tie Rod	MN-DL-12293		
	02/09→	Tie Rod End		MN-ES-8490	for vehicles with Hinged Trailing Axle
	02/09→	Track Control Arm		MN-DL-5225	Trailing Arm, Drive Axle
	02/09→	Track Control Arm		MN-DL-5225	Trailing Arm, Tag Axle;Air Suspension Axle; for vehicles with Hinged Trailing Axle
	02/09→	Track Control Arm		MN-DL-5225	Trailing Arm, Tag Axle;Air Suspension Axle; not for vehicles with Hinged Trailing Axle
	02/09→	Track Control Arm		MN-DL-8544	Trailing Arm, Drive Axle
	02/09→	Track Control Arm		MN-DL-8709	Trailing Arm, Air Suspension Axle; for vehicles with Hinged Trailing Axle
	02/09→	Track Control Arm		MN-TC-12399	Control Arm
	02/09→	Track Control Arm		MN-VB-5238	Wishbone (CV), Drive Axle;Air Suspension Axle
	02/09→	Track Control Arm		MN-VB-8514	Suspension Rod, Wishbone (CV), Drive Axle; Air Suspension Axle
	02/09→	Track Control Arm		MN-VB-8514	Suspension Rod, Wishbone (CV), Drive Axle; Leaf Spring Axle
	02/09→	Track Control Arm		MN-VB-9403	Wishbone (CV), Air Suspension Axle
	26.480 FDK, FDLK	07/08→	Centre Rod	MN-DL-7801	
07/08→		Tie Rod	MN-DL-7802		
07/08→		Tie Rod	MN-DL-12293		
07/08→		Track Control Arm		MN-DL-5225	Trailing Arm, Drive Axle
07/08→		Track Control Arm		MN-DL-8544	Trailing Arm, Drive Axle
07/08→		Track Control Arm		MN-VB-5238	Wishbone (CV), Drive Axle;Air Suspension Axle
07/08→		Track Control Arm		MN-VB-8514	Suspension Rod, Wishbone (CV), Drive Axle; Air Suspension Axle
07/08→		Track Control Arm		MN-VB-8514	Suspension Rod, Wishbone (CV), Drive Axle; Leaf Spring Axle
26.480 FDS, FDLS, FDRS, FDLRS, FNHLS, FPHLS, FVHLS	05/08→	Centre Rod	MN-DL-7801		Push Rod, Leaf Spring Axle
	05/08→	Tie Rod	MN-DL-7802		
	05/08→	Tie Rod	MN-DL-12284		
	05/08→	Tie Rod	MN-DL-12293		
	05/08→	Tie Rod End		MN-ES-8490	for vehicles with Hinged Trailing Axle
	05/08→	Track Control Arm		MN-DL-5225	Trailing Arm, Drive Axle
	05/08→	Track Control Arm		MN-DL-5225	Trailing Arm, Tag Axle;Air Suspension Axle; for vehicles with Hinged Trailing Axle
	05/08→	Track Control Arm		MN-DL-5225	Trailing Arm, Tag Axle;Air Suspension Axle; not for vehicles with Hinged Trailing Axle
	05/08→	Track Control Arm		MN-DL-8544	Trailing Arm, Drive Axle
	05/08→	Track Control Arm		MN-DL-8709	Trailing Arm, Air Suspension Axle; for vehicles with Hinged Trailing Axle
	05/08→	Track Control Arm		MN-TC-12399	Control Arm
	05/08→	Track Control Arm		MN-VB-5238	Wishbone (CV), Drive Axle;Air Suspension Axle
	05/08→	Track Control Arm		MN-VB-8514	Suspension Rod, Wishbone (CV), Drive Axle; Air Suspension Axle
	05/08→	Track Control Arm		MN-VB-8514	Suspension Rod, Wishbone (CV), Drive Axle; Leaf Spring Axle
	05/08→	Track Control Arm		MN-VB-9403	Wishbone (CV), Air Suspension Axle

MN-DL-5225

Length: 572 Ø: 48
Hole Distance: 130 / 130

03301500A, 81432206229, 81432206236,
81432206267, 81432206270, 81432206272,
81432206304, 81432206305, 81432209236,
81432209267, 81432209272



MN-DL-7801

Length: 995 Ø: 52
Cone Ø: d1 Ø 30 / d2 Ø 27

81466106807, 81466106808, 81466116087,
81466116088, 81466116096, 81466116097,
81466116099, 81466116132, 81466116133,
81466116136, 81466116197, 81466116198,
81466116205

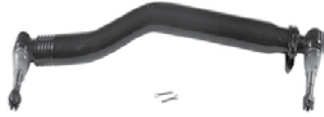

MN-DL-7802

Length: 1680 Ø: 52
Cone Ø: d1 Ø 30 / d2 Ø 27

03208300A, 81467116773, 81467116858,
81467116859, 81467116860, 81467116861,
81467116863, 81467116882, 81467116883,
81467116920, 81467116921



MN-DL-8544

Length: 596 Ø: 48
Hole Distance: 130 / 130

81432206196, 81432206232, 81432206233



MN-DL-8646

Length: 1021 Ø: 52
Cone Ø: d1 Ø 30 / d2 Ø 27

81466106811, 81466106812, 81466116138,
81466116139, 81466116201, 81466116202

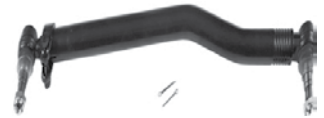

MN-DL-8709

Length: 572 Ø: 52
Hole Distance: 130 / 130

81432206268, 81432206274, 81432206291,
81432206292, 82432206007



MN-DL-12284

Length: 1530 Ø: 50
Cone Ø: d1 Ø 30 / d2 Ø 27

81466106579, 81466106580, 81466106624,
81466116720, 81467116720, 81467116730,
81467116952



MN-DL-12288

Length: 585 Ø: 58
Hole Distance: 130 / 130

81432206386, 82432206008, 82432209008

No Image

MN-DL-12293

Length: 1680 Ø: 42
Cone Ø: d1 Ø 30 / d2 Ø 27

81467106236, 81467106268, 81467106356,
81467116356, 81467116723, 81467116794,
81467116933, 81467116934, 81467116966



MN-ES-8490

Length: 90
Cone Ø: d1 Ø 30 / d2 Ø 27
Thread: M26 x 1,5 RHT

0014606948, 14606948, 81953016281,
81953016337, 82953016016



MN-TC-12399

Length: 694 Ø: 50
Hole Distance: 130 / 130

81432206265



MN-VB-5238

Length: 627 Ø: 48
Hole Distance: 130 / 130

81432206221, 81432706096, 81432706114,
81432706116, 81432706121



MN-VB-8514

Length: 627 Ø: 48
Hole Ø 25 / 25 / 25
Hole Distance: 152 / 130 / 130

81432706087, 81432706088, 81432706094,
81432706095, 81432796094



MN-VB-9403

Length: 627 Ø: 48
Hole Ø 25 / 23 / 23
Hole Distance: 152 / 130 / 130

81432706097, 81432706113, 81432706135,
81432706160, 81432706161





TGS ...

26.480 FD-TM	05/08→	Tie Rod	MN-DL-12293		
26.480 FNLC, FNLRC, FNLLC, FNLLRC, FNLLW, FVLC, FVL-KO	10/07→	Centre Rod	MN-DL-7801		Push Rod, Leaf Spring Axle
	10/07→	Centre Rod	MN-DL-8560		Push Rod, Air Suspension Axle
	10/07→	Tie Rod	MN-DL-7802		
	10/07→	Tie Rod	MN-DL-12284		
	10/07→	Tie Rod End		MN-ES-8490	for vehicles with Hinged Trailing Axle
	10/07→	Track Control Arm		MN-DL-5225	Trailing Arm, Drive Axle
	10/07→	Track Control Arm		MN-DL-5225	Trailing Arm, Trailing Axle;for vehicles with Hinged Trailing Axle
	10/07→	Track Control Arm		MN-DL-5225	Trailing Arm, Trailing Axle;for vehicles with Rigid Trailing Axle
	10/07→	Track Control Arm		MN-DL-8709	Trailing Arm, Trailing Axle;for vehicles with Hinged Trailing Axle
	10/07→	Track Control Arm		MN-TC-12399	Control Arm
	10/07→	Track Control Arm		MN-VB-5238	Wishbone (CV), Drive Axle
	10/07→	Track Control Arm		MN-VB-9403	Wishbone (CV)
	10/07→	Track Control Arm	MN-DL-8663		Control Arm, Air Suspension Axle
	26.480 FNLS, FNLLS, FNLRS, FPLS, FPLRS, FVLS	02/09→	Centre Rod	MN-DL-7801	
02/09→		Centre Rod	MN-DL-8560		Push Rod, Air Suspension Axle
02/09→		Tie Rod	MN-DL-7802		
02/09→		Tie Rod	MN-DL-12284		
02/09→		Tie Rod End		MN-ES-8490	for vehicles with Hinged Trailing Axle
02/09→		Track Control Arm		MN-DL-5225	Trailing Arm, Drive Axle
02/09→		Track Control Arm		MN-DL-5225	Trailing Arm, Trailing Axle;for vehicles with Hinged Trailing Axle
02/09→		Track Control Arm		MN-DL-5225	Trailing Arm, Trailing Axle;for vehicles with Rigid Trailing Axle
02/09→		Track Control Arm		MN-DL-8709	Trailing Arm, Trailing Axle;for vehicles with Hinged Trailing Axle
02/09→		Track Control Arm		MN-TC-12399	Control Arm
02/09→		Track Control Arm		MN-VB-5238	Wishbone (CV), Drive Axle
02/09→		Track Control Arm		MN-VB-9403	Wishbone (CV)
02/09→		Track Control Arm	MN-DL-8663		Control Arm, Air Suspension Axle
26.480 FPHLS		05/08→	Centre Rod	MN-DL-8560	
	05/08→	Track Control Arm		MN-DL-5225	Trailing Arm
26.480 FVHLC	10/07→	Track Control Arm		MN-DL-5225	Trailing Arm
26.480 FVHLS	05/08→	Centre Rod	MN-DL-8560		Push Rod
	05/08→	Track Control Arm		MN-DL-5225	Trailing Arm
26.540 FDAC, FDALC, FDHLC, FDHLC/M	02/09→	Centre Rod	MN-DL-7801		Push Rod, Leaf Spring Axle
	02/09→	Centre Rod	MN-DL-8646		Push Rod, Drive Axle
	02/09→	Tie Rod	MN-DL-7802		
	02/09→	Tie Rod	MN-DL-12293		
	02/09→	Track Control Arm		MN-DL-5225	Trailing Arm, Drive Axle;Air Suspension Axle
	02/09→	Track Control Arm		MN-DL-8544	Trailing Arm, Drive Axle;Air Suspension Axle
	02/09→	Track Control Arm		MN-DL-8544	Trailing Arm, Drive Axle;Leaf Spring Axle
	02/09→	Track control arm		MN-DL-12288	Trailing Arm
	02/09→	Track Control Arm		MN-VB-5238	Wishbone (CV), Drive Axle;Air Suspension Axle
	02/09→	Track Control Arm		MN-VB-8514	Suspension Rod, Wishbone (CV), Drive Axle; Air Suspension Axle
	02/09→	Track Control Arm		MN-VB-8514	Suspension Rod, Wishbone (CV), Drive Axle; Leaf Spring Axle
26.540 FDAK, FDALK, FDHLK	11/07→	Centre Rod	MN-DL-7801		Push Rod, Leaf Spring Axle
	11/07→	Centre Rod	MN-DL-8646		Push Rod, Drive Axle
	11/07→	Tie Rod	MN-DL-7802		
	11/07→	Tie Rod	MN-DL-12293		
	11/07→	Track Control Arm		MN-DL-5225	Trailing Arm, Drive Axle;Air Suspension Axle
	11/07→	Track Control Arm		MN-DL-8544	Trailing Arm, Drive Axle;Air Suspension Axle
	11/07→	Track Control Arm		MN-DL-8544	Trailing Arm, Drive Axle;Leaf Spring Axle
	11/07→	Track control arm		MN-DL-12288	Trailing Arm
	11/07→	Track Control Arm		MN-VB-5238	Wishbone (CV), Drive Axle;Air Suspension Axle
	11/07→	Track Control Arm		MN-VB-8514	Suspension Rod, Wishbone (CV), Drive Axle; Air Suspension Axle
	11/07→	Track Control Arm		MN-VB-8514	Suspension Rod, Wishbone (CV), Drive Axle; Leaf Spring Axle

MN-DL-5225

Length: 572 Ø: 48
Hole Distance: 130 / 130

03301500A, 81432206229, 81432206236,
81432206267, 81432206270, 81432206272,
81432206304, 81432206305, 81432209236,
81432209267, 81432209272



MN-DL-7801

Length: 995 Ø: 52
Cone Ø: d1 Ø 30 / d2 Ø 27

81466106807, 81466106808, 81466116087,
81466116088, 81466116096, 81466116097,
81466116099, 81466116132, 81466116133,
81466116136, 81466116197, 81466116198,
81466116205



MN-DL-7802

Length: 1680 Ø: 52
Cone Ø: d1 Ø 30 / d2 Ø 27

03208300A, 81467116773, 81467116858,
81467116859, 81467116860, 81467116861,
81467116863, 81467116882, 81467116883,
81467116920, 81467116921



MN-DL-8544

Length: 596 Ø: 48
Hole Distance: 130 / 130

81432206196, 81432206232, 81432206233



MN-DL-8560

Length: 970 Ø: 52
Cone Ø: d1 Ø 30 / d2 Ø 27

03206900A, 81466106809, 81466106810,
81466106823, 81466106838, 81466106839,
81466116104, 81466116105, 81466116107,
81466116134, 81466116135, 81466116137,
81466116199, 81466116200, 81466116206



MN-DL-8646

Length: 1021 Ø: 52
Cone Ø: d1 Ø 30 / d2 Ø 27

81466106811, 81466106812, 81466116138,
81466116139, 81466116201, 81466116202

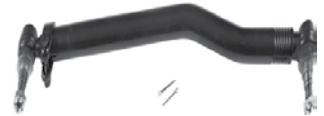

MN-DL-8663

Length: 947 Ø: 60
Hole Distance: 115 / 115

03307400A, 81432206222, 81432206260,
81432206283, 81432206284



MN-DL-8709

Length: 572 Ø: 52
Hole Distance: 130 / 130

81432206268, 81432206274, 81432206291,
81432206292, 82432206007



MN-DL-12284

Length: 1530 Ø: 50
Cone Ø: d1 Ø 30 / d2 Ø 27

81466106579, 81466106580, 81466106624,
81466116720, 81467116720, 81467116730,
81467116952

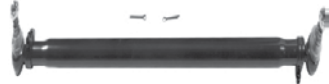

MN-DL-12288

Length: 585 Ø: 58
Hole Distance: 130 / 130

81432206386, 82432206008, 82432209008

No Image

MN-DL-12293

Length: 1680 Ø: 42
Cone Ø: d1 Ø 30 / d2 Ø 27

81467106236, 81467106268, 81467106356,
81467116356, 81467116723, 81467116794,
81467116933, 81467116934, 81467116966



MN-ES-8490

Length: 90
Cone Ø: d1 Ø 30 / d2 Ø 27
Thread: M26 x 1,5 RHT

14606948, 0014606948, 81953016281,
81953016337, 82953016016



MN-TC-12399

Length: 694 Ø: 50
Hole Distance: 130 / 130

81432206265



MN-VB-5238

Length: 627 Ø: 48
Hole Distance: 130 / 130

81432206221, 81432706096, 81432706114,
81432706116, 81432706121



MN-VB-8514

Length: 627 Ø: 48
Hole Ø 25 / 25 / 25
Hole Distance: 152 / 130 / 130

81432706087, 81432706088, 81432706094,
81432706095, 81432796094



MN-VB-9403

Length: 627 Ø: 48
Hole Ø 25 / 23 / 23
Hole Distance: 152 / 130 / 130

81432706097, 81432706113, 81432706135,
81432706160, 81432706161





TGS ...

26.540 FDAS, FDALS, FDHLS	02/09→	Centre Rod	MN-DL-7801		Push Rod, Leaf Spring Axle	
	02/09→	Centre Rod	MN-DL-8646		Push Rod, Drive Axle	
	02/09→	Tie Rod	MN-DL-7802			
	02/09→	Tie Rod	MN-DL-12293			
	02/09→	Track Control Arm		MN-DL-5225	Trailing Arm, Drive Axle;Air Suspension Axle	
	02/09→	Track Control Arm		MN-DL-8544	Trailing Arm, Drive Axle;Air Suspension Axle	
	02/09→	Track Control Arm		MN-DL-8544	Trailing Arm, Drive Axle;Leaf Spring Axle	
	02/09→	Track control arm		MN-DL-12288	Trailing Arm	
	02/09→	Track Control Arm		MN-VB-5238	Wishbone (CV), Drive Axle;Air Suspension Axle	
	02/09→	Track Control Arm		MN-VB-8514	Suspension Rod, Wishbone (CV), Drive Axle; Air Suspension Axle	
	02/09→	Track Control Arm		MN-VB-8514	Suspension Rod, Wishbone (CV), Drive Axle; Leaf Spring Axle	
26.540 FDC, FDC/M, FDLC, FDLC/M, FDLRC, FNHLC, FVHLC	02/09→	Centre Rod	MN-DL-7801		Push Rod, Leaf Spring Axle	
	02/09→	Tie Rod	MN-DL-7802			
	02/09→	Tie Rod	MN-DL-12284			
	02/09→	Tie Rod	MN-DL-12293			
	02/09→	Tie Rod End		MN-ES-8490	for vehicles with Hinged Trailing Axle	
	02/09→	Track Control Arm		MN-DL-5225	Trailing Arm, Drive Axle	
	02/09→	Track Control Arm		MN-DL-5225	Trailing Arm, Tag Axle;Air Suspension Axle; for vehicles with Hinged Trailing Axle	
	02/09→	Track Control Arm		MN-DL-5225	Trailing Arm, Tag Axle;Air Suspension Axle; not for vehicles with Hinged Trailing Axle	
	02/09→	Track Control Arm		MN-DL-8544	Trailing Arm, Drive Axle	
	02/09→	Track Control Arm		MN-DL-8709	Trailing Arm, Air Suspension Axle; for vehicles with Hinged Trailing Axle	
	02/09→	Track Control Arm		MN-TC-12399	Control Arm	
	02/09→	Track Control Arm		MN-VB-5238	Wishbone (CV), Drive Axle;Air Suspension Axle	
	02/09→	Track Control Arm		MN-VB-8514	Suspension Rod, Wishbone (CV), Drive Axle; Air Suspension Axle	
	02/09→	Track Control Arm		MN-VB-8514	Suspension Rod, Wishbone (CV), Drive Axle; Leaf Spring Axle	
	02/09→	Track Control Arm		MN-VB-9403	Wishbone (CV), Air Suspension Axle	
	26.540 FDK, FDLK	02/09→	Centre Rod	MN-DL-7801		Push Rod, Leaf Spring Axle
		02/09→	Tie Rod	MN-DL-7802		
02/09→		Tie Rod	MN-DL-12293			
02/09→		Track Control Arm		MN-DL-5225	Trailing Arm, Drive Axle	
02/09→		Track Control Arm		MN-DL-8544	Trailing Arm, Drive Axle	
02/09→		Track Control Arm		MN-VB-5238	Wishbone (CV), Drive Axle;Air Suspension Axle	
02/09→		Track Control Arm		MN-VB-8514	Suspension Rod, Wishbone (CV), Drive Axle; Air Suspension Axle	
02/09→		Track Control Arm		MN-VB-8514	Suspension Rod, Wishbone (CV), Drive Axle; Leaf Spring Axle	
26.540 FDS, FDLS, FDRS, FDLRS, FNHLS, FPHLS, FVHLS	05/08→	Centre Rod	MN-DL-7801		Push Rod, Leaf Spring Axle	
	05/08→	Tie Rod	MN-DL-7802			
	05/08→	Tie Rod	MN-DL-12293			
	05/08→	Track Control Arm		MN-DL-5225	Trailing Arm, Drive Axle	
	05/08→	Track Control Arm		MN-DL-8544	Trailing Arm, Drive Axle	
	05/08→	Track Control Arm		MN-VB-5238	Wishbone (CV), Drive Axle;Air Suspension Axle	
	05/08→	Track Control Arm		MN-VB-8514	Suspension Rod, Wishbone (CV), Drive Axle; Air Suspension Axle	
05/08→	Track Control Arm		MN-VB-8514	Suspension Rod, Wishbone (CV), Drive Axle; Leaf Spring Axle		
26.540 FNLC, FNLRC, FNLLC, FNLLRC, FNLLW, FVLC, FVL-KO	10/07→	Centre Rod	MN-DL-7801		Push Rod, Leaf Spring Axle	
	10/07→	Centre Rod	MN-DL-8560		Push Rod, Air Suspension Axle	
	10/07→	Tie Rod	MN-DL-7802			
	10/07→	Tie Rod	MN-DL-12284			
	10/07→	Tie Rod End		MN-ES-8490	for vehicles with Hinged Trailing Axle	
	10/07→	Track Control Arm		MN-DL-5225	for Control Arm	
	10/07→	Track Control Arm		MN-DL-5225	Trailing Arm, Drive Axle	
	10/07→	Track Control Arm		MN-DL-5225	Trailing Arm, Trailing Axle;for vehicles with Rigid Trailing Axle	

MN-DL-5225

Length: 572 Ø: 48
Hole Distance: 130 / 130

03301500A, 81432206229, 81432206236,
81432206267, 81432206270, 81432206272,
81432206304, 81432206305, 81432209236,
81432209267, 81432209272



MN-DL-7801

Length: 995 Ø: 52
Cone Ø: d1 Ø 30 / d2 Ø 27

81466106807, 81466106808, 81466116087,
81466116088, 81466116096, 81466116097,
81466116099, 81466116132, 81466116133,
81466116136, 81466116197, 81466116198,
81466116205

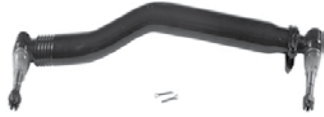

MN-DL-7802

Length: 1680 Ø: 52
Cone Ø: d1 Ø 30 / d2 Ø 27

03208300A, 81467116773, 81467116858,
81467116859, 81467116860, 81467116861,
81467116863, 81467116882, 81467116883,
81467116920, 81467116921



MN-DL-8544

Length: 596 Ø: 48
Hole Distance: 130 / 130

81432206196, 81432206232, 81432206233



MN-DL-8560

Length: 970 Ø: 52
Cone Ø: d1 Ø 30 / d2 Ø 27

03206900A, 81466106809, 81466106810,
81466106823, 81466106838, 81466106839,
81466116104, 81466116105, 81466116107,
81466116134, 81466116135, 81466116137,
81466116199, 81466116200, 81466116206



MN-DL-8646

Length: 1021 Ø: 52
Cone Ø: d1 Ø 30 / d2 Ø 27

81466106811, 81466106812, 81466116138,
81466116139, 81466116201, 81466116202

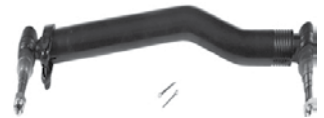

MN-DL-8709

Length: 572 Ø: 52
Hole Distance: 130 / 130

81432206268, 81432206274, 81432206291,
81432206292, 82432206007



MN-DL-12284

Length: 1530 Ø: 50
Cone Ø: d1 Ø 30 / d2 Ø 27

81466106579, 81466106580, 81466106624,
81466116720, 81467116720, 81467116730,
81467116952

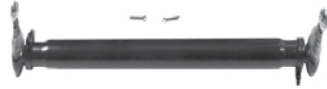

MN-DL-12288

Length: 585 Ø: 58
Hole Distance: 130 / 130

81432206386, 82432206008, 82432209008

No Image

MN-DL-12293

Length: 1680 Ø: 42
Cone Ø: d1 Ø 30 / d2 Ø 27

81467106236, 81467106268, 81467106356,
81467116356, 81467116723, 81467116794,
81467116933, 81467116934, 81467116966



MN-ES-8490

Length: 90
Cone Ø: d1 Ø 30 / d2 Ø 27
Thread: M26 x 1,5 RHT

14606948, 0014606948, 81953016281,
81953016337, 82953016016



MN-TC-12399

Length: 694 Ø: 50
Hole Distance: 130 / 130

81432206265



MN-VB-5238

Length: 627 Ø: 48
Hole Distance: 130 / 130

81432206221, 81432706096, 81432706114,
81432706116, 81432706121



MN-VB-8514

Length: 627 Ø: 48
Hole Ø 25 / 25 / 25
Hole Distance: 152 / 130 / 130

81432706087, 81432706088, 81432706094,
81432706095, 81432796094



MN-VB-9403

Length: 627 Ø: 48
Hole Ø 25 / 23 / 23
Hole Distance: 152 / 130 / 130

81432706097, 81432706113, 81432706135,
81432706160, 81432706161





TGS ...

26.540 FNLC, FNLRC, FNLLC, FNLLRC, FNLLW, FVLC, FVL-KO ...	10/07 →	Track Control Arm		MN-DL-8709	Trailing Arm, Trailing Axle; for vehicles with Hinged Trailing Axle
	10/07 →	Track Control Arm		MN-TC-12399	Control Arm
	10/07 →	Track Control Arm		MN-VB-5238	Wishbone (CV), Drive Axle
	10/07 →	Track Control Arm		MN-VB-9403	Wishbone (CV)
	10/07 →	Track Control Arm	MN-DL-8663		Control Arm, Air Suspension Axle
26.540 FNLS, FNLLS, FPLS, FPLRS, FVLS, FNLRS, FNLS	02/09 →	Centre Rod	MN-DL-7801		Push Rod, Leaf Spring Axle
	02/09 →	Centre Rod	MN-DL-8560		Push Rod, Air Suspension Axle
	02/09 →	Tie Rod	MN-DL-7802		
	02/09 →	Tie Rod	MN-DL-12284		
	02/09 →	Tie Rod End		MN-ES-8490	for vehicles with Hinged Trailing Axle
	02/09 →	Track Control Arm		MN-DL-5225	Trailing Arm, Drive Axle
	02/09 →	Track Control Arm		MN-DL-5225	Trailing Arm, Trailing Axle; for vehicles with Hinged Trailing Axle
	02/09 →	Track Control Arm		MN-DL-5225	Trailing Arm, Trailing Axle; for vehicles with Rigid Trailing Axle
	02/09 →	Track Control Arm		MN-DL-8709	Trailing Arm, Trailing Axle; for vehicles with Hinged Trailing Axle
	02/09 →	Track Control Arm		MN-TC-12399	Control Arm
	02/09 →	Track Control Arm		MN-VB-5238	Wishbone (CV), Drive Axle
	02/09 →	Track Control Arm		MN-VB-9403	Wishbone (CV)
	02/09 →	Track Control Arm	MN-DL-8663		Control Arm, Air Suspension Axle
	28.320 FANLC, FNHLC	07/08 →	Track Control Arm		MN-DL-5225
28.320 FNLC	07/08 →	Centre Rod	MN-DL-7801		Push Rod, Leaf Spring Axle
	07/08 →	Tie Rod	MN-DL-7802		
	07/08 →	Track Control Arm		MN-DL-5225	Trailing Arm
28.320 FNLS	07/08 →	Centre Rod	MN-DL-7801		Push Rod, Leaf Spring Axle
	07/08 →	Tie Rod	MN-DL-7802		
	07/08 →	Track Control Arm		MN-DL-5225	Trailing Arm
28.360 FANLC, FNHLC	08/08 →	Tie Rod End		IV-ES-8507	Air Suspension Axle; for vehicles with Hinged Trailing Axle
	08/08 →	Track Control Arm		MN-DL-5225	Trailing Arm
	08/08 →	Track Control Arm		MN-VB-8514	Suspension Rod, Wishbone (CV)
28.360 FANLK	08/08 →	Tie Rod End		IV-ES-8507	Air Suspension Axle; for vehicles with Hinged Trailing Axle
	08/08 →	Track Control Arm		MN-DL-5225	Trailing Arm
	08/08 →	Track Control Arm		MN-VB-8514	Suspension Rod, Wishbone (CV)
	08/08 →	Track Control Arm		MN-DL-5225	Trailing Arm
28.360 FNLC, FNLRC	08/08 →	Centre Rod	MN-DL-7801		Push Rod, Leaf Spring Axle
	08/08 →	Tie Rod	MN-DL-7802		
	08/08 →	Tie Rod End		IV-ES-8507	Air Suspension Axle; for vehicles with Hinged Trailing Axle
	08/08 →	Track Control Arm		MN-DL-5225	Trailing Arm
28.360 FNLS, FNLRS	08/08 →	Track Control Arm		MN-TC-12399	Control Arm
	08/08 →	Centre Rod	MN-DL-7801		Push Rod, Leaf Spring Axle
	08/08 →	Tie Rod	MN-DL-7802		
	08/08 →	Track Control Arm		MN-DL-5225	Trailing Arm
28.400 FANLC, FNHLC	08/08 →	Tie Rod End		IV-ES-8507	Air Suspension Axle; for vehicles with Hinged Trailing Axle
	08/08 →	Track Control Arm		MN-DL-5225	Trailing Arm
	08/08 →	Track Control Arm		MN-VB-8514	Suspension Rod, Wishbone (CV)
28.400 FANLK	08/08 →	Tie Rod End		IV-ES-8507	Air Suspension Axle; for vehicles with Hinged Trailing Axle
	08/08 →	Track Control Arm		MN-DL-5225	Trailing Arm
	08/08 →	Track Control Arm		MN-VB-8514	Suspension Rod, Wishbone (CV)
	08/08 →	Track Control Arm		MN-DL-5225	Trailing Arm
28.400 FNLC, FNLRC	08/08 →	Centre Rod	MN-DL-7801		Push Rod, Leaf Spring Axle
	08/08 →	Tie Rod	MN-DL-7802		
	08/08 →	Tie Rod End		IV-ES-8507	Air Suspension Axle; for vehicles with Hinged Trailing Axle
	08/08 →	Track Control Arm		MN-DL-5225	Trailing Arm
28.400 FNLS, FBLRS	08/08 →	Track Control Arm		MN-TC-12399	Control Arm
	08/08 →	Centre Rod	MN-DL-7801		Push Rod, Leaf Spring Axle
	08/08 →	Tie Rod	MN-DL-7802		
	08/08 →	Track Control Arm		MN-DL-5225	Trailing Arm

IV-ES-8507

Length: 80
Cone Ø: d1 Ø 30 / d2 Ø 27
Thread: M30 x 1,5 RHT
11019869, 12216380, 55175540,
81953016238



MN-DL-5225

Length: 572 Ø: 48
Hole Distance: 130 / 130
03301500A, 81432206229, 81432206236,
81432206267, 81432206270, 81432206272,
81432206304, 81432206305, 81432209236,
81432209267, 81432209272



MN-DL-7801

Length: 995 Ø: 52
Cone Ø: d1 Ø 30 / d2 Ø 27
81466106807, 81466106808, 81466116087,
81466116088, 81466116096, 81466116097,
81466116099, 81466116132, 81466116133,
81466116136, 81466116197, 81466116198,
81466116205



MN-DL-7802

Length: 1680 Ø: 52
Cone Ø: d1 Ø 30 / d2 Ø 27
03208300A, 81467116773, 81467116858,
81467116859, 81467116860, 81467116861,
81467116863, 81467116882, 81467116883,
81467116920, 81467116921



MN-DL-8560

Length: 970 Ø: 52
Cone Ø: d1 Ø 30 / d2 Ø 27
03206900A, 81466106809, 81466106810,
81466106823, 81466106838, 81466106839,
81466116104, 81466116105, 81466116107,
81466116134, 81466116135, 81466116137,
81466116199, 81466116200, 81466116206



MN-DL-8663

Length: 947 Ø: 60
Hole Distance: 115 / 115
03307400A, 81432206222, 81432206260,
81432206283, 81432206284



MN-DL-8709

Length: 572 Ø: 52
Hole Distance: 130 / 130
81432206268, 81432206274, 81432206291,
81432206292, 82432206007



MN-DL-12284

Length: 1530 Ø: 50
Cone Ø: d1 Ø 30 / d2 Ø 27
81466106579, 81466106580, 81466106624,
81466116720, 81467116720, 81467116730,
81467116952



MN-ES-8490

Length: 90
Cone Ø: d1 Ø 30 / d2 Ø 27
Thread: M26 x 1,5 RHT
0014606948, 14606948, 81953016281,
81953016337, 82953016016



MN-TC-12399

Length: 694 Ø: 50
Hole Distance: 130 / 130
81432206265



MN-VB-5238

Length: 627 Ø: 48
Hole Distance: 130 / 130
81432206221, 81432706096, 81432706114,
81432706116, 81432706121



MN-VB-8514

Length: 627 Ø: 48
Hole Ø 25 / 25 / 25
Hole Distance: 152 / 130 / 130
81432706087, 81432706088, 81432706094,
81432706095, 81432796094



MN-VB-9403

Length: 627 Ø: 48
Hole Ø 25 / 23 / 23
Hole Distance: 152 / 130 / 130
81432706097, 81432706113, 81432706135,
81432706160, 81432706161





TGS ...

28.440 FANLC, FNHLC	08/08 →	Tie Rod End		IV-ES-8507	Air Suspension Axle;for vehicles with Hinged Trailing Axle
	08/08 →	Track Control Arm		MN-DL-5225	Trailing Arm
	08/08 →	Track Control Arm		MN-VB-8514	Suspension Rod, Wishbone (CV)
28.440 FANLK	08/08 →	Tie Rod End		IV-ES-8507	Air Suspension Axle;for vehicles with Hinged Trailing Axle
	08/08 →	Track Control Arm		MN-DL-5225	Trailing Arm
	08/08 →	Track Control Arm		MN-VB-8514	Suspension Rod, Wishbone (CV)
28.440 FNLC, FNLRC	08/08 →	Centre Rod	MN-DL-7801		Push Rod, Leaf Spring Axle
	08/08 →	Tie Rod	MN-DL-7802		
	08/08 →	Tie Rod End		IV-ES-8507	Air Suspension Axle;for vehicles with Hinged Trailing Axle
	08/08 →	Track Control Arm		MN-DL-5225	Trailing Arm
	08/08 →	Track Control Arm		MN-TC-12399	Control Arm
	08/08 →	Track Control Arm		MN-VB-8514	Suspension Rod, Wishbone (CV)
28.440 FNLS, FNLRS	08/08 →	Centre Rod	MN-DL-7801		Push Rod, Leaf Spring Axle
	08/08 →	Tie Rod	MN-DL-7802		
	08/08 →	Track Control Arm		MN-DL-5225	Trailing Arm
28.480 FANLC, FNHLC	08/08 →	Tie Rod End		IV-ES-8507	Air Suspension Axle;for vehicles with Hinged Trailing Axle
	08/08 →	Track Control Arm		MN-DL-5225	Trailing Arm
	08/08 →	Track Control Arm		MN-VB-8514	Suspension Rod, Wishbone (CV)
28.480 FANLK	08/08 →	Tie Rod End		IV-ES-8507	Air Suspension Axle;for vehicles with Hinged Trailing Axle
	08/08 →	Track Control Arm		MN-DL-5225	Trailing Arm
	08/08 →	Track Control Arm		MN-VB-8514	Suspension Rod, Wishbone (CV)
28.480 FNLC, FNLRC	08/08 →	Centre Rod	MN-DL-7801		Push Rod, Leaf Spring Axle
	08/08 →	Tie Rod	MN-DL-7802		
	08/08 →	Tie Rod End		IV-ES-8507	Air Suspension Axle;for vehicles with Hinged Trailing Axle
	08/08 →	Track Control Arm		MN-DL-5225	Trailing Arm
	08/08 →	Track Control Arm		MN-TC-12399	Control Arm
	08/08 →	Track Control Arm		MN-VB-8514	Suspension Rod, Wishbone (CV)
28.480 FNLS, FNLRS	08/08 →	Centre Rod	MN-DL-7801		Push Rod, Leaf Spring Axle
	08/08 →	Tie Rod	MN-DL-7802		
	08/08 →	Track Control Arm		MN-DL-5225	Trailing Arm
28.540 FANLC, FNHLC	06/08 →	Track Control Arm		MN-DL-5225	Trailing Arm
28.540 FNLC	02/09 →	Centre Rod	MN-DL-7801		Push Rod, Leaf Spring Axle
	02/09 →	Tie Rod	MN-DL-7802		
	02/09 →	Tie Rod End		IV-ES-8507	Air Suspension Axle;for vehicles with Hinged Trailing Axle
	02/09 →	Track Control Arm		MN-DL-5225	Trailing Arm
	02/09 →	Track Control Arm		MN-TC-12399	Control Arm
28.540 FNLS	02/09 →	Centre Rod	MN-DL-7801		Push Rod, Leaf Spring Axle
	02/09 →	Tie Rod	MN-DL-7802		
	02/09 →	Track Control Arm		MN-DL-5225	Trailing Arm
32.320 FFDR	08/08 →	Centre Rod	MN-DL-12289		Push Rod
32.320 FFD-TM	02/09 →	Centre Rod	MN-DL-12289		Push Rod
	02/09 →	Centre Rod	MN-DL-12393		for Steering Rod
	02/09 →	Tie Rod End	CV-ES-14163		for Steering Rod
	02/09 →	Track Control Arm		MN-VB-8514	Suspension Rod, Wishbone (CV)
	02/09 →	Track Control Arm		MN-TC-12399	Control Arm
32.360 FFDR	08/08 →	Centre Rod	MN-DL-12289		Push Rod
	08/08 →	Centre Rod	MN-DL-12393		for Steering Rod
	08/08 →	Tie Rod End	CV-ES-14163		for Steering Rod
	08/08 →	Track Control Arm		MN-VB-8514	Suspension Rod, Wishbone (CV)
32.360 FFD-TM, FFDR-TM	10/07 →	Centre Rod	MN-DL-12289		Push Rod
	10/07 →	Centre Rod	MN-DL-12393		for Steering Rod
	10/07 →	Tie Rod End	CV-ES-14163		for Steering Rod
	10/07 →	Track Control Arm		MN-VB-8514	Suspension Rod, Wishbone (CV)
32.400 FFDR	08/08 →	Centre Rod	MN-DL-12289		Push Rod
	08/08 →	Centre Rod	MN-DL-12393		for Steering Rod
	08/08 →	Tie Rod End	CV-ES-14163		for Steering Rod
	08/08 →	Track Control Arm		MN-VB-8514	Suspension Rod, Wishbone (CV)

CV-ES-14163

Length: 125

Cone Ø: d1 Ø 30 / d2 Ø 27

Thread: M30 x 1,5 RHT

95301.0084, 90804102156, 90804102272, 90804102696, 90804102710, 81953010016, 81953010075, 81953010084, 81953010088, 81953010094, 81953010103, 81953016030, 81953016043, 81953016048, 81953016049, 81953016053, 81953016061, 81953016090, 81953016108, 81953016112, 81953016126, 81953016143, 81953016149, 81953016154, 81953016156, 81953016168, 81953016178, 81953016194, 81953016206, 81953016224, 81953016234, 81953016242, 81953016252, 81953016274, 81953016278, 81953016284, 81953016286, 81953016308, 81953016310, 81953016312, 81953016347, 81953016350, 81953016352, 82953016012, 88953016014, N2953016001



IV-ES-8507

Length: 80

Cone Ø: d1 Ø 30 / d2 Ø 27

Thread: M30 x 1,5 RHT

11019869, 12216380, 55175540, 81953016238



MN-DL-5225

Length: 572 Ø: 48

Hole Distance: 130 / 130

03301500A, 81432206229, 81432206236, 81432206267, 81432206270, 81432206272, 81432206304, 81432206305, 81432209236, 81432209267, 81432209272



MN-DL-7801

Length: 995 Ø: 52

Cone Ø: d1 Ø 30 / d2 Ø 27

81466106807, 81466106808, 81466116087, 81466116088, 81466116096, 81466116097, 81466116099, 81466116132, 81466116133, 81466116136, 81466116197, 81466116198, 81466116205

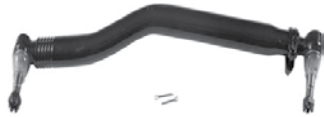

MN-DL-7802

Length: 1680 Ø: 52

Cone Ø: d1 Ø 30 / d2 Ø 27

03208300A, 81467116773, 81467116858, 81467116859, 81467116860, 81467116861, 81467116863, 81467116882, 81467116883, 81467116920, 81467116921



MN-DL-12289

Length: 1796 Ø: 62

Cone Ø: d1 Ø 30 / d2 Ø 27

81466116174, 81466116175, 81466116176, 81466116244

No Image

MN-DL-12393

Length: 1796 Ø: 62

Cone Ø: d1 Ø 30 / d2 Ø 27

81466116154, 81466116155, 81466116156



MN-TC-12399

Length: 694 Ø: 50

Hole Distance: 130 / 130

81432206265



MN-VB-8514

Length: 627 Ø: 48

Hole Ø 25 / 25 / 25

Hole Distance: 152 / 130 / 130

81432706087, 81432706088, 81432706094, 81432706095, 81432796094





TGS ...

32.400 FFD-TM, FFDR-TM	10/07→	Centre Rod	MN-DL-12289	Push Rod
	10/07→	Centre Rod	MN-DL-12393	for Steering Rod
	10/07→	Tie Rod End	CV-ES-14163	for Steering Rod
	10/07→	Track Control Arm		MN-VB-8514 Suspension Rod, Wishbone (CV)
32.440 FFDR	08/08→	Centre Rod	MN-DL-12289	Push Rod
	08/08→	Centre Rod	MN-DL-12393	for Steering Rod
	08/08→	Tie Rod End	CV-ES-14163	for Steering Rod
	08/08→	Track Control Arm		MN-VB-8514 Suspension Rod, Wishbone (CV)
32.440 FFD-TM, FFDR-TM	10/07→	Centre Rod	MN-DL-12289	Push Rod
	10/07→	Centre Rod	MN-DL-12393	for Steering Rod
	10/07→	Tie Rod End	CV-ES-14163	for Steering Rod
	10/07→	Track Control Arm		MN-VB-8514 Suspension Rod, Wishbone (CV)
32.480 FFDR	08/08→	Centre Rod	MN-DL-12289	Push Rod
32.480 FFD-TM	08/08→	Centre Rod	MN-DL-12289	Push Rod
	08/08→	Tie Rod End	CV-ES-14163	for Steering Rod
	08/08→	Track Control Arm		MN-VB-8514 Suspension Rod, Wishbone (CV)
33.320 FDAK, FDALK	06/08→	Track control arm		MN-DL-12288 Trailing Arm
33.320 FDC, FDLC, FDLRC, FDR	06/08→	Centre Rod	MN-DL-8560	Push Rod
33.320 FDK, FDLK	06/08→	Centre Rod	MN-DL-8560	Push Rod
	06/08→	Tie Rod	MN-DL-12293	
33.320 FDLS, FDS	06/08→	Centre Rod	MN-DL-8560	Push Rod
	06/08→	Tie Rod	MN-DL-12293	
33.360 FDAC, FDALC, FDARC	06/08→	Centre Rod	MN-DL-8646	Push Rod, Drive Axle
	06/08→	Track Control Arm		MN-DL-8544 Trailing Arm, Drive Axle;Air Suspension Axle
	06/08→	Track Control Arm		MN-DL-8544 Trailing Arm, Drive Axle;Leaf Spring Axle
	06/08→	Track control arm		MN-DL-12288 Trailing Arm
	06/08→	Track Control Arm		MN-VB-8514 Suspension Rod, Wishbone (CV), Drive Axle; Air Suspension Axle
	06/08→	Track Control Arm		MN-VB-8514 Suspension Rod, Wishbone (CV), Drive Axle; Leaf Spring Axle
33.360 FDAK, FDALK, FDHK, FDARK	10/07→	Centre Rod	MN-DL-8646	Push Rod, Drive Axle
	10/07→	Track Control Arm		MN-DL-8544 Trailing Arm, Drive Axle;Air Suspension Axle
	10/07→	Track Control Arm		MN-DL-8544 Trailing Arm, Drive Axle;Leaf Spring Axle
	10/07→	Track control arm		MN-DL-12288 Trailing Arm
	10/07→	Track Control Arm		MN-VB-8514 Suspension Rod, Wishbone (CV), Drive Axle; Air Suspension Axle
	10/07→	Track Control Arm		MN-VB-8514 Suspension Rod, Wishbone (CV), Drive Axle; Leaf Spring Axle
33.360 FDAS, FDALS, FDHS, FDARS	10/07→	Centre Rod	MN-DL-8646	Push Rod, Drive Axle
	10/07→	Track Control Arm		MN-DL-8544 Trailing Arm, Drive Axle;Air Suspension Axle
	10/07→	Track Control Arm		MN-DL-8544 Trailing Arm, Drive Axle;Leaf Spring Axle
	10/07→	Track control arm		MN-DL-12288 Trailing Arm
	10/07→	Track Control Arm		MN-VB-8514 Suspension Rod, Wishbone (CV), Drive Axle; Air Suspension Axle
	10/07→	Track Control Arm		MN-VB-8514 Suspension Rod, Wishbone (CV), Drive Axle; Leaf Spring Axle
33.360 FDC, FDLC, FDLRC, FDR, FDR	06/08→	Centre Rod	MN-DL-7801	Push Rod, Leaf Spring Axle
	06/08→	Tie Rod	MN-DL-7802	
	06/08→	Tie Rod	MN-DL-12293	
	06/08→	Track Control Arm		MN-DL-5225 Trailing Arm, Drive Axle
	06/08→	Track Control Arm		MN-DL-8544 Trailing Arm, Drive Axle
	06/08→	Track Control Arm		MN-VB-5238 Wishbone (CV), Drive Axle;Air Suspension Axle
	06/08→	Track Control Arm		MN-VB-8514 Suspension Rod, Wishbone (CV), Drive Axle; Air Suspension Axle
	06/08→	Track Control Arm		MN-VB-8514 Suspension Rod, Wishbone (CV), Drive Axle; Leaf Spring Axle
33.360 FDK, FDLK, FDRK	02/09→	Centre Rod	MN-DL-7801	Push Rod, Leaf Spring Axle
	02/09→	Tie Rod	MN-DL-7802	
	02/09→	Tie Rod	MN-DL-12293	
	02/09→	Track Control Arm		MN-DL-5225 Trailing Arm, Drive Axle
	02/09→	Track Control Arm		MN-DL-8544 Trailing Arm, Drive Axle
	02/09→	Track Control Arm		MN-VB-5238 Wishbone (CV), Drive Axle;Air Suspension Axle

CV-ES-14163

Length: 125
Cone Ø: d1 Ø 30 / d2 Ø 27
Thread: M30 x 1,5 RHT

95301.0084, 90804102156, 90804102272, 90804102696, 90804102710, 81953010016, 81953010075, 81953010084, 81953010088, 81953010094, 81953010103, 81953016030, 81953016043, 81953016048, 81953016049, 81953016053, 81953016061, 81953016090, 81953016108, 81953016112, 81953016126, 81953016143, 81953016149, 81953016154, 81953016156, 81953016168, 81953016178, 81953016194, 81953016206, 81953016224, 81953016234, 81953016242, 81953016252, 81953016274, 81953016278, 81953016284, 81953016286, 81953016308, 81953016310, 81953016312, 81953016347, 81953016350, 81953016352, 82953016012, 88953016014, N2953016001



MN-DL-5225

Length: 572 Ø: 48
Hole Distance: 130 / 130

03301500A, 81432206229, 81432206236, 81432206267, 81432206270, 81432206272, 81432206304, 81432206305, 81432209236, 81432209267, 81432209272



MN-DL-7801

Length: 995 Ø: 52
Cone Ø: d1 Ø 30 / d2 Ø 27

81466106807, 81466106808, 81466116087, 81466116088, 81466116096, 81466116097, 81466116099, 81466116132, 81466116133, 81466116136, 81466116197, 81466116198, 81466116205

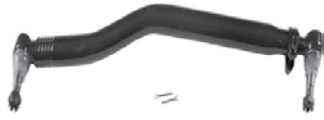

MN-DL-7802

Length: 1680 Ø: 52
Cone Ø: d1 Ø 30 / d2 Ø 27

03208300A, 81467116773, 81467116858, 81467116859, 81467116860, 81467116861, 81467116863, 81467116882, 81467116883, 81467116920, 81467116921



MN-DL-8544

Length: 596 Ø: 48
Hole Distance: 130 / 130

81432206196, 81432206232, 81432206233



MN-DL-8560

Length: 970 Ø: 52
Cone Ø: d1 Ø 30 / d2 Ø 27

03206900A, 81466106809, 81466106810, 81466106823, 81466106838, 81466106839, 81466116104, 81466116105, 81466116107, 81466116134, 81466116135, 81466116137, 81466116199, 81466116200, 81466116206



MN-DL-8646

Length: 1021 Ø: 52
Cone Ø: d1 Ø 30 / d2 Ø 27

81466106811, 81466106812, 81466116138, 81466116139, 81466116201, 81466116202

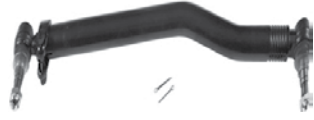

MN-DL-12288

Length: 585 Ø: 58
Hole Distance: 130 / 130

81432206386, 82432206008, 82432209008

No Image

MN-DL-12289

Length: 1796 Ø: 62
Cone Ø: d1 Ø 30 / d2 Ø 27

81466116174, 81466116175, 81466116176, 81466116244

No Image

MN-DL-12293

Length: 1680 Ø: 42
Cone Ø: d1 Ø 30 / d2 Ø 27

81467106236, 81467106268, 81467106356, 81467116356, 81467116723, 81467116794, 81467116933, 81467116934, 81467116966



MN-DL-12393

Length: 1796 Ø: 62
Cone Ø: d1 Ø 30 / d2 Ø 27

81466116154, 81466116155, 81466116156



MN-VB-5238

Length: 627 Ø: 48
Hole Distance: 130 / 130

81432206221, 81432706096, 81432706114, 81432706116, 81432706121



MN-VB-8514

Length: 627 Ø: 48
Hole Ø 25 / 25 / 25
Hole Distance: 152 / 130 / 130

81432706087, 81432706088, 81432706094, 81432706095, 81432796094





TGS ...

33.360 FDK, FDLK, FDRK ...	02/09 →	Track Control Arm		MN-VB-8514	Suspension Rod, Wishbone (CV), Drive Axle; Air Suspension Axle
	02/09 →	Track Control Arm		MN-VB-8514	Suspension Rod, Wishbone (CV), Drive Axle; Leaf Spring Axle
33.360 FDS, FDLS, FDRS	06/08 →	Centre Rod	MN-DL-7801		Push Rod, Leaf Spring Axle
	06/08 →	Tie Rod	MN-DL-7802		
	06/08 →	Tie Rod	MN-DL-12293		
	06/08 →	Track Control Arm		MN-DL-5225	Trailing Arm, Drive Axle
	06/08 →	Track Control Arm		MN-DL-8544	Trailing Arm, Drive Axle
	06/08 →	Track Control Arm		MN-VB-5238	Wishbone (CV), Drive Axle; Air Suspension Axle
	06/08 →	Track Control Arm		MN-VB-8514	Suspension Rod, Wishbone (CV), Drive Axle; Air Suspension Axle
33.400 FDAC, FDALC, FDARC	07/08 →	Centre Rod	MN-DL-8646		Push Rod, Drive Axle
	07/08 →	Track Control Arm		MN-DL-8544	Trailing Arm, Drive Axle; Leaf Spring Axle
	07/08 →	Track control arm		MN-DL-12288	Trailing Arm
	07/08 →	Track Control Arm		MN-VB-8514	Suspension Rod, Wishbone (CV), Drive Axle; Leaf Spring Axle
33.400 FDAK, FDALK, FDHK, FDARK	07/08 →	Centre Rod	MN-DL-8646		Push Rod, Drive Axle
	07/08 →	Track Control Arm		MN-DL-8544	Trailing Arm, Drive Axle; Leaf Spring Axle
	07/08 →	Track control arm		MN-DL-12288	Trailing Arm
	07/08 →	Track Control Arm		MN-VB-8514	Suspension Rod, Wishbone (CV), Drive Axle; Leaf Spring Axle
33.400 FDAS, FDALS, FDHS, FDARS	07/08 →	Centre Rod	MN-DL-8646		Push Rod, Drive Axle
	07/08 →	Track Control Arm		MN-DL-8544	Trailing Arm, Drive Axle; Leaf Spring Axle
	07/08 →	Track control arm		MN-DL-12288	Trailing Arm
	07/08 →	Track Control Arm		MN-VB-8514	Suspension Rod, Wishbone (CV), Drive Axle; Leaf Spring Axle
33.400 FDC, FDLC, FDLRC, FDR, FDRC	06/08 →	Centre Rod	MN-DL-7801		Push Rod, Leaf Spring Axle
	06/08 →	Tie Rod	MN-DL-7802		
	06/08 →	Tie Rod	MN-DL-12293		
	06/08 →	Track Control Arm		MN-DL-5225	Trailing Arm, Drive Axle
	06/08 →	Track Control Arm		MN-DL-8544	Trailing Arm, Drive Axle
	06/08 →	Track Control Arm		MN-VB-5238	Wishbone (CV), Drive Axle; Air Suspension Axle
	06/08 →	Track Control Arm		MN-VB-8514	Suspension Rod, Wishbone (CV), Drive Axle; Air Suspension Axle
33.400 FDK, FDLK, FDRK	07/08 →	Centre Rod	MN-DL-7801		Push Rod, Leaf Spring Axle
	07/08 →	Tie Rod	MN-DL-7802		
	07/08 →	Tie Rod	MN-DL-12293		
	07/08 →	Track Control Arm		MN-DL-5225	Trailing Arm, Drive Axle
	07/08 →	Track Control Arm		MN-DL-8544	Trailing Arm, Drive Axle
	07/08 →	Track Control Arm		MN-VB-5238	Wishbone (CV), Drive Axle; Air Suspension Axle
	07/08 →	Track Control Arm		MN-VB-8514	Suspension Rod, Wishbone (CV), Drive Axle; Air Suspension Axle
33.400 FDS, FDLS, FDRS	07/08 →	Centre Rod	MN-DL-7801		Push Rod, Leaf Spring Axle
	07/08 →	Tie Rod	MN-DL-7802		
	07/08 →	Tie Rod	MN-DL-12293		
	07/08 →	Track Control Arm		MN-DL-5225	Trailing Arm, Drive Axle
	07/08 →	Track Control Arm		MN-DL-8544	Trailing Arm, Drive Axle
	07/08 →	Track Control Arm		MN-VB-5238	Wishbone (CV), Drive Axle; Air Suspension Axle
	07/08 →	Track Control Arm		MN-VB-8514	Suspension Rod, Wishbone (CV), Drive Axle; Air Suspension Axle
33.440 FDAC, FDALC, FDARC	07/08 →	Centre Rod	MN-DL-8646		Push Rod, Drive Axle
	07/08 →	Track Control Arm		MN-DL-8544	Trailing Arm, Drive Axle; Air Suspension Axle
	07/08 →	Track Control Arm		MN-DL-8544	Trailing Arm, Drive Axle; Leaf Spring Axle
	07/08 →	Track control arm		MN-DL-12288	Trailing Arm

MN-DL-5225

Length: 572 Ø: 48
Hole Distance: 130 / 130

03301500A, 81432206229, 81432206236,
81432206267, 81432206270, 81432206272,
81432206304, 81432206305, 81432209236,
81432209267, 81432209272



MN-VB-5238

Length: 627 Ø: 48
Hole Distance: 130 / 130

81432206221, 81432706096, 81432706114,
81432706116, 81432706121



MN-DL-7801

Length: 995 Ø: 52
Cone Ø: d1 Ø 30 / d2 Ø 27

81466106807, 81466106808, 81466116087,
81466116088, 81466116096, 81466116097,
81466116099, 81466116132, 81466116133,
81466116136, 81466116197, 81466116198,
81466116205

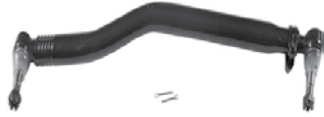

MN-VB-8514

Length: 627 Ø: 48
Hole Ø 25 / 25 / 25
Hole Distance: 152 / 130 / 130

81432706087, 81432706088, 81432706094,
81432706095, 81432796094



MN-DL-7802

Length: 1680 Ø: 52
Cone Ø: d1 Ø 30 / d2 Ø 27

03208300A, 81467116773, 81467116858,
81467116859, 81467116860, 81467116861,
81467116863, 81467116882, 81467116883,
81467116920, 81467116921



MN-DL-8544

Length: 596 Ø: 48
Hole Distance: 130 / 130

81432206196, 81432206232, 81432206233



MN-DL-8646

Length: 1021 Ø: 52
Cone Ø: d1 Ø 30 / d2 Ø 27

81466106811, 81466106812, 81466116138,
81466116139, 81466116201, 81466116202

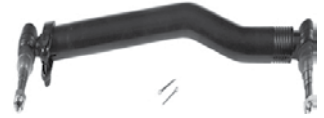

MN-DL-12288

Length: 585 Ø: 58
Hole Distance: 130 / 130

81432206386, 82432206008, 82432209008

No Image

MN-DL-12293

Length: 1680 Ø: 42
Cone Ø: d1 Ø 30 / d2 Ø 27

81467106236, 81467106268, 81467106356,
81467116356, 81467116723, 81467116794,
81467116933, 81467116934, 81467116966





TGS ...

33.440 FDAC, FDALC, FDARC ...	07/08→	Track Control Arm		MN-VB-8514	Suspension Rod, Wishbone (CV), Drive Axle; Air Suspension Axle
	07/08→	Track Control Arm		MN-VB-8514	Suspension Rod, Wishbone (CV), Drive Axle; Leaf Spring Axle
33.440 FDAK, FDALK, FDARK, FDHK	07/08→	Track control arm		MN-DL-12288	Trailing Arm
33.440 FDAK, FDALK, FDHK, FDARK	11/07→	Centre Rod	MN-DL-8646		Push Rod, Drive Axle
	11/07→	Track Control Arm		MN-DL-8544	Trailing Arm, Drive Axle;Air Suspension Axle
	11/07→	Track Control Arm		MN-DL-8544	Trailing Arm, Drive Axle;Leaf Spring Axle
	11/07→	Track control arm		MN-DL-12288	Trailing Arm
	11/07→	Track Control Arm		MN-VB-8514	Suspension Rod, Wishbone (CV), Drive Axle; Air Suspension Axle
	11/07→	Track Control Arm		MN-VB-8514	Suspension Rod, Wishbone (CV), Drive Axle; Leaf Spring Axle
33.440 FDAS, FDALS, FDARS, FDHS	07/08→	Track control arm		MN-DL-12288	Trailing Arm
33.440 FDAS, FDALS, FDHS, FDARS	10/07→	Centre Rod	MN-DL-8646		Push Rod, Drive Axle
	10/07→	Track Control Arm		MN-DL-8544	Trailing Arm, Drive Axle;Air Suspension Axle
	10/07→	Track Control Arm		MN-DL-8544	Trailing Arm, Drive Axle;Leaf Spring Axle
	10/07→	Track control arm		MN-DL-12288	Trailing Arm
	10/07→	Track Control Arm		MN-VB-8514	Suspension Rod, Wishbone (CV), Drive Axle; Air Suspension Axle
	10/07→	Track Control Arm		MN-VB-8514	Suspension Rod, Wishbone (CV), Drive Axle; Leaf Spring Axle
33.440 FDC, FDLC, FDLRC, FDR, FDRC	06/08→	Centre Rod	MN-DL-7801		Push Rod, Leaf Spring Axle
	06/08→	Tie Rod	MN-DL-7802		
	06/08→	Tie Rod	MN-DL-12293		
	06/08→	Track Control Arm		MN-DL-5225	Trailing Arm, Drive Axle
	06/08→	Track Control Arm		MN-DL-8544	Trailing Arm, Drive Axle
	06/08→	Track Control Arm		MN-VB-5238	Wishbone (CV), Drive Axle;Air Suspension Axle
	06/08→	Track Control Arm		MN-VB-8514	Suspension Rod, Wishbone (CV), Drive Axle; Air Suspension Axle
	06/08→	Track Control Arm		MN-VB-8514	Suspension Rod, Wishbone (CV), Drive Axle; Leaf Spring Axle
	08/08→	Centre Rod	MN-DL-8560		Push Rod
33.440 FDK, FDLK, FDRK	10/07→	Centre Rod	MN-DL-8560		Push Rod
	06/08→	Centre Rod	MN-DL-7801		Push Rod, Leaf Spring Axle
	06/08→	Tie Rod	MN-DL-7802		
	06/08→	Tie Rod	MN-DL-12293		
	06/08→	Track Control Arm		MN-DL-5225	Trailing Arm, Drive Axle
	06/08→	Track Control Arm		MN-DL-8544	Trailing Arm, Drive Axle
	06/08→	Track Control Arm		MN-VB-5238	Wishbone (CV), Drive Axle;Air Suspension Axle
	06/08→	Track Control Arm		MN-VB-8514	Suspension Rod, Wishbone (CV), Drive Axle; Air Suspension Axle
	06/08→	Track Control Arm		MN-VB-8514	Suspension Rod, Wishbone (CV), Drive Axle; Leaf Spring Axle
33.440 FDS, FDLS, FDLS/M, FDRS	10/07→	Centre Rod	MN-DL-8560		Push Rod
	06/08→	Centre Rod	MN-DL-7801		Push Rod, Leaf Spring Axle
	06/08→	Tie Rod	MN-DL-7802		
	06/08→	Tie Rod	MN-DL-12293		
	06/08→	Track Control Arm		MN-DL-5225	Trailing Arm, Drive Axle
	06/08→	Track Control Arm		MN-DL-8544	Trailing Arm, Drive Axle
	06/08→	Track Control Arm		MN-VB-5238	Wishbone (CV), Drive Axle;Air Suspension Axle
	06/08→	Track Control Arm		MN-VB-8514	Suspension Rod, Wishbone (CV), Drive Axle; Air Suspension Axle
	06/08→	Track Control Arm		MN-VB-8514	Suspension Rod, Wishbone (CV), Drive Axle; Leaf Spring Axle
33.480 FDAC, FDALC, FDARC	08/08→	Centre Rod	MN-DL-8646		Push Rod, Drive Axle
	08/08→	Track Control Arm		MN-DL-8544	Trailing Arm, Drive Axle;Air Suspension Axle
	08/08→	Track Control Arm		MN-DL-8544	Trailing Arm, Drive Axle;Leaf Spring Axle
	08/08→	Track control arm		MN-DL-12288	Trailing Arm
	08/08→	Track Control Arm		MN-VB-8514	Suspension Rod, Wishbone (CV), Drive Axle; Air Suspension Axle
	08/08→	Track Control Arm		MN-VB-8514	Suspension Rod, Wishbone (CV), Drive Axle; Leaf Spring Axle

MN-DL-5225

Length: 572 Ø: 48
Hole Distance: 130 / 130

03301500A, 81432206229, 81432206236,
81432206267, 81432206270, 81432206272,
81432206304, 81432206305, 81432209236,
81432209267, 81432209272



MN-DL-12293

Length: 1680 Ø: 42
Cone Ø: d1 Ø 30 / d2 Ø 27

81467106236, 81467106268, 81467106356,
81467116356, 81467116723, 81467116794,
81467116933, 81467116934, 81467116966



MN-VB-5238

Length: 627 Ø: 48
Hole Distance: 130 / 130

81432206221, 81432706096, 81432706114,
81432706116, 81432706121



MN-DL-7801

Length: 995 Ø: 52
Cone Ø: d1 Ø 30 / d2 Ø 27

81466106807, 81466106808, 81466116087,
81466116088, 81466116096, 81466116097,
81466116099, 81466116132, 81466116133,
81466116136, 81466116197, 81466116198,
81466116205

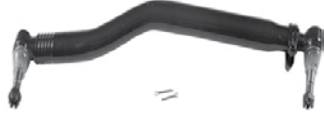

MN-VB-8514

Length: 627 Ø: 48
Hole Ø 25 / 25 / 25

Hole Distance: 152 / 130 / 130

81432706087, 81432706088, 81432706094,
81432706095, 81432796094



MN-DL-7802

Length: 1680 Ø: 52
Cone Ø: d1 Ø 30 / d2 Ø 27

03208300A, 81467116773, 81467116858,
81467116859, 81467116860, 81467116861,
81467116863, 81467116882, 81467116883,
81467116920, 81467116921



MN-DL-8544

Length: 596 Ø: 48
Hole Distance: 130 / 130

81432206196, 81432206232, 81432206233



MN-DL-8560

Length: 970 Ø: 52
Cone Ø: d1 Ø 30 / d2 Ø 27

03206900A, 81466106809, 81466106810,
81466106823, 81466106838, 81466106839,
81466116104, 81466116105, 81466116107,
81466116134, 81466116135, 81466116137,
81466116199, 81466116200, 81466116206



MN-DL-8646

Length: 1021 Ø: 52
Cone Ø: d1 Ø 30 / d2 Ø 27

81466106811, 81466106812, 81466116138,
81466116139, 81466116201, 81466116202

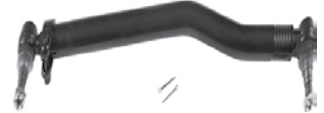

MN-DL-12288

Length: 585 Ø: 58
Hole Distance: 130 / 130

81432206386, 82432206008, 82432209008

No Image



TGS ...

33.480 FDAK, FDALK, FDARK, FDHK	08/08→	Centre Rod	MN-DL-8646		Push Rod, Drive Axle
	08/08→	Track Control Arm		MN-DL-8544	Trailing Arm, Drive Axle;Air Suspension Axle
	08/08→	Track Control Arm		MN-DL-8544	Trailing Arm, Drive Axle;Leaf Spring Axle
	08/08→	Track control arm		MN-DL-12288	Trailing Arm
	08/08→	Track Control Arm		MN-VB-8514	Suspension Rod, Wishbone (CV), Drive Axle; Air Suspension Axle
	08/08→	Track Control Arm		MN-VB-8514	Suspension Rod, Wishbone (CV), Drive Axle; Leaf Spring Axle
33.480 FDAS, FDALS, FDHS, FDARS	10/07→	Centre Rod	MN-DL-8646		Push Rod, Drive Axle
	10/07→	Track Control Arm		MN-DL-8544	Trailing Arm, Drive Axle;Air Suspension Axle
	10/07→	Track Control Arm		MN-DL-8544	Trailing Arm, Drive Axle;Leaf Spring Axle
	10/07→	Track control arm		MN-DL-12288	Trailing Arm
	10/07→	Track Control Arm		MN-VB-8514	Suspension Rod, Wishbone (CV), Drive Axle; Air Suspension Axle
	10/07→	Track Control Arm		MN-VB-8514	Suspension Rod, Wishbone (CV), Drive Axle; Leaf Spring Axle
33.480 FDC, FDC/M, FDLC, FDLC/M, FDLRC, FDR, FDRC	08/08→	Centre Rod	MN-DL-7801		Push Rod, Leaf Spring Axle
	08/08→	Tie Rod	MN-DL-7802		
	08/08→	Tie Rod	MN-DL-12293		
	08/08→	Track Control Arm		MN-DL-5225	Trailing Arm, Drive Axle
	08/08→	Track Control Arm		MN-DL-8544	Trailing Arm, Drive Axle
	08/08→	Track Control Arm		MN-VB-5238	Wishbone (CV), Drive Axle;Air Suspension Axle
	08/08→	Track Control Arm		MN-VB-8514	Suspension Rod, Wishbone (CV), Drive Axle; Air Suspension Axle
33.480 FDK, FDLK	08/08→	Centre Rod	MN-DL-7801		Push Rod, Leaf Spring Axle
	08/08→	Tie Rod	MN-DL-7802		
	08/08→	Tie Rod	MN-DL-12293		
	08/08→	Track Control Arm		MN-DL-5225	Trailing Arm, Drive Axle
	08/08→	Track Control Arm		MN-DL-8544	Trailing Arm, Drive Axle
	08/08→	Track Control Arm		MN-VB-5238	Wishbone (CV), Drive Axle;Air Suspension Axle
	08/08→	Track Control Arm		MN-VB-8514	Suspension Rod, Wishbone (CV), Drive Axle; Air Suspension Axle
	08/08→	Track Control Arm		MN-VB-8514	Suspension Rod, Wishbone (CV), Drive Axle; Leaf Spring Axle
33.480 FDS, FDLS, FDLS/M, FDRS	08/08→	Centre Rod	MN-DL-7801		Push Rod, Leaf Spring Axle
	08/08→	Tie Rod	MN-DL-7802		
	08/08→	Tie Rod	MN-DL-12293		
	08/08→	Track Control Arm		MN-DL-5225	Trailing Arm, Drive Axle
	08/08→	Track Control Arm		MN-DL-8544	Trailing Arm, Drive Axle
	08/08→	Track Control Arm		MN-VB-5238	Wishbone (CV), Drive Axle;Air Suspension Axle
	08/08→	Track Control Arm		MN-VB-8514	Suspension Rod, Wishbone (CV), Drive Axle; Air Suspension Axle
	08/08→	Track Control Arm		MN-VB-8514	Suspension Rod, Wishbone (CV), Drive Axle; Leaf Spring Axle
33.540 FDAC, FDALC	02/09→	Centre Rod	MN-DL-8646		Push Rod, Drive Axle
	02/09→	Track Control Arm		MN-DL-8544	Trailing Arm, Drive Axle;Air Suspension Axle
	02/09→	Track Control Arm		MN-DL-8544	Trailing Arm, Drive Axle;Leaf Spring Axle
	02/09→	Track control arm		MN-DL-12288	Trailing Arm
	02/09→	Track Control Arm		MN-VB-8514	Suspension Rod, Wishbone (CV), Drive Axle; Air Suspension Axle
	02/09→	Track Control Arm		MN-VB-8514	Suspension Rod, Wishbone (CV), Drive Axle; Leaf Spring Axle
33.540 FDAK, FDALK	02/09→	Centre Rod	MN-DL-8646		Push Rod, Drive Axle
	02/09→	Track Control Arm		MN-DL-8544	Trailing Arm, Drive Axle;Air Suspension Axle
	02/09→	Track Control Arm		MN-DL-8544	Trailing Arm, Drive Axle;Leaf Spring Axle
	02/09→	Track control arm		MN-DL-12288	Trailing Arm
	02/09→	Track Control Arm		MN-VB-8514	Suspension Rod, Wishbone (CV), Drive Axle; Air Suspension Axle
	02/09→	Track Control Arm		MN-VB-8514	Suspension Rod, Wishbone (CV), Drive Axle; Leaf Spring Axle

MN-DL-5225

Length: 572 Ø: 48
Hole Distance: 130 / 130

03301500A, 81432206229, 81432206236,
81432206267, 81432206270, 81432206272,
81432206304, 81432206305, 81432209236,
81432209267, 81432209272



MN-VB-5238

Length: 627 Ø: 48
Hole Distance: 130 / 130

81432206221, 81432706096, 81432706114,
81432706116, 81432706121



MN-DL-7801

Length: 995 Ø: 52
Cone Ø: d1 Ø 30 / d2 Ø 27

81466106807, 81466106808, 81466116087,
81466116088, 81466116096, 81466116097,
81466116099, 81466116132, 81466116133,
81466116136, 81466116197, 81466116198,
81466116205

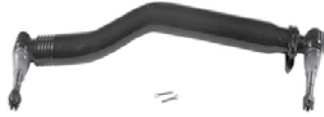

MN-VB-8514

Length: 627 Ø: 48
Hole Ø 25 / 25 / 25
Hole Distance: 152 / 130 / 130

81432706087, 81432706088, 81432706094,
81432706095, 81432796094



MN-DL-7802

Length: 1680 Ø: 52
Cone Ø: d1 Ø 30 / d2 Ø 27

03208300A, 81467116773, 81467116858,
81467116859, 81467116860, 81467116861,
81467116863, 81467116882, 81467116883,
81467116920, 81467116921



MN-DL-8544

Length: 596 Ø: 48
Hole Distance: 130 / 130

81432206196, 81432206232, 81432206233



MN-DL-8646

Length: 1021 Ø: 52
Cone Ø: d1 Ø 30 / d2 Ø 27

81466106811, 81466106812, 81466116138,
81466116139, 81466116201, 81466116202

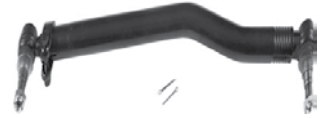

MN-DL-12288

Length: 585 Ø: 58
Hole Distance: 130 / 130

81432206386, 82432206008, 82432209008

No Image

MN-DL-12293

Length: 1680 Ø: 42
Cone Ø: d1 Ø 30 / d2 Ø 27

81467106236, 81467106268, 81467106356,
81467116356, 81467116723, 81467116794,
81467116933, 81467116934, 81467116966





TGS ...

33.540 FDAS, FDALS	02/09→	Centre Rod	MN-DL-8646		Push Rod, Drive Axle
	02/09→	Track Control Arm		MN-DL-8544	Trailing Arm, Drive Axle;Air Suspension Axle
	02/09→	Track Control Arm		MN-DL-8544	Trailing Arm, Drive Axle;Leaf Spring Axle
	02/09→	Track control arm		MN-DL-12288	Trailing Arm
	02/09→	Track Control Arm		MN-VB-8514	Suspension Rod, Wishbone (CV), Drive Axle; Air Suspension Axle
	02/09→	Track Control Arm		MN-VB-8514	Suspension Rod, Wishbone (CV), Drive Axle; Leaf Spring Axle
33.540 FDC, FDLC, FDLC/M, FDLRC, FDRC	02/09→	Centre Rod	MN-DL-7801		Push Rod, Leaf Spring Axle
	02/09→	Tie Rod	MN-DL-7802		
	02/09→	Tie Rod	MN-DL-12293		
	02/09→	Track Control Arm		MN-DL-5225	Trailing Arm, Drive Axle
	02/09→	Track Control Arm		MN-DL-8544	Trailing Arm, Drive Axle
	02/09→	Track Control Arm		MN-VB-5238	Wishbone (CV), Drive Axle;Air Suspension Axle
	02/09→	Track Control Arm		MN-VB-8514	Suspension Rod, Wishbone (CV), Drive Axle; Air Suspension Axle
	02/09→	Track Control Arm		MN-VB-8514	Suspension Rod, Wishbone (CV), Drive Axle; Leaf Spring Axle
33.540 FDK, FDLK	02/09→	Centre Rod	MN-DL-7801		Push Rod, Leaf Spring Axle
	02/09→	Tie Rod	MN-DL-7802		
	02/09→	Tie Rod	MN-DL-12293		
	02/09→	Track Control Arm		MN-DL-5225	Trailing Arm, Drive Axle
	02/09→	Track Control Arm		MN-DL-8544	Trailing Arm, Drive Axle
	02/09→	Track Control Arm		MN-VB-5238	Wishbone (CV), Drive Axle;Air Suspension Axle
	02/09→	Track Control Arm		MN-VB-8514	Suspension Rod, Wishbone (CV), Drive Axle; Air Suspension Axle
	02/09→	Track Control Arm		MN-VB-8514	Suspension Rod, Wishbone (CV), Drive Axle; Leaf Spring Axle
33.540 FDS, FDLS, FDLS/M	02/09→	Centre Rod	MN-DL-7801		Push Rod, Leaf Spring Axle
	02/09→	Tie Rod	MN-DL-7802		
	02/09→	Tie Rod	MN-DL-12293		
	02/09→	Track Control Arm		MN-DL-5225	Trailing Arm, Drive Axle
	02/09→	Track Control Arm		MN-DL-8544	Trailing Arm, Drive Axle
	02/09→	Track Control Arm		MN-VB-5238	Wishbone (CV), Drive Axle;Air Suspension Axle
	02/09→	Track Control Arm		MN-VB-8514	Suspension Rod, Wishbone (CV), Drive Axle; Air Suspension Axle
	02/09→	Track Control Arm		MN-VB-8514	Suspension Rod, Wishbone (CV), Drive Axle; Leaf Spring Axle
35.320 FFDK	06/08→	Centre Rod	MN-DL-8646		Push Rod
	06/08→	Mounting, stabilizer coupling rod	MN-SB-5246		
	06/08→	Tie Rod	MN-DL-12287		
	06/08→	Tie Rod End	CV-ES-14163		for Steering Rod
	06/08→	Tie Rod End	MN-ES-10333		for Steering Rod
	06/08→	Track Control Arm		MN-DL-8544	Trailing Arm
	06/08→	Track control arm		MN-DL-12288	Trailing Arm
	06/08→	Track Control Arm		MN-VB-8514	Suspension Rod, Wishbone (CV), 1st RA;2nd RA
35.320 FFDK, FFDHLK	06/08→	Centre Rod	MN-DL-7801		Push Rod, Leaf Spring Axle
	06/08→	Centre Rod	MN-DL-8646		Push Rod
	06/08→	Centre Rod	MN-DL-12285		for Steering Rod
	06/08→	Mounting, stabilizer coupling rod	MN-SB-5246		
	06/08→	Tie Rod End	MN-ES-10333		for Steering Rod
	06/08→	Track Control Arm		MN-DL-8544	Trailing Arm
	06/08→	Track Control Arm		MN-VB-8514	Suspension Rod, Wishbone (CV)
	06/08→	Track Control Arm			
35.320 FFDC, FFDLC, FDNLC	06/08→	Centre Rod	MN-DL-7801		Push Rod, Leaf Spring Axle
	06/08→	Centre Rod	MN-DL-8599		Push Rod
	06/08→	Centre Rod	MN-DL-12285		for Steering Rod
	06/08→	Centre Rod	MN-DL-12289		Push Rod
	06/08→	Centre Rod	MN-DL-12393		for Steering Rod
	06/08→	Tie Rod	MN-DL-7802		
	06/08→	Tie Rod	MN-DL-12284		
	06/08→	Tie Rod	MN-DL-12293		
	06/08→	Tie Rod End		IV-ES-8507	Air Suspension Axle;for vehicles with Hinged Trailing Axle
	06/08→	Tie Rod End			

CV-ES-14163

Length: 125
Cone Ø: d1 Ø 30 / d2 Ø 27
Thread: M30 x 1,5 RHT

95301.0084, 90804102156, 90804102272, 90804102696, 90804102710, 81953010016, 81953010075, 81953010084, 81953010088, 81953010094, 81953010103, 81953016030, 81953016043, 81953016048, 81953016049, 81953016053, 81953016061, 81953016090, 81953016108, 81953016112, 81953016126, 81953016143, 81953016149, 81953016154, 81953016156, 81953016168, 81953016178, 81953016194, 81953016206, 81953016224, 81953016234, 81953016242, 81953016252, 81953016274, 81953016278, 81953016284, 81953016286, 81953016308, 81953016310, 81953016312, 81953016347, 81953016350, 81953016352, 82953016012, 88953016014, N2953016001



IV-ES-8507

Length: 80
Cone Ø: d1 Ø 30 / d2 Ø 27
Thread: M30 x 1,5 RHT

11019869, 12216380, 55175540, 81953016238



MN-DL-5225

Length: 572 Ø: 48
Hole Distance: 130 / 130

03301500A, 81432206229, 81432206236, 81432206267, 81432206270, 81432206272, 81432206304, 81432206305, 81432209236, 81432209267, 81432209272



MN-DL-7801

Length: 995 Ø: 52
Cone Ø: d1 Ø 30 / d2 Ø 27

81466106807, 81466106808, 81466116087, 81466116088, 81466116096, 81466116097, 81466116099, 81466116132, 81466116133, 81466116136, 81466116197, 81466116198, 81466116205

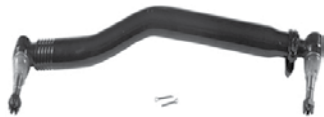

MN-DL-7802

Length: 1680 Ø: 52
Cone Ø: d1 Ø 30 / d2 Ø 27

03208300A, 81467116773, 81467116858, 81467116859, 81467116860, 81467116861, 81467116863, 81467116882, 81467116883, 81467116920, 81467116921



MN-DL-8544

Length: 596 Ø: 48
Hole Distance: 130 / 130

81432206196, 81432206232, 81432206233



MN-DL-8599

Length: 1800 Ø: 62
Cone Ø: d1 Ø 30 / d2 Ø 27

81466116161, 81466116162, 82466106183, 82466106186, 82466106187



MN-DL-8646

Length: 1021 Ø: 52
Cone Ø: d1 Ø 30 / d2 Ø 27

81466106811, 81466106812, 81466116138, 81466116139, 81466116201, 81466116202

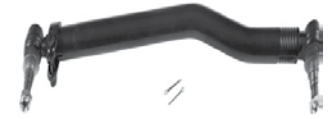

MN-DL-12284

Length: 1530 Ø: 50
Cone Ø: d1 Ø 30 / d2 Ø 27

81466106579, 81466106580, 81466106624, 81466116720, 81467116720, 81467116730, 81467116952



MN-DL-12285

Length: 993 Ø: 40
Cone Ø: d1 Ø 30 / d2 Ø 27

81466106816, 81466106826, 81466116151, 82466106184, 82466106185



MN-DL-12287

Length: 1531 Ø: 42
Cone Ø: d1 Ø 30 / d2 Ø 27

81467116855, 81467116856, 81467116857



MN-DL-12288

Length: 585 Ø: 58
Hole Distance: 130 / 130

81432206386, 82432206008, 82432209008

No Image

MN-DL-12289

Length: 1796 Ø: 62
Cone Ø: d1 Ø 30 / d2 Ø 27

81466116174, 81466116175, 81466116176, 81466116244

No Image

MN-DL-12293

Length: 1680 Ø: 42
Cone Ø: d1 Ø 30 / d2 Ø 27

81467106236, 81467106268, 81467106356, 81467116356, 81467116723, 81467116794, 81467116933, 81467116934, 81467116966



MN-DL-12393

Length: 1796 Ø: 62
Cone Ø: d1 Ø 30 / d2 Ø 27

81466116154, 81466116155, 81466116156



MN-ES-10333

Length: 90
Cone Ø: d1 Ø 38 / d2 Ø 34,35
Thread: M36 x 1,5 RHT

1271126, 3090291, 3099128, 42538048, 81953016268, 82953016018, 82953016019



MN-SB-5246

Ø: 45 Thick/Height: 47
81437220022, 81437220038, 81962100450, 81962100469



MN-VB-5238

Length: 627 Ø: 48
Hole Distance: 130 / 130

81432206221, 81432706096, 81432706114, 81432706116, 81432706121



MN-VB-8514

Length: 627 Ø: 48
Hole Ø 25 / 25 / 25
Hole Distance: 152 / 130 / 130

81432706087, 81432706088, 81432706094, 81432706095, 81432796094





TGS ...

35.320 FFDK, FFDLC, FDNLC ...	06/08→	Tie Rod End	CV-ES-14163		for Steering Rod
	06/08→	Tie Rod End	MN-ES-10333		for Steering Rod
	06/08→	Track Control Arm		MN-DL-5225	Trailing Arm, Drive Axle;Air Suspension Axle
	06/08→	Track Control Arm		MN-DL-5225	Trailing Arm, for vehicles with Hinged Trailing Axle;Air Suspension Axle
	06/08→	Track Control Arm		MN-DL-8544	Trailing Arm, Drive Axle
	06/08→	Track Control Arm		MN-DL-8544	Trailing Arm, Drive Axle;Air Suspension Axle
	06/08→	Track Control Arm		MN-DL-8709	Trailing Arm, for vehicles with Hinged Trailing Axle;Air Suspension Axle
	06/08→	Track Control Arm		MN-VB-5238	Wishbone (CV), Drive Axle;Air Suspension Axle
	06/08→	Track Control Arm		MN-VB-8514	Suspension Rod, Wishbone (CV), Drive Axle; Air Suspension Axle
	06/08→	Track Control Arm		MN-VB-8514	Suspension Rod, Wishbone (CV), Drive Axle; Leaf Spring Axle
	06/08→	Track Control Arm		MN-VB-8669	Suspension Rod, Wishbone (CV), Drive Axle; Leaf Spring Axle
	06/08→	Track Control Arm		MN-VB-9403	Wishbone (CV), Air Suspension Axle
35.320 FFDK, FFDLK, FFDK	08/08→	Centre Rod	MN-DL-7801		Push Rod, Leaf Spring Axle
	08/08→	Centre Rod	MN-DL-8599		Push Rod
	08/08→	Centre Rod	MN-DL-12285		for Steering Rod
	08/08→	Centre Rod	MN-DL-12289		Push Rod
	08/08→	Centre Rod	MN-DL-12393		for Steering Rod
	08/08→	Tie Rod	MN-DL-7802		
	08/08→	Tie Rod	MN-DL-12293		
	08/08→	Tie Rod End	CV-ES-14163		for Steering Rod
	08/08→	Tie Rod End	MN-ES-10333		for Steering Rod
	08/08→	Track Control Arm		MN-DL-5225	Trailing Arm, Drive Axle;Air Suspension Axle
	08/08→	Track Control Arm		MN-DL-8544	Trailing Arm, Drive Axle
	08/08→	Track Control Arm		MN-DL-8544	Trailing Arm, Drive Axle;Air Suspension Axle
	08/08→	Track Control Arm		MN-VB-5238	Wishbone (CV), Drive Axle;Air Suspension Axle
	08/08→	Track Control Arm		MN-VB-8514	Suspension Rod, Wishbone (CV), Drive Axle; Air Suspension Axle
	08/08→	Track Control Arm		MN-VB-8514	Suspension Rod, Wishbone (CV), Drive Axle; Leaf Spring Axle
	08/08→	Track Control Arm		MN-VB-8669	Suspension Rod, Wishbone (CV), Drive Axle; Leaf Spring Axle
35.320 FFD-TM	10/07→	Centre Rod	MN-DL-7801		Push Rod
	10/07→	Centre Rod	MN-DL-12289		Push Rod
	10/07→	Centre Rod	MN-DL-12393		for Steering Rod
	10/07→	Tie Rod	MN-DL-7802		
	10/07→	Tie Rod	MN-DL-12293		
	10/07→	Tie Rod End	CV-ES-14163		for Steering Rod
	10/07→	Track Control Arm		MN-DL-8544	Trailing Arm
	10/07→	Track Control Arm		MN-VB-8514	Suspension Rod, Wishbone (CV), Drive Axle, for Leaf-Spring Suspension vehicles
10/07→	Track Control Arm		MN-VB-8669	Suspension Rod, Wishbone (CV)	
35.320 FFNLC	01/09→	Centre Rod	MN-DL-7801		Push Rod, Leaf Spring Axle
	01/09→	Centre Rod	MN-DL-8599	MN-DL-8599	Push Rod, not for vehicles with Hinged Trailing Axle
	01/09→	Centre Rod	MN-DL-12285		for Steering Rod
	01/09→	Centre Rod	MN-DL-12393		for Steering Rod
	01/09→	Tie Rod	MN-DL-7802		
	01/09→	Tie Rod	MN-DL-12284		
	01/09→	Tie Rod End		IV-ES-8507	Air Suspension Axle;for vehicles with Hinged Trailing Axle
	01/09→	Tie Rod End	CV-ES-14163		for Steering Rod
	01/09→	Tie Rod End	MN-ES-10333		for Steering Rod
	01/09→	Track Control Arm		MN-DL-5225	Trailing Arm, Trailing Axle;Drive Axle; for vehicles with Rigid Trailing Axle
	01/09→	Track Control Arm		MN-DL-5225	Trailing Arm, Trailing Axle;for vehicles with Hinged Trailing Axle
	01/09→	Track Control Arm		MN-DL-8709	Trailing Arm, for vehicles with Hinged Trailing Axle

CV-ES-14163

Length: 125
Cone Ø: d1 Ø 30 / d2 Ø 27
Thread: M30 x 1,5 RHT

95301.0084, 90804102156, 90804102272, 90804102696, 90804102710, 81953010016, 81953010075, 81953010084, 81953010088, 81953010094, 81953010103, 81953016030, 81953016043, 81953016048, 81953016049, 81953016053, 81953016061, 81953016090, 81953016108, 81953016112, 81953016126, 81953016143, 81953016149, 81953016154, 81953016156, 81953016168, 81953016178, 81953016194, 81953016206, 81953016224, 81953016234, 81953016242, 81953016252, 81953016274, 81953016278, 81953016284, 81953016286, 81953016308, 81953016310, 81953016312, 81953016347, 81953016350, 81953016352, 82953016012, 88953016014, N2953016001



IV-ES-8507

Length: 80
Cone Ø: d1 Ø 30 / d2 Ø 27
Thread: M30 x 1,5 RHT

11019869, 12216380, 55175540, 81953016238



MN-DL-5225

Length: 572 Ø: 48
Hole Distance: 130 / 130

03301500A, 81432206229, 81432206236, 81432206267, 81432206270, 81432206272, 81432206304, 81432206305, 81432209236, 81432209267, 81432209272



MN-DL-7801

Length: 995 Ø: 52
Cone Ø: d1 Ø 30 / d2 Ø 27

81466106807, 81466106808, 81466116087, 81466116088, 81466116096, 81466116097, 81466116099, 81466116132, 81466116133, 81466116136, 81466116197, 81466116198, 81466116205

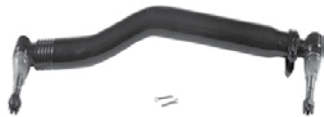

MN-DL-7802

Length: 1680 Ø: 52
Cone Ø: d1 Ø 30 / d2 Ø 27

03208300A, 81467116773, 81467116858, 81467116859, 81467116860, 81467116861, 81467116863, 81467116882, 81467116883, 81467116920, 81467116921



MN-DL-8544

Length: 596 Ø: 48
Hole Distance: 130 / 130

81432206196, 81432206232, 81432206233



MN-DL-8599

Length: 1800 Ø: 62
Cone Ø: d1 Ø 30 / d2 Ø 27

81466116161, 81466116162, 82466106183, 82466106186, 82466106187



MN-DL-8709

Length: 572 Ø: 52
Hole Distance: 130 / 130

81432206268, 81432206274, 81432206291, 81432206292, 82432206007



MN-DL-12284

Length: 1530 Ø: 50
Cone Ø: d1 Ø 30 / d2 Ø 27

81466106579, 81466106580, 81466106624, 81466116720, 81467116720, 81467116730, 81467116952

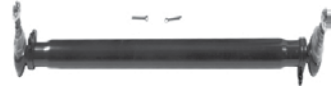

MN-DL-12285

Length: 993 Ø: 40
Cone Ø: d1 Ø 30 / d2 Ø 27

81466106816, 81466106826, 81466116151, 82466106184, 82466106185



MN-DL-12289

Length: 1796 Ø: 62
Cone Ø: d1 Ø 30 / d2 Ø 27

81466116174, 81466116175, 81466116176, 81466116244

No Image

MN-DL-12293

Length: 1680 Ø: 42
Cone Ø: d1 Ø 30 / d2 Ø 27

81467106236, 81467106268, 81467106356, 81467116356, 81467116723, 81467116794, 81467116933, 81467116934, 81467116966



MN-DL-12393

Length: 1796 Ø: 62
Cone Ø: d1 Ø 30 / d2 Ø 27

81466116154, 81466116155, 81466116156



MN-ES-10333

Length: 90
Cone Ø: d1 Ø 38 / d2 Ø 34,35
Thread: M36 x 1,5 RHT

1271126, 3090291, 3099128, 42538048, 81953016268, 82953016018, 82953016019



MN-VB-5238

Length: 627 Ø: 48
Hole Distance: 130 / 130

81432206221, 81432706096, 81432706114, 81432706116, 81432706121



MN-VB-8514

Length: 627 Ø: 48
Hole Ø 25 / 25 / 25
Hole Distance: 152 / 130 / 130

81432706087, 81432706088, 81432706094, 81432706095, 81432796094



MN-VB-8669

Length: 627 Ø: 48
Hole Ø 25 / 25 / 25
Hole Distance: 152 / 130 / 130

81432706116, 81432706137, 81432706150, 81432706151



MN-VB-9403

Length: 627 Ø: 48
Hole Ø 25 / 23 / 23
Hole Distance: 152 / 130 / 130

81432706097, 81432706113, 81432706135, 81432706160, 81432706161





TGS ...

35.320 FFNLC ...	01/09 →	Track Control Arm		MN-TC-12399	Control Arm	
	01/09 →	Track Control Arm		MN-VB-5238	Wishbone (CV), Drive Axle	
	01/09 →	Track Control Arm		MN-VB-9403	Wishbone (CV), Air Suspension Axle	
35.360 FFDAK	06/08 →	Centre Rod	MN-DL-8646		Push Rod	
	06/08 →	Mounting, stabilizer coupling rod	MN-SB-5246			
	06/08 →	Tie Rod	MN-DL-12287			
	06/08 →	Tie Rod End	CV-ES-14163		for Steering Rod	
	06/08 →	Tie Rod End	MN-ES-10333		for Steering Rod	
	06/08 →	Track Control Arm		MN-DL-8544	Trailing Arm	
	06/08 →	Track control arm		MN-DL-12288	Trailing Arm	
	06/08 →	Track Control Arm		MN-VB-8514	Suspension Rod, Wishbone (CV), 1st RA;2nd RA	
35.360 FFDAK, FFHDLK	06/08 →	Centre Rod	MN-DL-7801		Push Rod, Leaf Spring Axle	
	06/08 →	Centre Rod	MN-DL-8646		Push Rod	
	06/08 →	Centre Rod	MN-DL-12285		for Steering Rod	
	06/08 →	Mounting, stabilizer coupling rod	MN-SB-5246			
	06/08 →	Tie Rod End	MN-ES-10333		for Steering Rod	
	06/08 →	Track Control Arm		MN-DL-8544	Trailing Arm	
	06/08 →	Track Control Arm		MN-VB-8514	Suspension Rod, Wishbone (CV)	
35.360 FFDC, FFDLC, FDNLC	06/08 →	Centre Rod	MN-DL-7801		Push Rod, Leaf Spring Axle	
	06/08 →	Centre Rod	MN-DL-8599		Push Rod	
	06/08 →	Centre Rod	MN-DL-12285		for Steering Rod	
	06/08 →	Centre Rod	MN-DL-12289		Push Rod	
	06/08 →	Centre Rod	MN-DL-12393		for Steering Rod	
	06/08 →	Tie Rod	MN-DL-7802			
	06/08 →	Tie Rod	MN-DL-12284			
	06/08 →	Tie Rod	MN-DL-12293			
	06/08 →	Tie Rod End		IV-ES-8507	Air Suspension Axle;for vehicles with Hinged Trailing Axle	
	06/08 →	Tie Rod End	CV-ES-14163		for Steering Rod	
	06/08 →	Tie Rod End	MN-ES-10333		for Steering Rod	
	06/08 →	Track Control Arm		MN-DL-5225	Trailing Arm, Drive Axle;Air Suspension Axle	
	06/08 →	Track Control Arm		MN-DL-5225	Trailing Arm, for vehicles with Hinged Trailing Axle;Air Suspension Axle	
	06/08 →	Track Control Arm		MN-DL-8544	Trailing Arm, Drive Axle	
	06/08 →	Track Control Arm		MN-DL-8544	Trailing Arm, Drive Axle;Air Suspension Axle	
	06/08 →	Track Control Arm		MN-DL-8709	Trailing Arm, for vehicles with Hinged Trailing Axle;Air Suspension Axle	
	06/08 →	Track Control Arm		MN-VB-5238	Wishbone (CV), Drive Axle;Air Suspension Axle	
	06/08 →	Track Control Arm		MN-VB-8514	Suspension Rod, Wishbone (CV), Drive Axle; Air Suspension Axle	
	06/08 →	Track Control Arm		MN-VB-8514	Suspension Rod, Wishbone (CV), Drive Axle; Leaf Spring Axle	
	06/08 →	Track Control Arm		MN-VB-8669	Suspension Rod, Wishbone (CV), Drive Axle; Leaf Spring Axle	
	06/08 →	Track Control Arm		MN-VB-9403	Wishbone (CV), Air Suspension Axle	
	35.360 FFDK, FFDLK, FFDRK	08/08 →	Centre Rod	MN-DL-7801		Push Rod
		08/08 →	Centre Rod	MN-DL-8599		Push Rod
		08/08 →	Centre Rod	MN-DL-12285		for Steering Rod
		08/08 →	Centre Rod	MN-DL-12289		Push Rod
		08/08 →	Centre Rod	MN-DL-12393		for Steering Rod
		08/08 →	Tie Rod	MN-DL-7802		
08/08 →		Tie Rod	MN-DL-12293			
08/08 →		Tie Rod End	CV-ES-14163		for Steering Rod	
08/08 →		Tie Rod End	MN-ES-10333		for Steering Rod	
08/08 →		Track Control Arm		MN-DL-5225	Trailing Arm	
08/08 →		Track Control Arm		MN-DL-8544	Trailing Arm	
08/08 →		Track Control Arm		MN-VB-8514	Suspension Rod, Wishbone (CV), Drive Axle, for Leaf-Spring Suspension vehicles	
08/08 →		Track Control Arm		MN-VB-8514	Suspension Rod, Wishbone (CV), Drive Axle, for Pneumatic Suspension vehicles	
08/08 →		Track Control Arm		MN-VB-8669	Suspension Rod, Wishbone (CV)	
08/08 →		Track Control Arm	MN-VB-5238	MN-VB-5238	Wishbone (CV);Control Arm	

CV-ES-14163

Length: 125
Cone Ø: d1 Ø 30 / d2 Ø 27
Thread: M30 x 1,5 RHT

95301.0084, 90804102156, 90804102272, 90804102696, 90804102710, 81953010016, 81953010075, 81953010084, 81953010088, 81953010094, 81953010103, 81953016030, 81953016043, 81953016048, 81953016049, 81953016053, 81953016061, 81953016090, 81953016108, 81953016112, 81953016126, 81953016143, 81953016149, 81953016154, 81953016156, 81953016168, 81953016178, 81953016194, 81953016206, 81953016224, 81953016234, 81953016242, 81953016252, 81953016274, 81953016278, 81953016284, 81953016286, 81953016308, 81953016310, 81953016312, 81953016347, 81953016350, 81953016352, 82953016012, 88953016014, N2953016001



IV-ES-8507

Length: 80
Cone Ø: d1 Ø 30 / d2 Ø 27
Thread: M30 x 1,5 RHT

11019869, 12216380, 55175540, 81953016238



MN-DL-5225

Length: 572 Ø: 48
Hole Distance: 130 / 130

03301500A, 81432206229, 81432206236, 81432206267, 81432206270, 81432206272, 81432206304, 81432206305, 81432209236, 81432209267, 81432209272



MN-DL-7801

Length: 995 Ø: 52
Cone Ø: d1 Ø 30 / d2 Ø 27

81466106807, 81466106808, 81466116087, 81466116088, 81466116096, 81466116097, 81466116099, 81466116132, 81466116133, 81466116136, 81466116197, 81466116198, 81466116205

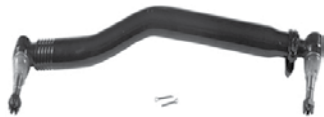

MN-DL-7802

Length: 1680 Ø: 52
Cone Ø: d1 Ø 30 / d2 Ø 27

03208300A, 81467116773, 81467116858, 81467116859, 81467116860, 81467116861, 81467116863, 81467116882, 81467116883, 81467116920, 81467116921



MN-DL-8544

Length: 596 Ø: 48
Hole Distance: 130 / 130

81432206196, 81432206232, 81432206233



MN-DL-8599

Length: 1800 Ø: 62
Cone Ø: d1 Ø 30 / d2 Ø 27

81466116161, 81466116162, 82466106183, 82466106186, 82466106187



MN-DL-8646

Length: 1021 Ø: 52
Cone Ø: d1 Ø 30 / d2 Ø 27

81466106811, 81466106812, 81466116138, 81466116139, 81466116201, 81466116202

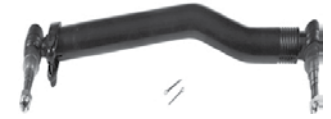

MN-DL-8709

Length: 572 Ø: 52
Hole Distance: 130 / 130

81432206268, 81432206274, 81432206291, 81432206292, 82432206007



MN-DL-12284

Length: 1530 Ø: 50
Cone Ø: d1 Ø 30 / d2 Ø 27

81466106579, 81466106580, 81466106624, 81466116720, 81467116720, 81467116730, 81467116952



MN-DL-12285

Length: 993 Ø: 40
Cone Ø: d1 Ø 30 / d2 Ø 27

81466106816, 81466106826, 81466116151, 82466106184, 82466106185



MN-DL-12287

Length: 1531 Ø: 42
Cone Ø: d1 Ø 30 / d2 Ø 27

81467116855, 81467116856, 81467116857



MN-DL-12288

Length: 585 Ø: 58
Hole Distance: 130 / 130

81432206386, 82432206008, 82432209008

No Image

MN-DL-12289

Length: 1796 Ø: 62
Cone Ø: d1 Ø 30 / d2 Ø 27

81466116174, 81466116175, 81466116176, 81466116244

No Image

MN-DL-12293

Length: 1680 Ø: 42
Cone Ø: d1 Ø 30 / d2 Ø 27

81467106236, 81467106268, 81467106356, 81467116356, 81467116723, 81467116794, 81467116933, 81467116934, 81467116966



MN-DL-12393

Length: 1796 Ø: 62
Cone Ø: d1 Ø 30 / d2 Ø 27

81466116154, 81466116155, 81466116156



MN-ES-10333

Length: 90
Cone Ø: d1 Ø 38 / d2 Ø 34,35
Thread: M36 x 1,5 RHT

1271126, 3090291, 3099128, 42538048, 81953016268, 82953016018, 82953016019



MN-SB-5246

Ø: 45 Thick/Height: 47
81437220022, 81437220038, 81962100450, 81962100469



MN-TC-12399

Length: 694 Ø: 50
Hole Distance: 130 / 130

81432206265



MN-VB-5238

Length: 627 Ø: 48
Hole Distance: 130 / 130

81432206221, 81432706096, 81432706114, 81432706116, 81432706121



MN-VB-8514

Length: 627 Ø: 48
Hole Ø 25 / 25 / 25

Hole Distance: 152 / 130 / 130
81432706087, 81432706088, 81432706094, 81432706095, 81432796094



MN-VB-8669

Length: 627 Ø: 48
Hole Ø 25 / 25 / 25

Hole Distance: 152 / 130 / 130
81432706116, 81432706137, 81432706150, 81432706151



MN-VB-9403

Length: 627 Ø: 48
Hole Ø 25 / 23 / 23

Hole Distance: 152 / 130 / 130
81432706097, 81432706113, 81432706135, 81432706160, 81432706161





TGS ...

35.360 FFD-TM	10/07→	Centre Rod	MN-DL-7801		Push Rod
	10/07→	Centre Rod	MN-DL-12289		Push Rod
	10/07→	Centre Rod	MN-DL-12393		for Steering Rod
	10/07→	Tie Rod	MN-DL-7802		
	10/07→	Tie Rod	MN-DL-12293		
	10/07→	Tie Rod End	CV-ES-14163		for Steering Rod
	10/07→	Track Control Arm		MN-DL-8544	Trailing Arm
	10/07→	Track Control Arm		MN-VB-8514	Suspension Rod, Wishbone (CV), Drive Axle, for Leaf-Spring Suspension vehicles
	10/07→	Track Control Arm		MN-VB-8669	Suspension Rod, Wishbone (CV)
35.360 FFNLC	06/08→	Centre Rod	MN-DL-7801		Push Rod, Leaf Spring Axle
	06/08→	Centre Rod	MN-DL-8599	MN-DL-8599	Push Rod, not for vehicles with Hinged Trailing Axle
	06/08→	Centre Rod	MN-DL-12285		for Steering Rod
	06/08→	Centre Rod	MN-DL-12393		for Steering Rod
	06/08→	Tie Rod	MN-DL-7802		
	06/08→	Tie Rod	MN-DL-12284		
	06/08→	Tie Rod End		IV-ES-8507	Air Suspension Axle;for vehicles with Hinged Trailing Axle
	06/08→	Tie Rod End	CV-ES-14163		for Steering Rod
	06/08→	Tie Rod End	MN-ES-10333		for Steering Rod
	06/08→	Track Control Arm		MN-DL-5225	Trailing Arm, Trailing Axle;Drive Axle; for vehicles with Rigid Trailing Axle
	06/08→	Track Control Arm		MN-DL-5225	Trailing Arm, Trailing Axle;for vehicles with Hinged Trailing Axle
	06/08→	Track Control Arm		MN-DL-8709	Trailing Arm, for vehicles with Hinged Trailing Axle
	06/08→	Track Control Arm		MN-TC-12399	Control Arm
	06/08→	Track Control Arm		MN-VB-5238	Wishbone (CV), Drive Axle
	06/08→	Track Control Arm		MN-VB-9403	Wishbone (CV), Air Suspension Axle
35.400 FFDAK	06/08→	Centre Rod	MN-DL-8646		Push Rod
	06/08→	Mounting, stabilizer coupling rod	MN-SB-5246		
	06/08→	Tie Rod	MN-DL-12287		
	06/08→	Tie Rod End	CV-ES-14163		for Steering Rod
	06/08→	Tie Rod End	MN-ES-10333		for Steering Rod
	06/08→	Track Control Arm		MN-DL-8544	Trailing Arm
	06/08→	Track control arm		MN-DL-12288	Trailing Arm
	06/08→	Track Control Arm		MN-VB-8514	Suspension Rod, Wishbone (CV), 1st RA;2nd RA
35.400 FFDAK, FFDHLK	06/08→	Centre Rod	MN-DL-7801		Push Rod, Leaf Spring Axle
	06/08→	Centre Rod	MN-DL-8646		Push Rod
	06/08→	Centre Rod	MN-DL-12285		for Steering Rod
	06/08→	Mounting, stabilizer coupling rod	MN-SB-5246		
	06/08→	Tie Rod	MN-DL-12287		
	06/08→	Tie Rod End	CV-ES-14163		for Steering Rod
	06/08→	Tie Rod End	MN-ES-10333		for Steering Rod
	06/08→	Track Control Arm		MN-DL-8544	Trailing Arm
	06/08→	Track control arm		MN-DL-12288	Trailing Arm
	06/08→	Track Control Arm		MN-VB-8514	Suspension Rod, Wishbone (CV), 1st RA;2nd RA
35.400 FFDC, FFDLC, FDNLC	06/08→	Centre Rod	MN-DL-7801		Push Rod, Leaf Spring Axle
	06/08→	Centre Rod	MN-DL-8599		Push Rod
	06/08→	Centre Rod	MN-DL-12289		Push Rod
	06/08→	Centre Rod	MN-DL-12393		for Steering Rod
	06/08→	Tie Rod	MN-DL-7802		
	06/08→	Tie Rod	MN-DL-12284		
	06/08→	Tie Rod	MN-DL-12293		
	06/08→	Tie Rod End		IV-ES-8507	Air Suspension Axle;for vehicles with Hinged Trailing Axle
	06/08→	Tie Rod End	CV-ES-14163		for Steering Rod
	06/08→	Track Control Arm		MN-DL-5225	Trailing Arm, Drive Axle;Air Suspension Axle
	06/08→	Track Control Arm		MN-DL-5225	Trailing Arm, for vehicles with Hinged Trailing Axle;Air Suspension Axle
	06/08→	Track Control Arm		MN-DL-8544	Trailing Arm, Drive Axle

CV-ES-14163

Length: 125
Cone Ø: d1 Ø 30 / d2 Ø 27
Thread: M30 x 1,5 RHT

95301.0084, 90804102156, 90804102272, 90804102696, 90804102710, 81953010016, 81953010075, 81953010084, 81953010088, 81953010094, 81953010103, 81953010030, 81953016043, 81953016048, 81953016049, 81953016053, 81953016061, 81953016090, 81953016108, 81953016112, 81953016126, 81953016143, 81953016149, 81953016154, 81953016156, 81953016168, 81953016178, 81953016194, 81953016206, 81953016224, 81953016234, 81953016242, 81953016252, 81953016274, 81953016278, 81953016284, 81953016286, 81953016308, 81953016310, 81953016312, 81953016347, 81953016350, 81953016352, 82953016012, 88953016014, N2953016001



IV-ES-8507

Length: 80
Cone Ø: d1 Ø 30 / d2 Ø 27
Thread: M30 x 1,5 RHT

11019869, 12216380, 55175540, 81953016238



MN-DL-5225

Length: 572 Ø: 48
Hole Distance: 130 / 130

03301500A, 81432206229, 81432206236, 81432206267, 81432206270, 81432206272, 81432206304, 81432206305, 81432209236, 81432209267, 81432209272



MN-DL-7801

Length: 995 Ø: 52
Cone Ø: d1 Ø 30 / d2 Ø 27

81466106807, 81466106808, 81466116087, 81466116088, 81466116096, 81466116097, 81466116099, 81466116132, 81466116133, 81466116136, 81466116197, 81466116198, 81466116205

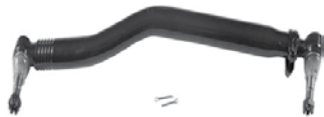

MN-DL-7802

Length: 1680 Ø: 52
Cone Ø: d1 Ø 30 / d2 Ø 27

03208300A, 81467116773, 81467116858, 81467116859, 81467116860, 81467116861, 81467116863, 81467116882, 81467116883, 81467116920, 81467116921



MN-DL-8544

Length: 596 Ø: 48
Hole Distance: 130 / 130

81432206196, 81432206232, 81432206233



MN-DL-8599

Length: 1800 Ø: 62
Cone Ø: d1 Ø 30 / d2 Ø 27

81466116161, 81466116162, 82466106183, 82466106186, 82466106187



MN-DL-8646

Length: 1021 Ø: 52
Cone Ø: d1 Ø 30 / d2 Ø 27

81466106811, 81466106812, 81466116138, 81466116139, 81466116201, 81466116202

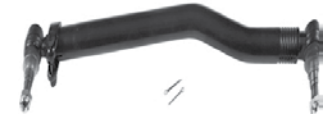

MN-DL-8709

Length: 572 Ø: 52
Hole Distance: 130 / 130

81432206268, 81432206274, 81432206291, 81432206292, 82432206007



MN-DL-12284

Length: 1530 Ø: 50
Cone Ø: d1 Ø 30 / d2 Ø 27

81466106579, 81466106580, 81466106624, 81466116720, 81467116720, 81467116730, 81467116952



MN-DL-12285

Length: 993 Ø: 40
Cone Ø: d1 Ø 30 / d2 Ø 27

81466106816, 81466106826, 81466116151, 82466106184, 82466106185



MN-DL-12287

Length: 1531 Ø: 42
Cone Ø: d1 Ø 30 / d2 Ø 27

81467116855, 81467116856, 81467116857



MN-DL-12288

Length: 585 Ø: 58
Hole Distance: 130 / 130

81432206386, 82432206008, 82432209008

No Image

MN-DL-12289

Length: 1796 Ø: 62
Cone Ø: d1 Ø 30 / d2 Ø 27

81466116174, 81466116175, 81466116176, 81466116244

No Image

MN-DL-12293

Length: 1680 Ø: 42
Cone Ø: d1 Ø 30 / d2 Ø 27

81467106236, 81467106268, 81467106356, 81467116356, 81467116723, 81467116794, 81467116933, 81467116934, 81467116966



MN-DL-12393

Length: 1796 Ø: 62
Cone Ø: d1 Ø 30 / d2 Ø 27

81466116154, 81466116155, 81466116156



MN-ES-10333

Length: 90
Cone Ø: d1 Ø 38 / d2 Ø 34,35
Thread: M36 x 1,5 RHT

1271126, 3090291, 3099128, 42538048, 81953016268, 82953016018, 82953016019



MN-SB-5246

Ø: 45 Thick/Height: 47
81437220022, 81437220038, 81962100450, 81962100469



MN-TC-12399

Length: 694 Ø: 50
Hole Distance: 130 / 130

81432206265



MN-VB-5238

Length: 627 Ø: 48
Hole Distance: 130 / 130

81432206221, 81432706096, 81432706114, 81432706116, 81432706121



MN-VB-8514

Length: 627 Ø: 48
Hole Ø 25 / 25 / 25

Hole Distance: 152 / 130 / 130
81432706087, 81432706088, 81432706094, 81432706095, 81432796094



MN-VB-8669

Length: 627 Ø: 48
Hole Ø 25 / 25 / 25

Hole Distance: 152 / 130 / 130
81432706116, 81432706137, 81432706150, 81432706151



MN-VB-9403

Length: 627 Ø: 48
Hole Ø 25 / 23 / 23

Hole Distance: 152 / 130 / 130
81432706097, 81432706113, 81432706135, 81432706160, 81432706161





TGS ...

35.400 FFDK, FFDLC, FDNLC ...	06/08→	Track Control Arm		MN-DL-8709	Trailing Arm, for vehicles with Hinged Trailing Axle;Air Suspension Axle
	06/08→	Track Control Arm		MN-VB-5238	Wishbone (CV), Drive Axle;Air Suspension Axle
	06/08→	Track Control Arm		MN-VB-8514	Suspension Rod, Wishbone (CV), Drive Axle; Leaf Spring Axle
	06/08→	Track Control Arm		MN-VB-8669	Suspension Rod, Wishbone (CV), Drive Axle; Leaf Spring Axle
	06/08→	Track Control Arm		MN-VB-9403	Wishbone (CV), Air Suspension Axle
35.400 FFDK, FFDLK, FFDRK	08/08→	Centre Rod	MN-DL-7801		Push Rod
	08/08→	Centre Rod	MN-DL-8599		Push Rod
	08/08→	Centre Rod	MN-DL-12285		for Steering Rod
	08/08→	Centre Rod	MN-DL-12289		Push Rod
	08/08→	Centre Rod	MN-DL-12393		for Steering Rod
	08/08→	Tie Rod	MN-DL-7802		
	08/08→	Tie Rod	MN-DL-12293		
	08/08→	Tie Rod End	CV-ES-14163		for Steering Rod
	08/08→	Tie Rod End	MN-ES-10333		for Steering Rod
	08/08→	Track Control Arm		MN-DL-5225	Trailing Arm
	08/08→	Track Control Arm		MN-DL-8544	Trailing Arm
	08/08→	Track Control Arm		MN-VB-8514	Suspension Rod, Wishbone (CV), Drive Axle, for Leaf-Spring Suspension vehicles
	08/08→	Track Control Arm		MN-VB-8514	Suspension Rod, Wishbone (CV), Drive Axle, for Pneumatic Suspension vehicles
	08/08→	Track Control Arm		MN-VB-8669	Suspension Rod, Wishbone (CV)
	35.400 FFD-TM	10/07→	Centre Rod	MN-DL-7801	
10/07→		Centre Rod	MN-DL-12289		Push Rod
10/07→		Centre Rod	MN-DL-12393		for Steering Rod
10/07→		Tie Rod	MN-DL-7802		
10/07→		Tie Rod	MN-DL-12293		
10/07→		Tie Rod End	CV-ES-14163		for Steering Rod
10/07→		Track Control Arm		MN-DL-8544	Trailing Arm
10/07→		Track Control Arm		MN-VB-8514	Suspension Rod, Wishbone (CV), Drive Axle, for Leaf-Spring Suspension vehicles
35.400 FFNHLK	10/07→	Track Control Arm		MN-VB-8669	Suspension Rod, Wishbone (CV)
	10/07→	Centre Rod	MN-DL-12285		for Steering Rod
	10/07→	Tie Rod End	CV-ES-14163		for Steering Rod
35.400 FFNLC	10/07→	Track Control Arm		MN-DL-5225	Trailing Arm
	06/08→	Centre Rod	MN-DL-7801		Push Rod, Leaf Spring Axle
	06/08→	Centre Rod	MN-DL-8599	MN-DL-8599	Push Rod, not for vehicles with Hinged Trailing Axle
	06/08→	Centre Rod	MN-DL-12393		for Steering Rod
	06/08→	Tie Rod	MN-DL-7802		
	06/08→	Tie Rod	MN-DL-12284		
	06/08→	Tie Rod End		IV-ES-8507	Air Suspension Axle;for vehicles with Hinged Trailing Axle
	06/08→	Tie Rod End	CV-ES-14163		for Steering Rod
	06/08→	Tie Rod End	MN-ES-10333		for Steering Rod
	06/08→	Track Control Arm		MN-DL-5225	Trailing Arm, Trailing Axle;Drive Axle; for vehicles with Rigid Trailing Axle
	06/08→	Track Control Arm		MN-DL-5225	Trailing Arm, Trailing Axle;for vehicles with Rigid Trailing Axle
	06/08→	Track Control Arm		MN-DL-8709	Trailing Arm, for vehicles with Hinged Trailing Axle
	06/08→	Track Control Arm		MN-TC-12399	Control Arm
	06/08→	Track Control Arm		MN-VB-5238	Wishbone (CV), Drive Axle
	06/08→	Track Control Arm		MN-VB-9403	Wishbone (CV), Air Suspension Axle
35.440 FDNLC, FFDK, FFDLC	06/08→	Centre Rod	MN-DL-7801		Push Rod, Leaf Spring Axle
	06/08→	Centre Rod	MN-DL-8599		Push Rod
	06/08→	Centre Rod	MN-DL-12285		for Steering Rod
	06/08→	Centre Rod	MN-DL-12289		Push Rod
	06/08→	Centre Rod	MN-DL-12393		for Steering Rod
	06/08→	Tie Rod	MN-DL-7802		

CV-ES-14163

Length: 125
Cone Ø: d1 Ø 30 / d2 Ø 27
Thread: M30 x 1,5 RHT

95301.0084, 90804102156, 90804102272, 90804102696, 90804102710, 81953010016, 81953010075, 81953010084, 81953010088, 81953010094, 81953010103, 81953016030, 81953016043, 81953016048, 81953016049, 81953016053, 81953016061, 81953016090, 81953016108, 81953016112, 81953016126, 81953016143, 81953016149, 81953016154, 81953016156, 81953016168, 81953016178, 81953016194, 81953016206, 81953016224, 81953016234, 81953016242, 81953016252, 81953016274, 81953016278, 81953016284, 81953016286, 81953016308, 81953016310, 81953016312, 81953016347, 81953016350, 81953016352, 82953016012, 88953016014, N2953016001



IV-ES-8507

Length: 80
Cone Ø: d1 Ø 30 / d2 Ø 27
Thread: M30 x 1,5 RHT

11019869, 12216380, 55175540, 81953016238



MN-DL-5225

Length: 572 Ø: 48
Hole Distance: 130 / 130

03301500A, 81432206229, 81432206236, 81432206267, 81432206270, 81432206272, 81432206304, 81432206305, 81432209236, 81432209267, 81432209272



MN-DL-7801

Length: 995 Ø: 52
Cone Ø: d1 Ø 30 / d2 Ø 27

81466106807, 81466106808, 81466116087, 81466116088, 81466116096, 81466116097, 81466116099, 81466116132, 81466116133, 81466116136, 81466116197, 81466116198, 81466116205

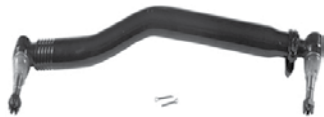

MN-DL-7802

Length: 1680 Ø: 52
Cone Ø: d1 Ø 30 / d2 Ø 27

03208300A, 81467116773, 81467116858, 81467116859, 81467116860, 81467116861, 81467116863, 81467116882, 81467116883, 81467116920, 81467116921



MN-DL-8544

Length: 596 Ø: 48
Hole Distance: 130 / 130
81432206196, 81432206232, 81432206233



MN-DL-8599

Length: 1800 Ø: 62
Cone Ø: d1 Ø 30 / d2 Ø 27
81466116161, 81466116162, 82466106183, 82466106186, 82466106187



MN-DL-8709

Length: 572 Ø: 52
Hole Distance: 130 / 130
81432206268, 81432206274, 81432206291, 81432206292, 82432206007



MN-DL-12284

Length: 1530 Ø: 50
Cone Ø: d1 Ø 30 / d2 Ø 27
81466106579, 81466106580, 81466106624, 81466116720, 81467116720, 81467116730, 81467116952



MN-DL-12285

Length: 993 Ø: 40
Cone Ø: d1 Ø 30 / d2 Ø 27
81466106816, 81466106826, 81466116151, 82466106184, 82466106185



MN-DL-12289

Length: 1796 Ø: 62
Cone Ø: d1 Ø 30 / d2 Ø 27
81466116174, 81466116175, 81466116176, 81466116244

No Image

MN-DL-12293

Length: 1680 Ø: 42
Cone Ø: d1 Ø 30 / d2 Ø 27
81467106236, 81467106268, 81467106356, 81467116356, 81467116723, 81467116794, 81467116933, 81467116934, 81467116966



MN-DL-12393

Length: 1796 Ø: 62
Cone Ø: d1 Ø 30 / d2 Ø 27
81466116154, 81466116155, 81466116156



MN-ES-10333

Length: 90
Cone Ø: d1 Ø 38 / d2 Ø 34,35
Thread: M36 x 1,5 RHT
1271126, 3090291, 3099128, 42538048, 81953016268, 82953016018, 82953016019



MN-TC-12399

Length: 694 Ø: 50
Hole Distance: 130 / 130
81432206265



MN-VB-5238

Length: 627 Ø: 48
Hole Distance: 130 / 130
81432206221, 81432706096, 81432706114, 81432706116, 81432706121



MN-VB-8514

Length: 627 Ø: 48
Hole Ø 25 / 25 / 25
Hole Distance: 152 / 130 / 130
81432706087, 81432706088, 81432706094, 81432706095, 81432796094



MN-VB-8669

Length: 627 Ø: 48
Hole Ø 25 / 25 / 25
Hole Distance: 152 / 130 / 130
81432706116, 81432706137, 81432706150, 81432706151



MN-VB-9403

Length: 627 Ø: 48
Hole Ø 25 / 23 / 23
Hole Distance: 152 / 130 / 130
81432706097, 81432706113, 81432706135, 81432706160, 81432706161





TGS ...

35.440 FDNLC, FFDC, FFDLC ...	06/08→	Tie Rod	MN-DL-12284			
	06/08→	Tie Rod	MN-DL-12293			
	06/08→	Tie Rod End		IV-ES-8507		
	06/08→	Tie Rod End	CV-ES-14163		for Steering Rod	
	06/08→	Tie Rod End	MN-ES-10333		for Steering Rod	
	06/08→	Track Control Arm		MN-DL-5225	Trailing Arm	
	06/08→	Track Control Arm		MN-DL-8544	Trailing Arm, Drive Axle	
	06/08→	Track Control Arm		MN-DL-8709	Trailing Arm	
	06/08→	Track Control Arm		MN-VB-8514	Suspension Rod, Wishbone (CV), Drive Axle	
	06/08→	Track Control Arm		MN-VB-8669	Suspension Rod, Wishbone (CV), Drive Axle	
	06/08→	Track Control Arm		MN-VB-9403	Wishbone (CV)	
35.440 FFDK	06/08→	Track Control Arm	MN-VB-5238	MN-VB-5238	Wishbone (CV);Control Arm	
	06/08→	Centre Rod	MN-DL-8646		Push Rod	
	06/08→	Mounting, stabilizer coupling rod	MN-SB-5246			
	06/08→	Tie Rod	MN-DL-12287			
	06/08→	Tie Rod End	CV-ES-14163		for Steering Rod	
	06/08→	Tie Rod End	MN-ES-10333		for Steering Rod	
	06/08→	Track Control Arm		MN-DL-8544	Trailing Arm	
35.440 FFDK, FFDHLK	06/08→	Track control arm		MN-DL-12288	Trailing Arm	
	06/08→	Track Control Arm		MN-VB-8514	Suspension Rod, Wishbone (CV)	
	06/08→	Centre Rod	MN-DL-7801		Push Rod	
	06/08→	Centre Rod	MN-DL-8646		Push Rod	
35.440 FFDK, FFDLK, FFDRK	06/08→	Mounting, stabilizer coupling rod	MN-SB-5246			
	06/08→	Tie Rod End	MN-ES-10333		for Steering Rod	
	06/08→	Track Control Arm		MN-DL-8544	Trailing Arm	
	06/08→	Track Control Arm		MN-VB-8514	Suspension Rod, Wishbone (CV)	
	08/08→	Centre Rod	MN-DL-7801		Push Rod	
	08/08→	Centre Rod	MN-DL-8599		Push Rod	
	08/08→	Centre Rod	MN-DL-12285		for Steering Rod	
	08/08→	Centre Rod	MN-DL-12289		Push Rod	
	08/08→	Centre Rod	MN-DL-12393		for Steering Rod	
	08/08→	Tie Rod	MN-DL-7802			
35.440 FFDK, FFDLK, FFDLK, FFDRK	08/08→	Tie Rod	MN-DL-12293			
	08/08→	Tie Rod End	CV-ES-14163		for Steering Rod	
	08/08→	Tie Rod End	MN-ES-10333		for Steering Rod	
	08/08→	Track Control Arm		MN-DL-5225	Trailing Arm	
	08/08→	Track Control Arm		MN-DL-8544	Trailing Arm	
	08/08→	Track Control Arm		MN-VB-8514	Suspension Rod, Wishbone (CV), Drive Axle, for Leaf-Spring Suspension vehicles	
	08/08→	Track Control Arm		MN-VB-8514	Suspension Rod, Wishbone (CV), Drive Axle, for Pneumatic Suspension vehicles	
	08/08→	Track Control Arm		MN-VB-8669	Suspension Rod, Wishbone (CV)	
	08/08→	Track Control Arm	MN-VB-5238	MN-VB-5238	Wishbone (CV);Control Arm	
	35.440 FFD-TM	10/07→	Centre Rod	MN-DL-7801		Push Rod
		10/07→	Centre Rod	MN-DL-12289		Push Rod
		10/07→	Centre Rod	MN-DL-12393		for Steering Rod
		10/07→	Tie Rod	MN-DL-7802		
		10/07→	Tie Rod	MN-DL-12293		
10/07→		Tie Rod End	CV-ES-14163		for Steering Rod	
10/07→		Track Control Arm		MN-DL-8544	Trailing Arm	
10/07→		Track Control Arm		MN-VB-8514	Suspension Rod, Wishbone (CV), Drive Axle, for Leaf-Spring Suspension vehicles	
10/07→		Track Control Arm		MN-VB-8669	Suspension Rod, Wishbone (CV)	
10/07→		Track Control Arm		MN-DL-5225	Trailing Arm	
35.440 FFNHLK	10/07→	Tie Rod End	CV-ES-14163		for Steering Rod	
35.440 FFNLC	06/08→	Track Control Arm		MN-DL-5225	Trailing Arm	
	06/08→	Centre Rod	MN-DL-7801		Push Rod, Leaf Spring Axle	
	06/08→	Centre Rod	MN-DL-8599	MN-DL-8599	Push Rod, not for vehicles with Hinged Trailing Axle	
	06/08→	Centre Rod	MN-DL-12285		for Steering Rod	
	06/08→	Centre Rod	MN-DL-12393		for Steering Rod	
	06/08→	Tie Rod	MN-DL-7802			
	06/08→	Tie Rod	MN-DL-12284			

CV-ES-14163

Length: 125
Cone Ø: d1 Ø 30 / d2 Ø 27
Thread: M30 x 1,5 RHT

95301.0084, 90804102156, 90804102272, 90804102696, 90804102710, 81953010016, 81953010075, 81953010084, 81953010088, 81953010094, 81953010103, 81953016030, 81953016043, 81953016048, 81953016049, 81953016053, 81953016061, 81953016090, 81953016108, 81953016112, 81953016126, 81953016143, 81953016149, 81953016154, 81953016156, 81953016168, 81953016178, 81953016194, 81953016206, 81953016224, 81953016234, 81953016242, 81953016252, 81953016274, 81953016278, 81953016284, 81953016286, 81953016308, 81953016310, 81953016312, 81953016347, 81953016350, 81953016352, 82953016012, 88953016014, N2953016001



IV-ES-8507

Length: 80
Cone Ø: d1 Ø 30 / d2 Ø 27
Thread: M30 x 1,5 RHT

11019869, 12216380, 55175540, 81953016238



MN-DL-5225

Length: 572 Ø: 48
Hole Distance: 130 / 130

03301500A, 81432206229, 81432206236, 81432206267, 81432206270, 81432206272, 81432206304, 81432206305, 81432209236, 81432209267, 81432209272



MN-DL-7801

Length: 995 Ø: 52
Cone Ø: d1 Ø 30 / d2 Ø 27

81466106807, 81466106808, 81466116087, 81466116088, 81466116096, 81466116097, 81466116099, 81466116132, 81466116133, 81466116136, 81466116197, 81466116198, 81466116205



MN-DL-7802

Length: 1680 Ø: 52
Cone Ø: d1 Ø 30 / d2 Ø 27

03208300A, 81467116773, 81467116858, 81467116859, 81467116860, 81467116861, 81467116863, 81467116882, 81467116883, 81467116920, 81467116921



MN-DL-8544

Length: 596 Ø: 48
Hole Distance: 130 / 130

81432206196, 81432206232, 81432206233



MN-DL-8599

Length: 1800 Ø: 62
Cone Ø: d1 Ø 30 / d2 Ø 27

81466116161, 81466116162, 82466106183, 82466106186, 82466106187



MN-DL-8646

Length: 1021 Ø: 52
Cone Ø: d1 Ø 30 / d2 Ø 27

81466106811, 81466106812, 81466116138, 81466116139, 81466116201, 81466116202

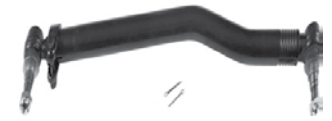

MN-DL-8709

Length: 572 Ø: 52
Hole Distance: 130 / 130

81432206268, 81432206274, 81432206291, 81432206292, 82432206007



MN-DL-12284

Length: 1530 Ø: 50
Cone Ø: d1 Ø 30 / d2 Ø 27

81466106579, 81466106580, 81466106624, 81466116720, 81467116720, 81467116730, 81467116952



MN-DL-12285

Length: 993 Ø: 40
Cone Ø: d1 Ø 30 / d2 Ø 27

81466106816, 81466106826, 81466116151, 82466106184, 82466106185



MN-DL-12287

Length: 1531 Ø: 42
Cone Ø: d1 Ø 30 / d2 Ø 27

81467116855, 81467116856, 81467116857



MN-DL-12288

Length: 585 Ø: 58
Hole Distance: 130 / 130

81432206386, 82432206008, 82432209008

No Image

MN-DL-12289

Length: 1796 Ø: 62
Cone Ø: d1 Ø 30 / d2 Ø 27

81466116174, 81466116175, 81466116176, 81466116244

No Image

MN-DL-12293

Length: 1680 Ø: 42
Cone Ø: d1 Ø 30 / d2 Ø 27

81467106236, 81467106268, 81467106356, 81467116356, 81467116723, 81467116794, 81467116933, 81467116934, 81467116966



MN-DL-12393

Length: 1796 Ø: 62
Cone Ø: d1 Ø 30 / d2 Ø 27

81466116154, 81466116155, 81466116156



MN-ES-10333

Length: 90
Cone Ø: d1 Ø 38 / d2 Ø 34,35
Thread: M36 x 1,5 RHT

1271126, 3090291, 3099128, 42538048, 81953016268, 82953016018, 82953016019



MN-SB-5246

Ø: 45 Thick/Height: 47
81437220022, 81437220038, 81962100450, 81962100469



MN-VB-5238

Length: 627 Ø: 48
Hole Distance: 130 / 130

81432206221, 81432706096, 81432706114, 81432706116, 81432706121



MN-VB-8514

Length: 627 Ø: 48
Hole Ø 25 / 25 / 25
Hole Distance: 152 / 130 / 130

81432706087, 81432706088, 81432706094, 81432706095, 81432796094



MN-VB-8669

Length: 627 Ø: 48
Hole Ø 25 / 25 / 25

Hole Distance: 152 / 130 / 130
81432706116, 81432706137, 81432706150, 81432706151



MN-VB-9403

Length: 627 Ø: 48
Hole Ø 25 / 23 / 23

Hole Distance: 152 / 130 / 130
81432706097, 81432706113, 81432706135, 81432706160, 81432706161





TGS ...

35.440 FFNLC ...	06/08 →	Tie Rod End		IV-ES-8507	Air Suspension Axle;for vehicles with Hinged Trailing Axle
	06/08 →	Tie Rod End	CV-ES-14163		for Steering Rod
	06/08 →	Tie Rod End	MN-ES-10333		for Steering Rod
	06/08 →	Track Control Arm		MN-DL-5225	Trailing Arm, Trailing Axle;Drive Axle; for vehicles with Rigid Trailing Axle
	06/08 →	Track Control Arm		MN-DL-5225	Trailing Arm, Trailing Axle;for vehicles with Hinged Trailing Axle
	06/08 →	Track Control Arm		MN-DL-8709	Trailing Arm, for vehicles with Hinged Trailing Axle
	06/08 →	Track Control Arm		MN-TC-12399	Control Arm
	06/08 →	Track Control Arm		MN-VB-5238	Wishbone (CV), Drive Axle
	06/08 →	Track Control Arm		MN-VB-9403	Wishbone (CV), Air Suspension Axle
35.480 FDNLC, FFDC, FFDLC	06/08 →	Centre Rod	MN-DL-7801		Push Rod
	06/08 →	Centre Rod	MN-DL-8599		Push Rod
	06/08 →	Centre Rod	MN-DL-12285		for Steering Rod
	06/08 →	Centre Rod	MN-DL-12289		Push Rod
	06/08 →	Centre Rod	MN-DL-12393		for Steering Rod
	06/08 →	Tie Rod	MN-DL-7802		
	06/08 →	Tie Rod	MN-DL-12284		
	06/08 →	Tie Rod	MN-DL-12293		
	06/08 →	Tie Rod End		IV-ES-8507	
	06/08 →	Tie Rod End	CV-ES-14163		for Steering Rod
	06/08 →	Tie Rod End	MN-ES-10333		for Steering Rod
	06/08 →	Track Control Arm		MN-DL-5225	Trailing Arm
	06/08 →	Track Control Arm		MN-DL-8544	Trailing Arm
	06/08 →	Track Control Arm		MN-DL-8709	Trailing Arm
	06/08 →	Track Control Arm		MN-VB-8514	Suspension Rod, Wishbone (CV), Drive Axle, for Leaf-Spring Suspension vehicles
	06/08 →	Track Control Arm		MN-VB-8514	Suspension Rod, Wishbone (CV), Drive Axle, for Pneumatic Suspension vehicles
	06/08 →	Track Control Arm		MN-VB-8669	Suspension Rod, Wishbone (CV)
	06/08 →	Track Control Arm		MN-VB-9403	Wishbone (CV)
	06/08 →	Track Control Arm	MN-VB-5238	MN-VB-5238	Wishbone (CV);Control Arm
	35.480 FFDAK	06/08 →	Centre Rod	MN-DL-8646	
06/08 →		Mounting, stabilizer coupling rod	MN-SB-5246		
06/08 →		Tie Rod	MN-DL-12287		
06/08 →		Tie Rod End	CV-ES-14163		for Steering Rod
06/08 →		Tie Rod End	MN-ES-10333		for Steering Rod
06/08 →		Track Control Arm		MN-DL-8544	Trailing Arm
06/08 →		Track control arm		MN-DL-12288	Trailing Arm
06/08 →		Track Control Arm		MN-VB-8514	Suspension Rod, Wishbone (CV)
35.480 FFDAK, FFDHLK	06/08 →	Centre Rod	MN-DL-8646		Push Rod
	06/08 →	Mounting, stabilizer coupling rod	MN-SB-5246		
	06/08 →	Tie Rod End	MN-ES-10333		for Steering Rod
	06/08 →	Track Control Arm		MN-DL-8544	Trailing Arm
	06/08 →	Track Control Arm		MN-VB-8514	Suspension Rod, Wishbone (CV)
35.480 FFDK, FFDLK, FFDRK	08/08 →	Centre Rod	MN-DL-7801		Push Rod
	08/08 →	Centre Rod	MN-DL-8599		Push Rod
	08/08 →	Centre Rod	MN-DL-12285		for Steering Rod
	08/08 →	Centre Rod	MN-DL-12289		Push Rod
	08/08 →	Centre Rod	MN-DL-12393		for Steering Rod
	08/08 →	Tie Rod	MN-DL-7802		
	08/08 →	Tie Rod	MN-DL-12293		
	08/08 →	Tie Rod End	CV-ES-14163		for Steering Rod
	08/08 →	Tie Rod End	MN-ES-10333		for Steering Rod
	08/08 →	Track Control Arm		MN-DL-5225	Trailing Arm
	08/08 →	Track Control Arm		MN-DL-8544	Trailing Arm
	08/08 →	Track Control Arm		MN-VB-8514	Suspension Rod, Wishbone (CV), Drive Axle, for Leaf-Spring Suspension vehicles
	08/08 →	Track Control Arm		MN-VB-8514	Suspension Rod, Wishbone (CV), Drive Axle, for Pneumatic Suspension vehicles
	08/08 →	Track Control Arm		MN-VB-8669	Suspension Rod, Wishbone (CV)
	08/08 →	Track Control Arm	MN-VB-5238	MN-VB-5238	Wishbone (CV);Control Arm

CV-ES-14163

Length: 125
Cone Ø: d1 Ø 30 / d2 Ø 27
Thread: M30 x 1,5 RHT

95301.0084, 90804102156, 90804102272, 90804102696, 90804102710, 81953010016, 81953010075, 81953010084, 81953010088, 81953010094, 81953010103, 81953016030, 81953016043, 81953016048, 81953016049, 81953016053, 81953016061, 81953016090, 81953016108, 81953016112, 81953016126, 81953016143, 81953016149, 81953016154, 81953016156, 81953016168, 81953016178, 81953016194, 81953016206, 81953016224, 81953016234, 81953016242, 81953016252, 81953016274, 81953016278, 81953016284, 81953016286, 81953016308, 81953016310, 81953016312, 81953016347, 81953016350, 81953016352, 82953016012, 88953016014, N2953016001



IV-ES-8507

Length: 80
Cone Ø: d1 Ø 30 / d2 Ø 27
Thread: M30 x 1,5 RHT

11019869, 12216380, 55175540, 81953016238



MN-DL-5225

Length: 572 Ø: 48
Hole Distance: 130 / 130

03301500A, 81432206229, 81432206236, 81432206267, 81432206270, 81432206272, 81432206304, 81432206305, 81432209236, 81432209267, 81432209272



MN-DL-7801

Length: 995 Ø: 52
Cone Ø: d1 Ø 30 / d2 Ø 27

81466106807, 81466106808, 81466116087, 81466116088, 81466116096, 81466116097, 81466116099, 81466116132, 81466116133, 81466116136, 81466116197, 81466116198, 81466116205



MN-DL-7802

Length: 1680 Ø: 52
Cone Ø: d1 Ø 30 / d2 Ø 27

03208300A, 81467116773, 81467116858, 81467116859, 81467116860, 81467116861, 81467116863, 81467116882, 81467116883, 81467116920, 81467116921



MN-DL-8544

Length: 596 Ø: 48
Hole Distance: 130 / 130

81432206196, 81432206232, 81432206233



MN-DL-8599

Length: 1800 Ø: 62
Cone Ø: d1 Ø 30 / d2 Ø 27

81466116161, 81466116162, 82466106183, 82466106186, 82466106187



MN-DL-8646

Length: 1021 Ø: 52
Cone Ø: d1 Ø 30 / d2 Ø 27

81466106811, 81466106812, 81466116138, 81466116139, 81466116201, 81466116202

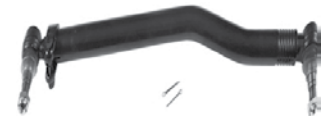

MN-DL-8709

Length: 572 Ø: 52
Hole Distance: 130 / 130

81432206268, 81432206274, 81432206291, 81432206292, 82432206007



MN-DL-12284

Length: 1530 Ø: 50
Cone Ø: d1 Ø 30 / d2 Ø 27

81466106579, 81466106580, 81466106624, 81466116720, 81467116720, 81467116730, 81467116952



MN-DL-12285

Length: 993 Ø: 40
Cone Ø: d1 Ø 30 / d2 Ø 27

81466106816, 81466106826, 81466116151, 82466106184, 82466106185



MN-DL-12287

Length: 1531 Ø: 42
Cone Ø: d1 Ø 30 / d2 Ø 27

81467116855, 81467116856, 81467116857

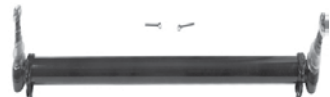

MN-DL-12288

Length: 585 Ø: 58
Hole Distance: 130 / 130

81432206386, 82432206008, 82432209008

No Image

MN-DL-12289

Length: 1796 Ø: 62
Cone Ø: d1 Ø 30 / d2 Ø 27

81466116174, 81466116175, 81466116176, 81466116244

No Image

MN-DL-12293

Length: 1680 Ø: 42
Cone Ø: d1 Ø 30 / d2 Ø 27

81467106236, 81467106268, 81467106356, 81467116356, 81467116723, 81467116794, 81467116933, 81467116934, 81467116966



MN-DL-12393

Length: 1796 Ø: 62
Cone Ø: d1 Ø 30 / d2 Ø 27

81466116154, 81466116155, 81466116156



MN-ES-10333

Length: 90
Cone Ø: d1 Ø 38 / d2 Ø 34,35
Thread: M36 x 1,5 RHT

1271126, 3090291, 3099128, 42538048, 81953016268, 82953016018, 82953016019



MN-SB-5246

Ø: 45 Thick/Height: 47
81437220022, 81437220038, 81962100450, 81962100469



MN-TC-12399

Length: 694 Ø: 50
Hole Distance: 130 / 130

81432206265



MN-VB-5238

Length: 627 Ø: 48
Hole Distance: 130 / 130

81432206221, 81432706096, 81432706114, 81432706116, 81432706121



MN-VB-8514

Length: 627 Ø: 48
Hole Ø 25 / 25 / 25
Hole Distance: 152 / 130 / 130

81432706087, 81432706088, 81432706094, 81432706095, 81432796094



MN-VB-8669

Length: 627 Ø: 48
Hole Ø 25 / 25 / 25
Hole Distance: 152 / 130 / 130

81432706116, 81432706137, 81432706150, 81432706151



MN-VB-9403

Length: 627 Ø: 48
Hole Ø 25 / 23 / 23
Hole Distance: 152 / 130 / 130

81432706097, 81432706113, 81432706135, 81432706160, 81432706161





TGS ...

35.480 FFD-TM	10/07→	Centre Rod	MN-DL-7801		Push Rod
	10/07→	Centre Rod	MN-DL-12289		Push Rod
	10/07→	Centre Rod	MN-DL-12393		for Steering Rod
	10/07→	Tie Rod	MN-DL-7802		
	10/07→	Tie Rod	MN-DL-12293		
	10/07→	Tie Rod End	CV-ES-14163		for Steering Rod
	10/07→	Track Control Arm		MN-DL-8544	Trailing Arm
	10/07→	Track Control Arm		MN-VB-8514	Suspension Rod, Wishbone (CV), Drive Axle, for Leaf-Spring Suspension vehicles
	10/07→	Track Control Arm		MN-VB-8669	Suspension Rod, Wishbone (CV)
35.480 FFNHLC	10/07→	Tie Rod End	CV-ES-14163		for Steering Rod
	10/07→	Track Control Arm		MN-DL-5225	Trailing Arm
35.480 FFNLC	06/08→	Centre Rod	MN-DL-7801		Push Rod, Leaf Spring Axle
	06/08→	Centre Rod	MN-DL-8599	MN-DL-8599	Push Rod, not for vehicles with Hinged Trailing Axle
	06/08→	Centre Rod	MN-DL-12285		for Steering Rod
	06/08→	Centre Rod	MN-DL-12393		for Steering Rod
	06/08→	Tie Rod	MN-DL-7802		
	06/08→	Tie Rod	MN-DL-12284		
	06/08→	Tie Rod End		IV-ES-8507	Air Suspension Axle;for vehicles with Hinged Trailing Axle
	06/08→	Tie Rod End	CV-ES-14163		for Steering Rod
	06/08→	Tie Rod End	MN-ES-10333		for Steering Rod
	06/08→	Track Control Arm		MN-DL-5225	Trailing Arm, Trailing Axle;Drive Axle; for vehicles with Rigid Trailing Axle
	06/08→	Track Control Arm		MN-DL-5225	Trailing Arm, Trailing Axle;for vehicles with Hinged Trailing Axle
	06/08→	Track Control Arm		MN-DL-8709	Trailing Arm, for vehicles with Hinged Trailing Axle
	06/08→	Track Control Arm		MN-TC-12399	Control Arm
	06/08→	Track Control Arm		MN-VB-5238	Wishbone (CV), Drive Axle
	06/08→	Track Control Arm		MN-VB-9403	Wishbone (CV), Air Suspension Axle
35.540 FDNLC, FFDC, FFDLC	06/08→	Track Control Arm		MN-DL-5225	Trailing Arm
35.540 FFDAK	02/09→	Centre Rod	MN-DL-8646		Push Rod
	02/09→	Mounting, stabilizer coupling rod	MN-SB-5246		
	02/09→	Tie Rod	MN-DL-12287		
	02/09→	Tie Rod End	CV-ES-14163		for Steering Rod
	02/09→	Tie Rod End	MN-ES-10333		for Steering Rod
	02/09→	Track Control Arm		MN-DL-8544	Trailing Arm
	02/09→	Track control arm		MN-DL-12288	Trailing Arm
	02/09→	Track Control Arm		MN-VB-8514	Suspension Rod, Wishbone (CV)
	02/09→	Track Control Arm			
35.540 FFDAK, FFDHLK	02/09→	Centre Rod	MN-DL-8646		Push Rod
	02/09→	Mounting, stabilizer coupling rod	MN-SB-5246		
	02/09→	Tie Rod End	MN-ES-10333		for Steering Rod
	02/09→	Track Control Arm		MN-DL-8544	Trailing Arm
	02/09→	Track Control Arm		MN-VB-8514	Suspension Rod, Wishbone (CV)
35.540 FFDK, FFDLK, FFDK	02/09→	Centre Rod	MN-DL-7801		Push Rod
	02/09→	Centre Rod	MN-DL-8599		Push Rod
	02/09→	Centre Rod	MN-DL-12285		for Steering Rod
	02/09→	Centre Rod	MN-DL-12289		Push Rod
	02/09→	Centre Rod	MN-DL-12393		for Steering Rod
	02/09→	Tie Rod	MN-DL-7802		
	02/09→	Tie Rod	MN-DL-12293		
	02/09→	Tie Rod End	CV-ES-14163		for Steering Rod
	02/09→	Tie Rod End	MN-ES-10333		for Steering Rod
	02/09→	Track Control Arm		MN-DL-5225	Trailing Arm
	02/09→	Track Control Arm		MN-DL-8544	Trailing Arm
	02/09→	Track Control Arm		MN-VB-8514	Suspension Rod, Wishbone (CV), Drive Axle, for Leaf-Spring Suspension vehicles
	02/09→	Track Control Arm		MN-VB-8514	Suspension Rod, Wishbone (CV), Drive Axle, for Pneumatic Suspension vehicles
	02/09→	Track Control Arm		MN-VB-8669	Suspension Rod, Wishbone (CV)
	02/09→	Track Control Arm	MN-VB-5238	MN-VB-5238	Wishbone (CV);Control Arm

CV-ES-14163

Length: 125
Cone Ø: d1 Ø 30 / d2 Ø 27
Thread: M30 x 1,5 RHT

95301.0084, 90804102156, 90804102272, 90804102696, 90804102710, 81953010016, 81953010075, 81953010084, 81953010088, 81953010094, 81953010103, 81953016030, 81953016043, 81953016048, 81953016049, 81953016053, 81953016061, 81953016090, 81953016108, 81953016112, 81953016126, 81953016143, 81953016149, 81953016154, 81953016156, 81953016168, 81953016178, 81953016194, 81953016206, 81953016224, 81953016234, 81953016242, 81953016252, 81953016274, 81953016278, 81953016284, 81953016286, 81953016308, 81953016310, 81953016312, 81953016347, 81953016350, 81953016352, 82953016012, 88953016014, N2953016001



IV-ES-8507

Length: 80
Cone Ø: d1 Ø 30 / d2 Ø 27
Thread: M30 x 1,5 RHT

11019869, 12216380, 55175540, 81953016238



MN-DL-5225

Length: 572 Ø: 48
Hole Distance: 130 / 130

03301500A, 81432206229, 81432206236, 81432206267, 81432206270, 81432206272, 81432206304, 81432206305, 81432209236, 81432209267, 81432209272



MN-DL-7801

Length: 995 Ø: 52
Cone Ø: d1 Ø 30 / d2 Ø 27

81466106807, 81466106808, 81466116087, 81466116088, 81466116096, 81466116097, 81466116099, 81466116132, 81466116133, 81466116136, 81466116197, 81466116198, 81466116205



MN-DL-7802

Length: 1680 Ø: 52
Cone Ø: d1 Ø 30 / d2 Ø 27

03208300A, 81467116773, 81467116858, 81467116859, 81467116860, 81467116861, 81467116863, 81467116882, 81467116883, 81467116920, 81467116921



MN-DL-8544

Length: 596 Ø: 48
Hole Distance: 130 / 130

81432206196, 81432206232, 81432206233



MN-DL-8599

Length: 1800 Ø: 62
Cone Ø: d1 Ø 30 / d2 Ø 27

81466116161, 81466116162, 82466106183, 82466106186, 82466106187



MN-DL-8646

Length: 1021 Ø: 52
Cone Ø: d1 Ø 30 / d2 Ø 27

81466106811, 81466106812, 81466116138, 81466116139, 81466116201, 81466116202

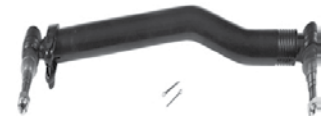

MN-DL-8709

Length: 572 Ø: 52
Hole Distance: 130 / 130

81432206268, 81432206274, 81432206291, 81432206292, 82432206007



MN-DL-12284

Length: 1530 Ø: 50
Cone Ø: d1 Ø 30 / d2 Ø 27

81466106579, 81466106580, 81466106624, 81466116720, 81467116720, 81467116730, 81467116952



MN-DL-12285

Length: 993 Ø: 40
Cone Ø: d1 Ø 30 / d2 Ø 27

81466106816, 81466106826, 81466116151, 82466106184, 82466106185



MN-DL-12287

Length: 1531 Ø: 42
Cone Ø: d1 Ø 30 / d2 Ø 27

81467116855, 81467116856, 81467116857



MN-DL-12288

Length: 585 Ø: 58
Hole Distance: 130 / 130

81432206386, 82432206008, 82432209008

No Image

MN-DL-12289

Length: 1796 Ø: 62
Cone Ø: d1 Ø 30 / d2 Ø 27

81466116174, 81466116175, 81466116176, 81466116244

No Image

MN-DL-12293

Length: 1680 Ø: 42
Cone Ø: d1 Ø 30 / d2 Ø 27

81467106236, 81467106268, 81467106356, 81467116356, 81467116723, 81467116794, 81467116933, 81467116934, 81467116966



MN-DL-12393

Length: 1796 Ø: 62
Cone Ø: d1 Ø 30 / d2 Ø 27

81466116154, 81466116155, 81466116156



MN-ES-10333

Length: 90
Cone Ø: d1 Ø 38 / d2 Ø 34,35
Thread: M36 x 1,5 RHT

1271126, 3090291, 3099128, 42538048, 81953016268, 82953016018, 82953016019



MN-SB-5246

Ø: 45 Thick/Height: 47
81437220022, 81437220038, 81962100450, 81962100469



MN-TC-12399

Length: 694 Ø: 50
Hole Distance: 130 / 130

81432206265



MN-VB-5238

Length: 627 Ø: 48
Hole Distance: 130 / 130

81432206221, 81432706096, 81432706114, 81432706116, 81432706121



MN-VB-8514

Length: 627 Ø: 48
Hole Ø 25 / 25 / 25

Hole Distance: 152 / 130 / 130
81432706087, 81432706088, 81432706094, 81432706095, 81432796094



MN-VB-8669

Length: 627 Ø: 48
Hole Ø 25 / 25 / 25

Hole Distance: 152 / 130 / 130
81432706116, 81432706137, 81432706150, 81432706151



MN-VB-9403

Length: 627 Ø: 48
Hole Ø 25 / 23 / 23

Hole Distance: 152 / 130 / 130
81432706097, 81432706113, 81432706135, 81432706160, 81432706161





TGS ...

35.540 FFD-TM	10/07→	Centre Rod	MN-DL-7801	Push Rod
	10/07→	Centre Rod	MN-DL-12289	Push Rod
	10/07→	Centre Rod	MN-DL-12393	for Steering Rod
	10/07→	Tie Rod	MN-DL-7802	
	10/07→	Tie Rod	MN-DL-12293	
	10/07→	Tie Rod End	CV-ES-14163	for Steering Rod
	10/07→	Track Control Arm		MN-DL-8544 Trailing Arm
	10/07→	Track Control Arm		MN-VB-8514 Suspension Rod, Wishbone (CV), Drive Axle, for Leaf-Spring Suspension vehicles
	10/07→	Track Control Arm		MN-VB-8669 Suspension Rod, Wishbone (CV)
35.540 FFNLC	02/09→	Tie Rod End	CV-ES-14163	for Steering Rod
	02/09→	Track Control Arm		MN-DL-5225 Trailing Arm
37.320 FFDC	07/08→	Centre Rod	MN-DL-7801	Push Rod, Leaf Spring Axle
	07/08→	Centre Rod	MN-DL-8599	Push Rod
	07/08→	Centre Rod	MN-DL-12285	for Steering Rod
	07/08→	Tie Rod	MN-DL-7802	
	07/08→	Tie Rod	MN-DL-12293	
	07/08→	Tie Rod End	MN-ES-10333	for Steering Rod
	07/08→	Track Control Arm		MN-DL-8544 Trailing Arm, Drive Axle
	07/08→	Track control arm		MN-DL-12288 Trailing Arm
	07/08→	Track Control Arm		MN-VB-8514 Suspension Rod, Wishbone (CV), Drive Axle
37.320 FFDK	07/08→	Track Control Arm		MN-VB-8669 Suspension Rod, Wishbone (CV), Drive Axle
	07/08→	Centre Rod	MN-DL-7801	Push Rod, Leaf Spring Axle
	07/08→	Centre Rod	MN-DL-8599	Push Rod
	07/08→	Centre Rod	MN-DL-12285	for Steering Rod
	07/08→	Tie Rod	MN-DL-7802	
	07/08→	Tie Rod	MN-DL-12293	
	07/08→	Tie Rod End	MN-ES-10333	for Steering Rod
	07/08→	Track Control Arm		MN-DL-8544 Trailing Arm, Drive Axle
	07/08→	Track control arm		MN-DL-12288 Trailing Arm
37.320 FFD-TM	07/08→	Track Control Arm		MN-VB-8514 Suspension Rod, Wishbone (CV), Drive Axle
	07/08→	Track Control Arm		MN-VB-8669 Suspension Rod, Wishbone (CV), Drive Axle
	10/07→	Centre Rod	MN-DL-7801	Push Rod, Leaf Spring Axle
	10/07→	Centre Rod	MN-DL-8599	Push Rod
	10/07→	Centre Rod	MN-DL-12285	for Steering Rod
	10/07→	Tie Rod	MN-DL-7802	
	10/07→	Tie Rod	MN-DL-12293	
	10/07→	Tie Rod End	MN-ES-10333	for Steering Rod
	10/07→	Track Control Arm		MN-DL-8544 Trailing Arm, Drive Axle
37.360 FFDC	10/07→	Track control arm		MN-DL-12288 Trailing Arm
	10/07→	Track Control Arm		MN-VB-8514 Suspension Rod, Wishbone (CV), Drive Axle
	10/07→	Track Control Arm		MN-VB-8669 Suspension Rod, Wishbone (CV), Drive Axle
	07/08→	Centre Rod	MN-DL-7801	Push Rod, Leaf Spring Axle
	07/08→	Centre Rod	MN-DL-8599	Push Rod
	07/08→	Centre Rod	MN-DL-12285	for Steering Rod
	07/08→	Tie Rod	MN-DL-7802	
	07/08→	Tie Rod	MN-DL-12293	
	07/08→	Tie Rod End	MN-ES-10333	for Steering Rod
37.360 FFDK	07/08→	Track Control Arm		MN-DL-8544 Trailing Arm, Drive Axle
	07/08→	Track control arm		MN-DL-12288 Trailing Arm
	07/08→	Track Control Arm		MN-VB-8514 Suspension Rod, Wishbone (CV), Drive Axle
	07/08→	Track Control Arm		MN-VB-8669 Suspension Rod, Wishbone (CV), Drive Axle
	07/08→	Centre Rod	MN-DL-7801	Push Rod, Leaf Spring Axle
	07/08→	Centre Rod	MN-DL-8599	Push Rod
	07/08→	Centre Rod	MN-DL-12285	for Steering Rod
	07/08→	Tie Rod	MN-DL-7802	
	07/08→	Tie Rod	MN-DL-12293	

CV-ES-14163

Length: 125
Cone Ø: d1 Ø 30 / d2 Ø 27
Thread: M30 x 1,5 RHT

95301.0084, 90804102156, 90804102272, 90804102696, 90804102710, 81953010016, 81953010075, 81953010084, 81953010088, 81953010094, 81953010103, 81953016030, 81953016043, 81953016048, 81953016049, 81953016053, 81953016061, 81953016090, 81953016108, 81953016112, 81953016126, 81953016143, 81953016149, 81953016154, 81953016156, 81953016168, 81953016178, 81953016194, 81953016206, 81953016224, 81953016234, 81953016242, 81953016252, 81953016274, 81953016278, 81953016284, 81953016286, 81953016308, 81953016310, 81953016312, 81953016347, 81953016350, 81953016352, 82953016012, 88953016014, N2953016001



MN-DL-5225

Length: 572 Ø: 48
Hole Distance: 130 / 130

03301500A, 81432206229, 81432206236, 81432206267, 81432206270, 81432206272, 81432206304, 81432206305, 81432209236, 81432209267, 81432209272



MN-DL-7801

Length: 995 Ø: 52
Cone Ø: d1 Ø 30 / d2 Ø 27

81466106807, 81466106808, 81466116087, 81466116088, 81466116096, 81466116097, 81466116099, 81466116132, 81466116133, 81466116136, 81466116197, 81466116198, 81466116205

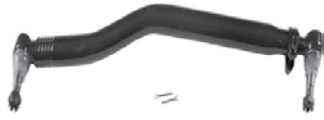

MN-DL-7802

Length: 1680 Ø: 52
Cone Ø: d1 Ø 30 / d2 Ø 27

03208300A, 81467116773, 81467116858, 81467116859, 81467116860, 81467116861, 81467116863, 81467116882, 81467116883, 81467116920, 81467116921



MN-DL-8544

Length: 596 Ø: 48
Hole Distance: 130 / 130

81432206196, 81432206232, 81432206233



MN-DL-8599

Length: 1800 Ø: 62
Cone Ø: d1 Ø 30 / d2 Ø 27

81466116161, 81466116162, 82466106183, 82466106186, 82466106187



MN-DL-12285

Length: 993 Ø: 40
Cone Ø: d1 Ø 30 / d2 Ø 27

81466106816, 81466106826, 81466116151, 82466106184, 82466106185



MN-DL-12288

Length: 585 Ø: 58
Hole Distance: 130 / 130

81432206386, 82432206008, 82432209008

No Image

MN-DL-12289

Length: 1796 Ø: 62
Cone Ø: d1 Ø 30 / d2 Ø 27

81466116174, 81466116175, 81466116176, 81466116244

No Image

MN-DL-12293

Length: 1680 Ø: 42
Cone Ø: d1 Ø 30 / d2 Ø 27

81467106236, 81467106268, 81467106356, 81467116356, 81467116723, 81467116794, 81467116933, 81467116934, 81467116966



MN-DL-12393

Length: 1796 Ø: 62
Cone Ø: d1 Ø 30 / d2 Ø 27

81466116154, 81466116155, 81466116156



MN-ES-10333

Length: 90
Cone Ø: d1 Ø 38 / d2 Ø 34,35
Thread: M36 x 1,5 RHT

1271126, 3090291, 3099128, 42538048, 81953016268, 82953016018, 82953016019



MN-VB-8514

Length: 627 Ø: 48
Hole Ø 25 / 25 / 25
Hole Distance: 152 / 130 / 130

81432706087, 81432706088, 81432706094, 81432706095, 81432796094



MN-VB-8669

Length: 627 Ø: 48
Hole Ø 25 / 25 / 25
Hole Distance: 152 / 130 / 130

81432706116, 81432706137, 81432706150, 81432706151





TGS ...

37.360 FFD-TM	10/07→	Centre Rod	MN-DL-7801	Push Rod, Leaf Spring Axle
	10/07→	Centre Rod	MN-DL-8599	Push Rod
	10/07→	Centre Rod	MN-DL-12285	for Steering Rod
	10/07→	Tie Rod	MN-DL-7802	
	10/07→	Tie Rod	MN-DL-12293	
	10/07→	Tie Rod End	MN-ES-10333	for Steering Rod
	10/07→	Track Control Arm	MN-DL-8544	Trailing Arm, Drive Axle
	10/07→	Track control arm	MN-DL-12288	Trailing Arm
	10/07→	Track Control Arm	MN-VB-8514	Suspension Rod, Wishbone (CV), Drive Axle
	10/07→	Track Control Arm	MN-VB-8669	Suspension Rod, Wishbone (CV), Drive Axle
37.400 FFDC	07/08→	Centre Rod	MN-DL-7801	Push Rod, Leaf Spring Axle
	07/08→	Centre Rod	MN-DL-8599	Push Rod
	07/08→	Centre Rod	MN-DL-12285	for Steering Rod
	07/08→	Tie Rod	MN-DL-7802	
	07/08→	Tie Rod	MN-DL-12293	
	07/08→	Tie Rod End	MN-ES-10333	for Steering Rod
	07/08→	Track Control Arm	MN-DL-8544	Trailing Arm, Drive Axle
	07/08→	Track control arm	MN-DL-12288	Trailing Arm
	07/08→	Track Control Arm	MN-VB-8514	Suspension Rod, Wishbone (CV), Drive Axle
	07/08→	Track Control Arm	MN-VB-8669	Suspension Rod, Wishbone (CV), Drive Axle
37.400 FFDC	07/08→	Centre Rod	MN-DL-7801	Push Rod, Leaf Spring Axle
	07/08→	Centre Rod	MN-DL-8599	Push Rod
	07/08→	Centre Rod	MN-DL-12285	for Steering Rod
	07/08→	Tie Rod	MN-DL-7802	
	07/08→	Tie Rod	MN-DL-12293	
	07/08→	Tie Rod End	MN-ES-10333	for Steering Rod
	07/08→	Track Control Arm	MN-DL-8544	Trailing Arm, Drive Axle
	07/08→	Track Control Arm	MN-VB-8514	Suspension Rod, Wishbone (CV), Drive Axle
	07/08→	Track Control Arm	MN-VB-8669	Suspension Rod, Wishbone (CV), Drive Axle
	37.400 FFD-TM	10/07→	Centre Rod	MN-DL-7801
10/07→		Centre Rod	MN-DL-8599	Push Rod
10/07→		Centre Rod	MN-DL-12285	for Steering Rod
10/07→		Tie Rod	MN-DL-7802	
10/07→		Tie Rod	MN-DL-12293	
10/07→		Tie Rod End	MN-ES-10333	for Steering Rod
10/07→		Track Control Arm	MN-DL-8544	Trailing Arm, Drive Axle
10/07→		Track control arm	MN-DL-12288	Trailing Arm
10/07→		Track Control Arm	MN-VB-8514	Suspension Rod, Wishbone (CV), Drive Axle
10/07→		Track Control Arm	MN-VB-8669	Suspension Rod, Wishbone (CV), Drive Axle
37.440 FFDC	07/08→	Centre Rod	MN-DL-7801	Push Rod, Leaf Spring Axle
	07/08→	Centre Rod	MN-DL-8599	Push Rod
	07/08→	Centre Rod	MN-DL-12285	for Steering Rod
	07/08→	Tie Rod	MN-DL-7802	
	07/08→	Tie Rod	MN-DL-12293	
	07/08→	Tie Rod End	MN-ES-10333	for Steering Rod
	07/08→	Track Control Arm	MN-DL-8544	Trailing Arm, Drive Axle
	07/08→	Track control arm	MN-DL-12288	Trailing Arm
	07/08→	Track Control Arm	MN-VB-8514	Suspension Rod, Wishbone (CV), Drive Axle
	07/08→	Track Control Arm	MN-VB-8669	Suspension Rod, Wishbone (CV), Drive Axle
37.440 FFDC	07/08→	Centre Rod	MN-DL-7801	Push Rod, Leaf Spring Axle
	07/08→	Centre Rod	MN-DL-8599	Push Rod
	07/08→	Centre Rod	MN-DL-12285	for Steering Rod
	07/08→	Tie Rod	MN-DL-7802	
	07/08→	Tie Rod	MN-DL-12293	
	07/08→	Tie Rod End	MN-ES-10333	for Steering Rod
	07/08→	Track Control Arm	MN-DL-8544	Trailing Arm, Drive Axle
	07/08→	Track control arm	MN-DL-12288	Trailing Arm
	07/08→	Track Control Arm	MN-VB-8514	Suspension Rod, Wishbone (CV), Drive Axle
	07/08→	Track Control Arm	MN-VB-8669	Suspension Rod, Wishbone (CV), Drive Axle
37.440 FFD-TM	10/07→	Centre Rod	MN-DL-7801	Push Rod, Leaf Spring Axle
	10/07→	Centre Rod	MN-DL-8599	Push Rod
	10/07→	Centre Rod	MN-DL-12285	for Steering Rod
	10/07→	Tie Rod	MN-DL-7802	

MN-DL-7801

Length: 995 Ø: 52
Cone Ø: d1 Ø 30 / d2 Ø 27

81466106807, 81466106808, 81466116087,
81466116088, 81466116096, 81466116097,
81466116099, 81466116132, 81466116133,
81466116136, 81466116197, 81466116198,
81466116205

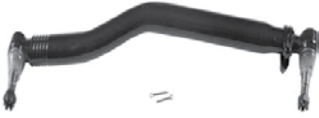

MN-VB-8514

Length: 627 Ø: 48
Hole Ø 25 / 25 / 25

Hole Distance: 152 / 130 / 130
81432706087, 81432706088, 81432706094,
81432706095, 81432796094



MN-DL-7802

Length: 1680 Ø: 52
Cone Ø: d1 Ø 30 / d2 Ø 27

03208300A, 81467116773, 81467116858,
81467116859, 81467116860, 81467116861,
81467116863, 81467116882, 81467116883,
81467116920, 81467116921



MN-VB-8669

Length: 627 Ø: 48
Hole Ø 25 / 25 / 25

Hole Distance: 152 / 130 / 130
81432706116, 81432706137, 81432706150,
81432706151



MN-DL-8544

Length: 596 Ø: 48
Hole Distance: 130 / 130

81432206196, 81432206232, 81432206233



MN-DL-8599

Length: 1800 Ø: 62
Cone Ø: d1 Ø 30 / d2 Ø 27

81466116161, 81466116162, 82466106183,
82466106186, 82466106187



MN-DL-12285

Length: 993 Ø: 40
Cone Ø: d1 Ø 30 / d2 Ø 27

81466106816, 81466106826, 81466116151,
82466106184, 82466106185



MN-DL-12288

Length: 585 Ø: 58
Hole Distance: 130 / 130

81432206386, 82432206008, 82432209008

No Image

MN-DL-12293

Length: 1680 Ø: 42
Cone Ø: d1 Ø 30 / d2 Ø 27

81467106236, 81467106268, 81467106356,
81467116356, 81467116723, 81467116794,
81467116933, 81467116934, 81467116966



MN-ES-10333

Length: 90
Cone Ø: d1 Ø 38 / d2 Ø 34,35
Thread: M36 x 1,5 RHT

1271126, 3090291, 3099128, 42538048,
81953016268, 82953016018, 82953016019





TGS ...

37.440 FFD-TM ...	10/07→	Tie Rod	MN-DL-12293		
	10/07→	Tie Rod End	MN-ES-10333		for Steering Rod
	10/07→	Track Control Arm		MN-DL-8544	Trailing Arm, Drive Axle
	10/07→	Track control arm		MN-DL-12288	Trailing Arm
	10/07→	Track Control Arm		MN-VB-8514	Suspension Rod, Wishbone (CV), Drive Axle
	10/07→	Track Control Arm		MN-VB-8669	Suspension Rod, Wishbone (CV), Drive Axle
37.480 FFDC	07/08→	Centre Rod	MN-DL-7801		Push Rod, Leaf Spring Axle
	07/08→	Centre Rod	MN-DL-8599		Push Rod
	07/08→	Centre Rod	MN-DL-12285		for Steering Rod
	07/08→	Tie Rod	MN-DL-7802		
	07/08→	Tie Rod	MN-DL-12293		
	07/08→	Tie Rod End	MN-ES-10333		for Steering Rod
	07/08→	Track Control Arm		MN-DL-8544	Trailing Arm, Drive Axle
	07/08→	Track control arm		MN-DL-12288	Trailing Arm
	07/08→	Track Control Arm		MN-VB-8514	Suspension Rod, Wishbone (CV), Drive Axle
37.480 FFDK	07/08→	Centre Rod	MN-DL-7801		Push Rod, Leaf Spring Axle
	07/08→	Centre Rod	MN-DL-8599		Push Rod
	07/08→	Centre Rod	MN-DL-12285		for Steering Rod
	07/08→	Tie Rod	MN-DL-7802		
	07/08→	Tie Rod	MN-DL-12293		
	07/08→	Track Control Arm		MN-DL-8544	Trailing Arm, Drive Axle
	07/08→	Track control arm		MN-DL-12288	Trailing Arm
	07/08→	Track Control Arm		MN-VB-8514	Suspension Rod, Wishbone (CV), Drive Axle
	07/08→	Track Control Arm		MN-VB-8669	Suspension Rod, Wishbone (CV), Drive Axle
37.480 FFD-TM	10/07→	Centre Rod	MN-DL-7801		Push Rod, Leaf Spring Axle
	10/07→	Centre Rod	MN-DL-8599		Push Rod
	10/07→	Centre Rod	MN-DL-12285		for Steering Rod
	10/07→	Tie Rod	MN-DL-7802		
	10/07→	Tie Rod	MN-DL-12293		
	10/07→	Tie Rod End	MN-ES-10333		for Steering Rod
	10/07→	Track Control Arm		MN-DL-8544	Trailing Arm, Drive Axle
	10/07→	Track control arm		MN-DL-12288	Trailing Arm
	10/07→	Track Control Arm		MN-VB-8514	Suspension Rod, Wishbone (CV), Drive Axle
37.540 FFDC	02/09→	Centre Rod	MN-DL-7801		Push Rod, Leaf Spring Axle
	02/09→	Centre Rod	MN-DL-8599		Push Rod
	02/09→	Centre Rod	MN-DL-12285		for Steering Rod
	02/09→	Tie Rod	MN-DL-7802		
	02/09→	Tie Rod	MN-DL-12293		
	02/09→	Tie Rod End	MN-ES-10333		for Steering Rod
	02/09→	Track Control Arm		MN-DL-8544	Trailing Arm, Drive Axle
	02/09→	Track control arm		MN-DL-12288	Trailing Arm
	02/09→	Track Control Arm		MN-VB-8514	Suspension Rod, Wishbone (CV), Drive Axle
37.540 FFDK	02/09→	Centre Rod	MN-DL-7801		Push Rod, Leaf Spring Axle
	02/09→	Centre Rod	MN-DL-8599		Push Rod
	02/09→	Centre Rod	MN-DL-12285		for Steering Rod
	02/09→	Tie Rod	MN-DL-7802		
	02/09→	Tie Rod	MN-DL-12293		
	02/09→	Tie Rod End	MN-ES-10333		for Steering Rod
	02/09→	Track Control Arm		MN-DL-8544	Trailing Arm, Drive Axle
	02/09→	Track control arm		MN-DL-12288	Trailing Arm
	02/09→	Track Control Arm		MN-VB-8514	Suspension Rod, Wishbone (CV), Drive Axle
37.540 FFD-TM	10/07→	Centre Rod	MN-DL-7801		Push Rod, Leaf Spring Axle
	10/07→	Centre Rod	MN-DL-8599		Push Rod
	10/07→	Centre Rod	MN-DL-12285		for Steering Rod
	10/07→	Tie Rod	MN-DL-7802		
	10/07→	Tie Rod	MN-DL-12293		
	10/07→	Tie Rod End	MN-ES-10333		for Steering Rod
	10/07→	Track Control Arm		MN-DL-8544	Trailing Arm, Drive Axle
	10/07→	Track control arm		MN-DL-12288	Trailing Arm
	10/07→	Track Control Arm		MN-VB-8514	Suspension Rod, Wishbone (CV), Drive Axle

MN-DL-7801

Length: 995 Ø: 52
Cone Ø: d1 Ø 30 / d2 Ø 27

81466106807, 81466106808, 81466116087,
81466116088, 81466116096, 81466116097,
81466116099, 81466116132, 81466116133,
81466116136, 81466116197, 81466116198,
81466116205

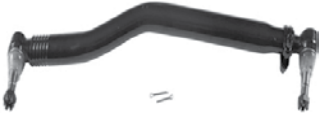

MN-VB-8514

Length: 627 Ø: 48
Hole Ø 25 / 25 / 25

Hole Distance: 152 / 130 / 130
81432706087, 81432706088, 81432706094,
81432706095, 81432796094



MN-DL-7802

Length: 1680 Ø: 52
Cone Ø: d1 Ø 30 / d2 Ø 27

03208300A, 81467116773, 81467116858,
81467116859, 81467116860, 81467116861,
81467116863, 81467116882, 81467116883,
81467116920, 81467116921



MN-VB-8669

Length: 627 Ø: 48
Hole Ø 25 / 25 / 25

Hole Distance: 152 / 130 / 130
81432706116, 81432706137, 81432706150,
81432706151



MN-DL-8544

Length: 596 Ø: 48
Hole Distance: 130 / 130

81432206196, 81432206232, 81432206233



MN-DL-8599

Length: 1800 Ø: 62
Cone Ø: d1 Ø 30 / d2 Ø 27

81466116161, 81466116162, 82466106183,
82466106186, 82466106187



MN-DL-12285

Length: 993 Ø: 40
Cone Ø: d1 Ø 30 / d2 Ø 27

81466106816, 81466106826, 81466116151,
82466106184, 82466106185



MN-DL-12288

Length: 585 Ø: 58
Hole Distance: 130 / 130

81432206386, 82432206008, 82432209008

No Image

MN-DL-12293

Length: 1680 Ø: 42
Cone Ø: d1 Ø 30 / d2 Ø 27

81467106236, 81467106268, 81467106356,
81467116356, 81467116723, 81467116794,
81467116933, 81467116934, 81467116966



MN-ES-10333

Length: 90
Cone Ø: d1 Ø 38 / d2 Ø 34,35
Thread: M36 x 1,5 RHT

1271126, 3090291, 3099128, 42538048,
81953016268, 82953016018, 82953016019





TGS ...

37.540 FFD-TM ...	10/07→	Track Control Arm		MN-VB-8514	Suspension Rod, Wishbone (CV), Drive Axle
	10/07→	Track Control Arm		MN-VB-8669	Suspension Rod, Wishbone (CV), Drive Axle
40.360 FDAK, FDARK	06/08→	Track control arm		MN-DL-12288	Trailing Arm
40.360 FDAS, FDARS	10/07→	Track control arm		MN-DL-12288	Trailing Arm
40.390 FDAK, FDARK	10/07→	Track control arm		MN-DL-12288	Trailing Arm
40.390 FDAS, FDARS	10/07→	Track control arm		MN-DL-12288	Trailing Arm
40.400 FDAK-WW, FDARK-WW	02/11→	Centre Rod	MN-DL-8646		Push Rod
	02/11→	Mounting, stabilizer coupling rod	MN-SB-5246		
	02/11→	Track control arm		MN-DL-12288	Trailing Arm
40.400 FDAS-WW, FDARS-WW	02/11→	Centre Rod	MN-DL-8646		Push Rod
	02/11→	Mounting, stabilizer coupling rod	MN-SB-5246		
	02/11→	Track control arm		MN-DL-12288	Trailing Arm
40.430 FDAK, FDARK	06/08→	Track control arm		MN-DL-12288	Trailing Arm
40.430 FDAS, FDARS	06/08→	Track control arm		MN-DL-12288	Trailing Arm
40.440 FDAK-WW, FDARK-WW	02/11→	Centre Rod	MN-DL-8646		Push Rod
	02/11→	Mounting, stabilizer coupling rod	MN-SB-5246		
	02/11→	Track control arm		MN-DL-12288	Trailing Arm
40.440 FDAS-WW, FDARS-WW	02/11→	Centre Rod	MN-DL-8646		Push Rod
	02/11→	Mounting, stabilizer coupling rod	MN-SB-5246		
	02/11→	Track control arm		MN-DL-12288	Trailing Arm
40.480 FDAK, FDARK	06/08→	Track control arm		MN-DL-12288	Trailing Arm
40.480 FDAS, FDARS	06/08→	Track control arm		MN-DL-12288	Trailing Arm
41.320 FFDK	06/08→	Centre Rod	MN-DL-8646		Push Rod
	06/08→	Mounting, stabilizer coupling rod	MN-SB-5246		
	06/08→	Tie Rod	MN-DL-12287		
	06/08→	Tie Rod End	CV-ES-14163		for Steering Rod
	06/08→	Tie Rod End	MN-ES-10333		for Steering Rod
	06/08→	Track Control Arm		MN-DL-8544	Trailing Arm
	06/08→	Track control arm		MN-DL-12288	Trailing Arm
	06/08→	Track Control Arm		MN-VB-8514	Suspension Rod, Wishbone (CV)
41.320 FFDC	06/08→	Tie Rod	MN-DL-12293		
	06/08→	Track control arm		MN-DL-12288	Trailing Arm
41.320 FFDK	06/08→	Tie Rod	MN-DL-12293		
	06/08→	Track control arm		MN-DL-12288	Trailing Arm
41.320 FFD-TM	06/08→	Tie Rod	MN-DL-12293		
	06/08→	Track control arm		MN-DL-12288	Trailing Arm
41.360	06/08→	Centre Rod	MN-DL-8646		Push Rod
	06/08→	Mounting, stabilizer coupling rod	MN-SB-5246		
	06/08→	Tie Rod End	MN-ES-10333		for Steering Rod
	06/08→	Track Control Arm		MN-DL-8544	Trailing Arm
	06/08→	Track Control Arm		MN-VB-8514	Suspension Rod, Wishbone (CV)
41.360 FFD, FFDC, FFDRK	07/08→	Centre Rod	MN-DL-7801		Push Rod, Leaf Spring Axle
	07/08→	Centre Rod	MN-DL-8599		Push Rod
	07/08→	Centre Rod	MN-DL-12285		for Steering Rod
	07/08→	Tie Rod	MN-DL-7802		
	07/08→	Tie Rod	MN-DL-12293		
	07/08→	Tie Rod End	MN-ES-10333		for Steering Rod
	07/08→	Track Control Arm		MN-DL-8544	Trailing Arm, Drive Axle
	07/08→	Track control arm		MN-DL-12288	Trailing Arm
	07/08→	Track Control Arm		MN-VB-8514	Suspension Rod, Wishbone (CV), Drive Axle
	07/08→	Track Control Arm		MN-VB-8669	Suspension Rod, Wishbone (CV), Drive Axle
41.360 FFDK	06/08→	Centre Rod	MN-DL-8646		Push Rod
	06/08→	Mounting, stabilizer coupling rod	MN-SB-5246		
	06/08→	Tie Rod	MN-DL-12287		
	06/08→	Tie Rod End	MN-ES-10333		for Steering Rod
	06/08→	Track Control Arm		MN-DL-8544	Trailing Arm
	06/08→	Track Control Arm		MN-VB-8514	Suspension Rod, Wishbone (CV)
41.360 FFDK, FFDRK	07/08→	Centre Rod	MN-DL-7801		Push Rod, Leaf Spring Axle
	07/08→	Centre Rod	MN-DL-8599		Push Rod
	07/08→	Centre Rod	MN-DL-12285		for Steering Rod
	07/08→	Tie Rod	MN-DL-7802		
	07/08→	Tie Rod	MN-DL-12293		
	07/08→	Tie Rod End	MN-ES-10333		for Steering Rod

CV-ES-14163

Length: 125
Cone Ø: d1 Ø 30 / d2 Ø 27
Thread: M30 x 1,5 RHT

95301.0084, 90804102156, 90804102272, 90804102696, 90804102710, 81953010016, 81953010075, 81953010084, 81953010088, 81953010094, 81953010103, 81953016030, 81953016043, 81953016048, 81953016049, 81953016053, 81953016061, 81953016090, 81953016108, 81953016112, 81953016126, 81953016143, 81953016149, 81953016154, 81953016156, 81953016168, 81953016178, 81953016194, 81953016206, 81953016224, 81953016234, 81953016242, 81953016252, 81953016274, 81953016278, 81953016284, 81953016286, 81953016308, 81953016310, 81953016312, 81953016347, 81953016350, 81953016352, 82953016012, 88953016014, N2953016001



MN-DL-7801

Length: 995 Ø: 52
Cone Ø: d1 Ø 30 / d2 Ø 27

81466106807, 81466106808, 81466116087, 81466116088, 81466116096, 81466116097, 81466116099, 81466116132, 81466116133, 81466116136, 81466116197, 81466116198, 81466116205

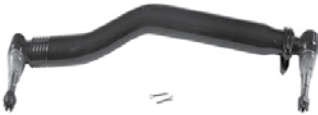

MN-DL-7802

Length: 1680 Ø: 52
Cone Ø: d1 Ø 30 / d2 Ø 27

03208300A, 81467116773, 81467116858, 81467116859, 81467116860, 81467116861, 81467116863, 81467116882, 81467116883, 81467116920, 81467116921



MN-DL-8544

Length: 596 Ø: 48
Hole Distance: 130 / 130

81432206196, 81432206232, 81432206233



MN-DL-8599

Length: 1800 Ø: 62
Cone Ø: d1 Ø 30 / d2 Ø 27

81466116161, 81466116162, 82466106183, 82466106186, 82466106187



MN-DL-8646

Length: 1021 Ø: 52
Cone Ø: d1 Ø 30 / d2 Ø 27

81466106811, 81466106812, 81466116138, 81466116139, 81466116201, 81466116202

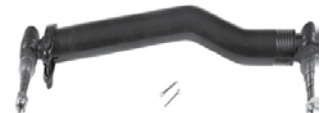

MN-DL-12285

Length: 993 Ø: 40
Cone Ø: d1 Ø 30 / d2 Ø 27

81466106816, 81466106826, 81466116151, 82466106184, 82466106185



MN-DL-12287

Length: 1531 Ø: 42
Cone Ø: d1 Ø 30 / d2 Ø 27

81467116855, 81467116856, 81467116857



MN-DL-12288

Length: 585 Ø: 58
Hole Distance: 130 / 130

81432206386, 82432206008, 82432209008

No Image

MN-DL-12293

Length: 1680 Ø: 42
Cone Ø: d1 Ø 30 / d2 Ø 27

81467106236, 81467106268, 81467106356, 81467116356, 81467116723, 81467116794, 81467116933, 81467116934, 81467116966



MN-ES-10333

Length: 90
Cone Ø: d1 Ø 38 / d2 Ø 34,35
Thread: M36 x 1,5 RHT

1271126, 3090291, 3099128, 42538048, 81953016268, 82953016018, 82953016019



MN-SB-5246

Ø: 45 Thick/Height: 47

81437220022, 81437220038, 81962100450, 81962100469



MN-VB-8514

Length: 627 Ø: 48
Hole Ø 25 / 25 / 25

Hole Distance: 152 / 130 / 130

81432706087, 81432706088, 81432706094, 81432706095, 81432796094



MN-VB-8669

Length: 627 Ø: 48
Hole Ø 25 / 25 / 25

Hole Distance: 152 / 130 / 130

81432706116, 81432706137, 81432706150, 81432706151





TGS ...

41.360 FFDK, FFDRK ...	07/08→	Track Control Arm		MN-DL-8544	Trailing Arm, Drive Axle
	07/08→	Track control arm		MN-DL-12288	Trailing Arm
	07/08→	Track Control Arm		MN-VB-8514	Suspension Rod, Wishbone (CV), Drive Axle
	07/08→	Track Control Arm		MN-VB-8669	Suspension Rod, Wishbone (CV), Drive Axle
41.360 FFD-TM, FFDC-TM, FFDRC-TM	10/07→	Centre Rod	MN-DL-7801		Push Rod, Leaf Spring Axle
	10/07→	Centre Rod	MN-DL-8599		Push Rod
	10/07→	Centre Rod	MN-DL-12285		for Steering Rod
	10/07→	Tie Rod	MN-DL-7802		
	10/07→	Tie Rod	MN-DL-12293		
	10/07→	Tie Rod End	MN-ES-10333		for Steering Rod
	10/07→	Track Control Arm		MN-DL-8544	Trailing Arm, Drive Axle
	10/07→	Track control arm		MN-DL-12288	Trailing Arm
	10/07→	Track Control Arm		MN-VB-8514	Suspension Rod, Wishbone (CV), Drive Axle
	10/07→	Track Control Arm		MN-VB-8669	Suspension Rod, Wishbone (CV), Drive Axle
41.400 FFD, FFDC, FFDRC	07/08→	Centre Rod	MN-DL-7801		Push Rod, Leaf Spring Axle
	07/08→	Centre Rod	MN-DL-8599		Push Rod
	07/08→	Centre Rod	MN-DL-12285		for Steering Rod
	07/08→	Tie Rod	MN-DL-7802		
	07/08→	Tie Rod	MN-DL-12293		
	07/08→	Tie Rod End	MN-ES-10333		for Steering Rod
	07/08→	Track Control Arm		MN-DL-8544	Trailing Arm, Drive Axle
	07/08→	Track control arm		MN-DL-12288	Trailing Arm
	07/08→	Track Control Arm		MN-VB-8514	Suspension Rod, Wishbone (CV), Drive Axle
	07/08→	Track Control Arm		MN-VB-8669	Suspension Rod, Wishbone (CV), Drive Axle
41.400 FFDC-TM, FFDRC-TM, FFD-TM	10/07→	Centre Rod	MN-DL-7801		Push Rod, Leaf Spring Axle
	10/07→	Centre Rod	MN-DL-8599		Push Rod
	10/07→	Centre Rod	MN-DL-12285		for Steering Rod
	10/07→	Tie Rod	MN-DL-7802		
	10/07→	Tie Rod	MN-DL-12293		
	10/07→	Tie Rod End	MN-ES-10333		for Steering Rod
	10/07→	Track Control Arm		MN-DL-8544	Trailing Arm, Drive Axle
	10/07→	Track control arm		MN-DL-12288	Trailing Arm
	10/07→	Track Control Arm		MN-VB-8514	Suspension Rod, Wishbone (CV), Drive Axle
	10/07→	Track Control Arm		MN-VB-8669	Suspension Rod, Wishbone (CV), Drive Axle
41.400 FFDK, FFDRK	07/08→	Centre Rod	MN-DL-7801		Push Rod, Leaf Spring Axle
	07/08→	Centre Rod	MN-DL-8599		Push Rod
	07/08→	Centre Rod	MN-DL-12285		for Steering Rod
	07/08→	Tie Rod	MN-DL-7802		
	07/08→	Tie Rod	MN-DL-12293		
	07/08→	Tie Rod End	MN-ES-10333		for Steering Rod
	07/08→	Track Control Arm		MN-DL-8544	Trailing Arm, Drive Axle
	07/08→	Track control arm		MN-DL-12288	Trailing Arm
	07/08→	Track Control Arm		MN-VB-8514	Suspension Rod, Wishbone (CV), Drive Axle
	07/08→	Track Control Arm		MN-VB-8669	Suspension Rod, Wishbone (CV), Drive Axle
41.440 FFD, FFDC, FFDRC	07/08→	Centre Rod	MN-DL-7801		Push Rod, Leaf Spring Axle
	07/08→	Centre Rod	MN-DL-8599		Push Rod
	07/08→	Centre Rod	MN-DL-12285		for Steering Rod
	07/08→	Tie Rod	MN-DL-7802		
	07/08→	Tie Rod	MN-DL-12293		
	07/08→	Tie Rod End	MN-ES-10333		for Steering Rod
	07/08→	Track Control Arm		MN-DL-8544	Trailing Arm, Drive Axle
	07/08→	Track control arm		MN-DL-12288	Trailing Arm
	07/08→	Track Control Arm		MN-VB-8514	Suspension Rod, Wishbone (CV), Drive Axle
	07/08→	Track Control Arm		MN-VB-8669	Suspension Rod, Wishbone (CV), Drive Axle
41.440 FFDAK	06/08→	Centre Rod	MN-DL-8646		Push Rod
	06/08→	Mounting, stabilizer coupling rod	MN-SB-5246		
	06/08→	Tie Rod	MN-DL-12287		
	06/08→	Tie Rod End	CV-ES-14163		for Steering Rod
	06/08→	Tie Rod End	MN-ES-10333		for Steering Rod
	06/08→	Track Control Arm		MN-DL-8544	Trailing Arm
	06/08→	Track control arm		MN-DL-12288	Trailing Arm
41.440 FFDAK	06/08→	Track Control Arm		MN-VB-8514	Suspension Rod, Wishbone (CV)
	06/08→	Track Control Arm		MN-VB-8669	Suspension Rod, Wishbone (CV), Drive Axle
41.440 FFDAK	06/08→	Track control arm		MN-DL-12288	Trailing Arm

CV-ES-14163

Length: 125
Cone Ø: d1 Ø 30 / d2 Ø 27
Thread: M30 x 1,5 RHT

95301.0084, 90804102156, 90804102272, 90804102696, 90804102710, 81953010016, 81953010075, 81953010084, 81953010088, 81953010094, 81953010103, 81953016030, 81953016043, 81953016048, 81953016049, 81953016053, 81953016061, 81953016090, 81953016108, 81953016112, 81953016126, 81953016143, 81953016149, 81953016154, 81953016156, 81953016168, 81953016178, 81953016194, 81953016206, 81953016224, 81953016234, 81953016242, 81953016252, 81953016274, 81953016278, 81953016284, 81953016286, 81953016308, 81953016310, 81953016312, 81953016347, 81953016350, 81953016352, 82953016012, 88953016014, N2953016001



MN-DL-7801

Length: 995 Ø: 52
Cone Ø: d1 Ø 30 / d2 Ø 27

81466106807, 81466106808, 81466116087, 81466116088, 81466116096, 81466116097, 81466116099, 81466116132, 81466116133, 81466116136, 81466116197, 81466116198, 81466116205

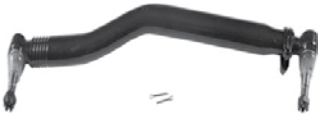

MN-DL-7802

Length: 1680 Ø: 52
Cone Ø: d1 Ø 30 / d2 Ø 27

03208300A, 81467116773, 81467116858, 81467116859, 81467116860, 81467116861, 81467116863, 81467116882, 81467116883, 81467116920, 81467116921



MN-DL-8544

Length: 596 Ø: 48
Hole Distance: 130 / 130

81432206196, 81432206232, 81432206233



MN-DL-8599

Length: 1800 Ø: 62
Cone Ø: d1 Ø 30 / d2 Ø 27

81466116161, 81466116162, 82466106183, 82466106186, 82466106187



MN-DL-8646

Length: 1021 Ø: 52
Cone Ø: d1 Ø 30 / d2 Ø 27

81466106811, 81466106812, 81466116138, 81466116139, 81466116201, 81466116202

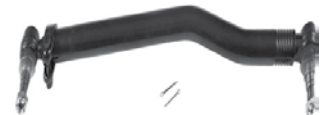

MN-DL-12285

Length: 993 Ø: 40
Cone Ø: d1 Ø 30 / d2 Ø 27

81466106816, 81466106826, 81466116151, 82466106184, 82466106185



MN-DL-12287

Length: 1531 Ø: 42
Cone Ø: d1 Ø 30 / d2 Ø 27

81467116855, 81467116856, 81467116857



MN-DL-12288

Length: 585 Ø: 58
Hole Distance: 130 / 130

81432206386, 82432206008, 82432209008

No Image

MN-DL-12293

Length: 1680 Ø: 42
Cone Ø: d1 Ø 30 / d2 Ø 27

81467106236, 81467106268, 81467106356, 81467116356, 81467116723, 81467116794, 81467116933, 81467116934, 81467116966



MN-ES-10333

Length: 90
Cone Ø: d1 Ø 38 / d2 Ø 34,35
Thread: M36 x 1,5 RHT

1271126, 3090291, 3099128, 42538048, 81953016268, 82953016018, 82953016019



MN-SB-5246

Ø: 45 Thick/Height: 47

81437220022, 81437220038, 81962100450, 81962100469



MN-VB-8514

Length: 627 Ø: 48
Hole Ø 25 / 25 / 25

Hole Distance: 152 / 130 / 130

81432706087, 81432706088, 81432706094, 81432706095, 81432796094



MN-VB-8669

Length: 627 Ø: 48
Hole Ø 25 / 25 / 25

Hole Distance: 152 / 130 / 130

81432706116, 81432706137, 81432706150, 81432706151



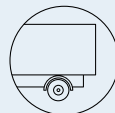

TGS ...

41.440 FFDC-TM, FFDRC-TM, FFD-TM	10/07→	Centre Rod	MN-DL-7801	Push Rod, Leaf Spring Axle	
	10/07→	Centre Rod	MN-DL-8599	Push Rod	
	10/07→	Centre Rod	MN-DL-12285	for Steering Rod	
	10/07→	Tie Rod	MN-DL-7802		
	10/07→	Tie Rod	MN-DL-12293		
	10/07→	Tie Rod End	MN-ES-10333	for Steering Rod	
	10/07→	Track Control Arm	MN-DL-8544	Trailing Arm, Drive Axle	
	10/07→	Track control arm	MN-DL-12288	Trailing Arm	
	10/07→	Track Control Arm	MN-VB-8514	Suspension Rod, Wishbone (CV), Drive Axle	
	10/07→	Track Control Arm	MN-VB-8669	Suspension Rod, Wishbone (CV), Drive Axle	
41.440 FFDK	07/08→	Centre Rod	MN-DL-7801	Push Rod, Leaf Spring Axle	
	07/08→	Centre Rod	MN-DL-8599	Push Rod	
	07/08→	Centre Rod	MN-DL-12285	for Steering Rod	
	07/08→	Tie Rod	MN-DL-7802		
	07/08→	Tie Rod	MN-DL-12293		
	07/08→	Tie Rod End	MN-ES-10333	for Steering Rod	
	07/08→	Track Control Arm	MN-DL-8544	Trailing Arm, Drive Axle	
	07/08→	Track control arm	MN-DL-12288	Trailing Arm	
	07/08→	Track Control Arm	MN-VB-8514	Suspension Rod, Wishbone (CV), Drive Axle	
	07/08→	Track Control Arm	MN-VB-8669	Suspension Rod, Wishbone (CV), Drive Axle	
41.440 FFDK, FFDRK	06/08→	Tie Rod	MN-DL-12293		
	06/08→	Track control arm	MN-DL-12288	Trailing Arm	
41.480 FFD, FFDC, FFDRK	07/08→	Centre Rod	MN-DL-7801	Push Rod, Leaf Spring Axle	
	07/08→	Centre Rod	MN-DL-8599	Push Rod	
	07/08→	Centre Rod	MN-DL-12285	for Steering Rod	
	07/08→	Tie Rod	MN-DL-7802		
	07/08→	Tie Rod	MN-DL-12293		
	07/08→	Tie Rod End	MN-ES-10333	for Steering Rod	
	07/08→	Track Control Arm	MN-DL-8544	Trailing Arm, Drive Axle	
	07/08→	Track control arm	MN-DL-12288	Trailing Arm	
	07/08→	Track Control Arm	MN-VB-8514	Suspension Rod, Wishbone (CV), Drive Axle	
	07/08→	Track Control Arm	MN-VB-8669	Suspension Rod, Wishbone (CV), Drive Axle	
41.480 FFDAK	06/08→	Centre Rod	MN-DL-8646	Push Rod	
	06/08→	Mounting, stabilizer coupling rod	MN-SB-5246		
	06/08→	Tie Rod	MN-DL-12287		
	06/08→	Tie Rod End	CV-ES-14163	for Steering Rod	
	06/08→	Tie Rod End	MN-ES-10333	for Steering Rod	
	06/08→	Track Control Arm	MN-DL-8544	Trailing Arm	
	06/08→	Track control arm	MN-DL-12288	Trailing Arm	
	06/08→	Track Control Arm	MN-VB-8514	Suspension Rod, Wishbone (CV)	
	41.480 FFDAK	06/08→	Centre Rod	MN-DL-8646	Push Rod
		06/08→	Mounting, stabilizer coupling rod	MN-SB-5246	
06/08→		Tie Rod	MN-DL-12287		
06/08→		Tie Rod End	MN-ES-10333	for Steering Rod	
06/08→		Track Control Arm	MN-DL-8544	Trailing Arm	
06/08→		Track Control Arm	MN-VB-8514	Suspension Rod, Wishbone (CV)	
41.480 FFDC, FFDRK, FFDARC	06/08→	Track control arm	MN-DL-12288	Trailing Arm	
41.480 FFDC-TM, FFDRK-TM, FFD-TM	10/07→	Centre Rod	MN-DL-7801	Push Rod, Leaf Spring Axle	
	10/07→	Centre Rod	MN-DL-8599	Push Rod	
	10/07→	Centre Rod	MN-DL-12285	for Steering Rod	
	10/07→	Tie Rod	MN-DL-7802		
	10/07→	Tie Rod	MN-DL-12293		
	10/07→	Tie Rod End	MN-ES-10333	for Steering Rod	
	10/07→	Track Control Arm	MN-DL-8544	Trailing Arm, Drive Axle	
	10/07→	Track control arm	MN-DL-12288	Trailing Arm	
	10/07→	Track Control Arm	MN-VB-8514	Suspension Rod, Wishbone (CV), Drive Axle	
	10/07→	Track Control Arm	MN-VB-8669	Suspension Rod, Wishbone (CV), Drive Axle	
41.480 FFDK, FDRK	07/08→	Centre Rod	MN-DL-7801	Push Rod, Leaf Spring Axle	
	07/08→	Centre Rod	MN-DL-8599	Push Rod	
	07/08→	Centre Rod	MN-DL-12285	for Steering Rod	
	07/08→	Tie Rod	MN-DL-7802		
	07/08→	Tie Rod	MN-DL-12293		
	07/08→	Tie Rod End	MN-ES-10333	for Steering Rod	

CV-ES-14163

Length: 125
Cone Ø: d1 Ø 30 / d2 Ø 27
Thread: M30 x 1,5 RHT

95301.0084, 90804102156, 90804102272, 90804102696, 90804102710, 81953010016, 81953010075, 81953010084, 81953010088, 81953010094, 81953010103, 81953016030, 81953016043, 81953016048, 81953016049, 81953016053, 81953016061, 81953016090, 81953016108, 81953016112, 81953016126, 81953016143, 81953016149, 81953016154, 81953016156, 81953016168, 81953016178, 81953016194, 81953016206, 81953016224, 81953016234, 81953016242, 81953016252, 81953016274, 81953016278, 81953016284, 81953016286, 81953016308, 81953016310, 81953016312, 81953016347, 81953016350, 81953016352, 82953016012, 88953016014, N2953016001



MN-DL-7801

Length: 995 Ø: 52
Cone Ø: d1 Ø 30 / d2 Ø 27

81466106807, 81466106808, 81466116087, 81466116088, 81466116096, 81466116097, 81466116099, 81466116132, 81466116133, 81466116136, 81466116197, 81466116198, 81466116205

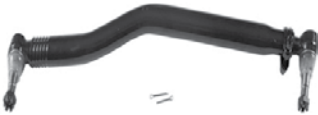

MN-DL-7802

Length: 1680 Ø: 52
Cone Ø: d1 Ø 30 / d2 Ø 27

03208300A, 81467116773, 81467116858, 81467116859, 81467116860, 81467116861, 81467116863, 81467116882, 81467116883, 81467116920, 81467116921



MN-DL-8544

Length: 596 Ø: 48
Hole Distance: 130 / 130

81432206196, 81432206232, 81432206233



MN-DL-8599

Length: 1800 Ø: 62
Cone Ø: d1 Ø 30 / d2 Ø 27

81466116161, 81466116162, 82466106183, 82466106186, 82466106187



MN-DL-8646

Length: 1021 Ø: 52
Cone Ø: d1 Ø 30 / d2 Ø 27

81466106811, 81466106812, 81466116138, 81466116139, 81466116201, 81466116202

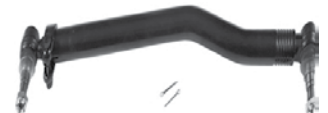

MN-DL-12285

Length: 993 Ø: 40
Cone Ø: d1 Ø 30 / d2 Ø 27

81466106816, 81466106826, 81466116151, 82466106184, 82466106185



MN-DL-12287

Length: 1531 Ø: 42
Cone Ø: d1 Ø 30 / d2 Ø 27

81467116855, 81467116856, 81467116857



MN-DL-12288

Length: 585 Ø: 58
Hole Distance: 130 / 130

81432206386, 82432206008, 82432209008

No Image

MN-DL-12293

Length: 1680 Ø: 42
Cone Ø: d1 Ø 30 / d2 Ø 27

81467106236, 81467106268, 81467106356, 81467116356, 81467116723, 81467116794, 81467116933, 81467116934, 81467116966



MN-ES-10333

Length: 90
Cone Ø: d1 Ø 38 / d2 Ø 34,35
Thread: M36 x 1,5 RHT

1271126, 3090291, 3099128, 42538048, 81953016268, 82953016018, 82953016019



MN-SB-5246

Ø: 45 Thick/Height: 47

81437220022, 81437220038, 81962100450, 81962100469



MN-VB-8514

Length: 627 Ø: 48
Hole Ø 25 / 25 / 25

Hole Distance: 152 / 130 / 130

81432706087, 81432706088, 81432706094, 81432706095, 81432796094



MN-VB-8669

Length: 627 Ø: 48
Hole Ø 25 / 25 / 25

Hole Distance: 152 / 130 / 130

81432706116, 81432706137, 81432706150, 81432706151





TGS ...

41.480 FFDK, FDRK ...	07/08→	Track Control Arm		MN-DL-8544	Trailing Arm, Drive Axle
	07/08→	Track control arm		MN-DL-12288	Trailing Arm
	07/08→	Track Control Arm		MN-VB-8514	Suspension Rod, Wishbone (CV), Drive Axle
	07/08→	Track Control Arm		MN-VB-8669	Suspension Rod, Wishbone (CV), Drive Axle
41.540 FFDK	02/09→	Centre Rod	MN-DL-8646		Push Rod
	02/09→	Mounting, stabilizer coupling rod	MN-SB-5246		
	02/09→	Tie Rod	MN-DL-12287		
	02/09→	Tie Rod End	CV-ES-14163		for Steering Rod
	02/09→	Tie Rod End	MN-ES-10333		for Steering Rod
	02/09→	Track Control Arm		MN-DL-8544	Trailing Arm
	02/09→	Track control arm		MN-DL-12288	Trailing Arm
	02/09→	Track Control Arm		MN-VB-8514	Suspension Rod, Wishbone (CV)
41.540 FFDC	02/09→	Centre Rod	MN-DL-7801		Push Rod, Leaf Spring Axle
	02/09→	Centre Rod	MN-DL-8599		Push Rod
	02/09→	Centre Rod	MN-DL-12285		for Steering Rod
	02/09→	Tie Rod	MN-DL-7802		
	02/09→	Tie Rod	MN-DL-12293		
	02/09→	Tie Rod End	MN-ES-10333		for Steering Rod
	02/09→	Track Control Arm		MN-DL-8544	Trailing Arm, Drive Axle
	02/09→	Track control arm		MN-DL-12288	Trailing Arm
	02/09→	Track Control Arm		MN-VB-8514	Suspension Rod, Wishbone (CV), Drive Axle
	02/09→	Track Control Arm		MN-VB-8669	Suspension Rod, Wishbone (CV), Drive Axle
41.540 FFDK	02/09→	Centre Rod	MN-DL-7801		Push Rod, Leaf Spring Axle
	02/09→	Centre Rod	MN-DL-8599		Push Rod
	02/09→	Centre Rod	MN-DL-12285		for Steering Rod
	02/09→	Tie Rod	MN-DL-7802		
	02/09→	Tie Rod	MN-DL-12293		
	02/09→	Tie Rod End	MN-ES-10333		for Steering Rod
	02/09→	Track Control Arm		MN-DL-8544	Trailing Arm, Drive Axle
	02/09→	Track control arm		MN-DL-12288	Trailing Arm
	02/09→	Track Control Arm		MN-VB-8514	Suspension Rod, Wishbone (CV), Drive Axle
	02/09→	Track Control Arm		MN-VB-8669	Suspension Rod, Wishbone (CV), Drive Axle
41.540 FFD-TM	10/07→	Centre Rod	MN-DL-7801		Push Rod, Leaf Spring Axle
	10/07→	Centre Rod	MN-DL-8599		Push Rod
	10/07→	Centre Rod	MN-DL-12285		for Steering Rod
	10/07→	Tie Rod	MN-DL-7802		
	10/07→	Tie Rod	MN-DL-12293		
	10/07→	Tie Rod End	MN-ES-10333		for Steering Rod
	10/07→	Track Control Arm		MN-DL-8544	Trailing Arm, Drive Axle
	10/07→	Track control arm		MN-DL-12288	Trailing Arm
	10/07→	Track Control Arm		MN-VB-8514	Suspension Rod, Wishbone (CV), Drive Axle
	10/07→	Track Control Arm		MN-VB-8669	Suspension Rod, Wishbone (CV), Drive Axle

TGX

18.360 FHLC	10/07→	Centre Rod	MN-DL-7801		Push Rod, Leaf Spring Axle
	10/07→	Suspension Strut Repair Kit		DB-RK-8581	
	10/07→	Tie Rod	MN-DL-7802		
	10/07→	Track Control Arm		MN-DL-5225	Trailing Arm, Drive Axle;Air Suspension Axle
	10/07→	Track Control Arm		MN-DL-8544	Trailing Arm, Drive Axle;Air Suspension Axle
	10/07→	Track Control Arm		MN-VB-5238	Wishbone (CV), Drive Axle;Air Suspension Axle
	10/07→	Track Control Arm		MN-VB-8514	Suspension Rod, Wishbone (CV), Drive Axle; Air Suspension Axle
18.360 FHLS, FHLS/M	10/07→	Centre Rod	MN-DL-7801		Push Rod, Leaf Spring Axle
	10/07→	Suspension Strut Repair Kit		DB-RK-8581	
	10/07→	Tie Rod	MN-DL-7802		
	10/07→	Track Control Arm		MN-DL-5225	Trailing Arm, Drive Axle;Air Suspension Axle
	10/07→	Track Control Arm		MN-DL-8544	Trailing Arm, Drive Axle;Air Suspension Axle
	10/07→	Track Control Arm		MN-VB-5238	Wishbone (CV), Drive Axle;Air Suspension Axle
	10/07→	Track Control Arm		MN-VB-8514	Suspension Rod, Wishbone (CV), Drive Axle; Air Suspension Axle
18.360 FLC, FLRC, FLLC, FLLRC, FLLW, FLLW/N	10/07→	Centre Rod	MN-DL-7801		Push Rod, Leaf Spring Axle
	10/07→	Centre Rod	MN-DL-8560		Push Rod, Air Suspension Axle
	10/07→	Suspension Strut Repair Kit		DB-RK-8581	

CV-ES-14163

Length: 125
Cone Ø: d1 Ø 30 / d2 Ø 27
Thread: M30 x 1,5 RHT

95301.0084, 90804102156, 90804102272, 90804102696, 90804102710, 81953010016, 81953010075, 81953010084, 81953010088, 81953010094, 81953010103, 81953016030, 81953016043, 81953016048, 81953016049, 81953016053, 81953016061, 81953016090, 81953016108, 81953016112, 81953016126, 81953016143, 81953016149, 81953016154, 81953016156, 81953016168, 81953016178, 81953016194, 81953016206, 81953016224, 81953016234, 81953016242, 81953016252, 81953016274, 81953016278, 81953016284, 81953016286, 81953016308, 81953016310, 81953016312, 81953016347, 81953016350, 81953016352, 82953016012, 88953016014, N2953016001



DB-RK-8581

Ø: 85
Hole Distance: 130
Thick/Height: 24
03305800A, 81432706105



MN-DL-5225

Length: 572 Ø: 48
Hole Distance: 130 / 130

03301500A, 81432206229, 81432206236, 81432206267, 81432206270, 81432206272, 81432206304, 81432206305, 81432209236, 81432209267, 81432209272



MN-DL-7801

Length: 995 Ø: 52
Cone Ø: d1 Ø 30 / d2 Ø 27

81466106807, 81466106808, 81466116087, 81466116088, 81466116096, 81466116097, 81466116099, 81466116132, 81466116133, 81466116136, 81466116197, 81466116198, 81466116205

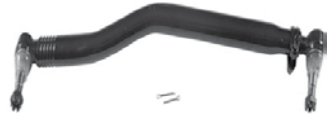

MN-DL-7802

Length: 1680 Ø: 52
Cone Ø: d1 Ø 30 / d2 Ø 27

03208300A, 81467116773, 81467116858, 81467116859, 81467116860, 81467116861, 81467116863, 81467116882, 81467116883, 81467116920, 81467116921



MN-DL-8544

Length: 596 Ø: 48
Hole Distance: 130 / 130
81432206196, 81432206232, 81432206233



MN-DL-8560

Length: 970 Ø: 52
Cone Ø: d1 Ø 30 / d2 Ø 27

03206900A, 81466106809, 81466106810, 81466106823, 81466106838, 81466106839, 81466116104, 81466116105, 81466116107, 81466116134, 81466116135, 81466116137, 81466116199, 81466116200, 81466116206



MN-DL-8599

Length: 1800 Ø: 62
Cone Ø: d1 Ø 30 / d2 Ø 27

81466116161, 81466116162, 82466106183, 82466106186, 82466106187



MN-DL-8646

Length: 1021 Ø: 52
Cone Ø: d1 Ø 30 / d2 Ø 27

81466106811, 81466106812, 81466116138, 81466116139, 81466116201, 81466116202

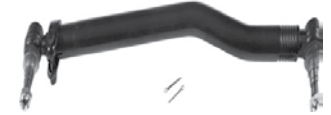

MN-DL-12285

Length: 993 Ø: 40
Cone Ø: d1 Ø 30 / d2 Ø 27

81466106816, 81466106826, 81466116151, 82466106184, 82466106185



MN-DL-12287

Length: 1531 Ø: 42
Cone Ø: d1 Ø 30 / d2 Ø 27

81467116855, 81467116856, 81467116857



MN-DL-12288

Length: 585 Ø: 58
Hole Distance: 130 / 130

81432206386, 82432206008, 82432209008



No Image

MN-DL-12293

Length: 1680 Ø: 42
Cone Ø: d1 Ø 30 / d2 Ø 27

81467106236, 81467106268, 81467106356, 81467116356, 81467116723, 81467116794, 81467116933, 81467116934, 81467116966



MN-ES-10333

Length: 90
Cone Ø: d1 Ø 38 / d2 Ø 34,35
Thread: M36 x 1,5 RHT
1271126, 3090291, 3099128, 42538048, 81953016268, 82953016018, 82953016019



MN-SB-5246

Ø: 45 Thick/Height: 47
81437220022, 81437220038, 81962100450, 81962100469



MN-VB-5238

Length: 627 Ø: 48
Hole Distance: 130 / 130
81432206221, 81432706096, 81432706114, 81432706116, 81432706121



MN-VB-8514

Length: 627 Ø: 48
Hole Ø 25 / 25 / 25
Hole Distance: 152 / 130 / 130
81432706087, 81432706088, 81432706094, 81432706095, 81432796094



MN-VB-8669

Length: 627 Ø: 48
Hole Ø 25 / 25 / 25
Hole Distance: 152 / 130 / 130
81432706116, 81432706137, 81432706150, 81432706151





TGX ...

18.360 FLC, FLRC, FLLC, FLRC, FLLW, FLLW/N ...	10/07→	Suspension Strut Repair Kit		MN-RK-12436	
	10/07→	Tie Rod	MN-DL-7802		
	10/07→	Tie Rod	MN-DL-12293		
	10/07→	Track Control Arm		MN-DL-5225	Trailing Arm, Drive Axle;Air Suspension Axle
	10/07→	Track Control Arm		MN-DL-8544	Trailing Arm, Drive Axle;Air Suspension Axle
	10/07→	Track Control Arm		MN-DL-8733	Trailing Arm, Air Suspension Axle;Drive Axle
	10/07→	Track Control Arm		MN-VB-5238	Wishbone (CV), 1st RA;Air Suspension Axle
	10/07→	Track Control Arm		MN-VB-5238	Wishbone (CV), Drive Axle;Air Suspension Axle
	10/07→	Track Control Arm		MN-VB-8514	Suspension Rod, Wishbone (CV), Drive Axle; Air Suspension Axle
	10/07→	Track Control Arm	MN-DL-8663		Control Arm, Air Suspension Axle
18.360 FLS, FLS/M, FLRS, FLRS/N, FLLS, FLLS/N, FLLRS,FLLRS/N	10/07→	Centre Rod	MN-DL-7801		Push Rod, Leaf Spring Axle
	10/07→	Centre Rod	MN-DL-8560		Push Rod, Air Suspension Axle
	10/07→	Suspension Strut Repair Kit		DB-RK-8581	
	10/07→	Suspension Strut Repair Kit		MN-RK-12436	
	10/07→	Tie Rod	MN-DL-7802		
	10/07→	Tie Rod	MN-DL-12293		
	10/07→	Track Control Arm		MN-DL-5225	Trailing Arm, Drive Axle;Air Suspension Axle
	10/07→	Track Control Arm		MN-DL-8488	Trailing Arm;for Wishbone (CV), Air Suspension Axle
	10/07→	Track Control Arm		MN-DL-8544	Trailing Arm, Drive Axle;Air Suspension Axle
	10/07→	Track Control Arm		MN-DL-8733	Trailing Arm, Air Suspension Axle;Drive Axle
	10/07→	Track Control Arm		MN-VB-5238	Wishbone (CV), 1st RA;Air Suspension Axle
	10/07→	Track Control Arm		MN-VB-8514	Suspension Rod, Wishbone (CV), Drive Axle; Air Suspension Axle
	10/07→	Track Control Arm	MN-DL-8663		Control Arm, Air Suspension Axle
	18.400 FHLC	10/07→	Centre Rod	MN-DL-7801	
10/07→		Suspension Strut Repair Kit		DB-RK-8581	
10/07→		Tie Rod	MN-DL-7802		
10/07→		Track Control Arm		MN-DL-5225	Trailing Arm, Drive Axle;Air Suspension Axle
10/07→		Track Control Arm		MN-DL-8544	Trailing Arm, Drive Axle;Air Suspension Axle
10/07→		Track Control Arm		MN-VB-5238	Wishbone (CV), Drive Axle;Air Suspension Axle
10/07→		Track Control Arm		MN-VB-8514	Suspension Rod, Wishbone (CV), Drive Axle; Air Suspension Axle
18.400 FHLS, FHLS/M	10/07→	Centre Rod	MN-DL-7801		Push Rod, Leaf Spring Axle
	10/07→	Suspension Strut Repair Kit		DB-RK-8581	
	10/07→	Tie Rod	MN-DL-7802		
	10/07→	Track Control Arm		MN-DL-5225	Trailing Arm, Drive Axle;Air Suspension Axle
	10/07→	Track Control Arm		MN-DL-8544	Trailing Arm, Drive Axle;Air Suspension Axle
	10/07→	Track Control Arm		MN-VB-5238	Wishbone (CV), Drive Axle;Air Suspension Axle
	10/07→	Track Control Arm		MN-VB-8514	Suspension Rod, Wishbone (CV), Drive Axle; Air Suspension Axle
18.400 FLC, FLRC, FLLC, FLRC, FLLW, FLLW/N	10/07→	Centre Rod	MN-DL-7801		Push Rod, Leaf Spring Axle
	10/07→	Centre Rod	MN-DL-8560		Push Rod, Air Suspension Axle
	10/07→	Suspension Strut Repair Kit		DB-RK-8581	
	10/07→	Suspension Strut Repair Kit		MN-RK-12436	
	10/07→	Tie Rod	MN-DL-7802		
	10/07→	Tie Rod	MN-DL-12293		
	10/07→	Track Control Arm		MN-DL-5225	Trailing Arm, Drive Axle;Air Suspension Axle
	10/07→	Track Control Arm		MN-DL-8544	Trailing Arm, Drive Axle;Air Suspension Axle
	10/07→	Track Control Arm		MN-DL-8733	Trailing Arm, Air Suspension Axle;Drive Axle
	10/07→	Track Control Arm		MN-VB-5238	Wishbone (CV), 1st RA;Air Suspension Axle
	10/07→	Track Control Arm		MN-VB-8514	Suspension Rod, Wishbone (CV), Drive Axle; Air Suspension Axle
18.400 FLS, FLS/M, FLRS, FLRS/N, FLLS, FLLS/N, FLLRS,FLLRS/N	10/07→	Track Control Arm	MN-DL-8663		Control Arm, Air Suspension Axle
	10/07→	Centre Rod	MN-DL-7801		Push Rod, Leaf Spring Axle
	10/07→	Centre Rod	MN-DL-8560		Push Rod, Air Suspension Axle
	10/07→	Suspension Strut Repair Kit		DB-RK-8581	
	10/07→	Suspension Strut Repair Kit		MN-RK-12436	
	10/07→	Tie Rod	MN-DL-7802		
	10/07→	Tie Rod	MN-DL-12293		
	10/07→	Track Control Arm		MN-DL-5225	Trailing Arm, Drive Axle;Air Suspension Axle
	10/07→	Track Control Arm		MN-DL-8544	Trailing Arm, Drive Axle;Air Suspension Axle
	10/07→	Track Control Arm		MN-DL-8733	Trailing Arm, Air Suspension Axle;Drive Axle
	10/07→	Track Control Arm		MN-VB-5238	Wishbone (CV), 1st RA;Air Suspension Axle

DB-RK-8581

Ø: 85
Hole Distance: 130
Thick/Height: 24
03305800A, 81432706105



MN-DL-5225

Length: 572 Ø: 48
Hole Distance: 130 / 130

03301500A, 81432206229, 81432206236,
81432206267, 81432206270, 81432206272,
81432206304, 81432206305, 81432209236,
81432209267, 81432209272



MN-DL-7801

Length: 995 Ø: 52
Cone Ø: d1 Ø 30 / d2 Ø 27

81466106807, 81466106808, 81466116087,
81466116088, 81466116096, 81466116097,
81466116099, 81466116132, 81466116133,
81466116136, 81466116197, 81466116198,
81466116205



MN-DL-7802

Length: 1680 Ø: 52
Cone Ø: d1 Ø 30 / d2 Ø 27

03208300A, 81467116773, 81467116858,
81467116859, 81467116860, 81467116861,
81467116863, 81467116882, 81467116883,
81467116920, 81467116921



MN-DL-8488

Length: 414 Ø: 50
Hole Distance: 130 / 130

81432206247, 81432206341, 81432206342



MN-DL-8544

Length: 596 Ø: 48
Hole Distance: 130 / 130

81432206196, 81432206232, 81432206233



MN-DL-8560

Length: 970 Ø: 52
Cone Ø: d1 Ø 30 / d2 Ø 27

03206900A, 81466106809, 81466106810,
81466106823, 81466106838, 81466106839,
81466116104, 81466116105, 81466116107,
81466116134, 81466116135, 81466116137,
81466116199, 81466116200, 81466116206



MN-DL-8663

Length: 947 Ø: 60
Hole Distance: 115 / 115

03307400A, 81432206222, 81432206260,
81432206283, 81432206284



MN-DL-8733

Length: 530 Ø: 48
Hole Distance: 130 / 130

81432206161, 81432206190, 81432206358,
81432206359



MN-DL-12293

Length: 1680 Ø: 42
Cone Ø: d1 Ø 30 / d2 Ø 27

81467106236, 81467106268, 81467106356,
81467116356, 81467116723, 81467116794,
81467116933, 81467116934, 81467116966



MN-RK-12436

Ø: 75
Hole Distance: 115
Thick/Height: 24

81432206244



MN-VB-5238

Length: 627 Ø: 48
Hole Distance: 130 / 130

81432206221, 81432706096, 81432706114,
81432706116, 81432706121



MN-VB-8514

Length: 627 Ø: 48
Hole Ø 25 / 25 / 25
Hole Distance: 152 / 130 / 130

81432706087, 81432706088, 81432706094,
81432706095, 81432796094





TGX ...

18.400 FLS, FLS/M, FLRS, FLRS/N, FLLS, FLLS/N, FLLRS, FLLRS/N ...	10/07→	Track Control Arm		MN-DL-8488	Trailing Arm;for Wishbone (CV), Air Suspension Axle	
	10/07→	Track Control Arm		MN-DL-8544	Trailing Arm, Drive Axle;Air Suspension Axle	
	10/07→	Track Control Arm		MN-DL-8733	Trailing Arm, Air Suspension Axle;Drive Axle	
	10/07→	Track Control Arm		MN-VB-5238	Wishbone (CV), 1st RA;Air Suspension Axle	
	10/07→	Track Control Arm		MN-VB-8514	Suspension Rod, Wishbone (CV), Drive Axle; Air Suspension Axle	
18.440 FHLC	10/07→	Track Control Arm	MN-DL-8663		Control Arm, Air Suspension Axle	
	10/07→	Centre Rod	MN-DL-7801		Push Rod, Leaf Spring Axle	
	10/07→	Suspension Strut Repair Kit		DB-RK-8581		
	10/07→	Tie Rod	MN-DL-7802			
	10/07→	Track Control Arm		MN-DL-5225	Trailing Arm, Drive Axle;Air Suspension Axle	
	10/07→	Track Control Arm		MN-DL-8544	Trailing Arm, Drive Axle;Air Suspension Axle	
	10/07→	Track Control Arm		MN-VB-5238	Wishbone (CV), Drive Axle;Air Suspension Axle	
18.440 FHLS, FHLS/M	10/07→	Centre Rod	MN-DL-7801		Push Rod, Leaf Spring Axle	
	10/07→	Suspension Strut Repair Kit		DB-RK-8581		
	10/07→	Tie Rod	MN-DL-7802			
	10/07→	Track Control Arm		MN-DL-5225	Trailing Arm, Drive Axle;Air Suspension Axle	
	10/07→	Track Control Arm		MN-DL-8544	Trailing Arm, Drive Axle;Air Suspension Axle	
	10/07→	Track Control Arm		MN-VB-5238	Wishbone (CV), Drive Axle;Air Suspension Axle	
18.440 FLC, FLLC, FLLRC, FLLW, FLRC	10/07→	Centre Rod	MN-DL-7801		Push Rod	
	10/07→	Mounting, stabilizer coupling rod	MN-SB-5246			
	10/07→	Tie Rod	MN-DL-7802			
	10/07→	Tie Rod	MN-DL-12293			
	10/07→	Track Control Arm		MN-DL-5225	Trailing Arm	
	10/07→	Track Control Arm		MN-DL-8544	Trailing Arm	
	10/07→	Track Control Arm		MN-DL-8733	Trailing Arm	
	10/07→	Track Control Arm		MN-TC-12399	Control Arm	
	10/07→	Track Control Arm		MN-VB-8514	Suspension Rod, Wishbone (CV)	
	10/07→	Track Control Arm	MN-VB-5238	MN-VB-5238	Wishbone (CV);Control Arm	
	10/07→	Track Control Arm	MN-DL-7801		Push Rod, Leaf Spring Axle	
18.440 FLC, FLRC, FLLC, FLLRC, FLLW, FLLW/N	10/07→	Centre Rod	MN-DL-8560		Push Rod, Air Suspension Axle	
	10/07→	Suspension Strut Repair Kit		DB-RK-8581		
	10/07→	Suspension Strut Repair Kit		MN-RK-12436		
	10/07→	Tie Rod	MN-DL-7802			
	10/07→	Tie Rod	MN-DL-12293			
	10/07→	Track Control Arm		MN-DL-5225	Trailing Arm, Drive Axle;Air Suspension Axle	
	10/07→	Track Control Arm		MN-DL-8544	Trailing Arm, Drive Axle;Air Suspension Axle	
	10/07→	Track Control Arm		MN-DL-8733	Trailing Arm, Air Suspension Axle;Drive Axle	
	10/07→	Track Control Arm		MN-VB-5238	Wishbone (CV), 1st RA;Air Suspension Axle	
	10/07→	Track Control Arm		MN-VB-8514	Suspension Rod, Wishbone (CV), Drive Axle; Air Suspension Axle	
	10/07→	Track Control Arm	MN-DL-8663		Control Arm, Air Suspension Axle	
	18.440 FLS, FLS/M, FLRS, FLRS/M, FLLS, FLLS/N, FLLRS, FLLRS	10/07→	Centre Rod	MN-DL-7801		Push Rod, Leaf Spring Axle
		10/07→	Centre Rod	MN-DL-8560		Push Rod, Air Suspension Axle
		10/07→	Suspension Strut Repair Kit		DB-RK-8581	
10/07→		Suspension Strut Repair Kit		MN-RK-12436		
10/07→		Tie Rod	MN-DL-7802			
10/07→		Tie Rod	MN-DL-12293			
10/07→		Track Control Arm		MN-DL-5225	Trailing Arm, Drive Axle;Air Suspension Axle	
10/07→		Track Control Arm		MN-DL-8544	Trailing Arm, Drive Axle;Air Suspension Axle	
10/07→		Track Control Arm		MN-DL-8733	Trailing Arm, Air Suspension Axle;Drive Axle	
10/07→		Track Control Arm		MN-VB-5238	Wishbone (CV), 1st RA;Air Suspension Axle	
18.440 FLS, FLS/M, FLRS, FLRS/M, FLLS, FLLS/N, FLLRS, FLLRS	10/07→	Track Control Arm		MN-VB-8514	Suspension Rod, Wishbone (CV), Drive Axle; Air Suspension Axle	
	10/07→	Track Control Arm	MN-DL-8663		Control Arm, Air Suspension Axle	

DB-RK-8581

Ø: 85
Hole Distance: 130
Thick/Height: 24
03305800A, 81432706105



MN-DL-5225

Length: 572 Ø: 48
Hole Distance: 130 / 130
03301500A, 81432206229, 81432206236,
81432206267, 81432206270, 81432206272,
81432206304, 81432206305, 81432209236,
81432209267, 81432209272



MN-DL-7801

Length: 995 Ø: 52
Cone Ø: d1 Ø 30 / d2 Ø 27
81466106807, 81466106808, 81466116087,
81466116088, 81466116096, 81466116097,
81466116099, 81466116132, 81466116133,
81466116136, 81466116197, 81466116198,
81466116205



MN-DL-7802

Length: 1680 Ø: 52
Cone Ø: d1 Ø 30 / d2 Ø 27
03208300A, 81467116773, 81467116858,
81467116859, 81467116860, 81467116861,
81467116863, 81467116882, 81467116883,
81467116920, 81467116921



MN-DL-8488

Length: 414 Ø: 50
Hole Distance: 130 / 130
81432206247, 81432206341, 81432206342



MN-DL-8544

Length: 596 Ø: 48
Hole Distance: 130 / 130
81432206196, 81432206232, 81432206233



MN-DL-8560

Length: 970 Ø: 52
Cone Ø: d1 Ø 30 / d2 Ø 27
03206900A, 81466106809, 81466106810,
81466106823, 81466106838, 81466106839,
81466116104, 81466116105, 81466116107,
81466116134, 81466116135, 81466116137,
81466116199, 81466116200, 81466116206



MN-DL-8663

Length: 947 Ø: 60
Hole Distance: 115 / 115
03307400A, 81432206222, 81432206260,
81432206283, 81432206284



MN-DL-8733

Length: 530 Ø: 48
Hole Distance: 130 / 130
81432206161, 81432206190, 81432206358,
81432206359



MN-DL-12293

Length: 1680 Ø: 42
Cone Ø: d1 Ø 30 / d2 Ø 27
81467106236, 81467106268, 81467106356,
81467116356, 81467116723, 81467116794,
81467116933, 81467116934, 81467116966



MN-RK-12436

Ø: 75
Hole Distance: 115
Thick/Height: 24
81432206244



MN-SB-5246

Ø: 45 Thick/Height: 47
81437220022, 81437220038, 81962100450,
81962100469



MN-TC-12399

Length: 694 Ø: 50
Hole Distance: 130 / 130
81432206265



MN-VB-5238

Length: 627 Ø: 48
Hole Distance: 130 / 130
81432206221, 81432706096, 81432706114,
81432706116, 81432706121



MN-VB-8514

Length: 627 Ø: 48
Hole Ø 25 / 25 / 25
Hole Distance: 152 / 130 / 130
81432706087, 81432706088, 81432706094,
81432706095, 81432796094





TGX ...

18.440 FLS, FLSS, FLSS/N, FLRS, FLRS/N, FLLRS, FLLS	10/07→	Centre Rod	MN-DL-7801		Push Rod
	10/07→	Mounting, stabilizer coupling rod	MN-SB-5246		
	10/07→	Tie Rod	MN-DL-7802		
	10/07→	Tie Rod	MN-DL-12293		
	10/07→	Track Control Arm		MN-DL-5225	Trailing Arm
	10/07→	Track Control Arm		MN-DL-8544	Trailing Arm
	10/07→	Track Control Arm		MN-DL-8733	Trailing Arm
	10/07→	Track Control Arm		MN-TC-12399	Control Arm
	10/07→	Track Control Arm		MN-VB-8514	Suspension Rod, Wishbone (CV)
	10/07→	Track Control Arm	MN-VB-5238	MN-VB-5238	Wishbone (CV);Control Arm
18.480 FHLC	10/07→	Centre Rod	MN-DL-7801		Push Rod, Leaf Spring Axle
	10/07→	Suspension Strut Repair Kit		DB-RK-8581	
	10/07→	Tie Rod	MN-DL-7802		
	10/07→	Track Control Arm		MN-DL-5225	Trailing Arm, Drive Axle;Air Suspension Axle
	10/07→	Track Control Arm		MN-DL-8544	Trailing Arm, Drive Axle;Air Suspension Axle
	10/07→	Track Control Arm		MN-VB-5238	Wishbone (CV), Drive Axle;Air Suspension Axle
	10/07→	Track Control Arm		MN-VB-8514	Suspension Rod, Wishbone (CV), Drive Axle; Air Suspension Axle
18.480 FHLS, FHLS/M	10/07→	Centre Rod	MN-DL-7801		Push Rod, Leaf Spring Axle
	10/07→	Suspension Strut Repair Kit		DB-RK-8581	
	10/07→	Tie Rod	MN-DL-7802		
	10/07→	Track Control Arm		MN-DL-5225	Trailing Arm, Drive Axle;Air Suspension Axle
	10/07→	Track Control Arm		MN-DL-8544	Trailing Arm, Drive Axle;Air Suspension Axle
	10/07→	Track Control Arm		MN-VB-5238	Wishbone (CV), Drive Axle;Air Suspension Axle
18.480 FLC, FLRC, FLLC, FLLRC, FLLW, FLLW/N	10/07→	Centre Rod	MN-DL-7801		Push Rod, Leaf Spring Axle
	10/07→	Centre Rod	MN-DL-8560		Push Rod, Air Suspension Axle
	10/07→	Suspension Strut Repair Kit		DB-RK-8581	
	10/07→	Suspension Strut Repair Kit		MN-RK-12436	
	10/07→	Tie Rod	MN-DL-7802		
	10/07→	Tie Rod	MN-DL-12293		
	10/07→	Track Control Arm		MN-DL-5225	Trailing Arm, Drive Axle;Air Suspension Axle
	10/07→	Track Control Arm		MN-DL-8544	Trailing Arm, Drive Axle;Air Suspension Axle
	10/07→	Track Control Arm		MN-DL-8733	Trailing Arm, Air Suspension Axle;Drive Axle
	10/07→	Track Control Arm		MN-VB-5238	Wishbone (CV), 1st RA;Air Suspension Axle
	10/07→	Track Control Arm		MN-VB-8514	Suspension Rod, Wishbone (CV), Drive Axle; Air Suspension Axle
	10/07→	Track Control Arm	MN-DL-8663		Control Arm, Air Suspension Axle
	18.480 FLS, FLS/M, FLRS, FLRS/N, FLLS, FLLS/N, FLLRS,FLLRS/N	10/07→	Centre Rod	MN-DL-7801	
10/07→		Centre Rod	MN-DL-8560		Push Rod, Air Suspension Axle
10/07→		Suspension Strut Repair Kit		DB-RK-8581	
10/07→		Suspension Strut Repair Kit		MN-RK-12436	
10/07→		Tie Rod	MN-DL-7802		
10/07→		Tie Rod	MN-DL-12293		
10/07→		Track Control Arm		MN-DL-5225	Trailing Arm, Drive Axle;Air Suspension Axle
10/07→		Track Control Arm		MN-DL-8488	Trailing Arm;for Wishbone (CV), Air Suspension Axle
10/07→		Track Control Arm		MN-DL-8544	Trailing Arm, Drive Axle;Air Suspension Axle
10/07→		Track Control Arm		MN-DL-8733	Trailing Arm, Air Suspension Axle;Drive Axle
10/07→		Track Control Arm		MN-VB-5238	Wishbone (CV), 1st RA;Air Suspension Axle
10/07→		Track Control Arm		MN-VB-8514	Suspension Rod, Wishbone (CV), Drive Axle; Air Suspension Axle
10/07→		Track Control Arm	MN-DL-8663		Control Arm, Air Suspension Axle
18.540 FHLC		10/07→	Centre Rod	MN-DL-7801	
	10/07→	Suspension Strut Repair Kit		DB-RK-8581	
	10/07→	Tie Rod	MN-DL-7802		
	10/07→	Track Control Arm		MN-DL-5225	Trailing Arm, Drive Axle;Air Suspension Axle
	10/07→	Track Control Arm		MN-DL-8544	Trailing Arm, Drive Axle;Air Suspension Axle
	10/07→	Track Control Arm		MN-VB-5238	Wishbone (CV), Drive Axle;Air Suspension Axle
	10/07→	Track Control Arm		MN-VB-8514	Suspension Rod, Wishbone (CV), Drive Axle; Air Suspension Axle

DB-RK-8581

Ø: 85
Hole Distance: 130
Thick/Height: 24
03305800A, 81432706105



MN-DL-5225

Length: 572 Ø: 48
Hole Distance: 130 / 130

03301500A, 81432206229, 81432206236,
81432206267, 81432206270, 81432206272,
81432206304, 81432206305, 81432209236,
81432209267, 81432209272



MN-DL-7801

Length: 995 Ø: 52
Cone Ø: d1 Ø 30 / d2 Ø 27

81466106807, 81466106808, 81466116087,
81466116088, 81466116096, 81466116097,
81466116099, 81466116132, 81466116133,
81466116136, 81466116197, 81466116198,
81466116205



MN-DL-7802

Length: 1680 Ø: 52
Cone Ø: d1 Ø 30 / d2 Ø 27

03208300A, 81467116773, 81467116858,
81467116859, 81467116860, 81467116861,
81467116863, 81467116882, 81467116883,
81467116920, 81467116921



MN-DL-8488

Length: 414 Ø: 50
Hole Distance: 130 / 130

81432206247, 81432206341, 81432206342



MN-DL-8544

Length: 596 Ø: 48
Hole Distance: 130 / 130

81432206196, 81432206232, 81432206233



MN-DL-8560

Length: 970 Ø: 52
Cone Ø: d1 Ø 30 / d2 Ø 27

03206900A, 81466106809, 81466106810,
81466106823, 81466106838, 81466106839,
81466116104, 81466116105, 81466116107,
81466116134, 81466116135, 81466116137,
81466116199, 81466116200, 81466116206



MN-DL-8663

Length: 947 Ø: 60
Hole Distance: 115 / 115

03307400A, 81432206222, 81432206260,
81432206283, 81432206284



MN-DL-8733

Length: 530 Ø: 48
Hole Distance: 130 / 130

81432206161, 81432206190, 81432206358,
81432206359



MN-DL-12293

Length: 1680 Ø: 42
Cone Ø: d1 Ø 30 / d2 Ø 27

81467106236, 81467106268, 81467106356,
81467116356, 81467116723, 81467116794,
81467116933, 81467116934, 81467116966



MN-RK-12436

Ø: 75
Hole Distance: 115
Thick/Height: 24

81432206244



MN-SB-5246

Ø: 45 Thick/Height: 47

81437220022, 81437220038, 81962100450,
81962100469



MN-TC-12399

Length: 694 Ø: 50
Hole Distance: 130 / 130

81432206265



MN-VB-5238

Length: 627 Ø: 48
Hole Distance: 130 / 130

81432206221, 81432706096, 81432706114,
81432706116, 81432706121



MN-VB-8514

Length: 627 Ø: 48
Hole Ø 25 / 25 / 25
Hole Distance: 152 / 130 / 130

81432706087, 81432706088, 81432706094,
81432706095, 81432796094



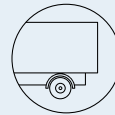

TGX ...

18.540 FHLS, FHLS/M	10/07→	Centre Rod	MN-DL-7801		Push Rod, Leaf Spring Axle	
	10/07→	Suspension Strut Repair Kit		DB-RK-8581		
	10/07→	Tie Rod	MN-DL-7802			
	10/07→	Track Control Arm		MN-DL-5225	Trailing Arm, Drive Axle;Air Suspension Axle	
	10/07→	Track Control Arm		MN-DL-8544	Trailing Arm, Drive Axle;Air Suspension Axle	
	10/07→	Track Control Arm		MN-VB-5238	Wishbone (CV), Drive Axle;Air Suspension Axle	
	10/07→	Track Control Arm		MN-VB-8514	Suspension Rod, Wishbone (CV), Drive Axle; Air Suspension Axle	
18.540 FLC, FLRC, FLLC, FLLRC, FLLW, FLLW/N	10/07→	Centre Rod	MN-DL-7801		Push Rod, Leaf Spring Axle	
	10/07→	Centre Rod	MN-DL-8560		Push Rod, Air Suspension Axle	
	10/07→	Suspension Strut Repair Kit		DB-RK-8581		
	10/07→	Suspension Strut Repair Kit		MN-RK-12436		
	10/07→	Tie Rod	MN-DL-7802			
	10/07→	Tie Rod	MN-DL-12293			
	10/07→	Track Control Arm		MN-DL-5225	Trailing Arm, Drive Axle;Air Suspension Axle	
	10/07→	Track Control Arm		MN-DL-8544	Trailing Arm, Drive Axle;Air Suspension Axle	
	10/07→	Track Control Arm		MN-DL-8733	Trailing Arm, Air Suspension Axle;Drive Axle	
	10/07→	Track Control Arm		MN-VB-5238	Wishbone (CV), 1st RA;Air Suspension Axle	
	10/07→	Track Control Arm		MN-VB-8514	Suspension Rod, Wishbone (CV), Drive Axle; Air Suspension Axle	
	10/07→	Track Control Arm	MN-DL-8663		Control Arm, Air Suspension Axle	
	10/07→	Centre Rod	MN-DL-7801		Push Rod, Leaf Spring Axle	
	10/07→	Centre Rod	MN-DL-8560		Push Rod, Air Suspension Axle	
18.540 FLS, FLS/M, FLRS, FLRS/N, FLLS, FLLS/N,FLLRS,FLLRS/N	10/07→	Suspension Strut Repair Kit		DB-RK-8581		
	10/07→	Suspension Strut Repair Kit		MN-RK-12436		
	10/07→	Tie Rod	MN-DL-7802			
	10/07→	Tie Rod	MN-DL-12293			
	10/07→	Track Control Arm		MN-DL-5225	Trailing Arm, Drive Axle;Air Suspension Axle	
	10/07→	Track Control Arm		MN-DL-8488	Trailing Arm;for Wishbone (CV), Air Suspension Axle	
	10/07→	Track Control Arm		MN-DL-8544	Trailing Arm, Drive Axle;Air Suspension Axle	
	10/07→	Track Control Arm		MN-DL-8733	Trailing Arm, Air Suspension Axle;Drive Axle	
	10/07→	Track Control Arm		MN-VB-5238	Wishbone (CV), 1st RA;Air Suspension Axle	
	10/07→	Track Control Arm		MN-VB-8514	Suspension Rod, Wishbone (CV), Drive Axle; Air Suspension Axle	
	10/07→	Track Control Arm	MN-DL-8663		Control Arm, Air Suspension Axle	
	18.680 FLS	10/07→	Centre Rod	MN-DL-7801		Push Rod, Leaf Spring Axle
		10/07→	Suspension Strut Repair Kit		DB-RK-8581	
		10/07→	Tie Rod	MN-DL-7802		
10/07→		Tie Rod	MN-DL-12293			
10/07→		Track Control Arm		MN-DL-5225	Trailing Arm, Drive Axle;Air Suspension Axle	
10/07→		Track Control Arm		MN-DL-8544	Trailing Arm, Drive Axle;Air Suspension Axle	
10/07→		Track Control Arm		MN-DL-8733	Trailing Arm, Air Suspension Axle;Drive Axle	
10/07→		Track Control Arm		MN-TC-12399	Control Arm	
10/07→		Track Control Arm		MN-VB-5238	Wishbone (CV), Drive Axle;Air Suspension Axle	
10/07→		Track Control Arm		MN-VB-8514	Suspension Rod, Wishbone (CV), Drive Axle; Air Suspension Axle	
24.360 FNLLW/N		10/07→	Centre Rod	MN-DL-8560		Push Rod, Air Suspension Axle
	10/07→	Suspension Strut Repair Kit		DB-RK-8581		
	10/07→	Suspension Strut Repair Kit		MN-RK-12436		
	10/07→	Tie Rod	MN-DL-7802			
	10/07→	Track Control Arm		MN-DL-5225	Trailing Arm, Drive Axle;Tag Axle; Air Suspension Axle	
	10/07→	Track Control Arm		MN-VB-9403	Wishbone (CV), Air Suspension Axle	
	10/07→	Track Control Arm	MN-DL-8663		Control Arm, Air Suspension Axle	
24.360 FPLS, FPLRS	10/07→	Centre Rod	MN-DL-7801		Push Rod	
	10/07→	Centre Rod	MN-DL-8560		Push Rod, Air Suspension Axle	
	10/07→	Mounting, stabilizer coupling rod	MN-SB-5246			
	10/07→	Suspension Strut Repair Kit		DB-RK-8581		
	10/07→	Suspension Strut Repair Kit		MN-RK-12436		
	10/07→	Tie Rod	MN-DL-7802			
	10/07→	Track Control Arm		MN-DL-5225	Trailing Arm, Drive Axle;Tag Axle; Air Suspension Axle	

DB-RK-8581

Ø: 85
Hole Distance: 130
Thick/Height: 24
03305800A, 81432706105



MN-DL-5225

Length: 572 Ø: 48
Hole Distance: 130 / 130
03301500A, 81432206229, 81432206236,
81432206267, 81432206270, 81432206272,
81432206304, 81432206305, 81432209236,
81432209267, 81432209272



MN-DL-7801

Length: 995 Ø: 52
Cone Ø: d1 Ø 30 / d2 Ø 27
81466106807, 81466106808, 81466116087,
81466116088, 81466116096, 81466116097,
81466116099, 81466116132, 81466116133,
81466116136, 81466116197, 81466116198,
81466116205



MN-DL-7802

Length: 1680 Ø: 52
Cone Ø: d1 Ø 30 / d2 Ø 27
03208300A, 81467116773, 81467116858,
81467116859, 81467116860, 81467116861,
81467116863, 81467116882, 81467116883,
81467116920, 81467116921



MN-DL-8488

Length: 414 Ø: 50
Hole Distance: 130 / 130
81432206247, 81432206341, 81432206342



MN-DL-8544

Length: 596 Ø: 48
Hole Distance: 130 / 130
81432206196, 81432206232, 81432206233



MN-DL-8560

Length: 970 Ø: 52
Cone Ø: d1 Ø 30 / d2 Ø 27
03206900A, 81466106809, 81466106810,
81466106823, 81466106838, 81466106839,
81466116104, 81466116105, 81466116107,
81466116134, 81466116135, 81466116137,
81466116199, 81466116200, 81466116206



MN-DL-8663

Length: 947 Ø: 60
Hole Distance: 115 / 115
03307400A, 81432206222, 81432206260,
81432206283, 81432206284



MN-DL-8733

Length: 530 Ø: 48
Hole Distance: 130 / 130
81432206161, 81432206190, 81432206358,
81432206359



MN-DL-12293

Length: 1680 Ø: 42
Cone Ø: d1 Ø 30 / d2 Ø 27
81467106236, 81467106268, 81467106356,
81467116356, 81467116723, 81467116794,
81467116933, 81467116934, 81467116966



MN-RK-12436

Ø: 75
Hole Distance: 115
Thick/Height: 24
81432206244



MN-SB-5246

Ø: 45 Thick/Height: 47
81437220022, 81437220038, 81962100450,
81962100469



MN-TC-12399

Length: 694 Ø: 50
Hole Distance: 130 / 130
81432206265



MN-VB-5238

Length: 627 Ø: 48
Hole Distance: 130 / 130
81432206221, 81432706096, 81432706114,
81432706116, 81432706121



MN-VB-8514

Length: 627 Ø: 48
Hole Ø 25 / 25 / 25
Hole Distance: 152 / 130 / 130
81432706087, 81432706088, 81432706094,
81432706095, 81432796094



MN-VB-9403

Length: 627 Ø: 48
Hole Ø 25 / 23 / 23
Hole Distance: 152 / 130 / 130
81432706097, 81432706113, 81432706135,
81432706160, 81432706161





TGX ...

24.360 FPLS, FPLRS ...	10/07→	Track Control Arm		MN-VB-9403	Wishbone (CV), Air Suspension Axle
	10/07→	Track Control Arm	MN-DL-8663		Control Arm, Air Suspension Axle
	10/07→	Track Control Arm	MN-VB-5238	MN-VB-5238	Wishbone (CV);Control Arm
24.400 FNLLW/N	10/07→	Centre Rod	MN-DL-8560		Push Rod, Air Suspension Axle
	10/07→	Suspension Strut Repair Kit		DB-RK-8581	
	10/07→	Suspension Strut Repair Kit		MN-RK-12436	
	10/07→	Tie Rod	MN-DL-7802		
	10/07→	Track Control Arm		MN-DL-5225	Trailing Arm, Drive Axle;Tag Axle; Air Suspension Axle
	10/07→	Track Control Arm		MN-VB-9403	Wishbone (CV), Air Suspension Axle
	10/07→	Track Control Arm	MN-DL-8663		Control Arm, Air Suspension Axle
	10/07→	Track Control Arm	MN-VB-5238	MN-VB-5238	Wishbone (CV);Control Arm
24.400 FPLS, FPLRS	10/07→	Centre Rod	MN-DL-7801		Push Rod
	10/07→	Centre Rod	MN-DL-8560		Push Rod, Air Suspension Axle
	10/07→	Mounting, stabilizer coupling rod	MN-SB-5246		
	10/07→	Suspension Strut Repair Kit		DB-RK-8581	
	10/07→	Suspension Strut Repair Kit		MN-RK-12436	
	10/07→	Tie Rod	MN-DL-7802		
	10/07→	Track Control Arm		MN-DL-5225	Trailing Arm, Drive Axle;Tag Axle; Air Suspension Axle
	10/07→	Track Control Arm		MN-VB-9403	Wishbone (CV), Air Suspension Axle
	10/07→	Track Control Arm	MN-DL-8663		Control Arm, Air Suspension Axle
	10/07→	Track Control Arm	MN-VB-5238	MN-VB-5238	Wishbone (CV);Control Arm
	10/07→	Track Control Arm	MN-DL-8560		Push Rod, Air Suspension Axle
	10/07→	Track Control Arm	MN-DL-7801		Push Rod
	24.440 FNLLW/N	10/07→	Centre Rod	MN-DL-8560	
10/07→		Suspension Strut Repair Kit		DB-RK-8581	
10/07→		Suspension Strut Repair Kit		MN-RK-12436	
10/07→		Tie Rod	MN-DL-7802		
10/07→		Track Control Arm		MN-DL-5225	Trailing Arm, Drive Axle;Tag Axle; Air Suspension Axle
10/07→		Track Control Arm		MN-VB-9403	Wishbone (CV), Air Suspension Axle
10/07→		Track Control Arm	MN-DL-8663		Control Arm, Air Suspension Axle
10/12→		Centre Rod	MN-DL-8560		Push Rod
10/07→		Centre Rod	MN-DL-7801		Push Rod
10/07→		Centre Rod	MN-DL-8560		Push Rod, Air Suspension Axle
10/07→		Mounting, stabilizer coupling rod	MN-SB-5246		
10/07→		Suspension Strut Repair Kit		DB-RK-8581	
10/07→		Suspension Strut Repair Kit		MN-RK-12436	
24.440 FPLS, FPLRS	10/07→	Tie Rod	MN-DL-7802		
	10/07→	Track Control Arm		MN-DL-5225	Trailing Arm
	10/07→	Track Control Arm		MN-DL-5225	Trailing Arm, Drive Axle;Tag Axle; Air Suspension Axle
	10/07→	Track Control Arm		MN-VB-9403	Wishbone (CV), Air Suspension Axle
	10/07→	Track Control Arm	MN-DL-8663		Control Arm, Air Suspension Axle
	10/07→	Track Control Arm	MN-VB-5238	MN-VB-5238	Wishbone (CV);Control Arm
	10/07→	Track Control Arm	MN-DL-8560		Push Rod, Air Suspension Axle
	10/07→	Suspension Strut Repair Kit		DB-RK-8581	
	10/07→	Suspension Strut Repair Kit		MN-RK-12436	
	10/07→	Tie Rod	MN-DL-7802		
	10/07→	Track Control Arm		MN-DL-5225	Trailing Arm, Drive Axle;Tag Axle; Air Suspension Axle
	10/07→	Track Control Arm		MN-VB-9403	Wishbone (CV), Air Suspension Axle
	10/07→	Track Control Arm	MN-DL-8663		Control Arm, Air Suspension Axle
24.480 FNLLW/N	10/07→	Centre Rod	MN-DL-8560		Push Rod, Air Suspension Axle
	10/07→	Suspension Strut Repair Kit		DB-RK-8581	
	10/07→	Suspension Strut Repair Kit		MN-RK-12436	
	10/07→	Tie Rod	MN-DL-7802		
	10/07→	Track Control Arm		MN-DL-5225	Trailing Arm, Drive Axle;Tag Axle; Air Suspension Axle
	10/07→	Track Control Arm		MN-VB-9403	Wishbone (CV), Air Suspension Axle
	10/07→	Track Control Arm	MN-DL-8663		Control Arm, Air Suspension Axle
	10/07→	Track Control Arm	MN-VB-5238	MN-VB-5238	Wishbone (CV);Control Arm
24.480 FPLS, FPLRS	10/07→	Centre Rod	MN-DL-7801		Push Rod
	10/07→	Centre Rod	MN-DL-8560		Push Rod, Air Suspension Axle
	10/07→	Mounting, stabilizer coupling rod	MN-SB-5246		
	10/07→	Suspension Strut Repair Kit		DB-RK-8581	
	10/07→	Suspension Strut Repair Kit		MN-RK-12436	
	10/07→	Tie Rod	MN-DL-7802		
	10/07→	Track Control Arm		MN-DL-5225	Trailing Arm, Drive Axle;Tag Axle; Air Suspension Axle
	10/07→	Track Control Arm		MN-VB-9403	Wishbone (CV), Air Suspension Axle
	10/07→	Track Control Arm	MN-DL-8663		Control Arm, Air Suspension Axle
	10/07→	Track Control Arm	MN-VB-5238	MN-VB-5238	Wishbone (CV);Control Arm

DB-RK-8581

Ø: 85
Hole Distance: 130
Thick/Height: 24
03305800A, 81432706105



MN-SB-5246

Ø: 45 Thick/Height: 47
81437220022, 81437220038, 81962100450,
81962100469



MN-VB-5238

Length: 627 Ø: 48
Hole Distance: 130 / 130

81432206221, 81432706096, 81432706114,
81432706116, 81432706121



MN-DL-5225

Length: 572 Ø: 48
Hole Distance: 130 / 130

03301500A, 81432206229, 81432206236,
81432206267, 81432206270, 81432206272,
81432206304, 81432206305, 81432209236,
81432209267, 81432209272



MN-VB-9403

Length: 627 Ø: 48
Hole Ø 25 / 23 / 23

Hole Distance: 152 / 130 / 130

81432706097, 81432706113, 81432706135,
81432706160, 81432706161



MN-DL-7801

Length: 995 Ø: 52
Cone Ø: d1 Ø 30 / d2 Ø 27

81466106807, 81466106808, 81466116087,
81466116088, 81466116096, 81466116097,
81466116099, 81466116132, 81466116133,
81466116136, 81466116197, 81466116198,
81466116205



MN-DL-7802

Length: 1680 Ø: 52
Cone Ø: d1 Ø 30 / d2 Ø 27

03208300A, 81467116773, 81467116858,
81467116859, 81467116860, 81467116861,
81467116863, 81467116882, 81467116883,
81467116920, 81467116921



MN-DL-8560

Length: 970 Ø: 52
Cone Ø: d1 Ø 30 / d2 Ø 27

03206900A, 81466106809, 81466106810,
81466106823, 81466106838, 81466106839,
81466116104, 81466116105, 81466116107,
81466116134, 81466116135, 81466116137,
81466116199, 81466116200, 81466116206



MN-DL-8663

Length: 947 Ø: 60
Hole Distance: 115 / 115

03307400A, 81432206222, 81432206260,
81432206283, 81432206284



MN-RK-12436

Ø: 75
Hole Distance: 115
Thick/Height: 24

81432206244





TGX ...

24.540 FNLLW/N	02/09→	Centre Rod	MN-DL-8560		Push Rod	
	02/09→	Tie Rod	MN-DL-7802			
	02/09→	Track Control Arm		MN-DL-5225	Trailing Arm	
	02/09→	Track Control Arm		MN-VB-9403	Wishbone (CV)	
	02/09→	Track Control Arm	MN-DL-8663		Control Arm	
	02/09→	Track Control Arm	MN-VB-5238	MN-VB-5238	Wishbone (CV);Control Arm	
24.540 FPLS, FPLRS	10/07→	Centre Rod	MN-DL-7801		Push Rod	
	10/07→	Centre Rod	MN-DL-8560		Push Rod, Air Suspension Axle	
	10/07→	Mounting, stabilizer coupling rod	MN-SB-5246			
	10/07→	Suspension Strut Repair Kit		DB-RK-8581		
	10/07→	Suspension Strut Repair Kit		MN-RK-12436		
	10/07→	Tie Rod	MN-DL-7802			
	10/07→	Track Control Arm		MN-DL-5225	Trailing Arm, Drive Axle;Tag Axle; Air Suspension Axle	
	10/07→	Track Control Arm		MN-VB-9403	Wishbone (CV), Air Suspension Axle	
	10/07→	Track Control Arm	MN-DL-8663		Control Arm, Air Suspension Axle	
	10/07→	Track Control Arm	MN-VB-5238	MN-VB-5238	Wishbone (CV);Control Arm	
26.320 FNLS, FNLLS, FNLRs	10/07→	Centre Rod	MN-DL-7801		Push Rod, Leaf Spring Axle	
	10/07→	Centre Rod	MN-DL-8560		Push Rod, Air Suspension Axle	
	10/07→	Suspension Strut Repair Kit		DB-RK-8581		
	10/07→	Suspension Strut Repair Kit		MN-RK-12436		
	10/07→	Tie Rod	MN-DL-7802			
	10/07→	Tie Rod End		MN-ES-8490	for vehicles with Hinged Trailing Axle	
	10/07→	Track Control Arm		MN-DL-5225	Trailing Arm, Drive Axle;Tag Axle; Air Suspension Axle	
	10/07→	Track Control Arm		MN-DL-5225	Trailing Arm, for vehicles with Hinged Trailing Axle;Air Suspension Axle	
	10/07→	Track Control Arm		MN-DL-8709	Trailing Arm, for vehicles with Hinged Trailing Axle;Air Suspension Axle	
	10/07→	Track Control Arm		MN-TC-12399	Control Arm	
	10/07→	Track Control Arm		MN-VB-5238	Wishbone (CV), Leading Axle;Drive Axle; Air Suspension Axle	
	10/07→	Track Control Arm		MN-VB-9403	Wishbone (CV), Air Suspension Axle	
	10/07→	Track Control Arm	MN-DL-8663		Control Arm, Air Suspension Axle	
	26.360 FDC, FDC/M, FDLc, FDRc, FDRc/M, FDLRC, FNHLc	07/08→	Centre Rod	MN-DL-7801		Push Rod
		07/08→	Tie Rod	MN-DL-7802		
		07/08→	Tie Rod	MN-DL-12293		
07/08→		Track Control Arm		MN-DL-5225	Trailing Arm	
07/08→		Track Control Arm		MN-DL-8544	Trailing Arm	
07/08→		Track control arm		MN-DL-12288	Trailing Arm	
07/08→		Track Control Arm		MN-VB-8514	Suspension Rod, Wishbone (CV), Drive Axle, for Leaf-Spring Suspension vehicles	
07/08→		Track Control Arm		MN-VB-8669	Suspension Rod, Wishbone (CV)	
07/08→		Track Control Arm		MN-VB-9404	Wishbone (CV)	
07/08→		Track Control Arm	MN-VB-5238	MN-VB-5238	Wishbone (CV);Control Arm	
26.360 FDLRS, FDLS, FDRS, FDS, FNHLS, FPHLS, FVHLS		10/07→	Centre Rod	MN-DL-7801		Push Rod
		10/07→	Tie Rod	MN-DL-7802		
		10/07→	Tie Rod	MN-DL-12293		
		10/07→	Track Control Arm		MN-DL-5225	Trailing Arm
	10/07→	Track Control Arm		MN-DL-8544	Trailing Arm	
	10/07→	Track control arm		MN-DL-12288	Trailing Arm	
	10/07→	Track Control Arm		MN-VB-8514	Suspension Rod, Wishbone (CV), Drive Axle, for Leaf-Spring Suspension vehicles	
	10/07→	Track Control Arm		MN-VB-8669	Suspension Rod, Wishbone (CV)	
	10/07→	Track Control Arm		MN-VB-9404	Wishbone (CV)	
	10/07→	Track Control Arm	MN-VB-5238	MN-VB-5238	Wishbone (CV);Control Arm	
26.360 FNHLc	10/07→	Centre Rod	MN-DL-8560		Push Rod	
26.360 FNLC, FNLRc, FNLLc, FNLLRC, FNLLW	10/07→	Centre Rod	MN-DL-7801		Push Rod, Leaf Spring Axle	
	10/07→	Centre Rod	MN-DL-8560		Push Rod, Air Suspension Axle	
	10/07→	Suspension Strut Repair Kit		DB-RK-8581		
	10/07→	Suspension Strut Repair Kit		MN-RK-12436		
	10/07→	Tie Rod	MN-DL-7802			
	10/07→	Tie Rod End		MN-ES-8490	for vehicles with Hinged Trailing Axle	

DB-RK-8581

Ø: 85
Hole Distance: 130
Thick/Height: 24
03305800A, 81432706105



MN-DL-5225

Length: 572 Ø: 48
Hole Distance: 130 / 130

03301500A, 81432206229, 81432206236,
81432206267, 81432206270, 81432206272,
81432206304, 81432206305, 81432209236,
81432209267, 81432209272



MN-DL-7801

Length: 995 Ø: 52
Cone Ø: d1 Ø 30 / d2 Ø 27

81466106807, 81466106808, 81466116087,
81466116088, 81466116096, 81466116097,
81466116099, 81466116132, 81466116133,
81466116136, 81466116197, 81466116198,
81466116205

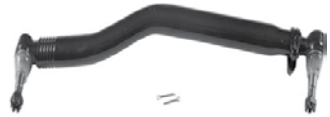

MN-DL-7802

Length: 1680 Ø: 52
Cone Ø: d1 Ø 30 / d2 Ø 27

03208300A, 81467116773, 81467116858,
81467116859, 81467116860, 81467116861,
81467116863, 81467116882, 81467116883,
81467116920, 81467116921



MN-DL-8544

Length: 596 Ø: 48
Hole Distance: 130 / 130

81432206196, 81432206232, 81432206233



MN-DL-8560

Length: 970 Ø: 52
Cone Ø: d1 Ø 30 / d2 Ø 27

03206900A, 81466106809, 81466106810,
81466106823, 81466106838, 81466106839,
81466116104, 81466116105, 81466116107,
81466116134, 81466116135, 81466116137,
81466116199, 81466116200, 81466116206



MN-DL-8663

Length: 947 Ø: 60
Hole Distance: 115 / 115

03307400A, 81432206222, 81432206260,
81432206283, 81432206284



MN-DL-8709

Length: 572 Ø: 52
Hole Distance: 130 / 130

81432206268, 81432206274, 81432206291,
81432206292, 82432206007



MN-DL-12288

Length: 585 Ø: 58
Hole Distance: 130 / 130

81432206386, 82432206008, 82432209008

No Image

MN-DL-12293

Length: 1680 Ø: 42
Cone Ø: d1 Ø 30 / d2 Ø 27

81467106236, 81467106268, 81467106356,
81467116356, 81467116723, 81467116794,
81467116933, 81467116934, 81467116966



MN-ES-8490

Length: 90
Cone Ø: d1 Ø 30 / d2 Ø 27
Thread: M26 x 1,5 RHT

14606948, 0014606948, 81953016281,
81953016337, 82953016016



MN-RK-12436

Ø: 75
Hole Distance: 115
Thick/Height: 24

81432206244



MN-SB-5246

Ø: 45 Thick/Height: 47
81437220022, 81437220038, 81962100450,
81962100469



MN-TC-12399

Length: 694 Ø: 50
Hole Distance: 130 / 130

81432206265



MN-VB-5238

Length: 627 Ø: 48
Hole Distance: 130 / 130

81432206221, 81432706096, 81432706114,
81432706116, 81432706121



MN-VB-8514

Length: 627 Ø: 48
Hole Ø 25 / 25 / 25
Hole Distance: 152 / 130 / 130

81432706087, 81432706088, 81432706094,
81432706095, 81432796094



MN-VB-8669

Length: 627 Ø: 48
Hole Ø 25 / 25 / 25
Hole Distance: 152 / 130 / 130

81432706116, 81432706137, 81432706150,
81432706151



MN-VB-9403

Length: 627 Ø: 48
Hole Ø 25 / 23 / 23
Hole Distance: 152 / 130 / 130

81432706097, 81432706113, 81432706135,
81432706160, 81432706161



MN-VB-9404

Length: 627 Ø: 58
Hole Distance: 130 / 130
81432706117, 81432706152, 81432706153





TGX ...

26.360 FNLC, FNLRC, FNLLC, FNLLRC, FNLLW ...	10/07→	Track Control Arm		MN-DL-5225	Trailing Arm, Drive Axle;Tag Axle; Air Suspension Axle	
	10/07→	Track Control Arm		MN-DL-5225	Trailing Arm, for vehicles with Hinged Trailing Axle;Air Suspension Axle	
	10/07→	Track Control Arm		MN-DL-8709	Trailing Arm, for vehicles with Hinged Trailing Axle;Air Suspension Axle	
	10/07→	Track Control Arm		MN-TC-12399	Control Arm	
	10/07→	Track Control Arm		MN-VB-5238	Wishbone (CV), Leading Axle;Drive Axle; Air Suspension Axle	
	10/07→	Track Control Arm		MN-VB-9403	Wishbone (CV), Air Suspension Axle	
26.360 FNLS, FNLLS, FNLRS, FNLLRS, FPLS, FPLRS, FVLS	10/07→	Track Control Arm	MN-DL-8663		Control Arm, Air Suspension Axle	
	10/07→	Centre Rod	MN-DL-7801		Push Rod, Leaf Spring Axle	
	10/07→	Centre Rod	MN-DL-8560		Push Rod, Air Suspension Axle	
	10/07→	Mounting, stabilizer coupling rod	MN-SB-5246			
	10/07→	Suspension Strut Repair Kit		DB-RK-8581		
	10/07→	Suspension Strut Repair Kit		MN-RK-12436		
	10/07→	Tie Rod	MN-DL-7802			
	10/07→	Tie Rod	MN-DL-12284			
	10/07→	Tie Rod End		MN-ES-8490	for vehicles with Hinged Trailing Axle	
	10/07→	Track Control Arm		MN-DL-5225	Trailing Arm, Drive Axle;Leading Axle; Air Suspension Axle	
	10/07→	Track Control Arm		MN-DL-5225	Trailing Arm, Drive Axle;Tag Axle; Air Suspension Axle	
	10/07→	Track Control Arm		MN-DL-5225	Trailing Arm, for vehicles with Hinged Trailing Axle;Air Suspension Axle	
	10/07→	Track Control Arm		MN-DL-8709	Trailing Arm, for vehicles with Hinged Trailing Axle;Air Suspension Axle	
	10/07→	Track Control Arm		MN-TC-12399	Control Arm	
	10/07→	Track Control Arm		MN-VB-5238	Wishbone (CV), Leading Axle;Drive Axle; Air Suspension Axle	
	10/07→	Track Control Arm		MN-VB-9403	Wishbone (CV), Air Suspension Axle	
	10/07→	Track Control Arm	MN-DL-8663		Control Arm, Air Suspension Axle	
	26.360 FVHLS	05/08→	Centre Rod	MN-DL-7801		Push Rod
		05/08→	Mounting, stabilizer coupling rod	MN-SB-5246		
		05/08→	Tie Rod	MN-DL-7802		
05/08→		Track Control Arm		MN-DL-5225	Trailing Arm	
05/08→		Track Control Arm	MN-VB-5238	MN-VB-5238	Wishbone (CV);Control Arm	
26.400 FDC, FDC/M, FDLC, FDRC, FDRC/M, FDLRC, FNHLC	07/08→	Centre Rod	MN-DL-7801		Push Rod	
	07/08→	Tie Rod	MN-DL-7802			
	07/08→	Tie Rod	MN-DL-12293			
	07/08→	Track Control Arm		MN-DL-5225	Trailing Arm	
	07/08→	Track Control Arm		MN-DL-8544	Trailing Arm	
	07/08→	Track control arm		MN-DL-12288	Trailing Arm	
	07/08→	Track Control Arm		MN-VB-8514	Suspension Rod, Wishbone (CV), Drive Axle, for Leaf-Spring Suspension vehicles	
	07/08→	Track Control Arm		MN-VB-8669	Suspension Rod, Wishbone (CV)	
	07/08→	Track Control Arm		MN-VB-9404	Wishbone (CV)	
	07/08→	Track Control Arm	MN-VB-5238	MN-VB-5238	Wishbone (CV);Control Arm	
26.400 FDLRS, FDLs, FDRS, FDS, FNHLS, FPHLS, FVHLS	12/07→	Centre Rod	MN-DL-7801		Push Rod	
	12/07→	Tie Rod	MN-DL-7802			
	12/07→	Tie Rod	MN-DL-12293			
	12/07→	Track Control Arm		MN-DL-5225	Trailing Arm	
	12/07→	Track Control Arm		MN-DL-8544	Trailing Arm	
	12/07→	Track control arm		MN-DL-12288	Trailing Arm	
	12/07→	Track Control Arm		MN-VB-8514	Suspension Rod, Wishbone (CV), Drive Axle, for Leaf-Spring Suspension vehicles	
	12/07→	Track Control Arm		MN-VB-8669	Suspension Rod, Wishbone (CV)	
26.400 FNHLC	12/07→	Track Control Arm		MN-VB-9404	Wishbone (CV)	
	12/07→	Track Control Arm	MN-VB-5238	MN-VB-5238	Wishbone (CV);Control Arm	
	12/07→	Centre Rod	MN-DL-8560		Push Rod	

DB-RK-8581

Ø: 85
Hole Distance: 130
Thick/Height: 24
03305800A, 81432706105



MN-DL-5225

Length: 572 Ø: 48
Hole Distance: 130 / 130
03301500A, 81432206229, 81432206236,
81432206267, 81432206270, 81432206272,
81432206304, 81432206305, 81432209236,
81432209267, 81432209272



MN-DL-7801

Length: 995 Ø: 52
Cone Ø: d1 Ø 30 / d2 Ø 27
81466106807, 81466106808, 81466116087,
81466116088, 81466116096, 81466116097,
81466116099, 81466116132, 81466116133,
81466116136, 81466116197, 81466116198,
81466116205

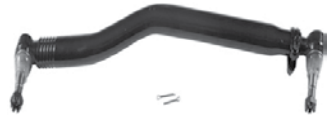

MN-DL-7802

Length: 1680 Ø: 52
Cone Ø: d1 Ø 30 / d2 Ø 27
03208300A, 81467116773, 81467116858,
81467116859, 81467116860, 81467116861,
81467116863, 81467116882, 81467116883,
81467116920, 81467116921



MN-DL-8544

Length: 596 Ø: 48
Hole Distance: 130 / 130
81432206196, 81432206232, 81432206233



MN-DL-8560

Length: 970 Ø: 52
Cone Ø: d1 Ø 30 / d2 Ø 27
03206900A, 81466106809, 81466106810,
81466106823, 81466106838, 81466106839,
81466116104, 81466116105, 81466116107,
81466116134, 81466116135, 81466116137,
81466116199, 81466116200, 81466116206



MN-DL-8663

Length: 947 Ø: 60
Hole Distance: 115 / 115
03307400A, 81432206222, 81432206260,
81432206283, 81432206284



MN-DL-8709

Length: 572 Ø: 52
Hole Distance: 130 / 130
81432206268, 81432206274, 81432206291,
81432206292, 82432206007



MN-DL-12284

Length: 1530 Ø: 50
Cone Ø: d1 Ø 30 / d2 Ø 27
81466106579, 81466106580, 81466106624,
81466116720, 81467116720, 81467116730,
81467116952



MN-DL-12288

Length: 585 Ø: 58
Hole Distance: 130 / 130
81432206386, 82432206008, 82432209008

No Image

MN-DL-12293

Length: 1680 Ø: 42
Cone Ø: d1 Ø 30 / d2 Ø 27
81467106236, 81467106268, 81467106356,
81467116356, 81467116723, 81467116794,
81467116933, 81467116934, 81467116966



MN-ES-8490

Length: 90
Cone Ø: d1 Ø 30 / d2 Ø 27
Thread: M26 x 1,5 RHT
0014606948, 14606948, 81953016281,
81953016337, 82953016016



MN-RK-12436

Ø: 75
Hole Distance: 115
Thick/Height: 24
81432206244

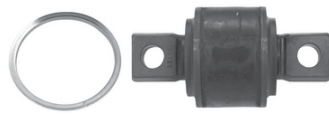

MN-SB-5246

Ø: 45 Thick/Height: 47
81437220022, 81437220038, 81962100450,
81962100469



MN-TC-12399

Length: 694 Ø: 50
Hole Distance: 130 / 130
81432206265



MN-VB-5238

Length: 627 Ø: 48
Hole Distance: 130 / 130
81432206221, 81432706096, 81432706114,
81432706116, 81432706121



MN-VB-8514

Length: 627 Ø: 48
Hole Ø 25 / 25 / 25
Hole Distance: 152 / 130 / 130
81432706087, 81432706088, 81432706094,
81432706095, 81432796094



MN-VB-8669

Length: 627 Ø: 48
Hole Ø 25 / 25 / 25
Hole Distance: 152 / 130 / 130
81432706116, 81432706137, 81432706150,
81432706151



MN-VB-9403

Length: 627 Ø: 48
Hole Ø 25 / 23 / 23
Hole Distance: 152 / 130 / 130
81432706097, 81432706113, 81432706135,
81432706160, 81432706161



MN-VB-9404

Length: 627 Ø: 58
Hole Distance: 130 / 130
81432706117, 81432706152, 81432706153





TGX ...

26.400 FNLC, FNLCR, FNLLC, FNLLRC, FNLLW	10/07→	Centre Rod	MN-DL-7801		Push Rod, Leaf Spring Axle	
	10/07→	Centre Rod	MN-DL-8560		Push Rod, Air Suspension Axle	
	10/07→	Suspension Strut Repair Kit		DB-RK-8581		
	10/07→	Suspension Strut Repair Kit		MN-RK-12436		
	10/07→	Tie Rod	MN-DL-7802			
	10/07→	Tie Rod End		MN-ES-8490	for vehicles with Hinged Trailing Axle	
	10/07→	Track Control Arm		MN-DL-5225	Trailing Arm, Drive Axle;Tag Axle; Air Suspension Axle	
	10/07→	Track Control Arm		MN-DL-5225	Trailing Arm, for vehicles with Hinged Trailing Axle;Air Suspension Axle	
	10/07→	Track Control Arm		MN-DL-8709	Trailing Arm, for vehicles with Hinged Trailing Axle;Air Suspension Axle	
	10/07→	Track Control Arm		MN-TC-12399	Control Arm	
	10/07→	Track Control Arm		MN-VB-5238	Wishbone (CV), Leading Axle;Drive Axle; Air Suspension Axle	
	10/07→	Track Control Arm		MN-VB-9403	Wishbone (CV), Air Suspension Axle	
	10/07→	Track Control Arm	MN-DL-8663		Control Arm, Air Suspension Axle	
	26.400 FNLS, FNLLS, FNLRs, FNLLRS, FPLS, FPLRS, FVLS	10/07→	Centre Rod	MN-DL-7801		Push Rod, Leaf Spring Axle
		10/07→	Centre Rod	MN-DL-8560		Push Rod, Air Suspension Axle
10/07→		Mounting, stabilizer coupling rod	MN-SB-5246			
10/07→		Suspension Strut Repair Kit		DB-RK-8581		
10/07→		Suspension Strut Repair Kit		MN-RK-12436		
10/07→		Tie Rod	MN-DL-7802			
10/07→		Tie Rod	MN-DL-12284			
10/07→		Track Control Arm		MN-DL-5225	Trailing Arm, Drive Axle;Leading Axle; Air Suspension Axle	
10/07→		Track Control Arm		MN-DL-5225	Trailing Arm, Drive Axle;Tag Axle; Air Suspension Axle	
10/07→		Track Control Arm		MN-DL-5225	Trailing Arm, for vehicles with Hinged Trailing Axle;Air Suspension Axle	
10/07→		Track Control Arm		MN-DL-8709	Trailing Arm, for vehicles with Hinged Trailing Axle;Air Suspension Axle	
10/07→		Track Control Arm		MN-TC-12399	Control Arm	
10/07→		Track Control Arm		MN-VB-5238	Wishbone (CV), Leading Axle;Drive Axle; Air Suspension Axle	
10/07→		Track Control Arm		MN-VB-9403	Wishbone (CV), Air Suspension Axle	
10/07→		Track Control Arm	MN-DL-8663		Control Arm, Air Suspension Axle	
26.400 FPHLS	05/08→	Centre Rod	MN-DL-7801		Push Rod	
	05/08→	Mounting, stabilizer coupling rod	MN-SB-5246			
	05/08→	Tie Rod	MN-DL-7802			
	05/08→	Track Control Arm		MN-DL-5225	Trailing Arm	
	05/08→	Track Control Arm	MN-VB-5238	MN-VB-5238	Wishbone (CV);Control Arm	
26.400 FVHLS	05/08→	Centre Rod	MN-DL-7801		Push Rod	
	05/08→	Mounting, stabilizer coupling rod	MN-SB-5246			
	05/08→	Tie Rod	MN-DL-7802			
	05/08→	Track Control Arm		MN-DL-5225	Trailing Arm	
	05/08→	Track Control Arm	MN-VB-5238	MN-VB-5238	Wishbone (CV);Control Arm	
26.440 FDC, FDC/M, FDLC, FDRC, FDRC/M, FDLRC, FNHLc	07/08→	Centre Rod	MN-DL-7801		Push Rod	
	07/08→	Tie Rod	MN-DL-7802			
	07/08→	Tie Rod	MN-DL-12293			
	07/08→	Track Control Arm		MN-DL-5225	Trailing Arm	
	07/08→	Track Control Arm		MN-DL-8544	Trailing Arm	
	07/08→	Track control arm		MN-DL-12288	Trailing Arm	
	07/08→	Track Control Arm		MN-VB-8514	Suspension Rod, Wishbone (CV), Drive Axle, for Leaf-Spring Suspension vehicles	
	07/08→	Track Control Arm		MN-VB-8669	Suspension Rod, Wishbone (CV)	
	07/08→	Track Control Arm		MN-VB-9404	Wishbone (CV)	
	07/08→	Track Control Arm	MN-VB-5238	MN-VB-5238	Wishbone (CV);Control Arm	
26.440 FDK, FDLK	10/12→	Centre Rod	MN-DL-8560		Push Rod	
	01/14→	Centre Rod	MN-DL-8560		Push Rod	

DB-RK-8581

Ø: 85
Hole Distance: 130
Thick/Height: 24
03305800A, 81432706105



MN-DL-5225

Length: 572 Ø: 48
Hole Distance: 130 / 130
03301500A, 81432206229, 81432206236,
81432206267, 81432206270, 81432206272,
81432206304, 81432206305, 81432209236,
81432209267, 81432209272



MN-DL-7801

Length: 995 Ø: 52
Cone Ø: d1 Ø 30 / d2 Ø 27
81466106807, 81466106808, 81466116087,
81466116088, 81466116096, 81466116097,
81466116099, 81466116132, 81466116133,
81466116136, 81466116197, 81466116198,
81466116205

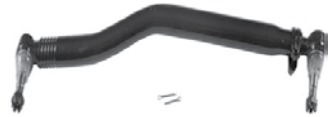

MN-DL-7802

Length: 1680 Ø: 52
Cone Ø: d1 Ø 30 / d2 Ø 27
03208300A, 81467116773, 81467116858,
81467116859, 81467116860, 81467116861,
81467116863, 81467116882, 81467116883,
81467116920, 81467116921



MN-DL-8544

Length: 596 Ø: 48
Hole Distance: 130 / 130
81432206196, 81432206232, 81432206233



MN-DL-8560

Length: 970 Ø: 52
Cone Ø: d1 Ø 30 / d2 Ø 27
03206900A, 81466106809, 81466106810,
81466106823, 81466106838, 81466106839,
81466116104, 81466116105, 81466116107,
81466116134, 81466116135, 81466116137,
81466116199, 81466116200, 81466116206



MN-DL-8663

Length: 947 Ø: 60
Hole Distance: 115 / 115
03307400A, 81432206222, 81432206260,
81432206283, 81432206284



MN-DL-8709

Length: 572 Ø: 52
Hole Distance: 130 / 130
81432206268, 81432206274, 81432206291,
81432206292, 82432206007



MN-DL-12284

Length: 1530 Ø: 50
Cone Ø: d1 Ø 30 / d2 Ø 27
81466106579, 81466106580, 81466106624,
81466116720, 81467116720, 81467116730,
81467116952



MN-DL-12288

Length: 585 Ø: 58
Hole Distance: 130 / 130
81432206386, 82432206008, 82432209008

No Image

MN-DL-12293

Length: 1680 Ø: 42
Cone Ø: d1 Ø 30 / d2 Ø 27
81467106236, 81467106268, 81467106356,
81467116356, 81467116723, 81467116794,
81467116933, 81467116934, 81467116966



MN-ES-8490

Length: 90
Cone Ø: d1 Ø 30 / d2 Ø 27
Thread: M26 x 1,5 RHT
0014606948, 14606948, 81953016281,
81953016337, 82953016016



MN-RK-12436

Ø: 75
Hole Distance: 115
Thick/Height: 24
81432206244



MN-SB-5246

Ø: 45 Thick/Height: 47
81437220022, 81437220038, 81962100450,
81962100469



MN-TC-12399

Length: 694 Ø: 50
Hole Distance: 130 / 130
81432206265



MN-VB-5238

Length: 627 Ø: 48
Hole Distance: 130 / 130
81432206221, 81432706096, 81432706114,
81432706116, 81432706121



MN-VB-8514

Length: 627 Ø: 48
Hole Ø 25 / 25 / 25
Hole Distance: 152 / 130 / 130
81432706087, 81432706088, 81432706094,
81432706095, 81432796094



MN-VB-8669

Length: 627 Ø: 48
Hole Ø 25 / 25 / 25
Hole Distance: 152 / 130 / 130
81432706116, 81432706137, 81432706150,
81432706151



MN-VB-9403

Length: 627 Ø: 48
Hole Ø 25 / 23 / 23
Hole Distance: 152 / 130 / 130
81432706097, 81432706113, 81432706135,
81432706160, 81432706161



MN-VB-9404

Length: 627 Ø: 58
Hole Distance: 130 / 130
81432706117, 81432706152, 81432706153





TGX ...

26.440 FDLRS, FDLS, FDRS, FDS, FNHLS, FPHLS, FVHLS	12/07→	Centre Rod	MN-DL-7801		Push Rod	
	12/07→	Tie Rod	MN-DL-7802			
	12/07→	Tie Rod	MN-DL-12293			
	12/07→	Track Control Arm		MN-DL-5225	Trailing Arm	
	12/07→	Track Control Arm		MN-DL-8544	Trailing Arm	
	12/07→	Track control arm		MN-DL-12288	Trailing Arm	
	12/07→	Track Control Arm		MN-VB-8514	Suspension Rod, Wishbone (CV), Drive Axle, for Leaf-Spring Suspension vehicles	
	12/07→	Track Control Arm		MN-VB-8669	Suspension Rod, Wishbone (CV)	
	12/07→	Track Control Arm		MN-VB-9404	Wishbone (CV)	
	12/07→	Track Control Arm	MN-VB-5238	MN-VB-5238	Wishbone (CV);Control Arm	
26.440 FNHLC	10/12→	Centre Rod	MN-DL-8560		Push Rod	
26.440 FNLC, FNLRC, FNLLC, FNLLRC, FNLLW	12/07→	Centre Rod	MN-DL-8560		Push Rod	
	10/07→	Centre Rod	MN-DL-7801		Push Rod	
	10/07→	Suspension Strut Repair Kit		DB-RK-8581		
	10/07→	Tie Rod	MN-DL-7802			
	10/07→	Tie Rod End		MN-ES-8490	for vehicles with Hinged Trailing Axle	
	10/07→	Track Control Arm		MN-DL-5225	Trailing Arm, Drive Axle;Air Suspension Axle	
	10/07→	Track Control Arm		MN-DL-5225	Trailing Arm, Drive Axle;Tag Axle; Air Suspension Axle	
	10/07→	Track Control Arm		MN-DL-5225	Trailing Arm, for vehicles with Hinged Trailing Axle;Air Suspension Axle	
	10/07→	Track Control Arm		MN-DL-8544	Trailing Arm, Drive Axle;Air Suspension Axle	
	10/07→	Track Control Arm		MN-DL-8709	Trailing Arm, for vehicles with Hinged Trailing Axle;Air Suspension Axle	
	10/07→	Track Control Arm		MN-TC-12399	Control Arm	
	10/07→	Track Control Arm		MN-VB-5238	Wishbone (CV), Drive Axle;Air Suspension Axle	
	10/07→	Track Control Arm		MN-VB-5238	Wishbone (CV), Leading Axle;Drive Axle; Air Suspension Axle	
	10/07→	Track Control Arm		MN-VB-8514	Suspension Rod, Wishbone (CV)	
	10/07→	Track Control Arm		MN-VB-9403	Wishbone (CV), Air Suspension Axle	
	10/12→	Centre Rod	MN-DL-8560		Push Rod	
	26.440 FNLS, FNLLS, FNLRS, FNLLRS, FPLS, FPLRS, FVLS	10/07→	Centre Rod	MN-DL-7801		Push Rod, Leaf Spring Axle
		10/07→	Mounting, stabilizer coupling rod	MN-SB-5246		
		10/07→	Suspension Strut Repair Kit		DB-RK-8581	
		10/07→	Tie Rod	MN-DL-7802		
10/07→		Tie Rod	MN-DL-12284			
10/07→		Tie Rod End		MN-ES-8490	for vehicles with Hinged Trailing Axle	
10/07→		Track Control Arm		MN-DL-5225	Trailing Arm, Drive Axle;Air Suspension Axle	
10/07→		Track Control Arm		MN-DL-5225	Trailing Arm, Drive Axle;Leading Axle; Air Suspension Axle	
10/07→		Track Control Arm		MN-DL-5225	Trailing Arm, Drive Axle;Tag Axle; Air Suspension Axle	
10/07→		Track Control Arm		MN-DL-5225	Trailing Arm, for vehicles with Hinged Trailing Axle;Air Suspension Axle	
10/07→		Track Control Arm		MN-DL-8544	Trailing Arm, Drive Axle;Air Suspension Axle	
10/07→		Track Control Arm		MN-DL-8709	Trailing Arm, for vehicles with Hinged Trailing Axle;Air Suspension Axle	
10/07→		Track Control Arm		MN-TC-12399	Control Arm	
10/07→		Track Control Arm		MN-VB-5238	Wishbone (CV), Drive Axle;Air Suspension Axle	
10/07→		Track Control Arm		MN-VB-5238	Wishbone (CV), Leading Axle;Drive Axle; Air Suspension Axle	
10/07→		Track Control Arm		MN-VB-8514	Suspension Rod, Wishbone (CV)	
10/07→		Track Control Arm		MN-VB-9403	Wishbone (CV), Air Suspension Axle	
26.440 FPHLS		05/08→	Centre Rod	MN-DL-7801		Push Rod
		05/08→	Mounting, stabilizer coupling rod	MN-SB-5246		
		05/08→	Tie Rod	MN-DL-7802		
	05/08→	Track Control Arm		MN-DL-5225	Trailing Arm	
26.440 FPLRS	05/08→	Track Control Arm	MN-VB-5238	MN-VB-5238	Wishbone (CV);Control Arm	
	07/08→	Centre Rod	MN-DL-7801		Push Rod	
	07/08→	Tie Rod	MN-DL-7802			
	07/08→	Track Control Arm		MN-DL-5225	Trailing Arm	
	07/08→	Track Control Arm	MN-VB-5238	MN-VB-5238	Wishbone (CV);Control Arm	

DB-RK-8581

Ø: 85
Hole Distance: 130
Thick/Height: 24
03305800A, 81432706105



MN-DL-5225

Length: 572 Ø: 48
Hole Distance: 130 / 130

03301500A, 81432206229, 81432206236,
81432206267, 81432206270, 81432206272,
81432206304, 81432206305, 81432209236,
81432209267, 81432209272



MN-DL-7801

Length: 995 Ø: 52
Cone Ø: d1 Ø 30 / d2 Ø 27

81466106807, 81466106808, 81466116087,
81466116088, 81466116096, 81466116097,
81466116099, 81466116132, 81466116133,
81466116136, 81466116197, 81466116198,
81466116205



MN-DL-7802

Length: 1680 Ø: 52
Cone Ø: d1 Ø 30 / d2 Ø 27

03208300A, 81467116773, 81467116858,
81467116859, 81467116860, 81467116861,
81467116863, 81467116882, 81467116883,
81467116920, 81467116921



MN-DL-8544

Length: 596 Ø: 48
Hole Distance: 130 / 130

81432206196, 81432206232, 81432206233



MN-DL-8560

Length: 970 Ø: 52
Cone Ø: d1 Ø 30 / d2 Ø 27

03206900A, 81466106809, 81466106810,
81466106823, 81466106838, 81466106839,
81466116104, 81466116105, 81466116107,
81466116134, 81466116135, 81466116137,
81466116199, 81466116200, 81466116206



MN-DL-8709

Length: 572 Ø: 52
Hole Distance: 130 / 130

81432206268, 81432206274, 81432206291,
81432206292, 82432206007



MN-DL-12284

Length: 1530 Ø: 50
Cone Ø: d1 Ø 30 / d2 Ø 27

81466106579, 81466106580, 81466106624,
81466116720, 81467116720, 81467116730,
81467116952

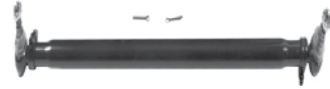

MN-DL-12288

Length: 585 Ø: 58
Hole Distance: 130 / 130

81432206386, 82432206008, 82432209008

No Image

MN-DL-12293

Length: 1680 Ø: 42
Cone Ø: d1 Ø 30 / d2 Ø 27

81467106236, 81467106268, 81467106356,
81467116356, 81467116723, 81467116794,
81467116933, 81467116934, 81467116966



MN-ES-8490

Length: 90
Cone Ø: d1 Ø 30 / d2 Ø 27
Thread: M26 x 1,5 RHT

14606948, 0014606948, 81953016281,
81953016337, 82953016016



MN-SB-5246

Ø: 45 Thick/Height: 47

81437220022, 81437220038, 81962100450,
81962100469



MN-TC-12399

Length: 694 Ø: 50
Hole Distance: 130 / 130

81432206265



MN-VB-5238

Length: 627 Ø: 48
Hole Distance: 130 / 130

81432206221, 81432706096, 81432706114,
81432706116, 81432706121



MN-VB-8514

Length: 627 Ø: 48
Hole Ø 25 / 25 / 25

Hole Distance: 152 / 130 / 130
81432706087, 81432706088, 81432706094,
81432706095, 81432796094



MN-VB-8669

Length: 627 Ø: 48
Hole Ø 25 / 25 / 25
Hole Distance: 152 / 130 / 130

81432706116, 81432706137, 81432706150,
81432706151



MN-VB-9403

Length: 627 Ø: 48
Hole Ø 25 / 23 / 23
Hole Distance: 152 / 130 / 130

81432706097, 81432706113, 81432706135,
81432706160, 81432706161



MN-VB-9404

Length: 627 Ø: 58
Hole Distance: 130 / 130

81432706117, 81432706152, 81432706153



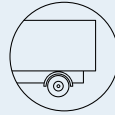
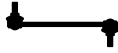

TGX ...

26.440 FVHLS	05/08→	Centre Rod	MN-DL-7801		Push Rod	
	05/08→	Mounting, stabilizer coupling rod	MN-SB-5246			
	05/08→	Tie Rod	MN-DL-7802			
	05/08→	Track Control Arm		MN-DL-5225	Trailing Arm	
	05/08→	Track Control Arm	MN-VB-5238	MN-VB-5238	Wishbone (CV);Control Arm	
26.480 FDC, FDC/M, FDL, FDRC, FDCR/M, FDLRC, FNHLC	07/08→	Centre Rod	MN-DL-7801		Push Rod	
	07/08→	Tie Rod	MN-DL-7802			
	07/08→	Tie Rod	MN-DL-12293			
	07/08→	Track Control Arm		MN-DL-5225	Trailing Arm	
	07/08→	Track Control Arm		MN-DL-8544	Trailing Arm	
	07/08→	Track control arm		MN-DL-12288	Trailing Arm	
	07/08→	Track Control Arm		MN-VB-8514	Suspension Rod, Wishbone (CV), Drive Axle, for Leaf-Spring Suspension vehicles	
	07/08→	Track Control Arm		MN-VB-8669	Suspension Rod, Wishbone (CV)	
	07/08→	Track Control Arm		MN-VB-9404	Wishbone (CV)	
	07/08→	Track Control Arm	MN-VB-5238	MN-VB-5238	Wishbone (CV);Control Arm	
26.480 FDK, FDLK	12/07→	Centre Rod	MN-DL-8560		Push Rod	
26.480 FDLRS, FDL, FDRS, FDS, FNHLS, FPHLS, FVHLS	12/07→	Centre Rod	MN-DL-7801		Push Rod	
	12/07→	Tie Rod	MN-DL-7802			
	12/07→	Tie Rod	MN-DL-12293			
	12/07→	Track Control Arm		MN-DL-5225	Trailing Arm	
	12/07→	Track Control Arm		MN-DL-8544	Trailing Arm	
	12/07→	Track control arm		MN-DL-12288	Trailing Arm	
	12/07→	Track Control Arm		MN-VB-8514	Suspension Rod, Wishbone (CV), Drive Axle, for Leaf-Spring Suspension vehicles	
	12/07→	Track Control Arm		MN-VB-8669	Suspension Rod, Wishbone (CV)	
	12/07→	Track Control Arm		MN-VB-9404	Wishbone (CV)	
	12/07→	Track Control Arm	MN-VB-5238	MN-VB-5238	Wishbone (CV);Control Arm	
26.480 FNHLC	12/07→	Centre Rod	MN-DL-8560		Push Rod	
26.480 FNLC, FNLCR, FNLLC, FNLLRC, FNLLW	10/07→	Centre Rod	MN-DL-7801		Push Rod, Leaf Spring Axle	
	10/07→	Centre Rod	MN-DL-8560		Push Rod, Air Suspension Axle	
	10/07→	Suspension Strut Repair Kit		DB-RK-8581		
	10/07→	Suspension Strut Repair Kit		MN-RK-12436		
	10/07→	Tie Rod	MN-DL-7802			
	10/07→	Tie Rod End		MN-ES-8490	for vehicles with Hinged Trailing Axle	
	10/07→	Track Control Arm		MN-DL-5225	Trailing Arm, Drive Axle;Tag Axle; Air Suspension Axle	
	10/07→	Track Control Arm		MN-DL-5225	Trailing Arm, for vehicles with Hinged Trailing Axle;Air Suspension Axle	
	10/07→	Track Control Arm		MN-DL-8709	Trailing Arm, for vehicles with Hinged Trailing Axle;Air Suspension Axle	
	10/07→	Track Control Arm		MN-TC-12399	Control Arm	
	10/07→	Track Control Arm		MN-VB-5238	Wishbone (CV), Leading Axle;Drive Axle; Air Suspension Axle	
	10/07→	Track Control Arm		MN-VB-9403	Wishbone (CV), Air Suspension Axle	
	10/07→	Track Control Arm	MN-DL-8663		Control Arm, Air Suspension Axle	
	26.480 FNLS, FNLLS, FNLSR, FNLLRS, FPLS, FPLRS, FVLS	10/07→	Centre Rod	MN-DL-7801		Push Rod, Leaf Spring Axle
		10/07→	Centre Rod	MN-DL-8560		Push Rod, Air Suspension Axle
		10/07→	Mounting, stabilizer coupling rod	MN-SB-5246		
		10/07→	Suspension Strut Repair Kit		DB-RK-8581	
10/07→		Suspension Strut Repair Kit		MN-RK-12436		
10/07→		Tie Rod	MN-DL-7802			
10/07→		Tie Rod	MN-DL-12284			
10/07→		Tie Rod End		MN-ES-8490	for vehicles with Hinged Trailing Axle	
10/07→		Track Control Arm		MN-DL-5225	Trailing Arm, Drive Axle;Air Suspension Axle	
10/07→		Track Control Arm		MN-DL-5225	Trailing Arm, Drive Axle;Tag Axle; Air Suspension Axle	
10/07→		Track Control Arm		MN-DL-5225	Trailing Arm, for vehicles with Hinged Trailing Axle;Air Suspension Axle	
10/07→		Track Control Arm		MN-DL-8544	Trailing Arm, Drive Axle;Air Suspension Axle	
10/07→		Track Control Arm		MN-DL-8709	Trailing Arm, for vehicles with Hinged Trailing Axle;Air Suspension Axle	
10/07→	Track Control Arm		MN-TC-12399	Control Arm		

DB-RK-8581

Ø: 85
Hole Distance: 130
Thick/Height: 24
03305800A, 81432706105



MN-DL-5225

Length: 572 Ø: 48
Hole Distance: 130 / 130

03301500A, 81432206229, 81432206236,
81432206267, 81432206270, 81432206272,
81432206304, 81432206305, 81432209236,
81432209267, 81432209272



MN-DL-7801

Length: 995 Ø: 52
Cone Ø: d1 Ø 30 / d2 Ø 27

81466106807, 81466106808, 81466116087,
81466116088, 81466116096, 81466116097,
81466116099, 81466116132, 81466116133,
81466116136, 81466116197, 81466116198,
81466116205



MN-DL-7802

Length: 1680 Ø: 52
Cone Ø: d1 Ø 30 / d2 Ø 27

03208300A, 81467116773, 81467116858,
81467116859, 81467116860, 81467116861,
81467116863, 81467116882, 81467116883,
81467116920, 81467116921



MN-DL-8544

Length: 596 Ø: 48
Hole Distance: 130 / 130

81432206196, 81432206232, 81432206233



MN-DL-8560

Length: 970 Ø: 52
Cone Ø: d1 Ø 30 / d2 Ø 27

03206900A, 81466106809, 81466106810,
81466106823, 81466106838, 81466106839,
81466116104, 81466116105, 81466116107,
81466116134, 81466116135, 81466116137,
81466116199, 81466116200, 81466116206



MN-DL-8663

Length: 947 Ø: 60
Hole Distance: 115 / 115

03307400A, 81432206222, 81432206260,
81432206283, 81432206284



MN-DL-8709

Length: 572 Ø: 52
Hole Distance: 130 / 130

81432206268, 81432206274, 81432206291,
81432206292, 82432206007



MN-DL-12284

Length: 1530 Ø: 50
Cone Ø: d1 Ø 30 / d2 Ø 27

81466106579, 81466106580, 81466106624,
81466116720, 81467116720, 81467116730,
81467116952



MN-DL-12288

Length: 585 Ø: 58
Hole Distance: 130 / 130

81432206386, 82432206008, 82432209008

No Image

MN-DL-12293

Length: 1680 Ø: 42
Cone Ø: d1 Ø 30 / d2 Ø 27

81467106236, 81467106268, 81467106356,
81467116356, 81467116723, 81467116794,
81467116933, 81467116934, 81467116966



MN-ES-8490

Length: 90
Cone Ø: d1 Ø 30 / d2 Ø 27
Thread: M26 x 1,5 RHT

0014606948, 14606948, 81953016281,
81953016337, 82953016016



MN-RK-12436

Ø: 75
Hole Distance: 115
Thick/Height: 24

81432206244



MN-SB-5246

Ø: 45 Thick/Height: 47

81437220022, 81437220038, 81962100450,
81962100469



MN-TC-12399

Length: 694 Ø: 50
Hole Distance: 130 / 130

81432206265



MN-VB-5238

Length: 627 Ø: 48
Hole Distance: 130 / 130

81432206221, 81432706096, 81432706114,
81432706116, 81432706121



MN-VB-8514

Length: 627 Ø: 48
Hole Ø 25 / 25 / 25
Hole Distance: 152 / 130 / 130

81432706087, 81432706088, 81432706094,
81432706095, 81432796094



MN-VB-8669

Length: 627 Ø: 48
Hole Ø 25 / 25 / 25
Hole Distance: 152 / 130 / 130

81432706116, 81432706137, 81432706150,
81432706151



MN-VB-9403

Length: 627 Ø: 48
Hole Ø 25 / 23 / 23
Hole Distance: 152 / 130 / 130

81432706097, 81432706113, 81432706135,
81432706160, 81432706161



MN-VB-9404

Length: 627 Ø: 58
Hole Distance: 130 / 130

81432706117, 81432706152, 81432706153



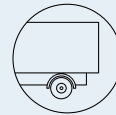

TGX ...

26.480 FNLS, FNLLS, FNLRS, FNLLRS, FPLS, FPLRS, FVLS ...	10/07→	Track Control Arm		MN-VB-5238	Wishbone (CV), Drive Axle;Air Suspension Axle
	10/07→	Track Control Arm		MN-VB-5238	Wishbone (CV), Leading Axle;Drive Axle; Air Suspension Axle
	10/07→	Track Control Arm		MN-VB-9403	Wishbone (CV), Air Suspension Axle
	10/07→	Track Control Arm	MN-DL-8663		Control Arm, Air Suspension Axle
26.480 FPHLS	05/08→	Centre Rod	MN-DL-7801		Push Rod
	05/08→	Mounting, stabilizer coupling rod	MN-SB-5246		
	05/08→	Tie Rod	MN-DL-7802		
	05/08→	Track Control Arm		MN-DL-5225	Trailing Arm
	05/08→	Track Control Arm	MN-VB-5238	MN-VB-5238	Wishbone (CV);Control Arm
26.480 FVHLS	05/08→	Centre Rod	MN-DL-7801		Push Rod
	05/08→	Mounting, stabilizer coupling rod	MN-SB-5246		
	05/08→	Tie Rod	MN-DL-7802		
	05/08→	Track Control Arm		MN-DL-5225	Trailing Arm
	05/08→	Track Control Arm	MN-VB-5238	MN-VB-5238	Wishbone (CV);Control Arm
	05/08→	Track Control Arm			
26.540 FDC, FDC/M, FDLC, FDRC, FDRC/M, FDLRC	02/09→	Centre Rod	MN-DL-7801		Push Rod
	02/09→	Tie Rod	MN-DL-7802		
	02/09→	Tie Rod	MN-DL-12293		
	02/09→	Track Control Arm		MN-DL-5225	Trailing Arm
	02/09→	Track Control Arm		MN-DL-8544	Trailing Arm
	02/09→	Track control arm		MN-DL-12288	Trailing Arm
	02/09→	Track Control Arm		MN-VB-8514	Suspension Rod, Wishbone (CV), Drive Axle, for Leaf-Spring Suspension vehicles
	02/09→	Track Control Arm		MN-VB-8669	Suspension Rod, Wishbone (CV)
	02/09→	Track Control Arm		MN-VB-9404	Wishbone (CV)
	02/09→	Track Control Arm	MN-VB-5238	MN-VB-5238	Wishbone (CV);Control Arm
	02/09→	Centre Rod	MN-DL-7801		Push Rod
	02/09→	Tie Rod	MN-DL-7802		
	02/09→	Tie Rod	MN-DL-12293		
	26.540 FDLRS, FDLS, FDRS, FDS, FVHLS	02/09→	Track Control Arm		MN-DL-5225
02/09→		Track Control Arm		MN-DL-8544	Trailing Arm
02/09→		Track control arm		MN-DL-12288	Trailing Arm
02/09→		Track Control Arm		MN-VB-8514	Suspension Rod, Wishbone (CV), Drive Axle, for Leaf-Spring Suspension vehicles
02/09→		Track Control Arm		MN-VB-8669	Suspension Rod, Wishbone (CV)
02/09→		Track Control Arm		MN-VB-9404	Wishbone (CV)
02/09→		Track Control Arm	MN-VB-5238	MN-VB-5238	Wishbone (CV);Control Arm
10/12→		Centre Rod	MN-DL-8560		Push Rod
10/07→		Centre Rod	MN-DL-7801		Push Rod, Leaf Spring Axle
10/07→		Centre Rod	MN-DL-8560		Push Rod, Air Suspension Axle
10/07→		Suspension Strut Repair Kit		DB-RK-8581	
10/07→		Suspension Strut Repair Kit		MN-RK-12436	
10/07→		Tie Rod	MN-DL-7802		
10/07→		Tie Rod End		MN-ES-8490	for vehicles with Hinged Trailing Axle
10/07→	Track Control Arm		MN-DL-5225	Trailing Arm, Drive Axle;Tag Axle; Air Suspension Axle	
10/07→	Track Control Arm		MN-DL-5225	Trailing Arm, for vehicles with Hinged Trailing Axle;Air Suspension Axle	
10/07→	Track Control Arm		MN-DL-8709	Trailing Arm, for vehicles with Hinged Trailing Axle;Air Suspension Axle	
10/07→	Track Control Arm		MN-TC-12399	Control Arm	
10/07→	Track Control Arm		MN-VB-5238	Wishbone (CV), Leading Axle;Drive Axle; Air Suspension Axle	
10/07→	Track Control Arm		MN-VB-9403	Wishbone (CV), Air Suspension Axle	
10/07→	Track Control Arm	MN-DL-8663		Control Arm, Air Suspension Axle	

DB-RK-8581

Ø: 85
Hole Distance: 130
Thick/Height: 24
03305800A, 81432706105



MN-DL-5225

Length: 572 Ø: 48
Hole Distance: 130 / 130

03301500A, 81432206229, 81432206236,
81432206267, 81432206270, 81432206272,
81432206304, 81432206305, 81432209236,
81432209267, 81432209272



MN-DL-7801

Length: 995 Ø: 52
Cone Ø: d1 Ø 30 / d2 Ø 27

81466106807, 81466106808, 81466116087,
81466116088, 81466116096, 81466116097,
81466116099, 81466116132, 81466116133,
81466116136, 81466116197, 81466116198,
81466116205



MN-DL-7802

Length: 1680 Ø: 52
Cone Ø: d1 Ø 30 / d2 Ø 27

03208300A, 81467116773, 81467116858,
81467116859, 81467116860, 81467116861,
81467116863, 81467116882, 81467116883,
81467116920, 81467116921



MN-DL-8544

Length: 596 Ø: 48
Hole Distance: 130 / 130

81432206196, 81432206232, 81432206233



MN-DL-8560

Length: 970 Ø: 52
Cone Ø: d1 Ø 30 / d2 Ø 27

03206900A, 81466106809, 81466106810,
81466106823, 81466106838, 81466106839,
81466116104, 81466116105, 81466116107,
81466116134, 81466116135, 81466116137,
81466116199, 81466116200, 81466116206



MN-DL-8663

Length: 947 Ø: 60
Hole Distance: 115 / 115

03307400A, 81432206222, 81432206260,
81432206283, 81432206284



MN-DL-8709

Length: 572 Ø: 52
Hole Distance: 130 / 130

81432206268, 81432206274, 81432206291,
81432206292, 82432206007



MN-DL-12288

Length: 585 Ø: 58
Hole Distance: 130 / 130

81432206386, 82432206008, 82432209008

No Image

MN-DL-12293

Length: 1680 Ø: 42
Cone Ø: d1 Ø 30 / d2 Ø 27

81467106236, 81467106268, 81467106356,
81467116356, 81467116723, 81467116794,
81467116933, 81467116934, 81467116966



MN-ES-8490

Length: 90
Cone Ø: d1 Ø 30 / d2 Ø 27
Thread: M26 x 1,5 RHT

0014606948, 14606948, 81953016281,
81953016337, 82953016016



MN-RK-12436

Ø: 75
Hole Distance: 115
Thick/Height: 24

81432206244

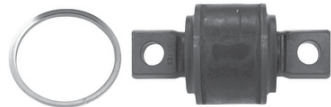

MN-SB-5246

Ø: 45 Thick/Height: 47

81437220022, 81437220038, 81962100450,
81962100469



MN-TC-12399

Length: 694 Ø: 50
Hole Distance: 130 / 130

81432206265



MN-VB-5238

Length: 627 Ø: 48
Hole Distance: 130 / 130

81432206221, 81432706096, 81432706114,
81432706116, 81432706121



MN-VB-8514

Length: 627 Ø: 48
Hole Ø 25 / 25 / 25
Hole Distance: 152 / 130 / 130

81432706087, 81432706088, 81432706094,
81432706095, 81432796094



MN-VB-8669

Length: 627 Ø: 48
Hole Ø 25 / 25 / 25
Hole Distance: 152 / 130 / 130

81432706116, 81432706137, 81432706150,
81432706151



MN-VB-9403

Length: 627 Ø: 48
Hole Ø 25 / 23 / 23
Hole Distance: 152 / 130 / 130

81432706097, 81432706113, 81432706135,
81432706160, 81432706161



MN-VB-9404

Length: 627 Ø: 58
Hole Distance: 130 / 130

81432706117, 81432706152, 81432706153





TGX ...

26.540 FNLS, FNLRs, FNLLS, FPLS, FPLRS, FVLS	10/07→	Centre Rod	MN-DL-7801		Push Rod, Leaf Spring Axle
	10/07→	Mounting, stabilizer coupling rod	MN-SB-5246		
	10/07→	Suspension Strut Repair Kit		DB-RK-8581	
	10/07→	Tie Rod	MN-DL-7802		
	10/07→	Tie Rod	MN-DL-12284		
	10/07→	Tie Rod End		MN-ES-8490	for vehicles with Hinged Trailing Axle
	10/07→	Track Control Arm		MN-DL-5225	Trailing Arm, Drive Axle;Leading Axle; Air Suspension Axle
	10/07→	Track Control Arm		MN-DL-5225	Trailing Arm, Drive Axle;Tag Axle; Air Suspension Axle
	10/07→	Track Control Arm		MN-DL-5225	Trailing Arm, for vehicles with Hinged Trailing Axle;Air Suspension Axle
	10/07→	Track Control Arm		MN-DL-8709	Trailing Arm, for vehicles with Hinged Trailing Axle;Air Suspension Axle
	10/07→	Track Control Arm		MN-TC-12399	Control Arm
	10/07→	Track Control Arm		MN-VB-5238	Wishbone (CV), Leading Axle;Drive Axle; Air Suspension Axle
	10/07→	Track Control Arm		MN-VB-9403	Wishbone (CV), Air Suspension Axle
	28.360 FNLC	10/07→	Centre Rod	MN-DL-7801	
10/07→		Suspension Strut Repair Kit		DB-RK-8581	
10/07→		Tie Rod	MN-DL-7802		
10/07→		Track Control Arm		MN-DL-5225	Trailing Arm, Drive Axle;Air Suspension Axle
10/07→		Track Control Arm		MN-VB-5238	Wishbone (CV), Drive Axle;Air Suspension Axle
28.360 FNLS	10/07→	Centre Rod	MN-DL-7801		Push Rod, Leaf Spring Axle
	10/07→	Suspension Strut Repair Kit		DB-RK-8581	
	10/07→	Tie Rod	MN-DL-7802		
	10/07→	Track Control Arm		MN-DL-5225	Trailing Arm, Drive Axle;Air Suspension Axle
	10/07→	Track Control Arm		MN-VB-5238	Wishbone (CV), Drive Axle;Air Suspension Axle
28.400 FNLC	10/07→	Centre Rod	MN-DL-7801		Push Rod, Leaf Spring Axle
	10/07→	Suspension Strut Repair Kit		DB-RK-8581	
	10/07→	Tie Rod	MN-DL-7802		
	10/07→	Track Control Arm		MN-DL-5225	Trailing Arm, Drive Axle;Air Suspension Axle
	10/07→	Track Control Arm		MN-VB-5238	Wishbone (CV), Drive Axle;Air Suspension Axle
28.400 FNLS	10/07→	Centre Rod	MN-DL-7801		Push Rod, Leaf Spring Axle
	10/07→	Suspension Strut Repair Kit		DB-RK-8581	
	10/07→	Tie Rod	MN-DL-7802		
	10/07→	Track Control Arm		MN-DL-5225	Trailing Arm, Drive Axle;Air Suspension Axle
	10/07→	Track Control Arm		MN-VB-5238	Wishbone (CV), Drive Axle;Air Suspension Axle
28.440 FNLC	10/07→	Centre Rod	MN-DL-7801		Push Rod, Leaf Spring Axle
	10/07→	Suspension Strut Repair Kit		DB-RK-8581	
	10/07→	Tie Rod	MN-DL-7802		
	10/07→	Track Control Arm		MN-DL-5225	Trailing Arm, Drive Axle;Air Suspension Axle
	10/07→	Track Control Arm		MN-VB-5238	Wishbone (CV), Drive Axle;Air Suspension Axle
28.440 FNLS	10/12→	Centre Rod	MN-DL-8560		Push Rod
	10/07→	Centre Rod	MN-DL-7801		Push Rod, Leaf Spring Axle
	10/07→	Suspension Strut Repair Kit		DB-RK-8581	
	10/07→	Tie Rod	MN-DL-7802		
	10/07→	Track Control Arm		MN-DL-5225	Trailing Arm, Drive Axle;Air Suspension Axle
28.480 FNLC	10/07→	Centre Rod	MN-DL-7801		Push Rod, Leaf Spring Axle
	10/07→	Suspension Strut Repair Kit		DB-RK-8581	
	10/07→	Tie Rod	MN-DL-7802		
	10/07→	Track Control Arm		MN-DL-5225	Trailing Arm, Drive Axle;Air Suspension Axle
	10/07→	Track Control Arm		MN-VB-5238	Wishbone (CV), Drive Axle;Air Suspension Axle
28.480 FNLS	10/07→	Centre Rod	MN-DL-7801		Push Rod, Leaf Spring Axle
	10/07→	Suspension Strut Repair Kit		DB-RK-8581	
	10/07→	Tie Rod	MN-DL-7802		
	10/07→	Track Control Arm		MN-DL-5225	Trailing Arm, Drive Axle;Air Suspension Axle
	10/07→	Track Control Arm		MN-VB-5238	Wishbone (CV), Drive Axle;Air Suspension Axle

DB-RK-8581

Ø: 85
Hole Distance: 130
Thick/Height: 24
03305800A, 81432706105



MN-ES-8490

Length: 90
Cone Ø: d1 Ø 30 / d2 Ø 27
Thread: M26 x 1,5 RHT
0014606948, 14606948, 81953016281,
81953016337, 82953016016



MN-DL-5225

Length: 572 Ø: 48
Hole Distance: 130 / 130
03301500A, 81432206229, 81432206236,
81432206267, 81432206270, 81432206272,
81432206304, 81432206305, 81432209236,
81432209267, 81432209272



MN-SB-5246

Ø: 45 Thick/Height: 47
81437220022, 81437220038, 81962100450,
81962100469



MN-DL-7801

Length: 995 Ø: 52
Cone Ø: d1 Ø 30 / d2 Ø 27
81466106807, 81466106808, 81466116087,
81466116088, 81466116096, 81466116097,
81466116099, 81466116132, 81466116133,
81466116136, 81466116197, 81466116198,
81466116205



MN-TC-12399

Length: 694 Ø: 50
Hole Distance: 130 / 130
81432206265



MN-VB-5238

Length: 627 Ø: 48
Hole Distance: 130 / 130
81432206221, 81432706096, 81432706114,
81432706116, 81432706121



MN-DL-7802

Length: 1680 Ø: 52
Cone Ø: d1 Ø 30 / d2 Ø 27
03208300A, 81467116773, 81467116858,
81467116859, 81467116860, 81467116861,
81467116863, 81467116882, 81467116883,
81467116920, 81467116921



MN-VB-9403

Length: 627 Ø: 48
Hole Ø 25 / 23 / 23
Hole Distance: 152 / 130 / 130
81432706097, 81432706113, 81432706135,
81432706160, 81432706161



MN-DL-8560

Length: 970 Ø: 52
Cone Ø: d1 Ø 30 / d2 Ø 27
03206900A, 81466106809, 81466106810,
81466106823, 81466106838, 81466106839,
81466116104, 81466116105, 81466116107,
81466116134, 81466116135, 81466116137,
81466116199, 81466116200, 81466116206



MN-DL-8709

Length: 572 Ø: 52
Hole Distance: 130 / 130
81432206268, 81432206274, 81432206291,
81432206292, 82432206007



MN-DL-12284

Length: 1530 Ø: 50
Cone Ø: d1 Ø 30 / d2 Ø 27
81466106579, 81466106580, 81466106624,
81466116720, 81467116720, 81467116730,
81467116952





TGX ...

28.540 FNLC	10/07→	Centre Rod	MN-DL-7801		Push Rod, Leaf Spring Axle	
	10/07→	Suspension Strut Repair Kit		DB-RK-8581		
	10/07→	Tie Rod	MN-DL-7802			
	10/07→	Track Control Arm		MN-DL-5225	Trailing Arm, Drive Axle;Air Suspension Axle	
	10/07→	Track Control Arm		MN-VB-5238	Wishbone (CV), Drive Axle;Air Suspension Axle	
28.540 FNLS	02/09→	Centre Rod	MN-DL-7801		Push Rod	
	02/09→	Tie Rod	MN-DL-7802			
	02/09→	Track Control Arm		MN-DL-5225	Trailing Arm	
	02/09→	Track Control Arm	MN-VB-5238	MN-VB-5238	Wishbone (CV);Control Arm	
32.440 FDC, FDLC, FDLRC, FDRC	10/07→	Tie Rod	MN-DL-12293			
	10/07→	Track control arm		MN-DL-12288	Trailing Arm	
33.360 FDC, FDC/M, FDLC, FDLRC	10/07→	Centre Rod	MN-DL-7801		Push Rod, Leaf Spring Axle	
	10/07→	Suspension Strut Repair Kit		DB-RK-8581		
	10/07→	Tie Rod	MN-DL-7802			
	10/07→	Tie Rod	MN-DL-12293			
	10/07→	Track Control Arm		MN-DL-5225	Trailing Arm	
	10/07→	Track Control Arm		MN-DL-8544	Trailing Arm, Drive Axle;Leaf Spring Axle	
	10/07→	Track control arm		MN-DL-12288	Trailing Arm	
	10/07→	Track Control Arm		MN-VB-8514	Suspension Rod, Wishbone (CV), Drive Axle; Leaf Spring Axle	
	10/07→	Track Control Arm		MN-VB-8669	Suspension Rod, Wishbone (CV), Drive Axle; Leaf Spring Axle	
	10/07→	Track Control Arm		MN-VB-9404	Wishbone (CV), 1st RA;2nd RA	
	33.360 FDS, FDS/M, FDLS, FDLS/M	10/07→	Centre Rod	MN-DL-7801		Push Rod, Leaf Spring Axle
		10/07→	Suspension Strut Repair Kit		DB-RK-8581	
		10/07→	Tie Rod	MN-DL-7802		
10/07→		Tie Rod	MN-DL-12293			
10/07→		Track Control Arm		MN-DL-5225	Trailing Arm	
10/07→		Track Control Arm		MN-DL-8544	Trailing Arm, Drive Axle;Leaf Spring Axle	
10/07→		Track control arm		MN-DL-12288	Trailing Arm	
10/07→		Track Control Arm		MN-VB-8514	Suspension Rod, Wishbone (CV), Drive Axle; Leaf Spring Axle	
10/07→		Track Control Arm		MN-VB-8669	Suspension Rod, Wishbone (CV), Drive Axle; Leaf Spring Axle	
10/07→		Track Control Arm		MN-VB-9404	Wishbone (CV), 1st RA;2nd RA	
33.400 FDC, FDC/M, FDLC, FDLRC, FDRC		10/07→	Centre Rod	MN-DL-7801		Push Rod, Leaf Spring Axle
		10/07→	Suspension Strut Repair Kit		DB-RK-8581	
		10/07→	Tie Rod	MN-DL-7802		
	10/07→	Tie Rod	MN-DL-12293			
	10/07→	Track Control Arm		MN-DL-5225	Trailing Arm, Drive Axle;Air Suspension Axle	
	10/07→	Track Control Arm		MN-DL-8544	Trailing Arm, Drive Axle;Air Suspension Axle	
	10/07→	Track Control Arm		MN-DL-8544	Trailing Arm, Drive Axle;Leaf Spring Axle	
	10/07→	Track control arm		MN-DL-12288	Trailing Arm	
	10/07→	Track Control Arm		MN-VB-5238	Wishbone (CV), Drive Axle;Air Suspension Axle	
	10/07→	Track Control Arm		MN-VB-8514	Suspension Rod, Wishbone (CV), Drive Axle; Air Suspension Axle	
	10/07→	Track Control Arm		MN-VB-8514	Suspension Rod, Wishbone (CV), Drive Axle; Leaf Spring Axle	
	10/07→	Track Control Arm		MN-VB-8669	Suspension Rod, Wishbone (CV), Drive Axle; Leaf Spring Axle	
	10/07→	Track Control Arm		MN-VB-9404	Wishbone (CV), 1st RA;2nd RA	
	10/07→	Track Control Arm		MN-VB-9404	Wishbone (CV), Drive Axle;Air Suspension Axle	

DB-RK-8581

Ø: 85
Hole Distance: 130
Thick/Height: 24
03305800A, 81432706105



MN-VB-5238

Length: 627 Ø: 48
Hole Distance: 130 / 130
81432206221, 81432706096, 81432706114,
81432706116, 81432706121



MN-DL-5225

Length: 572 Ø: 48
Hole Distance: 130 / 130
03301500A, 81432206229, 81432206236,
81432206267, 81432206270, 81432206272,
81432206304, 81432206305, 81432209236,
81432209267, 81432209272



MN-VB-8514

Length: 627 Ø: 48
Hole Ø 25 / 25 / 25
Hole Distance: 152 / 130 / 130
81432706087, 81432706088, 81432706094,
81432706095, 81432796094



MN-DL-7801

Length: 995 Ø: 52
Cone Ø: d1 Ø 30 / d2 Ø 27
81466106807, 81466106808, 81466116087,
81466116088, 81466116096, 81466116097,
81466116099, 81466116132, 81466116133,
81466116136, 81466116197, 81466116198,
81466116205

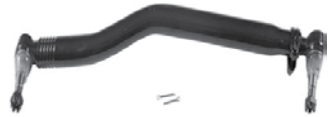

MN-VB-8669

Length: 627 Ø: 48
Hole Ø 25 / 25 / 25
Hole Distance: 152 / 130 / 130
81432706116, 81432706137, 81432706150,
81432706151



MN-DL-7802

Length: 1680 Ø: 52
Cone Ø: d1 Ø 30 / d2 Ø 27
03208300A, 81467116773, 81467116858,
81467116859, 81467116860, 81467116861,
81467116863, 81467116882, 81467116883,
81467116920, 81467116921



MN-VB-9404

Length: 627 Ø: 58
Hole Distance: 130 / 130
81432706117, 81432706152, 81432706153



MN-DL-8544

Length: 596 Ø: 48
Hole Distance: 130 / 130
81432206196, 81432206232, 81432206233



MN-DL-12288

Length: 585 Ø: 58
Hole Distance: 130 / 130
81432206386, 82432206008, 82432209008

No Image

MN-DL-12293

Length: 1680 Ø: 42
Cone Ø: d1 Ø 30 / d2 Ø 27
81467106236, 81467106268, 81467106356,
81467116356, 81467116723, 81467116794,
81467116933, 81467116934, 81467116966





TGX ...

33.400 FDS, FDS/M, FDLS, FDLS/M	10/07→	Centre Rod	MN-DL-7801		Push Rod, Leaf Spring Axle
	10/07→	Suspension Strut Repair Kit		DB-RK-8581	
	10/07→	Tie Rod	MN-DL-7802		
	10/07→	Tie Rod	MN-DL-12293		
	10/07→	Track Control Arm		MN-DL-5225	Trailing Arm, Drive Axle;Air Suspension Axle
	10/07→	Track Control Arm		MN-DL-8544	Trailing Arm, Drive Axle;Air Suspension Axle
	10/07→	Track Control Arm		MN-DL-8544	Trailing Arm, Drive Axle;Leaf Spring Axle
	10/07→	Track control arm		MN-DL-12288	Trailing Arm
	10/07→	Track Control Arm		MN-VB-5238	Wishbone (CV), Drive Axle;Air Suspension Axle
	10/07→	Track Control Arm		MN-VB-8514	Suspension Rod, Wishbone (CV), Drive Axle; Air Suspension Axle
	10/07→	Track Control Arm		MN-VB-8514	Suspension Rod, Wishbone (CV), Drive Axle; Leaf Spring Axle
	10/07→	Track Control Arm		MN-VB-8669	Suspension Rod, Wishbone (CV), Drive Axle; Leaf Spring Axle
	10/07→	Track Control Arm		MN-VB-9404	Wishbone (CV), 1st RA;2nd RA
	10/07→	Track Control Arm		MN-VB-9404	Wishbone (CV), Drive Axle;Air Suspension Axle
	33.440 FDC, FDC/M, FDLC, FDLC, FDRC	10/07→	Centre Rod	MN-DL-7801	
10/07→		Suspension Strut Repair Kit		DB-RK-8581	
10/07→		Tie Rod	MN-DL-7802		
10/07→		Tie Rod	MN-DL-12293		
10/07→		Track Control Arm		MN-DL-5225	Trailing Arm, Drive Axle;Air Suspension Axle
10/07→		Track Control Arm		MN-DL-8544	Trailing Arm, Drive Axle;Air Suspension Axle
10/07→		Track Control Arm		MN-DL-8544	Trailing Arm, Drive Axle;Leaf Spring Axle
10/07→		Track control arm		MN-DL-12288	Trailing Arm
10/07→		Track Control Arm		MN-VB-5238	Wishbone (CV), Drive Axle;Air Suspension Axle
10/07→		Track Control Arm		MN-VB-8514	Suspension Rod, Wishbone (CV), Drive Axle; Leaf Spring Axle
10/07→		Track Control Arm		MN-VB-8669	Suspension Rod, Wishbone (CV), Drive Axle; Leaf Spring Axle
10/07→		Track Control Arm		MN-VB-9404	Wishbone (CV), 1st RA;2nd RA
10/07→		Track Control Arm		MN-VB-9404	Wishbone (CV), Drive Axle;Air Suspension Axle
09/09→		Centre Rod	MN-DL-8560		Push Rod
01/14→		Centre Rod	MN-DL-8560		Push Rod
33.440 FDK, FDLK	10/07→	Centre Rod	MN-DL-7801		Push Rod, Leaf Spring Axle
	10/07→	Suspension Strut Repair Kit		DB-RK-8581	
	10/07→	Tie Rod	MN-DL-7802		
	10/07→	Tie Rod	MN-DL-12293		
	10/07→	Track Control Arm		MN-DL-5225	Trailing Arm, Drive Axle;Air Suspension Axle
	10/07→	Track Control Arm		MN-DL-8544	Trailing Arm, Drive Axle;Air Suspension Axle
	10/07→	Track Control Arm		MN-DL-8544	Trailing Arm, Drive Axle;Leaf Spring Axle
	10/07→	Track control arm		MN-DL-12288	Trailing Arm
	10/07→	Track Control Arm		MN-VB-5238	Wishbone (CV), Drive Axle;Air Suspension Axle
	10/07→	Track Control Arm		MN-VB-8514	Suspension Rod, Wishbone (CV), Drive Axle; Air Suspension Axle
	10/07→	Track Control Arm		MN-VB-8514	Suspension Rod, Wishbone (CV), Drive Axle; Leaf Spring Axle
	10/07→	Track Control Arm		MN-VB-8669	Suspension Rod, Wishbone (CV), Drive Axle; Leaf Spring Axle
	10/07→	Track Control Arm		MN-VB-9404	Wishbone (CV), 1st RA;2nd RA
	10/07→	Track Control Arm		MN-VB-9404	Wishbone (CV), Drive Axle;Air Suspension Axle
	10/12→	Centre Rod	MN-DL-8560		Push Rod

DB-RK-8581

Ø: 85
Hole Distance: 130
Thick/Height: 24
03305800A, 81432706105



MN-DL-5225

Length: 572 Ø: 48
Hole Distance: 130 / 130
03301500A, 81432206229, 81432206236,
81432206267, 81432206270, 81432206272,
81432206304, 81432206305, 81432209236,
81432209267, 81432209272



MN-DL-7801

Length: 995 Ø: 52
Cone Ø: d1 Ø 30 / d2 Ø 27
81466106807, 81466106808, 81466116087,
81466116088, 81466116096, 81466116097,
81466116099, 81466116132, 81466116133,
81466116136, 81466116197, 81466116198,
81466116205

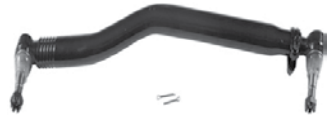

MN-DL-7802

Length: 1680 Ø: 52
Cone Ø: d1 Ø 30 / d2 Ø 27
03208300A, 81467116773, 81467116858,
81467116859, 81467116860, 81467116861,
81467116863, 81467116882, 81467116883,
81467116920, 81467116921



MN-DL-8544

Length: 596 Ø: 48
Hole Distance: 130 / 130
81432206196, 81432206232, 81432206233



MN-DL-8560

Length: 970 Ø: 52
Cone Ø: d1 Ø 30 / d2 Ø 27
03206900A, 81466106809, 81466106810,
81466106823, 81466106838, 81466106839,
81466116104, 81466116105, 81466116107,
81466116134, 81466116135, 81466116137,
81466116199, 81466116200, 81466116206



MN-DL-12288

Length: 585 Ø: 58
Hole Distance: 130 / 130
81432206386, 82432206008, 82432209008

No Image

MN-DL-12293

Length: 1680 Ø: 42
Cone Ø: d1 Ø 30 / d2 Ø 27
81467106236, 81467106268, 81467106356,
81467116356, 81467116723, 81467116794,
81467116933, 81467116934, 81467116966



MN-VB-5238

Length: 627 Ø: 48
Hole Distance: 130 / 130
81432206221, 81432706096, 81432706114,
81432706116, 81432706121



MN-VB-8514

Length: 627 Ø: 48
Hole Ø 25 / 25 / 25
Hole Distance: 152 / 130 / 130
81432706087, 81432706088, 81432706094,
81432706095, 81432796094



MN-VB-8669

Length: 627 Ø: 48
Hole Ø 25 / 25 / 25
Hole Distance: 152 / 130 / 130
81432706116, 81432706137, 81432706150,
81432706151



MN-VB-9404

Length: 627 Ø: 58
Hole Distance: 130 / 130
81432706117, 81432706152, 81432706153



DB-RK-8581

Ø: 85
Hole Distance: 130
Thick/Height: 24
03305800A, 81432706105



MN-DL-12293

Length: 1680 Ø: 42
Cone Ø: d1 Ø 30 / d2 Ø 27
81467106236, 81467106268, 81467106356,
81467116356, 81467116723, 81467116794,
81467116933, 81467116934, 81467116966



MN-VB-5238

Length: 627 Ø: 48
Hole Distance: 130 / 130
81432206221, 81432706096, 81432706114,
81432706116, 81432706121



MN-DL-5225

Length: 572 Ø: 48
Hole Distance: 130 / 130
03301500A, 81432206229, 81432206236,
81432206267, 81432206270, 81432206272,
81432206304, 81432206305, 81432209236,
81432209267, 81432209272



MN-VB-8514

Length: 627 Ø: 48
Hole Ø 25 / 25 / 25
Hole Distance: 152 / 130 / 130
81432706087, 81432706088, 81432706094,
81432706095, 81432796094



MN-DL-7801

Length: 995 Ø: 52
Cone Ø: d1 Ø 30 / d2 Ø 27
81466106807, 81466106808, 81466116087,
81466116088, 81466116096, 81466116097,
81466116099, 81466116132, 81466116133,
81466116136, 81466116197, 81466116198,
81466116205



MN-VB-8669

Length: 627 Ø: 48
Hole Ø 25 / 25 / 25
Hole Distance: 152 / 130 / 130
81432706116, 81432706137, 81432706150,
81432706151



MN-DL-7802

Length: 1680 Ø: 52
Cone Ø: d1 Ø 30 / d2 Ø 27
03208300A, 81467116773, 81467116858,
81467116859, 81467116860, 81467116861,
81467116863, 81467116882, 81467116883,
81467116920, 81467116921



MN-VB-9404

Length: 627 Ø: 58
Hole Distance: 130 / 130
81432706117, 81432706152, 81432706153



MN-DL-8544

Length: 596 Ø: 48
Hole Distance: 130 / 130
81432206196, 81432206232, 81432206233



MN-DL-8560

Length: 970 Ø: 52
Cone Ø: d1 Ø 30 / d2 Ø 27
03206900A, 81466106809, 81466106810,
81466106823, 81466106838, 81466106839,
81466116104, 81466116105, 81466116107,
81466116134, 81466116135, 81466116137,
81466116199, 81466116200, 81466116206



MN-DL-12288

Length: 585 Ø: 58
Hole Distance: 130 / 130
81432206386, 82432206008, 82432209008

No Image



TGX ...

33.540 FDS, FDS/M, FDLS, FDLS/M ...	10/07→	Track Control Arm		MN-VB-8514	Suspension Rod, Wishbone (CV), Drive Axle; Leaf Spring Axle
	10/07→	Track Control Arm		MN-VB-8669	Suspension Rod, Wishbone (CV), Drive Axle; Leaf Spring Axle
	10/07→	Track Control Arm		MN-VB-9404	Wishbone (CV), 1st RA;2nd RA
	10/07→	Track Control Arm		MN-VB-9404	Wishbone (CV), Drive Axle;Air Suspension Axle
33.680 FDLC	10/07→	Centre Rod	MN-DL-7801		Push Rod, Leaf Spring Axle
	10/07→	Suspension Strut Repair Kit		DB-RK-8581	
	10/07→	Tie Rod	MN-DL-7802		
	10/07→	Track Control Arm		MN-DL-5225	Trailing Arm, Leading Axle;Air Suspension Axle
	10/07→	Track Control Arm		MN-DL-8544	Trailing Arm, Drive Axle;Air Suspension Axle
	10/07→	Track Control Arm		MN-VB-9404	Wishbone (CV), 1st RA;2nd RA; Air Suspension Axle
33.680 FDLS	10/07→	Centre Rod	MN-DL-7801		Push Rod, Leaf Spring Axle
	10/07→	Suspension Strut Repair Kit		DB-RK-8581	
	10/07→	Tie Rod	MN-DL-7802		
	10/07→	Track Control Arm		MN-DL-5225	Trailing Arm, Leading Axle;Air Suspension Axle
	10/07→	Track Control Arm		MN-DL-8544	Trailing Arm, Drive Axle;Air Suspension Axle
	10/07→	Track Control Arm		MN-VB-9404	Wishbone (CV), 1st RA;2nd RA; Air Suspension Axle
35.360 FDNLC	06/08→	Centre Rod	MN-DL-7801		Push Rod, Leaf Spring Axle
	06/08→	Suspension Strut Repair Kit		DB-RK-8581	
	06/08→	Tie Rod	MN-DL-7802		
	06/08→	Tie Rod	MN-DL-12284		
	06/08→	Tie Rod End		IV-ES-8507	Air Suspension Axle;for vehicles with Hinged Trailing Axle
	06/08→	Track Control Arm		MN-DL-5225	Trailing Arm, Drive Axle;Air Suspension Axle
	06/08→	Track Control Arm		MN-DL-5225	Trailing Arm, Tag Axle;for vehicles with Hinged Trailing Axle;Air Suspension Axle
	06/08→	Track Control Arm		MN-DL-8709	Trailing Arm, for vehicles with Hinged Trailing Axle;Air Suspension Axle
	06/08→	Track Control Arm		MN-VB-5238	Wishbone (CV), Drive Axle;Air Suspension Axle;for vehicles with Hinged Trailing Axle
	06/08→	Track Control Arm		MN-VB-9403	Wishbone (CV), Air Suspension Axle; for vehicles with Hinged Trailing Axle
35.400 FDNLC	06/08→	Centre Rod	MN-DL-7801		Push Rod, Leaf Spring Axle
	06/08→	Suspension Strut Repair Kit		DB-RK-8581	
	06/08→	Tie Rod	MN-DL-7802		
	06/08→	Tie Rod	MN-DL-12284		
	06/08→	Tie Rod End		IV-ES-8507	Air Suspension Axle;for vehicles with Hinged Trailing Axle
	06/08→	Track Control Arm		MN-DL-5225	Trailing Arm, Drive Axle;Air Suspension Axle
	06/08→	Track Control Arm		MN-DL-5225	Trailing Arm, Tag Axle;for vehicles with Hinged Trailing Axle;Air Suspension Axle
	06/08→	Track Control Arm		MN-DL-8709	Trailing Arm, for vehicles with Hinged Trailing Axle;Air Suspension Axle
	06/08→	Track Control Arm		MN-VB-5238	Wishbone (CV), Drive Axle;Air Suspension Axle;for vehicles with Hinged Trailing Axle
	06/08→	Track Control Arm		MN-VB-9403	Wishbone (CV), Air Suspension Axle; for vehicles with Hinged Trailing Axle
35.440 FDNLC	06/08→	Centre Rod	MN-DL-7801		Push Rod, Leaf Spring Axle
	06/08→	Suspension Strut Repair Kit		DB-RK-8581	
	06/08→	Tie Rod	MN-DL-7802		
	06/08→	Tie Rod	MN-DL-12284		
	06/08→	Tie Rod End		IV-ES-8507	Air Suspension Axle;for vehicles with Hinged Trailing Axle
	06/08→	Track Control Arm		MN-DL-5225	Trailing Arm, Drive Axle;Air Suspension Axle
	06/08→	Track Control Arm		MN-DL-5225	Trailing Arm, Tag Axle;for vehicles with Hinged Trailing Axle;Air Suspension Axle
	06/08→	Track Control Arm		MN-DL-8709	Trailing Arm, for vehicles with Hinged Trailing Axle;Air Suspension Axle
	06/08→	Track Control Arm		MN-VB-5238	Wishbone (CV), Drive Axle;Air Suspension Axle;for vehicles with Hinged Trailing Axle
	06/08→	Track Control Arm		MN-VB-9403	Wishbone (CV), Air Suspension Axle; for vehicles with Hinged Trailing Axle

DB-RK-8581

Ø: 85
Hole Distance: 130
Thick/Height: 24
03305800A, 81432706105



IV-ES-8507

Length: 80
Cone Ø: d1 Ø 30 / d2 Ø 27
Thread: M30 x 1,5 RHT
11019869, 12216380, 55175540,
81953016238



MN-DL-5225

Length: 572 Ø: 48
Hole Distance: 130 / 130
03301500A, 81432206229, 81432206236,
81432206267, 81432206270, 81432206272,
81432206304, 81432206305, 81432209236,
81432209267, 81432209272



MN-DL-7801

Length: 995 Ø: 52
Cone Ø: d1 Ø 30 / d2 Ø 27
81466106807, 81466106808, 81466116087,
81466116088, 81466116096, 81466116097,
81466116099, 81466116132, 81466116133,
81466116136, 81466116197, 81466116198,
81466116205



MN-DL-7802

Length: 1680 Ø: 52
Cone Ø: d1 Ø 30 / d2 Ø 27
03208300A, 81467116773, 81467116858,
81467116859, 81467116860, 81467116861,
81467116863, 81467116882, 81467116883,
81467116920, 81467116921



MN-DL-8544

Length: 596 Ø: 48
Hole Distance: 130 / 130
81432206196, 81432206232, 81432206233



MN-DL-8709

Length: 572 Ø: 52
Hole Distance: 130 / 130
81432206268, 81432206274, 81432206291,
81432206292, 82432206007



MN-DL-12284

Length: 1530 Ø: 50
Cone Ø: d1 Ø 30 / d2 Ø 27
81466106579, 81466106580, 81466106624,
81466116720, 81467116720, 81467116730,
81467116952



MN-VB-5238

Length: 627 Ø: 48
Hole Distance: 130 / 130
81432206221, 81432706096, 81432706114,
81432706116, 81432706121



MN-VB-8514

Length: 627 Ø: 48
Hole Ø 25 / 25 / 25
Hole Distance: 152 / 130 / 130
81432706087, 81432706088, 81432706094,
81432706095, 81432796094



MN-VB-8669

Length: 627 Ø: 48
Hole Ø 25 / 25 / 25
Hole Distance: 152 / 130 / 130
81432706116, 81432706137, 81432706150,
81432706151



MN-VB-9403

Length: 627 Ø: 48
Hole Ø 25 / 23 / 23
Hole Distance: 152 / 130 / 130
81432706097, 81432706113, 81432706135,
81432706160, 81432706161



MN-VB-9404

Length: 627 Ø: 58
Hole Distance: 130 / 130
81432706117, 81432706152, 81432706153





TGX ...

35.480 FDNLC	06/08→	Centre Rod	MN-DL-7801		Push Rod, Leaf Spring Axle
	06/08→	Suspension Strut Repair Kit		DB-RK-8581	
	06/08→	Tie Rod	MN-DL-7802		
	06/08→	Tie Rod	MN-DL-12284		
	06/08→	Tie Rod End		IV-ES-8507	Air Suspension Axle;for vehicles with Hinged Trailing Axle
	06/08→	Track Control Arm		MN-DL-5225	Trailing Arm, Drive Axle;Air Suspension Axle
	06/08→	Track Control Arm		MN-DL-5225	Trailing Arm, Tag Axle;for vehicles with Hinged Trailing Axle;Air Suspension Axle
	06/08→	Track Control Arm		MN-DL-8709	Trailing Arm, for vehicles with Hinged Trailing Axle;Air Suspension Axle
	06/08→	Track Control Arm		MN-VB-5238	Wishbone (CV), Drive Axle;Air Suspension Axle;for vehicles with Hinged Trailing Axle
	06/08→	Track Control Arm		MN-VB-9403	Wishbone (CV), Air Suspension Axle; for vehicles with Hinged Trailing Axle
35.540 FDNLC	06/08→	Centre Rod	MN-DL-7801		Push Rod, Leaf Spring Axle
	06/08→	Suspension Strut Repair Kit		DB-RK-8581	
	06/08→	Tie Rod	MN-DL-7802		
	06/08→	Tie Rod	MN-DL-12284		
	06/08→	Tie Rod End		IV-ES-8507	Air Suspension Axle;for vehicles with Hinged Trailing Axle
	06/08→	Track Control Arm		MN-DL-5225	Trailing Arm, Drive Axle;Air Suspension Axle
	06/08→	Track Control Arm		MN-DL-5225	Trailing Arm, Tag Axle;for vehicles with Hinged Trailing Axle;Air Suspension Axle
	06/08→	Track Control Arm		MN-DL-8709	Trailing Arm, for vehicles with Hinged Trailing Axle;Air Suspension Axle
	06/08→	Track Control Arm		MN-VB-5238	Wishbone (CV), Drive Axle;Air Suspension Axle;for vehicles with Hinged Trailing Axle
	06/08→	Track Control Arm		MN-VB-9403	Wishbone (CV), Air Suspension Axle; for vehicles with Hinged Trailing Axle
41.540 FVDS, FVDLS	06/08→	Centre Rod	MN-DL-7801		Push Rod, Leaf Spring Axle
	06/08→	Suspension Strut Repair Kit		DB-RK-8581	
	06/08→	Tie Rod	MN-DL-7802		
	06/08→	Track Control Arm		MN-DL-5225	Trailing Arm, Leading Axle;Air Suspension Axle
	06/08→	Track Control Arm		MN-DL-8544	Trailing Arm, Drive Axle;Air Suspension Axle
	06/08→	Track Control Arm		MN-VB-8514	Suspension Rod, Wishbone (CV)
	06/08→	Track Control Arm		MN-VB-9404	Wishbone (CV), Drive Axle;Air Suspension Axle
41.680 FVDS, FVDLS	10/07→	Centre Rod	MN-DL-7801		Push Rod, Leaf Spring Axle
	10/07→	Suspension Strut Repair Kit		DB-RK-8581	
	10/07→	Tie Rod	MN-DL-7802		
	10/07→	Track Control Arm		MN-DL-5225	Trailing Arm, Leading Axle;Air Suspension Axle
	10/07→	Track Control Arm		MN-DL-5225	Trailing Arm, Leading Axle;Leaf Spring Axle
	10/07→	Track Control Arm		MN-DL-8544	Trailing Arm, Drive Axle;Air Suspension Axle
	10/07→	Track Control Arm		MN-DL-8544	Trailing Arm, Drive Axle;Leaf Spring Axle
	10/07→	Track Control Arm		MN-VB-8514	Suspension Rod, Wishbone (CV)
10/07→	Track Control Arm		MN-VB-9404	Wishbone (CV), Drive Axle;Air Suspension Axle	

ÜL

ÜL 242	09/89→03/93	Ball Head, gearshift linkage	CV-ES-2119		
	09/89→03/93	Ball Head, gearshift linkage	CV-ES-2120		
	09/89→03/93	Ball Head, gearshift linkage	CV-ES-2182		
	09/89→03/93	Centre Rod	MN-DL-2293		Push Rod
	09/89→03/93	Tie Rod	MN-DL-8624		
	09/89→03/93	Tie Rod End	CV-ES-14162		for Steering Rod
	09/89→03/93	Tie Rod End	CV-ES-14163		for Steering Rod
ÜL 272	03/93→	Ball Head, gearshift linkage	CV-ES-2119		
	03/93→	Ball Head, gearshift linkage	CV-ES-2120		
	03/93→	Ball Head, gearshift linkage	CV-ES-2182		
	03/93→	Centre Rod	MN-DL-2293		Push Rod
	03/93→	Tie Rod	MN-DL-8624		
	03/93→	Tie Rod End	CV-ES-14162		for Steering Rod
	03/93→	Tie Rod End	CV-ES-14163		for Steering Rod

CV-ES-2119

Length: 55
Cone Ø: d1 Ø 10 / d2 Ø 10
Thread: M12 x 1,75 LHT
81953016063, 81953016131



CV-ES-2120

Length: 115
Cone Ø: d1 Ø 12,4 / d2 Ø 10,8
Thread: M14 x 1,5 RHT
03008500A, 81953016200, 81953016202,
81953016203, 81953016227



CV-ES-2182

Length: 55
Cone Ø: d1 Ø 10 / d2 Ø 10
Thread: M12 x 1,75 RHT
81953016064, 81953016170



CV-ES-14162

Length: 125
Cone Ø: d1 Ø 30 / d2 Ø 27
Thread: M30 x 1,5 LHT
81953010015, 81953010083, 81953010087,
81953016029, 81953016030, 81953016043,
81953016044, 81953016050, 81953016054,
81953016087, 81953016091, 81953016107,
81953016120, 81953016125, 81953016152,
81953016155, 81953016157, 81953016168,
81953016179, 81953016181, 81953016223,
81953016237, 81953016254, 81953016275,
81953016279, 81953016351



CV-ES-14163

Length: 125
Cone Ø: d1 Ø 30 / d2 Ø 27
Thread: M30 x 1,5 RHT
95301.0084, 90804102156, 90804102272,
90804102696, 90804102710, 81953010016,
81953010075, 81953010084, 81953010088,
81953010094, 81953010103, 81953016030,
81953016043, 81953016048, 81953016049,
81953016053, 81953016061, 81953016090,
81953016108, 81953016112, 81953016126,
81953016143, 81953016149, 81953016154,
81953016156, 81953016168, 81953016178,
81953016194, 81953016206, 81953016224,
81953016234, 81953016242, 81953016252,
81953016274, 81953016278, 81953016284,
81953016286, 81953016308, 81953016310,
81953016312, 81953016347, 81953016350,
81953016352, 82953016012, 88953016014,
N2953016001



DB-RK-8581

Ø: 85
Hole Distance: 130
Thick/Height: 24
03305800A, 81432706105



IV-ES-8507

Length: 80
Cone Ø: d1 Ø 30 / d2 Ø 27
Thread: M30 x 1,5 RHT
11019869, 12216380, 55175540,
81953016238



MN-DL-2293

Length: 729
Ø: 40
Cone Ø: d1 Ø 30 / d2 Ø 27
81467106081, 81467106137



MN-DL-5225

Length: 572 Ø: 48
Hole Distance: 130 / 130
03301500A, 81432206229, 81432206236,
81432206267, 81432206270, 81432206272,
81432206304, 81432206305, 81432209236,
81432209267, 81432209272



MN-DL-7801

Length: 995 Ø: 52
Cone Ø: d1 Ø 30 / d2 Ø 27
81466106807, 81466106808, 81466116087,
81466116088, 81466116096, 81466116097,
81466116099, 81466116132, 81466116133,
81466116136, 81466116197, 81466116198,
81466116205



MN-DL-7802

Length: 1680 Ø: 52
Cone Ø: d1 Ø 30 / d2 Ø 27
03208300A, 81467116773, 81467116858,
81467116859, 81467116860, 81467116861,
81467116863, 81467116882, 81467116883,
81467116920, 81467116921



MN-DL-8544

Length: 596 Ø: 48
Hole Distance: 130 / 130
81432206196, 81432206232, 81432206233



MN-DL-8624

Length: 1676 Ø: 50
Cone Ø: d1 Ø 30 / d2 Ø 27
81467106902, 81467116722



MN-DL-8709

Length: 572 Ø: 52
Hole Distance: 130 / 130
81432206268, 81432206274, 81432206291,
81432206292, 82432206007



MN-DL-12284

Length: 1530 Ø: 50
Cone Ø: d1 Ø 30 / d2 Ø 27
81466106579, 81466106580, 81466106624,
81466116720, 81467116720, 81467116730,
81467116952



MN-VB-5238

Length: 627 Ø: 48
Hole Distance: 130 / 130
81432206221, 81432706096, 81432706114,
81432706116, 81432706121



MN-VB-8514

Length: 627 Ø: 48
Hole Ø 25 / 25 / 25
Hole Distance: 152 / 130 / 130
81432706087, 81432706088, 81432706094,
81432706095, 81432796094



MN-VB-9403

Length: 627 Ø: 48
Hole Ø 25 / 23 / 23
Hole Distance: 152 / 130 / 130
81432706097, 81432706113, 81432706135,
81432706160, 81432706161



MN-VB-9404

Length: 627 Ø: 58
Hole Distance: 130 / 130
81432706117, 81432706152, 81432706153



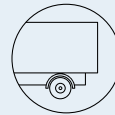

ÜL ...

ÜL 292	09/89→03/93	Ball Head, gearshift linkage	CV-ES-2119		
	09/89→03/93	Ball Head, gearshift linkage	CV-ES-2120		
	09/89→03/93	Ball Head, gearshift linkage	CV-ES-2182		
	09/89→03/93	Centre Rod	MN-DL-2293		Push Rod
	09/89→03/93	Tie Rod	MN-DL-8624		
	09/89→03/93	Tie Rod End	CV-ES-14162		for Steering Rod
	09/89→03/93	Tie Rod End	CV-ES-14163		for Steering Rod
ÜL 312,ÜL 322	04/92→09/96	Ball Head, gearshift linkage	CV-ES-2119		
	04/92→09/96	Ball Head, gearshift linkage	CV-ES-2120		
	04/92→09/96	Ball Head, gearshift linkage	CV-ES-2182		
	04/92→09/96	Centre Rod	MN-DL-2293		Push Rod
	04/92→09/96	Tie Rod	MN-DL-8624		
	04/92→09/96	Tie Rod End	CV-ES-14162		for Steering Rod
	04/92→09/96	Tie Rod End	CV-ES-14163		for Steering Rod
ÜL 313	09/96→	Ball Head, gearshift linkage	CV-ES-2119		
	09/96→	Ball Head, gearshift linkage	CV-ES-2120		
	09/96→	Ball Head, gearshift linkage	CV-ES-2182		
	09/96→	Centre Rod	MN-DL-2293		Push Rod
	09/96→	Suspension Arm Repair Kit		IV-RK-8998	for Wishbone (CV)
	09/96→	Suspension Strut Repair Kit		CV-RK-5311	
	09/96→	Suspension Strut Repair Kit		MN-RK-8558	
	09/96→	Tie Rod	MN-DL-8370		
	09/96→	Tie Rod	MN-DL-8734		
	09/96→	Tie Rod	MN-DL-10268		
	09/96→	Tie Rod End	CV-ES-14162		for Steering Rod
	09/96→	Tie Rod End	CV-ES-14163		for Steering Rod
	09/96→	Track Control Arm		MN-DL-10281	Trailing Arm
	09/96→	Track Control Arm		MN-DL-10284	Trailing Arm
	09/96→	Track Control Arm		MN-DL-10286	Trailing Arm
	09/96→	Track Control Arm	MN-DL-9368	MN-DL-9368	Trailing Arm
	09/96→	Track Control Arm	MN-DL-9369		Control Arm
ÜL 353	06/97→	Ball Head, gearshift linkage	CV-ES-2119		
	06/97→	Ball Head, gearshift linkage	CV-ES-2120		
	06/97→	Ball Head, gearshift linkage	CV-ES-2182		
	06/97→	Centre Rod	MN-DL-2293		Push Rod
	06/97→	Suspension Arm Repair Kit		IV-RK-8998	for Wishbone (CV)
	06/97→	Suspension Strut Repair Kit		CV-RK-5311	
	06/97→	Suspension Strut Repair Kit		MN-RK-8558	
	06/97→	Tie Rod	MN-DL-8370		
	06/97→	Tie Rod	MN-DL-8734		
	06/97→	Tie Rod	MN-DL-10268		
	06/97→	Tie Rod End	CV-ES-14162		for Steering Rod
	06/97→	Tie Rod End	CV-ES-14163		for Steering Rod
	06/97→	Track Control Arm		MN-DL-10281	Trailing Arm
	06/97→	Track Control Arm		MN-DL-10284	Trailing Arm
	06/97→	Track Control Arm		MN-DL-10286	Trailing Arm
	06/97→	Track Control Arm	MN-DL-9368	MN-DL-9368	Trailing Arm
	06/97→	Track Control Arm	MN-DL-9369		Control Arm

CV-ES-2119

Length: 55
Cone Ø: d1 Ø 10 / d2 Ø 10
Thread: M12 x 1,75 LHT
81953016063, 81953016131



CV-ES-2120

Length: 115
Cone Ø: d1 Ø 12,4 / d2 Ø 10,8
Thread: M14 x 1,5 RHT
03008500A, 81953016200, 81953016202, 81953016203, 81953016227



CV-ES-2182

Length: 55
Cone Ø: d1 Ø 10 / d2 Ø 10
Thread: M12 x 1,75 RHT
81953016064, 81953016170



CV-ES-14162

Length: 125
Cone Ø: d1 Ø 30 / d2 Ø 27
Thread: M30 x 1,5 LHT
81953010015, 81953010083, 81953010087, 81953016029, 81953016030, 81953016043, 81953016044, 81953016050, 81953016054, 81953016087, 81953016091, 81953016107, 81953016120, 81953016125, 81953016152, 81953016155, 81953016157, 81953016168, 81953016179, 81953016181, 81953016223, 81953016237, 81953016254, 81953016275, 81953016279, 81953016351



CV-ES-14163

Length: 125
Cone Ø: d1 Ø 30 / d2 Ø 27
Thread: M30 x 1,5 RHT
95301.0084, 90804102156, 90804102272, 90804102696, 90804102710, 81953010016, 81953010075, 81953010084, 81953010088, 81953010094, 81953010103, 81953016030, 81953016043, 81953016048, 81953016049, 81953016053, 81953016061, 81953016090, 81953016108, 81953016112, 81953016126, 81953016143, 81953016149, 81953016154, 81953016156, 81953016168, 81953016178, 81953016194, 81953016206, 81953016224, 81953016234, 81953016242, 81953016252, 81953016274, 81953016278, 81953016284, 81953016286, 81953016308, 81953016310, 81953016312, 81953016347, 81953016350, 81953016352, 82953016012, 88953016014, N2953016001



CV-RK-5311

638862, 639287, 938423, 1104335, 1953248, 0003500506, 3500506, 11013547, 42488722, 070550504, 634303610, 81432206055, 81432206073, 82262320660, 5001842823, 7000307001, 8226232066



IV-RK-8998

Ø: 85
Hole Distance: 130
Thick/Height: 30
81432206203



MN-DL-2293

Length: 729
Ø: 40
Cone Ø: d1 Ø 30 / d2 Ø 27
81467106081, 81467106137



MN-DL-8370

Length: 501 Ø: 40
Cone Ø: d1 Ø 30 / d2 Ø 27
81467106080, 81467106136, 81467106172, 81467106295, 81467106337, 81467106345, 81467106421, 81467106451, 81467106876, 81467116762



MN-DL-8624

Length: 1676 Ø: 50
Cone Ø: d1 Ø 30 / d2 Ø 27
81467106902, 81467116722



MN-DL-8734

Length: 413 Ø: 36
Cone Ø: d1 Ø 30 / d2 Ø 27
81467116771, 81467116877, 81467116878, 81467116879



MN-DL-9368

Length: 330 Ø: 36
Hole Distance: 80
81432206177



MN-DL-9369

Length: 330 Ø: 36
Hole Distance: 80
81432206177, 81432206294



MN-DL-10268

Length: 661 Ø: 38
Cone Ø: d1 Ø 30 / d2 Ø 27
81467116770, 81467116772, 81467116874, 81467116875, 81467116876



MN-DL-10281

Length: 633 Ø: 50
Hole Distance: 130
81432206134, 81432206135, 81432206136, 81432206137, 81432206138, 81432206191



MN-DL-10284

Length: 633 Ø: 50
Hole Distance: 130
81432206187



MN-DL-10286

Length: 570 Ø: 48
Hole Distance: 130 / 130
81432206151, 81432206183, 81432206276



MN-RK-8558

Length: 100 Ø: 95
81432206204



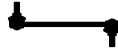

ACTROS

1831 AK

04/97→10/02	Ball Head, gearshift linkage	DB-ES-8387		
04/97→10/02	Ball Head, gearshift linkage	DB-ES-8491		
04/97→10/02	Ball Head, gearshift linkage	DB-ES-8492		
04/97→10/02	Ball Head, gearshift linkage	DB-ES-8500		
04/97→10/02	Ball Head, gearshift linkage	DB-ES-8510		
04/97→10/02	Bush, driver cab suspension	DB-SB-10384		
04/97→10/02	Bush, parabolic spring		DB-SB-10400	
04/97→10/02	Bush, parabolic spring		DB-SB-10401	
04/97→10/02	Centre Rod	DB-DL-2144		Push Rod
04/97→10/02	Centre Rod	DB-DL-5230		Push Rod
04/97→10/02	Centre Rod	DB-DL-5405		Push Rod
04/97→10/02	Centre Rod	DB-DL-8184		Push Rod
04/97→10/02	Centre Rod	DB-DL-8188		Push Rod
04/97→10/02	Centre Rod	DB-DL-8307		Push Rod, Leaf Spring Axle
04/97→10/02	Centre Rod	DB-DL-8639		Push Rod, Leaf Spring Axle
04/97→10/02	Centre Rod	DB-DL-8702		Push Rod, Leaf Spring Axle
04/97→10/02	Centre Rod	DB-DL-9259		Push Rod
04/97→10/02	Centre Rod	DB-DL-12300		for Steering Rod
04/97→10/02	Rod Assembly	DB-DL-2178		Guide Rod
04/97→10/02	Stabiliser Link	DB-DL-9254		Pressure Rod
04/97→10/02	Stabiliser Mounting		DB-SB-5250	
04/97→10/02	Stabiliser Mounting		DB-SB-5261	
04/97→10/02	Stabiliser Mounting		DB-SB-10406	
04/97→10/02	Stabiliser Mounting		DB-SB-10407	
04/97→10/02	Stabiliser Mounting		DB-SB-10409	
04/97→10/02	Stabiliser Mounting	DB-SB-5260		
04/97→10/02	Stabiliser Mounting	DB-SB-5279		
04/97→10/02	Suspension Arm Repair Kit		DB-RK-8626	for Wishbone (CV)
04/97→10/02	Suspension Arm Repair Kit		DB-RK-10374	for Wishbone (CV)
04/97→10/02	Suspension Arm Repair Kit		DB-RK-10375	for Wishbone (CV)
04/97→10/02	Suspension Arm Repair Kit	DB-RK-8638		for Control Arm
04/97→10/02	Suspension Strut Repair Kit		DB-RK-8391	
04/97→10/02	Tie Rod	DB-DL-12310		
04/97→10/02	Tie Rod	DB-ES-5227		Guide Rod
04/97→10/02	Tie Rod	MN-DL-7834		Guide Rod
04/97→10/02	Tie Rod End	CV-ES-0543		for Push Rod
04/97→10/02	Tie Rod End	CV-ES-0888		for Push Rod
04/97→10/02	Tie Rod End	CV-ES-14162		for Steering Rod
04/97→10/02	Tie Rod End	CV-ES-14163		for Steering Rod
04/97→10/02	Tie Rod End	DB-ES-5234		for Steering Rod
04/97→10/02	Tie Rod End	DB-ES-8530		for Push Rod
04/97→10/02	Track Control Arm		DB-DL-3475	Trailing Arm
04/97→10/02	Track Control Arm		DB-VB-7261	Suspension Rod, Wishbone (CV), 1st RA, →517142 01/517142 02
04/97→10/02	Track Control Arm	DB-DL-5224		Control Arm
04/97→10/02	Track Control Arm	DB-DL-9218	DB-DL-9218	Trailing Arm

1831 K

04/97→10/02	Ball Head, gearshift linkage	DB-ES-8387		
04/97→10/02	Ball Head, gearshift linkage	DB-ES-8491		
04/97→10/02	Ball Head, gearshift linkage	DB-ES-8492		
04/97→10/02	Ball Head, gearshift linkage	DB-ES-8500		
04/97→10/02	Ball Head, gearshift linkage	DB-ES-8510		
04/97→10/02	Bush, driver cab suspension	DB-SB-10384		
04/97→10/02	Bush, parabolic spring		DB-SB-10400	
04/97→10/02	Bush, parabolic spring		DB-SB-10401	
04/97→10/02	Centre Rod	DB-DL-2144		Push Rod
04/97→10/02	Centre Rod	DB-DL-5230		Push Rod, 1st FA;Leaf Spring Axle
04/97→10/02	Centre Rod	DB-DL-5241		Push Rod
04/97→10/02	Centre Rod	DB-DL-5405		Push Rod, Leaf Spring Axle
04/97→10/02	Centre Rod	DB-DL-7270		Push Rod
04/97→10/02	Centre Rod	DB-DL-8167		Push Rod, Leaf Spring Axle
04/97→10/02	Centre Rod	DB-DL-8184		Push Rod
04/97→10/02	Centre Rod	DB-DL-8185		Push Rod
04/97→10/02	Centre Rod	DB-DL-8188		Push Rod





ACTROS ...

1831 K ...	04/97→10/02	Centre Rod	DB-DL-8307		Push Rod	
	04/97→10/02	Centre Rod	DB-DL-12300		for Steering Rod	
	04/97→10/02	Rod Assembly	DB-DL-2178		Guide Rod	
	04/97→10/02	Stabiliser Link	DB-DL-9254		Pressure Rod	
	04/97→10/02	Stabiliser Mounting		DB-SB-5250		
	04/97→10/02	Stabiliser Mounting		DB-SB-5261		
	04/97→10/02	Stabiliser Mounting		DB-SB-10406		
	04/97→10/02	Stabiliser Mounting		DB-SB-10407		
	04/97→10/02	Stabiliser Mounting		DB-SB-10409		
	04/97→10/02	Stabiliser Mounting	DB-SB-5260			
	04/97→10/02	Stabiliser Mounting	DB-SB-5279			
	04/97→10/02	Suspension Arm Repair Kit		DB-RK-8550	for Wishbone (CV)	
	04/97→10/02	Suspension Arm Repair Kit		DB-RK-8626	for Wishbone (CV)	
	04/97→10/02	Suspension Arm Repair Kit		DB-RK-10374	for Wishbone (CV)	
	04/97→10/02	Suspension Arm Repair Kit		DB-RK-10375	for Wishbone (CV)	
	04/97→10/02	Suspension Arm Repair Kit	DB-RK-8638		for Control Arm	
	04/97→10/02	Suspension Strut Repair Kit		DB-RK-8391		
	04/97→10/02	Tie Rod	DB-DL-8171		Guide Rod	
	04/97→10/02	Tie Rod	DB-DL-8327		Guide Rod	
	04/97→10/02	Tie Rod	DB-DL-8640		Guide Rod	
	04/97→10/02	Tie Rod	DB-DL-12310			
	04/97→10/02	Tie Rod	DB-ES-5227		Guide Rod	
	04/97→10/02	Tie Rod End	CV-ES-0543		for Push Rod	
	04/97→10/02	Tie Rod End	CV-ES-0888		for Push Rod	
	04/97→10/02	Tie Rod End	CV-ES-14162		for Steering Rod	
	04/97→10/02	Tie Rod End	CV-ES-14163		for Steering Rod	
	04/97→10/02	Tie Rod End	DB-ES-5234		for Steering Rod	
	04/97→10/02	Tie Rod End	DB-ES-8164		for Push Rod	
	04/97→10/02	Tie Rod End	DB-ES-8530		for Push Rod	
	04/97→10/02	Track Control Arm		DB-DL-3475	Trailing Arm	
	04/97→10/02	Track Control Arm		DB-VB-7261	Suspension Rod, Wishbone (CV), 1st RA, →517142 01/517142 02	
	04/97→10/02	Track Control Arm	DB-DL-5224		Control Arm	
	04/97→10/02	Track Control Arm	DB-DL-9218	DB-DL-9218	Trailing Arm	
	1831 S, 1831 LS	04/96→10/02	Ball Head, gearshift linkage	DB-ES-8387		
		04/96→10/02	Ball Head, gearshift linkage	DB-ES-8491		
		04/96→10/02	Ball Head, gearshift linkage	DB-ES-8492		
		04/96→10/02	Ball Head, gearshift linkage	DB-ES-8500		
		04/96→10/02	Ball Head, gearshift linkage	DB-ES-8510		
		04/96→10/02	Bush, driver cab suspension	DB-SB-10384		
		04/96→10/02	Bush, parabolic spring		DB-SB-10400	
		04/96→10/02	Bush, parabolic spring		DB-SB-10401	
		04/96→10/02	Centre Rod	DB-DL-2144		Push Rod
		04/96→10/02	Centre Rod	DB-DL-5230		Push Rod, 1st FA;Leaf Spring Axle
		04/96→10/02	Centre Rod	DB-DL-5241		Push Rod
		04/96→10/02	Centre Rod	DB-DL-5405		Push Rod
04/96→10/02		Centre Rod	DB-DL-5405		Push Rod, Leaf Spring Axle	
04/96→10/02		Centre Rod	DB-DL-7270		Push Rod	
04/96→10/02		Centre Rod	DB-DL-8167		Push Rod	
04/96→10/02		Centre Rod	DB-DL-8184		Push Rod	
04/96→10/02		Centre Rod	DB-DL-8185		Push Rod	
04/96→10/02		Centre Rod	DB-DL-8188		Push Rod	
04/96→10/02		Centre Rod	DB-DL-8307		Push Rod	
04/96→10/02		Centre Rod	DB-DL-8392		Push Rod	
04/96→10/02		Centre Rod	DB-DL-12300		for Steering Rod	
04/96→10/02		Rod Assembly	DB-DL-2178		Guide Rod	
04/96→10/02		Stabiliser Mounting		DB-SB-5261		
04/96→10/02		Stabiliser Mounting		DB-SB-10406		
04/96→10/02		Stabiliser Mounting		DB-SB-10407		
04/96→10/02		Stabiliser Mounting		DB-SB-10409		
04/96→10/02		Stabiliser Mounting	DB-SB-5260			
04/96→10/02		Stabiliser Mounting	DB-SB-5279			
04/96→10/02		Stabiliser Mounting	DB-SB-10410			



ACTROS ...

1831 S, 1831 LS ...	04/96→10/02	Suspension Arm Repair Kit		DB-RK-8626	for Wishbone (CV)	
	04/96→10/02	Suspension Arm Repair Kit		DB-RK-10374	for Wishbone (CV)	
	04/96→10/02	Suspension Arm Repair Kit		DB-RK-10375	for Wishbone (CV)	
	04/96→10/02	Suspension Arm Repair Kit	DB-RK-8638		for Control Arm	
	04/96→10/02	Suspension Strut Repair Kit		DB-RK-8391		
	04/96→10/02	Suspension Strut Repair Kit		DB-RK-9294		
	04/96→10/02	Suspension Strut Repair Kit		MN-RK-8997		
	04/96→10/02	Tie Rod	DB-DL-8327		Guide Rod	
	04/96→10/02	Tie Rod	DB-DL-8388		Guide Rod	
	04/96→10/02	Tie Rod	DB-DL-8389			
	04/96→10/02	Tie Rod	DB-DL-8640		Guide Rod	
	04/96→10/02	Tie Rod	DB-DL-12310			
	04/96→10/02	Tie Rod	DB-ES-5227		Guide Rod	
	04/96→10/02	Tie Rod End	CV-ES-0543		for Push Rod	
	04/96→10/02	Tie Rod End	CV-ES-0888		for Push Rod	
	04/96→10/02	Tie Rod End	CV-ES-14162		for Steering Rod	
	04/96→10/02	Tie Rod End	CV-ES-14163		for Steering Rod	
	04/96→10/02	Tie Rod End	DB-ES-5234		for Steering Rod	
	04/96→10/02	Tie Rod End	DB-ES-8164		for Push Rod	
	04/96→10/02	Tie Rod End	DB-ES-8530		for Push Rod	
	04/96→10/02	Track Control Arm		DB-DL-3475	Trailing Arm	
	04/96→10/02	Track Control Arm		DB-VB-3707	Suspension Rod, Wishbone (CV), 1st RA; Air Suspension Axle, →* K 864073 *	
	04/96→10/02	Track Control Arm		DB-VB-7261	Suspension Rod, Wishbone (CV), 1st RA, →517142 01/517142 02	
	04/96→10/02	Track Control Arm		DB-VB-7798	Wishbone (CV), Air Suspension Axle, * K 864074 *→	
	04/96→10/02	Track Control Arm	DB-DL-5224		Control Arm, 1st FA;Air Suspension Axle	
	04/96→10/02	Track Control Arm	DB-DL-9218	DB-DL-9218	Trailing Arm, 1st FA;Air Suspension Axle	
	1831, 1831 L	04/96→10/02	Ball Head, gearshift linkage	DB-ES-8387		
		04/96→10/02	Ball Head, gearshift linkage	DB-ES-8491		
		04/96→10/02	Ball Head, gearshift linkage	DB-ES-8492		
		04/96→10/02	Ball Head, gearshift linkage	DB-ES-8500		
04/96→10/02		Ball Head, gearshift linkage	DB-ES-8510			
04/96→10/02		Bush, driver cab suspension	DB-SB-10384			
04/96→10/02		Bush, parabolic spring		DB-SB-10400		
04/96→10/02		Bush, parabolic spring		DB-SB-10401		
04/96→10/02		Centre Rod	DB-DL-2144		Push Rod	
04/96→10/02		Centre Rod	DB-DL-5230		Push Rod, 1st FA;Leaf Spring Axle	
04/96→10/02		Centre Rod	DB-DL-5241		Push Rod, 1st FA;Air Suspension Axle	
04/96→10/02		Centre Rod	DB-DL-5241		Push Rod, Leaf Spring Axle	
04/96→10/02		Centre Rod	DB-DL-5405		Push Rod	
04/96→10/02		Centre Rod	DB-DL-5405		Push Rod, Leaf Spring Axle	
04/96→10/02		Centre Rod	DB-DL-7270		Push Rod	
04/96→10/02		Centre Rod	DB-DL-8167		Push Rod, 1st FA;Leaf Spring Axle	
04/96→10/02		Centre Rod	DB-DL-8168		Push Rod	
04/96→10/02		Centre Rod	DB-DL-8184		Push Rod	
04/96→10/02		Centre Rod	DB-DL-8185		Push Rod	
04/96→10/02		Centre Rod	DB-DL-8188		Push Rod	
04/96→10/02		Centre Rod	DB-DL-8307		Push Rod	
04/96→10/02		Centre Rod	DB-DL-8622		Push Rod	
04/96→10/02		Centre Rod	DB-DL-8641		Push Rod	
04/96→10/02		Centre Rod	DB-DL-8642		Push Rod	
04/96→10/02		Centre Rod	DB-DL-12298		for Steering Rod	
04/96→10/02		Centre Rod	DB-DL-12300		for Steering Rod	
04/96→10/02		Rod Assembly	DB-DL-2178		Guide Rod	
04/96→10/02		Stabiliser Mounting		DB-RK-9296		
04/96→10/02		Stabiliser Mounting		DB-SB-5250		
04/96→10/02		Stabiliser Mounting		DB-SB-5261		
04/96→10/02		Stabiliser Mounting		DB-SB-10406		
04/96→10/02		Stabiliser Mounting		DB-SB-10407		
04/96→10/02		Stabiliser Mounting	DB-SB-5260			
04/96→10/02	Stabiliser Mounting	DB-SB-5277	DB-SB-5277			

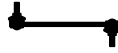

ACTROS ...

1831, 1831 L ...	04/96→10/02	Stabiliser Mounting	DB-SB-5279			
	04/96→10/02	Suspension Arm Repair Kit		DB-RK-8550	for Wishbone (CV)	
	04/96→10/02	Suspension Arm Repair Kit		DB-RK-8626	for Wishbone (CV)	
	04/96→10/02	Suspension Arm Repair Kit		DB-RK-8638	for Control Arm	
	04/96→10/02	Suspension Arm Repair Kit		DB-RK-10374	for Wishbone (CV)	
	04/96→10/02	Tie Rod	DB-DL-8327		Guide Rod	
	04/96→10/02	Tie Rod	DB-DL-8388		Guide Rod	
	04/96→10/02	Tie Rod	DB-DL-8389			
	04/96→10/02	Tie Rod	DB-DL-8640		Guide Rod	
	04/96→10/02	Tie Rod	DB-DL-12310			
	04/96→10/02	Tie Rod	DB-ES-5227		Guide Rod	
	04/96→10/02	Tie Rod End	CV-ES-0543		for Push Rod	
	04/96→10/02	Tie Rod End	CV-ES-0888		for Push Rod	
	04/96→10/02	Tie Rod End	CV-ES-14162		for Steering Rod	
	04/96→10/02	Tie Rod End	CV-ES-14163		for Steering Rod	
	04/96→10/02	Tie Rod End	DB-ES-8164		for Push Rod	
	04/96→10/02	Tie Rod End	DB-ES-8530		for Push Rod	
	04/96→10/02	Track Control Arm		DB-DL-3475	Trailing Arm	
	04/96→10/02	Track Control Arm		DB-VB-3707	Suspension Rod, Wishbone (CV), 1st RA; Air Suspension Axle, →* K 864073 *	
	04/96→10/02	Track Control Arm		DB-VB-7261	Suspension Rod, Wishbone (CV), 1st RA, →517142 01/517142 02	
	04/96→10/02	Track Control Arm	DB-DL-5224		Control Arm, 1st FA; Air Suspension Axle	
	04/96→10/02	Track Control Arm	DB-DL-9218	DB-DL-9218	Trailing Arm, 1st FA; Air Suspension Axle	
	1835 AK	04/97→10/02	Ball Head, gearshift linkage	DB-ES-8387		
		04/97→10/02	Ball Head, gearshift linkage	DB-ES-8491		
04/97→10/02		Ball Head, gearshift linkage	DB-ES-8492			
04/97→10/02		Ball Head, gearshift linkage	DB-ES-8500			
04/97→10/02		Ball Head, gearshift linkage	DB-ES-8510			
04/97→10/02		Bush, driver cab suspension	DB-SB-10384			
04/97→10/02		Bush, parabolic spring		DB-SB-10400		
04/97→10/02		Bush, parabolic spring		DB-SB-10401		
04/97→10/02		Centre Rod	DB-DL-2144		Push Rod	
04/97→10/02		Centre Rod	DB-DL-5230		Push Rod	
04/97→10/02		Centre Rod	DB-DL-5405		Push Rod	
04/97→10/02		Centre Rod	DB-DL-8184		Push Rod	
04/97→10/02		Centre Rod	DB-DL-8188		Push Rod	
04/97→10/02		Centre Rod	DB-DL-8307		Push Rod, Leaf Spring Axle	
04/97→10/02		Centre Rod	DB-DL-8639		Push Rod, Leaf Spring Axle	
04/97→10/02		Centre Rod	DB-DL-8702		Push Rod, Leaf Spring Axle	
04/97→10/02		Centre Rod	DB-DL-9259		Push Rod	
04/97→10/02		Centre Rod	DB-DL-12300		for Steering Rod	
04/97→10/02		Rod Assembly	DB-DL-2178		Guide Rod	
04/97→10/02		Stabiliser Link	DB-DL-9254		Pressure Rod	
04/97→10/02		Stabiliser Mounting		DB-SB-5250		
04/97→10/02		Stabiliser Mounting		DB-SB-5261		
04/97→10/02		Stabiliser Mounting		DB-SB-10406		
04/97→10/02		Stabiliser Mounting		DB-SB-10407		
04/97→10/02		Stabiliser Mounting		DB-SB-10409		
04/97→10/02		Stabiliser Mounting	DB-SB-5260			
04/97→10/02		Stabiliser Mounting	DB-SB-5279			
04/97→10/02		Suspension Arm Repair Kit		DB-RK-8626	for Wishbone (CV)	
04/97→10/02		Suspension Arm Repair Kit		DB-RK-10374	for Wishbone (CV)	
04/97→10/02		Suspension Arm Repair Kit		DB-RK-10375	for Wishbone (CV)	
04/97→10/02		Suspension Arm Repair Kit	DB-RK-8638		for Control Arm	
04/97→10/02		Suspension Strut Repair Kit		DB-RK-8391		
04/97→10/02		Tie Rod	DB-DL-12310			
04/97→10/02		Tie Rod	DB-ES-5227		Guide Rod	
04/97→10/02		Tie Rod	MN-DL-7834		Guide Rod	
04/97→10/02		Tie Rod End	CV-ES-0543		for Push Rod	
04/97→10/02		Tie Rod End	CV-ES-0888		for Push Rod	
04/97→10/02		Tie Rod End	CV-ES-14162		for Steering Rod	
04/97→10/02		Tie Rod End	CV-ES-14163		for Steering Rod	



ACTROS ...

1835 AK ...	04/97→10/02	Tie Rod End	DB-ES-5234		for Steering Rod
	04/97→10/02	Tie Rod End	DB-ES-8530		for Push Rod
	04/97→10/02	Track Control Arm		DB-DL-3475	Trailing Arm
	04/97→10/02	Track Control Arm		DB-VB-7261	Suspension Rod, Wishbone (CV), 1st RA, →517142 01/517142 02
	04/97→10/02	Track Control Arm	DB-DL-5224		Control Arm
	04/97→10/02	Track Control Arm	DB-DL-9218	DB-DL-9218	Trailing Arm
1835 K	04/97→10/02	Ball Head, gearshift linkage	DB-ES-8387		
	04/97→10/02	Ball Head, gearshift linkage	DB-ES-8491		
	04/97→10/02	Ball Head, gearshift linkage	DB-ES-8492		
	04/97→10/02	Ball Head, gearshift linkage	DB-ES-8500		
	04/97→10/02	Ball Head, gearshift linkage	DB-ES-8510		
	04/97→10/02	Bush, driver cab suspension	DB-SB-10384		
	04/97→10/02	Bush, parabolic spring		DB-SB-10400	
	04/97→10/02	Bush, parabolic spring		DB-SB-10401	
	04/97→10/02	Centre Rod	DB-DL-2144		Push Rod
	04/97→10/02	Centre Rod	DB-DL-5230		Push Rod, 1st FA;Leaf Spring Axle
	04/97→10/02	Centre Rod	DB-DL-5241		Push Rod
	04/97→10/02	Centre Rod	DB-DL-5405		Push Rod, Leaf Spring Axle
	04/97→10/02	Centre Rod	DB-DL-7270		Push Rod
	04/97→10/02	Centre Rod	DB-DL-8167		Push Rod, Leaf Spring Axle
	04/97→10/02	Centre Rod	DB-DL-8184		Push Rod
	04/97→10/02	Centre Rod	DB-DL-8185		Push Rod
	04/97→10/02	Centre Rod	DB-DL-8188		Push Rod
	04/97→10/02	Centre Rod	DB-DL-8307		Push Rod
	04/97→10/02	Centre Rod	DB-DL-12300		for Steering Rod
	04/97→10/02	Rod Assembly	DB-DL-2178		Guide Rod
	04/97→10/02	Stabiliser Link	DB-DL-9254		Pressure Rod
	04/97→10/02	Stabiliser Mounting		DB-SB-5250	
	04/97→10/02	Stabiliser Mounting		DB-SB-5261	
	04/97→10/02	Stabiliser Mounting		DB-SB-10406	
	04/97→10/02	Stabiliser Mounting		DB-SB-10407	
	04/97→10/02	Stabiliser Mounting		DB-SB-10409	
	04/97→10/02	Stabiliser Mounting	DB-SB-5260		
	04/97→10/02	Stabiliser Mounting	DB-SB-5279		
	04/97→10/02	Suspension Arm Repair Kit		DB-RK-8550	for Wishbone (CV)
	04/97→10/02	Suspension Arm Repair Kit		DB-RK-8626	for Wishbone (CV)
	04/97→10/02	Suspension Arm Repair Kit		DB-RK-10374	for Wishbone (CV)
	04/97→10/02	Suspension Arm Repair Kit		DB-RK-10375	for Wishbone (CV)
	04/97→10/02	Suspension Arm Repair Kit	DB-RK-8638		for Control Arm
	04/97→10/02	Suspension Strut Repair Kit		DB-RK-8391	
	04/97→10/02	Tie Rod	DB-DL-8171		Guide Rod
	04/97→10/02	Tie Rod	DB-DL-8327		Guide Rod
	04/97→10/02	Tie Rod	DB-DL-8640		Guide Rod
	04/97→10/02	Tie Rod	DB-DL-12310		
	04/97→10/02	Tie Rod	DB-ES-5227		Guide Rod
	04/97→10/02	Tie Rod End	CV-ES-0543		for Push Rod
	04/97→10/02	Tie Rod End	CV-ES-0888		for Push Rod
	04/97→10/02	Tie Rod End	CV-ES-14162		for Steering Rod
	04/97→10/02	Tie Rod End	CV-ES-14163		for Steering Rod
	04/97→10/02	Tie Rod End	DB-ES-5234		for Steering Rod
	04/97→10/02	Tie Rod End	DB-ES-8164		for Push Rod
	04/97→10/02	Tie Rod End	DB-ES-8530		for Push Rod
	04/97→10/02	Track Control Arm		DB-DL-3475	Trailing Arm
04/97→10/02	Track Control Arm		DB-VB-7261	Suspension Rod, Wishbone (CV), 1st RA, →517142 01/517142 02	
04/97→10/02	Track Control Arm	DB-DL-5224		Control Arm	
04/97→10/02	Track Control Arm	DB-DL-9218	DB-DL-9218	Trailing Arm	
1835 S, 1835 LS	04/96→10/02	Ball Head, gearshift linkage	DB-ES-8387		
	04/96→10/02	Ball Head, gearshift linkage	DB-ES-8491		
	04/96→10/02	Ball Head, gearshift linkage	DB-ES-8492		
	04/96→10/02	Ball Head, gearshift linkage	DB-ES-8500		
	04/96→10/02	Ball Head, gearshift linkage	DB-ES-8510		



ACTROS ...

1835 S, 1835 LS ...

04/96→10/02	Bush, driver cab suspension	DB-SB-10384		
04/96→10/02	Bush, parabolic spring		DB-SB-10400	
04/96→10/02	Bush, parabolic spring		DB-SB-10401	
04/96→10/02	Centre Rod	DB-DL-2144		Push Rod
04/96→10/02	Centre Rod	DB-DL-5230		Push Rod, 1st FA;Leaf Spring Axle
04/96→10/02	Centre Rod	DB-DL-5241		Push Rod
04/96→10/02	Centre Rod	DB-DL-5405		Push Rod
04/96→10/02	Centre Rod	DB-DL-5405		Push Rod, Leaf Spring Axle
04/96→10/02	Centre Rod	DB-DL-7270		Push Rod
04/96→10/02	Centre Rod	DB-DL-8167		Push Rod
04/96→10/02	Centre Rod	DB-DL-8184		Push Rod
04/96→10/02	Centre Rod	DB-DL-8185		Push Rod
04/96→10/02	Centre Rod	DB-DL-8188		Push Rod
04/96→10/02	Centre Rod	DB-DL-8307		Push Rod
04/96→10/02	Centre Rod	DB-DL-8392		Push Rod
04/96→10/02	Centre Rod	DB-DL-12300		for Steering Rod
04/96→10/02	Rod Assembly	DB-DL-2178		Guide Rod
04/96→10/02	Stabiliser Mounting		DB-SB-5261	
04/96→10/02	Stabiliser Mounting		DB-SB-10406	
04/96→10/02	Stabiliser Mounting		DB-SB-10407	
04/96→10/02	Stabiliser Mounting		DB-SB-10409	
04/96→10/02	Stabiliser Mounting	DB-SB-5260		
04/96→10/02	Stabiliser Mounting	DB-SB-5279		
04/96→10/02	Stabiliser Mounting	DB-SB-10410		
04/96→10/02	Suspension Arm Repair Kit		DB-RK-8626	for Wishbone (CV)
04/96→10/02	Suspension Arm Repair Kit		DB-RK-10374	for Wishbone (CV)
04/96→10/02	Suspension Arm Repair Kit		DB-RK-10375	for Wishbone (CV)
04/96→10/02	Suspension Arm Repair Kit	DB-RK-8638		for Control Arm
04/96→10/02	Suspension Strut Repair Kit		DB-RK-8391	
04/96→10/02	Suspension Strut Repair Kit		DB-RK-9294	
04/96→10/02	Suspension Strut Repair Kit		MN-RK-8997	
04/96→10/02	Tie Rod	DB-DL-8327		Guide Rod
04/96→10/02	Tie Rod	DB-DL-8388		Guide Rod
04/96→10/02	Tie Rod	DB-DL-8389		
04/96→10/02	Tie Rod	DB-DL-8640		Guide Rod
04/96→10/02	Tie Rod	DB-DL-12310		
04/96→10/02	Tie Rod	DB-ES-5227		Guide Rod
04/96→10/02	Tie Rod End	CV-ES-0543		for Push Rod
04/96→10/02	Tie Rod End	CV-ES-0888		for Push Rod
04/96→10/02	Tie Rod End	CV-ES-14162		for Steering Rod
04/96→10/02	Tie Rod End	CV-ES-14163		for Steering Rod
04/96→10/02	Tie Rod End	DB-ES-5234		for Steering Rod
04/96→10/02	Tie Rod End	DB-ES-8164		for Push Rod
04/96→10/02	Tie Rod End	DB-ES-8530		for Push Rod
04/96→10/02	Track Control Arm		DB-DL-3475	Trailing Arm
04/96→10/02	Track Control Arm		DB-VB-3707	Suspension Rod, Wishbone (CV), 1st RA; Air Suspension Axle, →* K 864073 *
04/96→10/02	Track Control Arm		DB-VB-7261	Suspension Rod, Wishbone (CV), 1st RA, →517142 01/517142 02
04/96→10/02	Track Control Arm		DB-VB-7798	Wishbone (CV), Air Suspension Axle, * K 864074 *→
04/96→10/02	Track Control Arm	DB-DL-5224		Control Arm, 1st FA;Air Suspension Axle
04/96→10/02	Track Control Arm	DB-DL-9218	DB-DL-9218	Trailing Arm, 1st FA;Air Suspension Axle
04/96→10/02	Ball Head, gearshift linkage	DB-ES-8387		
04/96→10/02	Ball Head, gearshift linkage	DB-ES-8491		
04/96→10/02	Ball Head, gearshift linkage	DB-ES-8492		
04/96→10/02	Ball Head, gearshift linkage	DB-ES-8500		
04/96→10/02	Ball Head, gearshift linkage	DB-ES-8510		
04/96→10/02	Bush, driver cab suspension	DB-SB-10384		
04/96→10/02	Bush, parabolic spring		DB-SB-10400	
04/96→10/02	Bush, parabolic spring		DB-SB-10401	
04/96→10/02	Centre Rod	DB-DL-2144		Push Rod
04/96→10/02	Centre Rod	DB-DL-5230		Push Rod, 1st FA;Leaf Spring Axle

1835, 1835 L

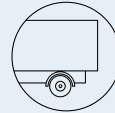

ACTROS ...

1835, 1835 L ...

04/96→10/02	Centre Rod	DB-DL-5230		Push Rod, Leaf Spring Axle
04/96→10/02	Centre Rod	DB-DL-5241		Push Rod, 1st FA;Air Suspension Axle
04/96→10/02	Centre Rod	DB-DL-5241		Push Rod, Leaf Spring Axle
04/96→10/02	Centre Rod	DB-DL-5405		Push Rod
04/96→10/02	Centre Rod	DB-DL-5405		Push Rod, Leaf Spring Axle
04/96→10/02	Centre Rod	DB-DL-7270		Push Rod
04/96→10/02	Centre Rod	DB-DL-8167		Push Rod, 1st FA;Leaf Spring Axle
04/96→10/02	Centre Rod	DB-DL-8168		Push Rod
04/96→10/02	Centre Rod	DB-DL-8184		Push Rod
04/96→10/02	Centre Rod	DB-DL-8185		Push Rod
04/96→10/02	Centre Rod	DB-DL-8188		Push Rod
04/96→10/02	Centre Rod	DB-DL-8307		Push Rod
04/96→10/02	Centre Rod	DB-DL-8622		Push Rod
04/96→10/02	Centre Rod	DB-DL-8641		Push Rod
04/96→10/02	Centre Rod	DB-DL-8642		Push Rod
04/96→10/02	Centre Rod	DB-DL-12298		for Steering Rod
04/96→10/02	Centre Rod	DB-DL-12300		for Steering Rod
04/96→10/02	Rod Assembly	DB-DL-2178		Guide Rod
04/96→10/02	Stabiliser Mounting		DB-RK-9296	
04/96→10/02	Stabiliser Mounting		DB-SB-5250	
04/96→10/02	Stabiliser Mounting		DB-SB-5261	
04/96→10/02	Stabiliser Mounting		DB-SB-10406	
04/96→10/02	Stabiliser Mounting		DB-SB-10407	
04/96→10/02	Stabiliser Mounting	DB-SB-5260		
04/96→10/02	Stabiliser Mounting	DB-SB-5277	DB-SB-5277	
04/96→10/02	Stabiliser Mounting	DB-SB-5279		
04/96→10/02	Suspension Arm Repair Kit		DB-RK-8550	for Wishbone (CV)
04/96→10/02	Suspension Arm Repair Kit		DB-RK-8626	for Wishbone (CV)
04/96→10/02	Suspension Arm Repair Kit		DB-RK-8638	for Control Arm
04/96→10/02	Suspension Arm Repair Kit		DB-RK-10374	for Wishbone (CV)
04/96→10/02	Tie Rod	DB-DL-8327		Guide Rod
04/96→10/02	Tie Rod	DB-DL-8388		Guide Rod
04/96→10/02	Tie Rod	DB-DL-8389		
04/96→10/02	Tie Rod	DB-DL-8640		Guide Rod
04/96→10/02	Tie Rod	DB-DL-12310		
04/96→10/02	Tie Rod	DB-ES-5227		Guide Rod
04/96→10/02	Tie Rod End	CV-ES-0543		for Push Rod
04/96→10/02	Tie Rod End	CV-ES-0888		for Push Rod
04/96→10/02	Tie Rod End	CV-ES-14162		for Steering Rod
04/96→10/02	Tie Rod End	CV-ES-14163		for Steering Rod
04/96→10/02	Tie Rod End	DB-ES-8164		for Push Rod
04/96→10/02	Tie Rod End	DB-ES-8530		for Push Rod
04/96→10/02	Track Control Arm		DB-DL-3475	Trailing Arm
04/96→10/02	Track Control Arm		DB-VB-3707	Suspension Rod, Wishbone (CV), 1st RA; Air Suspension Axle, →* K 864073 *
04/96→10/02	Track Control Arm		DB-VB-7261	Suspension Rod, Wishbone (CV), 1st RA, →517142 01/517142 02
04/96→10/02	Track Control Arm	DB-DL-5224		Control Arm, 1st FA;Air Suspension Axle
04/96→10/02	Track Control Arm	DB-DL-9218	DB-DL-9218	Trailing Arm, 1st FA;Air Suspension Axle
04/97→10/02	Ball Head, gearshift linkage	DB-ES-8387		
04/97→10/02	Ball Head, gearshift linkage	DB-ES-8491		
04/97→10/02	Ball Head, gearshift linkage	DB-ES-8492		
04/97→10/02	Ball Head, gearshift linkage	DB-ES-8500		
04/97→10/02	Ball Head, gearshift linkage	DB-ES-8510		
04/97→10/02	Bush, driver cab suspension	DB-SB-10384		
04/97→10/02	Bush, parabolic spring		DB-SB-10400	
04/97→10/02	Bush, parabolic spring		DB-SB-10401	
04/97→10/02	Centre Rod	DB-DL-2144		Push Rod
04/97→10/02	Centre Rod	DB-DL-5230		Push Rod
04/97→10/02	Centre Rod	DB-DL-5405		Push Rod
04/97→10/02	Centre Rod	DB-DL-8184		Push Rod
04/97→10/02	Centre Rod	DB-DL-8188		Push Rod
04/97→10/02	Centre Rod	DB-DL-8307		Push Rod, Leaf Spring Axle

1840 AK

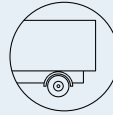

ACTROS ...

1840 AK ...	04/97→10/02	Centre Rod	DB-DL-8639		Push Rod, Leaf Spring Axle	
	04/97→10/02	Centre Rod	DB-DL-8702		Push Rod, Leaf Spring Axle	
	04/97→10/02	Centre Rod	DB-DL-9259		Push Rod	
	04/97→10/02	Centre Rod	DB-DL-12300		for Steering Rod	
	04/97→10/02	Rod Assembly	DB-DL-2178		Guide Rod	
	04/97→10/02	Stabiliser Link	DB-DL-9254		Pressure Rod	
	04/97→10/02	Stabiliser Mounting		DB-SB-5250		
	04/97→10/02	Stabiliser Mounting		DB-SB-5261		
	04/97→10/02	Stabiliser Mounting		DB-SB-10406		
	04/97→10/02	Stabiliser Mounting		DB-SB-10407		
	04/97→10/02	Stabiliser Mounting		DB-SB-10409		
	04/97→10/02	Stabiliser Mounting	DB-SB-5260			
	04/97→10/02	Stabiliser Mounting	DB-SB-5279			
	04/97→10/02	Suspension Arm Repair Kit		DB-RK-8626	for Wishbone (CV)	
	04/97→10/02	Suspension Arm Repair Kit		DB-RK-10374	for Wishbone (CV)	
	04/97→10/02	Suspension Arm Repair Kit		DB-RK-10375	for Wishbone (CV)	
	04/97→10/02	Suspension Arm Repair Kit	DB-RK-8638		for Control Arm	
	04/97→10/02	Suspension Strut Repair Kit		DB-RK-8391		
	04/97→10/02	Tie Rod	DB-DL-12310			
	04/97→10/02	Tie Rod	DB-ES-5227		Guide Rod	
	04/97→10/02	Tie Rod	MN-DL-7834		Guide Rod	
	04/97→10/02	Tie Rod End	CV-ES-0543		for Push Rod	
	04/97→10/02	Tie Rod End	CV-ES-0888		for Push Rod	
	04/97→10/02	Tie Rod End	CV-ES-14162		for Steering Rod	
	04/97→10/02	Tie Rod End	CV-ES-14163		for Steering Rod	
	04/97→10/02	Tie Rod End	DB-ES-5234		for Steering Rod	
	04/97→10/02	Tie Rod End	DB-ES-8530		for Push Rod	
	04/97→10/02	Track Control Arm		DB-DL-3475	Trailing Arm	
	04/97→10/02	Track Control Arm		DB-VB-7261	Suspension Rod, Wishbone (CV), 1st RA, →517142 01/517142 02	
	04/97→10/02	Track Control Arm	DB-DL-5224		Control Arm	
	04/97→10/02	Track Control Arm	DB-DL-9218	DB-DL-9218	Trailing Arm	
	1840 K	04/97→10/02	Ball Head, gearshift linkage	DB-ES-8387		
		04/97→10/02	Ball Head, gearshift linkage	DB-ES-8491		
04/97→10/02		Ball Head, gearshift linkage	DB-ES-8492			
04/97→10/02		Ball Head, gearshift linkage	DB-ES-8500			
04/97→10/02		Ball Head, gearshift linkage	DB-ES-8510			
04/97→10/02		Bush, driver cab suspension	DB-SB-10384			
04/97→10/02		Bush, parabolic spring		DB-SB-10400		
04/97→10/02		Bush, parabolic spring		DB-SB-10401		
04/97→10/02		Centre Rod	DB-DL-2144		Push Rod	
04/97→10/02		Centre Rod	DB-DL-5230		Push Rod, 1st FA;Leaf Spring Axle	
04/97→10/02		Centre Rod	DB-DL-5241		Push Rod	
04/97→10/02		Centre Rod	DB-DL-5405		Push Rod, Leaf Spring Axle	
04/97→10/02		Centre Rod	DB-DL-7270		Push Rod	
04/97→10/02		Centre Rod	DB-DL-8167		Push Rod, Leaf Spring Axle	
04/97→10/02		Centre Rod	DB-DL-8184		Push Rod	
04/97→10/02		Centre Rod	DB-DL-8185		Push Rod	
04/97→10/02		Centre Rod	DB-DL-8188		Push Rod	
04/97→10/02		Centre Rod	DB-DL-8307		Push Rod	
04/97→10/02		Centre Rod	DB-DL-12300		for Steering Rod	
04/97→10/02		Rod Assembly	DB-DL-2178		Guide Rod	
04/97→10/02		Stabiliser Link	DB-DL-9254		Pressure Rod	
04/97→10/02		Stabiliser Mounting		DB-SB-5250		
04/97→10/02		Stabiliser Mounting		DB-SB-5261		
04/97→10/02		Stabiliser Mounting		DB-SB-10406		
04/97→10/02		Stabiliser Mounting		DB-SB-10407		
04/97→10/02		Stabiliser Mounting		DB-SB-10409		
04/97→10/02		Stabiliser Mounting	DB-SB-5260			
04/97→10/02		Stabiliser Mounting	DB-SB-5279			
04/97→10/02		Suspension Arm Repair Kit		DB-RK-8550	for Wishbone (CV)	
04/97→10/02		Suspension Arm Repair Kit		DB-RK-8626	for Wishbone (CV)	
04/97→10/02		Suspension Arm Repair Kit		DB-RK-10374	for Wishbone (CV)	



ACTROS ...

1840 K ...	04/97→10/02	Suspension Arm Repair Kit		DB-RK-10375	for Wishbone (CV)
	04/97→10/02	Suspension Arm Repair Kit	DB-RK-8638		for Control Arm
	04/97→10/02	Suspension Strut Repair Kit		DB-RK-8391	
	04/97→10/02	Tie Rod	DB-DL-8171		Guide Rod
	04/97→10/02	Tie Rod	DB-DL-8327		Guide Rod
	04/97→10/02	Tie Rod	DB-DL-8640		Guide Rod
	04/97→10/02	Tie Rod	DB-DL-12310		
	04/97→10/02	Tie Rod	DB-ES-5227		Guide Rod
	04/97→10/02	Tie Rod End	CV-ES-0543		for Push Rod
	04/97→10/02	Tie Rod End	CV-ES-0888		for Push Rod
	04/97→10/02	Tie Rod End	CV-ES-14162		for Steering Rod
	04/97→10/02	Tie Rod End	CV-ES-14163		for Steering Rod
	04/97→10/02	Tie Rod End	DB-ES-5234		for Steering Rod
	04/97→10/02	Tie Rod End	DB-ES-8164		for Push Rod
	04/97→10/02	Tie Rod End	DB-ES-8530		for Push Rod
	04/97→10/02	Track Control Arm		DB-DL-3475	Trailing Arm
	04/97→10/02	Track Control Arm		DB-VB-7261	Suspension Rod, Wishbone (CV), 1st RA, →517142 01/517142 02
04/97→10/02	Track Control Arm	DB-DL-5224		Control Arm	
04/97→10/02	Track Control Arm	DB-DL-9218	DB-DL-9218	Trailing Arm	
1840 S, 1840 LS	04/96→10/02	Ball Head, gearshift linkage	DB-ES-8387		
	04/96→10/02	Ball Head, gearshift linkage	DB-ES-8491		
	04/96→10/02	Ball Head, gearshift linkage	DB-ES-8492		
	04/96→10/02	Ball Head, gearshift linkage	DB-ES-8500		
	04/96→10/02	Ball Head, gearshift linkage	DB-ES-8510		
	04/96→10/02	Bush, driver cab suspension	DB-SB-10384		
	04/96→10/02	Bush, parabolic spring		DB-SB-10400	
	04/96→10/02	Bush, parabolic spring		DB-SB-10401	
	04/96→10/02	Centre Rod	DB-DL-2144		Push Rod
	04/96→10/02	Centre Rod	DB-DL-5230		Push Rod, 1st FA;Leaf Spring Axle
	04/96→10/02	Centre Rod	DB-DL-5241		Push Rod
	04/96→10/02	Centre Rod	DB-DL-5405		Push Rod
	04/96→10/02	Centre Rod	DB-DL-5405		Push Rod, Leaf Spring Axle
	04/96→10/02	Centre Rod	DB-DL-7270		Push Rod
	04/96→10/02	Centre Rod	DB-DL-8167		Push Rod
	04/96→10/02	Centre Rod	DB-DL-8184		Push Rod
	04/96→10/02	Centre Rod	DB-DL-8185		Push Rod
	04/96→10/02	Centre Rod	DB-DL-8188		Push Rod
	04/96→10/02	Centre Rod	DB-DL-8307		Push Rod
	04/96→10/02	Centre Rod	DB-DL-8392		Push Rod
	04/96→10/02	Centre Rod	DB-DL-12300		for Steering Rod
	04/96→10/02	Rod Assembly	DB-DL-2178		Guide Rod
	04/96→10/02	Stabiliser Mounting		DB-SB-5261	
	04/96→10/02	Stabiliser Mounting		DB-SB-10406	
	04/96→10/02	Stabiliser Mounting		DB-SB-10407	
	04/96→10/02	Stabiliser Mounting		DB-SB-10409	
	04/96→10/02	Stabiliser Mounting	DB-SB-5260		
	04/96→10/02	Stabiliser Mounting	DB-SB-5279		
	04/96→10/02	Stabiliser Mounting	DB-SB-10410		
	04/96→10/02	Suspension Arm Repair Kit		DB-RK-8626	for Wishbone (CV)
	04/96→10/02	Suspension Arm Repair Kit		DB-RK-10374	for Wishbone (CV)
	04/96→10/02	Suspension Arm Repair Kit		DB-RK-10375	for Wishbone (CV)
	04/96→10/02	Suspension Arm Repair Kit	DB-RK-8638		for Control Arm
	04/96→10/02	Suspension Strut Repair Kit		DB-RK-8391	
	04/96→10/02	Suspension Strut Repair Kit		DB-RK-9294	
	04/96→10/02	Suspension Strut Repair Kit		MN-RK-8997	
	04/96→10/02	Tie Rod	DB-DL-8327		Guide Rod
	04/96→10/02	Tie Rod	DB-DL-8388		Guide Rod
	04/96→10/02	Tie Rod	DB-DL-8389		
	04/96→10/02	Tie Rod	DB-DL-8640		Guide Rod
	04/96→10/02	Tie Rod	DB-DL-12310		
	04/96→10/02	Tie Rod	DB-ES-5227		Guide Rod
	04/96→10/02	Tie Rod End	CV-ES-0543		for Push Rod



ACTROS ...

1840 S, 1840 LS ...	04/96→10/02	Tie Rod End	CV-ES-0888		for Push Rod
	04/96→10/02	Tie Rod End	CV-ES-14162		for Steering Rod
	04/96→10/02	Tie Rod End	CV-ES-14163		for Steering Rod
	04/96→10/02	Tie Rod End	DB-ES-5234		for Steering Rod
	04/96→10/02	Tie Rod End	DB-ES-8164		for Push Rod
	04/96→10/02	Tie Rod End	DB-ES-8530		for Push Rod
	04/96→10/02	Track Control Arm		DB-DL-3475	Trailing Arm
	04/96→10/02	Track Control Arm		DB-VB-3707	Suspension Rod, Wishbone (CV), 1st RA; Air Suspension Axle, →* K 864073 *
	04/96→10/02	Track Control Arm		DB-VB-7261	Suspension Rod, Wishbone (CV), 1st RA, →517142 01/517142 02
	04/96→10/02	Track Control Arm		DB-VB-7798	Wishbone (CV), Air Suspension Axle, * K 864074 *→
	04/96→10/02	Track Control Arm	DB-DL-5224		Control Arm, 1st FA;Air Suspension Axle
	1840, 1840 L	04/96→10/02	Track Control Arm	DB-DL-9218	DB-DL-9218
04/96→10/02		Ball Head, gearshift linkage	DB-ES-8387		
04/96→10/02		Ball Head, gearshift linkage	DB-ES-8491		
04/96→10/02		Ball Head, gearshift linkage	DB-ES-8492		
04/96→10/02		Ball Head, gearshift linkage	DB-ES-8500		
04/96→10/02		Ball Head, gearshift linkage	DB-ES-8510		
04/96→10/02		Bush, driver cab suspension	DB-SB-10384		
04/96→10/02		Bush, parabolic spring		DB-SB-10400	
04/96→10/02		Bush, parabolic spring		DB-SB-10401	
04/96→10/02		Centre Rod	DB-DL-2144		Push Rod
04/96→10/02		Centre Rod	DB-DL-5230		Push Rod
04/96→10/02		Centre Rod	DB-DL-5230		Push Rod, Leaf Spring Axle
04/96→10/02		Centre Rod	DB-DL-5241		Push Rod, 1st FA;Air Suspension Axle
04/96→10/02		Centre Rod	DB-DL-5405		Push Rod
04/96→10/02		Centre Rod	DB-DL-5405		Push Rod, Leaf Spring Axle
04/96→10/02		Centre Rod	DB-DL-7270		Push Rod
04/96→10/02		Centre Rod	DB-DL-8167		Push Rod, 1st FA;Leaf Spring Axle
04/96→10/02		Centre Rod	DB-DL-8168		Push Rod
04/96→10/02		Centre Rod	DB-DL-8184		Push Rod
04/96→10/02		Centre Rod	DB-DL-8185		Push Rod
04/96→10/02		Centre Rod	DB-DL-8188		Push Rod
04/96→10/02		Centre Rod	DB-DL-8307		Push Rod
04/96→10/02		Centre Rod	DB-DL-8622		Push Rod
04/96→10/02		Centre Rod	DB-DL-8641		Push Rod
04/96→10/02		Centre Rod	DB-DL-8642		Push Rod
04/96→10/02		Centre Rod	DB-DL-12298		for Steering Rod
04/96→10/02		Centre Rod	DB-DL-12300		for Steering Rod
04/96→10/02		Rod Assembly	DB-DL-2178		Guide Rod
04/96→10/02		Stabiliser Mounting		DB-RK-9296	
04/96→10/02		Stabiliser Mounting		DB-SB-5250	
04/96→10/02		Stabiliser Mounting		DB-SB-5261	
04/96→10/02		Stabiliser Mounting		DB-SB-10406	
04/96→10/02		Stabiliser Mounting		DB-SB-10407	
04/96→10/02		Stabiliser Mounting	DB-SB-5260		
04/96→10/02		Stabiliser Mounting	DB-SB-5277	DB-SB-5277	
04/96→10/02		Stabiliser Mounting	DB-SB-5279		
04/96→10/02		Suspension Arm Repair Kit		DB-RK-8550	for Wishbone (CV)
04/96→10/02		Suspension Arm Repair Kit		DB-RK-8626	for Wishbone (CV)
04/96→10/02		Suspension Arm Repair Kit		DB-RK-8638	for Control Arm
04/96→10/02		Suspension Arm Repair Kit		DB-RK-10374	for Wishbone (CV)
04/96→10/02		Tie Rod	DB-DL-8327		Guide Rod
04/96→10/02		Tie Rod	DB-DL-8388		Guide Rod
04/96→10/02		Tie Rod	DB-DL-8389		
04/96→10/02		Tie Rod	DB-DL-8640		Guide Rod
04/96→10/02		Tie Rod	DB-DL-12310		
04/96→10/02		Tie Rod	DB-ES-5227		Guide Rod
04/96→10/02	Tie Rod End	CV-ES-0543		for Push Rod	
04/96→10/02	Tie Rod End	CV-ES-0888		for Push Rod	
04/96→10/02	Tie Rod End	CV-ES-14162		for Steering Rod	



ACTROS ...

1840, 1840 L ...	04/96→10/02	Tie Rod End	CV-ES-14163		for Steering Rod	
	04/96→10/02	Tie Rod End	DB-ES-8164		for Push Rod	
	04/96→10/02	Tie Rod End	DB-ES-8530		for Push Rod	
	04/96→10/02	Track Control Arm		DB-DL-3475	Trailing Arm	
	04/96→10/02	Track Control Arm		DB-VB-3707	Suspension Rod, Wishbone (CV), 1st RA; Air Suspension Axle, →* K 864073 *	
	04/96→10/02	Track Control Arm		DB-VB-7261	Suspension Rod, Wishbone (CV), 1st RA, →517142 01/517142 02	
	04/96→10/02	Track Control Arm	DB-DL-5224		Control Arm, 1st FA; Air Suspension Axle	
	04/96→10/02	Track Control Arm	DB-DL-9218	DB-DL-9218	Trailing Arm, 1st FA; Air Suspension Axle	
1843 AK	04/97→10/02	Ball Head, gearshift linkage	DB-ES-8387			
	04/97→10/02	Ball Head, gearshift linkage	DB-ES-8491			
	04/97→10/02	Ball Head, gearshift linkage	DB-ES-8492			
	04/97→10/02	Ball Head, gearshift linkage	DB-ES-8500			
	04/97→10/02	Ball Head, gearshift linkage	DB-ES-8510			
	04/97→10/02	Bush, driver cab suspension	DB-SB-10384			
	04/97→10/02	Bush, parabolic spring		DB-SB-10400		
	04/97→10/02	Bush, parabolic spring		DB-SB-10401		
	04/97→10/02	Centre Rod	DB-DL-2144		Push Rod	
	04/97→10/02	Centre Rod	DB-DL-5230		Push Rod	
	04/97→10/02	Centre Rod	DB-DL-5405		Push Rod	
	04/97→10/02	Centre Rod	DB-DL-8184		Push Rod	
	04/97→10/02	Centre Rod	DB-DL-8188		Push Rod	
	04/97→10/02	Centre Rod	DB-DL-8307		Push Rod, Leaf Spring Axle	
	04/97→10/02	Centre Rod	DB-DL-8639		Push Rod, Leaf Spring Axle	
	04/97→10/02	Centre Rod	DB-DL-8702		Push Rod, Leaf Spring Axle	
	04/97→10/02	Centre Rod	DB-DL-9259		Push Rod	
	04/97→10/02	Centre Rod	DB-DL-12300		for Steering Rod	
	04/97→10/02	Rod Assembly	DB-DL-2178		Guide Rod	
	04/97→10/02	Stabiliser Link	DB-DL-9254		Pressure Rod	
	04/97→10/02	Stabiliser Mounting		DB-SB-5250		
	04/97→10/02	Stabiliser Mounting		DB-SB-5261		
	04/97→10/02	Stabiliser Mounting		DB-SB-10406		
	04/97→10/02	Stabiliser Mounting		DB-SB-10407		
	04/97→10/02	Stabiliser Mounting		DB-SB-10409		
	04/97→10/02	Stabiliser Mounting	DB-SB-5260			
	04/97→10/02	Stabiliser Mounting	DB-SB-5279			
	04/97→10/02	Suspension Arm Repair Kit		DB-RK-8626	for Wishbone (CV)	
	04/97→10/02	Suspension Arm Repair Kit		DB-RK-10374	for Wishbone (CV)	
	04/97→10/02	Suspension Arm Repair Kit		DB-RK-10375	for Wishbone (CV)	
	04/97→10/02	Suspension Arm Repair Kit	DB-RK-8638		for Control Arm	
	04/97→10/02	Suspension Strut Repair Kit		DB-RK-8391		
	04/97→10/02	Tie Rod	DB-DL-12310			
	04/97→10/02	Tie Rod	DB-ES-5227		Guide Rod	
	04/97→10/02	Tie Rod	MN-DL-7834		Guide Rod	
	04/97→10/02	Tie Rod End	CV-ES-0543		for Push Rod	
	04/97→10/02	Tie Rod End	CV-ES-0888		for Push Rod	
	04/97→10/02	Tie Rod End	CV-ES-14162		for Steering Rod	
	04/97→10/02	Tie Rod End	CV-ES-14163		for Steering Rod	
	04/97→10/02	Tie Rod End	DB-ES-5234		for Steering Rod	
	04/97→10/02	Tie Rod End	DB-ES-8530		for Push Rod	
	04/97→10/02	Track Control Arm		DB-DL-3475	Trailing Arm	
	04/97→10/02	Track Control Arm		DB-VB-7261	Suspension Rod, Wishbone (CV), 1st RA, →517142 01/517142 02	
	04/97→10/02	Track Control Arm	DB-DL-5224		Control Arm	
	04/97→10/02	Track Control Arm	DB-DL-9218	DB-DL-9218	Trailing Arm	
	1843 K	04/97→10/02	Ball Head, gearshift linkage	DB-ES-8387		
		04/97→10/02	Ball Head, gearshift linkage	DB-ES-8491		
04/97→10/02		Ball Head, gearshift linkage	DB-ES-8492			
04/97→10/02		Ball Head, gearshift linkage	DB-ES-8500			
04/97→10/02		Ball Head, gearshift linkage	DB-ES-8510			
04/97→10/02		Bush, driver cab suspension	DB-SB-10384			
04/97→10/02		Bush, parabolic spring		DB-SB-10400		



ACTROS ...

1843 K ...	04/97→10/02	Bush, parabolic spring		DB-SB-10401	
	04/97→10/02	Centre Rod	DB-DL-2144		Push Rod
	04/97→10/02	Centre Rod	DB-DL-5230		Push Rod, 1st FA;Leaf Spring Axle
	04/97→10/02	Centre Rod	DB-DL-5241		Push Rod
	04/97→10/02	Centre Rod	DB-DL-5405		Push Rod, Leaf Spring Axle
	04/97→10/02	Centre Rod	DB-DL-7270		Push Rod
	04/97→10/02	Centre Rod	DB-DL-8167		Push Rod, Leaf Spring Axle
	04/97→10/02	Centre Rod	DB-DL-8184		Push Rod
	04/97→10/02	Centre Rod	DB-DL-8185		Push Rod
	04/97→10/02	Centre Rod	DB-DL-8188		Push Rod
	04/97→10/02	Centre Rod	DB-DL-8307		Push Rod
	04/97→10/02	Centre Rod	DB-DL-12300		for Steering Rod
	04/97→10/02	Rod Assembly	DB-DL-2178		Guide Rod
	04/97→10/02	Stabiliser Link	DB-DL-9254		Pressure Rod
	04/97→10/02	Stabiliser Mounting		DB-SB-5250	
	04/97→10/02	Stabiliser Mounting		DB-SB-5261	
	04/97→10/02	Stabiliser Mounting		DB-SB-10406	
	04/97→10/02	Stabiliser Mounting		DB-SB-10407	
	04/97→10/02	Stabiliser Mounting		DB-SB-10409	
	04/97→10/02	Stabiliser Mounting	DB-SB-5260		
	04/97→10/02	Stabiliser Mounting	DB-SB-5279		
	04/97→10/02	Suspension Arm Repair Kit		DB-RK-8550	for Wishbone (CV)
	04/97→10/02	Suspension Arm Repair Kit		DB-RK-8626	for Wishbone (CV)
	04/97→10/02	Suspension Arm Repair Kit		DB-RK-10374	for Wishbone (CV)
	04/97→10/02	Suspension Arm Repair Kit		DB-RK-10375	for Wishbone (CV)
	04/97→10/02	Suspension Arm Repair Kit	DB-RK-8638		for Control Arm
	04/97→10/02	Suspension Strut Repair Kit		DB-RK-8391	
	04/97→10/02	Tie Rod	DB-DL-8171		Guide Rod
	04/97→10/02	Tie Rod	DB-DL-8327		Guide Rod
	04/97→10/02	Tie Rod	DB-DL-8640		Guide Rod
	04/97→10/02	Tie Rod	DB-DL-12310		
	04/97→10/02	Tie Rod	DB-ES-5227		Guide Rod
	04/97→10/02	Tie Rod End	CV-ES-0543		for Push Rod
	04/97→10/02	Tie Rod End	CV-ES-0888		for Push Rod
	04/97→10/02	Tie Rod End	CV-ES-14162		for Steering Rod
	04/97→10/02	Tie Rod End	CV-ES-14163		for Steering Rod
	04/97→10/02	Tie Rod End	DB-ES-5234		for Steering Rod
	04/97→10/02	Tie Rod End	DB-ES-8164		for Push Rod
	04/97→10/02	Tie Rod End	DB-ES-8530		for Push Rod
	04/97→10/02	Track Control Arm		DB-DL-3475	Trailing Arm
	04/97→10/02	Track Control Arm		DB-VB-7261	Suspension Rod, Wishbone (CV), 1st RA, →517142 01/517142 02
	04/97→10/02	Track Control Arm	DB-DL-5224		Control Arm
	04/97→10/02	Track Control Arm	DB-DL-9218	DB-DL-9218	Trailing Arm
1843 S, 1843 LS	04/96→10/02	Ball Head, gearshift linkage	DB-ES-8387		
	04/96→10/02	Ball Head, gearshift linkage	DB-ES-8491		
	04/96→10/02	Ball Head, gearshift linkage	DB-ES-8492		
	04/96→10/02	Ball Head, gearshift linkage	DB-ES-8500		
	04/96→10/02	Ball Head, gearshift linkage	DB-ES-8510		
	04/96→10/02	Bush, driver cab suspension	DB-SB-10384		
	04/96→10/02	Bush, parabolic spring		DB-SB-10400	
	04/96→10/02	Bush, parabolic spring		DB-SB-10401	
	04/96→10/02	Centre Rod	DB-DL-2144		Push Rod
	04/96→10/02	Centre Rod	DB-DL-5230		Push Rod
	04/96→10/02	Centre Rod	DB-DL-5241		Push Rod
	04/96→10/02	Centre Rod	DB-DL-5405		Push Rod
	04/96→10/02	Centre Rod	DB-DL-5405		Push Rod, Leaf Spring Axle
	04/96→10/02	Centre Rod	DB-DL-7270		Push Rod
	04/96→10/02	Centre Rod	DB-DL-8167		Push Rod
	04/96→10/02	Centre Rod	DB-DL-8184		Push Rod
	04/96→10/02	Centre Rod	DB-DL-8185		Push Rod
	04/96→10/02	Centre Rod	DB-DL-8188		Push Rod
	04/96→10/02	Centre Rod	DB-DL-8307		Push Rod



ACTROS ...

1843 S, 1843 LS ...

04/96→10/02	Centre Rod	DB-DL-8392		Push Rod
04/96→10/02	Centre Rod	DB-DL-12300		for Steering Rod
04/96→10/02	Rod Assembly	DB-DL-2178		Guide Rod
04/96→10/02	Stabiliser Mounting		DB-SB-5261	
04/96→10/02	Stabiliser Mounting		DB-SB-10406	
04/96→10/02	Stabiliser Mounting		DB-SB-10407	
04/96→10/02	Stabiliser Mounting		DB-SB-10409	
04/96→10/02	Stabiliser Mounting	DB-SB-5260		
04/96→10/02	Stabiliser Mounting	DB-SB-5279		
04/96→10/02	Stabiliser Mounting	DB-SB-10410		
04/96→10/02	Suspension Arm Repair Kit		DB-RK-8626	for Wishbone (CV)
04/96→10/02	Suspension Arm Repair Kit		DB-RK-10374	for Wishbone (CV)
04/96→10/02	Suspension Arm Repair Kit		DB-RK-10375	for Wishbone (CV)
04/96→10/02	Suspension Arm Repair Kit	DB-RK-8638		for Control Arm
04/96→10/02	Suspension Strut Repair Kit		DB-RK-8391	
04/96→10/02	Suspension Strut Repair Kit		DB-RK-9294	
04/96→10/02	Suspension Strut Repair Kit		MN-RK-8997	
04/96→10/02	Tie Rod	DB-DL-8327		Guide Rod
04/96→10/02	Tie Rod	DB-DL-8388		Guide Rod
04/96→10/02	Tie Rod	DB-DL-8389		
04/96→10/02	Tie Rod	DB-DL-8640		Guide Rod
04/96→10/02	Tie Rod	DB-DL-12310		
04/96→10/02	Tie Rod	DB-ES-5227		Guide Rod
04/96→10/02	Tie Rod End	CV-ES-0543		for Push Rod
04/96→10/02	Tie Rod End	CV-ES-0888		for Push Rod
04/96→10/02	Tie Rod End	CV-ES-14162		for Steering Rod
04/96→10/02	Tie Rod End	CV-ES-14163		for Steering Rod
04/96→10/02	Tie Rod End	DB-ES-5234		for Steering Rod
04/96→10/02	Tie Rod End	DB-ES-8164		for Push Rod
04/96→10/02	Tie Rod End	DB-ES-8530		for Push Rod
04/96→10/02	Track Control Arm		DB-DL-3475	Trailing Arm
04/96→10/02	Track Control Arm		DB-VB-3707	Suspension Rod, Wishbone (CV), 1st RA; Air Suspension Axle, →* K 864073 *
04/96→10/02	Track Control Arm		DB-VB-7261	Suspension Rod, Wishbone (CV), 1st RA, →517142 01/517142 02
04/96→10/02	Track Control Arm		DB-VB-7798	Wishbone (CV), Air Suspension Axle, * K 864074 *→
04/96→10/02	Track Control Arm	DB-DL-5224		Control Arm, 1st FA;Air Suspension Axle
04/96→10/02	Track Control Arm	DB-DL-9218	DB-DL-9218	Trailing Arm, 1st FA;Air Suspension Axle

1843, 1843 L

04/96→10/02	Ball Head, gearshift linkage	DB-ES-8387		
04/96→10/02	Ball Head, gearshift linkage	DB-ES-8491		
04/96→10/02	Ball Head, gearshift linkage	DB-ES-8492		
04/96→10/02	Ball Head, gearshift linkage	DB-ES-8500		
04/96→10/02	Ball Head, gearshift linkage	DB-ES-8510		
04/96→10/02	Bush, driver cab suspension	DB-SB-10384		
04/96→10/02	Bush, parabolic spring		DB-SB-10400	
04/96→10/02	Bush, parabolic spring		DB-SB-10401	
04/96→10/02	Centre Rod	DB-DL-2144		Push Rod
04/96→10/02	Centre Rod	DB-DL-5230		Push Rod
04/96→10/02	Centre Rod	DB-DL-5230		Push Rod, Leaf Spring Axle
04/96→10/02	Centre Rod	DB-DL-5241		Push Rod, 1st FA;Air Suspension Axle
04/96→10/02	Centre Rod	DB-DL-5405		Push Rod
04/96→10/02	Centre Rod	DB-DL-5405		Push Rod, Leaf Spring Axle
04/96→10/02	Centre Rod	DB-DL-7270		Push Rod
04/96→10/02	Centre Rod	DB-DL-8167		Push Rod, 1st FA;Leaf Spring Axle
04/96→10/02	Centre Rod	DB-DL-8168		Push Rod
04/96→10/02	Centre Rod	DB-DL-8184		Push Rod
04/96→10/02	Centre Rod	DB-DL-8185		Push Rod
04/96→10/02	Centre Rod	DB-DL-8188		Push Rod
04/96→10/02	Centre Rod	DB-DL-8307		Push Rod
04/96→10/02	Centre Rod	DB-DL-8622		Push Rod
04/96→10/02	Centre Rod	DB-DL-8641		Push Rod
04/96→10/02	Centre Rod	DB-DL-8642		Push Rod



ACTROS ...

1843, 1843 L ...	04/96→10/02	Centre Rod	DB-DL-12298		for Steering Rod
	04/96→10/02	Centre Rod	DB-DL-12300		for Steering Rod
	04/96→10/02	Rod Assembly	DB-DL-2178		Guide Rod
	04/96→10/02	Stabiliser Mounting		DB-RK-9296	
	04/96→10/02	Stabiliser Mounting		DB-SB-5250	
	04/96→10/02	Stabiliser Mounting		DB-SB-5261	
	04/96→10/02	Stabiliser Mounting		DB-SB-10406	
	04/96→10/02	Stabiliser Mounting		DB-SB-10407	
	04/96→10/02	Stabiliser Mounting	DB-SB-5260		
	04/96→10/02	Stabiliser Mounting	DB-SB-5277	DB-SB-5277	
	04/96→10/02	Stabiliser Mounting	DB-SB-5279		
	04/96→10/02	Suspension Arm Repair Kit		DB-RK-8550	for Wishbone (CV)
	04/96→10/02	Suspension Arm Repair Kit		DB-RK-8626	for Wishbone (CV)
	04/96→10/02	Suspension Arm Repair Kit		DB-RK-8638	for Control Arm
	04/96→10/02	Suspension Arm Repair Kit		DB-RK-10374	for Wishbone (CV)
	04/96→10/02	Tie Rod	DB-DL-8327		Guide Rod
	04/96→10/02	Tie Rod	DB-DL-8388		Guide Rod
	04/96→10/02	Tie Rod	DB-DL-8389		
	04/96→10/02	Tie Rod	DB-DL-8640		Guide Rod
	04/96→10/02	Tie Rod	DB-DL-12310		
	04/96→10/02	Tie Rod	DB-ES-5227		Guide Rod
	04/96→10/02	Tie Rod End	CV-ES-0543		for Push Rod
	04/96→10/02	Tie Rod End	CV-ES-0888		for Push Rod
	04/96→10/02	Tie Rod End	CV-ES-14162		for Steering Rod
	04/96→10/02	Tie Rod End	CV-ES-14163		for Steering Rod
	04/96→10/02	Tie Rod End	DB-ES-8164		for Push Rod
	04/96→10/02	Tie Rod End	DB-ES-8530		for Push Rod
	04/96→10/02	Track Control Arm		DB-DL-3475	Trailing Arm
	04/96→10/02	Track Control Arm		DB-VB-3707	Suspension Rod, Wishbone (CV), 1st RA; Air Suspension Axle, →* K 864073 *
	04/96→10/02	Track Control Arm		DB-VB-7261	Suspension Rod, Wishbone (CV), 1st RA, →517142 01/517142 02
	04/96→10/02	Track Control Arm	DB-DL-5224		Control Arm, 1st FA; Air Suspension Axle
	04/96→10/02	Track Control Arm	DB-DL-9218	DB-DL-9218	Trailing Arm, 1st FA; Air Suspension Axle
	1846 AK	04/97→10/03	Ball Head, gearshift linkage	DB-ES-8387	
04/97→10/03		Ball Head, gearshift linkage	DB-ES-8491		
04/97→10/03		Ball Head, gearshift linkage	DB-ES-8492		
04/97→10/03		Bush, parabolic spring		DB-SB-10400	
04/97→10/03		Bush, parabolic spring		DB-SB-10401	
04/97→10/03		Centre Rod	DB-DL-5230		Push Rod
04/97→10/03		Centre Rod	DB-DL-5405		Push Rod
04/97→10/03		Centre Rod	DB-DL-8307		Push Rod
04/97→10/03		Centre Rod	DB-DL-8639		Push Rod
04/97→10/03		Centre Rod	DB-DL-8702		Push Rod
04/97→10/03		Tie Rod	DB-ES-5227		Guide Rod
04/97→10/03		Tie Rod	MN-DL-7834		Guide Rod
04/97→10/03		Tie Rod End	CV-ES-14163		for Steering Rod
04/97→10/03		Track Control Arm		DB-DL-3475	Trailing Arm
04/97→10/03		Track Control Arm	DB-DL-5224		Control Arm
04/97→10/03	Track Control Arm	DB-DL-9218	DB-DL-9218	Trailing Arm	
1846 S, 1846 LS	10/98→	Ball Head, gearshift linkage	DB-ES-8387		
	10/98→	Ball Head, gearshift linkage	DB-ES-8491		
	10/98→	Ball Head, gearshift linkage	DB-ES-8492		
	10/98→	Ball Head, gearshift linkage	DB-ES-8500		
	10/98→	Bush, parabolic spring		DB-SB-10400	
	10/98→	Bush, parabolic spring		DB-SB-10401	
	10/98→	Centre Rod	DB-DL-2144		Push Rod
	10/98→	Centre Rod	DB-DL-5230		Push Rod
	10/98→	Centre Rod	DB-DL-5241		Push Rod
	10/98→	Centre Rod	DB-DL-5405		Push Rod
	10/98→	Centre Rod	DB-DL-7270		Push Rod
	10/98→	Centre Rod	DB-DL-8167		Push Rod
	10/98→	Centre Rod	DB-DL-8392		Push Rod



ACTROS ...

1846 S, 1846 LS ...	10/98→	Rod Assembly	DB-DL-2178		Guide Rod, 1st Front Axle, →504310 03	
	10/98→	Suspension Arm Repair Kit		DB-RK-8626	for Wishbone (CV)	
	10/98→	Suspension Arm Repair Kit		DB-RK-10374	for Wishbone (CV)	
	10/98→	Suspension Strut Repair Kit		DB-RK-8391		
	10/98→	Suspension Strut Repair Kit		DB-RK-8710		
	10/98→	Tie Rod	DB-DL-8388		Guide Rod	
	10/98→	Tie Rod	DB-DL-8389			
	10/98→	Tie Rod	DB-DL-8640		Guide Rod, 1st Front Axle	
	10/98→	Tie Rod End	CV-ES-0543		for Push Rod	
	10/98→	Tie Rod End	CV-ES-0888		for Push Rod	
	10/98→	Tie Rod End	CV-ES-14163		for Steering Rod	
	10/98→	Tie Rod End	DB-ES-8164		for Push Rod	
	10/98→	Tie Rod End	DB-ES-8530		for Push Rod	
	10/98→	Track Control Arm		DB-DL-3475	Trailing Arm	
	10/98→	Track Control Arm		DB-VB-3707	Suspension Rod, Wishbone (CV)	
	10/98→	Track Control Arm		DB-VB-7261	Suspension Rod, Wishbone (CV), 1st RA, →517142 01/517142 02	
	10/98→	Track Control Arm		DB-VB-7798	Wishbone (CV)	
	10/98→	Track Control Arm	DB-DL-5224		Control Arm	
	1848 AK	10/98→	Track Control Arm	DB-DL-9218	DB-DL-9218	Trailing Arm
		04/97→10/02	Ball Head, gearshift linkage	DB-ES-8387		
04/97→10/02		Ball Head, gearshift linkage	DB-ES-8491			
04/97→10/02		Ball Head, gearshift linkage	DB-ES-8492			
04/97→10/02		Ball Head, gearshift linkage	DB-ES-8500			
04/97→10/02		Ball Head, gearshift linkage	DB-ES-8510			
04/97→10/02		Bush, driver cab suspension	DB-SB-10384			
04/97→10/02		Bush, parabolic spring		DB-SB-10400		
04/97→10/02		Bush, parabolic spring		DB-SB-10401		
04/97→10/02		Centre Rod	DB-DL-5230		Push Rod	
04/97→10/02		Centre Rod	DB-DL-5405		Push Rod	
04/97→10/02		Centre Rod	DB-DL-8184		Push Rod	
04/97→10/02		Centre Rod	DB-DL-8188		Push Rod	
04/97→10/02		Centre Rod	DB-DL-8307		Push Rod, Leaf Spring Axle	
04/97→10/02		Centre Rod	DB-DL-8639		Push Rod, Leaf Spring Axle	
04/97→10/02		Centre Rod	DB-DL-8702		Push Rod, Leaf Spring Axle	
04/97→10/02		Centre Rod	DB-DL-9259		Push Rod	
04/97→10/02		Centre Rod	DB-DL-12300		for Steering Rod	
04/97→10/02		Stabiliser Link	DB-DL-9254		Pressure Rod	
04/97→10/02		Stabiliser Mounting		DB-SB-5250		
04/97→10/02		Stabiliser Mounting		DB-SB-5261		
04/97→10/02		Stabiliser Mounting		DB-SB-10406		
04/97→10/02		Stabiliser Mounting		DB-SB-10407		
04/97→10/02		Stabiliser Mounting		DB-SB-10409		
04/97→10/02		Stabiliser Mounting	DB-SB-5260			
04/97→10/02		Stabiliser Mounting	DB-SB-5279			
04/97→10/02		Suspension Arm Repair Kit		DB-RK-8626	for Wishbone (CV)	
04/97→10/02		Suspension Arm Repair Kit		DB-RK-10374	for Wishbone (CV)	
04/97→10/02		Suspension Arm Repair Kit		DB-RK-10375	for Wishbone (CV)	
04/97→10/02		Suspension Arm Repair Kit	DB-RK-8638		for Control Arm	
04/97→10/02		Suspension Strut Repair Kit		DB-RK-8391		
04/97→10/02		Tie Rod	DB-DL-12310			
04/97→10/02		Tie Rod	DB-ES-5227		Guide Rod	
04/97→10/02		Tie Rod	MN-DL-7834		Guide Rod	
04/97→10/02		Tie Rod End	CV-ES-0543		for Push Rod	
04/97→10/02		Tie Rod End	CV-ES-14163		for Steering Rod	
04/97→10/02		Tie Rod End	DB-ES-5234		for Steering Rod	
04/97→10/02		Tie Rod End	DB-ES-8530		for Push Rod	
04/97→10/02		Track Control Arm		DB-DL-3475	Trailing Arm	
04/97→10/02		Track Control Arm		DB-VB-7261	Suspension Rod, Wishbone (CV), 1st RA, →517142 01/517142 02	
04/97→10/02		Track Control Arm	DB-DL-5224		Control Arm	
04/97→10/02		Track Control Arm	DB-DL-9218	DB-DL-9218	Trailing Arm	



ACTROS ...

1848 K	04/97→10/02	Ball Head, gearshift linkage	DB-ES-8387		
	04/97→10/02	Ball Head, gearshift linkage	DB-ES-8491		
	04/97→10/02	Ball Head, gearshift linkage	DB-ES-8492		
	04/97→10/02	Ball Head, gearshift linkage	DB-ES-8500		
	04/97→10/02	Ball Head, gearshift linkage	DB-ES-8510		
	04/97→10/02	Bush, driver cab suspension	DB-SB-10384		
	04/97→10/02	Bush, parabolic spring		DB-SB-10400	
	04/97→10/02	Bush, parabolic spring		DB-SB-10401	
	04/97→10/02	Centre Rod	DB-DL-2144		Push Rod
	04/97→10/02	Centre Rod	DB-DL-5230		Push Rod, 1st FA;Leaf Spring Axle
	04/97→10/02	Centre Rod	DB-DL-5241		Push Rod
	04/97→10/02	Centre Rod	DB-DL-5405		Push Rod, Leaf Spring Axle
	04/97→10/02	Centre Rod	DB-DL-7270		Push Rod
	04/97→10/02	Centre Rod	DB-DL-8167		Push Rod, Leaf Spring Axle
	04/97→10/02	Centre Rod	DB-DL-8184		Push Rod
	04/97→10/02	Centre Rod	DB-DL-8185		Push Rod
	04/97→10/02	Centre Rod	DB-DL-8188		Push Rod
	04/97→10/02	Centre Rod	DB-DL-8307		Push Rod
	04/97→10/02	Centre Rod	DB-DL-12300		for Steering Rod
	04/97→10/02	Rod Assembly	DB-DL-2178		Guide Rod, 1st Front Axle, →504310 03
	04/97→10/02	Stabiliser Link	DB-DL-9254		Pressure Rod
	04/97→10/02	Stabiliser Mounting		DB-SB-5250	
	04/97→10/02	Stabiliser Mounting		DB-SB-5261	
	04/97→10/02	Stabiliser Mounting		DB-SB-10406	
	04/97→10/02	Stabiliser Mounting		DB-SB-10407	
	04/97→10/02	Stabiliser Mounting		DB-SB-10409	
	04/97→10/02	Stabiliser Mounting	DB-SB-5260		
	04/97→10/02	Stabiliser Mounting	DB-SB-5279		
	04/97→10/02	Suspension Arm Repair Kit		DB-RK-8550	for Wishbone (CV)
	04/97→10/02	Suspension Arm Repair Kit		DB-RK-8626	for Wishbone (CV)
	04/97→10/02	Suspension Arm Repair Kit		DB-RK-10374	for Wishbone (CV)
	04/97→10/02	Suspension Arm Repair Kit		DB-RK-10375	for Wishbone (CV)
	04/97→10/02	Suspension Arm Repair Kit	DB-RK-8638		for Control Arm
	04/97→10/02	Suspension Strut Repair Kit		DB-RK-8391	
	04/97→10/02	Tie Rod	DB-DL-8171		Guide Rod
	04/97→10/02	Tie Rod	DB-DL-8327		Guide Rod
	04/97→10/02	Tie Rod	DB-DL-8640		Guide Rod
	04/97→10/02	Tie Rod	DB-DL-12310		
	04/97→10/02	Tie Rod	DB-ES-5227		Guide Rod
	04/97→10/02	Tie Rod End	CV-ES-0543		for Push Rod
	04/97→10/02	Tie Rod End	CV-ES-0888		for Push Rod
	04/97→10/02	Tie Rod End	CV-ES-14163		for Steering Rod
	04/97→10/02	Tie Rod End	DB-ES-5234		for Steering Rod
	04/97→10/02	Tie Rod End	DB-ES-8164		for Push Rod
	04/97→10/02	Tie Rod End	DB-ES-8530		for Push Rod
	04/97→10/02	Track Control Arm		DB-DL-3475	Trailing Arm
	04/97→10/02	Track Control Arm		DB-VB-7261	Suspension Rod, Wishbone (CV), 1st RA, →517142 01/517142 02
04/97→10/02	Track Control Arm	DB-DL-5224		Control Arm	
04/97→10/02	Track Control Arm	DB-DL-9218	DB-DL-9218	Trailing Arm	
1848 S, 1848 LS	04/96→10/02	Ball Head, gearshift linkage	DB-ES-8387		
	04/96→10/02	Ball Head, gearshift linkage	DB-ES-8491		
	04/96→10/02	Ball Head, gearshift linkage	DB-ES-8492		
	04/96→10/02	Ball Head, gearshift linkage	DB-ES-8500		
	04/96→10/02	Ball Head, gearshift linkage	DB-ES-8510		
	04/96→10/02	Bush, driver cab suspension	DB-SB-10384		
	04/96→10/02	Bush, parabolic spring		DB-SB-10400	
	04/96→10/02	Bush, parabolic spring		DB-SB-10401	
	04/96→10/02	Centre Rod	DB-DL-2144		Push Rod
	04/96→10/02	Centre Rod	DB-DL-5230		Push Rod
04/96→10/02	Centre Rod	DB-DL-5241		Push Rod	
04/96→10/02	Centre Rod	DB-DL-5405		Push Rod	
04/96→10/02	Centre Rod	DB-DL-5405		Push Rod, Leaf Spring Axle	



ACTROS ...

1848 S, 1848 LS ...	04/96→10/02	Centre Rod	DB-DL-7270		Push Rod	
	04/96→10/02	Centre Rod	DB-DL-8167		Push Rod	
	04/96→10/02	Centre Rod	DB-DL-8184		Push Rod	
	04/96→10/02	Centre Rod	DB-DL-8185		Push Rod	
	04/96→10/02	Centre Rod	DB-DL-8188		Push Rod	
	04/96→10/02	Centre Rod	DB-DL-8307		Push Rod	
	04/96→10/02	Centre Rod	DB-DL-8392		Push Rod	
	04/96→10/02	Centre Rod	DB-DL-12300		for Steering Rod	
	04/96→10/02	Rod Assembly	DB-DL-2178		Guide Rod, 1st Front Axle, →504310 03	
	04/96→10/02	Stabiliser Mounting		DB-SB-5261		
	04/96→10/02	Stabiliser Mounting		DB-SB-10406		
	04/96→10/02	Stabiliser Mounting		DB-SB-10407		
	04/96→10/02	Stabiliser Mounting		DB-SB-10409		
	04/96→10/02	Stabiliser Mounting	DB-SB-5260			
	04/96→10/02	Stabiliser Mounting	DB-SB-5279			
	04/96→10/02	Stabiliser Mounting	DB-SB-10410			
	04/96→10/02	Suspension Arm Repair Kit		DB-RK-8626	for Wishbone (CV)	
	04/96→10/02	Suspension Arm Repair Kit		DB-RK-10374	for Wishbone (CV)	
	04/96→10/02	Suspension Arm Repair Kit		DB-RK-10375	for Wishbone (CV)	
	04/96→10/02	Suspension Arm Repair Kit	DB-RK-8638		for Control Arm	
	04/96→10/02	Suspension Strut Repair Kit		DB-RK-8391		
	04/96→10/02	Suspension Strut Repair Kit		DB-RK-9294		
	04/96→10/02	Suspension Strut Repair Kit		MN-RK-8997		
	04/96→10/02	Tie Rod	DB-DL-8327		Guide Rod	
	04/96→10/02	Tie Rod	DB-DL-8640		Guide Rod	
	04/96→10/02	Tie Rod	DB-DL-12310			
	04/96→10/02	Tie Rod	DB-ES-5227		Guide Rod	
	04/96→10/02	Tie Rod End	CV-ES-0543		for Push Rod	
	04/96→10/02	Tie Rod End	CV-ES-0888		for Push Rod	
	04/96→10/02	Tie Rod End	CV-ES-14163		for Steering Rod	
	04/96→10/02	Tie Rod End	DB-ES-5234		for Steering Rod	
	04/96→10/02	Tie Rod End	DB-ES-8164		for Push Rod	
	04/96→10/02	Tie Rod End	DB-ES-8530		for Push Rod	
	04/96→10/02	Track Control Arm		DB-DL-3475	Trailing Arm	
	04/96→10/02	Track Control Arm		DB-VB-3707	Suspension Rod, Wishbone (CV), 1st RA; Air Suspension Axle, →* K 864073 *	
	04/96→10/02	Track Control Arm		DB-VB-7261	Suspension Rod, Wishbone (CV), 1st RA, →517142 01/517142 02	
	04/96→10/02	Track Control Arm		DB-VB-7798	Wishbone (CV), Air Suspension Axle, * K 864074 *→	
	04/96→10/02	Track Control Arm	DB-DL-5224		Control Arm, 1st FA; Air Suspension Axle	
	04/96→10/02	Track Control Arm	DB-DL-9218	DB-DL-9218	Trailing Arm, 1st FA; Air Suspension Axle	
	1848, 1848 L	04/96→10/02	Ball Head, gearshift linkage	DB-ES-8387		
		04/96→10/02	Ball Head, gearshift linkage	DB-ES-8491		
		04/96→10/02	Ball Head, gearshift linkage	DB-ES-8492		
		04/96→10/02	Ball Head, gearshift linkage	DB-ES-8500		
		04/96→10/02	Ball Head, gearshift linkage	DB-ES-8510		
		04/96→10/02	Bush, driver cab suspension	DB-SB-10384		
		04/96→10/02	Bush, parabolic spring		DB-SB-10400	
		04/96→10/02	Bush, parabolic spring		DB-SB-10401	
04/96→10/02		Centre Rod	DB-DL-2144		Push Rod	
04/96→10/02		Centre Rod	DB-DL-5230		Push Rod	
04/96→10/02		Centre Rod	DB-DL-5230		Push Rod, Leaf Spring Axle	
04/96→10/02		Centre Rod	DB-DL-5241		Push Rod, 1st FA; Air Suspension Axle	
04/96→10/02		Centre Rod	DB-DL-5405		Push Rod	
04/96→10/02		Centre Rod	DB-DL-5405		Push Rod, Leaf Spring Axle	
04/96→10/02		Centre Rod	DB-DL-7270		Push Rod	
04/96→10/02		Centre Rod	DB-DL-8167		Push Rod, 1st FA; Leaf Spring Axle	
04/96→10/02		Centre Rod	DB-DL-8168		Push Rod	
04/96→10/02		Centre Rod	DB-DL-8184		Push Rod	
04/96→10/02		Centre Rod	DB-DL-8185		Push Rod	
04/96→10/02		Centre Rod	DB-DL-8188		Push Rod	
04/96→10/02		Centre Rod	DB-DL-8307		Push Rod	



ACTROS ...

1848, 1848 L ...	04/96→10/02	Centre Rod	DB-DL-8622		Push Rod	
	04/96→10/02	Centre Rod	DB-DL-8641		Push Rod	
	04/96→10/02	Centre Rod	DB-DL-8642		Push Rod	
	04/96→10/02	Centre Rod	DB-DL-12298		for Steering Rod	
	04/96→10/02	Centre Rod	DB-DL-12300		for Steering Rod	
	04/96→10/02	Rod Assembly	DB-DL-2178		Guide Rod, 1st Front Axle, →504310 03	
	04/96→10/02	Stabiliser Mounting		DB-RK-9296		
	04/96→10/02	Stabiliser Mounting		DB-SB-5250		
	04/96→10/02	Stabiliser Mounting		DB-SB-5261		
	04/96→10/02	Stabiliser Mounting		DB-SB-10406		
	04/96→10/02	Stabiliser Mounting		DB-SB-10407		
	04/96→10/02	Stabiliser Mounting	DB-SB-5260			
	04/96→10/02	Stabiliser Mounting	DB-SB-5277	DB-SB-5277		
	04/96→10/02	Stabiliser Mounting	DB-SB-5279			
	04/96→10/02	Suspension Arm Repair Kit		DB-RK-8550	for Wishbone (CV)	
	04/96→10/02	Suspension Arm Repair Kit		DB-RK-8626	for Wishbone (CV)	
	04/96→10/02	Suspension Arm Repair Kit		DB-RK-8638	for Control Arm	
	04/96→10/02	Suspension Arm Repair Kit		DB-RK-10374	for Wishbone (CV)	
	04/96→10/02	Tie Rod	DB-DL-8327		Guide Rod	
	04/96→10/02	Tie Rod	DB-DL-8640		Guide Rod	
	04/96→10/02	Tie Rod	DB-DL-12310			
	04/96→10/02	Tie Rod	DB-ES-5227		Guide Rod	
	04/96→10/02	Tie Rod End	CV-ES-0543		for Push Rod	
	04/96→10/02	Tie Rod End	CV-ES-0888		for Push Rod	
	04/96→10/02	Tie Rod End	CV-ES-14163		for Steering Rod	
	04/96→10/02	Tie Rod End	DB-ES-8164		for Push Rod	
	04/96→10/02	Tie Rod End	DB-ES-8530		for Push Rod	
	04/96→10/02	Track Control Arm		DB-DL-3475	Trailing Arm	
	04/96→10/02	Track Control Arm		DB-VB-3707	Suspension Rod, Wishbone (CV), 1st RA; Air Suspension Axle, →* K 864073 *	
	04/96→10/02	Track Control Arm	DB-DL-5224		Control Arm, 1st FA; Air Suspension Axle	
	04/96→10/02	Track Control Arm	DB-DL-9218	DB-DL-9218	Trailing Arm, 1st FA; Air Suspension Axle	
	1850 AK	10/97→	Ball Head, gearshift linkage	DB-ES-8387		
		10/97→	Ball Head, gearshift linkage	DB-ES-8491		
10/97→		Ball Head, gearshift linkage	DB-ES-8492			
10/97→		Bush, parabolic spring		DB-SB-10400		
10/97→		Bush, parabolic spring		DB-SB-10401		
10/97→		Centre Rod	DB-DL-5230		Push Rod	
10/97→		Centre Rod	DB-DL-5405		Push Rod	
10/97→		Centre Rod	DB-DL-8307		Push Rod	
10/97→		Centre Rod	DB-DL-8639		Push Rod	
10/97→		Centre Rod	DB-DL-8702		Push Rod	
10/97→		Tie Rod	DB-ES-5227		Guide Rod	
10/97→		Tie Rod	MN-DL-7834		Guide Rod	
10/97→		Tie Rod End	CV-ES-14163		for Steering Rod	
10/97→		Track Control Arm		DB-DL-3475	Trailing Arm	
10/97→		Track Control Arm	DB-DL-5224		Control Arm	
10/97→	Track Control Arm	DB-DL-9218	DB-DL-9218	Trailing Arm		
1853 S, 1853 LS	04/96→10/02	Ball Head, gearshift linkage	DB-ES-8387			
	04/96→10/02	Ball Head, gearshift linkage	DB-ES-8491			
	04/96→10/02	Ball Head, gearshift linkage	DB-ES-8492			
	04/96→10/02	Ball Head, gearshift linkage	DB-ES-8500			
	04/96→10/02	Ball Head, gearshift linkage	DB-ES-8510			
	04/96→10/02	Bush, driver cab suspension	DB-SB-10384			
	04/96→10/02	Bush, parabolic spring		DB-SB-10400		
	04/96→10/02	Bush, parabolic spring		DB-SB-10401		
	04/96→10/02	Centre Rod	DB-DL-2144		Push Rod	
	04/96→10/02	Centre Rod	DB-DL-5230		Push Rod	
	04/96→10/02	Centre Rod	DB-DL-5241		Push Rod	
	04/96→10/02	Centre Rod	DB-DL-5405		Push Rod	
	04/96→10/02	Centre Rod	DB-DL-5405		Push Rod, Leaf Spring Axle	
	04/96→10/02	Centre Rod	DB-DL-7270		Push Rod	
	04/96→10/02	Centre Rod	DB-DL-8167		Push Rod	



ACTROS ...

1853 S, 1853 LS ...	04/96→10/02	Centre Rod	DB-DL-8184		Push Rod	
	04/96→10/02	Centre Rod	DB-DL-8185		Push Rod	
	04/96→10/02	Centre Rod	DB-DL-8188		Push Rod	
	04/96→10/02	Centre Rod	DB-DL-8307		Push Rod	
	04/96→10/02	Centre Rod	DB-DL-8392		Push Rod	
	04/96→10/02	Centre Rod	DB-DL-12300		for Steering Rod	
	04/96→10/02	Rod Assembly	DB-DL-2178		Guide Rod	
	04/96→10/02	Stabiliser Mounting		DB-SB-5261		
	04/96→10/02	Stabiliser Mounting		DB-SB-10406		
	04/96→10/02	Stabiliser Mounting		DB-SB-10407		
	04/96→10/02	Stabiliser Mounting		DB-SB-10409		
	04/96→10/02	Stabiliser Mounting	DB-SB-5260			
	04/96→10/02	Stabiliser Mounting	DB-SB-5279			
	04/96→10/02	Stabiliser Mounting	DB-SB-10410			
	04/96→10/02	Suspension Arm Repair Kit		DB-RK-8626	for Wishbone (CV)	
	04/96→10/02	Suspension Arm Repair Kit		DB-RK-10374	for Wishbone (CV)	
	04/96→10/02	Suspension Arm Repair Kit		DB-RK-10375	for Wishbone (CV)	
	04/96→10/02	Suspension Arm Repair Kit	DB-RK-8638		for Control Arm	
	04/96→10/02	Suspension Strut Repair Kit		DB-RK-8391		
	04/96→10/02	Suspension Strut Repair Kit		DB-RK-9294		
	04/96→10/02	Suspension Strut Repair Kit		MN-RK-8997		
	04/96→10/02	Tie Rod	DB-DL-8327		Guide Rod	
	04/96→10/02	Tie Rod	DB-DL-8640		Guide Rod	
	04/96→10/02	Tie Rod	DB-DL-12310			
	04/96→10/02	Tie Rod	DB-ES-5227		Guide Rod	
	04/96→10/02	Tie Rod End	CV-ES-0543		for Push Rod	
	04/96→10/02	Tie Rod End	CV-ES-0888		for Push Rod	
	04/96→10/02	Tie Rod End	CV-ES-14162		for Steering Rod	
	04/96→10/02	Tie Rod End	CV-ES-14163		for Steering Rod	
	04/96→10/02	Tie Rod End	DB-ES-5234		for Steering Rod	
	04/96→10/02	Tie Rod End	DB-ES-8164		for Push Rod	
	04/96→10/02	Tie Rod End	DB-ES-8530		for Push Rod	
	04/96→10/02	Track Control Arm		DB-DL-3475	Trailing Arm	
	04/96→10/02	Track Control Arm		DB-VB-3707	Suspension Rod, Wishbone (CV), 1st RA; Air Suspension Axle, →* K 864073 *	
	04/96→10/02	Track Control Arm		DB-VB-7261	Suspension Rod, Wishbone (CV), 1st RA, →517142 01/517142 02	
	04/96→10/02	Track Control Arm		DB-VB-7798	Wishbone (CV), Air Suspension Axle, * K 864074 *→	
	04/96→10/02	Track Control Arm	DB-DL-5224		Control Arm, 1st FA;Air Suspension Axle	
	04/96→10/02	Track Control Arm	DB-DL-9218	DB-DL-9218	Trailing Arm, 1st FA;Air Suspension Axle	
	1853, 1853 L	04/96→10/02	Ball Head, gearshift linkage	DB-ES-8387		
		04/96→10/02	Ball Head, gearshift linkage	DB-ES-8491		
		04/96→10/02	Ball Head, gearshift linkage	DB-ES-8492		
		04/96→10/02	Ball Head, gearshift linkage	DB-ES-8500		
		04/96→10/02	Ball Head, gearshift linkage	DB-ES-8510		
		04/96→10/02	Bush, driver cab suspension	DB-SB-10384		
		04/96→10/02	Bush, parabolic spring		DB-SB-10400	
04/96→10/02		Bush, parabolic spring		DB-SB-10401		
04/96→10/02		Centre Rod	DB-DL-2144		Push Rod	
04/96→10/02		Centre Rod	DB-DL-5230		Push Rod	
04/96→10/02		Centre Rod	DB-DL-5230		Push Rod, Leaf Spring Axle	
04/96→10/02		Centre Rod	DB-DL-5241		Push Rod, 1st FA;Air Suspension Axle	
04/96→10/02		Centre Rod	DB-DL-5405		Push Rod	
04/96→10/02		Centre Rod	DB-DL-5405		Push Rod, Leaf Spring Axle	
04/96→10/02		Centre Rod	DB-DL-7270		Push Rod	
04/96→10/02		Centre Rod	DB-DL-8167		Push Rod, 1st FA;Leaf Spring Axle	
04/96→10/02		Centre Rod	DB-DL-8168		Push Rod	
04/96→10/02		Centre Rod	DB-DL-8184		Push Rod	
04/96→10/02		Centre Rod	DB-DL-8185		Push Rod	
04/96→10/02		Centre Rod	DB-DL-8188		Push Rod	
04/96→10/02		Centre Rod	DB-DL-8307		Push Rod	
04/96→10/02		Centre Rod	DB-DL-8622		Push Rod	



ACTROS ...

1853, 1853 L ...	04/96→10/02	Centre Rod	DB-DL-8641		Push Rod	
	04/96→10/02	Centre Rod	DB-DL-8642		Push Rod	
	04/96→10/02	Centre Rod	DB-DL-12298		for Steering Rod	
	04/96→10/02	Centre Rod	DB-DL-12300		for Steering Rod	
	04/96→10/02	Rod Assembly	DB-DL-2178		Guide Rod	
	04/96→10/02	Stabiliser Mounting		DB-RK-9296		
	04/96→10/02	Stabiliser Mounting		DB-SB-5250		
	04/96→10/02	Stabiliser Mounting		DB-SB-5261		
	04/96→10/02	Stabiliser Mounting		DB-SB-10406		
	04/96→10/02	Stabiliser Mounting		DB-SB-10407		
	04/96→10/02	Stabiliser Mounting	DB-SB-5260			
	04/96→10/02	Stabiliser Mounting	DB-SB-5277	DB-SB-5277		
	04/96→10/02	Stabiliser Mounting	DB-SB-5279			
	04/96→10/02	Suspension Arm Repair Kit		DB-RK-8550	for Wishbone (CV)	
	04/96→10/02	Suspension Arm Repair Kit		DB-RK-8626	for Wishbone (CV)	
	04/96→10/02	Suspension Arm Repair Kit		DB-RK-8638	for Control Arm	
	04/96→10/02	Suspension Arm Repair Kit		DB-RK-10374	for Wishbone (CV)	
	04/96→10/02	Tie Rod	DB-DL-8327		Guide Rod	
	04/96→10/02	Tie Rod	DB-DL-8640		Guide Rod	
	04/96→10/02	Tie Rod	DB-DL-12310			
	04/96→10/02	Tie Rod	DB-ES-5227		Guide Rod	
	04/96→10/02	Tie Rod End	CV-ES-0543		for Push Rod	
	04/96→10/02	Tie Rod End	CV-ES-0888		for Push Rod	
	04/96→10/02	Tie Rod End	CV-ES-14162		for Steering Rod	
	04/96→10/02	Tie Rod End	CV-ES-14163		for Steering Rod	
	04/96→10/02	Tie Rod End	DB-ES-8164		for Push Rod	
	04/96→10/02	Tie Rod End	DB-ES-8530		for Push Rod	
	04/96→10/02	Track Control Arm		DB-DL-3475	Trailing Arm	
	04/96→10/02	Track Control Arm		DB-VB-3707	Suspension Rod, Wishbone (CV), 1st RA; Air Suspension Axle, →* K 864073 *	
	04/96→10/02	Track Control Arm		DB-VB-7261	Suspension Rod, Wishbone (CV), 1st RA, →517142 01/517142 02	
	04/96→10/02	Track Control Arm	DB-DL-5224		Control Arm, 1st FA; Air Suspension Axle	
	04/96→10/02	Track Control Arm	DB-DL-9218	DB-DL-9218	Trailing Arm, 1st FA; Air Suspension Axle	
	1857 L	04/97→10/02	Ball Head, gearshift linkage	DB-ES-8387		
		04/97→10/02	Ball Head, gearshift linkage	DB-ES-8491		
		04/97→10/02	Ball Head, gearshift linkage	DB-ES-8492		
		04/97→10/02	Ball Head, gearshift linkage	DB-ES-8500		
		04/97→10/02	Ball Head, gearshift linkage	DB-ES-8510		
		04/97→10/02	Bush, driver cab suspension	DB-SB-10384		
		04/97→10/02	Bush, parabolic spring		DB-SB-10400	
		04/97→10/02	Bush, parabolic spring		DB-SB-10401	
		04/97→10/02	Centre Rod	DB-DL-2144		Push Rod
		04/97→10/02	Centre Rod	DB-DL-5230		Push Rod
		04/97→10/02	Centre Rod	DB-DL-5241		Push Rod, 1st FA; Air Suspension Axle
		04/97→10/02	Centre Rod	DB-DL-5405		Push Rod
		04/97→10/02	Centre Rod	DB-DL-7270		Push Rod
04/97→10/02		Centre Rod	DB-DL-8167		Push Rod	
04/97→10/02		Centre Rod	DB-DL-8168		Push Rod	
04/97→10/02		Centre Rod	DB-DL-8184		Push Rod	
04/97→10/02		Centre Rod	DB-DL-8185		Push Rod	
04/97→10/02		Centre Rod	DB-DL-8188		Push Rod	
04/97→10/02		Centre Rod	DB-DL-8307		Push Rod	
04/97→10/02		Centre Rod	DB-DL-8622		Push Rod	
04/97→10/02		Centre Rod	DB-DL-8641		Push Rod	
04/97→10/02		Centre Rod	DB-DL-8642		Push Rod	
04/97→10/02		Centre Rod	DB-DL-12298		for Steering Rod	
04/97→10/02		Centre Rod	DB-DL-12300		for Steering Rod	
04/97→10/02		Rod Assembly	DB-DL-2178		Guide Rod, 1st Front Axle, →504310 03	
04/97→10/02		Stabiliser Mounting		DB-RK-9296		
04/97→10/02		Stabiliser Mounting		DB-SB-5250		
04/97→10/02		Stabiliser Mounting		DB-SB-5261		
04/97→10/02		Stabiliser Mounting		DB-SB-10406		



ACTROS ...

1857 L ...	04/97→10/02	Stabiliser Mounting		DB-SB-10407	
	04/97→10/02	Stabiliser Mounting	DB-SB-5260		
	04/97→10/02	Stabiliser Mounting	DB-SB-5277	DB-SB-5277	
	04/97→10/02	Stabiliser Mounting	DB-SB-5279		
	04/97→10/02	Suspension Arm Repair Kit		DB-RK-8626	for Wishbone (CV)
	04/97→10/02	Suspension Arm Repair Kit		DB-RK-8638	for Control Arm
	04/97→10/02	Suspension Arm Repair Kit		DB-RK-10374	for Wishbone (CV)
	04/97→10/02	Tie Rod	DB-DL-8327		Guide Rod
	04/97→10/02	Tie Rod	DB-DL-8640		Guide Rod
	04/97→10/02	Tie Rod	DB-DL-12310		
	04/97→10/02	Tie Rod	DB-ES-5227		Guide Rod
	04/97→10/02	Tie Rod End	CV-ES-0543		for Push Rod
	04/97→10/02	Tie Rod End	CV-ES-0888		for Push Rod
	04/97→10/02	Tie Rod End	CV-ES-14163		for Steering Rod
	04/97→10/02	Tie Rod End	DB-ES-8164		for Push Rod
	04/97→10/02	Tie Rod End	DB-ES-8530		for Push Rod
	04/97→10/02	Track Control Arm		DB-DL-3475	Trailing Arm
	04/97→10/02	Track Control Arm		DB-VB-3707	Suspension Rod, Wishbone (CV), 1st RA; Air Suspension Axle, →* K 864073 *
	04/97→10/02	Track Control Arm	DB-DL-5224		Control Arm, 1st FA; Air Suspension Axle
	04/97→10/02	Track Control Arm	DB-DL-9218	DB-DL-9218	Trailing Arm, 1st FA; Air Suspension Axle
1857 LS	04/97→10/02	Ball Head, gearshift linkage	DB-ES-8387		
	04/97→10/02	Ball Head, gearshift linkage	DB-ES-8491		
	04/97→10/02	Ball Head, gearshift linkage	DB-ES-8492		
	04/97→10/02	Ball Head, gearshift linkage	DB-ES-8500		
	04/97→10/02	Ball Head, gearshift linkage	DB-ES-8510		
	04/97→10/02	Bush, driver cab suspension	DB-SB-10384		
	04/97→10/02	Bush, parabolic spring		DB-SB-10400	
	04/97→10/02	Bush, parabolic spring		DB-SB-10401	
	04/97→10/02	Centre Rod	DB-DL-2144		Push Rod
	04/97→10/02	Centre Rod	DB-DL-5230		Push Rod, 1st FA; Leaf Spring Axle
	04/97→10/02	Centre Rod	DB-DL-5241		Push Rod
	04/97→10/02	Centre Rod	DB-DL-5405		Push Rod
	04/97→10/02	Centre Rod	DB-DL-5405		Push Rod, Leaf Spring Axle
	04/97→10/02	Centre Rod	DB-DL-7270		Push Rod
	04/97→10/02	Centre Rod	DB-DL-8167		Push Rod, 1st FA; Leaf Spring Axle
	04/97→10/02	Centre Rod	DB-DL-8184		Push Rod
	04/97→10/02	Centre Rod	DB-DL-8185		Push Rod
	04/97→10/02	Centre Rod	DB-DL-8188		Push Rod
	04/97→10/02	Centre Rod	DB-DL-8307		Push Rod
	04/97→10/02	Centre Rod	DB-DL-8392		Push Rod
	04/97→10/02	Centre Rod	DB-DL-12300		for Steering Rod
	04/97→10/02	Rod Assembly	DB-DL-2178		Guide Rod, 1st Front Axle, →504310 03
	04/97→10/02	Stabiliser Mounting		DB-SB-5261	
	04/97→10/02	Stabiliser Mounting		DB-SB-10406	
	04/97→10/02	Stabiliser Mounting		DB-SB-10407	
	04/97→10/02	Stabiliser Mounting		DB-SB-10409	
	04/97→10/02	Stabiliser Mounting	DB-SB-5260		
	04/97→10/02	Stabiliser Mounting	DB-SB-5279		
	04/97→10/02	Stabiliser Mounting	DB-SB-10410		
	04/97→10/02	Suspension Arm Repair Kit		DB-RK-8626	for Wishbone (CV)
	04/97→10/02	Suspension Arm Repair Kit		DB-RK-10374	for Wishbone (CV)
	04/97→10/02	Suspension Arm Repair Kit		DB-RK-10375	for Wishbone (CV)
	04/97→10/02	Suspension Arm Repair Kit	DB-RK-8638		for Control Arm
	04/97→10/02	Suspension Strut Repair Kit		DB-RK-8391	
	04/97→10/02	Suspension Strut Repair Kit		DB-RK-9294	
	04/97→10/02	Suspension Strut Repair Kit		MN-RK-8997	
	04/97→10/02	Tie Rod	DB-DL-8327		Guide Rod
	04/97→10/02	Tie Rod	DB-DL-8640		Guide Rod
	04/97→10/02	Tie Rod	DB-DL-12310		
	04/97→10/02	Tie Rod	DB-ES-5227		Guide Rod
	04/97→10/02	Tie Rod End	CV-ES-0543		for Push Rod
	04/97→10/02	Tie Rod End	CV-ES-0888		for Push Rod

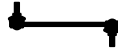

ACTROS ...

1857 LS ...	04/97→10/02	Tie Rod End	CV-ES-14163		for Steering Rod
	04/97→10/02	Tie Rod End	DB-ES-5234		for Steering Rod
	04/97→10/02	Tie Rod End	DB-ES-8164		for Push Rod
	04/97→10/02	Tie Rod End	DB-ES-8530		for Push Rod
	04/97→10/02	Track Control Arm		DB-DL-3475	Trailing Arm
	04/97→10/02	Track Control Arm		DB-VB-3707	Suspension Rod, Wishbone (CV), 1st RA; Air Suspension Axle, →* K 864073 *
	04/97→10/02	Track Control Arm		DB-VB-7798	Wishbone (CV), Air Suspension Axle, * K 864074 *→
	04/97→10/02	Track Control Arm	DB-DL-5224		Control Arm, 1st FA;Air Suspension Axle
	04/97→10/02	Track Control Arm	DB-DL-9218	DB-DL-9218	Trailing Arm, 1st FA;Air Suspension Axle
	2031	04/97→10/02	Ball Head, gearshift linkage	DB-ES-8387	
04/97→10/02		Ball Head, gearshift linkage	DB-ES-8491		
04/97→10/02		Ball Head, gearshift linkage	DB-ES-8492		
04/97→10/02		Ball Head, gearshift linkage	DB-ES-8500		
04/97→10/02		Ball Head, gearshift linkage	DB-ES-8510		
04/97→10/02		Bush, driver cab suspension	DB-SB-10384		
04/97→10/02		Bush, parabolic spring		DB-SB-10400	
04/97→10/02		Bush, parabolic spring		DB-SB-10401	
04/97→10/02		Centre Rod	DB-DL-2144		Push Rod
04/97→10/02		Centre Rod	DB-DL-5230		Push Rod, Leaf Spring Axle
04/97→10/02		Centre Rod	DB-DL-5241		Push Rod
04/97→10/02		Centre Rod	DB-DL-5405		Push Rod, Leaf Spring Axle
04/97→10/02		Centre Rod	DB-DL-7270		Push Rod;Suspension Rod
04/97→10/02		Centre Rod	DB-DL-8167		Push Rod, 1st FA;Leaf Spring Axle
04/97→10/02		Centre Rod	DB-DL-8168		Push Rod
04/97→10/02		Centre Rod	DB-DL-8184		Push Rod
04/97→10/02		Centre Rod	DB-DL-8185		Push Rod
04/97→10/02		Centre Rod	DB-DL-8188		Push Rod
04/97→10/02		Centre Rod	DB-DL-8307		Push Rod
04/97→10/02		Centre Rod	DB-DL-8622		Push Rod
04/97→10/02		Centre Rod	DB-DL-8641		Push Rod
04/97→10/02		Centre Rod	DB-DL-8642		Push Rod
04/97→10/02		Centre Rod	DB-DL-8702		Push Rod, Leaf Spring Axle
04/97→10/02		Centre Rod	DB-DL-12298		for Steering Rod
04/97→10/02		Centre Rod	DB-DL-12300		for Steering Rod
04/97→10/02		Rod Assembly	DB-DL-2178		Guide Rod
04/97→10/02		Stabiliser Mounting		DB-SB-5250	
04/97→10/02		Stabiliser Mounting		DB-SB-5261	
04/97→10/02		Stabiliser Mounting		DB-SB-10406	
04/97→10/02		Stabiliser Mounting		DB-SB-10407	
04/97→10/02		Stabiliser Mounting	DB-SB-5260		
04/97→10/02		Stabiliser Mounting	DB-SB-5277	DB-SB-5277	
04/97→10/02		Stabiliser Mounting	DB-SB-5279		
04/97→10/02		Suspension Arm Repair Kit		DB-RK-8550	for Wishbone (CV)
04/97→10/02		Tie Rod	DB-DL-8171		Guide Rod
04/97→10/02		Tie Rod	DB-DL-8327		Guide Rod
04/97→10/02		Tie Rod	DB-DL-8640		Guide Rod
04/97→10/02		Tie Rod	DB-DL-12310		
04/97→10/02		Tie Rod	DB-ES-5227		Guide Rod
04/97→10/02		Tie Rod End	CV-ES-0543		for Push Rod
04/97→10/02		Tie Rod End	CV-ES-0888		for Push Rod
04/97→10/02		Tie Rod End	CV-ES-14162		for Steering Rod
04/97→10/02		Tie Rod End	CV-ES-14163		for Steering Rod
04/97→10/02		Tie Rod End	DB-ES-8164		for Push Rod
04/97→10/02		Tie Rod End	DB-ES-8530		for Push Rod
04/97→10/02		Track Control Arm		DB-DL-3475	Trailing Arm
04/97→10/02		Track Control Arm		DB-VB-7261	Suspension Rod, Wishbone (CV), 1st RA, →517142 01/517142 02
04/97→10/02		Track Control Arm	DB-DL-5224		Control Arm
04/97→10/02		Track Control Arm	DB-DL-9218	DB-DL-9218	Trailing Arm



ACTROS ...

2031 A	04/97→10/02	Ball Head, gearshift linkage	DB-ES-8387		
	04/97→10/02	Ball Head, gearshift linkage	DB-ES-8491		
	04/97→10/02	Ball Head, gearshift linkage	DB-ES-8492		
	04/97→10/02	Ball Head, gearshift linkage	DB-ES-8500		
	04/97→10/02	Ball Head, gearshift linkage	DB-ES-8510		
	04/97→10/02	Bush, driver cab suspension	DB-SB-10384		
	04/97→10/02	Bush, parabolic spring		DB-SB-10400	
	04/97→10/02	Bush, parabolic spring		DB-SB-10401	
	04/97→10/02	Centre Rod	DB-DL-2144		Push Rod
	04/97→10/02	Centre Rod	DB-DL-5230		Push Rod
	04/97→10/02	Centre Rod	DB-DL-5241		Push Rod
	04/97→10/02	Centre Rod	DB-DL-5405		Push Rod
	04/97→10/02	Centre Rod	DB-DL-8168		Push Rod
	04/97→10/02	Centre Rod	DB-DL-8184		Push Rod
	04/97→10/02	Centre Rod	DB-DL-8188		Push Rod
	04/97→10/02	Centre Rod	DB-DL-8307		Push Rod, Leaf Spring Axle
	04/97→10/02	Centre Rod	DB-DL-8622		Push Rod
	04/97→10/02	Centre Rod	DB-DL-8639		Push Rod, 1st FA;Leaf Spring Axle
	04/97→10/02	Centre Rod	DB-DL-8641		Push Rod
	04/97→10/02	Centre Rod	DB-DL-8642		Push Rod
	04/97→10/02	Centre Rod	DB-DL-8702		Push Rod, Leaf Spring Axle
	04/97→10/02	Centre Rod	DB-DL-9259		Push Rod
	04/97→10/02	Centre Rod	DB-DL-12298		for Steering Rod
	04/97→10/02	Centre Rod	DB-DL-12300		for Steering Rod
	04/97→10/02	Rod Assembly	DB-DL-2178		Guide Rod
	04/97→10/02	Stabiliser Mounting		DB-SB-5250	
	04/97→10/02	Stabiliser Mounting		DB-SB-5261	
	04/97→10/02	Stabiliser Mounting		DB-SB-10406	
	04/97→10/02	Stabiliser Mounting		DB-SB-10407	
	04/97→10/02	Stabiliser Mounting	DB-SB-5260		
	04/97→10/02	Stabiliser Mounting	DB-SB-5279		
	04/97→10/02	Suspension Arm Repair Kit		DB-RK-8626	for Wishbone (CV)
	04/97→10/02	Suspension Arm Repair Kit		DB-RK-10374	for Wishbone (CV)
	04/97→10/02	Suspension Strut Repair Kit		DB-RK-8391	
	04/97→10/02	Suspension Strut Repair Kit		DB-RK-8710	
	04/97→10/02	Tie Rod	DB-DL-12310		
	04/97→10/02	Tie Rod	DB-ES-5227		Guide Rod
	04/97→10/02	Tie Rod	MN-DL-7834		Guide Rod
	04/97→10/02	Tie Rod End	CV-ES-0543		for Push Rod
	04/97→10/02	Tie Rod End	CV-ES-0888		for Push Rod
	04/97→10/02	Tie Rod End	CV-ES-14162		for Steering Rod
	04/97→10/02	Tie Rod End	CV-ES-14163		for Steering Rod
	04/97→10/02	Tie Rod End	DB-ES-5234		for Steering Rod
	04/97→10/02	Track Control Arm		DB-DL-3475	Trailing Arm
04/97→10/02	Track Control Arm		DB-VB-7261	Suspension Rod, Wishbone (CV), 1st RA, →517142 01/517142 02	
04/97→10/02	Track Control Arm	DB-DL-5224		Control Arm	
04/97→10/02	Track Control Arm	DB-DL-9218	DB-DL-9218	Trailing Arm	
2031 AK	09/96→10/02	Ball Head, gearshift linkage	DB-ES-8387		
	09/96→10/02	Ball Head, gearshift linkage	DB-ES-8491		
	09/96→10/02	Ball Head, gearshift linkage	DB-ES-8492		
	09/96→10/02	Ball Head, gearshift linkage	DB-ES-8500		
	09/96→10/02	Ball Head, gearshift linkage	DB-ES-8510		
	09/96→10/02	Bush, driver cab suspension	DB-SB-10384		
	09/96→10/02	Bush, parabolic spring		DB-SB-10400	
	09/96→10/02	Bush, parabolic spring		DB-SB-10401	
	09/96→10/02	Centre Rod	DB-DL-2144		Push Rod
	09/96→10/02	Centre Rod	DB-DL-5230		Push Rod
	09/96→10/02	Centre Rod	DB-DL-5405		Push Rod
	09/96→10/02	Centre Rod	DB-DL-8184		Push Rod
	09/96→10/02	Centre Rod	DB-DL-8188		Push Rod
	09/96→10/02	Centre Rod	DB-DL-8307		Push Rod, Leaf Spring Axle
	09/96→10/02	Centre Rod	DB-DL-8639		Push Rod, Leaf Spring Axle



ACTROS ...

2031 AK ...	09/96→10/02	Centre Rod	DB-DL-8702		Push Rod, Leaf Spring Axle	
	09/96→10/02	Centre Rod	DB-DL-9259		Push Rod	
	09/96→10/02	Centre Rod	DB-DL-12300		for Steering Rod	
	09/96→10/02	Rod Assembly	DB-DL-2178		Guide Rod	
	09/96→10/02	Stabiliser Link	DB-DL-9254		Pressure Rod	
	09/96→10/02	Stabiliser Mounting		DB-SB-5250		
	09/96→10/02	Stabiliser Mounting		DB-SB-5261		
	09/96→10/02	Stabiliser Mounting		DB-SB-10406		
	09/96→10/02	Stabiliser Mounting		DB-SB-10407		
	09/96→10/02	Stabiliser Mounting		DB-SB-10409		
	09/96→10/02	Stabiliser Mounting	DB-SB-5260			
	09/96→10/02	Stabiliser Mounting	DB-SB-5279			
	09/96→10/02	Suspension Arm Repair Kit		DB-RK-8626	for Wishbone (CV)	
	09/96→10/02	Suspension Arm Repair Kit		DB-RK-10374	for Wishbone (CV)	
	09/96→10/02	Suspension Arm Repair Kit		DB-RK-10375	for Wishbone (CV)	
	09/96→10/02	Suspension Arm Repair Kit	DB-RK-8638		for Control Arm	
	09/96→10/02	Suspension Strut Repair Kit		DB-RK-8391		
	09/96→10/02	Tie Rod	DB-DL-12310			
	09/96→10/02	Tie Rod	DB-ES-5227		Guide Rod	
	09/96→10/02	Tie Rod	MN-DL-7834		Guide Rod	
	09/96→10/02	Tie Rod End	CV-ES-0543		for Push Rod	
	09/96→10/02	Tie Rod End	CV-ES-0888		for Push Rod	
	09/96→10/02	Tie Rod End	CV-ES-14162		for Steering Rod	
	09/96→10/02	Tie Rod End	CV-ES-14163		for Steering Rod	
	09/96→10/02	Tie Rod End	DB-ES-5234		for Steering Rod	
	09/96→10/02	Tie Rod End	DB-ES-8530		for Push Rod	
	09/96→10/02	Track Control Arm		DB-DL-3475	Trailing Arm	
	09/96→10/02	Track Control Arm		DB-VB-7261	Suspension Rod, Wishbone (CV), 1st RA, →517142 01/517142 02	
	09/96→10/02	Track Control Arm	DB-DL-5224		Control Arm	
	09/96→10/02	Track Control Arm	DB-DL-9218	DB-DL-9218	Trailing Arm	
	2031 AS	04/96→10/02	Ball Head, gearshift linkage	DB-ES-8387		
		04/96→10/02	Ball Head, gearshift linkage	DB-ES-8491		
04/96→10/02		Ball Head, gearshift linkage	DB-ES-8492			
04/96→10/02		Ball Head, gearshift linkage	DB-ES-8500			
04/96→10/02		Ball Head, gearshift linkage	DB-ES-8510			
04/96→10/02		Bush, driver cab suspension	DB-SB-10384			
04/96→10/02		Bush, parabolic spring		DB-SB-10400		
04/96→10/02		Bush, parabolic spring		DB-SB-10401		
04/96→10/02		Centre Rod	DB-DL-2144		Push Rod	
04/96→10/02		Centre Rod	DB-DL-5230		Push Rod	
04/96→10/02		Centre Rod	DB-DL-5241		Push Rod	
04/96→10/02		Centre Rod	DB-DL-5405		Push Rod	
04/96→10/02		Centre Rod	DB-DL-8188		Push Rod	
04/96→10/02		Centre Rod	DB-DL-8307		Push Rod, Leaf Spring Axle	
04/96→10/02		Centre Rod	DB-DL-8639		Push Rod, 1st FA;Leaf Spring Axle	
04/96→10/02		Centre Rod	DB-DL-8702		Push Rod, Leaf Spring Axle	
04/96→10/02		Centre Rod	DB-DL-9259		Push Rod	
04/96→10/02		Centre Rod	DB-DL-12300		for Steering Rod	
04/96→10/02		Rod Assembly	DB-DL-2178		Guide Rod	
04/96→10/02		Stabiliser Mounting		DB-SB-5261		
04/96→10/02		Stabiliser Mounting		DB-SB-10406		
04/96→10/02		Stabiliser Mounting		DB-SB-10407		
04/96→10/02		Stabiliser Mounting		DB-SB-10409		
04/96→10/02		Stabiliser Mounting	DB-SB-5260			
04/96→10/02		Stabiliser Mounting	DB-SB-5279			
04/96→10/02		Stabiliser Mounting	DB-SB-10410			
04/96→10/02		Suspension Arm Repair Kit		DB-RK-8626	for Wishbone (CV)	
04/96→10/02		Suspension Arm Repair Kit		DB-RK-10374	for Wishbone (CV)	
04/96→10/02		Suspension Arm Repair Kit		DB-RK-10375	for Wishbone (CV)	
04/96→10/02		Suspension Arm Repair Kit	DB-RK-8638		for Control Arm	
04/96→10/02		Suspension Strut Repair Kit		DB-RK-8391		
04/96→10/02		Suspension Strut Repair Kit		MN-RK-8997		

CV-ES-0543
Length: 125
Cone Ø: d1 Ø 32 / d2 Ø 29
Thread: M30 x 1,5 RHT
0004605748, 0004606048, 0004606848,
0004607048, 0014600448, 0014601148,
0014601748, 0014602448, 0014607648,
0014609648



CV-ES-0888
Length: 125
Cone Ø: d1 Ø 32 / d2 Ø 29
Thread: M30 x 1,5 LHT
0004605848, 0004606148, 0004606948,
0004607148, 0004609048, 0014600548,
0014601348, 0014602548, 0014607948,
0024600448



CV-ES-14162
Length: 125
Cone Ø: d1 Ø 30 / d2 Ø 27
Thread: M30 x 1,5 LHT
4600648, 4601248, 4603448, 0004603548,
14600348, 14601448, 14602348,
0014603748, 0014607848, 0024600348



CV-ES-14163
Length: 125
Cone Ø: d1 Ø 30 / d2 Ø 27
Thread: M30 x 1,5 RHT
0003305248, 0003387310, 0004600348,
0004600948, 0004602848, 0004602948,
0004608948, 0014600248, 0014600848,
0014601248, 0014602248, 0014607748,
0024600148, A0003387310, A0004600348,
A0004602848, A0004602948, A0014600848,
A0014601248, A0014602248, A0014607748



DB-DL-2144
Length: 872 Ø: 35
Cone Ø: d1 Ø 28,6 / d2 Ø 23,9
0024604305, 0024604405, 0034604805



DB-DL-2178
Length: 1735 Ø: 52
Cone Ø: d1 Ø 32 / d2 Ø 29
9423300003, 9423300103, 9423300203



DB-DL-3475
Length: 565 Ø: 52
Hole Distance: 152 / 152
3753500006, 3753500206, 9473500805,
9483500006, 9483500805, 9483501205,
9483501305, 9483501905, 9483502005,
9483502405, A3753500006,
A3753500206



DB-DL-5224
Length: 850 Ø: 60
Hole Distance: 100 / 100
01336100A, 9413300007



DB-DL-5230
Length: 879 Ø: 42
Cone Ø: d1 Ø 30 / d2 Ø 27
01208600A, 0004607105, 0004607205,
0014606705



DB-DL-5241
Length: 875 Ø: 40
Cone Ø: d1 Ø 30 / d2 Ø 27
01215300A, 0004609205, 0004609305,
0014606905



DB-DL-5405
Length: 890 Ø: 35
Cone Ø: d1 Ø 28,6 / d2 Ø 23,9
01215900A, 1460248, 0024604505,
0024604605, 0034605005, 3752600637,
3754600405, A3752600637, A3754600405



DB-DL-8188
Length: 895 Ø: 40
Cone Ø: d1 Ø 28,6 / d2 Ø 23,9
01217200A, 0024604905, 0024605005,
0034605605



DB-DL-8307
Length: 885 Ø: 38
Cone Ø: d1 Ø 32 / d2 Ø 30
01215500A, 0004604005, 0024605105,
0024605205, 0034604005



DB-DL-8639
Length: 888 Ø: 38
Cone Ø: d1 Ø 30 / d2 Ø 27
0014600705, 0014600805, 0014607005



DB-DL-8702
Length: 958 Ø: 38
Cone Ø: d1 Ø 32 / d2 Ø 30
0024606105, 0024606205, 0034604205



DB-DL-9218
Length: 754 Ø: 40
Hole Distance: 100
000360098524, 000390098524,
3753300111, 9413300011,
A3753300111, SA50831601



DB-DL-9254
Length: 1815 Ø: 58
0003220323, 0003220623, 3753220423



DB-DL-9259
Length: 883 Ø: 38
Cone Ø: d1 Ø 32 / d2 Ø 29
0024608605, 0024608705,
A0024608605, A0024608705



DB-DL-12300
Length: 733 Ø: 36
Cone Ø: d1 Ø 32 / d2 Ø 29
0014601505, 0014607305, 0034603305,
3754601605, A0014601505,
A0034603305, A3754601605



DB-DL-12310
Length: 1532 Ø: 50
Cone Ø: d1 Ø 32 / d2 Ø 29
Thread: M27 x 1,5 LHT
9493301203, 9493301303, 9493301803,
9493302203, A9493301203, A9493301303,
A9493301803, A9493302203



DB-ES-5227
Length: 1588 Ø: 60
Cone Ø: d1 Ø 38 / d2 Ø 34,3
6253300903, 6253301203, 9443300203



DB-ES-5234
Length: 135
Cone Ø: d1 Ø 38 / d2 Ø 34,3
Thread: M38 x 1,5 RHT
0004601748, 120322305, 2205000400



DB-ES-8387
Length: 55
Cone Ø: d1 Ø 10 / d2 Ø 10
Thread: M14 x 1,5 RHT
0009966845, 0009967045



DB-ES-8491
Length: 60
Cone Ø: d1 Ø 10 / d2 Ø 10
Thread: M12 x 1,75 LHT
0009966745



DB-ES-8492
Length: 60
Cone Ø: d1 Ø 10 / d2 Ø 10
Thread: M12 x 1,75 RHT
0009966645, 3752680189, A3752680189



DB-ES-8500
Length: 55
Cone Ø: d1 Ø 12 / d2 Ø 10,8
Thread: M14 x 1,5 RHT
0002685989



DB-ES-8510
Length: 56
Cone Ø: d1 Ø 10 / d2 Ø 10
Thread: M12 x 1,75 LHT
0009965145, 0009965645, 0019963145



DB-ES-8530
Length: 115
Cone Ø: d1 Ø 28,6 / d2 Ø 23,9
Thread: M30 x 1,5 RHT
0014603848, 0014604848, 0014605148,
0014608648, 0014609948



DB-RK-8391
Ø: 85 Hole Distance: 152
Thick/Height: 24
01336800A, 0003502705



DB-RK-8626
Ø: 75 Hole Distance: 130
Thick/Height: 24
0003502205, 0003502505, 0003503405,
0003504505, GL11319



DB-RK-8638
Length: 100 Ø: 67
Hole Distance: 100
Thick/Height: 20
0003301411



DB-RK-10374
Ø: 85 Hole Distance: 152
Thick/Height: 24
0003504405



DB-RK-10375
Ø: 100 Hole Distance: 152
Thick/Height: 24
0003502405, 0003503505, 0003504905



DB-SB-5250
Ø: 66 Thick/Height: 56
01320400A, 0003262681, 0003263081,
0003263281



DB-SB-5260
Ø: 70 Thick/Height: 36,5 / 46
01320700A, 0003237485, 0003237585,
0003237985



DB-SB-5261
Length: 85 Ø: 82
Thick/Height: 56
01320600A, 0003264481, 0003264781



DB-SB-5279
Ø: 42 Thick/Height: 55
0003236285, 0003237185



DB-SB-10384
Ø: 73 Thick/Height: 47
9303170012, 9423171812



DB-SB-10400
Length: 230
Thick/Height: 167,5 / 115
0003250696, 0003250896



DB-SB-10401
Length: 232
Thick/Height: 163,5 / 152,5
0003250596, 0003250796



DB-SB-10406
Ø: 80 Thick/Height: 46
0003238185



DB-SB-10407
Ø: 61 Thick/Height: 46
0003235985, 0003262481, 0003262981



DB-SB-10409
Ø: 77 Thick/Height: 56
0003265181



DB-SB-10410
Ø: 73 Hole Distance: 100
Thick/Height: 24
9413230050



DB-VB-7261
Length: 622 Ø: 46
Hole Ø 25 / 25 / 25
Hole Distance: 152 / 130 / 130
01337800A, 9443500305, 9443500505,
9443500605, 9473500705, 9473500905,
9483500405, 9483503005



MN-DL-7834
Length: 1588 Ø: 58
Cone Ø: d1 Ø 30 / d2 Ø 27
3463303903, 3463304903, 6253303203,
9443300503, 9443301303, 9443301703



MN-RK-8997
Ø: 85 Hole Distance: 130
Thick/Height: 30
0003504805





ACTROS ...

2031 AS ...	04/96→10/02	Tie Rod	DB-DL-12310		
	04/96→10/02	Tie Rod	DB-ES-5227		Guide Rod
	04/96→10/02	Tie Rod	MN-DL-7834		Guide Rod
	04/96→10/02	Tie Rod End	CV-ES-0543		for Push Rod
	04/96→10/02	Tie Rod End	CV-ES-0888		for Push Rod
	04/96→10/02	Tie Rod End	CV-ES-14162		for Steering Rod
	04/96→10/02	Tie Rod End	CV-ES-14163		for Steering Rod
	04/96→10/02	Tie Rod End	DB-ES-5234		for Steering Rod
	04/96→10/02	Track Control Arm		DB-DL-3475	Trailing Arm
	04/96→10/02	Track Control Arm		DB-VB-7261	Suspension Rod, Wishbone (CV), 1st RA, →517142 01/517142 02
	04/96→10/02	Track Control Arm		DB-VB-7798	Wishbone (CV)
	04/96→10/02	Track Control Arm	DB-DL-5224		Control Arm
	04/96→10/02	Track Control Arm	DB-DL-9218	DB-DL-9218	Trailing Arm
	2031 K	04/97→10/02	Ball Head, gearshift linkage	DB-ES-8387	
04/97→10/02		Ball Head, gearshift linkage	DB-ES-8491		
04/97→10/02		Ball Head, gearshift linkage	DB-ES-8492		
04/97→10/02		Ball Head, gearshift linkage	DB-ES-8500		
04/97→10/02		Ball Head, gearshift linkage	DB-ES-8510		
04/97→10/02		Bush, driver cab suspension	DB-SB-10384		
04/97→10/02		Bush, parabolic spring		DB-SB-10400	
04/97→10/02		Bush, parabolic spring		DB-SB-10401	
04/97→10/02		Centre Rod	DB-DL-2144		Push Rod
04/97→10/02		Centre Rod	DB-DL-5230		Push Rod, 1st FA;Leaf Spring Axle
04/97→10/02		Centre Rod	DB-DL-5241		Push Rod
04/97→10/02		Centre Rod	DB-DL-5405		Push Rod, 1st FA;Leaf Spring Axle
04/97→10/02		Centre Rod	DB-DL-7270		Push Rod
04/97→10/02		Centre Rod	DB-DL-8167		Push Rod, 1st FA;Leaf Spring Axle
04/97→10/02		Centre Rod	DB-DL-8184		Push Rod
04/97→10/02		Centre Rod	DB-DL-8185		Push Rod
04/97→10/02		Centre Rod	DB-DL-8188		Push Rod
04/97→10/02		Centre Rod	DB-DL-8307		Push Rod
04/97→10/02		Centre Rod	DB-DL-8702		Push Rod, 1st FA;Leaf Spring Axle
04/97→10/02		Centre Rod	DB-DL-12300		for Steering Rod
04/97→10/02		Rod Assembly	DB-DL-2178		Guide Rod
04/97→10/02		Stabiliser Link	DB-DL-9254		Pressure Rod
04/97→10/02		Stabiliser Mounting		DB-SB-5261	
04/97→10/02		Stabiliser Mounting		DB-SB-10406	
04/97→10/02		Stabiliser Mounting		DB-SB-10407	
04/97→10/02		Stabiliser Mounting		DB-SB-10409	
04/97→10/02		Stabiliser Mounting	DB-SB-5260		
04/97→10/02		Stabiliser Mounting	DB-SB-5279		
04/97→10/02		Suspension Arm Repair Kit		DB-RK-8550	for Wishbone (CV)
04/97→10/02		Suspension Arm Repair Kit		DB-RK-8626	for Wishbone (CV)
04/97→10/02		Suspension Arm Repair Kit		DB-RK-10374	for Wishbone (CV)
04/97→10/02		Suspension Arm Repair Kit		DB-RK-10375	for Wishbone (CV)
04/97→10/02		Suspension Arm Repair Kit	DB-RK-8638		for Control Arm
04/97→10/02		Suspension Strut Repair Kit		DB-RK-8391	
04/97→10/02		Tie Rod	DB-DL-8171		Guide Rod
04/97→10/02		Tie Rod	DB-DL-8327		Guide Rod
04/97→10/02		Tie Rod	DB-DL-8640		Guide Rod
04/97→10/02		Tie Rod	DB-DL-12310		
04/97→10/02		Tie Rod	DB-ES-5227		Guide Rod
04/97→10/02		Tie Rod End	CV-ES-0543		for Push Rod
04/97→10/02		Tie Rod End	CV-ES-0888		for Push Rod
04/97→10/02		Tie Rod End	CV-ES-14162		for Steering Rod
04/97→10/02		Tie Rod End	CV-ES-14163		for Steering Rod
04/97→10/02		Tie Rod End	DB-ES-5234		for Steering Rod
04/97→10/02		Tie Rod End	DB-ES-8164		for Push Rod
04/97→10/02		Tie Rod End	DB-ES-8530		for Push Rod
04/97→10/02		Track Control Arm		DB-DL-3475	Trailing Arm
04/97→10/02	Track Control Arm		DB-VB-7261	Suspension Rod, Wishbone (CV), 1st RA, →517142 01/517142 02	

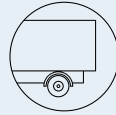

ACTROS ...

2031 K ...	04/97→10/02	Track Control Arm	DB-DL-5224		Control Arm
	04/97→10/02	Track Control Arm	DB-DL-9218	DB-DL-9218	Trailing Arm
2031 S	04/96→10/02	Ball Head, gearshift linkage	DB-ES-8387		
	04/96→10/02	Ball Head, gearshift linkage	DB-ES-8491		
	04/96→10/02	Ball Head, gearshift linkage	DB-ES-8492		
	04/96→10/02	Ball Head, gearshift linkage	DB-ES-8500		
	04/96→10/02	Ball Head, gearshift linkage	DB-ES-8510		
	04/96→10/02	Bush, driver cab suspension	DB-SB-10384		
	04/96→10/02	Bush, parabolic spring		DB-SB-10400	
	04/96→10/02	Bush, parabolic spring		DB-SB-10401	
	04/96→10/02	Centre Rod	DB-DL-2144		Push Rod
	04/96→10/02	Centre Rod	DB-DL-5230		Push Rod, 1st FA;Leaf Spring Axle
	04/96→10/02	Centre Rod	DB-DL-5241		Push Rod
	04/96→10/02	Centre Rod	DB-DL-5405		Push Rod, Leaf Spring Axle
	04/96→10/02	Centre Rod	DB-DL-7270		Push Rod;Suspension Rod
	04/96→10/02	Centre Rod	DB-DL-8167		Push Rod, 1st FA;Leaf Spring Axle
	04/96→10/02	Centre Rod	DB-DL-8184		Push Rod
	04/96→10/02	Centre Rod	DB-DL-8185		Push Rod
	04/96→10/02	Centre Rod	DB-DL-8188		Push Rod
	04/96→10/02	Centre Rod	DB-DL-8307		Push Rod
	04/96→10/02	Centre Rod	DB-DL-8702		Push Rod, Leaf Spring Axle
	04/96→10/02	Centre Rod	DB-DL-12300		for Steering Rod
	04/96→10/02	Rod Assembly	DB-DL-2178		Guide Rod
	04/96→10/02	Stabiliser Mounting		DB-SB-5261	
	04/96→10/02	Stabiliser Mounting		DB-SB-10406	
	04/96→10/02	Stabiliser Mounting		DB-SB-10407	
	04/96→10/02	Stabiliser Mounting		DB-SB-10409	
	04/96→10/02	Stabiliser Mounting	DB-SB-5260		
	04/96→10/02	Stabiliser Mounting	DB-SB-5279		
	04/96→10/02	Stabiliser Mounting	DB-SB-10410		
	04/96→10/02	Suspension Arm Repair Kit		DB-RK-8626	for Wishbone (CV)
	04/96→10/02	Suspension Arm Repair Kit		DB-RK-10374	for Wishbone (CV)
	04/96→10/02	Suspension Arm Repair Kit		DB-RK-10375	for Wishbone (CV)
	04/96→10/02	Suspension Arm Repair Kit	DB-RK-8638		for Control Arm
	04/96→10/02	Suspension Strut Repair Kit		DB-RK-8391	
04/96→10/02	Suspension Strut Repair Kit		MN-RK-8997		
04/96→10/02	Tie Rod	DB-DL-8171		Guide Rod	
04/96→10/02	Tie Rod	DB-DL-8327		Guide Rod	
04/96→10/02	Tie Rod	DB-DL-8640		Guide Rod	
04/96→10/02	Tie Rod	DB-DL-12310			
04/96→10/02	Tie Rod	DB-ES-5227		Guide Rod	
04/96→10/02	Tie Rod End	CV-ES-0543		for Push Rod	
04/96→10/02	Tie Rod End	CV-ES-0888		for Push Rod	
04/96→10/02	Tie Rod End	CV-ES-14162		for Steering Rod	
04/96→10/02	Tie Rod End	CV-ES-14163		for Steering Rod	
04/96→10/02	Tie Rod End	DB-ES-5234		for Steering Rod	
04/96→10/02	Tie Rod End	DB-ES-8164		for Push Rod	
04/96→10/02	Tie Rod End	DB-ES-8530		for Push Rod	
04/96→10/02	Track Control Arm		DB-DL-3475	Trailing Arm	
04/96→10/02	Track Control Arm		DB-VB-7261	Suspension Rod, Wishbone (CV), 1st RA, →517142 01/517142 02	
04/96→10/02	Track Control Arm		DB-VB-7798	Wishbone (CV)	
04/96→10/02	Track Control Arm	DB-DL-5224		Control Arm	
04/96→10/02	Track Control Arm	DB-DL-9218	DB-DL-9218	Trailing Arm	
2035 A	04/97→10/02	Ball Head, gearshift linkage	DB-ES-8387		
	04/97→10/02	Ball Head, gearshift linkage	DB-ES-8491		
	04/97→10/02	Ball Head, gearshift linkage	DB-ES-8492		
	04/97→10/02	Ball Head, gearshift linkage	DB-ES-8500		
	04/97→10/02	Ball Head, gearshift linkage	DB-ES-8510		
	04/97→10/02	Bush, driver cab suspension	DB-SB-10384		
	04/97→10/02	Bush, parabolic spring		DB-SB-10400	
04/97→10/02	Bush, parabolic spring		DB-SB-10401		
04/97→10/02	Centre Rod	DB-DL-5230		Push Rod	



ACTROS ...

2035 A ...	04/97→10/02	Centre Rod	DB-DL-5241		Push Rod
	04/97→10/02	Centre Rod	DB-DL-5405		Push Rod
	04/97→10/02	Centre Rod	DB-DL-8168		Push Rod
	04/97→10/02	Centre Rod	DB-DL-8184		Push Rod
	04/97→10/02	Centre Rod	DB-DL-8188		Push Rod
	04/97→10/02	Centre Rod	DB-DL-8307		Push Rod, Leaf Spring Axle
	04/97→10/02	Centre Rod	DB-DL-8622		Push Rod
	04/97→10/02	Centre Rod	DB-DL-8639		Push Rod, 1st FA;Leaf Spring Axle
	04/97→10/02	Centre Rod	DB-DL-8641		Push Rod
	04/97→10/02	Centre Rod	DB-DL-8642		Push Rod
	04/97→10/02	Centre Rod	DB-DL-8702		Push Rod, Leaf Spring Axle
	04/97→10/02	Centre Rod	DB-DL-9259		Push Rod
	04/97→10/02	Centre Rod	DB-DL-12298		for Steering Rod
	04/97→10/02	Centre Rod	DB-DL-12300		for Steering Rod
	04/97→10/02	Stabiliser Mounting		DB-SB-5250	
	04/97→10/02	Stabiliser Mounting		DB-SB-5261	
	04/97→10/02	Stabiliser Mounting		DB-SB-10406	
	04/97→10/02	Stabiliser Mounting		DB-SB-10407	
	04/97→10/02	Stabiliser Mounting	DB-SB-5260		
	04/97→10/02	Stabiliser Mounting	DB-SB-5279		
	04/97→10/02	Suspension Arm Repair Kit		DB-RK-8626	for Wishbone (CV)
	04/97→10/02	Suspension Arm Repair Kit		DB-RK-10374	for Wishbone (CV)
	04/97→10/02	Suspension Strut Repair Kit		DB-RK-8391	
	04/97→10/02	Suspension Strut Repair Kit		DB-RK-8710	
	04/97→10/02	Tie Rod	DB-DL-12310		
	04/97→10/02	Tie Rod	DB-ES-5227		Guide Rod
	04/97→10/02	Tie Rod	MN-DL-7834		Guide Rod
	04/97→10/02	Tie Rod End	CV-ES-0543		for Push Rod
	04/97→10/02	Tie Rod End	CV-ES-14163		for Steering Rod
	04/97→10/02	Tie Rod End	DB-ES-5234		for Steering Rod
	04/97→10/02	Track Control Arm		DB-DL-3475	Trailing Arm
	04/97→10/02	Track Control Arm		DB-VB-7261	Suspension Rod, Wishbone (CV), 1st RA, →517142 01/517142 02
	04/97→10/02	Track Control Arm	DB-DL-5224		Control Arm
04/97→10/02	Track Control Arm	DB-DL-9218	DB-DL-9218	Trailing Arm	
2035 S	04/96→10/02	Ball Head, gearshift linkage	DB-ES-8387		
	04/96→10/02	Ball Head, gearshift linkage	DB-ES-8491		
	04/96→10/02	Ball Head, gearshift linkage	DB-ES-8492		
	04/96→10/02	Ball Head, gearshift linkage	DB-ES-8500		
	04/96→10/02	Ball Head, gearshift linkage	DB-ES-8510		
	04/96→10/02	Bush, driver cab suspension	DB-SB-10384		
	04/96→10/02	Bush, parabolic spring		DB-SB-10400	
	04/96→10/02	Bush, parabolic spring		DB-SB-10401	
	04/96→10/02	Centre Rod	DB-DL-2144		Push Rod
	04/96→10/02	Centre Rod	DB-DL-5230		Push Rod, 1st FA;Leaf Spring Axle
	04/96→10/02	Centre Rod	DB-DL-5241		Push Rod
	04/96→10/02	Centre Rod	DB-DL-5405		Push Rod, Leaf Spring Axle
	04/96→10/02	Centre Rod	DB-DL-7270		Push Rod;Suspension Rod
	04/96→10/02	Centre Rod	DB-DL-8167		Push Rod, 1st FA;Leaf Spring Axle
	04/96→10/02	Centre Rod	DB-DL-8184		Push Rod
	04/96→10/02	Centre Rod	DB-DL-8185		Push Rod
	04/96→10/02	Centre Rod	DB-DL-8188		Push Rod
	04/96→10/02	Centre Rod	DB-DL-8307		Push Rod
	04/96→10/02	Centre Rod	DB-DL-8702		Push Rod, Leaf Spring Axle
	04/96→10/02	Centre Rod	DB-DL-12300		for Steering Rod
	04/96→10/02	Rod Assembly	DB-DL-2178		Guide Rod, 1st Front Axle, →504310 03
	04/96→10/02	Stabiliser Mounting		DB-SB-10406	
	04/96→10/02	Stabiliser Mounting		DB-SB-10409	
	04/96→10/02	Stabiliser Mounting	DB-SB-10410		
	04/96→10/02	Suspension Arm Repair Kit		DB-RK-8626	for Wishbone (CV)
	04/96→10/02	Suspension Arm Repair Kit		DB-RK-10374	for Wishbone (CV)
	04/96→10/02	Suspension Arm Repair Kit		DB-RK-10375	for Wishbone (CV)
	04/96→10/02	Suspension Arm Repair Kit	DB-RK-8638		for Control Arm



ACTROS ...

2035 S ...	04/96→10/02	Suspension Strut Repair Kit		DB-RK-8391		
	04/96→10/02	Suspension Strut Repair Kit		MN-RK-8997		
	04/96→10/02	Tie Rod	DB-DL-8171		Guide Rod	
	04/96→10/02	Tie Rod	DB-DL-8327		Guide Rod	
	04/96→10/02	Tie Rod	DB-DL-8640		Guide Rod	
	04/96→10/02	Tie Rod	DB-DL-12310			
	04/96→10/02	Tie Rod	DB-ES-5227		Guide Rod	
	04/96→10/02	Tie Rod End	CV-ES-0543		for Push Rod	
	04/96→10/02	Tie Rod End	CV-ES-0888		for Push Rod	
	04/96→10/02	Tie Rod End	CV-ES-14163		for Steering Rod	
	04/96→10/02	Tie Rod End	DB-ES-5234		for Steering Rod	
	04/96→10/02	Tie Rod End	DB-ES-8164		for Push Rod	
	04/96→10/02	Tie Rod End	DB-ES-8530		for Push Rod	
	04/96→10/02	Track Control Arm		DB-DL-3475	Trailing Arm	
	04/96→10/02	Track Control Arm		DB-VB-7261	Suspension Rod, Wishbone (CV), 1st RA, →517142 01/517142 02	
	04/96→10/02	Track Control Arm		DB-VB-7798	Wishbone (CV)	
	04/96→10/02	Track Control Arm	DB-DL-5224		Control Arm	
	04/96→10/02	Track Control Arm	DB-DL-9218	DB-DL-9218	Trailing Arm	
	2040	09/96→10/02	Ball Head, gearshift linkage	DB-ES-8387		
		09/96→10/02	Ball Head, gearshift linkage	DB-ES-8491		
09/96→10/02		Ball Head, gearshift linkage	DB-ES-8492			
09/96→10/02		Ball Head, gearshift linkage	DB-ES-8500			
09/96→10/02		Ball Head, gearshift linkage	DB-ES-8510			
09/96→10/02		Bush, driver cab suspension	DB-SB-10384			
09/96→10/02		Bush, parabolic spring		DB-SB-10400		
09/96→10/02		Bush, parabolic spring		DB-SB-10401		
09/96→10/02		Centre Rod	DB-DL-2144		Push Rod	
09/96→10/02		Centre Rod	DB-DL-5230		Push Rod, Leaf Spring Axle	
09/96→10/02		Centre Rod	DB-DL-5241		Push Rod	
09/96→10/02		Centre Rod	DB-DL-5405		Push Rod, Leaf Spring Axle	
09/96→10/02		Centre Rod	DB-DL-7270		Push Rod;Suspension Rod	
09/96→10/02		Centre Rod	DB-DL-8167		Push Rod, 1st FA;Leaf Spring Axle	
09/96→10/02		Centre Rod	DB-DL-8168		Push Rod	
09/96→10/02		Centre Rod	DB-DL-8184		Push Rod	
09/96→10/02		Centre Rod	DB-DL-8185		Push Rod	
09/96→10/02		Centre Rod	DB-DL-8188		Push Rod	
09/96→10/02		Centre Rod	DB-DL-8307		Push Rod	
09/96→10/02		Centre Rod	DB-DL-8622		Push Rod	
09/96→10/02		Centre Rod	DB-DL-8641		Push Rod	
09/96→10/02		Centre Rod	DB-DL-8642		Push Rod	
09/96→10/02		Centre Rod	DB-DL-8702		Push Rod, Leaf Spring Axle	
09/96→10/02		Centre Rod	DB-DL-12298		for Steering Rod	
09/96→10/02		Centre Rod	DB-DL-12300		for Steering Rod	
09/96→10/02		Rod Assembly	DB-DL-2178		Guide Rod	
09/96→10/02		Stabiliser Mounting		DB-SB-5250		
09/96→10/02		Stabiliser Mounting		DB-SB-5261		
09/96→10/02		Stabiliser Mounting		DB-SB-10406		
09/96→10/02		Stabiliser Mounting		DB-SB-10407		
09/96→10/02		Stabiliser Mounting	DB-SB-5260			
09/96→10/02		Stabiliser Mounting	DB-SB-5277	DB-SB-5277		
09/96→10/02		Stabiliser Mounting	DB-SB-5279			
09/96→10/02		Suspension Arm Repair Kit		DB-RK-8550	for Wishbone (CV)	
09/96→10/02		Tie Rod	DB-DL-8171		Guide Rod	
09/96→10/02		Tie Rod	DB-DL-8327		Guide Rod	
09/96→10/02		Tie Rod	DB-DL-8640		Guide Rod	
09/96→10/02		Tie Rod	DB-DL-12310			
09/96→10/02		Tie Rod	DB-ES-5227		Guide Rod	
09/96→10/02		Tie Rod End	CV-ES-0543		for Push Rod	
09/96→10/02		Tie Rod End	CV-ES-0888		for Push Rod	
09/96→10/02		Tie Rod End	CV-ES-14162		for Steering Rod	
09/96→10/02	Tie Rod End	CV-ES-14163		for Steering Rod		
09/96→10/02	Tie Rod End	DB-ES-8164		for Push Rod		



ACTROS ...

2040 ...	09/96→10/02	Tie Rod End	DB-ES-8530		for Push Rod	
	09/96→10/02	Track Control Arm		DB-DL-3475	Trailing Arm	
	09/96→10/02	Track Control Arm		DB-VB-7261	Suspension Rod, Wishbone (CV), 1st RA, →517142 01/517142 02	
	09/96→10/02	Track Control Arm	DB-DL-5224		Control Arm	
	09/96→10/02	Track Control Arm	DB-DL-9218	DB-DL-9218	Trailing Arm	
	2040 AK	09/96→10/02	Ball Head, gearshift linkage	DB-ES-8387		
09/96→10/02		Ball Head, gearshift linkage	DB-ES-8491			
09/96→10/02		Ball Head, gearshift linkage	DB-ES-8492			
09/96→10/02		Ball Head, gearshift linkage	DB-ES-8500			
09/96→10/02		Ball Head, gearshift linkage	DB-ES-8510			
09/96→10/02		Bush, driver cab suspension	DB-SB-10384			
09/96→10/02		Bush, parabolic spring		DB-SB-10400		
09/96→10/02		Bush, parabolic spring		DB-SB-10401		
09/96→10/02		Centre Rod	DB-DL-2144		Push Rod	
09/96→10/02		Centre Rod	DB-DL-5230		Push Rod	
09/96→10/02		Centre Rod	DB-DL-5405		Push Rod	
09/96→10/02		Centre Rod	DB-DL-8184		Push Rod	
09/96→10/02		Centre Rod	DB-DL-8188		Push Rod	
09/96→10/02		Centre Rod	DB-DL-8307		Push Rod, Leaf Spring Axle	
09/96→10/02		Centre Rod	DB-DL-8639		Push Rod, Leaf Spring Axle	
09/96→10/02		Centre Rod	DB-DL-8702		Push Rod, Leaf Spring Axle	
09/96→10/02		Centre Rod	DB-DL-9259		Push Rod	
09/96→10/02		Centre Rod	DB-DL-12300		for Steering Rod	
09/96→10/02		Rod Assembly	DB-DL-2178		Guide Rod	
09/96→10/02		Stabiliser Link	DB-DL-9254		Pressure Rod	
09/96→10/02		Stabiliser Mounting		DB-SB-5250		
09/96→10/02		Stabiliser Mounting		DB-SB-5261		
09/96→10/02		Stabiliser Mounting		DB-SB-10406		
09/96→10/02		Stabiliser Mounting		DB-SB-10407		
09/96→10/02		Stabiliser Mounting		DB-SB-10409		
09/96→10/02		Stabiliser Mounting	DB-SB-5260			
09/96→10/02		Stabiliser Mounting	DB-SB-5279			
09/96→10/02		Suspension Arm Repair Kit		DB-RK-8626	for Wishbone (CV)	
09/96→10/02		Suspension Arm Repair Kit		DB-RK-10374	for Wishbone (CV)	
09/96→10/02		Suspension Arm Repair Kit		DB-RK-10375	for Wishbone (CV)	
09/96→10/02		Suspension Arm Repair Kit	DB-RK-8638		for Control Arm	
09/96→10/02		Suspension Strut Repair Kit		DB-RK-8391		
09/96→10/02		Tie Rod	DB-DL-12310			
09/96→10/02		Tie Rod	DB-ES-5227		Guide Rod	
09/96→10/02		Tie Rod	MN-DL-7834		Guide Rod	
09/96→10/02		Tie Rod End	CV-ES-0543		for Push Rod	
09/96→10/02		Tie Rod End	CV-ES-0888		for Push Rod	
09/96→10/02		Tie Rod End	CV-ES-14162		for Steering Rod	
09/96→10/02		Tie Rod End	CV-ES-14163		for Steering Rod	
09/96→10/02		Tie Rod End	DB-ES-5234		for Steering Rod	
09/96→10/02		Tie Rod End	DB-ES-8530		for Push Rod	
09/96→10/02		Track Control Arm		DB-DL-3475	Trailing Arm	
09/96→10/02		Track Control Arm		DB-VB-7261	Suspension Rod, Wishbone (CV), 1st RA, →517142 01/517142 02	
09/96→10/02		Track Control Arm	DB-DL-5224		Control Arm	
09/96→10/02		Track Control Arm	DB-DL-9218	DB-DL-9218	Trailing Arm	
2040 AS		04/96→10/02	Ball Head, gearshift linkage	DB-ES-8387		
		04/96→10/02	Ball Head, gearshift linkage	DB-ES-8491		
		04/96→10/02	Ball Head, gearshift linkage	DB-ES-8492		
		04/96→10/02	Ball Head, gearshift linkage	DB-ES-8500		
		04/96→10/02	Ball Head, gearshift linkage	DB-ES-8510		
	04/96→10/02	Bush, driver cab suspension	DB-SB-10384			
04/96→10/02	Bush, parabolic spring		DB-SB-10400			
04/96→10/02	Bush, parabolic spring		DB-SB-10401			
04/96→10/02	Centre Rod	DB-DL-2144		Push Rod		
04/96→10/02	Centre Rod	DB-DL-5230		Push Rod		
04/96→10/02	Centre Rod	DB-DL-5241		Push Rod		



ACTROS ...

2040 AS ...	04/96→10/02	Centre Rod	DB-DL-5405		Push Rod	
	04/96→10/02	Centre Rod	DB-DL-8188		Push Rod	
	04/96→10/02	Centre Rod	DB-DL-8307		Push Rod, Leaf Spring Axle	
	04/96→10/02	Centre Rod	DB-DL-8639		Push Rod, 1st FA;Leaf Spring Axle	
	04/96→10/02	Centre Rod	DB-DL-8702		Push Rod, Leaf Spring Axle	
	04/96→10/02	Centre Rod	DB-DL-9259		Push Rod	
	04/96→10/02	Centre Rod	DB-DL-12300		for Steering Rod	
	04/96→10/02	Rod Assembly	DB-DL-2178		Guide Rod	
	04/96→10/02	Stabiliser Mounting		DB-SB-5261		
	04/96→10/02	Stabiliser Mounting		DB-SB-10406		
	04/96→10/02	Stabiliser Mounting		DB-SB-10407		
	04/96→10/02	Stabiliser Mounting		DB-SB-10409		
	04/96→10/02	Stabiliser Mounting	DB-SB-5260			
	04/96→10/02	Stabiliser Mounting	DB-SB-5279			
	04/96→10/02	Stabiliser Mounting	DB-SB-10410			
	04/96→10/02	Suspension Arm Repair Kit		DB-RK-8626	for Wishbone (CV)	
	04/96→10/02	Suspension Arm Repair Kit		DB-RK-10374	for Wishbone (CV)	
	04/96→10/02	Suspension Arm Repair Kit		DB-RK-10375	for Wishbone (CV)	
	04/96→10/02	Suspension Arm Repair Kit	DB-RK-8638		for Control Arm	
	04/96→10/02	Suspension Strut Repair Kit		DB-RK-8391		
	04/96→10/02	Suspension Strut Repair Kit		MN-RK-8997		
	04/96→10/02	Tie Rod	DB-DL-12310			
	04/96→10/02	Tie Rod	DB-ES-5227		Guide Rod	
	04/96→10/02	Tie Rod	MN-DL-7834		Guide Rod	
	04/96→10/02	Tie Rod End	CV-ES-0543		for Push Rod	
	04/96→10/02	Tie Rod End	CV-ES-0888		for Push Rod	
	04/96→10/02	Tie Rod End	CV-ES-14162		for Steering Rod	
	04/96→10/02	Tie Rod End	CV-ES-14163		for Steering Rod	
	04/96→10/02	Tie Rod End	DB-ES-5234		for Steering Rod	
	04/96→10/02	Track Control Arm		DB-DL-3475	Trailing Arm	
	04/96→10/02	Track Control Arm		DB-VB-7261	Suspension Rod, Wishbone (CV), 1st RA, →517142 01/517142 02	
	04/96→10/02	Track Control Arm		DB-VB-7798	Wishbone (CV)	
	04/96→10/02	Track Control Arm	DB-DL-5224		Control Arm	
	04/96→10/02	Track Control Arm	DB-DL-9218	DB-DL-9218	Trailing Arm	
	2040 S	04/96→10/02	Ball Head, gearshift linkage	DB-ES-8387		
		04/96→10/02	Ball Head, gearshift linkage	DB-ES-8491		
		04/96→10/02	Ball Head, gearshift linkage	DB-ES-8492		
		04/96→10/02	Ball Head, gearshift linkage	DB-ES-8500		
		04/96→10/02	Ball Head, gearshift linkage	DB-ES-8510		
		04/96→10/02	Bush, driver cab suspension	DB-SB-10384		
		04/96→10/02	Bush, parabolic spring		DB-SB-10400	
		04/96→10/02	Bush, parabolic spring		DB-SB-10401	
		04/96→10/02	Centre Rod	DB-DL-2144		Push Rod
		04/96→10/02	Centre Rod	DB-DL-5230		Push Rod, 1st FA;Leaf Spring Axle
		04/96→10/02	Centre Rod	DB-DL-5241		Push Rod
04/96→10/02		Centre Rod	DB-DL-5405		Push Rod, Leaf Spring Axle	
04/96→10/02		Centre Rod	DB-DL-7270		Push Rod;Suspension Rod	
04/96→10/02		Centre Rod	DB-DL-8167		Push Rod, 1st FA;Leaf Spring Axle	
04/96→10/02		Centre Rod	DB-DL-8184		Push Rod	
04/96→10/02		Centre Rod	DB-DL-8185		Push Rod	
04/96→10/02		Centre Rod	DB-DL-8188		Push Rod	
04/96→10/02		Centre Rod	DB-DL-8307		Push Rod	
04/96→10/02		Centre Rod	DB-DL-8702		Push Rod, Leaf Spring Axle	
04/96→10/02		Centre Rod	DB-DL-12300		for Steering Rod	
04/96→10/02		Rod Assembly	DB-DL-2178		Guide Rod	
04/96→10/02		Stabiliser Mounting		DB-SB-5261		
04/96→10/02		Stabiliser Mounting		DB-SB-10406		
04/96→10/02		Stabiliser Mounting		DB-SB-10407		
04/96→10/02		Stabiliser Mounting		DB-SB-10409		
04/96→10/02		Stabiliser Mounting	DB-SB-5260			
04/96→10/02		Stabiliser Mounting	DB-SB-5279			
04/96→10/02		Stabiliser Mounting	DB-SB-10410			



ACTROS ...

2040 S ...	04/96→10/02	Suspension Arm Repair Kit		DB-RK-8626	for Wishbone (CV)	
	04/96→10/02	Suspension Arm Repair Kit		DB-RK-10374	for Wishbone (CV)	
	04/96→10/02	Suspension Arm Repair Kit		DB-RK-10375	for Wishbone (CV)	
	04/96→10/02	Suspension Arm Repair Kit	DB-RK-8638		for Control Arm	
	04/96→10/02	Suspension Strut Repair Kit		DB-RK-8391		
	04/96→10/02	Suspension Strut Repair Kit		MN-RK-8997		
	04/96→10/02	Tie Rod	DB-DL-8171		Guide Rod	
	04/96→10/02	Tie Rod	DB-DL-8327		Guide Rod	
	04/96→10/02	Tie Rod	DB-DL-8640		Guide Rod	
	04/96→10/02	Tie Rod	DB-DL-12310			
	04/96→10/02	Tie Rod	DB-ES-5227		Guide Rod	
	04/96→10/02	Tie Rod End	CV-ES-0543		for Push Rod	
	04/96→10/02	Tie Rod End	CV-ES-0888		for Push Rod	
	04/96→10/02	Tie Rod End	CV-ES-14162		for Steering Rod	
	04/96→10/02	Tie Rod End	CV-ES-14163		for Steering Rod	
	04/96→10/02	Tie Rod End	DB-ES-5234		for Steering Rod	
	04/96→10/02	Tie Rod End	DB-ES-8164		for Push Rod	
	04/96→10/02	Tie Rod End	DB-ES-8530		for Push Rod	
	04/96→10/02	Track Control Arm		DB-DL-3475	Trailing Arm	
	04/96→10/02	Track Control Arm		DB-VB-7261	Suspension Rod, Wishbone (CV), 1st RA, →517142 01/517142 02	
	04/96→10/02	Track Control Arm		DB-VB-7798	Wishbone (CV)	
	04/96→10/02	Track Control Arm	DB-DL-5224		Control Arm	
	04/96→10/02	Track Control Arm	DB-DL-9218	DB-DL-9218	Trailing Arm	
	2043 AS	04/96→10/02	Ball Head, gearshift linkage	DB-ES-8387		
		04/96→10/02	Ball Head, gearshift linkage	DB-ES-8491		
		04/96→10/02	Ball Head, gearshift linkage	DB-ES-8492		
		04/96→10/02	Ball Head, gearshift linkage	DB-ES-8500		
04/96→10/02		Ball Head, gearshift linkage	DB-ES-8510			
04/96→10/02		Bush, driver cab suspension	DB-SB-10384			
04/96→10/02		Bush, parabolic spring		DB-SB-10400		
04/96→10/02		Bush, parabolic spring		DB-SB-10401		
04/96→10/02		Centre Rod	DB-DL-5230		Push Rod	
04/96→10/02		Centre Rod	DB-DL-5241		Push Rod	
04/96→10/02		Centre Rod	DB-DL-5405		Push Rod	
04/96→10/02		Centre Rod	DB-DL-8188		Push Rod	
04/96→10/02		Centre Rod	DB-DL-8307		Push Rod, Leaf Spring Axle	
04/96→10/02		Centre Rod	DB-DL-8639		Push Rod, 1st FA;Leaf Spring Axle	
04/96→10/02		Centre Rod	DB-DL-8702		Push Rod, Leaf Spring Axle	
04/96→10/02		Centre Rod	DB-DL-9259		Push Rod	
04/96→10/02		Centre Rod	DB-DL-12300		for Steering Rod	
04/96→10/02		Stabiliser Mounting		DB-SB-10406		
04/96→10/02		Stabiliser Mounting		DB-SB-10409		
04/96→10/02		Stabiliser Mounting	DB-SB-10410			
04/96→10/02		Suspension Arm Repair Kit		DB-RK-8626	for Wishbone (CV)	
04/96→10/02		Suspension Arm Repair Kit		DB-RK-10374	for Wishbone (CV)	
04/96→10/02		Suspension Arm Repair Kit		DB-RK-10375	for Wishbone (CV)	
04/96→10/02		Suspension Arm Repair Kit	DB-RK-8638		for Control Arm	
04/96→10/02		Suspension Strut Repair Kit		DB-RK-8391		
04/96→10/02		Suspension Strut Repair Kit		MN-RK-8997		
04/96→10/02		Tie Rod	DB-DL-12310			
04/96→10/02		Tie Rod	DB-ES-5227		Guide Rod	
04/96→10/02		Tie Rod	MN-DL-7834		Guide Rod	
04/96→10/02		Tie Rod End	CV-ES-0543		for Push Rod	
04/96→10/02		Tie Rod End	CV-ES-14163		for Steering Rod	
04/96→10/02		Tie Rod End	DB-ES-5234		for Steering Rod	
04/96→10/02		Track Control Arm		DB-DL-3475	Trailing Arm	
04/96→10/02		Track Control Arm		DB-VB-7261	Suspension Rod, Wishbone (CV), 1st RA, →517142 01/517142 02	
04/96→10/02		Track Control Arm		DB-VB-7798	Wishbone (CV)	
04/96→10/02		Track Control Arm	DB-DL-5224		Control Arm	
04/96→10/02		Track Control Arm	DB-DL-9218	DB-DL-9218	Trailing Arm	



ACTROS ...

2046 AS	10/96 →	Ball Head, gearshift linkage	DB-ES-8387		
	10/96 →	Ball Head, gearshift linkage	DB-ES-8491		
	10/96 →	Ball Head, gearshift linkage	DB-ES-8492		
	10/96 →	Ball Head, gearshift linkage	DB-ES-8500		
	10/96 →	Bush, parabolic spring		DB-SB-10400	
	10/96 →	Bush, parabolic spring		DB-SB-10401	
	10/96 →	Centre Rod	DB-DL-5230		Push Rod
	10/96 →	Centre Rod	DB-DL-5405		Push Rod
	10/96 →	Centre Rod	DB-DL-8307		Push Rod
	10/96 →	Centre Rod	DB-DL-8639		Push Rod
	10/96 →	Centre Rod	DB-DL-8702		Push Rod
	10/96 →	Tie Rod	DB-ES-5227		Guide Rod
	10/96 →	Tie Rod	MN-DL-7834		Guide Rod
	10/96 →	Tie Rod End	CV-ES-14163		for Steering Rod
	10/96 →	Track Control Arm		DB-DL-3475	Trailing Arm
10/96 →	Track Control Arm	DB-DL-5224		Control Arm	
10/96 →	Track Control Arm	DB-DL-9218	DB-DL-9218	Trailing Arm	
2048 AS	04/96 →10/02	Ball Head, gearshift linkage	DB-ES-8387		
	04/96 →10/02	Ball Head, gearshift linkage	DB-ES-8491		
	04/96 →10/02	Ball Head, gearshift linkage	DB-ES-8492		
	04/96 →10/02	Ball Head, gearshift linkage	DB-ES-8500		
	04/96 →10/02	Ball Head, gearshift linkage	DB-ES-8510		
	04/96 →10/02	Bush, driver cab suspension	DB-SB-10384		
	04/96 →10/02	Bush, parabolic spring		DB-SB-10400	
	04/96 →10/02	Bush, parabolic spring		DB-SB-10401	
	04/96 →10/02	Centre Rod	DB-DL-5230		Push Rod
	04/96 →10/02	Centre Rod	DB-DL-5241		Push Rod
	04/96 →10/02	Centre Rod	DB-DL-5405		Push Rod
	04/96 →10/02	Centre Rod	DB-DL-8188		Push Rod
	04/96 →10/02	Centre Rod	DB-DL-8307		Push Rod, Leaf Spring Axle
	04/96 →10/02	Centre Rod	DB-DL-8639		Push Rod, 1st FA;Leaf Spring Axle
	04/96 →10/02	Centre Rod	DB-DL-8702		Push Rod, Leaf Spring Axle
	04/96 →10/02	Centre Rod	DB-DL-9259		Push Rod
	04/96 →10/02	Centre Rod	DB-DL-12300		for Steering Rod
	04/96 →10/02	Stabiliser Mounting		DB-SB-10406	
	04/96 →10/02	Stabiliser Mounting		DB-SB-10409	
	04/96 →10/02	Stabiliser Mounting	DB-SB-10410		
	04/96 →10/02	Suspension Arm Repair Kit		DB-RK-8626	for Wishbone (CV)
	04/96 →10/02	Suspension Arm Repair Kit		DB-RK-10374	for Wishbone (CV)
	04/96 →10/02	Suspension Arm Repair Kit		DB-RK-10375	for Wishbone (CV)
	04/96 →10/02	Suspension Arm Repair Kit	DB-RK-8638		for Control Arm
	04/96 →10/02	Suspension Strut Repair Kit		DB-RK-8391	
	04/96 →10/02	Suspension Strut Repair Kit		MN-RK-8997	
	04/96 →10/02	Tie Rod	DB-DL-12310		
	04/96 →10/02	Tie Rod	DB-ES-5227		Guide Rod
	04/96 →10/02	Tie Rod	MN-DL-7834		Guide Rod
	04/96 →10/02	Tie Rod End	CV-ES-0543		for Push Rod
	04/96 →10/02	Tie Rod End	CV-ES-14163		for Steering Rod
	04/96 →10/02	Tie Rod End	DB-ES-5234		for Steering Rod
	04/96 →10/02	Track Control Arm		DB-DL-3475	Trailing Arm
04/96 →10/02	Track Control Arm		DB-VB-7261	Suspension Rod, Wishbone (CV), 1st RA, →517142 01/517142 02	
04/96 →10/02	Track Control Arm		DB-VB-7798	Wishbone (CV)	
04/96 →10/02	Track Control Arm	DB-DL-5224		Control Arm	
04/96 →10/02	Track Control Arm	DB-DL-9218	DB-DL-9218	Trailing Arm	
2050 AS	10/96 →	Ball Head, gearshift linkage	DB-ES-8387		
	10/96 →	Ball Head, gearshift linkage	DB-ES-8491		
	10/96 →	Ball Head, gearshift linkage	DB-ES-8492		
	10/96 →	Ball Head, gearshift linkage	DB-ES-8500		
	10/96 →	Bush, parabolic spring		DB-SB-10400	
	10/96 →	Bush, parabolic spring		DB-SB-10401	
	10/96 →	Centre Rod	DB-DL-5230		Push Rod
10/96 →	Centre Rod	DB-DL-5405		Push Rod	

CV-ES-0543

Length: 125
Cone Ø: d1 Ø 32 / d2 Ø 29
Thread: M30 x 1,5 RHT
0004605748, 0004606048, 0004606848,
0004607048, 0014600448, 0014601148,
0014601748, 0014602448, 0014607648,
0014609648



CV-ES-14163

Length: 125
Cone Ø: d1 Ø 30 / d2 Ø 27
Thread: M30 x 1,5 RHT
0003305248, 0003387310, 0004600348,
0004600948, 0004602848, 0004602948,
0004608948, 0014600248, 0014600848,
0014601248, 0014602248, 0014607748,
0024600148, A0003387310, A0004600348,
A0004602848, A0004602948, A0014600848,
A0014601248, A0014602248, A0014607748



DB-DL-3475

Length: 565 Ø: 52
Hole Distance: 152 / 152
3753500006, 3753500206, 9473500805,
9483500006, 9483500805, 9483501205,
9483501305, 9483501905, 9483502005,
9483502405, A3753500006,
A3753500206



DB-DL-5224

Length: 850 Ø: 60
Hole Distance: 100 / 100
01336100A, 9413300007



DB-DL-5230

Length: 879 Ø: 42
Cone Ø: d1 Ø 30 / d2 Ø 27
01208600A, 0004607105, 0004607205,
0014606705



DB-DL-5241

Length: 875 Ø: 40
Cone Ø: d1 Ø 30 / d2 Ø 27
01215300A, 0004609205, 0004609305,
0014606905



DB-DL-5405

Length: 890 Ø: 35
Cone Ø: d1 Ø 28,6 / d2 Ø 23,9
01215900A, 1460248, 0024604505,
0024604605, 0034605005, 3752600637,
3754600405, A3752600637, A3754600405



DB-DL-8188

Length: 895 Ø: 40
Cone Ø: d1 Ø 28,6 / d2 Ø 23,9
01217200A, 0024604905, 0024605005,
0034605605



DB-DL-8307

Length: 885 Ø: 38
Cone Ø: d1 Ø 32 / d2 Ø 30
01215500A, 0004604005, 0024605105,
0024605205, 0034604005



DB-DL-8639

Length: 888 Ø: 38
Cone Ø: d1 Ø 30 / d2 Ø 27
0014600705, 0014600805, 0014600705



DB-DL-8702

Length: 958 Ø: 38
Cone Ø: d1 Ø 32 / d2 Ø 30
0024606105, 0024606205, 0034604205



DB-DL-9218

Length: 754 Ø: 40
Hole Distance: 100
000360098524, 000390098524,
3753300111, 9413300011,
A3753300111, SA50831601



DB-DL-9259

Length: 883 Ø: 38
Cone Ø: d1 Ø 32 / d2 Ø 29
0024608605, 0024608705,
A0024608605, A0024608705



DB-DL-12300

Length: 733 Ø: 36
Cone Ø: d1 Ø 32 / d2 Ø 29
0014601505, 0014607305, 0034603305,
3754601605, A0014601505,
A0034603305, A3754601605



DB-DL-12310

Length: 1532 Ø: 50
Cone Ø: d1 Ø 32 / d2 Ø 29
Thread: M27 x 1,5 LHT
9493301203, 9493301303, 9493301803,
9493302203, A9493301203, A9493301303,
A9493301803, A9493302203



DB-ES-5227

Length: 1588 Ø: 60
Cone Ø: d1 Ø 38 / d2 Ø 34,3
6253300903, 6253301203, 9443300203



DB-ES-5234

Length: 135
Cone Ø: d1 Ø 38 / d2 Ø 34,3
Thread: M38 x 1,5 RHT
0004601748, 120322305, 2205000400



DB-ES-8387

Length: 55
Cone Ø: d1 Ø 10 / d2 Ø 10
Thread: M14 x 1,5 RHT
0009966845, 0009967045



DB-ES-8491

Length: 60
Cone Ø: d1 Ø 10 / d2 Ø 10
Thread: M12 x 1,75 LHT
0009966745



DB-ES-8492

Length: 60
Cone Ø: d1 Ø 10 / d2 Ø 10
Thread: M12 x 1,75 RHT
0009966645, 3752680189, A3752680189



DB-ES-8500

Length: 55
Cone Ø: d1 Ø 12 / d2 Ø 10,8
Thread: M14 x 1,5 RHT
0002685989



DB-ES-8510

Length: 56
Cone Ø: d1 Ø 10 / d2 Ø 10
Thread: M12 x 1,75 LHT
0009965145, 0009965645, 0019963145



DB-RK-8391

Ø: 85 Hole Distance: 152
Thick/Height: 24
01336800A, 0003502705



DB-RK-8626

Ø: 75 Hole Distance: 130
Thick/Height: 24
0003502205, 0003502505, 0003503405,
0003504505, GL11319



DB-RK-8638

Length: 100 Ø: 67
Hole Distance: 100
Thick/Height: 20
0003301411



DB-RK-10374

Ø: 85 Hole Distance: 152
Thick/Height: 24
0003504405



DB-RK-10375

Ø: 100 Hole Distance: 152
Thick/Height: 24
0003502405, 0003503505, 0003504905



DB-SB-10384

Ø: 73 Thick/Height: 47
9303170012, 9423171812



DB-SB-10400

Length: 230
Thick/Height: 167,5 / 115
0003250696, 0003250896



DB-SB-10401

Length: 232
Thick/Height: 163,5 / 152,5
0003250596, 0003250796



DB-SB-10406

Ø: 80 Thick/Height: 46
0003238185



DB-SB-10409

Ø: 77 Thick/Height: 56
0003265181



DB-SB-10410

Ø: 73 Hole Distance: 100
Thick/Height: 24
9413230050



DB-VB-7261

Length: 622 Ø: 46
Hole Ø 25 / 25 / 25
Hole Distance: 152 / 130 / 130
01337800A, 9443500305, 9443500505,
9443500605, 9473500705, 9473500905,
9483500405, 9483500305



DB-VB-7798

Length: 622 Ø: 48
Hole Ø 25 / 23 / 23
Hole Distance: 152 / 130 / 130
9423500505, 9423500805, 9423501205,
A9423501205



MN-DL-7834

Length: 1588 Ø: 58
Cone Ø: d1 Ø 30 / d2 Ø 27
3463303903, 3463304903, 6253303203,
9443300503, 9443301303, 9443301703



MN-RK-8997

Ø: 85 Hole Distance: 130
Thick/Height: 30
0003504805





ACTROS ...

2050 AS ...	10/96 →	Centre Rod	DB-DL-8307		Push Rod
	10/96 →	Centre Rod	DB-DL-8639		Push Rod
	10/96 →	Centre Rod	DB-DL-8702		Push Rod
	10/96 →	Tie Rod	DB-ES-5227		Guide Rod
	10/96 →	Tie Rod	MN-DL-7834		Guide Rod
	10/96 →	Tie Rod End	CV-ES-14163		for Steering Rod
	10/96 →	Track Control Arm		DB-DL-3475	Trailing Arm
	10/96 →	Track Control Arm	DB-DL-5224		Control Arm
	10/96 →	Track Control Arm	DB-DL-9218	DB-DL-9218	Trailing Arm
2053 S	04/96 →10/02	Ball Head, gearshift linkage	DB-ES-8387		
	04/96 →10/02	Ball Head, gearshift linkage	DB-ES-8491		
	04/96 →10/02	Ball Head, gearshift linkage	DB-ES-8492		
	04/96 →10/02	Ball Head, gearshift linkage	DB-ES-8500		
	04/96 →10/02	Ball Head, gearshift linkage	DB-ES-8510		
	04/96 →10/02	Bush, driver cab suspension	DB-SB-10384		
	04/96 →10/02	Bush, parabolic spring		DB-SB-10400	
	04/96 →10/02	Bush, parabolic spring		DB-SB-10401	
	04/96 →10/02	Centre Rod	DB-DL-2144		Push Rod
	04/96 →10/02	Centre Rod	DB-DL-5230		Push Rod, 1st FA;Leaf Spring Axle
	04/96 →10/02	Centre Rod	DB-DL-5241		Push Rod
	04/96 →10/02	Centre Rod	DB-DL-5405		Push Rod, Leaf Spring Axle
	04/96 →10/02	Centre Rod	DB-DL-7270		Push Rod;Suspension Rod
	04/96 →10/02	Centre Rod	DB-DL-8167		Push Rod, 1st FA;Leaf Spring Axle
	04/96 →10/02	Centre Rod	DB-DL-8184		Push Rod
	04/96 →10/02	Centre Rod	DB-DL-8185		Push Rod
	04/96 →10/02	Centre Rod	DB-DL-8188		Push Rod
	04/96 →10/02	Centre Rod	DB-DL-8307		Push Rod
	04/96 →10/02	Centre Rod	DB-DL-8702		Push Rod, Leaf Spring Axle
	04/96 →10/02	Centre Rod	DB-DL-12300		for Steering Rod
	04/96 →10/02	Rod Assembly	DB-DL-2178		Guide Rod
	04/96 →10/02	Stabiliser Mounting		DB-SB-5261	
	04/96 →10/02	Stabiliser Mounting		DB-SB-10406	
	04/96 →10/02	Stabiliser Mounting		DB-SB-10407	
	04/96 →10/02	Stabiliser Mounting		DB-SB-10409	
	04/96 →10/02	Stabiliser Mounting	DB-SB-5260		
	04/96 →10/02	Stabiliser Mounting	DB-SB-5279		
	04/96 →10/02	Stabiliser Mounting	DB-SB-10410		
	04/96 →10/02	Suspension Arm Repair Kit		DB-RK-8626	for Wishbone (CV)
	04/96 →10/02	Suspension Arm Repair Kit		DB-RK-10374	for Wishbone (CV)
	04/96 →10/02	Suspension Arm Repair Kit		DB-RK-10375	for Wishbone (CV)
	04/96 →10/02	Suspension Arm Repair Kit	DB-RK-8638		for Control Arm
	04/96 →10/02	Suspension Strut Repair Kit		DB-RK-8391	
	04/96 →10/02	Suspension Strut Repair Kit		MN-RK-8997	
	04/96 →10/02	Tie Rod	DB-DL-8171		Guide Rod
	04/96 →10/02	Tie Rod	DB-DL-8327		Guide Rod
	04/96 →10/02	Tie Rod	DB-DL-8640		Guide Rod
	04/96 →10/02	Tie Rod	DB-DL-12310		
	04/96 →10/02	Tie Rod	DB-ES-5227		Guide Rod
	04/96 →10/02	Tie Rod End	CV-ES-0543		for Push Rod
	04/96 →10/02	Tie Rod End	CV-ES-0888		for Push Rod
	04/96 →10/02	Tie Rod End	CV-ES-14162		for Steering Rod
	04/96 →10/02	Tie Rod End	CV-ES-14163		for Steering Rod
	04/96 →10/02	Tie Rod End	DB-ES-5234		for Steering Rod
	04/96 →10/02	Tie Rod End	DB-ES-8164		for Push Rod
	04/96 →10/02	Tie Rod End	DB-ES-8530		for Push Rod
	04/96 →10/02	Track Control Arm		DB-DL-3475	Trailing Arm
	04/96 →10/02	Track Control Arm		DB-VB-7261	Suspension Rod, Wishbone (CV), 1st RA, →517142 01/517142 02
	04/96 →10/02	Track Control Arm		DB-VB-7798	Wishbone (CV)
	04/96 →10/02	Track Control Arm	DB-DL-5224		Control Arm
04/96 →10/02	Track Control Arm	DB-DL-9218	DB-DL-9218	Trailing Arm	



ACTROS ...

2531 LS

09/96→10/02	Ball Head, gearshift linkage	DB-ES-8387		
09/96→10/02	Ball Head, gearshift linkage	DB-ES-8491		
09/96→10/02	Ball Head, gearshift linkage	DB-ES-8492		
09/96→10/02	Ball Head, gearshift linkage	DB-ES-8500		
09/96→10/02	Ball Head, gearshift linkage	DB-ES-8510		
09/96→10/02	Bush, driver cab suspension	DB-SB-10384		
09/96→10/02	Bush, parabolic spring		DB-SB-10400	
09/96→10/02	Bush, parabolic spring		DB-SB-10401	
09/96→10/02	Centre Rod	DB-DL-2144		Push Rod
09/96→10/02	Centre Rod	DB-DL-5230		Push Rod, 1st FA;Leaf Spring Axle
09/96→10/02	Centre Rod	DB-DL-5241		Push Rod
09/96→10/02	Centre Rod	DB-DL-5405		Push Rod
09/96→10/02	Centre Rod	DB-DL-7270		Push Rod
09/96→10/02	Centre Rod	DB-DL-8167		Push Rod, 1st FA;Leaf Spring Axle
09/96→10/02	Centre Rod	DB-DL-8184		Push Rod
09/96→10/02	Centre Rod	DB-DL-8185		Push Rod
09/96→10/02	Centre Rod	DB-DL-8188		Push Rod
09/96→10/02	Centre Rod	DB-DL-8307		Push Rod
09/96→10/02	Centre Rod	DB-DL-12299		for Steering Rod
09/96→10/02	Centre Rod	DB-DL-12300		for Steering Rod
09/96→10/02	Centre Rod	DB-DL-12470		Push Rod
09/96→10/02	Rod Assembly	DB-DL-2178		Guide Rod
09/96→10/02	Stabiliser Mounting		DB-RK-9296	
09/96→10/02	Stabiliser Mounting		DB-SB-5261	
09/96→10/02	Stabiliser Mounting		DB-SB-10406	
09/96→10/02	Stabiliser Mounting		DB-SB-10407	
09/96→10/02	Stabiliser Mounting		DB-SB-10409	
09/96→10/02	Stabiliser Mounting	DB-SB-5260		
09/96→10/02	Stabiliser Mounting	DB-SB-5279		
09/96→10/02	Stabiliser Mounting	DB-SB-10410		
09/96→10/02	Suspension Arm Repair Kit		DB-RK-8626	for Wishbone (CV)
09/96→10/02	Suspension Arm Repair Kit		DB-RK-10374	for Wishbone (CV)
09/96→10/02	Suspension Arm Repair Kit		DB-RK-10375	for Wishbone (CV)
09/96→10/02	Suspension Arm Repair Kit	DB-RK-8638		for Control Arm
09/96→10/02	Suspension Strut Repair Kit		DB-RK-8391	
09/96→10/02	Suspension Strut Repair Kit		DB-RK-9294	
09/96→10/02	Suspension Strut Repair Kit		MN-RK-8997	
09/96→10/02	Tie Rod	DB-DL-8327		Guide Rod
09/96→10/02	Tie Rod	DB-DL-8388		Guide Rod
09/96→10/02	Tie Rod	DB-DL-8389		
09/96→10/02	Tie Rod	DB-DL-12310		
09/96→10/02	Tie Rod	DB-ES-5227		Guide Rod
09/96→10/02	Tie Rod End	CV-ES-0543		for Push Rod
09/96→10/02	Tie Rod End	CV-ES-0888		for Push Rod
09/96→10/02	Tie Rod End	CV-ES-14162		for Steering Rod
09/96→10/02	Tie Rod End	CV-ES-14163		for Steering Rod
09/96→10/02	Tie Rod End	DB-ES-5234		for Steering Rod
09/96→10/02	Tie Rod End	DB-ES-8164		for Push Rod
09/96→10/02	Track Control Arm		DB-DL-3475	Trailing Arm
09/96→10/02	Track Control Arm		DB-VB-3707	Suspension Rod, Wishbone (CV), Drive Axle; Air Suspension Axle
09/96→10/02	Track Control Arm		DB-VB-7798	Wishbone (CV)
09/96→10/02	Track Control Arm	DB-DL-5224		Control Arm
09/96→10/02	Track Control Arm	DB-DL-9218	DB-DL-9218	Trailing Arm

2531, 2531 L

09/96→10/02	Ball Head, gearshift linkage	DB-ES-8387		
09/96→10/02	Ball Head, gearshift linkage	DB-ES-8491		
09/96→10/02	Ball Head, gearshift linkage	DB-ES-8492		
09/96→10/02	Ball Head, gearshift linkage	DB-ES-8500		
09/96→10/02	Ball Head, gearshift linkage	DB-ES-8510		
09/96→10/02	Bush, driver cab suspension	DB-SB-10384		
09/96→10/02	Bush, parabolic spring		DB-SB-10400	
09/96→10/02	Bush, parabolic spring		DB-SB-10401	
09/96→10/02	Centre Rod	DB-DL-2144		Push Rod



ACTROS ...

2531, 2531 L ...

09/96→10/02	Centre Rod	DB-DL-5230		Push Rod, 1st FA;Leaf Spring Axle
09/96→10/02	Centre Rod	DB-DL-5230		Push Rod, Leaf Spring Axle;Tag Axle
09/96→10/02	Centre Rod	DB-DL-5241		Push Rod
09/96→10/02	Centre Rod	DB-DL-5405		Push Rod
09/96→10/02	Centre Rod	DB-DL-5405		Push Rod, Leaf Spring Axle;Tag Axle
09/96→10/02	Centre Rod	DB-DL-7270		Push Rod
09/96→10/02	Centre Rod	DB-DL-8167		Push Rod, 1st FA;Leaf Spring Axle
09/96→10/02	Centre Rod	DB-DL-8167		Push Rod, 1st FA;Leaf Spring Axle;Tag Axle
09/96→10/02	Centre Rod	DB-DL-8168		Push Rod
09/96→10/02	Centre Rod	DB-DL-8184		Push Rod
09/96→10/02	Centre Rod	DB-DL-8185		Push Rod
09/96→10/02	Centre Rod	DB-DL-8188		Push Rod
09/96→10/02	Centre Rod	DB-DL-8307		Push Rod
09/96→10/02	Centre Rod	DB-DL-8622		Push Rod
09/96→10/02	Centre Rod	DB-DL-8641		Push Rod
09/96→10/02	Centre Rod	DB-DL-8642		Push Rod
09/96→10/02	Centre Rod	DB-DL-12298		for Steering Rod
09/96→10/02	Centre Rod	DB-DL-12299		for Steering Rod
09/96→10/02	Centre Rod	DB-DL-12300		for Steering Rod
09/96→10/02	Centre Rod	DB-DL-12470		Push Rod
09/96→10/02	Rod Assembly	DB-DL-2178		Guide Rod
09/96→10/02	Stabiliser Mounting		DB-RK-9296	
09/96→10/02	Stabiliser Mounting		DB-SB-5250	
09/96→10/02	Stabiliser Mounting		DB-SB-5261	
09/96→10/02	Stabiliser Mounting		DB-SB-10406	
09/96→10/02	Stabiliser Mounting		DB-SB-10407	
09/96→10/02	Stabiliser Mounting	DB-SB-5260		
09/96→10/02	Stabiliser Mounting	DB-SB-5277	DB-SB-5277	
09/96→10/02	Stabiliser Mounting	DB-SB-5279		
09/96→10/02	Suspension Arm Repair Kit		DB-RK-8550	for Wishbone (CV)
09/96→10/02	Suspension Arm Repair Kit		DB-RK-8626	for Wishbone (CV)
09/96→10/02	Suspension Arm Repair Kit		DB-RK-8638	for Control Arm
09/96→10/02	Suspension Arm Repair Kit		DB-RK-10374	for Wishbone (CV)
09/96→10/02	Suspension Strut Repair Kit		DB-RK-8555	
09/96→10/02	Tie Rod		DB-DL-8390	Tag Axle
09/96→10/02	Tie Rod	DB-DL-8172		Guide Rod
09/96→10/02	Tie Rod	DB-DL-8327		Guide Rod
09/96→10/02	Tie Rod	DB-DL-8388		Guide Rod
09/96→10/02	Tie Rod	DB-DL-8389		
09/96→10/02	Tie Rod	DB-DL-8640		Guide Rod
09/96→10/02	Tie Rod	DB-DL-12310		
09/96→10/02	Tie Rod	DB-ES-5227		Guide Rod
09/96→10/02	Tie Rod End	CV-ES-0543		for Push Rod
09/96→10/02	Tie Rod End	CV-ES-0888		for Push Rod
09/96→10/02	Tie Rod End	CV-ES-14162		for Steering Rod
09/96→10/02	Tie Rod End	CV-ES-14163		for Steering Rod
09/96→10/02	Tie Rod End	DB-ES-8164		for Push Rod
09/96→10/02	Tie Rod End	DB-ES-8530		for Push Rod
09/96→10/02	Track Control Arm		DB-DL-3475	Trailing Arm
09/96→10/02	Track Control Arm		DB-VB-3707	Suspension Rod, Wishbone (CV), 1st RA; Air Suspension Axle
09/96→10/02	Track Control Arm		DB-VB-3707	Suspension Rod, Wishbone (CV), 1st RA; Air Suspension Axle, →* K 864073 *
09/96→10/02	Track Control Arm		DB-VB-7261	Suspension Rod, Wishbone (CV), 1st RA, →517142 01/517142 02
09/96→10/02	Track Control Arm		DB-VB-7790	Wishbone (CV), Tag Axle
09/96→10/02	Track Control Arm	DB-DL-5224		Control Arm, 1st FA;Air Suspension Axle
09/96→10/02	Track Control Arm	DB-DL-9218	DB-DL-9218	Trailing Arm, 1st FA;Air Suspension Axle
2535 L	09/96→10/02	Ball Head, gearshift linkage	DB-ES-8387	
	09/96→10/02	Ball Head, gearshift linkage	DB-ES-8491	
	09/96→10/02	Ball Head, gearshift linkage	DB-ES-8492	
	09/96→10/02	Ball Head, gearshift linkage	DB-ES-8500	
	09/96→10/02	Ball Head, gearshift linkage	DB-ES-8510	



ACTROS ...

2535 L ...	09/96→10/02	Bush, driver cab suspension	DB-SB-10384		
	09/96→10/02	Bush, parabolic spring		DB-SB-10400	
	09/96→10/02	Bush, parabolic spring		DB-SB-10401	
	09/96→10/02	Centre Rod	DB-DL-2144		Push Rod
	09/96→10/02	Centre Rod	DB-DL-5230		Push Rod
	09/96→10/02	Centre Rod	DB-DL-5230		Push Rod, 1st FA;Leaf Spring Axle
	09/96→10/02	Centre Rod	DB-DL-5241		Push Rod
	09/96→10/02	Centre Rod	DB-DL-5405		Push Rod
	09/96→10/02	Centre Rod	DB-DL-7270		Push Rod
	09/96→10/02	Centre Rod	DB-DL-8167		Push Rod
	09/96→10/02	Centre Rod	DB-DL-8168		Push Rod
	09/96→10/02	Centre Rod	DB-DL-8184		Push Rod
	09/96→10/02	Centre Rod	DB-DL-8185		Push Rod
	09/96→10/02	Centre Rod	DB-DL-8188		Push Rod
	09/96→10/02	Centre Rod	DB-DL-8307		Push Rod
	09/96→10/02	Centre Rod	DB-DL-8622		Push Rod
	09/96→10/02	Centre Rod	DB-DL-8641		Push Rod
	09/96→10/02	Centre Rod	DB-DL-8642		Push Rod
	09/96→10/02	Centre Rod	DB-DL-12298		for Steering Rod
	09/96→10/02	Centre Rod	DB-DL-12299		for Steering Rod
	09/96→10/02	Centre Rod	DB-DL-12300		for Steering Rod
	09/96→10/02	Centre Rod	DB-DL-12470		Push Rod
	09/96→10/02	Rod Assembly	DB-DL-2178		Guide Rod, 1st Front Axle, →504310 03
	09/96→10/02	Rod Assembly	DB-DL-2178	DB-DL-2178	Guide Rod, Leading Axle Steered, →504310 03
	09/96→10/02	Stabiliser Mounting		DB-RK-9296	
	09/96→10/02	Stabiliser Mounting		DB-SB-5250	
	09/96→10/02	Stabiliser Mounting		DB-SB-5261	
	09/96→10/02	Stabiliser Mounting		DB-SB-10406	
	09/96→10/02	Stabiliser Mounting		DB-SB-10407	
	09/96→10/02	Stabiliser Mounting	DB-SB-5260		
	09/96→10/02	Stabiliser Mounting	DB-SB-5277	DB-SB-5277	
	09/96→10/02	Stabiliser Mounting	DB-SB-5279		
	09/96→10/02	Suspension Arm Repair Kit		DB-RK-8550	for Wishbone (CV)
	09/96→10/02	Suspension Arm Repair Kit		DB-RK-8626	for Wishbone (CV)
	09/96→10/02	Suspension Arm Repair Kit		DB-RK-8638	for Control Arm
	09/96→10/02	Suspension Arm Repair Kit		DB-RK-10374	for Wishbone (CV)
	09/96→10/02	Suspension Strut Repair Kit		DB-RK-8555	
	09/96→10/02	Tie Rod		DB-DL-8390	Tag Axle
	09/96→10/02	Tie Rod	DB-DL-8172		Guide Rod
	09/96→10/02	Tie Rod	DB-DL-8327		Guide Rod
	09/96→10/02	Tie Rod	DB-DL-8388		Guide Rod
	09/96→10/02	Tie Rod	DB-DL-8389		
	09/96→10/02	Tie Rod	DB-DL-8640		Guide Rod
	09/96→10/02	Tie Rod	DB-DL-12310		
	09/96→10/02	Tie Rod	DB-ES-5227		Guide Rod
09/96→10/02	Tie Rod End	CV-ES-0543	CV-ES-0543	for Push Rod	
09/96→10/02	Tie Rod End	CV-ES-0888	CV-ES-0888	for Push Rod	
09/96→10/02	Tie Rod End	CV-ES-14162		for Steering Rod	
09/96→10/02	Tie Rod End	CV-ES-14163		for Steering Rod	
09/96→10/02	Tie Rod End	DB-ES-8164		for Push Rod	
09/96→10/02	Tie Rod End	DB-ES-8530		for Push Rod	
09/96→10/02	Track Control Arm		DB-DL-3475	Trailing Arm	
09/96→10/02	Track Control Arm		DB-VB-3707	Suspension Rod, Wishbone (CV), 1st RA; Air Suspension Axle, →* K 864073 *	
09/96→10/02	Track Control Arm		DB-VB-7790	Wishbone (CV), Tag Axle	
09/96→10/02	Track Control Arm	DB-DL-5224		Control Arm, 1st FA;Air Suspension Axle	
09/96→10/02	Track Control Arm	DB-DL-9218	DB-DL-9218	Trailing Arm, 1st FA;Air Suspension Axle	
2535 LS	09/96→10/02	Ball Head, gearshift linkage	DB-ES-8387		
	09/96→10/02	Ball Head, gearshift linkage	DB-ES-8491		
	09/96→10/02	Ball Head, gearshift linkage	DB-ES-8492		
	09/96→10/02	Ball Head, gearshift linkage	DB-ES-8500		
	09/96→10/02	Ball Head, gearshift linkage	DB-ES-8510		
	09/96→10/02	Bush, driver cab suspension	DB-SB-10384		



ACTROS ...

2535 LS ...

09/96→10/02	Bush, parabolic spring		DB-SB-10400	
09/96→10/02	Bush, parabolic spring		DB-SB-10401	
09/96→10/02	Centre Rod	DB-DL-5230		Push Rod, 1st FA;Leaf Spring Axle
09/96→10/02	Centre Rod	DB-DL-5241		Push Rod
09/96→10/02	Centre Rod	DB-DL-5405		Push Rod
09/96→10/02	Centre Rod	DB-DL-7270		Push Rod
09/96→10/02	Centre Rod	DB-DL-8167		Push Rod, 1st FA;Leaf Spring Axle
09/96→10/02	Centre Rod	DB-DL-8167		Push Rod, 1st FA;Leaf Spring Axle; for vehicles with Rigid Leading Axle
09/96→10/02	Centre Rod	DB-DL-8184		Push Rod
09/96→10/02	Centre Rod	DB-DL-8185		Push Rod
09/96→10/02	Centre Rod	DB-DL-8188		Push Rod
09/96→10/02	Centre Rod	DB-DL-8307		Push Rod
09/96→10/02	Centre Rod	DB-DL-12298		for Steering Rod
09/96→10/02	Centre Rod	DB-DL-12299		for Steering Rod
09/96→10/02	Centre Rod	DB-DL-12300		for Steering Rod
09/96→10/02	Centre Rod	DB-DL-12470		Push Rod
09/96→10/02	Rod Assembly	DB-DL-2178		Guide Rod, 1st Front Axle, →504310 03
09/96→10/02	Stabiliser Mounting		DB-RK-9296	
09/96→10/02	Stabiliser Mounting		DB-SB-5261	
09/96→10/02	Stabiliser Mounting		DB-SB-10406	
09/96→10/02	Stabiliser Mounting		DB-SB-10407	
09/96→10/02	Stabiliser Mounting		DB-SB-10409	
09/96→10/02	Stabiliser Mounting	DB-SB-5260		
09/96→10/02	Stabiliser Mounting	DB-SB-5279		
09/96→10/02	Stabiliser Mounting	DB-SB-10410		
09/96→10/02	Suspension Arm Repair Kit		DB-RK-8626	for Wishbone (CV)
09/96→10/02	Suspension Arm Repair Kit		DB-RK-10374	for Wishbone (CV)
09/96→10/02	Suspension Arm Repair Kit		DB-RK-10375	for Wishbone (CV)
09/96→10/02	Suspension Arm Repair Kit	DB-RK-8638		for Control Arm
09/96→10/02	Suspension Strut Repair Kit		DB-RK-8391	
09/96→10/02	Suspension Strut Repair Kit		DB-RK-9294	
09/96→10/02	Suspension Strut Repair Kit		MN-RK-8997	
09/96→10/02	Tie Rod	DB-DL-8327		Guide Rod
09/96→10/02	Tie Rod	DB-DL-8388		Guide Rod
09/96→10/02	Tie Rod	DB-DL-8389		
09/96→10/02	Tie Rod	DB-DL-12310		
09/96→10/02	Tie Rod	DB-ES-5227		Guide Rod
09/96→10/02	Tie Rod End	CV-ES-0543		for Push Rod
09/96→10/02	Tie Rod End	CV-ES-0888		for Push Rod
09/96→10/02	Tie Rod End	CV-ES-14162		for Steering Rod
09/96→10/02	Tie Rod End	CV-ES-14163		for Steering Rod
09/96→10/02	Tie Rod End	DB-ES-5234		for Steering Rod
09/96→10/02	Tie Rod End	DB-ES-8164		for Push Rod
09/96→10/02	Track Control Arm		DB-DL-3475	Trailing Arm
09/96→10/02	Track Control Arm		DB-VB-3707	Suspension Rod, Wishbone (CV), Drive Axle; Air Suspension Axle
09/96→10/02	Track Control Arm		DB-VB-3707	Suspension Rod, Wishbone (CV), Drive Axle; Air Suspension Axle;for vehicles with Rigid Leading Axle
09/96→10/02	Track Control Arm		DB-VB-7798	Wishbone (CV)
09/96→10/02	Track Control Arm	DB-DL-5224		Control Arm, 1st FA;Air Suspension Axle; for vehicles with Rigid Leading Axle
09/96→10/02	Track Control Arm	DB-DL-9218	DB-DL-9218	Trailing Arm, 1st FA;Air Suspension Axle; for vehicles with Rigid Leading Axle
2540 LS	09/96→10/02	Ball Head, gearshift linkage	DB-ES-8387	
	09/96→10/02	Ball Head, gearshift linkage	DB-ES-8491	
	09/96→10/02	Ball Head, gearshift linkage	DB-ES-8492	
	09/96→10/02	Ball Head, gearshift linkage	DB-ES-8500	
	09/96→10/02	Ball Head, gearshift linkage	DB-ES-8510	
	09/96→10/02	Bush, driver cab suspension	DB-SB-10384	
	09/96→10/02	Bush, parabolic spring		DB-SB-10400
	09/96→10/02	Bush, parabolic spring		DB-SB-10401



ACTROS ...

2540 LS ...	09/96→10/02	Centre Rod	DB-DL-2144	Push Rod
	09/96→10/02	Centre Rod	DB-DL-5230	Push Rod, 1st FA;Leaf Spring Axle
	09/96→10/02	Centre Rod	DB-DL-5241	Push Rod
	09/96→10/02	Centre Rod	DB-DL-5405	Push Rod
	09/96→10/02	Centre Rod	DB-DL-7270	Push Rod
	09/96→10/02	Centre Rod	DB-DL-8167	Push Rod, 1st FA;Leaf Spring Axle
	09/96→10/02	Centre Rod	DB-DL-8167	Push Rod, 1st FA;Leaf Spring Axle; for vehicles with Rigid Leading Axle
	09/96→10/02	Centre Rod	DB-DL-8184	Push Rod
	09/96→10/02	Centre Rod	DB-DL-8185	Push Rod
	09/96→10/02	Centre Rod	DB-DL-8188	Push Rod
	09/96→10/02	Centre Rod	DB-DL-8307	Push Rod
	09/96→10/02	Centre Rod	DB-DL-12299	for Steering Rod
	09/96→10/02	Centre Rod	DB-DL-12300	for Steering Rod
	09/96→10/02	Centre Rod	DB-DL-12470	Push Rod
	09/96→10/02	Rod Assembly	DB-DL-2178	Guide Rod
	09/96→10/02	Stabiliser Mounting		DB-RK-9296
	09/96→10/02	Stabiliser Mounting		DB-SB-5261
	09/96→10/02	Stabiliser Mounting		DB-SB-10406
	09/96→10/02	Stabiliser Mounting		DB-SB-10407
	09/96→10/02	Stabiliser Mounting		DB-SB-10409
	09/96→10/02	Stabiliser Mounting	DB-SB-5260	
	09/96→10/02	Stabiliser Mounting	DB-SB-5279	
	09/96→10/02	Stabiliser Mounting	DB-SB-10410	
	09/96→10/02	Suspension Arm Repair Kit		DB-RK-8626 for Wishbone (CV)
	09/96→10/02	Suspension Arm Repair Kit		DB-RK-10374 for Wishbone (CV)
	09/96→10/02	Suspension Arm Repair Kit		DB-RK-10375 for Wishbone (CV)
	09/96→10/02	Suspension Arm Repair Kit	DB-RK-8638	for Control Arm
	09/96→10/02	Suspension Strut Repair Kit		DB-RK-8391
	09/96→10/02	Suspension Strut Repair Kit		DB-RK-9294
	09/96→10/02	Suspension Strut Repair Kit		MN-RK-8997
	09/96→10/02	Tie Rod	DB-DL-8327	Guide Rod
	09/96→10/02	Tie Rod	DB-DL-8388	Guide Rod
	09/96→10/02	Tie Rod	DB-DL-8389	
	09/96→10/02	Tie Rod	DB-DL-12310	
	09/96→10/02	Tie Rod	DB-ES-5227	Guide Rod
	09/96→10/02	Tie Rod End	CV-ES-0543	for Push Rod
	09/96→10/02	Tie Rod End	CV-ES-0888	for Push Rod
	09/96→10/02	Tie Rod End	CV-ES-14162	for Steering Rod
	09/96→10/02	Tie Rod End	CV-ES-14163	for Steering Rod
	09/96→10/02	Tie Rod End	DB-ES-5234	for Steering Rod
09/96→10/02	Tie Rod End	DB-ES-8164	for Push Rod	
09/96→10/02	Track Control Arm		DB-DL-3475 Trailing Arm	
09/96→10/02	Track Control Arm		DB-VB-3707 Suspension Rod, Wishbone (CV), Drive Axle; Air Suspension Axle	
09/96→10/02	Track Control Arm		DB-VB-3707 Suspension Rod, Wishbone (CV), Drive Axle; Air Suspension Axle;for vehicles with Rigid Leading Axle	
09/96→10/02	Track Control Arm		DB-VB-7798 Wishbone (CV)	
09/96→10/02	Track Control Arm	DB-DL-5224	Control Arm, 1st FA;Air Suspension Axle; for vehicles with Rigid Leading Axle	
09/96→10/02	Track Control Arm	DB-DL-9218	DB-DL-9218 Trailing Arm, 1st FA;Air Suspension Axle; for vehicles with Rigid Leading Axle	
2540, 2540 L	09/96→10/02	Ball Head, gearshift linkage	DB-ES-8387	
	09/96→10/02	Ball Head, gearshift linkage	DB-ES-8491	
	09/96→10/02	Ball Head, gearshift linkage	DB-ES-8492	
	09/96→10/02	Ball Head, gearshift linkage	DB-ES-8500	
	09/96→10/02	Ball Head, gearshift linkage	DB-ES-8510	
	09/96→10/02	Bush, driver cab suspension	DB-SB-10384	
	09/96→10/02	Bush, parabolic spring		DB-SB-10400
	09/96→10/02	Bush, parabolic spring		DB-SB-10401
09/96→10/02	Centre Rod	DB-DL-2144	Push Rod	
09/96→10/02	Centre Rod	DB-DL-5230	Push Rod, 1st FA;Leaf Spring Axle	



ACTROS ...

2540, 2540 L ...	09/96→10/02	Centre Rod	DB-DL-5230		Push Rod, Leaf Spring Axle;Tag Axle
	09/96→10/02	Centre Rod	DB-DL-5241		Push Rod
	09/96→10/02	Centre Rod	DB-DL-5405		Push Rod
	09/96→10/02	Centre Rod	DB-DL-5405		Push Rod, Leaf Spring Axle;Tag Axle
	09/96→10/02	Centre Rod	DB-DL-7270		Push Rod
	09/96→10/02	Centre Rod	DB-DL-8167		Push Rod, 1st FA;Leaf Spring Axle
	09/96→10/02	Centre Rod	DB-DL-8167		Push Rod, 1st FA;Leaf Spring Axle;Tag Axle
	09/96→10/02	Centre Rod	DB-DL-8168		Push Rod
	09/96→10/02	Centre Rod	DB-DL-8184		Push Rod
	09/96→10/02	Centre Rod	DB-DL-8185		Push Rod
	09/96→10/02	Centre Rod	DB-DL-8188		Push Rod
	09/96→10/02	Centre Rod	DB-DL-8307		Push Rod
	09/96→10/02	Centre Rod	DB-DL-8622		Push Rod
	09/96→10/02	Centre Rod	DB-DL-8641		Push Rod
	09/96→10/02	Centre Rod	DB-DL-8642		Push Rod
	09/96→10/02	Centre Rod	DB-DL-12298		for Steering Rod
	09/96→10/02	Centre Rod	DB-DL-12300		for Steering Rod
	09/96→10/02	Rod Assembly	DB-DL-2178		Guide Rod
	09/96→10/02	Stabiliser Mounting		DB-RK-9296	
	09/96→10/02	Stabiliser Mounting		DB-SB-5250	
	09/96→10/02	Stabiliser Mounting		DB-SB-5261	
	09/96→10/02	Stabiliser Mounting		DB-SB-10406	
	09/96→10/02	Stabiliser Mounting		DB-SB-10407	
	09/96→10/02	Stabiliser Mounting	DB-SB-5260		
	09/96→10/02	Stabiliser Mounting	DB-SB-5277	DB-SB-5277	
	09/96→10/02	Stabiliser Mounting	DB-SB-5279		
	09/96→10/02	Suspension Arm Repair Kit		DB-RK-8550	for Wishbone (CV)
	09/96→10/02	Suspension Arm Repair Kit		DB-RK-8626	for Wishbone (CV)
	09/96→10/02	Suspension Arm Repair Kit		DB-RK-8638	for Control Arm
	09/96→10/02	Suspension Arm Repair Kit		DB-RK-10374	for Wishbone (CV)
	09/96→10/02	Suspension Strut Repair Kit		DB-RK-8555	
	09/96→10/02	Tie Rod		DB-DL-8390	Tag Axle
	09/96→10/02	Tie Rod	DB-DL-8327		Guide Rod
	09/96→10/02	Tie Rod	DB-DL-8388		Guide Rod
	09/96→10/02	Tie Rod	DB-DL-8389		
	09/96→10/02	Tie Rod	DB-DL-8640		Guide Rod
	09/96→10/02	Tie Rod	DB-DL-12310		
	09/96→10/02	Tie Rod	DB-ES-5227		Guide Rod
	09/96→10/02	Tie Rod End	CV-ES-0543		for Push Rod
	09/96→10/02	Tie Rod End	CV-ES-0888		for Push Rod
	09/96→10/02	Tie Rod End	CV-ES-14162		for Steering Rod
	09/96→10/02	Tie Rod End	CV-ES-14163		for Steering Rod
	09/96→10/02	Tie Rod End	DB-ES-8164		for Push Rod
	09/96→10/02	Tie Rod End	DB-ES-8530		for Push Rod
	09/96→10/02	Track Control Arm		DB-DL-3475	Trailing Arm
09/96→10/02	Track Control Arm		DB-VB-3707	Suspension Rod, Wishbone (CV), 1st RA; Air Suspension Axle, →* K 864073 *	
09/96→10/02	Track Control Arm		DB-VB-7261	Suspension Rod, Wishbone (CV), 1st RA, →517142 01/517142 02	
09/96→10/02	Track Control Arm		DB-VB-7790	Wishbone (CV), Tag Axle	
09/96→10/02	Track Control Arm	DB-DL-5224		Control Arm, 1st FA;Air Suspension Axle	
09/96→10/02	Track Control Arm	DB-DL-9218	DB-DL-9218	Trailing Arm, 1st FA;Air Suspension Axle	
2543 LS	09/96→10/02	Ball Head, gearshift linkage	DB-ES-8387		
	09/96→10/02	Ball Head, gearshift linkage	DB-ES-8491		
	09/96→10/02	Ball Head, gearshift linkage	DB-ES-8492		
	09/96→10/02	Ball Head, gearshift linkage	DB-ES-8500		
	09/96→10/02	Ball Head, gearshift linkage	DB-ES-8510		
	09/96→10/02	Bush, driver cab suspension	DB-SB-10384		
	09/96→10/02	Bush, parabolic spring		DB-SB-10400	
	09/96→10/02	Bush, parabolic spring		DB-SB-10401	
	09/96→10/02	Centre Rod	DB-DL-2144		Push Rod
09/96→10/02	Centre Rod	DB-DL-5230		Push Rod, 1st FA;Leaf Spring Axle	
09/96→10/02	Centre Rod	DB-DL-5241		Push Rod	



ACTROS ...

2543 LS ...	09/96→10/02	Centre Rod	DB-DL-5405		Push Rod
	09/96→10/02	Centre Rod	DB-DL-7270		Push Rod
	09/96→10/02	Centre Rod	DB-DL-8167		Push Rod, 1st FA;Leaf Spring Axle
	09/96→10/02	Centre Rod	DB-DL-8167		Push Rod, 1st FA;Leaf Spring Axle; for vehicles with Rigid Leading Axle
	09/96→10/02	Centre Rod	DB-DL-8184		Push Rod
	09/96→10/02	Centre Rod	DB-DL-8185		Push Rod
	09/96→10/02	Centre Rod	DB-DL-8188		Push Rod
	09/96→10/02	Centre Rod	DB-DL-8307		Push Rod
	09/96→10/02	Centre Rod	DB-DL-12299		for Steering Rod
	09/96→10/02	Centre Rod	DB-DL-12300		for Steering Rod
	09/96→10/02	Centre Rod	DB-DL-12470		Push Rod
	09/96→10/02	Rod Assembly	DB-DL-2178		Guide Rod
	09/96→10/02	Stabiliser Mounting		DB-RK-9296	
	09/96→10/02	Stabiliser Mounting		DB-SB-5261	
	09/96→10/02	Stabiliser Mounting		DB-SB-10406	
	09/96→10/02	Stabiliser Mounting		DB-SB-10407	
	09/96→10/02	Stabiliser Mounting		DB-SB-10409	
	09/96→10/02	Stabiliser Mounting	DB-SB-5260		
	09/96→10/02	Stabiliser Mounting	DB-SB-5279		
	09/96→10/02	Stabiliser Mounting	DB-SB-10410		
	09/96→10/02	Suspension Arm Repair Kit		DB-RK-8626	for Wishbone (CV)
	09/96→10/02	Suspension Arm Repair Kit		DB-RK-10374	for Wishbone (CV)
	09/96→10/02	Suspension Arm Repair Kit		DB-RK-10375	for Wishbone (CV)
	09/96→10/02	Suspension Arm Repair Kit	DB-RK-8638		for Control Arm
	09/96→10/02	Suspension Strut Repair Kit		DB-RK-8391	
	09/96→10/02	Suspension Strut Repair Kit		DB-RK-9294	
	09/96→10/02	Suspension Strut Repair Kit		MN-RK-8997	
	09/96→10/02	Tie Rod	DB-DL-8327		Guide Rod
	09/96→10/02	Tie Rod	DB-DL-8388		Guide Rod
	09/96→10/02	Tie Rod	DB-DL-8389		
	09/96→10/02	Tie Rod	DB-DL-12310		
	09/96→10/02	Tie Rod	DB-ES-5227		Guide Rod
	09/96→10/02	Tie Rod End	CV-ES-0543		for Push Rod
	09/96→10/02	Tie Rod End	CV-ES-0888		for Push Rod
	09/96→10/02	Tie Rod End	CV-ES-14162		for Steering Rod
	09/96→10/02	Tie Rod End	CV-ES-14163		for Steering Rod
	09/96→10/02	Tie Rod End	DB-ES-5234		for Steering Rod
	09/96→10/02	Tie Rod End	DB-ES-8164		for Push Rod
	09/96→10/02	Track Control Arm		DB-DL-3475	Trailing Arm
	09/96→10/02	Track Control Arm		DB-VB-3707	Suspension Rod, Wishbone (CV), Drive Axle; Air Suspension Axle
	09/96→10/02	Track Control Arm		DB-VB-3707	Suspension Rod, Wishbone (CV), Drive Axle; Air Suspension Axle;for vehicles with Rigid Leading Axle
	09/96→10/02	Track Control Arm		DB-VB-7798	Wishbone (CV)
	09/96→10/02	Track Control Arm	DB-DL-5224		Control Arm, 1st FA;Air Suspension Axle; for vehicles with Rigid Leading Axle
09/96→10/02	Track Control Arm	DB-DL-9218	DB-DL-9218	Trailing Arm, 1st FA;Air Suspension Axle; for vehicles with Rigid Leading Axle	
2543, 2543 L	09/96→10/02	Ball Head, gearshift linkage	DB-ES-8387		
	09/96→10/02	Ball Head, gearshift linkage	DB-ES-8491		
	09/96→10/02	Ball Head, gearshift linkage	DB-ES-8492		
	09/96→10/02	Ball Head, gearshift linkage	DB-ES-8500		
	09/96→10/02	Ball Head, gearshift linkage	DB-ES-8510		
	09/96→10/02	Bush, driver cab suspension	DB-SB-10384		
	09/96→10/02	Bush, parabolic spring		DB-SB-10400	
	09/96→10/02	Bush, parabolic spring		DB-SB-10401	
	09/96→10/02	Centre Rod	DB-DL-2144		Push Rod
	09/96→10/02	Centre Rod	DB-DL-5230		Push Rod, 1st FA;Leaf Spring Axle
	09/96→10/02	Centre Rod	DB-DL-5230		Push Rod, Leaf Spring Axle;Tag Axle
	09/96→10/02	Centre Rod	DB-DL-5241		Push Rod
	09/96→10/02	Centre Rod	DB-DL-5405		Push Rod



ACTROS ...

2543, 2543 L ...	09/96→10/02	Centre Rod	DB-DL-5405		Push Rod, Leaf Spring Axle;Tag Axle
	09/96→10/02	Centre Rod	DB-DL-7270		Push Rod
	09/96→10/02	Centre Rod	DB-DL-8167		Push Rod, 1st FA;Leaf Spring Axle
	09/96→10/02	Centre Rod	DB-DL-8167		Push Rod, 1st FA;Leaf Spring Axle;Tag Axle
	09/96→10/02	Centre Rod	DB-DL-8168		Push Rod
	09/96→10/02	Centre Rod	DB-DL-8184		Push Rod
	09/96→10/02	Centre Rod	DB-DL-8185		Push Rod
	09/96→10/02	Centre Rod	DB-DL-8188		Push Rod
	09/96→10/02	Centre Rod	DB-DL-8307		Push Rod
	09/96→10/02	Centre Rod	DB-DL-8622		Push Rod
	09/96→10/02	Centre Rod	DB-DL-8641		Push Rod
	09/96→10/02	Centre Rod	DB-DL-8642		Push Rod
	09/96→10/02	Centre Rod	DB-DL-12298		for Steering Rod
	09/96→10/02	Centre Rod	DB-DL-12300		for Steering Rod
	09/96→10/02	Rod Assembly	DB-DL-2178		Guide Rod
	09/96→10/02	Stabiliser Mounting		DB-RK-9296	
	09/96→10/02	Stabiliser Mounting		DB-SB-5250	
	09/96→10/02	Stabiliser Mounting		DB-SB-5261	
	09/96→10/02	Stabiliser Mounting		DB-SB-10406	
	09/96→10/02	Stabiliser Mounting		DB-SB-10407	
	09/96→10/02	Stabiliser Mounting	DB-SB-5260		
	09/96→10/02	Stabiliser Mounting	DB-SB-5277	DB-SB-5277	
	09/96→10/02	Stabiliser Mounting	DB-SB-5279		
	09/96→10/02	Suspension Arm Repair Kit		DB-RK-8550	for Wishbone (CV)
	09/96→10/02	Suspension Arm Repair Kit		DB-RK-8626	for Wishbone (CV)
	09/96→10/02	Suspension Arm Repair Kit		DB-RK-8638	for Control Arm
	09/96→10/02	Suspension Arm Repair Kit		DB-RK-10374	for Wishbone (CV)
	09/96→10/02	Suspension Strut Repair Kit		DB-RK-8555	
	09/96→10/02	Tie Rod		DB-DL-8390	Tag Axle
	09/96→10/02	Tie Rod	DB-DL-8327		Guide Rod
	09/96→10/02	Tie Rod	DB-DL-8388		Guide Rod
	09/96→10/02	Tie Rod	DB-DL-8389		
	09/96→10/02	Tie Rod	DB-DL-8640		Guide Rod
	09/96→10/02	Tie Rod	DB-DL-12310		
	09/96→10/02	Tie Rod	DB-ES-5227		Guide Rod
	09/96→10/02	Tie Rod End	CV-ES-0543		for Push Rod
	09/96→10/02	Tie Rod End	CV-ES-0888		for Push Rod
	09/96→10/02	Tie Rod End	CV-ES-14162		for Steering Rod
	09/96→10/02	Tie Rod End	CV-ES-14163		for Steering Rod
	09/96→10/02	Tie Rod End	DB-ES-8164		for Push Rod
	09/96→10/02	Tie Rod End	DB-ES-8530		for Push Rod
	09/96→10/02	Track Control Arm		DB-DL-3475	Trailing Arm
	09/96→10/02	Track Control Arm		DB-VB-3707	Suspension Rod, Wishbone (CV), 1st RA; Air Suspension Axle, →* K 864073 *
	09/96→10/02	Track Control Arm		DB-VB-7261	Suspension Rod, Wishbone (CV), 1st RA, →517142 01/517142 02
	09/96→10/02	Track Control Arm		DB-VB-7790	Wishbone (CV), Tag Axle
09/96→10/02	Track Control Arm	DB-DL-5224		Control Arm, 1st FA;Air Suspension Axle	
09/96→10/02	Track Control Arm	DB-DL-9218	DB-DL-9218	Trailing Arm, 1st FA;Air Suspension Axle	
2546 LS	10/97→	Ball Head, gearshift linkage	DB-ES-8387		
	10/97→	Ball Head, gearshift linkage	DB-ES-8491		
	10/97→	Ball Head, gearshift linkage	DB-ES-8492		
	10/97→	Ball Head, gearshift linkage	DB-ES-8500		
	10/97→	Bush, parabolic spring		DB-SB-10400	
	10/97→	Bush, parabolic spring		DB-SB-10401	
	10/97→	Centre Rod	DB-DL-5230		Push Rod
	10/97→	Centre Rod	DB-DL-5405		Push Rod
	10/97→	Centre Rod	DB-DL-8167		Push Rod
	10/97→	Centre Rod	DB-DL-12299		for Steering Rod
	10/97→	Centre Rod	DB-DL-12470		Push Rod
	10/97→	Rod Assembly	DB-DL-2178		Guide Rod, 1st Front Axle, →504310 03
	10/97→	Suspension Arm Repair Kit		DB-RK-8626	for Wishbone (CV)
10/97→	Suspension Arm Repair Kit		DB-RK-10374	for Wishbone (CV)	



ACTROS ...

2546 LS ...	10/97→	Tie Rod	DB-DL-8388		Guide Rod
	10/97→	Tie Rod	DB-DL-8389		
	10/97→	Tie Rod End	CV-ES-0543		for Push Rod
	10/97→	Tie Rod End	CV-ES-0888		for Push Rod
	10/97→	Tie Rod End	CV-ES-14162		for Steering Rod
	10/97→	Tie Rod End	CV-ES-14163		for Steering Rod
	10/97→	Track Control Arm		DB-DL-3475	Trailing Arm
	10/97→	Track Control Arm		DB-VB-3707	Suspension Rod, Wishbone (CV)
	10/97→	Track Control Arm	DB-DL-5224		Control Arm
2548 LS	10/97→	Track Control Arm	DB-DL-9218	DB-DL-9218	Trailing Arm
	09/96→10/02	Ball Head, gearshift linkage	DB-ES-8387		
	09/96→10/02	Ball Head, gearshift linkage	DB-ES-8491		
	09/96→10/02	Ball Head, gearshift linkage	DB-ES-8492		
	09/96→10/02	Ball Head, gearshift linkage	DB-ES-8500		
	09/96→10/02	Ball Head, gearshift linkage	DB-ES-8510		
	09/96→10/02	Bush, driver cab suspension	DB-SB-10384		
	09/96→10/02	Bush, parabolic spring		DB-SB-10400	
	09/96→10/02	Bush, parabolic spring		DB-SB-10401	
	09/96→10/02	Centre Rod	DB-DL-2144		Push Rod
	09/96→10/02	Centre Rod	DB-DL-5230		Push Rod, 1st FA;Leaf Spring Axle
	09/96→10/02	Centre Rod	DB-DL-5241		Push Rod
	09/96→10/02	Centre Rod	DB-DL-5405		Push Rod
	09/96→10/02	Centre Rod	DB-DL-7270		Push Rod
	09/96→10/02	Centre Rod	DB-DL-8167		Push Rod, 1st FA;Leaf Spring Axle
	09/96→10/02	Centre Rod	DB-DL-8167		Push Rod, 1st FA;Leaf Spring Axle; for vehicles with Rigid Leading Axle
	09/96→10/02	Centre Rod	DB-DL-8184		Push Rod
	09/96→10/02	Centre Rod	DB-DL-8185		Push Rod
	09/96→10/02	Centre Rod	DB-DL-8188		Push Rod
	09/96→10/02	Centre Rod	DB-DL-8307		Push Rod
	09/96→10/02	Centre Rod	DB-DL-12299		for Steering Rod
	09/96→10/02	Centre Rod	DB-DL-12300		for Steering Rod
	09/96→10/02	Centre Rod	DB-DL-12470		Push Rod
	09/96→10/02	Rod Assembly	DB-DL-2178		Guide Rod
	09/96→10/02	Stabiliser Mounting		DB-RK-9296	
	09/96→10/02	Stabiliser Mounting		DB-SB-5261	
	09/96→10/02	Stabiliser Mounting		DB-SB-10406	
	09/96→10/02	Stabiliser Mounting		DB-SB-10407	
	09/96→10/02	Stabiliser Mounting		DB-SB-10409	
	09/96→10/02	Stabiliser Mounting	DB-SB-5260		
	09/96→10/02	Stabiliser Mounting	DB-SB-5279		
	09/96→10/02	Stabiliser Mounting	DB-SB-10410		
	09/96→10/02	Suspension Arm Repair Kit		DB-RK-8626	for Wishbone (CV)
	09/96→10/02	Suspension Arm Repair Kit		DB-RK-10374	for Wishbone (CV)
	09/96→10/02	Suspension Arm Repair Kit		DB-RK-10375	for Wishbone (CV)
	09/96→10/02	Suspension Arm Repair Kit	DB-RK-8638		for Control Arm
	09/96→10/02	Suspension Strut Repair Kit		DB-RK-8391	
	09/96→10/02	Suspension Strut Repair Kit		DB-RK-9294	
	09/96→10/02	Suspension Strut Repair Kit		MN-RK-8997	
	09/96→10/02	Tie Rod	DB-DL-8327		Guide Rod
	09/96→10/02	Tie Rod	DB-DL-8388		Guide Rod
	09/96→10/02	Tie Rod	DB-DL-8389		
	09/96→10/02	Tie Rod	DB-DL-12310		
09/96→10/02	Tie Rod	DB-ES-5227		Guide Rod	
09/96→10/02	Tie Rod End	CV-ES-0543		for Push Rod	
09/96→10/02	Tie Rod End	CV-ES-0888		for Push Rod	
09/96→10/02	Tie Rod End	CV-ES-14162		for Steering Rod	
09/96→10/02	Tie Rod End	CV-ES-14163		for Steering Rod	
09/96→10/02	Tie Rod End	DB-ES-5234		for Steering Rod	
09/96→10/02	Tie Rod End	DB-ES-8164		for Push Rod	
09/96→10/02	Track Control Arm		DB-DL-3475	Trailing Arm	
09/96→10/02	Track Control Arm		DB-VB-3707	Suspension Rod, Wishbone (CV), Drive Axle; Air Suspension Axle	



ACTROS ...

2548 LS ...	09/96 → 10/02	Track Control Arm		DB-VB-3707	Suspension Rod, Wishbone (CV), Drive Axle; Air Suspension Axle; for vehicles with Rigid Leading Axle
	09/96 → 10/02	Track Control Arm		DB-VB-7798	Wishbone (CV)
	09/96 → 10/02	Track Control Arm	DB-DL-5224		Control Arm, 1st FA; Air Suspension Axle; for vehicles with Rigid Leading Axle
	09/96 → 10/02	Track Control Arm	DB-DL-9218	DB-DL-9218	Trailing Arm, 1st FA; Air Suspension Axle; for vehicles with Rigid Leading Axle
2548, 2548 L	09/96 → 10/02	Ball Head, gearshift linkage	DB-ES-8387		
	09/96 → 10/02	Ball Head, gearshift linkage	DB-ES-8491		
	09/96 → 10/02	Ball Head, gearshift linkage	DB-ES-8492		
	09/96 → 10/02	Ball Head, gearshift linkage	DB-ES-8500		
	09/96 → 10/02	Ball Head, gearshift linkage	DB-ES-8510		
	09/96 → 10/02	Bush, driver cab suspension	DB-SB-10384		
	09/96 → 10/02	Bush, parabolic spring		DB-SB-10400	
	09/96 → 10/02	Bush, parabolic spring		DB-SB-10401	
	09/96 → 10/02	Centre Rod	DB-DL-2144		Push Rod
	09/96 → 10/02	Centre Rod	DB-DL-5230		Push Rod, 1st FA; Leaf Spring Axle
	09/96 → 10/02	Centre Rod	DB-DL-5230		Push Rod, Leaf Spring Axle; Tag Axle
	09/96 → 10/02	Centre Rod	DB-DL-5241		Push Rod
	09/96 → 10/02	Centre Rod	DB-DL-5405		Push Rod
	09/96 → 10/02	Centre Rod	DB-DL-5405		Push Rod, Leaf Spring Axle; Tag Axle
	09/96 → 10/02	Centre Rod	DB-DL-7270		Push Rod
	09/96 → 10/02	Centre Rod	DB-DL-8167		Push Rod, 1st FA; Leaf Spring Axle
	09/96 → 10/02	Centre Rod	DB-DL-8167		Push Rod, 1st FA; Leaf Spring Axle; Tag Axle
	09/96 → 10/02	Centre Rod	DB-DL-8168		Push Rod
	09/96 → 10/02	Centre Rod	DB-DL-8184		Push Rod
	09/96 → 10/02	Centre Rod	DB-DL-8185		Push Rod
	09/96 → 10/02	Centre Rod	DB-DL-8188		Push Rod
	09/96 → 10/02	Centre Rod	DB-DL-8307		Push Rod
	09/96 → 10/02	Centre Rod	DB-DL-8622		Push Rod
	09/96 → 10/02	Centre Rod	DB-DL-8641		Push Rod
	09/96 → 10/02	Centre Rod	DB-DL-8642		Push Rod
	09/96 → 10/02	Centre Rod	DB-DL-12298		for Steering Rod
	09/96 → 10/02	Centre Rod	DB-DL-12300		for Steering Rod
	09/96 → 10/02	Rod Assembly	DB-DL-2178		Guide Rod
	09/96 → 10/02	Stabiliser Mounting		DB-RK-9296	
	09/96 → 10/02	Stabiliser Mounting		DB-SB-5250	
	09/96 → 10/02	Stabiliser Mounting		DB-SB-5261	
	09/96 → 10/02	Stabiliser Mounting		DB-SB-10406	
	09/96 → 10/02	Stabiliser Mounting		DB-SB-10407	
	09/96 → 10/02	Stabiliser Mounting	DB-SB-5260		
	09/96 → 10/02	Stabiliser Mounting	DB-SB-5277	DB-SB-5277	
	09/96 → 10/02	Stabiliser Mounting	DB-SB-5279		
	09/96 → 10/02	Suspension Arm Repair Kit		DB-RK-8550	for Wishbone (CV)
	09/96 → 10/02	Suspension Arm Repair Kit		DB-RK-8626	for Wishbone (CV)
	09/96 → 10/02	Suspension Arm Repair Kit		DB-RK-8638	for Control Arm
	09/96 → 10/02	Suspension Arm Repair Kit		DB-RK-10374	for Wishbone (CV)
	09/96 → 10/02	Suspension Strut Repair Kit		DB-RK-8555	
	09/96 → 10/02	Tie Rod		DB-DL-8390	Tag Axle
	09/96 → 10/02	Tie Rod	DB-DL-8327		Guide Rod
	09/96 → 10/02	Tie Rod	DB-DL-8640		Guide Rod
	09/96 → 10/02	Tie Rod	DB-DL-12310		
	09/96 → 10/02	Tie Rod	DB-ES-5227		Guide Rod
	09/96 → 10/02	Tie Rod End	CV-ES-0543		for Push Rod
	09/96 → 10/02	Tie Rod End	CV-ES-0888		for Push Rod
	09/96 → 10/02	Tie Rod End	CV-ES-14162		for Steering Rod
	09/96 → 10/02	Tie Rod End	CV-ES-14163		for Steering Rod
	09/96 → 10/02	Tie Rod End	DB-ES-8164		for Push Rod
	09/96 → 10/02	Tie Rod End	DB-ES-8530		for Push Rod
	09/96 → 10/02	Track Control Arm		DB-DL-3475	Trailing Arm
	09/96 → 10/02	Track Control Arm		DB-VB-3707	Suspension Rod, Wishbone (CV), 1st RA; Air Suspension Axle, →* K 864073 *

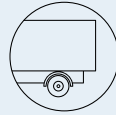

ACTROS ...

2548, 2548 L ...	09/96→10/02	Track Control Arm		DB-VB-7790	Wishbone (CV), Tag Axle
	09/96→10/02	Track Control Arm	DB-DL-5224		Control Arm, 1st FA;Air Suspension Axle
	09/96→10/02	Track Control Arm	DB-DL-9218	DB-DL-9218	Trailing Arm, 1st FA;Air Suspension Axle
2553 LS	09/96→10/02	Ball Head, gearshift linkage	DB-ES-8387		
	09/96→10/02	Ball Head, gearshift linkage	DB-ES-8491		
	09/96→10/02	Ball Head, gearshift linkage	DB-ES-8492		
	09/96→10/02	Ball Head, gearshift linkage	DB-ES-8500		
	09/96→10/02	Ball Head, gearshift linkage	DB-ES-8510		
	09/96→10/02	Bush, driver cab suspension	DB-SB-10384		
	09/96→10/02	Bush, parabolic spring		DB-SB-10400	
	09/96→10/02	Bush, parabolic spring		DB-SB-10401	
	09/96→10/02	Centre Rod	DB-DL-5230		Push Rod, 1st FA;Leaf Spring Axle
	09/96→10/02	Centre Rod	DB-DL-5241		Push Rod
	09/96→10/02	Centre Rod	DB-DL-5405		Push Rod
	09/96→10/02	Centre Rod	DB-DL-7270		Push Rod
	09/96→10/02	Centre Rod	DB-DL-8167		Push Rod, 1st FA;Leaf Spring Axle
	09/96→10/02	Centre Rod	DB-DL-8167		Push Rod, 1st FA;Leaf Spring Axle; for vehicles with Rigid Leading Axle
	09/96→10/02	Centre Rod	DB-DL-8184		Push Rod
	09/96→10/02	Centre Rod	DB-DL-8185		Push Rod
	09/96→10/02	Centre Rod	DB-DL-8188		Push Rod
	09/96→10/02	Centre Rod	DB-DL-8307		Push Rod
	09/96→10/02	Centre Rod	DB-DL-12299		for Steering Rod
	09/96→10/02	Centre Rod	DB-DL-12300		for Steering Rod
	09/96→10/02	Centre Rod	DB-DL-12470		Push Rod
	09/96→10/02	Rod Assembly	DB-DL-2178		Guide Rod, 1st Front Axle, →504310 03
	09/96→10/02	Stabiliser Mounting		DB-RK-9296	
	09/96→10/02	Stabiliser Mounting		DB-SB-5261	
	09/96→10/02	Stabiliser Mounting		DB-SB-10406	
	09/96→10/02	Stabiliser Mounting		DB-SB-10407	
	09/96→10/02	Stabiliser Mounting		DB-SB-10409	
	09/96→10/02	Stabiliser Mounting	DB-SB-5260		
	09/96→10/02	Stabiliser Mounting	DB-SB-5279		
	09/96→10/02	Stabiliser Mounting	DB-SB-10410		
	09/96→10/02	Suspension Arm Repair Kit		DB-RK-8626	for Wishbone (CV)
	09/96→10/02	Suspension Arm Repair Kit		DB-RK-10374	for Wishbone (CV)
	09/96→10/02	Suspension Arm Repair Kit		DB-RK-10375	for Wishbone (CV)
	09/96→10/02	Suspension Arm Repair Kit	DB-RK-8638		for Control Arm
	09/96→10/02	Suspension Strut Repair Kit		DB-RK-8391	
	09/96→10/02	Suspension Strut Repair Kit		DB-RK-9294	
	09/96→10/02	Suspension Strut Repair Kit		MN-RK-8997	
	09/96→10/02	Tie Rod	DB-DL-8327		Guide Rod
	09/96→10/02	Tie Rod	DB-DL-8388		Guide Rod
	09/96→10/02	Tie Rod	DB-DL-8389		
	09/96→10/02	Tie Rod	DB-DL-12310		
	09/96→10/02	Tie Rod	DB-ES-5227		Guide Rod
	09/96→10/02	Tie Rod End	CV-ES-0543		for Push Rod
	09/96→10/02	Tie Rod End	CV-ES-0888		for Push Rod
	09/96→10/02	Tie Rod End	CV-ES-14162		for Steering Rod
	09/96→10/02	Tie Rod End	CV-ES-14163		for Steering Rod
	09/96→10/02	Tie Rod End	DB-ES-5234		for Steering Rod
	09/96→10/02	Tie Rod End	DB-ES-8164		for Push Rod
	09/96→10/02	Track Control Arm		DB-DL-3475	Trailing Arm
	09/96→10/02	Track Control Arm		DB-VB-3707	Suspension Rod, Wishbone (CV), Drive Axle; Air Suspension Axle
	09/96→10/02	Track Control Arm		DB-VB-3707	Suspension Rod, Wishbone (CV), Drive Axle; Air Suspension Axle;for vehicles with Rigid Leading Axle
	09/96→10/02	Track Control Arm		DB-VB-7798	Wishbone (CV)
	09/96→10/02	Track Control Arm	DB-DL-5224		Control Arm, 1st FA;Air Suspension Axle; for vehicles with Rigid Leading Axle
	09/96→10/02	Track Control Arm	DB-DL-9218	DB-DL-9218	Trailing Arm, 1st FA;Air Suspension Axle; for vehicles with Rigid Leading Axle

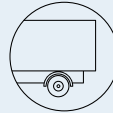
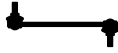

ACTROS ...

2553, 2553 L

09/96→10/02	Ball Head, gearshift linkage	DB-ES-8387		
09/96→10/02	Ball Head, gearshift linkage	DB-ES-8491		
09/96→10/02	Ball Head, gearshift linkage	DB-ES-8492		
09/96→10/02	Ball Head, gearshift linkage	DB-ES-8500		
09/96→10/02	Ball Head, gearshift linkage	DB-ES-8510		
09/96→10/02	Bush, driver cab suspension	DB-SB-10384		
09/96→10/02	Bush, parabolic spring		DB-SB-10400	
09/96→10/02	Bush, parabolic spring		DB-SB-10401	
09/96→10/02	Centre Rod	DB-DL-2144		Push Rod
09/96→10/02	Centre Rod	DB-DL-5230		Push Rod, 1st FA;Leaf Spring Axle
09/96→10/02	Centre Rod	DB-DL-5230		Push Rod, Leaf Spring Axle;Tag Axle
09/96→10/02	Centre Rod	DB-DL-5241		Push Rod
09/96→10/02	Centre Rod	DB-DL-5405		Push Rod
09/96→10/02	Centre Rod	DB-DL-5405		Push Rod, Leaf Spring Axle;Tag Axle
09/96→10/02	Centre Rod	DB-DL-7270		Push Rod
09/96→10/02	Centre Rod	DB-DL-8167		Push Rod, 1st FA;Leaf Spring Axle
09/96→10/02	Centre Rod	DB-DL-8167		Push Rod, 1st FA;Leaf Spring Axle;Tag Axle
09/96→10/02	Centre Rod	DB-DL-8168		Push Rod
09/96→10/02	Centre Rod	DB-DL-8184		Push Rod
09/96→10/02	Centre Rod	DB-DL-8185		Push Rod
09/96→10/02	Centre Rod	DB-DL-8188		Push Rod
09/96→10/02	Centre Rod	DB-DL-8307		Push Rod
09/96→10/02	Centre Rod	DB-DL-8622		Push Rod
09/96→10/02	Centre Rod	DB-DL-8641		Push Rod
09/96→10/02	Centre Rod	DB-DL-8642		Push Rod
09/96→10/02	Centre Rod	DB-DL-12298		for Steering Rod
09/96→10/02	Centre Rod	DB-DL-12300		for Steering Rod
09/96→10/02	Rod Assembly	DB-DL-2178		Guide Rod, 1st Front Axle, →504310 03
09/96→10/02	Stabiliser Mounting		DB-RK-9296	
09/96→10/02	Stabiliser Mounting		DB-SB-5250	
09/96→10/02	Stabiliser Mounting		DB-SB-5261	
09/96→10/02	Stabiliser Mounting		DB-SB-10406	
09/96→10/02	Stabiliser Mounting		DB-SB-10407	
09/96→10/02	Stabiliser Mounting	DB-SB-5260		
09/96→10/02	Stabiliser Mounting	DB-SB-5277	DB-SB-5277	
09/96→10/02	Stabiliser Mounting	DB-SB-5279		
09/96→10/02	Suspension Arm Repair Kit		DB-RK-8550	for Wishbone (CV)
09/96→10/02	Suspension Arm Repair Kit		DB-RK-8626	for Wishbone (CV)
09/96→10/02	Suspension Arm Repair Kit		DB-RK-8638	for Control Arm
09/96→10/02	Suspension Arm Repair Kit		DB-RK-10374	for Wishbone (CV)
09/96→10/02	Suspension Strut Repair Kit		DB-RK-8555	
09/96→10/02	Tie Rod		DB-DL-8390	Tag Axle
09/96→10/02	Tie Rod	DB-DL-8327		Guide Rod
09/96→10/02	Tie Rod	DB-DL-8640		Guide Rod
09/96→10/02	Tie Rod	DB-DL-12310		
09/96→10/02	Tie Rod	DB-ES-5227		Guide Rod
09/96→10/02	Tie Rod End	CV-ES-0543		for Push Rod
09/96→10/02	Tie Rod End	CV-ES-0888		for Push Rod
09/96→10/02	Tie Rod End	CV-ES-14163		for Steering Rod
09/96→10/02	Tie Rod End	DB-ES-8164		for Push Rod
09/96→10/02	Tie Rod End	DB-ES-8530		for Push Rod
09/96→10/02	Track Control Arm		DB-DL-3475	Trailing Arm
09/96→10/02	Track Control Arm		DB-VB-3707	Suspension Rod, Wishbone (CV), 1st RA; Air Suspension Axle, →* K 864073 *
09/96→10/02	Track Control Arm		DB-VB-7261	Suspension Rod, Wishbone (CV), 1st RA, →517142 01/517142 02
09/96→10/02	Track Control Arm		DB-VB-7790	Wishbone (CV), Tag Axle
09/96→10/02	Track Control Arm	DB-DL-5224		Control Arm, 1st FA;Air Suspension Axle
09/96→10/02	Track Control Arm	DB-DL-9218	DB-DL-9218	Trailing Arm, 1st FA;Air Suspension Axle

CV-ES-0543
Length: 125
Cone Ø: d1 Ø 32 / d2 Ø 29
Thread: M30 x 1,5 RHT
0004605748, 0004606048, 0004606848,
0004607048, 0014600448, 0014601148,
0014601748, 0014602448, 0014607648,
0014609648



CV-ES-0888
Length: 125
Cone Ø: d1 Ø 32 / d2 Ø 29
Thread: M30 x 1,5 LHT
0004605848, 0004606148, 0004606948,
0004607148, 0004609048, 0014600548,
0014601348, 0014602548, 0014607948,
0024600448



CV-ES-14163
Length: 125
Cone Ø: d1 Ø 30 / d2 Ø 27
Thread: M30 x 1,5 RHT
0003305248, 0003387310, 0004600348,
0004600948, 0004602848, 0004602948,
0004608948, 0014600248, 0014600848,
0014601248, 0014602248, 0014607748,
0024600148, 0003387310, 0004600348,
A0004602848, A0004602948, A0014600848,
A0014601248, A0014602248, A0014607748



DB-DL-2144
Length: 872 Ø: 35
Cone Ø: d1 Ø 28,6 / d2 Ø 23,9
0024604305, 0024604405, 0034604805



DB-DL-2178
Length: 1735 Ø: 52
Cone Ø: d1 Ø 32 / d2 Ø 29
9423300003, 9423300103, 9423300203



DB-DL-3475
Length: 565 Ø: 52
Hole Distance: 152 / 152
3753500006, 3753500206, 9473500805,
9483500006, 9483500805, 9483501205,
9483501305, 9483501905, 9483502005,
9483502405, A3753500006,
A3753500206



DB-DL-5224
Length: 850 Ø: 60
Hole Distance: 100 / 100
01336100A, 9413300007



DB-DL-5230
Length: 879 Ø: 42
Cone Ø: d1 Ø 30 / d2 Ø 27
01208600A, 0004607105, 0004607205,
0014606705



DB-DL-5241
Length: 875 Ø: 40
Cone Ø: d1 Ø 30 / d2 Ø 27
01215300A, 0004609205, 0004609305,
0014606905



DB-DL-5405
Length: 890 Ø: 35
Cone Ø: d1 Ø 28,6 / d2 Ø 23,9
01215900A, 1460248, 0024604505,
0024604605, 0034605005, 3752600637,
3754600405, A3752600637, A3754600405



DB-DL-7270
Length: 875 Ø: 40
Cone Ø: d1 Ø 28,6 / d2 Ø 23,9
01208300A, 0024604705, 0024604805,
0034604905, A0024604705



DB-DL-8167
Length: 866 Ø: 38
Cone Ø: d1 Ø 30 / d2 Ø 27
0014609805, 0014609905, 0024606305,
0024606405



DB-DL-8168
Length: 904 Ø: 52
Cone Ø: d1 Ø 32 / d2 Ø 29
0004609405, 0004609505, 0014607105



DB-DL-8184
Length: 1095 Ø: 42
Cone Ø: d1 Ø 32 / d2 Ø 28,8
01217700A, 0014601305, 0014601405,
0024600505, 0034603205, 3754601505,
A0014601305, A0014601405, A0024600505



DB-DL-8185
Length: 711 Ø: 42
Cone Ø: d1 Ø 32 / d2 Ø 28,8
01213600A, 0014601105, 0024600405,
0034603105, A0014601105, A0024600405



DB-DL-8188
Length: 895 Ø: 40
Cone Ø: d1 Ø 28,6 / d2 Ø 23,9
01217200A, 0024604905, 0024605005,
0034605605



DB-DL-8307
Length: 885 Ø: 38
Cone Ø: d1 Ø 32 / d2 Ø 30
01215500A, 0004604005, 0024605105,
0024605205, 0034604005



DB-DL-8327
Length: 1745 Ø: 48
Cone Ø: d1 Ø 32 / d2 Ø 29
01219800A, 9413300003, 9413300103,
9413300203, 9413300303, 9413300503



DB-DL-8390
Length: 1596 Ø: 50
Cone Ø: d1 Ø 32 / d2 Ø 29
9493301003, 9493301103, 9493301703



DB-DL-8622
Length: 1558 Ø: 52
Cone Ø: d1 Ø 30 / d2 Ø 27
0014609005, 0014609105



DB-DL-8640
Length: 1615 Ø: 50
Cone Ø: d1 Ø 32 / d2 Ø 29
6253301503, 6253301603, 6253302403,
6253302503, 9423300803, 9423302103,
9493300203, 9493300303, 9493300903



DB-DL-8641
Length: 905 Ø: 42
Cone Ø: d1 Ø 30 / d2 Ø 27
0014605105, 0014608105



DB-DL-8642
Length: 954 Ø: 42
Cone Ø: d1 Ø 30 / d2 Ø 27
0014608605, 0014608705



DB-DL-9218
Length: 754 Ø: 40
Hole Distance: 100
000360098524, 000390098524,
3753300111, 9413300011,
A3753300111, SA50831601



DB-DL-12298
Length: 927 Ø: 50
Cone Ø: d1 Ø 30 / d2 Ø 27
0024602405, 0024603005



DB-DL-12300
Length: 733 Ø: 36
Cone Ø: d1 Ø 32 / d2 Ø 29
0014601505, 0014607305, 0034603305,
3754601605, A0014601505,
A0034603305, A3754601605



DB-DL-12310
Length: 1532 Ø: 50
Cone Ø: d1 Ø 32 / d2 Ø 29
Thread: M27 x 1,5 LHT
9493301203, 9493301303, 9493301803,
9493302203, A9493301203, A9493301303,
A9493301803, A9493302203



DB-ES-5227
Length: 1588 Ø: 60
Cone Ø: d1 Ø 38 / d2 Ø 34,3
6253300903, 6253301203, 9443300203



DB-ES-8164
Length: 140
Cone Ø: d1 Ø 28,6 / d2 Ø 23,9
Thread: M28 x 1,5 RHT
0014604248, 0014605048, 0014608548,
0024600548



DB-ES-8387
Length: 55
Cone Ø: d1 Ø 10 / d2 Ø 10
Thread: M14 x 1,5 RHT
0009966845, 0009967045



DB-ES-8491
Length: 60
Cone Ø: d1 Ø 10 / d2 Ø 10
Thread: M12 x 1,75 LHT
0009966745



DB-ES-8492
Length: 60
Cone Ø: d1 Ø 10 / d2 Ø 10
Thread: M12 x 1,75 RHT
0009966645, 3752680189, A3752680189



DB-ES-8500
Length: 55
Cone Ø: d1 Ø 12 / d2 Ø 10,8
Thread: M14 x 1,5 RHT
0002685989



DB-ES-8510
Length: 56
Cone Ø: d1 Ø 10 / d2 Ø 10
Thread: M12 x 1,75 LHT
0009965145, 0009965645, 0019963145



DB-ES-8530
Length: 115
Cone Ø: d1 Ø 28,6 / d2 Ø 23,9
Thread: M30 x 1,5 RHT
0014603848, 0014604848, 0014605148,
0014608648, 0014609948



DB-RK-8550
Ø: 75 Hole Distance: 152
Thick/Height: 24
0003502105, 0003504605



DB-RK-8555
Ø: 67 Hole Distance: 130
Thick/Height: 24
01335600A, 0003502005, 0003504705



DB-RK-8626
Ø: 75 Hole Distance: 130
Thick/Height: 24
0003502205, 0003502505, 0003503405,
0003504505, GL11319



DB-RK-8638
Length: 100 Ø: 67
Hole Distance: 100
Thick/Height: 20
0003301411



DB-RK-9296
Ø: 88 Hole Distance: 130
Thick/Height: 24
9423260050



DB-RK-10374
Ø: 85 Hole Distance: 152
Thick/Height: 24
0003504405



DB-SB-5250
Ø: 66 Thick/Height: 56
01320400A, 0003262681, 0003263081,
0003263281



DB-SB-5260
Ø: 70 Thick/Height: 36,5 / 46
01320700A, 0003237485, 0003237585,
0003237985



DB-SB-5261
Length: 85 Ø: 82
Thick/Height: 56
01320600A, 0003264481, 0003264781



DB-SB-5277
Ø: 52
01320100A, 9413230350



DB-SB-5279
Ø: 42 Thick/Height: 55
0003263285, 0003237185



DB-SB-10384
Ø: 73 Thick/Height: 47
9303170012, 9423171812



DB-SB-10400
Length: 230
Thick/Height: 167,5 / 115
0003250696, 0003250896



DB-SB-10401
Length: 232
Thick/Height: 163,5 / 152,5
0003250596, 0003250796



DB-SB-10406
Ø: 80 Thick/Height: 46
0003238185



DB-SB-10407
Ø: 61 Thick/Height: 46
0003235985, 0003262481, 0003262981



DB-VB-3707
Length: 622 Ø: 46
Hole Ø 25 / 25 / 25
Hole Distance: 152 / 130 / 130
01337100A, 9423501005, 9423501505,
9443500005, 9473500105, 9473501005,
A3753500005, A9423501005, A9423501505,
A9443500005, A9473500105, A9473501005



DB-VB-7261
Length: 622 Ø: 46
Hole Ø 25 / 25 / 25
Hole Distance: 152 / 130 / 130
01337800A, 9443500305, 9443500505,
9443500605, 9473500705, 9473500905,
9483500405, 9483500505



DB-VB-7790
Length: 622 Ø: 46
Hole Ø 25 / 23 / 23
Hole Distance: 152 / 130 / 130
01337000A, 3753500105, 9423500105,
9423500705, 9423501105, 9423501605,
9443500205



MERCEDES-BENZ

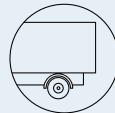

ACTROS ...

2557 L	09/96→10/02	Ball Head, gearshift linkage	DB-ES-8387		
	09/96→10/02	Ball Head, gearshift linkage	DB-ES-8491		
	09/96→10/02	Ball Head, gearshift linkage	DB-ES-8492		
	09/96→10/02	Ball Head, gearshift linkage	DB-ES-8500		
	09/96→10/02	Ball Head, gearshift linkage	DB-ES-8510		
	09/96→10/02	Bush, driver cab suspension	DB-SB-10384		
	09/96→10/02	Bush, parabolic spring		DB-SB-10400	
	09/96→10/02	Bush, parabolic spring		DB-SB-10401	
	09/96→10/02	Centre Rod	DB-DL-2144		Push Rod
	09/96→10/02	Centre Rod	DB-DL-5230		Push Rod, 1st FA;Leaf Spring Axle
	09/96→10/02	Centre Rod	DB-DL-5241		Push Rod
	09/96→10/02	Centre Rod	DB-DL-5405		Push Rod
	09/96→10/02	Centre Rod	DB-DL-7270		Push Rod
	09/96→10/02	Centre Rod	DB-DL-8167		Push Rod, 1st FA;Leaf Spring Axle
	09/96→10/02	Centre Rod	DB-DL-8168		Push Rod
	09/96→10/02	Centre Rod	DB-DL-8184		Push Rod
	09/96→10/02	Centre Rod	DB-DL-8185		Push Rod
	09/96→10/02	Centre Rod	DB-DL-8188		Push Rod
	09/96→10/02	Centre Rod	DB-DL-8307		Push Rod
	09/96→10/02	Centre Rod	DB-DL-8622		Push Rod
	09/96→10/02	Centre Rod	DB-DL-8641		Push Rod
	09/96→10/02	Centre Rod	DB-DL-8642		Push Rod
	09/96→10/02	Centre Rod	DB-DL-12298		for Steering Rod
	09/96→10/02	Centre Rod	DB-DL-12300		for Steering Rod
	09/96→10/02	Rod Assembly	DB-DL-2178		Guide Rod, 1st Front Axle, →504310 03
	09/96→10/02	Stabiliser Mounting		DB-RK-9296	
	09/96→10/02	Stabiliser Mounting		DB-SB-5250	
	09/96→10/02	Stabiliser Mounting		DB-SB-5261	
	09/96→10/02	Stabiliser Mounting		DB-SB-10406	
	09/96→10/02	Stabiliser Mounting		DB-SB-10407	
	09/96→10/02	Stabiliser Mounting	DB-SB-5260		
	09/96→10/02	Stabiliser Mounting	DB-SB-5277	DB-SB-5277	
	09/96→10/02	Stabiliser Mounting	DB-SB-5279		
	09/96→10/02	Suspension Arm Repair Kit		DB-RK-8550	for Wishbone (CV)
	09/96→10/02	Suspension Arm Repair Kit		DB-RK-8626	for Wishbone (CV)
	09/96→10/02	Suspension Arm Repair Kit		DB-RK-8638	for Control Arm
	09/96→10/02	Suspension Arm Repair Kit		DB-RK-10374	for Wishbone (CV)
	09/96→10/02	Suspension Strut Repair Kit		DB-RK-8555	
	09/96→10/02	Tie Rod		DB-DL-8390	Tag Axle
	09/96→10/02	Tie Rod	DB-DL-8327		Guide Rod
	09/96→10/02	Tie Rod	DB-DL-8640		Guide Rod
	09/96→10/02	Tie Rod	DB-DL-12310		
	09/96→10/02	Tie Rod	DB-ES-5227		Guide Rod
	09/96→10/02	Tie Rod End	CV-ES-0543		for Push Rod
	09/96→10/02	Tie Rod End	CV-ES-0888		for Push Rod
	09/96→10/02	Tie Rod End	CV-ES-14163		for Steering Rod
	09/96→10/02	Tie Rod End	DB-ES-8164		for Push Rod
	09/96→10/02	Tie Rod End	DB-ES-8530		for Push Rod
09/96→10/02	Track Control Arm		DB-DL-3475	Trailing Arm	
09/96→10/02	Track Control Arm		DB-VB-3707	Suspension Rod, Wishbone (CV), 1st RA; Air Suspension Axle, →* K 864073 *	
09/96→10/02	Track Control Arm		DB-VB-7790	Wishbone (CV), Tag Axle	
09/96→10/02	Track Control Arm	DB-DL-5224		Control Arm, 1st FA;Air Suspension Axle	
09/96→10/02	Track Control Arm	DB-DL-9218	DB-DL-9218	Trailing Arm, 1st FA;Air Suspension Axle	
2631 B	04/97→10/02	Ball Head, gearshift linkage	DB-ES-8387		
	04/97→10/02	Ball Head, gearshift linkage	DB-ES-8491		
	04/97→10/02	Ball Head, gearshift linkage	DB-ES-8492		
	04/97→10/02	Ball Head, gearshift linkage	DB-ES-8500		
	04/97→10/02	Ball Head, gearshift linkage	DB-ES-8510		
	04/97→10/02	Bush, driver cab suspension	DB-SB-10384		
	04/97→10/02	Bush, parabolic spring		DB-SB-10400	
	04/97→10/02	Bush, parabolic spring		DB-SB-10401	
	04/97→10/02	Centre Rod	DB-DL-2144		Push Rod



ACTROS ...

2631 B ...	04/97→10/02	Centre Rod	DB-DL-5230		Push Rod, Leaf Spring Axle	
	04/97→10/02	Centre Rod	DB-DL-5241		Push Rod	
	04/97→10/02	Centre Rod	DB-DL-5405		Push Rod, Leaf Spring Axle	
	04/97→10/02	Centre Rod	DB-DL-7270		Push Rod	
	04/97→10/02	Centre Rod	DB-DL-8167		Push Rod, 1st FA;Leaf Spring Axle	
	04/97→10/02	Centre Rod	DB-DL-8184		Push Rod	
	04/97→10/02	Centre Rod	DB-DL-8185		Push Rod	
	04/97→10/02	Centre Rod	DB-DL-8188		Push Rod	
	04/97→10/02	Centre Rod	DB-DL-8307		Push Rod	
	04/97→10/02	Centre Rod	DB-DL-12300		for Steering Rod	
	04/97→10/02	Rod Assembly	DB-DL-2178		Guide Rod	
	04/97→10/02	Stabiliser Link	DB-DL-9254		Pressure Rod	
	04/97→10/02	Stabiliser Mounting		DB-SB-5261		
	04/97→10/02	Stabiliser Mounting		DB-SB-10406		
	04/97→10/02	Stabiliser Mounting		DB-SB-10407		
	04/97→10/02	Stabiliser Mounting		DB-SB-10409		
	04/97→10/02	Stabiliser Mounting	DB-SB-5250			
	04/97→10/02	Stabiliser Mounting	DB-SB-5260			
	04/97→10/02	Stabiliser Mounting	DB-SB-5279			
	04/97→10/02	Suspension Arm Repair Kit		DB-RK-8550	for Wishbone (CV)	
	04/97→10/02	Suspension Arm Repair Kit		DB-RK-8626	for Wishbone (CV)	
	04/97→10/02	Suspension Arm Repair Kit		DB-RK-10374	for Wishbone (CV)	
	04/97→10/02	Suspension Arm Repair Kit		DB-RK-10375	for Wishbone (CV)	
	04/97→10/02	Suspension Arm Repair Kit	DB-RK-8638		for Control Arm	
	04/97→10/02	Suspension Strut Repair Kit		DB-RK-8391		
	04/97→10/02	Suspension Strut Repair Kit		DB-RK-9294		
	04/97→10/02	Tie Rod	DB-DL-8327		Guide Rod	
	04/97→10/02	Tie Rod	DB-DL-8640		Guide Rod	
	04/97→10/02	Tie Rod	DB-DL-12310			
	04/97→10/02	Tie Rod End	CV-ES-0543		for Push Rod	
	04/97→10/02	Tie Rod End	CV-ES-0888		for Push Rod	
	04/97→10/02	Tie Rod End	CV-ES-14162		for Steering Rod	
	04/97→10/02	Tie Rod End	CV-ES-14163		for Steering Rod	
	04/97→10/02	Tie Rod End	DB-ES-5234		for Steering Rod	
	04/97→10/02	Tie Rod End	DB-ES-8164		for Push Rod	
	04/97→10/02	Tie Rod End	DB-ES-8530		for Push Rod	
	04/97→10/02	Track Control Arm		DB-DL-3475	Trailing Arm	
	04/97→10/02	Track Control Arm		DB-VB-3707	Suspension Rod, Wishbone (CV)	
	04/97→10/02	Track Control Arm		DB-VB-7261	Suspension Rod, Wishbone (CV), 1st RA;2nd RA; Leaf Spring Axle	
	04/97→10/02	Track Control Arm	DB-DL-5224		Control Arm	
	04/97→10/02	Track Control Arm	DB-DL-9218	DB-DL-9218	Trailing Arm	
	2631 K	04/97→10/02	Ball Head, gearshift linkage	DB-ES-8387		
		04/97→10/02	Ball Head, gearshift linkage	DB-ES-8491		
04/97→10/02		Ball Head, gearshift linkage	DB-ES-8492			
04/97→10/02		Ball Head, gearshift linkage	DB-ES-8500			
04/97→10/02		Ball Head, gearshift linkage	DB-ES-8510			
04/97→10/02		Bush, driver cab suspension	DB-SB-10384			
04/97→10/02		Bush, parabolic spring		DB-SB-10400		
04/97→10/02		Bush, parabolic spring		DB-SB-10401		
04/97→10/02		Centre Rod	DB-DL-2144		Push Rod	
04/97→10/02		Centre Rod	DB-DL-5230		Push Rod, 1st FA;Leaf Spring Axle	
04/97→10/02		Centre Rod	DB-DL-5241		Push Rod	
04/97→10/02		Centre Rod	DB-DL-5405		Push Rod, 1st FA;Leaf Spring Axle	
04/97→10/02		Centre Rod	DB-DL-7270		Push Rod	
04/97→10/02		Centre Rod	DB-DL-8167		Push Rod, 1st FA;Leaf Spring Axle	
04/97→10/02		Centre Rod	DB-DL-8184		Push Rod	
04/97→10/02		Centre Rod	DB-DL-8185		Push Rod	
04/97→10/02		Centre Rod	DB-DL-8188		Push Rod	
04/97→10/02		Centre Rod	DB-DL-8307		Push Rod	
04/97→10/02		Centre Rod	DB-DL-12300		for Steering Rod	
04/97→10/02		Rod Assembly	DB-DL-2178		Guide Rod	
04/97→10/02		Stabiliser Link	DB-DL-9254		Pressure Rod	



ACTROS ...

2631 K ...	04/97→10/02	Stabiliser Mounting		DB-RK-9296		
	04/97→10/02	Stabiliser Mounting		DB-SB-5261		
	04/97→10/02	Stabiliser Mounting		DB-SB-10406		
	04/97→10/02	Stabiliser Mounting		DB-SB-10407		
	04/97→10/02	Stabiliser Mounting		DB-SB-10409		
	04/97→10/02	Stabiliser Mounting	DB-SB-5260			
	04/97→10/02	Stabiliser Mounting	DB-SB-5279			
	04/97→10/02	Suspension Arm Repair Kit		DB-RK-8550	for Wishbone (CV)	
	04/97→10/02	Suspension Arm Repair Kit		DB-RK-8626	for Wishbone (CV)	
	04/97→10/02	Suspension Arm Repair Kit		DB-RK-10374	for Wishbone (CV)	
	04/97→10/02	Suspension Arm Repair Kit		DB-RK-10375	for Wishbone (CV)	
	04/97→10/02	Suspension Arm Repair Kit	DB-RK-8638		for Control Arm	
	04/97→10/02	Suspension Strut Repair Kit		DB-RK-8391		
	04/97→10/02	Suspension Strut Repair Kit		DB-RK-9294		
	04/97→10/02	Tie Rod	DB-DL-8171		Guide Rod	
	04/97→10/02	Tie Rod	DB-DL-8327		Guide Rod	
	04/97→10/02	Tie Rod	DB-DL-8640		Guide Rod	
	04/97→10/02	Tie Rod	DB-DL-12310			
	04/97→10/02	Tie Rod	DB-ES-5227		Guide Rod	
	04/97→10/02	Tie Rod End	CV-ES-0543		for Push Rod	
	04/97→10/02	Tie Rod End	CV-ES-0888		for Push Rod	
	04/97→10/02	Tie Rod End	CV-ES-14162		for Steering Rod	
	04/97→10/02	Tie Rod End	CV-ES-14163		for Steering Rod	
	04/97→10/02	Tie Rod End	DB-ES-5234		for Steering Rod	
	04/97→10/02	Tie Rod End	DB-ES-8164		for Push Rod	
	04/97→10/02	Tie Rod End	DB-ES-8530		for Push Rod	
	04/97→10/02	Track Control Arm		DB-DL-3475	Trailing Arm	
	04/97→10/02	Track Control Arm		DB-VB-3707	Suspension Rod, Wishbone (CV)	
	04/97→10/02	Track Control Arm		DB-VB-7261	Suspension Rod, Wishbone (CV), 1st RA;2nd RA; Leaf Spring Axle	
	04/97→10/02	Track Control Arm	DB-DL-5224		Control Arm	
	04/97→10/02	Track Control Arm	DB-DL-9218	DB-DL-9218	Trailing Arm	
	2631, 2631 L	04/96→10/02	Ball Head, gearshift linkage	DB-ES-8387		
		04/96→10/02	Ball Head, gearshift linkage	DB-ES-8491		
04/96→10/02		Ball Head, gearshift linkage	DB-ES-8492			
04/96→10/02		Ball Head, gearshift linkage	DB-ES-8500			
04/96→10/02		Ball Head, gearshift linkage	DB-ES-8510			
04/96→10/02		Bush, driver cab suspension	DB-SB-10384			
04/96→10/02		Bush, parabolic spring		DB-SB-10400		
04/96→10/02		Bush, parabolic spring		DB-SB-10401		
04/96→10/02		Centre Rod	DB-DL-2144		Push Rod	
04/96→10/02		Centre Rod	DB-DL-5230		Push Rod	
04/96→10/02		Centre Rod	DB-DL-5230		Push Rod, 1st FA;Leaf Spring Axle	
04/96→10/02		Centre Rod	DB-DL-5230		Push Rod, Leaf Spring Axle	
04/96→10/02		Centre Rod	DB-DL-5241		Push Rod	
04/96→10/02		Centre Rod	DB-DL-5405		Push Rod	
04/96→10/02		Centre Rod	DB-DL-5405		Push Rod, 1st FA;Leaf Spring Axle	
04/96→10/02		Centre Rod	DB-DL-7270		Push Rod	
04/96→10/02		Centre Rod	DB-DL-8167		Push Rod, 1st FA;Leaf Spring Axle	
04/96→10/02		Centre Rod	DB-DL-8168		Push Rod	
04/96→10/02		Centre Rod	DB-DL-8184		Push Rod	
04/96→10/02		Centre Rod	DB-DL-8185		Push Rod	
04/96→10/02		Centre Rod	DB-DL-8188		Push Rod	
04/96→10/02		Centre Rod	DB-DL-8307		Push Rod	
04/96→10/02		Centre Rod	DB-DL-8622		Push Rod	
04/96→10/02		Centre Rod	DB-DL-8641		Push Rod	
04/96→10/02		Centre Rod	DB-DL-8642		Push Rod	
04/96→10/02		Centre Rod	DB-DL-12298		for Steering Rod	
04/96→10/02		Centre Rod	DB-DL-12300		for Steering Rod	
04/96→10/02		Rod Assembly	DB-DL-2178		Guide Rod	
04/96→10/02		Stabiliser Mounting		DB-SB-5250		
04/96→10/02		Stabiliser Mounting		DB-SB-5261		
04/96→10/02		Stabiliser Mounting		DB-SB-10406		



ACTROS ...

2631, 2631 L ...	04/96→10/02	Stabiliser Mounting		DB-SB-10407		
	04/96→10/02	Stabiliser Mounting	DB-SB-5260			
	04/96→10/02	Stabiliser Mounting	DB-SB-5277	DB-SB-5277		
	04/96→10/02	Stabiliser Mounting	DB-SB-5279			
	04/96→10/02	Suspension Arm Repair Kit		DB-RK-8550	for Wishbone (CV)	
	04/96→10/02	Suspension Arm Repair Kit		DB-RK-8626	for Wishbone (CV)	
	04/96→10/02	Suspension Arm Repair Kit		DB-RK-8638	for Control Arm	
	04/96→10/02	Suspension Arm Repair Kit		DB-RK-10374	for Wishbone (CV)	
	04/96→10/02	Suspension Strut Repair Kit		DB-RK-9294		
	04/96→10/02	Tie Rod	DB-DL-8327		Guide Rod	
	04/96→10/02	Tie Rod	DB-DL-8640		Guide Rod	
	04/96→10/02	Tie Rod	DB-DL-12310			
	04/96→10/02	Tie Rod	DB-ES-5227		Guide Rod	
	04/96→10/02	Tie Rod End	CV-ES-0543		for Push Rod	
	04/96→10/02	Tie Rod End	CV-ES-0888		for Push Rod	
	04/96→10/02	Tie Rod End	CV-ES-14162		for Steering Rod	
	04/96→10/02	Tie Rod End	CV-ES-14163		for Steering Rod	
	04/96→10/02	Tie Rod End	DB-ES-8164		for Push Rod	
	04/96→10/02	Tie Rod End	DB-ES-8530		for Push Rod	
	04/96→10/02	Track Control Arm		DB-DL-3475	Trailing Arm	
	04/96→10/02	Track Control Arm		DB-VB-3707	Suspension Rod, Wishbone (CV), 1st RA; Air Suspension Axle, →* K 864073 *	
	04/96→10/02	Track Control Arm		DB-VB-7261	Suspension Rod, Wishbone (CV), 1st RA;2nd RA; Leaf Spring Axle	
	04/96→10/02	Track Control Arm	DB-DL-5224		Control Arm, 1st FA;Air Suspension Axle	
	04/96→10/02	Track Control Arm	DB-DL-9218	DB-DL-9218	Trailing Arm, 1st FA;Air Suspension Axle	
	2635 B	04/97→10/02	Ball Head, gearshift linkage	DB-ES-8387		
		04/97→10/02	Ball Head, gearshift linkage	DB-ES-8491		
		04/97→10/02	Ball Head, gearshift linkage	DB-ES-8492		
		04/97→10/02	Ball Head, gearshift linkage	DB-ES-8500		
		04/97→10/02	Ball Head, gearshift linkage	DB-ES-8510		
		04/97→10/02	Bush, driver cab suspension	DB-SB-10384		
04/97→10/02		Bush, parabolic spring		DB-SB-10400		
04/97→10/02		Bush, parabolic spring		DB-SB-10401		
04/97→10/02		Centre Rod	DB-DL-2144		Push Rod	
04/97→10/02		Centre Rod	DB-DL-5230		Push Rod, Leaf Spring Axle	
04/97→10/02		Centre Rod	DB-DL-5241		Push Rod	
04/97→10/02		Centre Rod	DB-DL-5405		Push Rod, Leaf Spring Axle	
04/97→10/02		Centre Rod	DB-DL-7270		Push Rod	
04/97→10/02		Centre Rod	DB-DL-8167		Push Rod, 1st FA;Leaf Spring Axle	
04/97→10/02		Centre Rod	DB-DL-8184		Push Rod	
04/97→10/02		Centre Rod	DB-DL-8185		Push Rod	
04/97→10/02		Centre Rod	DB-DL-8188		Push Rod	
04/97→10/02		Centre Rod	DB-DL-8307		Push Rod	
04/97→10/02		Centre Rod	DB-DL-12300		for Steering Rod	
04/97→10/02		Rod Assembly	DB-DL-2178		Guide Rod	
04/97→10/02		Stabiliser Link	DB-DL-9254		Pressure Rod	
04/97→10/02		Stabiliser Mounting		DB-SB-5261		
04/97→10/02		Stabiliser Mounting		DB-SB-10406		
04/97→10/02		Stabiliser Mounting		DB-SB-10407		
04/97→10/02		Stabiliser Mounting		DB-SB-10409		
04/97→10/02		Stabiliser Mounting	DB-SB-5250			
04/97→10/02		Stabiliser Mounting	DB-SB-5260			
04/97→10/02		Stabiliser Mounting	DB-SB-5279			
04/97→10/02		Suspension Arm Repair Kit		DB-RK-8550	for Wishbone (CV)	
04/97→10/02		Suspension Arm Repair Kit		DB-RK-8626	for Wishbone (CV)	
04/97→10/02	Suspension Arm Repair Kit		DB-RK-10374	for Wishbone (CV)		
04/97→10/02	Suspension Arm Repair Kit		DB-RK-10375	for Wishbone (CV)		
04/97→10/02	Suspension Arm Repair Kit	DB-RK-8638		for Control Arm		
04/97→10/02	Suspension Strut Repair Kit		DB-RK-8391			
04/97→10/02	Suspension Strut Repair Kit		DB-RK-9294			
04/97→10/02	Tie Rod	DB-DL-8327		Guide Rod		
04/97→10/02	Tie Rod	DB-DL-8640		Guide Rod		

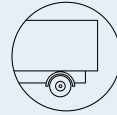
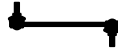

ACTROS ...

2635 B ...	04/97→10/02	Tie Rod	DB-DL-12310		
	04/97→10/02	Tie Rod End	CV-ES-0543		for Push Rod
	04/97→10/02	Tie Rod End	CV-ES-0888		for Push Rod
	04/97→10/02	Tie Rod End	CV-ES-14162		for Steering Rod
	04/97→10/02	Tie Rod End	CV-ES-14163		for Steering Rod
	04/97→10/02	Tie Rod End	DB-ES-5234		for Steering Rod
	04/97→10/02	Tie Rod End	DB-ES-8164		for Push Rod
	04/97→10/02	Tie Rod End	DB-ES-8530		for Push Rod
	04/97→10/02	Track Control Arm		DB-DL-3475	Trailing Arm
	04/97→10/02	Track Control Arm		DB-VB-3707	Suspension Rod, Wishbone (CV)
2635 K, 2635 LK	04/97→10/02	Track Control Arm		DB-VB-7261	Suspension Rod, Wishbone (CV), 1st RA;2nd RA; Leaf Spring Axle
	04/97→10/02	Track Control Arm	DB-DL-5224		Control Arm
	04/97→10/02	Track Control Arm	DB-DL-9218	DB-DL-9218	Trailing Arm
	04/97→10/02	Ball Head, gearshift linkage	DB-ES-8387		
	04/97→10/02	Ball Head, gearshift linkage	DB-ES-8491		
	04/97→10/02	Ball Head, gearshift linkage	DB-ES-8492		
	04/97→10/02	Ball Head, gearshift linkage	DB-ES-8500		
	04/97→10/02	Ball Head, gearshift linkage	DB-ES-8510		
	04/97→10/02	Bush, driver cab suspension	DB-SB-10384		
	04/97→10/02	Bush, parabolic spring		DB-SB-10400	
	04/97→10/02	Bush, parabolic spring		DB-SB-10401	
	04/97→10/02	Centre Rod	DB-DL-2144		Push Rod
	04/97→10/02	Centre Rod	DB-DL-5230		Push Rod, 1st FA;Leaf Spring Axle
	04/97→10/02	Centre Rod	DB-DL-5241		Push Rod
	04/97→10/02	Centre Rod	DB-DL-5405		Push Rod, 1st FA;Leaf Spring Axle
	04/97→10/02	Centre Rod	DB-DL-7270		Push Rod
	04/97→10/02	Centre Rod	DB-DL-8167		Push Rod, 1st FA;Leaf Spring Axle
	04/97→10/02	Centre Rod	DB-DL-8184		Push Rod
	04/97→10/02	Centre Rod	DB-DL-8185		Push Rod
	04/97→10/02	Centre Rod	DB-DL-8188		Push Rod
	04/97→10/02	Centre Rod	DB-DL-8307		Push Rod
	04/97→10/02	Centre Rod	DB-DL-12300		for Steering Rod
	04/97→10/02	Rod Assembly	DB-DL-2178		Guide Rod
	04/97→10/02	Stabiliser Link	DB-DL-9254		Pressure Rod
	04/97→10/02	Stabiliser Mounting		DB-RK-9296	
	04/97→10/02	Stabiliser Mounting		DB-SB-5261	
	04/97→10/02	Stabiliser Mounting		DB-SB-10406	
	04/97→10/02	Stabiliser Mounting		DB-SB-10407	
	04/97→10/02	Stabiliser Mounting		DB-SB-10409	
	04/97→10/02	Stabiliser Mounting	DB-SB-5260		
04/97→10/02	Stabiliser Mounting	DB-SB-5279			
04/97→10/02	Suspension Arm Repair Kit		DB-RK-8550	for Wishbone (CV)	
04/97→10/02	Suspension Arm Repair Kit		DB-RK-8626	for Wishbone (CV)	
04/97→10/02	Suspension Arm Repair Kit		DB-RK-10374	for Wishbone (CV)	
04/97→10/02	Suspension Arm Repair Kit		DB-RK-10375	for Wishbone (CV)	
04/97→10/02	Suspension Arm Repair Kit	DB-RK-8638		for Control Arm	
04/97→10/02	Suspension Strut Repair Kit		DB-RK-8391		
04/97→10/02	Suspension Strut Repair Kit		DB-RK-9294		
04/97→10/02	Tie Rod	DB-DL-8171		Guide Rod	
04/97→10/02	Tie Rod	DB-DL-8327		Guide Rod	
04/97→10/02	Tie Rod	DB-DL-8640		Guide Rod	
04/97→10/02	Tie Rod	DB-DL-12310			
04/97→10/02	Tie Rod	DB-ES-5227		Guide Rod	
04/97→10/02	Tie Rod End	CV-ES-0543		for Push Rod	
04/97→10/02	Tie Rod End	CV-ES-0888		for Push Rod	
04/97→10/02	Tie Rod End	CV-ES-14162		for Steering Rod	
04/97→10/02	Tie Rod End	CV-ES-14163		for Steering Rod	
04/97→10/02	Tie Rod End	DB-ES-5234		for Steering Rod	
04/97→10/02	Tie Rod End	DB-ES-8164		for Push Rod	
04/97→10/02	Tie Rod End	DB-ES-8530		for Push Rod	
04/97→10/02	Track Control Arm		DB-DL-3475	Trailing Arm	
04/97→10/02	Track Control Arm		DB-VB-3707	Suspension Rod, Wishbone (CV)	



ACTROS ...

2635 K, 2635 LK ...	04/97→10/02	Track Control Arm		DB-VB-7261	Suspension Rod, Wishbone (CV), 1st RA;2nd RA; Leaf Spring Axle
	04/97→10/02	Track Control Arm	DB-DL-5224		Control Arm
	04/97→10/02	Track Control Arm	DB-DL-9218	DB-DL-9218	Trailing Arm
2635, 2635 L	04/96→10/02	Ball Head, gearshift linkage	DB-ES-8387		
	04/96→10/02	Ball Head, gearshift linkage	DB-ES-8491		
	04/96→10/02	Ball Head, gearshift linkage	DB-ES-8492		
	04/96→10/02	Ball Head, gearshift linkage	DB-ES-8500		
	04/96→10/02	Ball Head, gearshift linkage	DB-ES-8510		
	04/96→10/02	Bush, driver cab suspension	DB-SB-10384		
	04/96→10/02	Bush, parabolic spring		DB-SB-10400	
	04/96→10/02	Bush, parabolic spring		DB-SB-10401	
	04/96→10/02	Centre Rod	DB-DL-2144		Push Rod
	04/96→10/02	Centre Rod	DB-DL-5230		Push Rod, 1st FA;Leaf Spring Axle
	04/96→10/02	Centre Rod	DB-DL-5241		Push Rod
	04/96→10/02	Centre Rod	DB-DL-5405		Push Rod
	04/96→10/02	Centre Rod	DB-DL-5405		Push Rod, 1st FA;Leaf Spring Axle
	04/96→10/02	Centre Rod	DB-DL-7270		Push Rod
	04/96→10/02	Centre Rod	DB-DL-8167		Push Rod, 1st FA;Leaf Spring Axle
	04/96→10/02	Centre Rod	DB-DL-8168		Push Rod
	04/96→10/02	Centre Rod	DB-DL-8184		Push Rod
	04/96→10/02	Centre Rod	DB-DL-8185		Push Rod
	04/96→10/02	Centre Rod	DB-DL-8188		Push Rod
	04/96→10/02	Centre Rod	DB-DL-8307		Push Rod
	04/96→10/02	Centre Rod	DB-DL-8622		Push Rod
	04/96→10/02	Centre Rod	DB-DL-8641		Push Rod
	04/96→10/02	Centre Rod	DB-DL-8642		Push Rod
	04/96→10/02	Centre Rod	DB-DL-12298		for Steering Rod
	04/96→10/02	Centre Rod	DB-DL-12300		for Steering Rod
	04/96→10/02	Rod Assembly	DB-DL-2178		Guide Rod
	04/96→10/02	Stabiliser Mounting		DB-SB-5250	
	04/96→10/02	Stabiliser Mounting		DB-SB-5261	
	04/96→10/02	Stabiliser Mounting		DB-SB-10406	
	04/96→10/02	Stabiliser Mounting		DB-SB-10407	
	04/96→10/02	Stabiliser Mounting	DB-SB-5260		
	04/96→10/02	Stabiliser Mounting	DB-SB-5277	DB-SB-5277	
	04/96→10/02	Stabiliser Mounting	DB-SB-5279		
	04/96→10/02	Suspension Arm Repair Kit		DB-RK-8550	for Wishbone (CV)
	04/96→10/02	Suspension Arm Repair Kit		DB-RK-8626	for Wishbone (CV)
	04/96→10/02	Suspension Arm Repair Kit		DB-RK-8638	for Control Arm
	04/96→10/02	Suspension Arm Repair Kit		DB-RK-10374	for Wishbone (CV)
	04/96→10/02	Suspension Strut Repair Kit		DB-RK-9294	
	04/96→10/02	Tie Rod	DB-DL-8327		Guide Rod
	04/96→10/02	Tie Rod	DB-DL-8640		Guide Rod
	04/96→10/02	Tie Rod	DB-DL-12310		
	04/96→10/02	Tie Rod	DB-ES-5227		Guide Rod
	04/96→10/02	Tie Rod End	CV-ES-0543		for Push Rod
	04/96→10/02	Tie Rod End	CV-ES-0888		for Push Rod
	04/96→10/02	Tie Rod End	CV-ES-14162		for Steering Rod
	04/96→10/02	Tie Rod End	CV-ES-14163		for Steering Rod
	04/96→10/02	Tie Rod End	DB-ES-8164		for Push Rod
	04/96→10/02	Tie Rod End	DB-ES-8530		for Push Rod
	04/96→10/02	Track Control Arm		DB-DL-3475	Trailing Arm
	04/96→10/02	Track Control Arm		DB-VB-3707	Suspension Rod, Wishbone (CV), 1st RA; Air Suspension Axle, →* K 864073 *
	04/96→10/02	Track Control Arm		DB-VB-7261	Suspension Rod, Wishbone (CV), 1st RA;2nd RA; Leaf Spring Axle
	04/96→10/02	Track Control Arm	DB-DL-5224		Control Arm, 1st FA;Air Suspension Axle
	04/96→10/02	Track Control Arm	DB-DL-9218	DB-DL-9218	Trailing Arm, 1st FA;Air Suspension Axle

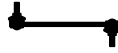

ACTROS ...

2640 B	04/97→10/02	Ball Head, gearshift linkage	DB-ES-8387		
	04/97→10/02	Ball Head, gearshift linkage	DB-ES-8491		
	04/97→10/02	Ball Head, gearshift linkage	DB-ES-8492		
	04/97→10/02	Ball Head, gearshift linkage	DB-ES-8500		
	04/97→10/02	Ball Head, gearshift linkage	DB-ES-8510		
	04/97→10/02	Bush, driver cab suspension	DB-SB-10384		
	04/97→10/02	Bush, parabolic spring		DB-SB-10400	
	04/97→10/02	Bush, parabolic spring		DB-SB-10401	
	04/97→10/02	Centre Rod	DB-DL-2144		Push Rod
	04/97→10/02	Centre Rod	DB-DL-5230		Push Rod, Leaf Spring Axle
	04/97→10/02	Centre Rod	DB-DL-5241		Push Rod
	04/97→10/02	Centre Rod	DB-DL-5405		Push Rod, Leaf Spring Axle
	04/97→10/02	Centre Rod	DB-DL-7270		Push Rod
	04/97→10/02	Centre Rod	DB-DL-8167		Push Rod, 1st FA;Leaf Spring Axle
	04/97→10/02	Centre Rod	DB-DL-8184		Push Rod
	04/97→10/02	Centre Rod	DB-DL-8185		Push Rod
	04/97→10/02	Centre Rod	DB-DL-8188		Push Rod
	04/97→10/02	Centre Rod	DB-DL-8307		Push Rod
	04/97→10/02	Centre Rod	DB-DL-12300		for Steering Rod
	04/97→10/02	Rod Assembly	DB-DL-2178		Guide Rod
	04/97→10/02	Stabiliser Link	DB-DL-9254		Pressure Rod
	04/97→10/02	Stabiliser Mounting		DB-SB-5261	
	04/97→10/02	Stabiliser Mounting		DB-SB-10406	
	04/97→10/02	Stabiliser Mounting		DB-SB-10407	
	04/97→10/02	Stabiliser Mounting		DB-SB-10409	
	04/97→10/02	Stabiliser Mounting	DB-SB-5250		
	04/97→10/02	Stabiliser Mounting	DB-SB-5260		
	04/97→10/02	Stabiliser Mounting	DB-SB-5279		
	04/97→10/02	Suspension Arm Repair Kit		DB-RK-8550	for Wishbone (CV)
	04/97→10/02	Suspension Arm Repair Kit		DB-RK-8626	for Wishbone (CV)
	04/97→10/02	Suspension Arm Repair Kit		DB-RK-10374	for Wishbone (CV)
	04/97→10/02	Suspension Arm Repair Kit		DB-RK-10375	for Wishbone (CV)
	04/97→10/02	Suspension Arm Repair Kit	DB-RK-8638		for Control Arm
	04/97→10/02	Suspension Strut Repair Kit		DB-RK-8391	
	04/97→10/02	Suspension Strut Repair Kit		DB-RK-9294	
	04/97→10/02	Tie Rod	DB-DL-8327		Guide Rod
	04/97→10/02	Tie Rod	DB-DL-8640		Guide Rod
	04/97→10/02	Tie Rod	DB-DL-12310		
	04/97→10/02	Tie Rod End	CV-ES-0543		for Push Rod
	04/97→10/02	Tie Rod End	CV-ES-0888		for Push Rod
	04/97→10/02	Tie Rod End	CV-ES-14162		for Steering Rod
	04/97→10/02	Tie Rod End	CV-ES-14163		for Steering Rod
	04/97→10/02	Tie Rod End	DB-ES-5234		for Steering Rod
	04/97→10/02	Tie Rod End	DB-ES-8164		for Push Rod
	04/97→10/02	Tie Rod End	DB-ES-8530		for Push Rod
	04/97→10/02	Track Control Arm		DB-DL-3475	Trailing Arm
	04/97→10/02	Track Control Arm		DB-VB-3707	Suspension Rod, Wishbone (CV)
04/97→10/02	Track Control Arm		DB-VB-7261	Suspension Rod, Wishbone (CV), 1st RA;2nd RA; Leaf Spring Axle	
04/97→10/02	Track Control Arm	DB-DL-5224		Control Arm	
04/97→10/02	Track Control Arm	DB-DL-9218	DB-DL-9218	Trailing Arm	
2640 K, 2640 LK	04/97→10/02	Ball Head, gearshift linkage	DB-ES-8387		
	04/97→10/02	Ball Head, gearshift linkage	DB-ES-8491		
	04/97→10/02	Ball Head, gearshift linkage	DB-ES-8492		
	04/97→10/02	Ball Head, gearshift linkage	DB-ES-8500		
	04/97→10/02	Ball Head, gearshift linkage	DB-ES-8510		
	04/97→10/02	Bush, driver cab suspension	DB-SB-10384		
	04/97→10/02	Bush, parabolic spring		DB-SB-10400	
	04/97→10/02	Bush, parabolic spring		DB-SB-10401	
	04/97→10/02	Centre Rod	DB-DL-2144		Push Rod
	04/97→10/02	Centre Rod	DB-DL-5230		Push Rod, 1st FA;Leaf Spring Axle
04/97→10/02	Centre Rod	DB-DL-5241		Push Rod	
04/97→10/02	Centre Rod	DB-DL-5405		Push Rod	

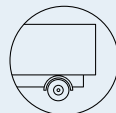

ACTROS ...

2640 K, 2640 LK ...

04/97→10/02	Centre Rod	DB-DL-5405		Push Rod, 1st FA;Leaf Spring Axle
04/97→10/02	Centre Rod	DB-DL-7270		Push Rod
04/97→10/02	Centre Rod	DB-DL-8167		Push Rod, 1st FA;Air Suspension Axle
04/97→10/02	Centre Rod	DB-DL-8167		Push Rod, 1st FA;Leaf Spring Axle
04/97→10/02	Centre Rod	DB-DL-8184		Push Rod
04/97→10/02	Centre Rod	DB-DL-8185		Push Rod
04/97→10/02	Centre Rod	DB-DL-8188		Push Rod
04/97→10/02	Centre Rod	DB-DL-8307		Push Rod
04/97→10/02	Centre Rod	DB-DL-12300		for Steering Rod
04/97→10/02	Rod Assembly	DB-DL-2178		Guide Rod
04/97→10/02	Stabiliser Link	DB-DL-9254		Pressure Rod
04/97→10/02	Stabiliser Mounting		DB-RK-9296	
04/97→10/02	Stabiliser Mounting		DB-SB-5261	
04/97→10/02	Stabiliser Mounting		DB-SB-10406	
04/97→10/02	Stabiliser Mounting		DB-SB-10407	
04/97→10/02	Stabiliser Mounting		DB-SB-10409	
04/97→10/02	Stabiliser Mounting	DB-SB-5260		
04/97→10/02	Stabiliser Mounting	DB-SB-5279		
04/97→10/02	Suspension Arm Repair Kit		DB-RK-8550	for Wishbone (CV)
04/97→10/02	Suspension Arm Repair Kit		DB-RK-8626	for Wishbone (CV)
04/97→10/02	Suspension Arm Repair Kit		DB-RK-10374	for Wishbone (CV)
04/97→10/02	Suspension Arm Repair Kit		DB-RK-10375	for Wishbone (CV)
04/97→10/02	Suspension Arm Repair Kit	DB-RK-8638		for Control Arm
04/97→10/02	Suspension Strut Repair Kit		DB-RK-8391	
04/97→10/02	Suspension Strut Repair Kit		DB-RK-9294	
04/97→10/02	Tie Rod	DB-DL-8171		Guide Rod
04/97→10/02	Tie Rod	DB-DL-8327		Guide Rod
04/97→10/02	Tie Rod	DB-DL-8640		Guide Rod
04/97→10/02	Tie Rod	DB-DL-12310		
04/97→10/02	Tie Rod	DB-ES-5227		Guide Rod
04/97→10/02	Tie Rod End	CV-ES-0543		for Push Rod
04/97→10/02	Tie Rod End	CV-ES-0888		for Push Rod
04/97→10/02	Tie Rod End	CV-ES-14162		for Steering Rod
04/97→10/02	Tie Rod End	CV-ES-14163		for Steering Rod
04/97→10/02	Tie Rod End	DB-ES-5234		for Steering Rod
04/97→10/02	Tie Rod End	DB-ES-8164		for Push Rod
04/97→10/02	Tie Rod End	DB-ES-8530		for Push Rod
04/97→10/02	Track Control Arm		DB-DL-3475	Trailing Arm
04/97→10/02	Track Control Arm		DB-VB-3707	Suspension Rod, Wishbone (CV), 1st RA; Air Suspension Axle, →* K 864073 *
04/97→10/02	Track Control Arm		DB-VB-7261	Suspension Rod, Wishbone (CV), 1st RA;2nd RA; Leaf Spring Axle
04/97→10/02	Track Control Arm	DB-DL-5224		Control Arm
04/97→10/02	Track Control Arm	DB-DL-9218	DB-DL-9218	Trailing Arm
09/96→10/02	Ball Head, gearshift linkage	DB-ES-8387		
09/96→10/02	Ball Head, gearshift linkage	DB-ES-8491		
09/96→10/02	Ball Head, gearshift linkage	DB-ES-8492		
09/96→10/02	Ball Head, gearshift linkage	DB-ES-8500		
09/96→10/02	Ball Head, gearshift linkage	DB-ES-8510		
09/96→10/02	Bush, driver cab suspension	DB-SB-10384		
09/96→10/02	Bush, parabolic spring		DB-SB-10400	
09/96→10/02	Bush, parabolic spring		DB-SB-10401	
09/96→10/02	Centre Rod	DB-DL-2144		Push Rod
09/96→10/02	Centre Rod	DB-DL-5230		Push Rod
09/96→10/02	Centre Rod	DB-DL-5241		Push Rod
09/96→10/02	Centre Rod	DB-DL-5405		Push Rod
09/96→10/02	Centre Rod	DB-DL-5405		Push Rod, Leaf Spring Axle
09/96→10/02	Centre Rod	DB-DL-7270		Push Rod
09/96→10/02	Centre Rod	DB-DL-8167		Push Rod, 1st FA;Leaf Spring Axle
09/96→10/02	Centre Rod	DB-DL-8167		Push Rod, Leaf Spring Axle
09/96→10/02	Centre Rod	DB-DL-8184		Push Rod
09/96→10/02	Centre Rod	DB-DL-8185		Push Rod
09/96→10/02	Centre Rod	DB-DL-8188		Push Rod

2640 S, 2640 LS



ACTROS ...

2640 S, 2640 LS ...	09/96→10/02	Centre Rod	DB-DL-8307		Push Rod
	09/96→10/02	Centre Rod	DB-DL-12300		for Steering Rod
	09/96→10/02	Rod Assembly	DB-DL-2178		Guide Rod
	09/96→10/02	Stabiliser Mounting		DB-SB-5261	
	09/96→10/02	Stabiliser Mounting		DB-SB-10406	
	09/96→10/02	Stabiliser Mounting		DB-SB-10407	
	09/96→10/02	Stabiliser Mounting		DB-SB-10409	
	09/96→10/02	Stabiliser Mounting	DB-SB-5260		
	09/96→10/02	Stabiliser Mounting	DB-SB-5279		
	09/96→10/02	Stabiliser Mounting	DB-SB-10410		
	09/96→10/02	Suspension Arm Repair Kit		DB-RK-8626	for Wishbone (CV)
	09/96→10/02	Suspension Arm Repair Kit		DB-RK-10374	for Wishbone (CV)
	09/96→10/02	Suspension Arm Repair Kit		DB-RK-10375	for Wishbone (CV)
	09/96→10/02	Suspension Arm Repair Kit	DB-RK-8638		for Control Arm
	09/96→10/02	Suspension Strut Repair Kit		DB-RK-8391	
	09/96→10/02	Suspension Strut Repair Kit		DB-RK-9294	
	09/96→10/02	Suspension Strut Repair Kit		MN-RK-8997	
	09/96→10/02	Tie Rod	DB-DL-8327		Guide Rod
	09/96→10/02	Tie Rod	DB-DL-8640		Guide Rod
	09/96→10/02	Tie Rod	DB-DL-12310		
	09/96→10/02	Tie Rod	DB-ES-5227		Guide Rod
	09/96→10/02	Tie Rod End	CV-ES-0543		for Push Rod
	09/96→10/02	Tie Rod End	CV-ES-0888		for Push Rod
	09/96→10/02	Tie Rod End	CV-ES-14162		for Steering Rod
	09/96→10/02	Tie Rod End	CV-ES-14163		for Steering Rod
	09/96→10/02	Tie Rod End	DB-ES-5234		for Steering Rod
	09/96→10/02	Tie Rod End	DB-ES-8164		for Push Rod
	09/96→10/02	Tie Rod End	DB-ES-8530		for Push Rod
	09/96→10/02	Track Control Arm		DB-DL-3475	Trailing Arm
	09/96→10/02	Track Control Arm		DB-VB-3707	Suspension Rod, Wishbone (CV), 1st RA; Air Suspension Axle, →* K 864073 *
	09/96→10/02	Track Control Arm		DB-VB-7261	Suspension Rod, Wishbone (CV), 1st RA;2nd RA; Leaf Spring Axle
	09/96→10/02	Track Control Arm		DB-VB-7798	Wishbone (CV)
	09/96→10/02	Track Control Arm	DB-DL-5224		Control Arm, 1st FA;Air Suspension Axle
09/96→10/02	Track Control Arm	DB-DL-9218	DB-DL-9218	Trailing Arm, 1st FA;Air Suspension Axle	
2640, 2640 L	04/96→10/02	Ball Head, gearshift linkage	DB-ES-8387		
	04/96→10/02	Ball Head, gearshift linkage	DB-ES-8491		
	04/96→10/02	Ball Head, gearshift linkage	DB-ES-8492		
	04/96→10/02	Ball Head, gearshift linkage	DB-ES-8500		
	04/96→10/02	Ball Head, gearshift linkage	DB-ES-8510		
	04/96→10/02	Bush, driver cab suspension	DB-SB-10384		
	04/96→10/02	Bush, parabolic spring		DB-SB-10400	
	04/96→10/02	Bush, parabolic spring		DB-SB-10401	
	04/96→10/02	Centre Rod	DB-DL-2144		Push Rod
	04/96→10/02	Centre Rod	DB-DL-5230		Push Rod, 1st FA;Leaf Spring Axle
	04/96→10/02	Centre Rod	DB-DL-5241		Push Rod
	04/96→10/02	Centre Rod	DB-DL-5405		Push Rod
	04/96→10/02	Centre Rod	DB-DL-5405		Push Rod, 1st FA;Leaf Spring Axle
	04/96→10/02	Centre Rod	DB-DL-7270		Push Rod
	04/96→10/02	Centre Rod	DB-DL-8167		Push Rod, 1st FA;Leaf Spring Axle
	04/96→10/02	Centre Rod	DB-DL-8168		Push Rod
	04/96→10/02	Centre Rod	DB-DL-8184		Push Rod
	04/96→10/02	Centre Rod	DB-DL-8185		Push Rod
	04/96→10/02	Centre Rod	DB-DL-8188		Push Rod
	04/96→10/02	Centre Rod	DB-DL-8307		Push Rod
	04/96→10/02	Centre Rod	DB-DL-8622		Push Rod
	04/96→10/02	Centre Rod	DB-DL-8641		Push Rod
	04/96→10/02	Centre Rod	DB-DL-8642		Push Rod
	04/96→10/02	Centre Rod	DB-DL-12298		for Steering Rod
	04/96→10/02	Centre Rod	DB-DL-12300		for Steering Rod
	04/96→10/02	Rod Assembly	DB-DL-2178		Guide Rod
	04/96→10/02	Stabiliser Mounting		DB-SB-5250	

CV-ES-0543

Length: 125
 Cone Ø: d1 Ø 32 / d2 Ø 29
 Thread: M30 x 1,5 RHT
 0004605748, 0004606048, 0004606848,
 0004607048, 0014600448, 0014601148,
 0014601748, 0014602448, 0014607648,
 0014609648

**CV-ES-0888**

Length: 125
 Cone Ø: d1 Ø 32 / d2 Ø 29
 Thread: M30 x 1,5 LHT
 0004605848, 0004606148, 0004606948,
 0004607148, 0004609048, 0014600548,
 0014601348, 0014602548, 0014607948,
 0024600448

**CV-ES-14162**

Length: 125
 Cone Ø: d1 Ø 30 / d2 Ø 27
 Thread: M30 x 1,5 LHT
 4600648, 4601248, 4603448, 4603548,
 0004603548, 14600348, 14601448,
 14602348, 0014603748, 0014607848,
 14607848, 0024600348

**CV-ES-14163**

Length: 125
 Cone Ø: d1 Ø 30 / d2 Ø 27
 Thread: M30 x 1,5 RHT
 0003305248, 0003387310, 0004600348,
 0004600948, 0004602848, 0004602948,
 0004608948, 0014600248, 0014600848,
 0014601248, 0014602248, 0014607748,
 0024600148, A0003387310, A0004600348,
 A0004602848, A0004602948, A0014600848,
 A0014601248, A0014602248, A0014607748

**DB-DL-2144**

Length: 872 Ø: 35
 Cone Ø: d1 Ø 28,6 / d2 Ø 23,9
 0024604305, 0024604405, 0034604805

**DB-DL-2178**

Length: 1735 Ø: 52
 Cone Ø: d1 Ø 32 / d2 Ø 29
 9423300003, 9423300103, 9423300203

**DB-DL-3475**

Length: 565 Ø: 52
 Hole Distance: 152 / 152
 3753500006, 3753500206, 9473500805,
 9483500006, 9483500805, 9483501205,
 9483501305, 9483501905, 9483502005,
 9483502405, A3753500006,
 A3753500206

**DB-DL-5224**

Length: 850 Ø: 60
 Hole Distance: 100 / 100
 01336100A, 9413300007

**DB-DL-5230**

Length: 879 Ø: 42
 Cone Ø: d1 Ø 30 / d2 Ø 27
 01208600A, 0004607105, 0004607205,
 0014606705

**DB-DL-5241**

Length: 875 Ø: 40
 Cone Ø: d1 Ø 30 / d2 Ø 27
 01215300A, 0004609205, 0004609305,
 0014606905

**DB-DL-5405**

Length: 890 Ø: 35
 Cone Ø: d1 Ø 28,6 / d2 Ø 23,9
 01215900A, 1460248, 0024604505,
 0024604605, 0034605005, 3752600637,
 3754600405, A3752600637, A3754600405

**DB-DL-7270**

Length: 875 Ø: 40
 Cone Ø: d1 Ø 28,6 / d2 Ø 23,9
 01208300A, 0024604705, 0024604805,
 0034604905, A0024604705

**DB-DL-8167**

Length: 866 Ø: 38
 Cone Ø: d1 Ø 30 / d2 Ø 27
 0014609805, 0014609905, 0024606305,
 0024606405

**DB-DL-8168**

Length: 904 Ø: 52
 Cone Ø: d1 Ø 32 / d2 Ø 29
 0004609405, 0004609505, 0014607105

**DB-DL-8184**

Length: 1095 Ø: 42
 Cone Ø: d1 Ø 32 / d2 Ø 28,8
 01217700A, 0014601305, 0014601405,
 0024600505, 0034603205, 3754601505,
 A0014601305, A0014601405, A0024600505

**DB-DL-8185**

Length: 711 Ø: 42
 Cone Ø: d1 Ø 32 / d2 Ø 28,8
 01213800A, 0014601105, 0024600405,
 0034603105, A0014601105, A0024600405

**DB-DL-8188**

Length: 895 Ø: 40
 Cone Ø: d1 Ø 28,6 / d2 Ø 23,9
 01217200A, 0024604905, 0024605005,
 0034605605

**DB-DL-8307**

Length: 885 Ø: 38
 Cone Ø: d1 Ø 32 / d2 Ø 30
 01215500A, 0004604005, 0024605105,
 0024605205, 0034604005

**DB-DL-8327**

Length: 1745 Ø: 48
 Cone Ø: d1 Ø 32 / d2 Ø 29
 01219800A, 9413300003, 9413300103,
 9413300203, 9413300303, 9413300503

**DB-DL-8622**

Length: 1558 Ø: 52
 Cone Ø: d1 Ø 30 / d2 Ø 27
 0014609005, 0014609105

**DB-DL-8640**

Length: 1615 Ø: 50
 Cone Ø: d1 Ø 32 / d2 Ø 29
 6253301503, 6253301603, 6253302403,
 6253302503, 9423300803, 9423302103,
 9493300203, 9493300303, 9493300903

**DB-DL-8641**

Length: 905 Ø: 42
 Cone Ø: d1 Ø 30 / d2 Ø 27
 0014605105, 0014608105

**DB-DL-8642**

Length: 954 Ø: 42
 Cone Ø: d1 Ø 30 / d2 Ø 27
 0014608605, 0014608705

**DB-DL-9218**

Length: 754 Ø: 40
 Hole Distance: 100
 000360098524, 000390098524,
 3753300111, 9413300011,
 A3753300111, SA50831601

**DB-DL-12298**

Length: 927 Ø: 50
 Cone Ø: d1 Ø 30 / d2 Ø 27
 0024602405, 0024603005

**DB-DL-12300**

Length: 733 Ø: 36
 Cone Ø: d1 Ø 32 / d2 Ø 29
 0014601505, 0014607305, 0034603305,
 3754601605, A0014601505,
 A0034603305, A3754601605

**DB-DL-12310**

Length: 1532 Ø: 50
 Cone Ø: d1 Ø 32 / d2 Ø 29
 Thread: M27 x 1,5 LHT
 9493301203, 9493301303, 9493301803,
 9493302203, A9493301203, A9493301303,
 A9493301803, A9493302203

**DB-ES-5227**

Length: 1588 Ø: 60
 Cone Ø: d1 Ø 38 / d2 Ø 34,3
 6253300903, 6253301203, 9443300203

**DB-ES-5234**

Length: 135
 Cone Ø: d1 Ø 38 / d2 Ø 34,3
 Thread: M38 x 1,5 RHT
 0004601748, 120322305, 2205000400

**DB-ES-8164**

Length: 140
 Cone Ø: d1 Ø 28,6 / d2 Ø 23,9
 Thread: M28 x 1,5 RHT
 0014604248, 0014605048, 0014608548,
 0024600548

**DB-ES-8387**

Length: 55
 Cone Ø: d1 Ø 10 / d2 Ø 10
 Thread: M14 x 1,5 RHT
 0009966845, 0009967045

**DB-ES-8491**

Length: 60
 Cone Ø: d1 Ø 10 / d2 Ø 10
 Thread: M12 x 1,75 LHT
 0009966745

**DB-ES-8492**

Length: 60
 Cone Ø: d1 Ø 10 / d2 Ø 10
 Thread: M12 x 1,75 RHT
 0009966645, 3752680189, A3752680189

**DB-ES-8500**

Length: 55
 Cone Ø: d1 Ø 12 / d2 Ø 10,8
 Thread: M14 x 1,5 RHT
 0002685989

**DB-ES-8510**

Length: 56
 Cone Ø: d1 Ø 10 / d2 Ø 10
 Thread: M12 x 1,75 LHT
 0009965145, 0009965645, 0019963145

**DB-ES-8530**

Length: 115
 Cone Ø: d1 Ø 28,6 / d2 Ø 23,9
 Thread: M30 x 1,5 RHT
 0014603848, 0014604848, 0014605148,
 0014608648, 0014609948

**DB-RK-8391**

Ø: 85 Hole Distance: 152
 Thick/Height: 24
 01336800A, 0003502705

**DB-RK-8626**

Ø: 75 Hole Distance: 130
 Thick/Height: 24
 0003502205, 0003502505, 0003503405,
 0003504505, GL11319

**DB-RK-8638**

Length: 100 Ø: 67
 Hole Distance: 100
 Thick/Height: 20
 0003301411

**DB-RK-9294**

Ø: 85 Hole Distance: 152
 Thick/Height: 24
 0003503105

**DB-RK-10374**

Ø: 85 Hole Distance: 152
 Thick/Height: 24
 0003504405

**DB-RK-10375**

Ø: 100 Hole Distance: 152
 Thick/Height: 24
 0003502405, 0003503505, 0003504905

**DB-SB-5250**

Ø: 66 Thick/Height: 56
 01320400A, 0003262681, 0003263081,
 0003263281

**DB-SB-5260**

Ø: 70 Thick/Height: 36,5 / 46
 01320700A, 0003237485, 0003237585,
 0003237985

**DB-SB-5261**

Length: 85 Ø: 82
 Thick/Height: 56
 01320600A, 0003264481, 0003264781

**DB-SB-5279**

Ø: 42 Thick/Height: 55
 0003263285, 0003237185

**DB-SB-10384**

Ø: 73 Thick/Height: 47
 9303170012, 9423171812

**DB-SB-10400**

Length: 230
 Thick/Height: 167,5 / 115
 0003250696, 0003250896

**DB-SB-10401**

Length: 232
 Thick/Height: 163,5 / 152,5
 0003250596, 0003250796

**DB-SB-10406**

Ø: 80 Thick/Height: 46
 0003238185

**DB-SB-10407**

Ø: 61 Thick/Height: 46
 0003235985, 0003262481, 0003262981

**DB-SB-10409**

Ø: 77 Thick/Height: 56
 0003265181

**DB-SB-10410**

Ø: 73 Hole Distance: 100
 Thick/Height: 24
 9413230050

**DB-VB-3707**

Length: 622 Ø: 46
 Hole Ø 25 / 25 / 25
 Hole Distance: 152 / 130 / 130
 01337100A, 9423501005, 9423501505,
 9443500005, 9473500105, 9473501005,
 A3753500005, A9423501005, A9423501505,
 A9443500005, A9473500105, A9473501005

**DB-VB-7261**

Length: 622 Ø: 46
 Hole Ø 25 / 25 / 25
 Hole Distance: 152 / 130 / 130
 01337800A, 9443500305, 9443500505,
 9443500605, 9473500705, 9473500905,
 9483500405, 9483500305

**DB-VB-7798**

Length: 622 Ø: 48
 Hole Ø 25 / 23 / 23
 Hole Distance: 152 / 130 / 130
 9423500505, 9423500805, 9423501205,
 A9423501205

**MN-RK-8997**

Ø: 85 Hole Distance: 130
 Thick/Height: 30
 0003504805





ACTROS ...

2640, 2640 L ...	04/96→10/02	Stabiliser Mounting		DB-SB-5261		
	04/96→10/02	Stabiliser Mounting		DB-SB-10406		
	04/96→10/02	Stabiliser Mounting		DB-SB-10407		
	04/96→10/02	Stabiliser Mounting	DB-SB-5260			
	04/96→10/02	Stabiliser Mounting	DB-SB-5277	DB-SB-5277		
	04/96→10/02	Stabiliser Mounting	DB-SB-5279			
	04/96→10/02	Suspension Arm Repair Kit		DB-RK-8550	for Wishbone (CV)	
	04/96→10/02	Suspension Arm Repair Kit		DB-RK-8626	for Wishbone (CV)	
	04/96→10/02	Suspension Arm Repair Kit		DB-RK-8638	for Control Arm	
	04/96→10/02	Suspension Arm Repair Kit		DB-RK-10374	for Wishbone (CV)	
	04/96→10/02	Suspension Strut Repair Kit		DB-RK-9294		
	04/96→10/02	Tie Rod	DB-DL-8327		Guide Rod	
	04/96→10/02	Tie Rod	DB-DL-8640		Guide Rod	
	04/96→10/02	Tie Rod	DB-DL-12310			
	04/96→10/02	Tie Rod	DB-ES-5227		Guide Rod	
	04/96→10/02	Tie Rod End	CV-ES-0543		for Push Rod	
	04/96→10/02	Tie Rod End	CV-ES-0888		for Push Rod	
	04/96→10/02	Tie Rod End	CV-ES-14162		for Steering Rod	
	04/96→10/02	Tie Rod End	CV-ES-14163		for Steering Rod	
	04/96→10/02	Tie Rod End	DB-ES-8164		for Push Rod	
	04/96→10/02	Tie Rod End	DB-ES-8530		for Push Rod	
	04/96→10/02	Track Control Arm		DB-DL-3475	Trailing Arm	
	04/96→10/02	Track Control Arm		DB-VB-3707	Suspension Rod, Wishbone (CV), 1st RA; Air Suspension Axle, →* K 864073 *	
	04/96→10/02	Track Control Arm		DB-VB-7261	Suspension Rod, Wishbone (CV), 1st RA;2nd RA; Leaf Spring Axle	
	04/96→10/02	Track Control Arm	DB-DL-5224		Control Arm, 1st FA;Air Suspension Axle	
	04/96→10/02	Track Control Arm	DB-DL-9218	DB-DL-9218	Trailing Arm, 1st FA;Air Suspension Axle	
	2643 B	04/97→10/02	Ball Head, gearshift linkage	DB-ES-8387		
		04/97→10/02	Ball Head, gearshift linkage	DB-ES-8491		
04/97→10/02		Ball Head, gearshift linkage	DB-ES-8492			
04/97→10/02		Ball Head, gearshift linkage	DB-ES-8500			
04/97→10/02		Ball Head, gearshift linkage	DB-ES-8510			
04/97→10/02		Bush, driver cab suspension	DB-SB-10384			
04/97→10/02		Bush, parabolic spring		DB-SB-10400		
04/97→10/02		Bush, parabolic spring		DB-SB-10401		
04/97→10/02		Centre Rod	DB-DL-2144		Push Rod	
04/97→10/02		Centre Rod	DB-DL-5230		Push Rod, Leaf Spring Axle	
04/97→10/02		Centre Rod	DB-DL-5241		Push Rod	
04/97→10/02		Centre Rod	DB-DL-5405		Push Rod, Leaf Spring Axle	
04/97→10/02		Centre Rod	DB-DL-7270		Push Rod	
04/97→10/02		Centre Rod	DB-DL-8167		Push Rod, 1st FA;Leaf Spring Axle	
04/97→10/02		Centre Rod	DB-DL-8184		Push Rod	
04/97→10/02		Centre Rod	DB-DL-8185		Push Rod	
04/97→10/02		Centre Rod	DB-DL-8188		Push Rod	
04/97→10/02		Centre Rod	DB-DL-8307		Push Rod	
04/97→10/02		Centre Rod	DB-DL-12300		for Steering Rod	
04/97→10/02		Rod Assembly	DB-DL-2178		Guide Rod	
04/97→10/02		Stabiliser Link	DB-DL-9254		Pressure Rod	
04/97→10/02		Stabiliser Mounting		DB-SB-5261		
04/97→10/02		Stabiliser Mounting		DB-SB-10406		
04/97→10/02		Stabiliser Mounting		DB-SB-10407		
04/97→10/02		Stabiliser Mounting		DB-SB-10409		
04/97→10/02		Stabiliser Mounting	DB-SB-5250			
04/97→10/02		Stabiliser Mounting	DB-SB-5260			
04/97→10/02		Stabiliser Mounting	DB-SB-5279			
04/97→10/02		Suspension Arm Repair Kit		DB-RK-8550	for Wishbone (CV)	
04/97→10/02		Suspension Arm Repair Kit		DB-RK-8626	for Wishbone (CV)	
04/97→10/02		Suspension Arm Repair Kit		DB-RK-10374	for Wishbone (CV)	
04/97→10/02		Suspension Arm Repair Kit		DB-RK-10375	for Wishbone (CV)	
04/97→10/02		Suspension Arm Repair Kit	DB-RK-8638		for Control Arm	
04/97→10/02	Suspension Strut Repair Kit		DB-RK-8391			
04/97→10/02	Suspension Strut Repair Kit		DB-RK-9294			

CV-ES-0543

Length: 125
 Cone Ø: d1 Ø 32 / d2 Ø 29
 Thread: M30 x 1,5 RHT
 0004605748, 0004606048, 0004606848,
 0004607048, 0014600448, 0014601148,
 0014601748, 0014602448, 0014607648,
 0014609648

**CV-ES-0888**

Length: 125
 Cone Ø: d1 Ø 32 / d2 Ø 29
 Thread: M30 x 1,5 LHT
 0004605848, 0004606148, 0004606948,
 0004607148, 0004609048, 0014600548,
 0014601348, 0014602548, 0014607948,
 0024600448

**CV-ES-14162**

Length: 125
 Cone Ø: d1 Ø 30 / d2 Ø 27
 Thread: M30 x 1,5 LHT
 4600648, 4601248, 4603448, 0004603548,
 14600348, 14601448, 14602348,
 0014603748, 0014607848, 0024600348

**CV-ES-14163**

Length: 125
 Cone Ø: d1 Ø 30 / d2 Ø 27
 Thread: M30 x 1,5 RHT
 0003305248, 0003387310, 0004600348,
 0004600948, 0004602848, 0004602948,
 0004608948, 0014600248, 0014600848,
 0014601248, 0014602248, 0014607748,
 0024600148, A0003387310, A0004600348,
 A0004602848, A0004602948, A0014600848,
 A0014601248, A0014602248, A0014607748

**DB-DL-2144**

Length: 872 Ø: 35
 Cone Ø: d1 Ø 28,6 / d2 Ø 23,9
 0024604305, 0024604405, 0034604805

**DB-DL-2178**

Length: 1735 Ø: 52
 Cone Ø: d1 Ø 32 / d2 Ø 29
 9423300003, 9423300103, 9423300203

**DB-DL-3475**

Length: 565 Ø: 52
 Hole Distance: 152 / 152
 3753500006, 3753500206, 9473500805,
 9483500006, 9483500805, 9483501205,
 9483501305, 9483501905, 9483502005,
 9483502405, A3753500006,
 A3753500206

**DB-DL-5224**

Length: 850 Ø: 60
 Hole Distance: 100 / 100
 01336100A, 9413300007

**DB-DL-5230**

Length: 879 Ø: 42
 Cone Ø: d1 Ø 30 / d2 Ø 27
 01208600A, 0004607105, 0004607205,
 0014606705

**DB-DL-5241**

Length: 875 Ø: 40
 Cone Ø: d1 Ø 30 / d2 Ø 27
 01215300A, 0004609205, 0004609305,
 0014606905

**DB-DL-5405**

Length: 890 Ø: 35
 Cone Ø: d1 Ø 28,6 / d2 Ø 23,9
 01215900A, 1460248, 0024604505,
 0024604605, 0034605005, 3752600637,
 3754600405, A3752600637, A3754600405

**DB-DL-7270**

Length: 875 Ø: 40
 Cone Ø: d1 Ø 28,6 / d2 Ø 23,9
 01208300A, 0024604705, 0024604805,
 0034604905, A0024604705

**DB-DL-8167**

Length: 866 Ø: 38
 Cone Ø: d1 Ø 30 / d2 Ø 27
 0014609805, 0014609905, 0024606305,
 0024606405

**DB-DL-8184**

Length: 1095 Ø: 42
 Cone Ø: d1 Ø 32 / d2 Ø 28,8
 01217700A, 0014601305, 0014601405,
 0024600505, 0034603205, 3754601505,
 A0014601305, A0014601405, A0024600505

**DB-DL-8185**

Length: 711 Ø: 42
 Cone Ø: d1 Ø 32 / d2 Ø 28,8
 01213600A, 0014601105, 0024600405,
 0034603105, A0014601105, A0024600405

**DB-DL-8188**

Length: 895 Ø: 40
 Cone Ø: d1 Ø 28,6 / d2 Ø 23,9
 01217200A, 0024604905, 0024605005,
 0034605605

**DB-DL-8307**

Length: 885 Ø: 38
 Cone Ø: d1 Ø 32 / d2 Ø 30
 01215500A, 0004604005, 0024605105,
 0024605205, 0034604005

**DB-DL-8327**

Length: 1745 Ø: 48
 Cone Ø: d1 Ø 32 / d2 Ø 29
 01219800A, 9413300003, 9413300103,
 9413300203, 9413300303, 9413300503

**DB-DL-8640**

Length: 1615 Ø: 50
 Cone Ø: d1 Ø 32 / d2 Ø 29
 6253301503, 6253301603, 6253302403,
 6253302503, 9423300803, 9423302103,
 9493300203, 9493300303, 9493300903

**DB-DL-9218**

Length: 754 Ø: 40
 Hole Distance: 100
 000360098524, 000390098524,
 3753300111, 9413300011,
 A3753300111, SA50831601

**DB-DL-9254**

Length: 1815 Ø: 58
 0003220323, 0003220623, 3753220423

**DB-DL-12300**

Length: 733 Ø: 36
 Cone Ø: d1 Ø 32 / d2 Ø 29
 0014601505, 0014607305, 0034603305,
 3754601605, A0014601505,
 A0034603305, A3754601605

**DB-DL-12310**

Length: 1532 Ø: 50
 Cone Ø: d1 Ø 32 / d2 Ø 29
 Thread: M27 x 1,5 LHT
 9493301203, 9493301303, 9493301803,
 9493302203, A9493301203, A9493301303,
 A9493301803, A9493302203

**DB-ES-5227**

Length: 1588 Ø: 60
 Cone Ø: d1 Ø 38 / d2 Ø 34,3
 6253300903, 6253301203, 9443300203

**DB-ES-8164**

Length: 140
 Cone Ø: d1 Ø 28,6 / d2 Ø 23,9
 Thread: M28 x 1,5 RHT
 0014604248, 0014605048, 0014608548,
 0024600548

**DB-ES-8387**

Length: 55
 Cone Ø: d1 Ø 10 / d2 Ø 10
 Thread: M14 x 1,5 RHT
 0009966845, 0009967045

**DB-ES-8491**

Length: 60
 Cone Ø: d1 Ø 10 / d2 Ø 10
 Thread: M12 x 1,75 LHT
 0009966745

**DB-ES-8492**

Length: 60
 Cone Ø: d1 Ø 10 / d2 Ø 10
 Thread: M12 x 1,75 RHT
 0009966645, 3752680189, A3752680189

**DB-ES-8500**

Length: 55
 Cone Ø: d1 Ø 12 / d2 Ø 10,8
 Thread: M14 x 1,5 RHT
 0002685989

**DB-ES-8510**

Length: 56
 Cone Ø: d1 Ø 10 / d2 Ø 10
 Thread: M12 x 1,75 LHT
 0009965145, 0009965645, 0019963145

**DB-ES-8530**

Length: 115
 Cone Ø: d1 Ø 28,6 / d2 Ø 23,9
 Thread: M30 x 1,5 RHT
 0014603848, 0014604848, 0014605148,
 0014608648, 0014609948

**DB-RK-8391**

Ø: 85 Hole Distance: 152
 Thick/Height: 24
 01336800A, 0003502705

**DB-RK-8550**

Ø: 75 Hole Distance: 152
 Thick/Height: 24
 0003502105, 0003504605

**DB-RK-8626**

Ø: 75 Hole Distance: 130
 Thick/Height: 24
 0003502205, 0003502505, 0003503405,
 0003504505, GL11319

**DB-RK-8638**

Length: 100 Ø: 67
 Hole Distance: 100
 Thick/Height: 20
 0003301411

**DB-RK-9294**

Ø: 85 Hole Distance: 152
 Thick/Height: 24
 0003503105

**DB-RK-10374**

Ø: 85 Hole Distance: 152
 Thick/Height: 24
 0003504405

**DB-RK-10375**

Ø: 100 Hole Distance: 152
 Thick/Height: 24
 0003502405, 0003503505, 0003504905

**DB-SB-5250**

Ø: 66 Thick/Height: 56
 01320400A, 0003262681, 0003263081,
 0003263281

**DB-SB-5260**

Ø: 70 Thick/Height: 36,5 / 46
 01320700A, 0003237485, 0003237585,
 0003237985

**DB-SB-5261**

Length: 85 Ø: 82
 Thick/Height: 56
 01320600A, 0003264481, 0003264781

**DB-SB-5277**

Ø: 52
 01320100A, 9413230350

**DB-SB-5279**

Ø: 42 Thick/Height: 55
 0003236285, 0003237185

**DB-SB-10384**

Ø: 73 Thick/Height: 47
 9303170012, 9423171812

**DB-SB-10400**

Length: 230
 Thick/Height: 167,5 / 115
 0003250696, 0003250896

**DB-SB-10401**

Length: 232
 Thick/Height: 163,5 / 152,5
 0003250596, 0003250796

**DB-SB-10406**

Ø: 80 Thick/Height: 46
 0003238185

**DB-SB-10407**

Ø: 61 Thick/Height: 46
 0003235985, 0003262481, 0003262981

**DB-SB-10409**

Ø: 77 Thick/Height: 56
 0003265181

**DB-VB-3707**

Length: 622 Ø: 46
 Hole Ø 25 / 25 / 25
 Hole Distance: 152 / 130 / 130
 01337100A, 9423501005, 9423501505,
 9443500005, 9473500105, 9473501005,
 A3753500005, A9423501005, A9423501505,
 A9443500005, A9473500105, A9473501005

**DB-VB-7261**

Length: 622 Ø: 46
 Hole Ø 25 / 25 / 25
 Hole Distance: 152 / 130 / 130
 01337800A, 9443500305, 9443500505,
 9443500605, 9473500705, 9473500905,
 9483500405, 9483500305





ACTROS ...

2643 B ...	04/97→10/02	Tie Rod	DB-DL-8327		Guide Rod
	04/97→10/02	Tie Rod	DB-DL-8640		Guide Rod
	04/97→10/02	Tie Rod	DB-DL-12310		
	04/97→10/02	Tie Rod End	CV-ES-0543		for Push Rod
	04/97→10/02	Tie Rod End	CV-ES-0888		for Push Rod
	04/97→10/02	Tie Rod End	CV-ES-14162		for Steering Rod
	04/97→10/02	Tie Rod End	CV-ES-14163		for Steering Rod
	04/97→10/02	Tie Rod End	DB-ES-5234		for Steering Rod
	04/97→10/02	Tie Rod End	DB-ES-8164		for Push Rod
	04/97→10/02	Tie Rod End	DB-ES-8530		for Push Rod
	04/97→10/02	Track Control Arm		DB-DL-3475	Trailing Arm
	04/97→10/02	Track Control Arm		DB-VB-3707	Suspension Rod, Wishbone (CV)
	04/97→10/02	Track Control Arm		DB-VB-7261	Suspension Rod, Wishbone (CV), 1st RA;2nd RA; Leaf Spring Axle
	2643 K, 2643 LK	04/97→10/02	Track Control Arm	DB-DL-5224	
04/97→10/02		Track Control Arm	DB-DL-9218	DB-DL-9218	Trailing Arm
2643 K, 2643 LK	04/97→10/02	Ball Head, gearshift linkage	DB-ES-8387		
	04/97→10/02	Ball Head, gearshift linkage	DB-ES-8491		
	04/97→10/02	Ball Head, gearshift linkage	DB-ES-8492		
	04/97→10/02	Ball Head, gearshift linkage	DB-ES-8500		
	04/97→10/02	Ball Head, gearshift linkage	DB-ES-8510		
	04/97→10/02	Bush, driver cab suspension	DB-SB-10384		
	04/97→10/02	Bush, parabolic spring		DB-SB-10400	
	04/97→10/02	Bush, parabolic spring		DB-SB-10401	
	04/97→10/02	Centre Rod	DB-DL-2144		Push Rod
	04/97→10/02	Centre Rod	DB-DL-5230		Push Rod, 1st FA;Leaf Spring Axle
	04/97→10/02	Centre Rod	DB-DL-5241		Push Rod
	04/97→10/02	Centre Rod	DB-DL-5405		Push Rod
	04/97→10/02	Centre Rod	DB-DL-5405		Push Rod, 1st FA;Leaf Spring Axle
	04/97→10/02	Centre Rod	DB-DL-7270		Push Rod
	04/97→10/02	Centre Rod	DB-DL-8167		Push Rod
	04/97→10/02	Centre Rod	DB-DL-8167		Push Rod, 1st FA;Leaf Spring Axle
	04/97→10/02	Centre Rod	DB-DL-8184		Push Rod
	04/97→10/02	Centre Rod	DB-DL-8185		Push Rod
	04/97→10/02	Centre Rod	DB-DL-8188		Push Rod
	04/97→10/02	Centre Rod	DB-DL-8307		Push Rod
	04/97→10/02	Centre Rod	DB-DL-12300		for Steering Rod
	04/97→10/02	Rod Assembly	DB-DL-2178		Guide Rod
	04/97→10/02	Stabiliser Link	DB-DL-9254		Pressure Rod
	04/97→10/02	Stabiliser Mounting		DB-RK-9296	
	04/97→10/02	Stabiliser Mounting		DB-SB-5261	
	04/97→10/02	Stabiliser Mounting		DB-SB-10406	
	04/97→10/02	Stabiliser Mounting		DB-SB-10407	
	04/97→10/02	Stabiliser Mounting		DB-SB-10409	
	04/97→10/02	Stabiliser Mounting	DB-SB-5260		
	04/97→10/02	Stabiliser Mounting	DB-SB-5279		
	04/97→10/02	Suspension Arm Repair Kit		DB-RK-8550	for Wishbone (CV)
	04/97→10/02	Suspension Arm Repair Kit		DB-RK-8626	for Wishbone (CV)
	04/97→10/02	Suspension Arm Repair Kit		DB-RK-10374	for Wishbone (CV)
	04/97→10/02	Suspension Arm Repair Kit		DB-RK-10375	for Wishbone (CV)
	04/97→10/02	Suspension Arm Repair Kit	DB-RK-8638		for Control Arm
	04/97→10/02	Suspension Strut Repair Kit		DB-RK-8391	
	04/97→10/02	Suspension Strut Repair Kit		DB-RK-9294	
	04/97→10/02	Tie Rod	DB-DL-8171		Guide Rod
	04/97→10/02	Tie Rod	DB-DL-8327		Guide Rod
	04/97→10/02	Tie Rod	DB-DL-8640		Guide Rod
	04/97→10/02	Tie Rod	DB-DL-12310		
	04/97→10/02	Tie Rod	DB-ES-5227		Guide Rod
04/97→10/02	Tie Rod End	CV-ES-0543		for Push Rod	
04/97→10/02	Tie Rod End	CV-ES-0888		for Push Rod	
04/97→10/02	Tie Rod End	CV-ES-14162		for Steering Rod	
04/97→10/02	Tie Rod End	CV-ES-14163		for Steering Rod	
04/97→10/02	Tie Rod End	DB-ES-5234		for Steering Rod	

CV-ES-0543

Length: 125
 Cone Ø: d1 Ø 32 / d2 Ø 29
 Thread: M30 x 1,5 RHT
 0004605748, 0004606048, 0004606848,
 0004607048, 0014600448, 0014601148,
 0014601748, 0014602448, 0014607648,
 0014609648

**CV-ES-0888**

Length: 125
 Cone Ø: d1 Ø 32 / d2 Ø 29
 Thread: M30 x 1,5 LHT
 0004605848, 0004606148, 0004606948,
 0004607148, 0004609048, 0014600548,
 0014601348, 0014602548, 0014607948,
 0024600448

**CV-ES-14162**

Length: 125
 Cone Ø: d1 Ø 30 / d2 Ø 27
 Thread: M30 x 1,5 LHT
 4600648, 4601248, 4603448, 4603548,
 0004603548, 14600348, 14601448,
 14602348, 0014603748, 0014607848,
 14607848, 0024600348

**CV-ES-14163**

Length: 125
 Cone Ø: d1 Ø 30 / d2 Ø 27
 Thread: M30 x 1,5 RHT
 0003305248, 0003387310, 0004600348,
 0004600948, 0004602848, 0004602948,
 0004608948, 0014600248, 0014600848,
 0014601248, 0014602248, 0014607748,
 0024600148, A0003387310, A0004600348,
 A0004602848, A0004602948, A0014600848,
 A0014601248, A0014602248, A0014607748

**DB-DL-2144**

Length: 872 Ø: 35
 Cone Ø: d1 Ø 28,6 / d2 Ø 23,9
 0024604305, 0024604405, 0034604805

**DB-DL-2178**

Length: 1735 Ø: 52
 Cone Ø: d1 Ø 32 / d2 Ø 29
 9423300003, 9423300103, 9423300203

**DB-DL-3475**

Length: 565 Ø: 52
 Hole Distance: 152 / 152
 3753500006, 3753500206, 9473500805,
 9483500006, 9483500805, 9483501205,
 9483501305, 9483501905, 9483502005,
 9483502405, A3753500006,
 A3753500206

**DB-DL-5224**

Length: 850 Ø: 60
 Hole Distance: 100 / 100
 01336100A, 9413300007

**DB-DL-5230**

Length: 879 Ø: 42
 Cone Ø: d1 Ø 30 / d2 Ø 27
 01208600A, 0004607105, 0004607205,
 0014606705

**DB-DL-5241**

Length: 875 Ø: 40
 Cone Ø: d1 Ø 30 / d2 Ø 27
 01215300A, 0004609205, 0004609305,
 0014606905

**DB-DL-5405**

Length: 890 Ø: 35
 Cone Ø: d1 Ø 28,6 / d2 Ø 23,9
 01215900A, 1460248, 0024604505,
 0024604605, 0034605005, 3752600637,
 3754600405, A3752600637, A3754600405

**DB-DL-7270**

Length: 875 Ø: 40
 Cone Ø: d1 Ø 28,6 / d2 Ø 23,9
 01208300A, 0024604705, 0024604805,
 0034604905, A0024604705

**DB-DL-8167**

Length: 866 Ø: 38
 Cone Ø: d1 Ø 30 / d2 Ø 27
 0014609805, 0014609905, 0024606305,
 0024606405

**DB-DL-8171**

Length: 1687 Ø: 52
 Cone Ø: d1 Ø 32 / d2 Ø 29
 9493300603, 9493300703, 9493301503,
 9493301603

**DB-DL-8184**

Length: 1095 Ø: 42
 Cone Ø: d1 Ø 32 / d2 Ø 28,8
 01217700A, 0014601305, 0014601405,
 0024600505, 0034603205, 3754601505,
 A0014601305, A0014601405, A0024600505

**DB-DL-8185**

Length: 711 Ø: 42
 Cone Ø: d1 Ø 32 / d2 Ø 28,8
 01217600A, 0014601105, 0024600405,
 0034603105, A0014601105, A0024600405

**DB-DL-8188**

Length: 895 Ø: 40
 Cone Ø: d1 Ø 28,6 / d2 Ø 23,9
 01217200A, 0024604905, 0024605005,
 0034605605

**DB-DL-8307**

Length: 885 Ø: 38
 Cone Ø: d1 Ø 32 / d2 Ø 30
 01215500A, 0004604005, 0024605105,
 0024605205, 0034604005

**DB-DL-8327**

Length: 1745 Ø: 48
 Cone Ø: d1 Ø 32 / d2 Ø 29
 01219800A, 9413300003, 9413300103,
 9413300203, 9413300303, 9413300503

**DB-DL-8640**

Length: 1615 Ø: 50
 Cone Ø: d1 Ø 32 / d2 Ø 29
 6253301503, 6253301603, 6253302403,
 6253302503, 9423300803, 9423302103,
 9493300203, 9493300303, 9493300903

**DB-DL-9218**

Length: 754 Ø: 40
 Hole Distance: 100
 000360098524, 000390098524,
 3753300111, 9413300011,
 A3753300111, SA50831601

**DB-DL-9254**

Length: 1815 Ø: 58
 0003220323, 0003220623, 3753220423

**DB-DL-12300**

Length: 733 Ø: 36
 Cone Ø: d1 Ø 32 / d2 Ø 29
 0014601505, 0014607305, 0034603305,
 3754601605, A0014601505,
 A0034603305, A3754601605

**DB-DL-12310**

Length: 1532 Ø: 50
 Cone Ø: d1 Ø 32 / d2 Ø 29
 Thread: M27 x 1,5 LHT
 9493301203, 9493301303, 9493301803,
 9493302203, A9493301203, A9493301303,
 A9493301803, A9493302203

**DB-ES-5227**

Length: 1588 Ø: 60
 Cone Ø: d1 Ø 38 / d2 Ø 34,3
 6253300903, 6253301203, 9443300203

**DB-ES-5234**

Length: 135
 Cone Ø: d1 Ø 38 / d2 Ø 34,3
 Thread: M38 x 1,5 RHT
 0004601748, 120322305, 2205000400

**DB-ES-8164**

Length: 140
 Cone Ø: d1 Ø 28,6 / d2 Ø 23,9
 Thread: M28 x 1,5 RHT
 0014604248, 0014605048, 0014608548,
 0024600548

**DB-ES-8387**

Length: 55
 Cone Ø: d1 Ø 10 / d2 Ø 10
 Thread: M14 x 1,5 RHT
 0009966845, 0009967045

**DB-ES-8491**

Length: 60
 Cone Ø: d1 Ø 10 / d2 Ø 10
 Thread: M12 x 1,75 LHT
 0009966745

**DB-ES-8492**

Length: 60
 Cone Ø: d1 Ø 10 / d2 Ø 10
 Thread: M12 x 1,75 RHT
 0009966645, 3752680189, A3752680189

**DB-ES-8500**

Length: 55
 Cone Ø: d1 Ø 12 / d2 Ø 10,8
 Thread: M14 x 1,5 RHT
 0002685989

**DB-ES-8510**

Length: 56
 Cone Ø: d1 Ø 10 / d2 Ø 10
 Thread: M12 x 1,75 LHT
 0009965145, 0009965645, 0019963145

**DB-ES-8530**

Length: 115
 Cone Ø: d1 Ø 28,6 / d2 Ø 23,9
 Thread: M30 x 1,5 RHT
 0014603848, 0014604848, 0014605148,
 0014608648, 0014609948

**DB-RK-8391**

Ø: 85 Hole Distance: 152
 Thick/Height: 24
 01336800A, 0003502705

**DB-RK-8550**

Ø: 75 Hole Distance: 152
 Thick/Height: 24
 0003502105, 0003504605

**DB-RK-8626**

Ø: 75 Hole Distance: 130
 Thick/Height: 24
 0003502205, 0003502505, 0003503405,
 0003504505, GL11319

**DB-RK-8638**

Length: 100 Ø: 67
 Hole Distance: 100
 Thick/Height: 20
 0003301411

**DB-RK-9294**

Ø: 85 Hole Distance: 152
 Thick/Height: 24
 0003503105

**DB-RK-9296**

Ø: 88 Hole Distance: 130
 Thick/Height: 24
 9423260050

**DB-RK-10374**

Ø: 85 Hole Distance: 152
 Thick/Height: 24
 0003504405

**DB-RK-10375**

Ø: 100 Hole Distance: 152
 Thick/Height: 24
 0003502405, 0003503505, 0003504905

**DB-SB-5260**

Ø: 70 Thick/Height: 36,5 / 46
 01320700A, 0003237485, 0003237585,
 0003237985

**DB-SB-5261**

Length: 85 Ø: 82
 Thick/Height: 56
 01320600A, 0003264481, 0003264781

**DB-SB-5279**

Ø: 42 Thick/Height: 55
 0003236285, 0003237185

**DB-SB-10384**

Ø: 73 Thick/Height: 47
 9303170012, 9423171812

**DB-SB-10400**

Length: 230
 Thick/Height: 167,5 / 115
 0003250696, 0003250896

**DB-SB-10401**

Length: 232
 Thick/Height: 163,5 / 152,5
 0003250596, 0003250796

**DB-SB-10406**

Ø: 80 Thick/Height: 46
 0003238185

**DB-SB-10407**

Ø: 61 Thick/Height: 46
 0003235985, 0003262481, 0003262981

**DB-SB-10409**

Ø: 77 Thick/Height: 56
 0003265181

**DB-VB-3707**

Length: 622 Ø: 46
 Hole Ø 25 / 25 / 25
 Hole Distance: 152 / 130 / 130
 01337100A, 9443501005, 9423501505,
 9443500005, 9473500105, 9473501005,
 A3753500005, A9423501005, A9423501505,
 A9443500005, A9473500105, A9473501005

**DB-VB-7261**

Length: 622 Ø: 46
 Hole Ø 25 / 25 / 25
 Hole Distance: 152 / 130 / 130
 01337800A, 9443500305, 9443500505,
 9443500605, 9473500705, 9473500905,
 9483500405, 9483503005

**MERCEDES-BENZ**



ACTROS ...

2643 K, 2643 LK ...	04/97→10/02	Tie Rod End	DB-ES-8164		for Push Rod
	04/97→10/02	Tie Rod End	DB-ES-8530		for Push Rod
	04/97→10/02	Track Control Arm		DB-DL-3475	Trailing Arm
	04/97→10/02	Track Control Arm		DB-VB-3707	Suspension Rod, Wishbone (CV), 1st RA; Air Suspension Axle, →* K 864073 *
	04/97→10/02	Track Control Arm		DB-VB-7261	Suspension Rod, Wishbone (CV), 1st RA;2nd RA; Leaf Spring Axle
	04/97→10/02	Track Control Arm	DB-DL-5224		Control Arm
	04/97→10/02	Track Control Arm	DB-DL-9218	DB-DL-9218	Trailing Arm
2643 S, 2643 LS	04/97→10/02	Ball Head, gearshift linkage	DB-ES-8387		
	04/97→10/02	Ball Head, gearshift linkage	DB-ES-8491		
	04/97→10/02	Ball Head, gearshift linkage	DB-ES-8492		
	04/97→10/02	Ball Head, gearshift linkage	DB-ES-8500		
	04/97→10/02	Ball Head, gearshift linkage	DB-ES-8510		
	04/97→10/02	Bush, driver cab suspension	DB-SB-10384		
	04/97→10/02	Bush, parabolic spring		DB-SB-10400	
	04/97→10/02	Bush, parabolic spring		DB-SB-10401	
	04/97→10/02	Centre Rod	DB-DL-2144		Push Rod
	04/97→10/02	Centre Rod	DB-DL-5230		Push Rod
	04/97→10/02	Centre Rod	DB-DL-5241		Push Rod
	04/97→10/02	Centre Rod	DB-DL-5405		Push Rod
	04/97→10/02	Centre Rod	DB-DL-5405		Push Rod, Leaf Spring Axle
	04/97→10/02	Centre Rod	DB-DL-7270		Push Rod
	04/97→10/02	Centre Rod	DB-DL-8167		Push Rod, 1st FA;Leaf Spring Axle
	04/97→10/02	Centre Rod	DB-DL-8167		Push Rod, Leaf Spring Axle
	04/97→10/02	Centre Rod	DB-DL-8184		Push Rod
	04/97→10/02	Centre Rod	DB-DL-8185		Push Rod
	04/97→10/02	Centre Rod	DB-DL-8188		Push Rod
	04/97→10/02	Centre Rod	DB-DL-8307		Push Rod
	04/97→10/02	Centre Rod	DB-DL-12300		for Steering Rod
	04/97→10/02	Rod Assembly	DB-DL-2178		Guide Rod
	04/97→10/02	Stabiliser Mounting		DB-SB-5261	
	04/97→10/02	Stabiliser Mounting		DB-SB-10406	
	04/97→10/02	Stabiliser Mounting		DB-SB-10407	
	04/97→10/02	Stabiliser Mounting		DB-SB-10409	
	04/97→10/02	Stabiliser Mounting	DB-SB-5260		
	04/97→10/02	Stabiliser Mounting	DB-SB-5279		
	04/97→10/02	Stabiliser Mounting	DB-SB-10410		
	04/97→10/02	Suspension Arm Repair Kit		DB-RK-8626	for Wishbone (CV)
	04/97→10/02	Suspension Arm Repair Kit		DB-RK-10374	for Wishbone (CV)
	04/97→10/02	Suspension Arm Repair Kit		DB-RK-10375	for Wishbone (CV)
	04/97→10/02	Suspension Arm Repair Kit	DB-RK-8638		for Control Arm
	04/97→10/02	Suspension Strut Repair Kit		DB-RK-8391	
	04/97→10/02	Suspension Strut Repair Kit		DB-RK-9294	
	04/97→10/02	Suspension Strut Repair Kit		MN-RK-8997	
	04/97→10/02	Tie Rod	DB-DL-8327		Guide Rod
	04/97→10/02	Tie Rod	DB-DL-8640		Guide Rod
	04/97→10/02	Tie Rod	DB-DL-12310		
	04/97→10/02	Tie Rod	DB-ES-5227		Guide Rod
	04/97→10/02	Tie Rod End	CV-ES-0543		for Push Rod
	04/97→10/02	Tie Rod End	CV-ES-0888		for Push Rod
	04/97→10/02	Tie Rod End	CV-ES-14162		for Steering Rod
	04/97→10/02	Tie Rod End	CV-ES-14163		for Steering Rod
04/97→10/02	Tie Rod End	DB-ES-5234		for Steering Rod	
04/97→10/02	Tie Rod End	DB-ES-8164		for Push Rod	
04/97→10/02	Tie Rod End	DB-ES-8530		for Push Rod	
04/97→10/02	Track Control Arm		DB-DL-3475	Trailing Arm	
04/97→10/02	Track Control Arm		DB-VB-3707	Suspension Rod, Wishbone (CV), 1st RA; Air Suspension Axle, →* K 864073 *	
04/97→10/02	Track Control Arm		DB-VB-7261	Suspension Rod, Wishbone (CV), 1st RA;2nd RA; Leaf Spring Axle	
04/97→10/02	Track Control Arm		DB-VB-7798	Wishbone (CV)	
04/97→10/02	Track Control Arm	DB-DL-5224		Control Arm, 1st FA;Air Suspension Axle	
04/97→10/02	Track Control Arm	DB-DL-9218	DB-DL-9218	Trailing Arm, 1st FA;Air Suspension Axle	

CV-ES-0543

Length: 125
Cone Ø: d1 Ø 32 / d2 Ø 29
Thread: M30 x 1,5 RHT
0004605748, 0004606048, 0004606848,
0004607048, 0014600448, 0014601148,
0014601748, 0014602448, 0014607648,
0014609648



CV-ES-0888

Length: 125
Cone Ø: d1 Ø 32 / d2 Ø 29
Thread: M30 x 1,5 LHT
0004605848, 0004606148, 0004606948,
0004607148, 0004609048, 0014600548,
0014601348, 0014602548, 0014607948,
0024600448



CV-ES-14162

Length: 125
Cone Ø: d1 Ø 30 / d2 Ø 27
Thread: M30 x 1,5 LHT
4600648, 4601248, 4603448, 0004603548,
14600348, 14601448, 14602348,
0014603748, 0014607848, 0024600348



CV-ES-14163

Length: 125
Cone Ø: d1 Ø 30 / d2 Ø 27
Thread: M30 x 1,5 RHT
0003305248, 0003387310, 0004600348,
0004600948, 0004602848, 0004602948,
0004608948, 0014600248, 0014600848,
0014601248, 0014602248, 0014607748,
0024600148, A0003387310, A0004600348,
A0004602848, A0004602948, A0014600848,
A0014601248, A0014602248, A0014607748



DB-DL-2144

Length: 872 Ø: 35
Cone Ø: d1 Ø 28,6 / d2 Ø 23,9
0024604305, 0024604405, 0034604805



DB-DL-2178

Length: 1735 Ø: 52
Cone Ø: d1 Ø 32 / d2 Ø 29
9423300003, 9423300103, 9423300203



DB-DL-3475

Length: 565 Ø: 52
Hole Distance: 152 / 152
3753500006, 3753500206, 9473500805,
9483500006, 9483500805, 9483501205,
9483501305, 9483501905, 9483502005,
9483502405, A3753500006,
A3753500206



DB-DL-5224

Length: 850 Ø: 60
Hole Distance: 100 / 100
01336100A, 9413300007



DB-DL-5230

Length: 879 Ø: 42
Cone Ø: d1 Ø 30 / d2 Ø 27
01208600A, 0004607105, 0004607205,
0014606705



DB-DL-5241

Length: 875 Ø: 40
Cone Ø: d1 Ø 30 / d2 Ø 27
01215300A, 0004609205, 0004609305,
0014606905



DB-DL-5405

Length: 890 Ø: 35
Cone Ø: d1 Ø 28,6 / d2 Ø 23,9
01215900A, 1460248, 0024604505,
0024604605, 0034605005, 3752600637,
3754600405, A3752600637, A3754600405



DB-DL-7270

Length: 875 Ø: 40
Cone Ø: d1 Ø 28,6 / d2 Ø 23,9
01208300A, 0024604705, 0024604805,
0034604905, A0024604705



DB-DL-8167

Length: 866 Ø: 38
Cone Ø: d1 Ø 30 / d2 Ø 27
0014609805, 0014609905, 0024606305,
0024606405



DB-DL-8184

Length: 1095 Ø: 42
Cone Ø: d1 Ø 32 / d2 Ø 28,8
01217700A, 0014601305, 0014601405,
0024600505, 0034603205, 3754601505,
A0014601305, A0014601405, A0024600505



DB-DL-8185

Length: 711 Ø: 42
Cone Ø: d1 Ø 32 / d2 Ø 28,8
01213600A, 0014601105, 0024600405,
0034603105, A0014601105, A0024600405



DB-DL-8188

Length: 895 Ø: 40
Cone Ø: d1 Ø 28,6 / d2 Ø 23,9
01217200A, 0024604905, 0024605005,
0034605605



DB-DL-8307

Length: 885 Ø: 38
Cone Ø: d1 Ø 32 / d2 Ø 30
01215500A, 0004604005, 0024605105,
0024605205, 0034604005



DB-DL-8327

Length: 1745 Ø: 48
Cone Ø: d1 Ø 32 / d2 Ø 29
01219800A, 9413300003, 9413300103,
9413300203, 9413300303, 9413300503



DB-DL-8640

Length: 1615 Ø: 50
Cone Ø: d1 Ø 32 / d2 Ø 29
6253301503, 6253301603, 6253302403,
6253302503, 9423300803, 9423302103,
9493300203, 9493300303, 9493300903



DB-DL-9218

Length: 754 Ø: 40
Hole Distance: 100
000360098524, 000390098524,
3753300111, 9413300011,
A3753300111, SA50831601



DB-DL-12300

Length: 733 Ø: 36
Cone Ø: d1 Ø 32 / d2 Ø 29
0014601505, 0014607305, 0034603305,
3754601605, A0014601505,
A0034603305, A3754601605



DB-DL-12310

Length: 1532 Ø: 50
Cone Ø: d1 Ø 32 / d2 Ø 29
Thread: M27 x 1,5 LHT
9493301203, 9493301303, 9493301803,
9493302203, A9493301203, A9493301303,
A9493301803, A9493302203



DB-ES-5227

Length: 1588 Ø: 60
Cone Ø: d1 Ø 38 / d2 Ø 34,3
6253300903, 6253301203, 9443300203



DB-ES-5234

Length: 135
Cone Ø: d1 Ø 38 / d2 Ø 34,3
Thread: M38 x 1,5 RHT
0004601748, 120322305, 2205000400



DB-ES-8164

Length: 140
Cone Ø: d1 Ø 28,6 / d2 Ø 23,9
Thread: M28 x 1,5 RHT
0014604248, 0014605048, 0014608548,
0024600548



DB-ES-8387

Length: 55
Cone Ø: d1 Ø 10 / d2 Ø 10
Thread: M14 x 1,5 RHT
0009966845, 0009967045



DB-ES-8491

Length: 60
Cone Ø: d1 Ø 10 / d2 Ø 10
Thread: M12 x 1,75 LHT
0009966745



DB-ES-8492

Length: 60
Cone Ø: d1 Ø 10 / d2 Ø 10
Thread: M12 x 1,75 RHT
0009966645, 3752680189, A3752680189



DB-ES-8500

Length: 55
Cone Ø: d1 Ø 12 / d2 Ø 10,8
Thread: M14 x 1,5 RHT
0002685989



DB-ES-8510

Length: 56
Cone Ø: d1 Ø 10 / d2 Ø 10
Thread: M12 x 1,75 LHT
0009965145, 0009965645, 0019963145



DB-ES-8530

Length: 115
Cone Ø: d1 Ø 28,6 / d2 Ø 23,9
Thread: M30 x 1,5 RHT
0014603848, 0014604848, 0014605148,
0014608648, 0014609948



DB-RK-8391

Ø: 85 Hole Distance: 152
Thick/Height: 24
01336800A, 0003502705



DB-RK-8626

Ø: 75 Hole Distance: 130
Thick/Height: 24
0003502205, 0003502505, 0003503405,
0003504505, GL11319



DB-RK-8638

Length: 100 Ø: 67
Hole Distance: 100
Thick/Height: 20
0003301411



DB-RK-9294

Ø: 85 Hole Distance: 152
Thick/Height: 24
0003503105



DB-RK-10374

Ø: 85 Hole Distance: 152
Thick/Height: 24
0003504405



DB-RK-10375

Ø: 100 Hole Distance: 152
Thick/Height: 24
0003502405, 0003503505, 0003504905



DB-SB-5260

Ø: 70 Thick/Height: 36,5 / 46
01320700A, 0003237485, 0003237585,
0003237985



DB-SB-5261

Length: 85 Ø: 82
Thick/Height: 56
01320600A, 0003264481, 0003264781



DB-SB-5279

Ø: 42 Thick/Height: 55
0003236285, 0003237185



DB-SB-10384

Ø: 73 Thick/Height: 47
9303170012, 9423171812



DB-SB-10400

Length: 230
Thick/Height: 167,5 / 115
0003250696, 0003250896



DB-SB-10401

Length: 232
Thick/Height: 163,5 / 152,5
0003250596, 0003250796



DB-SB-10406

Ø: 80 Thick/Height: 46
0003238185



DB-SB-10407

Ø: 61 Thick/Height: 46
0003235985, 0003262481, 0003262981



DB-SB-10409

Ø: 77 Thick/Height: 56
0003265181



DB-SB-10410

Ø: 73 Hole Distance: 100
Thick/Height: 24
9413230050



DB-VB-3707

Length: 622 Ø: 46
Hole Ø 25 / 25 / 25
Hole Distance: 152 / 130 / 130
01337100A, 9423501005, 9423501505,
9443500005, 9473500105, 9473501005,
A3753500005, A9423501005, A9423501505,
A9443500005, A9473500105, A9473501005



DB-VB-7261

Length: 622 Ø: 46
Hole Ø 25 / 25 / 25
Hole Distance: 152 / 130 / 130
01337800A, 9443500305, 9443500505,
9443500605, 9473500705, 9473500905,
9483500405, 9483503005



DB-VB-7798

Length: 622 Ø: 48
Hole Ø 25 / 23 / 23
Hole Distance: 152 / 130 / 130
9423500505, 9423500805, 9423501205,
A9423501205



MN-RK-8997

Ø: 85 Hole Distance: 130
Thick/Height: 30
0003504805





ACTROS ...

2643, 2643 L

04/96→10/02	Ball Head, gearshift linkage	DB-ES-8387		
04/96→10/02	Ball Head, gearshift linkage	DB-ES-8491		
04/96→10/02	Ball Head, gearshift linkage	DB-ES-8492		
04/96→10/02	Ball Head, gearshift linkage	DB-ES-8500		
04/96→10/02	Ball Head, gearshift linkage	DB-ES-8510		
04/96→10/02	Bush, driver cab suspension	DB-SB-10384		
04/96→10/02	Bush, parabolic spring		DB-SB-10400	
04/96→10/02	Bush, parabolic spring		DB-SB-10401	
04/96→10/02	Centre Rod	DB-DL-2144		Push Rod
04/96→10/02	Centre Rod	DB-DL-5230		Push Rod, 1st FA;Leaf Spring Axle
04/96→10/02	Centre Rod	DB-DL-5241		Push Rod
04/96→10/02	Centre Rod	DB-DL-5405		Push Rod
04/96→10/02	Centre Rod	DB-DL-5405		Push Rod, 1st FA;Leaf Spring Axle
04/96→10/02	Centre Rod	DB-DL-7270		Push Rod
04/96→10/02	Centre Rod	DB-DL-8167		Push Rod, 1st FA;Leaf Spring Axle
04/96→10/02	Centre Rod	DB-DL-8168		Push Rod
04/96→10/02	Centre Rod	DB-DL-8184		Push Rod
04/96→10/02	Centre Rod	DB-DL-8185		Push Rod
04/96→10/02	Centre Rod	DB-DL-8188		Push Rod
04/96→10/02	Centre Rod	DB-DL-8307		Push Rod
04/96→10/02	Centre Rod	DB-DL-8622		Push Rod
04/96→10/02	Centre Rod	DB-DL-8641		Push Rod
04/96→10/02	Centre Rod	DB-DL-8642		Push Rod
04/96→10/02	Centre Rod	DB-DL-12298		for Steering Rod
04/96→10/02	Centre Rod	DB-DL-12300		for Steering Rod
04/96→10/02	Rod Assembly	DB-DL-2178		Guide Rod
04/96→10/02	Stabiliser Mounting		DB-SB-5250	
04/96→10/02	Stabiliser Mounting		DB-SB-5261	
04/96→10/02	Stabiliser Mounting		DB-SB-10406	
04/96→10/02	Stabiliser Mounting		DB-SB-10407	
04/96→10/02	Stabiliser Mounting	DB-SB-5260		
04/96→10/02	Stabiliser Mounting	DB-SB-5277	DB-SB-5277	
04/96→10/02	Stabiliser Mounting	DB-SB-5279		
04/96→10/02	Suspension Arm Repair Kit		DB-RK-8550	for Wishbone (CV)
04/96→10/02	Suspension Arm Repair Kit		DB-RK-8626	for Wishbone (CV)
04/96→10/02	Suspension Arm Repair Kit		DB-RK-8638	for Control Arm
04/96→10/02	Suspension Arm Repair Kit		DB-RK-10374	for Wishbone (CV)
04/96→10/02	Suspension Strut Repair Kit		DB-RK-9294	
04/96→10/02	Tie Rod	DB-DL-8327		Guide Rod
04/96→10/02	Tie Rod	DB-DL-8640		Guide Rod
04/96→10/02	Tie Rod	DB-DL-12310		
04/96→10/02	Tie Rod	DB-ES-5227		Guide Rod
04/96→10/02	Tie Rod End	CV-ES-0543		for Push Rod
04/96→10/02	Tie Rod End	CV-ES-0888		for Push Rod
04/96→10/02	Tie Rod End	CV-ES-14162		for Steering Rod
04/96→10/02	Tie Rod End	CV-ES-14163		for Steering Rod
04/96→10/02	Tie Rod End	DB-ES-8164		for Push Rod
04/96→10/02	Tie Rod End	DB-ES-8530		for Push Rod
04/96→10/02	Track Control Arm		DB-DL-3475	Trailing Arm
04/96→10/02	Track Control Arm		DB-VB-3707	Suspension Rod, Wishbone (CV), 1st RA; Air Suspension Axle, →* K 864073 *
04/96→10/02	Track Control Arm		DB-VB-7261	Suspension Rod, Wishbone (CV), 1st RA;2nd RA; Leaf Spring Axle
04/96→10/02	Track Control Arm	DB-DL-5224		Control Arm, 1st FA;Air Suspension Axle
04/96→10/02	Track Control Arm	DB-DL-9218	DB-DL-9218	Trailing Arm, 1st FA;Air Suspension Axle
10/97→	Ball Head, gearshift linkage	DB-ES-8387		
10/97→	Ball Head, gearshift linkage	DB-ES-8491		
10/97→	Ball Head, gearshift linkage	DB-ES-8492		
10/97→	Ball Head, gearshift linkage	DB-ES-8500		
10/97→	Bush, parabolic spring		DB-SB-10400	
10/97→	Bush, parabolic spring		DB-SB-10401	
10/97→	Centre Rod	DB-DL-2144		Push Rod
10/97→	Centre Rod	DB-DL-5230		Push Rod

2646 B

CV-ES-0543

Length: 125
 Cone Ø: d1 Ø 32 / d2 Ø 29
 Thread: M30 x 1,5 RHT
 0004605748, 0004606048, 0004606848,
 0004607048, 0014600448, 0014601148,
 0014601748, 0014602448, 0014607648,
 0014609648

**CV-ES-0888**

Length: 125
 Cone Ø: d1 Ø 32 / d2 Ø 29
 Thread: M30 x 1,5 LHT
 0004605848, 0004606148, 0004606948,
 0004607148, 0004609048, 0014600548,
 0014601348, 0014602548, 0014607948,
 0024600448

**CV-ES-14162**

Length: 125
 Cone Ø: d1 Ø 30 / d2 Ø 27
 Thread: M30 x 1,5 LHT
 4600648, 4601248, 4603448, 0004603548,
 14600348, 14601448, 14602348,
 0014603748, 0014607848, 0024600348

**CV-ES-14163**

Length: 125
 Cone Ø: d1 Ø 30 / d2 Ø 27
 Thread: M30 x 1,5 RHT
 0003305248, 0003387310, 0004600348,
 0004600948, 0004602848, 0004602948,
 0004608948, 0014600248, 0014600848,
 0014601248, 0014602248, 0014607748,
 0024600148, 0003387310, 0004600348,
 A0004602848, A0004602948, A0014600848,
 A0014601248, A0014602248, A0014607748

**DB-DL-2144**

Length: 872 Ø: 35
 Cone Ø: d1 Ø 28,6 / d2 Ø 23,9
 0024604305, 0024604405, 0034604805

**DB-DL-2178**

Length: 1735 Ø: 52
 Cone Ø: d1 Ø 32 / d2 Ø 29
 9423300003, 9423300103, 9423300203

**DB-DL-3475**

Length: 565 Ø: 52
 Hole Distance: 152 / 152
 3753500006, 3753500206, 9473500805,
 9483500006, 9483500805, 9483501205,
 9483501305, 9483501905, 9483502005,
 9483502405, A3753500006,
 A3753500206

**DB-DL-5224**

Length: 850 Ø: 60
 Hole Distance: 100 / 100
 01336100A, 9413300007

**DB-DL-5230**

Length: 879 Ø: 42
 Cone Ø: d1 Ø 30 / d2 Ø 27
 01208600A, 0004607105, 0004607205,
 0014606705

**DB-DL-5241**

Length: 875 Ø: 40
 Cone Ø: d1 Ø 30 / d2 Ø 27
 01215300A, 0004609205, 0004609305,
 0014606905

**DB-DL-5405**

Length: 890 Ø: 35
 Cone Ø: d1 Ø 28,6 / d2 Ø 23,9
 01215900A, 1460248, 0024604505,
 0024604605, 0034605005, 3752600637,
 3754600405, A3752600637, A3754600405

**DB-DL-7270**

Length: 875 Ø: 40
 Cone Ø: d1 Ø 28,6 / d2 Ø 23,9
 01208300A, 0024604705, 0024604805,
 0034604905, A0024604705

**DB-DL-8167**

Length: 866 Ø: 38
 Cone Ø: d1 Ø 30 / d2 Ø 27
 0014609805, 0014609905, 0024606305,
 0024606405

**DB-DL-8168**

Length: 904 Ø: 52
 Cone Ø: d1 Ø 32 / d2 Ø 29
 0004609405, 0004609505, 0014607105

**DB-DL-8184**

Length: 1095 Ø: 42
 Cone Ø: d1 Ø 32 / d2 Ø 28,8
 01217700A, 0014601305, 0014601405,
 0024600505, 0034603205, 3754601505,
 A0014601305, A0014601405, A0024600505

**DB-DL-8185**

Length: 711 Ø: 42
 Cone Ø: d1 Ø 32 / d2 Ø 28,8
 01213600A, 0014601105, 0024600405,
 0034603105, A0014601105, A0024600405

**DB-DL-8188**

Length: 895 Ø: 40
 Cone Ø: d1 Ø 28,6 / d2 Ø 23,9
 01217200A, 0024604905, 0024605005,
 0034605605

**DB-DL-8307**

Length: 885 Ø: 38
 Cone Ø: d1 Ø 32 / d2 Ø 30
 01215500A, 0004604005, 0024605105,
 0024605205, 0034604005

**DB-DL-8327**

Length: 1745 Ø: 48
 Cone Ø: d1 Ø 32 / d2 Ø 29
 01219800A, 9413300003, 9413300103,
 9413300203, 9413300303, 9413300503

**DB-DL-8622**

Length: 1558 Ø: 52
 Cone Ø: d1 Ø 30 / d2 Ø 27
 0014609005, 0014609105

**DB-DL-8640**

Length: 1615 Ø: 50
 Cone Ø: d1 Ø 32 / d2 Ø 29
 6253301503, 6253301603, 6253302403,
 6253302503, 9423300803, 9423302103,
 9493300203, 9493300303, 9493300903

**DB-DL-8641**

Length: 905 Ø: 42
 Cone Ø: d1 Ø 30 / d2 Ø 27
 0014605105, 0014608105

**DB-DL-8642**

Length: 954 Ø: 42
 Cone Ø: d1 Ø 30 / d2 Ø 27
 0014608605, 0014608705

**DB-DL-9218**

Length: 754 Ø: 40
 Hole Distance: 100
 000360098524, 000390098524,
 3753300111, 9413300011,
 A3753300111, SA50831601

**DB-DL-12298**

Length: 927 Ø: 50
 Cone Ø: d1 Ø 30 / d2 Ø 27
 0024602405, 0024603005

**DB-DL-12300**

Length: 733 Ø: 36
 Cone Ø: d1 Ø 32 / d2 Ø 29
 0014601505, 0014607305, 0034603305,
 3754601605, A0014601505,
 A0034603305, A3754601605

**DB-DL-12310**

Length: 1532 Ø: 50
 Cone Ø: d1 Ø 32 / d2 Ø 29
 Thread: M27 x 1,5 LHT
 9493301203, 9493301303, 9493301803,
 9493302203, A9493301203, A9493301303,
 A9493301803, A9493302203

**DB-ES-5227**

Length: 1588 Ø: 60
 Cone Ø: d1 Ø 38 / d2 Ø 34,3
 6253300903, 6253301203, 9443300203

**DB-ES-8164**

Length: 140
 Cone Ø: d1 Ø 28,6 / d2 Ø 23,9
 Thread: M28 x 1,5 RHT
 0014604248, 0014605048, 0014608548,
 0024600548

**DB-ES-8387**

Length: 55
 Cone Ø: d1 Ø 10 / d2 Ø 10
 Thread: M14 x 1,5 RHT
 0009966845, 0009967045

**DB-ES-8491**

Length: 60
 Cone Ø: d1 Ø 10 / d2 Ø 10
 Thread: M12 x 1,75 LHT
 0009966745

**DB-ES-8492**

Length: 60
 Cone Ø: d1 Ø 10 / d2 Ø 10
 Thread: M12 x 1,75 RHT
 0009966645, 3752680189, A3752680189

**DB-ES-8500**

Length: 55
 Cone Ø: d1 Ø 12 / d2 Ø 10,8
 Thread: M14 x 1,5 RHT
 0002685989

**DB-ES-8510**

Length: 56
 Cone Ø: d1 Ø 10 / d2 Ø 10
 Thread: M12 x 1,75 LHT
 0009965145, 0009965645, 0019963145

**DB-ES-8530**

Length: 115
 Cone Ø: d1 Ø 28,6 / d2 Ø 23,9
 Thread: M30 x 1,5 RHT
 0014603848, 0014604848, 0014605148,
 0014608648, 0014609948

**DB-RK-8550**

Ø: 75 Hole Distance: 152
 Thick/Height: 24
 0003502105, 0003504605

**DB-RK-8626**

Ø: 75 Hole Distance: 130
 Thick/Height: 24
 0003502205, 0003502505, 0003503405,
 0003504505, GL11319

**DB-RK-8638**

Length: 100 Ø: 67
 Hole Distance: 100
 Thick/Height: 20
 0003301411

**DB-RK-9294**

Ø: 85 Hole Distance: 152
 Thick/Height: 24
 0003503105

**DB-RK-10374**

Ø: 85 Hole Distance: 152
 Thick/Height: 24
 0003504405

**DB-SB-5250**

Ø: 66 Thick/Height: 56
 01320400A, 0003262681, 0003263081,
 0003263281

**DB-SB-5260**

Ø: 70 Thick/Height: 36,5 / 46
 01320700A, 0003237485, 0003237585,
 0003237985

**DB-SB-5261**

Length: 85 Ø: 82
 Thick/Height: 56
 01320600A, 0003264481, 0003264781

**DB-SB-5277**

Ø: 52
 01320100A, 9413230350

**DB-SB-5279**

Ø: 42 Thick/Height: 55
 0003236285, 0003237185

**DB-SB-10384**

Ø: 73 Thick/Height: 47
 9303170012, 9423171812

**DB-SB-10400**

Length: 230
 Thick/Height: 167,5 / 115
 0003250696, 0003250896

**DB-SB-10401**

Length: 232
 Thick/Height: 163,5 / 152,5
 0003250596, 0003250796

**DB-SB-10406**

Ø: 80 Thick/Height: 46
 0003238185

**DB-SB-10407**

Ø: 61 Thick/Height: 46
 0003235985, 0003262481, 0003262981

**DB-VB-3707**

Length: 622 Ø: 46
 Hole Ø 25 / 25 / 25
 Hole Distance: 152 / 130 / 130
 01337100A, 9423501005, 9423501505,
 9443500005, 9473500105, 9473501005,
 A3753500005, A9423501005, A9423501505,
 A9443500005, A9473500105, A9473501005

**DB-VB-7261**

Length: 622 Ø: 46
 Hole Ø 25 / 25 / 25
 Hole Distance: 152 / 130 / 130
 01337800A, 9443500305, 9443500505,
 9443500605, 9473500705, 9473500905,
 9483500405, 9483500305

**MERCEDES-BENZ**



ACTROS ...

2646 B ...	10/97→	Centre Rod	DB-DL-5405		Push Rod	
	10/97→	Centre Rod	DB-DL-7270		Push Rod	
	10/97→	Centre Rod	DB-DL-8167		Push Rod	
	10/97→	Rod Assembly	DB-DL-2178		Guide Rod, 1st Front Axle, →504310 03	
	10/97→	Suspension Arm Repair Kit		DB-RK-8626	for Wishbone (CV)	
	10/97→	Suspension Arm Repair Kit		DB-RK-10374	for Wishbone (CV)	
	10/97→	Suspension Strut Repair Kit		DB-RK-8391		
	10/97→	Tie Rod	DB-DL-8327		Guide Rod	
	10/97→	Tie Rod	DB-DL-8640		Guide Rod	
	10/97→	Tie Rod End	CV-ES-0543		for Push Rod	
	10/97→	Tie Rod End	CV-ES-0888		for Push Rod	
	10/97→	Tie Rod End	CV-ES-14163		for Steering Rod	
	10/97→	Tie Rod End	DB-ES-8164		for Push Rod	
	10/97→	Tie Rod End	DB-ES-8530		for Push Rod	
	10/97→	Track Control Arm		DB-DL-3475	Trailing Arm	
	10/97→	Track Control Arm		DB-VB-7261	Suspension Rod, Wishbone (CV)	
	10/97→	Track Control Arm	DB-DL-5224		Control Arm	
	10/97→	Track Control Arm	DB-DL-9218	DB-DL-9218	Trailing Arm	
	2646 S, 2646 LS	10/97→	Ball Head, gearshift linkage	DB-ES-8387		
		10/97→	Ball Head, gearshift linkage	DB-ES-8491		
		10/97→	Ball Head, gearshift linkage	DB-ES-8492		
		10/97→	Ball Head, gearshift linkage	DB-ES-8500		
		10/97→	Bush, parabolic spring		DB-SB-10400	
		10/97→	Bush, parabolic spring		DB-SB-10401	
10/97→		Centre Rod	DB-DL-2144		Push Rod	
10/97→		Centre Rod	DB-DL-5230		Push Rod	
10/97→		Centre Rod	DB-DL-5241		Push Rod	
10/97→		Centre Rod	DB-DL-5405		Push Rod	
10/97→		Centre Rod	DB-DL-7270		Push Rod	
10/97→		Centre Rod	DB-DL-8167		Push Rod	
10/97→		Rod Assembly	DB-DL-2178		Guide Rod, 1st Front Axle, →504310 03	
10/97→		Suspension Arm Repair Kit		DB-RK-8626	for Wishbone (CV)	
10/97→		Suspension Arm Repair Kit		DB-RK-10374	for Wishbone (CV)	
10/97→		Tie Rod	DB-DL-8640		Guide Rod, 1st Front Axle	
10/97→		Tie Rod End	CV-ES-0543		for Push Rod	
10/97→		Tie Rod End	CV-ES-0888		for Push Rod	
10/97→		Tie Rod End	CV-ES-14163		for Steering Rod	
10/97→		Tie Rod End	DB-ES-8164		for Push Rod	
10/97→		Tie Rod End	DB-ES-8530		for Push Rod	
10/97→		Track Control Arm		DB-DL-3475	Trailing Arm	
10/97→		Track Control Arm		DB-VB-3707	Suspension Rod, Wishbone (CV)	
10/97→		Track Control Arm	DB-DL-5224		Control Arm	
10/97→		Track Control Arm	DB-DL-9218	DB-DL-9218	Trailing Arm	
2648 K, 2648 LK		04/97→10/02	Ball Head, gearshift linkage	DB-ES-8510		
		04/97→10/02	Bush, driver cab suspension	DB-SB-10384		
		04/97→10/02	Centre Rod	DB-DL-5230		Push Rod, 1st FA;Leaf Spring Axle
		04/97→10/02	Centre Rod	DB-DL-5241		Push Rod
		04/97→10/02	Centre Rod	DB-DL-5405		Push Rod, 1st FA;Leaf Spring Axle
		04/97→10/02	Centre Rod	DB-DL-8167		Push Rod, 1st FA;Leaf Spring Axle
		04/97→10/02	Centre Rod	DB-DL-8184		Push Rod
		04/97→10/02	Centre Rod	DB-DL-8185		Push Rod
	04/97→10/02	Centre Rod	DB-DL-8188		Push Rod	
	04/97→10/02	Centre Rod	DB-DL-8307		Push Rod	
	04/97→10/02	Rod Assembly	DB-DL-2178		Guide Rod	
	04/97→10/02	Stabiliser Link	DB-DL-9254		Pressure Rod	
	04/97→10/02	Stabiliser Mounting		DB-RK-9296		
	04/97→10/02	Stabiliser Mounting		DB-SB-5261		
	04/97→10/02	Stabiliser Mounting		DB-SB-10406		
	04/97→10/02	Stabiliser Mounting		DB-SB-10407		
	04/97→10/02	Stabiliser Mounting		DB-SB-10409		
	04/97→10/02	Stabiliser Mounting	DB-SB-5260			
	04/97→10/02	Stabiliser Mounting	DB-SB-5279			
	04/97→10/02	Suspension Arm Repair Kit		DB-RK-8550	for Wishbone (CV)	

CV-ES-0543

Length: 125
Cone Ø: d1 Ø 32 / d2 Ø 29
Thread: M30 x 1,5 RHT
0004605748, 0004606048, 0004606848,
0004607048, 0014600448, 0014601148,
0014601748, 0014602448, 0014607648,
0014609648



CV-ES-0888

Length: 125
Cone Ø: d1 Ø 32 / d2 Ø 29
Thread: M30 x 1,5 LHT
0004605848, 0004606148, 0004606948,
0004607148, 0004609048, 0014600548,
0014601348, 0014602548, 0014607948,
0024600448



CV-ES-14163

Length: 125
Cone Ø: d1 Ø 30 / d2 Ø 27
Thread: M30 x 1,5 RHT
0003305248, 0003387310, 0004600348,
0004600948, 0004602848, 0004602948,
0004608948, 0014600248, 0014600848,
0014601248, 0014602248, 0014607748,
0024600148, A0003387310, A0004600348,
A0004602848, A0004602948, A0014600848,
A0014601248, A0014602248, A0014607748



DB-DL-2144

Length: 872 Ø: 35
Cone Ø: d1 Ø 28,6 / d2 Ø 23,9
0024604305, 0024604405, 0034604805



DB-DL-2178

Length: 1735 Ø: 52
Cone Ø: d1 Ø 32 / d2 Ø 29
9423300003, 9423300103, 9423300203



DB-DL-3475

Length: 565 Ø: 52
Hole Distance: 152 / 152
3753500006, 3753500206, 9473500805,
9483500006, 9483500805, 9483501205,
9483501305, 9483501905, 9483502005,
9483502405, A3753500006,
A3753500206



DB-DL-5224

Length: 850 Ø: 60
Hole Distance: 100 / 100
01336100A, 9413300007



DB-DL-5230

Length: 879 Ø: 42
Cone Ø: d1 Ø 30 / d2 Ø 27
01208600A, 0004607105, 0004607205,
0014606705



DB-DL-5241

Length: 875 Ø: 40
Cone Ø: d1 Ø 30 / d2 Ø 27
01215300A, 0004609205, 0004609305,
0014606905



DB-DL-5405

Length: 890 Ø: 35
Cone Ø: d1 Ø 28,6 / d2 Ø 23,9
01215900A, 1460248, 0024604505,
0024604605, 0034605005, 3752600637,
3754600405, A3752600637, A3754600405



DB-DL-7270

Length: 875 Ø: 40
Cone Ø: d1 Ø 28,6 / d2 Ø 23,9
01208300A, 0024604705, 0024604805,
0034604905, A0024604705



DB-DL-8167

Length: 866 Ø: 38
Cone Ø: d1 Ø 30 / d2 Ø 27
0014609805, 0014609905, 0024606305,
0024606405



DB-DL-8184

Length: 1095 Ø: 42
Cone Ø: d1 Ø 32 / d2 Ø 28,8
01217700A, 0014601305, 0014601405,
0024600505, 0034603205, 3754601505,
A0014601305, A0014601405, A0024600505



DB-DL-8185

Length: 711 Ø: 42
Cone Ø: d1 Ø 32 / d2 Ø 28,8
01213600A, 0014601105, 0024600405,
0034603105, A0014601105, A0024600405



DB-DL-8188

Length: 895 Ø: 40
Cone Ø: d1 Ø 28,6 / d2 Ø 23,9
01217200A, 0024604905, 0024605005,
0034605605



DB-DL-8307

Length: 885 Ø: 38
Cone Ø: d1 Ø 32 / d2 Ø 30
01215500A, 0004604005, 0024605105,
0024605205, 0034604005



DB-DL-8327

Length: 1745 Ø: 48
Cone Ø: d1 Ø 32 / d2 Ø 29
01219800A, 9413300003, 9413300103,
9413300203, 9413300303, 9413300503



DB-DL-8640

Length: 1615 Ø: 50
Cone Ø: d1 Ø 32 / d2 Ø 29
6253301503, 6253301603, 6253302403,
6253302503, 9423300803, 9423302103,
9493300203, 9493300303, 9493300903



DB-DL-9218

Length: 754 Ø: 40
Hole Distance: 100
000360098524, 000390098524,
3753300111, 9413300011,
A3753300111, SA50831601



DB-DL-9254

Length: 1815 Ø: 58
0003220323, 0003220623, 3753220423



DB-ES-8164

Length: 140
Cone Ø: d1 Ø 28,6 / d2 Ø 23,9
Thread: M28 x 1,5 RHT
0014604248, 0014605048, 0014608548,
0024600548



DB-ES-8387

Length: 55
Cone Ø: d1 Ø 10 / d2 Ø 10
Thread: M14 x 1,5 RHT
0009966845, 0009967045



DB-ES-8491

Length: 60
Cone Ø: d1 Ø 10 / d2 Ø 10
Thread: M12 x 1,75 LHT
0009966745



DB-ES-8492

Length: 60
Cone Ø: d1 Ø 10 / d2 Ø 10
Thread: M12 x 1,75 RHT
0009966645, 3752680189, A3752680189



DB-ES-8500

Length: 55
Cone Ø: d1 Ø 12 / d2 Ø 10,8
Thread: M14 x 1,5 RHT
0002685989



DB-ES-8510

Length: 56
Cone Ø: d1 Ø 10 / d2 Ø 10
Thread: M12 x 1,75 LHT
0009965145, 0009965645, 0019963145



DB-ES-8530

Length: 115
Cone Ø: d1 Ø 28,6 / d2 Ø 23,9
Thread: M30 x 1,5 RHT
0014603848, 0014604848, 0014605148,
0014608648, 0014609948



DB-RK-8391

Ø: 85 Hole Distance: 152
Thick/Height: 24
01336800A, 0003502705



DB-RK-8550

Ø: 75 Hole Distance: 152
Thick/Height: 24
0003502105, 0003504605



DB-RK-8626

Ø: 75 Hole Distance: 130
Thick/Height: 24
0003502205, 0003502505, 0003503405,
0003504505, GL11319



DB-RK-9296

Ø: 88 Hole Distance: 130
Thick/Height: 24
9423260050



DB-RK-10374

Ø: 85 Hole Distance: 152
Thick/Height: 24
0003504405



DB-SB-5260

Ø: 70 Thick/Height: 36,5 / 46
01320700A, 0003237485, 0003237585,
0003237985



DB-SB-5261

Length: 85 Ø: 82
Thick/Height: 56
01320600A, 0003264481, 0003264781



DB-SB-5279

Ø: 42 Thick/Height: 55
0003236285, 0003237185



DB-SB-10384

Ø: 73 Thick/Height: 47
9303170012, 9423171812



DB-SB-10400

Length: 230
Thick/Height: 167,5 / 115
0003250696, 0003250896



DB-SB-10401

Length: 232
Thick/Height: 163,5 / 152,5
0003250596, 0003250796



DB-SB-10406

Ø: 80 Thick/Height: 46
0003238185



DB-SB-10407

Ø: 61 Thick/Height: 46
0003235985, 0003262481, 0003262981



DB-SB-10409

Ø: 77 Thick/Height: 56
0003265181



DB-VB-3707

Length: 622 Ø: 46
Hole Ø 25 / 25 / 25
Hole Distance: 152 / 130 / 130
01337100A, 9423501005, 9423501505,
9443500005, 9473500105, 9473501005,
A3753500005, A9423501005, A9423501505,
A9443500005, A9473500105, A9473501005



DB-VB-7261

Length: 622 Ø: 46
Hole Ø 25 / 25 / 25
Hole Distance: 152 / 130 / 130
01337800A, 9443500305, 9443500505,
9443500605, 9473500705, 9473500905,
9483500405, 9483500305



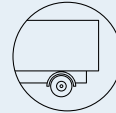

ACTROS ...

2648 K, 2648 LK ...

04/97→10/02	Suspension Arm Repair Kit		DB-RK-10375	for Wishbone (CV)
04/97→10/02	Suspension Arm Repair Kit	DB-RK-8638		for Control Arm
04/97→10/02	Suspension Strut Repair Kit		DB-RK-9294	
04/97→10/02	Tie Rod	DB-ES-5227		Guide Rod
04/97→10/02	Tie Rod End	CV-ES-14162		for Steering Rod
04/97→10/02	Tie Rod End	DB-ES-5234		for Steering Rod
04/97→10/02	Track Control Arm		DB-VB-3707	Suspension Rod, Wishbone (CV), 1st RA; Air Suspension Axle, →* K 864073 *
04/97→10/02	Track Control Arm		DB-VB-7261	Suspension Rod, Wishbone (CV), 1st RA;2nd RA; Leaf Spring Axle
04/97→	Ball Head, gearshift linkage	DB-ES-8387		
04/97→	Ball Head, gearshift linkage	DB-ES-8491		
04/97→	Ball Head, gearshift linkage	DB-ES-8492		
04/97→	Ball Head, gearshift linkage	DB-ES-8500		
04/97→	Bush, parabolic spring		DB-SB-10400	
04/97→	Bush, parabolic spring		DB-SB-10401	
04/97→	Centre Rod	DB-DL-2144		Push Rod
04/97→	Centre Rod	DB-DL-5405		Push Rod
04/97→	Centre Rod	DB-DL-7270		Push Rod
04/97→	Centre Rod	DB-DL-8167		Push Rod
04/97→	Centre Rod	DB-DL-12300		for Steering Rod
04/97→	Suspension Arm Repair Kit		DB-RK-8626	for Wishbone (CV)
04/97→	Suspension Arm Repair Kit		DB-RK-10374	for Wishbone (CV)
04/97→	Suspension Strut Repair Kit		DB-RK-8391	
04/97→	Tie Rod	DB-DL-8171		Guide Rod
04/97→	Tie Rod	DB-DL-8327		Guide Rod
04/97→	Tie Rod	DB-DL-8640		Guide Rod
04/97→	Tie Rod	DB-DL-12310		
04/97→	Tie Rod End	CV-ES-0543		for Push Rod
04/97→	Tie Rod End	CV-ES-0888		for Push Rod
04/97→	Tie Rod End	CV-ES-14163		for Steering Rod
04/97→	Tie Rod End	DB-ES-8164		for Push Rod
04/97→	Tie Rod End	DB-ES-8530		for Push Rod
04/97→	Track Control Arm		DB-DL-3475	Trailing Arm
04/97→	Track Control Arm	DB-DL-5224		Control Arm
04/97→	Track Control Arm	DB-DL-9218	DB-DL-9218	Trailing Arm
10/97→	Centre Rod	DB-DL-5230		Push Rod
10/97→	Rod Assembly	DB-DL-2178		Guide Rod, 1st Front Axle, →504310 03
10/97→	Track Control Arm		DB-VB-3707	Suspension Rod, Wishbone (CV)
10/97→	Track Control Arm		DB-VB-7261	Suspension Rod, Wishbone (CV)

2648 S, 2648 LS

09/96→10/02	Ball Head, gearshift linkage	DB-ES-8510		
09/96→10/02	Bush, driver cab suspension	DB-SB-10384		
09/96→10/02	Centre Rod	DB-DL-5405		Push Rod, Leaf Spring Axle
09/96→10/02	Centre Rod	DB-DL-8167		Push Rod, 1st FA;Leaf Spring Axle
09/96→10/02	Centre Rod	DB-DL-8167		Push Rod, Leaf Spring Axle
09/96→10/02	Centre Rod	DB-DL-8184		Push Rod
09/96→10/02	Centre Rod	DB-DL-8185		Push Rod
09/96→10/02	Centre Rod	DB-DL-8188		Push Rod
09/96→10/02	Centre Rod	DB-DL-8307		Push Rod
09/96→10/02	Rod Assembly	DB-DL-2178		Guide Rod
09/96→10/02	Stabiliser Mounting		DB-SB-5261	
09/96→10/02	Stabiliser Mounting		DB-SB-10406	
09/96→10/02	Stabiliser Mounting		DB-SB-10407	
09/96→10/02	Stabiliser Mounting		DB-SB-10409	
09/96→10/02	Stabiliser Mounting	DB-SB-5260		
09/96→10/02	Stabiliser Mounting	DB-SB-5279		
09/96→10/02	Stabiliser Mounting	DB-SB-10410		
09/96→10/02	Suspension Arm Repair Kit		DB-RK-10375	for Wishbone (CV)
09/96→10/02	Suspension Arm Repair Kit	DB-RK-8638		for Control Arm
09/96→10/02	Suspension Strut Repair Kit		DB-RK-8391	
09/96→10/02	Suspension Strut Repair Kit		DB-RK-9294	
09/96→10/02	Suspension Strut Repair Kit		MN-RK-8997	
09/96→10/02	Tie Rod	DB-DL-8327		Guide Rod

CV-ES-0543

Length: 125
 Cone Ø: d1 Ø 32 / d2 Ø 29
 Thread: M30 x 1,5 RHT
 0004605748, 0004606048, 0004606848,
 0004607048, 0014600448, 0014601148,
 0014601748, 0014602448, 0014607648,
 0014609648

**CV-ES-0888**

Length: 125
 Cone Ø: d1 Ø 32 / d2 Ø 29
 Thread: M30 x 1,5 LHT
 0004605848, 0004606148, 0004606948,
 0004607148, 0004609048, 0014600548,
 0014601348, 0014602548, 0014607948,
 0024600448

**CV-ES-14162**

Length: 125
 Cone Ø: d1 Ø 30 / d2 Ø 27
 Thread: M30 x 1,5 LHT
 4600648, 4601248, 4603448, 0004603548,
 14600348, 14601448, 14602348,
 0014603748, 0014607848, 0024600348

**CV-ES-14163**

Length: 125
 Cone Ø: d1 Ø 30 / d2 Ø 27
 Thread: M30 x 1,5 RHT
 0003305248, 0003387310, 0004600348,
 0004600948, 0004602848, 0004602948,
 0004608948, 0014600248, 0014600848,
 0014601248, 0014602248, 0014607748,
 0024600148, 0003387310, 0004600348,
 A0004602848, A0004602948, A0014600848,
 A0014601248, A0014602248, A0014607748

**DB-DL-2144**

Length: 872 Ø: 35
 Cone Ø: d1 Ø 28,6 / d2 Ø 23,9
 0024604305, 0024604405, 0034604805

**DB-DL-2178**

Length: 1735 Ø: 52
 Cone Ø: d1 Ø 32 / d2 Ø 29
 9423300003, 9423300103, 9423300203

**DB-DL-3475**

Length: 565 Ø: 52
 Hole Distance: 152 / 152
 3753500006, 3753500206, 9473500805,
 9483500006, 9483500805, 9483501205,
 9483501305, 9483501905, 9483502005,
 9483502405, A3753500006,
 A3753500206

**DB-DL-5224**

Length: 850 Ø: 60
 Hole Distance: 100 / 100
 01336100A, 9413300007

**DB-DL-5230**

Length: 879 Ø: 42
 Cone Ø: d1 Ø 30 / d2 Ø 27
 01208600A, 0004607105, 0004607205,
 0014606705

**DB-DL-5405**

Length: 890 Ø: 35
 Cone Ø: d1 Ø 28,6 / d2 Ø 23,9
 01215900A, 1460248, 0024604505,
 0024604605, 0034605005, 3752600637,
 3754600405, A3752600637, A3754600405

**DB-DL-7270**

Length: 875 Ø: 40
 Cone Ø: d1 Ø 28,6 / d2 Ø 23,9
 01208300A, 0024604705, 0024604805,
 0034604905, A0024604705

**DB-DL-8167**

Length: 866 Ø: 38
 Cone Ø: d1 Ø 30 / d2 Ø 27
 0014609805, 0014609905, 0024606305,
 0024606405

**DB-DL-8171**

Length: 1687 Ø: 52
 Cone Ø: d1 Ø 32 / d2 Ø 29
 9493300603, 9493300703, 9493301503,
 9493301603

**DB-DL-8184**

Length: 1095 Ø: 42
 Cone Ø: d1 Ø 32 / d2 Ø 28,8
 01217700A, 0014601305, 0014601405,
 0024600505, 0034603205, 3754601505,
 A0014601305, A0014601405, A0024600505

**DB-DL-8185**

Length: 711 Ø: 42
 Cone Ø: d1 Ø 32 / d2 Ø 28,8
 01213600A, 0014601105, 0024600405,
 0034603105, A0014601105, A0024600405

**DB-DL-8188**

Length: 895 Ø: 40
 Cone Ø: d1 Ø 28,6 / d2 Ø 23,9
 01217200A, 0024604905, 0024605005,
 0034605605

**DB-DL-8307**

Length: 885 Ø: 38
 Cone Ø: d1 Ø 32 / d2 Ø 30
 01215500A, 0004604005, 0024605105,
 0024605205, 0034604005

**DB-DL-8327**

Length: 1745 Ø: 48
 Cone Ø: d1 Ø 32 / d2 Ø 29
 01219800A, 9413300003, 9413300103,
 9413300203, 9413300303, 9413300503

**DB-DL-8640**

Length: 1615 Ø: 50
 Cone Ø: d1 Ø 32 / d2 Ø 29
 6253301503, 6253301603, 6253302403,
 6253302503, 9423300803, 9423302103,
 9493300203, 9493300303, 9493300903

**DB-DL-9218**

Length: 754 Ø: 40
 Hole Distance: 100
 000360098524, 000390098524,
 3753300111, 9413300111,
 A3753300111, SA50831601

**DB-DL-12300**

Length: 733 Ø: 36
 Cone Ø: d1 Ø 32 / d2 Ø 29
 0014601505, 0014607305, 0034603305,
 3754601605, A0014601505, A0034603305,
 A3754601605

**DB-DL-12310**

Length: 1532 Ø: 50
 Cone Ø: d1 Ø 32 / d2 Ø 29
 Thread: M27 x 1,5 LHT
 9493301203, 9493301303, 9493301803,
 9493302203, A9493301203, A9493301303,
 A9493301803, A9493302203

**DB-ES-5227**

Length: 1588 Ø: 60
 Cone Ø: d1 Ø 38 / d2 Ø 34,3
 6253300903, 6253301203, 9443300203

**DB-ES-5234**

Length: 135
 Cone Ø: d1 Ø 38 / d2 Ø 34,3
 Thread: M38 x 1,5 RHT
 0004601748, 120322305, 2205000400

**DB-ES-8164**

Length: 140
 Cone Ø: d1 Ø 28,6 / d2 Ø 23,9
 Thread: M28 x 1,5 RHT
 0014604248, 0014605048, 0014608548,
 0024600548

**DB-ES-8387**

Length: 55
 Cone Ø: d1 Ø 10 / d2 Ø 10
 Thread: M14 x 1,5 RHT
 0009966845, 0009967045

**DB-ES-8491**

Length: 60
 Cone Ø: d1 Ø 10 / d2 Ø 10
 Thread: M12 x 1,5 LHT
 0009966745

**DB-ES-8492**

Length: 60
 Cone Ø: d1 Ø 10 / d2 Ø 10
 Thread: M12 x 1,75 RHT
 0009966645, 3752680189, A3752680189

**DB-ES-8500**

Length: 55
 Cone Ø: d1 Ø 12 / d2 Ø 10,8
 Thread: M14 x 1,5 RHT
 0002685989

**DB-ES-8510**

Length: 56
 Cone Ø: d1 Ø 10 / d2 Ø 10
 Thread: M12 x 1,75 LHT
 0009965145, 0009965645, 0019963145

**DB-ES-8530**

Length: 115
 Cone Ø: d1 Ø 28,6 / d2 Ø 23,9
 Thread: M30 x 1,5 RHT
 0014603848, 0014604848, 0014605148,
 0014608648, 0014609948

**DB-RK-8391**

Ø: 85 Hole Distance: 152
 Thick/Height: 24
 01336800A, 0003502705

**DB-RK-8626**

Ø: 75 Hole Distance: 130
 Thick/Height: 24
 0003502205, 0003502505, 0003503405,
 0003504505, GL11319

**DB-RK-8638**

Length: 100 Ø: 67
 Hole Distance: 100
 Thick/Height: 20
 0003301411

**DB-RK-9294**

Ø: 85 Hole Distance: 152
 Thick/Height: 24
 0003503105

**DB-RK-10374**

Ø: 85 Hole Distance: 152
 Thick/Height: 24
 0003504405

**DB-RK-10375**

Ø: 100 Hole Distance: 152
 Thick/Height: 24
 0003502405, 0003503505, 0003504905

**DB-SB-5260**

Ø: 70 Thick/Height: 36,5 / 46
 01320700A, 0003237485, 0003237585,
 0003237985

**DB-SB-5261**

Length: 85 Ø: 82
 Thick/Height: 56
 01320600A, 0003264481, 0003264781

**DB-SB-5279**

Ø: 42 Thick/Height: 55
 0003236285, 0003237185

**DB-SB-10384**

Ø: 73 Thick/Height: 47
 9303170012, 9423171812

**DB-SB-10400**

Length: 230
 Thick/Height: 167,5 / 115
 0003250696, 0003250896

**DB-SB-10401**

Length: 232
 Thick/Height: 163,5 / 152,5
 0003250596, 0003250796

**DB-SB-10406**

Ø: 80 Thick/Height: 46
 0003238185

**DB-SB-10407**

Ø: 61 Thick/Height: 46
 0003235985, 0003262481, 0003262981

**DB-SB-10409**

Ø: 77 Thick/Height: 56
 0003265181

**DB-SB-10410**

Ø: 73 Hole Distance: 100
 Thick/Height: 24
 9413230050

**DB-VB-3707**

Length: 622 Ø: 46
 Hole Ø 25 / 25 / 25
 Hole Distance: 152 / 130 / 130
 01337100A, 9423501005, 9423501505,
 9443500005, 9473500105, 9473501005,
 A3753500005, A9423501005, A9423501505,
 A9443500005, A9473500105, A9473501005

**DB-VB-7261**

Length: 622 Ø: 46
 Hole Ø 25 / 25 / 25
 Hole Distance: 152 / 130 / 130
 01337800A, 9443500305, 9443500505,
 9443500605, 9473500705, 9473500905,
 9483500405, 9483503005

**MN-RK-8997**

Ø: 85 Hole Distance: 130
 Thick/Height: 30
 0003504805





ACTROS ...

2648 S, 2648 LS ...	09/96→10/02	Tie Rod	DB-ES-5227		Guide Rod	
	09/96→10/02	Tie Rod End	CV-ES-14162		for Steering Rod	
	09/96→10/02	Tie Rod End	DB-ES-5234		for Steering Rod	
	09/96→10/02	Track Control Arm		DB-VB-3707	Suspension Rod, Wishbone (CV), 1st RA; Air Suspension Axle, →* K 864073 *	
	09/96→10/02	Track Control Arm		DB-VB-7261	Suspension Rod, Wishbone (CV), 1st RA;2nd RA; Leaf Spring Axle	
	09/96→10/02	Track Control Arm		DB-VB-7798	Wishbone (CV)	
	09/96→10/02	Track Control Arm	DB-DL-5224		Control Arm, 1st FA;Air Suspension Axle	
	09/96→10/02	Track Control Arm	DB-DL-9218	DB-DL-9218	Trailing Arm, 1st FA;Air Suspension Axle	
	09/96→	Ball Head, gearshift linkage	DB-ES-8387			
	09/96→	Ball Head, gearshift linkage	DB-ES-8491			
	09/96→	Ball Head, gearshift linkage	DB-ES-8492			
	09/96→	Ball Head, gearshift linkage	DB-ES-8500			
	09/96→	Bush, parabolic spring		DB-SB-10400		
	09/96→	Bush, parabolic spring		DB-SB-10401		
	09/96→	Centre Rod	DB-DL-2144		Push Rod	
	09/96→	Centre Rod	DB-DL-5230		Push Rod	
	09/96→	Centre Rod	DB-DL-5241		Push Rod	
	09/96→	Centre Rod	DB-DL-5405		Push Rod	
	09/96→	Centre Rod	DB-DL-7270		Push Rod	
	09/96→	Centre Rod	DB-DL-12300		for Steering Rod	
	09/96→	Suspension Arm Repair Kit		DB-RK-8626	for Wishbone (CV)	
	09/96→	Suspension Arm Repair Kit		DB-RK-10374	for Wishbone (CV)	
	09/96→	Tie Rod	DB-DL-8640		Guide Rod	
	09/96→	Tie Rod	DB-DL-12310			
	09/96→	Tie Rod End	CV-ES-0543		for Push Rod	
	09/96→	Tie Rod End	CV-ES-0888		for Push Rod	
	09/96→	Tie Rod End	CV-ES-14163		for Steering Rod	
	09/96→	Tie Rod End	DB-ES-8164		for Push Rod	
	09/96→	Tie Rod End	DB-ES-8530		for Push Rod	
	09/96→	Track Control Arm		DB-DL-3475	Trailing Arm	
	10/97→	Centre Rod	DB-DL-8167		Push Rod	
	10/97→	Rod Assembly	DB-DL-2178		Guide Rod, 1st Front Axle, →504310 03	
	10/97→	Track Control Arm		DB-VB-3707	Suspension Rod, Wishbone (CV)	
	10/97→	Track Control Arm		DB-VB-7261	Suspension Rod, Wishbone (CV)	
	10/97→	Track Control Arm	DB-DL-5224		Control Arm	
	10/97→	Track Control Arm	DB-DL-9218	DB-DL-9218	Trailing Arm	
	2648, 2648 L	04/96→10/02	Ball Head, gearshift linkage	DB-ES-8387		
		04/96→10/02	Ball Head, gearshift linkage	DB-ES-8491		
		04/96→10/02	Ball Head, gearshift linkage	DB-ES-8492		
		04/96→10/02	Ball Head, gearshift linkage	DB-ES-8500		
04/96→10/02		Ball Head, gearshift linkage	DB-ES-8510			
04/96→10/02		Bush, driver cab suspension	DB-SB-10384			
04/96→10/02		Bush, parabolic spring		DB-SB-10400		
04/96→10/02		Bush, parabolic spring		DB-SB-10401		
04/96→10/02		Centre Rod	DB-DL-2144		Push Rod	
04/96→10/02		Centre Rod	DB-DL-5230		Push Rod, 1st FA;Leaf Spring Axle	
04/96→10/02		Centre Rod	DB-DL-5241		Push Rod	
04/96→10/02		Centre Rod	DB-DL-5405		Push Rod	
04/96→10/02		Centre Rod	DB-DL-5405		Push Rod, 1st FA;Leaf Spring Axle	
04/96→10/02		Centre Rod	DB-DL-7270		Push Rod	
04/96→10/02		Centre Rod	DB-DL-8167		Push Rod, 1st FA;Leaf Spring Axle	
04/96→10/02		Centre Rod	DB-DL-8168		Push Rod	
04/96→10/02		Centre Rod	DB-DL-8184		Push Rod	
04/96→10/02		Centre Rod	DB-DL-8185		Push Rod	
04/96→10/02		Centre Rod	DB-DL-8188		Push Rod	
04/96→10/02		Centre Rod	DB-DL-8307		Push Rod	
04/96→10/02		Centre Rod	DB-DL-8622		Push Rod	
04/96→10/02		Centre Rod	DB-DL-8641		Push Rod	
04/96→10/02		Centre Rod	DB-DL-8642		Push Rod	
04/96→10/02		Centre Rod	DB-DL-12298		for Steering Rod	
04/96→10/02		Centre Rod	DB-DL-12300		for Steering Rod	

CV-ES-0543

Length: 125
Cone Ø: d1 Ø 32 / d2 Ø 29
Thread: M30 x 1,5 RHT
0004605748, 0004606048, 0004606848,
0004607048, 0014600448, 0014601148,
0014601748, 0014602448, 0014607648,
0014609648



CV-ES-0888

Length: 125
Cone Ø: d1 Ø 32 / d2 Ø 29
Thread: M30 x 1,5 LHT
0004605848, 0004606148, 0004606948,
0004607148, 0004609048, 0014600548,
0014601348, 0014602548, 0014607948,
0024600448



CV-ES-14162

Length: 125
Cone Ø: d1 Ø 30 / d2 Ø 27
Thread: M30 x 1,5 LHT
4600648, 4601248, 4603448, 0004603548,
14600348, 14601448, 14602348,
0014603748, 0014607848, 0024600348



CV-ES-14163

Length: 125
Cone Ø: d1 Ø 30 / d2 Ø 27
Thread: M30 x 1,5 RHT
0003305248, 0003387310, 0004600348,
0004600948, 0004602848, 0004602948,
0004608948, 0014600248, 0014600848,
0014601248, 0014602248, 0014607748,
0024600148, A0003387310, A0004600348,
A0004602848, A0004602948, A0014600848,
A0014601248, A0014602248, A0014607748



DB-DL-2144

Length: 872 Ø: 35
Cone Ø: d1 Ø 28,6 / d2 Ø 23,9
0024604305, 0024604405, 0034604805



DB-DL-2178

Length: 1735 Ø: 52
Cone Ø: d1 Ø 32 / d2 Ø 29
9423300003, 9423300103, 9423300203



DB-DL-3475

Length: 565 Ø: 52
Hole Distance: 152 / 152
3753500006, 3753500206, 9473500805,
9483500006, 9483500805, 9483501205,
9483501305, 9483501905, 9483502005,
9483502405, A3753500006,
A3753500206



DB-DL-5224

Length: 850 Ø: 60
Hole Distance: 100 / 100
01336100A, 9413300007



DB-DL-5230

Length: 879 Ø: 42
Cone Ø: d1 Ø 30 / d2 Ø 27
01208600A, 0004607105, 0004607205,
0014606705



DB-DL-5241

Length: 875 Ø: 40
Cone Ø: d1 Ø 30 / d2 Ø 27
01215300A, 0004609205, 0004609305,
0014606905



DB-DL-5405

Length: 890 Ø: 35
Cone Ø: d1 Ø 28,6 / d2 Ø 23,9
01215900A, 1460248, 0024604505,
0024604605, 0034605005, 3752600637,
3754600405, A3752600637, A3754600405



DB-DL-7270

Length: 875 Ø: 40
Cone Ø: d1 Ø 28,6 / d2 Ø 23,9
01208300A, 0024604705, 0024604805,
0034604905, A0024604705



DB-DL-8167

Length: 866 Ø: 38
Cone Ø: d1 Ø 30 / d2 Ø 27
0014609805, 0014609905, 0024606305,
0024606405



DB-DL-8168

Length: 904 Ø: 52
Cone Ø: d1 Ø 32 / d2 Ø 29
0004609405, 0004609505, 0014607105



DB-DL-8184

Length: 1095 Ø: 42
Cone Ø: d1 Ø 32 / d2 Ø 28,8
01217700A, 0014601305, 0014601405,
0024600505, 0034603205, 3754601505,
A0014601305, A0014601405, A0024600505



DB-DL-8185

Length: 711 Ø: 42
Cone Ø: d1 Ø 32 / d2 Ø 28,8
01213600A, 0014601105, 0024600405,
0034603105, A0014601105, A0024600405



DB-DL-8188

Length: 895 Ø: 40
Cone Ø: d1 Ø 28,6 / d2 Ø 23,9
01217200A, 0024604905, 0024605005,
0034605605



DB-DL-8307

Length: 885 Ø: 38
Cone Ø: d1 Ø 32 / d2 Ø 30
01215500A, 0004604005, 0024605105,
0024605205, 0034604005



DB-DL-8622

Length: 1558 Ø: 52
Cone Ø: d1 Ø 30 / d2 Ø 27
0014609005, 0014609105



DB-DL-8640

Length: 1615 Ø: 50
Cone Ø: d1 Ø 32 / d2 Ø 29
6253301503, 6253301603, 6253302403,
6253302503, 9423300803, 9423302103,
9493300203, 9493300303, 9493300903



DB-DL-8641

Length: 905 Ø: 42
Cone Ø: d1 Ø 30 / d2 Ø 27
0014605105, 0014608105



DB-DL-8642

Length: 954 Ø: 42
Cone Ø: d1 Ø 30 / d2 Ø 27
0014608605, 0014608705



DB-DL-9218

Length: 754 Ø: 40
Hole Distance: 100
000360098524, 000390098524,
3753300111, 9413300011,
A3753300111, SA50831601



DB-DL-12298

Length: 927 Ø: 50
Cone Ø: d1 Ø 30 / d2 Ø 27
0024602405, 0024603005



DB-DL-12300

Length: 733 Ø: 36
Cone Ø: d1 Ø 32 / d2 Ø 29
0014601505, 0014607305, 0034603305,
3754601605, A0014601505, A0034603305,
A3754601605



DB-DL-12310

Length: 1532 Ø: 50
Cone Ø: d1 Ø 32 / d2 Ø 29
Thread: M27 x 1,5 LHT
9493301203, 9493301303, 9493301803,
9493302203, A9493301203, A9493301303,
A9493301803, A9493302203



DB-ES-5227

Length: 1588 Ø: 60
Cone Ø: d1 Ø 38 / d2 Ø 34,3
6253300903, 6253301203, 9443300203



DB-ES-5234

Length: 135
Cone Ø: d1 Ø 38 / d2 Ø 34,3
Thread: M38 x 1,5 RHT
0004601748, 120322305, 2205000400



DB-ES-8164

Length: 140
Cone Ø: d1 Ø 28,6 / d2 Ø 23,9
Thread: M28 x 1,5 RHT
0014604248, 0014605048, 0014608548,
0024600548



DB-ES-8387

Length: 55
Cone Ø: d1 Ø 10 / d2 Ø 10
Thread: M14 x 1,5 RHT
0009966845, 0009967045



DB-ES-8491

Length: 60
Cone Ø: d1 Ø 10 / d2 Ø 10
Thread: M12 x 1,75 LHT
0009966745



DB-ES-8492

Length: 60
Cone Ø: d1 Ø 10 / d2 Ø 10
Thread: M12 x 1,75 RHT
0009966645, 3752680189, A3752680189



DB-ES-8500

Length: 55
Cone Ø: d1 Ø 12 / d2 Ø 10,8
Thread: M14 x 1,5 RHT
0002685989



DB-ES-8510

Length: 56
Cone Ø: d1 Ø 10 / d2 Ø 10
Thread: M12 x 1,75 LHT
0009965145, 0009965645, 0019963145



DB-ES-8530

Length: 115
Cone Ø: d1 Ø 28,6 / d2 Ø 23,9
Thread: M30 x 1,5 RHT
0014603848, 0014604848, 0014605148,
0014608648, 0014609948



DB-RK-8626

Ø: 75 Hole Distance: 130
Thick/Height: 24
0003502205, 0003502505, 0003503405,
0003504505, GL11319



DB-RK-10374

Ø: 85 Hole Distance: 152
Thick/Height: 24
0003504405



DB-SB-10384

Ø: 73 Thick/Height: 47
9303170012, 9423171812



DB-SB-10400

Length: 230
Thick/Height: 167,5 / 115
0003250696, 0003250896



DB-SB-10401

Length: 232
Thick/Height: 163,5 / 152,5
0003250596, 0003250796



DB-VB-3707

Length: 622 Ø: 46
Hole Ø 25 / 25 / 25
Hole Distance: 152 / 130 / 130
01337100A, 9423501005, 9423501505,
9443500005, 9473500105, 9473501005,
A3753500005, A9423501005, A9423501505,
A9443500005, A9473500105, A9473501005



DB-VB-7261

Length: 622 Ø: 46
Hole Ø 25 / 25 / 25
Hole Distance: 152 / 130 / 130
01337800A, 9443500305, 9443500505,
9443500605, 9473500705, 9473500905,
9483500405, 9483500305



DB-VB-7798

Length: 622 Ø: 48
Hole Ø 25 / 23 / 23
Hole Distance: 152 / 130 / 130
9423500505, 9423500805, 9423501205,
A9423501205





ACTROS ...

2648, 2648 L ...	04/96→10/02	Rod Assembly	DB-DL-2178		Guide Rod	
	04/96→10/02	Stabiliser Mounting		DB-SB-5250		
	04/96→10/02	Stabiliser Mounting		DB-SB-5261		
	04/96→10/02	Stabiliser Mounting		DB-SB-10406		
	04/96→10/02	Stabiliser Mounting		DB-SB-10407		
	04/96→10/02	Stabiliser Mounting	DB-SB-5260			
	04/96→10/02	Stabiliser Mounting	DB-SB-5277	DB-SB-5277		
	04/96→10/02	Stabiliser Mounting	DB-SB-5279			
	04/96→10/02	Suspension Arm Repair Kit		DB-RK-8550	for Wishbone (CV)	
	04/96→10/02	Suspension Arm Repair Kit		DB-RK-8626	for Wishbone (CV)	
	04/96→10/02	Suspension Arm Repair Kit		DB-RK-8638	for Control Arm	
	04/96→10/02	Suspension Arm Repair Kit		DB-RK-10374	for Wishbone (CV)	
	04/96→10/02	Suspension Strut Repair Kit		DB-RK-9294		
	04/96→10/02	Tie Rod	DB-DL-8327		Guide Rod	
	04/96→10/02	Tie Rod	DB-DL-8640		Guide Rod	
	04/96→10/02	Tie Rod	DB-DL-12310			
	04/96→10/02	Tie Rod	DB-ES-5227		Guide Rod	
	04/96→10/02	Tie Rod End	CV-ES-0543		for Push Rod	
	04/96→10/02	Tie Rod End	CV-ES-0888		for Push Rod	
	04/96→10/02	Tie Rod End	CV-ES-14162		for Steering Rod	
	04/96→10/02	Tie Rod End	CV-ES-14163		for Steering Rod	
	04/96→10/02	Tie Rod End	DB-ES-8164		for Push Rod	
	04/96→10/02	Tie Rod End	DB-ES-8530		for Push Rod	
	04/96→10/02	Track Control Arm		DB-DL-3475	Trailing Arm	
	04/96→10/02	Track Control Arm		DB-VB-3707	Suspension Rod, Wishbone (CV), 1st RA; Air Suspension Axle, →* K 864073 *	
	04/96→10/02	Track Control Arm		DB-VB-7261	Suspension Rod, Wishbone (CV), 1st RA;2nd RA; Leaf Spring Axle	
	04/96→10/02	Track Control Arm	DB-DL-5224		Control Arm, 1st FA;Air Suspension Axle	
	04/96→10/02	Track Control Arm	DB-DL-9218	DB-DL-9218	Trailing Arm, 1st FA;Air Suspension Axle	
	2650 S, 2650 LS	10/97→	Ball Head, gearshift linkage	DB-ES-8387		
		10/97→	Ball Head, gearshift linkage	DB-ES-8491		
		10/97→	Ball Head, gearshift linkage	DB-ES-8492		
		10/97→	Ball Head, gearshift linkage	DB-ES-8500		
10/97→		Bush, parabolic spring		DB-SB-10400		
10/97→		Bush, parabolic spring		DB-SB-10401		
10/97→		Centre Rod	DB-DL-2144		Push Rod	
10/97→		Centre Rod	DB-DL-5230		Push Rod	
10/97→		Centre Rod	DB-DL-5241		Push Rod	
10/97→		Centre Rod	DB-DL-5405		Push Rod	
10/97→		Centre Rod	DB-DL-7270		Push Rod	
10/97→		Centre Rod	DB-DL-8167		Push Rod	
10/97→		Rod Assembly	DB-DL-2178		Guide Rod, 1st Front Axle, →504310 03	
10/97→		Suspension Arm Repair Kit		DB-RK-8626	for Wishbone (CV)	
10/97→		Suspension Arm Repair Kit		DB-RK-10374	for Wishbone (CV)	
10/97→		Tie Rod	DB-DL-8640		Guide Rod	
10/97→		Tie Rod End	CV-ES-0543		for Push Rod	
10/97→		Tie Rod End	CV-ES-0888		for Push Rod	
10/97→		Tie Rod End	CV-ES-14163		for Steering Rod	
10/97→		Tie Rod End	DB-ES-8164		for Push Rod	
10/97→		Tie Rod End	DB-ES-8530		for Push Rod	
10/97→		Track Control Arm		DB-DL-3475	Trailing Arm	
10/97→		Track Control Arm		DB-VB-3707	Suspension Rod, Wishbone (CV)	
10/97→		Track Control Arm		DB-VB-7261	Suspension Rod, Wishbone (CV)	
10/97→		Track Control Arm	DB-DL-5224		Control Arm	
10/97→		Track Control Arm	DB-DL-9218	DB-DL-9218	Trailing Arm	
2653 K, 2653 LK	04/97→10/02	Ball Head, gearshift linkage	DB-ES-8387			
	04/97→10/02	Ball Head, gearshift linkage	DB-ES-8491			
	04/97→10/02	Ball Head, gearshift linkage	DB-ES-8492			
	04/97→10/02	Ball Head, gearshift linkage	DB-ES-8500			
	04/97→10/02	Ball Head, gearshift linkage	DB-ES-8510			
	04/97→10/02	Bush, driver cab suspension	DB-SB-10384			
	04/97→10/02	Bush, parabolic spring		DB-SB-10400		



ACTROS ...

2653 K, 2653 LK ...	04/97→10/02	Bush, parabolic spring		DB-SB-10401	
	04/97→10/02	Centre Rod	DB-DL-2144		Push Rod
	04/97→10/02	Centre Rod	DB-DL-5230		Push Rod, 1st FA;Leaf Spring Axle
	04/97→10/02	Centre Rod	DB-DL-5241		Push Rod
	04/97→10/02	Centre Rod	DB-DL-5405		Push Rod
	04/97→10/02	Centre Rod	DB-DL-5405		Push Rod, 1st FA;Leaf Spring Axle
	04/97→10/02	Centre Rod	DB-DL-7270		Push Rod
	04/97→10/02	Centre Rod	DB-DL-8167		Push Rod
	04/97→10/02	Centre Rod	DB-DL-8167		Push Rod, 1st FA;Leaf Spring Axle
	04/97→10/02	Centre Rod	DB-DL-8184		Push Rod
	04/97→10/02	Centre Rod	DB-DL-8185		Push Rod
	04/97→10/02	Centre Rod	DB-DL-8188		Push Rod
	04/97→10/02	Centre Rod	DB-DL-8307		Push Rod
	04/97→10/02	Centre Rod	DB-DL-12300		for Steering Rod
	04/97→10/02	Rod Assembly	DB-DL-2178		Guide Rod
	04/97→10/02	Stabiliser Link	DB-DL-9254		Pressure Rod
	04/97→10/02	Stabiliser Mounting		DB-RK-9296	
	04/97→10/02	Stabiliser Mounting		DB-SB-5261	
	04/97→10/02	Stabiliser Mounting		DB-SB-10406	
	04/97→10/02	Stabiliser Mounting		DB-SB-10407	
	04/97→10/02	Stabiliser Mounting		DB-SB-10409	
	04/97→10/02	Stabiliser Mounting	DB-SB-5260		
	04/97→10/02	Stabiliser Mounting	DB-SB-5279		
	04/97→10/02	Suspension Arm Repair Kit		DB-RK-8550	for Wishbone (CV)
	04/97→10/02	Suspension Arm Repair Kit		DB-RK-8626	for Wishbone (CV)
	04/97→10/02	Suspension Arm Repair Kit		DB-RK-10374	for Wishbone (CV)
	04/97→10/02	Suspension Arm Repair Kit		DB-RK-10375	for Wishbone (CV)
	04/97→10/02	Suspension Arm Repair Kit	DB-RK-8638		for Control Arm
	04/97→10/02	Suspension Strut Repair Kit		DB-RK-8391	
	04/97→10/02	Suspension Strut Repair Kit		DB-RK-9294	
	04/97→10/02	Tie Rod	DB-DL-8171		Guide Rod
	04/97→10/02	Tie Rod	DB-DL-8327		Guide Rod
	04/97→10/02	Tie Rod	DB-DL-8640		Guide Rod
	04/97→10/02	Tie Rod	DB-DL-12310		
	04/97→10/02	Tie Rod	DB-ES-5227		Guide Rod
	04/97→10/02	Tie Rod End	CV-ES-0543		for Push Rod
	04/97→10/02	Tie Rod End	CV-ES-0888		for Push Rod
	04/97→10/02	Tie Rod End	CV-ES-14162		for Steering Rod
	04/97→10/02	Tie Rod End	CV-ES-14163		for Steering Rod
	04/97→10/02	Tie Rod End	DB-ES-5234		for Steering Rod
	04/97→10/02	Tie Rod End	DB-ES-8164		for Push Rod
	04/97→10/02	Tie Rod End	DB-ES-8530		for Push Rod
04/97→10/02	Track Control Arm		DB-DL-3475	Trailing Arm	
04/97→10/02	Track Control Arm		DB-VB-3707	Suspension Rod, Wishbone (CV), 1st RA; Air Suspension Axle, →* K 864073 *	
04/97→10/02	Track Control Arm		DB-VB-7261	Suspension Rod, Wishbone (CV), 1st RA;2nd RA; Leaf Spring Axle	
04/97→10/02	Track Control Arm	DB-DL-5224		Control Arm	
04/97→10/02	Track Control Arm	DB-DL-9218	DB-DL-9218	Trailing Arm	
2653 S, 2653 LS	09/96→10/02	Ball Head, gearshift linkage	DB-ES-8387		
	09/96→10/02	Ball Head, gearshift linkage	DB-ES-8491		
	09/96→10/02	Ball Head, gearshift linkage	DB-ES-8492		
	09/96→10/02	Ball Head, gearshift linkage	DB-ES-8500		
	09/96→10/02	Ball Head, gearshift linkage	DB-ES-8510		
	09/96→10/02	Bush, driver cab suspension	DB-SB-10384		
	09/96→10/02	Bush, parabolic spring		DB-SB-10400	
	09/96→10/02	Bush, parabolic spring		DB-SB-10401	
	09/96→10/02	Centre Rod	DB-DL-2144		Push Rod
	09/96→10/02	Centre Rod	DB-DL-5230		Push Rod
	09/96→10/02	Centre Rod	DB-DL-5241		Push Rod
09/96→10/02	Centre Rod	DB-DL-5405		Push Rod	
09/96→10/02	Centre Rod	DB-DL-5405		Push Rod, Leaf Spring Axle	
09/96→10/02	Centre Rod	DB-DL-7270		Push Rod	

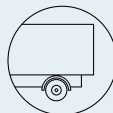

ACTROS ...

2653 S, 2653 LS ...	09/96→10/02	Centre Rod	DB-DL-8167		Push Rod, 1st FA;Leaf Spring Axle
	09/96→10/02	Centre Rod	DB-DL-8167		Push Rod, Leaf Spring Axle
	09/96→10/02	Centre Rod	DB-DL-8184		Push Rod
	09/96→10/02	Centre Rod	DB-DL-8185		Push Rod
	09/96→10/02	Centre Rod	DB-DL-8188		Push Rod
	09/96→10/02	Centre Rod	DB-DL-8307		Push Rod
	09/96→10/02	Centre Rod	DB-DL-12300		for Steering Rod
	09/96→10/02	Rod Assembly	DB-DL-2178		Guide Rod
	09/96→10/02	Stabiliser Mounting		DB-SB-5261	
	09/96→10/02	Stabiliser Mounting		DB-SB-10406	
	09/96→10/02	Stabiliser Mounting		DB-SB-10407	
	09/96→10/02	Stabiliser Mounting		DB-SB-10409	
	09/96→10/02	Stabiliser Mounting	DB-SB-5260		
	09/96→10/02	Stabiliser Mounting	DB-SB-5279		
	09/96→10/02	Stabiliser Mounting	DB-SB-10410		
	09/96→10/02	Suspension Arm Repair Kit		DB-RK-8626	for Wishbone (CV)
	09/96→10/02	Suspension Arm Repair Kit		DB-RK-10374	for Wishbone (CV)
	09/96→10/02	Suspension Arm Repair Kit		DB-RK-10375	for Wishbone (CV)
	09/96→10/02	Suspension Arm Repair Kit	DB-RK-8638		for Control Arm
	09/96→10/02	Suspension Strut Repair Kit		DB-RK-8391	
	09/96→10/02	Suspension Strut Repair Kit		DB-RK-9294	
	09/96→10/02	Suspension Strut Repair Kit		MN-RK-8997	
	09/96→10/02	Tie Rod	DB-DL-8327		Guide Rod
	09/96→10/02	Tie Rod	DB-DL-8640		Guide Rod
	09/96→10/02	Tie Rod	DB-DL-12310		
	09/96→10/02	Tie Rod	DB-ES-5227		Guide Rod
	09/96→10/02	Tie Rod End	CV-ES-0543		for Push Rod
	09/96→10/02	Tie Rod End	CV-ES-0888		for Push Rod
	09/96→10/02	Tie Rod End	CV-ES-14162		for Steering Rod
	09/96→10/02	Tie Rod End	CV-ES-14163		for Steering Rod
	09/96→10/02	Tie Rod End	DB-ES-5234		for Steering Rod
	09/96→10/02	Tie Rod End	DB-ES-8164		for Push Rod
	09/96→10/02	Tie Rod End	DB-ES-8530		for Push Rod
	09/96→10/02	Track Control Arm		DB-DL-3475	Trailing Arm
	09/96→10/02	Track Control Arm		DB-VB-3707	Suspension Rod, Wishbone (CV), 1st RA; Air Suspension Axle, →* K 864073 *
	09/96→10/02	Track Control Arm		DB-VB-7261	Suspension Rod, Wishbone (CV), 1st RA;2nd RA; Leaf Spring Axle
	09/96→10/02	Track Control Arm		DB-VB-7798	Wishbone (CV)
09/96→10/02	Track Control Arm	DB-DL-5224		Control Arm, 1st FA;Air Suspension Axle	
09/96→10/02	Track Control Arm	DB-DL-9218	DB-DL-9218	Trailing Arm, 1st FA;Air Suspension Axle	
2653, 2653 L	04/96→10/02	Ball Head, gearshift linkage	DB-ES-8387		
	04/96→10/02	Ball Head, gearshift linkage	DB-ES-8491		
	04/96→10/02	Ball Head, gearshift linkage	DB-ES-8492		
	04/96→10/02	Ball Head, gearshift linkage	DB-ES-8500		
	04/96→10/02	Ball Head, gearshift linkage	DB-ES-8510		
	04/96→10/02	Bush, driver cab suspension	DB-SB-10384		
	04/96→10/02	Bush, parabolic spring		DB-SB-10400	
	04/96→10/02	Bush, parabolic spring		DB-SB-10401	
	04/96→10/02	Centre Rod	DB-DL-2144		Push Rod
	04/96→10/02	Centre Rod	DB-DL-5230		Push Rod, 1st FA;Leaf Spring Axle
	04/96→10/02	Centre Rod	DB-DL-5241		Push Rod
	04/96→10/02	Centre Rod	DB-DL-5405		Push Rod
	04/96→10/02	Centre Rod	DB-DL-5405		Push Rod, 1st FA;Leaf Spring Axle
	04/96→10/02	Centre Rod	DB-DL-7270		Push Rod
	04/96→10/02	Centre Rod	DB-DL-8167		Push Rod, 1st FA;Leaf Spring Axle
	04/96→10/02	Centre Rod	DB-DL-8168		Push Rod
	04/96→10/02	Centre Rod	DB-DL-8184		Push Rod
	04/96→10/02	Centre Rod	DB-DL-8185		Push Rod
	04/96→10/02	Centre Rod	DB-DL-8188		Push Rod
	04/96→10/02	Centre Rod	DB-DL-8307		Push Rod
	04/96→10/02	Centre Rod	DB-DL-8622		Push Rod
	04/96→10/02	Centre Rod	DB-DL-8641		Push Rod

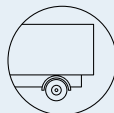

ACTROS ...

2653, 2653 L ...	04/96→10/02	Centre Rod	DB-DL-8642		Push Rod	
	04/96→10/02	Centre Rod	DB-DL-12298		for Steering Rod	
	04/96→10/02	Centre Rod	DB-DL-12300		for Steering Rod	
	04/96→10/02	Rod Assembly	DB-DL-2178		Guide Rod	
	04/96→10/02	Stabiliser Mounting		DB-SB-5250		
	04/96→10/02	Stabiliser Mounting		DB-SB-5261		
	04/96→10/02	Stabiliser Mounting		DB-SB-10406		
	04/96→10/02	Stabiliser Mounting		DB-SB-10407		
	04/96→10/02	Stabiliser Mounting	DB-SB-5260			
	04/96→10/02	Stabiliser Mounting	DB-SB-5277	DB-SB-5277		
	04/96→10/02	Stabiliser Mounting	DB-SB-5279			
	04/96→10/02	Suspension Arm Repair Kit		DB-RK-8626	for Wishbone (CV)	
	04/96→10/02	Suspension Arm Repair Kit		DB-RK-8638	for Control Arm	
	04/96→10/02	Suspension Arm Repair Kit		DB-RK-10374	for Wishbone (CV)	
	04/96→10/02	Suspension Strut Repair Kit		DB-RK-9294		
	04/96→10/02	Tie Rod	DB-DL-8327		Guide Rod	
	04/96→10/02	Tie Rod	DB-DL-8640		Guide Rod	
	04/96→10/02	Tie Rod	DB-DL-12310			
	04/96→10/02	Tie Rod	DB-ES-5227		Guide Rod	
	04/96→10/02	Tie Rod End	CV-ES-0543		for Push Rod	
	04/96→10/02	Tie Rod End	CV-ES-0888		for Push Rod	
	04/96→10/02	Tie Rod End	CV-ES-14162		for Steering Rod	
	04/96→10/02	Tie Rod End	CV-ES-14163		for Steering Rod	
	04/96→10/02	Tie Rod End	DB-ES-8164		for Push Rod	
	04/96→10/02	Tie Rod End	DB-ES-8530		for Push Rod	
	04/96→10/02	Track Control Arm		DB-DL-3475	Trailing Arm	
	04/96→10/02	Track Control Arm		DB-VB-3707	Suspension Rod, Wishbone (CV), 1st RA; Air Suspension Axle, →* K 864073 *	
	04/96→10/02	Track Control Arm		DB-VB-7261	Suspension Rod, Wishbone (CV), 1st RA;2nd RA; Leaf Spring Axle	
	04/96→10/02	Track Control Arm	DB-DL-5224		Control Arm, 1st FA;Air Suspension Axle	
	04/96→10/02	Track Control Arm	DB-DL-9218	DB-DL-9218	Trailing Arm, 1st FA;Air Suspension Axle	
	2657 K, 2657 LK	04/97→10/02	Ball Head, gearshift linkage	DB-ES-8387		
		04/97→10/02	Ball Head, gearshift linkage	DB-ES-8491		
		04/97→10/02	Ball Head, gearshift linkage	DB-ES-8492		
04/97→10/02		Ball Head, gearshift linkage	DB-ES-8500			
04/97→10/02		Ball Head, gearshift linkage	DB-ES-8510			
04/97→10/02		Bush, driver cab suspension	DB-SB-10384			
04/97→10/02		Bush, parabolic spring		DB-SB-10400		
04/97→10/02		Bush, parabolic spring		DB-SB-10401		
04/97→10/02		Centre Rod	DB-DL-2144		Push Rod	
04/97→10/02		Centre Rod	DB-DL-5230		Push Rod	
04/97→10/02		Centre Rod	DB-DL-5241		Push Rod	
04/97→10/02		Centre Rod	DB-DL-5405		Push Rod	
04/97→10/02		Centre Rod	DB-DL-5405		Push Rod, 1st FA;Leaf Spring Axle	
04/97→10/02		Centre Rod	DB-DL-7270		Push Rod	
04/97→10/02		Centre Rod	DB-DL-8167		Push Rod	
04/97→10/02		Centre Rod	DB-DL-8167		Push Rod, 1st FA;Leaf Spring Axle	
04/97→10/02		Centre Rod	DB-DL-8184		Push Rod	
04/97→10/02		Centre Rod	DB-DL-8185		Push Rod	
04/97→10/02		Centre Rod	DB-DL-8188		Push Rod	
04/97→10/02		Centre Rod	DB-DL-8307		Push Rod	
04/97→10/02		Centre Rod	DB-DL-12300		for Steering Rod	
04/97→10/02		Rod Assembly	DB-DL-2178		Guide Rod	
04/97→10/02		Stabiliser Link	DB-DL-9254		Pressure Rod	
04/97→10/02		Stabiliser Mounting		DB-RK-9296		
04/97→10/02		Stabiliser Mounting		DB-SB-5261		
04/97→10/02		Stabiliser Mounting		DB-SB-10406		
04/97→10/02		Stabiliser Mounting		DB-SB-10407		
04/97→10/02		Stabiliser Mounting		DB-SB-10409		
04/97→10/02		Stabiliser Mounting	DB-SB-5260			
04/97→10/02		Stabiliser Mounting	DB-SB-5279			
04/97→10/02		Suspension Arm Repair Kit		DB-RK-8550	for Wishbone (CV)	

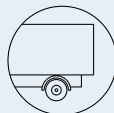

ACTROS ...

2657 K, 2657 LK ...	04/97→10/02	Suspension Arm Repair Kit		DB-RK-8626	for Wishbone (CV)
	04/97→10/02	Suspension Arm Repair Kit		DB-RK-10374	for Wishbone (CV)
	04/97→10/02	Suspension Arm Repair Kit		DB-RK-10375	for Wishbone (CV)
	04/97→10/02	Suspension Arm Repair Kit	DB-RK-8638		for Control Arm
	04/97→10/02	Suspension Strut Repair Kit		DB-RK-8391	
	04/97→10/02	Suspension Strut Repair Kit		DB-RK-9294	
	04/97→10/02	Tie Rod	DB-DL-8171		Guide Rod
	04/97→10/02	Tie Rod	DB-DL-8327		Guide Rod
	04/97→10/02	Tie Rod	DB-DL-8640		Guide Rod
	04/97→10/02	Tie Rod	DB-DL-12310		
	04/97→10/02	Tie Rod	DB-ES-5227		Guide Rod
	04/97→10/02	Tie Rod End	CV-ES-0543		for Push Rod
	04/97→10/02	Tie Rod End	CV-ES-0888		for Push Rod
	04/97→10/02	Tie Rod End	CV-ES-14162		for Steering Rod
	04/97→10/02	Tie Rod End	CV-ES-14163		for Steering Rod
	04/97→10/02	Tie Rod End	DB-ES-5234		for Steering Rod
	04/97→10/02	Tie Rod End	DB-ES-8164		for Push Rod
	04/97→10/02	Tie Rod End	DB-ES-8530		for Push Rod
	04/97→10/02	Track Control Arm		DB-DL-3475	Trailing Arm
	04/97→10/02	Track Control Arm		DB-VB-3707	Suspension Rod, Wishbone (CV), 1st RA; Air Suspension Axle, →* K 864073 *
	04/97→10/02	Track Control Arm		DB-VB-7261	Suspension Rod, Wishbone (CV), 1st RA;2nd RA; Leaf Spring Axle
	04/97→10/02	Track Control Arm	DB-DL-5224		Control Arm
	04/97→10/02	Track Control Arm	DB-DL-9218	DB-DL-9218	Trailing Arm
	2657 L	04/97→10/02	Ball Head, gearshift linkage	DB-ES-8387	
04/97→10/02		Ball Head, gearshift linkage	DB-ES-8491		
04/97→10/02		Ball Head, gearshift linkage	DB-ES-8492		
04/97→10/02		Ball Head, gearshift linkage	DB-ES-8500		
04/97→10/02		Ball Head, gearshift linkage	DB-ES-8510		
04/97→10/02		Bush, driver cab suspension	DB-SB-10384		
04/97→10/02		Bush, parabolic spring		DB-SB-10400	
04/97→10/02		Bush, parabolic spring		DB-SB-10401	
04/97→10/02		Centre Rod	DB-DL-2144		Push Rod
04/97→10/02		Centre Rod	DB-DL-5230		Push Rod, 1st FA;Leaf Spring Axle
04/97→10/02		Centre Rod	DB-DL-5241		Push Rod
04/97→10/02		Centre Rod	DB-DL-5405		Push Rod
04/97→10/02		Centre Rod	DB-DL-7270		Push Rod
04/97→10/02		Centre Rod	DB-DL-8167		Push Rod
04/97→10/02		Centre Rod	DB-DL-8168		Push Rod
04/97→10/02		Centre Rod	DB-DL-8184		Push Rod
04/97→10/02		Centre Rod	DB-DL-8185		Push Rod
04/97→10/02		Centre Rod	DB-DL-8188		Push Rod
04/97→10/02		Centre Rod	DB-DL-8307		Push Rod
04/97→10/02		Centre Rod	DB-DL-8622		Push Rod
04/97→10/02		Centre Rod	DB-DL-8641		Push Rod
04/97→10/02		Centre Rod	DB-DL-8642		Push Rod
04/97→10/02		Centre Rod	DB-DL-12298		for Steering Rod
04/97→10/02		Centre Rod	DB-DL-12300		for Steering Rod
04/97→10/02		Rod Assembly	DB-DL-2178		Guide Rod
04/97→10/02		Stabiliser Mounting		DB-SB-5250	
04/97→10/02		Stabiliser Mounting		DB-SB-5261	
04/97→10/02		Stabiliser Mounting		DB-SB-10406	
04/97→10/02		Stabiliser Mounting		DB-SB-10407	
04/97→10/02		Stabiliser Mounting	DB-SB-5260		
04/97→10/02		Stabiliser Mounting	DB-SB-5277	DB-SB-5277	
04/97→10/02		Stabiliser Mounting	DB-SB-5279		
04/97→10/02		Suspension Arm Repair Kit		DB-RK-8626	for Wishbone (CV)
04/97→10/02		Suspension Arm Repair Kit		DB-RK-8638	for Control Arm
04/97→10/02		Suspension Arm Repair Kit		DB-RK-10374	for Wishbone (CV)
04/97→10/02		Tie Rod	DB-DL-8327		Guide Rod
04/97→10/02		Tie Rod	DB-DL-8640		Guide Rod
04/97→10/02		Tie Rod	DB-DL-12310		

CV-ES-0543

Length: 125
 Cone Ø: d1 Ø 32 / d2 Ø 29
 Thread: M30 x 1,5 RHT
 0004605748, 0004606048, 0004606848,
 0004607048, 0014600448, 0014601148,
 0014601748, 0014602448, 0014607648,
 0014609648

**CV-ES-0888**

Length: 125
 Cone Ø: d1 Ø 32 / d2 Ø 29
 Thread: M30 x 1,5 LHT
 0004605848, 0004606148, 0004606948,
 0004607148, 0004609048, 0014600548,
 0014601348, 0014602548, 0014607948,
 0024600448

**CV-ES-14162**

Length: 125
 Cone Ø: d1 Ø 30 / d2 Ø 27
 Thread: M30 x 1,5 LHT
 4600648, 4601248, 4603448, 0004603548,
 14600348, 14601448, 14602348,
 0014603748, 0014607848, 0024600348

**CV-ES-14163**

Length: 125
 Cone Ø: d1 Ø 30 / d2 Ø 27
 Thread: M30 x 1,5 RHT
 0003305248, 0003387310, 0004600348,
 0004600948, 0004602848, 0004602948,
 0004608948, 0014600248, 0014600848,
 0014601248, 0014602248, 0014607748,
 0024600148, 0003387310, 0004600348,
 0004602848, 0004602948, 0014600848,
 0014601248, 0014602248, 0014607748

**DB-DL-2144**

Length: 872 Ø: 35
 Cone Ø: d1 Ø 28,6 / d2 Ø 23,9
 0024604305, 0024604405, 0034604805

**DB-DL-2178**

Length: 1735 Ø: 52
 Cone Ø: d1 Ø 32 / d2 Ø 29
 9423300003, 9423300103, 9423300203

**DB-DL-3475**

Length: 565 Ø: 52
 Hole Distance: 152 / 152
 3753500006, 3753500206, 9473500805,
 9483500006, 9483500805, 9483501205,
 9483501305, 9483501905, 9483502005,
 9483502405, A3753500006,
 A3753500206

**DB-DL-5224**

Length: 850 Ø: 60
 Hole Distance: 100 / 100
 01336100A, 9413300007

**DB-DL-5230**

Length: 879 Ø: 42
 Cone Ø: d1 Ø 30 / d2 Ø 27
 01208600A, 0004607105, 0004607205,
 0014606705

**DB-DL-5241**

Length: 875 Ø: 40
 Cone Ø: d1 Ø 30 / d2 Ø 27
 01215300A, 0004609205, 0004609305,
 0014606905

**DB-DL-5405**

Length: 890 Ø: 35
 Cone Ø: d1 Ø 28,6 / d2 Ø 23,9
 01215900A, 1460248, 0024604505,
 0024604605, 0034605005, 3752600637,
 3754600405, A3752600637, A3754600405

**DB-DL-7270**

Length: 875 Ø: 40
 Cone Ø: d1 Ø 28,6 / d2 Ø 23,9
 01208300A, 0024604705, 0024604805,
 0034604905, A0024604705

**DB-DL-8167**

Length: 866 Ø: 38
 Cone Ø: d1 Ø 30 / d2 Ø 27
 0014609805, 0014609905, 0024606305,
 0024606405

**DB-DL-8168**

Length: 904 Ø: 52
 Cone Ø: d1 Ø 32 / d2 Ø 29
 0004609405, 0004609505, 0014607105

**DB-DL-8171**

Length: 1687 Ø: 52
 Cone Ø: d1 Ø 32 / d2 Ø 29
 9493300603, 9493300703, 9493301503,
 9493301603

**DB-DL-8184**

Length: 1095 Ø: 42
 Cone Ø: d1 Ø 32 / d2 Ø 28,8
 01217700A, 0014601305, 0014601405,
 0024600505, 0034603205, 3754601505,
 A0014601305, A0014601405, A0024600505

**DB-DL-8185**

Length: 711 Ø: 42
 Cone Ø: d1 Ø 32 / d2 Ø 28,8
 01213600A, 0014601105, 0024600405,
 0034603105, A0014601105, A0024600405

**DB-DL-8188**

Length: 895 Ø: 40
 Cone Ø: d1 Ø 28,6 / d2 Ø 23,9
 01217200A, 0024604905, 0024605005,
 0034605605

**DB-DL-8307**

Length: 885 Ø: 38
 Cone Ø: d1 Ø 32 / d2 Ø 30
 01215500A, 0004604005, 0024605105,
 0024605205, 0034604005

**DB-DL-8327**

Length: 1745 Ø: 48
 Cone Ø: d1 Ø 32 / d2 Ø 29
 01219800A, 9413300003, 9413300103,
 9413300203, 9413300303, 9413300503

**DB-DL-8622**

Length: 1558 Ø: 52
 Cone Ø: d1 Ø 30 / d2 Ø 27
 0014609005, 0014609105

**DB-DL-8640**

Length: 1615 Ø: 50
 Cone Ø: d1 Ø 32 / d2 Ø 29
 6253301503, 6253301603, 6253302403,
 6253302503, 9423300803, 9423302103,
 9493300203, 9493300303, 9493300903

**DB-DL-8641**

Length: 905 Ø: 42
 Cone Ø: d1 Ø 30 / d2 Ø 27
 0014605105, 0014608105

**DB-DL-8642**

Length: 954 Ø: 42
 Cone Ø: d1 Ø 30 / d2 Ø 27
 0014608605, 0014608705

**DB-DL-9218**

Length: 754 Ø: 40
 Hole Distance: 100
 000360098524, 000390098524,
 3753300111, 9413300111,
 A3753300111, SA50831601

**DB-DL-12298**

Length: 927 Ø: 50
 Cone Ø: d1 Ø 30 / d2 Ø 27
 0024602405, 0024603005

**DB-DL-12300**

Length: 733 Ø: 36
 Cone Ø: d1 Ø 32 / d2 Ø 29
 0014601505, 0014607305, 0034603305,
 3754601605, A0014601505,
 A0034603305, A3754601605

**DB-DL-12310**

Length: 1532 Ø: 50
 Cone Ø: d1 Ø 32 / d2 Ø 29
 Thread: M27 x 1,5 LHT
 9493301203, 9493301303, 9493301803,
 9493302203, A9493301203, A9493301303,
 A9493301803, A9493302203

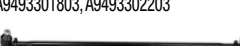
**DB-ES-5227**

Length: 1588 Ø: 60
 Cone Ø: d1 Ø 38 / d2 Ø 34,3
 6253300903, 6253301203, 9443300203

**DB-ES-5234**

Length: 135
 Cone Ø: d1 Ø 38 / d2 Ø 34,3
 Thread: M38 x 1,5 RHT
 0004601748, 120322305, 2205000400

**DB-ES-8164**

Length: 140
 Cone Ø: d1 Ø 28,6 / d2 Ø 23,9
 Thread: M28 x 1,5 RHT
 0014604248, 0014605048, 0014608548,
 0024600548

**DB-ES-8387**

Length: 55
 Cone Ø: d1 Ø 10 / d2 Ø 10
 Thread: M14 x 1,5 RHT
 0009966845, 0009967045

**DB-ES-8491**

Length: 60
 Cone Ø: d1 Ø 10 / d2 Ø 10
 Thread: M12 x 1,75 LHT
 0009966745

**DB-ES-8492**

Length: 60
 Cone Ø: d1 Ø 10 / d2 Ø 10
 Thread: M12 x 1,75 RHT
 0009966645, 3752680189, A3752680189

**DB-ES-8500**

Length: 55
 Cone Ø: d1 Ø 12 / d2 Ø 10,8
 Thread: M14 x 1,5 RHT
 0002685989

**DB-ES-8510**

Length: 56
 Cone Ø: d1 Ø 10 / d2 Ø 10
 Thread: M12 x 1,75 LHT
 0009965145, 0009965645, 0019963145

**DB-ES-8530**

Length: 115
 Cone Ø: d1 Ø 28,6 / d2 Ø 23,9
 Thread: M30 x 1,5 RHT
 0014603848, 0014604848, 0014605148,
 0014608648, 0014609948

**DB-RK-8391**

Ø: 85 Hole Distance: 152
 Thick/Height: 24
 01336800A, 0003502705

**DB-RK-8626**

Ø: 75 Hole Distance: 130
 Thick/Height: 24
 0003502205, 0003502505, 0003503405,
 0003504505, GL11319

**DB-RK-8638**

Length: 100 Ø: 67
 Hole Distance: 100
 Thick/Height: 20
 0003301411

**DB-RK-9294**

Ø: 85 Hole Distance: 152
 Thick/Height: 24
 0003503105

**DB-RK-10374**

Ø: 85 Hole Distance: 152
 Thick/Height: 24
 0003504405

**DB-RK-10375**

Ø: 100 Hole Distance: 152
 Thick/Height: 24
 0003502405, 0003503505, 0003504905

**DB-SB-5250**

Ø: 66 Thick/Height: 56
 01320400A, 0003262681, 0003263081,
 0003263281

**DB-SB-5260**

Ø: 70 Thick/Height: 36,5 / 46
 01320700A, 0003237485, 0003237585,
 0003237985

**DB-SB-5261**

Length: 85 Ø: 82
 Thick/Height: 56
 01320600A, 0003264481, 0003264781

**DB-SB-5277**

Ø: 52
 01320100A, 9413230350

**DB-SB-5279**

Ø: 42 Thick/Height: 55
 000326285, 0003237185

**DB-SB-10384**

Ø: 73 Thick/Height: 47
 9303170012, 9423171812

**DB-SB-10400**

Length: 230
 Thick/Height: 167,5 / 115
 0003250696, 0003250896

**DB-SB-10401**

Length: 232
 Thick/Height: 163,5 / 152,5
 0003250596, 0003250796

**DB-SB-10406**

Ø: 80 Thick/Height: 46
 0003238185

**DB-SB-10407**

Ø: 61 Thick/Height: 46
 0003235985, 0003262481, 0003262981

**DB-VB-3707**

Length: 622 Ø: 46
 Hole Ø 25 / 25 / 25
 Hole Distance: 152 / 130 / 130
 01337100A, 9423501005, 9423501505,
 9443500005, 9473500105, 9473501005,
 A3753500005, A9423501005, A9423501505,
 A9443500005, A9473500105, A9473501005

**DB-VB-7261**

Length: 622 Ø: 46
 Hole Ø 25 / 25 / 25
 Hole Distance: 152 / 130 / 130
 01337800A, 9443500305, 9443500505,
 9443500605, 9473500705, 9473500905,
 9483500405, 9483503005

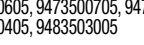



ACTROS ...

2657 L ...	04/97→10/02	Tie Rod	DB-ES-5227		Guide Rod
	04/97→10/02	Tie Rod End	CV-ES-0543		for Push Rod
	04/97→10/02	Tie Rod End	CV-ES-0888		for Push Rod
	04/97→10/02	Tie Rod End	CV-ES-14162		for Steering Rod
	04/97→10/02	Tie Rod End	CV-ES-14163		for Steering Rod
	04/97→10/02	Tie Rod End	DB-ES-8164		for Push Rod
	04/97→10/02	Tie Rod End	DB-ES-8530		for Push Rod
	04/97→10/02	Track Control Arm		DB-DL-3475	Trailing Arm
	04/97→10/02	Track Control Arm		DB-VB-3707	Suspension Rod, Wishbone (CV), 1st RA; Air Suspension Axle, →* K 864073 *
	04/97→10/02	Track Control Arm	DB-DL-5224		Control Arm, 1st FA;Air Suspension Axle
2657 S, 2657 LS	04/97→10/02	Track Control Arm	DB-DL-9218	DB-DL-9218	Trailing Arm, 1st FA;Air Suspension Axle
	04/97→10/02	Ball Head, gearshift linkage	DB-ES-8387		
	04/97→10/02	Ball Head, gearshift linkage	DB-ES-8491		
	04/97→10/02	Ball Head, gearshift linkage	DB-ES-8492		
	04/97→10/02	Ball Head, gearshift linkage	DB-ES-8500		
	04/97→10/02	Ball Head, gearshift linkage	DB-ES-8510		
	04/97→10/02	Bush, driver cab suspension	DB-SB-10384		
	04/97→10/02	Bush, parabolic spring		DB-SB-10400	
	04/97→10/02	Bush, parabolic spring		DB-SB-10401	
	04/97→10/02	Centre Rod	DB-DL-2144		Push Rod
	04/97→10/02	Centre Rod	DB-DL-5230		Push Rod, 1st FA;Leaf Spring Axle
	04/97→10/02	Centre Rod	DB-DL-5241		Push Rod
	04/97→10/02	Centre Rod	DB-DL-5405		Push Rod
	04/97→10/02	Centre Rod	DB-DL-7270		Push Rod
	04/97→10/02	Centre Rod	DB-DL-8167		Push Rod, 1st FA;Leaf Spring Axle
	04/97→10/02	Centre Rod	DB-DL-8184		Push Rod
	04/97→10/02	Centre Rod	DB-DL-8185		Push Rod
	04/97→10/02	Centre Rod	DB-DL-8188		Push Rod
	04/97→10/02	Centre Rod	DB-DL-8307		Push Rod
	04/97→10/02	Centre Rod	DB-DL-12300		for Steering Rod
	04/97→10/02	Rod Assembly	DB-DL-2178		Guide Rod
	04/97→10/02	Stabiliser Mounting		DB-SB-5261	
	04/97→10/02	Stabiliser Mounting		DB-SB-10406	
	04/97→10/02	Stabiliser Mounting		DB-SB-10407	
	04/97→10/02	Stabiliser Mounting		DB-SB-10409	
	04/97→10/02	Stabiliser Mounting	DB-SB-5260		
	04/97→10/02	Stabiliser Mounting	DB-SB-5279		
	04/97→10/02	Stabiliser Mounting	DB-SB-10410		
	04/97→10/02	Suspension Arm Repair Kit		DB-RK-8626	for Wishbone (CV)
	04/97→10/02	Suspension Arm Repair Kit		DB-RK-10374	for Wishbone (CV)
	04/97→10/02	Suspension Arm Repair Kit		DB-RK-10375	for Wishbone (CV)
	04/97→10/02	Suspension Arm Repair Kit	DB-RK-8638		for Control Arm
	04/97→10/02	Suspension Strut Repair Kit		DB-RK-8391	
	04/97→10/02	Suspension Strut Repair Kit		DB-RK-9294	
	04/97→10/02	Suspension Strut Repair Kit		MN-RK-8997	
	04/97→10/02	Tie Rod	DB-DL-8327		Guide Rod
	04/97→10/02	Tie Rod	DB-DL-8640		Guide Rod
	04/97→10/02	Tie Rod	DB-DL-12310		
	04/97→10/02	Tie Rod	DB-ES-5227		Guide Rod
	04/97→10/02	Tie Rod End	CV-ES-0543		for Push Rod
	04/97→10/02	Tie Rod End	CV-ES-0888		for Push Rod
	04/97→10/02	Tie Rod End	CV-ES-14162		for Steering Rod
04/97→10/02	Tie Rod End	CV-ES-14163		for Steering Rod	
04/97→10/02	Tie Rod End	DB-ES-5234		for Steering Rod	
04/97→10/02	Tie Rod End	DB-ES-8164		for Push Rod	
04/97→10/02	Tie Rod End	DB-ES-8530		for Push Rod	
04/97→10/02	Track Control Arm		DB-DL-3475	Trailing Arm	
04/97→10/02	Track Control Arm		DB-VB-3707	Suspension Rod, Wishbone (CV), Drive Axle; Air Suspension Axle	
04/97→10/02	Track Control Arm		DB-VB-7798	Wishbone (CV)	
04/97→10/02	Track Control Arm	DB-DL-5224		Control Arm, 1st FA;Air Suspension Axle	
04/97→10/02	Track Control Arm	DB-DL-9218	DB-DL-9218	Trailing Arm, 1st FA;Air Suspension Axle	

CV-ES-0543

Length: 125
Cone Ø: d1 Ø 32 / d2 Ø 29
Thread: M30 x 1,5 RHT
0004605748, 0004606048, 0004606848,
0004607048, 0014600448, 0014601148,
0014601748, 0014602448, 0014607648,
0014609648



CV-ES-0888

Length: 125
Cone Ø: d1 Ø 32 / d2 Ø 29
Thread: M30 x 1,5 LHT
0004605848, 0004606148, 0004606948,
0004607148, 0004609048, 0014600548,
0014601348, 0014602548, 0014607948,
0024600448



CV-ES-14162

Length: 125
Cone Ø: d1 Ø 30 / d2 Ø 27
Thread: M30 x 1,5 LHT
4600648, 4601248, 4603448, 0004603548,
14600348, 14601448, 14602348,
0014603748, 0014607848, 0024600348



CV-ES-14163

Length: 125
Cone Ø: d1 Ø 30 / d2 Ø 27
Thread: M30 x 1,5 RHT
0003305248, 0003387310, 0004600348,
0004600948, 0004602848, 0004602948,
0004608948, 0014600248, 0014600848,
0014601248, 0014602248, 0014607748,
0024600148, A0003387310, A0004600348,
A0004602848, A0004602948, A0014600848,
A0014601248, A0014602248, A0014607748



DB-DL-2144

Length: 872 Ø: 35
Cone Ø: d1 Ø 28,6 / d2 Ø 23,9
0024604305, 0024604405, 0034604805



DB-DL-2178

Length: 1735 Ø: 52
Cone Ø: d1 Ø 32 / d2 Ø 29
9423300003, 9423300103, 9423300203



DB-DL-3475

Length: 565 Ø: 52
Hole Distance: 152 / 152
3753500006, 3753500206, 9473500805,
9483500006, 9483500805, 9483501205,
9483501305, 9483501905, 9483502005,
9483502405, A3753500006,
A3753500206



DB-DL-5224

Length: 850 Ø: 60
Hole Distance: 100 / 100
01336100A, 9413300007



DB-DL-5230

Length: 879 Ø: 42
Cone Ø: d1 Ø 30 / d2 Ø 27
01208600A, 0004607105, 0004607205,
0014606705



DB-DL-5241

Length: 875 Ø: 40
Cone Ø: d1 Ø 30 / d2 Ø 27
01215300A, 0004609205, 0004609305,
0014606905



DB-DL-5405

Length: 890 Ø: 35
Cone Ø: d1 Ø 28,6 / d2 Ø 23,9
01215900A, 1460248, 0024604505,
0024604605, 0034605005, 3752600637,
3754600405, A3752600637, A3754600405



DB-DL-7270

Length: 875 Ø: 40
Cone Ø: d1 Ø 28,6 / d2 Ø 23,9
01208300A, 0024604705, 0024604805,
0034604905, A0024604705



DB-DL-8167

Length: 866 Ø: 38
Cone Ø: d1 Ø 30 / d2 Ø 27
0014609805, 0014609905, 0024606305,
0024606405



DB-DL-8184

Length: 1095 Ø: 42
Cone Ø: d1 Ø 32 / d2 Ø 28,8
01217700A, 0014601305, 0014601405,
0024600505, 0034603205, 3754601505,
A0014601305, A0014601405, A0024600505



DB-DL-8185

Length: 711 Ø: 42
Cone Ø: d1 Ø 32 / d2 Ø 28,8
01213600A, 0014601105, 0024600405,
0034603105, A0014601105, A0024600405



DB-DL-8188

Length: 895 Ø: 40
Cone Ø: d1 Ø 28,6 / d2 Ø 23,9
01217200A, 0024604905, 0024605005,
0034605605



DB-DL-8307

Length: 885 Ø: 38
Cone Ø: d1 Ø 32 / d2 Ø 30
01215500A, 0004604005, 0024605105,
0024605205, 0034604005



DB-DL-8327

Length: 1745 Ø: 48
Cone Ø: d1 Ø 32 / d2 Ø 29
01219800A, 9413300003, 9413300103,
9413300203, 9413300303, 9413300503



DB-DL-8640

Length: 1615 Ø: 50
Cone Ø: d1 Ø 32 / d2 Ø 29
6253301503, 6253301603, 6253302403,
6253302503, 9423300803, 9423302103,
9493300203, 9493300303, 9493300903



DB-DL-9218

Length: 754 Ø: 40
Hole Distance: 100
000360098524, 000390098524,
3753300111, 9413300011,
A3753300111, SA50831601



DB-DL-12300

Length: 733 Ø: 36
Cone Ø: d1 Ø 32 / d2 Ø 29
0014601505, 0014607305, 0034603305,
3754601605, A0014601505,
A0034603305, A3754601605



DB-DL-12310

Length: 1532 Ø: 50
Cone Ø: d1 Ø 32 / d2 Ø 29
Thread: M27 x 1,5 LHT
9493301203, 9493301303, 9493301803,
9493302203, A9493301203, A9493301303,
A9493301803, A9493302203



DB-ES-5227

Length: 1588 Ø: 60
Cone Ø: d1 Ø 38 / d2 Ø 34,3
6253300903, 6253301203, 9443300203



DB-ES-5234

Length: 135
Cone Ø: d1 Ø 38 / d2 Ø 34,3
Thread: M38 x 1,5 RHT
0004601748, 120322305, 2205000400



DB-ES-8164

Length: 140
Cone Ø: d1 Ø 28,6 / d2 Ø 23,9
Thread: M28 x 1,5 RHT
0014604248, 0014605048, 0014608548,
0024600548



DB-ES-8387

Length: 55
Cone Ø: d1 Ø 10 / d2 Ø 10
Thread: M14 x 1,5 RHT
0009966845, 0009967045



DB-ES-8491

Length: 60
Cone Ø: d1 Ø 10 / d2 Ø 10
Thread: M12 x 1,75 LHT
0009966745



DB-ES-8492

Length: 60
Cone Ø: d1 Ø 10 / d2 Ø 10
Thread: M12 x 1,75 RHT
0009966645, 3752680189, A3752680189



DB-ES-8500

Length: 55
Cone Ø: d1 Ø 12 / d2 Ø 10,8
Thread: M14 x 1,5 RHT
0002685989



DB-ES-8510

Length: 56
Cone Ø: d1 Ø 10 / d2 Ø 10
Thread: M12 x 1,75 LHT
0009965145, 0009965645, 0019963145



DB-ES-8530

Length: 115
Cone Ø: d1 Ø 28,6 / d2 Ø 23,9
Thread: M30 x 1,5 RHT
0014603848, 0014604848, 0014605148,
0014608648, 0014609948



DB-RK-8391

Ø: 85 Hole Distance: 152
Thick/Height: 24
01336800A, 0003502705



DB-RK-8626

Ø: 75 Hole Distance: 130
Thick/Height: 24
0003502205, 0003502505, 0003503405,
0003504505, GL11319



DB-RK-8638

Length: 100 Ø: 67
Hole Distance: 100
Thick/Height: 20
0003301411



DB-RK-9294

Ø: 85 Hole Distance: 152
Thick/Height: 24
0003503105



DB-RK-10374

Ø: 85 Hole Distance: 152
Thick/Height: 24
0003504405



DB-RK-10375

Ø: 100 Hole Distance: 152
Thick/Height: 24
0003502405, 0003503505, 0003504905



DB-SB-5260

Ø: 70 Thick/Height: 36,5 / 46
01320700A, 0003237485, 0003237585,
0003237985



DB-SB-5261

Length: 85 Ø: 82
Thick/Height: 56
01320600A, 0003264481, 0003264781



DB-SB-5279

Ø: 42 Thick/Height: 55
0003236285, 0003237185



DB-SB-10384

Ø: 73 Thick/Height: 47
9303170012, 9423171812



DB-SB-10400

Length: 230
Thick/Height: 167,5 / 115
0003250696, 0003250896



DB-SB-10401

Length: 232
Thick/Height: 163,5 / 152,5
0003250596, 0003250796



DB-SB-10406

Ø: 80 Thick/Height: 46
0003238185



DB-SB-10407

Ø: 61 Thick/Height: 46
0003235985, 0003262481, 0003262981



DB-SB-10409

Ø: 77 Thick/Height: 56
0003265181



DB-SB-10410

Ø: 73 Hole Distance: 100
Thick/Height: 24
9413230050



DB-VB-3707

Length: 622 Ø: 46
Hole Ø 25 / 25 / 25
Hole Distance: 152 / 130 / 130
01337100A, 9423501005, 9423501505,
9443500005, 9473500105, 9473501005,
A3753500005, A9423501005, A9423501505,
A9443500005, A9473500105, A9473501005



DB-VB-7798

Length: 622 Ø: 48
Hole Ø 25 / 23 / 23
Hole Distance: 152 / 130 / 130
9423500505, 9423500805, 9423501205,
A9423501205



MN-RK-8997

Ø: 85 Hole Distance: 130
Thick/Height: 30
0003504805





ACTROS ...

3231 B	04/97→10/02	Ball Head, gearshift linkage	DB-ES-8387		
	04/97→10/02	Ball Head, gearshift linkage	DB-ES-8491		
	04/97→10/02	Ball Head, gearshift linkage	DB-ES-8492		
	04/97→10/02	Ball Head, gearshift linkage	DB-ES-8500		
	04/97→10/02	Ball Head, gearshift linkage	DB-ES-8510		
	04/97→10/02	Bush, driver cab suspension	DB-SB-10384		
	04/97→10/02	Bush, parabolic spring		DB-SB-10400	
	04/97→10/02	Bush, parabolic spring		DB-SB-10401	
	04/97→10/02	Centre Rod	DB-DL-5230		Push Rod
	04/97→10/02	Centre Rod	DB-DL-5405		Push Rod
	04/97→10/02	Centre Rod	DB-DL-8168		Push Rod, Leaf Spring Axle
	04/97→10/02	Centre Rod	DB-DL-8184		Push Rod, Leaf Spring Axle
	04/97→10/02	Centre Rod	DB-DL-8185		Push Rod, Leaf Spring Axle
	04/97→10/02	Centre Rod	DB-DL-8188		Push Rod
	04/97→10/02	Centre Rod	DB-DL-8307		Push Rod
	04/97→10/02	Centre Rod	DB-DL-12300		for Steering Rod
	04/97→10/02	Stabiliser Link	DB-DL-9254		Pressure Rod
	04/97→10/02	Stabiliser Link	DB-DL-9271		Pressure Rod
	04/97→10/02	Stabiliser Link	DB-DL-9272		Pressure Rod
	04/97→10/02	Stabiliser Mounting		DB-SB-5261	
	04/97→10/02	Stabiliser Mounting		DB-SB-10406	
	04/97→10/02	Stabiliser Mounting		DB-SB-10407	
	04/97→10/02	Stabiliser Mounting		DB-SB-10409	
	04/97→10/02	Stabiliser Mounting	DB-SB-5260		
	04/97→10/02	Stabiliser Mounting	DB-SB-5279		
	04/97→10/02	Suspension Arm Repair Kit		DB-RK-8626	for Wishbone (CV)
	04/97→10/02	Suspension Arm Repair Kit		DB-RK-10374	for Wishbone (CV)
	04/97→10/02	Suspension Arm Repair Kit		DB-RK-10375	for Wishbone (CV)
	04/97→10/02	Suspension Arm Repair Kit	DB-RK-8638		for Control Arm
	04/97→10/02	Suspension Strut Repair Kit		DB-RK-8391	
	04/97→10/02	Suspension Strut Repair Kit		DB-RK-9294	
	04/97→10/02	Tie Rod	DB-DL-8171		Guide Rod
	04/97→10/02	Tie Rod	DB-DL-8172		Guide Rod
	04/97→10/02	Tie Rod	DB-DL-8327		Guide Rod
	04/97→10/02	Tie Rod	DB-DL-8390		
	04/97→10/02	Tie Rod	DB-DL-8640		Guide Rod
	04/97→10/02	Tie Rod	DB-DL-12310		
	04/97→10/02	Tie Rod End	CV-ES-0543		for Push Rod
	04/97→10/02	Tie Rod End	CV-ES-0888		for Push Rod
	04/97→10/02	Tie Rod End	CV-ES-14163		for Steering Rod
	04/97→10/02	Tie Rod End	DB-ES-5234		for Steering Rod
	04/97→10/02	Tie Rod End	DB-ES-8323		Leaf Spring Axle
	04/97→10/02	Tie Rod End	DB-ES-8530		for Push Rod
	04/97→10/02	Track Control Arm		DB-DL-3475	Trailing Arm
04/97→10/02	Track Control Arm		DB-VB-3707	Suspension Rod, Wishbone (CV)	
04/97→10/02	Track Control Arm		DB-VB-7261	Suspension Rod, Wishbone (CV), 1st RA;2nd RA; Leaf Spring Axle	
04/97→10/02	Track Control Arm	DB-DL-5224		Control Arm	
04/97→10/02	Track Control Arm	DB-DL-9218	DB-DL-9218	Trailing Arm	
3231 K	04/97→10/02	Ball Head, gearshift linkage	DB-ES-8387		
	04/97→10/02	Ball Head, gearshift linkage	DB-ES-8491		
	04/97→10/02	Ball Head, gearshift linkage	DB-ES-8492		
	04/97→10/02	Ball Head, gearshift linkage	DB-ES-8500		
	04/97→10/02	Ball Head, gearshift linkage	DB-ES-8510		
	04/97→10/02	Bush, driver cab suspension	DB-SB-10384		
	04/97→10/02	Bush, parabolic spring		DB-SB-10400	
	04/97→10/02	Bush, parabolic spring		DB-SB-10401	
	04/97→10/02	Centre Rod	DB-DL-5230		Push Rod
	04/97→10/02	Centre Rod	DB-DL-5405		Push Rod
	04/97→10/02	Centre Rod	DB-DL-8168		Push Rod, 1st FA;Leaf Spring Axle
	04/97→10/02	Centre Rod	DB-DL-8184		Push Rod, Leaf Spring Axle
	04/97→10/02	Centre Rod	DB-DL-8185		Push Rod, Leaf Spring Axle
04/97→10/02	Centre Rod	DB-DL-8188		Push Rod	

CV-ES-0543

Length: 125
 Cone Ø: d1 Ø 32 / d2 Ø 29
 Thread: M30 x 1,5 RHT
 0004605748, 0004606048, 0004606848,
 0004607048, 0014600448, 0014601148,
 0014601748, 0014602448, 0014607648,
 0014609648

**CV-ES-0888**

Length: 125
 Cone Ø: d1 Ø 32 / d2 Ø 29
 Thread: M30 x 1,5 LHT
 0004605848, 0004606148, 0004606948,
 0004607148, 0004609048, 0014600548,
 0014601348, 0014602548, 0014607948,
 0024600448

**CV-ES-14163**

Length: 125
 Cone Ø: d1 Ø 30 / d2 Ø 27
 Thread: M30 x 1,5 RHT
 0003305248, 0003387310, 0004600348,
 0004600948, 0004602848, 0004602948,
 0004608948, 0014600248, 0014600848,
 0014601248, 0014602248, 0014607748,
 0024600148, A0003387310, A0004600348,
 A0004602848, A0004602948, A0014600848,
 A0014601248, A0014602248, A0014607748

**DB-DL-3475**

Length: 565 Ø: 52
 Hole Distance: 152 / 152
 3753500006, 3753500206, 9473500805,
 9483500006, 9483500805, 9483501205,
 9483501305, 9483501905, 9483502005,
 9483502405, A3753500006,
 A3753500206

**DB-DL-5224**

Length: 850 Ø: 60
 Hole Distance: 100 / 100
 01336100A, 9413300007

**DB-DL-5230**

Length: 879 Ø: 42
 Cone Ø: d1 Ø 30 / d2 Ø 27
 01208600A, 0004607105, 0004607205,
 0014606705

**DB-DL-5405**

Length: 890 Ø: 35
 Cone Ø: d1 Ø 28,6 / d2 Ø 23,9
 01215900A, 1460248, 0024604505,
 0024604605, 0034605005, 3752600637,
 3754600405, A3752600637, A3754600405

**DB-DL-8168**

Length: 904 Ø: 52
 Cone Ø: d1 Ø 32 / d2 Ø 29
 0004609405, 0004609505, 0014607105

**DB-DL-8171**

Length: 1687 Ø: 52
 Cone Ø: d1 Ø 32 / d2 Ø 29
 9493300603, 9493300703, 9493301503,
 9493301603

**DB-DL-8172**

Length: 1700 Ø: 52
 Cone Ø: d1 Ø 32 / d2 Ø 29
 01219700A, 9493300403, 9493300503,
 9493300803, 9493301403

**DB-DL-8184**

Length: 1095 Ø: 42
 Cone Ø: d1 Ø 32 / d2 Ø 28,8
 01217700A, 0014601305, 0014601405,
 0024600505, 0034603205, 3754601505,
 A0014601305, A0014601405, A0024600505

**DB-DL-8185**

Length: 711 Ø: 42
 Cone Ø: d1 Ø 32 / d2 Ø 28,8
 01217700A, 0014601105, 0024600405,
 0034603105, A0014601105, A0024600405

**DB-DL-8188**

Length: 895 Ø: 40
 Cone Ø: d1 Ø 28,6 / d2 Ø 23,9
 01217200A, 0024604905, 0024605005,
 0034605605

**DB-DL-8307**

Length: 885 Ø: 38
 Cone Ø: d1 Ø 32 / d2 Ø 30
 01215500A, 0004604005, 0024605105,
 0024605205, 0034604005

**DB-DL-8327**

Length: 1745 Ø: 48
 Cone Ø: d1 Ø 32 / d2 Ø 29
 01219800A, 9413300003, 9413300103,
 9413300203, 9413300303, 9413300503

**DB-DL-8390**

Length: 1596 Ø: 50
 Cone Ø: d1 Ø 32 / d2 Ø 29
 9493301003, 9493301103, 9493301703

**DB-DL-8640**

Length: 1615 Ø: 50
 Cone Ø: d1 Ø 32 / d2 Ø 29
 6253301503, 6253301603, 6253302403,
 6253302503, 9423300803, 9423302103,
 9493300203, 9493300303, 9493300903

**DB-DL-9218**

Length: 754 Ø: 40
 Hole Distance: 100
 000360098524, 000390098524,
 3753300111, 9413300011,
 A3753300111, SA50831601

**DB-DL-9254**

Length: 1815 Ø: 58
 0003220323, 0003220623, 3753220423

**DB-DL-9271**

Length: 1815 Ø: 60
 0003220423, 0003220723

**DB-DL-9272**

Length: 1815 Ø: 80
 0003220223

**DB-DL-12300**

Length: 733 Ø: 36
 Cone Ø: d1 Ø 32 / d2 Ø 29
 0014601505, 0014607305, 0034603305,
 3754601605, A0014601505,
 A0034603305, A3754601605

**DB-DL-12310**

Length: 1532 Ø: 50
 Cone Ø: d1 Ø 32 / d2 Ø 29
 Thread: M27 x 1,5 LHT
 9493301203, 9493301303, 9493301803,
 9493302203, A9493301203, A9493301303,
 A9493301803, A9493302203

**DB-ES-5234**

Length: 135
 Cone Ø: d1 Ø 38 / d2 Ø 34,3
 Thread: M38 x 1,5 RHT
 0004601748, 120322305, 2205000400

**DB-ES-8323**

Length: 75
 Cone Ø: d1 Ø 32 / d2 Ø 28,8
 Thread: M26 x 1,5 RHT
 0014601548, 0014601648, 0024600648,
 A0014601648, A0024600648

**DB-ES-8387**

Length: 55
 Cone Ø: d1 Ø 10 / d2 Ø 10
 Thread: M14 x 1,5 RHT
 0009966845, 0009967045

**DB-ES-8491**

Length: 60
 Cone Ø: d1 Ø 10 / d2 Ø 10
 Thread: M12 x 1,75 LHT
 0009966745

**DB-ES-8492**

Length: 60
 Cone Ø: d1 Ø 10 / d2 Ø 10
 Thread: M12 x 1,75 RHT
 0009966645, 3752680189, A3752680189

**DB-ES-8500**

Length: 55
 Cone Ø: d1 Ø 12 / d2 Ø 10,8
 Thread: M14 x 1,5 RHT
 0002685989

**DB-ES-8510**

Length: 56
 Cone Ø: d1 Ø 10 / d2 Ø 10
 Thread: M12 x 1,75 LHT
 0009965145, 0009965645, 0019963145

**DB-ES-8530**

Length: 115
 Cone Ø: d1 Ø 28,6 / d2 Ø 23,9
 Thread: M30 x 1,5 RHT
 0014603848, 0014604848, 0014605148,
 0014608648, 0014609948

**DB-RK-8391**

Ø: 85 Hole Distance: 152
 Thick/Height: 24
 01336800A, 0003502705

**DB-RK-8626**

Ø: 75 Hole Distance: 130
 Thick/Height: 24
 0003502205, 0003502505, 0003503405,
 0003504505, GL11319

**DB-RK-8638**

Length: 100 Ø: 67
 Hole Distance: 100
 Thick/Height: 20
 0003301411

**DB-RK-9294**

Ø: 85 Hole Distance: 152
 Thick/Height: 24
 0003503105

**DB-RK-10374**

Ø: 85 Hole Distance: 152
 Thick/Height: 24
 0003504405

**DB-RK-10375**

Ø: 100 Hole Distance: 152
 Thick/Height: 24
 0003502405, 0003503505, 0003504905

**DB-SB-5260**

Ø: 70 Thick/Height: 36,5 / 46
 01320700A, 0003237485, 0003237585,
 0003237985

**DB-SB-5261**

Length: 85 Ø: 82
 Thick/Height: 56
 01320600A, 0003264481, 0003264781

**DB-SB-5279**

Ø: 42 Thick/Height: 55
 0003236285, 0003237185

**DB-SB-10384**

Ø: 73 Thick/Height: 47
 9303170012, 9423171812

**DB-SB-10400**

Length: 230
 Thick/Height: 167,5 / 115
 0003250696, 0003250896

**DB-SB-10401**

Length: 232
 Thick/Height: 163,5 / 152,5
 0003250596, 0003250796

**DB-SB-10406**

Ø: 80 Thick/Height: 46
 0003238185

**DB-SB-10407**

Ø: 61 Thick/Height: 46
 0003235985, 0003262481, 0003262981

**DB-SB-10409**

Ø: 77 Thick/Height: 56
 0003265181

**DB-VB-3707**

Length: 622 Ø: 46
 Hole Ø 25 / 25 / 25
 Hole Distance: 152 / 130 / 130
 01337100A, 9423501005, 9423501505,
 9443500005, 9473500105, 9473501005,
 A3753500005, A9423501005, A9423501505,
 A9443500005, A9473500105, A9473501005

**DB-VB-7261**

Length: 622 Ø: 46
 Hole Ø 25 / 25 / 25
 Hole Distance: 152 / 130 / 130
 01337800A, 9443500305, 9443500505,
 9443500605, 9473500705, 9473500905,
 9483500405, 9483500305





ACTROS ...

3231 K ...	04/97→10/02	Centre Rod	DB-DL-8307		Push Rod
	04/97→10/02	Centre Rod	DB-DL-12300		for Steering Rod
	04/97→10/02	Stabiliser Link	DB-DL-9254		Pressure Rod
	04/97→10/02	Stabiliser Link	DB-DL-9271		Pressure Rod
	04/97→10/02	Stabiliser Link	DB-DL-9272		Pressure Rod
	04/97→10/02	Stabiliser Mounting		DB-SB-5261	
	04/97→10/02	Stabiliser Mounting		DB-SB-10406	
	04/97→10/02	Stabiliser Mounting		DB-SB-10407	
	04/97→10/02	Stabiliser Mounting		DB-SB-10409	
	04/97→10/02	Stabiliser Mounting	DB-SB-5260		
	04/97→10/02	Stabiliser Mounting	DB-SB-5279		
	04/97→10/02	Suspension Arm Repair Kit		DB-RK-8626	for Wishbone (CV)
	04/97→10/02	Suspension Arm Repair Kit		DB-RK-10374	for Wishbone (CV)
	04/97→10/02	Suspension Arm Repair Kit		DB-RK-10375	for Wishbone (CV)
	04/97→10/02	Suspension Arm Repair Kit	DB-RK-8638		for Control Arm
	04/97→10/02	Suspension Strut Repair Kit		DB-RK-8391	
	04/97→10/02	Suspension Strut Repair Kit		DB-RK-9294	
	04/97→10/02	Tie Rod	DB-DL-8171		Guide Rod
	04/97→10/02	Tie Rod	DB-DL-8327		Guide Rod
	04/97→10/02	Tie Rod	DB-DL-8390		
	04/97→10/02	Tie Rod	DB-DL-8640		Guide Rod
	04/97→10/02	Tie Rod	DB-DL-12310		
	04/97→10/02	Tie Rod	DB-ES-5227		Guide Rod
	04/97→10/02	Tie Rod End	CV-ES-0543		for Push Rod
	04/97→10/02	Tie Rod End	CV-ES-0888		for Push Rod
	04/97→10/02	Tie Rod End	CV-ES-14163		for Steering Rod
	04/97→10/02	Tie Rod End	DB-ES-5234		for Steering Rod
	04/97→10/02	Tie Rod End	DB-ES-8323		Leaf Spring Axle
	04/97→10/02	Tie Rod End	DB-ES-8530		for Push Rod
	04/97→10/02	Track Control Arm		DB-DL-3475	Trailing Arm
	04/97→10/02	Track Control Arm		DB-VB-3707	Suspension Rod, Wishbone (CV)
	04/97→10/02	Track Control Arm		DB-VB-7261	Suspension Rod, Wishbone (CV), 1st RA;2nd RA; Leaf Spring Axle
	04/97→10/02	Track Control Arm	DB-DL-5224		Control Arm
	04/97→10/02	Track Control Arm	DB-DL-9218	DB-DL-9218	Trailing Arm
3235	04/97→10/02	Ball Head, gearshift linkage	DB-ES-8387		
	04/97→10/02	Ball Head, gearshift linkage	DB-ES-8491		
	04/97→10/02	Ball Head, gearshift linkage	DB-ES-8492		
	04/97→10/02	Ball Head, gearshift linkage	DB-ES-8500		
	04/97→10/02	Ball Head, gearshift linkage	DB-ES-8510		
	04/97→10/02	Bush, driver cab suspension	DB-SB-10384		
	04/97→10/02	Bush, parabolic spring		DB-SB-10401	
	04/97→10/02	Centre Rod	DB-DL-5230		Push Rod
	04/97→10/02	Centre Rod	DB-DL-8168		Push Rod, Leaf Spring Axle
	04/97→10/02	Centre Rod	DB-DL-8184		Push Rod, Leaf Spring Axle
	04/97→10/02	Centre Rod	DB-DL-8185		Push Rod, Leaf Spring Axle
	04/97→10/02	Centre Rod	DB-DL-8188		Push Rod
	04/97→10/02	Centre Rod	DB-DL-8307		Push Rod
	04/97→10/02	Centre Rod	DB-DL-12300		for Steering Rod
	04/97→10/02	Stabiliser Link	DB-DL-9254		Pressure Rod
	04/97→10/02	Stabiliser Link	DB-DL-9271		Pressure Rod
	04/97→10/02	Stabiliser Link	DB-DL-9272		Pressure Rod
	04/97→10/02	Stabiliser Mounting		DB-SB-5261	
	04/97→10/02	Stabiliser Mounting		DB-SB-10406	
	04/97→10/02	Stabiliser Mounting		DB-SB-10407	
	04/97→10/02	Stabiliser Mounting		DB-SB-10409	
	04/97→10/02	Stabiliser Mounting	DB-SB-5250		
	04/97→10/02	Stabiliser Mounting	DB-SB-5260		
	04/97→10/02	Stabiliser Mounting	DB-SB-5279		
	04/97→10/02	Suspension Arm Repair Kit		DB-RK-8626	for Wishbone (CV)
	04/97→10/02	Suspension Arm Repair Kit		DB-RK-10374	for Wishbone (CV)
	04/97→10/02	Suspension Arm Repair Kit		DB-RK-10375	for Wishbone (CV)
	04/97→10/02	Suspension Arm Repair Kit	DB-RK-8638		for Control Arm

CV-ES-0543

Length: 125
Cone Ø: d1 Ø 32 / d2 Ø 29
Thread: M30 x 1,5 RHT
0004605748, 0004606048, 0004606848,
0004607048, 0014600448, 0014601148,
0014601748, 0014602448, 0014607648,
0014609648



CV-ES-0888

Length: 125
Cone Ø: d1 Ø 32 / d2 Ø 29
Thread: M30 x 1,5 LHT
0004605848, 0004606148, 0004606948,
0004607148, 0004609048, 0014600548,
0014601348, 0014602548, 0014607948,
0024600448



CV-ES-14163

Length: 125
Cone Ø: d1 Ø 30 / d2 Ø 27
Thread: M30 x 1,5 RHT
0003305248, 0003387310, 0004600348,
0004600948, 0004602848, 0004602948,
0004608948, 0014600248, 0014600848,
0014601248, 0014602248, 0014607748,
0024600148, A0003387310, A0004600348,
A0004602848, A0004602948, A0014600848,
A0014601248, A0014602248, A0014607748



DB-DL-3475

Length: 565 Ø: 52
Hole Distance: 152 / 152
3753500006, 3753500206, 9473500805,
9483500006, 9483500805, 9483501205,
9483501305, 9483501905, 9483502005,
9483502405, A3753500006,
A3753500206



DB-DL-5224

Length: 850 Ø: 60
Hole Distance: 100 / 100
01336100A, 9413300007



DB-DL-5230

Length: 879 Ø: 42
Cone Ø: d1 Ø 30 / d2 Ø 27
01208600A, 0004607105, 0004607205,
0014606705



DB-DL-8168

Length: 904 Ø: 52
Cone Ø: d1 Ø 32 / d2 Ø 29
0004609405, 0004609505, 0014607105



DB-DL-8171

Length: 1687 Ø: 52
Cone Ø: d1 Ø 32 / d2 Ø 29
9493300603, 9493300703, 9493301503,
9493301603



DB-DL-8184

Length: 1095 Ø: 42
Cone Ø: d1 Ø 32 / d2 Ø 28,8
01217700A, 0014601305, 0014601405,
0024600505, 0034603205, 3754601505,
A0014601305, A0014601405, A0024600505



DB-DL-8185

Length: 711 Ø: 42
Cone Ø: d1 Ø 32 / d2 Ø 28,8
01213600A, 0014601105, 0024600405,
0034603105, A0014601105, A0024600405



DB-DL-8188

Length: 895 Ø: 40
Cone Ø: d1 Ø 28,6 / d2 Ø 23,9
01217200A, 0024604905, 0024605005,
0034605605



DB-DL-8307

Length: 885 Ø: 38
Cone Ø: d1 Ø 32 / d2 Ø 30
01215500A, 0004604005, 0024605105,
0024605205, 0034604005



DB-DL-8327

Length: 1745 Ø: 48
Cone Ø: d1 Ø 32 / d2 Ø 29
01219800A, 9413300003, 9413300103,
9413300203, 9413300303, 9413300503



DB-DL-8390

Length: 1596 Ø: 50
Cone Ø: d1 Ø 32 / d2 Ø 29
9493301003, 9493301103, 9493301703



DB-DL-8640

Length: 1615 Ø: 50
Cone Ø: d1 Ø 32 / d2 Ø 29
6253301503, 6253301603, 6253302403,
6253302503, 9423300803, 9423302103,
9493300203, 9493300303, 9493300903



DB-DL-9218

Length: 754 Ø: 40
Hole Distance: 100
000360098524, 000390098524,
3753300111, 9413300011,
A3753300111, SA50831601



DB-DL-9254

Length: 1815 Ø: 58
0003220323, 0003220623, 3753220423



DB-DL-9271

Length: 1815 Ø: 60
0003220423, 0003220723



DB-DL-9272

Length: 1815 Ø: 80
0003220223



DB-DL-12300

Length: 733 Ø: 36
Cone Ø: d1 Ø 32 / d2 Ø 29
0014601505, 0014607305, 0034603305,
3754601605, A0014601505,
A0034603305, A3754601605



DB-DL-12310

Length: 1532 Ø: 50
Cone Ø: d1 Ø 32 / d2 Ø 29
Thread: M27 x 1,5 LHT
9493301203, 9493301303, 9493301803,
9493302203, A9493301203, A9493301303,
A9493301803, A9493302203



DB-ES-5227

Length: 1588 Ø: 60
Cone Ø: d1 Ø 38 / d2 Ø 34,3
6253300903, 6253301203, 9443300203



DB-ES-5234

Length: 135
Cone Ø: d1 Ø 38 / d2 Ø 34,3
Thread: M38 x 1,5 RHT
0004601748, 120322305, 2205000400



DB-ES-8323

Length: 75
Cone Ø: d1 Ø 32 / d2 Ø 28,8
Thread: M26 x 1,5 RHT
0014601548, 0014601648, 0024600648,
A0014601648, A0024600648



DB-ES-8387

Length: 55
Cone Ø: d1 Ø 10 / d2 Ø 10
Thread: M14 x 1,5 RHT
0009966845, 0009967045



DB-ES-8491

Length: 60
Cone Ø: d1 Ø 10 / d2 Ø 10
Thread: M12 x 1,75 LHT
0009966745



DB-ES-8492

Length: 60
Cone Ø: d1 Ø 10 / d2 Ø 10
Thread: M12 x 1,75 RHT
0009966645, 3752680189, A3752680189



DB-ES-8500

Length: 55
Cone Ø: d1 Ø 12 / d2 Ø 10,8
Thread: M14 x 1,5 RHT
0002685989



DB-ES-8510

Length: 56
Cone Ø: d1 Ø 10 / d2 Ø 10
Thread: M12 x 1,75 LHT
0009965145, 0009965645, 0019963145



DB-ES-8530

Length: 115
Cone Ø: d1 Ø 28,6 / d2 Ø 23,9
Thread: M30 x 1,5 RHT
0014603848, 0014604848, 0014605148,
0014608648, 0014609948



DB-RK-8391

Ø: 85 Hole Distance: 152
Thick/Height: 24
01336800A, 0003502705



DB-RK-8626

Ø: 75 Hole Distance: 130
Thick/Height: 24
0003502205, 0003502505, 0003503405,
0003504505, GL11319



DB-RK-8638

Length: 100 Ø: 67
Hole Distance: 100
Thick/Height: 20
0003301411



DB-RK-9294

Ø: 85 Hole Distance: 152
Thick/Height: 24
0003503105



DB-RK-10374

Ø: 85 Hole Distance: 152
Thick/Height: 24
0003504405



DB-RK-10375

Ø: 100 Hole Distance: 152
Thick/Height: 24
0003502405, 0003503505, 0003504905



DB-SB-5250

Ø: 66 Thick/Height: 56
01320400A, 0003262681, 0003263081,
0003263281



DB-SB-5260

Ø: 70 Thick/Height: 36,5 / 46
01320700A, 0003237485, 0003237585,
0003237985



DB-SB-5261

Length: 85 Ø: 82
Thick/Height: 56
01320600A, 0003264481, 0003264781



DB-SB-5279

Ø: 42 Thick/Height: 55
0003236285, 0003237185



DB-SB-10384

Ø: 73 Thick/Height: 47
9303170012, 9423171812



DB-SB-10401

Length: 232
Thick/Height: 163,5 / 152,5
0003250596, 0003250796



DB-SB-10406

Ø: 80 Thick/Height: 46
0003238185



DB-SB-10407

Ø: 61 Thick/Height: 46
0003235985, 0003262481, 0003262981



DB-SB-10409

Ø: 77 Thick/Height: 56
0003265181



DB-VB-3707

Length: 622 Ø: 46
Hole Ø 25 / 25 / 25
Hole Distance: 152 / 130 / 130
01337100A, 9423501005, 9423501505,
9443500005, 9473500105, 9473501005,
A9443500005, A9473500105, A9473501005



DB-VB-7261

Length: 622 Ø: 46
Hole Ø 25 / 25 / 25
Hole Distance: 152 / 130 / 130
01337800A, 9443500305, 9443500505,
9443500605, 9473500705, 9473500905,
9483500405, 9483503005





ACTROS ...

3235 ...	04/97→10/02	Suspension Strut Repair Kit		DB-RK-8391	
	04/97→10/02	Suspension Strut Repair Kit		DB-RK-9294	
	04/97→10/02	Tie Rod	DB-DL-8172		Guide Rod
	04/97→10/02	Tie Rod	DB-DL-8640		Guide Rod
	04/97→10/02	Tie Rod	DB-DL-12310		
	04/97→10/02	Tie Rod End	DB-ES-5234		for Steering Rod
	04/97→10/02	Tie Rod End	DB-ES-8323		Leaf Spring Axle
	04/97→10/02	Tie Rod End	DB-ES-8530		for Push Rod
	04/97→10/02	Track Control Arm		DB-DL-3475	Trailing Arm
	04/97→10/02	Track Control Arm		DB-VB-3707	Suspension Rod, Wishbone (CV)
04/97→10/02	Track Control Arm		DB-VB-7261	Suspension Rod, Wishbone (CV), 1st RA;2nd RA; Leaf Spring Axle	
3235 B	04/97→10/02	Ball Head, gearshift linkage	DB-ES-8387		
	04/97→10/02	Ball Head, gearshift linkage	DB-ES-8491		
	04/97→10/02	Ball Head, gearshift linkage	DB-ES-8492		
	04/97→10/02	Ball Head, gearshift linkage	DB-ES-8500		
	04/97→10/02	Ball Head, gearshift linkage	DB-ES-8510		
	04/97→10/02	Bush, driver cab suspension	DB-SB-10384		
	04/97→10/02	Bush, parabolic spring		DB-SB-10400	
	04/97→10/02	Bush, parabolic spring		DB-SB-10401	
	04/97→10/02	Centre Rod	DB-DL-5230		Push Rod
	04/97→10/02	Centre Rod	DB-DL-5405		Push Rod
	04/97→10/02	Centre Rod	DB-DL-8168		Push Rod, Leaf Spring Axle
	04/97→10/02	Centre Rod	DB-DL-8184		Push Rod, Leaf Spring Axle
	04/97→10/02	Centre Rod	DB-DL-8185		Push Rod, Leaf Spring Axle
	04/97→10/02	Centre Rod	DB-DL-8188		Push Rod
	04/97→10/02	Centre Rod	DB-DL-8307		Push Rod
	04/97→10/02	Centre Rod	DB-DL-12300		for Steering Rod
	04/97→10/02	Stabiliser Link	DB-DL-9254		Pressure Rod
	04/97→10/02	Stabiliser Link	DB-DL-9271		Pressure Rod
	04/97→10/02	Stabiliser Link	DB-DL-9272		Pressure Rod
	04/97→10/02	Stabiliser Mounting		DB-SB-5261	
	04/97→10/02	Stabiliser Mounting		DB-SB-10406	
	04/97→10/02	Stabiliser Mounting		DB-SB-10407	
	04/97→10/02	Stabiliser Mounting		DB-SB-10409	
	04/97→10/02	Stabiliser Mounting	DB-SB-5260		
	04/97→10/02	Stabiliser Mounting	DB-SB-5279		
	04/97→10/02	Suspension Arm Repair Kit		DB-RK-8626	for Wishbone (CV)
	04/97→10/02	Suspension Arm Repair Kit		DB-RK-10374	for Wishbone (CV)
	04/97→10/02	Suspension Arm Repair Kit		DB-RK-10375	for Wishbone (CV)
	04/97→10/02	Suspension Arm Repair Kit	DB-RK-8638		for Control Arm
	04/97→10/02	Suspension Strut Repair Kit		DB-RK-8391	
	04/97→10/02	Suspension Strut Repair Kit		DB-RK-9294	
	04/97→10/02	Tie Rod	DB-DL-8171		Guide Rod
	04/97→10/02	Tie Rod	DB-DL-8172		Guide Rod
	04/97→10/02	Tie Rod	DB-DL-8327		Guide Rod
	04/97→10/02	Tie Rod	DB-DL-8390		
	04/97→10/02	Tie Rod	DB-DL-8640		Guide Rod
	04/97→10/02	Tie Rod	DB-DL-12310		
	04/97→10/02	Tie Rod End	CV-ES-0543		for Push Rod
	04/97→10/02	Tie Rod End	CV-ES-0888		for Push Rod
	04/97→10/02	Tie Rod End	CV-ES-14163		for Steering Rod
	04/97→10/02	Tie Rod End	DB-ES-5234		for Steering Rod
	04/97→10/02	Tie Rod End	DB-ES-8323		Leaf Spring Axle
	04/97→10/02	Tie Rod End	DB-ES-8530		for Push Rod
	04/97→10/02	Track Control Arm		DB-DL-3475	Trailing Arm
	04/97→10/02	Track Control Arm		DB-VB-3707	Suspension Rod, Wishbone (CV)
	04/97→10/02	Track Control Arm		DB-VB-7261	Suspension Rod, Wishbone (CV), 1st RA;2nd RA; Leaf Spring Axle
	04/97→10/02	Track Control Arm	DB-DL-5224		Control Arm
04/97→10/02	Track Control Arm	DB-DL-9218	DB-DL-9218	Trailing Arm	



ACTROS ...

3235 K	04/97→10/02	Ball Head, gearshift linkage	DB-ES-8387		
	04/97→10/02	Ball Head, gearshift linkage	DB-ES-8491		
	04/97→10/02	Ball Head, gearshift linkage	DB-ES-8492		
	04/97→10/02	Ball Head, gearshift linkage	DB-ES-8500		
	04/97→10/02	Ball Head, gearshift linkage	DB-ES-8510		
	04/97→10/02	Bush, driver cab suspension	DB-SB-10384		
	04/97→10/02	Bush, parabolic spring		DB-SB-10400	
	04/97→10/02	Bush, parabolic spring		DB-SB-10401	
	04/97→10/02	Centre Rod	DB-DL-5230		Push Rod
	04/97→10/02	Centre Rod	DB-DL-5405		Push Rod
	04/97→10/02	Centre Rod	DB-DL-8168		Push Rod, 1st FA;Leaf Spring Axle
	04/97→10/02	Centre Rod	DB-DL-8184		Push Rod, Leaf Spring Axle
	04/97→10/02	Centre Rod	DB-DL-8185		Push Rod, Leaf Spring Axle
	04/97→10/02	Centre Rod	DB-DL-8188		Push Rod
	04/97→10/02	Centre Rod	DB-DL-8307		Push Rod
	04/97→10/02	Centre Rod	DB-DL-12300		for Steering Rod
	04/97→10/02	Stabiliser Link	DB-DL-9254		Pressure Rod
	04/97→10/02	Stabiliser Link	DB-DL-9271		Pressure Rod
	04/97→10/02	Stabiliser Link	DB-DL-9272		Pressure Rod
	04/97→10/02	Stabiliser Mounting		DB-SB-5261	
	04/97→10/02	Stabiliser Mounting		DB-SB-10406	
	04/97→10/02	Stabiliser Mounting		DB-SB-10407	
	04/97→10/02	Stabiliser Mounting		DB-SB-10409	
	04/97→10/02	Stabiliser Mounting	DB-SB-5260		
	04/97→10/02	Stabiliser Mounting	DB-SB-5279		
	04/97→10/02	Suspension Arm Repair Kit		DB-RK-8626	for Wishbone (CV)
	04/97→10/02	Suspension Arm Repair Kit		DB-RK-10374	for Wishbone (CV)
	04/97→10/02	Suspension Arm Repair Kit		DB-RK-10375	for Wishbone (CV)
	04/97→10/02	Suspension Arm Repair Kit	DB-RK-8638		for Control Arm
	04/97→10/02	Suspension Strut Repair Kit		DB-RK-8391	
	04/97→10/02	Suspension Strut Repair Kit		DB-RK-9294	
	04/97→10/02	Tie Rod	DB-DL-8171		Guide Rod
	04/97→10/02	Tie Rod	DB-DL-8327		Guide Rod
	04/97→10/02	Tie Rod	DB-DL-8390		
	04/97→10/02	Tie Rod	DB-DL-8640		Guide Rod
	04/97→10/02	Tie Rod	DB-DL-12310		
	04/97→10/02	Tie Rod	DB-ES-5227		Guide Rod
	04/97→10/02	Tie Rod End	CV-ES-0543		for Push Rod
	04/97→10/02	Tie Rod End	CV-ES-0888		for Push Rod
	04/97→10/02	Tie Rod End	CV-ES-14163		for Steering Rod
	04/97→10/02	Tie Rod End	DB-ES-5234		for Steering Rod
	04/97→10/02	Tie Rod End	DB-ES-8323		Leaf Spring Axle
	04/97→10/02	Tie Rod End	DB-ES-8530		for Push Rod
	04/97→10/02	Track Control Arm		DB-DL-3475	Trailing Arm
04/97→10/02	Track Control Arm		DB-VB-3707	Suspension Rod, Wishbone (CV)	
04/97→10/02	Track Control Arm		DB-VB-7261	Suspension Rod, Wishbone (CV), 1st RA;2nd RA; Leaf Spring Axle	
04/97→10/02	Track Control Arm	DB-DL-5224		Control Arm	
04/97→10/02	Track Control Arm	DB-DL-9218	DB-DL-9218	Trailing Arm	
3240	04/97→10/02	Ball Head, gearshift linkage	DB-ES-8387		
	04/97→10/02	Ball Head, gearshift linkage	DB-ES-8491		
	04/97→10/02	Ball Head, gearshift linkage	DB-ES-8492		
	04/97→10/02	Ball Head, gearshift linkage	DB-ES-8500		
	04/97→10/02	Ball Head, gearshift linkage	DB-ES-8510		
	04/97→10/02	Bush, driver cab suspension	DB-SB-10384		
	04/97→10/02	Bush, parabolic spring		DB-SB-10400	
	04/97→10/02	Bush, parabolic spring		DB-SB-10401	
	04/97→10/02	Centre Rod	DB-DL-5230		Push Rod
	04/97→10/02	Centre Rod	DB-DL-5241		Push Rod
	04/97→10/02	Centre Rod	DB-DL-5405		Push Rod
	04/97→10/02	Centre Rod	DB-DL-7270		Push Rod
	04/97→10/02	Centre Rod	DB-DL-8168		Push Rod, 1st FA;Leaf Spring Axle
04/97→10/02	Centre Rod	DB-DL-8168		Push Rod, Leaf Spring Axle	

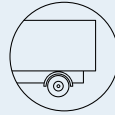
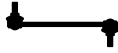

ACTROS ...

3240 ...	04/97→10/02	Centre Rod	DB-DL-8184		Push Rod, Leaf Spring Axle
	04/97→10/02	Centre Rod	DB-DL-8185		Push Rod, Leaf Spring Axle
	04/97→10/02	Centre Rod	DB-DL-8188		Push Rod
	04/97→10/02	Centre Rod	DB-DL-8307		Push Rod
	04/97→10/02	Centre Rod	DB-DL-8622		Push Rod
	04/97→10/02	Centre Rod	DB-DL-8641		Push Rod
	04/97→10/02	Centre Rod	DB-DL-8642		Push Rod
	04/97→10/02	Centre Rod	DB-DL-12298		for Steering Rod
	04/97→10/02	Centre Rod	DB-DL-12300		for Steering Rod
	04/97→10/02	Stabiliser Link	DB-DL-9254		Pressure Rod
	04/97→10/02	Stabiliser Link	DB-DL-9271		Pressure Rod
	04/97→10/02	Stabiliser Link	DB-DL-9272		Pressure Rod
	04/97→10/02	Stabiliser Mounting		DB-SB-5261	
	04/97→10/02	Stabiliser Mounting		DB-SB-10406	
	04/97→10/02	Stabiliser Mounting		DB-SB-10407	
	04/97→10/02	Stabiliser Mounting		DB-SB-10409	
	04/97→10/02	Stabiliser Mounting	DB-SB-5250	DB-SB-5250	
	04/97→10/02	Stabiliser Mounting	DB-SB-5260		
	04/97→10/02	Stabiliser Mounting	DB-SB-5279		
	04/97→10/02	Suspension Arm Repair Kit		DB-RK-8626	for Wishbone (CV)
	04/97→10/02	Suspension Arm Repair Kit		DB-RK-10374	for Wishbone (CV)
	04/97→10/02	Suspension Arm Repair Kit		DB-RK-10375	for Wishbone (CV)
	04/97→10/02	Suspension Arm Repair Kit	DB-RK-8638		for Control Arm
	04/97→10/02	Suspension Strut Repair Kit		DB-RK-8391	
	04/97→10/02	Suspension Strut Repair Kit		DB-RK-9294	
	04/97→10/02	Tie Rod	DB-DL-8171		Guide Rod
	04/97→10/02	Tie Rod	DB-DL-8172		Guide Rod, 1st & 2nd Front Axle
	04/97→10/02	Tie Rod	DB-DL-8327		Guide Rod
	04/97→10/02	Tie Rod	DB-DL-8390		Guide Rod
	04/97→10/02	Tie Rod	DB-DL-8640		Guide Rod
	04/97→10/02	Tie Rod	DB-DL-12310		Guide Rod
	04/97→10/02	Tie Rod	DB-ES-5227		Guide Rod
	04/97→10/02	Tie Rod End	CV-ES-0543		for Push Rod
	04/97→10/02	Tie Rod End	CV-ES-0888		for Push Rod
	04/97→10/02	Tie Rod End	CV-ES-14163		for Steering Rod
	04/97→10/02	Tie Rod End	DB-ES-5234		for Steering Rod
	04/97→10/02	Tie Rod End	DB-ES-8323		Leaf Spring Axle
	04/97→10/02	Tie Rod End	DB-ES-8530		for Push Rod
	04/97→10/02	Track Control Arm		DB-DL-3475	Trailing Arm
	04/97→10/02	Track Control Arm		DB-VB-3707	Suspension Rod, Wishbone (CV)
	04/97→10/02	Track Control Arm		DB-VB-7261	Suspension Rod, Wishbone (CV), 1st RA;2nd RA; Leaf Spring Axle
	04/97→10/02	Track Control Arm	DB-DL-5224		Control Arm
	04/97→10/02	Track Control Arm	DB-DL-9218	DB-DL-9218	Trailing Arm
	3240 B	04/97→10/02	Ball Head, gearshift linkage	DB-ES-8387	
04/97→10/02		Ball Head, gearshift linkage	DB-ES-8491		
04/97→10/02		Ball Head, gearshift linkage	DB-ES-8492		
04/97→10/02		Ball Head, gearshift linkage	DB-ES-8500		
04/97→10/02		Ball Head, gearshift linkage	DB-ES-8510		
04/97→10/02		Bush, driver cab suspension	DB-SB-10384		
04/97→10/02		Bush, parabolic spring		DB-SB-10400	
04/97→10/02		Bush, parabolic spring		DB-SB-10401	
04/97→10/02		Centre Rod	DB-DL-5230		Push Rod
04/97→10/02		Centre Rod	DB-DL-5405		Push Rod
04/97→10/02		Centre Rod	DB-DL-8168		Push Rod, Leaf Spring Axle
04/97→10/02		Centre Rod	DB-DL-8184		Push Rod, Leaf Spring Axle
04/97→10/02		Centre Rod	DB-DL-8185		Push Rod, Leaf Spring Axle
04/97→10/02		Centre Rod	DB-DL-8188		Push Rod
04/97→10/02		Centre Rod	DB-DL-8307		Push Rod
04/97→10/02		Centre Rod	DB-DL-12300		for Steering Rod
04/97→10/02		Stabiliser Link	DB-DL-9254		Pressure Rod
04/97→10/02		Stabiliser Link	DB-DL-9271		Pressure Rod
04/97→10/02		Stabiliser Link	DB-DL-9272		Pressure Rod



ACTROS ...

3240 B ...	04/97→10/02	Stabiliser Mounting		DB-SB-5261	
	04/97→10/02	Stabiliser Mounting		DB-SB-10406	
	04/97→10/02	Stabiliser Mounting		DB-SB-10407	
	04/97→10/02	Stabiliser Mounting		DB-SB-10409	
	04/97→10/02	Stabiliser Mounting	DB-SB-5260		
	04/97→10/02	Stabiliser Mounting	DB-SB-5279		
	04/97→10/02	Suspension Arm Repair Kit		DB-RK-8626	for Wishbone (CV)
	04/97→10/02	Suspension Arm Repair Kit		DB-RK-10374	for Wishbone (CV)
	04/97→10/02	Suspension Arm Repair Kit		DB-RK-10375	for Wishbone (CV)
	04/97→10/02	Suspension Arm Repair Kit	DB-RK-8638		for Control Arm
	04/97→10/02	Suspension Strut Repair Kit		DB-RK-8391	
	04/97→10/02	Suspension Strut Repair Kit		DB-RK-9294	
	04/97→10/02	Tie Rod	DB-DL-8171		Guide Rod
	04/97→10/02	Tie Rod	DB-DL-8172		Guide Rod
	04/97→10/02	Tie Rod	DB-DL-8327		Guide Rod
	04/97→10/02	Tie Rod	DB-DL-8390		
	04/97→10/02	Tie Rod	DB-DL-8640		Guide Rod
	04/97→10/02	Tie Rod	DB-DL-12310		
	04/97→10/02	Tie Rod End	CV-ES-0543		for Push Rod
	04/97→10/02	Tie Rod End	CV-ES-0888		for Push Rod
	04/97→10/02	Tie Rod End	CV-ES-14163		for Steering Rod
	04/97→10/02	Tie Rod End	DB-ES-5234		for Steering Rod
	04/97→10/02	Tie Rod End	DB-ES-8323		Leaf Spring Axle
	04/97→10/02	Tie Rod End	DB-ES-8530		for Push Rod
	04/97→10/02	Track Control Arm		DB-DL-3475	Trailing Arm
	04/97→10/02	Track Control Arm		DB-VB-3707	Suspension Rod, Wishbone (CV)
	04/97→10/02	Track Control Arm		DB-VB-7261	Suspension Rod, Wishbone (CV), 1st RA;2nd RA; Leaf Spring Axle
	04/97→10/02	Track Control Arm	DB-DL-5224		Control Arm
	04/97→10/02	Track Control Arm	DB-DL-9218	DB-DL-9218	Trailing Arm
	3240 K	04/97→10/02	Ball Head, gearshift linkage	DB-ES-8387	
04/97→10/02		Ball Head, gearshift linkage	DB-ES-8491		
04/97→10/02		Ball Head, gearshift linkage	DB-ES-8492		
04/97→10/02		Ball Head, gearshift linkage	DB-ES-8500		
04/97→10/02		Ball Head, gearshift linkage	DB-ES-8510		
04/97→10/02		Bush, driver cab suspension	DB-SB-10384		
04/97→10/02		Bush, parabolic spring		DB-SB-10400	
04/97→10/02		Bush, parabolic spring		DB-SB-10401	
04/97→10/02		Centre Rod	DB-DL-5230		Push Rod
04/97→10/02		Centre Rod	DB-DL-5405		Push Rod
04/97→10/02		Centre Rod	DB-DL-8168		Push Rod, 1st FA;Leaf Spring Axle
04/97→10/02		Centre Rod	DB-DL-8184		Push Rod, Leaf Spring Axle
04/97→10/02		Centre Rod	DB-DL-8185		Push Rod, Leaf Spring Axle
04/97→10/02		Centre Rod	DB-DL-8188		Push Rod
04/97→10/02		Centre Rod	DB-DL-8307		Push Rod
04/97→10/02		Centre Rod	DB-DL-12300		for Steering Rod
04/97→10/02		Stabiliser Link	DB-DL-9254		Pressure Rod
04/97→10/02		Stabiliser Link	DB-DL-9271		Pressure Rod
04/97→10/02		Stabiliser Link	DB-DL-9272		Pressure Rod
04/97→10/02		Stabiliser Mounting		DB-SB-5261	
04/97→10/02		Stabiliser Mounting		DB-SB-10406	
04/97→10/02		Stabiliser Mounting		DB-SB-10407	
04/97→10/02		Stabiliser Mounting		DB-SB-10409	
04/97→10/02		Stabiliser Mounting	DB-SB-5260		
04/97→10/02		Stabiliser Mounting	DB-SB-5279		
04/97→10/02		Suspension Arm Repair Kit		DB-RK-8626	for Wishbone (CV)
04/97→10/02		Suspension Arm Repair Kit		DB-RK-10374	for Wishbone (CV)
04/97→10/02		Suspension Arm Repair Kit		DB-RK-10375	for Wishbone (CV)
04/97→10/02		Suspension Arm Repair Kit	DB-RK-8638		for Control Arm
04/97→10/02		Suspension Strut Repair Kit		DB-RK-8391	
04/97→10/02	Suspension Strut Repair Kit		DB-RK-9294		
04/97→10/02	Tie Rod	DB-DL-8171		Guide Rod	
04/97→10/02	Tie Rod	DB-DL-8327		Guide Rod	

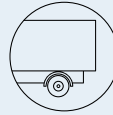

ACTROS ...

3240 K ...	04/97→10/02	Tie Rod	DB-DL-8390		
	04/97→10/02	Tie Rod	DB-DL-8640		Guide Rod
	04/97→10/02	Tie Rod	DB-DL-12310		
	04/97→10/02	Tie Rod	DB-ES-5227		Guide Rod
	04/97→10/02	Tie Rod End	CV-ES-0543		for Push Rod
	04/97→10/02	Tie Rod End	CV-ES-0888		for Push Rod
	04/97→10/02	Tie Rod End	CV-ES-14163		for Steering Rod
	04/97→10/02	Tie Rod End	DB-ES-5234		for Steering Rod
	04/97→10/02	Tie Rod End	DB-ES-8323		Leaf Spring Axle
	04/97→10/02	Tie Rod End	DB-ES-8530		for Push Rod
	04/97→10/02	Track Control Arm		DB-DL-3475	Trailing Arm
	04/97→10/02	Track Control Arm		DB-VB-3707	Suspension Rod, Wishbone (CV)
	04/97→10/02	Track Control Arm		DB-VB-7261	Suspension Rod, Wishbone (CV), 1st RA;2nd RA; Leaf Spring Axle
	04/97→10/02	Track Control Arm	DB-DL-5224		Control Arm
04/97→10/02	Track Control Arm	DB-DL-9218	DB-DL-9218	Trailing Arm	
3243	04/97→10/02	Ball Head, gearshift linkage	DB-ES-8387		
	04/97→10/02	Ball Head, gearshift linkage	DB-ES-8491		
	04/97→10/02	Ball Head, gearshift linkage	DB-ES-8492		
	04/97→10/02	Ball Head, gearshift linkage	DB-ES-8500		
	04/97→10/02	Ball Head, gearshift linkage	DB-ES-8510		
	04/97→10/02	Bush, driver cab suspension	DB-SB-10384		
	04/97→10/02	Bush, parabolic spring		DB-SB-10400	
	04/97→10/02	Bush, parabolic spring		DB-SB-10401	
	04/97→10/02	Centre Rod	DB-DL-5230		Push Rod
	04/97→10/02	Centre Rod	DB-DL-5241		Push Rod
	04/97→10/02	Centre Rod	DB-DL-5405		Push Rod
	04/97→10/02	Centre Rod	DB-DL-7270		Push Rod
	04/97→10/02	Centre Rod	DB-DL-8168		Push Rod, 1st FA;Leaf Spring Axle
	04/97→10/02	Centre Rod	DB-DL-8168		Push Rod, Leaf Spring Axle
	04/97→10/02	Centre Rod	DB-DL-8184		Push Rod, Leaf Spring Axle
	04/97→10/02	Centre Rod	DB-DL-8185		Push Rod, Leaf Spring Axle
	04/97→10/02	Centre Rod	DB-DL-8188		Push Rod
	04/97→10/02	Centre Rod	DB-DL-8307		Push Rod
	04/97→10/02	Centre Rod	DB-DL-8622		Push Rod
	04/97→10/02	Centre Rod	DB-DL-8641		Push Rod
	04/97→10/02	Centre Rod	DB-DL-8642		Push Rod
	04/97→10/02	Centre Rod	DB-DL-12298		for Steering Rod
	04/97→10/02	Centre Rod	DB-DL-12300		for Steering Rod
	04/97→10/02	Stabiliser Link	DB-DL-9254		Pressure Rod
	04/97→10/02	Stabiliser Link	DB-DL-9271		Pressure Rod
	04/97→10/02	Stabiliser Link	DB-DL-9272		Pressure Rod
	04/97→10/02	Stabiliser Mounting		DB-SB-5261	
	04/97→10/02	Stabiliser Mounting		DB-SB-10406	
	04/97→10/02	Stabiliser Mounting		DB-SB-10407	
	04/97→10/02	Stabiliser Mounting		DB-SB-10409	
	04/97→10/02	Stabiliser Mounting	DB-SB-5250	DB-SB-5250	
	04/97→10/02	Stabiliser Mounting	DB-SB-5260		
	04/97→10/02	Stabiliser Mounting	DB-SB-5279		
	04/97→10/02	Suspension Arm Repair Kit		DB-RK-8626	for Wishbone (CV)
	04/97→10/02	Suspension Arm Repair Kit		DB-RK-10374	for Wishbone (CV)
	04/97→10/02	Suspension Arm Repair Kit		DB-RK-10375	for Wishbone (CV)
	04/97→10/02	Suspension Arm Repair Kit	DB-RK-8638		for Control Arm
	04/97→10/02	Suspension Strut Repair Kit		DB-RK-8391	
	04/97→10/02	Suspension Strut Repair Kit		DB-RK-9294	
	04/97→10/02	Tie Rod	DB-DL-8171		Guide Rod
	04/97→10/02	Tie Rod	DB-DL-8172		Guide Rod, 1st & 2nd Front Axle
	04/97→10/02	Tie Rod	DB-DL-8327		Guide Rod
	04/97→10/02	Tie Rod	DB-DL-8390		
	04/97→10/02	Tie Rod	DB-DL-8640		Guide Rod
	04/97→10/02	Tie Rod	DB-DL-12310		
	04/97→10/02	Tie Rod	DB-ES-5227		Guide Rod
	04/97→10/02	Tie Rod End	CV-ES-0543		for Push Rod



ACTROS ...

3243 ...	04/97→10/02	Tie Rod End	CV-ES-0888		for Push Rod
	04/97→10/02	Tie Rod End	CV-ES-14163		for Steering Rod
	04/97→10/02	Tie Rod End	DB-ES-5234		for Steering Rod
	04/97→10/02	Tie Rod End	DB-ES-8323		Leaf Spring Axle
	04/97→10/02	Tie Rod End	DB-ES-8530		for Push Rod
	04/97→10/02	Track Control Arm		DB-DL-3475	Trailing Arm
	04/97→10/02	Track Control Arm		DB-VB-3707	Suspension Rod, Wishbone (CV)
	04/97→10/02	Track Control Arm		DB-VB-7261	Suspension Rod, Wishbone (CV), 1st RA;2nd RA; Leaf Spring Axle
	04/97→10/02	Track Control Arm	DB-DL-5224		Control Arm
	04/97→10/02	Track Control Arm	DB-DL-9218	DB-DL-9218	Trailing Arm
3243 B	04/97→10/02	Ball Head, gearshift linkage	DB-ES-8387		
	04/97→10/02	Ball Head, gearshift linkage	DB-ES-8491		
	04/97→10/02	Ball Head, gearshift linkage	DB-ES-8492		
	04/97→10/02	Ball Head, gearshift linkage	DB-ES-8500		
	04/97→10/02	Ball Head, gearshift linkage	DB-ES-8510		
	04/97→10/02	Bush, driver cab suspension	DB-SB-10384		
	04/97→10/02	Bush, parabolic spring		DB-SB-10400	
	04/97→10/02	Bush, parabolic spring		DB-SB-10401	
	04/97→10/02	Centre Rod	DB-DL-5230		Push Rod
	04/97→10/02	Centre Rod	DB-DL-5405		Push Rod
	04/97→10/02	Centre Rod	DB-DL-8168		Push Rod, Leaf Spring Axle
	04/97→10/02	Centre Rod	DB-DL-8184		Push Rod, Leaf Spring Axle
	04/97→10/02	Centre Rod	DB-DL-8185		Push Rod, Leaf Spring Axle
	04/97→10/02	Centre Rod	DB-DL-8188		Push Rod
	04/97→10/02	Centre Rod	DB-DL-8307		Push Rod
	04/97→10/02	Centre Rod	DB-DL-12300		for Steering Rod
	04/97→10/02	Stabiliser Link	DB-DL-9254		Pressure Rod
	04/97→10/02	Stabiliser Link	DB-DL-9271		Pressure Rod
	04/97→10/02	Stabiliser Link	DB-DL-9272		Pressure Rod
	04/97→10/02	Stabiliser Mounting		DB-SB-5261	
	04/97→10/02	Stabiliser Mounting		DB-SB-10406	
	04/97→10/02	Stabiliser Mounting		DB-SB-10407	
	04/97→10/02	Stabiliser Mounting		DB-SB-10409	
	04/97→10/02	Stabiliser Mounting	DB-SB-5260		
	04/97→10/02	Stabiliser Mounting	DB-SB-5279		
	04/97→10/02	Suspension Arm Repair Kit		DB-RK-8626	for Wishbone (CV)
	04/97→10/02	Suspension Arm Repair Kit		DB-RK-10374	for Wishbone (CV)
	04/97→10/02	Suspension Arm Repair Kit		DB-RK-10375	for Wishbone (CV)
	04/97→10/02	Suspension Arm Repair Kit	DB-RK-8638		for Control Arm
	04/97→10/02	Suspension Strut Repair Kit		DB-RK-8391	
	04/97→10/02	Suspension Strut Repair Kit		DB-RK-9294	
	04/97→10/02	Tie Rod	DB-DL-8171		Guide Rod
	04/97→10/02	Tie Rod	DB-DL-8172		Guide Rod
	04/97→10/02	Tie Rod	DB-DL-8327		Guide Rod
	04/97→10/02	Tie Rod	DB-DL-8390		
	04/97→10/02	Tie Rod	DB-DL-8640		Guide Rod
	04/97→10/02	Tie Rod	DB-DL-12310		
	04/97→10/02	Tie Rod End	CV-ES-0543		for Push Rod
	04/97→10/02	Tie Rod End	CV-ES-0888		for Push Rod
	04/97→10/02	Tie Rod End	CV-ES-14163		for Steering Rod
	04/97→10/02	Tie Rod End	DB-ES-5234		for Steering Rod
	04/97→10/02	Tie Rod End	DB-ES-8323		Leaf Spring Axle
	04/97→10/02	Tie Rod End	DB-ES-8530		for Push Rod
	04/97→10/02	Track Control Arm		DB-DL-3475	Trailing Arm
	04/97→10/02	Track Control Arm		DB-VB-3707	Suspension Rod, Wishbone (CV)
	04/97→10/02	Track Control Arm		DB-VB-7261	Suspension Rod, Wishbone (CV), 1st RA;2nd RA; Leaf Spring Axle
04/97→10/02	Track Control Arm	DB-DL-5224		Control Arm	
04/97→10/02	Track Control Arm	DB-DL-9218	DB-DL-9218	Trailing Arm	



ACTROS ...

3243 K	04/97→10/02	Ball Head, gearshift linkage	DB-ES-8387		
	04/97→10/02	Ball Head, gearshift linkage	DB-ES-8491		
	04/97→10/02	Ball Head, gearshift linkage	DB-ES-8492		
	04/97→10/02	Ball Head, gearshift linkage	DB-ES-8500		
	04/97→10/02	Ball Head, gearshift linkage	DB-ES-8510		
	04/97→10/02	Bush, driver cab suspension	DB-SB-10384		
	04/97→10/02	Bush, parabolic spring		DB-SB-10400	
	04/97→10/02	Bush, parabolic spring		DB-SB-10401	
	04/97→10/02	Centre Rod	DB-DL-5230		Push Rod
	04/97→10/02	Centre Rod	DB-DL-5405		Push Rod
	04/97→10/02	Centre Rod	DB-DL-8168		Push Rod, 1st FA;Leaf Spring Axle
	04/97→10/02	Centre Rod	DB-DL-8184		Push Rod, Leaf Spring Axle
	04/97→10/02	Centre Rod	DB-DL-8185		Push Rod, Leaf Spring Axle
	04/97→10/02	Centre Rod	DB-DL-8188		Push Rod
	04/97→10/02	Centre Rod	DB-DL-8307		Push Rod
	04/97→10/02	Centre Rod	DB-DL-12300		for Steering Rod
	04/97→10/02	Stabiliser Link	DB-DL-9254		Pressure Rod
	04/97→10/02	Stabiliser Link	DB-DL-9271		Pressure Rod
	04/97→10/02	Stabiliser Link	DB-DL-9272		Pressure Rod
	04/97→10/02	Stabiliser Mounting		DB-SB-5261	
	04/97→10/02	Stabiliser Mounting		DB-SB-10406	
	04/97→10/02	Stabiliser Mounting		DB-SB-10407	
	04/97→10/02	Stabiliser Mounting		DB-SB-10409	
	04/97→10/02	Stabiliser Mounting	DB-SB-5260		
	04/97→10/02	Stabiliser Mounting	DB-SB-5279		
	04/97→10/02	Suspension Arm Repair Kit		DB-RK-8626	for Wishbone (CV)
	04/97→10/02	Suspension Arm Repair Kit		DB-RK-10374	for Wishbone (CV)
	04/97→10/02	Suspension Arm Repair Kit		DB-RK-10375	for Wishbone (CV)
	04/97→10/02	Suspension Arm Repair Kit	DB-RK-8638		for Control Arm
	04/97→10/02	Suspension Strut Repair Kit		DB-RK-8391	
	04/97→10/02	Suspension Strut Repair Kit		DB-RK-9294	
	04/97→10/02	Tie Rod	DB-DL-8171		Guide Rod
	04/97→10/02	Tie Rod	DB-DL-8327		Guide Rod
	04/97→10/02	Tie Rod	DB-DL-8390		
	04/97→10/02	Tie Rod	DB-DL-8640		Guide Rod
	04/97→10/02	Tie Rod	DB-DL-12310		
	04/97→10/02	Tie Rod	DB-ES-5227		Guide Rod
	04/97→10/02	Tie Rod End	CV-ES-0543		for Push Rod
	04/97→10/02	Tie Rod End	CV-ES-0888		for Push Rod
	04/97→10/02	Tie Rod End	CV-ES-14163		for Steering Rod
	04/97→10/02	Tie Rod End	DB-ES-5234		for Steering Rod
	04/97→10/02	Tie Rod End	DB-ES-8323		Leaf Spring Axle
	04/97→10/02	Tie Rod End	DB-ES-8530		for Push Rod
04/97→10/02	Track Control Arm		DB-DL-3475	Trailing Arm	
04/97→10/02	Track Control Arm		DB-VB-3707	Suspension Rod, Wishbone (CV)	
04/97→10/02	Track Control Arm		DB-VB-7261	Suspension Rod, Wishbone (CV), 1st RA;2nd RA; Leaf Spring Axle	
04/97→10/02	Track Control Arm	DB-DL-5224		Control Arm	
04/97→10/02	Track Control Arm	DB-DL-9218	DB-DL-9218	Trailing Arm	
3246 B	10/97→	Ball Head, gearshift linkage	DB-ES-8387		
	10/97→	Ball Head, gearshift linkage	DB-ES-8491		
	10/97→	Ball Head, gearshift linkage	DB-ES-8492		
	10/97→	Ball Head, gearshift linkage	DB-ES-8500		
	10/97→	Bush, parabolic spring		DB-SB-10400	
	10/97→	Bush, parabolic spring		DB-SB-10401	
	10/97→	Centre Rod	DB-DL-5230		Push Rod
	10/97→	Centre Rod	DB-DL-5405		Push Rod
	10/97→	Centre Rod	DB-DL-8168		Push Rod
	10/97→	Centre Rod	DB-DL-8184		Push Rod
	10/97→	Centre Rod	DB-DL-8185		Push Rod
	10/97→	Centre Rod	DB-DL-12300		for Steering Rod
	10/97→	Stabiliser Link	DB-DL-9254		Coupling Rod
	10/97→	Stabiliser Link	DB-DL-9271		Coupling Rod



ACTROS ...

3246 B ...	10/97→	Stabiliser Link	DB-DL-9272		Coupling Rod
	10/97→	Suspension Arm Repair Kit		DB-RK-8626	for Wishbone (CV)
	10/97→	Suspension Arm Repair Kit		DB-RK-10374	for Wishbone (CV)
	10/97→	Suspension Strut Repair Kit		DB-RK-8391	
	10/97→	Tie Rod	DB-DL-8171		Guide Rod
	10/97→	Tie Rod	DB-DL-8172		Guide Rod
	10/97→	Tie Rod	DB-DL-8390		
	10/97→	Tie Rod	DB-DL-8640		Guide Rod
	10/97→	Tie Rod End	CV-ES-0543		for Push Rod
	10/97→	Tie Rod End	CV-ES-0888		for Push Rod
	10/97→	Tie Rod End	CV-ES-14163		for Steering Rod
	10/97→	Tie Rod End	DB-ES-8323		
	10/97→	Track Control Arm		DB-DL-3475	Trailing Arm
	10/97→	Track Control Arm		DB-VB-7261	Suspension Rod, Wishbone (CV)
	10/97→	Track Control Arm	DB-DL-5224		Control Arm
10/97→	Track Control Arm	DB-DL-9218	DB-DL-9218	Trailing Arm	
3246 K	10/97→	Ball Head, gearshift linkage	DB-ES-8387		
	10/97→	Ball Head, gearshift linkage	DB-ES-8491		
	10/97→	Ball Head, gearshift linkage	DB-ES-8492		
	10/97→	Ball Head, gearshift linkage	DB-ES-8500		
	10/97→	Bush, parabolic spring		DB-SB-10400	
	10/97→	Bush, parabolic spring		DB-SB-10401	
	10/97→	Centre Rod	DB-DL-5230		Push Rod
	10/97→	Centre Rod	DB-DL-5405		Push Rod
	10/97→	Centre Rod	DB-DL-8168		Push Rod
	10/97→	Centre Rod	DB-DL-8184		Push Rod
	10/97→	Centre Rod	DB-DL-8185		Push Rod
	10/97→	Centre Rod	DB-DL-12300		for Steering Rod
	10/97→	Stabiliser Link	DB-DL-9254		Coupling Rod
	10/97→	Stabiliser Link	DB-DL-9271		Coupling Rod
	10/97→	Stabiliser Link	DB-DL-9272		Coupling Rod
	10/97→	Tie Rod	DB-DL-8171		Guide Rod
	10/97→	Tie Rod	DB-DL-8390		
	10/97→	Tie Rod	DB-DL-8640		Guide Rod
	10/97→	Tie Rod End	CV-ES-14163		for Steering Rod
	10/97→	Tie Rod End	DB-ES-8323		
	10/97→	Track Control Arm		DB-DL-3475	Trailing Arm
	10/97→	Track Control Arm		DB-VB-7261	Suspension Rod, Wishbone (CV)
	10/97→	Track Control Arm	DB-DL-5224		Control Arm
	10/97→	Track Control Arm	DB-DL-9218	DB-DL-9218	Trailing Arm
	3331	04/97→10/02	Ball Head, gearshift linkage	DB-ES-8387	
04/97→10/02		Ball Head, gearshift linkage	DB-ES-8491		
04/97→10/02		Ball Head, gearshift linkage	DB-ES-8492		
04/97→10/02		Ball Head, gearshift linkage	DB-ES-8500		
04/97→10/02		Ball Head, gearshift linkage	DB-ES-8510		
04/97→10/02		Bush, driver cab suspension	DB-SB-10384		
04/97→10/02		Bush, parabolic spring		DB-SB-10400	
04/97→10/02		Bush, parabolic spring		DB-SB-10401	
04/97→10/02		Centre Rod	DB-DL-2144		Push Rod
04/97→10/02		Centre Rod	DB-DL-5230		Push Rod, Leaf Spring Axle
04/97→10/02		Centre Rod	DB-DL-5241		Push Rod
04/97→10/02		Centre Rod	DB-DL-5405		Push Rod, Leaf Spring Axle
04/97→10/02		Centre Rod	DB-DL-7270		Push Rod;Suspension Rod
04/97→10/02		Centre Rod	DB-DL-8167		Push Rod, Leaf Spring Axle
04/97→10/02		Centre Rod	DB-DL-8168		Push Rod
04/97→10/02		Centre Rod	DB-DL-8184		Push Rod
04/97→10/02		Centre Rod	DB-DL-8185		Push Rod
04/97→10/02		Centre Rod	DB-DL-8188		Push Rod
04/97→10/02		Centre Rod	DB-DL-8307		Push Rod
04/97→10/02		Centre Rod	DB-DL-8622		Push Rod
04/97→10/02		Centre Rod	DB-DL-8641		Push Rod
04/97→10/02		Centre Rod	DB-DL-8642		Push Rod
04/97→10/02		Centre Rod	DB-DL-8702		Push Rod, Leaf Spring Axle

CV-ES-0543

Length: 125
Cone Ø: d1 Ø 32 / d2 Ø 29
Thread: M30 x 1,5 RHT
0004605748, 0004606048, 0004606848,
0004607048, 0014600448, 0014601148,
0014601748, 0014602448, 0014607648,
0014609648

**CV-ES-0888**

Length: 125
Cone Ø: d1 Ø 32 / d2 Ø 29
Thread: M30 x 1,5 LHT
0004605848, 0004606148, 0004606948,
0004607148, 0004609048, 0014600548,
0014601348, 0014602548, 0014607948,
0024600448

**CV-ES-14163**

Length: 125
Cone Ø: d1 Ø 30 / d2 Ø 27
Thread: M30 x 1,5 RHT
0003305248, 0003387310, 0004600348,
0004600948, 0004602848, 0004602948,
0004608948, 0014600248, 0014600848,
0014601248, 0014602248, 0014607748,
0024600148, A0003387310, A0004600348,
A0004602848, A0004602948, A0014600848,
A0014601248, A0014602248, A0014607748

**DB-DL-2144**

Length: 872 **Ø:** 35
Cone Ø: d1 Ø 28,6 / d2 Ø 23,9
0024604305, 0024604405, 0034604805

**DB-DL-3475**

Length: 565 **Ø:** 52
Hole Distance: 152 / 152
3753500006, 3753500206, 9473500805,
9483500006, 9483500805, 9483501205,
9483501305, 9483501905, 9483502005,
9483502405, A3753500006,
A3753500206

**DB-DL-5224**

Length: 850 **Ø:** 60
Hole Distance: 100 / 100
01336100A, 9413300007

**DB-DL-5230**

Length: 879 **Ø:** 42
Cone Ø: d1 Ø 30 / d2 Ø 27
01208600A, 0004607105, 0004607205,
0014606705

**DB-DL-5241**

Length: 875 **Ø:** 40
Cone Ø: d1 Ø 30 / d2 Ø 27
01215300A, 0004609205, 0004609305,
0014606905

**DB-DL-5405**

Length: 890 **Ø:** 35
Cone Ø: d1 Ø 28,6 / d2 Ø 23,9
01215900A, 1460248, 0024604505,
0024604605, 0034605005, 3752600637,
3754600405, A3752600637, A3754600405

**DB-DL-7270**

Length: 875 **Ø:** 40
Cone Ø: d1 Ø 28,6 / d2 Ø 23,9
01208300A, 0024604705, 0024604805,
0034604905, A0024604705

**DB-DL-8167**

Length: 866 **Ø:** 38
Cone Ø: d1 Ø 30 / d2 Ø 27
0014609805, 0014609905, 0024606305,
0024606405

**DB-DL-8168**

Length: 904 **Ø:** 52
Cone Ø: d1 Ø 32 / d2 Ø 29
0004609405, 0004609505, 0014607105

**DB-DL-8171**

Length: 1687 **Ø:** 52
Cone Ø: d1 Ø 32 / d2 Ø 29
9493300603, 9493300703, 9493301503,
9493301603

**DB-DL-8172**

Length: 1700 **Ø:** 52
Cone Ø: d1 Ø 32 / d2 Ø 29
01219700A, 9493300403, 9493300503,
9493300803, 9493301403

**DB-DL-8184**

Length: 1095 **Ø:** 42
Cone Ø: d1 Ø 32 / d2 Ø 28,8
01217700A, 0014601305, 0014601405,
0024600505, 0034603205, 3754601505,
A0014601305, A0014601405, A0024600505

**DB-DL-8185**

Length: 711 **Ø:** 42
Cone Ø: d1 Ø 32 / d2 Ø 28,8
01213600A, 0014601105, 0024600405,
0034603105, A0014601105, A0024600405

**DB-DL-8188**

Length: 895 **Ø:** 40
Cone Ø: d1 Ø 28,6 / d2 Ø 23,9
01217200A, 0024604905, 0024605005,
0034605605

**DB-DL-8307**

Length: 885 **Ø:** 38
Cone Ø: d1 Ø 32 / d2 Ø 30
01215500A, 0004604005, 0024605105,
0024605205, 0034604005

**DB-DL-8390**

Length: 1596 **Ø:** 50
Cone Ø: d1 Ø 32 / d2 Ø 29
9493301003, 9493301103, 9493301703

**DB-DL-8622**

Length: 1558 **Ø:** 52
Cone Ø: d1 Ø 30 / d2 Ø 27
0014609005, 0014609105

**DB-DL-8640**

Length: 1615 **Ø:** 50
Cone Ø: d1 Ø 32 / d2 Ø 29
6253301503, 6253301603, 6253302403,
6253302503, 9423300803, 9423302103,
9493300203, 9493300303, 9493300903

**DB-DL-8641**

Length: 905 **Ø:** 42
Cone Ø: d1 Ø 30 / d2 Ø 27
0014605105, 0014608105

**DB-DL-8642**

Length: 954 **Ø:** 42
Cone Ø: d1 Ø 30 / d2 Ø 27
0014608605, 0014608705

**DB-DL-8702**

Length: 958 **Ø:** 38
Cone Ø: d1 Ø 32 / d2 Ø 30
0024606105, 0024606205, 0034604205

**DB-DL-9218**

Length: 754 **Ø:** 40
Hole Distance: 100
000360098524, 000390098524,
3753300111, 9413300011,
A3753300111, SA50831601

**DB-DL-9254**

Length: 1815 **Ø:** 58
0003220323, 0003220623, 3753220423

**DB-DL-9271**

Length: 1815 **Ø:** 60
0003220423, 0003220723

**DB-DL-9272**

Length: 1815 **Ø:** 80
0003220223

**DB-DL-12300**

Length: 733 **Ø:** 36
Cone Ø: d1 Ø 32 / d2 Ø 29
0014601505, 0014607305, 0034603305,
3754601605, A0014601505,
A0034603305, A3754601605

**DB-ES-8323**

Length: 75
Cone Ø: d1 Ø 32 / d2 Ø 28,8
Thread: M26 x 1,5 RHT
0014601548, 0014601648, 0024600648,
A0014601648, A0024600648

**DB-ES-8387**

Length: 55
Cone Ø: d1 Ø 10 / d2 Ø 10
Thread: M14 x 1,5 RHT
0009966845, 0009967045

**DB-ES-8491**

Length: 60
Cone Ø: d1 Ø 10 / d2 Ø 10
Thread: M12 x 1,75 LHT
0009966745

**DB-ES-8492**

Length: 60
Cone Ø: d1 Ø 10 / d2 Ø 10
Thread: M12 x 1,75 RHT
0009966645, 3752680189, A3752680189

**DB-ES-8500**

Length: 55
Cone Ø: d1 Ø 12 / d2 Ø 10,8
Thread: M14 x 1,5 RHT
0002685989

**DB-ES-8510**

Length: 56
Cone Ø: d1 Ø 10 / d2 Ø 10
Thread: M12 x 1,75 LHT
0009965145, 0009965645, 0019963145

**DB-RK-8391**

Ø: 85 **Hole Distance:** 152
Thick/Height: 24
01336800A, 0003502705

**DB-RK-8626**

Ø: 75 **Hole Distance:** 130
Thick/Height: 24
0003502205, 0003502505, 0003503405,
0003504505, GL11319

**DB-RK-10374**

Ø: 85 **Hole Distance:** 152
Thick/Height: 24
0003504405

**DB-SB-10384**

Ø: 73 **Thick/Height:** 47
9303170012, 9423171812

**DB-SB-10400**

Length: 230
Thick/Height: 167,5 / 115
0003250696, 0003250896

**DB-SB-10401**

Length: 232
Thick/Height: 163,5 / 152,5
0003250596, 0003250796

**DB-VB-7261**

Length: 622 **Ø:** 46
Hole Ø: 25 / 25 / 25
Hole Distance: 152 / 130 / 130
01337800A, 9443500305, 9443500505,
9443500605, 9473500705, 9473500905,
9483500405, 9483503005





ACTROS ...

3331 ...	04/97→10/02	Centre Rod	DB-DL-12298		for Steering Rod
	04/97→10/02	Centre Rod	DB-DL-12300		for Steering Rod
	04/97→10/02	Rod Assembly	DB-DL-2178		Guide Rod
	04/97→10/02	Stabiliser Mounting		DB-SB-5250	
	04/97→10/02	Stabiliser Mounting		DB-SB-5261	
	04/97→10/02	Stabiliser Mounting		DB-SB-10406	
	04/97→10/02	Stabiliser Mounting		DB-SB-10407	
	04/97→10/02	Stabiliser Mounting	DB-SB-5260		
	04/97→10/02	Stabiliser Mounting	DB-SB-5277	DB-SB-5277	
	04/97→10/02	Stabiliser Mounting	DB-SB-5279		
	04/97→10/02	Suspension Arm Repair Kit		DB-RK-8550	for Wishbone (CV)
	04/97→10/02	Suspension Arm Repair Kit		DB-RK-8626	for Wishbone (CV)
	04/97→10/02	Suspension Strut Repair Kit		DB-RK-8710	
	04/97→10/02	Suspension Strut Repair Kit		DB-RK-9291	
	04/97→10/02	Tie Rod	DB-DL-8171		Guide Rod
	04/97→10/02	Tie Rod	DB-DL-8327		Guide Rod
	04/97→10/02	Tie Rod	DB-DL-8640		Guide Rod
	04/97→10/02	Tie Rod	DB-DL-12310		
	04/97→10/02	Tie Rod	DB-ES-5227		Guide Rod
	04/97→10/02	Tie Rod End	CV-ES-0543		for Push Rod
	04/97→10/02	Tie Rod End	CV-ES-0888		for Push Rod
	04/97→10/02	Tie Rod End	CV-ES-14162		for Steering Rod
	04/97→10/02	Tie Rod End	CV-ES-14163		for Steering Rod
	04/97→10/02	Tie Rod End	DB-ES-8164		for Push Rod
	04/97→10/02	Tie Rod End	DB-ES-8530		for Push Rod
	04/97→10/02	Track Control Arm		DB-DL-3475	Trailing Arm
	04/97→10/02	Track Control Arm		DB-VB-7261	Suspension Rod, Wishbone (CV), 1st RA;2nd RA; Leaf Spring Axle
	04/97→10/02	Track Control Arm	DB-DL-5224		Control Arm
	04/97→10/02	Track Control Arm	DB-DL-9218	DB-DL-9218	Trailing Arm
	3331 A	04/97→10/02	Ball Head, gearshift linkage	DB-ES-8387	
04/97→10/02		Ball Head, gearshift linkage	DB-ES-8491		
04/97→10/02		Ball Head, gearshift linkage	DB-ES-8492		
04/97→10/02		Ball Head, gearshift linkage	DB-ES-8500		
04/97→10/02		Ball Head, gearshift linkage	DB-ES-8510		
04/97→10/02		Bush, driver cab suspension	DB-SB-10384		
04/97→10/02		Bush, parabolic spring		DB-SB-10400	
04/97→10/02		Bush, parabolic spring		DB-SB-10401	
04/97→10/02		Centre Rod	DB-DL-2144		Push Rod
04/97→10/02		Centre Rod	DB-DL-5230		Push Rod
04/97→10/02		Centre Rod	DB-DL-5241		Push Rod
04/97→10/02		Centre Rod	DB-DL-5405		Push Rod
04/97→10/02		Centre Rod	DB-DL-8168		Push Rod
04/97→10/02		Centre Rod	DB-DL-8184		Push Rod
04/97→10/02		Centre Rod	DB-DL-8188		Push Rod
04/97→10/02		Centre Rod	DB-DL-8307		Push Rod, Leaf Spring Axle
04/97→10/02		Centre Rod	DB-DL-8622		Push Rod
04/97→10/02		Centre Rod	DB-DL-8639		Push Rod, Leaf Spring Axle
04/97→10/02		Centre Rod	DB-DL-8641		Push Rod
04/97→10/02		Centre Rod	DB-DL-8642		Push Rod
04/97→10/02		Centre Rod	DB-DL-8702		Push Rod, Leaf Spring Axle
04/97→10/02		Centre Rod	DB-DL-9259		Push Rod
04/97→10/02		Centre Rod	DB-DL-12298		for Steering Rod
04/97→10/02		Centre Rod	DB-DL-12300		for Steering Rod
04/97→10/02		Rod Assembly	DB-DL-2178		Guide Rod
04/97→10/02		Stabiliser Mounting		DB-SB-5250	
04/97→10/02		Stabiliser Mounting		DB-SB-5261	
04/97→10/02		Stabiliser Mounting		DB-SB-10406	
04/97→10/02		Stabiliser Mounting		DB-SB-10407	
04/97→10/02		Stabiliser Mounting	DB-SB-5260		
04/97→10/02		Stabiliser Mounting	DB-SB-5279		
04/97→10/02		Suspension Arm Repair Kit		DB-RK-8626	for Wishbone (CV)
04/97→10/02		Suspension Strut Repair Kit		DB-RK-8710	

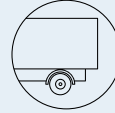

ACTROS ...

3331 A ...	04/97→10/02	Suspension Strut Repair Kit		DB-RK-9291	
	04/97→10/02	Tie Rod	DB-DL-12310		
	04/97→10/02	Tie Rod	DB-ES-5227		Guide Rod
	04/97→10/02	Tie Rod	MN-DL-7834		Guide Rod
	04/97→10/02	Tie Rod End	CV-ES-0543		for Push Rod
	04/97→10/02	Tie Rod End	CV-ES-0888		for Push Rod
	04/97→10/02	Tie Rod End	CV-ES-14162		for Steering Rod
	04/97→10/02	Tie Rod End	CV-ES-14163		for Steering Rod
	04/97→10/02	Tie Rod End	DB-ES-5234		for Steering Rod
	04/97→10/02	Track Control Arm		DB-DL-3475	Trailing Arm
	04/97→10/02	Track Control Arm		DB-VB-7261	Suspension Rod, Wishbone (CV), 1st RA;2nd RA; Leaf Spring Axle
	04/97→10/02	Track Control Arm	DB-DL-5224		Control Arm
	3331 AK	04/97→10/02	Track Control Arm	DB-DL-9218	DB-DL-9218
04/97→10/02		Ball Head, gearshift linkage	DB-ES-8387		
04/97→10/02		Ball Head, gearshift linkage	DB-ES-8491		
04/97→10/02		Ball Head, gearshift linkage	DB-ES-8492		
04/97→10/02		Ball Head, gearshift linkage	DB-ES-8500		
04/97→10/02		Ball Head, gearshift linkage	DB-ES-8510		
04/97→10/02		Bush, driver cab suspension	DB-SB-10384		
04/97→10/02		Bush, parabolic spring		DB-SB-10400	
04/97→10/02		Bush, parabolic spring		DB-SB-10401	
04/97→10/02		Centre Rod	DB-DL-2144		Push Rod
04/97→10/02		Centre Rod	DB-DL-5230		Push Rod
04/97→10/02		Centre Rod	DB-DL-5241		Push Rod
04/97→10/02		Centre Rod	DB-DL-5405		Push Rod
04/97→10/02		Centre Rod	DB-DL-8184		Push Rod
04/97→10/02		Centre Rod	DB-DL-8188		Push Rod
04/97→10/02		Centre Rod	DB-DL-8307		Push Rod, Leaf Spring Axle
04/97→10/02		Centre Rod	DB-DL-8639		Push Rod, 1st FA;Leaf Spring Axle
04/97→10/02		Centre Rod	DB-DL-8702		Push Rod, 1st FA;Leaf Spring Axle
04/97→10/02		Centre Rod	DB-DL-9259		Push Rod
04/97→10/02		Centre Rod	DB-DL-12300		for Steering Rod
04/97→10/02		Rod Assembly	DB-DL-2178		Guide Rod
04/97→10/02		Stabiliser Link	DB-DL-9254		Pressure Rod
04/97→10/02		Stabiliser Mounting		DB-SB-5261	
04/97→10/02		Stabiliser Mounting		DB-SB-10406	
04/97→10/02		Stabiliser Mounting		DB-SB-10407	
04/97→10/02		Stabiliser Mounting		DB-SB-10409	
04/97→10/02		Stabiliser Mounting	DB-SB-5260		
04/97→10/02		Stabiliser Mounting	DB-SB-5279		
04/97→10/02		Suspension Arm Repair Kit		DB-RK-8626	for Wishbone (CV)
04/97→10/02		Suspension Arm Repair Kit		DB-RK-10374	for Wishbone (CV)
04/97→10/02		Suspension Arm Repair Kit		DB-RK-10375	for Wishbone (CV)
04/97→10/02		Suspension Arm Repair Kit	DB-RK-8638		for Control Arm
04/97→10/02		Suspension Strut Repair Kit		DB-RK-8391	
04/97→10/02		Suspension Strut Repair Kit		DB-RK-8710	
04/97→10/02		Tie Rod	DB-DL-12310		
04/97→10/02		Tie Rod	DB-ES-5227		Guide Rod
04/97→10/02		Tie Rod	MN-DL-7834		Guide Rod
04/97→10/02		Tie Rod End	CV-ES-0543		for Push Rod
04/97→10/02		Tie Rod End	CV-ES-0888		for Push Rod
04/97→10/02		Tie Rod End	CV-ES-14162		for Steering Rod
04/97→10/02		Tie Rod End	CV-ES-14163		for Steering Rod
04/97→10/02		Tie Rod End	DB-ES-5234		for Steering Rod
04/97→10/02		Tie Rod End	DB-ES-8530		for Push Rod
04/97→10/02		Track Control Arm		DB-DL-3475	Trailing Arm
04/97→10/02		Track Control Arm		DB-VB-7261	Suspension Rod, Wishbone (CV), 1st RA;2nd RA; Leaf Spring Axle
04/97→10/02		Track Control Arm	DB-DL-5224		Control Arm
04/97→10/02		Track Control Arm	DB-DL-9218	DB-DL-9218	Trailing Arm

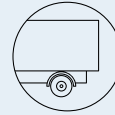

ACTROS ...

3331 AS

04/97→10/02	Ball Head, gearshift linkage	DB-ES-8387	
04/97→10/02	Ball Head, gearshift linkage	DB-ES-8491	
04/97→10/02	Ball Head, gearshift linkage	DB-ES-8492	
04/97→10/02	Ball Head, gearshift linkage	DB-ES-8500	
04/97→10/02	Ball Head, gearshift linkage	DB-ES-8510	
04/97→10/02	Bush, driver cab suspension	DB-SB-10384	
04/97→10/02	Bush, parabolic spring		DB-SB-10400
04/97→10/02	Bush, parabolic spring		DB-SB-10401
04/97→10/02	Centre Rod	DB-DL-2144	Push Rod
04/97→10/02	Centre Rod	DB-DL-5230	Push Rod
04/97→10/02	Centre Rod	DB-DL-5241	Push Rod
04/97→10/02	Centre Rod	DB-DL-5405	Push Rod
04/97→10/02	Centre Rod	DB-DL-8188	Push Rod
04/97→10/02	Centre Rod	DB-DL-8307	Push Rod, Leaf Spring Axle
04/97→10/02	Centre Rod	DB-DL-8639	Push Rod, 1st FA;Leaf Spring Axle
04/97→10/02	Centre Rod	DB-DL-8702	Push Rod;Suspension Rod
04/97→10/02	Centre Rod	DB-DL-9259	Push Rod
04/97→10/02	Centre Rod	DB-DL-12300	for Steering Rod
04/97→10/02	Rod Assembly	DB-DL-2178	Guide Rod
04/97→10/02	Stabiliser Mounting		DB-SB-5261
04/97→10/02	Stabiliser Mounting		DB-SB-10406
04/97→10/02	Stabiliser Mounting		DB-SB-10407
04/97→10/02	Stabiliser Mounting		DB-SB-10409
04/97→10/02	Stabiliser Mounting	DB-SB-5260	
04/97→10/02	Stabiliser Mounting	DB-SB-5279	
04/97→10/02	Stabiliser Mounting	DB-SB-10410	
04/97→10/02	Suspension Arm Repair Kit		DB-RK-8626 for Wishbone (CV)
04/97→10/02	Suspension Arm Repair Kit		DB-RK-10374 for Wishbone (CV)
04/97→10/02	Suspension Arm Repair Kit		DB-RK-10375 for Wishbone (CV)
04/97→10/02	Suspension Arm Repair Kit	DB-RK-8638	for Control Arm
04/97→10/02	Suspension Strut Repair Kit		DB-RK-8391
04/97→10/02	Suspension Strut Repair Kit		DB-RK-8710
04/97→10/02	Suspension Strut Repair Kit		DB-RK-9291
04/97→10/02	Suspension Strut Repair Kit		MN-RK-8997
04/97→10/02	Tie Rod	DB-DL-12310	
04/97→10/02	Tie Rod	DB-ES-5227	Guide Rod
04/97→10/02	Tie Rod	MN-DL-7834	Guide Rod
04/97→10/02	Tie Rod End	CV-ES-0543	for Push Rod
04/97→10/02	Tie Rod End	CV-ES-0888	for Push Rod
04/97→10/02	Tie Rod End	CV-ES-14162	for Steering Rod
04/97→10/02	Tie Rod End	CV-ES-14163	for Steering Rod
04/97→10/02	Tie Rod End	DB-ES-5234	for Steering Rod
04/97→10/02	Track Control Arm		DB-DL-3475 Trailing Arm
04/97→10/02	Track Control Arm		DB-VB-7261 Suspension Rod, Wishbone (CV), 1st RA;2nd RA; Leaf Spring Axle
04/97→10/02	Track Control Arm		DB-VB-7798 Wishbone (CV)
04/97→10/02	Track Control Arm	DB-DL-5224	Control Arm
04/97→10/02	Track Control Arm	DB-DL-9218	DB-DL-9218 Trailing Arm

3331 B

04/97→10/02	Ball Head, gearshift linkage	DB-ES-8387	
04/97→10/02	Ball Head, gearshift linkage	DB-ES-8491	
04/97→10/02	Ball Head, gearshift linkage	DB-ES-8492	
04/97→10/02	Ball Head, gearshift linkage	DB-ES-8500	
04/97→10/02	Ball Head, gearshift linkage	DB-ES-8510	
04/97→10/02	Bush, driver cab suspension	DB-SB-10384	
04/97→10/02	Bush, parabolic spring		DB-SB-10400
04/97→10/02	Bush, parabolic spring		DB-SB-10401
04/97→10/02	Centre Rod	DB-DL-2144	Push Rod
04/97→10/02	Centre Rod	DB-DL-5230	Push Rod
04/97→10/02	Centre Rod	DB-DL-5241	Push Rod
04/97→10/02	Centre Rod	DB-DL-5405	Push Rod, Leaf Spring Axle
04/97→10/02	Centre Rod	DB-DL-7270	Push Rod
04/97→10/02	Centre Rod	DB-DL-8167	Push Rod, 1st FA;Leaf Spring Axle
04/97→10/02	Centre Rod	DB-DL-8184	Push Rod



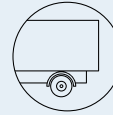
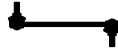

ACTROS ...

3331 B ...	04/97→10/02	Centre Rod	DB-DL-8185		Push Rod	
	04/97→10/02	Centre Rod	DB-DL-8188		Push Rod	
	04/97→10/02	Centre Rod	DB-DL-8307		Push Rod	
	04/97→10/02	Centre Rod	DB-DL-8702		Push Rod, Leaf Spring Axle	
	04/97→10/02	Centre Rod	DB-DL-12300		for Steering Rod	
	04/97→10/02	Rod Assembly	DB-DL-2178		Guide Rod	
	04/97→10/02	Stabiliser Link	DB-DL-9254		Pressure Rod	
	04/97→10/02	Stabiliser Mounting		DB-SB-5261		
	04/97→10/02	Stabiliser Mounting		DB-SB-10406		
	04/97→10/02	Stabiliser Mounting		DB-SB-10407		
	04/97→10/02	Stabiliser Mounting		DB-SB-10409		
	04/97→10/02	Stabiliser Mounting	DB-SB-5250			
	04/97→10/02	Stabiliser Mounting	DB-SB-5260			
	04/97→10/02	Stabiliser Mounting	DB-SB-5279			
	04/97→10/02	Suspension Arm Repair Kit		DB-RK-8550	for Wishbone (CV)	
	04/97→10/02	Suspension Arm Repair Kit		DB-RK-8626	for Wishbone (CV)	
	04/97→10/02	Suspension Arm Repair Kit		DB-RK-10374	for Wishbone (CV)	
	04/97→10/02	Suspension Arm Repair Kit		DB-RK-10375	for Wishbone (CV)	
	04/97→10/02	Suspension Arm Repair Kit	DB-RK-8638		for Control Arm	
	04/97→10/02	Suspension Strut Repair Kit		DB-RK-8391		
	04/97→10/02	Suspension Strut Repair Kit		DB-RK-8710		
	04/97→10/02	Suspension Strut Repair Kit		DB-RK-9291		
	04/97→10/02	Tie Rod	DB-DL-8171		Guide Rod	
	04/97→10/02	Tie Rod	DB-DL-8327		Guide Rod	
	04/97→10/02	Tie Rod	DB-DL-8640		Guide Rod	
	04/97→10/02	Tie Rod	DB-DL-12310			
	04/97→10/02	Tie Rod End	CV-ES-0543		for Push Rod	
	04/97→10/02	Tie Rod End	CV-ES-0888		for Push Rod	
	04/97→10/02	Tie Rod End	CV-ES-14162		for Steering Rod	
	04/97→10/02	Tie Rod End	CV-ES-14163		for Steering Rod	
	04/97→10/02	Tie Rod End	DB-ES-5234		for Steering Rod	
	04/97→10/02	Tie Rod End	DB-ES-8164		for Push Rod	
	04/97→10/02	Tie Rod End	DB-ES-8530		for Push Rod	
	04/97→10/02	Track Control Arm		DB-DL-3475	Trailing Arm	
	04/97→10/02	Track Control Arm		DB-VB-7261	Suspension Rod, Wishbone (CV), 1st RA;2nd RA; Leaf Spring Axle	
	04/97→10/02	Track Control Arm	DB-DL-5224		Control Arm	
	04/97→10/02	Track Control Arm	DB-DL-9218	DB-DL-9218	Trailing Arm	
	3331 K	04/97→10/02	Ball Head, gearshift linkage	DB-ES-8387		
		04/97→10/02	Ball Head, gearshift linkage	DB-ES-8491		
		04/97→10/02	Ball Head, gearshift linkage	DB-ES-8492		
		04/97→10/02	Ball Head, gearshift linkage	DB-ES-8500		
04/97→10/02		Ball Head, gearshift linkage	DB-ES-8510			
04/97→10/02		Bush, driver cab suspension	DB-SB-10384			
04/97→10/02		Bush, parabolic spring		DB-SB-10400		
04/97→10/02		Bush, parabolic spring		DB-SB-10401		
04/97→10/02		Centre Rod	DB-DL-2144		Push Rod	
04/97→10/02		Centre Rod	DB-DL-5230		Push Rod, 1st FA;Leaf Spring Axle	
04/97→10/02		Centre Rod	DB-DL-5241		Push Rod	
04/97→10/02		Centre Rod	DB-DL-5405		Push Rod, 1st FA;Leaf Spring Axle	
04/97→10/02		Centre Rod	DB-DL-7270		Push Rod	
04/97→10/02		Centre Rod	DB-DL-8167		Push Rod, 1st FA;Leaf Spring Axle	
04/97→10/02		Centre Rod	DB-DL-8184		Push Rod	
04/97→10/02		Centre Rod	DB-DL-8185		Push Rod	
04/97→10/02		Centre Rod	DB-DL-8188		Push Rod	
04/97→10/02		Centre Rod	DB-DL-8307		Push Rod	
04/97→10/02		Centre Rod	DB-DL-8702		Push Rod, 1st FA;Leaf Spring Axle	
04/97→10/02		Centre Rod	DB-DL-12300		for Steering Rod	
04/97→10/02		Rod Assembly	DB-DL-2178		Guide Rod	
04/97→10/02		Stabiliser Link	DB-DL-9254		Pressure Rod	
04/97→10/02		Stabiliser Mounting		DB-SB-5261		
04/97→10/02		Stabiliser Mounting		DB-SB-10406		
04/97→10/02		Stabiliser Mounting		DB-SB-10407		



ACTROS ...

3331 K ...	04/97→10/02	Stabiliser Mounting		DB-SB-10409		
	04/97→10/02	Stabiliser Mounting	DB-SB-5260			
	04/97→10/02	Stabiliser Mounting	DB-SB-5279			
	04/97→10/02	Suspension Arm Repair Kit		DB-RK-8550	for Wishbone (CV)	
	04/97→10/02	Suspension Arm Repair Kit		DB-RK-8626	for Wishbone (CV)	
	04/97→10/02	Suspension Arm Repair Kit		DB-RK-10374	for Wishbone (CV)	
	04/97→10/02	Suspension Arm Repair Kit		DB-RK-10375	for Wishbone (CV)	
	04/97→10/02	Suspension Arm Repair Kit	DB-RK-8638		for Control Arm	
	04/97→10/02	Suspension Strut Repair Kit		DB-RK-8391		
	04/97→10/02	Suspension Strut Repair Kit		DB-RK-8710		
	04/97→10/02	Suspension Strut Repair Kit		DB-RK-9291		
	04/97→10/02	Tie Rod	DB-DL-8171		Guide Rod	
	04/97→10/02	Tie Rod	DB-DL-8327		Guide Rod	
	04/97→10/02	Tie Rod	DB-DL-8640		Guide Rod	
	04/97→10/02	Tie Rod	DB-DL-12310			
	04/97→10/02	Tie Rod	DB-ES-5227		Guide Rod	
	04/97→10/02	Tie Rod End	CV-ES-0543		for Push Rod	
	04/97→10/02	Tie Rod End	CV-ES-0888		for Push Rod	
	04/97→10/02	Tie Rod End	CV-ES-14162		for Steering Rod	
	04/97→10/02	Tie Rod End	CV-ES-14163		for Steering Rod	
	04/97→10/02	Tie Rod End	DB-ES-5234		for Steering Rod	
	04/97→10/02	Tie Rod End	DB-ES-8164		for Push Rod	
	04/97→10/02	Tie Rod End	DB-ES-8530		for Push Rod	
	04/97→10/02	Track Control Arm		DB-DL-3475	Trailing Arm	
	04/97→10/02	Track Control Arm		DB-VB-7261	Suspension Rod, Wishbone (CV), 1st RA;2nd RA; Leaf Spring Axle	
	04/97→10/02	Track Control Arm	DB-DL-5224		Control Arm	
	04/97→10/02	Track Control Arm	DB-DL-9218	DB-DL-9218	Trailing Arm	
	3331 S	04/97→10/02	Ball Head, gearshift linkage	DB-ES-8387		
		04/97→10/02	Ball Head, gearshift linkage	DB-ES-8491		
		04/97→10/02	Ball Head, gearshift linkage	DB-ES-8492		
		04/97→10/02	Ball Head, gearshift linkage	DB-ES-8500		
		04/97→10/02	Ball Head, gearshift linkage	DB-ES-8510		
		04/97→10/02	Bush, driver cab suspension	DB-SB-10384		
04/97→10/02		Bush, parabolic spring		DB-SB-10400		
04/97→10/02		Bush, parabolic spring		DB-SB-10401		
04/97→10/02		Centre Rod	DB-DL-2144		Push Rod	
04/97→10/02		Centre Rod	DB-DL-5230		Push Rod, 1st FA;Leaf Spring Axle	
04/97→10/02		Centre Rod	DB-DL-5241		Push Rod	
04/97→10/02		Centre Rod	DB-DL-5405		Push Rod, Leaf Spring Axle	
04/97→10/02		Centre Rod	DB-DL-7270		Push Rod	
04/97→10/02		Centre Rod	DB-DL-8167		Push Rod, 1st FA;Leaf Spring Axle	
04/97→10/02		Centre Rod	DB-DL-8184		Push Rod	
04/97→10/02		Centre Rod	DB-DL-8185		Push Rod	
04/97→10/02		Centre Rod	DB-DL-8188		Push Rod	
04/97→10/02		Centre Rod	DB-DL-8307		Push Rod	
04/97→10/02		Centre Rod	DB-DL-8702		Push Rod, Leaf Spring Axle	
04/97→10/02		Centre Rod	DB-DL-12300		for Steering Rod	
04/97→10/02		Rod Assembly	DB-DL-2178		Guide Rod	
04/97→10/02		Stabiliser Mounting		DB-SB-5261		
04/97→10/02		Stabiliser Mounting		DB-SB-10406		
04/97→10/02		Stabiliser Mounting		DB-SB-10407		
04/97→10/02		Stabiliser Mounting		DB-SB-10409		
04/97→10/02		Stabiliser Mounting	DB-SB-5260			
04/97→10/02		Stabiliser Mounting	DB-SB-5279			
04/97→10/02		Stabiliser Mounting	DB-SB-10410			
04/97→10/02		Suspension Arm Repair Kit		DB-RK-8550	for Wishbone (CV)	
04/97→10/02		Suspension Arm Repair Kit		DB-RK-8626	for Wishbone (CV)	
04/97→10/02		Suspension Arm Repair Kit		DB-RK-10374	for Wishbone (CV)	
04/97→10/02		Suspension Arm Repair Kit		DB-RK-10375	for Wishbone (CV)	
04/97→10/02		Suspension Arm Repair Kit	DB-RK-8638		for Control Arm	
04/97→10/02	Suspension Strut Repair Kit		DB-RK-8391			
04/97→10/02	Suspension Strut Repair Kit		DB-RK-8710			

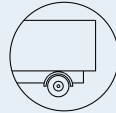

ACTROS ...

3331 S ...	04/97→10/02	Suspension Strut Repair Kit		DB-RK-9291		
	04/97→10/02	Suspension Strut Repair Kit		MN-RK-8997		
	04/97→10/02	Tie Rod	DB-DL-8171		Guide Rod	
	04/97→10/02	Tie Rod	DB-DL-8327		Guide Rod	
	04/97→10/02	Tie Rod	DB-DL-8640		Guide Rod	
	04/97→10/02	Tie Rod	DB-DL-12310			
	04/97→10/02	Tie Rod	DB-ES-5227		Guide Rod	
	04/97→10/02	Tie Rod End	CV-ES-0543		for Push Rod	
	04/97→10/02	Tie Rod End	CV-ES-0888		for Push Rod	
	04/97→10/02	Tie Rod End	CV-ES-14162		for Steering Rod	
	04/97→10/02	Tie Rod End	CV-ES-14163		for Steering Rod	
	04/97→10/02	Tie Rod End	DB-ES-5234		for Steering Rod	
	04/97→10/02	Tie Rod End	DB-ES-8164		for Push Rod	
	04/97→10/02	Tie Rod End	DB-ES-8530		for Push Rod	
	04/97→10/02	Track Control Arm		DB-DL-3475	Trailing Arm	
	04/97→10/02	Track Control Arm		DB-VB-7261	Suspension Rod, Wishbone (CV), 1st RA;2nd RA; Leaf Spring Axle	
	04/97→10/02	Track Control Arm		DB-VB-7798	Wishbone (CV)	
	04/97→10/02	Track Control Arm	DB-DL-5224		Control Arm	
	3335	04/97→10/02	Track Control Arm	DB-DL-9218	DB-DL-9218	Trailing Arm
		04/97→10/02	Ball Head, gearshift linkage	DB-ES-8387		
04/97→10/02		Ball Head, gearshift linkage	DB-ES-8491			
04/97→10/02		Ball Head, gearshift linkage	DB-ES-8492			
04/97→10/02		Ball Head, gearshift linkage	DB-ES-8500			
04/97→10/02		Ball Head, gearshift linkage	DB-ES-8510			
04/97→10/02		Bush, driver cab suspension	DB-SB-10384			
04/97→10/02		Bush, parabolic spring		DB-SB-10400		
04/97→10/02		Bush, parabolic spring		DB-SB-10401		
04/97→10/02		Centre Rod	DB-DL-2144		Push Rod	
04/97→10/02		Centre Rod	DB-DL-5230		Push Rod, Leaf Spring Axle	
04/97→10/02		Centre Rod	DB-DL-5241		Push Rod	
04/97→10/02		Centre Rod	DB-DL-5405		Push Rod, Leaf Spring Axle	
04/97→10/02		Centre Rod	DB-DL-7270		Push Rod;Suspension Rod	
04/97→10/02		Centre Rod	DB-DL-8167		Push Rod, Leaf Spring Axle	
04/97→10/02		Centre Rod	DB-DL-8168		Push Rod	
04/97→10/02		Centre Rod	DB-DL-8184		Push Rod	
04/97→10/02		Centre Rod	DB-DL-8185		Push Rod	
04/97→10/02		Centre Rod	DB-DL-8188		Push Rod	
04/97→10/02		Centre Rod	DB-DL-8307		Push Rod	
04/97→10/02		Centre Rod	DB-DL-8622		Push Rod	
04/97→10/02		Centre Rod	DB-DL-8641		Push Rod	
04/97→10/02		Centre Rod	DB-DL-8642		Push Rod	
04/97→10/02		Centre Rod	DB-DL-8702		Push Rod, Leaf Spring Axle	
04/97→10/02		Centre Rod	DB-DL-12298		for Steering Rod	
04/97→10/02		Centre Rod	DB-DL-12300		for Steering Rod	
04/97→10/02		Rod Assembly	DB-DL-2178		Guide Rod	
04/97→10/02		Stabiliser Mounting		DB-SB-5250		
04/97→10/02		Stabiliser Mounting		DB-SB-5261		
04/97→10/02		Stabiliser Mounting		DB-SB-10406		
04/97→10/02		Stabiliser Mounting		DB-SB-10407		
04/97→10/02		Stabiliser Mounting	DB-SB-5260			
04/97→10/02		Stabiliser Mounting	DB-SB-5277	DB-SB-5277		
04/97→10/02		Stabiliser Mounting	DB-SB-5279			
04/97→10/02		Suspension Arm Repair Kit		DB-RK-8550	for Wishbone (CV)	
04/97→10/02		Suspension Arm Repair Kit		DB-RK-8626	for Wishbone (CV)	
04/97→10/02		Suspension Strut Repair Kit		DB-RK-8710		
04/97→10/02		Suspension Strut Repair Kit		DB-RK-9291		
04/97→10/02		Tie Rod	DB-DL-8171		Guide Rod	
04/97→10/02		Tie Rod	DB-DL-8327		Guide Rod	
04/97→10/02		Tie Rod	DB-DL-8640		Guide Rod	
04/97→10/02		Tie Rod	DB-DL-12310			
04/97→10/02		Tie Rod	DB-ES-5227		Guide Rod	
04/97→10/02		Tie Rod End	CV-ES-0543		for Push Rod	

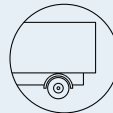

ACTROS ...

3335 ...	04/97→10/02	Tie Rod End	CV-ES-0888		for Push Rod	
	04/97→10/02	Tie Rod End	CV-ES-14162		for Steering Rod	
	04/97→10/02	Tie Rod End	CV-ES-14163		for Steering Rod	
	04/97→10/02	Tie Rod End	DB-ES-8164		for Push Rod	
	04/97→10/02	Tie Rod End	DB-ES-8530		for Push Rod	
	04/97→10/02	Track Control Arm		DB-DL-3475	Trailing Arm	
	04/97→10/02	Track Control Arm		DB-VB-7261	Suspension Rod, Wishbone (CV), 1st RA;2nd RA; Leaf Spring Axle	
	04/97→10/02	Track Control Arm	DB-DL-5224		Control Arm	
	04/97→10/02	Track Control Arm	DB-DL-9218	DB-DL-9218	Trailing Arm	
	3335 AK	10/97→10/03	Ball Head, gearshift linkage	DB-ES-8387		
10/97→10/03		Ball Head, gearshift linkage	DB-ES-8491			
10/97→10/03		Ball Head, gearshift linkage	DB-ES-8492			
10/97→10/03		Ball Head, gearshift linkage	DB-ES-8500			
10/97→10/03		Bush, parabolic spring		DB-SB-10400		
10/97→10/03		Bush, parabolic spring		DB-SB-10401		
10/97→10/03		Centre Rod	DB-DL-5230		Push Rod	
10/97→10/03		Centre Rod	DB-DL-5405		Push Rod	
10/97→10/03		Centre Rod	DB-DL-8307		Push Rod	
10/97→10/03		Centre Rod	DB-DL-8639		Push Rod	
10/97→10/03		Centre Rod	DB-DL-8702		Push Rod	
10/97→10/03		Centre Rod	DB-DL-9259		Push Rod	
10/97→10/03		Suspension Arm Repair Kit		DB-RK-8626	for Wishbone (CV)	
10/97→10/03		Suspension Strut Repair Kit		DB-RK-8391		
10/97→10/03		Suspension Strut Repair Kit		DB-RK-8710		
10/97→10/03		Tie Rod	DB-ES-5227		Guide Rod	
10/97→10/03		Tie Rod	MN-DL-7834		Guide Rod	
10/97→10/03		Tie Rod End	CV-ES-0543		for Push Rod	
10/97→10/03		Tie Rod End	CV-ES-14163		for Steering Rod	
10/97→10/03		Tie Rod End	DB-ES-5234		for Steering Rod	
10/97→10/03		Track Control Arm		DB-DL-3475	Trailing Arm	
10/97→10/03		Track Control Arm		DB-VB-7261	Suspension Rod, Wishbone (CV)	
10/97→10/03		Track Control Arm	DB-DL-5224		Control Arm	
10/97→10/03		Track Control Arm	DB-DL-9218	DB-DL-9218	Trailing Arm	
3335 B		04/97→10/02	Ball Head, gearshift linkage	DB-ES-8387		
		04/97→10/02	Ball Head, gearshift linkage	DB-ES-8491		
		04/97→10/02	Ball Head, gearshift linkage	DB-ES-8492		
		04/97→10/02	Ball Head, gearshift linkage	DB-ES-8500		
		04/97→10/02	Ball Head, gearshift linkage	DB-ES-8510		
		04/97→10/02	Bush, driver cab suspension	DB-SB-10384		
	04/97→10/02	Bush, parabolic spring		DB-SB-10400		
	04/97→10/02	Bush, parabolic spring		DB-SB-10401		
	04/97→10/02	Centre Rod	DB-DL-2144		Push Rod	
	04/97→10/02	Centre Rod	DB-DL-5230		Push Rod, Leaf Spring Axle	
	04/97→10/02	Centre Rod	DB-DL-5241		Push Rod	
	04/97→10/02	Centre Rod	DB-DL-5405		Push Rod, Leaf Spring Axle	
	04/97→10/02	Centre Rod	DB-DL-7270		Push Rod	
	04/97→10/02	Centre Rod	DB-DL-8167		Push Rod, 1st FA;Leaf Spring Axle	
	04/97→10/02	Centre Rod	DB-DL-8184		Push Rod	
	04/97→10/02	Centre Rod	DB-DL-8185		Push Rod	
	04/97→10/02	Centre Rod	DB-DL-8188		Push Rod	
	04/97→10/02	Centre Rod	DB-DL-8307		Push Rod	
	04/97→10/02	Centre Rod	DB-DL-8702		Push Rod, Leaf Spring Axle	
	04/97→10/02	Centre Rod	DB-DL-12300		for Steering Rod	
	04/97→10/02	Rod Assembly	DB-DL-2178		Guide Rod	
	04/97→10/02	Stabiliser Link	DB-DL-9254		Pressure Rod	
	04/97→10/02	Stabiliser Mounting		DB-SB-5261		
	04/97→10/02	Stabiliser Mounting		DB-SB-10406		
	04/97→10/02	Stabiliser Mounting		DB-SB-10407		
	04/97→10/02	Stabiliser Mounting		DB-SB-10409		
	04/97→10/02	Stabiliser Mounting	DB-SB-5250			
	04/97→10/02	Stabiliser Mounting	DB-SB-5260			
	04/97→10/02	Stabiliser Mounting	DB-SB-5279			

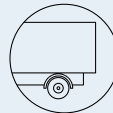

ACTROS ...

3335 B ...	04/97→10/02	Suspension Arm Repair Kit		DB-RK-8550	for Wishbone (CV)
	04/97→10/02	Suspension Arm Repair Kit		DB-RK-8626	for Wishbone (CV)
	04/97→10/02	Suspension Arm Repair Kit		DB-RK-10374	for Wishbone (CV)
	04/97→10/02	Suspension Arm Repair Kit		DB-RK-10375	for Wishbone (CV)
	04/97→10/02	Suspension Arm Repair Kit	DB-RK-8638		for Control Arm
	04/97→10/02	Suspension Strut Repair Kit		DB-RK-8391	
	04/97→10/02	Suspension Strut Repair Kit		DB-RK-8710	
	04/97→10/02	Suspension Strut Repair Kit		DB-RK-9291	
	04/97→10/02	Tie Rod	DB-DL-8171		Guide Rod
	04/97→10/02	Tie Rod	DB-DL-8327		Guide Rod
	04/97→10/02	Tie Rod	DB-DL-8640		Guide Rod
	04/97→10/02	Tie Rod	DB-DL-12310		
	04/97→10/02	Tie Rod End	CV-ES-0543		for Push Rod
	04/97→10/02	Tie Rod End	CV-ES-0888		for Push Rod
	04/97→10/02	Tie Rod End	CV-ES-14162		for Steering Rod
	04/97→10/02	Tie Rod End	CV-ES-14163		for Steering Rod
	04/97→10/02	Tie Rod End	DB-ES-5234		for Steering Rod
	04/97→10/02	Tie Rod End	DB-ES-8164		for Push Rod
	04/97→10/02	Tie Rod End	DB-ES-8530		for Push Rod
	04/97→10/02	Track Control Arm		DB-DL-3475	Trailing Arm
	04/97→10/02	Track Control Arm		DB-VB-7261	Suspension Rod, Wishbone (CV), 1st RA;2nd RA; Leaf Spring Axle
	04/97→10/02	Track Control Arm	DB-DL-5224		Control Arm
	04/97→10/02	Track Control Arm	DB-DL-9218	DB-DL-9218	Trailing Arm
	3335 K	04/97→10/02	Ball Head, gearshift linkage	DB-ES-8387	
04/97→10/02		Ball Head, gearshift linkage	DB-ES-8491		
04/97→10/02		Ball Head, gearshift linkage	DB-ES-8492		
04/97→10/02		Ball Head, gearshift linkage	DB-ES-8500		
04/97→10/02		Ball Head, gearshift linkage	DB-ES-8510		
04/97→10/02		Bush, driver cab suspension	DB-SB-10384		
04/97→10/02		Bush, parabolic spring		DB-SB-10400	
04/97→10/02		Bush, parabolic spring		DB-SB-10401	
04/97→10/02		Centre Rod	DB-DL-2144		Push Rod
04/97→10/02		Centre Rod	DB-DL-5230		Push Rod, 1st FA;Leaf Spring Axle
04/97→10/02		Centre Rod	DB-DL-5241		Push Rod
04/97→10/02		Centre Rod	DB-DL-5405		Push Rod, 1st FA;Leaf Spring Axle
04/97→10/02		Centre Rod	DB-DL-7270		Push Rod
04/97→10/02		Centre Rod	DB-DL-8167		Push Rod, 1st FA;Leaf Spring Axle
04/97→10/02		Centre Rod	DB-DL-8184		Push Rod
04/97→10/02		Centre Rod	DB-DL-8185		Push Rod
04/97→10/02		Centre Rod	DB-DL-8188		Push Rod
04/97→10/02		Centre Rod	DB-DL-8307		Push Rod
04/97→10/02		Centre Rod	DB-DL-8702		Push Rod, 1st FA;Leaf Spring Axle
04/97→10/02		Centre Rod	DB-DL-12300		for Steering Rod
04/97→10/02		Rod Assembly	DB-DL-2178		Guide Rod
04/97→10/02		Stabiliser Link	DB-DL-9254		Pressure Rod
04/97→10/02		Stabiliser Mounting		DB-SB-5261	
04/97→10/02		Stabiliser Mounting		DB-SB-10406	
04/97→10/02		Stabiliser Mounting		DB-SB-10407	
04/97→10/02		Stabiliser Mounting		DB-SB-10409	
04/97→10/02		Stabiliser Mounting	DB-SB-5260		
04/97→10/02		Stabiliser Mounting	DB-SB-5279		
04/97→10/02		Suspension Arm Repair Kit		DB-RK-8550	for Wishbone (CV)
04/97→10/02		Suspension Arm Repair Kit		DB-RK-8626	for Wishbone (CV)
04/97→10/02		Suspension Arm Repair Kit		DB-RK-10374	for Wishbone (CV)
04/97→10/02		Suspension Arm Repair Kit		DB-RK-10375	for Wishbone (CV)
04/97→10/02		Suspension Arm Repair Kit	DB-RK-8638		for Control Arm
04/97→10/02	Suspension Strut Repair Kit		DB-RK-8391		
04/97→10/02	Suspension Strut Repair Kit		DB-RK-8710		
04/97→10/02	Suspension Strut Repair Kit		DB-RK-9291		
04/97→10/02	Tie Rod	DB-DL-8171		Guide Rod	
04/97→10/02	Tie Rod	DB-DL-8327		Guide Rod	
04/97→10/02	Tie Rod	DB-DL-8640		Guide Rod	

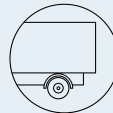

ACTROS ...

3335 K ...	04/97→10/02	Tie Rod	DB-DL-12310		
	04/97→10/02	Tie Rod	DB-ES-5227		Guide Rod
	04/97→10/02	Tie Rod End	CV-ES-0543		for Push Rod
	04/97→10/02	Tie Rod End	CV-ES-0888		for Push Rod
	04/97→10/02	Tie Rod End	CV-ES-14162		for Steering Rod
	04/97→10/02	Tie Rod End	CV-ES-14163		for Steering Rod
	04/97→10/02	Tie Rod End	DB-ES-5234		for Steering Rod
	04/97→10/02	Tie Rod End	DB-ES-8164		for Push Rod
	04/97→10/02	Tie Rod End	DB-ES-8530		for Push Rod
	04/97→10/02	Track Control Arm		DB-DL-3475	Trailing Arm
04/97→10/02	Track Control Arm		DB-VB-7261	Suspension Rod, Wishbone (CV), 1st RA;2nd RA; Leaf Spring Axle	
04/97→10/02	Track Control Arm	DB-DL-5224		Control Arm	
04/97→10/02	Track Control Arm	DB-DL-9218	DB-DL-9218	Trailing Arm	
3335 S	04/97→10/02	Ball Head, gearshift linkage	DB-ES-8387		
	04/97→10/02	Ball Head, gearshift linkage	DB-ES-8491		
	04/97→10/02	Ball Head, gearshift linkage	DB-ES-8492		
	04/97→10/02	Ball Head, gearshift linkage	DB-ES-8500		
	04/97→10/02	Ball Head, gearshift linkage	DB-ES-8510		
	04/97→10/02	Bush, driver cab suspension	DB-SB-10384		
	04/97→10/02	Bush, parabolic spring		DB-SB-10400	
	04/97→10/02	Bush, parabolic spring		DB-SB-10401	
	04/97→10/02	Centre Rod	DB-DL-2144		Push Rod
	04/97→10/02	Centre Rod	DB-DL-5230		Push Rod, 1st FA;Leaf Spring Axle
	04/97→10/02	Centre Rod	DB-DL-5241		Push Rod
	04/97→10/02	Centre Rod	DB-DL-5405		Push Rod, Leaf Spring Axle
	04/97→10/02	Centre Rod	DB-DL-7270		Push Rod
	04/97→10/02	Centre Rod	DB-DL-8167		Push Rod, 1st FA;Leaf Spring Axle
	04/97→10/02	Centre Rod	DB-DL-8184		Push Rod
	04/97→10/02	Centre Rod	DB-DL-8185		Push Rod
	04/97→10/02	Centre Rod	DB-DL-8188		Push Rod
	04/97→10/02	Centre Rod	DB-DL-8307		Push Rod
	04/97→10/02	Centre Rod	DB-DL-8702		Push Rod, Leaf Spring Axle
	04/97→10/02	Centre Rod	DB-DL-12300		for Steering Rod
	04/97→10/02	Rod Assembly	DB-DL-2178		Guide Rod
	04/97→10/02	Stabiliser Mounting		DB-SB-5261	
	04/97→10/02	Stabiliser Mounting		DB-SB-10406	
	04/97→10/02	Stabiliser Mounting		DB-SB-10407	
	04/97→10/02	Stabiliser Mounting		DB-SB-10409	
	04/97→10/02	Stabiliser Mounting	DB-SB-5260		
	04/97→10/02	Stabiliser Mounting	DB-SB-5279		
	04/97→10/02	Stabiliser Mounting	DB-SB-10410		
	04/97→10/02	Suspension Arm Repair Kit		DB-RK-8550	for Wishbone (CV)
	04/97→10/02	Suspension Arm Repair Kit		DB-RK-8626	for Wishbone (CV)
	04/97→10/02	Suspension Arm Repair Kit		DB-RK-10374	for Wishbone (CV)
	04/97→10/02	Suspension Arm Repair Kit		DB-RK-10375	for Wishbone (CV)
	04/97→10/02	Suspension Arm Repair Kit	DB-RK-8638		for Control Arm
	04/97→10/02	Suspension Strut Repair Kit		DB-RK-8391	
	04/97→10/02	Suspension Strut Repair Kit		DB-RK-8710	
	04/97→10/02	Suspension Strut Repair Kit		DB-RK-9291	
	04/97→10/02	Suspension Strut Repair Kit		MN-RK-8997	
	04/97→10/02	Tie Rod	DB-DL-8171		Guide Rod
	04/97→10/02	Tie Rod	DB-DL-8327		Guide Rod
	04/97→10/02	Tie Rod	DB-DL-8640		Guide Rod
	04/97→10/02	Tie Rod	DB-DL-12310		
	04/97→10/02	Tie Rod	DB-ES-5227		Guide Rod
	04/97→10/02	Tie Rod End	CV-ES-0543		for Push Rod
	04/97→10/02	Tie Rod End	CV-ES-0888		for Push Rod
	04/97→10/02	Tie Rod End	CV-ES-14162		for Steering Rod
04/97→10/02	Tie Rod End	CV-ES-14163		for Steering Rod	
04/97→10/02	Tie Rod End	DB-ES-5234		for Steering Rod	
04/97→10/02	Tie Rod End	DB-ES-8164		for Push Rod	
04/97→10/02	Tie Rod End	DB-ES-8530		for Push Rod	

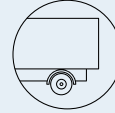

ACTROS ...

3335 S ...	04/97→10/02	Track Control Arm		DB-DL-3475	Trailing Arm
	04/97→10/02	Track Control Arm		DB-VB-7261	Suspension Rod, Wishbone (CV), 1st RA;2nd RA; Leaf Spring Axle
	04/97→10/02	Track Control Arm		DB-VB-7798	Wishbone (CV)
	04/97→10/02	Track Control Arm	DB-DL-5224		Control Arm
	04/97→10/02	Track Control Arm	DB-DL-9218	DB-DL-9218	Trailing Arm
3336 S	10/97→	Ball Head, gearshift linkage	DB-ES-8387		
	10/97→	Ball Head, gearshift linkage	DB-ES-8491		
	10/97→	Ball Head, gearshift linkage	DB-ES-8492		
	10/97→	Ball Head, gearshift linkage	DB-ES-8500		
	10/97→	Bush, parabolic spring		DB-SB-10400	
	10/97→	Bush, parabolic spring		DB-SB-10401	
	10/97→	Centre Rod	DB-DL-2144		Push Rod
	10/97→	Centre Rod	DB-DL-5230		Push Rod
	10/97→	Centre Rod	DB-DL-5405		Push Rod
	10/97→	Centre Rod	DB-DL-7270		Push Rod
	10/97→	Centre Rod	DB-DL-8167		Push Rod
	10/97→	Centre Rod	DB-DL-8307		Push Rod
	10/97→	Centre Rod	DB-DL-8702		Push Rod
	10/97→	Rod Assembly	DB-DL-2178		Guide Rod, 1st Front Axle, →504310 03
	10/97→	Suspension Arm Repair Kit		DB-RK-8626	for Wishbone (CV)
	10/97→	Suspension Strut Repair Kit		DB-RK-8391	
	10/97→	Suspension Strut Repair Kit		DB-RK-8710	
	10/97→	Tie Rod	DB-DL-8171		Guide Rod
	10/97→	Tie Rod	DB-DL-8327		Guide Rod
	10/97→	Tie Rod	DB-DL-8640		Guide Rod
	10/97→	Tie Rod	DB-DL-12310		
	10/97→	Tie Rod End	CV-ES-0543		for Push Rod
	10/97→	Tie Rod End	CV-ES-0888		for Push Rod
	10/97→	Tie Rod End	CV-ES-14163		for Steering Rod
	10/97→	Tie Rod End	DB-ES-8164		for Push Rod
	10/97→	Tie Rod End	DB-ES-8530		for Push Rod
	10/97→	Track Control Arm		DB-DL-3475	Trailing Arm
	10/97→	Track Control Arm		DB-VB-7261	Suspension Rod, Wishbone (CV)
10/97→	Track Control Arm	DB-DL-5224		Control Arm	
10/97→	Track Control Arm	DB-DL-9218	DB-DL-9218	Trailing Arm	
3340	04/97→10/02	Ball Head, gearshift linkage	DB-ES-8387		
	04/97→10/02	Ball Head, gearshift linkage	DB-ES-8491		
	04/97→10/02	Ball Head, gearshift linkage	DB-ES-8492		
	04/97→10/02	Ball Head, gearshift linkage	DB-ES-8500		
	04/97→10/02	Ball Head, gearshift linkage	DB-ES-8510		
	04/97→10/02	Bush, driver cab suspension	DB-SB-10384		
	04/97→10/02	Bush, parabolic spring		DB-SB-10400	
	04/97→10/02	Bush, parabolic spring		DB-SB-10401	
	04/97→10/02	Centre Rod	DB-DL-2144		Push Rod
	04/97→10/02	Centre Rod	DB-DL-5230		Push Rod, Leaf Spring Axle
	04/97→10/02	Centre Rod	DB-DL-5241		Push Rod
	04/97→10/02	Centre Rod	DB-DL-5405		Push Rod, Leaf Spring Axle
	04/97→10/02	Centre Rod	DB-DL-7270		Push Rod,Suspension Rod
	04/97→10/02	Centre Rod	DB-DL-8167		Push Rod, Leaf Spring Axle
	04/97→10/02	Centre Rod	DB-DL-8168		Push Rod
	04/97→10/02	Centre Rod	DB-DL-8184		Push Rod
	04/97→10/02	Centre Rod	DB-DL-8185		Push Rod
	04/97→10/02	Centre Rod	DB-DL-8188		Push Rod
	04/97→10/02	Centre Rod	DB-DL-8307		Push Rod
	04/97→10/02	Centre Rod	DB-DL-8622		Push Rod
	04/97→10/02	Centre Rod	DB-DL-8641		Push Rod
	04/97→10/02	Centre Rod	DB-DL-8642		Push Rod
	04/97→10/02	Centre Rod	DB-DL-8702		Push Rod, Leaf Spring Axle
	04/97→10/02	Centre Rod	DB-DL-12298		for Steering Rod
	04/97→10/02	Centre Rod	DB-DL-12300		for Steering Rod
	04/97→10/02	Rod Assembly	DB-DL-2178		Guide Rod
	04/97→10/02	Stabiliser Mounting		DB-SB-5250	

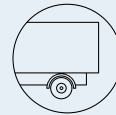

ACTROS ...

3340 ...	04/97→10/02	Stabiliser Mounting		DB-SB-5261		
	04/97→10/02	Stabiliser Mounting		DB-SB-10406		
	04/97→10/02	Stabiliser Mounting		DB-SB-10407		
	04/97→10/02	Stabiliser Mounting	DB-SB-5260			
	04/97→10/02	Stabiliser Mounting	DB-SB-5277	DB-SB-5277		
	04/97→10/02	Stabiliser Mounting	DB-SB-5279			
	04/97→10/02	Suspension Arm Repair Kit		DB-RK-8550	for Wishbone (CV)	
	04/97→10/02	Suspension Arm Repair Kit		DB-RK-8626	for Wishbone (CV)	
	04/97→10/02	Suspension Strut Repair Kit		DB-RK-8710		
	04/97→10/02	Suspension Strut Repair Kit		DB-RK-9291		
	04/97→10/02	Tie Rod	DB-DL-8171		Guide Rod	
	04/97→10/02	Tie Rod	DB-DL-8327		Guide Rod	
	04/97→10/02	Tie Rod	DB-DL-8640		Guide Rod	
	04/97→10/02	Tie Rod	DB-DL-12310			
	04/97→10/02	Tie Rod	DB-ES-5227		Guide Rod	
	04/97→10/02	Tie Rod End	CV-ES-0543		for Push Rod	
	04/97→10/02	Tie Rod End	CV-ES-0888		for Push Rod	
	04/97→10/02	Tie Rod End	CV-ES-14162		for Steering Rod	
	04/97→10/02	Tie Rod End	CV-ES-14163		for Steering Rod	
	04/97→10/02	Tie Rod End	DB-ES-8164		for Push Rod	
	04/97→10/02	Tie Rod End	DB-ES-8530		for Push Rod	
	04/97→10/02	Track Control Arm		DB-DL-3475	Trailing Arm	
	04/97→10/02	Track Control Arm		DB-VB-7261	Suspension Rod, Wishbone (CV), 1st RA;2nd RA; Leaf Spring Axle	
	04/97→10/02	Track Control Arm	DB-DL-5224		Control Arm	
	04/97→10/02	Track Control Arm	DB-DL-9218	DB-DL-9218	Trailing Arm	
	3340 A	04/97→10/02	Ball Head, gearshift linkage	DB-ES-8387		
		04/97→10/02	Ball Head, gearshift linkage	DB-ES-8491		
		04/97→10/02	Ball Head, gearshift linkage	DB-ES-8492		
04/97→10/02		Ball Head, gearshift linkage	DB-ES-8500			
04/97→10/02		Ball Head, gearshift linkage	DB-ES-8510			
04/97→10/02		Bush, driver cab suspension	DB-SB-10384			
04/97→10/02		Bush, parabolic spring		DB-SB-10400		
04/97→10/02		Bush, parabolic spring		DB-SB-10401		
04/97→10/02		Centre Rod	DB-DL-2144		Push Rod	
04/97→10/02		Centre Rod	DB-DL-5230		Push Rod	
04/97→10/02		Centre Rod	DB-DL-5241		Push Rod	
04/97→10/02		Centre Rod	DB-DL-5405		Push Rod	
04/97→10/02		Centre Rod	DB-DL-8168		Push Rod	
04/97→10/02		Centre Rod	DB-DL-8184		Push Rod	
04/97→10/02		Centre Rod	DB-DL-8188		Push Rod	
04/97→10/02		Centre Rod	DB-DL-8307		Push Rod, Leaf Spring Axle	
04/97→10/02		Centre Rod	DB-DL-8622		Push Rod	
04/97→10/02		Centre Rod	DB-DL-8639		Push Rod, Leaf Spring Axle	
04/97→10/02		Centre Rod	DB-DL-8641		Push Rod	
04/97→10/02		Centre Rod	DB-DL-8642		Push Rod	
04/97→10/02		Centre Rod	DB-DL-8702		Push Rod, Leaf Spring Axle	
04/97→10/02		Centre Rod	DB-DL-9259		Push Rod	
04/97→10/02		Centre Rod	DB-DL-12298		for Steering Rod	
04/97→10/02		Centre Rod	DB-DL-12300		for Steering Rod	
04/97→10/02		Rod Assembly	DB-DL-2178		Guide Rod	
04/97→10/02		Stabiliser Mounting		DB-SB-5250		
04/97→10/02		Stabiliser Mounting		DB-SB-5261		
04/97→10/02		Stabiliser Mounting		DB-SB-10406		
04/97→10/02		Stabiliser Mounting		DB-SB-10407		
04/97→10/02		Stabiliser Mounting	DB-SB-5260			
04/97→10/02		Stabiliser Mounting	DB-SB-5279			
04/97→10/02		Suspension Arm Repair Kit		DB-RK-8626	for Wishbone (CV)	
04/97→10/02		Suspension Strut Repair Kit		DB-RK-8710		
04/97→10/02	Suspension Strut Repair Kit		DB-RK-9291			
04/97→10/02	Tie Rod	DB-DL-12310		Guide Rod		
04/97→10/02	Tie Rod	DB-ES-5227		Guide Rod		
04/97→10/02	Tie Rod	MN-DL-7834		Guide Rod		



ACTROS ...

3340 A ...	04/97→10/02	Tie Rod End	CV-ES-0543		for Push Rod	
	04/97→10/02	Tie Rod End	CV-ES-0888		for Push Rod	
	04/97→10/02	Tie Rod End	CV-ES-14162		for Steering Rod	
	04/97→10/02	Tie Rod End	CV-ES-14163		for Steering Rod	
	04/97→10/02	Tie Rod End	DB-ES-5234		for Steering Rod	
	04/97→10/02	Track Control Arm		DB-DL-3475	Trailing Arm	
	04/97→10/02	Track Control Arm		DB-VB-7261	Suspension Rod, Wishbone (CV), 1st RA;2nd RA; Leaf Spring Axle	
	04/97→10/02	Track Control Arm	DB-DL-5224		Control Arm	
	04/97→10/02	Track Control Arm	DB-DL-9218	DB-DL-9218	Trailing Arm	
	3340 AK	04/97→10/02	Ball Head, gearshift linkage	DB-ES-8387		
04/97→10/02		Ball Head, gearshift linkage	DB-ES-8491			
04/97→10/02		Ball Head, gearshift linkage	DB-ES-8492			
04/97→10/02		Ball Head, gearshift linkage	DB-ES-8500			
04/97→10/02		Ball Head, gearshift linkage	DB-ES-8510			
04/97→10/02		Bush, driver cab suspension	DB-SB-10384			
04/97→10/02		Bush, parabolic spring		DB-SB-10400		
04/97→10/02		Bush, parabolic spring		DB-SB-10401		
04/97→10/02		Centre Rod	DB-DL-2144		Push Rod	
04/97→10/02		Centre Rod	DB-DL-5230		Push Rod	
04/97→10/02		Centre Rod	DB-DL-5241		Push Rod	
04/97→10/02		Centre Rod	DB-DL-5405		Push Rod	
04/97→10/02		Centre Rod	DB-DL-8184		Push Rod	
04/97→10/02		Centre Rod	DB-DL-8188		Push Rod	
04/97→10/02		Centre Rod	DB-DL-8307		Push Rod, Leaf Spring Axle	
04/97→10/02		Centre Rod	DB-DL-8639		Push Rod, 1st FA;Leaf Spring Axle	
04/97→10/02		Centre Rod	DB-DL-8702		Push Rod, 1st FA;Leaf Spring Axle	
04/97→10/02		Centre Rod	DB-DL-9259		Push Rod	
04/97→10/02		Centre Rod	DB-DL-12300		for Steering Rod	
04/97→10/02		Rod Assembly	DB-DL-2178		Guide Rod	
04/97→10/02		Stabiliser Link	DB-DL-9254		Pressure Rod	
04/97→10/02		Stabiliser Mounting		DB-SB-5261		
04/97→10/02		Stabiliser Mounting		DB-SB-10406		
04/97→10/02		Stabiliser Mounting		DB-SB-10407		
04/97→10/02		Stabiliser Mounting		DB-SB-10409		
04/97→10/02		Stabiliser Mounting	DB-SB-5260			
04/97→10/02		Stabiliser Mounting	DB-SB-5279			
04/97→10/02		Suspension Arm Repair Kit		DB-RK-8626	for Wishbone (CV)	
04/97→10/02		Suspension Arm Repair Kit		DB-RK-10374	for Wishbone (CV)	
04/97→10/02		Suspension Arm Repair Kit		DB-RK-10375	for Wishbone (CV)	
04/97→10/02		Suspension Arm Repair Kit	DB-RK-8638		for Control Arm	
04/97→10/02		Suspension Strut Repair Kit		DB-RK-8391		
04/97→10/02		Suspension Strut Repair Kit		DB-RK-8710		
04/97→10/02		Tie Rod	DB-DL-12310			
04/97→10/02		Tie Rod	DB-ES-5227		Guide Rod	
04/97→10/02		Tie Rod	MN-DL-7834		Guide Rod	
04/97→10/02		Tie Rod End	CV-ES-0543		for Push Rod	
04/97→10/02		Tie Rod End	CV-ES-0888		for Push Rod	
04/97→10/02		Tie Rod End	CV-ES-14162		for Steering Rod	
04/97→10/02		Tie Rod End	CV-ES-14163		for Steering Rod	
04/97→10/02		Tie Rod End	DB-ES-5234		for Steering Rod	
04/97→10/02		Tie Rod End	DB-ES-8530		for Push Rod	
04/97→10/02		Track Control Arm		DB-DL-3475	Trailing Arm	
04/97→10/02		Track Control Arm		DB-VB-7261	Suspension Rod, Wishbone (CV), 1st RA;2nd RA; Leaf Spring Axle	
04/97→10/02		Track Control Arm	DB-DL-5224		Control Arm	
04/97→10/02		Track Control Arm	DB-DL-9218	DB-DL-9218	Trailing Arm	
3340 AS		04/97→10/02	Ball Head, gearshift linkage	DB-ES-8387		
		04/97→10/02	Ball Head, gearshift linkage	DB-ES-8491		
	04/97→10/02	Ball Head, gearshift linkage	DB-ES-8492			
	04/97→10/02	Ball Head, gearshift linkage	DB-ES-8500			
	04/97→10/02	Ball Head, gearshift linkage	DB-ES-8510			
	04/97→10/02	Bush, driver cab suspension	DB-SB-10384			



ACTROS ...

3340 AS ...	04/97→10/02	Bush, parabolic spring		DB-SB-10400	
	04/97→10/02	Bush, parabolic spring		DB-SB-10401	
	04/97→10/02	Centre Rod	DB-DL-2144		Push Rod
	04/97→10/02	Centre Rod	DB-DL-5230		Push Rod
	04/97→10/02	Centre Rod	DB-DL-5241		Push Rod
	04/97→10/02	Centre Rod	DB-DL-5405		Push Rod
	04/97→10/02	Centre Rod	DB-DL-8188		Push Rod
	04/97→10/02	Centre Rod	DB-DL-8307		Push Rod, Leaf Spring Axle
	04/97→10/02	Centre Rod	DB-DL-8639		Push Rod, 1st FA;Leaf Spring Axle
	04/97→10/02	Centre Rod	DB-DL-8702		Push Rod, Leaf Spring Axle
	04/97→10/02	Centre Rod	DB-DL-9259		Push Rod
	04/97→10/02	Centre Rod	DB-DL-12300		for Steering Rod
	04/97→10/02	Rod Assembly	DB-DL-2178		Guide Rod
	04/97→10/02	Stabiliser Mounting		DB-SB-5261	
	04/97→10/02	Stabiliser Mounting		DB-SB-10406	
	04/97→10/02	Stabiliser Mounting		DB-SB-10407	
	04/97→10/02	Stabiliser Mounting		DB-SB-10409	
	04/97→10/02	Stabiliser Mounting	DB-SB-5260		
	04/97→10/02	Stabiliser Mounting	DB-SB-5279		
	04/97→10/02	Stabiliser Mounting	DB-SB-10410		
	04/97→10/02	Suspension Arm Repair Kit		DB-RK-8626	for Wishbone (CV)
	04/97→10/02	Suspension Arm Repair Kit		DB-RK-10374	for Wishbone (CV)
	04/97→10/02	Suspension Arm Repair Kit		DB-RK-10375	for Wishbone (CV)
	04/97→10/02	Suspension Arm Repair Kit	DB-RK-8638		for Control Arm
	04/97→10/02	Suspension Strut Repair Kit		DB-RK-8391	
	04/97→10/02	Suspension Strut Repair Kit		DB-RK-8710	
	04/97→10/02	Suspension Strut Repair Kit		DB-RK-9291	
	04/97→10/02	Suspension Strut Repair Kit		MN-RK-8997	
	04/97→10/02	Tie Rod	DB-DL-12310		
	04/97→10/02	Tie Rod	DB-ES-5227		Guide Rod
	04/97→10/02	Tie Rod	MN-DL-7834		Guide Rod
	04/97→10/02	Tie Rod End	CV-ES-0543		for Push Rod
	04/97→10/02	Tie Rod End	CV-ES-0888		for Push Rod
	04/97→10/02	Tie Rod End	CV-ES-14162		for Steering Rod
	04/97→10/02	Tie Rod End	CV-ES-14163		for Steering Rod
04/97→10/02	Tie Rod End	DB-ES-5234		for Steering Rod	
04/97→10/02	Track Control Arm		DB-DL-3475	Trailing Arm	
04/97→10/02	Track Control Arm		DB-VB-7261	Suspension Rod, Wishbone (CV), 1st RA;2nd RA; Leaf Spring Axle	
04/97→10/02	Track Control Arm		DB-VB-7798	Wishbone (CV)	
04/97→10/02	Track Control Arm	DB-DL-5224		Control Arm	
04/97→10/02	Track Control Arm	DB-DL-9218	DB-DL-9218	Trailing Arm	
3340 B	04/97→10/02	Ball Head, gearshift linkage	DB-ES-8387		
	04/97→10/02	Ball Head, gearshift linkage	DB-ES-8491		
	04/97→10/02	Ball Head, gearshift linkage	DB-ES-8492		
	04/97→10/02	Ball Head, gearshift linkage	DB-ES-8500		
	04/97→10/02	Ball Head, gearshift linkage	DB-ES-8510		
	04/97→10/02	Bush, driver cab suspension	DB-SB-10384		
	04/97→10/02	Bush, parabolic spring		DB-SB-10400	
	04/97→10/02	Bush, parabolic spring		DB-SB-10401	
	04/97→10/02	Centre Rod	DB-DL-2144		Push Rod
	04/97→10/02	Centre Rod	DB-DL-5230		Push Rod
	04/97→10/02	Centre Rod	DB-DL-5230		Push Rod, Leaf Spring Axle
	04/97→10/02	Centre Rod	DB-DL-5241		Push Rod
	04/97→10/02	Centre Rod	DB-DL-5405		Push Rod, Leaf Spring Axle
	04/97→10/02	Centre Rod	DB-DL-7270		Push Rod
	04/97→10/02	Centre Rod	DB-DL-8167		Push Rod, 1st FA;Leaf Spring Axle
	04/97→10/02	Centre Rod	DB-DL-8168		Push Rod, Leaf Spring Axle
	04/97→10/02	Centre Rod	DB-DL-8184		Push Rod
	04/97→10/02	Centre Rod	DB-DL-8184		Push Rod, Leaf Spring Axle
	04/97→10/02	Centre Rod	DB-DL-8185		Push Rod
	04/97→10/02	Centre Rod	DB-DL-8185		Push Rod, Leaf Spring Axle
	04/97→10/02	Centre Rod	DB-DL-8188		Push Rod



ACTROS ...

3340 B ...	04/97→10/02	Centre Rod	DB-DL-8307		Push Rod	
	04/97→10/02	Centre Rod	DB-DL-8702		Push Rod, Leaf Spring Axle	
	04/97→10/02	Centre Rod	DB-DL-12300		for Steering Rod	
	04/97→10/02	Rod Assembly	DB-DL-2178		Guide Rod	
	04/97→10/02	Stabiliser Link	DB-DL-9254		Pressure Rod	
	04/97→10/02	Stabiliser Link	DB-DL-9271		Pressure Rod	
	04/97→10/02	Stabiliser Link	DB-DL-9272		Pressure Rod	
	04/97→10/02	Stabiliser Mounting		DB-SB-5261		
	04/97→10/02	Stabiliser Mounting		DB-SB-10406		
	04/97→10/02	Stabiliser Mounting		DB-SB-10407		
	04/97→10/02	Stabiliser Mounting		DB-SB-10409		
	04/97→10/02	Stabiliser Mounting	DB-SB-5250			
	04/97→10/02	Stabiliser Mounting	DB-SB-5260			
	04/97→10/02	Stabiliser Mounting	DB-SB-5279			
	04/97→10/02	Suspension Arm Repair Kit		DB-RK-8550	for Wishbone (CV)	
	04/97→10/02	Suspension Arm Repair Kit		DB-RK-8626	for Wishbone (CV)	
	04/97→10/02	Suspension Arm Repair Kit		DB-RK-10374	for Wishbone (CV)	
	04/97→10/02	Suspension Arm Repair Kit		DB-RK-10375	for Wishbone (CV)	
	04/97→10/02	Suspension Arm Repair Kit	DB-RK-8638		for Control Arm	
	04/97→10/02	Suspension Strut Repair Kit		DB-RK-8391		
	04/97→10/02	Suspension Strut Repair Kit		DB-RK-8710		
	04/97→10/02	Suspension Strut Repair Kit		DB-RK-9291		
	04/97→10/02	Suspension Strut Repair Kit		DB-RK-9294		
	04/97→10/02	Tie Rod	DB-DL-8171		Guide Rod	
	04/97→10/02	Tie Rod	DB-DL-8172		Guide Rod	
	04/97→10/02	Tie Rod	DB-DL-8327		Guide Rod	
	04/97→10/02	Tie Rod	DB-DL-8640		Guide Rod	
	04/97→10/02	Tie Rod	DB-DL-12310			
	04/97→10/02	Tie Rod End	CV-ES-0543		for Push Rod	
	04/97→10/02	Tie Rod End	CV-ES-0888		for Push Rod	
	04/97→10/02	Tie Rod End	CV-ES-14162		for Steering Rod	
	04/97→10/02	Tie Rod End	CV-ES-14163		for Steering Rod	
	04/97→10/02	Tie Rod End	DB-ES-5234		for Steering Rod	
	04/97→10/02	Tie Rod End	DB-ES-8164		for Push Rod	
	04/97→10/02	Tie Rod End	DB-ES-8323		Leaf Spring Axle	
	04/97→10/02	Tie Rod End	DB-ES-8530		for Push Rod	
	04/97→10/02	Track Control Arm		DB-DL-3475	Trailing Arm	
	04/97→10/02	Track Control Arm		DB-VB-3707	Suspension Rod, Wishbone (CV)	
	04/97→10/02	Track Control Arm		DB-VB-7261	Suspension Rod, Wishbone (CV), 1st RA;2nd RA; Leaf Spring Axle	
	04/97→10/02	Track Control Arm	DB-DL-5224		Control Arm	
	04/97→10/02	Track Control Arm	DB-DL-9218	DB-DL-9218	Trailing Arm	
	3340 K	04/97→10/02	Ball Head, gearshift linkage	DB-ES-8387		
		04/97→10/02	Ball Head, gearshift linkage	DB-ES-8491		
		04/97→10/02	Ball Head, gearshift linkage	DB-ES-8492		
		04/97→10/02	Ball Head, gearshift linkage	DB-ES-8500		
04/97→10/02		Ball Head, gearshift linkage	DB-ES-8510			
04/97→10/02		Bush, driver cab suspension	DB-SB-10384			
04/97→10/02		Bush, parabolic spring		DB-SB-10400		
04/97→10/02		Bush, parabolic spring		DB-SB-10401		
04/97→10/02		Centre Rod	DB-DL-2144		Push Rod	
04/97→10/02		Centre Rod	DB-DL-5230		Push Rod, 1st FA;Leaf Spring Axle	
04/97→10/02		Centre Rod	DB-DL-5241		Push Rod	
04/97→10/02		Centre Rod	DB-DL-5405		Push Rod, 1st FA;Leaf Spring Axle	
04/97→10/02		Centre Rod	DB-DL-7270		Push Rod	
04/97→10/02		Centre Rod	DB-DL-8167		Push Rod, 1st FA;Leaf Spring Axle	
04/97→10/02		Centre Rod	DB-DL-8184		Push Rod	
04/97→10/02		Centre Rod	DB-DL-8185		Push Rod	
04/97→10/02		Centre Rod	DB-DL-8188		Push Rod	
04/97→10/02		Centre Rod	DB-DL-8307		Push Rod	
04/97→10/02		Centre Rod	DB-DL-8702		Push Rod, 1st FA;Leaf Spring Axle	
04/97→10/02		Centre Rod	DB-DL-12300		for Steering Rod	
04/97→10/02		Rod Assembly	DB-DL-2178		Guide Rod	

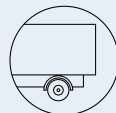

ACTROS ...

3340 K ...	04/97→10/02	Stabiliser Link	DB-DL-9254		Pressure Rod	
	04/97→10/02	Stabiliser Mounting		DB-SB-5261		
	04/97→10/02	Stabiliser Mounting		DB-SB-10406		
	04/97→10/02	Stabiliser Mounting		DB-SB-10407		
	04/97→10/02	Stabiliser Mounting		DB-SB-10409		
	04/97→10/02	Stabiliser Mounting	DB-SB-5260			
	04/97→10/02	Stabiliser Mounting	DB-SB-5279			
	04/97→10/02	Suspension Arm Repair Kit		DB-RK-8550	for Wishbone (CV)	
	04/97→10/02	Suspension Arm Repair Kit		DB-RK-8626	for Wishbone (CV)	
	04/97→10/02	Suspension Arm Repair Kit		DB-RK-10374	for Wishbone (CV)	
	04/97→10/02	Suspension Arm Repair Kit		DB-RK-10375	for Wishbone (CV)	
	04/97→10/02	Suspension Arm Repair Kit	DB-RK-8638		for Control Arm	
	04/97→10/02	Suspension Strut Repair Kit		DB-RK-8391		
	04/97→10/02	Suspension Strut Repair Kit		DB-RK-8710		
	04/97→10/02	Suspension Strut Repair Kit		DB-RK-9291		
	04/97→10/02	Tie Rod	DB-DL-8171		Guide Rod	
	04/97→10/02	Tie Rod	DB-DL-8327		Guide Rod	
	04/97→10/02	Tie Rod	DB-DL-8640		Guide Rod	
	04/97→10/02	Tie Rod	DB-DL-12310			
	04/97→10/02	Tie Rod	DB-ES-5227		Guide Rod	
	04/97→10/02	Tie Rod End	CV-ES-0543		for Push Rod	
	04/97→10/02	Tie Rod End	CV-ES-0888		for Push Rod	
	04/97→10/02	Tie Rod End	CV-ES-14162		for Steering Rod	
	04/97→10/02	Tie Rod End	CV-ES-14163		for Steering Rod	
	04/97→10/02	Tie Rod End	DB-ES-5234		for Steering Rod	
	04/97→10/02	Tie Rod End	DB-ES-8164		for Push Rod	
	04/97→10/02	Tie Rod End	DB-ES-8530		for Push Rod	
	04/97→10/02	Track Control Arm		DB-DL-3475	Trailing Arm	
	04/97→10/02	Track Control Arm		DB-VB-7261	Suspension Rod, Wishbone (CV), 1st RA;2nd RA; Leaf Spring Axle	
	04/97→10/02	Track Control Arm	DB-DL-5224		Control Arm	
	04/97→10/02	Track Control Arm	DB-DL-9218	DB-DL-9218	Trailing Arm	
	3340 S	04/97→10/02	Ball Head, gearshift linkage	DB-ES-8387		
		04/97→10/02	Ball Head, gearshift linkage	DB-ES-8491		
		04/97→10/02	Ball Head, gearshift linkage	DB-ES-8492		
04/97→10/02		Ball Head, gearshift linkage	DB-ES-8500			
04/97→10/02		Ball Head, gearshift linkage	DB-ES-8510			
04/97→10/02		Bush, driver cab suspension	DB-SB-10384			
04/97→10/02		Bush, parabolic spring		DB-SB-10400		
04/97→10/02		Bush, parabolic spring		DB-SB-10401		
04/97→10/02		Centre Rod	DB-DL-2144		Push Rod	
04/97→10/02		Centre Rod	DB-DL-5230		Push Rod, 1st FA;Leaf Spring Axle	
04/97→10/02		Centre Rod	DB-DL-5241		Push Rod	
04/97→10/02		Centre Rod	DB-DL-5405		Push Rod, Leaf Spring Axle	
04/97→10/02		Centre Rod	DB-DL-7270		Push Rod	
04/97→10/02		Centre Rod	DB-DL-8167		Push Rod, 1st FA;Leaf Spring Axle	
04/97→10/02		Centre Rod	DB-DL-8184		Push Rod	
04/97→10/02		Centre Rod	DB-DL-8185		Push Rod	
04/97→10/02		Centre Rod	DB-DL-8188		Push Rod	
04/97→10/02		Centre Rod	DB-DL-8307		Push Rod	
04/97→10/02		Centre Rod	DB-DL-8702		Push Rod, Leaf Spring Axle	
04/97→10/02		Centre Rod	DB-DL-12300		for Steering Rod	
04/97→10/02		Rod Assembly	DB-DL-2178		Guide Rod	
04/97→10/02		Stabiliser Mounting		DB-SB-5261		
04/97→10/02		Stabiliser Mounting		DB-SB-10406		
04/97→10/02		Stabiliser Mounting		DB-SB-10407		
04/97→10/02		Stabiliser Mounting		DB-SB-10409		
04/97→10/02		Stabiliser Mounting	DB-SB-5260			
04/97→10/02		Stabiliser Mounting	DB-SB-5279			
04/97→10/02		Stabiliser Mounting	DB-SB-10410			
04/97→10/02		Suspension Arm Repair Kit		DB-RK-8550	for Wishbone (CV)	
04/97→10/02		Suspension Arm Repair Kit		DB-RK-8626	for Wishbone (CV)	
04/97→10/02		Suspension Arm Repair Kit		DB-RK-10374	for Wishbone (CV)	

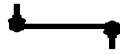

ACTROS ...

3340 S ...	04/97→10/02	Suspension Arm Repair Kit		DB-RK-10375	for Wishbone (CV)	
	04/97→10/02	Suspension Arm Repair Kit	DB-RK-8638		for Control Arm	
	04/97→10/02	Suspension Strut Repair Kit		DB-RK-8391		
	04/97→10/02	Suspension Strut Repair Kit		DB-RK-8710		
	04/97→10/02	Suspension Strut Repair Kit		DB-RK-9291		
	04/97→10/02	Suspension Strut Repair Kit		MN-RK-8997		
	04/97→10/02	Tie Rod	DB-DL-8171		Guide Rod	
	04/97→10/02	Tie Rod	DB-DL-8327		Guide Rod	
	04/97→10/02	Tie Rod	DB-DL-8640		Guide Rod	
	04/97→10/02	Tie Rod	DB-DL-12310			
	04/97→10/02	Tie Rod	DB-ES-5227		Guide Rod	
	04/97→10/02	Tie Rod End	CV-ES-0543		for Push Rod	
	04/97→10/02	Tie Rod End	CV-ES-0888		for Push Rod	
	04/97→10/02	Tie Rod End	CV-ES-14162		for Steering Rod	
	04/97→10/02	Tie Rod End	CV-ES-14163		for Steering Rod	
	04/97→10/02	Tie Rod End	DB-ES-5234		for Steering Rod	
	04/97→10/02	Tie Rod End	DB-ES-8164		for Push Rod	
	04/97→10/02	Tie Rod End	DB-ES-8530		for Push Rod	
	04/97→10/02	Track Control Arm		DB-DL-3475	Trailing Arm	
	04/97→10/02	Track Control Arm		DB-VB-7261	Suspension Rod, Wishbone (CV), 1st RA;2nd RA; Leaf Spring Axle	
	04/97→10/02	Track Control Arm		DB-VB-7798	Wishbone (CV)	
	04/97→10/02	Track Control Arm	DB-DL-5224		Control Arm	
	04/97→10/02	Track Control Arm	DB-DL-9218	DB-DL-9218	Trailing Arm	
	3341 S	10/97→	Ball Head, gearshift linkage	DB-ES-8387		
		10/97→	Ball Head, gearshift linkage	DB-ES-8491		
		10/97→	Ball Head, gearshift linkage	DB-ES-8492		
		10/97→	Ball Head, gearshift linkage	DB-ES-8500		
		10/97→	Bush, parabolic spring		DB-SB-10400	
		10/97→	Bush, parabolic spring		DB-SB-10401	
10/97→		Centre Rod	DB-DL-2144		Push Rod	
10/97→		Centre Rod	DB-DL-5230		Push Rod	
10/97→		Centre Rod	DB-DL-5405		Push Rod	
10/97→		Centre Rod	DB-DL-7270		Push Rod	
10/97→		Centre Rod	DB-DL-8167		Push Rod	
10/97→		Centre Rod	DB-DL-8307		Push Rod	
10/97→		Centre Rod	DB-DL-8702		Push Rod	
10/97→		Rod Assembly	DB-DL-2178		Guide Rod, 1st Front Axle, →504310 03	
10/97→		Suspension Arm Repair Kit		DB-RK-8626	for Wishbone (CV)	
10/97→		Suspension Strut Repair Kit		DB-RK-8391		
10/97→		Suspension Strut Repair Kit		DB-RK-8710		
10/97→		Tie Rod	DB-DL-8171		Guide Rod	
10/97→		Tie Rod	DB-DL-8327		Guide Rod	
10/97→		Tie Rod	DB-DL-8640		Guide Rod	
10/97→		Tie Rod	DB-DL-12310			
10/97→		Tie Rod End	CV-ES-0543		for Push Rod	
10/97→		Tie Rod End	CV-ES-0888		for Push Rod	
10/97→		Tie Rod End	CV-ES-14163		for Steering Rod	
10/97→		Tie Rod End	DB-ES-8164		for Push Rod	
10/97→		Tie Rod End	DB-ES-8530		for Push Rod	
10/97→		Track Control Arm		DB-DL-3475	Trailing Arm	
10/97→		Track Control Arm		DB-VB-7261	Suspension Rod, Wishbone (CV)	
10/97→		Track Control Arm	DB-DL-5224		Control Arm	
10/97→		Track Control Arm	DB-DL-9218	DB-DL-9218	Trailing Arm	
3343		04/97→10/02	Ball Head, gearshift linkage	DB-ES-8387		
		04/97→10/02	Ball Head, gearshift linkage	DB-ES-8491		
	04/97→10/02	Ball Head, gearshift linkage	DB-ES-8492			
	04/97→10/02	Ball Head, gearshift linkage	DB-ES-8500			
	04/97→10/02	Ball Head, gearshift linkage	DB-ES-8510			
	04/97→10/02	Bush, driver cab suspension	DB-SB-10384			
	04/97→10/02	Bush, parabolic spring		DB-SB-10400		
	04/97→10/02	Bush, parabolic spring		DB-SB-10401		
	04/97→10/02	Centre Rod	DB-DL-2144		Push Rod	

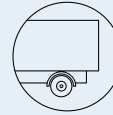

ACTROS ...

3343 ...	04/97→10/02	Centre Rod	DB-DL-5230	Push Rod, Leaf Spring Axle	
	04/97→10/02	Centre Rod	DB-DL-5241	Push Rod	
	04/97→10/02	Centre Rod	DB-DL-5405	Push Rod, Leaf Spring Axle	
	04/97→10/02	Centre Rod	DB-DL-7270	Push Rod;Suspension Rod	
	04/97→10/02	Centre Rod	DB-DL-8167	Push Rod, Leaf Spring Axle	
	04/97→10/02	Centre Rod	DB-DL-8168	Push Rod	
	04/97→10/02	Centre Rod	DB-DL-8184	Push Rod	
	04/97→10/02	Centre Rod	DB-DL-8185	Push Rod	
	04/97→10/02	Centre Rod	DB-DL-8188	Push Rod	
	04/97→10/02	Centre Rod	DB-DL-8307	Push Rod	
	04/97→10/02	Centre Rod	DB-DL-8622	Push Rod	
	04/97→10/02	Centre Rod	DB-DL-8641	Push Rod	
	04/97→10/02	Centre Rod	DB-DL-8642	Push Rod	
	04/97→10/02	Centre Rod	DB-DL-8702	Push Rod, Leaf Spring Axle	
	04/97→10/02	Centre Rod	DB-DL-12298	for Steering Rod	
	04/97→10/02	Centre Rod	DB-DL-12300	for Steering Rod	
	04/97→10/02	Rod Assembly	DB-DL-2178	Guide Rod	
	04/97→10/02	Stabiliser Mounting		DB-SB-5250	
	04/97→10/02	Stabiliser Mounting		DB-SB-5261	
	04/97→10/02	Stabiliser Mounting		DB-SB-10406	
	04/97→10/02	Stabiliser Mounting		DB-SB-10407	
	04/97→10/02	Stabiliser Mounting	DB-SB-5260		
	04/97→10/02	Stabiliser Mounting	DB-SB-5277	DB-SB-5277	
	04/97→10/02	Stabiliser Mounting	DB-SB-5279		
	04/97→10/02	Suspension Arm Repair Kit		DB-RK-8550	for Wishbone (CV)
	04/97→10/02	Suspension Arm Repair Kit		DB-RK-8626	for Wishbone (CV)
	04/97→10/02	Suspension Strut Repair Kit		DB-RK-8710	
	04/97→10/02	Suspension Strut Repair Kit		DB-RK-9291	
	04/97→10/02	Tie Rod	DB-DL-8171		Guide Rod
	04/97→10/02	Tie Rod	DB-DL-8327		Guide Rod
	04/97→10/02	Tie Rod	DB-DL-8640		Guide Rod
	04/97→10/02	Tie Rod	DB-DL-12310		
	04/97→10/02	Tie Rod	DB-ES-5227		Guide Rod
	04/97→10/02	Tie Rod End	CV-ES-0543		for Push Rod
	04/97→10/02	Tie Rod End	CV-ES-0888		for Push Rod
	04/97→10/02	Tie Rod End	CV-ES-14162		for Steering Rod
	04/97→10/02	Tie Rod End	CV-ES-14163		for Steering Rod
	04/97→10/02	Tie Rod End	DB-ES-8164		for Push Rod
	04/97→10/02	Tie Rod End	DB-ES-8530		for Push Rod
	04/97→10/02	Track Control Arm		DB-DL-3475	Trailing Arm
	04/97→10/02	Track Control Arm		DB-VB-7261	Suspension Rod, Wishbone (CV), 1st RA;2nd RA; Leaf Spring Axle
	04/97→10/02	Track Control Arm	DB-DL-5224		Control Arm
	04/97→10/02	Track Control Arm	DB-DL-9218	DB-DL-9218	Trailing Arm
	3343 AK	04/97→10/02	Ball Head, gearshift linkage	DB-ES-8387	
		04/97→10/02	Ball Head, gearshift linkage	DB-ES-8491	
	04/97→10/02	Ball Head, gearshift linkage	DB-ES-8492		
	04/97→10/02	Ball Head, gearshift linkage	DB-ES-8500		
	04/97→10/02	Ball Head, gearshift linkage	DB-ES-8510		
	04/97→10/02	Bush, driver cab suspension	DB-SB-10384		
	04/97→10/02	Bush, parabolic spring		DB-SB-10400	
	04/97→10/02	Bush, parabolic spring		DB-SB-10401	
	04/97→10/02	Centre Rod	DB-DL-2144	Push Rod	
	04/97→10/02	Centre Rod	DB-DL-5230	Push Rod	
	04/97→10/02	Centre Rod	DB-DL-5241	Push Rod	
	04/97→10/02	Centre Rod	DB-DL-5405	Push Rod	
	04/97→10/02	Centre Rod	DB-DL-8184	Push Rod	
	04/97→10/02	Centre Rod	DB-DL-8188	Push Rod	
	04/97→10/02	Centre Rod	DB-DL-8307	Push Rod, Leaf Spring Axle	
	04/97→10/02	Centre Rod	DB-DL-8639	Push Rod, 1st FA;Leaf Spring Axle	
	04/97→10/02	Centre Rod	DB-DL-8702	Push Rod, 1st FA;Leaf Spring Axle	
	04/97→10/02	Centre Rod	DB-DL-9259	Push Rod	
	04/97→10/02	Centre Rod	DB-DL-12300	for Steering Rod	



ACTROS ...

3343 AK ...	04/97→10/02	Rod Assembly	DB-DL-2178		Guide Rod	
	04/97→10/02	Stabiliser Link	DB-DL-9254		Pressure Rod	
	04/97→10/02	Stabiliser Mounting		DB-SB-5261		
	04/97→10/02	Stabiliser Mounting		DB-SB-10406		
	04/97→10/02	Stabiliser Mounting		DB-SB-10407		
	04/97→10/02	Stabiliser Mounting		DB-SB-10409		
	04/97→10/02	Stabiliser Mounting	DB-SB-5260			
	04/97→10/02	Stabiliser Mounting	DB-SB-5279			
	04/97→10/02	Suspension Arm Repair Kit		DB-RK-8626	for Wishbone (CV)	
	04/97→10/02	Suspension Arm Repair Kit		DB-RK-10374	for Wishbone (CV)	
	04/97→10/02	Suspension Arm Repair Kit		DB-RK-10375	for Wishbone (CV)	
	04/97→10/02	Suspension Arm Repair Kit	DB-RK-8638		for Control Arm	
	04/97→10/02	Suspension Strut Repair Kit		DB-RK-8391		
	04/97→10/02	Suspension Strut Repair Kit		DB-RK-8710		
	04/97→10/02	Tie Rod	DB-DL-12310			
	04/97→10/02	Tie Rod	DB-ES-5227		Guide Rod	
	04/97→10/02	Tie Rod	MN-DL-7834		Guide Rod	
	04/97→10/02	Tie Rod End	CV-ES-0543		for Push Rod	
	04/97→10/02	Tie Rod End	CV-ES-0888		for Push Rod	
	04/97→10/02	Tie Rod End	CV-ES-14162		for Steering Rod	
	04/97→10/02	Tie Rod End	CV-ES-14163		for Steering Rod	
	04/97→10/02	Tie Rod End	DB-ES-5234		for Steering Rod	
	04/97→10/02	Tie Rod End	DB-ES-8530		for Push Rod	
	04/97→10/02	Track Control Arm		DB-DL-3475	Trailing Arm	
	04/97→10/02	Track Control Arm		DB-VB-7261	Suspension Rod, Wishbone (CV), 1st RA;2nd RA; Leaf Spring Axle	
	04/97→10/02	Track Control Arm	DB-DL-5224		Control Arm	
	04/97→10/02	Track Control Arm	DB-DL-9218	DB-DL-9218	Trailing Arm	
	3343 AS	04/97→10/02	Ball Head, gearshift linkage	DB-ES-8387		
		04/97→10/02	Ball Head, gearshift linkage	DB-ES-8491		
		04/97→10/02	Ball Head, gearshift linkage	DB-ES-8492		
		04/97→10/02	Ball Head, gearshift linkage	DB-ES-8500		
		04/97→10/02	Ball Head, gearshift linkage	DB-ES-8510		
		04/97→10/02	Bush, driver cab suspension	DB-SB-10384		
		04/97→10/02	Bush, parabolic spring		DB-SB-10400	
		04/97→10/02	Bush, parabolic spring		DB-SB-10401	
		04/97→10/02	Centre Rod	DB-DL-2144		Push Rod
		04/97→10/02	Centre Rod	DB-DL-5230		Push Rod
		04/97→10/02	Centre Rod	DB-DL-5241		Push Rod
04/97→10/02		Centre Rod	DB-DL-5405		Push Rod	
04/97→10/02		Centre Rod	DB-DL-8188		Push Rod	
04/97→10/02		Centre Rod	DB-DL-8307		Push Rod, Leaf Spring Axle	
04/97→10/02		Centre Rod	DB-DL-8639		Push Rod, 1st FA;Leaf Spring Axle	
04/97→10/02		Centre Rod	DB-DL-8702		Push Rod, Leaf Spring Axle	
04/97→10/02		Centre Rod	DB-DL-9259		Push Rod	
04/97→10/02		Centre Rod	DB-DL-12300		for Steering Rod	
04/97→10/02		Rod Assembly	DB-DL-2178		Guide Rod	
04/97→10/02		Stabiliser Mounting		DB-SB-5261		
04/97→10/02		Stabiliser Mounting		DB-SB-10406		
04/97→10/02		Stabiliser Mounting		DB-SB-10407		
04/97→10/02		Stabiliser Mounting		DB-SB-10409		
04/97→10/02		Stabiliser Mounting	DB-SB-5260			
04/97→10/02		Stabiliser Mounting	DB-SB-5279			
04/97→10/02		Stabiliser Mounting	DB-SB-10410			
04/97→10/02		Suspension Arm Repair Kit		DB-RK-8626	for Wishbone (CV)	
04/97→10/02		Suspension Arm Repair Kit		DB-RK-10374	for Wishbone (CV)	
04/97→10/02		Suspension Arm Repair Kit		DB-RK-10375	for Wishbone (CV)	
04/97→10/02		Suspension Arm Repair Kit	DB-RK-8638		for Control Arm	
04/97→10/02		Suspension Strut Repair Kit		DB-RK-8391		
04/97→10/02		Suspension Strut Repair Kit		DB-RK-8710		
04/97→10/02		Suspension Strut Repair Kit		DB-RK-9291		
04/97→10/02		Suspension Strut Repair Kit		MN-RK-8997		
04/97→10/02		Tie Rod	DB-DL-12310			

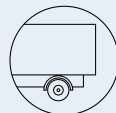

ACTROS ...

3343 AS ...	04/97→10/02	Tie Rod	DB-ES-5227		Guide Rod
	04/97→10/02	Tie Rod	MN-DL-7834		Guide Rod
	04/97→10/02	Tie Rod End	CV-ES-0543		for Push Rod
	04/97→10/02	Tie Rod End	CV-ES-0888		for Push Rod
	04/97→10/02	Tie Rod End	CV-ES-14162		for Steering Rod
	04/97→10/02	Tie Rod End	CV-ES-14163		for Steering Rod
	04/97→10/02	Tie Rod End	DB-ES-5234		for Steering Rod
	04/97→10/02	Track Control Arm		DB-DL-3475	Trailing Arm
	04/97→10/02	Track Control Arm		DB-VB-7261	Suspension Rod, Wishbone (CV), 1st RA;2nd RA; Leaf Spring Axle
	04/97→10/02	Track Control Arm		DB-VB-7798	Wishbone (CV)
	04/97→10/02	Track Control Arm	DB-DL-5224		Control Arm
04/97→10/02	Track Control Arm	DB-DL-9218	DB-DL-9218	Trailing Arm	
3343 B	04/97→10/02	Ball Head, gearshift linkage	DB-ES-8387		
	04/97→10/02	Ball Head, gearshift linkage	DB-ES-8491		
	04/97→10/02	Ball Head, gearshift linkage	DB-ES-8492		
	04/97→10/02	Ball Head, gearshift linkage	DB-ES-8500		
	04/97→10/02	Ball Head, gearshift linkage	DB-ES-8510		
	04/97→10/02	Bush, driver cab suspension	DB-SB-10384		
	04/97→10/02	Bush, parabolic spring		DB-SB-10401	
	04/97→10/02	Centre Rod	DB-DL-2144		Push Rod
	04/97→10/02	Centre Rod	DB-DL-5230		Push Rod
	04/97→10/02	Centre Rod	DB-DL-8168		Push Rod, Leaf Spring Axle
	04/97→10/02	Centre Rod	DB-DL-8184		Push Rod, Leaf Spring Axle
	04/97→10/02	Centre Rod	DB-DL-8185		Push Rod, Leaf Spring Axle
	04/97→10/02	Centre Rod	DB-DL-8188		Push Rod
	04/97→10/02	Centre Rod	DB-DL-8307		Push Rod
	04/97→10/02	Centre Rod	DB-DL-12300		for Steering Rod
	04/97→10/02	Rod Assembly	DB-DL-2178		Guide Rod
	04/97→10/02	Stabiliser Link	DB-DL-9254		Pressure Rod
	04/97→10/02	Stabiliser Link	DB-DL-9271		Pressure Rod
	04/97→10/02	Stabiliser Link	DB-DL-9272		Pressure Rod
	04/97→10/02	Stabiliser Mounting		DB-SB-10406	
	04/97→10/02	Stabiliser Mounting		DB-SB-10409	
	04/97→10/02	Suspension Arm Repair Kit		DB-RK-8626	for Wishbone (CV)
	04/97→10/02	Suspension Arm Repair Kit		DB-RK-10374	for Wishbone (CV)
	04/97→10/02	Suspension Arm Repair Kit		DB-RK-10375	for Wishbone (CV)
	04/97→10/02	Suspension Arm Repair Kit	DB-RK-8638		for Control Arm
	04/97→10/02	Suspension Strut Repair Kit		DB-RK-8391	
	04/97→10/02	Suspension Strut Repair Kit		DB-RK-9294	
	04/97→10/02	Tie Rod	DB-DL-8172		Guide Rod
	04/97→10/02	Tie Rod	DB-DL-8640		Guide Rod
	04/97→10/02	Tie Rod	DB-DL-12310		
	04/97→10/02	Tie Rod End	CV-ES-0543		for Push Rod
	04/97→10/02	Tie Rod End	CV-ES-0888		for Push Rod
	04/97→10/02	Tie Rod End	CV-ES-14162		for Steering Rod
	04/97→10/02	Tie Rod End	CV-ES-14163		for Steering Rod
	04/97→10/02	Tie Rod End	DB-ES-5234		for Steering Rod
	04/97→10/02	Tie Rod End	DB-ES-8323		Leaf Spring Axle
	04/97→10/02	Tie Rod End	DB-ES-8530		for Push Rod
	04/97→10/02	Track Control Arm		DB-DL-3475	Trailing Arm
04/97→10/02	Track Control Arm		DB-VB-3707	Suspension Rod, Wishbone (CV)	
04/97→10/02	Track Control Arm		DB-VB-7261	Suspension Rod, Wishbone (CV), 1st RA;2nd RA; Leaf Spring Axle	
3343 K	04/97→10/02	Ball Head, gearshift linkage	DB-ES-8387		
	04/97→10/02	Ball Head, gearshift linkage	DB-ES-8491		
	04/97→10/02	Ball Head, gearshift linkage	DB-ES-8492		
	04/97→10/02	Ball Head, gearshift linkage	DB-ES-8500		
	04/97→10/02	Ball Head, gearshift linkage	DB-ES-8510		
	04/97→10/02	Bush, driver cab suspension	DB-SB-10384		
	04/97→10/02	Bush, parabolic spring		DB-SB-10400	
04/97→10/02	Bush, parabolic spring		DB-SB-10401		
04/97→10/02	Centre Rod	DB-DL-2144		Push Rod	



ACTROS ...

3343 K ...

04/97→10/02	Centre Rod	DB-DL-5230	Push Rod, 1st FA;Leaf Spring Axle
04/97→10/02	Centre Rod	DB-DL-5241	Push Rod
04/97→10/02	Centre Rod	DB-DL-5405	Push Rod, 1st FA;Leaf Spring Axle
04/97→10/02	Centre Rod	DB-DL-7270	Push Rod
04/97→10/02	Centre Rod	DB-DL-8167	Push Rod, 1st FA;Leaf Spring Axle
04/97→10/02	Centre Rod	DB-DL-8184	Push Rod
04/97→10/02	Centre Rod	DB-DL-8185	Push Rod
04/97→10/02	Centre Rod	DB-DL-8188	Push Rod
04/97→10/02	Centre Rod	DB-DL-8307	Push Rod
04/97→10/02	Centre Rod	DB-DL-8702	Push Rod, 1st FA;Leaf Spring Axle
04/97→10/02	Centre Rod	DB-DL-12300	for Steering Rod
04/97→10/02	Rod Assembly	DB-DL-2178	Guide Rod
04/97→10/02	Stabiliser Link	DB-DL-9254	Pressure Rod
04/97→10/02	Stabiliser Mounting	DB-SB-5261	
04/97→10/02	Stabiliser Mounting	DB-SB-10406	
04/97→10/02	Stabiliser Mounting	DB-SB-10407	
04/97→10/02	Stabiliser Mounting	DB-SB-10409	
04/97→10/02	Stabiliser Mounting	DB-SB-5260	
04/97→10/02	Stabiliser Mounting	DB-SB-5279	
04/97→10/02	Suspension Arm Repair Kit	DB-RK-8550	for Wishbone (CV)
04/97→10/02	Suspension Arm Repair Kit	DB-RK-8626	for Wishbone (CV)
04/97→10/02	Suspension Arm Repair Kit	DB-RK-10374	for Wishbone (CV)
04/97→10/02	Suspension Arm Repair Kit	DB-RK-10375	for Wishbone (CV)
04/97→10/02	Suspension Arm Repair Kit	DB-RK-8638	for Control Arm
04/97→10/02	Suspension Strut Repair Kit	DB-RK-8391	
04/97→10/02	Suspension Strut Repair Kit	DB-RK-8710	
04/97→10/02	Suspension Strut Repair Kit	DB-RK-9291	
04/97→10/02	Tie Rod	DB-DL-8171	Guide Rod
04/97→10/02	Tie Rod	DB-DL-8327	Guide Rod
04/97→10/02	Tie Rod	DB-DL-8640	Guide Rod
04/97→10/02	Tie Rod	DB-DL-12310	
04/97→10/02	Tie Rod	DB-ES-5227	Guide Rod
04/97→10/02	Tie Rod End	CV-ES-0543	for Push Rod
04/97→10/02	Tie Rod End	CV-ES-0888	for Push Rod
04/97→10/02	Tie Rod End	CV-ES-14162	for Steering Rod
04/97→10/02	Tie Rod End	CV-ES-14163	for Steering Rod
04/97→10/02	Tie Rod End	DB-ES-5234	for Steering Rod
04/97→10/02	Tie Rod End	DB-ES-8164	for Push Rod
04/97→10/02	Tie Rod End	DB-ES-8530	for Push Rod
04/97→10/02	Track Control Arm	DB-DL-3475	Trailing Arm
04/97→10/02	Track Control Arm	DB-VB-7261	Suspension Rod, Wishbone (CV), 1st RA;2nd RA; Leaf Spring Axle
04/97→10/02	Track Control Arm	DB-DL-5224	Control Arm
04/97→10/02	Track Control Arm	DB-DL-9218	DB-DL-9218
04/97→10/02	Ball Head, gearshift linkage	DB-ES-8387	
04/97→10/02	Ball Head, gearshift linkage	DB-ES-8491	
04/97→10/02	Ball Head, gearshift linkage	DB-ES-8492	
04/97→10/02	Ball Head, gearshift linkage	DB-ES-8500	
04/97→10/02	Ball Head, gearshift linkage	DB-ES-8510	
04/97→10/02	Bush, driver cab suspension	DB-SB-10384	
04/97→10/02	Bush, parabolic spring	DB-SB-10400	
04/97→10/02	Bush, parabolic spring	DB-SB-10401	
04/97→10/02	Centre Rod	DB-DL-2144	Push Rod
04/97→10/02	Centre Rod	DB-DL-5230	Push Rod, 1st FA;Leaf Spring Axle
04/97→10/02	Centre Rod	DB-DL-5241	Push Rod
04/97→10/02	Centre Rod	DB-DL-5405	Push Rod, Leaf Spring Axle
04/97→10/02	Centre Rod	DB-DL-7270	Push Rod
04/97→10/02	Centre Rod	DB-DL-8167	Push Rod, 1st FA;Leaf Spring Axle
04/97→10/02	Centre Rod	DB-DL-8184	Push Rod
04/97→10/02	Centre Rod	DB-DL-8185	Push Rod
04/97→10/02	Centre Rod	DB-DL-8188	Push Rod
04/97→10/02	Centre Rod	DB-DL-8307	Push Rod
04/97→10/02	Centre Rod	DB-DL-8702	Push Rod, Leaf Spring Axle

3343 S

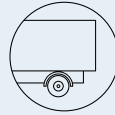

ACTROS ...

3343 S ...	04/97→10/02	Centre Rod	DB-DL-12300		for Steering Rod	
	04/97→10/02	Rod Assembly	DB-DL-2178		Guide Rod	
	04/97→10/02	Stabiliser Mounting		DB-SB-5261		
	04/97→10/02	Stabiliser Mounting		DB-SB-10406		
	04/97→10/02	Stabiliser Mounting		DB-SB-10407		
	04/97→10/02	Stabiliser Mounting		DB-SB-10409		
	04/97→10/02	Stabiliser Mounting	DB-SB-5260			
	04/97→10/02	Stabiliser Mounting	DB-SB-5279			
	04/97→10/02	Stabiliser Mounting	DB-SB-10410			
	04/97→10/02	Suspension Arm Repair Kit		DB-RK-8550	for Wishbone (CV)	
	04/97→10/02	Suspension Arm Repair Kit		DB-RK-8626	for Wishbone (CV)	
	04/97→10/02	Suspension Arm Repair Kit		DB-RK-10374	for Wishbone (CV)	
	04/97→10/02	Suspension Arm Repair Kit		DB-RK-10375	for Wishbone (CV)	
	04/97→10/02	Suspension Arm Repair Kit	DB-RK-8638		for Control Arm	
	04/97→10/02	Suspension Strut Repair Kit		DB-RK-8391		
	04/97→10/02	Suspension Strut Repair Kit		DB-RK-8710		
	04/97→10/02	Suspension Strut Repair Kit		DB-RK-9291		
	04/97→10/02	Suspension Strut Repair Kit		MN-RK-8997		
	04/97→10/02	Tie Rod	DB-DL-8171		Guide Rod	
	04/97→10/02	Tie Rod	DB-DL-8327		Guide Rod	
	04/97→10/02	Tie Rod	DB-DL-8640		Guide Rod	
	04/97→10/02	Tie Rod	DB-DL-12310			
	04/97→10/02	Tie Rod	DB-ES-5227		Guide Rod	
	04/97→10/02	Tie Rod End	CV-ES-0543		for Push Rod	
	04/97→10/02	Tie Rod End	CV-ES-0888		for Push Rod	
	04/97→10/02	Tie Rod End	CV-ES-14162		for Steering Rod	
	04/97→10/02	Tie Rod End	CV-ES-14163		for Steering Rod	
	04/97→10/02	Tie Rod End	DB-ES-5234		for Steering Rod	
	04/97→10/02	Tie Rod End	DB-ES-8164		for Push Rod	
	04/97→10/02	Tie Rod End	DB-ES-8530		for Push Rod	
	04/97→10/02	Track Control Arm		DB-DL-3475	Trailing Arm	
	04/97→10/02	Track Control Arm		DB-VB-7261	Suspension Rod, Wishbone (CV), 1st RA;2nd RA; Leaf Spring Axle	
	04/97→10/02	Track Control Arm		DB-VB-7798	Wishbone (CV)	
	04/97→10/02	Track Control Arm	DB-DL-5224		Control Arm	
	04/97→10/02	Track Control Arm	DB-DL-9218	DB-DL-9218	Trailing Arm	
	3346	04/97→10/02	Ball Head, gearshift linkage	DB-ES-8387		
		04/97→10/02	Ball Head, gearshift linkage	DB-ES-8491		
		04/97→10/02	Ball Head, gearshift linkage	DB-ES-8492		
		04/97→10/02	Ball Head, gearshift linkage	DB-ES-8500		
		04/97→10/02	Ball Head, gearshift linkage	DB-ES-8510		
04/97→10/02		Bush, driver cab suspension	DB-SB-10384			
04/97→10/02		Bush, parabolic spring		DB-SB-10400		
04/97→10/02		Bush, parabolic spring		DB-SB-10401		
04/97→10/02		Centre Rod	DB-DL-5230		Push Rod, Leaf Spring Axle	
04/97→10/02		Centre Rod	DB-DL-5241		Push Rod	
04/97→10/02		Centre Rod	DB-DL-5405		Push Rod, Leaf Spring Axle	
04/97→10/02		Centre Rod	DB-DL-7270		Push Rod;Suspension Rod	
04/97→10/02		Centre Rod	DB-DL-8167		Push Rod, Leaf Spring Axle	
04/97→10/02		Centre Rod	DB-DL-8168		Push Rod	
04/97→10/02		Centre Rod	DB-DL-8184		Push Rod	
04/97→10/02		Centre Rod	DB-DL-8185		Push Rod	
04/97→10/02		Centre Rod	DB-DL-8188		Push Rod	
04/97→10/02		Centre Rod	DB-DL-8307		Push Rod	
04/97→10/02		Centre Rod	DB-DL-8622		Push Rod	
04/97→10/02		Centre Rod	DB-DL-8641		Push Rod	
04/97→10/02		Centre Rod	DB-DL-8642		Push Rod	
04/97→10/02		Centre Rod	DB-DL-8702		Push Rod, Leaf Spring Axle	
04/97→10/02		Centre Rod	DB-DL-12298		for Steering Rod	
04/97→10/02		Stabiliser Mounting		DB-SB-5261		
04/97→10/02		Stabiliser Mounting		DB-SB-10407		
04/97→10/02		Stabiliser Mounting	DB-SB-5260			
04/97→10/02		Stabiliser Mounting	DB-SB-5279			



ACTROS ...

3346 ...	04/97→10/02	Suspension Arm Repair Kit		DB-RK-8550	for Wishbone (CV)
	04/97→10/02	Suspension Arm Repair Kit		DB-RK-8626	for Wishbone (CV)
	04/97→10/02	Suspension Strut Repair Kit		DB-RK-8710	
	04/97→10/02	Suspension Strut Repair Kit		DB-RK-9291	
	04/97→10/02	Tie Rod	DB-DL-8171		Guide Rod
	04/97→10/02	Tie Rod	DB-DL-8327		Guide Rod
	04/97→10/02	Tie Rod	DB-DL-8640		Guide Rod
	04/97→10/02	Tie Rod	DB-DL-12310		
	04/97→10/02	Tie Rod	DB-ES-5227		Guide Rod
	04/97→10/02	Tie Rod End	CV-ES-14163		for Steering Rod
	04/97→10/02	Track Control Arm		DB-DL-3475	Trailing Arm
	04/97→10/02	Track Control Arm		DB-VB-7261	Suspension Rod, Wishbone (CV), 1st RA;2nd RA; Leaf Spring Axle
3346 AK	10/97→	Ball Head, gearshift linkage	DB-ES-8387		
	10/97→	Ball Head, gearshift linkage	DB-ES-8491		
	10/97→	Ball Head, gearshift linkage	DB-ES-8492		
	10/97→	Ball Head, gearshift linkage	DB-ES-8500		
	10/97→	Bush, parabolic spring		DB-SB-10400	
	10/97→	Bush, parabolic spring		DB-SB-10401	
	10/97→	Centre Rod	DB-DL-5230		Push Rod
	10/97→	Centre Rod	DB-DL-5405		Push Rod
	10/97→	Centre Rod	DB-DL-8307		Push Rod
	10/97→	Centre Rod	DB-DL-8639		Push Rod
	10/97→	Centre Rod	DB-DL-8702		Push Rod
	10/97→	Tie Rod	DB-ES-5227		Guide Rod
	10/97→	Tie Rod	MN-DL-7834		Guide Rod
	10/97→	Tie Rod End	CV-ES-14163		for Steering Rod
	10/97→	Track Control Arm		DB-DL-3475	Trailing Arm
	10/97→	Track Control Arm		DB-VB-7261	Suspension Rod, Wishbone (CV)
	3346 AS	10/97→	Track Control Arm	DB-DL-5224	
10/97→		Track Control Arm	DB-DL-9218	DB-DL-9218	Trailing Arm
10/97→		Ball Head, gearshift linkage	DB-ES-8387		
10/97→		Ball Head, gearshift linkage	DB-ES-8491		
10/97→		Ball Head, gearshift linkage	DB-ES-8492		
10/97→		Ball Head, gearshift linkage	DB-ES-8500		
10/97→		Bush, parabolic spring		DB-SB-10400	
10/97→		Bush, parabolic spring		DB-SB-10401	
10/97→		Centre Rod	DB-DL-5230		Push Rod
10/97→		Centre Rod	DB-DL-5405		Push Rod
3346 K	10/97→	Centre Rod	DB-DL-8307		Push Rod
	10/97→	Centre Rod	DB-DL-8639		Push Rod
	10/97→	Centre Rod	DB-DL-8702		Push Rod
	10/97→	Tie Rod	DB-ES-5227		Guide Rod
	10/97→	Tie Rod	MN-DL-7834		Guide Rod
	10/97→	Tie Rod End	CV-ES-14163		for Steering Rod
	10/97→	Track Control Arm		DB-DL-3475	Trailing Arm
	10/97→	Track Control Arm		DB-VB-7261	Suspension Rod, Wishbone (CV)
	10/97→	Track Control Arm	DB-DL-5224		Control Arm
	10/97→	Track Control Arm	DB-DL-9218	DB-DL-9218	Trailing Arm
	10/97→	Ball Head, gearshift linkage	DB-ES-8387		
	10/97→	Ball Head, gearshift linkage	DB-ES-8491		
	10/97→	Ball Head, gearshift linkage	DB-ES-8492		
	10/97→	Ball Head, gearshift linkage	DB-ES-8500		
	3346 K	10/97→	Bush, parabolic spring		DB-SB-10400
10/97→		Bush, parabolic spring		DB-SB-10401	
10/97→		Centre Rod	DB-DL-5230		Push Rod
10/97→		Centre Rod	DB-DL-5405		Push Rod
10/97→		Centre Rod	DB-DL-7270		Push Rod
10/97→		Centre Rod	DB-DL-8167		Push Rod
10/97→		Centre Rod	DB-DL-8307		Push Rod
10/97→		Centre Rod	DB-DL-8702		Push Rod
10/97→		Rod Assembly	DB-DL-2178		Guide Rod, 1st Front Axle, →504310 03
10/97→		Suspension Arm Repair Kit		DB-RK-8626	for Wishbone (CV)

CV-ES-14163

Length: 125
 Cone Ø: d1 Ø 30 / d2 Ø 27
 Thread: M30 x 1,5 RHT
 0003305248, 0003387310, 0004600348,
 0004600948, 0004602848, 0004602948,
 0004608948, 0014600248, 0014600848,
 0014601248, 0014602248, 0014607748,
 0024600148, A0003387310, A0004600348,
 A0004602848, A0004602948, A0014600848,
 A0014601248, A0014602248, A0014607748



DB-DL-2178

Length: 1735 Ø: 52
 Cone Ø: d1 Ø 32 / d2 Ø 29
 9423300003, 9423300103, 9423300203



DB-DL-3475

Length: 565 Ø: 52
 Hole Distance: 152 / 152
 3753500006, 3753500206, 9473500805,
 9483500006, 9483500805, 9483501205,
 9483501305, 9483501905, 9483502005,
 9483502405, A3753500006,
 A3753500206



DB-DL-5224

Length: 850 Ø: 60
 Hole Distance: 100 / 100
 01336100A, 9413300007



DB-DL-5230

Length: 879 Ø: 42
 Cone Ø: d1 Ø 30 / d2 Ø 27
 01208600A, 0004607105, 0004607205,
 0014606705



DB-DL-5405

Length: 890 Ø: 35
 Cone Ø: d1 Ø 28,6 / d2 Ø 23,9
 01215900A, 1460248, 0024604505,
 0024604605, 0034605005, 3752600637,
 3754600405, A3752600637, A3754600405



DB-DL-7270

Length: 875 Ø: 40
 Cone Ø: d1 Ø 28,6 / d2 Ø 23,9
 01208300A, 0024604705, 0024604805,
 0034604905, A0024604705



DB-DL-8167

Length: 866 Ø: 38
 Cone Ø: d1 Ø 30 / d2 Ø 27
 0014609805, 0014609905, 0024606305,
 0024606405



DB-DL-8171

Length: 1687 Ø: 52
 Cone Ø: d1 Ø 32 / d2 Ø 29
 9493300603, 9493300703, 9493301503,
 9493301603



DB-DL-8307

Length: 885 Ø: 38
 Cone Ø: d1 Ø 32 / d2 Ø 30
 01215500A, 0004604005, 0024605105,
 0024605205, 0034604005



DB-DL-8327

Length: 1745 Ø: 48
 Cone Ø: d1 Ø 32 / d2 Ø 29
 01219800A, 9413300003, 9413300103,
 9413300203, 9413300303, 9413300503



DB-DL-8639

Length: 888 Ø: 38
 Cone Ø: d1 Ø 30 / d2 Ø 27
 0014600705, 0014600805, 0014607005



DB-DL-8640

Length: 1615 Ø: 50
 Cone Ø: d1 Ø 32 / d2 Ø 29
 6253301503, 6253301603, 6253302403,
 6253302503, 9423300803, 9423302103,
 9493300203, 9493300303, 9493300903



DB-DL-8702

Length: 958 Ø: 38
 Cone Ø: d1 Ø 32 / d2 Ø 30
 0024606105, 0024606205, 0034604205



DB-DL-9218

Length: 754 Ø: 40
 Hole Distance: 100
 000360098524, 000390098524,
 3753300111, 9413300011,
 A3753300111, SA50831601



DB-DL-12310

Length: 1532 Ø: 50
 Cone Ø: d1 Ø 32 / d2 Ø 29
 Thread: M27 x 1,5 LHT
 9493301203, 9493301303, 9493301803,
 9493302203, A9493301203, A9493301303,
 A9493301803, A9493302203



DB-ES-5227

Length: 1588 Ø: 60
 Cone Ø: d1 Ø 38 / d2 Ø 34,3
 6253300903, 6253301203, 9443300203



DB-ES-8387

Length: 55
 Cone Ø: d1 Ø 10 / d2 Ø 10
 Thread: M14 x 1,5 RHT
 0009966845, 0009967045



DB-ES-8491

Length: 60
 Cone Ø: d1 Ø 10 / d2 Ø 10
 Thread: M12 x 1,75 LHT
 0009966745



DB-ES-8492

Length: 60
 Cone Ø: d1 Ø 10 / d2 Ø 10
 Thread: M12 x 1,75 RHT
 0009966645, 3752680189, A3752680189



DB-ES-8500

Length: 55
 Cone Ø: d1 Ø 12 / d2 Ø 10,8
 Thread: M14 x 1,5 RHT
 0002685989



DB-RK-8550

Ø: 75 Hole Distance: 152
 Thick/Height: 24
 0003502105, 0003504605



DB-RK-8626

Ø: 75 Hole Distance: 130
 Thick/Height: 24
 0003502205, 0003502505, 0003503405,
 0003504505, GL11319



DB-RK-8710

Ø: 85 Hole Distance: 130
 Thick/Height: 30
 0003503705



DB-RK-9291

Ø: 107,5 Hole Distance: 152
 Thick/Height: 30
 0003503605



DB-SB-10400

Length: 230
 Thick/Height: 167,5 / 115
 0003250696, 0003250896



DB-SB-10401

Length: 232
 Thick/Height: 163,5 / 152,5
 0003250596, 0003250796



DB-VB-7261

Length: 622 Ø: 46
 Hole Ø 25 / 25 / 25
 Hole Distance: 152 / 130 / 130
 01337800A, 9443500305, 9443500505,
 9443500605, 9473500705, 9473500905,
 9483500405, 9483500305



MN-DL-7834

Length: 1588 Ø: 58
 Cone Ø: d1 Ø 30 / d2 Ø 27
 3463303903, 3463304903, 6253303203,
 9443300503, 9443301303, 9443301703



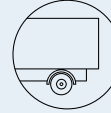

ACTROS ...

3346 K ...	10/97→	Suspension Strut Repair Kit		DB-RK-8391		
	10/97→	Suspension Strut Repair Kit		DB-RK-8710		
	10/97→	Tie Rod	DB-DL-8171		Guide Rod	
	10/97→	Tie Rod	DB-DL-8327		Guide Rod	
	10/97→	Tie Rod	DB-DL-8640		Guide Rod	
	10/97→	Tie Rod	DB-DL-12310			
	10/97→	Tie Rod End	CV-ES-0543		for Push Rod	
	10/97→	Tie Rod End	CV-ES-0888		for Push Rod	
	10/97→	Tie Rod End	CV-ES-14163		for Steering Rod	
	10/97→	Tie Rod End	DB-ES-8164		for Push Rod	
	10/97→	Tie Rod End	DB-ES-8530		for Push Rod	
	10/97→	Track Control Arm		DB-DL-3475	Trailing Arm	
	10/97→	Track Control Arm		DB-VB-7261	Suspension Rod, Wishbone (CV)	
	10/97→	Track Control Arm	DB-DL-5224		Control Arm	
10/97→	Track Control Arm	DB-DL-9218	DB-DL-9218	Trailing Arm		
3346 S	10/97→	Ball Head, gearshift linkage	DB-ES-8387			
	10/97→	Ball Head, gearshift linkage	DB-ES-8491			
	10/97→	Ball Head, gearshift linkage	DB-ES-8492			
	10/97→	Ball Head, gearshift linkage	DB-ES-8500			
	10/97→	Bush, parabolic spring		DB-SB-10400		
	10/97→	Bush, parabolic spring		DB-SB-10401		
	10/97→	Centre Rod	DB-DL-2144		Push Rod	
	10/97→	Centre Rod	DB-DL-5230		Push Rod	
	10/97→	Centre Rod	DB-DL-5405		Push Rod	
	10/97→	Centre Rod	DB-DL-7270		Push Rod	
	10/97→	Centre Rod	DB-DL-8167		Push Rod	
	10/97→	Centre Rod	DB-DL-8307		Push Rod	
	10/97→	Centre Rod	DB-DL-8702		Push Rod	
	10/97→	Rod Assembly	DB-DL-2178		Guide Rod, 1st Front Axle, →504310 03	
	10/97→	Suspension Arm Repair Kit		DB-RK-8626	for Wishbone (CV)	
	10/97→	Suspension Strut Repair Kit		DB-RK-8391		
	10/97→	Suspension Strut Repair Kit		DB-RK-8710		
	10/97→	Tie Rod	DB-DL-8171		Guide Rod	
	10/97→	Tie Rod	DB-DL-8327		Guide Rod	
	10/97→	Tie Rod	DB-DL-8640		Guide Rod	
	10/97→	Tie Rod	DB-DL-12310			
	10/97→	Tie Rod End	CV-ES-0543		for Push Rod	
	10/97→	Tie Rod End	CV-ES-0888		for Push Rod	
	10/97→	Tie Rod End	CV-ES-14163		for Steering Rod	
	10/97→	Tie Rod End	DB-ES-8164		for Push Rod	
	10/97→	Tie Rod End	DB-ES-8530		for Push Rod	
	10/97→	Track Control Arm		DB-DL-3475	Trailing Arm	
	10/97→	Track Control Arm		DB-VB-7261	Suspension Rod, Wishbone (CV)	
	10/97→	Track Control Arm	DB-DL-5224		Control Arm	
	10/97→	Track Control Arm	DB-DL-9218	DB-DL-9218	Trailing Arm	
	3348	04/97→10/02	Ball Head, gearshift linkage	DB-ES-8387		
		04/97→10/02	Ball Head, gearshift linkage	DB-ES-8491		
04/97→10/02		Ball Head, gearshift linkage	DB-ES-8492			
04/97→10/02		Ball Head, gearshift linkage	DB-ES-8500			
04/97→10/02		Ball Head, gearshift linkage	DB-ES-8510			
04/97→10/02		Bush, driver cab suspension	DB-SB-10384			
04/97→10/02		Bush, parabolic spring		DB-SB-10400		
04/97→10/02		Bush, parabolic spring		DB-SB-10401		
04/97→10/02		Centre Rod	DB-DL-2144		Push Rod	
04/97→10/02		Centre Rod	DB-DL-5230		Push Rod, Leaf Spring Axle	
04/97→10/02		Centre Rod	DB-DL-5241		Push Rod	
04/97→10/02		Centre Rod	DB-DL-5405		Push Rod, Leaf Spring Axle	
04/97→10/02		Centre Rod	DB-DL-7270		Push Rod;Suspension Rod	
04/97→10/02		Centre Rod	DB-DL-8167		Push Rod, Leaf Spring Axle	
04/97→10/02		Centre Rod	DB-DL-8168		Push Rod	
04/97→10/02		Centre Rod	DB-DL-8184		Push Rod	
04/97→10/02		Centre Rod	DB-DL-8185		Push Rod	
04/97→10/02	Centre Rod	DB-DL-8188		Push Rod		



ACTROS ...

3348 ...	04/97→10/02	Centre Rod	DB-DL-8307		Push Rod	
	04/97→10/02	Centre Rod	DB-DL-8622		Push Rod	
	04/97→10/02	Centre Rod	DB-DL-8641		Push Rod	
	04/97→10/02	Centre Rod	DB-DL-8642		Push Rod	
	04/97→10/02	Centre Rod	DB-DL-8702		Push Rod, Leaf Spring Axle	
	04/97→10/02	Centre Rod	DB-DL-12298		for Steering Rod	
	04/97→10/02	Centre Rod	DB-DL-12300		for Steering Rod	
	04/97→10/02	Rod Assembly	DB-DL-2178		Guide Rod	
	04/97→10/02	Stabiliser Mounting		DB-SB-5250		
	04/97→10/02	Stabiliser Mounting		DB-SB-5261		
	04/97→10/02	Stabiliser Mounting		DB-SB-10406		
	04/97→10/02	Stabiliser Mounting		DB-SB-10407		
	04/97→10/02	Stabiliser Mounting	DB-SB-5260			
	04/97→10/02	Stabiliser Mounting	DB-SB-5277	DB-SB-5277		
	04/97→10/02	Stabiliser Mounting	DB-SB-5279			
	04/97→10/02	Suspension Arm Repair Kit		DB-RK-8550	for Wishbone (CV)	
	04/97→10/02	Suspension Arm Repair Kit		DB-RK-8626	for Wishbone (CV)	
	04/97→10/02	Suspension Strut Repair Kit		DB-RK-8710		
	04/97→10/02	Suspension Strut Repair Kit		DB-RK-9291		
	04/97→10/02	Tie Rod	DB-DL-8171		Guide Rod	
	04/97→10/02	Tie Rod	DB-DL-8327		Guide Rod	
	04/97→10/02	Tie Rod	DB-DL-8640		Guide Rod	
	04/97→10/02	Tie Rod	DB-DL-12310			
	04/97→10/02	Tie Rod	DB-ES-5227		Guide Rod	
	04/97→10/02	Tie Rod End	CV-ES-0543		for Push Rod	
	04/97→10/02	Tie Rod End	CV-ES-0888		for Push Rod	
	04/97→10/02	Tie Rod End	CV-ES-14162		for Steering Rod	
	04/97→10/02	Tie Rod End	CV-ES-14163		for Steering Rod	
	04/97→10/02	Tie Rod End	DB-ES-8164		for Push Rod	
	04/97→10/02	Tie Rod End	DB-ES-8530		for Push Rod	
	04/97→10/02	Track Control Arm		DB-DL-3475	Trailing Arm	
	04/97→10/02	Track Control Arm		DB-VB-7261	Suspension Rod, Wishbone (CV), 1st RA;2nd RA; Leaf Spring Axle	
	04/97→10/02	Track Control Arm	DB-DL-5224		Control Arm	
	04/97→10/02	Track Control Arm	DB-DL-9218	DB-DL-9218	Trailing Arm	
	3348 AK	04/97→10/02	Ball Head, gearshift linkage	DB-ES-8387		
		04/97→10/02	Ball Head, gearshift linkage	DB-ES-8491		
		04/97→10/02	Ball Head, gearshift linkage	DB-ES-8492		
		04/97→10/02	Ball Head, gearshift linkage	DB-ES-8500		
		04/97→10/02	Ball Head, gearshift linkage	DB-ES-8510		
		04/97→10/02	Bush, driver cab suspension	DB-SB-10384		
		04/97→10/02	Bush, parabolic spring		DB-SB-10400	
		04/97→10/02	Bush, parabolic spring		DB-SB-10401	
		04/97→10/02	Centre Rod	DB-DL-2144		Push Rod
		04/97→10/02	Centre Rod	DB-DL-5230		Push Rod
		04/97→10/02	Centre Rod	DB-DL-5241		Push Rod
		04/97→10/02	Centre Rod	DB-DL-5405		Push Rod
		04/97→10/02	Centre Rod	DB-DL-8184		Push Rod
		04/97→10/02	Centre Rod	DB-DL-8188		Push Rod
		04/97→10/02	Centre Rod	DB-DL-8307		Push Rod, Leaf Spring Axle
		04/97→10/02	Centre Rod	DB-DL-8639		Push Rod, 1st FA;Leaf Spring Axle
		04/97→10/02	Centre Rod	DB-DL-8702		Push Rod, 1st FA;Leaf Spring Axle
		04/97→10/02	Centre Rod	DB-DL-9259		Push Rod
		04/97→10/02	Centre Rod	DB-DL-12300		for Steering Rod
		04/97→10/02	Rod Assembly	DB-DL-2178		Guide Rod
04/97→10/02		Stabiliser Link	DB-DL-9254		Pressure Rod	
04/97→10/02		Stabiliser Mounting		DB-SB-5261		
04/97→10/02		Stabiliser Mounting		DB-SB-10406		
04/97→10/02		Stabiliser Mounting		DB-SB-10407		
04/97→10/02		Stabiliser Mounting		DB-SB-10409		
04/97→10/02		Stabiliser Mounting	DB-SB-5260			
04/97→10/02		Stabiliser Mounting	DB-SB-5279			
04/97→10/02		Suspension Arm Repair Kit		DB-RK-8626	for Wishbone (CV)	

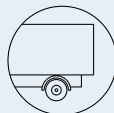

ACTROS ...

3348 AK ...	04/97→10/02	Suspension Arm Repair Kit		DB-RK-10374	for Wishbone (CV)
	04/97→10/02	Suspension Arm Repair Kit		DB-RK-10375	for Wishbone (CV)
	04/97→10/02	Suspension Arm Repair Kit	DB-RK-8638		for Control Arm
	04/97→10/02	Suspension Strut Repair Kit		DB-RK-8391	
	04/97→10/02	Suspension Strut Repair Kit		DB-RK-8710	
	04/97→10/02	Tie Rod	DB-DL-12310		
	04/97→10/02	Tie Rod	DB-ES-5227		Guide Rod
	04/97→10/02	Tie Rod	MN-DL-7834		Guide Rod
	04/97→10/02	Tie Rod End	CV-ES-0543		for Push Rod
	04/97→10/02	Tie Rod End	CV-ES-0888		for Push Rod
	04/97→10/02	Tie Rod End	CV-ES-14162		for Steering Rod
	04/97→10/02	Tie Rod End	CV-ES-14163		for Steering Rod
	04/97→10/02	Tie Rod End	DB-ES-5234		for Steering Rod
	04/97→10/02	Tie Rod End	DB-ES-8530		for Push Rod
	04/97→10/02	Track Control Arm		DB-DL-3475	Trailing Arm
	04/97→10/02	Track Control Arm		DB-VB-7261	Suspension Rod, Wishbone (CV), 1st RA;2nd RA; Leaf Spring Axle
	04/97→10/02	Track Control Arm	DB-DL-5224		Control Arm
04/97→10/02	Track Control Arm	DB-DL-9218	DB-DL-9218	Trailing Arm	
3348 AS	04/97→10/02	Ball Head, gearshift linkage	DB-ES-8387		
	04/97→10/02	Ball Head, gearshift linkage	DB-ES-8491		
	04/97→10/02	Ball Head, gearshift linkage	DB-ES-8492		
	04/97→10/02	Ball Head, gearshift linkage	DB-ES-8500		
	04/97→10/02	Ball Head, gearshift linkage	DB-ES-8510		
	04/97→10/02	Bush, driver cab suspension	DB-SB-10384		
	04/97→10/02	Bush, parabolic spring		DB-SB-10400	
	04/97→10/02	Bush, parabolic spring		DB-SB-10401	
	04/97→10/02	Centre Rod	DB-DL-2144		Push Rod
	04/97→10/02	Centre Rod	DB-DL-5230		Push Rod
	04/97→10/02	Centre Rod	DB-DL-5241		Push Rod
	04/97→10/02	Centre Rod	DB-DL-5405		Push Rod
	04/97→10/02	Centre Rod	DB-DL-8188		Push Rod
	04/97→10/02	Centre Rod	DB-DL-8307		Push Rod, Leaf Spring Axle
	04/97→10/02	Centre Rod	DB-DL-8639		Push Rod, 1st FA;Leaf Spring Axle
	04/97→10/02	Centre Rod	DB-DL-8702		Push Rod, Leaf Spring Axle
	04/97→10/02	Centre Rod	DB-DL-9259		Push Rod
	04/97→10/02	Centre Rod	DB-DL-12300		for Steering Rod
	04/97→10/02	Rod Assembly	DB-DL-2178		Guide Rod
	04/97→10/02	Stabiliser Mounting		DB-SB-5261	
	04/97→10/02	Stabiliser Mounting		DB-SB-10406	
	04/97→10/02	Stabiliser Mounting		DB-SB-10407	
	04/97→10/02	Stabiliser Mounting		DB-SB-10409	
	04/97→10/02	Stabiliser Mounting	DB-SB-5260		
	04/97→10/02	Stabiliser Mounting	DB-SB-5279		
	04/97→10/02	Stabiliser Mounting	DB-SB-10410		
	04/97→10/02	Suspension Arm Repair Kit		DB-RK-8626	for Wishbone (CV)
	04/97→10/02	Suspension Arm Repair Kit		DB-RK-10374	for Wishbone (CV)
	04/97→10/02	Suspension Arm Repair Kit		DB-RK-10375	for Wishbone (CV)
	04/97→10/02	Suspension Arm Repair Kit	DB-RK-8638		for Control Arm
	04/97→10/02	Suspension Strut Repair Kit		DB-RK-8391	
	04/97→10/02	Suspension Strut Repair Kit		DB-RK-8710	
	04/97→10/02	Suspension Strut Repair Kit		DB-RK-9291	
	04/97→10/02	Suspension Strut Repair Kit		MN-RK-8997	
	04/97→10/02	Tie Rod	DB-DL-12310		
	04/97→10/02	Tie Rod	DB-ES-5227		Guide Rod
04/97→10/02	Tie Rod	MN-DL-7834		Guide Rod	
04/97→10/02	Tie Rod End	CV-ES-0543		for Push Rod	
04/97→10/02	Tie Rod End	CV-ES-0888		for Push Rod	
04/97→10/02	Tie Rod End	CV-ES-14162		for Steering Rod	
04/97→10/02	Tie Rod End	CV-ES-14163		for Steering Rod	
04/97→10/02	Tie Rod End	DB-ES-5234		for Steering Rod	
04/97→10/02	Track Control Arm		DB-DL-3475	Trailing Arm	



ACTROS ...

3348 AS ...	04/97→10/02	Track Control Arm		DB-VB-7261	Suspension Rod, Wishbone (CV), 1st RA;2nd RA; Leaf Spring Axle
	04/97→10/02	Track Control Arm		DB-VB-7798	Wishbone (CV)
	04/97→10/02	Track Control Arm	DB-DL-5224		Control Arm
	04/97→10/02	Track Control Arm	DB-DL-9218	DB-DL-9218	Trailing Arm
3348 K	04/97→10/02	Ball Head, gearshift linkage	DB-ES-8387		
	04/97→10/02	Ball Head, gearshift linkage	DB-ES-8491		
	04/97→10/02	Ball Head, gearshift linkage	DB-ES-8492		
	04/97→10/02	Ball Head, gearshift linkage	DB-ES-8500		
	04/97→10/02	Ball Head, gearshift linkage	DB-ES-8510		
	04/97→10/02	Bush, driver cab suspension	DB-SB-10384		
	04/97→10/02	Bush, parabolic spring		DB-SB-10400	
	04/97→10/02	Bush, parabolic spring		DB-SB-10401	
	04/97→10/02	Centre Rod	DB-DL-2144		Push Rod
	04/97→10/02	Centre Rod	DB-DL-5230		Push Rod, 1st FA;Leaf Spring Axle
	04/97→10/02	Centre Rod	DB-DL-5241		Push Rod
	04/97→10/02	Centre Rod	DB-DL-5405		Push Rod, 1st FA;Leaf Spring Axle
	04/97→10/02	Centre Rod	DB-DL-7270		Push Rod
	04/97→10/02	Centre Rod	DB-DL-8167		Push Rod, 1st FA;Leaf Spring Axle
	04/97→10/02	Centre Rod	DB-DL-8184		Push Rod
	04/97→10/02	Centre Rod	DB-DL-8185		Push Rod
	04/97→10/02	Centre Rod	DB-DL-8188		Push Rod
	04/97→10/02	Centre Rod	DB-DL-8307		Push Rod
	04/97→10/02	Centre Rod	DB-DL-8702		Push Rod, 1st FA;Leaf Spring Axle
	04/97→10/02	Centre Rod	DB-DL-12300		for Steering Rod
	04/97→10/02	Rod Assembly	DB-DL-2178		Guide Rod
	04/97→10/02	Stabiliser Link	DB-DL-9254		Pressure Rod
	04/97→10/02	Stabiliser Mounting		DB-SB-5261	
	04/97→10/02	Stabiliser Mounting		DB-SB-10406	
	04/97→10/02	Stabiliser Mounting		DB-SB-10407	
	04/97→10/02	Stabiliser Mounting		DB-SB-10409	
	04/97→10/02	Stabiliser Mounting	DB-SB-5260		
	04/97→10/02	Stabiliser Mounting	DB-SB-5279		
	04/97→10/02	Suspension Arm Repair Kit		DB-RK-8550	for Wishbone (CV)
	04/97→10/02	Suspension Arm Repair Kit		DB-RK-8626	for Wishbone (CV)
	04/97→10/02	Suspension Arm Repair Kit		DB-RK-10374	for Wishbone (CV)
	04/97→10/02	Suspension Arm Repair Kit		DB-RK-10375	for Wishbone (CV)
	04/97→10/02	Suspension Arm Repair Kit	DB-RK-8638		for Control Arm
	04/97→10/02	Suspension Strut Repair Kit		DB-RK-8391	
	04/97→10/02	Suspension Strut Repair Kit		DB-RK-8710	
	04/97→10/02	Suspension Strut Repair Kit		DB-RK-9291	
	04/97→10/02	Tie Rod	DB-DL-8171		Guide Rod
	04/97→10/02	Tie Rod	DB-DL-8327		Guide Rod
	04/97→10/02	Tie Rod	DB-DL-8640		Guide Rod
	04/97→10/02	Tie Rod	DB-DL-12310		
	04/97→10/02	Tie Rod	DB-ES-5227		Guide Rod
	04/97→10/02	Tie Rod End	CV-ES-0543		for Push Rod
	04/97→10/02	Tie Rod End	CV-ES-0888		for Push Rod
	04/97→10/02	Tie Rod End	CV-ES-14162		for Steering Rod
	04/97→10/02	Tie Rod End	CV-ES-14163		for Steering Rod
	04/97→10/02	Tie Rod End	DB-ES-5234		for Steering Rod
	04/97→10/02	Tie Rod End	DB-ES-8164		for Push Rod
04/97→10/02	Tie Rod End	DB-ES-8530		for Push Rod	
04/97→10/02	Track Control Arm		DB-DL-3475	Trailing Arm	
04/97→10/02	Track Control Arm		DB-VB-7261	Suspension Rod, Wishbone (CV), 1st RA;2nd RA; Leaf Spring Axle	
04/97→10/02	Track Control Arm	DB-DL-5224		Control Arm	
04/97→10/02	Track Control Arm	DB-DL-9218	DB-DL-9218	Trailing Arm	
3348 S	04/97→10/02	Ball Head, gearshift linkage	DB-ES-8387		
	04/97→10/02	Ball Head, gearshift linkage	DB-ES-8491		
	04/97→10/02	Ball Head, gearshift linkage	DB-ES-8492		
	04/97→10/02	Ball Head, gearshift linkage	DB-ES-8500		
	04/97→10/02	Ball Head, gearshift linkage	DB-ES-8510		

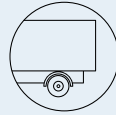

ACTROS ...

3348 S ...	04/97→10/02	Bush, driver cab suspension	DB-SB-10384		
	04/97→10/02	Bush, parabolic spring		DB-SB-10400	
	04/97→10/02	Bush, parabolic spring		DB-SB-10401	
	04/97→10/02	Centre Rod	DB-DL-2144		Push Rod
	04/97→10/02	Centre Rod	DB-DL-5230		Push Rod, 1st FA;Leaf Spring Axle
	04/97→10/02	Centre Rod	DB-DL-5241		Push Rod
	04/97→10/02	Centre Rod	DB-DL-5405		Push Rod, Leaf Spring Axle
	04/97→10/02	Centre Rod	DB-DL-7270		Push Rod
	04/97→10/02	Centre Rod	DB-DL-8167		Push Rod, 1st FA;Leaf Spring Axle
	04/97→10/02	Centre Rod	DB-DL-8184		Push Rod
	04/97→10/02	Centre Rod	DB-DL-8185		Push Rod
	04/97→10/02	Centre Rod	DB-DL-8188		Push Rod
	04/97→10/02	Centre Rod	DB-DL-8307		Push Rod
	04/97→10/02	Centre Rod	DB-DL-8702		Push Rod, Leaf Spring Axle
	04/97→10/02	Centre Rod	DB-DL-12300		for Steering Rod
	04/97→10/02	Rod Assembly	DB-DL-2178		Guide Rod
	04/97→10/02	Stabiliser Mounting		DB-SB-5261	
	04/97→10/02	Stabiliser Mounting		DB-SB-10406	
	04/97→10/02	Stabiliser Mounting		DB-SB-10407	
	04/97→10/02	Stabiliser Mounting		DB-SB-10409	
	04/97→10/02	Stabiliser Mounting	DB-SB-5260		
	04/97→10/02	Stabiliser Mounting	DB-SB-5279		
	04/97→10/02	Stabiliser Mounting	DB-SB-10410		
	04/97→10/02	Suspension Arm Repair Kit		DB-RK-8550	for Wishbone (CV)
	04/97→10/02	Suspension Arm Repair Kit		DB-RK-8626	for Wishbone (CV)
	04/97→10/02	Suspension Arm Repair Kit		DB-RK-10374	for Wishbone (CV)
	04/97→10/02	Suspension Arm Repair Kit		DB-RK-10375	for Wishbone (CV)
	04/97→10/02	Suspension Arm Repair Kit	DB-RK-8638		for Control Arm
	04/97→10/02	Suspension Strut Repair Kit		DB-RK-8391	
	04/97→10/02	Suspension Strut Repair Kit		DB-RK-8710	
	04/97→10/02	Suspension Strut Repair Kit		DB-RK-9291	
	04/97→10/02	Suspension Strut Repair Kit		MN-RK-8997	
	04/97→10/02	Tie Rod	DB-DL-8171		Guide Rod
	04/97→10/02	Tie Rod	DB-DL-8327		Guide Rod
	04/97→10/02	Tie Rod	DB-DL-8640		Guide Rod
	04/97→10/02	Tie Rod	DB-DL-12310		
	04/97→10/02	Tie Rod	DB-ES-5227		Guide Rod
	04/97→10/02	Tie Rod End	CV-ES-0543		for Push Rod
	04/97→10/02	Tie Rod End	CV-ES-0888		for Push Rod
	04/97→10/02	Tie Rod End	CV-ES-14162		for Steering Rod
	04/97→10/02	Tie Rod End	CV-ES-14163		for Steering Rod
	04/97→10/02	Tie Rod End	DB-ES-5234		for Steering Rod
	04/97→10/02	Tie Rod End	DB-ES-8164		for Push Rod
	04/97→10/02	Tie Rod End	DB-ES-8530		for Push Rod
	04/97→10/02	Track Control Arm		DB-DL-3475	Trailing Arm
04/97→10/02	Track Control Arm		DB-VB-7261	Suspension Rod, Wishbone (CV), 1st RA;2nd RA; Leaf Spring Axle	
04/97→10/02	Track Control Arm		DB-VB-7798	Wishbone (CV)	
04/97→10/02	Track Control Arm	DB-DL-5224		Control Arm	
04/97→10/02	Track Control Arm	DB-DL-9218	DB-DL-9218	Trailing Arm	
3350 AK	10/97→	Ball Head, gearshift linkage	DB-ES-8387		
	10/97→	Ball Head, gearshift linkage	DB-ES-8491		
	10/97→	Ball Head, gearshift linkage	DB-ES-8492		
	10/97→	Ball Head, gearshift linkage	DB-ES-8500		
	10/97→	Bush, parabolic spring		DB-SB-10400	
	10/97→	Bush, parabolic spring		DB-SB-10401	
	10/97→	Centre Rod	DB-DL-5230		Push Rod
	10/97→	Centre Rod	DB-DL-5405		Push Rod
	10/97→	Centre Rod	DB-DL-8307		Push Rod
	10/97→	Centre Rod	DB-DL-8639		Push Rod
	10/97→	Centre Rod	DB-DL-8702		Push Rod
	10/97→	Tie Rod	DB-ES-5227		Guide Rod
	10/97→	Tie Rod	MN-DL-7834		Guide Rod



ACTROS ...

3350 AK ...	10/97→	Tie Rod End	CV-ES-14163		for Steering Rod	
	10/97→	Track Control Arm		DB-DL-3475	Trailing Arm	
	10/97→	Track Control Arm		DB-VB-7261	Suspension Rod, Wishbone (CV)	
	10/97→	Track Control Arm	DB-DL-5224		Control Arm	
	10/97→	Track Control Arm	DB-DL-9218	DB-DL-9218	Trailing Arm	
3350 AS	10/97→	Ball Head, gearshift linkage	DB-ES-8387			
	10/97→	Ball Head, gearshift linkage	DB-ES-8491			
	10/97→	Ball Head, gearshift linkage	DB-ES-8492			
	10/97→	Ball Head, gearshift linkage	DB-ES-8500			
	10/97→	Bush, parabolic spring		DB-SB-10400		
	10/97→	Bush, parabolic spring		DB-SB-10401		
	10/97→	Centre Rod	DB-DL-5230		Push Rod	
	10/97→	Centre Rod	DB-DL-5405		Push Rod	
	10/97→	Centre Rod	DB-DL-8307		Push Rod	
	10/97→	Centre Rod	DB-DL-8639		Push Rod	
	10/97→	Centre Rod	DB-DL-8702		Push Rod	
	10/97→	Centre Rod	DB-DL-9259		Push Rod	
	10/97→	Suspension Arm Repair Kit		DB-RK-8626	for Wishbone (CV)	
	10/97→	Suspension Strut Repair Kit		DB-RK-8391		
	10/97→	Suspension Strut Repair Kit		DB-RK-8710		
	10/97→	Tie Rod	DB-ES-5227		Guide Rod	
	10/97→	Tie Rod	MN-DL-7834		Guide Rod	
	10/97→	Tie Rod End	CV-ES-0543		for Push Rod	
	10/97→	Tie Rod End	CV-ES-14163		for Steering Rod	
	10/97→	Tie Rod End	DB-ES-5234		for Steering Rod	
	10/97→	Track Control Arm		DB-DL-3475	Trailing Arm	
	10/97→	Track Control Arm		DB-VB-7261	Suspension Rod, Wishbone (CV)	
	10/97→	Track Control Arm	DB-DL-5224		Control Arm	
	10/97→	Track Control Arm	DB-DL-9218	DB-DL-9218	Trailing Arm	
	3350 K	10/97→	Ball Head, gearshift linkage	DB-ES-8387		
10/97→		Ball Head, gearshift linkage	DB-ES-8491			
10/97→		Ball Head, gearshift linkage	DB-ES-8492			
10/97→		Ball Head, gearshift linkage	DB-ES-8500			
10/97→		Bush, parabolic spring		DB-SB-10400		
10/97→		Bush, parabolic spring		DB-SB-10401		
10/97→		Centre Rod	DB-DL-5230		Push Rod	
10/97→		Centre Rod	DB-DL-5405		Push Rod	
10/97→		Centre Rod	DB-DL-7270		Push Rod	
10/97→		Centre Rod	DB-DL-8167		Push Rod	
10/97→		Centre Rod	DB-DL-8307		Push Rod	
10/97→		Centre Rod	DB-DL-8702		Push Rod	
10/97→		Rod Assembly	DB-DL-2178		Guide Rod, 1st Front Axle, →504310 03	
10/97→		Suspension Arm Repair Kit		DB-RK-8626	for Wishbone (CV)	
10/97→		Suspension Strut Repair Kit		DB-RK-8391		
10/97→		Suspension Strut Repair Kit		DB-RK-8710		
10/97→		Tie Rod	DB-DL-8171		Guide Rod	
10/97→		Tie Rod	DB-DL-8327		Guide Rod	
10/97→		Tie Rod	DB-DL-8640		Guide Rod	
10/97→		Tie Rod	DB-DL-12310			
10/97→		Tie Rod End	CV-ES-0543		for Push Rod	
10/97→		Tie Rod End	CV-ES-0888		for Push Rod	
10/97→		Tie Rod End	CV-ES-14163		for Steering Rod	
10/97→		Tie Rod End	DB-ES-8164		for Push Rod	
10/97→		Tie Rod End	DB-ES-8530		for Push Rod	
10/97→		Track Control Arm		DB-DL-3475	Trailing Arm	
10/97→		Track Control Arm		DB-VB-7261	Suspension Rod, Wishbone (CV)	
10/97→		Track Control Arm	DB-DL-5224		Control Arm	
10/97→		Track Control Arm	DB-DL-9218	DB-DL-9218	Trailing Arm	
3350 S		10/97→	Ball Head, gearshift linkage	DB-ES-8387		
		10/97→	Ball Head, gearshift linkage	DB-ES-8491		
		10/97→	Ball Head, gearshift linkage	DB-ES-8492		
	10/97→	Ball Head, gearshift linkage	DB-ES-8500			
	10/97→	Bush, parabolic spring		DB-SB-10400		

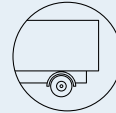
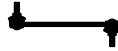

ACTROS ...

3350 S ...	10/97→	Bush, parabolic spring		DB-SB-10401		
	10/97→	Centre Rod	DB-DL-2144		Push Rod	
	10/97→	Centre Rod	DB-DL-5230		Push Rod	
	10/97→	Centre Rod	DB-DL-5405		Push Rod	
	10/97→	Centre Rod	DB-DL-7270		Push Rod	
	10/97→	Centre Rod	DB-DL-8167		Push Rod	
	10/97→	Centre Rod	DB-DL-8307		Push Rod	
	10/97→	Centre Rod	DB-DL-8702		Push Rod	
	10/97→	Rod Assembly	DB-DL-2178		Guide Rod, 1st Front Axle, →504310 03	
	10/97→	Suspension Arm Repair Kit		DB-RK-8626	for Wishbone (CV)	
	10/97→	Suspension Strut Repair Kit		DB-RK-8391		
	10/97→	Suspension Strut Repair Kit		DB-RK-8710		
	10/97→	Tie Rod	DB-DL-8171		Guide Rod	
	10/97→	Tie Rod	DB-DL-8327		Guide Rod	
	10/97→	Tie Rod	DB-DL-8640		Guide Rod	
	10/97→	Tie Rod	DB-DL-12310			
	10/97→	Tie Rod End	CV-ES-0543		for Push Rod	
	10/97→	Tie Rod End	CV-ES-0888		for Push Rod	
	10/97→	Tie Rod End	CV-ES-14163		for Steering Rod	
	10/97→	Tie Rod End	DB-ES-8164		for Push Rod	
	10/97→	Tie Rod End	DB-ES-8530		for Push Rod	
	10/97→	Track Control Arm		DB-DL-3475	Trailing Arm	
	10/97→	Track Control Arm		DB-VB-7261	Suspension Rod, Wishbone (CV)	
	10/97→	Track Control Arm	DB-DL-5224		Control Arm	
	10/97→	Track Control Arm	DB-DL-9218	DB-DL-9218	Trailing Arm	
	3353	04/97→10/02	Ball Head, gearshift linkage	DB-ES-8387		
		04/97→10/02	Ball Head, gearshift linkage	DB-ES-8491		
		04/97→10/02	Ball Head, gearshift linkage	DB-ES-8492		
		04/97→10/02	Ball Head, gearshift linkage	DB-ES-8500		
		04/97→10/02	Ball Head, gearshift linkage	DB-ES-8510		
		04/97→10/02	Bush, driver cab suspension	DB-SB-10384		
		04/97→10/02	Bush, parabolic spring		DB-SB-10400	
		04/97→10/02	Bush, parabolic spring		DB-SB-10401	
04/97→10/02		Centre Rod	DB-DL-2144		Push Rod	
04/97→10/02		Centre Rod	DB-DL-5230		Push Rod, Leaf Spring Axle	
04/97→10/02		Centre Rod	DB-DL-5241		Push Rod	
04/97→10/02		Centre Rod	DB-DL-5405		Push Rod, Leaf Spring Axle	
04/97→10/02		Centre Rod	DB-DL-7270		Push Rod;Suspension Rod	
04/97→10/02		Centre Rod	DB-DL-8167		Push Rod, Leaf Spring Axle	
04/97→10/02		Centre Rod	DB-DL-8168		Push Rod	
04/97→10/02		Centre Rod	DB-DL-8184		Push Rod	
04/97→10/02		Centre Rod	DB-DL-8185		Push Rod	
04/97→10/02		Centre Rod	DB-DL-8188		Push Rod	
04/97→10/02		Centre Rod	DB-DL-8307		Push Rod	
04/97→10/02		Centre Rod	DB-DL-8622		Push Rod	
04/97→10/02		Centre Rod	DB-DL-8641		Push Rod	
04/97→10/02		Centre Rod	DB-DL-8642		Push Rod	
04/97→10/02		Centre Rod	DB-DL-8702		Push Rod, Leaf Spring Axle	
04/97→10/02		Centre Rod	DB-DL-12298		for Steering Rod	
04/97→10/02		Centre Rod	DB-DL-12300		for Steering Rod	
04/97→10/02		Rod Assembly	DB-DL-2178		Guide Rod	
04/97→10/02		Stabiliser Mounting		DB-SB-5250		
04/97→10/02		Stabiliser Mounting		DB-SB-5261		
04/97→10/02		Stabiliser Mounting		DB-SB-10406		
04/97→10/02		Stabiliser Mounting		DB-SB-10407		
04/97→10/02		Stabiliser Mounting	DB-SB-5260			
04/97→10/02		Stabiliser Mounting	DB-SB-5277	DB-SB-5277		
04/97→10/02		Stabiliser Mounting	DB-SB-5279			
04/97→10/02		Suspension Arm Repair Kit		DB-RK-8550	for Wishbone (CV)	
04/97→10/02		Suspension Arm Repair Kit		DB-RK-8626	for Wishbone (CV)	
04/97→10/02		Suspension Strut Repair Kit		DB-RK-8710		
04/97→10/02		Suspension Strut Repair Kit		DB-RK-9291		
04/97→10/02		Tie Rod	DB-DL-8171		Guide Rod	



ACTROS ...

3353 ...	04/97→10/02	Tie Rod	DB-DL-8327		Guide Rod
	04/97→10/02	Tie Rod	DB-DL-8640		Guide Rod
	04/97→10/02	Tie Rod	DB-DL-12310		
	04/97→10/02	Tie Rod	DB-ES-5227		Guide Rod
	04/97→10/02	Tie Rod End	CV-ES-0543		for Push Rod
	04/97→10/02	Tie Rod End	CV-ES-0888		for Push Rod
	04/97→10/02	Tie Rod End	CV-ES-14162		for Steering Rod
	04/97→10/02	Tie Rod End	CV-ES-14163		for Steering Rod
	04/97→10/02	Tie Rod End	DB-ES-8164		for Push Rod
	04/97→10/02	Tie Rod End	DB-ES-8530		for Push Rod
	04/97→10/02	Track Control Arm		DB-DL-3475	Trailing Arm
	04/97→10/02	Track Control Arm		DB-VB-7261	Suspension Rod, Wishbone (CV), 1st RA;2nd RA; Leaf Spring Axle
	04/97→10/02	Track Control Arm	DB-DL-5224		Control Arm
	04/97→10/02	Track Control Arm	DB-DL-9218	DB-DL-9218	Trailing Arm
3353 AS	04/97→10/02	Ball Head, gearshift linkage	DB-ES-8387		
	04/97→10/02	Ball Head, gearshift linkage	DB-ES-8491		
	04/97→10/02	Ball Head, gearshift linkage	DB-ES-8492		
	04/97→10/02	Ball Head, gearshift linkage	DB-ES-8500		
	04/97→10/02	Ball Head, gearshift linkage	DB-ES-8510		
	04/97→10/02	Bush, driver cab suspension	DB-SB-10384		
	04/97→10/02	Bush, parabolic spring		DB-SB-10400	
	04/97→10/02	Bush, parabolic spring		DB-SB-10401	
	04/97→10/02	Centre Rod	DB-DL-2144		Push Rod
	04/97→10/02	Centre Rod	DB-DL-5230		Push Rod
	04/97→10/02	Centre Rod	DB-DL-5241		Push Rod
	04/97→10/02	Centre Rod	DB-DL-5405		Push Rod
	04/97→10/02	Centre Rod	DB-DL-8188		Push Rod
	04/97→10/02	Centre Rod	DB-DL-8307		Push Rod, Leaf Spring Axle
	04/97→10/02	Centre Rod	DB-DL-8639		Push Rod, 1st FA;Leaf Spring Axle
	04/97→10/02	Centre Rod	DB-DL-8702		Push Rod, Leaf Spring Axle
	04/97→10/02	Centre Rod	DB-DL-9259		Push Rod
	04/97→10/02	Centre Rod	DB-DL-12300		for Steering Rod
	04/97→10/02	Rod Assembly	DB-DL-2178		Guide Rod
	04/97→10/02	Stabiliser Mounting		DB-SB-5261	
	04/97→10/02	Stabiliser Mounting		DB-SB-10406	
	04/97→10/02	Stabiliser Mounting		DB-SB-10407	
	04/97→10/02	Stabiliser Mounting		DB-SB-10409	
	04/97→10/02	Stabiliser Mounting	DB-SB-5260		
	04/97→10/02	Stabiliser Mounting	DB-SB-5279		
	04/97→10/02	Stabiliser Mounting	DB-SB-10410		
	04/97→10/02	Suspension Arm Repair Kit		DB-RK-8626	for Wishbone (CV)
	04/97→10/02	Suspension Arm Repair Kit		DB-RK-10374	for Wishbone (CV)
	04/97→10/02	Suspension Arm Repair Kit		DB-RK-10375	for Wishbone (CV)
	04/97→10/02	Suspension Arm Repair Kit	DB-RK-8638		for Control Arm
	04/97→10/02	Suspension Strut Repair Kit		DB-RK-8391	
	04/97→10/02	Suspension Strut Repair Kit		DB-RK-8710	
	04/97→10/02	Suspension Strut Repair Kit		DB-RK-9291	
	04/97→10/02	Suspension Strut Repair Kit		MN-RK-8997	
	04/97→10/02	Tie Rod	DB-DL-12310		
	04/97→10/02	Tie Rod	DB-ES-5227		Guide Rod
	04/97→10/02	Tie Rod	MN-DL-7834		Guide Rod
	04/97→10/02	Tie Rod End	CV-ES-0543		for Push Rod
	04/97→10/02	Tie Rod End	CV-ES-0888		for Push Rod
	04/97→10/02	Tie Rod End	CV-ES-14162		for Steering Rod
	04/97→10/02	Tie Rod End	CV-ES-14163		for Steering Rod
	04/97→10/02	Tie Rod End	DB-ES-5234		for Steering Rod
	04/97→10/02	Track Control Arm		DB-DL-3475	Trailing Arm
	04/97→10/02	Track Control Arm		DB-VB-7261	Suspension Rod, Wishbone (CV), 1st RA;2nd RA; Leaf Spring Axle
	04/97→10/02	Track Control Arm		DB-VB-7798	Wishbone (CV)
	04/97→10/02	Track Control Arm	DB-DL-5224		Control Arm
	04/97→10/02	Track Control Arm	DB-DL-9218	DB-DL-9218	Trailing Arm



ACTROS ...

3353 S	04/97→10/02	Ball Head, gearshift linkage	DB-ES-8387		
	04/97→10/02	Ball Head, gearshift linkage	DB-ES-8491		
	04/97→10/02	Ball Head, gearshift linkage	DB-ES-8492		
	04/97→10/02	Ball Head, gearshift linkage	DB-ES-8500		
	04/97→10/02	Ball Head, gearshift linkage	DB-ES-8510		
	04/97→10/02	Bush, driver cab suspension	DB-SB-10384		
	04/97→10/02	Bush, parabolic spring		DB-SB-10400	
	04/97→10/02	Bush, parabolic spring		DB-SB-10401	
	04/97→10/02	Centre Rod	DB-DL-2144		Push Rod
	04/97→10/02	Centre Rod	DB-DL-5230		Push Rod, 1st FA;Leaf Spring Axle
	04/97→10/02	Centre Rod	DB-DL-5241		Push Rod
	04/97→10/02	Centre Rod	DB-DL-5405		Push Rod, Leaf Spring Axle
	04/97→10/02	Centre Rod	DB-DL-7270		Push Rod
	04/97→10/02	Centre Rod	DB-DL-8167		Push Rod, 1st FA;Leaf Spring Axle
	04/97→10/02	Centre Rod	DB-DL-8184		Push Rod
	04/97→10/02	Centre Rod	DB-DL-8185		Push Rod
	04/97→10/02	Centre Rod	DB-DL-8188		Push Rod
	04/97→10/02	Centre Rod	DB-DL-8307		Push Rod
	04/97→10/02	Centre Rod	DB-DL-8702		Push Rod, Leaf Spring Axle
	04/97→10/02	Centre Rod	DB-DL-12300		for Steering Rod
	04/97→10/02	Rod Assembly	DB-DL-2178		Guide Rod
	04/97→10/02	Stabiliser Mounting		DB-SB-5261	
	04/97→10/02	Stabiliser Mounting		DB-SB-10406	
	04/97→10/02	Stabiliser Mounting		DB-SB-10407	
	04/97→10/02	Stabiliser Mounting		DB-SB-10409	
	04/97→10/02	Stabiliser Mounting	DB-SB-5260		
	04/97→10/02	Stabiliser Mounting	DB-SB-5279		
	04/97→10/02	Stabiliser Mounting	DB-SB-10410		
	04/97→10/02	Suspension Arm Repair Kit		DB-RK-8550	for Wishbone (CV)
	04/97→10/02	Suspension Arm Repair Kit		DB-RK-8626	for Wishbone (CV)
	04/97→10/02	Suspension Arm Repair Kit		DB-RK-10374	for Wishbone (CV)
	04/97→10/02	Suspension Arm Repair Kit		DB-RK-10375	for Wishbone (CV)
	04/97→10/02	Suspension Arm Repair Kit	DB-RK-8638		for Control Arm
	04/97→10/02	Suspension Strut Repair Kit		DB-RK-8391	
	04/97→10/02	Suspension Strut Repair Kit		DB-RK-8710	
	04/97→10/02	Suspension Strut Repair Kit		DB-RK-9291	
	04/97→10/02	Suspension Strut Repair Kit		MN-RK-8997	
	04/97→10/02	Tie Rod	DB-DL-8171		Guide Rod
	04/97→10/02	Tie Rod	DB-DL-8327		Guide Rod
	04/97→10/02	Tie Rod	DB-DL-8640		Guide Rod
	04/97→10/02	Tie Rod	DB-DL-12310		
	04/97→10/02	Tie Rod	DB-ES-5227		Guide Rod
	04/97→10/02	Tie Rod End	CV-ES-0543		for Push Rod
	04/97→10/02	Tie Rod End	CV-ES-0888		for Push Rod
	04/97→10/02	Tie Rod End	CV-ES-14162		for Steering Rod
04/97→10/02	Tie Rod End	CV-ES-14163		for Steering Rod	
04/97→10/02	Tie Rod End	DB-ES-5234		for Steering Rod	
04/97→10/02	Tie Rod End	DB-ES-8164		for Push Rod	
04/97→10/02	Tie Rod End	DB-ES-8530		for Push Rod	
04/97→10/02	Track Control Arm		DB-DL-3475	Trailing Arm	
04/97→10/02	Track Control Arm		DB-VB-7261	Suspension Rod, Wishbone (CV), 1st RA;2nd RA; Leaf Spring Axle	
04/97→10/02	Track Control Arm		DB-VB-7798	Wishbone (CV)	
04/97→10/02	Track Control Arm	DB-DL-5224		Control Arm	
04/97→10/02	Track Control Arm	DB-DL-9218	DB-DL-9218	Trailing Arm	
3357	04/97→10/02	Ball Head, gearshift linkage	DB-ES-8387		
	04/97→10/02	Ball Head, gearshift linkage	DB-ES-8491		
	04/97→10/02	Ball Head, gearshift linkage	DB-ES-8492		
	04/97→10/02	Ball Head, gearshift linkage	DB-ES-8500		
	04/97→10/02	Ball Head, gearshift linkage	DB-ES-8510		
	04/97→10/02	Bush, driver cab suspension	DB-SB-10384		
	04/97→10/02	Bush, parabolic spring		DB-SB-10400	
04/97→10/02	Bush, parabolic spring		DB-SB-10401		

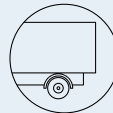

ACTROS ...

3357 ...	04/97→10/02	Centre Rod	DB-DL-2144		Push Rod	
	04/97→10/02	Centre Rod	DB-DL-5230		Push Rod, Leaf Spring Axle	
	04/97→10/02	Centre Rod	DB-DL-5241		Push Rod	
	04/97→10/02	Centre Rod	DB-DL-5405		Push Rod, Leaf Spring Axle	
	04/97→10/02	Centre Rod	DB-DL-7270		Push Rod;Suspension Rod	
	04/97→10/02	Centre Rod	DB-DL-8167		Push Rod, Leaf Spring Axle	
	04/97→10/02	Centre Rod	DB-DL-8168		Push Rod	
	04/97→10/02	Centre Rod	DB-DL-8184		Push Rod	
	04/97→10/02	Centre Rod	DB-DL-8185		Push Rod	
	04/97→10/02	Centre Rod	DB-DL-8188		Push Rod	
	04/97→10/02	Centre Rod	DB-DL-8307		Push Rod	
	04/97→10/02	Centre Rod	DB-DL-8622		Push Rod	
	04/97→10/02	Centre Rod	DB-DL-8641		Push Rod	
	04/97→10/02	Centre Rod	DB-DL-8642		Push Rod	
	04/97→10/02	Centre Rod	DB-DL-8702		Push Rod, Leaf Spring Axle	
	04/97→10/02	Centre Rod	DB-DL-12298		for Steering Rod	
	04/97→10/02	Centre Rod	DB-DL-12300		for Steering Rod	
	04/97→10/02	Rod Assembly	DB-DL-2178		Guide Rod	
	04/97→10/02	Stabiliser Mounting		DB-SB-5250		
	04/97→10/02	Stabiliser Mounting		DB-SB-5261		
	04/97→10/02	Stabiliser Mounting		DB-SB-10406		
	04/97→10/02	Stabiliser Mounting		DB-SB-10407		
	04/97→10/02	Stabiliser Mounting	DB-SB-5260			
	04/97→10/02	Stabiliser Mounting	DB-SB-5277	DB-SB-5277		
	04/97→10/02	Stabiliser Mounting	DB-SB-5279			
	04/97→10/02	Suspension Arm Repair Kit		DB-RK-8550	for Wishbone (CV)	
	04/97→10/02	Suspension Arm Repair Kit		DB-RK-8626	for Wishbone (CV)	
	04/97→10/02	Suspension Strut Repair Kit		DB-RK-8710		
	04/97→10/02	Suspension Strut Repair Kit		DB-RK-9291		
	04/97→10/02	Tie Rod	DB-DL-8171		Guide Rod	
	04/97→10/02	Tie Rod	DB-DL-8327		Guide Rod	
	04/97→10/02	Tie Rod	DB-DL-8640		Guide Rod	
	04/97→10/02	Tie Rod	DB-DL-12310			
	04/97→10/02	Tie Rod	DB-ES-5227		Guide Rod	
	04/97→10/02	Tie Rod End	CV-ES-0543		for Push Rod	
	04/97→10/02	Tie Rod End	CV-ES-0888		for Push Rod	
	04/97→10/02	Tie Rod End	CV-ES-14162		for Steering Rod	
	04/97→10/02	Tie Rod End	CV-ES-14163		for Steering Rod	
	04/97→10/02	Tie Rod End	DB-ES-8164		for Push Rod	
	04/97→10/02	Tie Rod End	DB-ES-8530		for Push Rod	
	04/97→10/02	Track Control Arm		DB-DL-3475	Trailing Arm	
	04/97→10/02	Track Control Arm		DB-VB-7261	Suspension Rod, Wishbone (CV), 1st RA;2nd RA; Leaf Spring Axle	
	04/97→10/02	Track Control Arm	DB-DL-5224		Control Arm	
	04/97→10/02	Track Control Arm	DB-DL-9218	DB-DL-9218	Trailing Arm	
	3357 S	04/97→10/02	Ball Head, gearshift linkage	DB-ES-8387		
		04/97→10/02	Ball Head, gearshift linkage	DB-ES-8491		
		04/97→10/02	Ball Head, gearshift linkage	DB-ES-8492		
04/97→10/02		Ball Head, gearshift linkage	DB-ES-8500			
04/97→10/02		Ball Head, gearshift linkage	DB-ES-8510			
04/97→10/02		Bush, driver cab suspension	DB-SB-10384			
04/97→10/02		Bush, parabolic spring		DB-SB-10400		
04/97→10/02		Bush, parabolic spring		DB-SB-10401		
04/97→10/02		Centre Rod	DB-DL-2144		Push Rod	
04/97→10/02		Centre Rod	DB-DL-5230		Push Rod, 1st FA;Leaf Spring Axle	
04/97→10/02		Centre Rod	DB-DL-5241		Push Rod	
04/97→10/02		Centre Rod	DB-DL-5405		Push Rod, Leaf Spring Axle	
04/97→10/02		Centre Rod	DB-DL-7270		Push Rod	
04/97→10/02		Centre Rod	DB-DL-8167		Push Rod, 1st FA;Leaf Spring Axle	
04/97→10/02		Centre Rod	DB-DL-8184		Push Rod	
04/97→10/02		Centre Rod	DB-DL-8185		Push Rod	
04/97→10/02		Centre Rod	DB-DL-8188		Push Rod	
04/97→10/02		Centre Rod	DB-DL-8307		Push Rod	



ACTROS ...

3357 S ...	04/97→10/02	Centre Rod	DB-DL-8702		Push Rod, Leaf Spring Axle	
	04/97→10/02	Centre Rod	DB-DL-12300		for Steering Rod	
	04/97→10/02	Rod Assembly	DB-DL-2178		Guide Rod	
	04/97→10/02	Stabiliser Mounting		DB-SB-5261		
	04/97→10/02	Stabiliser Mounting		DB-SB-10406		
	04/97→10/02	Stabiliser Mounting		DB-SB-10407		
	04/97→10/02	Stabiliser Mounting		DB-SB-10409		
	04/97→10/02	Stabiliser Mounting	DB-SB-5260			
	04/97→10/02	Stabiliser Mounting	DB-SB-5279			
	04/97→10/02	Stabiliser Mounting	DB-SB-10410			
	04/97→10/02	Suspension Arm Repair Kit		DB-RK-8550	for Wishbone (CV)	
	04/97→10/02	Suspension Arm Repair Kit		DB-RK-8626	for Wishbone (CV)	
	04/97→10/02	Suspension Arm Repair Kit		DB-RK-10374	for Wishbone (CV)	
	04/97→10/02	Suspension Arm Repair Kit		DB-RK-10375	for Wishbone (CV)	
	04/97→10/02	Suspension Arm Repair Kit	DB-RK-8638		for Control Arm	
	04/97→10/02	Suspension Strut Repair Kit		DB-RK-8391		
	04/97→10/02	Suspension Strut Repair Kit		DB-RK-8710		
	04/97→10/02	Suspension Strut Repair Kit		DB-RK-9291		
	04/97→10/02	Suspension Strut Repair Kit		MN-RK-8997		
	04/97→10/02	Tie Rod	DB-DL-8171		Guide Rod	
	04/97→10/02	Tie Rod	DB-DL-8327		Guide Rod	
	04/97→10/02	Tie Rod	DB-DL-8640		Guide Rod	
	04/97→10/02	Tie Rod	DB-DL-12310			
	04/97→10/02	Tie Rod	DB-ES-5227		Guide Rod	
	04/97→10/02	Tie Rod End	CV-ES-0543		for Push Rod	
	04/97→10/02	Tie Rod End	CV-ES-0888		for Push Rod	
	04/97→10/02	Tie Rod End	CV-ES-14162		for Steering Rod	
	04/97→10/02	Tie Rod End	CV-ES-14163		for Steering Rod	
	04/97→10/02	Tie Rod End	DB-ES-5234		for Steering Rod	
	04/97→10/02	Tie Rod End	DB-ES-8164		for Push Rod	
	04/97→10/02	Tie Rod End	DB-ES-8530		for Push Rod	
	04/97→10/02	Track Control Arm		DB-DL-3475	Trailing Arm	
	04/97→10/02	Track Control Arm		DB-VB-7261	Suspension Rod, Wishbone (CV), 1st RA;2nd RA; Leaf Spring Axle	
	04/97→10/02	Track Control Arm		DB-VB-7798	Wishbone (CV)	
	04/97→10/02	Track Control Arm	DB-DL-5224		Control Arm	
	04/97→10/02	Track Control Arm	DB-DL-9218	DB-DL-9218	Trailing Arm	
	4140 AK	04/97→10/02	Ball Head, gearshift linkage	DB-ES-8387		
		04/97→10/02	Ball Head, gearshift linkage	DB-ES-8491		
		04/97→10/02	Ball Head, gearshift linkage	DB-ES-8492		
		04/97→10/02	Ball Head, gearshift linkage	DB-ES-8500		
04/97→10/02		Ball Head, gearshift linkage	DB-ES-8510			
04/97→10/02		Bush, driver cab suspension	DB-SB-10384			
04/97→10/02		Bush, parabolic spring		DB-SB-10400		
04/97→10/02		Bush, parabolic spring		DB-SB-10401		
04/97→10/02		Centre Rod	DB-DL-2144		Push Rod	
04/97→10/02		Centre Rod	DB-DL-5230		Push Rod	
04/97→10/02		Centre Rod	DB-DL-5405		Push Rod	
04/97→10/02		Centre Rod	DB-DL-8184		Push Rod	
04/97→10/02		Centre Rod	DB-DL-8188		Push Rod	
04/97→10/02		Centre Rod	DB-DL-8307		Push Rod	
04/97→10/02		Centre Rod	DB-DL-10208		Push Rod, Leaf Spring Axle	
04/97→10/02		Centre Rod	DB-DL-12300		for Steering Rod	
04/97→10/02		Centre Rod	DB-DL-12403		Push Rod	
04/97→10/02		Rod Assembly	DB-DL-2178		Guide Rod	
04/97→10/02		Stabiliser Link	DB-DL-9254		Pressure Rod	
04/97→10/02		Stabiliser Mounting		DB-SB-5261		
04/97→10/02		Stabiliser Mounting		DB-SB-10406		
04/97→10/02		Stabiliser Mounting		DB-SB-10407		
04/97→10/02		Stabiliser Mounting		DB-SB-10409		
04/97→10/02		Stabiliser Mounting	DB-SB-5260			
04/97→10/02		Stabiliser Mounting	DB-SB-5279			
04/97→10/02		Suspension Arm Repair Kit		DB-RK-8626	for Wishbone (CV)	



ACTROS ...

4140 AK ...	04/97→10/02	Suspension Arm Repair Kit		DB-RK-10374	for Wishbone (CV)
	04/97→10/02	Suspension Arm Repair Kit		DB-RK-10375	for Wishbone (CV)
	04/97→10/02	Suspension Arm Repair Kit	DB-RK-8638		for Control Arm
	04/97→10/02	Suspension Strut Repair Kit		DB-RK-8391	
	04/97→10/02	Suspension Strut Repair Kit		DB-RK-8710	
	04/97→10/02	Suspension Strut Repair Kit		DB-RK-9291	
	04/97→10/02	Tie Rod	DB-DL-12310		
	04/97→10/02	Tie Rod	DB-ES-5227		Guide Rod, 1st FA
	04/97→10/02	Tie Rod End	CV-ES-0543		for Push Rod
	04/97→10/02	Tie Rod End	CV-ES-0888		for Push Rod
	04/97→10/02	Tie Rod End	CV-ES-14162		for Steering Rod
	04/97→10/02	Tie Rod End	CV-ES-14163		for Steering Rod
	04/97→10/02	Tie Rod End	DB-ES-5234		for Steering Rod
	04/97→10/02	Tie Rod End	DB-ES-8323		Leaf Spring Axle
	04/97→10/02	Tie Rod End	DB-ES-8530		for Push Rod
	04/97→10/02	Track Control Arm		DB-DL-3475	Trailing Arm
	04/97→10/02	Track Control Arm		DB-VB-7261	Suspension Rod, Wishbone (CV), 1st RA;2nd RA; Leaf Spring Axle
	04/97→10/02	Track Control Arm	DB-DL-5224		Control Arm
04/97→10/02	Track Control Arm	DB-DL-9218	DB-DL-9218	Trailing Arm	
4140 B	04/97→10/02	Ball Head, gearshift linkage	DB-ES-8387		
	04/97→10/02	Ball Head, gearshift linkage	DB-ES-8491		
	04/97→10/02	Ball Head, gearshift linkage	DB-ES-8492		
	04/97→10/02	Ball Head, gearshift linkage	DB-ES-8500		
	04/97→10/02	Ball Head, gearshift linkage	DB-ES-8510		
	04/97→10/02	Bush, driver cab suspension	DB-SB-10384		
	04/97→10/02	Bush, parabolic spring		DB-SB-10400	
	04/97→10/02	Bush, parabolic spring		DB-SB-10401	
	04/97→10/02	Centre Rod	DB-DL-2144		Push Rod
	04/97→10/02	Centre Rod	DB-DL-5230		Push Rod
	04/97→10/02	Centre Rod	DB-DL-5405		Push Rod
	04/97→10/02	Centre Rod	DB-DL-8168		Push Rod, Leaf Spring Axle
	04/97→10/02	Centre Rod	DB-DL-8184		Push Rod, Leaf Spring Axle
	04/97→10/02	Centre Rod	DB-DL-8185		Push Rod, Leaf Spring Axle
	04/97→10/02	Centre Rod	DB-DL-8188		Push Rod
	04/97→10/02	Centre Rod	DB-DL-8307		Push Rod
	04/97→10/02	Centre Rod	DB-DL-9259		Push Rod, Leaf Spring Axle
	04/97→10/02	Centre Rod	DB-DL-10212		Push Rod, Leaf Spring Axle
	04/97→10/02	Centre Rod	DB-DL-12300		for Steering Rod
	04/97→10/02	Rod Assembly	DB-DL-2178		Guide Rod
	04/97→10/02	Stabiliser Link	DB-DL-9254		Pressure Rod
	04/97→10/02	Stabiliser Link	DB-DL-9271		Pressure Rod
	04/97→10/02	Stabiliser Link	DB-DL-9272		Pressure Rod
	04/97→10/02	Stabiliser Mounting		DB-SB-5261	
	04/97→10/02	Stabiliser Mounting		DB-SB-10406	
	04/97→10/02	Stabiliser Mounting		DB-SB-10407	
	04/97→10/02	Stabiliser Mounting		DB-SB-10409	
	04/97→10/02	Stabiliser Mounting	DB-SB-5260		
	04/97→10/02	Stabiliser Mounting	DB-SB-5279		
	04/97→10/02	Suspension Arm Repair Kit		DB-RK-8626	for Wishbone (CV)
	04/97→10/02	Suspension Arm Repair Kit		DB-RK-10374	for Wishbone (CV)
	04/97→10/02	Suspension Arm Repair Kit		DB-RK-10375	for Wishbone (CV)
	04/97→10/02	Suspension Arm Repair Kit	DB-RK-8638		for Control Arm
	04/97→10/02	Suspension Strut Repair Kit		DB-RK-8391	
	04/97→10/02	Suspension Strut Repair Kit		DB-RK-8710	
	04/97→10/02	Suspension Strut Repair Kit		DB-RK-9291	
	04/97→10/02	Tie Rod	DB-DL-8171		Guide Rod
	04/97→10/02	Tie Rod	DB-DL-8172		Guide Rod
	04/97→10/02	Tie Rod	DB-DL-8327		Guide Rod
	04/97→10/02	Tie Rod	DB-DL-8390		
	04/97→10/02	Tie Rod	DB-DL-8640		Guide Rod
04/97→10/02	Tie Rod	DB-DL-12310			
04/97→10/02	Tie Rod End	CV-ES-0543		for Push Rod	

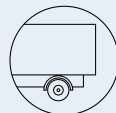

ACTROS ...

4140 B ...	04/97→10/02	Tie Rod End	CV-ES-0888		for Push Rod
	04/97→10/02	Tie Rod End	CV-ES-14162		for Steering Rod
	04/97→10/02	Tie Rod End	CV-ES-14163		for Steering Rod
	04/97→10/02	Tie Rod End	DB-ES-5234		for Steering Rod
	04/97→10/02	Tie Rod End	DB-ES-8323		Leaf Spring Axle
	04/97→10/02	Tie Rod End	DB-ES-8530		for Push Rod
	04/97→10/02	Track Control Arm		DB-DL-3475	Trailing Arm
	04/97→10/02	Track Control Arm		DB-VB-7261	Suspension Rod, Wishbone (CV), 1st RA;2nd RA; Leaf Spring Axle
	04/97→10/02	Track Control Arm	DB-DL-5224		Control Arm
	04/97→10/02	Track Control Arm	DB-DL-9218	DB-DL-9218	Trailing Arm
4140 K	04/97→10/02	Ball Head, gearshift linkage	DB-ES-8387		
	04/97→10/02	Ball Head, gearshift linkage	DB-ES-8491		
	04/97→10/02	Ball Head, gearshift linkage	DB-ES-8492		
	04/97→10/02	Ball Head, gearshift linkage	DB-ES-8500		
	04/97→10/02	Ball Head, gearshift linkage	DB-ES-8510		
	04/97→10/02	Bush, driver cab suspension	DB-SB-10384		
	04/97→10/02	Bush, parabolic spring		DB-SB-10400	
	04/97→10/02	Bush, parabolic spring		DB-SB-10401	
	04/97→10/02	Centre Rod	DB-DL-2144		Push Rod
	04/97→10/02	Centre Rod	DB-DL-5230		Push Rod
	04/97→10/02	Centre Rod	DB-DL-5405		Push Rod
	04/97→10/02	Centre Rod	DB-DL-7270		Push Rod
	04/97→10/02	Centre Rod	DB-DL-8168		Push Rod, 1st FA;Leaf Spring Axle
	04/97→10/02	Centre Rod	DB-DL-8184		Push Rod
	04/97→10/02	Centre Rod	DB-DL-8184		Push Rod, Leaf Spring Axle
	04/97→10/02	Centre Rod	DB-DL-8185		Push Rod, Leaf Spring Axle
	04/97→10/02	Centre Rod	DB-DL-8188		Push Rod
	04/97→10/02	Centre Rod	DB-DL-8307		Push Rod
	04/97→10/02	Centre Rod	DB-DL-9259		Push Rod, 1st FA;Leaf Spring Axle
	04/97→10/02	Centre Rod	DB-DL-10208		Push Rod, Leaf Spring Axle
	04/97→10/02	Centre Rod	DB-DL-10212		Push Rod, Leaf Spring Axle
	04/97→10/02	Centre Rod	DB-DL-12300		for Steering Rod
	04/97→10/02	Centre Rod	DB-DL-12301		Push Rod, Leaf Spring Axle
	04/97→10/02	Centre Rod	DB-DL-12403		Push Rod
	04/97→10/02	Rod Assembly	DB-DL-2178		Guide Rod
	04/97→10/02	Stabiliser Link	DB-DL-9254		Pressure Rod
	04/97→10/02	Stabiliser Link	DB-DL-9271		Pressure Rod
	04/97→10/02	Stabiliser Link	DB-DL-9272		Pressure Rod
	04/97→10/02	Stabiliser Mounting		DB-SB-5261	
	04/97→10/02	Stabiliser Mounting		DB-SB-10406	
	04/97→10/02	Stabiliser Mounting		DB-SB-10407	
	04/97→10/02	Stabiliser Mounting		DB-SB-10409	
	04/97→10/02	Stabiliser Mounting	DB-SB-5260		
	04/97→10/02	Stabiliser Mounting	DB-SB-5279		
	04/97→10/02	Suspension Arm Repair Kit		DB-RK-8626	for Wishbone (CV)
	04/97→10/02	Suspension Arm Repair Kit		DB-RK-10374	for Wishbone (CV)
	04/97→10/02	Suspension Arm Repair Kit		DB-RK-10375	for Wishbone (CV)
	04/97→10/02	Suspension Arm Repair Kit	DB-RK-8638		for Control Arm
	04/97→10/02	Suspension Strut Repair Kit		DB-RK-8391	
	04/97→10/02	Suspension Strut Repair Kit		DB-RK-8710	
	04/97→10/02	Suspension Strut Repair Kit		DB-RK-9291	
	04/97→10/02	Tie Rod	DB-DL-8171		Guide Rod
	04/97→10/02	Tie Rod	DB-DL-8327		Guide Rod
	04/97→10/02	Tie Rod	DB-DL-8390		
	04/97→10/02	Tie Rod	DB-DL-8640		Guide Rod
	04/97→10/02	Tie Rod	DB-DL-12310		
	04/97→10/02	Tie Rod	DB-ES-5227		Guide Rod
	04/97→10/02	Tie Rod	DB-ES-5227		Guide Rod, 2nd FA
	04/97→10/02	Tie Rod	MN-DL-7834		Guide Rod
	04/97→10/02	Tie Rod End	CV-ES-0543		for Push Rod
	04/97→10/02	Tie Rod End	CV-ES-0888		for Push Rod
	04/97→10/02	Tie Rod End	CV-ES-14162		for Steering Rod

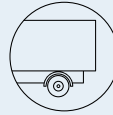
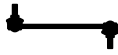

ACTROS ...

4140 K ...	04/97→10/02	Tie Rod End	CV-ES-14163		for Steering Rod
	04/97→10/02	Tie Rod End	DB-ES-5234		for Steering Rod
	04/97→10/02	Tie Rod End	DB-ES-8164		for Push Rod
	04/97→10/02	Tie Rod End	DB-ES-8323		Leaf Spring Axle
	04/97→10/02	Tie Rod End	DB-ES-8530		for Push Rod
	04/97→10/02	Track Control Arm		DB-DL-3475	Trailing Arm
	04/97→10/02	Track Control Arm		DB-VB-7261	Suspension Rod, Wishbone (CV), 1st RA;2nd RA; Leaf Spring Axle
	04/97→10/02	Track Control Arm	DB-DL-5224		Control Arm
	04/97→10/02	Track Control Arm	DB-DL-9218	DB-DL-9218	Trailing Arm
	4143 AK	04/97→10/02	Ball Head, gearshift linkage	DB-ES-8387	
04/97→10/02		Ball Head, gearshift linkage	DB-ES-8491		
04/97→10/02		Ball Head, gearshift linkage	DB-ES-8492		
04/97→10/02		Ball Head, gearshift linkage	DB-ES-8500		
04/97→10/02		Ball Head, gearshift linkage	DB-ES-8510		
04/97→10/02		Bush, driver cab suspension	DB-SB-10384		
04/97→10/02		Bush, parabolic spring		DB-SB-10400	
04/97→10/02		Bush, parabolic spring		DB-SB-10401	
04/97→10/02		Centre Rod	DB-DL-2144		Push Rod
04/97→10/02		Centre Rod	DB-DL-5230		Push Rod
04/97→10/02		Centre Rod	DB-DL-5405		Push Rod
04/97→10/02		Centre Rod	DB-DL-8184		Push Rod
04/97→10/02		Centre Rod	DB-DL-8188		Push Rod
04/97→10/02		Centre Rod	DB-DL-8307		Push Rod
04/97→10/02		Centre Rod	DB-DL-10208		Push Rod, Leaf Spring Axle
04/97→10/02		Centre Rod	DB-DL-12300		for Steering Rod
04/97→10/02		Centre Rod	DB-DL-12403		Push Rod
04/97→10/02		Rod Assembly	DB-DL-2178		Guide Rod
04/97→10/02		Stabiliser Link	DB-DL-9254		Pressure Rod
04/97→10/02		Stabiliser Mounting		DB-SB-5261	
04/97→10/02		Stabiliser Mounting		DB-SB-10406	
04/97→10/02		Stabiliser Mounting		DB-SB-10407	
04/97→10/02		Stabiliser Mounting		DB-SB-10409	
04/97→10/02		Stabiliser Mounting	DB-SB-5260		
04/97→10/02		Stabiliser Mounting	DB-SB-5279		
04/97→10/02		Suspension Arm Repair Kit		DB-RK-8626	for Wishbone (CV)
04/97→10/02		Suspension Arm Repair Kit		DB-RK-10374	for Wishbone (CV)
04/97→10/02		Suspension Arm Repair Kit		DB-RK-10375	for Wishbone (CV)
04/97→10/02		Suspension Arm Repair Kit	DB-RK-8638		for Control Arm
04/97→10/02		Suspension Strut Repair Kit		DB-RK-8391	
04/97→10/02		Suspension Strut Repair Kit		DB-RK-8710	
04/97→10/02		Suspension Strut Repair Kit		DB-RK-9291	
04/97→10/02		Tie Rod	DB-DL-12310		
04/97→10/02		Tie Rod	DB-ES-5227		Guide Rod, 1st FA
04/97→10/02		Tie Rod End	CV-ES-0543		for Push Rod
04/97→10/02		Tie Rod End	CV-ES-0888		for Push Rod
04/97→10/02		Tie Rod End	CV-ES-14162		for Steering Rod
04/97→10/02		Tie Rod End	CV-ES-14163		for Steering Rod
04/97→10/02		Tie Rod End	DB-ES-5234		for Steering Rod
04/97→10/02		Tie Rod End	DB-ES-8323		Leaf Spring Axle
04/97→10/02		Tie Rod End	DB-ES-8530		for Push Rod
04/97→10/02		Track Control Arm		DB-DL-3475	Trailing Arm
04/97→10/02		Track Control Arm		DB-VB-7261	Suspension Rod, Wishbone (CV), 1st RA;2nd RA; Leaf Spring Axle
04/97→10/02		Track Control Arm	DB-DL-5224		Control Arm
04/97→10/02		Track Control Arm	DB-DL-9218	DB-DL-9218	Trailing Arm
4143 K	04/97→10/02	Ball Head, gearshift linkage	DB-ES-8387		
	04/97→10/02	Ball Head, gearshift linkage	DB-ES-8491		
	04/97→10/02	Ball Head, gearshift linkage	DB-ES-8492		
	04/97→10/02	Ball Head, gearshift linkage	DB-ES-8500		
	04/97→10/02	Ball Head, gearshift linkage	DB-ES-8510		
	04/97→10/02	Bush, driver cab suspension	DB-SB-10384		
	04/97→10/02	Bush, parabolic spring		DB-SB-10400	

CV-ES-0543

Length: 125
Cone Ø: d1 Ø 32 / d2 Ø 29
Thread: M30 x 1,5 RHT
0004605748, 0004606048, 0004606848,
0004607048, 0014600448, 0014601148,
0014601748, 0014602448, 0014607648,
0014609648

**CV-ES-0888**

Length: 125
Cone Ø: d1 Ø 32 / d2 Ø 29
Thread: M30 x 1,5 LHT
0004605848, 0004606148, 0004606948,
0004607148, 0004609048, 0014600548,
0014601348, 0014602548, 0014607948,
0024600448

**CV-ES-14162**

Length: 125
Cone Ø: d1 Ø 30 / d2 Ø 27
Thread: M30 x 1,5 LHT
4600648, 4601248, 4603448,
0004603548, 4603548, 14600348,
14601448, 14602348, 0014603748,
14607848, 0014607848, 0024600348

**CV-ES-14163**

Length: 125
Cone Ø: d1 Ø 30 / d2 Ø 27
Thread: M30 x 1,5 RHT
0003305248, 0003387310, 0004600348,
0004600948, 0004602848, 0004602948,
0004608948, 0014600248, 0014600848,
0014601248, 0014602248, 0014607748,
0024600148, A0003387310, A0004600348,
A0004602848, A0004602948, A0014600848,
A0014601248, A0014602248, A0014607748

**DB-DL-2144**

Length: 872 Ø: 35
Cone Ø: d1 Ø 28,6 / d2 Ø 23,9
0024604305, 0024604405, 0034604805

**DB-DL-2178**

Length: 1735 Ø: 52
Cone Ø: d1 Ø 32 / d2 Ø 29
9423300003, 9423300103, 9423300203

**DB-DL-3475**

Length: 565 Ø: 52
Hole Distance: 152 / 152
3753500006, 3753500206, 9473500805,
9483500006, 9483500805, 9483501205,
9483501305, 9483501905, 9483502005,
9483502405, A3753500006,
A3753500206

**DB-DL-5224**

Length: 850 Ø: 60
Hole Distance: 100 / 100
01336100A, 9413300007

**DB-DL-5230**

Length: 879 Ø: 42
Cone Ø: d1 Ø 30 / d2 Ø 27
01208600A, 0004607105, 0004607205,
0014606705

**DB-DL-5405**

Length: 890 Ø: 35
Cone Ø: d1 Ø 28,6 / d2 Ø 23,9
01215900A, 1460248, 0024604505,
0024604605, 0034605005, 3752600637,
3754600405, A3752600637, A3754600405

**DB-DL-8184**

Length: 1095 Ø: 42
Cone Ø: d1 Ø 32 / d2 Ø 28,8
01217700A, 0014601305, 0014601405,
0024600505, 0034603205, 3754601505,
A0014601305, A0014601405, A0024600505

**DB-DL-8188**

Length: 895 Ø: 40
Cone Ø: d1 Ø 28,6 / d2 Ø 23,9
01217200A, 0024604905, 0024605005,
0034605605

**DB-DL-8307**

Length: 885 Ø: 38
Cone Ø: d1 Ø 32 / d2 Ø 30
01215500A, 0004604005, 0024605105,
0024605205, 0034604005

**DB-DL-9218**

Length: 754 Ø: 40
Hole Distance: 100
000360098524, 000390098524,
3753300111, 9413300011,
A3753300111, SA50831601

**DB-DL-9254**

Length: 1815 Ø: 58
0003220323, 0003220623, 3753220423

**DB-DL-10208**

Length: 708 Ø: 40
Cone Ø: d1 Ø 32 / d2 Ø 29
0014605305, 0024600605

**DB-DL-12300**

Length: 733 Ø: 36
Cone Ø: d1 Ø 32 / d2 Ø 29
0014601505, 0014607305, 0034603305,
3754601605, A0014601505,
A0034603305, A3754601605

**DB-DL-12310**

Length: 1532 Ø: 50
Cone Ø: d1 Ø 32 / d2 Ø 29
Thread: M27 x 1,5 LHT
9493301203, 9493301303, 9493301803,
9493302203, A9493301203, A9493301303,
A9493301803, A9493302203

**DB-DL-12403**

Length: 893 Ø: 42
Cone Ø: d1 Ø 32 / d2 Ø 29
0014604905, 0014607405

**DB-ES-5227**

Length: 1588 Ø: 60
Cone Ø: d1 Ø 38 / d2 Ø 34,3
6253300903, 6253301203, 9443300203

**DB-ES-5234**

Length: 135
Cone Ø: d1 Ø 38 / d2 Ø 34,3
Thread: M38 x 1,5 RHT
0004601748, 120322305, 2205000400

**DB-ES-8164**

Length: 140
Cone Ø: d1 Ø 28,6 / d2 Ø 23,9
Thread: M28 x 1,5 RHT
0014604248, 0014605048, 0014608548,
0024600548

**DB-ES-8323**

Length: 75
Cone Ø: d1 Ø 32 / d2 Ø 28,8
Thread: M26 x 1,5 RHT
0014601548, 0014601648, 0024600648,
A0014601648, A0024600648

**DB-ES-8387**

Length: 55
Cone Ø: d1 Ø 10 / d2 Ø 10
Thread: M14 x 1,5 RHT
0009966845, 0009967045

**DB-ES-8491**

Length: 60
Cone Ø: d1 Ø 10 / d2 Ø 10
Thread: M12 x 1,75 LHT
0009966745

**DB-ES-8492**

Length: 60
Cone Ø: d1 Ø 10 / d2 Ø 10
Thread: M12 x 1,75 RHT
0009966645, 3752680189, A3752680189

**DB-ES-8500**

Length: 55
Cone Ø: d1 Ø 12 / d2 Ø 10,8
Thread: M14 x 1,5 RHT
0002685989

**DB-ES-8510**

Length: 56
Cone Ø: d1 Ø 10 / d2 Ø 10
Thread: M12 x 1,75 LHT
0009965145, 0009965645, 0019963145

**DB-ES-8530**

Length: 115
Cone Ø: d1 Ø 28,6 / d2 Ø 23,9
Thread: M30 x 1,5 RHT
0014603848, 0014604848, 0014605148,
0014608648, 0014609948

**DB-RK-8391**

Ø: 85 Hole Distance: 152
Thick/Height: 24
01336800A, 0003502705

**DB-RK-8626**

Ø: 75 Hole Distance: 130
Thick/Height: 24
0003502205, 0003502505, 0003503405,
0003504505, GL11319

**DB-RK-8638**

Length: 100 Ø: 67
Hole Distance: 100
Thick/Height: 20
0003301411

**DB-RK-8710**

Ø: 85 Hole Distance: 130
Thick/Height: 30
0003503705

**DB-RK-9291**

Ø: 107,5 Hole Distance: 152
Thick/Height: 30
0003503605

**DB-RK-10374**

Ø: 85 Hole Distance: 152
Thick/Height: 24
0003504405

**DB-RK-10375**

Ø: 100 Hole Distance: 152
Thick/Height: 24
0003502405, 0003503505, 0003504905

**DB-SB-5260**

Ø: 70 Thick/Height: 36,5 / 46
01320700A, 0003237485, 0003237585,
0003237985

**DB-SB-5261**

Length: 85 Ø: 82
Thick/Height: 56
01320600A, 0003264481, 0003264781

**DB-SB-5279**

Ø: 42 Thick/Height: 55
0003236285, 0003237185

**DB-SB-10384**

Ø: 73 Thick/Height: 47
9303170012, 9423171812

**DB-SB-10400**

Length: 230
Thick/Height: 167,5 / 115
0003250696, 0003250896

**DB-SB-10401**

Length: 232
Thick/Height: 163,5 / 152,5
0003250596, 0003250796

**DB-SB-10406**

Ø: 80 Thick/Height: 46
0003238185

**DB-SB-10407**

Ø: 61 Thick/Height: 46
0003235985, 0003262481, 0003262981

**DB-SB-10409**

Ø: 77 Thick/Height: 56
0003265181

**DB-VB-7261**

Length: 622 Ø: 46
Hole Ø 25 / 25 / 25
Hole Distance: 152 / 130 / 130
01337800A, 9443500305, 9443500505,
9443500605, 9473500705, 9473500905,
9483500405, 9483503005





ACTROS ...

4143 K ...	04/97→10/02	Bush, parabolic spring		DB-SB-10401	
	04/97→10/02	Centre Rod	DB-DL-2144		Push Rod
	04/97→10/02	Centre Rod	DB-DL-5230		Push Rod
	04/97→10/02	Centre Rod	DB-DL-5405		Push Rod
	04/97→10/02	Centre Rod	DB-DL-7270		Push Rod
	04/97→10/02	Centre Rod	DB-DL-8168		Push Rod, 1st FA;Leaf Spring Axle
	04/97→10/02	Centre Rod	DB-DL-8184		Push Rod
	04/97→10/02	Centre Rod	DB-DL-8184		Push Rod, Leaf Spring Axle
	04/97→10/02	Centre Rod	DB-DL-8185		Push Rod, Leaf Spring Axle
	04/97→10/02	Centre Rod	DB-DL-8188		Push Rod
	04/97→10/02	Centre Rod	DB-DL-8307		Push Rod
	04/97→10/02	Centre Rod	DB-DL-9259		Push Rod, 1st FA;Leaf Spring Axle
	04/97→10/02	Centre Rod	DB-DL-10208		Push Rod, Leaf Spring Axle
	04/97→10/02	Centre Rod	DB-DL-10212		Push Rod, Leaf Spring Axle
	04/97→10/02	Centre Rod	DB-DL-12300		for Steering Rod
	04/97→10/02	Centre Rod	DB-DL-12301		Push Rod, Leaf Spring Axle
	04/97→10/02	Centre Rod	DB-DL-12403		Push Rod
	04/97→10/02	Rod Assembly	DB-DL-2178		Guide Rod
	04/97→10/02	Stabiliser Link	DB-DL-9254		Pressure Rod
	04/97→10/02	Stabiliser Link	DB-DL-9271		Pressure Rod
	04/97→10/02	Stabiliser Link	DB-DL-9272		Pressure Rod
	04/97→10/02	Stabiliser Mounting		DB-SB-5261	
	04/97→10/02	Stabiliser Mounting		DB-SB-10406	
	04/97→10/02	Stabiliser Mounting		DB-SB-10407	
	04/97→10/02	Stabiliser Mounting		DB-SB-10409	
	04/97→10/02	Stabiliser Mounting	DB-SB-5260		
	04/97→10/02	Stabiliser Mounting	DB-SB-5279		
	04/97→10/02	Suspension Arm Repair Kit		DB-RK-8626	for Wishbone (CV)
	04/97→10/02	Suspension Arm Repair Kit		DB-RK-10374	for Wishbone (CV)
	04/97→10/02	Suspension Arm Repair Kit		DB-RK-10375	for Wishbone (CV)
	04/97→10/02	Suspension Arm Repair Kit	DB-RK-8638		for Control Arm
	04/97→10/02	Suspension Strut Repair Kit		DB-RK-8391	
	04/97→10/02	Suspension Strut Repair Kit		DB-RK-8710	
	04/97→10/02	Suspension Strut Repair Kit		DB-RK-9291	
	04/97→10/02	Tie Rod	DB-DL-8171		Guide Rod
	04/97→10/02	Tie Rod	DB-DL-8327		Guide Rod
	04/97→10/02	Tie Rod	DB-DL-8390		
	04/97→10/02	Tie Rod	DB-DL-8640		Guide Rod
	04/97→10/02	Tie Rod	DB-DL-12310		
	04/97→10/02	Tie Rod	DB-ES-5227		Guide Rod
	04/97→10/02	Tie Rod	DB-ES-5227		Guide Rod, 2nd FA
	04/97→10/02	Tie Rod	MN-DL-7834		Guide Rod
	04/97→10/02	Tie Rod End	CV-ES-0543		for Push Rod
	04/97→10/02	Tie Rod End	CV-ES-0888		for Push Rod
	04/97→10/02	Tie Rod End	CV-ES-14162		for Steering Rod
	04/97→10/02	Tie Rod End	CV-ES-14163		for Steering Rod
	04/97→10/02	Tie Rod End	DB-ES-5234		for Steering Rod
04/97→10/02	Tie Rod End	DB-ES-8164		for Push Rod	
04/97→10/02	Tie Rod End	DB-ES-8323		Leaf Spring Axle	
04/97→10/02	Tie Rod End	DB-ES-8530		for Push Rod	
04/97→10/02	Track Control Arm		DB-DL-3475	Trailing Arm	
04/97→10/02	Track Control Arm		DB-VB-7261	Suspension Rod, Wishbone (CV), 1st RA;2nd RA; Leaf Spring Axle	
04/97→10/02	Track Control Arm	DB-DL-5224		Control Arm	
04/97→10/02	Track Control Arm	DB-DL-9218	DB-DL-9218	Trailing Arm	
4146 AK	10/97→	Ball Head, gearshift linkage	DB-ES-8387		
	10/97→	Ball Head, gearshift linkage	DB-ES-8491		
	10/97→	Ball Head, gearshift linkage	DB-ES-8492		
	10/97→	Ball Head, gearshift linkage	DB-ES-8500		
	10/97→	Bush, parabolic spring		DB-SB-10401	
	10/97→	Centre Rod	DB-DL-10208		Push Rod
10/97→	Centre Rod	DB-DL-12403		Push Rod	
10/97→	Stabiliser Link	DB-DL-9254		Coupling Rod	

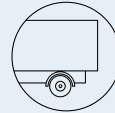
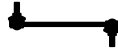

ACTROS ...

4146 AK ...	10/97→	Tie Rod	DB-ES-5227		Guide Rod
	10/97→	Tie Rod End	DB-ES-8323		
	10/97→	Track Control Arm		DB-VB-7261	Suspension Rod, Wishbone (CV)
4146 K	10/97→	Ball Head, gearshift linkage	DB-ES-8387		
	10/97→	Ball Head, gearshift linkage	DB-ES-8491		
	10/97→	Ball Head, gearshift linkage	DB-ES-8492		
	10/97→	Ball Head, gearshift linkage	DB-ES-8500		
	10/97→	Bush, parabolic spring		DB-SB-10400	
	10/97→	Bush, parabolic spring		DB-SB-10401	
	10/97→	Centre Rod	DB-DL-5230		Push Rod
	10/97→	Centre Rod	DB-DL-5405		Push Rod
	10/97→	Centre Rod	DB-DL-8168		Push Rod
	10/97→	Centre Rod	DB-DL-8184		Push Rod
	10/97→	Centre Rod	DB-DL-8185		Push Rod
	10/97→	Centre Rod	DB-DL-9259		Push Rod
	10/97→	Centre Rod	DB-DL-10212		Push Rod
	10/97→	Centre Rod	DB-DL-12300		for Steering Rod
	10/97→	Centre Rod	DB-DL-12301		Push Rod, Leaf Spring Axle
	10/97→	Stabiliser Link	DB-DL-9254		Coupling Rod
	10/97→	Stabiliser Link	DB-DL-9271		Coupling Rod
	10/97→	Stabiliser Link	DB-DL-9272		Coupling Rod
	10/97→	Suspension Arm Repair Kit		DB-RK-8626	for Wishbone (CV)
	10/97→	Suspension Strut Repair Kit		DB-RK-8391	
	10/97→	Suspension Strut Repair Kit		DB-RK-8710	
	10/97→	Tie Rod	DB-DL-8171		Guide Rod
	10/97→	Tie Rod	DB-DL-8390		
	10/97→	Tie Rod	DB-DL-8640		Guide Rod
	10/97→	Tie Rod	DB-DL-12310		
	10/97→	Tie Rod End	CV-ES-0543		for Push Rod
	10/97→	Tie Rod End	CV-ES-0888		for Push Rod
	10/97→	Tie Rod End	CV-ES-14163		for Steering Rod
	10/97→	Tie Rod End	DB-ES-8323		
	10/97→	Track Control Arm		DB-DL-3475	Trailing Arm
	10/97→	Track Control Arm		DB-VB-7261	Suspension Rod, Wishbone (CV)
	10/97→	Track Control Arm	DB-DL-5224		Control Arm
	10/97→	Track Control Arm	DB-DL-9218	DB-DL-9218	Trailing Arm
4148 AK	04/97→10/02	Ball Head, gearshift linkage	DB-ES-8387		
	04/97→10/02	Ball Head, gearshift linkage	DB-ES-8491		
	04/97→10/02	Ball Head, gearshift linkage	DB-ES-8492		
	04/97→10/02	Ball Head, gearshift linkage	DB-ES-8500		
	04/97→10/02	Ball Head, gearshift linkage	DB-ES-8510		
	04/97→10/02	Bush, driver cab suspension	DB-SB-10384		
	04/97→10/02	Bush, parabolic spring		DB-SB-10400	
	04/97→10/02	Bush, parabolic spring		DB-SB-10401	
	04/97→10/02	Centre Rod	DB-DL-2144		Push Rod
	04/97→10/02	Centre Rod	DB-DL-5230		Push Rod
	04/97→10/02	Centre Rod	DB-DL-5405		Push Rod
	04/97→10/02	Centre Rod	DB-DL-8184		Push Rod
	04/97→10/02	Centre Rod	DB-DL-8188		Push Rod
	04/97→10/02	Centre Rod	DB-DL-8307		Push Rod
	04/97→10/02	Centre Rod	DB-DL-10208		Push Rod, Leaf Spring Axle
	04/97→10/02	Centre Rod	DB-DL-12300		for Steering Rod
	04/97→10/02	Centre Rod	DB-DL-12403		Push Rod
	04/97→10/02	Rod Assembly	DB-DL-2178		Guide Rod
	04/97→10/02	Stabiliser Link	DB-DL-9254		Pressure Rod
	04/97→10/02	Stabiliser Mounting		DB-SB-5261	
	04/97→10/02	Stabiliser Mounting		DB-SB-10406	
	04/97→10/02	Stabiliser Mounting		DB-SB-10407	
	04/97→10/02	Stabiliser Mounting		DB-SB-10409	
	04/97→10/02	Stabiliser Mounting	DB-SB-5260		
	04/97→10/02	Stabiliser Mounting	DB-SB-5279		
	04/97→10/02	Suspension Arm Repair Kit		DB-RK-8626	for Wishbone (CV)
	04/97→10/02	Suspension Arm Repair Kit		DB-RK-10374	for Wishbone (CV)

CV-ES-0543

Length: 125
 Cone Ø: d1 Ø 32 / d2 Ø 29
 Thread: M30 x 1,5 RHT
 0004605748, 0004606048, 0004606848,
 0004607048, 0014600448, 0014601148,
 0014601748, 0014602448, 0014607648,
 0014609648

**CV-ES-0888**

Length: 125
 Cone Ø: d1 Ø 32 / d2 Ø 29
 Thread: M30 x 1,5 LHT
 0004605848, 0004606148, 0004606948,
 0004607148, 0004609048, 0014600548,
 0014601348, 0014602548, 0014607948,
 0024600448

**CV-ES-14163**

Length: 125
 Cone Ø: d1 Ø 30 / d2 Ø 27
 Thread: M30 x 1,5 RHT
 0003305248, 0003387310, 0004600348,
 0004600948, 0004602848, 0004602948,
 0004608948, 0014600248, 0014600848,
 0014601248, 0014602248, 0014607748,
 0024600148, A0003387310, A0004600348,
 A0004602848, A0004602948, A0014600848,
 A0014601248, A0014602248, A0014607748

**DB-DL-2144**

Length: 872 Ø: 35
 Cone Ø: d1 Ø 28,6 / d2 Ø 23,9
 0024604305, 0024604405, 0034604805

**DB-DL-2178**

Length: 1735 Ø: 52
 Cone Ø: d1 Ø 32 / d2 Ø 29
 9423300003, 9423300103, 9423300203

**DB-DL-3475**

Length: 565 Ø: 52
 Hole Distance: 152 / 152
 3753500006, 3753500206, 9473500805,
 9483500006, 9483500805, 9483501205,
 9483501305, 9483501905, 9483502005,
 9483502405, A3753500006,
 A3753500206

**DB-DL-5224**

Length: 850 Ø: 60
 Hole Distance: 100 / 100
 01336100A, 9413300007

**DB-DL-5230**

Length: 879 Ø: 42
 Cone Ø: d1 Ø 30 / d2 Ø 27
 01208600A, 0004607105, 0004607205,
 0014606705

**DB-DL-5405**

Length: 890 Ø: 35
 Cone Ø: d1 Ø 28,6 / d2 Ø 23,9
 01215900A, 1460248, 0024604505,
 0024604605, 0034605005, 3752600637,
 3754600405, A3752600637, A3754600405

**DB-DL-8168**

Length: 904 Ø: 52
 Cone Ø: d1 Ø 32 / d2 Ø 29
 0004609405, 0004609505, 0014607105

**DB-DL-8171**

Length: 1687 Ø: 52
 Cone Ø: d1 Ø 32 / d2 Ø 29
 9493300603, 9493300703, 9493301503,
 9493301603

**DB-DL-8184**

Length: 1095 Ø: 42
 Cone Ø: d1 Ø 32 / d2 Ø 28,8
 01217700A, 0014601305, 0014601405,
 0024600505, 0034603205, 3754601505,
 A0014601305, A0014601405, A0024600505

**DB-DL-8185**

Length: 711 Ø: 42
 Cone Ø: d1 Ø 32 / d2 Ø 28,8
 01213600A, 0014601105, 0024600405,
 0034603105, A0014601105, A0024600405

**DB-DL-8188**

Length: 895 Ø: 40
 Cone Ø: d1 Ø 28,6 / d2 Ø 23,9
 01217200A, 0024604905, 0024605005,
 0034605605

**DB-DL-8307**

Length: 885 Ø: 38
 Cone Ø: d1 Ø 32 / d2 Ø 30
 01215500A, 0004604005, 0024605105,
 0024605205, 0034604005

**DB-DL-8390**

Length: 1596 Ø: 50
 Cone Ø: d1 Ø 32 / d2 Ø 29
 9493301003, 9493301103, 9493301703

**DB-DL-8640**

Length: 1615 Ø: 50
 Cone Ø: d1 Ø 32 / d2 Ø 29
 6253301503, 6253301603, 6253302403,
 6253302503, 9423300803, 9423302103,
 9493300203, 9493300303, 9493300903

**DB-DL-9218**

Length: 754 Ø: 40
 Hole Distance: 100
 000360098524, 000390098524,
 3753300111, 9413300011,
 A3753300111, SA50831601

**DB-DL-9254**

Length: 1815 Ø: 58
 0003220323, 0003220623, 3753220423

**DB-DL-9259**

Length: 883 Ø: 38
 Cone Ø: d1 Ø 32 / d2 Ø 29
 0024608605, 0024608705,
 A0024608605, A0024608705

**DB-DL-9271**

Length: 1815 Ø: 60
 0003220423, 0003220723

**DB-DL-9272**

Length: 1815 Ø: 80
 0003220223

**DB-DL-10208**

Length: 708 Ø: 40
 Cone Ø: d1 Ø 32 / d2 Ø 29
 0014605305, 0024600605

**DB-DL-10212**

Length: 953 Ø: 42
 Cone Ø: d1 Ø 32 / d2 Ø 29
 0024609205, 0024609305, 0034604505

**DB-DL-12300**

Length: 733 Ø: 36
 Cone Ø: d1 Ø 32 / d2 Ø 30
 0014601505, 0014607305, 0034603305,
 3754601605, A0014601505,
 A0034603305, A3754601605

**DB-DL-12301**

Length: 716 Ø: 38
 Cone Ø: d1 Ø 32 / d2 Ø 29
 Thread: M30 x 1,5
 0024608805, 0024608905,
 A0024608805, A0024608905

**DB-DL-12310**

Length: 1532 Ø: 50
 Cone Ø: d1 Ø 32 / d2 Ø 29
 Thread: M27 x 1,5 LHT
 9493301203, 9493301303, 9493301803,
 9493302203, A9493301203, A9493301303,
 A9493301803, A9493302203

**DB-DL-12403**

Length: 893 Ø: 42
 Cone Ø: d1 Ø 32 / d2 Ø 29
 0014604905, 0014607405

**DB-ES-5227**

Length: 1588 Ø: 60
 Cone Ø: d1 Ø 38 / d2 Ø 34,3
 6253300903, 6253301203, 9443300203

**DB-ES-8323**

Length: 75
 Cone Ø: d1 Ø 32 / d2 Ø 28,8
 Thread: M26 x 1,5 RHT
 14601548, 0014601548, 14601648,
 0014601648, 0024600648, 24600648,
 A0014601648, A0024600648

**DB-ES-8387**

Length: 55
 Cone Ø: d1 Ø 10 / d2 Ø 10
 Thread: M14 x 1,5 RHT
 0009966845, 0009967045

**DB-ES-8491**

Length: 60
 Cone Ø: d1 Ø 10 / d2 Ø 10
 Thread: M12 x 1,75 LHT
 0009966745

**DB-ES-8492**

Length: 60
 Cone Ø: d1 Ø 10 / d2 Ø 10
 Thread: M12 x 1,75 RHT
 0009966645, 3752680189, A3752680189

**DB-ES-8500**

Length: 55
 Cone Ø: d1 Ø 12 / d2 Ø 10,8
 Thread: M14 x 1,5 RHT
 0002685989

**DB-ES-8510**

Length: 56
 Cone Ø: d1 Ø 10 / d2 Ø 10
 Thread: M12 x 1,75 LHT
 0009965145, 0009966545, 0019963145

**DB-RK-8391**

Ø: 85 Hole Distance: 152
 Thick/Height: 24
 01336800A, 0003502705

**DB-RK-8626**

Ø: 75 Hole Distance: 130
 Thick/Height: 24
 0003502205, 0003502505, 0003503405,
 0003504505, GL11319

**DB-RK-8710**

Ø: 85 Hole Distance: 130
 Thick/Height: 30
 0003503705

**DB-RK-10374**

Ø: 85 Hole Distance: 152
 Thick/Height: 24
 0003504405

**DB-SB-5260**

Ø: 70 Thick/Height: 36,5 / 46
 01320700A, 0003237485, 0003237585,
 0003237985

**DB-SB-5261**

Length: 85 Ø: 82
 Thick/Height: 56
 01320600A, 0003264481, 0003264781

**DB-SB-5279**

Ø: 42 Thick/Height: 55
 0003236285, 0003237185

**DB-SB-10384**

Ø: 73 Thick/Height: 47
 9303170012, 9423171812

**DB-SB-10400**

Length: 230
 Thick/Height: 167,5 / 115
 0003250696, 0003250896

**DB-SB-10401**

Length: 232
 Thick/Height: 163,5 / 152,5
 0003250596, 0003250796

**DB-SB-10406**

Ø: 80 Thick/Height: 46
 0003238185

**DB-SB-10407**

Ø: 61 Thick/Height: 46
 0003235985, 0003262481, 0003262981

**DB-SB-10409**

Ø: 77 Thick/Height: 56
 0003265181

**DB-VB-7261**

Length: 622 Ø: 46
 Hole Ø: 25 / 25 / 25
 Hole Distance: 152 / 130 / 130
 01337800A, 9443500305, 9443500505,
 9443500605, 9473500705, 9473500905,
 9483500405, 9483503005





ACTROS ...

4148 AK ...	04/97→10/02	Suspension Arm Repair Kit		DB-RK-10375	for Wishbone (CV)
	04/97→10/02	Suspension Arm Repair Kit	DB-RK-8638		for Control Arm
	04/97→10/02	Suspension Strut Repair Kit		DB-RK-8391	
	04/97→10/02	Suspension Strut Repair Kit		DB-RK-8710	
	04/97→10/02	Suspension Strut Repair Kit		DB-RK-9291	
	04/97→10/02	Tie Rod	DB-DL-12310		
	04/97→10/02	Tie Rod	DB-ES-5227		Guide Rod, 1st FA
	04/97→10/02	Tie Rod End	CV-ES-0543		for Push Rod
	04/97→10/02	Tie Rod End	CV-ES-0888		for Push Rod
	04/97→10/02	Tie Rod End	CV-ES-14162		for Steering Rod
	04/97→10/02	Tie Rod End	CV-ES-14163		for Steering Rod
	04/97→10/02	Tie Rod End	DB-ES-5234		for Steering Rod
	04/97→10/02	Tie Rod End	DB-ES-8323		Leaf Spring Axle
	04/97→10/02	Tie Rod End	DB-ES-8530		for Push Rod
	04/97→10/02	Track Control Arm		DB-DL-3475	Trailing Arm
	04/97→10/02	Track Control Arm		DB-VB-7261	Suspension Rod, Wishbone (CV), 1st RA;2nd RA; Leaf Spring Axle
04/97→10/02	Track Control Arm	DB-DL-5224		Control Arm	
04/97→10/02	Track Control Arm	DB-DL-9218	DB-DL-9218	Trailing Arm	
4148 K	04/97→10/02	Ball Head, gearshift linkage	DB-ES-8387		
	04/97→10/02	Ball Head, gearshift linkage	DB-ES-8491		
	04/97→10/02	Ball Head, gearshift linkage	DB-ES-8492		
	04/97→10/02	Ball Head, gearshift linkage	DB-ES-8500		
	04/97→10/02	Ball Head, gearshift linkage	DB-ES-8510		
	04/97→10/02	Bush, driver cab suspension	DB-SB-10384		
	04/97→10/02	Bush, parabolic spring		DB-SB-10400	
	04/97→10/02	Bush, parabolic spring		DB-SB-10401	
	04/97→10/02	Centre Rod	DB-DL-2144		Push Rod
	04/97→10/02	Centre Rod	DB-DL-5230		Push Rod
	04/97→10/02	Centre Rod	DB-DL-5405		Push Rod
	04/97→10/02	Centre Rod	DB-DL-7270		Push Rod
	04/97→10/02	Centre Rod	DB-DL-8168		Push Rod, 1st FA;Leaf Spring Axle
	04/97→10/02	Centre Rod	DB-DL-8184		Push Rod
	04/97→10/02	Centre Rod	DB-DL-8184		Push Rod, Leaf Spring Axle
	04/97→10/02	Centre Rod	DB-DL-8185		Push Rod, Leaf Spring Axle
	04/97→10/02	Centre Rod	DB-DL-8188		Push Rod
	04/97→10/02	Centre Rod	DB-DL-8307		Push Rod
	04/97→10/02	Centre Rod	DB-DL-9259		Push Rod, 1st FA;Leaf Spring Axle
	04/97→10/02	Centre Rod	DB-DL-10208		Push Rod, Leaf Spring Axle
	04/97→10/02	Centre Rod	DB-DL-10212		Push Rod, Leaf Spring Axle
	04/97→10/02	Centre Rod	DB-DL-12300		for Steering Rod
	04/97→10/02	Centre Rod	DB-DL-12301		Push Rod, Leaf Spring Axle
	04/97→10/02	Centre Rod	DB-DL-12403		Push Rod
	04/97→10/02	Rod Assembly	DB-DL-2178		Guide Rod
	04/97→10/02	Stabiliser Link	DB-DL-9254		Pressure Rod
	04/97→10/02	Stabiliser Link	DB-DL-9271		Pressure Rod
	04/97→10/02	Stabiliser Link	DB-DL-9272		Pressure Rod
	04/97→10/02	Stabiliser Mounting		DB-SB-5261	
	04/97→10/02	Stabiliser Mounting		DB-SB-10406	
	04/97→10/02	Stabiliser Mounting		DB-SB-10407	
	04/97→10/02	Stabiliser Mounting		DB-SB-10409	
	04/97→10/02	Stabiliser Mounting	DB-SB-5260		
	04/97→10/02	Stabiliser Mounting	DB-SB-5279		
	04/97→10/02	Suspension Arm Repair Kit		DB-RK-8626	for Wishbone (CV)
	04/97→10/02	Suspension Arm Repair Kit		DB-RK-10374	for Wishbone (CV)
	04/97→10/02	Suspension Arm Repair Kit		DB-RK-10375	for Wishbone (CV)
	04/97→10/02	Suspension Arm Repair Kit	DB-RK-8638		for Control Arm
	04/97→10/02	Suspension Strut Repair Kit		DB-RK-8391	
	04/97→10/02	Suspension Strut Repair Kit		DB-RK-8710	
	04/97→10/02	Suspension Strut Repair Kit		DB-RK-9291	
	04/97→10/02	Tie Rod	DB-DL-8171		Guide Rod
04/97→10/02	Tie Rod	DB-DL-8327		Guide Rod	
04/97→10/02	Tie Rod	DB-DL-8390			



ACTROS ...

4148 K ...	04/97→10/02	Tie Rod	DB-DL-8640		Guide Rod
	04/97→10/02	Tie Rod	DB-DL-12310		
	04/97→10/02	Tie Rod	DB-ES-5227		Guide Rod
	04/97→10/02	Tie Rod	DB-ES-5227		Guide Rod, 2nd FA
	04/97→10/02	Tie Rod	MN-DL-7834		Guide Rod
	04/97→10/02	Tie Rod End	CV-ES-0543		for Push Rod
	04/97→10/02	Tie Rod End	CV-ES-0888		for Push Rod
	04/97→10/02	Tie Rod End	CV-ES-14162		for Steering Rod
	04/97→10/02	Tie Rod End	CV-ES-14163		for Steering Rod
	04/97→10/02	Tie Rod End	DB-ES-5234		for Steering Rod
	04/97→10/02	Tie Rod End	DB-ES-8164		for Push Rod
	04/97→10/02	Tie Rod End	DB-ES-8323		Leaf Spring Axle
	04/97→10/02	Tie Rod End	DB-ES-8530		for Push Rod
	04/97→10/02	Track Control Arm		DB-DL-3475	Trailing Arm
	04/97→10/02	Track Control Arm		DB-VB-7261	Suspension Rod, Wishbone (CV), 1st RA;2nd RA; Leaf Spring Axle
04/97→10/02	Track Control Arm	DB-DL-5224		Control Arm	
04/97→10/02	Track Control Arm	DB-DL-9218	DB-DL-9218	Trailing Arm	

ACTROS MP2 / MP3

1831 AK	04/03→	Centre Rod	DB-DL-8307		Push Rod
	04/03→	Centre Rod	DB-DL-8702		Push Rod
	04/03→	Suspension Arm Repair Kit		DB-RK-8626	for Wishbone (CV)
	04/03→	Suspension Arm Repair Kit		DB-RK-10374	for Wishbone (CV)
	04/03→	Suspension Arm Repair Kit		DB-RK-10375	for Wishbone (CV)
	04/03→	Suspension Strut Repair Kit		DB-RK-8710	
	04/03→	Suspension Strut Repair Kit		DB-RK-9291	
	04/03→	Tie Rod	DB-ES-5227		Guide Rod
	04/03→	Tie Rod	MN-DL-7834		Guide Rod
	04/03→	Tie Rod End	CV-ES-0543		for Push Rod
	04/03→	Tie Rod End	CV-ES-14163		for Steering Rod
	04/03→	Tie Rod End	DB-ES-5234		for Steering Rod
	04/03→	Track Control Arm		DB-VB-7261	Suspension Rod, Wishbone (CV), 1st RA, →517142 01/517142 02
	04/03→	Track Control Arm		DB-VB-7776	Wishbone (CV)
	04/03→	Track Control Arm		DB-VB-9307	Suspension Rod, Wishbone (CV)
04/03→	Track Control Arm		DB-VB-9308	Suspension Rod, Wishbone (CV)	
04/03→	Track Control Arm		DB-VB-10426	Wishbone (CV), 1st RA, →517142 05	
1831 K	04/03→	Centre Rod	DB-DL-2144		Push Rod
	04/03→	Centre Rod	DB-DL-5405		Push Rod
	04/03→	Centre Rod	DB-DL-7270		Push Rod
	04/03→	Centre Rod	DB-DL-8167		Push Rod
	04/03→	Rod Assembly	DB-DL-2178		Guide Rod, 1st Front Axle, →504310 03
	04/03→	Suspension Arm Repair Kit		DB-RK-8626	for Wishbone (CV)
	04/03→	Suspension Arm Repair Kit		DB-RK-10374	for Wishbone (CV)
	04/03→	Suspension Arm Repair Kit		DB-RK-10375	for Wishbone (CV)
	04/03→	Suspension Strut Repair Kit		DB-RK-8710	
	04/03→	Suspension Strut Repair Kit		DB-RK-9291	
	04/03→	Tie Rod	DB-DL-8171		Guide Rod
	04/03→	Tie Rod	DB-DL-8327		Guide Rod
	04/03→	Tie Rod	DB-DL-8640		Guide Rod
	04/03→	Tie Rod End	CV-ES-0543		for Push Rod
	04/03→	Tie Rod End	CV-ES-0888		for Push Rod
	04/03→	Tie Rod End	CV-ES-14163		for Steering Rod
	04/03→	Tie Rod End	DB-ES-8164		for Push Rod
	04/03→	Tie Rod End	DB-ES-8530		for Push Rod
	04/03→	Track Control Arm		DB-VB-7261	Suspension Rod, Wishbone (CV), 1st RA, →517142 01/517142 02
	04/03→	Track Control Arm		DB-VB-7776	Wishbone (CV)
	04/03→	Track Control Arm		DB-VB-9307	Suspension Rod, Wishbone (CV)
04/03→	Track Control Arm		DB-VB-9308	Suspension Rod, Wishbone (CV)	
04/03→	Track Control Arm		DB-VB-10426	Wishbone (CV), 1st RA, →517142 05	

CV-ES-0543

Length: 125
Cone Ø: d1 Ø 32 / d2 Ø 29
Thread: M30 x 1,5 RHT
0004605748, 0004606048, 0004606848,
0004607048, 0014600448, 0014601148,
0014601748, 0014602448, 0014607648,
0014609648



CV-ES-0888

Length: 125
Cone Ø: d1 Ø 32 / d2 Ø 29
Thread: M30 x 1,5 LHT
0004605848, 0004606148, 0004606948,
0004607148, 0004609048, 0014600548,
0014601348, 0014602548, 0014607948,
0024600448



CV-ES-14162

Length: 125
Cone Ø: d1 Ø 30 / d2 Ø 27
Thread: M30 x 1,5 LHT
4600648, 4601248, 4603448, 4603548,
4604603548, 14600348, 14601448,
14602348, 0014603748, 0014607848,
14607848, 0024600348



CV-ES-14163

Length: 125
Cone Ø: d1 Ø 30 / d2 Ø 27
Thread: M30 x 1,5 RHT
0003305248, 0003387310, 0004600348,
0004600948, 0004602848, 0004602948,
0004608948, 0014600248, 0014600848,
0014601248, 0014602248, 0014607748,
0024600148, A0003387310, A0004600348,
A0004602848, A0004602948, A0014600848,
A0014601248, A0014602248, A0014607748



DB-DL-2144

Length: 872 Ø: 35
Cone Ø: d1 Ø 28,6 / d2 Ø 23,9
0024604305, 0024604405, 0034604805



DB-DL-2178

Length: 1735 Ø: 52
Cone Ø: d1 Ø 32 / d2 Ø 29
9423300003, 9423300103, 9423300203



DB-DL-3475

Length: 565 Ø: 52
Hole Distance: 152 / 152
3753500006, 3753500206, 9473500805,
9483500006, 9483500805, 9483501205,
9483501305, 9483501905, 9483502005,
9483502405, A3753500006,
A3753500206



DB-DL-5224

Length: 850 Ø: 60
Hole Distance: 100 / 100
01336100A, 9413300007



DB-DL-5405

Length: 890 Ø: 35
Cone Ø: d1 Ø 28,6 / d2 Ø 23,9
01215900A, 1460248, 0024604505,
0024604605, 0034605005, 3752600637,
3754600405, A3752600637, A3754600405



DB-DL-7270

Length: 875 Ø: 40
Cone Ø: d1 Ø 28,6 / d2 Ø 23,9
01208300A, 0024604705, 0024604805,
0034604905, A0024604705



DB-DL-8167

Length: 866 Ø: 38
Cone Ø: d1 Ø 30 / d2 Ø 27
0014609805, 0014609905, 0024606305,
0024606405



DB-DL-8171

Length: 1687 Ø: 52
Cone Ø: d1 Ø 32 / d2 Ø 29
9493300603, 9493300703, 9493301503,
9493301603



DB-DL-8307

Length: 885 Ø: 38
Cone Ø: d1 Ø 32 / d2 Ø 30
01215500A, 0004604005, 0024605105,
0024605205, 0034604005



DB-DL-8327

Length: 1745 Ø: 48
Cone Ø: d1 Ø 32 / d2 Ø 29
01219800A, 9413300003, 9413300103,
9413300203, 9413300303, 9413300503



DB-DL-8640

Length: 1615 Ø: 50
Cone Ø: d1 Ø 32 / d2 Ø 29
6253301503, 6253301603, 6253302403,
6253302503, 9423300803, 9423302103,
9493300203, 9493300303, 9493300903



DB-DL-8702

Length: 958 Ø: 38
Cone Ø: d1 Ø 32 / d2 Ø 30
0024606105, 0024606205, 0034604205



DB-DL-9218

Length: 754 Ø: 40
Hole Distance: 100
000360098524, 000390098524,
3753300111, 9413300011,
A3753300111, SA50831601



DB-DL-12310

Length: 1532 Ø: 50
Cone Ø: d1 Ø 32 / d2 Ø 29
Thread: M27 x 1,5 LHT
9493301203, 9493301303, 9493301803,
9493302203, A9493301203, A9493301303,
A9493301803, A9493302203



DB-ES-5227

Length: 1588 Ø: 60
Cone Ø: d1 Ø 38 / d2 Ø 34,3
6253300903, 6253301203, 9443300203



DB-ES-5234

Length: 135
Cone Ø: d1 Ø 38 / d2 Ø 34,3
Thread: M38 x 1,5 RHT
0004601748, 120322305, 2205000400



DB-ES-8164

Length: 140
Cone Ø: d1 Ø 28,6 / d2 Ø 23,9
Thread: M28 x 1,5 RHT
0014604248, 0014605048, 0014608548,
0024600548



DB-ES-8323

Length: 75
Cone Ø: d1 Ø 32 / d2 Ø 28,8
Thread: M26 x 1,5 RHT
0014601548, 0014601648, 0024600648,
A0014601648, A0024600648



DB-ES-8530

Length: 115
Cone Ø: d1 Ø 28,6 / d2 Ø 23,9
Thread: M30 x 1,5 RHT
0014603848, 0014604848, 0014605148,
0014608648, 0014609948



DB-RK-8626

Ø: 75 Hole Distance: 130
Thick/Height: 24
0003502205, 0003502505, 0003503405,
0003504505, GL11319



DB-RK-8710

Ø: 85 Hole Distance: 130
Thick/Height: 30
0003503705



DB-RK-9291

Ø: 107,5 Hole Distance: 152
Thick/Height: 30
0003503605



DB-RK-10374

Ø: 85 Hole Distance: 152
Thick/Height: 24
0003504405



DB-RK-10375

Ø: 100 Hole Distance: 152
Thick/Height: 24
0003502405, 0003503505, 0003504905



DB-VB-7261

Length: 622 Ø: 46
Hole Ø 25 / 25 / 25
Hole Distance: 152 / 130 / 130
01337800A, 9443500305, 9443500505,
9443500605, 9473500705, 9473500905,
9483500405, 9483503005



DB-VB-7776

Length: 622 Ø: 56
Hole Distance: 152 / 152
6533500205, 6583500205



DB-VB-9307

Length: 667 Ø: 60
Hole Ø 25 / 23 / 23
Hole Distance: 152 / 130 / 130
9483502805



DB-VB-9308

Length: 622 Ø: 46
Hole Ø 25 / 25 / 25
Hole Distance: 152 / 130 / 130
9483502905



DB-VB-10426

Length: 622 Ø: 46
Hole Ø 25 / 25 / 25
Hole Distance: 152 / 130 / 130
9443500405





ACTROS MP2 / MP3 ...

1832 AK	04/03→	Ball Head, gearshift linkage	DB-ES-8510			
	04/03→	Bush, driver cab suspension	DB-SB-10384			
	04/03→	Centre Rod	DB-DL-2144		Push Rod	
	04/03→	Centre Rod	DB-DL-8184		Push Rod	
	04/03→	Centre Rod	DB-DL-8307		Push Rod, Leaf Spring Axle	
	04/03→	Centre Rod	DB-DL-8702		Push Rod, Leaf Spring Axle	
	04/03→	Rod Assembly	DB-DL-2178		Guide Rod	
	04/03→	Stabiliser Mounting		DB-SB-10406		
	04/03→	Stabiliser Mounting		DB-SB-10409		
	04/03→	Suspension Arm Repair Kit		DB-RK-8626	for Wishbone (CV)	
	04/03→	Suspension Arm Repair Kit		DB-RK-10374	for Wishbone (CV)	
	04/03→	Suspension Arm Repair Kit		DB-RK-10375	for Wishbone (CV)	
	04/03→	Suspension Arm Repair Kit	DB-RK-8638		for Control Arm	
	04/03→	Suspension Strut Repair Kit		DB-RK-8391		
	04/03→	Tie Rod	DB-DL-12310			
	04/03→	Tie Rod	DB-ES-5227		Guide Rod, 1st FA;Leaf Spring Axle	
	04/03→	Tie Rod	MN-DL-7834		Guide Rod, 1st FA;Leaf Spring Axle	
	04/03→	Tie Rod End	CV-ES-0543		for Push Rod	
	04/03→	Tie Rod End	CV-ES-0888		for Push Rod	
	04/03→	Tie Rod End	CV-ES-14162		for Steering Rod	
	04/03→	Tie Rod End	CV-ES-14163		for Steering Rod	
	04/03→	Tie Rod End	DB-ES-5234		for Steering Rod	
	04/03→	Tie Rod End	DB-ES-8530		for Push Rod	
	04/03→	Track Control Arm		DB-VB-7261	Suspension Rod, Wishbone (CV), 1st RA, →517142 01/517142 02	
	04/03→	Track Control Arm		DB-VB-9307	Suspension Rod, Wishbone (CV), 1st Drive Axle, →517142 07	
	04/03→	Track Control Arm		DB-VB-9308	Suspension Rod, Wishbone (CV), 1st Drive Axle, →517142 06	
	04/03→	Track Control Arm		DB-VB-10426	Wishbone (CV), 1st RA, →517142 05	
	1832 K	04/03→	Ball Head, gearshift linkage	DB-ES-8510		
		04/03→	Bush, driver cab suspension	DB-SB-10384		
		04/03→	Centre Rod	DB-DL-2144		Push Rod
04/03→		Centre Rod	DB-DL-5230		Suspension Rod	
04/03→		Centre Rod	DB-DL-5241		Push Rod	
04/03→		Centre Rod	DB-DL-5405		Push Rod, Leaf Spring Axle	
04/03→		Centre Rod	DB-DL-7270		Push Rod	
04/03→		Centre Rod	DB-DL-8167		Push Rod	
04/03→		Centre Rod	DB-DL-8184		Push Rod	
04/03→		Centre Rod	DB-DL-8185		Push Rod	
04/03→		Centre Rod	DB-DL-8307		Push Rod	
04/03→		Rod Assembly	DB-DL-2178		Guide Rod	
04/03→		Stabiliser Mounting		DB-SB-10406		
04/03→		Stabiliser Mounting		DB-SB-10409		
04/03→		Suspension Arm Repair Kit		DB-RK-8550	for Wishbone (CV)	
04/03→		Suspension Arm Repair Kit		DB-RK-8626	for Wishbone (CV)	
04/03→		Suspension Arm Repair Kit		DB-RK-10374	for Wishbone (CV)	
04/03→		Suspension Arm Repair Kit		DB-RK-10375	for Wishbone (CV)	
04/03→		Suspension Arm Repair Kit	DB-RK-8638		for Control Arm	
04/03→		Suspension Strut Repair Kit		DB-RK-8391		
04/03→		Tie Rod	DB-DL-8171		Guide Rod, 1st FA;Leaf Spring Axle	
04/03→		Tie Rod	DB-DL-8327		Guide Rod, 1st FA;Leaf Spring Axle	
04/03→		Tie Rod	DB-DL-8640		Guide Rod	
04/03→		Tie Rod	DB-DL-12310			
04/03→		Tie Rod	DB-ES-5227		Guide Rod	
04/03→		Tie Rod End	CV-ES-0543		for Push Rod	
04/03→		Tie Rod End	CV-ES-0888		for Push Rod	
04/03→		Tie Rod End	CV-ES-14162		for Steering Rod	
04/03→		Tie Rod End	CV-ES-14163		for Steering Rod	
04/03→		Tie Rod End	DB-ES-5234		for Steering Rod	
04/03→	Tie Rod End	DB-ES-8164		for Push Rod		
04/03→	Tie Rod End	DB-ES-8530		for Push Rod		

CV-ES-0543

Length: 125
Cone Ø: d1 Ø 32 / d2 Ø 29
Thread: M30 x 1,5 RHT
0004605748, 0004606048, 0004606848,
0004607048, 0014600448, 0014601148,
0014601748, 0014602448, 0014607648,
0014609648



CV-ES-0888

Length: 125
Cone Ø: d1 Ø 32 / d2 Ø 29
Thread: M30 x 1,5 LHT
0004605848, 0004606148, 0004606948,
0004607148, 0004609048, 0014600548,
0014601348, 0014602548, 0014607948,
0024600448



CV-ES-14162

Length: 125
Cone Ø: d1 Ø 30 / d2 Ø 27
Thread: M30 x 1,5 LHT
4600648, 4601248, 4603448, 0004603548,
14600348, 14601448, 14602348,
0014603748, 0014607848, 0024600348



CV-ES-14163

Length: 125
Cone Ø: d1 Ø 30 / d2 Ø 27
Thread: M30 x 1,5 RHT
0003305248, 0003387310, 0004600348,
0004600948, 0004602848, 0004602948,
0004608948, 0014600248, 0014600848,
0014601248, 0014602248, 0014607748,
0024600148, 0003387310, 0004600348,
A0004602848, A0004602948, A0014600848,
A0014601248, A0014602248, A0014607748



DB-DL-2144

Length: 872 Ø: 35
Cone Ø: d1 Ø 28,6 / d2 Ø 23,9
0024604305, 0024604405, 0034604805



DB-DL-2178

Length: 1735 Ø: 52
Cone Ø: d1 Ø 32 / d2 Ø 29
9423300003, 9423300103, 9423300203



DB-DL-5230

Length: 879 Ø: 42
Cone Ø: d1 Ø 30 / d2 Ø 27
01208600A, 0004607105, 0004607205,
0014606705



DB-DL-5241

Length: 875 Ø: 40
Cone Ø: d1 Ø 30 / d2 Ø 27
01215300A, 0004609205, 0004609305,
0014606905



DB-DL-5405

Length: 890 Ø: 35
Cone Ø: d1 Ø 28,6 / d2 Ø 23,9
01215900A, 1460248, 0024604505,
0024604605, 0034605005, 3752600637,
3754600405, A3752600637, A3754600405



DB-DL-7270

Length: 875 Ø: 40
Cone Ø: d1 Ø 28,6 / d2 Ø 23,9
01208300A, 0024604705, 0024604805,
0034604905, A0024604705



DB-DL-8167

Length: 866 Ø: 38
Cone Ø: d1 Ø 30 / d2 Ø 27
0014609805, 0014609905, 0024606305,
0024606405



DB-DL-8171

Length: 1687 Ø: 52
Cone Ø: d1 Ø 32 / d2 Ø 29
9493300603, 9493300703, 9493301503,
9493301603



DB-DL-8184

Length: 1095 Ø: 42
Cone Ø: d1 Ø 32 / d2 Ø 28,8
01217700A, 0014601305, 0014601405,
0024600505, 0034603205, 3754601505,
A0014601305, A0014601405, A0024600505



DB-DL-8185

Length: 711 Ø: 42
Cone Ø: d1 Ø 32 / d2 Ø 28,8
01213600A, 0014601105, 0024600405,
0034603105, A0014601105, A0024600405



DB-DL-8307

Length: 885 Ø: 38
Cone Ø: d1 Ø 32 / d2 Ø 30
01215500A, 0004604005, 0024605105,
0024605205, 0034604005



DB-DL-8327

Length: 1745 Ø: 48
Cone Ø: d1 Ø 32 / d2 Ø 29
01219800A, 9413300003, 9413300103,
9413300203, 9413300303, 9413300503



DB-DL-8640

Length: 1615 Ø: 50
Cone Ø: d1 Ø 32 / d2 Ø 29
6253301503, 6253301603, 6253302403,
6253302503, 9423300803, 9423302103,
9493300203, 9493300303, 9493300903



DB-DL-8702

Length: 958 Ø: 38
Cone Ø: d1 Ø 32 / d2 Ø 30
0024606105, 0024606205, 0034604205



DB-DL-12310

Length: 1532 Ø: 50
Cone Ø: d1 Ø 32 / d2 Ø 29
Thread: M27 x 1,5 LHT
9493301203, 9493301303, 9493301803,
9493302203, A9493301203, A9493301303,
A9493301803, A9493302203



DB-ES-5227

Length: 1588 Ø: 60
Cone Ø: d1 Ø 38 / d2 Ø 34,3
6253300903, 6253301203, 9443300203



DB-ES-5234

Length: 135
Cone Ø: d1 Ø 38 / d2 Ø 34,3
Thread: M38 x 1,5 RHT
0004601748, 120322305, 2205000400



DB-ES-8164

Length: 140
Cone Ø: d1 Ø 28,6 / d2 Ø 23,9
Thread: M28 x 1,5 RHT
0014604248, 0014605048, 0014608548,
0024600548



DB-ES-8510

Length: 56
Cone Ø: d1 Ø 10 / d2 Ø 10
Thread: M12 x 1,75 LHT
0009965145, 0009965645, 0019963145



DB-ES-8530

Length: 115
Cone Ø: d1 Ø 28,6 / d2 Ø 23,9
Thread: M30 x 1,5 RHT
0014603848, 0014604848, 0014605148,
0014608648, 0014609948



DB-RK-8391

Ø: 85 Hole Distance: 152
Thick/Height: 24
01336800A, 0003502705



DB-RK-8550

Ø: 75 Hole Distance: 152
Thick/Height: 24
0003502105, 0003504605



DB-RK-8626

Ø: 75 Hole Distance: 130
Thick/Height: 24
0003502205, 0003502505, 0003503405,
0003504505, GL11319



DB-RK-8638

Length: 100 Ø: 67
Hole Distance: 100
Thick/Height: 20
0003301411



DB-RK-10374

Ø: 85 Hole Distance: 152
Thick/Height: 24
0003504405



DB-RK-10375

Ø: 100 Hole Distance: 152
Thick/Height: 24
0003502405, 0003503505, 0003504905



DB-SB-10384

Ø: 73 Thick/Height: 47
9303170012, 9423171812



DB-SB-10406

Ø: 80 Thick/Height: 46
0003238185



DB-SB-10409

Ø: 77 Thick/Height: 56
0003265181



DB-VB-7261

Length: 622 Ø: 46
Hole Ø 25 / 25 / 25
Hole Distance: 152 / 130 / 130
01337800A, 9443500305, 9443500505,
9443500605, 9473500705, 9473500905,
9483500405, 9483500305



DB-VB-9307

Length: 667 Ø: 60
Hole Ø 25 / 23 / 23
Hole Distance: 152 / 130 / 130
9483502805



DB-VB-9308

Length: 622 Ø: 46
Hole Ø 25 / 25 / 25
Hole Distance: 152 / 130 / 130
9483502905



DB-VB-10426

Length: 622 Ø: 46
Hole Ø 25 / 25 / 25
Hole Distance: 152 / 130 / 130
9443500405



MN-DL-7834

Length: 1588 Ø: 58
Cone Ø: d1 Ø 30 / d2 Ø 27
3463303903, 3463304903, 6253303203,
9443300503, 9443301303, 9443301703





ACTROS MP2 / MP3 ...

1832 K ...	04/03→	Track Control Arm		DB-VB-7261	Suspension Rod, Wishbone (CV), 1st RA, →517142 01/517142 02
	04/03→	Track Control Arm		DB-VB-9307	Suspension Rod, Wishbone (CV), 1st Drive Axle, →517142 07
	04/03→	Track Control Arm		DB-VB-9308	Suspension Rod, Wishbone (CV), 1st Drive Axle, →517142 06
	04/03→	Track Control Arm		DB-VB-10426	Wishbone (CV), 1st RA, →517142 05
1832, L, LL	04/03→	Ball Head, gearshift linkage	DB-ES-8510		
	04/03→	Bush, driver cab suspension	DB-SB-10384		
	04/03→	Centre Rod	DB-DL-2144		Push Rod
	04/03→	Centre Rod	DB-DL-5230		Suspension Rod
	04/03→	Centre Rod	DB-DL-5241		Push Rod
	04/03→	Centre Rod	DB-DL-5405		Push Rod
	04/03→	Centre Rod	DB-DL-5405		Push Rod, Leaf Spring Axle
	04/03→	Centre Rod	DB-DL-7270		Push Rod
	04/03→	Centre Rod	DB-DL-8167		Push Rod
	04/03→	Centre Rod	DB-DL-8168		Push Rod
	04/03→	Centre Rod	DB-DL-8184		Push Rod
	04/03→	Centre Rod	DB-DL-8185		Push Rod
	04/03→	Centre Rod	DB-DL-8307		Push Rod
	04/03→	Centre Rod	DB-DL-8392		Push Rod
	04/03→	Centre Rod	DB-DL-8622		Push Rod
	04/03→	Centre Rod	DB-DL-8641		Push Rod
	04/03→	Centre Rod	DB-DL-8642		Push Rod
	04/03→	Centre Rod	DB-DL-12300		for Steering Rod
	04/03→	Centre Rod	DB-DL-12303		Push Rod, Leaf Spring Axle
	04/03→	Rod Assembly	DB-DL-2178		Guide Rod
	04/03→	Stabiliser Link	DB-DL-9254		Pressure Rod
	04/03→	Stabiliser Mounting		DB-SB-10406	
	04/03→	Stabiliser Mounting		DB-SB-10409	
	04/03→	Stabiliser Mounting	DB-SB-10410		
	04/03→	Suspension Arm Repair Kit		DB-RK-8550	for Wishbone (CV)
	04/03→	Suspension Arm Repair Kit		DB-RK-8626	for Wishbone (CV)
	04/03→	Suspension Arm Repair Kit		DB-RK-10374	for Wishbone (CV)
	04/03→	Suspension Arm Repair Kit		DB-RK-10375	for Wishbone (CV)
	04/03→	Suspension Arm Repair Kit	DB-RK-8638		for Control Arm
	04/03→	Suspension Strut Repair Kit		DB-RK-8391	
	04/03→	Suspension Strut Repair Kit		DB-RK-9294	
	04/03→	Suspension Strut Repair Kit		MN-RK-8997	
	04/03→	Tie Rod	DB-DL-8327		Guide Rod
	04/03→	Tie Rod	DB-DL-8327		Guide Rod, 1st FA;Leaf Spring Axle
	04/03→	Tie Rod	DB-DL-8388		Guide Rod
	04/03→	Tie Rod	DB-DL-8388		Guide Rod, 1st FA;Leaf Spring Axle
	04/03→	Tie Rod	DB-DL-8389		
	04/03→	Tie Rod	DB-DL-8389		1st FA;Leaf Spring Axle
	04/03→	Tie Rod	DB-DL-8640		Guide Rod
	04/03→	Tie Rod	DB-DL-12310		
	04/03→	Tie Rod	DB-ES-5227		Guide Rod
	04/03→	Tie Rod End	CV-ES-0543		for Push Rod
	04/03→	Tie Rod End	CV-ES-0888		for Push Rod
	04/03→	Tie Rod End	CV-ES-14162		for Steering Rod
	04/03→	Tie Rod End	CV-ES-14163		for Steering Rod
	04/03→	Tie Rod End	DB-ES-5234		for Steering Rod
	04/03→	Tie Rod End	DB-ES-8164		for Push Rod
04/03→	Tie Rod End	DB-ES-8530		for Push Rod	
04/03→	Track Control Arm		DB-TC-12410	Control Arm	
04/03→	Track Control Arm		DB-VB-3707	Suspension Rod, Wishbone (CV)	
04/03→	Track Control Arm		DB-VB-7261	Suspension Rod, Wishbone (CV), 1st RA, →517142 01/517142 02	
04/03→	Track Control Arm		DB-VB-7798	Wishbone (CV), Air Suspension Axle, * K 864074 *→	
04/03→	Track Control Arm		DB-VB-9307	Suspension Rod, Wishbone (CV), 1st Drive Axle, →517142 07	

CV-ES-0543

Length: 125
 Cone Ø: d1 Ø 32 / d2 Ø 29
 Thread: M30 x 1,5 RHT
 0004605748, 0004606048, 0004606848,
 0004607048, 0014600448, 0014601148,
 0014601748, 0014602448, 0014607648,
 0014609648

**CV-ES-0888**

Length: 125
 Cone Ø: d1 Ø 32 / d2 Ø 29
 Thread: M30 x 1,5 LHT
 0004605848, 0004606148, 0004606948,
 0004607148, 0004609048, 0014600548,
 0014601348, 0014602548, 0014607948,
 0024600448

**CV-ES-14162**

Length: 125
 Cone Ø: d1 Ø 30 / d2 Ø 27
 Thread: M30 x 1,5 LHT
 4600648, 4601248, 4603448, 0004603548,
 14600348, 14601448, 14602348,
 0014603748, 0014607848, 0024600348

**CV-ES-14163**

Length: 125
 Cone Ø: d1 Ø 30 / d2 Ø 27
 Thread: M30 x 1,5 RHT
 0003305248, 0003387310, 0004600348,
 0004600948, 0004602848, 0004602948,
 0004608948, 0014600248, 0014600848,
 0014601248, 0014602248, 0014607748,
 0024600148, A0003387310, A0004600348,
 A0004602848, A0004602948, A0014600848,
 A0014601248, A0014602248, A0014607748

**DB-DL-2144**

Length: 872 Ø: 35
 Cone Ø: d1 Ø 28,6 / d2 Ø 23,9
 0024604305, 0024604405, 0034604805

**DB-DL-2178**

Length: 1735 Ø: 52
 Cone Ø: d1 Ø 32 / d2 Ø 29
 9423300003, 9423300103, 9423300203

**DB-DL-5230**

Length: 879 Ø: 42
 Cone Ø: d1 Ø 30 / d2 Ø 27
 01208600A, 0004607105, 0004607205,
 0014606705

**DB-DL-5241**

Length: 875 Ø: 40
 Cone Ø: d1 Ø 30 / d2 Ø 27
 01215300A, 0004609205, 0004609305,
 0014606905

**DB-DL-5405**

Length: 890 Ø: 35
 Cone Ø: d1 Ø 28,6 / d2 Ø 23,9
 01215900A, 1460248, 0024604505,
 0024604605, 0034605005, 3752600637,
 3754600405, A3752600637, A3754600405

**DB-DL-7270**

Length: 875 Ø: 40
 Cone Ø: d1 Ø 28,6 / d2 Ø 23,9
 01208300A, 0024604705, 0024604805,
 0034604905, A0024604705

**DB-DL-8167**

Length: 866 Ø: 38
 Cone Ø: d1 Ø 30 / d2 Ø 27
 0014609805, 0014609905, 0024606305,
 0024606405

**DB-DL-8168**

Length: 904 Ø: 52
 Cone Ø: d1 Ø 32 / d2 Ø 29
 0004609405, 0004609505, 0014607105

**DB-DL-8184**

Length: 1095 Ø: 42
 Cone Ø: d1 Ø 32 / d2 Ø 28,8
 01217700A, 0014601305, 0014601405,
 0024600505, 0034603205, 3754601505,
 A0014601305, A0014601405, A0024600505

**DB-DL-8185**

Length: 711 Ø: 42
 Cone Ø: d1 Ø 32 / d2 Ø 28,8
 01213600A, 0014601105, 0024600405,
 0034603105, A0014601105, A0024600405

**DB-DL-8307**

Length: 885 Ø: 38
 Cone Ø: d1 Ø 32 / d2 Ø 30
 01215500A, 0004604005, 0024605105,
 0024605205, 0034604005

**DB-DL-8327**

Length: 1745 Ø: 48
 Cone Ø: d1 Ø 32 / d2 Ø 29
 01219800A, 9413300003, 9413300103,
 9413300203, 9413300303, 9413300503

**DB-DL-8388**

Length: 1735 Ø: 62
 Cone Ø: d1 Ø 32 / d2 Ø 28,8
 01219900A, 9453300003, 9453300103,
 9453300403, 9453300603, A9453300003

**DB-DL-8389**

Length: 1465 Ø: 40
 Cone Ø: d1 Ø 32 / d2 Ø 29
 9453300203, 9453300303, 9453300503

**DB-DL-8392**

Length: 860
 Ø: 40
 Cone Ø: d1 Ø 28,6 / d2 Ø 23,9
 0024609605, 24609605, 24609705,
 0024609705, 0034605705

**DB-DL-8622**

Length: 1558 Ø: 52
 Cone Ø: d1 Ø 30 / d2 Ø 27
 0014609005, 0014609105

**DB-DL-8640**

Length: 1615 Ø: 50
 Cone Ø: d1 Ø 32 / d2 Ø 29
 6253301503, 6253301603, 6253302403,
 6253302503, 9423300803, 9423302103,
 9493300203, 9493300303, 9493300903

**DB-DL-8641**

Length: 905 Ø: 42
 Cone Ø: d1 Ø 30 / d2 Ø 27
 0014605105, 0014608105

**DB-DL-8642**

Length: 954 Ø: 42
 Cone Ø: d1 Ø 30 / d2 Ø 27
 0014608605, 0014608705

**DB-DL-9254**

Length: 1815 Ø: 58
 0003220323, 0003220623, 3753220423

**DB-DL-12300**

Length: 733 Ø: 36
 Cone Ø: d1 Ø 32 / d2 Ø 29
 0014601505, 0014607305, 0034603305,
 3754601605, A0014601505,
 A0034603305, A3754601605

**DB-DL-12303**

Length: 888 Ø: 42
 Cone Ø: d1 Ø 28,6 / d2 Ø 23,9
 0034601805, 0034601905, 0034605805,
 A0034601905, A0034605805

**DB-DL-12310**

Length: 1532 Ø: 50
 Cone Ø: d1 Ø 32 / d2 Ø 29
 Thread: M27 x 1,5 LHT
 9493301203, 9493301303, 9493301803,
 9493302203, A9493301203, A9493301303,
 A9493301803, A9493302203

**DB-ES-5227**

Length: 1588 Ø: 60
 Cone Ø: d1 Ø 38 / d2 Ø 34,3
 6253300903, 6253301203, 9443300203

**DB-ES-5234**

Length: 135
 Cone Ø: d1 Ø 38 / d2 Ø 34,3
 Thread: M38 x 1,5 RHT
 0004601748, 120322305, 2205000400

**DB-ES-8164**

Length: 140
 Cone Ø: d1 Ø 28,6 / d2 Ø 23,9
 Thread: M28 x 1,5 RHT
 0014604248, 0014605048, 0014608548,
 0024600548

**DB-ES-8510**

Length: 56
 Cone Ø: d1 Ø 10 / d2 Ø 10
 Thread: M12 x 1,75 LHT
 0009965145, 0009965645, 0019963145

**DB-ES-8530**

Length: 115
 Cone Ø: d1 Ø 28,6 / d2 Ø 23,9
 Thread: M30 x 1,5 RHT
 0014603848, 0014604848, 0014605148,
 0014608648, 0014609948

**DB-RK-8391**

Ø: 85 Hole Distance: 152
 Thick/Height: 24
 01336800A, 0003502705

**DB-RK-8550**

Ø: 75 Hole Distance: 152
 Thick/Height: 24
 0003502105, 0003504605

**DB-RK-8626**

Ø: 75 Hole Distance: 130
 Thick/Height: 24
 0003502205, 0003502505, 0003503405,
 0003504505, GL11319

**DB-RK-8638**

Length: 100 Ø: 67
 Hole Distance: 100
 Thick/Height: 20
 0003301411

**DB-RK-9294**

Ø: 85 Hole Distance: 152
 Thick/Height: 24
 0003503105

**DB-RK-10374**

Ø: 85 Hole Distance: 152
 Thick/Height: 24
 0003504405

**DB-RK-10375**

Ø: 100 Hole Distance: 152
 Thick/Height: 24
 0003502405, 0003503505, 0003504905

**DB-SB-10384**

Ø: 73 Thick/Height: 47
 9303170012, 9423171812

**DB-SB-10406**

Ø: 80 Thick/Height: 46
 0003238185

**DB-SB-10409**

Ø: 77 Thick/Height: 56
 0003265181

**DB-SB-10410**

Ø: 73 Hole Distance: 100
 Thick/Height: 24
 9413230050

**DB-TC-12410**

Length: 925 Ø: 62
 Hole Distance: 100 / 100
 9423300707

**DB-VB-3707**

Length: 622 Ø: 46
 Hole Ø 25 / 25 / 25
 Hole Distance: 152 / 130 / 130
 01337100A, 9423501005, 9423501505,
 9443500005, 9473500105, 9473501005,
 A3753500005, A9473501005, A9473501505,
 A9483500005, A9473500105, A9473501005

**DB-VB-7261**

Length: 622 Ø: 46
 Hole Ø 25 / 25 / 25
 Hole Distance: 152 / 130 / 130
 01337800A, 9443500305, 9443500505,
 9443500605, 9473500705, 9473500905,
 9483500405, 9483503005

**DB-VB-7798**

Length: 622 Ø: 48
 Hole Ø 25 / 23 / 23
 Hole Distance: 152 / 130 / 130
 9423500505, 9423500805, 9423501205,
 A9423501205

**DB-VB-9307**

Length: 667 Ø: 60
 Hole Ø 25 / 23 / 23
 Hole Distance: 152 / 130 / 130
 9483502805

**DB-VB-9308**

Length: 622 Ø: 46
 Hole Ø 25 / 25 / 25
 Hole Distance: 152 / 130 / 130
 9483502905

**DB-VB-10426**

Length: 622 Ø: 46
 Hole Ø 25 / 25 / 25
 Hole Distance: 152 / 130 / 130
 9443500405

**MN-RK-8997**

Ø: 85 Hole Distance: 130
 Thick/Height: 30
 0003504805



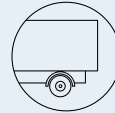

ACTROS MP2 / MP3 ...

1832, L, LL ...	04/03→	Track Control Arm		DB-VB-9308	Suspension Rod, Wishbone (CV), 1st Drive Axle, →517142 06
	04/03→	Track Control Arm		DB-VB-10425	Wishbone (CV)
	04/03→	Track Control Arm		DB-VB-10426	Wishbone (CV), 1st RA, →517142 05
	04/03→	Track Control Arm	DB-DL-5224		Control Arm, 1st FA;Air Suspension Axle
	04/03→	Track Control Arm	DB-DL-9218	DB-DL-9218	Trailing Arm, 1st FA;Air Suspension Axle
1835 AK	04/03→	Centre Rod	DB-DL-8307		Push Rod
	04/03→	Centre Rod	DB-DL-8702		Push Rod
	04/03→	Suspension Arm Repair Kit		DB-RK-8626	for Wishbone (CV)
	04/03→	Suspension Arm Repair Kit		DB-RK-10374	for Wishbone (CV)
	04/03→	Suspension Arm Repair Kit		DB-RK-10375	for Wishbone (CV)
	04/03→	Suspension Strut Repair Kit		DB-RK-8710	
	04/03→	Suspension Strut Repair Kit		DB-RK-9291	
	04/03→	Tie Rod	DB-ES-5227		Guide Rod
	04/03→	Tie Rod	MN-DL-7834		Guide Rod
	04/03→	Tie Rod End	CV-ES-0543		for Push Rod
	04/03→	Tie Rod End	CV-ES-14163		for Steering Rod
	04/03→	Tie Rod End	DB-ES-5234		for Steering Rod
	04/03→	Track Control Arm		DB-VB-7261	Suspension Rod, Wishbone (CV), 1st RA, →517142 01/517142 02
	04/03→	Track Control Arm		DB-VB-7776	Wishbone (CV)
	04/03→	Track Control Arm		DB-VB-9307	Suspension Rod, Wishbone (CV)
	04/03→	Track Control Arm		DB-VB-9308	Suspension Rod, Wishbone (CV)
	04/03→	Track Control Arm		DB-VB-10426	Wishbone (CV), 1st RA, →517142 05
1835 K	04/03→	Centre Rod	DB-DL-2144		Push Rod
	04/03→	Centre Rod	DB-DL-5405		Push Rod
	04/03→	Centre Rod	DB-DL-7270		Push Rod
	04/03→	Centre Rod	DB-DL-8167		Push Rod
	04/03→	Rod Assembly	DB-DL-2178		Guide Rod, 1st Front Axle, →504310 03
	04/03→	Suspension Arm Repair Kit		DB-RK-8626	for Wishbone (CV)
	04/03→	Suspension Arm Repair Kit		DB-RK-10374	for Wishbone (CV)
	04/03→	Suspension Arm Repair Kit		DB-RK-10375	for Wishbone (CV)
	04/03→	Suspension Strut Repair Kit		DB-RK-8710	
	04/03→	Suspension Strut Repair Kit		DB-RK-9291	
	04/03→	Tie Rod	DB-DL-8171		Guide Rod
	04/03→	Tie Rod	DB-DL-8327		Guide Rod
	04/03→	Tie Rod	DB-DL-8640		Guide Rod
	04/03→	Tie Rod End	CV-ES-0543		for Push Rod
	04/03→	Tie Rod End	CV-ES-0888		for Push Rod
	04/03→	Tie Rod End	CV-ES-14163		for Steering Rod
	04/03→	Tie Rod End	DB-ES-8164		for Push Rod
	04/03→	Tie Rod End	DB-ES-8530		for Push Rod
	04/03→	Track Control Arm		DB-VB-7261	Suspension Rod, Wishbone (CV), 1st RA, →517142 01/517142 02
	04/03→	Track Control Arm		DB-VB-7776	Wishbone (CV)
	04/03→	Track Control Arm		DB-VB-9307	Suspension Rod, Wishbone (CV)
04/03→	Track Control Arm		DB-VB-9308	Suspension Rod, Wishbone (CV)	
04/03→	Track Control Arm		DB-VB-10426	Wishbone (CV), 1st RA, →517142 05	
1836 A	10/02→	Ball Head, gearshift linkage	DB-ES-8387		
	10/02→	Ball Head, gearshift linkage	DB-ES-8491		
	10/02→	Ball Head, gearshift linkage	DB-ES-8492		
	10/02→	Bush, parabolic spring		DB-SB-10401	
	10/02→	Centre Rod	DB-DL-8307		Push Rod, Leaf Spring Axle
	10/02→	Centre Rod	DB-DL-8639		Push Rod, Leaf Spring Axle
	10/02→	Centre Rod	DB-DL-8702		Push Rod, Leaf Spring Axle
	10/02→	Tie Rod	DB-ES-5227		Guide Rod
	10/02→	Tie Rod	MN-DL-7834		Guide Rod
1836 AK	04/03→	Ball Head, gearshift linkage	DB-ES-8510		
	04/03→	Bush, driver cab suspension	DB-SB-10384		
	04/03→	Centre Rod	DB-DL-2144		Push Rod
	04/03→	Centre Rod	DB-DL-8184		Push Rod
	04/03→	Centre Rod	DB-DL-8307		Push Rod, Leaf Spring Axle
04/03→	Centre Rod	DB-DL-8702		Push Rod, Leaf Spring Axle	

CV-ES-0543

Length: 125
Cone Ø: d1 Ø 32 / d2 Ø 29
Thread: M30 x 1,5 RHT
0004605748, 0004606048, 0004606848,
0004607048, 0014600448, 0014601148,
0014601748, 0014602448, 0014607648,
0014609648



CV-ES-0888

Length: 125
Cone Ø: d1 Ø 32 / d2 Ø 29
Thread: M30 x 1,5 LHT
0004605848, 0004606148, 0004606948,
0004607148, 0004609048, 0014600548,
0014601348, 0014602548, 0014607948,
0024600448



CV-ES-14163

Length: 125
Cone Ø: d1 Ø 30 / d2 Ø 27
Thread: M30 x 1,5 RHT
0003305248, 0003387310, 0004600348,
0004600948, 0004602848, 0004602948,
0004608948, 0014600248, 0014600848,
0014601248, 0014602248, 0014607748,
0024600148, A0003387310, A0004600348,
A0004602848, A0004602948, A0014600848,
A0014601248, A0014602248, A0014607748



DB-DL-2144

Length: 872 Ø: 35
Cone Ø: d1 Ø 28,6 / d2 Ø 23,9
0024604305, 0024604405, 0034604805



DB-DL-2178

Length: 1735 Ø: 52
Cone Ø: d1 Ø 32 / d2 Ø 29
9423300003, 9423300103, 9423300203



DB-DL-5224

Length: 850 Ø: 60
Hole Distance: 100 / 100
01336100A, 9413300007



DB-DL-5405

Length: 890 Ø: 35
Cone Ø: d1 Ø 28,6 / d2 Ø 23,9
01215900A, 1460248, 0024604505,
0024604605, 0034605005, 3752600637,
3754600405, A3752600637, A3754600405



DB-DL-7270

Length: 875 Ø: 40
Cone Ø: d1 Ø 28,6 / d2 Ø 23,9
01208300A, 0024604705, 0024604805,
0034604905, A0024604705



DB-DL-8167

Length: 866 Ø: 38
Cone Ø: d1 Ø 30 / d2 Ø 27
0014609805, 0014609905, 0024606305,
0024606405



DB-DL-8171

Length: 1687 Ø: 52
Cone Ø: d1 Ø 32 / d2 Ø 29
9493300603, 9493300703, 9493301503,
9493301603



DB-DL-8184

Length: 1095 Ø: 42
Cone Ø: d1 Ø 32 / d2 Ø 28,8
01217700A, 0014601305, 0014601405,
0024600505, 0034603205, 3754601505,
A0014601305, A0014601405, A0024600505



DB-DL-8307

Length: 885 Ø: 38
Cone Ø: d1 Ø 32 / d2 Ø 30
01215500A, 0004604005, 0024605105,
0024605205, 0034604005



DB-DL-8327

Length: 1745 Ø: 48
Cone Ø: d1 Ø 32 / d2 Ø 29
01219800A, 9413300003, 9413300103,
9413300203, 9413300303, 9413300503



DB-DL-8639

Length: 888 Ø: 38
Cone Ø: d1 Ø 30 / d2 Ø 27
0014600705, 0014600805, 0014607005



DB-DL-8640

Length: 1615 Ø: 50
Cone Ø: d1 Ø 32 / d2 Ø 29
6253301503, 6253301603, 6253302403,
6253302503, 9423300803, 9423302103,
9493300203, 9493300303, 9493300903



DB-DL-8702

Length: 958 Ø: 38
Cone Ø: d1 Ø 32 / d2 Ø 30
0024606105, 0024606205, 0034604205



DB-DL-9218

Length: 754 Ø: 40
Hole Distance: 100
000360098524, 000390098524,
3753300111, 9413300011,
A3753300111, SA50831601



DB-ES-5227

Length: 1588 Ø: 60
Cone Ø: d1 Ø 38 / d2 Ø 34,3
6253300903, 6253301203, 9443300203



DB-ES-5234

Length: 135
Cone Ø: d1 Ø 38 / d2 Ø 34,3
Thread: M38 x 1,5 RHT
0004601748, 120322305, 2205000400



DB-ES-8164

Length: 140
Cone Ø: d1 Ø 28,6 / d2 Ø 23,9
Thread: M28 x 1,5 RHT
0014604248, 0014605048, 0014608548,
0024600548



DB-ES-8387

Length: 55
Cone Ø: d1 Ø 10 / d2 Ø 10
Thread: M14 x 1,5 RHT
0009966845, 0009967045



DB-ES-8491

Length: 60
Cone Ø: d1 Ø 10 / d2 Ø 10
Thread: M12 x 1,75 LHT
0009966745



DB-ES-8492

Length: 60
Cone Ø: d1 Ø 10 / d2 Ø 10
Thread: M12 x 1,75 RHT
0009966845, 3752680189, A3752680189



DB-ES-8510

Length: 56
Cone Ø: d1 Ø 10 / d2 Ø 10
Thread: M12 x 1,75 LHT
0009965145, 0009965645, 0019963145



DB-ES-8530

Length: 115
Cone Ø: d1 Ø 28,6 / d2 Ø 23,9
Thread: M30 x 1,5 RHT
0014603848, 0014604848, 0014605148,
0014608648, 0014609948



DB-RK-8626

Ø: 75 Hole Distance: 130
Thick/Height: 24
0003502205, 0003502505, 0003503405,
0003504505, GL11319



DB-RK-8710

Ø: 85 Hole Distance: 130
Thick/Height: 30
0003503705



DB-RK-9291

Ø: 107,5 Hole Distance: 152
Thick/Height: 30
0003503605



DB-RK-10374

Ø: 85 Hole Distance: 152
Thick/Height: 24
0003504405



DB-RK-10375

Ø: 100 Hole Distance: 152
Thick/Height: 24
0003502405, 0003503505, 0003504905



DB-SB-10384

Ø: 73 Thick/Height: 47
9303170012, 9423171812



DB-SB-10401

Length: 232
Thick/Height: 163,5 / 152,5
0003250596, 0003250796



DB-VB-7261

Length: 622 Ø: 46
Hole Ø 25 / 25 / 25
Hole Distance: 152 / 130 / 130
01337800A, 9443500305, 9443500505,
9443500605, 9473500705, 9473500905,
9483500405, 9483500305



DB-VB-7776

Length: 622 Ø: 56
Hole Distance: 152 / 152
6533500205, 6583500205



DB-VB-9307

Length: 667 Ø: 60
Hole Ø 25 / 23 / 23
Hole Distance: 152 / 130 / 130
9483502805



DB-VB-9308

Length: 622 Ø: 46
Hole Ø 25 / 25 / 25
Hole Distance: 152 / 130 / 130
9483502905



DB-VB-10425

Length: 622 Ø: 46
Hole Ø 25 / 23 / 23
Hole Distance: 152 / 130 / 130
9423500905, 9423501305



DB-VB-10426

Length: 622 Ø: 46
Hole Ø 25 / 25 / 25
Hole Distance: 152 / 130 / 130
9443500405



MN-DL-7834

Length: 1588 Ø: 58
Cone Ø: d1 Ø 30 / d2 Ø 27
3463303903, 3463304903, 6253303203,
9443300503, 9443301303, 9443301703





ACTROS MP2 / MP3 ...

1836 AK ...	04/03→	Centre Rod	DB-DL-12300		for Steering Rod	
	04/03→	Rod Assembly	DB-DL-2178		Guide Rod	
	04/03→	Stabiliser Mounting		DB-SB-10406		
	04/03→	Stabiliser Mounting		DB-SB-10409		
	04/03→	Suspension Arm Repair Kit		DB-RK-8626	for Wishbone (CV)	
	04/03→	Suspension Arm Repair Kit		DB-RK-10374	for Wishbone (CV)	
	04/03→	Suspension Arm Repair Kit		DB-RK-10375	for Wishbone (CV)	
	04/03→	Suspension Arm Repair Kit	DB-RK-8638		for Control Arm	
	04/03→	Suspension Strut Repair Kit		DB-RK-8391		
	04/03→	Tie Rod	DB-DL-12310			
	04/03→	Tie Rod	DB-ES-5227		Guide Rod, 1st FA;Leaf Spring Axle	
	04/03→	Tie Rod	MN-DL-7834		Guide Rod, 1st FA;Leaf Spring Axle	
	04/03→	Tie Rod End	CV-ES-0543		for Push Rod	
	04/03→	Tie Rod End	CV-ES-0888		for Push Rod	
	04/03→	Tie Rod End	CV-ES-14162		for Steering Rod	
	04/03→	Tie Rod End	CV-ES-14163		for Steering Rod	
	04/03→	Tie Rod End	DB-ES-5234		for Steering Rod	
	04/03→	Tie Rod End	DB-ES-8530		for Push Rod	
	04/03→	Track Control Arm		DB-VB-7261	Suspension Rod, Wishbone (CV), 1st RA, →517142 01/517142 02	
	04/03→	Track Control Arm		DB-VB-9307	Suspension Rod, Wishbone (CV), 1st Drive Axle, →517142 07	
	04/03→	Track Control Arm		DB-VB-9308	Suspension Rod, Wishbone (CV), 1st Drive Axle, →517142 06	
	04/03→	Track Control Arm		DB-VB-10426	Wishbone (CV), 1st RA, →517142 05	
	1836 K	04/03→	Ball Head, gearshift linkage	DB-ES-8510		
		04/03→	Bush, driver cab suspension	DB-SB-10384		
04/03→		Centre Rod	DB-DL-2144		Push Rod	
04/03→		Centre Rod	DB-DL-5230		Suspension Rod	
04/03→		Centre Rod	DB-DL-5241		Push Rod	
04/03→		Centre Rod	DB-DL-5405		Push Rod, Leaf Spring Axle	
04/03→		Centre Rod	DB-DL-7270		Push Rod	
04/03→		Centre Rod	DB-DL-8167		Push Rod	
04/03→		Centre Rod	DB-DL-8184		Push Rod	
04/03→		Centre Rod	DB-DL-8185		Push Rod	
04/03→		Centre Rod	DB-DL-8307		Push Rod	
04/03→		Centre Rod	DB-DL-12300		for Steering Rod	
04/03→		Rod Assembly	DB-DL-2178		Guide Rod	
04/03→		Stabiliser Mounting		DB-SB-10406		
04/03→		Stabiliser Mounting		DB-SB-10409		
04/03→		Suspension Arm Repair Kit		DB-RK-8550	for Wishbone (CV)	
04/03→		Suspension Arm Repair Kit		DB-RK-8626	for Wishbone (CV)	
04/03→		Suspension Arm Repair Kit		DB-RK-10374	for Wishbone (CV)	
04/03→		Suspension Arm Repair Kit		DB-RK-10375	for Wishbone (CV)	
04/03→		Suspension Arm Repair Kit	DB-RK-8638		for Control Arm	
04/03→		Suspension Strut Repair Kit		DB-RK-8391		
04/03→		Tie Rod	DB-DL-8171		Guide Rod, 1st FA;Leaf Spring Axle	
04/03→		Tie Rod	DB-DL-8327		Guide Rod, 1st FA;Leaf Spring Axle	
04/03→		Tie Rod	DB-DL-8640		Guide Rod	
04/03→		Tie Rod	DB-DL-12310			
04/03→		Tie Rod	DB-ES-5227		Guide Rod	
04/03→		Tie Rod End	CV-ES-0543		for Push Rod	
04/03→		Tie Rod End	CV-ES-0888		for Push Rod	
04/03→		Tie Rod End	CV-ES-14162		for Steering Rod	
04/03→		Tie Rod End	CV-ES-14163		for Steering Rod	
04/03→		Tie Rod End	DB-ES-5234		for Steering Rod	
04/03→		Tie Rod End	DB-ES-8164		for Push Rod	
04/03→		Tie Rod End	DB-ES-8530		for Push Rod	
04/03→		Track Control Arm		DB-VB-7261	Suspension Rod, Wishbone (CV), 1st RA, →517142 01/517142 02	
04/03→		Track Control Arm		DB-VB-9307	Suspension Rod, Wishbone (CV), 1st Drive Axle, →517142 07	

CV-ES-0543

Length: 125
Cone Ø: d1 Ø 32 / d2 Ø 29
Thread: M30 x 1,5 RHT
0004605748, 0004606048, 0004606848,
0004607048, 0014600448, 0014601148,
0014601748, 0014602448, 0014607648,
0014609648



CV-ES-0888

Length: 125
Cone Ø: d1 Ø 32 / d2 Ø 29
Thread: M30 x 1,5 LHT
0004605848, 0004606148, 0004606948,
0004607148, 0004609048, 0014600548,
0014601348, 0014602548, 0014607948,
0024600448



CV-ES-14162

Length: 125
Cone Ø: d1 Ø 30 / d2 Ø 27
Thread: M30 x 1,5 LHT
4600648, 4601248, 4603448, 0004603548,
14600348, 14601448, 14602348,
0014603748, 0014607848, 0024600348



CV-ES-14163

Length: 125
Cone Ø: d1 Ø 30 / d2 Ø 27
Thread: M30 x 1,5 RHT
0003305248, 0003387310, 0004600348,
0004600948, 0004602848, 0004602948,
0004608948, 0014600248, 0014600848,
0014601248, 0014602248, 0014607748,
0024600148, 0003387310, 0004600348,
A0004602848, A0004602948, A0014600848,
A0014601248, A0014602248, A0014607748



DB-DL-2144

Length: 872 Ø: 35
Cone Ø: d1 Ø 28,6 / d2 Ø 23,9
0024604305, 0024604405, 0034604805



DB-DL-2178

Length: 1735 Ø: 52
Cone Ø: d1 Ø 32 / d2 Ø 29
9423300003, 9423300103, 9423300203



DB-DL-5230

Length: 879 Ø: 42
Cone Ø: d1 Ø 30 / d2 Ø 27
01208600A, 0004607105, 0004607205,
0014606705



DB-DL-5241

Length: 875 Ø: 40
Cone Ø: d1 Ø 30 / d2 Ø 27
01215300A, 0004609205, 0004609305,
0014606905



DB-DL-5405

Length: 890 Ø: 35
Cone Ø: d1 Ø 28,6 / d2 Ø 23,9
01215900A, 1460248, 0024604505,
0024604605, 0034605005, 3752600637,
3754600405, A3752600637, A3754600405



DB-DL-7270

Length: 875 Ø: 40
Cone Ø: d1 Ø 28,6 / d2 Ø 23,9
01208300A, 0024604705, 0024604805,
0034604905, A0024604705



DB-DL-8167

Length: 866 Ø: 38
Cone Ø: d1 Ø 30 / d2 Ø 27
0014609805, 0014609905, 0024606305,
0024606405



DB-DL-8171

Length: 1687 Ø: 52
Cone Ø: d1 Ø 32 / d2 Ø 29
9493300603, 9493300703, 9493301503,
9493301603



DB-DL-8184

Length: 1095 Ø: 42
Cone Ø: d1 Ø 32 / d2 Ø 28,8
01217700A, 0014601305, 0014601405,
0024600505, 0034603205, 3754601505,
A0014601305, A0014601405, A0024600505



DB-DL-8185

Length: 711 Ø: 42
Cone Ø: d1 Ø 32 / d2 Ø 28,8
01213600A, 0014601105, 0024600405,
0034603105, A0014601105, A0024600405



DB-DL-8307

Length: 885 Ø: 38
Cone Ø: d1 Ø 32 / d2 Ø 30
01215500A, 0004604005, 0024605105,
0024605205, 0034604005



DB-DL-8327

Length: 1745 Ø: 48
Cone Ø: d1 Ø 32 / d2 Ø 29
01219800A, 9413300003, 9413300103,
9413300203, 9413300303, 9413300503



DB-DL-8640

Length: 1615 Ø: 50
Cone Ø: d1 Ø 32 / d2 Ø 29
6253301503, 6253301603, 6253302403,
6253302503, 9423300803, 9423302103,
9493300203, 9493300303, 9493300903



DB-DL-12300

Length: 733 Ø: 36
Cone Ø: d1 Ø 32 / d2 Ø 29
0014601505, 0014607305, 0034603305,
3754601605, A0014601505,
A0034603305, A3754601605



DB-DL-12310

Length: 1532 Ø: 50
Cone Ø: d1 Ø 32 / d2 Ø 29
Thread: M27 x 1,5 LHT
9493301203, 9493301303, 9493301803,
9493302203, A9493301203, A9493301303,
A9493301803, A9493302203



DB-ES-5227

Length: 1588 Ø: 60
Cone Ø: d1 Ø 38 / d2 Ø 34,3
6253300903, 6253301203, 9443300203



DB-ES-5234

Length: 135
Cone Ø: d1 Ø 38 / d2 Ø 34,3
Thread: M38 x 1,5 RHT
0004601748, 120322305, 2205000400



DB-ES-8164

Length: 140
Cone Ø: d1 Ø 28,6 / d2 Ø 23,9
Thread: M28 x 1,5 RHT
0014604248, 0014605048, 0014608548,
0024600548



DB-ES-8510

Length: 56
Cone Ø: d1 Ø 10 / d2 Ø 10
Thread: M12 x 1,75 LHT
0009965145, 0009965645, 0019963145



DB-ES-8530

Length: 115
Cone Ø: d1 Ø 28,6 / d2 Ø 23,9
Thread: M30 x 1,5 RHT
0014603848, 0014604848, 0014605148,
0014608648, 0014609948



DB-RK-8391

Ø: 85 Hole Distance: 152
Thick/Height: 24
01336800A, 0003502705



DB-RK-8550

Ø: 75 Hole Distance: 152
Thick/Height: 24
0003502105, 0003504605



DB-RK-8626

Ø: 75 Hole Distance: 130
Thick/Height: 24
0003502205, 0003502505, 0003503405,
0003504505, GL11319



DB-RK-8638

Length: 100 Ø: 67
Hole Distance: 100
Thick/Height: 20
0003301411



DB-RK-10374

Ø: 85 Hole Distance: 152
Thick/Height: 24
0003504405



DB-RK-10375

Ø: 100 Hole Distance: 152
Thick/Height: 24
0003502405, 0003503505, 0003504905



DB-SB-10384

Ø: 73 Thick/Height: 47
9303170012, 9423171812



DB-SB-10406

Ø: 80 Thick/Height: 46
0003238185



DB-SB-10409

Ø: 77 Thick/Height: 56
0003265181



DB-VB-7261

Length: 622 Ø: 46
Hole Ø 25 / 25 / 25
Hole Distance: 152 / 130 / 130
01337800A, 9443500305, 9443500505,
9443500605, 9473500705, 9473500905,
9483500405, 9483503005



DB-VB-9307

Length: 667 Ø: 60
Hole Ø 25 / 23 / 23
Hole Distance: 152 / 130 / 130
9483502805



DB-VB-9308

Length: 622 Ø: 46
Hole Ø 25 / 25 / 25
Hole Distance: 152 / 130 / 130
9483502905



DB-VB-10426

Length: 622 Ø: 46
Hole Ø 25 / 25 / 25
Hole Distance: 152 / 130 / 130
9443500405



MN-DL-7834

Length: 1588 Ø: 58
Cone Ø: d1 Ø 30 / d2 Ø 27
3463303903, 3463304903, 6253303203,
9443300503, 9443301303, 9443301703





ACTROS MP2 / MP3 ...

1836 K ...	04/03 →	Track Control Arm		DB-VB-9308	Suspension Rod, Wishbone (CV), 1st Drive Axle, →517142 06
	04/03 →	Track Control Arm		DB-VB-10426	Wishbone (CV), 1st RA, →517142 05
1836 LS, LLS	04/03 →	Ball Head, gearshift linkage	DB-ES-8510		
	04/03 →	Bush, driver cab suspension	DB-SB-10384		
	04/03 →	Centre Rod	DB-DL-2144		Push Rod
	04/03 →	Centre Rod	DB-DL-5230		Suspension Rod
	04/03 →	Centre Rod	DB-DL-5241		Push Rod
	04/03 →	Centre Rod	DB-DL-5405		Push Rod
	04/03 →	Centre Rod	DB-DL-7270		Push Rod
	04/03 →	Centre Rod	DB-DL-8167		Push Rod
	04/03 →	Centre Rod	DB-DL-8184		Push Rod
	04/03 →	Centre Rod	DB-DL-8185		Push Rod
	04/03 →	Centre Rod	DB-DL-8307		Push Rod
	04/03 →	Centre Rod	DB-DL-8392		Push Rod
	04/03 →	Centre Rod	DB-DL-12303		Push Rod, Leaf Spring Axle
	04/03 →	Rod Assembly	DB-DL-2178		Guide Rod
	04/03 →	Stabiliser Mounting		DB-SB-10406	
	04/03 →	Stabiliser Mounting		DB-SB-10409	
	04/03 →	Stabiliser Mounting	DB-SB-10410		
	04/03 →	Suspension Arm Repair Kit		DB-RK-8626	for Wishbone (CV)
	04/03 →	Suspension Arm Repair Kit		DB-RK-10374	for Wishbone (CV)
	04/03 →	Suspension Arm Repair Kit		DB-RK-10375	for Wishbone (CV)
	04/03 →	Suspension Arm Repair Kit	DB-RK-8638		for Control Arm
	04/03 →	Suspension Strut Repair Kit		DB-RK-8391	
	04/03 →	Suspension Strut Repair Kit		MN-RK-8997	
	04/03 →	Tie Rod	DB-DL-8327		Guide Rod
	04/03 →	Tie Rod	DB-DL-8388		Guide Rod
	04/03 →	Tie Rod	DB-DL-8389		
	04/03 →	Tie Rod	DB-DL-8640		Guide Rod
	04/03 →	Tie Rod	DB-DL-12310		
	04/03 →	Tie Rod	DB-ES-5227		Guide Rod
	04/03 →	Tie Rod End	CV-ES-0543		for Push Rod
	04/03 →	Tie Rod End	CV-ES-0888		for Push Rod
	04/03 →	Tie Rod End	CV-ES-14162		for Steering Rod
	04/03 →	Tie Rod End	CV-ES-14163		for Steering Rod
	04/03 →	Tie Rod End	DB-ES-5234		for Steering Rod
	04/03 →	Tie Rod End	DB-ES-8164		for Push Rod
	04/03 →	Tie Rod End	DB-ES-8530		for Push Rod
	04/03 →	Track Control Arm		DB-TC-12410	Control Arm
	04/03 →	Track Control Arm		DB-VB-7798	Wishbone (CV), Air Suspension Axle, * K 864074 * →
	04/03 →	Track Control Arm		DB-VB-10425	Wishbone (CV)
	04/03 →	Track Control Arm	DB-DL-5224		Control Arm, 1st FA; Air Suspension Axle
	04/03 →	Track Control Arm	DB-DL-9218	DB-DL-9218	Trailing Arm, 1st FA; Air Suspension Axle
	1836, L, LL	04/03 →	Ball Head, gearshift linkage	DB-ES-8510	
04/03 →		Bush, driver cab suspension	DB-SB-10384		
04/03 →		Centre Rod	DB-DL-2144		Push Rod
04/03 →		Centre Rod	DB-DL-5230		Suspension Rod
04/03 →		Centre Rod	DB-DL-5241		Push Rod
04/03 →		Centre Rod	DB-DL-5405		Push Rod
04/03 →		Centre Rod	DB-DL-5405		Push Rod, Leaf Spring Axle
04/03 →		Centre Rod	DB-DL-7270		Push Rod
04/03 →		Centre Rod	DB-DL-8167		Push Rod
04/03 →		Centre Rod	DB-DL-8168		Push Rod
04/03 →		Centre Rod	DB-DL-8184		Push Rod
04/03 →		Centre Rod	DB-DL-8185		Push Rod
04/03 →		Centre Rod	DB-DL-8307		Push Rod
04/03 →		Centre Rod	DB-DL-8622		Push Rod
04/03 →		Centre Rod	DB-DL-8641		Push Rod
04/03 →		Centre Rod	DB-DL-8642		Push Rod
04/03 →		Centre Rod	DB-DL-12300		for Steering Rod
04/03 →		Rod Assembly	DB-DL-2178		Guide Rod

CV-ES-0543

Length: 125
 Cone Ø: d1 Ø 32 / d2 Ø 29
 Thread: M30 x 1,5 RHT
 0004605748, 0004606048, 0004606848,
 0004607048, 0014600448, 0014601148,
 0014601748, 0014602448, 0014607648,
 0014609648

**CV-ES-0888**

Length: 125
 Cone Ø: d1 Ø 32 / d2 Ø 29
 Thread: M30 x 1,5 LHT
 0004605848, 0004606148, 0004606948,
 0004607148, 0004609048, 0014600548,
 0014601348, 0014602548, 0014607948,
 0024600448

**CV-ES-14162**

Length: 125
 Cone Ø: d1 Ø 30 / d2 Ø 27
 Thread: M30 x 1,5 LHT
 4600648, 4601248, 4603448,
 0004603548, 4603548, 14600348,
 14601448, 14602348, 0014603748,
 14607848, 0014607848, 0024600348

**CV-ES-14163**

Length: 125
 Cone Ø: d1 Ø 30 / d2 Ø 27
 Thread: M30 x 1,5 RHT
 0003305248, 0003387310, 0004600348,
 0004600948, 0004602848, 0004602948,
 0004608948, 0014600248, 0014600848,
 0014601248, 0014602248, 0014607748,
 0024600148, A0003387310, A0004600348,
 A0004602848, A0004602948, A0014600848,
 A0014601248, A0014602248, A0014607748

**DB-DL-2144**

Length: 872 Ø: 35
 Cone Ø: d1 Ø 28,6 / d2 Ø 23,9
 0024604305, 0024604405, 0034604805

**DB-DL-2178**

Length: 1735 Ø: 52
 Cone Ø: d1 Ø 32 / d2 Ø 29
 9423300003, 9423300103, 9423300203

**DB-DL-5224**

Length: 850 Ø: 60
 Hole Distance: 100 / 100
 01336100A, 9413300007

**DB-DL-5230**

Length: 879 Ø: 42
 Cone Ø: d1 Ø 30 / d2 Ø 27
 01208600A, 0004607105, 0004607205,
 0014606705

**DB-DL-5241**

Length: 875 Ø: 40
 Cone Ø: d1 Ø 30 / d2 Ø 27
 01215300A, 0004609205, 0004609305,
 0014606905

**DB-DL-5405**

Length: 890 Ø: 35
 Cone Ø: d1 Ø 28,6 / d2 Ø 23,9
 01215900A, 1460248, 0024604505,
 0024604605, 0034605005, 3752600637,
 3754600405, A3752600637, A3754600405

**DB-DL-7270**

Length: 875 Ø: 40
 Cone Ø: d1 Ø 28,6 / d2 Ø 23,9
 01208300A, 0024604705, 0024604805,
 0034604905, A0024604705

**DB-DL-8167**

Length: 866 Ø: 38
 Cone Ø: d1 Ø 30 / d2 Ø 27
 0014609805, 0014609905, 0024606305,
 0024606405

**DB-DL-8168**

Length: 904 Ø: 52
 Cone Ø: d1 Ø 32 / d2 Ø 29
 0004609405, 0004609505, 0014607105

**DB-DL-8184**

Length: 1095 Ø: 42
 Cone Ø: d1 Ø 32 / d2 Ø 28,8
 01217700A, 0014601305, 0014601405,
 0024600505, 0034603205, 3754601505,
 A0014601305, A0014601405, A0024600505

**DB-DL-8185**

Length: 711 Ø: 42
 Cone Ø: d1 Ø 32 / d2 Ø 28,8
 01213600A, 0014601105, 0024600405,
 0034603105, A0014601105, A0024600405

**DB-DL-8307**

Length: 885 Ø: 38
 Cone Ø: d1 Ø 32 / d2 Ø 30
 01215500A, 0004604005, 0024605105,
 0024605205, 0034604005

**DB-DL-8327**

Length: 1745 Ø: 48
 Cone Ø: d1 Ø 32 / d2 Ø 29
 01219800A, 9413300003, 9413300103,
 9413300203, 9413300303, 9413300503

**DB-DL-8388**

Length: 1735 Ø: 62
 Cone Ø: d1 Ø 32 / d2 Ø 28,8
 01219900A, 9453300003, 9453300103,
 9453300403, 9453300603, A9453300003

**DB-DL-8389**

Length: 1465 Ø: 40
 Cone Ø: d1 Ø 32 / d2 Ø 29
 9453300203, 9453300303, 9453300503

**DB-DL-8392**

Length: 860
 Ø: 40
 Cone Ø: d1 Ø 28,6 / d2 Ø 23,9
 0024609605, 24609605, 24609705,
 0024609705, 0034605705

**DB-DL-8622**

Length: 1558 Ø: 52
 Cone Ø: d1 Ø 30 / d2 Ø 27
 0014609005, 0014609105

**DB-DL-8640**

Length: 1615 Ø: 50
 Cone Ø: d1 Ø 32 / d2 Ø 29
 6253301503, 6253301603, 6253302403,
 6253302503, 9423300803, 9423302103,
 9493300203, 9493300303, 9493300903

**DB-DL-8641**

Length: 905 Ø: 42
 Cone Ø: d1 Ø 30 / d2 Ø 27
 0014605105, 0014608105

**DB-DL-8642**

Length: 954 Ø: 42
 Cone Ø: d1 Ø 30 / d2 Ø 27
 0014608605, 0014608705

**DB-DL-9218**

Length: 754 Ø: 40
 Hole Distance: 100
 000360098524, 000390098524,
 3753300111, 9413300011,
 A3753300111, SA50831601

**DB-DL-12300**

Length: 733 Ø: 36
 Cone Ø: d1 Ø 32 / d2 Ø 29
 0014601505, 0014607305, 0034603305,
 3754601605, A0014601505,
 A0034603305, A3754601605

**DB-DL-12303**

Length: 888 Ø: 42
 Cone Ø: d1 Ø 28,6 / d2 Ø 23,9
 0034601805, 0034601905, 0034605805,
 A0034601905, A0034605805

**DB-DL-12310**

Length: 1532 Ø: 50
 Cone Ø: d1 Ø 32 / d2 Ø 29
 Thread: M27 x 1,5 LHT
 9493301203, 9493301303, 9493301803,
 9493302203, A9493301203, A9493301303,
 A9493301803, A9493302203

**DB-ES-5227**

Length: 1588 Ø: 60
 Cone Ø: d1 Ø 38 / d2 Ø 34,3
 6253300903, 6253301203, 9443300203

**DB-ES-5234**

Length: 135
 Cone Ø: d1 Ø 38 / d2 Ø 34,3
 Thread: M38 x 1,5 RHT
 0004601748, 120322305, 2205000400

**DB-ES-8164**

Length: 140
 Cone Ø: d1 Ø 28,6 / d2 Ø 23,9
 Thread: M28 x 1,5 RHT
 0014604248, 0014605048, 0014608548,
 0024600548

**DB-ES-8510**

Length: 56
 Cone Ø: d1 Ø 10 / d2 Ø 10
 Thread: M12 x 1,75 LHT
 0009965145, 0009965645, 0019963145

**DB-ES-8530**

Length: 115
 Cone Ø: d1 Ø 28,6 / d2 Ø 23,9
 Thread: M30 x 1,5 RHT
 0014603848, 0014604848, 0014605148,
 0014608648, 0014609948

**DB-RK-8391**

Ø: 85 Hole Distance: 152
 Thick/Height: 24
 01336800A, 0003502705

**DB-RK-8626**

Ø: 75 Hole Distance: 130
 Thick/Height: 24
 0003502205, 0003502505, 0003503405,
 0003504505, GL11319

**DB-RK-8638**

Length: 100 Ø: 67
 Hole Distance: 100
 Thick/Height: 20
 0003301411

**DB-RK-10374**

Ø: 85 Hole Distance: 152
 Thick/Height: 24
 0003504405

**DB-RK-10375**

Ø: 100 Hole Distance: 152
 Thick/Height: 24
 0003502405, 0003503505, 0003504905

**DB-SB-10384**

Ø: 73 Thick/Height: 47
 9303170012, 9423171812

**DB-SB-10406**

Ø: 80 Thick/Height: 46
 0003238185

**DB-SB-10409**

Ø: 77 Thick/Height: 56
 0003265181

**DB-SB-10410**

Ø: 73 Hole Distance: 100
 Thick/Height: 24
 9413230050

**DB-TC-12410**

Length: 925 Ø: 62
 Hole Distance: 100 / 100
 9423300707

**DB-VB-7798**

Length: 622 Ø: 48
 Hole Ø 25 / 23 / 23
 Hole Distance: 152 / 130 / 130
 9423500505, 9423500805, 9423501205,
 A9423501205

**DB-VB-9308**

Length: 622 Ø: 46
 Hole Ø 25 / 25 / 25
 Hole Distance: 152 / 130 / 130
 9483502905

**DB-VB-10425**

Length: 622 Ø: 46
 Hole Ø 25 / 23 / 23
 Hole Distance: 152 / 130 / 130
 9423500905, 9423501305

**DB-VB-10426**

Length: 622 Ø: 46
 Hole Ø 25 / 25 / 25
 Hole Distance: 152 / 130 / 130
 9443500405

**MN-RK-8997**

Ø: 85
 Hole Distance: 130
 Thick/Height: 30
 0003504805, 3504805





ACTROS MP2 / MP3 ...

1836, L, LL ...	04/03→	Stabiliser Link	DB-DL-9254		Pressure Rod	
	04/03→	Stabiliser Mounting		DB-SB-10406		
	04/03→	Stabiliser Mounting		DB-SB-10409		
	04/03→	Stabiliser Mounting	DB-SB-10410			
	04/03→	Suspension Arm Repair Kit		DB-RK-8550	for Wishbone (CV)	
	04/03→	Suspension Arm Repair Kit		DB-RK-8626	for Wishbone (CV)	
	04/03→	Suspension Arm Repair Kit		DB-RK-10374	for Wishbone (CV)	
	04/03→	Suspension Arm Repair Kit		DB-RK-10375	for Wishbone (CV)	
	04/03→	Suspension Arm Repair Kit	DB-RK-8638		for Control Arm	
	04/03→	Suspension Strut Repair Kit		DB-RK-8391		
	04/03→	Suspension Strut Repair Kit		DB-RK-9294		
	04/03→	Tie Rod	DB-DL-8327		Guide Rod, 1st FA;Leaf Spring Axle	
	04/03→	Tie Rod	DB-DL-8388		Guide Rod, 1st FA;Leaf Spring Axle	
	04/03→	Tie Rod	DB-DL-8389		1st FA;Leaf Spring Axle	
	04/03→	Tie Rod	DB-DL-8640		Guide Rod	
	04/03→	Tie Rod	DB-DL-12310			
	04/03→	Tie Rod	DB-ES-5227		Guide Rod	
	04/03→	Tie Rod End	CV-ES-0543		for Push Rod	
	04/03→	Tie Rod End	CV-ES-0888		for Push Rod	
	04/03→	Tie Rod End	CV-ES-14162		for Steering Rod	
	04/03→	Tie Rod End	CV-ES-14163		for Steering Rod	
	04/03→	Tie Rod End	DB-ES-5234		for Steering Rod	
	04/03→	Tie Rod End	DB-ES-8164		for Push Rod	
	04/03→	Tie Rod End	DB-ES-8530		for Push Rod	
	04/03→	Track Control Arm		DB-VB-3707	Suspension Rod, Wishbone (CV)	
	04/03→	Track Control Arm		DB-VB-7261	Suspension Rod, Wishbone (CV), 1st RA, →517142 01/517142 02	
	04/03→	Track Control Arm		DB-VB-9307	Suspension Rod, Wishbone (CV), 1st Drive Axle, →517142 07	
	04/03→	Track Control Arm		DB-VB-9308	Suspension Rod, Wishbone (CV), 1st Drive Axle, →517142 06	
	04/03→	Track Control Arm		DB-VB-10426	Wishbone (CV), 1st RA, →517142 05	
	04/03→	Track Control Arm	DB-DL-5224		Control Arm, 1st FA;Air Suspension Axle	
	04/03→	Track Control Arm	DB-DL-9218	DB-DL-9218	Trailing Arm, 1st FA;Air Suspension Axle	
	1840 AK	04/03→	Centre Rod	DB-DL-8307		Push Rod
		04/03→	Centre Rod	DB-DL-8702		Push Rod
		04/03→	Suspension Arm Repair Kit		DB-RK-8626	for Wishbone (CV)
04/03→		Suspension Arm Repair Kit		DB-RK-10374	for Wishbone (CV)	
04/03→		Suspension Arm Repair Kit		DB-RK-10375	for Wishbone (CV)	
04/03→		Suspension Strut Repair Kit		DB-RK-8710		
04/03→		Suspension Strut Repair Kit		DB-RK-9291		
04/03→		Tie Rod	DB-ES-5227		Guide Rod	
04/03→		Tie Rod	MN-DL-7834		Guide Rod, 1st FA, →504522 01	
04/03→		Tie Rod End	CV-ES-0543		for Push Rod	
04/03→		Tie Rod End	CV-ES-14163		for Steering Rod	
04/03→		Tie Rod End	DB-ES-5234		for Steering Rod	
04/03→		Track Control Arm		DB-VB-7261	Suspension Rod, Wishbone (CV), 1st RA, →517142 01/517142 02	
04/03→		Track Control Arm		DB-VB-7776	Wishbone (CV)	
04/03→		Track Control Arm		DB-VB-9307	Suspension Rod, Wishbone (CV)	
04/03→		Track Control Arm		DB-VB-9308	Suspension Rod, Wishbone (CV)	
04/03→		Track Control Arm		DB-VB-10426	Wishbone (CV), 1st RA, →517142 05	
1840 K	04/03→	Centre Rod	DB-DL-2144		Push Rod	
	04/03→	Centre Rod	DB-DL-5405		Push Rod	
	04/03→	Centre Rod	DB-DL-7270		Push Rod	
	04/03→	Centre Rod	DB-DL-8167		Push Rod	
	04/03→	Rod Assembly	DB-DL-2178		Guide Rod, 1st Front Axle, →504310 03	
	04/03→	Suspension Arm Repair Kit		DB-RK-8626	for Wishbone (CV)	
	04/03→	Suspension Arm Repair Kit		DB-RK-10374	for Wishbone (CV)	
	04/03→	Suspension Arm Repair Kit		DB-RK-10375	for Wishbone (CV)	
	04/03→	Suspension Strut Repair Kit		DB-RK-8710		
	04/03→	Suspension Strut Repair Kit		DB-RK-9291		
	04/03→	Tie Rod	DB-DL-8171		Guide Rod	

CV-ES-0543

Length: 125
Cone Ø: d1 Ø 32 / d2 Ø 29
Thread: M30 x 1,5 RHT
0004605748, 0004606048, 0004606848,
0004607048, 0014600448, 0014601148,
0014601748, 0014602448, 0014607648,
0014609648



CV-ES-0888

Length: 125
Cone Ø: d1 Ø 32 / d2 Ø 29
Thread: M30 x 1,5 LHT
0004605848, 0004606148, 0004606948,
0004607148, 0004609048, 0014600548,
0014601348, 0014602548, 0014607948,
0024600448



CV-ES-14162

Length: 125
Cone Ø: d1 Ø 30 / d2 Ø 27
Thread: M30 x 1,5 LHT
4600648, 4601248, 4603448, 0004603548,
14600348, 14601448, 14602348,
0014603748, 0014607848, 0024600348



CV-ES-14163

Length: 125
Cone Ø: d1 Ø 30 / d2 Ø 27
Thread: M30 x 1,5 RHT
0003305248, 0003387310, 0004600348,
0004600948, 0004602848, 0004602948,
0004608948, 0014600248, 0014600848,
0014601248, 0014602248, 0014607748,
0024600148, A0003387310, A0004600348,
A0004602848, A0004602948, A0014600848,
A0014601248, A0014602248, A0014607748



DB-DL-2144

Length: 872 Ø: 35
Cone Ø: d1 Ø 28,6 / d2 Ø 23,9
0024604305, 0024604405, 0034604805



DB-DL-2178

Length: 1735 Ø: 52
Cone Ø: d1 Ø 32 / d2 Ø 29
9423300003, 9423300103, 9423300203



DB-DL-5224

Length: 850 Ø: 60
Hole Distance: 100 / 100
01336100A, 9413300007



DB-DL-5405

Length: 890 Ø: 35
Cone Ø: d1 Ø 28,6 / d2 Ø 23,9
01215900A, 1460248, 0024604505,
0024604605, 0034605005, 3752600637,
3754600405, A3752600637, A3754600405



DB-DL-7270

Length: 875 Ø: 40
Cone Ø: d1 Ø 28,6 / d2 Ø 23,9
01208300A, 0024604705, 0024604805,
0034604905, A0024604705



DB-DL-8167

Length: 866 Ø: 38
Cone Ø: d1 Ø 30 / d2 Ø 27
0014609805, 0014609905, 0024606305,
0024606405



DB-DL-8171

Length: 1687 Ø: 52
Cone Ø: d1 Ø 32 / d2 Ø 29
9493300603, 9493300703, 9493301503,
9493301603



DB-DL-8307

Length: 885 Ø: 38
Cone Ø: d1 Ø 32 / d2 Ø 30
01215500A, 0004604005, 0024605105,
0024605205, 0034604005



DB-DL-8327

Length: 1745 Ø: 48
Cone Ø: d1 Ø 32 / d2 Ø 29
01219800A, 9413300003, 9413300103,
9413300203, 9413300303, 9413300503



DB-DL-8388

Length: 1735 Ø: 62
Cone Ø: d1 Ø 32 / d2 Ø 28,8
01219900A, 9453300003, 9453300103,
9453300403, 9453300603, A9453300003



DB-DL-8389

Length: 1465 Ø: 40
Cone Ø: d1 Ø 32 / d2 Ø 29
9453300203, 9453300303, 9453300503



DB-DL-8640

Length: 1615 Ø: 50
Cone Ø: d1 Ø 32 / d2 Ø 29
6253301503, 6253301603, 6253302403,
6253302503, 9423300803, 9423302103,
9493300203, 9493300303, 9493300903



DB-DL-8702

Length: 958 Ø: 38
Cone Ø: d1 Ø 32 / d2 Ø 30
0024606105, 0024606205, 0034604205



DB-DL-9218

Length: 754 Ø: 40
Hole Distance: 100
000360098524, 000390098524,
3753300111, 9413300011,
A3753300111, SA50831601



DB-DL-9254

Length: 1815 Ø: 58
0003220323, 0003220623, 3753220423



DB-DL-12310

Length: 1532 Ø: 50
Cone Ø: d1 Ø 32 / d2 Ø 29
Thread: M27 x 1,5 LHT
9493301203, 9493301303, 9493301803,
9493302203, A9493301203, A9493301303,
A9493301803, A9493302203



DB-ES-5227

Length: 1588 Ø: 60
Cone Ø: d1 Ø 38 / d2 Ø 34,3
6253300903, 6253301203, 9443300203



DB-ES-5234

Length: 135
Cone Ø: d1 Ø 38 / d2 Ø 34,3
Thread: M38 x 1,5 RHT
0004601748, 120322305, 2205000400



DB-ES-8164

Length: 140
Cone Ø: d1 Ø 28,6 / d2 Ø 23,9
Thread: M28 x 1,5 RHT
0014604248, 0014605048, 0014608548,
0024600548



DB-ES-8530

Length: 115
Cone Ø: d1 Ø 28,6 / d2 Ø 23,9
Thread: M30 x 1,5 RHT
0014603848, 0014604848, 0014605148,
0014608648, 0014609948



DB-RK-8391

Ø: 85 Hole Distance: 152
Thick/Height: 24
01336800A, 0003502705



DB-RK-8550

Ø: 75 Hole Distance: 152
Thick/Height: 24
0003502105, 0003504605



DB-RK-8626

Ø: 75 Hole Distance: 130
Thick/Height: 24
0003502205, 0003502505, 0003503405,
0003504505, GL11319



DB-RK-8638

Length: 100 Ø: 67
Hole Distance: 100
Thick/Height: 20
0003301411



DB-RK-8710

Ø: 85 Hole Distance: 130
Thick/Height: 30
0003503705



DB-RK-9291

Ø: 107,5 Hole Distance: 152
Thick/Height: 30
0003503605



DB-RK-9294

Ø: 85 Hole Distance: 152
Thick/Height: 24
0003503105



DB-RK-10374

Ø: 85 Hole Distance: 152
Thick/Height: 24
0003504405



DB-RK-10375

Ø: 100 Hole Distance: 152
Thick/Height: 24
0003502405, 0003503505, 0003504905



DB-SB-10406

Ø: 80 Thick/Height: 46
0003238185



DB-SB-10409

Ø: 77 Thick/Height: 56
0003265181



DB-SB-10410

Ø: 73 Hole Distance: 100
Thick/Height: 24
9413230050



DB-VB-3707

Length: 622 Ø: 46
Hole Ø 25 / 25 / 25
Hole Distance: 152 / 130 / 130
01337100A, 9423501005, 9423501505,
9443500005, 9473500105, 9473501005,
A3753500005, A9423501005, A9423501505,
A9443500005, A9473500105, A9473501005



DB-VB-7261

Length: 622 Ø: 46
Hole Ø 25 / 25 / 25
Hole Distance: 152 / 130 / 130
01337800A, 9443500305, 9443500505,
9443500605, 9473500705, 9473500905,
9483500405, 9483503005



DB-VB-7776

Length: 622 Ø: 56
Hole Distance: 152 / 152
6533500205, 6583500205



DB-VB-9307

Length: 667 Ø: 60
Hole Ø 25 / 23 / 23
Hole Distance: 152 / 130 / 130
9483502805



DB-VB-9308

Length: 622 Ø: 46
Hole Ø 25 / 25 / 25
Hole Distance: 152 / 130 / 130
9483502905



DB-VB-10426

Length: 622 Ø: 46
Hole Ø 25 / 25 / 25
Hole Distance: 152 / 130 / 130
9443500405



MN-DL-7834

Length: 1588 Ø: 58
Cone Ø: d1 Ø 30 / d2 Ø 27
3463303903, 3463304903, 6253303203,
9443300503, 9443301303, 9443301703





ACTROS MP2 / MP3 ...

1840 K ...	04/03→	Tie Rod	DB-DL-8327		Guide Rod
	04/03→	Tie Rod	DB-DL-8640		Guide Rod
	04/03→	Tie Rod End	CV-ES-0543		for Push Rod
	04/03→	Tie Rod End	CV-ES-0888		for Push Rod
	04/03→	Tie Rod End	CV-ES-14163		for Steering Rod
	04/03→	Tie Rod End	DB-ES-8164		for Push Rod
	04/03→	Tie Rod End	DB-ES-8530		for Push Rod
	04/03→	Track Control Arm		DB-VB-7261	Suspension Rod, Wishbone (CV), 1st RA, →517142 01/517142 02
	04/03→	Track Control Arm		DB-VB-7776	Wishbone (CV)
	04/03→	Track Control Arm		DB-VB-9307	Suspension Rod, Wishbone (CV)
	04/03→	Track Control Arm		DB-VB-9308	Suspension Rod, Wishbone (CV)
	04/03→	Track Control Arm		DB-VB-10426	Wishbone (CV), 1st RA, →517142 05
1840 LS, LLS	06/08→	Centre Rod	DB-DL-2144		Push Rod
	06/08→	Centre Rod	DB-DL-7270		Push Rod
	06/08→	Centre Rod	DB-DL-8167		Push Rod
	06/08→	Centre Rod	DB-DL-8392		Push Rod
	06/08→	Centre Rod	DB-DL-12303		Push Rod
	06/08→	Rod Assembly	DB-DL-2178		Guide Rod, 1st Front Axle, →504310 03
	06/08→	Suspension Arm Repair Kit		DB-RK-10374	for Wishbone (CV)
	06/08→	Tie Rod	DB-DL-8327		Guide Rod, 1st Front Axle
	06/08→	Tie Rod	DB-DL-8388		Guide Rod, 1st Front Axle
	06/08→	Tie Rod	DB-DL-8389		1st Front Axle
	06/08→	Tie Rod	DB-DL-8640		Guide Rod, 1st Front Axle
	06/08→	Tie Rod End	CV-ES-0543		for Push Rod
	06/08→	Tie Rod End	CV-ES-0888		for Push Rod
	06/08→	Tie Rod End	CV-ES-14163		for Steering Rod
	06/08→	Tie Rod End	DB-ES-8164		for Push Rod
	06/08→	Tie Rod End	DB-ES-8530		for Push Rod
	06/08→	Track Control Arm		DB-TC-12410	Control Arm
	06/08→	Track Control Arm		DB-VB-7798	Wishbone (CV)
	06/08→	Track Control Arm		DB-VB-10425	Wishbone (CV), 1st Drive Axle, →508306 06
	06/08→	Track Control Arm	DB-DL-5224	DB-DL-5224	Trailing Arm, 1st FA, →508315 01
06/08→	Track Control Arm	DB-DL-9218	DB-DL-9218	Trailing Arm	
1841 A	10/02→	Bush, parabolic spring		DB-SB-10400	
	10/02→	Bush, parabolic spring		DB-SB-10401	
	10/02→	Centre Rod	DB-DL-8167		Push Rod
	10/02→	Tie Rod	DB-DL-8327		Guide Rod
	10/02→	Tie Rod	DB-DL-8640		Guide Rod
1841 AK	04/03→	Centre Rod	DB-DL-8307		Push Rod
	04/03→	Centre Rod	DB-DL-8702		Push Rod
	04/03→	Stabiliser Mounting		DB-SB-10406	
	04/03→	Suspension Arm Repair Kit		DB-RK-8626	for Wishbone (CV)
	04/03→	Suspension Arm Repair Kit		DB-RK-10374	for Wishbone (CV)
	04/03→	Suspension Arm Repair Kit		DB-RK-10375	for Wishbone (CV)
	04/03→	Suspension Strut Repair Kit		DB-RK-8710	
	04/03→	Suspension Strut Repair Kit		DB-RK-9291	
	04/03→	Tie Rod	DB-DL-12310		
	04/03→	Tie Rod	DB-ES-5227		Guide Rod
	04/03→	Tie Rod	MN-DL-7834		Guide Rod
	04/03→	Tie Rod End	CV-ES-0543		for Push Rod
	04/03→	Tie Rod End	CV-ES-14163		for Steering Rod
	04/03→	Tie Rod End	DB-ES-5234		for Steering Rod
	04/03→	Track Control Arm		DB-VB-7261	Suspension Rod, Wishbone (CV), 1st RA, →517142 01/517142 02
	04/03→	Track Control Arm		DB-VB-7776	Wishbone (CV)
	04/03→	Track Control Arm		DB-VB-9307	Suspension Rod, Wishbone (CV)
	04/03→	Track Control Arm		DB-VB-9308	Suspension Rod, Wishbone (CV)
04/03→	Track Control Arm		DB-VB-10426	Wishbone (CV), 1st RA, →517142 05	

CV-ES-0543

Length: 125
 Cone Ø: d1 Ø 32 / d2 Ø 29
 Thread: M30 x 1,5 RHT
 0004605748, 0004606048, 0004606848,
 0004607048, 0014600448, 0014601148,
 0014601748, 0014602448, 0014607648,
 0014609648

**CV-ES-0888**

Length: 125
 Cone Ø: d1 Ø 32 / d2 Ø 29
 Thread: M30 x 1,5 LHT
 0004605848, 0004606148, 0004606948,
 0004607148, 0004609048, 0014600548,
 0014601348, 0014602548, 0014607948,
 0024600448

**CV-ES-14163**

Length: 125
 Cone Ø: d1 Ø 30 / d2 Ø 27
 Thread: M30 x 1,5 RHT
 0003305248, 0003387310, 0004600348,
 0004600948, 0004602848, 0004602948,
 0004608948, 0014600248, 0014600848,
 0014601248, 0014602248, 0014607748,
 0024600148, A0003387310, A0004600348,
 A0004602848, A0004602948, A0014600848,
 A0014601248, A0014602248, A0014607748

**DB-DL-2144**

Length: 872 Ø: 35
 Cone Ø: d1 Ø 28,6 / d2 Ø 23,9
 0024604305, 0024604405, 0034604805

**DB-DL-2178**

Length: 1735 Ø: 52
 Cone Ø: d1 Ø 32 / d2 Ø 29
 9423300003, 9423300103, 9423300203

**DB-DL-5224**

Length: 850 Ø: 60
 Hole Distance: 100 / 100
 01336100A, 9413300007

**DB-DL-7270**

Length: 875 Ø: 40
 Cone Ø: d1 Ø 28,6 / d2 Ø 23,9
 01208300A, 0024604705, 0024604805,
 0034604905, A0024604705

**DB-DL-8167**

Length: 866 Ø: 38
 Cone Ø: d1 Ø 30 / d2 Ø 27
 0014609805, 0014609905, 0024606305,
 0024606405

**DB-DL-8307**

Length: 885 Ø: 38
 Cone Ø: d1 Ø 32 / d2 Ø 30
 01215500A, 0004604005, 0024605105,
 0024605205, 0034604005

**DB-DL-8327**

Length: 1745 Ø: 48
 Cone Ø: d1 Ø 32 / d2 Ø 29
 01219800A, 9413300003, 9413300103,
 9413300203, 9413300303, 9413300503

**DB-DL-8388**

Length: 1735 Ø: 62
 Cone Ø: d1 Ø 32 / d2 Ø 28,8
 01219900A, 9453300003, 9453300103,
 9453300403, 9453300603, A9453300003

**DB-DL-8389**

Length: 1465 Ø: 40
 Cone Ø: d1 Ø 32 / d2 Ø 29
 9453300203, 9453300303, 9453300503

**DB-DL-8392**

Length: 860 Ø: 40
 Cone Ø: d1 Ø 28,6 / d2 Ø 23,9
 0024609605, 0024609705, 0034605705

**DB-DL-8640**

Length: 1615 Ø: 50
 Cone Ø: d1 Ø 32 / d2 Ø 29
 6253301503, 6253301603, 6253302403,
 6253302503, 9423300803, 9423302103,
 9493300203, 9493300303, 9493300903

**DB-DL-8702**

Length: 958 Ø: 38
 Cone Ø: d1 Ø 32 / d2 Ø 30
 0024606105, 0024606205, 0034604205

**DB-DL-9218**

Length: 754 Ø: 40
 Hole Distance: 100
 000360098524, 000390098524,
 3753300111, 9413300011,
 A3753300111, SA50831601

**DB-DL-12303**

Length: 888 Ø: 42
 Cone Ø: d1 Ø 28,6 / d2 Ø 23,9
 0034601805, 0034601905, 0034605805,
 A0034601905, A0034605805

**DB-DL-12310**

Length: 1532 Ø: 50
 Cone Ø: d1 Ø 32 / d2 Ø 29
 Thread: M27 x 1,5 LHT

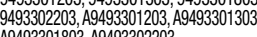
**DB-ES-5227**

Length: 1588 Ø: 60
 Cone Ø: d1 Ø 38 / d2 Ø 34,3
 6253300903, 6253301203, 9443300203

**DB-ES-5234**

Length: 135
 Cone Ø: d1 Ø 38 / d2 Ø 34,3
 Thread: M38 x 1,5 RHT
 0004601748, 120322305, 2205000400

**DB-ES-8164**

Length: 140
 Cone Ø: d1 Ø 28,6 / d2 Ø 23,9
 Thread: M28 x 1,5 RHT
 0014604248, 0014605048, 0014608548,
 0024600548

**DB-ES-8530**

Length: 115
 Cone Ø: d1 Ø 28,6 / d2 Ø 23,9
 Thread: M30 x 1,5 RHT
 0014603848, 0014604848, 0014605148,
 0014608648, 0014609948

**DB-RK-8626**

Ø: 75 Hole Distance: 130
 Thick/Height: 24
 0003502205, 0003502505, 0003503405,
 0003504505, GL11319

**DB-RK-8710**

Ø: 85 Hole Distance: 130
 Thick/Height: 30
 0003503705

**DB-RK-9291**

Ø: 107,5 Hole Distance: 152
 Thick/Height: 30
 0003503605

**DB-RK-10374**

Ø: 85 Hole Distance: 152
 Thick/Height: 24
 0003504405

**DB-RK-10375**

Ø: 100 Hole Distance: 152
 Thick/Height: 24
 0003502405, 0003503505, 0003504905

**DB-SB-10400**

Length: 230
 Thick/Height: 167,5 / 115
 0003250696, 0003250896

**DB-SB-10401**

Length: 232
 Thick/Height: 163,5 / 152,5
 0003250596, 0003250796

**DB-SB-10406**

Ø: 80 Thick/Height: 46
 0003238185

**DB-TC-12410**

Length: 925 Ø: 62
 Hole Distance: 100 / 100
 9423300707

**DB-VB-7261**

Length: 622 Ø: 46
 Hole Ø 25 / 25 / 25
 Hole Distance: 152 / 130 / 130
 01337800A, 9443500305, 9443500505,
 9443500605, 9473500705, 9473500905,
 9483500405, 9483500305

**DB-VB-7776**

Length: 622 Ø: 56
 Hole Distance: 152 / 152
 6533500205, 6583500205

**DB-VB-7798**

Length: 622 Ø: 48
 Hole Ø 25 / 23 / 23
 Hole Distance: 152 / 130 / 130
 9423500505, 9423500805, 9423501205,
 A9423501205

**DB-VB-9307**

Length: 667 Ø: 60
 Hole Ø 25 / 23 / 23
 Hole Distance: 152 / 130 / 130
 9483502805

**DB-VB-9308**

Length: 622 Ø: 46
 Hole Ø 25 / 25 / 25
 Hole Distance: 152 / 130 / 130
 9483502905

**DB-VB-10425**

Length: 622 Ø: 46
 Hole Ø 25 / 23 / 23
 Hole Distance: 152 / 130 / 130
 9423500905, 9423501305

**DB-VB-10426**

Length: 622 Ø: 46
 Hole Ø 25 / 25 / 25
 Hole Distance: 152 / 130 / 130
 9443500405

**MN-DL-7834**

Length: 1588 Ø: 58
 Cone Ø: d1 Ø 30 / d2 Ø 27
 3463303903, 3463304903, 6253303203,
 9443300503, 9443301303, 9443301703





ACTROS MP2 / MP3 ...

1841 K	04/03→	Centre Rod	DB-DL-2144		Push Rod
	04/03→	Centre Rod	DB-DL-5405		Push Rod
	04/03→	Centre Rod	DB-DL-7270		Push Rod
	04/03→	Centre Rod	DB-DL-8167		Push Rod
	04/03→	Centre Rod	DB-DL-8307		Push Rod, Leaf Spring Axle
	04/03→	Centre Rod	DB-DL-8702		Push Rod, Leaf Spring Axle
	04/03→	Rod Assembly	DB-DL-2178		Guide Rod
	04/03→	Suspension Arm Repair Kit		DB-RK-8626	for Wishbone (CV)
	04/03→	Suspension Arm Repair Kit		DB-RK-10374	for Wishbone (CV)
	04/03→	Suspension Arm Repair Kit		DB-RK-10375	for Wishbone (CV)
	04/03→	Suspension Strut Repair Kit		DB-RK-8710	
	04/03→	Suspension Strut Repair Kit		DB-RK-9291	
	04/03→	Tie Rod	DB-DL-8171		Guide Rod, 1st Front Axle, →504310 15
	04/03→	Tie Rod	DB-DL-8327		Guide Rod, 1st Front Axle
	04/03→	Tie Rod	DB-DL-8640		Guide Rod, 1st Front Axle
	04/03→	Tie Rod	DB-ES-5227		Guide Rod, 1st FA;Leaf Spring Axle
	04/03→	Tie Rod	MN-DL-7834		Guide Rod, 1st FA;Leaf Spring Axle
	04/03→	Tie Rod End	CV-ES-0543		for Push Rod
	04/03→	Tie Rod End	CV-ES-0888		for Push Rod
	04/03→	Tie Rod End	CV-ES-14162		for Steering Rod
	04/03→	Tie Rod End	CV-ES-14163		for Steering Rod
	04/03→	Tie Rod End	DB-ES-5234		for Steering Rod
	04/03→	Tie Rod End	DB-ES-8164		for Push Rod
	04/03→	Tie Rod End	DB-ES-8530		for Push Rod
	04/03→	Track Control Arm		DB-VB-7261	Suspension Rod, Wishbone (CV), 1st RA, →517142 01/517142 02
	04/03→	Track Control Arm		DB-VB-7776	Wishbone (CV)
	04/03→	Track Control Arm		DB-VB-9307	Suspension Rod, Wishbone (CV)
	04/03→	Track Control Arm		DB-VB-9308	Suspension Rod, Wishbone (CV)
	04/03→	Track Control Arm		DB-VB-10426	Wishbone (CV), 1st RA, →517142 05
	1841 L, LL	04/03→	Ball Head, gearshift linkage	DB-ES-8510	
04/03→		Bush, driver cab suspension	DB-SB-10384		
04/03→		Centre Rod	DB-DL-2144		Push Rod
04/03→		Centre Rod	DB-DL-5230		Suspension Rod
04/03→		Centre Rod	DB-DL-5241		Push Rod
04/03→		Centre Rod	DB-DL-5405		Push Rod, Leaf Spring Axle
04/03→		Centre Rod	DB-DL-7270		Push Rod
04/03→		Centre Rod	DB-DL-8184		Push Rod
04/03→		Centre Rod	DB-DL-8185		Push Rod
04/03→		Centre Rod	DB-DL-8307		Push Rod
04/03→		Centre Rod	DB-DL-12300		for Steering Rod
04/03→		Rod Assembly	DB-DL-2178		Guide Rod
04/03→		Stabiliser Mounting		DB-SB-10406	
04/03→		Stabiliser Mounting		DB-SB-10409	
04/03→		Suspension Arm Repair Kit		DB-RK-8550	for Wishbone (CV)
04/03→		Suspension Arm Repair Kit		DB-RK-8626	for Wishbone (CV)
04/03→		Suspension Arm Repair Kit		DB-RK-10374	for Wishbone (CV)
04/03→		Suspension Arm Repair Kit		DB-RK-10375	for Wishbone (CV)
04/03→		Suspension Arm Repair Kit	DB-RK-8638		for Control Arm
04/03→		Suspension Strut Repair Kit		DB-RK-8391	
04/03→		Tie Rod	DB-DL-8171		Guide Rod, 1st FA;Leaf Spring Axle
04/03→		Tie Rod	DB-DL-8327		Guide Rod, 1st FA;Leaf Spring Axle
04/03→		Tie Rod	DB-DL-8640		Guide Rod
04/03→		Tie Rod	DB-DL-12310		
04/03→		Tie Rod	DB-ES-5227		Guide Rod
04/03→		Tie Rod End	CV-ES-0543		for Push Rod
04/03→		Tie Rod End	CV-ES-0888		for Push Rod
04/03→		Tie Rod End	CV-ES-14162		for Steering Rod
04/03→		Tie Rod End	CV-ES-14163		for Steering Rod
04/03→		Tie Rod End	DB-ES-5234		for Steering Rod
04/03→		Tie Rod End	DB-ES-8164		for Push Rod
04/03→		Tie Rod End	DB-ES-8530		for Push Rod

CV-ES-0543

Length: 125
 Cone Ø: d1 Ø 32 / d2 Ø 29
 Thread: M30 x 1,5 RHT
 0004605748, 0004606048, 0004606848,
 0004607048, 0014600448, 0014601148,
 0014601748, 0014602448, 0014607648,
 0014609648

**CV-ES-0888**

Length: 125
 Cone Ø: d1 Ø 32 / d2 Ø 29
 Thread: M30 x 1,5 LHT
 0004605848, 0004606148, 0004606948,
 0004607148, 0004609048, 0014600548,
 0014601348, 0014602548, 0014607948,
 0024600448

**CV-ES-14162**

Length: 125
 Cone Ø: d1 Ø 30 / d2 Ø 27
 Thread: M30 x 1,5 LHT
 4600648, 4601248, 4603448,
 0004603548, 4603548, 14600348,
 14601448, 14602348, 0014603748,
 14607848, 0014607848, 0024600348

**CV-ES-14163**

Length: 125
 Cone Ø: d1 Ø 30 / d2 Ø 27
 Thread: M30 x 1,5 RHT
 0003305248, 0003387310, 0004600348,
 0004600948, 0004602848, 0004602948,
 0004608948, 0014600248, 0014600848,
 0014601248, 0014602248, 0014607748,
 0024600148, A0003387310, A0004600348,
 A0004602848, A0004602948, A0014600848,
 A0014601248, A0014602248, A0014607748

**DB-DL-2144**

Length: 872 Ø: 35
 Cone Ø: d1 Ø 28,6 / d2 Ø 23,9
 0024604305, 0024604405, 0034604805

**DB-DL-2178**

Length: 1735 Ø: 52
 Cone Ø: d1 Ø 32 / d2 Ø 29
 9423300003, 9423300103, 9423300203

**DB-DL-5230**

Length: 879 Ø: 42
 Cone Ø: d1 Ø 30 / d2 Ø 27
 01208600A, 0004607105, 0004607205,
 0014606705

**DB-DL-5241**

Length: 875 Ø: 40
 Cone Ø: d1 Ø 30 / d2 Ø 27
 01215300A, 0004609205, 0004609305,
 0014606905

**DB-DL-5405**

Length: 890 Ø: 35
 Cone Ø: d1 Ø 28,6 / d2 Ø 23,9
 01215900A, 1460248, 0024604505,
 0024604605, 0034605005, 3752600637,
 3754600405, A3752600637, A3754600405

**DB-DL-7270**

Length: 875 Ø: 40
 Cone Ø: d1 Ø 28,6 / d2 Ø 23,9
 01208300A, 0024604705, 0024604805,
 0034604905, A0024604705

**DB-DL-8167**

Length: 866 Ø: 38
 Cone Ø: d1 Ø 30 / d2 Ø 27
 0014609805, 0014609905, 0024606305,
 0024606405

**DB-DL-8171**

Length: 1687 Ø: 52
 Cone Ø: d1 Ø 32 / d2 Ø 29
 9493300603, 9493300703, 9493301503,
 9493301603

**DB-DL-8184**

Length: 1095 Ø: 42
 Cone Ø: d1 Ø 32 / d2 Ø 28,8
 01217700A, 0014601305, 0014601405,
 0024600505, 0034603205, 3754601505,
 A0014601305, A0014601405, A0024600505

**DB-DL-8185**

Length: 711 Ø: 42
 Cone Ø: d1 Ø 32 / d2 Ø 28,8
 01213600A, 0014601105, 0024600405,
 0034603105, A0014601105, A0024600405

**DB-DL-8307**

Length: 885 Ø: 38
 Cone Ø: d1 Ø 32 / d2 Ø 30
 01215500A, 0004604005, 0024605105,
 0024605205, 0034604005

**DB-DL-8327**

Length: 1745 Ø: 48
 Cone Ø: d1 Ø 32 / d2 Ø 29
 01219800A, 9413300003, 9413300103,
 9413300203, 9413300303, 9413300503

**DB-DL-8640**

Length: 1615 Ø: 50
 Cone Ø: d1 Ø 32 / d2 Ø 29
 6253301503, 6253301603, 6253302403,
 6253302503, 9423300803, 9423302103,
 9493300203, 9493300303, 9493300903

**DB-DL-8702**

Length: 958 Ø: 38
 Cone Ø: d1 Ø 32 / d2 Ø 30
 0024606105, 0024606205, 0034604205

**DB-DL-12300**

Length: 733 Ø: 36
 Cone Ø: d1 Ø 32 / d2 Ø 29
 0014601505, 0014607305, 0034603305,
 3754601605, A0014601505, A0034603305,
 A3754601605

**DB-DL-12310**

Length: 1532 Ø: 50
 Cone Ø: d1 Ø 32 / d2 Ø 29
 Thread: M27 x 1,5 LHT
 9493301203, 9493301303, 9493301803,
 9493302203, A9493301203, A9493301303,
 A9493301803, A9493302203

**DB-ES-5227**

Length: 1588 Ø: 60
 Cone Ø: d1 Ø 38 / d2 Ø 34,3
 6253300903, 6253301203, 9443300203

**DB-ES-5234**

Length: 135
 Cone Ø: d1 Ø 38 / d2 Ø 34,3
 Thread: M38 x 1,5 RHT
 0004601748, 120322305, 2205000400

**DB-ES-8164**

Length: 140
 Cone Ø: d1 Ø 28,6 / d2 Ø 23,9
 Thread: M28 x 1,5 RHT
 0014604248, 0014605048, 0014608548,
 0024600548

**DB-ES-8510**

Length: 56
 Cone Ø: d1 Ø 10 / d2 Ø 10
 Thread: M12 x 1,75 LHT
 0009965145, 0009965645, 0019963145

**DB-ES-8530**

Length: 115
 Cone Ø: d1 Ø 28,6 / d2 Ø 23,9
 Thread: M30 x 1,5 RHT
 0014603848, 0014604848, 0014605148,
 0014608648, 0014609948

**DB-RK-8391**

Ø: 85 Hole Distance: 152
 Thick/Height: 24
 01336800A, 0003502705

**DB-RK-8550**

Ø: 75 Hole Distance: 152
 Thick/Height: 24
 0003502105, 0003504605

**DB-RK-8626**

Ø: 75 Hole Distance: 130
 Thick/Height: 24
 0003502205, 0003502505, 0003503405,
 0003504505, GL11319

**DB-RK-8638**

Length: 100 Ø: 67
 Hole Distance: 100
 Thick/Height: 20
 0003301411

**DB-RK-8710**

Ø: 85 Hole Distance: 130
 Thick/Height: 30
 0003503705

**DB-RK-9291**

Ø: 107,5 Hole Distance: 152
 Thick/Height: 30
 0003503605

**DB-RK-10374**

Ø: 85 Hole Distance: 152
 Thick/Height: 24
 0003504405

**DB-RK-10375**

Ø: 100 Hole Distance: 152
 Thick/Height: 24
 0003502405, 0003503505, 0003504905

**DB-SB-10384**

Ø: 73 Thick/Height: 47
 9303170012, 9423171812

**DB-SB-10406**

Ø: 80 Thick/Height: 46
 0003238185

**DB-SB-10409**

Ø: 77 Thick/Height: 56
 0003265181

**DB-VB-7261**

Length: 622 Ø: 46
 Hole Ø 25 / 25 / 25
 Hole Distance: 152 / 130 / 130
 01337800A, 9443500305, 9443500505,
 9443500605, 9473500705, 9473500905,
 9483500405, 9483500305

**DB-VB-7776**

Length: 622 Ø: 56
 Hole Distance: 152 / 152
 6533500205, 6583500205

**DB-VB-9307**

Length: 667 Ø: 60
 Hole Ø 25 / 23 / 23
 Hole Distance: 152 / 130 / 130
 9483502805

**DB-VB-9308**

Length: 622 Ø: 46
 Hole Ø 25 / 25 / 25
 Hole Distance: 152 / 130 / 130
 9483502905



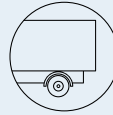

ACTROS MP2 / MP3 ...

1841 LS, LLS	04/03→	Ball Head, gearshift linkage	DB-ES-8510			
	04/03→	Bush, driver cab suspension	DB-SB-10384			
	04/03→	Centre Rod	DB-DL-2144		Push Rod	
	04/03→	Centre Rod	DB-DL-5230		Suspension Rod	
	04/03→	Centre Rod	DB-DL-5241		Push Rod	
	04/03→	Centre Rod	DB-DL-5405		Push Rod	
	04/03→	Centre Rod	DB-DL-7270		Push Rod	
	04/03→	Centre Rod	DB-DL-8167		Push Rod	
	04/03→	Centre Rod	DB-DL-8184		Push Rod	
	04/03→	Centre Rod	DB-DL-8185		Push Rod	
	04/03→	Centre Rod	DB-DL-8307		Push Rod	
	04/03→	Centre Rod	DB-DL-8392		Push Rod	
	04/03→	Centre Rod	DB-DL-12303		Push Rod, Leaf Spring Axle	
	04/03→	Rod Assembly	DB-DL-2178		Guide Rod	
	04/03→	Stabiliser Mounting		DB-SB-10406		
	04/03→	Stabiliser Mounting		DB-SB-10409		
	04/03→	Stabiliser Mounting	DB-SB-10410			
	04/03→	Suspension Arm Repair Kit		DB-RK-8626	for Wishbone (CV)	
	04/03→	Suspension Arm Repair Kit		DB-RK-10374	for Wishbone (CV)	
	04/03→	Suspension Arm Repair Kit		DB-RK-10375	for Wishbone (CV)	
	04/03→	Suspension Arm Repair Kit	DB-RK-8638		for Control Arm	
	04/03→	Suspension Strut Repair Kit		DB-RK-8391		
	04/03→	Suspension Strut Repair Kit		MN-RK-8997		
	04/03→	Tie Rod	DB-DL-8327		Guide Rod	
	04/03→	Tie Rod	DB-DL-8388		Guide Rod	
	04/03→	Tie Rod	DB-DL-8389			
	04/03→	Tie Rod	DB-DL-8640		Guide Rod	
	04/03→	Tie Rod	DB-DL-12310			
	04/03→	Tie Rod	DB-ES-5227		Guide Rod	
	04/03→	Tie Rod End	CV-ES-0543		for Push Rod	
	04/03→	Tie Rod End	CV-ES-0888		for Push Rod	
	04/03→	Tie Rod End	CV-ES-14162		for Steering Rod	
	04/03→	Tie Rod End	CV-ES-14163		for Steering Rod	
	04/03→	Tie Rod End	DB-ES-5234		for Steering Rod	
	04/03→	Tie Rod End	DB-ES-8164		for Push Rod	
	04/03→	Tie Rod End	DB-ES-8530		for Push Rod	
	04/03→	Track Control Arm		DB-TC-12410	Control Arm	
	04/03→	Track Control Arm		DB-VB-7798	Wishbone (CV), Air Suspension Axle, * K 864074 *→	
	04/03→	Track Control Arm		DB-VB-10425	Wishbone (CV)	
	04/03→	Track Control Arm	DB-DL-5224		Control Arm, 1st FA;Air Suspension Axle	
	04/03→	Track Control Arm	DB-DL-9218	DB-DL-9218	Trailing Arm, 1st FA;Air Suspension Axle	
	1841, L, LL	04/03→	Ball Head, gearshift linkage	DB-ES-8510		
		04/03→	Bush, driver cab suspension	DB-SB-10384		
		04/03→	Centre Rod	DB-DL-2144		Push Rod
		04/03→	Centre Rod	DB-DL-5230		Suspension Rod
04/03→		Centre Rod	DB-DL-5241		Push Rod	
04/03→		Centre Rod	DB-DL-5405		Push Rod	
04/03→		Centre Rod	DB-DL-5405		Push Rod, Leaf Spring Axle	
04/03→		Centre Rod	DB-DL-7270		Push Rod	
04/03→		Centre Rod	DB-DL-8167		Push Rod	
04/03→		Centre Rod	DB-DL-8168		Push Rod	
04/03→		Centre Rod	DB-DL-8184		Push Rod	
04/03→		Centre Rod	DB-DL-8185		Push Rod	
04/03→		Centre Rod	DB-DL-8307		Push Rod	
04/03→		Centre Rod	DB-DL-8622		Push Rod	
04/03→		Centre Rod	DB-DL-8641		Push Rod	
04/03→		Centre Rod	DB-DL-8642		Push Rod	
04/03→		Centre Rod	DB-DL-12300		for Steering Rod	
04/03→		Rod Assembly	DB-DL-2178		Guide Rod	
04/03→		Stabiliser Link	DB-DL-9254		Pressure Rod	
04/03→		Stabiliser Mounting		DB-SB-10406		
04/03→		Stabiliser Mounting		DB-SB-10409		

CV-ES-0543

Length: 125
 Cone Ø: d1 Ø 32 / d2 Ø 29
 Thread: M30 x 1,5 RHT
 0004605748, 0004606048, 0004606848,
 0004607048, 0014600448, 0014601148,
 0014601748, 0014602448, 0014607648,
 0014609648

**CV-ES-0888**

Length: 125
 Cone Ø: d1 Ø 32 / d2 Ø 29
 Thread: M30 x 1,5 LHT
 0004605848, 0004606148, 0004606948,
 0004607148, 0004609048, 0014600548,
 0014601348, 0014602548, 0014607948,
 0024600448

**CV-ES-14162**

Length: 125
 Cone Ø: d1 Ø 30 / d2 Ø 27
 Thread: M30 x 1,5 LHT
 4600648, 4601248, 4603448, 0004603548,
 14600348, 14601448, 14602348,
 0014603748, 0014607848, 0024600348

**CV-ES-14163**

Length: 125
 Cone Ø: d1 Ø 30 / d2 Ø 27
 Thread: M30 x 1,5 RHT
 0003305248, 0003387310, 0004600348,
 0004600948, 0004602848, 0004602948,
 0004608948, 0014600248, 0014600848,
 0014601248, 0014602248, 0014607748,
 0024600148, A0003387310, A0004600348,
 A0004602848, A0004602948, A0014600848,
 A0014601248, A0014602248, A0014607748

**DB-DL-2144**

Length: 872 Ø: 35
 Cone Ø: d1 Ø 28,6 / d2 Ø 23,9
 0024604305, 0024604405, 0034604805

**DB-DL-2178**

Length: 1735 Ø: 52
 Cone Ø: d1 Ø 32 / d2 Ø 29
 9423300003, 9423300103, 9423300203

**DB-DL-5224**

Length: 850 Ø: 60
 Hole Distance: 100 / 100
 01336100A, 9413300007

**DB-DL-5230**

Length: 879 Ø: 42
 Cone Ø: d1 Ø 30 / d2 Ø 27
 01208600A, 0004607105, 0004607205,
 0014606705

**DB-DL-5241**

Length: 875 Ø: 40
 Cone Ø: d1 Ø 30 / d2 Ø 27
 01215300A, 0004609205, 0004609305,
 0014606905

**DB-DL-5405**

Length: 890 Ø: 35
 Cone Ø: d1 Ø 28,6 / d2 Ø 23,9
 01215900A, 1460248, 0024604505,
 0024604605, 0034605005, 3752600637,
 3754600405, A3752600637, A3754600405

**DB-DL-7270**

Length: 875 Ø: 40
 Cone Ø: d1 Ø 28,6 / d2 Ø 23,9
 01208300A, 0024604705, 0024604805,
 0034604905, A0024604705

**DB-DL-8167**

Length: 866 Ø: 38
 Cone Ø: d1 Ø 30 / d2 Ø 27
 0014609805, 0014609905, 0024606305,
 0024606405

**DB-DL-8168**

Length: 904 Ø: 52
 Cone Ø: d1 Ø 32 / d2 Ø 29
 0004609405, 0004609505, 0014607105

**DB-DL-8184**

Length: 1095 Ø: 42
 Cone Ø: d1 Ø 32 / d2 Ø 28,8
 01217700A, 0014601305, 0014601405,
 0024600505, 0034603205, 3754601505,
 A0014601305, A0014601405, A0024600505

**DB-DL-8185**

Length: 711 Ø: 42
 Cone Ø: d1 Ø 32 / d2 Ø 28,8
 01213600A, 0014601105, 0024600405,
 0034603105, A0014601105, A0024600405

**DB-DL-8307**

Length: 885 Ø: 38
 Cone Ø: d1 Ø 32 / d2 Ø 30
 01215500A, 0004604005, 0024605105,
 0024605205, 0034604005

**DB-DL-8327**

Length: 1745 Ø: 48
 Cone Ø: d1 Ø 32 / d2 Ø 29
 01219800A, 9413300003, 9413300103,
 9413300203, 9413300303, 9413300503

**DB-DL-8388**

Length: 1735 Ø: 62
 Cone Ø: d1 Ø 32 / d2 Ø 28,8
 01219900A, 9453300003, 9453300103,
 9453300403, 9453300603, A9453300003

**DB-DL-8389**

Length: 1465 Ø: 40
 Cone Ø: d1 Ø 32 / d2 Ø 29
 9453300203, 9453300303, 9453300503

**DB-DL-8392**

Length: 860 Ø: 40
 Cone Ø: d1 Ø 28,6 / d2 Ø 23,9
 0024609605, 0024609705, 0034605705

**DB-DL-8622**

Length: 1558 Ø: 52
 Cone Ø: d1 Ø 30 / d2 Ø 27
 0014609005, 0014609105

**DB-DL-8640**

Length: 1615 Ø: 50
 Cone Ø: d1 Ø 32 / d2 Ø 29
 6253301503, 6253301603, 6253302403,
 6253302503, 9423300803, 9423302103,
 9493300203, 9493300303, 9493300903

**DB-DL-8641**

Length: 905 Ø: 42
 Cone Ø: d1 Ø 30 / d2 Ø 27
 0014605105, 0014608105

**DB-DL-8642**

Length: 954 Ø: 42
 Cone Ø: d1 Ø 30 / d2 Ø 27
 0014608605, 0014608705

**DB-DL-9218**

Length: 754 Ø: 40
 Hole Distance: 100
 000360098524, 000390098524,
 3753300111, 9413300011,
 A3753300111, SA50831601

**DB-DL-9254**

Length: 1815 Ø: 58
 0003220323, 0003220623, 3753220423

**DB-DL-12300**

Length: 733 Ø: 36
 Cone Ø: d1 Ø 32 / d2 Ø 29
 0014601505, 0014607305, 0034603305,
 3754601605, A0014601505,
 A0034603305, A3754601605

**DB-DL-12303**

Length: 888 Ø: 42
 Cone Ø: d1 Ø 28,6 / d2 Ø 23,9
 0034601805, 0034601905, 0034605805,
 A0034601905, A0034605805

**DB-DL-12310**

Length: 1532 Ø: 50
 Cone Ø: d1 Ø 32 / d2 Ø 29
 Thread: M27 x 1,5 LHT
 9493301203, 9493301303, 9493301803,
 9493302203, A9493301203, A9493301303,
 A9493301803, A9493302203

**DB-ES-5227**

Length: 1588 Ø: 60
 Cone Ø: d1 Ø 38 / d2 Ø 34,3
 6253300903, 6253301203, 9443300203

**DB-ES-5234**

Length: 135
 Cone Ø: d1 Ø 38 / d2 Ø 34,3
 Thread: M38 x 1,5 RHT
 0004601748, 120322305, 2205000400

**DB-ES-8164**

Length: 140
 Cone Ø: d1 Ø 28,6 / d2 Ø 23,9
 Thread: M28 x 1,5 RHT
 0014604248, 0014605048, 0014608548,
 0024600548

**DB-ES-8510**

Length: 56
 Cone Ø: d1 Ø 10 / d2 Ø 10
 Thread: M12 x 1,75 LHT
 0009965145, 0009965645, 0019963145

**DB-ES-8530**

Length: 115
 Cone Ø: d1 Ø 28,6 / d2 Ø 23,9
 Thread: M30 x 1,5 RHT
 0014603848, 0014604848, 0014605148,
 0014608648, 0014609948

**DB-RK-8391**

Ø: 85 Hole Distance: 152
 Thick/Height: 24
 01336800A, 0003502705

**DB-RK-8626**

Ø: 75 Hole Distance: 130
 Thick/Height: 24
 0003502205, 0003502505, 0003503405,
 0003504505, GL11319

**DB-RK-8638**

Length: 100 Ø: 67
 Hole Distance: 100
 Thick/Height: 20
 0003301411

**DB-RK-10374**

Ø: 85 Hole Distance: 152
 Thick/Height: 24
 0003504405

**DB-RK-10375**

Ø: 100 Hole Distance: 152
 Thick/Height: 24
 0003502405, 0003503505, 0003504905

**DB-SB-10384**

Ø: 73 Thick/Height: 47
 9303170012, 9423171812

**DB-SB-10406**

Ø: 80 Thick/Height: 46
 0003238185

**DB-SB-10409**

Ø: 77 Thick/Height: 56
 0003265181

**DB-SB-10410**

Ø: 73 Hole Distance: 100
 Thick/Height: 24
 9413230050

**DB-TC-12410**

Length: 925 Ø: 62
 Hole Distance: 100 / 100
 9423300707

**DB-VB-7798**

Length: 622 Ø: 48
 Hole Ø 25 / 23 / 23
 Hole Distance: 152 / 130 / 130
 9423500505, 9423500805, 9423501205,
 A9423501205

**DB-VB-10425**

Length: 622 Ø: 46
 Hole Ø 25 / 23 / 23
 Hole Distance: 152 / 130 / 130
 9423500905, 9423501305

**MN-RK-8997**

Ø: 85 Hole Distance: 130
 Thick/Height: 30
 0003504805

**MERCEDES-BENZ**



ACTROS MP2 / MP3 ...

1841, L, LL ...	04/03→	Stabiliser Mounting	DB-SB-10410			
	04/03→	Suspension Arm Repair Kit		DB-RK-8550	for Wishbone (CV)	
	04/03→	Suspension Arm Repair Kit		DB-RK-8626	for Wishbone (CV)	
	04/03→	Suspension Arm Repair Kit		DB-RK-10374	for Wishbone (CV)	
	04/03→	Suspension Arm Repair Kit		DB-RK-10375	for Wishbone (CV)	
	04/03→	Suspension Arm Repair Kit	DB-RK-8638		for Control Arm	
	04/03→	Suspension Strut Repair Kit		DB-RK-8391		
	04/03→	Suspension Strut Repair Kit		DB-RK-9294		
	04/03→	Tie Rod	DB-DL-8327		Guide Rod, 1st FA;Leaf Spring Axle	
	04/03→	Tie Rod	DB-DL-8388		Guide Rod, 1st FA;Leaf Spring Axle	
	04/03→	Tie Rod	DB-DL-8389		1st FA;Leaf Spring Axle	
	04/03→	Tie Rod	DB-DL-8640		Guide Rod	
	04/03→	Tie Rod	DB-DL-12310			
	04/03→	Tie Rod	DB-ES-5227		Guide Rod	
	04/03→	Tie Rod End	CV-ES-0543		for Push Rod	
	04/03→	Tie Rod End	CV-ES-0888		for Push Rod	
	04/03→	Tie Rod End	CV-ES-14162		for Steering Rod	
	04/03→	Tie Rod End	CV-ES-14163		for Steering Rod	
	04/03→	Tie Rod End	DB-ES-5234		for Steering Rod	
	04/03→	Tie Rod End	DB-ES-8164		for Push Rod	
	04/03→	Tie Rod End	DB-ES-8530		for Push Rod	
	04/03→	Track Control Arm		DB-VB-3707	Suspension Rod, Wishbone (CV)	
	04/03→	Track Control Arm		DB-VB-7261	Suspension Rod, Wishbone (CV), 1st RA, →517142 01/517142 02	
	04/03→	Track Control Arm		DB-VB-9307	Suspension Rod, Wishbone (CV), 1st Drive Axle, →517142 07	
	04/03→	Track Control Arm		DB-VB-9308	Suspension Rod, Wishbone (CV), 1st Drive Axle, →517142 06	
	04/03→	Track Control Arm		DB-VB-10426	Wishbone (CV), 1st RA, →517142 05	
	04/03→	Track Control Arm	DB-DL-5224		Control Arm, 1st FA;Air Suspension Axle	
	04/03→	Track Control Arm	DB-DL-9218	DB-DL-9218	Trailing Arm, 1st FA;Air Suspension Axle	
	1843 LS, LLS	06/08→	Centre Rod	DB-DL-2144		Push Rod
		06/08→	Centre Rod	DB-DL-7270		Push Rod
06/08→		Centre Rod	DB-DL-8167		Push Rod	
06/08→		Centre Rod	DB-DL-8392		Push Rod	
06/08→		Centre Rod	DB-DL-12303		Push Rod, Leaf Spring Axle	
06/08→		Rod Assembly	DB-DL-2178		Guide Rod	
06/08→		Suspension Arm Repair Kit		DB-RK-10374	for Wishbone (CV)	
06/08→		Tie Rod	DB-DL-8327		Guide Rod	
06/08→		Tie Rod	DB-DL-8388		Guide Rod	
06/08→		Tie Rod	DB-DL-8389		1st Front Axle	
06/08→		Tie Rod	DB-DL-8640		Guide Rod	
06/08→		Tie Rod End	CV-ES-0543		for Push Rod	
06/08→		Tie Rod End	CV-ES-0888		for Push Rod	
06/08→		Tie Rod End	CV-ES-14163		for Steering Rod	
06/08→		Tie Rod End	DB-ES-8164		for Push Rod	
06/08→		Tie Rod End	DB-ES-8530		for Push Rod	
06/08→		Track Control Arm		DB-TC-12410	Control Arm	
06/08→		Track Control Arm		DB-VB-7798	Wishbone (CV)	
06/08→		Track Control Arm		DB-VB-10425	Wishbone (CV), 1st Drive Axle, →508306 06	
06/08→		Track Control Arm	DB-DL-5224	DB-DL-5224	Trailing Arm, 1st FA, →508315 01	
06/08→	Track Control Arm	DB-DL-9218	DB-DL-9218	Trailing Arm		
1844 A	04/03→	Bush, parabolic spring		DB-SB-10400		
	04/03→	Bush, parabolic spring		DB-SB-10401		
	04/03→	Centre Rod	DB-DL-8167		Push Rod	
	04/03→	Tie Rod	DB-DL-8327		Guide Rod	
	04/03→	Tie Rod	DB-DL-8640		Guide Rod	
1844 AK	04/03→	Ball Head, gearshift linkage	DB-ES-8510			
	04/03→	Bush, driver cab suspension	DB-SB-10384			
	04/03→	Centre Rod	DB-DL-2144		Push Rod	
	04/03→	Centre Rod	DB-DL-8184		Push Rod	
	04/03→	Centre Rod	DB-DL-8307		Push Rod, Leaf Spring Axle	
	04/03→	Centre Rod	DB-DL-8702		Push Rod, Leaf Spring Axle	

CV-ES-0543

Length: 125
Cone Ø: d1 Ø 32 / d2 Ø 29
Thread: M30 x 1,5 RHT
0004605748, 0004606048, 0004606848,
0004607048, 0014600448, 0014601148,
0014601748, 0014602448, 0014607648,
0014609648



CV-ES-0888

Length: 125
Cone Ø: d1 Ø 32 / d2 Ø 29
Thread: M30 x 1,5 LHT
0004605848, 0004606148, 0004606948,
0004607148, 0004609048, 0014600548,
0014601348, 0014602548, 0014607948,
0024600448



CV-ES-14162

Length: 125
Cone Ø: d1 Ø 30 / d2 Ø 27
Thread: M30 x 1,5 LHT
4600648, 4601248, 4603448, 0004603548,
14600348, 14601448, 14602348,
0014603748, 0014607848, 0024600348



CV-ES-14163

Length: 125
Cone Ø: d1 Ø 30 / d2 Ø 27
Thread: M30 x 1,5 RHT
0003305248, 0003387310, 0004600348,
0004600948, 0004602848, 0004602948,
0004608948, 0014600248, 0014600848,
0014601248, 0014602248, 0014607748,
0024600148, 0003387310, 0004600348,
0004602848, 0004602948, 0014600848,
0014601248, 0014602248, 0014607748



DB-DL-2144

Length: 872 Ø: 35
Cone Ø: d1 Ø 28,6 / d2 Ø 23,9
0024604305, 0024604405, 0034604805



DB-DL-2178

Length: 1735 Ø: 52
Cone Ø: d1 Ø 32 / d2 Ø 29
9423300003, 9423300103, 9423300203



DB-DL-5224

Length: 850 Ø: 60
Hole Distance: 100 / 100
01336100A, 9413300007



DB-DL-7270

Length: 875 Ø: 40
Cone Ø: d1 Ø 28,6 / d2 Ø 23,9
01208300A, 0024604705, 0024604805,
0034604905, 0024604705



DB-DL-8167

Length: 866 Ø: 38
Cone Ø: d1 Ø 30 / d2 Ø 27
0014609805, 0014609905, 0024606305,
0024606405



DB-DL-8184

Length: 1095 Ø: 42
Cone Ø: d1 Ø 32 / d2 Ø 28,8
01217700A, 0014601305, 0014601405,
0024600505, 0034603205, 3754601505,
A0014601305, A0014601405, A0024600505



DB-DL-8307

Length: 885 Ø: 38
Cone Ø: d1 Ø 32 / d2 Ø 30
01215500A, 0004604005, 0024605105,
0024605205, 0034604005



DB-DL-8327

Length: 1745 Ø: 48
Cone Ø: d1 Ø 32 / d2 Ø 29
01219800A, 9413300003, 9413300103,
9413300203, 9413300303, 9413300503



DB-DL-8388

Length: 1735 Ø: 62
Cone Ø: d1 Ø 32 / d2 Ø 28,8
01219900A, 9453300003, 9453300103,
9453300403, 9453300603, A9453300003



DB-DL-8389

Length: 1465 Ø: 40
Cone Ø: d1 Ø 32 / d2 Ø 29
9453300203, 9453300303, 9453300503



DB-DL-8392

Length: 860 Ø: 40
Cone Ø: d1 Ø 28,6 / d2 Ø 23,9
0024609605, 0024609705, 0034605705



DB-DL-8640

Length: 1615 Ø: 50
Cone Ø: d1 Ø 32 / d2 Ø 29
6253301503, 6253301603, 6253302403,
6253302503, 9423300803, 9423302103,
9493300203, 9493300303, 9493300903



DB-DL-8702

Length: 958 Ø: 38
Cone Ø: d1 Ø 32 / d2 Ø 30
0024606105, 0024606205, 0034604205



DB-DL-9218

Length: 754 Ø: 40
Hole Distance: 100
000360098524, 000390098524,
3753300111, 9413300011,
A3753300111, SA50831601



DB-DL-12303

Length: 888 Ø: 42
Cone Ø: d1 Ø 28,6 / d2 Ø 23,9
0034601805, 0034601905, 0034605805,
A0034601905, A0034605805



DB-DL-12310

Length: 1532 Ø: 50
Cone Ø: d1 Ø 32 / d2 Ø 29
Thread: M27 x 1,5 LHT
9493301203, 9493301303, 9493301803,
9493302203, A9493301203, A9493301303,
A9493301803, A9493302203



DB-ES-5227

Length: 1588 Ø: 60
Cone Ø: d1 Ø 38 / d2 Ø 34,3
6253300903, 6253301203, 9443300203



DB-ES-5234

Length: 135
Cone Ø: d1 Ø 38 / d2 Ø 34,3
Thread: M38 x 1,5 RHT
0004601748, 120322305, 2205000400



DB-ES-8164

Length: 140
Cone Ø: d1 Ø 28,6 / d2 Ø 23,9
Thread: M28 x 1,5 RHT
0014604248, 0014605048, 0014608548,
0024600548



DB-ES-8510

Length: 56
Cone Ø: d1 Ø 10 / d2 Ø 10
Thread: M12 x 1,75 LHT
0009965145, 0009965645, 0019963145



DB-ES-8530

Length: 115
Cone Ø: d1 Ø 28,6 / d2 Ø 23,9
Thread: M30 x 1,5 RHT
0014603848, 0014604848, 0014605148,
0014608648, 0014609948



DB-RK-8391

Ø: 85 Hole Distance: 152
Thick/Height: 24
01336800A, 0003502705



DB-RK-8550

Ø: 75 Hole Distance: 152
Thick/Height: 24
0003502105, 0003504605



DB-RK-8626

Ø: 75 Hole Distance: 130
Thick/Height: 24
0003502205, 0003502505, 0003503405,
0003504505, GL11319



DB-RK-8638

Length: 100 Ø: 67
Hole Distance: 100
Thick/Height: 20
0003301411



DB-RK-9294

Ø: 85 Hole Distance: 152
Thick/Height: 24
0003503105



DB-RK-10374

Ø: 85 Hole Distance: 152
Thick/Height: 24
0003504405



DB-RK-10375

Ø: 100 Hole Distance: 152
Thick/Height: 24
0003502405, 0003503505, 0003504905



DB-SB-10384

Ø: 73 Thick/Height: 47
9303170012, 9423171812



DB-SB-10400

Length: 230
Thick/Height: 167,5 / 115
0003250696, 0003250896



DB-SB-10401

Length: 232
Thick/Height: 163,5 / 152,5
0003250596, 0003250796



DB-SB-10410

Ø: 73 Hole Distance: 100
Thick/Height: 24
9413230050



DB-TC-12410

Length: 925 Ø: 62
Hole Distance: 100 / 100
9423300707



DB-VB-3707

Length: 622 Ø: 46
Hole Ø 25 / 25 / 25
Hole Distance: 152 / 130 / 130
01337100A, 9423501005, 9423501505,
9443500005, 9473500105, 9473501005,
A375350005, A9423501005, A9423501505,
A944350005, A9473500105, A9473501005



DB-VB-7261

Length: 622 Ø: 46
Hole Ø 25 / 25 / 25
Hole Distance: 152 / 130 / 130
01337800A, 9443500305, 9443500505,
9443500605, 9473500705, 9473500905,
9483500405, 9483503005



DB-VB-7798

Length: 622 Ø: 48
Hole Ø 25 / 23 / 23
Hole Distance: 152 / 130 / 130
9423500505, 9423500805, 9423501205,
A9423501205



DB-VB-9307

Length: 667 Ø: 60
Hole Ø 25 / 23 / 23
Hole Distance: 152 / 130 / 130
9483502805



DB-VB-9308

Length: 622 Ø: 46
Hole Ø 25 / 25 / 25
Hole Distance: 152 / 130 / 130
9483502905



DB-VB-10425

Length: 622 Ø: 46
Hole Ø 25 / 23 / 23
Hole Distance: 152 / 130 / 130
9423500905, 9423501305



DB-VB-10426

Length: 622 Ø: 46
Hole Ø 25 / 25 / 25
Hole Distance: 152 / 130 / 130
9443500405





ACTROS MP2 / MP3 ...

1844 AK ...	04/03→	Rod Assembly	DB-DL-2178		Guide Rod
	04/03→	Stabiliser Mounting		DB-SB-10406	
	04/03→	Stabiliser Mounting		DB-SB-10409	
	04/03→	Suspension Arm Repair Kit		DB-RK-8626	for Wishbone (CV)
	04/03→	Suspension Arm Repair Kit		DB-RK-10374	for Wishbone (CV)
	04/03→	Suspension Arm Repair Kit		DB-RK-10375	for Wishbone (CV)
	04/03→	Suspension Arm Repair Kit	DB-RK-8638		for Control Arm
	04/03→	Suspension Strut Repair Kit		DB-RK-8391	
	04/03→	Tie Rod	DB-DL-12310		
	04/03→	Tie Rod	DB-ES-5227		Guide Rod, 1st FA;Leaf Spring Axle
	04/03→	Tie Rod	MN-DL-7834		Guide Rod, 1st FA;Leaf Spring Axle
	04/03→	Tie Rod End	CV-ES-0543		for Push Rod
	04/03→	Tie Rod End	CV-ES-0888		for Push Rod
	04/03→	Tie Rod End	CV-ES-14162		for Steering Rod
	04/03→	Tie Rod End	CV-ES-14163		for Steering Rod
	04/03→	Tie Rod End	DB-ES-5234		for Steering Rod
	04/03→	Tie Rod End	DB-ES-8530		for Push Rod
	04/03→	Track Control Arm		DB-VB-7261	Suspension Rod, Wishbone (CV), 1st RA, →517142 01/517142 02
	04/03→	Track Control Arm		DB-VB-9307	Suspension Rod, Wishbone (CV), 1st Drive Axle, →517142 07
	04/03→	Track Control Arm		DB-VB-9308	Suspension Rod, Wishbone (CV), 1st Drive Axle, →517142 06
04/03→	Track Control Arm		DB-VB-10426	Wishbone (CV), 1st RA, →517142 05	
1844 K	04/03→	Ball Head, gearshift linkage	DB-ES-8510		
	04/03→	Bush, driver cab suspension	DB-SB-10384		
	04/03→	Centre Rod	DB-DL-2144		Push Rod
	04/03→	Centre Rod	DB-DL-5230		Suspension Rod
	04/03→	Centre Rod	DB-DL-5241		Push Rod
	04/03→	Centre Rod	DB-DL-5405		Push Rod, Leaf Spring Axle
	04/03→	Centre Rod	DB-DL-7270		Push Rod
	04/03→	Centre Rod	DB-DL-8167		Push Rod
	04/03→	Centre Rod	DB-DL-8184		Push Rod
	04/03→	Centre Rod	DB-DL-8185		Push Rod
	04/03→	Centre Rod	DB-DL-8307		Push Rod
	04/03→	Centre Rod	DB-DL-12300		for Steering Rod
	04/03→	Rod Assembly	DB-DL-2178		Guide Rod
	04/03→	Stabiliser Mounting		DB-SB-10406	
	04/03→	Stabiliser Mounting		DB-SB-10409	
	04/03→	Suspension Arm Repair Kit		DB-RK-8550	for Wishbone (CV)
	04/03→	Suspension Arm Repair Kit		DB-RK-8626	for Wishbone (CV)
	04/03→	Suspension Arm Repair Kit		DB-RK-10374	for Wishbone (CV)
	04/03→	Suspension Arm Repair Kit		DB-RK-10375	for Wishbone (CV)
	04/03→	Suspension Arm Repair Kit	DB-RK-8638		for Control Arm
	04/03→	Suspension Strut Repair Kit		DB-RK-8391	
	04/03→	Tie Rod	DB-DL-8171		Guide Rod, 1st FA;Leaf Spring Axle
	04/03→	Tie Rod	DB-DL-8327		Guide Rod, 1st FA;Leaf Spring Axle
	04/03→	Tie Rod	DB-DL-8640		Guide Rod
	04/03→	Tie Rod	DB-DL-12310		
	04/03→	Tie Rod	DB-ES-5227		Guide Rod
	04/03→	Tie Rod End	CV-ES-0543		for Push Rod
	04/03→	Tie Rod End	CV-ES-0888		for Push Rod
	04/03→	Tie Rod End	CV-ES-14162		for Steering Rod
	04/03→	Tie Rod End	CV-ES-14163		for Steering Rod
	04/03→	Tie Rod End	DB-ES-5234		for Steering Rod
	04/03→	Tie Rod End	DB-ES-8164		for Push Rod
	04/03→	Tie Rod End	DB-ES-8530		for Push Rod
	04/03→	Track Control Arm		DB-VB-7261	Suspension Rod, Wishbone (CV), 1st RA, →517142 01/517142 02
	04/03→	Track Control Arm		DB-VB-9307	Suspension Rod, Wishbone (CV), 1st Drive Axle, →517142 07
	04/03→	Track Control Arm		DB-VB-9308	Suspension Rod, Wishbone (CV), 1st Drive Axle, →517142 06
	04/03→	Track Control Arm		DB-VB-10426	Wishbone (CV), 1st RA, →517142 05

CV-ES-0543

Length: 125
Cone Ø: d1 Ø 32 / d2 Ø 29
Thread: M30 x 1,5 RHT
0004605748, 0004606048, 0004606848,
0004607048, 0014600448, 0014601148,
0014601748, 0014602448, 0014607648,
0014609648



CV-ES-0888

Length: 125
Cone Ø: d1 Ø 32 / d2 Ø 29
Thread: M30 x 1,5 LHT
0004605848, 0004606148, 0004606948,
0004607148, 0004609048, 0014600548,
0014601348, 0014602548, 0014607948,
0024600448



CV-ES-14162

Length: 125
Cone Ø: d1 Ø 30 / d2 Ø 27
Thread: M30 x 1,5 LHT
4600648, 4601248, 4603448, 4603548,
0004603548, 14600348, 14601448,
14602348, 0014603748, 0014607848,
14607848, 0024600348



CV-ES-14163

Length: 125
Cone Ø: d1 Ø 30 / d2 Ø 27
Thread: M30 x 1,5 RHT
0003305248, 0003387310, 0004600348,
0004600948, 0004602848, 0004602948,
0004608948, 0014600248, 0014600848,
0014601248, 0014602248, 0014607748,
0024600148, A0003387310, A0004600348,
A0004602848, A0004602948, A0014600848,
A0014601248, A0014602248, A0014607748



DB-DL-2144

Length: 872 Ø: 35
Cone Ø: d1 Ø 28,6 / d2 Ø 23,9
0024604305, 0024604405, 0034604805



DB-DL-2178

Length: 1735 Ø: 52
Cone Ø: d1 Ø 32 / d2 Ø 29
9423300003, 9423300103, 9423300203



DB-DL-5230

Length: 879 Ø: 42
Cone Ø: d1 Ø 30 / d2 Ø 27
01208600A, 0004607105, 0004607205,
0014606705



DB-DL-5241

Length: 875 Ø: 40
Cone Ø: d1 Ø 30 / d2 Ø 27
01215300A, 0004609205, 0004609305,
0014606905



DB-DL-5405

Length: 890 Ø: 35
Cone Ø: d1 Ø 28,6 / d2 Ø 23,9
01215900A, 1460248, 0024604505,
0024604605, 0034605005, 3752600637,
3754600405, A3752600637, A3754600405



DB-DL-7270

Length: 875 Ø: 40
Cone Ø: d1 Ø 28,6 / d2 Ø 23,9
01208300A, 0024604705, 0024604805,
0034604905, A0024604705



DB-DL-8167

Length: 866 Ø: 38
Cone Ø: d1 Ø 30 / d2 Ø 27
0014609805, 0014609905, 0024606305,
0024606405



DB-DL-8171

Length: 1687 Ø: 52
Cone Ø: d1 Ø 32 / d2 Ø 29
9493300603, 9493300703, 9493301503,
9493301603



DB-DL-8184

Length: 1095 Ø: 42
Cone Ø: d1 Ø 32 / d2 Ø 28,8
01217700A, 0014601305, 0014601405,
0024600505, 0034603205, 3754601505,
A0014601305, A0014601405, A0024600505



DB-DL-8185

Length: 711 Ø: 42
Cone Ø: d1 Ø 32 / d2 Ø 28,8
01213600A, 0014601105, 0024600405,
0034603105, A0014601105, A0024600405



DB-DL-8307

Length: 885 Ø: 38
Cone Ø: d1 Ø 32 / d2 Ø 30
01215500A, 0004604005, 0024605105,
0024605205, 0034604005



DB-DL-8327

Length: 1745 Ø: 48
Cone Ø: d1 Ø 32 / d2 Ø 29
01219800A, 9413300003, 9413300103,
9413300203, 9413300303, 9413300503



DB-DL-8640

Length: 1615 Ø: 50
Cone Ø: d1 Ø 32 / d2 Ø 29
6253301503, 6253301603, 6253302403,
6253302503, 9423300803, 9423302103,
9493300203, 9493300303, 9493300903



DB-DL-12300

Length: 733 Ø: 36
Cone Ø: d1 Ø 32 / d2 Ø 29
0014601505, 0014607305, 0034603305,
3754601605, A0014601505,
A0034603305, A3754601605



DB-DL-12310

Length: 1532 Ø: 50
Cone Ø: d1 Ø 32 / d2 Ø 29
Thread: M27 x 1,5 LHT
9493301203, 9493301303, 9493301803,
9493302203, A9493301203, A9493301303,
A9493301803, A9493302203



DB-ES-5227

Length: 1588 Ø: 60
Cone Ø: d1 Ø 38 / d2 Ø 34,3
6253300903, 6253301203, 9443300203



DB-ES-5234

Length: 135
Cone Ø: d1 Ø 38 / d2 Ø 34,3
Thread: M38 x 1,5 RHT
0004601748, 120322305, 2205000400



DB-ES-8164

Length: 140
Cone Ø: d1 Ø 28,6 / d2 Ø 23,9
Thread: M28 x 1,5 RHT
0014604248, 0014605048, 0014608548,
0024600548



DB-ES-8510

Length: 56
Cone Ø: d1 Ø 10 / d2 Ø 10
Thread: M12 x 1,75 LHT
0009965145, 0009965645, 0019963145



DB-ES-8530

Length: 115
Cone Ø: d1 Ø 28,6 / d2 Ø 23,9
Thread: M30 x 1,5 RHT
0014603848, 0014604848, 0014605148,
0014608648, 0014609948



DB-RK-8391

Ø: 85 Hole Distance: 152
Thick/Height: 24
01336800A, 0003502705



DB-RK-8550

Ø: 75 Hole Distance: 152
Thick/Height: 24
0003502105, 0003504605



DB-RK-8626

Ø: 75 Hole Distance: 130
Thick/Height: 24
0003502205, 0003502505, 0003503405,
0003504505, GL11319



DB-RK-8638

Length: 100 Ø: 67
Hole Distance: 100
Thick/Height: 20
0003301411



DB-RK-10374

Ø: 85 Hole Distance: 152
Thick/Height: 24
0003504405



DB-RK-10375

Ø: 100 Hole Distance: 152
Thick/Height: 24
0003502405, 0003503505, 0003504905



DB-SB-10384

Ø: 73 Thick/Height: 47
9303170012, 9423171812



DB-SB-10406

Ø: 80 Thick/Height: 46
0003238185



DB-SB-10409

Ø: 77 Thick/Height: 56
0003265181



DB-VB-7261

Length: 622 Ø: 46
Hole Ø 25 / 25 / 25
Hole Distance: 152 / 130 / 130
01337800A, 9443500305, 9443500505,
9443500605, 9473500705, 9473500905,
9483500405, 9483503005



DB-VB-9307

Length: 667 Ø: 60
Hole Ø 25 / 23 / 23
Hole Distance: 152 / 130 / 130
9483502805



DB-VB-9308

Length: 622 Ø: 46
Hole Ø 25 / 25 / 25
Hole Distance: 152 / 130 / 130
9483502905



DB-VB-10426

Length: 622 Ø: 46
Hole Ø 25 / 25 / 25
Hole Distance: 152 / 130 / 130
9443500405



MN-DL-7834

Length: 1588 Ø: 58
Cone Ø: d1 Ø 30 / d2 Ø 27
3463303903, 3463304903, 6253303203,
9443300503, 9443301303, 9443301703





ACTROS MP2 / MP3 ...

1844 LS, LLS

04/03→	Ball Head, gearshift linkage	DB-ES-8510		
04/03→	Bush, driver cab suspension	DB-SB-10384		
04/03→	Centre Rod	DB-DL-2144		Push Rod
04/03→	Centre Rod	DB-DL-5230		Suspension Rod
04/03→	Centre Rod	DB-DL-5241		Push Rod
04/03→	Centre Rod	DB-DL-5405		Push Rod
04/03→	Centre Rod	DB-DL-7270		Push Rod
04/03→	Centre Rod	DB-DL-8167		Push Rod
04/03→	Centre Rod	DB-DL-8184		Push Rod
04/03→	Centre Rod	DB-DL-8185		Push Rod
04/03→	Centre Rod	DB-DL-8307		Push Rod
04/03→	Centre Rod	DB-DL-8392		Push Rod
04/03→	Centre Rod	DB-DL-12303		Push Rod, Leaf Spring Axle
04/03→	Rod Assembly	DB-DL-2178		Guide Rod
04/03→	Stabiliser Mounting		DB-SB-10406	
04/03→	Stabiliser Mounting		DB-SB-10409	
04/03→	Stabiliser Mounting	DB-SB-10410		
04/03→	Suspension Arm Repair Kit		DB-RK-8626	for Wishbone (CV)
04/03→	Suspension Arm Repair Kit		DB-RK-10374	for Wishbone (CV)
04/03→	Suspension Arm Repair Kit		DB-RK-10375	for Wishbone (CV)
04/03→	Suspension Arm Repair Kit	DB-RK-8638		for Control Arm
04/03→	Suspension Strut Repair Kit		DB-RK-8391	
04/03→	Suspension Strut Repair Kit		MN-RK-8997	
04/03→	Tie Rod	DB-DL-8327		Guide Rod
04/03→	Tie Rod	DB-DL-8388		Guide Rod
04/03→	Tie Rod	DB-DL-8389		
04/03→	Tie Rod	DB-DL-8640		Guide Rod
04/03→	Tie Rod	DB-DL-12310		
04/03→	Tie Rod	DB-ES-5227		Guide Rod
04/03→	Tie Rod End	CV-ES-0543		for Push Rod
04/03→	Tie Rod End	CV-ES-0888		for Push Rod
04/03→	Tie Rod End	CV-ES-14162		for Steering Rod
04/03→	Tie Rod End	CV-ES-14163		for Steering Rod
04/03→	Tie Rod End	DB-ES-5234		for Steering Rod
04/03→	Tie Rod End	DB-ES-8164		for Push Rod
04/03→	Tie Rod End	DB-ES-8530		for Push Rod
04/03→	Track Control Arm		DB-TC-12410	Control Arm
04/03→	Track Control Arm		DB-VB-7798	Wishbone (CV), Air Suspension Axle, * K 864074 *→
04/03→	Track Control Arm		DB-VB-10425	Wishbone (CV)
04/03→	Track Control Arm	DB-DL-5224		Control Arm, 1st FA;Air Suspension Axle
04/03→	Track Control Arm	DB-DL-9218	DB-DL-9218	Trailing Arm, 1st FA;Air Suspension Axle

1844, L, LL

04/03→	Ball Head, gearshift linkage	DB-ES-8510		
04/03→	Bush, driver cab suspension	DB-SB-10384		
04/03→	Centre Rod	DB-DL-2144		Push Rod
04/03→	Centre Rod	DB-DL-5230		Suspension Rod
04/03→	Centre Rod	DB-DL-5241		Push Rod
04/03→	Centre Rod	DB-DL-5405		Push Rod
04/03→	Centre Rod	DB-DL-5405		Push Rod, Leaf Spring Axle
04/03→	Centre Rod	DB-DL-7270		Push Rod
04/03→	Centre Rod	DB-DL-8167		Push Rod
04/03→	Centre Rod	DB-DL-8168		Push Rod
04/03→	Centre Rod	DB-DL-8184		Push Rod
04/03→	Centre Rod	DB-DL-8185		Push Rod
04/03→	Centre Rod	DB-DL-8307		Push Rod
04/03→	Centre Rod	DB-DL-8622		Push Rod
04/03→	Centre Rod	DB-DL-8641		Push Rod
04/03→	Centre Rod	DB-DL-8642		Push Rod
04/03→	Centre Rod	DB-DL-12300		for Steering Rod
04/03→	Rod Assembly	DB-DL-2178		Guide Rod
04/03→	Stabiliser Link	DB-DL-9254		Pressure Rod
04/03→	Stabiliser Mounting		DB-SB-10406	
04/03→	Stabiliser Mounting		DB-SB-10409	

CV-ES-0543

Length: 125
Cone Ø: d1 Ø 32 / d2 Ø 29
Thread: M30 x 1,5 RHT
0004605748, 0004606048, 0004606848,
0004607048, 0014600448, 0014601148,
0014601748, 0014602448, 0014607648,
0014609648



CV-ES-0888

Length: 125
Cone Ø: d1 Ø 32 / d2 Ø 29
Thread: M30 x 1,5 LHT
0004605848, 0004606148, 0004606948,
0004607148, 0004609048, 0014600548,
0014601348, 0014602548, 0014607948,
0024600448



CV-ES-14162

Length: 125
Cone Ø: d1 Ø 30 / d2 Ø 27
Thread: M30 x 1,5 LHT
4600648, 4601248, 4603448, 0004603548,
14600348, 14601448, 14602348,
0014603748, 0014607848, 0024600348



CV-ES-14163

Length: 125
Cone Ø: d1 Ø 30 / d2 Ø 27
Thread: M30 x 1,5 RHT
0003305248, 0003387310, 0004600348,
0004600948, 0004602848, 0004602948,
0004608948, 0014600248, 0014600848,
0014601248, 0014602248, 0014607748,
0024600148, A0003387310, A0004600348,
A0004602848, A0004602948, A0014600848,
A0014601248, A0014602248, A0014607748



DB-DL-2144

Length: 872 Ø: 35
Cone Ø: d1 Ø 28,6 / d2 Ø 23,9
0024604305, 0024604405, 0034604805



DB-DL-2178

Length: 1735 Ø: 52
Cone Ø: d1 Ø 32 / d2 Ø 29
9423300003, 9423300103, 9423300203



DB-DL-5224

Length: 850 Ø: 60
Hole Distance: 100 / 100
01336100A, 9413300007



DB-DL-5230

Length: 879 Ø: 42
Cone Ø: d1 Ø 30 / d2 Ø 27
01208600A, 0004607105, 0004607205,
0014606705



DB-DL-5241

Length: 875 Ø: 40
Cone Ø: d1 Ø 30 / d2 Ø 27
01215300A, 0004609205, 0004609305,
0014606905



DB-DL-5405

Length: 890 Ø: 35
Cone Ø: d1 Ø 28,6 / d2 Ø 23,9
01215900A, 1460248, 0024604505,
0024604605, 0034605005, 3752600637,
3754600405, A3752600637, A3754600405



DB-DL-7270

Length: 875 Ø: 40
Cone Ø: d1 Ø 28,6 / d2 Ø 23,9
01208300A, 0024604705, 0024604805,
0034604905, A0024604705



DB-DL-8167

Length: 866 Ø: 38
Cone Ø: d1 Ø 30 / d2 Ø 27
0014609805, 0014609905, 0024606305,
0024606405



DB-DL-8168

Length: 904 Ø: 52
Cone Ø: d1 Ø 32 / d2 Ø 29
0004609405, 0004609505, 0014607105



DB-DL-8184

Length: 1095 Ø: 42
Cone Ø: d1 Ø 32 / d2 Ø 28,8
01217700A, 0014601305, 0014601405,
0024600505, 0034603205, 3754601505,
A0014601305, A0014601405, A0024600505



DB-DL-8185

Length: 711 Ø: 42
Cone Ø: d1 Ø 32 / d2 Ø 28,8
01213600A, 0014601105, 0024600405,
0034603105, A0014601105, A0024600405



DB-DL-8307

Length: 885 Ø: 38
Cone Ø: d1 Ø 32 / d2 Ø 30
01215500A, 0004604005, 0024605105,
0024605205, 0034604005



DB-DL-8327

Length: 1745 Ø: 48
Cone Ø: d1 Ø 32 / d2 Ø 29
01219800A, 9413300003, 9413300103,
9413300203, 9413300303, 9413300503



DB-DL-8388

Length: 1735 Ø: 62
Cone Ø: d1 Ø 32 / d2 Ø 28,8
01219900A, 9453300003, 9453300103,
9453300403, 9453300603, A9453300003



DB-DL-8389

Length: 1465 Ø: 40
Cone Ø: d1 Ø 32 / d2 Ø 29
9453300203, 9453300303, 9453300503



DB-DL-8392

Length: 860
Ø: 40
Cone Ø: d1 Ø 28,6 / d2 Ø 23,9
24609605, 0024609605, 24609705,
0024609705, 0034605705



DB-DL-8622

Length: 1558 Ø: 52
Cone Ø: d1 Ø 30 / d2 Ø 27
0014609005, 0014609105



DB-DL-8640

Length: 1615 Ø: 50
Cone Ø: d1 Ø 32 / d2 Ø 29
6253301503, 6253301603, 6253302403,
6253302503, 9423300803, 9423302103,
9493300203, 9493300303, 9493300903



DB-DL-8641

Length: 905 Ø: 42
Cone Ø: d1 Ø 30 / d2 Ø 27
0014605105, 0014608105



DB-DL-8642

Length: 954 Ø: 42
Cone Ø: d1 Ø 30 / d2 Ø 27
0014608605, 0014608705



DB-DL-9218

Length: 754 Ø: 40
Hole Distance: 100
000360098524, 000390098524,
3753300111, 9413300011,
A3753300111, SA50831601



DB-DL-9254

Length: 1815 Ø: 58
0003220323, 0003220623, 3753220423



DB-DL-12300

Length: 733 Ø: 36
Cone Ø: d1 Ø 32 / d2 Ø 29
0014601505, 0014607305, 0034603305,
3754601605, A0014601505,
A0034603305, A3754601605



DB-DL-12303

Length: 888 Ø: 42
Cone Ø: d1 Ø 28,6 / d2 Ø 23,9
0034601805, 0034601905, 0034605805,
A0034601905, A0034605805



DB-DL-12310

Length: 1532 Ø: 50
Cone Ø: d1 Ø 32 / d2 Ø 29
Thread: M27 x 1,5 LHT
9493301203, 9493301303, 9493301803,
9493302203, A9493301203, A9493301303,
A9493301803, A9493302203



DB-ES-5227

Length: 1588 Ø: 60
Cone Ø: d1 Ø 38 / d2 Ø 34,3
6253300903, 6253301203, 9443300203



DB-ES-5234

Length: 135
Cone Ø: d1 Ø 38 / d2 Ø 34,3
Thread: M38 x 1,5 RHT
0004601748, 120322305, 2205000400



DB-ES-8164

Length: 140
Cone Ø: d1 Ø 28,6 / d2 Ø 23,9
Thread: M28 x 1,5 RHT
0014604248, 0014605048, 0014608548,
0024600548



DB-ES-8510

Length: 56
Cone Ø: d1 Ø 10 / d2 Ø 10
Thread: M12 x 1,75 LHT
0009965145, 0009965645, 0019963145



DB-ES-8530

Length: 115
Cone Ø: d1 Ø 28,6 / d2 Ø 23,9
Thread: M30 x 1,5 RHT
0014603848, 0014604848, 0014605148,
0014608648, 0014609948



DB-RK-8391

Ø: 85 Hole Distance: 152
Thick/Height: 24
01336800A, 0003502705



DB-RK-8626

Ø: 75 Hole Distance: 130
Thick/Height: 24
0003502205, 0003502505, 0003503405,
0003504505, GL11319



DB-RK-8638

Length: 100 Ø: 67
Hole Distance: 100
Thick/Height: 20
0003301411



DB-RK-10374

Ø: 85 Hole Distance: 152
Thick/Height: 24
0003504405



DB-RK-10375

Ø: 100 Hole Distance: 152
Thick/Height: 24
0003502405, 0003503505, 0003504905



DB-SB-10384

Ø: 73 Thick/Height: 47
9303170012, 9423171812



DB-SB-10406

Ø: 80 Thick/Height: 46
0003238185



DB-SB-10409

Ø: 77 Thick/Height: 56
0003265181



DB-SB-10410

Ø: 73 Hole Distance: 100
Thick/Height: 24
9413230050



DB-TC-12410

Length: 925 Ø: 62
Hole Distance: 100 / 100
9423300707



DB-VB-7798

Length: 622 Ø: 48
Hole Ø 25 / 23 / 23
Hole Distance: 152 / 130 / 130
9423500505, 9423500805, 9423501205,
A9423501205



DB-VB-10425

Length: 622 Ø: 46
Hole Ø 25 / 23 / 23
Hole Distance: 152 / 130 / 130
9423500905, 9423501305



MN-RK-8997

Ø: 85
Hole Distance: 130
Thick/Height: 30
0003504805, 3504805



MERCEDES-BENZ



ACTROS MP2 / MP3 ...

1844, L, LL ...	04/03→	Stabiliser Mounting	DB-SB-10410			
	04/03→	Suspension Arm Repair Kit		DB-RK-8550	for Wishbone (CV)	
	04/03→	Suspension Arm Repair Kit		DB-RK-8626	for Wishbone (CV)	
	04/03→	Suspension Arm Repair Kit		DB-RK-10374	for Wishbone (CV)	
	04/03→	Suspension Arm Repair Kit		DB-RK-10375	for Wishbone (CV)	
	04/03→	Suspension Arm Repair Kit	DB-RK-8638		for Control Arm	
	04/03→	Suspension Strut Repair Kit		DB-RK-8391		
	04/03→	Suspension Strut Repair Kit		DB-RK-9294		
	04/03→	Tie Rod	DB-DL-8327		Guide Rod, 1st FA;Leaf Spring Axle	
	04/03→	Tie Rod	DB-DL-8388		Guide Rod, 1st FA;Leaf Spring Axle	
	04/03→	Tie Rod	DB-DL-8389		1st FA;Leaf Spring Axle	
	04/03→	Tie Rod	DB-DL-8640		Guide Rod	
	04/03→	Tie Rod	DB-DL-12310			
	04/03→	Tie Rod	DB-ES-5227		Guide Rod	
	04/03→	Tie Rod End	CV-ES-0543		for Push Rod	
	04/03→	Tie Rod End	CV-ES-0888		for Push Rod	
	04/03→	Tie Rod End	CV-ES-14162		for Steering Rod	
	04/03→	Tie Rod End	CV-ES-14163		for Steering Rod	
	04/03→	Tie Rod End	DB-ES-5234		for Steering Rod	
	04/03→	Tie Rod End	DB-ES-8164		for Push Rod	
	04/03→	Tie Rod End	DB-ES-8530		for Push Rod	
	04/03→	Track Control Arm		DB-VB-3707	Suspension Rod, Wishbone (CV)	
	04/03→	Track Control Arm	DB-DL-5224		Control Arm, 1st FA;Air Suspension Axle	
	04/03→	Track Control Arm	DB-DL-9218	DB-DL-9218	Trailing Arm, 1st FA;Air Suspension Axle	
	1846 A	04/03→	Bush, parabolic spring		DB-SB-10400	
		04/03→	Bush, parabolic spring		DB-SB-10401	
		04/03→	Centre Rod	DB-DL-8167		Push Rod
		04/03→	Tie Rod	DB-DL-8327		Guide Rod
		04/03→	Tie Rod	DB-DL-8640		Guide Rod
	1846 AK	04/03→	Ball Head, gearshift linkage	DB-ES-8510		
		04/03→	Bush, driver cab suspension	DB-SB-10384		
		04/03→	Centre Rod	DB-DL-2144		Push Rod
04/03→		Centre Rod	DB-DL-8184		Push Rod	
04/03→		Centre Rod	DB-DL-8307		Push Rod, Leaf Spring Axle	
04/03→		Centre Rod	DB-DL-8702		Push Rod, Leaf Spring Axle	
04/03→		Rod Assembly	DB-DL-2178		Guide Rod	
04/03→		Stabiliser Mounting		DB-SB-10406		
04/03→		Stabiliser Mounting		DB-SB-10409		
04/03→		Suspension Arm Repair Kit		DB-RK-8626	for Wishbone (CV)	
04/03→		Suspension Arm Repair Kit		DB-RK-10374	for Wishbone (CV)	
04/03→		Suspension Arm Repair Kit		DB-RK-10375	for Wishbone (CV)	
04/03→		Suspension Arm Repair Kit	DB-RK-8638		for Control Arm	
04/03→		Suspension Strut Repair Kit		DB-RK-8391		
04/03→		Tie Rod	DB-DL-12310			
04/03→		Tie Rod	DB-ES-5227		Guide Rod, 1st FA;Leaf Spring Axle	
04/03→		Tie Rod	MN-DL-7834		Guide Rod, 1st FA;Leaf Spring Axle	
04/03→		Tie Rod End	CV-ES-0543		for Push Rod	
04/03→		Tie Rod End	CV-ES-0888		for Push Rod	
04/03→		Tie Rod End	CV-ES-14162		for Steering Rod	
04/03→		Tie Rod End	CV-ES-14163		for Steering Rod	
04/03→		Tie Rod End	DB-ES-5234		for Steering Rod	
04/03→		Tie Rod End	DB-ES-8530		for Push Rod	
04/03→		Track Control Arm		DB-VB-7261	Suspension Rod, Wishbone (CV), 1st RA, →517142 01/517142 02	
04/03→		Track Control Arm		DB-VB-9307	Suspension Rod, Wishbone (CV), 1st Drive Axle, →517142 07	
04/03→		Track Control Arm		DB-VB-9308	Suspension Rod, Wishbone (CV), 1st Drive Axle, →517142 06	
04/03→		Track Control Arm		DB-VB-10426	Wishbone (CV), 1st RA, →517142 05	
1846 K		04/03→	Ball Head, gearshift linkage	DB-ES-8510		
		04/03→	Bush, driver cab suspension	DB-SB-10384		
		04/03→	Centre Rod	DB-DL-2144		Push Rod
		04/03→	Centre Rod	DB-DL-5230		Suspension Rod



CV-ES-0543

Length: 125
Cone Ø: d1 Ø 32 / d2 Ø 29
Thread: M30 x 1,5 RHT
0004605748, 0004606048, 0004606848,
0004607048, 0014600448, 0014601148,
0014601748, 0014602448, 0014607648,
0014609648



CV-ES-0888

Length: 125
Cone Ø: d1 Ø 32 / d2 Ø 29
Thread: M30 x 1,5 LHT
0004605848, 0004606148, 0004606948,
0004607148, 0004609048, 0014600548,
0014601348, 0014602548, 0014607948,
0024600448



CV-ES-14162

Length: 125
Cone Ø: d1 Ø 30 / d2 Ø 27
Thread: M30 x 1,5 LHT
4600648, 4601248, 4603448, 0004603548,
14600348, 14601448, 14602348,
0014603748, 0014607848, 0024600348



CV-ES-14163

Length: 125
Cone Ø: d1 Ø 30 / d2 Ø 27
Thread: M30 x 1,5 RHT
0003305248, 0003387310, 0004600348,
0004600948, 0004602848, 0004602948,
0004608948, 0014600248, 0014600848,
0014601248, 0014602248, 0014607748,
0024600148, A0003387310, A0004600348,
A0004602848, A0004602948, A0014600848,
A0014601248, A0014602248, A0014607748



DB-DL-2144

Length: 872 Ø: 35
Cone Ø: d1 Ø 28,6 / d2 Ø 23,9
0024604305, 0024604405, 0034604805



DB-DL-2178

Length: 1735 Ø: 52
Cone Ø: d1 Ø 32 / d2 Ø 29
9423300003, 9423300103, 9423300203



DB-DL-5224

Length: 850 Ø: 60
Hole Distance: 100 / 100
01336100A, 9413300007



DB-DL-5230

Length: 879 Ø: 42
Cone Ø: d1 Ø 30 / d2 Ø 27
01208600A, 0004607105, 0004607205,
0014606705



DB-DL-8167

Length: 866 Ø: 38
Cone Ø: d1 Ø 30 / d2 Ø 27
0014609805, 0014609905, 0024606305,
0024606405



DB-DL-8184

Length: 1095 Ø: 42
Cone Ø: d1 Ø 32 / d2 Ø 28,8
01217700A, 0014601305, 0014601405,
0024600505, 0034603205, 3754601505,
A0014601305, A0014601405, A0024600505



DB-DL-8307

Length: 885 Ø: 38
Cone Ø: d1 Ø 32 / d2 Ø 30
01215500A, 0004604005, 0024605105,
0024605205, 0034604005



DB-DL-8327

Length: 1745 Ø: 48
Cone Ø: d1 Ø 32 / d2 Ø 29
01219800A, 9413300003, 9413300103,
9413300203, 9413300303, 9413300503



DB-DL-8388

Length: 1735 Ø: 62
Cone Ø: d1 Ø 32 / d2 Ø 28,8
01219900A, 9453300003, 9453300103,
9453300403, 9453300603, A9453300003



DB-DL-8389

Length: 1465 Ø: 40
Cone Ø: d1 Ø 32 / d2 Ø 29
9453300203, 9453300303, 9453300503



DB-DL-8640

Length: 1615 Ø: 50
Cone Ø: d1 Ø 32 / d2 Ø 29
6253301503, 6253301603, 6253302403,
6253302503, 9423300803, 9423302103,
9493300203, 9493300303, 9493300903



DB-DL-8702

Length: 958 Ø: 38
Cone Ø: d1 Ø 32 / d2 Ø 30
0024606105, 0024606205, 0034604205



DB-DL-9218

Length: 754 Ø: 40
Hole Distance: 100
000360098524, 000390098524,
3753300111, 9413300011,
A3753300111, SA50831601



DB-DL-12310

Length: 1532 Ø: 50
Cone Ø: d1 Ø 32 / d2 Ø 29
Thread: M27 x 1,5 LHT
9493301203, 9493301303, 9493301803,
9493302203, A9493301203, A9493301303,
A9493301803, A9493302203



DB-ES-5227

Length: 1588 Ø: 60
Cone Ø: d1 Ø 38 / d2 Ø 34,3
6253300903, 6253301203, 9443300203



DB-ES-5234

Length: 135
Cone Ø: d1 Ø 38 / d2 Ø 34,3
Thread: M38 x 1,5 RHT
0004601748, 120322305, 2205000400



DB-ES-8164

Length: 140
Cone Ø: d1 Ø 28,6 / d2 Ø 23,9
Thread: M28 x 1,5 RHT
0014604248, 0014605048, 0014608548,
0024600548



DB-ES-8510

Length: 56
Cone Ø: d1 Ø 10 / d2 Ø 10
Thread: M12 x 1,75 LHT
0009965145, 0009965645, 0019963145



DB-ES-8530

Length: 115
Cone Ø: d1 Ø 28,6 / d2 Ø 23,9
Thread: M30 x 1,5 RHT
0014603848, 0014604848, 0014605148,
0014608648, 0014609948



DB-RK-8391

Ø: 85 Hole Distance: 152
Thick/Height: 24
01336800A, 0003502705



DB-RK-8550

Ø: 75 Hole Distance: 152
Thick/Height: 24
0003502105, 0003504605



DB-RK-8626

Ø: 75 Hole Distance: 130
Thick/Height: 24
0003502205, 0003502505, 0003503405,
0003504505, GL11319



DB-RK-8638

Length: 100 Ø: 67
Hole Distance: 100
Thick/Height: 20
0003301411



DB-RK-9294

Ø: 85 Hole Distance: 152
Thick/Height: 24
0003503105



DB-RK-10374

Ø: 85 Hole Distance: 152
Thick/Height: 24
0003504405



DB-RK-10375

Ø: 100 Hole Distance: 152
Thick/Height: 24
0003502405, 0003503505, 0003504905



DB-SB-10384

Ø: 73 Thick/Height: 47
9303170012, 9423171812



DB-SB-10400

Length: 230
Thick/Height: 167,5 / 115
0003250696, 0003250896



DB-SB-10401

Length: 232
Thick/Height: 163,5 / 152,5
0003250596, 0003250796



DB-SB-10406

Ø: 80 Thick/Height: 46
0003238185



DB-SB-10409

Ø: 77 Thick/Height: 56
0003265181



DB-SB-10410

Ø: 73 Hole Distance: 100
Thick/Height: 24
9413230050



DB-VB-3707

Length: 622 Ø: 46
Hole Ø 25 / 25 / 25
Hole Distance: 152 / 130 / 130
01337100A, 9423501005, 9423501505,
9443500005, 9473500105, 9473501005,
A3753500005, A9423501005, A9423501505,
A9443500005, A9473500105, A9473501005



DB-VB-7261

Length: 622 Ø: 46
Hole Ø 25 / 25 / 25
Hole Distance: 152 / 130 / 130
01337800A, 9443500305, 9443500505,
9443500605, 9473500705, 9473500905,
9483500405, 9483500305



DB-VB-9307

Length: 667 Ø: 60
Hole Ø 25 / 23 / 23
Hole Distance: 152 / 130 / 130
9483502805



DB-VB-9308

Length: 622 Ø: 46
Hole Ø 25 / 25 / 25
Hole Distance: 152 / 130 / 130
9483502905



DB-VB-10426

Length: 622 Ø: 46
Hole Ø 25 / 25 / 25
Hole Distance: 152 / 130 / 130
9443500405



MN-DL-7834

Length: 1588 Ø: 58
Cone Ø: d1 Ø 30 / d2 Ø 27
3463303903, 3463304903, 6253303203,
9443300503, 9443301303, 9443301703





ACTROS MP2 / MP3 ...

1846 K ...	04/03→	Centre Rod	DB-DL-5241	Push Rod	
	04/03→	Centre Rod	DB-DL-5405	Push Rod, Leaf Spring Axle	
	04/03→	Centre Rod	DB-DL-7270	Push Rod	
	04/03→	Centre Rod	DB-DL-8167	Push Rod	
	04/03→	Centre Rod	DB-DL-8184	Push Rod	
	04/03→	Centre Rod	DB-DL-8185	Push Rod	
	04/03→	Centre Rod	DB-DL-8307	Push Rod	
	04/03→	Centre Rod	DB-DL-12300	for Steering Rod	
	04/03→	Rod Assembly	DB-DL-2178	Guide Rod	
	04/03→	Stabiliser Mounting		DB-SB-10406	
	04/03→	Stabiliser Mounting		DB-SB-10409	
	04/03→	Suspension Arm Repair Kit		DB-RK-8550	for Wishbone (CV)
	04/03→	Suspension Arm Repair Kit		DB-RK-8626	for Wishbone (CV)
	04/03→	Suspension Arm Repair Kit		DB-RK-10374	for Wishbone (CV)
	04/03→	Suspension Arm Repair Kit		DB-RK-10375	for Wishbone (CV)
	04/03→	Suspension Arm Repair Kit	DB-RK-8638		for Control Arm
	04/03→	Suspension Strut Repair Kit		DB-RK-8391	
	04/03→	Tie Rod	DB-DL-8171		Guide Rod, 1st FA;Leaf Spring Axle
	04/03→	Tie Rod	DB-DL-8327		Guide Rod, 1st FA;Leaf Spring Axle
	04/03→	Tie Rod	DB-DL-8640		Guide Rod
	04/03→	Tie Rod	DB-DL-12310		
	04/03→	Tie Rod	DB-ES-5227		Guide Rod
	04/03→	Tie Rod End	CV-ES-0543		for Push Rod
	04/03→	Tie Rod End	CV-ES-0888		for Push Rod
	04/03→	Tie Rod End	CV-ES-14162		for Steering Rod
	04/03→	Tie Rod End	CV-ES-14163		for Steering Rod
	04/03→	Tie Rod End	DB-ES-5234		for Steering Rod
	04/03→	Tie Rod End	DB-ES-8164		for Push Rod
	04/03→	Tie Rod End	DB-ES-8530		for Push Rod
	04/03→	Track Control Arm		DB-VB-7261	Suspension Rod, Wishbone (CV), 1st RA, →517142 01/517142 02
	04/03→	Track Control Arm		DB-VB-9307	Suspension Rod, Wishbone (CV), 1st Drive Axle, →517142 07
	04/03→	Track Control Arm		DB-VB-9308	Suspension Rod, Wishbone (CV), 1st Drive Axle, →517142 06
	04/03→	Track Control Arm		DB-VB-10426	Wishbone (CV), 1st RA, →517142 05
	1846 LS, LLS	04/03→	Ball Head, gearshift linkage	DB-ES-8510	
		04/03→	Bush, driver cab suspension	DB-SB-10384	
		04/03→	Centre Rod	DB-DL-2144	Push Rod
		04/03→	Centre Rod	DB-DL-5230	Suspension Rod
04/03→		Centre Rod	DB-DL-5241	Push Rod	
04/03→		Centre Rod	DB-DL-5405	Push Rod	
04/03→		Centre Rod	DB-DL-7270	Push Rod	
04/03→		Centre Rod	DB-DL-8167	Push Rod	
04/03→		Centre Rod	DB-DL-8184	Push Rod	
04/03→		Centre Rod	DB-DL-8185	Push Rod	
04/03→		Centre Rod	DB-DL-8307	Push Rod	
04/03→		Centre Rod	DB-DL-8392	Push Rod	
04/03→		Centre Rod	DB-DL-12300	for Steering Rod	
04/03→		Centre Rod	DB-DL-12303	Push Rod, Leaf Spring Axle	
04/03→		Rod Assembly	DB-DL-2178	Guide Rod	
04/03→		Stabiliser Mounting		DB-RK-9296	
04/03→		Stabiliser Mounting		DB-SB-10406	
04/03→		Stabiliser Mounting		DB-SB-10409	
04/03→		Stabiliser Mounting	DB-SB-10410		
04/03→		Suspension Arm Repair Kit		DB-RK-8626	for Wishbone (CV)
04/03→		Suspension Arm Repair Kit		DB-RK-10374	for Wishbone (CV)
04/03→		Suspension Arm Repair Kit		DB-RK-10375	for Wishbone (CV)
04/03→		Suspension Arm Repair Kit	DB-RK-8638		for Control Arm
04/03→		Suspension Strut Repair Kit		DB-RK-8391	
04/03→		Suspension Strut Repair Kit		MN-RK-8997	
04/03→		Tie Rod	DB-DL-8327		Guide Rod
04/03→		Tie Rod	DB-DL-8388		Guide Rod

CV-ES-0543

Length: 125
 Cone Ø: d1 Ø 32 / d2 Ø 29
 Thread: M30 x 1,5 RHT
 0004605748, 0004606048, 0004606848,
 0004607048, 0014600448, 0014601148,
 0014601748, 0014602448, 0014607648,
 0014609648

**CV-ES-0888**

Length: 125
 Cone Ø: d1 Ø 32 / d2 Ø 29
 Thread: M30 x 1,5 LHT
 0004605848, 0004606148, 0004606948,
 0004607148, 0004609048, 0014600548,
 0014601348, 0014602548, 0014607948,
 0024600448

**CV-ES-14162**

Length: 125
 Cone Ø: d1 Ø 30 / d2 Ø 27
 Thread: M30 x 1,5 LHT
 4600648, 4601248, 4603448, 0004603548,
 14600348, 14601448, 14602348,
 0014603748, 0014607848, 0024600348

**CV-ES-14163**

Length: 125
 Cone Ø: d1 Ø 30 / d2 Ø 27
 Thread: M30 x 1,5 RHT
 0003305248, 0003387310, 0004600348,
 0004600948, 0004602848, 0004602948,
 0004608948, 0014600248, 0014600848,
 0014601248, 0014602248, 0014607748,
 0024600148, A0003387310, A0004600348,
 A0004602848, A0004602948, A0014600848,
 A0014601248, A0014602248, A0014607748

**DB-DL-2144**

Length: 872 Ø: 35
 Cone Ø: d1 Ø 28,6 / d2 Ø 23,9
 0024604305, 0024604405, 0034604805

**DB-DL-2178**

Length: 1735 Ø: 52
 Cone Ø: d1 Ø 32 / d2 Ø 29
 9423300003, 9423300103, 9423300203

**DB-DL-5230**

Length: 879 Ø: 42
 Cone Ø: d1 Ø 30 / d2 Ø 27
 01208600A, 0004607105, 0004607205,
 0014606705

**DB-DL-5241**

Length: 875 Ø: 40
 Cone Ø: d1 Ø 30 / d2 Ø 27
 01215300A, 0004609205, 0004609305,
 0014606905

**DB-DL-5405**

Length: 890 Ø: 35
 Cone Ø: d1 Ø 28,6 / d2 Ø 23,9
 01215900A, 1460248, 0024604505,
 0024604605, 0034605005, 3752600637,
 3754600405, A3752600637, A3754600405

**DB-DL-7270**

Length: 875 Ø: 40
 Cone Ø: d1 Ø 28,6 / d2 Ø 23,9
 01208300A, 0024604705, 0024604805,
 0034604905, A0024604705

**DB-DL-8167**

Length: 866 Ø: 38
 Cone Ø: d1 Ø 30 / d2 Ø 27
 0014609805, 0014609905, 0024606305,
 0024606405

**DB-DL-8171**

Length: 1687 Ø: 52
 Cone Ø: d1 Ø 32 / d2 Ø 29
 9493300603, 9493300703, 9493301503,
 9493301603

**DB-DL-8184**

Length: 1095 Ø: 42
 Cone Ø: d1 Ø 32 / d2 Ø 28,8
 01217700A, 0014601305, 0014601405,
 0024600505, 0034603205, 3754601505,
 A0014601305, A0014601405, A0024600505

**DB-DL-8185**

Length: 711 Ø: 42
 Cone Ø: d1 Ø 32 / d2 Ø 28,8
 01213600A, 0014601105, 0024600405,
 0034603105, A0014601105, A0024600405

**DB-DL-8307**

Length: 885 Ø: 38
 Cone Ø: d1 Ø 32 / d2 Ø 30
 01215500A, 0004604005, 0024605105,
 0024605205, 0034604005

**DB-DL-8327**

Length: 1745 Ø: 48
 Cone Ø: d1 Ø 32 / d2 Ø 29
 01219800A, 9413300003, 9413300103,
 9413300203, 9413300303, 9413300503

**DB-DL-8388**

Length: 1735 Ø: 62
 Cone Ø: d1 Ø 32 / d2 Ø 28,8
 01219900A, 9453300003, 9453300103,
 9453300403, 9453300603, A9453300003

**DB-DL-8392**

Length: 860 Ø: 40
 Cone Ø: d1 Ø 28,6 / d2 Ø 23,9
 0024609605, 0024609705, 0034605705

**DB-DL-8640**

Length: 1615 Ø: 50
 Cone Ø: d1 Ø 32 / d2 Ø 29
 6253301503, 6253301603, 6253302403,
 6253302503, 9423300803, 9423302103,
 9493300203, 9493300303, 9493300903

**DB-DL-12300**

Length: 733 Ø: 36
 Cone Ø: d1 Ø 32 / d2 Ø 29
 0014601505, 0014607305, 0034603305,
 3754601605, A0014601505,
 A0034603305, A3754601605

**DB-DL-12303**

Length: 888 Ø: 42
 Cone Ø: d1 Ø 28,6 / d2 Ø 23,9
 0034601805, 0034601905, 0034605805,
 A0034601905, A0034605805

**DB-DL-12310**

Length: 1532 Ø: 50
 Cone Ø: d1 Ø 32 / d2 Ø 29
 Thread: M27 x 1,5 LHT
 9493301203, 9493301303, 9493301803,
 9493302203, A9493301203, A9493301303,
 A9493301803, A9493302203

**DB-ES-5227**

Length: 1588 Ø: 60
 Cone Ø: d1 Ø 38 / d2 Ø 34,3
 6253300903, 6253301203, 9443300203

**DB-ES-5234**

Length: 135
 Cone Ø: d1 Ø 38 / d2 Ø 34,3
 Thread: M38 x 1,5 RHT
 0004601748, 120322305, 2205000400

**DB-ES-8164**

Length: 140
 Cone Ø: d1 Ø 28,6 / d2 Ø 23,9
 Thread: M28 x 1,5 RHT
 0014604248, 0014605048, 0014608548,
 0024600548

**DB-ES-8510**

Length: 56
 Cone Ø: d1 Ø 10 / d2 Ø 10
 Thread: M12 x 1,75 LHT
 0009965145, 0009965645, 0019963145

**DB-ES-8530**

Length: 115
 Cone Ø: d1 Ø 28,6 / d2 Ø 23,9
 Thread: M30 x 1,5 RHT
 0014603848, 0014604848, 0014605148,
 0014608648, 0014609948

**DB-RK-8391**

Ø: 85 Hole Distance: 152
 Thick/Height: 24
 01336800A, 0003502705

**DB-RK-8550**

Ø: 75 Hole Distance: 152
 Thick/Height: 24
 0003502105, 0003504605

**DB-RK-8626**

Ø: 75 Hole Distance: 130
 Thick/Height: 24
 0003502205, 0003502505, 0003503405,
 0003504505, GL11319

**DB-RK-8638**

Length: 100 Ø: 67
 Hole Distance: 100
 Thick/Height: 20
 0003301411

**DB-RK-9296**

Ø: 88 Hole Distance: 130
 Thick/Height: 24
 9423260050

**DB-RK-10374**

Ø: 85 Hole Distance: 152
 Thick/Height: 24
 0003504405

**DB-RK-10375**

Ø: 100 Hole Distance: 152
 Thick/Height: 24
 0003502405, 0003503505, 0003504905

**DB-SB-10384**

Ø: 73 Thick/Height: 47
 9303170012, 9423171812

**DB-SB-10406**

Ø: 80 Thick/Height: 46
 0003238185

**DB-SB-10409**

Ø: 77 Thick/Height: 56
 0003265181

**DB-SB-10410**

Ø: 73 Hole Distance: 100
 Thick/Height: 24
 9413230050

**DB-VB-7261**

Length: 622 Ø: 46
 Hole Ø 25 / 25 / 25
 Hole Distance: 152 / 130 / 130
 01337800A, 9443500305, 9443500505,
 9443500605, 9473500705, 9473500905,
 9483500405, 9483500305

**DB-VB-9307**

Length: 667 Ø: 60
 Hole Ø 25 / 23 / 23
 Hole Distance: 152 / 130 / 130
 9483502805

**DB-VB-9308**

Length: 622 Ø: 46
 Hole Ø 25 / 25 / 25
 Hole Distance: 152 / 130 / 130
 9483502905

**DB-VB-10426**

Length: 622 Ø: 46
 Hole Ø 25 / 25 / 25
 Hole Distance: 152 / 130 / 130
 9443500405

**MN-RK-8997**

Ø: 85
 Hole Distance: 130
 Thick/Height: 30
 0003504805, 3504805

**MERCEDES-BENZ**



ACTROS MP2 / MP3 ...

1846 LS, LLS ...

04/03→	Tie Rod	DB-DL-8389		
04/03→	Tie Rod	DB-DL-8640		Guide Rod
04/03→	Tie Rod	DB-DL-12310		
04/03→	Tie Rod	DB-ES-5227		Guide Rod
04/03→	Tie Rod End	CV-ES-0543		for Push Rod
04/03→	Tie Rod End	CV-ES-0888		for Push Rod
04/03→	Tie Rod End	CV-ES-14162		for Steering Rod
04/03→	Tie Rod End	CV-ES-14163		for Steering Rod
04/03→	Tie Rod End	DB-ES-5234		for Steering Rod
04/03→	Tie Rod End	DB-ES-8164		for Push Rod
04/03→	Tie Rod End	DB-ES-8530		for Push Rod
04/03→	Track Control Arm		DB-TC-12410	Control Arm
04/03→	Track Control Arm		DB-VB-7798	Wishbone (CV), Air Suspension Axle, * K 864074 *→
04/03→	Track Control Arm		DB-VB-10425	Wishbone (CV)
04/03→	Track Control Arm	DB-DL-5224		Control Arm, 1st FA;Air Suspension Axle
04/03→	Track Control Arm	DB-DL-9218	DB-DL-9218	Trailing Arm, 1st FA;Air Suspension Axle

1846, L, LL

04/03→	Ball Head, gearshift linkage	DB-ES-8510		
04/03→	Bush, driver cab suspension	DB-SB-10384		
04/03→	Centre Rod	DB-DL-2144		Push Rod
04/03→	Centre Rod	DB-DL-5230		Suspension Rod
04/03→	Centre Rod	DB-DL-5241		Push Rod
04/03→	Centre Rod	DB-DL-5405		Push Rod
04/03→	Centre Rod	DB-DL-5405		Push Rod, Leaf Spring Axle
04/03→	Centre Rod	DB-DL-7270		Push Rod
04/03→	Centre Rod	DB-DL-8167		Push Rod
04/03→	Centre Rod	DB-DL-8168		Push Rod
04/03→	Centre Rod	DB-DL-8184		Push Rod
04/03→	Centre Rod	DB-DL-8185		Push Rod
04/03→	Centre Rod	DB-DL-8307		Push Rod
04/03→	Centre Rod	DB-DL-8622		Push Rod
04/03→	Centre Rod	DB-DL-8641		Push Rod
04/03→	Centre Rod	DB-DL-8642		Push Rod
04/03→	Centre Rod	DB-DL-12300		for Steering Rod
04/03→	Rod Assembly	DB-DL-2178		Guide Rod
04/03→	Stabiliser Link	DB-DL-9254		Pressure Rod
04/03→	Stabiliser Mounting		DB-RK-9296	
04/03→	Stabiliser Mounting		DB-SB-10406	
04/03→	Stabiliser Mounting		DB-SB-10409	
04/03→	Stabiliser Mounting	DB-SB-10410		
04/03→	Suspension Arm Repair Kit		DB-RK-8550	for Wishbone (CV)
04/03→	Suspension Arm Repair Kit		DB-RK-8626	for Wishbone (CV)
04/03→	Suspension Arm Repair Kit		DB-RK-10374	for Wishbone (CV)
04/03→	Suspension Arm Repair Kit		DB-RK-10375	for Wishbone (CV)
04/03→	Suspension Arm Repair Kit	DB-RK-8638		for Control Arm
04/03→	Suspension Strut Repair Kit		DB-RK-8391	
04/03→	Suspension Strut Repair Kit		DB-RK-9294	
04/03→	Tie Rod	DB-DL-8327		Guide Rod, 1st FA;Leaf Spring Axle
04/03→	Tie Rod	DB-DL-8388		Guide Rod, 1st FA;Leaf Spring Axle
04/03→	Tie Rod	DB-DL-8389		1st FA;Leaf Spring Axle
04/03→	Tie Rod	DB-DL-8640		Guide Rod
04/03→	Tie Rod	DB-DL-12310		
04/03→	Tie Rod	DB-ES-5227		Guide Rod
04/03→	Tie Rod End	CV-ES-0543		for Push Rod
04/03→	Tie Rod End	CV-ES-0888		for Push Rod
04/03→	Tie Rod End	CV-ES-14162		for Steering Rod
04/03→	Tie Rod End	CV-ES-14163		for Steering Rod
04/03→	Tie Rod End	DB-ES-5234		for Steering Rod
04/03→	Tie Rod End	DB-ES-8164		for Push Rod
04/03→	Tie Rod End	DB-ES-8530		for Push Rod
04/03→	Track Control Arm		DB-VB-3707	Suspension Rod, Wishbone (CV)



ACTROS MP2 / MP3 ...

1846, L, LL ...	04/03→	Track Control Arm		DB-VB-7261	Suspension Rod, Wishbone (CV), 1st RA, for Leaf-Spring Suspension vehicles, →517142 01/517142 02
	04/03→	Track Control Arm		DB-VB-9307	Suspension Rod, Wishbone (CV), 1st Drive Axle, for Leaf-Spring Suspension vehicles, →517142 07
	04/03→	Track Control Arm		DB-VB-9308	Suspension Rod, Wishbone (CV), 1st Drive Axle, for Leaf-Spring Suspension vehicles, →517142 06
	04/03→	Track Control Arm		DB-VB-10426	Wishbone (CV), 1st RA, for Leaf-Spring Suspension vehicles, →517142 05
	04/03→	Track Control Arm	DB-DL-5224		Control Arm, 1st FA;Air Suspension Axle
	04/03→	Track Control Arm	DB-DL-9218	DB-DL-9218	Trailing Arm, 1st FA;Air Suspension Axle
1848 A	04/03→	Bush, parabolic spring		DB-SB-10400	
	04/03→	Bush, parabolic spring		DB-SB-10401	
	04/03→	Centre Rod	DB-DL-8167		Push Rod
	04/03→	Tie Rod	DB-DL-8327		Guide Rod
1848 AK	04/03→	Tie Rod	DB-DL-8640		Guide Rod
	04/03→	Ball Head, gearshift linkage	DB-ES-8510		
	04/03→	Bush, driver cab suspension	DB-SB-10384		
	04/03→	Centre Rod	DB-DL-8184		Push Rod
	04/03→	Centre Rod	DB-DL-8307		Push Rod
	04/03→	Centre Rod	DB-DL-8307		Push Rod, Leaf Spring Axle
	04/03→	Centre Rod	DB-DL-8702		Push Rod
	04/03→	Centre Rod	DB-DL-8702		Push Rod, Leaf Spring Axle
	04/03→	Centre Rod	DB-DL-12300		for Steering Rod
	04/03→	Stabiliser Mounting		DB-SB-10406	
	04/03→	Stabiliser Mounting		DB-SB-10409	
	04/03→	Suspension Arm Repair Kit		DB-RK-8626	for Wishbone (CV)
	04/03→	Suspension Arm Repair Kit		DB-RK-10374	for Wishbone (CV)
	04/03→	Suspension Arm Repair Kit		DB-RK-10375	for Wishbone (CV)
	04/03→	Suspension Arm Repair Kit	DB-RK-8638		for Control Arm
	04/03→	Suspension Strut Repair Kit		DB-RK-8391	
	04/03→	Suspension Strut Repair Kit		DB-RK-8710	
	04/03→	Suspension Strut Repair Kit		DB-RK-9291	
	04/03→	Tie Rod	DB-DL-12310		
	04/03→	Tie Rod	DB-ES-5227		Guide Rod
	04/03→	Tie Rod	DB-ES-5227		Guide Rod, 1st FA;Leaf Spring Axle
	04/03→	Tie Rod	MN-DL-7834		Guide Rod
	04/03→	Tie Rod	MN-DL-7834		Guide Rod, 1st FA;Leaf Spring Axle
	04/03→	Tie Rod End	CV-ES-0543		for Push Rod
	04/03→	Tie Rod End	CV-ES-14163		for Steering Rod
	04/03→	Tie Rod End	DB-ES-5234		for Steering Rod
04/03→	Tie Rod End	DB-ES-8530		for Push Rod	
04/03→	Track Control Arm		DB-VB-7261	Suspension Rod, Wishbone (CV), 1st RA, →517142 01/517142 02	
04/03→	Track Control Arm		DB-VB-7776	Wishbone (CV)	
04/03→	Track Control Arm		DB-VB-9307	Suspension Rod, Wishbone (CV)	
04/03→	Track Control Arm		DB-VB-9307	Suspension Rod, Wishbone (CV), 1st Drive Axle, →517142 07	
04/03→	Track Control Arm		DB-VB-9308	Suspension Rod, Wishbone (CV)	
04/03→	Track Control Arm		DB-VB-9308	Suspension Rod, Wishbone (CV), 1st Drive Axle, →517142 06	
04/03→	Track Control Arm		DB-VB-10426	Wishbone (CV), 1st RA, →517142 05	
1848 K	04/03→	Ball Head, gearshift linkage	DB-ES-8510		
	04/03→	Bush, driver cab suspension	DB-SB-10384		
	04/03→	Centre Rod	DB-DL-2144		Push Rod
	04/03→	Centre Rod	DB-DL-5230		Suspension Rod
	04/03→	Centre Rod	DB-DL-5241		Push Rod
	04/03→	Centre Rod	DB-DL-5405		Push Rod, Leaf Spring Axle
	04/03→	Centre Rod	DB-DL-7270		Push Rod
	04/03→	Centre Rod	DB-DL-8167		Push Rod
04/03→	Centre Rod	DB-DL-8184		Push Rod	

CV-ES-0543

Length: 125
Cone Ø: d1 Ø 32 / d2 Ø 29
Thread: M30 x 1,5 RHT
0004605748, 0004606048, 0004606848,
0004607048, 0014600448, 0014601148,
0014601748, 0014602448, 0014607648,
0014609648



CV-ES-14163

Length: 125
Cone Ø: d1 Ø 30 / d2 Ø 27
Thread: M30 x 1,5 RHT
0003305248, 0003387310, 0004600348,
0004600948, 0004602848, 0004602948,
0004608948, 0014600248, 0014600848,
0014601248, 0014602248, 0014607748,
0024600148, A0003387310, A0004600348,
A0004602848, A0004602948, A0014600848,
A0014601248, A0014602248, A0014607748



DB-DL-2144

Length: 872 Ø: 35
Cone Ø: d1 Ø 28,6 / d2 Ø 23,9
0024604305, 0024604405, 0034604805



DB-DL-5224

Length: 850 Ø: 60
Hole Distance: 100 / 100
01336100A, 9413300007



DB-DL-5230

Length: 879 Ø: 42
Cone Ø: d1 Ø 30 / d2 Ø 27
01208600A, 0004607105, 0004607205,
0014606705



DB-DL-5241

Length: 875 Ø: 40
Cone Ø: d1 Ø 30 / d2 Ø 27
01215300A, 0004609205, 0004609305,
0014606905



DB-DL-5405

Length: 890 Ø: 35
Cone Ø: d1 Ø 28,6 / d2 Ø 23,9
01215900A, 1460248, 0024604505,
0024604605, 0034605005, 3752600637,
3754600405, A3752600637, A3754600405



DB-DL-7270

Length: 875 Ø: 40
Cone Ø: d1 Ø 28,6 / d2 Ø 23,9
01208300A, 0024604705, 0024604805,
0034604905, A0024604705



DB-DL-8167

Length: 866 Ø: 38
Cone Ø: d1 Ø 30 / d2 Ø 27
0014609805, 0014609905, 0024606305,
0024606405



DB-DL-8184

Length: 1095 Ø: 42
Cone Ø: d1 Ø 32 / d2 Ø 28,8
01217700A, 0014601305, 0014601405,
0024600505, 0034603205, 3754601505,
A0014601305, A0014601405, A0024600505



DB-DL-8307

Length: 885 Ø: 38
Cone Ø: d1 Ø 32 / d2 Ø 30
01215500A, 0004604005, 0024605105,
0024605205, 0034604005



DB-DL-8327

Length: 1745 Ø: 48
Cone Ø: d1 Ø 32 / d2 Ø 29
01219800A, 9413300003, 9413300103,
9413300203, 9413300303, 9413300503



DB-DL-8640

Length: 1615 Ø: 50
Cone Ø: d1 Ø 32 / d2 Ø 29
6253301503, 6253301603, 6253302403,
6253302503, 9423300803, 9423302103,
9493300203, 9493300303, 9493300903



DB-DL-8702

Length: 958 Ø: 38
Cone Ø: d1 Ø 32 / d2 Ø 30
0024606105, 0024606205, 0034604205



DB-DL-9218

Length: 754 Ø: 40
Hole Distance: 100
000360098524, 000390098524,
3753300111, 9413300011,
A3753300111, SA50831601



DB-DL-12300

Length: 733 Ø: 36
Cone Ø: d1 Ø 32 / d2 Ø 29
0014601505, 0014607305, 0034603305,
3754601605, A0014601505,
A0034603305, A3754601605



DB-DL-12310

Length: 1532 Ø: 50
Cone Ø: d1 Ø 32 / d2 Ø 29
Thread: M27 x 1,5 LHT
9493301203, 9493301303, 9493301803,
9493302203, A9493301203, A9493301303,
A9493301803, A9493302203



DB-ES-5227

Length: 1588 Ø: 60
Cone Ø: d1 Ø 38 / d2 Ø 34,3
6253300903, 6253301203, 9443300203



DB-ES-5234

Length: 135
Cone Ø: d1 Ø 38 / d2 Ø 34,3
Thread: M38 x 1,5 RHT
0004601748, 120322305, 2205000400



DB-ES-8510

Length: 56
Cone Ø: d1 Ø 10 / d2 Ø 10
Thread: M12 x 1,75 LHT
0009965145, 0009965645, 0019963145



DB-ES-8530

Length: 115
Cone Ø: d1 Ø 28,6 / d2 Ø 23,9
Thread: M30 x 1,5 RHT
0014603848, 0014604848, 0014605148,
0014608648, 0014609948



DB-RK-8391

Ø: 85 Hole Distance: 152
Thick/Height: 24
01336800A, 0003502705



DB-RK-8626

Ø: 75 Hole Distance: 130
Thick/Height: 24
0003502205, 0003502505, 0003503405,
0003504505, GL11319



DB-RK-8638

Length: 100 Ø: 67
Hole Distance: 100
Thick/Height: 20
0003301411



DB-RK-8710

Ø: 85 Hole Distance: 130
Thick/Height: 30
0003503705



DB-RK-9291

Ø: 107,5 Hole Distance: 152
Thick/Height: 30
0003503605



DB-RK-10374

Ø: 85 Hole Distance: 152
Thick/Height: 24
0003504405



DB-RK-10375

Ø: 100 Hole Distance: 152
Thick/Height: 24
0003502405, 0003503505, 0003504905



DB-SB-10384

Ø: 73 Thick/Height: 47
9303170012, 9423171812



DB-SB-10400

Length: 230
Thick/Height: 167,5 / 115
0003250696, 0003250896



DB-SB-10401

Length: 232
Thick/Height: 163,5 / 152,5
0003250596, 0003250796



DB-SB-10406

Ø: 80 Thick/Height: 46
0003238185



DB-SB-10409

Ø: 77 Thick/Height: 56
0003265181



DB-VB-7261

Length: 622 Ø: 46
Hole Ø 25 / 25 / 25
Hole Distance: 152 / 130 / 130
01337800A, 9443500305, 9443500505,
9443500605, 9473500705, 9473500905,
9483500405, 9483503005



DB-VB-7776

Length: 622 Ø: 56
Hole Distance: 152 / 152
6533500205, 6583500205



DB-VB-9307

Length: 667 Ø: 60
Hole Ø 25 / 23 / 23
Hole Distance: 152 / 130 / 130
9483502805



DB-VB-9308

Length: 622 Ø: 46
Hole Ø 25 / 25 / 25
Hole Distance: 152 / 130 / 130
9483502905



DB-VB-10426

Length: 622 Ø: 46
Hole Ø 25 / 25 / 25
Hole Distance: 152 / 130 / 130
9443500405



MN-DL-7834

Length: 1588 Ø: 58
Cone Ø: d1 Ø 30 / d2 Ø 27
3463303903, 3463304903, 6253303203,
9443300503, 9443301303, 9443301703



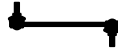

ACTROS MP2 / MP3 ...

1848 K ...	04/03→	Centre Rod	DB-DL-8185		Push Rod	
	04/03→	Centre Rod	DB-DL-8307		Push Rod	
	04/03→	Centre Rod	DB-DL-12300		for Steering Rod	
	04/03→	Rod Assembly	DB-DL-2178		Guide Rod, 1st Front Axle, →504310 03	
	04/03→	Stabiliser Mounting		DB-SB-10406		
	04/03→	Stabiliser Mounting		DB-SB-10409		
	04/03→	Suspension Arm Repair Kit		DB-RK-8550	for Wishbone (CV)	
	04/03→	Suspension Arm Repair Kit		DB-RK-8626	for Wishbone (CV)	
	04/03→	Suspension Arm Repair Kit		DB-RK-10374	for Wishbone (CV)	
	04/03→	Suspension Arm Repair Kit		DB-RK-10375	for Wishbone (CV)	
	04/03→	Suspension Arm Repair Kit	DB-RK-8638		for Control Arm	
	04/03→	Suspension Strut Repair Kit		DB-RK-8391		
	04/03→	Tie Rod	DB-DL-8171		Guide Rod, 1st FA;Leaf Spring Axle	
	04/03→	Tie Rod	DB-DL-8327		Guide Rod, 1st FA;Leaf Spring Axle	
	04/03→	Tie Rod	DB-DL-8640		Guide Rod	
	04/03→	Tie Rod	DB-DL-12310			
	04/03→	Tie Rod	DB-ES-5227		Guide Rod	
	04/03→	Tie Rod End	CV-ES-0543		for Push Rod	
	04/03→	Tie Rod End	CV-ES-0888		for Push Rod	
	04/03→	Tie Rod End	CV-ES-14163		for Steering Rod	
	04/03→	Tie Rod End	DB-ES-5234		for Steering Rod	
	04/03→	Tie Rod End	DB-ES-8164		for Push Rod	
	04/03→	Tie Rod End	DB-ES-8530		for Push Rod	
	04/03→	Track Control Arm		DB-VB-7261	Suspension Rod, Wishbone (CV), 1st RA, →517142 01/517142 02	
	04/03→	Track Control Arm		DB-VB-9307	Suspension Rod, Wishbone (CV), 1st Drive Axle, →517142 07	
	04/03→	Track Control Arm		DB-VB-9308	Suspension Rod, Wishbone (CV), 1st Drive Axle, →517142 06	
	04/03→	Track Control Arm		DB-VB-10426	Wishbone (CV), 1st RA, →517142 05	
	1848 S, LS	04/03→	Bush, driver cab suspension	DB-SB-10384		
		04/03→	Centre Rod	DB-DL-2144		Push Rod
		04/03→	Centre Rod	DB-DL-7270		Push Rod
04/03→		Centre Rod	DB-DL-8167		Push Rod	
04/03→		Centre Rod	DB-DL-8185		Push Rod	
04/03→		Centre Rod	DB-DL-8307		Push Rod	
04/03→		Centre Rod	DB-DL-12300		for Steering Rod	
04/03→		Centre Rod	DB-DL-12303		Push Rod, Leaf Spring Axle	
04/03→		Rod Assembly	DB-DL-2178		Guide Rod, 1st Front Axle, →504310 03	
04/03→		Stabiliser Mounting		DB-SB-10406		
04/03→		Stabiliser Mounting		DB-SB-10409		
04/03→		Stabiliser Mounting	DB-SB-10410			
04/03→		Suspension Arm Repair Kit		DB-RK-8626	for Wishbone (CV)	
04/03→		Suspension Arm Repair Kit		DB-RK-10374	for Wishbone (CV)	
04/03→		Suspension Arm Repair Kit		DB-RK-10375	for Wishbone (CV)	
04/03→		Suspension Arm Repair Kit	DB-RK-8638		for Control Arm	
04/03→		Suspension Strut Repair Kit		DB-RK-8391		
04/03→		Suspension Strut Repair Kit		MN-RK-8997		
04/03→		Tie Rod	DB-DL-8327		Guide Rod, 1st Front Axle	
04/03→		Tie Rod	DB-DL-8640		Guide Rod	
04/03→		Tie Rod	DB-DL-12310			
04/03→		Tie Rod	DB-ES-5227		Guide Rod	
04/03→		Tie Rod End	CV-ES-0543		for Push Rod	
04/03→		Tie Rod End	CV-ES-0888		for Push Rod	
04/03→		Tie Rod End	CV-ES-14163		for Steering Rod	
04/03→		Tie Rod End	DB-ES-5234		for Steering Rod	
04/03→		Tie Rod End	DB-ES-8164		for Push Rod	
04/03→		Tie Rod End	DB-ES-8530		for Push Rod	
04/03→		Track Control Arm		DB-TC-12410	Control Arm	
04/03→		Track Control Arm		DB-VB-7798	Wishbone (CV), Air Suspension Axle	
04/03→	Track Control Arm	DB-DL-9218	DB-DL-9218	Trailing Arm, 1st FA, →508316 01/508316 04		
04/03→	Track Control Arm	DB-DL-9218	DB-DL-9218	Trailing Arm, 1st FA, →532040 04		

CV-ES-0543

Length: 125
 Cone Ø: d1 Ø 32 / d2 Ø 29
 Thread: M30 x 1,5 RHT
 0004605748, 0004606048, 0004606848,
 0004607048, 0014600448, 0014601148,
 0014601748, 0014602448, 0014607648,
 0014609648

**CV-ES-0888**

Length: 125
 Cone Ø: d1 Ø 32 / d2 Ø 29
 Thread: M30 x 1,5 LHT
 0004605848, 0004606148, 0004606948,
 0004607148, 0004609048, 0014600548,
 0014601348, 0014602548, 0014607948,
 0024600448

**CV-ES-14163**

Length: 125
 Cone Ø: d1 Ø 30 / d2 Ø 27
 Thread: M30 x 1,5 RHT
 0003305248, 0003387310, 0004600348,
 0004600948, 0004602848, 0004602948,
 0004608948, 0014600248, 0014600848,
 0014601248, 0014602248, 0014607748,
 0024600148, A0003387310, A0004600348,
 A0004602848, A0004602948, A0014600848,
 A0014601248, A0014602248, A0014607748

**DB-DL-2144**

Length: 872 Ø: 35
 Cone Ø: d1 Ø 28,6 / d2 Ø 23,9
 0024604305, 0024604405, 0034604805

**DB-DL-2178**

Length: 1735 Ø: 52
 Cone Ø: d1 Ø 32 / d2 Ø 29
 9423300003, 9423300103, 9423300203

**DB-DL-7270**

Length: 875 Ø: 40
 Cone Ø: d1 Ø 28,6 / d2 Ø 23,9
 01208300A, 0024604705, 0024604805,
 0034604905, A0024604705

**DB-DL-8167**

Length: 866 Ø: 38
 Cone Ø: d1 Ø 30 / d2 Ø 27
 0014609805, 0014609905, 0024606305,
 0024606405

**DB-DL-8171**

Length: 1687 Ø: 52
 Cone Ø: d1 Ø 32 / d2 Ø 29
 9493300603, 9493300703, 9493301503,
 9493301603

**DB-DL-8185**

Length: 711 Ø: 42
 Cone Ø: d1 Ø 32 / d2 Ø 28,8
 01213600A, 0014601105, 0024600405,
 0034603105, A0014601105, A0024600405

**DB-DL-8307**

Length: 885 Ø: 38
 Cone Ø: d1 Ø 32 / d2 Ø 30
 01215500A, 0004604005, 0024605105,
 0024605205, 0034604005

**DB-DL-8327**

Length: 1745 Ø: 48
 Cone Ø: d1 Ø 32 / d2 Ø 29
 01219800A, 9413300003, 9413300103,
 9413300203, 9413300303, 9413300503

**DB-DL-8640**

Length: 1615 Ø: 50
 Cone Ø: d1 Ø 32 / d2 Ø 29
 6253301503, 6253301603, 6253302403,
 6253302503, 9423300803, 9423302103,
 9493300203, 9493300303, 9493300903

**DB-DL-9218**

Length: 754 Ø: 40
 Hole Distance: 100
 000360098524, 000390098524,
 3753300111, 9413300011,
 A3753300111, SA50831601

**DB-DL-12300**

Length: 733 Ø: 36
 Cone Ø: d1 Ø 32 / d2 Ø 29
 0014601505, 0014607305, 0034603305,
 3754601605, A0014601505,
 A0034603305, A3754601605

**DB-DL-12303**

Length: 888 Ø: 42
 Cone Ø: d1 Ø 28,6 / d2 Ø 23,9
 0034601805, 0034601905, 0034605805,
 A0034601905, A0034605805

**DB-DL-12310**

Length: 1532 Ø: 50
 Cone Ø: d1 Ø 32 / d2 Ø 29
 Thread: M27 x 1,5 LHT
 9493301203, 9493301303, 9493301803,
 9493302203, A9493301203, A9493301303,
 A9493301803, A9493302203

**DB-ES-5227**

Length: 1588 Ø: 60
 Cone Ø: d1 Ø 38 / d2 Ø 34,3
 6253300903, 6253301203, 9443300203

**DB-ES-5234**

Length: 135
 Cone Ø: d1 Ø 38 / d2 Ø 34,3
 Thread: M38 x 1,5 RHT
 0004601748, 120322305, 2205000400

**DB-ES-8164**

Length: 140
 Cone Ø: d1 Ø 28,6 / d2 Ø 23,9
 Thread: M28 x 1,5 RHT
 0014604248, 0014605048, 0014608548,
 0024600548

**DB-ES-8530**

Length: 115
 Cone Ø: d1 Ø 28,6 / d2 Ø 23,9
 Thread: M30 x 1,5 RHT
 0014603848, 0014604848, 0014605148,
 0014608648, 0014609948

**DB-RK-8391**

Ø: 85 Hole Distance: 152
 Thick/Height: 24
 01336800A, 0003502705

**DB-RK-8550**

Ø: 75 Hole Distance: 152
 Thick/Height: 24
 0003502105, 0003504605

**DB-RK-8626**

Ø: 75 Hole Distance: 130
 Thick/Height: 24
 0003502205, 0003502505, 0003503405,
 0003504505, GL11319

**DB-RK-8638**

Length: 100 Ø: 67
 Hole Distance: 100
 Thick/Height: 20
 0003301411

**DB-RK-10374**

Ø: 85 Hole Distance: 152
 Thick/Height: 24
 0003504405

**DB-RK-10375**

Ø: 100 Hole Distance: 152
 Thick/Height: 24
 0003502405, 0003503505, 0003504905

**DB-SB-10384**

Ø: 73 Thick/Height: 47
 9303170012, 9423171812

**DB-SB-10406**

Ø: 80 Thick/Height: 46
 0003238185

**DB-SB-10409**

Ø: 77 Thick/Height: 56
 0003265181

**DB-SB-10410**

Ø: 73 Hole Distance: 100
 Thick/Height: 24
 9413230050

**DB-TC-12410**

Length: 925 Ø: 62
 Hole Distance: 100 / 100
 9423300707

**DB-VB-7261**

Length: 622 Ø: 46
 Hole Ø 25 / 25 / 25
 Hole Distance: 152 / 130 / 130
 01337800A, 9443500305, 9443500505,
 9443500605, 9473500705, 9473500905,
 9483500405, 9483503005

**DB-VB-7798**

Length: 622 Ø: 48
 Hole Ø 25 / 23 / 23
 Hole Distance: 152 / 130 / 130
 9423500505, 9423500805, 9423501205,
 A9423501205

**DB-VB-9307**

Length: 667 Ø: 60
 Hole Ø 25 / 23 / 23
 Hole Distance: 152 / 130 / 130
 9483502805

**DB-VB-9308**

Length: 622 Ø: 46
 Hole Ø 25 / 25 / 25
 Hole Distance: 152 / 130 / 130
 9483502905

**DB-VB-10426**

Length: 622 Ø: 46
 Hole Ø 25 / 25 / 25
 Hole Distance: 152 / 130 / 130
 9443500405

**MERCEDES-BENZ**

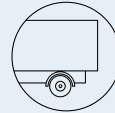

ACTROS MP2 / MP3 ...

1848, L, LL

04/03→	Ball Head, gearshift linkage	DB-ES-8510		
04/03→	Bush, driver cab suspension	DB-SB-10384		
04/03→	Centre Rod	DB-DL-2144		Push Rod
04/03→	Centre Rod	DB-DL-5230		Suspension Rod
04/03→	Centre Rod	DB-DL-5241		Push Rod
04/03→	Centre Rod	DB-DL-5405		Push Rod
04/03→	Centre Rod	DB-DL-5405		Push Rod, Leaf Spring Axle
04/03→	Centre Rod	DB-DL-7270		Push Rod
04/03→	Centre Rod	DB-DL-8167		Push Rod
04/03→	Centre Rod	DB-DL-8168		Push Rod
04/03→	Centre Rod	DB-DL-8184		Push Rod
04/03→	Centre Rod	DB-DL-8185		Push Rod
04/03→	Centre Rod	DB-DL-8307		Push Rod
04/03→	Centre Rod	DB-DL-8622		Push Rod
04/03→	Centre Rod	DB-DL-8641		Push Rod
04/03→	Centre Rod	DB-DL-8642		Push Rod
04/03→	Centre Rod	DB-DL-12300		for Steering Rod
04/03→	Rod Assembly	DB-DL-2178		Guide Rod, 1st Front Axle, →504310 03
04/03→	Stabiliser Link	DB-DL-9254		Pressure Rod
04/03→	Stabiliser Mounting		DB-SB-10406	
04/03→	Stabiliser Mounting		DB-SB-10409	
04/03→	Stabiliser Mounting	DB-SB-10410		
04/03→	Suspension Arm Repair Kit		DB-RK-8550	for Wishbone (CV)
04/03→	Suspension Arm Repair Kit		DB-RK-8626	for Wishbone (CV)
04/03→	Suspension Arm Repair Kit		DB-RK-10374	for Wishbone (CV)
04/03→	Suspension Arm Repair Kit		DB-RK-10375	for Wishbone (CV)
04/03→	Suspension Arm Repair Kit	DB-RK-8638		for Control Arm
04/03→	Suspension Strut Repair Kit		DB-RK-8391	
04/03→	Suspension Strut Repair Kit		DB-RK-9294	
04/03→	Tie Rod	DB-DL-8327		Guide Rod, 1st FA;Leaf Spring Axle
04/03→	Tie Rod	DB-DL-8388		Guide Rod, 1st FA;Leaf Spring Axle
04/03→	Tie Rod	DB-DL-8389		1st FA;Leaf Spring Axle
04/03→	Tie Rod	DB-DL-8640		Guide Rod
04/03→	Tie Rod	DB-DL-12310		
04/03→	Tie Rod	DB-ES-5227		Guide Rod
04/03→	Tie Rod End	CV-ES-0543		for Push Rod
04/03→	Tie Rod End	CV-ES-0888		for Push Rod
04/03→	Tie Rod End	CV-ES-14163		for Steering Rod
04/03→	Tie Rod End	DB-ES-5234		for Steering Rod
04/03→	Tie Rod End	DB-ES-8164		for Push Rod
04/03→	Tie Rod End	DB-ES-8530		for Push Rod
04/03→	Track Control Arm		DB-VB-3707	Suspension Rod, Wishbone (CV)
04/03→	Track Control Arm		DB-VB-3707	Suspension Rod, Wishbone (CV), 1st RA, →508306 01
04/03→	Track Control Arm		DB-VB-7261	Suspension Rod, Wishbone (CV), 1st RA, →517142 01/517142 02
04/03→	Track Control Arm		DB-VB-9307	Suspension Rod, Wishbone (CV), 1st Drive Axle, →517142 07
04/03→	Track Control Arm		DB-VB-9308	Suspension Rod, Wishbone (CV), 1st Drive Axle, →517142 06
04/03→	Track Control Arm		DB-VB-10426	Wishbone (CV), 1st RA, →517142 05
04/03→	Track Control Arm	DB-DL-5224		Control Arm, 1st FA;Air Suspension Axle
04/03→	Track Control Arm	DB-DL-9218	DB-DL-9218	Trailing Arm, 1st FA;Air Suspension Axle

1848, LS, LLS

04/03→	Ball Head, gearshift linkage	DB-ES-8510		
04/03→	Bush, driver cab suspension	DB-SB-10384		
04/03→	Centre Rod	DB-DL-2144		Push Rod
04/03→	Centre Rod	DB-DL-5230		Suspension Rod
04/03→	Centre Rod	DB-DL-5241		Push Rod
04/03→	Centre Rod	DB-DL-5405		Push Rod
04/03→	Centre Rod	DB-DL-7270		Push Rod
04/03→	Centre Rod	DB-DL-8167		Push Rod
04/03→	Centre Rod	DB-DL-8184		Push Rod
04/03→	Centre Rod	DB-DL-8185		Push Rod



ACTROS MP2 / MP3 ...

1848, LS, LLS ...	04/03→	Centre Rod	DB-DL-8307		Push Rod	
	04/03→	Centre Rod	DB-DL-8392		Push Rod	
	04/03→	Centre Rod	DB-DL-12300		for Steering Rod	
	04/03→	Centre Rod	DB-DL-12303		Push Rod, Leaf Spring Axle	
	04/03→	Rod Assembly	DB-DL-2178		Guide Rod, 1st Front Axle, →504310 03	
	04/03→	Stabiliser Mounting		DB-RK-9296		
	04/03→	Stabiliser Mounting		DB-SB-10406		
	04/03→	Stabiliser Mounting		DB-SB-10409		
	04/03→	Stabiliser Mounting	DB-SB-10410			
	04/03→	Suspension Arm Repair Kit		DB-RK-8626	for Wishbone (CV)	
	04/03→	Suspension Arm Repair Kit		DB-RK-10374	for Wishbone (CV)	
	04/03→	Suspension Arm Repair Kit		DB-RK-10375	for Wishbone (CV)	
	04/03→	Suspension Arm Repair Kit	DB-RK-8638		for Control Arm	
	04/03→	Suspension Strut Repair Kit		DB-RK-8391		
	04/03→	Suspension Strut Repair Kit		MN-RK-8997		
	04/03→	Tie Rod	DB-DL-8327		Guide Rod	
	04/03→	Tie Rod	DB-DL-8388		Guide Rod	
	04/03→	Tie Rod	DB-DL-8389			
	04/03→	Tie Rod	DB-DL-8640		Guide Rod	
	04/03→	Tie Rod	DB-DL-12310			
	04/03→	Tie Rod	DB-ES-5227		Guide Rod	
	04/03→	Tie Rod End	CV-ES-0543		for Push Rod	
	04/03→	Tie Rod End	CV-ES-0888		for Push Rod	
	04/03→	Tie Rod End	CV-ES-14163		for Steering Rod	
	04/03→	Tie Rod End	DB-ES-5234		for Steering Rod	
	04/03→	Tie Rod End	DB-ES-8164		for Push Rod	
	04/03→	Tie Rod End	DB-ES-8530		for Push Rod	
	04/03→	Track Control Arm		DB-TC-12410	Control Arm	
	04/03→	Track Control Arm		DB-VB-7798	Wishbone (CV), Air Suspension Axle	
	04/03→	Track Control Arm		DB-VB-10425	Wishbone (CV), 1st Drive Axle, →508306 06	
	04/03→	Track Control Arm	DB-DL-5224		Control Arm, 1st FA;Air Suspension Axle	
	04/03→	Track Control Arm	DB-DL-9218	DB-DL-9218	Trailing Arm, 1st FA;Air Suspension Axle	
	1850 AK, 1851 AK	04/03→	Ball Head, gearshift linkage	DB-ES-8510		
		04/03→	Bush, driver cab suspension	DB-SB-10384		
		04/03→	Centre Rod	DB-DL-2144		Push Rod
		04/03→	Centre Rod	DB-DL-8184		Push Rod
		04/03→	Centre Rod	DB-DL-8307		Push Rod, Leaf Spring Axle
		04/03→	Centre Rod	DB-DL-8702		Push Rod, Leaf Spring Axle
		04/03→	Centre Rod	DB-DL-12300		for Steering Rod
		04/03→	Rod Assembly	DB-DL-2178		Guide Rod
		04/03→	Stabiliser Mounting		DB-SB-10406	
		04/03→	Stabiliser Mounting		DB-SB-10409	
04/03→		Suspension Arm Repair Kit		DB-RK-8626	for Wishbone (CV)	
04/03→		Suspension Arm Repair Kit		DB-RK-10374	for Wishbone (CV)	
04/03→		Suspension Arm Repair Kit		DB-RK-10375	for Wishbone (CV)	
04/03→		Suspension Arm Repair Kit	DB-RK-8638		for Control Arm	
04/03→		Suspension Strut Repair Kit		DB-RK-8391		
04/03→		Tie Rod	DB-DL-12310			
04/03→		Tie Rod	DB-ES-5227		Guide Rod, 1st FA;Leaf Spring Axle	
04/03→		Tie Rod	MN-DL-7834		Guide Rod, 1st FA;Leaf Spring Axle	
04/03→		Tie Rod End	CV-ES-0543		for Push Rod	
04/03→		Tie Rod End	CV-ES-0888		for Push Rod	
04/03→		Tie Rod End	CV-ES-14162		for Steering Rod	
04/03→		Tie Rod End	CV-ES-14163		for Steering Rod	
04/03→		Tie Rod End	DB-ES-5234		for Steering Rod	
04/03→		Tie Rod End	DB-ES-8530		for Push Rod	
04/03→		Track Control Arm		DB-VB-7261	Suspension Rod, Wishbone (CV), 1st RA, →517142 01/517142 02	
04/03→		Track Control Arm		DB-VB-9307	Suspension Rod, Wishbone (CV), 1st Drive Axle, →517142 07	
04/03→		Track Control Arm		DB-VB-9308	Suspension Rod, Wishbone (CV), 1st Drive Axle, →517142 06	
04/03→		Track Control Arm		DB-VB-10426	Wishbone (CV), 1st RA, →517142 05	

CV-ES-0543

Length: 125
Cone Ø: d1 Ø 32 / d2 Ø 29
Thread: M30 x 1,5 RHT
0004605748, 0004606048, 0004606684,
0004607048, 0014600448, 0014601148,
0014601748, 0014602448, 0014607648,
0014609648



CV-ES-0888

Length: 125
Cone Ø: d1 Ø 32 / d2 Ø 29
Thread: M30 x 1,5 LHT
0004605848, 0004606148, 0004606948,
0004607148, 0004609048, 0014600548,
0014601348, 0014602548, 0014607948,
0024600448



CV-ES-14162

Length: 125
Cone Ø: d1 Ø 30 / d2 Ø 27
Thread: M30 x 1,5 LHT
4600648, 4601248, 4603448, 4603548,
0004603548, 14600348, 14601448,
14602348, 001 460 37 48, 0014607848,
14607848, 002 460 03 48



CV-ES-14163

Length: 125
Cone Ø: d1 Ø 30 / d2 Ø 27
Thread: M30 x 1,5 RHT
0003305248, 0003387310, 0004600348,
0004600948, 0004602848, 0004602948,
0004608948, 0014600248, 0014600848,
0014601248, 0014602248, 0014607748,
0024600148, A0003387310, A0004600348,
A0004602848, A0004602948, A0014600848,
A0014601248, A0014602248, A0014607748



DB-DL-2144

Length: 872 Ø: 35
Cone Ø: d1 Ø 28,6 / d2 Ø 23,9
0024604305, 0024604405, 0034604805



DB-DL-2178

Length: 1735 Ø: 52
Cone Ø: d1 Ø 32 / d2 Ø 29
9423300003, 9423300103, 9423300203



DB-DL-5224

Length: 850 Ø: 60
Hole Distance: 100 / 100
01336100A, 9413300007



DB-DL-8184

Length: 1095 Ø: 42
Cone Ø: d1 Ø 32 / d2 Ø 28,8
01217700A, 0014601305, 0014601405,
0024600505, 0034603205, 3754601505,
A0014601305, A0014601405, A0024600505



DB-DL-8307

Length: 885 Ø: 38
Cone Ø: d1 Ø 32 / d2 Ø 30
01215500A, 0004604005, 0024605105,
0024605205, 0034604005



DB-DL-8327

Length: 1745 Ø: 48
Cone Ø: d1 Ø 32 / d2 Ø 29
01219800A, 9413300003, 9413300103,
9413300203, 9413300303, 9413300503



DB-DL-8388

Length: 1735 Ø: 62
Cone Ø: d1 Ø 32 / d2 Ø 28,8
01219900A, 9453300003, 9453300103,
9453300403, 9453300603, A9453300003



DB-DL-8389

Length: 1465 Ø: 40
Cone Ø: d1 Ø 32 / d2 Ø 29
9453300203, 9453300303, 9453300503



DB-DL-8392

Length: 860 Ø: 40
Cone Ø: d1 Ø 28,6 / d2 Ø 23,9
0024609605, 0024609705, 0034605705



DB-DL-8640

Length: 1615 Ø: 50
Cone Ø: d1 Ø 32 / d2 Ø 29
6253301503, 6253301603, 6253302403,
6253302503, 9423300803, 9423302103,
9493300203, 9493300303, 9493300903



DB-DL-8702

Length: 958 Ø: 38
Cone Ø: d1 Ø 32 / d2 Ø 30
0024606105, 0024606205, 0034604205



DB-DL-9218

Length: 754 Ø: 40
Hole Distance: 100
000360098524, 000390098524,
3753300111, 9413300011,
A3753300111, SA50831601



DB-DL-12300

Length: 733 Ø: 36
Cone Ø: d1 Ø 32 / d2 Ø 29
0014601505, 0014607305, 0034603305,
3754601605, A0014601505,
A0034603305, A3754601605



DB-DL-12303

Length: 888 Ø: 42
Cone Ø: d1 Ø 28,6 / d2 Ø 23,9
0034601805, 0034601905, 0034605805,
A0034601905, A0034605805



DB-DL-12310

Length: 1532 Ø: 50
Cone Ø: d1 Ø 32 / d2 Ø 29
Thread: M27 x 1,5 LHT
9493301203, 9493301303, 9493301803,
9493302203, A9493301203, A9493301303,
A9493301803, A9493302203



DB-ES-5227

Length: 1588 Ø: 60
Cone Ø: d1 Ø 38 / d2 Ø 34,3
6253300903, 6253301203, 9443300203



DB-ES-5234

Length: 135
Cone Ø: d1 Ø 38 / d2 Ø 34,3
Thread: M38 x 1,5 RHT
0004601748, 120322305, 2205000400



DB-ES-8164

Length: 140
Cone Ø: d1 Ø 28,6 / d2 Ø 23,9
Thread: M28 x 1,5 RHT
0014604248, 0014605048, 0014608548,
0024600548



DB-ES-8510

Length: 56
Cone Ø: d1 Ø 10 / d2 Ø 10
Thread: M12 x 1,75 LHT
0009965145, 0009965645, 0019963145



DB-ES-8530

Length: 115
Cone Ø: d1 Ø 28,6 / d2 Ø 23,9
Thread: M30 x 1,5 RHT
0014603848, 0014604848, 0014605148,
0014608648, 0014609948



DB-RK-8391

Ø: 85 Hole Distance: 152
Thick/Height: 24
01336800A, 0003502705



DB-RK-8626

Ø: 75 Hole Distance: 130
Thick/Height: 24
0003502205, 0003502505, 0003503405,
0003504505, GL11319



DB-RK-8638

Length: 100 Ø: 67
Hole Distance: 100
Thick/Height: 20
0003301411



DB-RK-9296

Ø: 88 Hole Distance: 130
Thick/Height: 24
9423260050



DB-RK-10374

Ø: 85 Hole Distance: 152
Thick/Height: 24
0003504405



DB-RK-10375

Ø: 100 Hole Distance: 152
Thick/Height: 24
0003502405, 0003503505, 0003504905



DB-SB-10384

Ø: 73 Thick/Height: 47
9303170012, 9423171812



DB-SB-10406

Ø: 80 Thick/Height: 46
0003238185



DB-SB-10409

Ø: 77 Thick/Height: 56
0003265181



DB-SB-10410

Ø: 73 Hole Distance: 100
Thick/Height: 24
9413230050



DB-TC-12410

Length: 925 Ø: 62
Hole Distance: 100 / 100
9423300707



DB-VB-7261

Length: 622 Ø: 46
Hole Ø 25 / 25 / 25
Hole Distance: 152 / 130 / 130
01337800A, 9443500305, 9443500505,
9443500605, 9473500705, 9473500905,
9483500405, 9483500305



DB-VB-7798

Length: 622 Ø: 48
Hole Ø 25 / 23 / 23
Hole Distance: 152 / 130 / 130
9423500505, 9423500805, 9423501205,
A9423501205



DB-VB-9307

Length: 667 Ø: 60
Hole Ø 25 / 23 / 23
Hole Distance: 152 / 130 / 130
9483502805



DB-VB-9308

Length: 622 Ø: 46
Hole Ø 25 / 25 / 25
Hole Distance: 152 / 130 / 130
9483502905



DB-VB-10425

Length: 622 Ø: 46
Hole Ø 25 / 23 / 23
Hole Distance: 152 / 130 / 130
9423500905, 9423501305



DB-VB-10426

Length: 622 Ø: 46
Hole Ø 25 / 25 / 25
Hole Distance: 152 / 130 / 130
9443500405



MN-DL-7834

Length: 1588 Ø: 58
Cone Ø: d1 Ø 30 / d2 Ø 27
3463303903, 3463304903, 6253303203,
9443300503, 9443301303, 9443301703



MN-RK-8997

Ø: 85
Hole Distance: 130
Thick/Height: 30
0003504805, 3504805





ACTROS MP2 / MP3 ...

1850, 1851 K	04/03→	Ball Head, gearshift linkage	DB-ES-8510		
	04/03→	Bush, driver cab suspension	DB-SB-10384		
	04/03→	Centre Rod	DB-DL-2144	Push Rod	
	04/03→	Centre Rod	DB-DL-5230	Suspension Rod	
	04/03→	Centre Rod	DB-DL-5241	Push Rod	
	04/03→	Centre Rod	DB-DL-5405	Push Rod, Leaf Spring Axle	
	04/03→	Centre Rod	DB-DL-7270	Push Rod	
	04/03→	Centre Rod	DB-DL-8167	Push Rod	
	04/03→	Centre Rod	DB-DL-8184	Push Rod	
	04/03→	Centre Rod	DB-DL-8185	Push Rod	
	04/03→	Centre Rod	DB-DL-8307	Push Rod	
	04/03→	Centre Rod	DB-DL-12300	for Steering Rod	
	04/03→	Rod Assembly	DB-DL-2178	Guide Rod	
	04/03→	Stabiliser Mounting		DB-SB-10406	
	04/03→	Stabiliser Mounting		DB-SB-10409	
	04/03→	Suspension Arm Repair Kit		DB-RK-8550	for Wishbone (CV)
	04/03→	Suspension Arm Repair Kit		DB-RK-8626	for Wishbone (CV)
	04/03→	Suspension Arm Repair Kit		DB-RK-10374	for Wishbone (CV)
	04/03→	Suspension Arm Repair Kit		DB-RK-10375	for Wishbone (CV)
	04/03→	Suspension Arm Repair Kit	DB-RK-8638		for Control Arm
	04/03→	Suspension Strut Repair Kit		DB-RK-8391	
	04/03→	Tie Rod	DB-DL-8171		Guide Rod, 1st FA;Leaf Spring Axle
	04/03→	Tie Rod	DB-DL-8327		Guide Rod, 1st FA;Leaf Spring Axle
	04/03→	Tie Rod	DB-DL-8640		Guide Rod
	04/03→	Tie Rod	DB-DL-12310		
	04/03→	Tie Rod	DB-ES-5227		Guide Rod
	04/03→	Tie Rod End	CV-ES-0543		for Push Rod
	04/03→	Tie Rod End	CV-ES-0888		for Push Rod
	04/03→	Tie Rod End	CV-ES-14162		for Steering Rod
	04/03→	Tie Rod End	CV-ES-14163		for Steering Rod
	04/03→	Tie Rod End	DB-ES-5234		for Steering Rod
	04/03→	Tie Rod End	DB-ES-8164		for Push Rod
	04/03→	Tie Rod End	DB-ES-8530		for Push Rod
	04/03→	Track Control Arm		DB-VB-7261	Suspension Rod, Wishbone (CV), 1st RA, →517142 01/517142 02
	04/03→	Track Control Arm		DB-VB-9307	Suspension Rod, Wishbone (CV), 1st Drive Axle, →517142 07
	04/03→	Track Control Arm		DB-VB-9308	Suspension Rod, Wishbone (CV), 1st Drive Axle, →517142 06
	04/03→	Track Control Arm		DB-VB-10426	Wishbone (CV), 1st RA, →517142 05
	1850, 1851 LS, LLS	04/03→	Ball Head, gearshift linkage	DB-ES-8510	
		04/03→	Bush, driver cab suspension	DB-SB-10384	
		04/03→	Centre Rod	DB-DL-2144	Push Rod
04/03→		Centre Rod	DB-DL-5230	Suspension Rod	
04/03→		Centre Rod	DB-DL-5241	Push Rod	
04/03→		Centre Rod	DB-DL-5405	Push Rod	
04/03→		Centre Rod	DB-DL-7270	Push Rod	
04/03→		Centre Rod	DB-DL-8167	Push Rod	
04/03→		Centre Rod	DB-DL-8184	Push Rod	
04/03→		Centre Rod	DB-DL-8185	Push Rod	
04/03→		Centre Rod	DB-DL-8307	Push Rod	
04/03→		Centre Rod	DB-DL-12300	for Steering Rod	
04/03→		Centre Rod	DB-DL-12301	Push Rod, Leaf Spring Axle	
04/03→		Centre Rod	DB-DL-12303	Push Rod, Leaf Spring Axle	
04/03→		Rod Assembly	DB-DL-2178	Guide Rod	
04/03→		Stabiliser Mounting		DB-SB-10406	
04/03→		Stabiliser Mounting		DB-SB-10409	
04/03→		Stabiliser Mounting	DB-SB-10410		
04/03→		Suspension Arm Repair Kit		DB-RK-8626	for Wishbone (CV)
04/03→		Suspension Arm Repair Kit		DB-RK-10374	for Wishbone (CV)
04/03→		Suspension Arm Repair Kit		DB-RK-10375	for Wishbone (CV)
04/03→		Suspension Arm Repair Kit	DB-RK-8638		for Control Arm
04/03→		Suspension Strut Repair Kit		DB-RK-8391	

CV-ES-0543

Length: 125
 Cone Ø: d1 Ø 32 / d2 Ø 29
 Thread: M30 x 1,5 RHT
 0004605748, 0004606048, 0004606848,
 0004607048, 0014600448, 0014601148,
 0014601748, 0014602448, 0014607648,
 0014609648

**CV-ES-0888**

Length: 125
 Cone Ø: d1 Ø 32 / d2 Ø 29
 Thread: M30 x 1,5 LHT
 0004605848, 0004606148, 0004606948,
 0004607148, 0004609048, 0014600548,
 0014601348, 0014602548, 0014607948,
 0024600448

**CV-ES-14162**

Length: 125
 Cone Ø: d1 Ø 30 / d2 Ø 27
 Thread: M30 x 1,5 LHT
 4600648, 4601248, 4603448,
 0004603548, 4603548, 14600348,
 14601448, 14602348, 0014603748,
 14607848, 0014607848, 0024600348

**CV-ES-14163**

Length: 125
 Cone Ø: d1 Ø 30 / d2 Ø 27
 Thread: M30 x 1,5 RHT
 0003305248, 0003387310, 0004600348,
 0004600948, 0004602848, 0004602948,
 0004608948, 0014600248, 0014600848,
 0014601248, 0014602248, 0014607748,
 0024600148, A0003387310, A0004600348,
 A0004602848, A0004602948, A0014600848,
 A0014601248, A0014602248, A0014607748

**DB-DL-2144**

Length: 872 Ø: 35
 Cone Ø: d1 Ø 28,6 / d2 Ø 23,9
 0024604305, 0024604405, 0034604805

**DB-DL-2178**

Length: 1735 Ø: 52
 Cone Ø: d1 Ø 32 / d2 Ø 29
 9423300003, 9423300103, 9423300203

**DB-DL-5230**

Length: 879 Ø: 42
 Cone Ø: d1 Ø 30 / d2 Ø 27
 01208600A, 0004607105, 0004607205,
 0014606705

**DB-DL-5241**

Length: 875 Ø: 40
 Cone Ø: d1 Ø 30 / d2 Ø 27
 01215300A, 0004609205, 0004609305,
 0014606905

**DB-DL-5405**

Length: 890 Ø: 35
 Cone Ø: d1 Ø 28,6 / d2 Ø 23,9
 01215900A, 1460248, 0024604505,
 0024604605, 0034605005, 3752600637,
 3754600405, A3752600637, A3754600405

**DB-DL-7270**

Length: 875 Ø: 40
 Cone Ø: d1 Ø 28,6 / d2 Ø 23,9
 01208300A, 0024604705, 0024604805,
 0034604905, A0024604705

**DB-DL-8167**

Length: 866 Ø: 38
 Cone Ø: d1 Ø 30 / d2 Ø 27
 0014609805, 0014609905, 0024606305,
 0024606405

**DB-DL-8171**

Length: 1687 Ø: 52
 Cone Ø: d1 Ø 32 / d2 Ø 29
 9493300603, 9493300703, 9493301503,
 9493301603

**DB-DL-8184**

Length: 1095 Ø: 42
 Cone Ø: d1 Ø 32 / d2 Ø 28,8
 01217700A, 0014601305, 0014601405,
 0024600505, 0034603205, 3754601505,
 A0014601305, A0014601405, A0024600505

**DB-DL-8185**

Length: 711 Ø: 42
 Cone Ø: d1 Ø 32 / d2 Ø 28,8
 01213600A, 0014601105, 0024600405,
 0034603105, A0014601105, A0024600405

**DB-DL-8307**

Length: 885 Ø: 38
 Cone Ø: d1 Ø 32 / d2 Ø 30
 01215500A, 0004604005, 0024605105,
 0024605205, 0034604005

**DB-DL-8327**

Length: 1745 Ø: 48
 Cone Ø: d1 Ø 32 / d2 Ø 29
 01219800A, 9413300003, 9413300103,
 9413300203, 9413300303, 9413300503

**DB-DL-8640**

Length: 1615 Ø: 50
 Cone Ø: d1 Ø 32 / d2 Ø 29
 6253301503, 6253301603, 6253302403,
 6253302503, 9423300803, 9423302103,
 9493300203, 9493300303, 9493300903

**DB-DL-12300**

Length: 733 Ø: 36
 Cone Ø: d1 Ø 32 / d2 Ø 29
 0014601505, 0014607305, 0034603305,
 3754601605, A0014601505,
 A0034603305, A3754601605

**DB-DL-12301**

Length: 716 Ø: 38
 Cone Ø: d1 Ø 32 / d2 Ø 29
 Thread: M30 x 1,5
 0024608805, 0024608905,
 A0024608805, A0024608905

**DB-DL-12303**

Length: 888 Ø: 42
 Cone Ø: d1 Ø 28,6 / d2 Ø 23,9
 0034601805, 0034601905, 0034605805,
 A0034601905, A0034605805

**DB-DL-12310**

Length: 1532 Ø: 50
 Cone Ø: d1 Ø 32 / d2 Ø 29
 Thread: M27 x 1,5 LHT
 9493301203, 9493301303, 9493301803,
 9493302203, A9493301203, A9493301303,
 A9493301803, A9493302203

**DB-ES-5227**

Length: 1588 Ø: 60
 Cone Ø: d1 Ø 38 / d2 Ø 34,3
 6253300903, 6253301203, 9443300203

**DB-ES-5234**

Length: 135
 Cone Ø: d1 Ø 38 / d2 Ø 34,3
 Thread: M38 x 1,5 RHT
 0004601748, 120322305, 2205000400

**DB-ES-8164**

Length: 140
 Cone Ø: d1 Ø 28,6 / d2 Ø 23,9
 Thread: M28 x 1,5 RHT
 0014604248, 0014605048, 0014608548,
 0024600548

**DB-ES-8510**

Length: 56
 Cone Ø: d1 Ø 10 / d2 Ø 10
 Thread: M12 x 1,75 LHT
 0009965145, 0009965645, 0019963145

**DB-ES-8530**

Length: 115
 Cone Ø: d1 Ø 28,6 / d2 Ø 23,9
 Thread: M30 x 1,5 RHT
 0014603848, 0014604848, 0014605148,
 0014608648, 0014609948

**DB-RK-8391**

Ø: 85 Hole Distance: 152
 Thick/Height: 24
 01336800A, 0003502705

**DB-RK-8550**

Ø: 75 Hole Distance: 152
 Thick/Height: 24
 0003502105, 0003504605

**DB-RK-8626**

Ø: 75 Hole Distance: 130
 Thick/Height: 24
 0003502205, 0003502505, 0003503405,
 0003504505, GL11319

**DB-RK-8638**

Length: 100 Ø: 67
 Hole Distance: 100
 Thick/Height: 20
 0003301411

**DB-RK-10374**

Ø: 85 Hole Distance: 152
 Thick/Height: 24
 0003504405

**DB-RK-10375**

Ø: 100 Hole Distance: 152
 Thick/Height: 24
 0003502405, 0003503505, 0003504905

**DB-SB-10384**

Ø: 73 Thick/Height: 47
 9303170012, 9423171812

**DB-SB-10406**

Ø: 80 Thick/Height: 46
 0003238185

**DB-SB-10409**

Ø: 77 Thick/Height: 56
 0003265181

**DB-SB-10410**

Ø: 73 Hole Distance: 100
 Thick/Height: 24
 9413230050

**DB-VB-7261**

Length: 622 Ø: 46
 Hole Ø 25 / 25 / 25
 Hole Distance: 152 / 130 / 130
 01337800A, 9443500305, 9443500505,
 9443500605, 9473500705, 9473500905,
 9483500405, 9483503005

**DB-VB-9307**

Length: 667 Ø: 60
 Hole Ø 25 / 23 / 23
 Hole Distance: 152 / 130 / 130
 9483502805

**DB-VB-9308**

Length: 622 Ø: 46
 Hole Ø 25 / 25 / 25
 Hole Distance: 152 / 130 / 130
 9483502905

**DB-VB-10426**

Length: 622 Ø: 46
 Hole Ø 25 / 25 / 25
 Hole Distance: 152 / 130 / 130
 9443500405

**MERCEDES-BENZ**



ACTROS MP2 / MP3 ...

1850, 1851 LS, LLS ...	04/03→	Suspension Strut Repair Kit		MN-RK-8997	
	04/03→	Tie Rod	DB-DL-8327		Guide Rod
	04/03→	Tie Rod	DB-DL-8640		Guide Rod
	04/03→	Tie Rod	DB-DL-12310		
	04/03→	Tie Rod	DB-ES-5227		Guide Rod
	04/03→	Tie Rod End	CV-ES-0543		for Push Rod
	04/03→	Tie Rod End	CV-ES-0888		for Push Rod
	04/03→	Tie Rod End	CV-ES-14162		for Steering Rod
	04/03→	Tie Rod End	CV-ES-14163		for Steering Rod
	04/03→	Tie Rod End	DB-ES-5234		for Steering Rod
	04/03→	Tie Rod End	DB-ES-8164		for Push Rod
	04/03→	Tie Rod End	DB-ES-8530		for Push Rod
	04/03→	Track Control Arm		DB-TC-12410	Control Arm
	04/03→	Track Control Arm		DB-VB-7798	Wishbone (CV), Air Suspension Axle, * K 864074 *→
1850, 1851, L, LL	04/03→	Track Control Arm	DB-DL-5224		Control Arm, 1st FA;Air Suspension Axle
	04/03→	Track Control Arm	DB-DL-9218	DB-DL-9218	Trailing Arm, 1st FA;Air Suspension Axle
	04/03→	Ball Head, gearshift linkage	DB-ES-8510		
	04/03→	Bush, driver cab suspension	DB-SB-10384		
	04/03→	Centre Rod	DB-DL-2144		Push Rod
	04/03→	Centre Rod	DB-DL-5230		Suspension Rod
	04/03→	Centre Rod	DB-DL-5241		Push Rod
	04/03→	Centre Rod	DB-DL-5405		Push Rod
	04/03→	Centre Rod	DB-DL-5405		Push Rod, Leaf Spring Axle
	04/03→	Centre Rod	DB-DL-7270		Push Rod;Suspension Rod
	04/03→	Centre Rod	DB-DL-8167		Push Rod
	04/03→	Centre Rod	DB-DL-8168		Push Rod
	04/03→	Centre Rod	DB-DL-8184		Push Rod
	04/03→	Centre Rod	DB-DL-8185		Push Rod
	04/03→	Centre Rod	DB-DL-8307		Push Rod
	04/03→	Centre Rod	DB-DL-8622		Push Rod
	04/03→	Centre Rod	DB-DL-8641		Push Rod
	04/03→	Centre Rod	DB-DL-8642		Push Rod
	04/03→	Centre Rod	DB-DL-12300		for Steering Rod
	04/03→	Rod Assembly	DB-DL-2178		Guide Rod
	04/03→	Stabiliser Link	DB-DL-9254		Pressure Rod
	04/03→	Stabiliser Mounting		DB-SB-10406	
	04/03→	Stabiliser Mounting		DB-SB-10409	
	04/03→	Stabiliser Mounting	DB-SB-10410		
	04/03→	Suspension Arm Repair Kit		DB-RK-8550	for Wishbone (CV)
	04/03→	Suspension Arm Repair Kit		DB-RK-8626	for Wishbone (CV)
	04/03→	Suspension Arm Repair Kit		DB-RK-10374	for Wishbone (CV)
	04/03→	Suspension Arm Repair Kit		DB-RK-10375	for Wishbone (CV)
	04/03→	Suspension Arm Repair Kit	DB-RK-8638		for Control Arm
	04/03→	Suspension Strut Repair Kit		DB-RK-8391	
	04/03→	Suspension Strut Repair Kit		DB-RK-9294	
	04/03→	Tie Rod	DB-DL-8327		Guide Rod, 1st FA;Leaf Spring Axle
	04/03→	Tie Rod	DB-DL-8640		Guide Rod
	04/03→	Tie Rod	DB-DL-12310		
04/03→	Tie Rod	DB-ES-5227		Guide Rod	
04/03→	Tie Rod End	CV-ES-0543		for Push Rod	
04/03→	Tie Rod End	CV-ES-0888		for Push Rod	
04/03→	Tie Rod End	CV-ES-14162		for Steering Rod	
04/03→	Tie Rod End	CV-ES-14163		for Steering Rod	
04/03→	Tie Rod End	DB-ES-5234		for Steering Rod	
04/03→	Tie Rod End	DB-ES-8164		for Push Rod	
04/03→	Tie Rod End	DB-ES-8530		for Push Rod	
04/03→	Track Control Arm		DB-VB-3707	Suspension Rod, Wishbone (CV)	
04/03→	Track Control Arm		DB-VB-7261	Suspension Rod, Wishbone (CV), 1st RA, →517142 01/517142 02	
04/03→	Track Control Arm		DB-VB-9307	Suspension Rod, Wishbone (CV), 1st Drive Axle, →517142 07	



ACTROS MP2 / MP3 ...

1850, 1851, L, LL ...	04/03→	Track Control Arm		DB-VB-9308	Suspension Rod, Wishbone (CV), 1st Drive Axle, →517142 06	
	04/03→	Track Control Arm		DB-VB-10426	Wishbone (CV), 1st RA, →517142 05	
	04/03→	Track Control Arm	DB-DL-5224		Control Arm, 1st FA;Air Suspension Axle	
	04/03→	Track Control Arm	DB-DL-9218	DB-DL-9218	Trailing Arm, 1st FA;Air Suspension Axle	
1851 A	04/03→	Centre Rod	DB-DL-8307		Push Rod	
	04/03→	Centre Rod	DB-DL-8702		Push Rod	
	04/03→	Tie Rod	DB-ES-5227		Guide Rod	
	04/03→	Tie Rod	MN-DL-7834		Guide Rod	
1854 LS	04/03→	Ball Head, gearshift linkage	DB-ES-8510			
	04/03→	Bush, driver cab suspension	DB-SB-10384			
	04/03→	Centre Rod	DB-DL-2144		Push Rod	
	04/03→	Centre Rod	DB-DL-5230		Suspension Rod	
	04/03→	Centre Rod	DB-DL-5241		Push Rod	
	04/03→	Centre Rod	DB-DL-5405		Push Rod	
	04/03→	Centre Rod	DB-DL-7270		Push Rod	
	04/03→	Centre Rod	DB-DL-8167		Push Rod	
	04/03→	Centre Rod	DB-DL-8184		Push Rod	
	04/03→	Centre Rod	DB-DL-8185		Push Rod	
	04/03→	Centre Rod	DB-DL-8307		Push Rod	
	04/03→	Centre Rod	DB-DL-12303		Push Rod, Leaf Spring Axle	
	04/03→	Rod Assembly	DB-DL-2178		Guide Rod	
	04/03→	Stabiliser Mounting		DB-RK-9296		
	04/03→	Stabiliser Mounting		DB-SB-10406		
	04/03→	Stabiliser Mounting		DB-SB-10409		
	04/03→	Stabiliser Mounting	DB-SB-10410			
	04/03→	Suspension Arm Repair Kit		DB-RK-8626	for Wishbone (CV)	
	04/03→	Suspension Arm Repair Kit		DB-RK-10374	for Wishbone (CV)	
	04/03→	Suspension Arm Repair Kit		DB-RK-10375	for Wishbone (CV)	
	04/03→	Suspension Arm Repair Kit	DB-RK-8638		for Control Arm	
	04/03→	Suspension Strut Repair Kit		DB-RK-8391		
	04/03→	Suspension Strut Repair Kit		MN-RK-8997		
	04/03→	Tie Rod	DB-DL-8327		Guide Rod	
	04/03→	Tie Rod	DB-DL-8640		Guide Rod	
	04/03→	Tie Rod	DB-DL-12310			
	04/03→	Tie Rod	DB-ES-5227		Guide Rod	
	04/03→	Tie Rod End	CV-ES-0543		for Push Rod	
	04/03→	Tie Rod End	CV-ES-0888		for Push Rod	
	04/03→	Tie Rod End	CV-ES-14162		for Steering Rod	
	04/03→	Tie Rod End	CV-ES-14163		for Steering Rod	
	04/03→	Tie Rod End	DB-ES-5234		for Steering Rod	
	04/03→	Tie Rod End	DB-ES-8164		for Push Rod	
	04/03→	Tie Rod End	DB-ES-8530		for Push Rod	
	04/03→	Track Control Arm		DB-TC-12410	Control Arm	
	04/03→	Track Control Arm		DB-VB-7798	Wishbone (CV), Air Suspension Axle, * K 864074 *→	
	04/03→	Track Control Arm	DB-DL-5224		Control Arm, 1st FA;Air Suspension Axle	
	04/03→	Track Control Arm	DB-DL-9218	DB-DL-9218	Trailing Arm, 1st FA;Air Suspension Axle	
	1854, L	04/03→	Ball Head, gearshift linkage	DB-ES-8510		
		04/03→	Bush, driver cab suspension	DB-SB-10384		
		04/03→	Centre Rod	DB-DL-2144		Push Rod
		04/03→	Centre Rod	DB-DL-5230		Suspension Rod
		04/03→	Centre Rod	DB-DL-5241		Push Rod
04/03→		Centre Rod	DB-DL-5405		Push Rod	
04/03→		Centre Rod	DB-DL-5405		Push Rod, Leaf Spring Axle	
04/03→		Centre Rod	DB-DL-7270		Push Rod	
04/03→		Centre Rod	DB-DL-8167		Push Rod	
04/03→		Centre Rod	DB-DL-8168		Push Rod	
04/03→		Centre Rod	DB-DL-8184		Push Rod	
04/03→		Centre Rod	DB-DL-8185		Push Rod	
04/03→		Centre Rod	DB-DL-8307		Push Rod	
04/03→		Centre Rod	DB-DL-8622		Push Rod	
04/03→		Centre Rod	DB-DL-8641		Push Rod	



ACTROS MP2 / MP3 ...

1854, L ...	04/03→	Centre Rod	DB-DL-8642		Push Rod	
	04/03→	Centre Rod	DB-DL-12300		for Steering Rod	
	04/03→	Rod Assembly	DB-DL-2178		Guide Rod	
	04/03→	Stabiliser Link	DB-DL-9254		Pressure Rod	
	04/03→	Stabiliser Mounting		DB-RK-9296		
	04/03→	Stabiliser Mounting		DB-SB-10406		
	04/03→	Stabiliser Mounting		DB-SB-10409		
	04/03→	Stabiliser Mounting	DB-SB-10410			
	04/03→	Suspension Arm Repair Kit		DB-RK-8550	for Wishbone (CV)	
	04/03→	Suspension Arm Repair Kit		DB-RK-8626	for Wishbone (CV)	
	04/03→	Suspension Arm Repair Kit		DB-RK-10374	for Wishbone (CV)	
	04/03→	Suspension Arm Repair Kit		DB-RK-10375	for Wishbone (CV)	
	04/03→	Suspension Arm Repair Kit	DB-RK-8638		for Control Arm	
	04/03→	Suspension Strut Repair Kit		DB-RK-8391		
	04/03→	Suspension Strut Repair Kit		DB-RK-9294		
	04/03→	Tie Rod	DB-DL-8327		Guide Rod, 1st FA;Leaf Spring Axle	
	04/03→	Tie Rod	DB-DL-8640		Guide Rod	
	04/03→	Tie Rod	DB-DL-12310			
	04/03→	Tie Rod	DB-ES-5227		Guide Rod	
	04/03→	Tie Rod End	CV-ES-0543		for Push Rod	
	04/03→	Tie Rod End	CV-ES-0888		for Push Rod	
	04/03→	Tie Rod End	CV-ES-14162		for Steering Rod	
	04/03→	Tie Rod End	CV-ES-14163		for Steering Rod	
	04/03→	Tie Rod End	DB-ES-5234		for Steering Rod	
	04/03→	Tie Rod End	DB-ES-8164		for Push Rod	
	04/03→	Tie Rod End	DB-ES-8530		for Push Rod	
	04/03→	Track Control Arm		DB-VB-3707	Suspension Rod, Wishbone (CV)	
	04/03→	Track Control Arm		DB-VB-7261	Suspension Rod, Wishbone (CV), 1st RA, →517142 01/517142 02	
	04/03→	Track Control Arm		DB-VB-9307	Suspension Rod, Wishbone (CV), 1st Drive Axle, →517142 07	
	04/03→	Track Control Arm		DB-VB-9308	Suspension Rod, Wishbone (CV), 1st Drive Axle, →517142 06	
	04/03→	Track Control Arm		DB-VB-10426	Wishbone (CV), 1st RA, →517142 05	
	04/03→	Track Control Arm	DB-DL-5224		Control Arm, 1st FA;Air Suspension Axle	
	04/03→	Track Control Arm	DB-DL-9218	DB-DL-9218	Trailing Arm, 1st FA;Air Suspension Axle	
	1855 LS, LLS	06/08→	Centre Rod	DB-DL-2144		Push Rod
		06/08→	Centre Rod	DB-DL-7270		Push Rod
06/08→		Centre Rod	DB-DL-8167		Push Rod	
06/08→		Centre Rod	DB-DL-8185		Push Rod	
06/08→		Centre Rod	DB-DL-12301		Push Rod, Leaf Spring Axle	
06/08→		Centre Rod	DB-DL-12303		Push Rod, Leaf Spring Axle	
06/08→		Rod Assembly	DB-DL-2178		Guide Rod, 1st Front Axle, →504310 03	
06/08→		Stabiliser Mounting		DB-SB-10406		
06/08→		Suspension Strut Repair Kit		MN-RK-8997		
06/08→		Tie Rod	DB-DL-8327		Guide Rod, 1st Front Axle	
06/08→		Tie Rod	DB-DL-8640		Guide Rod	
06/08→		Tie Rod	DB-DL-12310			
06/08→		Tie Rod	DB-ES-5227		Guide Rod	
06/08→		Tie Rod End	CV-ES-0543		for Push Rod	
06/08→		Tie Rod End	CV-ES-0888		for Push Rod	
06/08→		Tie Rod End	CV-ES-14163		for Steering Rod	
06/08→		Tie Rod End	DB-ES-8164		for Push Rod	
06/08→		Tie Rod End	DB-ES-8530		for Push Rod	
06/08→		Track Control Arm		DB-TC-12410	Control Arm	
06/08→		Track Control Arm		DB-VB-7798	Wishbone (CV), Air Suspension Axle	
06/08→		Track Control Arm	DB-DL-9218	DB-DL-9218	Trailing Arm, 1st FA, →508316 01/508316 04	
06/08→		Track Control Arm	DB-DL-9218	DB-DL-9218	Trailing Arm, 1st FA, →532040 04	
1855, L, LL		06/08→	Centre Rod	DB-DL-2144		Push Rod
		06/08→	Centre Rod	DB-DL-5405		Push Rod
		06/08→	Centre Rod	DB-DL-5405		Push Rod, Leaf Spring Axle
	06/08→	Centre Rod	DB-DL-7270		Push Rod	
	06/08→	Centre Rod	DB-DL-8167		Push Rod	



ACTROS MP2 / MP3 ...

1855, L, LL ...	06/08→	Rod Assembly	DB-DL-2178		Guide Rod, 1st Front Axle, →504310 03	
	06/08→	Stabiliser Mounting		DB-SB-10406		
	06/08→	Suspension Strut Repair Kit		DB-RK-9294		
	06/08→	Tie Rod	DB-DL-8327		Guide Rod, 1st FA;Leaf Spring Axle	
	06/08→	Tie Rod	DB-DL-8640		Guide Rod	
	06/08→	Tie Rod	DB-DL-12310			
	06/08→	Tie Rod	DB-ES-5227		Guide Rod	
	06/08→	Tie Rod End	CV-ES-0543		for Push Rod	
	06/08→	Tie Rod End	CV-ES-0888		for Push Rod	
	06/08→	Tie Rod End	CV-ES-14163		for Steering Rod	
	06/08→	Tie Rod End	DB-ES-8164		for Push Rod	
	06/08→	Tie Rod End	DB-ES-8530		for Push Rod	
	06/08→	Track Control Arm		DB-VB-3707	Suspension Rod, Wishbone (CV)	
	06/08→	Track Control Arm		DB-VB-7261	Suspension Rod, Wishbone (CV), 1st RA, →517142 01/517142 02	
	06/08→	Track Control Arm		DB-VB-9307	Suspension Rod, Wishbone (CV)	
	06/08→	Track Control Arm		DB-VB-9308	Suspension Rod, Wishbone (CV)	
	06/08→	Track Control Arm		DB-VB-10426	Wishbone (CV), 1st RA, →517142 05	
	06/08→	Track Control Arm	DB-DL-5224		Control Arm, 1st FA;Air Suspension Axle	
	06/08→	Track Control Arm	DB-DL-9218	DB-DL-9218	Trailing Arm, 1st FA;Air Suspension Axle	
	1858 LS	10/02→	Ball Head, gearshift linkage	DB-ES-8510		
		10/02→	Bush, driver cab suspension	DB-SB-10384		
		10/02→	Centre Rod	DB-DL-2144		Push Rod
		10/02→	Centre Rod	DB-DL-5230		Suspension Rod
		10/02→	Centre Rod	DB-DL-5241		Push Rod
		10/02→	Centre Rod	DB-DL-5405		Push Rod
		10/02→	Centre Rod	DB-DL-7270		Push Rod
		10/02→	Centre Rod	DB-DL-8167		Push Rod
10/02→		Centre Rod	DB-DL-8184		Push Rod	
10/02→		Centre Rod	DB-DL-8185		Push Rod	
10/02→		Centre Rod	DB-DL-8307		Push Rod	
10/02→		Centre Rod	DB-DL-12303		Push Rod, Leaf Spring Axle	
10/02→		Rod Assembly	DB-DL-2178		Guide Rod, 1st Front Axle, →504310 03	
10/02→		Stabiliser Mounting		DB-RK-9296		
10/02→		Stabiliser Mounting		DB-SB-10406		
10/02→		Stabiliser Mounting		DB-SB-10409		
10/02→		Stabiliser Mounting	DB-SB-10410			
10/02→		Suspension Arm Repair Kit		DB-RK-8626	for Wishbone (CV)	
10/02→		Suspension Arm Repair Kit		DB-RK-10374	for Wishbone (CV)	
10/02→		Suspension Arm Repair Kit		DB-RK-10375	for Wishbone (CV)	
10/02→		Suspension Arm Repair Kit	DB-RK-8638		for Control Arm	
10/02→		Suspension Strut Repair Kit		DB-RK-8391		
10/02→		Suspension Strut Repair Kit		MN-RK-8997		
10/02→		Tie Rod	DB-DL-8327		Guide Rod	
10/02→		Tie Rod	DB-DL-8640		Guide Rod	
10/02→		Tie Rod	DB-DL-12310			
10/02→		Tie Rod	DB-ES-5227		Guide Rod	
10/02→		Tie Rod End	CV-ES-0543		for Push Rod	
10/02→		Tie Rod End	CV-ES-0888		for Push Rod	
10/02→		Tie Rod End	CV-ES-14163		for Steering Rod	
10/02→		Tie Rod End	DB-ES-5234		for Steering Rod	
10/02→		Tie Rod End	DB-ES-8164		for Push Rod	
10/02→		Tie Rod End	DB-ES-8530		for Push Rod	
10/02→		Track Control Arm		DB-TC-12410	Control Arm	
10/02→		Track Control Arm		DB-VB-7798	Wishbone (CV), Air Suspension Axle, * K 864074 *→	
10/02→		Track Control Arm	DB-DL-5224		Control Arm, 1st FA;Air Suspension Axle	
10/02→		Track Control Arm	DB-DL-9218	DB-DL-9218	Trailing Arm, 1st FA;Air Suspension Axle	
1858, L		04/03→	Ball Head, gearshift linkage	DB-ES-8510		
		04/03→	Bush, driver cab suspension	DB-SB-10384		
		04/03→	Centre Rod	DB-DL-2144		Push Rod
		04/03→	Centre Rod	DB-DL-5230		Suspension Rod
		04/03→	Centre Rod	DB-DL-5241		Push Rod

CV-ES-0543

Length: 125
Cone Ø: d1 Ø 32 / d2 Ø 29
Thread: M30 x 1,5 RHT
0004605748, 0004606048, 0004606848,
0004607048, 0014600448, 0014601148,
0014601748, 0014602448, 0014607648,
0014609648



CV-ES-0888

Length: 125
Cone Ø: d1 Ø 32 / d2 Ø 29
Thread: M30 x 1,5 LHT
0004605848, 0004606148, 0004606948,
0004607148, 0004609048, 0014600548,
0014601348, 0014602548, 0014607948,
0024600448



CV-ES-14163

Length: 125
Cone Ø: d1 Ø 30 / d2 Ø 27
Thread: M30 x 1,5 RHT
0003305248, 0003387310, 0004600348,
0004600948, 0004602848, 0004602948,
0004608948, 0014600248, 0014600848,
0014601248, 0014602248, 0014607748,
0024600148, A0003387310, A0004600348,
A0004602848, A0004602948, A0014600848,
A0014601248, A0014602248, A0014607748



DB-DL-2144

Length: 872 Ø: 35
Cone Ø: d1 Ø 28,6 / d2 Ø 23,9
0024604305, 0024604405, 0034604805



DB-DL-2178

Length: 1735 Ø: 52
Cone Ø: d1 Ø 32 / d2 Ø 29
9423300003, 9423300103, 9423300203



DB-DL-5224

Length: 850 Ø: 60
Hole Distance: 100 / 100
01336100A, 9413300007



DB-DL-5230

Length: 879 Ø: 42
Cone Ø: d1 Ø 30 / d2 Ø 27
01208600A, 0004607105, 0004607205,
0014606705



DB-DL-5241

Length: 875 Ø: 40
Cone Ø: d1 Ø 30 / d2 Ø 27
01215300A, 0004609205, 0004609305,
0014606905



DB-DL-5405

Length: 890 Ø: 35
Cone Ø: d1 Ø 28,6 / d2 Ø 23,9
01215900A, 1460248, 0024604505,
0024604605, 0034605005, 3752600637,
3754600405, A3752600637, A3754600405



DB-DL-7270

Length: 875 Ø: 40
Cone Ø: d1 Ø 28,6 / d2 Ø 23,9
01208300A, 0024604705, 0024604805,
0034604905, A0024604705



DB-DL-8167

Length: 866 Ø: 38
Cone Ø: d1 Ø 30 / d2 Ø 27
0014609805, 0014609905, 0024606305,
0024606405



DB-DL-8184

Length: 1095 Ø: 42
Cone Ø: d1 Ø 32 / d2 Ø 28,8
01217700A, 0014601305, 0014601405,
0024600505, 0034603205, 3754601505,
A0014601305, A0014601405, A0024600505



DB-DL-8185

Length: 711 Ø: 42
Cone Ø: d1 Ø 32 / d2 Ø 28,8
01213600A, 0014601105, 0024600405,
0034603105, A0014601105, A0024600405



DB-DL-8307

Length: 885 Ø: 38
Cone Ø: d1 Ø 32 / d2 Ø 30
01215500A, 0004604005, 0024605105,
0024605205, 0034604005



DB-DL-8327

Length: 1745 Ø: 48
Cone Ø: d1 Ø 32 / d2 Ø 29
01219800A, 9413300003, 9413300103,
9413300203, 9413300303, 9413300503



DB-DL-8640

Length: 1615 Ø: 50
Cone Ø: d1 Ø 32 / d2 Ø 29
6253301503, 6253301603, 6253302403,
6253302503, 9423300803, 9423302103,
9493300203, 9493300303, 9493300903



DB-DL-9218

Length: 754 Ø: 40
Hole Distance: 100
000360098524, 000390098524,
3753300111, 9413300011,
A3753300111, SA50831601



DB-DL-12303

Length: 888 Ø: 42
Cone Ø: d1 Ø 28,6 / d2 Ø 23,9
0034601805, 0034601905, 0034605805,
A0034601905, A0034605805



DB-DL-12310

Length: 1532 Ø: 50
Cone Ø: d1 Ø 32 / d2 Ø 29
Thread: M27 x 1,5 LHT
9493301203, 9493301303, 9493301803,
9493302203, A9493301203, A9493301303,
A9493301803, A9493302203



DB-ES-5227

Length: 1588 Ø: 60
Cone Ø: d1 Ø 38 / d2 Ø 34,3
6253300903, 6253301203, 9443300203



DB-ES-5234

Length: 135
Cone Ø: d1 Ø 38 / d2 Ø 34,3
Thread: M38 x 1,5 RHT
0004601748, 120322305, 2205000400



DB-ES-8164

Length: 140
Cone Ø: d1 Ø 28,6 / d2 Ø 23,9
Thread: M28 x 1,5 RHT
0014604248, 0014605048, 0014608548,
0024600548



DB-ES-8510

Length: 56
Cone Ø: d1 Ø 10 / d2 Ø 10
Thread: M12 x 1,75 LHT
0009965145, 0009965645, 0019963145



DB-ES-8530

Length: 115
Cone Ø: d1 Ø 28,6 / d2 Ø 23,9
Thread: M30 x 1,5 RHT
0014603848, 0014604848, 0014605148,
0014608648, 0014609948



DB-RK-8391

Ø: 85 Hole Distance: 152
Thick/Height: 24
01336800A, 0003502705



DB-RK-8626

Ø: 75 Hole Distance: 130
Thick/Height: 24
0003502205, 0003502505, 0003503405,
0003504505, GL11319



DB-RK-8638

Length: 100 Ø: 67
Hole Distance: 100
Thick/Height: 20
0003301411



DB-RK-9294

Ø: 85 Hole Distance: 152
Thick/Height: 24
0003503105



DB-RK-9296

Ø: 88 Hole Distance: 130
Thick/Height: 24
9423260050



DB-RK-10374

Ø: 85 Hole Distance: 152
Thick/Height: 24
0003504405



DB-RK-10375

Ø: 100 Hole Distance: 152
Thick/Height: 24
0003502405, 0003503505, 0003504905



DB-SB-10384

Ø: 73 Thick/Height: 47
9303170012, 9423171812



DB-SB-10406

Ø: 80 Thick/Height: 46
0003238185



DB-SB-10409

Ø: 77 Thick/Height: 56
0003265181



DB-SB-10410

Ø: 73 Hole Distance: 100
Thick/Height: 24
9413230050



DB-TC-12410

Length: 925 Ø: 62
Hole Distance: 100 / 100
9423300707



DB-VB-3707

Length: 622 Ø: 46
Hole Ø 25 / 25 / 25
Hole Distance: 152 / 130 / 130
01337100A, 9423501005, 9423501505,
9443500005, 9473500105, 9473501005,
A3753500005, A9423501005, A9423501505,
A9443500005, A9473500105, A9473501005



DB-VB-7261

Length: 622 Ø: 46
Hole Ø 25 / 25 / 25
Hole Distance: 152 / 130 / 130
01337800A, 9443500305, 9443500505,
9443500605, 9473500705, 9473500905,
9483500405, 9483500305



DB-VB-7798

Length: 622 Ø: 48
Hole Ø 25 / 23 / 23
Hole Distance: 152 / 130 / 130
9423500505, 9423500805, 9423501205,
A9423501205



DB-VB-9307

Length: 667 Ø: 60
Hole Ø 25 / 23 / 23
Hole Distance: 152 / 130 / 130
9483502805



DB-VB-9308

Length: 622 Ø: 46
Hole Ø 25 / 25 / 25
Hole Distance: 152 / 130 / 130
9483502905



DB-VB-10426

Length: 622 Ø: 46
Hole Ø 25 / 25 / 25
Hole Distance: 152 / 130 / 130
9443500405



MN-RK-8997

Ø: 85
Hole Distance: 130
Thick/Height: 30
3504805, 0003504805





ACTROS MP2 / MP3 ...

1858, L ...	04/03 →	Centre Rod	DB-DL-5405		Push Rod, for vehicles with Part-Pneumatic Suspension
	04/03 →	Centre Rod	DB-DL-7270		Push Rod
	04/03 →	Centre Rod	DB-DL-8167		Push Rod
	04/03 →	Centre Rod	DB-DL-8168		Push Rod
	04/03 →	Centre Rod	DB-DL-8184		Push Rod
	04/03 →	Centre Rod	DB-DL-8185		Push Rod
	04/03 →	Centre Rod	DB-DL-8307		Push Rod
	04/03 →	Centre Rod	DB-DL-8622		Push Rod
	04/03 →	Centre Rod	DB-DL-8641		Push Rod
	04/03 →	Centre Rod	DB-DL-8642		Push Rod
	04/03 →	Centre Rod	DB-DL-12300		for Steering Rod
	04/03 →	Rod Assembly	DB-DL-2178		Guide Rod
	04/03 →	Stabiliser Link	DB-DL-9254		Pressure Rod
	04/03 →	Stabiliser Mounting		DB-RK-9296	
	04/03 →	Stabiliser Mounting		DB-SB-10406	
	04/03 →	Stabiliser Mounting		DB-SB-10409	
	04/03 →	Stabiliser Mounting	DB-SB-10410		
	04/03 →	Suspension Arm Repair Kit		DB-RK-8550	for Wishbone (CV)
	04/03 →	Suspension Arm Repair Kit		DB-RK-8626	for Wishbone (CV)
	04/03 →	Suspension Arm Repair Kit		DB-RK-10374	for Wishbone (CV)
	04/03 →	Suspension Arm Repair Kit		DB-RK-10375	for Wishbone (CV)
	04/03 →	Suspension Arm Repair Kit	DB-RK-8638		for Control Arm
	04/03 →	Suspension Strut Repair Kit		DB-RK-8391	
	04/03 →	Suspension Strut Repair Kit		DB-RK-9294	
	04/03 →	Tie Rod	DB-DL-8327		Guide Rod
	04/03 →	Tie Rod	DB-DL-8640		Guide Rod
	04/03 →	Tie Rod	DB-DL-12310		
	04/03 →	Tie Rod	DB-ES-5227		Guide Rod
	04/03 →	Tie Rod End	CV-ES-0543		for Push Rod
	04/03 →	Tie Rod End	CV-ES-0888		for Push Rod
	04/03 →	Tie Rod End	CV-ES-14162		for Steering Rod
	04/03 →	Tie Rod End	CV-ES-14163		for Steering Rod
	04/03 →	Tie Rod End	DB-ES-5234		for Steering Rod
	04/03 →	Tie Rod End	DB-ES-8164		for Push Rod
04/03 →	Tie Rod End	DB-ES-8530		for Push Rod	
04/03 →	Track Control Arm		DB-VB-3707	Suspension Rod, Wishbone (CV)	
04/03 →	Track Control Arm	DB-DL-5224		Control Arm, 1st FA;Air Suspension Axle	
04/03 →	Track Control Arm	DB-DL-9218	DB-DL-9218	Trailing Arm, 1st FA;Air Suspension Axle	
1860 L, LL	05/05 →	Ball Head, gearshift linkage	DB-ES-8510		
	05/05 →	Bush, driver cab suspension	DB-SB-10384		
	05/05 →	Centre Rod	DB-DL-2144		Push Rod
	05/05 →	Centre Rod	DB-DL-5230		Suspension Rod
	05/05 →	Centre Rod	DB-DL-5241		Push Rod
	05/05 →	Centre Rod	DB-DL-5405		Push Rod, for vehicles with Part-Pneumatic Suspension
	05/05 →	Centre Rod	DB-DL-7270		Push Rod
	05/05 →	Centre Rod	DB-DL-8167		Push Rod
	05/05 →	Centre Rod	DB-DL-8168		Push Rod
	05/05 →	Centre Rod	DB-DL-8184		Push Rod
	05/05 →	Centre Rod	DB-DL-8185		Push Rod
	05/05 →	Centre Rod	DB-DL-8307		Push Rod
	05/05 →	Centre Rod	DB-DL-8622		Push Rod
	05/05 →	Centre Rod	DB-DL-8641		Push Rod
	05/05 →	Centre Rod	DB-DL-8642		Push Rod
	05/05 →	Centre Rod	DB-DL-12300		for Steering Rod
	05/05 →	Rod Assembly	DB-DL-2178		Guide Rod, 1st Front Axle, →504310 03
	05/05 →	Stabiliser Link	DB-DL-9254		Pressure Rod
	05/05 →	Stabiliser Mounting		DB-SB-10406	
	05/05 →	Stabiliser Mounting		DB-SB-10409	
	05/05 →	Stabiliser Mounting	DB-SB-10410		
	05/05 →	Suspension Arm Repair Kit		DB-RK-8550	for Wishbone (CV)
	05/05 →	Suspension Arm Repair Kit		DB-RK-8626	for Wishbone (CV)

CV-ES-0543

Length: 125
 Cone Ø: d1 Ø 32 / d2 Ø 29
 Thread: M30 x 1,5 RHT
 0004605748, 0004606048, 0004606848,
 0004607048, 0014600448, 0014601148,
 0014601748, 0014602448, 0014607648,
 0014609648

**CV-ES-0888**

Length: 125
 Cone Ø: d1 Ø 32 / d2 Ø 29
 Thread: M30 x 1,5 LHT
 0004605848, 0004606148, 0004606948,
 0004607148, 0004609048, 0014600548,
 0014601348, 0014602548, 0014607948,
 0024600448

**CV-ES-14162**

Length: 125
 Cone Ø: d1 Ø 30 / d2 Ø 27
 Thread: M30 x 1,5 LHT
 4600648, 4601248, 4603448, 0004603548,
 14600348, 14601448, 14602348,
 0014603748, 0014607848, 0024600348

**CV-ES-14163**

Length: 125
 Cone Ø: d1 Ø 30 / d2 Ø 27
 Thread: M30 x 1,5 RHT
 0003305248, 0003387310, 0004600348,
 0004600948, 0004602848, 0004602948,
 0004608948, 0014600248, 0014600848,
 0014601248, 0014602248, 0014607748,
 0024600148, A0003387310, A0004600348,
 A0004602848, A0004602948, A0014600848,
 A0014601248, A0014602248, A0014607748

**DB-DL-2144**

Length: 872 Ø: 35
 Cone Ø: d1 Ø 28,6 / d2 Ø 23,9
 0024604305, 0024604405, 0034604805

**DB-DL-2178**

Length: 1735 Ø: 52
 Cone Ø: d1 Ø 32 / d2 Ø 29
 9423300003, 9423300103, 9423300203

**DB-DL-5224**

Length: 850 Ø: 60
 Hole Distance: 100 / 100
 01336100A, 9413300007

**DB-DL-5230**

Length: 879 Ø: 42
 Cone Ø: d1 Ø 30 / d2 Ø 27
 01208600A, 0004607105, 0004607205,
 0014606705

**DB-DL-5241**

Length: 875 Ø: 40
 Cone Ø: d1 Ø 30 / d2 Ø 27
 01215300A, 0004609205, 0004609305,
 0014606905

**DB-DL-5405**

Length: 890 Ø: 35
 Cone Ø: d1 Ø 28,6 / d2 Ø 23,9
 01215900A, 1460248, 0024604505,
 0024604605, 0034605005, 3752600637,
 3754600405, A3752600637, A3754600405

**DB-DL-7270**

Length: 875 Ø: 40
 Cone Ø: d1 Ø 28,6 / d2 Ø 23,9
 01208300A, 0024604705, 0024604805,
 0034604905, A0024604705

**DB-DL-8167**

Length: 866 Ø: 38
 Cone Ø: d1 Ø 30 / d2 Ø 27
 0014609805, 0014609905, 0024606305,
 0024606405

**DB-DL-8168**

Length: 904 Ø: 52
 Cone Ø: d1 Ø 32 / d2 Ø 29
 0004609405, 0004609505, 0014607105

**DB-DL-8184**

Length: 1095 Ø: 42
 Cone Ø: d1 Ø 32 / d2 Ø 28,8
 01217700A, 0014601305, 0014601405,
 0024600505, 0034603205, 3754601505,
 A0014601305, A0014601405, A0024600505

**DB-DL-8185**

Length: 711 Ø: 42
 Cone Ø: d1 Ø 32 / d2 Ø 28,8
 01213600A, 0014601105, 0024600405,
 0034603105, A0014601105, A0024600405

**DB-DL-8307**

Length: 885 Ø: 38
 Cone Ø: d1 Ø 32 / d2 Ø 30
 01215500A, 0004604005, 0024605105,
 0024605205, 0034604005

**DB-DL-8327**

Length: 1745 Ø: 48
 Cone Ø: d1 Ø 32 / d2 Ø 29
 01219800A, 9413300003, 9413300103,
 9413300203, 9413300303, 9413300503

**DB-DL-8622**

Length: 1558 Ø: 52
 Cone Ø: d1 Ø 30 / d2 Ø 27
 0014609005, 0014609105

**DB-DL-8640**

Length: 1615 Ø: 50
 Cone Ø: d1 Ø 32 / d2 Ø 29
 6253301503, 6253301603, 6253302403,
 6253302503, 9423300803, 9423302103,
 9493300203, 9493300303, 9493300903

**DB-DL-8641**

Length: 905 Ø: 42
 Cone Ø: d1 Ø 30 / d2 Ø 27
 0014605105, 0014608105

**DB-DL-8642**

Length: 954 Ø: 42
 Cone Ø: d1 Ø 30 / d2 Ø 27
 0014608605, 0014608705

**DB-DL-9218**

Length: 754 Ø: 40
 Hole Distance: 100
 000360098524, 000390098524,
 3753300111, 9413300011,
 A3753300111, SA50831601

**DB-DL-9254**

Length: 1815 Ø: 58
 0003220323, 0003220623, 3753220423

**DB-DL-12300**

Length: 733 Ø: 36
 Cone Ø: d1 Ø 32 / d2 Ø 29
 0014601505, 0014607305, 0034603305,
 3754601605, A0014601505,
 A0034603305, A3754601605

**DB-DL-12310**

Length: 1532 Ø: 50
 Cone Ø: d1 Ø 32 / d2 Ø 29
 Thread: M27 x 1,5 LHT
 9493301203, 9493301303, 9493301803,
 9493302203, A9493301203, A9493301303,
 A9493301803, A9493302203

**DB-ES-5227**

Length: 1588 Ø: 60
 Cone Ø: d1 Ø 38 / d2 Ø 34,3
 6253300903, 6253301203, 9443300203

**DB-ES-5234**

Length: 135
 Cone Ø: d1 Ø 38 / d2 Ø 34,3
 Thread: M38 x 1,5 RHT
 0004601748, 120322305, 2205000400

**DB-ES-8164**

Length: 140
 Cone Ø: d1 Ø 28,6 / d2 Ø 23,9
 Thread: M28 x 1,5 RHT
 0014604248, 0014605048, 0014608548,
 0024600548

**DB-ES-8510**

Length: 56
 Cone Ø: d1 Ø 10 / d2 Ø 10
 Thread: M12 x 1,75 LHT
 0009965145, 0009965645, 0019963145

**DB-ES-8530**

Length: 115
 Cone Ø: d1 Ø 28,6 / d2 Ø 23,9
 Thread: M30 x 1,5 RHT
 0014603848, 0014604848, 0014605148,
 0014608648, 0014609948

**DB-RK-8391**

Ø: 85 Hole Distance: 152
 Thick/Height: 24
 01336800A, 0003502705

**DB-RK-8550**

Ø: 75 Hole Distance: 152
 Thick/Height: 24
 0003502105, 0003504605

**DB-RK-8626**

Ø: 75 Hole Distance: 130
 Thick/Height: 24
 0003502205, 0003502505, 0003503405,
 0003504505, GL11319

**DB-RK-8638**

Length: 100 Ø: 67
 Hole Distance: 100
 Thick/Height: 20
 0003301411

**DB-RK-9294**

Ø: 85 Hole Distance: 152
 Thick/Height: 24
 0003503105

**DB-RK-9296**

Ø: 88 Hole Distance: 130
 Thick/Height: 24
 9423260050

**DB-RK-10374**

Ø: 85 Hole Distance: 152
 Thick/Height: 24
 0003504405

**DB-RK-10375**

Ø: 100 Hole Distance: 152
 Thick/Height: 24
 0003502405, 0003503505, 0003504905

**DB-SB-10384**

Ø: 73 Thick/Height: 47
 9303170012, 9423171812

**DB-SB-10406**

Ø: 80 Thick/Height: 46
 0003238185

**DB-SB-10409**

Ø: 77 Thick/Height: 56
 0003265181

**DB-SB-10410**

Ø: 73 Hole Distance: 100
 Thick/Height: 24
 9413230050

**DB-VB-3707**

Length: 622 Ø: 46
 Hole Ø 25 / 25 / 25
 Hole Distance: 152 / 130 / 130
 01337100A, 9423501005, 9423501505,
 9443500005, 9473500105, 9473501005,
 A3753500005, A9423501005, A9423501505,
 A9443500005, A9473500105, A9473501005

**MERCEDES-BENZ**



ACTROS MP2 / MP3 ...

1860 L, LL ...	05/05→	Suspension Arm Repair Kit		DB-RK-10374	for Wishbone (CV)	
	05/05→	Suspension Arm Repair Kit		DB-RK-10375	for Wishbone (CV)	
	05/05→	Suspension Arm Repair Kit	DB-RK-8638		for Control Arm	
	05/05→	Suspension Strut Repair Kit		DB-RK-8391		
	05/05→	Suspension Strut Repair Kit		DB-RK-9294		
	05/05→	Tie Rod	DB-DL-8327		Guide Rod	
	05/05→	Tie Rod	DB-DL-8640		Guide Rod	
	05/05→	Tie Rod	DB-DL-12310			
	05/05→	Tie Rod	DB-ES-5227		Guide Rod	
	05/05→	Tie Rod End	CV-ES-0543		for Push Rod	
	05/05→	Tie Rod End	CV-ES-0888		for Push Rod	
	05/05→	Tie Rod End	CV-ES-14163		for Steering Rod	
	05/05→	Tie Rod End	DB-ES-5234		for Steering Rod	
	05/05→	Tie Rod End	DB-ES-8164		for Push Rod	
	05/05→	Tie Rod End	DB-ES-8530		for Push Rod	
	05/05→	Track Control Arm		DB-VB-3707	Suspension Rod, Wishbone (CV)	
	05/05→	Track Control Arm	DB-DL-5224		Control Arm, 1st FA;Air Suspension Axle	
	05/05→	Track Control Arm	DB-DL-9218	DB-DL-9218	Trailing Arm, 1st FA;Air Suspension Axle	
	1860 LS	06/08→	Centre Rod	DB-DL-2144		Push Rod
		06/08→	Centre Rod	DB-DL-5405		Push Rod
06/08→		Centre Rod	DB-DL-7270		Push Rod	
06/08→		Centre Rod	DB-DL-8167		Push Rod	
06/08→		Centre Rod	DB-DL-8185		Push Rod	
06/08→		Centre Rod	DB-DL-12303		Push Rod, Leaf Spring Axle	
06/08→		Rod Assembly	DB-DL-2178		Guide Rod, 1st Front Axle, →504310 03	
06/08→		Stabiliser Mounting		DB-SB-10406		
06/08→		Suspension Strut Repair Kit		MN-RK-8997		
06/08→		Tie Rod	DB-DL-8327		Guide Rod	
06/08→		Tie Rod	DB-DL-8640		Guide Rod	
06/08→		Tie Rod	DB-DL-12310			
06/08→		Tie Rod	DB-ES-5227		Guide Rod	
06/08→		Tie Rod End	CV-ES-0543		for Push Rod	
06/08→		Tie Rod End	CV-ES-0888		for Push Rod	
06/08→		Tie Rod End	CV-ES-14163		for Steering Rod	
06/08→		Tie Rod End	DB-ES-8164		for Push Rod	
06/08→		Tie Rod End	DB-ES-8530		for Push Rod	
06/08→		Track Control Arm		DB-TC-12410	Control Arm	
06/08→		Track Control Arm		DB-VB-7798	Wishbone (CV), Air Suspension Axle	
06/08→	Track Control Arm	DB-DL-5224		Control Arm, 1st FA;Air Suspension Axle		
06/08→	Track Control Arm	DB-DL-9218	DB-DL-9218	Trailing Arm, 1st FA;Air Suspension Axle		
1861 LS	05/05→	Centre Rod	DB-DL-2144		Push Rod	
	05/05→	Centre Rod	DB-DL-5405		Push Rod	
	05/05→	Centre Rod	DB-DL-7270		Push Rod	
	05/05→	Centre Rod	DB-DL-8167		Push Rod	
	05/05→	Centre Rod	DB-DL-8185		Push Rod	
	05/05→	Centre Rod	DB-DL-12303		Push Rod, Leaf Spring Axle	
	05/05→	Rod Assembly	DB-DL-2178		Guide Rod, 1st Front Axle, →504310 03	
	05/05→	Suspension Arm Repair Kit		DB-RK-10374	for Wishbone (CV)	
	05/05→	Tie Rod	DB-DL-8327		Guide Rod	
	05/05→	Tie Rod	DB-DL-8640		Guide Rod	
	05/05→	Tie Rod	DB-ES-5227		Guide Rod	
	05/05→	Tie Rod End	CV-ES-0543		for Push Rod	
	05/05→	Tie Rod End	CV-ES-0888		for Push Rod	
	05/05→	Tie Rod End	CV-ES-14163		for Steering Rod	
	05/05→	Tie Rod End	DB-ES-8164		for Push Rod	
	05/05→	Tie Rod End	DB-ES-8530		for Push Rod	
	05/05→	Track Control Arm		DB-TC-12410	Control Arm	
	05/05→	Track Control Arm		DB-VB-7798	Wishbone (CV), Air Suspension Axle	
	05/05→	Track Control Arm	DB-DL-5224		Control Arm, 1st FA;Air Suspension Axle	
	05/05→	Track Control Arm	DB-DL-9218	DB-DL-9218	Trailing Arm, 1st FA;Air Suspension Axle	

CV-ES-0543

Length: 125
Cone Ø: d1 Ø 32 / d2 Ø 29
Thread: M30 x 1,5 RHT
0004605748, 0004606048, 0004606848,
0004607048, 0014600448, 0014601148,
0014601748, 0014602448, 0014607648,
0014609648



CV-ES-0888

Length: 125
Cone Ø: d1 Ø 32 / d2 Ø 29
Thread: M30 x 1,5 LHT
0004605848, 0004606148, 0004606948,
0004607148, 0004609048, 0014600548,
0014601348, 0014602548, 0014607948,
0024600448



CV-ES-14163

Length: 125
Cone Ø: d1 Ø 30 / d2 Ø 27
Thread: M30 x 1,5 RHT
0003305248, 0003387310, 0004600348,
0004600948, 0004602848, 0004602948,
0004608948, 0014600248, 0014600848,
0014601248, 0014602248, 0014607748,
0024600148, A0003387310, A0004600348,
A0004602848, A0004602948, A0014600848,
A0014601248, A0014602248, A0014607748



DB-DL-2144

Length: 872 Ø: 35
Cone Ø: d1 Ø 28,6 / d2 Ø 23,9
0024604305, 0024604405, 0034604805



DB-DL-2178

Length: 1735 Ø: 52
Cone Ø: d1 Ø 32 / d2 Ø 29
9423300003, 9423300103, 9423300203



DB-DL-5224

Length: 850 Ø: 60
Hole Distance: 100 / 100
01336100A, 9413300007



DB-DL-5405

Length: 890 Ø: 35
Cone Ø: d1 Ø 28,6 / d2 Ø 23,9
01215900A, 1460248, 0024604505,
0024604605, 0034605005, 3752600637,
3754600405, A3752600637, A3754600405



DB-DL-7270

Length: 875 Ø: 40
Cone Ø: d1 Ø 28,6 / d2 Ø 23,9
01208300A, 0024604705, 0024604805,
0034604905, A0024604705



DB-DL-8167

Length: 866 Ø: 38
Cone Ø: d1 Ø 30 / d2 Ø 27
0014609805, 0014609905, 0024606305,
0024606405



DB-DL-8185

Length: 711 Ø: 42
Cone Ø: d1 Ø 32 / d2 Ø 28,8
01213600A, 0014601105, 0024600405,
0034603105, A0014601105, A0024600405



DB-DL-8327

Length: 1745 Ø: 48
Cone Ø: d1 Ø 32 / d2 Ø 29
01219800A, 9413300003, 9413300103,
9413300203, 9413300303, 9413300503



DB-DL-8640

Length: 1615 Ø: 50
Cone Ø: d1 Ø 32 / d2 Ø 29
6253301503, 6253301603, 6253302403,
6253302503, 9423300803, 9423302103,
9493300203, 9493300303, 9493300903



DB-DL-9218

Length: 754 Ø: 40
Hole Distance: 100
000360098524, 000390098524,
3753300111, 9413300011,
A3753300111, SA50831601



DB-DL-12303

Length: 888 Ø: 42
Cone Ø: d1 Ø 28,6 / d2 Ø 23,9
0034601805, 0034601905, 0034605805,
A0034601905, A0034605805



DB-DL-12310

Length: 1532 Ø: 50
Cone Ø: d1 Ø 32 / d2 Ø 29
Thread: M27 x 1,5 LHT
9493301203, 9493301303, 9493301803,
9493302203, A9493301203, A9493301303,
A9493301803, A9493302203



DB-ES-5227

Length: 1588 Ø: 60
Cone Ø: d1 Ø 38 / d2 Ø 34,3
6253300903, 6253301203, 9443300203



DB-ES-5234

Length: 135
Cone Ø: d1 Ø 38 / d2 Ø 34,3
Thread: M38 x 1,5 RHT
0004601748, 120322305, 2205000400



DB-ES-8164

Length: 140
Cone Ø: d1 Ø 28,6 / d2 Ø 23,9
Thread: M28 x 1,5 RHT
0014604248, 0014605048, 0014608548,
0024600548



DB-ES-8530

Length: 115
Cone Ø: d1 Ø 28,6 / d2 Ø 23,9
Thread: M30 x 1,5 RHT
0014603848, 0014604848, 0014605148,
0014608648, 0014609948



DB-RK-8391

Ø: 85 Hole Distance: 152
Thick/Height: 24
01336800A, 0003502705



DB-RK-8638

Length: 100 Ø: 67
Hole Distance: 100
Thick/Height: 20
0003301411



DB-RK-9294

Ø: 85 Hole Distance: 152
Thick/Height: 24
0003503105



DB-RK-10374

Ø: 85 Hole Distance: 152
Thick/Height: 24
0003504405



DB-RK-10375

Ø: 100 Hole Distance: 152
Thick/Height: 24
0003502405, 0003503505, 0003504905



DB-SB-10406

Ø: 80 Thick/Height: 46
0003238185



DB-TC-12410

Length: 925 Ø: 62
Hole Distance: 100 / 100
9423300707



DB-VB-3707

Length: 622 Ø: 46
Hole Ø 25 / 25 / 25
Hole Distance: 152 / 130 / 130
01337100A, 9423501005, 9423501505,
9443500005, 9473500105, 9473501005,
A3753500005, A9423501005, A9423501505,
A9443500005, A9473500105, A9473501005



DB-VB-7798

Length: 622 Ø: 48
Hole Ø 25 / 23 / 23
Hole Distance: 152 / 130 / 130
9423500505, 9423500805, 9423501205,
A9423501205



MN-RK-8997

Ø: 85
Hole Distance: 130
Thick/Height: 30
0003504805, 3504805





ACTROS MP2 / MP3 ...

2032	04/03→	Ball Head, gearshift linkage	DB-ES-8510		
	04/03→	Bush, driver cab suspension	DB-SB-10384		
	04/03→	Centre Rod	DB-DL-2144		Push Rod
	04/03→	Centre Rod	DB-DL-5230		Suspension Rod
	04/03→	Centre Rod	DB-DL-5241		Push Rod
	04/03→	Centre Rod	DB-DL-5405		Push Rod, Leaf Spring Axle
	04/03→	Centre Rod	DB-DL-7270		Push Rod;Suspension Rod
	04/03→	Centre Rod	DB-DL-8167		Push Rod, Leaf Spring Axle
	04/03→	Centre Rod	DB-DL-8168		Push Rod
	04/03→	Centre Rod	DB-DL-8184		Push Rod
	04/03→	Centre Rod	DB-DL-8185		Push Rod
	04/03→	Centre Rod	DB-DL-8307		Push Rod
	04/03→	Centre Rod	DB-DL-8622		Push Rod
	04/03→	Centre Rod	DB-DL-8641		Push Rod
	04/03→	Centre Rod	DB-DL-8642		Push Rod
	04/03→	Centre Rod	DB-DL-8702		Push Rod, Leaf Spring Axle
	04/03→	Centre Rod	DB-DL-12300		for Steering Rod
	04/03→	Rod Assembly	DB-DL-2178		Guide Rod
	04/03→	Stabiliser Link	DB-DL-9254		Pressure Rod
	04/03→	Stabiliser Mounting		DB-SB-10406	
	04/03→	Stabiliser Mounting		DB-SB-10409	
	04/03→	Stabiliser Mounting	DB-SB-10410		
	04/03→	Suspension Arm Repair Kit		DB-RK-8550	for Wishbone (CV)
	04/03→	Suspension Arm Repair Kit		DB-RK-8626	for Wishbone (CV)
	04/03→	Suspension Arm Repair Kit		DB-RK-10374	for Wishbone (CV)
	04/03→	Suspension Arm Repair Kit		DB-RK-10375	for Wishbone (CV)
	04/03→	Suspension Arm Repair Kit	DB-RK-8638		for Control Arm
	04/03→	Suspension Strut Repair Kit		DB-RK-8391	
	04/03→	Tie Rod	DB-DL-8171		Guide Rod
	04/03→	Tie Rod	DB-DL-8327		Guide Rod
	04/03→	Tie Rod	DB-DL-8640		Guide Rod
	04/03→	Tie Rod	DB-DL-12310		
	04/03→	Tie Rod	DB-ES-5227		Guide Rod
	04/03→	Tie Rod End	CV-ES-0543		for Push Rod
	04/03→	Tie Rod End	CV-ES-0888		for Push Rod
	04/03→	Tie Rod End	CV-ES-14162		for Steering Rod
	04/03→	Tie Rod End	CV-ES-14163		for Steering Rod
	04/03→	Tie Rod End	DB-ES-5234		for Steering Rod
	04/03→	Tie Rod End	DB-ES-8164		for Push Rod
	04/03→	Tie Rod End	DB-ES-8530		for Push Rod
	04/03→	Track Control Arm		DB-VB-7261	Suspension Rod, Wishbone (CV), 1st RA, →517142 01/517142 02
04/03→	Track Control Arm		DB-VB-9307	Suspension Rod, Wishbone (CV), 1st Drive Axle, →517142 07	
04/03→	Track Control Arm		DB-VB-9308	Suspension Rod, Wishbone (CV), 1st Drive Axle, →517142 06	
04/03→	Track Control Arm		DB-VB-10426	Wishbone (CV), 1st RA, →517142 05	
2032 A, AE	04/03→	Ball Head, gearshift linkage	DB-ES-8510		
	04/03→	Bush, driver cab suspension	DB-SB-10384		
	04/03→	Centre Rod	DB-DL-2144		Push Rod
	04/03→	Centre Rod	DB-DL-8168		Push Rod
	04/03→	Centre Rod	DB-DL-8184		Push Rod
	04/03→	Centre Rod	DB-DL-8307		Push Rod
	04/03→	Centre Rod	DB-DL-8622		Push Rod
	04/03→	Centre Rod	DB-DL-8641		Push Rod
	04/03→	Centre Rod	DB-DL-8642		Push Rod
	04/03→	Centre Rod	DB-DL-8702		Push Rod, Leaf Spring Axle
	04/03→	Centre Rod	DB-DL-12300		for Steering Rod
	04/03→	Rod Assembly	DB-DL-2178		Guide Rod
	04/03→	Stabiliser Link	DB-DL-9254		Pressure Rod
	04/03→	Stabiliser Mounting		DB-SB-10406	
	04/03→	Stabiliser Mounting		DB-SB-10409	
	04/03→	Stabiliser Mounting	DB-SB-10410		

CV-ES-0543

Length: 125
 Cone Ø: d1 Ø 32 / d2 Ø 29
 Thread: M30 x 1,5 RHT
 0004605748, 0004606048, 0004606848,
 0004607048, 0014600448, 0014601148,
 0014601748, 0014602448, 0014607648,
 0014609648

**CV-ES-0888**

Length: 125
 Cone Ø: d1 Ø 32 / d2 Ø 29
 Thread: M30 x 1,5 LHT
 0004605848, 0004606148, 0004606948,
 0004607148, 0004609048, 0014600548,
 0014601348, 0014602548, 0014607948,
 0024600448

**CV-ES-14162**

Length: 125
 Cone Ø: d1 Ø 30 / d2 Ø 27
 Thread: M30 x 1,5 LHT
 4600648, 4601248, 4603448, 4603548,
 0004603548, 14600348, 14601448,
 14602348, 0014603748, 0014607848,
 14607848, 0024600348

**CV-ES-14163**

Length: 125
 Cone Ø: d1 Ø 30 / d2 Ø 27
 Thread: M30 x 1,5 RHT
 0003305248, 0003387310, 0004600348,
 0004600948, 0004602848, 0004602948,
 0004608948, 0014600248, 0014600848,
 0014601248, 0014602248, 0014607748,
 0024600148, A0003387310, A0004600348,
 A0004602848, A0004602948, A0014600848,
 A0014601248, A0014602248, A0014607748

**DB-DL-2144**

Length: 872 Ø: 35
 Cone Ø: d1 Ø 28,6 / d2 Ø 23,9
 0024604305, 0024604405, 0034604805

**DB-DL-2178**

Length: 1735 Ø: 52
 Cone Ø: d1 Ø 32 / d2 Ø 29
 9423300003, 9423300103, 9423300203

**DB-DL-5230**

Length: 879 Ø: 42
 Cone Ø: d1 Ø 30 / d2 Ø 27
 01208600A, 0004607105, 0004607205,
 0014606705

**DB-DL-5241**

Length: 875 Ø: 40
 Cone Ø: d1 Ø 30 / d2 Ø 27
 01215300A, 0004609205, 0004609305,
 0014606905

**DB-DL-5405**

Length: 890 Ø: 35
 Cone Ø: d1 Ø 28,6 / d2 Ø 23,9
 01215900A, 1460248, 0024604505,
 0024604605, 0034605005, 3752600637,
 3754600405, A3752600637, A3754600405

**DB-DL-7270**

Length: 875 Ø: 40
 Cone Ø: d1 Ø 28,6 / d2 Ø 23,9
 01208300A, 0024604705, 0024604805,
 0034604905, A0024604705

**DB-DL-8167**

Length: 866 Ø: 38
 Cone Ø: d1 Ø 30 / d2 Ø 27
 0014609805, 0014609905, 0024606305,
 0024606405

**DB-DL-8168**

Length: 904 Ø: 52
 Cone Ø: d1 Ø 32 / d2 Ø 29
 0004609405, 0004609505, 0014607105

**DB-DL-8171**

Length: 1687 Ø: 52
 Cone Ø: d1 Ø 32 / d2 Ø 29
 9493300603, 9493300703, 9493301503,
 9493301603

**DB-DL-8184**

Length: 1095 Ø: 42
 Cone Ø: d1 Ø 32 / d2 Ø 28,8
 01217700A, 0014601305, 0014601405,
 0024600505, 0034603205, 3754601505,
 A0014601305, A0014601405, A0024600505

**DB-DL-8185**

Length: 711 Ø: 42
 Cone Ø: d1 Ø 32 / d2 Ø 28,8
 01213600A, 0014601105, 0024600405,
 0034603105, A0014601105, A0024600405

**DB-DL-8307**

Length: 885 Ø: 38
 Cone Ø: d1 Ø 32 / d2 Ø 30
 01215500A, 0004604005, 0024605105,
 0024605205, 0034604005

**DB-DL-8327**

Length: 1745 Ø: 48
 Cone Ø: d1 Ø 32 / d2 Ø 29
 01219800A, 9413300003, 9413300103,
 9413300203, 9413300303, 9413300503

**DB-DL-8622**

Length: 1558 Ø: 52
 Cone Ø: d1 Ø 30 / d2 Ø 27
 0014609005, 0014609105

**DB-DL-8640**

Length: 1615 Ø: 50
 Cone Ø: d1 Ø 32 / d2 Ø 29
 6253301503, 6253301603, 6253302403,
 6253302503, 9423300803, 9423302103,
 9493300203, 9493300303, 9493300903

**DB-DL-8641**

Length: 905 Ø: 42
 Cone Ø: d1 Ø 30 / d2 Ø 27
 0014605105, 0014608105

**DB-DL-8642**

Length: 954 Ø: 42
 Cone Ø: d1 Ø 30 / d2 Ø 27
 0014608605, 0014608705

**DB-DL-8702**

Length: 958 Ø: 38
 Cone Ø: d1 Ø 32 / d2 Ø 30
 0024606105, 0024606205, 0034604205

**DB-DL-9254**

Length: 1815 Ø: 58
 0003220323, 0003220623, 3753220423

**DB-DL-12300**

Length: 733 Ø: 36
 Cone Ø: d1 Ø 32 / d2 Ø 29
 0014601505, 0014607305, 0034603305,
 3754601605, A0014601505,
 A0034603305, A3754601605

**DB-DL-12310**

Length: 1532 Ø: 50
 Cone Ø: d1 Ø 32 / d2 Ø 29
 Thread: M27 x 1,5 LHT
 9493301203, 9493301303, 9493301803,
 9493302203, A9493301203, A9493301303,
 A9493301803, A9493302203

**DB-ES-5227**

Length: 1588 Ø: 60
 Cone Ø: d1 Ø 38 / d2 Ø 34,3
 6253300903, 6253301203, 9443300203

**DB-ES-5234**

Length: 135
 Cone Ø: d1 Ø 38 / d2 Ø 34,3
 Thread: M38 x 1,5 RHT
 0004601748, 120322305, 2205000400

**DB-ES-8164**

Length: 140
 Cone Ø: d1 Ø 28,6 / d2 Ø 23,9
 Thread: M28 x 1,5 RHT
 0014604248, 0014605048, 0014608548,
 0024600548

**DB-ES-8510**

Length: 56
 Cone Ø: d1 Ø 10 / d2 Ø 10
 Thread: M12 x 1,75 LHT
 0009965145, 0009965645, 0019963145

**DB-ES-8530**

Length: 115
 Cone Ø: d1 Ø 28,6 / d2 Ø 23,9
 Thread: M30 x 1,5 RHT
 0014603848, 0014604848, 0014605148,
 0014608648, 0014609948

**DB-RK-8391**

Ø: 85 Hole Distance: 152
 Thick/Height: 24
 01336800A, 0003502705

**DB-RK-8550**

Ø: 75 Hole Distance: 152
 Thick/Height: 24
 0003502105, 0003504605

**DB-RK-8626**

Ø: 75 Hole Distance: 130
 Thick/Height: 24
 0003502205, 0003502505, 0003503405,
 0003504505, GL11319

**DB-RK-8638**

Length: 100 Ø: 67
 Hole Distance: 100
 Thick/Height: 20
 0003301411

**DB-RK-10374**

Ø: 85 Hole Distance: 152
 Thick/Height: 24
 0003504405

**DB-RK-10375**

Ø: 100 Hole Distance: 152
 Thick/Height: 24
 0003502405, 0003503505, 0003504905

**DB-SB-10384**

Ø: 73 Thick/Height: 47
 9303170012, 9423171812

**DB-SB-10406**

Ø: 80 Thick/Height: 46
 0003238185

**DB-SB-10409**

Ø: 77 Thick/Height: 56
 0003265181

**DB-SB-10410**

Ø: 73 Hole Distance: 100
 Thick/Height: 24
 9413230050

**DB-VB-7261**

Length: 622 Ø: 46
 Hole Ø 25 / 25 / 25
 Hole Distance: 152 / 130 / 130
 01337800A, 9443500305, 9443500505,
 9443500605, 9473500705, 9473500905,
 9483500405, 9483500305

**DB-VB-9307**

Length: 667 Ø: 60
 Hole Ø 25 / 23 / 23
 Hole Distance: 152 / 130 / 130
 9483502805

**DB-VB-9308**

Length: 622 Ø: 46
 Hole Ø 25 / 25 / 25
 Hole Distance: 152 / 130 / 130
 9483502905

**DB-VB-10426**

Length: 622 Ø: 46
 Hole Ø 25 / 25 / 25
 Hole Distance: 152 / 130 / 130
 9443500405



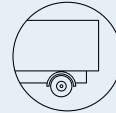

ACTROS MP2 / MP3 ...

2032 A, AE ...	04/03→	Suspension Arm Repair Kit		DB-RK-8550	for Wishbone (CV)
	04/03→	Suspension Arm Repair Kit		DB-RK-8626	for Wishbone (CV)
	04/03→	Suspension Arm Repair Kit		DB-RK-10374	for Wishbone (CV)
	04/03→	Suspension Arm Repair Kit		DB-RK-10375	for Wishbone (CV)
	04/03→	Suspension Arm Repair Kit	DB-RK-8638		for Control Arm
	04/03→	Suspension Strut Repair Kit		DB-RK-8391	
	04/03→	Tie Rod	DB-DL-12310		
	04/03→	Tie Rod	DB-ES-5227		Guide Rod, 1st FA;Leaf Spring Axle
	04/03→	Tie Rod	MN-DL-7834		Guide Rod, 1st FA;Leaf Spring Axle
	04/03→	Tie Rod End	CV-ES-0543		for Push Rod
	04/03→	Tie Rod End	CV-ES-0888		for Push Rod
	04/03→	Tie Rod End	CV-ES-14162		for Steering Rod
	04/03→	Tie Rod End	CV-ES-14163		for Steering Rod
	04/03→	Tie Rod End	DB-ES-5234		for Steering Rod
	04/03→	Tie Rod End	DB-ES-8530		for Push Rod
	04/03→	Track Control Arm		DB-VB-7261	Suspension Rod, Wishbone (CV), 1st RA, →517142 01/517142 02
	04/03→	Track Control Arm		DB-VB-9307	Suspension Rod, Wishbone (CV), 1st Drive Axle, →517142 07
	04/03→	Track Control Arm		DB-VB-9308	Suspension Rod, Wishbone (CV), 1st Drive Axle, →517142 06
	04/03→	Track Control Arm		DB-VB-10426	Wishbone (CV), 1st RA, →517142 05
	2032 AK	04/03→	Ball Head, gearshift linkage	DB-ES-8510	
04/03→		Bush, driver cab suspension	DB-SB-10384		
04/03→		Centre Rod	DB-DL-2144		Push Rod
04/03→		Centre Rod	DB-DL-8184		Push Rod
04/03→		Centre Rod	DB-DL-8307		Push Rod, Leaf Spring Axle
04/03→		Centre Rod	DB-DL-8702		Push Rod, Leaf Spring Axle
04/03→		Centre Rod	DB-DL-12300		for Steering Rod
04/03→		Rod Assembly	DB-DL-2178		Guide Rod
04/03→		Stabiliser Mounting		DB-SB-10406	
04/03→		Stabiliser Mounting		DB-SB-10409	
04/03→		Suspension Arm Repair Kit		DB-RK-8626	for Wishbone (CV)
04/03→		Suspension Arm Repair Kit		DB-RK-10374	for Wishbone (CV)
04/03→		Suspension Arm Repair Kit		DB-RK-10375	for Wishbone (CV)
04/03→		Suspension Arm Repair Kit	DB-RK-8638		for Control Arm
04/03→		Suspension Strut Repair Kit		DB-RK-8391	
04/03→		Tie Rod	DB-DL-12310		
04/03→		Tie Rod	DB-ES-5227		Guide Rod, 1st FA;Leaf Spring Axle
04/03→		Tie Rod	MN-DL-7834		Guide Rod, 1st FA;Leaf Spring Axle
04/03→		Tie Rod End	CV-ES-0543		for Push Rod
04/03→		Tie Rod End	CV-ES-0888		for Push Rod
04/03→		Tie Rod End	CV-ES-14162		for Steering Rod
04/03→		Tie Rod End	CV-ES-14163		for Steering Rod
04/03→		Tie Rod End	DB-ES-5234		for Steering Rod
04/03→		Tie Rod End	DB-ES-8530		for Push Rod
04/03→		Track Control Arm		DB-VB-7261	Suspension Rod, Wishbone (CV), 1st RA, →517142 01/517142 02
04/03→		Track Control Arm		DB-VB-9307	Suspension Rod, Wishbone (CV), 1st Drive Axle, →517142 07
04/03→		Track Control Arm		DB-VB-9308	Suspension Rod, Wishbone (CV), 1st Drive Axle, →517142 06
04/03→		Track Control Arm		DB-VB-10426	Wishbone (CV), 1st RA, →517142 05
2032 AS	04/03→	Ball Head, gearshift linkage	DB-ES-8510		
	04/03→	Bush, driver cab suspension	DB-SB-10384		
	04/03→	Centre Rod	DB-DL-2144		Push Rod
	04/03→	Centre Rod	DB-DL-8307		Push Rod, Leaf Spring Axle
	04/03→	Centre Rod	DB-DL-8702		Push Rod
	04/03→	Centre Rod	DB-DL-12300		for Steering Rod
	04/03→	Rod Assembly	DB-DL-2178		Guide Rod
	04/03→	Stabiliser Mounting		DB-SB-10406	
	04/03→	Stabiliser Mounting		DB-SB-10409	
	04/03→	Stabiliser Mounting	DB-SB-10410		

CV-ES-0543

Length: 125
Cone Ø: d1 Ø 32 / d2 Ø 29
Thread: M30 x 1,5 RHT
0004605748, 0004606048, 0004606848,
0004607048, 0014600448, 0014601148,
0014601748, 0014602448, 0014607648,
0014609648



CV-ES-0888

Length: 125
Cone Ø: d1 Ø 32 / d2 Ø 29
Thread: M30 x 1,5 LHT
0004605848, 0004606148, 0004606948,
0004607148, 0004609048, 0014600548,
0014601348, 0014602548, 0014607948,
0024600448



CV-ES-14162

Length: 125
Cone Ø: d1 Ø 30 / d2 Ø 27
Thread: M30 x 1,5 LHT
4600648, 4601248, 4603448,
0004603548, 4603548, 14600348,
14601448, 14602348, 001 460 37 48,
14607848, 0014607848, 002 460 03 48



CV-ES-14163

Length: 125
Cone Ø: d1 Ø 30 / d2 Ø 27
Thread: M30 x 1,5 RHT
0003305248, 0003387310, 0004600348,
0004600948, 0004602848, 0004602948,
0004608948, 0014600248, 0014600848,
0014601248, 0014602248, 0014607748,
0024600148, A0003387310, A0004600348,
A0004602848, A0004602948, A0014600848,
A0014601248, A0014602248, A0014607748



DB-DL-2144

Length: 872 Ø: 35
Cone Ø: d1 Ø 28,6 / d2 Ø 23,9
0024604305, 0024604405, 0034604805



DB-DL-2178

Length: 1735 Ø: 52
Cone Ø: d1 Ø 32 / d2 Ø 29
9423300003, 9423300103, 9423300203



DB-DL-8184

Length: 1095 Ø: 42
Cone Ø: d1 Ø 32 / d2 Ø 28,8
01217700A, 0014601305, 0014601405,
0024600505, 0034603205, 3754601505,
A0014601305, A0014601405, A0024600505



DB-DL-8307

Length: 885 Ø: 38
Cone Ø: d1 Ø 32 / d2 Ø 30
01215500A, 0004604005, 0024605105,
0024605205, 0034604005



DB-DL-8702

Length: 958 Ø: 38
Cone Ø: d1 Ø 32 / d2 Ø 30
0024606105, 0024606205, 0034604205



DB-DL-12300

Length: 733 Ø: 36
Cone Ø: d1 Ø 32 / d2 Ø 29
0014601505, 0014607305, 0034603305,
3754601605, A0014601505, A0034603305,
A3754601605



DB-DL-12310

Length: 1532 Ø: 50
Cone Ø: d1 Ø 32 / d2 Ø 29
Thread: M27 x 1,5 LHT
9493301203, 9493301303, 9493301803,
9493302203, A9493301203, A9493301303,
A9493301803, A9493302203



DB-ES-5227

Length: 1588 Ø: 60
Cone Ø: d1 Ø 38 / d2 Ø 34,3
6253300903, 6253301203, 9443300203



DB-ES-5234

Length: 135
Cone Ø: d1 Ø 38 / d2 Ø 34,3
Thread: M38 x 1,5 RHT
0004601748, 120322305, 2205000400



DB-ES-8510

Length: 56
Cone Ø: d1 Ø 10 / d2 Ø 10
Thread: M12 x 1,75 LHT
0009965145, 0009965645, 0019963145



DB-ES-8530

Length: 115
Cone Ø: d1 Ø 28,6 / d2 Ø 23,9
Thread: M30 x 1,5 RHT
0014603848, 0014604848, 0014605148,
0014608648, 0014609948



DB-RK-8391

Ø: 85 Hole Distance: 152
Thick/Height: 24
01336800A, 0003502705



DB-RK-8550

Ø: 75 Hole Distance: 152
Thick/Height: 24
0003502105, 0003504605



DB-RK-8626

Ø: 75 Hole Distance: 130
Thick/Height: 24
0003502205, 0003502505, 0003503405,
0003504505, GL11319



DB-RK-8638

Length: 100 Ø: 67
Hole Distance: 100
Thick/Height: 20
0003301411



DB-RK-10374

Ø: 85 Hole Distance: 152
Thick/Height: 24
0003504405



DB-RK-10375

Ø: 100 Hole Distance: 152
Thick/Height: 24
0003502405, 0003503505, 0003504905



DB-SB-10384

Ø: 73 Thick/Height: 47
9303170012, 9423171812



DB-SB-10406

Ø: 80 Thick/Height: 46
0003238185



DB-SB-10409

Ø: 77 Thick/Height: 56
0003265181



DB-SB-10410

Ø: 73 Hole Distance: 100
Thick/Height: 24
9413230050



DB-VB-7261

Length: 622 Ø: 46
Hole Ø 25 / 25 / 25
Hole Distance: 152 / 130 / 130
01337800A, 9443500305, 9443500505,
9443500605, 9473500705, 9473500905,
9483500405, 9483500305



DB-VB-9307

Length: 667 Ø: 60
Hole Ø 25 / 23 / 23
Hole Distance: 152 / 130 / 130
9483502805



DB-VB-9308

Length: 622 Ø: 46
Hole Ø 25 / 25 / 25
Hole Distance: 152 / 130 / 130
9483502905



DB-VB-10426

Length: 622 Ø: 46
Hole Ø 25 / 25 / 25
Hole Distance: 152 / 130 / 130
9443500405



MN-DL-7834

Length: 1588 Ø: 58
Cone Ø: d1 Ø 30 / d2 Ø 27
3463303903, 3463304903, 6253303203,
9443300503, 9443301303, 9443301703





ACTROS MP2 / MP3 ...

2032 AS ...	04/03→	Suspension Arm Repair Kit		DB-RK-8626	for Wishbone (CV)	
	04/03→	Suspension Arm Repair Kit		DB-RK-10374	for Wishbone (CV)	
	04/03→	Suspension Arm Repair Kit		DB-RK-10375	for Wishbone (CV)	
	04/03→	Suspension Arm Repair Kit	DB-RK-8638		for Control Arm	
	04/03→	Suspension Strut Repair Kit		DB-RK-8391		
	04/03→	Suspension Strut Repair Kit		MN-RK-8997		
	04/03→	Tie Rod	DB-DL-12310			
	04/03→	Tie Rod	DB-ES-5227		Guide Rod	
	04/03→	Tie Rod	MN-DL-7834		Guide Rod	
	04/03→	Tie Rod End	CV-ES-0543		for Push Rod	
	04/03→	Tie Rod End	CV-ES-0888		for Push Rod	
	04/03→	Tie Rod End	CV-ES-14162		for Steering Rod	
	04/03→	Tie Rod End	CV-ES-14163		for Steering Rod	
	04/03→	Tie Rod End	DB-ES-5234		for Steering Rod	
	04/03→	Tie Rod End	DB-ES-8530		for Push Rod	
	04/03→	Track Control Arm		DB-VB-7261	Suspension Rod, Wishbone (CV), 1st RA, →517142 01/517142 02	
	04/03→	Track Control Arm		DB-VB-7798	Wishbone (CV)	
	04/03→	Track Control Arm		DB-VB-9307	Suspension Rod, Wishbone (CV), 1st Drive Axle, →517142 07	
	2032 K	04/03→	Track Control Arm		DB-VB-9308	Suspension Rod, Wishbone (CV), 1st Drive Axle, →517142 06
		04/03→	Track Control Arm		DB-VB-10426	Wishbone (CV), 1st RA, →517142 05
04/03→		Ball Head, gearshift linkage	DB-ES-8510			
04/03→		Bush, driver cab suspension	DB-SB-10384			
04/03→		Centre Rod	DB-DL-2144		Push Rod	
04/03→		Centre Rod	DB-DL-5230		Suspension Rod	
04/03→		Centre Rod	DB-DL-5241		Push Rod	
04/03→		Centre Rod	DB-DL-5405		Push Rod, Leaf Spring Axle	
04/03→		Centre Rod	DB-DL-7270		Push Rod	
04/03→		Centre Rod	DB-DL-8167		Push Rod	
04/03→		Centre Rod	DB-DL-8184		Push Rod	
04/03→		Centre Rod	DB-DL-8185		Push Rod	
04/03→		Centre Rod	DB-DL-8307		Push Rod	
04/03→		Centre Rod	DB-DL-8702		Push Rod, Leaf Spring Axle	
04/03→		Centre Rod	DB-DL-12300		for Steering Rod	
04/03→		Rod Assembly	DB-DL-2178		Guide Rod	
04/03→		Stabiliser Mounting		DB-SB-10406		
04/03→		Stabiliser Mounting		DB-SB-10409		
04/03→		Suspension Arm Repair Kit		DB-RK-8550	for Wishbone (CV)	
04/03→		Suspension Arm Repair Kit		DB-RK-8626	for Wishbone (CV)	
04/03→	Suspension Arm Repair Kit		DB-RK-10374	for Wishbone (CV)		
04/03→	Suspension Arm Repair Kit		DB-RK-10375	for Wishbone (CV)		
04/03→	Suspension Arm Repair Kit	DB-RK-8638		for Control Arm		
04/03→	Suspension Strut Repair Kit		DB-RK-8391			
04/03→	Tie Rod	DB-DL-8171		Guide Rod, 1st FA;Leaf Spring Axle		
04/03→	Tie Rod	DB-DL-8327		Guide Rod, 1st FA;Leaf Spring Axle		
04/03→	Tie Rod	DB-DL-8640		Guide Rod		
04/03→	Tie Rod	DB-DL-12310				
04/03→	Tie Rod	DB-ES-5227		Guide Rod		
04/03→	Tie Rod End	CV-ES-0543		for Push Rod		
04/03→	Tie Rod End	CV-ES-0888		for Push Rod		
04/03→	Tie Rod End	CV-ES-14162		for Steering Rod		
04/03→	Tie Rod End	CV-ES-14163		for Steering Rod		
04/03→	Tie Rod End	DB-ES-5234		for Steering Rod		
04/03→	Tie Rod End	DB-ES-8164		for Push Rod		
04/03→	Tie Rod End	DB-ES-8530		for Push Rod		
04/03→	Track Control Arm		DB-VB-7261	Suspension Rod, Wishbone (CV), 1st RA, →517142 01/517142 02		
04/03→	Track Control Arm		DB-VB-9307	Suspension Rod, Wishbone (CV), 1st Drive Axle, →517142 07		
04/03→	Track Control Arm		DB-VB-9308	Suspension Rod, Wishbone (CV), 1st Drive Axle, →517142 06		
04/03→	Track Control Arm		DB-VB-10426	Wishbone (CV), 1st RA, →517142 05		

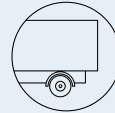

ACTROS MP2 / MP3 ...

2032 S	04/03→	Ball Head, gearshift linkage	DB-ES-8510		
	04/03→	Bush, driver cab suspension	DB-SB-10384		
	04/03→	Centre Rod	DB-DL-2144	Push Rod	
	04/03→	Centre Rod	DB-DL-5230	Suspension Rod	
	04/03→	Centre Rod	DB-DL-5241	Push Rod	
	04/03→	Centre Rod	DB-DL-5405	Push Rod, Leaf Spring Axle	
	04/03→	Centre Rod	DB-DL-7270	Push Rod;Suspension Rod	
	04/03→	Centre Rod	DB-DL-8167	Push Rod	
	04/03→	Centre Rod	DB-DL-8184	Push Rod	
	04/03→	Centre Rod	DB-DL-8185	Push Rod	
	04/03→	Centre Rod	DB-DL-8307	Push Rod	
	04/03→	Centre Rod	DB-DL-8702	Push Rod, Leaf Spring Axle	
	04/03→	Centre Rod	DB-DL-12300	for Steering Rod	
	04/03→	Rod Assembly	DB-DL-2178	Guide Rod	
	04/03→	Stabiliser Mounting		DB-SB-10406	
	04/03→	Stabiliser Mounting		DB-SB-10409	
	04/03→	Stabiliser Mounting	DB-SB-10410		
	04/03→	Suspension Arm Repair Kit		DB-RK-8550 for Wishbone (CV)	
	04/03→	Suspension Arm Repair Kit		DB-RK-8626 for Wishbone (CV)	
	04/03→	Suspension Arm Repair Kit		DB-RK-10374 for Wishbone (CV)	
	04/03→	Suspension Arm Repair Kit		DB-RK-10375 for Wishbone (CV)	
	04/03→	Suspension Arm Repair Kit	DB-RK-8638	for Control Arm	
	04/03→	Suspension Strut Repair Kit		DB-RK-8391	
	04/03→	Suspension Strut Repair Kit		MN-RK-8997	
	04/03→	Tie Rod	DB-DL-8171	Guide Rod	
	04/03→	Tie Rod	DB-DL-8327	Guide Rod	
	04/03→	Tie Rod	DB-DL-8640	Guide Rod	
	04/03→	Tie Rod	DB-DL-12310		
	04/03→	Tie Rod	DB-ES-5227	Guide Rod	
	04/03→	Tie Rod End	CV-ES-0543	for Push Rod	
	04/03→	Tie Rod End	CV-ES-0888	for Push Rod	
	04/03→	Tie Rod End	CV-ES-14162	for Steering Rod	
	04/03→	Tie Rod End	CV-ES-14163	for Steering Rod	
	04/03→	Tie Rod End	DB-ES-5234	for Steering Rod	
	04/03→	Tie Rod End	DB-ES-8164	for Push Rod	
	04/03→	Tie Rod End	DB-ES-8530	for Push Rod	
	04/03→	Track Control Arm		DB-VB-7261 Suspension Rod, Wishbone (CV), 1st RA, →517142 01/517142 02	
	04/03→	Track Control Arm		DB-VB-7798 Wishbone (CV)	
	04/03→	Track Control Arm		DB-VB-9307 Suspension Rod, Wishbone (CV), 1st Drive Axle, →517142 07	
	04/03→	Track Control Arm		DB-VB-9308 Suspension Rod, Wishbone (CV), 1st Drive Axle, →517142 06	
	04/03→	Track Control Arm		DB-VB-10426 Wishbone (CV), 1st RA, →517142 05	
	2036	04/03→	Ball Head, gearshift linkage	DB-ES-8510	
		04/03→	Bush, driver cab suspension	DB-SB-10384	
		04/03→	Centre Rod	DB-DL-2144	Push Rod
		04/03→	Centre Rod	DB-DL-5230	Suspension Rod
04/03→		Centre Rod	DB-DL-5241	Push Rod	
04/03→		Centre Rod	DB-DL-5405	Push Rod, Leaf Spring Axle	
04/03→		Centre Rod	DB-DL-7270	Push Rod;Suspension Rod	
04/03→		Centre Rod	DB-DL-8167	Push Rod	
04/03→		Centre Rod	DB-DL-8168	Push Rod	
04/03→		Centre Rod	DB-DL-8184	Push Rod	
04/03→		Centre Rod	DB-DL-8185	Push Rod	
04/03→		Centre Rod	DB-DL-8307	Push Rod	
04/03→		Centre Rod	DB-DL-8622	Push Rod	
04/03→		Centre Rod	DB-DL-8641	Push Rod	
04/03→		Centre Rod	DB-DL-8642	Push Rod	
04/03→		Centre Rod	DB-DL-8702	Push Rod, Leaf Spring Axle	
04/03→		Centre Rod	DB-DL-12300	for Steering Rod	
04/03→		Rod Assembly	DB-DL-2178	Guide Rod, 1st Front Axle, →504310 03	
04/03→		Stabiliser Link	DB-DL-9254	Pressure Rod	



ACTROS MP2 / MP3 ...

2036 ...	04/03→	Stabiliser Mounting		DB-SB-10406		
	04/03→	Stabiliser Mounting		DB-SB-10409		
	04/03→	Stabiliser Mounting	DB-SB-10410			
	04/03→	Suspension Arm Repair Kit		DB-RK-8550	for Wishbone (CV)	
	04/03→	Suspension Arm Repair Kit		DB-RK-8626	for Wishbone (CV)	
	04/03→	Suspension Arm Repair Kit		DB-RK-10374	for Wishbone (CV)	
	04/03→	Suspension Arm Repair Kit		DB-RK-10375	for Wishbone (CV)	
	04/03→	Suspension Arm Repair Kit	DB-RK-8638		for Control Arm	
	04/03→	Suspension Strut Repair Kit		DB-RK-8391		
	04/03→	Tie Rod	DB-DL-8171		Guide Rod, 1st FA;Leaf Spring Axle	
	04/03→	Tie Rod	DB-DL-8327		Guide Rod, 1st FA;Leaf Spring Axle	
	04/03→	Tie Rod	DB-DL-8640		Guide Rod	
	04/03→	Tie Rod	DB-DL-12310			
	04/03→	Tie Rod	DB-ES-5227		Guide Rod	
	04/03→	Tie Rod End	CV-ES-0543		for Push Rod	
	04/03→	Tie Rod End	CV-ES-0888		for Push Rod	
	04/03→	Tie Rod End	CV-ES-14163		for Steering Rod	
	04/03→	Tie Rod End	DB-ES-5234		for Steering Rod	
	04/03→	Tie Rod End	DB-ES-8164		for Push Rod	
	04/03→	Tie Rod End	DB-ES-8530		for Push Rod	
	04/03→	Track Control Arm		DB-VB-7261	Suspension Rod, Wishbone (CV), 1st RA, →517142 01/517142 02	
	04/03→	Track Control Arm		DB-VB-9307	Suspension Rod, Wishbone (CV), 1st Drive Axle, →517142 07	
	04/03→	Track Control Arm		DB-VB-9308	Suspension Rod, Wishbone (CV), 1st Drive Axle, →517142 06	
	04/03→	Track Control Arm		DB-VB-10426	Wishbone (CV), 1st RA, →517142 05	
	2036 A, AE	04/03→	Ball Head, gearshift linkage	DB-ES-8510		
		04/03→	Bush, driver cab suspension	DB-SB-10384		
		04/03→	Centre Rod	DB-DL-8168		Push Rod
04/03→		Centre Rod	DB-DL-8184		Push Rod	
04/03→		Centre Rod	DB-DL-8307		Push Rod	
04/03→		Centre Rod	DB-DL-8622		Push Rod	
04/03→		Centre Rod	DB-DL-8641		Push Rod	
04/03→		Centre Rod	DB-DL-8642		Push Rod	
04/03→		Centre Rod	DB-DL-8702		Push Rod, Leaf Spring Axle	
04/03→		Centre Rod	DB-DL-12300		for Steering Rod	
04/03→		Stabiliser Link	DB-DL-9254		Pressure Rod	
04/03→		Stabiliser Mounting		DB-SB-10406		
04/03→		Stabiliser Mounting		DB-SB-10409		
04/03→		Stabiliser Mounting	DB-SB-10410			
04/03→		Suspension Arm Repair Kit		DB-RK-8550	for Wishbone (CV)	
04/03→		Suspension Arm Repair Kit		DB-RK-8626	for Wishbone (CV)	
04/03→		Suspension Arm Repair Kit		DB-RK-10374	for Wishbone (CV)	
04/03→		Suspension Arm Repair Kit		DB-RK-10375	for Wishbone (CV)	
04/03→		Suspension Arm Repair Kit	DB-RK-8638		for Control Arm	
04/03→		Suspension Strut Repair Kit		DB-RK-8391		
04/03→		Tie Rod	DB-DL-12310			
04/03→		Tie Rod	DB-ES-5227		Guide Rod, 1st FA;Leaf Spring Axle	
04/03→		Tie Rod	MN-DL-7834		Guide Rod, 1st FA;Leaf Spring Axle	
04/03→		Tie Rod End	CV-ES-0543		for Push Rod	
04/03→		Tie Rod End	CV-ES-14163		for Steering Rod	
04/03→		Tie Rod End	DB-ES-5234		for Steering Rod	
04/03→		Tie Rod End	DB-ES-8530		for Push Rod	
04/03→		Track Control Arm		DB-VB-7261	Suspension Rod, Wishbone (CV), 1st RA, →517142 01/517142 02	
04/03→		Track Control Arm		DB-VB-9307	Suspension Rod, Wishbone (CV), 1st Drive Axle, →517142 07	
04/03→		Track Control Arm		DB-VB-9308	Suspension Rod, Wishbone (CV), 1st Drive Axle, →517142 06	
04/03→		Track Control Arm		DB-VB-10426	Wishbone (CV), 1st RA, →517142 05	

CV-ES-0543

Length: 125
 Cone Ø: d1 Ø 32 / d2 Ø 29
 Thread: M30 x 1,5 RHT
 0004605748, 0004606048, 0004606848,
 0004607048, 0014600448, 0014601148,
 0014601748, 0014602448, 0014607648,
 0014609648



CV-ES-0888

Length: 125
 Cone Ø: d1 Ø 32 / d2 Ø 29
 Thread: M30 x 1,5 RHT
 0004605848, 0004606148, 0004606948,
 0004607148, 0004609048, 0014600548,
 0014601348, 0014602548, 0014607948,
 0024600448



CV-ES-14163

Length: 125
 Cone Ø: d1 Ø 30 / d2 Ø 27
 Thread: M30 x 1,5 RHT
 0003305248, 0003387310, 0004600348,
 0004600948, 0004602848, 0004602948,
 0004608948, 0014600248, 0014600848,
 0014601248, 0014602248, 0014607748,
 0024600148, A0003387310, A0004600348,
 A0004602848, A0004602948, A0014600848,
 A0014601248, A0014602248, A0014607748



DB-DL-8168

Length: 904 Ø: 52
 Cone Ø: d1 Ø 32 / d2 Ø 29
 0004609405, 0004609505, 0014607105



DB-DL-8171

Length: 1687 Ø: 52
 Cone Ø: d1 Ø 32 / d2 Ø 29
 9493300603, 9493300703, 9493301503,
 9493301603



DB-DL-8184

Length: 1095 Ø: 42
 Cone Ø: d1 Ø 32 / d2 Ø 28,8
 01217700A, 0014601305, 0014601405,
 0024600505, 0034603205, 3754601505,
 A0014601305, A0014601405, A0024600505



DB-DL-8307

Length: 885 Ø: 38
 Cone Ø: d1 Ø 32 / d2 Ø 30
 01215500A, 0004604005, 0024605105,
 0024605205, 0034604005



DB-DL-8327

Length: 1745 Ø: 48
 Cone Ø: d1 Ø 32 / d2 Ø 29
 01219800A, 9413300003, 9413300103,
 9413300203, 9413300303, 9413300503



DB-DL-8622

Length: 1558 Ø: 52
 Cone Ø: d1 Ø 30 / d2 Ø 27
 0014609005, 0014609105



DB-DL-8640

Length: 1615 Ø: 50
 Cone Ø: d1 Ø 32 / d2 Ø 29
 6253301503, 6253301603, 6253302403,
 6253302503, 9423300803, 9423302103,
 9493300203, 9493300303, 9493300903



DB-DL-8641

Length: 905 Ø: 42
 Cone Ø: d1 Ø 30 / d2 Ø 27
 0014605105, 0014608105



DB-DL-8642

Length: 954 Ø: 42
 Cone Ø: d1 Ø 30 / d2 Ø 27
 0014608605, 0014608705



DB-DL-8702

Length: 958 Ø: 38
 Cone Ø: d1 Ø 32 / d2 Ø 30
 0024606105, 0024606205, 0034604205



DB-DL-9254

Length: 1815 Ø: 58
 0003220323, 0003220623, 3753220423



DB-DL-12300

Length: 733 Ø: 36
 Cone Ø: d1 Ø 32 / d2 Ø 29
 0014601505, 0014607305, 0034603305,
 3754601605, A0014601505,
 A0034603305, A3754601605



DB-DL-12310

Length: 1532 Ø: 50
 Cone Ø: d1 Ø 32 / d2 Ø 29
 Thread: M27 x 1,5 LHT
 9493301203, 9493301303, 9493301803,
 9493302203, A9493301203, A9493301303,
 A9493301803, A9493302203



DB-ES-5227

Length: 1588 Ø: 60
 Cone Ø: d1 Ø 38 / d2 Ø 34,3
 6253300903, 6253301203, 9443300203



DB-ES-5234

Length: 135
 Cone Ø: d1 Ø 38 / d2 Ø 34,3
 Thread: M38 x 1,5 RHT
 0004601748, 120322305, 2205000400



DB-ES-8164

Length: 140
 Cone Ø: d1 Ø 28,6 / d2 Ø 23,9
 Thread: M28 x 1,5 RHT
 0014604248, 0014605048, 0014608548,
 0024600548



DB-ES-8510

Length: 56
 Cone Ø: d1 Ø 10 / d2 Ø 10
 Thread: M12 x 1,75 LHT
 0009965145, 0009965645, 0019963145



DB-ES-8530

Length: 115
 Cone Ø: d1 Ø 28,6 / d2 Ø 23,9
 Thread: M30 x 1,5 RHT
 0014603848, 0014604848, 0014605148,
 0014608648, 0014609948



DB-RK-8391

Ø: 85 Hole Distance: 152
 Thick/Height: 24
 01336800A, 0003502705



DB-RK-8550

Ø: 75 Hole Distance: 152
 Thick/Height: 24
 0003502105, 0003504605



DB-RK-8626

Ø: 75 Hole Distance: 130
 Thick/Height: 24
 0003502205, 0003502505, 0003503405,
 0003504505, GL11319



DB-RK-8638

Length: 100 Ø: 67
 Hole Distance: 100
 Thick/Height: 20
 0003301411



DB-RK-10374

Ø: 85 Hole Distance: 152
 Thick/Height: 24
 0003504405



DB-RK-10375

Ø: 100 Hole Distance: 152
 Thick/Height: 24
 0003502405, 0003503505, 0003504905



DB-SB-10384

Ø: 73 Thick/Height: 47
 9303170012, 9423171812



DB-SB-10406

Ø: 80 Thick/Height: 46
 0003238185



DB-SB-10409

Ø: 77 Thick/Height: 56
 0003265181



DB-SB-10410

Ø: 73 Hole Distance: 100
 Thick/Height: 24
 9413230050



DB-VB-7261

Length: 622 Ø: 46
 Hole Ø 25 / 25 / 25
 Hole Distance: 152 / 130 / 130
 01337800A, 9443500305, 9443500505,
 9443500605, 9473500705, 9473500905,
 9483500405, 9483503005



DB-VB-9307

Length: 667 Ø: 60
 Hole Ø 25 / 23 / 23
 Hole Distance: 152 / 130 / 130
 9483502805



DB-VB-9308

Length: 622 Ø: 46
 Hole Ø 25 / 25 / 25
 Hole Distance: 152 / 130 / 130
 9483502905



DB-VB-10426

Length: 622 Ø: 46
 Hole Ø 25 / 25 / 25
 Hole Distance: 152 / 130 / 130
 9443500405





ACTROS MP2 / MP3 ...

2036 AK	04/03→	Ball Head, gearshift linkage	DB-ES-8510			
	04/03→	Bush, driver cab suspension	DB-SB-10384			
	04/03→	Centre Rod	DB-DL-8184		Push Rod	
	04/03→	Centre Rod	DB-DL-8307		Push Rod, Leaf Spring Axle	
	04/03→	Centre Rod	DB-DL-8702		Push Rod, Leaf Spring Axle	
	04/03→	Centre Rod	DB-DL-12300		for Steering Rod	
	04/03→	Stabiliser Mounting		DB-SB-10406		
	04/03→	Stabiliser Mounting		DB-SB-10409		
	04/03→	Suspension Arm Repair Kit		DB-RK-8626	for Wishbone (CV)	
	04/03→	Suspension Arm Repair Kit		DB-RK-10374	for Wishbone (CV)	
	04/03→	Suspension Arm Repair Kit		DB-RK-10375	for Wishbone (CV)	
	04/03→	Suspension Arm Repair Kit	DB-RK-8638		for Control Arm	
	04/03→	Suspension Strut Repair Kit		DB-RK-8391		
	04/03→	Tie Rod	DB-DL-12310			
	04/03→	Tie Rod	DB-ES-5227		Guide Rod, 1st FA;Leaf Spring Axle	
	04/03→	Tie Rod	MN-DL-7834		Guide Rod, 1st FA;Leaf Spring Axle	
	04/03→	Tie Rod End	CV-ES-0543		for Push Rod	
	04/03→	Tie Rod End	CV-ES-14163		for Steering Rod	
	04/03→	Tie Rod End	DB-ES-5234		for Steering Rod	
	04/03→	Tie Rod End	DB-ES-8530		for Push Rod	
	04/03→	Track Control Arm		DB-VB-7261	Suspension Rod, Wishbone (CV), 1st RA, →517142 01/517142 02	
	04/03→	Track Control Arm		DB-VB-9307	Suspension Rod, Wishbone (CV), 1st Drive Axle, →517142 07	
	04/03→	Track Control Arm		DB-VB-9308	Suspension Rod, Wishbone (CV), 1st Drive Axle, →517142 06	
	04/03→	Track Control Arm		DB-VB-10426	Wishbone (CV), 1st RA, →517142 05	
	2036 AS	04/03→	Ball Head, gearshift linkage	DB-ES-8510		
		04/03→	Bush, driver cab suspension	DB-SB-10384		
04/03→		Centre Rod	DB-DL-8307		Push Rod, Leaf Spring Axle	
04/03→		Centre Rod	DB-DL-8702		Push Rod	
04/03→		Centre Rod	DB-DL-12300		for Steering Rod	
04/03→		Stabiliser Mounting		DB-SB-10406		
04/03→		Stabiliser Mounting		DB-SB-10409		
04/03→		Stabiliser Mounting	DB-SB-10410			
04/03→		Suspension Arm Repair Kit		DB-RK-8626	for Wishbone (CV)	
04/03→		Suspension Arm Repair Kit		DB-RK-10374	for Wishbone (CV)	
04/03→		Suspension Arm Repair Kit		DB-RK-10375	for Wishbone (CV)	
04/03→		Suspension Arm Repair Kit	DB-RK-8638		for Control Arm	
04/03→		Suspension Strut Repair Kit		DB-RK-8391		
04/03→		Suspension Strut Repair Kit		MN-RK-8997		
04/03→		Tie Rod	DB-DL-12310			
04/03→		Tie Rod	DB-ES-5227		Guide Rod	
04/03→		Tie Rod	MN-DL-7834		Guide Rod	
04/03→		Tie Rod End	CV-ES-14163		for Steering Rod	
04/03→		Tie Rod End	DB-ES-5234		for Steering Rod	
04/03→		Tie Rod End	DB-ES-8530		for Push Rod	
04/03→		Track Control Arm		DB-VB-7261	Suspension Rod, Wishbone (CV), 1st RA, →517142 01/517142 02	
04/03→		Track Control Arm		DB-VB-7798	Wishbone (CV)	
04/03→		Track Control Arm		DB-VB-9307	Suspension Rod, Wishbone (CV), 1st Drive Axle, →517142 07	
04/03→		Track Control Arm		DB-VB-9308	Suspension Rod, Wishbone (CV), 1st Drive Axle, →517142 06	
04/03→		Track Control Arm		DB-VB-10426	Wishbone (CV), 1st RA, →517142 05	
2036 K		04/03→	Centre Rod	DB-DL-2144		Push Rod
	04/03→	Centre Rod	DB-DL-5405		Push Rod, Leaf Spring Axle	
	04/03→	Centre Rod	DB-DL-7270		Push Rod	
	04/03→	Centre Rod	DB-DL-8167		Push Rod	
	04/03→	Centre Rod	DB-DL-8307		Push Rod	
	04/03→	Centre Rod	DB-DL-8702		Push Rod, Leaf Spring Axle	
	04/03→	Rod Assembly	DB-DL-2178		Guide Rod, 1st Front Axle, →504310 03	
	04/03→	Stabiliser Mounting		DB-SB-10406		

CV-ES-0543

Length: 125
Cone Ø: d1 Ø 32 / d2 Ø 29
Thread: M30 x 1,5 RHT
 0004605748, 0004606048, 0004606848,
 0004607048, 0014600448, 0014601148,
 0014601748, 0014602448, 0014607648,
 0014609648



CV-ES-14163

Length: 125
Cone Ø: d1 Ø 30 / d2 Ø 27
Thread: M30 x 1,5 RHT
 0003305248, 0003387310, 0004600348,
 0004600948, 0004602848, 0004602948,
 0004608948, 0014600248, 0014600848,
 0014601248, 0014602248, 0014607748,
 0024600148, A0003387310, A0004600348,
 A0004602848, A0004602948, A0014600848,
 A0014601248, A0014602248, A0014607748



DB-DL-2144

Length: 872 Ø: 35
Cone Ø: d1 Ø 28,6 / d2 Ø 23,9
 0024604305, 0024604405, 0034604805



DB-DL-2178

Length: 1735 Ø: 52
Cone Ø: d1 Ø 32 / d2 Ø 29
 9423300003, 9423300103, 9423300203



DB-DL-5405

Length: 890 Ø: 35
Cone Ø: d1 Ø 28,6 / d2 Ø 23,9
 01215900A, 1460248, 0024604505,
 0024604605, 0034605005, 3752600637,
 3754600405, A3752600637, A3754600405



DB-DL-7270

Length: 875 Ø: 40
Cone Ø: d1 Ø 28,6 / d2 Ø 23,9
 01208300A, 0024604705, 0024604805,
 0034604905, A0024604705



DB-DL-8167

Length: 866 Ø: 38
Cone Ø: d1 Ø 30 / d2 Ø 27
 0014609805, 0014609905, 0024606305,
 0024606405



DB-DL-8184

Length: 1095 Ø: 42
Cone Ø: d1 Ø 32 / d2 Ø 28,8
 01217700A, 0014601305, 0014601405,
 0024600505, 0034603205, 3754601505,
 A0014601305, A0014601405, A0024600505



DB-DL-8307

Length: 885 Ø: 38
Cone Ø: d1 Ø 32 / d2 Ø 30
 01215500A, 0004604005, 0024605105,
 0024605205, 0034604005



DB-DL-8702

Length: 958 Ø: 38
Cone Ø: d1 Ø 32 / d2 Ø 30
 0024606105, 0024606205, 0034604205



DB-DL-12300

Length: 733 Ø: 36
Cone Ø: d1 Ø 32 / d2 Ø 29
 0014601505, 0014607305, 0034603305,
 3754601605, A0014601505,
 A0034603305, A3754601605



DB-DL-12310

Length: 1532 Ø: 50
Cone Ø: d1 Ø 32 / d2 Ø 29
Thread: M27 x 1,5 LHT
 9493301203, 9493301303, 9493301803,
 9493302203, A9493301203, A9493301303,
 A9493301803, A9493302203



DB-ES-5227

Length: 1588 Ø: 60
Cone Ø: d1 Ø 38 / d2 Ø 34,3
 6253300903, 6253301203, 9443300203



DB-ES-5234

Length: 135
Cone Ø: d1 Ø 38 / d2 Ø 34,3
Thread: M38 x 1,5 RHT
 0004601748, 120322305, 2205000400



DB-ES-8510

Length: 56
Cone Ø: d1 Ø 10 / d2 Ø 10
Thread: M12 x 1,75 LHT
 0009965145, 0009965645, 0019963145



DB-ES-8530

Length: 115
Cone Ø: d1 Ø 28,6 / d2 Ø 23,9
Thread: M30 x 1,5 RHT
 0014603848, 0014604848, 0014605148,
 0014608648, 0014609948



DB-RK-8391

Ø: 85 Hole Distance: 152
Thick/Height: 24
 01336800A, 0003502705



DB-RK-8626

Ø: 75 Hole Distance: 130
Thick/Height: 24
 0003502205, 0003502505, 0003503405,
 0003504505, GL11319



DB-RK-8638

Length: 100 Ø: 67
Hole Distance: 100
Thick/Height: 20
 0003301411



DB-RK-10374

Ø: 85 Hole Distance: 152
Thick/Height: 24
 0003504405



DB-RK-10375

Ø: 100 Hole Distance: 152
Thick/Height: 24
 0003502405, 0003503505, 0003504905



DB-SB-10384

Ø: 73 **Thick/Height:** 47
 9303170012, 9423171812



DB-SB-10406

Ø: 80 **Thick/Height:** 46
 0003238185



DB-SB-10409

Ø: 77 **Thick/Height:** 56
 0003265181



DB-SB-10410

Ø: 73 Hole Distance: 100
Thick/Height: 24
 9413230050



DB-VB-7261

Length: 622 Ø: 46
Hole Ø: 25 / 25 / 25
Hole Distance: 152 / 130 / 130
 01337800A, 9443500305, 9443500505,
 9443500605, 9473500705, 9473500905,
 9483500405, 9483500305



DB-VB-7798

Length: 622 Ø: 48
Hole Ø: 25 / 23 / 23
Hole Distance: 152 / 130 / 130
 9423500505, 9423500805, 9423501205,
 A9423501205



DB-VB-9307

Length: 667 Ø: 60
Hole Ø: 25 / 23 / 23
Hole Distance: 152 / 130 / 130
 9483502805



DB-VB-9308

Length: 622 Ø: 46
Hole Ø: 25 / 25 / 25
Hole Distance: 152 / 130 / 130
 9483502905



DB-VB-10426

Length: 622 Ø: 46
Hole Ø: 25 / 25 / 25
Hole Distance: 152 / 130 / 130
 9443500405



MN-DL-7834

Length: 1588 Ø: 58
Cone Ø: d1 Ø 30 / d2 Ø 27
 3463303903, 3463304903, 6253303203,
 9443300503, 9443301303, 9443301703



MN-RK-8997

Ø: 85 Hole Distance: 130
Thick/Height: 30
 0003504805





ACTROS MP2 / MP3 ...

2036 K ...	04/03→	Suspension Arm Repair Kit		DB-RK-8626	for Wishbone (CV)	
	04/03→	Suspension Arm Repair Kit		DB-RK-10374	for Wishbone (CV)	
	04/03→	Suspension Arm Repair Kit		DB-RK-10375	for Wishbone (CV)	
	04/03→	Suspension Strut Repair Kit		DB-RK-8710		
	04/03→	Suspension Strut Repair Kit		DB-RK-9291		
	04/03→	Tie Rod	DB-DL-8171		Guide Rod, 1st FA;Leaf Spring Axle	
	04/03→	Tie Rod	DB-DL-8327		Guide Rod, 1st FA;Leaf Spring Axle	
	04/03→	Tie Rod	DB-DL-8640		Guide Rod	
	04/03→	Tie Rod	DB-DL-12310			
	04/03→	Tie Rod	DB-ES-5227		Guide Rod	
	04/03→	Tie Rod End	CV-ES-0543		for Push Rod	
	04/03→	Tie Rod End	CV-ES-0888		for Push Rod	
	04/03→	Track Control Arm		DB-VB-7261	Suspension Rod, Wishbone (CV), 1st RA, →517142 01/517142 02	
	04/03→	Track Control Arm		DB-VB-7776	Wishbone (CV)	
	04/03→	Track Control Arm		DB-VB-9307	Suspension Rod, Wishbone (CV)	
	04/03→	Track Control Arm		DB-VB-9308	Suspension Rod, Wishbone (CV)	
	04/03→	Track Control Arm		DB-VB-10426	Wishbone (CV), 1st RA, →517142 05	
	2036 S	04/03→	Ball Head, gearshift linkage	DB-ES-8510		
		04/03→	Bush, driver cab suspension	DB-SB-10384		
		04/03→	Centre Rod	DB-DL-2144		Push Rod
04/03→		Centre Rod	DB-DL-5230		Suspension Rod	
04/03→		Centre Rod	DB-DL-5241		Push Rod	
04/03→		Centre Rod	DB-DL-5405		Push Rod, Leaf Spring Axle	
04/03→		Centre Rod	DB-DL-7270		Push Rod;Suspension Rod	
04/03→		Centre Rod	DB-DL-8167		Push Rod	
04/03→		Centre Rod	DB-DL-8184		Push Rod	
04/03→		Centre Rod	DB-DL-8185		Push Rod	
04/03→		Centre Rod	DB-DL-8307		Push Rod	
04/03→		Centre Rod	DB-DL-8702		Push Rod, Leaf Spring Axle	
04/03→		Centre Rod	DB-DL-12300		for Steering Rod	
04/03→		Rod Assembly	DB-DL-2178		Guide Rod, 1st Front Axle, →504310 03	
04/03→		Stabiliser Mounting		DB-SB-10406		
04/03→		Stabiliser Mounting		DB-SB-10409		
04/03→		Stabiliser Mounting	DB-SB-10410			
04/03→		Suspension Arm Repair Kit		DB-RK-8550	for Wishbone (CV)	
04/03→		Suspension Arm Repair Kit		DB-RK-8626	for Wishbone (CV)	
04/03→		Suspension Arm Repair Kit		DB-RK-10374	for Wishbone (CV)	
04/03→		Suspension Arm Repair Kit		DB-RK-10375	for Wishbone (CV)	
04/03→		Suspension Arm Repair Kit	DB-RK-8638		for Control Arm	
04/03→		Suspension Strut Repair Kit		DB-RK-8391		
04/03→		Suspension Strut Repair Kit		MN-RK-8997		
04/03→		Tie Rod	DB-DL-8171		Guide Rod	
04/03→		Tie Rod	DB-DL-8327		Guide Rod	
04/03→		Tie Rod	DB-DL-8640		Guide Rod	
04/03→		Tie Rod	DB-DL-12310			
04/03→		Tie Rod	DB-ES-5227		Guide Rod	
04/03→		Tie Rod End	CV-ES-0543		for Push Rod	
04/03→		Tie Rod End	CV-ES-0888		for Push Rod	
04/03→		Tie Rod End	CV-ES-14163		for Steering Rod	
04/03→		Tie Rod End	DB-ES-5234		for Steering Rod	
04/03→		Tie Rod End	DB-ES-8164		for Push Rod	
04/03→		Tie Rod End	DB-ES-8530		for Push Rod	
04/03→		Track Control Arm		DB-VB-7261	Suspension Rod, Wishbone (CV), 1st RA, →517142 01/517142 02	
04/03→		Track Control Arm		DB-VB-7798	Wishbone (CV)	
04/03→		Track Control Arm		DB-VB-9307	Suspension Rod, Wishbone (CV), 1st Drive Axle, →517142 07	
04/03→		Track Control Arm		DB-VB-9308	Suspension Rod, Wishbone (CV), 1st Drive Axle, →517142 06	
04/03→		Track Control Arm		DB-VB-10426	Wishbone (CV), 1st RA, →517142 05	

CV-ES-0543

Length: 125
Cone Ø: d1 Ø 32 / d2 Ø 29
Thread: M30 x 1,5 RHT
0004605748, 0004606048, 0004606848,
0004607048, 0014600448, 0014601148,
0014601748, 0014602448, 0014607648,
0014609648



CV-ES-0888

Length: 125
Cone Ø: d1 Ø 32 / d2 Ø 29
Thread: M30 x 1,5 LHT
0004605848, 0004606148, 0004606948,
0004607148, 0004609048, 0014600548,
0014601348, 0014602548, 0014607948,
0024600448



CV-ES-14163

Length: 125
Cone Ø: d1 Ø 30 / d2 Ø 27
Thread: M30 x 1,5 RHT
0003305248, 0003387310, 0004600348,
0004600948, 0004602848, 0004602948,
0004608948, 0014600248, 0014600848,
0014601248, 0014602248, 0014607748,
0024600148, A0003387310, A0004600348,
A0004602848, A0004602948, A0014600848,
A0014601248, A0014602248, A0014607748



DB-DL-2144

Length: 872 Ø: 35
Cone Ø: d1 Ø 28,6 / d2 Ø 23,9
0024604305, 0024604405, 0034604805



DB-DL-2178

Length: 1735 Ø: 52
Cone Ø: d1 Ø 32 / d2 Ø 29
9423300003, 9423300103, 9423300203



DB-DL-5230

Length: 879 Ø: 42
Cone Ø: d1 Ø 30 / d2 Ø 27
01208600A, 0004607105, 0004607205,
0014606705



DB-DL-5241

Length: 875 Ø: 40
Cone Ø: d1 Ø 30 / d2 Ø 27
01215300A, 0004609205, 0004609305,
0014606905



DB-DL-5405

Length: 890 Ø: 35
Cone Ø: d1 Ø 28,6 / d2 Ø 23,9
01215900A, 1460248, 0024604505,
0024604605, 0034605005, 3752600637,
3754600405, A3752600637, A3754600405



DB-DL-7270

Length: 875 Ø: 40
Cone Ø: d1 Ø 28,6 / d2 Ø 23,9
01208300A, 0024604705, 0024604805,
0034604905, A0024604705



DB-DL-8167

Length: 866 Ø: 38
Cone Ø: d1 Ø 30 / d2 Ø 27
0014609805, 0014609905, 0024606305,
0024606405



DB-DL-8171

Length: 1687 Ø: 52
Cone Ø: d1 Ø 32 / d2 Ø 29
9493300603, 9493300703, 9493301503,
9493301603



DB-DL-8184

Length: 1095 Ø: 42
Cone Ø: d1 Ø 32 / d2 Ø 28,8
01217700A, 0014601305, 0014601405,
0024600505, 0034603205, 3754601505,
A0014601305, A0014601405, A0024600505



DB-DL-8185

Length: 711 Ø: 42
Cone Ø: d1 Ø 32 / d2 Ø 28,8
01213600A, 0014601105, 0024600405,
0034603105, A0014601105, A0024600405



DB-DL-8307

Length: 885 Ø: 38
Cone Ø: d1 Ø 32 / d2 Ø 30
01215500A, 0004604005, 0024605105,
0024605205, 0034604005



DB-DL-8327

Length: 1745 Ø: 48
Cone Ø: d1 Ø 32 / d2 Ø 29
01219800A, 9413300003, 9413300103,
9413300203, 9413300303, 9413300503



DB-DL-8640

Length: 1615 Ø: 50
Cone Ø: d1 Ø 32 / d2 Ø 29
6253301503, 6253301603, 6253302403,
6253302503, 9423300803, 9423302103,
9493300203, 9493300303, 9493300903



DB-DL-8702

Length: 958 Ø: 38
Cone Ø: d1 Ø 32 / d2 Ø 30
0024606105, 0024606205, 0034604205



DB-DL-12300

Length: 733 Ø: 36
Cone Ø: d1 Ø 32 / d2 Ø 29
0014601505, 0014607305, 0034603305,
3754601605, A0014601505,
A0034603305, A3754601605



DB-DL-12310

Length: 1532 Ø: 50
Cone Ø: d1 Ø 32 / d2 Ø 29
Thread: M27 x 1,5 LHT
9493301203, 9493301303, 9493301803,
9493302203, A9493301203, A9493301303,
A9493301803, A9493302203



DB-ES-5227

Length: 1588 Ø: 60
Cone Ø: d1 Ø 38 / d2 Ø 34,3
6253300903, 6253301203, 9443300203



DB-ES-5234

Length: 135
Cone Ø: d1 Ø 38 / d2 Ø 34,3
Thread: M38 x 1,5 RHT
0004601748, 120322305, 2205000400



DB-ES-8164

Length: 140
Cone Ø: d1 Ø 28,6 / d2 Ø 23,9
Thread: M28 x 1,5 RHT
0014604248, 0014605048, 0014608548,
0024600548



DB-ES-8510

Length: 56
Cone Ø: d1 Ø 10 / d2 Ø 10
Thread: M12 x 1,75 LHT
0009965145, 0009965645, 0019963145



DB-ES-8530

Length: 115
Cone Ø: d1 Ø 28,6 / d2 Ø 23,9
Thread: M30 x 1,5 RHT
0014603848, 0014604848, 0014605148,
0014608648, 0014609948



DB-RK-8391

Ø: 85 Hole Distance: 152
Thick/Height: 24
01336800A, 0003502705



DB-RK-8550

Ø: 75 Hole Distance: 152
Thick/Height: 24
0003502105, 0003504605



DB-RK-8626

Ø: 75 Hole Distance: 130
Thick/Height: 24
0003502205, 0003502505, 0003503405,
0003504505, GL11319



DB-RK-8638

Length: 100 Ø: 67
Hole Distance: 100
Thick/Height: 20
0003301411



DB-RK-8710

Ø: 85 Hole Distance: 130
Thick/Height: 30
0003503705



DB-RK-9291

Ø: 107,5 Hole Distance: 152
Thick/Height: 30
0003503605



DB-RK-10374

Ø: 85 Hole Distance: 152
Thick/Height: 24
0003504405



DB-RK-10375

Ø: 100 Hole Distance: 152
Thick/Height: 24
0003502405, 0003503505, 0003504905



DB-SB-10384

Ø: 73 Thick/Height: 47
9303170012, 9423171812



DB-SB-10406

Ø: 80 Thick/Height: 46
0003238185



DB-SB-10409

Ø: 77 Thick/Height: 56
0003265181



DB-SB-10410

Ø: 73 Hole Distance: 100
Thick/Height: 24
9413230050



DB-VB-7261

Length: 622 Ø: 46
Hole Ø 25 / 25 / 25
Hole Distance: 152 / 130 / 130
01337800A, 9443500305, 9443500505,
9443500605, 9473500705, 9473500905,
9483500405, 9483503005



DB-VB-7776

Length: 622 Ø: 56
Hole Distance: 152 / 152
6533500205, 6583500205



DB-VB-7798

Length: 622 Ø: 48
Hole Ø 25 / 23 / 23
Hole Distance: 152 / 130 / 130
9423500505, 9423500805, 9423501205,
A9423501205



DB-VB-9307

Length: 667 Ø: 60
Hole Ø 25 / 23 / 23
Hole Distance: 152 / 130 / 130
9483502805



DB-VB-9308

Length: 622 Ø: 46
Hole Ø 25 / 25 / 25
Hole Distance: 152 / 130 / 130
9483502905



DB-VB-10426

Length: 622 Ø: 46
Hole Ø 25 / 25 / 25
Hole Distance: 152 / 130 / 130
9443500405



MN-RK-8997

Ø: 85 Hole Distance: 130
Thick/Height: 30
0003504805





ACTROS MP2 / MP3 ...

2040	10/02→	Centre Rod	DB-DL-2144		Push Rod
	10/02→	Centre Rod	DB-DL-5405		Push Rod, Leaf Spring Axle
	10/02→	Centre Rod	DB-DL-8167		Push Rod, Leaf Spring Axle
	10/02→	Centre Rod	DB-DL-8307		Push Rod
	10/02→	Centre Rod	DB-DL-8702		Push Rod
	10/02→	Rod Assembly	DB-DL-2178		Guide Rod, 1st Front Axle, →504310 03
	10/02→	Suspension Arm Repair Kit		DB-RK-8626	for Wishbone (CV)
	10/02→	Suspension Arm Repair Kit		DB-RK-10374	for Wishbone (CV)
	10/02→	Suspension Arm Repair Kit		DB-RK-10375	for Wishbone (CV)
	10/02→	Suspension Strut Repair Kit		DB-RK-8710	
	10/02→	Suspension Strut Repair Kit		DB-RK-9291	
	10/02→	Tie Rod	DB-DL-8171		Guide Rod
	10/02→	Tie Rod	DB-DL-8327		Guide Rod
	10/02→	Tie Rod	DB-DL-8640		Guide Rod
	10/02→	Tie Rod	DB-DL-12310		
	10/02→	Tie Rod End	CV-ES-0543		for Push Rod
	10/02→	Tie Rod End	CV-ES-0888		for Push Rod
	10/02→	Tie Rod End	CV-ES-14163		for Steering Rod
	10/02→	Tie Rod End	DB-ES-8164		for Push Rod
	10/02→	Track Control Arm		DB-VB-7261	Suspension Rod, Wishbone (CV), 1st RA, →517142 01/517142 02
	10/02→	Track Control Arm		DB-VB-7776	Wishbone (CV)
	10/02→	Track Control Arm		DB-VB-9307	Suspension Rod, Wishbone (CV)
	10/02→	Track Control Arm		DB-VB-9308	Suspension Rod, Wishbone (CV)
	10/02→	Track Control Arm		DB-VB-10426	Wishbone (CV), 1st RA, →517142 05
2041	04/03→	Ball Head, gearshift linkage	DB-ES-8510		
	04/03→	Bush, driver cab suspension	DB-SB-10384		
	04/03→	Centre Rod	DB-DL-2144		Push Rod
	04/03→	Centre Rod	DB-DL-5230		Suspension Rod
	04/03→	Centre Rod	DB-DL-5241		Push Rod
	04/03→	Centre Rod	DB-DL-5405		Push Rod, Leaf Spring Axle
	04/03→	Centre Rod	DB-DL-7270		Push Rod;Suspension Rod
	04/03→	Centre Rod	DB-DL-8167		Push Rod, Leaf Spring Axle
	04/03→	Centre Rod	DB-DL-8168		Push Rod
	04/03→	Centre Rod	DB-DL-8184		Push Rod
	04/03→	Centre Rod	DB-DL-8185		Push Rod
	04/03→	Centre Rod	DB-DL-8307		Push Rod
	04/03→	Centre Rod	DB-DL-8622		Push Rod
	04/03→	Centre Rod	DB-DL-8641		Push Rod
	04/03→	Centre Rod	DB-DL-8642		Push Rod
	04/03→	Centre Rod	DB-DL-8702		Push Rod, Leaf Spring Axle
	04/03→	Centre Rod	DB-DL-12300		for Steering Rod
	04/03→	Rod Assembly	DB-DL-2178		Guide Rod, 1st Front Axle, →504310 03
	04/03→	Stabiliser Link	DB-DL-9254		Pressure Rod
	04/03→	Stabiliser Mounting		DB-SB-10406	
	04/03→	Stabiliser Mounting		DB-SB-10409	
	04/03→	Stabiliser Mounting	DB-SB-10410		
	04/03→	Suspension Arm Repair Kit		DB-RK-8550	for Wishbone (CV)
	04/03→	Suspension Arm Repair Kit		DB-RK-8626	for Wishbone (CV)
	04/03→	Suspension Arm Repair Kit		DB-RK-10374	for Wishbone (CV)
	04/03→	Suspension Arm Repair Kit		DB-RK-10375	for Wishbone (CV)
	04/03→	Suspension Arm Repair Kit	DB-RK-8638		for Control Arm
	04/03→	Suspension Strut Repair Kit		DB-RK-8391	
	04/03→	Tie Rod	DB-DL-8171		Guide Rod
	04/03→	Tie Rod	DB-DL-8327		Guide Rod
	04/03→	Tie Rod	DB-DL-8640		Guide Rod
	04/03→	Tie Rod	DB-DL-12310		
	04/03→	Tie Rod	DB-ES-5227		Guide Rod
	04/03→	Tie Rod End	CV-ES-0543		for Push Rod
	04/03→	Tie Rod End	CV-ES-0888		for Push Rod
	04/03→	Tie Rod End	CV-ES-14163		for Steering Rod
	04/03→	Tie Rod End	DB-ES-5234		for Steering Rod
	04/03→	Tie Rod End	DB-ES-8164		for Push Rod

CV-ES-0543

Length: 125
Cone Ø: d1 Ø 32 / d2 Ø 29
Thread: M30 x 1,5 RHT
0004605748, 0004606048, 0004606688,
0004607048, 0014600448, 0014601148,
0014601748, 0014602448, 0014607648,
0014609648



CV-ES-0888

Length: 125
Cone Ø: d1 Ø 32 / d2 Ø 29
Thread: M30 x 1,5 LHT
0004605848, 0004606148, 0004606948,
0004607148, 0004609048, 0014600548,
0014601348, 0014602548, 0014607948,
0024600448



CV-ES-14163

Length: 125
Cone Ø: d1 Ø 30 / d2 Ø 27
Thread: M30 x 1,5 RHT
0003305248, 0003387310, 0004600348,
0004600948, 0004602848, 0004602948,
0004608948, 0014600248, 0014600848,
0014601248, 0014602248, 0014607748,
0024600148, A0003387310, A0004600348,
A0004602848, A0004602948, A0014600848,
A0014601248, A0014602248, A0014607748



DB-DL-2144

Length: 872 Ø: 35
Cone Ø: d1 Ø 28,6 / d2 Ø 23,9
0024604305, 0024604405, 0034604805



DB-DL-2178

Length: 1735 Ø: 52
Cone Ø: d1 Ø 32 / d2 Ø 29
9423300003, 9423300103, 9423300203



DB-DL-5230

Length: 879 Ø: 42
Cone Ø: d1 Ø 30 / d2 Ø 27
01208600A, 0004607105, 0004607205,
0014606705



DB-DL-5241

Length: 875 Ø: 40
Cone Ø: d1 Ø 30 / d2 Ø 27
01215300A, 0004609205, 0004609305,
0014606905



DB-DL-5405

Length: 890 Ø: 35
Cone Ø: d1 Ø 28,6 / d2 Ø 23,9
01215900A, 1460248, 0024604505,
0024604605, 0034605005, 3752600637,
3754600405, A3752600637, A3754600405



DB-DL-7270

Length: 875 Ø: 40
Cone Ø: d1 Ø 28,6 / d2 Ø 23,9
01208300A, 0024604705, 0024604805,
0034604905, A0024604705



DB-DL-8167

Length: 866 Ø: 38
Cone Ø: d1 Ø 30 / d2 Ø 27
0014609805, 0014609905, 0024606305,
0024606405



DB-DL-8168

Length: 904 Ø: 52
Cone Ø: d1 Ø 32 / d2 Ø 29
0004609405, 0004609505, 0014607105



DB-DL-8171

Length: 1687 Ø: 52
Cone Ø: d1 Ø 32 / d2 Ø 29
9493300603, 9493300703, 9493301503,
9493301603



DB-DL-8184

Length: 1095 Ø: 42
Cone Ø: d1 Ø 32 / d2 Ø 28,8
01217700A, 0014601305, 0014601405,
0024600505, 0034603205, 3754601505,
A0014601305, A0014601405, A0024600505



DB-DL-8185

Length: 711 Ø: 42
Cone Ø: d1 Ø 32 / d2 Ø 28,8
01213600A, 0014601105, 0024600405,
0034603105, A0014601105, A0024600405



DB-DL-8307

Length: 885 Ø: 38
Cone Ø: d1 Ø 32 / d2 Ø 30
01215500A, 0004604005, 0024605105,
0024605205, 0034604005



DB-DL-8327

Length: 1745 Ø: 48
Cone Ø: d1 Ø 32 / d2 Ø 29
01219800A, 9413300003, 9413300103,
9413300203, 9413300303, 9413300503

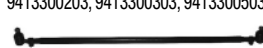

DB-DL-8622

Length: 1558 Ø: 52
Cone Ø: d1 Ø 30 / d2 Ø 27
0014609005, 0014609105

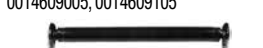

DB-DL-8640

Length: 1615 Ø: 50
Cone Ø: d1 Ø 32 / d2 Ø 29
6253301503, 6253301603, 6253302403,
6253302503, 9423300803, 9423302103,
9493300203, 9493300303, 9493300903

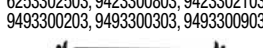

DB-DL-8641

Length: 905 Ø: 42
Cone Ø: d1 Ø 30 / d2 Ø 27
0014605105, 0014608105

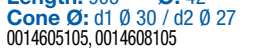

DB-DL-8642

Length: 954 Ø: 42
Cone Ø: d1 Ø 30 / d2 Ø 27
0014608605, 0014608705



DB-DL-8702

Length: 958 Ø: 38
Cone Ø: d1 Ø 32 / d2 Ø 30
0024606105, 0024606205, 0034604205



DB-DL-9254

Length: 1815 Ø: 58
0003220323, 0003220623, 3753220423



DB-DL-12300

Length: 733 Ø: 36
Cone Ø: d1 Ø 32 / d2 Ø 29
0014601505, 0014607305, 0034603305,
3754601605, A0014601505,
A0034603305, A3754601605

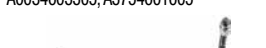

DB-DL-12310

Length: 1532 Ø: 50
Cone Ø: d1 Ø 32 / d2 Ø 29
Thread: M27 x 1,5 LHT
9493301203, 9493301303, 9493301803,
9493302203, A9493301203, A9493301303,
A9493301803, A9493302203

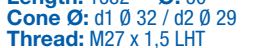

DB-ES-5227

Length: 1588 Ø: 60
Cone Ø: d1 Ø 38 / d2 Ø 34,3
6253300903, 6253301203, 9443300203



DB-ES-5234

Length: 135
Cone Ø: d1 Ø 38 / d2 Ø 34,3
Thread: M38 x 1,5 RHT
0004601748, 120322305, 2205000400



DB-ES-8164

Length: 140
Cone Ø: d1 Ø 28,6 / d2 Ø 23,9
Thread: M28 x 1,5 RHT
0014604248, 0014605048, 0014608548,
0024600548



DB-ES-8510

Length: 56
Cone Ø: d1 Ø 10 / d2 Ø 10
Thread: M12 x 1,75 LHT
0009965145, 0009965645, 0019963145



DB-RK-8391

Ø: 85 Hole Distance: 152
Thick/Height: 24
01336800A, 0003502705



DB-RK-8550

Ø: 75 Hole Distance: 152
Thick/Height: 24
0003502105, 0003504605



DB-RK-8626

Ø: 75 Hole Distance: 130
Thick/Height: 24
0003502205, 0003502505, 0003503405,
0003504505, GL11319



DB-RK-8638

Length: 100 Ø: 67
Hole Distance: 100
Thick/Height: 20
0003301411



DB-RK-8710

Ø: 85 Hole Distance: 130
Thick/Height: 30
0003503705



DB-RK-9291

Ø: 107,5 Hole Distance: 152
Thick/Height: 30
0003503605



DB-RK-10374

Ø: 85 Hole Distance: 152
Thick/Height: 24
0003504405



DB-RK-10375

Ø: 100 Hole Distance: 152
Thick/Height: 24
0003502405, 0003503505, 0003504905



DB-SB-10384

Ø: 73 Thick/Height: 47
9303170012, 9423171812



DB-SB-10406

Ø: 80 Thick/Height: 46
0003238185



DB-SB-10409

Ø: 77 Thick/Height: 56
0003265181



DB-SB-10410

Ø: 73 Hole Distance: 100
Thick/Height: 24
9413230050

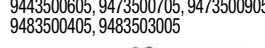

DB-VB-7261

Length: 622 Ø: 46
Hole Ø 25 / 25 / 25
Hole Distance: 152 / 130 / 130
01337800A, 9443500305, 9443500505,
9443500605, 9473500705, 9473500905,
9483500405, 9483500305



DB-VB-7776

Length: 622 Ø: 56
Hole Distance: 152 / 152
6533500205, 6583500205



DB-VB-9307

Length: 667 Ø: 60
Hole Ø 25 / 23 / 23
Hole Distance: 152 / 130 / 130
9483502805



DB-VB-9308

Length: 622 Ø: 46
Hole Ø 25 / 25 / 25
Hole Distance: 152 / 130 / 130
9483502905



DB-VB-10426

Length: 622 Ø: 46
Hole Ø 25 / 25 / 25
Hole Distance: 152 / 130 / 130
9443500405



DB-VB-10426

Length: 622 Ø: 46
Hole Ø 25 / 25 / 25
Hole Distance: 152 / 130 / 130
9443500405



DB-VB-10426

Length: 622 Ø: 46
Hole Ø 25 / 25 / 25
Hole Distance: 152 / 130 / 130
9443500405



DB-VB-10426

Length: 622 Ø: 46
Hole Ø 25 / 25 / 25
Hole Distance: 152 / 130 / 130
9443500405



DB-VB-10426

Length: 622 Ø: 46
Hole Ø 25 / 25 / 25
Hole Distance: 152 / 130 / 130
9443500405



DB-VB-10426

Length: 622 Ø: 46
Hole Ø 25 / 25 / 25
Hole Distance: 152 / 130 / 130
9443500405



DB-VB-10426

Length: 622 Ø: 46
Hole Ø 25 / 25 / 25
Hole Distance: 152 / 130 / 130
9443500405

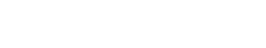

DB-VB-10426

Length: 622 Ø: 46
Hole Ø 25 / 25 / 25
Hole Distance: 152 / 130 / 130
9443500405



DB-VB-10426

Length: 622 Ø: 46
Hole Ø 25 / 25 / 25
Hole Distance: 152 / 130 / 130
9443500405



DB-VB-10426

Length: 622 Ø: 46
Hole Ø 25 / 25 / 25
Hole Distance: 152 / 130 / 130
9443500405





ACTROS MP2 / MP3 ...

2041 ...	04/03→	Tie Rod End	DB-ES-8530		for Push Rod	
	04/03→	Track Control Arm		DB-VB-7261	Suspension Rod, Wishbone (CV), 1st RA, →517142 01/517142 02	
	04/03→	Track Control Arm		DB-VB-9307	Suspension Rod, Wishbone (CV), 1st Drive Axle, →517142 07	
	04/03→	Track Control Arm		DB-VB-9308	Suspension Rod, Wishbone (CV), 1st Drive Axle, →517142 06	
	04/03→	Track Control Arm		DB-VB-10426	Wishbone (CV), 1st RA, →517142 05	
2041 AK	04/03→	Ball Head, gearshift linkage	DB-ES-8510			
	04/03→	Bush, driver cab suspension	DB-SB-10384			
	04/03→	Centre Rod	DB-DL-8184		Push Rod	
	04/03→	Centre Rod	DB-DL-8307		Push Rod, Leaf Spring Axle	
	04/03→	Centre Rod	DB-DL-8702		Push Rod, Leaf Spring Axle	
	04/03→	Centre Rod	DB-DL-12300		for Steering Rod	
	04/03→	Stabiliser Mounting		DB-SB-10406		
	04/03→	Stabiliser Mounting		DB-SB-10409		
	04/03→	Suspension Arm Repair Kit		DB-RK-8626	for Wishbone (CV)	
	04/03→	Suspension Arm Repair Kit		DB-RK-10374	for Wishbone (CV)	
	04/03→	Suspension Arm Repair Kit		DB-RK-10375	for Wishbone (CV)	
	04/03→	Suspension Arm Repair Kit	DB-RK-8638		for Control Arm	
	04/03→	Suspension Strut Repair Kit		DB-RK-8391		
	04/03→	Tie Rod	DB-DL-12310			
	04/03→	Tie Rod	DB-ES-5227		Guide Rod, 1st FA;Leaf Spring Axle	
	04/03→	Tie Rod	MN-DL-7834		Guide Rod, 1st FA;Leaf Spring Axle	
	04/03→	Tie Rod End	CV-ES-0543		for Push Rod	
	04/03→	Tie Rod End	CV-ES-14163		for Steering Rod	
	04/03→	Tie Rod End	DB-ES-5234		for Steering Rod	
	04/03→	Tie Rod End	DB-ES-8530		for Push Rod	
	04/03→	Track Control Arm		DB-VB-7261	Suspension Rod, Wishbone (CV), 1st RA, →517142 01/517142 02	
	04/03→	Track Control Arm		DB-VB-9307	Suspension Rod, Wishbone (CV), 1st Drive Axle, →517142 07	
	04/03→	Track Control Arm		DB-VB-9308	Suspension Rod, Wishbone (CV), 1st Drive Axle, →517142 06	
	04/03→	Track Control Arm		DB-VB-10426	Wishbone (CV), 1st RA, →517142 05	
	2041 AS	04/03→	Ball Head, gearshift linkage	DB-ES-8510		
		04/03→	Bush, driver cab suspension	DB-SB-10384		
		04/03→	Centre Rod	DB-DL-8307		Push Rod, Leaf Spring Axle
04/03→		Centre Rod	DB-DL-8702		Push Rod	
04/03→		Centre Rod	DB-DL-12300		for Steering Rod	
04/03→		Stabiliser Mounting		DB-SB-10406		
04/03→		Stabiliser Mounting		DB-SB-10409		
04/03→		Stabiliser Mounting	DB-SB-10410			
04/03→		Suspension Arm Repair Kit		DB-RK-8626	for Wishbone (CV)	
04/03→		Suspension Arm Repair Kit		DB-RK-10374	for Wishbone (CV)	
04/03→		Suspension Arm Repair Kit		DB-RK-10375	for Wishbone (CV)	
04/03→		Suspension Arm Repair Kit	DB-RK-8638		for Control Arm	
04/03→		Suspension Strut Repair Kit		DB-RK-8391		
04/03→		Suspension Strut Repair Kit		MN-RK-8997		
04/03→		Tie Rod	DB-DL-12310			
04/03→		Tie Rod	DB-ES-5227		Guide Rod	
04/03→		Tie Rod	MN-DL-7834		Guide Rod	
04/03→		Tie Rod End	CV-ES-14163		for Steering Rod	
04/03→		Tie Rod End	DB-ES-5234		for Steering Rod	
04/03→		Tie Rod End	DB-ES-8530		for Push Rod	
04/03→		Track Control Arm		DB-VB-7261	Suspension Rod, Wishbone (CV), 1st RA, →517142 01/517142 02	
04/03→		Track Control Arm		DB-VB-7798	Wishbone (CV)	
04/03→		Track Control Arm		DB-VB-9307	Suspension Rod, Wishbone (CV), 1st Drive Axle, →517142 07	
04/03→		Track Control Arm		DB-VB-9308	Suspension Rod, Wishbone (CV), 1st Drive Axle, →517142 06	
04/03→		Track Control Arm		DB-VB-10426	Wishbone (CV), 1st RA, →517142 05	

CV-ES-0543

Length: 125
Cone Ø: d1 Ø 32 / d2 Ø 29
Thread: M30 x 1,5 RHT
0004605748, 0004606048, 0004606848,
0004607048, 0014600448, 0014601148,
0014601748, 0014602448, 0014607648,
0014609648



CV-ES-14163

Length: 125
Cone Ø: d1 Ø 30 / d2 Ø 27
Thread: M30 x 1,5 RHT
0003305248, 0003387310, 0004600348,
0004600948, 0004602848, 0004602948,
0004608948, 0014600248, 0014600848,
0014601248, 0014602248, 0014607748,
0024600148, A0003387310, A0004600348,
A0004602848, A0004602948, A0014600848,
A0014601248, A0014602248, A0014607748



DB-DL-8184

Length: 1095 Ø: 42
Cone Ø: d1 Ø 32 / d2 Ø 28,8
01217700A, 0014601305, 0014601405,
0024600505, 0034603205, 3754601505,
A0014601305, A0014601405, A0024600505



DB-DL-8307

Length: 885 Ø: 38
Cone Ø: d1 Ø 32 / d2 Ø 30
01215500A, 0004604005, 0024605105,
0024605205, 0034604005



DB-DL-8702

Length: 958 Ø: 38
Cone Ø: d1 Ø 32 / d2 Ø 30
0024606105, 0024606205, 0034604205



DB-DL-12300

Length: 733 Ø: 36
Cone Ø: d1 Ø 32 / d2 Ø 29
0014601505, 0014607305, 0034603305,
3754601605, A0014601505,
A0034603305, A3754601605



DB-DL-12310

Length: 1532 Ø: 50
Cone Ø: d1 Ø 32 / d2 Ø 29
Thread: M27 x 1,5 LHT
9493301203, 9493301303, 9493301803,
9493302203, A9493301203, A9493301303,
A9493301803, A9493302203



DB-ES-5227

Length: 1588 Ø: 60
Cone Ø: d1 Ø 38 / d2 Ø 34,3
6253300903, 6253301203, 9443300203



DB-ES-5234

Length: 135
Cone Ø: d1 Ø 38 / d2 Ø 34,3
Thread: M38 x 1,5 RHT
0004601748, 120322305, 2205000400



DB-ES-8510

Length: 56
Cone Ø: d1 Ø 10 / d2 Ø 10
Thread: M12 x 1,75 LHT
0009965145, 0009965645, 0019963145



DB-ES-8530

Length: 115
Cone Ø: d1 Ø 28,6 / d2 Ø 23,9
Thread: M30 x 1,5 RHT
0014603848, 0014604848, 0014605148,
0014608648, 0014609948



DB-RK-8391

Ø: 85 Hole Distance: 152
Thick/Height: 24
01336800A, 0003502705



DB-RK-8626

Ø: 75 Hole Distance: 130
Thick/Height: 24
0003502205, 0003502505, 0003503405,
0003504505, GL11319



DB-RK-8638

Length: 100 Ø: 67
Hole Distance: 100
Thick/Height: 20
0003301411



DB-RK-10374

Ø: 85 Hole Distance: 152
Thick/Height: 24
0003504405



DB-RK-10375

Ø: 100 Hole Distance: 152
Thick/Height: 24
0003502405, 0003503505, 0003504905



DB-SB-10384

Ø: 73 Thick/Height: 47
9303170012, 9423171812



DB-SB-10406

Ø: 80 Thick/Height: 46
0003238185



DB-SB-10409

Ø: 77 Thick/Height: 56
0003265181



DB-SB-10410

Ø: 73 Hole Distance: 100
Thick/Height: 24
9413230050



DB-VB-7261

Length: 622 Ø: 46
Hole Ø 25 / 25 / 25
Hole Distance: 152 / 130 / 130
01337800A, 9443500305, 9443500505,
9443500605, 9473500705, 9473500905,
9483500405, 9483503005



DB-VB-7798

Length: 622 Ø: 48
Hole Ø 25 / 23 / 23
Hole Distance: 152 / 130 / 130
9423500505, 9423500805, 9423501205,
A9423501205



DB-VB-9307

Length: 667 Ø: 60
Hole Ø 25 / 23 / 23
Hole Distance: 152 / 130 / 130
9483502805



DB-VB-9308

Length: 622 Ø: 46
Hole Ø 25 / 25 / 25
Hole Distance: 152 / 130 / 130
9483502905



DB-VB-10426

Length: 622 Ø: 46
Hole Ø 25 / 25 / 25
Hole Distance: 152 / 130 / 130
9443500405



MN-DL-7834

Length: 1588 Ø: 58
Cone Ø: d1 Ø 30 / d2 Ø 27
3463303903, 3463304903, 6253303203,
9443300503, 9443301303, 9443301703



MN-RK-8997

Ø: 85 Hole Distance: 130
Thick/Height: 30
0003504805





ACTROS MP2 / MP3 ...

2041 K	04/03→	Ball Head, gearshift linkage	DB-ES-8510	
	04/03→	Bush, driver cab suspension	DB-SB-10384	
	04/03→	Centre Rod	DB-DL-2144	Push Rod
	04/03→	Centre Rod	DB-DL-5230	Suspension Rod
	04/03→	Centre Rod	DB-DL-5241	Push Rod
	04/03→	Centre Rod	DB-DL-5405	Push Rod, Leaf Spring Axle
	04/03→	Centre Rod	DB-DL-7270	Push Rod
	04/03→	Centre Rod	DB-DL-8167	Push Rod
	04/03→	Centre Rod	DB-DL-8184	Push Rod
	04/03→	Centre Rod	DB-DL-8185	Push Rod
	04/03→	Centre Rod	DB-DL-8307	Push Rod
	04/03→	Centre Rod	DB-DL-8702	Push Rod, Leaf Spring Axle
	04/03→	Centre Rod	DB-DL-12300	for Steering Rod
	04/03→	Rod Assembly	DB-DL-2178	Guide Rod, 1st Front Axle, →504310 03
	04/03→	Stabiliser Mounting		DB-SB-10406
	04/03→	Stabiliser Mounting		DB-SB-10409
	04/03→	Suspension Arm Repair Kit		DB-RK-8550 for Wishbone (CV)
	04/03→	Suspension Arm Repair Kit		DB-RK-8626 for Wishbone (CV)
	04/03→	Suspension Arm Repair Kit		DB-RK-10374 for Wishbone (CV)
	04/03→	Suspension Arm Repair Kit		DB-RK-10375 for Wishbone (CV)
	04/03→	Suspension Arm Repair Kit	DB-RK-8638	for Control Arm
	04/03→	Suspension Strut Repair Kit		DB-RK-8391
	04/03→	Tie Rod	DB-DL-8171	Guide Rod, 1st FA;Leaf Spring Axle
	04/03→	Tie Rod	DB-DL-8327	Guide Rod, 1st FA;Leaf Spring Axle
	04/03→	Tie Rod	DB-DL-8640	Guide Rod
	04/03→	Tie Rod	DB-DL-12310	
	04/03→	Tie Rod	DB-ES-5227	Guide Rod
	04/03→	Tie Rod End	CV-ES-0543	for Push Rod
	04/03→	Tie Rod End	CV-ES-0888	for Push Rod
	04/03→	Tie Rod End	DB-ES-5234	for Steering Rod
	04/03→	Tie Rod End	DB-ES-8164	for Push Rod
	04/03→	Tie Rod End	DB-ES-8530	for Push Rod
	04/03→	Track Control Arm		DB-VB-7261 Suspension Rod, Wishbone (CV), 1st RA, →517142 01/517142 02
	04/03→	Track Control Arm		DB-VB-9307 Suspension Rod, Wishbone (CV), 1st Drive Axle, →517142 07
	04/03→	Track Control Arm		DB-VB-9308 Suspension Rod, Wishbone (CV), 1st Drive Axle, →517142 06
	04/03→	Track Control Arm		DB-VB-10426 Wishbone (CV), 1st RA, →517142 05
	2041 S	04/03→	Ball Head, gearshift linkage	DB-ES-8510
04/03→		Bush, driver cab suspension	DB-SB-10384	
04/03→		Centre Rod	DB-DL-2144	Push Rod
04/03→		Centre Rod	DB-DL-5230	Suspension Rod
04/03→		Centre Rod	DB-DL-5241	Push Rod
04/03→		Centre Rod	DB-DL-5405	Push Rod, Leaf Spring Axle
04/03→		Centre Rod	DB-DL-7270	Push Rod;Suspension Rod
04/03→		Centre Rod	DB-DL-8167	Push Rod
04/03→		Centre Rod	DB-DL-8184	Push Rod
04/03→		Centre Rod	DB-DL-8185	Push Rod
04/03→		Centre Rod	DB-DL-8307	Push Rod
04/03→		Centre Rod	DB-DL-8702	Push Rod, Leaf Spring Axle
04/03→		Centre Rod	DB-DL-12300	for Steering Rod
04/03→		Rod Assembly	DB-DL-2178	Guide Rod, 1st Front Axle, →504310 03
04/03→		Stabiliser Mounting		DB-SB-10406
04/03→		Stabiliser Mounting		DB-SB-10409
04/03→		Stabiliser Mounting	DB-SB-10410	
04/03→		Suspension Arm Repair Kit		DB-RK-8550 for Wishbone (CV)
04/03→		Suspension Arm Repair Kit		DB-RK-8626 for Wishbone (CV)
04/03→		Suspension Arm Repair Kit		DB-RK-10374 for Wishbone (CV)
04/03→		Suspension Arm Repair Kit		DB-RK-10375 for Wishbone (CV)
04/03→		Suspension Arm Repair Kit	DB-RK-8638	for Control Arm
04/03→		Suspension Strut Repair Kit		DB-RK-8391
04/03→		Suspension Strut Repair Kit		MN-RK-8997

CV-ES-0543

Length: 125
Cone Ø: d1 Ø 32 / d2 Ø 29
Thread: M30 x 1,5 RHT
0004605748, 0004606048, 0004606848,
0004607048, 0014600448, 0014601148,
0014601748, 0014602448, 0014607648,
0014609648



CV-ES-0888

Length: 125
Cone Ø: d1 Ø 32 / d2 Ø 29
Thread: M30 x 1,5 LHT
0004605848, 0004606148, 0004606948,
0004607148, 0004609048, 0014600548,
0014601348, 0014602548, 0014607948,
0024600448



DB-DL-2144

Length: 872 Ø: 35
Cone Ø: d1 Ø 28,6 / d2 Ø 23,9
0024604305, 0024604405, 0034604805



DB-DL-2178

Length: 1735 Ø: 52
Cone Ø: d1 Ø 32 / d2 Ø 29
9423300003, 9423300103, 9423300203



DB-DL-5230

Length: 879 Ø: 42
Cone Ø: d1 Ø 30 / d2 Ø 27
01208600A, 0004607105, 0004607205,
0014606705



DB-DL-5241

Length: 875 Ø: 40
Cone Ø: d1 Ø 30 / d2 Ø 27
01215300A, 0004609205, 0004609305,
0014606905



DB-DL-5405

Length: 890 Ø: 35
Cone Ø: d1 Ø 28,6 / d2 Ø 23,9
01215900A, 1460248, 0024604505,
0024604605, 0034605005, 3752600637,
3754600405, A3752600637, A3754600405



DB-DL-7270

Length: 875 Ø: 40
Cone Ø: d1 Ø 28,6 / d2 Ø 23,9
01208300A, 0024604705, 0024604805,
0034604905, A0024604705



DB-DL-8167

Length: 866 Ø: 38
Cone Ø: d1 Ø 30 / d2 Ø 27
0014609805, 0014609905, 0024606305,
0024606405



DB-DL-8171

Length: 1687 Ø: 52
Cone Ø: d1 Ø 32 / d2 Ø 29
9493300603, 9493300703, 9493301503,
9493301603



DB-DL-8184

Length: 1095 Ø: 42
Cone Ø: d1 Ø 32 / d2 Ø 28,8
01217700A, 0014601305, 0014601405,
0024600505, 0034603205, 3754601505,
A0014601305, A0014601405, A0024600505



DB-DL-8185

Length: 711 Ø: 42
Cone Ø: d1 Ø 32 / d2 Ø 28,8
01213600A, 0014601105, 0024600405,
0034603105, A0014601105, A0024600405



DB-DL-8307

Length: 885 Ø: 38
Cone Ø: d1 Ø 32 / d2 Ø 30
01215500A, 0004604005, 0024605105,
0024605205, 0034604005



DB-DL-8327

Length: 1745 Ø: 48
Cone Ø: d1 Ø 32 / d2 Ø 29
01219800A, 9413300003, 9413300103,
9413300203, 9413300303, 9413300503



DB-DL-8640

Length: 1615 Ø: 50
Cone Ø: d1 Ø 32 / d2 Ø 29
6253301503, 6253301603, 6253302403,
6253302503, 9423300803, 9423302103,
9493300203, 9493300303, 9493300903



DB-DL-8702

Length: 958 Ø: 38
Cone Ø: d1 Ø 32 / d2 Ø 30
0024606105, 0024606205, 0034604205



DB-DL-12300

Length: 733 Ø: 36
Cone Ø: d1 Ø 32 / d2 Ø 29
0014601505, 0014607305, 0034603305,
3754601605, A0014601505,
A0034603305, A3754601605



DB-DL-12310

Length: 1532 Ø: 50
Cone Ø: d1 Ø 32 / d2 Ø 29
Thread: M27 x 1,5 LHT
9493301203, 9493301303, 9493301803,
9493302203, A9493301203, A9493301303,
A9493301803, A9493302203



DB-ES-5227

Length: 1588 Ø: 60
Cone Ø: d1 Ø 38 / d2 Ø 34,3
6253300903, 6253301203, 9443300203



DB-ES-5234

Length: 135
Cone Ø: d1 Ø 38 / d2 Ø 34,3
Thread: M38 x 1,5 RHT
0004601748, 120322305, 2205000400



DB-ES-8164

Length: 140
Cone Ø: d1 Ø 28,6 / d2 Ø 23,9
Thread: M28 x 1,5 RHT
0014604248, 0014605048, 0014608548,
0024600548



DB-ES-8510

Length: 56
Cone Ø: d1 Ø 10 / d2 Ø 10
Thread: M12 x 1,75 LHT
0009965145, 0009965645, 0019963145



DB-ES-8530

Length: 115
Cone Ø: d1 Ø 28,6 / d2 Ø 23,9
Thread: M30 x 1,5 RHT
0014603848, 0014604848, 0014605148,
0014608648, 0014609948



DB-RK-8391

Ø: 85 Hole Distance: 152
Thick/Height: 24
01336800A, 0003502705



DB-RK-8550

Ø: 75 Hole Distance: 152
Thick/Height: 24
0003502105, 0003504605



DB-RK-8626

Ø: 75 Hole Distance: 130
Thick/Height: 24
0003502205, 0003502505, 0003503405,
0003504505, GL11319



DB-RK-8638

Length: 100 Ø: 67
Hole Distance: 100
Thick/Height: 20
0003301411



DB-RK-10374

Ø: 85 Hole Distance: 152
Thick/Height: 24
0003504405



DB-RK-10375

Ø: 100 Hole Distance: 152
Thick/Height: 24
0003502405, 0003503505, 0003504905



DB-SB-10384

Ø: 73 Thick/Height: 47
9303170012, 9423171812



DB-SB-10406

Ø: 80 Thick/Height: 46
0003238185



DB-SB-10409

Ø: 77 Thick/Height: 56
0003265181



DB-SB-10410

Ø: 73 Hole Distance: 100
Thick/Height: 24
9413230050



DB-VB-7261

Length: 622 Ø: 46
Hole Ø 25 / 25 / 25
Hole Distance: 152 / 130 / 130
01337800A, 9443500305, 9443500505,
9443500605, 9473500705, 9473500905,
9483500405, 9483500305



DB-VB-9307

Length: 667 Ø: 60
Hole Ø 25 / 23 / 23
Hole Distance: 152 / 130 / 130
9483502805



DB-VB-9308

Length: 622 Ø: 46
Hole Ø 25 / 25 / 25
Hole Distance: 152 / 130 / 130
9483502905



DB-VB-10426

Length: 622 Ø: 46
Hole Ø 25 / 25 / 25
Hole Distance: 152 / 130 / 130
9443500405



MN-RK-8997

Ø: 85 Hole Distance: 130
Thick/Height: 30
0003504805,





ACTROS MP2 / MP3 ...

2041 S ...	04/03→	Tie Rod	DB-DL-8171		Guide Rod
	04/03→	Tie Rod	DB-DL-8327		Guide Rod
	04/03→	Tie Rod	DB-DL-8640		Guide Rod
	04/03→	Tie Rod	DB-DL-12310		
	04/03→	Tie Rod	DB-ES-5227		Guide Rod
	04/03→	Tie Rod End	CV-ES-0543		for Push Rod
	04/03→	Tie Rod End	CV-ES-0888		for Push Rod
	04/03→	Tie Rod End	CV-ES-14163		for Steering Rod
	04/03→	Tie Rod End	DB-ES-5234		for Steering Rod
	04/03→	Tie Rod End	DB-ES-8164		for Push Rod
	04/03→	Tie Rod End	DB-ES-8530		for Push Rod
	04/03→	Track Control Arm		DB-VB-7261	Suspension Rod, Wishbone (CV), 1st RA, →517142 01/517142 02
	04/03→	Track Control Arm		DB-VB-7798	Wishbone (CV)
	04/03→	Track Control Arm		DB-VB-9307	Suspension Rod, Wishbone (CV), 1st Drive Axle, →517142 07
	04/03→	Track Control Arm		DB-VB-9308	Suspension Rod, Wishbone (CV), 1st Drive Axle, →517142 06
	04/03→	Track Control Arm		DB-VB-10426	Wishbone (CV), 1st RA, →517142 05
2044	04/03→	Ball Head, gearshift linkage	DB-ES-8510		
	04/03→	Bush, driver cab suspension	DB-SB-10384		
	04/03→	Centre Rod	DB-DL-2144		Push Rod
	04/03→	Centre Rod	DB-DL-5230		Suspension Rod
	04/03→	Centre Rod	DB-DL-5241		Push Rod
	04/03→	Centre Rod	DB-DL-5405		Push Rod, Leaf Spring Axle
	04/03→	Centre Rod	DB-DL-7270		Push Rod;Suspension Rod
	04/03→	Centre Rod	DB-DL-8167		Push Rod
	04/03→	Centre Rod	DB-DL-8168		Push Rod
	04/03→	Centre Rod	DB-DL-8184		Push Rod
	04/03→	Centre Rod	DB-DL-8185		Push Rod
	04/03→	Centre Rod	DB-DL-8307		Push Rod
	04/03→	Centre Rod	DB-DL-8622		Push Rod
	04/03→	Centre Rod	DB-DL-8641		Push Rod
	04/03→	Centre Rod	DB-DL-8642		Push Rod
	04/03→	Centre Rod	DB-DL-8702		Push Rod, Leaf Spring Axle
	04/03→	Centre Rod	DB-DL-12300		for Steering Rod
	04/03→	Rod Assembly	DB-DL-2178		Guide Rod, 1st Front Axle, →504310 03
	04/03→	Stabiliser Link	DB-DL-9254		Pressure Rod
	04/03→	Stabiliser Mounting		DB-SB-10406	
	04/03→	Stabiliser Mounting		DB-SB-10409	
	04/03→	Stabiliser Mounting	DB-SB-10410		
	04/03→	Suspension Arm Repair Kit		DB-RK-8550	for Wishbone (CV)
	04/03→	Suspension Arm Repair Kit		DB-RK-8626	for Wishbone (CV)
	04/03→	Suspension Arm Repair Kit		DB-RK-10374	for Wishbone (CV)
	04/03→	Suspension Arm Repair Kit		DB-RK-10375	for Wishbone (CV)
	04/03→	Suspension Arm Repair Kit	DB-RK-8638		for Control Arm
	04/03→	Suspension Strut Repair Kit		DB-RK-8391	
	04/03→	Tie Rod	DB-DL-8171		Guide Rod, 1st FA;Leaf Spring Axle
	04/03→	Tie Rod	DB-DL-8327		Guide Rod, 1st FA;Leaf Spring Axle
	04/03→	Tie Rod	DB-DL-8640		Guide Rod
	04/03→	Tie Rod	DB-DL-12310		
	04/03→	Tie Rod	DB-ES-5227		Guide Rod
	04/03→	Tie Rod End	CV-ES-0543		for Push Rod
	04/03→	Tie Rod End	CV-ES-0888		for Push Rod
	04/03→	Tie Rod End	CV-ES-14163		for Steering Rod
	04/03→	Tie Rod End	DB-ES-5234		for Steering Rod
	04/03→	Tie Rod End	DB-ES-8164		for Push Rod
	04/03→	Tie Rod End	DB-ES-8530		for Push Rod
	04/03→	Track Control Arm		DB-VB-7261	Suspension Rod, Wishbone (CV), 1st RA, →517142 01/517142 02
	04/03→	Track Control Arm		DB-VB-9307	Suspension Rod, Wishbone (CV), 1st Drive Axle, →517142 07

CV-ES-0543

Length: 125
 Cone Ø: d1 Ø 32 / d2 Ø 29
 Thread: M30 x 1,5 RHT
 0004605748, 0004606048, 0004606848,
 0004607048, 0014600448, 0014601148,
 0014601748, 0014602448, 0014607648,
 0014609648

**CV-ES-0888**

Length: 125
 Cone Ø: d1 Ø 32 / d2 Ø 29
 Thread: M30 x 1,5 LHT
 0004605848, 0004606148, 0004606948,
 0004607148, 0004609048, 0014600548,
 0014601348, 0014602548, 0014607948,
 0024600448

**CV-ES-14163**

Length: 125
 Cone Ø: d1 Ø 30 / d2 Ø 27
 Thread: M30 x 1,5 RHT
 0003305248, 0003387310, 0004600348,
 0004600948, 0004602848, 0004602948,
 0004608948, 0014600248, 0014600848,
 0014601248, 0014602248, 0014607748,
 0024600148, A0003387310, A0004600348,
 A0004602848, A0004602948, A0014600848,
 A0014601248, A0014602248, A0014607748

**DB-DL-2144**

Length: 872 Ø: 35
 Cone Ø: d1 Ø 28,6 / d2 Ø 23,9
 0024604305, 0024604405, 0034604805

**DB-DL-2178**

Length: 1735 Ø: 52
 Cone Ø: d1 Ø 32 / d2 Ø 29
 9423300003, 9423300103, 9423300203

**DB-DL-5230**

Length: 879 Ø: 42
 Cone Ø: d1 Ø 30 / d2 Ø 27
 01208600A, 0004607105, 0004607205,
 0014606705

**DB-DL-5241**

Length: 875 Ø: 40
 Cone Ø: d1 Ø 30 / d2 Ø 27
 01215300A, 0004609205, 0004609305,
 0014606905

**DB-DL-5405**

Length: 890 Ø: 35
 Cone Ø: d1 Ø 28,6 / d2 Ø 23,9
 01215900A, 1460248, 0024604505,
 0024604605, 0034605005, 3752600637,
 3754600405, A3752600637, A3754600405

**DB-DL-7270**

Length: 875 Ø: 40
 Cone Ø: d1 Ø 28,6 / d2 Ø 23,9
 01208300A, 0024604705, 0024604805,
 0034604905, A0024604705

**DB-DL-8167**

Length: 866 Ø: 38
 Cone Ø: d1 Ø 30 / d2 Ø 27
 0014609805, 0014609905, 0024606305,
 0024606405

**DB-DL-8168**

Length: 904 Ø: 52
 Cone Ø: d1 Ø 32 / d2 Ø 29
 0004609405, 0004609505, 0014607105

**DB-DL-8171**

Length: 1687 Ø: 52
 Cone Ø: d1 Ø 32 / d2 Ø 29
 9493300603, 9493300703, 9493301503,
 9493301603

**DB-DL-8184**

Length: 1095 Ø: 42
 Cone Ø: d1 Ø 32 / d2 Ø 28,8
 01217700A, 0014601305, 0014601405,
 0024600505, 0034603205, 3754601505,
 A0014601305, A0014601405, A0024600505

**DB-DL-8185**

Length: 711 Ø: 42
 Cone Ø: d1 Ø 32 / d2 Ø 28,8
 01213600A, 0014601105, 0024600405,
 0034603105, A0014601105, A0024600405

**DB-DL-8307**

Length: 885 Ø: 38
 Cone Ø: d1 Ø 32 / d2 Ø 30
 01215500A, 0004604005, 0024605105,
 0024605205, 0034604005

**DB-DL-8327**

Length: 1745 Ø: 48
 Cone Ø: d1 Ø 32 / d2 Ø 29
 01219800A, 9413300003, 9413300103,
 9413300203, 9413300303, 9413300503

**DB-DL-8622**

Length: 1558 Ø: 52
 Cone Ø: d1 Ø 30 / d2 Ø 27
 0014609005, 0014609105

**DB-DL-8640**

Length: 1615 Ø: 50
 Cone Ø: d1 Ø 32 / d2 Ø 29
 6253301503, 6253301603, 6253302403,
 6253302503, 9423300803, 9423302103,
 9493300203, 9493300303, 9493300903

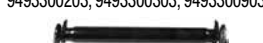
**DB-DL-8641**

Length: 905 Ø: 42
 Cone Ø: d1 Ø 30 / d2 Ø 27
 0014605105, 0014608105

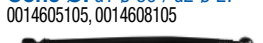
**DB-DL-8642**

Length: 954 Ø: 42
 Cone Ø: d1 Ø 30 / d2 Ø 27
 0014608605, 0014608705

**DB-DL-8702**

Length: 958 Ø: 38
 Cone Ø: d1 Ø 32 / d2 Ø 30
 0024606105, 0024606205, 0034604205

**DB-DL-9254**

Length: 1815 Ø: 58
 0003220323, 0003220623, 3753220423

**DB-DL-12300**

Length: 733 Ø: 36
 Cone Ø: d1 Ø 32 / d2 Ø 29
 0014601505, 0014607305, 0034603305,
 3754601605, A0014601505,
 A0034603305, A3754601605

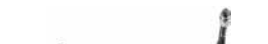
**DB-DL-12310**

Length: 1532 Ø: 50
 Cone Ø: d1 Ø 32 / d2 Ø 29
 Thread: M27 x 1,5 LHT
 9493301203, 9493301303, 9493301803,
 9493302203, A9493301203, A9493301303,
 A9493301803, A9493302203

**DB-ES-5227**

Length: 1588 Ø: 60
 Cone Ø: d1 Ø 38 / d2 Ø 34,3
 6253300903, 6253301203, 9443300203

**DB-ES-5234**

Length: 135
 Cone Ø: d1 Ø 38 / d2 Ø 34,3
 Thread: M38 x 1,5 RHT
 0004601748, 120322305, 2205000400

**DB-ES-8164**

Length: 140
 Cone Ø: d1 Ø 28,6 / d2 Ø 23,9
 Thread: M28 x 1,5 RHT
 0014604248, 0014605048, 0014608548,
 0024600548

**DB-ES-8510**

Length: 56
 Cone Ø: d1 Ø 10 / d2 Ø 10
 Thread: M12 x 1,75 LHT
 0009965145, 0009965645, 0019963145

**DB-ES-8530**

Length: 115
 Cone Ø: d1 Ø 28,6 / d2 Ø 23,9
 Thread: M30 x 1,5 RHT
 0014603848, 0014604848, 0014605148,
 0014608648, 0014609948

**DB-RK-8391**

Ø: 85 Hole Distance: 152
 Thick/Height: 24
 01336800A, 0003502705

**DB-RK-8550**

Ø: 75 Hole Distance: 152
 Thick/Height: 24
 0003502105, 0003504605

**DB-RK-8626**

Ø: 75 Hole Distance: 130
 Thick/Height: 24
 0003502205, 0003502505, 0003503405,
 0003504505, GL11319

**DB-RK-8638**

Length: 100 Ø: 67
 Hole Distance: 100
 Thick/Height: 20
 0003301411

**DB-RK-10374**

Ø: 85 Hole Distance: 152
 Thick/Height: 24
 0003504405

**DB-RK-10375**

Ø: 100 Hole Distance: 152
 Thick/Height: 24
 0003502405, 0003503505, 0003504905

**DB-SB-10384**

Ø: 73 Thick/Height: 47
 9303170012, 9423171812

**DB-SB-10406**

Ø: 80 Thick/Height: 46
 0003238185

**DB-SB-10409**

Ø: 77 Thick/Height: 56
 0003265181

**DB-SB-10410**

Ø: 73 Hole Distance: 100
 Thick/Height: 24
 9413230050

**DB-VB-7261**

Length: 622 Ø: 46
 Hole Ø 25 / 25 / 25
 Hole Distance: 152 / 130 / 130
 01337800A, 9443500305, 9443500505,
 9443500605, 9473500705, 9473500905,
 9483500405, 9483500305

**DB-VB-7798**

Length: 622 Ø: 48
 Hole Ø 25 / 23 / 23
 Hole Distance: 152 / 130 / 130
 9423500505, 9423500805, 9423501205,
 A9423501205

**DB-VB-9307**

Length: 667 Ø: 60
 Hole Ø 25 / 23 / 23
 Hole Distance: 152 / 130 / 130
 9483502805

**DB-VB-9308**

Length: 622 Ø: 46
 Hole Ø 25 / 25 / 25
 Hole Distance: 152 / 130 / 130
 9483502905

**DB-VB-10426**

Length: 622 Ø: 46
 Hole Ø 25 / 25 / 25
 Hole Distance: 152 / 130 / 130
 9443500405





ACTROS MP2 / MP3 ...

2044 ...	04/03 →	Track Control Arm		DB-VB-9308	Suspension Rod, Wishbone (CV), 1st Drive Axle, →517142 06	
	04/03 →	Track Control Arm		DB-VB-10426	Wishbone (CV), 1st RA, →517142 05	
2044 AK	04/03 →	Ball Head, gearshift linkage	DB-ES-8510			
	04/03 →	Bush, driver cab suspension	DB-SB-10384			
	04/03 →	Centre Rod	DB-DL-8184		Push Rod	
	04/03 →	Centre Rod	DB-DL-8307		Push Rod, Leaf Spring Axle	
	04/03 →	Centre Rod	DB-DL-8702		Push Rod, Leaf Spring Axle	
	04/03 →	Centre Rod	DB-DL-12300		for Steering Rod	
	04/03 →	Stabiliser Mounting		DB-SB-10406		
	04/03 →	Stabiliser Mounting		DB-SB-10409		
	04/03 →	Suspension Arm Repair Kit		DB-RK-8626	for Wishbone (CV)	
	04/03 →	Suspension Arm Repair Kit		DB-RK-10374	for Wishbone (CV)	
	04/03 →	Suspension Arm Repair Kit		DB-RK-10375	for Wishbone (CV)	
	04/03 →	Suspension Arm Repair Kit	DB-RK-8638		for Control Arm	
	04/03 →	Suspension Strut Repair Kit		DB-RK-8391		
	04/03 →	Tie Rod	DB-DL-12310			
	04/03 →	Tie Rod	DB-ES-5227		Guide Rod, 1st FA; Leaf Spring Axle	
	04/03 →	Tie Rod	MN-DL-7834		Guide Rod, 1st FA; Leaf Spring Axle	
	04/03 →	Tie Rod End	CV-ES-0543		for Push Rod	
	04/03 →	Tie Rod End	CV-ES-14163		for Steering Rod	
	04/03 →	Tie Rod End	DB-ES-5234		for Steering Rod	
	04/03 →	Tie Rod End	DB-ES-8530		for Push Rod	
	04/03 →	Track Control Arm		DB-VB-7261	Suspension Rod, Wishbone (CV), 1st RA, →517142 01/517142 02	
	04/03 →	Track Control Arm		DB-VB-9307	Suspension Rod, Wishbone (CV), 1st Drive Axle, →517142 07	
	04/03 →	Track Control Arm		DB-VB-9308	Suspension Rod, Wishbone (CV), 1st Drive Axle, →517142 06	
	04/03 →	Track Control Arm		DB-VB-10426	Wishbone (CV), 1st RA, →517142 05	
	2044 AS	04/03 →	Ball Head, gearshift linkage	DB-ES-8510		
		04/03 →	Bush, driver cab suspension	DB-SB-10384		
04/03 →		Centre Rod	DB-DL-8307		Push Rod, Leaf Spring Axle	
04/03 →		Centre Rod	DB-DL-8702		Push Rod	
04/03 →		Centre Rod	DB-DL-12300		for Steering Rod	
04/03 →		Stabiliser Mounting		DB-SB-10406		
04/03 →		Stabiliser Mounting		DB-SB-10409		
04/03 →		Stabiliser Mounting	DB-SB-10410			
04/03 →		Suspension Arm Repair Kit		DB-RK-8626	for Wishbone (CV)	
04/03 →		Suspension Arm Repair Kit		DB-RK-10374	for Wishbone (CV)	
04/03 →		Suspension Arm Repair Kit		DB-RK-10375	for Wishbone (CV)	
04/03 →		Suspension Arm Repair Kit	DB-RK-8638		for Control Arm	
04/03 →		Suspension Strut Repair Kit		DB-RK-8391		
04/03 →		Suspension Strut Repair Kit		MN-RK-8997		
04/03 →		Tie Rod	DB-DL-12310			
04/03 →		Tie Rod	DB-ES-5227		Guide Rod	
04/03 →		Tie Rod	MN-DL-7834		Guide Rod	
04/03 →		Tie Rod End	CV-ES-14163		for Steering Rod	
04/03 →		Tie Rod End	DB-ES-5234		for Steering Rod	
04/03 →		Tie Rod End	DB-ES-8530		for Push Rod	
04/03 →		Track Control Arm		DB-VB-7261	Suspension Rod, Wishbone (CV), 1st RA, →517142 01/517142 02	
04/03 →		Track Control Arm		DB-VB-7798	Wishbone (CV)	
04/03 →		Track Control Arm		DB-VB-9307	Suspension Rod, Wishbone (CV), 1st Drive Axle, →517142 07	
04/03 →		Track Control Arm		DB-VB-9308	Suspension Rod, Wishbone (CV), 1st Drive Axle, →517142 06	
04/03 →		Track Control Arm		DB-VB-10426	Wishbone (CV), 1st RA, →517142 05	
2044 K		04/03 →	Centre Rod	DB-DL-2144		Push Rod
		04/03 →	Centre Rod	DB-DL-5405		Push Rod, Leaf Spring Axle
		04/03 →	Centre Rod	DB-DL-7270		Push Rod
		04/03 →	Centre Rod	DB-DL-8167		Push Rod
		04/03 →	Centre Rod	DB-DL-8307		Push Rod

CV-ES-0543

Length: 125
Cone Ø: d1 Ø 32 / d2 Ø 29
Thread: M30 x 1,5 RHT
0004605748, 0004606048, 0004606848,
0004607048, 0014600448, 0014601148,
0014601748, 0014602448, 0014607648,
0014609648



CV-ES-14163

Length: 125
Cone Ø: d1 Ø 30 / d2 Ø 27
Thread: M30 x 1,5 RHT
0003305248, 0003387310, 0004600348,
0004600948, 0004602848, 0004602948,
0004608948, 0014600248, 0014600848,
0014601248, 0014602248, 0014607748,
0024600148, A0003387310, A0004600348,
A0004602848, A0004602948, A0014600848,
A0014601248, A0014602248, A0014607748



DB-DL-2144

Length: 872 Ø: 35
Cone Ø: d1 Ø 28,6 / d2 Ø 23,9
0024604305, 0024604405, 0034604805



DB-DL-5405

Length: 890 Ø: 35
Cone Ø: d1 Ø 28,6 / d2 Ø 23,9
01215900A, 1460248, 0024604505,
0024604605, 0034605005, 3752600637,
3754600405, A3752600637, A3754600405



DB-DL-7270

Length: 875 Ø: 40
Cone Ø: d1 Ø 28,6 / d2 Ø 23,9
01208300A, 0024604705, 0024604805,
0034604905, A0024604705



DB-DL-8167

Length: 866 Ø: 38
Cone Ø: d1 Ø 30 / d2 Ø 27
0014609805, 0014609905, 0024606305,
0024606405



DB-DL-8184

Length: 1095 Ø: 42
Cone Ø: d1 Ø 32 / d2 Ø 28,8
01217700A, 0014601305, 0014601405,
0024600505, 0034603205, 3754601505,
A0014601305, A0014601405, A0024600505



DB-DL-8307

Length: 885 Ø: 38
Cone Ø: d1 Ø 32 / d2 Ø 30
01215500A, 0004604005, 0024605105,
0024605205, 0034604005



DB-DL-8702

Length: 958 Ø: 38
Cone Ø: d1 Ø 32 / d2 Ø 30
0024606105, 0024606205, 0034604205



DB-DL-12300

Length: 733 Ø: 36
Cone Ø: d1 Ø 32 / d2 Ø 29
0014601505, 0014607305, 0034603305,
3754601605, A0014601505, A0034603305,
A3754601605



DB-DL-12310

Length: 1532 Ø: 50
Cone Ø: d1 Ø 32 / d2 Ø 29
Thread: M27 x 1,5 LHT
9493301203, 9493301303, 9493301803,
9493302203, A9493301203, A9493301303,
A9493301803, A9493302203



DB-ES-5227

Length: 1588 Ø: 60
Cone Ø: d1 Ø 38 / d2 Ø 34,3
6253300903, 6253301203, 9443300203



DB-ES-5234

Length: 135
Cone Ø: d1 Ø 38 / d2 Ø 34,3
Thread: M38 x 1,5 RHT
0004601748, 120322305, 2205000400



DB-ES-8510

Length: 56
Cone Ø: d1 Ø 10 / d2 Ø 10
Thread: M12 x 1,75 LHT
0009965145, 0009965645, 0019963145



DB-ES-8530

Length: 115
Cone Ø: d1 Ø 28,6 / d2 Ø 23,9
Thread: M30 x 1,5 RHT
0014603848, 0014604848, 0014605148,
0014608648, 0014609948



DB-RK-8391

Ø: 85 Hole Distance: 152
Thick/Height: 24
01336800A, 0003502705



DB-RK-8626

Ø: 75 Hole Distance: 130
Thick/Height: 24
0003502205, 0003502505, 0003503405,
0003504505, GL11319



DB-RK-8638

Length: 100 Ø: 67
Hole Distance: 100
Thick/Height: 20
0003301411



DB-RK-10374

Ø: 85 Hole Distance: 152
Thick/Height: 24
0003504405



DB-RK-10375

Ø: 100 Hole Distance: 152
Thick/Height: 24
0003502405, 0003503505, 0003504905



DB-SB-10384

Ø: 73 Thick/Height: 47
9303170012, 9423171812



DB-SB-10406

Ø: 80 Thick/Height: 46
0003238185



DB-SB-10409

Ø: 77 Thick/Height: 56
0003265181



DB-SB-10410

Ø: 73 Hole Distance: 100
Thick/Height: 24
9413230050



DB-VB-7798

Length: 622 Ø: 48
Hole Ø 25 / 23 / 23
Hole Distance: 152 / 130 / 130
9423500505, 9423500805, 9423501205,
A9423501205



DB-VB-9307

Length: 667 Ø: 60
Hole Ø 25 / 23 / 23
Hole Distance: 152 / 130 / 130
9483502805



DB-VB-9308

Length: 622 Ø: 46
Hole Ø 25 / 25 / 25
Hole Distance: 152 / 130 / 130
9483502905



DB-VB-10426

Length: 622 Ø: 46
Hole Ø 25 / 25 / 25
Hole Distance: 152 / 130 / 130
9443500405



MN-DL-7834

Length: 1588 Ø: 58
Cone Ø: d1 Ø 30 / d2 Ø 27
3463303903, 3463304903, 6253303203,
9443300503, 9443301303, 9443301703



MN-RK-8997

Ø: 85
Hole Distance: 130
Thick/Height: 30
0003504805, 3504805





ACTROS MP2 / MP3 ...

2044 K ...	04/03→	Centre Rod	DB-DL-8702		Push Rod, Leaf Spring Axle	
	04/03→	Rod Assembly	DB-DL-2178		Guide Rod, 1st Front Axle, →504310 03	
	04/03→	Stabiliser Mounting		DB-SB-10406		
	04/03→	Suspension Arm Repair Kit		DB-RK-8626	for Wishbone (CV)	
	04/03→	Suspension Arm Repair Kit		DB-RK-10374	for Wishbone (CV)	
	04/03→	Suspension Arm Repair Kit		DB-RK-10375	for Wishbone (CV)	
	04/03→	Suspension Strut Repair Kit		DB-RK-8710		
	04/03→	Suspension Strut Repair Kit		DB-RK-9291		
	04/03→	Tie Rod	DB-DL-8171		Guide Rod, 1st FA;Leaf Spring Axle	
	04/03→	Tie Rod	DB-DL-8327		Guide Rod, 1st FA;Leaf Spring Axle	
	04/03→	Tie Rod	DB-DL-8640		Guide Rod	
	04/03→	Tie Rod	DB-DL-12310			
	04/03→	Tie Rod	DB-ES-5227		Guide Rod	
	04/03→	Tie Rod End	CV-ES-0543		for Push Rod	
	04/03→	Tie Rod End	CV-ES-0888		for Push Rod	
	04/03→	Track Control Arm		DB-VB-7261	Suspension Rod, Wishbone (CV), 1st RA, →517142 01/517142 02	
	04/03→	Track Control Arm		DB-VB-7776	Wishbone (CV)	
	04/03→	Track Control Arm		DB-VB-9307	Suspension Rod, Wishbone (CV)	
	2044 S	04/03→	Track Control Arm		DB-VB-9308	Suspension Rod, Wishbone (CV)
		04/03→	Track Control Arm		DB-VB-10426	Wishbone (CV), 1st RA, →517142 05
04/03→		Ball Head, gearshift linkage	DB-ES-8510			
04/03→		Bush, driver cab suspension	DB-SB-10384			
04/03→		Centre Rod	DB-DL-2144		Push Rod	
04/03→		Centre Rod	DB-DL-5230		Suspension Rod	
04/03→		Centre Rod	DB-DL-5241		Push Rod	
04/03→		Centre Rod	DB-DL-5405		Push Rod, Leaf Spring Axle	
04/03→		Centre Rod	DB-DL-7270		Push Rod;Suspension Rod	
04/03→		Centre Rod	DB-DL-8167		Push Rod	
04/03→		Centre Rod	DB-DL-8184		Push Rod	
04/03→		Centre Rod	DB-DL-8185		Push Rod	
04/03→		Centre Rod	DB-DL-8307		Push Rod	
04/03→		Centre Rod	DB-DL-8702		Push Rod, Leaf Spring Axle	
04/03→		Centre Rod	DB-DL-12300		for Steering Rod	
04/03→		Rod Assembly	DB-DL-2178		Guide Rod, 1st Front Axle, →504310 03	
04/03→		Stabiliser Mounting		DB-SB-10406		
04/03→		Stabiliser Mounting		DB-SB-10409		
04/03→		Stabiliser Mounting	DB-SB-10410			
04/03→		Suspension Arm Repair Kit		DB-RK-8550	for Wishbone (CV)	
04/03→		Suspension Arm Repair Kit		DB-RK-8626	for Wishbone (CV)	
04/03→		Suspension Arm Repair Kit		DB-RK-10374	for Wishbone (CV)	
04/03→		Suspension Arm Repair Kit		DB-RK-10375	for Wishbone (CV)	
04/03→		Suspension Arm Repair Kit	DB-RK-8638		for Control Arm	
04/03→		Suspension Strut Repair Kit		DB-RK-8391		
04/03→		Suspension Strut Repair Kit		MN-RK-8997		
04/03→		Tie Rod	DB-DL-8171		Guide Rod	
04/03→		Tie Rod	DB-DL-8327		Guide Rod	
04/03→		Tie Rod	DB-DL-8640		Guide Rod	
04/03→		Tie Rod	DB-DL-12310			
04/03→		Tie Rod	DB-ES-5227		Guide Rod	
04/03→		Tie Rod End	CV-ES-0543		for Push Rod	
04/03→		Tie Rod End	CV-ES-0888		for Push Rod	
04/03→		Tie Rod End	CV-ES-14163		for Steering Rod	
04/03→		Tie Rod End	DB-ES-5234		for Steering Rod	
04/03→		Tie Rod End	DB-ES-8164		for Push Rod	
04/03→		Tie Rod End	DB-ES-8530		for Push Rod	
04/03→		Track Control Arm		DB-VB-7261	Suspension Rod, Wishbone (CV), 1st RA, →517142 01/517142 02	
04/03→		Track Control Arm		DB-VB-7798	Wishbone (CV)	
04/03→		Track Control Arm		DB-VB-9307	Suspension Rod, Wishbone (CV), 1st Drive Axle, →517142 07	
04/03→	Track Control Arm		DB-VB-9308	Suspension Rod, Wishbone (CV), 1st Drive Axle, →517142 06		
04/03→	Track Control Arm		DB-VB-10426	Wishbone (CV), 1st RA, →517142 05		

CV-ES-0543

Length: 125
 Cone Ø: d1 Ø 32 / d2 Ø 29
 Thread: M30 x 1,5 RHT
 0004605748, 0004606048, 0004606848,
 0004607048, 0014600448, 0014601148,
 0014601748, 0014602448, 0014607648,
 0014609648

**CV-ES-0888**

Length: 125
 Cone Ø: d1 Ø 32 / d2 Ø 29
 Thread: M30 x 1,5 LHT
 0004605848, 0004606148, 0004606948,
 0004607148, 0004609048, 0014600548,
 0014601348, 0014602548, 0014607948,
 0024600448

**CV-ES-14163**

Length: 125
 Cone Ø: d1 Ø 30 / d2 Ø 27
 Thread: M30 x 1,5 RHT
 0003305248, 0003387310, 0004600348,
 0004600948, 0004602848, 0004602948,
 0004608948, 0014600248, 0014600848,
 0014601248, 0014602248, 0014607748,
 0024600148, 0003387310, 0004600348,
 0004602848, 0004602948, 0014600848,
 0014601248, 0014602248, 0014607748

**DB-DL-2144**

Length: 872 Ø: 35
 Cone Ø: d1 Ø 28,6 / d2 Ø 23,9
 0024604305, 0024604405, 0034604805

**DB-DL-2178**

Length: 1735 Ø: 52
 Cone Ø: d1 Ø 32 / d2 Ø 29
 9423300003, 9423300103, 9423300203

**DB-DL-5230**

Length: 879 Ø: 42
 Cone Ø: d1 Ø 30 / d2 Ø 27
 01208600A, 0004607105, 0004607205,
 0014606705

**DB-DL-5241**

Length: 875 Ø: 40
 Cone Ø: d1 Ø 30 / d2 Ø 27
 01215300A, 0004609205, 0004609305,
 0014606905

**DB-DL-5405**

Length: 890 Ø: 35
 Cone Ø: d1 Ø 28,6 / d2 Ø 23,9
 01215900A, 1460248, 0024604505,
 0024604605, 0034605005, 3752600637,
 3754600405, A3752600637, A3754600405

**DB-DL-7270**

Length: 875 Ø: 40
 Cone Ø: d1 Ø 28,6 / d2 Ø 23,9
 01208300A, 0024604705, 0024604805,
 0034604905, A0024604705

**DB-DL-8167**

Length: 866 Ø: 38
 Cone Ø: d1 Ø 30 / d2 Ø 27
 0014609805, 0014609905, 0024606305,
 0024606405

**DB-DL-8171**

Length: 1687 Ø: 52
 Cone Ø: d1 Ø 32 / d2 Ø 29
 9493300603, 9493300703, 9493301503,
 9493301603

**DB-DL-8184**

Length: 1095 Ø: 42
 Cone Ø: d1 Ø 32 / d2 Ø 28,8
 01217700A, 0014601305, 0014601405,
 0024600505, 0034603205, 3754601505,
 A0014601305, A0014601405, A0024600505

**DB-DL-8185**

Length: 711 Ø: 42
 Cone Ø: d1 Ø 32 / d2 Ø 28,8
 01213600A, 0014601105, 0024600405,
 0034603105, A0014601105, A0024600405

**DB-DL-8307**

Length: 885 Ø: 38
 Cone Ø: d1 Ø 32 / d2 Ø 30
 01215500A, 0004604005, 0024605105,
 0024605205, 0034604005

**DB-DL-8327**

Length: 1745 Ø: 48
 Cone Ø: d1 Ø 32 / d2 Ø 29
 01219800A, 9413300003, 9413300103,
 9413300203, 9413300303, 9413300503

**DB-DL-8640**

Length: 1615 Ø: 50
 Cone Ø: d1 Ø 32 / d2 Ø 29
 6253301503, 6253301603, 6253302403,
 6253302503, 9423300803, 9423302103,
 9493300203, 9493300303, 9493300903

**DB-DL-8702**

Length: 958 Ø: 38
 Cone Ø: d1 Ø 32 / d2 Ø 30
 0024606105, 0024606205, 0034604205

**DB-DL-12300**

Length: 733 Ø: 36
 Cone Ø: d1 Ø 32 / d2 Ø 29
 0014601505, 0014607305, 0034603305,
 3754601605, A0014601505,
 A0034603305, A3754601605

**DB-DL-12310**

Length: 1532 Ø: 50
 Cone Ø: d1 Ø 32 / d2 Ø 29
 Thread: M27 x 1,5 LHT
 9493301203, 9493301303, 9493301803,
 9493302203, A9493301203, A9493301303,
 A9493301803, A9493302203

**DB-ES-5227**

Length: 1588 Ø: 60
 Cone Ø: d1 Ø 38 / d2 Ø 34,3
 6253300903, 6253301203, 9443300203

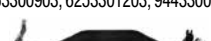
**DB-ES-5234**

Length: 135
 Cone Ø: d1 Ø 38 / d2 Ø 34,3
 Thread: M38 x 1,5 RHT
 0004601748, 120322305, 2205000400

**DB-ES-8164**

Length: 140
 Cone Ø: d1 Ø 28,6 / d2 Ø 23,9
 Thread: M28 x 1,5 RHT
 0014604248, 0014605048, 0014608548,
 0024600548

**DB-ES-8510**

Length: 56
 Cone Ø: d1 Ø 10 / d2 Ø 10
 Thread: M12 x 1,75 LHT
 0009965145, 0009965645, 0019963145

**DB-ES-8530**

Length: 115
 Cone Ø: d1 Ø 28,6 / d2 Ø 23,9
 Thread: M30 x 1,5 RHT
 0014603848, 0014604848, 0014605148,
 0014608648, 0014609948

**DB-RK-8391**

Ø: 85 Hole Distance: 152
 Thick/Height: 24
 01336800A, 0003502705

**DB-RK-8550**

Ø: 75 Hole Distance: 152
 Thick/Height: 24
 0003502105, 0003504605

**DB-RK-8626**

Ø: 75 Hole Distance: 130
 Thick/Height: 24
 0003502205, 0003502505, 0003503405,
 0003504505, GL11319

**DB-RK-8638**

Length: 100 Ø: 67
 Hole Distance: 100
 Thick/Height: 20
 0003301411

**DB-RK-8710**

Ø: 85 Hole Distance: 130
 Thick/Height: 30
 0003503705

**DB-RK-9291**

Ø: 107,5 Hole Distance: 152
 Thick/Height: 30
 0003503605

**DB-RK-10374**

Ø: 85 Hole Distance: 152
 Thick/Height: 24
 0003504405

**DB-RK-10375**

Ø: 100 Hole Distance: 152
 Thick/Height: 24
 0003502405, 0003503505, 0003504905

**DB-SB-10384**

Ø: 73 Thick/Height: 47
 9303170012, 9423171812

**DB-SB-10406**

Ø: 80 Thick/Height: 46
 0003238185

**DB-SB-10409**

Ø: 77 Thick/Height: 56
 0003265181

**DB-SB-10410**

Ø: 73 Hole Distance: 100
 Thick/Height: 24
 9413230050

**DB-VB-7261**

Length: 622 Ø: 46
 Hole Ø 25 / 25 / 25
 Hole Distance: 152 / 130 / 130
 01337800A, 9443500305, 9443500505,
 9443500605, 9473500705, 9473500905,
 9483500405, 9483500305

**DB-VB-7776**

Length: 622 Ø: 56
 Hole Distance: 152 / 152
 6533500205, 6583500205

**DB-VB-7798**

Length: 622 Ø: 48
 Hole Ø 25 / 23 / 23
 Hole Distance: 152 / 130 / 130
 9423500505, 9423500805, 9423501205,
 A9423501205

**DB-VB-9307**

Length: 667 Ø: 60
 Hole Ø 25 / 23 / 23
 Hole Distance: 152 / 130 / 130
 9483502805

**DB-VB-9308**

Length: 622 Ø: 46
 Hole Ø 25 / 25 / 25
 Hole Distance: 152 / 130 / 130
 9483502905

**DB-VB-10426**

Length: 622 Ø: 46
 Hole Ø 25 / 25 / 25
 Hole Distance: 152 / 130 / 130
 9443500405

**MN-RK-8997**

Ø: 85
 Hole Distance: 130
 Thick/Height: 30
 0003504805, 3504805



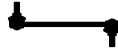

ACTROS MP2 / MP3 ...

2046	04/03→	Ball Head, gearshift linkage	DB-ES-8510		
	04/03→	Bush, driver cab suspension	DB-SB-10384		
	04/03→	Centre Rod	DB-DL-2144	Push Rod	
	04/03→	Centre Rod	DB-DL-5230	Suspension Rod	
	04/03→	Centre Rod	DB-DL-5241	Push Rod	
	04/03→	Centre Rod	DB-DL-5405	Push Rod, Leaf Spring Axle	
	04/03→	Centre Rod	DB-DL-7270	Push Rod;Suspension Rod	
	04/03→	Centre Rod	DB-DL-8167	Push Rod, Leaf Spring Axle	
	04/03→	Centre Rod	DB-DL-8168	Push Rod	
	04/03→	Centre Rod	DB-DL-8184	Push Rod	
	04/03→	Centre Rod	DB-DL-8185	Push Rod	
	04/03→	Centre Rod	DB-DL-8307	Push Rod	
	04/03→	Centre Rod	DB-DL-8622	Push Rod	
	04/03→	Centre Rod	DB-DL-8641	Push Rod	
	04/03→	Centre Rod	DB-DL-8642	Push Rod	
	04/03→	Centre Rod	DB-DL-8702	Push Rod, Leaf Spring Axle	
	04/03→	Centre Rod	DB-DL-12300	for Steering Rod	
	04/03→	Rod Assembly	DB-DL-2178	Guide Rod, 1st Front Axle, →504310 03	
	04/03→	Stabiliser Link	DB-DL-9254	Pressure Rod	
	04/03→	Stabiliser Mounting		DB-SB-10406	
	04/03→	Stabiliser Mounting		DB-SB-10409	
	04/03→	Stabiliser Mounting	DB-SB-10410		
	04/03→	Suspension Arm Repair Kit		DB-RK-8550 for Wishbone (CV)	
	04/03→	Suspension Arm Repair Kit		DB-RK-8626 for Wishbone (CV)	
	04/03→	Suspension Arm Repair Kit		DB-RK-10374 for Wishbone (CV)	
	04/03→	Suspension Arm Repair Kit		DB-RK-10375 for Wishbone (CV)	
	04/03→	Suspension Arm Repair Kit	DB-RK-8638	for Control Arm	
	04/03→	Suspension Strut Repair Kit		DB-RK-8391	
	04/03→	Tie Rod	DB-DL-8171	Guide Rod	
	04/03→	Tie Rod	DB-DL-8327	Guide Rod	
	04/03→	Tie Rod	DB-DL-8640	Guide Rod	
	04/03→	Tie Rod	DB-DL-12310		
	04/03→	Tie Rod	DB-ES-5227	Guide Rod	
	04/03→	Tie Rod End	CV-ES-0543	for Push Rod	
	04/03→	Tie Rod End	CV-ES-0888	for Push Rod	
	04/03→	Tie Rod End	CV-ES-14163	for Steering Rod	
	04/03→	Tie Rod End	DB-ES-5234	for Steering Rod	
	04/03→	Tie Rod End	DB-ES-8164	for Push Rod	
	04/03→	Tie Rod End	DB-ES-8530	for Push Rod	
	04/03→	Track Control Arm		DB-VB-7261 Suspension Rod, Wishbone (CV), 1st RA, →517142 01/517142 02	
	04/03→	Track Control Arm		DB-VB-9307 Suspension Rod, Wishbone (CV), 1st Drive Axle, →517142 07	
	04/03→	Track Control Arm		DB-VB-9308 Suspension Rod, Wishbone (CV), 1st Drive Axle, →517142 06	
	04/03→	Track Control Arm		DB-VB-10426 Wishbone (CV), 1st RA, →517142 05	
	2046 AK	04/03→	Ball Head, gearshift linkage	DB-ES-8510	
		04/03→	Bush, driver cab suspension	DB-SB-10384	
04/03→		Centre Rod	DB-DL-8184	Push Rod	
04/03→		Centre Rod	DB-DL-8307	Push Rod, Leaf Spring Axle	
04/03→		Centre Rod	DB-DL-8702	Push Rod, Leaf Spring Axle	
04/03→		Centre Rod	DB-DL-12300	for Steering Rod	
04/03→		Stabiliser Mounting		DB-SB-10406	
04/03→		Stabiliser Mounting		DB-SB-10409	
04/03→		Suspension Arm Repair Kit		DB-RK-8626 for Wishbone (CV)	
04/03→		Suspension Arm Repair Kit		DB-RK-10374 for Wishbone (CV)	
04/03→		Suspension Arm Repair Kit		DB-RK-10375 for Wishbone (CV)	
04/03→		Suspension Arm Repair Kit	DB-RK-8638	for Control Arm	
04/03→		Suspension Strut Repair Kit		DB-RK-8391	
04/03→		Tie Rod	DB-DL-12310		
04/03→		Tie Rod	DB-ES-5227	Guide Rod, 1st FA;Leaf Spring Axle	
04/03→		Tie Rod	MN-DL-7834	Guide Rod, 1st FA;Leaf Spring Axle	
04/03→		Tie Rod End	CV-ES-0543	for Push Rod	

CV-ES-0543

Length: 125
 Cone Ø: d1 Ø 32 / d2 Ø 29
 Thread: M30 x 1,5 RHT
 0004605748, 0004606048, 0004606848,
 0004607048, 0014600448, 0014601148,
 0014601748, 0014602448, 0014607648,
 0014609648

**CV-ES-0888**

Length: 125
 Cone Ø: d1 Ø 32 / d2 Ø 29
 Thread: M30 x 1,5 LHT
 0004605848, 0004606148, 0004606948,
 0004607148, 0004609048, 0014600548,
 0014601348, 0014602548, 0014607948,
 0024600448

**CV-ES-14163**

Length: 125
 Cone Ø: d1 Ø 30 / d2 Ø 27
 Thread: M30 x 1,5 RHT
 0003305248, 0003387310, 0004600348,
 0004600948, 0004602848, 0004602948,
 0004608948, 0014600248, 0014600848,
 0014601248, 0014602248, 0014607748,
 0024600148, A0003387310, A0004600348,
 A0004602848, A0004602948, A0014600848,
 A0014601248, A0014602248, A0014607748

**DB-DL-2144**

Length: 872 Ø: 35
 Cone Ø: d1 Ø 28,6 / d2 Ø 23,9
 0024604305, 0024604405, 0034604805

**DB-DL-2178**

Length: 1735 Ø: 52
 Cone Ø: d1 Ø 32 / d2 Ø 29
 9423300003, 9423300103, 9423300203

**DB-DL-5230**

Length: 879 Ø: 42
 Cone Ø: d1 Ø 30 / d2 Ø 27
 01208600A, 0004607105, 0004607205,
 0014606705

**DB-DL-5241**

Length: 875 Ø: 40
 Cone Ø: d1 Ø 30 / d2 Ø 27
 01215300A, 0004609205, 0004609305,
 0014606905

**DB-DL-5405**

Length: 890 Ø: 35
 Cone Ø: d1 Ø 28,6 / d2 Ø 23,9
 01215900A, 1460248, 0024604505,
 0024604605, 0034605005, 3752600637,
 3754600405, A3752600637, A3754600405

**DB-DL-7270**

Length: 875 Ø: 40
 Cone Ø: d1 Ø 28,6 / d2 Ø 23,9
 01208300A, 0024604705, 0024604805,
 0034604905, A0024604705

**DB-DL-8167**

Length: 866 Ø: 38
 Cone Ø: d1 Ø 30 / d2 Ø 27
 0014609805, 0014609905, 0024606305,
 0024606405

**DB-DL-8168**

Length: 904 Ø: 52
 Cone Ø: d1 Ø 32 / d2 Ø 29
 0004609405, 0004609505, 0014607105

**DB-DL-8171**

Length: 1687 Ø: 52
 Cone Ø: d1 Ø 32 / d2 Ø 29
 9493300603, 9493300703, 9493301503,
 9493301603

**DB-DL-8184**

Length: 1095 Ø: 42
 Cone Ø: d1 Ø 32 / d2 Ø 28,8
 01217700A, 0014601305, 0014601405,
 0024600505, 0034603205, 3754601505,
 A0014601305, A0014601405, A0024600505

**DB-DL-8185**

Length: 711 Ø: 42
 Cone Ø: d1 Ø 32 / d2 Ø 28,8
 01213600A, 0014601105, 0024600405,
 0034603105, A0014601105, A0024600405

**DB-DL-8307**

Length: 885 Ø: 38
 Cone Ø: d1 Ø 32 / d2 Ø 30
 01215500A, 0004604005, 0024605105,
 0024605205, 0034604005

**DB-DL-8327**

Length: 1745 Ø: 48
 Cone Ø: d1 Ø 32 / d2 Ø 29
 01219800A, 9413300003, 9413300103,
 9413300203, 9413300303, 9413300503

**DB-DL-8622**

Length: 1558 Ø: 52
 Cone Ø: d1 Ø 30 / d2 Ø 27
 0014609005, 0014609105

**DB-DL-8640**

Length: 1615 Ø: 50
 Cone Ø: d1 Ø 32 / d2 Ø 29
 6253301503, 6253301603, 6253302403,
 6253302503, 9423300803, 9423302103,
 9493300203, 9493300303, 9493300903

**DB-DL-8641**

Length: 905 Ø: 42
 Cone Ø: d1 Ø 30 / d2 Ø 27
 0014605105, 0014608105

**DB-DL-8642**

Length: 954 Ø: 42
 Cone Ø: d1 Ø 30 / d2 Ø 27
 0014608605, 0014608705

**DB-DL-8702**

Length: 958 Ø: 38
 Cone Ø: d1 Ø 32 / d2 Ø 30
 0024606105, 0024606205, 0034604205

**DB-DL-9254**

Length: 1815 Ø: 58
 0003220323, 0003220623, 3753220423

**DB-DL-12300**

Length: 733 Ø: 36
 Cone Ø: d1 Ø 32 / d2 Ø 29
 0014601505, 0014607305, 0034603305,
 3754601605, A0014601505,
 A0034603305, A3754601605

**DB-DL-12310**

Length: 1532 Ø: 50
 Cone Ø: d1 Ø 32 / d2 Ø 29
 Thread: M27 x 1,5 LHT
 9493301203, 9493301303, 9493301803,
 9493302203, A9493301203, A9493301303,
 A9493301803, A9493302203

**DB-ES-5227**

Length: 1588 Ø: 60
 Cone Ø: d1 Ø 38 / d2 Ø 34,3
 6253300903, 6253301203, 9443300203

**DB-ES-5234**

Length: 135
 Cone Ø: d1 Ø 38 / d2 Ø 34,3
 Thread: M38 x 1,5 RHT
 0004601748, 120322305, 2205000400

**DB-ES-8164**

Length: 140
 Cone Ø: d1 Ø 28,6 / d2 Ø 23,9
 Thread: M28 x 1,5 RHT
 0014604248, 0014605048, 0014608548,
 0024600548

**DB-ES-8510**

Length: 56
 Cone Ø: d1 Ø 10 / d2 Ø 10
 Thread: M12 x 1,75 LHT
 0009965145, 0009965645, 0019963145

**DB-ES-8530**

Length: 115
 Cone Ø: d1 Ø 28,6 / d2 Ø 23,9
 Thread: M30 x 1,5 RHT
 0014603848, 0014604848, 0014605148,
 0014608648, 0014609948

**DB-RK-8391**

Ø: 85 Hole Distance: 152
 Thick/Height: 24
 01336800A, 0003502705

**DB-RK-8550**

Ø: 75 Hole Distance: 152
 Thick/Height: 24
 0003502105, 0003504605

**DB-RK-8626**

Ø: 75 Hole Distance: 130
 Thick/Height: 24
 0003502205, 0003502505, 0003503405,
 0003504505, GL11319

**DB-RK-8638**

Length: 100 Ø: 67
 Hole Distance: 100
 Thick/Height: 20
 0003301411

**DB-RK-10374**

Ø: 85 Hole Distance: 152
 Thick/Height: 24
 0003504405

**DB-RK-10375**

Ø: 100 Hole Distance: 152
 Thick/Height: 24
 0003502405, 0003503505, 0003504905

**DB-SB-10384**

Ø: 73 Thick/Height: 47
 9303170012, 9423171812

**DB-SB-10406**

Ø: 80 Thick/Height: 46
 0003238185

**DB-SB-10409**

Ø: 77 Thick/Height: 56
 0003265181

**DB-SB-10410**

Ø: 73 Hole Distance: 100
 Thick/Height: 24
 9413230050

**DB-VB-7261**

Length: 622 Ø: 46
 Hole Ø 25 / 25 / 25
 Hole Distance: 152 / 130 / 130
 01337800A, 9443500305, 9443500505,
 9443500605, 9473500705, 9473500905,
 9483500405, 9483500305

**DB-VB-9307**

Length: 667 Ø: 60
 Hole Ø 25 / 23 / 23
 Hole Distance: 152 / 130 / 130
 9483502805

**DB-VB-9308**

Length: 622 Ø: 46
 Hole Ø 25 / 25 / 25
 Hole Distance: 152 / 130 / 130
 9483502905

**DB-VB-10426**

Length: 622 Ø: 46
 Hole Ø 25 / 25 / 25
 Hole Distance: 152 / 130 / 130
 9443500405

**MN-DL-7834**

Length: 1588 Ø: 58
 Cone Ø: d1 Ø 30 / d2 Ø 27
 3463303903, 3463304903, 6253303203,
 9443300503, 9443301303, 9443301703





ACTROS MP2 / MP3 ...

2046 AK ...	04/03→	Tie Rod End	CV-ES-14163		for Steering Rod	
	04/03→	Tie Rod End	DB-ES-5234		for Steering Rod	
	04/03→	Tie Rod End	DB-ES-8530		for Push Rod	
	04/03→	Track Control Arm		DB-VB-7261	Suspension Rod, Wishbone (CV), 1st RA, →517142 01/517142 02	
	04/03→	Track Control Arm		DB-VB-9307	Suspension Rod, Wishbone (CV), 1st Drive Axle, →517142 07	
	04/03→	Track Control Arm		DB-VB-9308	Suspension Rod, Wishbone (CV), 1st Drive Axle, →517142 06	
	04/03→	Track Control Arm		DB-VB-10426	Wishbone (CV), 1st RA, →517142 05	
2046 AS	04/03→	Ball Head, gearshift linkage	DB-ES-8510			
	04/03→	Bush, driver cab suspension	DB-SB-10384			
	04/03→	Centre Rod	DB-DL-8307		Push Rod, Leaf Spring Axle	
	04/03→	Centre Rod	DB-DL-8702		Push Rod	
	04/03→	Centre Rod	DB-DL-12300		for Steering Rod	
	04/03→	Stabiliser Mounting		DB-SB-10406		
	04/03→	Stabiliser Mounting		DB-SB-10409		
	04/03→	Stabiliser Mounting	DB-SB-10410			
	04/03→	Suspension Arm Repair Kit		DB-RK-8626	for Wishbone (CV)	
	04/03→	Suspension Arm Repair Kit		DB-RK-10374	for Wishbone (CV)	
	04/03→	Suspension Arm Repair Kit		DB-RK-10375	for Wishbone (CV)	
	04/03→	Suspension Arm Repair Kit	DB-RK-8638		for Control Arm	
	04/03→	Suspension Strut Repair Kit		DB-RK-8391		
	04/03→	Suspension Strut Repair Kit		MN-RK-8997		
	04/03→	Tie Rod	DB-DL-12310			
	04/03→	Tie Rod	DB-ES-5227		Guide Rod	
	04/03→	Tie Rod	MN-DL-7834		Guide Rod	
	04/03→	Tie Rod End	CV-ES-14163		for Steering Rod	
	04/03→	Tie Rod End	DB-ES-5234		for Steering Rod	
	04/03→	Tie Rod End	DB-ES-8530		for Push Rod	
	04/03→	Track Control Arm		DB-VB-7261	Suspension Rod, Wishbone (CV), 1st RA, →517142 01/517142 02	
	04/03→	Track Control Arm		DB-VB-7798	Wishbone (CV)	
	04/03→	Track Control Arm		DB-VB-9307	Suspension Rod, Wishbone (CV), 1st Drive Axle, →517142 07	
	04/03→	Track Control Arm		DB-VB-9308	Suspension Rod, Wishbone (CV), 1st Drive Axle, →517142 06	
	04/03→	Track Control Arm		DB-VB-10426	Wishbone (CV), 1st RA, →517142 05	
	2046 K	04/03→	Centre Rod	DB-DL-2144		Push Rod
		04/03→	Centre Rod	DB-DL-5405		Push Rod, Leaf Spring Axle
04/03→		Centre Rod	DB-DL-7270		Push Rod	
04/03→		Centre Rod	DB-DL-8167		Push Rod	
04/03→		Centre Rod	DB-DL-8307		Push Rod	
04/03→		Centre Rod	DB-DL-8702		Push Rod, Leaf Spring Axle	
04/03→		Rod Assembly	DB-DL-2178		Guide Rod, 1st Front Axle, →504310 03	
04/03→		Stabiliser Mounting		DB-SB-10406		
04/03→		Suspension Arm Repair Kit		DB-RK-8626	for Wishbone (CV)	
04/03→		Suspension Arm Repair Kit		DB-RK-10374	for Wishbone (CV)	
04/03→		Suspension Arm Repair Kit		DB-RK-10375	for Wishbone (CV)	
04/03→		Suspension Strut Repair Kit		DB-RK-8710		
04/03→		Suspension Strut Repair Kit		DB-RK-9291		
04/03→		Tie Rod	DB-DL-8171		Guide Rod, 1st FA;Leaf Spring Axle	
04/03→		Tie Rod	DB-DL-8327		Guide Rod, 1st FA;Leaf Spring Axle	
04/03→		Tie Rod	DB-DL-8640		Guide Rod	
04/03→		Tie Rod	DB-DL-12310			
04/03→		Tie Rod	DB-ES-5227		Guide Rod	
04/03→		Tie Rod End	CV-ES-0543		for Push Rod	
04/03→		Tie Rod End	CV-ES-0888		for Push Rod	
04/03→		Track Control Arm		DB-VB-7261	Suspension Rod, Wishbone (CV), 1st RA, →517142 01/517142 02	
04/03→		Track Control Arm		DB-VB-7776	Wishbone (CV)	
04/03→		Track Control Arm		DB-VB-9307	Suspension Rod, Wishbone (CV)	
04/03→		Track Control Arm		DB-VB-9308	Suspension Rod, Wishbone (CV)	
04/03→		Track Control Arm		DB-VB-10426	Wishbone (CV), 1st RA, →517142 05	

CV-ES-0543

Length: 125
Cone Ø: d1 Ø 32 / d2 Ø 29
Thread: M30 x 1,5 RHT
0004605748, 0004606048, 0004606848,
0004607048, 0014600448, 0014601148,
0014601748, 0014602448, 0014607648,
0014609648



CV-ES-0888

Length: 125
Cone Ø: d1 Ø 32 / d2 Ø 29
Thread: M30 x 1,5 LHT
0004605848, 0004606148, 0004606948,
0004607148, 0004609048, 0014600548,
0014601348, 0014602548, 0014607948,
0024600448



CV-ES-14163

Length: 125
Cone Ø: d1 Ø 30 / d2 Ø 27
Thread: M30 x 1,5 RHT
0003305248, 0003387310, 0004600348,
0004600948, 0004602848, 0004602948,
0004608948, 0014600248, 0014600848,
0014601248, 0014602248, 0014607748,
0024600148, A0003387310, A0004600348,
A0004602848, A0004602948, A0014600848,
A0014601248, A0014602248, A0014607748



DB-DL-2144

Length: 872 Ø: 35
Cone Ø: d1 Ø 28,6 / d2 Ø 23,9
0024604305, 0024604405, 0034604805



DB-DL-2178

Length: 1735 Ø: 52
Cone Ø: d1 Ø 32 / d2 Ø 29
9423300003, 9423300103, 9423300203



DB-DL-5405

Length: 890 Ø: 35
Cone Ø: d1 Ø 28,6 / d2 Ø 23,9
01215900A, 1460248, 0024604505,
0024604605, 0034605005, 3752600637,
3754600405, A3752600637, A3754600405



DB-DL-7270

Length: 875 Ø: 40
Cone Ø: d1 Ø 28,6 / d2 Ø 23,9
01208300A, 0024604705, 0024604805,
0034604905, A0024604705



DB-DL-8167

Length: 866 Ø: 38
Cone Ø: d1 Ø 30 / d2 Ø 27
0014609805, 0014609905, 0024606305,
0024606405



DB-DL-8171

Length: 1687 Ø: 52
Cone Ø: d1 Ø 32 / d2 Ø 29
9493300603, 9493300703, 9493301503,
9493301603



DB-DL-8307

Length: 885 Ø: 38
Cone Ø: d1 Ø 32 / d2 Ø 30
01215500A, 0004604005, 0024605105,
0024605205, 0034604005



DB-DL-8327

Length: 1745 Ø: 48
Cone Ø: d1 Ø 32 / d2 Ø 29
01219800A, 9413300003, 9413300103,
9413300203, 9413300303, 9413300503



DB-DL-8640

Length: 1615 Ø: 50
Cone Ø: d1 Ø 32 / d2 Ø 29
6253301503, 6253301603, 6253302403,
6253302503, 9423300803, 9423302103,
9493300203, 9493300303, 9493300903



DB-DL-8702

Length: 958 Ø: 38
Cone Ø: d1 Ø 32 / d2 Ø 30
0024606105, 0024606205, 0034604205



DB-DL-12300

Length: 733 Ø: 36
Cone Ø: d1 Ø 32 / d2 Ø 29
0014601505, 0014607305, 0034603305,
3754601605, A0014601505, A0034603305,
A3754601605



DB-DL-12310

Length: 1532 Ø: 50
Cone Ø: d1 Ø 32 / d2 Ø 29
Thread: M27 x 1,5 LHT
9493301203, 9493301303, 9493301803,
9493302203, A9493301203, A9493301303,
A9493301803, A9493302203



DB-ES-5227

Length: 1588 Ø: 60
Cone Ø: d1 Ø 38 / d2 Ø 34,3
6253300903, 6253301203, 9443300203



DB-ES-5234

Length: 135
Cone Ø: d1 Ø 38 / d2 Ø 34,3
Thread: M38 x 1,5 RHT
0004601748, 120322305, 2205000400



DB-ES-8510

Length: 56
Cone Ø: d1 Ø 10 / d2 Ø 10
Thread: M12 x 1,75 LHT
0009965145, 0009965645, 0019963145



DB-ES-8530

Length: 115
Cone Ø: d1 Ø 28,6 / d2 Ø 23,9
Thread: M30 x 1,5 RHT
0014603848, 0014604848, 0014605148,
0014608648, 0014609948



DB-RK-8391

Ø: 85 Hole Distance: 152
Thick/Height: 24
01336800A, 0003502705



DB-RK-8626

Ø: 75 Hole Distance: 130
Thick/Height: 24
0003502205, 0003502505, 0003503405,
0003504505, GL11319



DB-RK-8638

Length: 100 Ø: 67
Hole Distance: 100
Thick/Height: 20
0003301411



DB-RK-8710

Ø: 85 Hole Distance: 130
Thick/Height: 30
0003503705



DB-RK-9291

Ø: 107,5 Hole Distance: 152
Thick/Height: 30
0003503605



DB-RK-10374

Ø: 85 Hole Distance: 152
Thick/Height: 24
0003504405



DB-RK-10375

Ø: 100 Hole Distance: 152
Thick/Height: 24
0003502405, 0003503505, 0003504905



DB-SB-10384

Ø: 73 Thick/Height: 47
9303170012, 9423171812



DB-SB-10406

Ø: 80 Thick/Height: 46
0003238185



DB-SB-10409

Ø: 77 Thick/Height: 56
0003265181



DB-SB-10410

Ø: 73 Hole Distance: 100
Thick/Height: 24
9413230050



DB-VB-7261

Length: 622 Ø: 46
Hole Ø 25 / 25 / 25
Hole Distance: 152 / 130 / 130
01337800A, 9443500305, 9443500505,
9443500605, 9473500705, 9473500905,
9483500405, 9483500305



DB-VB-7776

Length: 622 Ø: 56
Hole Distance: 152 / 152
6533500205, 6583500205



DB-VB-7798

Length: 622 Ø: 48
Hole Ø 25 / 23 / 23
Hole Distance: 152 / 130 / 130
9423500505, 9423500805, 9423501205,
A9423501205



DB-VB-9307

Length: 667 Ø: 60
Hole Ø 25 / 23 / 23
Hole Distance: 152 / 130 / 130
9483502805



DB-VB-9308

Length: 622 Ø: 46
Hole Ø 25 / 25 / 25
Hole Distance: 152 / 130 / 130
9483502905



DB-VB-10426

Length: 622 Ø: 46
Hole Ø 25 / 25 / 25
Hole Distance: 152 / 130 / 130
9443500405



MN-DL-7834

Length: 1588 Ø: 58
Cone Ø: d1 Ø 30 / d2 Ø 27
3463303903, 3463304903, 6253303203,
9443300503, 9443301303, 9443301703



MN-RK-8997

Ø: 85 Hole Distance: 130
Thick/Height: 30
0003504805





ACTROS MP2 / MP3 ...

2046 S	04/03→	Ball Head, gearshift linkage	DB-ES-8510		
	04/03→	Bush, driver cab suspension	DB-SB-10384		
	04/03→	Centre Rod	DB-DL-2144	Push Rod	
	04/03→	Centre Rod	DB-DL-5230	Suspension Rod	
	04/03→	Centre Rod	DB-DL-5241	Push Rod	
	04/03→	Centre Rod	DB-DL-5405	Push Rod, Leaf Spring Axle	
	04/03→	Centre Rod	DB-DL-7270	Push Rod;Suspension Rod	
	04/03→	Centre Rod	DB-DL-8167	Push Rod	
	04/03→	Centre Rod	DB-DL-8184	Push Rod	
	04/03→	Centre Rod	DB-DL-8185	Push Rod	
	04/03→	Centre Rod	DB-DL-8307	Push Rod	
	04/03→	Centre Rod	DB-DL-8702	Push Rod, Leaf Spring Axle	
	04/03→	Centre Rod	DB-DL-12300	for Steering Rod	
	04/03→	Rod Assembly	DB-DL-2178	Guide Rod, 1st Front Axle, →504310 03	
	04/03→	Stabiliser Mounting		DB-SB-10406	
	04/03→	Stabiliser Mounting		DB-SB-10409	
	04/03→	Stabiliser Mounting	DB-SB-10410		
	04/03→	Suspension Arm Repair Kit		DB-RK-8550 for Wishbone (CV)	
	04/03→	Suspension Arm Repair Kit		DB-RK-8626 for Wishbone (CV)	
	04/03→	Suspension Arm Repair Kit		DB-RK-10374 for Wishbone (CV)	
	04/03→	Suspension Arm Repair Kit		DB-RK-10375 for Wishbone (CV)	
	04/03→	Suspension Arm Repair Kit	DB-RK-8638	for Control Arm	
	04/03→	Suspension Strut Repair Kit		DB-RK-8391	
	04/03→	Suspension Strut Repair Kit		MN-RK-8997	
	04/03→	Tie Rod	DB-DL-8171	Guide Rod	
	04/03→	Tie Rod	DB-DL-8327	Guide Rod	
	04/03→	Tie Rod	DB-DL-8640	Guide Rod	
	04/03→	Tie Rod	DB-DL-12310		
	04/03→	Tie Rod	DB-ES-5227	Guide Rod	
	04/03→	Tie Rod End	CV-ES-0543	for Push Rod	
	04/03→	Tie Rod End	CV-ES-0888	for Push Rod	
	04/03→	Tie Rod End	CV-ES-14163	for Steering Rod	
	04/03→	Tie Rod End	DB-ES-5234	for Steering Rod	
	04/03→	Tie Rod End	DB-ES-8164	for Push Rod	
	04/03→	Tie Rod End	DB-ES-8530	for Push Rod	
	04/03→	Track Control Arm		DB-VB-7261 Suspension Rod, Wishbone (CV), 1st RA, →517142 01/517142 02	
	04/03→	Track Control Arm		DB-VB-7798 Wishbone (CV)	
	04/03→	Track Control Arm		DB-VB-9307 Suspension Rod, Wishbone (CV), 1st Drive Axle, →517142 07	
	04/03→	Track Control Arm		DB-VB-9308 Suspension Rod, Wishbone (CV), 1st Drive Axle, →517142 06	
	04/03→	Track Control Arm		DB-VB-10426 Wishbone (CV), 1st RA, →517142 05	
	2048	06/08→	Centre Rod	DB-DL-2144	Push Rod
		06/08→	Centre Rod	DB-DL-5405	Push Rod, Leaf Spring Axle
		06/08→	Centre Rod	DB-DL-8167	Push Rod, Leaf Spring Axle
06/08→		Centre Rod	DB-DL-8307	Push Rod	
06/08→		Centre Rod	DB-DL-8702	Push Rod, Leaf Spring Axle	
06/08→		Rod Assembly	DB-DL-2178	Guide Rod, 1st Front Axle, →504310 03	
06/08→		Stabiliser Mounting		DB-SB-10406	
06/08→		Suspension Arm Repair Kit		DB-RK-8626 for Wishbone (CV)	
06/08→		Suspension Arm Repair Kit		DB-RK-10374 for Wishbone (CV)	
06/08→		Suspension Arm Repair Kit		DB-RK-10375 for Wishbone (CV)	
06/08→		Suspension Strut Repair Kit		DB-RK-8710	
06/08→		Suspension Strut Repair Kit		DB-RK-9291	
06/08→		Tie Rod	DB-DL-8171	Guide Rod	
06/08→		Tie Rod	DB-DL-8327	Guide Rod	
06/08→		Tie Rod	DB-DL-8640	Guide Rod	
06/08→		Tie Rod	DB-DL-12310		
06/08→		Tie Rod	DB-ES-5227	Guide Rod	
06/08→		Tie Rod End	CV-ES-0543	for Push Rod	
06/08→		Tie Rod End	CV-ES-0888	for Push Rod	
06/08→		Tie Rod End	CV-ES-14163	for Steering Rod	

CV-ES-0543

Length: 125
Cone Ø: d1 Ø 32 / d2 Ø 29
Thread: M30 x 1,5 RHT
 0004605748, 0004606048, 0004606688,
 0004607048, 0014600448, 0014601148,
 0014601748, 0014602448, 0014607648,
 0014609648

**CV-ES-0888**

Length: 125
Cone Ø: d1 Ø 32 / d2 Ø 29
Thread: M30 x 1,5 LHT
 0004605848, 0004606148, 0004606948,
 0004607148, 0004609048, 0014600548,
 0014601348, 0014602548, 0014607948,
 0024600448

**CV-ES-14163**

Length: 125
Cone Ø: d1 Ø 30 / d2 Ø 27
Thread: M30 x 1,5 RHT
 0003305248, 0003387310, 0004600348,
 0004600948, 0004602848, 0004602948,
 0004608948, 0014600248, 0014600848,
 0014601248, 0014602248, 0014607748,
 0024600148, A0003387310, A0004600348,
 A0004602848, A0004602948, A0014600848,
 A0014601248, A0014602248, A0014607748

**DB-DL-2144**

Length: 872 **Ø:** 35
Cone Ø: d1 Ø 28,6 / d2 Ø 23,9
 0024604305, 0024604405, 0034604805

**DB-DL-2178**

Length: 1735 **Ø:** 52
Cone Ø: d1 Ø 32 / d2 Ø 29
 9423300003, 9423300103, 9423300203

**DB-DL-5230**

Length: 879 **Ø:** 42
Cone Ø: d1 Ø 30 / d2 Ø 27
 01208600A, 0004607105, 0004607205,
 0014606705

**DB-DL-5241**

Length: 875 **Ø:** 40
Cone Ø: d1 Ø 30 / d2 Ø 27
 01215300A, 0004609205, 0004609305,
 0014606905

**DB-DL-5405**

Length: 890 **Ø:** 35
Cone Ø: d1 Ø 28,6 / d2 Ø 23,9
 01215900A, 1460248, 0024604505,
 0024604605, 0034605005, 3752600637,
 3754600405, A3752600637, A3754600405

**DB-DL-7270**

Length: 875 **Ø:** 40
Cone Ø: d1 Ø 28,6 / d2 Ø 23,9
 01208300A, 0024604705, 0024604805,
 0034604905, A0024604705

**DB-DL-8167**

Length: 866 **Ø:** 38
Cone Ø: d1 Ø 30 / d2 Ø 27
 0014609805, 0014609905, 0024606305,
 0024606405

**DB-DL-8171**

Length: 1687 **Ø:** 52
Cone Ø: d1 Ø 32 / d2 Ø 29
 9493300603, 9493300703, 9493301503,
 9493301603

**DB-DL-8184**

Length: 1095 **Ø:** 42
Cone Ø: d1 Ø 32 / d2 Ø 28,8
 01217700A, 0014601305, 0014601405,
 0024600505, 0034603205, 3754601505,
 A0014601305, A0014601405, A0024600505

**DB-DL-8185**

Length: 711 **Ø:** 42
Cone Ø: d1 Ø 32 / d2 Ø 28,8
 01213600A, 0014601105, 0024600405,
 0034603105, A0014601105, A0024600405

**DB-DL-8307**

Length: 885 **Ø:** 38
Cone Ø: d1 Ø 32 / d2 Ø 30
 01215500A, 0004604005, 0024605105,
 0024605205, 0034604005

**DB-DL-8327**

Length: 1745 **Ø:** 48
Cone Ø: d1 Ø 32 / d2 Ø 29
 01219800A, 9413300003, 9413300103,
 9413300203, 9413300303, 9413300503

**DB-DL-8640**

Length: 1615 **Ø:** 50
Cone Ø: d1 Ø 32 / d2 Ø 29
 6253301503, 6253301603, 6253302403,
 6253302503, 9423300803, 9423302103,
 9493300203, 9493300303, 9493300903

**DB-DL-8702**

Length: 958 **Ø:** 38
Cone Ø: d1 Ø 32 / d2 Ø 30
 0024606105, 0024606205, 0034604205

**DB-DL-12300**

Length: 733 **Ø:** 36
Cone Ø: d1 Ø 32 / d2 Ø 29
 0014601505, 0014607305, 0034603305,
 3754601605, A0014601505,
 A0034603305, A3754601605

**DB-DL-12310**

Length: 1532 **Ø:** 50
Cone Ø: d1 Ø 32 / d2 Ø 29
Thread: M27 x 1,5 LHT
 9493301203, 9493301303, 9493301803,
 9493302203, A9493301203, A9493301303,
 A9493301803, A9493302203

**DB-ES-5227**

Length: 1588 **Ø:** 60
Cone Ø: d1 Ø 38 / d2 Ø 34,3
 6253300903, 6253301203, 9443300203

**DB-ES-5234**

Length: 135
Cone Ø: d1 Ø 38 / d2 Ø 34,3
Thread: M38 x 1,5 RHT
 0004601748, 120322305, 2205000400

**DB-ES-8164**

Length: 140
Cone Ø: d1 Ø 28,6 / d2 Ø 23,9
Thread: M28 x 1,5 RHT
 0014604248, 0014605048, 0014608548,
 0024600548

**DB-ES-8510**

Length: 56
Cone Ø: d1 Ø 10 / d2 Ø 10
Thread: M12 x 1,75 LHT
 0009965145, 0009965645, 0019963145

**DB-ES-8530**

Length: 115
Cone Ø: d1 Ø 28,6 / d2 Ø 23,9
Thread: M30 x 1,5 RHT
 0014603848, 0014604848, 0014605148,
 0014608648, 0014609948

**DB-RK-8391**

Ø: 85 **Hole Distance:** 152
Thick/Height: 24
 01336800A, 0003502705

**DB-RK-8550**

Ø: 75 **Hole Distance:** 152
Thick/Height: 24
 0003502105, 0003504605

**DB-RK-8626**

Ø: 75 **Hole Distance:** 130
Thick/Height: 24
 0003502205, 0003502505, 0003503405,
 0003504505, GL11319

**DB-RK-8638**

Length: 100 **Ø:** 67
Hole Distance: 100
Thick/Height: 20
 0003301411

**DB-RK-8710**

Ø: 85 **Hole Distance:** 130
Thick/Height: 30
 0003503705

**DB-RK-9291**

Ø: 107,5 **Hole Distance:** 152
Thick/Height: 30
 0003503605

**DB-RK-10374**

Ø: 85 **Hole Distance:** 152
Thick/Height: 24
 0003504405

**DB-RK-10375**

Ø: 100 **Hole Distance:** 152
Thick/Height: 24
 0003502405, 0003503505, 0003504905

**DB-SB-10384**

Ø: 73 **Thick/Height:** 47
 9303170012, 9423171812

**DB-SB-10406**

Ø: 80 **Thick/Height:** 46
 0003238185

**DB-SB-10409**

Ø: 77 **Thick/Height:** 56
 0003265181

**DB-SB-10410**

Ø: 73 **Hole Distance:** 100
Thick/Height: 24
 9413230050

**DB-VB-7261**

Length: 622 **Ø:** 46
Hole Ø: 25 / 25 / 25
Hole Distance: 152 / 130 / 130
 01337800A, 9443500305, 9443500505,
 9443500605, 9473500705, 9473500905,
 9483500405, 9483500305

**DB-VB-7798**

Length: 622 **Ø:** 48
Hole Ø: 25 / 23 / 23
Hole Distance: 152 / 130 / 130
 9423500505, 9423500805, 9423501205,
 A9423501205

**DB-VB-9307**

Length: 667 **Ø:** 60
Hole Ø: 25 / 23 / 23
Hole Distance: 152 / 130 / 130
 9483502805

**DB-VB-9308**

Length: 622 **Ø:** 46
Hole Ø: 25 / 25 / 25
Hole Distance: 152 / 130 / 130
 9483502905

**DB-VB-10426**

Length: 622 **Ø:** 46
Hole Ø: 25 / 25 / 25
Hole Distance: 152 / 130 / 130
 9443500405

**MN-RK-8997**

Ø: 85 **Hole Distance:** 130
Thick/Height: 30
 0003504805





ACTROS MP2 / MP3 ...

2048 ...	06/08 →	Tie Rod End	DB-ES-8164		for Push Rod	
	06/08 →	Track Control Arm		DB-VB-7261	Suspension Rod, Wishbone (CV), 1st RA, →517142 01/517142 02	
	06/08 →	Track Control Arm		DB-VB-7776	Wishbone (CV)	
	06/08 →	Track Control Arm		DB-VB-9307	Suspension Rod, Wishbone (CV)	
	06/08 →	Track Control Arm		DB-VB-9308	Suspension Rod, Wishbone (CV)	
	06/08 →	Track Control Arm		DB-VB-10426	Wishbone (CV), 1st RA, →517142 05	
2048 AK	04/03 →	Ball Head, gearshift linkage	DB-ES-8510			
	04/03 →	Bush, driver cab suspension	DB-SB-10384			
	04/03 →	Centre Rod	DB-DL-8184		Push Rod	
	04/03 →	Centre Rod	DB-DL-8307		Push Rod, Leaf Spring Axle	
	04/03 →	Centre Rod	DB-DL-8702		Push Rod, Leaf Spring Axle	
	04/03 →	Centre Rod	DB-DL-12300		for Steering Rod	
	04/03 →	Stabiliser Mounting		DB-SB-10406		
	04/03 →	Stabiliser Mounting		DB-SB-10409		
	04/03 →	Suspension Arm Repair Kit		DB-RK-8626	for Wishbone (CV)	
	04/03 →	Suspension Arm Repair Kit		DB-RK-10374	for Wishbone (CV)	
	04/03 →	Suspension Arm Repair Kit		DB-RK-10375	for Wishbone (CV)	
	04/03 →	Suspension Arm Repair Kit	DB-RK-8638		for Control Arm	
	04/03 →	Suspension Strut Repair Kit		DB-RK-8391		
	04/03 →	Tie Rod	DB-DL-12310			
	04/03 →	Tie Rod	DB-ES-5227		Guide Rod, 1st FA; Leaf Spring Axle	
	04/03 →	Tie Rod	MN-DL-7834		Guide Rod, 1st FA; Leaf Spring Axle	
	04/03 →	Tie Rod End	CV-ES-0543		for Push Rod	
	04/03 →	Tie Rod End	CV-ES-14163		for Steering Rod	
	04/03 →	Tie Rod End	DB-ES-5234		for Steering Rod	
	04/03 →	Tie Rod End	DB-ES-8530		for Push Rod	
	04/03 →	Track Control Arm		DB-VB-7261	Suspension Rod, Wishbone (CV), 1st RA, →517142 01/517142 02	
	04/03 →	Track Control Arm		DB-VB-9307	Suspension Rod, Wishbone (CV), 1st Drive Axle, →517142 07	
	04/03 →	Track Control Arm		DB-VB-9308	Suspension Rod, Wishbone (CV), 1st Drive Axle, →517142 06	
	04/03 →	Track Control Arm		DB-VB-10426	Wishbone (CV), 1st RA, →517142 05	
	2048 AS	04/03 →	Ball Head, gearshift linkage	DB-ES-8510		
		04/03 →	Bush, driver cab suspension	DB-SB-10384		
		04/03 →	Bush, parabolic spring		DB-SB-10400	
04/03 →		Bush, parabolic spring		DB-SB-10401		
04/03 →		Centre Rod	DB-DL-5230		Push Rod	
04/03 →		Centre Rod	DB-DL-5405		Push Rod	
04/03 →		Centre Rod	DB-DL-8307		Push Rod, Leaf Spring Axle	
04/03 →		Centre Rod	DB-DL-8702		Push Rod	
04/03 →		Centre Rod	DB-DL-12300		for Steering Rod	
04/03 →		Stabiliser Mounting		DB-SB-10406		
04/03 →		Stabiliser Mounting		DB-SB-10409		
04/03 →		Stabiliser Mounting	DB-SB-10410			
04/03 →		Suspension Arm Repair Kit		DB-RK-8626	for Wishbone (CV)	
04/03 →		Suspension Arm Repair Kit		DB-RK-10374	for Wishbone (CV)	
04/03 →		Suspension Arm Repair Kit		DB-RK-10375	for Wishbone (CV)	
04/03 →		Suspension Arm Repair Kit	DB-RK-8638		for Control Arm	
04/03 →		Suspension Strut Repair Kit		DB-RK-8391		
04/03 →		Suspension Strut Repair Kit		MN-RK-8997		
04/03 →		Tie Rod	DB-DL-12310			
04/03 →		Tie Rod	DB-ES-5227		Guide Rod	
04/03 →		Tie Rod	MN-DL-7834		Guide Rod	
04/03 →		Tie Rod	MN-DL-7834		Guide Rod, 1st Front Axle	
04/03 →		Tie Rod End	CV-ES-14163		for Steering Rod	
04/03 →		Tie Rod End	DB-ES-5234		for Steering Rod	
04/03 →		Tie Rod End	DB-ES-8530		for Push Rod	
04/03 →		Track Control Arm		DB-DL-3475	Trailing Arm	
04/03 →		Track Control Arm		DB-VB-7261	Suspension Rod, Wishbone (CV), 1st RA, →517142 01/517142 02	
04/03 →		Track Control Arm		DB-VB-7798	Wishbone (CV)	

CV-ES-0543

Length: 125
Cone Ø: d1 Ø 32 / d2 Ø 29
Thread: M30 x 1,5 RHT
0004605748, 0004606048, 0004606848,
0004607048, 0014600448, 0014601148,
0014601748, 0014602448, 0014607648,
0014609648



CV-ES-14163

Length: 125
Cone Ø: d1 Ø 30 / d2 Ø 27
Thread: M30 x 1,5 RHT
0003305248, 0003387310, 0004600348,
0004600948, 0004602848, 0004602948,
0004608948, 0014600248, 0014600848,
0014601248, 0014602248, 0014607748,
0024600148, A0003387310, A0004600348,
A0004602848, A0004602948, A0014600848,
A0014601248, A0014602248, A0014607748



DB-DL-3475

Length: 565 Ø: 52
Hole Distance: 152 / 152
3753500006, 3753500206, 9473500805,
9483500006, 9483500805, 9483501205,
9483501305, 9483501905, 9483502005,
9483502405, A3753500006,
A3753500206



DB-DL-5230

Length: 879 Ø: 42
Cone Ø: d1 Ø 30 / d2 Ø 27
01208600A, 0004607105, 0004607205,
0014606705



DB-DL-5405

Length: 890 Ø: 35
Cone Ø: d1 Ø 28,6 / d2 Ø 23,9
01215900A, 1460248, 0024604505,
0024604605, 0034605005, 3752600637,
3754600405, A3752600637, A3754600405



DB-DL-8184

Length: 1095 Ø: 42
Cone Ø: d1 Ø 32 / d2 Ø 28,8
01217700A, 0014601305, 0014601405,
0024600505, 0034603205, 3754601505,
A0014601305, A0014601405, A0024600505



DB-DL-8307

Length: 885 Ø: 38
Cone Ø: d1 Ø 32 / d2 Ø 30
01215500A, 0004604005, 0024605105,
0024605205, 0034604005



DB-DL-8702

Length: 958 Ø: 38
Cone Ø: d1 Ø 32 / d2 Ø 30
0024606105, 0024606205, 0034604205



DB-DL-12300

Length: 733 Ø: 36
Cone Ø: d1 Ø 32 / d2 Ø 29
0014601505, 0014607305, 0034603305,
3754601605, A0014601505,
A0034603305, A3754601605



DB-DL-12310

Length: 1532 Ø: 50
Cone Ø: d1 Ø 32 / d2 Ø 29
Thread: M27 x 1,5 LHT
9493301203, 9493301303, 9493301803,
9493302203, A9493301203, A9493301303,
A9493301803, A9493302203



DB-ES-5227

Length: 1588 Ø: 60
Cone Ø: d1 Ø 38 / d2 Ø 34,3
6253300903, 6253301203, 9443300203



DB-ES-5234

Length: 135
Cone Ø: d1 Ø 38 / d2 Ø 34,3
Thread: M38 x 1,5 RHT
0004601748, 120322305, 2205000400



DB-ES-8164

Length: 140
Cone Ø: d1 Ø 28,6 / d2 Ø 23,9
Thread: M28 x 1,5 RHT
0014604248, 0014605048, 0014608548,
0024600548



DB-ES-8510

Length: 56
Cone Ø: d1 Ø 10 / d2 Ø 10
Thread: M12 x 1,75 LHT
0009965145, 0009965645, 0019963145



DB-ES-8530

Length: 115
Cone Ø: d1 Ø 28,6 / d2 Ø 23,9
Thread: M30 x 1,5 RHT
0014603848, 0014604848, 0014605148,
0014608648, 0014609948



DB-RK-8391

Ø: 85 Hole Distance: 152
Thick/Height: 24
01336800A, 0003502705



DB-RK-8626

Ø: 75 Hole Distance: 130
Thick/Height: 24
0003502205, 0003502505, 0003503405,
0003504505, GL11319



DB-RK-8638

Length: 100 Ø: 67
Hole Distance: 100
Thick/Height: 20
0003301411



DB-RK-10374

Ø: 85 Hole Distance: 152
Thick/Height: 24
0003504405



DB-RK-10375

Ø: 100 Hole Distance: 152
Thick/Height: 24
0003502405, 0003503505, 0003504905



DB-SB-10384

Ø: 73 Thick/Height: 47
9303170012, 9423171812



DB-SB-10400

Length: 230
Thick/Height: 167,5 / 115
0003250696, 0003250896



DB-SB-10401

Length: 232
Thick/Height: 163,5 / 152,5
0003250596, 0003250796



DB-SB-10406

Ø: 80 Thick/Height: 46
0003238185



DB-SB-10409

Ø: 77 Thick/Height: 56
0003265181



DB-SB-10410

Ø: 73 Hole Distance: 100
Thick/Height: 24
9413230050



DB-VB-7261

Length: 622 Ø: 46
Hole Ø 25 / 25 / 25
Hole Distance: 152 / 130 / 130
01337800A, 9443500305, 9443500505,
9443500605, 9473500705, 9473500905,
9483500405, 9483503005



DB-VB-7776

Length: 622 Ø: 56
Hole Distance: 152 / 152
6533500205, 6583500205



DB-VB-7798

Length: 622 Ø: 48
Hole Ø 25 / 23 / 23
Hole Distance: 152 / 130 / 130
9423500505, 9423500805, 9423501205,
A9423501205



DB-VB-9307

Length: 667 Ø: 60
Hole Ø 25 / 23 / 23
Hole Distance: 152 / 130 / 130
9483502805



DB-VB-9308

Length: 622 Ø: 46
Hole Ø 25 / 25 / 25
Hole Distance: 152 / 130 / 130
9483502905



DB-VB-10426

Length: 622 Ø: 46
Hole Ø 25 / 25 / 25
Hole Distance: 152 / 130 / 130
9443500405



MN-DL-7834

Length: 1588 Ø: 58
Cone Ø: d1 Ø 30 / d2 Ø 27
3463303903, 3463304903, 6253303203,
9443300503, 9443301303, 9443301703



MN-RK-8997

Ø: 85 Hole Distance: 130
Thick/Height: 30
0003504805





ACTROS MP2 / MP3 ...

2048 AS ...	04/03 →	Track Control Arm		DB-VB-9307	Suspension Rod, Wishbone (CV), 1st Drive Axle, →517142 07	
	04/03 →	Track Control Arm		DB-VB-9308	Suspension Rod, Wishbone (CV), 1st Drive Axle, →517142 06	
	04/03 →	Track Control Arm		DB-VB-10426	Wishbone (CV), 1st RA, →517142 05	
	04/03 →	Track Control Arm	DB-DL-5224		Control Arm	
	04/03 →	Track Control Arm	DB-DL-9218	DB-DL-9218	Trailing Arm	
2048 K	04/03 →	Centre Rod	DB-DL-2144		Push Rod	
	04/03 →	Centre Rod	DB-DL-5405		Push Rod, Leaf Spring Axle	
	04/03 →	Centre Rod	DB-DL-7270		Push Rod	
	04/03 →	Centre Rod	DB-DL-8167		Push Rod	
	04/03 →	Centre Rod	DB-DL-8307		Push Rod	
	04/03 →	Centre Rod	DB-DL-8702		Push Rod, Leaf Spring Axle	
	04/03 →	Rod Assembly	DB-DL-2178		Guide Rod, 1st Front Axle, →504310 03	
	04/03 →	Stabiliser Mounting		DB-SB-10406		
	04/03 →	Suspension Arm Repair Kit		DB-RK-8626	for Wishbone (CV)	
	04/03 →	Suspension Arm Repair Kit		DB-RK-10374	for Wishbone (CV)	
	04/03 →	Suspension Arm Repair Kit		DB-RK-10375	for Wishbone (CV)	
	04/03 →	Suspension Strut Repair Kit		DB-RK-8710		
	04/03 →	Suspension Strut Repair Kit		DB-RK-9291		
	04/03 →	Tie Rod	DB-DL-8171		Guide Rod, 1st FA; Leaf Spring Axle	
	04/03 →	Tie Rod	DB-DL-8327		Guide Rod, 1st FA; Leaf Spring Axle	
	04/03 →	Tie Rod	DB-DL-8640		Guide Rod	
	04/03 →	Tie Rod	DB-DL-12310			
	04/03 →	Tie Rod	DB-ES-5227		Guide Rod	
	04/03 →	Tie Rod End	CV-ES-0543		for Push Rod	
	04/03 →	Tie Rod End	CV-ES-0888		for Push Rod	
	04/03 →	Track Control Arm		DB-VB-7261	Suspension Rod, Wishbone (CV), 1st RA, →517142 01/517142 02	
	04/03 →	Track Control Arm		DB-VB-7776	Wishbone (CV)	
	04/03 →	Track Control Arm		DB-VB-9307	Suspension Rod, Wishbone (CV)	
	04/03 →	Track Control Arm		DB-VB-9308	Suspension Rod, Wishbone (CV)	
	04/03 →	Track Control Arm		DB-VB-10426	Wishbone (CV), 1st RA, →517142 05	
	2048 S	06/08 →	Centre Rod	DB-DL-2144		Push Rod
		06/08 →	Centre Rod	DB-DL-5405		Push Rod, Leaf Spring Axle
06/08 →		Centre Rod	DB-DL-8167		Push Rod	
06/08 →		Centre Rod	DB-DL-8307		Push Rod	
06/08 →		Centre Rod	DB-DL-8702		Push Rod, Leaf Spring Axle	
06/08 →		Rod Assembly	DB-DL-2178		Guide Rod, 1st Front Axle, →504310 03	
06/08 →		Stabiliser Mounting		DB-SB-10406		
06/08 →		Suspension Arm Repair Kit		DB-RK-8626	for Wishbone (CV)	
06/08 →		Suspension Arm Repair Kit		DB-RK-10374	for Wishbone (CV)	
06/08 →		Suspension Arm Repair Kit		DB-RK-10375	for Wishbone (CV)	
06/08 →		Suspension Strut Repair Kit		DB-RK-8710		
06/08 →		Suspension Strut Repair Kit		DB-RK-9291		
06/08 →		Tie Rod	DB-DL-8171		Guide Rod	
06/08 →		Tie Rod	DB-DL-8327		Guide Rod	
06/08 →		Tie Rod	DB-DL-8640		Guide Rod	
06/08 →		Tie Rod	DB-DL-12310			
06/08 →		Tie Rod	DB-ES-5227		Guide Rod	
06/08 →		Tie Rod End	CV-ES-0543		for Push Rod	
06/08 →		Tie Rod End	CV-ES-0888		for Push Rod	
06/08 →		Tie Rod End	CV-ES-14163		for Steering Rod	
06/08 →		Tie Rod End	DB-ES-8164		for Push Rod	
06/08 →		Track Control Arm		DB-VB-7261	Suspension Rod, Wishbone (CV), 1st RA, →517142 01/517142 02	
06/08 →		Track Control Arm		DB-VB-7776	Wishbone (CV)	
06/08 →		Track Control Arm		DB-VB-9307	Suspension Rod, Wishbone (CV)	
06/08 →		Track Control Arm		DB-VB-9308	Suspension Rod, Wishbone (CV)	
06/08 →		Track Control Arm		DB-VB-10426	Wishbone (CV), 1st RA, →517142 05	

CV-ES-0543

Length: 125
Cone Ø: d1 Ø 32 / d2 Ø 29
Thread: M30 x 1,5 RHT
0004605748, 0004606048, 0004606848,
0004607048, 0014600448, 0014601148,
0014601748, 0014602448, 0014607648,
0014609648



CV-ES-0888

Length: 125
Cone Ø: d1 Ø 32 / d2 Ø 29
Thread: M30 x 1,5 LHT
0004605848, 0004606148, 0004606948,
0004607148, 0004609048, 0014600548,
0014601348, 0014602548, 0014607948,
0024600448



CV-ES-14163

Length: 125
Cone Ø: d1 Ø 30 / d2 Ø 27
Thread: M30 x 1,5 RHT
0003305248, 0003387310, 0004600348,
0004600948, 0004602848, 0004602948,
0004608948, 0014600248, 0014600848,
0014601248, 0014602248, 0014607748,
0024600148, A0003387310, A0004600348,
A0004602848, A0004602948, A0014600848,
A0014601248, A0014602248, A0014607748



DB-DL-2144

Length: 872 Ø: 35
Cone Ø: d1 Ø 28,6 / d2 Ø 23,9
0024604305, 0024604405, 0034604805



DB-DL-2178

Length: 1735 Ø: 52
Cone Ø: d1 Ø 32 / d2 Ø 29
9423300003, 9423300103, 9423300203



DB-DL-5224

Length: 850 Ø: 60
Hole Distance: 100 / 100
01336100A, 9413300007



DB-DL-5405

Length: 890 Ø: 35
Cone Ø: d1 Ø 28,6 / d2 Ø 23,9
01215900A, 1460248, 0024604505,
0024604605, 0034605005, 3752600637,
3754600405, A3752600637, A3754600405



DB-DL-7270

Length: 875 Ø: 40
Cone Ø: d1 Ø 28,6 / d2 Ø 23,9
01208300A, 0024604705, 0024604805,
0034604905, A0024604705



DB-DL-8167

Length: 866 Ø: 38
Cone Ø: d1 Ø 30 / d2 Ø 27
0014609805, 0014609905, 0024606305,
0024606405



DB-DL-8171

Length: 1687 Ø: 52
Cone Ø: d1 Ø 32 / d2 Ø 29
9493300603, 9493300703, 9493301503,
9493301603



DB-DL-8307

Length: 885 Ø: 38
Cone Ø: d1 Ø 32 / d2 Ø 30
01215500A, 0004604005, 0024605105,
0024605205, 0034604005



DB-DL-8327

Length: 1745 Ø: 48
Cone Ø: d1 Ø 32 / d2 Ø 29
01219800A, 9413300003, 9413300103,
9413300203, 9413300303, 9413300503



DB-DL-8640

Length: 1615 Ø: 50
Cone Ø: d1 Ø 32 / d2 Ø 29
6253301503, 6253301603, 6253302403,
6253302503, 9423300803, 9423302103,
9493300203, 9493300303, 9493300903



DB-DL-8702

Length: 958 Ø: 38
Cone Ø: d1 Ø 32 / d2 Ø 30
0024606105, 0024606205, 0034604205



DB-DL-9218

Length: 754 Ø: 40
Hole Distance: 100
000360098524, 000390098524,
3753300111, 9413300011,
A3753300111, SA50831601



DB-DL-12310

Length: 1532 Ø: 50
Cone Ø: d1 Ø 32 / d2 Ø 29
Thread: M27 x 1,5 LHT
9493301203, 9493301303, 9493301803,
9493302203, A9493301203, A9493301303,
A9493301803, A9493302203



DB-ES-5227

Length: 1588 Ø: 60
Cone Ø: d1 Ø 38 / d2 Ø 34,3
6253300903, 6253301203, 9443300203



DB-ES-8164

Length: 140
Cone Ø: d1 Ø 28,6 / d2 Ø 23,9
Thread: M28 x 1,5 RHT
0014604248, 0014605048, 0014608548,
0024600548



DB-RK-8626

Ø: 75 Hole Distance: 130
Thick/Height: 24
0003502205, 0003502505, 0003503405,
0003504505, GL11319



DB-RK-8710

Ø: 85 Hole Distance: 130
Thick/Height: 30
0003503705



DB-RK-9291

Ø: 107,5 Hole Distance: 152
Thick/Height: 30
0003503605



DB-RK-10374

Ø: 85 Hole Distance: 152
Thick/Height: 24
0003504405



DB-RK-10375

Ø: 100 Hole Distance: 152
Thick/Height: 24
0003502405, 0003503505, 0003504905



DB-SB-10406

Ø: 80 Thick/Height: 46
0003238185



DB-VB-7261

Length: 622 Ø: 46
Hole Ø 25 / 25 / 25
Hole Distance: 152 / 130 / 130
01337800A, 9443500305, 9443500505,
9443500605, 9473500705, 9473500905,
9483500405, 9483503005



DB-VB-7776

Length: 622 Ø: 56
Hole Distance: 152 / 152
6533500205, 6583500205



DB-VB-9307

Length: 667 Ø: 60
Hole Ø 25 / 23 / 23
Hole Distance: 152 / 130 / 130
9483502805



DB-VB-9308

Length: 622 Ø: 46
Hole Ø 25 / 25 / 25
Hole Distance: 152 / 130 / 130
9483502905



DB-VB-10426

Length: 622 Ø: 46
Hole Ø 25 / 25 / 25
Hole Distance: 152 / 130 / 130
9443500405





ACTROS MP2 / MP3 ...

2050 S	04/03→	Ball Head, gearshift linkage	DB-ES-8510		
	04/03→	Bush, driver cab suspension	DB-SB-10384		
	04/03→	Centre Rod	DB-DL-2144	Push Rod	
	04/03→	Centre Rod	DB-DL-5230	Suspension Rod	
	04/03→	Centre Rod	DB-DL-5241	Push Rod	
	04/03→	Centre Rod	DB-DL-5405	Push Rod, Leaf Spring Axle	
	04/03→	Centre Rod	DB-DL-7270	Push Rod;Suspension Rod	
	04/03→	Centre Rod	DB-DL-8167	Push Rod	
	04/03→	Centre Rod	DB-DL-8184	Push Rod	
	04/03→	Centre Rod	DB-DL-8185	Push Rod	
	04/03→	Centre Rod	DB-DL-8307	Push Rod	
	04/03→	Centre Rod	DB-DL-8702	Push Rod, Leaf Spring Axle	
	04/03→	Centre Rod	DB-DL-12300	for Steering Rod	
	04/03→	Rod Assembly	DB-DL-2178	Guide Rod, 1st Front Axle, →504310 03	
	04/03→	Stabiliser Mounting		DB-SB-10406	
	04/03→	Stabiliser Mounting		DB-SB-10409	
	04/03→	Stabiliser Mounting	DB-SB-10410		
	04/03→	Suspension Arm Repair Kit		DB-RK-8550 for Wishbone (CV)	
	04/03→	Suspension Arm Repair Kit		DB-RK-8626 for Wishbone (CV)	
	04/03→	Suspension Arm Repair Kit		DB-RK-10374 for Wishbone (CV)	
	04/03→	Suspension Arm Repair Kit		DB-RK-10375 for Wishbone (CV)	
	04/03→	Suspension Arm Repair Kit	DB-RK-8638	for Control Arm	
	04/03→	Suspension Strut Repair Kit		DB-RK-8391	
	04/03→	Suspension Strut Repair Kit		MN-RK-8997	
	04/03→	Tie Rod	DB-DL-8171	Guide Rod	
	04/03→	Tie Rod	DB-DL-8327	Guide Rod	
	04/03→	Tie Rod	DB-DL-8640	Guide Rod	
	04/03→	Tie Rod	DB-DL-12310		
	04/03→	Tie Rod	DB-ES-5227	Guide Rod	
	04/03→	Tie Rod End	CV-ES-0543	for Push Rod	
	04/03→	Tie Rod End	CV-ES-0888	for Push Rod	
	04/03→	Tie Rod End	CV-ES-14163	for Steering Rod	
	04/03→	Tie Rod End	DB-ES-5234	for Steering Rod	
	04/03→	Tie Rod End	DB-ES-8164	for Push Rod	
	04/03→	Tie Rod End	DB-ES-8530	for Push Rod	
	04/03→	Track Control Arm		DB-VB-7261 Suspension Rod, Wishbone (CV), 1st RA, →517142 01/517142 02	
	04/03→	Track Control Arm		DB-VB-7798 Wishbone (CV)	
	04/03→	Track Control Arm		DB-VB-9307 Suspension Rod, Wishbone (CV), 1st Drive Axle, →517142 07	
	04/03→	Track Control Arm		DB-VB-9308 Suspension Rod, Wishbone (CV), 1st Drive Axle, →517142 06	
	04/03→	Track Control Arm		DB-VB-10426 Wishbone (CV), 1st RA, →517142 05	
	2051 AS	04/03→	Ball Head, gearshift linkage	DB-ES-8510	
		04/03→	Bush, driver cab suspension	DB-SB-10384	
04/03→		Centre Rod	DB-DL-8307	Push Rod, Leaf Spring Axle	
04/03→		Centre Rod	DB-DL-8702	Push Rod	
04/03→		Centre Rod	DB-DL-12300	for Steering Rod	
04/03→		Stabiliser Mounting		DB-SB-10406	
04/03→		Stabiliser Mounting		DB-SB-10409	
04/03→		Stabiliser Mounting	DB-SB-10410		
04/03→		Suspension Arm Repair Kit		DB-RK-8626 for Wishbone (CV)	
04/03→		Suspension Arm Repair Kit		DB-RK-10374 for Wishbone (CV)	
04/03→		Suspension Arm Repair Kit		DB-RK-10375 for Wishbone (CV)	
04/03→		Suspension Arm Repair Kit	DB-RK-8638	for Control Arm	
04/03→		Suspension Strut Repair Kit		DB-RK-8391	
04/03→		Suspension Strut Repair Kit		MN-RK-8997	
04/03→		Tie Rod	DB-DL-12310		
04/03→		Tie Rod	DB-ES-5227	Guide Rod	
04/03→		Tie Rod	MN-DL-7834	Guide Rod	
04/03→		Tie Rod End	CV-ES-14163	for Steering Rod	
04/03→		Tie Rod End	DB-ES-5234	for Steering Rod	
04/03→		Tie Rod End	DB-ES-8530	for Push Rod	

CV-ES-0543

Length: 125
 Cone Ø: d1 Ø 32 / d2 Ø 29
 Thread: M30 x 1,5 RHT
 0004605748, 0004606048, 0004606848,
 0004607048, 0014600448, 0014601148,
 0014601748, 0014602448, 0014607648,
 0014609648

**CV-ES-0888**

Length: 125
 Cone Ø: d1 Ø 32 / d2 Ø 29
 Thread: M30 x 1,5 LHT
 0004605848, 0004606148, 0004606948,
 0004607148, 0004609048, 0014600548,
 0014601348, 0014602548, 0014607948,
 0024600448

**CV-ES-14163**

Length: 125
 Cone Ø: d1 Ø 30 / d2 Ø 27
 Thread: M30 x 1,5 RHT
 0003305248, 0003387310, 0004600348,
 0004600948, 0004602848, 0004602948,
 0004608948, 0014600248, 0014600848,
 0014601248, 0014602248, 0014607748,
 0024600148, 0003387310, 0004600348,
 0004602848, 0004602948, 0014600848,
 0014601248, 0014602248, 0014607748

**DB-DL-2144**

Length: 872 Ø: 35
 Cone Ø: d1 Ø 28,6 / d2 Ø 23,9
 0024604305, 0024604405, 0034604805

**DB-DL-2178**

Length: 1735 Ø: 52
 Cone Ø: d1 Ø 32 / d2 Ø 29
 9423300003, 9423300103, 9423300203

**DB-DL-5230**

Length: 879 Ø: 42
 Cone Ø: d1 Ø 30 / d2 Ø 27
 01208600A, 0004607105, 0004607205,
 0014606705

**DB-DL-5241**

Length: 875 Ø: 40
 Cone Ø: d1 Ø 30 / d2 Ø 27
 01215300A, 0004609205, 0004609305,
 0014606905

**DB-DL-5405**

Length: 890 Ø: 35
 Cone Ø: d1 Ø 28,6 / d2 Ø 23,9
 01215900A, 1460248, 0024604505,
 0024604605, 0034605005, 3752600637,
 3754600405, A3752600637, A3754600405

**DB-DL-7270**

Length: 875 Ø: 40
 Cone Ø: d1 Ø 28,6 / d2 Ø 23,9
 01208300A, 0024604705, 0024604805,
 0034604905, A0024604705

**DB-DL-8167**

Length: 866 Ø: 38
 Cone Ø: d1 Ø 30 / d2 Ø 27
 0014609805, 0014609905, 0024606305,
 0024606405

**DB-DL-8171**

Length: 1687 Ø: 52
 Cone Ø: d1 Ø 32 / d2 Ø 29
 9493300603, 9493300703, 9493301503,
 9493301603

**DB-DL-8184**

Length: 1095 Ø: 42
 Cone Ø: d1 Ø 32 / d2 Ø 28,8
 01217700A, 0014601305, 0014601405,
 0024600505, 0034603205, 3754601505,
 A0014601305, A0014601405, A0024600505

**DB-DL-8185**

Length: 711 Ø: 42
 Cone Ø: d1 Ø 32 / d2 Ø 28,8
 01213600A, 0014601105, 0024600405,
 0034603105, A0014601105, A0024600405

**DB-DL-8307**

Length: 885 Ø: 38
 Cone Ø: d1 Ø 32 / d2 Ø 30
 01215500A, 0004604005, 0024605105,
 0024605205, 0034604005

**DB-DL-8327**

Length: 1745 Ø: 48
 Cone Ø: d1 Ø 32 / d2 Ø 29
 01219800A, 9413300003, 9413300103,
 9413300203, 9413300303, 9413300503

**DB-DL-8640**

Length: 1615 Ø: 50
 Cone Ø: d1 Ø 32 / d2 Ø 29
 6253301503, 6253301603, 6253302403,
 6253302503, 9423300803, 9423302103,
 9493300203, 9493300303, 9493300903

**DB-DL-8702**

Length: 958 Ø: 38
 Cone Ø: d1 Ø 32 / d2 Ø 30
 0024606105, 0024606205, 0034604205

**DB-DL-12300**

Length: 733 Ø: 36
 Cone Ø: d1 Ø 32 / d2 Ø 29
 0014601505, 0014607305, 0034603305,
 3754601605, A0014601505,
 A0034603305, A3754601605

**DB-DL-12310**

Length: 1532 Ø: 50
 Cone Ø: d1 Ø 32 / d2 Ø 29
 Thread: M27 x 1,5 LHT
 9493301203, 9493301303, 9493301803,
 9493302203, A9493301203, A9493301303,
 A9493301803, A9493302203

**DB-ES-5227**

Length: 1588 Ø: 60
 Cone Ø: d1 Ø 38 / d2 Ø 34,3
 6253300903, 6253301203, 9443300203

**DB-ES-5234**

Length: 135
 Cone Ø: d1 Ø 38 / d2 Ø 34,3
 Thread: M38 x 1,5 RHT
 0004601748, 120322305, 2205000400

**DB-ES-8164**

Length: 140
 Cone Ø: d1 Ø 28,6 / d2 Ø 23,9
 Thread: M28 x 1,5 RHT
 0014604248, 0014605048, 0014608548,
 0024600548

**DB-ES-8510**

Length: 56
 Cone Ø: d1 Ø 10 / d2 Ø 10
 Thread: M12 x 1,75 LHT
 0009965145, 0009965645, 0019963145

**DB-ES-8530**

Length: 115
 Cone Ø: d1 Ø 28,6 / d2 Ø 23,9
 Thread: M30 x 1,5 RHT
 0014603848, 0014604848, 0014605148,
 0014608648, 0014609948

**DB-RK-8391**

Ø: 85 Hole Distance: 152
 Thick/Height: 24
 01336800A, 0003502705

**DB-RK-8550**

Ø: 75 Hole Distance: 152
 Thick/Height: 24
 0003502105, 0003504605

**DB-RK-8626**

Ø: 75 Hole Distance: 130
 Thick/Height: 24
 0003502205, 0003502505, 0003503405,
 0003504505, GL11319

**DB-RK-8638**

Length: 100 Ø: 67
 Hole Distance: 100
 Thick/Height: 20
 0003301411

**DB-RK-10374**

Ø: 85 Hole Distance: 152
 Thick/Height: 24
 0003504405

**DB-RK-10375**

Ø: 100 Hole Distance: 152
 Thick/Height: 24
 0003502405, 0003503505, 0003504905

**DB-SB-10384**

Ø: 73 Thick/Height: 47
 9303170012, 9423171812

**DB-SB-10406**

Ø: 80 Thick/Height: 46
 0003238185

**DB-SB-10409**

Ø: 77 Thick/Height: 56
 0003265181

**DB-SB-10410**

Ø: 73 Hole Distance: 100
 Thick/Height: 24
 9413230050

**DB-VB-7261**

Length: 622 Ø: 46
 Hole Ø 25 / 25 / 25
 Hole Distance: 152 / 130 / 130
 01337800A, 9443500305, 9443500505,
 9443500605, 9473500705, 9473500905,
 9483500405, 9483500305

**DB-VB-7798**

Length: 622 Ø: 48
 Hole Ø 25 / 23 / 23
 Hole Distance: 152 / 130 / 130
 9423500505, 9423500805, 9423501205,
 A9423501205

**DB-VB-9307**

Length: 667 Ø: 60
 Hole Ø 25 / 23 / 23
 Hole Distance: 152 / 130 / 130
 9483502805

**DB-VB-9308**

Length: 622 Ø: 46
 Hole Ø 25 / 25 / 25
 Hole Distance: 152 / 130 / 130
 9483502905

**DB-VB-10426**

Length: 622 Ø: 46
 Hole Ø 25 / 25 / 25
 Hole Distance: 152 / 130 / 130
 9443500405



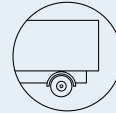

ACTROS MP2 / MP3 ...

2051 AS ...	04/03 →	Track Control Arm		DB-VB-7261	Suspension Rod, Wishbone (CV), 1st RA, →517142 01/517142 02
	04/03 →	Track Control Arm		DB-VB-7798	Wishbone (CV)
	04/03 →	Track Control Arm		DB-VB-9307	Suspension Rod, Wishbone (CV), 1st Drive Axle, →517142 07
	04/03 →	Track Control Arm		DB-VB-9308	Suspension Rod, Wishbone (CV), 1st Drive Axle, →517142 06
	04/03 →	Track Control Arm		DB-VB-10426	Wishbone (CV), 1st RA, →517142 05
2051 S	06/08 →	Centre Rod	DB-DL-2144		Push Rod
	06/08 →	Centre Rod	DB-DL-5405		Push Rod, Leaf Spring Axle
	06/08 →	Centre Rod	DB-DL-8167		Push Rod
	06/08 →	Centre Rod	DB-DL-8307		Push Rod
	06/08 →	Centre Rod	DB-DL-8702		Push Rod, Leaf Spring Axle
	06/08 →	Rod Assembly	DB-DL-2178		Guide Rod, 1st Front Axle, →504310 03
	06/08 →	Stabiliser Mounting		DB-SB-10406	
	06/08 →	Suspension Arm Repair Kit		DB-RK-8626	for Wishbone (CV)
	06/08 →	Suspension Arm Repair Kit		DB-RK-10374	for Wishbone (CV)
	06/08 →	Suspension Arm Repair Kit		DB-RK-10375	for Wishbone (CV)
	06/08 →	Suspension Strut Repair Kit		DB-RK-8710	
	06/08 →	Suspension Strut Repair Kit		DB-RK-9291	
	06/08 →	Tie Rod	DB-DL-8171		Guide Rod
	06/08 →	Tie Rod	DB-DL-8327		Guide Rod
	06/08 →	Tie Rod	DB-DL-8640		Guide Rod
	06/08 →	Tie Rod	DB-DL-12310		
	06/08 →	Tie Rod	DB-ES-5227		Guide Rod
	06/08 →	Tie Rod End	CV-ES-0543		for Push Rod
	06/08 →	Tie Rod End	CV-ES-0888		for Push Rod
	06/08 →	Tie Rod End	CV-ES-14163		for Steering Rod
	06/08 →	Tie Rod End	DB-ES-8164		for Push Rod
	06/08 →	Track Control Arm		DB-VB-7261	Suspension Rod, Wishbone (CV), 1st RA, →517142 01/517142 02
	06/08 →	Track Control Arm		DB-VB-7776	Wishbone (CV)
	06/08 →	Track Control Arm		DB-VB-9307	Suspension Rod, Wishbone (CV)
	06/08 →	Track Control Arm		DB-VB-9308	Suspension Rod, Wishbone (CV)
	06/08 →	Track Control Arm		DB-VB-10426	Wishbone (CV), 1st RA, →517142 05
	2054 S	04/03 →	Centre Rod	DB-DL-2144	
04/03 →		Centre Rod	DB-DL-5405		Push Rod
04/03 →		Centre Rod	DB-DL-8167		Push Rod
04/03 →		Centre Rod	DB-DL-8307		Push Rod
04/03 →		Centre Rod	DB-DL-8702		Push Rod
04/03 →		Rod Assembly	DB-DL-2178		Guide Rod, 1st Front Axle, →504310 03
04/03 →		Suspension Arm Repair Kit		DB-RK-8626	for Wishbone (CV)
04/03 →		Suspension Arm Repair Kit		DB-RK-10374	for Wishbone (CV)
04/03 →		Suspension Arm Repair Kit		DB-RK-10375	for Wishbone (CV)
04/03 →		Suspension Strut Repair Kit		DB-RK-8710	
04/03 →		Suspension Strut Repair Kit		DB-RK-9291	
04/03 →		Tie Rod	DB-DL-8171		Guide Rod
04/03 →		Tie Rod	DB-DL-8327		Guide Rod
04/03 →		Tie Rod	DB-DL-8640		Guide Rod
04/03 →		Tie Rod	DB-DL-12310		
04/03 →		Tie Rod End	CV-ES-0543		for Push Rod
04/03 →		Tie Rod End	CV-ES-0888		for Push Rod
04/03 →		Tie Rod End	CV-ES-14163		for Steering Rod
04/03 →		Tie Rod End	DB-ES-8164		for Push Rod
04/03 →		Track Control Arm		DB-VB-7261	Suspension Rod, Wishbone (CV), 1st RA, →517142 01/517142 02
04/03 →		Track Control Arm		DB-VB-7776	Wishbone (CV)
04/03 →		Track Control Arm		DB-VB-9307	Suspension Rod, Wishbone (CV)
04/03 →		Track Control Arm		DB-VB-9308	Suspension Rod, Wishbone (CV)
04/03 →		Track Control Arm		DB-VB-10426	Wishbone (CV), 1st RA, →517142 05

CV-ES-0543

Length: 125
Cone Ø: d1 Ø 32 / d2 Ø 29
Thread: M30 x 1,5 RHT
0004605748, 0004606048, 0004606848,
0004607048, 0014600448, 0014601148,
0014601748, 0014602448, 0014607648,
0014609648



CV-ES-0888

Length: 125
Cone Ø: d1 Ø 32 / d2 Ø 29
Thread: M30 x 1,5 LHT
0004605848, 0004606148, 0004606948,
0004607148, 0004609048, 0014600548,
0014601348, 0014602548, 0014607948,
0024600448



CV-ES-14163

Length: 125
Cone Ø: d1 Ø 30 / d2 Ø 27
Thread: M30 x 1,5 RHT
0003305248, 0003387310, 0004600348,
0004600948, 0004602848, 0004602948,
0004608948, 0014600248, 0014600848,
0014601248, 0014602248, 0014607748,
0024600148, A0003387310, A0004600348,
A0004602848, A0004602948, A0014600848,
A0014601248, A0014602248, A0014607748



DB-DL-2144

Length: 872 Ø: 35
Cone Ø: d1 Ø 28,6 / d2 Ø 23,9
0024604305, 0024604405, 0034604805



DB-DL-2178

Length: 1735 Ø: 52
Cone Ø: d1 Ø 32 / d2 Ø 29
9423300003, 9423300103, 9423300203



DB-DL-5405

Length: 890 Ø: 35
Cone Ø: d1 Ø 28,6 / d2 Ø 23,9
01215900A, 1460248, 0024604505,
0024604605, 0034605005, 3752600637,
3754600405, A3752600637, A3754600405



DB-DL-8167

Length: 866 Ø: 38
Cone Ø: d1 Ø 30 / d2 Ø 27
0014609805, 0014609905, 0024606305,
0024606405



DB-DL-8171

Length: 1687 Ø: 52
Cone Ø: d1 Ø 32 / d2 Ø 29
9493300603, 9493300703, 9493301503,
9493301603



DB-DL-8307

Length: 885 Ø: 38
Cone Ø: d1 Ø 32 / d2 Ø 30
01215500A, 0004604005, 0024605105,
0024605205, 0034604005



DB-DL-8327

Length: 1745 Ø: 48
Cone Ø: d1 Ø 32 / d2 Ø 29
01219800A, 9413300003, 9413300103,
9413300203, 9413300303, 9413300503



DB-DL-8640

Length: 1615 Ø: 50
Cone Ø: d1 Ø 32 / d2 Ø 29
6253301503, 6253301603, 6253302403,
6253302503, 9423300803, 9423302103,
9493300203, 9493300303, 9493300903



DB-DL-8702

Length: 958 Ø: 38
Cone Ø: d1 Ø 32 / d2 Ø 30
0024606105, 0024606205, 0034604205



DB-DL-12310

Length: 1532 Ø: 50
Cone Ø: d1 Ø 32 / d2 Ø 29
Thread: M27 x 1,5 LHT
9493301203, 9493301303, 9493301803,
9493302203, A9493301203, A9493301303,
A9493301803, A9493302203



DB-ES-5227

Length: 1588 Ø: 60
Cone Ø: d1 Ø 38 / d2 Ø 34,3
6253300903, 6253301203, 9443300203



DB-ES-8164

Length: 140
Cone Ø: d1 Ø 28,6 / d2 Ø 23,9
Thread: M28 x 1,5 RHT
0014604248, 0014605048, 0014608548,
0024600548



DB-RK-8626

Ø: 75 Hole Distance: 130
Thick/Height: 24
0003502205, 0003502505, 0003503405,
0003504505, GL11319



DB-RK-8710

Ø: 85 Hole Distance: 130
Thick/Height: 30
0003503705



DB-RK-9291

Ø: 107,5 Hole Distance: 152
Thick/Height: 30
0003503605



DB-RK-10374

Ø: 85 Hole Distance: 152
Thick/Height: 24
0003504405



DB-RK-10375

Ø: 100 Hole Distance: 152
Thick/Height: 24
0003502405, 0003503505, 0003504905



DB-SB-10406

Ø: 80 Thick/Height: 46
0003238185



DB-VB-7261

Length: 622 Ø: 46
Hole Ø 25 / 25 / 25
Hole Distance: 152 / 130 / 130
01337800A, 9443500305, 9443500505,
9443500605, 9473500705, 9473500905,
9483500405, 9483500305



DB-VB-7776

Length: 622 Ø: 56
Hole Distance: 152 / 152
6533500205, 6583500205



DB-VB-7798

Length: 622 Ø: 48
Hole Ø 25 / 23 / 23
Hole Distance: 152 / 130 / 130
9423500505, 9423500805, 9423501205,
A9423501205



DB-VB-9307

Length: 667 Ø: 60
Hole Ø 25 / 23 / 23
Hole Distance: 152 / 130 / 130
9483502805



DB-VB-9308

Length: 622 Ø: 46
Hole Ø 25 / 25 / 25
Hole Distance: 152 / 130 / 130
9483502905



DB-VB-10426

Length: 622 Ø: 46
Hole Ø 25 / 25 / 25
Hole Distance: 152 / 130 / 130
9443500405



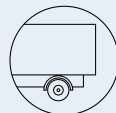

ACTROS MP2 / MP3 ...

2055 S	06/08 →	Centre Rod	DB-DL-2144	Push Rod	
	06/08 →	Centre Rod	DB-DL-5405	Push Rod, Leaf Spring Axle	
	06/08 →	Centre Rod	DB-DL-8167	Push Rod	
	06/08 →	Centre Rod	DB-DL-8307	Push Rod	
	06/08 →	Centre Rod	DB-DL-8702	Push Rod, Leaf Spring Axle	
	06/08 →	Rod Assembly	DB-DL-2178	Guide Rod, 1st Front Axle, →504310 03	
	06/08 →	Stabiliser Mounting	DB-SB-10406		
	06/08 →	Suspension Arm Repair Kit	DB-RK-8626	for Wishbone (CV)	
	06/08 →	Suspension Arm Repair Kit	DB-RK-10374	for Wishbone (CV)	
	06/08 →	Suspension Arm Repair Kit	DB-RK-10375	for Wishbone (CV)	
	06/08 →	Suspension Strut Repair Kit	DB-RK-8710		
	06/08 →	Suspension Strut Repair Kit	DB-RK-9291		
	06/08 →	Tie Rod	DB-DL-8171	Guide Rod	
	06/08 →	Tie Rod	DB-DL-8327	Guide Rod	
	06/08 →	Tie Rod	DB-DL-8640	Guide Rod	
	06/08 →	Tie Rod	DB-DL-12310		
	06/08 →	Tie Rod	DB-ES-5227	Guide Rod	
	06/08 →	Tie Rod End	CV-ES-0543	for Push Rod	
	06/08 →	Tie Rod End	CV-ES-0888	for Push Rod	
	06/08 →	Tie Rod End	CV-ES-14163	for Steering Rod	
	06/08 →	Tie Rod End	DB-ES-8164	for Push Rod	
	06/08 →	Track Control Arm	DB-VB-7261	Suspension Rod, Wishbone (CV), 1st RA, →517142 01/517142 02	
	06/08 →	Track Control Arm	DB-VB-7776	Wishbone (CV)	
	06/08 →	Track Control Arm	DB-VB-9307	Suspension Rod, Wishbone (CV)	
	06/08 →	Track Control Arm	DB-VB-9308	Suspension Rod, Wishbone (CV)	
	06/08 →	Track Control Arm	DB-VB-10426	Wishbone (CV), 1st RA, →517142 05	
	2432 LS	06/08 →	Centre Rod	DB-DL-7270	Push Rod
		06/08 →	Centre Rod	DB-DL-8167	Push Rod
06/08 →		Tie Rod	DB-DL-8640	Guide Rod	
06/08 →		Tie Rod	DB-DL-12310		
06/08 →		Tie Rod	DB-ES-5227	Guide Rod	
06/08 →		Track Control Arm	DB-VB-7798	Wishbone (CV), Drive Axle; Air Suspension Axle	
2436 LS	06/08 →	Centre Rod	DB-DL-7270	Push Rod	
	06/08 →	Centre Rod	DB-DL-8167	Push Rod	
	06/08 →	Tie Rod	DB-DL-8640	Guide Rod	
	06/08 →	Tie Rod	DB-DL-12310		
	06/08 →	Tie Rod	DB-ES-5227	Guide Rod	
	06/08 →	Track Control Arm	DB-VB-7798	Wishbone (CV), Drive Axle; Air Suspension Axle	
2441 LS	06/08 →	Centre Rod	DB-DL-7270	Push Rod	
	06/08 →	Centre Rod	DB-DL-8167	Push Rod	
	06/08 →	Tie Rod	DB-DL-8640	Guide Rod	
	06/08 →	Tie Rod	DB-DL-12310		
	06/08 →	Tie Rod	DB-ES-5227	Guide Rod	
	06/08 →	Track Control Arm	DB-VB-7798	Wishbone (CV), Drive Axle; Air Suspension Axle	
2444 LS	06/08 →	Centre Rod	DB-DL-7270	Push Rod	
	06/08 →	Centre Rod	DB-DL-8167	Push Rod	
	06/08 →	Tie Rod	DB-DL-8640	Guide Rod	
	06/08 →	Tie Rod	DB-DL-12310		
	06/08 →	Tie Rod	DB-ES-5227	Guide Rod	
	06/08 →	Track Control Arm	DB-VB-7798	Wishbone (CV), Drive Axle; Air Suspension Axle	
2446 LS	06/08 →	Centre Rod	DB-DL-7270	Push Rod	
	06/08 →	Centre Rod	DB-DL-8167	Push Rod	
	06/08 →	Tie Rod	DB-DL-8640	Guide Rod	
	06/08 →	Tie Rod	DB-DL-12310		
	06/08 →	Tie Rod	DB-ES-5227	Guide Rod	
	06/08 →	Track Control Arm	DB-VB-7798	Wishbone (CV), Drive Axle; Air Suspension Axle	
2448 LS	06/08 →	Centre Rod	DB-DL-7270	Push Rod	
	06/08 →	Centre Rod	DB-DL-8167	Push Rod	
	06/08 →	Tie Rod	DB-DL-8640	Guide Rod	
	06/08 →	Tie Rod	DB-DL-12310		
	06/08 →	Tie Rod	DB-ES-5227	Guide Rod	
	06/08 →	Track Control Arm	DB-VB-7798	Wishbone (CV), Drive Axle; Air Suspension Axle	

CV-ES-0543

Length: 125
Cone Ø: d1 Ø 32 / d2 Ø 29
Thread: M30 x 1,5 RHT
0004605748, 0004606048, 0004606848,
0004607048, 0014600448, 0014601148,
0014601748, 0014602448, 0014607648,
0014609648



CV-ES-0888

Length: 125
Cone Ø: d1 Ø 32 / d2 Ø 29
Thread: M30 x 1,5 LHT
0004605848, 0004606148, 0004606948,
0004607148, 0004609048, 0014600548,
0014601348, 0014602548, 0014607948,
0024600448



CV-ES-14163

Length: 125
Cone Ø: d1 Ø 30 / d2 Ø 27
Thread: M30 x 1,5 RHT
0003305248, 0003387310, 0004600348,
0004600948, 0004602848, 0004602948,
0004608948, 0014600248, 0014600848,
0014601248, 0014602248, 0014607748,
0024600148, A0003387310, A0004600348,
A0004602848, A0004602948, A0014600848,
A0014601248, A0014602248, A0014607748



DB-DL-2144

Length: 872 Ø: 35
Cone Ø: d1 Ø 28,6 / d2 Ø 23,9
0024604305, 0024604405, 0034604805



DB-DL-2178

Length: 1735 Ø: 52
Cone Ø: d1 Ø 32 / d2 Ø 29
9423300003, 9423300103, 9423300203



DB-DL-5405

Length: 890 Ø: 35
Cone Ø: d1 Ø 28,6 / d2 Ø 23,9
01215900A, 1460248, 0024604505,
0024604605, 0034605005, 3752600637,
3754600405, A3752600637, A3754600405



DB-DL-7270

Length: 875 Ø: 40
Cone Ø: d1 Ø 28,6 / d2 Ø 23,9
01208300A, 0024604705, 0024604805,
0034604905, A0024604705



DB-DL-8167

Length: 866 Ø: 38
Cone Ø: d1 Ø 30 / d2 Ø 27
0014609805, 0014609905, 0024606305,
0024606405



DB-DL-8171

Length: 1687 Ø: 52
Cone Ø: d1 Ø 32 / d2 Ø 29
9493300603, 9493300703, 9493301503,
9493301603



DB-DL-8307

Length: 885 Ø: 38
Cone Ø: d1 Ø 32 / d2 Ø 30
01215500A, 0004604005, 0024605105,
0024605205, 0034604005



DB-DL-8327

Length: 1745 Ø: 48
Cone Ø: d1 Ø 32 / d2 Ø 29
01219800A, 9413300003, 9413300103,
9413300203, 9413300303, 9413300503



DB-DL-8640

Length: 1615 Ø: 50
Cone Ø: d1 Ø 32 / d2 Ø 29
6253301503, 6253301603, 6253302403,
6253302503, 9423300803, 9423302103,
9493300203, 9493300303, 9493300903



DB-DL-8702

Length: 958 Ø: 38
Cone Ø: d1 Ø 32 / d2 Ø 30
0024606105, 0024606205, 0034604205



DB-DL-12310

Length: 1532 Ø: 50
Cone Ø: d1 Ø 32 / d2 Ø 29
Thread: M27 x 1,5 LHT
9493301203, 9493301303, 9493301803,
9493302203, A9493301203, A9493301303,
A9493301803, A9493302203



DB-ES-5227

Length: 1588 Ø: 60
Cone Ø: d1 Ø 38 / d2 Ø 34,3
6253300903, 6253301203, 9443300203



DB-ES-8164

Length: 140
Cone Ø: d1 Ø 28,6 / d2 Ø 23,9
Thread: M28 x 1,5 RHT
0014604248, 0014605048, 0014608548,
0024600548



DB-RK-8626

Ø: 75 Hole Distance: 130
Thick/Height: 24
0003502205, 0003502505, 0003503405,
0003504505, GL11319



DB-RK-8710

Ø: 85 Hole Distance: 130
Thick/Height: 30
0003503705



DB-RK-9291

Ø: 107,5 Hole Distance: 152
Thick/Height: 30
0003503605



DB-RK-10374

Ø: 85 Hole Distance: 152
Thick/Height: 24
0003504405



DB-RK-10375

Ø: 100 Hole Distance: 152
Thick/Height: 24
0003502405, 0003503505, 0003504905



DB-SB-10406

Ø: 80 Thick/Height: 46
0003238185



DB-VB-7261

Length: 622 Ø: 46
Hole Ø 25 / 25 / 25
Hole Distance: 152 / 130 / 130
01337800A, 9443500305, 9443500505,
9443500605, 9473500705, 9473500905,
9483500405, 9483503005



DB-VB-7776

Length: 622 Ø: 56
Hole Distance: 152 / 152
6533500205, 6583500205



DB-VB-7798

Length: 622 Ø: 48
Hole Ø 25 / 23 / 23
Hole Distance: 152 / 130 / 130
9423500505, 9423500805, 9423501205,
A9423501205



DB-VB-9307

Length: 667 Ø: 60
Hole Ø 25 / 23 / 23
Hole Distance: 152 / 130 / 130
9483502805



DB-VB-9308

Length: 622 Ø: 46
Hole Ø 25 / 25 / 25
Hole Distance: 152 / 130 / 130
9483502905



DB-VB-10426

Length: 622 Ø: 46
Hole Ø 25 / 25 / 25
Hole Distance: 152 / 130 / 130
9443500405





ACTROS MP2 / MP3 ...

2451 LS	06/08 →	Centre Rod	DB-DL-7270		Push Rod
	06/08 →	Centre Rod	DB-DL-8167		Push Rod
	06/08 →	Tie Rod	DB-DL-8640		Guide Rod
	06/08 →	Track Control Arm		DB-VB-7798	Wishbone (CV)
2455 LS	06/08 →	Centre Rod	DB-DL-7270		Push Rod
	06/08 →	Centre Rod	DB-DL-8167		Push Rod
	06/08 →	Tie Rod	DB-DL-8640		Guide Rod
	06/08 →	Track Control Arm		DB-VB-7798	Wishbone (CV)
2460 LS	06/08 →	Centre Rod	DB-DL-7270		Push Rod
	06/08 →	Centre Rod	DB-DL-8167		Push Rod
	06/08 →	Tie Rod	DB-DL-8640		Guide Rod
	06/08 →	Track Control Arm		DB-VB-7798	Wishbone (CV)
2532 LS	04/03 →	Ball Head, gearshift linkage	DB-ES-8510		
	04/03 →	Bush, driver cab suspension	DB-SB-10384		
	04/03 →	Centre Rod	DB-DL-2144		Push Rod
	04/03 →	Centre Rod	DB-DL-5230		Suspension Rod
	04/03 →	Centre Rod	DB-DL-5241		Push Rod
	04/03 →	Centre Rod	DB-DL-5405		Push Rod
	04/03 →	Centre Rod	DB-DL-7270		Push Rod
	04/03 →	Centre Rod	DB-DL-8184		Push Rod
	04/03 →	Centre Rod	DB-DL-8185		Push Rod
	04/03 →	Centre Rod	DB-DL-8307		Push Rod
	04/03 →	Centre Rod	DB-DL-12299		for Steering Rod
	04/03 →	Centre Rod	DB-DL-12300		for Steering Rod
	04/03 →	Centre Rod	DB-DL-12470		Push Rod
	04/03 →	Rod Assembly	DB-DL-2178		Guide Rod, 1st Front Axle, →504310 03
	04/03 →	Rod Assembly	DB-DL-2178	DB-DL-2178	Guide Rod, Leading Axle Steered, →504310 03
	04/03 →	Stabiliser Mounting		DB-RK-9296	
	04/03 →	Stabiliser Mounting		DB-SB-10409	
	04/03 →	Stabiliser Mounting	DB-SB-10410		
	04/03 →	Suspension Arm Repair Kit		DB-RK-8626	for Wishbone (CV)
	04/03 →	Suspension Arm Repair Kit		DB-RK-10374	for Wishbone (CV)
	04/03 →	Suspension Arm Repair Kit		DB-RK-10375	for Wishbone (CV)
	04/03 →	Suspension Arm Repair Kit	DB-RK-8638		for Control Arm
	04/03 →	Suspension Strut Repair Kit		DB-RK-8391	
	04/03 →	Suspension Strut Repair Kit		MN-RK-8997	
	04/03 →	Tie Rod		DB-DL-8172	Guide Rod, Leading Axle Steered
	04/03 →	Tie Rod	DB-DL-8172		Guide Rod, 1st Front Axle
	04/03 →	Tie Rod	DB-DL-8327		Guide Rod
	04/03 →	Tie Rod	DB-DL-8388		Guide Rod
	04/03 →	Tie Rod	DB-DL-8389		
	04/03 →	Tie Rod	DB-DL-12310		
	04/03 →	Tie Rod	DB-ES-5227		Guide Rod
	04/03 →	Tie Rod End	CV-ES-0543	CV-ES-0543	for Push Rod
	04/03 →	Tie Rod End	CV-ES-0888	CV-ES-0888	for Push Rod
	04/03 →	Tie Rod End	CV-ES-14162		for Steering Rod
	04/03 →	Tie Rod End	CV-ES-14163		for Steering Rod
	04/03 →	Tie Rod End	DB-ES-5234		for Steering Rod
	04/03 →	Tie Rod End	DB-ES-8164		for Push Rod
	04/03 →	Tie Rod End	DB-ES-8530		for Push Rod
	04/03 →	Track Control Arm		DB-DL-9218	Trailing Arm, Leading Axle not Steered, →508316 01/508316 04
	04/03 →	Track Control Arm		DB-DL-9218	Trailing Arm, Leading Axle not Steered, →532040 04
	04/03 →	Track Control Arm		DB-VB-7798	Wishbone (CV), Air Suspension Axle
	04/03 →	Track Control Arm	DB-DL-5224	DB-DL-5224	Trailing Arm, Leading Axle not Steered, →508315 01
06/08 →	Centre Rod	DB-DL-8641		Push Rod	
06/08 →	Stabiliser Mounting		DB-SB-10406		
06/08 →	Suspension Strut Repair Kit		DB-RK-8555		
06/08 →	Suspension Strut Repair Kit		DB-RK-9294		
06/08 →	Tie Rod		DB-DL-10209	Tag Axle; for vehicles with Hinged Trailing Axle	
06/08 →	Tie Rod	DB-DL-8640		Guide Rod	

CV-ES-0543

Length: 125
 Cone Ø: d1 Ø 32 / d2 Ø 29
 Thread: M30 x 1,5 RHT
 0004605748, 0004606048, 0004606848,
 0004607048, 0014600448, 0014601148,
 0014601748, 0014602448, 0014607648,
 0014609648

**CV-ES-0888**

Length: 125
 Cone Ø: d1 Ø 32 / d2 Ø 29
 Thread: M30 x 1,5 LHT
 0004605848, 0004606148, 0004606948,
 0004607148, 0004609048, 0014600548,
 0014601348, 0014602548, 0014607948,
 0024600448

**CV-ES-14162**

Length: 125
 Cone Ø: d1 Ø 30 / d2 Ø 27
 Thread: M30 x 1,5 LHT
 4600648, 4601248, 4603448, 0004603548,
 14600348, 14601448, 14602348,
 0014603748, 0014607848, 0024600348

**CV-ES-14163**

Length: 125
 Cone Ø: d1 Ø 30 / d2 Ø 27
 Thread: M30 x 1,5 RHT
 0003305248, 0003387310, 0004600348,
 0004600948, 0004602848, 0004602948,
 0004608948, 0014600248, 0014600848,
 0014601248, 0014602248, 0014607748,
 0024600148, A0003387310, A0004600348,
 A0004602848, A0004602948, A0014600848,
 A0014601248, A0014602248, A0014607748

**DB-DL-2144**

Length: 872 Ø: 35
 Cone Ø: d1 Ø 28,6 / d2 Ø 23,9
 0024604305, 0024604405, 0034604805

**DB-DL-2178**

Length: 1735 Ø: 52
 Cone Ø: d1 Ø 32 / d2 Ø 29
 9423300003, 9423300103, 9423300203

**DB-DL-5224**

Length: 850 Ø: 60
 Hole Distance: 100 / 100
 01336100A, 9413300007

**DB-DL-5230**

Length: 879 Ø: 42
 Cone Ø: d1 Ø 30 / d2 Ø 27
 01208600A, 0004607105, 0004607205,
 0014606705

**DB-DL-5241**

Length: 875 Ø: 40
 Cone Ø: d1 Ø 30 / d2 Ø 27
 01215300A, 0004609205, 0004609305,
 0014606905

**DB-DL-5405**

Length: 890 Ø: 35
 Cone Ø: d1 Ø 28,6 / d2 Ø 23,9
 01215900A, 1460248, 0024604505,
 0024604605, 0034605005, 3752600637,
 3754600405, A3752600637, A3754600405

**DB-DL-7270**

Length: 875 Ø: 40
 Cone Ø: d1 Ø 28,6 / d2 Ø 23,9
 01208300A, 0024604705, 0024604805,
 0034604905, A0024604705

**DB-DL-8167**

Length: 866 Ø: 38
 Cone Ø: d1 Ø 30 / d2 Ø 27
 0014609805, 0014609905, 0024606305,
 0024606405

**DB-DL-8172**

Length: 1700 Ø: 52
 Cone Ø: d1 Ø 32 / d2 Ø 29
 01219700A, 9493300403, 9493300503,
 9493300803, 9493301403

**DB-DL-8184**

Length: 1095 Ø: 42
 Cone Ø: d1 Ø 32 / d2 Ø 28,8
 01217700A, 0014601305, 0014601405,
 0024600505, 0034603205, 3754601505,
 A0014601305, A0014601405, A0024600505

**DB-DL-8185**

Length: 711 Ø: 42
 Cone Ø: d1 Ø 32 / d2 Ø 28,8
 01213600A, 0014601105, 0024600405,
 0034603105, A0014601105, A0024600405

**DB-DL-8307**

Length: 885 Ø: 38
 Cone Ø: d1 Ø 32 / d2 Ø 30
 01215500A, 0004604005, 0024605105,
 0024605205, 0034604005

**DB-DL-8327**

Length: 1745 Ø: 48
 Cone Ø: d1 Ø 32 / d2 Ø 29
 01219800A, 9413300003, 9413300103,
 9413300203, 9413300303, 9413300503

**DB-DL-8388**

Length: 1735 Ø: 62
 Cone Ø: d1 Ø 32 / d2 Ø 28,8
 01219900A, 9453300003, 9453300103,
 9453300403, 9453300603, A9453300003

**DB-DL-8389**

Length: 1465 Ø: 40
 Cone Ø: d1 Ø 32 / d2 Ø 29
 9453300203, 9453300303, 9453300503

**DB-DL-8640**

Length: 1615 Ø: 50
 Cone Ø: d1 Ø 32 / d2 Ø 29
 6253301503, 6253301603, 6253302403,
 6253302503, 9423300803, 9423302103,
 9493300203, 9493300303, 9493300903

**DB-DL-8641**

Length: 905 Ø: 42
 Cone Ø: d1 Ø 30 / d2 Ø 27
 0014605105, 0014608105

**DB-DL-9218**

Length: 754 Ø: 40
 Hole Distance: 100
 000360098524, 000390098524,
 3753300111, 9413300011,
 A3753300111, SA50831601

**DB-DL-10209**

Length: 1281 Ø: 38
 Cone Ø: d1 Ø 30 / d2 Ø 27
 3574603505, 9423301003, 9423301703

**DB-DL-12299**

Length: 2069 Ø: 40
 Cone Ø: d1 Ø 30 / d2 Ø 27
 0004608505, 0024601005, 0034602905

**DB-DL-12300**

Length: 733 Ø: 36
 Cone Ø: d1 Ø 32 / d2 Ø 29
 0014601505, 0014607305, 0034603305,
 3754601605, A0014601505,
 A0034603305, A3754601605

**DB-DL-12310**

Length: 1532 Ø: 50
 Cone Ø: d1 Ø 32 / d2 Ø 29
 Thread: M27 x 1,5 LHT
 9493301203, 9493301303, 9493301803,
 9493302203, A9493301203, A9493301303,
 A9493301803, A9493302203

**DB-DL-12470**

Length: 723 Ø: 42
 Cone Ø: d1 Ø 30 / d2 Ø 27
 A0014607505, A0024600905



No Image

DB-ES-5227

Length: 1588 Ø: 60
 Cone Ø: d1 Ø 38 / d2 Ø 34,3
 6253300903, 6253301203, 9443300203

**DB-ES-5234**

Length: 135
 Cone Ø: d1 Ø 38 / d2 Ø 34,3
 Thread: M38 x 1,5 RHT
 0004601748, 120322305, 2205000400

**DB-ES-8164**

Length: 140
 Cone Ø: d1 Ø 28,6 / d2 Ø 23,9
 Thread: M28 x 1,5 RHT
 0014604248, 0014605048, 0014608548,
 0024600548

**DB-ES-8510**

Length: 56
 Cone Ø: d1 Ø 10 / d2 Ø 10
 Thread: M12 x 1,75 LHT
 0009965145, 0009965645, 0019963145

**DB-ES-8530**

Length: 115
 Cone Ø: d1 Ø 28,6 / d2 Ø 23,9
 Thread: M30 x 1,5 RHT
 0014603848, 0014604848, 0014605148,
 0014608648, 0014609948

**DB-RK-8391**

Ø: 85 Hole Distance: 152
 Thick/Height: 24
 01336800A, 0003502705

**DB-RK-8555**

Ø: 67 Hole Distance: 130
 Thick/Height: 24
 01335600A, 0003502005, 0003504705

**DB-RK-8626**

Ø: 75 Hole Distance: 130
 Thick/Height: 24
 0003502205, 0003502505, 0003503405,
 0003504505, GL11319

**DB-RK-8638**

Length: 100 Ø: 67
 Hole Distance: 100
 Thick/Height: 20
 0003301411

**DB-RK-9294**

Ø: 85 Hole Distance: 152
 Thick/Height: 24
 0003503105

**DB-RK-9296**

Ø: 88 Hole Distance: 130
 Thick/Height: 24
 9423260050

**DB-RK-10374**

Ø: 85 Hole Distance: 152
 Thick/Height: 24
 0003504405

**DB-RK-10375**

Ø: 100 Hole Distance: 152
 Thick/Height: 24
 0003502405, 0003503505, 0003504905

**DB-SB-10384**

Ø: 73 Thick/Height: 47
 9303170012, 9423171812

**DB-SB-10406**

Ø: 80 Thick/Height: 46
 0003238185

**DB-SB-10409**

Ø: 77 Thick/Height: 56
 0003265181

**DB-SB-10410**

Ø: 73 Hole Distance: 100
 Thick/Height: 24
 9413230050

**DB-VB-7798**

Length: 622 Ø: 48
 Hole Ø 25 / 23 / 23
 Hole Distance: 152 / 130 / 130
 9423500505, 9423500805, 9423501205,
 A9423501205

**MN-RK-8997**

Ø: 85 Hole Distance: 130
 Thick/Height: 30
 0003504805





ACTROS MP2 / MP3 ...

2532 LS ...	06/08→	Track Control Arm		DB-VB-7790	Wishbone (CV), Tag Axle
	06/08→	Track Control Arm	DB-DL-5224		Control Arm, 1st FA;Air Suspension Axle
	06/08→	Track Control Arm	DB-DL-9218	DB-DL-9218	Trailing Arm, 1st FA;Air Suspension Axle
2532, L, LL	04/03→	Ball Head, gearshift linkage	DB-ES-8510		
	04/03→	Bush, driver cab suspension	DB-SB-10384		
	04/03→	Centre Rod	DB-DL-2144		Push Rod
	04/03→	Centre Rod	DB-DL-5230		Suspension Rod
	04/03→	Centre Rod	DB-DL-5241		Push Rod
	04/03→	Centre Rod	DB-DL-5405		Push Rod
	04/03→	Centre Rod	DB-DL-5405		Push Rod, Leaf Spring Axle;Tag Axle
	04/03→	Centre Rod	DB-DL-7270		Push Rod
	04/03→	Centre Rod	DB-DL-8167		Push Rod
	04/03→	Centre Rod	DB-DL-8168		Push Rod
	04/03→	Centre Rod	DB-DL-8184		Push Rod
	04/03→	Centre Rod	DB-DL-8185		Push Rod
	04/03→	Centre Rod	DB-DL-8307		Push Rod
	04/03→	Centre Rod	DB-DL-8622		Push Rod
	04/03→	Centre Rod	DB-DL-8641		Push Rod
	04/03→	Centre Rod	DB-DL-8642		Push Rod
	04/03→	Centre Rod	DB-DL-12300		for Steering Rod
	04/03→	Centre Rod	DB-DL-12301		Push Rod
	04/03→	Centre Rod	DB-DL-12470		Push Rod
	04/03→	Rod Assembly	DB-DL-2178		Guide Rod, 1st Front Axle, →504310 03
	04/03→	Rod Assembly	DB-DL-2178	DB-DL-2178	Guide Rod, Leading Axle Steered, →504310 03
	04/03→	Stabiliser Link	DB-DL-9254		Pressure Rod
	04/03→	Stabiliser Mounting		DB-RK-9296	
	04/03→	Stabiliser Mounting		DB-SB-10406	
	04/03→	Stabiliser Mounting		DB-SB-10409	
	04/03→	Stabiliser Mounting	DB-SB-10410		
	04/03→	Suspension Arm Repair Kit		DB-RK-8550	for Wishbone (CV)
	04/03→	Suspension Arm Repair Kit		DB-RK-8626	for Wishbone (CV)
	04/03→	Suspension Arm Repair Kit		DB-RK-10374	for Wishbone (CV)
	04/03→	Suspension Arm Repair Kit		DB-RK-10375	for Wishbone (CV)
	04/03→	Suspension Arm Repair Kit	DB-RK-8638		for Control Arm
	04/03→	Suspension Strut Repair Kit		DB-RK-8391	
	04/03→	Suspension Strut Repair Kit		DB-RK-8555	
	04/03→	Suspension Strut Repair Kit		DB-RK-9294	
	04/03→	Tie Rod		DB-DL-10209	Tag Axle;for vehicles with Hinged Trailing Axle
	04/03→	Tie Rod	DB-DL-8172		Guide Rod, 1st FA;Leaf Spring Axle
	04/03→	Tie Rod	DB-DL-8327		Guide Rod
	04/03→	Tie Rod	DB-DL-8388		Guide Rod, 1st FA;Leaf Spring Axle
	04/03→	Tie Rod	DB-DL-8389		1st FA;Leaf Spring Axle
	04/03→	Tie Rod	DB-DL-8640		Guide Rod
	04/03→	Tie Rod	DB-DL-12310		
	04/03→	Tie Rod	DB-ES-5227		Guide Rod
	04/03→	Tie Rod End	CV-ES-0543	CV-ES-0543	for Push Rod
	04/03→	Tie Rod End	CV-ES-0888	CV-ES-0888	for Push Rod
	04/03→	Tie Rod End	CV-ES-14162		for Steering Rod
04/03→	Tie Rod End	CV-ES-14163		for Steering Rod	
04/03→	Tie Rod End	DB-ES-5234		for Steering Rod	
04/03→	Tie Rod End	DB-ES-8164		for Push Rod	
04/03→	Tie Rod End	DB-ES-8530		for Push Rod	
04/03→	Track Control Arm		DB-VB-3707	Suspension Rod, Wishbone (CV)	
04/03→	Track Control Arm		DB-VB-7261	Suspension Rod, Wishbone (CV), 1st RA, →517142 01/517142 02	
04/03→	Track Control Arm		DB-VB-7790	Wishbone (CV), Tag Axle	
04/03→	Track Control Arm		DB-VB-9307	Suspension Rod, Wishbone (CV), 1st Drive Axle, →517142 07	
04/03→	Track Control Arm		DB-VB-9308	Suspension Rod, Wishbone (CV), 1st Drive Axle, →517142 06	
04/03→	Track Control Arm		DB-VB-10426	Wishbone (CV), 1st RA, →517142 05	
04/03→	Track Control Arm	DB-DL-5224		Control Arm, 1st FA;Air Suspension Axle	
04/03→	Track Control Arm	DB-DL-9218	DB-DL-9218	Trailing Arm, 1st FA;Air Suspension Axle	



ACTROS MP2 / MP3 ...

2536 L, LL	06/08→	Centre Rod	DB-DL-2144		Push Rod	
	06/08→	Centre Rod	DB-DL-8167		Push Rod	
	06/08→	Centre Rod	DB-DL-8622		Push Rod	
	06/08→	Centre Rod	DB-DL-12300		for Steering Rod	
	06/08→	Centre Rod	DB-DL-12301		Push Rod	
	06/08→	Centre Rod	DB-DL-12470		Push Rod	
	06/08→	Rod Assembly	DB-DL-2178		Guide Rod, 1st Front Axle, →504310 03	
	06/08→	Rod Assembly	DB-DL-2178	DB-DL-2178	Guide Rod, Leading Axle Steered, →504310 03	
	06/08→	Suspension Arm Repair Kit		DB-RK-8550	for Wishbone (CV)	
	06/08→	Suspension Arm Repair Kit		DB-RK-8626	for Wishbone (CV)	
	06/08→	Suspension Arm Repair Kit		DB-RK-10374	for Wishbone (CV)	
	06/08→	Tie Rod	DB-DL-12310			
	06/08→	Tie Rod End	CV-ES-0543	CV-ES-0543	for Push Rod	
	06/08→	Tie Rod End	CV-ES-0888	CV-ES-0888	for Push Rod	
	06/08→	Tie Rod End	CV-ES-14162		for Steering Rod	
	06/08→	Tie Rod End	CV-ES-14163		for Steering Rod	
	06/08→	Tie Rod End	DB-ES-8164		for Push Rod	
	06/08→	Track Control Arm		DB-VB-3707	Suspension Rod, Wishbone (CV)	
	06/08→	Track Control Arm		DB-VB-7790	Wishbone (CV)	
	06/08→	Track Control Arm	DB-DL-9218	DB-DL-9218	Trailing Arm	
	2536 LS	04/03→	Ball Head, gearshift linkage	DB-ES-8510		
		04/03→	Bush, driver cab suspension	DB-SB-10384		
		04/03→	Centre Rod	DB-DL-2144		Push Rod
		04/03→	Centre Rod	DB-DL-5230		Suspension Rod
		04/03→	Centre Rod	DB-DL-5241		Push Rod
		04/03→	Centre Rod	DB-DL-5405		Push Rod
		04/03→	Centre Rod	DB-DL-7270		Push Rod
04/03→		Centre Rod	DB-DL-8184		Push Rod	
04/03→		Centre Rod	DB-DL-8185		Push Rod	
04/03→		Centre Rod	DB-DL-8307		Push Rod	
04/03→		Centre Rod	DB-DL-12299		for Steering Rod	
04/03→		Centre Rod	DB-DL-12300		for Steering Rod	
04/03→		Centre Rod	DB-DL-12470		Push Rod	
04/03→		Rod Assembly	DB-DL-2178		Guide Rod, 1st Front Axle, →504310 03	
04/03→		Rod Assembly	DB-DL-2178	DB-DL-2178	Guide Rod, Leading Axle Steered, →504310 03	
04/03→		Stabiliser Mounting		DB-RK-9296		
04/03→		Stabiliser Mounting		DB-SB-10409		
04/03→		Stabiliser Mounting	DB-SB-10410			
04/03→		Suspension Arm Repair Kit		DB-RK-8626	for Wishbone (CV)	
04/03→		Suspension Arm Repair Kit		DB-RK-10374	for Wishbone (CV)	
04/03→		Suspension Arm Repair Kit		DB-RK-10375	for Wishbone (CV)	
04/03→		Suspension Arm Repair Kit	DB-RK-8638		for Control Arm	
04/03→		Suspension Strut Repair Kit		DB-RK-8391		
04/03→		Suspension Strut Repair Kit		MN-RK-8997		
04/03→		Tie Rod		DB-DL-8172	Guide Rod, Leading Axle Steered	
04/03→		Tie Rod	DB-DL-8172		Guide Rod, 1st Front Axle	
04/03→		Tie Rod	DB-DL-8327		Guide Rod	
04/03→		Tie Rod	DB-DL-8388		Guide Rod	
04/03→		Tie Rod	DB-DL-8389			
04/03→		Tie Rod	DB-DL-12310			
04/03→		Tie Rod	DB-ES-5227		Guide Rod	
04/03→		Tie Rod End	CV-ES-0543	CV-ES-0543	for Push Rod	
04/03→		Tie Rod End	CV-ES-0888	CV-ES-0888	for Push Rod	
04/03→		Tie Rod End	CV-ES-14162		for Steering Rod	
04/03→		Tie Rod End	CV-ES-14163		for Steering Rod	
04/03→		Tie Rod End	DB-ES-5234		for Steering Rod	
04/03→		Tie Rod End	DB-ES-8164		for Push Rod	
04/03→		Tie Rod End	DB-ES-8530		for Push Rod	
04/03→		Track Control Arm		DB-DL-9218	Trailing Arm, Leading Axle not Steered, →508316 01/508316 04	
04/03→		Track Control Arm		DB-DL-9218	Trailing Arm, Leading Axle not Steered, →532040 04	
04/03→		Track Control Arm		DB-VB-7798	Wishbone (CV), Air Suspension Axle	



ACTROS MP2 / MP3 ...

2536 LS ...	04/03 →	Track Control Arm	DB-DL-5224	DB-DL-5224	Trailing Arm, Leading Axle not Steered, →508315 01
	06/08 →	Centre Rod	DB-DL-8641		Push Rod
	06/08 →	Stabiliser Mounting		DB-SB-10406	
	06/08 →	Suspension Strut Repair Kit		DB-RK-8555	
	06/08 →	Suspension Strut Repair Kit		DB-RK-9294	
	06/08 →	Tie Rod		DB-DL-10209	Tag Axle;for vehicles with Hinged Trailing Axle
	06/08 →	Tie Rod	DB-DL-8640		Guide Rod
	06/08 →	Track Control Arm		DB-VB-7790	Wishbone (CV), Tag Axle
	06/08 →	Track Control Arm	DB-DL-5224		Control Arm, 1st FA;Air Suspension Axle
	06/08 →	Track Control Arm	DB-DL-9218	DB-DL-9218	Trailing Arm, 1st FA;Air Suspension Axle
2536, L, LL	04/03 →	Ball Head, gearshift linkage	DB-ES-8510		
	04/03 →	Bush, driver cab suspension	DB-SB-10384		
	04/03 →	Centre Rod	DB-DL-2144		Push Rod
	04/03 →	Centre Rod	DB-DL-5230		Suspension Rod
	04/03 →	Centre Rod	DB-DL-5241		Push Rod
	04/03 →	Centre Rod	DB-DL-5405		Push Rod
	04/03 →	Centre Rod	DB-DL-5405		Push Rod, Leaf Spring Axle;Tag Axle
	04/03 →	Centre Rod	DB-DL-7270		Push Rod
	04/03 →	Centre Rod	DB-DL-8167		Push Rod
	04/03 →	Centre Rod	DB-DL-8168		Push Rod
	04/03 →	Centre Rod	DB-DL-8184		Push Rod
	04/03 →	Centre Rod	DB-DL-8185		Push Rod
	04/03 →	Centre Rod	DB-DL-8307		Push Rod
	04/03 →	Centre Rod	DB-DL-8622		Push Rod
	04/03 →	Centre Rod	DB-DL-8641		Push Rod
	04/03 →	Centre Rod	DB-DL-8641		Push Rod, Leaf Spring Axle;Tag Axle
	04/03 →	Centre Rod	DB-DL-8642		Push Rod
	04/03 →	Centre Rod	DB-DL-12300		for Steering Rod
	04/03 →	Centre Rod	DB-DL-12301		Push Rod
	04/03 →	Centre Rod	DB-DL-12470		Push Rod
	04/03 →	Rod Assembly	DB-DL-2178		Guide Rod, 1st Front Axle, →504310 03
	04/03 →	Rod Assembly	DB-DL-2178	DB-DL-2178	Guide Rod, Leading Axle Steered, →504310 03
	04/03 →	Stabiliser Link	DB-DL-9254		Pressure Rod
	04/03 →	Stabiliser Mounting		DB-RK-9296	
	04/03 →	Stabiliser Mounting		DB-SB-10406	
	04/03 →	Stabiliser Mounting		DB-SB-10409	
	04/03 →	Stabiliser Mounting	DB-SB-10410		
	04/03 →	Suspension Arm Repair Kit		DB-RK-8550	for Wishbone (CV)
	04/03 →	Suspension Arm Repair Kit		DB-RK-8626	for Wishbone (CV)
	04/03 →	Suspension Arm Repair Kit		DB-RK-10374	for Wishbone (CV)
	04/03 →	Suspension Arm Repair Kit		DB-RK-10375	for Wishbone (CV)
	04/03 →	Suspension Arm Repair Kit	DB-RK-8638		for Control Arm
	04/03 →	Suspension Strut Repair Kit		DB-RK-8391	
	04/03 →	Suspension Strut Repair Kit		DB-RK-8555	
	04/03 →	Suspension Strut Repair Kit		DB-RK-9294	
	04/03 →	Tie Rod		DB-DL-10209	Tag Axle;for vehicles with Hinged Trailing Axle
	04/03 →	Tie Rod	DB-DL-8172		Guide Rod, 1st FA;Leaf Spring Axle
	04/03 →	Tie Rod	DB-DL-8327		Guide Rod
	04/03 →	Tie Rod	DB-DL-8388		Guide Rod, 1st FA;Leaf Spring Axle
	04/03 →	Tie Rod	DB-DL-8389		1st FA;Leaf Spring Axle
	04/03 →	Tie Rod	DB-DL-8640		Guide Rod
	04/03 →	Tie Rod	DB-DL-12310		
	04/03 →	Tie Rod	DB-ES-5227		Guide Rod
	04/03 →	Tie Rod End	CV-ES-0543	CV-ES-0543	for Push Rod
	04/03 →	Tie Rod End	CV-ES-0888	CV-ES-0888	for Push Rod
	04/03 →	Tie Rod End	CV-ES-14162		for Steering Rod
	04/03 →	Tie Rod End	CV-ES-14163		for Steering Rod
	04/03 →	Tie Rod End	DB-ES-5234		for Steering Rod
	04/03 →	Tie Rod End	DB-ES-8164		for Push Rod
	04/03 →	Tie Rod End	DB-ES-8530		for Push Rod
04/03 →	Track Control Arm		DB-VB-3707	Suspension Rod, Wishbone (CV)	



ACTROS MP2 / MP3 ...

2536, L, LL ...	04/03 →	Track Control Arm		DB-VB-7261	Suspension Rod, Wishbone (CV), 1st RA, →517142 01/517142 02
	04/03 →	Track Control Arm		DB-VB-7790	Wishbone (CV), Tag Axle
	04/03 →	Track Control Arm		DB-VB-9307	Suspension Rod, Wishbone (CV), 1st Drive Axle, →517142 07
	04/03 →	Track Control Arm		DB-VB-9308	Suspension Rod, Wishbone (CV), 1st Drive Axle, →517142 06
	04/03 →	Track Control Arm		DB-VB-10426	Wishbone (CV), →517142 05
	04/03 →	Track Control Arm	DB-DL-5224		Control Arm, 1st FA;Air Suspension Axle
	04/03 →	Track Control Arm	DB-DL-9218	DB-DL-9218	Trailing Arm, 1st FA;Air Suspension Axle
2541 LS	04/03 →	Ball Head, gearshift linkage	DB-ES-8510		
	04/03 →	Bush, driver cab suspension	DB-SB-10384		
	04/03 →	Centre Rod	DB-DL-2144		Push Rod
	04/03 →	Centre Rod	DB-DL-5230		Suspension Rod
	04/03 →	Centre Rod	DB-DL-5241		Push Rod
	04/03 →	Centre Rod	DB-DL-5405		Push Rod
	04/03 →	Centre Rod	DB-DL-7270		Push Rod
	04/03 →	Centre Rod	DB-DL-8184		Push Rod
	04/03 →	Centre Rod	DB-DL-8185		Push Rod
	04/03 →	Centre Rod	DB-DL-8307		Push Rod
	04/03 →	Centre Rod	DB-DL-12299		for Steering Rod
	04/03 →	Centre Rod	DB-DL-12300		for Steering Rod
	04/03 →	Centre Rod	DB-DL-12470		Push Rod
	04/03 →	Rod Assembly	DB-DL-2178		Guide Rod, 1st Front Axle, →504310 03
	04/03 →	Rod Assembly	DB-DL-2178	DB-DL-2178	Guide Rod, Leading Axle Steered, →504310 03
	04/03 →	Stabiliser Mounting		DB-RK-9296	
	04/03 →	Stabiliser Mounting		DB-SB-10409	
	04/03 →	Stabiliser Mounting	DB-SB-10410		
	04/03 →	Suspension Arm Repair Kit		DB-RK-8626	for Wishbone (CV)
	04/03 →	Suspension Arm Repair Kit		DB-RK-10374	for Wishbone (CV)
	04/03 →	Suspension Arm Repair Kit		DB-RK-10375	for Wishbone (CV)
	04/03 →	Suspension Arm Repair Kit	DB-RK-8638		for Control Arm
	04/03 →	Suspension Strut Repair Kit		DB-RK-8391	
	04/03 →	Suspension Strut Repair Kit		MN-RK-8997	
	04/03 →	Tie Rod		DB-DL-8172	Guide Rod, Leading Axle Steered
	04/03 →	Tie Rod	DB-DL-8172		Guide Rod, 1st Front Axle
	04/03 →	Tie Rod	DB-DL-8327		Guide Rod
	04/03 →	Tie Rod	DB-DL-8388		Guide Rod
	04/03 →	Tie Rod	DB-DL-8389		
	04/03 →	Tie Rod	DB-DL-12310		
	04/03 →	Tie Rod	DB-ES-5227		Guide Rod
	04/03 →	Tie Rod End	CV-ES-0543	CV-ES-0543	for Push Rod
	04/03 →	Tie Rod End	CV-ES-0888	CV-ES-0888	for Push Rod
	04/03 →	Tie Rod End	CV-ES-14162		for Steering Rod
	04/03 →	Tie Rod End	CV-ES-14163		for Steering Rod
	04/03 →	Tie Rod End	DB-ES-5234		for Steering Rod
	04/03 →	Tie Rod End	DB-ES-8164		for Push Rod
04/03 →	Tie Rod End	DB-ES-8530		for Push Rod	
04/03 →	Track Control Arm		DB-DL-9218	Trailing Arm, Leading Axle not Steered, →508316 01/508316 04	
04/03 →	Track Control Arm		DB-DL-9218	Trailing Arm, Leading Axle not Steered, →532040 04	
04/03 →	Track Control Arm		DB-VB-7798	Wishbone (CV), Air Suspension Axle	
04/03 →	Track Control Arm	DB-DL-5224	DB-DL-5224	Trailing Arm, Leading Axle not Steered, →508315 01	
06/08 →	Centre Rod	DB-DL-8641		Push Rod	
06/08 →	Stabiliser Mounting		DB-SB-10406		
06/08 →	Suspension Strut Repair Kit		DB-RK-8555		
06/08 →	Suspension Strut Repair Kit		DB-RK-9294		
06/08 →	Tie Rod		DB-DL-10209	Tag Axle;for vehicles with Hinged Trailing Axle	
06/08 →	Tie Rod	DB-DL-8640		Guide Rod	
06/08 →	Track Control Arm		DB-VB-7790	Wishbone (CV), Tag Axle	
06/08 →	Track Control Arm	DB-DL-5224		Control Arm, 1st FA;Air Suspension Axle	
06/08 →	Track Control Arm	DB-DL-9218	DB-DL-9218	Trailing Arm, 1st FA;Air Suspension Axle	



ACTROS MP2 / MP3 ...

2541, L, LL

04/03→	Ball Head, gearshift linkage	DB-ES-8510		
04/03→	Bush, driver cab suspension	DB-SB-10384		
04/03→	Centre Rod	DB-DL-2144		Push Rod
04/03→	Centre Rod	DB-DL-5230		Suspension Rod
04/03→	Centre Rod	DB-DL-5241		Push Rod
04/03→	Centre Rod	DB-DL-5405		Push Rod
04/03→	Centre Rod	DB-DL-5405		Push Rod, Leaf Spring Axle;Tag Axle
04/03→	Centre Rod	DB-DL-7270		Push Rod
04/03→	Centre Rod	DB-DL-8167		Push Rod
04/03→	Centre Rod	DB-DL-8168		Push Rod
04/03→	Centre Rod	DB-DL-8184		Push Rod
04/03→	Centre Rod	DB-DL-8185		Push Rod
04/03→	Centre Rod	DB-DL-8307		Push Rod
04/03→	Centre Rod	DB-DL-8622		Push Rod
04/03→	Centre Rod	DB-DL-8641		Push Rod
04/03→	Centre Rod	DB-DL-8642		Push Rod
04/03→	Centre Rod	DB-DL-12300		for Steering Rod
04/03→	Rod Assembly	DB-DL-2178		Guide Rod, 1st Front Axle, →504310 03
04/03→	Stabiliser Link	DB-DL-9254		Pressure Rod
04/03→	Stabiliser Mounting		DB-RK-9296	
04/03→	Stabiliser Mounting		DB-SB-10406	
04/03→	Stabiliser Mounting		DB-SB-10409	
04/03→	Stabiliser Mounting	DB-SB-10410		
04/03→	Suspension Arm Repair Kit		DB-RK-8550	for Wishbone (CV)
04/03→	Suspension Arm Repair Kit		DB-RK-8626	for Wishbone (CV)
04/03→	Suspension Arm Repair Kit		DB-RK-10374	for Wishbone (CV)
04/03→	Suspension Arm Repair Kit		DB-RK-10375	for Wishbone (CV)
04/03→	Suspension Arm Repair Kit	DB-RK-8638		for Control Arm
04/03→	Suspension Strut Repair Kit		DB-RK-8391	
04/03→	Suspension Strut Repair Kit		DB-RK-8555	
04/03→	Suspension Strut Repair Kit		DB-RK-9294	
04/03→	Tie Rod		DB-DL-10209	Tag Axle;for vehicles with Hinged Trailing Axle
04/03→	Tie Rod	DB-DL-8327		Guide Rod
04/03→	Tie Rod	DB-DL-8388		Guide Rod, 1st FA;Leaf Spring Axle
04/03→	Tie Rod	DB-DL-8389		1st FA;Leaf Spring Axle
04/03→	Tie Rod	DB-DL-8640		Guide Rod
04/03→	Tie Rod	DB-DL-12310		
04/03→	Tie Rod	DB-ES-5227		Guide Rod
04/03→	Tie Rod End	CV-ES-0543		for Push Rod
04/03→	Tie Rod End	CV-ES-0888		for Push Rod
04/03→	Tie Rod End	CV-ES-14163		for Steering Rod
04/03→	Tie Rod End	DB-ES-5234		for Steering Rod
04/03→	Tie Rod End	DB-ES-8164		for Push Rod
04/03→	Tie Rod End	DB-ES-8530		for Push Rod
04/03→	Track Control Arm		DB-VB-3707	Suspension Rod, Wishbone (CV)
04/03→	Track Control Arm		DB-VB-7261	Suspension Rod, Wishbone (CV), 1st RA, →517142 01/517142 02
04/03→	Track Control Arm		DB-VB-7790	Wishbone (CV), Tag Axle
04/03→	Track Control Arm		DB-VB-9307	Suspension Rod, Wishbone (CV), 1st Drive Axle, →517142 07
04/03→	Track Control Arm		DB-VB-9308	Suspension Rod, Wishbone (CV), 1st Drive Axle, →517142 06
04/03→	Track Control Arm		DB-VB-10426	Wishbone (CV), 1st RA, →517142 05
04/03→	Track Control Arm	DB-DL-5224		Control Arm, 1st FA;Air Suspension Axle
04/03→	Track Control Arm	DB-DL-9218	DB-DL-9218	Trailing Arm, 1st FA;Air Suspension Axle

2544 LS

CV-ES-0543

Length: 125
 Cone Ø: d1 Ø 32 / d2 Ø 29
 Thread: M30 x 1,5 RHT
 0004605748, 0004606048, 0004606848,
 0004607048, 0014600448, 0014601148,
 0014601748, 0014602448, 0014607648,
 0014609648

**CV-ES-0888**

Length: 125
 Cone Ø: d1 Ø 32 / d2 Ø 29
 Thread: M30 x 1,5 LHT
 0004605848, 0004606148, 0004606948,
 0004607148, 0004609048, 0014600548,
 0014601348, 0014602548, 0014607948,
 0024600448

**CV-ES-14163**

Length: 125
 Cone Ø: d1 Ø 30 / d2 Ø 27
 Thread: M30 x 1,5 RHT
 0003305248, 0003387310, 0004600348,
 0004600948, 0004602848, 0004602948,
 0004608948, 0014600248, 0014600848,
 0014601248, 0014602248, 0014607748,
 0024600148, A0003387310, A0004600348,
 A0004602848, A0004602948, A0014600848,
 A0014601248, A0014602248, A0014607748

**DB-DL-2144**

Length: 872 Ø: 35
 Cone Ø: d1 Ø 28,6 / d2 Ø 23,9
 0024604305, 0024604405, 0034604805

**DB-DL-2178**

Length: 1735 Ø: 52
 Cone Ø: d1 Ø 32 / d2 Ø 29
 9423300003, 9423300103, 9423300203

**DB-DL-5224**

Length: 850 Ø: 60
 Hole Distance: 100 / 100
 01336100A, 9413300007

**DB-DL-5230**

Length: 879 Ø: 42
 Cone Ø: d1 Ø 30 / d2 Ø 27
 01208600A, 0004607105, 0004607205,
 0014606705

**DB-DL-5241**

Length: 875 Ø: 40
 Cone Ø: d1 Ø 30 / d2 Ø 27
 01215300A, 0004609205, 0004609305,
 0014606905

**DB-DL-5405**

Length: 890 Ø: 35
 Cone Ø: d1 Ø 28,6 / d2 Ø 23,9
 01215900A, 1460248, 0024604505,
 0024604605, 0034605005, 3752600637,
 3754600405, A3752600637, A3754600405

**DB-DL-7270**

Length: 875 Ø: 40
 Cone Ø: d1 Ø 28,6 / d2 Ø 23,9
 01208300A, 0024604705, 0024604805,
 0034604905, A0024604705

**DB-DL-8167**

Length: 866 Ø: 38
 Cone Ø: d1 Ø 30 / d2 Ø 27
 0014609805, 0014609905, 0024606305,
 0024606405

**DB-DL-8168**

Length: 904 Ø: 52
 Cone Ø: d1 Ø 32 / d2 Ø 29
 0004609405, 0004609505, 0014607105

**DB-DL-8184**

Length: 1095 Ø: 42
 Cone Ø: d1 Ø 32 / d2 Ø 28,8
 01217700A, 0014601305, 0014601405,
 0024600505, 0034603205, 3754601505,
 A0014601305, A0014601405, A0024600505

**DB-DL-8185**

Length: 711 Ø: 42
 Cone Ø: d1 Ø 32 / d2 Ø 28,8
 01213600A, 0014601105, 0024600405,
 0034603105, A0014601105, A0024600405

**DB-DL-8307**

Length: 885 Ø: 38
 Cone Ø: d1 Ø 32 / d2 Ø 30
 01215500A, 0004604005, 0024605105,
 0024605205, 0034604005

**DB-DL-8327**

Length: 1745 Ø: 48
 Cone Ø: d1 Ø 32 / d2 Ø 29
 01219800A, 9413300003, 9413300103,
 9413300203, 9413300303, 9413300503

**DB-DL-8388**

Length: 1735 Ø: 62
 Cone Ø: d1 Ø 32 / d2 Ø 28,8
 01219900A, 9453300003, 9453300103,
 9453300403, 9453300603, A9453300003

**DB-DL-8389**

Length: 1465 Ø: 40
 Cone Ø: d1 Ø 32 / d2 Ø 29
 9453300203, 9453300303, 9453300503

**DB-DL-8622**

Length: 1558 Ø: 52
 Cone Ø: d1 Ø 30 / d2 Ø 27
 0014609005, 0014609105

**DB-DL-8640**

Length: 1615 Ø: 50
 Cone Ø: d1 Ø 32 / d2 Ø 29
 6253301503, 6253301603, 6253302403,
 6253302503, 9423300803, 9423302103,
 9493300203, 9493300303, 9493300903

**DB-DL-8641**

Length: 905 Ø: 42
 Cone Ø: d1 Ø 30 / d2 Ø 27
 0014605105, 0014608105

**DB-DL-8642**

Length: 954 Ø: 42
 Cone Ø: d1 Ø 30 / d2 Ø 27
 0014608605, 0014608705

**DB-DL-9218**

Length: 754 Ø: 40
 Hole Distance: 100
 000360098524, 000390098524,
 3753300111, 9413300011,
 A3753300111, SA50831601

**DB-DL-9254**

Length: 1815 Ø: 58
 0003220323, 0003220623, 3753220423

**DB-DL-10209**

Length: 1281 Ø: 38
 Cone Ø: d1 Ø 30 / d2 Ø 27
 3574603505, 9423301003, 9423301703

**DB-DL-12300**

Length: 733 Ø: 36
 Cone Ø: d1 Ø 32 / d2 Ø 29
 0014601505, 0014607305, 0034603305,
 3754601605, A0014601505,
 A0034603305, A3754601605

**DB-DL-12310**

Length: 1532 Ø: 50
 Cone Ø: d1 Ø 32 / d2 Ø 29
 Thread: M27 x 1,5 LHT
 9493301203, 9493301303, 9493301803,
 9493302203, A9493301203, A9493301303,
 A9493301803, A9493302203

**DB-ES-5227**

Length: 1588 Ø: 60
 Cone Ø: d1 Ø 38 / d2 Ø 34,3
 6253300903, 6253301203, 9443300203

**DB-ES-5234**

Length: 135
 Cone Ø: d1 Ø 38 / d2 Ø 34,3
 Thread: M38 x 1,5 RHT
 0004601748, 120322305, 2205000400

**DB-ES-8164**

Length: 140
 Cone Ø: d1 Ø 28,6 / d2 Ø 23,9
 Thread: M28 x 1,5 RHT
 0014604248, 0014605048, 0014608548,
 0024600548

**DB-ES-8510**

Length: 56
 Cone Ø: d1 Ø 10 / d2 Ø 10
 Thread: M12 x 1,75 LHT
 0009965145, 0009965645, 0019963145

**DB-ES-8530**

Length: 115
 Cone Ø: d1 Ø 28,6 / d2 Ø 23,9
 Thread: M30 x 1,5 RHT
 0014603848, 0014604848, 0014605148,
 0014608648, 0014609948

**DB-RK-8391**

Ø: 85 Hole Distance: 152
 Thick/Height: 24
 01336800A, 0003502705

**DB-RK-8550**

Ø: 75 Hole Distance: 152
 Thick/Height: 24
 0003502105, 0003504605

**DB-RK-8555**

Ø: 67 Hole Distance: 130
 Thick/Height: 24
 01335600A, 0003502005, 0003504705

**DB-RK-8626**

Ø: 75 Hole Distance: 130
 Thick/Height: 24
 0003502205, 0003502505, 0003503405,
 0003504505, GL11319

**DB-RK-8638**

Length: 100 Ø: 67
 Hole Distance: 100
 Thick/Height: 20
 0003301411

**DB-RK-9294**

Ø: 85 Hole Distance: 152
 Thick/Height: 24
 0003503105

**DB-RK-9296**

Ø: 88 Hole Distance: 130
 Thick/Height: 24
 9423260050

**DB-RK-10374**

Ø: 85 Hole Distance: 152
 Thick/Height: 24
 0003504405

**DB-RK-10375**

Ø: 100 Hole Distance: 152
 Thick/Height: 24
 0003502405, 0003503505, 0003504905

**DB-SB-10384**

Ø: 73 Thick/Height: 47
 9303170012, 9423171812

**DB-SB-10406**

Ø: 80 Thick/Height: 46
 0003238185

**DB-SB-10409**

Ø: 77 Thick/Height: 56
 0003265181

**DB-SB-10410**

Ø: 73 Hole Distance: 100
 Thick/Height: 24
 9413230050

**DB-VB-3707**

Length: 622 Ø: 46
 Hole Ø 25 / 25 / 25
 Hole Distance: 152 / 130 / 130
 01337100A, 9423501005, 9423501505,
 9443500005, 9473500105, 9473501005,
 A3753500005, A9423501005, A9423501505,
 A9443500005, A9473500105, A9473501005

**DB-VB-7261**

Length: 622 Ø: 46
 Hole Ø 25 / 25 / 25
 Hole Distance: 152 / 130 / 130
 01337800A, 9443500305, 9443500505,
 9443500605, 9473500705, 9473500905,
 9483500405, 9483503005

**DB-VB-7790**

Length: 622 Ø: 46
 Hole Ø 25 / 23 / 23
 Hole Distance: 152 / 130 / 130
 01337000A, 3753500105, 9423500105,
 9423500705, 9423501105, 9423501605,
 9443500205

**DB-VB-9307**

Length: 667 Ø: 60
 Hole Ø 25 / 23 / 23
 Hole Distance: 152 / 130 / 130
 9483502805

**DB-VB-9308**

Length: 622 Ø: 46
 Hole Ø 25 / 25 / 25
 Hole Distance: 152 / 130 / 130
 9483502905

**DB-VB-10426**

Length: 622 Ø: 46
 Hole Ø 25 / 25 / 25
 Hole Distance: 152 / 130 / 130
 9443500405





ACTROS MP2 / MP3 ...

2544 LS ...	04/03→	Centre Rod	DB-DL-8185		Push Rod	
	04/03→	Centre Rod	DB-DL-8307		Push Rod	
	04/03→	Centre Rod	DB-DL-12299		for Steering Rod	
	04/03→	Centre Rod	DB-DL-12470		Push Rod	
	04/03→	Rod Assembly	DB-DL-2178		Guide Rod, 1st Front Axle, →504310 03	
	04/03→	Rod Assembly	DB-DL-2178	DB-DL-2178	Guide Rod, Leading Axle Steered, →504310 03	
	04/03→	Stabiliser Mounting		DB-RK-9296		
	04/03→	Stabiliser Mounting		DB-SB-10409		
	04/03→	Stabiliser Mounting	DB-SB-10410			
	04/03→	Suspension Arm Repair Kit		DB-RK-8626	for Wishbone (CV)	
	04/03→	Suspension Arm Repair Kit		DB-RK-10374	for Wishbone (CV)	
	04/03→	Suspension Arm Repair Kit		DB-RK-10375	for Wishbone (CV)	
	04/03→	Suspension Arm Repair Kit	DB-RK-8638		for Control Arm	
	04/03→	Suspension Strut Repair Kit		DB-RK-8391		
	04/03→	Suspension Strut Repair Kit		MN-RK-8997		
	04/03→	Tie Rod		DB-DL-8172	Guide Rod, Leading Axle Steered	
	04/03→	Tie Rod	DB-DL-8172		Guide Rod, 1st Front Axle	
	04/03→	Tie Rod	DB-DL-8327		Guide Rod	
	04/03→	Tie Rod	DB-DL-8388		Guide Rod	
	04/03→	Tie Rod	DB-DL-8389			
	04/03→	Tie Rod	DB-DL-12310			
	04/03→	Tie Rod	DB-ES-5227		Guide Rod	
	04/03→	Tie Rod End	CV-ES-0543	CV-ES-0543	for Push Rod	
	04/03→	Tie Rod End	CV-ES-0888	CV-ES-0888	for Push Rod	
	04/03→	Tie Rod End	CV-ES-14162		for Steering Rod	
	04/03→	Tie Rod End	CV-ES-14163		for Steering Rod	
	04/03→	Tie Rod End	DB-ES-5234		for Steering Rod	
	04/03→	Tie Rod End	DB-ES-8164		for Push Rod	
	04/03→	Tie Rod End	DB-ES-8530		for Push Rod	
	04/03→	Track Control Arm		DB-DL-9218	Trailing Arm, Leading Axle not Steered, →508316 01/508316 04	
	04/03→	Track Control Arm		DB-DL-9218	Trailing Arm, Leading Axle not Steered, →532040 04	
	04/03→	Track Control Arm		DB-VB-7798	Wishbone (CV), Air Suspension Axle	
	04/03→	Track Control Arm	DB-DL-5224	DB-DL-5224	Trailing Arm, Leading Axle not Steered, →508315 01	
	06/08→	Centre Rod	DB-DL-8641		Push Rod	
	06/08→	Centre Rod	DB-DL-12300		for Steering Rod	
	06/08→	Stabiliser Mounting		DB-SB-10406		
	06/08→	Suspension Strut Repair Kit		DB-RK-8555		
	06/08→	Suspension Strut Repair Kit		DB-RK-9294		
	06/08→	Tie Rod		DB-DL-10209	Tag Axle;for vehicles with Hinged Trailing Axle	
	06/08→	Tie Rod	DB-DL-8640		Guide Rod	
	06/08→	Track Control Arm		DB-VB-7790	Wishbone (CV), Tag Axle	
	06/08→	Track Control Arm	DB-DL-5224		Control Arm, 1st FA;Air Suspension Axle	
	06/08→	Track Control Arm	DB-DL-9218	DB-DL-9218	Trailing Arm, 1st FA;Air Suspension Axle	
	2544, L, LL	04/03→	Ball Head, gearshift linkage	DB-ES-8510		
		04/03→	Bush, driver cab suspension	DB-SB-10384		
04/03→		Centre Rod	DB-DL-2144		Push Rod	
04/03→		Centre Rod	DB-DL-5230		Suspension Rod	
04/03→		Centre Rod	DB-DL-5241		Push Rod	
04/03→		Centre Rod	DB-DL-5405		Push Rod	
04/03→		Centre Rod	DB-DL-5405		Push Rod, Leaf Spring Axle;Tag Axle	
04/03→		Centre Rod	DB-DL-7270		Push Rod	
04/03→		Centre Rod	DB-DL-8167		Push Rod	
04/03→		Centre Rod	DB-DL-8168		Push Rod	
04/03→		Centre Rod	DB-DL-8184		Push Rod	
04/03→		Centre Rod	DB-DL-8185		Push Rod	
04/03→		Centre Rod	DB-DL-8307		Push Rod	
04/03→		Centre Rod	DB-DL-8622		Push Rod	
04/03→		Centre Rod	DB-DL-8641		Push Rod	
04/03→		Centre Rod	DB-DL-8642		Push Rod	
04/03→		Centre Rod	DB-DL-12300		for Steering Rod	

CV-ES-0543

Length: 125
 Cone Ø: d1 Ø 32 / d2 Ø 29
 Thread: M30 x 1,5 RHT
 0004605748, 0004606048, 0004606848,
 0004607048, 0014600448, 0014601148,
 0014601748, 0014602448, 0014607648,
 0014609648

**CV-ES-0888**

Length: 125
 Cone Ø: d1 Ø 32 / d2 Ø 29
 Thread: M30 x 1,5 LHT
 0004605848, 0004606148, 0004606948,
 0004607148, 0004609048, 0014600548,
 0014601348, 0014602548, 0014607948,
 0024600448

**CV-ES-14162**

Length: 125
 Cone Ø: d1 Ø 30 / d2 Ø 27
 Thread: M30 x 1,5 LHT
 4600648, 4601248, 4603448, 0004603548,
 14600348, 14601448, 14602348,
 0014603748, 0014607848, 0024600348

**CV-ES-14163**

Length: 125
 Cone Ø: d1 Ø 30 / d2 Ø 27
 Thread: M30 x 1,5 RHT
 0003305248, 0003387310, 0004600348,
 0004600948, 0004602848, 0004602948,
 0004608948, 0014600248, 0014600848,
 0014601248, 0014602248, 0014607748,
 0024600148, 0003387310, 0004600348,
 A0004602848, A0004602948, A0014600848,
 A0014601248, A0014602248, A0014607748

**DB-DL-2144**

Length: 872 Ø: 35
 Cone Ø: d1 Ø 28,6 / d2 Ø 23,9
 0024604305, 0024604405, 0034604805

**DB-DL-2178**

Length: 1735 Ø: 52
 Cone Ø: d1 Ø 32 / d2 Ø 29
 9423300003, 9423300103, 9423300203

**DB-DL-5224**

Length: 850 Ø: 60
 Hole Distance: 100 / 100
 01336100A, 9413300007

**DB-DL-5230**

Length: 879 Ø: 42
 Cone Ø: d1 Ø 30 / d2 Ø 27
 01208600A, 0004607105, 0004607205,
 0014606705

**DB-DL-5241**

Length: 875 Ø: 40
 Cone Ø: d1 Ø 30 / d2 Ø 27
 01215300A, 0004609205, 0004609305,
 0014606905

**DB-DL-5405**

Length: 890 Ø: 35
 Cone Ø: d1 Ø 28,6 / d2 Ø 23,9
 01215900A, 1460248, 0024604505,
 0024604605, 0034605005, 3752600637,
 3754600405, A3752600637, A3754600405

**DB-DL-7270**

Length: 875 Ø: 40
 Cone Ø: d1 Ø 28,6 / d2 Ø 23,9
 01208300A, 0024604705, 0024604805,
 0034604905, A0024604705

**DB-DL-8167**

Length: 866 Ø: 38
 Cone Ø: d1 Ø 30 / d2 Ø 27
 0014609805, 0014609905, 0024606305,
 0024606405

**DB-DL-8168**

Length: 904 Ø: 52
 Cone Ø: d1 Ø 32 / d2 Ø 29
 0004609405, 0004609505, 0014607105

**DB-DL-8172**

Length: 1700 Ø: 52
 Cone Ø: d1 Ø 32 / d2 Ø 29
 01219700A, 9493300403, 9493300503,
 9493300803, 9493301403

**DB-DL-8184**

Length: 1095 Ø: 42
 Cone Ø: d1 Ø 32 / d2 Ø 28,8
 01217700A, 0014601305, 0014601405,
 0024600505, 0034603205, 3754601505,
 A0014601305, A0014601405, A0024600505

**DB-DL-8185**

Length: 711 Ø: 42
 Cone Ø: d1 Ø 32 / d2 Ø 28,8
 01213600A, 0014601105, 0024600405,
 0034603105, A0014601105, A0024600405

**DB-DL-8307**

Length: 885 Ø: 38
 Cone Ø: d1 Ø 32 / d2 Ø 30
 01215500A, 0004604005, 0024605105,
 0024605205, 0034604005

**DB-DL-8327**

Length: 1745 Ø: 48
 Cone Ø: d1 Ø 32 / d2 Ø 29
 01219800A, 9413300003, 9413300103,
 9413300203, 9413300303, 9413300503

**DB-DL-8388**

Length: 1735 Ø: 62
 Cone Ø: d1 Ø 32 / d2 Ø 28,8
 01219900A, 9453300003, 9453300103,
 9453300403, 9453300603, A9453300003

**DB-DL-8389**

Length: 1465 Ø: 40
 Cone Ø: d1 Ø 32 / d2 Ø 29
 9453300203, 9453300303, 9453300503

**DB-DL-8622**

Length: 1558 Ø: 52
 Cone Ø: d1 Ø 30 / d2 Ø 27
 0014609005, 0014609105

**DB-DL-8640**

Length: 1615 Ø: 50
 Cone Ø: d1 Ø 32 / d2 Ø 29
 6253301503, 6253301603, 6253302403,
 6253302503, 9423300803, 9423302103,
 9493300203, 9493300303, 9493300903

**DB-DL-8641**

Length: 905 Ø: 42
 Cone Ø: d1 Ø 30 / d2 Ø 27
 0014605105, 0014608105

**DB-DL-8642**

Length: 954 Ø: 42
 Cone Ø: d1 Ø 30 / d2 Ø 27
 0014608605, 0014608705

**DB-DL-9218**

Length: 754 Ø: 40
 Hole Distance: 100
 000360098524, 000390098524,
 3753300111, 9413300011,
 A3753300111, SA50831601

**DB-DL-10209**

Length: 1281 Ø: 38
 Cone Ø: d1 Ø 30 / d2 Ø 27
 3574603505, 9423301003, 9423301703

**DB-DL-12299**

Length: 2069 Ø: 40
 Cone Ø: d1 Ø 30 / d2 Ø 27
 0004608505, 0024601005, 0034602905

**DB-DL-12300**

Length: 733 Ø: 36
 Cone Ø: d1 Ø 32 / d2 Ø 29
 0014601505, 0014607305, 0034603305,
 3754601605, A0014601505,
 A0034603305, A3754601605

**DB-DL-12310**

Length: 1532 Ø: 50
 Cone Ø: d1 Ø 32 / d2 Ø 29
 Thread: M27 x 1,5 LHT
 9493301203, 9493301303, 9493301803,
 9493302203, A9493301203, A9493301303,
 A9493301803, A9493302203

**DB-DL-12470**

Length: 723 Ø: 42
 Cone Ø: d1 Ø 30 / d2 Ø 27
 A0014607505, A0024600905



No Image

DB-ES-5227

Length: 1588 Ø: 60
 Cone Ø: d1 Ø 38 / d2 Ø 34,3
 6253300903, 6253301203, 9443300203

**DB-ES-5234**

Length: 135
 Cone Ø: d1 Ø 38 / d2 Ø 34,3
 Thread: M38 x 1,5 RHT
 0004601748, 120322305, 2205000400

**DB-ES-8164**

Length: 140
 Cone Ø: d1 Ø 28,6 / d2 Ø 23,9
 Thread: M28 x 1,5 RHT
 0014604248, 0014605048, 0014608548,
 0024600548

**DB-ES-8510**

Length: 56
 Cone Ø: d1 Ø 10 / d2 Ø 10
 Thread: M12 x 1,75 LHT
 0009965145, 0009965645, 0019963145

**DB-ES-8530**

Length: 115
 Cone Ø: d1 Ø 28,6 / d2 Ø 23,9
 Thread: M30 x 1,5 RHT
 0014603848, 0014604848, 0014605148,
 0014608648, 0014609948

**DB-RK-8391**

Ø: 85 Hole Distance: 152
 Thick/Height: 24
 01336800A, 0003502705

**DB-RK-8555**

Ø: 67 Hole Distance: 130
 Thick/Height: 24
 01335600A, 0003502005, 0003504705

**DB-RK-8626**

Ø: 75 Hole Distance: 130
 Thick/Height: 24
 0003502205, 0003502505, 0003503405,
 0003504505, GL11319

**DB-RK-8638**

Length: 100 Ø: 67
 Hole Distance: 100
 Thick/Height: 20
 0003301411

**DB-RK-9294**

Ø: 85 Hole Distance: 152
 Thick/Height: 24
 0003503105

**DB-RK-9296**

Ø: 88 Hole Distance: 130
 Thick/Height: 24
 9423260050

**DB-RK-10374**

Ø: 85 Hole Distance: 152
 Thick/Height: 24
 0003504405

**DB-RK-10375**

Ø: 100
 Hole Distance: 152
 Thick/Height: 24
 3502405, 0003502405, 3503505,
 0003503505, 0003504905, 3504905

**DB-SB-10384**

Ø: 73 Thick/Height: 47
 9303170012, 9423171812

**DB-SB-10406**

Ø: 80 Thick/Height: 46
 0003238185

**DB-SB-10409**

Ø: 77 Thick/Height: 56
 0003265181

**DB-SB-10410**

Ø: 73 Hole Distance: 100
 Thick/Height: 24
 9413230050

**DB-VB-7790**

Length: 622 Ø: 46
 Hole Ø 25 / 23 / 23
 Hole Distance: 152 / 130 / 130
 01337000A, 3753500105, 9423500105,
 9423500705, 9423501105, 9423501605,
 9443500205

**DB-VB-7798**

Length: 622 Ø: 48
 Hole Ø 25 / 23 / 23
 Hole Distance: 152 / 130 / 130
 9423500505, 9423500805, 9423501205,
 A9423501205

**MN-RK-8997**

Ø: 85 Hole Distance: 130
 Thick/Height: 30
 0003504805



MERCEDES-BENZ



ACTROS MP2 / MP3 ...

2544, L, LL ...

04/03→	Rod Assembly	DB-DL-2178		Guide Rod, 1st Front Axle, →504310 03
04/03→	Stabiliser Link	DB-DL-9254		Pressure Rod
04/03→	Stabiliser Mounting		DB-RK-9296	
04/03→	Stabiliser Mounting		DB-SB-10406	
04/03→	Stabiliser Mounting		DB-SB-10409	
04/03→	Stabiliser Mounting	DB-SB-10410		
04/03→	Suspension Arm Repair Kit		DB-RK-8550	for Wishbone (CV)
04/03→	Suspension Arm Repair Kit		DB-RK-8626	for Wishbone (CV)
04/03→	Suspension Arm Repair Kit		DB-RK-10374	for Wishbone (CV)
04/03→	Suspension Arm Repair Kit		DB-RK-10375	for Wishbone (CV)
04/03→	Suspension Arm Repair Kit	DB-RK-8638		for Control Arm
04/03→	Suspension Strut Repair Kit		DB-RK-8391	
04/03→	Suspension Strut Repair Kit		DB-RK-8555	
04/03→	Suspension Strut Repair Kit		DB-RK-9294	
04/03→	Tie Rod		DB-DL-10209	Tag Axle;for vehicles with Hinged Trailing Axle
04/03→	Tie Rod	DB-DL-8327		Guide Rod
04/03→	Tie Rod	DB-DL-8388		Guide Rod, 1st FA;Leaf Spring Axle
04/03→	Tie Rod	DB-DL-8389		1st FA;Leaf Spring Axle
04/03→	Tie Rod	DB-DL-8640		Guide Rod
04/03→	Tie Rod	DB-DL-12310		
04/03→	Tie Rod	DB-ES-5227		Guide Rod
04/03→	Tie Rod End	CV-ES-0543		for Push Rod
04/03→	Tie Rod End	CV-ES-0888		for Push Rod
04/03→	Tie Rod End	CV-ES-14163		for Steering Rod
04/03→	Tie Rod End	DB-ES-5234		for Steering Rod
04/03→	Tie Rod End	DB-ES-8164		for Push Rod
04/03→	Tie Rod End	DB-ES-8530		for Push Rod
04/03→	Track Control Arm		DB-VB-3707	Suspension Rod, Wishbone (CV)
04/03→	Track Control Arm		DB-VB-7261	Suspension Rod, Wishbone (CV), 1st RA, →517142 01/517142 02
04/03→	Track Control Arm		DB-VB-7790	Wishbone (CV), Tag Axle
04/03→	Track Control Arm		DB-VB-9307	Suspension Rod, Wishbone (CV), 1st Drive Axle, →517142 07
04/03→	Track Control Arm		DB-VB-9308	Suspension Rod, Wishbone (CV), 1st Drive Axle, →517142 06
04/03→	Track Control Arm		DB-VB-10426	Wishbone (CV), 1st RA, →517142 05
04/03→	Track Control Arm	DB-DL-5224		Control Arm, 1st FA;Air Suspension Axle
04/03→	Track Control Arm	DB-DL-9218	DB-DL-9218	Trailing Arm, 1st FA;Air Suspension Axle

2546 LS

04/03→	Ball Head, gearshift linkage	DB-ES-8510		
04/03→	Bush, driver cab suspension	DB-SB-10384		
04/03→	Centre Rod	DB-DL-2144		Push Rod
04/03→	Centre Rod	DB-DL-5230		Suspension Rod
04/03→	Centre Rod	DB-DL-5241		Push Rod
04/03→	Centre Rod	DB-DL-5405		Push Rod
04/03→	Centre Rod	DB-DL-5405		Push Rod, for vehicles with Rigid Leading Axle
04/03→	Centre Rod	DB-DL-7270		Push Rod
04/03→	Centre Rod	DB-DL-8168		Push Rod
04/03→	Centre Rod	DB-DL-8184		Push Rod
04/03→	Centre Rod	DB-DL-8185		Push Rod
04/03→	Centre Rod	DB-DL-8307		Push Rod
04/03→	Centre Rod	DB-DL-12299		for Steering Rod
04/03→	Centre Rod	DB-DL-12300		for Steering Rod
04/03→	Centre Rod	DB-DL-12470		Push Rod
04/03→	Rod Assembly	DB-DL-2178		Guide Rod, 1st Front Axle, →504310 03
04/03→	Rod Assembly	DB-DL-2178	DB-DL-2178	Guide Rod, Leading Axle Steered, →504310 03
04/03→	Stabiliser Mounting		DB-RK-9296	
04/03→	Stabiliser Mounting		DB-SB-10409	
04/03→	Stabiliser Mounting	DB-SB-10410		
04/03→	Suspension Arm Repair Kit		DB-RK-8626	for Wishbone (CV)
04/03→	Suspension Arm Repair Kit		DB-RK-10374	for Wishbone (CV)
04/03→	Suspension Arm Repair Kit		DB-RK-10375	for Wishbone (CV)
04/03→	Suspension Arm Repair Kit	DB-RK-8638		for Control Arm
04/03→	Suspension Strut Repair Kit		DB-RK-8391	

CV-ES-0543

Length: 125
Cone Ø: d1 Ø 32 / d2 Ø 29
Thread: M30 x 1,5 RHT
0004605748, 0004606048, 0004606848,
0004607048, 0014600448, 0014601148,
0014601748, 0014602448, 0014607648,
0014609648



CV-ES-0888

Length: 125
Cone Ø: d1 Ø 32 / d2 Ø 29
Thread: M30 x 1,5 LHT
0004605848, 0004606148, 0004606948,
0004607148, 0004609048, 0014600548,
0014601348, 0014602548, 0014607948,
0024600448



CV-ES-14163

Length: 125
Cone Ø: d1 Ø 30 / d2 Ø 27
Thread: M30 x 1,5 RHT
0003305248, 0003387310, 0004600348,
0004600948, 0004602848, 0004602948,
0004608948, 0014600248, 0014600848,
0014601248, 0014602248, 0014607748,
0024600148, A0003387310, A0004600348,
A0004602848, A0004602948, A0014600848,
A0014601248, A0014602248, A0014607748



DB-DL-2144

Length: 872 Ø: 35
Cone Ø: d1 Ø 28,6 / d2 Ø 23,9
0024604305, 0024604405, 0034604805



DB-DL-2178

Length: 1735 Ø: 52
Cone Ø: d1 Ø 32 / d2 Ø 29
9423300003, 9423300103, 9423300203



DB-DL-5224

Length: 850 Ø: 60
Hole Distance: 100 / 100
01336100A, 9413300007



DB-DL-5230

Length: 879 Ø: 42
Cone Ø: d1 Ø 30 / d2 Ø 27
01208600A, 0004607105, 0004607205,
0014606705



DB-DL-5241

Length: 875 Ø: 40
Cone Ø: d1 Ø 30 / d2 Ø 27
01215300A, 0004609205, 0004609305,
0014606905



DB-DL-5405

Length: 890 Ø: 35
Cone Ø: d1 Ø 28,6 / d2 Ø 23,9
01215900A, 1460248, 0024604505,
0024604605, 0034605005, 3752600637,
3754600405, A3752600637, A3754600405



DB-DL-7270

Length: 875 Ø: 40
Cone Ø: d1 Ø 28,6 / d2 Ø 23,9
01208300A, 0024604705, 0024604805,
0034604905, A0024604705



DB-DL-8168

Length: 904 Ø: 52
Cone Ø: d1 Ø 32 / d2 Ø 29
0004609405, 0004609505, 0014607105



DB-DL-8184

Length: 1095 Ø: 42
Cone Ø: d1 Ø 32 / d2 Ø 28,8
01217700A, 0014601305, 0014601405,
0024600505, 0034603205, 3754601505,
A0014601305, A0014601405, A0024600505



DB-DL-8185

Length: 711 Ø: 42
Cone Ø: d1 Ø 32 / d2 Ø 28,8
01213600A, 0014601105, 0024600405,
0034603105, A0014601105, A0024600405



DB-DL-8307

Length: 885 Ø: 38
Cone Ø: d1 Ø 32 / d2 Ø 30
01215500A, 0004604005, 0024605105,
0024605205, 0034604005



DB-DL-8327

Length: 1745 Ø: 48
Cone Ø: d1 Ø 32 / d2 Ø 29
01219800A, 9413300003, 9413300103,
9413300203, 9413300303, 9413300503



DB-DL-8388

Length: 1735 Ø: 62
Cone Ø: d1 Ø 32 / d2 Ø 28,8
01219900A, 9453300003, 9453300103,
9453300403, 9453300603, A9453300003



DB-DL-8389

Length: 1465 Ø: 40
Cone Ø: d1 Ø 32 / d2 Ø 29
9453300203, 9453300303, 9453300503



DB-DL-8640

Length: 1615 Ø: 50
Cone Ø: d1 Ø 32 / d2 Ø 29
6253301503, 6253301603, 6253302403,
6253302503, 9423300803, 9423302103,
9493300203, 9493300303, 9493300903



DB-DL-9218

Length: 754 Ø: 40
Hole Distance: 100
000360098524, 000390098524,
3753300111, 9413300011,
A3753300111, SA50831601



DB-DL-9254

Length: 1815 Ø: 58
0003220323, 0003220623, 3753220423



DB-DL-10209

Length: 1281 Ø: 38
Cone Ø: d1 Ø 30 / d2 Ø 27
3574603505, 9423301003, 9423301703



DB-DL-12299

Length: 2069 Ø: 40
Cone Ø: d1 Ø 30 / d2 Ø 27
0004608505, 0024601005, 0034602905



DB-DL-12300

Length: 733 Ø: 36
Cone Ø: d1 Ø 32 / d2 Ø 29
0014601505, 0014607305, 0034603305,
3754601605, A0014601505,
A0034603305, A3754601605



DB-DL-12310

Length: 1532 Ø: 50
Cone Ø: d1 Ø 32 / d2 Ø 29
Thread: M27 x 1,5 LHT
9493301203, 9493301303, 9493301803,
9493302203, A9493301203, A9493301303,
A9493301803, A9493302203



DB-DL-12470

Length: 723 Ø: 42
Cone Ø: d1 Ø 30 / d2 Ø 27
A0014607505, A0024600905



No Image

DB-ES-5227

Length: 1588 Ø: 60
Cone Ø: d1 Ø 38 / d2 Ø 34,3
6253300903, 6253301203, 9443300203



DB-ES-5234

Length: 135
Cone Ø: d1 Ø 38 / d2 Ø 34,3
Thread: M38 x 1,5 RHT
0004601748, 1203223005, 2205000400



DB-ES-8164

Length: 140
Cone Ø: d1 Ø 28,6 / d2 Ø 23,9
Thread: M28 x 1,5 RHT
0014604248, 0014605048, 0014608548,
0024600548



DB-ES-8510

Length: 56
Cone Ø: d1 Ø 10 / d2 Ø 10
Thread: M12 x 1,75 LHT
0009965145, 0009965645, 0019963145



DB-ES-8530

Length: 115
Cone Ø: d1 Ø 28,6 / d2 Ø 23,9
Thread: M30 x 1,5 RHT
0014603848, 0014604848, 0014605148,
0014608648, 0014609948



DB-RK-8391

Ø: 85 Hole Distance: 152
Thick/Height: 24
01336800A, 0003502705



DB-RK-8550

Ø: 75 Hole Distance: 152
Thick/Height: 24
0003502105, 0003504605



DB-RK-8555

Ø: 67 Hole Distance: 130
Thick/Height: 24
01335600A, 0003502005, 0003504705



DB-RK-8626

Ø: 75 Hole Distance: 130
Thick/Height: 24
0003502205, 0003502505, 0003503405,
0003504505, GL11319



DB-RK-8638

Length: 100 Ø: 67
Hole Distance: 100
Thick/Height: 20
0003301411



DB-RK-9294

Ø: 85 Hole Distance: 152
Thick/Height: 24
0003503105



DB-RK-9296

Ø: 88 Hole Distance: 130
Thick/Height: 24
9423260050



DB-RK-10374

Ø: 85 Hole Distance: 152
Thick/Height: 24
0003504405



DB-RK-10375

Ø: 100 Hole Distance: 152
Thick/Height: 24
0003502405, 0003503505, 0003504905



DB-SB-10384

Ø: 73 Thick/Height: 47
9303170012, 9423171812



DB-SB-10406

Ø: 80 Thick/Height: 46
0003238185



DB-SB-10409

Ø: 77 Thick/Height: 56
0003265181



DB-SB-10410

Ø: 73 Hole Distance: 100
Thick/Height: 24
9413230050



DB-VB-3707

Length: 622 Ø: 46
Hole Ø 25 / 25 / 25
Hole Distance: 152 / 130 / 130
01337100A, 9423501005, 9423501505,
9443500005, 9473500105, 9473501005,
A3753500005, A9423501005, A9423501505,
A9443500005, A9473500105, A9473501005



DB-VB-7261

Length: 622 Ø: 46
Hole Ø 25 / 25 / 25
Hole Distance: 152 / 130 / 130
01337800A, 9443500305, 9443500505,
9443500605, 9473500705, 9473500905,
9483500405, 9483500305



DB-VB-7790

Length: 622 Ø: 46
Hole Ø 25 / 23 / 23
Hole Distance: 152 / 130 / 130
01337000A, 3753500105, 9423500105,
9423500705, 9423501105, 9423501605,
9443500205



DB-VB-9307

Length: 667 Ø: 60
Hole Ø 25 / 23 / 23
Hole Distance: 152 / 130 / 130
9483502805



DB-VB-9308

Length: 622 Ø: 46
Hole Ø 25 / 25 / 25
Hole Distance: 152 / 130 / 130
9483502905



DB-VB-10426

Length: 622 Ø: 46
Hole Ø 25 / 25 / 25
Hole Distance: 152 / 130 / 130
9443500405



MERCEDES-BENZ



ACTROS MP2 / MP3 ...

2546 LS ...	04/03→	Suspension Strut Repair Kit		MN-RK-8997		
	04/03→	Tie Rod		DB-DL-8172	Guide Rod, Leading Axle Steered	
	04/03→	Tie Rod	DB-DL-8172		Guide Rod, 1st Front Axle	
	04/03→	Tie Rod	DB-DL-8327		Guide Rod	
	04/03→	Tie Rod	DB-DL-8388		Guide Rod	
	04/03→	Tie Rod	DB-DL-8389			
	04/03→	Tie Rod	DB-DL-12310			
	04/03→	Tie Rod	DB-ES-5227		Guide Rod	
	04/03→	Tie Rod End	CV-ES-0543	CV-ES-0543	for Push Rod	
	04/03→	Tie Rod End	CV-ES-0888	CV-ES-0888	for Push Rod	
	04/03→	Tie Rod End	CV-ES-14162		for Steering Rod	
	04/03→	Tie Rod End	CV-ES-14163		for Steering Rod	
	04/03→	Tie Rod End	DB-ES-5234		for Steering Rod	
	04/03→	Tie Rod End	DB-ES-8164		for Push Rod	
	04/03→	Tie Rod End	DB-ES-8530		for Push Rod	
	04/03→	Track Control Arm		DB-DL-9218	Trailing Arm, Leading Axle not Steered, →508316 01/508316 04	
	04/03→	Track Control Arm		DB-DL-9218	Trailing Arm, Leading Axle not Steered, →532040 04	
	04/03→	Track Control Arm		DB-VB-7798	Wishbone (CV), Air Suspension Axle	
	04/03→	Track Control Arm	DB-DL-5224	DB-DL-5224	Trailing Arm, Leading Axle not Steered, →508315 01	
	06/08→	Centre Rod	DB-DL-8641		Push Rod	
	06/08→	Stabiliser Mounting		DB-SB-10406		
	06/08→	Suspension Strut Repair Kit		DB-RK-8555		
	06/08→	Suspension Strut Repair Kit		DB-RK-9294		
	06/08→	Tie Rod		DB-DL-10209	Tag Axle;for vehicles with Hinged Trailing Axle	
	06/08→	Tie Rod	DB-DL-8640		Guide Rod	
	06/08→	Track Control Arm		DB-VB-7790	Wishbone (CV), Tag Axle	
	06/08→	Track Control Arm	DB-DL-5224		Control Arm, 1st FA;Air Suspension Axle	
	06/08→	Track Control Arm	DB-DL-9218	DB-DL-9218	Trailing Arm, 1st FA;Air Suspension Axle	
	12/09→	Tie Rod End	CV-ES-0543		for Push Rod	
	12/09→	Track Control Arm		DB-DL-9218	Trailing Arm, Leading Axle	
	12/09→	Track Control Arm		DB-VB-7798	Wishbone (CV)	
	2546, L, LL	04/03→	Ball Head, gearshift linkage	DB-ES-8510		
		04/03→	Bush, driver cab suspension	DB-SB-10384		
04/03→		Centre Rod	DB-DL-2144		Push Rod	
04/03→		Centre Rod	DB-DL-5230		Suspension Rod	
04/03→		Centre Rod	DB-DL-5241		Push Rod	
04/03→		Centre Rod	DB-DL-5405		Push Rod	
04/03→		Centre Rod	DB-DL-5405		Push Rod, Leaf Spring Axle;Tag Axle	
04/03→		Centre Rod	DB-DL-7270		Push Rod	
04/03→		Centre Rod	DB-DL-8167		Push Rod	
04/03→		Centre Rod	DB-DL-8168		Push Rod	
04/03→		Centre Rod	DB-DL-8184		Push Rod	
04/03→		Centre Rod	DB-DL-8185		Push Rod	
04/03→		Centre Rod	DB-DL-8307		Push Rod	
04/03→		Centre Rod	DB-DL-8622		Push Rod	
04/03→		Centre Rod	DB-DL-8641		Push Rod	
04/03→		Centre Rod	DB-DL-8642		Push Rod	
04/03→		Centre Rod	DB-DL-12300		for Steering Rod	
04/03→		Rod Assembly	DB-DL-2178		Guide Rod, 1st Front Axle, →504310 03	
04/03→		Stabiliser Link	DB-DL-9254		Pressure Rod	
04/03→		Stabiliser Mounting		DB-RK-9296		
04/03→		Stabiliser Mounting		DB-SB-10406		
04/03→		Stabiliser Mounting		DB-SB-10409		
04/03→		Stabiliser Mounting	DB-SB-10410			
04/03→		Suspension Arm Repair Kit		DB-RK-8550	for Wishbone (CV)	
04/03→		Suspension Arm Repair Kit		DB-RK-8626	for Wishbone (CV)	
04/03→		Suspension Arm Repair Kit		DB-RK-10374	for Wishbone (CV)	
04/03→		Suspension Arm Repair Kit		DB-RK-10375	for Wishbone (CV)	
04/03→		Suspension Arm Repair Kit	DB-RK-8638		for Control Arm	
04/03→		Suspension Strut Repair Kit		DB-RK-8391		

CV-ES-0543

Length: 125
 Cone Ø: d1 Ø 32 / d2 Ø 29
 Thread: M30 x 1,5 RHT
 0004605748, 0004606048, 0004606848,
 0004607048, 0014600448, 0014601148,
 0014601748, 0014602448, 0014607648,
 0014609648

**CV-ES-0888**

Length: 125
 Cone Ø: d1 Ø 32 / d2 Ø 29
 Thread: M30 x 1,5 LHT
 0004605848, 0004606148, 0004606948,
 0004607148, 0004609048, 0014600548,
 0014601348, 0014602548, 0014607948,
 0024600448

**CV-ES-14162**

Length: 125
 Cone Ø: d1 Ø 30 / d2 Ø 27
 Thread: M30 x 1,5 LHT
 4600648, 4601248, 4603448, 0004603548,
 14600348, 14601448, 14602348,
 0014603748, 0014607848, 0024600348

**CV-ES-14163**

Length: 125
 Cone Ø: d1 Ø 30 / d2 Ø 27
 Thread: M30 x 1,5 RHT
 0003305248, 0003387310, 0004600348,
 0004600948, 0004602848, 0004602948,
 0004608948, 0014600248, 0014600848,
 0014601248, 0014602248, 0014607748,
 0024600148, A0003387310, A0004600348,
 A0004602848, A0004602948, A0014600848,
 A0014601248, A0014602248, A0014607748

**DB-DL-2144**

Length: 872 Ø: 35
 Cone Ø: d1 Ø 28,6 / d2 Ø 23,9
 0024604305, 0024604405, 0034604805

**DB-DL-2178**

Length: 1735 Ø: 52
 Cone Ø: d1 Ø 32 / d2 Ø 29
 9423300003, 9423300103, 9423300203

**DB-DL-5224**

Length: 850 Ø: 60
 Hole Distance: 100 / 100
 01336100A, 9413300007

**DB-DL-5230**

Length: 879 Ø: 42
 Cone Ø: d1 Ø 30 / d2 Ø 27
 01208600A, 0004607105, 0004607205,
 0014606705

**DB-DL-5241**

Length: 875 Ø: 40
 Cone Ø: d1 Ø 30 / d2 Ø 27
 01215300A, 0004609205, 0004609305,
 0014606905

**DB-DL-5405**

Length: 890 Ø: 35
 Cone Ø: d1 Ø 28,6 / d2 Ø 23,9
 01215900A, 1460248, 0024604505,
 0024604605, 0034605005, 3752600637,
 3754600405, A3752600637, A3754600405

**DB-DL-7270**

Length: 875 Ø: 40
 Cone Ø: d1 Ø 28,6 / d2 Ø 23,9
 01208300A, 0024604705, 0024604805,
 0034604905, A0024604705

**DB-DL-8167**

Length: 866 Ø: 38
 Cone Ø: d1 Ø 30 / d2 Ø 27
 0014609805, 0014609905, 0024606305,
 0024606405

**DB-DL-8168**

Length: 904 Ø: 52
 Cone Ø: d1 Ø 32 / d2 Ø 29
 0004609405, 0004609505, 0014607105

**DB-DL-8172**

Length: 1700 Ø: 52
 Cone Ø: d1 Ø 32 / d2 Ø 29
 01219700A, 9493300403, 9493300503,
 9493300803, 9493301403

**DB-DL-8184**

Length: 1095 Ø: 42
 Cone Ø: d1 Ø 32 / d2 Ø 28,8
 01217700A, 0014601305, 0014601405,
 0024600505, 0034603205, 3754601505,
 A0014601305, A0014601405, A0024600505

**DB-DL-8185**

Length: 711 Ø: 42
 Cone Ø: d1 Ø 32 / d2 Ø 28,8
 01213600A, 0014601105, 0024600405,
 0034603105, A0014601105, A0024600405

**DB-DL-8307**

Length: 885 Ø: 38
 Cone Ø: d1 Ø 32 / d2 Ø 30
 01215500A, 0004604005, 0024605105,
 0024605205, 0034604005

**DB-DL-8327**

Length: 1745 Ø: 48
 Cone Ø: d1 Ø 32 / d2 Ø 29
 01219800A, 9413300003, 9413300103,
 9413300203, 9413300303, 9413300503

**DB-DL-8388**

Length: 1735 Ø: 62
 Cone Ø: d1 Ø 32 / d2 Ø 28,8
 01219900A, 9453300003, 9453300103,
 9453300403, 9453300603, A9453300003

**DB-DL-8389**

Length: 1465 Ø: 40
 Cone Ø: d1 Ø 32 / d2 Ø 29
 9453300203, 9453300303, 9453300503

**DB-DL-8622**

Length: 1558 Ø: 52
 Cone Ø: d1 Ø 30 / d2 Ø 27
 0014609005, 0014609105

**DB-DL-8640**

Length: 1615 Ø: 50
 Cone Ø: d1 Ø 32 / d2 Ø 29
 6253301503, 6253301603, 6253302403,
 6253302503, 9423300803, 9423302103,
 9493300203, 9493300303, 9493300903

**DB-DL-8641**

Length: 905 Ø: 42
 Cone Ø: d1 Ø 30 / d2 Ø 27
 0014605105, 0014608105

**DB-DL-8642**

Length: 954 Ø: 42
 Cone Ø: d1 Ø 30 / d2 Ø 27
 0014608605, 0014608705

**DB-DL-9218**

Length: 754 Ø: 40
 Hole Distance: 100
 000360098524, 000390098524,
 3753300111, 9413300011,
 A3753300111, SA50831601

**DB-DL-9254**

Length: 1815 Ø: 58
 0003220323, 0003220623, 3753220423

**DB-DL-10209**

Length: 1281 Ø: 38
 Cone Ø: d1 Ø 30 / d2 Ø 27
 3574603505, 9423301003, 9423301703

**DB-DL-12300**

Length: 733 Ø: 36
 Cone Ø: d1 Ø 32 / d2 Ø 29
 0014601505, 0014607305, 0034603305,
 3754601605, A0014601505,
 A0034603305, A3754601605

**DB-DL-12310**

Length: 1532 Ø: 50
 Cone Ø: d1 Ø 32 / d2 Ø 29
 Thread: M27 x 1,5 LHT
 9493301203, 9493301303, 9493301803,
 9493302203, A9493301203, A9493301303,
 A9493301803, A9493302203

**DB-ES-5227**

Length: 1588 Ø: 60
 Cone Ø: d1 Ø 38 / d2 Ø 34,3
 6253300903, 6253301203, 9443300203

**DB-ES-5234**

Length: 135
 Cone Ø: d1 Ø 38 / d2 Ø 34,3
 Thread: M38 x 1,5 RHT
 0004601748, 120322305, 2205000400

**DB-ES-8164**

Length: 140
 Cone Ø: d1 Ø 28,6 / d2 Ø 23,9
 Thread: M28 x 1,5 RHT
 0014604248, 0014605048, 0014608548,
 0024600548

**DB-ES-8510**

Length: 56
 Cone Ø: d1 Ø 10 / d2 Ø 10
 Thread: M12 x 1,75 LHT
 0009965145, 0009965645, 0019963145

**DB-ES-8530**

Length: 115
 Cone Ø: d1 Ø 28,6 / d2 Ø 23,9
 Thread: M30 x 1,5 RHT
 0014603848, 0014604848, 0014605148,
 0014608648, 0014609948

**DB-RK-8391**

Ø: 85 Hole Distance: 152
 Thick/Height: 24
 01336800A, 0003502705

**DB-RK-8550**

Ø: 75 Hole Distance: 152
 Thick/Height: 24
 0003502105, 0003504605

**DB-RK-8555**

Ø: 67 Hole Distance: 130
 Thick/Height: 20
 01335600A, 0003502005, 0003504705

**DB-RK-8626**

Ø: 75 Hole Distance: 130
 Thick/Height: 24
 0003502205, 0003502505, 0003503405,
 0003504505, GL11319

**DB-RK-8638**

Length: 100 Ø: 67
 Hole Distance: 100
 Thick/Height: 20
 0003301411

**DB-RK-9294**

Ø: 85 Hole Distance: 152
 Thick/Height: 24
 0003503105

**DB-RK-9296**

Ø: 88 Hole Distance: 130
 Thick/Height: 24
 9423260050

**DB-RK-10374**

Ø: 85 Hole Distance: 152
 Thick/Height: 24
 0003504405

**DB-RK-10375**

Ø: 100 Hole Distance: 152
 Thick/Height: 24
 0003502405, 0003503505, 0003504905

**DB-SB-10384**

Ø: 73 Thick/Height: 47
 9303170012, 9423171812

**DB-SB-10406**

Ø: 80 Thick/Height: 46
 0003238185

**DB-SB-10409**

Ø: 77 Thick/Height: 56
 0003265181

**DB-SB-10410**

Ø: 73 Hole Distance: 100
 Thick/Height: 24
 9413230050

**DB-VB-7790**

Length: 622 Ø: 46
 Hole Ø 25 / 23 / 23
 Hole Distance: 152 / 130 / 130
 01337000A, 3753500105, 9423500105,
 9423500705, 9423501105, 9423501605,
 9443500205

**DB-VB-7798**

Length: 622 Ø: 48
 Hole Ø 25 / 23 / 23
 Hole Distance: 152 / 130 / 130
 9423500505, 9423500805, 9423501205,
 A9423501205

**MN-RK-8997**

Ø: 85 Hole Distance: 130
 Thick/Height: 30
 0003504805





ACTROS MP2 / MP3 ...

2546, L, LL ...	04/03→	Suspension Strut Repair Kit		DB-RK-8555		
	04/03→	Suspension Strut Repair Kit		DB-RK-9294		
	04/03→	Tie Rod		DB-DL-10209	Tag Axle;for vehicles with Hinged Trailing Axle	
	04/03→	Tie Rod	DB-DL-8327		Guide Rod	
	04/03→	Tie Rod	DB-DL-8388		Guide Rod, 1st FA;Leaf Spring Axle	
	04/03→	Tie Rod	DB-DL-8389		1st FA;Leaf Spring Axle	
	04/03→	Tie Rod	DB-DL-8640		Guide Rod	
	04/03→	Tie Rod	DB-DL-12310			
	04/03→	Tie Rod	DB-ES-5227		Guide Rod	
	04/03→	Tie Rod End	CV-ES-0543		for Push Rod	
	04/03→	Tie Rod End	CV-ES-0888		for Push Rod	
	04/03→	Tie Rod End	CV-ES-14163		for Steering Rod	
	04/03→	Tie Rod End	DB-ES-5234		for Steering Rod	
	04/03→	Tie Rod End	DB-ES-8164		for Push Rod	
	04/03→	Tie Rod End	DB-ES-8530		for Push Rod	
	04/03→	Track Control Arm		DB-VB-3707	Suspension Rod, Wishbone (CV)	
	04/03→	Track Control Arm		DB-VB-7261	Suspension Rod, Wishbone (CV), 1st RA, →517142 01/517142 02	
	04/03→	Track Control Arm		DB-VB-7790	Wishbone (CV), Tag Axle	
	04/03→	Track Control Arm		DB-VB-9307	Suspension Rod, Wishbone (CV), 1st Drive Axle, →517142 07	
	04/03→	Track Control Arm		DB-VB-9308	Suspension Rod, Wishbone (CV), 1st Drive Axle, →517142 06	
	04/03→	Track Control Arm		DB-VB-10426	Wishbone (CV), 1st RA, →517142 05	
	04/03→	Track Control Arm	DB-DL-5224		Control Arm, 1st FA;Air Suspension Axle	
	04/03→	Track Control Arm	DB-DL-9218	DB-DL-9218	Trailing Arm, 1st FA;Air Suspension Axle	
	2548 L	04/03→	Centre Rod	DB-DL-5405		Push Rod
		04/03→	Centre Rod	DB-DL-7270		Push Rod
04/03→		Centre Rod	DB-DL-8641		Push Rod	
04/03→		Tie Rod		DB-DL-10209		
04/03→		Track Control Arm		DB-VB-7790	Wishbone (CV)	
04/03→		Track Control Arm	DB-DL-5224		Control Arm	
2548 LS	04/03→	Track Control Arm	DB-DL-9218	DB-DL-9218	Trailing Arm	
	04/03→	Ball Head, gearshift linkage	DB-ES-8510			
	04/03→	Bush, driver cab suspension	DB-SB-10384			
	04/03→	Centre Rod	DB-DL-2144		Push Rod	
	04/03→	Centre Rod	DB-DL-5230		Suspension Rod	
	04/03→	Centre Rod	DB-DL-5241		Push Rod	
	04/03→	Centre Rod	DB-DL-5405		Push Rod	
	04/03→	Centre Rod	DB-DL-5405		Push Rod, for vehicles with Rigid Leading Axle	
	04/03→	Centre Rod	DB-DL-7270		Push Rod	
	04/03→	Centre Rod	DB-DL-8184		Push Rod	
	04/03→	Centre Rod	DB-DL-8185		Push Rod	
	04/03→	Centre Rod	DB-DL-8307		Push Rod	
	04/03→	Centre Rod	DB-DL-12299		for Steering Rod	
	04/03→	Centre Rod	DB-DL-12300		for Steering Rod	
	04/03→	Centre Rod	DB-DL-12470		Push Rod	
	04/03→	Rod Assembly	DB-DL-2178		Guide Rod, 1st Front Axle, →504310 03	
	04/03→	Rod Assembly	DB-DL-2178	DB-DL-2178	Guide Rod, Leading Axle Steered, →504310 03	
	04/03→	Stabiliser Mounting		DB-RK-9296		
	04/03→	Stabiliser Mounting		DB-SB-10409		
	04/03→	Stabiliser Mounting	DB-SB-10410			
	04/03→	Suspension Arm Repair Kit		DB-RK-8626	for Wishbone (CV)	
	04/03→	Suspension Arm Repair Kit		DB-RK-10374	for Wishbone (CV)	
	04/03→	Suspension Arm Repair Kit		DB-RK-10375	for Wishbone (CV)	
	04/03→	Suspension Arm Repair Kit	DB-RK-8638		for Control Arm	
	04/03→	Suspension Strut Repair Kit		DB-RK-8391		
	04/03→	Suspension Strut Repair Kit		MN-RK-8997		
	04/03→	Tie Rod		DB-DL-8172	Guide Rod, Leading Axle Steered	
	04/03→	Tie Rod	DB-DL-8172		Guide Rod, 1st Front Axle	
	04/03→	Tie Rod	DB-DL-8327		Guide Rod	
	04/03→	Tie Rod	DB-DL-8388		Guide Rod	
	04/03→	Tie Rod	DB-DL-8389		Guide Rod	

CV-ES-0543

Length: 125
 Cone Ø: d1 Ø 32 / d2 Ø 29
 Thread: M30 x 1,5 RHT
 0004605748, 0004606048, 0004606848,
 0004607048, 0014600448, 0014601148,
 0014601748, 0014602448, 0014607648,
 0014609648

**CV-ES-0888**

Length: 125
 Cone Ø: d1 Ø 32 / d2 Ø 29
 Thread: M30 x 1,5 LHT
 0004605848, 0004606148, 0004606948,
 0004607148, 0004609048, 0014600548,
 0014601348, 0014602548, 0014607948,
 0024600448

**CV-ES-14163**

Length: 125
 Cone Ø: d1 Ø 30 / d2 Ø 27
 Thread: M30 x 1,5 RHT
 0003305248, 0003387310, 0004600348,
 0004600948, 0004602848, 0004602948,
 0004608948, 0014600248, 0014600848,
 0014601248, 0014602248, 0014607748,
 0024600148, A0003387310, A0004600348,
 A0004602848, A0004602948, A0014600848,
 A0014601248, A0014602248, A0014607748

**DB-DL-2144**

Length: 872 Ø: 35
 Cone Ø: d1 Ø 28,6 / d2 Ø 23,9
 0024604305, 0024604405, 0034604805

**DB-DL-2178**

Length: 1735 Ø: 52
 Cone Ø: d1 Ø 32 / d2 Ø 29
 9423300003, 9423300103, 9423300203

**DB-DL-5224**

Length: 850 Ø: 60
 Hole Distance: 100 / 100
 01336100A, 9413300007

**DB-DL-5230**

Length: 879 Ø: 42
 Cone Ø: d1 Ø 30 / d2 Ø 27
 01208600A, 0004607105, 0004607205,
 0014606705

**DB-DL-5241**

Length: 875 Ø: 40
 Cone Ø: d1 Ø 30 / d2 Ø 27
 01215300A, 0004609205, 0004609305,
 0014606905

**DB-DL-5405**

Length: 890 Ø: 35
 Cone Ø: d1 Ø 28,6 / d2 Ø 23,9
 01215900A, 1460248, 0024604505,
 0024604605, 0034605005, 3752600637,
 3754600405, A3752600637, A3754600405

**DB-DL-7270**

Length: 875 Ø: 40
 Cone Ø: d1 Ø 28,6 / d2 Ø 23,9
 01208300A, 0024604705, 0024604805,
 0034604905, A0024604705

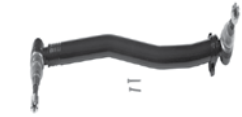
**DB-DL-8172**

Length: 1700 Ø: 52
 Cone Ø: d1 Ø 32 / d2 Ø 29
 01219700A, 9493300403, 9493300503,
 9493300803, 9493301403

**DB-DL-8184**

Length: 1095 Ø: 42
 Cone Ø: d1 Ø 32 / d2 Ø 28,8
 01217700A, 0014601305, 0014601405,
 0024600505, 0034603205, 3754601505,
 A0014601305, A0014601405, A0024600505

**DB-DL-8185**

Length: 711 Ø: 42
 Cone Ø: d1 Ø 32 / d2 Ø 28,8
 01213600A, 0014601105, 0024600405,
 0034603105, A0014601105, A0024600405

**DB-DL-8307**

Length: 885 Ø: 38
 Cone Ø: d1 Ø 32 / d2 Ø 30
 01215500A, 0004604005, 0024605105,
 0024605205, 0034604005

**DB-DL-8327**

Length: 1745 Ø: 48
 Cone Ø: d1 Ø 32 / d2 Ø 29
 01219800A, 9413300003, 9413300103,
 9413300203, 9413300303, 9413300503

**DB-DL-8388**

Length: 1735 Ø: 62
 Cone Ø: d1 Ø 32 / d2 Ø 28,8
 01219900A, 9453300003, 9453300103,
 9453300403, 9453300603, A9453300003

**DB-DL-8389**

Length: 1465 Ø: 40
 Cone Ø: d1 Ø 32 / d2 Ø 29
 9453300203, 9453300303, 9453300503

**DB-DL-8640**

Length: 1615 Ø: 50
 Cone Ø: d1 Ø 32 / d2 Ø 29
 6253301503, 6253301603, 6253302403,
 6253302503, 9423300803, 9423302103,
 9493300203, 9493300303, 9493300903

**DB-DL-8641**

Length: 905 Ø: 42
 Cone Ø: d1 Ø 30 / d2 Ø 27
 0014605105, 0014608105

**DB-DL-9218**

Length: 754 Ø: 40
 Hole Distance: 100
 000360098524, 000390098524,
 3753300111, 9413300111,
 A3753300111, SA50831601

**DB-DL-10209**

Length: 1281 Ø: 38
 Cone Ø: d1 Ø 30 / d2 Ø 27
 3574603505, 9423301003, 9423301703

**DB-DL-12299**

Length: 2069 Ø: 40
 Cone Ø: d1 Ø 30 / d2 Ø 27
 0004608505, 0024601005, 0034602905

**DB-DL-12300**

Length: 733 Ø: 36
 Cone Ø: d1 Ø 32 / d2 Ø 29
 0014601505, 0014607305, 0034603305,
 3754601605, A0014601505,
 A0034603305, A3754601605

**DB-DL-12310**

Length: 1532 Ø: 50
 Cone Ø: d1 Ø 32 / d2 Ø 29
 Thread: M27 x 1,5 LHT
 9493301203, 9493301303, 9493301803,
 9493302203, A9493301203, A9493301303,
 A9493301803, A9493302203

**DB-DL-12470**

Length: 723 Ø: 42
 Cone Ø: d1 Ø 30 / d2 Ø 27
 A0014607505, A0024600905



No Image

DB-ES-5227

Length: 1588 Ø: 60
 Cone Ø: d1 Ø 38 / d2 Ø 34,3
 6253300903, 6253301203, 9443300203

**DB-ES-5234**

Length: 135
 Cone Ø: d1 Ø 38 / d2 Ø 34,3
 Thread: M38 x 1,5 RHT
 0004601748, 120322305, 2205000400

**DB-ES-8164**

Length: 140
 Cone Ø: d1 Ø 28,6 / d2 Ø 23,9
 Thread: M28 x 1,5 RHT
 0014604248, 0014605048, 0014608548,
 0024600548

**DB-ES-8510**

Length: 56
 Cone Ø: d1 Ø 10 / d2 Ø 10
 Thread: M12 x 1,75 LHT
 0009965145, 0009965645, 0019963145

**DB-ES-8530**

Length: 115
 Cone Ø: d1 Ø 28,6 / d2 Ø 23,9
 Thread: M30 x 1,5 RHT
 0014603848, 0014604848, 0014605148,
 0014608648, 0014609948

**DB-RK-8391**

Ø: 85 Hole Distance: 152
 Thick/Height: 24
 01336800A, 0003502705

**DB-RK-8555**

Ø: 67 Hole Distance: 130
 Thick/Height: 24
 01335600A, 0003502005, 0003504705

**DB-RK-8626**

Ø: 75 Hole Distance: 130
 Thick/Height: 24
 0003502205, 0003502505, 0003503405,
 0003504505, GL11319

**DB-RK-8638**

Length: 100 Ø: 67
 Hole Distance: 100
 Thick/Height: 20
 0003301411

**DB-RK-9294**

Ø: 85 Hole Distance: 152
 Thick/Height: 24
 0003503105

**DB-RK-9296**

Ø: 88 Hole Distance: 130
 Thick/Height: 24
 9423260050

**DB-RK-10374**

Ø: 85 Hole Distance: 152
 Thick/Height: 24
 0003504405

**DB-RK-10375**

Ø: 100 Hole Distance: 152
 Thick/Height: 24
 0003502405, 0003503505, 0003504905

**DB-SB-10384**

Ø: 73 Thick/Height: 47
 9303170012, 9423171812

**DB-SB-10409**

Ø: 77 Thick/Height: 56
 0003265181

**DB-SB-10410**

Ø: 73 Hole Distance: 100
 Thick/Height: 24
 9413230050

**DB-VB-3707**

Length: 622 Ø: 46
 Hole Ø 25 / 25 / 25
 Hole Distance: 152 / 130 / 130
 01337100A, 9423501005, 9423501505,
 9443500005, 9473500105, 9473501005,
 A3753500005, A9423501005, A9423501505,
 A9443500005, A9473500105, A9473501005

**DB-VB-7261**

Length: 622 Ø: 46
 Hole Ø 25 / 25 / 25
 Hole Distance: 152 / 130 / 130
 01337800A, 9443500305, 9443500505,
 9443500605, 9473500705, 9473500905,
 9483500405, 9483500305

**DB-VB-7790**

Length: 622 Ø: 46
 Hole Ø 25 / 23 / 23
 Hole Distance: 152 / 130 / 130
 01337000A, 3753500105, 9423500105,
 9423500705, 9423501105, 9423501605,
 9443500205

**DB-VB-9307**

Length: 667 Ø: 60
 Hole Ø 25 / 23 / 23
 Hole Distance: 152 / 130 / 130
 9483502805

**DB-VB-9308**

Length: 622 Ø: 46
 Hole Ø 25 / 25 / 25
 Hole Distance: 152 / 130 / 130
 9483502905

**DB-VB-10426**

Length: 622 Ø: 46
 Hole Ø 25 / 25 / 25
 Hole Distance: 152 / 130 / 130
 9443500405

**MN-RK-8997**

Ø: 85 Hole Distance: 130
 Thick/Height: 30
 0003504805





ACTROS MP2 / MP3 ...

2548 LS ...	04/03→	Tie Rod	DB-DL-12310			
	04/03→	Tie Rod	DB-ES-5227		Guide Rod	
	04/03→	Tie Rod End	CV-ES-0543	CV-ES-0543	for Push Rod	
	04/03→	Tie Rod End	CV-ES-0888	CV-ES-0888	for Push Rod	
	04/03→	Tie Rod End	CV-ES-14162		for Steering Rod	
	04/03→	Tie Rod End	CV-ES-14163		for Steering Rod	
	04/03→	Tie Rod End	DB-ES-5234		for Steering Rod	
	04/03→	Tie Rod End	DB-ES-8164		for Push Rod	
	04/03→	Tie Rod End	DB-ES-8530		for Push Rod	
	04/03→	Track Control Arm		DB-DL-9218	Trailing Arm, Leading Axle not Steered, →508316 01/508316 04	
	04/03→	Track Control Arm		DB-DL-9218	Trailing Arm, Leading Axle not Steered, →532040 04	
	04/03→	Track Control Arm		DB-VB-7798	Wishbone (CV), Air Suspension Axle	
	04/03→	Track Control Arm	DB-DL-5224	DB-DL-5224	Trailing Arm, Leading Axle not Steered, →508315 01	
	06/08→	Centre Rod	DB-DL-8641		Push Rod	
	06/08→	Stabiliser Mounting		DB-SB-10406		
	06/08→	Suspension Strut Repair Kit		DB-RK-8555		
	06/08→	Suspension Strut Repair Kit		DB-RK-9294		
	06/08→	Tie Rod		DB-DL-10209	Tag Axle;for vehicles with Hinged Trailing Axle	
	06/08→	Tie Rod	DB-DL-8640		Guide Rod	
	06/08→	Track Control Arm		DB-VB-7790	Wishbone (CV), Tag Axle	
	06/08→	Track Control Arm	DB-DL-5224		Control Arm, 1st FA;Air Suspension Axle	
	06/08→	Track Control Arm	DB-DL-9218	DB-DL-9218	Trailing Arm, 1st FA;Air Suspension Axle	
	2548, L,LL	04/03→	Ball Head, gearshift linkage	DB-ES-8510		
		04/03→	Bush, driver cab suspension	DB-SB-10384		
		04/03→	Centre Rod	DB-DL-2144		Push Rod
		04/03→	Centre Rod	DB-DL-5230		Suspension Rod
		04/03→	Centre Rod	DB-DL-5241		Push Rod
		04/03→	Centre Rod	DB-DL-5405		Push Rod
		04/03→	Centre Rod	DB-DL-5405		Push Rod, Leaf Spring Axle;Tag Axle
		04/03→	Centre Rod	DB-DL-7270		Push Rod
		04/03→	Centre Rod	DB-DL-8167		Push Rod
		04/03→	Centre Rod	DB-DL-8168		Push Rod
		04/03→	Centre Rod	DB-DL-8184		Push Rod
04/03→		Centre Rod	DB-DL-8185		Push Rod	
04/03→		Centre Rod	DB-DL-8307		Push Rod	
04/03→		Centre Rod	DB-DL-8622		Push Rod	
04/03→		Centre Rod	DB-DL-8641		Push Rod	
04/03→		Centre Rod	DB-DL-8642		Push Rod	
04/03→		Centre Rod	DB-DL-12300		for Steering Rod	
04/03→		Rod Assembly	DB-DL-2178		Guide Rod, 1st Front Axle, →504310 03	
04/03→		Stabiliser Link	DB-DL-9254		Pressure Rod	
04/03→		Stabiliser Mounting		DB-RK-9296		
04/03→		Stabiliser Mounting		DB-SB-10406		
04/03→		Stabiliser Mounting		DB-SB-10409		
04/03→		Stabiliser Mounting	DB-SB-10410			
04/03→		Suspension Arm Repair Kit		DB-RK-8550	for Wishbone (CV)	
04/03→		Suspension Arm Repair Kit		DB-RK-8626	for Wishbone (CV)	
04/03→		Suspension Arm Repair Kit		DB-RK-10374	for Wishbone (CV)	
04/03→		Suspension Arm Repair Kit		DB-RK-10375	for Wishbone (CV)	
04/03→		Suspension Arm Repair Kit	DB-RK-8638		for Control Arm	
04/03→		Suspension Strut Repair Kit		DB-RK-8391		
04/03→		Suspension Strut Repair Kit		DB-RK-8555		
04/03→		Suspension Strut Repair Kit		DB-RK-9294		
04/03→		Tie Rod		DB-DL-10209	Tag Axle;for vehicles with Hinged Trailing Axle	
04/03→		Tie Rod	DB-DL-8327		Guide Rod	
04/03→		Tie Rod	DB-DL-8388		Guide Rod, 1st FA;Leaf Spring Axle	
04/03→		Tie Rod	DB-DL-8389		1st FA;Leaf Spring Axle	
04/03→		Tie Rod	DB-DL-8640		Guide Rod	
04/03→		Tie Rod	DB-DL-12310			
04/03→		Tie Rod	DB-ES-5227		Guide Rod	

CV-ES-0543

Length: 125
 Cone Ø: d1 Ø 32 / d2 Ø 29
 Thread: M30 x 1,5 RHT
 0004605748, 0004606048, 0004606848,
 0004607048, 0014600448, 0014601148,
 0014601748, 0014602448, 0014607648,
 0014609648

**CV-ES-0888**

Length: 125
 Cone Ø: d1 Ø 32 / d2 Ø 29
 Thread: M30 x 1,5 LHT
 0004605848, 0004606148, 0004606948,
 0004607148, 0004609048, 0014600548,
 0014601348, 0014602548, 0014607948,
 0024600448

**CV-ES-14162**

Length: 125
 Cone Ø: d1 Ø 30 / d2 Ø 27
 Thread: M30 x 1,5 LHT
 4600648, 4601248, 4603448, 0004603548,
 14600348, 14601448, 14602348,
 0014603748, 0014607848, 0024600348

**CV-ES-14163**

Length: 125
 Cone Ø: d1 Ø 30 / d2 Ø 27
 Thread: M30 x 1,5 RHT
 0003305248, 0003387310, 0004600348,
 0004600948, 0004602848, 0004602948,
 0004608948, 0014600248, 0014600848,
 0014601248, 0014602248, 0014607748,
 0024600148, 0003387310, 0004600348,
 A0004602848, A0004602948, A0014600848,
 A0014601248, A0014602248, A0014607748

**DB-DL-2144**

Length: 872 Ø: 35
 Cone Ø: d1 Ø 28,6 / d2 Ø 23,9
 0024604305, 0024604405, 0034604805

**DB-DL-2178**

Length: 1735 Ø: 52
 Cone Ø: d1 Ø 32 / d2 Ø 29
 9423300003, 9423300103, 9423300203

**DB-DL-5224**

Length: 850 Ø: 60
 Hole Distance: 100 / 100
 01336100A, 9413300007

**DB-DL-5230**

Length: 879 Ø: 42
 Cone Ø: d1 Ø 30 / d2 Ø 27
 01208600A, 0004607105, 0004607205,
 0014606705

**DB-DL-5241**

Length: 875 Ø: 40
 Cone Ø: d1 Ø 30 / d2 Ø 27
 01215300A, 0004609205, 0004609305,
 0014606905

**DB-DL-5405**

Length: 890 Ø: 35
 Cone Ø: d1 Ø 28,6 / d2 Ø 23,9
 01215900A, 1460248, 0024604505,
 0024604605, 0034605005, 3752600637,
 3754600405, A3752600637, A3754600405

**DB-DL-7270**

Length: 875 Ø: 40
 Cone Ø: d1 Ø 28,6 / d2 Ø 23,9
 01208300A, 0024604705, 0024604805,
 0034604905, A0024604705

**DB-DL-8167**

Length: 866 Ø: 38
 Cone Ø: d1 Ø 30 / d2 Ø 27
 0014609805, 0014609905, 0024606305,
 0024606405

**DB-DL-8168**

Length: 904 Ø: 52
 Cone Ø: d1 Ø 32 / d2 Ø 29
 0004609405, 0004609505, 0014607105

**DB-DL-8184**

Length: 1095 Ø: 42
 Cone Ø: d1 Ø 32 / d2 Ø 28,8
 01217700A, 0014601305, 0014601405,
 0024600505, 0034603205, 3754601505,
 A0014601305, A0014601405, A0024600505

**DB-DL-8185**

Length: 711 Ø: 42
 Cone Ø: d1 Ø 32 / d2 Ø 28,8
 01213600A, 0014601105, 0024600405,
 0034603105, A0014601105, A0024600405

**DB-DL-8307**

Length: 885 Ø: 38
 Cone Ø: d1 Ø 32 / d2 Ø 30
 01215500A, 0004604005, 0024605105,
 0024605205, 0034604005

**DB-DL-8327**

Length: 1745 Ø: 48
 Cone Ø: d1 Ø 32 / d2 Ø 29
 01219800A, 9413300003, 9413300103,
 9413300203, 9413300303, 9413300503

**DB-DL-8388**

Length: 1735 Ø: 62
 Cone Ø: d1 Ø 32 / d2 Ø 28,8
 01219900A, 9453300003, 9453300103,
 9453300403, 9453300603, A9453300003

**DB-DL-8389**

Length: 1465 Ø: 40
 Cone Ø: d1 Ø 32 / d2 Ø 29
 9453300203, 9453300303, 9453300503

**DB-DL-8622**

Length: 1558 Ø: 52
 Cone Ø: d1 Ø 30 / d2 Ø 27
 0014609005, 0014609105

**DB-DL-8640**

Length: 1615 Ø: 50
 Cone Ø: d1 Ø 32 / d2 Ø 29
 6253301503, 6253301603, 6253302403,
 6253302503, 9423300803, 9423302103,
 9493300203, 9493300303, 9493300903

**DB-DL-8641**

Length: 905 Ø: 42
 Cone Ø: d1 Ø 30 / d2 Ø 27
 0014605105, 0014608105

**DB-DL-8642**

Length: 954 Ø: 42
 Cone Ø: d1 Ø 30 / d2 Ø 27
 0014608605, 0014608705

**DB-DL-9218**

Length: 754 Ø: 40
 Hole Distance: 100
 000360098524, 000390098524,
 3753300111, 9413300011,
 A3753300111, SA50831601

**DB-DL-9254**

Length: 1815 Ø: 58
 0003220323, 0003220623, 3753220423

**DB-DL-10209**

Length: 1281 Ø: 38
 Cone Ø: d1 Ø 30 / d2 Ø 27
 3574603505, 9423301003, 9423301703

**DB-DL-12300**

Length: 733 Ø: 36
 Cone Ø: d1 Ø 32 / d2 Ø 29
 0014601505, 0014607305, 0034603305,
 3754601605, A0014601505,
 A0034603305, A3754601605

**DB-DL-12310**

Length: 1532 Ø: 50
 Cone Ø: d1 Ø 32 / d2 Ø 29
 Thread: M27 x 1,5 LHT
 9493301203, 9493301303, 9493301803,
 9493302203, A9493301203, A9493301303,
 A9493301803, A9493302203

**DB-ES-5227**

Length: 1588 Ø: 60
 Cone Ø: d1 Ø 38 / d2 Ø 34,3
 6253300903, 6253301203, 9443300203

**DB-ES-5234**

Length: 135
 Cone Ø: d1 Ø 38 / d2 Ø 34,3
 Thread: M38 x 1,5 RHT
 0004601748, 120322305, 2205000400

**DB-ES-8164**

Length: 140
 Cone Ø: d1 Ø 28,6 / d2 Ø 23,9
 Thread: M28 x 1,5 RHT
 0014604248, 0014605048, 0014608548,
 0024600548

**DB-ES-8510**

Length: 56
 Cone Ø: d1 Ø 10 / d2 Ø 10
 Thread: M12 x 1,75 LHT
 0009965145, 0009965645, 0019963145

**DB-ES-8530**

Length: 115
 Cone Ø: d1 Ø 28,6 / d2 Ø 23,9
 Thread: M30 x 1,5 RHT
 0014603848, 0014604848, 0014605148,
 0014608648, 0014609948

**DB-RK-8391**

Ø: 85 Hole Distance: 152
 Thick/Height: 24
 01336800A, 0003502705

**DB-RK-8550**

Ø: 75 Hole Distance: 152
 Thick/Height: 24
 0003502105, 0003504605

**DB-RK-8555**

Ø: 67 Hole Distance: 130
 Thick/Height: 24
 01335600A, 0003502005, 0003504705

**DB-RK-8626**

Ø: 75 Hole Distance: 130
 Thick/Height: 24
 0003502205, 0003502505, 0003503405,
 0003504505, GL11319

**DB-RK-8638**

Length: 100 Ø: 67
 Hole Distance: 100
 Thick/Height: 20
 0003301411

**DB-RK-9294**

Ø: 85 Hole Distance: 152
 Thick/Height: 24
 0003503105

**DB-RK-9296**

Ø: 88 Hole Distance: 130
 Thick/Height: 24
 9423260050

**DB-RK-10374**

Ø: 85 Hole Distance: 152
 Thick/Height: 24
 0003504405

**DB-RK-10375**

Ø: 100 Hole Distance: 152
 Thick/Height: 24
 0003502405, 0003503505, 0003504905

**DB-SB-10384**

Ø: 73 Thick/Height: 47
 9303170012, 9423171812

**DB-SB-10406**

Ø: 80 Thick/Height: 46
 0003238185

**DB-SB-10409**

Ø: 77 Thick/Height: 56
 0003265181

**DB-SB-10410**

Ø: 73 Hole Distance: 100
 Thick/Height: 24
 9413230050

**DB-VB-7790**

Length: 622 Ø: 46
 Hole Ø 25 / 23 / 23
 Hole Distance: 152 / 130 / 130
 01337000A, 3753500105, 9423500105,
 9423500705, 9423501105, 9423501605,
 9443500205

**DB-VB-7798**

Length: 622 Ø: 48
 Hole Ø 25 / 23 / 23
 Hole Distance: 152 / 130 / 130
 9423500505, 9423500805, 9423501205,
 A9423501205





ACTROS MP2 / MP3 ...

2548, L,LL ...	04/03→	Tie Rod End	CV-ES-0543		for Push Rod
	04/03→	Tie Rod End	CV-ES-0888		for Push Rod
	04/03→	Tie Rod End	CV-ES-14163		for Steering Rod
	04/03→	Tie Rod End	DB-ES-5234		for Steering Rod
	04/03→	Tie Rod End	DB-ES-8164		for Push Rod
	04/03→	Tie Rod End	DB-ES-8530		for Push Rod
	04/03→	Track Control Arm		DB-VB-3707	Suspension Rod, Wishbone (CV)
	04/03→	Track Control Arm		DB-VB-7261	Suspension Rod, Wishbone (CV), 1st RA, →517142 01/517142 02
	04/03→	Track Control Arm		DB-VB-7790	Wishbone (CV), Tag Axle
	04/03→	Track Control Arm		DB-VB-9307	Suspension Rod, Wishbone (CV), 1st Drive Axle, →517142 07
	04/03→	Track Control Arm		DB-VB-9308	Suspension Rod, Wishbone (CV), 1st Drive Axle, →517142 06
	04/03→	Track Control Arm		DB-VB-10426	Wishbone (CV), 1st RA, →517142 05
	04/03→	Track Control Arm	DB-DL-5224		Control Arm, 1st FA;Air Suspension Axle
	04/03→	Track Control Arm	DB-DL-9218	DB-DL-9218	Trailing Arm, 1st FA;Air Suspension Axle
	2550 LS	04/03→	Centre Rod	DB-DL-5405	
04/03→		Centre Rod	DB-DL-7270		Push Rod
04/03→		Tie Rod	DB-DL-8388		Guide Rod
04/03→		Tie Rod	DB-DL-8389		Guide Rod
2550, LS	04/03→	Track Control Arm		DB-VB-7798	Wishbone (CV)
	04/03→	Centre Rod	DB-DL-5405		Push Rod
	04/03→	Centre Rod	DB-DL-12299		for Steering Rod
	04/03→	Tie Rod	DB-DL-8388		Guide Rod
	04/03→	Tie Rod	DB-DL-8389		Guide Rod
2551 LS	04/03→	Track Control Arm		DB-VB-7798	Wishbone (CV)
	04/03→	Ball Head, gearshift linkage	DB-ES-8510		
	04/03→	Bush, driver cab suspension	DB-SB-10384		
	04/03→	Centre Rod	DB-DL-2144		Push Rod
	04/03→	Centre Rod	DB-DL-5230		Suspension Rod
	04/03→	Centre Rod	DB-DL-5241		Push Rod
	04/03→	Centre Rod	DB-DL-5405		Push Rod
	04/03→	Centre Rod	DB-DL-5405		Push Rod, for vehicles with Rigid Leading Axle
	04/03→	Centre Rod	DB-DL-7270		Push Rod
	04/03→	Centre Rod	DB-DL-8184		Push Rod
	04/03→	Centre Rod	DB-DL-8185		Push Rod
	04/03→	Centre Rod	DB-DL-8307		Push Rod
	04/03→	Centre Rod	DB-DL-12299		for Steering Rod
	04/03→	Centre Rod	DB-DL-12300		for Steering Rod
	04/03→	Centre Rod	DB-DL-12470		Push Rod
	04/03→	Rod Assembly	DB-DL-2178		Guide Rod, 1st Front Axle, →504310 03
	04/03→	Rod Assembly	DB-DL-2178	DB-DL-2178	Guide Rod, Leading Axle Steered, →504310 03
	04/03→	Stabiliser Mounting		DB-RK-9296	
	04/03→	Stabiliser Mounting		DB-SB-10409	
	04/03→	Stabiliser Mounting	DB-SB-10410		
	04/03→	Suspension Arm Repair Kit		DB-RK-8626	for Wishbone (CV)
	04/03→	Suspension Arm Repair Kit		DB-RK-10374	for Wishbone (CV)
	04/03→	Suspension Arm Repair Kit		DB-RK-10375	for Wishbone (CV)
	04/03→	Suspension Arm Repair Kit	DB-RK-8638		for Control Arm
	04/03→	Suspension Strut Repair Kit		DB-RK-8391	
	04/03→	Suspension Strut Repair Kit		MN-RK-8997	
	04/03→	Tie Rod		DB-DL-8172	Guide Rod, Leading Axle Steered
	04/03→	Tie Rod	DB-DL-8172		Guide Rod, 1st Front Axle
	04/03→	Tie Rod	DB-DL-8327		Guide Rod
	04/03→	Tie Rod	DB-DL-8388		Guide Rod
	04/03→	Tie Rod	DB-DL-8389		Guide Rod
	04/03→	Tie Rod	DB-DL-12310		
	04/03→	Tie Rod	DB-ES-5227		Guide Rod
	04/03→	Tie Rod End	CV-ES-0543	CV-ES-0543	for Push Rod
	04/03→	Tie Rod End	CV-ES-0888	CV-ES-0888	for Push Rod
04/03→	Tie Rod End	CV-ES-14162		for Steering Rod	
04/03→	Tie Rod End	CV-ES-14163		for Steering Rod	

CV-ES-0543

Length: 125
Cone Ø: d1 Ø 32 / d2 Ø 29
Thread: M30 x 1,5 RHT
0004605748, 0004606048, 0004606848,
0004607048, 0014600448, 0014601148,
0014601748, 0014602448, 0014607648,
0014609648



CV-ES-0888

Length: 125
Cone Ø: d1 Ø 32 / d2 Ø 29
Thread: M30 x 1,5 LHT
0004605848, 0004606148, 0004606948,
0004607148, 0004609048, 0014600548,
0014601348, 0014602548, 0014607948,
0024600448



CV-ES-14162

Length: 125
Cone Ø: d1 Ø 30 / d2 Ø 27
Thread: M30 x 1,5 LHT
4600648, 4601248, 4603448, 0004603548,
14600348, 14601448, 14602348,
0014603748, 0014607848, 0024600348



CV-ES-14163

Length: 125
Cone Ø: d1 Ø 30 / d2 Ø 27
Thread: M30 x 1,5 RHT
0003305248, 0003387310, 0004600348,
0004600948, 0004602848, 0004602948,
0004608948, 0014600248, 0014600848,
0014601248, 0014602248, 0014607748,
0024600148, 0003387310, 0004600348,
A0004602848, A0004602948, A0014600848,
A0014601248, A0014602248, A0014607748



DB-DL-2144

Length: 872 Ø: 35
Cone Ø: d1 Ø 28,6 / d2 Ø 23,9
0024604305, 0024604405, 0034604805



DB-DL-2178

Length: 1735 Ø: 52
Cone Ø: d1 Ø 32 / d2 Ø 29
9423300003, 9423300103, 9423300203



DB-DL-5224

Length: 850 Ø: 60
Hole Distance: 100 / 100
01336100A, 9413300007



DB-DL-5230

Length: 879 Ø: 42
Cone Ø: d1 Ø 30 / d2 Ø 27
01208600A, 0004607105, 0004607205,
0014606705



DB-DL-5241

Length: 875 Ø: 40
Cone Ø: d1 Ø 30 / d2 Ø 27
01215300A, 0004609205, 0004609305,
0014606905



DB-DL-5405

Length: 890 Ø: 35
Cone Ø: d1 Ø 28,6 / d2 Ø 23,9
01215900A, 1460248, 0024604505,
0024604605, 0034605005, 3752600637,
3754600405, A3752600637, A3754600405



DB-DL-7270

Length: 875 Ø: 40
Cone Ø: d1 Ø 28,6 / d2 Ø 23,9
01208300A, 0024604705, 0024604805,
0034604905, A0024604705



DB-DL-8172

Length: 1700 Ø: 52
Cone Ø: d1 Ø 32 / d2 Ø 29
01219700A, 9493300403, 9493300503,
9493300803, 9493301403



DB-DL-8184

Length: 1095 Ø: 42
Cone Ø: d1 Ø 32 / d2 Ø 28,8
01217700A, 0014601305, 0014601405,
0024600505, 0034603205, 3754601505,
A0014601305, A0014601405, A0024600505



DB-DL-8185

Length: 711 Ø: 42
Cone Ø: d1 Ø 32 / d2 Ø 28,8
01213600A, 0014601105, 0024600405,
0034603105, A0014601105, A0024600405



DB-DL-8307

Length: 885 Ø: 38
Cone Ø: d1 Ø 32 / d2 Ø 30
01215500A, 0004604005, 0024605105,
0024605205, 0034604005



DB-DL-8327

Length: 1745 Ø: 48
Cone Ø: d1 Ø 32 / d2 Ø 29
01219800A, 9413300003, 9413300103,
9413300203, 9413300303, 9413300503



DB-DL-8388

Length: 1735 Ø: 62
Cone Ø: d1 Ø 32 / d2 Ø 28,8
01219900A, 9453300003, 9453300103,
9453300403, 9453300603, A9453300003



DB-DL-8389

Length: 1465 Ø: 40
Cone Ø: d1 Ø 32 / d2 Ø 29
9453300203, 9453300303, 9453300503



DB-DL-9218

Length: 754 Ø: 40
Hole Distance: 100
000360098524, 000390098524,
3753300111, 9413300011,
A3753300111, SA50831601



DB-DL-12299

Length: 2069 Ø: 40
Cone Ø: d1 Ø 30 / d2 Ø 27
0004608505, 0024601005, 0034602905



DB-DL-12300

Length: 733 Ø: 36
Cone Ø: d1 Ø 32 / d2 Ø 29
0014601505, 0014607305, 0034603305,
3754601605, A0014601505,
A0034603305, A3754601605



DB-DL-12310

Length: 1532 Ø: 50
Cone Ø: d1 Ø 32 / d2 Ø 29
Thread: M27 x 1,5 LHT
9493301203, 9493301303, 9493301803,
9493302203, A9493301203, A9493301303,
A9493301803, A9493302203



DB-DL-12470

Length: 723 Ø: 42
Cone Ø: d1 Ø 30 / d2 Ø 27
A0014607505, A0024600905



No Image

DB-ES-5227

Length: 1588 Ø: 60
Cone Ø: d1 Ø 38 / d2 Ø 34,3
6253300903, 6253301203, 9443300203



DB-ES-5234

Length: 135
Cone Ø: d1 Ø 38 / d2 Ø 34,3
Thread: M38 x 1,5 RHT
0004601748, 120322305, 2205000400



DB-ES-8164

Length: 140
Cone Ø: d1 Ø 28,6 / d2 Ø 23,9
Thread: M28 x 1,5 RHT
0014604248, 0014605048, 0014608548,
0024600548



DB-ES-8510

Length: 56
Cone Ø: d1 Ø 10 / d2 Ø 10
Thread: M12 x 1,75 LHT
0009965145, 0009965645, 0019963145



DB-ES-8530

Length: 115
Cone Ø: d1 Ø 28,6 / d2 Ø 23,9
Thread: M30 x 1,5 RHT
0014603848, 0014604848, 0014605148,
0014608648, 0014609948



DB-RK-8391

Ø: 85 Hole Distance: 152
Thick/Height: 24
01336800A, 0003502705



DB-RK-8626

Ø: 75 Hole Distance: 130
Thick/Height: 24
0003502205, 0003502505, 0003503405,
0003504505, GL11319



DB-RK-8638

Length: 100 Ø: 67
Hole Distance: 100
Thick/Height: 20
0003301411



DB-RK-9296

Ø: 88 Hole Distance: 130
Thick/Height: 24
9423260050



DB-RK-10374

Ø: 85 Hole Distance: 152
Thick/Height: 24
0003504405



DB-RK-10375

Ø: 100 Hole Distance: 152
Thick/Height: 24
0003502405, 0003503505, 0003504905



DB-SB-10384

Ø: 73 Thick/Height: 47
9303170012, 9423171812



DB-SB-10409

Ø: 77 Thick/Height: 56
0003265181



DB-SB-10410

Ø: 73 Hole Distance: 100
Thick/Height: 24
9413230050



DB-VB-3707

Length: 622 Ø: 46
Hole Ø 25 / 25 / 25
Hole Distance: 152 / 130 / 130
01337100A, 9423501005, 9423501505,
9443500005, 9473500105, 9473501005,
A375350005, A9423501005, A9423501505,
A944350005, A9473500105, A9473501005



DB-VB-7261

Length: 622 Ø: 46
Hole Ø 25 / 25 / 25
Hole Distance: 152 / 130 / 130
01337800A, 9443500305, 9443500505,
9443500605, 9473500705, 9473500905,
9483500405, 9483503005



DB-VB-7790

Length: 622 Ø: 46
Hole Ø 25 / 23 / 23
Hole Distance: 152 / 130 / 130
01337000A, 3753500105, 9423500105,
9423500705, 9423501105, 9423501605,
9443500205



DB-VB-7798

Length: 622 Ø: 48
Hole Ø 25 / 23 / 23
Hole Distance: 152 / 130 / 130
9423500505, 9423500805, 9423501205,
A9423501205



DB-VB-9307

Length: 667 Ø: 60
Hole Ø 25 / 23 / 23
Hole Distance: 152 / 130 / 130
9483502805



DB-VB-9308

Length: 622 Ø: 46
Hole Ø 25 / 25 / 25
Hole Distance: 152 / 130 / 130
9483502905



DB-VB-10426

Length: 622 Ø: 46
Hole Ø 25 / 25 / 25
Hole Distance: 152 / 130 / 130
9443500405



MN-RK-8997

Ø: 85 Hole Distance: 130
Thick/Height: 30
0003504805





ACTROS MP2 / MP3 ...

2551 LS ...	04/03→	Tie Rod End	DB-ES-5234		for Steering Rod	
	04/03→	Tie Rod End	DB-ES-8164		for Push Rod	
	04/03→	Tie Rod End	DB-ES-8530		for Push Rod	
	04/03→	Track Control Arm		DB-VB-7798	Wishbone (CV), Air Suspension Axle	
	04/03→	Track Control Arm	DB-DL-5224		Control Arm, 1st FA;Air Suspension Axle; for vehicles with Rigid Leading Axle	
	04/03→	Track Control Arm	DB-DL-9218	DB-DL-9218	Trailing Arm, 1st FA;Air Suspension Axle; for vehicles with Rigid Leading Axle	
2551, L, LL	04/03→	Centre Rod	DB-DL-2144		Push Rod	
	04/03→	Centre Rod	DB-DL-5405		Push Rod	
	04/03→	Centre Rod	DB-DL-5405		Push Rod, Leaf Spring Axle;Tag Axle	
	04/03→	Centre Rod	DB-DL-7270		Push Rod	
	04/03→	Centre Rod	DB-DL-8167		Push Rod	
	04/03→	Centre Rod	DB-DL-8641		Push Rod	
	04/03→	Centre Rod	DB-DL-8641		Push Rod, Leaf Spring Axle;Tag Axle	
	04/03→	Rod Assembly	DB-DL-2178		Guide Rod, 1st Front Axle, →504310 03	
	04/03→	Stabiliser Mounting		DB-SB-10406		
	04/03→	Suspension Strut Repair Kit		DB-RK-8555		
	04/03→	Suspension Strut Repair Kit		DB-RK-9294		
	04/03→	Tie Rod		DB-DL-10209	Tag Axle;for vehicles with Hinged Trailing Axle	
	04/03→	Tie Rod	DB-DL-8640		Guide Rod	
	04/03→	Tie Rod	DB-DL-12310			
	04/03→	Tie Rod	DB-ES-5227		Guide Rod	
	04/03→	Tie Rod End	CV-ES-0543		for Push Rod	
	04/03→	Tie Rod End	CV-ES-0888		for Push Rod	
	04/03→	Tie Rod End	CV-ES-14163		for Steering Rod	
	04/03→	Tie Rod End	DB-ES-8164		for Push Rod	
	04/03→	Tie Rod End	DB-ES-8530		for Push Rod	
	04/03→	Track Control Arm		DB-VB-3707	Suspension Rod, Wishbone (CV), 1st RA, →508306 01	
	04/03→	Track Control Arm		DB-VB-3707	Suspension Rod, Wishbone (CV), Trailing Axle not Steered, →508306 11	
	04/03→	Track Control Arm		DB-VB-7261	Suspension Rod, Wishbone (CV), 1st RA, →517142 01/517142 02	
	04/03→	Track Control Arm		DB-VB-7790	Wishbone (CV), Tag Axle	
	04/03→	Track Control Arm		DB-VB-9307	Suspension Rod, Wishbone (CV), 1st Drive Axle, →517142 07	
	04/03→	Track Control Arm		DB-VB-9308	Suspension Rod, Wishbone (CV), 1st Drive Axle, →517142 06	
	04/03→	Track Control Arm		DB-VB-10426	Wishbone (CV), 1st RA, →517142 05	
	04/03→	Track Control Arm	DB-DL-5224		Control Arm, 1st FA;Air Suspension Axle	
	04/03→	Track Control Arm	DB-DL-9218	DB-DL-9218	Trailing Arm, 1st FA;Air Suspension Axle	
	2553 L	04/03→	Centre Rod	DB-DL-5405		Push Rod
		04/03→	Centre Rod	DB-DL-7270		Push Rod
		04/03→	Centre Rod	DB-DL-8641		Push Rod
		04/03→	Tie Rod		DB-DL-10209	
04/03→		Track Control Arm		DB-VB-7790	Wishbone (CV)	
04/03→		Track Control Arm	DB-DL-5224		Control Arm	
04/03→	Track Control Arm	DB-DL-9218	DB-DL-9218	Trailing Arm		
2554 LS	04/03→	Centre Rod	DB-DL-2144		Push Rod	
	04/03→	Centre Rod	DB-DL-5405		Push Rod	
	04/03→	Centre Rod	DB-DL-7270		Push Rod	
	04/03→	Centre Rod	DB-DL-12299		for Steering Rod	
	04/03→	Centre Rod	DB-DL-12470		Push Rod	
	04/03→	Rod Assembly	DB-DL-2178		Guide Rod, 1st Front Axle, →504310 03	
	04/03→	Rod Assembly	DB-DL-2178	DB-DL-2178	Guide Rod, Leading Axle Steered, →504310 03	
	04/03→	Suspension Arm Repair Kit		DB-RK-10374	for Wishbone (CV)	
	04/03→	Tie Rod		DB-DL-8172	Guide Rod, Leading Axle Steered	
	04/03→	Tie Rod	DB-DL-8172		Guide Rod, 1st Front Axle	
	04/03→	Tie Rod	DB-DL-8388		Guide Rod	
	04/03→	Tie Rod	DB-DL-8389			
	04/03→	Tie Rod End	CV-ES-0543	CV-ES-0543	for Push Rod	
	04/03→	Tie Rod End	CV-ES-0888	CV-ES-0888	for Push Rod	

CV-ES-0543

Length: 125
 Cone Ø: d1 Ø 32 / d2 Ø 29
 Thread: M30 x 1,5 RHT
 0004605748, 0004606048, 0004606848,
 0004607048, 0014600448, 0014601148,
 0014601748, 0014602448, 0014607648,
 0014609648

**CV-ES-0888**

Length: 125
 Cone Ø: d1 Ø 32 / d2 Ø 29
 Thread: M30 x 1,5 LHT
 0004605848, 0004606148, 0004606948,
 0004607148, 0004609048, 0014600548,
 0014601348, 0014602548, 0014607948,
 0024600448

**CV-ES-14163**

Length: 125
 Cone Ø: d1 Ø 30 / d2 Ø 27
 Thread: M30 x 1,5 RHT
 0003305248, 0003387310, 0004600348,
 0004600948, 0004602848, 0004602948,
 0004608948, 0014600248, 0014600848,
 0014601248, 0014602248, 0014607748,
 0024600148, A0003387310, A0004600348,
 A0004602848, A0004602948, A0014600848,
 A0014601248, A0014602248, A0014607748

**DB-DL-2144**

Length: 872 Ø: 35
 Cone Ø: d1 Ø 28,6 / d2 Ø 23,9
 0024604305, 0024604405, 0034604805

**DB-DL-2178**

Length: 1735 Ø: 52
 Cone Ø: d1 Ø 32 / d2 Ø 29
 9423300003, 9423300103, 9423300203

**DB-DL-5224**

Length: 850 Ø: 60
 Hole Distance: 100 / 100
 01336100A, 9413300007

**DB-DL-5405**

Length: 890 Ø: 35
 Cone Ø: d1 Ø 28,6 / d2 Ø 23,9
 01215900A, 1460248, 0024604505,
 0024604605, 0034605005, 3752600637,
 3754600405, A3752600637, A3754600405

**DB-DL-7270**

Length: 875 Ø: 40
 Cone Ø: d1 Ø 28,6 / d2 Ø 23,9
 01208300A, 0024604705, 0024604805,
 0034604905, A0024604705

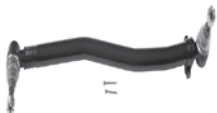
**DB-DL-8167**

Length: 866 Ø: 38
 Cone Ø: d1 Ø 30 / d2 Ø 27
 0014609805, 0014609905, 0024606305,
 0024606405

**DB-DL-8172**

Length: 1700 Ø: 52
 Cone Ø: d1 Ø 32 / d2 Ø 29
 01219700A, 9493300403, 9493300503,
 9493300803, 9493301403

**DB-DL-8388**

Length: 1735 Ø: 62
 Cone Ø: d1 Ø 32 / d2 Ø 28,8
 01219900A, 9453300003, 9453300103,
 9453300403, 9453300603, A9453300003

**DB-DL-8389**

Length: 1465 Ø: 40
 Cone Ø: d1 Ø 32 / d2 Ø 29
 9453300203, 9453300303, 9453300503

**DB-DL-8640**

Length: 1615 Ø: 50
 Cone Ø: d1 Ø 32 / d2 Ø 29
 6253301503, 6253301603, 6253302403,
 6253302503, 9423300803, 9423302103,
 9493300203, 9493300303, 9493300903

**DB-DL-8641**

Length: 905 Ø: 42
 Cone Ø: d1 Ø 30 / d2 Ø 27
 0014605105, 0014608105

**DB-DL-9218**

Length: 754 Ø: 40
 Hole Distance: 100
 000360098524, 000390098524,
 3753300111, 9413300011,
 A3753300111, SA50831601

**DB-DL-10209**

Length: 1281 Ø: 38
 Cone Ø: d1 Ø 30 / d2 Ø 27
 3574603505, 9423301003, 9423301703

**DB-DL-12299**

Length: 2069 Ø: 40
 Cone Ø: d1 Ø 30 / d2 Ø 27
 0004608505, 0024601005, 0034602905

**DB-DL-12310**

Length: 1532 Ø: 50
 Cone Ø: d1 Ø 32 / d2 Ø 29
 Thread: M27 x 1,5 LHT
 9493301203, 9493301303, 9493301803,
 9493302203, A9493301203, A9493301303,
 A9493301803, A9493302203

**DB-DL-12470**

Length: 723 Ø: 42
 Cone Ø: d1 Ø 30 / d2 Ø 27
 A0014607505, A0024600905

No Image

DB-ES-5227

Length: 1588 Ø: 60
 Cone Ø: d1 Ø 38 / d2 Ø 34,3
 6253300903, 6253301203, 9443300203

**DB-ES-5234**

Length: 135
 Cone Ø: d1 Ø 38 / d2 Ø 34,3
 Thread: M38 x 1,5 RHT
 0004601748, 120322305, 2205000400

**DB-ES-8164**

Length: 140
 Cone Ø: d1 Ø 28,6 / d2 Ø 23,9
 Thread: M28 x 1,5 RHT
 0014604248, 0014605048, 0014608548,
 0024600548

**DB-ES-8530**

Length: 115
 Cone Ø: d1 Ø 28,6 / d2 Ø 23,9
 Thread: M30 x 1,5 RHT
 0014603848, 0014604848, 0014605148,
 0014608648, 0014609948

**DB-RK-8555**

Ø: 67 Hole Distance: 130
 Thick/Height: 24
 01335600A, 0003502005, 0003504705

**DB-RK-9294**

Ø: 85 Hole Distance: 152
 Thick/Height: 24
 0003503105

**DB-RK-10374**

Ø: 85 Hole Distance: 152
 Thick/Height: 24
 0003504405

**DB-SB-10406**

Ø: 80 Thick/Height: 46
 0003238185

**DB-VB-3707**

Length: 622 Ø: 46
 Hole Ø 25 / 25 / 25
 Hole Distance: 152 / 130 / 130
 01337100A, 9423501005, 9423501505,
 9443500005, 9473500105, 9473501005,
 A3753500005, A9423501005, A9423501505,
 A9443500005, A9473500105, A9473501005

**DB-VB-7261**

Length: 622 Ø: 46
 Hole Ø 25 / 25 / 25
 Hole Distance: 152 / 130 / 130
 01337800A, 9443500305, 9443500505,
 9443500605, 9473500705, 9473500905,
 9483500405, 9483500305

**DB-VB-7790**

Length: 622 Ø: 46
 Hole Ø 25 / 23 / 23
 Hole Distance: 152 / 130 / 130
 01337000A, 3753500105, 9423500105,
 9423500705, 9423501105, 9423501605,
 9443500205

**DB-VB-7798**

Length: 622 Ø: 48
 Hole Ø 25 / 23 / 23
 Hole Distance: 152 / 130 / 130
 9423500505, 9423500805, 9423501205,
 A9423501205

**DB-VB-9307**

Length: 667 Ø: 60
 Hole Ø 25 / 23 / 23
 Hole Distance: 152 / 130 / 130
 9483502805

**DB-VB-9308**

Length: 622 Ø: 46
 Hole Ø 25 / 25 / 25
 Hole Distance: 152 / 130 / 130
 9483502905

**DB-VB-10426**

Length: 622 Ø: 46
 Hole Ø 25 / 25 / 25
 Hole Distance: 152 / 130 / 130
 9443500405





ACTROS MP2 / MP3 ...

2554 LS ...	04/03→	Tie Rod End	CV-ES-14162		for Steering Rod	
	04/03→	Tie Rod End	CV-ES-14163		for Steering Rod	
	04/03→	Tie Rod End	DB-ES-8164		for Push Rod	
	04/03→	Track Control Arm		DB-VB-7798	Wishbone (CV)	
2554, L	04/03→	Centre Rod	DB-DL-2144		Push Rod	
	04/03→	Centre Rod	DB-DL-8167		Push Rod	
	04/03→	Rod Assembly	DB-DL-2178		Guide Rod, 1st Front Axle, →504310 03	
	04/03→	Suspension Arm Repair Kit		DB-RK-8550	for Wishbone (CV)	
	04/03→	Suspension Arm Repair Kit		DB-RK-8626	for Wishbone (CV)	
	04/03→	Suspension Arm Repair Kit		DB-RK-10374	for Wishbone (CV)	
	04/03→	Suspension Arm Repair Kit		DB-RK-10375	for Wishbone (CV)	
	04/03→	Suspension Strut Repair Kit		DB-RK-8710		
	04/03→	Suspension Strut Repair Kit		DB-RK-9291		
	04/03→	Tie Rod	DB-DL-8640		Guide Rod	
	04/03→	Tie Rod End	CV-ES-0543		for Push Rod	
	04/03→	Tie Rod End	CV-ES-0888		for Push Rod	
	04/03→	Tie Rod End	CV-ES-14163		for Steering Rod	
	04/03→	Tie Rod End	DB-ES-8164		for Push Rod	
	04/03→	Track Control Arm		DB-DL-9218	Trailing Arm	
	04/03→	Track Control Arm		DB-VB-3707	Suspension Rod, Wishbone (CV), Trailing Axle not Steered, →508306 11	
	04/03→	Track Control Arm		DB-VB-7261	Suspension Rod, Wishbone (CV), 1st RA, →517142 01/517142 02	
	04/03→	Track Control Arm		DB-VB-7776	Wishbone (CV)	
	04/03→	Track Control Arm		DB-VB-7790	Wishbone (CV)	
	04/03→	Track Control Arm		DB-VB-9307	Suspension Rod, Wishbone (CV)	
	04/03→	Track Control Arm		DB-VB-9308	Suspension Rod, Wishbone (CV)	
	04/03→	Track Control Arm		DB-VB-10426	Wishbone (CV), 1st RA, →517142 05	
	04/03→	Track Control Arm	DB-DL-5224	DB-DL-5224	Trailing Arm, Leading Axle not Steered, →508315 01	
	2555 LS	09/05→	Ball Head, gearshift linkage	DB-ES-8510		
		09/05→	Bush, driver cab suspension	DB-SB-10384		
		09/05→	Centre Rod	DB-DL-2144		Push Rod
09/05→		Centre Rod	DB-DL-5230		Suspension Rod	
09/05→		Centre Rod	DB-DL-5241		Push Rod	
09/05→		Centre Rod	DB-DL-5405		Push Rod	
09/05→		Centre Rod	DB-DL-5405		Push Rod, for vehicles with Rigid Leading Axle	
09/05→		Centre Rod	DB-DL-7270		Push Rod	
09/05→		Centre Rod	DB-DL-8184		Push Rod	
09/05→		Centre Rod	DB-DL-8185		Push Rod	
09/05→		Centre Rod	DB-DL-8307		Push Rod	
09/05→		Centre Rod	DB-DL-12299		for Steering Rod	
09/05→		Centre Rod	DB-DL-12300		for Steering Rod	
09/05→		Centre Rod	DB-DL-12470		Push Rod	
09/05→		Rod Assembly	DB-DL-2178		Guide Rod, 1st Front Axle, →504310 03	
09/05→		Rod Assembly	DB-DL-2178	DB-DL-2178	Guide Rod, Leading Axle Steered, →504310 03	
09/05→		Stabiliser Mounting		DB-RK-9296		
09/05→		Stabiliser Mounting		DB-SB-10409		
09/05→		Stabiliser Mounting	DB-SB-10410			
09/05→		Suspension Arm Repair Kit		DB-RK-8626	for Wishbone (CV)	
09/05→		Suspension Arm Repair Kit		DB-RK-10374	for Wishbone (CV)	
09/05→		Suspension Arm Repair Kit		DB-RK-10375	for Wishbone (CV)	
09/05→		Suspension Arm Repair Kit	DB-RK-8638		for Control Arm	
09/05→		Suspension Strut Repair Kit		DB-RK-8391		
09/05→		Suspension Strut Repair Kit		MN-RK-8997		
09/05→		Tie Rod		DB-DL-8172	Guide Rod, Leading Axle Steered	
09/05→		Tie Rod	DB-DL-8172		Guide Rod, 1st Front Axle	
09/05→		Tie Rod	DB-DL-8327		Guide Rod	
09/05→		Tie Rod	DB-DL-8388		Guide Rod	
09/05→		Tie Rod	DB-DL-8389			
09/05→		Tie Rod	DB-DL-12310			
09/05→		Tie Rod	DB-ES-5227		Guide Rod	
09/05→		Tie Rod End	CV-ES-0543	CV-ES-0543	for Push Rod	

CV-ES-0543

Length: 125
Cone Ø: d1 Ø 32 / d2 Ø 29
Thread: M30 x 1,5 RHT
0004605748, 0004606048, 0004606848,
0004607048, 0014600448, 0014601148,
0014601748, 0014602448, 0014607648,
0014609648



CV-ES-0888

Length: 125
Cone Ø: d1 Ø 32 / d2 Ø 29
Thread: M30 x 1,5 LHT
0004605848, 0004606148, 0004606948,
0004607148, 0004609048, 0014600548,
0014601348, 0014602548, 0014607948,
0024600448



CV-ES-14162

Length: 125
Cone Ø: d1 Ø 30 / d2 Ø 27
Thread: M30 x 1,5 LHT
4600648, 4601248, 4603448, 0004603548,
14600348, 14601448, 14602348,
0014603748, 0014607848, 0024600348



CV-ES-14163

Length: 125
Cone Ø: d1 Ø 30 / d2 Ø 27
Thread: M30 x 1,5 RHT
0003305248, 0003387310, 0004600348,
0004600948, 0004602848, 0004602948,
0004608948, 0014600248, 0014600848,
0014601248, 0014602248, 0014607748,
0024600148, 0003387310, 0004600348,
0004602848, 0004602948, 0014600848,
0014601248, 0014602248, 0014607748



DB-DL-2144

Length: 872 Ø: 35
Cone Ø: d1 Ø 28,6 / d2 Ø 23,9
0024604305, 0024604405, 0034604805



DB-DL-2178

Length: 1735 Ø: 52
Cone Ø: d1 Ø 32 / d2 Ø 29
9423300003, 9423300103, 9423300203



DB-DL-5224

Length: 850 Ø: 60
Hole Distance: 100 / 100
01336100A, 9413300007



DB-DL-5230

Length: 879 Ø: 42
Cone Ø: d1 Ø 30 / d2 Ø 27
01208600A, 0004607105, 0004607205,
0014606705



DB-DL-5241

Length: 875 Ø: 40
Cone Ø: d1 Ø 30 / d2 Ø 27
01215300A, 0004609205, 0004609305,
0014606905



DB-DL-5405

Length: 890 Ø: 35
Cone Ø: d1 Ø 28,6 / d2 Ø 23,9
01215900A, 1460248, 0024604505,
0024604605, 0034605005, 3752600637,
3754600405, A3752600637, A3754600405



DB-DL-7270

Length: 875 Ø: 40
Cone Ø: d1 Ø 28,6 / d2 Ø 23,9
01208300A, 0024604705, 0024604805,
0034604905, A0024604705

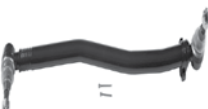

DB-DL-8167

Length: 866 Ø: 38
Cone Ø: d1 Ø 30 / d2 Ø 27
0014609805, 0014609905, 0024606305,
0024606405



DB-DL-8172

Length: 1700 Ø: 52
Cone Ø: d1 Ø 32 / d2 Ø 29
01219700A, 9493300403, 9493300503,
9493300803, 9493301403



DB-DL-8184

Length: 1095 Ø: 42
Cone Ø: d1 Ø 32 / d2 Ø 28,8
01217700A, 0014601305, 0014601405,
0024600505, 0034603205, 3754601505,
A0014601305, A0014601405, A0024600505



DB-DL-8185

Length: 711 Ø: 42
Cone Ø: d1 Ø 32 / d2 Ø 28,8
01213600A, 0014601105, 0024600405,
0034603105, A0014601105, A0024600405



DB-DL-8307

Length: 885 Ø: 38
Cone Ø: d1 Ø 32 / d2 Ø 30
01215500A, 0004604005, 0024605105,
0024605205, 0034604005



DB-DL-8327

Length: 1745 Ø: 48
Cone Ø: d1 Ø 32 / d2 Ø 29
01219800A, 9413300003, 9413300103,
9413300203, 9413300303, 9413300503



DB-DL-8388

Length: 1735 Ø: 62
Cone Ø: d1 Ø 32 / d2 Ø 28,8
01219900A, 9453300003, 9453300103,
9453300403, 9453300603, A9453300003



DB-DL-8389

Length: 1465 Ø: 40
Cone Ø: d1 Ø 32 / d2 Ø 29
9453300203, 9453300303, 9453300503



DB-DL-8640

Length: 1615 Ø: 50
Cone Ø: d1 Ø 32 / d2 Ø 29
6253301503, 6253301603, 6253302403,
6253302503, 9423300803, 9423302103,
9493300203, 9493300303, 9493300903



DB-DL-9218

Length: 754 Ø: 40
Hole Distance: 100
000360098524, 000390098524,
3753300111, 9413300011,
A3753300111, SA50831601



DB-DL-12299

Length: 2069 Ø: 40
Cone Ø: d1 Ø 30 / d2 Ø 27
0004608505, 0024601005, 0034602905



DB-DL-12300

Length: 733 Ø: 36
Cone Ø: d1 Ø 32 / d2 Ø 29
0014601505, 0014607305, 0034603305,
3754601605, A0014601505,
A0034603305, A3754601605



DB-DL-12310

Length: 1532 Ø: 50
Cone Ø: d1 Ø 32 / d2 Ø 29
Thread: M27 x 1,5 LHT
9493301203, 9493301303, 9493301803,
9493302203, A9493301203, A9493301303,
A9493301803, A9493302203



DB-DL-12470

Length: 723 Ø: 42
Cone Ø: d1 Ø 30 / d2 Ø 27
A0014607505, A0024600905



No Image

DB-ES-5227

Length: 1588 Ø: 60
Cone Ø: d1 Ø 38 / d2 Ø 34,3
6253300903, 6253301203, 9443300203



DB-ES-8164

Length: 140
Cone Ø: d1 Ø 28,6 / d2 Ø 23,9
Thread: M28 x 1,5 RHT
0014604248, 0014605048, 0014608548,
0024600548



DB-ES-8510

Length: 56
Cone Ø: d1 Ø 10 / d2 Ø 10
Thread: M12 x 1,75 LHT
0009965145, 0009965645, 0019963145



DB-RK-8391

Ø: 85 Hole Distance: 152
Thick/Height: 24
01336800A, 0003502705



DB-RK-8550

Ø: 75 Hole Distance: 152
Thick/Height: 24
0003502105, 0003504605



DB-RK-8626

Ø: 75 Hole Distance: 130
Thick/Height: 24
0003502205, 0003502505, 0003503405,
0003504505, GL11319



DB-RK-8638

Length: 100 Ø: 67
Hole Distance: 100
Thick/Height: 20
0003301411



DB-RK-8710

Ø: 85 Hole Distance: 130
Thick/Height: 30
0003503705



DB-RK-9291

Ø: 107,5 Hole Distance: 152
Thick/Height: 30
0003503605



DB-RK-9296

Ø: 88 Hole Distance: 130
Thick/Height: 24
9423260050



DB-RK-10374

Ø: 85 Hole Distance: 152
Thick/Height: 24
0003504405



DB-RK-10375

Ø: 100 Hole Distance: 152
Thick/Height: 24
0003502405, 0003503505, 0003504905



DB-SB-10384

Ø: 73 Thick/Height: 47
9303170012, 9423171812



DB-SB-10409

Ø: 77 Thick/Height: 56
0003265181



DB-SB-10410

Ø: 73 Hole Distance: 100
Thick/Height: 24
9413230050



DB-VB-3707

Length: 622 Ø: 46
Hole Ø 25 / 25 / 25
Hole Distance: 152 / 130 / 130
01337100A, 9423501005, 9423501505,
9443500005, 9473500105, 9473501005,
A3753500005, A9423501005, A9423501505,
A9443500005, A9473500105, A9473501005



DB-VB-7261

Length: 622 Ø: 46
Hole Ø 25 / 25 / 25
Hole Distance: 152 / 130 / 130
01337800A, 9443500305, 9443500505,
9443500605, 9473500705, 9473500905,
9483500405, 9483503005



DB-VB-7776

Length: 622 Ø: 56
Hole Distance: 152 / 152
6533500205, 6583500205



DB-VB-7790

Length: 622 Ø: 46
Hole Ø 25 / 23 / 23
Hole Distance: 152 / 130 / 130
01337000A, 3753500105, 9423500105,
9423500705, 9423501105, 9423501605,
9443500205



DB-VB-7798

Length: 622 Ø: 48
Hole Ø 25 / 23 / 23
Hole Distance: 152 / 130 / 130
9423500505, 9423500805, 9423501205,
A9423501205



DB-VB-9307

Length: 667 Ø: 60
Hole Ø 25 / 23 / 23
Hole Distance: 152 / 130 / 130
9483502805



DB-VB-9308

Length: 622 Ø: 46
Hole Ø 25 / 25 / 25
Hole Distance: 152 / 130 / 130
9483502905



DB-VB-10426

Length: 622 Ø: 46
Hole Ø 25 / 25 / 25
Hole Distance: 152 / 130 / 130
9443500405



MN-RK-8997

Ø: 85 Hole Distance: 130
Thick/Height: 30
0003504805





ACTROS MP2 / MP3 ...

2555 LS ...	09/05→	Tie Rod End	CV-ES-0888	CV-ES-0888	for Push Rod	
	09/05→	Tie Rod End	CV-ES-14162		for Steering Rod	
	09/05→	Tie Rod End	CV-ES-14163		for Steering Rod	
	09/05→	Tie Rod End	DB-ES-5234		for Steering Rod	
	09/05→	Tie Rod End	DB-ES-8164		for Push Rod	
	09/05→	Tie Rod End	DB-ES-8530		for Push Rod	
	09/05→	Track Control Arm		DB-VB-7798	Wishbone (CV), Air Suspension Axle	
2555, L, LL	04/03→	Centre Rod	DB-DL-2144		Push Rod	
	04/03→	Centre Rod	DB-DL-5405		Push Rod	
	04/03→	Centre Rod	DB-DL-5405		Push Rod, Leaf Spring Axle;Tag Axle	
	04/03→	Centre Rod	DB-DL-7270		Push Rod	
	04/03→	Centre Rod	DB-DL-8167		Push Rod	
	04/03→	Centre Rod	DB-DL-8641		Push Rod	
	04/03→	Centre Rod	DB-DL-8641		Push Rod, Leaf Spring Axle;Tag Axle	
	04/03→	Rod Assembly	DB-DL-2178		Guide Rod, 1st Front Axle, →504310 03	
	04/03→	Stabiliser Mounting		DB-SB-10406		
	04/03→	Suspension Strut Repair Kit		DB-RK-8555		
	04/03→	Suspension Strut Repair Kit		DB-RK-9294		
	04/03→	Tie Rod		DB-DL-10209	Tag Axle;for vehicles with Hinged Trailing Axle	
	04/03→	Tie Rod	DB-DL-8640		Guide Rod	
	04/03→	Tie Rod	DB-DL-12310			
	04/03→	Tie Rod	DB-ES-5227		Guide Rod	
	04/03→	Tie Rod End	CV-ES-0543		for Push Rod	
	04/03→	Tie Rod End	CV-ES-0888		for Push Rod	
	04/03→	Tie Rod End	CV-ES-14163		for Steering Rod	
	04/03→	Tie Rod End	DB-ES-8164		for Push Rod	
	04/03→	Tie Rod End	DB-ES-8530		for Push Rod	
	04/03→	Track Control Arm		DB-VB-3707	Suspension Rod, Wishbone (CV), 1st RA, →508306 01	
	04/03→	Track Control Arm		DB-VB-3707	Suspension Rod, Wishbone (CV), Trailing Axle not Steered, →508306 11	
	04/03→	Track Control Arm		DB-VB-7261	Suspension Rod, Wishbone (CV), 1st RA, →517142 01/517142 02	
	04/03→	Track Control Arm		DB-VB-7790	Wishbone (CV), Tag Axle	
	04/03→	Track Control Arm		DB-VB-9307	Suspension Rod, Wishbone (CV), 1st Drive Axle, →517142 07	
	04/03→	Track Control Arm		DB-VB-9308	Suspension Rod, Wishbone (CV), 1st Drive Axle, →517142 06	
	04/03→	Track Control Arm		DB-VB-10426	Wishbone (CV), 1st RA, →517142 05	
	04/03→	Track Control Arm	DB-DL-5224		Control Arm, 1st FA;Air Suspension Axle	
	04/03→	Track Control Arm	DB-DL-9218	DB-DL-9218	Trailing Arm, 1st FA;Air Suspension Axle	
	2558, L	04/03→	Centre Rod	DB-DL-7270		Push Rod
		04/03→	Centre Rod	DB-DL-8167		Push Rod
		04/03→	Tie Rod		DB-DL-10209	
		04/03→	Tie Rod	DB-DL-8640		Guide Rod
04/03→		Track Control Arm		DB-VB-3707	Suspension Rod, Wishbone (CV)	
04/03→		Track Control Arm		DB-VB-7790	Wishbone (CV)	
04/03→		Track Control Arm	DB-DL-5224		Control Arm	
04/03→	Track Control Arm	DB-DL-9218	DB-DL-9218	Trailing Arm		
2560, L, LL	04/03→	Centre Rod	DB-DL-2144		Push Rod	
	04/03→	Centre Rod	DB-DL-5405		Push Rod	
	04/03→	Centre Rod	DB-DL-7270		Push Rod	
	04/03→	Centre Rod	DB-DL-8167		Push Rod	
	04/03→	Centre Rod	DB-DL-8641		Push Rod	
	04/03→	Rod Assembly	DB-DL-2178		Guide Rod, 1st Front Axle, →504310 03	
	04/03→	Stabiliser Mounting		DB-SB-10406		
	04/03→	Suspension Strut Repair Kit		DB-RK-8555		
	04/03→	Suspension Strut Repair Kit		DB-RK-9294		
	04/03→	Tie Rod		DB-DL-10209	Tag Axle;for vehicles with Hinged Trailing Axle	
	04/03→	Tie Rod	DB-DL-8640		Guide Rod	
	04/03→	Tie Rod	DB-DL-12310			
	04/03→	Tie Rod	DB-ES-5227		Guide Rod	
	04/03→	Tie Rod End	CV-ES-0543		for Push Rod	

CV-ES-0543

Length: 125
Cone Ø: d1 Ø 32 / d2 Ø 29
Thread: M30 x 1,5 RHT
0004605748, 0004606048, 0004606848,
0004607048, 0014600448, 0014601148,
0014601748, 0014602448, 0014607648,
0014609648



CV-ES-0888

Length: 125
Cone Ø: d1 Ø 32 / d2 Ø 29
Thread: M30 x 1,5 LHT
0004605848, 0004606148, 0004606948,
0004607148, 0004609048, 0014600548,
0014601348, 0014602548, 0014607948,
0024600448



CV-ES-14162

Length: 125
Cone Ø: d1 Ø 30 / d2 Ø 27
Thread: M30 x 1,5 LHT
4600648, 4601248, 4603448, 0004603548,
14600348, 14601448, 14602348,
0014603748, 0014607848, 0024600348



CV-ES-14163

Length: 125
Cone Ø: d1 Ø 30 / d2 Ø 27
Thread: M30 x 1,5 RHT
0003305248, 0003387310, 0004600348,
0004600948, 0004602848, 0004602948,
0004608948, 0014600248, 0014600848,
0014601248, 0014602248, 0014607748,
0024600148, A0003387310, A0004600348,
A0004602848, A0004602948, A0014600848,
A0014601248, A0014602248, A0014607748



DB-DL-2144

Length: 872 Ø: 35
Cone Ø: d1 Ø 28,6 / d2 Ø 23,9
0024604305, 0024604405, 0034604805



DB-DL-2178

Length: 1735 Ø: 52
Cone Ø: d1 Ø 32 / d2 Ø 29
9423300003, 9423300103, 9423300203



DB-DL-5224

Length: 850 Ø: 60
Hole Distance: 100 / 100
01336100A, 9413300007



DB-DL-5405

Length: 890 Ø: 35
Cone Ø: d1 Ø 28,6 / d2 Ø 23,9
01215900A, 1460248, 0024604505,
0024604605, 0034605005, 3752600637,
3754600405, A3752600637, A3754600405



DB-DL-7270

Length: 875 Ø: 40
Cone Ø: d1 Ø 28,6 / d2 Ø 23,9
01208300A, 0024604705, 0024604805,
0034604905, A0024604705



DB-DL-8167

Length: 866 Ø: 38
Cone Ø: d1 Ø 30 / d2 Ø 27
0014609805, 0014609905, 0024606305,
0024606405



DB-DL-8640

Length: 1615 Ø: 50
Cone Ø: d1 Ø 32 / d2 Ø 29
6253301503, 6253301603, 6253302403,
6253302503, 9423300803, 9423302103,
9493300203, 9493300303, 9493300903



DB-DL-8641

Length: 905 Ø: 42
Cone Ø: d1 Ø 30 / d2 Ø 27
0014605105, 0014608105



DB-DL-9218

Length: 754 Ø: 40
Hole Distance: 100
000360098524, 000390098524,
3753300111, 9413300011,
A3753300111, SA50831601



DB-DL-10209

Length: 1281 Ø: 38
Cone Ø: d1 Ø 30 / d2 Ø 27
3574603505, 9423301003, 9423301703



DB-DL-12310

Length: 1532 Ø: 50
Cone Ø: d1 Ø 32 / d2 Ø 29
Thread: M27 x 1,5 LHT
9493301203, 9493301303, 9493301803,
9493302203, A9493301203, A9493301303,
A9493301803, A9493302203



DB-ES-5227

Length: 1588 Ø: 60
Cone Ø: d1 Ø 38 / d2 Ø 34,3
6253300903, 6253301203, 9443300203



DB-ES-5234

Length: 135
Cone Ø: d1 Ø 38 / d2 Ø 34,3
Thread: M38 x 1,5 RHT
0004601748, 120322305, 2205000400



DB-ES-8164

Length: 140
Cone Ø: d1 Ø 28,6 / d2 Ø 23,9
Thread: M28 x 1,5 RHT
0014604248, 0014605048, 0014608548,
0024600548



DB-ES-8530

Length: 115
Cone Ø: d1 Ø 28,6 / d2 Ø 23,9
Thread: M30 x 1,5 RHT
0014603848, 0014604848, 0014605148,
0014608648, 0014609948



DB-RK-8555

Ø: 67 Hole Distance: 130
Thick/Height: 24
01335600A, 0003502005, 0003504705



DB-RK-9294

Ø: 85 Hole Distance: 152
Thick/Height: 24
0003503105



DB-SB-10406

Ø: 80 Thick/Height: 46
0003238185



DB-VB-3707

Length: 622 Ø: 46
Hole Ø 25 / 25 / 25
Hole Distance: 152 / 130 / 130
01337100A, 9423501005, 9423501505,
9443500005, 9473500105, 9473501005,
A3753500005, A9423501005, A9423501505,
A9443500005, A9473500105, A9473501005



DB-VB-7261

Length: 622 Ø: 46
Hole Ø 25 / 25 / 25
Hole Distance: 152 / 130 / 130
01337800A, 9443500305, 9443500505,
9443500605, 9473500705, 9473500905,
9483500405, 9483503005



DB-VB-7790

Length: 622 Ø: 46
Hole Ø 25 / 23 / 23
Hole Distance: 152 / 130 / 130
01337000A, 3753500105, 9423500105,
9423500705, 9423501105, 9423501605,
9443500205



DB-VB-7798

Length: 622 Ø: 48
Hole Ø 25 / 23 / 23
Hole Distance: 152 / 130 / 130
9423500505, 9423500805, 9423501205,
A9423501205



DB-VB-9307

Length: 667 Ø: 60
Hole Ø 25 / 23 / 23
Hole Distance: 152 / 130 / 130
9483502805



DB-VB-9308

Length: 622 Ø: 46
Hole Ø 25 / 25 / 25
Hole Distance: 152 / 130 / 130
9483502905



DB-VB-10426

Length: 622 Ø: 46
Hole Ø 25 / 25 / 25
Hole Distance: 152 / 130 / 130
9443500405





ACTROS MP2 / MP3 ...

2560, L, LL ...	04/03→	Tie Rod End	CV-ES-0888		for Push Rod	
	04/03→	Tie Rod End	CV-ES-14163		for Steering Rod	
	04/03→	Tie Rod End	DB-ES-8164		for Push Rod	
	04/03→	Tie Rod End	DB-ES-8530		for Push Rod	
	04/03→	Track Control Arm		DB-VB-3707	Suspension Rod, Wishbone (CV), 1st RA, →508306 01	
	04/03→	Track Control Arm		DB-VB-7790	Wishbone (CV), Tag Axle	
	04/03→	Track Control Arm	DB-DL-5224		Control Arm, 1st FA;Air Suspension Axle	
	04/03→	Track Control Arm	DB-DL-9218	DB-DL-9218	Trailing Arm, 1st FA;Air Suspension Axle	
2631 B	04/03→	Bush, parabolic spring		DB-SB-10400		
	04/03→	Bush, parabolic spring		DB-SB-10401		
	04/03→	Centre Rod	DB-DL-2144		Push Rod	
	04/03→	Centre Rod	DB-DL-5405		Push Rod	
	04/03→	Centre Rod	DB-DL-7270		Push Rod	
	04/03→	Centre Rod	DB-DL-8167		Push Rod	
	04/03→	Rod Assembly	DB-DL-2178		Guide Rod, 1st Front Axle, →504310 03	
	04/03→	Suspension Arm Repair Kit		DB-RK-8626	for Wishbone (CV)	
	04/03→	Suspension Arm Repair Kit		DB-RK-10374	for Wishbone (CV)	
	04/03→	Tie Rod	DB-DL-8327		Guide Rod	
	04/03→	Tie Rod	DB-DL-8640		Guide Rod	
	04/03→	Tie Rod End	CV-ES-0543		for Push Rod	
	04/03→	Tie Rod End	CV-ES-0888		for Push Rod	
	04/03→	Tie Rod End	CV-ES-14163		for Steering Rod	
	04/03→	Tie Rod End	DB-ES-8164		for Push Rod	
	04/03→	Tie Rod End	DB-ES-8530		for Push Rod	
	04/03→	Track Control Arm		DB-DL-3475	Trailing Arm, 1st RA;2nd RA, →517144 05/517144 08	
	04/03→	Track Control Arm		DB-VB-7261	Suspension Rod, Wishbone (CV)	
	04/03→	Track Control Arm		DB-VB-10426	Wishbone (CV)	
	2631 K, LK	04/03→	Bush, parabolic spring		DB-SB-10400	
		04/03→	Bush, parabolic spring		DB-SB-10401	
		04/03→	Centre Rod	DB-DL-2144		Push Rod
04/03→		Centre Rod	DB-DL-5405		Push Rod	
04/03→		Centre Rod	DB-DL-7270		Push Rod	
04/03→		Centre Rod	DB-DL-8167		Push Rod	
04/03→		Rod Assembly	DB-DL-2178		Guide Rod, 1st Front Axle, →504310 03	
04/03→		Suspension Arm Repair Kit		DB-RK-8626	for Wishbone (CV)	
04/03→		Suspension Arm Repair Kit		DB-RK-10374	for Wishbone (CV)	
04/03→		Tie Rod	DB-DL-8171		Guide Rod	
04/03→		Tie Rod	DB-DL-8327		Guide Rod	
04/03→		Tie Rod	DB-DL-8640		Guide Rod	
04/03→		Tie Rod End	CV-ES-0543		for Push Rod	
04/03→		Tie Rod End	CV-ES-0888		for Push Rod	
04/03→		Tie Rod End	CV-ES-14163		for Steering Rod	
04/03→		Tie Rod End	DB-ES-8164		for Push Rod	
04/03→		Tie Rod End	DB-ES-8530		for Push Rod	
04/03→		Track Control Arm		DB-DL-3475	Trailing Arm, 1st RA;2nd RA, →517144 03/517144 06	
04/03→		Track Control Arm		DB-DL-3475	Trailing Arm, 1st RA;2nd RA, →517144 05/517144 08	
04/03→		Track Control Arm		DB-DL-3475	Trailing Arm, 1st RA;2nd RA, →517144 07/517144 09	
04/03→		Track Control Arm		DB-DL-3475	Trailing Arm, 1st RA;2nd RA, →517144 26/517144 27	
04/03→		Track Control Arm		DB-VB-3707	Suspension Rod, Wishbone (CV)	
04/03→		Track Control Arm		DB-VB-7261	Suspension Rod, Wishbone (CV)	
04/03→		Track Control Arm		DB-VB-10426	Wishbone (CV)	
2631 L		04/03→	Centre Rod	DB-DL-2144		Push Rod
		04/03→	Centre Rod	DB-DL-5405		Push Rod
		04/03→	Centre Rod	DB-DL-7270		Push Rod
		04/03→	Centre Rod	DB-DL-8167		Push Rod
		04/03→	Centre Rod	DB-DL-8307		Push Rod
		04/03→	Rod Assembly	DB-DL-2178		Guide Rod, 1st Front Axle, →504310 03

CV-ES-0543

Length: 125
Cone Ø: d1 Ø 32 / d2 Ø 29
Thread: M30 x 1,5 RHT
0004605748, 0004606048, 0004606848,
0004607048, 0014600448, 0014601148,
0014601748, 0014602448, 0014607648,
0014609648



CV-ES-0888

Length: 125
Cone Ø: d1 Ø 32 / d2 Ø 29
Thread: M30 x 1,5 LHT
0004605848, 0004606148, 0004606948,
0004607148, 0004609048, 0014600548,
0014601348, 0014602548, 0014607948,
0024600448



CV-ES-14163

Length: 125
Cone Ø: d1 Ø 30 / d2 Ø 27
Thread: M30 x 1,5 RHT
0003305248, 0003387310, 0004600348,
0004600948, 0004602848, 0004602948,
0004608948, 0014600248, 0014600848,
0014601248, 0014602248, 0014607748,
0024600148, A0003387310, A0004600348,
A0004602848, A0004602948, A0014600848,
A0014601248, A0014602248, A0014607748



DB-DL-2144

Length: 872 Ø: 35
Cone Ø: d1 Ø 28,6 / d2 Ø 23,9
0024604305, 0024604405, 0034604805



DB-DL-2178

Length: 1735 Ø: 52
Cone Ø: d1 Ø 32 / d2 Ø 29
9423300003, 9423300103, 9423300203



DB-DL-3475

Length: 565 Ø: 52
Hole Distance: 152 / 152
3753500006, 3753500206, 9473500805,
9483500006, 9483500805, 9483501205,
9483501305, 9483501905, 9483502005,
9483502405, A3753500006,
A3753500206



DB-DL-5224

Length: 850 Ø: 60
Hole Distance: 100 / 100
01336100A, 9413300007



DB-DL-5405

Length: 890 Ø: 35
Cone Ø: d1 Ø 28,6 / d2 Ø 23,9
01215900A, 1460248, 0024604505,
0024604605, 0034605005, 3752600637,
3754600405, A3752600637, A3754600405



DB-DL-7270

Length: 875 Ø: 40
Cone Ø: d1 Ø 28,6 / d2 Ø 23,9
01208300A, 0024604705, 0024604805,
0034604905, A0024604705



DB-DL-8167

Length: 866 Ø: 38
Cone Ø: d1 Ø 30 / d2 Ø 27
0014609805, 0014609905, 0024606305,
0024606405



DB-DL-8171

Length: 1687 Ø: 52
Cone Ø: d1 Ø 32 / d2 Ø 29
9493300603, 9493300703, 9493301503,
9493301603



DB-DL-8307

Length: 885 Ø: 38
Cone Ø: d1 Ø 32 / d2 Ø 30
01215500A, 0004604005, 0024605105,
0024605205, 0034604005



DB-DL-8327

Length: 1745 Ø: 48
Cone Ø: d1 Ø 32 / d2 Ø 29
01219800A, 9413300003, 9413300103,
9413300203, 9413300303, 9413300503



DB-DL-8640

Length: 1615 Ø: 50
Cone Ø: d1 Ø 32 / d2 Ø 29
6253301503, 6253301603, 6253302403,
6253302503, 9423300803, 9423302103,
9493300203, 9493300303, 9493300903



DB-DL-9218

Length: 754 Ø: 40
Hole Distance: 100
000360098524, 000390098524,
3753300111, 9413300011,
A3753300111, SA50831601



DB-ES-8164

Length: 140
Cone Ø: d1 Ø 28,6 / d2 Ø 23,9
Thread: M28 x 1,5 RHT
0014604248, 0014605048, 0014608548,
0024600548



DB-ES-8530

Length: 115
Cone Ø: d1 Ø 28,6 / d2 Ø 23,9
Thread: M30 x 1,5 RHT
0014603848, 0014604848, 0014605148,
0014608648, 0014609948



DB-RK-8626

Ø: 75 Hole Distance: 130
Thick/Height: 24
0003502205, 0003502505, 0003503405,
0003504505, GL11319



DB-RK-10374

Ø: 85 Hole Distance: 152
Thick/Height: 24
0003504405



DB-SB-10400

Length: 230
Thick/Height: 167,5 / 115
0003250696, 0003250896



DB-SB-10401

Length: 232
Thick/Height: 163,5 / 152,5
0003250596, 0003250796



DB-VB-3707

Length: 622 Ø: 46
Hole Ø 25 / 25 / 25
Hole Distance: 152 / 130 / 130
01337100A, 9423501005, 9423501505,
9443500005, 9473500105, 9473501005,
A3753500005, A9423501005, A9423501505,
A9443500005, A9473500105, A9473501005



DB-VB-7261

Length: 622 Ø: 46
Hole Ø 25 / 25 / 25
Hole Distance: 152 / 130 / 130
01337800A, 9443500305, 9443500505,
9443500605, 9473500705, 9473500905,
9483500405, 9483500305



DB-VB-7790

Length: 622 Ø: 46
Hole Ø 25 / 23 / 23
Hole Distance: 152 / 130 / 130
01337000A, 3753500105, 9423500105,
9423500705, 9423501105, 9423501605,
9443500205



DB-VB-10426

Length: 622 Ø: 46
Hole Ø 25 / 25 / 25
Hole Distance: 152 / 130 / 130
9443500405





ACTROS MP2 / MP3 ...

2631 L ...	04/03→	Suspension Arm Repair Kit		DB-RK-8626	for Wishbone (CV)	
	04/03→	Suspension Arm Repair Kit		DB-RK-10374	for Wishbone (CV)	
	04/03→	Tie Rod	DB-DL-8640		Guide Rod	
	04/03→	Tie Rod End	CV-ES-0543		for Push Rod	
	04/03→	Tie Rod End	CV-ES-0888		for Push Rod	
	04/03→	Tie Rod End	CV-ES-14163		for Steering Rod	
	04/03→	Tie Rod End	DB-ES-8164		for Push Rod	
	04/03→	Tie Rod End	DB-ES-8530		for Push Rod	
	04/03→	Track Control Arm		DB-VB-3707	Suspension Rod, Wishbone (CV)	
	04/03→	Track Control Arm	DB-DL-5224		Control Arm	
2631 LS	04/03→	Track Control Arm	DB-DL-9218	DB-DL-9218	Trailing Arm	
	10/02→	Centre Rod	DB-DL-2144		Push Rod	
	10/02→	Centre Rod	DB-DL-5405		Push Rod	
	10/02→	Centre Rod	DB-DL-7270		Push Rod	
	10/02→	Centre Rod	DB-DL-8167		Push Rod	
	10/02→	Centre Rod	DB-DL-8307		Push Rod	
	10/02→	Rod Assembly	DB-DL-2178		Guide Rod, 1st Front Axle, →504310 03	
	10/02→	Suspension Arm Repair Kit		DB-RK-8626	for Wishbone (CV)	
	10/02→	Suspension Arm Repair Kit		DB-RK-10374	for Wishbone (CV)	
	10/02→	Tie Rod	DB-DL-8327		Guide Rod, 1st Front Axle	
	10/02→	Tie Rod	DB-DL-8640		Guide Rod, 1st Front Axle	
	10/02→	Tie Rod	DB-DL-12310			
	10/02→	Tie Rod End	CV-ES-0543		for Push Rod	
	10/02→	Tie Rod End	CV-ES-0888		for Push Rod	
	10/02→	Tie Rod End	CV-ES-14163		for Steering Rod	
	10/02→	Tie Rod End	DB-ES-8164		for Push Rod	
	10/02→	Track Control Arm		DB-VB-3707	Suspension Rod, Wishbone (CV)	
	10/09→	Tie Rod	DB-DL-8640		Guide Rod	
	2632 B	04/03→	Ball Head, gearshift linkage	DB-ES-8510		
		04/03→	Bush, driver cab suspension	DB-SB-10384		
04/03→		Bush, parabolic spring		DB-SB-10400		
04/03→		Bush, parabolic spring		DB-SB-10401		
04/03→		Centre Rod	DB-DL-2144		Push Rod	
04/03→		Centre Rod	DB-DL-5230		Suspension Rod	
04/03→		Centre Rod	DB-DL-5241		Push Rod	
04/03→		Centre Rod	DB-DL-5405		Push Rod, Leaf Spring Axle	
04/03→		Centre Rod	DB-DL-7270		Push Rod	
04/03→		Centre Rod	DB-DL-8167		Push Rod	
04/03→		Centre Rod	DB-DL-8184		Push Rod	
04/03→		Centre Rod	DB-DL-8185		Push Rod	
04/03→		Centre Rod	DB-DL-8307		Push Rod	
04/03→		Centre Rod	DB-DL-12300		for Steering Rod	
04/03→		Rod Assembly	DB-DL-2178		Guide Rod, 1st Front Axle, →504310 03	
04/03→		Stabiliser Mounting		DB-SB-10406		
04/03→		Stabiliser Mounting		DB-SB-10409		
04/03→		Suspension Arm Repair Kit		DB-RK-8550	for Wishbone (CV)	
04/03→		Suspension Arm Repair Kit		DB-RK-8626	for Wishbone (CV)	
04/03→		Suspension Arm Repair Kit		DB-RK-10374	for Wishbone (CV)	
04/03→		Suspension Arm Repair Kit	DB-RK-8638		for Control Arm	
04/03→		Suspension Strut Repair Kit		DB-RK-8391		
04/03→		Suspension Strut Repair Kit		DB-RK-9294		
04/03→		Tie Rod	DB-DL-8327		Guide Rod	
04/03→		Tie Rod	DB-DL-8640		Guide Rod	
04/03→		Tie Rod	DB-DL-12310			
04/03→		Tie Rod End	CV-ES-0543		for Push Rod	
04/03→		Tie Rod End	CV-ES-0888		for Push Rod	
04/03→		Tie Rod End	CV-ES-14163		for Steering Rod	
04/03→		Tie Rod End	DB-ES-5234		for Steering Rod	
04/03→		Tie Rod End	DB-ES-8164		for Push Rod	
04/03→		Tie Rod End	DB-ES-8530		for Push Rod	
04/03→		Track Control Arm		DB-DL-3475	Trailing Arm	
04/03→		Track Control Arm		DB-VB-3707	Suspension Rod, Wishbone (CV)	

CV-ES-0543

Length: 125
Cone Ø: d1 Ø 32 / d2 Ø 29
Thread: M30 x 1,5 RHT
0004605748, 0004606048, 0004606848,
0004607048, 0014600448, 0014601148,
0014601748, 0014602448, 0014607648,
0014609648



CV-ES-0888

Length: 125
Cone Ø: d1 Ø 32 / d2 Ø 29
Thread: M30 x 1,5 LHT
0004605848, 0004606148, 0004606948,
0004607148, 0004609048, 0014600548,
0014601348, 0014602548, 0014607948,
0024600448



CV-ES-14163

Length: 125
Cone Ø: d1 Ø 30 / d2 Ø 27
Thread: M30 x 1,5 RHT
0003305248, 0003387310, 0004600348,
0004600948, 0004602848, 0004602948,
0004608948, 0014600248, 0014600848,
0014601248, 0014602248, 0014607748,
0024600148, A0003387310, A0004600348,
A0004602848, A0004602948, A0014600848,
A0014601248, A0014602248, A0014607748



DB-DL-2144

Length: 872 Ø: 35
Cone Ø: d1 Ø 28,6 / d2 Ø 23,9
0024604305, 0024604405, 0034604805



DB-DL-2178

Length: 1735 Ø: 52
Cone Ø: d1 Ø 32 / d2 Ø 29
9423300003, 9423300103, 9423300203



DB-DL-3475

Length: 565 Ø: 52
Hole Distance: 152 / 152
3753500006, 3753500206, 9473500805,
9483500006, 9483500805, 9483501205,
9483501305, 9483501905, 9483502005,
9483502405, A3753500006,
A3753500206



DB-DL-5224

Length: 850 Ø: 60
Hole Distance: 100 / 100
01336100A, 9413300007



DB-DL-5230

Length: 879 Ø: 42
Cone Ø: d1 Ø 30 / d2 Ø 27
01208600A, 0004607105, 0004607205,
0014606705



DB-DL-5241

Length: 875 Ø: 40
Cone Ø: d1 Ø 30 / d2 Ø 27
01215300A, 0004609205, 0004609305,
0014606905



DB-DL-5405

Length: 890 Ø: 35
Cone Ø: d1 Ø 28,6 / d2 Ø 23,9
01215900A, 1460248, 0024604505,
0024604605, 0034605005, 3752600637,
3754600405, A3752600637, A3754600405



DB-DL-7270

Length: 875 Ø: 40
Cone Ø: d1 Ø 28,6 / d2 Ø 23,9
01208300A, 0024604705, 0024604805,
0034604905, A0024604705



DB-DL-8167

Length: 866 Ø: 38
Cone Ø: d1 Ø 30 / d2 Ø 27
0014609805, 0014609905, 0024606305,
0024606405



DB-DL-8184

Length: 1095 Ø: 42
Cone Ø: d1 Ø 32 / d2 Ø 28,8
01217700A, 0014601305, 0014601405,
0024600505, 0034603205, 3754601505,
A0014601305, A0014601405, A0024600505



DB-DL-8185

Length: 711 Ø: 42
Cone Ø: d1 Ø 32 / d2 Ø 28,8
01213600A, 0014601105, 0024600405,
0034603105, A0014601105, A0024600405



DB-DL-8307

Length: 885 Ø: 38
Cone Ø: d1 Ø 32 / d2 Ø 30
01215500A, 0004604005, 0024605105,
0024605205, 0034604005



DB-DL-8327

Length: 1745 Ø: 48
Cone Ø: d1 Ø 32 / d2 Ø 29
01219800A, 9413300003, 9413300103,
9413300203, 9413300303, 9413300503



DB-DL-8640

Length: 1615 Ø: 50
Cone Ø: d1 Ø 32 / d2 Ø 29
6253301503, 6253301603, 6253302403,
6253302503, 9423300803, 9423302103,
9493300203, 9493300303, 9493300903



DB-DL-9218

Length: 754 Ø: 40
Hole Distance: 100
000360098524, 000390098524,
3753300111, 9413300111,
A3753300111, SA50831601



DB-DL-12300

Length: 733 Ø: 36
Cone Ø: d1 Ø 32 / d2 Ø 29
0014601505, 0014607305, 0034603305,
3754601605, A0014601505,
A0034603305, A3754601605



DB-DL-12310

Length: 1532 Ø: 50
Cone Ø: d1 Ø 32 / d2 Ø 29
Thread: M27 x 1,5 LHT
9493301203, 9493301303, 9493301803,
9493302203, A9493301203, A9493301303,
A9493301803, A9493302203



DB-ES-5234

Length: 135
Cone Ø: d1 Ø 38 / d2 Ø 34,3
Thread: M38 x 1,5 RHT
0004601748, 120322305, 2205000400



DB-ES-8164

Length: 140
Cone Ø: d1 Ø 28,6 / d2 Ø 23,9
Thread: M28 x 1,5 RHT
0014604248, 0014605048, 0014608548,
0024600548



DB-ES-8510

Length: 56
Cone Ø: d1 Ø 10 / d2 Ø 10
Thread: M12 x 1,75 LHT
0009965145, 0009965645, 0019963145



DB-ES-8530

Length: 115
Cone Ø: d1 Ø 28,6 / d2 Ø 23,9
Thread: M30 x 1,5 RHT
0014603848, 0014604848, 0014605148,
0014608648, 0014609948



DB-RK-8391

Ø: 85 Hole Distance: 152
Thick/Height: 24
01336800A, 0003502705



DB-RK-8550

Ø: 75 Hole Distance: 152
Thick/Height: 24
0003502105, 0003504605



DB-RK-8626

Ø: 75 Hole Distance: 130
Thick/Height: 24
0003502205, 0003502505, 0003503405,
0003504505, GL11319



DB-RK-8638

Length: 100 Ø: 67
Hole Distance: 100
Thick/Height: 20
0003301411



DB-RK-9294

Ø: 85 Hole Distance: 152
Thick/Height: 24
0003503105



DB-RK-10374

Ø: 85 Hole Distance: 152
Thick/Height: 24
0003504405



DB-SB-10384

Ø: 73 Thick/Height: 47
9303170012, 9423171812



DB-SB-10400

Length: 230
Thick/Height: 167,5 / 115
0003250696, 0003250896



DB-SB-10401

Length: 232
Thick/Height: 163,5 / 152,5
0003250596, 0003250796



DB-SB-10406

Ø: 80 Thick/Height: 46
0003238185



DB-SB-10409

Ø: 77 Thick/Height: 56
0003265181



DB-VB-3707

Length: 622 Ø: 46
Hole Ø 25 / 25 / 25
Hole Distance: 152 / 130 / 130
01337100A, 9423501005, 9423501505,
9443500005, 9473500105, 9473501005,
A375350005, A9423501005, A9423501505,
A9443500005, A9473500105, A9473501005





ACTROS MP2 / MP3 ...

2632 B ...	04/03 →	Track Control Arm		DB-VB-7261	Suspension Rod, Wishbone (CV), 1st RA;2nd RA; Leaf Spring Axle
	04/03 →	Track Control Arm		DB-VB-10426	Wishbone (CV), Leaf Spring Axle;Unit
2632 K, LK	04/03 →	Ball Head, gearshift linkage	DB-ES-8510		
	04/03 →	Bush, driver cab suspension	DB-SB-10384		
	04/03 →	Bush, parabolic spring		DB-SB-10400	
	04/03 →	Bush, parabolic spring		DB-SB-10401	
	04/03 →	Centre Rod	DB-DL-2144		Push Rod
	04/03 →	Centre Rod	DB-DL-5230		Suspension Rod
	04/03 →	Centre Rod	DB-DL-5241		Push Rod
	04/03 →	Centre Rod	DB-DL-5405		Push Rod
	04/03 →	Centre Rod	DB-DL-5405		Push Rod, Leaf Spring Axle
	04/03 →	Centre Rod	DB-DL-7270		Push Rod
	04/03 →	Centre Rod	DB-DL-8167		Push Rod
	04/03 →	Centre Rod	DB-DL-8184		Push Rod
	04/03 →	Centre Rod	DB-DL-8185		Push Rod
	04/03 →	Centre Rod	DB-DL-8307		Push Rod
	04/03 →	Centre Rod	DB-DL-12300		for Steering Rod
	04/03 →	Rod Assembly	DB-DL-2178		Guide Rod
	04/03 →	Stabiliser Mounting		DB-RK-9296	
	04/03 →	Stabiliser Mounting		DB-SB-10406	
	04/03 →	Stabiliser Mounting		DB-SB-10409	
	04/03 →	Suspension Arm Repair Kit		DB-RK-8550	for Wishbone (CV)
	04/03 →	Suspension Arm Repair Kit		DB-RK-8626	for Wishbone (CV)
	04/03 →	Suspension Arm Repair Kit		DB-RK-10374	for Wishbone (CV)
	04/03 →	Suspension Arm Repair Kit		DB-RK-10375	for Wishbone (CV)
	04/03 →	Suspension Arm Repair Kit	DB-RK-8638		for Control Arm
	04/03 →	Suspension Strut Repair Kit		DB-RK-8391	
	04/03 →	Suspension Strut Repair Kit		DB-RK-9294	
	04/03 →	Tie Rod	DB-DL-8171		Guide Rod
	04/03 →	Tie Rod	DB-DL-8327		Guide Rod
	04/03 →	Tie Rod	DB-DL-8640		Guide Rod
	04/03 →	Tie Rod	DB-DL-12310		
	04/03 →	Tie Rod	DB-ES-5227		Guide Rod
	04/03 →	Tie Rod End	CV-ES-0543		for Push Rod
	04/03 →	Tie Rod End	CV-ES-0888		for Push Rod
	04/03 →	Tie Rod End	CV-ES-14162		for Steering Rod
	04/03 →	Tie Rod End	CV-ES-14163		for Steering Rod
	04/03 →	Tie Rod End	DB-ES-5234		for Steering Rod
	04/03 →	Tie Rod End	DB-ES-8164		for Push Rod
	04/03 →	Tie Rod End	DB-ES-8530		for Push Rod
	04/03 →	Track Control Arm		DB-DL-3475	Trailing Arm
	04/03 →	Track Control Arm		DB-VB-3707	Suspension Rod, Wishbone (CV)
	04/03 →	Track Control Arm		DB-VB-7261	Suspension Rod, Wishbone (CV), 1st RA;2nd RA; Leaf Spring Axle
	04/03 →	Track Control Arm		DB-VB-10426	Wishbone (CV), Leaf Spring Axle;Unit
2632 LS	04/03 →	Ball Head, gearshift linkage	DB-ES-8510		
	04/03 →	Bush, driver cab suspension	DB-SB-10384		
	04/03 →	Centre Rod	DB-DL-2144		Push Rod
	04/03 →	Centre Rod	DB-DL-5230		Suspension Rod
	04/03 →	Centre Rod	DB-DL-5241		Push Rod
	04/03 →	Centre Rod	DB-DL-5405		Push Rod
	04/03 →	Centre Rod	DB-DL-7270		Push Rod
	04/03 →	Centre Rod	DB-DL-8167		Push Rod
	04/03 →	Centre Rod	DB-DL-8184		Push Rod
	04/03 →	Centre Rod	DB-DL-8185		Push Rod
	04/03 →	Centre Rod	DB-DL-8307		Push Rod
	04/03 →	Centre Rod	DB-DL-12300		for Steering Rod
	04/03 →	Centre Rod	DB-DL-12470		Push Rod
	04/03 →	Rod Assembly	DB-DL-2178		Guide Rod
	04/03 →	Stabiliser Mounting		DB-SB-10409	
	04/03 →	Stabiliser Mounting	DB-SB-10410		
	04/03 →	Suspension Arm Repair Kit		DB-RK-8626	for Wishbone (CV)

CV-ES-0543

Length: 125
Cone Ø: d1 Ø 32 / d2 Ø 29
Thread: M30 x 1,5 RHT
0004605748, 0004606048, 0004606848,
0004607048, 0014600448, 0014601148,
0014601748, 0014602448, 0014607648,
0014609648



CV-ES-0888

Length: 125
Cone Ø: d1 Ø 32 / d2 Ø 29
Thread: M30 x 1,5 LHT
0004605848, 0004606148, 0004606948,
0004607148, 0004609048, 0014600548,
0014601348, 0014602548, 0014607948,
0024600448



CV-ES-14162

Length: 125
Cone Ø: d1 Ø 30 / d2 Ø 27
Thread: M30 x 1,5 LHT
4600648, 4601248, 4603448, 0004603548,
14600348, 14601448, 14602348,
0014603748, 0014607848, 0024600348



CV-ES-14163

Length: 125
Cone Ø: d1 Ø 30 / d2 Ø 27
Thread: M30 x 1,5 RHT
0003305248, 0003387310, 0004600348,
0004600948, 0004602848, 0004602948,
0004608948, 0014600248, 0014600848,
0014601248, 0014602248, 0014607748,
0024600148, 0003387310, 0004600348,
0004602848, 0004602948, 0014600848,
0014601248, 0014602248, 0014607748



DB-DL-2144

Length: 872 Ø: 35
Cone Ø: d1 Ø 28,6 / d2 Ø 23,9
0024604305, 0024604405, 0034604805



DB-DL-2178

Length: 1735 Ø: 52
Cone Ø: d1 Ø 32 / d2 Ø 29
9423300003, 9423300103, 9423300203



DB-DL-3475

Length: 565 Ø: 52
Hole Distance: 152 / 152
3753500006, 3753500206, 9473500805,
9483500006, 9483500805, 9483501205,
9483501305, 9483501905, 9483502005,
9483502405, A3753500006,
A3753500206



DB-DL-5230

Length: 879 Ø: 42
Cone Ø: d1 Ø 30 / d2 Ø 27
01208600A, 0004607105, 0004607205,
0014606705



DB-DL-5241

Length: 875 Ø: 40
Cone Ø: d1 Ø 30 / d2 Ø 27
01215300A, 0004609205, 0004609305,
0014606905



DB-DL-5405

Length: 890 Ø: 35
Cone Ø: d1 Ø 28,6 / d2 Ø 23,9
01215900A, 1460248, 0024604505,
0024604605, 0034605005, 3752600637,
3754600405, A3752600637, A3754600405



DB-DL-7270

Length: 875 Ø: 40
Cone Ø: d1 Ø 28,6 / d2 Ø 23,9
01208300A, 0024604705, 0024604805,
0034604905, A0024604705



DB-DL-8167

Length: 866 Ø: 38
Cone Ø: d1 Ø 30 / d2 Ø 27
0014609805, 0014609905, 0024606305,
0024606405



DB-DL-8171

Length: 1687 Ø: 52
Cone Ø: d1 Ø 32 / d2 Ø 29
9493300603, 9493300703, 9493301503,
9493301603



DB-DL-8184

Length: 1095 Ø: 42
Cone Ø: d1 Ø 32 / d2 Ø 28,8
01217700A, 0014601305, 0014601405,
0024600505, 0034603205, 3754601505,
A0014601305, A0014601405, A0024600505



DB-DL-8185

Length: 711 Ø: 42
Cone Ø: d1 Ø 32 / d2 Ø 28,8
01213600A, 0014601105, 0024600405,
0034603105, A0014601105, A0024600405



DB-DL-8307

Length: 885 Ø: 38
Cone Ø: d1 Ø 32 / d2 Ø 30
01215500A, 0004604005, 0024605105,
0024605205, 0034604005



DB-DL-8327

Length: 1745 Ø: 48
Cone Ø: d1 Ø 32 / d2 Ø 29
01219800A, 9413300003, 9413300103,
9413300203, 9413300303, 9413300503



DB-DL-8640

Length: 1615 Ø: 50
Cone Ø: d1 Ø 32 / d2 Ø 29
6253301503, 6253301603, 6253302403,
6253302503, 9423300803, 9423302103,
9493300203, 9493300303, 9493300903



DB-DL-12300

Length: 733 Ø: 36
Cone Ø: d1 Ø 32 / d2 Ø 29
0014601505, 0014607305, 0034603305,
3754601605, A0014601505, A0034603305,
A3754601605



DB-DL-12310

Length: 1532 Ø: 50
Cone Ø: d1 Ø 32 / d2 Ø 29
Thread: M27 x 1,5 LHT
9493301203, 9493301303, 9493301803,
9493302203, A9493301203, A9493301303,
A9493301803, A9493302203



DB-DL-12470

Length: 723 Ø: 42
Cone Ø: d1 Ø 30 / d2 Ø 27
A0014607505, A0024600905

No Image

DB-ES-5227

Length: 1588 Ø: 60
Cone Ø: d1 Ø 38 / d2 Ø 34,3
6253300903, 6253301203, 9443300203



DB-ES-5234

Length: 135
Cone Ø: d1 Ø 38 / d2 Ø 34,3
Thread: M38 x 1,5 RHT
0004601748, 120322305, 2205000400



DB-ES-8164

Length: 140
Cone Ø: d1 Ø 28,6 / d2 Ø 23,9
Thread: M28 x 1,5 RHT
0014604248, 0014605048, 0014608548,
0024600548



DB-ES-8510

Length: 56
Cone Ø: d1 Ø 10 / d2 Ø 10
Thread: M12 x 1,75 LHT
0009965145, 0009965645, 0019963145



DB-ES-8530

Length: 115
Cone Ø: d1 Ø 28,6 / d2 Ø 23,9
Thread: M30 x 1,5 RHT
0014603848, 0014604848, 0014605148,
0014608648, 0014609948



DB-RK-8391

Ø: 85 Hole Distance: 152
Thick/Height: 24
01336800A, 0003502705



DB-RK-8550

Ø: 75 Hole Distance: 152
Thick/Height: 24
0003502105, 0003504605



DB-RK-8626

Ø: 75 Hole Distance: 130
Thick/Height: 24
0003502205, 0003502505, 0003503405,
0003504505, GL11319



DB-RK-8638

Length: 100 Ø: 67
Hole Distance: 100
Thick/Height: 20
0003301411



DB-RK-9294

Ø: 85 Hole Distance: 152
Thick/Height: 24
0003503105



DB-RK-9296

Ø: 88 Hole Distance: 130
Thick/Height: 24
9423260050



DB-RK-10374

Ø: 85 Hole Distance: 152
Thick/Height: 24
0003504405



DB-RK-10375

Ø: 100 Hole Distance: 152
Thick/Height: 24
0003502405, 0003503505, 0003504905



DB-SB-10384

Ø: 73 Thick/Height: 47
9303170012, 9423171812



DB-SB-10400

Length: 230
Thick/Height: 167,5 / 115
0003250696, 0003250896



DB-SB-10401

Length: 232
Thick/Height: 163,5 / 152,5
0003250596, 0003250796



DB-SB-10406

Ø: 80 Thick/Height: 46
0003238185



DB-SB-10409

Ø: 77 Thick/Height: 56
0003265181



DB-SB-10410

Ø: 73 Hole Distance: 100
Thick/Height: 24
9413230050





ACTROS MP2 / MP3 ...

2632 LS ...	04/03→	Suspension Arm Repair Kit		DB-RK-10374	for Wishbone (CV)
	04/03→	Suspension Arm Repair Kit		DB-RK-10375	for Wishbone (CV)
	04/03→	Suspension Arm Repair Kit	DB-RK-8638		for Control Arm
	04/03→	Suspension Strut Repair Kit		DB-RK-8391	
	04/03→	Suspension Strut Repair Kit		DB-RK-9294	
	04/03→	Suspension Strut Repair Kit		MN-RK-8997	
	04/03→	Tie Rod	DB-DL-8327		Guide Rod
	04/03→	Tie Rod	DB-DL-8388		Guide Rod
	04/03→	Tie Rod	DB-DL-8389		
	04/03→	Tie Rod	DB-DL-8640		Guide Rod
	04/03→	Tie Rod	DB-DL-12310		
	04/03→	Tie Rod	DB-ES-5227		Guide Rod
	04/03→	Tie Rod End	CV-ES-0543		for Push Rod
	04/03→	Tie Rod End	CV-ES-0888		for Push Rod
	04/03→	Tie Rod End	CV-ES-14162		for Steering Rod
	04/03→	Tie Rod End	CV-ES-14163		for Steering Rod
	04/03→	Tie Rod End	DB-ES-5234		for Steering Rod
	04/03→	Tie Rod End	DB-ES-8164		for Push Rod
	04/03→	Tie Rod End	DB-ES-8530		for Push Rod
	04/03→	Track Control Arm		DB-VB-3707	Suspension Rod, Wishbone (CV)
04/03→	Track Control Arm		DB-VB-7798	Wishbone (CV)	
10/09→	Centre Rod	DB-DL-12299		for Steering Rod	
10/09→	Rod Assembly	DB-DL-2178		Guide Rod, 1st Front Axle, →504310 03	
2632, L, LL	04/03→	Ball Head, gearshift linkage	DB-ES-8510		
	04/03→	Bush, driver cab suspension	DB-SB-10384		
	04/03→	Bush, parabolic spring		DB-SB-10400	
	04/03→	Bush, parabolic spring		DB-SB-10401	
	04/03→	Centre Rod	DB-DL-2144		Push Rod
	04/03→	Centre Rod	DB-DL-5230		Suspension Rod
	04/03→	Centre Rod	DB-DL-5241		Push Rod
	04/03→	Centre Rod	DB-DL-5405		Push Rod
	04/03→	Centre Rod	DB-DL-5405		Push Rod, Leaf Spring Axle
	04/03→	Centre Rod	DB-DL-7270		Push Rod;Suspension Rod
	04/03→	Centre Rod	DB-DL-8167		Push Rod
	04/03→	Centre Rod	DB-DL-8168		Push Rod
	04/03→	Centre Rod	DB-DL-8184		Push Rod
	04/03→	Centre Rod	DB-DL-8185		Push Rod
	04/03→	Centre Rod	DB-DL-8307		Push Rod
	04/03→	Centre Rod	DB-DL-8622		Push Rod
	04/03→	Centre Rod	DB-DL-8641		Push Rod
	04/03→	Centre Rod	DB-DL-8642		Push Rod
	04/03→	Centre Rod	DB-DL-12300		for Steering Rod
	04/03→	Rod Assembly	DB-DL-2178		Guide Rod
	04/03→	Stabiliser Link	DB-DL-9254		Pressure Rod
	04/03→	Stabiliser Mounting		DB-RK-9296	
	04/03→	Stabiliser Mounting		DB-SB-10406	
	04/03→	Stabiliser Mounting		DB-SB-10409	
	04/03→	Stabiliser Mounting	DB-SB-10410		
	04/03→	Suspension Arm Repair Kit		DB-RK-8550	for Wishbone (CV)
	04/03→	Suspension Arm Repair Kit		DB-RK-8626	for Wishbone (CV)
	04/03→	Suspension Arm Repair Kit		DB-RK-10374	for Wishbone (CV)
	04/03→	Suspension Arm Repair Kit		DB-RK-10375	for Wishbone (CV)
	04/03→	Suspension Arm Repair Kit	DB-RK-8638		for Control Arm
	04/03→	Suspension Strut Repair Kit		DB-RK-8391	
	04/03→	Suspension Strut Repair Kit		DB-RK-9294	
	04/03→	Tie Rod	DB-DL-8327		Guide Rod
	04/03→	Tie Rod	DB-DL-8640		Guide Rod
	04/03→	Tie Rod	DB-DL-12310		
	04/03→	Tie Rod	DB-ES-5227		Guide Rod
	04/03→	Tie Rod End	CV-ES-0543		for Push Rod
	04/03→	Tie Rod End	CV-ES-0888		for Push Rod
	04/03→	Tie Rod End	CV-ES-14162		for Steering Rod
	04/03→	Tie Rod End	CV-ES-14163		for Steering Rod

CV-ES-0543

Length: 125
 Cone Ø: d1 Ø 32 / d2 Ø 29
 Thread: M30 x 1,5 RHT
 0004605748, 0004606048, 0004606848,
 0004607048, 0014600448, 0014601148,
 0014601748, 0014602448, 0014607648,
 0014609648

**CV-ES-0888**

Length: 125
 Cone Ø: d1 Ø 32 / d2 Ø 29
 Thread: M30 x 1,5 LHT
 0004605848, 0004606148, 0004606948,
 0004607148, 0004609048, 0014600548,
 0014601348, 0014602548, 0014607948,
 0024600448

**CV-ES-14162**

Length: 125
 Cone Ø: d1 Ø 30 / d2 Ø 27
 Thread: M30 x 1,5 LHT
 4600648, 4601248, 4603448, 4603548,
 0004603548, 14600348, 14601448,
 14602348, 001 460 37 48, 0014607848,
 14607848, 002 460 03 48

**CV-ES-14163**

Length: 125
 Cone Ø: d1 Ø 30 / d2 Ø 27
 Thread: M30 x 1,5 RHT
 0003305248, 0003387310, 0004600348,
 0004600948, 0004602848, 0004602948,
 0004608948, 0014600248, 0014600848,
 0014601248, 0014602248, 0014607748,
 0024600148, A0003387310, A0004600348,
 A0004602848, A0004602948, A0014600848,
 A0014601248, A0014602248, A0014607748

**DB-DL-2144**

Length: 872 Ø: 35
 Cone Ø: d1 Ø 28,6 / d2 Ø 23,9
 0024604305, 0024604405, 0034604805

**DB-DL-2178**

Length: 1735 Ø: 52
 Cone Ø: d1 Ø 32 / d2 Ø 29
 9423300003, 9423300103, 9423300203

**DB-DL-5230**

Length: 879 Ø: 42
 Cone Ø: d1 Ø 30 / d2 Ø 27
 01208600A, 0004607105, 0004607205,
 0014606705

**DB-DL-5241**

Length: 875 Ø: 40
 Cone Ø: d1 Ø 30 / d2 Ø 27
 01215300A, 0004609205, 0004609305,
 0014606905

**DB-DL-5405**

Length: 890 Ø: 35
 Cone Ø: d1 Ø 28,6 / d2 Ø 23,9
 01215900A, 1460248, 0024604505,
 0024604605, 0034605005, 3752600637,
 3754600405, A3752600637, A3754600405

**DB-DL-7270**

Length: 875 Ø: 40
 Cone Ø: d1 Ø 28,6 / d2 Ø 23,9
 01208300A, 0024604705, 0024604805,
 0034604905, A0024604705

**DB-DL-8167**

Length: 866 Ø: 38
 Cone Ø: d1 Ø 30 / d2 Ø 27
 0014609805, 0014609905, 0024606305,
 0024606405

**DB-DL-8168**

Length: 904 Ø: 52
 Cone Ø: d1 Ø 32 / d2 Ø 29
 0004609405, 0004609505, 0014607105

**DB-DL-8184**

Length: 1095 Ø: 42
 Cone Ø: d1 Ø 32 / d2 Ø 28,8
 01217700A, 0014601305, 0014601405,
 0024600505, 0034603205, 3754601505,
 A0014601305, A0014601405, A0024600505

**DB-DL-8185**

Length: 711 Ø: 42
 Cone Ø: d1 Ø 32 / d2 Ø 28,8
 01213600A, 0014601105, 0024600405,
 0034603105, A0014601105, A0024600405

**DB-DL-8307**

Length: 885 Ø: 38
 Cone Ø: d1 Ø 32 / d2 Ø 30
 01215500A, 0004604005, 0024605105,
 0024605205, 0034604005

**DB-DL-8327**

Length: 1745 Ø: 48
 Cone Ø: d1 Ø 32 / d2 Ø 29
 01219800A, 9413300003, 9413300103,
 9413300203, 9413300303, 9413300503

**DB-DL-8388**

Length: 1735 Ø: 62
 Cone Ø: d1 Ø 32 / d2 Ø 28,8
 01219900A, 9453300003, 9453300103,
 9453300403, 9453300603, A9453300003

**DB-DL-8389**

Length: 1465 Ø: 40
 Cone Ø: d1 Ø 32 / d2 Ø 29
 9453300203, 9453300303, 9453300503

**DB-DL-8622**

Length: 1558 Ø: 52
 Cone Ø: d1 Ø 30 / d2 Ø 27
 0014609005, 0014609105

**DB-DL-8640**

Length: 1615 Ø: 50
 Cone Ø: d1 Ø 32 / d2 Ø 29
 6253301503, 6253301603, 6253302403,
 6253302503, 9423300803, 9423302103,
 9493300203, 9493300303, 9493300903

**DB-DL-8641**

Length: 905 Ø: 42
 Cone Ø: d1 Ø 30 / d2 Ø 27
 0014605105, 0014608105

**DB-DL-8642**

Length: 954 Ø: 42
 Cone Ø: d1 Ø 30 / d2 Ø 27
 0014608605, 0014608705

**DB-DL-9254**

Length: 1815 Ø: 58
 0003220323, 0003220623, 3753220423

**DB-DL-12299**

Length: 2069 Ø: 40
 Cone Ø: d1 Ø 30 / d2 Ø 27
 0004608505, 0024601005, 0034602905

**DB-DL-12300**

Length: 733 Ø: 36
 Cone Ø: d1 Ø 32 / d2 Ø 29
 0014601505, 0014607305, 0034603305,
 3754601605, A0014601505,
 A0034603305, A3754601605

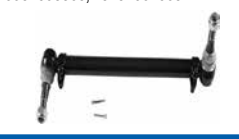
**DB-DL-12310**

Length: 1532 Ø: 50
 Cone Ø: d1 Ø 32 / d2 Ø 29
 Thread: M27 x 1,5 LHT
 9493301203, 9493301303, 9493301803,
 9493302203, A9493301203, A9493301303,
 A9493301803, A9493302203

**DB-ES-5227**

Length: 1588 Ø: 60
 Cone Ø: d1 Ø 38 / d2 Ø 34,3
 6253300903, 6253301203, 9443300203

**DB-ES-5234**

Length: 135
 Cone Ø: d1 Ø 38 / d2 Ø 34,3
 Thread: M38 x 1,5 RHT
 0004601748, 120322305, 2205000400

**DB-ES-8164**

Length: 140
 Cone Ø: d1 Ø 28,6 / d2 Ø 23,9
 Thread: M28 x 1,5 RHT
 0014604248, 0014605048, 0014608548,
 0024600548

**DB-ES-8510**

Length: 56
 Cone Ø: d1 Ø 10 / d2 Ø 10
 Thread: M12 x 1,75 LHT
 0009965145, 0009965645, 0019963145

**DB-ES-8530**

Length: 115
 Cone Ø: d1 Ø 28,6 / d2 Ø 23,9
 Thread: M30 x 1,5 RHT
 0014603848, 0014604848, 0014605148,
 0014608648, 0014609948

**DB-RK-8391**

Ø: 85 Hole Distance: 152
 Thick/Height: 24
 01336800A, 0003502705

**DB-RK-8550**

Ø: 75 Hole Distance: 152
 Thick/Height: 24
 0003502105, 0003504605

**DB-RK-8626**

Ø: 75 Hole Distance: 130
 Thick/Height: 24
 0003502205, 0003502505, 0003503405,
 0003504505, GL11319

**DB-RK-8638**

Length: 100 Ø: 67
 Hole Distance: 100
 Thick/Height: 20
 0003301411

**DB-RK-9294**

Ø: 85 Hole Distance: 152
 Thick/Height: 24
 0003503105

**DB-RK-9296**

Ø: 88 Hole Distance: 130
 Thick/Height: 24
 9423260050

**DB-RK-10374**

Ø: 85 Hole Distance: 152
 Thick/Height: 24
 0003504405

**DB-RK-10375**

Ø: 100 Hole Distance: 152
 Thick/Height: 24
 0003502405, 0003503505, 0003504905

**DB-SB-10384**

Ø: 73 Thick/Height: 47
 9303170012, 9423171812

**DB-SB-10400**

Length: 230
 Thick/Height: 167,5 / 115
 0003250696, 0003250896

**DB-SB-10401**

Length: 232
 Thick/Height: 163,5 / 152,5
 0003250596, 0003250796

**DB-SB-10406**

Ø: 80 Thick/Height: 46
 0003238185

**DB-SB-10409**

Ø: 77 Thick/Height: 56
 0003265181

**DB-SB-10410**

Ø: 73 Hole Distance: 100
 Thick/Height: 24
 9413230050

**DB-VB-3707**

Length: 622 Ø: 46
 Hole Ø 25 / 25 / 25
 Hole Distance: 152 / 130 / 130
 01337100A, 9423501005, 9423501505,
 9443500005, 9473500105, 9473501005,
 A3753500005, A9423501005, A9423501505,
 A9443500005, A9473500105, A9473501005

**DB-VB-7798**

Length: 622 Ø: 48
 Hole Ø 25 / 23 / 23
 Hole Distance: 152 / 130 / 130
 9423500505, 9423500805, 9423501205,
 A9423501205

**MN-RK-8997**

Ø: 85 Hole Distance: 130
 Thick/Height: 30
 0003504805





ACTROS MP2 / MP3 ...

2632 L, LL ...	04/03→	Tie Rod End	DB-ES-5234		for Steering Rod	
	04/03→	Tie Rod End	DB-ES-8164		for Push Rod	
	04/03→	Tie Rod End	DB-ES-8530		for Push Rod	
	04/03→	Track Control Arm		DB-DL-3475	Trailing Arm	
	04/03→	Track Control Arm		DB-VB-3707	Suspension Rod, Wishbone (CV)	
	04/03→	Track Control Arm		DB-VB-7261	Suspension Rod, Wishbone (CV), 1st RA;2nd RA; Leaf Spring Axle	
	04/03→	Track Control Arm		DB-VB-10426	Wishbone (CV), Leaf Spring Axle;Unit	
	04/03→	Track Control Arm	DB-DL-5224		Control Arm, 1st FA;Air Suspension Axle	
	04/03→	Track Control Arm	DB-DL-9218	DB-DL-9218	Trailing Arm, 1st FA;Air Suspension Axle	
2635 B	04/03→	Bush, parabolic spring		DB-SB-10400		
	04/03→	Bush, parabolic spring		DB-SB-10401		
	04/03→	Centre Rod	DB-DL-2144		Push Rod	
	04/03→	Centre Rod	DB-DL-5405		Push Rod	
	04/03→	Centre Rod	DB-DL-7270		Push Rod	
	04/03→	Centre Rod	DB-DL-8167		Push Rod	
	04/03→	Rod Assembly	DB-DL-2178		Guide Rod, 1st Front Axle, →504310 03	
	04/03→	Suspension Arm Repair Kit		DB-RK-8626	for Wishbone (CV)	
	04/03→	Suspension Arm Repair Kit		DB-RK-10374	for Wishbone (CV)	
	04/03→	Tie Rod	DB-DL-8327		Guide Rod	
	04/03→	Tie Rod	DB-DL-8640		Guide Rod	
	04/03→	Tie Rod End	CV-ES-0543		for Push Rod	
	04/03→	Tie Rod End	CV-ES-0888		for Push Rod	
	04/03→	Tie Rod End	CV-ES-14163		for Steering Rod	
	04/03→	Tie Rod End	DB-ES-8164		for Push Rod	
	04/03→	Tie Rod End	DB-ES-8530		for Push Rod	
	04/03→	Track Control Arm		DB-DL-3475	Trailing Arm, 1st RA;2nd RA, →517144 05/517144 08	
	04/03→	Track Control Arm		DB-VB-7261	Suspension Rod, Wishbone (CV)	
	04/03→	Track Control Arm		DB-VB-10426	Wishbone (CV)	
	2635 K, LK	04/03→	Bush, parabolic spring		DB-SB-10400	
04/03→		Bush, parabolic spring		DB-SB-10401		
04/03→		Centre Rod	DB-DL-2144		Push Rod	
04/03→		Centre Rod	DB-DL-5405		Push Rod	
04/03→		Centre Rod	DB-DL-7270		Push Rod	
04/03→		Centre Rod	DB-DL-8167		Push Rod	
04/03→		Rod Assembly	DB-DL-2178		Guide Rod, 1st Front Axle, →504310 03	
04/03→		Suspension Arm Repair Kit		DB-RK-8626	for Wishbone (CV)	
04/03→		Suspension Arm Repair Kit		DB-RK-10374	for Wishbone (CV)	
04/03→		Tie Rod	DB-DL-8171		Guide Rod	
04/03→		Tie Rod	DB-DL-8327		Guide Rod	
04/03→		Tie Rod	DB-DL-8640		Guide Rod	
04/03→		Tie Rod End	CV-ES-0543		for Push Rod	
04/03→		Tie Rod End	CV-ES-0888		for Push Rod	
04/03→		Tie Rod End	CV-ES-14163		for Steering Rod	
04/03→		Tie Rod End	DB-ES-8164		for Push Rod	
04/03→		Tie Rod End	DB-ES-8530		for Push Rod	
04/03→		Track Control Arm		DB-DL-3475	Trailing Arm, 1st RA;2nd RA, →517144 03/517144 06	
04/03→		Track Control Arm		DB-DL-3475	Trailing Arm, 1st RA;2nd RA, →517144 05/517144 08	
04/03→		Track Control Arm		DB-DL-3475	Trailing Arm, 1st RA;2nd RA, →517144 07/517144 09	
04/03→		Track Control Arm		DB-DL-3475	Trailing Arm, 1st RA;2nd RA, →517144 26/517144 27	
04/03→		Track Control Arm		DB-VB-3707	Suspension Rod, Wishbone (CV)	
04/03→		Track Control Arm		DB-VB-7261	Suspension Rod, Wishbone (CV)	
04/03→		Track Control Arm		DB-VB-10426	Wishbone (CV)	
2635 L		04/03→	Centre Rod	DB-DL-2144		Push Rod
		04/03→	Centre Rod	DB-DL-5405		Push Rod
		04/03→	Centre Rod	DB-DL-7270		Push Rod
		04/03→	Centre Rod	DB-DL-8167		Push Rod
		04/03→	Centre Rod	DB-DL-8307		Push Rod

CV-ES-0543

Length: 125
Cone Ø: d1 Ø 32 / d2 Ø 29
Thread: M30 x 1,5 RHT
0004605748, 0004606048, 0004606848,
0004607048, 0014600448, 0014601148,
0014601748, 0014602448, 0014607648,
0014609648



CV-ES-0888

Length: 125
Cone Ø: d1 Ø 32 / d2 Ø 29
Thread: M30 x 1,5 LHT
0004605848, 0004606148, 0004606948,
0004607148, 0004609048, 0014600548,
0014601348, 0014602548, 0014607948,
0024600448



CV-ES-14163

Length: 125
Cone Ø: d1 Ø 30 / d2 Ø 27
Thread: M30 x 1,5 RHT
0003305248, 0003387310, 0004600348,
0004600948, 0004602848, 0004602948,
0004608948, 0014600248, 0014600848,
0014601248, 0014602248, 0014607748,
0024600148, A0003387310, A0004600348,
A0004602848, A0004602948, A0014600848,
A0014601248, A0014602248, A0014607748



DB-DL-2144

Length: 872 Ø: 35
Cone Ø: d1 Ø 28,6 / d2 Ø 23,9
0024604305, 0024604405, 0034604805



DB-DL-2178

Length: 1735 Ø: 52
Cone Ø: d1 Ø 32 / d2 Ø 29
9423300003, 9423300103, 9423300203



DB-DL-3475

Length: 565 Ø: 52
Hole Distance: 152 / 152
3753500006, 3753500206, 9473500805,
9483500006, 9483500805, 9483501205,
9483501305, 9483501905, 9483502005,
9483502405, A3753500006,
A3753500206



DB-DL-5224

Length: 850 Ø: 60
Hole Distance: 100 / 100
01336100A, 9413300007



DB-DL-5405

Length: 890 Ø: 35
Cone Ø: d1 Ø 28,6 / d2 Ø 23,9
01215900A, 1460248, 0024604505,
0024604605, 0034605005, 3752600637,
3754600405, A3752600637, A3754600405



DB-DL-7270

Length: 875 Ø: 40
Cone Ø: d1 Ø 28,6 / d2 Ø 23,9
01208300A, 0024604705, 0024604805,
0034604905, A0024604705



DB-DL-8167

Length: 866 Ø: 38
Cone Ø: d1 Ø 30 / d2 Ø 27
0014609805, 0014609905, 0024606305,
0024606405



DB-DL-8171

Length: 1687 Ø: 52
Cone Ø: d1 Ø 32 / d2 Ø 29
9493300603, 9493300703, 9493301503,
9493301603



DB-DL-8307

Length: 885 Ø: 38
Cone Ø: d1 Ø 32 / d2 Ø 30
01215500A, 0004604005, 0024605105,
0024605205, 0034604005



DB-DL-8327

Length: 1745 Ø: 48
Cone Ø: d1 Ø 32 / d2 Ø 29
01219800A, 9413300003, 9413300103,
9413300203, 9413300303, 9413300503



DB-DL-8640

Length: 1615 Ø: 50
Cone Ø: d1 Ø 32 / d2 Ø 29
6253301503, 6253301603, 6253302403,
6253302503, 9423300803, 9423302103,
9493300203, 9493300303, 9493300903



DB-DL-9218

Length: 754 Ø: 40
Hole Distance: 100
000360098524, 000390098524,
3753300111, 9413300011,
A3753300111, SA50831601



DB-ES-5234

Length: 135
Cone Ø: d1 Ø 38 / d2 Ø 34,3
Thread: M38 x 1,5 RHT
0004601748, 120322305, 2205000400



DB-ES-8164

Length: 140
Cone Ø: d1 Ø 28,6 / d2 Ø 23,9
Thread: M28 x 1,5 RHT
0014604248, 0014605048, 0014608548,
0024600548



DB-ES-8530

Length: 115
Cone Ø: d1 Ø 28,6 / d2 Ø 23,9
Thread: M30 x 1,5 RHT
0014603848, 0014604848, 0014605148,
0014608648, 0014609948



DB-RK-8626

Ø: 75 Hole Distance: 130
Thick/Height: 24
0003502205, 0003502505, 0003503405,
0003504505, GL11319



DB-RK-10374

Ø: 85 Hole Distance: 152
Thick/Height: 24
0003504405



DB-SB-10400

Length: 230
Thick/Height: 167,5 / 115
0003250696, 0003250896



DB-SB-10401

Length: 232
Thick/Height: 163,5 / 152,5
0003250596, 0003250796



DB-VB-3707

Length: 622 Ø: 46
Hole Ø 25 / 25 / 25
Hole Distance: 152 / 130 / 130
01337100A, 9423501005, 9423501505,
9443500005, 9473500105, 9473501005,
A3753500005, A9423501005, A9423501505,
A9443500005, A9473500105, A9473501005



DB-VB-7261

Length: 622 Ø: 46
Hole Ø 25 / 25 / 25
Hole Distance: 152 / 130 / 130
01337800A, 9443500305, 9443500505,
9443500605, 9473500705, 9473500905,
9483500405, 9483503005



DB-VB-10426

Length: 622 Ø: 46
Hole Ø 25 / 25 / 25
Hole Distance: 152 / 130 / 130
9443500405



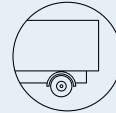

ACTROS MP2 / MP3 ...

2635 L ...	04/03→	Rod Assembly	DB-DL-2178		Guide Rod, 1st Front Axle, →504310 03
	04/03→	Suspension Arm Repair Kit		DB-RK-8626	for Wishbone (CV)
	04/03→	Suspension Arm Repair Kit		DB-RK-10374	for Wishbone (CV)
	04/03→	Tie Rod	DB-DL-8640		Guide Rod
	04/03→	Tie Rod End	CV-ES-0543		for Push Rod
	04/03→	Tie Rod End	CV-ES-0888		for Push Rod
	04/03→	Tie Rod End	CV-ES-14163		for Steering Rod
	04/03→	Tie Rod End	DB-ES-8164		for Push Rod
	04/03→	Tie Rod End	DB-ES-8530		for Push Rod
	04/03→	Track Control Arm		DB-VB-3707	Suspension Rod, Wishbone (CV)
	04/03→	Track Control Arm	DB-DL-5224		Control Arm
2635 LS	04/03→	Track Control Arm	DB-DL-9218	DB-DL-9218	Trailing Arm
	10/02→	Centre Rod	DB-DL-2144		Push Rod
	10/02→	Centre Rod	DB-DL-5405		Push Rod
	10/02→	Centre Rod	DB-DL-7270		Push Rod
	10/02→	Centre Rod	DB-DL-8167		Push Rod
	10/02→	Centre Rod	DB-DL-8307		Push Rod
	10/02→	Rod Assembly	DB-DL-2178		Guide Rod, 1st Front Axle, →504310 03
	10/02→	Suspension Arm Repair Kit		DB-RK-8626	for Wishbone (CV)
	10/02→	Suspension Arm Repair Kit		DB-RK-10374	for Wishbone (CV)
	10/02→	Tie Rod	DB-DL-8327		Guide Rod, 1st Front Axle
	10/02→	Tie Rod	DB-DL-8640		Guide Rod, 1st Front Axle
	10/02→	Tie Rod	DB-DL-12310		
	10/02→	Tie Rod End	CV-ES-0543		for Push Rod
	10/02→	Tie Rod End	CV-ES-0888		for Push Rod
	10/02→	Tie Rod End	CV-ES-14163		for Steering Rod
	10/02→	Tie Rod End	DB-ES-8164		for Push Rod
	10/02→	Track Control Arm		DB-VB-3707	Suspension Rod, Wishbone (CV)
	10/09→	Tie Rod	DB-DL-8640		Guide Rod
	2636 B	04/03→	Ball Head, gearshift linkage	DB-ES-8510	
04/03→		Bush, driver cab suspension	DB-SB-10384		
04/03→		Bush, parabolic spring		DB-SB-10400	
04/03→		Bush, parabolic spring		DB-SB-10401	
04/03→		Centre Rod	DB-DL-2144		Push Rod
04/03→		Centre Rod	DB-DL-5230		Suspension Rod
04/03→		Centre Rod	DB-DL-5241		Push Rod
04/03→		Centre Rod	DB-DL-5405		Push Rod, Leaf Spring Axle
04/03→		Centre Rod	DB-DL-7270		Push Rod
04/03→		Centre Rod	DB-DL-8167		Push Rod
04/03→		Centre Rod	DB-DL-8184		Push Rod
04/03→		Centre Rod	DB-DL-8185		Push Rod
04/03→		Centre Rod	DB-DL-8307		Push Rod
04/03→		Centre Rod	DB-DL-12300		for Steering Rod
04/03→		Rod Assembly	DB-DL-2178		Guide Rod, 1st Front Axle, →504310 03
04/03→		Stabiliser Mounting		DB-SB-10406	
04/03→		Stabiliser Mounting		DB-SB-10409	
04/03→		Suspension Arm Repair Kit		DB-RK-8550	for Wishbone (CV)
04/03→		Suspension Arm Repair Kit		DB-RK-8626	for Wishbone (CV)
04/03→		Suspension Arm Repair Kit		DB-RK-10374	for Wishbone (CV)
04/03→		Suspension Arm Repair Kit	DB-RK-8638		for Control Arm
04/03→		Suspension Strut Repair Kit		DB-RK-8391	
04/03→		Suspension Strut Repair Kit		DB-RK-9294	
04/03→		Tie Rod	DB-DL-8327		Guide Rod
04/03→		Tie Rod	DB-DL-8640		Guide Rod
04/03→		Tie Rod	DB-DL-12310		
04/03→		Tie Rod End	CV-ES-0543		for Push Rod
04/03→		Tie Rod End	CV-ES-0888		for Push Rod
04/03→		Tie Rod End	CV-ES-14163		for Steering Rod
04/03→		Tie Rod End	DB-ES-5234		for Steering Rod
04/03→		Tie Rod End	DB-ES-8164		for Push Rod
04/03→		Tie Rod End	DB-ES-8530		for Push Rod
04/03→		Track Control Arm		DB-DL-3475	Trailing Arm
04/03→		Track Control Arm		DB-VB-3707	Suspension Rod, Wishbone (CV)

CV-ES-0543

Length: 125
 Cone Ø: d1 Ø 32 / d2 Ø 29
 Thread: M30 x 1,5 RHT
 0004605748, 0004606048, 0004606848,
 0004607048, 0014600448, 0014601148,
 0014601748, 0014602448, 0014607648,
 0014609648

**CV-ES-0888**

Length: 125
 Cone Ø: d1 Ø 32 / d2 Ø 29
 Thread: M30 x 1,5 LHT
 0004605848, 0004606148, 0004606948,
 0004607148, 0004609048, 0014600548,
 0014601348, 0014602548, 0014607948,
 0024600448

**CV-ES-14163**

Length: 125
 Cone Ø: d1 Ø 30 / d2 Ø 27
 Thread: M30 x 1,5 RHT
 0003305248, 0003387310, 0004600348,
 0004600948, 0004602848, 0004602948,
 0004608948, 0014600248, 0014600848,
 0014601248, 0014602248, 0014607748,
 0024600148, A0003387310, A0004600348,
 A0004602848, A0004602948, A0014600848,
 A0014601248, A0014602248, A0014607748

**DB-DL-2144**

Length: 872 Ø: 35
 Cone Ø: d1 Ø 28,6 / d2 Ø 23,9
 0024604305, 0024604405, 0034604805

**DB-DL-2178**

Length: 1735 Ø: 52
 Cone Ø: d1 Ø 32 / d2 Ø 29
 9423300003, 9423300103, 9423300203

**DB-DL-3475**

Length: 565 Ø: 52
 Hole Distance: 152 / 152
 3753500006, 3753500206, 9473500805,
 9483500006, 9483500805, 9483501205,
 9483501305, 9483501905, 9483502005,
 9483502405, A3753500006,
 A3753500206

**DB-DL-5224**

Length: 850 Ø: 60
 Hole Distance: 100 / 100
 01336100A, 9413300007

**DB-DL-5230**

Length: 879 Ø: 42
 Cone Ø: d1 Ø 30 / d2 Ø 27
 01208600A, 0004607105, 0004607205,
 0014606705

**DB-DL-5241**

Length: 875 Ø: 40
 Cone Ø: d1 Ø 30 / d2 Ø 27
 01215300A, 0004609205, 0004609305,
 0014606905

**DB-DL-5405**

Length: 890 Ø: 35
 Cone Ø: d1 Ø 28,6 / d2 Ø 23,9
 01215900A, 1460248, 0024604505,
 0024604605, 0034605005, 3752600637,
 3754600405, A3752600637, A3754600405

**DB-DL-7270**

Length: 875 Ø: 40
 Cone Ø: d1 Ø 28,6 / d2 Ø 23,9
 01208300A, 0024604705, 0024604805,
 0034604905, A0024604705

**DB-DL-8167**

Length: 866 Ø: 38
 Cone Ø: d1 Ø 30 / d2 Ø 27
 0014609805, 0014609905, 0024606305,
 0024606405

**DB-DL-8184**

Length: 1095 Ø: 42
 Cone Ø: d1 Ø 32 / d2 Ø 28,8
 01217700A, 0014601305, 0014601405,
 0024600505, 0034603205, 3754601505,
 A0014601305, A0014601405, A0024600505

**DB-DL-8185**

Length: 711 Ø: 42
 Cone Ø: d1 Ø 32 / d2 Ø 28,8
 01213600A, 0014601105, 0024600405,
 0034603105, A0014601105, A0024600405

**DB-DL-8307**

Length: 885 Ø: 38
 Cone Ø: d1 Ø 32 / d2 Ø 30
 01215500A, 0004604005, 0024605105,
 0024605205, 0034604005

**DB-DL-8327**

Length: 1745 Ø: 48
 Cone Ø: d1 Ø 32 / d2 Ø 29
 01219800A, 9413300003, 9413300103,
 9413300203, 9413300303, 9413300503

**DB-DL-8640**

Length: 1615 Ø: 50
 Cone Ø: d1 Ø 32 / d2 Ø 29
 6253301503, 6253301603, 6253302403,
 6253302503, 9423300803, 9423302103,
 9493300203, 9493300303, 9493300903

**DB-DL-9218**

Length: 754 Ø: 40
 Hole Distance: 100
 000360098524, 000390098524,
 3753300111, 9413300011,
 A3753300111, SA50831601

**DB-DL-12300**

Length: 733 Ø: 36
 Cone Ø: d1 Ø 32 / d2 Ø 29
 0014601505, 0014607305, 0034603305,
 3754601605, A0014601505,
 A0034603305, A3754601605

**DB-DL-12310**

Length: 1532 Ø: 50
 Cone Ø: d1 Ø 32 / d2 Ø 29
 Thread: M27 x 1,5 LHT
 9493301203, 9493301303, 9493301803,
 9493302203, A9493301203, A9493301303,
 A9493301803, A9493302203

**DB-ES-5234**

Length: 135
 Cone Ø: d1 Ø 38 / d2 Ø 34,3
 Thread: M38 x 1,5 RHT
 0004601748, 120322305, 2205000400

**DB-ES-8164**

Length: 140
 Cone Ø: d1 Ø 28,6 / d2 Ø 23,9
 Thread: M28 x 1,5 RHT
 0014604248, 0014605048, 0014608548,
 0024600548

**DB-ES-8510**

Length: 56
 Cone Ø: d1 Ø 10 / d2 Ø 10
 Thread: M12 x 1,75 LHT
 0009965145, 0009965645, 0019963145

**DB-ES-8530**

Length: 115
 Cone Ø: d1 Ø 28,6 / d2 Ø 23,9
 Thread: M30 x 1,5 RHT
 0014603848, 0014604848, 0014605148,
 0014608648, 0014609948

**DB-RK-8391**

Ø: 85 Hole Distance: 152
 Thick/Height: 24
 01336800A, 0003502705

**DB-RK-8550**

Ø: 75 Hole Distance: 152
 Thick/Height: 24
 0003502105, 0003504605

**DB-RK-8626**

Ø: 75 Hole Distance: 130
 Thick/Height: 24
 0003502205, 0003502505, 0003503405,
 0003504505, GL11319

**DB-RK-8638**

Length: 100 Ø: 67
 Hole Distance: 100
 Thick/Height: 20
 0003301411

**DB-RK-9294**

Ø: 85 Hole Distance: 152
 Thick/Height: 24
 0003503105

**DB-RK-10374**

Ø: 85 Hole Distance: 152
 Thick/Height: 24
 0003504405

**DB-SB-10384**

Ø: 73 Thick/Height: 47
 9303170012, 9423171812

**DB-SB-10400**

Length: 230
 Thick/Height: 167,5 / 115
 0003250696, 0003250896

**DB-SB-10401**

Length: 232
 Thick/Height: 163,5 / 152,5
 0003250596, 0003250796

**DB-SB-10406**

Ø: 80 Thick/Height: 46
 0003238185

**DB-SB-10409**

Ø: 77 Thick/Height: 56
 0003265181

**DB-VB-3707**

Length: 622 Ø: 46
 Hole Ø 25 / 25 / 25
 Hole Distance: 152 / 130 / 130
 01337100A, 9423501005, 9423501505,
 9443500005, 9473500105, 9473501005,
 A3753500005, A9423501005, A9423501505,
 A9443500005, A9473500105, A9473501005



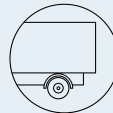

ACTROS MP2 / MP3 ...

2636 B ...	04/03 →	Track Control Arm		DB-VB-7261	Suspension Rod, Wishbone (CV), 1st RA;2nd RA; Leaf Spring Axle
	04/03 →	Track Control Arm		DB-VB-10426	Wishbone (CV), Leaf Spring Axle;Unit
2636 K, LK	04/03 →	Ball Head, gearshift linkage	DB-ES-8510		
	04/03 →	Bush, driver cab suspension	DB-SB-10384		
	04/03 →	Bush, parabolic spring		DB-SB-10400	
	04/03 →	Bush, parabolic spring		DB-SB-10401	
	04/03 →	Centre Rod	DB-DL-2144		Push Rod
	04/03 →	Centre Rod	DB-DL-5230		Suspension Rod
	04/03 →	Centre Rod	DB-DL-5241		Push Rod
	04/03 →	Centre Rod	DB-DL-5405		Push Rod
	04/03 →	Centre Rod	DB-DL-5405		Push Rod, Leaf Spring Axle
	04/03 →	Centre Rod	DB-DL-7270		Push Rod
	04/03 →	Centre Rod	DB-DL-8167		Push Rod
	04/03 →	Centre Rod	DB-DL-8184		Push Rod
	04/03 →	Centre Rod	DB-DL-8185		Push Rod
	04/03 →	Centre Rod	DB-DL-8307		Push Rod
	04/03 →	Centre Rod	DB-DL-12300		for Steering Rod
	04/03 →	Rod Assembly	DB-DL-2178		Guide Rod
	04/03 →	Stabiliser Mounting		DB-SB-10406	
	04/03 →	Stabiliser Mounting		DB-SB-10409	
	04/03 →	Suspension Arm Repair Kit		DB-RK-8550	for Wishbone (CV)
	04/03 →	Suspension Arm Repair Kit		DB-RK-8626	for Wishbone (CV)
	04/03 →	Suspension Arm Repair Kit		DB-RK-10374	for Wishbone (CV)
	04/03 →	Suspension Arm Repair Kit		DB-RK-10375	for Wishbone (CV)
	04/03 →	Suspension Arm Repair Kit	DB-RK-8638		for Control Arm
	04/03 →	Suspension Strut Repair Kit		DB-RK-8391	
	04/03 →	Suspension Strut Repair Kit		DB-RK-9294	
	04/03 →	Tie Rod	DB-DL-8171		Guide Rod
	04/03 →	Tie Rod	DB-DL-8327		Guide Rod
	04/03 →	Tie Rod	DB-DL-8640		Guide Rod
	04/03 →	Tie Rod	DB-DL-12310		
	04/03 →	Tie Rod	DB-ES-5227		Guide Rod
	04/03 →	Tie Rod End	CV-ES-0543		for Push Rod
	04/03 →	Tie Rod End	CV-ES-0888		for Push Rod
	04/03 →	Tie Rod End	CV-ES-14162		for Steering Rod
	04/03 →	Tie Rod End	CV-ES-14163		for Steering Rod
	04/03 →	Tie Rod End	DB-ES-5234		for Steering Rod
	04/03 →	Tie Rod End	DB-ES-8164		for Push Rod
	04/03 →	Tie Rod End	DB-ES-8530		for Push Rod
	04/03 →	Track Control Arm		DB-DL-3475	Trailing Arm
	04/03 →	Track Control Arm		DB-VB-3707	Suspension Rod, Wishbone (CV)
	04/03 →	Track Control Arm		DB-VB-7261	Suspension Rod, Wishbone (CV), 1st RA;2nd RA; Leaf Spring Axle
	04/03 →	Track Control Arm		DB-VB-10426	Wishbone (CV), Leaf Spring Axle;Unit
2636 LS	04/03 →	Ball Head, gearshift linkage	DB-ES-8510		
	04/03 →	Bush, driver cab suspension	DB-SB-10384		
	04/03 →	Centre Rod	DB-DL-2144		Push Rod
	04/03 →	Centre Rod	DB-DL-5230		Suspension Rod
	04/03 →	Centre Rod	DB-DL-5241		Push Rod
	04/03 →	Centre Rod	DB-DL-5405		Push Rod
	04/03 →	Centre Rod	DB-DL-5405		Push Rod, for vehicles with Rigid Leading Axle
	04/03 →	Centre Rod	DB-DL-5405		Push Rod, Leaf Spring Axle
	04/03 →	Centre Rod	DB-DL-7270		Push Rod
	04/03 →	Centre Rod	DB-DL-8167		Push Rod
	04/03 →	Centre Rod	DB-DL-8184		Push Rod
	04/03 →	Centre Rod	DB-DL-8185		Push Rod
	04/03 →	Centre Rod	DB-DL-8307		Push Rod
	04/03 →	Centre Rod	DB-DL-12300		for Steering Rod
	04/03 →	Centre Rod	DB-DL-12470		Push Rod
	04/03 →	Rod Assembly	DB-DL-2178		Guide Rod
	04/03 →	Stabiliser Mounting		DB-SB-10409	
	04/03 →	Stabiliser Mounting	DB-SB-10410		

CV-ES-0543

Length: 125
Cone Ø: d1 Ø 32 / d2 Ø 29
Thread: M30 x 1,5 RHT
0004605748, 0004606048, 0004606848,
0004607048, 0014600448, 0014601148,
0014601748, 0014602448, 0014607648,
0014609648



CV-ES-0888

Length: 125
Cone Ø: d1 Ø 32 / d2 Ø 29
Thread: M30 x 1,5 LHT
0004605848, 0004606148, 0004606948,
0004607148, 0004609048, 0014600548,
0014601348, 0014602548, 0014607948,
0024600448



CV-ES-14162

Length: 125
Cone Ø: d1 Ø 30 / d2 Ø 27
Thread: M30 x 1,5 LHT
4600648, 4601248, 4603448, 4603548,
0004603548, 14600348, 14601448,
14602348, 0014603748, 0014607848,
14607848, 0024600348



CV-ES-14163

Length: 125
Cone Ø: d1 Ø 30 / d2 Ø 27
Thread: M30 x 1,5 RHT
0003305248, 0003387310, 0004600348,
0004600948, 0004602848, 0004602948,
0004608948, 0014600248, 0014600848,
0014601248, 0014602248, 0014607748,
0024600148, A0003387310, A0004600348,
A0004602848, A0004602948, A0014600848,
A0014601248, A0014602248, A0014607748



DB-DL-2144

Length: 872 Ø: 35
Cone Ø: d1 Ø 28,6 / d2 Ø 23,9
0024604305, 0024604405, 0034604805



DB-DL-2178

Length: 1735 Ø: 52
Cone Ø: d1 Ø 32 / d2 Ø 29
9423300003, 9423300103, 9423300203



DB-DL-3475

Length: 565 Ø: 52
Hole Distance: 152 / 152
3753500006, 3753500206, 9473500805,
9483500006, 9483500805, 9483501205,
9483501305, 9483501905, 9483502005,
9483502405, A3753500006,
A3753500206



DB-DL-5230

Length: 879 Ø: 42
Cone Ø: d1 Ø 30 / d2 Ø 27
01208600A, 0004607105, 0004607205,
0014606705



DB-DL-5241

Length: 875 Ø: 40
Cone Ø: d1 Ø 30 / d2 Ø 27
01215300A, 0004609205, 0004609305,
0014606905



DB-DL-5405

Length: 890 Ø: 35
Cone Ø: d1 Ø 28,6 / d2 Ø 23,9
01215900A, 1460248, 0024604505,
0024604605, 0034605005, 3752600637,
3754600405, A3752600637, A3754600405



DB-DL-7270

Length: 875 Ø: 40
Cone Ø: d1 Ø 28,6 / d2 Ø 23,9
01208300A, 0024604705, 0024604805,
0034604905, A0024604705

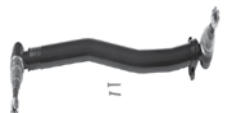

DB-DL-8167

Length: 866 Ø: 38
Cone Ø: d1 Ø 30 / d2 Ø 27
0014609805, 0014609905, 0024606305,
0024606405



DB-DL-8171

Length: 1687 Ø: 52
Cone Ø: d1 Ø 32 / d2 Ø 29
9493300603, 9493300703, 9493301503,
9493301603



DB-DL-8184

Length: 1095 Ø: 42
Cone Ø: d1 Ø 32 / d2 Ø 28,8
01217700A, 0014601305, 0014601405,
0024600505, 0034603205, 3754601505,
A0014601305, A0014601405, A0024600505



DB-DL-8185

Length: 711 Ø: 42
Cone Ø: d1 Ø 32 / d2 Ø 28,8
01213600A, 0014601105, 0024600405,
0034603105, A0014601105, A0024600405



DB-DL-8307

Length: 885 Ø: 38
Cone Ø: d1 Ø 32 / d2 Ø 30
01215500A, 0004604005, 0024605105,
0024605205, 0034604005



DB-DL-8327

Length: 1745 Ø: 48
Cone Ø: d1 Ø 32 / d2 Ø 29
01219800A, 9413300003, 9413300103,
9413300203, 9413300303, 9413300503



DB-DL-8640

Length: 1615 Ø: 50
Cone Ø: d1 Ø 32 / d2 Ø 29
6253301503, 6253301603, 6253302403,
6253302503, 9423300803, 9423302103,
9493300203, 9493300303, 9493300903



DB-DL-12300

Length: 733 Ø: 36
Cone Ø: d1 Ø 32 / d2 Ø 29
0014601505, 0014607305, 0034603305,
3754601605, A0014601505,
A0034603305, A3754601605



DB-DL-12310

Length: 1532 Ø: 50
Cone Ø: d1 Ø 32 / d2 Ø 29
Thread: M27 x 1,5 LHT
9493301203, 9493301303, 9493301803,
9493302203, A9493301203, A9493301303,
A9493301803, A9493302203



DB-DL-12470

Length: 723 Ø: 42
Cone Ø: d1 Ø 30 / d2 Ø 27
A0014607505, A0024600905

No Image

DB-ES-5227

Length: 1588 Ø: 60
Cone Ø: d1 Ø 38 / d2 Ø 34,3
6253300903, 6253301203, 9443300203



DB-ES-5234

Length: 135
Cone Ø: d1 Ø 38 / d2 Ø 34,3
Thread: M38 x 1,5 RHT
0004601748, 120322305, 2205000400



DB-ES-8164

Length: 140
Cone Ø: d1 Ø 28,6 / d2 Ø 23,9
Thread: M28 x 1,5 RHT
0014604248, 0014605048, 0014608548,
0024600548



DB-ES-8510

Length: 56
Cone Ø: d1 Ø 10 / d2 Ø 10
Thread: M12 x 1,75 LHT
0009965145, 0009965645, 0019963145



DB-ES-8530

Length: 115
Cone Ø: d1 Ø 28,6 / d2 Ø 23,9
Thread: M30 x 1,5 RHT
0014603848, 0014604848, 0014605148,
0014608648, 0014609948



DB-RK-8391

Ø: 85 Hole Distance: 152
Thick/Height: 24
01336800A, 0003502705



DB-RK-8550

Ø: 75 Hole Distance: 152
Thick/Height: 24
0003502105, 0003504605



DB-RK-8626

Ø: 75 Hole Distance: 130
Thick/Height: 24
0003502205, 0003502505, 0003503405,
0003504505, GL11319



DB-RK-8638

Length: 100 Ø: 67
Hole Distance: 100
Thick/Height: 20
0003301411



DB-RK-9294

Ø: 85 Hole Distance: 152
Thick/Height: 24
0003503105



DB-RK-10374

Ø: 85 Hole Distance: 152
Thick/Height: 24
0003504405



DB-RK-10375

Ø: 100 Hole Distance: 152
Thick/Height: 24
0003502405, 0003503505, 0003504905



DB-SB-10384

Ø: 73 Thick/Height: 47
9303170012, 9423171812



DB-SB-10400

Length: 230
Thick/Height: 167,5 / 115
0003250696, 0003250896



DB-SB-10401

Length: 232
Thick/Height: 163,5 / 152,5
0003250596, 0003250796



DB-SB-10406

Ø: 80 Thick/Height: 46
0003238185



DB-SB-10409

Ø: 77 Thick/Height: 56
0003265181



DB-SB-10410

Ø: 73 Hole Distance: 100
Thick/Height: 24
9413230050



DB-VB-3707

Length: 622 Ø: 46
Hole Ø 25 / 25 / 25
Hole Distance: 152 / 130 / 130
01337100A, 9423501005, 9423501505,
9443500005, 9473500105, 9473501005,
A375350005, A9423501005, A9423501505,
A947350005, A9473500105, A9473501005



DB-VB-7261

Length: 622 Ø: 46
Hole Ø 25 / 25 / 25
Hole Distance: 152 / 130 / 130
01337800A, 9443500305, 9443500505,
9443500605, 9473500705, 9473500905,
9483500405, 9483500305



DB-VB-10426

Length: 622 Ø: 46
Hole Ø 25 / 25 / 25
Hole Distance: 152 / 130 / 130
9443500405



MERCEDES-BENZ



ACTROS MP2 / MP3 ...

2636 LS ...	04/03→	Suspension Arm Repair Kit		DB-RK-8626	for Wishbone (CV)	
	04/03→	Suspension Arm Repair Kit		DB-RK-10374	for Wishbone (CV)	
	04/03→	Suspension Arm Repair Kit		DB-RK-10375	for Wishbone (CV)	
	04/03→	Suspension Arm Repair Kit	DB-RK-8638		for Control Arm	
	04/03→	Suspension Strut Repair Kit		DB-RK-8391		
	04/03→	Suspension Strut Repair Kit		DB-RK-9294		
	04/03→	Suspension Strut Repair Kit		MN-RK-8997		
	04/03→	Tie Rod	DB-DL-8327		Guide Rod	
	04/03→	Tie Rod	DB-DL-8388		Guide Rod	
	04/03→	Tie Rod	DB-DL-8389			
	04/03→	Tie Rod	DB-DL-8640		Guide Rod	
	04/03→	Tie Rod	DB-DL-12310			
	04/03→	Tie Rod	DB-ES-5227		Guide Rod	
	04/03→	Tie Rod End	CV-ES-0543		for Push Rod	
	04/03→	Tie Rod End	CV-ES-0888		for Push Rod	
	04/03→	Tie Rod End	CV-ES-14162		for Steering Rod	
	04/03→	Tie Rod End	CV-ES-14163		for Steering Rod	
	04/03→	Tie Rod End	DB-ES-5234		for Steering Rod	
	04/03→	Tie Rod End	DB-ES-8164		for Push Rod	
	04/03→	Tie Rod End	DB-ES-8530		for Push Rod	
	04/03→	Track Control Arm		DB-VB-3707	Suspension Rod, Wishbone (CV)	
	04/03→	Track Control Arm		DB-VB-7798	Wishbone (CV)	
	04/03→	Track Control Arm	DB-DL-5224		Control Arm, 1st FA;Air Suspension Axle; for vehicles with Rigid Leading Axle	
	04/03→	Track Control Arm	DB-DL-9218	DB-DL-9218	Trailing Arm, 1st FA;Air Suspension Axle; for vehicles with Rigid Leading Axle	
	10/09→	Centre Rod	DB-DL-12299		for Steering Rod	
	10/09→	Rod Assembly	DB-DL-2178		Guide Rod, 1st Front Axle, →504310 03	
	2636, L, LL	04/03→	Ball Head, gearshift linkage	DB-ES-8510		
		04/03→	Bush, driver cab suspension	DB-SB-10384		
		04/03→	Bush, parabolic spring		DB-SB-10400	
		04/03→	Bush, parabolic spring		DB-SB-10401	
		04/03→	Centre Rod	DB-DL-2144		Push Rod
		04/03→	Centre Rod	DB-DL-5230		Suspension Rod
		04/03→	Centre Rod	DB-DL-5241		Push Rod
04/03→		Centre Rod	DB-DL-5405		Push Rod	
04/03→		Centre Rod	DB-DL-5405		Push Rod, Leaf Spring Axle	
04/03→		Centre Rod	DB-DL-7270		Push Rod;Suspension Rod	
04/03→		Centre Rod	DB-DL-8167		Push Rod	
04/03→		Centre Rod	DB-DL-8168		Push Rod	
04/03→		Centre Rod	DB-DL-8184		Push Rod	
04/03→		Centre Rod	DB-DL-8185		Push Rod	
04/03→		Centre Rod	DB-DL-8307		Push Rod	
04/03→		Centre Rod	DB-DL-8622		Push Rod	
04/03→		Centre Rod	DB-DL-8641		Push Rod	
04/03→		Centre Rod	DB-DL-8642		Push Rod	
04/03→		Centre Rod	DB-DL-12300		for Steering Rod	
04/03→		Rod Assembly	DB-DL-2178		Guide Rod	
04/03→		Stabiliser Link	DB-DL-9254		Pressure Rod	
04/03→		Stabiliser Mounting		DB-SB-10406		
04/03→		Stabiliser Mounting		DB-SB-10409		
04/03→		Stabiliser Mounting	DB-SB-10410			
04/03→		Suspension Arm Repair Kit		DB-RK-8550	for Wishbone (CV)	
04/03→		Suspension Arm Repair Kit		DB-RK-8626	for Wishbone (CV)	
04/03→		Suspension Arm Repair Kit		DB-RK-10374	for Wishbone (CV)	
04/03→		Suspension Arm Repair Kit		DB-RK-10375	for Wishbone (CV)	
04/03→		Suspension Arm Repair Kit	DB-RK-8638		for Control Arm	
04/03→		Suspension Strut Repair Kit		DB-RK-8391		
04/03→		Suspension Strut Repair Kit		DB-RK-9294		
04/03→		Tie Rod	DB-DL-8327		Guide Rod	
04/03→		Tie Rod	DB-DL-8640		Guide Rod	
04/03→	Tie Rod	DB-DL-12310				
04/03→	Tie Rod	DB-ES-5227		Guide Rod		



ACTROS MP2 / MP3 ...

2636, L, LL ...	04/03→	Tie Rod End	CV-ES-0543		for Push Rod	
	04/03→	Tie Rod End	CV-ES-0888		for Push Rod	
	04/03→	Tie Rod End	CV-ES-14162		for Steering Rod	
	04/03→	Tie Rod End	CV-ES-14163		for Steering Rod	
	04/03→	Tie Rod End	DB-ES-5234		for Steering Rod	
	04/03→	Tie Rod End	DB-ES-8164		for Push Rod	
	04/03→	Tie Rod End	DB-ES-8530		for Push Rod	
	04/03→	Track Control Arm		DB-DL-3475	Trailing Arm	
	04/03→	Track Control Arm		DB-VB-3707	Suspension Rod, Wishbone (CV)	
	04/03→	Track Control Arm		DB-VB-7261	Suspension Rod, Wishbone (CV), 1st RA;2nd RA; Leaf Spring Axle	
	04/03→	Track Control Arm		DB-VB-10426	Wishbone (CV), Leaf Spring Axle;Unit	
	04/03→	Track Control Arm	DB-DL-5224		Control Arm, 1st FA;Air Suspension Axle	
	04/03→	Track Control Arm	DB-DL-9218	DB-DL-9218	Trailing Arm, 1st FA;Air Suspension Axle	
	2640 B	04/03→	Bush, parabolic spring		DB-SB-10400	
		04/03→	Bush, parabolic spring		DB-SB-10401	
04/03→		Centre Rod	DB-DL-2144		Push Rod	
04/03→		Centre Rod	DB-DL-5405		Push Rod	
04/03→		Centre Rod	DB-DL-7270		Push Rod	
04/03→		Centre Rod	DB-DL-8167		Push Rod	
04/03→		Rod Assembly	DB-DL-2178		Guide Rod, 1st Front Axle, →504310 03	
04/03→		Suspension Arm Repair Kit		DB-RK-8626	for Wishbone (CV)	
04/03→		Suspension Arm Repair Kit		DB-RK-10374	for Wishbone (CV)	
04/03→		Tie Rod	DB-DL-8327		Guide Rod	
04/03→		Tie Rod	DB-DL-8640		Guide Rod	
04/03→		Tie Rod End	CV-ES-0543		for Push Rod	
04/03→		Tie Rod End	CV-ES-0888		for Push Rod	
04/03→		Tie Rod End	CV-ES-14163		for Steering Rod	
04/03→		Tie Rod End	DB-ES-8164		for Push Rod	
04/03→		Tie Rod End	DB-ES-8530		for Push Rod	
04/03→		Track Control Arm		DB-DL-3475	Trailing Arm, 1st RA;2nd RA, →517144 05/517144 08	
04/03→		Track Control Arm		DB-VB-7261	Suspension Rod, Wishbone (CV)	
04/03→		Track Control Arm		DB-VB-10426	Wishbone (CV)	
2640 K, LK		04/03→	Bush, parabolic spring		DB-SB-10400	
		04/03→	Bush, parabolic spring		DB-SB-10401	
		04/03→	Centre Rod	DB-DL-2144		Push Rod
		04/03→	Centre Rod	DB-DL-5405		Push Rod
	04/03→	Centre Rod	DB-DL-7270		Push Rod	
	04/03→	Centre Rod	DB-DL-8167		Push Rod	
	04/03→	Rod Assembly	DB-DL-2178		Guide Rod, 1st Front Axle, →504310 03	
	04/03→	Suspension Arm Repair Kit		DB-RK-8626	for Wishbone (CV)	
	04/03→	Suspension Arm Repair Kit		DB-RK-10374	for Wishbone (CV)	
	04/03→	Tie Rod	DB-DL-8171		Guide Rod	
	04/03→	Tie Rod	DB-DL-8327		Guide Rod	
	04/03→	Tie Rod	DB-DL-8640		Guide Rod	
	04/03→	Tie Rod End	CV-ES-0543		for Push Rod	
	04/03→	Tie Rod End	CV-ES-0888		for Push Rod	
	04/03→	Tie Rod End	CV-ES-14163		for Steering Rod	
	04/03→	Tie Rod End	DB-ES-8164		for Push Rod	
	04/03→	Tie Rod End	DB-ES-8530		for Push Rod	
	04/03→	Track Control Arm		DB-DL-3475	Trailing Arm, 1st RA;2nd RA, →517144 03/517144 06	
	04/03→	Track Control Arm		DB-DL-3475	Trailing Arm, 1st RA;2nd RA, →517144 05/517144 08	
	04/03→	Track Control Arm		DB-DL-3475	Trailing Arm, 1st RA;2nd RA, →517144 07/517144 09	
	04/03→	Track Control Arm		DB-DL-3475	Trailing Arm, 1st RA;2nd RA, →517144 26/517144 27	
	04/03→	Track Control Arm		DB-VB-3707	Suspension Rod, Wishbone (CV)	
	04/03→	Track Control Arm		DB-VB-7261	Suspension Rod, Wishbone (CV)	
	04/03→	Track Control Arm		DB-VB-10426	Wishbone (CV)	

CV-ES-0543

Length: 125
Cone Ø: d1 Ø 32 / d2 Ø 29
Thread: M30 x 1,5 RHT
0004605748, 0004606048, 0004606848,
0004607048, 0014600448, 0014601148,
0014601748, 0014602448, 0014607648,
0014609648



CV-ES-0888

Length: 125
Cone Ø: d1 Ø 32 / d2 Ø 29
Thread: M30 x 1,5 LHT
0004605848, 0004606148, 0004606948,
0004607148, 0004609048, 0014600548,
0014601348, 0014602548, 0014607948,
0024600448



CV-ES-14162

Length: 125
Cone Ø: d1 Ø 30 / d2 Ø 27
Thread: M30 x 1,5 LHT
4600648, 4601248, 4603448, 0004603548,
14600348, 14601448, 14602348,
0014603748, 0014607848, 0024600348



CV-ES-14163

Length: 125
Cone Ø: d1 Ø 30 / d2 Ø 27
Thread: M30 x 1,5 RHT
0003305248, 0003387310, 0004600348,
0004600948, 0004602848, 0004602948,
0004608948, 0014600248, 0014600848,
0014601248, 0014602248, 0014607748,
0024600148, A0003387310, A0004600348,
A0004602848, A0004602948, A0014600548,
A0014601248, A0014602248, A0014607748



DB-DL-2144

Length: 872 Ø: 35
Cone Ø: d1 Ø 28,6 / d2 Ø 23,9
0024604305, 0024604405, 0034604805



DB-DL-2178

Length: 1735 Ø: 52
Cone Ø: d1 Ø 32 / d2 Ø 29
9423300003, 9423300103, 9423300203



DB-DL-3475

Length: 565 Ø: 52
Hole Distance: 152 / 152
3753500006, 3753500206, 9473500805,
9483500006, 9483500805, 9483501205,
9483501305, 9483501905, 9483502005,
9483502405, A3753500006,
A3753500206



DB-DL-5224

Length: 850 Ø: 60
Hole Distance: 100 / 100
01336100A, 9413300007



DB-DL-5405

Length: 890 Ø: 35
Cone Ø: d1 Ø 28,6 / d2 Ø 23,9
01215900A, 1460248, 0024604505,
0024604605, 0034605005, 3752600637,
3754600405, A3752600637, A3754600405



DB-DL-7270

Length: 875 Ø: 40
Cone Ø: d1 Ø 28,6 / d2 Ø 23,9
01208300A, 0024604705, 0024604805,
0034604905, A0024604705



DB-DL-8167

Length: 866 Ø: 38
Cone Ø: d1 Ø 30 / d2 Ø 27
0014609805, 0014609905, 0024606305,
0024606405



DB-DL-8171

Length: 1687 Ø: 52
Cone Ø: d1 Ø 32 / d2 Ø 29
9493300603, 9493300703, 9493301503,
9493301603



DB-DL-8327

Length: 1745 Ø: 48
Cone Ø: d1 Ø 32 / d2 Ø 29
01219800A, 9413300003, 9413300103,
9413300203, 9413300303, 9413300503



DB-DL-8640

Length: 1615 Ø: 50
Cone Ø: d1 Ø 32 / d2 Ø 29
6253301503, 6253301603, 6253302403,
6253302503, 9423300803, 9423302103,
9493300203, 9493300303, 9493300903



DB-DL-9218

Length: 754 Ø: 40
Hole Distance: 100
000360098524, 000390098524,
3753300111, 9413300011,
A3753300111, SA50831601



DB-ES-5234

Length: 135
Cone Ø: d1 Ø 38 / d2 Ø 34,3
Thread: M38 x 1,5 RHT
0004601748, 120322305, 2205000400



DB-ES-8164

Length: 140
Cone Ø: d1 Ø 28,6 / d2 Ø 23,9
Thread: M28 x 1,5 RHT
0014604248, 0014605048, 0014608548,
0024600548



DB-ES-8530

Length: 115
Cone Ø: d1 Ø 28,6 / d2 Ø 23,9
Thread: M30 x 1,5 RHT
0014603848, 0014604848, 0014605148,
0014608648, 0014609948



DB-RK-8626

Ø: 75 Hole Distance: 130
Thick/Height: 24
0003502205, 0003502505, 0003503405,
0003504505, GL11319



DB-RK-10374

Ø: 85 Hole Distance: 152
Thick/Height: 24
0003504405



DB-SB-10400

Length: 230
Thick/Height: 167,5 / 115
0003250696, 0003250896



DB-SB-10401

Length: 232
Thick/Height: 163,5 / 152,5
0003250596, 0003250796



DB-VB-3707

Length: 622 Ø: 46
Hole Ø 25 / 25 / 25
Hole Distance: 152 / 130 / 130
01337100A, 9423501005, 9423501505,
9443500005, 9473500105, 9473501005,
A3753500005, A9423501005, A9423501505,
A9443500005, A9473500105, A9473501005



DB-VB-7261

Length: 622 Ø: 46
Hole Ø 25 / 25 / 25
Hole Distance: 152 / 130 / 130
01337800A, 9443500305, 9443500505,
9443500605, 9473500705, 9473500905,
9483500405, 9483503005



DB-VB-10426

Length: 622 Ø: 46
Hole Ø 25 / 25 / 25
Hole Distance: 152 / 130 / 130
9443500405





ACTROS MP2 / MP3 ...

2640 L	04/03→	Centre Rod	DB-DL-2144		Push Rod	
	04/03→	Centre Rod	DB-DL-5405		Push Rod	
	04/03→	Centre Rod	DB-DL-7270		Push Rod	
	04/03→	Centre Rod	DB-DL-8167		Push Rod	
	04/03→	Centre Rod	DB-DL-8307		Push Rod	
	04/03→	Rod Assembly	DB-DL-2178		Guide Rod, 1st Front Axle, →504310 03	
	04/03→	Suspension Arm Repair Kit		DB-RK-8626	for Wishbone (CV)	
	04/03→	Suspension Arm Repair Kit		DB-RK-10374	for Wishbone (CV)	
	04/03→	Tie Rod	DB-DL-8640		Guide Rod	
	04/03→	Tie Rod End	CV-ES-0543		for Push Rod	
	04/03→	Tie Rod End	CV-ES-0888		for Push Rod	
	04/03→	Tie Rod End	CV-ES-14163		for Steering Rod	
	04/03→	Tie Rod End	DB-ES-8164		for Push Rod	
	04/03→	Tie Rod End	DB-ES-8530		for Push Rod	
	04/03→	Track Control Arm		DB-VB-3707	Suspension Rod, Wishbone (CV)	
	04/03→	Track Control Arm	DB-DL-5224		Control Arm	
	04/03→	Track Control Arm	DB-DL-9218	DB-DL-9218	Trailing Arm	
	2640 LS	10/02→	Centre Rod	DB-DL-2144		Push Rod
		10/02→	Centre Rod	DB-DL-5405		Push Rod
		10/02→	Centre Rod	DB-DL-7270		Push Rod
10/02→		Centre Rod	DB-DL-8167		Push Rod	
10/02→		Centre Rod	DB-DL-8307		Push Rod	
10/02→		Rod Assembly	DB-DL-2178		Guide Rod, 1st Front Axle, →504310 03	
10/02→		Suspension Arm Repair Kit		DB-RK-8626	for Wishbone (CV)	
10/02→		Suspension Arm Repair Kit		DB-RK-10374	for Wishbone (CV)	
10/02→		Tie Rod	DB-DL-8327		Guide Rod, 1st Front Axle	
10/02→		Tie Rod	DB-DL-8640		Guide Rod, 1st Front Axle	
10/02→		Tie Rod	DB-DL-12310			
10/02→		Tie Rod End	CV-ES-0543		for Push Rod	
10/02→		Tie Rod End	CV-ES-0888		for Push Rod	
10/02→		Tie Rod End	CV-ES-14163		for Steering Rod	
10/02→		Tie Rod End	DB-ES-8164		for Push Rod	
10/02→		Track Control Arm		DB-VB-3707	Suspension Rod, Wishbone (CV)	
10/09→		Tie Rod	DB-DL-8640		Guide Rod	
2641 B		04/03→	Ball Head, gearshift linkage	DB-ES-8510		
		04/03→	Bush, driver cab suspension	DB-SB-10384		
		04/03→	Bush, parabolic spring		DB-SB-10400	
	04/03→	Bush, parabolic spring		DB-SB-10401		
	04/03→	Centre Rod	DB-DL-2144		Push Rod	
	04/03→	Centre Rod	DB-DL-5230		Suspension Rod	
	04/03→	Centre Rod	DB-DL-5241		Push Rod	
	04/03→	Centre Rod	DB-DL-5405		Push Rod, Leaf Spring Axle	
	04/03→	Centre Rod	DB-DL-7270		Push Rod	
	04/03→	Centre Rod	DB-DL-8167		Push Rod	
	04/03→	Centre Rod	DB-DL-8184		Push Rod	
	04/03→	Centre Rod	DB-DL-8185		Push Rod	
	04/03→	Centre Rod	DB-DL-8307		Push Rod	
	04/03→	Centre Rod	DB-DL-12300		for Steering Rod	
	04/03→	Rod Assembly	DB-DL-2178		Guide Rod, 1st Front Axle, →504310 03	
	04/03→	Stabiliser Mounting		DB-SB-10406		
	04/03→	Stabiliser Mounting		DB-SB-10409		
	04/03→	Suspension Arm Repair Kit		DB-RK-8550	for Wishbone (CV)	
	04/03→	Suspension Arm Repair Kit		DB-RK-8626	for Wishbone (CV)	
	04/03→	Suspension Arm Repair Kit		DB-RK-10374	for Wishbone (CV)	
	04/03→	Suspension Arm Repair Kit	DB-RK-8638		for Control Arm	
	04/03→	Suspension Strut Repair Kit		DB-RK-8391		
	04/03→	Suspension Strut Repair Kit		DB-RK-9294		
	04/03→	Tie Rod	DB-DL-8327		Guide Rod	
	04/03→	Tie Rod	DB-DL-8640		Guide Rod	
	04/03→	Tie Rod	DB-DL-12310			
	04/03→	Tie Rod End	CV-ES-0543		for Push Rod	
	04/03→	Tie Rod End	CV-ES-0888		for Push Rod	
	04/03→	Tie Rod End	CV-ES-14163		for Steering Rod	

CV-ES-0543

Length: 125
 Cone Ø: d1 Ø 32 / d2 Ø 29
 Thread: M30 x 1,5 RHT
 0004605748, 0004606048, 0004606848,
 0004607048, 0014600448, 0014601148,
 0014601748, 0014602448, 0014607648,
 0014609648

**CV-ES-0888**

Length: 125
 Cone Ø: d1 Ø 32 / d2 Ø 29
 Thread: M30 x 1,5 LHT
 0004605848, 0004606148, 0004606948,
 0004607148, 0004609048, 0014600548,
 0014601348, 0014602548, 0014607948,
 0024600448

**CV-ES-14163**

Length: 125
 Cone Ø: d1 Ø 30 / d2 Ø 27
 Thread: M30 x 1,5 RHT
 0003305248, 0003387310, 0004600348,
 0004600948, 0004602848, 0004602948,
 0004608948, 0014600248, 0014600848,
 0014601248, 0014602248, 0014607748,
 0024600148, A0003387310, A0004600348,
 A0004602848, A0004602948, A0014600848,
 A0014601248, A0014602248, A0014607748

**DB-DL-2144**

Length: 872 Ø: 35
 Cone Ø: d1 Ø 28,6 / d2 Ø 23,9
 0024604305, 0024604405, 0034604805

**DB-DL-2178**

Length: 1735 Ø: 52
 Cone Ø: d1 Ø 32 / d2 Ø 29
 9423300003, 9423300103, 9423300203

**DB-DL-5224**

Length: 850 Ø: 60
 Hole Distance: 100 / 100
 01336100A, 9413300007

**DB-DL-5230**

Length: 879 Ø: 42
 Cone Ø: d1 Ø 30 / d2 Ø 27
 01208600A, 0004607105, 0004607205,
 0014606705

**DB-DL-5241**

Length: 875 Ø: 40
 Cone Ø: d1 Ø 30 / d2 Ø 27
 01215300A, 0004609205, 0004609305,
 0014606905

**DB-DL-5405**

Length: 890 Ø: 35
 Cone Ø: d1 Ø 28,6 / d2 Ø 23,9
 01215900A, 1460248, 0024604505,
 0024604605, 0034605005, 3752600637,
 3754600405, A3752600637, A3754600405

**DB-DL-7270**

Length: 875 Ø: 40
 Cone Ø: d1 Ø 28,6 / d2 Ø 23,9
 01208300A, 0024604705, 0024604805,
 0034604905, A0024604705

**DB-DL-8167**

Length: 866 Ø: 38
 Cone Ø: d1 Ø 30 / d2 Ø 27
 0014609805, 0014609905, 0024606305,
 0024606405

**DB-DL-8184**

Length: 1095 Ø: 42
 Cone Ø: d1 Ø 32 / d2 Ø 28,8
 01217700A, 0014601305, 0014601405,
 0024600505, 0034603205, 3754601505,
 A0014601305, A0014601405, A0024600505

**DB-DL-8185**

Length: 711 Ø: 42
 Cone Ø: d1 Ø 32 / d2 Ø 28,8
 01213600A, 0014601105, 0024600405,
 0034603105, A0014601105, A0024600405

**DB-DL-8307**

Length: 885 Ø: 38
 Cone Ø: d1 Ø 32 / d2 Ø 30
 01215500A, 0004604005, 0024605105,
 0024605205, 0034604005

**DB-DL-8327**

Length: 1745 Ø: 48
 Cone Ø: d1 Ø 32 / d2 Ø 29
 01219800A, 9413300003, 9413300103,
 9413300203, 9413300303, 9413300503

**DB-DL-8640**

Length: 1615 Ø: 50
 Cone Ø: d1 Ø 32 / d2 Ø 29
 6253301503, 6253301603, 6253302403,
 6253302503, 9423300803, 9423302103,
 9493300203, 9493300303, 9493300903

**DB-DL-9218**

Length: 754 Ø: 40
 Hole Distance: 100
 000360098524, 000390098524,
 3753300111, 9413300011,
 A3753300111, SA50831601

**DB-DL-12300**

Length: 733 Ø: 36
 Cone Ø: d1 Ø 32 / d2 Ø 29
 0014601505, 0014607305, 0034603305,
 3754601605, A0014601505,
 A0034603305, A3754601605

**DB-DL-12310**

Length: 1532 Ø: 50
 Cone Ø: d1 Ø 32 / d2 Ø 29
 Thread: M27 x 1,5 LHT
 9493301203, 9493301303, 9493301803,
 9493302203, A9493301203, A9493301303,
 A9493301803, A9493302203

**DB-ES-8164**

Length: 140
 Cone Ø: d1 Ø 28,6 / d2 Ø 23,9
 Thread: M28 x 1,5 RHT
 0014604248, 0014605048, 0014608548,
 0024600548

**DB-ES-8510**

Length: 56
 Cone Ø: d1 Ø 10 / d2 Ø 10
 Thread: M12 x 1,75 LHT
 0009965145, 0009965645, 0019963145

**DB-ES-8530**

Length: 115
 Cone Ø: d1 Ø 28,6 / d2 Ø 23,9
 Thread: M30 x 1,5 RHT
 0014603848, 0014604848, 0014605148,
 0014608648, 0014609948

**DB-RK-8391**

Ø: 85 Hole Distance: 152
 Thick/Height: 24
 01336800A, 0003502705

**DB-RK-8550**

Ø: 75 Hole Distance: 152
 Thick/Height: 24
 0003502105, 0003504605

**DB-RK-8626**

Ø: 75 Hole Distance: 130
 Thick/Height: 24
 0003502205, 0003502505, 0003503405,
 0003504505, GL11319

**DB-RK-8638**

Length: 100 Ø: 67
 Hole Distance: 100
 Thick/Height: 20
 0003301411

**DB-RK-9294**

Ø: 85 Hole Distance: 152
 Thick/Height: 24
 0003503105

**DB-RK-10374**

Ø: 85 Hole Distance: 152
 Thick/Height: 24
 0003504405

**DB-SB-10384**

Ø: 73 Thick/Height: 47
 9303170012, 9423171812

**DB-SB-10400**

Length: 230
 Thick/Height: 167,5 / 115
 0003250696, 0003250896

**DB-SB-10401**

Length: 232
 Thick/Height: 163,5 / 152,5
 0003250596, 0003250796

**DB-SB-10406**

Ø: 80 Thick/Height: 46
 0003238185

**DB-SB-10409**

Ø: 77 Thick/Height: 56
 0003265181

**DB-VB-3707**

Length: 622 Ø: 46
 Hole Ø 25 / 25 / 25
 Hole Distance: 152 / 130 / 130
 01337100A, 9423501005, 9423501505,
 9443500005, 9473500105, 9473501005,
 A3753500005, A9423501005, A9423501505,
 A9443500005, A9473500105, A9473501005





ACTROS MP2 / MP3 ...

2641 B ...	04/03→	Tie Rod End	DB-ES-5234		for Steering Rod	
	04/03→	Tie Rod End	DB-ES-8164		for Push Rod	
	04/03→	Tie Rod End	DB-ES-8530		for Push Rod	
	04/03→	Track Control Arm		DB-DL-3475	Trailing Arm	
	04/03→	Track Control Arm		DB-VB-3707	Suspension Rod, Wishbone (CV)	
	04/03→	Track Control Arm		DB-VB-7261	Suspension Rod, Wishbone (CV), 1st RA;2nd RA; Leaf Spring Axle	
	04/03→	Track Control Arm		DB-VB-10426	Wishbone (CV), Leaf Spring Axle;Unit	
2641 K, LK	04/03→	Ball Head, gearshift linkage	DB-ES-8510			
	04/03→	Bush, driver cab suspension	DB-SB-10384			
	04/03→	Bush, parabolic spring		DB-SB-10400		
	04/03→	Bush, parabolic spring		DB-SB-10401		
	04/03→	Centre Rod	DB-DL-2144		Push Rod	
	04/03→	Centre Rod	DB-DL-5230		Suspension Rod	
	04/03→	Centre Rod	DB-DL-5241		Push Rod	
	04/03→	Centre Rod	DB-DL-5405		Push Rod	
	04/03→	Centre Rod	DB-DL-5405		Push Rod, Leaf Spring Axle	
	04/03→	Centre Rod	DB-DL-7270		Push Rod	
	04/03→	Centre Rod	DB-DL-8167		Push Rod	
	04/03→	Centre Rod	DB-DL-8184		Push Rod	
	04/03→	Centre Rod	DB-DL-8185		Push Rod	
	04/03→	Centre Rod	DB-DL-8307		Push Rod	
	04/03→	Centre Rod	DB-DL-12300		for Steering Rod	
	04/03→	Rod Assembly	DB-DL-2178		Guide Rod	
	04/03→	Stabiliser Mounting		DB-RK-9296		
	04/03→	Stabiliser Mounting		DB-SB-10406		
	04/03→	Stabiliser Mounting		DB-SB-10409		
	04/03→	Suspension Arm Repair Kit		DB-RK-8550	for Wishbone (CV)	
	04/03→	Suspension Arm Repair Kit		DB-RK-8626	for Wishbone (CV)	
	04/03→	Suspension Arm Repair Kit		DB-RK-10374	for Wishbone (CV)	
	04/03→	Suspension Arm Repair Kit		DB-RK-10375	for Wishbone (CV)	
	04/03→	Suspension Arm Repair Kit	DB-RK-8638		for Control Arm	
	04/03→	Suspension Strut Repair Kit		DB-RK-8391		
	04/03→	Suspension Strut Repair Kit		DB-RK-9294		
	04/03→	Tie Rod	DB-DL-8171		Guide Rod	
	04/03→	Tie Rod	DB-DL-8327		Guide Rod	
	04/03→	Tie Rod	DB-DL-8640		Guide Rod	
	04/03→	Tie Rod	DB-DL-12310			
	04/03→	Tie Rod	DB-ES-5227		Guide Rod	
	04/03→	Tie Rod End	CV-ES-0543		for Push Rod	
	04/03→	Tie Rod End	CV-ES-0888		for Push Rod	
	04/03→	Tie Rod End	CV-ES-14162		for Steering Rod	
	04/03→	Tie Rod End	CV-ES-14163		for Steering Rod	
	04/03→	Tie Rod End	DB-ES-5234		for Steering Rod	
	04/03→	Tie Rod End	DB-ES-8164		for Push Rod	
	04/03→	Tie Rod End	DB-ES-8530		for Push Rod	
	04/03→	Track Control Arm		DB-DL-3475	Trailing Arm	
	04/03→	Track Control Arm		DB-VB-3707	Suspension Rod, Wishbone (CV)	
	04/03→	Track Control Arm		DB-VB-7261	Suspension Rod, Wishbone (CV), 1st RA;2nd RA; Leaf Spring Axle	
	04/03→	Track Control Arm		DB-VB-10426	Wishbone (CV), Leaf Spring Axle;Unit	
	2641 LS	10/09→	Centre Rod	DB-DL-2144		Push Rod
		10/09→	Centre Rod	DB-DL-8167		Push Rod
		10/09→	Rod Assembly	DB-DL-2178		Guide Rod, 1st Front Axle, →504310 03
		10/09→	Suspension Arm Repair Kit		DB-RK-8626	for Wishbone (CV)
		10/09→	Suspension Arm Repair Kit		DB-RK-10374	for Wishbone (CV)
10/09→		Tie Rod	DB-DL-8640		Guide Rod	
10/09→		Tie Rod	DB-DL-12310			
10/09→		Tie Rod End	CV-ES-0543		for Push Rod	
10/09→		Tie Rod End	CV-ES-0888		for Push Rod	
10/09→		Tie Rod End	CV-ES-14163		for Steering Rod	
10/09→		Tie Rod End	DB-ES-8164		for Push Rod	
10/09→		Track Control Arm		DB-VB-3707	Suspension Rod, Wishbone (CV)	

CV-ES-0543

Length: 125
Cone Ø: d1 Ø 32 / d2 Ø 29
Thread: M30 x 1,5 RHT
0004605748, 0004606048, 0004606848,
0004607048, 0014600448, 0014601148,
0014601748, 0014602448, 0014607648,
0014609648



CV-ES-0888

Length: 125
Cone Ø: d1 Ø 32 / d2 Ø 29
Thread: M30 x 1,5 LHT
0004605848, 0004606148, 0004606948,
0004607148, 0004609048, 0014600548,
0014601348, 0014602548, 0014607948,
0024600448



CV-ES-14162

Length: 125
Cone Ø: d1 Ø 30 / d2 Ø 27
Thread: M30 x 1,5 LHT
4600648, 4601248, 4603448, 0004603548,
14600348, 14601448, 14602348,
0014603748, 0014607848, 0024600348



CV-ES-14163

Length: 125
Cone Ø: d1 Ø 30 / d2 Ø 27
Thread: M30 x 1,5 RHT
0003305248, 0003387310, 0004600348,
0004600948, 0004602848, 0004602948,
0004608948, 0014600248, 0014600848,
0014601248, 0014602248, 0014607748,
0024600148, 0003387310, 0004600348,
0004602848, 0004602948, 0014600848,
0014601248, 0014602248, 0014607748



DB-DL-2144

Length: 872 Ø: 35
Cone Ø: d1 Ø 28,6 / d2 Ø 23,9
0024604305, 0024604405, 0034604805



DB-DL-2178

Length: 1735 Ø: 52
Cone Ø: d1 Ø 32 / d2 Ø 29
9423300003, 9423300103, 9423300203



DB-DL-3475

Length: 565 Ø: 52
Hole Distance: 152 / 152
3753500006, 3753500206, 9473500805,
9483500006, 9483500805, 9483501205,
9483501305, 9483501905, 9483502005,
9483502405, A3753500006,
A3753500206



DB-DL-5230

Length: 879 Ø: 42
Cone Ø: d1 Ø 30 / d2 Ø 27
01208600A, 0004607105, 0004607205,
0014606705



DB-DL-5241

Length: 875 Ø: 40
Cone Ø: d1 Ø 30 / d2 Ø 27
01215900A, 0004609205, 0004609305,
0014606905



DB-DL-5405

Length: 890 Ø: 35
Cone Ø: d1 Ø 28,6 / d2 Ø 23,9
01215900A, 1460248, 0024604505,
0024604605, 0034605005, 3752600637,
3754600405, A3752600637, A3754600405



DB-DL-7270

Length: 875 Ø: 40
Cone Ø: d1 Ø 28,6 / d2 Ø 23,9
01208300A, 0024604705, 0024604805,
0034604905, A0024604705



DB-DL-8167

Length: 866 Ø: 38
Cone Ø: d1 Ø 30 / d2 Ø 27
0014609805, 0014609905, 0024606305,
0024606405



DB-DL-8171

Length: 1687 Ø: 52
Cone Ø: d1 Ø 32 / d2 Ø 29
9493300603, 9493300703, 9493301503,
9493301603



DB-DL-8184

Length: 1095 Ø: 42
Cone Ø: d1 Ø 32 / d2 Ø 28,8
01217700A, 0014601305, 0014601405,
0024600505, 0034603205, 3754601505,
A0014601305, A0014601405, A0024600505



DB-DL-8185

Length: 711 Ø: 42
Cone Ø: d1 Ø 32 / d2 Ø 28,8
01213600A, 0014601105, 0024600405,
0034603105, A0014601105, A0024600405



DB-DL-8307

Length: 885 Ø: 38
Cone Ø: d1 Ø 32 / d2 Ø 30
01215500A, 0004604005, 0024605105,
0024605205, 0034604005



DB-DL-8327

Length: 1745 Ø: 48
Cone Ø: d1 Ø 32 / d2 Ø 29
01219800A, 9413300003, 9413300103,
9413300203, 9413300303, 9413300503



DB-DL-8640

Length: 1615 Ø: 50
Cone Ø: d1 Ø 32 / d2 Ø 29
6253301503, 6253301603, 6253302403,
6253302503, 9423300803, 9423302103,
9493300203, 9493300303, 9493300903



DB-DL-12300

Length: 733 Ø: 36
Cone Ø: d1 Ø 32 / d2 Ø 29
0014601505, 0014607305, 0034603305,
3754601605, A0014601505,
A0034603305, A3754601605



DB-DL-12310

Length: 1532 Ø: 50
Cone Ø: d1 Ø 32 / d2 Ø 29
Thread: M27 x 1,5 LHT
9493301203, 9493301303, 9493301803,
9493302203, A9493301203, A9493301303,
A9493301803, A9493302203



DB-ES-5227

Length: 1588 Ø: 60
Cone Ø: d1 Ø 38 / d2 Ø 34,3
6253300903, 6253301203, 9443300203



DB-ES-5234

Length: 135
Cone Ø: d1 Ø 38 / d2 Ø 34,3
Thread: M38 x 1,5 RHT
0004601748, 120322305, 2205000400



DB-ES-8164

Length: 140
Cone Ø: d1 Ø 28,6 / d2 Ø 23,9
Thread: M28 x 1,5 RHT
0014604248, 0014605048, 0014608548,
0024600548



DB-ES-8510

Length: 56
Cone Ø: d1 Ø 10 / d2 Ø 10
Thread: M12 x 1,75 LHT
0009965145, 0009965645, 0019963145



DB-ES-8530

Length: 115
Cone Ø: d1 Ø 28,6 / d2 Ø 23,9
Thread: M30 x 1,5 RHT
0014603848, 0014604848, 0014605148,
0014608648, 0014609948



DB-RK-8391

Ø: 85 Hole Distance: 152
Thick/Height: 24
01336800A, 0003502705



DB-RK-8550

Ø: 75 Hole Distance: 152
Thick/Height: 24
0003502105, 0003504605



DB-RK-8626

Ø: 75 Hole Distance: 130
Thick/Height: 24
0003502205, 0003502505, 0003503405,
0003504505, GL11319



DB-RK-8638

Length: 100 Ø: 67
Hole Distance: 100
Thick/Height: 20
0003301411



DB-RK-9294

Ø: 85 Hole Distance: 152
Thick/Height: 24
0003503105



DB-RK-9296

Ø: 88 Hole Distance: 130
Thick/Height: 24
9423260050



DB-RK-10374

Ø: 85 Hole Distance: 152
Thick/Height: 24
0003504405



DB-RK-10375

Ø: 100 Hole Distance: 152
Thick/Height: 24
0003502405, 0003503505, 0003504905



DB-SB-10384

Ø: 73 Thick/Height: 47
9303170012, 9423171812



DB-SB-10400

Length: 230
Thick/Height: 167,5 / 115
0003250696, 0003250896



DB-SB-10401

Length: 232
Thick/Height: 163,5 / 152,5
0003250596, 0003250796



DB-SB-10406

Ø: 80 Thick/Height: 46
0003238185



DB-SB-10409

Ø: 77 Thick/Height: 56
0003265181



DB-VB-3707

Length: 622 Ø: 46
Hole Ø 25 / 25 / 25
Hole Distance: 152 / 130 / 130
01337100A, 9423501005, 9423501505,
9443500005, 9473500105, 9473501005,
A3753500005, A9423501005, A9423501505,
A9443500005, A9473500105, A9473501005



DB-VB-7261

Length: 622 Ø: 46
Hole Ø 25 / 25 / 25
Hole Distance: 152 / 130 / 130
01337800A, 9443500305, 9443500505,
9443500605, 9473500705, 9473500905,
9483500405, 9483500305



DB-VB-10426

Length: 622 Ø: 46
Hole Ø 25 / 25 / 25
Hole Distance: 152 / 130 / 130
9443500405



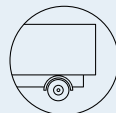

ACTROS MP2 / MP3 ...

2641 S, LS	04/03→	Ball Head, gearshift linkage	DB-ES-8510		
	04/03→	Bush, driver cab suspension	DB-SB-10384		
	04/03→	Bush, parabolic spring		DB-SB-10400	
	04/03→	Bush, parabolic spring		DB-SB-10401	
	04/03→	Centre Rod	DB-DL-2144		Push Rod
	04/03→	Centre Rod	DB-DL-5230		Suspension Rod
	04/03→	Centre Rod	DB-DL-5241		Push Rod
	04/03→	Centre Rod	DB-DL-5405		Push Rod
	04/03→	Centre Rod	DB-DL-5405		Push Rod, for vehicles with Rigid Leading Axle
	04/03→	Centre Rod	DB-DL-5405		Push Rod, Leaf Spring Axle
	04/03→	Centre Rod	DB-DL-7270		Push Rod
	04/03→	Centre Rod	DB-DL-8167		Push Rod
	04/03→	Centre Rod	DB-DL-8184		Push Rod
	04/03→	Centre Rod	DB-DL-8185		Push Rod
	04/03→	Centre Rod	DB-DL-8307		Push Rod
	04/03→	Centre Rod	DB-DL-12300		for Steering Rod
	04/03→	Centre Rod	DB-DL-12470		Push Rod
	04/03→	Rod Assembly	DB-DL-2178		Guide Rod
	04/03→	Stabiliser Mounting		DB-SB-10406	
	04/03→	Stabiliser Mounting		DB-SB-10409	
	04/03→	Stabiliser Mounting	DB-SB-10410		
	04/03→	Suspension Arm Repair Kit		DB-RK-8550	for Wishbone (CV)
	04/03→	Suspension Arm Repair Kit		DB-RK-8626	for Wishbone (CV)
	04/03→	Suspension Arm Repair Kit		DB-RK-10374	for Wishbone (CV)
	04/03→	Suspension Arm Repair Kit		DB-RK-10375	for Wishbone (CV)
	04/03→	Suspension Arm Repair Kit	DB-RK-8638		for Control Arm
	04/03→	Suspension Strut Repair Kit		DB-RK-8391	
	04/03→	Suspension Strut Repair Kit		DB-RK-9294	
	04/03→	Suspension Strut Repair Kit		MN-RK-8997	
	04/03→	Tie Rod	DB-DL-8171		Guide Rod
	04/03→	Tie Rod	DB-DL-8327		Guide Rod
	04/03→	Tie Rod	DB-DL-8388		Guide Rod
	04/03→	Tie Rod	DB-DL-8389		
	04/03→	Tie Rod	DB-DL-8640		Guide Rod
	04/03→	Tie Rod	DB-DL-12310		
	04/03→	Tie Rod	DB-ES-5227		Guide Rod
	04/03→	Tie Rod End	CV-ES-0543		for Push Rod
	04/03→	Tie Rod End	CV-ES-0888		for Push Rod
	04/03→	Tie Rod End	CV-ES-14162		for Steering Rod
	04/03→	Tie Rod End	CV-ES-14163		for Steering Rod
	04/03→	Tie Rod End	DB-ES-5234		for Steering Rod
	04/03→	Tie Rod End	DB-ES-8164		for Push Rod
	04/03→	Tie Rod End	DB-ES-8530		for Push Rod
	04/03→	Track Control Arm		DB-DL-3475	Trailing Arm
	04/03→	Track Control Arm		DB-VB-3707	Suspension Rod, Wishbone (CV)
	04/03→	Track Control Arm		DB-VB-7261	Suspension Rod, Wishbone (CV), 1st RA;2nd RA; Leaf Spring Axle
	04/03→	Track Control Arm		DB-VB-7798	Wishbone (CV)
04/03→	Track Control Arm		DB-VB-10426	Wishbone (CV), Leaf Spring Axle;Unit	
04/03→	Track Control Arm	DB-DL-5224		Control Arm, 1st FA;Air Suspension Axle; for vehicles with Rigid Leading Axle	
04/03→	Track Control Arm	DB-DL-9218	DB-DL-9218	Trailing Arm, 1st FA;Air Suspension Axle; for vehicles with Rigid Leading Axle	
2641, L, LL	04/03→	Ball Head, gearshift linkage	DB-ES-8510		
	04/03→	Bush, driver cab suspension	DB-SB-10384		
	04/03→	Bush, parabolic spring		DB-SB-10400	
	04/03→	Bush, parabolic spring		DB-SB-10401	
	04/03→	Centre Rod	DB-DL-2144		Push Rod
	04/03→	Centre Rod	DB-DL-5230		Suspension Rod
	04/03→	Centre Rod	DB-DL-5241		Push Rod
	04/03→	Centre Rod	DB-DL-5405		Push Rod
04/03→	Centre Rod	DB-DL-5405		Push Rod, 1st FA;Leaf Spring Axle	
04/03→	Centre Rod	DB-DL-7270		Push Rod;Suspension Rod	

CV-ES-0543

Length: 125
Cone Ø: d1 Ø 32 / d2 Ø 29
Thread: M30 x 1,5 RHT
0004605748, 0004606048, 0004606848,
0004607048, 0014600448, 0014601148,
0014601748, 0014602448, 0014607648,
0014609648



CV-ES-0888

Length: 125
Cone Ø: d1 Ø 32 / d2 Ø 29
Thread: M30 x 1,5 LHT
0004605848, 0004606148, 0004606948,
0004607148, 0004609048, 0014600548,
0014601348, 0014602548, 0014607948,
0024600448



CV-ES-14162

Length: 125
Cone Ø: d1 Ø 30 / d2 Ø 27
Thread: M30 x 1,5 LHT
4600648, 4601248, 4603448, 0004603548,
14600348, 14601448, 14602348,
0014603748, 0014607848, 0024600348



CV-ES-14163

Length: 125
Cone Ø: d1 Ø 30 / d2 Ø 27
Thread: M30 x 1,5 RHT
0003305248, 0003387310, 0004600348,
0004600948, 0004602848, 0004602948,
0004608948, 0014600248, 0014600848,
0014601248, 0014602248, 0014607748,
0024600148, A0003387310, A0004600348,
A0004602848, A0004602948, A0014600848,
A0014601248, A0014602248, A0014607748



DB-DL-2144

Length: 872 Ø: 35
Cone Ø: d1 Ø 28,6 / d2 Ø 23,9
0024604305, 0024604405, 0034604805



DB-DL-2178

Length: 1735 Ø: 52
Cone Ø: d1 Ø 32 / d2 Ø 29
9423300003, 9423300103, 9423300203



DB-DL-3475

Length: 565 Ø: 52
Hole Distance: 152 / 152
3753500006, 3753500206, 9473500805,
9483500006, 9483500805, 9483501205,
9483501305, 9483501905, 9483502005,
9483502405, A3753500006,
A3753500206



DB-DL-5224

Length: 850 Ø: 60
Hole Distance: 100 / 100
01336100A, 9413300007



DB-DL-5230

Length: 879 Ø: 42
Cone Ø: d1 Ø 30 / d2 Ø 27
01208600A, 0004607105, 0004607205,
0014606705



DB-DL-5241

Length: 875 Ø: 40
Cone Ø: d1 Ø 30 / d2 Ø 27
01215300A, 0004609205, 0004609305,
0014606905



DB-DL-5405

Length: 890 Ø: 35
Cone Ø: d1 Ø 28,6 / d2 Ø 23,9
01215900A, 1460248, 0024604505,
0024604605, 0034605005, 3752600637,
3754600405, A3752600637, A3754600405



DB-DL-7270

Length: 875 Ø: 40
Cone Ø: d1 Ø 28,6 / d2 Ø 23,9
01208300A, 0024604705, 0024604805,
0034604905, A0024604705



DB-DL-8167

Length: 866 Ø: 38
Cone Ø: d1 Ø 30 / d2 Ø 27
0014609805, 0014609905, 0024606305,
0024606405



DB-DL-8171

Length: 1687 Ø: 52
Cone Ø: d1 Ø 32 / d2 Ø 29
9493300603, 9493300703, 9493301503,
9493301603



DB-DL-8184

Length: 1095 Ø: 42
Cone Ø: d1 Ø 32 / d2 Ø 28,8
01217700A, 0014601105, 0014601405,
0024600505, 0034603205, 3754601505,
A0014601305, A0014601405, A0024600505



DB-DL-8185

Length: 711 Ø: 42
Cone Ø: d1 Ø 32 / d2 Ø 28,8
01213600A, 0014601105, 0024600405,
0034603105, A0014601105, A0024600405



DB-DL-8307

Length: 885 Ø: 38
Cone Ø: d1 Ø 32 / d2 Ø 30
01215500A, 0004604005, 0024605105,
0024605205, 0034604005



DB-DL-8327

Length: 1745 Ø: 48
Cone Ø: d1 Ø 32 / d2 Ø 29
01219800A, 9413300003, 9413300103,
9413300203, 9413300303, 9413300503



DB-DL-8388

Length: 1735 Ø: 62
Cone Ø: d1 Ø 32 / d2 Ø 28,8
01219900A, 9453300003, 9453300103,
9453300403, 9453300603, A9453300003



DB-DL-8389

Length: 1465 Ø: 40
Cone Ø: d1 Ø 32 / d2 Ø 29
9453300203, 9453300303, 9453300503



DB-DL-8640

Length: 1615 Ø: 50
Cone Ø: d1 Ø 32 / d2 Ø 29
6253301503, 6253301603, 6253302403,
6253302503, 9423300803, 9423302103,
9493300203, 9493300303, 9493300903



DB-DL-9218

Length: 754 Ø: 40
Hole Distance: 100
000360098524, 000390098524,
3753300111, 9413300011,
A3753300111, SA50831601



DB-DL-12300

Length: 733 Ø: 36
Cone Ø: d1 Ø 32 / d2 Ø 29
0014601505, 0014607305, 0034603305,
3754601605, A0014601505,
A0034603305, A3754601605



DB-DL-12310

Length: 1532 Ø: 50
Cone Ø: d1 Ø 32 / d2 Ø 29
Thread: M27 x 1,5 LHT
9493301203, 9493301303, 9493301803,
9493302203, A9493301203, A9493301303,
A9493301803, A9493302203



DB-DL-12470

Length: 723 Ø: 42
Cone Ø: d1 Ø 30 / d2 Ø 27
A0014607505, A0024600905



No Image

DB-ES-5227

Length: 1588 Ø: 60
Cone Ø: d1 Ø 38 / d2 Ø 34,3
6253300903, 6253301203, 9443300203



DB-ES-5234

Length: 135
Cone Ø: d1 Ø 38 / d2 Ø 34,3
Thread: M38 x 1,5 RHT
0004601748, 120322305, 2205000400



DB-ES-8164

Length: 140
Cone Ø: d1 Ø 28,6 / d2 Ø 23,9
Thread: M28 x 1,5 RHT
0014604248, 0014605048, 0014608548,
0024600548



DB-ES-8510

Length: 56
Cone Ø: d1 Ø 10 / d2 Ø 10
Thread: M12 x 1,75 LHT
0009965145, 0009965645, 0019963145



DB-ES-8530

Length: 115
Cone Ø: d1 Ø 28,6 / d2 Ø 23,9
Thread: M30 x 1,5 RHT
0014603848, 0014604848, 0014605148,
0014608648, 0014609948



DB-RK-8391

Ø: 85 Hole Distance: 152
Thick/Height: 24
01336800A, 0003502705



DB-RK-8550

Ø: 75 Hole Distance: 152
Thick/Height: 24
0003502105, 0003504605



DB-RK-8626

Ø: 75 Hole Distance: 130
Thick/Height: 24
0003502205, 0003502505, 0003503405,
0003504505, GL11319



DB-RK-8638

Length: 100 Ø: 67
Hole Distance: 100
Thick/Height: 20
0003301411



DB-RK-9294

Ø: 85 Hole Distance: 152
Thick/Height: 24
0003503105



DB-RK-10374

Ø: 85 Hole Distance: 152
Thick/Height: 24
0003504405



DB-RK-10375

Ø: 100 Hole Distance: 152
Thick/Height: 24
0003502405, 0003503505, 0003504905



DB-SB-10384

Ø: 73 Thick/Height: 47
9303170012, 9423171812



DB-SB-10400

Length: 230
Thick/Height: 167,5 / 115
0003250696, 0003250896



DB-SB-10401

Length: 232
Thick/Height: 163,5 / 152,5
0003250596, 0003250796



DB-SB-10406

Ø: 80 Thick/Height: 46
0003238185



DB-SB-10409

Ø: 77 Thick/Height: 56
0003265181



DB-SB-10410

Ø: 73 Hole Distance: 100
Thick/Height: 24
9413230050



DB-VB-3707

Length: 622 Ø: 46
Hole Ø 25 / 25 / 25
Hole Distance: 152 / 130 / 130
01337100A, 9423501005, 9423501505,
9443500005, 9473500105, 9473501005,
A3753500005, A9423501005, A9423501505,
A9443500005, A9473500105, A9473501005



DB-VB-7261

Length: 622 Ø: 46
Hole Ø 25 / 25 / 25
Hole Distance: 152 / 130 / 130
01337800A, 9443500305, 9443500505,
9443500605, 9473500705, 9473500905,
9483500405, 9483503005



DB-VB-7798

Length: 622 Ø: 48
Hole Ø 25 / 23 / 23
Hole Distance: 152 / 130 / 130
9423500505, 9423500805, 9423501205,
A9423501205



DB-VB-10426

Length: 622 Ø: 46
Hole Ø 25 / 25 / 25
Hole Distance: 152 / 130 / 130
9443500405



MN-RK-8997

Ø: 85 Hole Distance: 130
Thick/Height: 30
0003504805



MERCEDES-BENZ



ACTROS MP2 / MP3 ...

2641, L, LL` ...	04/03→	Centre Rod	DB-DL-8167		Push Rod	
	04/03→	Centre Rod	DB-DL-8168		Push Rod	
	04/03→	Centre Rod	DB-DL-8184		Push Rod	
	04/03→	Centre Rod	DB-DL-8185		Push Rod	
	04/03→	Centre Rod	DB-DL-8307		Push Rod	
	04/03→	Centre Rod	DB-DL-8622		Push Rod	
	04/03→	Centre Rod	DB-DL-8641		Push Rod	
	04/03→	Centre Rod	DB-DL-8642		Push Rod	
	04/03→	Centre Rod	DB-DL-12300		for Steering Rod	
	04/03→	Rod Assembly	DB-DL-2178		Guide Rod	
	04/03→	Stabiliser Link	DB-DL-9254		Pressure Rod	
	04/03→	Stabiliser Mounting		DB-SB-10406		
	04/03→	Stabiliser Mounting		DB-SB-10409		
	04/03→	Stabiliser Mounting	DB-SB-10410			
	04/03→	Suspension Arm Repair Kit		DB-RK-8550	for Wishbone (CV)	
	04/03→	Suspension Arm Repair Kit		DB-RK-8626	for Wishbone (CV)	
	04/03→	Suspension Arm Repair Kit		DB-RK-10374	for Wishbone (CV)	
	04/03→	Suspension Arm Repair Kit		DB-RK-10375	for Wishbone (CV)	
	04/03→	Suspension Arm Repair Kit	DB-RK-8638		for Control Arm	
	04/03→	Suspension Strut Repair Kit		DB-RK-8391		
	04/03→	Suspension Strut Repair Kit		DB-RK-9294		
	04/03→	Tie Rod	DB-DL-8327		Guide Rod	
	04/03→	Tie Rod	DB-DL-8640		Guide Rod	
	04/03→	Tie Rod	DB-DL-12310			
	04/03→	Tie Rod	DB-ES-5227		Guide Rod	
	04/03→	Tie Rod End	CV-ES-0543		for Push Rod	
	04/03→	Tie Rod End	CV-ES-0888		for Push Rod	
	04/03→	Tie Rod End	CV-ES-14162		for Steering Rod	
	04/03→	Tie Rod End	CV-ES-14163		for Steering Rod	
	04/03→	Tie Rod End	DB-ES-5234		for Steering Rod	
	04/03→	Tie Rod End	DB-ES-8164		for Push Rod	
	04/03→	Tie Rod End	DB-ES-8530		for Push Rod	
	04/03→	Track Control Arm		DB-DL-3475	Trailing Arm	
	04/03→	Track Control Arm		DB-VB-3707	Suspension Rod, Wishbone (CV)	
	04/03→	Track Control Arm		DB-VB-7261	Suspension Rod, Wishbone (CV), 1st RA;2nd RA; Leaf Spring Axle	
	04/03→	Track Control Arm		DB-VB-10426	Wishbone (CV), Leaf Spring Axle;Unit	
	04/03→	Track Control Arm	DB-DL-5224		Control Arm, 1st FA;Air Suspension Axle	
	04/03→	Track Control Arm	DB-DL-9218	DB-DL-9218	Trailing Arm, 1st FA;Air Suspension Axle	
	2643 B	04/03→	Bush, parabolic spring		DB-SB-10400	
		04/03→	Bush, parabolic spring		DB-SB-10401	
04/03→		Centre Rod	DB-DL-2144		Push Rod	
04/03→		Centre Rod	DB-DL-5405		Push Rod	
04/03→		Centre Rod	DB-DL-7270		Push Rod	
04/03→		Centre Rod	DB-DL-8167		Push Rod	
04/03→		Rod Assembly	DB-DL-2178		Guide Rod, 1st Front Axle, →504310 03	
04/03→		Suspension Arm Repair Kit		DB-RK-8626	for Wishbone (CV)	
04/03→		Suspension Arm Repair Kit		DB-RK-10374	for Wishbone (CV)	
04/03→		Tie Rod	DB-DL-8327		Guide Rod	
04/03→		Tie Rod	DB-DL-8640		Guide Rod	
04/03→		Tie Rod End	CV-ES-0543		for Push Rod	
04/03→		Tie Rod End	CV-ES-0888		for Push Rod	
04/03→		Tie Rod End	CV-ES-14163		for Steering Rod	
04/03→		Tie Rod End	DB-ES-8164		for Push Rod	
04/03→		Tie Rod End	DB-ES-8530		for Push Rod	
04/03→		Track Control Arm		DB-DL-3475	Trailing Arm, 1st RA;2nd RA, →517144 05/517144 08	
04/03→		Track Control Arm		DB-VB-7261	Suspension Rod, Wishbone (CV)	
04/03→		Track Control Arm		DB-VB-10426	Wishbone (CV)	
2643 K, LK		04/03→	Bush, parabolic spring		DB-SB-10400	
		04/03→	Bush, parabolic spring		DB-SB-10401	
		04/03→	Centre Rod	DB-DL-2144		Push Rod
		04/03→	Centre Rod	DB-DL-5405		Push Rod

CV-ES-0543

Length: 125
 Cone Ø: d1 Ø 32 / d2 Ø 29
 Thread: M30 x 1,5 RHT
 0004605748, 0004606048, 0004606848,
 0004607048, 0014600448, 0014601148,
 0014601748, 0014602448, 0014607648,
 0014609648

**CV-ES-0888**

Length: 125
 Cone Ø: d1 Ø 32 / d2 Ø 29
 Thread: M30 x 1,5 LHT
 0004605848, 0004606148, 0004606948,
 0004607148, 0004609048, 0014600548,
 0014601348, 0014602548, 0014607948,
 0024600448

**CV-ES-14162**

Length: 125
 Cone Ø: d1 Ø 30 / d2 Ø 27
 Thread: M30 x 1,5 LHT
 4600648, 4601248, 4603448, 0004603548,
 14600348, 14601448, 14602348,
 0014603748, 0014607848, 0024600348

**CV-ES-14163**

Length: 125
 Cone Ø: d1 Ø 30 / d2 Ø 27
 Thread: M30 x 1,5 RHT
 0003305248, 0003387310, 0004600348,
 0004600948, 0004602848, 0004602948,
 0004608948, 0014600248, 0014600848,
 0014601248, 0014602248, 0014607748,
 0024600148, 0003387310, 0004600348,
 A0004602848, A0004602948, A0014600848,
 A0014601248, A0014602248, A0014607748

**DB-DL-2144**

Length: 872 Ø: 35
 Cone Ø: d1 Ø 28,6 / d2 Ø 23,9
 0024604305, 0024604405, 0034604805

**DB-DL-2178**

Length: 1735 Ø: 52
 Cone Ø: d1 Ø 32 / d2 Ø 29
 9423300003, 9423300103, 9423300203

**DB-DL-3475**

Length: 565 Ø: 52
 Hole Distance: 152 / 152
 3753500006, 3753500206, 9473500805,
 9483500006, 9483500805, 9483501205,
 9483501305, 9483501905, 9483502005,
 9483502405, A3753500006,
 A3753500206

**DB-DL-5224**

Length: 850 Ø: 60
 Hole Distance: 100 / 100
 01336100A, 9413300007

**DB-DL-5405**

Length: 890 Ø: 35
 Cone Ø: d1 Ø 28,6 / d2 Ø 23,9
 01215900A, 1460248, 0024604505,
 0024604605, 0034605005, 3752600637,
 3754600405, A3752600637, A3754600405

**DB-DL-7270**

Length: 875 Ø: 40
 Cone Ø: d1 Ø 28,6 / d2 Ø 23,9
 01208300A, 0024604705, 0024604805,
 0034604905, A0024604705

**DB-DL-8167**

Length: 866 Ø: 38
 Cone Ø: d1 Ø 30 / d2 Ø 27
 0014609805, 0014609905, 0024606305,
 0024606405

**DB-DL-8168**

Length: 904 Ø: 52
 Cone Ø: d1 Ø 32 / d2 Ø 29
 0004609405, 0004609505, 0014607105

**DB-DL-8184**

Length: 1095 Ø: 42
 Cone Ø: d1 Ø 32 / d2 Ø 28,8
 01217700A, 0014601305, 0014601405,
 0024600505, 0034603205, 3754601505,
 A0014601305, A0014601405, A0024600505

**DB-DL-8185**

Length: 711 Ø: 42
 Cone Ø: d1 Ø 32 / d2 Ø 28,8
 01213600A, 0014601105, 0024600405,
 0034603105, A0014601105, A0024600405

**DB-DL-8307**

Length: 885 Ø: 38
 Cone Ø: d1 Ø 32 / d2 Ø 30
 01215500A, 0004604005, 0024605105,
 0024605205, 0034604005

**DB-DL-8327**

Length: 1745 Ø: 48
 Cone Ø: d1 Ø 32 / d2 Ø 29
 01219800A, 9413300003, 9413300103,
 9413300203, 9413300303, 9413300503

**DB-DL-8622**

Length: 1558 Ø: 52
 Cone Ø: d1 Ø 30 / d2 Ø 27
 0014609005, 0014609105

**DB-DL-8640**

Length: 1615 Ø: 50
 Cone Ø: d1 Ø 32 / d2 Ø 29
 6253301503, 6253301603, 6253302403,
 6253302503, 9423300803, 9423302103,
 9493300203, 9493300303, 9493300903

**DB-DL-8641**

Length: 905 Ø: 42
 Cone Ø: d1 Ø 30 / d2 Ø 27
 0014605105, 0014608105

**DB-DL-8642**

Length: 954 Ø: 42
 Cone Ø: d1 Ø 30 / d2 Ø 27
 0014608605, 0014608705

**DB-DL-9218**

Length: 754 Ø: 40
 Hole Distance: 100
 000360098524, 000390098524,
 3753300111, 9413300011,
 A3753300111, SA50831601

**DB-DL-9254**

Length: 1815 Ø: 58
 0003220323, 0003220623, 3753220423

**DB-DL-12300**

Length: 733 Ø: 36
 Cone Ø: d1 Ø 32 / d2 Ø 29
 0014601505, 0014607305, 0034603305,
 3754601605, A0014601505, A0034603305,
 A3754601605

**DB-DL-12310**

Length: 1532 Ø: 50
 Cone Ø: d1 Ø 32 / d2 Ø 29
 Thread: M27 x 1,5 LHT
 9493301203, 9493301303, 9493301803,
 9493302203, A9493301203, A9493301303,
 A9493301803, A9493302203

**DB-ES-5227**

Length: 1588 Ø: 60
 Cone Ø: d1 Ø 38 / d2 Ø 34,3
 6253300903, 6253301203, 9443300203

**DB-ES-5234**

Length: 135
 Cone Ø: d1 Ø 38 / d2 Ø 34,3
 Thread: M38 x 1,5 RHT
 0004601748, 120322305, 2205000400

**DB-ES-8164**

Length: 140
 Cone Ø: d1 Ø 28,6 / d2 Ø 23,9
 Thread: M28 x 1,5 RHT
 0014604248, 0014605048, 0014608548,
 0024600548

**DB-ES-8530**

Length: 115
 Cone Ø: d1 Ø 28,6 / d2 Ø 23,9
 Thread: M30 x 1,5 RHT
 0014603848, 0014604848, 0014605148,
 0014608648, 0014609948

**DB-RK-8391**

Ø: 85 Hole Distance: 152
 Thick/Height: 24
 01336800A, 0003502705

**DB-RK-8550**

Ø: 75 Hole Distance: 152
 Thick/Height: 24
 0003502105, 0003504605

**DB-RK-8626**

Ø: 75 Hole Distance: 130
 Thick/Height: 24
 0003502205, 0003502505, 0003503405,
 0003504505, GL11319

**DB-RK-8638**

Length: 100 Ø: 67
 Hole Distance: 100
 Thick/Height: 20
 0003301411

**DB-RK-9294**

Ø: 85 Hole Distance: 152
 Thick/Height: 24
 0003503105

**DB-RK-10374**

Ø: 85 Hole Distance: 152
 Thick/Height: 24
 0003504405

**DB-RK-10375**

Ø: 100 Hole Distance: 152
 Thick/Height: 24
 0003502405, 0003503505, 0003504905

**DB-SB-10400**

Length: 230
 Thick/Height: 167,5 / 115
 0003250696, 0003250896

**DB-SB-10401**

Length: 232
 Thick/Height: 163,5 / 152,5
 0003250596, 0003250796

**DB-SB-10406**

Ø: 80 Thick/Height: 46
 0003238185

**DB-SB-10409**

Ø: 77 Thick/Height: 56
 0003265181

**DB-SB-10410**

Ø: 73 Hole Distance: 100
 Thick/Height: 24
 9413230050

**DB-VB-3707**

Length: 622 Ø: 46
 Hole Ø 25 / 25 / 25
 Hole Distance: 152 / 130 / 130
 01337100A, 9423501005, 9423501505,
 9443500005, 9473500105, 9473501005,
 A3753500005, A9423501005, A9423501505,
 A943500005, A9473500105, A9473501005

**DB-VB-7261**

Length: 622 Ø: 46
 Hole Ø 25 / 25 / 25
 Hole Distance: 152 / 130 / 130
 01337800A, 9443500305, 9443500505,
 9443500605, 9473500705, 9473500905,
 9483500405, 9483503005

**DB-VB-10426**

Length: 622 Ø: 46
 Hole Ø 25 / 25 / 25
 Hole Distance: 152 / 130 / 130
 9443500405





ACTROS MP2 / MP3 ...

2643 K, LK ...	04/03→	Centre Rod	DB-DL-7270		Push Rod
	04/03→	Centre Rod	DB-DL-8167		Push Rod
	04/03→	Rod Assembly	DB-DL-2178		Guide Rod, 1st Front Axle, →504310 03
	04/03→	Suspension Arm Repair Kit		DB-RK-8626	for Wishbone (CV)
	04/03→	Suspension Arm Repair Kit		DB-RK-10374	for Wishbone (CV)
	04/03→	Tie Rod	DB-DL-8171		Guide Rod
	04/03→	Tie Rod	DB-DL-8327		Guide Rod
	04/03→	Tie Rod	DB-DL-8640		Guide Rod
	04/03→	Tie Rod End	CV-ES-0543		for Push Rod
	04/03→	Tie Rod End	CV-ES-0888		for Push Rod
	04/03→	Tie Rod End	CV-ES-14163		for Steering Rod
	04/03→	Tie Rod End	DB-ES-8164		for Push Rod
	04/03→	Tie Rod End	DB-ES-8530		for Push Rod
	04/03→	Track Control Arm		DB-DL-3475	Trailing Arm, 1st RA;2nd RA, →517144 03/517144 06
	04/03→	Track Control Arm		DB-DL-3475	Trailing Arm, 1st RA;2nd RA, →517144 05/517144 08
	04/03→	Track Control Arm		DB-DL-3475	Trailing Arm, 1st RA;2nd RA, →517144 07/517144 09
	04/03→	Track Control Arm		DB-DL-3475	Trailing Arm, 1st RA;2nd RA, →517144 26/517144 27
	04/03→	Track Control Arm		DB-VB-3707	Suspension Rod, Wishbone (CV)
	04/03→	Track Control Arm		DB-VB-7261	Suspension Rod, Wishbone (CV)
	04/03→	Track Control Arm		DB-VB-10426	Wishbone (CV)
2643 L	04/03→	Centre Rod	DB-DL-2144		Push Rod
	04/03→	Centre Rod	DB-DL-5405		Push Rod
	04/03→	Centre Rod	DB-DL-7270		Push Rod
	04/03→	Centre Rod	DB-DL-8167		Push Rod
	04/03→	Centre Rod	DB-DL-8307		Push Rod
	04/03→	Rod Assembly	DB-DL-2178		Guide Rod, 1st Front Axle, →504310 03
	04/03→	Suspension Arm Repair Kit		DB-RK-8626	for Wishbone (CV)
	04/03→	Suspension Arm Repair Kit		DB-RK-10374	for Wishbone (CV)
	04/03→	Tie Rod	DB-DL-8640		Guide Rod
	04/03→	Tie Rod End	CV-ES-0543		for Push Rod
	04/03→	Tie Rod End	CV-ES-0888		for Push Rod
	04/03→	Tie Rod End	CV-ES-14163		for Steering Rod
	04/03→	Tie Rod End	DB-ES-8164		for Push Rod
	04/03→	Tie Rod End	DB-ES-8530		for Push Rod
	04/03→	Track Control Arm		DB-VB-3707	Suspension Rod, Wishbone (CV)
	04/03→	Track Control Arm	DB-DL-5224		Control Arm
	04/03→	Track Control Arm	DB-DL-9218	DB-DL-9218	Trailing Arm
2643 LS	10/09→	Centre Rod	DB-DL-2144		Push Rod
	10/09→	Centre Rod	DB-DL-8167		Push Rod
	10/09→	Rod Assembly	DB-DL-2178		Guide Rod, 1st Front Axle, →504310 03
	10/09→	Suspension Arm Repair Kit		DB-RK-8626	for Wishbone (CV)
	10/09→	Suspension Arm Repair Kit		DB-RK-10374	for Wishbone (CV)
	10/09→	Tie Rod	DB-DL-8640		Guide Rod
	10/09→	Tie Rod	DB-DL-12310		
	10/09→	Tie Rod End	CV-ES-0543		for Push Rod
	10/09→	Tie Rod End	CV-ES-0888		for Push Rod
	10/09→	Tie Rod End	CV-ES-14163		for Steering Rod
	10/09→	Tie Rod End	DB-ES-8164		for Push Rod
	10/09→	Track Control Arm		DB-VB-3707	Suspension Rod, Wishbone (CV)
	2644 B	04/03→	Ball Head, gearshift linkage	DB-ES-8510	
04/03→		Bush, driver cab suspension	DB-SB-10384		
04/03→		Bush, parabolic spring		DB-SB-10400	
04/03→		Bush, parabolic spring		DB-SB-10401	
04/03→		Centre Rod	DB-DL-2144		Push Rod
04/03→		Centre Rod	DB-DL-5230		Suspension Rod
04/03→		Centre Rod	DB-DL-5241		Push Rod
04/03→		Centre Rod	DB-DL-5405		Push Rod, Leaf Spring Axle
04/03→		Centre Rod	DB-DL-7270		Push Rod
04/03→	Centre Rod	DB-DL-8167		Push Rod	

CV-ES-0543

Length: 125
Cone Ø: d1 Ø 32 / d2 Ø 29
Thread: M30 x 1,5 RHT
0004605748, 0004606048, 0004606848,
0004607048, 0014600448, 0014601148,
0014601748, 0014602448, 0014607648,
0014609648



CV-ES-0888

Length: 125
Cone Ø: d1 Ø 32 / d2 Ø 29
Thread: M30 x 1,5 LHT
0004605848, 0004606148, 0004606948,
0004607148, 0004609048, 0014600548,
0014601348, 0014602548, 0014607948,
0024600448



CV-ES-14163

Length: 125
Cone Ø: d1 Ø 30 / d2 Ø 27
Thread: M30 x 1,5 RHT
0003305248, 0003387310, 0004600348,
0004600948, 0004602848, 0004602948,
0004608948, 0014600248, 0014600848,
0014601248, 0014602248, 0014607748,
0024600148, A0003387310, A0004600348,
A0004602848, A0004602948, A0014600848,
A0014601248, A0014602248, A0014607748



DB-DL-2144

Length: 872 Ø: 35
Cone Ø: d1 Ø 28,6 / d2 Ø 23,9
0024604305, 0024604405, 0034604805



DB-DL-2178

Length: 1735 Ø: 52
Cone Ø: d1 Ø 32 / d2 Ø 29
9423300003, 9423300103, 9423300203



DB-DL-3475

Length: 565 Ø: 52
Hole Distance: 152 / 152
3753500006, 3753500206, 9473500805,
9483500006, 9483500805, 9483501205,
9483501305, 9483501905, 9483502005,
9483502405, A3753500006,
A3753500206



DB-DL-5224

Length: 850 Ø: 60
Hole Distance: 100 / 100
01336100A, 9413300007



DB-DL-5230

Length: 879 Ø: 42
Cone Ø: d1 Ø 30 / d2 Ø 27
01208600A, 0004607105, 0004607205,
0014606705



DB-DL-5241

Length: 875 Ø: 40
Cone Ø: d1 Ø 30 / d2 Ø 27
01215300A, 0004609205, 0004609305,
0014606905



DB-DL-5405

Length: 890 Ø: 35
Cone Ø: d1 Ø 28,6 / d2 Ø 23,9
01215900A, 1460248, 0024604505,
0024604605, 0034605005, 3752600637,
3754600405, A3752600637, A3754600405



DB-DL-7270

Length: 875 Ø: 40
Cone Ø: d1 Ø 28,6 / d2 Ø 23,9
01208300A, 0024604705, 0024604805,
0034604905, A0024604705



DB-DL-8167

Length: 866 Ø: 38
Cone Ø: d1 Ø 30 / d2 Ø 27
0014609805, 0014609905, 0024606305,
0024606405



DB-DL-8171

Length: 1687 Ø: 52
Cone Ø: d1 Ø 32 / d2 Ø 29
9493300603, 9493300703, 9493301503,
9493301603



DB-DL-8307

Length: 885 Ø: 38
Cone Ø: d1 Ø 32 / d2 Ø 30
01215500A, 0004604005, 0024605105,
0024605205, 0034604005



DB-DL-8327

Length: 1745 Ø: 48
Cone Ø: d1 Ø 32 / d2 Ø 29
01219800A, 9413300003, 9413300103,
9413300203, 9413300303, 9413300503



DB-DL-8640

Length: 1615 Ø: 50
Cone Ø: d1 Ø 32 / d2 Ø 29
6253301503, 6253301603, 6253302403,
6253302503, 9423300803, 9423302103,
9493300203, 9493300303, 9493300903



DB-DL-9218

Length: 754 Ø: 40
Hole Distance: 100
000360098524, 000390098524,
3753300111, 9413300011,
A3753300111, SA50831601



DB-DL-12310

Length: 1532 Ø: 50
Cone Ø: d1 Ø 32 / d2 Ø 29
Thread: M27 x 1,5 LHT
9493301203, 9493301303, 9493301803,
9493302203, A9493301203, A9493301303,
A9493301803, A9493302203



DB-ES-8164

Length: 140
Cone Ø: d1 Ø 28,6 / d2 Ø 23,9
Thread: M28 x 1,5 RHT
0014604248, 0014605048, 0014608548,
0024600548



DB-ES-8510

Length: 56
Cone Ø: d1 Ø 10 / d2 Ø 10
Thread: M12 x 1,75 LHT
0009965145, 0009965645, 0019963145



DB-ES-8530

Length: 115
Cone Ø: d1 Ø 28,6 / d2 Ø 23,9
Thread: M30 x 1,5 RHT
0014603848, 0014604848, 0014605148,
0014608648, 0014609948



DB-RK-8626

Ø: 75 Hole Distance: 130
Thick/Height: 24
0003502205, 0003502505, 0003503405,
0003504505, GL11319



DB-RK-10374

Ø: 85 Hole Distance: 152
Thick/Height: 24
0003504405



DB-SB-10384

Ø: 73 Thick/Height: 47
9303170012, 9423171812



DB-SB-10400

Length: 230
Thick/Height: 167,5 / 115
0003250696, 0003250896



DB-SB-10401

Length: 232
Thick/Height: 163,5 / 152,5
0003250596, 0003250796



DB-VB-3707

Length: 622 Ø: 46
Hole Ø 25 / 25 / 25
Hole Distance: 152 / 130 / 130
01337100A, 9423501005, 9423501505,
9443500005, 9473500105, 9473501005,
A3753500005, A9423501005, A9423501505,
A9443500005, A9473500105, A9473501005



DB-VB-7261

Length: 622 Ø: 46
Hole Ø 25 / 25 / 25
Hole Distance: 152 / 130 / 130
01337800A, 9443500305, 9443500505,
9443500605, 9473500705, 9473500905,
9483500405, 9483500305



DB-VB-10426

Length: 622 Ø: 46
Hole Ø 25 / 25 / 25
Hole Distance: 152 / 130 / 130
9443500405





ACTROS MP2 / MP3 ...

2644 B ...	04/03→	Centre Rod	DB-DL-8184	Push Rod	
	04/03→	Centre Rod	DB-DL-8185	Push Rod	
	04/03→	Centre Rod	DB-DL-8307	Push Rod	
	04/03→	Centre Rod	DB-DL-12300	for Steering Rod	
	04/03→	Rod Assembly	DB-DL-2178	Guide Rod, 1st Front Axle, →504310 03	
	04/03→	Stabiliser Mounting		DB-SB-10406	
	04/03→	Stabiliser Mounting		DB-SB-10409	
	04/03→	Suspension Arm Repair Kit		DB-RK-8550 for Wishbone (CV)	
	04/03→	Suspension Arm Repair Kit		DB-RK-8626 for Wishbone (CV)	
	04/03→	Suspension Arm Repair Kit		DB-RK-10374 for Wishbone (CV)	
	04/03→	Suspension Arm Repair Kit	DB-RK-8638	for Control Arm	
	04/03→	Suspension Strut Repair Kit		DB-RK-8391	
	04/03→	Suspension Strut Repair Kit		DB-RK-9294	
	04/03→	Tie Rod	DB-DL-8327	Guide Rod	
	04/03→	Tie Rod	DB-DL-8640	Guide Rod	
	04/03→	Tie Rod	DB-DL-12310		
	04/03→	Tie Rod End	CV-ES-0543	for Push Rod	
	04/03→	Tie Rod End	CV-ES-0888	for Push Rod	
	04/03→	Tie Rod End	CV-ES-14163	for Steering Rod	
	04/03→	Tie Rod End	DB-ES-5234	for Steering Rod	
	04/03→	Tie Rod End	DB-ES-8164	for Push Rod	
	04/03→	Tie Rod End	DB-ES-8530	for Push Rod	
	04/03→	Track Control Arm		DB-DL-3475 Trailing Arm	
	04/03→	Track Control Arm		DB-VB-3707 Suspension Rod, Wishbone (CV)	
	04/03→	Track Control Arm		DB-VB-7261 Suspension Rod, Wishbone (CV), 1st RA;2nd RA; Leaf Spring Axle	
	04/03→	Track Control Arm		DB-VB-10426 Wishbone (CV), Leaf Spring Axle;Unit	
	2644 K, LK	04/03→	Ball Head, gearshift linkage	DB-ES-8510	
		04/03→	Bush, driver cab suspension	DB-SB-10384	
		04/03→	Bush, parabolic spring		DB-SB-10400
		04/03→	Bush, parabolic spring		DB-SB-10401
		04/03→	Centre Rod	DB-DL-2144	Push Rod
		04/03→	Centre Rod	DB-DL-5230	Suspension Rod
04/03→		Centre Rod	DB-DL-5241	Push Rod	
04/03→		Centre Rod	DB-DL-5405	Push Rod	
04/03→		Centre Rod	DB-DL-5405	Push Rod, Leaf Spring Axle	
04/03→		Centre Rod	DB-DL-7270	Push Rod	
04/03→		Centre Rod	DB-DL-8167	Push Rod	
04/03→		Centre Rod	DB-DL-8184	Push Rod	
04/03→		Centre Rod	DB-DL-8185	Push Rod	
04/03→		Centre Rod	DB-DL-8307	Push Rod	
04/03→		Centre Rod	DB-DL-12300	for Steering Rod	
04/03→		Rod Assembly	DB-DL-2178	Guide Rod	
04/03→		Stabiliser Mounting		DB-RK-9296	
04/03→		Stabiliser Mounting		DB-SB-10406	
04/03→		Stabiliser Mounting		DB-SB-10409	
04/03→		Suspension Arm Repair Kit		DB-RK-8550 for Wishbone (CV)	
04/03→		Suspension Arm Repair Kit		DB-RK-8626 for Wishbone (CV)	
04/03→		Suspension Arm Repair Kit		DB-RK-10374 for Wishbone (CV)	
04/03→		Suspension Arm Repair Kit		DB-RK-10375 for Wishbone (CV)	
04/03→		Suspension Arm Repair Kit	DB-RK-8638	for Control Arm	
04/03→		Suspension Strut Repair Kit		DB-RK-8391	
04/03→		Suspension Strut Repair Kit		DB-RK-9294	
04/03→		Tie Rod	DB-DL-8171	Guide Rod	
04/03→		Tie Rod	DB-DL-8327	Guide Rod	
04/03→		Tie Rod	DB-DL-8640	Guide Rod	
04/03→		Tie Rod	DB-DL-12310		
04/03→		Tie Rod	DB-ES-5227	Guide Rod	
04/03→		Tie Rod End	CV-ES-0543	for Push Rod	
04/03→		Tie Rod End	CV-ES-0888	for Push Rod	
04/03→		Tie Rod End	CV-ES-14162	for Steering Rod	
04/03→		Tie Rod End	CV-ES-14163	for Steering Rod	
04/03→		Tie Rod End	DB-ES-5234	for Steering Rod	

CV-ES-0543

Length: 125
 Cone Ø: d1 Ø 32 / d2 Ø 29
 Thread: M30 x 1,5 RHT
 0004605748, 0004606048, 0004606848,
 0004607048, 0014600448, 0014601148,
 0014601748, 0014602448, 0014607648,
 0014609648

**CV-ES-0888**

Length: 125
 Cone Ø: d1 Ø 32 / d2 Ø 29
 Thread: M30 x 1,5 LHT
 0004605848, 0004606148, 0004606948,
 0004607148, 0004609048, 0014600548,
 0014601348, 0014602548, 0014607948,
 0024600448

**CV-ES-14162**

Length: 125
 Cone Ø: d1 Ø 30 / d2 Ø 27
 Thread: M30 x 1,5 LHT
 4600648, 4601248, 4603448, 0004603548,
 14600348, 14601448, 14602348,
 0014603748, 0014607848, 0024600348

**CV-ES-14163**

Length: 125
 Cone Ø: d1 Ø 30 / d2 Ø 27
 Thread: M30 x 1,5 RHT
 0003305248, 0003387310, 0004600348,
 0004600948, 0004602848, 0004602948,
 0004608948, 0014600248, 0014600848,
 0014601248, 0014602248, 0014607748,
 0024600148, A0003387310, A0004600348,
 A0004602848, A0004602948, A0014600848,
 A0014601248, A0014602248, A0014607748

**DB-DL-2144**

Length: 872 Ø: 35
 Cone Ø: d1 Ø 28,6 / d2 Ø 23,9
 0024604305, 0024604405, 0034604805

**DB-DL-2178**

Length: 1735 Ø: 52
 Cone Ø: d1 Ø 32 / d2 Ø 29
 9423300003, 9423300103, 9423300203

**DB-DL-3475**

Length: 565 Ø: 52
 Hole Distance: 152 / 152
 3753500006, 3753500206, 9473500805,
 9483500006, 9483500805, 9483501205,
 9483501305, 9483501905, 9483502005,
 9483502405, A3753500006,
 A3753500206

**DB-DL-5230**

Length: 879 Ø: 42
 Cone Ø: d1 Ø 30 / d2 Ø 27
 01208600A, 0004607105, 0004607205,
 0014606705

**DB-DL-5241**

Length: 875 Ø: 40
 Cone Ø: d1 Ø 30 / d2 Ø 27
 01215300A, 0004609205, 0004609305,
 0014606905

**DB-DL-5405**

Length: 890 Ø: 35
 Cone Ø: d1 Ø 28,6 / d2 Ø 23,9
 01215900A, 1460248, 0024604505,
 0024604605, 0034605005, 3752600637,
 3754600405, A3752600637, A3754600405

**DB-DL-7270**

Length: 875 Ø: 40
 Cone Ø: d1 Ø 28,6 / d2 Ø 23,9
 01208300A, 0024604705, 0024604805,
 0034604905, A0024604705

**DB-DL-8167**

Length: 866 Ø: 38
 Cone Ø: d1 Ø 30 / d2 Ø 27
 0014609805, 0014609905, 0024606305,
 0024606405

**DB-DL-8171**

Length: 1687 Ø: 52
 Cone Ø: d1 Ø 32 / d2 Ø 29
 9493300603, 9493300703, 9493301503,
 9493301603

**DB-DL-8184**

Length: 1095 Ø: 42
 Cone Ø: d1 Ø 32 / d2 Ø 28,8
 01217700A, 0014601305, 0014601405,
 0024600505, 0034603205, 3754601505,
 A0014601305, A0014601405, A0024600505

**DB-DL-8185**

Length: 711 Ø: 42
 Cone Ø: d1 Ø 32 / d2 Ø 28,8
 01213600A, 0014601105, 0024600405,
 0034603105, A0014601105, A0024600405

**DB-DL-8307**

Length: 885 Ø: 38
 Cone Ø: d1 Ø 32 / d2 Ø 30
 01215500A, 0004604005, 0024605105,
 0024605205, 0034604005

**DB-DL-8327**

Length: 1745 Ø: 48
 Cone Ø: d1 Ø 32 / d2 Ø 29
 01219800A, 9413300003, 9413300103,
 9413300203, 9413300303, 9413300503

**DB-DL-8640**

Length: 1615 Ø: 50
 Cone Ø: d1 Ø 32 / d2 Ø 29
 6253301503, 6253301603, 6253302403,
 6253302503, 9423300803, 9423302103,
 9493300203, 9493300303, 9493300903

**DB-DL-12300**

Length: 733 Ø: 36
 Cone Ø: d1 Ø 32 / d2 Ø 29
 0014601505, 0014607305, 0034603305,
 3754601605, A0014601505,
 A0034603305, A3754601605

**DB-DL-12310**

Length: 1532 Ø: 50
 Cone Ø: d1 Ø 32 / d2 Ø 29
 Thread: M27 x 1,5 LHT
 9493301203, 9493301303, 9493301803,
 9493302203, A9493301203, A9493301303,
 A9493301803, A9493302203

**DB-ES-5227**

Length: 1588 Ø: 60
 Cone Ø: d1 Ø 38 / d2 Ø 34,3
 6253300903, 6253301203, 9443300203

**DB-ES-5234**

Length: 135
 Cone Ø: d1 Ø 38 / d2 Ø 34,3
 Thread: M38 x 1,5 RHT
 0004601748, 120322305, 2205000400

**DB-ES-8164**

Length: 140
 Cone Ø: d1 Ø 28,6 / d2 Ø 23,9
 Thread: M28 x 1,5 RHT
 0014604248, 0014605048, 0014608548,
 0024600548

**DB-ES-8510**

Length: 56
 Cone Ø: d1 Ø 10 / d2 Ø 10
 Thread: M12 x 1,75 LHT
 0009965145, 0009965645, 0019963145

**DB-ES-8530**

Length: 115
 Cone Ø: d1 Ø 28,6 / d2 Ø 23,9
 Thread: M30 x 1,5 RHT
 0014603848, 0014604848, 0014605148,
 0014608648, 0014609948

**DB-RK-8391**

Ø: 85 Hole Distance: 152
 Thick/Height: 24
 01336800A, 0003502705

**DB-RK-8550**

Ø: 75 Hole Distance: 152
 Thick/Height: 24
 0003502105, 0003504605

**DB-RK-8626**

Ø: 75 Hole Distance: 130
 Thick/Height: 24
 0003502205, 0003502505, 0003503405,
 0003504505, GL11319

**DB-RK-8638**

Length: 100 Ø: 67
 Hole Distance: 100
 Thick/Height: 20
 0003301411

**DB-RK-9294**

Ø: 85 Hole Distance: 152
 Thick/Height: 24
 0003503105

**DB-RK-9296**

Ø: 88 Hole Distance: 130
 Thick/Height: 24
 9423260050

**DB-RK-10374**

Ø: 85 Hole Distance: 152
 Thick/Height: 24
 0003504405

**DB-RK-10375**

Ø: 100 Hole Distance: 152
 Thick/Height: 24
 0003502405, 0003503505, 0003504905

**DB-SB-10384**

Ø: 73 Thick/Height: 47
 9303170012, 9423171812

**DB-SB-10400**

Length: 230
 Thick/Height: 167,5 / 115
 0003250696, 0003250896

**DB-SB-10401**

Length: 232
 Thick/Height: 163,5 / 152,5
 0003250596, 0003250796

**DB-SB-10406**

Ø: 80 Thick/Height: 46
 0003238185

**DB-SB-10409**

Ø: 77 Thick/Height: 56
 0003265181

**DB-VB-3707**

Length: 622 Ø: 46
 Hole Ø 25 / 25 / 25
 Hole Distance: 152 / 130 / 130
 01337100A, 9423501005, 9423501505,
 9443500005, 9473500105, 9473501005,
 A3753500005, A9423501005, A9423501505,
 A9443500005, A9473500105, A9473501005

**DB-VB-7261**

Length: 622 Ø: 46
 Hole Ø 25 / 25 / 25
 Hole Distance: 152 / 130 / 130
 01337800A, 9443500305, 9443500505,
 9443500605, 9473500705, 9473500905,
 9483500405, 9483503005

**DB-VB-10426**

Length: 622 Ø: 46
 Hole Ø 25 / 25 / 25
 Hole Distance: 152 / 130 / 130
 9443500405



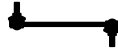

ACTROS MP2 / MP3 ...

2644 K, LK ...	04/03→	Tie Rod End	DB-ES-8164		for Push Rod
	04/03→	Tie Rod End	DB-ES-8530		for Push Rod
	04/03→	Track Control Arm		DB-DL-3475	Trailing Arm
	04/03→	Track Control Arm		DB-VB-3707	Suspension Rod, Wishbone (CV)
	04/03→	Track Control Arm		DB-VB-7261	Suspension Rod, Wishbone (CV), 1st RA;2nd RA; Leaf Spring Axle
	04/03→	Track Control Arm		DB-VB-10426	Wishbone (CV), Leaf Spring Axle;Unit
2644 S, LS	04/03→	Ball Head, gearshift linkage	DB-ES-8510		
	04/03→	Bush, driver cab suspension	DB-SB-10384		
	04/03→	Bush, parabolic spring		DB-SB-10400	
	04/03→	Bush, parabolic spring		DB-SB-10401	
	04/03→	Centre Rod	DB-DL-2144		Push Rod
	04/03→	Centre Rod	DB-DL-5230		Suspension Rod
	04/03→	Centre Rod	DB-DL-5241		Push Rod
	04/03→	Centre Rod	DB-DL-5405		Push Rod
	04/03→	Centre Rod	DB-DL-5405		Push Rod, for vehicles with Rigid Leading Axle
	04/03→	Centre Rod	DB-DL-5405		Push Rod, Leaf Spring Axle
	04/03→	Centre Rod	DB-DL-7270		Push Rod
	04/03→	Centre Rod	DB-DL-8167		Push Rod
	04/03→	Centre Rod	DB-DL-8184		Push Rod
	04/03→	Centre Rod	DB-DL-8185		Push Rod
	04/03→	Centre Rod	DB-DL-8307		Push Rod
	04/03→	Centre Rod	DB-DL-12300		for Steering Rod
	04/03→	Centre Rod	DB-DL-12470		Push Rod
	04/03→	Rod Assembly	DB-DL-2178		Guide Rod
	04/03→	Stabiliser Mounting		DB-SB-10406	
	04/03→	Stabiliser Mounting		DB-SB-10409	
	04/03→	Stabiliser Mounting	DB-SB-10410		
	04/03→	Suspension Arm Repair Kit		DB-RK-8550	for Wishbone (CV)
	04/03→	Suspension Arm Repair Kit		DB-RK-8626	for Wishbone (CV)
	04/03→	Suspension Arm Repair Kit		DB-RK-10374	for Wishbone (CV)
	04/03→	Suspension Arm Repair Kit		DB-RK-10375	for Wishbone (CV)
	04/03→	Suspension Arm Repair Kit	DB-RK-8638		for Control Arm
	04/03→	Suspension Strut Repair Kit		DB-RK-8391	
	04/03→	Suspension Strut Repair Kit		DB-RK-9294	
	04/03→	Suspension Strut Repair Kit		MN-RK-8997	
	04/03→	Tie Rod	DB-DL-8171		Guide Rod
	04/03→	Tie Rod	DB-DL-8327		Guide Rod
	04/03→	Tie Rod	DB-DL-8388		Guide Rod
	04/03→	Tie Rod	DB-DL-8389		
	04/03→	Tie Rod	DB-DL-8640		Guide Rod
	04/03→	Tie Rod	DB-DL-12310		
	04/03→	Tie Rod	DB-ES-5227		Guide Rod
	04/03→	Tie Rod End	CV-ES-0543		for Push Rod
	04/03→	Tie Rod End	CV-ES-0888		for Push Rod
	04/03→	Tie Rod End	CV-ES-14162		for Steering Rod
	04/03→	Tie Rod End	CV-ES-14163		for Steering Rod
	04/03→	Tie Rod End	DB-ES-5234		for Steering Rod
	04/03→	Tie Rod End	DB-ES-8164		for Push Rod
	04/03→	Tie Rod End	DB-ES-8530		for Push Rod
	04/03→	Track Control Arm		DB-DL-3475	Trailing Arm
	04/03→	Track Control Arm		DB-VB-3707	Suspension Rod, Wishbone (CV)
	04/03→	Track Control Arm		DB-VB-7261	Suspension Rod, Wishbone (CV), 1st RA;2nd RA; Leaf Spring Axle
	04/03→	Track Control Arm		DB-VB-7798	Wishbone (CV)
04/03→	Track Control Arm		DB-VB-10426	Wishbone (CV), Leaf Spring Axle;Unit	
04/03→	Track Control Arm	DB-DL-5224		Control Arm, 1st FA;Air Suspension Axle; for vehicles with Rigid Leading Axle	
04/03→	Track Control Arm	DB-DL-9218	DB-DL-9218	Trailing Arm, 1st FA;Air Suspension Axle; for vehicles with Rigid Leading Axle	

CV-ES-0543

Length: 125
Cone Ø: d1 Ø 32 / d2 Ø 29
Thread: M30 x 1,5 RHT
0004605748, 0004606048, 0004606848,
0004607048, 0014600448, 0014601148,
0014601748, 0014602448, 0014607648,
0014609648



CV-ES-0888

Length: 125
Cone Ø: d1 Ø 32 / d2 Ø 29
Thread: M30 x 1,5 LHT
0004605848, 0004606148, 0004606948,
0004607148, 0004609048, 0014600548,
0014601348, 0014602548, 0014607948,
0024600448



CV-ES-14162

Length: 125
Cone Ø: d1 Ø 30 / d2 Ø 27
Thread: M30 x 1,5 LHT
4600648, 4601248, 4603448, 4603548,
0004603548, 14600348, 14601448,
14602348, 0014603748, 0014607848,
14607848, 0024600348



CV-ES-14163

Length: 125
Cone Ø: d1 Ø 30 / d2 Ø 27
Thread: M30 x 1,5 RHT
0003305248, 0003387310, 0004600348,
0004600948, 0004602848, 0004602948,
0004608948, 0014600248, 0014600848,
0014601248, 0014602248, 0014607748,
0024600148, A0003387310, A0004600348,
A0004602848, A0004602948, A0014600848,
A0014601248, A0014602248, A0014607748



DB-DL-2144

Length: 872 Ø: 35
Cone Ø: d1 Ø 28,6 / d2 Ø 23,9
0024604305, 0024604405, 0034604805



DB-DL-2178

Length: 1735 Ø: 52
Cone Ø: d1 Ø 32 / d2 Ø 29
9423300003, 9423300103, 9423300203



DB-DL-3475

Length: 565 Ø: 52
Hole Distance: 152 / 152
3753500006, 3753500206, 9473500805,
9483500006, 9483500805, 9483501205,
9483501305, 9483501905, 9483502005,
9483502405, A3753500006,
A3753500206



DB-DL-5224

Length: 850 Ø: 60
Hole Distance: 100 / 100
01336100A, 9413300007



DB-DL-5230

Length: 879 Ø: 42
Cone Ø: d1 Ø 30 / d2 Ø 27
01208600A, 0004607105, 0004607205,
0014606705



DB-DL-5241

Length: 875 Ø: 40
Cone Ø: d1 Ø 30 / d2 Ø 27
01215300A, 0004609205, 0004609305,
0014606905



DB-DL-5405

Length: 890 Ø: 35
Cone Ø: d1 Ø 28,6 / d2 Ø 23,9
01215900A, 1460248, 0024604505,
0024604605, 0034605005, 3752600637,
3754600405, A3752600637, A3754600405



DB-DL-7270

Length: 875 Ø: 40
Cone Ø: d1 Ø 28,6 / d2 Ø 23,9
01208300A, 0024604705, 0024604805,
0034604905, A0024604705



DB-DL-8167

Length: 866 Ø: 38
Cone Ø: d1 Ø 30 / d2 Ø 27
0014609805, 0014609905, 0024606305,
0024606405



DB-DL-8171

Length: 1687 Ø: 52
Cone Ø: d1 Ø 32 / d2 Ø 29
9493300603, 9493300703, 9493301503,
9493301603



DB-DL-8184

Length: 1095 Ø: 42
Cone Ø: d1 Ø 32 / d2 Ø 28,8
01217700A, 0014601305, 0014601405,
0024600505, 0034603205, 3754601505,
A0014601305, A0014601405, A0024600505



DB-DL-8185

Length: 711 Ø: 42
Cone Ø: d1 Ø 32 / d2 Ø 28,8
01213600A, 0014601105, 0024600405,
0034603105, A0014601105, A0024600405



DB-DL-8307

Length: 885 Ø: 38
Cone Ø: d1 Ø 32 / d2 Ø 30
01215500A, 0004604005, 0024605105,
0034605205, 0034604005



DB-DL-8327

Length: 1745 Ø: 48
Cone Ø: d1 Ø 32 / d2 Ø 29
01219800A, 9413300003, 9413300103,
9413300203, 9413300303, 9413300503



DB-DL-8388

Length: 1735 Ø: 62
Cone Ø: d1 Ø 32 / d2 Ø 28,8
01219900A, 9453300003, 9453300103,
9453300403, 9453300603, A9453300003



DB-DL-8389

Length: 1465 Ø: 40
Cone Ø: d1 Ø 32 / d2 Ø 29
9453300203, 9453300303, 9453300503



DB-DL-8640

Length: 1615 Ø: 50
Cone Ø: d1 Ø 32 / d2 Ø 29
6253301503, 6253301603, 6253302403,
6253302503, 9423300803, 9423302103,
9493300203, 9493300303, 9493300903



DB-DL-9218

Length: 754 Ø: 40
Hole Distance: 100
000360098524, 000390098524,
3753300111, 9413300011,
A3753300111, SA50831601



DB-DL-12300

Length: 733 Ø: 36
Cone Ø: d1 Ø 32 / d2 Ø 29
0014601505, 0014607305, 0034603305,
3754601605, A0014601505,
A0034603305, A3754601605



DB-DL-12310

Length: 1532 Ø: 50
Cone Ø: d1 Ø 32 / d2 Ø 29
Thread: M27 x 1,5 LHT
9493301203, 9493301303, 9493301803,
9493302203, A9493301203, A9493301303,
A9493301803, A9493302203



DB-DL-12470

Length: 723 Ø: 42
Cone Ø: d1 Ø 30 / d2 Ø 27
A0014607505, A0024600905



No Image

DB-ES-5227

Length: 1588 Ø: 60
Cone Ø: d1 Ø 38 / d2 Ø 34,3
6253300903, 6253301203, 9443300203



DB-ES-5234

Length: 135
Cone Ø: d1 Ø 38 / d2 Ø 34,3
Thread: M38 x 1,5 RHT
0004601748, 120322305, 2205000400



DB-ES-8164

Length: 140
Cone Ø: d1 Ø 28,6 / d2 Ø 23,9
Thread: M28 x 1,5 RHT
0014604248, 0014605048, 0014608548,
0024600548



DB-ES-8510

Length: 56
Cone Ø: d1 Ø 10 / d2 Ø 10
Thread: M12 x 1,75 LHT
0009965145, 0009965645, 0019963145



DB-ES-8530

Length: 115
Cone Ø: d1 Ø 28,6 / d2 Ø 23,9
Thread: M30 x 1,5 RHT
0014603848, 0014604848, 0014605148,
0014608648, 0014609948



DB-RK-8391

Ø: 85 Hole Distance: 152
Thick/Height: 24
01336800A, 0003502705



DB-RK-8550

Ø: 75 Hole Distance: 152
Thick/Height: 24
0003502105, 0003504605



DB-RK-8626

Ø: 75 Hole Distance: 130
Thick/Height: 24
0003502205, 0003502505, 0003503405,
0003504505, GL11319



DB-RK-8638

Length: 100 Ø: 67
Hole Distance: 100
Thick/Height: 20
0003301411



DB-RK-9294

Ø: 85 Hole Distance: 152
Thick/Height: 24
0003503105



DB-RK-10374

Ø: 85 Hole Distance: 152
Thick/Height: 24
0003504405



DB-RK-10375

Ø: 100 Hole Distance: 152
Thick/Height: 24
0003502405, 0003503505, 0003504905



DB-SB-10384

Ø: 73 Thick/Height: 47
9303170012, 9423171812



DB-SB-10400

Length: 230
Thick/Height: 167,5 / 115
0003250696, 0003250896



DB-SB-10401

Length: 232
Thick/Height: 163,5 / 152,5
0003250596, 0003250796



DB-SB-10406

Ø: 80 Thick/Height: 46
0003238185



DB-SB-10409

Ø: 77 Thick/Height: 56
0003265181



DB-SB-10410

Ø: 73 Hole Distance: 100
Thick/Height: 24
9413230050



DB-VB-3707

Length: 622 Ø: 46
Hole Ø 25 / 25 / 25
Hole Distance: 152 / 130 / 130
01337100A, 9423501005, 9423501505,
9443500005, 9473500105, 9473501005,
A3753500005, A9423501005, A9423501505,
A9443500005, A9473500105, A9473501005



DB-VB-7261

Length: 622 Ø: 46
Hole Ø 25 / 25 / 25
Hole Distance: 152 / 130 / 130
01337800A, 9443500305, 9443500505,
9443500605, 9473500705, 9473500905,
9483500405, 9483503005



DB-VB-7798

Length: 622 Ø: 48
Hole Ø 25 / 23 / 23
Hole Distance: 152 / 130 / 130
9423500505, 9423500805, 9423501205,
A9423501205



DB-VB-10426

Length: 622 Ø: 46
Hole Ø 25 / 25 / 25
Hole Distance: 152 / 130 / 130
9443500405



MN-RK-8997

Ø: 85 Hole Distance: 130
Thick/Height: 30
0003504805





ACTROS MP2 / MP3 ...

2644, L, LL

04/03→	Ball Head, gearshift linkage	DB-ES-8510		
04/03→	Bush, driver cab suspension	DB-SB-10384		
04/03→	Bush, parabolic spring		DB-SB-10400	
04/03→	Bush, parabolic spring		DB-SB-10401	
04/03→	Centre Rod	DB-DL-2144		Push Rod
04/03→	Centre Rod	DB-DL-5230		Suspension Rod
04/03→	Centre Rod	DB-DL-5241		Push Rod
04/03→	Centre Rod	DB-DL-5405		Push Rod
04/03→	Centre Rod	DB-DL-5405		Push Rod, Leaf Spring Axle
04/03→	Centre Rod	DB-DL-7270		Push Rod;Suspension Rod
04/03→	Centre Rod	DB-DL-8167		Push Rod
04/03→	Centre Rod	DB-DL-8168		Push Rod
04/03→	Centre Rod	DB-DL-8184		Push Rod
04/03→	Centre Rod	DB-DL-8185		Push Rod
04/03→	Centre Rod	DB-DL-8307		Push Rod
04/03→	Centre Rod	DB-DL-8622		Push Rod
04/03→	Centre Rod	DB-DL-8641		Push Rod
04/03→	Centre Rod	DB-DL-8642		Push Rod
04/03→	Centre Rod	DB-DL-12300		for Steering Rod
04/03→	Rod Assembly	DB-DL-2178		Guide Rod
04/03→	Stabiliser Link	DB-DL-9254		Pressure Rod
04/03→	Stabiliser Mounting		DB-SB-10406	
04/03→	Stabiliser Mounting		DB-SB-10409	
04/03→	Stabiliser Mounting	DB-SB-10410		
04/03→	Suspension Arm Repair Kit		DB-RK-8550	for Wishbone (CV)
04/03→	Suspension Arm Repair Kit		DB-RK-8626	for Wishbone (CV)
04/03→	Suspension Arm Repair Kit		DB-RK-10374	for Wishbone (CV)
04/03→	Suspension Arm Repair Kit		DB-RK-10375	for Wishbone (CV)
04/03→	Suspension Arm Repair Kit	DB-RK-8638		for Control Arm
04/03→	Suspension Strut Repair Kit		DB-RK-8391	
04/03→	Suspension Strut Repair Kit		DB-RK-9294	
04/03→	Tie Rod	DB-DL-8327		Guide Rod
04/03→	Tie Rod	DB-DL-8640		Guide Rod
04/03→	Tie Rod	DB-DL-12310		
04/03→	Tie Rod	DB-ES-5227		Guide Rod
04/03→	Tie Rod End	CV-ES-0543		for Push Rod
04/03→	Tie Rod End	CV-ES-0888		for Push Rod
04/03→	Tie Rod End	CV-ES-14162		for Steering Rod
04/03→	Tie Rod End	CV-ES-14163		for Steering Rod
04/03→	Tie Rod End	DB-ES-5234		for Steering Rod
04/03→	Tie Rod End	DB-ES-8164		for Push Rod
04/03→	Tie Rod End	DB-ES-8530		for Push Rod
04/03→	Track Control Arm		DB-DL-3475	Trailing Arm
04/03→	Track Control Arm		DB-VB-3707	Suspension Rod, Wishbone (CV)
04/03→	Track Control Arm		DB-VB-7261	Suspension Rod, Wishbone (CV), 1st RA;2nd RA; Leaf Spring Axle
04/03→	Track Control Arm		DB-VB-10426	Wishbone (CV), Leaf Spring Axle;Unit
04/03→	Track Control Arm	DB-DL-5224		Control Arm, 1st FA;Air Suspension Axle
04/03→	Track Control Arm	DB-DL-9218	DB-DL-9218	Trailing Arm, 1st FA;Air Suspension Axle

2646 B

CV-ES-0543

Length: 125
 Cone Ø: d1 Ø 32 / d2 Ø 29
 Thread: M30 x 1,5 RHT
 0004605748, 0004606048, 0004606848,
 0004607048, 0014600448, 0014601148,
 0014601748, 0014602448, 0014607648,
 0014609648

**CV-ES-0888**

Length: 125
 Cone Ø: d1 Ø 32 / d2 Ø 29
 Thread: M30 x 1,5 LHT
 0004605848, 0004606148, 0004606948,
 0004607148, 0004609048, 0014600548,
 0014601348, 0014602548, 0014607948,
 0024600448

**CV-ES-14162**

Length: 125
 Cone Ø: d1 Ø 30 / d2 Ø 27
 Thread: M30 x 1,5 LHT
 4600648, 4601248, 4603448, 0004603548,
 14600348, 14601448, 14602348,
 0014603748, 0014607848, 0024600348

**CV-ES-14163**

Length: 125
 Cone Ø: d1 Ø 30 / d2 Ø 27
 Thread: M30 x 1,5 RHT
 0003305248, 0003387310, 0004600348,
 0004600948, 0004602848, 0004602948,
 0004608948, 0014600248, 0014600848,
 0014601248, 0014602248, 0014607748,
 0024600148, A0003387310, A0004600348,
 A0004602848, A0004602948, A0014600848,
 A0014601248, A0014602248, A0014607748

**DB-DL-2144**

Length: 872 Ø: 35
 Cone Ø: d1 Ø 28,6 / d2 Ø 23,9
 0024604305, 0024604405, 0034604805

**DB-DL-2178**

Length: 1735 Ø: 52
 Cone Ø: d1 Ø 32 / d2 Ø 29
 9423300003, 9423300103, 9423300203

**DB-DL-3475**

Length: 565 Ø: 52
 Hole Distance: 152 / 152
 3753500006, 3753500206, 9473500805,
 9483500006, 9483500805, 9483501205,
 9483501305, 9483501905, 9483502005,
 9483502405, A3753500006,
 A3753500206

**DB-DL-5224**

Length: 850 Ø: 60
 Hole Distance: 100 / 100
 01336100A, 9413300007

**DB-DL-5230**

Length: 879 Ø: 42
 Cone Ø: d1 Ø 30 / d2 Ø 27
 01208600A, 0004607105, 0004607205,
 0014606705

**DB-DL-5241**

Length: 875 Ø: 40
 Cone Ø: d1 Ø 30 / d2 Ø 27
 01215900A, 0004609205, 0004609305,
 0014606905

**DB-DL-5405**

Length: 890 Ø: 35
 Cone Ø: d1 Ø 28,6 / d2 Ø 23,9
 01215900A, 1460248, 0024604505,
 0024604605, 0034605005, 3752600637,
 3754600405, A3752600637, A3754600405

**DB-DL-7270**

Length: 875 Ø: 40
 Cone Ø: d1 Ø 28,6 / d2 Ø 23,9
 01208300A, 0024604705, 0024604805,
 0034604905, A0024604705

**DB-DL-8167**

Length: 866 Ø: 38
 Cone Ø: d1 Ø 30 / d2 Ø 27
 0014609805, 0014609905, 0024606305,
 0024606405

**DB-DL-8168**

Length: 904 Ø: 52
 Cone Ø: d1 Ø 32 / d2 Ø 29
 0004609405, 0004609505, 0014607105

**DB-DL-8184**

Length: 1095 Ø: 42
 Cone Ø: d1 Ø 32 / d2 Ø 28,8
 01217700A, 0014601305, 0014601405,
 0024600505, 0034603205, 3754601505,
 A0014601305, A0014601405, A0024600505

**DB-DL-8185**

Length: 711 Ø: 42
 Cone Ø: d1 Ø 32 / d2 Ø 28,8
 01213600A, 0014601105, 0024600405,
 0034603105, A0014601105, A0024600405

**DB-DL-8307**

Length: 885 Ø: 38
 Cone Ø: d1 Ø 32 / d2 Ø 30
 01215500A, 0004604005, 0024605105,
 0024605205, 0034604005

**DB-DL-8327**

Length: 1745 Ø: 48
 Cone Ø: d1 Ø 32 / d2 Ø 29
 01219800A, 9413300003, 9413300103,
 9413300203, 9413300303, 9413300503

**DB-DL-8622**

Length: 1558 Ø: 52
 Cone Ø: d1 Ø 30 / d2 Ø 27
 0014609005, 0014609105

**DB-DL-8640**

Length: 1615 Ø: 50
 Cone Ø: d1 Ø 32 / d2 Ø 29
 6253301503, 6253301603, 6253302403,
 6253302503, 9423300803, 9423302103,
 9493300203, 9493300303, 9493300903

**DB-DL-8641**

Length: 905 Ø: 42
 Cone Ø: d1 Ø 30 / d2 Ø 27
 0014605105, 0014608105

**DB-DL-8642**

Length: 954 Ø: 42
 Cone Ø: d1 Ø 30 / d2 Ø 27
 0014608605, 0014608705

**DB-DL-9218**

Length: 754 Ø: 40
 Hole Distance: 100
 000360098524, 000390098524,
 3753300111, 9413300011,
 A3753300111, SA50831601

**DB-DL-9254**

Length: 1815 Ø: 58
 0003220323, 0003220623, 3753220423

**DB-DL-12300**

Length: 733 Ø: 36
 Cone Ø: d1 Ø 32 / d2 Ø 29
 0014601505, 0014607305, 0034603305,
 3754601605, A0014601505,
 A0034603305, A3754601605

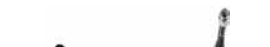
**DB-DL-12310**

Length: 1532 Ø: 50
 Cone Ø: d1 Ø 32 / d2 Ø 29
 Thread: M27 x 1,5 LHT
 9493301203, 9493301303, 9493301803,
 9493302203, A9493301203, A9493301303,
 A9493301803, A9493302203

**DB-ES-5227**

Length: 1588 Ø: 60
 Cone Ø: d1 Ø 38 / d2 Ø 34,3
 6253300903, 6253301203, 9443300203

**DB-ES-5234**

Length: 135
 Cone Ø: d1 Ø 38 / d2 Ø 34,3
 Thread: M38 x 1,5 RHT
 0004601748, 120322305, 2205000400

**DB-ES-8164**

Length: 140
 Cone Ø: d1 Ø 28,6 / d2 Ø 23,9
 Thread: M28 x 1,5 RHT
 0014604248, 0014605048, 0014608548,
 0024600548

**DB-ES-8510**

Length: 56
 Cone Ø: d1 Ø 10 / d2 Ø 10
 Thread: M12 x 1,75 LHT
 0009965145, 0009965645, 0019963145

**DB-ES-8530**

Length: 115
 Cone Ø: d1 Ø 28,6 / d2 Ø 23,9
 Thread: M30 x 1,5 RHT
 0014603848, 0014604848, 0014605148,
 0014608648, 0014609948

**DB-RK-8391**

Ø: 85 Hole Distance: 152
 Thick/Height: 24
 01336800A, 0003502705

**DB-RK-8550**

Ø: 75 Hole Distance: 152
 Thick/Height: 24
 0003502105, 0003504605

**DB-RK-8626**

Ø: 75 Hole Distance: 130
 Thick/Height: 24
 0003502205, 0003502505, 0003503405,
 0003504505, GL11319

**DB-RK-8638**

Length: 100 Ø: 67
 Hole Distance: 100
 Thick/Height: 20
 0003301411

**DB-RK-9294**

Ø: 85 Hole Distance: 152
 Thick/Height: 24
 0003503105

**DB-RK-10374**

Ø: 85 Hole Distance: 152
 Thick/Height: 24
 0003504405

**DB-RK-10375**

Ø: 100 Hole Distance: 152
 Thick/Height: 24
 0003502405, 0003503505, 0003504905

**DB-SB-10384**

Ø: 73 Thick/Height: 47
 9303170012, 9423171812

**DB-SB-10400**

Length: 230
 Thick/Height: 167,5 / 115
 0003250696, 0003250896

**DB-SB-10401**

Length: 232
 Thick/Height: 163,5 / 152,5
 0003250596, 0003250796

**DB-SB-10406**

Ø: 80 Thick/Height: 46
 0003238185

**DB-SB-10409**

Ø: 77 Thick/Height: 56
 0003265181

**DB-SB-10410**

Ø: 73 Hole Distance: 100
 Thick/Height: 24
 9413230050

**DB-VB-3707**

Length: 622 Ø: 46
 Hole Ø 25 / 25 / 25
 Hole Distance: 152 / 130 / 130
 01337100A, 9423501005, 9423501505,
 9443500005, 9473500105, 9473501005,
 A373500005, A9423501005, A9423501505,
 A9443500005, A9473500105, A9473501005

**DB-VB-7261**

Length: 622 Ø: 46
 Hole Ø 25 / 25 / 25
 Hole Distance: 152 / 130 / 130
 01337800A, 9443500305, 9443500505,
 9443500605, 9473500705, 9473500905,
 9483500405, 9483503005

**DB-VB-10426**

Length: 622 Ø: 46
 Hole Ø 25 / 25 / 25
 Hole Distance: 152 / 130 / 130
 9443500405





ACTROS MP2 / MP3 ...

2646 B ...	04/03→	Rod Assembly	DB-DL-2178		Guide Rod, 1st Front Axle, →504310 03
	04/03→	Stabiliser Mounting		DB-SB-10406	
	04/03→	Stabiliser Mounting		DB-SB-10409	
	04/03→	Suspension Arm Repair Kit		DB-RK-8550	for Wishbone (CV)
	04/03→	Suspension Arm Repair Kit		DB-RK-8626	for Wishbone (CV)
	04/03→	Suspension Arm Repair Kit		DB-RK-10374	for Wishbone (CV)
	04/03→	Suspension Arm Repair Kit	DB-RK-8638		for Control Arm
	04/03→	Suspension Strut Repair Kit		DB-RK-8391	
	04/03→	Suspension Strut Repair Kit		DB-RK-9294	
	04/03→	Tie Rod	DB-DL-8327		Guide Rod
	04/03→	Tie Rod	DB-DL-8640		Guide Rod
	04/03→	Tie Rod	DB-DL-12310		
	04/03→	Tie Rod End	CV-ES-0543		for Push Rod
	04/03→	Tie Rod End	CV-ES-0888		for Push Rod
	04/03→	Tie Rod End	CV-ES-14163		for Steering Rod
	04/03→	Tie Rod End	DB-ES-5234		for Steering Rod
	04/03→	Tie Rod End	DB-ES-8164		for Push Rod
	04/03→	Tie Rod End	DB-ES-8530		for Push Rod
	04/03→	Track Control Arm		DB-DL-3475	Trailing Arm
	04/03→	Track Control Arm		DB-VB-3707	Suspension Rod, Wishbone (CV)
04/03→	Track Control Arm		DB-VB-7261	Suspension Rod, Wishbone (CV), 1st RA;2nd RA; Leaf Spring Axle	
04/03→	Track Control Arm		DB-VB-10426	Wishbone (CV), Leaf Spring Axle;Unit	
2646 K, LK	04/03→	Ball Head, gearshift linkage	DB-ES-8510		
	04/03→	Bush, driver cab suspension	DB-SB-10384		
	04/03→	Bush, parabolic spring		DB-SB-10400	
	04/03→	Bush, parabolic spring		DB-SB-10401	
	04/03→	Centre Rod	DB-DL-2144		Push Rod
	04/03→	Centre Rod	DB-DL-5230		Suspension Rod
	04/03→	Centre Rod	DB-DL-5241		Push Rod
	04/03→	Centre Rod	DB-DL-5405		Push Rod
	04/03→	Centre Rod	DB-DL-5405		Push Rod, Leaf Spring Axle
	04/03→	Centre Rod	DB-DL-7270		Push Rod
	04/03→	Centre Rod	DB-DL-8167		Push Rod
	04/03→	Centre Rod	DB-DL-8184		Push Rod
	04/03→	Centre Rod	DB-DL-8185		Push Rod
	04/03→	Centre Rod	DB-DL-8307		Push Rod
	04/03→	Centre Rod	DB-DL-12300		for Steering Rod
	04/03→	Rod Assembly	DB-DL-2178		Guide Rod
	04/03→	Stabiliser Mounting		DB-RK-9296	
	04/03→	Stabiliser Mounting		DB-SB-10406	
	04/03→	Stabiliser Mounting		DB-SB-10409	
	04/03→	Suspension Arm Repair Kit		DB-RK-8550	for Wishbone (CV)
	04/03→	Suspension Arm Repair Kit		DB-RK-8626	for Wishbone (CV)
	04/03→	Suspension Arm Repair Kit		DB-RK-10374	for Wishbone (CV)
	04/03→	Suspension Arm Repair Kit		DB-RK-10375	for Wishbone (CV)
	04/03→	Suspension Arm Repair Kit	DB-RK-8638		for Control Arm
	04/03→	Suspension Strut Repair Kit		DB-RK-8391	
	04/03→	Suspension Strut Repair Kit		DB-RK-9294	
	04/03→	Tie Rod	DB-DL-8171		Guide Rod
	04/03→	Tie Rod	DB-DL-8327		Guide Rod
	04/03→	Tie Rod	DB-DL-8640		Guide Rod
	04/03→	Tie Rod	DB-DL-12310		
	04/03→	Tie Rod	DB-ES-5227		Guide Rod
	04/03→	Tie Rod End	CV-ES-0543		for Push Rod
	04/03→	Tie Rod End	CV-ES-0888		for Push Rod
	04/03→	Tie Rod End	CV-ES-14162		for Steering Rod
	04/03→	Tie Rod End	CV-ES-14163		for Steering Rod
	04/03→	Tie Rod End	DB-ES-5234		for Steering Rod
	04/03→	Tie Rod End	DB-ES-8164		for Push Rod
	04/03→	Tie Rod End	DB-ES-8530		for Push Rod
	04/03→	Track Control Arm		DB-DL-3475	Trailing Arm
	04/03→	Track Control Arm		DB-VB-3707	Suspension Rod, Wishbone (CV)

CV-ES-0543

Length: 125
Cone Ø: d1 Ø 32 / d2 Ø 29
Thread: M30 x 1,5 RHT
0004605748, 0004606048, 0004606848,
0004607048, 0014600448, 0014601148,
0014601748, 0014602448, 0014607648,
0014609648



CV-ES-0888

Length: 125
Cone Ø: d1 Ø 32 / d2 Ø 29
Thread: M30 x 1,5 LHT
0004605848, 0004606148, 0004606948,
0004607148, 0004609048, 0014600548,
0014601348, 0014602548, 0014607948,
0024600448



CV-ES-14162

Length: 125
Cone Ø: d1 Ø 30 / d2 Ø 27
Thread: M30 x 1,5 LHT
4600648, 4601248, 4603448, 0004603548,
14600348, 14601448, 14602348, 0014603748,
0014607848, 0024600348



CV-ES-14163

Length: 125
Cone Ø: d1 Ø 30 / d2 Ø 27
Thread: M30 x 1,5 RHT
0003305248, 0003387310, 0004600348,
0004600948, 0004602848, 0004602948,
0004608948, 0014600248, 0014600848,
0014601248, 0014602248, 0014607748,
0024600148, A0003387310, A0004600348,
A0004602848, A0004602948, A0014600848,
A0014601248, A0014602248, A0014607748



DB-DL-2144

Length: 872 Ø: 35
Cone Ø: d1 Ø 28,6 / d2 Ø 23,9
0024604305, 0024604405, 0034604805



DB-DL-2178

Length: 1735 Ø: 52
Cone Ø: d1 Ø 32 / d2 Ø 29
9423300003, 9423300103, 9423300203



DB-DL-3475

Length: 565 Ø: 52
Hole Distance: 152 / 152
3753500006, 3753500206, 9473500805,
9483500006, 9483500805, 9483501205,
9483501305, 9483501905, 9483502005,
9483502405, A3753500006, A3753500206



DB-DL-5230

Length: 879 Ø: 42
Cone Ø: d1 Ø 30 / d2 Ø 27
01208600A, 0004607105, 0004607205,
0014606705



DB-DL-5241

Length: 875 Ø: 40
Cone Ø: d1 Ø 30 / d2 Ø 27
01215300A, 0004609205, 0004609305,
0014606905



DB-DL-5405

Length: 890 Ø: 35
Cone Ø: d1 Ø 28,6 / d2 Ø 23,9
01215900A, 1460248, 0024604505, 0024604605,
0034605005, 3752600637, 3754600405,
A3752600637, A3754600405



DB-DL-7270

Length: 875 Ø: 40
Cone Ø: d1 Ø 28,6 / d2 Ø 23,9
01208300A, 0024604705, 0024604805,
0034604905, A0024604705



DB-DL-8167

Length: 866 Ø: 38
Cone Ø: d1 Ø 30 / d2 Ø 27
0014609805, 0014609905, 0024606305,
0024606405



DB-DL-8171

Length: 1687 Ø: 52
Cone Ø: d1 Ø 32 / d2 Ø 29
9493300603, 9493300703, 9493301503,
9493301603



DB-DL-8184

Length: 1095 Ø: 42
Cone Ø: d1 Ø 32 / d2 Ø 28,8
01217700A, 0014601305, 0014601405,
0024600505, 0034603205, 3754601505,
A0014601305, A0014601405, A0024600505



DB-DL-8185

Length: 711 Ø: 42
Cone Ø: d1 Ø 32 / d2 Ø 28,8
01213600A, 0014601105, 0024600405,
0034603105, A0014601105, A0024600405



DB-DL-8307

Length: 885 Ø: 38
Cone Ø: d1 Ø 32 / d2 Ø 30
01215500A, 0004604005, 0024605105,
0024605205, 0034604005



DB-DL-8327

Length: 1745 Ø: 48
Cone Ø: d1 Ø 32 / d2 Ø 29
01219800A, 9413300003, 9413300103,
9413300203, 9413300303, 9413300503



DB-DL-8640

Length: 1615 Ø: 50
Cone Ø: d1 Ø 32 / d2 Ø 29
6253301503, 6253301603, 6253302403,
6253302503, 9423300803, 9423302103,
9493300203, 9493300303, 9493300903



DB-DL-12300

Length: 733 Ø: 36
Cone Ø: d1 Ø 32 / d2 Ø 29
0014601505, 0014607305, 0034603305,
3754601605, A0014601505, A0034603305,
A3754601605



DB-DL-12310

Length: 1532 Ø: 50
Cone Ø: d1 Ø 32 / d2 Ø 29
Thread: M27 x 1,5 LHT
9493301203, 9493301303, 9493301803,
9493302203, A9493301203, A9493301303,
A9493301803, A9493302203



DB-ES-5227

Length: 1588 Ø: 60
Cone Ø: d1 Ø 38 / d2 Ø 34,3
6253300903, 6253301203, 9443300203



DB-ES-5234

Length: 135
Cone Ø: d1 Ø 38 / d2 Ø 34,3
Thread: M38 x 1,5 RHT
0004601748, 120322305, 2205000400



DB-ES-8164

Length: 140
Cone Ø: d1 Ø 28,6 / d2 Ø 23,9
Thread: M28 x 1,5 RHT
0014604248, 0014605048, 0014608548,
0024600548



DB-ES-8510

Length: 56
Cone Ø: d1 Ø 10 / d2 Ø 10
Thread: M12 x 1,75 LHT
0009965145, 0009965645, 0019963145



DB-ES-8530

Length: 115
Cone Ø: d1 Ø 28,6 / d2 Ø 23,9
Thread: M30 x 1,5 RHT
0014603848, 0014604848, 0014605148,
0014608648, 0014609948



DB-RK-8391

Ø: 85 Hole Distance: 152
Thick/Height: 24
01336800A, 0003502705



DB-RK-8550

Ø: 75 Hole Distance: 152
Thick/Height: 24
0003502105, 0003504605



DB-RK-8626

Ø: 75 Hole Distance: 130
Thick/Height: 24
0003502205, 0003502505, 0003503405,
0003504505, GL11319



DB-RK-8638

Length: 100 Ø: 67
Hole Distance: 100
Thick/Height: 20
0003301411



DB-RK-9294

Ø: 85 Hole Distance: 152
Thick/Height: 24
0003503105



DB-RK-9296

Ø: 88 Hole Distance: 130
Thick/Height: 24
9423260050



DB-RK-10374

Ø: 85 Hole Distance: 152
Thick/Height: 24
0003504405



DB-RK-10375

Ø: 100 Hole Distance: 152
Thick/Height: 24
0003502405, 0003503505, 0003504905



DB-SB-10384

Ø: 73 Thick/Height: 47
9303170012, 9423171812



DB-SB-10400

Length: 230
Thick/Height: 167,5 / 115
0003250696, 0003250896



DB-SB-10401

Length: 232
Thick/Height: 163,5 / 152,5
0003250596, 0003250796



DB-SB-10406

Ø: 80 Thick/Height: 46
0003238185



DB-SB-10409

Ø: 77 Thick/Height: 56
0003265181



DB-VB-3707

Length: 622 Ø: 46
Hole Ø 25 / 25 / 25
Hole Distance: 152 / 130 / 130
01337100A, 9423501005, 9423501505,
9443500005, 9473500105, 9473501005,
A375350005, A9423501005, A9423501505,
A9443500005, A9473500105, A9473501005



DB-VB-7261

Length: 622 Ø: 46
Hole Ø 25 / 25 / 25
Hole Distance: 152 / 130 / 130
01337800A, 9443500305, 9443500505,
9443500605, 9473500705, 9473500905,
9483500405, 9483503005



DB-VB-10426

Length: 622 Ø: 46
Hole Ø 25 / 25 / 25
Hole Distance: 152 / 130 / 130
9443500405





ACTROS MP2 / MP3 ...

2646 K, LK ...	04/03 →	Track Control Arm		DB-VB-7261	Suspension Rod, Wishbone (CV), 1st RA;2nd RA; Leaf Spring Axle	
	04/03 →	Track Control Arm		DB-VB-10426	Wishbone (CV), Leaf Spring Axle;Unit	
2646 LS	10/09 →	Centre Rod	DB-DL-2144		Push Rod	
	10/09 →	Centre Rod	DB-DL-8167		Push Rod	
	10/09 →	Rod Assembly	DB-DL-2178		Guide Rod, 1st Front Axle, →504310 03	
	10/09 →	Suspension Arm Repair Kit		DB-RK-8626	for Wishbone (CV)	
	10/09 →	Suspension Arm Repair Kit		DB-RK-10374	for Wishbone (CV)	
	10/09 →	Tie Rod	DB-DL-8640		Guide Rod	
	10/09 →	Tie Rod	DB-DL-12310			
	10/09 →	Tie Rod End	CV-ES-0543		for Push Rod	
	10/09 →	Tie Rod End	CV-ES-0888		for Push Rod	
	10/09 →	Tie Rod End	CV-ES-14163		for Steering Rod	
	10/09 →	Tie Rod End	DB-ES-8164		for Push Rod	
	10/09 →	Track Control Arm		DB-VB-3707	Suspension Rod, Wishbone (CV)	
	2646 S, LS	04/03 →	Ball Head, gearshift linkage	DB-ES-8510		
		04/03 →	Bush, driver cab suspension	DB-SB-10384		
04/03 →		Bush, parabolic spring		DB-SB-10400		
04/03 →		Bush, parabolic spring		DB-SB-10401		
04/03 →		Centre Rod	DB-DL-2144		Push Rod	
04/03 →		Centre Rod	DB-DL-5230		Suspension Rod	
04/03 →		Centre Rod	DB-DL-5241		Push Rod	
04/03 →		Centre Rod	DB-DL-5405		Push Rod, Leaf Spring Axle	
04/03 →		Centre Rod	DB-DL-7270		Push Rod;Suspension Rod	
04/03 →		Centre Rod	DB-DL-8167		Push Rod	
04/03 →		Centre Rod	DB-DL-8184		Push Rod	
04/03 →		Centre Rod	DB-DL-8185		Push Rod	
04/03 →		Centre Rod	DB-DL-8307		Push Rod	
04/03 →		Centre Rod	DB-DL-12300		for Steering Rod	
04/03 →		Rod Assembly	DB-DL-2178		Guide Rod	
04/03 →		Stabiliser Mounting		DB-SB-10406		
04/03 →		Stabiliser Mounting		DB-SB-10409		
04/03 →		Stabiliser Mounting	DB-SB-10410			
04/03 →		Suspension Arm Repair Kit		DB-RK-8550	for Wishbone (CV)	
04/03 →		Suspension Arm Repair Kit		DB-RK-8626	for Wishbone (CV)	
04/03 →		Suspension Arm Repair Kit		DB-RK-10374	for Wishbone (CV)	
04/03 →		Suspension Arm Repair Kit		DB-RK-10375	for Wishbone (CV)	
04/03 →		Suspension Arm Repair Kit	DB-RK-8638		for Control Arm	
04/03 →		Suspension Strut Repair Kit		DB-RK-8391		
04/03 →		Suspension Strut Repair Kit		DB-RK-9294		
04/03 →		Suspension Strut Repair Kit		MN-RK-8997		
04/03 →		Tie Rod	DB-DL-8171		Guide Rod	
04/03 →		Tie Rod	DB-DL-8327		Guide Rod	
04/03 →		Tie Rod	DB-DL-8640		Guide Rod	
04/03 →		Tie Rod	DB-DL-12310			
04/03 →		Tie Rod	DB-ES-5227		Guide Rod	
04/03 →		Tie Rod End	CV-ES-0543		for Push Rod	
04/03 →		Tie Rod End	CV-ES-0888		for Push Rod	
04/03 →		Tie Rod End	CV-ES-14162		for Steering Rod	
04/03 →		Tie Rod End	CV-ES-14163		for Steering Rod	
04/03 →		Tie Rod End	DB-ES-5234		for Steering Rod	
04/03 →		Tie Rod End	DB-ES-8164		for Push Rod	
04/03 →		Tie Rod End	DB-ES-8530		for Push Rod	
04/03 →		Track Control Arm		DB-DL-3475	Trailing Arm	
04/03 →		Track Control Arm		DB-VB-3707	Suspension Rod, Wishbone (CV)	
04/03 →		Track Control Arm		DB-VB-7261	Suspension Rod, Wishbone (CV), 1st RA;2nd RA; Leaf Spring Axle	
04/03 →		Track Control Arm		DB-VB-7798	Wishbone (CV)	
04/03 →		Track Control Arm		DB-VB-10426	Wishbone (CV), Leaf Spring Axle;Unit	
2646, L, LL		04/03 →	Ball Head, gearshift linkage	DB-ES-8510		
		04/03 →	Bush, driver cab suspension	DB-SB-10384		
		04/03 →	Bush, parabolic spring		DB-SB-10400	
		04/03 →	Bush, parabolic spring		DB-SB-10401	



ACTROS MP2 / MP3 ...

2646, L, LL ...	04/03→	Centre Rod	DB-DL-2144	Push Rod	
	04/03→	Centre Rod	DB-DL-5230	Suspension Rod	
	04/03→	Centre Rod	DB-DL-5241	Push Rod	
	04/03→	Centre Rod	DB-DL-5405	Push Rod, Leaf Spring Axle	
	04/03→	Centre Rod	DB-DL-7270	Push Rod;Suspension Rod	
	04/03→	Centre Rod	DB-DL-8167	Push Rod	
	04/03→	Centre Rod	DB-DL-8168	Push Rod	
	04/03→	Centre Rod	DB-DL-8184	Push Rod	
	04/03→	Centre Rod	DB-DL-8185	Push Rod	
	04/03→	Centre Rod	DB-DL-8307	Push Rod	
	04/03→	Centre Rod	DB-DL-8622	Push Rod	
	04/03→	Centre Rod	DB-DL-8641	Push Rod	
	04/03→	Centre Rod	DB-DL-8642	Push Rod	
	04/03→	Centre Rod	DB-DL-12300	for Steering Rod	
	04/03→	Rod Assembly	DB-DL-2178	Guide Rod	
	04/03→	Stabiliser Link	DB-DL-9254	Pressure Rod	
	04/03→	Stabiliser Mounting		DB-SB-10406	
	04/03→	Stabiliser Mounting		DB-SB-10409	
	04/03→	Stabiliser Mounting	DB-SB-10410		
	04/03→	Suspension Arm Repair Kit		DB-RK-8550 for Wishbone (CV)	
	04/03→	Suspension Arm Repair Kit		DB-RK-8626 for Wishbone (CV)	
	04/03→	Suspension Arm Repair Kit		DB-RK-10374 for Wishbone (CV)	
	04/03→	Suspension Arm Repair Kit		DB-RK-10375 for Wishbone (CV)	
	04/03→	Suspension Arm Repair Kit	DB-RK-8638	for Control Arm	
	04/03→	Suspension Strut Repair Kit		DB-RK-8391	
	04/03→	Suspension Strut Repair Kit		DB-RK-9294	
	04/03→	Tie Rod	DB-DL-8327	Guide Rod	
	04/03→	Tie Rod	DB-DL-8640	Guide Rod	
	04/03→	Tie Rod	DB-DL-12310		
	04/03→	Tie Rod	DB-ES-5227	Guide Rod	
	04/03→	Tie Rod End	CV-ES-0543	for Push Rod	
	04/03→	Tie Rod End	CV-ES-0888	for Push Rod	
	04/03→	Tie Rod End	CV-ES-14162	for Steering Rod	
	04/03→	Tie Rod End	CV-ES-14163	for Steering Rod	
	04/03→	Tie Rod End	DB-ES-5234	for Steering Rod	
	04/03→	Tie Rod End	DB-ES-8164	for Push Rod	
	04/03→	Tie Rod End	DB-ES-8530	for Push Rod	
	04/03→	Track Control Arm		DB-DL-3475 Trailing Arm	
	04/03→	Track Control Arm		DB-VB-3707 Suspension Rod, Wishbone (CV)	
	04/03→	Track Control Arm		DB-VB-7261 Suspension Rod, Wishbone (CV), 1st RA;2nd RA; Leaf Spring Axle	
	04/03→	Track Control Arm		DB-VB-10426 Wishbone (CV), Leaf Spring Axle;Unit	
	2648 B	04/03→	Ball Head, gearshift linkage	DB-ES-8510	
		04/03→	Bush, driver cab suspension	DB-SB-10384	
04/03→		Bush, parabolic spring		DB-SB-10400	
04/03→		Bush, parabolic spring		DB-SB-10401	
04/03→		Centre Rod	DB-DL-2144	Push Rod	
04/03→		Centre Rod	DB-DL-5230	Suspension Rod	
04/03→		Centre Rod	DB-DL-5241	Push Rod	
04/03→		Centre Rod	DB-DL-5405	Push Rod, Leaf Spring Axle	
04/03→		Centre Rod	DB-DL-7270	Push Rod	
04/03→		Centre Rod	DB-DL-8167	Push Rod	
04/03→		Centre Rod	DB-DL-8184	Push Rod	
04/03→		Centre Rod	DB-DL-8185	Push Rod	
04/03→		Centre Rod	DB-DL-8307	Push Rod	
04/03→		Centre Rod	DB-DL-12300	for Steering Rod	
04/03→		Rod Assembly	DB-DL-2178	Guide Rod, 1st Front Axle, →504310 03	
04/03→		Stabiliser Mounting		DB-SB-10406	
04/03→		Stabiliser Mounting		DB-SB-10409	
04/03→		Suspension Arm Repair Kit		DB-RK-8550 for Wishbone (CV)	
04/03→		Suspension Arm Repair Kit		DB-RK-8626 for Wishbone (CV)	
04/03→		Suspension Arm Repair Kit		DB-RK-10374 for Wishbone (CV)	
04/03→		Suspension Arm Repair Kit	DB-RK-8638	for Control Arm	

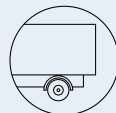

ACTROS MP2 / MP3 ...

2648 B ...	04/03→	Suspension Strut Repair Kit		DB-RK-8391	
	04/03→	Suspension Strut Repair Kit		DB-RK-9294	
	04/03→	Tie Rod	DB-DL-8327		Guide Rod
	04/03→	Tie Rod	DB-DL-8640		Guide Rod
	04/03→	Tie Rod	DB-DL-12310		
	04/03→	Tie Rod End	CV-ES-0543		for Push Rod
	04/03→	Tie Rod End	CV-ES-0888		for Push Rod
	04/03→	Tie Rod End	CV-ES-14163		for Steering Rod
	04/03→	Tie Rod End	DB-ES-5234		for Steering Rod
	04/03→	Tie Rod End	DB-ES-8164		for Push Rod
	04/03→	Tie Rod End	DB-ES-8530		for Push Rod
	04/03→	Track Control Arm		DB-DL-3475	Trailing Arm
	04/03→	Track Control Arm		DB-VB-3707	Suspension Rod, Wishbone (CV)
	04/03→	Track Control Arm		DB-VB-7261	Suspension Rod, Wishbone (CV), 1st RA;2nd RA; Leaf Spring Axle
04/03→	Track Control Arm		DB-VB-10426	Wishbone (CV), Leaf Spring Axle;Unit	
2648 K, LK	04/03→	Ball Head, gearshift linkage	DB-ES-8510		
	04/03→	Bush, driver cab suspension	DB-SB-10384		
	04/03→	Bush, parabolic spring		DB-SB-10400	
	04/03→	Bush, parabolic spring		DB-SB-10401	
	04/03→	Centre Rod	DB-DL-2144		Push Rod
	04/03→	Centre Rod	DB-DL-5230		Suspension Rod
	04/03→	Centre Rod	DB-DL-5241		Push Rod
	04/03→	Centre Rod	DB-DL-5405		Push Rod
	04/03→	Centre Rod	DB-DL-5405		Push Rod, Leaf Spring Axle
	04/03→	Centre Rod	DB-DL-7270		Push Rod
	04/03→	Centre Rod	DB-DL-8167		Push Rod
	04/03→	Centre Rod	DB-DL-8184		Push Rod
	04/03→	Centre Rod	DB-DL-8185		Push Rod
	04/03→	Centre Rod	DB-DL-8307		Push Rod
	04/03→	Centre Rod	DB-DL-12300		for Steering Rod
	04/03→	Rod Assembly	DB-DL-2178		Guide Rod, 1st Front Axle, →504310 03
	04/03→	Stabiliser Mounting		DB-RK-9296	
	04/03→	Stabiliser Mounting		DB-SB-10406	
	04/03→	Stabiliser Mounting		DB-SB-10409	
	04/03→	Suspension Arm Repair Kit		DB-RK-8550	for Wishbone (CV)
	04/03→	Suspension Arm Repair Kit		DB-RK-8626	for Wishbone (CV)
	04/03→	Suspension Arm Repair Kit		DB-RK-10374	for Wishbone (CV)
	04/03→	Suspension Arm Repair Kit		DB-RK-10375	for Wishbone (CV)
	04/03→	Suspension Arm Repair Kit	DB-RK-8638		for Control Arm
	04/03→	Suspension Strut Repair Kit		DB-RK-8391	
	04/03→	Suspension Strut Repair Kit		DB-RK-9294	
	04/03→	Tie Rod	DB-DL-8171		Guide Rod
	04/03→	Tie Rod	DB-DL-8327		Guide Rod
	04/03→	Tie Rod	DB-DL-8640		Guide Rod
	04/03→	Tie Rod	DB-DL-12310		
	04/03→	Tie Rod	DB-ES-5227		Guide Rod
	04/03→	Tie Rod End	CV-ES-0543		for Push Rod
	04/03→	Tie Rod End	CV-ES-0888		for Push Rod
	04/03→	Tie Rod End	CV-ES-14163		for Steering Rod
	04/03→	Tie Rod End	DB-ES-5234		for Steering Rod
	04/03→	Tie Rod End	DB-ES-8164		for Push Rod
	04/03→	Tie Rod End	DB-ES-8530		for Push Rod
	04/03→	Track Control Arm		DB-DL-3475	Trailing Arm
	04/03→	Track Control Arm		DB-DL-3475	Trailing Arm, 1st RA;2nd RA, →517144 03/517144 06
	04/03→	Track Control Arm		DB-DL-3475	Trailing Arm, 1st RA;2nd RA, →517144 05/517144 08
	04/03→	Track Control Arm		DB-DL-3475	Trailing Arm, 1st RA;2nd RA, →517144 07/517144 09
	04/03→	Track Control Arm		DB-DL-3475	Trailing Arm, 1st RA;2nd RA, →517144 26/517144 27
	04/03→	Track Control Arm		DB-VB-3707	Suspension Rod, Wishbone (CV)



ACTROS MP2 / MP3 ...

2648 K, LK ...	04/03→	Track Control Arm		DB-VB-7261	Suspension Rod, Wishbone (CV)	
	04/03→	Track Control Arm		DB-VB-7261	Suspension Rod, Wishbone (CV), 1st RA;2nd RA; Leaf Spring Axle	
	04/03→	Track Control Arm		DB-VB-10426	Wishbone (CV)	
	04/03→	Track Control Arm		DB-VB-10426	Wishbone (CV), Leaf Spring Axle;Unit	
2648 L	04/03→	Centre Rod	DB-DL-2144		Push Rod	
	04/03→	Centre Rod	DB-DL-5405		Push Rod	
	04/03→	Centre Rod	DB-DL-7270		Push Rod	
	04/03→	Centre Rod	DB-DL-8167		Push Rod	
	04/03→	Centre Rod	DB-DL-8307		Push Rod	
	04/03→	Suspension Arm Repair Kit		DB-RK-8626	for Wishbone (CV)	
	04/03→	Suspension Arm Repair Kit		DB-RK-10374	for Wishbone (CV)	
	04/03→	Tie Rod	DB-DL-8640		Guide Rod	
	04/03→	Tie Rod End	CV-ES-0543		for Push Rod	
	04/03→	Tie Rod End	CV-ES-14163		for Steering Rod	
	04/03→	Tie Rod End	DB-ES-8164		for Push Rod	
	04/03→	Tie Rod End	DB-ES-8530		for Push Rod	
	04/03→	Track Control Arm		DB-VB-3707	Suspension Rod, Wishbone (CV)	
	04/03→	Track Control Arm	DB-DL-5224		Control Arm	
	04/03→	Track Control Arm	DB-DL-9218	DB-DL-9218	Trailing Arm	
	2648 LS	10/02→	Centre Rod	DB-DL-2144		Push Rod
10/02→		Centre Rod	DB-DL-5405		Push Rod	
10/02→		Centre Rod	DB-DL-7270		Push Rod	
10/02→		Centre Rod	DB-DL-8167		Push Rod	
10/02→		Centre Rod	DB-DL-8307		Push Rod	
10/02→		Rod Assembly	DB-DL-2178		Guide Rod, 1st Front Axle, →504310 03	
10/02→		Suspension Arm Repair Kit		DB-RK-8626	for Wishbone (CV)	
10/02→		Suspension Arm Repair Kit		DB-RK-10374	for Wishbone (CV)	
10/02→		Tie Rod	DB-DL-8327		Guide Rod, 1st Front Axle	
10/02→		Tie Rod	DB-DL-8640		Guide Rod, 1st Front Axle	
10/02→		Tie Rod	DB-DL-12310			
10/02→		Tie Rod End	CV-ES-0543		for Push Rod	
10/02→		Tie Rod End	CV-ES-0888		for Push Rod	
10/02→		Tie Rod End	CV-ES-14163		for Steering Rod	
10/02→		Tie Rod End	DB-ES-8164		for Push Rod	
10/02→		Track Control Arm		DB-VB-3707	Suspension Rod, Wishbone (CV)	
10/09→		Tie Rod	DB-DL-8640		Guide Rod	
2648 S, LS		04/03→	Centre Rod	DB-DL-2144		Push Rod
		04/03→	Centre Rod	DB-DL-5405		Push Rod
		04/03→	Centre Rod	DB-DL-5405		Push Rod, Leaf Spring Axle
	04/03→	Centre Rod	DB-DL-7270		Push Rod	
	04/03→	Centre Rod	DB-DL-8167		Push Rod	
	04/03→	Centre Rod	DB-DL-8307		Push Rod	
	04/03→	Rod Assembly	DB-DL-2178		Guide Rod, 1st Front Axle, →504310 03	
	04/03→	Stabiliser Mounting		DB-SB-10406		
	04/03→	Suspension Strut Repair Kit		DB-RK-9294		
	04/03→	Tie Rod	DB-DL-8171		Guide Rod	
	04/03→	Tie Rod	DB-DL-8327		Guide Rod	
	04/03→	Tie Rod	DB-DL-8640		Guide Rod	
	04/03→	Tie Rod	DB-DL-12310			
	04/03→	Tie Rod	DB-ES-5227		Guide Rod	
	04/03→	Tie Rod End	CV-ES-0543		for Push Rod	
	04/03→	Tie Rod End	CV-ES-0888		for Push Rod	
	04/03→	Tie Rod End	CV-ES-14163		for Steering Rod	
	04/03→	Tie Rod End	DB-ES-8164		for Push Rod	
	04/03→	Track Control Arm		DB-DL-3475	Trailing Arm, 1st RA;2nd RA, →517144 05/517144 08	
	04/03→	Track Control Arm		DB-VB-3707	Suspension Rod, Wishbone (CV), 1st RA;2nd RA, →508306 01	
	04/03→	Track Control Arm		DB-VB-7261	Suspension Rod, Wishbone (CV), 1st RA;2nd RA; Leaf Spring Axle	
	04/03→	Track Control Arm		DB-VB-10426	Wishbone (CV), Leaf Spring Axle;Unit	

CV-ES-0543

Length: 125
Cone Ø: d1 Ø 32 / d2 Ø 29
Thread: M30 x 1,5 RHT
0004605748, 0004606048, 0004606848,
0004607048, 0014600448, 0014601148,
0014601748, 0014602448, 0014607648,
0014609648



CV-ES-0888

Length: 125
Cone Ø: d1 Ø 32 / d2 Ø 29
Thread: M30 x 1,5 LHT
0004605848, 0004606148, 0004606948,
0004607148, 0004609048, 0014600548,
0014601348, 0014602548, 0014607948,
0024600448



CV-ES-14163

Length: 125
Cone Ø: d1 Ø 30 / d2 Ø 27
Thread: M30 x 1,5 RHT
0003305248, 0003387310, 0004600348,
0004600948, 0004602848, 0004602948,
0004608948, 0014600248, 0014600848,
0014601248, 0014602248, 0014607748,
0024600148, A0003387310, A0004600348,
A0004602848, A0004602948, A0014600848,
A0014601248, A0014602248, A0014607748



DB-DL-2144

Length: 872 Ø: 35
Cone Ø: d1 Ø 28,6 / d2 Ø 23,9
0024604305, 0024604405, 0034604805



DB-DL-2178

Length: 1735 Ø: 52
Cone Ø: d1 Ø 32 / d2 Ø 29
9423300003, 9423300103, 9423300203



DB-DL-3475

Length: 565 Ø: 52
Hole Distance: 152 / 152
3753500006, 3753500206, 9473500805,
9483500006, 9483500805, 9483501205,
9483501305, 9483501905, 9483502005,
9483502405, A3753500006,
A3753500206



DB-DL-5224

Length: 850 Ø: 60
Hole Distance: 100 / 100
01336100A, 9413300007



DB-DL-5405

Length: 890 Ø: 35
Cone Ø: d1 Ø 28,6 / d2 Ø 23,9
01215900A, 1460248, 0024604505,
0024604605, 0034605005, 3752600637,
3754600405, A3752600637, A3754600405



DB-DL-7270

Length: 875 Ø: 40
Cone Ø: d1 Ø 28,6 / d2 Ø 23,9
01208300A, 0024604705, 0024604805,
0034604905, A0024604705



DB-DL-8167

Length: 866 Ø: 38
Cone Ø: d1 Ø 30 / d2 Ø 27
0014609805, 0014609905, 0024606305,
0024606405



DB-DL-8171

Length: 1687 Ø: 52
Cone Ø: d1 Ø 32 / d2 Ø 29
9493300603, 9493300703, 9493301503,
9493301603



DB-DL-8307

Length: 885 Ø: 38
Cone Ø: d1 Ø 32 / d2 Ø 30
01215500A, 0004604005, 0024605105,
0024605205, 0034604005



DB-DL-8327

Length: 1745 Ø: 48
Cone Ø: d1 Ø 32 / d2 Ø 29
01219800A, 9413300003, 9413300103,
9413300203, 9413300303, 9413300503



DB-DL-8640

Length: 1615 Ø: 50
Cone Ø: d1 Ø 32 / d2 Ø 29
6253301503, 6253301603, 6253302403,
6253302503, 9423300803, 9423302103,
9493300203, 9493300303, 9493300903



DB-DL-9218

Length: 754 Ø: 40
Hole Distance: 100
000360098524, 000390098524,
3753300111, 9413300011,
A3753300111, SA50831601



DB-DL-12310

Length: 1532 Ø: 50
Cone Ø: d1 Ø 32 / d2 Ø 29
Thread: M27 x 1,5 LHT
9493301203, 9493301303, 9493301803,
9493302203, A9493301203, A9493301303,
A9493301803, A9493302203



DB-ES-5227

Length: 1588 Ø: 60
Cone Ø: d1 Ø 38 / d2 Ø 34,3
6253300903, 6253301203, 9443300203



DB-ES-8164

Length: 140
Cone Ø: d1 Ø 28,6 / d2 Ø 23,9
Thread: M28 x 1,5 RHT
0014604248, 0014605048, 0014608548,
0024600548



DB-ES-8530

Length: 115
Cone Ø: d1 Ø 28,6 / d2 Ø 23,9
Thread: M30 x 1,5 RHT
0014603848, 0014604848, 0014605148,
0014608648, 0014609948



DB-RK-8626

Ø: 75 Hole Distance: 130
Thick/Height: 24
0003502205, 0003502505, 0003503405,
0003504505, GL11319



DB-RK-9294

Ø: 85 Hole Distance: 152
Thick/Height: 24
0003503105



DB-RK-10374

Ø: 85 Hole Distance: 152
Thick/Height: 24
0003504405



DB-SB-10406

Ø: 80 Thick/Height: 46
0003238185



DB-VB-3707

Length: 622 Ø: 46
Hole Ø 25 / 25 / 25
Hole Distance: 152 / 130 / 130
01337100A, 9423501005, 9423501505,
9443500005, 9473500105, 9473501005,
A3753500005, A9423501005, A9423501505,
A9443500005, A9473500105, A9473501005



DB-VB-7261

Length: 622 Ø: 46
Hole Ø 25 / 25 / 25
Hole Distance: 152 / 130 / 130
01337800A, 9443500305, 9443500505,
9443500605, 9473500705, 9473500905,
9483500405, 9483500305



DB-VB-10426

Length: 622 Ø: 46
Hole Ø 25 / 25 / 25
Hole Distance: 152 / 130 / 130
9443500405





ACTROS MP2 / MP3 ...

2648, L, LL	04/03→	Centre Rod	DB-DL-2144		Push Rod	
	04/03→	Centre Rod	DB-DL-5405		Push Rod	
	04/03→	Centre Rod	DB-DL-7270		Push Rod	
	04/03→	Centre Rod	DB-DL-8167		Push Rod	
	04/03→	Centre Rod	DB-DL-8307		Push Rod	
	04/03→	Rod Assembly	DB-DL-2178		Guide Rod, 1st Front Axle, →504310 03	
	04/03→	Stabiliser Mounting		DB-SB-10406		
	04/03→	Suspension Strut Repair Kit		DB-RK-9294		
	04/03→	Tie Rod	DB-DL-8640		Guide Rod	
	04/03→	Tie Rod	DB-DL-12310		Guide Rod	
	04/03→	Tie Rod	DB-ES-5227		Guide Rod	
	04/03→	Tie Rod End	CV-ES-0543		for Push Rod	
	04/03→	Tie Rod End	CV-ES-0888		for Push Rod	
	04/03→	Tie Rod End	CV-ES-14163		for Steering Rod	
	04/03→	Tie Rod End	DB-ES-8164		for Push Rod	
	04/03→	Tie Rod End	DB-ES-8530		for Push Rod	
	04/03→	Track Control Arm		DB-DL-3475	Trailing Arm, 1st RA;2nd RA, →517144 03/517144 06	
	04/03→	Track Control Arm		DB-DL-3475	Trailing Arm, 1st RA;2nd RA, →517144 05/517144 08	
	04/03→	Track Control Arm		DB-DL-3475	Trailing Arm, 1st RA;2nd RA, →517144 07/517144 09	
	04/03→	Track Control Arm		DB-DL-3475	Trailing Arm, 1st RA;2nd RA, →517144 26/517144 27	
	04/03→	Track Control Arm		DB-VB-3707	Suspension Rod, Wishbone (CV), 1st RA;2nd RA, →508306 01	
	04/03→	Track Control Arm		DB-VB-7261	Suspension Rod, Wishbone (CV), 1st RA;2nd RA, →517142 01	
	04/03→	Track Control Arm		DB-VB-10426	Wishbone (CV), Leaf Spring Axle;Unit	
	04/03→	Track Control Arm	DB-DL-5224		Control Arm, 1st FA;Air Suspension Axle	
	04/03→	Track Control Arm	DB-DL-9218	DB-DL-9218	Trailing Arm, 1st FA;Air Suspension Axle	
	2650 K, 2651 K, LK	04/03→	Ball Head, gearshift linkage	DB-ES-8510		
		04/03→	Bush, driver cab suspension	DB-SB-10384		
		04/03→	Bush, parabolic spring		DB-SB-10400	
04/03→		Bush, parabolic spring		DB-SB-10401		
04/03→		Centre Rod	DB-DL-2144		Push Rod	
04/03→		Centre Rod	DB-DL-5230		Suspension Rod	
04/03→		Centre Rod	DB-DL-5241		Push Rod	
04/03→		Centre Rod	DB-DL-5405		Push Rod	
04/03→		Centre Rod	DB-DL-5405		Push Rod, Leaf Spring Axle	
04/03→		Centre Rod	DB-DL-7270		Push Rod	
04/03→		Centre Rod	DB-DL-8167		Push Rod	
04/03→		Centre Rod	DB-DL-8184		Push Rod	
04/03→		Centre Rod	DB-DL-8185		Push Rod	
04/03→		Centre Rod	DB-DL-8307		Push Rod	
04/03→		Centre Rod	DB-DL-12300		for Steering Rod	
04/03→		Rod Assembly	DB-DL-2178		Guide Rod	
04/03→		Stabiliser Mounting		DB-SB-10406		
04/03→		Stabiliser Mounting		DB-SB-10409		
04/03→		Suspension Arm Repair Kit		DB-RK-8550	for Wishbone (CV)	
04/03→		Suspension Arm Repair Kit		DB-RK-8626	for Wishbone (CV)	
04/03→		Suspension Arm Repair Kit		DB-RK-10374	for Wishbone (CV)	
04/03→		Suspension Arm Repair Kit		DB-RK-10375	for Wishbone (CV)	
04/03→		Suspension Arm Repair Kit	DB-RK-8638		for Control Arm	
04/03→		Suspension Strut Repair Kit		DB-RK-8391		
04/03→		Suspension Strut Repair Kit		DB-RK-9294		
04/03→		Tie Rod	DB-DL-8171		Guide Rod	
04/03→		Tie Rod	DB-DL-8327		Guide Rod	
04/03→		Tie Rod	DB-DL-8640		Guide Rod	
04/03→		Tie Rod	DB-DL-12310		Guide Rod	
04/03→		Tie Rod	DB-ES-5227		Guide Rod	
04/03→		Tie Rod End	CV-ES-0543		for Push Rod	
04/03→		Tie Rod End	CV-ES-0888		for Push Rod	

CV-ES-0543

Length: 125
 Cone Ø: d1 Ø 32 / d2 Ø 29
 Thread: M30 x 1,5 RHT
 0004605748, 0004606048, 0004606848,
 0004607048, 0014600448, 0014601148,
 0014601748, 0014602448, 0014607648,
 0014609648

**CV-ES-0888**

Length: 125
 Cone Ø: d1 Ø 32 / d2 Ø 29
 Thread: M30 x 1,5 LHT
 0004605848, 0004606148, 0004606948,
 0004607148, 0004609048, 0014600548,
 0014601348, 0014602548, 0014607948,
 0024600448

**CV-ES-14163**

Length: 125
 Cone Ø: d1 Ø 30 / d2 Ø 27
 Thread: M30 x 1,5 RHT
 0003305248, 0003387310, 0004600348,
 0004600948, 0004602848, 0004602948,
 0004608948, 0014600248, 0014600848,
 0014601248, 0014602248, 0014607748,
 0024600148, A0003387310, A0004600348,
 A0004602848, A0004602948, A0014600848,
 A0014601248, A0014602248, A0014607748

**DB-DL-2144**

Length: 872 Ø: 35
 Cone Ø: d1 Ø 28,6 / d2 Ø 23,9
 0024604305, 0024604405, 0034604805

**DB-DL-2178**

Length: 1735 Ø: 52
 Cone Ø: d1 Ø 32 / d2 Ø 29
 9423300003, 9423300103, 9423300203

**DB-DL-3475**

Length: 565 Ø: 52
 Hole Distance: 152 / 152
 3753500006, 3753500206, 9473500805,
 9483500006, 9483500805, 9483501205,
 9483501305, 9483501905, 9483502005,
 9483502405, A3753500006, A3753500206

**DB-DL-5224**

Length: 850 Ø: 60
 Hole Distance: 100 / 100
 01336100A, 9413300007

**DB-DL-5230**

Length: 879 Ø: 42
 Cone Ø: d1 Ø 30 / d2 Ø 27
 01208600A, 0004607105, 0004607205,
 0014606705

**DB-DL-5241**

Length: 875 Ø: 40
 Cone Ø: d1 Ø 30 / d2 Ø 27
 01215300A, 0004609205, 0004609305,
 0014606905

**DB-DL-5405**

Length: 890 Ø: 35
 Cone Ø: d1 Ø 28,6 / d2 Ø 23,9
 01215900A, 1460248, 0024604505, 0024604605,
 0034605005, 3752600637, 3754600405,
 A3752600637, A3754600405

**DB-DL-7270**

Length: 875 Ø: 40
 Cone Ø: d1 Ø 28,6 / d2 Ø 23,9
 01208300A, 0024604705, 0024604805,
 0034604905, A0024604705

**DB-DL-8167**

Length: 866 Ø: 38
 Cone Ø: d1 Ø 30 / d2 Ø 27
 0014609805, 0014609905, 0024606305,
 0024606405

**DB-DL-8171**

Length: 1687 Ø: 52
 Cone Ø: d1 Ø 32 / d2 Ø 29
 9493300603, 9493300703, 9493301503,
 9493301603

**DB-DL-8184**

Length: 1095 Ø: 42
 Cone Ø: d1 Ø 32 / d2 Ø 28,8
 01217700A, 0014601305, 0014601405,
 0024600505, 0034603205, 3754601505,
 A0014601305, A0014601405, A0024600505

**DB-DL-8185**

Length: 711 Ø: 42
 Cone Ø: d1 Ø 32 / d2 Ø 28,8
 01213600A, 0014601105, 0024600405,
 0034603105, A0014601105, A0024600405

**DB-DL-8307**

Length: 885 Ø: 38
 Cone Ø: d1 Ø 32 / d2 Ø 30
 01215500A, 0004604005, 0024605105,
 0024605205, 0034604005

**DB-DL-8327**

Length: 1745 Ø: 48
 Cone Ø: d1 Ø 32 / d2 Ø 29
 01219800A, 9413300003, 9413300103,
 9413300203, 9413300303, 9413300503

**DB-DL-8640**

Length: 1615 Ø: 50
 Cone Ø: d1 Ø 32 / d2 Ø 29
 6253301503, 6253301603, 6253302403,
 6253302503, 9423300803, 9423302103,
 9493300203, 9493300303, 9493300903

**DB-DL-9218**

Length: 754 Ø: 40
 Hole Distance: 100
 000360098524, 000390098524, 3753300111,
 9413300011, A3753300111, SA50831601

**DB-DL-12300**

Length: 733 Ø: 36
 Cone Ø: d1 Ø 32 / d2 Ø 29
 0014601505, 0014607305, 0034603305,
 3754601605, A0014601505, A0034603305,
 A3754601605

**DB-DL-12310**

Length: 1532 Ø: 50
 Cone Ø: d1 Ø 32 / d2 Ø 29
 Thread: M27 x 1,5 LHT
 9493301203, 9493301303, 9493301803,
 9493302203, A9493301203, A9493301303,
 A9493301803, A9493302203

**DB-ES-5227**

Length: 1588 Ø: 60
 Cone Ø: d1 Ø 38 / d2 Ø 34,3
 6253300903, 6253301203, 9443300203

**DB-ES-8164**

Length: 140
 Cone Ø: d1 Ø 28,6 / d2 Ø 23,9
 Thread: M28 x 1,5 RHT
 0014604248, 0014605048, 0014608548,
 0024600548

**DB-ES-8510**

Length: 56
 Cone Ø: d1 Ø 10 / d2 Ø 10
 Thread: M12 x 1,75 LHT
 0009965145, 0009965645, 0019963145

**DB-ES-8530**

Length: 115
 Cone Ø: d1 Ø 28,6 / d2 Ø 23,9
 Thread: M30 x 1,5 RHT
 0014603848, 0014604848, 0014605148,
 0014608648, 0014609948

**DB-RK-8391**

Ø: 85 Hole Distance: 152
 Thick/Height: 24
 01336800A, 0003502705

**DB-RK-8550**

Ø: 75 Hole Distance: 152
 Thick/Height: 24
 0003502105, 0003504605

**DB-RK-8626**

Ø: 75 Hole Distance: 130
 Thick/Height: 24
 0003502205, 0003502505, 0003503405,
 0003504505, GL11319

**DB-RK-8638**

Length: 100 Ø: 67
 Hole Distance: 100
 Thick/Height: 20
 0003301411

**DB-RK-9294**

Ø: 85 Hole Distance: 152
 Thick/Height: 24
 0003503105

**DB-RK-10374**

Ø: 85 Hole Distance: 152
 Thick/Height: 24
 0003504405

**DB-RK-10375**

Ø: 100 Hole Distance: 152
 Thick/Height: 24
 0003502405, 0003503505, 0003504905

**DB-SB-10384**

Ø: 73 Thick/Height: 47
 9303170012, 9423171812

**DB-SB-10400**

Length: 230
 Thick/Height: 167,5 / 115
 0003250696, 0003250896

**DB-SB-10401**

Length: 232
 Thick/Height: 163,5 / 152,5
 0003250596, 0003250796

**DB-SB-10406**

Ø: 80 Thick/Height: 46
 0003238185

**DB-SB-10409**

Ø: 77 Thick/Height: 56
 0003265181

**DB-VB-3707**

Length: 622 Ø: 46
 Hole Ø 25 / 25 / 25
 Hole Distance: 152 / 130 / 130
 01337100A, 9423501005, 9423501505,
 9443500005, 9473500105, 9473501005,
 A3753500005, A9423501005, A9423501505,
 A9443500005, A9473500105, A9473501005

**DB-VB-7261**

Length: 622 Ø: 46
 Hole Ø 25 / 25 / 25
 Hole Distance: 152 / 130 / 130
 01337800A, 9443500305, 9443500505,
 9443500605, 9473500705, 9473500905,
 9483500405, 9483503005

**DB-VB-10426**

Length: 622 Ø: 46
 Hole Ø 25 / 25 / 25
 Hole Distance: 152 / 130 / 130
 9443500405

**MERCEDES-BENZ**



ACTROS MP2 / MP3 ...

2650 K, 2651 K, LK ...	04/03→	Tie Rod End	CV-ES-14162		for Steering Rod
	04/03→	Tie Rod End	CV-ES-14163		for Steering Rod
	04/03→	Tie Rod End	DB-ES-5234		for Steering Rod
	04/03→	Tie Rod End	DB-ES-8164		for Push Rod
	04/03→	Tie Rod End	DB-ES-8530		for Push Rod
	04/03→	Track Control Arm		DB-DL-3475	Trailing Arm
	04/03→	Track Control Arm		DB-VB-3707	Suspension Rod, Wishbone (CV)
	04/03→	Track Control Arm		DB-VB-7261	Suspension Rod, Wishbone (CV), 1st RA;2nd RA; Leaf Spring Axle
	04/03→	Track Control Arm		DB-VB-10426	Wishbone (CV), Leaf Spring Axle;Unit
2650 S, LS	04/03→	Ball Head, gearshift linkage	DB-ES-8510		
	04/03→	Bush, driver cab suspension	DB-SB-10384		
	04/03→	Bush, parabolic spring		DB-SB-10400	
	04/03→	Bush, parabolic spring		DB-SB-10401	
	04/03→	Centre Rod	DB-DL-2144		Push Rod
	04/03→	Centre Rod	DB-DL-5230		Suspension Rod
	04/03→	Centre Rod	DB-DL-5241		Push Rod
	04/03→	Centre Rod	DB-DL-5405		Push Rod
	04/03→	Centre Rod	DB-DL-5405		Push Rod, for vehicles with Rigid Leading Axle
	04/03→	Centre Rod	DB-DL-5405		Push Rod, Leaf Spring Axle
	04/03→	Centre Rod	DB-DL-7270		Push Rod
	04/03→	Centre Rod	DB-DL-8167		Push Rod
	04/03→	Centre Rod	DB-DL-8184		Push Rod
	04/03→	Centre Rod	DB-DL-8185		Push Rod
	04/03→	Centre Rod	DB-DL-8307		Push Rod
	04/03→	Centre Rod	DB-DL-12300		for Steering Rod
	04/03→	Centre Rod	DB-DL-12470		Push Rod
	04/03→	Rod Assembly	DB-DL-2178		Guide Rod
	04/03→	Stabiliser Mounting		DB-SB-10406	
	04/03→	Stabiliser Mounting		DB-SB-10409	
	04/03→	Stabiliser Mounting	DB-SB-10410		
	04/03→	Suspension Arm Repair Kit		DB-RK-8550	for Wishbone (CV)
	04/03→	Suspension Arm Repair Kit		DB-RK-8626	for Wishbone (CV)
	04/03→	Suspension Arm Repair Kit		DB-RK-10374	for Wishbone (CV)
	04/03→	Suspension Arm Repair Kit		DB-RK-10375	for Wishbone (CV)
	04/03→	Suspension Arm Repair Kit	DB-RK-8638		for Control Arm
	04/03→	Suspension Strut Repair Kit		DB-RK-8391	
	04/03→	Suspension Strut Repair Kit		DB-RK-9294	
	04/03→	Suspension Strut Repair Kit		MN-RK-8997	
	04/03→	Tie Rod	DB-DL-8171		Guide Rod
	04/03→	Tie Rod	DB-DL-8327		Guide Rod
	04/03→	Tie Rod	DB-DL-8388		Guide Rod
	04/03→	Tie Rod	DB-DL-8389		Guide Rod
	04/03→	Tie Rod	DB-DL-8640		Guide Rod
	04/03→	Tie Rod	DB-DL-12310		Guide Rod
	04/03→	Tie Rod	DB-ES-5227		Guide Rod
	04/03→	Tie Rod End	CV-ES-0543		for Push Rod
	04/03→	Tie Rod End	CV-ES-0888		for Push Rod
	04/03→	Tie Rod End	CV-ES-14162		for Steering Rod
	04/03→	Tie Rod End	CV-ES-14163		for Steering Rod
	04/03→	Tie Rod End	DB-ES-5234		for Steering Rod
	04/03→	Tie Rod End	DB-ES-8164		for Push Rod
	04/03→	Tie Rod End	DB-ES-8530		for Push Rod
	04/03→	Track Control Arm		DB-DL-3475	Trailing Arm
	04/03→	Track Control Arm		DB-VB-3707	Suspension Rod, Wishbone (CV)
	04/03→	Track Control Arm		DB-VB-7261	Suspension Rod, Wishbone (CV), 1st RA;2nd RA; Leaf Spring Axle
	04/03→	Track Control Arm		DB-VB-7798	Wishbone (CV)
04/03→	Track Control Arm		DB-VB-10426	Wishbone (CV), Leaf Spring Axle;Unit	
04/03→	Track Control Arm	DB-DL-5224		Control Arm, 1st FA;Air Suspension Axle; for vehicles with Rigid Leading Axle	
04/03→	Track Control Arm	DB-DL-9218	DB-DL-9218	Trailing Arm, 1st FA;Air Suspension Axle; for vehicles with Rigid Leading Axle	

CV-ES-0543

Length: 125
 Cone Ø: d1 Ø 32 / d2 Ø 29
 Thread: M30 x 1,5 RHT
 0004605748, 0004606048, 0004606848,
 0004607048, 0014600448, 0014601148,
 0014601748, 0014602448, 0014607648,
 0014609648

**CV-ES-0888**

Length: 125
 Cone Ø: d1 Ø 32 / d2 Ø 29
 Thread: M30 x 1,5 LHT
 0004605848, 0004606148, 0004606948,
 0004607148, 0004609048, 0014600548,
 0014601348, 0014602548, 0014607948,
 0024600448

**CV-ES-14162**

Length: 125
 Cone Ø: d1 Ø 30 / d2 Ø 27
 Thread: M30 x 1,5 LHT
 4600648, 4601248, 4603448, 0004603548,
 14600348, 14601448, 14602348,
 0014603748, 0014607848, 0024600348

**CV-ES-14163**

Length: 125
 Cone Ø: d1 Ø 30 / d2 Ø 27
 Thread: M30 x 1,5 RHT
 0003305248, 0003387310, 0004600348,
 0004600948, 0004602848, 0004602948,
 0004608948, 0014600248, 0014600848,
 0014601248, 0014602248, 0014607748,
 0024600148, A0003387310, A0004600348,
 A0004602848, A0004602948, A0014600848,
 A0014601248, A0014602248, A0014607748

**DB-DL-2144**

Length: 872 Ø: 35
 Cone Ø: d1 Ø 28,6 / d2 Ø 23,9
 0024604305, 0024604405, 0034604805

**DB-DL-2178**

Length: 1735 Ø: 52
 Cone Ø: d1 Ø 32 / d2 Ø 29
 9423300003, 9423300103, 9423300203

**DB-DL-3475**

Length: 565 Ø: 52
 Hole Distance: 152 / 152
 3753500006, 3753500206, 9473500805,
 9483500006, 9483500805, 9483501205,
 9483501305, 9483501905, 9483502005,
 9483502405, A3753500006,
 A3753500206

**DB-DL-5224**

Length: 850 Ø: 60
 Hole Distance: 100 / 100
 01336100A, 9413300007

**DB-DL-5230**

Length: 879 Ø: 42
 Cone Ø: d1 Ø 30 / d2 Ø 27
 01208600A, 0004607105, 0004607205,
 0014606705

**DB-DL-5241**

Length: 875 Ø: 40
 Cone Ø: d1 Ø 30 / d2 Ø 27
 01215300A, 0004609205, 0004609305,
 0014606905

**DB-DL-5405**

Length: 890 Ø: 35
 Cone Ø: d1 Ø 28,6 / d2 Ø 23,9
 01215900A, 1460248, 0024604505,
 0024604605, 0034605005, 3752600637,
 3754600405, A3752600637, A3754600405

**DB-DL-7270**

Length: 875 Ø: 40
 Cone Ø: d1 Ø 28,6 / d2 Ø 23,9
 01208300A, 0024604705, 0024604805,
 0034604905, A0024604705

**DB-DL-8167**

Length: 866 Ø: 38
 Cone Ø: d1 Ø 30 / d2 Ø 27
 0014609805, 0014609905, 0024606305,
 0024606405

**DB-DL-8171**

Length: 1687 Ø: 52
 Cone Ø: d1 Ø 32 / d2 Ø 29
 9493300603, 9493300703, 9493301503,
 9493301603

**DB-DL-8184**

Length: 1095 Ø: 42
 Cone Ø: d1 Ø 32 / d2 Ø 28,8
 01217700A, 0014601305, 0014601405,
 0024600505, 0034603205, 3754601505,
 A0014601305, A0014601405, A0024600505

**DB-DL-8185**

Length: 711 Ø: 42
 Cone Ø: d1 Ø 32 / d2 Ø 28,8
 01213600A, 0014601105, 0024600405,
 0034603105, A0014601105, A0024600405

**DB-DL-8307**

Length: 885 Ø: 38
 Cone Ø: d1 Ø 32 / d2 Ø 30
 01215500A, 0004604005, 0024605105,
 0024605205, 0034604005

**DB-DL-8327**

Length: 1745 Ø: 48
 Cone Ø: d1 Ø 32 / d2 Ø 29
 01219800A, 9413300003, 9413300103,
 9413300203, 9413300303, 9413300503

**DB-DL-8388**

Length: 1735 Ø: 62
 Cone Ø: d1 Ø 32 / d2 Ø 28,8
 01219900A, 9453300003, 9453300103,
 9453300403, 9453300603, A9453300003

**DB-DL-8389**

Length: 1465 Ø: 40
 Cone Ø: d1 Ø 32 / d2 Ø 29
 9453300203, 9453300303, 9453300503

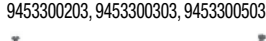
**DB-DL-8640**

Length: 1615 Ø: 50
 Cone Ø: d1 Ø 32 / d2 Ø 29
 6253301503, 6253301603, 6253302403,
 6253302503, 9423300803, 9423302103,
 9493300203, 9493300303, 9493300903

**DB-DL-9218**

Length: 754 Ø: 40
 Hole Distance: 100
 000360098524, 000390098524,
 3753300111, 9413300011,
 A3753300111, SA50831601

**DB-DL-12300**

Length: 733 Ø: 36
 Cone Ø: d1 Ø 32 / d2 Ø 29
 0014601505, 0014607305, 0034603305,
 3754601605, A0014601505,
 A0034603305, A3754601605

**DB-DL-12310**

Length: 1532 Ø: 50
 Cone Ø: d1 Ø 32 / d2 Ø 29
 Thread: M27 x 1,5 LHT
 9493301203, 9493301303, 9493301803,
 9493302203, A9493301203, A9493301303,
 A9493301803, A9493302203

**DB-DL-12470**

Length: 723 Ø: 42
 Cone Ø: d1 Ø 30 / d2 Ø 27
 A0014607505, A0024600905



No Image

DB-ES-5227

Length: 1588 Ø: 60
 Cone Ø: d1 Ø 38 / d2 Ø 34,3
 6253300903, 6253301203, 9443300203

**DB-ES-5234**

Length: 135
 Cone Ø: d1 Ø 38 / d2 Ø 34,3
 Thread: M38 x 1,5 RHT
 0004601748, 120322305, 2205000400

**DB-ES-8164**

Length: 140
 Cone Ø: d1 Ø 28,6 / d2 Ø 23,9
 Thread: M28 x 1,5 RHT
 0014604248, 0014605048, 0014608548,
 0024600548

**DB-ES-8510**

Length: 56
 Cone Ø: d1 Ø 10 / d2 Ø 10
 Thread: M12 x 1,75 LHT
 0009965145, 0009965645, 0019963145

**DB-ES-8530**

Length: 115
 Cone Ø: d1 Ø 28,6 / d2 Ø 23,9
 Thread: M30 x 1,5 RHT
 0014603848, 0014604848, 0014605148,
 0014608648, 0014609948

**DB-RK-8391**

Ø: 85 Hole Distance: 152
 Thick/Height: 24
 01336800A, 0003502705

**DB-RK-8550**

Ø: 75 Hole Distance: 152
 Thick/Height: 24
 0003502105, 0003504605

**DB-RK-8626**

Ø: 75 Hole Distance: 130
 Thick/Height: 24
 0003502205, 0003502505, 0003503405,
 0003504505, GL11319

**DB-RK-8638**

Length: 100 Ø: 67
 Hole Distance: 100
 Thick/Height: 20
 0003301411

**DB-RK-9294**

Ø: 85 Hole Distance: 152
 Thick/Height: 24
 0003503105

**DB-RK-10374**

Ø: 85 Hole Distance: 152
 Thick/Height: 24
 0003504405

**DB-RK-10375**

Ø: 100 Hole Distance: 152
 Thick/Height: 24
 0003502405, 0003503505, 0003504905

**DB-SB-10384**

Ø: 73 Thick/Height: 47
 9303170012, 9423171812

**DB-SB-10400**

Length: 230
 Thick/Height: 167,5 / 115
 0003250696, 0003250896

**DB-SB-10401**

Length: 232
 Thick/Height: 163,5 / 152,5
 0003250596, 0003250796

**DB-SB-10406**

Ø: 80 Thick/Height: 46
 0003238185

**DB-SB-10409**

Ø: 77 Thick/Height: 56
 0003265181

**DB-SB-10410**

Ø: 73 Hole Distance: 100
 Thick/Height: 24
 9413230050

**DB-VB-3707**

Length: 622 Ø: 46
 Hole Ø 25 / 25 / 25
 Hole Distance: 152 / 130 / 130
 01337100A, 9423501005, 9423501505,
 9443500005, 9473500105, 9473501005,
 A3753500005, A9423501005, A9423501505,
 A9443500005, A9473500105, A9473501005

**DB-VB-7261**

Length: 622 Ø: 46
 Hole Ø 25 / 25 / 25
 Hole Distance: 152 / 130 / 130
 01337800A, 9443500305, 9443500505,
 9443500605, 9473500705, 9473500905,
 9483500405, 9483503005

**DB-VB-7798**

Length: 622 Ø: 48
 Hole Ø 25 / 23 / 23
 Hole Distance: 152 / 130 / 130
 9423500505, 9423500805, 9423501205,
 A9423501205

**DB-VB-10426**

Length: 622 Ø: 46
 Hole Ø 25 / 25 / 25
 Hole Distance: 152 / 130 / 130
 9443500405

**MN-RK-8997**

Ø: 85 Hole Distance: 130
 Thick/Height: 30
 0003504805



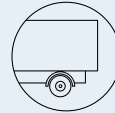

ACTROS MP2 / MP3 ...

2650, L, 2651, L, LL

04/03→	Ball Head, gearshift linkage	DB-ES-8510		
04/03→	Bush, driver cab suspension	DB-SB-10384		
04/03→	Bush, parabolic spring		DB-SB-10400	
04/03→	Bush, parabolic spring		DB-SB-10401	
04/03→	Centre Rod	DB-DL-2144		Push Rod
04/03→	Centre Rod	DB-DL-5230		Suspension Rod
04/03→	Centre Rod	DB-DL-5241		Push Rod
04/03→	Centre Rod	DB-DL-5405		Push Rod, 1st FA;Leaf Spring Axle
04/03→	Centre Rod	DB-DL-7270		Push Rod;Suspension Rod
04/03→	Centre Rod	DB-DL-8167		Push Rod
04/03→	Centre Rod	DB-DL-8168		Push Rod
04/03→	Centre Rod	DB-DL-8184		Push Rod
04/03→	Centre Rod	DB-DL-8185		Push Rod
04/03→	Centre Rod	DB-DL-8307		Push Rod
04/03→	Centre Rod	DB-DL-8622		Push Rod
04/03→	Centre Rod	DB-DL-8641		Push Rod
04/03→	Centre Rod	DB-DL-8642		Push Rod
04/03→	Centre Rod	DB-DL-12300		for Steering Rod
04/03→	Rod Assembly	DB-DL-2178		Guide Rod
04/03→	Stabiliser Link	DB-DL-9254		Pressure Rod
04/03→	Stabiliser Mounting		DB-SB-10406	
04/03→	Stabiliser Mounting		DB-SB-10409	
04/03→	Stabiliser Mounting	DB-SB-10410		
04/03→	Suspension Arm Repair Kit		DB-RK-8550	for Wishbone (CV)
04/03→	Suspension Arm Repair Kit		DB-RK-8626	for Wishbone (CV)
04/03→	Suspension Arm Repair Kit		DB-RK-10374	for Wishbone (CV)
04/03→	Suspension Arm Repair Kit		DB-RK-10375	for Wishbone (CV)
04/03→	Suspension Arm Repair Kit	DB-RK-8638		for Control Arm
04/03→	Suspension Strut Repair Kit		DB-RK-8391	
04/03→	Suspension Strut Repair Kit		DB-RK-9294	
04/03→	Tie Rod	DB-DL-8327		Guide Rod
04/03→	Tie Rod	DB-DL-8640		Guide Rod
04/03→	Tie Rod	DB-DL-12310		
04/03→	Tie Rod	DB-ES-5227		Guide Rod
04/03→	Tie Rod End	CV-ES-0543		for Push Rod
04/03→	Tie Rod End	CV-ES-0888		for Push Rod
04/03→	Tie Rod End	CV-ES-14162		for Steering Rod
04/03→	Tie Rod End	CV-ES-14163		for Steering Rod
04/03→	Tie Rod End	DB-ES-5234		for Steering Rod
04/03→	Tie Rod End	DB-ES-8164		for Push Rod
04/03→	Tie Rod End	DB-ES-8530		for Push Rod
04/03→	Track Control Arm		DB-DL-3475	Trailing Arm
04/03→	Track Control Arm		DB-VB-3707	Suspension Rod, Wishbone (CV)
04/03→	Track Control Arm		DB-VB-7261	Suspension Rod, Wishbone (CV), 1st RA;2nd RA; Leaf Spring Axle
04/03→	Track Control Arm		DB-VB-10426	Wishbone (CV), Leaf Spring Axle;Unit
04/03→	Track Control Arm	DB-DL-5224		Control Arm, 1st FA;Air Suspension Axle
04/03→	Track Control Arm	DB-DL-9218	DB-DL-9218	Trailing Arm, 1st FA;Air Suspension Axle
2651 L	04/03→	Centre Rod	DB-DL-2144	Push Rod
	04/03→	Centre Rod	DB-DL-5405	Push Rod
	04/03→	Centre Rod	DB-DL-7270	Push Rod
	04/03→	Centre Rod	DB-DL-8167	Push Rod
	04/03→	Centre Rod	DB-DL-8307	Push Rod
	04/03→	Suspension Arm Repair Kit		DB-RK-8626 for Wishbone (CV)
	04/03→	Suspension Arm Repair Kit		DB-RK-10374 for Wishbone (CV)
	04/03→	Tie Rod	DB-DL-8640	Guide Rod
	04/03→	Tie Rod End	CV-ES-0543	for Push Rod
	04/03→	Tie Rod End	CV-ES-14163	for Steering Rod
	04/03→	Tie Rod End	DB-ES-8164	for Push Rod
	04/03→	Tie Rod End	DB-ES-8530	for Push Rod
	04/03→	Track Control Arm		DB-VB-3707 Suspension Rod, Wishbone (CV)
	04/03→	Track Control Arm	DB-DL-5224	Control Arm
	04/03→	Track Control Arm	DB-DL-9218	DB-DL-9218 Trailing Arm

CV-ES-0543

Length: 125
 Cone Ø: d1 Ø 32 / d2 Ø 29
 Thread: M30 x 1,5 RHT
 0004605748, 0004606048, 0004606848,
 0004607048, 0014600448, 0014601148,
 0014601748, 0014602448, 0014607648,
 0014609648

**CV-ES-0888**

Length: 125
 Cone Ø: d1 Ø 32 / d2 Ø 29
 Thread: M30 x 1,5 LHT
 0004605848, 0004606148, 0004606948,
 0004607148, 0004609048, 0014600548,
 0014601348, 0014602548, 0014607948,
 0024600448

**CV-ES-14162**

Length: 125
 Cone Ø: d1 Ø 30 / d2 Ø 27
 Thread: M30 x 1,5 LHT
 4600648, 4601248, 4603448, 0004603548,
 14600348, 14601448, 14602348,
 0014603748, 0014607848, 0024600348

**CV-ES-14163**

Length: 125
 Cone Ø: d1 Ø 30 / d2 Ø 27
 Thread: M30 x 1,5 RHT
 0003305248, 0003387310, 0004600348,
 0004600948, 0004602848, 0004602948,
 0004608948, 0014600248, 0014600848,
 0014601248, 0014602248, 0014607748,
 0024600148, A0003387310, A0004600348,
 A0004602848, A0004602948, A0014600848,
 A0014601248, A0014602248, A0014607748

**DB-DL-2144**

Length: 872 Ø: 35
 Cone Ø: d1 Ø 28,6 / d2 Ø 23,9
 0024604305, 0024604405, 0034604805

**DB-DL-2178**

Length: 1735 Ø: 52
 Cone Ø: d1 Ø 32 / d2 Ø 29
 9423300003, 9423300103, 9423300203

**DB-DL-3475**

Length: 565 Ø: 52
 Hole Distance: 152 / 152
 3753500006, 3753500206, 9473500805,
 9483500006, 9483500805, 9483501205,
 9483501305, 9483501905, 9483502005,
 9483502405, A3753500006,
 A3753500206

**DB-DL-5224**

Length: 850 Ø: 60
 Hole Distance: 100 / 100
 01336100A, 9413300007

**DB-DL-5230**

Length: 879 Ø: 42
 Cone Ø: d1 Ø 30 / d2 Ø 27
 01208600A, 0004607105, 0004607205,
 0014606705

**DB-DL-5241**

Length: 875 Ø: 40
 Cone Ø: d1 Ø 30 / d2 Ø 27
 01215900A, 0004609205, 0004609305,
 0014606905

**DB-DL-5405**

Length: 890 Ø: 35
 Cone Ø: d1 Ø 28,6 / d2 Ø 23,9
 01215900A, 1460248, 0024604505,
 0024604605, 0034605005, 3752600637,
 3754600405, A3752600637, A3754600405

**DB-DL-7270**

Length: 875 Ø: 40
 Cone Ø: d1 Ø 28,6 / d2 Ø 23,9
 01208300A, 0024604705, 0024604805,
 0034604905, A0024604705

**DB-DL-8167**

Length: 866 Ø: 38
 Cone Ø: d1 Ø 30 / d2 Ø 27
 0014609805, 0014609905, 0024606305,
 0024606405

**DB-DL-8168**

Length: 904 Ø: 52
 Cone Ø: d1 Ø 32 / d2 Ø 29
 0004609405, 0004609505, 0014607105

**DB-DL-8184**

Length: 1095 Ø: 42
 Cone Ø: d1 Ø 32 / d2 Ø 28,8
 01217700A, 0014601305, 0014601405,
 0024600505, 0034603205, 3754601505,
 A0014601305, A0014601405, A0024600505

**DB-DL-8185**

Length: 711 Ø: 42
 Cone Ø: d1 Ø 32 / d2 Ø 28,8
 01213600A, 0014601105, 0024600405,
 0034603105, A0014601105, A0024600405

**DB-DL-8307**

Length: 885 Ø: 38
 Cone Ø: d1 Ø 32 / d2 Ø 30
 01215500A, 0004604005, 0024605105,
 0024605205, 0034604005

**DB-DL-8327**

Length: 1745 Ø: 48
 Cone Ø: d1 Ø 32 / d2 Ø 29
 01219800A, 9413300003, 9413300103,
 9413300203, 9413300303, 9413300503

**DB-DL-8622**

Length: 1558 Ø: 52
 Cone Ø: d1 Ø 30 / d2 Ø 27
 0014609005, 0014609105

**DB-DL-8640**

Length: 1615 Ø: 50
 Cone Ø: d1 Ø 32 / d2 Ø 29
 6253301503, 6253301603, 6253302403,
 6253302503, 9423300803, 9423302103,
 9493300203, 9493300303, 9493300903

**DB-DL-8641**

Length: 905 Ø: 42
 Cone Ø: d1 Ø 30 / d2 Ø 27
 0014605105, 0014608105

**DB-DL-8642**

Length: 954 Ø: 42
 Cone Ø: d1 Ø 30 / d2 Ø 27
 0014608605, 0014608705

**DB-DL-9218**

Length: 754 Ø: 40
 Hole Distance: 100
 000360098524, 000390098524,
 3753300111, 9413300011,
 A3753300111, SA50831601

**DB-DL-9254**

Length: 1815 Ø: 58
 0003220323, 0003220623, 3753220423

**DB-DL-12300**

Length: 733 Ø: 36
 Cone Ø: d1 Ø 32 / d2 Ø 29
 0014601505, 0014607305, 0034603305,
 3754601605, A0014601505,
 A0034603305, A3754601605

**DB-DL-12310**

Length: 1532 Ø: 50
 Cone Ø: d1 Ø 32 / d2 Ø 29
 Thread: M27 x 1,5 LHT
 9493301203, 9493301303, 9493301803,
 9493302203, A9493301203, A9493301303,
 A9493301803, A9493302203

**DB-ES-5227**

Length: 1588 Ø: 60
 Cone Ø: d1 Ø 38 / d2 Ø 34,3
 6253300903, 6253301203, 9443300203

**DB-ES-5234**

Length: 135
 Cone Ø: d1 Ø 38 / d2 Ø 34,3
 Thread: M38 x 1,5 RHT
 0004601748, 120322305, 2205000400

**DB-ES-8164**

Length: 140
 Cone Ø: d1 Ø 28,6 / d2 Ø 23,9
 Thread: M28 x 1,5 RHT
 0014604248, 0014605048, 0014608548,
 0024600548

**DB-ES-8510**

Length: 56
 Cone Ø: d1 Ø 10 / d2 Ø 10
 Thread: M12 x 1,75 LHT
 0009965145, 0009965645, 0019963145

**DB-ES-8530**

Length: 115
 Cone Ø: d1 Ø 28,6 / d2 Ø 23,9
 Thread: M30 x 1,5 RHT
 0014603848, 0014604848, 0014605148,
 0014608648, 0014609948

**DB-RK-8391**

Ø: 85 Hole Distance: 152
 Thick/Height: 24
 01336800A, 0003502705

**DB-RK-8550**

Ø: 75 Hole Distance: 152
 Thick/Height: 24
 0003502105, 0003504605

**DB-RK-8626**

Ø: 75 Hole Distance: 130
 Thick/Height: 24
 0003502205, 0003502505, 0003503405,
 0003504505, GL11319

**DB-RK-8638**

Length: 100 Ø: 67
 Hole Distance: 100
 Thick/Height: 20
 0003301411

**DB-RK-9294**

Ø: 85 Hole Distance: 152
 Thick/Height: 24
 0003503105

**DB-RK-10374**

Ø: 85 Hole Distance: 152
 Thick/Height: 24
 0003504405

**DB-RK-10375**

Ø: 100 Hole Distance: 152
 Thick/Height: 24
 0003502405, 0003503505, 0003504905

**DB-SB-10384**

Ø: 73 Thick/Height: 47
 9303170012, 9423171812

**DB-SB-10400**

Length: 230
 Thick/Height: 167,5 / 115
 0003250696, 0003250896

**DB-SB-10401**

Length: 232
 Thick/Height: 163,5 / 152,5
 0003250596, 0003250796

**DB-SB-10406**

Ø: 80 Thick/Height: 46
 0003238185

**DB-SB-10409**

Ø: 77 Thick/Height: 56
 0003265181

**DB-SB-10410**

Ø: 73 Hole Distance: 100
 Thick/Height: 24
 9413230050

**DB-VB-3707**

Length: 622 Ø: 46
 Hole Ø 25 / 25 / 25
 Hole Distance: 152 / 130 / 130
 01337100A, 9423501005, 9423501505,
 9443500005, 9473500105, 9473501005,
 A3753500005, A9423501005, A9423501505,
 A9443500005, A9473500105, A9473501005

**DB-VB-7261**

Length: 622 Ø: 46
 Hole Ø 25 / 25 / 25
 Hole Distance: 152 / 130 / 130
 01337800A, 9443500305, 9443500505,
 9443500605, 9473500705, 9473500905,
 9483500405, 9483503005

**DB-VB-10426**

Length: 622 Ø: 46
 Hole Ø 25 / 25 / 25
 Hole Distance: 152 / 130 / 130
 9443500405





ACTROS MP2 / MP3 ...

2651 LS	10/09→	Centre Rod	DB-DL-2144	Push Rod	
	10/09→	Centre Rod	DB-DL-8167	Push Rod	
	10/09→	Rod Assembly	DB-DL-2178	Guide Rod, 1st Front Axle, →504310 03	
	10/09→	Suspension Arm Repair Kit		DB-RK-8626 for Wishbone (CV)	
	10/09→	Suspension Arm Repair Kit		DB-RK-10374 for Wishbone (CV)	
	10/09→	Tie Rod	DB-DL-8640	Guide Rod	
	10/09→	Tie Rod	DB-DL-12310		
	10/09→	Tie Rod End	CV-ES-0543	for Push Rod	
	10/09→	Tie Rod End	CV-ES-0888	for Push Rod	
	10/09→	Tie Rod End	CV-ES-14163	for Steering Rod	
	10/09→	Tie Rod End	DB-ES-8164	for Push Rod	
	10/09→	Track Control Arm		DB-VB-3707 Suspension Rod, Wishbone (CV)	
	2651 S, LS	04/03→	Centre Rod	DB-DL-2144	Push Rod
		04/03→	Centre Rod	DB-DL-5405	Push Rod
		04/03→	Centre Rod	DB-DL-5405	Push Rod, Leaf Spring Axle
04/03→		Centre Rod	DB-DL-7270	Push Rod	
04/03→		Centre Rod	DB-DL-8167	Push Rod	
04/03→		Centre Rod	DB-DL-8307	Push Rod	
04/03→		Rod Assembly	DB-DL-2178	Guide Rod, 1st Front Axle, →504310 03	
04/03→		Stabiliser Mounting		DB-SB-10406	
04/03→		Suspension Strut Repair Kit		DB-RK-9294	
04/03→		Tie Rod	DB-DL-8171	Guide Rod	
04/03→		Tie Rod	DB-DL-8327	Guide Rod	
04/03→		Tie Rod	DB-DL-8640	Guide Rod	
04/03→		Tie Rod	DB-DL-12310		
04/03→		Tie Rod	DB-ES-5227	Guide Rod	
04/03→		Tie Rod End	CV-ES-0543	for Push Rod	
04/03→		Tie Rod End	CV-ES-0888	for Push Rod	
04/03→		Tie Rod End	CV-ES-14163	for Steering Rod	
04/03→		Tie Rod End	DB-ES-8164	for Push Rod	
04/03→		Track Control Arm		DB-DL-3475 Trailing Arm, 1st RA;2nd RA, →517144 05/517144 08	
04/03→		Track Control Arm		DB-VB-3707 Suspension Rod, Wishbone (CV), 1st RA;2nd RA, →508306 01	
04/03→		Track Control Arm		DB-VB-7261 Suspension Rod, Wishbone (CV), 1st RA;2nd RA; Leaf Spring Axle	
04/03→		Track Control Arm		DB-VB-10426 Wishbone (CV), Leaf Spring Axle;Unit	
2653 K, LK		04/03→	Bush, parabolic spring		DB-SB-10400
		04/03→	Bush, parabolic spring		DB-SB-10401
		04/03→	Centre Rod	DB-DL-2144	Push Rod
	04/03→	Centre Rod	DB-DL-5405	Push Rod	
	04/03→	Centre Rod	DB-DL-7270	Push Rod	
	04/03→	Centre Rod	DB-DL-8167	Push Rod	
	04/03→	Rod Assembly	DB-DL-2178	Guide Rod, 1st Front Axle, →504310 03	
	04/03→	Suspension Arm Repair Kit		DB-RK-8626 for Wishbone (CV)	
	04/03→	Suspension Arm Repair Kit		DB-RK-10374 for Wishbone (CV)	
	04/03→	Tie Rod	DB-DL-8171	Guide Rod	
	04/03→	Tie Rod	DB-DL-8327	Guide Rod	
	04/03→	Tie Rod	DB-DL-8640	Guide Rod	
	04/03→	Tie Rod End	CV-ES-0543	for Push Rod	
	04/03→	Tie Rod End	CV-ES-0888	for Push Rod	
	04/03→	Tie Rod End	CV-ES-14163	for Steering Rod	
	04/03→	Tie Rod End	DB-ES-8164	for Push Rod	
	04/03→	Tie Rod End	DB-ES-8530	for Push Rod	
	04/03→	Track Control Arm		DB-DL-3475 Trailing Arm, 1st RA;2nd RA, →517144 03/517144 06	
	04/03→	Track Control Arm		DB-DL-3475 Trailing Arm, 1st RA;2nd RA, →517144 05/517144 08	
	04/03→	Track Control Arm		DB-DL-3475 Trailing Arm, 1st RA;2nd RA, →517144 07/517144 09	
	04/03→	Track Control Arm		DB-DL-3475 Trailing Arm, 1st RA;2nd RA, →517144 26/517144 27	
	04/03→	Track Control Arm		DB-VB-3707 Suspension Rod, Wishbone (CV)	

CV-ES-0543

Length: 125
Cone Ø: d1 Ø 32 / d2 Ø 29
Thread: M30 x 1,5 RHT
0004605748, 0004606048, 0004606848,
0004607048, 0014600448, 0014601148,
0014601748, 0014602448, 0014607648,
0014609648



CV-ES-0888

Length: 125
Cone Ø: d1 Ø 32 / d2 Ø 29
Thread: M30 x 1,5 LHT
0004605848, 0004606148, 0004606948,
0004607148, 0004609048, 0014600548,
0014601348, 0014602548, 0014607948,
0024600448



CV-ES-14163

Length: 125
Cone Ø: d1 Ø 30 / d2 Ø 27
Thread: M30 x 1,5 RHT
0003305248, 0003387310, 0004600348,
0004600948, 0004602848, 0004602948,
0004608948, 0014600248, 0014600848,
0014601248, 0014602248, 0014607748,
0024600148, A0003387310, A0004600348,
A0004602848, A0004602948, A0014600848,
A0014601248, A0014602248, A0014607748



DB-DL-2144

Length: 872 Ø: 35
Cone Ø: d1 Ø 28,6 / d2 Ø 23,9
0024604305, 0024604405, 0034604805



DB-DL-2178

Length: 1735 Ø: 52
Cone Ø: d1 Ø 32 / d2 Ø 29
9423300003, 9423300103, 9423300203



DB-DL-3475

Length: 565 Ø: 52
Hole Distance: 152 / 152
3753500006, 3753500206, 9473500805,
9483500006, 9483500805, 9483501205,
9483501305, 9483501905, 9483502005,
9483502405, A3753500006,
A3753500206



DB-DL-5405

Length: 890 Ø: 35
Cone Ø: d1 Ø 28,6 / d2 Ø 23,9
01215900A, 1460248, 0024604505,
0024604605, 0034605005, 3752600637,
3754600405, A3752600637, A3754600405



DB-DL-7270

Length: 875 Ø: 40
Cone Ø: d1 Ø 28,6 / d2 Ø 23,9
01208300A, 0024604705, 0024604805,
0034604905, A0024604705



DB-DL-8167

Length: 866 Ø: 38
Cone Ø: d1 Ø 30 / d2 Ø 27
0014609805, 0014609905, 0024606305,
0024606405



DB-DL-8171

Length: 1687 Ø: 52
Cone Ø: d1 Ø 32 / d2 Ø 29
9493300603, 9493300703, 9493301503,
9493301603



DB-DL-8307

Length: 885 Ø: 38
Cone Ø: d1 Ø 32 / d2 Ø 30
01215500A, 0004604005, 0024605105,
0024605205, 0034604005



DB-DL-8327

Length: 1745 Ø: 48
Cone Ø: d1 Ø 32 / d2 Ø 29
01219800A, 9413300003, 9413300103,
9413300203, 9413300303, 9413300503



DB-DL-8640

Length: 1615 Ø: 50
Cone Ø: d1 Ø 32 / d2 Ø 29
6253301503, 6253301603, 6253302403,
6253302503, 9423300803, 9423302103,
9493300203, 9493300303, 9493300903



DB-DL-12310

Length: 1532 Ø: 50
Cone Ø: d1 Ø 32 / d2 Ø 29
Thread: M27 x 1,5 LHT
9493301203, 9493301303, 9493301803,
9493302203, A9493301203, A9493301303,
A9493301803, A9493302203



DB-ES-5227

Length: 1588 Ø: 60
Cone Ø: d1 Ø 38 / d2 Ø 34,3
6253300903, 6253301203, 9443300203



DB-ES-8164

Length: 140
Cone Ø: d1 Ø 28,6 / d2 Ø 23,9
Thread: M28 x 1,5 RHT
0014604248, 0014605048, 0014608548,
0024600548



DB-ES-8530

Length: 115
Cone Ø: d1 Ø 28,6 / d2 Ø 23,9
Thread: M30 x 1,5 RHT
0014603848, 0014604848, 0014605148,
0014608648, 0014609948



DB-RK-8626

Ø: 75 Hole Distance: 130
Thick/Height: 24
0003502205, 0003502505, 0003503405,
0003504505, GL11319



DB-RK-9294

Ø: 85 Hole Distance: 152
Thick/Height: 24
0003503105



DB-RK-10374

Ø: 85 Hole Distance: 152
Thick/Height: 24
0003504405



DB-SB-10400

Length: 230
Thick/Height: 167,5 / 115
0003250696, 0003250896



DB-SB-10401

Length: 232
Thick/Height: 163,5 / 152,5
0003250596, 0003250796



DB-SB-10406

Ø: 80 Thick/Height: 46
0003238185



DB-VB-3707

Length: 622 Ø: 46
Hole Ø 25 / 25 / 25
Hole Distance: 152 / 130 / 130
01337100A, 9423501005, 9423501505,
9443500005, 9473500105, 9473501005,
A3753500005, A9423501005, A9423501505,
A9443500005, A9473500105, A9473501005



DB-VB-7261

Length: 622 Ø: 46
Hole Ø 25 / 25 / 25
Hole Distance: 152 / 130 / 130
01337800A, 9443500305, 9443500505,
9443500605, 9473500705, 9473500905,
9483500405, 9483503005



DB-VB-10426

Length: 622 Ø: 46
Hole Ø 25 / 25 / 25
Hole Distance: 152 / 130 / 130
9443500405





ACTROS MP2 / MP3 ...

2653 K, LK ...	04/03→	Track Control Arm		DB-VB-7261	Suspension Rod, Wishbone (CV)	
	04/03→	Track Control Arm		DB-VB-10426	Wishbone (CV)	
2653 L	04/03→	Centre Rod	DB-DL-2144		Push Rod	
	04/03→	Centre Rod	DB-DL-5405		Push Rod	
	04/03→	Centre Rod	DB-DL-7270		Push Rod	
	04/03→	Centre Rod	DB-DL-8167		Push Rod	
	04/03→	Centre Rod	DB-DL-8307		Push Rod	
	04/03→	Suspension Arm Repair Kit		DB-RK-8626	for Wishbone (CV)	
	04/03→	Suspension Arm Repair Kit		DB-RK-10374	for Wishbone (CV)	
	04/03→	Tie Rod	DB-DL-8640		Guide Rod	
	04/03→	Tie Rod End	CV-ES-0543		for Push Rod	
	04/03→	Tie Rod End	CV-ES-14163		for Steering Rod	
	04/03→	Tie Rod End	DB-ES-8164		for Push Rod	
	04/03→	Tie Rod End	DB-ES-8530		for Push Rod	
	04/03→	Track Control Arm		DB-VB-3707	Suspension Rod, Wishbone (CV)	
	04/03→	Track Control Arm	DB-DL-5224		Control Arm	
	04/03→	Track Control Arm	DB-DL-9218	DB-DL-9218	Trailing Arm	
	2653 LS	10/09→	Centre Rod	DB-DL-2144		Push Rod
10/09→		Centre Rod	DB-DL-8167		Push Rod	
10/09→		Rod Assembly	DB-DL-2178		Guide Rod, 1st Front Axle, →504310 03	
10/09→		Suspension Arm Repair Kit		DB-RK-8626	for Wishbone (CV)	
10/09→		Suspension Arm Repair Kit		DB-RK-10374	for Wishbone (CV)	
10/09→		Tie Rod	DB-DL-8640		Guide Rod	
10/09→		Tie Rod	DB-DL-12310			
10/09→		Tie Rod End	CV-ES-0543		for Push Rod	
10/09→		Tie Rod End	CV-ES-0888		for Push Rod	
10/09→		Tie Rod End	CV-ES-14163		for Steering Rod	
10/09→		Tie Rod End	DB-ES-8164		for Push Rod	
10/09→		Track Control Arm		DB-VB-3707	Suspension Rod, Wishbone (CV)	
2654 K, LK, 2655 K, LK		04/03→	Ball Head, gearshift linkage	DB-ES-8510		
		04/03→	Bush, driver cab suspension	DB-SB-10384		
	04/03→	Bush, parabolic spring		DB-SB-10400		
	04/03→	Bush, parabolic spring		DB-SB-10401		
	04/03→	Centre Rod	DB-DL-2144		Push Rod	
	04/03→	Centre Rod	DB-DL-5230		Suspension Rod	
	04/03→	Centre Rod	DB-DL-5241		Push Rod	
	04/03→	Centre Rod	DB-DL-5405		Push Rod	
	04/03→	Centre Rod	DB-DL-5405		Push Rod, Leaf Spring Axle	
	04/03→	Centre Rod	DB-DL-7270		Push Rod	
	04/03→	Centre Rod	DB-DL-8167		Push Rod	
	04/03→	Centre Rod	DB-DL-8184		Push Rod	
	04/03→	Centre Rod	DB-DL-8185		Push Rod	
	04/03→	Centre Rod	DB-DL-8307		Push Rod	
	04/03→	Centre Rod	DB-DL-12300		for Steering Rod	
	04/03→	Rod Assembly	DB-DL-2178		Guide Rod	
	04/03→	Stabiliser Mounting		DB-RK-9296		
	04/03→	Stabiliser Mounting		DB-SB-10406		
	04/03→	Stabiliser Mounting		DB-SB-10409		
	04/03→	Suspension Arm Repair Kit		DB-RK-8550	for Wishbone (CV)	
	04/03→	Suspension Arm Repair Kit		DB-RK-8626	for Wishbone (CV)	
	04/03→	Suspension Arm Repair Kit		DB-RK-10374	for Wishbone (CV)	
	04/03→	Suspension Arm Repair Kit		DB-RK-10375	for Wishbone (CV)	
	04/03→	Suspension Arm Repair Kit	DB-RK-8638		for Control Arm	
	04/03→	Suspension Strut Repair Kit		DB-RK-8391		
	04/03→	Suspension Strut Repair Kit		DB-RK-9294		
	04/03→	Tie Rod	DB-DL-8171		Guide Rod	
	04/03→	Tie Rod	DB-DL-8327		Guide Rod	
	04/03→	Tie Rod	DB-DL-8640		Guide Rod	
	04/03→	Tie Rod	DB-DL-12310			
	04/03→	Tie Rod	DB-ES-5227		Guide Rod	
	04/03→	Tie Rod End	CV-ES-0543		for Push Rod	
	04/03→	Tie Rod End	CV-ES-0888		for Push Rod	
	04/03→	Tie Rod End	CV-ES-14162		for Steering Rod	

CV-ES-0543

Length: 125
 Cone Ø: d1 Ø 32 / d2 Ø 29
 Thread: M30 x 1,5 RHT
 0004605748, 0004606048, 0004606848,
 0004607048, 0014600448, 0014601148,
 0014601748, 0014602448, 0014607648,
 0014609648

**CV-ES-0888**

Length: 125
 Cone Ø: d1 Ø 32 / d2 Ø 29
 Thread: M30 x 1,5 LHT
 0004605848, 0004606148, 0004606948,
 0004607148, 0004609048, 0014600548,
 0014601348, 0014602548, 0014607948,
 0024600448

**CV-ES-14162**

Length: 125
 Cone Ø: d1 Ø 30 / d2 Ø 27
 Thread: M30 x 1,5 LHT
 4600648, 4601248, 4603448, 0004603548,
 14600348, 14601448, 14602348,
 0014603748, 0014607848, 0024600348

**CV-ES-14163**

Length: 125
 Cone Ø: d1 Ø 30 / d2 Ø 27
 Thread: M30 x 1,5 RHT
 0003305248, 0003387310, 0004600348,
 0004600948, 0004602848, 0004602948,
 0004608948, 0014600248, 0014600848,
 0014601248, 0014602248, 0014607748,
 0024600148, 0003387310, 0004600348,
 A0004602848, A0004602948, A0014600848,
 A0014601248, A0014602248, A0014607748

**DB-DL-2144**

Length: 872 Ø: 35
 Cone Ø: d1 Ø 28,6 / d2 Ø 23,9
 0024604305, 0024604405, 0034604805

**DB-DL-2178**

Length: 1735 Ø: 52
 Cone Ø: d1 Ø 32 / d2 Ø 29
 9423300003, 9423300103, 9423300203

**DB-DL-5224**

Length: 850 Ø: 60
 Hole Distance: 100 / 100
 01336100A, 9413300007

**DB-DL-5230**

Length: 879 Ø: 42
 Cone Ø: d1 Ø 30 / d2 Ø 27
 01208600A, 0004607105, 0004607205,
 0014606705

**DB-DL-5241**

Length: 875 Ø: 40
 Cone Ø: d1 Ø 30 / d2 Ø 27
 01215300A, 0004609205, 0004609305,
 0014606905

**DB-DL-5405**

Length: 890 Ø: 35
 Cone Ø: d1 Ø 28,6 / d2 Ø 23,9
 01215900A, 1460248, 0024604505,
 0024604605, 0034605005, 3752600637,
 3754600405, A3752600637, A3754600405

**DB-DL-7270**

Length: 875 Ø: 40
 Cone Ø: d1 Ø 28,6 / d2 Ø 23,9
 01208300A, 0024604705, 0024604805,
 0034604905, A0024604705

**DB-DL-8167**

Length: 866 Ø: 38
 Cone Ø: d1 Ø 30 / d2 Ø 27
 0014609805, 0014609905, 0024606305,
 0024606405

**DB-DL-8171**

Length: 1687 Ø: 52
 Cone Ø: d1 Ø 32 / d2 Ø 29
 9493300603, 9493300703, 9493301503,
 9493301603

**DB-DL-8184**

Length: 1095 Ø: 42
 Cone Ø: d1 Ø 32 / d2 Ø 28,8
 01217700A, 0014601305, 0014601405,
 0024600505, 0034603205, 3754601505,
 A0014601305, A0014601405, A0024600505

**DB-DL-8185**

Length: 711 Ø: 42
 Cone Ø: d1 Ø 32 / d2 Ø 28,8
 01213600A, 0014601105, 0024600405,
 0034603105, A0014601105, A0024600405

**DB-DL-8307**

Length: 885 Ø: 38
 Cone Ø: d1 Ø 32 / d2 Ø 30
 01215500A, 0004604005, 0024605105,
 0024605205, 0034604005

**DB-DL-8327**

Length: 1745 Ø: 48
 Cone Ø: d1 Ø 32 / d2 Ø 29
 01219800A, 9413300003, 9413300103,
 9413300203, 9413300303, 9413300503

**DB-DL-8640**

Length: 1615 Ø: 50
 Cone Ø: d1 Ø 32 / d2 Ø 29
 6253301503, 6253301603, 6253302403,
 6253302503, 9423300803, 9423302103,
 9493300203, 9493300303, 9493300903

**DB-DL-9218**

Length: 754 Ø: 40
 Hole Distance: 100
 000360098524, 000390098524,
 3753300111, 9413300011,
 A3753300111, SA50831601

**DB-DL-12300**

Length: 733 Ø: 36
 Cone Ø: d1 Ø 32 / d2 Ø 29
 0014601505, 0014607305, 0034603305,
 3754601605, A0014601505,
 A0034603305, A3754601605

**DB-DL-12310**

Length: 1532 Ø: 50
 Cone Ø: d1 Ø 32 / d2 Ø 29
 Thread: M27 x 1,5 LHT
 9493301203, 9493301303, 9493301803,
 9493302203, A9493301203, A9493301303,
 A9493301803, A9493302203

**DB-ES-5227**

Length: 1588 Ø: 60
 Cone Ø: d1 Ø 38 / d2 Ø 34,3
 6253300903, 6253301203, 9443300203

**DB-ES-8164**

Length: 140
 Cone Ø: d1 Ø 28,6 / d2 Ø 23,9
 Thread: M28 x 1,5 RHT
 0014604248, 0014605048, 0014608548,
 0024600548

**DB-ES-8510**

Length: 56
 Cone Ø: d1 Ø 10 / d2 Ø 10
 Thread: M12 x 1,75 LHT
 0009965145, 0009965645, 0019963145

**DB-ES-8530**

Length: 115
 Cone Ø: d1 Ø 28,6 / d2 Ø 23,9
 Thread: M30 x 1,5 RHT
 0014603848, 0014604848, 0014605148,
 0014608648, 0014609948

**DB-RK-8391**

Ø: 85 Hole Distance: 152
 Thick/Height: 24
 01336800A, 0003502705

**DB-RK-8550**

Ø: 75 Hole Distance: 152
 Thick/Height: 24
 0003502105, 0003504605

**DB-RK-8626**

Ø: 75 Hole Distance: 130
 Thick/Height: 24
 0003502205, 0003502505, 0003503405,
 0003504505, GL11319

**DB-RK-8638**

Length: 100 Ø: 67
 Hole Distance: 100
 Thick/Height: 20
 0003301411

**DB-RK-9294**

Ø: 85 Hole Distance: 152
 Thick/Height: 24
 0003503105

**DB-RK-9296**

Ø: 88 Hole Distance: 130
 Thick/Height: 24
 9423260050

**DB-RK-10374**

Ø: 85 Hole Distance: 152
 Thick/Height: 24
 0003504405

**DB-RK-10375**

Ø: 100
 Hole Distance: 152
 Thick/Height: 24
 3502405, 0003502405, 3503505,
 0003503505, 0003504905, 3504905

**DB-SB-10384**

Ø: 73 Thick/Height: 47
 9303170012, 9423171812

**DB-SB-10400**

Length: 230
 Thick/Height: 167,5 / 115
 0003250696, 0003250896

**DB-SB-10401**

Length: 232
 Thick/Height: 163,5 / 152,5
 0003250596, 0003250796

**DB-SB-10406**

Ø: 80 Thick/Height: 46
 0003238185

**DB-SB-10409**

Ø: 77 Thick/Height: 56
 0003265181

**DB-VB-3707**

Length: 622 Ø: 46
 Hole Ø 25 / 25 / 25
 Hole Distance: 152 / 130 / 130
 01337100A, 9423501005, 9423501505,
 9443500005, 9473500105, 9473501005,
 A3753500005, A9423501005, A9423501505,
 A9443500005, A9473500105, A9473501005

**DB-VB-7261**

Length: 622 Ø: 46
 Hole Ø 25 / 25 / 25
 Hole Distance: 152 / 130 / 130
 01337800A, 9443500305, 9443500505,
 9443500605, 9473500705, 9473500905,
 9483500405, 9483503005

**DB-VB-10426**

Length: 622 Ø: 46
 Hole Ø 25 / 25 / 25
 Hole Distance: 152 / 130 / 130
 9443500405



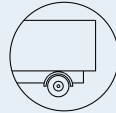

ACTROS MP2 / MP3 ...

2654 K, LK, 2655 K, LK ...	04/03→	Tie Rod End	CV-ES-14163		for Steering Rod
	04/03→	Tie Rod End	DB-ES-5234		for Steering Rod
	04/03→	Tie Rod End	DB-ES-8164		for Push Rod
	04/03→	Tie Rod End	DB-ES-8530		for Push Rod
	04/03→	Track Control Arm		DB-DL-3475	Trailing Arm
	04/03→	Track Control Arm		DB-VB-3707	Suspension Rod, Wishbone (CV)
	04/03→	Track Control Arm		DB-VB-7261	Suspension Rod, Wishbone (CV), 1st RA;2nd RA; Leaf Spring Axle
	04/03→	Track Control Arm		DB-VB-10426	Wishbone (CV), Leaf Spring Axle;Unit
2654 S, LS	04/03→	Ball Head, gearshift linkage	DB-ES-8510		
	04/03→	Bush, driver cab suspension	DB-SB-10384		
	04/03→	Bush, parabolic spring		DB-SB-10400	
	04/03→	Bush, parabolic spring		DB-SB-10401	
	04/03→	Centre Rod	DB-DL-2144		Push Rod
	04/03→	Centre Rod	DB-DL-5230		Suspension Rod
	04/03→	Centre Rod	DB-DL-5241		Push Rod
	04/03→	Centre Rod	DB-DL-5405		Push Rod
	04/03→	Centre Rod	DB-DL-5405		Push Rod, for vehicles with Rigid Leading Axle
	04/03→	Centre Rod	DB-DL-5405		Push Rod, Leaf Spring Axle
	04/03→	Centre Rod	DB-DL-7270		Push Rod
	04/03→	Centre Rod	DB-DL-8167		Push Rod
	04/03→	Centre Rod	DB-DL-8184		Push Rod
	04/03→	Centre Rod	DB-DL-8185		Push Rod
	04/03→	Centre Rod	DB-DL-8307		Push Rod
	04/03→	Centre Rod	DB-DL-12300		for Steering Rod
	04/03→	Centre Rod	DB-DL-12470		Push Rod
	04/03→	Rod Assembly	DB-DL-2178		Guide Rod
	04/03→	Stabiliser Mounting		DB-SB-10406	
	04/03→	Stabiliser Mounting		DB-SB-10409	
	04/03→	Stabiliser Mounting	DB-SB-10410		
	04/03→	Suspension Arm Repair Kit		DB-RK-8550	for Wishbone (CV)
	04/03→	Suspension Arm Repair Kit		DB-RK-8626	for Wishbone (CV)
	04/03→	Suspension Arm Repair Kit		DB-RK-10374	for Wishbone (CV)
	04/03→	Suspension Arm Repair Kit		DB-RK-10375	for Wishbone (CV)
	04/03→	Suspension Arm Repair Kit	DB-RK-8638		for Control Arm
	04/03→	Suspension Strut Repair Kit		DB-RK-8391	
	04/03→	Suspension Strut Repair Kit		DB-RK-9294	
	04/03→	Suspension Strut Repair Kit		MN-RK-8997	
	04/03→	Tie Rod	DB-DL-8171		Guide Rod
	04/03→	Tie Rod	DB-DL-8327		Guide Rod
	04/03→	Tie Rod	DB-DL-8388		Guide Rod
	04/03→	Tie Rod	DB-DL-8389		
	04/03→	Tie Rod	DB-DL-8640		Guide Rod
	04/03→	Tie Rod	DB-DL-12310		
	04/03→	Tie Rod	DB-ES-5227		Guide Rod
	04/03→	Tie Rod End	CV-ES-0543		for Push Rod
	04/03→	Tie Rod End	CV-ES-0888		for Push Rod
	04/03→	Tie Rod End	CV-ES-14162		for Steering Rod
	04/03→	Tie Rod End	CV-ES-14163		for Steering Rod
	04/03→	Tie Rod End	DB-ES-5234		for Steering Rod
	04/03→	Tie Rod End	DB-ES-8164		for Push Rod
	04/03→	Tie Rod End	DB-ES-8530		for Push Rod
	04/03→	Track Control Arm		DB-DL-3475	Trailing Arm
	04/03→	Track Control Arm		DB-VB-3707	Suspension Rod, Wishbone (CV)
	04/03→	Track Control Arm		DB-VB-7261	Suspension Rod, Wishbone (CV), 1st RA;2nd RA; Leaf Spring Axle
	04/03→	Track Control Arm		DB-VB-7798	Wishbone (CV)
04/03→	Track Control Arm		DB-VB-10426	Wishbone (CV), Leaf Spring Axle;Unit	
04/03→	Track Control Arm	DB-DL-5224		Control Arm, 1st FA;Air Suspension Axle; for vehicles with Rigid Leading Axle	
04/03→	Track Control Arm	DB-DL-9218	DB-DL-9218	Trailing Arm, 1st FA;Air Suspension Axle; for vehicles with Rigid Leading Axle	

CV-ES-0543

Length: 125
 Cone Ø: d1 Ø 32 / d2 Ø 29
 Thread: M30 x 1,5 RHT
 0004605748, 0004606048, 0004606848,
 0004607048, 0014600448, 0014601148,
 0014601748, 0014602448, 0014607648,
 0014609648

**CV-ES-0888**

Length: 125
 Cone Ø: d1 Ø 32 / d2 Ø 29
 Thread: M30 x 1,5 LHT
 0004605848, 0004606148, 0004606948,
 0004607148, 0004609048, 0014600548,
 0014601348, 0014602548, 0014607948,
 0024600448

**CV-ES-14162**

Length: 125
 Cone Ø: d1 Ø 30 / d2 Ø 27
 Thread: M30 x 1,5 LHT
 4600648, 4601248, 4603448, 0004603548,
 14600348, 14601448, 14602348,
 0014603748, 0014607848, 0024600348

**CV-ES-14163**

Length: 125
 Cone Ø: d1 Ø 30 / d2 Ø 27
 Thread: M30 x 1,5 RHT
 0003305248, 0003387310, 0004600348,
 0004600948, 0004602848, 0004602948,
 0004608948, 0014600248, 0014600848,
 0014601248, 0014602248, 0014607748,
 0024600148, 0003387310, 0004600348,
 A0004602848, A0004602948, A0014600848,
 A0014601248, A0014602248, A0014607748

**DB-DL-2144**

Length: 872 Ø: 35
 Cone Ø: d1 Ø 28,6 / d2 Ø 23,9
 0024604305, 0024604405, 0034604805

**DB-DL-2178**

Length: 1735 Ø: 52
 Cone Ø: d1 Ø 32 / d2 Ø 29
 9423300003, 9423300103, 9423300203

**DB-DL-3475**

Length: 565 Ø: 52
 Hole Distance: 152 / 152
 3753500006, 3753500206, 9473500805,
 9483500006, 9483500805, 9483501205,
 9483501305, 9483501905, 9483502005,
 9483502405, A3753500006,
 A3753500206

**DB-DL-5224**

Length: 850 Ø: 60
 Hole Distance: 100 / 100
 01336100A, 9413300007

**DB-DL-5230**

Length: 879 Ø: 42
 Cone Ø: d1 Ø 30 / d2 Ø 27
 01208600A, 0004607105, 0004607205,
 0014606705

**DB-DL-5241**

Length: 875 Ø: 40
 Cone Ø: d1 Ø 30 / d2 Ø 27
 01215300A, 0004609205, 0004609305,
 0014606905

**DB-DL-5405**

Length: 890 Ø: 35
 Cone Ø: d1 Ø 28,6 / d2 Ø 23,9
 01215900A, 1460248, 0024604505,
 0024604605, 0034605005, 3752600637,
 3754600405, A3752600637, A3754600405

**DB-DL-7270**

Length: 875 Ø: 40
 Cone Ø: d1 Ø 28,6 / d2 Ø 23,9
 01208300A, 0024604705, 0024604805,
 0034604905, A0024604705

**DB-DL-8167**

Length: 866 Ø: 38
 Cone Ø: d1 Ø 30 / d2 Ø 27
 0014609805, 0014609905, 0024606305,
 0024606405

**DB-DL-8171**

Length: 1687 Ø: 52
 Cone Ø: d1 Ø 32 / d2 Ø 29
 9493300603, 9493300703, 9493301503,
 9493301603

**DB-DL-8184**

Length: 1095 Ø: 42
 Cone Ø: d1 Ø 32 / d2 Ø 28,8
 01217700A, 0014601305, 0014601405,
 0024600505, 0034603205, 3754601505,
 A0014601305, A0014601405, A0024600505

**DB-DL-8185**

Length: 711 Ø: 42
 Cone Ø: d1 Ø 32 / d2 Ø 28,8
 01213600A, 0014601105, 0024600405,
 0034603105, A0014601105, A0024600405

**DB-DL-8307**

Length: 885 Ø: 38
 Cone Ø: d1 Ø 32 / d2 Ø 30
 01215500A, 0004604005, 0024605105,
 0024605205, 0034604005

**DB-DL-8327**

Length: 1745 Ø: 48
 Cone Ø: d1 Ø 32 / d2 Ø 29
 01219800A, 9413300003, 9413300103,
 9413300203, 9413300303, 9413300503

**DB-DL-8388**

Length: 1735 Ø: 62
 Cone Ø: d1 Ø 32 / d2 Ø 28,8
 01219900A, 9453300003, 9453300103,
 9453300403, 9453300603, A9453300003

**DB-DL-8389**

Length: 1465 Ø: 40
 Cone Ø: d1 Ø 32 / d2 Ø 29
 9453300203, 9453300303, 9453300503

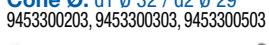
**DB-DL-8640**

Length: 1615 Ø: 50
 Cone Ø: d1 Ø 32 / d2 Ø 29
 6253301503, 6253301603, 6253302403,
 6253302503, 9423300803, 9423302103,
 9493300203, 9493300303, 9493300903

**DB-DL-9218**

Length: 754 Ø: 40
 Hole Distance: 100
 000360098524, 000390098524,
 3753300111, 9413300011,
 A3753300111, SA50831601

**DB-DL-12300**

Length: 733 Ø: 36
 Cone Ø: d1 Ø 32 / d2 Ø 29
 0014601505, 0014607305, 0034603305,
 3754601605, A0014601505,
 A0034603305, A3754601605

**DB-DL-12310**

Length: 1532 Ø: 50
 Cone Ø: d1 Ø 32 / d2 Ø 29
 Thread: M27 x 1,5 LHT
 9493301203, 9493301303, 9493301803,
 9493302203, A9493301203, A9493301303,
 A9493301803, A9493302203

**DB-DL-12470**

Length: 723 Ø: 42
 Cone Ø: d1 Ø 30 / d2 Ø 27
 A0014607505, A0024600905



No Image

DB-ES-5227

Length: 1588 Ø: 60
 Cone Ø: d1 Ø 38 / d2 Ø 34,3
 6253300903, 6253301203, 9443300203

**DB-ES-5234**

Length: 135
 Cone Ø: d1 Ø 38 / d2 Ø 34,3
 Thread: M38 x 1,5 RHT
 0004601748, 120322305, 2205000400

**DB-ES-8164**

Length: 140
 Cone Ø: d1 Ø 28,6 / d2 Ø 23,9
 Thread: M28 x 1,5 RHT
 0014604248, 0014605048, 0014608548,
 0024600548

**DB-ES-8510**

Length: 56
 Cone Ø: d1 Ø 10 / d2 Ø 10
 Thread: M12 x 1,75 LHT
 0009965145, 0009965645, 0019963145

**DB-ES-8530**

Length: 115
 Cone Ø: d1 Ø 28,6 / d2 Ø 23,9
 Thread: M30 x 1,5 RHT
 0014603848, 0014604848, 0014605148,
 0014608648, 0014609948

**DB-RK-8391**

Ø: 85 Hole Distance: 152
 Thick/Height: 24
 01336800A, 0003502705

**DB-RK-8550**

Ø: 75 Hole Distance: 152
 Thick/Height: 24
 0003502105, 0003504605

**DB-RK-8626**

Ø: 75 Hole Distance: 130
 Thick/Height: 24
 0003502205, 0003502505, 0003503405,
 0003504505, GL11319

**DB-RK-8638**

Length: 100 Ø: 67
 Hole Distance: 100
 Thick/Height: 20
 0003301411

**DB-RK-9294**

Ø: 85 Hole Distance: 152
 Thick/Height: 24
 0003503105

**DB-RK-10374**

Ø: 85 Hole Distance: 152
 Thick/Height: 24
 0003504405

**DB-RK-10375**

Ø: 100 Hole Distance: 152
 Thick/Height: 24
 0003502405, 0003503505, 0003504905

**DB-SB-10384**

Ø: 73 Thick/Height: 47
 9303170012, 9423171812

**DB-SB-10400**

Length: 230
 Thick/Height: 167,5 / 115
 0003250696, 0003250896

**DB-SB-10401**

Length: 232
 Thick/Height: 163,5 / 152,5
 0003250596, 0003250796

**DB-SB-10406**

Ø: 80 Thick/Height: 46
 0003238185

**DB-SB-10409**

Ø: 77 Thick/Height: 56
 0003265181

**DB-SB-10410**

Ø: 73 Hole Distance: 100
 Thick/Height: 24
 9413230050

**DB-VB-3707**

Length: 622 Ø: 46
 Hole Ø 25 / 25 / 25
 Hole Distance: 152 / 130 / 130
 01337100A, 9423501005, 9423501505,
 9443500005, 9473500105, 9473501005,
 A3753500005, A9423501005, A9423501505,
 A9443500005, A9473500105, A9473501005

**DB-VB-7261**

Length: 622 Ø: 46
 Hole Ø 25 / 25 / 25
 Hole Distance: 152 / 130 / 130
 01337800A, 9443500305, 9443500505,
 9443500605, 9473500705, 9473500905,
 9483500405, 9483503005

**DB-VB-7798**

Length: 622 Ø: 48
 Hole Ø 25 / 23 / 23
 Hole Distance: 152 / 130 / 130
 9423500505, 9423500805, 9423501205,
 A9423501205

**DB-VB-10426**

Length: 622 Ø: 46
 Hole Ø 25 / 25 / 25
 Hole Distance: 152 / 130 / 130
 9443500405

**MN-RK-8997**

Ø: 85 Hole Distance: 130
 Thick/Height: 30
 0003504805





ACTROS MP2 / MP3 ...

2654, L, 2655, L, LL

04/03→	Ball Head, gearshift linkage	DB-ES-8510		
04/03→	Bush, driver cab suspension	DB-SB-10384		
04/03→	Bush, parabolic spring		DB-SB-10400	
04/03→	Bush, parabolic spring		DB-SB-10401	
04/03→	Centre Rod	DB-DL-2144		Push Rod
04/03→	Centre Rod	DB-DL-5230		Suspension Rod
04/03→	Centre Rod	DB-DL-5241		Push Rod
04/03→	Centre Rod	DB-DL-5405		Push Rod, 1st FA;Leaf Spring Axle
04/03→	Centre Rod	DB-DL-7270		Push Rod;Suspension Rod
04/03→	Centre Rod	DB-DL-8167		Push Rod
04/03→	Centre Rod	DB-DL-8168		Push Rod
04/03→	Centre Rod	DB-DL-8184		Push Rod
04/03→	Centre Rod	DB-DL-8185		Push Rod
04/03→	Centre Rod	DB-DL-8307		Push Rod
04/03→	Centre Rod	DB-DL-8622		Push Rod
04/03→	Centre Rod	DB-DL-8641		Push Rod
04/03→	Centre Rod	DB-DL-8642		Push Rod
04/03→	Centre Rod	DB-DL-12300		for Steering Rod
04/03→	Rod Assembly	DB-DL-2178		Guide Rod
04/03→	Stabiliser Link	DB-DL-9254		Pressure Rod
04/03→	Stabiliser Mounting		DB-SB-10406	
04/03→	Stabiliser Mounting		DB-SB-10409	
04/03→	Stabiliser Mounting	DB-SB-10410		
04/03→	Suspension Arm Repair Kit		DB-RK-8550	for Wishbone (CV)
04/03→	Suspension Arm Repair Kit		DB-RK-8626	for Wishbone (CV)
04/03→	Suspension Arm Repair Kit		DB-RK-10374	for Wishbone (CV)
04/03→	Suspension Arm Repair Kit		DB-RK-10375	for Wishbone (CV)
04/03→	Suspension Arm Repair Kit	DB-RK-8638		for Control Arm
04/03→	Suspension Strut Repair Kit		DB-RK-8391	
04/03→	Suspension Strut Repair Kit		DB-RK-9294	
04/03→	Tie Rod	DB-DL-8327		Guide Rod
04/03→	Tie Rod	DB-DL-8640		Guide Rod
04/03→	Tie Rod	DB-DL-12310		
04/03→	Tie Rod	DB-ES-5227		Guide Rod
04/03→	Tie Rod End	CV-ES-0543		for Push Rod
04/03→	Tie Rod End	CV-ES-0888		for Push Rod
04/03→	Tie Rod End	CV-ES-14162		for Steering Rod
04/03→	Tie Rod End	CV-ES-14163		for Steering Rod
04/03→	Tie Rod End	DB-ES-5234		for Steering Rod
04/03→	Tie Rod End	DB-ES-8164		for Push Rod
04/03→	Tie Rod End	DB-ES-8530		for Push Rod
04/03→	Track Control Arm		DB-DL-3475	Trailing Arm
04/03→	Track Control Arm		DB-VB-3707	Suspension Rod, Wishbone (CV)
04/03→	Track Control Arm		DB-VB-7261	Suspension Rod, Wishbone (CV), 1st RA;2nd RA; Leaf Spring Axle
04/03→	Track Control Arm		DB-VB-10426	Wishbone (CV), Leaf Spring Axle;Unit
2655 LS	10/09→	Centre Rod	DB-DL-2144	Push Rod
	10/09→	Centre Rod	DB-DL-8167	Push Rod
	10/09→	Rod Assembly	DB-DL-2178	Guide Rod, 1st Front Axle, →504310 03
	10/09→	Suspension Arm Repair Kit		DB-RK-8626 for Wishbone (CV)
	10/09→	Suspension Arm Repair Kit		DB-RK-10374 for Wishbone (CV)
	10/09→	Tie Rod	DB-DL-8640	Guide Rod
	10/09→	Tie Rod	DB-DL-12310	
	10/09→	Tie Rod End	CV-ES-0543	for Push Rod
	10/09→	Tie Rod End	CV-ES-0888	for Push Rod
	10/09→	Tie Rod End	CV-ES-14163	for Steering Rod
	10/09→	Tie Rod End	DB-ES-8164	for Push Rod
	10/09→	Track Control Arm		DB-VB-3707 Suspension Rod, Wishbone (CV)
2655 S, LS	04/03→	Centre Rod	DB-DL-2144	Push Rod
	04/03→	Centre Rod	DB-DL-5405	Push Rod
	04/03→	Centre Rod	DB-DL-5405	Push Rod, Leaf Spring Axle
	04/03→	Centre Rod	DB-DL-7270	Push Rod
	04/03→	Centre Rod	DB-DL-8167	Push Rod

CV-ES-0543

Length: 125
Cone Ø: d1 Ø 32 / d2 Ø 29
Thread: M30 x 1,5 RHT
0004605748, 0004606048, 0004606848,
0004607048, 0014600448, 0014601148,
0014601748, 0014602448, 0014607648,
0014609648



CV-ES-0888

Length: 125
Cone Ø: d1 Ø 32 / d2 Ø 29
Thread: M30 x 1,5 LHT
0004605848, 0004606148, 0004606948,
0004607148, 0004609048, 0014600548,
0014601348, 0014602548, 0014607948,
0024600448



CV-ES-14162

Length: 125
Cone Ø: d1 Ø 30 / d2 Ø 27
Thread: M30 x 1,5 LHT
4600648, 4601248, 4603448, 0004603548,
14600348, 14601448, 14602348,
0014603748, 0014607848, 0024600348



CV-ES-14163

Length: 125
Cone Ø: d1 Ø 30 / d2 Ø 27
Thread: M30 x 1,5 RHT
0003305248, 0003387310, 0004600348,
0004600948, 0004602848, 0004602948,
0004608948, 0014600248, 0014600848,
0014601248, 0014602248, 0014607748,
0024600148, 0003387310, 0004600348,
0004602848, 0004602948, 0014600848,
A0014601248, A0014602248, A0014607748



DB-DL-2144

Length: 872 Ø: 35
Cone Ø: d1 Ø 28,6 / d2 Ø 23,9
0024604305, 0024604405, 0034604805



DB-DL-2178

Length: 1735 Ø: 52
Cone Ø: d1 Ø 32 / d2 Ø 29
9423300003, 9423300103, 9423300203



DB-DL-3475

Length: 565 Ø: 52
Hole Distance: 152 / 152
3753500006, 3753500206, 9473500805,
9483500006, 9483500805, 9483501205,
9483501305, 9483501905, 9483502005,
9483502405, A3753500006,
A3753500206



DB-DL-5230

Length: 879 Ø: 42
Cone Ø: d1 Ø 30 / d2 Ø 27
01208600A, 0004607105, 0004607205,
0014606705



DB-DL-5241

Length: 875 Ø: 40
Cone Ø: d1 Ø 30 / d2 Ø 27
01215300A, 0004609205, 0004609305,
0014606905



DB-DL-5405

Length: 890 Ø: 35
Cone Ø: d1 Ø 28,6 / d2 Ø 23,9
01215900A, 1460248, 0024604505,
0024604605, 0034605005, 3752600637,
3754600405, A3752600637, A3754600405



DB-DL-7270

Length: 875 Ø: 40
Cone Ø: d1 Ø 28,6 / d2 Ø 23,9
01208300A, 0024604705, 0024604805,
0034604905, A0024604705



DB-DL-8167

Length: 866 Ø: 38
Cone Ø: d1 Ø 30 / d2 Ø 27
0014609805, 0014609905, 0024606305,
0024606405



DB-DL-8168

Length: 904 Ø: 52
Cone Ø: d1 Ø 32 / d2 Ø 29
0004609405, 0004609505, 0014607105



DB-DL-8184

Length: 1095 Ø: 42
Cone Ø: d1 Ø 32 / d2 Ø 28,8
01217700A, 0014601305, 0014601405,
0024600505, 0034603205, 3754601505,
A0014601305, A0014601405, A0024600505



DB-DL-8185

Length: 711 Ø: 42
Cone Ø: d1 Ø 32 / d2 Ø 28,8
01213600A, 0014601105, 0024600405,
0034603105, A0014601105, A0024600405



DB-DL-8307

Length: 885 Ø: 38
Cone Ø: d1 Ø 32 / d2 Ø 30
01215500A, 0004604005, 0024605105,
0024605205, 0034604005



DB-DL-8327

Length: 1745 Ø: 48
Cone Ø: d1 Ø 32 / d2 Ø 29
01219800A, 9413300003, 9413300103,
9413300203, 9413300303, 9413300503



DB-DL-8622

Length: 1558 Ø: 52
Cone Ø: d1 Ø 30 / d2 Ø 27
0014609005, 0014609105



DB-DL-8640

Length: 1615 Ø: 50
Cone Ø: d1 Ø 32 / d2 Ø 29
6253301503, 6253301603, 6253302403,
6253302503, 9423300803, 9423302103,
9493300203, 9493300303, 9493300903



DB-DL-8641

Length: 905 Ø: 42
Cone Ø: d1 Ø 30 / d2 Ø 27
0014605105, 0014608105



DB-DL-8642

Length: 954 Ø: 42
Cone Ø: d1 Ø 30 / d2 Ø 27
0014608605, 0014608705



DB-DL-9254

Length: 1815 Ø: 58
0003220323, 0003220623, 3753220423



DB-DL-12300

Length: 733 Ø: 36
Cone Ø: d1 Ø 32 / d2 Ø 29
0014601505, 0014607305, 0034603305,
3754601605, A0014601505,
A0034603305, A3754601605



DB-DL-12310

Length: 1532 Ø: 50
Cone Ø: d1 Ø 32 / d2 Ø 29
Thread: M27 x 1,5 LHT
9493301203, 9493301303, 9493301803,
9493302203, A9493301203, A9493301303,
A9493301803, A9493302203



DB-ES-5227

Length: 1588 Ø: 60
Cone Ø: d1 Ø 38 / d2 Ø 34,3
6253300903, 6253301203, 9443300203



DB-ES-5234

Length: 135
Cone Ø: d1 Ø 38 / d2 Ø 34,3
Thread: M38 x 1,5 RHT
0004601748, 120322305, 2205000400



DB-ES-8164

Length: 140
Cone Ø: d1 Ø 28,6 / d2 Ø 23,9
Thread: M28 x 1,5 RHT
0014604248, 0014605048, 0014608548,
0024600548



DB-ES-8510

Length: 56
Cone Ø: d1 Ø 10 / d2 Ø 10
Thread: M12 x 1,75 LHT
0009965145, 0009965645, 0019963145



DB-ES-8530

Length: 115
Cone Ø: d1 Ø 28,6 / d2 Ø 23,9
Thread: M30 x 1,5 RHT
0014603848, 0014604848, 0014605148,
0014608648, 0014609948



DB-RK-8391

Ø: 85 Hole Distance: 152
Thick/Height: 24
01336800A, 0003502705



DB-RK-8550

Ø: 75 Hole Distance: 152
Thick/Height: 24
0003502105, 0003504605



DB-RK-8626

Ø: 75 Hole Distance: 130
Thick/Height: 24
0003502205, 0003502505, 0003503405,
0003504505, GL11319



DB-RK-8638

Length: 100 Ø: 67
Hole Distance: 100
Thick/Height: 20
0003301411



DB-RK-9294

Ø: 85 Hole Distance: 152
Thick/Height: 24
0003503105



DB-RK-10374

Ø: 85 Hole Distance: 152
Thick/Height: 24
0003504405



DB-RK-10375

Ø: 100 Hole Distance: 152
Thick/Height: 24
0003502405, 0003503505, 0003504905



DB-SB-10384

Ø: 73 Thick/Height: 47
9303170012, 9423171812



DB-SB-10400

Length: 230
Thick/Height: 167,5 / 115
0003250696, 0003250896



DB-SB-10401

Length: 232
Thick/Height: 163,5 / 152,5
0003250596, 0003250796



DB-SB-10406

Ø: 80 Thick/Height: 46
0003238185



DB-SB-10409

Ø: 77 Thick/Height: 56
0003265181



DB-SB-10410

Ø: 73 Hole Distance: 100
Thick/Height: 24
9413230050



DB-VB-3707

Length: 622 Ø: 46
Hole Ø 25 / 25 / 25
Hole Distance: 152 / 130 / 130
01337100A, 9423501005, 9423501505,
9443500005, 9473500105, 9473501005,
A3753500005, A9423501005, A9423501505,
A9443500005, A9473500105, A9473501005



DB-VB-7261

Length: 622 Ø: 46
Hole Ø 25 / 25 / 25
Hole Distance: 152 / 130 / 130
01337800A, 9443500305, 9443500505,
9443500605, 9473500705, 9473500905,
9483500405, 9483503005



DB-VB-10426

Length: 622 Ø: 46
Hole Ø 25 / 25 / 25
Hole Distance: 152 / 130 / 130
9443500405





ACTROS MP2 / MP3 ...

2655 S, LS ...	04/03→	Centre Rod	DB-DL-8307	Push Rod
	04/03→	Rod Assembly	DB-DL-2178	Guide Rod, 1st Front Axle, →504310 03
	04/03→	Stabiliser Mounting		DB-SB-10406
	04/03→	Suspension Strut Repair Kit		DB-RK-9294
	04/03→	Tie Rod	DB-DL-8171	Guide Rod
	04/03→	Tie Rod	DB-DL-8327	Guide Rod
	04/03→	Tie Rod	DB-DL-8640	Guide Rod
	04/03→	Tie Rod	DB-DL-12310	
	04/03→	Tie Rod	DB-ES-5227	Guide Rod
	04/03→	Tie Rod End	CV-ES-0543	for Push Rod
	04/03→	Tie Rod End	CV-ES-0888	for Push Rod
	04/03→	Tie Rod End	CV-ES-14163	for Steering Rod
	04/03→	Tie Rod End	DB-ES-8164	for Push Rod
	04/03→	Track Control Arm		DB-DL-3475 Trailing Arm, 1st RA;2nd RA, →517144 05/517144 08
	04/03→	Track Control Arm		DB-VB-3707 Suspension Rod, Wishbone (CV), 1st RA;2nd RA, →508306 01
	04/03→	Track Control Arm		DB-VB-7261 Suspension Rod, Wishbone (CV), 1st RA;2nd RA; Leaf Spring Axle
	2658 K, LK	04/03→	Track Control Arm	
04/03→		Ball Head, gearshift linkage	DB-ES-8510	
04/03→		Bush, driver cab suspension	DB-SB-10384	
04/03→		Bush, parabolic spring		DB-SB-10400
04/03→		Bush, parabolic spring		DB-SB-10401
04/03→		Centre Rod	DB-DL-2144	Push Rod
04/03→		Centre Rod	DB-DL-5230	Suspension Rod
04/03→		Centre Rod	DB-DL-5241	Push Rod
04/03→		Centre Rod	DB-DL-5405	Push Rod, Leaf Spring Axle
04/03→		Centre Rod	DB-DL-7270	Push Rod
04/03→		Centre Rod	DB-DL-8167	Push Rod
04/03→		Centre Rod	DB-DL-8184	Push Rod
04/03→		Centre Rod	DB-DL-8185	Push Rod
04/03→		Centre Rod	DB-DL-8307	Push Rod
04/03→		Centre Rod	DB-DL-12300	for Steering Rod
04/03→		Rod Assembly	DB-DL-2178	Guide Rod
04/03→		Stabiliser Mounting		DB-SB-10406
04/03→		Stabiliser Mounting		DB-SB-10409
04/03→		Suspension Arm Repair Kit		DB-RK-8550 for Wishbone (CV)
04/03→		Suspension Arm Repair Kit		DB-RK-8626 for Wishbone (CV)
04/03→		Suspension Arm Repair Kit		DB-RK-10374 for Wishbone (CV)
04/03→		Suspension Arm Repair Kit		DB-RK-10375 for Wishbone (CV)
04/03→		Suspension Arm Repair Kit	DB-RK-8638	for Control Arm
04/03→		Suspension Strut Repair Kit		DB-RK-8391
04/03→		Suspension Strut Repair Kit		DB-RK-9294
04/03→		Tie Rod	DB-DL-8171	Guide Rod
04/03→		Tie Rod	DB-DL-8327	Guide Rod
04/03→		Tie Rod	DB-DL-8640	Guide Rod
04/03→		Tie Rod	DB-DL-12310	
04/03→		Tie Rod	DB-ES-5227	Guide Rod
04/03→		Tie Rod End	CV-ES-0543	for Push Rod
04/03→		Tie Rod End	CV-ES-0888	for Push Rod
04/03→		Tie Rod End	CV-ES-14162	for Steering Rod
04/03→		Tie Rod End	CV-ES-14163	for Steering Rod
04/03→		Tie Rod End	DB-ES-5234	for Steering Rod
04/03→		Tie Rod End	DB-ES-8164	for Push Rod
04/03→		Tie Rod End	DB-ES-8530	for Push Rod
04/03→		Track Control Arm		DB-DL-3475 Trailing Arm
04/03→		Track Control Arm		DB-VB-3707 Suspension Rod, Wishbone (CV)
04/03→		Track Control Arm		DB-VB-7261 Suspension Rod, Wishbone (CV), 1st RA;2nd RA; Leaf Spring Axle
04/03→		Track Control Arm		DB-VB-10426 Wishbone (CV), Leaf Spring Axle;Unit

CV-ES-0543

Length: 125
 Cone Ø: d1 Ø 32 / d2 Ø 29
 Thread: M30 x 1,5 RHT
 0004605748, 0004606048, 0004606848,
 0004607048, 0014600448, 0014601148,
 0014601748, 0014602448, 0014607648,
 0014609648

**CV-ES-0888**

Length: 125
 Cone Ø: d1 Ø 32 / d2 Ø 29
 Thread: M30 x 1,5 LHT
 0004605848, 0004606148, 0004606948,
 0004607148, 0004609048, 0014600548,
 0014601348, 0014602548, 0014607948,
 0024600448

**CV-ES-14162**

Length: 125
 Cone Ø: d1 Ø 30 / d2 Ø 27
 Thread: M30 x 1,5 LHT
 4600648, 4601248, 4603448, 4603548,
 0004603548, 14600348, 14601448,
 14602348, 0014603748, 0014607848,
 14607848, 0024600348

**CV-ES-14163**

Length: 125
 Cone Ø: d1 Ø 30 / d2 Ø 27
 Thread: M30 x 1,5 RHT
 0003305248, 0003387310, 0004600348,
 0004600948, 0004602848, 0004602948,
 0004608948, 0014600248, 0014600848,
 0014601248, 0014602248, 0014607748,
 0024600148, A0003387310, A0004600348,
 A0004602848, A0004602948, A0014600848,
 A0014601248, A0014602248, A0014607748

**DB-DL-2144**

Length: 872 Ø: 35
 Cone Ø: d1 Ø 28,6 / d2 Ø 23,9
 0024604305, 0024604405, 0034604805

**DB-DL-2178**

Length: 1735 Ø: 52
 Cone Ø: d1 Ø 32 / d2 Ø 29
 9423300003, 9423300103, 9423300203

**DB-DL-3475**

Length: 565 Ø: 52
 Hole Distance: 152 / 152
 3753500006, 3753500206, 9473500805,
 9483500006, 9483500805, 9483501205,
 9483501305, 9483501905, 9483502005,
 9483502405, A3753500006,
 A3753500206

**DB-DL-5230**

Length: 879 Ø: 42
 Cone Ø: d1 Ø 30 / d2 Ø 27
 01208600A, 0004607105, 0004607205,
 0014606705

**DB-DL-5241**

Length: 875 Ø: 40
 Cone Ø: d1 Ø 30 / d2 Ø 27
 01215300A, 0004609205, 0004609305,
 0014606905

**DB-DL-5405**

Length: 890 Ø: 35
 Cone Ø: d1 Ø 28,6 / d2 Ø 23,9
 01215900A, 1460248, 0024604505,
 0024604605, 0034605005, 3752600637,
 3754600405, A3752600637, A3754600405

**DB-DL-7270**

Length: 875 Ø: 40
 Cone Ø: d1 Ø 28,6 / d2 Ø 23,9
 01208300A, 0024604705, 0024604805,
 0034604905, A0024604705

**DB-DL-8167**

Length: 866 Ø: 38
 Cone Ø: d1 Ø 30 / d2 Ø 27
 0014609805, 0014609905, 0024606305,
 0024606405

**DB-DL-8171**

Length: 1687 Ø: 52
 Cone Ø: d1 Ø 32 / d2 Ø 29
 9493300603, 9493300703, 9493301503,
 9493301603

**DB-DL-8184**

Length: 1095 Ø: 42
 Cone Ø: d1 Ø 32 / d2 Ø 28,8
 01217700A, 0014601305, 0014601405,
 0024600505, 0034603205, 3754601505,
 A0014601305, A0014601405, A0024600505

**DB-DL-8185**

Length: 711 Ø: 42
 Cone Ø: d1 Ø 32 / d2 Ø 28,8
 01213600A, 0014601105, 0024600405,
 0034603105, A0014601105, A0024600405

**DB-DL-8307**

Length: 885 Ø: 38
 Cone Ø: d1 Ø 32 / d2 Ø 30
 01215500A, 0004604005, 0024605105,
 0024605205, 0034604005

**DB-DL-8327**

Length: 1745 Ø: 48
 Cone Ø: d1 Ø 32 / d2 Ø 29
 01219800A, 9413300003, 9413300103,
 9413300203, 9413300303, 9413300503

**DB-DL-8640**

Length: 1615 Ø: 50
 Cone Ø: d1 Ø 32 / d2 Ø 29
 6253301503, 6253301603, 6253302403,
 6253302503, 9423300803, 9423302103,
 9493300203, 9493300303, 9493300903

**DB-DL-12300**

Length: 733 Ø: 36
 Cone Ø: d1 Ø 32 / d2 Ø 29
 0014601505, 0014607305, 0034603305,
 3754601605, A0014601505, A0034603305,
 A3754601605

**DB-DL-12310**

Length: 1532 Ø: 50
 Cone Ø: d1 Ø 32 / d2 Ø 29
 Thread: M27 x 1,5 LHT
 9493301203, 9493301303, 9493301803,
 9493302203, A9493301203, A9493301303,
 A9493301803, A9493302203

**DB-ES-5227**

Length: 1588 Ø: 60
 Cone Ø: d1 Ø 38 / d2 Ø 34,3
 6253300903, 6253301203, 9443300203

**DB-ES-5234**

Length: 135
 Cone Ø: d1 Ø 38 / d2 Ø 34,3
 Thread: M38 x 1,5 RHT
 0004601748, 120322305, 2205000400

**DB-ES-8164**

Length: 140
 Cone Ø: d1 Ø 28,6 / d2 Ø 23,9
 Thread: M28 x 1,5 RHT
 0014604248, 0014605048, 0014608548,
 0024600548

**DB-ES-8510**

Length: 56
 Cone Ø: d1 Ø 10 / d2 Ø 10
 Thread: M12 x 1,75 LHT
 0009965145, 0009965645, 0019963145

**DB-ES-8530**

Length: 115
 Cone Ø: d1 Ø 28,6 / d2 Ø 23,9
 Thread: M30 x 1,5 RHT
 0014603848, 0014604848, 0014605148,
 0014608648, 0014609948

**DB-RK-8391**

Ø: 85 Hole Distance: 152
 Thick/Height: 24
 01336800A, 0003502705

**DB-RK-8550**

Ø: 75 Hole Distance: 152
 Thick/Height: 24
 0003502105, 0003504605

**DB-RK-8626**

Ø: 75 Hole Distance: 130
 Thick/Height: 24
 0003502205, 0003502505, 0003503405,
 0003504505, GL11319

**DB-RK-8638**

Length: 100 Ø: 67
 Hole Distance: 100
 Thick/Height: 20
 0003301411

**DB-RK-9294**

Ø: 85 Hole Distance: 152
 Thick/Height: 24
 0003503105

**DB-RK-10374**

Ø: 85 Hole Distance: 152
 Thick/Height: 24
 0003504405

**DB-RK-10375**

Ø: 100 Hole Distance: 152
 Thick/Height: 24
 0003502405, 0003503505, 0003504905

**DB-SB-10384**

Ø: 73 Thick/Height: 47
 9303170012, 9423171812

**DB-SB-10400**

Length: 230
 Thick/Height: 167,5 / 115
 0003250696, 0003250896

**DB-SB-10401**

Length: 232
 Thick/Height: 163,5 / 152,5
 0003250596, 0003250796

**DB-SB-10406**

Ø: 80 Thick/Height: 46
 0003238185

**DB-SB-10409**

Ø: 77 Thick/Height: 56
 0003265181

**DB-VB-3707**

Length: 622 Ø: 46
 Hole Ø 25 / 25 / 25
 Hole Distance: 152 / 130 / 130
 01337100A, 9423501005, 9423501505,
 9443500005, 9473500105, 9473501005,
 A3753500005, A9423501005, A9423501505,
 A9443500005, A9473500105, A9473501005

**DB-VB-7261**

Length: 622 Ø: 46
 Hole Ø 25 / 25 / 25
 Hole Distance: 152 / 130 / 130
 01337800A, 9443500305, 9443500505,
 9443500605, 9473500705, 9473500905,
 9483500405, 9483500305



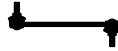

ACTROS MP2 / MP3 ...

2658 L	04/03→	Ball Head, gearshift linkage	DB-ES-8510			
	04/03→	Bush, driver cab suspension	DB-SB-10384			
	04/03→	Bush, parabolic spring		DB-SB-10400		
	04/03→	Bush, parabolic spring		DB-SB-10401		
	04/03→	Centre Rod	DB-DL-2144		Push Rod	
	04/03→	Centre Rod	DB-DL-5230		Suspension Rod	
	04/03→	Centre Rod	DB-DL-5241		Push Rod	
	04/03→	Centre Rod	DB-DL-5405		Push Rod, 1st FA;Leaf Spring Axle	
	04/03→	Centre Rod	DB-DL-7270		Push Rod	
	04/03→	Centre Rod	DB-DL-8167		Push Rod	
	04/03→	Centre Rod	DB-DL-8168		Push Rod	
	04/03→	Centre Rod	DB-DL-8184		Push Rod	
	04/03→	Centre Rod	DB-DL-8185		Push Rod	
	04/03→	Centre Rod	DB-DL-8307		Push Rod	
	04/03→	Centre Rod	DB-DL-8622		Push Rod	
	04/03→	Centre Rod	DB-DL-8641		Push Rod	
	04/03→	Centre Rod	DB-DL-8642		Push Rod	
	04/03→	Centre Rod	DB-DL-12300		for Steering Rod	
	04/03→	Rod Assembly	DB-DL-2178		Guide Rod	
	04/03→	Stabiliser Link	DB-DL-9254		Pressure Rod	
	04/03→	Stabiliser Mounting		DB-SB-10406		
	04/03→	Stabiliser Mounting		DB-SB-10409		
	04/03→	Stabiliser Mounting	DB-SB-10410			
	04/03→	Suspension Arm Repair Kit		DB-RK-8550	for Wishbone (CV)	
	04/03→	Suspension Arm Repair Kit		DB-RK-8626	for Wishbone (CV)	
	04/03→	Suspension Arm Repair Kit		DB-RK-10374	for Wishbone (CV)	
	04/03→	Suspension Arm Repair Kit		DB-RK-10375	for Wishbone (CV)	
	04/03→	Suspension Arm Repair Kit	DB-RK-8638		for Control Arm	
	04/03→	Suspension Strut Repair Kit		DB-RK-8391		
	04/03→	Suspension Strut Repair Kit		DB-RK-9294		
	04/03→	Tie Rod	DB-DL-8327		Guide Rod	
	04/03→	Tie Rod	DB-DL-8640		Guide Rod	
	04/03→	Tie Rod	DB-DL-12310			
	04/03→	Tie Rod	DB-ES-5227		Guide Rod	
	04/03→	Tie Rod End	CV-ES-0543		for Push Rod	
	04/03→	Tie Rod End	CV-ES-0888		for Push Rod	
	04/03→	Tie Rod End	CV-ES-14162		for Steering Rod	
	04/03→	Tie Rod End	CV-ES-14163		for Steering Rod	
	04/03→	Tie Rod End	DB-ES-5234		for Steering Rod	
	04/03→	Tie Rod End	DB-ES-8164		for Push Rod	
	04/03→	Tie Rod End	DB-ES-8530		for Push Rod	
	04/03→	Track Control Arm		DB-VB-3707	Suspension Rod, Wishbone (CV)	
	04/03→	Track Control Arm	DB-DL-5224		Control Arm, 1st FA;Air Suspension Axle	
	04/03→	Track Control Arm	DB-DL-9218	DB-DL-9218	Trailing Arm, 1st FA;Air Suspension Axle	
	2658 LS	04/03→	Ball Head, gearshift linkage	DB-ES-8510		
		04/03→	Bush, driver cab suspension	DB-SB-10384		
		04/03→	Centre Rod	DB-DL-2144		Push Rod
04/03→		Centre Rod	DB-DL-5230		Suspension Rod	
04/03→		Centre Rod	DB-DL-5241		Push Rod	
04/03→		Centre Rod	DB-DL-5405		Push Rod	
04/03→		Centre Rod	DB-DL-7270		Push Rod	
04/03→		Centre Rod	DB-DL-8167		Push Rod	
04/03→		Centre Rod	DB-DL-8184		Push Rod	
04/03→		Centre Rod	DB-DL-8185		Push Rod	
04/03→		Centre Rod	DB-DL-8307		Push Rod	
04/03→		Centre Rod	DB-DL-12300		for Steering Rod	
04/03→		Rod Assembly	DB-DL-2178		Guide Rod	
04/03→		Stabiliser Mounting		DB-SB-10409		
04/03→		Stabiliser Mounting	DB-SB-10410			
04/03→		Suspension Arm Repair Kit		DB-RK-8626	for Wishbone (CV)	
04/03→		Suspension Arm Repair Kit		DB-RK-10374	for Wishbone (CV)	
04/03→		Suspension Arm Repair Kit		DB-RK-10375	for Wishbone (CV)	
04/03→		Suspension Arm Repair Kit	DB-RK-8638		for Control Arm	

CV-ES-0543

Length: 125
 Cone Ø: d1 Ø 32 / d2 Ø 29
 Thread: M30 x 1,5 RHT
 0004605748, 0004606048, 0004606848,
 0004607048, 0014600448, 0014601148,
 0014601748, 0014602448, 0014607648,
 0014609648

**CV-ES-0888**

Length: 125
 Cone Ø: d1 Ø 32 / d2 Ø 29
 Thread: M30 x 1,5 LHT
 0004605848, 0004606148, 0004606948,
 0004607148, 0004609048, 0014600548,
 0014601348, 0014602548, 0014607948,
 0024600448

**CV-ES-14162**

Length: 125
 Cone Ø: d1 Ø 30 / d2 Ø 27
 Thread: M30 x 1,5 LHT
 4600648, 4601248, 4603448, 0004603548,
 14600348, 14601448, 14602348,
 0014603748, 0014607848, 0024600348

**CV-ES-14163**

Length: 125
 Cone Ø: d1 Ø 30 / d2 Ø 27
 Thread: M30 x 1,5 RHT
 0003305248, 0003387310, 0004600348,
 0004600948, 0004602848, 0004602948,
 0004608948, 0014600248, 0014600848,
 0014601248, 0014602248, 0014607748,
 0024600148, A0003387310, A0004600348,
 A0004602848, A0004602948, A0014600848,
 A0014601248, A0014602248, A0014607748

**DB-DL-2144**

Length: 872 Ø: 35
 Cone Ø: d1 Ø 28,6 / d2 Ø 23,9
 0024604305, 0024604405, 0034604805

**DB-DL-2178**

Length: 1735 Ø: 52
 Cone Ø: d1 Ø 32 / d2 Ø 29
 9423300003, 9423300103, 9423300203

**DB-DL-5224**

Length: 850 Ø: 60
 Hole Distance: 100 / 100
 01336100A, 9413300007

**DB-DL-5230**

Length: 879 Ø: 42
 Cone Ø: d1 Ø 30 / d2 Ø 27
 01208600A, 0004607105, 0004607205,
 0014606705

**DB-DL-5241**

Length: 875 Ø: 40
 Cone Ø: d1 Ø 30 / d2 Ø 27
 01215300A, 0004609205, 0004609305,
 0014606905

**DB-DL-5405**

Length: 890 Ø: 35
 Cone Ø: d1 Ø 28,6 / d2 Ø 23,9
 01215900A, 1460248, 0024604505,
 0024604605, 0034605005, 3752600637,
 3754600405, A3752600637, A3754600405

**DB-DL-7270**

Length: 875 Ø: 40
 Cone Ø: d1 Ø 28,6 / d2 Ø 23,9
 01208300A, 0024604705, 0024604805,
 0034604905, A0024604705

**DB-DL-8167**

Length: 866 Ø: 38
 Cone Ø: d1 Ø 30 / d2 Ø 27
 0014609805, 0014609905, 0024606305,
 0024606405

**DB-DL-8168**

Length: 904 Ø: 52
 Cone Ø: d1 Ø 32 / d2 Ø 29
 0004609405, 0004609505, 0014607105

**DB-DL-8184**

Length: 1095 Ø: 42
 Cone Ø: d1 Ø 32 / d2 Ø 28,8
 01217700A, 0014601305, 0014601405,
 0024600505, 0034603205, 3754601505,
 A0014601305, A0014601405, A0024600505

**DB-DL-8185**

Length: 711 Ø: 42
 Cone Ø: d1 Ø 32 / d2 Ø 28,8
 01213600A, 0014601105, 0024600405,
 0034603105, A0014601105, A0024600405

**DB-DL-8307**

Length: 885 Ø: 38
 Cone Ø: d1 Ø 32 / d2 Ø 30
 01215500A, 0004604005, 0024605105,
 0024605205, 0034604005

**DB-DL-8327**

Length: 1745 Ø: 48
 Cone Ø: d1 Ø 32 / d2 Ø 29
 01219800A, 9413300003, 9413300103,
 9413300203, 9413300303, 9413300503

**DB-DL-8622**

Length: 1558 Ø: 52
 Cone Ø: d1 Ø 30 / d2 Ø 27
 0014609005, 0014609105

**DB-DL-8640**

Length: 1615 Ø: 50
 Cone Ø: d1 Ø 32 / d2 Ø 29
 6253301503, 6253301603, 6253302403,
 6253302503, 9423300803, 9423302103,
 9493300203, 9493300303, 9493300903

**DB-DL-8641**

Length: 905 Ø: 42
 Cone Ø: d1 Ø 30 / d2 Ø 27
 0014605105, 0014608105

**DB-DL-8642**

Length: 954 Ø: 42
 Cone Ø: d1 Ø 30 / d2 Ø 27
 0014608605, 0014608705

**DB-DL-9218**

Length: 754 Ø: 40
 Hole Distance: 100
 000360098524, 000390098524,
 3753300111, 9413300011,
 A3753300111, SA50831601

**DB-DL-9254**

Length: 1815 Ø: 58
 0003220323, 0003220623, 3753220423

**DB-DL-12300**

Length: 733 Ø: 36
 Cone Ø: d1 Ø 32 / d2 Ø 29
 0014601505, 0014607305, 0034603305,
 3754601605, A0014601505,
 A0034603305, A3754601605

**DB-DL-12310**

Length: 1532 Ø: 50
 Cone Ø: d1 Ø 32 / d2 Ø 29
 Thread: M27 x 1,5 LHT
 9493301203, 9493301303, 9493301803,
 9493302203, A9493301203, A9493301303,
 A9493301803, A9493302203

**DB-ES-5227**

Length: 1588 Ø: 60
 Cone Ø: d1 Ø 38 / d2 Ø 34,3
 6253300903, 6253301203, 9443300203

**DB-ES-5234**

Length: 135
 Cone Ø: d1 Ø 38 / d2 Ø 34,3
 Thread: M38 x 1,5 RHT
 0004601748, 120322305, 2205000400

**DB-ES-8164**

Length: 140
 Cone Ø: d1 Ø 28,6 / d2 Ø 23,9
 Thread: M28 x 1,5 RHT
 0014604248, 0014605048, 0014608548,
 0024600548

**DB-ES-8510**

Length: 56
 Cone Ø: d1 Ø 10 / d2 Ø 10
 Thread: M12 x 1,75 LHT
 0009965145, 0009965645, 0019963145

**DB-ES-8530**

Length: 115
 Cone Ø: d1 Ø 28,6 / d2 Ø 23,9
 Thread: M30 x 1,5 RHT
 0014603848, 0014604848, 0014605148,
 0014608648, 0014609948

**DB-RK-8391**

Ø: 85 Hole Distance: 152
 Thick/Height: 24
 01336800A, 0003502705

**DB-RK-8550**

Ø: 75 Hole Distance: 152
 Thick/Height: 24
 0003502105, 0003504605

**DB-RK-8626**

Ø: 75 Hole Distance: 130
 Thick/Height: 24
 0003502205, 0003502505, 0003503405,
 0003504505, GL11319

**DB-RK-8638**

Length: 100 Ø: 67
 Hole Distance: 100
 Thick/Height: 20
 0003301411

**DB-RK-9294**

Ø: 85 Hole Distance: 152
 Thick/Height: 24
 0003503105

**DB-RK-10374**

Ø: 85 Hole Distance: 152
 Thick/Height: 24
 0003504405

**DB-RK-10375**

Ø: 100 Hole Distance: 152
 Thick/Height: 24
 0003502405, 0003503505, 0003504905

**DB-SB-10384**

Ø: 73 Thick/Height: 47
 9303170012, 9423171812

**DB-SB-10400**

Length: 230
 Thick/Height: 167,5 / 115
 0003250696, 0003250896

**DB-SB-10401**

Length: 232
 Thick/Height: 163,5 / 152,5
 0003250596, 0003250796

**DB-SB-10406**

Ø: 80 Thick/Height: 46
 0003238185

**DB-SB-10409**

Ø: 77 Thick/Height: 56
 0003265181

**DB-SB-10410**

Ø: 73 Hole Distance: 100
 Thick/Height: 24
 9413230050

**DB-VB-3707**

Length: 622 Ø: 46
 Hole Ø 25 / 25 / 25
 Hole Distance: 152 / 130 / 130
 01337100A, 9423501005, 9423501505,
 9443500005, 9473500105, 9473501005,
 A3753500005, A9423501005, A9423501505,
 A9443500005, A9473500105, A9473501005

**MERCEDES-BENZ**

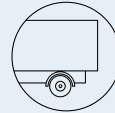

ACTROS MP2 / MP3 ...

2658 LS ...	04/03→	Suspension Strut Repair Kit		DB-RK-8391	
	04/03→	Suspension Strut Repair Kit		DB-RK-9294	
	04/03→	Suspension Strut Repair Kit		MN-RK-8997	
	04/03→	Tie Rod	DB-DL-8327		Guide Rod
	04/03→	Tie Rod	DB-DL-8640		Guide Rod
	04/03→	Tie Rod	DB-DL-12310		
	04/03→	Tie Rod	DB-ES-5227		Guide Rod
	04/03→	Tie Rod End	CV-ES-0543		for Push Rod
	04/03→	Tie Rod End	CV-ES-0888		for Push Rod
	04/03→	Tie Rod End	CV-ES-14162		for Steering Rod
	04/03→	Tie Rod End	CV-ES-14163		for Steering Rod
	04/03→	Tie Rod End	DB-ES-5234		for Steering Rod
	04/03→	Tie Rod End	DB-ES-8164		for Push Rod
	04/03→	Tie Rod End	DB-ES-8530		for Push Rod
	2660 L, LL	04/03→	Track Control Arm		DB-VB-3707
04/03→		Track Control Arm		DB-VB-7798	Wishbone (CV)
2660 LK	05/05→	Bush, parabolic spring		DB-SB-10400	
	05/05→	Bush, parabolic spring		DB-SB-10401	
	05/05→	Centre Rod	DB-DL-2144		Push Rod
	05/05→	Centre Rod	DB-DL-7270		Push Rod
	05/05→	Centre Rod	DB-DL-8167		Push Rod
	05/05→	Centre Rod	DB-DL-8307		Push Rod
	05/05→	Stabiliser Mounting		DB-SB-10406	
	05/05→	Suspension Strut Repair Kit		DB-RK-9294	
	05/05→	Tie Rod	DB-DL-8640		Guide Rod
	05/05→	Tie Rod	DB-DL-12310		
	05/05→	Tie Rod	DB-ES-5227		Guide Rod
	05/05→	Tie Rod End	CV-ES-0543		for Push Rod
	05/05→	Tie Rod End	CV-ES-14163		for Steering Rod
	05/05→	Tie Rod End	DB-ES-8164		for Push Rod
	05/05→	Tie Rod End	DB-ES-8530		for Push Rod
	05/05→	Track Control Arm		DB-VB-3707	Suspension Rod, Wishbone (CV)
	05/05→	Track Control Arm	DB-DL-5224		Control Arm
	05/05→	Track Control Arm	DB-DL-9218	DB-DL-9218	Trailing Arm
2660 S, LS	06/08→	Centre Rod	DB-DL-2144		Push Rod
	06/08→	Centre Rod	DB-DL-5405		Push Rod
	06/08→	Centre Rod	DB-DL-7270		Push Rod
	06/08→	Centre Rod	DB-DL-8167		Push Rod
	06/08→	Centre Rod	DB-DL-8307		Push Rod
	06/08→	Rod Assembly	DB-DL-2178		Guide Rod, 1st Front Axle, →504310 03
	06/08→	Suspension Strut Repair Kit		DB-RK-9294	
	06/08→	Tie Rod	DB-DL-8327		Guide Rod, 1st Front Axle
	06/08→	Tie Rod	DB-DL-8640		Guide Rod
2665 LS	04/03→	Centre Rod	DB-DL-5405		Push Rod
	04/03→	Centre Rod	DB-DL-7270		Push Rod

CV-ES-0543

Length: 125
Cone Ø: d1 Ø 32 / d2 Ø 29
Thread: M30 x 1,5 RHT
0004605748, 0004606048, 0004606848,
0004607048, 0014600448, 0014601148,
0014601748, 0014602448, 0014607648,
0014609648



CV-ES-0888

Length: 125
Cone Ø: d1 Ø 32 / d2 Ø 29
Thread: M30 x 1,5 LHT
0004605848, 0004606148, 0004606948,
0004607148, 0004609048, 0014600548,
0014601348, 0014602548, 0014607948,
0024600448



CV-ES-14162

Length: 125
Cone Ø: d1 Ø 30 / d2 Ø 27
Thread: M30 x 1,5 LHT
4600648, 4601248, 4603448, 4603548,
0004603548, 14600348, 14601448, 14602348,
0014603748, 0014607848, 14607848, 002460
0348



CV-ES-14163

Length: 125
Cone Ø: d1 Ø 30 / d2 Ø 27
Thread: M30 x 1,5 RHT
0003305248, 0003387310, 0004600348,
0004600948, 0004602848, 0004602948,
0004608948, 0014600248, 0014600848,
0014601248, 0014602248, 0014607748,
0024600148, A0003387310, A0004600348,
A0004602848, A0004602948, A0014600848,
A0014601248, A0014602248, A0014607748



DB-DL-2144

Length: 872 Ø: 35
Cone Ø: d1 Ø 28,6 / d2 Ø 23,9
0024604305, 0024604405, 0034604805



DB-DL-2178

Length: 1735 Ø: 52
Cone Ø: d1 Ø 32 / d2 Ø 29
9423300003, 9423300103, 9423300203



DB-DL-5224

Length: 850 Ø: 60
Hole Distance: 100 / 100
01336100A, 9413300007



DB-DL-5405

Length: 890 Ø: 35
Cone Ø: d1 Ø 28,6 / d2 Ø 23,9
01215900A, 1460248, 0024604505, 0024604605,
0034605005, 3752600637, 3754600405,
A3752600637, A3754600405



DB-DL-7270

Length: 875 Ø: 40
Cone Ø: d1 Ø 28,6 / d2 Ø 23,9
01208300A, 0024604705, 0024604805,
0034604905, A0024604705



DB-DL-8167

Length: 866 Ø: 38
Cone Ø: d1 Ø 30 / d2 Ø 27
0014609805, 0014609905, 0024606305,
0024606405



DB-DL-8171

Length: 1687 Ø: 52
Cone Ø: d1 Ø 32 / d2 Ø 29
9493300603, 9493300703, 9493301503,
9493301603



DB-DL-8307

Length: 885 Ø: 38
Cone Ø: d1 Ø 32 / d2 Ø 30
01215500A, 0004604005, 0024605105,
0024605205, 0034604005



DB-DL-8327

Length: 1745 Ø: 48
Cone Ø: d1 Ø 32 / d2 Ø 29
01219800A, 9413300003, 9413300103,
9413300203, 9413300303, 9413300503



DB-DL-8640

Length: 1615 Ø: 50
Cone Ø: d1 Ø 32 / d2 Ø 29
6253301503, 6253301603, 6253302403,
6253302503, 9423300803, 9423302103,
9493300203, 9493300303, 9493300903



DB-DL-9218

Length: 754 Ø: 40
Hole Distance: 100
000360098524, 000390098524, 3753300111,
9413300011, A3753300111, SA50831601



DB-DL-12310

Length: 1532 Ø: 50
Cone Ø: d1 Ø 32 / d2 Ø 29
Thread: M27 x 1,5 LHT
9493301203, 9493301303, 9493301803,
9493302203, A9493301203, A9493301303,
A9493301803, A9493302203



DB-ES-5227

Length: 1588 Ø: 60
Cone Ø: d1 Ø 38 / d2 Ø 34,3
6253300903, 6253301203, 9443300203



DB-ES-5234

Length: 135
Cone Ø: d1 Ø 38 / d2 Ø 34,3
Thread: M38 x 1,5 RHT
0004601748, 120322305, 2205000400



DB-ES-8164

Length: 140
Cone Ø: d1 Ø 28,6 / d2 Ø 23,9
Thread: M28 x 1,5 RHT
0014604248, 0014605048, 0014608548,
0024600548



DB-ES-8530

Length: 115
Cone Ø: d1 Ø 28,6 / d2 Ø 23,9
Thread: M30 x 1,5 RHT
0014603848, 0014604848, 0014605148,
0014608648, 0014609948



DB-RK-8391

Ø: 85 Hole Distance: 152
Thick/Height: 24
01336800A, 0003502705



DB-RK-9294

Ø: 85 Hole Distance: 152
Thick/Height: 24
0003503105



DB-SB-10400

Length: 230
Thick/Height: 167,5 / 115
0003250696, 0003250896



DB-SB-10401

Length: 232
Thick/Height: 163,5 / 152,5
0003250596, 0003250796



DB-SB-10406

Ø: 80 Thick/Height: 46
0003238185



DB-VB-3707

Length: 622 Ø: 46
Hole Ø 25 / 25 / 25
Hole Distance: 152 / 130 / 130
01337100A, 9423501005, 9423501505,
9443500005, 9473500105, 9473501005,
A3753500005, A9423501005, A9423501505,
A9443500005, A9473500105, A9473501005



DB-VB-7261

Length: 622 Ø: 46
Hole Ø 25 / 25 / 25
Hole Distance: 152 / 130 / 130
01337800A, 9443500305, 9443500505,
9443500605, 9473500705, 9473500905,
9483500405, 9483503005



DB-VB-7798

Length: 622 Ø: 48
Hole Ø 25 / 23 / 23
Hole Distance: 152 / 130 / 130
9423500505, 9423500805, 9423501205,
A9423501205



DB-VB-10426

Length: 622 Ø: 46
Hole Ø 25 / 25 / 25
Hole Distance: 152 / 130 / 130
9443500405



MN-RK-8997

Ø: 85 Hole Distance: 130
Thick/Height: 30
0003504805



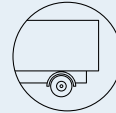

ACTROS MP2 / MP3 ...

2732 AE	06/08→	Bush, parabolic spring		DB-SB-10401		
	06/08→	Centre Rod	DB-DL-8307		Push Rod, Leaf Spring Axle	
	06/08→	Centre Rod	DB-DL-8702		Push Rod	
	06/08→	Suspension Strut Repair Kit		DB-RK-8710		
	06/08→	Suspension Strut Repair Kit		DB-RK-9291		
	06/08→	Tie Rod	DB-DL-12310			
	06/08→	Tie Rod	DB-ES-5227		Guide Rod	
	06/08→	Tie Rod	MN-DL-7834		Guide Rod	
	06/08→	Tie Rod End	CV-ES-0543		for Push Rod	
	06/08→	Tie Rod End	CV-ES-14163		for Steering Rod	
	06/08→	Tie Rod End	DB-ES-5234		for Steering Rod	
	06/08→	Track Control Arm		DB-DL-3475	Trailing Arm, 1st RA;2nd RA, →517144 03/517144 06	
	06/08→	Track Control Arm		DB-DL-3475	Trailing Arm, 1st RA;2nd RA, →517144 05/517144 08	
	06/08→	Track Control Arm		DB-DL-3475	Trailing Arm, 1st RA;2nd RA, →517144 07/517144 09	
	06/08→	Track Control Arm		DB-DL-3475	Trailing Arm, 1st RA;2nd RA, →517144 26/517144 27	
	06/08→	Track Control Arm		DB-VB-7261	Suspension Rod, Wishbone (CV)	
	06/08→	Track Control Arm		DB-VB-9307	Suspension Rod, Wishbone (CV)	
	06/08→	Track Control Arm		DB-VB-9308	Suspension Rod, Wishbone (CV)	
	2732 AKE	06/08→	Centre Rod	DB-DL-8307		Push Rod
		06/08→	Centre Rod	DB-DL-8702		Push Rod
06/08→		Stabiliser Mounting		DB-SB-10406		
06/08→		Suspension Strut Repair Kit		DB-RK-8710		
06/08→		Suspension Strut Repair Kit		DB-RK-9291		
06/08→		Tie Rod	DB-DL-12310			
06/08→		Tie Rod	DB-ES-5227		Guide Rod	
06/08→		Tie Rod	MN-DL-7834		Guide Rod	
06/08→		Tie Rod End	CV-ES-0543		for Push Rod	
06/08→		Tie Rod End	DB-ES-5234		for Steering Rod	
06/08→		Track Control Arm		DB-DL-3475	Trailing Arm, 1st RA;2nd RA, →517144 03/517144 06	
06/08→		Track Control Arm		DB-DL-3475	Trailing Arm, 1st RA;2nd RA, →517144 05/517144 08	
06/08→		Track Control Arm		DB-DL-3475	Trailing Arm, 1st RA;2nd RA, →517144 07/517144 09	
06/08→		Track Control Arm		DB-DL-3475	Trailing Arm, 1st RA;2nd RA, →517144 26/517144 27	
06/08→		Track Control Arm		DB-VB-7261	Suspension Rod, Wishbone (CV)	
06/08→		Track Control Arm		DB-VB-9307	Suspension Rod, Wishbone (CV)	
06/08→		Track Control Arm		DB-VB-9308	Suspension Rod, Wishbone (CV)	
2736 AE		06/08→	Bush, parabolic spring		DB-SB-10401	
		06/08→	Centre Rod	DB-DL-8307		Push Rod, Leaf Spring Axle
		06/08→	Centre Rod	DB-DL-8702		Push Rod
	06/08→	Suspension Strut Repair Kit		DB-RK-8710		
	06/08→	Suspension Strut Repair Kit		DB-RK-9291		
	06/08→	Tie Rod	DB-DL-12310			
	06/08→	Tie Rod	DB-ES-5227		Guide Rod	
	06/08→	Tie Rod	MN-DL-7834		Guide Rod	
	06/08→	Tie Rod End	CV-ES-0543		for Push Rod	
	06/08→	Tie Rod End	CV-ES-14163		for Steering Rod	
	06/08→	Tie Rod End	DB-ES-5234		for Steering Rod	
	06/08→	Track Control Arm		DB-DL-3475	Trailing Arm, 1st RA;2nd RA, →517144 03/517144 06	
	06/08→	Track Control Arm		DB-DL-3475	Trailing Arm, 1st RA;2nd RA, →517144 05/517144 08	
	06/08→	Track Control Arm		DB-DL-3475	Trailing Arm, 1st RA;2nd RA, →517144 07/517144 09	
	06/08→	Track Control Arm		DB-DL-3475	Trailing Arm, 1st RA;2nd RA, →517144 26/517144 27	
	06/08→	Track Control Arm		DB-VB-7261	Suspension Rod, Wishbone (CV)	

CV-ES-0543

Length: 125
Cone Ø: d1 Ø 32 / d2 Ø 29
Thread: M30 x 1,5 RHT
0004605748, 0004606048, 0004606848,
0004607048, 0014600448, 0014601148,
0014601748, 0014602448, 0014607648,
0014609648



CV-ES-14163

Length: 125
Cone Ø: d1 Ø 30 / d2 Ø 27
Thread: M30 x 1,5 RHT
0003305248, 0003387310, 0004600348,
0004600948, 0004602848, 0004602948,
0004608948, 0014600248, 0014600848,
0014601248, 0014602248, 0014607748,
0024600148, A0003387310, A0004600348,
A0004602848, A0004602948, A0014600848,
A0014601248, A0014602248, A0014607748



DB-DL-3475

Length: 565 Ø: 52
Hole Distance: 152 / 152
3753500006, 3753500206, 9473500805,
9483500006, 9483500805, 9483501205,
9483501305, 9483501905, 9483502005,
9483502405, A3753500006, A3753500206



DB-DL-8307

Length: 885 Ø: 38
Cone Ø: d1 Ø 32 / d2 Ø 30
01215500A, 0004604005, 0024605105,
0024605205, 0034604005



DB-DL-8702

Length: 958 Ø: 38
Cone Ø: d1 Ø 32 / d2 Ø 30
0024606105, 0024606205, 0034604205



DB-DL-12310

Length: 1532 Ø: 50
Cone Ø: d1 Ø 32 / d2 Ø 29
Thread: M27 x 1,5 LHT
9493301203, 9493301303, 9493301803,
9493302203, A9493301203, A9493301303,
A9493301803, A9493302203



DB-ES-5227

Length: 1588 Ø: 60
Cone Ø: d1 Ø 38 / d2 Ø 34,3
6253300903, 6253301203, 9443300203



DB-ES-5234

Length: 135
Cone Ø: d1 Ø 38 / d2 Ø 34,3
Thread: M38 x 1,5 RHT
0004601748, 120322305, 2205000400



DB-RK-8710

Ø: 85 Hole Distance: 130
Thick/Height: 30
0003503705



DB-RK-9291

Ø: 107,5 Hole Distance: 152
Thick/Height: 30
0003503605



DB-SB-10401

Length: 232
Thick/Height: 163,5 / 152,5
0003250596, 0003250796



DB-SB-10406

Ø: 80 Thick/Height: 46
0003238185



DB-VB-7261

Length: 622 Ø: 46
Hole Ø 25 / 25 / 25
Hole Distance: 152 / 130 / 130
01337800A, 9443500305, 9443500505,
9443500605, 9473500705, 9473500905,
9483500405, 9483503005



DB-VB-9307

Length: 667 Ø: 60
Hole Ø 25 / 23 / 23
Hole Distance: 152 / 130 / 130
9483502805



DB-VB-9308

Length: 622 Ø: 46
Hole Ø 25 / 25 / 25
Hole Distance: 152 / 130 / 130
9483502905



MN-DL-7834

Length: 1588 Ø: 58
Cone Ø: d1 Ø 30 / d2 Ø 27
3463303903, 3463304903, 6253303203,
9443300503, 9443301303, 9443301703





ACTROS MP2 / MP3 ...

2736 AE ...	06/08 →	Track Control Arm		DB-VB-9307	Suspension Rod, Wishbone (CV)
	06/08 →	Track Control Arm		DB-VB-9308	Suspension Rod, Wishbone (CV)
2736 AKE	06/08 →	Centre Rod	DB-DL-8307		Push Rod
	06/08 →	Centre Rod	DB-DL-8702		Push Rod
	06/08 →	Stabiliser Mounting		DB-SB-10406	
	06/08 →	Suspension Strut Repair Kit		DB-RK-8710	
	06/08 →	Suspension Strut Repair Kit		DB-RK-9291	
	06/08 →	Tie Rod	DB-DL-12310		
	06/08 →	Tie Rod	DB-ES-5227		Guide Rod
	06/08 →	Tie Rod	MN-DL-7834		Guide Rod
	06/08 →	Tie Rod End	CV-ES-0543		for Push Rod
	06/08 →	Tie Rod End	DB-ES-5234		for Steering Rod
	06/08 →	Track Control Arm		DB-DL-3475	Trailing Arm, 1st RA;2nd RA, →517144 03/517144 06
	06/08 →	Track Control Arm		DB-DL-3475	Trailing Arm, 1st RA;2nd RA, →517144 05/517144 08
	06/08 →	Track Control Arm		DB-DL-3475	Trailing Arm, 1st RA;2nd RA, →517144 07/517144 09
	06/08 →	Track Control Arm		DB-DL-3475	Trailing Arm, 1st RA;2nd RA, →517144 26/517144 27
	06/08 →	Track Control Arm		DB-VB-7261	Suspension Rod, Wishbone (CV)
	06/08 →	Track Control Arm		DB-VB-9307	Suspension Rod, Wishbone (CV)
	06/08 →	Track Control Arm		DB-VB-9308	Suspension Rod, Wishbone (CV)
2741 AE	06/08 →	Bush, parabolic spring		DB-SB-10401	
	06/08 →	Centre Rod	DB-DL-8307		Push Rod, Leaf Spring Axle
	06/08 →	Centre Rod	DB-DL-8702		Push Rod
	06/08 →	Suspension Strut Repair Kit		DB-RK-8710	
	06/08 →	Suspension Strut Repair Kit		DB-RK-9291	
	06/08 →	Tie Rod	DB-DL-12310		
	06/08 →	Tie Rod	DB-ES-5227		Guide Rod
	06/08 →	Tie Rod	MN-DL-7834		Guide Rod
	06/08 →	Tie Rod End	CV-ES-0543		for Push Rod
	06/08 →	Tie Rod End	CV-ES-14163		for Steering Rod
	06/08 →	Tie Rod End	DB-ES-5234		for Steering Rod
	06/08 →	Track Control Arm		DB-DL-3475	Trailing Arm, 1st RA;2nd RA, →517144 03/517144 06
	06/08 →	Track Control Arm		DB-DL-3475	Trailing Arm, 1st RA;2nd RA, →517144 05/517144 08
	06/08 →	Track Control Arm		DB-DL-3475	Trailing Arm, 1st RA;2nd RA, →517144 07/517144 09
	06/08 →	Track Control Arm		DB-DL-3475	Trailing Arm, 1st RA;2nd RA, →517144 26/517144 27
	06/08 →	Track Control Arm		DB-VB-7261	Suspension Rod, Wishbone (CV)
	06/08 →	Track Control Arm		DB-VB-9307	Suspension Rod, Wishbone (CV)
06/08 →	Track Control Arm		DB-VB-9308	Suspension Rod, Wishbone (CV)	
2741 AKE	06/08 →	Centre Rod	DB-DL-8307		Push Rod
	06/08 →	Centre Rod	DB-DL-8702		Push Rod
	06/08 →	Stabiliser Mounting		DB-SB-10406	
	06/08 →	Suspension Strut Repair Kit		DB-RK-8710	
	06/08 →	Suspension Strut Repair Kit		DB-RK-9291	
	06/08 →	Tie Rod	DB-DL-12310		
	06/08 →	Tie Rod	DB-ES-5227		Guide Rod
	06/08 →	Tie Rod	MN-DL-7834		Guide Rod
	06/08 →	Tie Rod End	CV-ES-0543		for Push Rod
	06/08 →	Tie Rod End	DB-ES-5234		for Steering Rod
	06/08 →	Track Control Arm		DB-DL-3475	Trailing Arm, 1st RA;2nd RA, →517144 03/517144 06
	06/08 →	Track Control Arm		DB-DL-3475	Trailing Arm, 1st RA;2nd RA, →517144 05/517144 08
	06/08 →	Track Control Arm		DB-DL-3475	Trailing Arm, 1st RA;2nd RA, →517144 07/517144 09
	06/08 →	Track Control Arm		DB-DL-3475	Trailing Arm, 1st RA;2nd RA, →517144 26/517144 27

CV-ES-0543

Length: 125
Cone Ø: d1 Ø 32 / d2 Ø 29
Thread: M30 x 1,5 RHT
0004605748, 0004606048, 0004606848,
0004607048, 0014600448, 0014601148,
0014601748, 0014602448, 0014607648,
0014609648



CV-ES-14163

Length: 125
Cone Ø: d1 Ø 30 / d2 Ø 27
Thread: M30 x 1,5 RHT
0003305248, 0003387310, 0004600348,
0004600948, 0004602848, 0004602948,
0004608948, 0014600248, 0014600848,
0014601248, 0014602248, 0014607748,
0024600148, A0003387310, A0004600348,
A0004602848, A0004602948, A0014600848,
A0014601248, A0014602248, A0014607748



DB-DL-3475

Length: 565 Ø: 52
Hole Distance: 152 / 152
3753500006, 3753500206, 9473500805,
9483500006, 9483500805, 9483501205,
9483501305, 9483501905, 9483502005,
9483502405, A3753500006, A3753500206



DB-DL-8307

Length: 885 Ø: 38
Cone Ø: d1 Ø 32 / d2 Ø 30
01215500A, 0004604005, 0024605105,
0024605205, 0034604005



DB-DL-8702

Length: 958 Ø: 38
Cone Ø: d1 Ø 32 / d2 Ø 30
0024606105, 0024606205, 0034604205



DB-DL-12310

Length: 1532 Ø: 50
Cone Ø: d1 Ø 32 / d2 Ø 29
Thread: M27 x 1,5 LHT
9493301203, 9493301303, 9493301803,
9493302203, A9493301203, A9493301303,
A9493301803, A9493302203



DB-ES-5227

Length: 1588 Ø: 60
Cone Ø: d1 Ø 38 / d2 Ø 34,3
6253300903, 6253301203, 9443300203



DB-ES-5234

Length: 135
Cone Ø: d1 Ø 38 / d2 Ø 34,3
Thread: M38 x 1,5 RHT
0004601748, 120322305, 2205000400



DB-RK-8710

Ø: 85 Hole Distance: 130
Thick/Height: 30
0003503705



DB-RK-9291

Ø: 107,5 Hole Distance: 152
Thick/Height: 30
0003503605



DB-SB-10401

Length: 232
Thick/Height: 163,5 / 152,5
0003250596, 0003250796



DB-SB-10406

Ø: 80 Thick/Height: 46
0003238185



DB-VB-7261

Length: 622 Ø: 46
Hole Ø 25 / 25 / 25
Hole Distance: 152 / 130 / 130
01337800A, 9443500305, 9443500505,
9443500605, 9473500705, 9473500905,
9483500405, 9483503005



DB-VB-9307

Length: 667 Ø: 60
Hole Ø 25 / 23 / 23
Hole Distance: 152 / 130 / 130
9483502805



DB-VB-9308

Length: 622 Ø: 46
Hole Ø 25 / 25 / 25
Hole Distance: 152 / 130 / 130
9483502905



MN-DL-7834

Length: 1588 Ø: 58
Cone Ø: d1 Ø 30 / d2 Ø 27
3463303903, 3463304903, 6253303203,
9443300503, 9443301303, 9443301703





ACTROS MP2 / MP3 ...

2741 AKE ...	06/08→	Track Control Arm		DB-VB-7261	Suspension Rod, Wishbone (CV)	
	06/08→	Track Control Arm		DB-VB-9307	Suspension Rod, Wishbone (CV)	
	06/08→	Track Control Arm		DB-VB-9308	Suspension Rod, Wishbone (CV)	
2744 AE	06/08→	Bush, parabolic spring		DB-SB-10401		
	06/08→	Centre Rod	DB-DL-8307		Push Rod, Leaf Spring Axle	
	06/08→	Centre Rod	DB-DL-8702		Push Rod	
	06/08→	Suspension Strut Repair Kit		DB-RK-8710		
	06/08→	Suspension Strut Repair Kit		DB-RK-9291		
	06/08→	Tie Rod	DB-DL-12310			
	06/08→	Tie Rod	DB-ES-5227		Guide Rod	
	06/08→	Tie Rod	MN-DL-7834		Guide Rod	
	06/08→	Tie Rod End	CV-ES-0543		for Push Rod	
	06/08→	Tie Rod End	CV-ES-14163		for Steering Rod	
	06/08→	Tie Rod End	DB-ES-5234		for Steering Rod	
	06/08→	Track Control Arm		DB-DL-3475	Trailing Arm, 1st RA;2nd RA, →517144 03/517144 06	
	06/08→	Track Control Arm		DB-DL-3475	Trailing Arm, 1st RA;2nd RA, →517144 05/517144 08	
	06/08→	Track Control Arm		DB-DL-3475	Trailing Arm, 1st RA;2nd RA, →517144 07/517144 09	
	06/08→	Track Control Arm		DB-DL-3475	Trailing Arm, 1st RA;2nd RA, →517144 26/517144 27	
	06/08→	Track Control Arm		DB-VB-7261	Suspension Rod, Wishbone (CV)	
	06/08→	Track Control Arm		DB-VB-9307	Suspension Rod, Wishbone (CV)	
	06/08→	Track Control Arm		DB-VB-9308	Suspension Rod, Wishbone (CV)	
	2744 AKE	06/08→	Centre Rod	DB-DL-8307		Push Rod
		06/08→	Centre Rod	DB-DL-8702		Push Rod
06/08→		Stabiliser Mounting		DB-SB-10406		
06/08→		Suspension Strut Repair Kit		DB-RK-8710		
06/08→		Suspension Strut Repair Kit		DB-RK-9291		
06/08→		Tie Rod	DB-DL-12310			
06/08→		Tie Rod	DB-ES-5227		Guide Rod	
06/08→		Tie Rod	MN-DL-7834		Guide Rod	
06/08→		Tie Rod End	CV-ES-0543		for Push Rod	
06/08→		Tie Rod End	DB-ES-5234		for Steering Rod	
06/08→		Track Control Arm		DB-DL-3475	Trailing Arm, 1st RA;2nd RA, →517144 03/517144 06	
06/08→		Track Control Arm		DB-DL-3475	Trailing Arm, 1st RA;2nd RA, →517144 05/517144 08	
06/08→		Track Control Arm		DB-DL-3475	Trailing Arm, 1st RA;2nd RA, →517144 07/517144 09	
06/08→		Track Control Arm		DB-DL-3475	Trailing Arm, 1st RA;2nd RA, →517144 26/517144 27	
06/08→		Track Control Arm		DB-VB-7261	Suspension Rod, Wishbone (CV)	
06/08→		Track Control Arm		DB-VB-9307	Suspension Rod, Wishbone (CV)	
06/08→		Track Control Arm		DB-VB-9308	Suspension Rod, Wishbone (CV)	
2746 AE		06/08→	Bush, parabolic spring		DB-SB-10401	
		06/08→	Centre Rod	DB-DL-8307		Push Rod, Leaf Spring Axle
		06/08→	Centre Rod	DB-DL-8702		Push Rod
	06/08→	Suspension Strut Repair Kit		DB-RK-8710		
	06/08→	Suspension Strut Repair Kit		DB-RK-9291		
	06/08→	Tie Rod	DB-DL-12310			
	06/08→	Tie Rod	DB-ES-5227		Guide Rod	
	06/08→	Tie Rod	MN-DL-7834		Guide Rod	
	06/08→	Tie Rod End	CV-ES-0543		for Push Rod	
	06/08→	Tie Rod End	CV-ES-14163		for Steering Rod	
	06/08→	Tie Rod End	DB-ES-5234		for Steering Rod	
	06/08→	Track Control Arm		DB-DL-3475	Trailing Arm, 1st RA;2nd RA, →517144 03/517144 06	
	06/08→	Track Control Arm		DB-DL-3475	Trailing Arm, 1st RA;2nd RA, →517144 05/517144 08	
	06/08→	Track Control Arm		DB-DL-3475	Trailing Arm, 1st RA;2nd RA, →517144 07/517144 09	

CV-ES-0543

Length: 125
Cone Ø: d1 Ø 32 / d2 Ø 29
Thread: M30 x 1,5 RHT
0004605748, 0004606048, 0004606848,
0004607048, 0014600448, 0014601148,
0014601748, 0014602448, 0014607648,
0014609648



CV-ES-14163

Length: 125
Cone Ø: d1 Ø 30 / d2 Ø 27
Thread: M30 x 1,5 RHT
0003305248, 0003387310, 0004600348,
0004600948, 0004602848, 0004602948,
0004608948, 0014600248, 0014600848,
0014601248, 0014602248, 0014607748,
0024600148, A0003387310, A0004600348,
A0004602848, A0004602948, A0014600848,
A0014601248, A0014602248, A0014607748



DB-DL-3475

Length: 565 Ø: 52
Hole Distance: 152 / 152
3753500006, 3753500206, 9473500805,
9483500006, 9483500805, 9483501205,
9483501305, 9483501905, 9483502005,
9483502405, A3753500006, A3753500206



DB-DL-8307

Length: 885 Ø: 38
Cone Ø: d1 Ø 32 / d2 Ø 30
01215500A, 0004604005, 0024605105,
0024605205, 0034604005



DB-DL-8702

Length: 958 Ø: 38
Cone Ø: d1 Ø 32 / d2 Ø 30
0024606105, 0024606205, 0034604205



DB-DL-12310

Length: 1532 Ø: 50
Cone Ø: d1 Ø 32 / d2 Ø 29
Thread: M27 x 1,5 LHT
9493301203, 9493301303, 9493301803,
9493302203, A9493301203, A9493301303,
A9493301803, A9493302203



DB-ES-5227

Length: 1588 Ø: 60
Cone Ø: d1 Ø 38 / d2 Ø 34,3
6253300903, 6253301203, 9443300203



DB-ES-5234

Length: 135
Cone Ø: d1 Ø 38 / d2 Ø 34,3
Thread: M38 x 1,5 RHT
0004601748, 120322305, 2205000400



DB-RK-8710

Ø: 85 Hole Distance: 130
Thick/Height: 30
0003503705



DB-RK-9291

Ø: 107,5 Hole Distance: 152
Thick/Height: 30
0003503605



DB-SB-10401

Length: 232
Thick/Height: 163,5 / 152,5
0003250596, 0003250796



DB-SB-10406

Ø: 80 Thick/Height: 46
0003238185



DB-VB-7261

Length: 622 Ø: 46
Hole Ø 25 / 25 / 25
Hole Distance: 152 / 130 / 130
01337800A, 9443500305, 9443500505,
9443500605, 9473500705, 9473500905,
9483500405, 9483503005



DB-VB-9307

Length: 667 Ø: 60
Hole Ø 25 / 23 / 23
Hole Distance: 152 / 130 / 130
9483502805



DB-VB-9308

Length: 622 Ø: 46
Hole Ø 25 / 25 / 25
Hole Distance: 152 / 130 / 130
9483502905



MN-DL-7834

Length: 1588 Ø: 58
Cone Ø: d1 Ø 30 / d2 Ø 27
3463303903, 3463304903, 6253303203,
9443300503, 9443301303, 9443301703





ACTROS MP2 / MP3 ...

2746 AE ...	06/08 →	Track Control Arm		DB-DL-3475	Trailing Arm, 1st RA;2nd RA, →517144 26/517144 27	
	06/08 →	Track Control Arm		DB-VB-7261	Suspension Rod, Wishbone (CV)	
	06/08 →	Track Control Arm		DB-VB-9307	Suspension Rod, Wishbone (CV)	
	06/08 →	Track Control Arm		DB-VB-9308	Suspension Rod, Wishbone (CV)	
2746 AKE	06/08 →	Centre Rod	DB-DL-8307		Push Rod	
	06/08 →	Centre Rod	DB-DL-8702		Push Rod	
	06/08 →	Stabiliser Mounting		DB-SB-10406		
	06/08 →	Suspension Strut Repair Kit		DB-RK-8710		
	06/08 →	Suspension Strut Repair Kit		DB-RK-9291		
	06/08 →	Tie Rod	DB-DL-12310			
	06/08 →	Tie Rod	DB-ES-5227		Guide Rod	
	06/08 →	Tie Rod	MN-DL-7834		Guide Rod	
	06/08 →	Tie Rod End	CV-ES-0543		for Push Rod	
	06/08 →	Tie Rod End	DB-ES-5234		for Steering Rod	
	06/08 →	Track Control Arm		DB-DL-3475	Trailing Arm, 1st RA;2nd RA, →517144 03/517144 06	
	06/08 →	Track Control Arm		DB-DL-3475	Trailing Arm, 1st RA;2nd RA, →517144 05/517144 08	
	06/08 →	Track Control Arm		DB-DL-3475	Trailing Arm, 1st RA;2nd RA, →517144 07/517144 09	
	06/08 →	Track Control Arm		DB-DL-3475	Trailing Arm, 1st RA;2nd RA, →517144 26/517144 27	
	06/08 →	Track Control Arm		DB-VB-7261	Suspension Rod, Wishbone (CV)	
	06/08 →	Track Control Arm		DB-VB-9307	Suspension Rod, Wishbone (CV)	
	06/08 →	Track Control Arm		DB-VB-9308	Suspension Rod, Wishbone (CV)	
	2748 AE	06/08 →	Bush, parabolic spring		DB-SB-10401	
		06/08 →	Centre Rod	DB-DL-8307		Push Rod, Leaf Spring Axle
06/08 →		Centre Rod	DB-DL-8702		Push Rod	
06/08 →		Suspension Strut Repair Kit		DB-RK-8710		
06/08 →		Suspension Strut Repair Kit		DB-RK-9291		
06/08 →		Tie Rod	DB-DL-12310			
06/08 →		Tie Rod	DB-ES-5227		Guide Rod	
06/08 →		Tie Rod	MN-DL-7834		Guide Rod	
06/08 →		Tie Rod End	CV-ES-0543		for Push Rod	
06/08 →		Tie Rod End	CV-ES-14163		for Steering Rod	
06/08 →		Tie Rod End	DB-ES-5234		for Steering Rod	
06/08 →		Track Control Arm		DB-DL-3475	Trailing Arm, 1st RA;2nd RA, →517144 03/517144 06	
06/08 →		Track Control Arm		DB-DL-3475	Trailing Arm, 1st RA;2nd RA, →517144 05/517144 08	
06/08 →		Track Control Arm		DB-DL-3475	Trailing Arm, 1st RA;2nd RA, →517144 07/517144 09	
06/08 →		Track Control Arm		DB-DL-3475	Trailing Arm, 1st RA;2nd RA, →517144 26/517144 27	
06/08 →		Track Control Arm		DB-VB-7261	Suspension Rod, Wishbone (CV)	
06/08 →		Track Control Arm		DB-VB-9307	Suspension Rod, Wishbone (CV)	
06/08 →		Track Control Arm		DB-VB-9308	Suspension Rod, Wishbone (CV)	
2748 AKE		06/08 →	Centre Rod	DB-DL-8307		Push Rod
	06/08 →	Centre Rod	DB-DL-8702		Push Rod	
	06/08 →	Stabiliser Mounting		DB-SB-10406		
	06/08 →	Suspension Strut Repair Kit		DB-RK-8710		
	06/08 →	Suspension Strut Repair Kit		DB-RK-9291		
	06/08 →	Tie Rod	DB-DL-12310			
	06/08 →	Tie Rod	DB-ES-5227		Guide Rod	
	06/08 →	Tie Rod	MN-DL-7834		Guide Rod	
	06/08 →	Tie Rod End	CV-ES-0543		for Push Rod	
	06/08 →	Tie Rod End	DB-ES-5234		for Steering Rod	
	06/08 →	Track Control Arm		DB-DL-3475	Trailing Arm, 1st RA;2nd RA, →517144 03/517144 06	
	06/08 →	Track Control Arm		DB-DL-3475	Trailing Arm, 1st RA;2nd RA, →517144 05/517144 08	

CV-ES-0543

Length: 125
Cone Ø: d1 Ø 32 / d2 Ø 29
Thread: M30 x 1,5 RHT
0004605748, 0004606048, 0004606848,
0004607048, 0014600448, 0014601148,
0014601748, 0014602448, 0014607648,
0014609648



CV-ES-14163

Length: 125
Cone Ø: d1 Ø 30 / d2 Ø 27
Thread: M30 x 1,5 RHT
0003305248, 0003387310, 0004600348,
0004600948, 0004602848, 0004602948,
0004608948, 0014600248, 0014600848,
0014601248, 0014602248, 0014607748,
0024600148, A0003387310, A0004600348,
A0004602848, A0004602948, A0014600848,
A0014601248, A0014602248, A0014607748



DB-DL-3475

Length: 565 Ø: 52
Hole Distance: 152 / 152
3753500006, 3753500206, 9473500805,
9483500006, 9483500805, 9483501205,
9483501305, 9483501905, 9483502005,
9483502405, A3753500006, A3753500206



DB-DL-8307

Length: 885 Ø: 38
Cone Ø: d1 Ø 32 / d2 Ø 30
01215500A, 0004604005, 0024605105,
0024605205, 0034604005



DB-DL-8702

Length: 958 Ø: 38
Cone Ø: d1 Ø 32 / d2 Ø 30
0024606105, 0024606205, 0034604205



DB-DL-12310

Length: 1532 Ø: 50
Cone Ø: d1 Ø 32 / d2 Ø 29
Thread: M27 x 1,5 LHT
9493301203, 9493301303, 9493301803,
9493302203, A9493301203, A9493301303,
A9493301803, A9493302203



DB-ES-5227

Length: 1588 Ø: 60
Cone Ø: d1 Ø 38 / d2 Ø 34,3
6253300903, 6253301203, 9443300203



DB-ES-5234

Length: 135
Cone Ø: d1 Ø 38 / d2 Ø 34,3
Thread: M38 x 1,5 RHT
0004601748, 120322305, 2205000400



DB-RK-8710

Ø: 85 Hole Distance: 130
Thick/Height: 30
0003503705



DB-RK-9291

Ø: 107,5 Hole Distance: 152
Thick/Height: 30
0003503605



DB-SB-10401

Length: 232
Thick/Height: 163,5 / 152,5
0003250596, 0003250796



DB-SB-10406

Ø: 80 Thick/Height: 46
0003238185



DB-VB-7261

Length: 622 Ø: 46
Hole Ø 25 / 25 / 25
Hole Distance: 152 / 130 / 130
01337800A, 9443500305, 9443500505,
9443500605, 9473500705, 9473500905,
9483500405, 9483503005



DB-VB-9307

Length: 667 Ø: 60
Hole Ø 25 / 23 / 23
Hole Distance: 152 / 130 / 130
9483502805



DB-VB-9308

Length: 622 Ø: 46
Hole Ø 25 / 25 / 25
Hole Distance: 152 / 130 / 130
9483502905



MN-DL-7834

Length: 1588 Ø: 60
Cone Ø: d1 Ø 30 / d2 Ø 27
3463303903, 3463304903, 6253303203,
9443300503, 9443301303, 9443301703





ACTROS MP2 / MP3 ...

2748 AKE ...	06/08 →	Track Control Arm		DB-DL-3475	Trailing Arm, 1st RA;2nd RA, →517144 07/517144 09	
	06/08 →	Track Control Arm		DB-DL-3475	Trailing Arm, 1st RA;2nd RA, →517144 26/517144 27	
	06/08 →	Track Control Arm		DB-VB-7261	Suspension Rod, Wishbone (CV)	
	06/08 →	Track Control Arm		DB-VB-9307	Suspension Rod, Wishbone (CV)	
	06/08 →	Track Control Arm		DB-VB-9308	Suspension Rod, Wishbone (CV)	
3231 B	04/03 →	Centre Rod	DB-DL-8168		Push Rod	
	04/03 →	Centre Rod	DB-DL-8184		Push Rod	
	04/03 →	Centre Rod	DB-DL-8185		Push Rod	
	04/03 →	Centre Rod	DB-DL-12300		for Steering Rod	
	04/03 →	Stabiliser Link	DB-DL-9254		Coupling Rod	
	04/03 →	Stabiliser Link	DB-DL-9271		Coupling Rod	
	04/03 →	Stabiliser Link	DB-DL-9272		Coupling Rod	
	04/03 →	Suspension Arm Repair Kit		DB-RK-8626	for Wishbone (CV)	
	04/03 →	Suspension Arm Repair Kit		DB-RK-10374	for Wishbone (CV)	
	04/03 →	Tie Rod	DB-DL-8172		Guide Rod	
	04/03 →	Tie Rod	DB-DL-8640		Guide Rod	
	04/03 →	Tie Rod End	CV-ES-0543		for Push Rod	
	04/03 →	Tie Rod End	CV-ES-0888		for Push Rod	
	04/03 →	Track Control Arm		DB-DL-3475	Trailing Arm, 1st RA;2nd RA, →517144 05/517144 08	
	04/03 →	Track Control Arm		DB-VB-7261	Suspension Rod, Wishbone (CV)	
	04/03 →	Track Control Arm		DB-VB-10426	Wishbone (CV)	
	3231 K, 3232 K	04/03 →	Ball Head, gearshift linkage	DB-ES-8510		
		04/03 →	Bush, driver cab suspension	DB-SB-10384		
		04/03 →	Bush, parabolic spring		DB-SB-10401	
04/03 →		Centre Rod	DB-DL-8168		Push Rod, Leaf Spring Axle	
04/03 →		Centre Rod	DB-DL-8184		Push Rod, Leaf Spring Axle	
04/03 →		Centre Rod	DB-DL-8185		Push Rod, Leaf Spring Axle	
04/03 →		Centre Rod	DB-DL-8307		Push Rod	
04/03 →		Centre Rod	DB-DL-12300		for Steering Rod	
04/03 →		Stabiliser Link	DB-DL-9254		Pressure Rod	
04/03 →		Stabiliser Link	DB-DL-9271		Pressure Rod	
04/03 →		Stabiliser Link	DB-DL-9272		Pressure Rod	
04/03 →		Stabiliser Mounting		DB-SB-10406		
04/03 →		Stabiliser Mounting		DB-SB-10409		
04/03 →		Suspension Arm Repair Kit		DB-RK-8626	for Wishbone (CV)	
04/03 →		Suspension Arm Repair Kit		DB-RK-10374	for Wishbone (CV)	
04/03 →		Suspension Arm Repair Kit		DB-RK-10375	for Wishbone (CV)	
04/03 →		Suspension Arm Repair Kit	DB-RK-8638		for Control Arm	
04/03 →		Suspension Strut Repair Kit		DB-RK-8391		
04/03 →		Suspension Strut Repair Kit		DB-RK-9294		
04/03 →		Tie Rod	DB-DL-8171		Guide Rod	
04/03 →		Tie Rod	DB-DL-8172		Guide Rod	
04/03 →		Tie Rod	DB-DL-8327		Guide Rod	
04/03 →		Tie Rod	DB-DL-8390			
04/03 →		Tie Rod	DB-DL-8640		Guide Rod	
04/03 →		Tie Rod	DB-DL-12310			
04/03 →		Tie Rod	DB-ES-5227		Guide Rod	
04/03 →		Tie Rod End	CV-ES-0543		for Push Rod	
04/03 →		Tie Rod End	CV-ES-0888		for Push Rod	
04/03 →		Tie Rod End	DB-ES-5234		for Steering Rod	
04/03 →		Tie Rod End	DB-ES-8323		Leaf Spring Axle	
04/03 →		Tie Rod End	DB-ES-8530		for Push Rod	
04/03 →		Track Control Arm		DB-DL-3475	Trailing Arm	
04/03 →		Track Control Arm		DB-VB-3707	Suspension Rod, Wishbone (CV)	
04/03 →		Track Control Arm		DB-VB-7261	Suspension Rod, Wishbone (CV), 1st RA;2nd RA; Leaf Spring Axle	
04/03 →		Track Control Arm		DB-VB-10426	Wishbone (CV), Leaf Spring Axle;Unit	

CV-ES-0543

Length: 125
Cone Ø: d1 Ø 32 / d2 Ø 29
Thread: M30 x 1,5 RHT
0004605748, 0004606048, 0004606848,
0004607048, 0014600448, 0014601148,
0014601748, 0014602448, 0014607648,
0014609648



CV-ES-0888

Length: 125
Cone Ø: d1 Ø 32 / d2 Ø 29
Thread: M30 x 1,5 LHT
0004605848, 0004606148, 0004606948,
0004607148, 0004609048, 0014600548,
0014601348, 0014602548, 0014607948,
0024600448



DB-DL-3475

Length: 565 Ø: 52
Hole Distance: 152 / 152
3753500006, 3753500206, 9473500805,
9483500006, 9483500805, 9483501205,
9483501305, 9483501905, 9483502005,
9483502405, A3753500006, A3753500206



DB-DL-8168

Length: 904 Ø: 52
Cone Ø: d1 Ø 32 / d2 Ø 29
0004609405, 0004609505, 0014607105



DB-DL-8171

Length: 1687 Ø: 52
Cone Ø: d1 Ø 32 / d2 Ø 29
9493300603, 9493300703, 9493301503,
9493301603



DB-DL-8172

Length: 1700 Ø: 52
Cone Ø: d1 Ø 32 / d2 Ø 29
01219700A, 9493300403, 9493300503,
9493300803, 9493301403



DB-DL-8184

Length: 1095 Ø: 42
Cone Ø: d1 Ø 32 / d2 Ø 28,8
01217700A, 0014601305, 0014601405,
0024600505, 0034603205, 3754601505,
A0014601305, A0014601405, A0024600505



DB-DL-8185

Length: 711 Ø: 42
Cone Ø: d1 Ø 32 / d2 Ø 28,8
01213600A, 0014601105, 0024600405,
0034603105, A0014601105, A0024600405



DB-DL-8307

Length: 885 Ø: 38
Cone Ø: d1 Ø 32 / d2 Ø 30
01215500A, 0004604005, 0024605105,
0024605205, 0034604005



DB-DL-8327

Length: 1745 Ø: 48
Cone Ø: d1 Ø 32 / d2 Ø 29
01219800A, 9413300003, 9413300103,
9413300203, 9413300303, 9413300503



DB-DL-8390

Length: 1596 Ø: 50
Cone Ø: d1 Ø 32 / d2 Ø 29
9493301003, 9493301103, 9493301703



DB-DL-8640

Length: 1615 Ø: 50
Cone Ø: d1 Ø 32 / d2 Ø 29
6253301503, 6253301603, 6253302403,
6253302503, 9423300803, 9423302103,
9493300203, 9493300303, 9493300903



DB-DL-9254

Length: 1815 Ø: 58
0003220323, 0003220623, 3753220423



DB-DL-9271

Length: 1815 Ø: 60
0003220423, 0003220723



DB-DL-9272

Length: 1815 Ø: 80
0003220223



DB-DL-12300

Length: 733 Ø: 36
Cone Ø: d1 Ø 32 / d2 Ø 29
0014601505, 0014607305, 0034603305,
3754601605, A0014601505, A0034603305,
A3754601605



DB-DL-12310

Length: 1532 Ø: 50
Cone Ø: d1 Ø 32 / d2 Ø 29
Thread: M27 x 1,5 LHT
9493301203, 9493301303, 9493301803,
9493302203, A9493301203, A9493301303,
A9493301803, A9493302203



DB-ES-5227

Length: 1588 Ø: 60
Cone Ø: d1 Ø 38 / d2 Ø 34,3
6253300903, 6253301203, 9443300203



DB-ES-5234

Length: 135
Cone Ø: d1 Ø 38 / d2 Ø 34,3
Thread: M38 x 1,5 RHT
0004601748, 120322305, 2205000400



DB-ES-8323

Length: 75
Cone Ø: d1 Ø 32 / d2 Ø 28,8
Thread: M26 x 1,5 RHT
0014601548, 0014601648, 0024600648,
A0014601648, A0024600648



DB-ES-8510

Length: 56
Cone Ø: d1 Ø 10 / d2 Ø 10
Thread: M12 x 1,75 LHT
0009965145, 0009965645, 0019963145



DB-ES-8530

Length: 115
Cone Ø: d1 Ø 28,6 / d2 Ø 23,9
Thread: M30 x 1,5 RHT
0014603848, 0014604848, 0014605148,
0014608648, 0014609948



DB-RK-8391

Ø: 85 Hole Distance: 152
Thick/Height: 24
01336800A, 0003502705



DB-RK-8626

Ø: 75 Hole Distance: 130
Thick/Height: 24
0003502205, 0003502505, 0003503405,
0003504505, GL11319



DB-RK-8638

Length: 100 Ø: 67
Hole Distance: 100
Thick/Height: 20
0003301411



DB-RK-9294

Ø: 85 Hole Distance: 152
Thick/Height: 24
0003503105



DB-RK-10374

Ø: 85 Hole Distance: 152
Thick/Height: 24
0003504405



DB-RK-10375

Ø: 100 Hole Distance: 152
Thick/Height: 24
0003502405, 0003503505, 0003504905



DB-SB-10384

Ø: 73 Thick/Height: 47
930170012, 9423171812



DB-SB-10401

Length: 232
Thick/Height: 163,5 / 152,5
0003250596, 0003250796



DB-SB-10406

Ø: 80 Thick/Height: 46
0003238185



DB-SB-10409

Ø: 77 Thick/Height: 56
0003265181



DB-VB-3707

Length: 622 Ø: 46
Hole Ø 25 / 25 / 25
Hole Distance: 152 / 130 / 130
01337100A, 9423501005, 9423501505,
9443500005, 9473500105, 9473501005,
A3753500005, A9423501005, A9423501505,
A9443500005, A9473500105, A9473501005



DB-VB-7261

Length: 622 Ø: 46
Hole Ø 25 / 25 / 25
Hole Distance: 152 / 130 / 130
01337800A, 9443500305, 9443500505,
9443500605, 9473500705, 9473500905,
9483500405, 9483503005



DB-VB-9307

Length: 667 Ø: 60
Hole Ø 25 / 23 / 23
Hole Distance: 152 / 130 / 130
9483502805



DB-VB-9308

Length: 622 Ø: 46
Hole Ø 25 / 25 / 25
Hole Distance: 152 / 130 / 130
9483502905



DB-VB-10426

Length: 622 Ø: 46
Hole Ø 25 / 25 / 25
Hole Distance: 152 / 130 / 130
9443500405





ACTROS MP2 / MP3 ...

3232 B	04/03→	Centre Rod	DB-DL-8168	Push Rod	
	04/03→	Centre Rod	DB-DL-8184	Push Rod, Leaf Spring Axle	
	04/03→	Centre Rod	DB-DL-8185	Push Rod, Leaf Spring Axle	
	04/03→	Centre Rod	DB-DL-12300	for Steering Rod	
	04/03→	Stabiliser Link	DB-DL-9254	Pressure Rod	
	04/03→	Stabiliser Link	DB-DL-9271	Pressure Rod	
	04/03→	Stabiliser Link	DB-DL-9272	Pressure Rod	
	04/03→	Stabiliser Mounting		DB-SB-10406	
	04/03→	Suspension Strut Repair Kit		DB-RK-9294	
	04/03→	Tie Rod	DB-DL-8172	Guide Rod	
	04/03→	Tie Rod	DB-DL-8640	Guide Rod	
	04/03→	Tie Rod	DB-DL-12310		
	04/03→	Tie Rod End	CV-ES-0543	for Push Rod	
	04/03→	Tie Rod End	CV-ES-0888	for Push Rod	
	04/03→	Track Control Arm		DB-DL-3475 Trailing Arm, 1st RA;2nd RA, →517144 05/517144 08	
	04/03→	Track Control Arm		DB-VB-7261 Suspension Rod, Wishbone (CV), 1st RA;2nd RA; Leaf Spring Axle	
	04/03→	Track Control Arm		DB-VB-10426 Wishbone (CV), Leaf Spring Axle;Unit	
3235 B	04/03→	Centre Rod	DB-DL-8168	Push Rod	
	04/03→	Centre Rod	DB-DL-8184	Push Rod	
	04/03→	Centre Rod	DB-DL-8185	Push Rod	
	04/03→	Centre Rod	DB-DL-12300	for Steering Rod	
	04/03→	Stabiliser Link	DB-DL-9254	Coupling Rod	
	04/03→	Stabiliser Link	DB-DL-9271	Coupling Rod	
	04/03→	Stabiliser Link	DB-DL-9272	Coupling Rod	
	04/03→	Suspension Arm Repair Kit		DB-RK-8626 for Wishbone (CV)	
	04/03→	Suspension Arm Repair Kit		DB-RK-10374 for Wishbone (CV)	
	04/03→	Tie Rod	DB-DL-8172	Guide Rod	
	04/03→	Tie Rod	DB-DL-8640	Guide Rod	
	04/03→	Tie Rod End	CV-ES-0543	for Push Rod	
	04/03→	Tie Rod End	CV-ES-0888	for Push Rod	
	04/03→	Track Control Arm		DB-DL-3475 Trailing Arm, 1st RA;2nd RA, →517144 05/517144 08	
	04/03→	Track Control Arm		DB-VB-7261 Suspension Rod, Wishbone (CV)	
	04/03→	Track Control Arm		DB-VB-10426 Wishbone (CV)	
	3235 K	04/03→	Centre Rod	DB-DL-8168	Push Rod
04/03→		Centre Rod	DB-DL-8184	Push Rod	
04/03→		Centre Rod	DB-DL-8185	Push Rod	
04/03→		Centre Rod	DB-DL-12300	for Steering Rod	
04/03→		Suspension Arm Repair Kit		DB-RK-8626 for Wishbone (CV)	
04/03→		Suspension Arm Repair Kit		DB-RK-10374 for Wishbone (CV)	
04/03→		Tie Rod	DB-DL-8171	Guide Rod	
04/03→		Tie Rod	DB-DL-8172	Guide Rod	
04/03→		Tie Rod	DB-DL-8390		
04/03→		Tie Rod	DB-DL-8640	Guide Rod	
04/03→		Tie Rod End	CV-ES-0543	for Push Rod	
04/03→		Tie Rod End	CV-ES-0888	for Push Rod	
04/03→		Track Control Arm		DB-DL-3475 Trailing Arm, 1st RA;2nd RA, →517144 05/517144 08	
04/03→		Track Control Arm		DB-VB-7261 Suspension Rod, Wishbone (CV)	
04/03→		Track Control Arm		DB-VB-10426 Wishbone (CV)	
3236 B		04/03→	Centre Rod	DB-DL-8168	Push Rod
		04/03→	Centre Rod	DB-DL-8184	Push Rod, Leaf Spring Axle
	04/03→	Centre Rod	DB-DL-8185	Push Rod, Leaf Spring Axle	
	04/03→	Centre Rod	DB-DL-12300	for Steering Rod	
	04/03→	Stabiliser Link	DB-DL-9254	Pressure Rod	
	04/03→	Stabiliser Link	DB-DL-9271	Pressure Rod	
	04/03→	Stabiliser Link	DB-DL-9272	Pressure Rod	
	04/03→	Stabiliser Mounting		DB-SB-10406	
	04/03→	Suspension Strut Repair Kit		DB-RK-9294	
	04/03→	Tie Rod	DB-DL-8172	Guide Rod	
	04/03→	Tie Rod	DB-DL-8640	Guide Rod	

CV-ES-0543

Length: 125
Cone Ø: d1 Ø 32 / d2 Ø 29
Thread: M30 x 1,5 RHT
0004605748, 0004606048, 0004606848,
0004607048, 0014600448, 0014601148,
0014601748, 0014602448, 0014607648,
0014609648



CV-ES-0888

Length: 125
Cone Ø: d1 Ø 32 / d2 Ø 29
Thread: M30 x 1,5 LHT
0004605848, 0004606148, 0004606948,
0004607148, 0004609048, 0014600548,
0014601348, 0014602548, 0014607948,
0024600448



DB-DL-3475

Length: 565 Ø: 52
Hole Distance: 152 / 152
3753500006, 3753500206, 9473500805,
9483500006, 9483500805, 9483501205,
9483501305, 9483501905, 9483502005,
9483502405, A3753500006, A3753500206



DB-DL-8168

Length: 904 Ø: 52
Cone Ø: d1 Ø 32 / d2 Ø 29
0004609405, 0004609505, 0014607105



DB-DL-8171

Length: 1687 Ø: 52
Cone Ø: d1 Ø 32 / d2 Ø 29
9493300603, 9493300703, 9493301503,
9493301603



DB-DL-8172

Length: 1700 Ø: 52
Cone Ø: d1 Ø 32 / d2 Ø 29
01219700A, 9493300403, 9493300503,
9493300803, 9493301403



DB-DL-8184

Length: 1095 Ø: 42
Cone Ø: d1 Ø 32 / d2 Ø 28,8
01217700A, 0014601305, 0014601405,
0024600505, 0034603205, 3754601505,
A0014601305, A0014601405, A0024600505



DB-DL-8185

Length: 711 Ø: 42
Cone Ø: d1 Ø 32 / d2 Ø 28,8
01213600A, 0014601105, 0024600405,
0034603105, A0014601105, A0024600405



DB-DL-8390

Length: 1596 Ø: 50
Cone Ø: d1 Ø 32 / d2 Ø 29
9493301003, 9493301103, 9493301703



DB-DL-8640

Length: 1615 Ø: 50
Cone Ø: d1 Ø 32 / d2 Ø 29
6253301503, 6253301603, 6253302403,
6253302503, 9423300803, 9423302103,
9493300203, 9493300303, 9493300903



DB-DL-9254

Length: 1815 Ø: 58
0003220323, 0003220623, 3753220423



DB-DL-9271

Length: 1815 Ø: 60
0003220423, 0003220723



DB-DL-9272

Length: 1815 Ø: 80
0003220223



DB-DL-12300

Length: 733 Ø: 36
Cone Ø: d1 Ø 32 / d2 Ø 29
0014601505, 0014607305, 0034603305,
3754601605, A0014601505, A0034603305,
A3754601605



DB-DL-12310

Length: 1532 Ø: 50
Cone Ø: d1 Ø 32 / d2 Ø 29
Thread: M27 x 1,5 LHT
9493301203, 9493301303, 9493301803,
9493302203, A9493301203, A9493301303,
A9493301803, A9493302203



DB-RK-8626

Ø: 75 Hole Distance: 130
Thick/Height: 24
0003502205, 0003502505, 0003503405,
0003504505, GL11319



DB-RK-9294

Ø: 85 Hole Distance: 152
Thick/Height: 24
0003503105



DB-RK-10374

Ø: 85 Hole Distance: 152
Thick/Height: 24
0003504405



DB-SB-10406

Ø: 80 Thick/Height: 46
0003238185



DB-VB-7261

Length: 622 Ø: 46
Hole Ø 25 / 25 / 25
Hole Distance: 152 / 130 / 130
01337800A, 9443500305, 9443500505,
9443500605, 9473500705, 9473500905,
9483500405, 9483503005



DB-VB-10426

Length: 622 Ø: 46
Hole Ø 25 / 25 / 25
Hole Distance: 152 / 130 / 130
9443500405





ACTROS MP2 / MP3 ...

3236 B ...	04/03→	Tie Rod	DB-DL-12310		
	04/03→	Tie Rod End	CV-ES-0543	for Push Rod	
	04/03→	Tie Rod End	CV-ES-0888	for Push Rod	
	04/03→	Track Control Arm		DB-DL-3475 Trailing Arm, 1st RA;2nd RA, →517144 05/517144 08	
	04/03→	Track Control Arm		DB-VB-7261 Suspension Rod, Wishbone (CV), 1st RA;2nd RA; Leaf Spring Axle	
	04/03→	Track Control Arm		DB-VB-10426 Wishbone (CV), Leaf Spring Axle;Unit	
3236 K	04/03→	Centre Rod	DB-DL-8168	Push Rod, Leaf Spring Axle	
	04/03→	Centre Rod	DB-DL-8184	Push Rod, Leaf Spring Axle	
	04/03→	Centre Rod	DB-DL-8185	Push Rod, Leaf Spring Axle	
	04/03→	Centre Rod	DB-DL-12300	for Steering Rod	
	04/03→	Stabiliser Mounting		DB-SB-10406	
	04/03→	Suspension Strut Repair Kit		DB-RK-9294	
	04/03→	Tie Rod	DB-DL-8171	Guide Rod	
	04/03→	Tie Rod	DB-DL-8172	Guide Rod	
	04/03→	Tie Rod	DB-DL-8390		
	04/03→	Tie Rod	DB-DL-8640	Guide Rod	
	04/03→	Tie Rod	DB-DL-12310		
	04/03→	Tie Rod	DB-ES-5227	Guide Rod	
	04/03→	Tie Rod End	CV-ES-0543	for Push Rod	
	04/03→	Tie Rod End	CV-ES-0888	for Push Rod	
	04/03→	Track Control Arm		DB-DL-3475 Trailing Arm, 1st RA;2nd RA, →517144 05/517144 08	
	04/03→	Track Control Arm		DB-VB-7261 Suspension Rod, Wishbone (CV), 1st RA;2nd RA; Leaf Spring Axle	
	04/03→	Track Control Arm		DB-VB-10426 Wishbone (CV), Leaf Spring Axle;Unit	
	3240	04/03→	Centre Rod	DB-DL-8168	Push Rod
04/03→		Centre Rod	DB-DL-8184	Push Rod	
04/03→		Centre Rod	DB-DL-8185	Push Rod	
04/03→		Centre Rod	DB-DL-12300	for Steering Rod	
04/03→		Stabiliser Link	DB-DL-9254	Coupling Rod	
04/03→		Stabiliser Link	DB-DL-9271	Coupling Rod	
04/03→		Stabiliser Link	DB-DL-9272	Coupling Rod	
04/03→		Suspension Arm Repair Kit		DB-RK-8626 for Wishbone (CV)	
04/03→		Suspension Arm Repair Kit		DB-RK-10374 for Wishbone (CV)	
04/03→		Suspension Strut Repair Kit		DB-RK-8391	
04/03→		Tie Rod	DB-DL-8172	Guide Rod	
04/03→		Tie Rod	DB-DL-8640	Guide Rod	
04/03→		Tie Rod End	CV-ES-0543	for Push Rod	
04/03→		Tie Rod End	CV-ES-0888	for Push Rod	
04/03→		Tie Rod End	DB-ES-8323		
04/03→		Track Control Arm		DB-DL-3475 Trailing Arm, 1st RA;2nd RA, →517144 03/517144 06	
04/03→		Track Control Arm		DB-DL-3475 Trailing Arm, 1st RA;2nd RA, →517144 05/517144 08	
04/03→		Track Control Arm		DB-DL-3475 Trailing Arm, 1st RA;2nd RA, →517144 07/517144 09	
04/03→		Track Control Arm		DB-DL-3475 Trailing Arm, 1st RA;2nd RA, →517144 26/517144 27	
04/03→		Track Control Arm		DB-VB-7261 Suspension Rod, Wishbone (CV)	
04/03→		Track Control Arm		DB-VB-10426 Wishbone (CV)	
3240 B		04/03→	Centre Rod	DB-DL-8168	Push Rod
		04/03→	Centre Rod	DB-DL-8184	Push Rod
		04/03→	Centre Rod	DB-DL-8185	Push Rod
	04/03→	Centre Rod	DB-DL-12300	for Steering Rod	
	04/03→	Stabiliser Link	DB-DL-9254	Coupling Rod	
	04/03→	Stabiliser Link	DB-DL-9271	Coupling Rod	
	04/03→	Stabiliser Link	DB-DL-9272	Coupling Rod	
	04/03→	Suspension Arm Repair Kit		DB-RK-8626 for Wishbone (CV)	
	04/03→	Suspension Arm Repair Kit		DB-RK-10374 for Wishbone (CV)	
	04/03→	Tie Rod	DB-DL-8172	Guide Rod	
	04/03→	Tie Rod	DB-DL-8640	Guide Rod	

CV-ES-0543

Length: 125
 Cone Ø: d1 Ø 32 / d2 Ø 29
 Thread: M30 x 1,5 RHT
 0004605748, 0004606048, 0004606848,
 0004607048, 0014600448, 0014601148,
 0014601748, 0014602448, 0014607648,
 0014609648

**CV-ES-0888**

Length: 125
 Cone Ø: d1 Ø 32 / d2 Ø 29
 Thread: M30 x 1,5 LHT
 0004605848, 0004606148, 0004606948,
 0004607148, 0004609048, 0014600548,
 0014601348, 0014602548, 0014607948,
 0024600448

**DB-DL-3475**

Length: 565 Ø: 52
 Hole Distance: 152 / 152
 3753500006, 3753500206, 9473500805,
 9483500006, 9483500805, 9483501205,
 9483501305, 9483501905, 9483502005,
 9483502405, A3753500006, A3753500206

**DB-DL-8168**

Length: 904 Ø: 52
 Cone Ø: d1 Ø 32 / d2 Ø 29
 0004609405, 0004609505, 0014607105

**DB-DL-8171**

Length: 1687 Ø: 52
 Cone Ø: d1 Ø 32 / d2 Ø 29
 9493300603, 9493300703, 9493301503,
 9493301603

**DB-DL-8172**

Length: 1700 Ø: 52
 Cone Ø: d1 Ø 32 / d2 Ø 29
 01219700A, 9493300403, 9493300503,
 9493300803, 9493301403

**DB-DL-8184**

Length: 1095 Ø: 42
 Cone Ø: d1 Ø 32 / d2 Ø 28,8
 01217700A, 0014601305, 0014601405,
 0024600505, 0034603205, 3754601505,
 A014601305, A014601405, A0024600505

**DB-DL-8185**

Length: 711 Ø: 42
 Cone Ø: d1 Ø 32 / d2 Ø 28,8
 01213600A, 0014601105, 0024600405,
 0034603105, A014601105, A0024600405

**DB-DL-8390**

Length: 1596 Ø: 50
 Cone Ø: d1 Ø 32 / d2 Ø 29
 9493301003, 9493301103, 9493301703

**DB-DL-8640**

Length: 1615 Ø: 50
 Cone Ø: d1 Ø 32 / d2 Ø 29
 6253301503, 6253301603, 6253302403,
 6253302503, 9423300803, 9423302103,
 9493300203, 9493300303, 9493300903

**DB-DL-9254**

Length: 1815 Ø: 58
 0003220323, 0003220623, 3753220423

**DB-DL-9271**

Length: 1815 Ø: 60
 0003220423, 0003220723

**DB-DL-9272**

Length: 1815 Ø: 80
 0003220223

**DB-DL-12300**

Length: 733 Ø: 36
 Cone Ø: d1 Ø 32 / d2 Ø 29
 0014601505, 0014607305, 0034603305,
 3754601605, A014601505, A0034603305,
 A3754601605

**DB-DL-12310**

Length: 1532 Ø: 50
 Cone Ø: d1 Ø 32 / d2 Ø 29
 Thread: M27 x 1,5 LHT
 9493301203, 9493301303, 9493301803,
 9493302203, A9493301203, A9493301303,
 A9493301803, A9493302203

**DB-ES-5227**

Length: 1588 Ø: 60
 Cone Ø: d1 Ø 38 / d2 Ø 34,3
 6253300903, 6253301203, 9443300203

**DB-ES-8323**

Length: 75
 Cone Ø: d1 Ø 32 / d2 Ø 28,8
 Thread: M26 x 1,5 RHT
 0014601548, 0014601648, 0024600648,
 A014601648, A0024600648

**DB-RK-8391**

Ø: 85 Hole Distance: 152
 Thick/Height: 24
 01336800A, 0003502705

**DB-RK-8626**

Ø: 75 Hole Distance: 130
 Thick/Height: 24
 0003502205, 0003502505, 0003503405,
 0003504505, GL11319

**DB-RK-9294**

Ø: 85 Hole Distance: 152
 Thick/Height: 24
 0003503105

**DB-RK-10374**

Ø: 85 Hole Distance: 152
 Thick/Height: 24
 0003504405

**DB-SB-10406**

Ø: 80 Thick/Height: 46
 0003238185

**DB-VB-7261**

Length: 622 Ø: 46
 Hole Ø 25 / 25 / 25
 Hole Distance: 152 / 130 / 130
 01337800A, 9443500305, 9443500505,
 9443500605, 9473500705, 9473500905,
 9483500405, 9483503005

**DB-VB-10426**

Length: 622 Ø: 46
 Hole Ø 25 / 25 / 25
 Hole Distance: 152 / 130 / 130
 9443500405



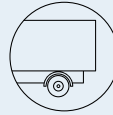
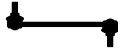

ACTROS MP2 / MP3 ...

3240 B ...	04/03→	Tie Rod End	CV-ES-0543		for Push Rod
	04/03→	Tie Rod End	CV-ES-0888		for Push Rod
	04/03→	Track Control Arm		DB-DL-3475	Trailing Arm, 1st RA;2nd RA, →517144 05/517144 08
	04/03→	Track Control Arm		DB-VB-7261	Suspension Rod, Wishbone (CV)
	04/03→	Track Control Arm		DB-VB-10426	Wishbone (CV)
3240 K	04/03→	Centre Rod	DB-DL-8168		Push Rod
	04/03→	Centre Rod	DB-DL-8184		Push Rod
	04/03→	Centre Rod	DB-DL-8185		Push Rod
	04/03→	Centre Rod	DB-DL-12300		for Steering Rod
	04/03→	Suspension Arm Repair Kit		DB-RK-8626	for Wishbone (CV)
	04/03→	Suspension Arm Repair Kit		DB-RK-10374	for Wishbone (CV)
	04/03→	Tie Rod	DB-DL-8171		Guide Rod
	04/03→	Tie Rod	DB-DL-8172		Guide Rod
	04/03→	Tie Rod	DB-DL-8390		Guide Rod
	04/03→	Tie Rod	DB-DL-8640		Guide Rod
	04/03→	Tie Rod End	CV-ES-0543		for Push Rod
	04/03→	Tie Rod End	CV-ES-0888		for Push Rod
	04/03→	Track Control Arm		DB-DL-3475	Trailing Arm, 1st RA;2nd RA, →517144 05/517144 08
	04/03→	Track Control Arm		DB-VB-7261	Suspension Rod, Wishbone (CV)
	04/03→	Track Control Arm		DB-VB-10426	Wishbone (CV)
	3241	04/03→	Ball Head, gearshift linkage	DB-ES-8510	
04/03→		Bush, driver cab suspension	DB-SB-10384		
04/03→		Bush, parabolic spring		DB-SB-10401	
04/03→		Centre Rod	DB-DL-8168		Push Rod
04/03→		Centre Rod	DB-DL-8184		Push Rod
04/03→		Centre Rod	DB-DL-8185		Push Rod
04/03→		Centre Rod	DB-DL-8307		Push Rod
04/03→		Centre Rod	DB-DL-8622		Push Rod
04/03→		Centre Rod	DB-DL-8641		Push Rod
04/03→		Centre Rod	DB-DL-8642		Push Rod
04/03→		Centre Rod	DB-DL-12300		for Steering Rod
04/03→		Stabiliser Link	DB-DL-9254		Pressure Rod
04/03→		Stabiliser Link	DB-DL-9271		Pressure Rod
04/03→		Stabiliser Link	DB-DL-9272		Pressure Rod
04/03→		Stabiliser Mounting		DB-SB-10406	
04/03→		Stabiliser Mounting		DB-SB-10409	
04/03→		Stabiliser Mounting	DB-SB-10410		
04/03→		Suspension Arm Repair Kit		DB-RK-8550	for Wishbone (CV)
04/03→		Suspension Arm Repair Kit		DB-RK-8626	for Wishbone (CV)
04/03→		Suspension Arm Repair Kit		DB-RK-10374	for Wishbone (CV)
04/03→		Suspension Arm Repair Kit		DB-RK-10375	for Wishbone (CV)
04/03→		Suspension Arm Repair Kit	DB-RK-8638		for Control Arm
04/03→		Suspension Strut Repair Kit		DB-RK-8391	
04/03→		Suspension Strut Repair Kit		DB-RK-9294	
04/03→		Tie Rod	DB-DL-8172		Guide Rod, 2nd FA
04/03→		Tie Rod	DB-DL-8640		Guide Rod
04/03→		Tie Rod	DB-DL-12310		
04/03→		Tie Rod	DB-ES-5227		Guide Rod
04/03→		Tie Rod End	CV-ES-0543		for Push Rod
04/03→		Tie Rod End	CV-ES-0888		for Push Rod
04/03→		Tie Rod End	DB-ES-5234		for Steering Rod
04/03→		Tie Rod End	DB-ES-8323		
04/03→		Tie Rod End	DB-ES-8530		for Push Rod
04/03→		Track Control Arm		DB-DL-3475	Trailing Arm
04/03→	Track Control Arm		DB-VB-3707	Suspension Rod, Wishbone (CV)	
04/03→	Track Control Arm		DB-VB-7261	Suspension Rod, Wishbone (CV)	
04/03→	Track Control Arm		DB-VB-10426	Wishbone (CV), Leaf Spring Axle;Unit	
3241 B	04/03→	Centre Rod	DB-DL-8168		Push Rod
	04/03→	Centre Rod	DB-DL-8184		Push Rod, Leaf Spring Axle
	04/03→	Centre Rod	DB-DL-8185		Push Rod, Leaf Spring Axle
	04/03→	Centre Rod	DB-DL-12300		for Steering Rod

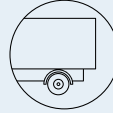
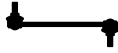

ACTROS MP2 / MP3 ...

3241 B ...	04/03→	Stabiliser Link	DB-DL-9254		Pressure Rod	
	04/03→	Stabiliser Link	DB-DL-9271		Pressure Rod	
	04/03→	Stabiliser Link	DB-DL-9272		Pressure Rod	
	04/03→	Stabiliser Mounting		DB-SB-10406		
	04/03→	Suspension Strut Repair Kit		DB-RK-9294		
	04/03→	Tie Rod	DB-DL-8172		Guide Rod	
	04/03→	Tie Rod	DB-DL-8640		Guide Rod	
	04/03→	Tie Rod	DB-DL-12310			
	04/03→	Tie Rod End	CV-ES-0543		for Push Rod	
	04/03→	Tie Rod End	CV-ES-0888		for Push Rod	
	04/03→	Track Control Arm		DB-DL-3475	Trailing Arm, 1st RA;2nd RA, →517144 05/517144 08	
	04/03→	Track Control Arm		DB-VB-7261	Suspension Rod, Wishbone (CV), 1st RA;2nd RA; Leaf Spring Axle	
	04/03→	Track Control Arm		DB-VB-10426	Wishbone (CV), Leaf Spring Axle;Unit	
	3241 K	04/03→	Centre Rod	DB-DL-8168		Push Rod, Leaf Spring Axle
04/03→		Centre Rod	DB-DL-8184		Push Rod, Leaf Spring Axle	
04/03→		Centre Rod	DB-DL-8185		Push Rod, Leaf Spring Axle	
04/03→		Centre Rod	DB-DL-12300		for Steering Rod	
04/03→		Stabiliser Mounting		DB-SB-10406		
04/03→		Suspension Strut Repair Kit		DB-RK-9294		
04/03→		Tie Rod	DB-DL-8171		Guide Rod	
04/03→		Tie Rod	DB-DL-8172		Guide Rod	
04/03→		Tie Rod	DB-DL-8390			
04/03→		Tie Rod	DB-DL-8640		Guide Rod	
04/03→		Tie Rod	DB-DL-12310			
04/03→		Tie Rod	DB-ES-5227		Guide Rod	
04/03→		Tie Rod End	CV-ES-0543		for Push Rod	
04/03→		Tie Rod End	CV-ES-0888		for Push Rod	
04/03→		Track Control Arm		DB-DL-3475	Trailing Arm, 1st RA;2nd RA, →517144 05/517144 08	
04/03→		Track Control Arm		DB-VB-7261	Suspension Rod, Wishbone (CV), 1st RA;2nd RA; Leaf Spring Axle	
04/03→		Track Control Arm		DB-VB-10426	Wishbone (CV), Leaf Spring Axle;Unit	
3241 L		06/08→	Centre Rod	DB-DL-8168		Push Rod
		06/08→	Centre Rod	DB-DL-8184		Push Rod
	06/08→	Centre Rod	DB-DL-8185		Push Rod	
	06/08→	Centre Rod	DB-DL-12300		for Steering Rod	
	06/08→	Stabiliser Link	DB-DL-9254		Coupling Rod	
	06/08→	Stabiliser Link	DB-DL-9271		Coupling Rod	
	06/08→	Stabiliser Link	DB-DL-9272		Coupling Rod	
	06/08→	Suspension Arm Repair Kit		DB-RK-8626	for Wishbone (CV)	
	06/08→	Suspension Arm Repair Kit		DB-RK-10374	for Wishbone (CV)	
	06/08→	Suspension Strut Repair Kit		DB-RK-8391		
	06/08→	Tie Rod	DB-DL-8172		Guide Rod	
	06/08→	Tie Rod	DB-DL-8640		Guide Rod	
	06/08→	Tie Rod End	CV-ES-0543		for Push Rod	
	06/08→	Tie Rod End	CV-ES-0888		for Push Rod	
	06/08→	Tie Rod End	DB-ES-8323			
	06/08→	Track Control Arm		DB-VB-7261	Suspension Rod, Wishbone (CV)	
	06/08→	Track Control Arm		DB-VB-10426	Wishbone (CV)	
	3243	10/02→	Centre Rod	DB-DL-8168		Push Rod
		10/02→	Centre Rod	DB-DL-8184		Push Rod
		10/02→	Centre Rod	DB-DL-8185		Push Rod
		10/02→	Centre Rod	DB-DL-12300		for Steering Rod
		10/02→	Stabiliser Link	DB-DL-9254		Pressure Rod
10/02→		Stabiliser Link	DB-DL-9271		Pressure Rod	
10/02→		Stabiliser Link	DB-DL-9272		Pressure Rod	
10/02→		Suspension Arm Repair Kit		DB-RK-8626	for Wishbone (CV)	
10/02→		Suspension Arm Repair Kit		DB-RK-10374	for Wishbone (CV)	
10/02→		Suspension Strut Repair Kit		DB-RK-8391		
10/02→		Tie Rod	DB-DL-8172		Guide Rod, 2nd FA	
10/02→		Tie Rod	DB-DL-8640		Guide Rod	

CV-ES-0543

Length: 125
 Cone Ø: d1 Ø 32 / d2 Ø 29
 Thread: M30 x 1,5 RHT
 0004605748, 0004606048, 0004606848,
 0004607048, 0014600448, 0014601148,
 0014601748, 0014602448, 0014607648,
 0014609648

**CV-ES-0888**

Length: 125
 Cone Ø: d1 Ø 32 / d2 Ø 29
 Thread: M30 x 1,5 LHT
 0004605848, 0004606148, 0004606948,
 0004607148, 0004609048, 0014600548,
 0014601348, 0014602548, 0014607948,
 0024600448

**DB-DL-3475**

Length: 565 Ø: 52
 Hole Distance: 152 / 152
 3753500006, 3753500206, 9473500805,
 9483500006, 9483500805, 9483501205,
 9483501305, 9483501905, 9483502005,
 9483502405, A3753500006, A3753500206

**DB-DL-8168**

Length: 904 Ø: 52
 Cone Ø: d1 Ø 32 / d2 Ø 29
 0004609405, 0004609505, 0014607105

**DB-DL-8171**

Length: 1687 Ø: 52
 Cone Ø: d1 Ø 32 / d2 Ø 29
 9493300603, 9493300703, 9493301503,
 9493301603

**DB-DL-8172**

Length: 1700 Ø: 52
 Cone Ø: d1 Ø 32 / d2 Ø 29
 01219700A, 9493300403, 9493300503,
 9493300803, 9493301403

**DB-DL-8184**

Length: 1095 Ø: 42
 Cone Ø: d1 Ø 32 / d2 Ø 28,8
 01217700A, 0014601305, 0014601405,
 0024600505, 0034603205, 3754601505,
 A014601305, A014601405, A0024600505

**DB-DL-8185**

Length: 711 Ø: 42
 Cone Ø: d1 Ø 32 / d2 Ø 28,8
 01213600A, 0014601105, 0024600405,
 0034603105, A014601105, A0024600405

**DB-DL-8390**

Length: 1596 Ø: 50
 Cone Ø: d1 Ø 32 / d2 Ø 29
 9493301003, 9493301103, 9493301703

**DB-DL-8640**

Length: 1615 Ø: 50
 Cone Ø: d1 Ø 32 / d2 Ø 29
 6253301503, 6253301603, 6253302403,
 6253302503, 9423300803, 9423302103,
 9493300203, 9493300303, 9493300903

**DB-DL-9254**

Length: 1815 Ø: 58
 0003220323, 0003220623, 3753220423

**DB-DL-9271**

Length: 1815 Ø: 60
 0003220423, 0003220723

**DB-DL-9272**

Length: 1815 Ø: 80
 0003220223

**DB-DL-12300**

Length: 733 Ø: 36
 Cone Ø: d1 Ø 32 / d2 Ø 29
 0014601505, 0014607305, 0034603305,
 3754601605, A0014601505, A0034603305,
 A3754601605

**DB-DL-12310**

Length: 1532 Ø: 50
 Cone Ø: d1 Ø 32 / d2 Ø 29
 Thread: M27 x 1,5 LHT
 9493301203, 9493301303, 9493301803,
 9493302203, A9493301203, A9493301303,
 A9493301803, A9493302203

**DB-ES-5227**

Length: 1588 Ø: 60
 Cone Ø: d1 Ø 38 / d2 Ø 34,3
 6253300903, 6253301203, 9443300203

**DB-ES-8323**

Length: 75
 Cone Ø: d1 Ø 32 / d2 Ø 28,8
 Thread: M26 x 1,5 RHT
 0014601548, 0014601648, 0024600648,
 A0014601648, A0024600648

**DB-RK-8391**

Ø: 85 Hole Distance: 152
 Thick/Height: 24
 01336800A, 0003502705

**DB-RK-8626**

Ø: 75 Hole Distance: 130
 Thick/Height: 24
 0003502205, 0003502505, 0003503405,
 0003504505, GL11319

**DB-RK-9294**

Ø: 85 Hole Distance: 152
 Thick/Height: 24
 0003503105

**DB-RK-10374**

Ø: 85 Hole Distance: 152
 Thick/Height: 24
 0003504405

**DB-SB-10406**

Ø: 80 Thick/Height: 46
 0003238185

**DB-VB-7261**

Length: 622 Ø: 46
 Hole Ø 25 / 25 / 25
 Hole Distance: 152 / 130 / 130
 01337800A, 9443500305, 9443500505,
 9443500605, 9473500705, 9473500905,
 9483500405, 9483503005

**DB-VB-10426**

Length: 622 Ø: 46
 Hole Ø 25 / 25 / 25
 Hole Distance: 152 / 130 / 130
 9443500405



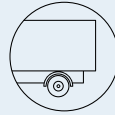

ACTROS MP2 / MP3 ...

3243 ...	10/02→	Tie Rod End	CV-ES-0543		for Push Rod
	10/02→	Tie Rod End	CV-ES-0888		for Push Rod
	10/02→	Tie Rod End	DB-ES-8323		
	10/02→	Track Control Arm		DB-DL-3475	Trailing Arm, 1st RA;2nd RA, →517144 03/517144 06
	10/02→	Track Control Arm		DB-DL-3475	Trailing Arm, 1st RA;2nd RA, →517144 05/517144 08
	10/02→	Track Control Arm		DB-DL-3475	Trailing Arm, 1st RA;2nd RA, →517144 07/517144 09
	10/02→	Track Control Arm		DB-DL-3475	Trailing Arm, 1st RA;2nd RA, →517144 26/517144 27
	10/02→	Track Control Arm		DB-VB-7261	Suspension Rod, Wishbone (CV)
	10/02→	Track Control Arm		DB-VB-10426	Wishbone (CV), Leaf Spring Axle;Unit
3243 B	04/03→	Centre Rod	DB-DL-8168		Push Rod
	04/03→	Centre Rod	DB-DL-8184		Push Rod
	04/03→	Centre Rod	DB-DL-8185		Push Rod
	04/03→	Centre Rod	DB-DL-12300		for Steering Rod
	04/03→	Stabiliser Link	DB-DL-9254		Coupling Rod
	04/03→	Stabiliser Link	DB-DL-9271		Coupling Rod
	04/03→	Stabiliser Link	DB-DL-9272		Coupling Rod
	04/03→	Suspension Arm Repair Kit		DB-RK-8626	for Wishbone (CV)
	04/03→	Suspension Arm Repair Kit		DB-RK-10374	for Wishbone (CV)
	04/03→	Tie Rod	DB-DL-8172		Guide Rod
	04/03→	Tie Rod	DB-DL-8640		Guide Rod
	04/03→	Tie Rod End	CV-ES-0543		for Push Rod
	04/03→	Tie Rod End	CV-ES-0888		for Push Rod
	04/03→	Track Control Arm		DB-DL-3475	Trailing Arm, 1st RA;2nd RA, →517144 05/517144 08
	04/03→	Track Control Arm		DB-VB-7261	Suspension Rod, Wishbone (CV)
	04/03→	Track Control Arm		DB-VB-10426	Wishbone (CV)
3243 K	04/03→	Centre Rod	DB-DL-8168		Push Rod
	04/03→	Centre Rod	DB-DL-8184		Push Rod
	04/03→	Centre Rod	DB-DL-8185		Push Rod
	04/03→	Centre Rod	DB-DL-12300		for Steering Rod
	04/03→	Suspension Arm Repair Kit		DB-RK-8626	for Wishbone (CV)
	04/03→	Suspension Arm Repair Kit		DB-RK-10374	for Wishbone (CV)
	04/03→	Tie Rod	DB-DL-8171		Guide Rod
	04/03→	Tie Rod	DB-DL-8172		Guide Rod
	04/03→	Tie Rod	DB-DL-8390		
	04/03→	Tie Rod	DB-DL-8640		Guide Rod
	04/03→	Tie Rod End	CV-ES-0543		for Push Rod
	04/03→	Tie Rod End	CV-ES-0888		for Push Rod
	04/03→	Track Control Arm		DB-DL-3475	Trailing Arm, 1st RA;2nd RA, →517144 05/517144 08
	04/03→	Track Control Arm		DB-VB-7261	Suspension Rod, Wishbone (CV)
	04/03→	Track Control Arm		DB-VB-10426	Wishbone (CV)
	3244	04/03→	Centre Rod	DB-DL-8168	
04/03→		Centre Rod	DB-DL-8184		Push Rod
04/03→		Centre Rod	DB-DL-8185		Push Rod
04/03→		Centre Rod	DB-DL-12300		for Steering Rod
04/03→		Stabiliser Link	DB-DL-9254		Pressure Rod
04/03→		Stabiliser Link	DB-DL-9271		Pressure Rod
04/03→		Stabiliser Link	DB-DL-9272		Pressure Rod
04/03→		Stabiliser Mounting		DB-SB-10406	
04/03→		Suspension Strut Repair Kit		DB-RK-9294	
04/03→		Tie Rod	DB-DL-8172		Guide Rod, 2nd FA
04/03→		Tie Rod	DB-DL-8640		Guide Rod
04/03→		Tie Rod	DB-DL-12310		
04/03→		Tie Rod	DB-ES-5227		Guide Rod
04/03→		Tie Rod End	CV-ES-0543		for Push Rod
04/03→		Tie Rod End	CV-ES-0888		for Push Rod
04/03→		Tie Rod End	DB-ES-8323		

CV-ES-0543

Length: 125
Cone Ø: d1 Ø 32 / d2 Ø 29
Thread: M30 x 1,5 RHT
0004605748, 0004606048, 0004606848,
0004607048, 0014600448, 0014601148,
0014601748, 0014602448, 0014607648,
0014609648



CV-ES-0888

Length: 125
Cone Ø: d1 Ø 32 / d2 Ø 29
Thread: M30 x 1,5 LHT
0004605848, 0004606148, 0004606948,
0004607148, 0004609048, 0014600548,
0014601348, 0014602548, 0014607948,
0024600448



DB-DL-3475

Length: 565 Ø: 52
Hole Distance: 152 / 152
3753500006, 3753500206, 9473500805,
9483500006, 9483500805, 9483501205,
9483501305, 9483501905, 9483502005,
9483502405, A3753500006, A3753500206



DB-DL-8168

Length: 904 Ø: 52
Cone Ø: d1 Ø 32 / d2 Ø 29
0004609405, 0004609505, 0014607105



DB-DL-8171

Length: 1687 Ø: 52
Cone Ø: d1 Ø 32 / d2 Ø 29
9493300603, 9493300703, 9493301503,
9493301603



DB-DL-8172

Length: 1700 Ø: 52
Cone Ø: d1 Ø 32 / d2 Ø 29
01219700A, 9493300403, 9493300503,
9493300803, 9493301403



DB-DL-8184

Length: 1095 Ø: 42
Cone Ø: d1 Ø 32 / d2 Ø 28,8
01217700A, 0014601305, 0014601405,
0024600505, 0034603205, 3754601505,
A014601305, A014601405, A0024600505



DB-DL-8185

Length: 711 Ø: 42
Cone Ø: d1 Ø 32 / d2 Ø 28,8
01213600A, 0014601105, 0024600405,
0034603105, A0014601105, A0024600405



DB-DL-8390

Length: 1596 Ø: 50
Cone Ø: d1 Ø 32 / d2 Ø 29
9493301003, 9493301103, 9493301703



DB-DL-8640

Length: 1615 Ø: 50
Cone Ø: d1 Ø 32 / d2 Ø 29
6253301503, 6253301603, 6253302403,
6253302503, 9423300803, 9423302103,
9493300203, 9493300303, 9493300903



DB-DL-9254

Length: 1815 Ø: 58
0003220323, 0003220623, 3753220423



DB-DL-9271

Length: 1815 Ø: 60
0003220423, 0003220723



DB-DL-9272

Length: 1815 Ø: 80
0003220223



DB-DL-12300

Length: 733 Ø: 36
Cone Ø: d1 Ø 32 / d2 Ø 29
0014601505, 0014607305, 0034603305,
3754601605, A0014601505, A0034603305,
A3754601605



DB-DL-12310

Length: 1532 Ø: 50
Cone Ø: d1 Ø 32 / d2 Ø 29
Thread: M27 x 1,5 LHT
9493301203, 9493301303, 9493301803,
9493302203, A9493301203, A9493301303,
A9493301803, A9493302203



DB-ES-5227

Length: 1588 Ø: 60
Cone Ø: d1 Ø 38 / d2 Ø 34,3
6253300903, 6253301203, 9443300203



DB-ES-8323

Length: 75
Cone Ø: d1 Ø 32 / d2 Ø 28,8
Thread: M26 x 1,5 RHT
0014601548, 0014601648, 0024600648,
A0014601648, A0024600648



DB-RK-8626

Ø: 75 Hole Distance: 130
Thick/Height: 24
0003502205, 0003502505, 0003503405,
0003504505, GL11319



DB-RK-9294

Ø: 85 Hole Distance: 152
Thick/Height: 24
0003503105



DB-RK-10374

Ø: 85 Hole Distance: 152
Thick/Height: 24
0003504405



DB-SB-10406

Ø: 80 Thick/Height: 46
0003238185



DB-VB-7261

Length: 622 Ø: 46
Hole Ø 25 / 25 / 25
Hole Distance: 152 / 130 / 130
01337800A, 9443500305, 9443500505,
9443500605, 9473500705, 9473500905,
9483500405, 9483503005



DB-VB-10426

Length: 622 Ø: 46
Hole Ø 25 / 25 / 25
Hole Distance: 152 / 130 / 130
9443500405



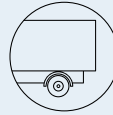

ACTROS MP2 / MP3 ...

3244 ...	04/03→	Track Control Arm		DB-DL-3475	Trailing Arm, 1st RA;2nd RA, →517144 03/517144 06	
	04/03→	Track Control Arm		DB-DL-3475	Trailing Arm, 1st RA;2nd RA, →517144 05/517144 08	
	04/03→	Track Control Arm		DB-DL-3475	Trailing Arm, 1st RA;2nd RA, →517144 07/517144 09	
	04/03→	Track Control Arm		DB-DL-3475	Trailing Arm, 1st RA;2nd RA, →517144 26/517144 27	
	04/03→	Track Control Arm		DB-VB-7261	Suspension Rod, Wishbone (CV)	
	04/03→	Track Control Arm		DB-VB-7261	Suspension Rod, Wishbone (CV), 1st RA;2nd RA; Leaf Spring Axle	
	04/03→	Track Control Arm		DB-VB-10426	Wishbone (CV), Leaf Spring Axle;Unit	
3244 B	04/03→	Centre Rod	DB-DL-8168		Push Rod	
	04/03→	Centre Rod	DB-DL-8184		Push Rod, Leaf Spring Axle	
	04/03→	Centre Rod	DB-DL-8185		Push Rod, Leaf Spring Axle	
	04/03→	Centre Rod	DB-DL-12300		for Steering Rod	
	04/03→	Stabiliser Link	DB-DL-9254		Pressure Rod	
	04/03→	Stabiliser Link	DB-DL-9271		Pressure Rod	
	04/03→	Stabiliser Link	DB-DL-9272		Pressure Rod	
	04/03→	Stabiliser Mounting		DB-SB-10406		
	04/03→	Suspension Strut Repair Kit		DB-RK-9294		
	04/03→	Tie Rod	DB-DL-8172		Guide Rod	
	04/03→	Tie Rod	DB-DL-8640		Guide Rod	
	04/03→	Tie Rod	DB-DL-12310			
	04/03→	Tie Rod End	CV-ES-0543		for Push Rod	
	04/03→	Tie Rod End	CV-ES-0888		for Push Rod	
	04/03→	Track Control Arm		DB-DL-3475	Trailing Arm, 1st RA;2nd RA, →517144 05/517144 08	
	04/03→	Track Control Arm		DB-VB-7261	Suspension Rod, Wishbone (CV), 1st RA;2nd RA; Leaf Spring Axle	
	04/03→	Track Control Arm		DB-VB-10426	Wishbone (CV), Leaf Spring Axle;Unit	
3244 K	04/03→	Centre Rod	DB-DL-8168		Push Rod, Leaf Spring Axle	
	04/03→	Centre Rod	DB-DL-8184		Push Rod, Leaf Spring Axle	
	04/03→	Centre Rod	DB-DL-8185		Push Rod, Leaf Spring Axle	
	04/03→	Centre Rod	DB-DL-12300		for Steering Rod	
	04/03→	Stabiliser Mounting		DB-SB-10406		
	04/03→	Suspension Strut Repair Kit		DB-RK-9294		
	04/03→	Tie Rod	DB-DL-8171		Guide Rod	
	04/03→	Tie Rod	DB-DL-8172		Guide Rod	
	04/03→	Tie Rod	DB-DL-8390			
	04/03→	Tie Rod	DB-DL-8640		Guide Rod	
	04/03→	Tie Rod	DB-DL-12310			
	04/03→	Tie Rod	DB-ES-5227		Guide Rod	
	04/03→	Tie Rod End	CV-ES-0543		for Push Rod	
	04/03→	Tie Rod End	CV-ES-0888		for Push Rod	
	04/03→	Track Control Arm		DB-DL-3475	Trailing Arm, 1st RA;2nd RA, →517144 05/517144 08	
	04/03→	Track Control Arm		DB-VB-7261	Suspension Rod, Wishbone (CV), 1st RA;2nd RA; Leaf Spring Axle	
	04/03→	Track Control Arm		DB-VB-10426	Wishbone (CV), Leaf Spring Axle;Unit	
	3246	04/03→	Centre Rod	DB-DL-8168		Push Rod
		04/03→	Centre Rod	DB-DL-8184		Push Rod
04/03→		Centre Rod	DB-DL-8185		Push Rod	
04/03→		Centre Rod	DB-DL-12300		for Steering Rod	
04/03→		Stabiliser Link	DB-DL-9254		Pressure Rod	
04/03→		Stabiliser Link	DB-DL-9271		Pressure Rod	
04/03→		Stabiliser Link	DB-DL-9272		Pressure Rod	
04/03→		Stabiliser Mounting		DB-SB-10406		
04/03→		Suspension Strut Repair Kit		DB-RK-9294		
04/03→		Tie Rod	DB-DL-8172		Guide Rod, 2nd FA	
04/03→		Tie Rod	DB-DL-8640		Guide Rod	
04/03→		Tie Rod	DB-DL-12310			
04/03→		Tie Rod	DB-ES-5227		Guide Rod	

CV-ES-0543

Length: 125
Cone Ø: d1 Ø 32 / d2 Ø 29
Thread: M30 x 1,5 RHT
0004605748, 0004606048, 0004606848,
0004607048, 0014600448, 0014601148,
0014601748, 0014602448, 0014607648,
0014609648



CV-ES-0888

Length: 125
Cone Ø: d1 Ø 32 / d2 Ø 29
Thread: M30 x 1,5 LHT
0004605848, 0004606148, 0004606948,
0004607148, 0004609048, 0014600548,
0014601348, 0014602548, 0014607948,
0024600448



DB-DL-3475

Length: 565 Ø: 52
Hole Distance: 152 / 152
3753500006, 3753500206, 9473500805,
9483500006, 9483500805, 9483501205,
9483501305, 9483501905, 9483502005,
9483502405, A3753500006, A3753500206



DB-DL-8168

Length: 904 Ø: 52
Cone Ø: d1 Ø 32 / d2 Ø 29
0004609405, 0004609505, 0014607105



DB-DL-8171

Length: 1687 Ø: 52
Cone Ø: d1 Ø 32 / d2 Ø 29
9493300603, 9493300703, 9493301503,
9493301603



DB-DL-8172

Length: 1700 Ø: 52
Cone Ø: d1 Ø 32 / d2 Ø 29
01219700A, 9493300403, 9493300503,
9493300803, 9493301403



DB-DL-8184

Length: 1095 Ø: 42
Cone Ø: d1 Ø 32 / d2 Ø 28,8
01217700A, 0014601305, 0014601405,
0024600505, 0034603205, 3754601505,
A014601305, A014601405, A0024600505



DB-DL-8185

Length: 711 Ø: 42
Cone Ø: d1 Ø 32 / d2 Ø 28,8
01213600A, 0014601105, 0024600405,
0034603105, A014601105, A0024600405



DB-DL-8390

Length: 1596 Ø: 50
Cone Ø: d1 Ø 32 / d2 Ø 29
9493301003, 9493301103, 9493301703



DB-DL-8640

Length: 1615 Ø: 50
Cone Ø: d1 Ø 32 / d2 Ø 29
6253301503, 6253301603, 6253302403,
6253302503, 9423300803, 9423302103,
9493300203, 9493300303, 9493300903



DB-DL-9254

Length: 1815 Ø: 58
0003220323, 0003220623, 3753220423



DB-DL-9271

Length: 1815 Ø: 60
0003220423, 0003220723



DB-DL-9272

Length: 1815 Ø: 80
0003220223



DB-DL-12300

Length: 733 Ø: 36
Cone Ø: d1 Ø 32 / d2 Ø 29
0014601505, 0014607305, 0034603305,
3754601605, A014601505, A0034603305,
A3754601605



DB-DL-12310

Length: 1532 Ø: 50
Cone Ø: d1 Ø 32 / d2 Ø 29
Thread: M27 x 1,5 LHT
9493301203, 9493301303, 9493301803,
9493302203, A9493301203, A9493301303,
A9493301803, A9493302203



DB-ES-5227

Length: 1588 Ø: 60
Cone Ø: d1 Ø 38 / d2 Ø 34,3
6253300903, 6253301203, 9443300203



DB-RK-9294

Ø: 85 Hole Distance: 152
Thick/Height: 24
0003503105



DB-SB-10406

Ø: 80 Thick/Height: 46
0003238185



DB-VB-7261

Length: 622 Ø: 46
Hole Ø 25 / 25 / 25
Hole Distance: 152 / 130 / 130
01337800A, 9443500305, 9443500505,
9443500605, 9473500705, 9473500905,
9483500405, 9483503005



DB-VB-10426

Length: 622 Ø: 46
Hole Ø 25 / 25 / 25
Hole Distance: 152 / 130 / 130
9443500405





ACTROS MP2 / MP3 ...

3246 ...	04/03→	Tie Rod End	CV-ES-0543		for Push Rod	
	04/03→	Tie Rod End	CV-ES-0888		for Push Rod	
	04/03→	Tie Rod End	DB-ES-8323			
	04/03→	Track Control Arm		DB-DL-3475	Trailing Arm, 1st RA;2nd RA, →517144 03/517144 06	
	04/03→	Track Control Arm		DB-DL-3475	Trailing Arm, 1st RA;2nd RA, →517144 05/517144 08	
	04/03→	Track Control Arm		DB-DL-3475	Trailing Arm, 1st RA;2nd RA, →517144 07/517144 09	
	04/03→	Track Control Arm		DB-DL-3475	Trailing Arm, 1st RA;2nd RA, →517144 26/517144 27	
	04/03→	Track Control Arm		DB-VB-7261	Suspension Rod, Wishbone (CV)	
3246 B	04/03→	Track Control Arm		DB-VB-10426	Wishbone (CV), Leaf Spring Axle;Unit	
	04/03→	Centre Rod	DB-DL-8168		Push Rod	
	04/03→	Centre Rod	DB-DL-8184		Push Rod, Leaf Spring Axle	
	04/03→	Centre Rod	DB-DL-8185		Push Rod, Leaf Spring Axle	
	04/03→	Centre Rod	DB-DL-12300		for Steering Rod	
	04/03→	Stabiliser Link	DB-DL-9254		Pressure Rod	
	04/03→	Stabiliser Link	DB-DL-9271		Pressure Rod	
	04/03→	Stabiliser Link	DB-DL-9272		Pressure Rod	
	04/03→	Stabiliser Mounting		DB-SB-10406		
	04/03→	Suspension Strut Repair Kit		DB-RK-9294		
	04/03→	Tie Rod	DB-DL-8172		Guide Rod	
	04/03→	Tie Rod	DB-DL-8640		Guide Rod	
	04/03→	Tie Rod	DB-DL-12310			
	04/03→	Tie Rod End	CV-ES-0543		for Push Rod	
	04/03→	Tie Rod End	CV-ES-0888		for Push Rod	
	04/03→	Track Control Arm		DB-DL-3475	Trailing Arm, 1st RA;2nd RA, →517144 05/517144 08	
	04/03→	Track Control Arm		DB-VB-7261	Suspension Rod, Wishbone (CV), 1st RA;2nd RA; Leaf Spring Axle	
	04/03→	Track Control Arm		DB-VB-10426	Wishbone (CV), Leaf Spring Axle;Unit	
	3246 K	04/03→	Bush, driver cab suspension	DB-SB-10384		
		04/03→	Centre Rod	DB-DL-8168		Push Rod, Leaf Spring Axle
04/03→		Centre Rod	DB-DL-8184		Push Rod, Leaf Spring Axle	
04/03→		Centre Rod	DB-DL-8185		Push Rod, Leaf Spring Axle	
04/03→		Centre Rod	DB-DL-8307		Push Rod	
04/03→		Centre Rod	DB-DL-12300		for Steering Rod	
04/03→		Stabiliser Mounting		DB-SB-10406		
04/03→		Stabiliser Mounting		DB-SB-10409		
04/03→		Suspension Arm Repair Kit		DB-RK-8626	for Wishbone (CV)	
04/03→		Suspension Arm Repair Kit		DB-RK-10374	for Wishbone (CV)	
04/03→		Suspension Arm Repair Kit		DB-RK-10375	for Wishbone (CV)	
04/03→		Suspension Arm Repair Kit	DB-RK-8638		for Control Arm	
04/03→		Suspension Strut Repair Kit		DB-RK-8391		
04/03→		Suspension Strut Repair Kit		DB-RK-9294		
04/03→		Tie Rod	DB-DL-8171		Guide Rod	
04/03→		Tie Rod	DB-DL-8172		Guide Rod	
04/03→		Tie Rod	DB-DL-8390			
04/03→		Tie Rod	DB-DL-8640		Guide Rod	
04/03→		Tie Rod	DB-DL-12310			
04/03→		Tie Rod	DB-ES-5227		Guide Rod	
04/03→		Tie Rod End	CV-ES-0543		for Push Rod	
04/03→		Tie Rod End	CV-ES-0888		for Push Rod	
04/03→		Tie Rod End	DB-ES-5234		for Steering Rod	
04/03→		Tie Rod End	DB-ES-8530		for Push Rod	
04/03→		Track Control Arm		DB-DL-3475	Trailing Arm, 1st RA;2nd RA, →517144 05/517144 08	
04/03→		Track Control Arm		DB-VB-7261	Suspension Rod, Wishbone (CV), 1st RA;2nd RA; Leaf Spring Axle	
04/03→		Track Control Arm		DB-VB-10426	Wishbone (CV), Leaf Spring Axle;Unit	

CV-ES-0543

Length: 125
Cone Ø: d1 Ø 32 / d2 Ø 29
Thread: M30 x 1,5 RHT
0004605748, 0004606048, 0004606848,
0004607048, 0014600448, 0014601148,
0014601748, 0014602448, 0014607648,
0014609648



CV-ES-0888

Length: 125
Cone Ø: d1 Ø 32 / d2 Ø 29
Thread: M30 x 1,5 LHT
0004605848, 0004606148, 0004606948,
0004607148, 0004609048, 0014600548,
0014601348, 0014602548, 0014607948,
0024600448



DB-DL-3475

Length: 565 Ø: 52
Hole Distance: 152 / 152
3753500006, 3753500206, 9473500805,
9483500006, 9483500805, 9483501205,
9483501305, 9483501905, 9483502005,
9483502405, A3753500006, A3753500206



DB-DL-8168

Length: 904 Ø: 52
Cone Ø: d1 Ø 32 / d2 Ø 29
0004609405, 0004609505, 0014607105



DB-DL-8171

Length: 1687 Ø: 52
Cone Ø: d1 Ø 32 / d2 Ø 29
9493300603, 9493300703, 9493301503,
9493301603



DB-DL-8172

Length: 1700 Ø: 52
Cone Ø: d1 Ø 32 / d2 Ø 29
01219700A, 9493300403, 9493300503,
9493300803, 9493301403



DB-DL-8184

Length: 1095 Ø: 42
Cone Ø: d1 Ø 32 / d2 Ø 28,8
01217700A, 0014601305, 0014601405,
0024600505, 0034603205, 3754601505,
A0014601305, A0014601405, A0024600505



DB-DL-8185

Length: 711 Ø: 42
Cone Ø: d1 Ø 32 / d2 Ø 28,8
01213600A, 0014601105, 0024600405,
0034603105, A0014601105, A0024600405



DB-DL-8307

Length: 885 Ø: 38
Cone Ø: d1 Ø 32 / d2 Ø 30
01215500A, 0004604005, 0024605105,
0024605205, 0034604005



DB-DL-8390

Length: 1596 Ø: 50
Cone Ø: d1 Ø 32 / d2 Ø 29
9493301003, 9493301103, 9493301703



DB-DL-8640

Length: 1615 Ø: 50
Cone Ø: d1 Ø 32 / d2 Ø 29
6253301503, 6253301603, 6253302403,
6253302503, 9423300803, 9423302103,
9493300203, 9493300303, 9493300903



DB-DL-9254

Length: 1815 Ø: 58
0003220323, 0003220623, 3753220423



DB-DL-9271

Length: 1815 Ø: 60
0003220423, 0003220723



DB-DL-9272

Length: 1815 Ø: 80
0003220223



DB-DL-12300

Length: 733 Ø: 36
Cone Ø: d1 Ø 32 / d2 Ø 29
0014601505, 0014607305, 0034603305,
3754601605, A0014601505, A0034603305,
A3754601605



DB-DL-12310

Length: 1532 Ø: 50
Cone Ø: d1 Ø 32 / d2 Ø 29
Thread: M27 x 1,5 LHT
9493301203, 9493301303, 9493301803,
9493302203, A9493301203, A9493301303,
A9493301803, A9493302203



DB-ES-5227

Length: 1588 Ø: 60
Cone Ø: d1 Ø 38 / d2 Ø 34,3
6253300903, 6253301203, 9443300203



DB-ES-5234

Length: 135
Cone Ø: d1 Ø 38 / d2 Ø 34,3
Thread: M38 x 1,5 RHT
0004601748, 120322305, 2205000400



DB-ES-8323

Length: 75
Cone Ø: d1 Ø 32 / d2 Ø 28,8
Thread: M26 x 1,5 RHT
0014601548, 0014601648, 0024600648,
A0014601648, A0024600648



DB-ES-8530

Length: 115
Cone Ø: d1 Ø 28,6 / d2 Ø 23,9
Thread: M30 x 1,5 RHT
0014603848, 0014604848, 0014605148,
0014608648, 0014609948



DB-RK-8391

Ø: 85 Hole Distance: 152
Thick/Height: 24
01336800A, 0003502705



DB-RK-8626

Ø: 75 Hole Distance: 130
Thick/Height: 24
0003502205, 0003502505, 0003503405,
0003504505, GL11319



DB-RK-8638

Length: 100 Ø: 67
Hole Distance: 100
Thick/Height: 20
0003301411



DB-RK-9294

Ø: 85 Hole Distance: 152
Thick/Height: 24
0003503105



DB-RK-10374

Ø: 85 Hole Distance: 152
Thick/Height: 24
0003504405



DB-RK-10375

Ø: 100 Hole Distance: 152
Thick/Height: 24
0003502405, 0003503505, 0003504905



DB-SB-10384

Ø: 73 Thick/Height: 47
9303170012, 9423171812



DB-SB-10406

Ø: 80 Thick/Height: 46
0003238185



DB-SB-10409

Ø: 77 Thick/Height: 56
0003265181



DB-VB-7261

Length: 622 Ø: 46
Hole Ø 25 / 25 / 25
Hole Distance: 152 / 130 / 130
01337800A, 9443500305, 9443500505,
9443500605, 9473500705, 9473500905,
9483500405, 9483503005



DB-VB-10426

Length: 622 Ø: 46
Hole Ø 25 / 25 / 25
Hole Distance: 152 / 130 / 130
9443500405





ACTROS MP2 / MP3 ...

3248 B	04/03→	Centre Rod	DB-DL-8168	Push Rod
	04/03→	Centre Rod	DB-DL-8184	Push Rod, Leaf Spring Axle
	04/03→	Centre Rod	DB-DL-8185	Push Rod, Leaf Spring Axle
	04/03→	Centre Rod	DB-DL-12300	for Steering Rod
	04/03→	Stabiliser Link	DB-DL-9254	Pressure Rod
	04/03→	Stabiliser Link	DB-DL-9271	Pressure Rod
	04/03→	Stabiliser Link	DB-DL-9272	Pressure Rod
	04/03→	Stabiliser Mounting		DB-SB-10406
	04/03→	Suspension Strut Repair Kit		DB-RK-9294
	04/03→	Tie Rod	DB-DL-8172	Guide Rod
	04/03→	Tie Rod	DB-DL-8640	Guide Rod
	04/03→	Tie Rod	DB-DL-12310	
	04/03→	Tie Rod End	CV-ES-0543	for Push Rod
	04/03→	Tie Rod End	CV-ES-0888	for Push Rod
	04/03→	Track Control Arm		DB-DL-3475 Trailing Arm, 1st RA;2nd RA, →517144 05/517144 08
	04/03→	Track Control Arm		DB-VB-7261 Suspension Rod, Wishbone (CV), 1st RA;2nd RA; Leaf Spring Axle
	04/03→	Track Control Arm		DB-VB-10426 Wishbone (CV), Leaf Spring Axle;Unit
3248 K	04/03→	Centre Rod	DB-DL-8168	Push Rod, Leaf Spring Axle
	04/03→	Centre Rod	DB-DL-8184	Push Rod, Leaf Spring Axle
	04/03→	Centre Rod	DB-DL-8185	Push Rod, Leaf Spring Axle
	04/03→	Centre Rod	DB-DL-12300	for Steering Rod
	04/03→	Stabiliser Mounting		DB-SB-10406
	04/03→	Suspension Strut Repair Kit		DB-RK-9294
	04/03→	Tie Rod	DB-DL-8171	Guide Rod
	04/03→	Tie Rod	DB-DL-8172	Guide Rod
	04/03→	Tie Rod	DB-DL-8390	
	04/03→	Tie Rod	DB-DL-8640	Guide Rod
	04/03→	Tie Rod	DB-DL-12310	
	04/03→	Tie Rod	DB-ES-5227	Guide Rod
	04/03→	Tie Rod End	CV-ES-0543	for Push Rod
	04/03→	Tie Rod End	CV-ES-0888	for Push Rod
	04/03→	Track Control Arm		DB-DL-3475 Trailing Arm, 1st RA;2nd RA, →517144 05/517144 08
	04/03→	Track Control Arm		DB-VB-7261 Suspension Rod, Wishbone (CV), 1st RA;2nd RA; Leaf Spring Axle
	04/03→	Track Control Arm		DB-VB-10426 Wishbone (CV), Leaf Spring Axle;Unit
3248, L	04/03→	Centre Rod	DB-DL-8168	Push Rod
	04/03→	Centre Rod	DB-DL-8184	Push Rod
	04/03→	Centre Rod	DB-DL-8185	Push Rod
	04/03→	Centre Rod	DB-DL-12300	for Steering Rod
	04/03→	Stabiliser Link	DB-DL-9254	Pressure Rod
	04/03→	Stabiliser Link	DB-DL-9271	Pressure Rod
	04/03→	Stabiliser Link	DB-DL-9272	Pressure Rod
	04/03→	Stabiliser Mounting		DB-SB-10406
	04/03→	Suspension Strut Repair Kit		DB-RK-9294
	04/03→	Tie Rod	DB-DL-8172	Guide Rod, 2nd FA
	04/03→	Tie Rod	DB-DL-8640	Guide Rod
	04/03→	Tie Rod	DB-DL-12310	
	04/03→	Tie Rod	DB-ES-5227	Guide Rod
	04/03→	Tie Rod End	CV-ES-0543	for Push Rod
	04/03→	Tie Rod End	CV-ES-0888	for Push Rod
	04/03→	Tie Rod End	DB-ES-8323	
	04/03→	Track Control Arm		DB-DL-3475 Trailing Arm, 1st RA;2nd RA, →517144 03/517144 06
	04/03→	Track Control Arm		DB-DL-3475 Trailing Arm, 1st RA;2nd RA, →517144 05/517144 08
	04/03→	Track Control Arm		DB-DL-3475 Trailing Arm, 1st RA;2nd RA, →517144 07/517144 09
	04/03→	Track Control Arm		DB-DL-3475 Trailing Arm, 1st RA;2nd RA, →517144 26/517144 27
04/03→	Track Control Arm		DB-VB-7261 Suspension Rod, Wishbone (CV)	
04/03→	Track Control Arm		DB-VB-10426 Wishbone (CV), Leaf Spring Axle;Unit	

CV-ES-0543

Length: 125
Cone Ø: d1 Ø 32 / d2 Ø 29
Thread: M30 x 1,5 RHT
0004605748, 0004606048, 0004606848,
0004607048, 0014600448, 0014601148,
0014601748, 0014602448, 0014607648,
0014609648



CV-ES-0888

Length: 125
Cone Ø: d1 Ø 32 / d2 Ø 29
Thread: M30 x 1,5 LHT
0004605848, 0004606148, 0004606948,
0004607148, 0004609048, 0014600548,
0014601348, 0014602548, 0014607948,
0024600448



DB-DL-3475

Length: 565 Ø: 52
Hole Distance: 152 / 152
3753500006, 3753500206, 9473500805,
9483500006, 9483500805, 9483501205,
9483501305, 9483501905, 9483502005,
9483502405, A3753500006, A3753500206



DB-DL-8168

Length: 904 Ø: 52
Cone Ø: d1 Ø 32 / d2 Ø 29
0004609405, 0004609505, 0014607105



DB-DL-8171

Length: 1687 Ø: 52
Cone Ø: d1 Ø 32 / d2 Ø 29
9493300603, 9493300703, 9493301503,
9493301603



DB-DL-8172

Length: 1700 Ø: 52
Cone Ø: d1 Ø 32 / d2 Ø 29
01219700A, 9493300403, 9493300503,
9493300803, 9493301403



DB-DL-8184

Length: 1095 Ø: 42
Cone Ø: d1 Ø 32 / d2 Ø 28,8
01217700A, 0014601305, 0014601405,
0024600505, 0034603205, 3754601505,
A0014601305, A0014601405, A0024600505



DB-DL-8185

Length: 711 Ø: 42
Cone Ø: d1 Ø 32 / d2 Ø 28,8
01213600A, 0014601105, 0024600405,
0034603105, A0014601105, A0024600405



DB-DL-8390

Length: 1596 Ø: 50
Cone Ø: d1 Ø 32 / d2 Ø 29
9493301003, 9493301103, 9493301703



DB-DL-8640

Length: 1615 Ø: 50
Cone Ø: d1 Ø 32 / d2 Ø 29
6253301503, 6253301603, 6253302403,
6253302503, 9423300803, 9423302103,
9493300203, 9493300303, 9493300903



DB-DL-9254

Length: 1815 Ø: 58
0003220323, 0003220623, 3753220423



DB-DL-9271

Length: 1815 Ø: 60
0003220423, 0003220723



DB-DL-9272

Length: 1815 Ø: 80
0003220223



DB-DL-12300

Length: 733 Ø: 36
Cone Ø: d1 Ø 32 / d2 Ø 29
0014601505, 0014607305, 0034603305,
3754601605, A0014601505, A0034603305,
A3754601605



DB-DL-12310

Length: 1532 Ø: 50
Cone Ø: d1 Ø 32 / d2 Ø 29
Thread: M27 x 1,5 LHT
9493301203, 9493301303, 9493301803,
9493302203, A9493301203, A9493301303,
A9493301803, A9493302203



DB-ES-5227

Length: 1588 Ø: 60
Cone Ø: d1 Ø 38 / d2 Ø 34,3
6253300903, 6253301203, 9443300203



DB-ES-8323

Length: 75
Cone Ø: d1 Ø 32 / d2 Ø 28,8
Thread: M26 x 1,5 RHT
0014601548, 0014601648, 0024600648,
A0014601648, A0024600648



DB-RK-9294

Ø: 85 Hole Distance: 152
Thick/Height: 24
0003503105



DB-SB-10406

Ø: 80 Thick/Height: 46
0003238185



DB-VB-7261

Length: 622 Ø: 46
Hole Ø 25 / 25 / 25
Hole Distance: 152 / 130 / 130
01337800A, 9443500305, 9443500505,
9443500605, 9473500705, 9473500905,
9483500405, 9483503005



DB-VB-10426

Length: 622 Ø: 46
Hole Ø 25 / 25 / 25
Hole Distance: 152 / 130 / 130
9443500405





ACTROS MP2 / MP3 ...

3250	04/03→	Ball Head, gearshift linkage	DB-ES-8387		
	04/03→	Ball Head, gearshift linkage	DB-ES-8491		
	04/03→	Ball Head, gearshift linkage	DB-ES-8492		
	04/03→	Ball Head, gearshift linkage	DB-ES-8500		
	04/03→	Bush, parabolic spring		DB-SB-10400	
	04/03→	Bush, parabolic spring		DB-SB-10401	
	04/03→	Centre Rod	DB-DL-5230	Push Rod	
	04/03→	Centre Rod	DB-DL-5405	Push Rod	
	04/03→	Centre Rod	DB-DL-8167	Push Rod	
	04/03→	Centre Rod	DB-DL-8702	Push Rod	
	04/03→	Tie Rod	DB-DL-8171	Guide Rod	
	04/03→	Tie Rod	DB-DL-8327	Guide Rod	
	04/03→	Tie Rod	DB-DL-8640	Guide Rod	
	04/03→	Tie Rod	DB-DL-12310		
3255 L	02/09→	Bush, parabolic spring		DB-SB-10400	
	02/09→	Bush, parabolic spring		DB-SB-10401	
	02/09→	Centre Rod	DB-DL-5405	Push Rod	
	02/09→	Centre Rod	DB-DL-8702	Push Rod	
	02/09→	Tie Rod	DB-DL-8171	Guide Rod	
	02/09→	Tie Rod	DB-DL-8327	Guide Rod	
	02/09→	Tie Rod	DB-DL-8640	Guide Rod	
	02/09→	Tie Rod	DB-DL-12310		
	02/09→	Track Control Arm		DB-VB-7261	Suspension Rod, Wishbone (CV)
	02/09→	Track Control Arm		DB-VB-9307	Suspension Rod, Wishbone (CV)
	02/09→	Track Control Arm		DB-VB-9308	Suspension Rod, Wishbone (CV)
	3260 L	02/09→	Bush, parabolic spring		DB-SB-10400
		02/09→	Bush, parabolic spring		DB-SB-10401
		02/09→	Centre Rod	DB-DL-5405	Push Rod
02/09→		Centre Rod	DB-DL-8702	Push Rod	
02/09→		Tie Rod	DB-DL-8171	Guide Rod	
02/09→		Tie Rod	DB-DL-8327	Guide Rod	
02/09→		Tie Rod	DB-DL-8640	Guide Rod	
02/09→		Tie Rod	DB-DL-12310		
02/09→		Track Control Arm		DB-VB-7261	Suspension Rod, Wishbone (CV)
02/09→		Track Control Arm		DB-VB-9307	Suspension Rod, Wishbone (CV)
02/09→		Track Control Arm		DB-VB-9308	Suspension Rod, Wishbone (CV)
3331 A, 3332 A		04/03→	Ball Head, gearshift linkage	DB-ES-8510	
		04/03→	Bush, driver cab suspension	DB-SB-10384	
		04/03→	Bush, parabolic spring		DB-SB-10401
	04/03→	Centre Rod	DB-DL-8168	Push Rod	
	04/03→	Centre Rod	DB-DL-8184	Push Rod	
	04/03→	Centre Rod	DB-DL-8307	Push Rod, Leaf Spring Axle	
	04/03→	Centre Rod	DB-DL-8622	Push Rod	
	04/03→	Centre Rod	DB-DL-8641	Push Rod	
	04/03→	Centre Rod	DB-DL-8642	Push Rod	
	04/03→	Centre Rod	DB-DL-8702	Push Rod, Leaf Spring Axle	
	04/03→	Centre Rod	DB-DL-12300	for Steering Rod	
	04/03→	Stabiliser Link	DB-DL-9254	Pressure Rod	
	04/03→	Stabiliser Mounting		DB-SB-10406	
	04/03→	Stabiliser Mounting		DB-SB-10409	
	04/03→	Stabiliser Mounting	DB-SB-10410		
	04/03→	Suspension Arm Repair Kit		DB-RK-8550	for Wishbone (CV)
	04/03→	Suspension Arm Repair Kit		DB-RK-8626	for Wishbone (CV)
	04/03→	Suspension Arm Repair Kit		DB-RK-10374	for Wishbone (CV)
	04/03→	Suspension Arm Repair Kit		DB-RK-10375	for Wishbone (CV)
	04/03→	Suspension Arm Repair Kit	DB-RK-8638		for Control Arm
	04/03→	Suspension Strut Repair Kit		DB-RK-8391	
	04/03→	Suspension Strut Repair Kit		DB-RK-8710	
	04/03→	Suspension Strut Repair Kit		DB-RK-9291	
	04/03→	Tie Rod	DB-DL-12310		
	04/03→	Tie Rod	DB-ES-5227		Guide Rod, 1st FA;Leaf Spring Axle
	04/03→	Tie Rod	MN-DL-7834		Guide Rod, 1st FA;Leaf Spring Axle

DB-DL-5230

Length: 879 Ø: 42
 Cone Ø: d1 Ø 30 / d2 Ø 27
 01208600A, 0004607105, 0004607205,
 0014606705

**DB-DL-5405**

Length: 890 Ø: 35
 Cone Ø: d1 Ø 28,6 / d2 Ø 23,9
 01215900A, 1460248, 0024604505, 0024604605,
 0034605005, 3752600637, 3754600405,
 A3752600637, A3754600405

**DB-DL-8167**

Length: 866 Ø: 38
 Cone Ø: d1 Ø 30 / d2 Ø 27
 0014609805, 0014609905, 0024606305,
 0024606405

**DB-DL-8168**

Length: 904 Ø: 52
 Cone Ø: d1 Ø 32 / d2 Ø 29
 0004609405, 0004609505, 0014607105

**DB-DL-8171**

Length: 1687 Ø: 52
 Cone Ø: d1 Ø 32 / d2 Ø 29
 9493300603, 9493300703, 9493301503,
 9493301603

**DB-DL-8184**

Length: 1095 Ø: 42
 Cone Ø: d1 Ø 32 / d2 Ø 28,8
 01217700A, 0014601305, 0014601405,
 0024605005, 0034603205, 3754601505,
 A0014601305, A0014601405, A0024600505

**DB-DL-8307**

Length: 885 Ø: 38
 Cone Ø: d1 Ø 32 / d2 Ø 30
 01215500A, 0004604005, 0024605105,
 0024605205, 0034604005

**DB-DL-8327**

Length: 1745 Ø: 48
 Cone Ø: d1 Ø 32 / d2 Ø 29
 01219800A, 9413300003, 9413300103,
 9413300203, 9413300303, 9413300503

**DB-DL-8622**

Length: 1558 Ø: 52
 Cone Ø: d1 Ø 30 / d2 Ø 27
 0014609005, 0014609105

**DB-DL-8640**

Length: 1615 Ø: 50
 Cone Ø: d1 Ø 32 / d2 Ø 29
 6253301503, 6253301603, 6253302403,
 6253302503, 9423300803, 9423302103,
 9493300203, 9493300303, 9493300903

**DB-DL-8641**

Length: 905 Ø: 42
 Cone Ø: d1 Ø 30 / d2 Ø 27
 0014605105, 0014608105

**DB-DL-8642**

Length: 954 Ø: 42
 Cone Ø: d1 Ø 30 / d2 Ø 27
 0014608605, 0014608705

**DB-DL-8702**

Length: 958 Ø: 38
 Cone Ø: d1 Ø 32 / d2 Ø 30
 0024606105, 0024606205, 0034604205

**DB-DL-9254**

Length: 1815 Ø: 58
 0003220323, 0003220623, 3753220423

**DB-DL-12300**

Length: 733 Ø: 36
 Cone Ø: d1 Ø 32 / d2 Ø 29
 0014601505, 0014607305, 0034603305,
 3754601605, A0014601505, A0034603305,
 A3754601605

**DB-DL-12310**

Length: 1532 Ø: 50
 Cone Ø: d1 Ø 32 / d2 Ø 29
 Thread: M27 x 1,5 LHT
 9493301203, 9493301303, 9493301803,
 9493302203, A9493301203, A9493301303,
 A9493301803, A9493302203

**DB-ES-5227**

Length: 1588 Ø: 60
 Cone Ø: d1 Ø 38 / d2 Ø 34,3
 6253300903, 6253301203, 9443300203

**DB-ES-8387**

Length: 55
 Cone Ø: d1 Ø 10 / d2 Ø 10
 Thread: M14 x 1,5 RHT
 0009966845, 0009967045

**DB-ES-8491**

Length: 60
 Cone Ø: d1 Ø 10 / d2 Ø 10
 Thread: M12 x 1,75 LHT
 0009966745

**DB-ES-8492**

Length: 60
 Cone Ø: d1 Ø 10 / d2 Ø 10
 Thread: M12 x 1,75 RHT
 0009966645, 3752680189, A3752680189

**DB-ES-8500**

Length: 55
 Cone Ø: d1 Ø 12 / d2 Ø 10,8
 Thread: M14 x 1,5 RHT
 0002685989

**DB-ES-8510**

Length: 56
 Cone Ø: d1 Ø 10 / d2 Ø 10
 Thread: M12 x 1,75 LHT
 0009965145, 0009965645, 0019963145

**DB-RK-8391**

Ø: 85 Hole Distance: 152
 Thick/Height: 24
 01336800A, 0003502705

**DB-RK-8550**

Ø: 75 Hole Distance: 152
 Thick/Height: 24
 0003502105, 0003504605

**DB-RK-8626**

Ø: 75 Hole Distance: 130
 Thick/Height: 24
 0003502205, 0003502505, 0003503405,
 0003504505, GL11319

**DB-RK-8638**

Length: 100 Ø: 67
 Hole Distance: 100
 Thick/Height: 20
 0003301411

**DB-RK-8710**

Ø: 85 Hole Distance: 130
 Thick/Height: 30
 0003503705

**DB-RK-9291**

Ø: 107,5 Hole Distance: 152
 Thick/Height: 30
 0003503605

**DB-RK-10374**

Ø: 85 Hole Distance: 152
 Thick/Height: 24
 0003504405

**DB-RK-10375**

Ø: 100 Hole Distance: 152
 Thick/Height: 24
 0003502405, 0003503505, 0003504905

**DB-SB-10384**

Ø: 73 Thick/Height: 47
 9303170012, 9423171812

**DB-SB-10400**

Length: 230
 Thick/Height: 167,5 / 115
 0003250596, 0003250896

**DB-SB-10401**

Length: 232
 Thick/Height: 163,5 / 152,5
 0003250596, 0003250796

**DB-SB-10406**

Ø: 80 Thick/Height: 46
 0003238185

**DB-SB-10409**

Ø: 77 Thick/Height: 56
 0003265181

**DB-SB-10410**

Ø: 73 Hole Distance: 100
 Thick/Height: 24
 9413230050

**DB-VB-7261**

Length: 622 Ø: 46
 Hole Ø 25 / 25 / 25
 Hole Distance: 152 / 130 / 130
 01337800A, 9443500305, 9443500505,
 9443500605, 9473500705, 9473500905,
 9483500405, 9483503005

**DB-VB-9307**

Length: 667 Ø: 80
 Hole Ø 25 / 23 / 23
 Hole Distance: 152 / 130 / 130
 9483502805

**DB-VB-9308**

Length: 622 Ø: 46
 Hole Ø 25 / 25 / 25
 Hole Distance: 152 / 130 / 130
 9483502905

**MN-DL-7834**

Length: 1588 Ø: 58
 Cone Ø: d1 Ø 30 / d2 Ø 27
 3463303903, 3463304903, 6253303203,
 9443300503, 9443301303, 9443301703





ACTROS MP2 / MP3 ...

3331 A, 3332 A ...	04/03→	Tie Rod End	CV-ES-0543		for Push Rod	
	04/03→	Tie Rod End	CV-ES-14163		for Steering Rod	
	04/03→	Tie Rod End	DB-ES-5234		for Steering Rod	
	04/03→	Tie Rod End	DB-ES-8530		for Push Rod	
	04/03→	Track Control Arm		DB-DL-3475	Trailing Arm	
	04/03→	Track Control Arm		DB-VB-7261	Suspension Rod, Wishbone (CV), 1st RA;2nd RA; Leaf Spring Axle	
	04/03→	Track Control Arm		DB-VB-9307	Suspension Rod, Wishbone (CV), 1st RA;2nd RA; Leaf Spring Axle	
	04/03→	Track Control Arm		DB-VB-9308	Suspension Rod, Wishbone (CV), 1st RA;2nd RA; Leaf Spring Axle	
3331 AK, 3332 AK	04/03→	Ball Head, gearshift linkage	DB-ES-8510			
	04/03→	Bush, driver cab suspension	DB-SB-10384			
	04/03→	Bush, parabolic spring		DB-SB-10401		
	04/03→	Centre Rod	DB-DL-8184		Push Rod	
	04/03→	Centre Rod	DB-DL-8307		Push Rod, Leaf Spring Axle	
	04/03→	Centre Rod	DB-DL-8702		Push Rod, Leaf Spring Axle	
	04/03→	Centre Rod	DB-DL-12300		for Steering Rod	
	04/03→	Stabiliser Mounting		DB-SB-10406		
	04/03→	Stabiliser Mounting		DB-SB-10409		
	04/03→	Suspension Arm Repair Kit		DB-RK-8626	for Wishbone (CV)	
	04/03→	Suspension Arm Repair Kit		DB-RK-10374	for Wishbone (CV)	
	04/03→	Suspension Arm Repair Kit		DB-RK-10375	for Wishbone (CV)	
	04/03→	Suspension Arm Repair Kit	DB-RK-8638		for Control Arm	
	04/03→	Suspension Strut Repair Kit		DB-RK-8391		
	04/03→	Suspension Strut Repair Kit		DB-RK-8710		
	04/03→	Suspension Strut Repair Kit		DB-RK-9291		
	04/03→	Tie Rod	DB-DL-12310			
	04/03→	Tie Rod	DB-ES-5227		Guide Rod	
	04/03→	Tie Rod	MN-DL-7834		Guide Rod	
	04/03→	Tie Rod End	CV-ES-0543		for Push Rod	
	04/03→	Tie Rod End	CV-ES-14163		for Steering Rod	
	04/03→	Tie Rod End	DB-ES-5234		for Steering Rod	
	04/03→	Tie Rod End	DB-ES-8530		for Push Rod	
	04/03→	Track Control Arm		DB-DL-3475	Trailing Arm	
	04/03→	Track Control Arm		DB-VB-7261	Suspension Rod, Wishbone (CV), 1st RA;2nd RA; Leaf Spring Axle	
	04/03→	Track Control Arm		DB-VB-9307	Suspension Rod, Wishbone (CV), 1st RA;2nd RA; Leaf Spring Axle	
	04/03→	Track Control Arm		DB-VB-9308	Suspension Rod, Wishbone (CV), 1st RA;2nd RA; Leaf Spring Axle	
	3331 B	04/03→	Bush, parabolic spring		DB-SB-10400	
		04/03→	Bush, parabolic spring		DB-SB-10401	
		04/03→	Centre Rod	DB-DL-2144		Push Rod
		04/03→	Centre Rod	DB-DL-5405		Push Rod
		04/03→	Centre Rod	DB-DL-7270		Push Rod
04/03→		Centre Rod	DB-DL-8167		Push Rod	
04/03→		Centre Rod	DB-DL-8307		Push Rod	
04/03→		Centre Rod	DB-DL-8702		Push Rod	
04/03→		Suspension Arm Repair Kit		DB-RK-8626	for Wishbone (CV)	
04/03→		Suspension Arm Repair Kit		DB-RK-10375	for Wishbone (CV)	
04/03→		Suspension Strut Repair Kit		DB-RK-8391		
04/03→		Suspension Strut Repair Kit		DB-RK-8710		
04/03→		Suspension Strut Repair Kit		DB-RK-9291		
04/03→		Tie Rod	DB-DL-8171		Guide Rod	
04/03→		Tie Rod	DB-DL-8327		Guide Rod, 1st Front Axle	
04/03→		Tie Rod	DB-DL-8640		Guide Rod, 1st Front Axle	
04/03→		Tie Rod	DB-DL-12310			
04/03→		Tie Rod End	CV-ES-0543		for Push Rod	
04/03→		Tie Rod End	CV-ES-0888		for Push Rod	
04/03→		Tie Rod End	CV-ES-14163		for Steering Rod	
04/03→		Tie Rod End	DB-ES-8164		for Push Rod	
04/03→		Tie Rod End	DB-ES-8530		for Push Rod	

CV-ES-0543

Length: 125
Cone Ø: d1 Ø 32 / d2 Ø 29
Thread: M30 x 1,5 RHT
0004605748, 0004606048, 0004606848,
0004607048, 0014600448, 0014601148,
0014601748, 0014602448, 0014607648,
0014609648



CV-ES-0888

Length: 125
Cone Ø: d1 Ø 32 / d2 Ø 29
Thread: M30 x 1,5 LHT
0004605848, 0004606148, 0004606948,
0004607148, 0004609048, 0014600548,
0014601348, 0014602548, 0014607948,
0024600448



CV-ES-14163

Length: 125
Cone Ø: d1 Ø 30 / d2 Ø 27
Thread: M30 x 1,5 RHT
0003305248, 0003387310, 0004600348,
0004600948, 0004602848, 0004602948,
0004608948, 0014600248, 0014600848,
0014601248, 0014602248, 0014607748,
0024600148, A0003387310, A0004600348,
A0004602848, A0004602948, A0014600848,
A0014601248, A0014602248, A0014607748



DB-DL-2144

Length: 872 Ø: 35
Cone Ø: d1 Ø 28,6 / d2 Ø 23,9
0024604305, 0024604405, 0034604805



DB-DL-3475

Length: 565 Ø: 52
Hole Distance: 152 / 152
3753500006, 3753500206, 9473500805,
9483500006, 9483500805, 9483501205,
9483501305, 9483501905, 9483502005,
9483502405, A3753500006, A3753500206



DB-DL-5405

Length: 890 Ø: 35
Cone Ø: d1 Ø 28,6 / d2 Ø 23,9
01215900A, 1460248, 0024604505, 0024604605,
0034605005, 3752600637, 3754600405,
A3752600637, A3754600405



DB-DL-7270

Length: 875 Ø: 40
Cone Ø: d1 Ø 28,6 / d2 Ø 23,9
01208300A, 0024604705, 0024604805,
0034604905, A0024604705



DB-DL-8167

Length: 866 Ø: 38
Cone Ø: d1 Ø 30 / d2 Ø 27
0014609805, 0014609905, 0024606305,
0024606405



DB-DL-8171

Length: 1687 Ø: 52
Cone Ø: d1 Ø 32 / d2 Ø 29
9493300603, 9493300703, 9493301503,
9493301603



DB-DL-8184

Length: 1095 Ø: 42
Cone Ø: d1 Ø 32 / d2 Ø 28,8
01217700A, 0014601305, 0014601405,
0024600505, 0034603205, 3754601505,
A0014601305, A0014601405, A0024600505



DB-DL-8307

Length: 885 Ø: 38
Cone Ø: d1 Ø 32 / d2 Ø 30
01215500A, 0004604005, 0024605105,
0024605205, 0034604005



DB-DL-8327

Length: 1745 Ø: 48
Cone Ø: d1 Ø 32 / d2 Ø 29
01219800A, 9413300003, 9413300103,
9413300203, 9413300303, 9413300503



DB-DL-8640

Length: 1615 Ø: 50
Cone Ø: d1 Ø 32 / d2 Ø 29
6253301503, 6253301603, 6253302403,
6253302503, 9423300803, 9423302103,
9493300203, 9493300303, 9493300903



DB-DL-8702

Length: 958 Ø: 38
Cone Ø: d1 Ø 32 / d2 Ø 30
0024606105, 0024606205, 0034604205



DB-DL-12300

Length: 733 Ø: 36
Cone Ø: d1 Ø 32 / d2 Ø 29
0014601505, 0014607305, 0034603305,
3754601605, A0014601505, A0034603305,
A3754601605



DB-DL-12310

Length: 1532 Ø: 50
Cone Ø: d1 Ø 32 / d2 Ø 29
Thread: M27 x 1,5 LHT
9493301203, 9493301303, 9493301803,
9493302203, A9493301203, A9493301303,
A9493301803, A9493302203



DB-ES-5227

Length: 1588 Ø: 60
Cone Ø: d1 Ø 38 / d2 Ø 34,3
6253300903, 6253301203, 9443300203



DB-ES-5234

Length: 135
Cone Ø: d1 Ø 38 / d2 Ø 34,3
Thread: M38 x 1,5 RHT
0004601748, 120322305, 2205000400



DB-ES-8164

Length: 140
Cone Ø: d1 Ø 28,6 / d2 Ø 23,9
Thread: M28 x 1,5 RHT
0014604248, 0014605048, 0014608548,
0024600548



DB-ES-8510

Length: 56
Cone Ø: d1 Ø 10 / d2 Ø 10
Thread: M12 x 1,75 LHT
0009965145, 0009965645, 0019963145



DB-ES-8530

Length: 115
Cone Ø: d1 Ø 28,6 / d2 Ø 23,9
Thread: M30 x 1,5 RHT
0014603848, 0014604848, 0014605148,
0014608648, 0014609948



DB-RK-8391

Ø: 85 Hole Distance: 152
Thick/Height: 24
01336800A, 0003502705



DB-RK-8626

Ø: 75 Hole Distance: 130
Thick/Height: 24
0003502205, 0003502505, 0003503405,
0003504505, GL11319



DB-RK-8638

Length: 100 Ø: 67
Hole Distance: 100
Thick/Height: 20
0003301411



DB-RK-8710

Ø: 85 Hole Distance: 130
Thick/Height: 30
0003503705



DB-RK-9291

Ø: 107,5 Hole Distance: 152
Thick/Height: 30
0003503605



DB-RK-10374

Ø: 85 Hole Distance: 152
Thick/Height: 24
0003504405



DB-RK-10375

Ø: 100
Hole Distance: 152
Thick/Height: 24
3502405, 0003502405, 3503505, 0003503505,
0003504905, 3504905



DB-SB-10384

Ø: 73 Thick/Height: 47
9303170012, 9423171812



DB-SB-10400

Length: 230
Thick/Height: 167,5 / 115
0003250696, 0003250896



DB-SB-10401

Length: 232
Thick/Height: 163,5 / 152,5
0003250596, 0003250796



DB-SB-10406

Ø: 80 Thick/Height: 46
0003238185



DB-SB-10409

Ø: 77 Thick/Height: 56
0003265181



DB-VB-7261

Length: 622 Ø: 46
Hole Ø 25 / 25 / 25
Hole Distance: 152 / 130 / 130
01337800A, 9443500305, 9443500505,
9443500605, 9473500705, 9473500905,
9483500405, 9483503005



DB-VB-9307

Length: 667 Ø: 60
Hole Ø 25 / 23 / 23
Hole Distance: 152 / 130 / 130
9483502805



DB-VB-9308

Length: 622 Ø: 46
Hole Ø 25 / 25 / 25
Hole Distance: 152 / 130 / 130
9483502905



MN-DL-7834

Length: 1588 Ø: 58
Cone Ø: d1 Ø 30 / d2 Ø 27
3463303903, 3463304903, 6253303203,
9443300503, 9443301303, 9443301703





ACTROS MP2 / MP3 ...

3331 B ...	04/03 →	Track Control Arm		DB-DL-3475	Trailing Arm, 1st RA;2nd RA, →517144 06/517144 09	
	04/03 →	Track Control Arm		DB-VB-7261	Suspension Rod, Wishbone (CV)	
	04/03 →	Track Control Arm		DB-VB-9307	Suspension Rod, Wishbone (CV)	
	04/03 →	Track Control Arm		DB-VB-9308	Suspension Rod, Wishbone (CV)	
3331 K	04/03 →	Centre Rod	DB-DL-2144		Push Rod	
	04/03 →	Centre Rod	DB-DL-5405		Push Rod	
	04/03 →	Centre Rod	DB-DL-7270		Push Rod	
	04/03 →	Centre Rod	DB-DL-8167		Push Rod	
	04/03 →	Centre Rod	DB-DL-8188		Push Rod	
	04/03 →	Centre Rod	DB-DL-8307		Push Rod	
	04/03 →	Centre Rod	DB-DL-8702		Push Rod	
	04/03 →	Suspension Arm Repair Kit		DB-RK-8626	for Wishbone (CV)	
	04/03 →	Suspension Arm Repair Kit		DB-RK-10375	for Wishbone (CV)	
	04/03 →	Suspension Strut Repair Kit		DB-RK-8391		
	04/03 →	Suspension Strut Repair Kit		DB-RK-8710		
	04/03 →	Suspension Strut Repair Kit		DB-RK-9291		
	04/03 →	Tie Rod	DB-DL-8171		Guide Rod	
	04/03 →	Tie Rod	DB-DL-8327		Guide Rod	
	04/03 →	Tie Rod	DB-DL-8640		Guide Rod	
	04/03 →	Tie Rod	DB-DL-12310			
	04/03 →	Tie Rod End	CV-ES-0543		for Push Rod	
	04/03 →	Tie Rod End	CV-ES-0888		for Push Rod	
	04/03 →	Tie Rod End	CV-ES-14163		for Steering Rod	
	04/03 →	Tie Rod End	DB-ES-8164		for Push Rod	
	04/03 →	Tie Rod End	DB-ES-8530		for Push Rod	
	04/03 →	Track Control Arm		DB-DL-3475	Trailing Arm, 1st RA;2nd RA, →517144 03/517144 07	
	04/03 →	Track Control Arm		DB-DL-3475	Trailing Arm, 1st RA;2nd RA, →517144 06/517144 09	
	04/03 →	Track Control Arm		DB-VB-7261	Suspension Rod, Wishbone (CV)	
	04/03 →	Track Control Arm		DB-VB-9307	Suspension Rod, Wishbone (CV)	
	04/03 →	Track Control Arm		DB-VB-9308	Suspension Rod, Wishbone (CV)	
	3331 S, 3332 S	04/03 →	Ball Head, gearshift linkage	DB-ES-8510		
		04/03 →	Bush, driver cab suspension	DB-SB-10384		
		04/03 →	Bush, parabolic spring		DB-SB-10400	
		04/03 →	Bush, parabolic spring		DB-SB-10401	
		04/03 →	Centre Rod	DB-DL-2144		Push Rod
		04/03 →	Centre Rod	DB-DL-5230		Suspension Rod
04/03 →		Centre Rod	DB-DL-5405		Push Rod, Leaf Spring Axle	
04/03 →		Centre Rod	DB-DL-7270		Push Rod;Suspension Rod	
04/03 →		Centre Rod	DB-DL-8167		Push Rod	
04/03 →		Centre Rod	DB-DL-8184		Push Rod	
04/03 →		Centre Rod	DB-DL-8185		Push Rod	
04/03 →		Centre Rod	DB-DL-8307		Push Rod	
04/03 →		Centre Rod	DB-DL-8702		Push Rod, Leaf Spring Axle	
04/03 →		Centre Rod	DB-DL-12300		for Steering Rod	
04/03 →		Stabiliser Mounting		DB-SB-10406		
04/03 →		Stabiliser Mounting		DB-SB-10409		
04/03 →		Stabiliser Mounting	DB-SB-10410			
04/03 →		Suspension Arm Repair Kit		DB-RK-8550	for Wishbone (CV)	
04/03 →		Suspension Arm Repair Kit		DB-RK-8626	for Wishbone (CV)	
04/03 →		Suspension Arm Repair Kit		DB-RK-10374	for Wishbone (CV)	
04/03 →		Suspension Arm Repair Kit		DB-RK-10375	for Wishbone (CV)	
04/03 →		Suspension Arm Repair Kit	DB-RK-8638		for Control Arm	
04/03 →		Suspension Strut Repair Kit		DB-RK-8391		
04/03 →		Suspension Strut Repair Kit		DB-RK-8710		
04/03 →		Suspension Strut Repair Kit		DB-RK-9291		
04/03 →		Suspension Strut Repair Kit		MN-RK-8997		
04/03 →		Tie Rod	DB-DL-8171		Guide Rod	
04/03 →		Tie Rod	DB-DL-8327		Guide Rod	
04/03 →		Tie Rod	DB-DL-8640		Guide Rod	
04/03 →		Tie Rod	DB-DL-12310			

CV-ES-0543

Length: 125
 Cone Ø: d1 Ø 32 / d2 Ø 29
 Thread: M30 x 1,5 RHT
 0004605748, 0004606048, 0004606848,
 0004607048, 0014600448, 0014601148,
 0014601748, 0014602448, 0014607648,
 0014609648

**CV-ES-0888**

Length: 125
 Cone Ø: d1 Ø 32 / d2 Ø 29
 Thread: M30 x 1,5 LHT
 0004605848, 0004606148, 0004606948,
 0004607148, 0004609048, 0014600548,
 0014601348, 0014602548, 0014607948,
 0024600448

**CV-ES-14163**

Length: 125
 Cone Ø: d1 Ø 30 / d2 Ø 27
 Thread: M30 x 1,5 RHT
 0003305248, 0003387310, 0004600348,
 0004600948, 0004602848, 0004602948,
 0004608948, 0014600248, 0014600848,
 0014601248, 0014602248, 0014607748,
 0024600148, A0003387310, A0004600348,
 A0004602848, A0004602948, A0014600848,
 A0014601248, A0014602248, A0014607748

**DB-DL-2144**

Length: 872 Ø: 35
 Cone Ø: d1 Ø 28,6 / d2 Ø 23,9
 0024604305, 0024604405, 0034604805

**DB-DL-3475**

Length: 565 Ø: 52
 Hole Distance: 152 / 152
 3753500006, 3753500206, 9473500805,
 9483500006, 9483500805, 9483501205,
 9483501305, 9483501905, 9483502005,
 9483502405, A3753500006, A3753500206

**DB-DL-5230**

Length: 879 Ø: 42
 Cone Ø: d1 Ø 30 / d2 Ø 27
 01208600A, 0004607105, 0004607205,
 0014606705

**DB-DL-5405**

Length: 890 Ø: 35
 Cone Ø: d1 Ø 28,6 / d2 Ø 23,9
 01215900A, 1460248, 0024604505, 0024604605,
 0034605005, 3752600637, 3754600405,
 A3752600637, A3754600405

**DB-DL-7270**

Length: 875 Ø: 40
 Cone Ø: d1 Ø 28,6 / d2 Ø 23,9
 01208300A, 0024604705, 0024604805,
 0034604905, A0024604705

**DB-DL-8167**

Length: 866 Ø: 38
 Cone Ø: d1 Ø 30 / d2 Ø 27
 0014609805, 0014609905, 0024606305,
 0024606405

**DB-DL-8171**

Length: 1687 Ø: 52
 Cone Ø: d1 Ø 32 / d2 Ø 29
 9493300603, 9493300703, 9493301503,
 9493301603

**DB-DL-8184**

Length: 1095 Ø: 42
 Cone Ø: d1 Ø 32 / d2 Ø 28,8
 01217700A, 0014601305, 0014601405,
 0024600505, 0034603205, 3754601505,
 A0014601305, A0014601405, A0024600505

**DB-DL-8185**

Length: 711 Ø: 42
 Cone Ø: d1 Ø 32 / d2 Ø 28,8
 01213600A, 0014601105, 0024600405,
 0034603105, A0014601105, A0024600405

**DB-DL-8188**

Length: 895 Ø: 40
 Cone Ø: d1 Ø 28,6 / d2 Ø 23,9
 01217200A, 0024604905, 0024605005,
 0034605605

**DB-DL-8307**

Length: 885 Ø: 38
 Cone Ø: d1 Ø 32 / d2 Ø 30
 01215500A, 0004604005, 0024605105,
 0024605205, 0034604005

**DB-DL-8327**

Length: 1745 Ø: 48
 Cone Ø: d1 Ø 32 / d2 Ø 29
 01219800A, 9413300003, 9413300103,
 9413300203, 9413300303, 9413300503

**DB-DL-8640**

Length: 1615 Ø: 50
 Cone Ø: d1 Ø 32 / d2 Ø 29
 6253301503, 6253301603, 6253302403,
 6253302503, 9423300803, 9423302103,
 9493300203, 9493300303, 9493300903

**DB-DL-8702**

Length: 958 Ø: 38
 Cone Ø: d1 Ø 32 / d2 Ø 30
 0024606105, 0024606205, 0034604205

**DB-DL-12300**

Length: 733 Ø: 36
 Cone Ø: d1 Ø 32 / d2 Ø 29
 0014601505, 0014607305, 0034603305,
 3754601605, A0014601505, A0034603305,
 A3754601605

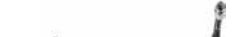
**DB-DL-12310**

Length: 1532 Ø: 50
 Cone Ø: d1 Ø 32 / d2 Ø 29
 Thread: M27 x 1,5 LHT
 9493301203, 9493301303, 9493301803,
 9493302203, A9493301203, A9493301303,
 A9493301803, A9493302203

**DB-ES-8164**

Length: 140
 Cone Ø: d1 Ø 28,6 / d2 Ø 23,9
 Thread: M28 x 1,5 RHT
 0014604248, 0014605048, 0014608548,
 0024600548

**DB-ES-8510**

Length: 56
 Cone Ø: d1 Ø 10 / d2 Ø 10
 Thread: M12 x 1,75 LHT
 0009965145, 0009965645, 0019963145

**DB-ES-8530**

Length: 115
 Cone Ø: d1 Ø 28,6 / d2 Ø 23,9
 Thread: M30 x 1,5 RHT
 0014603848, 0014604848, 0014605148,
 0014608648, 0014609948

**DB-RK-8391**

Ø: 85 Hole Distance: 152
 Thick/Height: 24
 01336800A, 0003502705

**DB-RK-8550**

Ø: 75 Hole Distance: 152
 Thick/Height: 24
 0003502105, 0003504605

**DB-RK-8626**

Ø: 75 Hole Distance: 130
 Thick/Height: 24
 0003502205, 0003502505, 0003503405,
 0003504505, GL11319

**DB-RK-8638**

Length: 100 Ø: 67
 Hole Distance: 100
 Thick/Height: 20
 0003301411

**DB-RK-8710**

Ø: 85 Hole Distance: 130
 Thick/Height: 30
 0003503705

**DB-RK-9291**

Ø: 107,5 Hole Distance: 152
 Thick/Height: 30
 0003503605

**DB-RK-10374**

Ø: 85 Hole Distance: 152
 Thick/Height: 24
 0003504405

**DB-RK-10375**

Ø: 100 Hole Distance: 152
 Thick/Height: 24
 0003502405, 0003503505, 0003504905

**DB-SB-10384**

Ø: 73 Thick/Height: 47
 9303170012, 9423171812

**DB-SB-10400**

Length: 230
 Thick/Height: 167,5 / 115
 0003250696, 0003250896

**DB-SB-10401**

Length: 232
 Thick/Height: 163,5 / 152,5
 0003250596, 0003250796

**DB-SB-10406**

Ø: 80 Thick/Height: 46
 0003238185

**DB-SB-10409**

Ø: 77 Thick/Height: 56
 0003265181

**DB-SB-10410**

Ø: 73 Hole Distance: 100
 Thick/Height: 24
 9413230050

**DB-VB-7261**

Length: 622 Ø: 46
 Hole Ø 25 / 25 / 25
 Hole Distance: 152 / 130 / 130
 01337800A, 9443500305, 9443500505,
 9443500605, 9473500705, 9473500905,
 9483500405, 9483503005

**DB-VB-9307**

Length: 667 Ø: 60
 Hole Ø 25 / 23 / 23
 Hole Distance: 152 / 130 / 130
 9483502805

**DB-VB-9308**

Length: 622 Ø: 46
 Hole Ø 25 / 25 / 25
 Hole Distance: 152 / 130 / 130
 9483502905

**MN-RK-8997**

Ø: 85 Hole Distance: 130
 Thick/Height: 30
 0003504805





ACTROS MP2 / MP3 ...

3331 S, 3332 S ...	04/03→	Tie Rod	DB-ES-5227		Guide Rod
	04/03→	Tie Rod End	CV-ES-0543		for Push Rod
	04/03→	Tie Rod End	CV-ES-0888		for Push Rod
	04/03→	Tie Rod End	CV-ES-14163		for Steering Rod
	04/03→	Tie Rod End	DB-ES-5234		for Steering Rod
	04/03→	Tie Rod End	DB-ES-8164		for Push Rod
	04/03→	Tie Rod End	DB-ES-8530		for Push Rod
	04/03→	Track Control Arm		DB-DL-3475	Trailing Arm
	04/03→	Track Control Arm		DB-VB-7261	Suspension Rod, Wishbone (CV), 1st RA;2nd RA; Leaf Spring Axle
	04/03→	Track Control Arm		DB-VB-7798	Wishbone (CV)
	04/03→	Track Control Arm		DB-VB-9307	Suspension Rod, Wishbone (CV), 1st RA;2nd RA; Leaf Spring Axle
	04/03→	Track Control Arm		DB-VB-9308	Suspension Rod, Wishbone (CV), 1st RA;2nd RA; Leaf Spring Axle
	3331, 3332	04/03→	Ball Head, gearshift linkage	DB-ES-8510	
04/03→		Bush, driver cab suspension	DB-SB-10384		
04/03→		Bush, parabolic spring		DB-SB-10400	
04/03→		Bush, parabolic spring		DB-SB-10401	
04/03→		Centre Rod	DB-DL-2144		Push Rod
04/03→		Centre Rod	DB-DL-5230		Suspension Rod
04/03→		Centre Rod	DB-DL-5405		Push Rod, Leaf Spring Axle
04/03→		Centre Rod	DB-DL-7270		Push Rod;Suspension Rod
04/03→		Centre Rod	DB-DL-8167		Push Rod
04/03→		Centre Rod	DB-DL-8168		Push Rod
04/03→		Centre Rod	DB-DL-8184		Push Rod
04/03→		Centre Rod	DB-DL-8185		Push Rod
04/03→		Centre Rod	DB-DL-8307		Push Rod
04/03→		Centre Rod	DB-DL-8622		Push Rod
04/03→		Centre Rod	DB-DL-8641		Push Rod
04/03→		Centre Rod	DB-DL-8642		Push Rod
04/03→		Centre Rod	DB-DL-8702		Push Rod, Leaf Spring Axle
04/03→		Centre Rod	DB-DL-12300		for Steering Rod
04/03→		Stabiliser Link	DB-DL-9254		Pressure Rod
04/03→		Stabiliser Mounting		DB-SB-10406	
04/03→		Stabiliser Mounting		DB-SB-10409	
04/03→		Stabiliser Mounting	DB-SB-10410		
04/03→		Suspension Arm Repair Kit		DB-RK-8550	for Wishbone (CV)
04/03→		Suspension Arm Repair Kit		DB-RK-8626	for Wishbone (CV)
04/03→		Suspension Arm Repair Kit		DB-RK-10374	for Wishbone (CV)
04/03→		Suspension Arm Repair Kit		DB-RK-10375	for Wishbone (CV)
04/03→		Suspension Arm Repair Kit	DB-RK-8638		for Control Arm
04/03→		Suspension Strut Repair Kit		DB-RK-8391	
04/03→		Suspension Strut Repair Kit		DB-RK-8710	
04/03→		Suspension Strut Repair Kit		DB-RK-9291	
04/03→		Tie Rod	DB-DL-8171		Guide Rod, 1st FA;Leaf Spring Axle
04/03→		Tie Rod	DB-DL-8327		Guide Rod, 1st FA;Leaf Spring Axle
04/03→		Tie Rod	DB-DL-8640		Guide Rod
04/03→		Tie Rod	DB-DL-12310		
04/03→		Tie Rod	DB-ES-5227		Guide Rod
04/03→		Tie Rod End	CV-ES-0543		for Push Rod
04/03→		Tie Rod End	CV-ES-0888		for Push Rod
04/03→		Tie Rod End	CV-ES-14163		for Steering Rod
04/03→		Tie Rod End	DB-ES-5234		for Steering Rod
04/03→		Tie Rod End	DB-ES-8164		for Push Rod
04/03→		Tie Rod End	DB-ES-8530		for Push Rod
04/03→		Track Control Arm		DB-DL-3475	Trailing Arm
04/03→		Track Control Arm		DB-VB-7261	Suspension Rod, Wishbone (CV), 1st RA;2nd RA; Leaf Spring Axle
04/03→		Track Control Arm		DB-VB-9307	Suspension Rod, Wishbone (CV), 1st RA;2nd RA; Leaf Spring Axle
04/03→		Track Control Arm		DB-VB-9308	Suspension Rod, Wishbone (CV), 1st RA;2nd RA; Leaf Spring Axle

CV-ES-0543

Length: 125
 Cone Ø: d1 Ø 32 / d2 Ø 29
 Thread: M30 x 1,5 RHT
 0004605748, 0004606048, 0004606848,
 0004607048, 0014600448, 0014601148,
 0014601748, 0014602448, 0014607648,
 0014609648



CV-ES-0888

Length: 125
 Cone Ø: d1 Ø 32 / d2 Ø 29
 Thread: M30 x 1,5 LHT
 0004605848, 0004606148, 0004606948,
 0004607148, 0004609048, 0014600548,
 0014601348, 0014602548, 0014607948,
 0024600448



CV-ES-14163

Length: 125
 Cone Ø: d1 Ø 30 / d2 Ø 27
 Thread: M30 x 1,5 RHT
 0003305248, 0003387310, 0004600348,
 0004600948, 0004602848, 0004602948,
 0004608948, 0014600248, 0014600848,
 0014601248, 0014602248, 0014607748,
 0024600148, A0003387310, A0004600348,
 A0004602848, A0004602948, A0014600848,
 A0014601248, A0014602248, A0014607748



DB-DL-2144

Length: 872 Ø: 35
 Cone Ø: d1 Ø 28,6 / d2 Ø 23,9
 0024604305, 0024604405, 0034604805



DB-DL-3475

Length: 565 Ø: 52
 Hole Distance: 152 / 152
 3753500006, 3753500206, 9473500805,
 9483500006, 9483500805, 9483501205,
 9483501305, 9483501905, 9483502005,
 9483502405, A3753500006,
 A3753500206



DB-DL-5230

Length: 879 Ø: 42
 Cone Ø: d1 Ø 30 / d2 Ø 27
 01208600A, 0004607105, 0004607205,
 0014606705



DB-DL-5405

Length: 890 Ø: 35
 Cone Ø: d1 Ø 28,6 / d2 Ø 23,9
 01215900A, 1460248, 0024604505,
 0024604605, 0034605005, 3752600637,
 3754600405, A3752600637, A3754600405



DB-DL-7270

Length: 875 Ø: 40
 Cone Ø: d1 Ø 28,6 / d2 Ø 23,9
 01208300A, 0024604705, 0024604805,
 0034604905, A0024604705



DB-DL-8167

Length: 866 Ø: 38
 Cone Ø: d1 Ø 30 / d2 Ø 27
 0014609805, 0014609905, 0024606305,
 0024606405



DB-DL-8168

Length: 904 Ø: 52
 Cone Ø: d1 Ø 32 / d2 Ø 29
 0004609405, 0004609505, 0014607105



DB-DL-8171

Length: 1687 Ø: 52
 Cone Ø: d1 Ø 32 / d2 Ø 29
 9493300603, 9493300703, 9493301503,
 9493301603



DB-DL-8184

Length: 1095 Ø: 42
 Cone Ø: d1 Ø 32 / d2 Ø 28,8
 01217700A, 0014601305, 0014601405,
 0024600505, 0034603205, 3754601505,
 A0014601305, A0014601405, A0024600505



DB-DL-8185

Length: 711 Ø: 42
 Cone Ø: d1 Ø 32 / d2 Ø 28,8
 01213600A, 0014601105, 0024600405,
 0034603105, A0014601105, A0024600405



DB-DL-8307

Length: 885 Ø: 38
 Cone Ø: d1 Ø 32 / d2 Ø 30
 01215500A, 0004604005, 0024605105,
 0024605205, 0034604005



DB-DL-8327

Length: 1745 Ø: 48
 Cone Ø: d1 Ø 32 / d2 Ø 29
 01219800A, 9413300003, 9413300103,
 9413300203, 9413300303, 9413300503



DB-DL-8622

Length: 1558 Ø: 52
 Cone Ø: d1 Ø 30 / d2 Ø 27
 0014609005, 0014609105



DB-DL-8640

Length: 1615 Ø: 50
 Cone Ø: d1 Ø 32 / d2 Ø 29
 6253301503, 6253301603, 6253302403,
 6253302503, 9423300803, 9423302103,
 9493300203, 9493300303, 9493300903



DB-DL-8641

Length: 905 Ø: 42
 Cone Ø: d1 Ø 30 / d2 Ø 27
 0014605105, 0014608105



DB-DL-8642

Length: 954 Ø: 42
 Cone Ø: d1 Ø 30 / d2 Ø 27
 0014608605, 0014608705



DB-DL-8702

Length: 958 Ø: 38
 Cone Ø: d1 Ø 32 / d2 Ø 30
 0024606105, 0024606205, 0034604205



DB-DL-9254

Length: 1815 Ø: 58
 0003220323, 0003220623, 3753220423



DB-DL-12300

Length: 733 Ø: 36
 Cone Ø: d1 Ø 32 / d2 Ø 29
 0014601505, 0014607305, 0034603305,
 3754601605, A0014601505,
 A0034603305, A3754601605



DB-DL-12310

Length: 1532 Ø: 50
 Cone Ø: d1 Ø 32 / d2 Ø 29
 Thread: M27 x 1,5 LHT
 9493301203, 9493301303, 9493301803,
 9493302203, A9493301203, A9493301303,
 A9493301803, A9493302203



DB-ES-5227

Length: 1588 Ø: 60
 Cone Ø: d1 Ø 38 / d2 Ø 34,3
 6253300903, 6253301203, 9443300203



DB-ES-5234

Length: 135
 Cone Ø: d1 Ø 38 / d2 Ø 34,3
 Thread: M38 x 1,5 RHT
 0004601748, 120322305, 2205000400



DB-ES-8164

Length: 140
 Cone Ø: d1 Ø 28,6 / d2 Ø 23,9
 Thread: M28 x 1,5 RHT
 0014604248, 0014605048, 0014608548,
 0024600548



DB-ES-8510

Length: 56
 Cone Ø: d1 Ø 10 / d2 Ø 10
 Thread: M12 x 1,75 LHT
 0009965145, 0009965645, 0019963145



DB-ES-8530

Length: 115
 Cone Ø: d1 Ø 28,6 / d2 Ø 23,9
 Thread: M30 x 1,5 RHT
 0014603848, 0014604848, 0014605148,
 0014608648, 0014609948



DB-RK-8391

Ø: 85 Hole Distance: 152
 Thick/Height: 24
 01336800A, 0003502705



DB-RK-8550

Ø: 75 Hole Distance: 152
 Thick/Height: 24
 0003502105, 0003504605



DB-RK-8626

Ø: 75 Hole Distance: 130
 Thick/Height: 24
 0003502205, 0003502505, 0003503405,
 0003504505, GL11319



DB-RK-8638

Length: 100 Ø: 67
 Hole Distance: 100
 Thick/Height: 20
 0003301411



DB-RK-8710

Ø: 85 Hole Distance: 130
 Thick/Height: 30
 0003503705



DB-RK-9291

Ø: 107,5 Hole Distance: 152
 Thick/Height: 30
 0003503605



DB-RK-10374

Ø: 85 Hole Distance: 152
 Thick/Height: 24
 0003504405



DB-RK-10375

Ø: 100 Hole Distance: 152
 Thick/Height: 24
 0003502405, 0003503505, 0003504905



DB-SB-10384

Ø: 73 Thick/Height: 47
 9303170012, 9423171812



DB-SB-10400

Length: 230
 Thick/Height: 167,5 / 115
 0003250696, 0003250896



DB-SB-10401

Length: 232
 Thick/Height: 163,5 / 152,5
 0003250596, 0003250796



DB-SB-10406

Ø: 80 Thick/Height: 46
 0003238185



DB-SB-10409

Ø: 77 Thick/Height: 56
 0003265181



DB-SB-10410

Ø: 73 Hole Distance: 100
 Thick/Height: 24
 9413230050



DB-VB-7261

Length: 622 Ø: 46
 Hole Ø 25 / 25 / 25
 Hole Distance: 152 / 130 / 130
 01337800A, 9443500305, 9443500505,
 9443500605, 9473500705, 9473500905,
 9483500405, 9483503005



DB-VB-7798

Length: 622 Ø: 48
 Hole Ø 25 / 23 / 23
 Hole Distance: 152 / 130 / 130
 9423500505, 9423500805, 9423501205,
 A9423501205



DB-VB-9307

Length: 667 Ø: 60
 Hole Ø 25 / 23 / 23
 Hole Distance: 152 / 130 / 130
 9483502805



DB-VB-9308

Length: 622 Ø: 46
 Hole Ø 25 / 25 / 25
 Hole Distance: 152 / 130 / 130
 9483502905





ACTROS MP2 / MP3 ...

3332 AK	04/03→	Ball Head, gearshift linkage	DB-ES-8510		
	04/03→	Bush, driver cab suspension	DB-SB-10384		
	04/03→	Bush, parabolic spring		DB-SB-10401	
	04/03→	Centre Rod	DB-DL-8184		Push Rod
	04/03→	Centre Rod	DB-DL-8307		Push Rod, Leaf Spring Axle
	04/03→	Centre Rod	DB-DL-8702		Push Rod, Leaf Spring Axle
	04/03→	Centre Rod	DB-DL-12300		for Steering Rod
	04/03→	Stabiliser Mounting		DB-SB-10406	
	04/03→	Stabiliser Mounting		DB-SB-10409	
	04/03→	Suspension Arm Repair Kit		DB-RK-8626	for Wishbone (CV)
	04/03→	Suspension Arm Repair Kit		DB-RK-10374	for Wishbone (CV)
	04/03→	Suspension Arm Repair Kit		DB-RK-10375	for Wishbone (CV)
	04/03→	Suspension Arm Repair Kit	DB-RK-8638		for Control Arm
	04/03→	Suspension Strut Repair Kit		DB-RK-8391	
	04/03→	Suspension Strut Repair Kit		DB-RK-8710	
	04/03→	Suspension Strut Repair Kit		DB-RK-9291	
	04/03→	Tie Rod	DB-DL-12310		
	04/03→	Tie Rod	DB-ES-5227		Guide Rod
	04/03→	Tie Rod	MN-DL-7834		Guide Rod
	04/03→	Tie Rod End	CV-ES-0543		for Push Rod
	04/03→	Tie Rod End	CV-ES-14163		for Steering Rod
	04/03→	Tie Rod End	DB-ES-5234		for Steering Rod
	04/03→	Tie Rod End	DB-ES-8530		for Push Rod
	04/03→	Track Control Arm		DB-DL-3475	Trailing Arm
	04/03→	Track Control Arm		DB-VB-7261	Suspension Rod, Wishbone (CV), 1st RA;2nd RA; Leaf Spring Axle
	04/03→	Track Control Arm		DB-VB-9307	Suspension Rod, Wishbone (CV), 1st RA;2nd RA; Leaf Spring Axle
	04/03→	Track Control Arm		DB-VB-9308	Suspension Rod, Wishbone (CV), 1st RA;2nd RA; Leaf Spring Axle
	3332 AKE	04/03→	Bush, driver cab suspension	DB-SB-10384	
04/03→		Bush, parabolic spring		DB-SB-10401	
04/03→		Centre Rod	DB-DL-8307		Push Rod, Leaf Spring Axle
04/03→		Centre Rod	DB-DL-8702		Push Rod, Drive Axle;Leaf Spring Axle
04/03→		Stabiliser Mounting		DB-SB-10406	
04/03→		Suspension Strut Repair Kit		DB-RK-8710	
04/03→		Suspension Strut Repair Kit		DB-RK-9291	
04/03→		Tie Rod	DB-DL-12310		
04/03→		Tie Rod	DB-ES-5227		Guide Rod
04/03→		Tie Rod	MN-DL-7834		Guide Rod
04/03→		Tie Rod End	DB-ES-5234		for Steering Rod
04/03→		Track Control Arm		DB-VB-7261	Suspension Rod, Wishbone (CV), 1st RA;2nd RA; Leaf Spring Axle
04/03→		Track Control Arm		DB-VB-9307	Suspension Rod, Wishbone (CV), 1st RA;2nd RA; Leaf Spring Axle
04/03→		Track Control Arm		DB-VB-9308	Suspension Rod, Wishbone (CV), 1st RA;2nd RA; Leaf Spring Axle
3332 AS	04/03→	Ball Head, gearshift linkage	DB-ES-8510		
	04/03→	Bush, driver cab suspension	DB-SB-10384		
	04/03→	Bush, parabolic spring		DB-SB-10401	
	04/03→	Centre Rod	DB-DL-8307		Push Rod
	04/03→	Centre Rod	DB-DL-8702		Push Rod, Leaf Spring Axle
	04/03→	Centre Rod	DB-DL-12300		for Steering Rod
	04/03→	Stabiliser Mounting		DB-SB-10406	
	04/03→	Stabiliser Mounting		DB-SB-10409	
	04/03→	Stabiliser Mounting	DB-SB-10410		
	04/03→	Suspension Arm Repair Kit		DB-RK-8626	for Wishbone (CV)
	04/03→	Suspension Arm Repair Kit		DB-RK-10374	for Wishbone (CV)
	04/03→	Suspension Arm Repair Kit		DB-RK-10375	for Wishbone (CV)
	04/03→	Suspension Arm Repair Kit	DB-RK-8638		for Control Arm
	04/03→	Suspension Strut Repair Kit		DB-RK-8391	
04/03→	Suspension Strut Repair Kit		DB-RK-8710		
04/03→	Suspension Strut Repair Kit		DB-RK-9291		

CV-ES-0543

Length: 125
Cone Ø: d1 Ø 32 / d2 Ø 29
Thread: M30 x 1,5 RHT
0004605748, 0004606048, 0004606848,
0004607048, 0014600448, 0014601148,
0014601748, 0014602448, 0014607648,
0014609648



CV-ES-14163

Length: 125
Cone Ø: d1 Ø 30 / d2 Ø 27
Thread: M30 x 1,5 RHT
0003305248, 0003387310, 0004600348,
0004600948, 0004602848, 0004602948,
0004608948, 0014600248, 0014600848,
0014601248, 0014602248, 0014607748,
0024600148, A0003387310, A0004600348,
A0004602848, A0004602948, A0014600848,
A0014601248, A0014602248, A0014607748



DB-DL-3475

Length: 565 Ø: 52
Hole Distance: 152 / 152
3753500006, 3753500206, 9473500805,
9483500006, 9483500805, 9483501205,
9483501305, 9483501905, 9483502005,
9483502405, A3753500006, A3753500206



DB-DL-8184

Length: 1095 Ø: 42
Cone Ø: d1 Ø 32 / d2 Ø 28,8
01217700A, 0014601305, 0014601405,
0024600505, 0034603205, 3754601505,
A0014601305, A0014601405, A0024600505



DB-DL-8307

Length: 885 Ø: 38
Cone Ø: d1 Ø 32 / d2 Ø 30
01215500A, 0004604005, 0024605105,
0024605205, 0034604005



DB-DL-8702

Length: 958 Ø: 38
Cone Ø: d1 Ø 32 / d2 Ø 30
0024606105, 0024606205, 0034604205



DB-DL-12300

Length: 733 Ø: 36
Cone Ø: d1 Ø 32 / d2 Ø 29
0014601505, 0014607305, 0034603305,
3754601605, A0014601505, A0034603305,
A3754601605



DB-DL-12310

Length: 1532 Ø: 50
Cone Ø: d1 Ø 32 / d2 Ø 29
Thread: M27 x 1,5 LHT
9493301203, 9493301303, 9493301803,
9493302203, A9493301203, A9493301303,
A9493301803, A9493302203



DB-ES-5227

Length: 1588 Ø: 60
Cone Ø: d1 Ø 38 / d2 Ø 34,3
6253300903, 6253301203, 9443300203



DB-ES-5234

Length: 135
Cone Ø: d1 Ø 38 / d2 Ø 34,3
Thread: M38 x 1,5 RHT
0004601748, 120322305, 2205000400



DB-ES-8510

Length: 56
Cone Ø: d1 Ø 10 / d2 Ø 10
Thread: M12 x 1,75 LHT
0009965145, 0009965645, 0019963145



DB-ES-8530

Length: 115
Cone Ø: d1 Ø 28,6 / d2 Ø 23,9
Thread: M30 x 1,5 RHT
0014603848, 0014604848, 0014605148,
0014608648, 0014609948



DB-RK-8391

Ø: 85 Hole Distance: 152
Thick/Height: 24
01336800A, 0003502705



DB-RK-8626

Ø: 75 Hole Distance: 130
Thick/Height: 24
0003502205, 0003502505, 0003503405,
0003504505, GL11319



DB-RK-8638

Length: 100 Ø: 67
Hole Distance: 100
Thick/Height: 20
0003301411



DB-RK-8710

Ø: 85 Hole Distance: 130
Thick/Height: 30
0003503705



DB-RK-9291

Ø: 107,5 Hole Distance: 152
Thick/Height: 30
0003503605



DB-RK-10374

Ø: 85 Hole Distance: 152
Thick/Height: 24
0003504405



DB-RK-10375

Ø: 100 Hole Distance: 152
Thick/Height: 24
0003502405, 0003503505, 0003504905



DB-SB-10384

Ø: 73 Thick/Height: 47
9303170012, 9423171812



DB-SB-10401

Length: 232
Thick/Height: 163,5 / 152,5
0003250596, 0003250796



DB-SB-10406

Ø: 80 Thick/Height: 46
0003238185



DB-SB-10409

Ø: 77 Thick/Height: 56
0003265181



DB-SB-10410

Ø: 73 Hole Distance: 100
Thick/Height: 24
9413230050



DB-VB-7261

Length: 622 Ø: 46
Hole Ø 25 / 25 / 25
Hole Distance: 152 / 130 / 130
01337800A, 9443500305, 9443500505,
9443500605, 9473500705, 9473500905,
9483500405, 9483503005



DB-VB-9307

Length: 667 Ø: 60
Hole Ø 25 / 23 / 23
Hole Distance: 152 / 130 / 130
9483502805



DB-VB-9308

Length: 622 Ø: 46
Hole Ø 25 / 25 / 25
Hole Distance: 152 / 130 / 130
9483502905



MN-DL-7834

Length: 1588 Ø: 58
Cone Ø: d1 Ø 30 / d2 Ø 27
3463303903, 3463304903, 6253303203,
9443300503, 9443301303, 9443301703





ACTROS MP2 / MP3 ...

3332 AS ...	04/03 →	Suspension Strut Repair Kit		MN-RK-8997		
	04/03 →	Tie Rod	DB-DL-12310			
	04/03 →	Tie Rod	DB-ES-5227		Guide Rod	
	04/03 →	Tie Rod	MN-DL-7834		Guide Rod	
	04/03 →	Tie Rod End	CV-ES-0543		for Push Rod	
	04/03 →	Tie Rod End	CV-ES-14163		for Steering Rod	
	04/03 →	Tie Rod End	DB-ES-5234		for Steering Rod	
	04/03 →	Tie Rod End	DB-ES-8530		for Push Rod	
	04/03 →	Track Control Arm		DB-DL-3475	Trailing Arm	
	04/03 →	Track Control Arm		DB-VB-7261	Suspension Rod, Wishbone (CV), 1st RA;2nd RA; Leaf Spring Axle	
	04/03 →	Track Control Arm		DB-VB-7798	Wishbone (CV)	
	04/03 →	Track Control Arm		DB-VB-9307	Suspension Rod, Wishbone (CV), 1st RA;2nd RA; Leaf Spring Axle	
	04/03 →	Track Control Arm		DB-VB-9308	Suspension Rod, Wishbone (CV), 1st RA;2nd RA; Leaf Spring Axle	
	3332 B	04/03 →	Ball Head, gearshift linkage	DB-ES-8510		
		04/03 →	Bush, driver cab suspension	DB-SB-10384		
04/03 →		Centre Rod	DB-DL-2144		Push Rod	
04/03 →		Centre Rod	DB-DL-5230		Suspension Rod	
04/03 →		Centre Rod	DB-DL-5405		Push Rod, Leaf Spring Axle	
04/03 →		Centre Rod	DB-DL-7270		Push Rod	
04/03 →		Centre Rod	DB-DL-8167		Push Rod	
04/03 →		Centre Rod	DB-DL-8184		Push Rod	
04/03 →		Centre Rod	DB-DL-8185		Push Rod	
04/03 →		Centre Rod	DB-DL-8307		Push Rod	
04/03 →		Centre Rod	DB-DL-8702		Push Rod, Leaf Spring Axle	
04/03 →		Centre Rod	DB-DL-12300		for Steering Rod	
04/03 →		Stabiliser Mounting		DB-SB-10406		
04/03 →		Stabiliser Mounting		DB-SB-10409		
04/03 →		Suspension Arm Repair Kit		DB-RK-8550	for Wishbone (CV)	
04/03 →		Suspension Arm Repair Kit		DB-RK-8626	for Wishbone (CV)	
04/03 →		Suspension Arm Repair Kit		DB-RK-10374	for Wishbone (CV)	
04/03 →		Suspension Arm Repair Kit	DB-RK-8638		for Control Arm	
04/03 →		Suspension Strut Repair Kit		DB-RK-8391		
04/03 →		Suspension Strut Repair Kit		DB-RK-8710		
04/03 →		Suspension Strut Repair Kit		DB-RK-9291		
04/03 →		Tie Rod	DB-DL-8171		Guide Rod	
04/03 →		Tie Rod	DB-DL-8327		Guide Rod	
04/03 →		Tie Rod	DB-DL-8640		Guide Rod	
04/03 →		Tie Rod	DB-DL-12310			
04/03 →		Tie Rod End	CV-ES-0543		for Push Rod	
04/03 →		Tie Rod End	CV-ES-0888		for Push Rod	
04/03 →		Tie Rod End	CV-ES-14163		for Steering Rod	
04/03 →		Tie Rod End	DB-ES-5234		for Steering Rod	
04/03 →		Tie Rod End	DB-ES-8164		for Push Rod	
04/03 →		Tie Rod End	DB-ES-8530		for Push Rod	
04/03 →		Track Control Arm		DB-DL-3475	Trailing Arm	
04/03 →		Track Control Arm		DB-VB-7261	Suspension Rod, Wishbone (CV), 1st RA;2nd RA; Leaf Spring Axle	
04/03 →		Track Control Arm		DB-VB-9307	Suspension Rod, Wishbone (CV), 1st RA;2nd RA; Leaf Spring Axle	
04/03 →		Track Control Arm		DB-VB-9308	Suspension Rod, Wishbone (CV), 1st RA;2nd RA; Leaf Spring Axle	
3332 K		04/03 →	Ball Head, gearshift linkage	DB-ES-8510		
		04/03 →	Bush, driver cab suspension	DB-SB-10384		
		04/03 →	Bush, parabolic spring		DB-SB-10400	
		04/03 →	Bush, parabolic spring		DB-SB-10401	
		04/03 →	Centre Rod	DB-DL-2144		Push Rod
	04/03 →	Centre Rod	DB-DL-5230		Suspension Rod	
	04/03 →	Centre Rod	DB-DL-5405		Push Rod, Leaf Spring Axle	
	04/03 →	Centre Rod	DB-DL-7270		Push Rod	
	04/03 →	Centre Rod	DB-DL-8167		Push Rod	

CV-ES-0543

Length: 125
Cone Ø: d1 Ø 32 / d2 Ø 29
Thread: M30 x 1,5 RHT
0004605748, 0004606048, 0004606848,
0004607048, 0014600448, 0014601148,
0014601748, 0014602448, 0014607648,
0014609648



CV-ES-0888

Length: 125
Cone Ø: d1 Ø 32 / d2 Ø 29
Thread: M30 x 1,5 LHT
0004605848, 0004606148, 0004606948,
0004607148, 0004609048, 0014600548,
0014601348, 0014602548, 0014607948,
0024600448



CV-ES-14163

Length: 125
Cone Ø: d1 Ø 30 / d2 Ø 27
Thread: M30 x 1,5 RHT
0003305248, 0003387310, 0004600348,
0004600948, 0004602848, 0004602948,
0004608948, 0014600248, 0014600848,
0014601248, 0014602248, 0014607748,
0024600148, A0003387310, A0004600348,
A0004602848, A0004602948, A0014600848,
A0014601248, A0014602248, A0014607748



DB-DL-2144

Length: 872 Ø: 35
Cone Ø: d1 Ø 28,6 / d2 Ø 23,9
0024604305, 0024604405, 0034604805



DB-DL-3475

Length: 565 Ø: 52
Hole Distance: 152 / 152
3753500006, 3753500206, 9473500805,
9483500006, 9483500805, 9483501205,
9483501305, 9483501905, 9483502005,
9483502405, A3753500006, A3753500206



DB-DL-5230

Length: 879 Ø: 42
Cone Ø: d1 Ø 30 / d2 Ø 27
01208600A, 0004607105, 0004607205,
0014606705



DB-DL-5405

Length: 890 Ø: 35
Cone Ø: d1 Ø 28,6 / d2 Ø 23,9
01215900A, 1460248, 0024604505, 0024604605,
0034605005, 3752600637, 3754600405,
A3752600637, A3754600405



DB-DL-7270

Length: 875 Ø: 40
Cone Ø: d1 Ø 28,6 / d2 Ø 23,9
01208300A, 0024604705, 0024604805,
0034604905, A0024604705



DB-DL-8167

Length: 866 Ø: 38
Cone Ø: d1 Ø 30 / d2 Ø 27
0014609805, 0014609905, 0024606305,
0024606405



DB-DL-8171

Length: 1687 Ø: 52
Cone Ø: d1 Ø 32 / d2 Ø 29
9493300603, 9493300703, 9493301503,
9493301603



DB-DL-8184

Length: 1095 Ø: 42
Cone Ø: d1 Ø 32 / d2 Ø 28,8
01217700A, 0014601305, 0014601405,
0024600505, 0034603205, 3754601505,
A0014601305, A0014601405, A0024600505



DB-DL-8185

Length: 711 Ø: 42
Cone Ø: d1 Ø 32 / d2 Ø 28,8
01213600A, 0014601105, 0024600405,
0034603105, A0014601105, A0024600405



DB-DL-8307

Length: 885 Ø: 38
Cone Ø: d1 Ø 32 / d2 Ø 30
01215500A, 0004604005, 0024605105,
0024605205, 0034604005



DB-DL-8327

Length: 1745 Ø: 48
Cone Ø: d1 Ø 32 / d2 Ø 29
01219800A, 9413300003, 9413300103,
9413300203, 9413300303, 9413300503



DB-DL-8640

Length: 1615 Ø: 50
Cone Ø: d1 Ø 32 / d2 Ø 29
6253301503, 6253301603, 6253302403,
6253302503, 9423300803, 9423302103,
9493300203, 9493300303, 9493300903



DB-DL-8702

Length: 958 Ø: 38
Cone Ø: d1 Ø 32 / d2 Ø 30
0024606105, 0024606205, 0034604205



DB-DL-12300

Length: 733 Ø: 36
Cone Ø: d1 Ø 32 / d2 Ø 29
0014601505, 0014607305, 0034603305,
3754601605, A0014601505, A0034603305,
A3754601605



DB-DL-12310

Length: 1532 Ø: 50
Cone Ø: d1 Ø 32 / d2 Ø 29
Thread: M27 x 1,5 LHT
9493301203, 9493301303, 9493301803,
9493302203, A9493301203, A9493301303,
A9493301803, A9493302203



DB-ES-5227

Length: 1588 Ø: 60
Cone Ø: d1 Ø 38 / d2 Ø 34,3
6253300903, 6253301203, 9443300203



DB-ES-5234

Length: 135
Cone Ø: d1 Ø 38 / d2 Ø 34,3
Thread: M38 x 1,5 RHT
0004601748, 120322305, 2205000400



DB-ES-8164

Length: 140
Cone Ø: d1 Ø 28,6 / d2 Ø 23,9
Thread: M28 x 1,5 RHT
0014604248, 0014605048, 0014608548,
0024600548



DB-ES-8510

Length: 56
Cone Ø: d1 Ø 10 / d2 Ø 10
Thread: M12 x 1,75 LHT
0009965145, 0009965645, 0019963145



DB-ES-8530

Length: 115
Cone Ø: d1 Ø 28,6 / d2 Ø 23,9
Thread: M30 x 1,5 RHT
0014603848, 0014604848, 0014605148,
0014608648, 0014609948



DB-RK-8391

Ø: 85 Hole Distance: 152
Thick/Height: 24
01336800A, 0003502705



DB-RK-8550

Ø: 75 Hole Distance: 152
Thick/Height: 24
0003502105, 0003504605



DB-RK-8626

Ø: 75 Hole Distance: 130
Thick/Height: 24
0003502205, 0003502505, 0003503405,
0003504505, GL11319



DB-RK-8638

Length: 100 Ø: 67
Hole Distance: 100
Thick/Height: 20
0003301411



DB-RK-8710

Ø: 85 Hole Distance: 130
Thick/Height: 30
0003503705



DB-RK-9291

Ø: 107,5 Hole Distance: 152
Thick/Height: 30
0003503605



DB-RK-10374

Ø: 85 Hole Distance: 152
Thick/Height: 24
0003504405



DB-SB-10384

Ø: 73 Thick/Height: 47
9303170012, 9423171812



DB-SB-10400

Length: 230
Thick/Height: 167,5 / 115
0003250696, 0003250896



DB-SB-10401

Length: 232
Thick/Height: 163,5 / 152,5
0003250596, 0003250796



DB-SB-10406

Ø: 80 Thick/Height: 46
0003238185



DB-SB-10409

Ø: 77 Thick/Height: 56
0003265181



DB-VB-7261

Length: 622 Ø: 46
Hole Ø 25 / 25 / 25
Hole Distance: 152 / 130 / 130
01337800A, 9443500305, 9443500505,
9443500605, 9473500705, 9473500905,
9483500405, 9483500305



DB-VB-7798

Length: 622 Ø: 48
Hole Ø 25 / 23 / 23
Hole Distance: 152 / 130 / 130
9423500505, 9423500805, 9423501205,
A9423501205



DB-VB-9307

Length: 667 Ø: 60
Hole Ø 25 / 23 / 23
Hole Distance: 152 / 130 / 130
9483502805



DB-VB-9308

Length: 622 Ø: 46
Hole Ø 25 / 25 / 25
Hole Distance: 152 / 130 / 130
9483502905



MN-DL-7834

Length: 1588 Ø: 58
Cone Ø: d1 Ø 30 / d2 Ø 27
3463303903, 3463304903, 6253303203,
9443300503, 9443301303, 9443301703



MN-RK-8997

Ø: 85 Hole Distance: 130
Thick/Height: 30
0003504805





ACTROS MP2 / MP3 ...

3332 K ...	04/03→	Centre Rod	DB-DL-8184	Push Rod	
	04/03→	Centre Rod	DB-DL-8185	Push Rod	
	04/03→	Centre Rod	DB-DL-8188	Push Rod	
	04/03→	Centre Rod	DB-DL-8307	Push Rod	
	04/03→	Centre Rod	DB-DL-8702	Push Rod, Leaf Spring Axle	
	04/03→	Centre Rod	DB-DL-12300	for Steering Rod	
	04/03→	Stabiliser Mounting		DB-SB-10406	
	04/03→	Stabiliser Mounting		DB-SB-10409	
	04/03→	Suspension Arm Repair Kit		DB-RK-8550 for Wishbone (CV)	
	04/03→	Suspension Arm Repair Kit		DB-RK-8626 for Wishbone (CV)	
	04/03→	Suspension Arm Repair Kit		DB-RK-10374 for Wishbone (CV)	
	04/03→	Suspension Arm Repair Kit		DB-RK-10375 for Wishbone (CV)	
	04/03→	Suspension Arm Repair Kit	DB-RK-8638	for Control Arm	
	04/03→	Suspension Strut Repair Kit		DB-RK-8391	
	04/03→	Suspension Strut Repair Kit		DB-RK-8710	
	04/03→	Suspension Strut Repair Kit		DB-RK-9291	
	04/03→	Tie Rod	DB-DL-8171	Guide Rod	
	04/03→	Tie Rod	DB-DL-8327	Guide Rod	
	04/03→	Tie Rod	DB-DL-8640	Guide Rod	
	04/03→	Tie Rod	DB-DL-12310		
	04/03→	Tie Rod	DB-ES-5227	Guide Rod	
	04/03→	Tie Rod End	CV-ES-0543	for Push Rod	
	04/03→	Tie Rod End	CV-ES-0888	for Push Rod	
	04/03→	Tie Rod End	CV-ES-14163	for Steering Rod	
	04/03→	Tie Rod End	DB-ES-5234	for Steering Rod	
	04/03→	Tie Rod End	DB-ES-8164	for Push Rod	
	04/03→	Tie Rod End	DB-ES-8530	for Push Rod	
	04/03→	Track Control Arm		DB-DL-3475 Trailing Arm	
	04/03→	Track Control Arm		DB-VB-7261 Suspension Rod, Wishbone (CV), 1st RA;2nd RA; Leaf Spring Axle	
	04/03→	Track Control Arm		DB-VB-9307 Suspension Rod, Wishbone (CV), 1st RA;2nd RA; Leaf Spring Axle	
	04/03→	Track Control Arm		DB-VB-9308 Suspension Rod, Wishbone (CV), 1st RA;2nd RA; Leaf Spring Axle	
	3335 A	04/03→	Bush, parabolic spring		DB-SB-10401
		04/03→	Centre Rod	DB-DL-8307	Push Rod
04/03→		Centre Rod	DB-DL-8702	Push Rod	
04/03→		Suspension Arm Repair Kit		DB-RK-8626 for Wishbone (CV)	
04/03→		Suspension Arm Repair Kit		DB-RK-10375 for Wishbone (CV)	
04/03→		Suspension Strut Repair Kit		DB-RK-8391	
04/03→		Suspension Strut Repair Kit		DB-RK-8710	
04/03→		Suspension Strut Repair Kit		DB-RK-9291	
04/03→		Tie Rod	DB-ES-5227	Guide Rod	
04/03→		Tie Rod	MN-DL-7834	Guide Rod	
04/03→		Tie Rod End	CV-ES-0543	for Push Rod	
04/03→		Tie Rod End	CV-ES-14163	for Steering Rod	
04/03→		Tie Rod End	DB-ES-5234	for Steering Rod	
04/03→		Track Control Arm		DB-DL-3475 Trailing Arm, 1st RA;2nd RA, →517144 03/517144 06	
04/03→		Track Control Arm		DB-DL-3475 Trailing Arm, 1st RA;2nd RA, →517144 05/517144 08	
04/03→		Track Control Arm		DB-DL-3475 Trailing Arm, 1st RA;2nd RA, →517144 07/517144 09	
04/03→		Track Control Arm		DB-DL-3475 Trailing Arm, 1st RA;2nd RA, →517144 26/517144 27	
04/03→		Track Control Arm		DB-VB-7261 Suspension Rod, Wishbone (CV)	
04/03→		Track Control Arm		DB-VB-9307 Suspension Rod, Wishbone (CV)	
04/03→		Track Control Arm		DB-VB-9308 Suspension Rod, Wishbone (CV)	
3335 B		04/03→	Bush, parabolic spring		DB-SB-10400
	04/03→	Bush, parabolic spring		DB-SB-10401	
	04/03→	Centre Rod	DB-DL-2144	Push Rod	
	04/03→	Centre Rod	DB-DL-5405	Push Rod	
	04/03→	Centre Rod	DB-DL-7270	Push Rod	

CV-ES-0543

Length: 125
 Cone Ø: d1 Ø 32 / d2 Ø 29
 Thread: M30 x 1,5 RHT
 0004605748, 0004606048, 0004606848,
 0004607048, 0014600448, 0014601148,
 0014601748, 0014602448, 0014607648,
 0014609648



CV-ES-0888

Length: 125
 Cone Ø: d1 Ø 32 / d2 Ø 29
 Thread: M30 x 1,5 LHT
 0004605848, 0004606148, 0004606948,
 0004607148, 0004609048, 0014600548,
 0014601348, 0014602548, 0014607948,
 0024600448



CV-ES-14163

Length: 125
 Cone Ø: d1 Ø 30 / d2 Ø 27
 Thread: M30 x 1,5 RHT
 0003305248, 0003387310, 0004600348,
 0004600948, 0004602848, 0004602948,
 0004608948, 0014600248, 0014600848,
 0014601248, 0014602248, 0014607748,
 0024600148, 0003387310, 0004600348,
 0004602848, 0004602948, 0014600848,
 0014601248, 0014602248, 0014607748



DB-DL-2144

Length: 872 Ø: 35
 Cone Ø: d1 Ø 28,6 / d2 Ø 23,9
 0024604305, 0024604405, 0034604805



DB-DL-3475

Length: 565 Ø: 52
 Hole Distance: 152 / 152
 3753500006, 3753500206, 9473500805,
 9483500006, 9483500805, 9483501205,
 9483501305, 9483501905, 9483502005,
 9483502405, A3753500006, A3753500206



DB-DL-5405

Length: 890 Ø: 35
 Cone Ø: d1 Ø 28,6 / d2 Ø 23,9
 01215900A, 1460248, 0024604505, 0024604605,
 0034600505, 3752600637, 3754600405,
 A3752600637, A3754600405



DB-DL-7270

Length: 875 Ø: 40
 Cone Ø: d1 Ø 28,6 / d2 Ø 23,9
 01208300A, 0024604705, 0024604805,
 0034604905, A0024604705



DB-DL-8171

Length: 1687 Ø: 52
 Cone Ø: d1 Ø 32 / d2 Ø 29
 9493300603, 9493300703, 9493301503,
 9493301603



DB-DL-8184

Length: 1095 Ø: 42
 Cone Ø: d1 Ø 32 / d2 Ø 28,8
 01217700A, 0014601305, 0014601405,
 0024600505, 0034603205, 3754601505,
 A0014601305, A0014601405, A0024600505



DB-DL-8185

Length: 711 Ø: 42
 Cone Ø: d1 Ø 32 / d2 Ø 28,8
 01213600A, 0014601105, 0024600405,
 0034603105, A0014601105, A0024600405



DB-DL-8188

Length: 895 Ø: 40
 Cone Ø: d1 Ø 28,6 / d2 Ø 23,9
 01217200A, 0024604905, 0024605005,
 0034605605



DB-DL-8307

Length: 885 Ø: 38
 Cone Ø: d1 Ø 32 / d2 Ø 30
 01215500A, 0004604005, 0024605105,
 0024605205, 0034604005



DB-DL-8327

Length: 1745 Ø: 48
 Cone Ø: d1 Ø 32 / d2 Ø 29
 01219800A, 9413300003, 9413300103,
 9413300203, 9413300303, 9413300503



DB-DL-8640

Length: 1615 Ø: 50
 Cone Ø: d1 Ø 32 / d2 Ø 29
 6253301503, 6253301603, 6253302403,
 6253302503, 9423300803, 9423302103,
 9493300203, 9493300303, 9493300903



DB-DL-8702

Length: 958 Ø: 38
 Cone Ø: d1 Ø 32 / d2 Ø 30
 0024606105, 0024606205, 0034604205



DB-DL-12300

Length: 733 Ø: 36
 Cone Ø: d1 Ø 32 / d2 Ø 29
 0014601505, 0014607305, 0034603305,
 3754601605, A0014601505, A0034603305,
 A3754601605



DB-DL-12310

Length: 1532 Ø: 50
 Cone Ø: d1 Ø 32 / d2 Ø 29
 Thread: M27 x 1,5 LHT
 9493301203, 9493301303, 9493301803,
 9493302203, A9493301203, A9493301303,
 A9493301803, A9493302203



DB-ES-5227

Length: 1588 Ø: 60
 Cone Ø: d1 Ø 38 / d2 Ø 34,3
 6253300903, 6253301203, 9443300203



DB-ES-5234

Length: 135
 Cone Ø: d1 Ø 38 / d2 Ø 34,3
 Thread: M38 x 1,5 RHT
 0004601748, 120322305, 2205000400



DB-ES-8164

Length: 140
 Cone Ø: d1 Ø 28,6 / d2 Ø 23,9
 Thread: M28 x 1,5 RHT
 0014604248, 0014605048, 0014608548,
 0024600548



DB-ES-8530

Length: 115
 Cone Ø: d1 Ø 28,6 / d2 Ø 23,9
 Thread: M30 x 1,5 RHT
 0014603848, 0014604848, 0014605148,
 0014608648, 0014609948



DB-RK-8391

Ø: 85 Hole Distance: 152
 Thick/Height: 24
 01336800A, 0003502705



DB-RK-8550

Ø: 75 Hole Distance: 152
 Thick/Height: 24
 0003502105, 0003504605



DB-RK-8626

Ø: 75 Hole Distance: 130
 Thick/Height: 24
 0003502205, 0003502505, 0003503405,
 0003504505, GL11319



DB-RK-8638

Length: 100 Ø: 67
 Hole Distance: 100
 Thick/Height: 20
 0003301411



DB-RK-8710

Ø: 85 Hole Distance: 130
 Thick/Height: 30
 0003503705



DB-RK-9291

Ø: 107,5 Hole Distance: 152
 Thick/Height: 30
 0003503605



DB-RK-10374

Ø: 85 Hole Distance: 152
 Thick/Height: 24
 0003504405



DB-RK-10375

Ø: 100 Hole Distance: 152
 Thick/Height: 24
 0003502405, 0003503505, 0003504905



DB-SB-10400

Length: 230
 Thick/Height: 167,5 / 115
 0003250696, 0003250896



DB-SB-10401

Length: 232
 Thick/Height: 163,5 / 152,5
 0003250596, 0003250796



DB-SB-10406

Ø: 80 Thick/Height: 46
 0003238185



DB-SB-10409

Ø: 77 Thick/Height: 56
 0003265181



DB-VB-7261

Length: 622 Ø: 46
 Hole Ø 25 / 25 / 25
 Hole Distance: 152 / 130 / 130
 01337800A, 9443500305, 9443500505,
 9443500605, 9473500705, 9473500905,
 9483500405, 9483503005



DB-VB-9307

Length: 667 Ø: 60
 Hole Ø 25 / 23 / 23
 Hole Distance: 152 / 130 / 130
 9483502805



DB-VB-9308

Length: 622 Ø: 46
 Hole Ø 25 / 25 / 25
 Hole Distance: 152 / 130 / 130
 9483502905



MN-DL-7834

Length: 1588 Ø: 58
 Cone Ø: d1 Ø 30 / d2 Ø 27
 3463303903, 3463304903, 6253303203,
 9443300503, 9443301303, 9443301703





ACTROS MP2 / MP3 ...

3335 B ...	04/03→	Centre Rod	DB-DL-8167		Push Rod
	04/03→	Centre Rod	DB-DL-8307		Push Rod
	04/03→	Centre Rod	DB-DL-8702		Push Rod
	04/03→	Suspension Arm Repair Kit		DB-RK-8626	for Wishbone (CV)
	04/03→	Suspension Arm Repair Kit		DB-RK-10375	for Wishbone (CV)
	04/03→	Suspension Strut Repair Kit		DB-RK-8391	
	04/03→	Suspension Strut Repair Kit		DB-RK-8710	
	04/03→	Suspension Strut Repair Kit		DB-RK-9291	
	04/03→	Tie Rod	DB-DL-8171		Guide Rod
	04/03→	Tie Rod	DB-DL-8327		Guide Rod, 1st Front Axle
	04/03→	Tie Rod	DB-DL-8640		Guide Rod, 1st Front Axle
	04/03→	Tie Rod	DB-DL-12310		
	04/03→	Tie Rod End	CV-ES-0543		for Push Rod
	04/03→	Tie Rod End	CV-ES-0888		for Push Rod
	04/03→	Tie Rod End	CV-ES-14163		for Steering Rod
	04/03→	Tie Rod End	DB-ES-8164		for Push Rod
	04/03→	Tie Rod End	DB-ES-8530		for Push Rod
	04/03→	Track Control Arm		DB-DL-3475	Trailing Arm, 1st RA;2nd RA, →517144 06/517144 09
	04/03→	Track Control Arm		DB-VB-7261	Suspension Rod, Wishbone (CV)
	04/03→	Track Control Arm		DB-VB-9307	Suspension Rod, Wishbone (CV)
04/03→	Track Control Arm		DB-VB-9308	Suspension Rod, Wishbone (CV)	
3335 K	04/03→	Centre Rod	DB-DL-2144		Push Rod
	04/03→	Centre Rod	DB-DL-5405		Push Rod
	04/03→	Centre Rod	DB-DL-7270		Push Rod
	04/03→	Centre Rod	DB-DL-8167		Push Rod
	04/03→	Centre Rod	DB-DL-8188		Push Rod
	04/03→	Centre Rod	DB-DL-8307		Push Rod
	04/03→	Centre Rod	DB-DL-8702		Push Rod
	04/03→	Suspension Arm Repair Kit		DB-RK-8626	for Wishbone (CV)
	04/03→	Suspension Arm Repair Kit		DB-RK-10375	for Wishbone (CV)
	04/03→	Suspension Strut Repair Kit		DB-RK-8391	
	04/03→	Suspension Strut Repair Kit		DB-RK-8710	
	04/03→	Suspension Strut Repair Kit		DB-RK-9291	
	04/03→	Tie Rod	DB-DL-8171		Guide Rod
	04/03→	Tie Rod	DB-DL-8327		Guide Rod
	04/03→	Tie Rod	DB-DL-8640		Guide Rod
	04/03→	Tie Rod	DB-DL-12310		
	04/03→	Tie Rod End	CV-ES-0543		for Push Rod
	04/03→	Tie Rod End	CV-ES-0888		for Push Rod
	04/03→	Tie Rod End	CV-ES-14163		for Steering Rod
	04/03→	Tie Rod End	DB-ES-8164		for Push Rod
	04/03→	Tie Rod End	DB-ES-8530		for Push Rod
	04/03→	Track Control Arm		DB-DL-3475	Trailing Arm, 1st RA;2nd RA, →517144 03/517144 07
	04/03→	Track Control Arm		DB-DL-3475	Trailing Arm, 1st RA;2nd RA, →517144 06/517144 09
	04/03→	Track Control Arm		DB-VB-7261	Suspension Rod, Wishbone (CV)
	04/03→	Track Control Arm		DB-VB-9307	Suspension Rod, Wishbone (CV)
	04/03→	Track Control Arm		DB-VB-9308	Suspension Rod, Wishbone (CV)
	3336	04/03→	Ball Head, gearshift linkage	DB-ES-8510	
04/03→		Bush, driver cab suspension	DB-SB-10384		
04/03→		Bush, parabolic spring		DB-SB-10400	
04/03→		Bush, parabolic spring		DB-SB-10401	
04/03→		Centre Rod	DB-DL-2144		Push Rod
04/03→		Centre Rod	DB-DL-5230		Suspension Rod
04/03→		Centre Rod	DB-DL-5405		Push Rod, Leaf Spring Axle
04/03→		Centre Rod	DB-DL-7270		Push Rod;Suspension Rod
04/03→		Centre Rod	DB-DL-8167		Push Rod
04/03→		Centre Rod	DB-DL-8168		Push Rod
04/03→		Centre Rod	DB-DL-8184		Push Rod
04/03→		Centre Rod	DB-DL-8185		Push Rod
04/03→		Centre Rod	DB-DL-8307		Push Rod

CV-ES-0543

Length: 125
Cone Ø: d1 Ø 32 / d2 Ø 29
Thread: M30 x 1,5 RHT
0004605748, 0004606048, 0004606848,
0004607048, 0014600448, 0014601148,
0014601748, 0014602448, 0014607648,
0014609648



CV-ES-0888

Length: 125
Cone Ø: d1 Ø 32 / d2 Ø 29
Thread: M30 x 1,5 LHT
0004605848, 0004606148, 0004606948,
0004607148, 0004609048, 0014600548,
0014601348, 0014602548, 0014607948,
0024600448



CV-ES-14163

Length: 125
Cone Ø: d1 Ø 30 / d2 Ø 27
Thread: M30 x 1,5 RHT
0003305248, 0003387310, 0004600348,
0004600948, 0004602848, 0004602948,
0004608948, 0014600248, 0014600848,
0014601248, 0014602248, 0014607748,
0024600148, A0003387310, A0004600348,
A0004602848, A0004602948, A0014600848,
A0014601248, A0014602248, A0014607748



DB-DL-2144

Length: 872 Ø: 35
Cone Ø: d1 Ø 28,6 / d2 Ø 23,9
0024604305, 0024604405, 0034604805



DB-DL-3475

Length: 565 Ø: 52
Hole Distance: 152 / 152
3753500006, 3753500206, 9473500805,
9483500006, 9483500805, 9483501205,
9483501305, 9483501905, 9483502005,
9483502405, A3753500006, A3753500206



DB-DL-5230

Length: 879 Ø: 42
Cone Ø: d1 Ø 30 / d2 Ø 27
01208600A, 0004607105, 0004607205,
0014606705



DB-DL-5405

Length: 890 Ø: 35
Cone Ø: d1 Ø 28,6 / d2 Ø 23,9
01215900A, 1460248, 0024604505, 0024604605,
0034605005, 3752600637, 3754600405,
A3752600637, A3754600405



DB-DL-7270

Length: 875 Ø: 40
Cone Ø: d1 Ø 28,6 / d2 Ø 23,9
01208300A, 0024604705, 0024604805,
0034604905, A0024604705

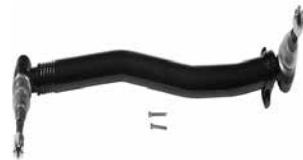

DB-DL-8167

Length: 866 Ø: 38
Cone Ø: d1 Ø 30 / d2 Ø 27
0014609805, 0014609905, 0024606305,
0024606405



DB-DL-8168

Length: 904 Ø: 52
Cone Ø: d1 Ø 32 / d2 Ø 29
0004609405, 0004609505, 0014607105



DB-DL-8171

Length: 1687 Ø: 52
Cone Ø: d1 Ø 32 / d2 Ø 29
9493300603, 9493300703, 9493301503,
9493301603



DB-DL-8184

Length: 1095 Ø: 42
Cone Ø: d1 Ø 32 / d2 Ø 28,8
01217700A, 0014601305, 0014601405,
0024600505, 0034603205, 3754601505,
A0014601305, A0014601405, A0024600505



DB-DL-8185

Length: 711 Ø: 42
Cone Ø: d1 Ø 32 / d2 Ø 28,8
01213600A, 0014601105, 0024600405,
0034603105, A0014601105, A0024600405



DB-DL-8188

Length: 895 Ø: 40
Cone Ø: d1 Ø 28,6 / d2 Ø 23,9
01217200A, 0024604905, 0024605005,
0034605605



DB-DL-8307

Length: 885 Ø: 38
Cone Ø: d1 Ø 32 / d2 Ø 30
01215500A, 0004604005, 0024605105,
0024605205, 0034604005



DB-DL-8327

Length: 1745 Ø: 48
Cone Ø: d1 Ø 32 / d2 Ø 29
01219800A, 9413300003, 9413300103,
9413300203, 9413300303, 9413300503



DB-DL-8640

Length: 1615 Ø: 50
Cone Ø: d1 Ø 32 / d2 Ø 29
6253301503, 6253301603, 6253302403,
6253302503, 9423300803, 9423302103,
9493300203, 9493300303, 9493300903



DB-DL-8702

Length: 958 Ø: 38
Cone Ø: d1 Ø 30 / d2 Ø 30
0024606105, 0024606205, 0034604205



DB-DL-12310

Length: 1532 Ø: 50
Cone Ø: d1 Ø 32 / d2 Ø 29
Thread: M27 x 1,5 LHT
9493301203, 9493301303, 9493301803,
9493302203, A9493301203, A9493301303,
A9493301803, A9493302203



DB-ES-8164

Length: 140
Cone Ø: d1 Ø 28,6 / d2 Ø 23,9
Thread: M28 x 1,5 RHT
0014604248, 0014605048, 0014608548,
0024600548



DB-ES-8510

Length: 56
Cone Ø: d1 Ø 10 / d2 Ø 10
Thread: M12 x 1,75 LHT
0009965145, 0009965645, 0019963145



DB-ES-8530

Length: 115
Cone Ø: d1 Ø 28,6 / d2 Ø 23,9
Thread: M30 x 1,5 RHT
0014603848, 0014604848, 0014605148,
0014608648, 0014609948



DB-RK-8391

Ø: 85 Hole Distance: 152
Thick/Height: 24
01336800A, 0003502705



DB-RK-8626

Ø: 75 Hole Distance: 130
Thick/Height: 24
0003502205, 0003502505, 0003503405,
0003504505, GL11319



DB-RK-8710

Ø: 85 Hole Distance: 130
Thick/Height: 30
0003503705



DB-RK-9291

Ø: 107,5 Hole Distance: 152
Thick/Height: 30
0003503605



DB-RK-10375

Ø: 100 Hole Distance: 152
Thick/Height: 24
0003502405, 0003503505, 0003504905



DB-SB-10384

Ø: 73 Thick/Height: 47
9303170012, 9423171812



DB-SB-10400

Length: 230
Thick/Height: 167,5 / 115
0003250696, 0003250896



DB-SB-10401

Length: 232
Thick/Height: 163,5 / 152,5
0003250596, 0003250796



DB-VB-7261

Length: 622 Ø: 46
Hole Ø 25 / 25 / 25
Hole Distance: 152 / 130 / 130
01337800A, 9443500305, 9443500505,
9443500605, 9473500705, 9473500905,
9483500405, 9483503005



DB-VB-9307

Length: 667 Ø: 60
Hole Ø 25 / 23 / 23
Hole Distance: 152 / 130 / 130
9483502805



DB-VB-9308

Length: 622 Ø: 46
Hole Ø 25 / 25 / 25
Hole Distance: 152 / 130 / 130
9483502905





ACTROS MP2 / MP3 ...

3336 ...	04/03→	Centre Rod	DB-DL-8622	Push Rod
	04/03→	Centre Rod	DB-DL-8641	Push Rod
	04/03→	Centre Rod	DB-DL-8642	Push Rod
	04/03→	Centre Rod	DB-DL-8702	Push Rod, Leaf Spring Axle
	04/03→	Centre Rod	DB-DL-12300	for Steering Rod
	04/03→	Stabiliser Link	DB-DL-9254	Pressure Rod
	04/03→	Stabiliser Mounting		DB-SB-10406
	04/03→	Stabiliser Mounting		DB-SB-10409
	04/03→	Stabiliser Mounting	DB-SB-10410	
	04/03→	Suspension Arm Repair Kit		DB-RK-8550 for Wishbone (CV)
	04/03→	Suspension Arm Repair Kit		DB-RK-8626 for Wishbone (CV)
	04/03→	Suspension Arm Repair Kit		DB-RK-10374 for Wishbone (CV)
	04/03→	Suspension Arm Repair Kit		DB-RK-10375 for Wishbone (CV)
	04/03→	Suspension Arm Repair Kit	DB-RK-8638	for Control Arm
	04/03→	Suspension Strut Repair Kit		DB-RK-8391
	04/03→	Suspension Strut Repair Kit		DB-RK-8710
	04/03→	Suspension Strut Repair Kit		DB-RK-9291
	04/03→	Tie Rod	DB-DL-8171	Guide Rod, 1st FA;Leaf Spring Axle
	04/03→	Tie Rod	DB-DL-8327	Guide Rod, 1st FA;Leaf Spring Axle
	04/03→	Tie Rod	DB-DL-8640	Guide Rod
	04/03→	Tie Rod	DB-DL-12310	
	04/03→	Tie Rod	DB-ES-5227	Guide Rod
	04/03→	Tie Rod End	CV-ES-0543	for Push Rod
	04/03→	Tie Rod End	CV-ES-0888	for Push Rod
	04/03→	Tie Rod End	CV-ES-14163	for Steering Rod
	04/03→	Tie Rod End	DB-ES-5234	for Steering Rod
	04/03→	Tie Rod End	DB-ES-8164	for Push Rod
	04/03→	Tie Rod End	DB-ES-8530	for Push Rod
	04/03→	Track Control Arm		DB-DL-3475 Trailing Arm
	04/03→	Track Control Arm		DB-VB-7261 Suspension Rod, Wishbone (CV), 1st RA;2nd RA; Leaf Spring Axle
	04/03→	Track Control Arm		DB-VB-9307 Suspension Rod, Wishbone (CV), 1st RA;2nd RA; Leaf Spring Axle
	04/03→	Track Control Arm		DB-VB-9308 Suspension Rod, Wishbone (CV), 1st RA;2nd RA; Leaf Spring Axle
	3336 A	04/03→	Ball Head, gearshift linkage	DB-ES-8510
04/03→		Bush, driver cab suspension	DB-SB-10384	
04/03→		Bush, parabolic spring		DB-SB-10401
04/03→		Centre Rod	DB-DL-8168	Push Rod
04/03→		Centre Rod	DB-DL-8184	Push Rod
04/03→		Centre Rod	DB-DL-8307	Push Rod, Leaf Spring Axle
04/03→		Centre Rod	DB-DL-8622	Push Rod
04/03→		Centre Rod	DB-DL-8641	Push Rod
04/03→		Centre Rod	DB-DL-8642	Push Rod
04/03→		Centre Rod	DB-DL-8702	Push Rod, Leaf Spring Axle
04/03→		Centre Rod	DB-DL-12300	for Steering Rod
04/03→		Stabiliser Link	DB-DL-9254	Pressure Rod
04/03→		Stabiliser Mounting		DB-SB-10406
04/03→		Stabiliser Mounting		DB-SB-10409
04/03→		Stabiliser Mounting	DB-SB-10410	
04/03→		Suspension Arm Repair Kit		DB-RK-8550 for Wishbone (CV)
04/03→		Suspension Arm Repair Kit		DB-RK-8626 for Wishbone (CV)
04/03→		Suspension Arm Repair Kit		DB-RK-10374 for Wishbone (CV)
04/03→		Suspension Arm Repair Kit		DB-RK-10375 for Wishbone (CV)
04/03→		Suspension Arm Repair Kit	DB-RK-8638	for Control Arm
04/03→		Suspension Strut Repair Kit		DB-RK-8391
04/03→		Suspension Strut Repair Kit		DB-RK-8710
04/03→		Suspension Strut Repair Kit		DB-RK-9291
04/03→		Tie Rod	DB-DL-12310	
04/03→		Tie Rod	DB-ES-5227	Guide Rod, 1st FA;Leaf Spring Axle
04/03→		Tie Rod	MN-DL-7834	Guide Rod, 1st FA;Leaf Spring Axle
04/03→		Tie Rod End	CV-ES-0543	for Push Rod
04/03→		Tie Rod End	CV-ES-14163	for Steering Rod

CV-ES-0543

Length: 125
Cone Ø: d1 Ø 32 / d2 Ø 29
Thread: M30 x 1,5 RHT
0004605748, 0004606048, 0004606848,
0004607048, 0014600448, 0014601148,
0014601748, 0014602448, 0014607648,
0014609648



CV-ES-0888

Length: 125
Cone Ø: d1 Ø 32 / d2 Ø 29
Thread: M30 x 1,5 LHT
0004605848, 0004606148, 0004606948,
0004607148, 0004609048, 0014600548,
0014601348, 0014602548, 0014607948,
0024600448



CV-ES-14163

Length: 125
Cone Ø: d1 Ø 30 / d2 Ø 27
Thread: M30 x 1,5 RHT
0003305248, 0003387310, 0004600348,
0004600948, 0004602848, 0004602948,
0004608948, 0014600248, 0014600848,
0014601248, 0014602248, 0014607748,
0024600148, A0003387310, A0004600348,
A0004602848, A0004602948, A0014600848,
A0014601248, A0014602248, A0014607748



DB-DL-3475

Length: 565 Ø: 52
Hole Distance: 152 / 152
3753500006, 3753500206, 9473500805,
9483500006, 9483500805, 9483501205,
9483501305, 9483501905, 9483502005,
9483502405, A3753500006, A3753500206



DB-DL-8168

Length: 904 Ø: 52
Cone Ø: d1 Ø 32 / d2 Ø 29
0004609405, 0004609505, 0014607105



DB-DL-8171

Length: 1687 Ø: 52
Cone Ø: d1 Ø 32 / d2 Ø 29
9493300603, 9493300703, 9493301503,
9493301603



DB-DL-8184

Length: 1095 Ø: 42
Cone Ø: d1 Ø 32 / d2 Ø 28,8
01217700A, 0014601305, 0014601405,
0024600505, 0034603205, 3754601505,
A0014601305, A0014601405, A0024600505



DB-DL-8307

Length: 885 Ø: 38
Cone Ø: d1 Ø 32 / d2 Ø 30
01215500A, 0004604005, 0024605105,
0024605205, 0034604005



DB-DL-8327

Length: 1745 Ø: 48
Cone Ø: d1 Ø 32 / d2 Ø 29
01219800A, 9413300003, 9413300103,
9413300203, 9413300303, 9413300503



DB-DL-8622

Length: 1558 Ø: 52
Cone Ø: d1 Ø 30 / d2 Ø 27
0014609005, 0014609105



DB-DL-8640

Length: 1615 Ø: 50
Cone Ø: d1 Ø 32 / d2 Ø 29
6253301503, 6253301603, 6253302403,
6253302503, 9423300803, 9423302103,
9493300203, 9493300303, 9493300903



DB-DL-8641

Length: 905 Ø: 42
Cone Ø: d1 Ø 30 / d2 Ø 27
0014605105, 0014608105



DB-DL-8642

Length: 954 Ø: 42
Cone Ø: d1 Ø 30 / d2 Ø 27
0014608605, 0014608705



DB-DL-8702

Length: 958 Ø: 38
Cone Ø: d1 Ø 32 / d2 Ø 30
0024606105, 0024606205, 0034604205



DB-DL-9254

Length: 1815 Ø: 58
0003220323, 0003220623, 3753220423



DB-DL-12300

Length: 733 Ø: 36
Cone Ø: d1 Ø 32 / d2 Ø 29
0014601505, 0014607305, 0034603305,
3754601605, A0014601505, A0034603305,
A3754601605



DB-DL-12310

Length: 1532 Ø: 50
Cone Ø: d1 Ø 32 / d2 Ø 29
Thread: M27 x 1,5 LHT
9493301203, 9493301303, 9493301803,
9493302203, A9493301203, A9493301303,
A9493301803, A9493302203



DB-ES-5227

Length: 1588 Ø: 60
Cone Ø: d1 Ø 38 / d2 Ø 34,3
6253300903, 6253301203, 9443300203



DB-ES-5234

Length: 135
Cone Ø: d1 Ø 38 / d2 Ø 34,3
Thread: M38 x 1,5 RHT
0004601748, 120322305, 2205000400



DB-ES-8164

Length: 140
Cone Ø: d1 Ø 28,6 / d2 Ø 23,9
Thread: M28 x 1,5 RHT
0014604248, 0014605048, 0014608548,
0024600548



DB-ES-8510

Length: 56
Cone Ø: d1 Ø 10 / d2 Ø 10
Thread: M12 x 1,75 LHT
0009965145, 0009965645, 0019963145



DB-ES-8530

Length: 115
Cone Ø: d1 Ø 28,6 / d2 Ø 23,9
Thread: M30 x 1,5 RHT
0014603848, 0014604848, 0014605148,
0014608648, 0014609948



DB-RK-8391

Ø: 85 Hole Distance: 152
Thick/Height: 24
01336800A, 0003502705



DB-RK-8550

Ø: 75 Hole Distance: 152
Thick/Height: 24
0003502105, 0003504605



DB-RK-8626

Ø: 75 Hole Distance: 130
Thick/Height: 24
0003502205, 0003502505, 0003503405,
0003504505, GL11319



DB-RK-8638

Length: 100 Ø: 67
Hole Distance: 100
Thick/Height: 20
0003301411



DB-RK-8710

Ø: 85 Hole Distance: 130
Thick/Height: 30
0003503705



DB-RK-9291

Ø: 107,5 Hole Distance: 152
Thick/Height: 30
0003503605



DB-RK-10374

Ø: 85 Hole Distance: 152
Thick/Height: 24
0003504405



DB-RK-10375

Ø: 100 Hole Distance: 152
Thick/Height: 24
0003502405, 0003503505, 0003504905



DB-SB-10384

Ø: 73 Thick/Height: 47
9303170012, 9423171812



DB-SB-10401

Length: 232
Thick/Height: 163,5 / 152,5
0003250596, 0003250796



DB-SB-10406

Ø: 80 Thick/Height: 46
0003238185



DB-SB-10409

Ø: 77 Thick/Height: 56
0003265181



DB-SB-10410

Ø: 73 Hole Distance: 100
Thick/Height: 24
9413230050



DB-VB-7261

Length: 622 Ø: 46
Hole Ø 25 / 25 / 25
Hole Distance: 152 / 130 / 130
01337800A, 9443500305, 9443500505,
9443500605, 9473500705, 9473500905,
9483500405, 9483500305



DB-VB-9307

Length: 667 Ø: 60
Hole Ø 25 / 23 / 23
Hole Distance: 152 / 130 / 130
9483502805



DB-VB-9308

Length: 622 Ø: 46
Hole Ø 25 / 25 / 25
Hole Distance: 152 / 130 / 130
9483502905



MN-DL-7834

Length: 1588 Ø: 58
Cone Ø: d1 Ø 30 / d2 Ø 27
3463303903, 3463304903, 6253303203,
9443300503, 9443301303, 9443301703





ACTROS MP2 / MP3 ...

3336 A ...	04/03 →	Tie Rod End	DB-ES-5234		for Steering Rod	
	04/03 →	Tie Rod End	DB-ES-8530		for Push Rod	
	04/03 →	Track Control Arm		DB-DL-3475	Trailing Arm	
	04/03 →	Track Control Arm		DB-VB-7261	Suspension Rod, Wishbone (CV), 1st RA;2nd RA; Leaf Spring Axle	
	04/03 →	Track Control Arm		DB-VB-9307	Suspension Rod, Wishbone (CV), 1st RA;2nd RA; Leaf Spring Axle	
	04/03 →	Track Control Arm		DB-VB-9308	Suspension Rod, Wishbone (CV), 1st RA;2nd RA; Leaf Spring Axle	
3336 AK	04/03 →	Ball Head, gearshift linkage	DB-ES-8510			
	04/03 →	Bush, driver cab suspension	DB-SB-10384			
	04/03 →	Centre Rod	DB-DL-8184		Push Rod	
	04/03 →	Centre Rod	DB-DL-8307		Push Rod, Leaf Spring Axle	
	04/03 →	Centre Rod	DB-DL-8702		Push Rod, Leaf Spring Axle	
	04/03 →	Centre Rod	DB-DL-12300		for Steering Rod	
	04/03 →	Stabiliser Mounting		DB-SB-10406		
	04/03 →	Stabiliser Mounting		DB-SB-10409		
	04/03 →	Suspension Arm Repair Kit		DB-RK-8626	for Wishbone (CV)	
	04/03 →	Suspension Arm Repair Kit		DB-RK-10374	for Wishbone (CV)	
	04/03 →	Suspension Arm Repair Kit		DB-RK-10375	for Wishbone (CV)	
	04/03 →	Suspension Arm Repair Kit	DB-RK-8638		for Control Arm	
	04/03 →	Suspension Strut Repair Kit		DB-RK-8391		
	04/03 →	Suspension Strut Repair Kit		DB-RK-8710		
	04/03 →	Suspension Strut Repair Kit		DB-RK-9291		
	04/03 →	Tie Rod	DB-DL-12310			
	04/03 →	Tie Rod	DB-ES-5227		Guide Rod	
	04/03 →	Tie Rod	MN-DL-7834		Guide Rod	
	04/03 →	Tie Rod End	CV-ES-0543		for Push Rod	
	04/03 →	Tie Rod End	CV-ES-14163		for Steering Rod	
	04/03 →	Tie Rod End	DB-ES-5234		for Steering Rod	
	04/03 →	Tie Rod End	DB-ES-8530		for Push Rod	
	04/03 →	Track Control Arm		DB-DL-3475	Trailing Arm	
	04/03 →	Track Control Arm		DB-VB-7261	Suspension Rod, Wishbone (CV), 1st RA;2nd RA; Leaf Spring Axle	
	04/03 →	Track Control Arm		DB-VB-9307	Suspension Rod, Wishbone (CV), 1st RA;2nd RA; Leaf Spring Axle	
	04/03 →	Track Control Arm		DB-VB-9308	Suspension Rod, Wishbone (CV), 1st RA;2nd RA; Leaf Spring Axle	
	3336 AKE	04/03 →	Bush, driver cab suspension	DB-SB-10384		
		04/03 →	Bush, parabolic spring		DB-SB-10401	
04/03 →		Centre Rod	DB-DL-8307		Push Rod, Leaf Spring Axle	
04/03 →		Centre Rod	DB-DL-8702		Push Rod, Drive Axle;Leaf Spring Axle	
04/03 →		Stabiliser Mounting		DB-SB-10406		
04/03 →		Suspension Strut Repair Kit		DB-RK-8710		
04/03 →		Suspension Strut Repair Kit		DB-RK-9291		
04/03 →		Tie Rod	DB-DL-12310			
04/03 →		Tie Rod	DB-ES-5227		Guide Rod	
04/03 →		Tie Rod	MN-DL-7834		Guide Rod	
04/03 →		Tie Rod End	DB-ES-5234		for Steering Rod	
04/03 →		Track Control Arm		DB-VB-7261	Suspension Rod, Wishbone (CV), 1st RA;2nd RA; Leaf Spring Axle	
04/03 →		Track Control Arm		DB-VB-9307	Suspension Rod, Wishbone (CV), 1st RA;2nd RA; Leaf Spring Axle	
04/03 →		Track Control Arm		DB-VB-9308	Suspension Rod, Wishbone (CV), 1st RA;2nd RA; Leaf Spring Axle	
3336 AS		04/03 →	Ball Head, gearshift linkage	DB-ES-8510		
		04/03 →	Bush, driver cab suspension	DB-SB-10384		
	04/03 →	Centre Rod	DB-DL-8307		Push Rod	
	04/03 →	Centre Rod	DB-DL-8702		Push Rod, Leaf Spring Axle	
	04/03 →	Centre Rod	DB-DL-12300		for Steering Rod	
	04/03 →	Stabiliser Mounting		DB-SB-10406		
	04/03 →	Stabiliser Mounting		DB-SB-10409		
	04/03 →	Stabiliser Mounting	DB-SB-10410			

CV-ES-0543

Length: 125
Cone Ø: d1 Ø 32 / d2 Ø 29
Thread: M30 x 1,5 RHT
0004605748, 0004606048, 0004606848,
0004607048, 0014600448, 0014601148,
0014601748, 0014602448, 0014607648,
0014609648



CV-ES-14163

Length: 125
Cone Ø: d1 Ø 30 / d2 Ø 27
Thread: M30 x 1,5 RHT
0003305248, 0003387310, 0004600348,
0004600948, 0004602848, 0004602948,
0004608948, 0014600248, 0014600848,
0014601248, 0014602248, 0014607748,
0024600148, A0003387310, A0004600348,
A0004602848, A0004602948, A0014600848,
A0014601248, A0014602248, A0014607748



DB-DL-3475

Length: 565 Ø: 52
Hole Distance: 152 / 152
3753500006, 3753500206, 9473500805,
9483500006, 9483500805, 9483501205,
9483501305, 9483501905, 9483502005,
9483502405, A3753500006, A3753500206



DB-DL-8184

Length: 1095 Ø: 42
Cone Ø: d1 Ø 32 / d2 Ø 28,8
01217700A, 0014601305, 0014601405,
0024600505, 0034603205, 3754601505,
A0014601305, A0014601405, A0024600505



DB-DL-8307

Length: 885 Ø: 38
Cone Ø: d1 Ø 32 / d2 Ø 30
01215500A, 0004604005, 0024605105,
0024605205, 0034604005



DB-DL-8702

Length: 958 Ø: 38
Cone Ø: d1 Ø 32 / d2 Ø 30
0024606105, 0024606205, 0034604205



DB-DL-12300

Length: 733 Ø: 36
Cone Ø: d1 Ø 32 / d2 Ø 29
0014601505, 0014607305, 0034603305,
3754601605, A0014601505, A0034603305,
A3754601605



DB-DL-12310

Length: 1532 Ø: 50
Cone Ø: d1 Ø 32 / d2 Ø 29
Thread: M27 x 1,5 LHT
9493301203, 9493301303, 9493301803,
9493302203, A9493301203, A9493301303,
A9493301803, A9493302203



DB-ES-5227

Length: 1588 Ø: 60
Cone Ø: d1 Ø 38 / d2 Ø 34,3
6253300903, 6253301203, 9443300203



DB-ES-5234

Length: 135
Cone Ø: d1 Ø 38 / d2 Ø 34,3
Thread: M38 x 1,5 RHT
0004601748, 120322305, 2205000400



DB-ES-8510

Length: 56
Cone Ø: d1 Ø 10 / d2 Ø 10
Thread: M12 x 1,75 LHT
0009965145, 0009965645, 0019963145



DB-ES-8530

Length: 115
Cone Ø: d1 Ø 28,6 / d2 Ø 23,9
Thread: M30 x 1,5 RHT
0014603848, 0014604848, 0014605148,
0014608648, 0014609948



DB-RK-8391

Ø: 85 Hole Distance: 152
Thick/Height: 24
01336800A, 0003502705



DB-RK-8626

Ø: 75 Hole Distance: 130
Thick/Height: 24
0003502205, 0003502505, 0003503405,
0003504505, GL11319



DB-RK-8638

Length: 100 Ø: 67
Hole Distance: 100
Thick/Height: 20
0003301411



DB-RK-8710

Ø: 85 Hole Distance: 130
Thick/Height: 30
0003503705



DB-RK-9291

Ø: 107,5 Hole Distance: 152
Thick/Height: 30
0003503605



DB-RK-10374

Ø: 85 Hole Distance: 152
Thick/Height: 24
0003504405



DB-RK-10375

Ø: 100 Hole Distance: 152
Thick/Height: 24
0003502405, 0003503505, 0003504905



DB-SB-10384

Ø: 73 Thick/Height: 47
9303170012, 9423171812



DB-SB-10401

Length: 232
Thick/Height: 163,5 / 152,5
0003250596, 0003250796



DB-SB-10406

Ø: 80 Thick/Height: 46
0003238185



DB-SB-10409

Ø: 77 Thick/Height: 56
0003265181



DB-SB-10410

Ø: 73 Hole Distance: 100
Thick/Height: 24
9413230050



DB-VB-7261

Length: 622 Ø: 46
Hole Ø 25 / 25 / 25
Hole Distance: 152 / 130 / 130
01337800A, 9443500305, 9443500505,
9443500605, 9473500705, 9473500905,
9483500405, 9483503005



DB-VB-9307

Length: 667 Ø: 60
Hole Ø 25 / 23 / 23
Hole Distance: 152 / 130 / 130
9483502805



DB-VB-9308

Length: 622 Ø: 46
Hole Ø 25 / 25 / 25
Hole Distance: 152 / 130 / 130
9483502905



MN-DL-7834

Length: 1588 Ø: 58
Cone Ø: d1 Ø 30 / d2 Ø 27
3463303903, 3463304903, 6253303203,
9443300503, 9443301303, 9443301703





ACTROS MP2 / MP3 ...

3336 AS ...	04/03→	Suspension Arm Repair Kit		DB-RK-8626	for Wishbone (CV)
	04/03→	Suspension Arm Repair Kit		DB-RK-10374	for Wishbone (CV)
	04/03→	Suspension Arm Repair Kit		DB-RK-10375	for Wishbone (CV)
	04/03→	Suspension Arm Repair Kit	DB-RK-8638		for Control Arm
	04/03→	Suspension Strut Repair Kit		DB-RK-8391	
	04/03→	Suspension Strut Repair Kit		DB-RK-8710	
	04/03→	Suspension Strut Repair Kit		DB-RK-9291	
	04/03→	Suspension Strut Repair Kit		MN-RK-8997	
	04/03→	Tie Rod	DB-DL-12310		
	04/03→	Tie Rod	DB-ES-5227		Guide Rod
	04/03→	Tie Rod	MN-DL-7834		Guide Rod
	04/03→	Tie Rod End	CV-ES-0543		for Push Rod
	04/03→	Tie Rod End	CV-ES-14163		for Steering Rod
	04/03→	Tie Rod End	DB-ES-5234		for Steering Rod
	04/03→	Tie Rod End	DB-ES-8530		for Push Rod
	04/03→	Track Control Arm		DB-DL-3475	Trailing Arm
	04/03→	Track Control Arm		DB-VB-7261	Suspension Rod, Wishbone (CV), 1st RA;2nd RA; Leaf Spring Axle
	04/03→	Track Control Arm		DB-VB-7798	Wishbone (CV)
	04/03→	Track Control Arm		DB-VB-9307	Suspension Rod, Wishbone (CV), 1st RA;2nd RA; Leaf Spring Axle
	04/03→	Track Control Arm		DB-VB-9308	Suspension Rod, Wishbone (CV), 1st RA;2nd RA; Leaf Spring Axle
3336 B	04/03→	Ball Head, gearshift linkage	DB-ES-8510		
	04/03→	Bush, driver cab suspension	DB-SB-10384		
	04/03→	Bush, parabolic spring		DB-SB-10400	
	04/03→	Bush, parabolic spring		DB-SB-10401	
	04/03→	Centre Rod	DB-DL-2144		Push Rod
	04/03→	Centre Rod	DB-DL-5230		Suspension Rod
	04/03→	Centre Rod	DB-DL-5405		Push Rod, Leaf Spring Axle
	04/03→	Centre Rod	DB-DL-7270		Push Rod
	04/03→	Centre Rod	DB-DL-8167		Push Rod
	04/03→	Centre Rod	DB-DL-8184		Push Rod
	04/03→	Centre Rod	DB-DL-8185		Push Rod
	04/03→	Centre Rod	DB-DL-8307		Push Rod
	04/03→	Centre Rod	DB-DL-8702		Push Rod, Leaf Spring Axle
	04/03→	Centre Rod	DB-DL-12300		for Steering Rod
	04/03→	Stabiliser Mounting		DB-SB-10406	
	04/03→	Stabiliser Mounting		DB-SB-10409	
	04/03→	Suspension Arm Repair Kit		DB-RK-8550	for Wishbone (CV)
	04/03→	Suspension Arm Repair Kit		DB-RK-8626	for Wishbone (CV)
	04/03→	Suspension Arm Repair Kit		DB-RK-10374	for Wishbone (CV)
	04/03→	Suspension Arm Repair Kit	DB-RK-8638		for Control Arm
	04/03→	Suspension Strut Repair Kit		DB-RK-8391	
	04/03→	Suspension Strut Repair Kit		DB-RK-8710	
	04/03→	Suspension Strut Repair Kit		DB-RK-9291	
	04/03→	Tie Rod	DB-DL-8171		Guide Rod
	04/03→	Tie Rod	DB-DL-8327		Guide Rod
	04/03→	Tie Rod	DB-DL-8640		Guide Rod
	04/03→	Tie Rod	DB-DL-12310		
	04/03→	Tie Rod End	CV-ES-0543		for Push Rod
	04/03→	Tie Rod End	CV-ES-0888		for Push Rod
	04/03→	Tie Rod End	CV-ES-14163		for Steering Rod
	04/03→	Tie Rod End	DB-ES-5234		for Steering Rod
	04/03→	Tie Rod End	DB-ES-8164		for Push Rod
	04/03→	Tie Rod End	DB-ES-8530		for Push Rod
	04/03→	Track Control Arm		DB-DL-3475	Trailing Arm
	04/03→	Track Control Arm		DB-VB-7261	Suspension Rod, Wishbone (CV), 1st RA;2nd RA; Leaf Spring Axle
	04/03→	Track Control Arm		DB-VB-9307	Suspension Rod, Wishbone (CV), 1st RA;2nd RA; Leaf Spring Axle
	04/03→	Track Control Arm		DB-VB-9308	Suspension Rod, Wishbone (CV), 1st RA;2nd RA; Leaf Spring Axle

CV-ES-0543

Length: 125
Cone Ø: d1 Ø 32 / d2 Ø 29
Thread: M30 x 1,5 RHT
0004605748, 0004606048, 0004606848,
0004607048, 0014600448, 0014601148,
0014601748, 0014602448, 0014607648,
0014609648



CV-ES-0888

Length: 125
Cone Ø: d1 Ø 32 / d2 Ø 29
Thread: M30 x 1,5 LHT
0004605848, 0004606148, 0004606948,
0004607148, 0004609048, 0014600548,
0014601348, 0014602548, 0014607948,
0024600448



CV-ES-14163

Length: 125
Cone Ø: d1 Ø 30 / d2 Ø 27
Thread: M30 x 1,5 RHT
0003305248, 0003387310, 0004600348,
0004600948, 0004602848, 0004602948,
0004608948, 0014600248, 0014600848,
0014601248, 0014602248, 0014607748,
0024600148, A0003387310, A0004600348,
A0004602848, A0004602948, A0014600848,
A0014601248, A0014602248, A0014607748



DB-DL-2144

Length: 872 Ø: 35
Cone Ø: d1 Ø 28,6 / d2 Ø 23,9
0024604305, 0024604405, 0034604805



DB-DL-3475

Length: 565 Ø: 52
Hole Distance: 152 / 152
3753500006, 3753500206, 9473500805,
9483500006, 9483500805, 9483501205,
9483501305, 9483501905, 9483502005,
9483502405, A3753500006, A3753500206



DB-DL-5230

Length: 879 Ø: 42
Cone Ø: d1 Ø 30 / d2 Ø 27
01208600A, 0004607105, 0004607205,
0014606705



DB-DL-5405

Length: 890 Ø: 35
Cone Ø: d1 Ø 28,6 / d2 Ø 23,9
01215900A, 1460248, 0024604505, 0024604605,
0034605005, 3752600637, 3754600405,
A3752600637, A3754600405



DB-DL-7270

Length: 875 Ø: 40
Cone Ø: d1 Ø 28,6 / d2 Ø 23,9
01208300A, 0024604705, 0024604805,
0034604905, A0024604705



DB-DL-8167

Length: 866 Ø: 38
Cone Ø: d1 Ø 30 / d2 Ø 27
0014609805, 0014609905, 0024606305,
0024606405



DB-DL-8171

Length: 1687 Ø: 52
Cone Ø: d1 Ø 32 / d2 Ø 29
9493300603, 9493300703, 9493301503,
9493301603



DB-DL-8184

Length: 1095 Ø: 42
Cone Ø: d1 Ø 32 / d2 Ø 28,8
01217700A, 0014601305, 0014601405,
0024600505, 0034603205, 3754601505,
A0014601305, A0014601405, A0024600505



DB-DL-8185

Length: 711 Ø: 42
Cone Ø: d1 Ø 32 / d2 Ø 28,8
01213600A, 0014601105, 0024600405,
0034603105, A0014601105, A0024600405



DB-DL-8307

Length: 885 Ø: 38
Cone Ø: d1 Ø 32 / d2 Ø 30
01215500A, 0004604005, 0024605105,
0024605205, 0034604005



DB-DL-8327

Length: 1745 Ø: 48
Cone Ø: d1 Ø 32 / d2 Ø 29
01219800A, 9413300003, 9413300103,
9413300203, 9413300303, 9413300503



DB-DL-8640

Length: 1615 Ø: 50
Cone Ø: d1 Ø 32 / d2 Ø 29
6253301503, 6253301603, 6253302403,
6253302503, 9423300803, 9423302103,
9493300203, 9493300303, 9493300903



DB-DL-8702

Length: 958 Ø: 38
Cone Ø: d1 Ø 32 / d2 Ø 30
0024606105, 0024606205, 0034604205



DB-DL-12300

Length: 733 Ø: 36
Cone Ø: d1 Ø 32 / d2 Ø 29
0014601505, 0014607305, 0034603305,
3754601605, A0014601505, A0034603305,
A3754601605



DB-DL-12310

Length: 1532 Ø: 50
Cone Ø: d1 Ø 32 / d2 Ø 29
Thread: M27 x 1,5 LHT
9493301203, 9493301303, 9493301803,
9493302203, A9493301203, A9493301303,
A9493301803, A9493302203



DB-ES-5227

Length: 1588 Ø: 60
Cone Ø: d1 Ø 38 / d2 Ø 34,3
6253300903, 6253301203, 9443300203



DB-ES-5234

Length: 135
Cone Ø: d1 Ø 38 / d2 Ø 34,3
Thread: M38 x 1,5 RHT
0004601748, 120322305, 2205000400



DB-ES-8164

Length: 140
Cone Ø: d1 Ø 28,6 / d2 Ø 23,9
Thread: M28 x 1,5 RHT
0014604248, 0014605048, 0014608548,
0024600548



DB-ES-8510

Length: 56
Cone Ø: d1 Ø 10 / d2 Ø 10
Thread: M12 x 1,75 LHT
0009965145, 0009965645, 0019963145



DB-ES-8530

Length: 115
Cone Ø: d1 Ø 28,6 / d2 Ø 23,9
Thread: M30 x 1,5 RHT
0014603848, 0014604848, 0014605148,
0014608648, 0014609948



DB-RK-8391

Ø: 85 Hole Distance: 152
Thick/Height: 24
01336800A, 0003502705



DB-RK-8550

Ø: 75 Hole Distance: 152
Thick/Height: 24
0003502105, 0003504605



DB-RK-8626

Ø: 75 Hole Distance: 130
Thick/Height: 24
0003502205, 0003502505, 0003503405,
0003504505, GL11319



DB-RK-8638

Length: 100 Ø: 67
Hole Distance: 100
Thick/Height: 20
0003301411



DB-RK-8710

Ø: 85 Hole Distance: 130
Thick/Height: 30
0003503705



DB-RK-9291

Ø: 107,5 Hole Distance: 152
Thick/Height: 30
0003503605



DB-RK-10374

Ø: 85 Hole Distance: 152
Thick/Height: 24
0003504405



DB-RK-10375

Ø: 100 Hole Distance: 152
Thick/Height: 24
0003502405, 0003503505, 0003504905



DB-SB-10384

Ø: 73 Thick/Height: 47
9303170012, 9423171812



DB-SB-10400

Length: 230
Thick/Height: 167,5 / 115
0003250696, 0003250896



DB-SB-10401

Length: 232
Thick/Height: 163,5 / 152,5
0003250596, 0003250796



DB-SB-10406

Ø: 80 Thick/Height: 46
0003238185



DB-SB-10409

Ø: 77 Thick/Height: 56
0003265181



DB-VB-7261

Length: 622 Ø: 46
Hole Ø 25 / 25 / 25
Hole Distance: 152 / 130 / 130
01337800A, 9443500305, 9443500505,
9443500605, 9473500705, 9473500905,
9483500405, 9483500305



DB-VB-7798

Length: 622 Ø: 48
Hole Ø 25 / 23 / 23
Hole Distance: 152 / 130 / 130
9423500505, 9423500805, 9423501205,
A9423501205



DB-VB-9307

Length: 667 Ø: 60
Hole Ø 25 / 23 / 23
Hole Distance: 152 / 130 / 130
9483502805



DB-VB-9308

Length: 622 Ø: 46
Hole Ø 25 / 25 / 25
Hole Distance: 152 / 130 / 130
9483502905



MN-DL-7834

Length: 1588 Ø: 58
Cone Ø: d1 Ø 30 / d2 Ø 27
3463303903, 3463304903, 6253303203,
9443300503, 9443301303, 9443301703



MN-RK-8997

Ø: 85 Hole Distance: 130
Thick/Height: 30
0003504805





ACTROS MP2 / MP3 ...

3336 K	04/03→	Ball Head, gearshift linkage	DB-ES-8510			
	04/03→	Bush, driver cab suspension	DB-SB-10384			
	04/03→	Bush, parabolic spring		DB-SB-10401		
	04/03→	Centre Rod	DB-DL-2144		Push Rod	
	04/03→	Centre Rod	DB-DL-5405		Push Rod, Leaf Spring Axle	
	04/03→	Centre Rod	DB-DL-7270		Push Rod	
	04/03→	Centre Rod	DB-DL-8167		Push Rod	
	04/03→	Centre Rod	DB-DL-8168		Push Rod, Leaf Spring Axle	
	04/03→	Centre Rod	DB-DL-8184		Push Rod	
	04/03→	Centre Rod	DB-DL-8184		Push Rod, Leaf Spring Axle	
	04/03→	Centre Rod	DB-DL-8185		Push Rod, Leaf Spring Axle	
	04/03→	Centre Rod	DB-DL-8188		Push Rod	
	04/03→	Centre Rod	DB-DL-8307		Push Rod	
	04/03→	Centre Rod	DB-DL-8702		Push Rod, Leaf Spring Axle	
	04/03→	Centre Rod	DB-DL-12300		for Steering Rod	
	04/03→	Stabiliser Link	DB-DL-9254		Pressure Rod	
	04/03→	Stabiliser Link	DB-DL-9271		Pressure Rod	
	04/03→	Stabiliser Link	DB-DL-9272		Pressure Rod	
	04/03→	Stabiliser Mounting		DB-SB-10406		
	04/03→	Stabiliser Mounting		DB-SB-10409		
	04/03→	Suspension Arm Repair Kit		DB-RK-8626		for Wishbone (CV)
	04/03→	Suspension Arm Repair Kit		DB-RK-10374		for Wishbone (CV)
	04/03→	Suspension Arm Repair Kit		DB-RK-10375		for Wishbone (CV)
	04/03→	Suspension Arm Repair Kit	DB-RK-8638			for Control Arm
	04/03→	Suspension Strut Repair Kit		DB-RK-8391		
	04/03→	Suspension Strut Repair Kit		DB-RK-8710		
	04/03→	Suspension Strut Repair Kit		DB-RK-9291		
	04/03→	Suspension Strut Repair Kit		DB-RK-9294		
	04/03→	Tie Rod	DB-DL-8171			Guide Rod
	04/03→	Tie Rod	DB-DL-8172			Guide Rod
	04/03→	Tie Rod	DB-DL-8327			Guide Rod
	04/03→	Tie Rod	DB-DL-8390			
	04/03→	Tie Rod	DB-DL-8640			Guide Rod
	04/03→	Tie Rod	DB-DL-12310			
	04/03→	Tie Rod	DB-ES-5227			Guide Rod
	04/03→	Tie Rod End	CV-ES-0543			for Push Rod
	04/03→	Tie Rod End	CV-ES-0888			for Push Rod
	04/03→	Tie Rod End	CV-ES-14163			for Steering Rod
	04/03→	Tie Rod End	DB-ES-5234			for Steering Rod
	04/03→	Tie Rod End	DB-ES-8164			for Push Rod
	04/03→	Tie Rod End	DB-ES-8323			Leaf Spring Axle
	04/03→	Tie Rod End	DB-ES-8530			for Push Rod
04/03→	Track Control Arm		DB-DL-3475		Trailing Arm	
04/03→	Track Control Arm		DB-DL-3475		Trailing Arm, 1st RA;2nd RA, →517144 03/517144 07	
04/03→	Track Control Arm		DB-DL-3475		Trailing Arm, 1st RA;2nd RA, →517144 06/517144 09	
04/03→	Track Control Arm		DB-VB-3707		Suspension Rod, Wishbone (CV)	
04/03→	Track Control Arm		DB-VB-7261		Suspension Rod, Wishbone (CV), 1st RA;2nd RA; Leaf Spring Axle	
04/03→	Track Control Arm		DB-VB-9307		Suspension Rod, Wishbone (CV), 1st RA;2nd RA; Leaf Spring Axle	
04/03→	Track Control Arm		DB-VB-9308		Suspension Rod, Wishbone (CV), 1st RA;2nd RA; Leaf Spring Axle	
04/03→	Track Control Arm		DB-VB-10426		Wishbone (CV), Leaf Spring Axle;Unit	
3336 S	04/03→	Ball Head, gearshift linkage	DB-ES-8510			
	04/03→	Bush, driver cab suspension	DB-SB-10384			
	04/03→	Bush, parabolic spring		DB-SB-10400		
	04/03→	Bush, parabolic spring		DB-SB-10401		
	04/03→	Centre Rod	DB-DL-2144		Push Rod	
	04/03→	Centre Rod	DB-DL-5230		Suspension Rod	
	04/03→	Centre Rod	DB-DL-5405		Push Rod, Leaf Spring Axle	
	04/03→	Centre Rod	DB-DL-7270		Push Rod;Suspension Rod	

CV-ES-0543

Length: 125
 Cone Ø: d1 Ø 32 / d2 Ø 29
 Thread: M30 x 1,5 RHT
 0004605748, 0004606048, 0004606848,
 0004607048, 0014600448, 0014601148,
 0014601748, 0014602448, 0014607648,
 0014609648

**CV-ES-0888**

Length: 125
 Cone Ø: d1 Ø 32 / d2 Ø 29
 Thread: M30 x 1,5 LHT
 0004605848, 0004606148, 0004606948,
 0004607148, 0004609048, 0014600548,
 0014601348, 0014602548, 0014607948,
 0024600448

**CV-ES-14163**

Length: 125
 Cone Ø: d1 Ø 30 / d2 Ø 27
 Thread: M30 x 1,5 RHT
 0003305248, 0003387310, 0004600348,
 0004600948, 0004602848, 0004602948,
 0004608948, 0014600248, 0014600848,
 0014601248, 0014602248, 0014607748,
 0024600148, A0003387310, A0004600348,
 A0004602848, A0004602948, A0014600848,
 A0014601248, A0014602248, A0014607748

**DB-DL-2144**

Length: 872 Ø: 35
 Cone Ø: d1 Ø 28,6 / d2 Ø 23,9
 0024604305, 0024604405, 0034604805

**DB-DL-3475**

Length: 565 Ø: 52
 Hole Distance: 152 / 152
 3753500006, 3753500206, 9473500805,
 9483500006, 9483500805, 9483501205,
 9483501305, 9483501905, 9483502005,
 9483502405, A3753500006,
 A3753500206

**DB-DL-5230**

Length: 879 Ø: 42
 Cone Ø: d1 Ø 30 / d2 Ø 27
 01208600A, 0004607105, 0004607205,
 0014606705

**DB-DL-5405**

Length: 890 Ø: 35
 Cone Ø: d1 Ø 28,6 / d2 Ø 23,9
 01215900A, 1460248, 0024604505,
 0024604605, 0034605005, 3752600637,
 3754600405, A3752600637, A3754600405

**DB-DL-7270**

Length: 875 Ø: 40
 Cone Ø: d1 Ø 28,6 / d2 Ø 23,9
 01208300A, 0024604705, 0024604805,
 0034604905, A0024604705

**DB-DL-8167**

Length: 866 Ø: 38
 Cone Ø: d1 Ø 30 / d2 Ø 27
 0014609805, 0014609905, 0024606305,
 0024606405

**DB-DL-8168**

Length: 904 Ø: 52
 Cone Ø: d1 Ø 32 / d2 Ø 29
 0004609405, 0004609505, 0014607105

**DB-DL-8171**

Length: 1687 Ø: 52
 Cone Ø: d1 Ø 32 / d2 Ø 29
 9493300603, 9493300703, 9493301503,
 9493301603

**DB-DL-8172**

Length: 1700 Ø: 52
 Cone Ø: d1 Ø 32 / d2 Ø 29
 01219700A, 9493300403, 9493300503,
 9493300803, 9493301403

**DB-DL-8184**

Length: 1095 Ø: 42
 Cone Ø: d1 Ø 32 / d2 Ø 28,8
 01217700A, 0014601305, 0014601405,
 0024600505, 0034603205, 3754601505,
 A0014601305, A0014601405, A0024600505

**DB-DL-8185**

Length: 711 Ø: 42
 Cone Ø: d1 Ø 32 / d2 Ø 28,8
 01213600A, 0014601105, 0024600405,
 0034603105, A0014601105, A0024600405

**DB-DL-8188**

Length: 895 Ø: 40
 Cone Ø: d1 Ø 28,6 / d2 Ø 23,9
 01217200A, 0024604905, 0024605005,
 0034605605

**DB-DL-8307**

Length: 885 Ø: 38
 Cone Ø: d1 Ø 32 / d2 Ø 30
 01215500A, 0004604005, 0024605105,
 0024605205, 0034604005

**DB-DL-8327**

Length: 1745 Ø: 48
 Cone Ø: d1 Ø 32 / d2 Ø 29
 01219800A, 9413300003, 9413300103,
 9413300203, 9413300303, 9413300503

**DB-DL-8390**

Length: 1596 Ø: 50
 Cone Ø: d1 Ø 32 / d2 Ø 29
 9493301003, 9493301103, 9493301703

**DB-DL-8640**

Length: 1615 Ø: 50
 Cone Ø: d1 Ø 32 / d2 Ø 29
 6253301503, 6253301603, 6253302403,
 6253302503, 9423300803, 9423302103,
 9493300203, 9493300303, 9493300903

**DB-DL-8702**

Length: 958 Ø: 38
 Cone Ø: d1 Ø 32 / d2 Ø 30
 0024606105, 0024606205, 0034604205

**DB-DL-9254**

Length: 1815 Ø: 58
 0003220323, 0003220623, 3753220423

**DB-DL-9271**

Length: 1815 Ø: 60
 0003220423, 0003220723

**DB-DL-9272**

Length: 1815 Ø: 80
 0003220223

**DB-DL-12300**

Length: 733 Ø: 36
 Cone Ø: d1 Ø 32 / d2 Ø 29
 0014601505, 0014607305, 0034603305,
 3754601605, A0014601505,
 A0034603305, A3754601605

**DB-DL-12310**

Length: 1532 Ø: 50
 Cone Ø: d1 Ø 32 / d2 Ø 29
 Thread: M27 x 1,5 LHT
 9493301203, 9493301303, 9493301803,
 9493302203, A9493301203, A9493301303,
 A9493301803, A9493302203

**DB-ES-5227**

Length: 1588 Ø: 60
 Cone Ø: d1 Ø 38 / d2 Ø 34,3
 6253300903, 6253301203, 9443300203

**DB-ES-5234**

Length: 135
 Cone Ø: d1 Ø 38 / d2 Ø 34,3
 Thread: M38 x 1,5 RHT
 0004601748, 1203223005, 2205000400

**DB-ES-8164**

Length: 140
 Cone Ø: d1 Ø 28,6 / d2 Ø 23,9
 Thread: M28 x 1,5 RHT
 0014604248, 0014605048, 0014608548,
 0024600548

**DB-ES-8323**

Length: 75
 Cone Ø: d1 Ø 32 / d2 Ø 28,8
 Thread: M26 x 1,5 RHT
 0014601548, 0014601648, 0024600648,
 A0014601648, A0024600648

**DB-ES-8510**

Length: 56
 Cone Ø: d1 Ø 10 / d2 Ø 10
 Thread: M12 x 1,75 LHT
 0009965145, 0009965645, 0019963145

**DB-ES-8530**

Length: 115
 Cone Ø: d1 Ø 28,6 / d2 Ø 23,9
 Thread: M30 x 1,5 RHT
 0014603848, 0014604848, 0014605148,
 0014608648, 0014609948

**DB-RK-8391**

Ø: 85 Hole Distance: 152
 Thick/Height: 24
 01336800A, 0003502705

**DB-RK-8626**

Ø: 75 Hole Distance: 130
 Thick/Height: 24
 0003502205, 0003502505, 0003503405,
 0003504505, GL11319

**DB-RK-8638**

Length: 100 Ø: 67
 Hole Distance: 100
 Thick/Height: 20
 0003301411

**DB-RK-8710**

Ø: 85 Hole Distance: 130
 Thick/Height: 30
 0003503705

**DB-RK-9291**

Ø: 107,5 Hole Distance: 152
 Thick/Height: 30
 0003503605

**DB-RK-9294**

Ø: 85 Hole Distance: 152
 Thick/Height: 24
 0003503105

**DB-RK-10374**

Ø: 85 Hole Distance: 152
 Thick/Height: 24
 0003504405

**DB-RK-10375**

Ø: 100 Hole Distance: 152
 Thick/Height: 24
 0003502405, 0003503505, 0003504905

**DB-SB-10384**

Ø: 73 Thick/Height: 47
 9303170012, 9423171812

**DB-SB-10400**

Length: 230
 Thick/Height: 167,5 / 115
 0003250696, 0003250896

**DB-SB-10401**

Length: 232
 Thick/Height: 163,5 / 152,5
 0003250596, 0003250796

**DB-SB-10406**

Ø: 80 Thick/Height: 46
 0003238185

**DB-SB-10409**

Ø: 77 Thick/Height: 56
 0003265181

**DB-VB-3707**

Length: 622 Ø: 46
 Hole Ø 25 / 25 / 25
 Hole Distance: 152 / 130 / 130
 01337100A, 9423501005, 9423501505,
 9443500005, 9473500105, 9473501005,
 A3753500005, A9423501005, A9423501505,
 A9443500005, A9473500105, A9473501005

**DB-VB-7261**

Length: 622 Ø: 46
 Hole Ø 25 / 25 / 25
 Hole Distance: 152 / 130 / 130
 01337800A, 9443500305, 9443500505,
 9443500605, 9473500705, 9473500905,
 9483500405, 9483500305

**DB-VB-9307**

Length: 667 Ø: 60
 Hole Ø 25 / 23 / 23
 Hole Distance: 152 / 130 / 130
 9483502805

**DB-VB-9308**

Length: 622 Ø: 46
 Hole Ø 25 / 25 / 25
 Hole Distance: 152 / 130 / 130
 9483502905

**DB-VB-10426**

Length: 622 Ø: 46
 Hole Ø 25 / 25 / 25
 Hole Distance: 152 / 130 / 130
 9443500405





ACTROS MP2 / MP3 ...

3336 S ...	04/03→	Centre Rod	DB-DL-8167		Push Rod
	04/03→	Centre Rod	DB-DL-8184		Push Rod
	04/03→	Centre Rod	DB-DL-8185		Push Rod
	04/03→	Centre Rod	DB-DL-8307		Push Rod
	04/03→	Centre Rod	DB-DL-8702		Push Rod, Leaf Spring Axle
	04/03→	Centre Rod	DB-DL-12300		for Steering Rod
	04/03→	Stabiliser Mounting		DB-SB-10406	
	04/03→	Stabiliser Mounting		DB-SB-10409	
	04/03→	Stabiliser Mounting	DB-SB-10410		
	04/03→	Suspension Arm Repair Kit		DB-RK-8550	for Wishbone (CV)
	04/03→	Suspension Arm Repair Kit		DB-RK-8626	for Wishbone (CV)
	04/03→	Suspension Arm Repair Kit		DB-RK-10374	for Wishbone (CV)
	04/03→	Suspension Arm Repair Kit		DB-RK-10375	for Wishbone (CV)
	04/03→	Suspension Arm Repair Kit	DB-RK-8638		for Control Arm
	04/03→	Suspension Strut Repair Kit		DB-RK-8391	
	04/03→	Suspension Strut Repair Kit		DB-RK-8710	
	04/03→	Suspension Strut Repair Kit		DB-RK-9291	
	04/03→	Suspension Strut Repair Kit		MN-RK-8997	
	04/03→	Tie Rod	DB-DL-8171		Guide Rod
	04/03→	Tie Rod	DB-DL-8327		Guide Rod
	04/03→	Tie Rod	DB-DL-8640		Guide Rod
	04/03→	Tie Rod	DB-DL-12310		
	04/03→	Tie Rod	DB-ES-5227		Guide Rod
	04/03→	Tie Rod End	CV-ES-0543		for Push Rod
	04/03→	Tie Rod End	CV-ES-0888		for Push Rod
	04/03→	Tie Rod End	CV-ES-14163		for Steering Rod
	04/03→	Tie Rod End	DB-ES-5234		for Steering Rod
	04/03→	Tie Rod End	DB-ES-8164		for Push Rod
	04/03→	Tie Rod End	DB-ES-8530		for Push Rod
	04/03→	Track Control Arm		DB-DL-3475	Trailing Arm
	04/03→	Track Control Arm		DB-VB-7261	Suspension Rod, Wishbone (CV), 1st RA;2nd RA; Leaf Spring Axle
	04/03→	Track Control Arm		DB-VB-7798	Wishbone (CV)
	04/03→	Track Control Arm		DB-VB-9307	Suspension Rod, Wishbone (CV), 1st RA;2nd RA; Leaf Spring Axle
04/03→	Track Control Arm		DB-VB-9308	Suspension Rod, Wishbone (CV), 1st RA;2nd RA; Leaf Spring Axle	
3339 A	04/03→	Bush, parabolic spring		DB-SB-10401	
	04/03→	Centre Rod	DB-DL-8307		Push Rod
	04/03→	Centre Rod	DB-DL-8702		Push Rod
	04/03→	Tie Rod	DB-ES-5227		Guide Rod
	04/03→	Tie Rod	MN-DL-7834		Guide Rod
	04/03→	Track Control Arm		DB-VB-7261	Suspension Rod, Wishbone (CV)
	04/03→	Track Control Arm		DB-VB-9307	Suspension Rod, Wishbone (CV)
	04/03→	Track Control Arm		DB-VB-9308	Suspension Rod, Wishbone (CV)
3339 AK	04/03→	Bush, driver cab suspension	DB-SB-10384		
	04/03→	Bush, parabolic spring		DB-SB-10401	
	04/03→	Centre Rod	DB-DL-8307		Push Rod
	04/03→	Centre Rod	DB-DL-8702		Push Rod
	04/03→	Tie Rod	DB-ES-5227		Guide Rod
	04/03→	Tie Rod	MN-DL-7834		Guide Rod
	04/03→	Track Control Arm		DB-VB-7261	Suspension Rod, Wishbone (CV)
	04/03→	Track Control Arm		DB-VB-9307	Suspension Rod, Wishbone (CV)
	04/03→	Track Control Arm		DB-VB-9308	Suspension Rod, Wishbone (CV)
	3339 B	04/03→	Bush, parabolic spring		DB-SB-10400
04/03→		Bush, parabolic spring		DB-SB-10401	
04/03→		Centre Rod	DB-DL-5405		Push Rod
04/03→		Centre Rod	DB-DL-7270		Push Rod
04/03→		Centre Rod	DB-DL-8702		Push Rod
04/03→		Tie Rod	DB-DL-8171		Guide Rod
04/03→		Tie Rod	DB-DL-12310		
04/03→		Track Control Arm		DB-VB-7261	Suspension Rod, Wishbone (CV)
04/03→		Track Control Arm		DB-VB-9307	Suspension Rod, Wishbone (CV)
04/03→		Track Control Arm		DB-VB-9308	Suspension Rod, Wishbone (CV)

CV-ES-0543

Length: 125
 Cone Ø: d1 Ø 32 / d2 Ø 29
 Thread: M30 x 1,5 RHT
 0004605748, 0004606048, 0004606848,
 0004607048, 0014600448, 0014601148,
 0014601748, 0014602448, 0014607648,
 0014609648



CV-ES-0888

Length: 125
 Cone Ø: d1 Ø 32 / d2 Ø 29
 Thread: M30 x 1,5 LHT
 0004605848, 0004606148, 0004606948,
 0004607148, 0004609048, 0014600548,
 0014601348, 0014602548, 0014607948,
 0024600448



CV-ES-14163

Length: 125
 Cone Ø: d1 Ø 30 / d2 Ø 27
 Thread: M30 x 1,5 RHT
 0003305248, 0003387310, 0004600348,
 0004600948, 0004602848, 0004602948,
 0004608948, 0014600248, 0014600848,
 0014601248, 0014602248, 0014607748,
 0024600148, A0003387310, A0004600348,
 A0004602848, A0004602948, A0014600848,
 A0014601248, A0014602248, A0014607748



DB-DL-3475

Length: 565 Ø: 52
 Hole Distance: 152 / 152
 3753500006, 3753500206, 9473500805,
 9483500006, 9483500805, 9483501205,
 9483501305, 9483501905, 9483502005,
 9483502405, A3753500006, A3753500206



DB-DL-5405

Length: 890 Ø: 35
 Cone Ø: d1 Ø 28,6 / d2 Ø 23,9
 01215900A, 1460248, 0024604505, 0024604605,
 0034605005, 3752600637, 3754600405,
 A3752600637, A3754600405



DB-DL-7270

Length: 875 Ø: 40
 Cone Ø: d1 Ø 28,6 / d2 Ø 23,9
 01208300A, 0024604705, 0024604805,
 0034604905, A0024604705



DB-DL-8167

Length: 866 Ø: 38
 Cone Ø: d1 Ø 30 / d2 Ø 27
 0014609805, 0014609905, 0024606305,
 0024606405



DB-DL-8171

Length: 1687 Ø: 52
 Cone Ø: d1 Ø 32 / d2 Ø 29
 9493300603, 9493300703, 9493301503,
 9493301603



DB-DL-8184

Length: 1095 Ø: 42
 Cone Ø: d1 Ø 32 / d2 Ø 28,8
 01217700A, 0014601305, 0014601405,
 0024600505, 0034603205, 3754601505,
 A0014601305, A0014601405, A0024600505



DB-DL-8185

Length: 711 Ø: 42
 Cone Ø: d1 Ø 32 / d2 Ø 28,8
 01213600A, 0014601105, 0024600405,
 0034603105, A0014601105, A0024600405



DB-DL-8307

Length: 885 Ø: 38
 Cone Ø: d1 Ø 32 / d2 Ø 30
 01215500A, 0004604005, 0024605105,
 0024605205, 0034604005



DB-DL-8327

Length: 1745 Ø: 48
 Cone Ø: d1 Ø 32 / d2 Ø 29
 01219800A, 9413300003, 9413300103,
 9413300203, 9413300303, 9413300503



DB-DL-8640

Length: 1615 Ø: 50
 Cone Ø: d1 Ø 32 / d2 Ø 29
 6253301503, 6253301603, 6253302403,
 6253302503, 9423300803, 9423302103,
 9493300203, 9493300303, 9493300903



DB-DL-8702

Length: 958 Ø: 38
 Cone Ø: d1 Ø 32 / d2 Ø 30
 0024606105, 0024606205, 0034604205



DB-DL-12300

Length: 733 Ø: 36
 Cone Ø: d1 Ø 32 / d2 Ø 29
 0014601505, 0014607305, 0034603305,
 3754601605, A0014601505, A0034603305,
 A3754601605



DB-DL-12310

Length: 1532 Ø: 50
 Cone Ø: d1 Ø 32 / d2 Ø 29
 Thread: M27 x 1,5 LHT
 9493301203, 9493301303, 9493301803,
 9493302203, A9493301203, A9493301303,
 A9493301803, A9493302203



DB-ES-5227

Length: 1588 Ø: 60
 Cone Ø: d1 Ø 38 / d2 Ø 34,3
 6253300903, 6253301203, 9443300203



DB-ES-5234

Length: 135
 Cone Ø: d1 Ø 38 / d2 Ø 34,3
 Thread: M38 x 1,5 RHT
 0004601748, 120322305, 2205000400



DB-ES-8164

Length: 140
 Cone Ø: d1 Ø 28,6 / d2 Ø 23,9
 Thread: M28 x 1,5 RHT
 0014604248, 0014605048, 0014608548,
 0024600548



DB-ES-8530

Length: 115
 Cone Ø: d1 Ø 28,6 / d2 Ø 23,9
 Thread: M30 x 1,5 RHT
 0014603848, 0014604848, 0014605148,
 0014608648, 0014609948



DB-RK-8391

Ø: 85 Hole Distance: 152
 Thick/Height: 24
 01336800A, 0003502705



DB-RK-8550

Ø: 75 Hole Distance: 152
 Thick/Height: 24
 0003502105, 0003504605



DB-RK-8626

Ø: 75 Hole Distance: 130
 Thick/Height: 24
 0003502205, 0003502505, 0003503405,
 0003504505, GL11319



DB-RK-8638

Length: 100 Ø: 67
 Hole Distance: 100
 Thick/Height: 20
 0003301411



DB-RK-8710

Ø: 85 Hole Distance: 130
 Thick/Height: 30
 0003503705



DB-RK-9291

Ø: 107,5 Hole Distance: 152
 Thick/Height: 30
 0003503605



DB-RK-10374

Ø: 85 Hole Distance: 152
 Thick/Height: 24
 0003504405



DB-RK-10375

Ø: 100 Hole Distance: 152
 Thick/Height: 24
 0003502405, 0003503505, 0003504905



DB-SB-10384

Ø: 73 Thick/Height: 47
 9303170012, 9423171812



DB-SB-10400

Length: 230
 Thick/Height: 167,5 / 115
 0003250696, 0003250896



DB-SB-10401

Length: 232
 Thick/Height: 163,5 / 152,5
 0003250596, 0003250796



DB-SB-10406

Ø: 80 Thick/Height: 46
 0003238185



DB-SB-10409

Ø: 77 Thick/Height: 56
 0003265181



DB-SB-10410

Ø: 73 Hole Distance: 100
 Thick/Height: 24
 9413230050



DB-VB-7261

Length: 622 Ø: 46
 Hole Ø 25 / 25 / 25
 Hole Distance: 152 / 130 / 130
 01337800A, 9443500305, 9443500505,
 9443500605, 9473500705, 9473500905,
 9483500405, 9483503005



DB-VB-7798

Length: 622 Ø: 48
 Hole Ø 25 / 23 / 23
 Hole Distance: 152 / 130 / 130
 9423500505, 9423500805, 9423501205,
 A9423501205



DB-VB-9307

Length: 667 Ø: 60
 Hole Ø 25 / 23 / 23
 Hole Distance: 152 / 130 / 130
 9483502805



DB-VB-9308

Length: 622 Ø: 46
 Hole Ø 25 / 25 / 25
 Hole Distance: 152 / 130 / 130
 9483502905



MN-DL-7834

Length: 1588 Ø: 58
 Cone Ø: d1 Ø 30 / d2 Ø 27
 3463303903, 3463304903, 6253303203,
 9443300503, 9443301303, 9443301703



MN-RK-8997

Ø: 85 Hole Distance: 130
 Thick/Height: 30
 0003504805



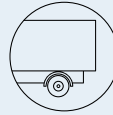

ACTROS MP2 / MP3 ...

3339 K	04/03→	Centre Rod	DB-DL-5405		Push Rod	
	04/03→	Centre Rod	DB-DL-7270		Push Rod	
	04/03→	Centre Rod	DB-DL-8702		Push Rod	
	04/03→	Tie Rod	DB-DL-8171		Guide Rod	
	04/03→	Tie Rod	DB-DL-8327		Guide Rod	
	04/03→	Tie Rod	DB-DL-8640		Guide Rod	
	04/03→	Tie Rod	DB-DL-12310		Guide Rod	
	04/03→	Track Control Arm		DB-VB-7261	Suspension Rod, Wishbone (CV)	
	04/03→	Track Control Arm		DB-VB-9307	Suspension Rod, Wishbone (CV)	
	04/03→	Track Control Arm		DB-VB-9308	Suspension Rod, Wishbone (CV)	
3341	04/03→	Ball Head, gearshift linkage	DB-ES-8510			
	04/03→	Bush, driver cab suspension	DB-SB-10384			
	04/03→	Bush, parabolic spring		DB-SB-10400		
	04/03→	Bush, parabolic spring		DB-SB-10401		
	04/03→	Centre Rod	DB-DL-2144		Push Rod	
	04/03→	Centre Rod	DB-DL-5230		Suspension Rod	
	04/03→	Centre Rod	DB-DL-5405		Push Rod, Leaf Spring Axle	
	04/03→	Centre Rod	DB-DL-7270		Push Rod;Suspension Rod	
	04/03→	Centre Rod	DB-DL-8167		Push Rod	
	04/03→	Centre Rod	DB-DL-8168		Push Rod	
	04/03→	Centre Rod	DB-DL-8184		Push Rod	
	04/03→	Centre Rod	DB-DL-8185		Push Rod	
	04/03→	Centre Rod	DB-DL-8307		Push Rod	
	04/03→	Centre Rod	DB-DL-8622		Push Rod	
	04/03→	Centre Rod	DB-DL-8641		Push Rod	
	04/03→	Centre Rod	DB-DL-8642		Push Rod	
	04/03→	Centre Rod	DB-DL-8702		Push Rod, Leaf Spring Axle	
	04/03→	Centre Rod	DB-DL-12300		for Steering Rod	
	04/03→	Stabiliser Link	DB-DL-9254		Pressure Rod	
	04/03→	Stabiliser Mounting		DB-SB-10406		
	04/03→	Stabiliser Mounting		DB-SB-10409		
	04/03→	Stabiliser Mounting	DB-SB-10410			
	04/03→	Suspension Arm Repair Kit		DB-RK-8550	for Wishbone (CV)	
	04/03→	Suspension Arm Repair Kit		DB-RK-8626	for Wishbone (CV)	
	04/03→	Suspension Arm Repair Kit		DB-RK-10374	for Wishbone (CV)	
	04/03→	Suspension Arm Repair Kit		DB-RK-10375	for Wishbone (CV)	
	04/03→	Suspension Arm Repair Kit	DB-RK-8638		for Control Arm	
	04/03→	Suspension Strut Repair Kit		DB-RK-8391		
	04/03→	Suspension Strut Repair Kit		DB-RK-8710		
	04/03→	Suspension Strut Repair Kit		DB-RK-9291		
	04/03→	Tie Rod	DB-DL-8171		Guide Rod, 1st FA;Leaf Spring Axle	
	04/03→	Tie Rod	DB-DL-8327		Guide Rod, 1st FA;Leaf Spring Axle	
	04/03→	Tie Rod	DB-DL-8640		Guide Rod	
	04/03→	Tie Rod	DB-DL-12310		Guide Rod	
	04/03→	Tie Rod	DB-ES-5227		Guide Rod	
	04/03→	Tie Rod End	CV-ES-0543		for Push Rod	
	04/03→	Tie Rod End	CV-ES-0888		for Push Rod	
	04/03→	Tie Rod End	CV-ES-14163		for Steering Rod	
	04/03→	Tie Rod End	DB-ES-5234		for Steering Rod	
	04/03→	Tie Rod End	DB-ES-8164		for Push Rod	
	04/03→	Tie Rod End	DB-ES-8530		for Push Rod	
	04/03→	Track Control Arm		DB-DL-3475	Trailing Arm	
	04/03→	Track Control Arm		DB-VB-7261	Suspension Rod, Wishbone (CV), 1st RA;2nd RA; Leaf Spring Axle	
	04/03→	Track Control Arm		DB-VB-9307	Suspension Rod, Wishbone (CV), 1st RA;2nd RA; Leaf Spring Axle	
	04/03→	Track Control Arm		DB-VB-9308	Suspension Rod, Wishbone (CV), 1st RA;2nd RA; Leaf Spring Axle	
	3341 A	04/03→	Bush, parabolic spring		DB-SB-10401	
		04/03→	Centre Rod	DB-DL-8307		Push Rod, Leaf Spring Axle
		04/03→	Centre Rod	DB-DL-8702		Push Rod
		04/03→	Stabiliser Mounting		DB-SB-10406	
		04/03→	Suspension Strut Repair Kit		DB-RK-8710	

CV-ES-0543

Length: 125
 Cone Ø: d1 Ø 32 / d2 Ø 29
 Thread: M30 x 1,5 RHT
 0004605748, 0004606048, 0004606848,
 0004607048, 0014600448, 0014601148,
 0014601748, 0014602448, 0014607648,
 0014609648

**CV-ES-0888**

Length: 125
 Cone Ø: d1 Ø 32 / d2 Ø 29
 Thread: M30 x 1,5 LHT
 0004605848, 0004606148, 0004606948,
 0004607148, 0004609048, 0014600548,
 0014601348, 0014602548, 0014607948,
 0024600448

**CV-ES-14163**

Length: 125
 Cone Ø: d1 Ø 30 / d2 Ø 27
 Thread: M30 x 1,5 RHT
 0003305248, 0003387310, 0004600348,
 0004600948, 0004602848, 0004602948,
 0004608948, 0014600248, 0014600848,
 0014601248, 0014602248, 0014607748,
 0024600148, A0003387310, A0004600348,
 A0004602848, A0004602948, A0014600848,
 A0014601248, A0014602248, A0014607748

**DB-DL-2144**

Length: 872 Ø: 35
 Cone Ø: d1 Ø 28,6 / d2 Ø 23,9
 0024604305, 0024604405, 0034604805

**DB-DL-3475**

Length: 565 Ø: 52
 Hole Distance: 152 / 152
 3753500006, 3753500206, 9473500805,
 9483500006, 9483500805, 9483501205,
 9483501305, 9483501905, 9483502005,
 9483502405, A3753500006,
 A3753500206

**DB-DL-5230**

Length: 879 Ø: 42
 Cone Ø: d1 Ø 30 / d2 Ø 27
 01208600A, 0004607105, 0004607205,
 0014606705

**DB-DL-5405**

Length: 890 Ø: 35
 Cone Ø: d1 Ø 28,6 / d2 Ø 23,9
 01215900A, 1460248, 0024604505,
 0024604605, 0034605005, 3752600637,
 3754600405, A3752600637, A3754600405

**DB-DL-7270**

Length: 875 Ø: 40
 Cone Ø: d1 Ø 28,6 / d2 Ø 23,9
 01208300A, 0024604705, 0024604805,
 0034604905, A0024604705

**DB-DL-8167**

Length: 866 Ø: 38
 Cone Ø: d1 Ø 30 / d2 Ø 27
 0014609805, 0014609905, 0024606305,
 0024606405

**DB-DL-8168**

Length: 904 Ø: 52
 Cone Ø: d1 Ø 32 / d2 Ø 29
 0004609405, 0004609505, 0014607105

**DB-DL-8171**

Length: 1687 Ø: 52
 Cone Ø: d1 Ø 32 / d2 Ø 29
 9493300603, 9493300703, 9493301503,
 9493301603

**DB-DL-8184**

Length: 1095 Ø: 42
 Cone Ø: d1 Ø 32 / d2 Ø 28,8
 01217700A, 0014601305, 0014601405,
 0024600505, 0034603205, 3754601505,
 A0014601305, A0014601405, A0024600505

**DB-DL-8185**

Length: 711 Ø: 42
 Cone Ø: d1 Ø 32 / d2 Ø 28,8
 01213600A, 0014601105, 0024600405,
 0034603105, A0014601105, A0024600405

**DB-DL-8307**

Length: 885 Ø: 38
 Cone Ø: d1 Ø 32 / d2 Ø 30
 01215500A, 0004604005, 0024605105,
 0024605205, 0034604005

**DB-DL-8327**

Length: 1745 Ø: 48
 Cone Ø: d1 Ø 32 / d2 Ø 29
 01219800A, 9413300003, 9413300103,
 9413300203, 9413300303, 9413300503

**DB-DL-8622**

Length: 1558 Ø: 52
 Cone Ø: d1 Ø 30 / d2 Ø 27
 0014609005, 0014609105

**DB-DL-8640**

Length: 1615 Ø: 50
 Cone Ø: d1 Ø 32 / d2 Ø 29
 6253301503, 6253301603, 6253302403,
 6253302503, 9423300803, 9423302103,
 9493300203, 9493300303, 9493300903

**DB-DL-8641**

Length: 905 Ø: 42
 Cone Ø: d1 Ø 30 / d2 Ø 27
 0014605105, 0014608105

**DB-DL-8642**

Length: 954 Ø: 42
 Cone Ø: d1 Ø 30 / d2 Ø 27
 0014608605, 0014608705

**DB-DL-8702**

Length: 958 Ø: 38
 Cone Ø: d1 Ø 32 / d2 Ø 30
 0024606105, 0024606205, 0034604205

**DB-DL-9254**

Length: 1815 Ø: 58
 0003220323, 0003220623, 3753220423

**DB-DL-12300**

Length: 733 Ø: 36
 Cone Ø: d1 Ø 32 / d2 Ø 29
 0014601505, 0014607305, 0034603305,
 3754601605, A0014601505,
 A0034603305, A3754601605

**DB-DL-12310**

Length: 1532 Ø: 50
 Cone Ø: d1 Ø 32 / d2 Ø 29
 Thread: M27 x 1,5 LHT
 9493301203, 9493301303, 9493301803,
 9493302203, A9493301203, A9493301303,
 A9493301803, A9493302203

**DB-ES-5227**

Length: 1588 Ø: 60
 Cone Ø: d1 Ø 38 / d2 Ø 34,3
 6253300903, 6253301203, 9443300203

**DB-ES-5234**

Length: 135
 Cone Ø: d1 Ø 38 / d2 Ø 34,3
 Thread: M38 x 1,5 RHT
 0004601748, 120322305, 2205000400

**DB-ES-8164**

Length: 140
 Cone Ø: d1 Ø 28,6 / d2 Ø 23,9
 Thread: M28 x 1,5 RHT
 0014604248, 0014605048, 0014608548,
 0024600548

**DB-ES-8510**

Length: 56
 Cone Ø: d1 Ø 10 / d2 Ø 10
 Thread: M12 x 1,75 LHT
 0009965145, 0009965645, 0019963145

**DB-ES-8530**

Length: 115
 Cone Ø: d1 Ø 28,6 / d2 Ø 23,9
 Thread: M30 x 1,5 RHT
 0014603848, 0014604848, 0014605148,
 0014608648, 0014609948

**DB-RK-8391**

Ø: 85 Hole Distance: 152
 Thick/Height: 24
 01336800A, 0003502705

**DB-RK-8550**

Ø: 75 Hole Distance: 152
 Thick/Height: 24
 0003502105, 0003504605

**DB-RK-8626**

Ø: 75 Hole Distance: 130
 Thick/Height: 24
 0003502205, 0003502505, 0003503405,
 0003504505, GL11319

**DB-RK-8638**

Length: 100 Ø: 67
 Hole Distance: 100
 Thick/Height: 20
 0003301411

**DB-RK-8710**

Ø: 85 Hole Distance: 130
 Thick/Height: 30
 0003503705

**DB-RK-9291**

Ø: 107,5 Hole Distance: 152
 Thick/Height: 30
 0003503605

**DB-RK-10374**

Ø: 85 Hole Distance: 152
 Thick/Height: 24
 0003504405

**DB-RK-10375**

Ø: 100 Hole Distance: 152
 Thick/Height: 24
 0003502405, 0003503505, 0003504905

**DB-SB-10384**

Ø: 73 Thick/Height: 47
 9303170012, 9423171812

**DB-SB-10400**

Length: 230
 Thick/Height: 167,5 / 115
 0003250696, 0003250896

**DB-SB-10401**

Length: 232
 Thick/Height: 163,5 / 152,5
 0003250596, 0003250796

**DB-SB-10406**

Ø: 80 Thick/Height: 46
 0003238185

**DB-SB-10409**

Ø: 77 Thick/Height: 56
 0003265181

**DB-SB-10410**

Ø: 73 Hole Distance: 100
 Thick/Height: 24
 9413230050

**DB-VB-7261**

Length: 622 Ø: 46
 Hole Ø 25 / 25 / 25
 Hole Distance: 152 / 130 / 130
 01337800A, 9443500305, 9443500505,
 9443500605, 9473500705, 9473500905,
 9483500405, 9483500305

**DB-VB-9307**

Length: 667 Ø: 60
 Hole Ø 25 / 23 / 23
 Hole Distance: 152 / 130 / 130
 9483502805

**DB-VB-9308**

Length: 622 Ø: 46
 Hole Ø 25 / 25 / 25
 Hole Distance: 152 / 130 / 130
 9483502905





ACTROS MP2 / MP3 ...

3341 A ...	04/03→	Suspension Strut Repair Kit		DB-RK-9291		
	04/03→	Tie Rod	DB-DL-12310			
	04/03→	Tie Rod	DB-ES-5227		Guide Rod	
	04/03→	Tie Rod	MN-DL-7834		Guide Rod	
	04/03→	Tie Rod End	CV-ES-0543		for Push Rod	
	04/03→	Tie Rod End	CV-ES-14163		for Steering Rod	
	04/03→	Tie Rod End	DB-ES-5234		for Steering Rod	
	04/03→	Track Control Arm		DB-DL-3475	Trailing Arm, 1st RA;2nd RA, →517144 03/517144 06	
	04/03→	Track Control Arm		DB-DL-3475	Trailing Arm, 1st RA;2nd RA, →517144 05/517144 08	
	04/03→	Track Control Arm		DB-DL-3475	Trailing Arm, 1st RA;2nd RA, →517144 07/517144 09	
	04/03→	Track Control Arm		DB-DL-3475	Trailing Arm, 1st RA;2nd RA, →517144 26/517144 27	
	04/03→	Track Control Arm		DB-VB-7261	Suspension Rod, Wishbone (CV)	
	04/03→	Track Control Arm		DB-VB-9307	Suspension Rod, Wishbone (CV)	
	04/03→	Track Control Arm		DB-VB-9308	Suspension Rod, Wishbone (CV)	
	3341 AK	04/03→	Ball Head, gearshift linkage	DB-ES-8510		
04/03→		Bush, driver cab suspension	DB-SB-10384			
04/03→		Bush, parabolic spring		DB-SB-10401		
04/03→		Centre Rod	DB-DL-8184		Push Rod	
04/03→		Centre Rod	DB-DL-8307		Push Rod, Leaf Spring Axle	
04/03→		Centre Rod	DB-DL-8702		Push Rod, Leaf Spring Axle	
04/03→		Centre Rod	DB-DL-12300		for Steering Rod	
04/03→		Stabiliser Mounting		DB-SB-10406		
04/03→		Stabiliser Mounting		DB-SB-10409		
04/03→		Suspension Arm Repair Kit		DB-RK-8626	for Wishbone (CV)	
04/03→		Suspension Arm Repair Kit		DB-RK-10374	for Wishbone (CV)	
04/03→		Suspension Arm Repair Kit		DB-RK-10375	for Wishbone (CV)	
04/03→		Suspension Arm Repair Kit	DB-RK-8638		for Control Arm	
04/03→		Suspension Strut Repair Kit		DB-RK-8391		
04/03→		Suspension Strut Repair Kit		DB-RK-8710		
04/03→		Suspension Strut Repair Kit		DB-RK-9291		
04/03→		Tie Rod	DB-DL-12310			
04/03→		Tie Rod	DB-ES-5227		Guide Rod	
04/03→		Tie Rod	MN-DL-7834		Guide Rod	
04/03→		Tie Rod End	CV-ES-0543		for Push Rod	
04/03→		Tie Rod End	CV-ES-14163		for Steering Rod	
04/03→		Tie Rod End	DB-ES-5234		for Steering Rod	
04/03→		Tie Rod End	DB-ES-8530		for Push Rod	
04/03→		Track Control Arm		DB-DL-3475	Trailing Arm	
04/03→		Track Control Arm		DB-VB-7261	Suspension Rod, Wishbone (CV), 1st RA;2nd RA; Leaf Spring Axle	
04/03→		Track Control Arm		DB-VB-9307	Suspension Rod, Wishbone (CV), 1st RA;2nd RA; Leaf Spring Axle	
04/03→		Track Control Arm		DB-VB-9308	Suspension Rod, Wishbone (CV), 1st RA;2nd RA; Leaf Spring Axle	
3341 AKE		04/03→	Bush, driver cab suspension	DB-SB-10384		
		04/03→	Bush, parabolic spring		DB-SB-10401	
		04/03→	Centre Rod	DB-DL-8307		Push Rod, Leaf Spring Axle
	04/03→	Centre Rod	DB-DL-8702		Push Rod, Drive Axle;Leaf Spring Axle	
	04/03→	Stabiliser Mounting		DB-SB-10406		
	04/03→	Suspension Strut Repair Kit		DB-RK-8710		
	04/03→	Suspension Strut Repair Kit		DB-RK-9291		
	04/03→	Tie Rod	DB-DL-12310			
	04/03→	Tie Rod	DB-ES-5227		Guide Rod	
	04/03→	Tie Rod	MN-DL-7834		Guide Rod	
	04/03→	Tie Rod End	DB-ES-5234		for Steering Rod	
	04/03→	Track Control Arm		DB-VB-7261	Suspension Rod, Wishbone (CV), 1st RA;2nd RA; Leaf Spring Axle	
	04/03→	Track Control Arm		DB-VB-9307	Suspension Rod, Wishbone (CV), 1st RA;2nd RA; Leaf Spring Axle	

CV-ES-0543

Length: 125
Cone Ø: d1 Ø 32 / d2 Ø 29
Thread: M30 x 1,5 RHT
0004605748, 0004606048, 0004606848,
0004607048, 0014600448, 0014601148,
0014601748, 0014602448, 0014607648,
0014609648



CV-ES-14163

Length: 125
Cone Ø: d1 Ø 30 / d2 Ø 27
Thread: M30 x 1,5 RHT
0003305248, 0003387310, 0004600348,
0004600948, 0004602848, 0004602948,
0004608948, 0014600248, 0014600848,
0014601248, 0014602248, 0014607748,
0024600148, A0003387310, A0004600348,
A0004602848, A0004602948, A0014600848,
A0014601248, A0014602248, A0014607748



DB-DL-3475

Length: 565 Ø: 52
Hole Distance: 152 / 152
3753500006, 3753500206, 9473500805,
9483500006, 9483500805, 9483501205,
9483501305, 9483501905, 9483502005,
9483502405, A3753500006, A3753500206



DB-DL-8184

Length: 1095 Ø: 42
Cone Ø: d1 Ø 32 / d2 Ø 28,8
01217700A, 0014601305, 0014601405,
0024600505, 0034603205, 3754601505,
A0014601305, A0014601405, A0024600505



DB-DL-8307

Length: 885 Ø: 38
Cone Ø: d1 Ø 32 / d2 Ø 30
01215500A, 0004604005, 0024605105,
0024605205, 0034604005



DB-DL-8702

Length: 958 Ø: 38
Cone Ø: d1 Ø 32 / d2 Ø 30
0024606105, 0024606205, 0034604205



DB-DL-12300

Length: 733 Ø: 36
Cone Ø: d1 Ø 32 / d2 Ø 29
0014601505, 0014607305, 0034603305,
3754601605, A0014601505, A0034603305,
A3754601605



DB-DL-12310

Length: 1532 Ø: 50
Cone Ø: d1 Ø 32 / d2 Ø 29
Thread: M27 x 1,5 LHT
9493301203, 9493301303, 9493301803,
9493302203, A9493301203, A9493301303,
A9493301803, A9493302203



DB-ES-5227

Length: 1588 Ø: 60
Cone Ø: d1 Ø 38 / d2 Ø 34,3
6253300903, 6253301203, 9443300203



DB-ES-5234

Length: 135
Cone Ø: d1 Ø 38 / d2 Ø 34,3
Thread: M38 x 1,5 RHT
0004601748, 120322305, 2205000400



DB-ES-8510

Length: 56
Cone Ø: d1 Ø 10 / d2 Ø 10
Thread: M12 x 1,75 LHT
0009965145, 0009965645, 0019963145



DB-ES-8530

Length: 115
Cone Ø: d1 Ø 28,6 / d2 Ø 23,9
Thread: M30 x 1,5 RHT
0014603848, 0014604848, 0014605148,
0014608648, 0014609948



DB-RK-8391

Ø: 85 Hole Distance: 152
Thick/Height: 24
01336800A, 0003502705



DB-RK-8626

Ø: 75 Hole Distance: 130
Thick/Height: 24
0003502205, 0003502505, 0003503405,
0003504505, GL11319



DB-RK-8638

Length: 100 Ø: 67
Hole Distance: 100
Thick/Height: 20
0003301411



DB-RK-8710

Ø: 85 Hole Distance: 130
Thick/Height: 30
0003503705



DB-RK-9291

Ø: 107,5 Hole Distance: 152
Thick/Height: 30
0003503605



DB-RK-10374

Ø: 85 Hole Distance: 152
Thick/Height: 24
0003504405



DB-RK-10375

Ø: 100 Hole Distance: 152
Thick/Height: 24
0003502405, 0003503505, 0003504905



DB-SB-10384

Ø: 73 Thick/Height: 47
9303170012, 9423171812



DB-SB-10401

Length: 232
Thick/Height: 163,5 / 152,5
0003250596, 0003250796



DB-SB-10406

Ø: 80 Thick/Height: 46
0003238185



DB-SB-10409

Ø: 77 Thick/Height: 56
0003265181



DB-VB-7261

Length: 622 Ø: 46
Hole Ø 25 / 25 / 25
Hole Distance: 152 / 130 / 130
01337800A, 9443500305, 9443500505,
9443500605, 9473500705, 9473500905,
9483500405, 9483503005



DB-VB-9307

Length: 667 Ø: 80
Hole Ø 25 / 23 / 23
Hole Distance: 152 / 130 / 130
9483502805



DB-VB-9308

Length: 622 Ø: 46
Hole Ø 25 / 25 / 25
Hole Distance: 152 / 130 / 130
9483502905



MN-DL-7834

Length: 1588 Ø: 58
Cone Ø: d1 Ø 30 / d2 Ø 27
3463303903, 3463304903, 6253303203,
9443300503, 9443301303, 9443301703





ACTROS MP2 / MP3 ...

3341 AKE ...	04/03 →	Track Control Arm		DB-VB-9308	Suspension Rod, Wishbone (CV), 1st RA;2nd RA; Leaf Spring Axle	
3341 AS	04/03 →	Ball Head, gearshift linkage	DB-ES-8510			
	04/03 →	Bush, driver cab suspension	DB-SB-10384			
	04/03 →	Bush, parabolic spring		DB-SB-10401		
	04/03 →	Centre Rod	DB-DL-8307		Push Rod	
	04/03 →	Centre Rod	DB-DL-8702		Push Rod, Leaf Spring Axle	
	04/03 →	Centre Rod	DB-DL-12300		for Steering Rod	
	04/03 →	Stabiliser Mounting		DB-SB-10406		
	04/03 →	Stabiliser Mounting		DB-SB-10409		
	04/03 →	Stabiliser Mounting	DB-SB-10410			
	04/03 →	Suspension Arm Repair Kit		DB-RK-8626	for Wishbone (CV)	
	04/03 →	Suspension Arm Repair Kit		DB-RK-10374	for Wishbone (CV)	
	04/03 →	Suspension Arm Repair Kit		DB-RK-10375	for Wishbone (CV)	
	04/03 →	Suspension Arm Repair Kit	DB-RK-8638		for Control Arm	
	04/03 →	Suspension Strut Repair Kit		DB-RK-8391		
	04/03 →	Suspension Strut Repair Kit		DB-RK-8710		
	04/03 →	Suspension Strut Repair Kit		DB-RK-9291		
	04/03 →	Suspension Strut Repair Kit		MN-RK-8997		
	04/03 →	Tie Rod	DB-DL-12310			
	04/03 →	Tie Rod	DB-ES-5227		Guide Rod	
	04/03 →	Tie Rod	MN-DL-7834		Guide Rod	
	04/03 →	Tie Rod End	CV-ES-0543		for Push Rod	
	04/03 →	Tie Rod End	CV-ES-14163		for Steering Rod	
	04/03 →	Tie Rod End	DB-ES-5234		for Steering Rod	
	04/03 →	Tie Rod End	DB-ES-8530		for Push Rod	
	04/03 →	Track Control Arm		DB-DL-3475	Trailing Arm	
	04/03 →	Track Control Arm		DB-VB-7261	Suspension Rod, Wishbone (CV), 1st RA;2nd RA; Leaf Spring Axle	
	04/03 →	Track Control Arm		DB-VB-7798	Wishbone (CV)	
	04/03 →	Track Control Arm		DB-VB-9307	Suspension Rod, Wishbone (CV), 1st RA;2nd RA; Leaf Spring Axle	
	04/03 →	Track Control Arm		DB-VB-9308	Suspension Rod, Wishbone (CV), 1st RA;2nd RA; Leaf Spring Axle	
	3341 B	04/03 →	Ball Head, gearshift linkage	DB-ES-8510		
		04/03 →	Bush, driver cab suspension	DB-SB-10384		
		04/03 →	Centre Rod	DB-DL-2144		Push Rod
		04/03 →	Centre Rod	DB-DL-5230		Suspension Rod
04/03 →		Centre Rod	DB-DL-5405		Push Rod, Leaf Spring Axle	
04/03 →		Centre Rod	DB-DL-7270		Push Rod	
04/03 →		Centre Rod	DB-DL-8167		Push Rod	
04/03 →		Centre Rod	DB-DL-8184		Push Rod	
04/03 →		Centre Rod	DB-DL-8185		Push Rod	
04/03 →		Centre Rod	DB-DL-8307		Push Rod	
04/03 →		Centre Rod	DB-DL-8702		Push Rod, Leaf Spring Axle	
04/03 →		Centre Rod	DB-DL-12300		for Steering Rod	
04/03 →		Stabiliser Mounting		DB-SB-10406		
04/03 →		Stabiliser Mounting		DB-SB-10409		
04/03 →		Suspension Arm Repair Kit		DB-RK-8550	for Wishbone (CV)	
04/03 →		Suspension Arm Repair Kit		DB-RK-8626	for Wishbone (CV)	
04/03 →		Suspension Arm Repair Kit		DB-RK-10374	for Wishbone (CV)	
04/03 →		Suspension Arm Repair Kit	DB-RK-8638		for Control Arm	
04/03 →		Suspension Strut Repair Kit		DB-RK-8391		
04/03 →		Suspension Strut Repair Kit		DB-RK-8710		
04/03 →		Suspension Strut Repair Kit		DB-RK-9291		
04/03 →		Tie Rod	DB-DL-8171		Guide Rod	
04/03 →		Tie Rod	DB-DL-8327		Guide Rod	
04/03 →		Tie Rod	DB-DL-8640		Guide Rod	
04/03 →		Tie Rod	DB-DL-12310			
04/03 →		Tie Rod End	CV-ES-0543		for Push Rod	
04/03 →		Tie Rod End	CV-ES-0888		for Push Rod	
04/03 →		Tie Rod End	CV-ES-14163		for Steering Rod	
04/03 →		Tie Rod End	DB-ES-5234		for Steering Rod	

CV-ES-0543

Length: 125
 Cone Ø: d1 Ø 32 / d2 Ø 29
 Thread: M30 x 1,5 RHT
 0004605748, 0004606048, 0004606848,
 0004607048, 0014600448, 0014601148,
 0014601748, 0014602448, 0014607648,
 0014609648

**CV-ES-0888**

Length: 125
 Cone Ø: d1 Ø 32 / d2 Ø 29
 Thread: M30 x 1,5 LHT
 0004605848, 0004606148, 0004606948,
 0004607148, 0004609048, 0014600548,
 0014601348, 0014602548, 0014607948,
 0024600448

**CV-ES-14163**

Length: 125
 Cone Ø: d1 Ø 30 / d2 Ø 27
 Thread: M30 x 1,5 RHT
 0003305248, 0003387310, 0004600348,
 0004600948, 0004602848, 0004602948,
 0004608948, 0014600248, 0014600848,
 0014601248, 0014602248, 0014607748,
 0024600148, A0003387310, A0004600348,
 A0004602848, A0004602948, A0014600848,
 A0014601248, A0014602248, A0014607748

**DB-DL-2144**

Length: 872 Ø: 35
 Cone Ø: d1 Ø 28,6 / d2 Ø 23,9
 0024604305, 0024604405, 0034604805

**DB-DL-3475**

Length: 565 Ø: 52
 Hole Distance: 152 / 152
 3753500006, 3753500206, 9473500805,
 9483500006, 9483500805, 9483501205,
 9483501305, 9483501905, 9483502005,
 9483502405, A3753500006, A3753500206

**DB-DL-5230**

Length: 879 Ø: 42
 Cone Ø: d1 Ø 30 / d2 Ø 27
 01208600A, 0004607105, 0004607205,
 0014606705

**DB-DL-5405**

Length: 890 Ø: 35
 Cone Ø: d1 Ø 28,6 / d2 Ø 23,9
 01215900A, 1460248, 0024604505, 0024604605,
 0034605005, 3752600637, 3754600405,
 A3752600637, A3754600405

**DB-DL-7270**

Length: 875 Ø: 40
 Cone Ø: d1 Ø 28,6 / d2 Ø 23,9
 01208300A, 0024604705, 0024604805,
 0034604905, A0024604705

**DB-DL-8167**

Length: 866 Ø: 38
 Cone Ø: d1 Ø 30 / d2 Ø 27
 0014609805, 0014609905, 0024606305,
 0024606405

**DB-DL-8171**

Length: 1687 Ø: 52
 Cone Ø: d1 Ø 32 / d2 Ø 29
 9493300603, 9493300703, 9493301503,
 9493301603

**DB-DL-8184**

Length: 1095 Ø: 42
 Cone Ø: d1 Ø 32 / d2 Ø 28,8
 01217700A, 0014601305, 0014601405,
 0024600505, 0034603205, 3754601505,
 A0014601305, A0014601405, A0024600505

**DB-DL-8185**

Length: 711 Ø: 42
 Cone Ø: d1 Ø 32 / d2 Ø 28,8
 01213600A, 0014601105, 0024600405,
 0034603105, A0014601105, A0024600405

**DB-DL-8307**

Length: 885 Ø: 38
 Cone Ø: d1 Ø 32 / d2 Ø 30
 01215500A, 0004604005, 0024605105,
 0024605205, 0034604005

**DB-DL-8327**

Length: 1745 Ø: 48
 Cone Ø: d1 Ø 32 / d2 Ø 29
 01219800A, 9413300003, 9413300103,
 9413300203, 9413300303, 9413300503

**DB-DL-8640**

Length: 1615 Ø: 50
 Cone Ø: d1 Ø 32 / d2 Ø 29
 6253301503, 6253301603, 6253302403,
 6253302503, 9423300803, 9423302103,
 9493300203, 9493300303, 9493300903

**DB-DL-8702**

Length: 958 Ø: 38
 Cone Ø: d1 Ø 32 / d2 Ø 30
 0024606105, 0024606205, 0034604205

**DB-DL-12300**

Length: 733 Ø: 36
 Cone Ø: d1 Ø 32 / d2 Ø 29
 0014601505, 0014607305, 0034603305,
 3754601605, A0014601505, A0034603305,
 A3754601605

**DB-DL-12310**

Length: 1532 Ø: 50
 Cone Ø: d1 Ø 32 / d2 Ø 29
 Thread: M27 x 1,5 LHT
 9493301203, 9493301303, 9493301803,
 9493302203, A9493301203, A9493301303,
 A9493301803, A9493302203

**DB-ES-5227**

Length: 1588 Ø: 60
 Cone Ø: d1 Ø 38 / d2 Ø 34,3
 6253300903, 6253301203, 9443300203

**DB-ES-5234**

Length: 135
 Cone Ø: d1 Ø 38 / d2 Ø 34,3
 Thread: M38 x 1,5 RHT
 0004601748, 120322305, 2205000400

**DB-ES-8510**

Length: 56
 Cone Ø: d1 Ø 10 / d2 Ø 10
 Thread: M12 x 1,75 LHT
 0009965145, 0009965645, 0019963145

**DB-ES-8530**

Length: 115
 Cone Ø: d1 Ø 28,6 / d2 Ø 23,9
 Thread: M30 x 1,5 RHT
 0014603848, 0014604848, 0014605148,
 0014608648, 0014609948

**DB-RK-8391**

Ø: 85 Hole Distance: 152
 Thick/Height: 24
 01336800A, 0003502705

**DB-RK-8550**

Ø: 75 Hole Distance: 152
 Thick/Height: 24
 0003502105, 0003504605

**DB-RK-8626**

Ø: 75 Hole Distance: 130
 Thick/Height: 24
 0003502205, 0003502505, 0003503405,
 0003504505, GL11319

**DB-RK-8638**

Length: 100 Ø: 67
 Hole Distance: 100
 Thick/Height: 20
 0003301411

**DB-RK-8710**

Ø: 85 Hole Distance: 130
 Thick/Height: 30
 0003503705

**DB-RK-9291**

Ø: 107,5 Hole Distance: 152
 Thick/Height: 30
 0003503605

**DB-RK-10374**

Ø: 85 Hole Distance: 152
 Thick/Height: 24
 0003504405

**DB-RK-10375**

Ø: 100 Hole Distance: 152
 Thick/Height: 24
 0003502405, 0003503505, 0003504905

**DB-SB-10384**

Ø: 73 Thick/Height: 47
 9303170012, 9423171812

**DB-SB-10401**

Length: 232
 Thick/Height: 163,5 / 152,5
 0003250596, 0003250796

**DB-SB-10406**

Ø: 80 Thick/Height: 46
 0003238185

**DB-SB-10409**

Ø: 77 Thick/Height: 56
 0003265181

**DB-SB-10410**

Ø: 73 Hole Distance: 100
 Thick/Height: 24
 9413230050

**DB-VB-7261**

Length: 622 Ø: 46
 Hole Ø 25 / 25 / 25
 Hole Distance: 152 / 130 / 130
 01337800A, 9443500305, 9443500505,
 9443500605, 9473500705, 9473500905,
 9483500405, 9483500305

**DB-VB-7798**

Length: 622 Ø: 48
 Hole Ø 25 / 23 / 23
 Hole Distance: 152 / 130 / 130
 9423500505, 9423500805, 9423501205,
 A9423501205

**DB-VB-9307**

Length: 667 Ø: 60
 Hole Ø 25 / 23 / 23
 Hole Distance: 152 / 130 / 130
 9483502805

**DB-VB-9308**

Length: 622 Ø: 46
 Hole Ø 25 / 25 / 25
 Hole Distance: 152 / 130 / 130
 9483502905

**MN-DL-7834**

Length: 1588 Ø: 58
 Cone Ø: d1 Ø 30 / d2 Ø 27
 3463303903, 3463304903, 6253303203,
 9443300503, 9443301303, 9443301703

**MN-RK-8997**

Ø: 85
 Hole Distance: 130
 Thick/Height: 30
 0003504805, 3504805





ACTROS MP2 / MP3 ...

3341 B ...	04/03 →	Tie Rod End	DB-ES-8164		for Push Rod	
	04/03 →	Tie Rod End	DB-ES-8530		for Push Rod	
	04/03 →	Track Control Arm		DB-DL-3475	Trailing Arm	
	04/03 →	Track Control Arm		DB-VB-7261	Suspension Rod, Wishbone (CV), 1st RA;2nd RA; Leaf Spring Axle	
	04/03 →	Track Control Arm		DB-VB-9307	Suspension Rod, Wishbone (CV), 1st RA;2nd RA; Leaf Spring Axle	
	04/03 →	Track Control Arm		DB-VB-9308	Suspension Rod, Wishbone (CV), 1st RA;2nd RA; Leaf Spring Axle	
3341 K	04/03 →	Centre Rod	DB-DL-2144		Push Rod	
	04/03 →	Centre Rod	DB-DL-5405		Push Rod, Leaf Spring Axle	
	04/03 →	Centre Rod	DB-DL-7270		Push Rod	
	04/03 →	Centre Rod	DB-DL-8167		Push Rod	
	04/03 →	Centre Rod	DB-DL-8188		Push Rod	
	04/03 →	Centre Rod	DB-DL-8307		Push Rod	
	04/03 →	Centre Rod	DB-DL-8702		Push Rod, Leaf Spring Axle	
	04/03 →	Stabiliser Mounting		DB-SB-10406		
	04/03 →	Suspension Strut Repair Kit		DB-RK-8710		
	04/03 →	Suspension Strut Repair Kit		DB-RK-9291		
	04/03 →	Tie Rod	DB-DL-8171		Guide Rod	
	04/03 →	Tie Rod	DB-DL-8327		Guide Rod	
	04/03 →	Tie Rod	DB-DL-8640		Guide Rod	
	04/03 →	Tie Rod	DB-DL-12310			
	04/03 →	Tie Rod	DB-ES-5227		Guide Rod	
	04/03 →	Tie Rod End	CV-ES-0543		for Push Rod	
	04/03 →	Tie Rod End	CV-ES-0888		for Push Rod	
	04/03 →	Tie Rod End	CV-ES-14163		for Steering Rod	
	04/03 →	Tie Rod End	DB-ES-8164		for Push Rod	
	04/03 →	Tie Rod End	DB-ES-8530		for Push Rod	
	04/03 →	Track Control Arm		DB-DL-3475	Trailing Arm, 1st RA;2nd RA, →517144 03/517144 07	
	04/03 →	Track Control Arm		DB-DL-3475	Trailing Arm, 1st RA;2nd RA, →517144 06/517144 09	
	04/03 →	Track Control Arm		DB-VB-7261	Suspension Rod, Wishbone (CV), 1st RA;2nd RA; Leaf Spring Axle	
	04/03 →	Track Control Arm		DB-VB-9307	Suspension Rod, Wishbone (CV), 1st RA;2nd RA; Leaf Spring Axle	
	04/03 →	Track Control Arm		DB-VB-9308	Suspension Rod, Wishbone (CV), 1st RA;2nd RA; Leaf Spring Axle	
	3341 S	04/03 →	Ball Head, gearshift linkage	DB-ES-8510		
		04/03 →	Bush, driver cab suspension	DB-SB-10384		
		04/03 →	Bush, parabolic spring		DB-SB-10400	
		04/03 →	Bush, parabolic spring		DB-SB-10401	
		04/03 →	Centre Rod	DB-DL-2144		Push Rod
		04/03 →	Centre Rod	DB-DL-5230		Suspension Rod
		04/03 →	Centre Rod	DB-DL-5405		Push Rod, Leaf Spring Axle
04/03 →		Centre Rod	DB-DL-7270		Push Rod;Suspension Rod	
04/03 →		Centre Rod	DB-DL-8167		Push Rod	
04/03 →		Centre Rod	DB-DL-8184		Push Rod	
04/03 →		Centre Rod	DB-DL-8185		Push Rod	
04/03 →		Centre Rod	DB-DL-8307		Push Rod	
04/03 →		Centre Rod	DB-DL-8702		Push Rod, Leaf Spring Axle	
04/03 →		Centre Rod	DB-DL-12300		for Steering Rod	
04/03 →		Stabiliser Mounting		DB-SB-10406		
04/03 →		Stabiliser Mounting		DB-SB-10409		
04/03 →		Stabiliser Mounting	DB-SB-10410			
04/03 →		Suspension Arm Repair Kit		DB-RK-8550	for Wishbone (CV)	
04/03 →		Suspension Arm Repair Kit		DB-RK-8626	for Wishbone (CV)	
04/03 →		Suspension Arm Repair Kit		DB-RK-10374	for Wishbone (CV)	
04/03 →		Suspension Arm Repair Kit		DB-RK-10375	for Wishbone (CV)	
04/03 →		Suspension Arm Repair Kit	DB-RK-8638		for Control Arm	
04/03 →		Suspension Strut Repair Kit		DB-RK-8391		
04/03 →		Suspension Strut Repair Kit		DB-RK-8710		

CV-ES-0543

Length: 125
Cone Ø: d1 Ø 32 / d2 Ø 29
Thread: M30 x 1,5 RHT
 0004605748, 0004606048, 0004606848,
 0004607048, 0014600448, 0014601148,
 0014601748, 0014602448, 0014607648,
 0014609648



CV-ES-0888

Length: 125
Cone Ø: d1 Ø 32 / d2 Ø 29
Thread: M30 x 1,5 LHT
 0004605848, 0004606148, 0004606948,
 0004607148, 0004609048, 0014600548,
 0014601348, 0014602548, 0014607948,
 0024600448



CV-ES-14163

Length: 125
Cone Ø: d1 Ø 30 / d2 Ø 27
Thread: M30 x 1,5 RHT
 0003305248, 0003387310, 0004600348,
 0004600948, 0004602848, 0004602948,
 0004608948, 0014600248, 0014600848,
 0014601248, 0014602248, 0014607748,
 0024600148, A0003387310, A0004600348,
 A0004602848, A0004602948, A0014600848,
 A0014601248, A0014602248, A0014607748



DB-DL-2144

Length: 872 Ø: 35
Cone Ø: d1 Ø 28,6 / d2 Ø 23,9
 0024604305, 0024604405, 0034604805



DB-DL-3475

Length: 565 Ø: 52
Hole Distance: 152 / 152
 3753500006, 3753500206, 9473500805,
 9483500006, 9483500805, 9483501205,
 9483501305, 9483501905, 9483502005,
 9483502405, A3753500006, A3753500206



DB-DL-5230

Length: 879 Ø: 42
Cone Ø: d1 Ø 30 / d2 Ø 27
 01208600A, 0004607105, 0004607205,
 0014606705



DB-DL-5405

Length: 890 Ø: 35
Cone Ø: d1 Ø 28,6 / d2 Ø 23,9
 01215900A, 1460248, 0024604505, 0024604605,
 0034605005, 3752600637, 3754600405,
 A3752600637, A3754600405



DB-DL-7270

Length: 875 Ø: 40
Cone Ø: d1 Ø 28,6 / d2 Ø 23,9
 01208300A, 0024604705, 0024604805,
 0034604905, A0024604705



DB-DL-8167

Length: 866 Ø: 38
Cone Ø: d1 Ø 30 / d2 Ø 27
 0014609805, 0014609905, 0024606305,
 0024606405



DB-DL-8171

Length: 1687 Ø: 52
Cone Ø: d1 Ø 32 / d2 Ø 29
 9493300603, 9493300703, 9493301503,
 9493301603



DB-DL-8184

Length: 1095 Ø: 42
Cone Ø: d1 Ø 32 / d2 Ø 28,8
 01217700A, 0014601305, 0014601405,
 0024600505, 0034603205, 3754601505,
 A0014601305, A0014601405, A0024600505



DB-DL-8185

Length: 711 Ø: 42
Cone Ø: d1 Ø 32 / d2 Ø 28,8
 01213600A, 0014601105, 0024600405,
 0034603105, A0014601105, A0024600405



DB-DL-8188

Length: 895 Ø: 40
Cone Ø: d1 Ø 28,6 / d2 Ø 23,9
 01217200A, 0024604905, 0024605005,
 0034605605



DB-DL-8307

Length: 885 Ø: 38
Cone Ø: d1 Ø 32 / d2 Ø 30
 01215500A, 0004604005, 0024605105,
 0024605205, 0034604005



DB-DL-8327

Length: 1745 Ø: 48
Cone Ø: d1 Ø 32 / d2 Ø 29
 01219800A, 9413300003, 9413300103,
 9413300203, 9413300303, 9413300503



DB-DL-8640

Length: 1615 Ø: 50
Cone Ø: d1 Ø 32 / d2 Ø 29
 6253301503, 6253301603, 6253302403,
 6253302503, 9423300803, 9423302103,
 9493300203, 9493300303, 9493300903



DB-DL-8702

Length: 958 Ø: 38
Cone Ø: d1 Ø 32 / d2 Ø 30
 0024606105, 0024606205, 0034604205



DB-DL-12300

Length: 733 Ø: 36
Cone Ø: d1 Ø 32 / d2 Ø 29
 0014601505, 0014607305, 0034603305,
 3754601605, A0014601505, A0034603305,
 A3754601605



DB-DL-12310

Length: 1532 Ø: 50
Cone Ø: d1 Ø 32 / d2 Ø 29
Thread: M27 x 1,5 LHT
 9493301203, 9493301303, 9493301803,
 9493302203, A9493301203, A9493301303,
 A9493301803, A9493302203



DB-ES-5227

Length: 1588 Ø: 60
Cone Ø: d1 Ø 38 / d2 Ø 34,3
 6253300903, 6253301203, 9443300203



DB-ES-8164

Length: 140
Cone Ø: d1 Ø 28,6 / d2 Ø 23,9
Thread: M28 x 1,5 RHT
 0014604248, 0014605048, 0014608548,
 0024600548



DB-ES-8510

Length: 56
Cone Ø: d1 Ø 10 / d2 Ø 10
Thread: M12 x 1,75 LHT
 0009965145, 0009965645, 0019963145



DB-ES-8530

Length: 115
Cone Ø: d1 Ø 28,6 / d2 Ø 23,9
Thread: M30 x 1,5 RHT
 0014603848, 0014604848, 0014605148,
 0014608648, 0014609948



DB-RK-8391

Ø: 85 **Hole Distance:** 152
Thick/Height: 24
 01336800A, 0003502705



DB-RK-8550

Ø: 75 **Hole Distance:** 152
Thick/Height: 24
 0003502105, 0003504605



DB-RK-8626

Ø: 75 **Hole Distance:** 130
Thick/Height: 24
 0003502205, 0003502505, 0003503405,
 0003504505, GL11319



DB-RK-8638

Length: 100 Ø: 67
Hole Distance: 100
Thick/Height: 20
 0003301411



DB-RK-8710

Ø: 85 **Hole Distance:** 130
Thick/Height: 30
 0003503705



DB-RK-9291

Ø: 107,5 **Hole Distance:** 152
Thick/Height: 30
 0003503605



DB-RK-10374

Ø: 85 **Hole Distance:** 152
Thick/Height: 24
 0003504405



DB-RK-10375

Ø: 100 **Hole Distance:** 152
Thick/Height: 24
 0003502405, 0003503505, 0003504905



DB-SB-10384

Ø: 73 **Thick/Height:** 47
 9303170012, 9423171812



DB-SB-10400

Length: 230
Thick/Height: 167,5 / 115
 0003250696, 0003250896



DB-SB-10401

Length: 232
Thick/Height: 163,5 / 152,5
 0003250596, 0003250796



DB-SB-10406

Ø: 80 **Thick/Height:** 46
 0003238185



DB-SB-10409

Ø: 77 **Thick/Height:** 56
 0003265181



DB-SB-10410

Ø: 73 **Hole Distance:** 100
Thick/Height: 24
 9413230050



DB-VB-7261

Length: 622 Ø: 46
Hole Ø: 25 / 25 / 25
Hole Distance: 152 / 130 / 130
 01337800A, 9443500305, 9443500505,
 9443500605, 9473500705, 9473500905,
 9483500405, 9483503005



DB-VB-9307

Length: 667 Ø: 60
Hole Ø: 25 / 23 / 23
Hole Distance: 152 / 130 / 130
 9483502805



DB-VB-9308

Length: 622 Ø: 46
Hole Ø: 25 / 25 / 25
Hole Distance: 152 / 130 / 130
 9483502905





ACTROS MP2 / MP3 ...

3341 S ...	04/03→	Suspension Strut Repair Kit		DB-RK-9291	
	04/03→	Suspension Strut Repair Kit		MN-RK-8997	
	04/03→	Tie Rod	DB-DL-8171		Guide Rod
	04/03→	Tie Rod	DB-DL-8327		Guide Rod
	04/03→	Tie Rod	DB-DL-8640		Guide Rod
	04/03→	Tie Rod	DB-DL-12310		
	04/03→	Tie Rod	DB-ES-5227		Guide Rod
	04/03→	Tie Rod End	CV-ES-0543		for Push Rod
	04/03→	Tie Rod End	CV-ES-0888		for Push Rod
	04/03→	Tie Rod End	CV-ES-14163		for Steering Rod
	04/03→	Tie Rod End	DB-ES-5234		for Steering Rod
	04/03→	Tie Rod End	DB-ES-8164		for Push Rod
	04/03→	Tie Rod End	DB-ES-8530		for Push Rod
	04/03→	Track Control Arm		DB-DL-3475	Trailing Arm
	04/03→	Track Control Arm		DB-VB-7261	Suspension Rod, Wishbone (CV), 1st RA;2nd RA; Leaf Spring Axle
	04/03→	Track Control Arm		DB-VB-7798	Wishbone (CV)
	04/03→	Track Control Arm		DB-VB-9307	Suspension Rod, Wishbone (CV), 1st RA;2nd RA; Leaf Spring Axle
	04/03→	Track Control Arm		DB-VB-9308	Suspension Rod, Wishbone (CV), 1st RA;2nd RA; Leaf Spring Axle
3343 AK	04/03→	Bush, driver cab suspension	DB-SB-10384		
	04/03→	Bush, parabolic spring		DB-SB-10401	
	04/03→	Centre Rod	DB-DL-8307		Push Rod
	04/03→	Centre Rod	DB-DL-8702		Push Rod
	04/03→	Suspension Arm Repair Kit		DB-RK-8626	for Wishbone (CV)
	04/03→	Suspension Arm Repair Kit		DB-RK-10375	for Wishbone (CV)
	04/03→	Suspension Strut Repair Kit		DB-RK-8391	
	04/03→	Suspension Strut Repair Kit		DB-RK-8710	
	04/03→	Suspension Strut Repair Kit		DB-RK-9291	
	04/03→	Tie Rod	DB-ES-5227		Guide Rod
	04/03→	Tie Rod	MN-DL-7834		Guide Rod
	04/03→	Tie Rod End	CV-ES-0543		for Push Rod
	04/03→	Tie Rod End	CV-ES-14163		for Steering Rod
	04/03→	Tie Rod End	DB-ES-5234		for Steering Rod
	04/03→	Track Control Arm		DB-DL-3475	Trailing Arm, 1st RA;2nd RA, →517144 03/517144 06
	04/03→	Track Control Arm		DB-DL-3475	Trailing Arm, 1st RA;2nd RA, →517144 05/517144 08
	04/03→	Track Control Arm		DB-DL-3475	Trailing Arm, 1st RA;2nd RA, →517144 07/517144 09
	04/03→	Track Control Arm		DB-DL-3475	Trailing Arm, 1st RA;2nd RA, →517144 26/517144 27
	04/03→	Track Control Arm		DB-VB-7261	Suspension Rod, Wishbone (CV)
	04/03→	Track Control Arm		DB-VB-9307	Suspension Rod, Wishbone (CV)
04/03→	Track Control Arm		DB-VB-9308	Suspension Rod, Wishbone (CV)	
3343 B	04/03→	Bush, parabolic spring		DB-SB-10400	
	04/03→	Bush, parabolic spring		DB-SB-10401	
	04/03→	Centre Rod	DB-DL-2144		Push Rod
	04/03→	Centre Rod	DB-DL-5405		Push Rod
	04/03→	Centre Rod	DB-DL-7270		Push Rod
	04/03→	Centre Rod	DB-DL-8167		Push Rod
	04/03→	Centre Rod	DB-DL-8307		Push Rod
	04/03→	Centre Rod	DB-DL-8702		Push Rod
	04/03→	Suspension Arm Repair Kit		DB-RK-8626	for Wishbone (CV)
	04/03→	Suspension Arm Repair Kit		DB-RK-10375	for Wishbone (CV)
	04/03→	Suspension Strut Repair Kit		DB-RK-8391	
	04/03→	Suspension Strut Repair Kit		DB-RK-8710	
	04/03→	Suspension Strut Repair Kit		DB-RK-9291	
	04/03→	Tie Rod	DB-DL-8171		Guide Rod
	04/03→	Tie Rod	DB-DL-8327		Guide Rod, 1st Front Axle
	04/03→	Tie Rod	DB-DL-8640		Guide Rod, 1st Front Axle
	04/03→	Tie Rod	DB-DL-12310		

CV-ES-0543

Length: 125
Cone Ø: d1 Ø 32 / d2 Ø 29
Thread: M30 x 1,5 RHT
0004605748, 0004606048, 0004606848,
0004607048, 0014600448, 0014601148,
0014601748, 0014602448, 0014607648,
0014609648



CV-ES-0888

Length: 125
Cone Ø: d1 Ø 32 / d2 Ø 29
Thread: M30 x 1,5 LHT
0004605848, 0004606148, 0004606948,
0004607148, 0004609048, 0014600548,
0014601348, 0014602548, 0014607948,
0024600448



CV-ES-14163

Length: 125
Cone Ø: d1 Ø 30 / d2 Ø 27
Thread: M30 x 1,5 RHT
0003305248, 0003387310, 0004600348,
0004600948, 0004602848, 0004602948,
0004608948, 0014600248, 0014600848,
0014601248, 0014602248, 0014607748,
0024600148, A0003387310, A0004600348,
A0004602848, A0004602948, A0014600848,
A0014601248, A0014602248, A0014607748



DB-DL-2144

Length: 872 Ø: 35
Cone Ø: d1 Ø 28,6 / d2 Ø 23,9
0024604305, 0024604405, 0034604805



DB-DL-3475

Length: 565 Ø: 52
Hole Distance: 152 / 152
3753500006, 3753500206, 9473500805,
9483500006, 9483500805, 9483501205,
9483501305, 9483501905, 9483502005,
9483502405, A3753500006, A3753500206



DB-DL-5405

Length: 890 Ø: 35
Cone Ø: d1 Ø 28,6 / d2 Ø 23,9
01215900A, 1460248, 0024604505, 0024604605,
0034605005, 3752600637, 3754600405,
A3752600637, A3754600405



DB-DL-7270

Length: 875 Ø: 40
Cone Ø: d1 Ø 28,6 / d2 Ø 23,9
01208300A, 0024604705, 0024604805,
0034604905, A0024604705



DB-DL-8167

Length: 866 Ø: 38
Cone Ø: d1 Ø 30 / d2 Ø 27
0014609805, 0014609905, 0024606305,
0024606405



DB-DL-8171

Length: 1687 Ø: 52
Cone Ø: d1 Ø 32 / d2 Ø 29
9493300603, 9493300703, 9493301503,
9493301603



DB-DL-8307

Length: 885 Ø: 38
Cone Ø: d1 Ø 32 / d2 Ø 30
01215500A, 0004604005, 0024605105,
0024605205, 0034604005



DB-DL-8327

Length: 1745 Ø: 48
Cone Ø: d1 Ø 32 / d2 Ø 29
01219800A, 9413300003, 9413300103,
9413300203, 9413300303, 9413300503



DB-DL-8640

Length: 1615 Ø: 50
Cone Ø: d1 Ø 32 / d2 Ø 29
6253301503, 6253301603, 6253302403,
6253302503, 9423300803, 9423302103,
9493300203, 9493300303, 9493300903



DB-DL-8702

Length: 958 Ø: 38
Cone Ø: d1 Ø 32 / d2 Ø 30
0024606105, 0024606205, 0034604205



DB-DL-12310

Length: 1532 Ø: 50
Cone Ø: d1 Ø 32 / d2 Ø 29
Thread: M27 x 1,5 LHT
9493301203, 9493301303, 9493301803,
9493302203, A9493301203, A9493301303,
A9493301803, A9493302203



DB-ES-5227

Length: 1588 Ø: 60
Cone Ø: d1 Ø 38 / d2 Ø 34,3
6253300903, 6253301203, 9443300203



DB-ES-5234

Length: 135
Cone Ø: d1 Ø 38 / d2 Ø 34,3
Thread: M38 x 1,5 RHT
0004601748, 120322305, 2205000400



DB-ES-8164

Length: 140
Cone Ø: d1 Ø 28,6 / d2 Ø 23,9
Thread: M28 x 1,5 RHT
0014604248, 0014605048, 0014608548,
0024600548



DB-ES-8530

Length: 115
Cone Ø: d1 Ø 28,6 / d2 Ø 23,9
Thread: M30 x 1,5 RHT
0014603848, 0014604848, 0014605148,
0014608648, 0014609948



DB-RK-8391

Ø: 85 Hole Distance: 152
Thick/Height: 24
01336800A, 0003502705



DB-RK-8626

Ø: 75 Hole Distance: 130
Thick/Height: 24
0003502205, 0003502505, 0003503405,
0003504505, GL11319



DB-RK-8710

Ø: 85 Hole Distance: 130
Thick/Height: 30
0003503705



DB-RK-9291

Ø: 107,5 Hole Distance: 152
Thick/Height: 30
0003503605



DB-RK-10375

Ø: 100 Hole Distance: 152
Thick/Height: 24
0003502405, 0003503505, 0003504905



DB-SB-10384

Ø: 73 Thick/Height: 47
9303170012, 9423171812



DB-SB-10400

Length: 230
Thick/Height: 167,5 / 115
0003250696, 0003250896



DB-SB-10401

Length: 232
Thick/Height: 163,5 / 152,5
0003250596, 0003250796



DB-VB-7261

Length: 622 Ø: 46
Hole Ø 25 / 25 / 25
Hole Distance: 152 / 130 / 130
01337800A, 9443500305, 9443500505,
9443500605, 9473500705, 9473500905,
9483500405, 9483503005



DB-VB-7798

Length: 622 Ø: 48
Hole Ø 25 / 23 / 23
Hole Distance: 152 / 130 / 130
9423500505, 9423500805, 9423501205,
A9423501205



DB-VB-9307

Length: 667 Ø: 60
Hole Ø 25 / 23 / 23
Hole Distance: 152 / 130 / 130
9483502805



DB-VB-9308

Length: 622 Ø: 46
Hole Ø 25 / 25 / 25
Hole Distance: 152 / 130 / 130
9483502905



MN-DL-7834

Length: 1588 Ø: 58
Cone Ø: d1 Ø 30 / d2 Ø 27
3463303903, 3463304903, 6253303203,
9443300503, 9443301303, 9443301703



MN-RK-8997

Ø: 85 Hole Distance: 130
Thick/Height: 30
0003504805





ACTROS MP2 / MP3 ...

3343 B ...	04/03→	Tie Rod End	CV-ES-0543		for Push Rod	
	04/03→	Tie Rod End	CV-ES-0888		for Push Rod	
	04/03→	Tie Rod End	CV-ES-14163		for Steering Rod	
	04/03→	Tie Rod End	DB-ES-8164		for Push Rod	
	04/03→	Tie Rod End	DB-ES-8530		for Push Rod	
	04/03→	Track Control Arm		DB-DL-3475	Trailing Arm, 1st RA;2nd RA, →517144 06/517144 09	
	04/03→	Track Control Arm		DB-VB-7261	Suspension Rod, Wishbone (CV)	
	04/03→	Track Control Arm		DB-VB-9307	Suspension Rod, Wishbone (CV)	
	04/03→	Track Control Arm		DB-VB-9308	Suspension Rod, Wishbone (CV)	
3343 K	04/03→	Centre Rod	DB-DL-2144		Push Rod	
	04/03→	Centre Rod	DB-DL-5405		Push Rod	
	04/03→	Centre Rod	DB-DL-7270		Push Rod	
	04/03→	Centre Rod	DB-DL-8167		Push Rod	
	04/03→	Centre Rod	DB-DL-8188		Push Rod	
	04/03→	Centre Rod	DB-DL-8307		Push Rod	
	04/03→	Centre Rod	DB-DL-8702		Push Rod	
	04/03→	Suspension Arm Repair Kit		DB-RK-8626	for Wishbone (CV)	
	04/03→	Suspension Arm Repair Kit		DB-RK-10375	for Wishbone (CV)	
	04/03→	Suspension Strut Repair Kit		DB-RK-8391		
	04/03→	Suspension Strut Repair Kit		DB-RK-8710		
	04/03→	Suspension Strut Repair Kit		DB-RK-9291		
	04/03→	Tie Rod	DB-DL-8171		Guide Rod	
	04/03→	Tie Rod	DB-DL-8327		Guide Rod	
	04/03→	Tie Rod	DB-DL-8640		Guide Rod	
	04/03→	Tie Rod	DB-DL-12310			
	04/03→	Tie Rod End	CV-ES-0543		for Push Rod	
	04/03→	Tie Rod End	CV-ES-0888		for Push Rod	
	04/03→	Tie Rod End	CV-ES-14163		for Steering Rod	
	04/03→	Tie Rod End	DB-ES-8164		for Push Rod	
	04/03→	Tie Rod End	DB-ES-8530		for Push Rod	
	04/03→	Track Control Arm		DB-DL-3475	Trailing Arm, 1st RA;2nd RA, →517144 03/517144 07	
	04/03→	Track Control Arm		DB-DL-3475	Trailing Arm, 1st RA;2nd RA, →517144 06/517144 09	
	04/03→	Track Control Arm		DB-VB-7261	Suspension Rod, Wishbone (CV)	
	04/03→	Track Control Arm		DB-VB-9307	Suspension Rod, Wishbone (CV)	
	04/03→	Track Control Arm		DB-VB-9308	Suspension Rod, Wishbone (CV)	
	3344	04/03→	Ball Head, gearshift linkage	DB-ES-8510		
		04/03→	Bush, driver cab suspension	DB-SB-10384		
		04/03→	Bush, parabolic spring		DB-SB-10400	
		04/03→	Bush, parabolic spring		DB-SB-10401	
		04/03→	Centre Rod	DB-DL-2144		Push Rod
		04/03→	Centre Rod	DB-DL-5230		Suspension Rod
		04/03→	Centre Rod	DB-DL-5405		Push Rod, Leaf Spring Axle
04/03→		Centre Rod	DB-DL-7270		Push Rod;Suspension Rod	
04/03→		Centre Rod	DB-DL-8167		Push Rod	
04/03→		Centre Rod	DB-DL-8168		Push Rod	
04/03→		Centre Rod	DB-DL-8184		Push Rod	
04/03→		Centre Rod	DB-DL-8185		Push Rod	
04/03→		Centre Rod	DB-DL-8307		Push Rod	
04/03→		Centre Rod	DB-DL-8622		Push Rod	
04/03→		Centre Rod	DB-DL-8641		Push Rod	
04/03→		Centre Rod	DB-DL-8642		Push Rod	
04/03→		Centre Rod	DB-DL-8702		Push Rod, Leaf Spring Axle	
04/03→		Centre Rod	DB-DL-12300		for Steering Rod	
04/03→		Stabiliser Link	DB-DL-9254		Pressure Rod	
04/03→		Stabiliser Mounting		DB-SB-10406		
04/03→		Stabiliser Mounting		DB-SB-10409		
04/03→		Stabiliser Mounting	DB-SB-10410			
04/03→		Suspension Arm Repair Kit		DB-RK-8550	for Wishbone (CV)	
04/03→		Suspension Arm Repair Kit		DB-RK-8626	for Wishbone (CV)	
04/03→		Suspension Arm Repair Kit		DB-RK-10374	for Wishbone (CV)	

CV-ES-0543

Length: 125
Cone Ø: d1 Ø 32 / d2 Ø 29
Thread: M30 x 1,5 RHT
0004605748, 0004606048, 0004606848,
0004607048, 0014600448, 0014601148,
0014601748, 0014602448, 0014607648,
0014609648



CV-ES-0888

Length: 125
Cone Ø: d1 Ø 32 / d2 Ø 29
Thread: M30 x 1,5 LHT
0004605848, 0004606148, 0004606948,
0004607148, 0004609048, 0014600548,
0014601348, 0014602548, 0014607948,
0024600448



CV-ES-14163

Length: 125
Cone Ø: d1 Ø 30 / d2 Ø 27
Thread: M30 x 1,5 RHT
0003305248, 0003387310, 0004600348,
0004600948, 0004602848, 0004602948,
0004608948, 0014600248, 0014600848,
0014601248, 0014602248, 0014607748,
0024600148, A0003387310, A0004600348,
A0004602848, A0004602948, A0014600848,
A0014601248, A0014602248, A0014607748



DB-DL-2144

Length: 872 Ø: 35
Cone Ø: d1 Ø 28,6 / d2 Ø 23,9
0024604305, 0024604405, 0034604805



DB-DL-3475

Length: 565 Ø: 52
Hole Distance: 152 / 152
3753500006, 3753500206, 9473500805,
9483500006, 9483500805, 9483501205,
9483501305, 9483501905, 9483502005,
9483502405, A3753500006, A3753500206



DB-DL-5230

Length: 879 Ø: 42
Cone Ø: d1 Ø 30 / d2 Ø 27
01208600A, 0004607105, 0004607205,
0014606705



DB-DL-5405

Length: 890 Ø: 35
Cone Ø: d1 Ø 28,6 / d2 Ø 23,9
01215900A, 1460248, 0024604505, 0024604605,
0034605005, 3752600637, 3754600405,
A3752600637, A3754600405



DB-DL-7270

Length: 875 Ø: 40
Cone Ø: d1 Ø 28,6 / d2 Ø 23,9
01208300A, 0024604705, 0024604805,
0034604905, A0024604705



DB-DL-8167

Length: 866 Ø: 38
Cone Ø: d1 Ø 30 / d2 Ø 27
0014609805, 0014609905, 0024606305,
0024606405



DB-DL-8168

Length: 904 Ø: 52
Cone Ø: d1 Ø 32 / d2 Ø 29
0004609405, 0004609505, 0014607105



DB-DL-8171

Length: 1687 Ø: 52
Cone Ø: d1 Ø 32 / d2 Ø 29
9493300603, 9493300703, 9493301503,
9493301603



DB-DL-8184

Length: 1095 Ø: 42
Cone Ø: d1 Ø 32 / d2 Ø 28,8
01217700A, 0014601305, 0014601405,
0024600505, 0034603205, 3754601505,
A0014601305, A0014601405, A0024600505



DB-DL-8185

Length: 711 Ø: 42
Cone Ø: d1 Ø 32 / d2 Ø 28,8
01213600A, 0014601105, 0024600405,
0034603105, A0014601105, A0024600405



DB-DL-8188

Length: 895 Ø: 40
Cone Ø: d1 Ø 28,6 / d2 Ø 23,9
01217200A, 0024604905, 0024605005,
0034605605



DB-DL-8307

Length: 885 Ø: 38
Cone Ø: d1 Ø 32 / d2 Ø 30
01215500A, 0004604005, 0024605105,
0024605205, 0034604005



DB-DL-8327

Length: 1745 Ø: 48
Cone Ø: d1 Ø 32 / d2 Ø 29
01219800A, 9413300003, 9413300103,
9413300203, 9413300303, 9413300503



DB-DL-8622

Length: 1558 Ø: 52
Cone Ø: d1 Ø 30 / d2 Ø 27
0014609005, 0014609105



DB-DL-8640

Length: 1615 Ø: 50
Cone Ø: d1 Ø 32 / d2 Ø 29
6253301503, 6253301603, 6253302403,
6253302503, 9423300803, 9423302103,
9493300203, 9493300303, 9493300903



DB-DL-8641

Length: 905 Ø: 42
Cone Ø: d1 Ø 30 / d2 Ø 27
0014605105, 0014608105



DB-DL-8642

Length: 954 Ø: 42
Cone Ø: d1 Ø 30 / d2 Ø 27
0014608605, 0014608705



DB-DL-8702

Length: 958 Ø: 38
Cone Ø: d1 Ø 32 / d2 Ø 30
0024606105, 0024606205, 0034604205



DB-DL-9254

Length: 1815 Ø: 58
0003220323, 0003220623, 3753220423



DB-DL-12300

Length: 733 Ø: 36
Cone Ø: d1 Ø 32 / d2 Ø 29
0014601505, 0014607305, 0034603305,
3754601605, A0014601505, A0034603305,
A3754601605



DB-DL-12310

Length: 1532 Ø: 50
Cone Ø: d1 Ø 32 / d2 Ø 29
Thread: M27 x 1,5 LHT
9493301203, 9493301303, 9493301803,
9493302203, A9493301203, A9493301303,
A9493301803, A9493302203



DB-ES-8164

Length: 140
Cone Ø: d1 Ø 28,6 / d2 Ø 23,9
Thread: M28 x 1,5 RHT
0014604248, 0014605048, 0014608548,
0024600548



DB-ES-8510

Length: 56
Cone Ø: d1 Ø 10 / d2 Ø 10
Thread: M12 x 1,75 LHT
0009965145, 0009965645, 0019963145



DB-ES-8530

Length: 115
Cone Ø: d1 Ø 28,6 / d2 Ø 23,9
Thread: M30 x 1,5 RHT
0014603848, 0014604848, 0014605148,
0014608648, 0014609948



DB-RK-8391

Ø: 85 Hole Distance: 152
Thick/Height: 24
01336800A, 0003502705



DB-RK-8550

Ø: 75 Hole Distance: 152
Thick/Height: 24
0003502105, 0003504605



DB-RK-8626

Ø: 75 Hole Distance: 130
Thick/Height: 24
0003502205, 0003502505, 0003503405,
0003504505, GL11319



DB-RK-8710

Ø: 85 Hole Distance: 130
Thick/Height: 30
0003503705



DB-RK-9291

Ø: 107,5 Hole Distance: 152
Thick/Height: 30
0003503605



DB-RK-10374

Ø: 85 Hole Distance: 152
Thick/Height: 24
0003504405



DB-RK-10375

Ø: 100 Hole Distance: 152
Thick/Height: 24
0003502405, 0003503505, 0003504905



DB-SB-10384

Ø: 73 Thick/Height: 47
9303170012, 9423171812



DB-SB-10400

Length: 230
Thick/Height: 167,5 / 115
0003250696, 0003250896



DB-SB-10401

Length: 232
Thick/Height: 163,5 / 152,5
0003250596, 0003250796



DB-SB-10406

Ø: 80 Thick/Height: 46
0003238185



DB-SB-10409

Ø: 77 Thick/Height: 56
0003265181



DB-SB-10410

Ø: 73 Hole Distance: 100
Thick/Height: 24
9413230050



DB-VB-7261

Length: 622 Ø: 46
Hole Ø 25 / 25 / 25
Hole Distance: 152 / 130 / 130
01337800A, 9443500305, 9443500505,
9443500605, 9473500705, 9473500905,
9483500405, 9483503005



DB-VB-9307

Length: 667 Ø: 60
Hole Ø 25 / 23 / 23
Hole Distance: 152 / 130 / 130
9483502805



DB-VB-9308

Length: 622 Ø: 46
Hole Ø 25 / 25 / 25
Hole Distance: 152 / 130 / 130
9483502905





ACTROS MP2 / MP3 ...

3344 ...	04/03→	Suspension Arm Repair Kit		DB-RK-10375	for Wishbone (CV)
	04/03→	Suspension Arm Repair Kit	DB-RK-8638		for Control Arm
	04/03→	Suspension Strut Repair Kit		DB-RK-8391	
	04/03→	Suspension Strut Repair Kit		DB-RK-8710	
	04/03→	Suspension Strut Repair Kit		DB-RK-9291	
	04/03→	Tie Rod	DB-DL-8171		Guide Rod, 1st FA;Leaf Spring Axle
	04/03→	Tie Rod	DB-DL-8327		Guide Rod, 1st FA;Leaf Spring Axle
	04/03→	Tie Rod	DB-DL-8640		Guide Rod
	04/03→	Tie Rod	DB-DL-12310		
	04/03→	Tie Rod	DB-ES-5227		Guide Rod
	04/03→	Tie Rod End	CV-ES-0543		for Push Rod
	04/03→	Tie Rod End	CV-ES-0888		for Push Rod
	04/03→	Tie Rod End	CV-ES-14163		for Steering Rod
	04/03→	Tie Rod End	DB-ES-5234		for Steering Rod
	04/03→	Tie Rod End	DB-ES-8164		for Push Rod
	04/03→	Tie Rod End	DB-ES-8530		for Push Rod
	04/03→	Track Control Arm		DB-DL-3475	Trailing Arm
	04/03→	Track Control Arm		DB-VB-7261	Suspension Rod, Wishbone (CV), 1st RA;2nd RA; Leaf Spring Axle
	04/03→	Track Control Arm		DB-VB-9307	Suspension Rod, Wishbone (CV), 1st RA;2nd RA; Leaf Spring Axle
	04/03→	Track Control Arm		DB-VB-9308	Suspension Rod, Wishbone (CV), 1st RA;2nd RA; Leaf Spring Axle
3344 A	04/03→	Ball Head, gearshift linkage	DB-ES-8510		
	04/03→	Bush, driver cab suspension	DB-SB-10384		
	04/03→	Bush, parabolic spring		DB-SB-10401	
	04/03→	Centre Rod	DB-DL-8168		Push Rod
	04/03→	Centre Rod	DB-DL-8184		Push Rod
	04/03→	Centre Rod	DB-DL-8307		Push Rod, Leaf Spring Axle
	04/03→	Centre Rod	DB-DL-8622		Push Rod
	04/03→	Centre Rod	DB-DL-8641		Push Rod
	04/03→	Centre Rod	DB-DL-8642		Push Rod
	04/03→	Centre Rod	DB-DL-8702		Push Rod, Leaf Spring Axle
	04/03→	Centre Rod	DB-DL-12300		for Steering Rod
	04/03→	Stabiliser Link	DB-DL-9254		Pressure Rod
	04/03→	Stabiliser Mounting		DB-SB-10406	
	04/03→	Stabiliser Mounting		DB-SB-10409	
	04/03→	Stabiliser Mounting	DB-SB-10410		
	04/03→	Suspension Arm Repair Kit		DB-RK-8550	for Wishbone (CV)
	04/03→	Suspension Arm Repair Kit		DB-RK-8626	for Wishbone (CV)
	04/03→	Suspension Arm Repair Kit		DB-RK-10374	for Wishbone (CV)
	04/03→	Suspension Arm Repair Kit		DB-RK-10375	for Wishbone (CV)
	04/03→	Suspension Arm Repair Kit	DB-RK-8638		for Control Arm
	04/03→	Suspension Strut Repair Kit		DB-RK-8391	
	04/03→	Suspension Strut Repair Kit		DB-RK-8710	
	04/03→	Suspension Strut Repair Kit		DB-RK-9291	
	04/03→	Tie Rod	DB-DL-12310		
	04/03→	Tie Rod	DB-ES-5227		Guide Rod, 1st FA;Leaf Spring Axle
	04/03→	Tie Rod	MN-DL-7834		Guide Rod, 1st FA;Leaf Spring Axle
	04/03→	Tie Rod End	CV-ES-0543		for Push Rod
	04/03→	Tie Rod End	CV-ES-14163		for Steering Rod
	04/03→	Tie Rod End	DB-ES-5234		for Steering Rod
	04/03→	Tie Rod End	DB-ES-8530		for Push Rod
	04/03→	Track Control Arm		DB-DL-3475	Trailing Arm
	04/03→	Track Control Arm		DB-VB-7261	Suspension Rod, Wishbone (CV), 1st RA;2nd RA; Leaf Spring Axle
	04/03→	Track Control Arm		DB-VB-9307	Suspension Rod, Wishbone (CV), 1st RA;2nd RA; Leaf Spring Axle
	04/03→	Track Control Arm		DB-VB-9308	Suspension Rod, Wishbone (CV), 1st RA;2nd RA; Leaf Spring Axle

CV-ES-0543

Length: 125
 Cone Ø: d1 Ø 32 / d2 Ø 29
 Thread: M30 x 1,5 RHT
 0004605748, 0004606048, 0004606848,
 0004607048, 0014600448, 0014601148,
 0014601748, 0014602448, 0014607648,
 0014609648

**CV-ES-0888**

Length: 125
 Cone Ø: d1 Ø 32 / d2 Ø 29
 Thread: M30 x 1,5 LHT
 0004605848, 0004606148, 0004606948,
 0004607148, 0004609048, 0014600548,
 0014601348, 0014602548, 0014607948,
 0024600448

**CV-ES-14163**

Length: 125
 Cone Ø: d1 Ø 30 / d2 Ø 27
 Thread: M30 x 1,5 RHT
 0003305248, 0003387310, 0004600348,
 0004600948, 0004602848, 0004602948,
 0004608948, 0014600248, 0014600848,
 0014601248, 0014602248, 0014607748,
 0024600148, A0003387310, A0004600348,
 A0004602848, A0004602948, A0014600848,
 A0014601248, A0014602248, A0014607748

**DB-DL-3475**

Length: 565 Ø: 52
 Hole Distance: 152 / 152
 3753500006, 3753500206, 9473500805,
 9483500006, 9483500805, 9483501205,
 9483501305, 9483501905, 9483502005,
 9483502405, A3753500006, A3753500206

**DB-DL-8168**

Length: 904 Ø: 52
 Cone Ø: d1 Ø 32 / d2 Ø 29
 0004609405, 0004609505, 0014607105

**DB-DL-8171**

Length: 1687 Ø: 52
 Cone Ø: d1 Ø 32 / d2 Ø 29
 9493300603, 9493300703, 9493301503,
 9493301603

**DB-DL-8184**

Length: 1095 Ø: 42
 Cone Ø: d1 Ø 32 / d2 Ø 28,8
 01217700A, 0014601305, 0014601405,
 0024600505, 0034603205, 3754601505,
 A0014601305, A0014601405, A0024600505

**DB-DL-8307**

Length: 885 Ø: 38
 Cone Ø: d1 Ø 32 / d2 Ø 30
 01215500A, 0004604005, 0024605105,
 0024605205, 0034604005

**DB-DL-8327**

Length: 1745 Ø: 48
 Cone Ø: d1 Ø 32 / d2 Ø 29
 01219800A, 9413300003, 9413300103,
 9413300203, 9413300303, 9413300503

**DB-DL-8622**

Length: 1558 Ø: 52
 Cone Ø: d1 Ø 30 / d2 Ø 27
 0014609005, 0014609105

**DB-DL-8640**

Length: 1615 Ø: 50
 Cone Ø: d1 Ø 32 / d2 Ø 29
 6253301503, 6253301603, 6253302403,
 6253302503, 9423300803, 9423302103,
 9493300203, 9493300303, 9493300903

**DB-DL-8641**

Length: 905 Ø: 42
 Cone Ø: d1 Ø 30 / d2 Ø 27
 0014605105, 0014608105

**DB-DL-8642**

Length: 954 Ø: 42
 Cone Ø: d1 Ø 30 / d2 Ø 27
 0014608605, 0014608705

**DB-DL-8702**

Length: 958 Ø: 38
 Cone Ø: d1 Ø 32 / d2 Ø 30
 0024606105, 0024606205, 0034604205

**DB-DL-9254**

Length: 1815 Ø: 58
 0003220323, 0003220623, 3753220423

**DB-DL-12300**

Length: 733 Ø: 36
 Cone Ø: d1 Ø 32 / d2 Ø 29
 0014601505, 0014607305, 0034603305,
 3754601605, A0014601505, A0034603305,
 A3754601605

**DB-DL-12310**

Length: 1532 Ø: 50
 Cone Ø: d1 Ø 32 / d2 Ø 29
 Thread: M27 x 1,5 LHT
 9493301203, 9493301303, 9493301803,
 9493302203, A9493301203, A9493301303,
 A9493301803, A9493302203

**DB-ES-5227**

Length: 1588 Ø: 60
 Cone Ø: d1 Ø 38 / d2 Ø 34,3
 6253300903, 6253301203, 9443300203

**DB-ES-5234**

Length: 135
 Cone Ø: d1 Ø 38 / d2 Ø 34,3
 Thread: M38 x 1,5 RHT
 0004601748, 120322305, 2205000400

**DB-ES-8164**

Length: 140
 Cone Ø: d1 Ø 28,6 / d2 Ø 23,9
 Thread: M28 x 1,5 RHT
 0014604248, 0014605048, 0014608548,
 0024600548

**DB-ES-8510**

Length: 56
 Cone Ø: d1 Ø 10 / d2 Ø 10
 Thread: M12 x 1,75 LHT
 0009965145, 0009965645, 0019963145

**DB-ES-8530**

Length: 115
 Cone Ø: d1 Ø 28,6 / d2 Ø 23,9
 Thread: M30 x 1,5 RHT
 0014603848, 0014604848, 0014605148,
 0014608648, 0014609948

**DB-RK-8391**

Ø: 85 Hole Distance: 152
 Thick/Height: 24
 01336800A, 0003502705

**DB-RK-8550**

Ø: 75 Hole Distance: 152
 Thick/Height: 24
 0003502105, 0003504605

**DB-RK-8626**

Ø: 75 Hole Distance: 130
 Thick/Height: 24
 0003502205, 0003502505, 0003503405,
 0003504505, GL11319

**DB-RK-8638**

Length: 100 Ø: 67
 Hole Distance: 100
 Thick/Height: 20
 0003301411

**DB-RK-8710**

Ø: 85 Hole Distance: 130
 Thick/Height: 30
 0003503705

**DB-RK-9291**

Ø: 107,5 Hole Distance: 152
 Thick/Height: 30
 0003503605

**DB-RK-10374**

Ø: 85 Hole Distance: 152
 Thick/Height: 24
 0003504405

**DB-RK-10375**

Ø: 100 Hole Distance: 152
 Thick/Height: 24
 0003502405, 0003503505, 0003504905

**DB-SB-10384**

Ø: 73 Thick/Height: 47
 9303170012, 9423171812

**DB-SB-10401**

Length: 232
 Thick/Height: 163,5 / 152,5
 0003250596, 0003250796

**DB-SB-10406**

Ø: 80 Thick/Height: 46
 0003238185

**DB-SB-10409**

Ø: 77 Thick/Height: 56
 0003255181

**DB-SB-10410**

Ø: 73 Hole Distance: 100
 Thick/Height: 24
 9413230050

**DB-VB-7261**

Length: 622 Ø: 46
 Hole Ø 25 / 25 / 25
 Hole Distance: 152 / 130 / 130
 01337800A, 9443500305, 9443500505,
 9443500605, 9473500705, 9473500905,
 9483500405, 9483503005

**DB-VB-9307**

Length: 667 Ø: 60
 Hole Ø 25 / 23 / 23
 Hole Distance: 152 / 130 / 130
 9483502805

**DB-VB-9308**

Length: 622 Ø: 46
 Hole Ø 25 / 25 / 25
 Hole Distance: 152 / 130 / 130
 9483502905

**MN-DL-7834**

Length: 1588 Ø: 58
 Cone Ø: d1 Ø 30 / d2 Ø 27
 3463303903, 3463304903, 6253303203,
 9443300503, 9443301303, 9443301703





ACTROS MP2 / MP3 ...

3344 AK	04/03→	Ball Head, gearshift linkage	DB-ES-8510		
	04/03→	Bush, driver cab suspension	DB-SB-10384		
	04/03→	Centre Rod	DB-DL-8184	Push Rod	
	04/03→	Centre Rod	DB-DL-8307	Push Rod, Leaf Spring Axle	
	04/03→	Centre Rod	DB-DL-8702	Push Rod, Leaf Spring Axle	
	04/03→	Centre Rod	DB-DL-12300	for Steering Rod	
	04/03→	Stabiliser Mounting		DB-SB-10406	
	04/03→	Stabiliser Mounting		DB-SB-10409	
	04/03→	Suspension Arm Repair Kit		DB-RK-8626 for Wishbone (CV)	
	04/03→	Suspension Arm Repair Kit		DB-RK-10374 for Wishbone (CV)	
	04/03→	Suspension Arm Repair Kit		DB-RK-10375 for Wishbone (CV)	
	04/03→	Suspension Arm Repair Kit	DB-RK-8638	for Control Arm	
	04/03→	Suspension Strut Repair Kit		DB-RK-8391	
	04/03→	Suspension Strut Repair Kit		DB-RK-8710	
	04/03→	Suspension Strut Repair Kit		DB-RK-9291	
	04/03→	Tie Rod	DB-DL-12310		
	04/03→	Tie Rod	DB-ES-5227	Guide Rod	
	04/03→	Tie Rod	MN-DL-7834	Guide Rod	
	04/03→	Tie Rod End	CV-ES-0543	for Push Rod	
	04/03→	Tie Rod End	CV-ES-14163	for Steering Rod	
	04/03→	Tie Rod End	DB-ES-5234	for Steering Rod	
	04/03→	Tie Rod End	DB-ES-8530	for Push Rod	
	04/03→	Track Control Arm		DB-DL-3475 Trailing Arm	
	04/03→	Track Control Arm		DB-VB-7261 Suspension Rod, Wishbone (CV), 1st RA;2nd RA; Leaf Spring Axle	
	04/03→	Track Control Arm		DB-VB-9307 Suspension Rod, Wishbone (CV), 1st RA;2nd RA; Leaf Spring Axle	
	04/03→	Track Control Arm		DB-VB-9308 Suspension Rod, Wishbone (CV), 1st RA;2nd RA; Leaf Spring Axle	
	3344 AKE	04/03→	Bush, driver cab suspension	DB-SB-10384	
		04/03→	Bush, parabolic spring		DB-SB-10401
		04/03→	Centre Rod	DB-DL-8307	Push Rod, Leaf Spring Axle
		04/03→	Centre Rod	DB-DL-8702	Push Rod, Drive Axle;Leaf Spring Axle
		04/03→	Stabiliser Mounting		DB-SB-10406
		04/03→	Suspension Strut Repair Kit		DB-RK-8710
		04/03→	Suspension Strut Repair Kit		DB-RK-9291
04/03→		Tie Rod	DB-DL-12310		
04/03→		Tie Rod	DB-ES-5227	Guide Rod	
04/03→		Tie Rod	MN-DL-7834	Guide Rod	
04/03→		Tie Rod End	DB-ES-5234	for Steering Rod	
04/03→		Track Control Arm		DB-VB-7261 Suspension Rod, Wishbone (CV), 1st RA;2nd RA; Leaf Spring Axle	
04/03→		Track Control Arm		DB-VB-9307 Suspension Rod, Wishbone (CV), 1st RA;2nd RA; Leaf Spring Axle	
04/03→	Track Control Arm		DB-VB-9308 Suspension Rod, Wishbone (CV), 1st RA;2nd RA; Leaf Spring Axle		
3344 AS	04/03→	Ball Head, gearshift linkage	DB-ES-8510		
	04/03→	Bush, driver cab suspension	DB-SB-10384		
	04/03→	Centre Rod	DB-DL-8307	Push Rod	
	04/03→	Centre Rod	DB-DL-8702	Push Rod, Leaf Spring Axle	
	04/03→	Centre Rod	DB-DL-12300	for Steering Rod	
	04/03→	Stabiliser Mounting		DB-SB-10406	
	04/03→	Stabiliser Mounting		DB-SB-10409	
	04/03→	Stabiliser Mounting	DB-SB-10410		
	04/03→	Suspension Arm Repair Kit		DB-RK-8626 for Wishbone (CV)	
	04/03→	Suspension Arm Repair Kit		DB-RK-10374 for Wishbone (CV)	
	04/03→	Suspension Arm Repair Kit		DB-RK-10375 for Wishbone (CV)	
	04/03→	Suspension Arm Repair Kit	DB-RK-8638	for Control Arm	
	04/03→	Suspension Strut Repair Kit		DB-RK-8391	
	04/03→	Suspension Strut Repair Kit		DB-RK-8710	
	04/03→	Suspension Strut Repair Kit		DB-RK-9291	
	04/03→	Suspension Strut Repair Kit		MN-RK-8997	
	04/03→	Tie Rod	DB-DL-12310		

CV-ES-0543

Length: 125
Cone Ø: d1 Ø 32 / d2 Ø 29
Thread: M30 x 1,5 RHT
0004605748, 0004606048, 0004606848,
0004607048, 0014600448, 0014601148,
0014601748, 0014602448, 0014607648,
0014609648



CV-ES-14163

Length: 125
Cone Ø: d1 Ø 30 / d2 Ø 27
Thread: M30 x 1,5 RHT
0003305248, 0003387310, 0004600348,
0004600948, 0004602848, 0004602948,
0004608948, 0014600248, 0014600848,
0014601248, 0014602248, 0014607748,
0024600148, A0003387310, A0004600348,
A0004602848, A0004602948, A0014600848,
A0014601248, A0014602248, A0014607748



DB-DL-3475

Length: 565 Ø: 52
Hole Distance: 152 / 152
3753500006, 3753500206, 9473500805,
9483500006, 9483500805, 9483501205,
9483501305, 9483501905, 9483502005,
9483502405, A3753500006, A3753500206



DB-DL-8184

Length: 1095 Ø: 42
Cone Ø: d1 Ø 32 / d2 Ø 28,8
01217700A, 0014601305, 0014601405,
0024600505, 0034603205, 3754601505,
A0014601305, A0014601405, A0024600505



DB-DL-8307

Length: 885 Ø: 38
Cone Ø: d1 Ø 32 / d2 Ø 30
01215500A, 0004604005, 0024605105,
0024605205, 0034604005



DB-DL-8702

Length: 958 Ø: 38
Cone Ø: d1 Ø 32 / d2 Ø 30
0024606105, 0024606205, 0034604205



DB-DL-12300

Length: 733 Ø: 36
Cone Ø: d1 Ø 32 / d2 Ø 29
0014601505, 0014607305, 0034603305,
3754601605, A0014601505, A0034603305,
A3754601605



DB-DL-12310

Length: 1532 Ø: 50
Cone Ø: d1 Ø 32 / d2 Ø 29
Thread: M27 x 1,5 LHT
9493301203, 9493301303, 9493301803,
9493302203, A9493301203, A9493301303,
A9493301803, A9493302203



DB-ES-5227

Length: 1588 Ø: 60
Cone Ø: d1 Ø 38 / d2 Ø 34,3
6253300903, 6253301203, 9443300203



DB-ES-5234

Length: 135
Cone Ø: d1 Ø 38 / d2 Ø 34,3
Thread: M38 x 1,5 RHT
0004601748, 120322305, 2205000400



DB-ES-8510

Length: 56
Cone Ø: d1 Ø 10 / d2 Ø 10
Thread: M12 x 1,75 LHT
0009965145, 0009965645, 0019963145



DB-ES-8530

Length: 115
Cone Ø: d1 Ø 28,6 / d2 Ø 23,9
Thread: M30 x 1,5 RHT
0014603848, 0014604848, 0014605148,
0014608648, 0014609948



DB-RK-8391

Ø: 85 Hole Distance: 152
Thick/Height: 24
01336800A, 0003502705



DB-RK-8626

Ø: 75 Hole Distance: 130
Thick/Height: 24
0003502205, 0003502505, 0003503405,
0003504505, GL11319



DB-RK-8638

Length: 100 Ø: 67
Hole Distance: 100
Thick/Height: 20
0003301411



DB-RK-8710

Ø: 85 Hole Distance: 130
Thick/Height: 30
0003503705



DB-RK-9291

Ø: 107,5 Hole Distance: 152
Thick/Height: 30
0003503605



DB-RK-10374

Ø: 85 Hole Distance: 152
Thick/Height: 24
0003504405



DB-RK-10375

Ø: 100 Hole Distance: 152
Thick/Height: 24
0003502405, 0003503505, 0003504905



DB-SB-10384

Ø: 73 Thick/Height: 47
9303170012, 9423171812



DB-SB-10401

Length: 232
Thick/Height: 163,5 / 152,5
0003250596, 0003250796



DB-SB-10406

Ø: 80 Thick/Height: 46
0003238185



DB-SB-10409

Ø: 77 Thick/Height: 56
0003265181



DB-SB-10410

Ø: 73 Hole Distance: 100
Thick/Height: 24
9413230050



DB-VB-7261

Length: 622 Ø: 46
Hole Ø 25 / 25 / 25
Hole Distance: 152 / 130 / 130
01337800A, 9443500305, 9443500505,
9443500605, 9473500705, 9473500905,
9483500405, 9483503005



DB-VB-9307

Length: 667 Ø: 60
Hole Ø 25 / 23 / 23
Hole Distance: 152 / 130 / 130
9483502805



DB-VB-9308

Length: 622 Ø: 46
Hole Ø 25 / 25 / 25
Hole Distance: 152 / 130 / 130
9483502805



MN-DL-7834

Length: 1588 Ø: 58
Cone Ø: d1 Ø 30 / d2 Ø 27
3463303903, 3463304903, 6253303203,
9443300503, 9443301303, 9443301703



MN-RK-8997

Ø: 85 Hole Distance: 130
Thick/Height: 30
0003504805





ACTROS MP2 / MP3 ...

3344 AS ...	04/03→	Tie Rod	DB-ES-5227	Guide Rod	
	04/03→	Tie Rod	MN-DL-7834	Guide Rod	
	04/03→	Tie Rod End	CV-ES-0543	for Push Rod	
	04/03→	Tie Rod End	CV-ES-14163	for Steering Rod	
	04/03→	Tie Rod End	DB-ES-5234	for Steering Rod	
	04/03→	Tie Rod End	DB-ES-8530	for Push Rod	
	04/03→	Track Control Arm		DB-DL-3475 Trailing Arm	
	04/03→	Track Control Arm		DB-VB-7261 Suspension Rod, Wishbone (CV), 1st RA;2nd RA; Leaf Spring Axle	
	04/03→	Track Control Arm		DB-VB-7798 Wishbone (CV)	
	04/03→	Track Control Arm		DB-VB-9307 Suspension Rod, Wishbone (CV), 1st RA;2nd RA; Leaf Spring Axle	
	04/03→	Track Control Arm		DB-VB-9308 Suspension Rod, Wishbone (CV), 1st RA;2nd RA; Leaf Spring Axle	
3344 B	04/03→	Ball Head, gearshift linkage	DB-ES-8510		
	04/03→	Bush, driver cab suspension	DB-SB-10384		
	04/03→	Bush, parabolic spring		DB-SB-10400	
	04/03→	Bush, parabolic spring		DB-SB-10401	
	04/03→	Centre Rod	DB-DL-2144	Push Rod	
	04/03→	Centre Rod	DB-DL-5230	Suspension Rod	
	04/03→	Centre Rod	DB-DL-5405	Push Rod, Leaf Spring Axle	
	04/03→	Centre Rod	DB-DL-7270	Push Rod	
	04/03→	Centre Rod	DB-DL-8167	Push Rod	
	04/03→	Centre Rod	DB-DL-8184	Push Rod	
	04/03→	Centre Rod	DB-DL-8185	Push Rod	
	04/03→	Centre Rod	DB-DL-8307	Push Rod	
	04/03→	Centre Rod	DB-DL-8702	Push Rod, Leaf Spring Axle	
	04/03→	Centre Rod	DB-DL-12300	for Steering Rod	
	04/03→	Stabiliser Mounting		DB-SB-10406	
	04/03→	Stabiliser Mounting		DB-SB-10409	
	04/03→	Suspension Arm Repair Kit		DB-RK-8550 for Wishbone (CV)	
	04/03→	Suspension Arm Repair Kit		DB-RK-8626 for Wishbone (CV)	
	04/03→	Suspension Arm Repair Kit		DB-RK-10374 for Wishbone (CV)	
	04/03→	Suspension Arm Repair Kit	DB-RK-8638	for Control Arm	
	04/03→	Suspension Strut Repair Kit		DB-RK-8391	
	04/03→	Suspension Strut Repair Kit		DB-RK-8710	
	04/03→	Suspension Strut Repair Kit		DB-RK-9291	
	04/03→	Tie Rod	DB-DL-8171	Guide Rod	
	04/03→	Tie Rod	DB-DL-8327	Guide Rod	
	04/03→	Tie Rod	DB-DL-8640	Guide Rod	
	04/03→	Tie Rod	DB-DL-12310		
	04/03→	Tie Rod End	CV-ES-0543	for Push Rod	
	04/03→	Tie Rod End	CV-ES-0888	for Push Rod	
	04/03→	Tie Rod End	CV-ES-14163	for Steering Rod	
	04/03→	Tie Rod End	DB-ES-5234	for Steering Rod	
	04/03→	Tie Rod End	DB-ES-8164	for Push Rod	
	04/03→	Tie Rod End	DB-ES-8530	for Push Rod	
	04/03→	Track Control Arm		DB-DL-3475 Trailing Arm	
	04/03→	Track Control Arm		DB-VB-7261 Suspension Rod, Wishbone (CV), 1st RA;2nd RA; Leaf Spring Axle	
	04/03→	Track Control Arm		DB-VB-9307 Suspension Rod, Wishbone (CV), 1st RA;2nd RA; Leaf Spring Axle	
	04/03→	Track Control Arm		DB-VB-9308 Suspension Rod, Wishbone (CV), 1st RA;2nd RA; Leaf Spring Axle	
	3344 K	04/03→	Centre Rod	DB-DL-2144	Push Rod
		04/03→	Centre Rod	DB-DL-5405	Push Rod, Leaf Spring Axle
		04/03→	Centre Rod	DB-DL-7270	Push Rod
04/03→		Centre Rod	DB-DL-8167	Push Rod	
04/03→		Centre Rod	DB-DL-8188	Push Rod	
04/03→		Centre Rod	DB-DL-8307	Push Rod	
04/03→		Centre Rod	DB-DL-8702	Push Rod, Leaf Spring Axle	
04/03→		Suspension Strut Repair Kit		DB-RK-8710	

CV-ES-0543

Length: 125
Cone Ø: d1 Ø 32 / d2 Ø 29
Thread: M30 x 1,5 RHT
0004605748, 0004606048, 0004606848,
0004607048, 0014600448, 0014601148,
0014601748, 0014602448, 0014607648,
0014609648



CV-ES-0888

Length: 125
Cone Ø: d1 Ø 32 / d2 Ø 29
Thread: M30 x 1,5 LHT
0004605848, 0004606148, 0004606948,
0004607148, 0004609048, 0014600548,
0014601348, 0014602548, 0014607948,
0024600448



CV-ES-14163

Length: 125
Cone Ø: d1 Ø 30 / d2 Ø 27
Thread: M30 x 1,5 RHT
0003305248, 0003387310, 0004600348,
0004600948, 0004602848, 0004602948,
0004608948, 0014600248, 0014600848,
0014601248, 0014602248, 0014607748,
0024600148, A0003387310, A0004600348,
A0004602848, A0004602948, A0014600848,
A0014601248, A0014602248, A0014607748



DB-DL-2144

Length: 872 Ø: 35
Cone Ø: d1 Ø 28,6 / d2 Ø 23,9
0024604305, 0024604405, 0034604805



DB-DL-3475

Length: 565 Ø: 52
Hole Distance: 152 / 152
3753500006, 3753500206, 9473500805,
9483500006, 9483500805, 9483501205,
9483501305, 9483501905, 9483502005,
9483502405, A3753500006, A3753500206



DB-DL-5230

Length: 879 Ø: 42
Cone Ø: d1 Ø 30 / d2 Ø 27
01208600A, 0004607105, 0004607205,
0014606705



DB-DL-5405

Length: 890 Ø: 35
Cone Ø: d1 Ø 28,6 / d2 Ø 23,9
01215900A, 1460248, 0024604505, 0024604605,
0034605005, 3752600637, 3754600405,
A3752600637, A3754600405



DB-DL-7270

Length: 875 Ø: 40
Cone Ø: d1 Ø 28,6 / d2 Ø 23,9
01208300A, 0024604705, 0024604805,
0034604905, A0024604705



DB-DL-8167

Length: 866 Ø: 38
Cone Ø: d1 Ø 30 / d2 Ø 27
0014609805, 0014609905, 0024606305,
0024606405



DB-DL-8171

Length: 1687 Ø: 52
Cone Ø: d1 Ø 32 / d2 Ø 29
9493300603, 9493300703, 9493301503,
9493301603



DB-DL-8184

Length: 1095 Ø: 42
Cone Ø: d1 Ø 32 / d2 Ø 28,8
01217700A, 0014601305, 0014601405,
0024600505, 0034603205, 3754601505,
A0014601305, A0014601405, A0024600505



DB-DL-8185

Length: 711 Ø: 42
Cone Ø: d1 Ø 32 / d2 Ø 28,8
01213600A, 0014601105, 0024600405,
0034603105, A0014601105, A0024600405



DB-DL-8188

Length: 895 Ø: 40
Cone Ø: d1 Ø 28,6 / d2 Ø 23,9
01217200A, 0024604905, 0024600505,
0034605605



DB-DL-8307

Length: 885 Ø: 38
Cone Ø: d1 Ø 32 / d2 Ø 30
01215500A, 0004604005, 0024605105,
0024605205, 0034604005



DB-DL-8327

Length: 1745 Ø: 48
Cone Ø: d1 Ø 32 / d2 Ø 29
01219800A, 9413300003, 9413300103,
9413300203, 9413300303, 9413300503



DB-DL-8640

Length: 1615 Ø: 50
Cone Ø: d1 Ø 32 / d2 Ø 29
6253301503, 6253301603, 6253302403,
6253302503, 9423300803, 9423302103,
9493300203, 9493300303, 9493300903



DB-DL-8702

Length: 958 Ø: 38
Cone Ø: d1 Ø 32 / d2 Ø 30
0024606105, 0024606205, 0034604205



DB-DL-12300

Length: 733 Ø: 36
Cone Ø: d1 Ø 32 / d2 Ø 29
0014601505, 0014607305, 0034603305,
3754601605, A0014601505, A0034603305,
A3754601605



DB-DL-12310

Length: 1532 Ø: 50
Cone Ø: d1 Ø 32 / d2 Ø 29
Thread: M27 x 1,5 LHT
9493301203, 9493301303, 9493301803,
9493302203, A9493301203, A9493301303,
A9493301803, A9493302203



DB-ES-5227

Length: 1588 Ø: 60
Cone Ø: d1 Ø 38 / d2 Ø 34,3
6253300903, 6253301203, 9443300203



DB-ES-5234

Length: 135
Cone Ø: d1 Ø 38 / d2 Ø 34,3
Thread: M38 x 1,5 RHT
0004601748, 120322305, 2205000400



DB-ES-8164

Length: 140
Cone Ø: d1 Ø 28,6 / d2 Ø 23,9
Thread: M28 x 1,5 RHT
0014604248, 0014605048, 0014608548,
0024600548



DB-ES-8510

Length: 56
Cone Ø: d1 Ø 10 / d2 Ø 10
Thread: M12 x 1,75 LHT
0009965145, 0009965645, 0019963145



DB-ES-8530

Length: 115
Cone Ø: d1 Ø 28,6 / d2 Ø 23,9
Thread: M30 x 1,5 RHT
0014603848, 0014604848, 0014605148,
0014608648, 0014609948



DB-RK-8391

Ø: 85 Hole Distance: 152
Thick/Height: 24
01336800A, 0003502705



DB-RK-8550

Ø: 75 Hole Distance: 152
Thick/Height: 24
0003502105, 0003504605



DB-RK-8626

Ø: 75 Hole Distance: 130
Thick/Height: 24
0003502205, 0003502505, 0003503405,
0003504505, GL11319



DB-RK-8638

Length: 100 Ø: 67
Hole Distance: 100
Thick/Height: 20
0003301411



DB-RK-8710

Ø: 85 Hole Distance: 130
Thick/Height: 30
0003503705



DB-RK-9291

Ø: 107,5 Hole Distance: 152
Thick/Height: 30
0003503605



DB-RK-10374

Ø: 85 Hole Distance: 152
Thick/Height: 24
0003504405



DB-SB-10384

Ø: 73 **Thick/Height:** 47
9303170012, 9423171812



DB-SB-10400

Length: 230
Thick/Height: 167,5 / 115
0003250696, 0003250896



DB-SB-10401

Length: 232
Thick/Height: 163,5 / 152,5
0003250596, 0003250796



DB-SB-10406

Ø: 80 **Thick/Height:** 46
0003238185



DB-SB-10409

Ø: 77 **Thick/Height:** 56
0003265181



DB-VB-7261

Length: 622 Ø: 46
Hole Ø: 25 / 25 / 25
Hole Distance: 152 / 130 / 130
01337800A, 9443500305, 9443500505,
9443500605, 9473500705, 9473500905,
9483500405, 9483500305



DB-VB-7798

Length: 622 Ø: 48
Hole Ø: 25 / 23 / 23
Hole Distance: 152 / 130 / 130
9423500505, 9423500805, 9423501205,
A9423501205



DB-VB-9307

Length: 667 Ø: 60
Hole Ø: 25 / 23 / 23
Hole Distance: 152 / 130 / 130
9483502805



DB-VB-9308

Length: 622 Ø: 46
Hole Ø: 25 / 25 / 25
Hole Distance: 152 / 130 / 130
9483502905



MN-DL-7834

Length: 1588 Ø: 58
Cone Ø: d1 Ø 30 / d2 Ø 27
3463303903, 3463304903, 6253303203,
9443300503, 9443301303, 9443301703





ACTROS MP2 / MP3 ...

3344 K ...	04/03→	Suspension Strut Repair Kit		DB-RK-9291	
	04/03→	Tie Rod	DB-DL-8171		Guide Rod
	04/03→	Tie Rod	DB-DL-8327		Guide Rod
	04/03→	Tie Rod	DB-DL-8640		Guide Rod
	04/03→	Tie Rod	DB-DL-12310		
	04/03→	Tie Rod	DB-ES-5227		Guide Rod
	04/03→	Tie Rod End	CV-ES-0543		for Push Rod
	04/03→	Tie Rod End	CV-ES-0888		for Push Rod
	04/03→	Tie Rod End	CV-ES-14163		for Steering Rod
	04/03→	Tie Rod End	DB-ES-8164		for Push Rod
	04/03→	Tie Rod End	DB-ES-8530		for Push Rod
	04/03→	Track Control Arm		DB-DL-3475	Trailing Arm, 1st RA;2nd RA, →517144 03/517144 07
	04/03→	Track Control Arm		DB-DL-3475	Trailing Arm, 1st RA;2nd RA, →517144 06/517144 09
	04/03→	Track Control Arm		DB-VB-7261	Suspension Rod, Wishbone (CV), 1st RA;2nd RA; Leaf Spring Axle
	3344 S	04/03→	Ball Head, gearshift linkage	DB-ES-8510	
04/03→		Bush, driver cab suspension	DB-SB-10384		
04/03→		Bush, parabolic spring		DB-SB-10400	
04/03→		Bush, parabolic spring		DB-SB-10401	
04/03→		Centre Rod	DB-DL-2144		Push Rod
04/03→		Centre Rod	DB-DL-5230		Suspension Rod
04/03→		Centre Rod	DB-DL-5405		Push Rod, Leaf Spring Axle
04/03→		Centre Rod	DB-DL-7270		Push Rod;Suspension Rod
04/03→		Centre Rod	DB-DL-8167		Push Rod
04/03→		Centre Rod	DB-DL-8184		Push Rod
04/03→		Centre Rod	DB-DL-8185		Push Rod
04/03→		Centre Rod	DB-DL-8307		Push Rod
04/03→		Centre Rod	DB-DL-8702		Push Rod, Leaf Spring Axle
04/03→		Centre Rod	DB-DL-12300		for Steering Rod
04/03→		Stabiliser Mounting		DB-SB-10406	
04/03→	Stabiliser Mounting		DB-SB-10409		
04/03→	Stabiliser Mounting	DB-SB-10410			
04/03→	Suspension Arm Repair Kit		DB-RK-8550	for Wishbone (CV)	
04/03→	Suspension Arm Repair Kit		DB-RK-8626	for Wishbone (CV)	
04/03→	Suspension Arm Repair Kit		DB-RK-10374	for Wishbone (CV)	
04/03→	Suspension Arm Repair Kit		DB-RK-10375	for Wishbone (CV)	
04/03→	Suspension Arm Repair Kit	DB-RK-8638		for Control Arm	
04/03→	Suspension Strut Repair Kit		DB-RK-8391		
04/03→	Suspension Strut Repair Kit		DB-RK-8710		
04/03→	Suspension Strut Repair Kit		DB-RK-9291		
04/03→	Suspension Strut Repair Kit		MN-RK-8997		
04/03→	Tie Rod	DB-DL-8171		Guide Rod	
04/03→	Tie Rod	DB-DL-8327		Guide Rod	
04/03→	Tie Rod	DB-DL-8640		Guide Rod	
04/03→	Tie Rod	DB-DL-12310			
04/03→	Tie Rod	DB-ES-5227		Guide Rod	
04/03→	Tie Rod End	CV-ES-0543		for Push Rod	
04/03→	Tie Rod End	CV-ES-0888		for Push Rod	
04/03→	Tie Rod End	CV-ES-14163		for Steering Rod	
04/03→	Tie Rod End	DB-ES-5234		for Steering Rod	
04/03→	Tie Rod End	DB-ES-8164		for Push Rod	
04/03→	Tie Rod End	DB-ES-8530		for Push Rod	
04/03→	Track Control Arm		DB-DL-3475	Trailing Arm	
04/03→	Track Control Arm		DB-VB-7261	Suspension Rod, Wishbone (CV), 1st RA;2nd RA; Leaf Spring Axle	
04/03→	Track Control Arm		DB-VB-7798	Wishbone (CV)	

CV-ES-0543

Length: 125
Cone Ø: d1 Ø 32 / d2 Ø 29
Thread: M30 x 1,5 RHT
0004605748, 0004606048, 0004606848,
0004607048, 0014600448, 0014601148,
0014601748, 0014602448, 0014607648,
0014609648



CV-ES-0888

Length: 125
Cone Ø: d1 Ø 32 / d2 Ø 29
Thread: M30 x 1,5 LHT
0004605848, 0004606148, 0004606948,
0004607148, 0004609048, 0014600548,
0014601348, 0014602548, 0014607948,
0024600448



CV-ES-14163

Length: 125
Cone Ø: d1 Ø 30 / d2 Ø 27
Thread: M30 x 1,5 RHT
0003305248, 0003387310, 0004600348,
0004600948, 0004602848, 0004602948,
0004608948, 0014600248, 0014600848,
0014601248, 0014602248, 0014607748,
0024600148, A0003387310, A0004600348,
A0004602848, A0004602948, A0014600848,
A0014601248, A0014602248, A0014607748



DB-DL-2144

Length: 872 Ø: 35
Cone Ø: d1 Ø 28,6 / d2 Ø 23,9
0024604305, 0024604405, 0034604805



DB-DL-3475

Length: 565 Ø: 52
Hole Distance: 152 / 152
3753500006, 3753500206, 9473500805,
9483500006, 9483500805, 9483501205,
9483501305, 9483501905, 9483502005,
9483502405, A3753500006, A3753500206



DB-DL-5230

Length: 879 Ø: 42
Cone Ø: d1 Ø 30 / d2 Ø 27
01208600A, 0004607105, 0004607205,
0014606705



DB-DL-5405

Length: 890 Ø: 35
Cone Ø: d1 Ø 28,6 / d2 Ø 23,9
01215900A, 1460248, 0024604505, 0024604605,
0034605005, 3752600637, 3754600405,
A3752600637, A3754600405



DB-DL-7270

Length: 875 Ø: 40
Cone Ø: d1 Ø 28,6 / d2 Ø 23,9
01208300A, 0024604705, 0024604805,
0034604905, A0024604705



DB-DL-8167

Length: 866 Ø: 38
Cone Ø: d1 Ø 30 / d2 Ø 27
0014609805, 0014609905, 0024606305,
0024606405



DB-DL-8171

Length: 1687 Ø: 52
Cone Ø: d1 Ø 32 / d2 Ø 29
9493300603, 9493300703, 9493301503,
9493301603



DB-DL-8184

Length: 1095 Ø: 42
Cone Ø: d1 Ø 32 / d2 Ø 28,8
01217700A, 0014601305, 0014601405,
0024600505, 0034603205, 3754601505,
A0014601305, A0014601405, A0024600505



DB-DL-8185

Length: 711 Ø: 42
Cone Ø: d1 Ø 32 / d2 Ø 28,8
01213600A, 0014601105, 0024600405,
0034603105, A0014601105, A0024600405



DB-DL-8307

Length: 885 Ø: 38
Cone Ø: d1 Ø 32 / d2 Ø 30
01215500A, 0004604005, 0024605105,
0024605205, 0034604005



DB-DL-8327

Length: 1745 Ø: 48
Cone Ø: d1 Ø 32 / d2 Ø 29
01219800A, 9413300003, 9413300103,
9413300203, 9413300303, 9413300503



DB-DL-8640

Length: 1615 Ø: 50
Cone Ø: d1 Ø 32 / d2 Ø 29
6253301503, 6253301603, 6253302403,
6253302503, 9423300803, 9423302103,
9493300203, 9493300303, 9493300903



DB-DL-8702

Length: 958 Ø: 38
Cone Ø: d1 Ø 32 / d2 Ø 30
0024606105, 0024606205, 0034604205



DB-DL-12300

Length: 733 Ø: 36
Cone Ø: d1 Ø 32 / d2 Ø 29
0014601505, 0014607305, 0034603305,
3754601605, A0014601505, A0034603305,
A3754601605



DB-DL-12310

Length: 1532 Ø: 50
Cone Ø: d1 Ø 32 / d2 Ø 29
Thread: M27 x 1,5 LHT
9493301203, 9493301303, 9493301803,
9493302203, A9493301203, A9493301303,
A9493301803, A9493302203



DB-ES-5227

Length: 1588 Ø: 60
Cone Ø: d1 Ø 38 / d2 Ø 34,3
6253300903, 6253301203, 9443300203



DB-ES-5234

Length: 135
Cone Ø: d1 Ø 38 / d2 Ø 34,3
Thread: M38 x 1,5 RHT
0004601748, 120322305, 2205000400



DB-ES-8164

Length: 140
Cone Ø: d1 Ø 28,6 / d2 Ø 23,9
Thread: M28 x 1,5 RHT
0014604248, 0014605048, 0014608548,
0024600548



DB-ES-8510

Length: 56
Cone Ø: d1 Ø 10 / d2 Ø 10
Thread: M12 x 1,75 LHT
0009965145, 0009965645, 0019963145



DB-ES-8530

Length: 115
Cone Ø: d1 Ø 28,6 / d2 Ø 23,9
Thread: M30 x 1,5 RHT
0014603848, 0014604848, 0014605148,
0014608648, 0014609948



DB-RK-8391

Ø: 85 Hole Distance: 152
Thick/Height: 24
01336800A, 0003502705



DB-RK-8550

Ø: 75 Hole Distance: 152
Thick/Height: 24
0003502105, 0003504605



DB-RK-8626

Ø: 75 Hole Distance: 130
Thick/Height: 24
0003502205, 0003502505, 0003503405,
0003504505, GL11319



DB-RK-8638

Length: 100 Ø: 67
Hole Distance: 100
Thick/Height: 20
0003301411



DB-RK-8710

Ø: 85 Hole Distance: 130
Thick/Height: 30
0003503705



DB-RK-9291

Ø: 107,5 Hole Distance: 152
Thick/Height: 30
0003503605



DB-RK-10374

Ø: 85 Hole Distance: 152
Thick/Height: 24
0003504405



DB-RK-10375

Ø: 100 Hole Distance: 152
Thick/Height: 24
0003502405, 0003503505, 0003504905



DB-SB-10384

Ø: 73 Thick/Height: 47
9303170012, 9423171812



DB-SB-10400

Length: 230
Thick/Height: 167,5 / 115
0003250696, 0003250896



DB-SB-10401

Length: 232
Thick/Height: 163,5 / 152,5
0003250596, 0003250796



DB-SB-10406

Ø: 80 Thick/Height: 46
0003238185



DB-SB-10409

Ø: 77 Thick/Height: 56
0003265181



DB-SB-10410

Ø: 73 Hole Distance: 100
Thick/Height: 24
9413230050



DB-VB-7261

Length: 622 Ø: 46
Hole Ø 25 / 25 / 25
Hole Distance: 152 / 130 / 130
01337800A, 9443500305, 9443500505,
9443500605, 9473500705, 9473500905,
9483500405, 9483503005



DB-VB-7798

Length: 622 Ø: 48
Hole Ø 25 / 23 / 23
Hole Distance: 152 / 130 / 130
9423500505, 9423500805, 9423501205,
A9423501205



DB-VB-9307

Length: 667 Ø: 60
Hole Ø 25 / 23 / 23
Hole Distance: 152 / 130 / 130
9483502805



DB-VB-9308

Length: 622 Ø: 46
Hole Ø 25 / 25 / 25
Hole Distance: 152 / 130 / 130
9483502905



MN-RK-8997

Ø: 85 Hole Distance: 130
Thick/Height: 30
0003504805





ACTROS MP2 / MP3 ...

3344 S ...	04/03 →	Track Control Arm		DB-VB-9307	Suspension Rod, Wishbone (CV), 1st RA;2nd RA; Leaf Spring Axle	
	04/03 →	Track Control Arm		DB-VB-9308	Suspension Rod, Wishbone (CV), 1st RA;2nd RA; Leaf Spring Axle	
3346	04/03 →	Ball Head, gearshift linkage	DB-ES-8510			
	04/03 →	Bush, driver cab suspension	DB-SB-10384			
	04/03 →	Bush, parabolic spring		DB-SB-10400		
	04/03 →	Bush, parabolic spring		DB-SB-10401		
	04/03 →	Centre Rod	DB-DL-2144		Push Rod	
	04/03 →	Centre Rod	DB-DL-5230		Suspension Rod	
	04/03 →	Centre Rod	DB-DL-5405		Push Rod, Leaf Spring Axle	
	04/03 →	Centre Rod	DB-DL-7270		Push Rod;Suspension Rod	
	04/03 →	Centre Rod	DB-DL-8167		Push Rod	
	04/03 →	Centre Rod	DB-DL-8168		Push Rod	
	04/03 →	Centre Rod	DB-DL-8184		Push Rod	
	04/03 →	Centre Rod	DB-DL-8185		Push Rod	
	04/03 →	Centre Rod	DB-DL-8307		Push Rod	
	04/03 →	Centre Rod	DB-DL-8622		Push Rod	
	04/03 →	Centre Rod	DB-DL-8641		Push Rod	
	04/03 →	Centre Rod	DB-DL-8642		Push Rod	
	04/03 →	Centre Rod	DB-DL-8702		Push Rod, Leaf Spring Axle	
	04/03 →	Centre Rod	DB-DL-12300		for Steering Rod	
	04/03 →	Stabiliser Link	DB-DL-9254		Pressure Rod	
	04/03 →	Stabiliser Mounting		DB-SB-10406		
	04/03 →	Stabiliser Mounting		DB-SB-10409		
	04/03 →	Stabiliser Mounting	DB-SB-10410			
	04/03 →	Suspension Arm Repair Kit		DB-RK-8550	for Wishbone (CV)	
	04/03 →	Suspension Arm Repair Kit		DB-RK-8626	for Wishbone (CV)	
	04/03 →	Suspension Arm Repair Kit		DB-RK-10374	for Wishbone (CV)	
	04/03 →	Suspension Arm Repair Kit		DB-RK-10375	for Wishbone (CV)	
	04/03 →	Suspension Arm Repair Kit	DB-RK-8638		for Control Arm	
	04/03 →	Suspension Strut Repair Kit		DB-RK-8391		
	04/03 →	Suspension Strut Repair Kit		DB-RK-8710		
	04/03 →	Suspension Strut Repair Kit		DB-RK-9291		
	04/03 →	Tie Rod	DB-DL-8171		Guide Rod, 1st FA;Leaf Spring Axle	
	04/03 →	Tie Rod	DB-DL-8327		Guide Rod, 1st FA;Leaf Spring Axle	
	04/03 →	Tie Rod	DB-DL-8640		Guide Rod	
	04/03 →	Tie Rod	DB-DL-12310			
	04/03 →	Tie Rod	DB-ES-5227		Guide Rod	
	04/03 →	Tie Rod End	CV-ES-0543		for Push Rod	
	04/03 →	Tie Rod End	CV-ES-0888		for Push Rod	
	04/03 →	Tie Rod End	CV-ES-14163		for Steering Rod	
	04/03 →	Tie Rod End	DB-ES-5234		for Steering Rod	
	04/03 →	Tie Rod End	DB-ES-8164		for Push Rod	
	04/03 →	Tie Rod End	DB-ES-8530		for Push Rod	
	04/03 →	Track Control Arm		DB-DL-3475	Trailing Arm	
	04/03 →	Track Control Arm		DB-VB-7261	Suspension Rod, Wishbone (CV), 1st RA;2nd RA; Leaf Spring Axle	
	04/03 →	Track Control Arm		DB-VB-9307	Suspension Rod, Wishbone (CV), 1st RA;2nd RA; Leaf Spring Axle	
	04/03 →	Track Control Arm		DB-VB-9308	Suspension Rod, Wishbone (CV), 1st RA;2nd RA; Leaf Spring Axle	
	3346 A	04/03 →	Bush, parabolic spring		DB-SB-10401	
		04/03 →	Centre Rod	DB-DL-8307		Push Rod, Leaf Spring Axle
04/03 →		Centre Rod	DB-DL-8702		Push Rod	
04/03 →		Stabiliser Mounting		DB-SB-10406		
04/03 →		Suspension Strut Repair Kit		DB-RK-8710		
04/03 →		Suspension Strut Repair Kit		DB-RK-9291		
04/03 →		Tie Rod	DB-DL-12310			
04/03 →		Tie Rod	DB-ES-5227		Guide Rod	
04/03 →		Tie Rod	MN-DL-7834		Guide Rod	
04/03 →		Tie Rod End	CV-ES-0543		for Push Rod	
04/03 →	Tie Rod End	CV-ES-14163		for Steering Rod		

CV-ES-0543

Length: 125
Cone Ø: d1 Ø 32 / d2 Ø 29
Thread: M30 x 1,5 RHT
0004605748, 0004606048, 0004606848,
0004607048, 0014600448, 0014601148,
0014601748, 0014602448, 0014607648,
0014609648



CV-ES-0888

Length: 125
Cone Ø: d1 Ø 32 / d2 Ø 29
Thread: M30 x 1,5 LHT
0004605848, 0004606148, 0004606948,
0004607148, 0004609048, 0014600548,
0014601348, 0014602548, 0014607948,
0024600448



CV-ES-14163

Length: 125
Cone Ø: d1 Ø 30 / d2 Ø 27
Thread: M30 x 1,5 RHT
0003305248, 0003387310, 0004600348,
0004600948, 0004602848, 0004602948,
0004608948, 0014600248, 0014600848,
0014601248, 0014602248, 0014607748,
0024600148, A0003387310, A0004600348,
A0004602848, A0004602948, A0014600848,
A0014601248, A0014602248, A0014607748



DB-DL-2144

Length: 872 Ø: 35
Cone Ø: d1 Ø 28,6 / d2 Ø 23,9
0024604305, 0024604405, 0034604805



DB-DL-3475

Length: 565 Ø: 52
Hole Distance: 152 / 152
3753500006, 3753500206, 9473500805,
9483500006, 9483500805, 9483501205,
9483501305, 9483501905, 9483502005,
9483502405, A3753500006,
A3753500206



DB-DL-5230

Length: 879 Ø: 42
Cone Ø: d1 Ø 30 / d2 Ø 27
01208600A, 0004607105, 0004607205,
0014606705



DB-DL-5405

Length: 890 Ø: 35
Cone Ø: d1 Ø 28,6 / d2 Ø 23,9
01215900A, 1460248, 0024604505,
0024604605, 0034605005, 3752600637,
3754600405, A3752600637, A3754600405



DB-DL-7270

Length: 875 Ø: 40
Cone Ø: d1 Ø 28,6 / d2 Ø 23,9
01208300A, 0024604705, 0024604805,
0034604905, A0024604705



DB-DL-8167

Length: 866 Ø: 38
Cone Ø: d1 Ø 30 / d2 Ø 27
0014609805, 0014609905, 0024606305,
0024606405



DB-DL-8168

Length: 904 Ø: 52
Cone Ø: d1 Ø 32 / d2 Ø 29
0004609405, 0004609505, 0014607105



DB-DL-8171

Length: 1687 Ø: 52
Cone Ø: d1 Ø 32 / d2 Ø 29
9493300603, 9493300703, 9493301503,
9493301603



DB-DL-8184

Length: 1095 Ø: 42
Cone Ø: d1 Ø 32 / d2 Ø 28,8
01217700A, 0014601305, 0014601405,
0024600505, 0034603205, 3754601505,
A0014601305, A0014601405, A0024600505



DB-DL-8185

Length: 711 Ø: 42
Cone Ø: d1 Ø 32 / d2 Ø 28,8
01213600A, 0014601105, 0024600405,
0034603105, A0014601105, A0024600405



DB-DL-8307

Length: 885 Ø: 38
Cone Ø: d1 Ø 32 / d2 Ø 30
01215500A, 0004604005, 0024605105,
0024605205, 0034604005



DB-DL-8327

Length: 1745 Ø: 48
Cone Ø: d1 Ø 32 / d2 Ø 29
01219800A, 9413300003, 9413300103,
9413300203, 9413300303, 9413300503



DB-DL-8622

Length: 1558 Ø: 52
Cone Ø: d1 Ø 30 / d2 Ø 27
0014609005, 0014609105



DB-DL-8640

Length: 1615 Ø: 50
Cone Ø: d1 Ø 32 / d2 Ø 29
6253301503, 6253301603, 6253302403,
6253302503, 9423300803, 9423302103,
9493300203, 9493300303, 9493300903

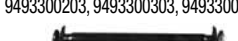

DB-DL-8641

Length: 905 Ø: 42
Cone Ø: d1 Ø 30 / d2 Ø 27
0014605105, 0014608105

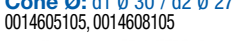

DB-DL-8642

Length: 954 Ø: 42
Cone Ø: d1 Ø 30 / d2 Ø 27
0014608605, 0014608705



DB-DL-8702

Length: 958 Ø: 38
Cone Ø: d1 Ø 32 / d2 Ø 30
0024606105, 0024606205, 0034604205



DB-DL-9254

Length: 1815 Ø: 58
0003220323, 0003220623, 3753220423



DB-DL-12300

Length: 733 Ø: 36
Cone Ø: d1 Ø 32 / d2 Ø 29
0014601505, 0014607305, 0034603305,
3754601605, A0014601505,
A0034603305, A3754601605



DB-DL-12310

Length: 1532 Ø: 50
Cone Ø: d1 Ø 32 / d2 Ø 29
Thread: M27 x 1,5 LHT
9493301203, 9493301303, 9493301803,
9493302203, A9493301203, A9493301303,
A9493301803, A9493302203



DB-ES-5227

Length: 1588 Ø: 60
Cone Ø: d1 Ø 38 / d2 Ø 34,3
6253300903, 6253301203, 9443300203



DB-ES-5234

Length: 135
Cone Ø: d1 Ø 38 / d2 Ø 34,3
Thread: M38 x 1,5 RHT
0004601748, 120322305, 2205000400



DB-ES-8164

Length: 140
Cone Ø: d1 Ø 28,6 / d2 Ø 23,9
Thread: M28 x 1,5 RHT
0014604248, 0014605048, 0014608548,
0024600548



DB-ES-8510

Length: 56
Cone Ø: d1 Ø 10 / d2 Ø 10
Thread: M12 x 1,75 LHT
0009965145, 0009965645, 0019963145



DB-ES-8530

Length: 115
Cone Ø: d1 Ø 28,6 / d2 Ø 23,9
Thread: M30 x 1,5 RHT
0014603848, 0014604848, 0014605148,
0014608648, 0014609948



DB-RK-8391

Ø: 85 Hole Distance: 152
Thick/Height: 24
01336800A, 0003502705



DB-RK-8550

Ø: 75 Hole Distance: 152
Thick/Height: 24
0003502105, 0003504605



DB-RK-8626

Ø: 75 Hole Distance: 130
Thick/Height: 24
0003502205, 0003502505, 0003503405,
0003504505, GL11319



DB-RK-8638

Length: 100 Ø: 67
Hole Distance: 100
Thick/Height: 20
0003301411



DB-RK-8710

Ø: 85 Hole Distance: 130
Thick/Height: 30
0003503705



DB-RK-9291

Ø: 107,5 Hole Distance: 152
Thick/Height: 30
0003503605



DB-RK-10374

Ø: 85 Hole Distance: 152
Thick/Height: 24
0003504405



DB-RK-10375

Ø: 100 Hole Distance: 152
Thick/Height: 24
0003502405, 0003503505, 0003504905



DB-SB-10384

Ø: 73 Thick/Height: 47
9303170012, 9423171812



DB-SB-10400

Length: 230
Thick/Height: 167,5 / 115
0003250696, 0003250896



DB-SB-10401

Length: 232
Thick/Height: 163,5 / 152,5
0003250596, 0003250796



DB-SB-10406

Ø: 80 Thick/Height: 46
0003238185



DB-SB-10409

Ø: 77 Thick/Height: 56
0003265181



DB-SB-10410

Ø: 73 Hole Distance: 100
Thick/Height: 24
9413230050



DB-VB-7261

Length: 622 Ø: 46
Hole Ø 25 / 25 / 25
Hole Distance: 152 / 130 / 130
01337800A, 9443500305, 9443500505,
9443500605, 9473500705, 9473500905,
9483500405, 9483503005



DB-VB-9307

Length: 667 Ø: 60
Hole Ø 25 / 23 / 23
Hole Distance: 152 / 130 / 130
9483502805



DB-VB-9308

Length: 622 Ø: 46
Hole Ø 25 / 25 / 25
Hole Distance: 152 / 130 / 130
9483502905



MN-DL-7834

Length: 1588 Ø: 58
Cone Ø: d1 Ø 30 / d2 Ø 27
3463303903, 3463304903, 6253303203,
9443300503, 9443301303, 9443301703





ACTROS MP2 / MP3 ...

3346 A ...	04/03 →	Tie Rod End	DB-ES-5234		for Steering Rod	
	04/03 →	Track Control Arm		DB-DL-3475	Trailing Arm, 1st RA;2nd RA, →517144 03/517144 06	
	04/03 →	Track Control Arm		DB-DL-3475	Trailing Arm, 1st RA;2nd RA, →517144 05/517144 08	
	04/03 →	Track Control Arm		DB-DL-3475	Trailing Arm, 1st RA;2nd RA, →517144 07/517144 09	
	04/03 →	Track Control Arm		DB-DL-3475	Trailing Arm, 1st RA;2nd RA, →517144 26/517144 27	
	04/03 →	Track Control Arm		DB-VB-7261	Suspension Rod, Wishbone (CV)	
	04/03 →	Track Control Arm		DB-VB-9307	Suspension Rod, Wishbone (CV)	
	04/03 →	Track Control Arm		DB-VB-9308	Suspension Rod, Wishbone (CV)	
3346 AK	04/03 →	Ball Head, gearshift linkage	DB-ES-8510			
	04/03 →	Bush, driver cab suspension	DB-SB-10384			
	04/03 →	Bush, parabolic spring		DB-SB-10401		
	04/03 →	Centre Rod	DB-DL-8184		Push Rod	
	04/03 →	Centre Rod	DB-DL-8307		Push Rod, Leaf Spring Axle	
	04/03 →	Centre Rod	DB-DL-8702		Push Rod, Leaf Spring Axle	
	04/03 →	Centre Rod	DB-DL-12300		for Steering Rod	
	04/03 →	Stabiliser Mounting		DB-SB-10406		
	04/03 →	Stabiliser Mounting		DB-SB-10409		
	04/03 →	Suspension Arm Repair Kit		DB-RK-8626	for Wishbone (CV)	
	04/03 →	Suspension Arm Repair Kit		DB-RK-10374	for Wishbone (CV)	
	04/03 →	Suspension Arm Repair Kit		DB-RK-10375	for Wishbone (CV)	
	04/03 →	Suspension Arm Repair Kit	DB-RK-8638		for Control Arm	
	04/03 →	Suspension Strut Repair Kit		DB-RK-8391		
	04/03 →	Suspension Strut Repair Kit		DB-RK-8710		
	04/03 →	Suspension Strut Repair Kit		DB-RK-9291		
	04/03 →	Tie Rod	DB-DL-12310			
	04/03 →	Tie Rod	DB-ES-5227		Guide Rod	
	04/03 →	Tie Rod	MN-DL-7834		Guide Rod	
	04/03 →	Tie Rod End	CV-ES-0543		for Push Rod	
	04/03 →	Tie Rod End	CV-ES-14163		for Steering Rod	
	04/03 →	Tie Rod End	DB-ES-5234		for Steering Rod	
	04/03 →	Tie Rod End	DB-ES-8530		for Push Rod	
	04/03 →	Track Control Arm		DB-DL-3475	Trailing Arm	
	04/03 →	Track Control Arm		DB-VB-7261	Suspension Rod, Wishbone (CV), 1st RA;2nd RA; Leaf Spring Axle	
	04/03 →	Track Control Arm		DB-VB-9307	Suspension Rod, Wishbone (CV), 1st RA;2nd RA; Leaf Spring Axle	
	04/03 →	Track Control Arm		DB-VB-9308	Suspension Rod, Wishbone (CV), 1st RA;2nd RA; Leaf Spring Axle	
	3346 AKE	04/03 →	Bush, driver cab suspension	DB-SB-10384		
04/03 →		Bush, parabolic spring		DB-SB-10401		
04/03 →		Centre Rod	DB-DL-8307		Push Rod, Leaf Spring Axle	
04/03 →		Centre Rod	DB-DL-8702		Push Rod, Drive Axle;Leaf Spring Axle	
04/03 →		Stabiliser Mounting		DB-SB-10406		
04/03 →		Suspension Strut Repair Kit		DB-RK-8710		
04/03 →		Suspension Strut Repair Kit		DB-RK-9291		
04/03 →		Tie Rod	DB-DL-12310			
04/03 →		Tie Rod	DB-ES-5227		Guide Rod	
04/03 →		Tie Rod	MN-DL-7834		Guide Rod	
04/03 →		Tie Rod End	DB-ES-5234		for Steering Rod	
04/03 →		Track Control Arm		DB-VB-7261	Suspension Rod, Wishbone (CV), 1st RA;2nd RA; Leaf Spring Axle	
04/03 →		Track Control Arm		DB-VB-9307	Suspension Rod, Wishbone (CV), 1st RA;2nd RA; Leaf Spring Axle	
04/03 →		Track Control Arm		DB-VB-9308	Suspension Rod, Wishbone (CV), 1st RA;2nd RA; Leaf Spring Axle	
3346 AS		04/03 →	Ball Head, gearshift linkage	DB-ES-8510		
		04/03 →	Bush, driver cab suspension	DB-SB-10384		
	04/03 →	Bush, parabolic spring		DB-SB-10401		
	04/03 →	Centre Rod	DB-DL-8307		Push Rod	

CV-ES-0543

Length: 125
 Cone Ø: d1 Ø 32 / d2 Ø 29
 Thread: M30 x 1,5 RHT
 0004605748, 0004606048, 0004606848,
 0004607048, 0014600448, 0014601148,
 0014601748, 0014602448, 0014607648,
 0014609648



CV-ES-14163

Length: 125
 Cone Ø: d1 Ø 30 / d2 Ø 27
 Thread: M30 x 1,5 RHT
 0003305248, 0003387310, 0004600348,
 0004600948, 0004602848, 0004602948,
 0004608948, 0014600248, 0014600848,
 0014601248, 0014602248, 0014607748,
 0024600148, A0003387310, A0004600348,
 A0004602848, A0004602948, A0014600848,
 A0014601248, A0014602248, A0014607748



DB-DL-3475

Length: 565 Ø: 52
 Hole Distance: 152 / 152
 3753500006, 3753500206, 9473500805,
 9483500006, 9483500805, 9483501205,
 9483501305, 9483501905, 9483502005,
 9483502405, A3753500006, A3753500206



DB-DL-8184

Length: 1095 Ø: 42
 Cone Ø: d1 Ø 32 / d2 Ø 28,8
 01217700A, 0014601305, 0014601405,
 0024600505, 0034603205, 3754601505,
 A0014601305, A0014601405, A0024600505



DB-DL-8307

Length: 885 Ø: 38
 Cone Ø: d1 Ø 32 / d2 Ø 30
 01215500A, 0004604005, 0024605105,
 0024605205, 0034604005



DB-DL-8702

Length: 958 Ø: 38
 Cone Ø: d1 Ø 32 / d2 Ø 30
 0024606105, 0024606205, 0034604205



DB-DL-12300

Length: 733 Ø: 36
 Cone Ø: d1 Ø 32 / d2 Ø 29
 0014601505, 0014607305, 0034603305,
 3754601605, A0014601505, A0034603305,
 A3754601605



DB-DL-12310

Length: 1532 Ø: 50
 Cone Ø: d1 Ø 32 / d2 Ø 29
 Thread: M27 x 1,5 LHT
 9493301203, 9493301303, 9493301803,
 9493302203, A9493301203, A9493301303,
 A9493301803, A9493302203



DB-ES-5227

Length: 1588 Ø: 60
 Cone Ø: d1 Ø 38 / d2 Ø 34,3
 6253300903, 6253301203, 9443300203



DB-ES-5234

Length: 135
 Cone Ø: d1 Ø 38 / d2 Ø 34,3
 Thread: M38 x 1,5 RHT
 0004601748, 120322305, 2205000400



DB-ES-8510

Length: 56
 Cone Ø: d1 Ø 10 / d2 Ø 10
 Thread: M12 x 1,75 LHT
 0009965145, 0009965645, 0019963145



DB-ES-8530

Length: 115
 Cone Ø: d1 Ø 28,6 / d2 Ø 23,9
 Thread: M30 x 1,5 RHT
 0014603848, 0014604848, 0014605148,
 0014608648, 0014609948



DB-RK-8391

Ø: 85 Hole Distance: 152
 Thick/Height: 24
 01336800A, 0003502705



DB-RK-8626

Ø: 75 Hole Distance: 130
 Thick/Height: 24
 0003502205, 0003502505, 0003503405,
 0003504505, GL11319



DB-RK-8638

Length: 100 Ø: 67
 Hole Distance: 100
 Thick/Height: 20
 0003301411



DB-RK-8710

Ø: 85 Hole Distance: 130
 Thick/Height: 30
 0003503705



DB-RK-9291

Ø: 107,5 Hole Distance: 152
 Thick/Height: 30
 0003503605



DB-RK-10374

Ø: 85 Hole Distance: 152
 Thick/Height: 24
 0003504405



DB-RK-10375

Ø: 100 Hole Distance: 152
 Thick/Height: 24
 0003502405, 0003503505, 0003504905



DB-SB-10384

Ø: 73 Thick/Height: 47
 9303170012, 9423171812



DB-SB-10401

Length: 232
 Thick/Height: 163,5 / 152,5
 0003250596, 0003250796



DB-SB-10406

Ø: 80 Thick/Height: 46
 0003238185



DB-SB-10409

Ø: 77 Thick/Height: 56
 0003265181



DB-VB-7261

Length: 622 Ø: 46
 Hole Ø 25 / 25 / 25
 Hole Distance: 152 / 130 / 130
 01337800A, 9443500305, 9443500505,
 9443500605, 9473500705, 9473500905,
 9483500405, 9483503005



DB-VB-9307

Length: 667 Ø: 60
 Hole Ø 25 / 23 / 23
 Hole Distance: 152 / 130 / 130
 9483502805



DB-VB-9308

Length: 622 Ø: 46
 Hole Ø 25 / 25 / 25
 Hole Distance: 152 / 130 / 130
 9483502905



MN-DL-7834

Length: 1588 Ø: 58
 Cone Ø: d1 Ø 30 / d2 Ø 27
 3463303903, 3463304903, 6253303203,
 9443300503, 9443301303, 9443301703





ACTROS MP2 / MP3 ...

3346 AS ...	04/03→	Centre Rod	DB-DL-8702		Push Rod, Leaf Spring Axle	
	04/03→	Centre Rod	DB-DL-12300		for Steering Rod	
	04/03→	Stabiliser Mounting		DB-SB-10406		
	04/03→	Stabiliser Mounting		DB-SB-10409		
	04/03→	Stabiliser Mounting	DB-SB-10410			
	04/03→	Suspension Arm Repair Kit		DB-RK-8626	for Wishbone (CV)	
	04/03→	Suspension Arm Repair Kit		DB-RK-10374	for Wishbone (CV)	
	04/03→	Suspension Arm Repair Kit		DB-RK-10375	for Wishbone (CV)	
	04/03→	Suspension Arm Repair Kit	DB-RK-8638		for Control Arm	
	04/03→	Suspension Strut Repair Kit		DB-RK-8391		
	04/03→	Suspension Strut Repair Kit		DB-RK-8710		
	04/03→	Suspension Strut Repair Kit		DB-RK-9291		
	04/03→	Suspension Strut Repair Kit		MN-RK-8997		
	04/03→	Tie Rod	DB-DL-12310			
	04/03→	Tie Rod	DB-ES-5227		Guide Rod	
	04/03→	Tie Rod	MN-DL-7834		Guide Rod	
	04/03→	Tie Rod End	CV-ES-0543		for Push Rod	
	04/03→	Tie Rod End	CV-ES-14163		for Steering Rod	
	04/03→	Tie Rod End	DB-ES-5234		for Steering Rod	
	04/03→	Tie Rod End	DB-ES-8530		for Push Rod	
	04/03→	Track Control Arm		DB-DL-3475	Trailing Arm	
	04/03→	Track Control Arm		DB-VB-7261	Suspension Rod, Wishbone (CV), 1st RA;2nd RA; Leaf Spring Axle	
	04/03→	Track Control Arm		DB-VB-7798	Wishbone (CV)	
	04/03→	Track Control Arm		DB-VB-9307	Suspension Rod, Wishbone (CV), 1st RA;2nd RA; Leaf Spring Axle	
	04/03→	Track Control Arm		DB-VB-9308	Suspension Rod, Wishbone (CV), 1st RA;2nd RA; Leaf Spring Axle	
	3346 B	04/03→	Ball Head, gearshift linkage	DB-ES-8510		
		04/03→	Bush, driver cab suspension	DB-SB-10384		
		04/03→	Centre Rod	DB-DL-2144		Push Rod
04/03→		Centre Rod	DB-DL-5230		Suspension Rod	
04/03→		Centre Rod	DB-DL-5405		Push Rod, Leaf Spring Axle	
04/03→		Centre Rod	DB-DL-7270		Push Rod	
04/03→		Centre Rod	DB-DL-8167		Push Rod	
04/03→		Centre Rod	DB-DL-8184		Push Rod	
04/03→		Centre Rod	DB-DL-8185		Push Rod	
04/03→		Centre Rod	DB-DL-8307		Push Rod	
04/03→		Centre Rod	DB-DL-8702		Push Rod, Leaf Spring Axle	
04/03→		Centre Rod	DB-DL-12300		for Steering Rod	
04/03→		Stabiliser Mounting		DB-SB-10406		
04/03→		Stabiliser Mounting		DB-SB-10409		
04/03→		Suspension Arm Repair Kit		DB-RK-8550	for Wishbone (CV)	
04/03→		Suspension Arm Repair Kit		DB-RK-8626	for Wishbone (CV)	
04/03→		Suspension Arm Repair Kit		DB-RK-10374	for Wishbone (CV)	
04/03→		Suspension Arm Repair Kit	DB-RK-8638		for Control Arm	
04/03→		Suspension Strut Repair Kit		DB-RK-8391		
04/03→		Suspension Strut Repair Kit		DB-RK-8710		
04/03→		Suspension Strut Repair Kit		DB-RK-9291		
04/03→		Tie Rod	DB-DL-8171		Guide Rod	
04/03→		Tie Rod	DB-DL-8327		Guide Rod	
04/03→		Tie Rod	DB-DL-8640		Guide Rod	
04/03→		Tie Rod	DB-DL-12310			
04/03→		Tie Rod End	CV-ES-0543		for Push Rod	
04/03→		Tie Rod End	CV-ES-0888		for Push Rod	
04/03→		Tie Rod End	CV-ES-14163		for Steering Rod	
04/03→		Tie Rod End	DB-ES-5234		for Steering Rod	
04/03→		Tie Rod End	DB-ES-8164		for Push Rod	
04/03→		Tie Rod End	DB-ES-8530		for Push Rod	
04/03→		Track Control Arm		DB-DL-3475	Trailing Arm	
04/03→		Track Control Arm		DB-VB-7261	Suspension Rod, Wishbone (CV), 1st RA;2nd RA; Leaf Spring Axle	



ACTROS MP2 / MP3 ...

3346 B ...	04/03 →	Track Control Arm		DB-VB-9307	Suspension Rod, Wishbone (CV), 1st RA;2nd RA; Leaf Spring Axle		
	04/03 →	Track Control Arm		DB-VB-9308	Suspension Rod, Wishbone (CV), 1st RA;2nd RA; Leaf Spring Axle		
3346 K	04/03 →	Centre Rod	DB-DL-2144		Push Rod		
	04/03 →	Centre Rod	DB-DL-5405		Push Rod, Leaf Spring Axle		
	04/03 →	Centre Rod	DB-DL-7270		Push Rod		
	04/03 →	Centre Rod	DB-DL-8167		Push Rod		
	04/03 →	Centre Rod	DB-DL-8188		Push Rod		
	04/03 →	Centre Rod	DB-DL-8307		Push Rod		
	04/03 →	Centre Rod	DB-DL-8702		Push Rod, Leaf Spring Axle		
	04/03 →	Stabiliser Mounting		DB-SB-10406			
	04/03 →	Suspension Strut Repair Kit		DB-RK-8710			
	04/03 →	Suspension Strut Repair Kit		DB-RK-9291			
	04/03 →	Tie Rod	DB-DL-8171			Guide Rod	
	04/03 →	Tie Rod	DB-DL-8327			Guide Rod	
	04/03 →	Tie Rod	DB-DL-8640			Guide Rod	
	04/03 →	Tie Rod	DB-DL-12310				
	04/03 →	Tie Rod	DB-ES-5227			Guide Rod	
	04/03 →	Tie Rod End	CV-ES-0543			for Push Rod	
	04/03 →	Tie Rod End	CV-ES-0888			for Push Rod	
	04/03 →	Tie Rod End	CV-ES-14163			for Steering Rod	
	04/03 →	Tie Rod End	DB-ES-8164			for Push Rod	
	04/03 →	Tie Rod End	DB-ES-8530			for Push Rod	
	04/03 →	Track Control Arm			DB-DL-3475	Trailing Arm, 1st RA;2nd RA, →517144 03/517144 07	
	04/03 →	Track Control Arm			DB-DL-3475	Trailing Arm, 1st RA;2nd RA, →517144 06/517144 09	
	04/03 →	Track Control Arm			DB-VB-7261	Suspension Rod, Wishbone (CV), 1st RA;2nd RA; Leaf Spring Axle	
	04/03 →	Track Control Arm			DB-VB-9307	Suspension Rod, Wishbone (CV), 1st RA;2nd RA; Leaf Spring Axle	
	04/03 →	Track Control Arm			DB-VB-9308	Suspension Rod, Wishbone (CV), 1st RA;2nd RA; Leaf Spring Axle	
	3346 S	04/03 →	Ball Head, gearshift linkage	DB-ES-8510			
		04/03 →	Bush, driver cab suspension	DB-SB-10384			
		04/03 →	Bush, parabolic spring		DB-SB-10400		
		04/03 →	Bush, parabolic spring		DB-SB-10401		
		04/03 →	Centre Rod	DB-DL-2144			Push Rod
		04/03 →	Centre Rod	DB-DL-5230			Suspension Rod
		04/03 →	Centre Rod	DB-DL-5405			Push Rod, Leaf Spring Axle
04/03 →		Centre Rod	DB-DL-7270			Push Rod;Suspension Rod	
04/03 →		Centre Rod	DB-DL-8167			Push Rod	
04/03 →		Centre Rod	DB-DL-8184			Push Rod	
04/03 →		Centre Rod	DB-DL-8185			Push Rod	
04/03 →		Centre Rod	DB-DL-8307			Push Rod	
04/03 →		Centre Rod	DB-DL-8702			Push Rod, Leaf Spring Axle	
04/03 →		Centre Rod	DB-DL-12300			for Steering Rod	
04/03 →		Stabiliser Mounting			DB-SB-10406		
04/03 →		Stabiliser Mounting			DB-SB-10409		
04/03 →		Stabiliser Mounting	DB-SB-10410				
04/03 →		Suspension Arm Repair Kit			DB-RK-8550	for Wishbone (CV)	
04/03 →		Suspension Arm Repair Kit			DB-RK-8626	for Wishbone (CV)	
04/03 →		Suspension Arm Repair Kit			DB-RK-10374	for Wishbone (CV)	
04/03 →		Suspension Arm Repair Kit			DB-RK-10375	for Wishbone (CV)	
04/03 →		Suspension Arm Repair Kit	DB-RK-8638			for Control Arm	
04/03 →		Suspension Strut Repair Kit			DB-RK-8391		
04/03 →		Suspension Strut Repair Kit			DB-RK-8710		
04/03 →		Suspension Strut Repair Kit			DB-RK-9291		
04/03 →		Suspension Strut Repair Kit			MN-RK-8997		
04/03 →		Tie Rod	DB-DL-8171			Guide Rod	
04/03 →		Tie Rod	DB-DL-8327			Guide Rod	
04/03 →		Tie Rod	DB-DL-8640			Guide Rod	



ACTROS MP2 / MP3 ...

3346 S ...	04/03→	Tie Rod	DB-DL-12310		
	04/03→	Tie Rod	DB-ES-5227	Guide Rod	
	04/03→	Tie Rod End	CV-ES-0543	for Push Rod	
	04/03→	Tie Rod End	CV-ES-0888	for Push Rod	
	04/03→	Tie Rod End	CV-ES-14163	for Steering Rod	
	04/03→	Tie Rod End	DB-ES-5234	for Steering Rod	
	04/03→	Tie Rod End	DB-ES-8164	for Push Rod	
	04/03→	Tie Rod End	DB-ES-8530	for Push Rod	
	04/03→	Track Control Arm		DB-DL-3475 Trailing Arm	
	04/03→	Track Control Arm		DB-VB-7261 Suspension Rod, Wishbone (CV), 1st RA;2nd RA; Leaf Spring Axle	
	04/03→	Track Control Arm		DB-VB-7798 Wishbone (CV)	
	04/03→	Track Control Arm		DB-VB-9307 Suspension Rod, Wishbone (CV), 1st RA;2nd RA; Leaf Spring Axle	
	04/03→	Track Control Arm		DB-VB-9308 Suspension Rod, Wishbone (CV), 1st RA;2nd RA; Leaf Spring Axle	
	3348	04/03→	Ball Head, gearshift linkage	DB-ES-8510	
		04/03→	Bush, driver cab suspension	DB-SB-10384	
04/03→		Bush, parabolic spring		DB-SB-10400	
04/03→		Bush, parabolic spring		DB-SB-10401	
04/03→		Centre Rod	DB-DL-2144	Push Rod	
04/03→		Centre Rod	DB-DL-5230	Suspension Rod	
04/03→		Centre Rod	DB-DL-5405	Push Rod	
04/03→		Centre Rod	DB-DL-5405	Push Rod, Leaf Spring Axle	
04/03→		Centre Rod	DB-DL-7270	Push Rod;Suspension Rod	
04/03→		Centre Rod	DB-DL-8167	Push Rod	
04/03→		Centre Rod	DB-DL-8168	Push Rod	
04/03→		Centre Rod	DB-DL-8184	Push Rod	
04/03→		Centre Rod	DB-DL-8185	Push Rod	
04/03→		Centre Rod	DB-DL-8307	Push Rod	
04/03→		Centre Rod	DB-DL-8622	Push Rod	
04/03→		Centre Rod	DB-DL-8641	Push Rod	
04/03→		Centre Rod	DB-DL-8642	Push Rod	
04/03→		Centre Rod	DB-DL-8702	Push Rod	
04/03→		Centre Rod	DB-DL-8702	Push Rod, Leaf Spring Axle	
04/03→		Centre Rod	DB-DL-12300	for Steering Rod	
04/03→		Stabiliser Link	DB-DL-9254	Pressure Rod	
04/03→		Stabiliser Mounting		DB-SB-10406	
04/03→		Stabiliser Mounting		DB-SB-10409	
04/03→		Stabiliser Mounting	DB-SB-10410		
04/03→		Suspension Arm Repair Kit		DB-RK-8550 for Wishbone (CV)	
04/03→		Suspension Arm Repair Kit		DB-RK-8626 for Wishbone (CV)	
04/03→		Suspension Arm Repair Kit		DB-RK-10374 for Wishbone (CV)	
04/03→		Suspension Arm Repair Kit		DB-RK-10375 for Wishbone (CV)	
04/03→		Suspension Arm Repair Kit	DB-RK-8638	for Control Arm	
04/03→		Suspension Strut Repair Kit		DB-RK-8391	
04/03→		Suspension Strut Repair Kit		DB-RK-8710	
04/03→		Suspension Strut Repair Kit		DB-RK-9291	
04/03→		Tie Rod	DB-DL-8171	Guide Rod	
04/03→		Tie Rod	DB-DL-8171	Guide Rod, 1st FA;Leaf Spring Axle	
04/03→		Tie Rod	DB-DL-8327	Guide Rod	
04/03→		Tie Rod	DB-DL-8327	Guide Rod, 1st FA;Leaf Spring Axle	
04/03→		Tie Rod	DB-DL-8640	Guide Rod	
04/03→		Tie Rod	DB-DL-12310		
04/03→		Tie Rod	DB-ES-5227	Guide Rod	
04/03→		Tie Rod End	CV-ES-0543	for Push Rod	
04/03→		Tie Rod End	CV-ES-0888	for Push Rod	
04/03→		Tie Rod End	CV-ES-14163	for Steering Rod	
04/03→	Tie Rod End	DB-ES-5234	for Steering Rod		
04/03→	Tie Rod End	DB-ES-8164	for Push Rod		
04/03→	Tie Rod End	DB-ES-8530	for Push Rod		
04/03→	Track Control Arm		DB-DL-3475 Trailing Arm		



ACTROS MP2 / MP3 ...

3348 ...	04/03 →	Track Control Arm		DB-DL-3475	Trailing Arm, 1st RA;2nd RA, →517144 03/517144 06
	04/03 →	Track Control Arm		DB-DL-3475	Trailing Arm, 1st RA;2nd RA, →517144 05/517144 08
	04/03 →	Track Control Arm		DB-DL-3475	Trailing Arm, 1st RA;2nd RA, →517144 07/517144 09
	04/03 →	Track Control Arm		DB-DL-3475	Trailing Arm, 1st RA;2nd RA, →517144 26/517144 27
	04/03 →	Track Control Arm		DB-VB-7261	Suspension Rod, Wishbone (CV), 1st RA;2nd RA; Leaf Spring Axle
	04/03 →	Track Control Arm		DB-VB-9307	Suspension Rod, Wishbone (CV)
	04/03 →	Track Control Arm		DB-VB-9307	Suspension Rod, Wishbone (CV), 1st RA;2nd RA; Leaf Spring Axle
	04/03 →	Track Control Arm		DB-VB-9308	Suspension Rod, Wishbone (CV), 1st RA;2nd RA; Leaf Spring Axle
3348 A	04/03 →	Centre Rod	DB-DL-8307		Push Rod, Leaf Spring Axle
	04/03 →	Stabiliser Mounting		DB-SB-10406	
	04/03 →	Suspension Strut Repair Kit		DB-RK-8710	
	04/03 →	Suspension Strut Repair Kit		DB-RK-9291	
	04/03 →	Tie Rod	DB-DL-12310		
	04/03 →	Tie Rod	DB-ES-5227		Guide Rod
3348 AK	04/03 →	Tie Rod End	DB-ES-5234		for Steering Rod
	04/03 →	Ball Head, gearshift linkage	DB-ES-8510		
	04/03 →	Bush, driver cab suspension	DB-SB-10384		
	04/03 →	Bush, parabolic spring		DB-SB-10401	
	04/03 →	Centre Rod	DB-DL-8184		Push Rod
	04/03 →	Centre Rod	DB-DL-8307		Push Rod, Leaf Spring Axle
	04/03 →	Centre Rod	DB-DL-8702		Push Rod, Drive Axle;Leaf Spring Axle
	04/03 →	Centre Rod	DB-DL-8702		Push Rod, Leaf Spring Axle
	04/03 →	Centre Rod	DB-DL-12300		for Steering Rod
	04/03 →	Stabiliser Mounting		DB-SB-10406	
	04/03 →	Stabiliser Mounting		DB-SB-10409	
	04/03 →	Suspension Arm Repair Kit		DB-RK-8626	for Wishbone (CV)
	04/03 →	Suspension Arm Repair Kit		DB-RK-10374	for Wishbone (CV)
	04/03 →	Suspension Arm Repair Kit		DB-RK-10375	for Wishbone (CV)
	04/03 →	Suspension Arm Repair Kit	DB-RK-8638		for Control Arm
	04/03 →	Suspension Strut Repair Kit		DB-RK-8391	
	04/03 →	Suspension Strut Repair Kit		DB-RK-8710	
	04/03 →	Suspension Strut Repair Kit		DB-RK-9291	
	04/03 →	Tie Rod	DB-DL-12310		
	04/03 →	Tie Rod	DB-ES-5227		Guide Rod
	04/03 →	Tie Rod	MN-DL-7834		Guide Rod
	04/03 →	Tie Rod End	CV-ES-0543		for Push Rod
	04/03 →	Tie Rod End	CV-ES-14163		for Steering Rod
	04/03 →	Tie Rod End	DB-ES-5234		for Steering Rod
	04/03 →	Tie Rod End	DB-ES-8530		for Push Rod
	04/03 →	Track Control Arm		DB-DL-3475	Trailing Arm
	04/03 →	Track Control Arm		DB-DL-3475	Trailing Arm, 1st RA;2nd RA, →517144 03/517144 06
	04/03 →	Track Control Arm		DB-DL-3475	Trailing Arm, 1st RA;2nd RA, →517144 05/517144 08
04/03 →	Track Control Arm		DB-DL-3475	Trailing Arm, 1st RA;2nd RA, →517144 07/517144 09	
04/03 →	Track Control Arm		DB-DL-3475	Trailing Arm, 1st RA;2nd RA, →517144 26/517144 27	
04/03 →	Track Control Arm		DB-VB-7261	Suspension Rod, Wishbone (CV), 1st RA;2nd RA; Leaf Spring Axle	
04/03 →	Track Control Arm		DB-VB-9307	Suspension Rod, Wishbone (CV), 1st RA;2nd RA; Leaf Spring Axle	
04/03 →	Track Control Arm		DB-VB-9308	Suspension Rod, Wishbone (CV), 1st RA;2nd RA; Leaf Spring Axle	

CV-ES-0543

Length: 125
Cone Ø: d1 Ø 32 / d2 Ø 29
Thread: M30 x 1,5 RHT
0004605748, 0004606048, 0004606848,
0004607048, 0014600448, 0014601148,
0014601748, 0014602448, 0014607648,
0014609648



CV-ES-14163

Length: 125
Cone Ø: d1 Ø 30 / d2 Ø 27
Thread: M30 x 1,5 RHT
0003305248, 0003387310, 0004600348,
0004600948, 0004602848, 0004602948,
0004608948, 0014600248, 0014600848,
0014601248, 0014602248, 0014607748,
0024600148, A0003387310, A0004600348,
A0004602848, A0004602948, A0014600848,
A0014601248, A0014602248, A0014607748



DB-DL-3475

Length: 565 Ø: 52
Hole Distance: 152 / 152
3753500006, 3753500206, 9473500805,
9483500006, 9483500805, 9483501205,
9483501305, 9483501905, 9483502005,
9483502405, A3753500006, A3753500206



DB-DL-8184

Length: 1095 Ø: 42
Cone Ø: d1 Ø 32 / d2 Ø 28,8
01217700A, 0014601305, 0014601405,
0024600505, 0034603205, 3754601505,
A0014601305, A0014601405, A0024600505



DB-DL-8307

Length: 885 Ø: 38
Cone Ø: d1 Ø 32 / d2 Ø 30
01215500A, 0004604005, 0024605105,
0024605205, 0034604005



DB-DL-8702

Length: 958 Ø: 38
Cone Ø: d1 Ø 32 / d2 Ø 30
0024606105, 0024606205, 0034604205



DB-DL-12300

Length: 733 Ø: 36
Cone Ø: d1 Ø 32 / d2 Ø 29
0014601505, 0014607305, 0034603305,
3754601605, A0014601505, A0034603305,
A3754601605



DB-DL-12310

Length: 1532 Ø: 50
Cone Ø: d1 Ø 32 / d2 Ø 29
Thread: M27 x 1,5 LHT
9493301203, 9493301303, 9493301803,
9493302203, A9493301203, A9493301303,
A9493301803, A9493302203



DB-ES-5227

Length: 1588 Ø: 60
Cone Ø: d1 Ø 38 / d2 Ø 34,3
6253300903, 6253301203, 9443300203



DB-ES-5234

Length: 135
Cone Ø: d1 Ø 38 / d2 Ø 34,3
Thread: M38 x 1,5 RHT
0004601748, 120322305, 2205000400



DB-ES-8510

Length: 56
Cone Ø: d1 Ø 10 / d2 Ø 10
Thread: M12 x 1,75 LHT
0009965145, 0009965645, 0019963145



DB-ES-8530

Length: 115
Cone Ø: d1 Ø 28,6 / d2 Ø 23,9
Thread: M30 x 1,5 RHT
0014603848, 0014604848, 0014605148,
0014608648, 0014609948



DB-RK-8391

Ø: 85 Hole Distance: 152
Thick/Height: 24
01336800A, 0003502705



DB-RK-8626

Ø: 75 Hole Distance: 130
Thick/Height: 24
0003502205, 0003502505, 0003503405,
0003504505, GL11319



DB-RK-8638

Length: 100 Ø: 67
Hole Distance: 100
Thick/Height: 20
0003301411



DB-RK-8710

Ø: 85 Hole Distance: 130
Thick/Height: 30
0003503705



DB-RK-9291

Ø: 107,5 Hole Distance: 152
Thick/Height: 30
0003503605



DB-RK-10374

Ø: 85 Hole Distance: 152
Thick/Height: 24
0003504405



DB-RK-10375

Ø: 100 Hole Distance: 152
Thick/Height: 24
0003502405, 0003503505, 0003504905



DB-SB-10384

Ø: 73 Thick/Height: 47
9303170012, 9423171812



DB-SB-10401

Length: 232
Thick/Height: 163,5 / 152,5
0003250596, 0003250796



DB-SB-10406

Ø: 80 Thick/Height: 46
0003238185



DB-SB-10409

Ø: 77 Thick/Height: 56
0003265181



DB-VB-7261

Length: 622 Ø: 46
Hole Ø 25 / 25 / 25
Hole Distance: 152 / 130 / 130
01337800A, 9443500305, 9443500505,
9443500605, 9473500705, 9473500905,
9483500405, 9483503005



DB-VB-9307

Length: 667 Ø: 80
Hole Ø 25 / 23 / 23
Hole Distance: 152 / 130 / 130
9483502805



DB-VB-9308

Length: 622 Ø: 46
Hole Ø 25 / 25 / 25
Hole Distance: 152 / 130 / 130
9483502905



MN-DL-7834

Length: 1588 Ø: 58
Cone Ø: d1 Ø 30 / d2 Ø 27
3463303903, 3463304903, 6253303203,
9443300503, 9443301303, 9443301703



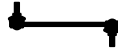

ACTROS MP2 / MP3 ...

3348 AKE	04/03→	Bush, driver cab suspension	DB-SB-10384		
	04/03→	Bush, parabolic spring		DB-SB-10401	
	04/03→	Centre Rod	DB-DL-8307		Push Rod, Leaf Spring Axle
	04/03→	Centre Rod	DB-DL-8702		Push Rod, Drive Axle;Leaf Spring Axle
	04/03→	Stabiliser Mounting		DB-SB-10406	
	04/03→	Suspension Strut Repair Kit		DB-RK-8710	
	04/03→	Suspension Strut Repair Kit		DB-RK-9291	
	04/03→	Tie Rod	DB-DL-12310		
	04/03→	Tie Rod	DB-ES-5227		Guide Rod
	04/03→	Tie Rod	MN-DL-7834		Guide Rod
	04/03→	Tie Rod End	DB-ES-5234		for Steering Rod
	04/03→	Track Control Arm		DB-VB-7261	Suspension Rod, Wishbone (CV), 1st RA;2nd RA; Leaf Spring Axle
	04/03→	Track Control Arm		DB-VB-9307	Suspension Rod, Wishbone (CV), 1st RA;2nd RA; Leaf Spring Axle
	04/03→	Track Control Arm		DB-VB-9308	Suspension Rod, Wishbone (CV), 1st RA;2nd RA; Leaf Spring Axle
3348 AS	04/03→	Ball Head, gearshift linkage	DB-ES-8510		
	04/03→	Bush, driver cab suspension	DB-SB-10384		
	04/03→	Centre Rod	DB-DL-8307		Push Rod
	04/03→	Centre Rod	DB-DL-8702		Push Rod
	04/03→	Centre Rod	DB-DL-8702		Push Rod, Leaf Spring Axle
	04/03→	Centre Rod	DB-DL-12300		for Steering Rod
	04/03→	Stabiliser Mounting		DB-SB-10406	
	04/03→	Stabiliser Mounting		DB-SB-10409	
	04/03→	Stabiliser Mounting	DB-SB-10410		
	04/03→	Suspension Arm Repair Kit		DB-RK-8626	for Wishbone (CV)
	04/03→	Suspension Arm Repair Kit		DB-RK-10374	for Wishbone (CV)
	04/03→	Suspension Arm Repair Kit		DB-RK-10375	for Wishbone (CV)
	04/03→	Suspension Arm Repair Kit	DB-RK-8638		for Control Arm
	04/03→	Suspension Strut Repair Kit		DB-RK-8391	
	04/03→	Suspension Strut Repair Kit		DB-RK-8710	
	04/03→	Suspension Strut Repair Kit		DB-RK-9291	
	04/03→	Suspension Strut Repair Kit		MN-RK-8997	
	04/03→	Tie Rod	DB-DL-12310		
	04/03→	Tie Rod	DB-ES-5227		Guide Rod
	04/03→	Tie Rod	DB-ES-5227		Guide Rod, 1st Front Axle
	04/03→	Tie Rod	MN-DL-7834		Guide Rod
	04/03→	Tie Rod	MN-DL-7834		Guide Rod, 1st Front Axle
	04/03→	Tie Rod End	CV-ES-0543		for Push Rod
	04/03→	Tie Rod End	CV-ES-14163		for Steering Rod
	04/03→	Tie Rod End	DB-ES-5234		for Steering Rod
	04/03→	Tie Rod End	DB-ES-8530		for Push Rod
	04/03→	Track Control Arm		DB-DL-3475	Trailing Arm
	04/03→	Track Control Arm		DB-DL-3475	Trailing Arm, 1st & 2nd Drive Axle
	04/03→	Track Control Arm		DB-VB-7261	Suspension Rod, Wishbone (CV), 1st RA;2nd RA, →517142 02
	04/03→	Track Control Arm		DB-VB-7261	Suspension Rod, Wishbone (CV), 1st RA;2nd RA; Leaf Spring Axle
	04/03→	Track Control Arm		DB-VB-7798	Wishbone (CV)
	04/03→	Track Control Arm		DB-VB-9307	Suspension Rod, Wishbone (CV)
	04/03→	Track Control Arm		DB-VB-9307	Suspension Rod, Wishbone (CV), 1st RA;2nd RA; Leaf Spring Axle
04/03→	Track Control Arm		DB-VB-9308	Suspension Rod, Wishbone (CV)	
04/03→	Track Control Arm		DB-VB-9308	Suspension Rod, Wishbone (CV), 1st RA;2nd RA; Leaf Spring Axle	
3348 B	04/03→	Ball Head, gearshift linkage	DB-ES-8510		
	04/03→	Bush, driver cab suspension	DB-SB-10384		
	04/03→	Bush, parabolic spring		DB-SB-10400	
	04/03→	Bush, parabolic spring		DB-SB-10401	
	04/03→	Centre Rod	DB-DL-2144		Push Rod
	04/03→	Centre Rod	DB-DL-5230		Suspension Rod
	04/03→	Centre Rod	DB-DL-5405		Push Rod, Leaf Spring Axle

CV-ES-0543

Length: 125
Cone Ø: d1 Ø 32 / d2 Ø 29
Thread: M30 x 1,5 RHT
0004605748, 0004606048, 0004606848,
0004607048, 0014600448, 0014601148,
0014601748, 0014602448, 0014607648,
0014609648



CV-ES-14163

Length: 125
Cone Ø: d1 Ø 30 / d2 Ø 27
Thread: M30 x 1,5 RHT
0003305248, 0003387310, 0004600348,
0004600948, 0004602848, 0004602948,
0004608948, 0014600248, 0014600848,
0014601248, 0014602248, 0014607748,
0024600148, 0003387310, 0004600348,
0004602848, 0004602948, 0014600848,
0014601248, 0014602248, 0014607748



DB-DL-2144

Length: 872 Ø: 35
Cone Ø: d1 Ø 28,6 / d2 Ø 23,9
0024604305, 0024604405, 0034604805



DB-DL-3475

Length: 565 Ø: 52
Hole Distance: 152 / 152
3753500006, 3753500206, 9473500805,
9483500006, 9483500805, 9483501205,
9483501305, 9483501905, 9483502005,
9483502405, A3753500006, A3753500206



DB-DL-5230

Length: 879 Ø: 42
Cone Ø: d1 Ø 30 / d2 Ø 27
01208600A, 0004607105, 0004607205,
0014606705



DB-DL-5405

Length: 890 Ø: 35
Cone Ø: d1 Ø 28,6 / d2 Ø 23,9
01215900A, 1460248, 0024604505, 0024604605,
0034605005, 3752600637, 3754600405,
A3752600637, A3754600405



DB-DL-8307

Length: 885 Ø: 38
Cone Ø: d1 Ø 32 / d2 Ø 30
01215500A, 0004604005, 0024605105,
0024605205, 0034604005



DB-DL-8702

Length: 958 Ø: 38
Cone Ø: d1 Ø 32 / d2 Ø 30
0024606105, 0024606205, 0034604205



DB-DL-12300

Length: 733 Ø: 36
Cone Ø: d1 Ø 32 / d2 Ø 29
0014601505, 0014607305, 0034603305,
3754601605, A0014601505, A0034603305,
A3754601605



DB-DL-12310

Length: 1532 Ø: 50
Cone Ø: d1 Ø 32 / d2 Ø 29
Thread: M27 x 1,5 LHT
9493301203, 9493301303, 9493301803,
9493302203, A9493301203, A9493301303,
A9493301803, A9493302203



DB-ES-5227

Length: 1588 Ø: 60
Cone Ø: d1 Ø 38 / d2 Ø 34,3
6253300903, 6253301203, 9443300203



DB-ES-5234

Length: 135
Cone Ø: d1 Ø 38 / d2 Ø 34,3
Thread: M38 x 1,5 RHT
0004601748, 120322305, 2205000400



DB-ES-8510

Length: 56
Cone Ø: d1 Ø 10 / d2 Ø 10
Thread: M12 x 1,75 LHT
0009965145, 0009965645, 0019963145



DB-ES-8530

Length: 115
Cone Ø: d1 Ø 28,6 / d2 Ø 23,9
Thread: M30 x 1,5 RHT
0014603848, 0014604848, 0014605148,
0014608648, 0014609948



DB-RK-8391

Ø: 85 Hole Distance: 152
Thick/Height: 24
01336800A, 0003502705



DB-RK-8626

Ø: 75 Hole Distance: 130
Thick/Height: 24
0003502205, 0003502505, 0003503405,
0003504505, GL11319



DB-RK-8638

Length: 100 Ø: 67
Hole Distance: 100
Thick/Height: 20
0003301411



DB-RK-8710

Ø: 85 Hole Distance: 130
Thick/Height: 30
0003503705



DB-RK-9291

Ø: 107,5 Hole Distance: 152
Thick/Height: 30
0003503605



DB-RK-10374

Ø: 85 Hole Distance: 152
Thick/Height: 24
0003504405



DB-RK-10375

Ø: 100 Hole Distance: 152
Thick/Height: 24
0003502405, 0003503505, 0003504905



DB-SB-10384

Ø: 73 Thick/Height: 47
9303170012, 9423171812



DB-SB-10400

Length: 230
Thick/Height: 167,5 / 115
0003250696, 0003250896



DB-SB-10401

Length: 232
Thick/Height: 163,5 / 152,5
0003250596, 0003250796



DB-SB-10406

Ø: 80 Thick/Height: 46
0003238185



DB-SB-10409

Ø: 77 Thick/Height: 56
0003265181



DB-SB-10410

Ø: 73 Hole Distance: 100
Thick/Height: 24
9413230050



DB-VB-7261

Length: 622 Ø: 46
Hole Ø 25 / 25 / 25
Hole Distance: 152 / 130 / 130
01337800A, 9443500305, 9443500505,
9443500605, 9473500705, 9473500905,
9483500405, 9483503005



DB-VB-7798

Length: 622 Ø: 48
Hole Ø 25 / 23 / 23
Hole Distance: 152 / 130 / 130
9423500505, 9423500805, 9423501205,
A9423501205



DB-VB-9307

Length: 667 Ø: 60
Hole Ø 25 / 23 / 23
Hole Distance: 152 / 130 / 130
9483502805



DB-VB-9308

Length: 622 Ø: 46
Hole Ø 25 / 25 / 25
Hole Distance: 152 / 130 / 130
9483502905



MN-DL-7834

Length: 1588 Ø: 58
Cone Ø: d1 Ø 30 / d2 Ø 27
3463303903, 3463304903, 6253303203,
9443300503, 9443301303, 9443301703



MN-RK-8997

Ø: 85 Hole Distance: 130
Thick/Height: 30
0003504805





ACTROS MP2 / MP3 ...

3348 B ...	04/03→	Centre Rod	DB-DL-7270	Push Rod	
	04/03→	Centre Rod	DB-DL-8167	Push Rod	
	04/03→	Centre Rod	DB-DL-8184	Push Rod	
	04/03→	Centre Rod	DB-DL-8185	Push Rod	
	04/03→	Centre Rod	DB-DL-8307	Push Rod	
	04/03→	Centre Rod	DB-DL-8702	Push Rod, Leaf Spring Axle	
	04/03→	Centre Rod	DB-DL-12300	for Steering Rod	
	04/03→	Stabiliser Mounting		DB-SB-10406	
	04/03→	Stabiliser Mounting		DB-SB-10409	
	04/03→	Suspension Arm Repair Kit		DB-RK-8550 for Wishbone (CV)	
	04/03→	Suspension Arm Repair Kit		DB-RK-8626 for Wishbone (CV)	
	04/03→	Suspension Arm Repair Kit		DB-RK-10374 for Wishbone (CV)	
	04/03→	Suspension Arm Repair Kit	DB-RK-8638	for Control Arm	
	04/03→	Suspension Strut Repair Kit		DB-RK-8391	
	04/03→	Suspension Strut Repair Kit		DB-RK-8710	
	04/03→	Suspension Strut Repair Kit		DB-RK-9291	
	04/03→	Tie Rod	DB-DL-8171	Guide Rod	
	04/03→	Tie Rod	DB-DL-8327	Guide Rod	
	04/03→	Tie Rod	DB-DL-8640	Guide Rod	
	04/03→	Tie Rod	DB-DL-12310		
	04/03→	Tie Rod End	CV-ES-0543	for Push Rod	
	04/03→	Tie Rod End	CV-ES-0888	for Push Rod	
	04/03→	Tie Rod End	CV-ES-14163	for Steering Rod	
	04/03→	Tie Rod End	DB-ES-5234	for Steering Rod	
	04/03→	Tie Rod End	DB-ES-8164	for Push Rod	
	04/03→	Tie Rod End	DB-ES-8530	for Push Rod	
	04/03→	Track Control Arm		DB-DL-3475 Trailing Arm	
	04/03→	Track Control Arm		DB-VB-7261 Suspension Rod, Wishbone (CV), 1st RA;2nd RA; Leaf Spring Axle	
	04/03→	Track Control Arm		DB-VB-9307 Suspension Rod, Wishbone (CV), 1st RA;2nd RA; Leaf Spring Axle	
	04/03→	Track Control Arm		DB-VB-9308 Suspension Rod, Wishbone (CV), 1st RA;2nd RA; Leaf Spring Axle	
	3348 K	04/03→	Centre Rod	DB-DL-2144	Push Rod
		04/03→	Centre Rod	DB-DL-5405	Push Rod
		04/03→	Centre Rod	DB-DL-5405	Push Rod, Leaf Spring Axle
04/03→		Centre Rod	DB-DL-7270	Push Rod	
04/03→		Centre Rod	DB-DL-8167	Push Rod	
04/03→		Centre Rod	DB-DL-8188	Push Rod	
04/03→		Centre Rod	DB-DL-8307	Push Rod	
04/03→		Centre Rod	DB-DL-8702	Push Rod	
04/03→		Centre Rod	DB-DL-8702	Push Rod, Leaf Spring Axle	
04/03→		Stabiliser Mounting		DB-SB-10406	
04/03→		Suspension Arm Repair Kit		DB-RK-8626 for Wishbone (CV)	
04/03→		Suspension Arm Repair Kit		DB-RK-10375 for Wishbone (CV)	
04/03→		Suspension Strut Repair Kit		DB-RK-8391	
04/03→		Suspension Strut Repair Kit		DB-RK-8710	
04/03→		Suspension Strut Repair Kit		DB-RK-9291	
04/03→		Tie Rod	DB-DL-8171	Guide Rod	
04/03→		Tie Rod	DB-DL-8327	Guide Rod	
04/03→		Tie Rod	DB-DL-8640	Guide Rod	
04/03→		Tie Rod	DB-DL-12310		
04/03→		Tie Rod	DB-ES-5227	Guide Rod	
04/03→		Tie Rod End	CV-ES-0543	for Push Rod	
04/03→		Tie Rod End	CV-ES-0888	for Push Rod	
04/03→		Tie Rod End	CV-ES-14163	for Steering Rod	
04/03→		Tie Rod End	DB-ES-8164	for Push Rod	
04/03→		Tie Rod End	DB-ES-8530	for Push Rod	
04/03→		Track Control Arm		DB-DL-3475 Trailing Arm, 1st RA;2nd RA, →517144 03/517144 07	
04/03→		Track Control Arm		DB-DL-3475 Trailing Arm, 1st RA;2nd RA, →517144 06/517144 09	
04/03→		Track Control Arm		DB-VB-7261 Suspension Rod, Wishbone (CV)	

CV-ES-0543

Length: 125
Cone Ø: d1 Ø 32 / d2 Ø 29
Thread: M30 x 1,5 RHT
0004605748, 0004606048, 0004606848,
0004607048, 0014600448, 0014601148,
0014601748, 0014602448, 0014607648,
0014609648



CV-ES-0888

Length: 125
Cone Ø: d1 Ø 32 / d2 Ø 29
Thread: M30 x 1,5 LHT
0004605848, 0004606148, 0004606948,
0004607148, 0004609048, 0014600548,
0014601348, 0014602548, 0014607948,
0024600448



CV-ES-14163

Length: 125
Cone Ø: d1 Ø 30 / d2 Ø 27
Thread: M30 x 1,5 RHT
0003305248, 0003387310, 0004600348,
0004600948, 0004602848, 0004602948,
0004608948, 0014600248, 0014600848,
0014601248, 0014602248, 0014607748,
0024600148, A0003387310, A0004600348,
A0004602848, A0004602948, A0014600848,
A0014601248, A0014602248, A0014607748



DB-DL-2144

Length: 872 Ø: 35
Cone Ø: d1 Ø 28,6 / d2 Ø 23,9
0024604305, 0024604405, 0034604805



DB-DL-3475

Length: 565 Ø: 52
Hole Distance: 152 / 152
3753500006, 3753500206, 9473500805,
9483500006, 9483500805, 9483501205,
9483501305, 9483501905, 9483502005,
9483502405, A3753500006, A3753500206



DB-DL-5405

Length: 890 Ø: 35
Cone Ø: d1 Ø 28,6 / d2 Ø 23,9
01215900A, 1460248, 0024604505, 0024604605,
0034605005, 3752600637, 3754600405,
A3752600637, A3754600405



DB-DL-7270

Length: 875 Ø: 40
Cone Ø: d1 Ø 28,6 / d2 Ø 23,9
01208300A, 0024604705, 0024604805,
0034604905, A0024604705



DB-DL-8167

Length: 866 Ø: 38
Cone Ø: d1 Ø 30 / d2 Ø 27
0014609805, 0014609905, 0024606305,
0024606405



DB-DL-8171

Length: 1687 Ø: 52
Cone Ø: d1 Ø 32 / d2 Ø 29
9493300603, 9493300703, 9493301503,
9493301603



DB-DL-8184

Length: 1095 Ø: 42
Cone Ø: d1 Ø 32 / d2 Ø 28,8
01217700A, 0014601305, 0014601405,
0024600505, 0034603205, 3754601505,
A0014601305, A0014601405, A0024600505



DB-DL-8185

Length: 711 Ø: 42
Cone Ø: d1 Ø 32 / d2 Ø 28,8
01213600A, 0014601105, 0024600405,
0034603105, A0014601105, A0024600405



DB-DL-8188

Length: 895 Ø: 40
Cone Ø: d1 Ø 28,6 / d2 Ø 23,9
01217200A, 0024604905, 0024605005,
0034605605



DB-DL-8307

Length: 885 Ø: 38
Cone Ø: d1 Ø 32 / d2 Ø 30
01215500A, 0004604005, 0024605105,
0024605205, 0034604005



DB-DL-8327

Length: 1745 Ø: 48
Cone Ø: d1 Ø 32 / d2 Ø 29
01219800A, 9413300003, 9413300103,
9413300203, 9413300303, 9413300503



DB-DL-8640

Length: 1615 Ø: 50
Cone Ø: d1 Ø 32 / d2 Ø 29
6253301503, 6253301603, 6253302403,
6253302503, 9423300803, 9423302103,
9493300203, 9493300303, 9493300903



DB-DL-8702

Length: 958 Ø: 38
Cone Ø: d1 Ø 32 / d2 Ø 30
0024606105, 0024606205, 0034604205



DB-DL-12300

Length: 733 Ø: 36
Cone Ø: d1 Ø 32 / d2 Ø 29
0014601505, 0014607305, 0034603305,
3754601605, A0014601505, A0034603305,
A3754601605



DB-DL-12310

Length: 1532 Ø: 50
Cone Ø: d1 Ø 32 / d2 Ø 29
Thread: M27 x 1,5 LHT
9493301203, 9493301303, 9493301803,
9493302203, A9493301203, A9493301303,
A9493301803, A9493302203



DB-ES-5227

Length: 1588 Ø: 60
Cone Ø: d1 Ø 38 / d2 Ø 34,3
6253300903, 6253301203, 9443300203



DB-ES-5234

Length: 135
Cone Ø: d1 Ø 38 / d2 Ø 34,3
Thread: M38 x 1,5 RHT
0004601748, 120322305, 2205000400



DB-ES-8164

Length: 140
Cone Ø: d1 Ø 28,6 / d2 Ø 23,9
Thread: M28 x 1,5 RHT
0014604248, 0014605048, 0014608548,
0024600548



DB-ES-8530

Length: 115
Cone Ø: d1 Ø 28,6 / d2 Ø 23,9
Thread: M30 x 1,5 RHT
0014603848, 0014604848, 0014605148,
0014608648, 0014609948



DB-RK-8391

Ø: 85 Hole Distance: 152
Thick/Height: 24
01336800A, 0003502705



DB-RK-8550

Ø: 75 Hole Distance: 152
Thick/Height: 24
0003502105, 0003504605



DB-RK-8626

Ø: 75 Hole Distance: 130
Thick/Height: 24
0003502205, 0003502505, 0003503405,
0003504505, GL11319



DB-RK-8638

Length: 100 Ø: 67
Hole Distance: 100
Thick/Height: 20
0003301411



DB-RK-8710

Ø: 85 Hole Distance: 130
Thick/Height: 30
0003503705



DB-RK-9291

Ø: 107,5 Hole Distance: 152
Thick/Height: 30
0003503605



DB-RK-10374

Ø: 85 Hole Distance: 152
Thick/Height: 24
0003504405



DB-RK-10375

Ø: 100 Hole Distance: 152
Thick/Height: 24
0003502405, 0003503505, 0003504905



DB-SB-10406

Ø: 80 Thick/Height: 46
0003238185



DB-SB-10409

Ø: 77 Thick/Height: 56
0003265181



DB-VB-7261

Length: 622 Ø: 46
Hole Ø 25 / 25 / 25
Hole Distance: 152 / 130 / 130
01337800A, 9443500305, 9443500505,
9443500605, 9473500705, 9473500905,
9483500405, 9483503005



DB-VB-9307

Length: 667 Ø: 60
Hole Ø 25 / 23 / 23
Hole Distance: 152 / 130 / 130
9483502805



DB-VB-9308

Length: 622 Ø: 46
Hole Ø 25 / 25 / 25
Hole Distance: 152 / 130 / 130
9483502905





ACTROS MP2 / MP3 ...

3348 K ...	04/03 →	Track Control Arm		DB-VB-7261	Suspension Rod, Wishbone (CV), 1st RA;2nd RA; Leaf Spring Axle	
	04/03 →	Track Control Arm		DB-VB-9307	Suspension Rod, Wishbone (CV)	
	04/03 →	Track Control Arm		DB-VB-9307	Suspension Rod, Wishbone (CV), 1st RA;2nd RA; Leaf Spring Axle	
	04/03 →	Track Control Arm		DB-VB-9308	Suspension Rod, Wishbone (CV)	
	04/03 →	Track Control Arm		DB-VB-9308	Suspension Rod, Wishbone (CV), 1st RA;2nd RA; Leaf Spring Axle	
	3348 S	04/03 →	Ball Head, gearshift linkage	DB-ES-8510		
04/03 →		Bush, driver cab suspension	DB-SB-10384			
04/03 →		Bush, parabolic spring		DB-SB-10400		
04/03 →		Bush, parabolic spring		DB-SB-10401		
04/03 →		Centre Rod	DB-DL-2144		Push Rod	
04/03 →		Centre Rod	DB-DL-5230		Suspension Rod	
04/03 →		Centre Rod	DB-DL-5405		Push Rod, Leaf Spring Axle	
04/03 →		Centre Rod	DB-DL-7270		Push Rod;Suspension Rod	
04/03 →		Centre Rod	DB-DL-8167		Push Rod	
04/03 →		Centre Rod	DB-DL-8184		Push Rod	
04/03 →		Centre Rod	DB-DL-8185		Push Rod	
04/03 →		Centre Rod	DB-DL-8307		Push Rod	
04/03 →		Centre Rod	DB-DL-8702		Push Rod, Leaf Spring Axle	
04/03 →		Centre Rod	DB-DL-12300		for Steering Rod	
04/03 →		Stabiliser Mounting		DB-SB-10406		
04/03 →		Stabiliser Mounting		DB-SB-10409		
04/03 →		Stabiliser Mounting	DB-SB-10410			
04/03 →		Suspension Arm Repair Kit		DB-RK-8550	for Wishbone (CV)	
04/03 →		Suspension Arm Repair Kit		DB-RK-8626	for Wishbone (CV)	
04/03 →		Suspension Arm Repair Kit		DB-RK-10374	for Wishbone (CV)	
04/03 →		Suspension Arm Repair Kit		DB-RK-10375	for Wishbone (CV)	
04/03 →		Suspension Arm Repair Kit	DB-RK-8638		for Control Arm	
04/03 →		Suspension Strut Repair Kit		DB-RK-8391		
04/03 →		Suspension Strut Repair Kit		DB-RK-8710		
04/03 →		Suspension Strut Repair Kit		DB-RK-9291		
04/03 →		Suspension Strut Repair Kit		MN-RK-8997		
04/03 →		Tie Rod	DB-DL-8171		Guide Rod	
04/03 →		Tie Rod	DB-DL-8327		Guide Rod	
04/03 →		Tie Rod	DB-DL-8640		Guide Rod	
04/03 →		Tie Rod	DB-DL-12310			
04/03 →		Tie Rod	DB-ES-5227		Guide Rod	
04/03 →		Tie Rod End	CV-ES-0543		for Push Rod	
04/03 →		Tie Rod End	CV-ES-0888		for Push Rod	
04/03 →		Tie Rod End	CV-ES-14163		for Steering Rod	
04/03 →		Tie Rod End	DB-ES-5234		for Steering Rod	
04/03 →		Tie Rod End	DB-ES-8164		for Push Rod	
04/03 →		Tie Rod End	DB-ES-8530		for Push Rod	
04/03 →		Track Control Arm		DB-DL-3475	Trailing Arm	
04/03 →		Track Control Arm		DB-DL-3475	Trailing Arm, 1st RA;2nd RA, →517144 06/517144 09	
04/03 →		Track Control Arm		DB-VB-7261	Suspension Rod, Wishbone (CV), 1st RA;2nd RA; Leaf Spring Axle	
04/03 →		Track Control Arm		DB-VB-7798	Wishbone (CV)	
04/03 →		Track Control Arm		DB-VB-9307	Suspension Rod, Wishbone (CV), 1st RA;2nd RA; Leaf Spring Axle	
04/03 →		Track Control Arm		DB-VB-9308	Suspension Rod, Wishbone (CV), 1st RA;2nd RA; Leaf Spring Axle	
3350 S		06/09 →	Centre Rod	DB-DL-8167		Push Rod, Leaf Spring Axle
		06/09 →	Tie Rod	DB-DL-8640		Guide Rod
		06/09 →	Tie Rod	DB-DL-12310		
		06/09 →	Tie Rod	DB-ES-5227		Guide Rod
	06/09 →	Track Control Arm		DB-VB-3707	Suspension Rod, Wishbone (CV), Drive Axle; Air Suspension Axle	

CV-ES-0543

Length: 125
Cone Ø: d1 Ø 32 / d2 Ø 29
Thread: M30 x 1,5 RHT
0004605748, 0004606048, 0004606848,
0004607048, 0014600448, 0014601148,
0014601748, 0014602448, 0014607648,
0014609648



CV-ES-0888

Length: 125
Cone Ø: d1 Ø 32 / d2 Ø 29
Thread: M30 x 1,5 LHT
0004605848, 0004606148, 0004606948,
0004607148, 0004609048, 0014600548,
0014601348, 0014602548, 0014607948,
0024600448



CV-ES-14163

Length: 125
Cone Ø: d1 Ø 30 / d2 Ø 27
Thread: M30 x 1,5 RHT
0003305248, 0003387310, 0004600348,
0004600948, 0004602848, 0004602948,
0004608948, 0014600248, 0014600848,
0014601248, 0014602248, 0014607748,
0024600148, A0003387310, A0004600348,
A0004602848, A0004602948, A0014600848,
A0014601248, A0014602248, A0014607748



DB-DL-2144

Length: 872 Ø: 35
Cone Ø: d1 Ø 28,6 / d2 Ø 23,9
0024604305, 0024604405, 0034604805



DB-DL-3475

Length: 565 Ø: 52
Hole Distance: 152 / 152
3753500006, 3753500206, 9473500805,
9483500006, 9483500805, 9483501205,
9483501305, 9483501905, 9483502005,
9483502405, A3753500006, A3753500206



DB-DL-5230

Length: 879 Ø: 42
Cone Ø: d1 Ø 30 / d2 Ø 27
01208600A, 0004607105, 0004607205,
0014606705



DB-DL-5405

Length: 890 Ø: 35
Cone Ø: d1 Ø 28,6 / d2 Ø 23,9
01215900A, 1460248, 0024604505, 0024604605,
0034605005, 3752600637, 3754600405,
A3752600637, A3754600405



DB-DL-7270

Length: 875 Ø: 40
Cone Ø: d1 Ø 28,6 / d2 Ø 23,9
01208300A, 0024604705, 0024604805,
0034604905, A0024604705



DB-DL-8167

Length: 866 Ø: 38
Cone Ø: d1 Ø 30 / d2 Ø 27
0014609805, 0014609905, 0024606305,
0024606405



DB-DL-8171

Length: 1687 Ø: 52
Cone Ø: d1 Ø 32 / d2 Ø 29
9493300603, 9493300703, 9493301503,
9493301603



DB-DL-8184

Length: 1095 Ø: 42
Cone Ø: d1 Ø 32 / d2 Ø 28,8
01217700A, 0014601305, 0014601405,
0024600505, 0034603205, 3754601505,
A0014601305, A0014601405, A0024600505



DB-DL-8185

Length: 711 Ø: 42
Cone Ø: d1 Ø 32 / d2 Ø 28,8
01213600A, 0014601105, 0024600405,
0034603105, A0014601105, A0024600405



DB-DL-8307

Length: 885 Ø: 38
Cone Ø: d1 Ø 32 / d2 Ø 30
01215500A, 0004604005, 0024605105,
0024605205, 0034604005



DB-DL-8327

Length: 1745 Ø: 48
Cone Ø: d1 Ø 32 / d2 Ø 29
01219800A, 9413300003, 9413300103,
9413300203, 9413300303, 9413300503



DB-DL-8640

Length: 1615 Ø: 50
Cone Ø: d1 Ø 32 / d2 Ø 29
6253301503, 6253301603, 6253302403,
6253302503, 9423300803, 9423302103,
9493300203, 9493300303, 9493300903



DB-DL-8702

Length: 958 Ø: 38
Cone Ø: d1 Ø 32 / d2 Ø 30
0024606105, 0024606205, 0034604205



DB-DL-12300

Length: 733 Ø: 36
Cone Ø: d1 Ø 32 / d2 Ø 29
0014601505, 0014607305, 0034603305,
3754601605, A0014601505, A0034603305,
A3754601605



DB-DL-12310

Length: 1532 Ø: 50
Cone Ø: d1 Ø 32 / d2 Ø 29
Thread: M27 x 1,5 LHT
9493301203, 9493301303, 9493301803,
9493302203, A9493301203, A9493301303,
A9493301803, A9493302203



DB-ES-5227

Length: 1588 Ø: 60
Cone Ø: d1 Ø 38 / d2 Ø 34,3
6253300903, 6253301203, 9443300203



DB-ES-5234

Length: 135
Cone Ø: d1 Ø 38 / d2 Ø 34,3
Thread: M38 x 1,5 RHT
0004601748, 120322305, 2205000400



DB-ES-8164

Length: 140
Cone Ø: d1 Ø 28,6 / d2 Ø 23,9
Thread: M28 x 1,5 RHT
0014604248, 0014605048, 0014608548,
0024600548



DB-ES-8510

Length: 56
Cone Ø: d1 Ø 10 / d2 Ø 10
Thread: M12 x 1,75 LHT
0009965145, 0009965645, 0019963145



DB-ES-8530

Length: 115
Cone Ø: d1 Ø 28,6 / d2 Ø 23,9
Thread: M30 x 1,5 RHT
0014603848, 0014604848, 0014605148,
0014608648, 0014609948



DB-RK-8391

Ø: 85 Hole Distance: 152
Thick/Height: 24
01336800A, 0003502705



DB-RK-8550

Ø: 75 Hole Distance: 152
Thick/Height: 24
0003502105, 0003504605



DB-RK-8626

Ø: 75 Hole Distance: 130
Thick/Height: 24
0003502205, 0003502505, 0003503405,
0003504505, GL11319



DB-RK-8638

Length: 100 Ø: 67
Hole Distance: 100
Thick/Height: 20
0003301411



DB-RK-8710

Ø: 85 Hole Distance: 130
Thick/Height: 30
0003503705



DB-RK-9291

Ø: 107,5 Hole Distance: 152
Thick/Height: 30
0003503605



DB-RK-10374

Ø: 85 Hole Distance: 152
Thick/Height: 24
0003504405



DB-RK-10375

Ø: 100 Hole Distance: 152
Thick/Height: 24
0003502405, 0003503505, 0003504905



DB-SB-10384

Ø: 73 Thick/Height: 47
9303170012, 9423171812



DB-SB-10400

Length: 230
Thick/Height: 167,5 / 115
0003250696, 0003250896



DB-SB-10401

Length: 232
Thick/Height: 163,5 / 152,5
0003250596, 0003250796



DB-SB-10406

Ø: 80 Thick/Height: 46
0003238185



DB-SB-10409

Ø: 77 Thick/Height: 56
0003265181



DB-SB-10410

Ø: 73 Hole Distance: 100
Thick/Height: 24
9413230050



DB-VB-3707

Length: 622 Ø: 46
Hole Ø 25 / 25 / 25
Hole Distance: 152 / 130 / 130
01337100A, 9423501005, 9423501505,
9443500005, 9473500105, 9473501005,
A3753500005, A9423501005, A9423501505,
A9443500005, A9473500105, A9473501005



DB-VB-7261

Length: 622 Ø: 46
Hole Ø 25 / 25 / 25
Hole Distance: 152 / 130 / 130
01337800A, 9443500305, 9443500505,
9443500605, 9473500705, 9473500905,
9483500405, 9483500305



DB-VB-7798

Length: 622 Ø: 48
Hole Ø 25 / 23 / 23
Hole Distance: 152 / 130 / 130
9423500505, 9423500805, 9423501205,
A9423501205



DB-VB-9307

Length: 667 Ø: 60
Hole Ø 25 / 23 / 23
Hole Distance: 152 / 130 / 130
9483502805



DB-VB-9308

Length: 622 Ø: 46
Hole Ø 25 / 25 / 25
Hole Distance: 152 / 130 / 130
9483502905



MN-RK-8997

Ø: 85
Hole Distance: 130
Thick/Height: 30
0003504805, 3504805





ACTROS MP2 / MP3 ...

3350, 3351	04/03→	Ball Head, gearshift linkage	DB-ES-8510		
	04/03→	Bush, driver cab suspension	DB-SB-10384		
	04/03→	Bush, parabolic spring		DB-SB-10400	
	04/03→	Bush, parabolic spring		DB-SB-10401	
	04/03→	Centre Rod	DB-DL-2144		Push Rod
	04/03→	Centre Rod	DB-DL-5230		Suspension Rod
	04/03→	Centre Rod	DB-DL-5405		Push Rod, Leaf Spring Axle
	04/03→	Centre Rod	DB-DL-7270		Push Rod;Suspension Rod
	04/03→	Centre Rod	DB-DL-8167		Push Rod
	04/03→	Centre Rod	DB-DL-8168		Push Rod
	04/03→	Centre Rod	DB-DL-8184		Push Rod
	04/03→	Centre Rod	DB-DL-8185		Push Rod
	04/03→	Centre Rod	DB-DL-8307		Push Rod
	04/03→	Centre Rod	DB-DL-8622		Push Rod
	04/03→	Centre Rod	DB-DL-8641		Push Rod
	04/03→	Centre Rod	DB-DL-8642		Push Rod
	04/03→	Centre Rod	DB-DL-8702		Push Rod, Leaf Spring Axle
	04/03→	Centre Rod	DB-DL-12300		for Steering Rod
	04/03→	Stabiliser Link	DB-DL-9254		Pressure Rod
	04/03→	Stabiliser Mounting		DB-SB-10406	
	04/03→	Stabiliser Mounting		DB-SB-10409	
	04/03→	Stabiliser Mounting	DB-SB-10410		
	04/03→	Suspension Arm Repair Kit		DB-RK-8550	for Wishbone (CV)
	04/03→	Suspension Arm Repair Kit		DB-RK-8626	for Wishbone (CV)
	04/03→	Suspension Arm Repair Kit		DB-RK-10374	for Wishbone (CV)
	04/03→	Suspension Arm Repair Kit		DB-RK-10375	for Wishbone (CV)
	04/03→	Suspension Arm Repair Kit	DB-RK-8638		for Control Arm
	04/03→	Suspension Strut Repair Kit		DB-RK-8391	
	04/03→	Suspension Strut Repair Kit		DB-RK-8710	
	04/03→	Suspension Strut Repair Kit		DB-RK-9291	
	04/03→	Tie Rod	DB-DL-8171		Guide Rod, 1st FA;Leaf Spring Axle
	04/03→	Tie Rod	DB-DL-8327		Guide Rod, 1st FA;Leaf Spring Axle
	04/03→	Tie Rod	DB-DL-8640		Guide Rod
	04/03→	Tie Rod	DB-DL-12310		
	04/03→	Tie Rod	DB-ES-5227		Guide Rod
	04/03→	Tie Rod End	CV-ES-0543		for Push Rod
	04/03→	Tie Rod End	CV-ES-0888		for Push Rod
	04/03→	Tie Rod End	CV-ES-14163		for Steering Rod
	04/03→	Tie Rod End	DB-ES-5234		for Steering Rod
	04/03→	Tie Rod End	DB-ES-8164		for Push Rod
04/03→	Tie Rod End	DB-ES-8530		for Push Rod	
04/03→	Track Control Arm		DB-DL-3475	Trailing Arm	
04/03→	Track Control Arm		DB-VB-7261	Suspension Rod, Wishbone (CV), 1st RA;2nd RA; Leaf Spring Axle	
04/03→	Track Control Arm		DB-VB-9307	Suspension Rod, Wishbone (CV), 1st RA;2nd RA; Leaf Spring Axle	
04/03→	Track Control Arm		DB-VB-9308	Suspension Rod, Wishbone (CV), 1st RA;2nd RA; Leaf Spring Axle	
3351 A	06/08→	Bush, parabolic spring		DB-SB-10401	
	06/08→	Centre Rod	DB-DL-8307		Push Rod, Leaf Spring Axle
	06/08→	Centre Rod	DB-DL-8702		Push Rod
	06/08→	Suspension Strut Repair Kit		DB-RK-8710	
	06/08→	Suspension Strut Repair Kit		DB-RK-9291	
	06/08→	Tie Rod	DB-DL-12310		
	06/08→	Tie Rod	DB-ES-5227		Guide Rod
	06/08→	Tie Rod	MN-DL-7834		Guide Rod
	06/08→	Tie Rod End	CV-ES-0543		for Push Rod
	06/08→	Tie Rod End	CV-ES-14163		for Steering Rod
	06/08→	Tie Rod End	DB-ES-5234		for Steering Rod
	06/08→	Track Control Arm		DB-DL-3475	Trailing Arm, 1st RA;2nd RA, →517144 03/517144 06
	06/08→	Track Control Arm		DB-DL-3475	Trailing Arm, 1st RA;2nd RA, →517144 05/517144 08

CV-ES-0543

Length: 125
Cone Ø: d1 Ø 32 / d2 Ø 29
Thread: M30 x 1,5 RHT
0004605748, 0004606048, 0004606848,
0004607048, 0014600448, 0014601148,
0014601748, 0014602448, 0014607648,
0014609648



CV-ES-0888

Length: 125
Cone Ø: d1 Ø 32 / d2 Ø 29
Thread: M30 x 1,5 LHT
0004605848, 0004606148, 0004606948,
0004607148, 0004609048, 0014600548,
0014601348, 0014602548, 0014607948,
0024600448



CV-ES-14163

Length: 125
Cone Ø: d1 Ø 30 / d2 Ø 27
Thread: M30 x 1,5 RHT
0003305248, 0003387310, 0004600348,
0004600948, 0004602848, 0004602948,
0004608948, 0014600248, 0014600848,
0014601248, 0014602248, 0014607748,
0024600148, A0003387310, A0004600348,
A0004602848, A0004602948, A0014600848,
A0014601248, A0014602248, A0014607748



DB-DL-2144

Length: 872 Ø: 35
Cone Ø: d1 Ø 28,6 / d2 Ø 23,9
0024604305, 0024604405, 0034604805



DB-DL-3475

Length: 565 Ø: 52
Hole Distance: 152 / 152
3753500006, 3753500206, 9473500805,
9483500006, 9483500805, 9483501205,
9483501305, 9483501905, 9483502005,
9483502405, A3753500006,
A3753500206



DB-DL-5230

Length: 879 Ø: 42
Cone Ø: d1 Ø 30 / d2 Ø 27
01208600A, 0004607105, 0004607205,
0014606705



DB-DL-5405

Length: 890 Ø: 35
Cone Ø: d1 Ø 28,6 / d2 Ø 23,9
01215900A, 1460248, 0024604505,
0024604605, 0034605005, 3752600637,
3754600405, A3752600637, A3754600405



DB-DL-7270

Length: 875 Ø: 40
Cone Ø: d1 Ø 28,6 / d2 Ø 23,9
01208300A, 0024604705, 0024604805,
0034604905, A0024604705



DB-DL-8167

Length: 866 Ø: 38
Cone Ø: d1 Ø 30 / d2 Ø 27
0014609805, 0014609905, 0024606305,
0024606405



DB-DL-8168

Length: 904 Ø: 52
Cone Ø: d1 Ø 32 / d2 Ø 29
0004609405, 0004609505, 0014607105



DB-DL-8171

Length: 1687 Ø: 52
Cone Ø: d1 Ø 32 / d2 Ø 29
9493300603, 9493300703, 9493301503,
9493301603



DB-DL-8184

Length: 1095 Ø: 42
Cone Ø: d1 Ø 32 / d2 Ø 28,8
01217700A, 0014601305, 0014601405,
0024600505, 0034603205, 3754601505,
A0014601305, A0014601405, A0024600505



DB-DL-8185

Length: 711 Ø: 42
Cone Ø: d1 Ø 32 / d2 Ø 28,8
01213600A, 0014601105, 0024600405,
0034603105, A0014601105, A0024600405



DB-DL-8307

Length: 885 Ø: 38
Cone Ø: d1 Ø 32 / d2 Ø 30
01215500A, 0004604005, 0024605105,
0024605205, 0034604005



DB-DL-8327

Length: 1745 Ø: 48
Cone Ø: d1 Ø 32 / d2 Ø 29
01219800A, 9413300003, 9413300103,
9413300203, 9413300303, 9413300503



DB-DL-8622

Length: 1558 Ø: 52
Cone Ø: d1 Ø 30 / d2 Ø 27
0014609005, 0014609105



DB-DL-8640

Length: 1615 Ø: 50
Cone Ø: d1 Ø 32 / d2 Ø 29
6253301503, 6253301603, 6253302403,
6253302503, 9423300803, 9423302103,
9493300203, 9493300303, 9493300903



DB-DL-8641

Length: 905 Ø: 42
Cone Ø: d1 Ø 30 / d2 Ø 27
0014605105, 0014608105



DB-DL-8642

Length: 954 Ø: 42
Cone Ø: d1 Ø 30 / d2 Ø 27
0014608605, 0014608705

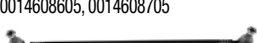

DB-DL-8702

Length: 958 Ø: 38
Cone Ø: d1 Ø 32 / d2 Ø 30
0024606105, 0024606205, 0034604205

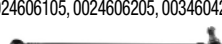

DB-DL-9254

Length: 1815 Ø: 58
0003220323, 0003220623, 3753220423



DB-DL-12300

Length: 733 Ø: 36
Cone Ø: d1 Ø 32 / d2 Ø 29
0014601505, 0014607305, 0034603305,
3754601605, A0014601505,
A0034603305, A3754601605



DB-DL-12310

Length: 1532 Ø: 50
Cone Ø: d1 Ø 32 / d2 Ø 29
Thread: M27 x 1,5 LHT
9493301203, 9493301303, 9493301803,
9493302203, A9493301203, A9493301303,
A9493301803, A9493302203



DB-ES-5227

Length: 1588 Ø: 60
Cone Ø: d1 Ø 38 / d2 Ø 34,3
6253300903, 6253301203, 9443300203



DB-ES-5234

Length: 135
Cone Ø: d1 Ø 38 / d2 Ø 34,3
Thread: M38 x 1,5 RHT
0004601748, 120322305, 2205000400



DB-ES-8164

Length: 140
Cone Ø: d1 Ø 28,6 / d2 Ø 23,9
Thread: M28 x 1,5 RHT
0014604248, 0014605048, 0014608548,
0024600548



DB-ES-8510

Length: 56
Cone Ø: d1 Ø 10 / d2 Ø 10
Thread: M12 x 1,75 LHT
0009965145, 0009965645, 0019963145



DB-ES-8530

Length: 115
Cone Ø: d1 Ø 28,6 / d2 Ø 23,9
Thread: M30 x 1,5 RHT
0014603848, 0014604848, 0014605148,
0014608648, 0014609948



DB-RK-8391

Ø: 85 Hole Distance: 152
Thick/Height: 24
01336800A, 0003502705



DB-RK-8550

Ø: 75 Hole Distance: 152
Thick/Height: 24
0003502105, 0003504605



DB-RK-8626

Ø: 75 Hole Distance: 130
Thick/Height: 24
0003502205, 0003502505, 0003503405,
0003504505, GL11319



DB-RK-8638

Length: 100 Ø: 67
Hole Distance: 100
Thick/Height: 20
0003301411



DB-RK-8710

Ø: 85 Hole Distance: 130
Thick/Height: 30
0003503705



DB-RK-9291

Ø: 107,5 Hole Distance: 152
Thick/Height: 30
0003503605



DB-RK-10374

Ø: 85 Hole Distance: 152
Thick/Height: 24
0003504405



DB-RK-10375

Ø: 100 Hole Distance: 152
Thick/Height: 24
0003502405, 0003503505, 0003504905



DB-SB-10384

Ø: 73 Thick/Height: 47
9303170012, 9423171812



DB-SB-10400

Length: 230
Thick/Height: 167,5 / 115
0003250696, 0003250896



DB-SB-10401

Length: 232
Thick/Height: 163,5 / 152,5
0003250596, 0003250796



DB-SB-10406

Ø: 80 Thick/Height: 46
0003238185



DB-SB-10409

Ø: 77 Thick/Height: 56
0003265181



DB-SB-10410

Ø: 73 Hole Distance: 100
Thick/Height: 24
9413230050



DB-VB-7261

Length: 622 Ø: 46
Hole Ø 25 / 25 / 25
Hole Distance: 152 / 130 / 130
01337800A, 9443500305, 9443500505,
9443500605, 9473500705, 9473500905,
9483500405, 9483503005



DB-VB-9307

Length: 667 Ø: 60
Hole Ø 25 / 23 / 23
Hole Distance: 152 / 130 / 130
9483502805



DB-VB-9308

Length: 622 Ø: 46
Hole Ø 25 / 25 / 25
Hole Distance: 152 / 130 / 130
9483502905



MN-DL-7834

Length: 1588 Ø: 58
Cone Ø: d1 Ø 30 / d2 Ø 27
3463303903, 3463304903, 6253303203,
9443300503, 9443301303, 9443301703





ACTROS MP2 / MP3 ...

3351 A ...	06/08 →	Track Control Arm		DB-DL-3475	Trailing Arm, 1st RA;2nd RA, →517144 07/517144 09	
	06/08 →	Track Control Arm		DB-DL-3475	Trailing Arm, 1st RA;2nd RA, →517144 26/517144 27	
	06/08 →	Track Control Arm		DB-VB-7261	Suspension Rod, Wishbone (CV)	
	06/08 →	Track Control Arm		DB-VB-9307	Suspension Rod, Wishbone (CV)	
	06/08 →	Track Control Arm		DB-VB-9308	Suspension Rod, Wishbone (CV)	
3351 AK	04/03 →	Ball Head, gearshift linkage	DB-ES-8510			
	04/03 →	Bush, driver cab suspension	DB-SB-10384			
	04/03 →	Bush, parabolic spring		DB-SB-10401		
	04/03 →	Centre Rod	DB-DL-8184		Push Rod	
	04/03 →	Centre Rod	DB-DL-8307		Push Rod, Leaf Spring Axle	
	04/03 →	Centre Rod	DB-DL-8702		Push Rod, Leaf Spring Axle	
	04/03 →	Centre Rod	DB-DL-12300		for Steering Rod	
	04/03 →	Stabiliser Mounting		DB-SB-10406		
	04/03 →	Stabiliser Mounting		DB-SB-10409		
	04/03 →	Suspension Arm Repair Kit		DB-RK-8626	for Wishbone (CV)	
	04/03 →	Suspension Arm Repair Kit		DB-RK-10374	for Wishbone (CV)	
	04/03 →	Suspension Arm Repair Kit		DB-RK-10375	for Wishbone (CV)	
	04/03 →	Suspension Arm Repair Kit	DB-RK-8638		for Control Arm	
	04/03 →	Suspension Strut Repair Kit		DB-RK-8391		
	04/03 →	Suspension Strut Repair Kit		DB-RK-8710		
	04/03 →	Suspension Strut Repair Kit		DB-RK-9291		
	04/03 →	Tie Rod	DB-DL-12310			
	04/03 →	Tie Rod	DB-ES-5227		Guide Rod	
	04/03 →	Tie Rod	MN-DL-7834		Guide Rod	
	04/03 →	Tie Rod End	CV-ES-0543		for Push Rod	
	04/03 →	Tie Rod End	CV-ES-14163		for Steering Rod	
	04/03 →	Tie Rod End	DB-ES-5234		for Steering Rod	
	04/03 →	Tie Rod End	DB-ES-8530		for Push Rod	
	04/03 →	Track Control Arm		DB-DL-3475	Trailing Arm	
	04/03 →	Track Control Arm		DB-VB-7261	Suspension Rod, Wishbone (CV), 1st RA;2nd RA; Leaf Spring Axle	
	04/03 →	Track Control Arm		DB-VB-9307	Suspension Rod, Wishbone (CV), 1st RA;2nd RA; Leaf Spring Axle	
	04/03 →	Track Control Arm		DB-VB-9308	Suspension Rod, Wishbone (CV), 1st RA;2nd RA; Leaf Spring Axle	
	3351 AS	04/03 →	Ball Head, gearshift linkage	DB-ES-8510		
		04/03 →	Bush, driver cab suspension	DB-SB-10384		
		04/03 →	Bush, parabolic spring		DB-SB-10401	
04/03 →		Centre Rod	DB-DL-8307		Push Rod	
04/03 →		Centre Rod	DB-DL-8702		Push Rod, Leaf Spring Axle	
04/03 →		Centre Rod	DB-DL-12300		for Steering Rod	
04/03 →		Stabiliser Mounting		DB-SB-10406		
04/03 →		Stabiliser Mounting		DB-SB-10409		
04/03 →		Stabiliser Mounting	DB-SB-10410			
04/03 →		Suspension Arm Repair Kit		DB-RK-8626	for Wishbone (CV)	
04/03 →		Suspension Arm Repair Kit		DB-RK-10374	for Wishbone (CV)	
04/03 →		Suspension Arm Repair Kit		DB-RK-10375	for Wishbone (CV)	
04/03 →		Suspension Arm Repair Kit	DB-RK-8638		for Control Arm	
04/03 →		Suspension Strut Repair Kit		DB-RK-8391		
04/03 →		Suspension Strut Repair Kit		DB-RK-8710		
04/03 →		Suspension Strut Repair Kit		DB-RK-9291		
04/03 →		Suspension Strut Repair Kit		MN-RK-8997		
04/03 →		Tie Rod	DB-DL-12310			
04/03 →		Tie Rod	DB-ES-5227		Guide Rod	
04/03 →		Tie Rod	MN-DL-7834		Guide Rod	
04/03 →		Tie Rod End	CV-ES-0543		for Push Rod	
04/03 →		Tie Rod End	CV-ES-14163		for Steering Rod	
04/03 →		Tie Rod End	DB-ES-5234		for Steering Rod	
04/03 →		Tie Rod End	DB-ES-8530		for Push Rod	
04/03 →		Track Control Arm		DB-DL-3475	Trailing Arm	

CV-ES-0543

Length: 125
 Cone Ø: d1 Ø 32 / d2 Ø 29
 Thread: M30 x 1,5 RHT
 0004605748, 0004606048, 0004606848,
 0004607048, 0014600448, 0014601148,
 0014601748, 0014602448, 0014607648,
 0014609648



CV-ES-14163

Length: 125
 Cone Ø: d1 Ø 30 / d2 Ø 27
 Thread: M30 x 1,5 RHT
 0003305248, 0003387310, 0004600348,
 0004600948, 0004602848, 0004602948,
 0004608948, 0014600248, 0014600848,
 0014601248, 0014602248, 0014607748,
 0024600148, A0003387310, A0004600348,
 A0004602848, A0004602948, A0014600848,
 A0014601248, A0014602248, A0014607748



DB-DL-3475

Length: 565 Ø: 52
 Hole Distance: 152 / 152
 3753500006, 3753500206, 9473500805,
 9483500006, 9483500805, 9483501205,
 9483501305, 9483501905, 9483502005,
 9483502405, A3753500006, A3753500206



DB-DL-8184

Length: 1095 Ø: 42
 Cone Ø: d1 Ø 32 / d2 Ø 28,8
 01217700A, 0014601305, 0014601405,
 0024600505, 0034603205, 3754601505,
 A0014601305, A0014601405, A0024600505



DB-DL-8307

Length: 885 Ø: 38
 Cone Ø: d1 Ø 32 / d2 Ø 30
 01215500A, 0004604005, 0024605105,
 0024605205, 0034604005



DB-DL-8702

Length: 958 Ø: 38
 Cone Ø: d1 Ø 32 / d2 Ø 30
 0024606105, 0024606205, 0034604205



DB-DL-12300

Length: 733 Ø: 36
 Cone Ø: d1 Ø 32 / d2 Ø 29
 0014601505, 0014607305, 0034603305,
 3754601605, A0014601505, A0034603305,
 A3754601605



DB-DL-12310

Length: 1532 Ø: 50
 Cone Ø: d1 Ø 32 / d2 Ø 29
 Thread: M27 x 1,5 LHT
 9493301203, 9493301303, 9493301803,
 9493302203, A9493301203, A9493301303,
 A9493301803, A9493302203



DB-ES-5227

Length: 1588 Ø: 60
 Cone Ø: d1 Ø 38 / d2 Ø 34,3
 6253300903, 6253301203, 9443300203



DB-ES-5234

Length: 135
 Cone Ø: d1 Ø 38 / d2 Ø 34,3
 Thread: M38 x 1,5 RHT
 0004601748, 120322305, 2205000400



DB-ES-8510

Length: 56
 Cone Ø: d1 Ø 10 / d2 Ø 10
 Thread: M12 x 1,75 LHT
 0009965145, 0009965645, 0019963145



DB-ES-8530

Length: 115
 Cone Ø: d1 Ø 28,6 / d2 Ø 23,9
 Thread: M30 x 1,5 RHT
 0014603848, 0014604848, 0014605148,
 0014608648, 0014609948



DB-RK-8391

Ø: 85 Hole Distance: 152
 Thick/Height: 24
 01336800A, 0003502705



DB-RK-8626

Ø: 75 Hole Distance: 130
 Thick/Height: 24
 0003502205, 0003502505, 0003503405,
 0003504505, GL11319



DB-RK-8638

Length: 100 Ø: 67
 Hole Distance: 100
 Thick/Height: 20
 0003301411



DB-RK-8710

Ø: 85 Hole Distance: 130
 Thick/Height: 30
 0003503705



DB-RK-9291

Ø: 107,5 Hole Distance: 152
 Thick/Height: 30
 0003503605



DB-RK-10374

Ø: 85 Hole Distance: 152
 Thick/Height: 24
 0003504405



DB-RK-10375

Ø: 100 Hole Distance: 152
 Thick/Height: 24
 0003502405, 0003503505, 0003504905



DB-SB-10384

Ø: 73 Thick/Height: 47
 9303170012, 9423171812



DB-SB-10401

Length: 232
 Thick/Height: 163,5 / 152,5
 0003250596, 0003250796



DB-SB-10406

Ø: 80 Thick/Height: 46
 0003238185



DB-SB-10409

Ø: 77 Thick/Height: 56
 0003265181



DB-SB-10410

Ø: 73 Hole Distance: 100
 Thick/Height: 24
 9413230050



DB-VB-7261

Length: 622 Ø: 46
 Hole Ø 25 / 25 / 25
 Hole Distance: 152 / 130 / 130
 01337800A, 9443500305, 9443500505,
 9443500605, 9473500705, 9473500905,
 9483500405, 9483503005



DB-VB-9307

Length: 667 Ø: 60
 Hole Ø 25 / 23 / 23
 Hole Distance: 152 / 130 / 130
 9483502805



DB-VB-9308

Length: 622 Ø: 46
 Hole Ø 25 / 25 / 25
 Hole Distance: 152 / 130 / 130
 9483502905



MN-DL-7834

Length: 1588 Ø: 58
 Cone Ø: d1 Ø 30 / d2 Ø 27
 3463303903, 3463304903, 6253303203,
 9443300503, 9443301303, 9443301703



MN-RK-8997

Ø: 85 Hole Distance: 130
 Thick/Height: 30
 0003504805





ACTROS MP2 / MP3 ...

3351 AS ...	04/03 →	Track Control Arm		DB-VB-7261	Suspension Rod, Wishbone (CV), 1st RA;2nd RA; Leaf Spring Axle	
	04/03 →	Track Control Arm		DB-VB-7798	Wishbone (CV)	
	04/03 →	Track Control Arm		DB-VB-9307	Suspension Rod, Wishbone (CV), 1st RA;2nd RA; Leaf Spring Axle	
	04/03 →	Track Control Arm		DB-VB-9308	Suspension Rod, Wishbone (CV), 1st RA;2nd RA; Leaf Spring Axle	
3351 K	04/03 →	Centre Rod	DB-DL-2144		Push Rod	
	04/03 →	Centre Rod	DB-DL-5405		Push Rod, Leaf Spring Axle	
	04/03 →	Centre Rod	DB-DL-7270		Push Rod	
	04/03 →	Centre Rod	DB-DL-8167		Push Rod	
	04/03 →	Centre Rod	DB-DL-8307		Push Rod	
	04/03 →	Centre Rod	DB-DL-8702		Push Rod, Leaf Spring Axle	
	04/03 →	Stabiliser Mounting		DB-SB-10406		
	04/03 →	Suspension Strut Repair Kit		DB-RK-8710		
	04/03 →	Suspension Strut Repair Kit		DB-RK-9291		
	04/03 →	Tie Rod	DB-DL-8171		Guide Rod	
	04/03 →	Tie Rod	DB-DL-8327		Guide Rod	
	04/03 →	Tie Rod	DB-DL-8640		Guide Rod	
	04/03 →	Tie Rod	DB-DL-12310			
	04/03 →	Tie Rod	DB-ES-5227		Guide Rod	
	04/03 →	Tie Rod End	CV-ES-0543		for Push Rod	
	04/03 →	Tie Rod End	CV-ES-0888		for Push Rod	
	04/03 →	Tie Rod End	CV-ES-14163		for Steering Rod	
	04/03 →	Tie Rod End	DB-ES-8164		for Push Rod	
	04/03 →	Tie Rod End	DB-ES-8530		for Push Rod	
	04/03 →	Track Control Arm		DB-DL-3475	Trailing Arm, 1st RA;2nd RA, →517144 03/517144 07	
	04/03 →	Track Control Arm		DB-DL-3475	Trailing Arm, 1st RA;2nd RA, →517144 06/517144 09	
	04/03 →	Track Control Arm		DB-VB-7261	Suspension Rod, Wishbone (CV), 1st RA;2nd RA; Leaf Spring Axle	
	04/03 →	Track Control Arm		DB-VB-9307	Suspension Rod, Wishbone (CV), 1st RA;2nd RA; Leaf Spring Axle	
	04/03 →	Track Control Arm		DB-VB-9308	Suspension Rod, Wishbone (CV), 1st RA;2nd RA; Leaf Spring Axle	
	3351 S	04/03 →	Ball Head, gearshift linkage	DB-ES-8510		
		04/03 →	Bush, driver cab suspension	DB-SB-10384		
04/03 →		Bush, parabolic spring		DB-SB-10400		
04/03 →		Bush, parabolic spring		DB-SB-10401		
04/03 →		Centre Rod	DB-DL-2144		Push Rod	
04/03 →		Centre Rod	DB-DL-5230		Suspension Rod	
04/03 →		Centre Rod	DB-DL-5405		Push Rod, Leaf Spring Axle	
04/03 →		Centre Rod	DB-DL-7270		Push Rod;Suspension Rod	
04/03 →		Centre Rod	DB-DL-8167		Push Rod	
04/03 →		Centre Rod	DB-DL-8184		Push Rod	
04/03 →		Centre Rod	DB-DL-8185		Push Rod	
04/03 →		Centre Rod	DB-DL-8307		Push Rod	
04/03 →		Centre Rod	DB-DL-8702		Push Rod, Leaf Spring Axle	
04/03 →		Centre Rod	DB-DL-12300		for Steering Rod	
04/03 →		Stabiliser Mounting		DB-SB-10406		
04/03 →		Stabiliser Mounting		DB-SB-10409		
04/03 →		Stabiliser Mounting	DB-SB-10410			
04/03 →		Suspension Arm Repair Kit		DB-RK-8550	for Wishbone (CV)	
04/03 →		Suspension Arm Repair Kit		DB-RK-8626	for Wishbone (CV)	
04/03 →		Suspension Arm Repair Kit		DB-RK-10374	for Wishbone (CV)	
04/03 →		Suspension Arm Repair Kit		DB-RK-10375	for Wishbone (CV)	
04/03 →		Suspension Arm Repair Kit	DB-RK-8638		for Control Arm	
04/03 →		Suspension Strut Repair Kit		DB-RK-8391		
04/03 →		Suspension Strut Repair Kit		DB-RK-8710		
04/03 →		Suspension Strut Repair Kit		DB-RK-9291		
04/03 →		Suspension Strut Repair Kit		MN-RK-8997		
04/03 →		Tie Rod	DB-DL-8171		Guide Rod	

CV-ES-0543

Length: 125
 Cone Ø: d1 Ø 32 / d2 Ø 29
 Thread: M30 x 1,5 RHT
 0004605748, 0004606048, 0004606848,
 0004607048, 0014600448, 0014601148,
 0014601748, 0014602448, 0014607648,
 0014609648



CV-ES-0888

Length: 125
 Cone Ø: d1 Ø 32 / d2 Ø 29
 Thread: M30 x 1,5 LHT
 0004605848, 0004606148, 0004606948,
 0004607148, 0004609048, 0014600548,
 0014601348, 0014602548, 0014607948,
 0024600448



CV-ES-14163

Length: 125
 Cone Ø: d1 Ø 30 / d2 Ø 27
 Thread: M30 x 1,5 RHT
 0003305248, 0003387310, 0004600348,
 0004600948, 0004602848, 0004602948,
 0004608948, 0014600248, 0014600848,
 0014601248, 0014602248, 0014607748,
 0024600148, A0003387310, A0004600348,
 A0004602848, A0004602948, A0014600848,
 A0014601248, A0014602248, A0014607748



DB-DL-2144

Length: 872 Ø: 35
 Cone Ø: d1 Ø 28,6 / d2 Ø 23,9
 0024604305, 0024604405, 0034604805



DB-DL-3475

Length: 565 Ø: 52
 Hole Distance: 152 / 152
 3753500006, 3753500206, 9473500805,
 9483500006, 9483500805, 9483501205,
 9483501305, 9483501905, 9483502005,
 9483502405, A3753500006, A3753500206



DB-DL-5230

Length: 879 Ø: 42
 Cone Ø: d1 Ø 30 / d2 Ø 27
 01208600A, 0004607105, 0004607205,
 0014606705



DB-DL-5405

Length: 890 Ø: 35
 Cone Ø: d1 Ø 28,6 / d2 Ø 23,9
 01215900A, 1460248, 0024604505, 0024604605,
 0034605005, 3752600637, 3754600405,
 A3752600637, A3754600405



DB-DL-7270

Length: 875 Ø: 40
 Cone Ø: d1 Ø 28,6 / d2 Ø 23,9
 01208300A, 0024604705, 0024604805,
 0034604905, A0024604705



DB-DL-8167

Length: 866 Ø: 38
 Cone Ø: d1 Ø 30 / d2 Ø 27
 0014609805, 0014609905, 0024606305,
 0024606405



DB-DL-8171

Length: 1687 Ø: 52
 Cone Ø: d1 Ø 32 / d2 Ø 29
 9493300603, 9493300703, 9493301503,
 9493301603



DB-DL-8184

Length: 1095 Ø: 42
 Cone Ø: d1 Ø 32 / d2 Ø 28,8
 01217700A, 0014601305, 0014601405,
 0024600505, 0034603205, 3754601505,
 A0014601305, A0014601405, A0024600505



DB-DL-8185

Length: 711 Ø: 42
 Cone Ø: d1 Ø 32 / d2 Ø 28,8
 01213600A, 0014601105, 0024600405,
 0034603105, A0014601105, A0024600405



DB-DL-8307

Length: 885 Ø: 38
 Cone Ø: d1 Ø 32 / d2 Ø 30
 01215500A, 0004604005, 0024605105,
 0024605205, 0034604005



DB-DL-8327

Length: 1745 Ø: 48
 Cone Ø: d1 Ø 32 / d2 Ø 29
 01219800A, 9413300003, 9413300103,
 9413300203, 9413300303, 9413300503



DB-DL-8640

Length: 1615 Ø: 50
 Cone Ø: d1 Ø 32 / d2 Ø 29
 6253301503, 6253301603, 6253302403,
 6253302503, 9423300803, 9423302103,
 9493300203, 9493300303, 9493300903



DB-DL-8702

Length: 958 Ø: 38
 Cone Ø: d1 Ø 32 / d2 Ø 30
 0024606105, 0024606205, 0034604205



DB-DL-12300

Length: 733 Ø: 36
 Cone Ø: d1 Ø 32 / d2 Ø 29
 0014601505, 0014607305, 0034603305,
 3754601605, A0014601505, A0034603305,
 A3754601605



DB-DL-12310

Length: 1532 Ø: 50
 Cone Ø: d1 Ø 32 / d2 Ø 29
 Thread: M27 x 1,5 LHT
 9493301203, 9493301303, 9493301803,
 9493302203, A9493301203, A9493301303,
 A9493301803, A9493302203



DB-ES-5227

Length: 1588 Ø: 60
 Cone Ø: d1 Ø 38 / d2 Ø 34,3
 6253300903, 6253301203, 9443300203



DB-ES-8164

Length: 140
 Cone Ø: d1 Ø 28,6 / d2 Ø 23,9
 Thread: M28 x 1,5 RHT
 0014604248, 0014605048, 0014608548,
 0024600548



DB-ES-8510

Length: 56
 Cone Ø: d1 Ø 10 / d2 Ø 10
 Thread: M12 x 1,75 LHT
 0009965145, 0009965645, 0019963145



DB-ES-8530

Length: 115
 Cone Ø: d1 Ø 28,6 / d2 Ø 23,9
 Thread: M30 x 1,5 RHT
 0014603848, 0014604848, 0014605148,
 0014608648, 0014609948



DB-RK-8391

Ø: 85 Hole Distance: 152
 Thick/Height: 24
 01336800A, 0003502705



DB-RK-8550

Ø: 75 Hole Distance: 152
 Thick/Height: 24
 0003502105, 0003504605



DB-RK-8626

Ø: 75 Hole Distance: 130
 Thick/Height: 24
 0003502205, 0003502505, 0003503405,
 0003504505, GL11319



DB-RK-8638

Length: 100 Ø: 67
 Hole Distance: 100
 Thick/Height: 20
 0003301411



DB-RK-8710

Ø: 85 Hole Distance: 130
 Thick/Height: 30
 0003503705



DB-RK-9291

Ø: 107,5 Hole Distance: 152
 Thick/Height: 30
 0003503605



DB-RK-10374

Ø: 85 Hole Distance: 152
 Thick/Height: 24
 0003504405



DB-RK-10375

Ø: 100 Hole Distance: 152
 Thick/Height: 24
 0003502405, 0003503505, 0003504905



DB-SB-10384

Ø: 73 Thick/Height: 47
 9303170012, 9423171812



DB-SB-10400

Length: 230
 Thick/Height: 167,5 / 115
 0003250696, 0003250896



DB-SB-10401

Length: 232
 Thick/Height: 163,5 / 152,5
 0003250596, 0003250796



DB-SB-10406

Ø: 80 Thick/Height: 46
 0003238185



DB-SB-10409

Ø: 77 Thick/Height: 56
 0003265181



DB-SB-10410

Ø: 73 Hole Distance: 100
 Thick/Height: 24
 9413230050



DB-VB-7261

Length: 622 Ø: 46
 Hole Ø 25 / 25 / 25
 Hole Distance: 152 / 130 / 130
 01337800A, 9443500305, 9443500505,
 9443500605, 9473500705, 9473500905,
 9483500405, 9483503005



DB-VB-7798

Length: 622 Ø: 48
 Hole Ø 25 / 23 / 23
 Hole Distance: 152 / 130 / 130
 9423500505, 9423500805, 9423501205,
 A9423501205



DB-VB-9307

Length: 667 Ø: 60
 Hole Ø 25 / 23 / 23
 Hole Distance: 152 / 130 / 130
 9483502805



DB-VB-9308

Length: 622 Ø: 46
 Hole Ø 25 / 25 / 25
 Hole Distance: 152 / 130 / 130
 9483502905



MN-RK-8997

Ø: 85 Hole Distance: 130
 Thick/Height: 30
 0003504805





ACTROS MP2 / MP3 ...

3351 S ...	04/03→	Tie Rod	DB-DL-8327		Guide Rod
	04/03→	Tie Rod	DB-DL-8640		Guide Rod
	04/03→	Tie Rod	DB-DL-12310		
	04/03→	Tie Rod	DB-ES-5227		Guide Rod
	04/03→	Tie Rod End	CV-ES-0543		for Push Rod
	04/03→	Tie Rod End	CV-ES-0888		for Push Rod
	04/03→	Tie Rod End	CV-ES-14163		for Steering Rod
	04/03→	Tie Rod End	DB-ES-5234		for Steering Rod
	04/03→	Tie Rod End	DB-ES-8164		for Push Rod
	04/03→	Tie Rod End	DB-ES-8530		for Push Rod
	04/03→	Track Control Arm		DB-DL-3475	Trailing Arm
	04/03→	Track Control Arm		DB-VB-7261	Suspension Rod, Wishbone (CV), 1st RA;2nd RA; Leaf Spring Axle
	04/03→	Track Control Arm		DB-VB-7798	Wishbone (CV)
	04/03→	Track Control Arm		DB-VB-9307	Suspension Rod, Wishbone (CV), 1st RA;2nd RA; Leaf Spring Axle
	04/03→	Track Control Arm		DB-VB-9308	Suspension Rod, Wishbone (CV), 1st RA;2nd RA; Leaf Spring Axle
3354, 3355	04/03→	Ball Head, gearshift linkage	DB-ES-8510		
	04/03→	Bush, driver cab suspension	DB-SB-10384		
	04/03→	Bush, parabolic spring		DB-SB-10400	
	04/03→	Bush, parabolic spring		DB-SB-10401	
	04/03→	Centre Rod	DB-DL-2144		Push Rod
	04/03→	Centre Rod	DB-DL-5230		Suspension Rod
	04/03→	Centre Rod	DB-DL-5405		Push Rod, Leaf Spring Axle
	04/03→	Centre Rod	DB-DL-7270		Push Rod;Suspension Rod
	04/03→	Centre Rod	DB-DL-8167		Push Rod
	04/03→	Centre Rod	DB-DL-8168		Push Rod
	04/03→	Centre Rod	DB-DL-8184		Push Rod
	04/03→	Centre Rod	DB-DL-8185		Push Rod
	04/03→	Centre Rod	DB-DL-8307		Push Rod
	04/03→	Centre Rod	DB-DL-8622		Push Rod
	04/03→	Centre Rod	DB-DL-8641		Push Rod
	04/03→	Centre Rod	DB-DL-8642		Push Rod
	04/03→	Centre Rod	DB-DL-8702		Push Rod, Leaf Spring Axle
	04/03→	Centre Rod	DB-DL-12300		for Steering Rod
	04/03→	Stabiliser Link	DB-DL-9254		Pressure Rod
	04/03→	Stabiliser Mounting		DB-SB-10406	
	04/03→	Stabiliser Mounting		DB-SB-10409	
	04/03→	Stabiliser Mounting	DB-SB-10410		
	04/03→	Suspension Arm Repair Kit		DB-RK-8550	for Wishbone (CV)
	04/03→	Suspension Arm Repair Kit		DB-RK-8626	for Wishbone (CV)
	04/03→	Suspension Arm Repair Kit		DB-RK-10374	for Wishbone (CV)
	04/03→	Suspension Arm Repair Kit		DB-RK-10375	for Wishbone (CV)
	04/03→	Suspension Arm Repair Kit	DB-RK-8638		for Control Arm
	04/03→	Suspension Strut Repair Kit		DB-RK-8391	
	04/03→	Suspension Strut Repair Kit		DB-RK-8710	
	04/03→	Suspension Strut Repair Kit		DB-RK-9291	
	04/03→	Tie Rod	DB-DL-8171		Guide Rod, 1st FA;Leaf Spring Axle
	04/03→	Tie Rod	DB-DL-8327		Guide Rod, 1st FA;Leaf Spring Axle
	04/03→	Tie Rod	DB-DL-8640		Guide Rod
	04/03→	Tie Rod	DB-DL-12310		
	04/03→	Tie Rod	DB-ES-5227		Guide Rod
	04/03→	Tie Rod End	CV-ES-0543		for Push Rod
	04/03→	Tie Rod End	CV-ES-0888		for Push Rod
	04/03→	Tie Rod End	CV-ES-14163		for Steering Rod
	04/03→	Tie Rod End	DB-ES-5234		for Steering Rod
	04/03→	Tie Rod End	DB-ES-8164		for Push Rod
	04/03→	Tie Rod End	DB-ES-8530		for Push Rod
	04/03→	Track Control Arm		DB-DL-3475	Trailing Arm
04/03→	Track Control Arm		DB-VB-7261	Suspension Rod, Wishbone (CV), 1st RA;2nd RA; Leaf Spring Axle	

CV-ES-0543

Length: 125
Cone Ø: d1 Ø 32 / d2 Ø 29
Thread: M30 x 1,5 RHT
0004605748, 0004606048, 0004606848,
0004607048, 0014600448, 0014601148,
0014601748, 0014602448, 0014607648,
0014609648



CV-ES-0888

Length: 125
Cone Ø: d1 Ø 32 / d2 Ø 29
Thread: M30 x 1,5 LHT
0004605848, 0004606148, 0004606948,
0004607148, 0004609048, 0014600548,
0014601348, 0014602548, 0014607948,
0024600448



CV-ES-14163

Length: 125
Cone Ø: d1 Ø 30 / d2 Ø 27
Thread: M30 x 1,5 RHT
0003305248, 0003387310, 0004600348,
0004600948, 0004602848, 0004602948,
0004608948, 0014600248, 0014600848,
0014601248, 0014602248, 0014607748,
0024600148, 0003387310, 0004600348,
0004602848, 0004602948, 0014600848,
0014601248, 0014602248, 0014607748



DB-DL-2144

Length: 872 Ø: 35
Cone Ø: d1 Ø 28,6 / d2 Ø 23,9
0024604305, 0024604405, 0034604805



DB-DL-3475

Length: 565 Ø: 52
Hole Distance: 152 / 152
3753500006, 3753500206, 9473500805,
9483500006, 9483500805, 9483501205,
9483501305, 9483501905, 9483502005,
9483502405, A3753500006,
A3753500206



DB-DL-5230

Length: 879 Ø: 42
Cone Ø: d1 Ø 30 / d2 Ø 27
01208600A, 0004607105, 0004607205,
0014606705



DB-DL-5405

Length: 890 Ø: 35
Cone Ø: d1 Ø 28,6 / d2 Ø 23,9
01215900A, 1460248, 0024604505,
0024604605, 0034605005, 3752600637,
3754600405, A3752600637, A3754600405



DB-DL-7270

Length: 875 Ø: 40
Cone Ø: d1 Ø 28,6 / d2 Ø 23,9
01208300A, 0024604705, 0024604805,
0034604905, A0024604705



DB-DL-8167

Length: 866 Ø: 38
Cone Ø: d1 Ø 30 / d2 Ø 27
0014609805, 0014609905, 0024606305,
0024606405



DB-DL-8168

Length: 904 Ø: 52
Cone Ø: d1 Ø 32 / d2 Ø 29
0004609405, 0004609505, 0014607105



DB-DL-8171

Length: 1687 Ø: 52
Cone Ø: d1 Ø 32 / d2 Ø 29
9493300603, 9493300703, 9493301503,
9493301603



DB-DL-8184

Length: 1095 Ø: 42
Cone Ø: d1 Ø 32 / d2 Ø 28,8
01217700A, 0014601305, 0014601405,
0024600505, 0034603205, 3754601505,
A0014601305, A0014601405, A0024600505



DB-DL-8185

Length: 711 Ø: 42
Cone Ø: d1 Ø 32 / d2 Ø 28,8
01213600A, 0014601105, 0024600405,
0034603105, A0014601105, A0024600405



DB-DL-8307

Length: 885 Ø: 38
Cone Ø: d1 Ø 32 / d2 Ø 30
01215500A, 0004604005, 0024605105,
0024605205, 0034604005



DB-DL-8327

Length: 1745 Ø: 48
Cone Ø: d1 Ø 32 / d2 Ø 29
01219800A, 9413300003, 9413300103,
9413300203, 9413300303, 9413300503



DB-DL-8622

Length: 1558 Ø: 52
Cone Ø: d1 Ø 30 / d2 Ø 27
0014609005, 0014609105



DB-DL-8640

Length: 1615 Ø: 50
Cone Ø: d1 Ø 32 / d2 Ø 29
6253301503, 6253301603, 6253302403,
6253302503, 9423300803, 9423302103,
9493300203, 9493300303, 9493300903



DB-DL-8641

Length: 905 Ø: 42
Cone Ø: d1 Ø 30 / d2 Ø 27
0014605105, 0014608105



DB-DL-8642

Length: 954 Ø: 42
Cone Ø: d1 Ø 30 / d2 Ø 27
0014608605, 0014608705



DB-DL-8702

Length: 958 Ø: 38
Cone Ø: d1 Ø 32 / d2 Ø 30
0024606105, 0024606205, 0034604205



DB-DL-9254

Length: 1815 Ø: 58
0003220323, 0003220623, 3753220423



DB-DL-12300

Length: 733 Ø: 36
Cone Ø: d1 Ø 32 / d2 Ø 29
0014601505, 0014607305, 0034603305,
3754601605, A0014601505,
A0034603305, A3754601605



DB-DL-12310

Length: 1532 Ø: 50
Cone Ø: d1 Ø 32 / d2 Ø 29
Thread: M27 x 1,5 LHT
9493301203, 9493301303, 9493301803,
9493302203, A9493301203, A9493301303,
A9493301803, A9493302203



DB-ES-5227

Length: 1588 Ø: 60
Cone Ø: d1 Ø 38 / d2 Ø 34,3
6253300903, 6253301203, 9443300203



DB-ES-5234

Length: 135
Cone Ø: d1 Ø 38 / d2 Ø 34,3
Thread: M38 x 1,5 RHT
0004601748, 120322305, 2205000400



DB-ES-8164

Length: 140
Cone Ø: d1 Ø 28,6 / d2 Ø 23,9
Thread: M28 x 1,5 RHT
0014604248, 0014605048, 0014608548,
0024600548



DB-ES-8510

Length: 56
Cone Ø: d1 Ø 10 / d2 Ø 10
Thread: M12 x 1,75 LHT
0009965145, 0009965645, 0019963145



DB-ES-8530

Length: 115
Cone Ø: d1 Ø 28,6 / d2 Ø 23,9
Thread: M30 x 1,5 RHT
0014603848, 0014604848, 0014605148,
0014608648, 0014609948



DB-RK-8391

Ø: 85 Hole Distance: 152
Thick/Height: 24
01336800A, 0003502705



DB-RK-8550

Ø: 75 Hole Distance: 152
Thick/Height: 24
0003502105, 0003504605



DB-RK-8626

Ø: 75 Hole Distance: 130
Thick/Height: 24
0003502205, 0003502505, 0003503405,
0003504505, GL11319



DB-RK-8638

Length: 100 Ø: 67
Hole Distance: 100
Thick/Height: 20
0003301411



DB-RK-8710

Ø: 85 Hole Distance: 130
Thick/Height: 30
0003503705



DB-RK-9291

Ø: 107,5 Hole Distance: 152
Thick/Height: 30
0003503605



DB-RK-10374

Ø: 85 Hole Distance: 152
Thick/Height: 24
0003504405



DB-RK-10375

Ø: 100 Hole Distance: 152
Thick/Height: 24
0003502405, 0003503505, 0003504905



DB-SB-10384

Ø: 73 Thick/Height: 47
9303170012, 9423171812



DB-SB-10400

Length: 230
Thick/Height: 167,5 / 115
0003250696, 0003250896



DB-SB-10401

Length: 232
Thick/Height: 163,5 / 152,5
0003250596, 0003250796



DB-SB-10406

Ø: 80 Thick/Height: 46
0003238185



DB-SB-10409

Ø: 77 Thick/Height: 56
0003265181



DB-SB-10410

Ø: 73 Hole Distance: 100
Thick/Height: 24
9413230050



DB-VB-7261

Length: 622 Ø: 46
Hole Ø 25 / 25 / 25
Hole Distance: 152 / 130 / 130
01337800A, 9443500305, 9443500505,
9443500605, 9473500705, 9473500905,
9483500405, 9483503005



DB-VB-7798

Length: 622 Ø: 48
Hole Ø 25 / 23 / 23
Hole Distance: 152 / 130 / 130
9423500505, 9423500805, 9423501205,
A9423501205



DB-VB-9307

Length: 667 Ø: 60
Hole Ø 25 / 23 / 23
Hole Distance: 152 / 130 / 130
9483502805



DB-VB-9308

Length: 622 Ø: 46
Hole Ø 25 / 25 / 25
Hole Distance: 152 / 130 / 130
9483502905





ACTROS MP2 / MP3 ...

3354, 3355 ...	04/03 →	Track Control Arm		DB-VB-9307	Suspension Rod, Wishbone (CV), 1st RA;2nd RA; Leaf Spring Axle	
	04/03 →	Track Control Arm		DB-VB-9308	Suspension Rod, Wishbone (CV), 1st RA;2nd RA; Leaf Spring Axle	
	04/03 →	Bush, parabolic spring		DB-SB-10401		
3355 A	04/03 →	Centre Rod	DB-DL-8307		Push Rod	
	04/03 →	Centre Rod	DB-DL-8702		Push Rod	
	04/03 →	Suspension Arm Repair Kit		DB-RK-8626	for Wishbone (CV)	
	04/03 →	Suspension Arm Repair Kit		DB-RK-10375	for Wishbone (CV)	
	04/03 →	Suspension Strut Repair Kit		DB-RK-8391		
	04/03 →	Suspension Strut Repair Kit		DB-RK-8710		
	04/03 →	Suspension Strut Repair Kit		DB-RK-9291		
	04/03 →	Tie Rod	DB-ES-5227		Guide Rod	
	04/03 →	Tie Rod	MN-DL-7834		Guide Rod	
	04/03 →	Tie Rod End	CV-ES-0543		for Push Rod	
	04/03 →	Tie Rod End	CV-ES-14163		for Steering Rod	
	04/03 →	Tie Rod End	DB-ES-5234		for Steering Rod	
	04/03 →	Track Control Arm		DB-DL-3475	Trailing Arm, 1st RA;2nd RA, →517144 03/517144 06	
	04/03 →	Track Control Arm		DB-DL-3475	Trailing Arm, 1st RA;2nd RA, →517144 05/517144 08	
	04/03 →	Track Control Arm		DB-DL-3475	Trailing Arm, 1st RA;2nd RA, →517144 07/517144 09	
	04/03 →	Track Control Arm		DB-DL-3475	Trailing Arm, 1st RA;2nd RA, →517144 26/517144 27	
	04/03 →	Track Control Arm		DB-VB-7261	Suspension Rod, Wishbone (CV)	
	04/03 →	Track Control Arm		DB-VB-9307	Suspension Rod, Wishbone (CV)	
	04/03 →	Track Control Arm		DB-VB-9308	Suspension Rod, Wishbone (CV)	
	3355 AK	04/03 →	Centre Rod	DB-DL-8307		Push Rod
		04/03 →	Centre Rod	DB-DL-8702		Push Rod
		04/03 →	Suspension Arm Repair Kit		DB-RK-8626	for Wishbone (CV)
04/03 →		Suspension Arm Repair Kit		DB-RK-10375	for Wishbone (CV)	
04/03 →		Suspension Strut Repair Kit		DB-RK-8391		
04/03 →		Suspension Strut Repair Kit		DB-RK-8710		
04/03 →		Suspension Strut Repair Kit		DB-RK-9291		
04/03 →		Tie Rod	DB-ES-5227		Guide Rod	
04/03 →		Tie Rod	MN-DL-7834		Guide Rod	
04/03 →		Tie Rod End	CV-ES-0543		for Push Rod	
04/03 →		Track Control Arm		DB-DL-3475	Trailing Arm, 1st RA;2nd RA, →517144 03/517144 06	
04/03 →		Track Control Arm		DB-DL-3475	Trailing Arm, 1st RA;2nd RA, →517144 05/517144 08	
04/03 →		Track Control Arm		DB-DL-3475	Trailing Arm, 1st RA;2nd RA, →517144 07/517144 09	
04/03 →		Track Control Arm		DB-DL-3475	Trailing Arm, 1st RA;2nd RA, →517144 26/517144 27	
04/03 →		Track Control Arm		DB-VB-7261	Suspension Rod, Wishbone (CV)	
04/03 →		Track Control Arm		DB-VB-9307	Suspension Rod, Wishbone (CV)	
04/03 →		Track Control Arm		DB-VB-9308	Suspension Rod, Wishbone (CV)	
3355 AS		04/03 →	Ball Head, gearshift linkage	DB-ES-8510		
		04/03 →	Bush, driver cab suspension	DB-SB-10384		
		04/03 →	Centre Rod	DB-DL-8307		Push Rod
		04/03 →	Centre Rod	DB-DL-8702		Push Rod, Leaf Spring Axle
		04/03 →	Centre Rod	DB-DL-12300		for Steering Rod
	04/03 →	Stabiliser Mounting		DB-SB-10406		
	04/03 →	Stabiliser Mounting		DB-SB-10409		
	04/03 →	Stabiliser Mounting	DB-SB-10410			
	04/03 →	Suspension Arm Repair Kit		DB-RK-8626	for Wishbone (CV)	
	04/03 →	Suspension Arm Repair Kit		DB-RK-10374	for Wishbone (CV)	
	04/03 →	Suspension Arm Repair Kit		DB-RK-10375	for Wishbone (CV)	
	04/03 →	Suspension Arm Repair Kit	DB-RK-8638		for Control Arm	
	04/03 →	Suspension Strut Repair Kit		DB-RK-8391		
	04/03 →	Suspension Strut Repair Kit		DB-RK-8710		

CV-ES-0543

Length: 125
 Cone Ø: d1 Ø 32 / d2 Ø 29
 Thread: M30 x 1,5 RHT
 0004605748, 0004606048, 0004606848,
 0004607048, 0014600448, 0014601148,
 0014601748, 0014602448, 0014607648,
 0014609648

**CV-ES-14163**

Length: 125
 Cone Ø: d1 Ø 30 / d2 Ø 27
 Thread: M30 x 1,5 RHT
 0003305248, 0003387310, 0004600348,
 0004600948, 0004602848, 0004602948,
 0004608948, 0014600248, 0014600848,
 0014601248, 0014602248, 0014607748,
 0024600148, A0003387310, A0004600348,
 A0004602848, A0004602948, A0014600848,
 A0014601248, A0014602248, A0014607748

**DB-DL-3475**

Length: 565 Ø: 52
 Hole Distance: 152 / 152
 3753500006, 3753500206, 9473500805,
 9483500006, 9483500805, 9483501205,
 9483501305, 9483501905, 9483502005,
 9483502405, A3753500006, A3753500206

**DB-DL-8307**

Length: 885 Ø: 38
 Cone Ø: d1 Ø 32 / d2 Ø 30
 01215500A, 0004604005, 0024605105,
 0024605205, 0034604005

**DB-DL-8702**

Length: 958 Ø: 38
 Cone Ø: d1 Ø 32 / d2 Ø 30
 0024606105, 0024606205, 0034604205

**DB-DL-12300**

Length: 733 Ø: 36
 Cone Ø: d1 Ø 32 / d2 Ø 29
 0014601505, 0014607305, 0034603305,
 3754601605, A0014601505, A0034603305,
 A3754601605

**DB-ES-5227**

Length: 1588 Ø: 60
 Cone Ø: d1 Ø 38 / d2 Ø 34,3
 6253300903, 6253301203, 9443300203

**DB-ES-5234**

Length: 135
 Cone Ø: d1 Ø 38 / d2 Ø 34,3
 Thread: M38 x 1,5 RHT
 0004601748, 120322305, 2205000400

**DB-ES-8510**

Length: 56
 Cone Ø: d1 Ø 10 / d2 Ø 10
 Thread: M12 x 1,75 LHT
 0009965145, 0009965645, 0019963145

**DB-RK-8391**

Ø: 85 Hole Distance: 152
 Thick/Height: 24
 01336800A, 0003502705

**DB-RK-8626**

Ø: 75 Hole Distance: 130
 Thick/Height: 24
 0003502205, 0003502505, 0003503405,
 0003504505, GL11319

**DB-RK-8638**

Length: 100 Ø: 67
 Hole Distance: 100
 Thick/Height: 20
 0003301411

**DB-RK-8710**

Ø: 85 Hole Distance: 130
 Thick/Height: 30
 0003503705

**DB-RK-9291**

Ø: 107,5 Hole Distance: 152
 Thick/Height: 30
 0003503605

**DB-RK-10374**

Ø: 85 Hole Distance: 152
 Thick/Height: 24
 0003504405

**DB-RK-10375**

Ø: 100
 Hole Distance: 152
 Thick/Height: 24
 3502405, 0003502405, 3503505, 0003503505,
 0003504905, 3504905

**DB-SB-10384**

Ø: 73 Thick/Height: 47
 9303170012, 9423171812

**DB-SB-10401**

Length: 232
 Thick/Height: 163,5 / 152,5
 0003250596, 0003250796

**DB-SB-10406**

Ø: 80 Thick/Height: 46
 0003238185

**DB-SB-10409**

Ø: 77 Thick/Height: 56
 0003265181

**DB-SB-10410**

Ø: 73 Hole Distance: 100
 Thick/Height: 24
 9413230050

**DB-VB-7261**

Length: 622 Ø: 46
 Hole Ø 25 / 25 / 25
 Hole Distance: 152 / 130 / 130
 01337800A, 9443500305, 9443500505,
 9443500605, 9473500705, 9473500905,
 9483500405, 9483503005

**DB-VB-9307**

Length: 667 Ø: 60
 Hole Ø 25 / 23 / 23
 Hole Distance: 152 / 130 / 130
 9483502805

**DB-VB-9308**

Length: 622 Ø: 46
 Hole Ø 25 / 25 / 25
 Hole Distance: 152 / 130 / 130
 9483502905

**MN-DL-7834**

Length: 1588 Ø: 88
 Cone Ø: d1 Ø 30 / d2 Ø 27
 3463303903, 3463304903, 6253303203,
 9443300503, 9443301303, 9443301703





ACTROS MP2 / MP3 ...

3355 AS ...	04/03 →	Suspension Strut Repair Kit		DB-RK-9291	
	04/03 →	Suspension Strut Repair Kit		MN-RK-8997	
	04/03 →	Tie Rod	DB-DL-12310		
	04/03 →	Tie Rod	DB-ES-5227		Guide Rod
	04/03 →	Tie Rod	MN-DL-7834		Guide Rod
	04/03 →	Tie Rod End	CV-ES-0543		for Push Rod
	04/03 →	Tie Rod End	CV-ES-14163		for Steering Rod
	04/03 →	Tie Rod End	DB-ES-5234		for Steering Rod
	04/03 →	Tie Rod End	DB-ES-8530		for Push Rod
	04/03 →	Track Control Arm		DB-DL-3475	Trailing Arm
	04/03 →	Track Control Arm		DB-VB-7261	Suspension Rod, Wishbone (CV), 1st RA;2nd RA; Leaf Spring Axle
	04/03 →	Track Control Arm		DB-VB-7798	Wishbone (CV)
	04/03 →	Track Control Arm		DB-VB-9307	Suspension Rod, Wishbone (CV), 1st RA;2nd RA; Leaf Spring Axle
	04/03 →	Track Control Arm		DB-VB-9308	Suspension Rod, Wishbone (CV), 1st RA;2nd RA; Leaf Spring Axle
3355 S	04/03 →	Ball Head, gearshift linkage	DB-ES-8510		
	04/03 →	Bush, driver cab suspension	DB-SB-10384		
	04/03 →	Centre Rod	DB-DL-2144		Push Rod
	04/03 →	Centre Rod	DB-DL-5230		Suspension Rod
	04/03 →	Centre Rod	DB-DL-5405		Push Rod, Leaf Spring Axle
	04/03 →	Centre Rod	DB-DL-7270		Push Rod;Suspension Rod
	04/03 →	Centre Rod	DB-DL-8167		Push Rod
	04/03 →	Centre Rod	DB-DL-8184		Push Rod
	04/03 →	Centre Rod	DB-DL-8185		Push Rod
	04/03 →	Centre Rod	DB-DL-8307		Push Rod
	04/03 →	Centre Rod	DB-DL-8702		Push Rod, Leaf Spring Axle
	04/03 →	Centre Rod	DB-DL-12300		for Steering Rod
	04/03 →	Stabiliser Mounting		DB-SB-10406	
	04/03 →	Stabiliser Mounting		DB-SB-10409	
	04/03 →	Stabiliser Mounting	DB-SB-10410		
	04/03 →	Suspension Arm Repair Kit		DB-RK-8550	for Wishbone (CV)
	04/03 →	Suspension Arm Repair Kit		DB-RK-8626	for Wishbone (CV)
	04/03 →	Suspension Arm Repair Kit		DB-RK-10374	for Wishbone (CV)
	04/03 →	Suspension Arm Repair Kit		DB-RK-10375	for Wishbone (CV)
	04/03 →	Suspension Arm Repair Kit	DB-RK-8638		for Control Arm
	04/03 →	Suspension Strut Repair Kit		DB-RK-8391	
	04/03 →	Suspension Strut Repair Kit		DB-RK-8710	
	04/03 →	Suspension Strut Repair Kit		DB-RK-9291	
	04/03 →	Suspension Strut Repair Kit		MN-RK-8997	
	04/03 →	Tie Rod	DB-DL-8171		Guide Rod
	04/03 →	Tie Rod	DB-DL-8327		Guide Rod
	04/03 →	Tie Rod	DB-DL-8640		Guide Rod
	04/03 →	Tie Rod	DB-DL-12310		
	04/03 →	Tie Rod	DB-ES-5227		Guide Rod
	04/03 →	Tie Rod End	CV-ES-0543		for Push Rod
	04/03 →	Tie Rod End	CV-ES-0888		for Push Rod
	04/03 →	Tie Rod End	CV-ES-14163		for Steering Rod
	04/03 →	Tie Rod End	DB-ES-5234		for Steering Rod
	04/03 →	Tie Rod End	DB-ES-8164		for Push Rod
	04/03 →	Tie Rod End	DB-ES-8530		for Push Rod
	04/03 →	Track Control Arm		DB-DL-3475	Trailing Arm
	04/03 →	Track Control Arm		DB-VB-7261	Suspension Rod, Wishbone (CV), 1st RA;2nd RA; Leaf Spring Axle
	04/03 →	Track Control Arm		DB-VB-7798	Wishbone (CV)
	04/03 →	Track Control Arm		DB-VB-9307	Suspension Rod, Wishbone (CV), 1st RA;2nd RA; Leaf Spring Axle
	04/03 →	Track Control Arm		DB-VB-9308	Suspension Rod, Wishbone (CV), 1st RA;2nd RA; Leaf Spring Axle

CV-ES-0543

Length: 125
 Cone Ø: d1 Ø 32 / d2 Ø 29
 Thread: M30 x 1,5 RHT
 0004605748, 0004606048, 0004606848,
 0004607048, 0014600448, 0014601148,
 0014601748, 0014602448, 0014607648,
 0014609648

**CV-ES-0888**

Length: 125
 Cone Ø: d1 Ø 32 / d2 Ø 29
 Thread: M30 x 1,5 LHT
 0004605848, 0004606148, 0004606948,
 0004607148, 0004609048, 0014600548,
 0014601348, 0014602548, 0014607948,
 0024600448

**CV-ES-14163**

Length: 125
 Cone Ø: d1 Ø 30 / d2 Ø 27
 Thread: M30 x 1,5 RHT
 0003305248, 0003387310, 0004600348,
 0004600948, 0004602848, 0004602948,
 0004608948, 0014600248, 0014600848,
 0014601248, 0014602248, 0014607748,
 0024600148, 0003387310, 0004600348,
 A0004602848, A0004602948, A0014600848,
 A0014601248, A0014602248, A0014607748

**DB-DL-2144**

Length: 872 Ø: 35
 Cone Ø: d1 Ø 28,6 / d2 Ø 23,9
 0024604305, 0024604405, 0034604805

**DB-DL-3475**

Length: 565 Ø: 52
 Hole Distance: 152 / 152
 3753500006, 3753500206, 9473500805,
 9483500006, 9483500805, 9483501205,
 9483501305, 9483501905, 9483502005,
 9483502405, A3753500006, A3753500206

**DB-DL-5230**

Length: 879 Ø: 42
 Cone Ø: d1 Ø 30 / d2 Ø 27
 01208600A, 0004607105, 0004607205,
 0014606705

**DB-DL-5405**

Length: 890 Ø: 35
 Cone Ø: d1 Ø 28,6 / d2 Ø 23,9
 01215900A, 1460248, 0024604505, 0024604605,
 0034605005, 3752600637, 3754600405,
 A3752600637, A3754600405

**DB-DL-7270**

Length: 875 Ø: 40
 Cone Ø: d1 Ø 28,6 / d2 Ø 23,9
 01208300A, 0024604705, 0024604805,
 0034604905, A0024604705

**DB-DL-8167**

Length: 866 Ø: 38
 Cone Ø: d1 Ø 30 / d2 Ø 27
 0014609805, 0014609905, 0024606305,
 0024606405

**DB-DL-8171**

Length: 1687 Ø: 52
 Cone Ø: d1 Ø 32 / d2 Ø 29
 9493300603, 9493300703, 9493301503,
 9493301603

**DB-DL-8184**

Length: 1095 Ø: 42
 Cone Ø: d1 Ø 32 / d2 Ø 28,8
 01217700A, 0014601305, 0014601405,
 0024600505, 0034603205, 3754601505,
 A0014601305, A0014601405, A0024600505

**DB-DL-8185**

Length: 711 Ø: 42
 Cone Ø: d1 Ø 32 / d2 Ø 28,8
 01213600A, 0014601105, 0024600405,
 0034603105, A0014601105, A0024600405

**DB-DL-8307**

Length: 885 Ø: 38
 Cone Ø: d1 Ø 32 / d2 Ø 30
 01215500A, 0004604005, 0024605105,
 0024605205, 0034604005

**DB-DL-8327**

Length: 1745 Ø: 48
 Cone Ø: d1 Ø 32 / d2 Ø 29
 01219800A, 9413300003, 9413300103,
 9413300203, 9413300303, 9413300503

**DB-DL-8640**

Length: 1615 Ø: 50
 Cone Ø: d1 Ø 32 / d2 Ø 29
 6253301503, 6253301603, 6253302403,
 6253302503, 9423300803, 9423302103,
 9493300203, 9493300303, 9493300903

**DB-DL-8702**

Length: 958 Ø: 38
 Cone Ø: d1 Ø 32 / d2 Ø 30
 0024606105, 0024606205, 0034604205

**DB-DL-12300**

Length: 733 Ø: 36
 Cone Ø: d1 Ø 32 / d2 Ø 29
 0014601505, 0014607305, 0034603305,
 3754601605, A0014601505, A0034603305,
 A3754601605

**DB-DL-12310**

Length: 1532 Ø: 50
 Cone Ø: d1 Ø 32 / d2 Ø 29
 Thread: M27 x 1,5 LHT
 9493301203, 9493301303, 9493301803,
 9493302203, A9493301203, A9493301303,
 A9493301803, A9493302203

**DB-ES-5227**

Length: 1588 Ø: 60
 Cone Ø: d1 Ø 38 / d2 Ø 34,3
 6253300903, 6253301203, 9443300203

**DB-ES-5234**

Length: 135
 Cone Ø: d1 Ø 38 / d2 Ø 34,3
 Thread: M38 x 1,5 RHT
 0004601748, 120322305, 2205000400

**DB-ES-8164**

Length: 140
 Cone Ø: d1 Ø 28,6 / d2 Ø 23,9
 Thread: M28 x 1,5 RHT
 0014604248, 0014605048, 0014608548,
 0024600548

**DB-ES-8510**

Length: 56
 Cone Ø: d1 Ø 10 / d2 Ø 10
 Thread: M12 x 1,75 LHT
 0009965145, 0009965645, 0019963145

**DB-ES-8530**

Length: 115
 Cone Ø: d1 Ø 28,6 / d2 Ø 23,9
 Thread: M30 x 1,5 RHT
 0014603848, 0014604848, 0014605148,
 0014608648, 0014609948

**DB-RK-8391**

Ø: 85 Hole Distance: 152
 Thick/Height: 24
 01336800A, 0003502705

**DB-RK-8550**

Ø: 75 Hole Distance: 152
 Thick/Height: 24
 0003502105, 0003504605

**DB-RK-8626**

Ø: 75 Hole Distance: 130
 Thick/Height: 24
 0003502205, 0003502505, 0003503405,
 0003504505, GL11319

**DB-RK-8638**

Length: 100 Ø: 67
 Hole Distance: 100
 Thick/Height: 20
 0003301411

**DB-RK-8710**

Ø: 85 Hole Distance: 130
 Thick/Height: 30
 0003503705

**DB-RK-9291**

Ø: 107,5 Hole Distance: 152
 Thick/Height: 30
 0003503605

**DB-RK-10374**

Ø: 85 Hole Distance: 152
 Thick/Height: 24
 0003504405

**DB-RK-10375**

Ø: 100 Hole Distance: 152
 Thick/Height: 24
 0003502405, 0003503505, 0003504905

**DB-SB-10384**

Ø: 73 Thick/Height: 47
 9303170012, 9423171812

**DB-SB-10406**

Ø: 80 Thick/Height: 46
 0003238185

**DB-SB-10409**

Ø: 77 Thick/Height: 56
 0003265181

**DB-SB-10410**

Ø: 73 Hole Distance: 100
 Thick/Height: 24
 9413230050

**DB-VB-7261**

Length: 622 Ø: 46
 Hole Ø 25 / 25 / 25
 Hole Distance: 152 / 130 / 130
 01337800A, 9443500305, 9443500505,
 9443500605, 9473500705, 9473500905,
 9483500405, 9483503005

**DB-VB-7798**

Length: 622 Ø: 48
 Hole Ø 25 / 23 / 23
 Hole Distance: 152 / 130 / 130
 9423500505, 9423500805, 9423501205,
 A9423501205

**DB-VB-9307**

Length: 667 Ø: 60
 Hole Ø 25 / 23 / 23
 Hole Distance: 152 / 130 / 130
 9483502805

**DB-VB-9308**

Length: 622 Ø: 46
 Hole Ø 25 / 25 / 25
 Hole Distance: 152 / 130 / 130
 9483502905

**MN-DL-7834**

Length: 1588 Ø: 58
 Cone Ø: d1 Ø 30 / d2 Ø 27
 3463303903, 3463304903, 6253303203,
 9443300503, 9443301303, 9443301703

**MN-RK-8997**

Ø: 85 Hole Distance: 130
 Thick/Height: 30
 0003504805



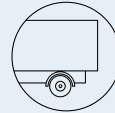

ACTROS MP2 / MP3 ...

3358	04/03→	Bush, parabolic spring		DB-SB-10400		
	04/03→	Bush, parabolic spring		DB-SB-10401		
	04/03→	Centre Rod	DB-DL-2144		Push Rod	
	04/03→	Centre Rod	DB-DL-5405		Push Rod, Leaf Spring Axle	
	04/03→	Centre Rod	DB-DL-8167		Push Rod	
	04/03→	Centre Rod	DB-DL-8307		Push Rod	
	04/03→	Centre Rod	DB-DL-8702		Push Rod, Leaf Spring Axle	
	04/03→	Suspension Arm Repair Kit		DB-RK-8626	for Wishbone (CV)	
	04/03→	Suspension Arm Repair Kit		DB-RK-10375	for Wishbone (CV)	
	04/03→	Suspension Strut Repair Kit		DB-RK-8391		
	04/03→	Suspension Strut Repair Kit		DB-RK-8710		
	04/03→	Suspension Strut Repair Kit		DB-RK-9291		
	04/03→	Tie Rod	DB-DL-8171		Guide Rod, 1st FA;Leaf Spring Axle	
	04/03→	Tie Rod	DB-DL-8327		Guide Rod, 1st FA;Leaf Spring Axle	
	04/03→	Tie Rod	DB-DL-8640		Guide Rod	
	04/03→	Tie Rod	DB-DL-12310			
	04/03→	Tie Rod End	CV-ES-0543		for Push Rod	
	04/03→	Tie Rod End	CV-ES-0888		for Push Rod	
	04/03→	Tie Rod End	CV-ES-14163		for Steering Rod	
	04/03→	Tie Rod End	DB-ES-8164		for Push Rod	
	04/03→	Tie Rod End	DB-ES-8530		for Push Rod	
	04/03→	Track Control Arm		DB-DL-3475	Trailing Arm, 1st RA;2nd RA, →517144 03/517144 06	
	04/03→	Track Control Arm		DB-DL-3475	Trailing Arm, 1st RA;2nd RA, →517144 05/517144 08	
	04/03→	Track Control Arm		DB-DL-3475	Trailing Arm, 1st RA;2nd RA, →517144 07/517144 09	
	04/03→	Track Control Arm		DB-DL-3475	Trailing Arm, 1st RA;2nd RA, →517144 26/517144 27	
	04/03→	Track Control Arm		DB-VB-7261	Suspension Rod, Wishbone (CV), 1st RA;2nd RA; Leaf Spring Axle	
	04/03→	Track Control Arm		DB-VB-9307	Suspension Rod, Wishbone (CV), 1st RA;2nd RA; Leaf Spring Axle	
	04/03→	Track Control Arm		DB-VB-9308	Suspension Rod, Wishbone (CV), 1st RA;2nd RA; Leaf Spring Axle	
	3360	04/03→	Bush, parabolic spring		DB-SB-10400	
		04/03→	Bush, parabolic spring		DB-SB-10401	
		04/03→	Centre Rod	DB-DL-2144		Push Rod
		04/03→	Centre Rod	DB-DL-5405		Push Rod
04/03→		Centre Rod	DB-DL-8167		Push Rod	
04/03→		Centre Rod	DB-DL-8307		Push Rod	
04/03→		Centre Rod	DB-DL-8702		Push Rod	
04/03→		Stabiliser Mounting		DB-SB-10406		
04/03→		Suspension Strut Repair Kit		DB-RK-8710		
04/03→		Suspension Strut Repair Kit		DB-RK-9291		
04/03→		Tie Rod	DB-DL-8171		Guide Rod	
04/03→		Tie Rod	DB-DL-8327		Guide Rod	
04/03→		Tie Rod	DB-DL-8640		Guide Rod	
04/03→		Tie Rod	DB-DL-12310			
04/03→		Tie Rod	DB-ES-5227		Guide Rod	
04/03→		Tie Rod End	CV-ES-0543		for Push Rod	
04/03→		Tie Rod End	CV-ES-0888		for Push Rod	
04/03→		Tie Rod End	CV-ES-14163		for Steering Rod	
04/03→		Tie Rod End	DB-ES-8164		for Push Rod	
04/03→		Tie Rod End	DB-ES-8530		for Push Rod	
04/03→		Track Control Arm		DB-DL-3475	Trailing Arm, 1st RA;2nd RA, →517144 03/517144 06	
04/03→		Track Control Arm		DB-DL-3475	Trailing Arm, 1st RA;2nd RA, →517144 05/517144 08	
04/03→		Track Control Arm		DB-DL-3475	Trailing Arm, 1st RA;2nd RA, →517144 07/517144 09	
04/03→		Track Control Arm		DB-DL-3475	Trailing Arm, 1st RA;2nd RA, →517144 26/517144 27	

CV-ES-0543

Length: 125
Cone Ø: d1 Ø 32 / d2 Ø 29
Thread: M30 x 1,5 RHT
0004605748, 0004606048, 0004606848,
0004607048, 0014600448, 0014601148,
0014601748, 0014602448, 0014607648,
0014609648

**CV-ES-0888**

Length: 125
Cone Ø: d1 Ø 32 / d2 Ø 29
Thread: M30 x 1,5 LHT
0004605848, 0004606148, 0004606948,
0004607148, 0004609048, 0014600548,
0014601348, 0014602548, 0014607948,
0024600448

**CV-ES-14163**

Length: 125
Cone Ø: d1 Ø 30 / d2 Ø 27
Thread: M30 x 1,5 RHT
0003305248, 0003387310, 0004600348,
0004600948, 0004602848, 0004602948,
0004608948, 0014600248, 0014600848,
0014601248, 0014602248, 0014607748,
0024600148, A0003387310, A0004600348,
A0004602848, A0004602948, A0014600848,
A0014601248, A0014602248, A0014607748

**DB-DL-2144**

Length: 872 Ø: 35
Cone Ø: d1 Ø 28,6 / d2 Ø 23,9
0024604305, 0024604405, 0034604805

**DB-DL-3475**

Length: 565 Ø: 52
Hole Distance: 152 / 152
3753500006, 3753500206, 9473500805,
9483500006, 9483500805, 9483501205,
9483501305, 9483501905, 9483502005,
9483502405, A3753500006, A3753500206

**DB-DL-5405**

Length: 890 Ø: 35
Cone Ø: d1 Ø 28,6 / d2 Ø 23,9
01215900A, 1460248, 0024604505, 0024604605,
0034605005, 3752600637, 3754600405,
A3752600637, A3754600405

**DB-DL-8167**

Length: 866 Ø: 38
Cone Ø: d1 Ø 30 / d2 Ø 27
0014609805, 0014609905, 0024606305,
0024606405

**DB-DL-8171**

Length: 1687 Ø: 52
Cone Ø: d1 Ø 32 / d2 Ø 29
9493300603, 9493300703, 9493301503,
9493301603

**DB-DL-8307**

Length: 885 Ø: 38
Cone Ø: d1 Ø 32 / d2 Ø 30
01215500A, 0004604005, 0024605105,
0024605205, 0034604005

**DB-DL-8327**

Length: 1745 Ø: 48
Cone Ø: d1 Ø 32 / d2 Ø 29
01219800A, 9413300003, 9413300103,
9413300203, 9413300303, 9413300503

**DB-DL-8640**

Length: 1615 Ø: 50
Cone Ø: d1 Ø 32 / d2 Ø 29
6253301503, 6253301603, 6253302403,
6253302503, 9423300803, 9423302103,
9493300203, 9493300303, 9493300903

**DB-DL-8702**

Length: 958 Ø: 38
Cone Ø: d1 Ø 32 / d2 Ø 30
0024606105, 0024606205, 0034604205

**DB-DL-12310**

Length: 1532 Ø: 50
Cone Ø: d1 Ø 32 / d2 Ø 29
Thread: M27 x 1,5 LHT
9493301203, 9493301303, 9493301803,
9493302203, A9493301203, A9493301303,
A9493301803, A9493302203

**DB-ES-5227**

Length: 1588 Ø: 60
Cone Ø: d1 Ø 38 / d2 Ø 34,3
6253300903, 6253301203, 9443300203

**DB-ES-8164**

Length: 140
Cone Ø: d1 Ø 28,6 / d2 Ø 23,9
Thread: M28 x 1,5 RHT
0014604248, 0014605048, 0014608548,
0024600548

**DB-ES-8530**

Length: 115
Cone Ø: d1 Ø 28,6 / d2 Ø 23,9
Thread: M30 x 1,5 RHT
0014603848, 0014604848, 0014605148,
0014608648, 0014609948

**DB-RK-8391**

Ø: 85 Hole Distance: 152
Thick/Height: 24
01336800A, 0003502705

**DB-RK-8626**

Ø: 75 Hole Distance: 130
Thick/Height: 24
0003502205, 0003502505, 0003503405,
0003504505, GL11319

**DB-RK-8710**

Ø: 85 Hole Distance: 130
Thick/Height: 30
0003503705

**DB-RK-9291**

Ø: 107,5 Hole Distance: 152
Thick/Height: 30
0003503605

**DB-RK-10375**

Ø: 100 Hole Distance: 152
Thick/Height: 24
0003502405, 0003503505, 0003504905

**DB-SB-10400**

Length: 230
Thick/Height: 167,5 / 115
0003250696, 0003250896

**DB-SB-10401**

Length: 232
Thick/Height: 163,5 / 152,5
0003250596, 0003250796

**DB-SB-10406**

Ø: 80 Thick/Height: 46
0003238185

**DB-VB-7261**

Length: 622 Ø: 46
Hole Ø 25 / 25 / 25
Hole Distance: 152 / 130 / 130
01337800A, 9443500305, 9443500505,
9443500605, 9473500705, 9473500905,
9483500405, 9483503005

**DB-VB-9307**

Length: 667 Ø: 60
Hole Ø 25 / 23 / 23
Hole Distance: 152 / 130 / 130
9483502805

**DB-VB-9308**

Length: 622 Ø: 46
Hole Ø 25 / 25 / 25
Hole Distance: 152 / 130 / 130
9483502905





ACTROS MP2 / MP3 ...

3360 ...	04/03 →	Track Control Arm		DB-VB-7261	Suspension Rod, Wishbone (CV), 1st RA;2nd RA; Leaf Spring Axle	
	04/03 →	Track Control Arm		DB-VB-9307	Suspension Rod, Wishbone (CV)	
	04/03 →	Track Control Arm		DB-VB-9308	Suspension Rod, Wishbone (CV), 1st RA;2nd RA; Leaf Spring Axle	
3360 A	04/03 →	Bush, parabolic spring		DB-SB-10401		
	04/03 →	Centre Rod	DB-DL-8307		Push Rod	
	04/03 →	Centre Rod	DB-DL-8702		Push Rod	
	04/03 →	Suspension Arm Repair Kit		DB-RK-8626	for Wishbone (CV)	
	04/03 →	Suspension Arm Repair Kit		DB-RK-10375	for Wishbone (CV)	
	04/03 →	Suspension Strut Repair Kit		DB-RK-8391		
	04/03 →	Suspension Strut Repair Kit		DB-RK-8710		
	04/03 →	Suspension Strut Repair Kit		DB-RK-9291		
	04/03 →	Tie Rod	DB-ES-5227		Guide Rod	
	04/03 →	Tie Rod	MN-DL-7834		Guide Rod	
	04/03 →	Tie Rod End	CV-ES-0543		for Push Rod	
	04/03 →	Tie Rod End	CV-ES-14163		for Steering Rod	
	04/03 →	Tie Rod End	DB-ES-5234		for Steering Rod	
	04/03 →	Track Control Arm		DB-DL-3475	Trailing Arm, 1st RA;2nd RA, →517144 03/517144 06	
	04/03 →	Track Control Arm		DB-DL-3475	Trailing Arm, 1st RA;2nd RA, →517144 05/517144 08	
	04/03 →	Track Control Arm		DB-DL-3475	Trailing Arm, 1st RA;2nd RA, →517144 07/517144 09	
	04/03 →	Track Control Arm		DB-DL-3475	Trailing Arm, 1st RA;2nd RA, →517144 26/517144 27	
	04/03 →	Track Control Arm		DB-VB-7261	Suspension Rod, Wishbone (CV)	
	04/03 →	Track Control Arm		DB-VB-9307	Suspension Rod, Wishbone (CV)	
	04/03 →	Track Control Arm		DB-VB-9308	Suspension Rod, Wishbone (CV)	
3360 AK	04/03 →	Centre Rod	DB-DL-8307		Push Rod	
	04/03 →	Centre Rod	DB-DL-8702		Push Rod	
	04/03 →	Suspension Arm Repair Kit		DB-RK-8626	for Wishbone (CV)	
	04/03 →	Suspension Arm Repair Kit		DB-RK-10375	for Wishbone (CV)	
	04/03 →	Suspension Strut Repair Kit		DB-RK-8391		
	04/03 →	Suspension Strut Repair Kit		DB-RK-8710		
	04/03 →	Suspension Strut Repair Kit		DB-RK-9291		
	04/03 →	Tie Rod	DB-ES-5227		Guide Rod	
	04/03 →	Tie Rod	MN-DL-7834		Guide Rod	
	04/03 →	Tie Rod End	CV-ES-0543		for Push Rod	
	04/03 →	Track Control Arm		DB-DL-3475	Trailing Arm, 1st RA;2nd RA, →517144 03/517144 06	
	04/03 →	Track Control Arm		DB-DL-3475	Trailing Arm, 1st RA;2nd RA, →517144 05/517144 08	
	04/03 →	Track Control Arm		DB-DL-3475	Trailing Arm, 1st RA;2nd RA, →517144 07/517144 09	
	04/03 →	Track Control Arm		DB-DL-3475	Trailing Arm, 1st RA;2nd RA, →517144 26/517144 27	
	04/03 →	Track Control Arm		DB-VB-7261	Suspension Rod, Wishbone (CV)	
	04/03 →	Track Control Arm		DB-VB-9307	Suspension Rod, Wishbone (CV)	
	04/03 →	Track Control Arm		DB-VB-9308	Suspension Rod, Wishbone (CV)	
	3365 A	04/03 →	Bush, parabolic spring		DB-SB-10401	
		04/03 →	Centre Rod	DB-DL-8307		Push Rod
		04/03 →	Centre Rod	DB-DL-8702		Push Rod
04/03 →		Tie Rod	DB-ES-5227		Guide Rod	
04/03 →		Tie Rod	MN-DL-7834		Guide Rod	
04/03 →		Track Control Arm		DB-VB-7261	Suspension Rod, Wishbone (CV)	
04/03 →		Track Control Arm		DB-VB-9307	Suspension Rod, Wishbone (CV)	
04/03 →		Track Control Arm		DB-VB-9308	Suspension Rod, Wishbone (CV)	
3550 S	06/09 →	Centre Rod	DB-DL-5405		Push Rod	
	06/09 →	Centre Rod	DB-DL-8702		Push Rod	
	06/09 →	Tie Rod	DB-DL-8171		Guide Rod	
	06/09 →	Tie Rod	DB-DL-8327		Guide Rod	
	06/09 →	Tie Rod	DB-DL-8640		Guide Rod	

CV-ES-0543

Length: 125
Cone Ø: d1 Ø 32 / d2 Ø 29
Thread: M30 x 1,5 RHT
0004605748, 0004606048, 0004606848,
0004607048, 0014600448, 0014601148,
0014601748, 0014602448, 0014607648,
0014609648



CV-ES-14163

Length: 125
Cone Ø: d1 Ø 30 / d2 Ø 27
Thread: M30 x 1,5 RHT
0003305248, 0003387310, 0004600348,
0004600948, 0004602848, 0004602948,
0004608948, 0014600248, 0014600848,
0014601248, 0014602248, 0014607748,
0024600148, A0003387310, A0004600348,
A0004602848, A0004602948, A0014600848,
A0014601248, A0014602248, A0014607748



DB-DL-3475

Length: 565 Ø: 52
Hole Distance: 152 / 152
3753500006, 3753500206, 9473500805,
9483500006, 9483500805, 9483501205,
9483501305, 9483501905, 9483502005,
9483502405, A3753500006, A3753500206



DB-DL-5405

Length: 890 Ø: 35
Cone Ø: d1 Ø 28,6 / d2 Ø 23,9
01215900A, 1460248, 0024604505, 0024604605,
0034605005, 3752600637, 3754600405,
A3752600637, A3754600405



DB-DL-8171

Length: 1687 Ø: 52
Cone Ø: d1 Ø 32 / d2 Ø 29
9493300603, 9493300703, 9493301503,
9493301603



DB-DL-8307

Length: 885 Ø: 38
Cone Ø: d1 Ø 32 / d2 Ø 30
01215500A, 0004604005, 0024605105,
0024605205, 0034604005



DB-DL-8327

Length: 1745 Ø: 48
Cone Ø: d1 Ø 32 / d2 Ø 29
01219800A, 9413300003, 9413300103,
9413300203, 9413300303, 9413300503



DB-DL-8640

Length: 1615 Ø: 50
Cone Ø: d1 Ø 32 / d2 Ø 29
6253301503, 6253301603, 6253302403,
6253302503, 9423300803, 9423302103,
9493300203, 9493300303, 9493300903



DB-DL-8702

Length: 958 Ø: 38
Cone Ø: d1 Ø 32 / d2 Ø 30
0024606105, 0024606205, 0034604205



DB-ES-5227

Length: 1588 Ø: 60
Cone Ø: d1 Ø 38 / d2 Ø 34,3
6253300903, 6253301203, 9443300203



DB-ES-5234

Length: 135
Cone Ø: d1 Ø 38 / d2 Ø 34,3
Thread: M38 x 1,5 RHT
0004601748, 120322305, 2205000400



DB-RK-8391

Ø: 85 Hole Distance: 152
Thick/Height: 24
01336800A, 0003502705



DB-RK-8626

Ø: 75 Hole Distance: 130
Thick/Height: 24
0003502205, 0003502505, 0003503405,
0003504505, GL11319



DB-RK-8710

Ø: 85 Hole Distance: 130
Thick/Height: 30
0003503705



DB-RK-9291

Ø: 107,5 Hole Distance: 152
Thick/Height: 30
0003503605



DB-RK-10375

Ø: 100 Hole Distance: 152
Thick/Height: 24
0003502405, 0003503505, 0003504905



DB-SB-10401

Length: 232
Thick/Height: 163,5 / 152,5
0003250596, 0003250796



DB-VB-7261

Length: 622 Ø: 46
Hole Ø 25 / 25 / 25
Hole Distance: 152 / 130 / 130
01337800A, 9443500305, 9443500505,
9443500605, 9473500705, 9473500905,
9483500405, 9483503005



DB-VB-9307

Length: 667 Ø: 60
Hole Ø 25 / 23 / 23
Hole Distance: 152 / 130 / 130
9483502805



DB-VB-9308

Length: 622 Ø: 46
Hole Ø 25 / 25 / 25
Hole Distance: 152 / 130 / 130
9483502905



MN-DL-7834

Length: 1588 Ø: 58
Cone Ø: d1 Ø 30 / d2 Ø 27
3463303903, 3463304903, 6253303203,
9443300503, 9443301303, 9443301703



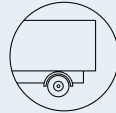

ACTROS MP2 / MP3 ...

3550 S ...	06/09→	Tie Rod	DB-DL-12310			
	06/09→	Track Control Arm		DB-VB-7261	Suspension Rod, Wishbone (CV)	
	06/09→	Track Control Arm		DB-VB-9307	Suspension Rod, Wishbone (CV)	
	06/09→	Track Control Arm		DB-VB-9308	Suspension Rod, Wishbone (CV)	
4140 AK	04/03→	Ball Head, gearshift linkage	DB-ES-8510			
	04/03→	Bush, driver cab suspension	DB-SB-10384			
	04/03→	Bush, parabolic spring		DB-SB-10401		
	04/03→	Centre Rod	DB-DL-8184		Push Rod	
	04/03→	Centre Rod	DB-DL-8307		Push Rod	
	04/03→	Centre Rod	DB-DL-10208		Push Rod, Leaf Spring Axle	
	04/03→	Centre Rod	DB-DL-12300		for Steering Rod	
	04/03→	Centre Rod	DB-DL-12403		Push Rod	
	04/03→	Stabiliser Link	DB-DL-9254		Pressure Rod	
	04/03→	Stabiliser Mounting		DB-SB-10406		
	04/03→	Stabiliser Mounting		DB-SB-10409		
	04/03→	Suspension Arm Repair Kit		DB-RK-8626	for Wishbone (CV)	
	04/03→	Suspension Arm Repair Kit		DB-RK-10374	for Wishbone (CV)	
	04/03→	Suspension Arm Repair Kit		DB-RK-10375	for Wishbone (CV)	
	04/03→	Suspension Arm Repair Kit	DB-RK-8638		for Control Arm	
	04/03→	Suspension Strut Repair Kit		DB-RK-8391		
	04/03→	Suspension Strut Repair Kit		DB-RK-8710		
	04/03→	Suspension Strut Repair Kit		DB-RK-9291		
	04/03→	Tie Rod	DB-DL-12310			
	04/03→	Tie Rod	DB-ES-5227		Guide Rod, 1st FA	
	04/03→	Tie Rod End	CV-ES-0543		for Push Rod	
	04/03→	Tie Rod End	CV-ES-0888		for Push Rod	
	04/03→	Tie Rod End	DB-ES-5234		for Steering Rod	
	04/03→	Tie Rod End	DB-ES-8323		Leaf Spring Axle	
	04/03→	Tie Rod End	DB-ES-8530		for Push Rod	
	04/03→	Track Control Arm		DB-DL-3475	Trailing Arm	
	04/03→	Track Control Arm		DB-VB-7261	Suspension Rod, Wishbone (CV), 1st RA;2nd RA; Leaf Spring Axle	
	04/03→	Track Control Arm		DB-VB-9307	Suspension Rod, Wishbone (CV), 1st RA;2nd RA; Leaf Spring Axle	
	04/03→	Track Control Arm		DB-VB-9308	Suspension Rod, Wishbone (CV), 1st RA;2nd RA; Leaf Spring Axle	
	04/03→	Track Control Arm		DB-VB-10426	Wishbone (CV), 1st RA;2nd RA, →517142 05	
	4140 B	04/03→	Centre Rod	DB-DL-8168		Push Rod
		04/03→	Centre Rod	DB-DL-8184		Push Rod
		04/03→	Centre Rod	DB-DL-8185		Push Rod
		04/03→	Centre Rod	DB-DL-9259		Push Rod
04/03→		Centre Rod	DB-DL-10212		Push Rod	
04/03→		Centre Rod	DB-DL-12300		for Steering Rod	
04/03→		Centre Rod	DB-DL-12301		Push Rod, Leaf Spring Axle	
04/03→		Stabiliser Link	DB-DL-9254		Coupling Rod	
04/03→		Stabiliser Link	DB-DL-9271		Coupling Rod	
04/03→		Stabiliser Link	DB-DL-9272		Coupling Rod	
04/03→		Suspension Arm Repair Kit		DB-RK-8626	for Wishbone (CV)	
04/03→		Suspension Arm Repair Kit		DB-RK-10375	for Wishbone (CV)	
04/03→		Suspension Strut Repair Kit		DB-RK-8391		
04/03→		Suspension Strut Repair Kit		DB-RK-8710		
04/03→		Suspension Strut Repair Kit		DB-RK-9291		
04/03→		Tie Rod	DB-DL-8171		Guide Rod	
04/03→		Tie Rod	DB-DL-8172		Guide Rod	
04/03→		Tie Rod	DB-DL-8390			
04/03→		Tie Rod	DB-DL-8640		Guide Rod	
04/03→		Tie Rod	DB-DL-12310			
04/03→		Tie Rod End	CV-ES-0543		for Push Rod	
04/03→		Tie Rod End	CV-ES-0888		for Push Rod	
04/03→		Tie Rod End	CV-ES-14163		for Steering Rod	
04/03→		Tie Rod End	DB-ES-8530		for Push Rod	
04/03→		Track Control Arm		DB-DL-3475	Trailing Arm, 1st RA;2nd RA, →517144 03/517144 07	

CV-ES-0543

Length: 125
 Cone Ø: d1 Ø 32 / d2 Ø 29
 Thread: M30 x 1,5 RHT
 0004605748, 0004606048, 0004606848,
 0004607048, 0014600448, 0014601148,
 0014601748, 0014602448, 0014607648,
 0014609648

**CV-ES-0888**

Length: 125
 Cone Ø: d1 Ø 32 / d2 Ø 29
 Thread: M30 x 1,5 LHT
 0004605848, 0004606148, 0004606948,
 0004607148, 0004609048, 0014600548,
 0014601348, 0014602548, 0014607948,
 0024600448

**CV-ES-14163**

Length: 125
 Cone Ø: d1 Ø 30 / d2 Ø 27
 Thread: M30 x 1,5 RHT
 0003305248, 0003387310, 0004600348,
 0004600948, 0004602848, 0004602948,
 0004608948, 0014600248, 0014600848,
 0014601248, 0014602248, 0014607748,
 0024600148, A0003387310, A0004600348,
 A0004602848, A0004602948, A0014600848,
 A0014601248, A0014602248, A0014607748

**DB-DL-3475**

Length: 565 Ø: 52
 Hole Distance: 152 / 152
 3753500006, 3753500206, 9473500805,
 9483500006, 9483500805, 9483501205,
 9483501305, 9483501905, 9483502005,
 9483502405, A3753500006, A3753500206

**DB-DL-8168**

Length: 904 Ø: 52
 Cone Ø: d1 Ø 32 / d2 Ø 29
 0004609405, 0004609505, 0014607105

**DB-DL-8171**

Length: 1687 Ø: 52
 Cone Ø: d1 Ø 32 / d2 Ø 29
 9493300603, 9493300703, 9493301503,
 9493301603

**DB-DL-8172**

Length: 1700 Ø: 52
 Cone Ø: d1 Ø 32 / d2 Ø 29
 01219700A, 9493300403, 9493300503,
 9493300803, 9493301403

**DB-DL-8184**

Length: 1095 Ø: 42
 Cone Ø: d1 Ø 32 / d2 Ø 28,8
 01217700A, 0014601305, 0014601405,
 0024600505, 0034603205, 3754601505,
 A0014601305, A0014601405, A0024600505

**DB-DL-8185**

Length: 711 Ø: 42
 Cone Ø: d1 Ø 32 / d2 Ø 28,8
 01213600A, 0014601105, 0024600405,
 0034603105, A0014601105, A0024600405

**DB-DL-8307**

Length: 885 Ø: 38
 Cone Ø: d1 Ø 32 / d2 Ø 30
 01215500A, 0004604005, 0024605105,
 0024605205, 0034604005

**DB-DL-8390**

Length: 1596 Ø: 50
 Cone Ø: d1 Ø 32 / d2 Ø 29
 9493301003, 9493301103, 9493301703

**DB-DL-8640**

Length: 1615 Ø: 50
 Cone Ø: d1 Ø 32 / d2 Ø 29
 6253301503, 6253301603, 6253302403,
 6253302503, 9423300803, 9423302103,
 9493300203, 9493300303, 9493300903

**DB-DL-9254**

Length: 1815 Ø: 58
 0003220323, 0003220623, 3753220423

**DB-DL-9259**

Length: 883 Ø: 38
 Cone Ø: d1 Ø 32 / d2 Ø 29
 0024608605, 0024608705, A0024608605,
 A0024608705

**DB-DL-9271**

Length: 1815 Ø: 60
 0003220423, 0003220723

**DB-DL-9272**

Length: 1815 Ø: 80
 0003220223

**DB-DL-10208**

Length: 708 Ø: 40
 Cone Ø: d1 Ø 32 / d2 Ø 29
 0014605305, 0024600605

**DB-DL-10212**

Length: 953 Ø: 42
 Cone Ø: d1 Ø 32 / d2 Ø 29
 0024609205, 0024609305, 0034604505

**DB-DL-12300**

Length: 733 Ø: 36
 Cone Ø: d1 Ø 32 / d2 Ø 29
 0014601505, 0014607305, 0034603305,
 3754601605, A0014601505, A0034603305,
 A3754601605

**DB-DL-12301**

Length: 716 Ø: 38
 Cone Ø: d1 Ø 32 / d2 Ø 29
 Thread: M30 x 1,5
 0024608805, 0024608905, A0024608805,
 A0024608905

**DB-DL-12310**

Length: 1532 Ø: 50
 Cone Ø: d1 Ø 32 / d2 Ø 29
 Thread: M27 x 1,5 LHT
 9493301203, 9493301303, 9493301803,
 9493302203, A9493301203, A9493301303,
 A9493301803, A9493302203

**DB-DL-12403**

Length: 893
 Ø: 42
 Cone Ø: d1 Ø 32 / d2 Ø 29
 0014604905, 14604905, 14607405, 0014607405

**DB-ES-5227**

Length: 1588 Ø: 60
 Cone Ø: d1 Ø 38 / d2 Ø 34,3
 6253300903, 6253301203, 9443300203

**DB-ES-5234**

Length: 135
 Cone Ø: d1 Ø 38 / d2 Ø 34,3
 Thread: M38 x 1,5 RHT
 0004601748, 120322305, 2205000400

**DB-ES-8323**

Length: 75
 Cone Ø: d1 Ø 32 / d2 Ø 28,8
 Thread: M26 x 1,5 RHT
 0014601548, 0014601648, 0024600648,
 A0014601648, A0024600648

**DB-ES-8510**

Length: 56
 Cone Ø: d1 Ø 10 / d2 Ø 10
 Thread: M12 x 1,75 LHT
 0009965145, 0009965645, 0019963145

**DB-ES-8530**

Length: 115
 Cone Ø: d1 Ø 28,6 / d2 Ø 23,9
 Thread: M30 x 1,5 RHT
 0014603848, 0014604848, 0014605148,
 0014608648, 0014609948

**DB-RK-8391**

Ø: 85 Hole Distance: 152
 Thick/Height: 24
 01336800A, 0003502705

**DB-RK-8626**

Ø: 75 Hole Distance: 130
 Thick/Height: 24
 0003502205, 0003502505, 0003503405,
 0003504505, GL11319

**DB-RK-8638**

Length: 100 Ø: 67
 Hole Distance: 100
 Thick/Height: 20
 0003301411

**DB-RK-8710**

Ø: 85 Hole Distance: 130
 Thick/Height: 30
 0003503705

**DB-RK-9291**

Ø: 107,5 Hole Distance: 152
 Thick/Height: 30
 0003503605

**DB-RK-10374**

Ø: 85 Hole Distance: 152
 Thick/Height: 24
 0003504405

**DB-RK-10375**

Ø: 100 Hole Distance: 152
 Thick/Height: 24
 0003502405, 0003503505, 0003504905

**DB-SB-10384**

Ø: 73 Thick/Height: 47
 9303170012, 9423171812

**DB-SB-10401**

Length: 232
 Thick/Height: 163,5 / 152,5
 0003250596, 0003250796

**DB-SB-10406**

Ø: 80 Thick/Height: 46
 0003238185

**DB-SB-10409**

Ø: 77 Thick/Height: 56
 0003265181

**DB-VB-7261**

Length: 622 Ø: 46
 Hole Ø 25 / 25 / 25
 Hole Distance: 152 / 130 / 130
 01337800A, 9443500305, 9443500505,
 9443500605, 9473500705, 9473500905,
 9483500405, 9483503005

**DB-VB-9307**

Length: 667 Ø: 60
 Hole Ø 25 / 23 / 23
 Hole Distance: 152 / 130 / 130
 9483502805

**DB-VB-9308**

Length: 622 Ø: 46
 Hole Ø 25 / 25 / 25
 Hole Distance: 152 / 130 / 130
 9483502905

**DB-VB-10426**

Length: 622 Ø: 46
 Hole Ø 25 / 25 / 25
 Hole Distance: 152 / 130 / 130
 9443500405





ACTROS MP2 / MP3 ...

4140 B ...	04/03 →	Track Control Arm		DB-DL-3475	Trailing Arm, 1st RA;2nd RA, →517144 06/517144 09
	04/03 →	Track Control Arm		DB-DL-3475	Trailing Arm, 1st RA;2nd RA, →517144 26/517144 27
	04/03 →	Track Control Arm		DB-VB-7261	Suspension Rod, Wishbone (CV)
	04/03 →	Track Control Arm		DB-VB-9307	Suspension Rod, Wishbone (CV)
	04/03 →	Track Control Arm		DB-VB-9308	Suspension Rod, Wishbone (CV)
	04/03 →	Track Control Arm		DB-VB-10426	Wishbone (CV), 1st RA;2nd RA, →517142 05
4140 K	04/03 →	Ball Head, gearshift linkage	DB-ES-8510		
	04/03 →	Bush, driver cab suspension	DB-SB-10384		
	04/03 →	Bush, parabolic spring		DB-SB-10401	
	04/03 →	Centre Rod	DB-DL-8168		Push Rod, Leaf Spring Axle
	04/03 →	Centre Rod	DB-DL-8184		Push Rod
	04/03 →	Centre Rod	DB-DL-8184		Push Rod, Leaf Spring Axle
	04/03 →	Centre Rod	DB-DL-8185		Push Rod, Leaf Spring Axle
	04/03 →	Centre Rod	DB-DL-8307		Push Rod
	04/03 →	Centre Rod	DB-DL-9259		Push Rod, Leaf Spring Axle
	04/03 →	Centre Rod	DB-DL-10208		Push Rod, Leaf Spring Axle
	04/03 →	Centre Rod	DB-DL-10212		Push Rod, Leaf Spring Axle
	04/03 →	Centre Rod	DB-DL-12300		for Steering Rod
	04/03 →	Centre Rod	DB-DL-12301		Push Rod, Leaf Spring Axle
	04/03 →	Centre Rod	DB-DL-12403		Push Rod
	04/03 →	Stabiliser Link	DB-DL-9254		Pressure Rod
	04/03 →	Stabiliser Link	DB-DL-9271		Pressure Rod
	04/03 →	Stabiliser Link	DB-DL-9272		Pressure Rod
	04/03 →	Stabiliser Mounting		DB-SB-10406	
	04/03 →	Stabiliser Mounting		DB-SB-10409	
	04/03 →	Suspension Arm Repair Kit		DB-RK-8626	for Wishbone (CV)
	04/03 →	Suspension Arm Repair Kit		DB-RK-10374	for Wishbone (CV)
	04/03 →	Suspension Arm Repair Kit		DB-RK-10375	for Wishbone (CV)
	04/03 →	Suspension Arm Repair Kit	DB-RK-8638		for Control Arm
	04/03 →	Suspension Strut Repair Kit		DB-RK-8391	
	04/03 →	Suspension Strut Repair Kit		DB-RK-8710	
	04/03 →	Suspension Strut Repair Kit		DB-RK-9291	
	04/03 →	Tie Rod	DB-DL-8171		Guide Rod
	04/03 →	Tie Rod	DB-DL-8172		Guide Rod
	04/03 →	Tie Rod	DB-DL-8327		Guide Rod
	04/03 →	Tie Rod	DB-DL-8390		
	04/03 →	Tie Rod	DB-DL-8640		Guide Rod
	04/03 →	Tie Rod	DB-DL-12310		
	04/03 →	Tie Rod	DB-ES-5227		Guide Rod
	04/03 →	Tie Rod	DB-ES-5227		Guide Rod, 2nd FA
	04/03 →	Tie Rod	MN-DL-7834		Guide Rod
	04/03 →	Tie Rod End	CV-ES-0543		for Push Rod
	04/03 →	Tie Rod End	CV-ES-0888		for Push Rod
	04/03 →	Tie Rod End	CV-ES-14163		for Steering Rod
	04/03 →	Tie Rod End	DB-ES-5234		for Steering Rod
	04/03 →	Tie Rod End	DB-ES-8323		Leaf Spring Axle
	04/03 →	Tie Rod End	DB-ES-8530		for Push Rod
	04/03 →	Track Control Arm		DB-DL-3475	Trailing Arm
	04/03 →	Track Control Arm		DB-VB-7261	Suspension Rod, Wishbone (CV), 1st RA;2nd RA; Leaf Spring Axle
04/03 →	Track Control Arm		DB-VB-9307	Suspension Rod, Wishbone (CV), 1st RA;2nd RA; Leaf Spring Axle	
04/03 →	Track Control Arm		DB-VB-9308	Suspension Rod, Wishbone (CV), 1st RA;2nd RA; Leaf Spring Axle	
04/03 →	Track Control Arm		DB-VB-10426	Wishbone (CV), 1st RA;2nd RA, →517142 05	
4141	06/08 →	Bush, parabolic spring		DB-SB-10401	
	06/08 →	Centre Rod	DB-DL-8168		Push Rod
	06/08 →	Centre Rod	DB-DL-8184		Push Rod
	06/08 →	Centre Rod	DB-DL-8185		Push Rod
	06/08 →	Centre Rod	DB-DL-9259		Push Rod
	06/08 →	Centre Rod	DB-DL-10212		Push Rod

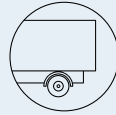

ACTROS MP2 / MP3 ...

4141 ...	06/08→	Centre Rod	DB-DL-12300		for Steering Rod
	06/08→	Stabiliser Link	DB-DL-9254		Coupling Rod
	06/08→	Stabiliser Link	DB-DL-9271		Coupling Rod
	06/08→	Suspension Arm Repair Kit		DB-RK-10375	for Wishbone (CV)
	06/08→	Suspension Strut Repair Kit		DB-RK-8391	
	06/08→	Tie Rod	DB-DL-8171		Guide Rod
	06/08→	Tie Rod	DB-DL-8390		
	06/08→	Tie Rod	DB-DL-8640		Guide Rod
	06/08→	Tie Rod	DB-DL-12310		
	06/08→	Tie Rod End	CV-ES-0543		for Push Rod
	06/08→	Tie Rod End	CV-ES-0888		for Push Rod
	06/08→	Tie Rod End	CV-ES-14163		for Steering Rod
	06/08→	Tie Rod End	DB-ES-8323		
	06/08→	Tie Rod End	DB-ES-8530		for Push Rod
	06/08→	Track Control Arm		DB-DL-3475	Trailing Arm, 1st RA;2nd RA, →517144 03/517144 07
	06/08→	Track Control Arm		DB-DL-3475	Trailing Arm, 1st RA;2nd RA, →517144 06/517144 09
	06/08→	Track Control Arm		DB-DL-3475	Trailing Arm, 1st RA;2nd RA, →517144 26/517144 27
06/08→	Track Control Arm		DB-VB-9308	Suspension Rod, Wishbone (CV)	
4141 AK	04/03→	Centre Rod	DB-DL-8184		Push Rod, Leaf Spring Axle
	04/03→	Centre Rod	DB-DL-10208		Push Rod, Leaf Spring Axle
	04/03→	Centre Rod	DB-DL-12403		Push Rod
	04/03→	Stabiliser Link	DB-DL-9254		Pressure Rod
	04/03→	Stabiliser Mounting		DB-SB-10406	
	04/03→	Suspension Strut Repair Kit		DB-RK-8710	
	04/03→	Suspension Strut Repair Kit		DB-RK-9291	
	04/03→	Tie Rod	DB-DL-12310		
	04/03→	Tie Rod	DB-ES-5227		Guide Rod, 1st FA
	04/03→	Tie Rod End	CV-ES-0543		for Push Rod
	04/03→	Tie Rod End	CV-ES-0888		for Push Rod
	04/03→	Tie Rod End	DB-ES-5234		for Steering Rod
	04/03→	Track Control Arm		DB-DL-3475	Trailing Arm, 1st RA;2nd RA, →517144 03/517144 07
	04/03→	Track Control Arm		DB-DL-3475	Trailing Arm, 1st RA;2nd RA, →517144 06/517144 09
	04/03→	Track Control Arm		DB-DL-3475	Trailing Arm, 1st RA;2nd RA, →517144 26/517144 27
	04/03→	Track Control Arm		DB-VB-7261	Suspension Rod, Wishbone (CV), 1st RA;2nd RA; Leaf Spring Axle
	04/03→	Track Control Arm		DB-VB-9307	Suspension Rod, Wishbone (CV), 1st RA;2nd RA; Leaf Spring Axle
04/03→	Track Control Arm		DB-VB-9308	Suspension Rod, Wishbone (CV), 1st RA;2nd RA; Leaf Spring Axle	
04/03→	Track Control Arm		DB-VB-10426	Wishbone (CV), 1st RA;2nd RA, →517142 05	
4141 B	04/03→	Centre Rod	DB-DL-8168		Push Rod, Leaf Spring Axle
	04/03→	Centre Rod	DB-DL-8184		Push Rod, Leaf Spring Axle
	04/03→	Centre Rod	DB-DL-8185		Push Rod, Leaf Spring Axle
	04/03→	Centre Rod	DB-DL-9259		Push Rod, Leaf Spring Axle
	04/03→	Centre Rod	DB-DL-10212		Push Rod, Leaf Spring Axle
	04/03→	Centre Rod	DB-DL-12300		for Steering Rod
	04/03→	Centre Rod	DB-DL-12301		Push Rod, Leaf Spring Axle
	04/03→	Stabiliser Link	DB-DL-9254		Pressure Rod
	04/03→	Stabiliser Link	DB-DL-9271		Pressure Rod
	04/03→	Stabiliser Link	DB-DL-9272		Pressure Rod
	04/03→	Stabiliser Mounting		DB-SB-10406	
	04/03→	Suspension Strut Repair Kit		DB-RK-8710	
	04/03→	Suspension Strut Repair Kit		DB-RK-9291	
	04/03→	Tie Rod	DB-DL-8171		Guide Rod
	04/03→	Tie Rod	DB-DL-8172		Guide Rod
	04/03→	Tie Rod	DB-DL-8390		
	04/03→	Tie Rod	DB-DL-8640		Guide Rod

CV-ES-0543

Length: 125
Cone Ø: d1 Ø 32 / d2 Ø 29
Thread: M30 x 1,5 RHT
 0004605748, 0004606048, 0004606848,
 0004607048, 0014600448, 0014601148,
 0014601748, 0014602448, 0014607648,
 0014609648

**CV-ES-0888**

Length: 125
Cone Ø: d1 Ø 32 / d2 Ø 29
Thread: M30 x 1,5 LHT
 0004605848, 0004606148, 0004606948,
 0004607148, 0004609048, 0014600548,
 0014601348, 0014602548, 0014607948,
 0024600448

**CV-ES-14163**

Length: 125
Cone Ø: d1 Ø 30 / d2 Ø 27
Thread: M30 x 1,5 RHT
 0003305248, 0003387310, 0004600348,
 0004600948, 0004602848, 0004602948,
 0004608948, 0014600248, 0014600848,
 0014601248, 0014602248, 0014607748,
 0024600148, A0003387310, A0004600348,
 A0004602848, A0004602948, A0014600848,
 A0014601248, A0014602248, A0014607748

**DB-DL-3475**

Length: 565 Ø: 52
Hole Distance: 152 / 152
 3753500006, 3753500206, 9473500805,
 9483500006, 9483500805, 9483501205,
 9483501305, 9483501905, 9483502005,
 9483502405, A3753500006, A3753500206

**DB-DL-8168**

Length: 904 Ø: 52
Cone Ø: d1 Ø 32 / d2 Ø 29
 0004609405, 0004609505, 0014607105

**DB-DL-8171**

Length: 1687 Ø: 52
Cone Ø: d1 Ø 32 / d2 Ø 29
 9493300603, 9493300703, 9493301503,
 9493301603

**DB-DL-8172**

Length: 1700 Ø: 52
Cone Ø: d1 Ø 32 / d2 Ø 29
 01219700A, 9493300403, 9493300503,
 9493300803, 9493301403

**DB-DL-8184**

Length: 1095 Ø: 42
Cone Ø: d1 Ø 32 / d2 Ø 28,8
 01217700A, 0014601305, 0014601405,
 0024600505, 0034603205, 3754601505,
 A0014601305, A0014601405, A0024600505

**DB-DL-8185**

Length: 711 Ø: 42
Cone Ø: d1 Ø 32 / d2 Ø 28,8
 01213600A, 0014601105, 0024600405,
 0034603105, A0014601105, A0024600405

**DB-DL-8390**

Length: 1596 Ø: 50
Cone Ø: d1 Ø 32 / d2 Ø 29
 9493301003, 9493301103, 9493301703

**DB-DL-8640**

Length: 1615 Ø: 50
Cone Ø: d1 Ø 32 / d2 Ø 29
 6253301503, 6253301603, 6253302403,
 6253302503, 9423300803, 9423302103,
 9493300203, 9493300303, 9493300903

**DB-DL-9254**

Length: 1815 Ø: 58
 0003220323, 0003220623, 3753220423

**DB-DL-9259**

Length: 883 Ø: 38
Cone Ø: d1 Ø 32 / d2 Ø 29
 0024608605, 0024608705, A0024608605,
 A0024608705

**DB-DL-9271**

Length: 1815 Ø: 60
 0003220423, 0003220723

**DB-DL-9272**

Length: 1815 Ø: 80
 0003220223

**DB-DL-10208**

Length: 708 Ø: 40
Cone Ø: d1 Ø 32 / d2 Ø 29
 0014605305, 0024600605

**DB-DL-10212**

Length: 953 Ø: 42
Cone Ø: d1 Ø 32 / d2 Ø 29
 0024609205, 0024609305, 0034604505

**DB-DL-12300**

Length: 733 Ø: 36
Cone Ø: d1 Ø 32 / d2 Ø 29
 0014601505, 0014607305, 0034603305,
 3754601605, A0014601505, A0034603305,
 A3754601605

**DB-DL-12301**

Length: 716 Ø: 38
Cone Ø: d1 Ø 32 / d2 Ø 29
Thread: M30 x 1,5
 0024608805, 0024608905, A0024608805,
 A0024608905

**DB-DL-12310**

Length: 1532 Ø: 50
Cone Ø: d1 Ø 32 / d2 Ø 29
Thread: M27 x 1,5 LHT
 9493301203, 9493301303, 9493301803,
 9493302203, A9493301203, A9493301303,
 A9493301803, A9493302203

**DB-DL-12403**

Length: 893 Ø: 42
Cone Ø: d1 Ø 32 / d2 Ø 29
 0014604905, 0014607405

**DB-ES-5227**

Length: 1588 Ø: 60
Cone Ø: d1 Ø 38 / d2 Ø 34,3
 6253300903, 6253301203, 9443300203

**DB-ES-5234**

Length: 135
Cone Ø: d1 Ø 38 / d2 Ø 34,3
Thread: M38 x 1,5 RHT
 0004601748, 120322305, 2205000400

**DB-ES-8323**

Length: 75
Cone Ø: d1 Ø 32 / d2 Ø 28,8
Thread: M26 x 1,5 RHT
 0014601548, 0014601648, 0024600648,
 A0014601648, A0024600648

**DB-ES-8530**

Length: 115
Cone Ø: d1 Ø 28,6 / d2 Ø 23,9
Thread: M30 x 1,5 RHT
 0014603848, 0014604848, 0014605148,
 0014608648, 0014609948

**DB-RK-8391**

Ø: 85 **Hole Distance:** 152
Thick/Height: 24
 01336800A, 0003502705

**DB-RK-8710**

Ø: 85 **Hole Distance:** 130
Thick/Height: 30
 0003503705

**DB-RK-9291**

Ø: 107,5 **Hole Distance:** 152
Thick/Height: 30
 0003503605

**DB-RK-10375**

Ø: 100 **Hole Distance:** 152
Thick/Height: 24
 0003502405, 0003503505, 0003504905

**DB-SB-10406**

Ø: 80 **Thick/Height:** 46
 0003238185

**DB-VB-7261**

Length: 622 Ø: 46
Hole Ø: 25 / 25 / 25
Hole Distance: 152 / 130 / 130
 01337800A, 9443500305, 9443500505,
 9443500605, 9473500705, 9473500905,
 9483500405, 9483503005

**DB-VB-9307**

Length: 667 Ø: 60
Hole Ø: 25 / 23 / 23
Hole Distance: 152 / 130 / 130
 9483502805

**DB-VB-9308**

Length: 622 Ø: 46
Hole Ø: 25 / 25 / 25
Hole Distance: 152 / 130 / 130
 9483502905

**DB-VB-10426**

Length: 622 Ø: 46
Hole Ø: 25 / 25 / 25
Hole Distance: 152 / 130 / 130
 9443500405





ACTROS MP2 / MP3 ...

4141 B ...	04/03→	Tie Rod	DB-DL-12310		
	04/03→	Tie Rod	DB-ES-5227	Guide Rod	
	04/03→	Tie Rod End	CV-ES-0543	for Push Rod	
	04/03→	Tie Rod End	CV-ES-0888	for Push Rod	
	04/03→	Tie Rod End	CV-ES-14163	for Steering Rod	
	04/03→	Tie Rod End	DB-ES-8530	for Push Rod	
	04/03→	Track Control Arm		DB-DL-3475	Trailing Arm, 1st RA;2nd RA, →517144 03/517144 07
	04/03→	Track Control Arm		DB-DL-3475	Trailing Arm, 1st RA;2nd RA, →517144 06/517144 09
	04/03→	Track Control Arm		DB-DL-3475	Trailing Arm, 1st RA;2nd RA, →517144 26/517144 27
	04/03→	Track Control Arm		DB-VB-7261	Suspension Rod, Wishbone (CV), 1st RA;2nd RA; Leaf Spring Axle
	04/03→	Track Control Arm		DB-VB-9307	Suspension Rod, Wishbone (CV), 1st RA;2nd RA; Leaf Spring Axle
	04/03→	Track Control Arm		DB-VB-9308	Suspension Rod, Wishbone (CV), 1st RA;2nd RA; Leaf Spring Axle
	04/03→	Track Control Arm		DB-VB-10426	Wishbone (CV), 1st RA;2nd RA, →517142 05
	4141 K	04/03→	Ball Head, gearshift linkage	DB-ES-8510	
		04/03→	Bush, driver cab suspension	DB-SB-10384	
04/03→		Bush, parabolic spring		DB-SB-10401	
04/03→		Centre Rod	DB-DL-8168	Push Rod	
04/03→		Centre Rod	DB-DL-8184	Push Rod, Leaf Spring Axle	
04/03→		Centre Rod	DB-DL-8185	Push Rod, Leaf Spring Axle	
04/03→		Centre Rod	DB-DL-8307	Push Rod	
04/03→		Centre Rod	DB-DL-9259	Push Rod, Leaf Spring Axle	
04/03→		Centre Rod	DB-DL-10208	Push Rod, Leaf Spring Axle	
04/03→		Centre Rod	DB-DL-10212	Push Rod, Leaf Spring Axle	
04/03→		Centre Rod	DB-DL-12300	for Steering Rod	
04/03→		Centre Rod	DB-DL-12301	Push Rod, Leaf Spring Axle	
04/03→		Centre Rod	DB-DL-12403	Push Rod	
04/03→		Stabiliser Link	DB-DL-9254	Pressure Rod	
04/03→		Stabiliser Link	DB-DL-9271	Pressure Rod	
04/03→		Stabiliser Link	DB-DL-9272	Pressure Rod	
04/03→		Stabiliser Mounting		DB-SB-10406	
04/03→		Stabiliser Mounting		DB-SB-10409	
04/03→		Suspension Arm Repair Kit		DB-RK-8626	for Wishbone (CV)
04/03→		Suspension Arm Repair Kit		DB-RK-10374	for Wishbone (CV)
04/03→		Suspension Arm Repair Kit		DB-RK-10375	for Wishbone (CV)
04/03→		Suspension Arm Repair Kit	DB-RK-8638		for Control Arm
04/03→		Suspension Strut Repair Kit		DB-RK-8391	
04/03→		Suspension Strut Repair Kit		DB-RK-8710	
04/03→		Suspension Strut Repair Kit		DB-RK-9291	
04/03→		Tie Rod	DB-DL-8171		Guide Rod
04/03→		Tie Rod	DB-DL-8172		Guide Rod
04/03→		Tie Rod	DB-DL-8327		Guide Rod
04/03→		Tie Rod	DB-DL-8390		
04/03→		Tie Rod	DB-DL-8640		Guide Rod
04/03→		Tie Rod	DB-DL-12310		
04/03→		Tie Rod	DB-ES-5227		Guide Rod
04/03→		Tie Rod	MN-DL-7834		Guide Rod
04/03→		Tie Rod End	CV-ES-0543		for Push Rod
04/03→		Tie Rod End	CV-ES-0888		for Push Rod
04/03→		Tie Rod End	CV-ES-14163		for Steering Rod
04/03→		Tie Rod End	DB-ES-5234		for Steering Rod
04/03→		Tie Rod End	DB-ES-8323		Leaf Spring Axle
04/03→		Tie Rod End	DB-ES-8530		for Push Rod
04/03→		Track Control Arm		DB-DL-3475	Trailing Arm
04/03→		Track Control Arm		DB-DL-3475	Trailing Arm, 1st RA;2nd RA, →517144 03/517144 07
04/03→		Track Control Arm		DB-DL-3475	Trailing Arm, 1st RA;2nd RA, →517144 06/517144 09



ACTROS MP2 / MP3 ...

4141 K ...	04/03 →	Track Control Arm		DB-DL-3475	Trailing Arm, 1st RA;2nd RA, →517144 26/517144 27
	04/03 →	Track Control Arm		DB-VB-7261	Suspension Rod, Wishbone (CV), 1st RA;2nd RA; Leaf Spring Axle
	04/03 →	Track Control Arm		DB-VB-9307	Suspension Rod, Wishbone (CV), 1st RA;2nd RA; Leaf Spring Axle
	04/03 →	Track Control Arm		DB-VB-9308	Suspension Rod, Wishbone (CV), 1st RA;2nd RA; Leaf Spring Axle
	04/03 →	Track Control Arm		DB-VB-10426	Wishbone (CV), 1st RA;2nd RA, →517142 05
4143 AK	04/03 →	Centre Rod	DB-DL-8184		Push Rod
	04/03 →	Centre Rod	DB-DL-10208		Push Rod
	04/03 →	Centre Rod	DB-DL-12403		Push Rod
	04/03 →	Stabiliser Link	DB-DL-9254		Coupling Rod
	04/03 →	Suspension Arm Repair Kit		DB-RK-8626	for Wishbone (CV)
	04/03 →	Suspension Arm Repair Kit		DB-RK-10375	for Wishbone (CV)
	04/03 →	Suspension Strut Repair Kit		DB-RK-8391	
	04/03 →	Suspension Strut Repair Kit		DB-RK-8710	
	04/03 →	Suspension Strut Repair Kit		DB-RK-9291	
	04/03 →	Tie Rod	DB-ES-5227		Guide Rod
	04/03 →	Tie Rod End	CV-ES-0543		for Push Rod
	04/03 →	Tie Rod End	CV-ES-0888		for Push Rod
	04/03 →	Tie Rod End	DB-ES-5234		for Steering Rod
	04/03 →	Track Control Arm		DB-DL-3475	Trailing Arm, 1st RA;2nd RA, →517144 03/517144 07
	04/03 →	Track Control Arm		DB-DL-3475	Trailing Arm, 1st RA;2nd RA, →517144 06/517144 09
	04/03 →	Track Control Arm		DB-DL-3475	Trailing Arm, 1st RA;2nd RA, →517144 26/517144 27
	04/03 →	Track Control Arm		DB-VB-7261	Suspension Rod, Wishbone (CV)
	04/03 →	Track Control Arm		DB-VB-9307	Suspension Rod, Wishbone (CV)
	04/03 →	Track Control Arm		DB-VB-9308	Suspension Rod, Wishbone (CV)
	04/03 →	Track Control Arm		DB-VB-10426	Wishbone (CV), 1st RA;2nd RA, →517142 05
4143 B	04/03 →	Centre Rod	DB-DL-8168		Push Rod
	04/03 →	Centre Rod	DB-DL-8184		Push Rod
	04/03 →	Centre Rod	DB-DL-8185		Push Rod
	04/03 →	Centre Rod	DB-DL-9259		Push Rod
	04/03 →	Centre Rod	DB-DL-10212		Push Rod
	04/03 →	Centre Rod	DB-DL-12300		for Steering Rod
	04/03 →	Centre Rod	DB-DL-12301		Push Rod, Leaf Spring Axle
	04/03 →	Stabiliser Link	DB-DL-9254		Coupling Rod
	04/03 →	Stabiliser Link	DB-DL-9271		Coupling Rod
	04/03 →	Stabiliser Link	DB-DL-9272		Coupling Rod
	04/03 →	Suspension Arm Repair Kit		DB-RK-8626	for Wishbone (CV)
	04/03 →	Suspension Arm Repair Kit		DB-RK-10375	for Wishbone (CV)
	04/03 →	Suspension Strut Repair Kit		DB-RK-8391	
	04/03 →	Suspension Strut Repair Kit		DB-RK-8710	
	04/03 →	Suspension Strut Repair Kit		DB-RK-9291	
	04/03 →	Tie Rod	DB-DL-8171		Guide Rod
	04/03 →	Tie Rod	DB-DL-8172		Guide Rod
	04/03 →	Tie Rod	DB-DL-8390		
	04/03 →	Tie Rod	DB-DL-8640		Guide Rod
	04/03 →	Tie Rod	DB-DL-12310		
	04/03 →	Tie Rod End	CV-ES-0543		for Push Rod
	04/03 →	Tie Rod End	CV-ES-0888		for Push Rod
	04/03 →	Tie Rod End	CV-ES-14163		for Steering Rod
	04/03 →	Tie Rod End	DB-ES-8530		for Push Rod
	04/03 →	Track Control Arm		DB-DL-3475	Trailing Arm, 1st RA;2nd RA, →517144 03/517144 07
	04/03 →	Track Control Arm		DB-DL-3475	Trailing Arm, 1st RA;2nd RA, →517144 06/517144 09
	04/03 →	Track Control Arm		DB-DL-3475	Trailing Arm, 1st RA;2nd RA, →517144 26/517144 27
	04/03 →	Track Control Arm		DB-VB-7261	Suspension Rod, Wishbone (CV)

CV-ES-0543

Length: 125
 Cone Ø: d1 Ø 32 / d2 Ø 29
 Thread: M30 x 1,5 RHT
 0004605748, 0004606048, 0004606848,
 0004607048, 0014600448, 0014601148,
 0014601748, 0014602448, 0014607648,
 0014609648



CV-ES-0888

Length: 125
 Cone Ø: d1 Ø 32 / d2 Ø 29
 Thread: M30 x 1,5 LHT
 0004605848, 0004606148, 0004606948,
 0004607148, 0004609048, 0014600548,
 0014601348, 0014602548, 0014607948,
 0024600448



CV-ES-14163

Length: 125
 Cone Ø: d1 Ø 30 / d2 Ø 27
 Thread: M30 x 1,5 RHT
 0003305248, 0003387310, 0004600348,
 0004600948, 0004602848, 0004602948,
 0004608948, 0014600248, 0014600848,
 0014601248, 0014602248, 0014607748,
 0024600148, A0003387310, A0004600348,
 A0004602848, A0004602948, A0014600848,
 A0014601248, A0014602248, A0014607748



DB-DL-3475

Length: 565 Ø: 52
 Hole Distance: 152 / 152
 3753500006, 3753500206, 9473500805,
 9483500006, 9483500805, 9483501205,
 9483501305, 9483501905, 9483502005,
 9483502405, A3753500006, A3753500206



DB-DL-8168

Length: 904 Ø: 52
 Cone Ø: d1 Ø 32 / d2 Ø 29
 0004609405, 0004609505, 0014607105



DB-DL-8171

Length: 1687 Ø: 52
 Cone Ø: d1 Ø 32 / d2 Ø 29
 9493300603, 9493300703, 9493301503,
 9493301603



DB-DL-8172

Length: 1700 Ø: 52
 Cone Ø: d1 Ø 32 / d2 Ø 29
 01219700A, 9493300403, 9493300503,
 9493300803, 9493301403



DB-DL-8184

Length: 1095 Ø: 42
 Cone Ø: d1 Ø 32 / d2 Ø 28,8
 01217700A, 0014601305, 0014601405,
 0024600505, 0034603205, 3754601505,
 A0014601305, A0014601405, A0024600505



DB-DL-8185

Length: 711 Ø: 42
 Cone Ø: d1 Ø 32 / d2 Ø 28,8
 01213600A, 0014601105, 0024600405,
 0034603105, A0014601105, A0024600405



DB-DL-8390

Length: 1596 Ø: 50
 Cone Ø: d1 Ø 32 / d2 Ø 29
 9493301003, 9493301103, 9493301703



DB-DL-8640

Length: 1615 Ø: 50
 Cone Ø: d1 Ø 32 / d2 Ø 29
 6253301503, 6253301603, 6253302403,
 6253302503, 9423300803, 9423302103,
 9493300203, 9493300303, 9493300903



DB-DL-9254

Length: 1815 Ø: 58
 0003220323, 0003220623, 3753220423



DB-DL-9259

Length: 883 Ø: 38
 Cone Ø: d1 Ø 32 / d2 Ø 29
 0024608605, 0024608705, A0024608605,
 A0024608705



DB-DL-9271

Length: 1815 Ø: 60
 0003220423, 0003220723



DB-DL-9272

Length: 1815 Ø: 80
 0003220223



DB-DL-10208

Length: 708 Ø: 40
 Cone Ø: d1 Ø 32 / d2 Ø 29
 0014605305, 0024600605



DB-DL-10212

Length: 953 Ø: 42
 Cone Ø: d1 Ø 32 / d2 Ø 29
 0024609205, 0024609305, 0034604505



DB-DL-12300

Length: 733 Ø: 36
 Cone Ø: d1 Ø 32 / d2 Ø 29
 0014601505, 0014607305, 0034603305,
 3754601605, A0014601505, A0034603305,
 A3754601605



DB-DL-12301

Length: 716 Ø: 38
 Cone Ø: d1 Ø 32 / d2 Ø 29
 Thread: M30 x 1,5
 0024608805, 0024608905, A0024608805,
 A0024608905



DB-DL-12310

Length: 1532 Ø: 50
 Cone Ø: d1 Ø 32 / d2 Ø 29
 Thread: M27 x 1,5 LHT
 9493301203, 9493301303, 9493301803,
 9493302203, A9493301203, A9493301303,
 A9493301803, A9493302203



DB-DL-12403

Length: 893 Ø: 42
 Cone Ø: d1 Ø 32 / d2 Ø 29
 0014604905, 0014607405



DB-ES-5227

Length: 1588 Ø: 60
 Cone Ø: d1 Ø 38 / d2 Ø 34,3
 6253300903, 6253301203, 9443300203



DB-ES-5234

Length: 135
 Cone Ø: d1 Ø 38 / d2 Ø 34,3
 Thread: M38 x 1,5 RHT
 0004601748, 120322305, 2205000400



DB-ES-8530

Length: 115
 Cone Ø: d1 Ø 28,6 / d2 Ø 23,9
 Thread: M30 x 1,5 RHT
 0014603848, 0014604848, 0014605148,
 0014608648, 0014609948



DB-RK-8391

Ø: 85 Hole Distance: 152
 Thick/Height: 24
 01336800A, 0003502705



DB-RK-8626

Ø: 75 Hole Distance: 130
 Thick/Height: 24
 0003502205, 0003502505, 0003503405,
 0003504505, GL11319



DB-RK-8710

Ø: 85 Hole Distance: 130
 Thick/Height: 30
 0003503705



DB-RK-9291

Ø: 107,5 Hole Distance: 152
 Thick/Height: 30
 0003503605



DB-RK-10375

Ø: 100 Hole Distance: 152
 Thick/Height: 24
 0003502405, 0003503505, 0003504905



DB-VB-7261

Length: 622 Ø: 46
 Hole Ø 25 / 25 / 25
 Hole Distance: 152 / 130 / 130
 01337800A, 9443500305, 9443500505,
 9443500605, 9473500705, 9473500905,
 9483500405, 9483503005



DB-VB-9307

Length: 667 Ø: 60
 Hole Ø 25 / 23 / 23
 Hole Distance: 152 / 130 / 130
 9483502805



DB-VB-9308

Length: 622 Ø: 46
 Hole Ø 25 / 25 / 25
 Hole Distance: 152 / 130 / 130
 9483502905



DB-VB-10426

Length: 622 Ø: 46
 Hole Ø 25 / 25 / 25
 Hole Distance: 152 / 130 / 130
 9443500405



MERCEDES-BENZ



ACTROS MP2 / MP3 ...

4143 B ...	04/03→	Track Control Arm		DB-VB-9307	Suspension Rod, Wishbone (CV)	
	04/03→	Track Control Arm		DB-VB-9308	Suspension Rod, Wishbone (CV)	
	04/03→	Track Control Arm		DB-VB-10426	Wishbone (CV), 1st RA;2nd RA, →517142 05	
	04/03→	Track Control Arm				
4143 K	04/03→	Centre Rod	DB-DL-10208		Push Rod	
	04/03→	Centre Rod	DB-DL-12403		Push Rod	
	04/03→	Stabiliser Link	DB-DL-9254		Coupling Rod	
	04/03→	Suspension Arm Repair Kit		DB-RK-8626	for Wishbone (CV)	
	04/03→	Suspension Arm Repair Kit		DB-RK-10375	for Wishbone (CV)	
	04/03→	Suspension Strut Repair Kit		DB-RK-8391		
	04/03→	Suspension Strut Repair Kit		DB-RK-8710		
	04/03→	Suspension Strut Repair Kit		DB-RK-9291		
	04/03→	Tie Rod	DB-DL-8390			
	04/03→	Tie Rod	DB-DL-8640		Guide Rod, 1st & 2nd Front Axle	
	04/03→	Tie Rod	DB-DL-12310			
	04/03→	Tie Rod	DB-ES-5227		Guide Rod, 1st & 2nd Front Axle	
	04/03→	Tie Rod	MN-DL-7834		Guide Rod	
	04/03→	Tie Rod End	CV-ES-0543		for Push Rod	
	04/03→	Tie Rod End	CV-ES-0888		for Push Rod	
	04/03→	Tie Rod End	CV-ES-14163		for Steering Rod	
	04/03→	Tie Rod End	DB-ES-5234		for Steering Rod	
	04/03→	Tie Rod End	DB-ES-8530		for Push Rod	
	04/03→	Track Control Arm		DB-DL-3475	Trailing Arm, 1st RA;2nd RA, →517144 03/517144 07	
	04/03→	Track Control Arm		DB-DL-3475	Trailing Arm, 1st RA;2nd RA, →517144 06/517144 09	
	04/03→	Track Control Arm		DB-DL-3475	Trailing Arm, 1st RA;2nd RA, →517144 26/517144 27	
	04/03→	Track Control Arm		DB-VB-7261	Suspension Rod, Wishbone (CV)	
	04/03→	Track Control Arm		DB-VB-9307	Suspension Rod, Wishbone (CV)	
	04/03→	Track Control Arm		DB-VB-9308	Suspension Rod, Wishbone (CV)	
	04/03→	Track Control Arm		DB-VB-10426	Wishbone (CV), 1st RA;2nd RA, →517142 05	
	4144 AK	04/03→	Centre Rod	DB-DL-8184		Push Rod, Leaf Spring Axle
		04/03→	Centre Rod	DB-DL-10208		Push Rod, Leaf Spring Axle
04/03→		Centre Rod	DB-DL-12403		Push Rod	
04/03→		Stabiliser Link	DB-DL-9254		Pressure Rod	
04/03→		Stabiliser Mounting		DB-SB-10406		
04/03→		Suspension Strut Repair Kit		DB-RK-8710		
04/03→		Suspension Strut Repair Kit		DB-RK-9291		
04/03→		Tie Rod	DB-DL-12310			
04/03→		Tie Rod	DB-ES-5227		Guide Rod, 1st FA	
04/03→		Tie Rod End	CV-ES-0543		for Push Rod	
04/03→		Tie Rod End	CV-ES-0888		for Push Rod	
04/03→		Tie Rod End	DB-ES-5234		for Steering Rod	
04/03→		Track Control Arm		DB-DL-3475	Trailing Arm, 1st RA;2nd RA, →517144 03/517144 07	
04/03→		Track Control Arm		DB-DL-3475	Trailing Arm, 1st RA;2nd RA, →517144 06/517144 09	
04/03→		Track Control Arm		DB-DL-3475	Trailing Arm, 1st RA;2nd RA, →517144 26/517144 27	
04/03→		Track Control Arm		DB-VB-7261	Suspension Rod, Wishbone (CV), 1st RA;2nd RA; Leaf Spring Axle	
04/03→		Track Control Arm		DB-VB-9307	Suspension Rod, Wishbone (CV), 1st RA;2nd RA; Leaf Spring Axle	
04/03→		Track Control Arm		DB-VB-9308	Suspension Rod, Wishbone (CV), 1st RA;2nd RA; Leaf Spring Axle	
04/03→		Track Control Arm		DB-VB-10426	Wishbone (CV), 1st RA;2nd RA, →517142 05	
4144 B		04/03→	Centre Rod	DB-DL-8168		Push Rod, Leaf Spring Axle
		04/03→	Centre Rod	DB-DL-8184		Push Rod, Leaf Spring Axle
	04/03→	Centre Rod	DB-DL-8185		Push Rod, Leaf Spring Axle	
	04/03→	Centre Rod	DB-DL-9259		Push Rod, Leaf Spring Axle	
	04/03→	Centre Rod	DB-DL-10212		Push Rod, Leaf Spring Axle	
	04/03→	Centre Rod	DB-DL-12300		for Steering Rod	
	04/03→	Centre Rod	DB-DL-12301		Push Rod, Leaf Spring Axle	
	04/03→	Centre Rod				

CV-ES-0543

Length: 125
Cone Ø: d1 Ø 32 / d2 Ø 29
Thread: M30 x 1,5 RHT
0004605748, 0004606048, 0004606848,
0004607048, 0014600448, 0014601148,
0014601748, 0014602448, 0014607648,
0014609648



CV-ES-0888

Length: 125
Cone Ø: d1 Ø 32 / d2 Ø 29
Thread: M30 x 1,5 LHT
0004605848, 0004606148, 0004606948,
0004607148, 0004609048, 0014600548,
0014601348, 0014602548, 0014607948,
0024600448



CV-ES-14163

Length: 125
Cone Ø: d1 Ø 30 / d2 Ø 27
Thread: M30 x 1,5 RHT
0003305248, 0003387310, 0004600348,
0004600948, 0004602848, 0004602948,
0004608948, 0014600248, 0014600848,
0014601248, 0014602248, 0014607748,
0024600148, A0003387310, A0004600348,
A0004602848, A0004602948, A0014600848,
A0014601248, A0014602248, A0014607748



DB-DL-3475

Length: 565 Ø: 52
Hole Distance: 152 / 152
3753500006, 3753500206, 9473500805,
9483500006, 9483500805, 9483501205,
9483501305, 9483501905, 9483502005,
9483502405, A3753500006, A3753500206



DB-DL-8168

Length: 904 Ø: 52
Cone Ø: d1 Ø 32 / d2 Ø 29
0004609405, 0004609505, 0014607105



DB-DL-8184

Length: 1095 Ø: 42
Cone Ø: d1 Ø 32 / d2 Ø 28,8
01217700A, 0014601305, 0014601405,
0024600505, 0034603205, 3754601505,
A0014601305, A0014601405, A0024600505



DB-DL-8185

Length: 711 Ø: 42
Cone Ø: d1 Ø 32 / d2 Ø 28,8
01213600A, 0014601105, 0024600405,
0034603105, A0014601105, A0024600405



DB-DL-8390

Length: 1596 Ø: 50
Cone Ø: d1 Ø 32 / d2 Ø 29
9493301003, 9493301103, 9493301703



DB-DL-8640

Length: 1615 Ø: 50
Cone Ø: d1 Ø 32 / d2 Ø 29
6253301503, 6253301603, 6253302403,
6253302503, 9423300803, 9423302103,
9493300203, 9493300303, 9493300903



DB-DL-9254

Length: 1815 Ø: 58
0003220323, 0003220623, 3753220423



DB-DL-9259

Length: 883 Ø: 38
Cone Ø: d1 Ø 32 / d2 Ø 29
0024608605, 0024608705, A0024608605,
A0024608705



DB-DL-10208

Length: 708 Ø: 40
Cone Ø: d1 Ø 32 / d2 Ø 29
0014605305, 0024600605



DB-DL-10212

Length: 953 Ø: 42
Cone Ø: d1 Ø 32 / d2 Ø 29
0024609205, 0024609305, 0034604505



DB-DL-12300

Length: 733 Ø: 36
Cone Ø: d1 Ø 32 / d2 Ø 29
0014601505, 0014607305, 0034603305,
3754601605, A0014601505, A0034603305,
A3754601605



DB-DL-12301

Length: 716 Ø: 38
Cone Ø: d1 Ø 32 / d2 Ø 29
Thread: M30 x 1,5
0024608805, 0024608905, A0024608805,
A0024608905



DB-DL-12310

Length: 1532 Ø: 50
Cone Ø: d1 Ø 32 / d2 Ø 29
Thread: M27 x 1,5 LHT
9493301203, 9493301303, 9493301803,
9493302203, A9493301203, A9493301303,
A9493301803, A9493302203



DB-DL-12403

Length: 893 Ø: 42
Cone Ø: d1 Ø 32 / d2 Ø 29
0014604905, 0014607405



DB-ES-5227

Length: 1588 Ø: 60
Cone Ø: d1 Ø 38 / d2 Ø 34,3
6253300903, 6253301203, 9443300203



DB-ES-5234

Length: 135
Cone Ø: d1 Ø 38 / d2 Ø 34,3
Thread: M38 x 1,5 RHT
0004601748, 120322305, 2205000400



DB-ES-8530

Length: 115
Cone Ø: d1 Ø 28,6 / d2 Ø 23,9
Thread: M30 x 1,5 RHT
0014603848, 0014604848, 0014605148,
0014608648, 0014609948



DB-RK-8391

Ø: 85 Hole Distance: 152
Thick/Height: 24
01336800A, 0003502705



DB-RK-8626

Ø: 75 Hole Distance: 130
Thick/Height: 24
0003502205, 0003502505, 0003503405,
0003504505, GL11319



DB-RK-8710

Ø: 85 Hole Distance: 130
Thick/Height: 30
0003503705



DB-RK-9291

Ø: 107,5 Hole Distance: 152
Thick/Height: 30
0003503605



DB-RK-10375

Ø: 100 Hole Distance: 152
Thick/Height: 24
0003502405, 0003503505, 0003504905



DB-SB-10406

Ø: 80 Thick/Height: 46
0003238185



DB-VB-7261

Length: 622 Ø: 46
Hole Ø 25 / 25 / 25
Hole Distance: 152 / 130 / 130
01337800A, 9443500305, 9443500505,
9443500605, 9473500705, 9473500905,
9483500405, 9483503005



DB-VB-9307

Length: 667 Ø: 60
Hole Ø 25 / 23 / 23
Hole Distance: 152 / 130 / 130
9483502805



DB-VB-9308

Length: 622 Ø: 46
Hole Ø 25 / 25 / 25
Hole Distance: 152 / 130 / 130
9483502905



DB-VB-10426

Length: 622 Ø: 46
Hole Ø 25 / 25 / 25
Hole Distance: 152 / 130 / 130
9443500405



MN-DL-7834

Length: 1588 Ø: 58
Cone Ø: d1 Ø 30 / d2 Ø 27
3463303903, 3463304903, 6253303203,
9443300503, 9443301303, 9443301703





ACTROS MP2 / MP3 ...

4144 B ...	04/03→	Stabiliser Link	DB-DL-9254		Pressure Rod
	04/03→	Stabiliser Link	DB-DL-9271		Pressure Rod
	04/03→	Stabiliser Link	DB-DL-9272		Pressure Rod
	04/03→	Stabiliser Mounting		DB-SB-10406	
	04/03→	Suspension Strut Repair Kit		DB-RK-8710	
	04/03→	Suspension Strut Repair Kit		DB-RK-9291	
	04/03→	Tie Rod	DB-DL-8171		Guide Rod
	04/03→	Tie Rod	DB-DL-8172		Guide Rod
	04/03→	Tie Rod	DB-DL-8390		
	04/03→	Tie Rod	DB-DL-8640		Guide Rod
	04/03→	Tie Rod	DB-DL-12310		
	04/03→	Tie Rod	DB-ES-5227		Guide Rod
	04/03→	Tie Rod End	CV-ES-0543		for Push Rod
	04/03→	Tie Rod End	CV-ES-0888		for Push Rod
	04/03→	Tie Rod End	CV-ES-14163		for Steering Rod
	04/03→	Tie Rod End	DB-ES-8530		for Push Rod
	04/03→	Track Control Arm		DB-DL-3475	Trailing Arm, 1st RA;2nd RA, →517144 03/517144 07
	04/03→	Track Control Arm		DB-DL-3475	Trailing Arm, 1st RA;2nd RA, →517144 06/517144 09
	04/03→	Track Control Arm		DB-DL-3475	Trailing Arm, 1st RA;2nd RA, →517144 26/517144 27
	04/03→	Track Control Arm		DB-VB-7261	Suspension Rod, Wishbone (CV), 1st RA;2nd RA; Leaf Spring Axle
	04/03→	Track Control Arm		DB-VB-9307	Suspension Rod, Wishbone (CV), 1st RA;2nd RA; Leaf Spring Axle
	04/03→	Track Control Arm		DB-VB-9308	Suspension Rod, Wishbone (CV), 1st RA;2nd RA; Leaf Spring Axle
	04/03→	Track Control Arm		DB-VB-10426	Wishbone (CV), 1st RA;2nd RA, →517142 05
	4144 K	04/03→	Ball Head, gearshift linkage	DB-ES-8510	
04/03→		Bush, driver cab suspension	DB-SB-10384		
04/03→		Bush, parabolic spring		DB-SB-10401	
04/03→		Centre Rod	DB-DL-8168		Push Rod, Leaf Spring Axle
04/03→		Centre Rod	DB-DL-8184		Push Rod, Leaf Spring Axle
04/03→		Centre Rod	DB-DL-8185		Push Rod, Leaf Spring Axle
04/03→		Centre Rod	DB-DL-8307		Push Rod
04/03→		Centre Rod	DB-DL-9259		Push Rod, Leaf Spring Axle
04/03→		Centre Rod	DB-DL-10208		Push Rod, Leaf Spring Axle
04/03→		Centre Rod	DB-DL-10212		Push Rod, Leaf Spring Axle
04/03→		Centre Rod	DB-DL-12300		for Steering Rod
04/03→		Centre Rod	DB-DL-12301		Push Rod, Leaf Spring Axle
04/03→		Centre Rod	DB-DL-12403		Push Rod
04/03→		Stabiliser Link	DB-DL-9254		Pressure Rod
04/03→		Stabiliser Link	DB-DL-9271		Pressure Rod
04/03→		Stabiliser Link	DB-DL-9272		Pressure Rod
04/03→		Stabiliser Mounting		DB-SB-10406	
04/03→		Stabiliser Mounting		DB-SB-10409	
04/03→		Suspension Arm Repair Kit		DB-RK-8626	for Wishbone (CV)
04/03→		Suspension Arm Repair Kit		DB-RK-10374	for Wishbone (CV)
04/03→		Suspension Arm Repair Kit		DB-RK-10375	for Wishbone (CV)
04/03→		Suspension Arm Repair Kit	DB-RK-8638		for Control Arm
04/03→		Suspension Strut Repair Kit		DB-RK-8391	
04/03→		Suspension Strut Repair Kit		DB-RK-8710	
04/03→		Suspension Strut Repair Kit		DB-RK-9291	
04/03→		Tie Rod	DB-DL-8171		Guide Rod
04/03→		Tie Rod	DB-DL-8172		Guide Rod
04/03→		Tie Rod	DB-DL-8327		Guide Rod
04/03→		Tie Rod	DB-DL-8390		
04/03→		Tie Rod	DB-DL-8640		Guide Rod
04/03→		Tie Rod	DB-DL-12310		
04/03→		Tie Rod	DB-ES-5227		Guide Rod
04/03→		Tie Rod	MN-DL-7834		Guide Rod
04/03→	Tie Rod End	CV-ES-0543		for Push Rod	

CV-ES-0543

Length: 125
Cone Ø: d1 Ø 32 / d2 Ø 29
Thread: M30 x 1,5 RHT
0004605748, 0004606048, 0004606848,
0004607048, 0014600448, 0014601148,
0014601748, 0014602448, 0014607648,
0014609648



CV-ES-0888

Length: 125
Cone Ø: d1 Ø 32 / d2 Ø 29
Thread: M30 x 1,5 LHT
0004605848, 0004606148, 0004606948,
0004607148, 0004609048, 0014600548,
0014601348, 0014602548, 0014607948,
0024600448



CV-ES-14163

Length: 125
Cone Ø: d1 Ø 30 / d2 Ø 27
Thread: M30 x 1,5 RHT
0003305248, 0003387310, 0004600348,
0004600948, 0004602848, 0004602948,
0004608948, 0014600248, 0014600848,
0014601248, 0014602248, 0014607748,
0024600148, A0003387310, A0004600348,
A0004602848, A0004602948, A0014600848,
A0014601248, A0014602248, A0014607748



DB-DL-3475

Length: 565 Ø: 52
Hole Distance: 152 / 152
3753500006, 3753500206, 9473500805,
9483500006, 9483500805, 9483501205,
9483501305, 9483501905, 9483502005,
9483502405, A3753500006, A3753500206



DB-DL-8168

Length: 904 Ø: 52
Cone Ø: d1 Ø 32 / d2 Ø 29
0004609405, 0004609505, 0014607105



DB-DL-8171

Length: 1687 Ø: 52
Cone Ø: d1 Ø 32 / d2 Ø 29
9493300603, 9493300703, 9493301503,
9493301603



DB-DL-8172

Length: 1700 Ø: 52
Cone Ø: d1 Ø 32 / d2 Ø 29
01219700A, 9493300403, 9493300503,
9493300803, 9493301403



DB-DL-8184

Length: 1095 Ø: 42
Cone Ø: d1 Ø 32 / d2 Ø 28,8
01217700A, 0014601305, 0014601405,
0024600505, 0034603205, 3754601505,
A0014601305, A0014601405, A0024600505



DB-DL-8185

Length: 711 Ø: 42
Cone Ø: d1 Ø 32 / d2 Ø 28,8
01213600A, 0014601105, 0024600405,
0034603105, A0014601105, A0024600405



DB-DL-8307

Length: 885 Ø: 38
Cone Ø: d1 Ø 32 / d2 Ø 30
01215500A, 0004604005, 0024605105,
0024605205, 0034604005



DB-DL-8327

Length: 1745 Ø: 48
Cone Ø: d1 Ø 32 / d2 Ø 29
01219800A, 9413300003, 9413300103,
9413300203, 9413300303, 9413300503



DB-DL-8390

Length: 1596 Ø: 50
Cone Ø: d1 Ø 32 / d2 Ø 29
9493301003, 9493301103, 9493301703



DB-DL-8640

Length: 1615 Ø: 50
Cone Ø: d1 Ø 32 / d2 Ø 29
6253301503, 6253301603, 6253302403,
6253302503, 9423300803, 9423302103,
9493300203, 9493300303, 9493300903



DB-DL-9254

Length: 1815 Ø: 58
0003220323, 0003220623, 3753220423



DB-DL-9259

Length: 883 Ø: 38
Cone Ø: d1 Ø 32 / d2 Ø 29
0024608605, 0024608705, A0024608605,
A0024608705



DB-DL-9271

Length: 1815 Ø: 60
0003220423, 0003220723



DB-DL-9272

Length: 1815 Ø: 80
0003220223



DB-DL-10208

Length: 708 Ø: 40
Cone Ø: d1 Ø 32 / d2 Ø 29
0014605305, 0024600605



DB-DL-10212

Length: 953 Ø: 42
Cone Ø: d1 Ø 32 / d2 Ø 29
0024609205, 0024609305, 0034604505



DB-DL-12300

Length: 733 Ø: 36
Cone Ø: d1 Ø 32 / d2 Ø 29
0014601505, 0014607305, 0034603305,
3754601605, A0014601505, A0034603305,
A3754601605



DB-DL-12301

Length: 716 Ø: 38
Cone Ø: d1 Ø 32 / d2 Ø 29
Thread: M30 x 1,5
0024608805, 0024608905, A0024608805,
A0024608905



DB-DL-12310

Length: 1532 Ø: 50
Cone Ø: d1 Ø 32 / d2 Ø 29
Thread: M27 x 1,5 LHT
9493301203, 9493301303, 9493301803,
9493302203, A9493301203, A9493301303,
A9493301803, A9493302203



DB-DL-12403

Length: 893 Ø: 42
Cone Ø: d1 Ø 32 / d2 Ø 29
0014604905, 0014607405



DB-ES-5227

Length: 1588 Ø: 60
Cone Ø: d1 Ø 38 / d2 Ø 34,3
6253300903, 6253301203, 9443300203



DB-ES-8510

Length: 56
Cone Ø: d1 Ø 10 / d2 Ø 10
Thread: M12 x 1,75 LHT
0009965145, 0009965645, 0019963145



DB-ES-8530

Length: 115
Cone Ø: d1 Ø 28,6 / d2 Ø 23,9
Thread: M30 x 1,5 RHT
0014603848, 0014604848, 0014605148,
0014608648, 0014609948



DB-RK-8391

Ø: 85 Hole Distance: 152
Thick/Height: 24
01336800A, 0003502705



DB-RK-8626

Ø: 75 Hole Distance: 130
Thick/Height: 24
0003502205, 0003502505, 0003503405,
0003504505, GL11319



DB-RK-8638

Length: 100 Ø: 67
Hole Distance: 100
Thick/Height: 20
0003301411



DB-RK-8710

Ø: 85 Hole Distance: 130
Thick/Height: 30
0003503705



DB-RK-9291

Ø: 107,5 Hole Distance: 152
Thick/Height: 30
0003503605



DB-RK-10374

Ø: 85 Hole Distance: 152
Thick/Height: 24
0003504405



DB-RK-10375

Ø: 100 Hole Distance: 152
Thick/Height: 24
0003502405, 0003503505, 0003504905



DB-SB-10384

Ø: 73 Thick/Height: 47
9303170012, 9423171812



DB-SB-10401

Length: 232
Thick/Height: 163,5 / 152,5
0003250596, 0003250796



DB-SB-10406

Ø: 80 Thick/Height: 46
0003238185



DB-SB-10409

Ø: 77 Thick/Height: 56
0003265181



DB-VB-7261

Length: 622 Ø: 46
Hole Ø 25 / 25 / 25
Hole Distance: 152 / 130 / 130
01337800A, 9443500305, 9443500505,
9443500605, 9473500705, 9473500905,
9483500405, 9483503005



DB-VB-9307

Length: 667 Ø: 60
Hole Ø 25 / 23 / 23
Hole Distance: 152 / 130 / 130
9483502805



DB-VB-9308

Length: 622 Ø: 46
Hole Ø 25 / 25 / 25
Hole Distance: 152 / 130 / 130
9483502905



DB-VB-10426

Length: 622 Ø: 46
Hole Ø 25 / 25 / 25
Hole Distance: 152 / 130 / 130
9443500405



MN-DL-7834

Length: 1588 Ø: 58
Cone Ø: d1 Ø 30 / d2 Ø 27
3463303903, 3463304903, 6253303203,
9443300503, 9443301303, 9443301703



MERCEDES-BENZ

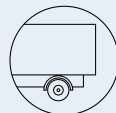

ACTROS MP2 / MP3 ...

4144 K ...	04/03→	Tie Rod End	CV-ES-0888		for Push Rod	
	04/03→	Tie Rod End	CV-ES-14163		for Steering Rod	
	04/03→	Tie Rod End	DB-ES-5234		for Steering Rod	
	04/03→	Tie Rod End	DB-ES-8323		Leaf Spring Axle	
	04/03→	Tie Rod End	DB-ES-8530		for Push Rod	
	04/03→	Track Control Arm		DB-DL-3475	Trailing Arm	
	04/03→	Track Control Arm		DB-DL-3475	Trailing Arm, 1st RA;2nd RA, →517144 03/517144 07	
	04/03→	Track Control Arm		DB-DL-3475	Trailing Arm, 1st RA;2nd RA, →517144 06/517144 09	
	04/03→	Track Control Arm		DB-DL-3475	Trailing Arm, 1st RA;2nd RA, →517144 26/517144 27	
	04/03→	Track Control Arm		DB-VB-7261	Suspension Rod, Wishbone (CV), 1st RA;2nd RA; Leaf Spring Axle	
	04/03→	Track Control Arm		DB-VB-9307	Suspension Rod, Wishbone (CV), 1st RA;2nd RA; Leaf Spring Axle	
	04/03→	Track Control Arm		DB-VB-9308	Suspension Rod, Wishbone (CV), 1st RA;2nd RA; Leaf Spring Axle	
	04/03→	Track Control Arm		DB-VB-10426	Wishbone (CV), 1st RA;2nd RA, →517142 05	
	4146 AK	04/03→	Centre Rod	DB-DL-8184		Push Rod, Leaf Spring Axle
		04/03→	Centre Rod	DB-DL-10208		Push Rod, Leaf Spring Axle
04/03→		Centre Rod	DB-DL-12403		Push Rod	
04/03→		Stabiliser Link	DB-DL-9254		Pressure Rod	
04/03→		Stabiliser Mounting		DB-SB-10406		
04/03→		Suspension Strut Repair Kit		DB-RK-8710		
04/03→		Suspension Strut Repair Kit		DB-RK-9291		
04/03→		Tie Rod	DB-DL-12310			
04/03→		Tie Rod	DB-ES-5227		Guide Rod, 1st FA	
04/03→		Tie Rod End	CV-ES-0543		for Push Rod	
04/03→		Tie Rod End	CV-ES-0888		for Push Rod	
04/03→		Tie Rod End	DB-ES-5234		for Steering Rod	
04/03→		Track Control Arm		DB-DL-3475	Trailing Arm, 1st RA;2nd RA, →517144 03/517144 07	
04/03→		Track Control Arm		DB-DL-3475	Trailing Arm, 1st RA;2nd RA, →517144 06/517144 09	
04/03→		Track Control Arm		DB-DL-3475	Trailing Arm, 1st RA;2nd RA, →517144 26/517144 27	
04/03→		Track Control Arm		DB-VB-7261	Suspension Rod, Wishbone (CV), 1st RA;2nd RA; Leaf Spring Axle	
04/03→		Track Control Arm		DB-VB-9307	Suspension Rod, Wishbone (CV), 1st RA;2nd RA; Leaf Spring Axle	
04/03→		Track Control Arm		DB-VB-9308	Suspension Rod, Wishbone (CV), 1st RA;2nd RA; Leaf Spring Axle	
04/03→		Track Control Arm		DB-VB-10426	Wishbone (CV), 1st RA;2nd RA, →517142 05	
4146 B		04/03→	Centre Rod	DB-DL-8168		Push Rod, Leaf Spring Axle
	04/03→	Centre Rod	DB-DL-8184		Push Rod, Leaf Spring Axle	
	04/03→	Centre Rod	DB-DL-8185		Push Rod, Leaf Spring Axle	
	04/03→	Centre Rod	DB-DL-9259		Push Rod, Leaf Spring Axle	
	04/03→	Centre Rod	DB-DL-10212		Push Rod, Leaf Spring Axle	
	04/03→	Centre Rod	DB-DL-12300		for Steering Rod	
	04/03→	Centre Rod	DB-DL-12301		Push Rod, Leaf Spring Axle	
	04/03→	Stabiliser Link	DB-DL-9254		Pressure Rod	
	04/03→	Stabiliser Link	DB-DL-9271		Pressure Rod	
	04/03→	Stabiliser Link	DB-DL-9272		Pressure Rod	
	04/03→	Stabiliser Mounting		DB-SB-10406		
	04/03→	Suspension Strut Repair Kit		DB-RK-9291		
	04/03→	Tie Rod	DB-DL-8171		Guide Rod	
	04/03→	Tie Rod	DB-DL-8172		Guide Rod	
	04/03→	Tie Rod	DB-DL-8390			
	04/03→	Tie Rod	DB-DL-8640		Guide Rod	
	04/03→	Tie Rod	DB-DL-12310			
	04/03→	Tie Rod End	CV-ES-0543		for Push Rod	
	04/03→	Tie Rod End	CV-ES-0888		for Push Rod	

CV-ES-0543

Length: 125
Cone Ø: d1 Ø 32 / d2 Ø 29
Thread: M30 x 1,5 RHT
0004605748, 0004606048, 0004606848,
0004607048, 0014600448, 0014601148,
0014601748, 0014602448, 0014607648,
0014609648



CV-ES-0888

Length: 125
Cone Ø: d1 Ø 32 / d2 Ø 29
Thread: M30 x 1,5 LHT
0004605848, 0004606148, 0004606948,
0004607148, 0004609048, 0014600548,
0014601348, 0014602548, 0014607948,
0024600448



CV-ES-14163

Length: 125
Cone Ø: d1 Ø 30 / d2 Ø 27
Thread: M30 x 1,5 RHT
0003305248, 0003387310, 0004600348,
0004600948, 0004602848, 0004602948,
0004608948, 0014600248, 0014600848,
0014601248, 0014602248, 0014607748,
0024600148, A0003387310, A0004600348,
A0004602848, A0004602948, A0014600848,
A0014601248, A0014602248, A0014607748



DB-DL-3475

Length: 565 Ø: 52
Hole Distance: 152 / 152
3753500006, 3753500206, 9473500805,
9483500006, 9483500805, 9483501205,
9483501305, 9483501905, 9483502005,
9483502405, A3753500006, A3753500206



DB-DL-8168

Length: 904 Ø: 52
Cone Ø: d1 Ø 32 / d2 Ø 29
0004609405, 0004609505, 0014607105



DB-DL-8171

Length: 1687 Ø: 52
Cone Ø: d1 Ø 32 / d2 Ø 29
9493300603, 9493300703, 9493301503,
9493301603



DB-DL-8172

Length: 1700 Ø: 52
Cone Ø: d1 Ø 32 / d2 Ø 29
01219700A, 9493300403, 9493300503,
9493300803, 9493301403



DB-DL-8184

Length: 1095 Ø: 42
Cone Ø: d1 Ø 32 / d2 Ø 28,8
01213600A, 0014601305, 0014601405,
0024600505, 0034603205, 3754601505,
A0014601305, A0014601405, A0024600505



DB-DL-8185

Length: 711 Ø: 42
Cone Ø: d1 Ø 32 / d2 Ø 28,8
01213600A, 0014601105, 0024600405,
0034603105, A0014601105, A0024600405



DB-DL-8390

Length: 1596 Ø: 50
Cone Ø: d1 Ø 32 / d2 Ø 29
9493301003, 9493301103, 9493301703



DB-DL-8640

Length: 1615 Ø: 50
Cone Ø: d1 Ø 32 / d2 Ø 29
6253301503, 6253301603, 6253302403,
6253302503, 9423300803, 9423302103,
9493300203, 9493300303, 9493300903



DB-DL-9254

Length: 1815 Ø: 58
0003220323, 0003220623, 3753220423



DB-DL-9259

Length: 883 Ø: 38
Cone Ø: d1 Ø 32 / d2 Ø 29
0024608605, 0024608705, A0024608605,
A0024608705



DB-DL-9271

Length: 1815 Ø: 60
0003220423, 0003220723



DB-DL-9272

Length: 1815 Ø: 80
0003220223



DB-DL-10208

Length: 708 Ø: 40
Cone Ø: d1 Ø 32 / d2 Ø 29
0014605305, 0024600605



DB-DL-10212

Length: 953 Ø: 42
Cone Ø: d1 Ø 32 / d2 Ø 29
0024609205, 0024609305, 0034604505



DB-DL-12300

Length: 733 Ø: 36
Cone Ø: d1 Ø 32 / d2 Ø 29
0014601505, 0014607305, 0034603305,
3754601605, A0014601505, A0034603305,
A3754601605



DB-DL-12301

Length: 716 Ø: 38
Cone Ø: d1 Ø 32 / d2 Ø 29
Thread: M30 x 1,5
0024608805, 0024608905, A0024608805,
A0024608905



DB-DL-12310

Length: 1532 Ø: 50
Cone Ø: d1 Ø 32 / d2 Ø 29
Thread: M27 x 1,5 LHT
9493301203, 9493301303, 9493301803,
9493302203, A9493301203, A9493301303,
A9493301803, A9493302203



DB-DL-12403

Length: 893 Ø: 42
Cone Ø: d1 Ø 32 / d2 Ø 29
0014604905, 0014607405



DB-ES-5227

Length: 1588 Ø: 60
Cone Ø: d1 Ø 38 / d2 Ø 34,3
6253300903, 6253301203, 9443300203



DB-ES-5234

Length: 135
Cone Ø: d1 Ø 38 / d2 Ø 34,3
Thread: M38 x 1,5 RHT
0004601748, 120322305, 2205000400



DB-ES-8323

Length: 75
Cone Ø: d1 Ø 32 / d2 Ø 28,8
Thread: M26 x 1,5 RHT
0014601548, 0014601648, 0024600648,
A0014601648, A0024600648



DB-ES-8530

Length: 115
Cone Ø: d1 Ø 28,6 / d2 Ø 23,9
Thread: M30 x 1,5 RHT
0014603848, 0014604848, 0014605148,
0014608648, 0014609948



DB-RK-8710

Ø: 85 Hole Distance: 130
Thick/Height: 30
0003503705



DB-RK-9291

Ø: 107,5 Hole Distance: 152
Thick/Height: 30
0003503605



DB-SB-10406

Ø: 80 Thick/Height: 46
0003238185



DB-VB-7261

Length: 622 Ø: 46
Hole Ø 25 / 25 / 25
Hole Distance: 152 / 130 / 130
01337800A, 9443500305, 9443500505,
9443500605, 9473500705, 9473500905,
9483500405, 9483500305



DB-VB-9307

Length: 667 Ø: 60
Hole Ø 25 / 23 / 23
Hole Distance: 152 / 130 / 130
9483502805



DB-VB-9308

Length: 622 Ø: 46
Hole Ø 25 / 25 / 25
Hole Distance: 152 / 130 / 130
9483502905



DB-VB-10426

Length: 622 Ø: 46
Hole Ø 25 / 25 / 25
Hole Distance: 152 / 130 / 130
9443500405





ACTROS MP2 / MP3 ...

4146 B ...	04/03→	Tie Rod End	CV-ES-14163		for Steering Rod
	04/03→	Tie Rod End	DB-ES-8530		for Push Rod
	04/03→	Track Control Arm		DB-DL-3475	Trailing Arm, 1st RA;2nd RA, →517144 03/517144 07
	04/03→	Track Control Arm		DB-DL-3475	Trailing Arm, 1st RA;2nd RA, →517144 06/517144 09
	04/03→	Track Control Arm		DB-DL-3475	Trailing Arm, 1st RA;2nd RA, →517144 26/517144 27
	04/03→	Track Control Arm		DB-VB-7261	Suspension Rod, Wishbone (CV), 1st RA;2nd RA; Leaf Spring Axle
	04/03→	Track Control Arm		DB-VB-9307	Suspension Rod, Wishbone (CV), 1st RA;2nd RA; Leaf Spring Axle
	04/03→	Track Control Arm		DB-VB-9308	Suspension Rod, Wishbone (CV), 1st RA;2nd RA; Leaf Spring Axle
4146 K	04/03→	Track Control Arm		DB-VB-10426	Wishbone (CV), 1st RA;2nd RA, →517142 05
	04/03→	Ball Head, gearshift linkage	DB-ES-8510		
	04/03→	Bush, driver cab suspension	DB-SB-10384		
	04/03→	Bush, parabolic spring		DB-SB-10401	
	04/03→	Centre Rod	DB-DL-8168		Push Rod
	04/03→	Centre Rod	DB-DL-8184		Push Rod, Leaf Spring Axle
	04/03→	Centre Rod	DB-DL-8185		Push Rod, Leaf Spring Axle
	04/03→	Centre Rod	DB-DL-8307		Push Rod
	04/03→	Centre Rod	DB-DL-9259		Push Rod, Leaf Spring Axle
	04/03→	Centre Rod	DB-DL-10208		Push Rod, Leaf Spring Axle
	04/03→	Centre Rod	DB-DL-10212		Push Rod, Leaf Spring Axle
	04/03→	Centre Rod	DB-DL-12300		for Steering Rod
	04/03→	Centre Rod	DB-DL-12301		Push Rod, Leaf Spring Axle
	04/03→	Centre Rod	DB-DL-12403		Push Rod
	04/03→	Stabiliser Link	DB-DL-9254		Pressure Rod
	04/03→	Stabiliser Link	DB-DL-9271		Pressure Rod
	04/03→	Stabiliser Link	DB-DL-9272		Pressure Rod
	04/03→	Stabiliser Mounting		DB-SB-10406	
	04/03→	Stabiliser Mounting		DB-SB-10409	
	04/03→	Suspension Arm Repair Kit		DB-RK-8626	for Wishbone (CV)
	04/03→	Suspension Arm Repair Kit		DB-RK-10374	for Wishbone (CV)
	04/03→	Suspension Arm Repair Kit		DB-RK-10375	for Wishbone (CV)
	04/03→	Suspension Arm Repair Kit	DB-RK-8638		for Control Arm
	04/03→	Suspension Strut Repair Kit		DB-RK-8391	
	04/03→	Suspension Strut Repair Kit		DB-RK-8710	
	04/03→	Suspension Strut Repair Kit		DB-RK-9291	
	04/03→	Tie Rod	DB-DL-8171		Guide Rod
	04/03→	Tie Rod	DB-DL-8172		Guide Rod
	04/03→	Tie Rod	DB-DL-8327		Guide Rod
	04/03→	Tie Rod	DB-DL-8390		
	04/03→	Tie Rod	DB-DL-8640		Guide Rod
	04/03→	Tie Rod	DB-DL-12310		
	04/03→	Tie Rod	DB-ES-5227		Guide Rod
	04/03→	Tie Rod	MN-DL-7834		Guide Rod
04/03→	Tie Rod End	CV-ES-0543		for Push Rod	
04/03→	Tie Rod End	CV-ES-0888		for Push Rod	
04/03→	Tie Rod End	CV-ES-14163		for Steering Rod	
04/03→	Tie Rod End	DB-ES-5234		for Steering Rod	
04/03→	Tie Rod End	DB-ES-8323		Leaf Spring Axle	
04/03→	Tie Rod End	DB-ES-8530		for Push Rod	
04/03→	Track Control Arm		DB-DL-3475	Trailing Arm	
04/03→	Track Control Arm		DB-DL-3475	Trailing Arm, 1st RA;2nd RA, →517144 03/517144 07	
04/03→	Track Control Arm		DB-DL-3475	Trailing Arm, 1st RA;2nd RA, →517144 06/517144 09	
04/03→	Track Control Arm		DB-DL-3475	Trailing Arm, 1st RA;2nd RA, →517144 26/517144 27	
04/03→	Track Control Arm		DB-VB-7261	Suspension Rod, Wishbone (CV), 1st RA;2nd RA; Leaf Spring Axle	

CV-ES-0543

Length: 125
 Cone Ø: d1 Ø 32 / d2 Ø 29
 Thread: M30 x 1,5 RHT
 0004605748, 0004606048, 0004606848,
 0004607048, 0014600448, 0014601148,
 0014601748, 0014602448, 0014607648,
 0014609648

**CV-ES-0888**

Length: 125
 Cone Ø: d1 Ø 32 / d2 Ø 29
 Thread: M30 x 1,5 LHT
 0004605848, 0004606148, 0004606948,
 0004607148, 0004609048, 0014600548,
 0014601348, 0014602548, 0014607948,
 0024600448

**CV-ES-14163**

Length: 125
 Cone Ø: d1 Ø 30 / d2 Ø 27
 Thread: M30 x 1,5 RHT
 0003305248, 0003387310, 0004600348,
 0004600948, 0004602848, 0004602948,
 0004608948, 0014600248, 0014600848,
 0014601248, 0014602248, 0014607748,
 0024600148, A0003387310, A0004600348,
 A0004602848, A0004602948, A0014600848,
 A0014601248, A0014602248, A0014607748

**DB-DL-3475**

Length: 565 Ø: 52
 Hole Distance: 152 / 152
 3753500006, 3753500206, 9473500805,
 9483500006, 9483500805, 9483501205,
 9483501305, 9483501905, 9483502005,
 9483502405, A3753500006, A3753500206

**DB-DL-8168**

Length: 904 Ø: 52
 Cone Ø: d1 Ø 32 / d2 Ø 29
 0004609405, 0004609505, 0014607105

**DB-DL-8171**

Length: 1687 Ø: 52
 Cone Ø: d1 Ø 32 / d2 Ø 29
 9493300603, 9493300703, 9493301503,
 9493301603

**DB-DL-8172**

Length: 1700 Ø: 52
 Cone Ø: d1 Ø 32 / d2 Ø 29
 01219700A, 9493300403, 9493300503,
 9493300803, 9493301403

**DB-DL-8184**

Length: 1095 Ø: 42
 Cone Ø: d1 Ø 32 / d2 Ø 28,8
 01217700A, 0014601305, 0014601405,
 0024600505, 0034603205, 3754601505,
 A0014601305, A0014601405, A0024600505

**DB-DL-8185**

Length: 711 Ø: 42
 Cone Ø: d1 Ø 32 / d2 Ø 28,8
 01213600A, 0014601105, 0024600405,
 0034603105, A0014601105, A0024600405

**DB-DL-8307**

Length: 885 Ø: 38
 Cone Ø: d1 Ø 32 / d2 Ø 30
 01215500A, 0004604005, 0024605105,
 0024605205, 0034604005

**DB-DL-8327**

Length: 1745 Ø: 48
 Cone Ø: d1 Ø 32 / d2 Ø 29
 01219800A, 9413300003, 9413300103,
 9413300203, 9413300303, 9413300503

**DB-DL-8390**

Length: 1596 Ø: 50
 Cone Ø: d1 Ø 32 / d2 Ø 29
 9493301003, 9493301103, 9493301703

**DB-DL-8640**

Length: 1615 Ø: 50
 Cone Ø: d1 Ø 32 / d2 Ø 29
 6253301503, 6253301603, 6253302403,
 6253302503, 9423300803, 9423302103,
 9493300203, 9493300303, 9493300903

**DB-DL-9254**

Length: 1815 Ø: 58
 0003220323, 0003220623, 3753220423

**DB-DL-9259**

Length: 883 Ø: 38
 Cone Ø: d1 Ø 32 / d2 Ø 29
 0024608605, 0024608705, A0024608605,
 A0024608705

**DB-DL-9271**

Length: 1815 Ø: 60
 0003220423, 0003220723

**DB-DL-9272**

Length: 1815 Ø: 80
 0003220223

**DB-DL-10208**

Length: 708 Ø: 40
 Cone Ø: d1 Ø 32 / d2 Ø 29
 0014605305, 0024600605

**DB-DL-10212**

Length: 953 Ø: 42
 Cone Ø: d1 Ø 32 / d2 Ø 29
 0024609205, 0024609305, 0034604505

**DB-DL-12300**

Length: 733 Ø: 36
 Cone Ø: d1 Ø 32 / d2 Ø 29
 0014601505, 0014607305, 0034603305,
 3754601605, A0014601505, A0034603305,
 A3754601605

**DB-DL-12301**

Length: 716 Ø: 38
 Cone Ø: d1 Ø 32 / d2 Ø 29
 Thread: M30 x 1,5
 0024608805, 0024608905, A0024608805,
 A0024608905

**DB-DL-12310**

Length: 1532 Ø: 50
 Cone Ø: d1 Ø 32 / d2 Ø 29
 Thread: M27 x 1,5 LHT
 9493301203, 9493301303, 9493301803,
 9493302203, A9493301203, A9493301303,
 A9493301803, A9493302203

**DB-DL-12403**

Length: 893 Ø: 42
 Cone Ø: d1 Ø 32 / d2 Ø 29
 0014604905, 0014607405

**DB-ES-5227**

Length: 1588 Ø: 60
 Cone Ø: d1 Ø 38 / d2 Ø 34,3
 6253300903, 6253301203, 9443300203

**DB-ES-5234**

Length: 135
 Cone Ø: d1 Ø 38 / d2 Ø 34,3
 Thread: M38 x 1,5 RHT
 0004601748, 120322305, 2205000400

**DB-ES-8323**

Length: 75
 Cone Ø: d1 Ø 32 / d2 Ø 28,8
 Thread: M26 x 1,5 RHT
 0014601548, 0014601648, 0024600648,
 A0014601648, A0024600648

**DB-ES-8510**

Length: 56
 Cone Ø: d1 Ø 10 / d2 Ø 10
 Thread: M12 x 1,75 LHT
 0009965145, 0009965645, 0019963145

**DB-ES-8530**

Length: 115
 Cone Ø: d1 Ø 28,6 / d2 Ø 23,9
 Thread: M30 x 1,5 RHT
 0014603848, 0014604848, 0014605148,
 0014608648, 0014609948

**DB-RK-8391**

Ø: 85 Hole Distance: 152
 Thick/Height: 24
 01336800A, 0003502705

**DB-RK-8626**

Ø: 75 Hole Distance: 130
 Thick/Height: 24
 0003502205, 0003502505, 0003503405,
 0003504505, GL11319

**DB-RK-8638**

Length: 100 Ø: 67
 Hole Distance: 100
 Thick/Height: 20
 0003301411

**DB-RK-8710**

Ø: 85 Hole Distance: 130
 Thick/Height: 30
 0003503705

**DB-RK-9291**

Ø: 107,5 Hole Distance: 152
 Thick/Height: 30
 0003503605

**DB-RK-10374**

Ø: 85 Hole Distance: 152
 Thick/Height: 24
 0003504405

**DB-RK-10375**

Ø: 100 Hole Distance: 152
 Thick/Height: 24
 0003502405, 0003503505, 0003504905

**DB-SB-10384**

Ø: 73 Thick/Height: 47
 9303170012, 9423171812

**DB-SB-10401**

Length: 232
 Thick/Height: 163,5 / 152,5
 0003250596, 0003250796

**DB-SB-10406**

Ø: 80 Thick/Height: 46
 0003238185

**DB-SB-10409**

Ø: 77 Thick/Height: 56
 0003265181

**DB-VB-7261**

Length: 622 Ø: 46
 Hole Ø 25 / 25 / 25
 Hole Distance: 152 / 130 / 130
 01337800A, 9443500305, 9443500505,
 9443500605, 9473500705, 9473500905,
 9483500405, 9483503005

**DB-VB-9307**

Length: 667 Ø: 60
 Hole Ø 25 / 23 / 23
 Hole Distance: 152 / 130 / 130
 9483502805

**DB-VB-9308**

Length: 622 Ø: 46
 Hole Ø 25 / 25 / 25
 Hole Distance: 152 / 130 / 130
 9483502905

**DB-VB-10426**

Length: 622 Ø: 46
 Hole Ø 25 / 25 / 25
 Hole Distance: 152 / 130 / 130
 9443500405

**MN-DL-7834**

Length: 1588 Ø: 58
 Cone Ø: d1 Ø 30 / d2 Ø 27
 3463303903, 3463304903, 6253303203,
 9443300503, 9443301303, 9443301703





ACTROS MP2 / MP3 ...

4146 K ...	04/03 →	Track Control Arm		DB-VB-9307	Suspension Rod, Wishbone (CV), 1st RA;2nd RA; Leaf Spring Axle	
	04/03 →	Track Control Arm		DB-VB-9308	Suspension Rod, Wishbone (CV), 1st RA;2nd RA; Leaf Spring Axle	
	04/03 →	Track Control Arm		DB-VB-10426	Wishbone (CV), 1st RA;2nd RA, →517142 05	
4148 AK	04/03 →	Centre Rod	DB-DL-8184		Push Rod	
	04/03 →	Centre Rod	DB-DL-8184		Push Rod, Leaf Spring Axle	
	04/03 →	Centre Rod	DB-DL-10208		Push Rod	
	04/03 →	Centre Rod	DB-DL-10208		Push Rod, Leaf Spring Axle	
	04/03 →	Centre Rod	DB-DL-12403		Push Rod	
	04/03 →	Stabiliser Link	DB-DL-9254		Coupling Rod	
	04/03 →	Stabiliser Link	DB-DL-9254		Pressure Rod	
	04/03 →	Stabiliser Mounting		DB-SB-10406		
	04/03 →	Suspension Arm Repair Kit		DB-RK-8626	for Wishbone (CV)	
	04/03 →	Suspension Arm Repair Kit		DB-RK-10375	for Wishbone (CV)	
	04/03 →	Suspension Strut Repair Kit		DB-RK-8391		
	04/03 →	Suspension Strut Repair Kit		DB-RK-8710		
	04/03 →	Suspension Strut Repair Kit		DB-RK-9291		
	04/03 →	Tie Rod	DB-DL-12310			
	04/03 →	Tie Rod	DB-ES-5227		Guide Rod	
	04/03 →	Tie Rod	DB-ES-5227		Guide Rod, 1st FA	
	04/03 →	Tie Rod End	CV-ES-0543		for Push Rod	
	04/03 →	Tie Rod End	CV-ES-0888		for Push Rod	
	04/03 →	Tie Rod End	DB-ES-5234		for Steering Rod	
	04/03 →	Track Control Arm		DB-DL-3475	Trailing Arm, 1st RA;2nd RA, →517144 03/517144 07	
	04/03 →	Track Control Arm		DB-DL-3475	Trailing Arm, 1st RA;2nd RA, →517144 06/517144 09	
	04/03 →	Track Control Arm		DB-DL-3475	Trailing Arm, 1st RA;2nd RA, →517144 26/517144 27	
	04/03 →	Track Control Arm		DB-VB-7261	Suspension Rod, Wishbone (CV)	
	04/03 →	Track Control Arm		DB-VB-7261	Suspension Rod, Wishbone (CV), 1st RA;2nd RA; Leaf Spring Axle	
	04/03 →	Track Control Arm		DB-VB-9307	Suspension Rod, Wishbone (CV)	
	04/03 →	Track Control Arm		DB-VB-9307	Suspension Rod, Wishbone (CV), 1st RA;2nd RA; Leaf Spring Axle	
	04/03 →	Track Control Arm		DB-VB-9308	Suspension Rod, Wishbone (CV)	
	04/03 →	Track Control Arm		DB-VB-9308	Suspension Rod, Wishbone (CV), 1st RA;2nd RA; Leaf Spring Axle	
	04/03 →	Track Control Arm		DB-VB-10426	Wishbone (CV), 1st RA;2nd RA, →517142 05	
	4148 B	04/03 →	Centre Rod	DB-DL-8168		Push Rod, Leaf Spring Axle
		04/03 →	Centre Rod	DB-DL-8184		Push Rod, Leaf Spring Axle
		04/03 →	Centre Rod	DB-DL-8185		Push Rod, Leaf Spring Axle
		04/03 →	Centre Rod	DB-DL-9259		Push Rod, Leaf Spring Axle
04/03 →		Centre Rod	DB-DL-10212		Push Rod, Leaf Spring Axle	
04/03 →		Centre Rod	DB-DL-12300		for Steering Rod	
04/03 →		Centre Rod	DB-DL-12301		Push Rod, Leaf Spring Axle	
04/03 →		Stabiliser Link	DB-DL-9254		Pressure Rod	
04/03 →		Stabiliser Link	DB-DL-9271		Pressure Rod	
04/03 →		Stabiliser Link	DB-DL-9272		Pressure Rod	
04/03 →		Stabiliser Mounting		DB-SB-10406		
04/03 →		Suspension Strut Repair Kit		DB-RK-9291		
04/03 →		Tie Rod	DB-DL-8171		Guide Rod	
04/03 →		Tie Rod	DB-DL-8172		Guide Rod	
04/03 →		Tie Rod	DB-DL-8390			
04/03 →		Tie Rod	DB-DL-8640		Guide Rod	
04/03 →		Tie Rod	DB-DL-12310			
04/03 →		Tie Rod End	CV-ES-0543		for Push Rod	
04/03 →		Tie Rod End	CV-ES-0888		for Push Rod	
04/03 →		Tie Rod End	CV-ES-14163		for Steering Rod	
04/03 →		Tie Rod End	DB-ES-8530		for Push Rod	
04/03 →		Track Control Arm		DB-DL-3475	Trailing Arm, 1st RA;2nd RA, →517144 03/517144 07	

CV-ES-0543

Length: 125
 Cone Ø: d1 Ø 32 / d2 Ø 29
 Thread: M30 x 1,5 RHT
 0004605748, 0004606048, 0004606848,
 0004607048, 0014600448, 0014601148,
 0014601748, 0014602448, 0014607648,
 0014609648

**CV-ES-0888**

Length: 125
 Cone Ø: d1 Ø 32 / d2 Ø 29
 Thread: M30 x 1,5 LHT
 0004605848, 0004606148, 0004606948,
 0004607148, 0004609048, 0014600548,
 0014601348, 0014602548, 0014607948,
 0024600448

**CV-ES-14163**

Length: 125
 Cone Ø: d1 Ø 30 / d2 Ø 27
 Thread: M30 x 1,5 RHT
 0003305248, 0003387310, 0004600348,
 0004600948, 0004602848, 0004602948,
 0004608948, 0014600248, 0014600848,
 0014601248, 0014602248, 0014607748,
 0024600148, A0003387310, A0004600348,
 A0004602848, A0004602948, A0014600848,
 A0014601248, A0014602248, A0014607748

**DB-DL-3475**

Length: 565 Ø: 52
 Hole Distance: 152 / 152
 3753500006, 3753500206, 9473500805,
 9483500006, 9483500805, 9483501205,
 9483501305, 9483501905, 9483502005,
 9483502405, A3753500006, A3753500206

**DB-DL-8168**

Length: 904 Ø: 52
 Cone Ø: d1 Ø 32 / d2 Ø 29
 0004609405, 0004609505, 0014607105

**DB-DL-8171**

Length: 1687 Ø: 52
 Cone Ø: d1 Ø 32 / d2 Ø 29
 9493300603, 9493300703, 9493301503,
 9493301603

**DB-DL-8172**

Length: 1700 Ø: 52
 Cone Ø: d1 Ø 32 / d2 Ø 29
 01219700A, 9493300403, 9493300503,
 9493300803, 9493301403

**DB-DL-8184**

Length: 1095 Ø: 42
 Cone Ø: d1 Ø 32 / d2 Ø 28,8
 01217700A, 0014601305, 0014601405,
 0024600505, 0034603205, 3754601505,
 A0014601305, A0014601405, A0024600505

**DB-DL-8185**

Length: 711 Ø: 42
 Cone Ø: d1 Ø 32 / d2 Ø 28,8
 01213600A, 0014601105, 0024600405,
 0034603105, A0014601105, A0024600405

**DB-DL-8390**

Length: 1596 Ø: 50
 Cone Ø: d1 Ø 32 / d2 Ø 29
 9493301003, 9493301103, 9493301703

**DB-DL-8640**

Length: 1615 Ø: 50
 Cone Ø: d1 Ø 32 / d2 Ø 29
 6253301503, 6253301603, 6253302403,
 6253302503, 9423300803, 9423302103,
 9493300203, 9493300303, 9493300903

**DB-DL-9254**

Length: 1815 Ø: 58
 0003220323, 0003220623, 3753220423

**DB-DL-9259**

Length: 883 Ø: 38
 Cone Ø: d1 Ø 32 / d2 Ø 29
 0024608605, 0024608705, A0024608605,
 A0024608705

**DB-DL-9271**

Length: 1815 Ø: 60
 0003220423, 0003220723

**DB-DL-9272**

Length: 1815 Ø: 80
 0003220223

**DB-DL-10208**

Length: 708 Ø: 40
 Cone Ø: d1 Ø 32 / d2 Ø 29
 0014605305, 0024600605

**DB-DL-10212**

Length: 953 Ø: 42
 Cone Ø: d1 Ø 32 / d2 Ø 29
 0024609205, 0024609305, 0034604505

**DB-DL-12300**

Length: 733 Ø: 36
 Cone Ø: d1 Ø 32 / d2 Ø 29
 0014601505, 0014607305, 0034603305,
 3754601605, A0014601505, A0034603305,
 A3754601605

**DB-DL-12301**

Length: 716 Ø: 38
 Cone Ø: d1 Ø 32 / d2 Ø 29
 Thread: M30 x 1,5
 0024608805, 0024608905, A0024608805,
 A0024608905

**DB-DL-12310**

Length: 1532 Ø: 50
 Cone Ø: d1 Ø 32 / d2 Ø 29
 Thread: M27 x 1,5 LHT
 9493301203, 9493301303, 9493301803,
 9493302203, A9493301203, A9493301303,
 A9493301803, A9493302203

**DB-DL-12403**

Length: 893 Ø: 42
 Cone Ø: d1 Ø 32 / d2 Ø 29
 0014604905, 0014607405

**DB-ES-5227**

Length: 1588 Ø: 60
 Cone Ø: d1 Ø 38 / d2 Ø 34,3
 6253300903, 6253301203, 9443300203

**DB-ES-5234**

Length: 135
 Cone Ø: d1 Ø 38 / d2 Ø 34,3
 Thread: M38 x 1,5 RHT
 0004601748, 120322305, 2205000400

**DB-ES-8530**

Length: 115
 Cone Ø: d1 Ø 28,6 / d2 Ø 23,9
 Thread: M30 x 1,5 RHT
 0014603848, 0014604848, 0014605148,
 0014608648, 0014609948

**DB-RK-8391**

Ø: 85 Hole Distance: 152
 Thick/Height: 24
 01336800A, 0003502705

**DB-RK-8626**

Ø: 75 Hole Distance: 130
 Thick/Height: 24
 0003502205, 0003502505, 0003503405,
 0003504505, GL11319

**DB-RK-8710**

Ø: 85 Hole Distance: 130
 Thick/Height: 30
 0003503705

**DB-RK-9291**

Ø: 107,5 Hole Distance: 152
 Thick/Height: 30
 0003503605

**DB-RK-10375**

Ø: 100 Hole Distance: 152
 Thick/Height: 24
 0003502405, 0003503505, 0003504905

**DB-SB-10406**

Ø: 80 Thick/Height: 46
 0003238185

**DB-VB-7261**

Length: 622 Ø: 46
 Hole Ø 25 / 25 / 25
 Hole Distance: 152 / 130 / 130
 01337800A, 9443500305, 9443500505,
 9443500605, 9473500705, 9473500905,
 9483500405, 9483503005

**DB-VB-9307**

Length: 667 Ø: 60
 Hole Ø 25 / 23 / 23
 Hole Distance: 152 / 130 / 130
 9483502805

**DB-VB-9308**

Length: 622 Ø: 46
 Hole Ø 25 / 25 / 25
 Hole Distance: 152 / 130 / 130
 9483502905

**DB-VB-10426**

Length: 622 Ø: 46
 Hole Ø 25 / 25 / 25
 Hole Distance: 152 / 130 / 130
 9443500405





ACTROS MP2 / MP3 ...

4148 B ...	04/03 →	Track Control Arm		DB-DL-3475	Trailing Arm, 1st RA;2nd RA, →517144 06/517144 09
	04/03 →	Track Control Arm		DB-DL-3475	Trailing Arm, 1st RA;2nd RA, →517144 26/517144 27
	04/03 →	Track Control Arm		DB-VB-7261	Suspension Rod, Wishbone (CV), 1st RA;2nd RA; Leaf Spring Axle
	04/03 →	Track Control Arm		DB-VB-9307	Suspension Rod, Wishbone (CV), 1st RA;2nd RA; Leaf Spring Axle
	04/03 →	Track Control Arm		DB-VB-9308	Suspension Rod, Wishbone (CV), 1st RA;2nd RA; Leaf Spring Axle
	04/03 →	Track Control Arm		DB-VB-10426	Wishbone (CV), 1st RA;2nd RA, →517142 05
4148 K	04/03 →	Ball Head, gearshift linkage	DB-ES-8510		
	04/03 →	Bush, driver cab suspension	DB-SB-10384		
	04/03 →	Bush, parabolic spring		DB-SB-10401	
	04/03 →	Centre Rod	DB-DL-8168		Push Rod
	04/03 →	Centre Rod	DB-DL-8168		Push Rod, Leaf Spring Axle
	04/03 →	Centre Rod	DB-DL-8184		Push Rod
	04/03 →	Centre Rod	DB-DL-8184		Push Rod, Leaf Spring Axle
	04/03 →	Centre Rod	DB-DL-8185		Push Rod
	04/03 →	Centre Rod	DB-DL-8185		Push Rod, Leaf Spring Axle
	04/03 →	Centre Rod	DB-DL-8307		Push Rod
	04/03 →	Centre Rod	DB-DL-9259		Push Rod
	04/03 →	Centre Rod	DB-DL-9259		Push Rod, Leaf Spring Axle
	04/03 →	Centre Rod	DB-DL-10208		Push Rod
	04/03 →	Centre Rod	DB-DL-10208		Push Rod, Leaf Spring Axle
	04/03 →	Centre Rod	DB-DL-10212		Push Rod
	04/03 →	Centre Rod	DB-DL-10212		Push Rod, Leaf Spring Axle
	04/03 →	Centre Rod	DB-DL-12300		for Steering Rod
	04/03 →	Centre Rod	DB-DL-12301		Push Rod, Leaf Spring Axle
	04/03 →	Centre Rod	DB-DL-12403		Push Rod
	04/03 →	Stabiliser Link	DB-DL-9254		Coupling Rod
	04/03 →	Stabiliser Link	DB-DL-9254		Pressure Rod
	04/03 →	Stabiliser Link	DB-DL-9271		Coupling Rod
	04/03 →	Stabiliser Link	DB-DL-9271		Pressure Rod
	04/03 →	Stabiliser Link	DB-DL-9272		Coupling Rod
	04/03 →	Stabiliser Link	DB-DL-9272		Pressure Rod
	04/03 →	Stabiliser Mounting		DB-SB-10406	
	04/03 →	Stabiliser Mounting		DB-SB-10409	
	04/03 →	Suspension Arm Repair Kit		DB-RK-8626	for Wishbone (CV)
	04/03 →	Suspension Arm Repair Kit		DB-RK-10374	for Wishbone (CV)
	04/03 →	Suspension Arm Repair Kit		DB-RK-10375	for Wishbone (CV)
	04/03 →	Suspension Arm Repair Kit	DB-RK-8638		for Control Arm
	04/03 →	Suspension Strut Repair Kit		DB-RK-8391	
	04/03 →	Suspension Strut Repair Kit		DB-RK-8710	
	04/03 →	Suspension Strut Repair Kit		DB-RK-9291	
	04/03 →	Tie Rod	DB-DL-8171		Guide Rod
	04/03 →	Tie Rod	DB-DL-8172		Guide Rod
	04/03 →	Tie Rod	DB-DL-8327		Guide Rod
	04/03 →	Tie Rod	DB-DL-8390		
	04/03 →	Tie Rod	DB-DL-8640		Guide Rod
	04/03 →	Tie Rod	DB-DL-12310		
	04/03 →	Tie Rod	DB-ES-5227		Guide Rod
	04/03 →	Tie Rod	MN-DL-7834		Guide Rod
	04/03 →	Tie Rod End	CV-ES-0543		for Push Rod
	04/03 →	Tie Rod End	CV-ES-0888		for Push Rod
	04/03 →	Tie Rod End	CV-ES-14163		for Steering Rod
	04/03 →	Tie Rod End	DB-ES-5234		for Steering Rod
	04/03 →	Tie Rod End	DB-ES-8323		
04/03 →	Tie Rod End	DB-ES-8323		Leaf Spring Axle	
04/03 →	Tie Rod End	DB-ES-8530		for Push Rod	
04/03 →	Track Control Arm		DB-DL-3475	Trailing Arm	
04/03 →	Track Control Arm		DB-DL-3475	Trailing Arm, 1st RA;2nd RA, →517144 03/517144 07	

CV-ES-0543

Length: 125
 Cone Ø: d1 Ø 32 / d2 Ø 29
 Thread: M30 x 1,5 RHT
 0004605748, 0004606048, 0004606848,
 0004607048, 0014600448, 0014601148,
 0014601748, 0014602448, 0014607648,
 0014609648



CV-ES-0888

Length: 125
 Cone Ø: d1 Ø 32 / d2 Ø 29
 Thread: M30 x 1,5 LHT
 0004605848, 0004606148, 0004606948,
 0004607148, 0004609048, 0014600548,
 0014601348, 0014602548, 0014607948,
 0024600448



CV-ES-14163

Length: 125
 Cone Ø: d1 Ø 30 / d2 Ø 27
 Thread: M30 x 1,5 RHT
 0003305248, 0003387310, 0004600348,
 0004600948, 0004602848, 0004602948,
 0004608948, 0014600248, 0014600848,
 0014601248, 0014602248, 0014607748,
 0024600148, A0003387310, A0004600348,
 A0004602848, A0004602948, A0014600848,
 A0014601248, A0014602248, A0014607748



DB-DL-3475

Length: 565 Ø: 52
 Hole Distance: 152 / 152
 3753500006, 3753500206, 9473500805,
 9483500006, 9483500805, 9483501205,
 9483501305, 9483501905, 9483502005,
 9483502405, A3753500006, A3753500206



DB-DL-8168

Length: 904 Ø: 52
 Cone Ø: d1 Ø 32 / d2 Ø 29
 0004609405, 0004609505, 0014607105



DB-DL-8171

Length: 1687 Ø: 52
 Cone Ø: d1 Ø 32 / d2 Ø 29
 9493300603, 9493300703, 9493301503,
 9493301603



DB-DL-8172

Length: 1700 Ø: 52
 Cone Ø: d1 Ø 32 / d2 Ø 29
 01219700A, 9493300403, 9493300503,
 9493300803, 9493301403



DB-DL-8184

Length: 1095 Ø: 42
 Cone Ø: d1 Ø 32 / d2 Ø 28,8
 01217700A, 0014601305, 0014601405,
 0024600505, 0034603205, 3754601505,
 A0014601305, A0014601405, A0024600505



DB-DL-8185

Length: 711 Ø: 42
 Cone Ø: d1 Ø 32 / d2 Ø 28,8
 01213600A, 0014601105, 0024600405,
 0034603105, A0014601105, A0024600405



DB-DL-8307

Length: 885 Ø: 38
 Cone Ø: d1 Ø 32 / d2 Ø 30
 01215500A, 0004604005, 0024605105,
 0024605205, 0034604005



DB-DL-8327

Length: 1745 Ø: 48
 Cone Ø: d1 Ø 32 / d2 Ø 29
 01219800A, 9413300003, 9413300103,
 9413300203, 9413300303, 9413300503



DB-DL-8390

Length: 1596 Ø: 50
 Cone Ø: d1 Ø 32 / d2 Ø 29
 9493301003, 9493301103, 9493301703



DB-DL-8640

Length: 1615 Ø: 50
 Cone Ø: d1 Ø 32 / d2 Ø 29
 6253301503, 6253301603, 6253302403,
 6253302503, 9423300803, 9423302103,
 9493300203, 9493300303, 9493300903



DB-DL-9254

Length: 1815 Ø: 58
 0003220323, 0003220623, 3753220423



DB-DL-9259

Length: 883 Ø: 38
 Cone Ø: d1 Ø 32 / d2 Ø 29
 0024608605, 0024608705, A0024608605,
 A0024608705



DB-DL-9271

Length: 1815 Ø: 60
 0003220423, 0003220723



DB-DL-9272

Length: 1815 Ø: 80
 0003220223



DB-DL-10208

Length: 708 Ø: 40
 Cone Ø: d1 Ø 32 / d2 Ø 29
 0014605305, 0024600605



DB-DL-10212

Length: 953 Ø: 42
 Cone Ø: d1 Ø 32 / d2 Ø 29
 0024609205, 0024609305, 0034604505



DB-DL-12300

Length: 733 Ø: 36
 Cone Ø: d1 Ø 32 / d2 Ø 29
 0014601505, 0014607305, 0034603305,
 3754601605, A0014601505, A0034603305,
 A3754601605



DB-DL-12301

Length: 716 Ø: 38
 Cone Ø: d1 Ø 32 / d2 Ø 29
 Thread: M30 x 1,5
 0024608805, 0024608905, A0024608805,
 A0024608905



DB-DL-12310

Length: 1532 Ø: 50
 Cone Ø: d1 Ø 32 / d2 Ø 29
 Thread: M27 x 1,5 LHT
 9493301203, 9493301303, 9493301803,
 9493302203, A9493301203, A9493301303,
 A9493301803, A9493302203



DB-DL-12403

Length: 893 Ø: 42
 Cone Ø: d1 Ø 32 / d2 Ø 29
 0014604905, 0014607405



DB-ES-5227

Length: 1588 Ø: 60
 Cone Ø: d1 Ø 38 / d2 Ø 34,3
 6253300903, 6253301203, 9443300203



DB-ES-5234

Length: 135
 Cone Ø: d1 Ø 38 / d2 Ø 34,3
 Thread: M38 x 1,5 RHT
 0004601748, 120322305, 2205000400



DB-ES-8323

Length: 75
 Cone Ø: d1 Ø 32 / d2 Ø 28,8
 Thread: M26 x 1,5 RHT
 0014601548, 0014601648, 0024600648,
 A0014601648, A0024600648



DB-ES-8510

Length: 56
 Cone Ø: d1 Ø 10 / d2 Ø 10
 Thread: M12 x 1,75 LHT
 0009965145, 0009965645, 0019963145



DB-ES-8530

Length: 115
 Cone Ø: d1 Ø 28,6 / d2 Ø 23,9
 Thread: M30 x 1,5 RHT
 0014603848, 0014604848, 0014605148,
 0014608648, 0014609948



DB-RK-8391

Ø: 85 Hole Distance: 152
 Thick/Height: 24
 01336800A, 0003502705



DB-RK-8626

Ø: 75 Hole Distance: 130
 Thick/Height: 24
 0003502205, 0003502505, 0003503405,
 0003504505, GL11319



DB-RK-8638

Length: 100 Ø: 67
 Hole Distance: 100
 Thick/Height: 20
 0003301411



DB-RK-8710

Ø: 85 Hole Distance: 130
 Thick/Height: 30
 0003503705



DB-RK-9291

Ø: 107,5 Hole Distance: 152
 Thick/Height: 30
 0003503605



DB-RK-10374

Ø: 85 Hole Distance: 152
 Thick/Height: 24
 0003504405



DB-RK-10375

Ø: 100 Hole Distance: 152
 Thick/Height: 24
 0003502405, 0003503505, 0003504905



DB-SB-10384

Ø: 73 Thick/Height: 47
 9303170012, 9423171812



DB-SB-10401

Length: 232
 Thick/Height: 163,5 / 152,5
 0003250596, 0003250796



DB-SB-10406

Ø: 80 Thick/Height: 46
 0003238185



DB-SB-10409

Ø: 77 Thick/Height: 56
 0003265181



DB-VB-7261

Length: 622 Ø: 46
 Hole Ø 25 / 25 / 25
 Hole Distance: 152 / 130 / 130
 01337800A, 9443500305, 9443500505,
 9443500605, 9473500705, 9473500905,
 9483500405, 9483503005



DB-VB-9307

Length: 667 Ø: 60
 Hole Ø 25 / 23 / 23
 Hole Distance: 152 / 130 / 130
 9483502805



DB-VB-9308

Length: 622 Ø: 46
 Hole Ø 25 / 25 / 25
 Hole Distance: 152 / 130 / 130
 9483502905



DB-VB-10426

Length: 622 Ø: 46
 Hole Ø 25 / 25 / 25
 Hole Distance: 152 / 130 / 130
 9443500405



MN-DL-7834

Length: 1588 Ø: 58
 Cone Ø: d1 Ø 30 / d2 Ø 27
 3463303903, 3463304903, 6253303203,
 9443300503, 9443301303, 9443301703



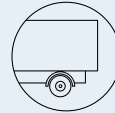

ACTROS MP2 / MP3 ...

4148 K ...	04/03 →	Track Control Arm		DB-DL-3475	Trailing Arm, 1st RA;2nd RA, →517144 06/517144 09
	04/03 →	Track Control Arm		DB-DL-3475	Trailing Arm, 1st RA;2nd RA, →517144 26/517144 27
	04/03 →	Track Control Arm		DB-VB-7261	Suspension Rod, Wishbone (CV)
	04/03 →	Track Control Arm		DB-VB-7261	Suspension Rod, Wishbone (CV), 1st RA;2nd RA; Leaf Spring Axle
	04/03 →	Track Control Arm		DB-VB-9307	Suspension Rod, Wishbone (CV)
	04/03 →	Track Control Arm		DB-VB-9307	Suspension Rod, Wishbone (CV), 1st RA;2nd RA; Leaf Spring Axle
	04/03 →	Track Control Arm		DB-VB-9308	Suspension Rod, Wishbone (CV)
	04/03 →	Track Control Arm		DB-VB-9308	Suspension Rod, Wishbone (CV), 1st RA;2nd RA; Leaf Spring Axle
4150 AK	04/03 →	Track Control Arm		DB-VB-10426	Wishbone (CV), 1st RA;2nd RA, →517142 05
	04/03 →	Centre Rod	DB-DL-8184		Push Rod
	04/03 →	Centre Rod	DB-DL-10208		Push Rod
	04/03 →	Centre Rod	DB-DL-12403		Push Rod
	04/03 →	Stabiliser Link	DB-DL-9254		Coupling Rod
	04/03 →	Suspension Arm Repair Kit		DB-RK-8626	for Wishbone (CV)
	04/03 →	Suspension Arm Repair Kit		DB-RK-10375	for Wishbone (CV)
	04/03 →	Suspension Strut Repair Kit		DB-RK-8391	
	04/03 →	Suspension Strut Repair Kit		DB-RK-8710	
	04/03 →	Suspension Strut Repair Kit		DB-RK-9291	
	04/03 →	Tie Rod	DB-ES-5227		Guide Rod
	04/03 →	Tie Rod End	CV-ES-0543		for Push Rod
	04/03 →	Tie Rod End	CV-ES-0888		for Push Rod
	04/03 →	Tie Rod End	DB-ES-5234		for Steering Rod
	04/03 →	Track Control Arm		DB-DL-3475	Trailing Arm, 1st RA;2nd RA, →517144 03/517144 07
	04/03 →	Track Control Arm		DB-DL-3475	Trailing Arm, 1st RA;2nd RA, →517144 06/517144 09
	04/03 →	Track Control Arm		DB-DL-3475	Trailing Arm, 1st RA;2nd RA, →517144 26/517144 27
	4150 K	04/03 →	Track Control Arm		DB-VB-7261
04/03 →		Track Control Arm		DB-VB-9307	Suspension Rod, Wishbone (CV)
04/03 →		Track Control Arm		DB-VB-9308	Suspension Rod, Wishbone (CV)
04/03 →		Track Control Arm		DB-VB-10426	Wishbone (CV), 1st RA;2nd RA, →517142 05
04/03 →		Bush, parabolic spring		DB-SB-10401	
04/03 →		Centre Rod	DB-DL-8168		Push Rod
04/03 →		Centre Rod	DB-DL-8184		Push Rod
04/03 →		Centre Rod	DB-DL-8185		Push Rod
04/03 →		Centre Rod	DB-DL-9259		Push Rod
04/03 →		Centre Rod	DB-DL-10208		Push Rod
04/03 →		Centre Rod	DB-DL-10212		Push Rod
04/03 →		Centre Rod	DB-DL-12300		for Steering Rod
04/03 →		Centre Rod	DB-DL-12301		Push Rod, Leaf Spring Axle
04/03 →		Centre Rod	DB-DL-12403		Push Rod
04/03 →		Stabiliser Link	DB-DL-9254		Coupling Rod
04/03 →		Stabiliser Link	DB-DL-9271		Coupling Rod
04/03 →		Stabiliser Link	DB-DL-9272		Coupling Rod
04/03 →		Suspension Arm Repair Kit		DB-RK-8626	for Wishbone (CV)
04/03 →	Suspension Arm Repair Kit		DB-RK-10375	for Wishbone (CV)	
04/03 →	Suspension Strut Repair Kit		DB-RK-8391		
04/03 →	Suspension Strut Repair Kit		DB-RK-8710		
04/03 →	Suspension Strut Repair Kit		DB-RK-9291		
04/03 →	Tie Rod	DB-DL-8171		Guide Rod	
04/03 →	Tie Rod	DB-DL-8172		Guide Rod	
04/03 →	Tie Rod	DB-DL-8390			
04/03 →	Tie Rod	DB-DL-8640		Guide Rod	
04/03 →	Tie Rod	DB-DL-8640		Guide Rod, 1st & 2nd Front Axle	
04/03 →	Tie Rod	DB-DL-12310			
04/03 →	Tie Rod	DB-ES-5227		Guide Rod, 1st & 2nd Front Axle	
04/03 →	Tie Rod	MN-DL-7834		Guide Rod	

CV-ES-0543

Length: 125
 Cone Ø: d1 Ø 32 / d2 Ø 29
 Thread: M30 x 1,5 RHT
 0004605748, 0004606048, 0004606848,
 0004607048, 0014600448, 0014601148,
 0014601748, 0014602448, 0014607648,
 0014609648

**CV-ES-0888**

Length: 125
 Cone Ø: d1 Ø 32 / d2 Ø 29
 Thread: M30 x 1,5 LHT
 0004605848, 0004606148, 0004606948,
 0004607148, 0004609048, 0014600548,
 0014601348, 0014602548, 0014607948,
 0024600448

**DB-DL-3475**

Length: 565 Ø: 52
 Hole Distance: 152 / 152
 3753500006, 3753500206, 9473500805,
 9483500006, 9483500805, 9483501205,
 9483501305, 9483501905, 9483502005,
 9483502405, A3753500006, A3753500206

**DB-DL-8168**

Length: 904 Ø: 52
 Cone Ø: d1 Ø 32 / d2 Ø 29
 0004609405, 0004609505, 0014607105

**DB-DL-8171**

Length: 1687 Ø: 52
 Cone Ø: d1 Ø 32 / d2 Ø 29
 9493300603, 9493300703, 9493301503,
 9493301603

**DB-DL-8172**

Length: 1700 Ø: 52
 Cone Ø: d1 Ø 32 / d2 Ø 29
 01219700A, 9493300403, 9493300503,
 9493300803, 9493301403

**DB-DL-8184**

Length: 1095 Ø: 42
 Cone Ø: d1 Ø 32 / d2 Ø 28,8
 01217700A, 0014601305, 0014601405,
 0024600505, 0034603205, 3754601505,
 A0014601305, A0014601405, A0024600505

**DB-DL-8185**

Length: 711 Ø: 42
 Cone Ø: d1 Ø 32 / d2 Ø 28,8
 01213600A, 0014601105, 0024600405,
 0034603105, A0014601105, A0024600405

**DB-DL-8390**

Length: 1596 Ø: 50
 Cone Ø: d1 Ø 32 / d2 Ø 29
 9493301003, 9493301103, 9493301703

**DB-DL-8640**

Length: 1615 Ø: 50
 Cone Ø: d1 Ø 32 / d2 Ø 29
 6253301503, 6253301603, 6253302403,
 6253302503, 9423300803, 9423302103,
 9493300203, 9493300303, 9493300903

**DB-DL-9254**

Length: 1815 Ø: 58
 0003220323, 0003220623, 3753220423

**DB-DL-9259**

Length: 883 Ø: 38
 Cone Ø: d1 Ø 32 / d2 Ø 29
 0024608605, 0024608705, A0024608605,
 A0024608705

**DB-DL-9271**

Length: 1815 Ø: 60
 0003220423, 0003220723

**DB-DL-9272**

Length: 1815 Ø: 80
 0003220223

**DB-DL-10208**

Length: 708 Ø: 40
 Cone Ø: d1 Ø 32 / d2 Ø 29
 0014605305, 0024600605

**DB-DL-10212**

Length: 953 Ø: 42
 Cone Ø: d1 Ø 32 / d2 Ø 29
 0024609205, 0024609305, 0034604505

**DB-DL-12300**

Length: 733 Ø: 36
 Cone Ø: d1 Ø 32 / d2 Ø 29
 0014601505, 0014607305, 0034603305,
 3754601605, A0014601505, A0034603305,
 A3754601605

**DB-DL-12301**

Length: 716 Ø: 38
 Cone Ø: d1 Ø 32 / d2 Ø 29
 Thread: M30 x 1,5
 0024608805, 0024608905, A0024608805,
 A0024608905

**DB-DL-12310**

Length: 1532 Ø: 50
 Cone Ø: d1 Ø 32 / d2 Ø 29
 Thread: M27 x 1,5 LHT
 9493301203, 9493301303, 9493301803,
 9493302203, A9493301203, A9493301303,
 A9493301803, A9493302203

**DB-DL-12403**

Length: 893 Ø: 42
 Cone Ø: d1 Ø 32 / d2 Ø 29
 0014604905, 0014607405

**DB-ES-5227**

Length: 1588 Ø: 60
 Cone Ø: d1 Ø 38 / d2 Ø 34,3
 6253300903, 6253301203, 9443300203

**DB-ES-5234**

Length: 135
 Cone Ø: d1 Ø 38 / d2 Ø 34,3
 Thread: M38 x 1,5 RHT
 0004601748, 120322305, 2205000400

**DB-RK-8391**

Ø: 85 Hole Distance: 152
 Thick/Height: 24
 01336800A, 0003502705

**DB-RK-8626**

Ø: 75 Hole Distance: 130
 Thick/Height: 24
 0003502205, 0003502505, 0003503405,
 0003504505, GL11319

**DB-RK-8710**

Ø: 85 Hole Distance: 130
 Thick/Height: 30
 0003503705

**DB-RK-9291**

Ø: 107,5 Hole Distance: 152
 Thick/Height: 30
 0003503605

**DB-RK-10375**

Ø: 100 Hole Distance: 152
 Thick/Height: 24
 0003502405, 0003503505, 0003504905

**DB-SB-10401**

Length: 232
 Thick/Height: 163,5 / 152,5
 0003250596, 0003250796

**DB-VB-7261**

Length: 622 Ø: 46
 Hole Ø 25 / 25 / 25
 Hole Distance: 152 / 130 / 130
 01337800A, 9443500305, 9443500505,
 9443500605, 9473500705, 9473500905,
 9483500405, 9483503005

**DB-VB-9307**

Length: 667 Ø: 60
 Hole Ø 25 / 23 / 23
 Hole Distance: 152 / 130 / 130
 9483502805

**DB-VB-9308**

Length: 622 Ø: 46
 Hole Ø 25 / 25 / 25
 Hole Distance: 152 / 130 / 130
 9483502905

**DB-VB-10426**

Length: 622 Ø: 46
 Hole Ø 25 / 25 / 25
 Hole Distance: 152 / 130 / 130
 9443500405

**MN-DL-7834**

Length: 1588 Ø: 58
 Cone Ø: d1 Ø 30 / d2 Ø 27
 3463303903, 3463304903, 6253303203,
 9443300503, 9443301303, 9443301703





ACTROS MP2 / MP3 ...

4150 K ...	04/03→	Tie Rod End	CV-ES-0543		for Push Rod
	04/03→	Tie Rod End	CV-ES-0888		for Push Rod
	04/03→	Tie Rod End	CV-ES-14163		for Steering Rod
	04/03→	Tie Rod End	DB-ES-5234		for Steering Rod
	04/03→	Tie Rod End	DB-ES-8323		
	04/03→	Tie Rod End	DB-ES-8530		for Push Rod
	04/03→	Track Control Arm		DB-DL-3475	Trailing Arm, 1st RA;2nd RA, →517144 03/517144 07
	04/03→	Track Control Arm		DB-DL-3475	Trailing Arm, 1st RA;2nd RA, →517144 06/517144 09
	04/03→	Track Control Arm		DB-DL-3475	Trailing Arm, 1st RA;2nd RA, →517144 26/517144 27
	04/03→	Track Control Arm		DB-VB-7261	Suspension Rod, Wishbone (CV)
	04/03→	Track Control Arm		DB-VB-9307	Suspension Rod, Wishbone (CV)
	04/03→	Track Control Arm		DB-VB-9308	Suspension Rod, Wishbone (CV)
	04/03→	Track Control Arm		DB-VB-10426	Wishbone (CV), 1st RA;2nd RA, →517142 05
	4151 AK	04/03→	Centre Rod	DB-DL-8184	
04/03→		Centre Rod	DB-DL-10208		Push Rod, Leaf Spring Axle
04/03→		Centre Rod	DB-DL-12403		Push Rod
04/03→		Stabiliser Link	DB-DL-9254		Pressure Rod
04/03→		Stabiliser Mounting		DB-SB-10406	
04/03→		Suspension Strut Repair Kit		DB-RK-8710	
04/03→		Suspension Strut Repair Kit		DB-RK-9291	
04/03→		Tie Rod	DB-DL-12310		
04/03→		Tie Rod	DB-ES-5227		Guide Rod, 1st FA
04/03→		Tie Rod End	CV-ES-0543		for Push Rod
04/03→		Tie Rod End	CV-ES-0888		for Push Rod
04/03→		Tie Rod End	DB-ES-5234		for Steering Rod
04/03→		Track Control Arm		DB-DL-3475	Trailing Arm, 1st RA;2nd RA, →517144 03/517144 07
04/03→		Track Control Arm		DB-DL-3475	Trailing Arm, 1st RA;2nd RA, →517144 06/517144 09
04/03→		Track Control Arm		DB-DL-3475	Trailing Arm, 1st RA;2nd RA, →517144 26/517144 27
04/03→		Track Control Arm		DB-VB-7261	Suspension Rod, Wishbone (CV), 1st RA;2nd RA; Leaf Spring Axle
04/03→		Track Control Arm		DB-VB-9307	Suspension Rod, Wishbone (CV), 1st RA;2nd RA; Leaf Spring Axle
04/03→		Track Control Arm		DB-VB-9308	Suspension Rod, Wishbone (CV), 1st RA;2nd RA; Leaf Spring Axle
04/03→		Track Control Arm		DB-VB-10426	Wishbone (CV), 1st RA;2nd RA, →517142 05
4151 K		04/03→	Centre Rod	DB-DL-10208	
	04/03→	Centre Rod	DB-DL-12300		for Steering Rod
	04/03→	Centre Rod	DB-DL-12301		Push Rod, Leaf Spring Axle
	04/03→	Centre Rod	DB-DL-12403		Push Rod
	04/03→	Stabiliser Link	DB-DL-9254		Pressure Rod
	04/03→	Stabiliser Mounting		DB-SB-10406	
	04/03→	Suspension Strut Repair Kit		DB-RK-8710	
	04/03→	Suspension Strut Repair Kit		DB-RK-9291	
	04/03→	Tie Rod	DB-DL-8390		
	04/03→	Tie Rod	DB-DL-8640		Guide Rod
	04/03→	Tie Rod	DB-DL-12310		
	04/03→	Tie Rod	DB-ES-5227		Guide Rod
	04/03→	Tie Rod	MN-DL-7834		Guide Rod
	04/03→	Tie Rod End	CV-ES-0543		for Push Rod
	04/03→	Tie Rod End	CV-ES-0888		for Push Rod
	04/03→	Tie Rod End	CV-ES-14163		for Steering Rod
	04/03→	Tie Rod End	DB-ES-5234		for Steering Rod
	04/03→	Tie Rod End	DB-ES-8530		for Push Rod
	04/03→	Track Control Arm		DB-DL-3475	Trailing Arm, 1st RA;2nd RA, →517144 03/517144 07
	04/03→	Track Control Arm		DB-DL-3475	Trailing Arm, 1st RA;2nd RA, →517144 06/517144 09

CV-ES-0543

Length: 125
Cone Ø: d1 Ø 32 / d2 Ø 29
Thread: M30 x 1,5 RHT
0004605748, 0004606048, 0004606848,
0004607048, 0014600448, 0014601148,
0014601748, 0014602448, 0014607648,
0014609648



CV-ES-0888

Length: 125
Cone Ø: d1 Ø 32 / d2 Ø 29
Thread: M30 x 1,5 LHT
0004605848, 0004606148, 0004606948,
0004607148, 0004609048, 0014600548,
0014601348, 0014602548, 0014607948,
0024600448



CV-ES-14163

Length: 125
Cone Ø: d1 Ø 30 / d2 Ø 27
Thread: M30 x 1,5 RHT
0003305248, 0003387310, 0004600348,
0004600948, 0004602848, 0004602948,
0004608948, 0014600248, 0014600848,
0014601248, 0014602248, 0014607748,
0024600148, A0003387310, A0004600348,
A0004602848, A0004602948, A0014600848,
A0014601248, A0014602248, A0014607748



DB-DL-3475

Length: 565 Ø: 52
Hole Distance: 152 / 152
3753500006, 3753500206, 9473500805,
9483500006, 9483500805, 9483501205,
9483501305, 9483501905, 9483502005,
9483502405, A3753500006, A3753500206



DB-DL-8184

Length: 1095 Ø: 42
Cone Ø: d1 Ø 32 / d2 Ø 28,8
01217700A, 0014601305, 0014601405,
0024600505, 0034603205, 3754601505,
A0014601305, A0014601405, A0024600505



DB-DL-8390

Length: 1596 Ø: 50
Cone Ø: d1 Ø 32 / d2 Ø 29
9493301003, 9493301103, 9493301703



DB-DL-8640

Length: 1615 Ø: 50
Cone Ø: d1 Ø 32 / d2 Ø 29
6253301503, 6253301603, 6253302403,
6253302503, 9423300803, 9423302103,
9493300203, 9493300303, 9493300903



DB-DL-9254

Length: 1815 Ø: 58
0003220323, 0003220623, 3753220423



DB-DL-10208

Length: 708 Ø: 40
Cone Ø: d1 Ø 32 / d2 Ø 29
0014605305, 0024600605



DB-DL-12300

Length: 733 Ø: 36
Cone Ø: d1 Ø 32 / d2 Ø 29
0014601505, 0014607305, 0034603305,
3754601605, A0014601505, A0034603305,
A3754601605



DB-DL-12301

Length: 716 Ø: 38
Cone Ø: d1 Ø 32 / d2 Ø 29
Thread: M30 x 1,5
0024608805, 0024608905, A0024608805,
A0024608905



DB-DL-12310

Length: 1532 Ø: 50
Cone Ø: d1 Ø 32 / d2 Ø 29
Thread: M27 x 1,5 LHT
9493301203, 9493301303, 9493301803,
9493302203, A9493301203, A9493301303,
A9493301803, A9493302203



DB-DL-12403

Length: 893 Ø: 42
Cone Ø: d1 Ø 32 / d2 Ø 29
0014604905, 0014607405



DB-ES-5227

Length: 1588 Ø: 60
Cone Ø: d1 Ø 38 / d2 Ø 34,3
6253300903, 6253301203, 9443300203



DB-ES-5234

Length: 135
Cone Ø: d1 Ø 38 / d2 Ø 34,3
Thread: M38 x 1,5 RHT
0004601748, 120322305, 2205000400



DB-ES-8323

Length: 75
Cone Ø: d1 Ø 32 / d2 Ø 28,8
Thread: M26 x 1,5 RHT
0014601548, 0014601648, 0024600648,
A0014601648, A0024600648



DB-ES-8530

Length: 115
Cone Ø: d1 Ø 28,6 / d2 Ø 23,9
Thread: M30 x 1,5 RHT
0014603848, 0014604848, 0014605148,
0014608648, 0014609948



DB-RK-8710

Ø: 85 Hole Distance: 130
Thick/Height: 30
0003503705



DB-RK-9291

Ø: 107,5 Hole Distance: 152
Thick/Height: 30
0003503605



DB-SB-10406

Ø: 80 Thick/Height: 46
0003238185



DB-VB-7261

Length: 622 Ø: 46
Hole Ø 25 / 25 / 25
Hole Distance: 152 / 130 / 130
01337800A, 9443500305, 9443500505,
9443500605, 9473500705, 9473500905,
9483500405, 9483503005



DB-VB-9307

Length: 667 Ø: 60
Hole Ø 25 / 23 / 23
Hole Distance: 152 / 130 / 130
9483502805



DB-VB-9308

Length: 622 Ø: 46
Hole Ø 25 / 25 / 25
Hole Distance: 152 / 130 / 130
9483502905



DB-VB-10426

Length: 622 Ø: 46
Hole Ø 25 / 25 / 25
Hole Distance: 152 / 130 / 130
9443500405



MN-DL-7834

Length: 1588 Ø: 58
Cone Ø: d1 Ø 30 / d2 Ø 27
3463303903, 3463304903, 6253303203,
9443300503, 9443301303, 9443301703





ACTROS MP2 / MP3 ...

4151 K ...	04/03 →	Track Control Arm		DB-DL-3475	Trailing Arm, 1st RA;2nd RA, →517144 26/517144 27
	04/03 →	Track Control Arm		DB-VB-7261	Suspension Rod, Wishbone (CV), 1st RA;2nd RA; Leaf Spring Axle
	04/03 →	Track Control Arm		DB-VB-9307	Suspension Rod, Wishbone (CV), 1st RA;2nd RA; Leaf Spring Axle
	04/03 →	Track Control Arm		DB-VB-9308	Suspension Rod, Wishbone (CV), 1st RA;2nd RA; Leaf Spring Axle
	04/03 →	Track Control Arm		DB-VB-10426	Wishbone (CV), 1st RA;2nd RA, →517142 05
	05/05 →	Ball Head, gearshift linkage	DB-ES-8510		
	05/05 →	Bush, driver cab suspension	DB-SB-10384		
	05/05 →	Bush, parabolic spring		DB-SB-10401	
	05/05 →	Centre Rod	DB-DL-8168		Push Rod, Leaf Spring Axle
	05/05 →	Centre Rod	DB-DL-8184		Push Rod, Leaf Spring Axle
	05/05 →	Centre Rod	DB-DL-8185		Push Rod, Leaf Spring Axle
	05/05 →	Centre Rod	DB-DL-8307		Push Rod
	05/05 →	Centre Rod	DB-DL-9259		Push Rod, Leaf Spring Axle
	05/05 →	Centre Rod	DB-DL-10212		Push Rod, Leaf Spring Axle
	05/05 →	Stabiliser Link	DB-DL-9271		Pressure Rod
	05/05 →	Stabiliser Link	DB-DL-9272		Pressure Rod
	05/05 →	Stabiliser Mounting		DB-SB-10409	
	05/05 →	Suspension Arm Repair Kit		DB-RK-8626	for Wishbone (CV)
	05/05 →	Suspension Arm Repair Kit		DB-RK-10374	for Wishbone (CV)
	05/05 →	Suspension Arm Repair Kit		DB-RK-10375	for Wishbone (CV)
	05/05 →	Suspension Arm Repair Kit	DB-RK-8638		for Control Arm
	05/05 →	Suspension Strut Repair Kit		DB-RK-8391	
	05/05 →	Tie Rod	DB-DL-8171		Guide Rod
	05/05 →	Tie Rod	DB-DL-8172		Guide Rod
05/05 →	Tie Rod	DB-DL-8327		Guide Rod	
05/05 →	Tie Rod End	DB-ES-8323		Leaf Spring Axle	
05/05 →	Track Control Arm		DB-DL-3475	Trailing Arm	
4155 AK	04/03 →	Centre Rod	DB-DL-8184		Push Rod
	04/03 →	Centre Rod	DB-DL-10208		Push Rod
	04/03 →	Centre Rod	DB-DL-12403		Push Rod
	04/03 →	Stabiliser Link	DB-DL-9254		Coupling Rod
	04/03 →	Suspension Arm Repair Kit		DB-RK-8626	for Wishbone (CV)
	04/03 →	Suspension Arm Repair Kit		DB-RK-10375	for Wishbone (CV)
	04/03 →	Suspension Strut Repair Kit		DB-RK-8391	
	04/03 →	Suspension Strut Repair Kit		DB-RK-8710	
	04/03 →	Suspension Strut Repair Kit		DB-RK-9291	
	04/03 →	Tie Rod	DB-ES-5227		Guide Rod
	04/03 →	Tie Rod End	CV-ES-0543		for Push Rod
	04/03 →	Tie Rod End	CV-ES-0888		for Push Rod
	04/03 →	Tie Rod End	DB-ES-5234		for Steering Rod
	04/03 →	Track Control Arm		DB-DL-3475	Trailing Arm, 1st RA;2nd RA, →517144 03/517144 07
	04/03 →	Track Control Arm		DB-DL-3475	Trailing Arm, 1st RA;2nd RA, →517144 06/517144 09
	04/03 →	Track Control Arm		DB-DL-3475	Trailing Arm, 1st RA;2nd RA, →517144 26/517144 27
	04/03 →	Track Control Arm		DB-VB-7261	Suspension Rod, Wishbone (CV)
	04/03 →	Track Control Arm		DB-VB-9307	Suspension Rod, Wishbone (CV)
04/03 →	Track Control Arm		DB-VB-9308	Suspension Rod, Wishbone (CV)	
04/03 →	Track Control Arm		DB-VB-10426	Wishbone (CV), 1st RA;2nd RA, →517142 05	
4155 K	04/03 →	Bush, parabolic spring		DB-SB-10401	
	04/03 →	Centre Rod	DB-DL-8168		Push Rod
	04/03 →	Centre Rod	DB-DL-8184		Push Rod
	04/03 →	Centre Rod	DB-DL-8185		Push Rod
	04/03 →	Centre Rod	DB-DL-9259		Push Rod
	04/03 →	Centre Rod	DB-DL-10212		Push Rod
	04/03 →	Centre Rod	DB-DL-12300		for Steering Rod
	04/03 →	Centre Rod	DB-DL-12301		Push Rod, Leaf Spring Axle
	04/03 →	Stabiliser Link	DB-DL-9254		Coupling Rod

CV-ES-0543

Length: 125
Cone Ø: d1 Ø 32 / d2 Ø 29
Thread: M30 x 1,5 RHT
0004605748, 0004606048, 0004606848,
0004607048, 0014600448, 0014601148,
0014601748, 0014602448, 0014607648,
0014609648



CV-ES-0888

Length: 125
Cone Ø: d1 Ø 32 / d2 Ø 29
Thread: M30 x 1,5 LHT
0004605848, 0004606148, 0004606948,
0004607148, 0004609048, 0014600548,
0014601348, 0014602548, 0014607948,
0024600448



DB-DL-3475

Length: 565 Ø: 52
Hole Distance: 152 / 152
3753500006, 3753500206, 9473500805,
9483500006, 9483500805, 9483501205,
9483501305, 9483501905, 9483502005,
9483502405, A3753500006, A3753500206



DB-DL-8168

Length: 904 Ø: 52
Cone Ø: d1 Ø 32 / d2 Ø 29
0004609405, 0004609505, 0014607105



DB-DL-8171

Length: 1687 Ø: 52
Cone Ø: d1 Ø 32 / d2 Ø 29
9493300603, 9493300703, 9493301503,
9493301603



DB-DL-8172

Length: 1700 Ø: 52
Cone Ø: d1 Ø 32 / d2 Ø 29
01219700A, 9493300403, 9493300503,
9493300803, 9493301403



DB-DL-8184

Length: 1095 Ø: 42
Cone Ø: d1 Ø 32 / d2 Ø 28,8
01217700A, 0014601305, 0014601405,
0024600505, 0034603205, 3754601505,
A0014601305, A0014601405, A0024600505



DB-DL-8185

Length: 711 Ø: 42
Cone Ø: d1 Ø 32 / d2 Ø 28,8
01213600A, 0014601105, 0024600405,
0034603105, A0014601105, A0024600405



DB-DL-8307

Length: 885 Ø: 38
Cone Ø: d1 Ø 32 / d2 Ø 30
01215500A, 0004604005, 0024605105,
0024605205, 0034604005



DB-DL-8327

Length: 1745 Ø: 48
Cone Ø: d1 Ø 32 / d2 Ø 29
01219800A, 9413300003, 9413300103,
9413300203, 9413300303, 9413300503



DB-DL-9254

Length: 1815 Ø: 58
0003220323, 0003220623, 3753220423



DB-DL-9259

Length: 883 Ø: 38
Cone Ø: d1 Ø 32 / d2 Ø 29
0024608605, 0024608705, A0024608605,
A0024608705



DB-DL-9271

Length: 1815 Ø: 60
0003220423, 0003220723



DB-DL-9272

Length: 1815 Ø: 80
0003220223



DB-DL-10208

Length: 708 Ø: 40
Cone Ø: d1 Ø 32 / d2 Ø 29
0014605305, 0024600605



DB-DL-10212

Length: 953 Ø: 42
Cone Ø: d1 Ø 32 / d2 Ø 29
0024609205, 0024609305, 0034604505



DB-DL-12300

Length: 733 Ø: 36
Cone Ø: d1 Ø 32 / d2 Ø 29
0014601505, 0014607305, 0034603305,
3754601605, A0014601505, A0034603305,
A3754601605



DB-DL-12301

Length: 716 Ø: 38
Cone Ø: d1 Ø 32 / d2 Ø 29
Thread: M30 x 1,5
0024608805, 0024608905, A0024608805,
A0024608905



DB-DL-12403

Length: 893 Ø: 42
Cone Ø: d1 Ø 32 / d2 Ø 29
0014604905, 0014607405



DB-ES-5227

Length: 1588 Ø: 60
Cone Ø: d1 Ø 38 / d2 Ø 34,3
6253300903, 6253301203, 9443300203



DB-ES-5234

Length: 135
Cone Ø: d1 Ø 38 / d2 Ø 34,3
Thread: M38 x 1,5 RHT
0004601748, 120322305, 2205000400



DB-ES-8323

Length: 75
Cone Ø: d1 Ø 32 / d2 Ø 28,8
Thread: M26 x 1,5 RHT
0014601548, 0014601648, 0024600648,
A0014601648, A0024600648



DB-ES-8510

Length: 56
Cone Ø: d1 Ø 10 / d2 Ø 10
Thread: M12 x 1,75 LHT
0009965145, 0009965645, 0019963145



DB-RK-8391

Ø: 85 Hole Distance: 152
Thick/Height: 24
01336800A, 0003502705



DB-RK-8626

Ø: 75 Hole Distance: 130
Thick/Height: 24
0003502205, 0003502505, 0003503405,
0003504505, GL11319



DB-RK-8638

Length: 100 Ø: 67
Hole Distance: 100
Thick/Height: 20
0003301411



DB-RK-8710

Ø: 85 Hole Distance: 130
Thick/Height: 30
0003503705



DB-RK-9291

Ø: 107,5 Hole Distance: 152
Thick/Height: 30
0003503605



DB-RK-10374

Ø: 85 Hole Distance: 152
Thick/Height: 24
0003504405



DB-RK-10375

Ø: 100 Hole Distance: 152
Thick/Height: 24
0003502405, 0003503505, 0003504905



DB-SB-10384

Ø: 73 Thick/Height: 47
9303170012, 9423171812



DB-SB-10401

Length: 232
Thick/Height: 163,5 / 152,5
0003250596, 0003250796



DB-SB-10409

Ø: 77 Thick/Height: 56
0003265181



DB-VB-7261

Length: 622 Ø: 46
Hole Ø 25 / 25 / 25
Hole Distance: 152 / 130 / 130
01337800A, 9443500305, 9443500505,
9443500605, 9473500705, 9473500905,
9483500405, 9483503005



DB-VB-9307

Length: 667 Ø: 60
Hole Ø 25 / 23 / 25
Hole Distance: 152 / 130 / 130
9483502805



DB-VB-9308

Length: 622 Ø: 46
Hole Ø 25 / 25 / 25
Hole Distance: 152 / 130 / 130
9483502905



DB-VB-10426

Length: 622 Ø: 46
Hole Ø 25 / 25 / 25
Hole Distance: 152 / 130 / 130
9443500405





ACTROS MP2 / MP3 ...

4155 K ...	04/03→	Stabiliser Link	DB-DL-9271		Coupling Rod	
	04/03→	Stabiliser Link	DB-DL-9272		Coupling Rod	
	04/03→	Suspension Arm Repair Kit		DB-RK-8626	for Wishbone (CV)	
	04/03→	Suspension Arm Repair Kit		DB-RK-10375	for Wishbone (CV)	
	04/03→	Suspension Strut Repair Kit		DB-RK-8391		
	04/03→	Suspension Strut Repair Kit		DB-RK-8710		
	04/03→	Suspension Strut Repair Kit		DB-RK-9291		
	04/03→	Tie Rod	DB-DL-8171		Guide Rod	
	04/03→	Tie Rod	DB-DL-8172		Guide Rod	
	04/03→	Tie Rod	DB-DL-8390			
	04/03→	Tie Rod	DB-DL-8640		Guide Rod	
	04/03→	Tie Rod	DB-DL-12310			
	04/03→	Tie Rod End	CV-ES-0543		for Push Rod	
	04/03→	Tie Rod End	CV-ES-0888		for Push Rod	
	04/03→	Tie Rod End	CV-ES-14163		for Steering Rod	
	04/03→	Tie Rod End	DB-ES-8323			
	04/03→	Tie Rod End	DB-ES-8530		for Push Rod	
	04/03→	Track Control Arm		DB-DL-3475	Trailing Arm, 1st RA;2nd RA, →517144 03/517144 07	
	04/03→	Track Control Arm		DB-DL-3475	Trailing Arm, 1st RA;2nd RA, →517144 06/517144 09	
	04/03→	Track Control Arm		DB-DL-3475	Trailing Arm, 1st RA;2nd RA, →517144 26/517144 27	
	04/03→	Track Control Arm		DB-VB-7261	Suspension Rod, Wishbone (CV)	
	04/03→	Track Control Arm		DB-VB-9307	Suspension Rod, Wishbone (CV)	
	04/03→	Track Control Arm		DB-VB-9308	Suspension Rod, Wishbone (CV)	
	04/03→	Track Control Arm		DB-VB-10426	Wishbone (CV), 1st RA;2nd RA, →517142 05	
	4160 AK	04/03→	Centre Rod	DB-DL-8184		Push Rod
		04/03→	Centre Rod	DB-DL-10208		Push Rod
		04/03→	Centre Rod	DB-DL-12403		Push Rod
04/03→		Stabiliser Link	DB-DL-9254		Coupling Rod	
04/03→		Suspension Arm Repair Kit		DB-RK-8626	for Wishbone (CV)	
04/03→		Suspension Arm Repair Kit		DB-RK-10375	for Wishbone (CV)	
04/03→		Suspension Strut Repair Kit		DB-RK-8391		
04/03→		Suspension Strut Repair Kit		DB-RK-8710		
04/03→		Suspension Strut Repair Kit		DB-RK-9291		
04/03→		Tie Rod	DB-ES-5227		Guide Rod	
04/03→		Tie Rod End	CV-ES-0543		for Push Rod	
04/03→		Tie Rod End	CV-ES-0888		for Push Rod	
04/03→		Tie Rod End	DB-ES-5234		for Steering Rod	
04/03→		Track Control Arm		DB-DL-3475	Trailing Arm, 1st RA;2nd RA, →517144 03/517144 07	
04/03→		Track Control Arm		DB-DL-3475	Trailing Arm, 1st RA;2nd RA, →517144 06/517144 09	
04/03→		Track Control Arm		DB-DL-3475	Trailing Arm, 1st RA;2nd RA, →517144 26/517144 27	
04/03→		Track Control Arm		DB-VB-7261	Suspension Rod, Wishbone (CV)	
04/03→		Track Control Arm		DB-VB-9307	Suspension Rod, Wishbone (CV)	
04/03→		Track Control Arm		DB-VB-9308	Suspension Rod, Wishbone (CV)	
04/03→		Track Control Arm		DB-VB-10426	Wishbone (CV), 1st RA;2nd RA, →517142 05	
4160 K	04/03→	Bush, parabolic spring		DB-SB-10401		
	04/03→	Centre Rod	DB-DL-8168		Push Rod	
	04/03→	Centre Rod	DB-DL-8184		Push Rod	
	04/03→	Centre Rod	DB-DL-8185		Push Rod	
	04/03→	Centre Rod	DB-DL-9259		Push Rod	
	04/03→	Centre Rod	DB-DL-10212		Push Rod	
	04/03→	Centre Rod	DB-DL-12300		for Steering Rod	
	04/03→	Centre Rod	DB-DL-12301		Push Rod, Leaf Spring Axle	
	04/03→	Stabiliser Link	DB-DL-9254		Coupling Rod	
	04/03→	Stabiliser Link	DB-DL-9271		Coupling Rod	
	04/03→	Stabiliser Link	DB-DL-9272		Coupling Rod	
	04/03→	Suspension Arm Repair Kit		DB-RK-8626	for Wishbone (CV)	
	04/03→	Suspension Arm Repair Kit		DB-RK-10375	for Wishbone (CV)	

CV-ES-0543

Length: 125
Cone Ø: d1 Ø 32 / d2 Ø 29
Thread: M30 x 1,5 RHT
0004605748, 0004606048, 0004606848,
0004607048, 0014600448, 0014601148,
0014601748, 0014602448, 0014607648,
0014609648



CV-ES-0888

Length: 125
Cone Ø: d1 Ø 32 / d2 Ø 29
Thread: M30 x 1,5 LHT
0004605848, 0004606148, 0004606948,
0004607148, 0004609048, 0014600548,
0014601348, 0014602548, 0014607948,
0024600448



CV-ES-14163

Length: 125
Cone Ø: d1 Ø 30 / d2 Ø 27
Thread: M30 x 1,5 RHT
0003305248, 0003387310, 0004600348,
0004600948, 0004602848, 0004602948,
0004608948, 0014600248, 0014600848,
0014601248, 0014602248, 0014607748,
0024600148, A0003387310, A0004600348,
A0004602848, A0004602948, A0014600848,
A0014601248, A0014602248, A0014607748



DB-DL-3475

Length: 565 Ø: 52
Hole Distance: 152 / 152
3753500006, 3753500206, 9473500805,
9483500006, 9483500805, 9483501205,
9483501305, 9483501905, 9483502005,
9483502405, A3753500006, A3753500206



DB-DL-8168

Length: 904 Ø: 52
Cone Ø: d1 Ø 32 / d2 Ø 29
0004609405, 0004609505, 0014607105



DB-DL-8171

Length: 1687 Ø: 52
Cone Ø: d1 Ø 32 / d2 Ø 29
9493300603, 9493300703, 9493301503,
9493301603



DB-DL-8172

Length: 1700 Ø: 52
Cone Ø: d1 Ø 32 / d2 Ø 29
01219700A, 9493300403, 9493300503,
9493300803, 9493301403



DB-DL-8184

Length: 1095 Ø: 42
Cone Ø: d1 Ø 32 / d2 Ø 28,8
01217700A, 0014601305, 0014601405,
0024600505, 0034603205, 3754601505,
A0014601305, A0014601405, A0024600505



DB-DL-8185

Length: 711 Ø: 42
Cone Ø: d1 Ø 32 / d2 Ø 28,8
01213600A, 0014601105, 0024600405,
0034603105, A0014601105, A0024600405



DB-DL-8390

Length: 1596 Ø: 50
Cone Ø: d1 Ø 32 / d2 Ø 29
9493301003, 9493301103, 9493301703



DB-DL-8640

Length: 1615 Ø: 50
Cone Ø: d1 Ø 32 / d2 Ø 29
6253301503, 6253301603, 6253302403,
6253302503, 9423300803, 9423302103,
9493300203, 9493300303, 9493300903



DB-DL-9254

Length: 1815 Ø: 58
0003220323, 0003220623, 3753220423



DB-DL-9259

Length: 883 Ø: 38
Cone Ø: d1 Ø 32 / d2 Ø 29
0024608605, 0024608705, A0024608605,
A0024608705



DB-DL-9271

Length: 1815 Ø: 60
0003220423, 0003220723



DB-DL-9272

Length: 1815 Ø: 80
0003220223



DB-DL-10208

Length: 708 Ø: 40
Cone Ø: d1 Ø 32 / d2 Ø 29
0014605305, 0024600605



DB-DL-10212

Length: 953 Ø: 42
Cone Ø: d1 Ø 32 / d2 Ø 29
0024609205, 0024609305, 0034604505



DB-DL-12300

Length: 733 Ø: 36
Cone Ø: d1 Ø 32 / d2 Ø 29
0014601505, 0014607305, 0034603305,
3754601605, A0014601505, A0034603305,
A3754601605



DB-DL-12301

Length: 716 Ø: 38
Cone Ø: d1 Ø 32 / d2 Ø 29
Thread: M30 x 1,5
0024608805, 0024608905, A0024608805,
A0024608905



DB-DL-12310

Length: 1532 Ø: 50
Cone Ø: d1 Ø 32 / d2 Ø 29
Thread: M27 x 1,5 LHT
9493301203, 9493301303, 9493301803,
9493302203, A9493301203, A9493301303,
A9493301803, A9493302203



DB-DL-12403

Length: 893 Ø: 42
Cone Ø: d1 Ø 32 / d2 Ø 29
0014604905, 0014607405



DB-ES-5227

Length: 1588 Ø: 60
Cone Ø: d1 Ø 38 / d2 Ø 34,3
6253300903, 6253301203, 9443300203



DB-ES-5234

Length: 135
Cone Ø: d1 Ø 38 / d2 Ø 34,3
Thread: M38 x 1,5 RHT
0004601748, 120322305, 2205000400



DB-ES-8323

Length: 75
Cone Ø: d1 Ø 32 / d2 Ø 28,8
Thread: M26 x 1,5 RHT
0014601548, 0014601648, 0024600648,
A0014601648, A0024600648



DB-ES-8530

Length: 115
Cone Ø: d1 Ø 28,6 / d2 Ø 23,9
Thread: M30 x 1,5 RHT
0014603848, 0014604848, 0014605148,
0014608648, 0014609948



DB-RK-8391

Ø: 85 Hole Distance: 152
Thick/Height: 24
01336800A, 0003502705



DB-RK-8626

Ø: 75 Hole Distance: 130
Thick/Height: 24
0003502205, 0003502505, 0003503405,
0003504505, GL11319



DB-RK-8710

Ø: 85 Hole Distance: 130
Thick/Height: 30
0003503705



DB-RK-9291

Ø: 107,5 Hole Distance: 152
Thick/Height: 30
0003503605



DB-RK-10375

Ø: 100 Hole Distance: 152
Thick/Height: 24
0003502405, 0003503505, 0003504905



DB-SB-10401

Length: 232
Thick/Height: 163,5 / 152,5
0003250596, 0003250796



DB-VB-7261

Length: 622 Ø: 46
Hole Ø 25 / 25 / 25
Hole Distance: 152 / 130 / 130
01337800A, 9443500305, 9443500505,
9443500605, 9473500705, 9473500905,
9483500405, 9483503005



DB-VB-9307

Length: 667 Ø: 60
Hole Ø 25 / 23 / 23
Hole Distance: 152 / 130 / 130
9483502805



DB-VB-9308

Length: 622 Ø: 46
Hole Ø 25 / 25 / 25
Hole Distance: 152 / 130 / 130
9483502905



DB-VB-10426

Length: 622 Ø: 46
Hole Ø 25 / 25 / 25
Hole Distance: 152 / 130 / 130
9443500405





ACTROS MP2 / MP3 ...

4160 K ...	04/03→	Suspension Strut Repair Kit		DB-RK-8391		
	04/03→	Suspension Strut Repair Kit		DB-RK-8710		
	04/03→	Suspension Strut Repair Kit		DB-RK-9291		
	04/03→	Tie Rod	DB-DL-8171		Guide Rod	
	04/03→	Tie Rod	DB-DL-8172		Guide Rod	
	04/03→	Tie Rod	DB-DL-8390			
	04/03→	Tie Rod	DB-DL-8640		Guide Rod	
	04/03→	Tie Rod	DB-DL-12310			
	04/03→	Tie Rod End	CV-ES-0543		for Push Rod	
	04/03→	Tie Rod End	CV-ES-0888		for Push Rod	
	04/03→	Tie Rod End	CV-ES-14163		for Steering Rod	
	04/03→	Tie Rod End	DB-ES-8323			
	04/03→	Tie Rod End	DB-ES-8530		for Push Rod	
	04/03→	Track Control Arm		DB-DL-3475	Trailing Arm, 1st RA;2nd RA, →517144 03/517144 07	
	04/03→	Track Control Arm		DB-DL-3475	Trailing Arm, 1st RA;2nd RA, →517144 06/517144 09	
	04/03→	Track Control Arm		DB-DL-3475	Trailing Arm, 1st RA;2nd RA, →517144 26/517144 27	
	04/03→	Track Control Arm		DB-VB-7261	Suspension Rod, Wishbone (CV)	
	04/03→	Track Control Arm		DB-VB-9307	Suspension Rod, Wishbone (CV)	
	4160 S	04/03→	Track Control Arm		DB-VB-9308	Suspension Rod, Wishbone (CV)
		04/03→	Track Control Arm		DB-VB-10426	Wishbone (CV), 1st RA;2nd RA, →517142 05
10/02→		Centre Rod	DB-DL-2144		Push Rod	
10/02→		Centre Rod	DB-DL-5405		Push Rod	
10/02→		Centre Rod	DB-DL-8167		Push Rod	
10/02→		Centre Rod	DB-DL-8307		Push Rod	
10/02→		Centre Rod	DB-DL-8702		Push Rod	
10/02→		Tie Rod	DB-DL-8171		Guide Rod, 1st Front Axle, →504310 15	
10/02→		Tie Rod	DB-DL-8327		Guide Rod, 1st Front Axle	
10/02→		Tie Rod	DB-DL-8640		Guide Rod, 1st Front Axle	
10/02→		Tie Rod	DB-DL-12310			
10/02→		Tie Rod End	CV-ES-0543		for Push Rod	
10/02→		Tie Rod End	CV-ES-0888		for Push Rod	
10/02→		Tie Rod End	CV-ES-14163		for Steering Rod	
10/02→		Tie Rod End	DB-ES-8164		for Push Rod	
10/02→		Tie Rod End	DB-ES-8530		for Push Rod	
10/02→		Track Control Arm		DB-DL-3475	Trailing Arm	
10/02→		Track Control Arm		DB-VB-7261	Suspension Rod, Wishbone (CV), 1st RA;2nd RA, →517142 02	
10/02→		Track Control Arm		DB-VB-9307	Suspension Rod, Wishbone (CV)	
10/02→		Track Control Arm		DB-VB-9308	Suspension Rod, Wishbone (CV)	
4165 AK	04/03→	Centre Rod	DB-DL-8184		Push Rod	
	04/03→	Centre Rod	DB-DL-10208		Push Rod	
	04/03→	Centre Rod	DB-DL-12403		Push Rod	
	04/03→	Stabiliser Link	DB-DL-9254		Coupling Rod	
	04/03→	Tie Rod	DB-ES-5227		Guide Rod	
	04/03→	Track Control Arm		DB-VB-7261	Suspension Rod, Wishbone (CV)	
	04/03→	Track Control Arm		DB-VB-9307	Suspension Rod, Wishbone (CV)	
04/03→	Track Control Arm		DB-VB-9308	Suspension Rod, Wishbone (CV)		
5041 AK	06/08→	Centre Rod	DB-DL-8184		Push Rod, Leaf Spring Axle	
	06/08→	Centre Rod	DB-DL-10208		Push Rod, Leaf Spring Axle	
	06/08→	Centre Rod	DB-DL-12403		Push Rod	
	06/08→	Stabiliser Link	DB-DL-9254		Pressure Rod	
	06/08→	Suspension Strut Repair Kit		DB-RK-8710		
	06/08→	Suspension Strut Repair Kit		DB-RK-9291		
	06/08→	Tie Rod	DB-DL-12310			
	06/08→	Tie Rod	DB-ES-5227		Guide Rod, 1st FA	
	06/08→	Tie Rod End	CV-ES-0543		for Push Rod	
	06/08→	Tie Rod End	CV-ES-0888		for Push Rod	
	06/08→	Tie Rod End	DB-ES-5234		for Steering Rod	
	06/08→	Track Control Arm		DB-DL-3475	Trailing Arm, 1st RA;2nd RA, →517144 03/517144 07	

CV-ES-0543

Length: 125
Cone Ø: d1 Ø 32 / d2 Ø 29
Thread: M30 x 1,5 RHT
0004605748, 0004606048, 0004606848,
0004607048, 0014600448, 0014601148,
0014601748, 0014602448, 0014607648,
0014609648



CV-ES-0888

Length: 125
Cone Ø: d1 Ø 32 / d2 Ø 29
Thread: M30 x 1,5 LHT
0004605848, 0004606148, 0004606948,
0004607148, 0004609048, 0014600548,
0024600448



CV-ES-14163

Length: 125
Cone Ø: d1 Ø 30 / d2 Ø 27
Thread: M30 x 1,5 RHT
0003305248, 0003387310, 0004600348,
0004600948, 0004602848, 0004602948,
0004608948, 0014600248, 0014600848,
0014601248, 0014602248, 0014607748,
0024600148, A0003387310, A0004600348,
A0004602848, A0004602948, A0014600848,
A0014601248, A0014602248, A0014607748



DB-DL-2144

Length: 872 Ø: 35
Cone Ø: d1 Ø 28,6 / d2 Ø 23,9
0024604305, 0024604405, 0034604805



DB-DL-3475

Length: 565 Ø: 52
Hole Distance: 152 / 152
3753500006, 3753500206, 9473500805,
9483500006, 9483500805, 9483501205,
9483501305, 9483501905, 9483502005,
9483502405, A3753500006, A3753500206



DB-DL-5405

Length: 890 Ø: 35
Cone Ø: d1 Ø 28,6 / d2 Ø 23,9
01215900A, 1460248, 0024604505, 0024604605,
0034605005, 3752600637, 3754600405,
A3752600637, A3754600405



DB-DL-8167

Length: 866 Ø: 38
Cone Ø: d1 Ø 30 / d2 Ø 27
0014609805, 0014609905, 0024606305,
0024606405



DB-DL-8171

Length: 1687 Ø: 52
Cone Ø: d1 Ø 32 / d2 Ø 29
9493300603, 9493300703, 9493301503,
9493301603



DB-DL-8172

Length: 1700 Ø: 52
Cone Ø: d1 Ø 32 / d2 Ø 29
01219700A, 9493300403, 9493300503,
9493300803, 9493301403



DB-DL-8184

Length: 1095 Ø: 42
Cone Ø: d1 Ø 32 / d2 Ø 28,8
01217700A, 0014601305, 0014601405,
0024600505, 0034603205, 3754601505,
A0014601305, A0014601405, A0024600505



DB-DL-8307

Length: 885 Ø: 38
Cone Ø: d1 Ø 32 / d2 Ø 30
01215500A, 0004604005, 0024605105,
0024605205, 0034604005



DB-DL-8327

Length: 1745 Ø: 48
Cone Ø: d1 Ø 32 / d2 Ø 29
01219800A, 9413300003, 9413300103,
9413300203, 9413300303, 9413300503



DB-DL-8390

Length: 1596 Ø: 50
Cone Ø: d1 Ø 32 / d2 Ø 29
9493301003, 9493301103, 9493301703



DB-DL-8640

Length: 1615 Ø: 50
Cone Ø: d1 Ø 32 / d2 Ø 29
6253301503, 6253301603, 6253302403,
6253302503, 9423300803, 9423302103,
9493300203, 9493300303, 9493300903



DB-DL-8702

Length: 958 Ø: 38
Cone Ø: d1 Ø 32 / d2 Ø 30
0024606105, 0024606205, 0034604205



DB-DL-9254

Length: 1815 Ø: 58
0003220323, 0003220623, 3753220423



DB-DL-10208

Length: 708 Ø: 40
Cone Ø: d1 Ø 32 / d2 Ø 29
0014605305, 0024600605



DB-DL-12310

Length: 1532 Ø: 50
Cone Ø: d1 Ø 32 / d2 Ø 29
Thread: M27 x 1,5 LHT
9493301203, 9493301303, 9493301803,
9493302203, A9493301203, A9493301303,
A9493301803, A9493302203



DB-DL-12403

Length: 893 Ø: 42
Cone Ø: d1 Ø 32 / d2 Ø 29
0014604905, 0014607405



DB-ES-5227

Length: 1588 Ø: 60
Cone Ø: d1 Ø 38 / d2 Ø 34,3
6253300903, 6253301203, 9443300203



DB-ES-5234

Length: 135
Cone Ø: d1 Ø 38 / d2 Ø 34,3
Thread: M38 x 1,5 RHT
0004601748, 120322305, 2205000400



DB-ES-8164

Length: 140
Cone Ø: d1 Ø 28,6 / d2 Ø 23,9
Thread: M28 x 1,5 RHT
0014604248, 0014605048, 0014608548,
0024600548



DB-ES-8323

Length: 75
Cone Ø: d1 Ø 32 / d2 Ø 28,8
Thread: M26 x 1,5 RHT
0014601548, 14601548, 14601648, 0014601648,
24600648, 0024600648, A0014601648,
A0024600648



DB-ES-8530

Length: 115
Cone Ø: d1 Ø 28,6 / d2 Ø 23,9
Thread: M30 x 1,5 RHT
0014603848, 0014604848, 0014605148,
0014608648, 0014609948



DB-RK-8391

Ø: 85 Hole Distance: 152
Thick/Height: 24
01336800A, 0003502705



DB-RK-8710

Ø: 85 Hole Distance: 130
Thick/Height: 30
0003503705



DB-RK-9291

Ø: 107,5 Hole Distance: 152
Thick/Height: 30
0003503605



DB-VB-7261

Length: 622 Ø: 46
Hole Ø 25 / 25 / 25
Hole Distance: 152 / 130 / 130
01337800A, 9443500305, 9443500505,
9443500605, 9473500705, 9473500905,
9483500405, 9483503005



DB-VB-9307

Length: 667 Ø: 60
Hole Ø 25 / 23 / 23
Hole Distance: 152 / 130 / 130
9483502805



DB-VB-9308

Length: 622 Ø: 46
Hole Ø 25 / 25 / 25
Hole Distance: 152 / 130 / 130
9483502905



DB-VB-10426

Length: 622 Ø: 46
Hole Ø 25 / 25 / 25
Hole Distance: 152 / 130 / 130
9443500405





ACTROS MP2 / MP3 ...

5041 AK ...	06/08 →	Track Control Arm		DB-DL-3475	Trailing Arm, 1st RA;2nd RA, →517144 06/517144 09	
	06/08 →	Track Control Arm		DB-DL-3475	Trailing Arm, 1st RA;2nd RA, →517144 26/517144 27	
	06/08 →	Track Control Arm		DB-VB-7261	Suspension Rod, Wishbone (CV), 1st RA;2nd RA; Leaf Spring Axle	
	06/08 →	Track Control Arm		DB-VB-9307	Suspension Rod, Wishbone (CV), 1st RA;2nd RA; Leaf Spring Axle	
	06/08 →	Track Control Arm		DB-VB-9308	Suspension Rod, Wishbone (CV), 1st RA;2nd RA; Leaf Spring Axle	
	06/08 →	Track Control Arm		DB-VB-10426	Wishbone (CV), 1st RA;2nd RA, →517142 05	
5041 B	06/08 →	Centre Rod	DB-DL-8168		Push Rod, Leaf Spring Axle	
	06/08 →	Centre Rod	DB-DL-8184		Push Rod, Leaf Spring Axle	
	06/08 →	Centre Rod	DB-DL-8185		Push Rod, Leaf Spring Axle	
	06/08 →	Centre Rod	DB-DL-9259		Push Rod, Leaf Spring Axle	
	06/08 →	Centre Rod	DB-DL-10212		Push Rod, Leaf Spring Axle	
	06/08 →	Centre Rod	DB-DL-12300		for Steering Rod	
	06/08 →	Centre Rod	DB-DL-12301		Push Rod, Leaf Spring Axle	
	06/08 →	Stabiliser Link	DB-DL-9254		Pressure Rod	
	06/08 →	Stabiliser Link	DB-DL-9271		Pressure Rod	
	06/08 →	Stabiliser Link	DB-DL-9272		Pressure Rod	
	06/08 →	Suspension Strut Repair Kit		DB-RK-9291		
	06/08 →	Tie Rod	DB-DL-8171		Guide Rod	
	06/08 →	Tie Rod	DB-DL-8172		Guide Rod	
	06/08 →	Tie Rod	DB-DL-8390			
	06/08 →	Tie Rod	DB-DL-8640		Guide Rod	
	06/08 →	Tie Rod	DB-DL-12310			
	06/08 →	Tie Rod End	CV-ES-0543		for Push Rod	
	06/08 →	Tie Rod End	CV-ES-0888		for Push Rod	
	06/08 →	Tie Rod End	CV-ES-14163		for Steering Rod	
	06/08 →	Track Control Arm		DB-DL-3475	Trailing Arm, 1st RA;2nd RA, →517144 03/517144 07	
	06/08 →	Track Control Arm		DB-DL-3475	Trailing Arm, 1st RA;2nd RA, →517144 06/517144 09	
	06/08 →	Track Control Arm		DB-DL-3475	Trailing Arm, 1st RA;2nd RA, →517144 26/517144 27	
	06/08 →	Track Control Arm		DB-VB-7261	Suspension Rod, Wishbone (CV), 1st RA;2nd RA; Leaf Spring Axle	
	06/08 →	Track Control Arm		DB-VB-9307	Suspension Rod, Wishbone (CV), 1st RA;2nd RA; Leaf Spring Axle	
	06/08 →	Track Control Arm		DB-VB-9308	Suspension Rod, Wishbone (CV), 1st RA;2nd RA; Leaf Spring Axle	
	06/08 →	Track Control Arm		DB-VB-10426	Wishbone (CV), 1st RA;2nd RA, →517142 05	
	5041 K	06/08 →	Centre Rod	DB-DL-8168		Push Rod, Leaf Spring Axle
		06/08 →	Centre Rod	DB-DL-8184		Push Rod, Leaf Spring Axle
		06/08 →	Centre Rod	DB-DL-8185		Push Rod, Leaf Spring Axle
		06/08 →	Centre Rod	DB-DL-9259		Push Rod, Leaf Spring Axle
06/08 →		Centre Rod	DB-DL-10212		Push Rod, Leaf Spring Axle	
06/08 →		Centre Rod	DB-DL-12300		for Steering Rod	
06/08 →		Centre Rod	DB-DL-12301		Push Rod, Leaf Spring Axle	
06/08 →		Stabiliser Link	DB-DL-9254		Pressure Rod	
06/08 →		Stabiliser Link	DB-DL-9271		Pressure Rod	
06/08 →		Stabiliser Link	DB-DL-9272		Pressure Rod	
06/08 →		Suspension Strut Repair Kit		DB-RK-8710		
06/08 →		Suspension Strut Repair Kit		DB-RK-9291		
06/08 →		Tie Rod	DB-DL-8171		Guide Rod	
06/08 →		Tie Rod	DB-DL-8172		Guide Rod	
06/08 →		Tie Rod	DB-DL-8390			
06/08 →		Tie Rod	DB-DL-8640		Guide Rod	
06/08 →		Tie Rod	DB-DL-12310			
06/08 →		Tie Rod	DB-ES-5227		Guide Rod	
06/08 →		Tie Rod End	CV-ES-0543		for Push Rod	
06/08 →		Tie Rod End	CV-ES-0888		for Push Rod	

CV-ES-0543

Length: 125
Cone Ø: d1 Ø 32 / d2 Ø 29
Thread: M30 x 1,5 RHT
0004605748, 0004606048, 0004606848,
0004607048, 0014600448, 0014601148,
0014601748, 0014602448, 0014607648,
0014609648



CV-ES-0888

Length: 125
Cone Ø: d1 Ø 32 / d2 Ø 29
Thread: M30 x 1,5 LHT
0004605848, 0004606148, 0004606948,
0004607148, 0004609048, 0014600548,
0014601348, 0014602548, 0014607948,
0024600448



CV-ES-14163

Length: 125
Cone Ø: d1 Ø 30 / d2 Ø 27
Thread: M30 x 1,5 RHT
0003305248, 0003387310, 0004600348,
0004600948, 0004602848, 0004602948,
0004608948, 0014600248, 0014600848,
0014601248, 0014602248, 0014607748,
0024600148, A0003387310, A0004600348,
A0004602848, A0004602948, A0014600848,
A0014601248, A0014602248, A0014607748



DB-DL-3475

Length: 565 Ø: 52
Hole Distance: 152 / 152
3753500006, 3753500206, 9473500805,
9483500006, 9483500805, 9483501205,
9483501305, 9483501905, 9483502005,
9483502405, A3753500006, A3753500206



DB-DL-8168

Length: 904 Ø: 52
Cone Ø: d1 Ø 32 / d2 Ø 29
0004609405, 0004609505, 0014607105



DB-DL-8171

Length: 1687 Ø: 52
Cone Ø: d1 Ø 32 / d2 Ø 29
9493300603, 9493300703, 9493301503,
9493301603



DB-DL-8172

Length: 1700 Ø: 52
Cone Ø: d1 Ø 32 / d2 Ø 29
01219700A, 9493300403, 9493300503,
9493300803, 9493301403



DB-DL-8184

Length: 1095 Ø: 42
Cone Ø: d1 Ø 32 / d2 Ø 28,8
01217700A, 0014601305, 0014601405,
0024600505, 0034603205, 3754601505,
A0014601305, A0014601405, A0024600505



DB-DL-8185

Length: 711 Ø: 42
Cone Ø: d1 Ø 32 / d2 Ø 28,8
01213600A, 0014601105, 0024600405,
0034603105, A0014601105, A0024600405



DB-DL-8390

Length: 1596 Ø: 50
Cone Ø: d1 Ø 32 / d2 Ø 29
9493301003, 9493301103, 9493301703



DB-DL-8640

Length: 1615 Ø: 50
Cone Ø: d1 Ø 32 / d2 Ø 29
6253301503, 6253301603, 6253302403,
6253302503, 9423300803, 9423302103,
9493300203, 9493300303, 9493300903



DB-DL-9254

Length: 1815 Ø: 58
0003220323, 0003220623, 3753220423



DB-DL-9259

Length: 883 Ø: 38
Cone Ø: d1 Ø 32 / d2 Ø 29
0024608605, 0024608705, A0024608605,
A0024608705



DB-DL-9271

Length: 1815 Ø: 60
0003220423, 0003220723



DB-DL-9272

Length: 1815 Ø: 80
0003220223



DB-DL-10212

Length: 953 Ø: 42
Cone Ø: d1 Ø 32 / d2 Ø 29
0024609205, 0024609305, 0034604505



DB-DL-12300

Length: 733 Ø: 36
Cone Ø: d1 Ø 32 / d2 Ø 29
0014601505, 0014607305, 0034603305,
3754601605, A0014601505, A0034603305,
A3754601605



DB-DL-12301

Length: 716 Ø: 38
Cone Ø: d1 Ø 32 / d2 Ø 29
Thread: M30 x 1,5
0024608805, 0024608905, A0024608805,
A0024608905



DB-DL-12310

Length: 1532 Ø: 50
Cone Ø: d1 Ø 32 / d2 Ø 29
Thread: M27 x 1,5 LHT
9493301203, 9493301303, 9493301803,
9493302203, A9493301203, A9493301303,
A9493301803, A9493302203



DB-ES-5227

Length: 1588 Ø: 60
Cone Ø: d1 Ø 38 / d2 Ø 34,3
6253300903, 6253301203, 9443300203



DB-RK-8710

Ø: 85 Hole Distance: 130
Thick/Height: 30
0003503705



DB-RK-9291

Ø: 107,5 Hole Distance: 152
Thick/Height: 30
0003503605



DB-VB-7261

Length: 622 Ø: 46
Hole Ø 25 / 25 / 25
Hole Distance: 152 / 130 / 130
01337800A, 9443500305, 9443500505,
9443500605, 9473500705, 9473500905,
9483500405, 9483503005



DB-VB-9307

Length: 667 Ø: 60
Hole Ø 25 / 23 / 23
Hole Distance: 152 / 130 / 130
9483502805



DB-VB-9308

Length: 622 Ø: 46
Hole Ø 25 / 25 / 25
Hole Distance: 152 / 130 / 130
9483502905



DB-VB-10426

Length: 622 Ø: 46
Hole Ø 25 / 25 / 25
Hole Distance: 152 / 130 / 130
9443500405



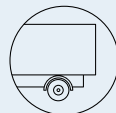

ACTROS MP2 / MP3 ...

5041 K ...	06/08→	Tie Rod End	CV-ES-14163		for Steering Rod
	06/08→	Tie Rod End	DB-ES-8530		for Push Rod
	06/08→	Track Control Arm		DB-DL-3475	Trailing Arm, 1st RA;2nd RA, →517144 03/517144 07
	06/08→	Track Control Arm		DB-DL-3475	Trailing Arm, 1st RA;2nd RA, →517144 06/517144 09
	06/08→	Track Control Arm		DB-DL-3475	Trailing Arm, 1st RA;2nd RA, →517144 26/517144 27
	06/08→	Track Control Arm		DB-VB-7261	Suspension Rod, Wishbone (CV), 1st RA;2nd RA; Leaf Spring Axle
	06/08→	Track Control Arm		DB-VB-9307	Suspension Rod, Wishbone (CV), 1st RA;2nd RA; Leaf Spring Axle
	06/08→	Track Control Arm		DB-VB-9308	Suspension Rod, Wishbone (CV), 1st RA;2nd RA; Leaf Spring Axle
5044 AK	06/08→	Track Control Arm		DB-VB-10426	Wishbone (CV), 1st RA;2nd RA, →517142 05
	06/08→	Centre Rod	DB-DL-8184		Push Rod, Leaf Spring Axle
	06/08→	Centre Rod	DB-DL-10208		Push Rod, Leaf Spring Axle
	06/08→	Centre Rod	DB-DL-12403		Push Rod
	06/08→	Stabiliser Link	DB-DL-9254		Pressure Rod
	06/08→	Suspension Strut Repair Kit		DB-RK-8710	
	06/08→	Suspension Strut Repair Kit		DB-RK-9291	
	06/08→	Tie Rod	DB-DL-12310		
	06/08→	Tie Rod	DB-ES-5227		Guide Rod, 1st FA
	06/08→	Tie Rod End	CV-ES-0543		for Push Rod
	06/08→	Tie Rod End	CV-ES-0888		for Push Rod
	06/08→	Tie Rod End	DB-ES-5234		for Steering Rod
	06/08→	Track Control Arm		DB-DL-3475	Trailing Arm, 1st RA;2nd RA, →517144 03/517144 07
	06/08→	Track Control Arm		DB-DL-3475	Trailing Arm, 1st RA;2nd RA, →517144 06/517144 09
	06/08→	Track Control Arm		DB-DL-3475	Trailing Arm, 1st RA;2nd RA, →517144 26/517144 27
	06/08→	Track Control Arm		DB-VB-7261	Suspension Rod, Wishbone (CV), 1st RA;2nd RA; Leaf Spring Axle
	06/08→	Track Control Arm		DB-VB-9307	Suspension Rod, Wishbone (CV), 1st RA;2nd RA; Leaf Spring Axle
	06/08→	Track Control Arm		DB-VB-9308	Suspension Rod, Wishbone (CV), 1st RA;2nd RA; Leaf Spring Axle
	06/08→	Track Control Arm		DB-VB-10426	Wishbone (CV), 1st RA;2nd RA, →517142 05
	5044 B	06/08→	Centre Rod	DB-DL-8168	
06/08→		Centre Rod	DB-DL-8184		Push Rod, Leaf Spring Axle
06/08→		Centre Rod	DB-DL-8185		Push Rod, Leaf Spring Axle
06/08→		Centre Rod	DB-DL-9259		Push Rod, Leaf Spring Axle
06/08→		Centre Rod	DB-DL-10212		Push Rod, Leaf Spring Axle
06/08→		Centre Rod	DB-DL-12300		for Steering Rod
06/08→		Centre Rod	DB-DL-12301		Push Rod, Leaf Spring Axle
06/08→		Stabiliser Link	DB-DL-9254		Pressure Rod
06/08→		Stabiliser Link	DB-DL-9271		Pressure Rod
06/08→		Stabiliser Link	DB-DL-9272		Pressure Rod
06/08→		Suspension Strut Repair Kit		DB-RK-9291	
06/08→		Tie Rod	DB-DL-8171		Guide Rod
06/08→		Tie Rod	DB-DL-8172		Guide Rod
06/08→		Tie Rod	DB-DL-8390		
06/08→		Tie Rod	DB-DL-8640		Guide Rod
06/08→		Tie Rod	DB-DL-12310		
06/08→		Tie Rod End	CV-ES-0543		for Push Rod
06/08→		Tie Rod End	CV-ES-0888		for Push Rod
06/08→		Tie Rod End	CV-ES-14163		for Steering Rod
06/08→		Track Control Arm		DB-DL-3475	Trailing Arm, 1st RA;2nd RA, →517144 03/517144 07
06/08→		Track Control Arm		DB-DL-3475	Trailing Arm, 1st RA;2nd RA, →517144 06/517144 09

CV-ES-0543

Length: 125
Cone Ø: d1 Ø 32 / d2 Ø 29
Thread: M30 x 1,5 RHT
0004605748, 0004606048, 0004606848,
0004607048, 0014600448, 0014601148,
0014601748, 0014602448, 0014607648,
0014609648



CV-ES-0888

Length: 125
Cone Ø: d1 Ø 32 / d2 Ø 29
Thread: M30 x 1,5 LHT
0004605848, 0004606148, 0004606948,
0004607148, 0004609048, 0014600548,
0014601348, 0014602548, 0014607948,
0024600448



CV-ES-14163

Length: 125
Cone Ø: d1 Ø 30 / d2 Ø 27
Thread: M30 x 1,5 RHT
0003305248, 0003387310, 0004600348,
0004600948, 0004602848, 0004602948,
0004608948, 0014600248, 0014600848,
0014601248, 0014602248, 0014607748,
0024600148, A0003387310, A0004600348,
A0004602848, A0004602948, A0014600848,
A0014601248, A0014602248, A0014607748



DB-DL-3475

Length: 565 Ø: 52
Hole Distance: 152 / 152
3753500006, 3753500206, 9473500805,
9483500006, 9483500805, 9483501205,
9483501305, 9483501905, 9483502005,
9483502405, A3753500006, A3753500206



DB-DL-8168

Length: 904 Ø: 52
Cone Ø: d1 Ø 32 / d2 Ø 29
0004609405, 0004609505, 0014607105



DB-DL-8171

Length: 1687 Ø: 52
Cone Ø: d1 Ø 32 / d2 Ø 29
9493300603, 9493300703, 9493301503,
9493301603



DB-DL-8172

Length: 1700 Ø: 52
Cone Ø: d1 Ø 32 / d2 Ø 29
01219700A, 9493300403, 9493300503,
9493300803, 9493301403



DB-DL-8184

Length: 1095 Ø: 42
Cone Ø: d1 Ø 32 / d2 Ø 28,8
01217700A, 0014601305, 0014601405,
0024600505, 0034603205, 3754601505,
A0014601305, A0014601405, A0024600505



DB-DL-8185

Length: 711 Ø: 42
Cone Ø: d1 Ø 32 / d2 Ø 28,8
01213600A, 0014601105, 0024600405,
0034603105, A0014601105, A0024600405



DB-DL-8390

Length: 1596 Ø: 50
Cone Ø: d1 Ø 32 / d2 Ø 29
9493301003, 9493301103, 9493301703



DB-DL-8640

Length: 1615 Ø: 50
Cone Ø: d1 Ø 32 / d2 Ø 29
6253301503, 6253301603, 6253302403,
6253302503, 9423300803, 9423302103,
9493300203, 9493300303, 9493300903



DB-DL-9254

Length: 1815 Ø: 58
0003220323, 0003220623, 3753220423



DB-DL-9259

Length: 883 Ø: 38
Cone Ø: d1 Ø 32 / d2 Ø 29
0024608605, 0024608705, A0024608605,
A0024608705



DB-DL-9271

Length: 1815 Ø: 40
0003220423, 0003220723



DB-DL-9272

Length: 1815 Ø: 40
0003220223



DB-DL-10208

Length: 708 Ø: 40
Cone Ø: d1 Ø 32 / d2 Ø 29
0014605305, 0024600605



DB-DL-10212

Length: 953 Ø: 42
Cone Ø: d1 Ø 32 / d2 Ø 29
0024609205, 0024609305, 0034604505



DB-DL-12300

Length: 733 Ø: 36
Cone Ø: d1 Ø 32 / d2 Ø 29
0014601505, 0014607305, 0034603305,
3754601605, A0014601505, A0034603305,
A3754601605



DB-DL-12301

Length: 716 Ø: 38
Cone Ø: d1 Ø 32 / d2 Ø 29
Thread: M30 x 1,5
0024608805, 0024608905, A0024608805,
A0024608905



DB-DL-12310

Length: 1532 Ø: 50
Cone Ø: d1 Ø 32 / d2 Ø 29
Thread: M27 x 1,5 LHT
9493301203, 9493301303, 9493301803,
9493302203, A9493301203, A9493301303,
A9493301803, A9493302203



DB-DL-12403

Length: 893 Ø: 42
Cone Ø: d1 Ø 32 / d2 Ø 29
0014604905, 0014607405



DB-ES-5227

Length: 1588 Ø: 60
Cone Ø: d1 Ø 38 / d2 Ø 34,3
6253300903, 6253301203, 9443300203



DB-ES-5234

Length: 135
Cone Ø: d1 Ø 38 / d2 Ø 34,3
Thread: M38 x 1,5 RHT
0004601748, 120322305, 2205000400



DB-ES-8530

Length: 115
Cone Ø: d1 Ø 28,6 / d2 Ø 23,9
Thread: M30 x 1,5 RHT
0014603848, 0014604848, 0014605148,
0014608648, 0014609948



DB-RK-8710

Ø: 85 Hole Distance: 130
Thick/Height: 30
0003503705



DB-RK-9291

Ø: 107,5 Hole Distance: 152
Thick/Height: 30
0003503605



DB-VB-7261

Length: 622 Ø: 46
Hole Ø 25 / 25 / 25
Hole Distance: 152 / 130 / 130
01337800A, 9443500305, 9443500505,
9443500605, 9473500705, 9473500905,
9483500405, 9483500305



DB-VB-9307

Length: 667 Ø: 60
Hole Ø 25 / 23 / 23
Hole Distance: 152 / 130 / 130
9483502805



DB-VB-9308

Length: 622 Ø: 46
Hole Ø 25 / 25 / 25
Hole Distance: 152 / 130 / 130
9483502905



DB-VB-10426

Length: 622 Ø: 46
Hole Ø 25 / 25 / 25
Hole Distance: 152 / 130 / 130
9443500405



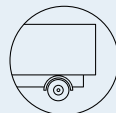

ACTROS MP2 / MP3 ...

5044 B ...	06/08 →	Track Control Arm		DB-DL-3475	Trailing Arm, 1st RA;2nd RA, →517144 26/517144 27	
	06/08 →	Track Control Arm		DB-VB-7261	Suspension Rod, Wishbone (CV), 1st RA;2nd RA; Leaf Spring Axle	
	06/08 →	Track Control Arm		DB-VB-9307	Suspension Rod, Wishbone (CV), 1st RA;2nd RA; Leaf Spring Axle	
	06/08 →	Track Control Arm		DB-VB-9308	Suspension Rod, Wishbone (CV), 1st RA;2nd RA; Leaf Spring Axle	
	06/08 →	Track Control Arm		DB-VB-10426	Wishbone (CV), 1st RA;2nd RA, →517142 05	
5044 K	06/08 →	Centre Rod	DB-DL-8168		Push Rod, Leaf Spring Axle	
	06/08 →	Centre Rod	DB-DL-8184		Push Rod, Leaf Spring Axle	
	06/08 →	Centre Rod	DB-DL-8185		Push Rod, Leaf Spring Axle	
	06/08 →	Centre Rod	DB-DL-9259		Push Rod, Leaf Spring Axle	
	06/08 →	Centre Rod	DB-DL-10212		Push Rod, Leaf Spring Axle	
	06/08 →	Centre Rod	DB-DL-12300		for Steering Rod	
	06/08 →	Centre Rod	DB-DL-12301		Push Rod, Leaf Spring Axle	
	06/08 →	Stabiliser Link	DB-DL-9254		Pressure Rod	
	06/08 →	Stabiliser Link	DB-DL-9271		Pressure Rod	
	06/08 →	Stabiliser Link	DB-DL-9272		Pressure Rod	
	06/08 →	Suspension Strut Repair Kit		DB-RK-8710		
	06/08 →	Suspension Strut Repair Kit		DB-RK-9291		
	06/08 →	Tie Rod	DB-DL-8171		Guide Rod	
	06/08 →	Tie Rod	DB-DL-8172		Guide Rod	
	06/08 →	Tie Rod	DB-DL-8390			
	06/08 →	Tie Rod	DB-DL-8640		Guide Rod	
	06/08 →	Tie Rod	DB-DL-12310			
	06/08 →	Tie Rod	DB-ES-5227		Guide Rod	
	06/08 →	Tie Rod End	CV-ES-0543		for Push Rod	
	06/08 →	Tie Rod End	CV-ES-0888		for Push Rod	
	06/08 →	Tie Rod End	CV-ES-14163		for Steering Rod	
	06/08 →	Tie Rod End	DB-ES-8530		for Push Rod	
	06/08 →	Track Control Arm		DB-DL-3475	Trailing Arm, 1st RA;2nd RA, →517144 03/517144 07	
	06/08 →	Track Control Arm		DB-DL-3475	Trailing Arm, 1st RA;2nd RA, →517144 06/517144 09	
	06/08 →	Track Control Arm		DB-DL-3475	Trailing Arm, 1st RA;2nd RA, →517144 26/517144 27	
	06/08 →	Track Control Arm		DB-VB-7261	Suspension Rod, Wishbone (CV), 1st RA;2nd RA; Leaf Spring Axle	
	06/08 →	Track Control Arm		DB-VB-9307	Suspension Rod, Wishbone (CV), 1st RA;2nd RA; Leaf Spring Axle	
	06/08 →	Track Control Arm		DB-VB-9308	Suspension Rod, Wishbone (CV), 1st RA;2nd RA; Leaf Spring Axle	
	06/08 →	Track Control Arm		DB-VB-10426	Wishbone (CV), 1st RA;2nd RA, →517142 05	
	5046 AK	06/08 →	Centre Rod	DB-DL-8184		Push Rod, Leaf Spring Axle
		06/08 →	Centre Rod	DB-DL-10208		Push Rod, Leaf Spring Axle
		06/08 →	Centre Rod	DB-DL-12403		Push Rod
		06/08 →	Stabiliser Link	DB-DL-9254		Pressure Rod
06/08 →		Suspension Strut Repair Kit		DB-RK-8710		
06/08 →		Suspension Strut Repair Kit		DB-RK-9291		
06/08 →		Tie Rod	DB-DL-12310			
06/08 →		Tie Rod	DB-ES-5227		Guide Rod, 1st FA	
06/08 →		Tie Rod End	CV-ES-0543		for Push Rod	
06/08 →		Tie Rod End	CV-ES-0888		for Push Rod	
06/08 →		Tie Rod End	DB-ES-5234		for Steering Rod	
06/08 →		Track Control Arm		DB-DL-3475	Trailing Arm, 1st RA;2nd RA, →517144 03/517144 07	
06/08 →		Track Control Arm		DB-DL-3475	Trailing Arm, 1st RA;2nd RA, →517144 06/517144 09	
06/08 →		Track Control Arm		DB-DL-3475	Trailing Arm, 1st RA;2nd RA, →517144 26/517144 27	
06/08 →		Track Control Arm		DB-VB-7261	Suspension Rod, Wishbone (CV), 1st RA;2nd RA; Leaf Spring Axle	

CV-ES-0543

Length: 125
Cone Ø: d1 Ø 32 / d2 Ø 29
Thread: M30 x 1,5 RHT
0004605748, 0004606048, 0004606848,
0004607048, 0014600448, 0014601148,
0014601748, 0014602448, 0014607648,
0014609648



CV-ES-0888

Length: 125
Cone Ø: d1 Ø 32 / d2 Ø 29
Thread: M30 x 1,5 LHT
0004605848, 0004606148, 0004606948,
0004607148, 0004609048, 0014600548,
0014601348, 0014602548, 0014607948,
0024600448



CV-ES-14163

Length: 125
Cone Ø: d1 Ø 30 / d2 Ø 27
Thread: M30 x 1,5 RHT
0003305248, 0003387310, 0004600348,
0004600948, 0004602848, 0004602948,
0004608948, 0014600248, 0014600848,
0014601248, 0014602248, 0014607748,
0024600148, A0003387310, A0004600348,
A0004602848, A0004602948, A0014600848,
A0014601248, A0014602248, A0014607748



DB-DL-3475

Length: 565 Ø: 52
Hole Distance: 152 / 152
3753500006, 3753500206, 9473500805,
9483500006, 9483500805, 9483501205,
9483501305, 9483501905, 9483502005,
9483502405, A3753500006, A3753500206



DB-DL-8168

Length: 904 Ø: 52
Cone Ø: d1 Ø 32 / d2 Ø 29
0004609405, 0004609505, 0014607105



DB-DL-8171

Length: 1687 Ø: 52
Cone Ø: d1 Ø 32 / d2 Ø 29
9493300603, 9493300703, 9493301503,
9493301603



DB-DL-8172

Length: 1700 Ø: 52
Cone Ø: d1 Ø 32 / d2 Ø 29
01219700A, 9493300403, 9493300503,
9493300803, 9493301403



DB-DL-8184

Length: 1095 Ø: 42
Cone Ø: d1 Ø 32 / d2 Ø 28,8
01217700A, 0014601305, 0014601405,
0024600505, 0034603205, 3754601505,
A0014601305, A0014601405, A0024600505



DB-DL-8185

Length: 711 Ø: 42
Cone Ø: d1 Ø 32 / d2 Ø 28,8
01213600A, 0014601105, 0024600405,
0034603105, A0014601105, A0024600405



DB-DL-8390

Length: 1596 Ø: 50
Cone Ø: d1 Ø 32 / d2 Ø 29
9493301003, 9493301103, 9493301703



DB-DL-8640

Length: 1615 Ø: 50
Cone Ø: d1 Ø 32 / d2 Ø 29
6253301503, 6253301603, 6253302403,
6253302503, 9423300803, 9423302103,
9493300203, 9493300303, 9493300903



DB-DL-9254

Length: 1815 Ø: 58
0003220323, 0003220623, 3753220423



DB-DL-9259

Length: 883 Ø: 38
Cone Ø: d1 Ø 32 / d2 Ø 29
0024608605, 0024608705, A0024608605,
A0024608705



DB-DL-9271

Length: 1815 Ø: 60
0003220423, 0003220723



DB-DL-9272

Length: 1815 Ø: 80
0003220223



DB-DL-10208

Length: 708 Ø: 40
Cone Ø: d1 Ø 32 / d2 Ø 29
0014605305, 0024600605



DB-DL-10212

Length: 953 Ø: 42
Cone Ø: d1 Ø 32 / d2 Ø 29
0024609205, 0024609305, 0034604505



DB-DL-12300

Length: 733 Ø: 36
Cone Ø: d1 Ø 32 / d2 Ø 29
0014601505, 0014607305, 0034603305,
3754601605, A0014601505, A0034603305,
A3754601605



DB-DL-12301

Length: 716 Ø: 38
Cone Ø: d1 Ø 32 / d2 Ø 29
Thread: M30 x 1,5
0024608805, 0024608905, A0024608805,
A0024608905



DB-DL-12310

Length: 1532 Ø: 50
Cone Ø: d1 Ø 32 / d2 Ø 29
Thread: M27 x 1,5 LHT
9493301203, 9493301303, 9493301803,
9493302203, A9493301203, A9493301303,
A9493301803, A9493302203



DB-DL-12403

Length: 893 Ø: 42
Cone Ø: d1 Ø 32 / d2 Ø 29
0014604905, 0014607405



DB-ES-5227

Length: 1588 Ø: 60
Cone Ø: d1 Ø 38 / d2 Ø 34,3
6253300903, 6253301203, 9443300203



DB-ES-5234

Length: 135
Cone Ø: d1 Ø 38 / d2 Ø 34,3
Thread: M38 x 1,5 RHT
0004601748, 120322305, 2205000400



DB-ES-8530

Length: 115
Cone Ø: d1 Ø 28,6 / d2 Ø 23,9
Thread: M30 x 1,5 RHT
0014603848, 0014604848, 0014605148,
0014608648, 0014609948



DB-RK-8710

Ø: 85 Hole Distance: 130
Thick/Height: 30
0003503705



DB-RK-9291

Ø: 107,5 Hole Distance: 152
Thick/Height: 30
0003503605



DB-VB-7261

Length: 622 Ø: 46
Hole Ø 25 / 25 / 25
Hole Distance: 152 / 130 / 130
01337800A, 9443500305, 9443500505,
9443500605, 9473500705, 9473500905,
9483500405, 9483500305



DB-VB-9307

Length: 667 Ø: 60
Hole Ø 25 / 23 / 23
Hole Distance: 152 / 130 / 130
9483502805



DB-VB-9308

Length: 622 Ø: 46
Hole Ø 25 / 25 / 25
Hole Distance: 152 / 130 / 130
9483502905



DB-VB-10426

Length: 622 Ø: 46
Hole Ø 25 / 25 / 25
Hole Distance: 152 / 130 / 130
9483500405





ACTROS MP2 / MP3 ...

5046 AK ...	06/08 →	Track Control Arm		DB-VB-9307	Suspension Rod, Wishbone (CV), 1st RA;2nd RA; Leaf Spring Axle
	06/08 →	Track Control Arm		DB-VB-9308	Suspension Rod, Wishbone (CV), 1st RA;2nd RA; Leaf Spring Axle
	06/08 →	Track Control Arm		DB-VB-10426	Wishbone (CV), 1st RA;2nd RA, →517142 05
5046 B	06/08 →	Centre Rod	DB-DL-8168		Push Rod, Leaf Spring Axle
	06/08 →	Centre Rod	DB-DL-8184		Push Rod, Leaf Spring Axle
	06/08 →	Centre Rod	DB-DL-8185		Push Rod, Leaf Spring Axle
	06/08 →	Centre Rod	DB-DL-8641		Push Rod, for vehicles with Hinged Leading Axle;Leaf Spring Axle
	06/08 →	Centre Rod	DB-DL-8642		Push Rod, for vehicles with Hinged Leading Axle
	06/08 →	Centre Rod	DB-DL-9259		Push Rod, Leaf Spring Axle
	06/08 →	Centre Rod	DB-DL-10212		Push Rod, Leaf Spring Axle
	06/08 →	Centre Rod	DB-DL-12300		for Steering Rod
	06/08 →	Centre Rod	DB-DL-12301		Push Rod, Leaf Spring Axle
	06/08 →	Stabiliser Link	DB-DL-9254		Pressure Rod
	06/08 →	Stabiliser Link	DB-DL-9271		Pressure Rod
	06/08 →	Stabiliser Link	DB-DL-9272		Pressure Rod
	06/08 →	Suspension Strut Repair Kit		DB-RK-9291	
	06/08 →	Tie Rod	DB-DL-8171		Guide Rod
	06/08 →	Tie Rod	DB-DL-8172		Guide Rod
	06/08 →	Tie Rod	DB-DL-8390		
	06/08 →	Tie Rod	DB-DL-8640		Guide Rod
	06/08 →	Tie Rod	DB-DL-12310		
	06/08 →	Tie Rod End	CV-ES-0543		for Push Rod
	06/08 →	Tie Rod End	CV-ES-0888		for Push Rod
	06/08 →	Tie Rod End	CV-ES-14163		for Steering Rod
	06/08 →	Tie Rod End	DB-ES-8323		
	06/08 →	Track Control Arm		DB-DL-3475	Trailing Arm, 1st RA;2nd RA, →517144 03/517144 07
	06/08 →	Track Control Arm		DB-DL-3475	Trailing Arm, 1st RA;2nd RA, →517144 06/517144 09
	06/08 →	Track Control Arm		DB-DL-3475	Trailing Arm, 1st RA;2nd RA, →517144 26/517144 27
	06/08 →	Track Control Arm		DB-DL-5224	Control Arm, for vehicles with Hinged Leading Axle;Air Suspension Axle
	06/08 →	Track Control Arm		DB-DL-9218	Trailing Arm, for vehicles with Hinged Leading Axle;Air Suspension Axle
	06/08 →	Track Control Arm		DB-VB-7261	Suspension Rod, Wishbone (CV), 1st RA;2nd RA; Leaf Spring Axle
	06/08 →	Track Control Arm		DB-VB-9307	Suspension Rod, Wishbone (CV), 1st RA;2nd RA; Leaf Spring Axle
	06/08 →	Track Control Arm		DB-VB-9308	Suspension Rod, Wishbone (CV), 1st RA;2nd RA; Leaf Spring Axle
06/08 →	Track Control Arm		DB-VB-10426	Wishbone (CV), 1st RA;2nd RA, →517142 05	
5046 K	06/08 →	Centre Rod	DB-DL-8168		Push Rod, Leaf Spring Axle
	06/08 →	Centre Rod	DB-DL-8184		Push Rod, Leaf Spring Axle
	06/08 →	Centre Rod	DB-DL-8185		Push Rod, Leaf Spring Axle
	06/08 →	Centre Rod	DB-DL-9259		Push Rod, Leaf Spring Axle
	06/08 →	Centre Rod	DB-DL-10212		Push Rod, Leaf Spring Axle
	06/08 →	Centre Rod	DB-DL-12300		for Steering Rod
	06/08 →	Centre Rod	DB-DL-12301		Push Rod, Leaf Spring Axle
	06/08 →	Stabiliser Link	DB-DL-9254		Pressure Rod
	06/08 →	Stabiliser Link	DB-DL-9271		Pressure Rod
	06/08 →	Stabiliser Link	DB-DL-9272		Pressure Rod
	06/08 →	Suspension Strut Repair Kit		DB-RK-8710	
	06/08 →	Suspension Strut Repair Kit		DB-RK-9291	
	06/08 →	Tie Rod	DB-DL-8171		Guide Rod
	06/08 →	Tie Rod	DB-DL-8172		Guide Rod
	06/08 →	Tie Rod	DB-DL-8390		
	06/08 →	Tie Rod	DB-DL-8640		Guide Rod
	06/08 →	Tie Rod	DB-DL-12310		
	06/08 →	Tie Rod	DB-ES-5227		Guide Rod

CV-ES-0543

Length: 125
Cone Ø: d1 Ø 32 / d2 Ø 29
Thread: M30 x 1,5 RHT
0004605748, 0004606048, 0004606848,
0004607048, 0014600448, 0014601148,
0014601748, 0014602448, 0014607648,
0014609648



CV-ES-0888

Length: 125
Cone Ø: d1 Ø 32 / d2 Ø 29
Thread: M30 x 1,5 LHT
0004605848, 0004606148, 0004606948,
0004607148, 0004609048, 0014600548,
0014601348, 0014602548, 0014607948,
0024600448



CV-ES-14163

Length: 125
Cone Ø: d1 Ø 30 / d2 Ø 27
Thread: M30 x 1,5 RHT
0003305248, 0003387310, 0004600348,
0004600948, 0004602848, 0004602948,
0004608948, 0014600248, 0014600848,
0014601248, 0014602248, 0014607748,
0024600148, A0003387310, A0004600348,
A0004602848, A0004602948, A0014600848,
A0014601248, A0014602248, A0014607748



DB-DL-3475

Length: 565 Ø: 52
Hole Distance: 152 / 152
3753500006, 3753500206, 9473500805,
9483500006, 9483500805, 9483501205,
9483501305, 9483501905, 9483502005,
9483502405, A3753500006, A3753500206



DB-DL-5224

Length: 850 Ø: 60
Hole Distance: 100 / 100
01336100A, 9413300007



DB-DL-8168

Length: 904 Ø: 52
Cone Ø: d1 Ø 32 / d2 Ø 29
0004609405, 0004609505, 0014607105



DB-DL-8171

Length: 1687 Ø: 52
Cone Ø: d1 Ø 32 / d2 Ø 29
9493300603, 9493300703, 9493301503,
9493301603



DB-DL-8172

Length: 1700 Ø: 52
Cone Ø: d1 Ø 32 / d2 Ø 29
01219700A, 9493300403, 9493300503,
9493300803, 9493301403



DB-DL-8184

Length: 1095 Ø: 42
Cone Ø: d1 Ø 32 / d2 Ø 28,8
01217700A, 0014601305, 0014601405,
0024600505, 0034603205, 3754601505,
A0014601305, A0014601405, A0024600505



DB-DL-8185

Length: 711 Ø: 42
Cone Ø: d1 Ø 32 / d2 Ø 28,8
01213600A, 0014601105, 0024600405,
0034603105, A0014601105, A0024600405



DB-DL-8390

Length: 1596 Ø: 50
Cone Ø: d1 Ø 32 / d2 Ø 29
9493301003, 9493301103, 9493301703



DB-DL-8640

Length: 1615 Ø: 50
Cone Ø: d1 Ø 32 / d2 Ø 29
6253301503, 6253301603, 6253302403,
6253302503, 9423300803, 9423302103,
9493300203, 9493300303, 9493300903



DB-DL-8641

Length: 905 Ø: 42
Cone Ø: d1 Ø 30 / d2 Ø 27
0014605105, 0014608105



DB-DL-8642

Length: 954 Ø: 42
Cone Ø: d1 Ø 30 / d2 Ø 27
0014608605, 0014608705



DB-DL-9218

Length: 754 Ø: 40
Hole Distance: 100
000360098524, 000390098524, 3753300111,
9413300011, A3753300111, SA50831601



DB-DL-9254

Length: 1815 Ø: 58
0003220323, 0003220623, 3753220423



DB-DL-9259

Length: 883 Ø: 38
Cone Ø: d1 Ø 32 / d2 Ø 29
0024608605, 0024608705, A0024608605,
A0024608705



DB-DL-9271

Length: 1815 Ø: 60
0003220423, 0003220723



DB-DL-9272

Length: 1815 Ø: 80
0003220223



DB-DL-10212

Length: 953 Ø: 42
Cone Ø: d1 Ø 32 / d2 Ø 29
0024609205, 0024609305, 0034604505



DB-DL-12300

Length: 733 Ø: 36
Cone Ø: d1 Ø 32 / d2 Ø 29
0014601505, 0014607305, 0034603305,
3754601605, A0014601505, A0034603305,
A3754601605



DB-DL-12301

Length: 716 Ø: 38
Cone Ø: d1 Ø 32 / d2 Ø 29
Thread: M30 x 1,5
0024608805, 0024608905, A0024608805,
A0024608905



DB-DL-12310

Length: 1532 Ø: 50
Cone Ø: d1 Ø 32 / d2 Ø 29
Thread: M27 x 1,5 LHT
9493301203, 9493301303, 9493301803,
9493302203, A9493301203, A9493301303,
A9493301803, A9493302203



DB-ES-5227

Length: 1588 Ø: 60
Cone Ø: d1 Ø 38 / d2 Ø 34,3
6253300903, 6253301203, 9443300203



DB-ES-8323

Length: 75
Cone Ø: d1 Ø 32 / d2 Ø 28,8
Thread: M26 x 1,5 RHT
0014601548, 0014601648, 0024600648,
A0014601648, A0024600648



DB-RK-8710

Ø: 85 Hole Distance: 130
Thick/Height: 30
0003503705



DB-RK-9291

Ø: 107,5 Hole Distance: 152
Thick/Height: 30
0003503605



DB-VB-7261

Length: 622 Ø: 46
Hole Ø 25 / 25 / 25
Hole Distance: 152 / 130 / 130
01337800A, 9443500305, 9443500505,
9443500605, 9473500705, 9473500905,
9483500405, 9483500305



DB-VB-9307

Length: 667 Ø: 60
Hole Ø 25 / 23 / 23
Hole Distance: 152 / 130 / 130
9483502805



DB-VB-9308

Length: 622 Ø: 46
Hole Ø 25 / 25 / 25
Hole Distance: 152 / 130 / 130
9483502905



DB-VB-10426

Length: 622 Ø: 46
Hole Ø 25 / 25 / 25
Hole Distance: 152 / 130 / 130
9443500405





ACTROS MP2 / MP3 ...

5046 K ...	06/08→	Tie Rod End	CV-ES-0543		for Push Rod
	06/08→	Tie Rod End	CV-ES-0888		for Push Rod
	06/08→	Tie Rod End	CV-ES-14163		for Steering Rod
	06/08→	Tie Rod End	DB-ES-8530		for Push Rod
	06/08→	Track Control Arm		DB-DL-3475	Trailing Arm, 1st RA;2nd RA, →517144 03/517144 07
	06/08→	Track Control Arm		DB-DL-3475	Trailing Arm, 1st RA;2nd RA, →517144 06/517144 09
	06/08→	Track Control Arm		DB-DL-3475	Trailing Arm, 1st RA;2nd RA, →517144 26/517144 27
	06/08→	Track Control Arm		DB-VB-7261	Suspension Rod, Wishbone (CV), 1st RA;2nd RA; Leaf Spring Axle
	06/08→	Track Control Arm		DB-VB-9307	Suspension Rod, Wishbone (CV), 1st RA;2nd RA; Leaf Spring Axle
	06/08→	Track Control Arm		DB-VB-9308	Suspension Rod, Wishbone (CV), 1st RA;2nd RA; Leaf Spring Axle
5048 AK	06/08→	Track Control Arm		DB-VB-10426	Wishbone (CV), 1st RA;2nd RA, →517142 05
	06/08→	Centre Rod	DB-DL-8184		Push Rod, Leaf Spring Axle
	06/08→	Centre Rod	DB-DL-10208		Push Rod, Leaf Spring Axle
	06/08→	Centre Rod	DB-DL-12403		Push Rod
	06/08→	Stabiliser Link	DB-DL-9254		Pressure Rod
	06/08→	Suspension Strut Repair Kit		DB-RK-8710	
	06/08→	Suspension Strut Repair Kit		DB-RK-9291	
	06/08→	Tie Rod	DB-DL-12310		
	06/08→	Tie Rod	DB-ES-5227		Guide Rod, 1st FA
	06/08→	Tie Rod End	CV-ES-0543		for Push Rod
	06/08→	Tie Rod End	CV-ES-0888		for Push Rod
	06/08→	Tie Rod End	DB-ES-5234		for Steering Rod
	06/08→	Track Control Arm		DB-DL-3475	Trailing Arm, 1st RA;2nd RA, →517144 03/517144 07
	06/08→	Track Control Arm		DB-DL-3475	Trailing Arm, 1st RA;2nd RA, →517144 06/517144 09
	06/08→	Track Control Arm		DB-DL-3475	Trailing Arm, 1st RA;2nd RA, →517144 26/517144 27
	06/08→	Track Control Arm		DB-VB-7261	Suspension Rod, Wishbone (CV), 1st RA;2nd RA; Leaf Spring Axle
	06/08→	Track Control Arm		DB-VB-9307	Suspension Rod, Wishbone (CV), 1st RA;2nd RA; Leaf Spring Axle
	06/08→	Track Control Arm		DB-VB-9308	Suspension Rod, Wishbone (CV), 1st RA;2nd RA; Leaf Spring Axle
06/08→	Track Control Arm		DB-VB-10426	Wishbone (CV), 1st RA;2nd RA, →517142 05	

ACTROS MP4

1842 L	07/11→	Bolt, wheel alignment	DB-ES-8498	DB-ES-8498	
	07/11→	Tie Rod End	DB-ES-8530		for Push Rod
	07/11→	Track Control Arm		DB-VB-7798	Wishbone (CV)

ATEGO

1014 K	01/98→10/04	Centre Rod	DB-DL-5405		Push Rod
	01/98→10/04	Centre Rod	DB-DL-7794		Push Rod
	01/98→10/04	Centre Rod	DB-DL-7799		Push Rod
	01/98→10/04	Tie Rod	DB-DL-8174		Guide Rod
	01/98→10/04	Tie Rod	DB-DL-12304		
	01/98→10/04	Tie Rod	DB-ES-5214		Guide Rod
1014, 1014 L	01/98→10/04	Centre Rod	DB-DL-5405		Push Rod
1017 A	01/98→10/04	Ball Head, gearshift linkage	DB-ES-8387		
	01/98→10/04	Centre Rod	DB-DL-5405		Push Rod
	01/98→10/04	Centre Rod	DB-DL-8620		for Steering Rod
	01/98→10/04	Centre Rod	DB-DL-9247		Push Rod
	01/98→10/04	Centre Rod	DB-DL-12405		Coupling Rod
	01/98→10/04	Stabiliser Mounting		DB-SB-10407	
	01/98→10/04	Stabiliser Mounting	DB-SB-10386	DB-SB-10386	
	01/98→10/04	Stabiliser Mounting	DB-SB-10386	DB-SB-10386	1st FA
	01/98→10/04	Tie Rod	DB-DL-12311		

CV-ES-0543

Length: 125
Cone Ø: d1 Ø 32 / d2 Ø 29
Thread: M30 x 1,5 RHT
0004605748, 0004606048, 0004606848,
0004607048, 0014600448, 0014601148,
0014601748, 0014602448, 0014607648,
0014609648



CV-ES-0888

Length: 125
Cone Ø: d1 Ø 32 / d2 Ø 29
Thread: M30 x 1,5 LHT
0004605848, 0004606148, 0004606948,
0004607148, 0004609048, 0014600548,
0014601348, 0014602548, 0014607948,
0024600448



CV-ES-14163

Length: 125
Cone Ø: d1 Ø 30 / d2 Ø 27
Thread: M30 x 1,5 RHT
0003305248, 0003387310, 0004600348,
0004600948, 0004602848, 0004602948,
0004608948, 0014600248, 0014600848,
0014601248, 0014602248, 0014607748,
0024600148, A0003387310, A0004600348,
A0004602848, A0004602948, A0014600848,
A0014601248, A0014602248, A0014607748



DB-DL-3475

Length: 565 Ø: 52
Hole Distance: 152 / 152
3753500006, 3753500206, 9473500805,
9483500006, 9483500805, 9483501205,
9483501305, 9483501905, 9483502005,
9483502405, A3753500006, A3753500206



DB-DL-5405

Length: 890 Ø: 35
Cone Ø: d1 Ø 28,6 / d2 Ø 23,9
01215900A, 1460248, 0024604505, 0024604605,
0034605005, 3752600637, 3754600405,
A3752600637, A3754600405



DB-DL-7794

Length: 837 Ø: 40
Cone Ø: d1 Ø 26 / d2 Ø 23,5
9724601405, 9724601605



DB-DL-7799

Length: 895 Ø: 50
Cone Ø: d1 Ø 30 / d2 Ø 26
0034605905, 3754600305, 9724601805,
9724602005



DB-DL-8174

Length: 1605 Ø: 40
Cone Ø: d1 Ø 30 / d2 Ø 27
9753300203, 9753300303, 9753300803,
9753301703, 9753302503



DB-DL-8184

Length: 1095 Ø: 42
Cone Ø: d1 Ø 32 / d2 Ø 28,8
01217700A, 0014601305, 0014601405,
0024600505, 0034603205, 3754601505,
A0014601305, A0014601405, A0024600505



DB-DL-8620

Length: 884
Ø: 50
Cone Ø: d1 Ø 30 / d2 Ø 27
Thread: M24 x 1,5 / M20 x 1,5
9744600405, 9744600805, A9744600405,
A9744600805



DB-DL-9247

Length: 873 Ø: 40
Cone Ø: d1 Ø 26 / d2 Ø 23,5
9724601005, 9724601205



DB-DL-9254

Length: 1815 Ø: 58
0003220323, 0003220623, 3753220423



DB-DL-10208

Length: 708 Ø: 40
Cone Ø: d1 Ø 32 / d2 Ø 29
0014605305, 0024600605



DB-DL-12304

Length: 1560 Ø: 40
Cone Ø: d1 Ø 30 / d2 Ø 27
Thread: M30 x 1,5 LHT / M30 x 1,5 RHT
9753300603, 9753300703, 9753300903,
A9753300603, A9753300703, A9753300903



DB-DL-12310

Length: 1532 Ø: 50
Cone Ø: d1 Ø 32 / d2 Ø 29
Thread: M27 x 1,5 LHT
9493301203, 9493301303, 9493301803,
9493302203, A9493301203, A9493301303,
A9493301803, A9493302203



DB-DL-12311

Length: 1565 Ø: 60
Cone Ø: d1 Ø 30 / d2 Ø 27
9753300003, 9753300403, 9753301003,
9753301903, A9753300003, A9753300403,
A9753301003, A9753301903



No Image

DB-DL-12403

Length: 893 Ø: 42
Cone Ø: d1 Ø 32 / d2 Ø 29
0014604905, 0014607405



DB-DL-12405

Length: 895 Ø: 50
Cone Ø: d1 Ø 30 / d2 Ø 28,6
Thread: M24 x 1,5 / M20 x 1,5
9744602205, 9764600205, 9764600405,
A9764600405



DB-ES-5214

Length: 1640 Ø: 40
Cone Ø: d1 Ø 26 / d2 Ø 23,5
01218000A, 9703300003, 9703300103,
9703300203, 9703300303, 9703300403



DB-ES-5227

Length: 1588 Ø: 60
Cone Ø: d1 Ø 38 / d2 Ø 34,3
6253300903, 6253301203, 9443300203



DB-ES-5234

Length: 135
Cone Ø: d1 Ø 38 / d2 Ø 34,3
Thread: M38 x 1,5 RHT
0004601748, 120322305, 2205000400



DB-ES-8387

Length: 55
Cone Ø: d1 Ø 10 / d2 Ø 10
Thread: M14 x 1,5 RHT
0009966845, 0009967045



DB-ES-8498

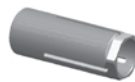

DB-ES-8530

Length: 115
Cone Ø: d1 Ø 28,6 / d2 Ø 23,9
Thread: M30 x 1,5 RHT
0014603848, 0014604848, 0014605148,
0014608648, 0014609948



DB-RK-8710

Ø: 85 Hole Distance: 130
Thick/Height: 30
0003503705



DB-RK-9291

Ø: 107,5 Hole Distance: 152
Thick/Height: 30
0003503605



DB-SB-10386

Ø: 38 Thick/Height: 38
3183200073



DB-SB-10407

Ø: 61 Thick/Height: 46
0003235985, 0003262481, 0003262981



DB-VB-7261

Length: 622 Ø: 46
Hole Ø 25 / 25 / 25
Hole Distance: 152 / 130 / 130
01337800A, 9443500305, 9443500505,
9443500605, 9473500705, 9473500905,
9483500405, 9483503005



DB-VB-7798

Length: 622 Ø: 48
Hole Ø 25 / 23 / 23
Hole Distance: 152 / 130 / 130
9423500505, 9423500805, 9423501205,
A9423501205



DB-VB-9307

Length: 667 Ø: 60
Hole Ø 25 / 23 / 23
Hole Distance: 152 / 130 / 130
9483502805



DB-VB-9308

Length: 622 Ø: 46
Hole Ø 25 / 25 / 25
Hole Distance: 152 / 130 / 130
9483502905



DB-VB-10426

Length: 622 Ø: 46
Hole Ø 25 / 25 / 25
Hole Distance: 152 / 130 / 130
9443500405





ATEGO ...

1017 A ...	01/98→10/04	Tie Rod End	CV-ES-12462		for Steering Rod	
	01/98→10/04	Tie Rod End	CV-ES-14163		for Steering Rod	
1017 AK	01/98→10/04	Ball Head, gearshift linkage	DB-ES-8387			
	01/98→10/04	Centre Rod	DB-DL-5405		Push Rod	
	01/98→10/04	Centre Rod	DB-DL-9247		Push Rod	
	01/98→10/04	Stabiliser Mounting		DB-SB-10407		
	01/98→10/04	Stabiliser Mounting	DB-SB-10386	DB-SB-10386		
	01/98→10/04	Stabiliser Mounting	DB-SB-10386	DB-SB-10386	1st FA	
	01/98→10/04	Tie Rod	DB-DL-12311		1st FA, →504522 02	
	01/98→10/04	Tie Rod End	CV-ES-12462		for Steering Rod	
1017 K	01/98→10/04	Ball Head, gearshift linkage	DB-ES-8387			
	01/98→10/04	Ball Head, gearshift linkage	DB-ES-8500			
	01/98→10/04	Centre Rod	DB-DL-5405		Push Rod	
	01/98→10/04	Centre Rod	DB-DL-7794		Push Rod, Leaf Spring Axle	
	01/98→10/04	Centre Rod	DB-DL-7799		Push Rod, Leaf Spring Axle	
	01/98→10/04	Centre Rod	DB-DL-7815		Push Rod;Suspension Rod	
	01/98→10/04	Stabiliser Mounting		DB-SB-10386		
	01/98→10/04	Stabiliser Mounting		DB-SB-10407		
	01/98→10/04	Stabiliser Mounting	DB-SB-10386	DB-SB-10386		
	01/98→10/04	Stabiliser Mounting	DB-SB-10386	DB-SB-10386	1st FA	
	01/98→10/04	Tie Rod	DB-DL-8174		Guide Rod	
	01/98→10/04	Tie Rod	DB-DL-12304			
	01/98→10/04	Tie Rod	DB-ES-5214		Guide Rod	
	01/98→10/04	Tie Rod End	CV-ES-12461		for Steering Rod	
	01/98→10/04	Tie Rod End	CV-ES-12462		for Steering Rod	
	01/98→10/04	Tie Rod End	CV-ES-14162		for Steering Rod	
	01/98→10/04	Tie Rod End	CV-ES-14163		for Steering Rod	
	1017 KO, 1018 KO	01/98→10/04	Ball Head, gearshift linkage	DB-ES-8387		
		01/98→10/04	Centre Rod	DB-DL-5405		Push Rod
		01/98→10/04	Centre Rod	DB-DL-7794		Push Rod, Leaf Spring Axle
01/98→10/04		Centre Rod	DB-DL-7799		Push Rod, Leaf Spring Axle	
01/98→10/04		Stabiliser Mounting		DB-SB-10386		
01/98→10/04		Stabiliser Mounting		DB-SB-10407		
01/98→10/04		Stabiliser Mounting	DB-SB-10386	DB-SB-10386		
01/98→10/04		Stabiliser Mounting	DB-SB-10386	DB-SB-10386	1st FA	
01/98→10/04		Tie Rod	DB-DL-8174		Guide Rod	
01/98→10/04		Tie Rod	DB-ES-5214		Guide Rod	
01/98→10/04		Tie Rod End	CV-ES-12461		for Steering Rod	
01/98→10/04		Tie Rod End	CV-ES-12462		for Steering Rod	
01/98→10/04		Tie Rod End	CV-ES-14162		for Steering Rod	
01/98→10/04		Tie Rod End	CV-ES-14163		for Steering Rod	
1017, 1017 L		01/98→10/04	Ball Head, gearshift linkage	DB-ES-8387		
		01/98→10/04	Ball Head, gearshift linkage	DB-ES-8500		
	01/98→10/04	Centre Rod	DB-DL-5405		Push Rod	
	01/98→10/04	Centre Rod	DB-DL-7794		Push Rod	
	01/98→10/04	Centre Rod	DB-DL-7794		Push Rod, Leaf Spring Axle	
	01/98→10/04	Centre Rod	DB-DL-7799		Push Rod, Leaf Spring Axle	
	01/98→10/04	Centre Rod	DB-DL-9187		Push Rod	
	01/98→10/04	Stabiliser Mounting		DB-SB-10385		
	01/98→10/04	Stabiliser Mounting		DB-SB-10385	1st RA	
	01/98→10/04	Stabiliser Mounting		DB-SB-10386		
	01/98→10/04	Stabiliser Mounting		DB-SB-10407		
	01/98→10/04	Stabiliser Mounting	DB-SB-10385	DB-SB-10385	1st FA	
	01/98→10/04	Stabiliser Mounting	DB-SB-10386	DB-SB-10386		
	01/98→10/04	Stabiliser Mounting	DB-SB-10386	DB-SB-10386	1st FA	
	01/98→10/04	Suspension Arm Repair Kit		DB-RK-8550	for Wishbone (CV)	
	01/98→10/04	Tie Rod	DB-DL-8174		Guide Rod	
	01/98→10/04	Tie Rod	DB-ES-5214		Guide Rod	
	01/98→10/04	Tie Rod End	CV-ES-12461		for Steering Rod	
	01/98→10/04	Tie Rod End	CV-ES-12462		for Steering Rod	
	01/98→10/04	Tie Rod End	CV-ES-14162		for Steering Rod	
	01/98→10/04	Tie Rod End	CV-ES-14163		for Steering Rod	
	01/98→10/04	Track Control Arm		DB-TC-12411	Control Arm	
	01/98→10/04	Track Control Arm		DB-VB-10423	Wishbone (CV), 1st Drive Axle, →508306 05	

CV-ES-12461

Length: 120
Cone Ø: d1 Ø 26 / d2 Ø 23,5
Thread: M30 x 1,5 LHT
 0003300035, 3300148, 0003406213, 0013306635,
 0013308835, 0014604048, 0014604348,
 14606448, 0024600248, 3023300035,
 3023300135, 3023300235, 3023300335,
 3453307235, 3453307435, 3503307135,
 A0003300148, A0013306635, A0013308835,
 A0014604048, A0014604348, A0014606448,
 A0024600248, A3023300035, A3023300135,
 A3023300235, A3023300335, A3503307135

**CV-ES-12462**

Length: 120
Cone Ø: d1 Ø 26 / d2 Ø 23,5
Thread: M30 x 1,5 RHT
 0003300135, 0003300248, 0003303235,
 0003305835, 0003307335, 0003383410,
 0004608348, 004608348, 0004632229,
 0004633129, 0004633429, 0004633529,
 0013300135, 0013300235, 0013306735,
 0014603448, 0014604148, 0014604448,
 0014606348, 0014608348, 0014608448,
 0014609748, 0023301535, 3453307135,
 3503307035, 3503307335, 3643307135,
 5001832582, A0003300248, A0003303235,
 A0003307335, A0003383410, A0004608348,
 A0004632229, A0004633429, A0013300135,
 A0013300235, A0013306735, A0014603448,
 A0014604148, A0014604448, A0014606348,
 A0014608348, A0014608448, A0014609748,
 A0023301535

**CV-ES-14162**

Length: 125
Cone Ø: d1 Ø 30 / d2 Ø 27
Thread: M30 x 1,5 LHT
 4600648, 4601248, 4603448, 0004603548,
 14600348, 14601448, 14602348, 0014603748,
 0014607848, 0024600348

**CV-ES-14163**

Length: 125
Cone Ø: d1 Ø 30 / d2 Ø 27
Thread: M30 x 1,5 RHT
 0003305248, 0003387310, 0004600348,
 0004600948, 0004602848, 0004602948,
 0004608948, 0014600248, 0014600848,
 0014601248, 0014602248, 0014607748,
 0024600148, A0003387310, A0004600348,
 A0004602848, A0004602948, A0014600848,
 A0014601248, A0014602248, A0014607748

**DB-DL-5405**

Length: 890 Ø: 35
Cone Ø: d1 Ø 28,6 / d2 Ø 23,9
 01215900A, 1460248, 0024604505, 0024604605,
 0034605005, 3752600637, 3754600405,
 A3752600637, A3754600405

**DB-DL-7794**

Length: 837 Ø: 40
Cone Ø: d1 Ø 26 / d2 Ø 23,5
 9724601405, 9724601605

**DB-DL-7799**

Length: 895 Ø: 50
Cone Ø: d1 Ø 30 / d2 Ø 26
 0034605905, 3754600305, 9724601805,
 9724602005

**DB-DL-7815**

Length: 895 Ø: 50
Cone Ø: d1 Ø 30 / d2 Ø 27
 01215800A, 0034604605, 3754600005,
 9744601005, 9744601205

**DB-DL-8174**

Length: 1605 Ø: 40
Cone Ø: d1 Ø 30 / d2 Ø 27
 9753300203, 9753300303, 9753300803,
 9753301703, 9753302503

**DB-DL-9187**

Length: 846 Ø: 42
Cone Ø: d1 Ø 26 / d2 Ø 23,5
 9704601105, 9724602805, A9704601105,
 A9724602805

**DB-DL-9247**

Length: 873 Ø: 40
Cone Ø: d1 Ø 26 / d2 Ø 23,5
 9724601005, 9724601205

**DB-DL-12304**

Length: 1560 Ø: 40
Cone Ø: d1 Ø 30 / d2 Ø 27
Thread: M30 x 1,5 LHT / M30 x 1,5 RHT
 9753300603, 9753300703, 9753300903,
 A9753300603, A9753300703, A9753300903

**DB-DL-12311**

Length: 1565 Ø: 60
Cone Ø: d1 Ø 30 / d2 Ø 27
 9753300003, 9753300403, 9753301003,
 9753301903, A9753300003, A9753300403,
 A9753301003, A9753301903

**DB-ES-5214**

Length: 1640 Ø: 40
Cone Ø: d1 Ø 26 / d2 Ø 23,5
 01218000A, 9703300003, 9703300103,
 9703300203, 9703300303, 9703300403

**DB-ES-8387**

Length: 55
Cone Ø: d1 Ø 10 / d2 Ø 10
Thread: M14 x 1,5 RHT
 0009966845, 0009967045

**DB-ES-8500**

Length: 55
Cone Ø: d1 Ø 12 / d2 Ø 10,8
Thread: M14 x 1,5 RHT
 0002685989

**DB-RK-8550**

Ø: 75 Hole Distance: 152
Thick/Height: 24
 0003502105, 0003504605

**DB-SB-10385**

Ø: 30 Thick/Height: 30
 3093200073, 3143260153

**DB-SB-10386**

Ø: 38 Thick/Height: 38
 3183200073

**DB-SB-10407**

Ø: 61 Thick/Height: 46
 0003235985, 0003262481, 0003262981

**DB-TC-12411**

Length: 655 Ø: 40
Hole Distance: 115 / 115
 9723500906



No Image



ATEGO ...

1023 AK	01/98 → 10/04	Centre Rod	DB-DL-5405		Push Rod	
	01/98 → 10/04	Centre Rod	DB-DL-9247		Push Rod	
	01/98 → 10/04	Tie Rod	DB-DL-12311		1st FA, →504522 02	
	01/98 → 10/04	Tie Rod End	CV-ES-12462		for Steering Rod	
1023 K	01/98 → 10/04	Centre Rod	DB-DL-5405		Push Rod	
	01/98 → 10/04	Centre Rod	DB-DL-7794		Push Rod	
	01/98 → 10/04	Centre Rod	DB-DL-7799		Push Rod	
	01/98 → 10/04	Tie Rod	DB-DL-8174		Guide Rod	
	01/98 → 10/04	Tie Rod	DB-DL-12304			
	01/98 → 10/04	Tie Rod	DB-ES-5214		Guide Rod	
	01/98 → 10/04	Tie Rod End	CV-ES-12461		for Steering Rod	
	01/98 → 10/04	Tie Rod End	CV-ES-12462		for Steering Rod	
	01/98 → 10/04	Tie Rod End	CV-ES-14162		for Steering Rod	
	01/98 → 10/04	Tie Rod End	CV-ES-14163		for Steering Rod	
	1023, 1023 L	01/98 → 10/04	Ball Head, gearshift linkage	DB-ES-8387		
01/98 → 10/04		Ball Head, gearshift linkage	DB-ES-8500			
01/98 → 10/04		Centre Rod	DB-DL-5405		Push Rod	
01/98 → 10/04		Centre Rod	DB-DL-7794		Push Rod	
01/98 → 10/04		Centre Rod	DB-DL-7794		Push Rod, Leaf Spring Axle	
01/98 → 10/04		Centre Rod	DB-DL-7799		Push Rod, Leaf Spring Axle	
01/98 → 10/04		Centre Rod	DB-DL-9187		Push Rod	
01/98 → 10/04		Stabiliser Mounting		DB-SB-10385		
01/98 → 10/04		Stabiliser Mounting		DB-SB-10385	1st RA	
01/98 → 10/04		Stabiliser Mounting		DB-SB-10386		
01/98 → 10/04		Stabiliser Mounting		DB-SB-10407		
01/98 → 10/04		Stabiliser Mounting	DB-SB-10385	DB-SB-10385	1st FA	
01/98 → 10/04		Stabiliser Mounting	DB-SB-10386	DB-SB-10386		
01/98 → 10/04		Stabiliser Mounting	DB-SB-10386	DB-SB-10386	1st FA	
01/98 → 10/04		Suspension Arm Repair Kit		DB-RK-8550	for Wishbone (CV)	
01/98 → 10/04		Tie Rod	DB-DL-8174		Guide Rod	
01/98 → 10/04		Tie Rod	DB-ES-5214		Guide Rod	
01/98 → 10/04		Tie Rod End	CV-ES-12461		for Steering Rod	
01/98 → 10/04		Tie Rod End	CV-ES-12462		for Steering Rod	
01/98 → 10/04		Track Control Arm		DB-TC-12411	Control Arm	
01/98 → 10/04		Track Control Arm		DB-VB-10423	Wishbone (CV), 1st Drive Axle, →508306 05	
1214 K		01/98 → 10/04	Ball Head, gearshift linkage	DB-ES-8387		
		01/98 → 10/04	Ball Head, gearshift linkage	DB-ES-8500		
		01/98 → 10/04	Centre Rod	DB-DL-5405		Push Rod
		01/98 → 10/04	Centre Rod	DB-DL-7799		Push Rod
		01/98 → 10/04	Centre Rod	DB-DL-7815		Push Rod
		01/98 → 10/04	Centre Rod	DB-DL-8644		Push Rod
	01/98 → 10/04	Tie Rod	DB-DL-8174		Guide Rod	
	01/98 → 10/04	Tie Rod	DB-DL-12304			
	01/98 → 10/04	Tie Rod	DB-ES-5214		Guide Rod, 1st Front Axle	
	01/98 → 10/04	Tie Rod End	CV-ES-12461		for Steering Rod	
	01/98 → 10/04	Tie Rod End	CV-ES-12462		for Steering Rod	
	01/98 → 10/04	Tie Rod End	CV-ES-14162		for Steering Rod	
	01/98 → 10/04	Tie Rod End	CV-ES-14163		for Steering Rod	
1214, 1214 L	01/98 → 10/04	Ball Head, gearshift linkage	DB-ES-8387			
	01/98 → 10/04	Ball Head, gearshift linkage	DB-ES-8500			
	01/98 → 10/04	Centre Rod	DB-DL-5405		Push Rod	
	01/98 → 10/04	Centre Rod	DB-DL-7799		Push Rod	
	01/98 → 10/04	Centre Rod	DB-DL-7799		Push Rod, Leaf Spring Axle	
	01/98 → 10/04	Centre Rod	DB-DL-7815		Push Rod	
	01/98 → 10/04	Centre Rod	DB-DL-7815		Push Rod, Leaf Spring Axle	
	01/98 → 10/04	Centre Rod	DB-DL-8644		Push Rod	
	01/98 → 10/04	Centre Rod	DB-DL-8644		Push Rod, Leaf Spring Axle	
	01/98 → 10/04	Centre Rod	DB-DL-12404		for Steering Rod	
	01/98 → 10/04	Centre Rod	DB-DL-12437		Push Rod	
	01/98 → 10/04	Centre Rod	DB-DL-12475		Push Rod	
	01/98 → 10/04	Stabiliser Mounting		DB-RK-9296		
	01/98 → 10/04	Stabiliser Mounting		DB-SB-10385		
	01/98 → 10/04	Stabiliser Mounting		DB-SB-10385	1st RA	

CV-ES-12461

Length: 120
Cone Ø: d1 Ø 26 / d2 Ø 23,5
Thread: M30 x 1,5 LHT
0003300035, 3300148, 0003406213, 0013306635,
0013308835, 0014604048, 0014604348,
14606448, 0024600248, 3023300035,
3023300135, 3023300235, 3023300335,
3453307235, 3453307435, 3503307135,
A0003300148, A0013306635, A0013308835,
A0014604048, A0014604348, A0014606448,
A0024600248, A3023300035, A3023300135,
A3023300235, A3023300335, A3503307135



CV-ES-12462

Length: 120
Cone Ø: d1 Ø 26 / d2 Ø 23,5
Thread: M30 x 1,5 RHT
0003300135, 0003300248, 0003303235,
0003305835, 0003307335, 0003383410,
0004608348, 004608348, 0004632229,
0004633129, 0004633429, 0004633529,
0013300135, 0013300235, 0013306735,
0014603448, 0014604148, 0014604448,
0014606348, 0014608348, 0014608448,
0014609748, 0023301535, 3453307135,
3503307035, 3503307335, 3643307135,
5001832582, A0003300248, A0003303235,
A0003307335, A0003383410, A0004608348,
A0004632229, A0004633429, A0013300135,
A0013300235, A0013306735, A0014603448,
A0014604148, A0014604448, A0014606348,
A0014608348, A0014608448, A0014609748,
A0023301535



CV-ES-14162

Length: 125
Cone Ø: d1 Ø 30 / d2 Ø 27
Thread: M30 x 1,5 LHT
4600648, 4601248, 4603448, 0004603548,
4603548, 14600348, 14601448, 14602348, 001
460 37 48, 14607848, 0014607848, 002 460 03 48



CV-ES-14163

Length: 125
Cone Ø: d1 Ø 30 / d2 Ø 27
Thread: M30 x 1,5 RHT
0003305248, 0003387310, 0004600348,
0004600948, 0004602848, 0004602948,
0004608948, 0014600248, 0014600848,
0014601248, 0014602248, 0014607748,
0024600148, A0003387310, A0004600348,
A0004602848, A0004602948, A0014600848,
A0014601248, A0014602248, A0014607748



DB-DL-5405

Length: 890 Ø: 35
Cone Ø: d1 Ø 28,6 / d2 Ø 23,9
01215900A, 1460248, 0024604505, 0024604605,
0034605005, 3752600637, 3754600405,
A3752600637, A3754600405



DB-DL-7794

Length: 837 Ø: 40
Cone Ø: d1 Ø 26 / d2 Ø 23,5
9724601405, 9724601605



DB-DL-7799

Length: 895 Ø: 50
Cone Ø: d1 Ø 30 / d2 Ø 26
0034605905, 3754600305, 9724601805,
9724602005



DB-DL-7815

Length: 895 Ø: 50
Cone Ø: d1 Ø 30 / d2 Ø 27
01215800A, 0034604605, 3754600005,
9744601005, 9744601205



DB-DL-8174

Length: 1605 Ø: 40
Cone Ø: d1 Ø 30 / d2 Ø 27
9753300203, 9753300303, 9753300803,
9753301703, 9753302503



DB-DL-8644

Length: 894 Ø: 50
Cone Ø: d1 Ø 30 / d2 Ø 27
0034604705, 9744601105, 9744601305

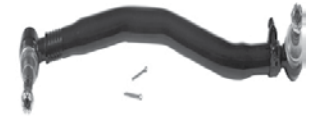

DB-DL-9187

Length: 846 Ø: 42
Cone Ø: d1 Ø 26 / d2 Ø 23,5
9704601105, 9724602805, A9704601105,
A9724602805



DB-DL-9247

Length: 873 Ø: 40
Cone Ø: d1 Ø 26 / d2 Ø 23,5
9724601005, 9724601205



DB-DL-12304

Length: 1560 Ø: 40
Cone Ø: d1 Ø 30 / d2 Ø 27
Thread: M30 x 1,5 LHT / M30 x 1,5 RHT
9753300603, 9753300703, 9753300903,
A9753300603, A9753300703, A9753300903



DB-DL-12311

Length: 1565 Ø: 60
Cone Ø: d1 Ø 30 / d2 Ø 27
9753300003, 9753300403, 9753301003,
9753301903, A9753300003, A9753300403,
A9753301003, A9753301903

No Image

DB-DL-12404

Length: 875 Ø: 50
Cone Ø: d1 Ø 30/26 / d2 Ø 27/23,5
9724600605



DB-DL-12437

Length: 875 Ø: 50
Cone Ø: d1 Ø 30 / d2 Ø 27
9744600005, 9744600605, A9744600005,
A9744600605



DB-DL-12475

Length: 888 Ø: 50
Cone Ø: d1 Ø 30 / d2 Ø 27
9744601505, A9744601505

No Image

DB-ES-5214

Length: 1640 Ø: 40
Cone Ø: d1 Ø 26 / d2 Ø 23,5
01218000A, 9703300003, 9703300103,
9703300203, 9703300303, 9703300403



DB-ES-8387

Length: 55
Cone Ø: d1 Ø 10 / d2 Ø 10
Thread: M14 x 1,5 RHT
0009966845, 0009967045



DB-ES-8500

Length: 55
Cone Ø: d1 Ø 12 / d2 Ø 10,8
Thread: M14 x 1,5 RHT
0002685989



DB-RK-8550

Ø: 75 Hole Distance: 152
Thick/Height: 24
0003502105, 0003504605



DB-RK-9296

Ø: 88 Hole Distance: 130
Thick/Height: 24
9423260050



DB-SB-10385

Ø: 30 Thick/Height: 30
3093200073, 3143260153



DB-SB-10386

Ø: 38 Thick/Height: 38
3183200073



DB-SB-10407

Ø: 61 Thick/Height: 46
0003235985, 0003262481, 0003262981



DB-TC-12411

Length: 655 Ø: 40
Hole Distance: 115 / 115
9723500906



DB-VB-10423

Length: 761,7 Ø: 46
Hole Ø 25 / 23 / 23
Hole Distance: 152 / 130 / 130
9743500005, 9743500405, 9743500505



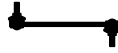

ATEGO ...

1214, 1214 L ...	01/98→10/04	Stabiliser Mounting		DB-SB-10386		
	01/98→10/04	Stabiliser Mounting	DB-SB-10386	DB-SB-10386		
	01/98→10/04	Stabiliser Mounting	DB-SB-10386	DB-SB-10386	1st FA	
	01/98→10/04	Suspension Arm Repair Kit		DB-RK-8550	for Wishbone (CV)	
	01/98→10/04	Suspension Strut Repair Kit		DB-RK-8555		
	01/98→10/04	Tie Rod	DB-DL-8174		Guide Rod	
	01/98→10/04	Tie Rod	DB-DL-12304			
	01/98→10/04	Tie Rod End	CV-ES-14162		for Steering Rod	
	01/98→10/04	Tie Rod End	CV-ES-14163		for Steering Rod	
	01/98→10/04	Track Control Arm		DB-VB-10423	Wishbone (CV), Air Suspension Axle	
1215 K	01/98→10/04	Ball Head, gearshift linkage	DB-ES-8387			
	01/98→10/04	Ball Head, gearshift linkage	DB-ES-8500			
	01/98→10/04	Centre Rod	DB-DL-5405		Push Rod	
	01/98→10/04	Centre Rod	DB-DL-7799		Push Rod, Leaf Spring Axle	
	01/98→10/04	Centre Rod	DB-DL-7815		Push Rod, Leaf Spring Axle	
	01/98→10/04	Centre Rod	DB-DL-8644		Push Rod, Leaf Spring Axle	
	01/98→10/04	Stabiliser Mounting		DB-SB-10386		
	01/98→10/04	Stabiliser Mounting		DB-SB-10407		
	01/98→10/04	Stabiliser Mounting	DB-SB-10386	DB-SB-10386		
	01/98→10/04	Stabiliser Mounting	DB-SB-10386	DB-SB-10386	1st FA	
	01/98→10/04	Tie Rod	DB-DL-8174		Guide Rod	
	01/98→10/04	Tie Rod	DB-DL-12304			
	01/98→10/04	Tie Rod	DB-ES-5214		Guide Rod, 1st Front Axle	
	01/98→10/04	Tie Rod End	CV-ES-12461		for Steering Rod	
	01/98→10/04	Tie Rod End	CV-ES-12462		for Steering Rod	
	01/98→10/04	Tie Rod End	CV-ES-14162		for Steering Rod	
	01/98→10/04	Tie Rod End	CV-ES-14163		for Steering Rod	
	1215, 1215 L	01/98→10/04	Ball Head, gearshift linkage	DB-ES-8387		
01/98→10/04		Ball Head, gearshift linkage	DB-ES-8500			
01/98→10/04		Centre Rod	DB-DL-5405		Push Rod	
01/98→10/04		Centre Rod	DB-DL-7799		Push Rod	
01/98→10/04		Centre Rod	DB-DL-7799		Push Rod, Leaf Spring Axle	
01/98→10/04		Centre Rod	DB-DL-7815		Push Rod	
01/98→10/04		Centre Rod	DB-DL-7815		Push Rod, Leaf Spring Axle	
01/98→10/04		Centre Rod	DB-DL-8644		Push Rod	
01/98→10/04		Centre Rod	DB-DL-8644		Push Rod, Leaf Spring Axle	
01/98→10/04		Centre Rod	DB-DL-12404		for Steering Rod	
01/98→10/04		Centre Rod	DB-DL-12437		Push Rod	
01/98→10/04		Centre Rod	DB-DL-12475		Push Rod	
01/98→10/04		Stabiliser Mounting		DB-RK-9296		
01/98→10/04		Stabiliser Mounting		DB-SB-10385		
01/98→10/04		Stabiliser Mounting		DB-SB-10385	1st RA	
01/98→10/04		Stabiliser Mounting		DB-SB-10386		
01/98→10/04		Stabiliser Mounting		DB-SB-10407		
01/98→10/04		Stabiliser Mounting	DB-SB-10386	DB-SB-10386		
01/98→10/04		Stabiliser Mounting	DB-SB-10386	DB-SB-10386	1st FA	
01/98→10/04		Suspension Arm Repair Kit		DB-RK-8550	for Wishbone (CV)	
01/98→10/04		Suspension Strut Repair Kit		DB-RK-8555		
01/98→10/04		Tie Rod	DB-DL-8174		Guide Rod	
01/98→10/04		Tie Rod	DB-DL-12304			
01/98→10/04		Tie Rod End	CV-ES-14162		for Steering Rod	
01/98→10/04		Tie Rod End	CV-ES-14163		for Steering Rod	
01/98→10/04		Track Control Arm		DB-VB-10423	Wishbone (CV), Air Suspension Axle	
1217 K		01/98→10/04	Ball Head, gearshift linkage	DB-ES-8387		
		01/98→10/04	Ball Head, gearshift linkage	DB-ES-8500		
		01/98→10/04	Centre Rod	DB-DL-5405		Push Rod
		01/98→10/04	Centre Rod	DB-DL-7799		Push Rod, Leaf Spring Axle
	01/98→10/04	Centre Rod	DB-DL-7815		Push Rod, Leaf Spring Axle	
	01/98→10/04	Centre Rod	DB-DL-8644		Push Rod, Leaf Spring Axle	
	01/98→10/04	Stabiliser Mounting		DB-SB-10386		
	01/98→10/04	Stabiliser Mounting		DB-SB-10407		
	01/98→10/04	Stabiliser Mounting	DB-SB-10386	DB-SB-10386		
	01/98→10/04	Stabiliser Mounting	DB-SB-10386	DB-SB-10386	1st FA	

CV-ES-12461

Length: 120
Cone Ø: d1 Ø 26 / d2 Ø 23,5
Thread: M30 x 1,5 LHT
 0003300035, 3300148, 0003406213, 0013306635, 0013308835, 0014604048, 0014604348, 14606448, 0024600248, 3023300035, 3023300135, 3023300235, 3023300335, 3453307235, 3453307435, 3503307135, A0003300148, A0013306635, A0013308835, A0014604048, A0014604348, A0014606448, A0024600248, A3023300035, A3023300135, A3023300235, A3023300335, A3503307135



CV-ES-12462

Length: 120
Cone Ø: d1 Ø 26 / d2 Ø 23,5
Thread: M30 x 1,5 RHT
 0003300135, 0003300248, 0003303235, 0003305835, 0003307335, 0003383410, 0004608348, 004608348, 0004632229, 0004633129, 0004633429, 0004633529, 0013300135, 0013300235, 0013306735, 0014603448, 0014604148, 0014604448, 0014606348, 0014608348, 0014608448, 0014609748, 0023301535, 3453307135, 3503307035, 3503307335, 3643307135, 5001832582, A0003300248, A0003303235, A0003307335, A0003383410, A0004608348, A0004632229, A0004633429, A0013300135, A0013300235, A0013306735, A0014603448, A0014604148, A0014604448, A0014606348, A0014608348, A0014608448, A0014609748, A0023301535



CV-ES-14162

Length: 125
Cone Ø: d1 Ø 30 / d2 Ø 27
Thread: M30 x 1,5 LHT
 4600648, 4601248, 4603448, 0004603548, 14600348, 14601448, 14602348, 0014603748, 0014607848, 0024600348



CV-ES-14163

Length: 125
Cone Ø: d1 Ø 30 / d2 Ø 27
Thread: M30 x 1,5 RHT
 0003305248, 0003387310, 0004600348, 0004600948, 0004602848, 0004602948, 0004608948, 0014600248, 0014600848, 0014601248, 0014602248, 0014607748, 0024600148, A0003387310, A0004600348, A0004602848, A0004602948, A0014600848, A0014601248, A0014602248, A0014607748



DB-DL-5405

Length: 890 Ø: 35
Cone Ø: d1 Ø 28,6 / d2 Ø 23,9
 01215900A, 1460248, 0024604505, 0024604605, 0034605005, 3752600637, 3754600405, A3752600637, A3754600405



DB-DL-7799

Length: 895 Ø: 50
Cone Ø: d1 Ø 30 / d2 Ø 26
 0034605905, 3754600305, 9724601805, 9724602005



DB-DL-7815

Length: 895
Ø: 50
Cone Ø: d1 Ø 30 / d2 Ø 27
 01215800A, 34604605, 0034604605, 3754600005, 9744601005, 9744601205



DB-DL-8174

Length: 1605 Ø: 40
Cone Ø: d1 Ø 30 / d2 Ø 27
 9753300203, 9753300303, 9753300803, 9753301703, 9753302503



DB-DL-8644

Length: 894 Ø: 50
Cone Ø: d1 Ø 30 / d2 Ø 27
 0034604705, 9744601105, 9744601305

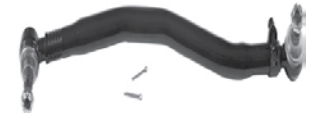

DB-DL-12304

Length: 1560 Ø: 40
Cone Ø: d1 Ø 30 / d2 Ø 27
Thread: M30 x 1,5 LHT / M30 x 1,5 RHT
 9753300603, 9753300703, 9753300903, A9753300603, A9753300703, A9753300903



DB-DL-12404

Length: 875 Ø: 50
Cone Ø: d1 Ø 30/26 / d2 Ø 27/23,5
 9724600605



DB-DL-12437

Length: 875 Ø: 50
Cone Ø: d1 Ø 30 / d2 Ø 27
 9744600005, 9744600605, A9744600005, A9744600605



DB-DL-12475

Length: 888 Ø: 50
Cone Ø: d1 Ø 30 / d2 Ø 27
 9744601505, A9744601505

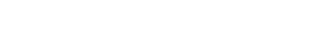

DB-ES-5214

Length: 1640 Ø: 40
Cone Ø: d1 Ø 26 / d2 Ø 23,5
 01218000A, 9703300003, 9703300103, 9703300203, 9703300303, 9703300403



DB-ES-8387

Length: 55
Cone Ø: d1 Ø 10 / d2 Ø 10
Thread: M14 x 1,5 RHT
 0009966845, 0009967045



DB-ES-8500

Length: 55
Cone Ø: d1 Ø 12 / d2 Ø 10,8
Thread: M14 x 1,5 RHT
 0002685989



DB-RK-8550

Ø: 75 **Hole Distance:** 152
Thick/Height: 24
 0003502105, 0003504605



DB-RK-8555

Ø: 67 **Hole Distance:** 130
Thick/Height: 24
 01335600A, 0003502005, 0003504705



DB-RK-9296

Ø: 88 **Hole Distance:** 130
Thick/Height: 24
 9423260050



DB-SB-10385

Ø: 30 **Thick/Height:** 30
 3093200073, 3143260153



DB-SB-10386

Ø: 38 **Thick/Height:** 38
 3183200073



DB-SB-10407

Ø: 61 **Thick/Height:** 46
 0003235985, 0003262481, 0003262981



DB-VB-10423

Length: 761,7 Ø: 46
Hole Ø: 25 / 23 / 23
Hole Distance: 152 / 130 / 130
 9743500005, 9743500405, 9743500505



No Image



ATEGO ...

1217 K ...	01/98 → 10/04	Tie Rod	DB-DL-8174		Guide Rod	
	01/98 → 10/04	Tie Rod	DB-DL-12304			
	01/98 → 10/04	Tie Rod	DB-ES-5214		Guide Rod, 1st Front Axle	
	01/98 → 10/04	Tie Rod End	CV-ES-12461		for Steering Rod	
	01/98 → 10/04	Tie Rod End	CV-ES-12462		for Steering Rod	
	01/98 → 10/04	Tie Rod End	CV-ES-14162		for Steering Rod	
	01/98 → 10/04	Tie Rod End	CV-ES-14163		for Steering Rod	
1217 KO	01/98 → 10/04	Ball Head, gearshift linkage	DB-ES-8387			
	01/98 → 10/04	Centre Rod	DB-DL-5405		Push Rod	
	01/98 → 10/04	Centre Rod	DB-DL-7799		Push Rod, Leaf Spring Axle	
	01/98 → 10/04	Centre Rod	DB-DL-7815		Push Rod, Leaf Spring Axle	
	01/98 → 10/04	Centre Rod	DB-DL-8644		Push Rod, Leaf Spring Axle	
	01/98 → 10/04	Stabiliser Mounting		DB-SB-10386		
	01/98 → 10/04	Stabiliser Mounting		DB-SB-10407		
	01/98 → 10/04	Stabiliser Mounting	DB-SB-10386	DB-SB-10386		
	01/98 → 10/04	Stabiliser Mounting	DB-SB-10386	DB-SB-10386	1st FA	
	01/98 → 10/04	Tie Rod	DB-DL-8174		Guide Rod	
	01/98 → 10/04	Tie Rod End	CV-ES-14163		for Steering Rod	
	1217, 1217 L	01/98 → 10/04	Ball Head, gearshift linkage	DB-ES-8387		
		01/98 → 10/04	Ball Head, gearshift linkage	DB-ES-8500		
		01/98 → 10/04	Centre Rod	DB-DL-5405		Push Rod
01/98 → 10/04		Centre Rod	DB-DL-7794		Push Rod	
01/98 → 10/04		Centre Rod	DB-DL-7799		Push Rod	
01/98 → 10/04		Centre Rod	DB-DL-7799		Push Rod, Leaf Spring Axle	
01/98 → 10/04		Centre Rod	DB-DL-7815		Push Rod	
01/98 → 10/04		Centre Rod	DB-DL-7815		Push Rod, Leaf Spring Axle	
01/98 → 10/04		Centre Rod	DB-DL-8644		Push Rod	
01/98 → 10/04		Centre Rod	DB-DL-8644		Push Rod, Leaf Spring Axle	
01/98 → 10/04		Centre Rod	DB-DL-9187		Push Rod	
01/98 → 10/04		Centre Rod	DB-DL-12404		for Steering Rod	
01/98 → 10/04		Centre Rod	DB-DL-12437		Push Rod	
01/98 → 10/04		Centre Rod	DB-DL-12475		Push Rod	
01/98 → 10/04		Stabiliser Mounting		DB-RK-9296		
01/98 → 10/04		Stabiliser Mounting		DB-SB-10385		
01/98 → 10/04		Stabiliser Mounting		DB-SB-10385	1st RA	
01/98 → 10/04		Stabiliser Mounting		DB-SB-10386		
01/98 → 10/04		Stabiliser Mounting		DB-SB-10407		
01/98 → 10/04		Stabiliser Mounting	DB-SB-10386	DB-SB-10386		
01/98 → 10/04		Stabiliser Mounting	DB-SB-10386	DB-SB-10386	1st FA	
01/98 → 10/04		Suspension Arm Repair Kit		DB-RK-8550	for Wishbone (CV)	
01/98 → 10/04		Suspension Strut Repair Kit		DB-RK-8555		
01/98 → 10/04		Tie Rod	DB-DL-8174		Guide Rod	
01/98 → 10/04		Tie Rod	DB-DL-12304			
01/98 → 10/04		Tie Rod	DB-ES-5214		Guide Rod, 1st Front Axle	
01/98 → 10/04		Tie Rod End	CV-ES-12461		for Steering Rod	
01/98 → 10/04		Tie Rod End	CV-ES-12462		for Steering Rod	
01/98 → 10/04		Tie Rod End	CV-ES-14162		for Steering Rod	
01/98 → 10/04		Tie Rod End	CV-ES-14163		for Steering Rod	
01/98 → 10/04		Track Control Arm		DB-VB-10423	Wishbone (CV), Air Suspension Axle	
1223 K		01/98 → 09/04	Ball Head, gearshift linkage	DB-ES-8387		
		01/98 → 09/04	Ball Head, gearshift linkage	DB-ES-8500		
		01/98 → 09/04	Centre Rod	DB-DL-5405		Push Rod
		01/98 → 09/04	Centre Rod	DB-DL-7799		Push Rod
		01/98 → 09/04	Centre Rod	DB-DL-7815		Push Rod
		01/98 → 09/04	Centre Rod	DB-DL-8644		Push Rod
	01/98 → 09/04	Tie Rod	DB-DL-8174		Guide Rod	
	01/98 → 09/04	Tie Rod	DB-DL-12304			
	01/98 → 09/04	Tie Rod	DB-ES-5214		Guide Rod, 1st Front Axle	
	01/98 → 09/04	Tie Rod End	CV-ES-12461		for Steering Rod	
	01/98 → 09/04	Tie Rod End	CV-ES-12462		for Steering Rod	
	01/98 → 09/04	Tie Rod End	CV-ES-14162		for Steering Rod	
	01/98 → 09/04	Tie Rod End	CV-ES-14163		for Steering Rod	

CV-ES-12461

Length: 120
Cone Ø: d1 Ø 26 / d2 Ø 23,5
Thread: M30 x 1,5 LHT
 0003300035, 3300148, 0003406213, 0013306635,
 0013308835, 0014604048, 0014604348,
 14606448, 0024600248, 3023300035,
 3023300135, 3023300235, 3023300335,
 3453307235, 3453307435, 3503307135,
 A0003300148, A0013306635, A0013308835,
 A0014604048, A0014604348, A0014606448,
 A0024600248, A3023300035, A3023300135,
 A3023300235, A3023300335, A3503307135



CV-ES-12462

Length: 120
Cone Ø: d1 Ø 26 / d2 Ø 23,5
Thread: M30 x 1,5 RHT
 0003300135, 0003300248, 0003303235,
 0003305835, 0003307335, 0003383410,
 0004608348, 004608348, 0004632229,
 0004633129, 0004633429, 0004633529,
 0013300135, 0013300235, 0013306735,
 0014603448, 0014604148, 0014604448,
 0014606348, 0014608348, 0014608448,
 0014609748, 0023301535, 3453307135,
 3503307035, 3503307335, 3643307135,
 5001832582, A0003300248, A0003303235,
 A0003307335, A0003383410, A0004608348,
 A0004632229, A0004633429, A0013300135,
 A0013300235, A0013306735, A0014603448,
 A0014604148, A0014604448, A0014606348,
 A0014608348, A0014608448, A0014609748,
 A0023301535



CV-ES-14162

Length: 125
Cone Ø: d1 Ø 30 / d2 Ø 27
Thread: M30 x 1,5 LHT
 4600648, 4601248, 4603448, 0004603548,
 14600348, 14601448, 14602348, 0014603748,
 0014607848, 0024600348



CV-ES-14163

Length: 125
Cone Ø: d1 Ø 30 / d2 Ø 27
Thread: M30 x 1,5 RHT
 0003305248, 0003387310, 0004600348,
 0004600948, 0004602848, 0004602948,
 0004608948, 0014600248, 0014600848,
 0014601248, 0014602248, 0014607748,
 0024600148, A0003387310, A0004600348,
 A0004602848, A0004602948, A0014600848,
 A0014601248, A0014602248, A0014607748



DB-DL-5405

Length: 890 Ø: 35
Cone Ø: d1 Ø 28,6 / d2 Ø 23,9
 01215900A, 1460248, 0024604505, 0024604605,
 0034605005, 3752600637, 3754600405,
 A3752600637, A3754600405



DB-DL-7794

Length: 837 Ø: 40
Cone Ø: d1 Ø 26 / d2 Ø 23,5
 9724601405, 9724601605



DB-DL-7799

Length: 895
 Ø: 50
Cone Ø: d1 Ø 30 / d2 Ø 26
 34605905, 0034605905, 3754600305,
 9724601805, 9724602005



DB-DL-7815

Length: 895 Ø: 50
Cone Ø: d1 Ø 30 / d2 Ø 27
 01215800A, 0034604605, 3754600005,
 9744601005, 9744601205



DB-DL-8174

Length: 1605 Ø: 40
Cone Ø: d1 Ø 30 / d2 Ø 27
 9753300203, 9753300303, 9753300803,
 9753301703, 9753302503



DB-DL-8644

Length: 894 Ø: 50
Cone Ø: d1 Ø 30 / d2 Ø 27
 0034604705, 9744601105, 9744601305

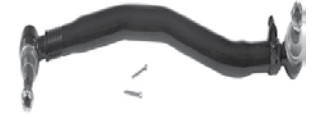

DB-DL-9187

Length: 846 Ø: 42
Cone Ø: d1 Ø 26 / d2 Ø 23,5
 9704601105, 9724602805, A9704601105,
 A9724602805



DB-DL-12304

Length: 1560 Ø: 40
Cone Ø: d1 Ø 30 / d2 Ø 27
Thread: M30 x 1,5 LHT / M30 x 1,5 RHT
 9753300603, 9753300703, 9753300903,
 A9753300603, A9753300703, A9753300903



DB-DL-12404

Length: 875 Ø: 50
Cone Ø: d1 Ø 30/26 / d2 Ø 27/23,5
 9724600605



DB-DL-12437

Length: 875 Ø: 50
Cone Ø: d1 Ø 30 / d2 Ø 27
 9744600005, 9744600605, A9744600005,
 A9744600605



DB-DL-12475

Length: 888 Ø: 50
Cone Ø: d1 Ø 30 / d2 Ø 27
 9744601505, A9744601505

No Image

DB-ES-5214

Length: 1640 Ø: 40
Cone Ø: d1 Ø 26 / d2 Ø 23,5
 01218000A, 9703300003, 9703300103,
 9703300203, 9703300303, 9703300403



DB-ES-8387

Length: 55
Cone Ø: d1 Ø 10 / d2 Ø 10
Thread: M14 x 1,5 RHT
 0009966845, 0009967045



DB-ES-8500

Length: 55
Cone Ø: d1 Ø 12 / d2 Ø 10,8
Thread: M14 x 1,5 RHT
 0002685989



DB-RK-8550

Ø: 75 Hole Distance: 152
Thick/Height: 24
 0003502105, 0003504605



DB-RK-8555

Ø: 67 Hole Distance: 130
Thick/Height: 24
 01335600A, 0003502005, 0003504705



DB-RK-9296

Ø: 88 Hole Distance: 130
Thick/Height: 24
 9423260050



DB-SB-10385

Ø: 30 Thick/Height: 30
 3093200073, 3143260153



DB-SB-10386

Ø: 38 Thick/Height: 38
 3183200073



DB-SB-10407

Ø: 61 Thick/Height: 46
 0003235985, 0003262481, 0003262981



DB-VB-10423

Length: 761,7 Ø: 46
Hole Ø: 25 / 23 / 23
Hole Distance: 152 / 130 / 130
 9743500005, 9743500405, 9743500505





ATEGO ...

1223, 1223 L	01/98 → 10/04	Ball Head, gearshift linkage	DB-ES-8387		
	01/98 → 10/04	Ball Head, gearshift linkage	DB-ES-8500		
	01/98 → 10/04	Centre Rod	DB-DL-5405		Push Rod
	01/98 → 10/04	Centre Rod	DB-DL-7794		Push Rod
	01/98 → 10/04	Centre Rod	DB-DL-7799		Push Rod
	01/98 → 10/04	Centre Rod	DB-DL-7799		Push Rod, Leaf Spring Axle
	01/98 → 10/04	Centre Rod	DB-DL-7815		Push Rod
	01/98 → 10/04	Centre Rod	DB-DL-7815		Push Rod, Leaf Spring Axle
	01/98 → 10/04	Centre Rod	DB-DL-8644		Push Rod
	01/98 → 10/04	Centre Rod	DB-DL-8644		Push Rod, Leaf Spring Axle
	01/98 → 10/04	Centre Rod	DB-DL-9187		Push Rod
	01/98 → 10/04	Centre Rod	DB-DL-12404		for Steering Rod
	01/98 → 10/04	Centre Rod	DB-DL-12437		Push Rod
	01/98 → 10/04	Centre Rod	DB-DL-12475		Push Rod
	01/98 → 10/04	Stabiliser Mounting		DB-RK-9296	
	01/98 → 10/04	Stabiliser Mounting		DB-SB-10385	
	01/98 → 10/04	Stabiliser Mounting		DB-SB-10385	1st RA
	01/98 → 10/04	Stabiliser Mounting		DB-SB-10386	
	01/98 → 10/04	Stabiliser Mounting		DB-SB-10407	
	01/98 → 10/04	Stabiliser Mounting	DB-SB-10386	DB-SB-10386	
	01/98 → 10/04	Stabiliser Mounting	DB-SB-10386	DB-SB-10386	1st FA
	01/98 → 10/04	Suspension Arm Repair Kit		DB-RK-8550	for Wishbone (CV)
	01/98 → 10/04	Suspension Strut Repair Kit		DB-RK-8555	
	01/98 → 10/04	Tie Rod	DB-DL-8174		Guide Rod
	01/98 → 10/04	Tie Rod	DB-DL-12304		
	01/98 → 10/04	Tie Rod	DB-ES-5214		Guide Rod, 1st Front Axle
	01/98 → 10/04	Tie Rod End	CV-ES-12461		for Steering Rod
	01/98 → 10/04	Tie Rod End	CV-ES-12462		for Steering Rod
	01/98 → 10/04	Tie Rod End	CV-ES-14162		for Steering Rod
	01/98 → 10/04	Tie Rod End	CV-ES-14163		for Steering Rod
01/98 → 10/04	Track Control Arm		DB-VB-10423	Wishbone (CV), Air Suspension Axle	
1225 AF	01/98 → 10/04	Ball Head, gearshift linkage	DB-ES-8387		
	01/98 → 10/04	Ball Head, gearshift linkage	DB-ES-8500		
	01/98 → 10/04	Centre Rod	DB-DL-5405		Push Rod
	01/98 → 10/04	Centre Rod	DB-DL-7815		Push Rod; Suspension Rod
	01/98 → 10/04	Centre Rod	DB-DL-12405		Coupling Rod
	01/98 → 10/04	Centre Rod	DB-DL-12475		Push Rod
	01/98 → 10/04	Stabiliser Mounting		DB-SB-10407	
	01/98 → 10/04	Stabiliser Mounting	DB-SB-10386	DB-SB-10386	
	01/98 → 10/04	Stabiliser Mounting	DB-SB-10386	DB-SB-10386	1st FA
	01/98 → 10/04	Tie Rod	DB-DL-12311		
	01/98 → 10/04	Tie Rod End	CV-ES-14163		for Steering Rod
	1225 F	01/98 → 10/04	Ball Head, gearshift linkage	DB-ES-8387	
01/98 → 10/04		Ball Head, gearshift linkage	DB-ES-8500		
01/98 → 10/04		Centre Rod	DB-DL-5405		Push Rod
01/98 → 10/04		Centre Rod	DB-DL-7799		Push Rod, Leaf Spring Axle
01/98 → 10/04		Centre Rod	DB-DL-7815		Push Rod, Leaf Spring Axle
01/98 → 10/04		Centre Rod	DB-DL-8644		Push Rod, Leaf Spring Axle
01/98 → 10/04		Centre Rod	DB-DL-12475		Push Rod
01/98 → 10/04		Stabiliser Mounting		DB-SB-10386	
01/98 → 10/04		Stabiliser Mounting		DB-SB-10407	
01/98 → 10/04		Stabiliser Mounting	DB-SB-10386	DB-SB-10386	
01/98 → 10/04		Stabiliser Mounting	DB-SB-10386	DB-SB-10386	1st FA
01/98 → 10/04		Tie Rod	DB-DL-8174		Guide Rod
01/98 → 10/04		Tie Rod	DB-DL-12304		
01/98 → 10/04		Tie Rod End	CV-ES-14162		for Steering Rod
01/98 → 10/04		Tie Rod End	CV-ES-14163		for Steering Rod
1228, 1228 L	01/98 → 10/04	Ball Head, gearshift linkage	DB-ES-8387		
	01/98 → 10/04	Ball Head, gearshift linkage	DB-ES-8500		
	01/98 → 10/04	Centre Rod	DB-DL-5405		Push Rod
	01/98 → 10/04	Centre Rod	DB-DL-7799		Push Rod
	01/98 → 10/04	Centre Rod	DB-DL-7799		Push Rod, Leaf Spring Axle
	01/98 → 10/04	Centre Rod	DB-DL-7815		Push Rod

CV-ES-12461

Length: 120
 Cone Ø: d1 Ø 26 / d2 Ø 23,5
 Thread: M30 x 1,5 LHT
 0003300035, 3300148, 0003406213, 0013306635,
 0013308835, 0014604048, 0014604348,
 14606448, 0024600248, 3023300035,
 3023300135, 3023300235, 3023300335,
 3453307235, 3453307435, 3503307135,
 A0003300148, A0013306635, A0013308835,
 A0014604048, A0014604348, A0014606448,
 A0024600248, A3023300035, A3023300135,
 A3023300235, A3023300335, A3503307135



CV-ES-12462

Length: 120
 Cone Ø: d1 Ø 26 / d2 Ø 23,5
 Thread: M30 x 1,5 RHT
 0003300135, 0003300248, 0003303235,
 0003305835, 0003307335, 0003383410,
 0004608348, 004608348, 0004632229,
 0004633129, 0004633429, 0004633529,
 0013300135, 0013300235, 0013306735,
 0014603448, 0014604148, 0014604448,
 0014606348, 0014608348, 0014608448,
 0014609748, 0023301535, 3453307135,
 3503307035, 3503307335, 3643307135,
 5001832582, A0003300248, A0003303235,
 A0003307335, A0003383410, A0004608348,
 A0004632229, A0004633429, A0013300135,
 A0013300235, A0013306735, A0014603448,
 A0014604148, A0014604448, A0014606348,
 A0014608348, A0014608448, A0014609748,
 A0023301535



CV-ES-14162

Length: 125
 Cone Ø: d1 Ø 30 / d2 Ø 27
 Thread: M30 x 1,5 LHT
 4600648, 4601248, 4603448, 0004603548,
 14600348, 14601448, 14602348, 0014603748,
 0014607848, 0024600348



CV-ES-14163

Length: 125
 Cone Ø: d1 Ø 30 / d2 Ø 27
 Thread: M30 x 1,5 RHT
 0003305248, 0003387310, 0004600348,
 0004600948, 0004602848, 0004602948,
 0004608948, 0014600248, 0014600848,
 0014601248, 0014602248, 0014607748,
 0024600148, A0003387310, A0004600348,
 A0004602848, A0004602948, A0014600848,
 A0014601248, A0014602248, A0014607748



DB-DL-5405

Length: 890 Ø: 35
 Cone Ø: d1 Ø 28,6 / d2 Ø 23,9
 01215900A, 1460248, 0024604505, 0024604605,
 0034605005, 3752600637, 3754600405,
 A3752600637, A3754600405



DB-DL-7794

Length: 837 Ø: 40
 Cone Ø: d1 Ø 26 / d2 Ø 23,5
 9724601405, 9724601605



DB-DL-7799

Length: 895 Ø: 50
 Cone Ø: d1 Ø 30 / d2 Ø 26
 0034605905, 3754600305, 9724601805,
 9724602005



DB-DL-7815

Length: 895 Ø: 50
 Cone Ø: d1 Ø 30 / d2 Ø 27
 01215800A, 0034604605, 3754600005,
 9744601005, 9744601205



DB-DL-8174

Length: 1605 Ø: 40
 Cone Ø: d1 Ø 30 / d2 Ø 27
 9753300203, 9753300303, 9753300803,
 9753301703, 9753302503



DB-DL-8644

Length: 894 Ø: 50
 Cone Ø: d1 Ø 30 / d2 Ø 27
 0034604705, 9744601105, 9744601305

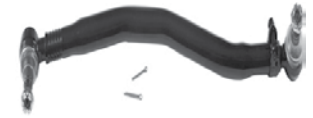

DB-DL-9187

Length: 846 Ø: 42
 Cone Ø: d1 Ø 26 / d2 Ø 23,5
 9704601105, 9724602805, A9704601105,
 A9724602805



DB-DL-12304

Length: 1560 Ø: 40
 Cone Ø: d1 Ø 30 / d2 Ø 27
 Thread: M30 x 1,5 LHT / M30 x 1,5 RHT
 9753300603, 9753300703, 9753300903,
 A9753300603, A9753300703, A9753300903



DB-DL-12311

Length: 1565 Ø: 60
 Cone Ø: d1 Ø 30 / d2 Ø 27
 9753300003, 9753300403, 9753301003,
 9753301903, A9753300003, A9753300403,
 A9753301003, A9753301903

No Image

DB-DL-12404

Length: 875 Ø: 50
 Cone Ø: d1 Ø 30/26 / d2 Ø 27/23,5
 9724600605



DB-DL-12405

Length: 895 Ø: 50
 Cone Ø: d1 Ø 30 / d2 Ø 28,6
 Thread: M24 x 1,5 / M20 x 1,5
 9744602205, 9764600205, 9764600405,
 A9764600405



DB-DL-12437

Length: 875 Ø: 50
 Cone Ø: d1 Ø 30 / d2 Ø 27
 9744600005, 9744600605, A9744600005,
 A9744600605



DB-DL-12475

Length: 888 Ø: 50
 Cone Ø: d1 Ø 30 / d2 Ø 27
 9744601505, A9744601505

No Image

DB-ES-5214

Length: 1640 Ø: 40
 Cone Ø: d1 Ø 26 / d2 Ø 23,5
 01218000A, 9703300003, 9703300103,
 9703300203, 9703300303, 9703300403



DB-ES-8387

Length: 55
 Cone Ø: d1 Ø 10 / d2 Ø 10
 Thread: M14 x 1,5 RHT
 0009966845, 0009967045



DB-ES-8500

Length: 55
 Cone Ø: d1 Ø 12 / d2 Ø 10,8
 Thread: M14 x 1,5 RHT
 0002685989



DB-RK-8550

Ø: 75 Hole Distance: 152
 Thick/Height: 24
 0003502105, 0003504605



DB-RK-8555

Ø: 67 Hole Distance: 130
 Thick/Height: 24
 01335600A, 0003502005, 0003504705



DB-RK-9296

Ø: 88 Hole Distance: 130
 Thick/Height: 24
 9423260050



DB-SB-10385

Ø: 30 Thick/Height: 30
 3093200073, 3143260153



DB-SB-10386

Ø: 38 Thick/Height: 38
 3183200073



DB-SB-10407

Ø: 61 Thick/Height: 46
 0003235985, 0003262481, 0003262981



DB-VB-10423

Length: 761,7 Ø: 46
 Hole Ø 25 / 23 / 23
 Hole Distance: 152 / 130 / 130
 9743500005, 9743500405, 9743500505





ATEGO ...

1228, 1228 L ...	01/98→10/04	Centre Rod	DB-DL-7815		Push Rod, Leaf Spring Axle	
	01/98→10/04	Centre Rod	DB-DL-8644		Push Rod	
	01/98→10/04	Centre Rod	DB-DL-8644		Push Rod, Leaf Spring Axle	
	01/98→10/04	Centre Rod	DB-DL-12404		for Steering Rod	
	01/98→10/04	Centre Rod	DB-DL-12437		Push Rod	
	01/98→10/04	Centre Rod	DB-DL-12475		Push Rod	
	01/98→10/04	Stabiliser Mounting		DB-RK-9296		
	01/98→10/04	Stabiliser Mounting		DB-SB-10385		
	01/98→10/04	Stabiliser Mounting		DB-SB-10385	1st RA	
	01/98→10/04	Stabiliser Mounting		DB-SB-10386		
	01/98→10/04	Stabiliser Mounting	DB-SB-10386	DB-SB-10386		
	01/98→10/04	Stabiliser Mounting	DB-SB-10386	DB-SB-10386	1st FA	
	01/98→10/04	Suspension Arm Repair Kit		DB-RK-8550	for Wishbone (CV)	
	01/98→10/04	Suspension Strut Repair Kit		DB-RK-8555		
	01/98→10/04	Tie Rod	DB-DL-8174		Guide Rod	
	01/98→10/04	Tie Rod	DB-DL-12304			
	01/98→10/04	Tie Rod End	CV-ES-14162		for Steering Rod	
	01/98→10/04	Tie Rod End	CV-ES-14163		for Steering Rod	
	01/98→10/04	Track Control Arm		DB-VB-10423	Wishbone (CV), Air Suspension Axle	
	1317 A	01/98→10/04	Ball Head, gearshift linkage	DB-ES-8387		
01/98→10/04		Centre Rod	DB-DL-5405		Push Rod	
01/98→10/04		Centre Rod	DB-DL-7815		Push Rod;Suspension Rod	
01/98→10/04		Centre Rod	DB-DL-8620		for Steering Rod	
01/98→10/04		Centre Rod	DB-DL-12405		Coupling Rod	
01/98→10/04		Stabiliser Mounting		DB-SB-10407		
01/98→10/04		Stabiliser Mounting	DB-SB-10386	DB-SB-10386		
01/98→10/04		Stabiliser Mounting	DB-SB-10386	DB-SB-10386	1st FA	
01/98→10/04		Tie Rod	DB-DL-12311			
01/98→10/04		Tie Rod End	CV-ES-14163		for Steering Rod	
1317 AK	01/98→10/04	Ball Head, gearshift linkage	DB-ES-8387			
	01/98→10/04	Centre Rod	DB-DL-5405		Push Rod	
	01/98→10/04	Centre Rod	DB-DL-7815		Push Rod;Suspension Rod	
	01/98→10/04	Centre Rod	DB-DL-12405		Coupling Rod	
	01/98→10/04	Stabiliser Mounting		DB-SB-10407		
	01/98→10/04	Stabiliser Mounting	DB-SB-10386	DB-SB-10386		
	01/98→10/04	Stabiliser Mounting	DB-SB-10386	DB-SB-10386	1st FA	
	01/98→10/04	Tie Rod	DB-DL-12311			
	01/98→10/04	Tie Rod End	CV-ES-14163		for Steering Rod	
	1317 K	01/98→10/04	Ball Head, gearshift linkage	DB-ES-8387		
01/98→10/04		Ball Head, gearshift linkage	DB-ES-8500			
01/98→10/04		Centre Rod	DB-DL-5405		Push Rod	
01/98→10/04		Centre Rod	DB-DL-7799		Push Rod;Suspension Rod	
01/98→10/04		Centre Rod	DB-DL-7815		Push Rod, Leaf Spring Axle	
01/98→10/04		Centre Rod	DB-DL-8644		Push Rod, Leaf Spring Axle	
01/98→10/04		Stabiliser Mounting		DB-SB-10386		
01/98→10/04		Stabiliser Mounting		DB-SB-10407		
01/98→10/04		Stabiliser Mounting	DB-SB-10386	DB-SB-10386		
01/98→10/04		Stabiliser Mounting	DB-SB-10386	DB-SB-10386	1st FA	
01/98→10/04		Tie Rod	DB-DL-8174		Guide Rod	
01/98→10/04		Tie Rod	DB-DL-12304			
01/98→10/04		Tie Rod	DB-ES-5214		Guide Rod, 1st Front Axle	
01/98→10/04		Tie Rod End	CV-ES-12461		for Steering Rod	
01/98→10/04		Tie Rod End	CV-ES-12462		for Steering Rod	
01/98→10/04		Tie Rod End	CV-ES-14162		for Steering Rod	
01/98→10/04		Tie Rod End	CV-ES-14163		for Steering Rod	
1317 KO, 1317 LKO, 1318 KO, 1318 LKO		01/98→10/04	Ball Head, gearshift linkage	DB-ES-8387		
		01/98→10/04	Ball Head, gearshift linkage	DB-ES-8500		
		01/98→10/04	Centre Rod	DB-DL-5405		Push Rod
	01/98→10/04	Centre Rod	DB-DL-7799		Push Rod	
	01/98→10/04	Centre Rod	DB-DL-7799		Push Rod, Leaf Spring Axle	
	01/98→10/04	Centre Rod	DB-DL-7815		Push Rod	
	01/98→10/04	Centre Rod	DB-DL-7815		Push Rod, Leaf Spring Axle	

CV-ES-12461

Length: 120
 Cone Ø: d1 Ø 26 / d2 Ø 23,5
 Thread: M30 x 1,5 LHT
 0003300035, 3300148, 0003406213, 0013306635,
 0013308835, 0014604048, 0014604348,
 14606448, 0024600248, 3023300035,
 3023300135, 3023300235, 3023300335,
 3453307235, 3453307435, 3503307135,
 A0003300148, A0013306635, A0013308835,
 A0014604048, A0014604348, A0014606448,
 A0024600248, A3023300035, A3023300135,
 A3023300235, A3023300335, A3503307135



CV-ES-12462

Length: 120
 Cone Ø: d1 Ø 26 / d2 Ø 23,5
 Thread: M30 x 1,5 RHT
 0003300135, 0003300248, 0003303235,
 0003305835, 0003307335, 0003383410,
 0004608348, 004608348, 0004632229,
 0004633129, 0004633429, 0004633529,
 0013300135, 0013300235, 0013306735,
 0014603448, 0014604148, 0014604448,
 0014606348, 0014608348, 0014608448,
 0014609748, 0023301535, 3453307135,
 3503307035, 3503307335, 3643307135,
 5001832582, A0003300248, A0003303235,
 A0003307335, A0003383410, A0004608348,
 A0004632229, A0004633429, A0013300135,
 A0013300235, A0013306735, A0014603448,
 A0014604148, A0014604448, A0014606348,
 A0014608348, A0014608448, A0014609748,
 A0023301535



CV-ES-14162

Length: 125
 Cone Ø: d1 Ø 30 / d2 Ø 27
 Thread: M30 x 1,5 LHT
 4600648, 4601248, 4603448, 0004603548,
 14600348, 14601448, 14602348, 0014603748,
 0014607848, 0024600348



CV-ES-14163

Length: 125
 Cone Ø: d1 Ø 30 / d2 Ø 27
 Thread: M30 x 1,5 RHT
 0003305248, 0003387310, 0004600348,
 0004600948, 0004602848, 0004602948,
 0004608948, 0014600248, 0014600848,
 0014601248, 0014602248, 0014607748,
 0024600148, A0003387310, A0004600348,
 A0004602848, A0004602948, A0014600848,
 A0014601248, A0014602248, A0014607748



DB-DL-5405

Length: 890 Ø: 35
 Cone Ø: d1 Ø 28,6 / d2 Ø 23,9
 01215900A, 1460248, 0024604505, 0024604605,
 0034605005, 3752600637, 3754600405,
 A3752600637, A3754600405



DB-DL-7799

Length: 895 Ø: 50
 Cone Ø: d1 Ø 30 / d2 Ø 26
 0034605905, 3754600305, 9724601805,
 9724602005



DB-DL-7815

Length: 895
 Ø: 50
 Cone Ø: d1 Ø 30 / d2 Ø 27
 01215800A, 34604605, 0034604605, 3754600005,
 9744601005, 9744601205



DB-DL-8174

Length: 1605 Ø: 40
 Cone Ø: d1 Ø 30 / d2 Ø 27
 9753300203, 9753300303, 9753300803,
 9753301703, 9753302503



DB-DL-8620

Length: 884
 Ø: 50
 Cone Ø: d1 Ø 30 / d2 Ø 27
 Thread: M24 x 1,5 / M20 x 1,5
 9744600405, 9744600805, A9744600405,
 A9744600805



DB-DL-8644

Length: 894 Ø: 50
 Cone Ø: d1 Ø 30 / d2 Ø 27
 0034604705, 9744601105, 9744601305

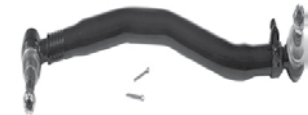

DB-DL-12304

Length: 1560 Ø: 40
 Cone Ø: d1 Ø 30 / d2 Ø 27
 Thread: M30 x 1,5 LHT / M30 x 1,5 RHT
 9753300603, 9753300703, 9753300903,
 A9753300603, A9753300703, A9753300903



DB-DL-12311

Length: 1565 Ø: 60
 Cone Ø: d1 Ø 30 / d2 Ø 27
 9753300003, 9753300403, 9753301003,
 9753301903, A9753300003, A9753300403,
 A9753301003, A9753301903

No Image

DB-DL-12404

Length: 875 Ø: 50
 Cone Ø: d1 Ø 30/26 / d2 Ø 27/23,5
 9724600605



DB-DL-12405

Length: 895 Ø: 50
 Cone Ø: d1 Ø 30 / d2 Ø 28,6
 Thread: M24 x 1,5 / M20 x 1,5
 9744602205, 9764600205, 9764600405,
 A9764600405



DB-DL-12437

Length: 875 Ø: 50
 Cone Ø: d1 Ø 30 / d2 Ø 27
 9744600005, 9744600605, A9744600005,
 A9744600605



DB-DL-12475

Length: 888 Ø: 50
 Cone Ø: d1 Ø 30 / d2 Ø 27
 9744601505, A9744601505



No Image

DB-ES-5214

Length: 1640 Ø: 40
 Cone Ø: d1 Ø 26 / d2 Ø 23,5
 01218000A, 9703300003, 9703300103,
 9703300203, 9703300303, 9703300403



DB-ES-8387

Length: 55
 Cone Ø: d1 Ø 10 / d2 Ø 10
 Thread: M14 x 1,5 RHT
 0009966845, 0009967045



DB-ES-8500

Length: 55
 Cone Ø: d1 Ø 12 / d2 Ø 10,8
 Thread: M14 x 1,5 RHT
 0002685989



DB-RK-8550

Ø: 75 Hole Distance: 152
 Thick/Height: 24
 0003502105, 0003504605



DB-RK-8555

Ø: 67 Hole Distance: 130
 Thick/Height: 24
 01335600A, 0003502005, 0003504705



DB-RK-9296

Ø: 88 Hole Distance: 130
 Thick/Height: 24
 9423260050



DB-SB-10385

Ø: 30 Thick/Height: 30
 3093200073, 3143260153



DB-SB-10386

Ø: 38 Thick/Height: 38
 3183200073



DB-SB-10407

Ø: 61 Thick/Height: 46
 0003235985, 0003262481, 0003262981



DB-VB-10423

Length: 761,7 Ø: 46
 Hole Ø 25 / 23 / 23
 Hole Distance: 152 / 130 / 130
 9743500005, 9743500405, 9743500505





ATEGO ...

1317 KO, 1317 LK0, 1318 KO, 1318 LK0 ...	01/98 → 10/04	Centre Rod	DB-DL-8644		Push Rod
	01/98 → 10/04	Centre Rod	DB-DL-8644		Push Rod, Leaf Spring Axle
1317, 1317 L	01/98 → 10/04	Stabiliser Mounting		DB-RK-9296	
	01/98 → 10/04	Stabiliser Mounting		DB-SB-10385	
	01/98 → 10/04	Stabiliser Mounting		DB-SB-10385	1st RA
	01/98 → 10/04	Stabiliser Mounting		DB-SB-10386	
	01/98 → 10/04	Stabiliser Mounting		DB-SB-10407	
	01/98 → 10/04	Stabiliser Mounting	DB-SB-10386	DB-SB-10386	
	01/98 → 10/04	Stabiliser Mounting	DB-SB-10386	DB-SB-10386	1st FA
	01/98 → 10/04	Suspension Arm Repair Kit		DB-RK-8550	for Wishbone (CV)
	01/98 → 10/04	Suspension Strut Repair Kit		DB-RK-8555	
	01/98 → 10/04	Tie Rod	DB-DL-8174		Guide Rod
	01/98 → 10/04	Tie Rod	DB-DL-12304		
	01/98 → 10/04	Tie Rod End	CV-ES-14162		for Steering Rod
	01/98 → 10/04	Tie Rod End	CV-ES-14163		for Steering Rod
	01/98 → 10/04	Track Control Arm		DB-VB-10423	Wishbone (CV), Air Suspension Axle
	01/98 → 10/04	Ball Head, gearshift linkage	DB-ES-8387		
	01/98 → 10/04	Ball Head, gearshift linkage	DB-ES-8500		
	01/98 → 10/04	Centre Rod	DB-DL-5405		Push Rod
	01/98 → 10/04	Centre Rod	DB-DL-7799		Push Rod
	01/98 → 10/04	Centre Rod	DB-DL-7799		Push Rod, Leaf Spring Axle
	01/98 → 10/04	Centre Rod	DB-DL-7815		Push Rod
01/98 → 10/04	Centre Rod	DB-DL-7815		Push Rod, Leaf Spring Axle	
01/98 → 10/04	Centre Rod	DB-DL-8644		Push Rod	
01/98 → 10/04	Centre Rod	DB-DL-8644		Push Rod, Leaf Spring Axle	
01/98 → 10/04	Centre Rod	DB-DL-12404		for Steering Rod	
01/98 → 10/04	Centre Rod	DB-DL-12437		Push Rod	
01/98 → 10/04	Centre Rod	DB-DL-12475		Push Rod	
01/98 → 10/04	Stabiliser Mounting		DB-RK-9296		
01/98 → 10/04	Stabiliser Mounting		DB-SB-10385		
01/98 → 10/04	Stabiliser Mounting		DB-SB-10385	1st RA	
01/98 → 10/04	Stabiliser Mounting		DB-SB-10386		
01/98 → 10/04	Stabiliser Mounting		DB-SB-10407		
01/98 → 10/04	Stabiliser Mounting	DB-SB-10386	DB-SB-10386		
01/98 → 10/04	Stabiliser Mounting	DB-SB-10386	DB-SB-10386	1st FA	
01/98 → 10/04	Suspension Arm Repair Kit		DB-RK-8550	for Wishbone (CV)	
01/98 → 10/04	Suspension Strut Repair Kit		DB-RK-8555		
01/98 → 10/04	Tie Rod	DB-DL-8174		Guide Rod	
01/98 → 10/04	Tie Rod	DB-DL-12304			
01/98 → 10/04	Tie Rod End	CV-ES-14162		for Steering Rod	
01/98 → 10/04	Tie Rod End	CV-ES-14163		for Steering Rod	
01/98 → 10/04	Track Control Arm		DB-VB-10423	Wishbone (CV), Air Suspension Axle	
1323 AK	01/98 → 09/04	Centre Rod	DB-DL-5405		Push Rod
	01/98 → 09/04	Centre Rod	DB-DL-12405		Coupling Rod
	01/98 → 09/04	Tie Rod	DB-DL-12311		
	01/98 → 09/04	Tie Rod End	CV-ES-14163		for Steering Rod
1323 K	01/98 → 09/04	Ball Head, gearshift linkage	DB-ES-8387		
	01/98 → 09/04	Ball Head, gearshift linkage	DB-ES-8500		
	01/98 → 09/04	Centre Rod	DB-DL-5405		Push Rod
	01/98 → 09/04	Centre Rod	DB-DL-7799		Push Rod
	01/98 → 09/04	Centre Rod	DB-DL-7815		Push Rod
	01/98 → 09/04	Centre Rod	DB-DL-8644		Push Rod
	01/98 → 09/04	Tie Rod	DB-DL-8174		Guide Rod
	01/98 → 09/04	Tie Rod	DB-DL-12304		
	01/98 → 09/04	Tie Rod	DB-ES-5214		Guide Rod, 1st Front Axle
	01/98 → 09/04	Tie Rod End	CV-ES-12461		for Steering Rod
	01/98 → 09/04	Tie Rod End	CV-ES-12462		for Steering Rod
	01/98 → 09/04	Tie Rod End	CV-ES-14162		for Steering Rod
	01/98 → 09/04	Tie Rod End	CV-ES-14163		for Steering Rod
	1323 KO, 1323 LK0	01/98 → 10/04	Ball Head, gearshift linkage	DB-ES-8387	
01/98 → 10/04		Ball Head, gearshift linkage	DB-ES-8500		
01/98 → 10/04		Centre Rod	DB-DL-5405		Push Rod
01/98 → 10/04		Centre Rod	DB-DL-7799		Push Rod

CV-ES-12461

Length: 120
Cone Ø: d1 Ø 26 / d2 Ø 23,5
Thread: M30 x 1,5 LHT
 0003300035, 3300148, 0003406213, 0013306635,
 0013308835, 0014604048, 0014604348,
 14606448, 0024600248, 3023300035,
 3023300135, 3023300235, 3023300335,
 3453307235, 3453307435, 3503307135,
 A0003300148, A0013306635, A0013308835,
 A0014604048, A0014604348, A0014606448,
 A0024600248, A3023300035, A3023300135,
 A3023300235, A3023300335, A3503307135



CV-ES-12462

Length: 120
Cone Ø: d1 Ø 26 / d2 Ø 23,5
Thread: M30 x 1,5 RHT
 0003300135, 0003300248, 0003303235,
 0003305835, 0003307335, 0003383410,
 0004608348, 004608348, 0004632229,
 0004633129, 0004633429, 0004633529,
 0013300135, 0013300235, 0013306735,
 0014603448, 0014604148, 0014604448,
 0014606348, 0014608348, 0014608448,
 0014609748, 0023301535, 3453307135,
 3503307035, 3503307335, 3643307135,
 5001832582, A0003300248, A0003303235,
 A0003307335, A0003383410, A0004608348,
 A0004632229, A0004633429, A0013300135,
 A0013300235, A0013306735, A0014603448,
 A0014604148, A0014604448, A0014606348,
 A0014608348, A0014608448, A0014609748,
 A0023301535



CV-ES-14162

Length: 125
Cone Ø: d1 Ø 30 / d2 Ø 27
Thread: M30 x 1,5 LHT
 4600648, 4601248, 4603448, 0004603548,
 14600348, 14601448, 14602348, 0014603748,
 0014607848, 0024600348



CV-ES-14163

Length: 125
Cone Ø: d1 Ø 30 / d2 Ø 27
Thread: M30 x 1,5 RHT
 0003305248, 0003387310, 0004600348,
 0004600948, 0004602848, 0004602948,
 0004608948, 0014600248, 0014600848,
 0014601248, 0014602248, 0014607748,
 0024600148, A0003387310, A0004600348,
 A0004602848, A0004602948, A0014600848,
 A0014601248, A0014602248, A0014607748



DB-DL-5405

Length: 890 Ø: 35
Cone Ø: d1 Ø 28,6 / d2 Ø 23,9
 01215900A, 1460248, 0024604505, 0024604605,
 0034605005, 3752600637, 3754600405,
 A3752600637, A3754600405



DB-DL-7799

Length: 895 Ø: 50
Cone Ø: d1 Ø 30 / d2 Ø 26
 0034605905, 3754600305, 9724601805,
 9724602005



DB-DL-7815

Length: 895 Ø: 50
Cone Ø: d1 Ø 30 / d2 Ø 27
 01215800A, 0034604605, 3754600005,
 9744601005, 9744601205



DB-DL-8174

Length: 1605 Ø: 40
Cone Ø: d1 Ø 30 / d2 Ø 27
 9753300203, 9753300303, 9753300803,
 9753301703, 9753302503



DB-DL-8644

Length: 894 Ø: 50
Cone Ø: d1 Ø 30 / d2 Ø 27
 0034604705, 9744601105, 9744601305

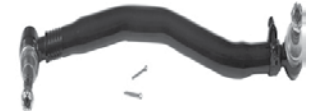

DB-DL-12304

Length: 1560 Ø: 40
Cone Ø: d1 Ø 30 / d2 Ø 27
Thread: M30 x 1,5 LHT / M30 x 1,5 RHT
 9753300603, 9753300703, 9753300903,
 A9753300603, A9753300703, A9753300903



DB-DL-12311

Length: 1565 Ø: 60
Cone Ø: d1 Ø 30 / d2 Ø 27
 9753300003, 9753300403, 9753301003,
 9753301903, A9753300003, A9753300403,
 A9753301003, A9753301903

No Image

DB-DL-12404

Length: 875 Ø: 50
Cone Ø: d1 Ø 30/26 / d2 Ø 27/23,5
 9724600605



DB-DL-12405

Length: 895 Ø: 50
Cone Ø: d1 Ø 30 / d2 Ø 28,6
Thread: M24 x 1,5 / M20 x 1,5
 9744602205, 9764600205, 9764600405,
 A9764600405



DB-DL-12437

Length: 875 Ø: 50
Cone Ø: d1 Ø 30 / d2 Ø 27
 9744600005, 9744600605, A9744600005,
 A9744600605



DB-DL-12475

Length: 888 Ø: 50
Cone Ø: d1 Ø 30 / d2 Ø 27
 9744601505, A9744601505

No Image

DB-ES-5214

Length: 1640 Ø: 40
Cone Ø: d1 Ø 26 / d2 Ø 23,5
 01218000A, 9703300003, 9703300103,
 9703300203, 9703300303, 9703300403



DB-ES-8387

Length: 55
Cone Ø: d1 Ø 10 / d2 Ø 10
Thread: M14 x 1,5 RHT
 0009966845, 0009967045



DB-ES-8500

Length: 55
Cone Ø: d1 Ø 12 / d2 Ø 10,8
Thread: M14 x 1,5 RHT
 0002685989



DB-RK-8550

Ø: 75 Hole Distance: 152
Thick/Height: 24
 0003502105, 0003504605



DB-RK-8555

Ø: 67
Hole Distance: 130
Thick/Height: 24
 01335600A, 3502005, 0003502005, 3504705,
 0003504705



DB-RK-9296

Ø: 88 Hole Distance: 130
Thick/Height: 24
 9423260050



DB-SB-10385

Ø: 30 Thick/Height: 30
 3093200073, 3143260153



DB-SB-10386

Ø: 38 Thick/Height: 38
 3183200073



DB-SB-10407

Ø: 61 Thick/Height: 46
 0003235985, 0003262481, 0003262981



DB-VB-10423

Length: 761,7 Ø: 46
Hole Ø: 25 / 23 / 23
Hole Distance: 152 / 130 / 130
 9743500005, 9743500405, 9743500505



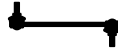

ATEGO ...

1323 KO, 1323 LKO ...	01/98→10/04	Centre Rod	DB-DL-7799		Push Rod, Leaf Spring Axle	
	01/98→10/04	Centre Rod	DB-DL-7815		Push Rod	
	01/98→10/04	Centre Rod	DB-DL-7815		Push Rod, Leaf Spring Axle	
	01/98→10/04	Centre Rod	DB-DL-8644		Push Rod	
	01/98→10/04	Centre Rod	DB-DL-8644		Push Rod, Leaf Spring Axle	
	01/98→10/04	Stabiliser Mounting		DB-RK-9296		
	01/98→10/04	Stabiliser Mounting		DB-SB-10385		
	01/98→10/04	Stabiliser Mounting		DB-SB-10385	1st RA	
	01/98→10/04	Stabiliser Mounting		DB-SB-10386		
	01/98→10/04	Stabiliser Mounting		DB-SB-10407		
	01/98→10/04	Stabiliser Mounting	DB-SB-10386	DB-SB-10386		
	01/98→10/04	Stabiliser Mounting	DB-SB-10386	DB-SB-10386	1st FA	
	01/98→10/04	Suspension Arm Repair Kit		DB-RK-8550	for Wishbone (CV)	
	01/98→10/04	Suspension Strut Repair Kit		DB-RK-8555		
	01/98→10/04	Tie Rod	DB-DL-8174		Guide Rod	
	01/98→10/04	Tie Rod	DB-DL-12304			
	01/98→10/04	Tie Rod End	CV-ES-14162		for Steering Rod	
	01/98→10/04	Tie Rod End	CV-ES-14163		for Steering Rod	
	01/98→10/04	Track Control Arm		DB-VB-10423	Wishbone (CV), Air Suspension Axle	
	1323 LS	01/98→10/04	Ball Head, gearshift linkage	DB-ES-8387		
		01/98→10/04	Ball Head, gearshift linkage	DB-ES-8500		
		01/98→10/04	Centre Rod	DB-DL-5405		Push Rod
		01/98→10/04	Centre Rod	DB-DL-7799		Push Rod
		01/98→10/04	Centre Rod	DB-DL-7815		Push Rod
		01/98→10/04	Centre Rod	DB-DL-8644		Push Rod
01/98→10/04		Stabiliser Mounting		DB-RK-9296		
01/98→10/04		Stabiliser Mounting		DB-SB-10385		
01/98→10/04		Stabiliser Mounting		DB-SB-10385	1st RA	
01/98→10/04		Stabiliser Mounting		DB-SB-10386		
01/98→10/04		Stabiliser Mounting		DB-SB-10407		
01/98→10/04		Stabiliser Mounting	DB-SB-10386	DB-SB-10386		
01/98→10/04		Stabiliser Mounting	DB-SB-10386	DB-SB-10386	1st FA	
01/98→10/04		Suspension Arm Repair Kit		DB-RK-8550	for Wishbone (CV)	
01/98→10/04		Suspension Strut Repair Kit		DB-RK-8555		
01/98→10/04		Tie Rod	DB-DL-8174		Guide Rod	
01/98→10/04		Tie Rod	DB-DL-12304			
01/98→10/04		Tie Rod End	CV-ES-14162		for Steering Rod	
01/98→10/04		Tie Rod End	CV-ES-14163		for Steering Rod	
01/98→10/04		Track Control Arm		DB-TC-12411	Control Arm	
01/98→10/04		Track Control Arm		DB-VB-10423	Wishbone (CV), Air Suspension Axle	
1323, 1323 L		01/98→10/04	Ball Head, gearshift linkage	DB-ES-8387		
		01/98→10/04	Ball Head, gearshift linkage	DB-ES-8500		
		01/98→10/04	Centre Rod	DB-DL-5405		Push Rod
		01/98→10/04	Centre Rod	DB-DL-7799		Push Rod
	01/98→10/04	Centre Rod	DB-DL-7799		Push Rod, Leaf Spring Axle	
	01/98→10/04	Centre Rod	DB-DL-7815		Push Rod	
	01/98→10/04	Centre Rod	DB-DL-7815		Push Rod, Leaf Spring Axle	
	01/98→10/04	Centre Rod	DB-DL-8644		Push Rod	
	01/98→10/04	Centre Rod	DB-DL-8644		Push Rod, Leaf Spring Axle	
	01/98→10/04	Centre Rod	DB-DL-12404		for Steering Rod	
	01/98→10/04	Centre Rod	DB-DL-12437		Push Rod	
	01/98→10/04	Centre Rod	DB-DL-12475		Push Rod	
	01/98→10/04	Stabiliser Mounting		DB-RK-9296		
	01/98→10/04	Stabiliser Mounting		DB-SB-10385		
	01/98→10/04	Stabiliser Mounting		DB-SB-10385	1st RA	
	01/98→10/04	Stabiliser Mounting		DB-SB-10386		
	01/98→10/04	Stabiliser Mounting		DB-SB-10407		
	01/98→10/04	Stabiliser Mounting	DB-SB-10386	DB-SB-10386		
	01/98→10/04	Stabiliser Mounting	DB-SB-10386	DB-SB-10386	1st FA	
	01/98→10/04	Suspension Arm Repair Kit		DB-RK-8550	for Wishbone (CV)	
	01/98→10/04	Suspension Strut Repair Kit		DB-RK-8555		
	01/98→10/04	Tie Rod	DB-DL-8174		Guide Rod	
	01/98→10/04	Tie Rod	DB-DL-12304			

CV-ES-14162

Length: 125
Cone Ø: d1 Ø 30 / d2 Ø 27
Thread: M30 x 1,5 LHT
4600648, 4601248, 4603448, 0004603548,
14600348, 14601448, 14602348, 0014603748,
0014607848, 0024600348



CV-ES-14163

Length: 125
Cone Ø: d1 Ø 30 / d2 Ø 27
Thread: M30 x 1,5 RHT
0003305248, 0003387310, 0004600348,
0004600948, 0004602848, 0004602948,
0004608948, 0014600248, 0014600848,
0014601248, 0014602248, 0014607748,
0024600148, A0003387310, A0004600348,
A0004602848, A0004602948, A0014600848,
A0014601248, A0014602248, A0014607748



DB-DL-5405

Length: 890 Ø: 35
Cone Ø: d1 Ø 28,6 / d2 Ø 23,9
01215900A, 1460248, 0024604505, 0024604605,
0034605005, 3752600637, 3754600405,
A3752600637, A3754600405



DB-DL-7799

Length: 895 Ø: 50
Cone Ø: d1 Ø 30 / d2 Ø 26
0034605905, 3754600305, 9724601805,
9724602005



DB-DL-7815

Length: 895 Ø: 50
Cone Ø: d1 Ø 30 / d2 Ø 27
01215800A, 0034604605, 3754600005,
9744601005, 9744601205



DB-DL-8174

Length: 1605 Ø: 40
Cone Ø: d1 Ø 30 / d2 Ø 27
9753300203, 9753300303, 9753300803,
9753301703, 9753302503



DB-DL-8644

Length: 894 Ø: 50
Cone Ø: d1 Ø 30 / d2 Ø 27
0034604705, 9744601105, 9744601305

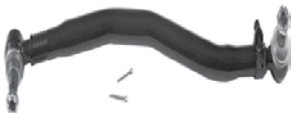

DB-DL-12304

Length: 1560 Ø: 40
Cone Ø: d1 Ø 30 / d2 Ø 27
Thread: M30 x 1,5 LHT / M30 x 1,5 RHT
9753300603, 9753300703, 9753300903,
A9753300603, A9753300703, A9753300903



DB-DL-12404

Length: 875 Ø: 50
Cone Ø: d1 Ø 30/26 / d2 Ø 27/23,5
9724600605



DB-DL-12437

Length: 875 Ø: 50
Cone Ø: d1 Ø 30 / d2 Ø 27
9744600005, 9744600605, A9744600005,
A9744600605



DB-DL-12475

Length: 888 Ø: 50
Cone Ø: d1 Ø 30 / d2 Ø 27
9744601505, A9744601505



No Image

DB-ES-8387

Length: 55
Cone Ø: d1 Ø 10 / d2 Ø 10
Thread: M14 x 1,5 RHT
0009966845, 0009967045



DB-ES-8500

Length: 55
Cone Ø: d1 Ø 12 / d2 Ø 10,8
Thread: M14 x 1,5 RHT
0002685989



DB-RK-8550

Ø: 75 Hole Distance: 152
Thick/Height: 24
0003502105, 0003504605



DB-RK-8555

Ø: 67 Hole Distance: 130
Thick/Height: 24
01335600A, 0003502005, 0003504705



DB-RK-9296

Ø: 88 Hole Distance: 130
Thick/Height: 24
9423260050



DB-SB-10385

Ø: 30 Thick/Height: 30
3093200073, 3143260153



DB-SB-10386

Ø: 38 Thick/Height: 38
3183200073



DB-SB-10407

Ø: 61 Thick/Height: 46
0003235985, 0003262481, 0003262981



DB-TC-12411

Length: 655 Ø: 40
Hole Distance: 115 / 115
9723500906



DB-VB-10423

Length: 761,7 Ø: 46
Hole Ø 25 / 23 / 23
Hole Distance: 152 / 130 / 130
9743500005, 9743500405, 9743500505



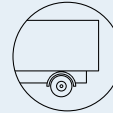
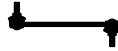

ATEGO ...

1323, 1323 L ...	01/98→10/04	Tie Rod End	CV-ES-14162		for Steering Rod	
	01/98→10/04	Tie Rod End	CV-ES-14163		for Steering Rod	
	01/98→10/04	Track Control Arm		DB-VB-10423	Wishbone (CV), Air Suspension Axle	
1325 AF	01/98→10/04	Ball Head, gearshift linkage	DB-ES-8387			
	01/98→10/04	Ball Head, gearshift linkage	DB-ES-8500			
	01/98→10/04	Centre Rod	DB-DL-5405		Push Rod	
	01/98→10/04	Centre Rod	DB-DL-7815		Push Rod;Suspension Rod	
	01/98→10/04	Centre Rod	DB-DL-12405		Coupling Rod	
	01/98→10/04	Centre Rod	DB-DL-12475		Push Rod	
	01/98→10/04	Stabiliser Mounting		DB-SB-10407		
	01/98→10/04	Stabiliser Mounting	DB-SB-10386	DB-SB-10386		
	01/98→10/04	Stabiliser Mounting	DB-SB-10386	DB-SB-10386	1st FA	
	01/98→10/04	Tie Rod	DB-DL-12311		1st FA, →504522 02	
	01/98→10/04	Tie Rod End	CV-ES-14163		for Steering Rod	
1325 F	01/98→10/04	Ball Head, gearshift linkage	DB-ES-8387			
	01/98→10/04	Ball Head, gearshift linkage	DB-ES-8500			
	01/98→10/04	Centre Rod	DB-DL-5405		Push Rod	
	01/98→10/04	Centre Rod	DB-DL-7799		Push Rod, Leaf Spring Axle	
	01/98→10/04	Centre Rod	DB-DL-7815		Push Rod, Leaf Spring Axle	
	01/98→10/04	Centre Rod	DB-DL-8644		Push Rod, Leaf Spring Axle	
	01/98→10/04	Centre Rod	DB-DL-12475		Push Rod	
	01/98→10/04	Stabiliser Mounting		DB-SB-10386		
	01/98→10/04	Stabiliser Mounting		DB-SB-10407		
	01/98→10/04	Stabiliser Mounting	DB-SB-10386	DB-SB-10386		
	01/98→10/04	Stabiliser Mounting	DB-SB-10386	DB-SB-10386	1st FA	
	01/98→10/04	Tie Rod	DB-DL-8174		Guide Rod	
	01/98→10/04	Tie Rod	DB-DL-12304			
	01/98→10/04	Tie Rod End	CV-ES-14162		for Steering Rod	
	01/98→10/04	Tie Rod End	CV-ES-14163		for Steering Rod	
	1328 AF	01/98→10/04	Ball Head, gearshift linkage	DB-ES-8387		
		01/98→10/04	Ball Head, gearshift linkage	DB-ES-8500		
01/98→10/04		Centre Rod	DB-DL-5405		Push Rod	
01/98→10/04		Centre Rod	DB-DL-7815		Push Rod;Suspension Rod	
01/98→10/04		Centre Rod	DB-DL-12405		Coupling Rod	
01/98→10/04		Centre Rod	DB-DL-12475		Push Rod	
01/98→10/04		Stabiliser Mounting		DB-SB-10407		
01/98→10/04		Stabiliser Mounting	DB-SB-10386	DB-SB-10386		
01/98→10/04		Stabiliser Mounting	DB-SB-10386	DB-SB-10386	1st FA	
01/98→10/04		Tie Rod	DB-DL-12311			
01/98→10/04		Tie Rod End	CV-ES-14163		for Steering Rod	
1328 F	01/98→10/04	Ball Head, gearshift linkage	DB-ES-8387			
	01/98→10/04	Ball Head, gearshift linkage	DB-ES-8500			
	01/98→10/04	Centre Rod	DB-DL-5405		Push Rod	
	01/98→10/04	Centre Rod	DB-DL-7799		Push Rod, Leaf Spring Axle	
	01/98→10/04	Centre Rod	DB-DL-7815		Push Rod, Leaf Spring Axle	
	01/98→10/04	Centre Rod	DB-DL-8644		Push Rod, Leaf Spring Axle	
	01/98→10/04	Centre Rod	DB-DL-12475		Push Rod	
	01/98→10/04	Stabiliser Mounting		DB-SB-10386		
	01/98→10/04	Stabiliser Mounting		DB-SB-10407		
	01/98→10/04	Stabiliser Mounting	DB-SB-10386	DB-SB-10386		
	01/98→10/04	Stabiliser Mounting	DB-SB-10386	DB-SB-10386	1st FA	
	01/98→10/04	Tie Rod	DB-DL-8174		Guide Rod	
	01/98→10/04	Tie Rod	DB-DL-12304			
	01/98→10/04	Tie Rod End	CV-ES-14162		for Steering Rod	
	01/98→10/04	Tie Rod End	CV-ES-14163		for Steering Rod	
	1328 LS	01/98→10/04	Ball Head, gearshift linkage	DB-ES-8387		
		01/98→10/04	Ball Head, gearshift linkage	DB-ES-8500		
01/98→10/04		Centre Rod	DB-DL-5405		Push Rod	
01/98→10/04		Centre Rod	DB-DL-7799		Push Rod	
01/98→10/04		Centre Rod	DB-DL-7815		Push Rod	
01/98→10/04		Centre Rod	DB-DL-8644		Push Rod	
01/98→10/04		Stabiliser Mounting		DB-RK-9296		
01/98→10/04		Stabiliser Mounting		DB-SB-10385		

CV-ES-14162

Length: 125
Cone Ø: d1 Ø 30 / d2 Ø 27
Thread: M30 x 1,5 LHT
4600648, 4601248, 4603448, 0004603548,
14600348, 14601448, 14602348, 0014603748,
0014607848, 0024600348



CV-ES-14163

Length: 125
Cone Ø: d1 Ø 30 / d2 Ø 27
Thread: M30 x 1,5 RHT
0003305248, 0003387310, 0004600348,
0004600948, 0004602848, 0004602948,
0004608948, 0014600248, 0014600848,
0014601248, 0014602248, 0014607748,
0024600148, A0003387310, A0004600348,
A0004602848, A0004602948, A0014600848,
A0014601248, A0014602248, A0014607748



DB-DL-5405

Length: 890 Ø: 35
Cone Ø: d1 Ø 28,6 / d2 Ø 23,9
01215900A, 1460248, 0024604505, 0024604605,
0034605005, 3752600637, 3754600405,
A3752600637, A3754600405



DB-DL-7799

Length: 895 Ø: 50
Cone Ø: d1 Ø 30 / d2 Ø 26
0034605905, 3754600305, 9724601805,
9724602005



DB-DL-7815

Length: 895
Ø: 50
Cone Ø: d1 Ø 30 / d2 Ø 27
01215800A, 34604605, 0034604605, 3754600005,
9744601005, 9744601205



DB-DL-8174

Length: 1605 Ø: 40
Cone Ø: d1 Ø 30 / d2 Ø 27
9753300203, 9753300303, 9753300803,
9753301703, 9753302503



DB-DL-8644

Length: 894 Ø: 50
Cone Ø: d1 Ø 30 / d2 Ø 27
0034604705, 9744601105, 9744601305

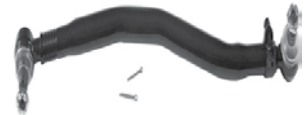

DB-DL-12304

Length: 1560 Ø: 40
Cone Ø: d1 Ø 30 / d2 Ø 27
Thread: M30 x 1,5 LHT / M30 x 1,5 RHT
9753300603, 9753300703, 9753300903,
A9753300603, A9753300703, A9753300903



DB-DL-12311

Length: 1565 Ø: 60
Cone Ø: d1 Ø 30 / d2 Ø 27
9753300003, 9753300403, 9753301003,
9753301903, A9753300003, A9753300403,
A9753301003, A9753301903

No Image

DB-DL-12405

Length: 895 Ø: 50
Cone Ø: d1 Ø 30 / d2 Ø 28,6
Thread: M24 x 1,5 / M20 x 1,5
9744602205, 9764600205, 9764600405,
A9764600405



DB-DL-12475

Length: 888 Ø: 50
Cone Ø: d1 Ø 30 / d2 Ø 27
9744601505, A9744601505

No Image

DB-ES-8387

Length: 55
Cone Ø: d1 Ø 10 / d2 Ø 10
Thread: M14 x 1,5 RHT
0009966845, 0009967045



DB-ES-8500

Length: 55
Cone Ø: d1 Ø 12 / d2 Ø 10,8
Thread: M14 x 1,5 RHT
0002685989



DB-RK-9296

Ø: 88 Hole Distance: 130
Thick/Height: 24
9423260050



DB-SB-10385

Ø: 30 Thick/Height: 30
3093200073, 3143260153



DB-SB-10386

Ø: 38 Thick/Height: 38
3183200073



DB-SB-10407

Ø: 61 Thick/Height: 46
0003235985, 0003262481, 0003262981



DB-VB-10423

Length: 761,7 Ø: 46
Hole Ø 25 / 23 / 23
Hole Distance: 152 / 130 / 130
9743500005, 9743500405, 9743500505





ATEGO ...

1328 LS ...	01/98 → 10/04	Stabiliser Mounting		DB-SB-10385	1st RA	
	01/98 → 10/04	Stabiliser Mounting		DB-SB-10386		
	01/98 → 10/04	Stabiliser Mounting		DB-SB-10407		
	01/98 → 10/04	Stabiliser Mounting	DB-SB-10386	DB-SB-10386		
	01/98 → 10/04	Stabiliser Mounting	DB-SB-10386	DB-SB-10386	1st FA	
	01/98 → 10/04	Suspension Arm Repair Kit		DB-RK-8550	for Wishbone (CV)	
	01/98 → 10/04	Suspension Strut Repair Kit		DB-RK-8555		
	01/98 → 10/04	Tie Rod	DB-DL-8174		Guide Rod	
	01/98 → 10/04	Tie Rod	DB-DL-12304			
	01/98 → 10/04	Tie Rod End	CV-ES-14162		for Steering Rod	
	01/98 → 10/04	Tie Rod End	CV-ES-14163		for Steering Rod	
	01/98 → 10/04	Track Control Arm		DB-TC-12411	Control Arm	
	01/98 → 10/04	Track Control Arm		DB-VB-10423	Wishbone (CV), Air Suspension Axle	
	1328, 1328 L	01/98 → 10/04	Ball Head, gearshift linkage	DB-ES-8387		
01/98 → 10/04		Ball Head, gearshift linkage	DB-ES-8500			
01/98 → 10/04		Centre Rod	DB-DL-5405		Push Rod	
01/98 → 10/04		Centre Rod	DB-DL-7799		Push Rod	
01/98 → 10/04		Centre Rod	DB-DL-7799		Push Rod, Leaf Spring Axle	
01/98 → 10/04		Centre Rod	DB-DL-7815		Push Rod	
01/98 → 10/04		Centre Rod	DB-DL-7815		Push Rod, Leaf Spring Axle	
01/98 → 10/04		Centre Rod	DB-DL-8644		Push Rod	
01/98 → 10/04		Centre Rod	DB-DL-8644		Push Rod, Leaf Spring Axle	
01/98 → 10/04		Centre Rod	DB-DL-12404		for Steering Rod	
01/98 → 10/04		Centre Rod	DB-DL-12437		Push Rod	
01/98 → 10/04		Centre Rod	DB-DL-12475		Push Rod	
01/98 → 10/04		Stabiliser Mounting		DB-RK-9296		
01/98 → 10/04		Stabiliser Mounting		DB-SB-10385		
01/98 → 10/04		Stabiliser Mounting		DB-SB-10385	1st RA	
01/98 → 10/04		Stabiliser Mounting		DB-SB-10386		
01/98 → 10/04		Stabiliser Mounting		DB-SB-10407		
01/98 → 10/04		Stabiliser Mounting	DB-SB-10386	DB-SB-10386		
01/98 → 10/04		Stabiliser Mounting	DB-SB-10386	DB-SB-10386	1st FA	
01/98 → 10/04		Suspension Arm Repair Kit		DB-RK-8550	for Wishbone (CV)	
01/98 → 10/04		Suspension Strut Repair Kit		DB-RK-8555		
01/98 → 10/04		Tie Rod	DB-DL-8174		Guide Rod	
01/98 → 10/04		Tie Rod	DB-DL-12304			
01/98 → 10/04		Tie Rod End	CV-ES-14162		for Steering Rod	
01/98 → 10/04		Tie Rod End	CV-ES-14163		for Steering Rod	
01/98 → 10/04		Track Control Arm		DB-VB-10423	Wishbone (CV), Air Suspension Axle	
1517 A		01/98 → 10/04	Ball Head, gearshift linkage	DB-ES-8387		
		01/98 → 10/04	Ball Head, gearshift linkage	DB-ES-8500		
		01/98 → 10/04	Centre Rod	DB-DL-5405		Push Rod
		01/98 → 10/04	Centre Rod	DB-DL-8620		for Steering Rod
		01/98 → 10/04	Centre Rod	DB-DL-12405		Coupling Rod
		01/98 → 10/04	Stabiliser Mounting		DB-SB-10407	
	01/98 → 10/04	Stabiliser Mounting	DB-SB-10386	DB-SB-10386		
	01/98 → 10/04	Stabiliser Mounting	DB-SB-10386	DB-SB-10386	1st FA	
	01/98 → 10/04	Tie Rod	DB-DL-12311			
	01/98 → 10/04	Tie Rod End	CV-ES-14163		for Steering Rod	
1517 AK	01/98 → 10/04	Ball Head, gearshift linkage	DB-ES-8387			
	01/98 → 10/04	Ball Head, gearshift linkage	DB-ES-8500			
	01/98 → 10/04	Centre Rod	DB-DL-5405		Push Rod	
	01/98 → 10/04	Centre Rod	DB-DL-12405		Coupling Rod	
	01/98 → 10/04	Tie Rod	DB-DL-12311			
1517 K	01/98 → 10/04	Ball Head, gearshift linkage	DB-ES-8387			
	01/98 → 10/04	Ball Head, gearshift linkage	DB-ES-8500			
	01/98 → 10/04	Centre Rod	DB-DL-5405		Push Rod	
	01/98 → 10/04	Centre Rod	DB-DL-7815		Push Rod, Leaf Spring Axle	
	01/98 → 10/04	Centre Rod	DB-DL-8644		Push Rod, Leaf Spring Axle	
	01/98 → 10/04	Stabiliser Mounting		DB-SB-10386		
	01/98 → 10/04	Stabiliser Mounting		DB-SB-10407		
	01/98 → 10/04	Stabiliser Mounting	DB-SB-10386	DB-SB-10386		
	01/98 → 10/04	Stabiliser Mounting	DB-SB-10386	DB-SB-10386	1st FA	

CV-ES-14162

Length: 125
Cone Ø: d1 Ø 30 / d2 Ø 27
Thread: M30 x 1,5 LHT
4600648, 4601248, 4603448, 4603548,
0004603548, 14600348, 14601448, 14602348,
0014603748, 0014607848, 14607848, 002460
0348



CV-ES-14163

Length: 125
Cone Ø: d1 Ø 30 / d2 Ø 27
Thread: M30 x 1,5 RHT
0003305248, 0003387310, 0004600348,
0004600948, 0004602848, 0004602948,
0004608948, 0014600248, 0014600848,
0014601248, 0014602248, 0014607748,
0024600148, A0003387310, A0004600348,
A0004602848, A0004602948, A0014600848,
A0014601248, A0014602248, A0014607748



DB-DL-5405

Length: 890 Ø: 35
Cone Ø: d1 Ø 28,6 / d2 Ø 23,9
01215900A, 1460248, 0024604505, 0024604605,
0034605005, 3752600637, 3754600405,
A3752600637, A3754600405



DB-DL-7799

Length: 895 Ø: 50
Cone Ø: d1 Ø 30 / d2 Ø 26
0034605905, 3754600305, 9724601805,
9724602005



DB-DL-7815

Length: 895 Ø: 50
Cone Ø: d1 Ø 30 / d2 Ø 27
01215800A, 0034604605, 3754600005,
9744601005, 9744601205



DB-DL-8174

Length: 1605 Ø: 40
Cone Ø: d1 Ø 30 / d2 Ø 27
9753300203, 9753300303, 9753300803,
9753301703, 9753302503



DB-DL-8620

Length: 884
Ø: 50
Cone Ø: d1 Ø 30 / d2 Ø 27
Thread: M24 x 1,5 / M20 x 1,5
9744600405, 9744600805, A9744600405,
A9744600805



DB-DL-8644

Length: 894 Ø: 50
Cone Ø: d1 Ø 30 / d2 Ø 27
0034604705, 9744601105, 9744601305

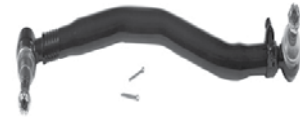

DB-DL-12304

Length: 1560 Ø: 40
Cone Ø: d1 Ø 30 / d2 Ø 27
Thread: M30 x 1,5 LHT / M30 x 1,5 RHT
9753300603, 9753300703, 9753300903,
A9753300603, A9753300703, A9753300903



DB-DL-12311

Length: 1565 Ø: 60
Cone Ø: d1 Ø 30 / d2 Ø 27
9753300003, 9753300403, 9753301003,
9753301903, A9753300003, A9753300403,
A9753301003, A9753301903

No Image

DB-DL-12404

Length: 875 Ø: 50
Cone Ø: d1 Ø 30/26 / d2 Ø 27/23,5
9724600605



DB-DL-12405

Length: 895 Ø: 50
Cone Ø: d1 Ø 30 / d2 Ø 28,6
Thread: M24 x 1,5 / M20 x 1,5
9744602205, 9764600205, 9764600405,
A9764600405



DB-DL-12437

Length: 875 Ø: 50
Cone Ø: d1 Ø 30 / d2 Ø 27
9744600005, 9744600605, A9744600005,
A9744600605



DB-DL-12475

Length: 888 Ø: 50
Cone Ø: d1 Ø 30 / d2 Ø 27
9744601505, A9744601505

No Image

DB-ES-8387

Length: 55
Cone Ø: d1 Ø 10 / d2 Ø 10
Thread: M14 x 1,5 RHT
0009966845, 0009967045



DB-ES-8500

Length: 55
Cone Ø: d1 Ø 12 / d2 Ø 10,8
Thread: M14 x 1,5 RHT
0002685989



DB-RK-8550

Ø: 75 Hole Distance: 152
Thick/Height: 24
0003502105, 0003504605



DB-RK-8555

Ø: 67 Hole Distance: 130
Thick/Height: 24
01335600A, 0003502005, 0003504705



DB-RK-9296

Ø: 88 Hole Distance: 130
Thick/Height: 24
9423260050



DB-SB-10385

Ø: 30 Thick/Height: 30
3093200073, 3143260153



DB-SB-10386

Ø: 38 Thick/Height: 38
3183200073



DB-SB-10407

Ø: 61 Thick/Height: 46
0003235985, 0003262481, 0003262981



DB-TC-12411

Length: 655 Ø: 40
Hole Distance: 115 / 115
9723500906





ATEGO ...

1517 K ...	01/98→10/04	Tie Rod	DB-DL-8174		Guide Rod
	01/98→10/04	Tie Rod	DB-DL-12304		
	01/98→10/04	Tie Rod	DB-ES-5214		Guide Rod, 1st Front Axle
	01/98→10/04	Tie Rod End	CV-ES-12461		for Steering Rod
	01/98→10/04	Tie Rod End	CV-ES-12462		for Steering Rod
	01/98→10/04	Tie Rod End	CV-ES-14162		for Steering Rod
	01/98→10/04	Tie Rod End	CV-ES-14163		for Steering Rod
1517, 1517 L	01/98→10/04	Ball Head, gearshift linkage	DB-ES-8387		
	01/98→10/04	Ball Head, gearshift linkage	DB-ES-8500		
	01/98→10/04	Centre Rod	DB-DL-5405		Push Rod
	01/98→10/04	Centre Rod	DB-DL-7815		Push Rod
	01/98→10/04	Centre Rod	DB-DL-7815		Push Rod, Leaf Spring Axle
	01/98→10/04	Centre Rod	DB-DL-8644		Push Rod
	01/98→10/04	Centre Rod	DB-DL-8644		Push Rod, Leaf Spring Axle
	01/98→10/04	Centre Rod	DB-DL-12437		Push Rod
	01/98→10/04	Stabiliser Mounting		DB-RK-9296	
	01/98→10/04	Stabiliser Mounting		DB-SB-10385	
	01/98→10/04	Stabiliser Mounting		DB-SB-10385	1st RA
	01/98→10/04	Stabiliser Mounting		DB-SB-10386	
	01/98→10/04	Stabiliser Mounting		DB-SB-10407	
	01/98→10/04	Stabiliser Mounting	DB-SB-10386	DB-SB-10386	
	01/98→10/04	Stabiliser Mounting	DB-SB-10386	DB-SB-10386	1st FA
	01/98→10/04	Suspension Arm Repair Kit		DB-RK-8550	for Wishbone (CV)
	01/98→10/04	Suspension Strut Repair Kit		DB-RK-8555	
	01/98→10/04	Tie Rod	DB-DL-8174		Guide Rod
	01/98→10/04	Tie Rod	DB-DL-12304		
	01/98→10/04	Tie Rod End	CV-ES-14162		for Steering Rod
	01/98→10/04	Tie Rod End	CV-ES-14163		for Steering Rod
01/98→10/04	Track Control Arm		DB-VB-10423	Wishbone (CV), Air Suspension Axle	
1523 A	01/98→10/04	Ball Head, gearshift linkage	DB-ES-8387		
	01/98→10/04	Ball Head, gearshift linkage	DB-ES-8500		
	01/98→10/04	Centre Rod	DB-DL-5405		Push Rod
	01/98→10/04	Centre Rod	DB-DL-12405		Coupling Rod
	01/98→10/04	Stabiliser Mounting		DB-SB-10407	
	01/98→10/04	Stabiliser Mounting	DB-SB-10386	DB-SB-10386	
	01/98→10/04	Stabiliser Mounting	DB-SB-10386	DB-SB-10386	1st FA
	01/98→10/04	Tie Rod	DB-DL-12311		
01/98→10/04	Tie Rod End	CV-ES-14163		for Steering Rod	
1523 AK	01/98→10/04	Ball Head, gearshift linkage	DB-ES-8387		
	01/98→10/04	Ball Head, gearshift linkage	DB-ES-8500		
	01/98→10/04	Centre Rod	DB-DL-5405		Push Rod
	01/98→10/04	Centre Rod	DB-DL-12405		Coupling Rod
	01/98→10/04	Stabiliser Mounting		DB-SB-10407	
	01/98→10/04	Stabiliser Mounting	DB-SB-10386	DB-SB-10386	
	01/98→10/04	Stabiliser Mounting	DB-SB-10386	DB-SB-10386	1st FA
	01/98→10/04	Tie Rod	DB-DL-12311		
01/98→10/04	Tie Rod End	CV-ES-14163		for Steering Rod	
1523 K	01/98→10/04	Ball Head, gearshift linkage	DB-ES-8387		
	01/98→10/04	Ball Head, gearshift linkage	DB-ES-8500		
	01/98→10/04	Centre Rod	DB-DL-5405		Push Rod
	01/98→10/04	Centre Rod	DB-DL-7815		Push Rod, Leaf Spring Axle
	01/98→10/04	Centre Rod	DB-DL-8644		Push Rod, Leaf Spring Axle
	01/98→10/04	Stabiliser Mounting		DB-SB-10386	
	01/98→10/04	Stabiliser Mounting		DB-SB-10407	
	01/98→10/04	Stabiliser Mounting	DB-SB-10386	DB-SB-10386	
	01/98→10/04	Stabiliser Mounting	DB-SB-10386	DB-SB-10386	1st FA
	01/98→10/04	Tie Rod	DB-DL-8174		Guide Rod
	01/98→10/04	Tie Rod	DB-DL-12304		
	01/98→10/04	Tie Rod	DB-ES-5214		Guide Rod, 1st Front Axle
	01/98→10/04	Tie Rod End	CV-ES-12461		for Steering Rod
	01/98→10/04	Tie Rod End	CV-ES-12462		for Steering Rod
	01/98→10/04	Tie Rod End	CV-ES-14162		for Steering Rod
	01/98→10/04	Tie Rod End	CV-ES-14163		for Steering Rod

CV-ES-12461

Length: 120
 Cone Ø: d1 Ø 26 / d2 Ø 23,5
 Thread: M30 x 1,5 LHT
 0003300035, 3300148, 0003406213, 0013306635,
 0013308835, 0014604048, 0014604348,
 14606448, 0024600248, 3023300035,
 3023300135, 3023300235, 3023300335,
 3453307235, 3453307435, 3503307135,
 A0003300148, A0013306635, A0013308835,
 A0014604048, A0014604348, A0014606448,
 A0024600248, A3023300035, A3023300135,
 A3023300235, A3023300335, A3503307135



CV-ES-12462

Length: 120
 Cone Ø: d1 Ø 26 / d2 Ø 23,5
 Thread: M30 x 1,5 RHT
 0003300135, 0003300248, 0003303235,
 0003305835, 0003307335, 0003383410,
 0004608348, 004608348, 0004632229,
 0004633129, 0004633429, 0004633529,
 0013300135, 0013300235, 0013306735,
 0014603448, 0014604148, 0014604448,
 0014606348, 0014608348, 0014608448,
 0014609748, 0023301535, 3453307135,
 3503307035, 3503307335, 3643307135,
 5001832582, A0003300248, A0003303235,
 A0003307335, A0003383410, A0004608348,
 A0004632229, A0004633429, A0013300135,
 A0013300235, A0013306735, A0014603448,
 A0014604148, A0014604448, A0014606348,
 A0014608348, A0014608448, A0014609748,
 A0023301535



CV-ES-14162

Length: 125
 Cone Ø: d1 Ø 30 / d2 Ø 27
 Thread: M30 x 1,5 LHT
 4600648, 4601248, 4603448, 0004603548,
 4603548, 14600348, 14601448, 14602348, 001
 460 37 48, 14607848, 0014607848, 002 460 03 48



CV-ES-14163

Length: 125
 Cone Ø: d1 Ø 30 / d2 Ø 27
 Thread: M30 x 1,5 RHT
 0003305248, 0003387310, 0004600348,
 0004600948, 0004602848, 0004602948,
 0004608948, 0014600248, 0014600848,
 0014601248, 0014602248, 0014607748,
 0024600148, A0003387310, A0004600348,
 A0004602848, A0004602948, A0014600848,
 A0014601248, A0014602248, A0014607748



DB-DL-5405

Length: 890 Ø: 35
 Cone Ø: d1 Ø 28,6 / d2 Ø 23,9
 01215900A, 1460248, 0024604505, 0024604605,
 0034605005, 3752600637, 3754600405,
 A3752600637, A3754600405



DB-DL-7815

Length: 895
 Ø: 50
 Cone Ø: d1 Ø 30 / d2 Ø 27
 01215800A, 34604605, 0034604605, 3754600005,
 9744601005, 9744601205



DB-DL-8174

Length: 1605 Ø: 40
 Cone Ø: d1 Ø 30 / d2 Ø 27
 9753300203, 9753300303, 9753300803,
 9753301703, 9753302503



DB-DL-8644

Length: 894 Ø: 50
 Cone Ø: d1 Ø 30 / d2 Ø 27
 0034604705, 9744601105, 9744601305

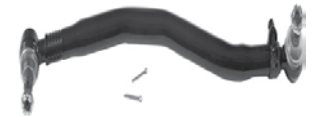

DB-DL-12304

Length: 1560 Ø: 40
 Cone Ø: d1 Ø 30 / d2 Ø 27
 Thread: M30 x 1,5 LHT / M30 x 1,5 RHT
 9753300603, 9753300703, 9753300903,
 A9753300603, A9753300703, A9753300903



DB-DL-12311

Length: 1565 Ø: 60
 Cone Ø: d1 Ø 30 / d2 Ø 27
 9753300003, 9753300403, 9753301003,
 9753301903, A9753300003, A9753300403,
 A9753301003, A9753301903

No Image

DB-DL-12405

Length: 895 Ø: 50
 Cone Ø: d1 Ø 30 / d2 Ø 28,6
 Thread: M24 x 1,5 / M20 x 1,5
 9744602205, 9764600205, 9764600405,
 A9764600405



DB-DL-12437

Length: 875 Ø: 50
 Cone Ø: d1 Ø 30 / d2 Ø 27
 9744600005, 9744600605, A9744600005,
 A9744600605



DB-ES-5214

Length: 1640 Ø: 40
 Cone Ø: d1 Ø 26 / d2 Ø 23,5
 01218000A, 9703300003, 9703300103,
 9703300203, 9703300303, 9703300403



DB-ES-8387

Length: 55
 Cone Ø: d1 Ø 10 / d2 Ø 10
 Thread: M14 x 1,5 RHT
 0009966845, 0009967045



DB-ES-8500

Length: 55
 Cone Ø: d1 Ø 12 / d2 Ø 10,8
 Thread: M14 x 1,5 RHT
 0002685989



DB-RK-8550

Ø: 75 Hole Distance: 152
 Thick/Height: 24
 0003502105, 0003504605



DB-RK-8555

Ø: 67 Hole Distance: 130
 Thick/Height: 24
 01335600A, 0003502005, 0003504705



DB-RK-9296

Ø: 88 Hole Distance: 130
 Thick/Height: 24
 9423260050



DB-SB-10385

Ø: 30 Thick/Height: 30
 3093200073, 3143260153



DB-SB-10386

Ø: 38 Thick/Height: 38
 3183200073



DB-SB-10407

Ø: 61 Thick/Height: 46
 0003235985, 0003262481, 0003262981



DB-VB-10423

Length: 761,7 Ø: 46
 Hole Ø 25 / 23 / 23
 Hole Distance: 152 / 130 / 130
 9743500005, 9743500405, 9743500505





ATEGO ...

1523 KO	01/98 → 10/04	Ball Head, gearshift linkage	DB-ES-8387			
	01/98 → 10/04	Ball Head, gearshift linkage	DB-ES-8500			
	01/98 → 10/04	Centre Rod	DB-DL-5405		Push Rod	
	01/98 → 10/04	Centre Rod	DB-DL-7815		Push Rod, Leaf Spring Axle	
	01/98 → 10/04	Centre Rod	DB-DL-8644		Push Rod, Leaf Spring Axle	
	01/98 → 10/04	Stabiliser Mounting		DB-SB-10407		
	01/98 → 10/04	Stabiliser Mounting	DB-SB-10386	DB-SB-10386		
	01/98 → 10/04	Stabiliser Mounting	DB-SB-10386	DB-SB-10386	1st FA	
	01/98 → 10/04	Tie Rod	DB-DL-8174		Guide Rod	
	01/98 → 10/04	Tie Rod	DB-DL-12304		1st FA, →504310 24	
	01/98 → 10/04	Tie Rod End	CV-ES-14162		for Steering Rod	
	01/98 → 10/04	Tie Rod End	CV-ES-14163		for Steering Rod	
	1523, 1523 L	01/98 → 10/04	Ball Head, gearshift linkage	DB-ES-8387		
		01/98 → 10/04	Ball Head, gearshift linkage	DB-ES-8500		
		01/98 → 10/04	Centre Rod	DB-DL-5405		Push Rod
		01/98 → 10/04	Centre Rod	DB-DL-7815		Push Rod
01/98 → 10/04		Centre Rod	DB-DL-7815		Push Rod, Leaf Spring Axle	
01/98 → 10/04		Centre Rod	DB-DL-8644		Push Rod	
01/98 → 10/04		Centre Rod	DB-DL-8644		Push Rod, Leaf Spring Axle	
01/98 → 10/04		Centre Rod	DB-DL-12437		Push Rod	
01/98 → 10/04		Stabiliser Mounting		DB-RK-9296		
01/98 → 10/04		Stabiliser Mounting		DB-SB-10385		
01/98 → 10/04		Stabiliser Mounting		DB-SB-10385	1st RA	
01/98 → 10/04		Stabiliser Mounting		DB-SB-10386		
01/98 → 10/04		Stabiliser Mounting		DB-SB-10407		
01/98 → 10/04		Stabiliser Mounting	DB-SB-10386	DB-SB-10386		
01/98 → 10/04		Stabiliser Mounting	DB-SB-10386	DB-SB-10386	1st FA	
01/98 → 10/04		Suspension Arm Repair Kit		DB-RK-8550	for Wishbone (CV)	
01/98 → 10/04		Suspension Strut Repair Kit		DB-RK-8555		
01/98 → 10/04		Tie Rod	DB-DL-8174		Guide Rod	
01/98 → 10/04		Tie Rod	DB-DL-12304		1st FA, →504310 24	
01/98 → 10/04		Tie Rod End	CV-ES-14162		for Steering Rod	
01/98 → 10/04		Tie Rod End	CV-ES-14163		for Steering Rod	
01/98 → 10/04		Track Control Arm		DB-VB-10423	Wishbone (CV), Air Suspension Axle	
1525 AF	01/98 → 10/04	Ball Head, gearshift linkage	DB-ES-8387			
	01/98 → 10/04	Ball Head, gearshift linkage	DB-ES-8500			
	01/98 → 10/04	Centre Rod	DB-DL-5405		Push Rod	
	01/98 → 10/04	Centre Rod	DB-DL-12405		Coupling Rod	
	01/98 → 10/04	Centre Rod	DB-DL-12475		Push Rod	
	01/98 → 10/04	Stabiliser Mounting		DB-SB-10407		
	01/98 → 10/04	Stabiliser Mounting	DB-SB-10386	DB-SB-10386		
	01/98 → 10/04	Stabiliser Mounting	DB-SB-10386	DB-SB-10386	1st FA	
	01/98 → 10/04	Tie Rod	DB-DL-12311			
	01/98 → 10/04	Tie Rod End	CV-ES-14163		for Steering Rod	
1528 AF	01/98 → 10/04	Ball Head, gearshift linkage	DB-ES-8387			
	01/98 → 10/04	Ball Head, gearshift linkage	DB-ES-8500			
	01/98 → 10/04	Centre Rod	DB-DL-5405		Push Rod	
	01/98 → 10/04	Centre Rod	DB-DL-12405		Coupling Rod	
	01/98 → 10/04	Centre Rod	DB-DL-12475		Push Rod	
	01/98 → 10/04	Stabiliser Mounting		DB-SB-10407		
	01/98 → 10/04	Stabiliser Mounting	DB-SB-10386	DB-SB-10386		
	01/98 → 10/04	Stabiliser Mounting	DB-SB-10386	DB-SB-10386	1st FA	
	01/98 → 10/04	Tie Rod	DB-DL-12311			
	01/98 → 10/04	Tie Rod End	CV-ES-14163		for Steering Rod	
1528 AK	01/98 → 09/04	Ball Head, gearshift linkage	DB-ES-8387			
	01/98 → 09/04	Ball Head, gearshift linkage	DB-ES-8500			
	01/98 → 09/04	Centre Rod	DB-DL-5405		Push Rod	
	01/98 → 09/04	Centre Rod	DB-DL-12405		Coupling Rod	
	01/98 → 09/04	Tie Rod	DB-DL-12311			
	01/98 → 09/04	Tie Rod End	CV-ES-14163		for Steering Rod	

CV-ES-14162

Length: 125
Cone Ø: d1 Ø 30 / d2 Ø 27
Thread: M30 x 1,5 LHT
4600648, 4601248, 4603448, 0004603548,
4603548, 14600348, 14601448, 14602348, 001
460 37 48, 14607848, 0014607848, 002 460 03 48



CV-ES-14163

Length: 125
Cone Ø: d1 Ø 30 / d2 Ø 27
Thread: M30 x 1,5 RHT
0003305248, 0003387310, 0004600348,
0004600948, 0004602848, 0004602948,
0004608948, 0014600248, 0014600848,
0014601248, 0014602248, 0014607748,
0024600148, A0003387310, A0004600348,
A0004602848, A0004602948, A0014600848,
A0014601248, A0014602248, A0014607748



DB-DL-5405

Length: 890 Ø: 35
Cone Ø: d1 Ø 28,6 / d2 Ø 23,9
01215900A, 1460248, 0024604505, 0024604605,
0034605005, 3752600637, 3754600405,
A3752600637, A3754600405



DB-DL-7815

Length: 895 Ø: 50
Cone Ø: d1 Ø 30 / d2 Ø 27
01215800A, 0034604605, 3754600005,
9744601005, 9744601205



DB-DL-8174

Length: 1605 Ø: 40
Cone Ø: d1 Ø 30 / d2 Ø 27
9753300203, 9753300303, 9753300803,
9753301703, 9753302503



DB-DL-8644

Length: 894 Ø: 50
Cone Ø: d1 Ø 30 / d2 Ø 27
0034604705, 9744601105, 9744601305

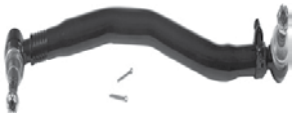

DB-DL-12304

Length: 1560 Ø: 40
Cone Ø: d1 Ø 30 / d2 Ø 27
Thread: M30 x 1,5 LHT / M30 x 1,5 RHT
9753300603, 9753300703, 9753300903,
A9753300603, A9753300703, A9753300903



DB-DL-12311

Length: 1565 Ø: 60
Cone Ø: d1 Ø 30 / d2 Ø 27
9753300003, 9753300403, 9753301003,
9753301903, A9753300003, A9753300403,
A9753301003, A9753301903

No Image

DB-DL-12405

Length: 895 Ø: 50
Cone Ø: d1 Ø 30 / d2 Ø 28,6
Thread: M24 x 1,5 / M20 x 1,5
9744602205, 9764600205, 9764600405,
A9764600405



DB-DL-12437

Length: 875 Ø: 50
Cone Ø: d1 Ø 30 / d2 Ø 27
9744600005, 9744600605, A9744600005,
A9744600605



DB-DL-12475

Length: 888 Ø: 50
Cone Ø: d1 Ø 30 / d2 Ø 27
9744601505, A9744601505

No Image

DB-ES-8387

Length: 55
Cone Ø: d1 Ø 10 / d2 Ø 10
Thread: M14 x 1,5 RHT
0009966845, 0009967045



DB-ES-8500

Length: 55
Cone Ø: d1 Ø 12 / d2 Ø 10,8
Thread: M14 x 1,5 RHT
0002685989



DB-RK-8550

Ø: 75 Hole Distance: 152
Thick/Height: 24
0003502105, 0003504605



DB-RK-8555

Ø: 67 Hole Distance: 130
Thick/Height: 24
01335600A, 0003502005, 0003504705



DB-RK-9296

Ø: 88 Hole Distance: 130
Thick/Height: 24
9423260050



DB-SB-10385

Ø: 30 Thick/Height: 30
3093200073, 3143260153



DB-SB-10386

Ø: 38 Thick/Height: 38
3183200073



DB-SB-10407

Ø: 61 Thick/Height: 46
0003235985, 0003262481, 0003262981



DB-VB-10423

Length: 761,7 Ø: 46
Hole Ø 25 / 23 / 23
Hole Distance: 152 / 130 / 130
9743500005, 9743500405, 9743500505





ATEGO ...

1528 F	01/98→10/04	Ball Head, gearshift linkage	DB-ES-8387			
	01/98→10/04	Ball Head, gearshift linkage	DB-ES-8500			
	01/98→10/04	Centre Rod	DB-DL-5405		Push Rod	
	01/98→10/04	Centre Rod	DB-DL-7815		Push Rod, Leaf Spring Axle	
	01/98→10/04	Centre Rod	DB-DL-8644		Push Rod, Leaf Spring Axle	
	01/98→10/04	Stabiliser Mounting		DB-SB-10407		
	01/98→10/04	Stabiliser Mounting	DB-SB-10386	DB-SB-10386		
	01/98→10/04	Stabiliser Mounting	DB-SB-10386	DB-SB-10386	1st FA	
	01/98→10/04	Tie Rod	DB-DL-8174		Guide Rod	
	01/98→10/04	Tie Rod	DB-DL-12304			
	01/98→10/04	Tie Rod End	CV-ES-14162		for Steering Rod	
	01/98→10/04	Tie Rod End	CV-ES-14163		for Steering Rod	
	1528 K	01/98→09/04	Centre Rod	DB-DL-5405		Push Rod
		01/98→09/04	Centre Rod	DB-DL-7815		Push Rod
01/98→09/04		Centre Rod	DB-DL-8644		Push Rod	
01/98→09/04		Tie Rod	DB-DL-8174		Guide Rod	
01/98→09/04		Tie Rod	DB-DL-12304			
01/98→09/04		Tie Rod	DB-ES-5214		Guide Rod, 1st Front Axle	
01/98→09/04		Tie Rod End	CV-ES-12461		for Steering Rod	
01/98→09/04		Tie Rod End	CV-ES-12462		for Steering Rod	
01/98→09/04		Tie Rod End	CV-ES-14162		for Steering Rod	
01/98→09/04		Tie Rod End	CV-ES-14163		for Steering Rod	
1528, 1528 L	01/98→10/04	Ball Head, gearshift linkage	DB-ES-8387			
	01/98→10/04	Ball Head, gearshift linkage	DB-ES-8500			
	01/98→10/04	Centre Rod	DB-DL-5405		Push Rod	
	01/98→10/04	Centre Rod	DB-DL-7815		Push Rod	
	01/98→10/04	Centre Rod	DB-DL-7815		Push Rod, Leaf Spring Axle	
	01/98→10/04	Centre Rod	DB-DL-8644		Push Rod	
	01/98→10/04	Centre Rod	DB-DL-8644		Push Rod, Leaf Spring Axle	
	01/98→10/04	Centre Rod	DB-DL-12437		Push Rod	
	01/98→10/04	Stabiliser Mounting		DB-RK-9296		
	01/98→10/04	Stabiliser Mounting		DB-SB-10385		
	01/98→10/04	Stabiliser Mounting		DB-SB-10385	1st RA	
	01/98→10/04	Stabiliser Mounting		DB-SB-10386		
	01/98→10/04	Stabiliser Mounting		DB-SB-10407		
	01/98→10/04	Stabiliser Mounting	DB-SB-10386	DB-SB-10386		
	01/98→10/04	Stabiliser Mounting	DB-SB-10386	DB-SB-10386	1st FA	
	01/98→10/04	Suspension Arm Repair Kit		DB-RK-8550	for Wishbone (CV)	
	01/98→10/04	Suspension Strut Repair Kit		DB-RK-8555		
	01/98→10/04	Tie Rod	DB-DL-8174		Guide Rod	
	01/98→10/04	Tie Rod	DB-DL-12304		1st FA, →504310 24	
	01/98→10/04	Tie Rod End	CV-ES-14162		for Steering Rod	
	01/98→10/04	Tie Rod End	CV-ES-14163		for Steering Rod	
	01/98→10/04	Track Control Arm		DB-VB-10423	Wishbone (CV), Air Suspension Axle	
1823 AK	04/98→10/04	Ball Head, gearshift linkage	DB-ES-8510			
	04/98→10/04	Centre Rod	DB-DL-2144		Push Rod	
	04/98→10/04	Centre Rod	DB-DL-7815		Push Rod;Suspension Rod	
	04/98→10/04	Centre Rod	DB-DL-8307		Push Rod, Leaf Spring Axle	
	04/98→10/04	Centre Rod	DB-DL-8702		Push Rod, Leaf Spring Axle	
	04/98→10/04	Centre Rod	DB-DL-12466		Push Rod	
	04/98→10/04	Rod Assembly	DB-DL-2178		Guide Rod	
	04/98→10/04	Stabiliser Mounting		DB-SB-10406		
	04/98→10/04	Suspension Arm Repair Kit		DB-RK-8626	for Wishbone (CV)	
	04/98→10/04	Suspension Arm Repair Kit		DB-RK-10374	for Wishbone (CV)	
	04/98→10/04	Tie Rod	DB-DL-12310			
	04/98→10/04	Tie Rod	DB-ES-5227		Guide Rod	
	04/98→10/04	Tie Rod	MN-DL-7834		Guide Rod	
	04/98→10/04	Tie Rod End	CV-ES-0543		for Push Rod	
	04/98→10/04	Tie Rod End	CV-ES-14162		for Steering Rod	
	04/98→10/04	Tie Rod End	CV-ES-14163		for Steering Rod	
	04/98→10/04	Tie Rod End	DB-ES-5234		for Steering Rod	
	04/98→10/04	Tie Rod End	DB-ES-8164		for Push Rod	

CV-ES-0543

Length: 125
Cone Ø: d1 Ø 32 / d2 Ø 29
Thread: M30 x 1,5 RHT
0004605748, 0004606048, 0004606848,
0004607048, 0014600448, 0014601148,
0014601748, 0014602448, 0014607648,
0014609648



CV-ES-12461

Length: 120
Cone Ø: d1 Ø 26 / d2 Ø 23,5
Thread: M30 x 1,5 LHT
0003300035, 3300148, 0003406213, 0013306635,
0013308835, 0014604048, 0014604348,
14606448, 0024600248, 3023300035,
3023300135, 3023300235, 3023300335,
3453307235, 3453307435, 3503307135,
A0003300148, A0013306635, A0013308835,
A0014604048, A0014604348, A0014606448,
A0024600248, A3023300035, A3023300135,
A3023300235, A3023300335, A3503307135



CV-ES-12462

Length: 120
Cone Ø: d1 Ø 26 / d2 Ø 23,5
Thread: M30 x 1,5 RHT
0003300135, 0003300248, 0003303235,
0003305835, 0003307335, 0003383410,
004608348, 0004608348, 0004632229,
0004633129, 0004633429, 0004633529,
0013300135, 0013300235, 0013306735,
0014603448, 0014604148, 0014604448,
0014606348, 0014608348, 0014608448,
0014609748, 0023301535, 3453307135,
3503307035, 3503307335, 3643307135,
5001832582, A0003300248, A0003303235,
A0003307335, A0003383410, A0004608348,
A0004632229, A0004633429, A0013300135,
A0013300235, A0013306735, A0014603448,
A0014604148, A0014604448, A0014606348,
A0014608348, A0014608448, A0014609748,
A0023301535



CV-ES-14162

Length: 125
Cone Ø: d1 Ø 30 / d2 Ø 27
Thread: M30 x 1,5 LHT
4600648, 4601248, 4603448, 4603548,
0004603548, 14600348, 14601448, 14602248,
0014603748, 0014607848, 14607848, 002460
0348



CV-ES-14163

Length: 125
Cone Ø: d1 Ø 30 / d2 Ø 27
Thread: M30 x 1,5 RHT
0003305248, 0003387310, 0004600348,
0004600948, 0004602848, 0004602948,
0004608948, 0014600248, 0014600848,
0014601248, 0014602248, 0014607748,
0024600148, A0003387310, A0004600348,
A0004602848, A0004602948, A0014600848,
A0014601248, A0014602248, A0014607748



DB-DL-2144

Length: 872 Ø: 35
Cone Ø: d1 Ø 28,6 / d2 Ø 23,9
0024604305, 0024604405, 0034604805



DB-DL-2178

Length: 1735 Ø: 52
Cone Ø: d1 Ø 32 / d2 Ø 29
9423300003, 9423300103, 9423300203

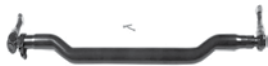

DB-DL-5405

Length: 890 Ø: 35
Cone Ø: d1 Ø 28,6 / d2 Ø 23,9
01215900A, 1460248, 0024604505, 0024604605,
0034605005, 3752600637, 3754600405,
A3752600637, A3754600405



DB-DL-7815

Length: 895
Ø: 50
Cone Ø: d1 Ø 30 / d2 Ø 27
01215800A, 34604605, 0034604605, 3754600005,
9744601005, 9744601205



DB-DL-8174

Length: 1605 Ø: 40
Cone Ø: d1 Ø 30 / d2 Ø 27
9753300203, 9753300303, 9753300803,
9753301703, 9753302503



DB-DL-8307

Length: 885 Ø: 38
Cone Ø: d1 Ø 32 / d2 Ø 30
01215500A, 0004604005, 0024605105,
0024605205, 0034604005



DB-DL-8644

Length: 894 Ø: 50
Cone Ø: d1 Ø 30 / d2 Ø 27
0034604705, 9744601105, 9744601305



DB-DL-8702

Length: 958 Ø: 38
Cone Ø: d1 Ø 32 / d2 Ø 30
0024606105, 0024606205, 0034604205



DB-DL-12304

Length: 1560 Ø: 40
Cone Ø: d1 Ø 30 / d2 Ø 27
Thread: M30 x 1,5 LHT / M30 x 1,5 RHT
9753300603, 9753300703, 9753300903,
A9753300603, A9753300703, A9753300903



DB-DL-12310

Length: 1532 Ø: 50
Cone Ø: d1 Ø 32 / d2 Ø 29
Thread: M27 x 1,5 LHT
9493301203, 9493301303, 9493301803,
9493302203, A9493301203, A9493301303,
A9493301803, A9493302203



DB-DL-12437

Length: 875 Ø: 50
Cone Ø: d1 Ø 30 / d2 Ø 27
9744600005, 9744600605, A9744600005,
A9744600605



DB-DL-12466

Length: 905 Ø: 38
Cone Ø: d1 Ø 32 / d2 Ø 29
0024605305, 0024605405, A0024605305,
A0024605405

No Image

DB-ES-5214

Length: 1640 Ø: 40
Cone Ø: d1 Ø 26 / d2 Ø 23,5
01218000A, 9703300003, 9703300103,
9703300203, 9703300303, 9703300403



DB-ES-5227

Length: 1588 Ø: 60
Cone Ø: d1 Ø 38 / d2 Ø 34,3
6253300903, 6253301203, 9443300203



DB-ES-5234

Length: 135
Cone Ø: d1 Ø 38 / d2 Ø 34,3
Thread: M38 x 1,5 RHT
0004601748, 120322305, 2205000400



DB-ES-8164

Length: 140
Cone Ø: d1 Ø 28,6 / d2 Ø 23,9
Thread: M28 x 1,5 RHT
0014604248, 0014605048, 0014608548,
0024600548



DB-ES-8387

Length: 55
Cone Ø: d1 Ø 10 / d2 Ø 10
Thread: M14 x 1,5 RHT
0009966845, 0009967045



DB-ES-8500

Length: 55
Cone Ø: d1 Ø 12 / d2 Ø 10,8
Thread: M14 x 1,5 RHT
0002685989



DB-ES-8510

Length: 56
Cone Ø: d1 Ø 10 / d2 Ø 10
Thread: M12 x 1,75 LHT
0009965145, 0009965645, 0019963145



DB-RK-8550

Ø: 75 Hole Distance: 152
Thick/Height: 24
0003502105, 0003504605



DB-RK-8555

Ø: 67 Hole Distance: 130
Thick/Height: 24
01335600A, 0003502005, 0003504705



DB-RK-8626

Ø: 75 Hole Distance: 130
Thick/Height: 24
0003502205, 0003502505, 0003503405,
0003504505, GL11319



DB-RK-9296

Ø: 88 Hole Distance: 130
Thick/Height: 24
9423260050



DB-RK-10374

Ø: 85 Hole Distance: 152
Thick/Height: 24
0003504405



DB-SB-10385

Ø: 30 Thick/Height: 30
3093200073, 3143260153



DB-SB-10386

Ø: 38 Thick/Height: 38
3183200073



DB-SB-10406

Ø: 80 Thick/Height: 46
0003238185



DB-SB-10407

Ø: 61 Thick/Height: 46
0003235985, 0003262481, 0003262981



DB-VB-10423

Length: 761,7 Ø: 46
Hole Ø 25 / 23 / 23
Hole Distance: 152 / 130 / 130
9743500005, 9743500405, 9743500505



MN-DL-7834

Length: 1588 Ø: 58
Cone Ø: d1 Ø 30 / d2 Ø 27
3463303903, 3463304903, 6253303203,
9443300503, 9443301303, 9443301703





ATEGO ...

1823 AK ...	04/98 → 10/04	Track Control Arm		DB-VB-7261	Suspension Rod, Wishbone (CV), 1st Drive Axle, →517142 01	
	04/98 → 10/04	Track Control Arm		DB-VB-10426	Wishbone (CV), 1st Drive Axle, →517142 05	
1823 K	04/98 → 10/04	Ball Head, gearshift linkage	DB-ES-8510			
	04/98 → 10/04	Centre Rod	DB-DL-2144		Push Rod	
	04/98 → 10/04	Centre Rod	DB-DL-5230		Suspension Rod	
	04/98 → 10/04	Centre Rod	DB-DL-5241		Push Rod	
	04/98 → 10/04	Centre Rod	DB-DL-5405		Push Rod, Leaf Spring Axle	
	04/98 → 10/04	Centre Rod	DB-DL-7270		Push Rod;Suspension Rod	
	04/98 → 10/04	Centre Rod	DB-DL-7815		Push Rod;Suspension Rod	
	04/98 → 10/04	Centre Rod	DB-DL-8184		Push Rod	
	04/98 → 10/04	Centre Rod	DB-DL-8185		Push Rod	
	04/98 → 10/04	Centre Rod	DB-DL-8188		Push Rod, Leaf Spring Axle	
	04/98 → 10/04	Centre Rod	DB-DL-8702		Push Rod, Leaf Spring Axle	
	04/98 → 10/04	Centre Rod	DB-DL-8717		Push Rod, Leaf Spring Axle	
	04/98 → 10/04	Centre Rod	DB-DL-12466		Push Rod	
	04/98 → 10/04	Rod Assembly	DB-DL-2178		Guide Rod	
	04/98 → 10/04	Stabiliser Mounting		DB-SB-10406		
	04/98 → 10/04	Suspension Arm Repair Kit		DB-RK-8550	for Wishbone (CV)	
	04/98 → 10/04	Tie Rod	DB-DL-8171		Guide Rod	
	04/98 → 10/04	Tie Rod	DB-DL-8327		Guide Rod	
	04/98 → 10/04	Tie Rod	DB-DL-8640		Guide Rod	
	04/98 → 10/04	Tie Rod	DB-DL-12310			
	04/98 → 10/04	Tie Rod	DB-ES-5227		Guide Rod	
	04/98 → 10/04	Tie Rod End	CV-ES-0543		for Push Rod	
	04/98 → 10/04	Tie Rod End	CV-ES-0888		for Push Rod	
	04/98 → 10/04	Tie Rod End	CV-ES-14162		for Steering Rod	
	04/98 → 10/04	Tie Rod End	CV-ES-14163		for Steering Rod	
	04/98 → 10/04	Tie Rod End	DB-ES-8164		for Push Rod	
	04/98 → 10/04	Tie Rod End	DB-ES-8530		for Push Rod	
	04/98 → 10/04	Track Control Arm		DB-VB-7261	Suspension Rod, Wishbone (CV), 1st Drive Axle, →517142 01	
	04/98 → 10/04	Track Control Arm		DB-VB-10426	Wishbone (CV), 1st Drive Axle, →517142 05	
	1823 LS	04/98 → 10/04	Ball Head, gearshift linkage	DB-ES-8510		
		04/98 → 10/04	Centre Rod	DB-DL-2144		Push Rod
		04/98 → 10/04	Centre Rod	DB-DL-5230		Suspension Rod
		04/98 → 10/04	Centre Rod	DB-DL-5241		Push Rod
04/98 → 10/04		Centre Rod	DB-DL-5405		Push Rod	
04/98 → 10/04		Centre Rod	DB-DL-7270		Push Rod;Suspension Rod	
04/98 → 10/04		Centre Rod	DB-DL-7815		Push Rod;Suspension Rod	
04/98 → 10/04		Centre Rod	DB-DL-8184		Push Rod	
04/98 → 10/04		Centre Rod	DB-DL-8185		Push Rod	
04/98 → 10/04		Centre Rod	DB-DL-8188		Push Rod, 1st FA;Leaf Spring Axle	
04/98 → 10/04		Centre Rod	DB-DL-8717		Push Rod	
04/98 → 10/04		Centre Rod	DB-DL-12466		Push Rod	
04/98 → 10/04		Rod Assembly	DB-DL-2178		Guide Rod	
04/98 → 10/04		Stabiliser Mounting		DB-RK-9296		
04/98 → 10/04		Stabiliser Mounting		DB-SB-10406		
04/98 → 10/04		Suspension Arm Repair Kit		DB-RK-8550	for Wishbone (CV)	
04/98 → 10/04		Suspension Arm Repair Kit		DB-RK-8626	for Wishbone (CV)	
04/98 → 10/04		Suspension Arm Repair Kit		DB-RK-8638	for Control Arm	
04/98 → 10/04		Suspension Arm Repair Kit		DB-RK-10374	for Wishbone (CV)	
04/98 → 10/04		Suspension Strut Repair Kit		DB-RK-9294		
04/98 → 10/04		Suspension Strut Repair Kit		MN-RK-8997		
04/98 → 10/04		Tie Rod	DB-DL-8171		Guide Rod	
04/98 → 10/04		Tie Rod	DB-DL-8327		Guide Rod	
04/98 → 10/04		Tie Rod	DB-DL-8640		Guide Rod	
04/98 → 10/04		Tie Rod	DB-DL-12310			
04/98 → 10/04		Tie Rod	DB-ES-5227		Guide Rod	
04/98 → 10/04		Tie Rod End	CV-ES-0543		for Push Rod	
04/98 → 10/04		Tie Rod End	CV-ES-0888		for Push Rod	
04/98 → 10/04		Tie Rod End	CV-ES-14162		for Steering Rod	
04/98 → 10/04		Tie Rod End	CV-ES-14163		for Steering Rod	

CV-ES-0543

Length: 125
Cone Ø: d1 Ø 32 / d2 Ø 29
Thread: M30 x 1,5 RHT
0004605748, 0004606048, 0004606848,
0004607048, 0014600448, 0014601148,
0014601748, 0014602448, 0014607648,
0014609648



CV-ES-0888

Length: 125
Cone Ø: d1 Ø 32 / d2 Ø 29
Thread: M30 x 1,5 LHT
0004605848, 0004606148, 0004606948,
0004607148, 0004609048, 0014600548,
0014601348, 0014602548, 0014607948,
0024600448



CV-ES-14162

Length: 125
Cone Ø: d1 Ø 30 / d2 Ø 27
Thread: M30 x 1,5 LHT
4600648, 4601248, 4603448, 4603548,
0004603548, 14600348, 14601448, 14602348,
001 460 37 48, 0014607848, 14607848, 002 460
03 48



CV-ES-14163

Length: 125
Cone Ø: d1 Ø 30 / d2 Ø 27
Thread: M30 x 1,5 RHT
0003305248, 0003387310, 0004600348,
0004600948, 0004602848, 0004602948,
0004608948, 0014600248, 0014600848,
0014601248, 0014602248, 0014607748,
0024600148, A0003387310, A0004600348,
A0004602848, A0004602948, A0014600848,
A0014601248, A0014602248, A0014607748



DB-DL-2144

Length: 872 Ø: 35
Cone Ø: d1 Ø 28,6 / d2 Ø 23,9
0024604305, 0024604405, 0034604805



DB-DL-2178

Length: 1735 Ø: 52
Cone Ø: d1 Ø 32 / d2 Ø 29
9423300003, 9423300103, 9423300203



DB-DL-5230

Length: 879 Ø: 42
Cone Ø: d1 Ø 30 / d2 Ø 27
01208600A, 0004607105, 0004607205,
0014606705



DB-DL-5241

Length: 875 Ø: 40
Cone Ø: d1 Ø 30 / d2 Ø 27
01215300A, 0004609205, 0004609305,
0014609605



DB-DL-5405

Length: 890 Ø: 35
Cone Ø: d1 Ø 28,6 / d2 Ø 23,9
01215900A, 1460248, 0024604505, 0024604605,
0034605005, 3752600637, 3754600405,
A3752600637, A3754600405



DB-DL-7270

Length: 875 Ø: 40
Cone Ø: d1 Ø 28,6 / d2 Ø 23,9
01208300A, 0024604705, 0024604805,
0034604905, A0024604705

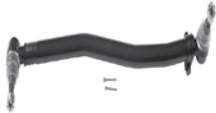

DB-DL-7815

Length: 895 Ø: 50
Cone Ø: d1 Ø 30 / d2 Ø 27
01215800A, 0034604605, 3754600005,
9744601005, 9744601205



DB-DL-8171

Length: 1687 Ø: 52
Cone Ø: d1 Ø 32 / d2 Ø 29
9493300603, 9493300703, 9493301503,
9493301603



DB-DL-8184

Length: 1095 Ø: 42
Cone Ø: d1 Ø 32 / d2 Ø 28,8
01217700A, 0014601305, 0014601405,
0024600505, 0034603205, 3754601505,
A0014601305, A0014601405, A0024600505



DB-DL-8185

Length: 711 Ø: 42
Cone Ø: d1 Ø 32 / d2 Ø 28,8
01213600A, 0014601105, 0024600405,
0034603105, A0014601105, A0024600405



DB-DL-8188

Length: 895 Ø: 40
Cone Ø: d1 Ø 28,6 / d2 Ø 23,9
01217200A, 0024604905, 0024605005,
0034605605



DB-DL-8327

Length: 1745 Ø: 48
Cone Ø: d1 Ø 32 / d2 Ø 29
01219800A, 9413300003, 9413300103,
9413300203, 9413300303, 9413300503



DB-DL-8640

Length: 1615 Ø: 50
Cone Ø: d1 Ø 32 / d2 Ø 29
6253301503, 6253301603, 6253302403,
6253302503, 9423300803, 9423302103,
9493300203, 9493300303, 9493300903



DB-DL-8702

Length: 958 Ø: 38
Cone Ø: d1 Ø 32 / d2 Ø 30
0024606105, 0024606205, 0034604205



DB-DL-8717

Length: 886
Ø: 38
Cone Ø: d1 Ø 30 / d2 Ø 27
0024601705, 24601705, 0024607505, 24607505,
0024607605, 24607605, 0034604405



DB-DL-12310

Length: 1532 Ø: 50
Cone Ø: d1 Ø 32 / d2 Ø 29
Thread: M27 x 1,5 LHT
9493301203, 9493301303, 9493301803,
9493302203, A9493301203, A9493301303,
A9493301803, A9493302203



DB-DL-12466

Length: 905 Ø: 38
Cone Ø: d1 Ø 32 / d2 Ø 29
0024605305, 0024605405, A0024605305,
A0024605405



No Image

DB-ES-5227

Length: 1588 Ø: 60
Cone Ø: d1 Ø 38 / d2 Ø 34,3
6253300903, 6253301203, 9443300203



DB-ES-8164

Length: 140
Cone Ø: d1 Ø 28,6 / d2 Ø 23,9
Thread: M28 x 1,5 RHT
0014604248, 0014605048, 0014608548,
0024600548



DB-ES-8510

Length: 56
Cone Ø: d1 Ø 10 / d2 Ø 10
Thread: M12 x 1,75 LHT
0009965145, 0009965645, 0019963145



DB-ES-8530

Length: 115
Cone Ø: d1 Ø 28,6 / d2 Ø 23,9
Thread: M30 x 1,5 RHT
0014603848, 0014604848, 0014605148,
0014608648, 0014609948



DB-RK-8550

Ø: 75 Hole Distance: 152
Thick/Height: 24
0003502105, 0003504605



DB-RK-8626

Ø: 75 Hole Distance: 130
Thick/Height: 24
0003502205, 0003502505, 0003503405,
0003504505, GL11319



DB-RK-8638

Length: 100 Ø: 67
Hole Distance: 100
Thick/Height: 20
0003301411



DB-RK-9294

Ø: 85 Hole Distance: 152
Thick/Height: 24
0003503105



DB-RK-9296

Ø: 88 Hole Distance: 130
Thick/Height: 24
9423260050



DB-RK-10374

Ø: 85 Hole Distance: 152
Thick/Height: 24
0003504405



DB-SB-10406

Ø: 80 Thick/Height: 46
0003238185



DB-VB-7261

Length: 622 Ø: 46
Hole Ø 25 / 25 / 25
Hole Distance: 152 / 130 / 130
01337800A, 9443500305, 9443500505,
9443500605, 9473500705, 9473500905,
9483500405, 9483500305



DB-VB-10426

Length: 622 Ø: 46
Hole Ø 25 / 25 / 25
Hole Distance: 152 / 130 / 130
9443500405



MN-RK-8997

Ø: 85
Hole Distance: 130
Thick/Height: 30
0003504805, 3504805





ATEGO ...

1823 LS ...	04/98 → 10/04	Tie Rod End	DB-ES-8164		for Push Rod	
	04/98 → 10/04	Tie Rod End	DB-ES-8530		for Push Rod	
	04/98 → 10/04	Track Control Arm		DB-VB-3707	Suspension Rod, Wishbone (CV), 1st RA; Air Suspension Axle	
	04/98 → 10/04	Track Control Arm		DB-VB-7798	Wishbone (CV), Air Suspension Axle	
	04/98 → 10/04	Track Control Arm	DB-DL-5224		Control Arm, 1st FA; Air Suspension Axle	
	04/98 → 10/04	Track Control Arm	DB-DL-9218	DB-DL-9218	Trailing Arm, 1st FA; Air Suspension Axle	
1823, 1823 L	01/98 → 10/04	Ball Head, gearshift linkage	DB-ES-8510			
	01/98 → 10/04	Centre Rod	DB-DL-2144		Push Rod	
	01/98 → 10/04	Centre Rod	DB-DL-5230		Suspension Rod	
	01/98 → 10/04	Centre Rod	DB-DL-5241		Push Rod	
	01/98 → 10/04	Centre Rod	DB-DL-5405		Push Rod	
	01/98 → 10/04	Centre Rod	DB-DL-5405		Push Rod, Leaf Spring Axle	
	01/98 → 10/04	Centre Rod	DB-DL-7270		Push Rod; Suspension Rod	
	01/98 → 10/04	Centre Rod	DB-DL-7815		Push Rod; Suspension Rod	
	01/98 → 10/04	Centre Rod	DB-DL-8184		Push Rod	
	01/98 → 10/04	Centre Rod	DB-DL-8185		Push Rod	
	01/98 → 10/04	Centre Rod	DB-DL-8188		Push Rod	
	01/98 → 10/04	Centre Rod	DB-DL-8188		Push Rod, 1st FA; Air Suspension Axle	
	01/98 → 10/04	Centre Rod	DB-DL-8622		Push Rod	
	01/98 → 10/04	Centre Rod	DB-DL-8702		Push Rod	
	01/98 → 10/04	Centre Rod	DB-DL-8702		Push Rod, Leaf Spring Axle	
	01/98 → 10/04	Centre Rod	DB-DL-8717		Push Rod	
	01/98 → 10/04	Centre Rod	DB-DL-8717		Push Rod, Leaf Spring Axle	
	01/98 → 10/04	Centre Rod	DB-DL-12466		Push Rod	
	01/98 → 10/04	Rod Assembly	DB-DL-2178		Guide Rod	
	01/98 → 10/04	Stabiliser Mounting		DB-RK-9296		
	01/98 → 10/04	Stabiliser Mounting		DB-SB-10406		
	01/98 → 10/04	Suspension Arm Repair Kit		DB-RK-8550	for Wishbone (CV)	
	01/98 → 10/04	Suspension Arm Repair Kit		DB-RK-8626	for Wishbone (CV)	
	01/98 → 10/04	Suspension Arm Repair Kit		DB-RK-8638	for Control Arm	
	01/98 → 10/04	Suspension Arm Repair Kit		DB-RK-10374	for Wishbone (CV)	
	01/98 → 10/04	Suspension Strut Repair Kit		DB-RK-9294		
	01/98 → 10/04	Tie Rod	DB-DL-8171		Guide Rod	
	01/98 → 10/04	Tie Rod	DB-DL-8327		Guide Rod	
	01/98 → 10/04	Tie Rod	DB-DL-8388		Guide Rod	
	01/98 → 10/04	Tie Rod	DB-DL-8389			
	01/98 → 10/04	Tie Rod	DB-DL-8640		Guide Rod	
	01/98 → 10/04	Tie Rod	DB-DL-12310			
	01/98 → 10/04	Tie Rod	DB-ES-5227		Guide Rod	
	01/98 → 10/04	Tie Rod End	CV-ES-0543		for Push Rod	
	01/98 → 10/04	Tie Rod End	CV-ES-0888		for Push Rod	
	01/98 → 10/04	Tie Rod End	CV-ES-14162		for Steering Rod	
	01/98 → 10/04	Tie Rod End	CV-ES-14163		for Steering Rod	
	01/98 → 10/04	Tie Rod End	DB-ES-8164		for Push Rod	
	01/98 → 10/04	Tie Rod End	DB-ES-8530		for Push Rod	
	01/98 → 10/04	Track Control Arm		DB-VB-3707	Suspension Rod, Wishbone (CV), 1st RA; Air Suspension Axle	
	01/98 → 10/04	Track Control Arm		DB-VB-7261	Suspension Rod, Wishbone (CV), 1st Drive Axle, →517142 01	
	01/98 → 10/04	Track Control Arm		DB-VB-10426	Wishbone (CV), 1st Drive Axle, →517142 05	
	01/98 → 10/04	Track Control Arm	DB-DL-5224		Control Arm, 1st FA; Air Suspension Axle	
	01/98 → 10/04	Track Control Arm	DB-DL-5224		Control Arm, Air Suspension Axle	
	01/98 → 10/04	Track Control Arm	DB-DL-9218	DB-DL-9218	Trailing Arm, 1st FA; Air Suspension Axle	
	1828 A	04/98 → 10/04	Ball Head, gearshift linkage	DB-ES-8510		
		04/98 → 10/04	Centre Rod	DB-DL-2144		Push Rod
04/98 → 10/04		Centre Rod	DB-DL-7815		Push Rod; Suspension Rod	
04/98 → 10/04		Centre Rod	DB-DL-8184		Push Rod	
04/98 → 10/04		Centre Rod	DB-DL-8307		Push Rod	
04/98 → 10/04		Centre Rod	DB-DL-8622		Push Rod	
04/98 → 10/04		Centre Rod	DB-DL-8702		Push Rod, Leaf Spring Axle	
04/98 → 10/04		Centre Rod	DB-DL-12466		Push Rod	
04/98 → 10/04	Rod Assembly	DB-DL-2178		Guide Rod		

CV-ES-0543

Length: 125
 Cone Ø: d1 Ø 32 / d2 Ø 29
 Thread: M30 x 1,5 RHT
 0004605748, 0004606048, 0004606848,
 0004607048, 0014600448, 0014601148,
 0014601748, 0014602448, 0014607648,
 0014609648

**CV-ES-0888**

Length: 125
 Cone Ø: d1 Ø 32 / d2 Ø 29
 Thread: M30 x 1,5 LHT
 0004605848, 0004606148, 0004606948,
 0004607148, 0004609048, 0014600548,
 0014601348, 0014602548, 0014607948,
 0024600448

**CV-ES-14162**

Length: 125
 Cone Ø: d1 Ø 30 / d2 Ø 27
 Thread: M30 x 1,5 LHT
 4600648, 4601248, 4603448, 0004603548,
 14600348, 14601448, 14602348, 0014603748,
 0014607848, 0024600348

**CV-ES-14163**

Length: 125
 Cone Ø: d1 Ø 30 / d2 Ø 27
 Thread: M30 x 1,5 RHT
 0003305248, 0003387310, 0004600348,
 0004600948, 0004602848, 0004602948,
 0004608948, 0014600248, 0014600848,
 0014601248, 0014602248, 0014607748,
 0024600148, A0003387310, A0004600348,
 A0004602848, A0004602948, A0014600848,
 A0014601248, A0014602248, A0014607748

**DB-DL-2144**

Length: 872 Ø: 35
 Cone Ø: d1 Ø 28,6 / d2 Ø 23,9
 0024604305, 0024604405, 0034604805

**DB-DL-2178**

Length: 1735 Ø: 52
 Cone Ø: d1 Ø 32 / d2 Ø 29
 9423300003, 9423300103, 9423300203

**DB-DL-5224**

Length: 850 Ø: 60
 Hole Distance: 100 / 100
 01336100A, 9413300007

**DB-DL-5230**

Length: 879 Ø: 42
 Cone Ø: d1 Ø 30 / d2 Ø 27
 01208600A, 0004607105, 0004607205,
 0014606705

**DB-DL-5241**

Length: 875 Ø: 40
 Cone Ø: d1 Ø 30 / d2 Ø 27
 01215300A, 0004609205, 0004609305,
 0014606905

**DB-DL-5405**

Length: 890 Ø: 35
 Cone Ø: d1 Ø 28,6 / d2 Ø 23,9
 01215900A, 1460248, 0024604505, 0024604605,
 0034605005, 3752600637, 3754600405,
 A3752600637, A3754600405

**DB-DL-7270**

Length: 875 Ø: 40
 Cone Ø: d1 Ø 28,6 / d2 Ø 23,9
 01208300A, 0024604705, 0024604805,
 0034604905, A0024604705

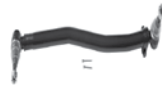
**DB-DL-7815**

Length: 895 Ø: 50
 Cone Ø: d1 Ø 30 / d2 Ø 27
 01215800A, 0034604605, 3754600005,
 9744601005, 9744601205

**DB-DL-8171**

Length: 1687 Ø: 52
 Cone Ø: d1 Ø 32 / d2 Ø 29
 9493300603, 9493300703, 9493301503,
 9493301603

**DB-DL-8184**

Length: 1095 Ø: 42
 Cone Ø: d1 Ø 32 / d2 Ø 28,8
 01217700A, 0014601305, 0014601405,
 0024600505, 0034603205, 3754601505,
 A0014601305, A0014601405, A0024600505

**DB-DL-8185**

Length: 711 Ø: 42
 Cone Ø: d1 Ø 32 / d2 Ø 28,8
 01213600A, 0014601105, 0024600405,
 0034603105, A0014601105, A0024600405

**DB-DL-8188**

Length: 895 Ø: 40
 Cone Ø: d1 Ø 28,6 / d2 Ø 23,9
 01217200A, 0024604905, 0024605005,
 0034605605

**DB-DL-8307**

Length: 885 Ø: 38
 Cone Ø: d1 Ø 32 / d2 Ø 30
 01215500A, 0004604005, 0024605105,
 0024605205, 0034604005

**DB-DL-8327**

Length: 1745 Ø: 48
 Cone Ø: d1 Ø 32 / d2 Ø 29
 01219800A, 9413300003, 9413300103,
 9413300203, 9413300303, 9413300503

**DB-DL-8388**

Length: 1735 Ø: 62
 Cone Ø: d1 Ø 32 / d2 Ø 28,8
 01219900A, 9453300003, 9453300103,
 9453300403, 9453300603, A9453300003

**DB-DL-8389**

Length: 1465 Ø: 40
 Cone Ø: d1 Ø 32 / d2 Ø 29
 9453300203, 9453300303, 9453300503

**DB-DL-8622**

Length: 1558 Ø: 52
 Cone Ø: d1 Ø 30 / d2 Ø 27
 0014609005, 0014609105

**DB-DL-8640**

Length: 1615 Ø: 50
 Cone Ø: d1 Ø 32 / d2 Ø 29
 6253301503, 6253301603, 6253302403,
 6253302503, 9423300803, 9423302103,
 9493300203, 9493300303, 9493300903

**DB-DL-8702**

Length: 958 Ø: 38
 Cone Ø: d1 Ø 32 / d2 Ø 30
 0024606105, 0024606205, 0034604205

**DB-DL-8717**

Length: 886
 Ø: 38
 Cone Ø: d1 Ø 30 / d2 Ø 27
 24601705, 0024601705, 0024607505, 24607505,
 0024607605, 24607605, 0034604405

**DB-DL-9218**

Length: 754 Ø: 40
 Hole Distance: 100
 000360098524, 000390098524, 3753300111,
 9413300011, A3753300111, SA50831601

**DB-DL-12310**

Length: 1532 Ø: 50
 Cone Ø: d1 Ø 32 / d2 Ø 29
 Thread: M27 x 1,5 LHT
 9493301203, 9493301303, 9493301803,
 9493302203, A9493301203, A9493301303,
 A9493301803, A9493302203

**DB-DL-12466**

Length: 905 Ø: 38
 Cone Ø: d1 Ø 32 / d2 Ø 29
 0024605305, 0024605405, A0024605305,
 A0024605405



No Image

DB-ES-5227

Length: 1588 Ø: 60
 Cone Ø: d1 Ø 38 / d2 Ø 34,3
 6253300903, 6253301203, 9443300203

**DB-ES-8164**

Length: 140
 Cone Ø: d1 Ø 28,6 / d2 Ø 23,9
 Thread: M28 x 1,5 RHT
 0014604248, 0014605048, 0014608548,
 0024600548

**DB-ES-8510**

Length: 56
 Cone Ø: d1 Ø 10 / d2 Ø 10
 Thread: M12 x 1,75 LHT
 0009965145, 0009965645, 0019963145

**DB-ES-8530**

Length: 115
 Cone Ø: d1 Ø 28,6 / d2 Ø 23,9
 Thread: M30 x 1,5 RHT
 0014603848, 0014604848, 0014605148,
 0014608648, 0014609948

**DB-RK-8550**

Ø: 75 Hole Distance: 152
 Thick/Height: 24
 0003502105, 0003504605

**DB-RK-8626**

Ø: 75 Hole Distance: 130
 Thick/Height: 24
 0003502205, 0003502505, 0003503405,
 0003504505, GL11319

**DB-RK-8638**

Length: 100 Ø: 67
 Hole Distance: 100
 Thick/Height: 20
 0003301411

**DB-RK-9294**

Ø: 85 Hole Distance: 152
 Thick/Height: 24
 0003503105

**DB-RK-9296**

Ø: 88 Hole Distance: 130
 Thick/Height: 24
 9423260050

**DB-RK-10374**

Ø: 85 Hole Distance: 152
 Thick/Height: 24
 0003504405

**DB-SB-10406**

Ø: 80 Thick/Height: 46
 0003238185

**DB-VB-3707**

Length: 622 Ø: 46
 Hole Ø 25 / 25 / 25
 Hole Distance: 152 / 130 / 130
 01337100A, 9423501005, 9423501505,
 9443500005, 9473500105, 9473501005,
 A3753500005, A9423501005, A9423501505,
 A9443500005, A9473500105, A9473501005

**DB-VB-7261**

Length: 622 Ø: 46
 Hole Ø 25 / 25 / 25
 Hole Distance: 152 / 130 / 130
 01337800A, 9443500305, 9443500505,
 9443500605, 9473500705, 9473500905,
 9483500405, 9483500305

**DB-VB-7798**

Length: 622 Ø: 48
 Hole Ø 25 / 23 / 23
 Hole Distance: 152 / 130 / 130
 9423500505, 9423500805, 9423501205,
 A9423501205

**DB-VB-10426**

Length: 622 Ø: 46
 Hole Ø 25 / 25 / 25
 Hole Distance: 152 / 130 / 130
 9443500405



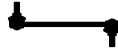

ATEGO ...

1828 A ...	04/98 → 10/04	Stabiliser Mounting		DB-SB-10406	
	04/98 → 10/04	Suspension Arm Repair Kit		DB-RK-8626	for Wishbone (CV)
	04/98 → 10/04	Suspension Arm Repair Kit		DB-RK-10374	for Wishbone (CV)
	04/98 → 10/04	Tie Rod	DB-DL-12310		
	04/98 → 10/04	Tie Rod	DB-ES-5227		Guide Rod
	04/98 → 10/04	Tie Rod	MN-DL-7834		Guide Rod
	04/98 → 10/04	Tie Rod End	CV-ES-0543		for Push Rod
	04/98 → 10/04	Tie Rod End	CV-ES-14162		for Steering Rod
	04/98 → 10/04	Tie Rod End	CV-ES-14163		for Steering Rod
	04/98 → 10/04	Tie Rod End	DB-ES-5234		for Steering Rod
1828 AK	04/98 → 10/04	Track Control Arm		DB-VB-7261	Suspension Rod, Wishbone (CV), 1st Drive Axle, →517142 01
	04/98 → 10/04	Track Control Arm		DB-VB-10426	Wishbone (CV), 1st Drive Axle, →517142 05
1828 K	04/98 → 10/04	Ball Head, gearshift linkage	DB-ES-8510		
	04/98 → 10/04	Centre Rod	DB-DL-2144		Push Rod
	04/98 → 10/04	Centre Rod	DB-DL-7815		Push Rod;Suspension Rod
	04/98 → 10/04	Centre Rod	DB-DL-8307		Push Rod, Leaf Spring Axle
	04/98 → 10/04	Centre Rod	DB-DL-8702		Push Rod, Leaf Spring Axle
	04/98 → 10/04	Centre Rod	DB-DL-12466		Push Rod
	04/98 → 10/04	Rod Assembly	DB-DL-2178		Guide Rod
	04/98 → 10/04	Stabiliser Mounting		DB-SB-10406	
	04/98 → 10/04	Suspension Arm Repair Kit		DB-RK-8626	for Wishbone (CV)
	04/98 → 10/04	Suspension Arm Repair Kit		DB-RK-10374	for Wishbone (CV)
	04/98 → 10/04	Tie Rod	DB-DL-12310		
	04/98 → 10/04	Tie Rod	DB-ES-5227		Guide Rod
	04/98 → 10/04	Tie Rod	MN-DL-7834		Guide Rod
	04/98 → 10/04	Tie Rod End	CV-ES-0543		for Push Rod
	04/98 → 10/04	Tie Rod End	CV-ES-14162		for Steering Rod
	04/98 → 10/04	Tie Rod End	CV-ES-14163		for Steering Rod
	04/98 → 10/04	Tie Rod End	DB-ES-5234		for Steering Rod
	1828 K	04/98 → 10/04	Track Control Arm		DB-VB-7261
04/98 → 10/04		Track Control Arm		DB-VB-10426	Wishbone (CV), 1st Drive Axle, →517142 05
04/98 → 10/04		Ball Head, gearshift linkage	DB-ES-8510		
04/98 → 10/04		Centre Rod	DB-DL-2144		Push Rod
04/98 → 10/04		Centre Rod	DB-DL-5230		Suspension Rod
04/98 → 10/04		Centre Rod	DB-DL-5241		Push Rod
04/98 → 10/04		Centre Rod	DB-DL-5405		Push Rod, Leaf Spring Axle
04/98 → 10/04		Centre Rod	DB-DL-7270		Push Rod;Suspension Rod
04/98 → 10/04		Centre Rod	DB-DL-7815		Push Rod;Suspension Rod
04/98 → 10/04		Centre Rod	DB-DL-8184		Push Rod
04/98 → 10/04		Centre Rod	DB-DL-8185		Push Rod
04/98 → 10/04		Centre Rod	DB-DL-8188		Push Rod, Leaf Spring Axle
04/98 → 10/04		Centre Rod	DB-DL-8702		Push Rod, Leaf Spring Axle
04/98 → 10/04		Centre Rod	DB-DL-8717		Push Rod, Leaf Spring Axle
04/98 → 10/04		Centre Rod	DB-DL-12466		Push Rod
04/98 → 10/04		Rod Assembly	DB-DL-2178		Guide Rod
04/98 → 10/04		Stabiliser Mounting		DB-SB-10406	
04/98 → 10/04		Suspension Arm Repair Kit		DB-RK-8550	for Wishbone (CV)
04/98 → 10/04		Tie Rod	DB-DL-8171		Guide Rod
04/98 → 10/04		Tie Rod	DB-DL-8327		Guide Rod
04/98 → 10/04		Tie Rod	DB-DL-8640		Guide Rod
04/98 → 10/04		Tie Rod	DB-DL-12310		
04/98 → 10/04		Tie Rod	DB-ES-5227		Guide Rod
04/98 → 10/04		Tie Rod End	CV-ES-0543		for Push Rod
04/98 → 10/04		Tie Rod End	CV-ES-0888		for Push Rod
04/98 → 10/04		Tie Rod End	CV-ES-14162		for Steering Rod
04/98 → 10/04		Tie Rod End	CV-ES-14163		for Steering Rod
04/98 → 10/04		Tie Rod End	DB-ES-8164		for Push Rod
04/98 → 10/04		Tie Rod End	DB-ES-8530		for Push Rod
04/98 → 10/04		Track Control Arm		DB-VB-7261	Suspension Rod, Wishbone (CV), 1st Drive Axle, →517142 01
04/98 → 10/04	Track Control Arm		DB-VB-10426	Wishbone (CV), 1st Drive Axle, →517142 05	

CV-ES-0543

Length: 125
Cone Ø: d1 Ø 32 / d2 Ø 29
Thread: M30 x 1,5 RHT
0004605748, 0004606048, 0004606848,
0004607048, 0014600448, 0014601148,
0014601748, 0014602448, 0014607648,
0014609648



CV-ES-0888

Length: 125
Cone Ø: d1 Ø 32 / d2 Ø 29
Thread: M30 x 1,5 LHT
0004605848, 0004606148, 0004606948,
0004607148, 0004609048, 0014600548,
0014601348, 0014602548, 0014607948,
0024600448



CV-ES-14162

Length: 125
Cone Ø: d1 Ø 30 / d2 Ø 27
Thread: M30 x 1,5 LHT
4600648, 4601248, 4603448, 0004603548,
14600348, 14601448, 14602348, 0014603748,
0014607848, 0024600348



CV-ES-14163

Length: 125
Cone Ø: d1 Ø 30 / d2 Ø 27
Thread: M30 x 1,5 RHT
0003305248, 0003387310, 0004600348,
0004600948, 0004602848, 0004602948,
0004608948, 0014600248, 0014600848,
0014601248, 0014602248, 0014607748,
0024600148, A0003387310, A0004600348,
A0004602848, A0004602948, A0014600848,
A0014601248, A0014602248, A0014607748



DB-DL-2144

Length: 872 Ø: 35
Cone Ø: d1 Ø 28,6 / d2 Ø 23,9
0024604305, 0024604405, 0034604805



DB-DL-2178

Length: 1735 Ø: 52
Cone Ø: d1 Ø 32 / d2 Ø 29
9423300003, 9423300103, 9423300203



DB-DL-5230

Length: 879 Ø: 42
Cone Ø: d1 Ø 30 / d2 Ø 27
01208600A, 0004607105, 0004607205,
0014606705



DB-DL-5241

Length: 875 Ø: 40
Cone Ø: d1 Ø 30 / d2 Ø 27
01215300A, 0004609205, 0004609305,
0014606905



DB-DL-5405

Length: 890 Ø: 35
Cone Ø: d1 Ø 28,6 / d2 Ø 23,9
01215900A, 1460248, 0024604505, 0024604605,
0034605005, 3752600637, 3754600405,
A3752600637, A3754600405



DB-DL-7270

Length: 875 Ø: 40
Cone Ø: d1 Ø 28,6 / d2 Ø 23,9
01208300A, 0024604705, 0024604805,
0034604905, A0024604705

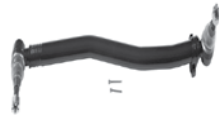

DB-DL-7815

Length: 895 Ø: 50
Cone Ø: d1 Ø 30 / d2 Ø 27
01215800A, 0034604605, 3754600005,
9744601005, 9744601205



DB-DL-8171

Length: 1687 Ø: 52
Cone Ø: d1 Ø 32 / d2 Ø 29
9493300603, 9493300703, 9493301503,
9493301603



DB-DL-8184

Length: 1095 Ø: 42
Cone Ø: d1 Ø 32 / d2 Ø 28,8
01217700A, 0014601305, 0014601405,
0024600505, 0034603205, 3754601505,
A0014601305, A0014601405, A0024600505



DB-DL-8185

Length: 711 Ø: 42
Cone Ø: d1 Ø 32 / d2 Ø 28,8
01213600A, 0014601105, 0024600405,
0034603105, A0014601105, A0024600405



DB-DL-8188

Length: 895 Ø: 40
Cone Ø: d1 Ø 28,6 / d2 Ø 23,9
01217200A, 0024604905, 0024605005,
0034605605



DB-DL-8307

Length: 885 Ø: 38
Cone Ø: d1 Ø 32 / d2 Ø 30
01215500A, 0004604005, 0024605105,
0024605205, 0034604005



DB-DL-8327

Length: 1745 Ø: 48
Cone Ø: d1 Ø 32 / d2 Ø 29
01219800A, 9413300003, 9413300103,
9413300203, 9413300303, 9413300503



DB-DL-8640

Length: 1615 Ø: 50
Cone Ø: d1 Ø 32 / d2 Ø 29
6253301503, 6253301603, 6253302403,
6253302503, 9423300803, 9423302103,
9493300203, 9493300303, 9493300903



DB-DL-8702

Length: 958 Ø: 38
Cone Ø: d1 Ø 32 / d2 Ø 30
0024606105, 0024606205, 0034604205



DB-DL-8717

Length: 886 Ø: 38
Cone Ø: d1 Ø 30 / d2 Ø 27
0024601705, 0024607505, 0024607605,
0034604405



DB-DL-12310

Length: 1532 Ø: 50
Cone Ø: d1 Ø 32 / d2 Ø 29
Thread: M27 x 1,5 LHT
9493301203, 9493301303, 9493301803,
9493302203, A9493301203, A9493301303,
A9493301803, A9493302203



DB-DL-12466

Length: 905 Ø: 38
Cone Ø: d1 Ø 32 / d2 Ø 29
0024605305, 0024605405, A0024605305,
A0024605405



No Image

DB-ES-5227

Length: 1588 Ø: 60
Cone Ø: d1 Ø 38 / d2 Ø 34,3
6253300903, 6253301203, 9443300203



DB-ES-5234

Length: 135
Cone Ø: d1 Ø 38 / d2 Ø 34,3
Thread: M38 x 1,5 RHT
0004601748, 120322305, 2205000400



DB-ES-8164

Length: 140
Cone Ø: d1 Ø 28,6 / d2 Ø 23,9
Thread: M28 x 1,5 RHT
0014604248, 0014605048, 0014608548,
0024600548



DB-ES-8510

Length: 56
Cone Ø: d1 Ø 10 / d2 Ø 10
Thread: M12 x 1,75 LHT
0009965145, 0009965645, 0019963145



DB-ES-8530

Length: 115
Cone Ø: d1 Ø 28,6 / d2 Ø 23,9
Thread: M30 x 1,5 RHT
0014603848, 0014604848, 0014605148,
0014608648, 0014609948



DB-RK-8550

Ø: 75 Hole Distance: 152
Thick/Height: 24
0003502105, 0003504605



DB-RK-8626

Ø: 75 Hole Distance: 130
Thick/Height: 24
0003502205, 0003502505, 0003503405,
0003504505, GL11319



DB-RK-10374

Ø: 85 Hole Distance: 152
Thick/Height: 24
0003504405



DB-SB-10406

Ø: 80 Thick/Height: 46
0003238185



DB-VB-7261

Length: 622 Ø: 46
Hole Ø 25 / 25 / 25
Hole Distance: 152 / 130 / 130
01337800A, 9443500305, 9443500505,
9443500605, 9473500705, 9473500905,
9483500405, 9483500305



DB-VB-10426

Length: 622 Ø: 46
Hole Ø 25 / 25 / 25
Hole Distance: 152 / 130 / 130
9443500405



MN-DL-7834

Length: 1588 Ø: 58
Cone Ø: d1 Ø 30 / d2 Ø 27
3463303903, 3463304903, 6253303203,
9443300503, 9443301303, 9443301703





ATEGO ...

1828 LS	04/98 → 10/04	Ball Head, gearshift linkage	DB-ES-8510			
	04/98 → 10/04	Centre Rod	DB-DL-2144		Push Rod	
	04/98 → 10/04	Centre Rod	DB-DL-5230		Suspension Rod	
	04/98 → 10/04	Centre Rod	DB-DL-5241		Push Rod	
	04/98 → 10/04	Centre Rod	DB-DL-5405		Push Rod	
	04/98 → 10/04	Centre Rod	DB-DL-7270		Push Rod;Suspension Rod	
	04/98 → 10/04	Centre Rod	DB-DL-7815		Push Rod;Suspension Rod	
	04/98 → 10/04	Centre Rod	DB-DL-8184		Push Rod	
	04/98 → 10/04	Centre Rod	DB-DL-8185		Push Rod	
	04/98 → 10/04	Centre Rod	DB-DL-8188		Push Rod, 1st FA;Leaf Spring Axle	
	04/98 → 10/04	Centre Rod	DB-DL-8717		Push Rod	
	04/98 → 10/04	Centre Rod	DB-DL-12466		Push Rod	
	04/98 → 10/04	Rod Assembly	DB-DL-2178		Guide Rod	
	04/98 → 10/04	Stabiliser Mounting		DB-RK-9296		
	04/98 → 10/04	Stabiliser Mounting		DB-SB-10406		
	04/98 → 10/04	Suspension Arm Repair Kit		DB-RK-8550	for Wishbone (CV)	
	04/98 → 10/04	Suspension Arm Repair Kit		DB-RK-8626	for Wishbone (CV)	
	04/98 → 10/04	Suspension Arm Repair Kit		DB-RK-8638	for Control Arm	
	04/98 → 10/04	Suspension Arm Repair Kit		DB-RK-10374	for Wishbone (CV)	
	04/98 → 10/04	Suspension Strut Repair Kit		DB-RK-9294		
	04/98 → 10/04	Suspension Strut Repair Kit		MN-RK-8997		
	04/98 → 10/04	Tie Rod	DB-DL-8171		Guide Rod	
	04/98 → 10/04	Tie Rod	DB-DL-8327		Guide Rod	
	04/98 → 10/04	Tie Rod	DB-DL-8640		Guide Rod	
	04/98 → 10/04	Tie Rod	DB-DL-12310			
	04/98 → 10/04	Tie Rod	DB-ES-5227		Guide Rod	
	04/98 → 10/04	Tie Rod End	CV-ES-0543		for Push Rod	
	04/98 → 10/04	Tie Rod End	CV-ES-0888		for Push Rod	
	04/98 → 10/04	Tie Rod End	CV-ES-14162		for Steering Rod	
	04/98 → 10/04	Tie Rod End	CV-ES-14163		for Steering Rod	
	04/98 → 10/04	Tie Rod End	DB-ES-8164		for Push Rod	
	04/98 → 10/04	Tie Rod End	DB-ES-8530		for Push Rod	
	04/98 → 10/04	Track Control Arm		DB-VB-3707	Suspension Rod, Wishbone (CV), 1st RA; Air Suspension Axle	
	04/98 → 10/04	Track Control Arm		DB-VB-7798	Wishbone (CV), Air Suspension Axle	
	04/98 → 10/04	Track Control Arm	DB-DL-5224		Control Arm, 1st FA;Air Suspension Axle	
	04/98 → 10/04	Track Control Arm	DB-DL-9218	DB-DL-9218	Trailing Arm, 1st FA;Air Suspension Axle	
	1828, 1828 L	04/98 → 10/04	Ball Head, gearshift linkage	DB-ES-8510		
		04/98 → 10/04	Centre Rod	DB-DL-2144		Push Rod
		04/98 → 10/04	Centre Rod	DB-DL-5230		Suspension Rod
		04/98 → 10/04	Centre Rod	DB-DL-5241		Push Rod
04/98 → 10/04		Centre Rod	DB-DL-5405		Push Rod	
04/98 → 10/04		Centre Rod	DB-DL-5405		Push Rod, Leaf Spring Axle	
04/98 → 10/04		Centre Rod	DB-DL-7270		Push Rod;Suspension Rod	
04/98 → 10/04		Centre Rod	DB-DL-7815		Push Rod;Suspension Rod	
04/98 → 10/04		Centre Rod	DB-DL-8184		Push Rod	
04/98 → 10/04		Centre Rod	DB-DL-8185		Push Rod	
04/98 → 10/04		Centre Rod	DB-DL-8188		Push Rod	
04/98 → 10/04		Centre Rod	DB-DL-8188		Push Rod, 1st FA;Air Suspension Axle	
04/98 → 10/04		Centre Rod	DB-DL-8622		Push Rod	
04/98 → 10/04		Centre Rod	DB-DL-8702		Push Rod	
04/98 → 10/04		Centre Rod	DB-DL-8702		Push Rod, Leaf Spring Axle	
04/98 → 10/04		Centre Rod	DB-DL-8717		Push Rod	
04/98 → 10/04		Centre Rod	DB-DL-8717		Push Rod, Leaf Spring Axle	
04/98 → 10/04		Centre Rod	DB-DL-12466		Push Rod	
04/98 → 10/04		Rod Assembly	DB-DL-2178		Guide Rod	
04/98 → 10/04		Stabiliser Mounting		DB-RK-9296		
04/98 → 10/04		Stabiliser Mounting		DB-SB-10406		
04/98 → 10/04		Suspension Arm Repair Kit		DB-RK-8550	for Wishbone (CV)	
04/98 → 10/04		Suspension Arm Repair Kit		DB-RK-8626	for Wishbone (CV)	
04/98 → 10/04		Suspension Arm Repair Kit		DB-RK-8638	for Control Arm	
04/98 → 10/04		Suspension Arm Repair Kit		DB-RK-10374	for Wishbone (CV)	
04/98 → 10/04		Suspension Strut Repair Kit		DB-RK-9294		

CV-ES-0543

Length: 125
Cone Ø: d1 Ø 32 / d2 Ø 29
Thread: M30 x 1,5 RHT
 0004605748, 0004606048, 0004606848,
 0004607048, 0014600448, 0014601148,
 0014601748, 0014602448, 0014607648,
 0014609648



CV-ES-0888

Length: 125
Cone Ø: d1 Ø 32 / d2 Ø 29
Thread: M30 x 1,5 LHT
 0004605848, 0004606148, 0004606948,
 0004607148, 0004609048, 0014600548,
 0014601348, 0014602548, 0014607948,
 0024600448



CV-ES-14162

Length: 125
Cone Ø: d1 Ø 30 / d2 Ø 27
Thread: M30 x 1,5 LHT
 4600648, 4601248, 4603448, 0004603548,
 14600348, 14601448, 14602348, 0014603748,
 0014607848, 0024600348



CV-ES-14163

Length: 125
Cone Ø: d1 Ø 30 / d2 Ø 27
Thread: M30 x 1,5 RHT
 0003305248, 0003387310, 0004600348,
 0004600948, 0004602848, 0004602948,
 0004608948, 0014600248, 0014600848,
 0014601248, 0014602248, 0014607748,
 0024600148, A0003387310, A0004600348,
 A0004602848, A0004602948, A0014600848,
 A0014601248, A0014602248, A0014607748



DB-DL-2144

Length: 872 Ø: 35
Cone Ø: d1 Ø 28,6 / d2 Ø 23,9
 0024604305, 0024604405, 0034604805



DB-DL-2178

Length: 1735 Ø: 52
Cone Ø: d1 Ø 32 / d2 Ø 29
 9423300003, 9423300103, 9423300203



DB-DL-5224

Length: 850 Ø: 60
Hole Distance: 100 / 100
 01336100A, 9413300007



DB-DL-5230

Length: 879 Ø: 42
Cone Ø: d1 Ø 30 / d2 Ø 27
 01208600A, 0004607105, 0004607205,
 0014606705



DB-DL-5241

Length: 875 Ø: 40
Cone Ø: d1 Ø 30 / d2 Ø 27
 01215300A, 0004609205, 0004609305,
 0014606905



DB-DL-5405

Length: 890 Ø: 35
Cone Ø: d1 Ø 28,6 / d2 Ø 23,9
 01215900A, 1460248, 0024604505, 0024604605,
 0034605005, 3752600637, 3754600405,
 A3752600637, A3754600405



DB-DL-7270

Length: 875 Ø: 40
Cone Ø: d1 Ø 28,6 / d2 Ø 23,9
 01208300A, 0024604705, 0024604805,
 0034604905, A0024604705

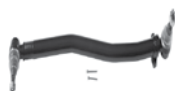

DB-DL-7815

Length: 895 Ø: 50
Cone Ø: d1 Ø 30 / d2 Ø 27
 01215800A, 0034604605, 3754600005,
 9744601005, 9744601205



DB-DL-8171

Length: 1687 Ø: 52
Cone Ø: d1 Ø 32 / d2 Ø 29
 9493300603, 9493300703, 9493301503,
 9493301603



DB-DL-8184

Length: 1095 Ø: 42
Cone Ø: d1 Ø 32 / d2 Ø 28,8
 01217700A, 0014601305, 0014601405,
 0024600505, 0034603205, 3754601505,
 A0014601305, A0014601405, A0024600505



DB-DL-8185

Length: 711 Ø: 42
Cone Ø: d1 Ø 32 / d2 Ø 28,8
 01213600A, 0014601105, 0024600405,
 0034603105, A0014601105, A0024600405



DB-DL-8188

Length: 895 Ø: 40
Cone Ø: d1 Ø 28,6 / d2 Ø 23,9
 01217200A, 0024604905, 0024605005,
 0034605605



DB-DL-8327

Length: 1745 Ø: 48
Cone Ø: d1 Ø 32 / d2 Ø 29
 01219800A, 9413300003, 9413300103,
 9413300203, 9413300303, 9413300503



DB-DL-8622

Length: 1558 Ø: 52
Cone Ø: d1 Ø 30 / d2 Ø 27
 0014609005, 0014609105



DB-DL-8640

Length: 1615 Ø: 50
Cone Ø: d1 Ø 32 / d2 Ø 29
 6253301503, 6253301603, 6253302403,
 6253302503, 9423300803, 9423302103,
 9493300203, 9493300303, 9493300903



DB-DL-8702

Length: 958 Ø: 38
Cone Ø: d1 Ø 32 / d2 Ø 30
 0024606105, 0024606205, 0034604205



DB-DL-8717

Length: 886 Ø: 38
Cone Ø: d1 Ø 30 / d2 Ø 27
 0024601705, 0024607505, 0024607605,
 0034604405



DB-DL-9218

Length: 754 Ø: 40
Hole Distance: 100
 000360098524, 000390098524, 3753300111,
 9413300011, A3753300111, SA50831601



DB-DL-12310

Length: 1532 Ø: 50
Cone Ø: d1 Ø 32 / d2 Ø 29
Thread: M27 x 1,5 LHT
 9493301203, 9493301303, 9493301803,
 9493302203, A9493301203, A9493301303,
 A9493301803, A9493302203



DB-DL-12466

Length: 905 Ø: 38
Cone Ø: d1 Ø 32 / d2 Ø 29
 0024605305, 0024605405, A0024605305,
 A0024605405

No Image

DB-ES-5227

Length: 1588 Ø: 60
Cone Ø: d1 Ø 38 / d2 Ø 34,3
 6253300903, 6253301203, 9443300203



DB-ES-8164

Length: 140
Cone Ø: d1 Ø 28,6 / d2 Ø 23,9
Thread: M28 x 1,5 RHT
 0014604248, 0014605048, 0014605848,
 0024600548



DB-ES-8510

Length: 56
Cone Ø: d1 Ø 10 / d2 Ø 10
Thread: M12 x 1,75 LHT
 0009965145, 0009965645, 0019963145



DB-ES-8530

Length: 115
Cone Ø: d1 Ø 28,6 / d2 Ø 23,9
Thread: M30 x 1,5 RHT
 0014603848, 0014604848, 0014605148,
 0014608648, 0014609948



DB-RK-8550

Ø: 75 **Hole Distance:** 152
Thick/Height: 24
 0003502105, 0003504605



DB-RK-8626

Ø: 75 **Hole Distance:** 130
Thick/Height: 24
 0003502205, 0003502505, 0003503405,
 0003504505, GL11319



DB-RK-8638

Length: 100 **Ø:** 67
Hole Distance: 100
Thick/Height: 20
 0003301411



DB-RK-9294

Ø: 85 **Hole Distance:** 152
Thick/Height: 24
 0003503105



DB-RK-9296

Ø: 88 **Hole Distance:** 130
Thick/Height: 24
 9423260050



DB-RK-10374

Ø: 85 **Hole Distance:** 152
Thick/Height: 24
 0003504405



DB-SB-10406

Ø: 80 **Thick/Height:** 46
 0003238185



DB-VB-3707

Length: 622 **Ø:** 46
Hole Ø: 25 / 25 / 25
Hole Distance: 152 / 130 / 130
 01337100A, 9423501005, 9423501505,
 9443500005, 9473500105, 9473501005,
 A3753500005, A9423501005, A9423501505,
 A9443500005, A9473500105, A9473501005



DB-VB-7798

Length: 622 **Ø:** 48
Hole Ø: 25 / 23 / 23
Hole Distance: 152 / 130 / 130
 9423500505, 9423500805, 9423501205,
 A9423501205



MN-RK-8997

Ø: 85 **Hole Distance:** 130
Thick/Height: 30
 0003504805



MERCEDES-BENZ



ATEGO ...

1828, 1828 L ...	04/98→10/04	Tie Rod	DB-DL-8171		Guide Rod	
	04/98→10/04	Tie Rod	DB-DL-8327		Guide Rod	
	04/98→10/04	Tie Rod	DB-DL-8388		Guide Rod	
	04/98→10/04	Tie Rod	DB-DL-8389			
	04/98→10/04	Tie Rod	DB-DL-8640		Guide Rod	
	04/98→10/04	Tie Rod	DB-DL-12310			
	04/98→10/04	Tie Rod	DB-ES-5227		Guide Rod	
	04/98→10/04	Tie Rod End	CV-ES-0543		for Push Rod	
	04/98→10/04	Tie Rod End	CV-ES-0888		for Push Rod	
	04/98→10/04	Tie Rod End	CV-ES-14162		for Steering Rod	
	04/98→10/04	Tie Rod End	CV-ES-14163		for Steering Rod	
	04/98→10/04	Tie Rod End	DB-ES-8164		for Push Rod	
	04/98→10/04	Tie Rod End	DB-ES-8530		for Push Rod	
	04/98→10/04	Track Control Arm		DB-VB-3707	Suspension Rod, Wishbone (CV), 1st RA; Air Suspension Axle	
	04/98→10/04	Track Control Arm		DB-VB-7261	Suspension Rod, Wishbone (CV), 1st Drive Axle, →517142 01	
	1923 L	04/98→10/04	Track Control Arm		DB-VB-10426	Wishbone (CV), 1st Drive Axle, →517142 05
		04/98→10/04	Track Control Arm	DB-DL-5224		Control Arm, 1st FA;Air Suspension Axle
04/98→10/04		Track Control Arm	DB-DL-9218	DB-DL-9218	Trailing Arm, 1st FA;Air Suspension Axle	
04/98→10/04		Centre Rod	DB-DL-5405		Push Rod	
04/98→10/04		Centre Rod	DB-DL-7815		Push Rod	
1928 L	04/98→10/04	Centre Rod	DB-DL-8644		Push Rod	
	04/98→10/04	Suspension Arm Repair Kit		DB-RK-8550	for Wishbone (CV)	
	04/98→10/04	Tie Rod	DB-DL-8174		Guide Rod	
	04/98→10/04	Tie Rod	DB-DL-12304			
	04/98→10/04	Tie Rod End	CV-ES-14162		for Steering Rod	
	04/98→10/04	Tie Rod End	CV-ES-14163		for Steering Rod	
	04/98→10/04	Track Control Arm		DB-VB-10423	Wishbone (CV), Air Suspension Axle	
	2223 L	04/98→10/04	Centre Rod	DB-DL-5405		Push Rod
		04/98→10/04	Centre Rod	DB-DL-7815		Push Rod
		04/98→10/04	Centre Rod	DB-DL-8644		Push Rod
04/98→10/04		Suspension Arm Repair Kit		DB-RK-8550	for Wishbone (CV)	
04/98→10/04		Tie Rod	DB-DL-8174		Guide Rod	
04/98→10/04		Tie Rod End	CV-ES-14162		for Steering Rod	
04/98→10/04		Tie Rod End	CV-ES-14163		for Steering Rod	
04/98→10/04		Track Control Arm		DB-VB-10423	Wishbone (CV), Air Suspension Axle	
2228 L	04/98→10/04	Centre Rod	DB-DL-5405		Push Rod	
	04/98→10/04	Centre Rod	DB-DL-7815		Push Rod	
	04/98→10/04	Centre Rod	DB-DL-8644		Push Rod	
	04/98→10/04	Suspension Arm Repair Kit		DB-RK-8550	for Wishbone (CV)	
	04/98→10/04	Tie Rod	DB-DL-8174		Guide Rod	
	04/98→10/04	Tie Rod End	CV-ES-14162		for Steering Rod	
	04/98→10/04	Tie Rod End	CV-ES-14163		for Steering Rod	
	04/98→10/04	Track Control Arm		DB-VB-10423	Wishbone (CV), Air Suspension Axle	
2523 L	04/98→10/04	Ball Head, gearshift linkage	DB-ES-8510			
	04/98→10/04	Centre Rod	DB-DL-2144		Push Rod	
	04/98→10/04	Centre Rod	DB-DL-5230		Suspension Rod	
	04/98→10/04	Centre Rod	DB-DL-5241		Push Rod	
	04/98→10/04	Centre Rod	DB-DL-5405		Push Rod	
	04/98→10/04	Centre Rod	DB-DL-7270		Push Rod;Suspension Rod	
	04/98→10/04	Centre Rod	DB-DL-7815		Push Rod;Suspension Rod	
	04/98→10/04	Centre Rod	DB-DL-8184		Push Rod	
	04/98→10/04	Centre Rod	DB-DL-8185		Push Rod	

CV-ES-0543

Length: 125
Cone Ø: d1 Ø 32 / d2 Ø 29
Thread: M30 x 1,5 RHT
0004605748, 0004606048, 0004606848,
0004607048, 0014600448, 0014601148,
0014601748, 0014602448, 0014607648,
0014609648



CV-ES-0888

Length: 125
Cone Ø: d1 Ø 32 / d2 Ø 29
Thread: M30 x 1,5 LHT
0004605848, 0004606148, 0004606948,
0004607148, 0004609048, 0014600548,
0014601348, 0014602548, 0014607948,
0024600448



CV-ES-14162

Length: 125
Cone Ø: d1 Ø 30 / d2 Ø 27
Thread: M30 x 1,5 LHT
4600648, 4601248, 4603448, 0004603548,
4603548, 14600348, 14601448, 14602348, 001
460 37 48, 14607848, 0014607848, 002 460 03 48



CV-ES-14163

Length: 125
Cone Ø: d1 Ø 30 / d2 Ø 27
Thread: M30 x 1,5 RHT
0003305248, 0003387310, 0004600348,
0004600948, 0004602848, 0004602948,
0004608948, 0014600248, 0014600848,
0014601248, 0014602248, 0014607748,
0024600148, A0003387310, A0004600348,
A0004602848, A0004602948, A0014600848,
A0014601248, A0014602248, A0014607748



DB-DL-2144

Length: 872 Ø: 35
Cone Ø: d1 Ø 28,6 / d2 Ø 23,9
0024604305, 0024604405, 0034604805



DB-DL-5224

Length: 850 Ø: 60
Hole Distance: 100 / 100
01336100A, 9413300007



DB-DL-5230

Length: 879 Ø: 42
Cone Ø: d1 Ø 30 / d2 Ø 27
01208600A, 0004607105, 0004607205,
0014606705



DB-DL-5241

Length: 875 Ø: 40
Cone Ø: d1 Ø 30 / d2 Ø 27
01215300A, 0004609205, 0004609305,
0014606905



DB-DL-5405

Length: 890 Ø: 35
Cone Ø: d1 Ø 28,6 / d2 Ø 23,9
01215900A, 1460248, 0024604505, 0024604605,
0034605005, 3752600637, 3754600405,
A3752600637, A3754600405



DB-DL-7270

Length: 875 Ø: 40
Cone Ø: d1 Ø 28,6 / d2 Ø 23,9
01208300A, 0024604705, 0024604805,
0034604905, A0024604705



DB-DL-7815

Length: 895 Ø: 50
Cone Ø: d1 Ø 30 / d2 Ø 27
01215800A, 0034604605, 3754600005,
9744601005, 9744601205



DB-DL-8171

Length: 1687 Ø: 52
Cone Ø: d1 Ø 32 / d2 Ø 29
9493300603, 9493300703, 9493301503,
9493301603



DB-DL-8174

Length: 1605 Ø: 40
Cone Ø: d1 Ø 30 / d2 Ø 27
9753300203, 9753300303, 9753300803,
9753301703, 9753302503



DB-DL-8184

Length: 1095 Ø: 42
Cone Ø: d1 Ø 32 / d2 Ø 28,8
01217700A, 0014601305, 0014601405,
0024600505, 0034603205, 3754601505,
A0014601305, A0014601405, A0024600505



DB-DL-8185

Length: 711 Ø: 42
Cone Ø: d1 Ø 32 / d2 Ø 28,8
01213600A, 0014601105, 0024600405,
0034603105, A0014601105, A0024600405



DB-DL-8327

Length: 1745 Ø: 48
Cone Ø: d1 Ø 32 / d2 Ø 29
01219800A, 9413300003, 9413300103,
9413300203, 9413300303, 9413300503



DB-DL-8388

Length: 1735 Ø: 62
Cone Ø: d1 Ø 32 / d2 Ø 28,8
01219900A, 9453300003, 9453300103,
9453300403, 9453300603, A9453300003



DB-DL-8389

Length: 1465 Ø: 40
Cone Ø: d1 Ø 32 / d2 Ø 29
9453300203, 9453300303, 9453300503



DB-DL-8640

Length: 1615 Ø: 50
Cone Ø: d1 Ø 32 / d2 Ø 29
6253301503, 6253301603, 6253302403,
6253302503, 9423300803, 9423302103,
9493300203, 9493300303, 9493300903



DB-DL-8644

Length: 894 Ø: 50
Cone Ø: d1 Ø 30 / d2 Ø 27
0034604705, 9744601105, 9744601305



DB-DL-9218

Length: 754 Ø: 40
Hole Distance: 100
000360098524, 000390098524, 3753300111,
9413300011, A3753300111, SA50831601



DB-DL-12304

Length: 1560 Ø: 40
Cone Ø: d1 Ø 30 / d2 Ø 27
Thread: M30 x 1,5 LHT / M30 x 1,5 RHT
9753300603, 9753300703, 9753300903,
A9753300603, A9753300703, A9753300903



DB-DL-12310

Length: 1532 Ø: 50
Cone Ø: d1 Ø 32 / d2 Ø 29
Thread: M27 x 1,5 LHT
9493301203, 9493301303, 9493301803,
9493302203, A9493301203, A9493301303,
A9493301803, A9493302203



DB-ES-5227

Length: 1588 Ø: 60
Cone Ø: d1 Ø 38 / d2 Ø 34,3
6253300903, 6253301203, 9443300203



DB-ES-8164

Length: 140
Cone Ø: d1 Ø 28,6 / d2 Ø 23,9
Thread: M28 x 1,5 RHT
0014604248, 0014605048, 0014608548,
0024600548



DB-ES-8510

Length: 56
Cone Ø: d1 Ø 10 / d2 Ø 10
Thread: M12 x 1,75 LHT
0009965145, 0009965645, 0019963145



DB-ES-8530

Length: 115
Cone Ø: d1 Ø 28,6 / d2 Ø 23,9
Thread: M30 x 1,5 RHT
0014603848, 0014604848, 0014605148,
0014608648, 0014609948



DB-RK-8550

Ø: 75 Hole Distance: 152
Thick/Height: 24
0003502105, 0003504605



DB-VB-3707

Length: 622 Ø: 46
Hole Ø 25 / 25 / 25
Hole Distance: 152 / 130 / 130
01337100A, 9423501005, 9423501505,
9443500005, 9473500105, 9473501005,
A3753500005, A9423501005, A9423501505,
A9443500005, A9473500105, A9473501005



DB-VB-7261

Length: 622 Ø: 46
Hole Ø 25 / 25 / 25
Hole Distance: 152 / 130 / 130
01337800A, 9443500305, 9443500505,
9443500605, 9473500705, 9473500905,
9483500405, 9483500505



DB-VB-10423

Length: 761,7 Ø: 46
Hole Ø 25 / 23 / 23
Hole Distance: 152 / 130 / 130
9743500005, 9743500405, 9743500505



DB-VB-10426

Length: 622 Ø: 46
Hole Ø 25 / 25 / 25
Hole Distance: 152 / 130 / 130
9443500405





ATEGO ...

2523 L ...	04/98→10/04	Centre Rod	DB-DL-8622		Push Rod
	04/98→10/04	Centre Rod	DB-DL-8642		Push Rod
	04/98→10/04	Centre Rod	DB-DL-12298		for Steering Rod
	04/98→10/04	Centre Rod	DB-DL-12438		for Steering Rod
	04/98→10/04	Centre Rod	DB-DL-12466		Push Rod
	04/98→10/04	Rod Assembly	DB-DL-2178		Guide Rod
	04/98→10/04	Suspension Arm Repair Kit		DB-RK-8626	for Wishbone (CV)
	04/98→10/04	Suspension Arm Repair Kit		DB-RK-8638	for Control Arm
	04/98→10/04	Suspension Arm Repair Kit		DB-RK-10374	for Wishbone (CV)
	04/98→10/04	Suspension Strut Repair Kit		DB-RK-9294	
	04/98→10/04	Tie Rod	DB-DL-8172		Guide Rod
	04/98→10/04	Tie Rod	DB-DL-8327		Guide Rod
	04/98→10/04	Tie Rod	DB-DL-8388		Guide Rod
	04/98→10/04	Tie Rod	DB-DL-8389		
	04/98→10/04	Tie Rod	DB-DL-12310		
	04/98→10/04	Tie Rod	DB-ES-5227		Guide Rod
	04/98→10/04	Tie Rod End	CV-ES-0543		for Push Rod
	04/98→10/04	Tie Rod End	CV-ES-0888	CV-ES-0888	for Push Rod
	04/98→10/04	Tie Rod End	CV-ES-14162		for Steering Rod
	04/98→10/04	Tie Rod End	CV-ES-14163		for Steering Rod
	04/98→10/04	Tie Rod End	DB-ES-8164		for Push Rod
	04/98→10/04	Track Control Arm		DB-DL-9218	Trailing Arm, Leading Axle Steered, →532040 04
	04/98→10/04	Track Control Arm		DB-VB-3707	Suspension Rod, Wishbone (CV), 1st RA; Air Suspension Axle
	2528 L	04/98→10/04	Ball Head, gearshift linkage	DB-ES-8510	
04/98→10/04		Centre Rod	DB-DL-2144		Push Rod
04/98→10/04		Centre Rod	DB-DL-5230		Suspension Rod
04/98→10/04		Centre Rod	DB-DL-5241		Push Rod
04/98→10/04		Centre Rod	DB-DL-5405		Push Rod, 1st FA;Leaf Spring Axle
04/98→10/04		Centre Rod	DB-DL-7270		Push Rod;Suspension Rod
04/98→10/04		Centre Rod	DB-DL-7815		Push Rod;Suspension Rod
04/98→10/04		Centre Rod	DB-DL-8184		Push Rod
04/98→10/04		Centre Rod	DB-DL-8185		Push Rod
04/98→10/04		Centre Rod	DB-DL-8188		Push Rod, 1st FA;Air Suspension Axle
04/98→10/04		Centre Rod	DB-DL-8622		Push Rod, for vehicles with Part-Pneumatic Suspension
04/98→10/04		Centre Rod	DB-DL-8642		Push Rod, for vehicles with Part-Pneumatic Suspension
04/98→10/04		Centre Rod	DB-DL-8717		Push Rod, 1st FA;Leaf Spring Axle
04/98→10/04		Centre Rod	DB-DL-12298		for Steering Rod
04/98→10/04		Centre Rod	DB-DL-12438		for Steering Rod
04/98→10/04		Centre Rod	DB-DL-12466		Push Rod
04/98→10/04		Rod Assembly	DB-DL-2178		Guide Rod
04/98→10/04		Stabiliser Mounting		DB-SB-10406	
04/98→10/04		Suspension Arm Repair Kit		DB-RK-8550	for Wishbone (CV)
04/98→10/04		Suspension Arm Repair Kit		DB-RK-8626	for Wishbone (CV)
04/98→10/04		Suspension Arm Repair Kit		DB-RK-8638	for Control Arm
04/98→10/04		Suspension Arm Repair Kit		DB-RK-10374	for Wishbone (CV)
04/98→10/04		Suspension Strut Repair Kit		DB-RK-8555	
04/98→10/04		Suspension Strut Repair Kit		DB-RK-9294	
04/98→10/04		Tie Rod		DB-DL-10209	Tag Axle;for vehicles with Hinged Trailing Axle
04/98→10/04		Tie Rod	DB-DL-8172		Guide Rod
04/98→10/04		Tie Rod	DB-DL-8327		Guide Rod
04/98→10/04		Tie Rod	DB-DL-8388		Guide Rod
04/98→10/04		Tie Rod	DB-DL-8389		
04/98→10/04		Tie Rod	DB-DL-8640		Guide Rod
04/98→10/04		Tie Rod	DB-DL-12310		
04/98→10/04		Tie Rod	DB-ES-5227		Guide Rod
04/98→10/04		Tie Rod End	CV-ES-0543		for Push Rod
04/98→10/04		Tie Rod End	CV-ES-0888	CV-ES-0888	for Push Rod
04/98→10/04		Tie Rod End	CV-ES-14162		for Steering Rod
04/98→10/04		Tie Rod End	CV-ES-14163		for Steering Rod
04/98→10/04		Tie Rod End	DB-ES-8164		for Push Rod

CV-ES-0543

Length: 125
 Cone Ø: d1 Ø 32 / d2 Ø 29
 Thread: M30 x 1,5 RHT
 0004605748, 0004606048, 0004606848,
 0004607048, 0014600448, 0014601148,
 0014601748, 0014602448, 0014607648,
 0014609648



CV-ES-0888

Length: 125
 Cone Ø: d1 Ø 32 / d2 Ø 29
 Thread: M30 x 1,5 LHT
 0004605848, 0004606148, 0004606948,
 0004607148, 0004609048, 0014600548,
 0014601348, 0014602548, 0014607948,
 0024600448



CV-ES-14162

Length: 125
 Cone Ø: d1 Ø 30 / d2 Ø 27
 Thread: M30 x 1,5 LHT
 4600648, 4601248, 4603448, 0004603548,
 14600348, 14601448, 14602348, 0014603748,
 0014607848, 0024600348



CV-ES-14163

Length: 125
 Cone Ø: d1 Ø 30 / d2 Ø 27
 Thread: M30 x 1,5 RHT
 0003305248, 0003387310, 0004600348,
 0004600948, 0004602848, 0004602948,
 0004608948, 0014600248, 0014600848,
 0014601248, 0014602248, 0014607748,
 0024600148, A0003387310, A0004600348,
 A0004602848, A0004602948, A0014600848,
 A0014601248, A0014602248, A0014607748



DB-DL-2144

Length: 872 Ø: 35
 Cone Ø: d1 Ø 28,6 / d2 Ø 23,9
 0024604305, 0024604405, 0034604805



DB-DL-2178

Length: 1735 Ø: 52
 Cone Ø: d1 Ø 32 / d2 Ø 29
 9423300003, 9423300103, 9423300203



DB-DL-5230

Length: 879 Ø: 42
 Cone Ø: d1 Ø 30 / d2 Ø 27
 01208600A, 0004607105, 0004607205,
 0014606705



DB-DL-5241

Length: 875 Ø: 40
 Cone Ø: d1 Ø 30 / d2 Ø 27
 01215300A, 0004609205, 0004609305,
 0014606905



DB-DL-5405

Length: 890 Ø: 35
 Cone Ø: d1 Ø 28,6 / d2 Ø 23,9
 01215900A, 1460248, 0024604505, 0024604605,
 0034605005, 3752600637, 3754600405,
 A3752600637, A3754600405



DB-DL-7270

Length: 875 Ø: 40
 Cone Ø: d1 Ø 28,6 / d2 Ø 23,9
 01208300A, 0024604705, 0024604805,
 0034604905, A0024604705

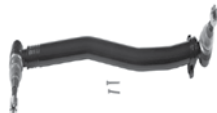

DB-DL-7815

Length: 895 Ø: 50
 Cone Ø: d1 Ø 30 / d2 Ø 27
 01215800A, 0034604605, 3754600005,
 9744601005, 9744601205



DB-DL-8172

Length: 1700 Ø: 52
 Cone Ø: d1 Ø 32 / d2 Ø 29
 01219700A, 9493300403, 9493300503,
 9493300803, 9493301403



DB-DL-8184

Length: 1095 Ø: 42
 Cone Ø: d1 Ø 32 / d2 Ø 28,8
 01217700A, 0014601305, 0014601405,
 0024600505, 0034603205, 3754601505,
 A0014601305, A0014601405, A0024600505



DB-DL-8185

Length: 711 Ø: 42
 Cone Ø: d1 Ø 32 / d2 Ø 28,8
 01213600A, 0014601105, 0024600405,
 0034603105, A0014601105, A0024600405



DB-DL-8188

Length: 895 Ø: 40
 Cone Ø: d1 Ø 28,6 / d2 Ø 23,9
 01217200A, 0024604905, 0024605005,
 0034605605



DB-DL-8327

Length: 1745 Ø: 48
 Cone Ø: d1 Ø 32 / d2 Ø 29
 01219800A, 9413300003, 9413300103,
 9413300203, 9413300303, 9413300503



DB-DL-8388

Length: 1735 Ø: 62
 Cone Ø: d1 Ø 32 / d2 Ø 28,8
 01219900A, 9453300003, 9453300103,
 9453300403, 9453300603, A9453300003



DB-DL-8389

Length: 1465 Ø: 40
 Cone Ø: d1 Ø 30 / d2 Ø 29
 9453300203, 9453300303, 9453300503



DB-DL-8622

Length: 1558 Ø: 52
 Cone Ø: d1 Ø 30 / d2 Ø 27
 0014609005, 0014609105



DB-DL-8640

Length: 1615 Ø: 50
 Cone Ø: d1 Ø 32 / d2 Ø 29
 6253301503, 6253301603, 6253302403,
 6253302503, 9423300803, 9423302103,
 9493300203, 9493300303, 9493300903



DB-DL-8642

Length: 954 Ø: 42
 Cone Ø: d1 Ø 30 / d2 Ø 27
 0014608605, 0014608705



DB-DL-8717

Length: 886 Ø: 38
 Cone Ø: d1 Ø 30 / d2 Ø 27
 0024601705, 0024607505, 0024607605,
 0034604405



DB-DL-9218

Length: 754 Ø: 40
 Hole Distance: 100
 00036098524, 000390098524, 3753300111,
 9413300011, A3753300111, SA50831601



DB-DL-10209

Length: 1281 Ø: 38
 Cone Ø: d1 Ø 30 / d2 Ø 27
 3574603505, 9423301003, 9423301703



DB-DL-12298

Length: 927 Ø: 50
 Cone Ø: d1 Ø 30 / d2 Ø 27
 0024602405, 0024603005



DB-DL-12310

Length: 1532 Ø: 50
 Cone Ø: d1 Ø 32 / d2 Ø 29
 Thread: M27 x 1,5 LHT
 9493301203, 9493301303, 9493301803,
 9493302203, A9493301203, A9493301303,
 A9493301803, A9493302203



DB-DL-12438

Length: 743 Ø: 42
 Cone Ø: d1 Ø 30 / d2 Ø 27
 0024602505, 0024603105, A0024602505,
 A0024603105



DB-DL-12466

Length: 905 Ø: 38
 Cone Ø: d1 Ø 32 / d2 Ø 29
 0024605305, 0024605405, A0024605305,
 A0024605405

No Image

DB-ES-5227

Length: 1588 Ø: 60
 Cone Ø: d1 Ø 38 / d2 Ø 34,3
 6253300903, 6253301203, 9443300203



DB-ES-8164

Length: 140
 Cone Ø: d1 Ø 28,6 / d2 Ø 23,9
 Thread: M28 x 1,5 RHT
 0014604248, 0014605048, 0014608548,
 0024600548



DB-ES-8510

Length: 56
 Cone Ø: d1 Ø 10 / d2 Ø 10
 Thread: M12 x 1,75 LHT
 0009965145, 0009965645, 0019963145



DB-RK-8550

Ø: 75 Hole Distance: 152
 Thick/Height: 24
 0003502105, 0003504605



DB-RK-8555

Ø: 67 Hole Distance: 130
 Thick/Height: 24
 01335600A, 0003502005, 0003504705



DB-RK-8626

Ø: 75 Hole Distance: 130
 Thick/Height: 24
 0003502205, 0003502505, 0003503405,
 0003504505, GL11319



DB-RK-8638

Length: 100 Ø: 67
 Hole Distance: 100
 Thick/Height: 20
 0003301411



DB-RK-9294

Ø: 85 Hole Distance: 152
 Thick/Height: 24
 0003503105



DB-RK-10374

Ø: 85 Hole Distance: 152
 Thick/Height: 24
 0003504405



DB-SB-10406

Ø: 80 Thick/Height: 46
 0003238185



DB-VB-3707

Length: 622 Ø: 46
 Hole Ø 25 / 25 / 25
 Hole Distance: 152 / 130 / 130
 01337100A, 9423501005, 9423501505,
 9443500005, 9473500105, 9473501005,
 A3753500005, A9423501005, A9423501505,
 A9443500005, A9473500105, A9473501005





ATEGO ...

2528 L ...	04/98 → 10/04	Tie Rod End	DB-ES-8530		for Push Rod
	04/98 → 10/04	Track Control Arm		DB-VB-3707	Suspension Rod, Wishbone (CV), 1st RA; Air Suspension Axle
	04/98 → 10/04	Track Control Arm		DB-VB-3707	Suspension Rod, Wishbone (CV), 1st RA; Air Suspension Axle, for vehicles with Part-Pneumatic Suspension
	04/98 → 10/04	Track Control Arm		DB-VB-7790	Wishbone (CV), Tag Axle; Air Suspension Axle
	04/98 → 10/04	Track Control Arm	DB-DL-5224		Control Arm, 1st FA; Air Suspension Axle
	04/98 → 10/04	Track Control Arm	DB-DL-9218	DB-DL-9218	Trailing Arm, 1st FA; Air Suspension Axle
	04/98 → 10/04	Track Control Arm	DB-VB-7790	DB-VB-7790	Wishbone (CV), Tag Axle; 1st FA; Air Suspension Axle
2628	04/98 → 10/04	Ball Head, gearshift linkage	DB-ES-8510		
	04/98 → 10/04	Bush, parabolic spring		DB-SB-10400	
	04/98 → 10/04	Bush, parabolic spring		DB-SB-10401	
	04/98 → 10/04	Centre Rod	DB-DL-2144		Push Rod
	04/98 → 10/04	Centre Rod	DB-DL-5230		Suspension Rod
	04/98 → 10/04	Centre Rod	DB-DL-5241		Push Rod
	04/98 → 10/04	Centre Rod	DB-DL-5405		Push Rod, 1st FA; Leaf Spring Axle
	04/98 → 10/04	Centre Rod	DB-DL-7270		Push Rod; Suspension Rod
	04/98 → 10/04	Centre Rod	DB-DL-7815		Push Rod; Suspension Rod
	04/98 → 10/04	Centre Rod	DB-DL-8184		Push Rod
	04/98 → 10/04	Centre Rod	DB-DL-8185		Push Rod
	04/98 → 10/04	Centre Rod	DB-DL-8188		Push Rod, 1st FA; Leaf Spring Axle
	04/98 → 10/04	Centre Rod	DB-DL-8622		Push Rod
	04/98 → 10/04	Centre Rod	DB-DL-8717		Push Rod, 1st FA; Leaf Spring Axle
	04/98 → 10/04	Centre Rod	DB-DL-12466		Push Rod
	04/98 → 10/04	Rod Assembly	DB-DL-2178		Guide Rod
	04/98 → 10/04	Stabiliser Mounting		DB-SB-10406	
	04/98 → 10/04	Suspension Arm Repair Kit		DB-RK-8550	for Wishbone (CV)
	04/98 → 10/04	Suspension Arm Repair Kit		DB-RK-8626	for Wishbone (CV)
	04/98 → 10/04	Suspension Arm Repair Kit		DB-RK-10374	for Wishbone (CV)
	04/98 → 10/04	Suspension Strut Repair Kit		DB-RK-9294	
	04/98 → 10/04	Tie Rod	DB-DL-8171		Guide Rod
	04/98 → 10/04	Tie Rod	DB-DL-8327		Guide Rod
	04/98 → 10/04	Tie Rod	DB-DL-8640		Guide Rod
	04/98 → 10/04	Tie Rod	DB-DL-12310		
	04/98 → 10/04	Tie Rod	DB-ES-5227		Guide Rod
	04/98 → 10/04	Tie Rod End	CV-ES-0543		for Push Rod
	04/98 → 10/04	Tie Rod End	CV-ES-0888		for Push Rod
	04/98 → 10/04	Tie Rod End	CV-ES-14162		for Steering Rod
	04/98 → 10/04	Tie Rod End	CV-ES-14163		for Steering Rod
	04/98 → 10/04	Tie Rod End	DB-ES-8164		for Push Rod
	04/98 → 10/04	Track Control Arm		DB-DL-3475	Trailing Arm
	04/98 → 10/04	Track Control Arm		DB-VB-3707	Suspension Rod, Wishbone (CV)
	04/98 → 10/04	Track Control Arm		DB-VB-7261	Suspension Rod, Wishbone (CV)
	04/98 → 10/04	Track Control Arm		DB-VB-10426	Wishbone (CV), Leaf Spring Axle; Unit
2628 B	04/98 → 10/04	Ball Head, gearshift linkage	DB-ES-8510		
	04/98 → 10/04	Bush, parabolic spring		DB-SB-10400	
	04/98 → 10/04	Bush, parabolic spring		DB-SB-10401	
	04/98 → 10/04	Centre Rod	DB-DL-2144		Push Rod
	04/98 → 10/04	Centre Rod	DB-DL-5230		Suspension Rod
	04/98 → 10/04	Centre Rod	DB-DL-5241		Push Rod
	04/98 → 10/04	Centre Rod	DB-DL-5405		Push Rod, Leaf Spring Axle
	04/98 → 10/04	Centre Rod	DB-DL-7270		Push Rod; Suspension Rod
	04/98 → 10/04	Centre Rod	DB-DL-7815		Push Rod; Suspension Rod
	04/98 → 10/04	Centre Rod	DB-DL-8184		Push Rod
	04/98 → 10/04	Centre Rod	DB-DL-8185		Push Rod
	04/98 → 10/04	Centre Rod	DB-DL-8188		Push Rod, Leaf Spring Axle
	04/98 → 10/04	Centre Rod	DB-DL-8717		Push Rod, Leaf Spring Axle
	04/98 → 10/04	Centre Rod	DB-DL-12466		Push Rod
	04/98 → 10/04	Rod Assembly	DB-DL-2178		Guide Rod
	04/98 → 10/04	Stabiliser Mounting		DB-SB-10406	
	04/98 → 10/04	Stabiliser Mounting	DB-SB-5250		

CV-ES-0543

Length: 125
Cone Ø: d1 Ø 32 / d2 Ø 29
Thread: M30 x 1,5 RHT
0004605748, 0004606048, 0004606848,
0004607048, 0014600448, 0014601148,
0014601748, 0014602448, 0014607648,
0014609648



CV-ES-0888

Length: 125
Cone Ø: d1 Ø 32 / d2 Ø 29
Thread: M30 x 1,5 LHT
0004605848, 0004606148, 0004606948,
0004607148, 0004609048, 0014600548,
0014601348, 0014602548, 0014607948,
0024600448



CV-ES-14162

Length: 125
Cone Ø: d1 Ø 30 / d2 Ø 27
Thread: M30 x 1,5 LHT
4600648, 4601248, 4603448, 0004603548,
14600348, 14601448, 14602348, 0014603748,
0014607848, 0024600348



CV-ES-14163

Length: 125
Cone Ø: d1 Ø 30 / d2 Ø 27
Thread: M30 x 1,5 RHT
0003305248, 0003387310, 0004600348,
0004600948, 0004602848, 0004602948,
0004608948, 0014600248, 0014600848,
0014601248, 0014602248, 0014607748,
0024600148, A0003387310, A0004600348,
A0004602848, A0004602948, A0014600848,
A0014601248, A0014602248, A0014607748



DB-DL-2144

Length: 872 Ø: 35
Cone Ø: d1 Ø 28,6 / d2 Ø 23,9
0024604305, 0024604405, 0034604805



DB-DL-2178

Length: 1735 Ø: 52
Cone Ø: d1 Ø 32 / d2 Ø 29
9423300003, 9423300103, 9423300203



DB-DL-3475

Length: 565 Ø: 52
Hole Distance: 152 / 152
3753500006, 3753500206, 9473500805,
9483500006, 9483500805, 9483501205,
9483501305, 9483501905, 9483502005,
9483502405, A3753500006, A3753500206



DB-DL-5224

Length: 850 Ø: 60
Hole Distance: 100 / 100
01336100A, 9413300007



DB-DL-5230

Length: 879 Ø: 42
Cone Ø: d1 Ø 30 / d2 Ø 27
01208600A, 0004607105, 0004607205,
0014606705



DB-DL-5241

Length: 875 Ø: 40
Cone Ø: d1 Ø 30 / d2 Ø 27
01215300A, 0004609205, 0004609305,
0014606905



DB-DL-5405

Length: 890 Ø: 35
Cone Ø: d1 Ø 28,6 / d2 Ø 23,9
01215900A, 1460248, 0024604505, 0024604605,
0034605005, 3752600637, 3754600405,
A3752600637, A3754600405



DB-DL-7270

Length: 875 Ø: 40
Cone Ø: d1 Ø 28,6 / d2 Ø 23,9
01208300A, 0024604705, 0024604805,
0034604905, A0024604705

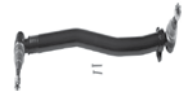

DB-DL-7815

Length: 895 Ø: 50
Cone Ø: d1 Ø 30 / d2 Ø 27
01215800A, 0034604605, 3754600005,
9744601005, 9744601205



DB-DL-8171

Length: 1687 Ø: 52
Cone Ø: d1 Ø 32 / d2 Ø 29
9493300603, 9493300703, 9493301503,
9493301603



DB-DL-8184

Length: 1095 Ø: 42
Cone Ø: d1 Ø 32 / d2 Ø 28,8
01217700A, 0014601305, 0014601405,
0024605005, 0034603205, 3754601505,
A0014601305, A0014601405, A0024605005



DB-DL-8185

Length: 711 Ø: 42
Cone Ø: d1 Ø 32 / d2 Ø 28,8
01213600A, 0014601105, 0024600405,
0034603105, A0014601105, A0024600405



DB-DL-8188

Length: 895 Ø: 40
Cone Ø: d1 Ø 28,6 / d2 Ø 23,9
01217200A, 0024604905, 0024605005,
0034605605



DB-DL-8327

Length: 1745 Ø: 48
Cone Ø: d1 Ø 32 / d2 Ø 29
01219800A, 9413300003, 9413300103,
9413300203, 9413300303, 9413300503



DB-DL-8622

Length: 1558 Ø: 52
Cone Ø: d1 Ø 30 / d2 Ø 27
0014609005, 0014609105



DB-DL-8640

Length: 1615 Ø: 50
Cone Ø: d1 Ø 32 / d2 Ø 29
6253301503, 6253301603, 6253302403,
6253302503, 9423300803, 9423302103,
9493300203, 9493300303, 9493300903



DB-DL-8717

Length: 886
Ø: 38
Cone Ø: d1 Ø 30 / d2 Ø 27
0024601705, 24601705, 24607505, 0024607505,
24607605, 0024607605, 0034604405



DB-DL-9218

Length: 754 Ø: 40
Hole Distance: 100
000360098524, 000390098524, 3753300111,
9413300011, A3753300111, SA50831601



DB-DL-12310

Length: 1532 Ø: 50
Cone Ø: d1 Ø 32 / d2 Ø 29
Thread: M27 x 1,5 LHT
9493301203, 9493301303, 9493301803,
9493302203, A9493301203, A9493301303,
A9493301803, A9493302203



DB-DL-12466

Length: 905 Ø: 38
Cone Ø: d1 Ø 32 / d2 Ø 29
0024605305, 0024605405, A0024605305,
A0024605405

No Image

DB-ES-5227

Length: 1588 Ø: 60
Cone Ø: d1 Ø 38 / d2 Ø 34,3
6253300903, 6253301203, 9443300203



DB-ES-8164

Length: 140
Cone Ø: d1 Ø 28,6 / d2 Ø 23,9
Thread: M28 x 1,5 RHT
0014604248, 0014605048, 0014608548,
0024600548



DB-ES-8510

Length: 56
Cone Ø: d1 Ø 10 / d2 Ø 10
Thread: M12 x 1,75 LHT
0009965145, 0009965645, 0019963145



DB-ES-8530

Length: 115
Cone Ø: d1 Ø 28,6 / d2 Ø 23,9
Thread: M30 x 1,5 RHT
0014603848, 0014604848, 0014605148,
0014608648, 0014609948



DB-RK-8550

Ø: 75 Hole Distance: 152
Thick/Height: 24
0003502105, 0003504605



DB-RK-8626

Ø: 75 Hole Distance: 130
Thick/Height: 24
0003502205, 0003502505, 0003503405,
0003504505, GL11319



DB-RK-9294

Ø: 85 Hole Distance: 152
Thick/Height: 24
0003503105



DB-RK-10374

Ø: 85 Hole Distance: 152
Thick/Height: 24
0003504405



DB-SB-5250

Ø: 66 Thick/Height: 56
01320400A, 0003262681, 0003263081,
0003263281



DB-SB-10400

Length: 230
Thick/Height: 167,5 / 115
0003250696, 0003250896



DB-SB-10401

Length: 232
Thick/Height: 163,5 / 152,5
0003250596, 0003250796



DB-SB-10406

Ø: 80 Thick/Height: 46
0003238185



DB-VB-3707

Length: 622 Ø: 46
Hole Ø 25 / 25 / 25
Hole Distance: 152 / 130 / 130
01337100A, 9423501005, 9423501505,
9443500005, 9473500105, 9473501005,
A373500005, A9423501005, A9423501505,
A9443500005, A9473500105, A9473501005



DB-VB-7261

Length: 622 Ø: 46
Hole Ø 25 / 25 / 25
Hole Distance: 152 / 130 / 130
01337800A, 9443500305, 9443500505,
9443500605, 9473500705, 9473500905,
9483500405, 9483500305



DB-VB-7790

Length: 622 Ø: 46
Hole Ø 25 / 23 / 23
Hole Distance: 152 / 130 / 130
01337000A, 3753500105, 9423500105,
9423500705, 9423501105, 9423501605,
9443500205



DB-VB-10426

Length: 622 Ø: 46
Hole Ø 25 / 25 / 25
Hole Distance: 152 / 130 / 130
9443500405





ATEGO ...

2628 B ...	04/98→10/04	Suspension Arm Repair Kit		DB-RK-8550	for Wishbone (CV)	
	04/98→10/04	Suspension Arm Repair Kit		DB-RK-8626	for Wishbone (CV)	
	04/98→10/04	Suspension Arm Repair Kit		DB-RK-10374	for Wishbone (CV)	
	04/98→10/04	Suspension Strut Repair Kit		DB-RK-9294		
	04/98→10/04	Tie Rod	DB-DL-8171		Guide Rod	
	04/98→10/04	Tie Rod	DB-DL-8327		Guide Rod	
	04/98→10/04	Tie Rod	DB-DL-8640		Guide Rod	
	04/98→10/04	Tie Rod	DB-DL-12310			
	04/98→10/04	Tie Rod End	CV-ES-0543		for Push Rod	
	04/98→10/04	Tie Rod End	CV-ES-0888		for Push Rod	
	04/98→10/04	Tie Rod End	CV-ES-14162		for Steering Rod	
	04/98→10/04	Tie Rod End	CV-ES-14163		for Steering Rod	
	04/98→10/04	Tie Rod End	DB-ES-8164		for Push Rod	
	04/98→10/04	Tie Rod End	DB-ES-8530		for Push Rod	
	04/98→10/04	Track Control Arm		DB-DL-3475	Trailing Arm	
	04/98→10/04	Track Control Arm		DB-VB-3707	Suspension Rod, Wishbone (CV)	
	04/98→10/04	Track Control Arm		DB-VB-7261	Suspension Rod, Wishbone (CV)	
	04/98→10/04	Track Control Arm		DB-VB-10426	Wishbone (CV), Leaf Spring Axle;Unit	
	2628 K	04/98→10/04	Ball Head, gearshift linkage	DB-ES-8510		
		04/98→10/04	Bush, parabolic spring		DB-SB-10400	
		04/98→10/04	Bush, parabolic spring		DB-SB-10401	
		04/98→10/04	Centre Rod	DB-DL-2144		Push Rod
		04/98→10/04	Centre Rod	DB-DL-5230		Suspension Rod
		04/98→10/04	Centre Rod	DB-DL-5241		Push Rod
		04/98→10/04	Centre Rod	DB-DL-5405		Push Rod, 1st FA;Leaf Spring Axle
04/98→10/04		Centre Rod	DB-DL-7270		Push Rod;Suspension Rod	
04/98→10/04		Centre Rod	DB-DL-7815		Push Rod;Suspension Rod	
04/98→10/04		Centre Rod	DB-DL-8184		Push Rod	
04/98→10/04		Centre Rod	DB-DL-8185		Push Rod	
04/98→10/04		Centre Rod	DB-DL-8188		Push Rod, 1st FA;Leaf Spring Axle	
04/98→10/04		Centre Rod	DB-DL-8717		Push Rod, 1st FA;Leaf Spring Axle	
04/98→10/04		Centre Rod	DB-DL-12466		Push Rod	
04/98→10/04		Rod Assembly	DB-DL-2178		Guide Rod	
04/98→10/04		Stabiliser Mounting		DB-SB-10406		
04/98→10/04		Suspension Arm Repair Kit		DB-RK-8550	for Wishbone (CV)	
04/98→10/04		Suspension Arm Repair Kit		DB-RK-8626	for Wishbone (CV)	
04/98→10/04		Suspension Arm Repair Kit		DB-RK-10374	for Wishbone (CV)	
04/98→10/04		Suspension Strut Repair Kit		DB-RK-9294		
04/98→10/04		Tie Rod	DB-DL-8171		Guide Rod	
04/98→10/04		Tie Rod	DB-DL-8327		Guide Rod	
04/98→10/04		Tie Rod	DB-DL-8640		Guide Rod	
04/98→10/04		Tie Rod	DB-DL-12310			
04/98→10/04		Tie Rod	DB-ES-5227		Guide Rod	
04/98→10/04		Tie Rod End	CV-ES-0543		for Push Rod	
04/98→10/04		Tie Rod End	CV-ES-0888		for Push Rod	
04/98→10/04		Tie Rod End	CV-ES-14162		for Steering Rod	
04/98→10/04		Tie Rod End	CV-ES-14163		for Steering Rod	
04/98→10/04		Tie Rod End	DB-ES-8164		for Push Rod	
04/98→10/04		Tie Rod End	DB-ES-8530		for Push Rod	
04/98→10/04		Track Control Arm		DB-DL-3475	Trailing Arm	
04/98→10/04		Track Control Arm		DB-VB-3707	Suspension Rod, Wishbone (CV)	
04/98→10/04		Track Control Arm		DB-VB-7261	Suspension Rod, Wishbone (CV)	
04/98→10/04		Track Control Arm		DB-VB-10426	Wishbone (CV), Leaf Spring Axle;Unit	
712		01/98→10/04	Ball Head, gearshift linkage	DB-ES-8387		
		01/98→10/04	Centre Rod	DB-DL-5213		Push Rod, Leaf Spring Axle
		01/98→10/04	Centre Rod	DB-DL-5405		Push Rod
		01/98→10/04	Centre Rod	DB-DL-7815		Push Rod;Suspension Rod
		01/98→10/04	Centre Rod	DB-DL-8644		Push Rod
		01/98→10/04	Centre Rod	DB-DL-8731		Push Rod, Leaf Spring Axle
		01/98→10/04	Centre Rod	DB-DL-9187		Push Rod
		01/98→10/04	Stabiliser Mounting		DB-SB-10385	
		01/98→10/04	Stabiliser Mounting		DB-SB-10407	
		01/98→10/04	Stabiliser Mounting	DB-SB-10385	DB-SB-10385	

CV-ES-0543

Length: 125
Cone Ø: d1 Ø 32 / d2 Ø 29
Thread: M30 x 1,5 RHT
0004605748, 0004606048, 0004606848,
0004607048, 0014600448, 0014601148,
0014601748, 0014602448, 0014607648,
0014609648



CV-ES-0888

Length: 125
Cone Ø: d1 Ø 32 / d2 Ø 29
Thread: M30 x 1,5 LHT
0004605848, 0004606148, 0004606948,
0004607148, 0004609048, 0014600548,
0014601348, 0014602548, 0014607948,
0024600448



CV-ES-14162

Length: 125
Cone Ø: d1 Ø 30 / d2 Ø 27
Thread: M30 x 1,5 LHT
4600648, 4601248, 4603448, 0004603548,
14600348, 14601448, 14602348, 0014603748,
0014607848, 0024600348



CV-ES-14163

Length: 125
Cone Ø: d1 Ø 30 / d2 Ø 27
Thread: M30 x 1,5 RHT
0003305248, 0003387310, 0004600348,
0004600948, 0004602848, 0004602948,
0004608948, 0014600248, 0014600848,
0014601248, 0014602248, 0014607748,
0024600148, 0003387310, 0004600348,
0004602848, 0004602948, 0014600848,
0014601248, 0014602248, 0014607748



DB-DL-2144

Length: 872 Ø: 35
Cone Ø: d1 Ø 28,6 / d2 Ø 23,9
0024604305, 0024604405, 0034604805



DB-DL-2178

Length: 1735 Ø: 52
Cone Ø: d1 Ø 32 / d2 Ø 29
9423300003, 9423300103, 9423300203



DB-DL-3475

Length: 565 Ø: 52
Hole Distance: 152 / 152
3753500006, 3753500206, 9473500805,
9483500006, 9483500805, 9483501205,
9483501305, 9483501905, 9483502005,
9483502405, A3753500006, A3753500206



DB-DL-5213

Length: 846
Ø: 42
Cone Ø: d1 Ø 26 / d2 Ø 23,5
01208200A, 9704600705, 9704600905



DB-DL-5230

Length: 879 Ø: 42
Cone Ø: d1 Ø 30 / d2 Ø 27
01208600A, 0004607105, 0004607205,
0014606705



DB-DL-5241

Length: 875 Ø: 40
Cone Ø: d1 Ø 30 / d2 Ø 27
01215300A, 0004609205, 0004609305,
0014606905



DB-DL-5405

Length: 890 Ø: 35
Cone Ø: d1 Ø 28,6 / d2 Ø 23,9
01215900A, 1460248, 0024604505, 0024604605,
0034605005, 3752600637, 3754600405,
A3752600637, A3754600405



DB-DL-7270

Length: 875 Ø: 40
Cone Ø: d1 Ø 28,6 / d2 Ø 23,9
01208300A, 0024604705, 0024604805,
0034604905, A0024604705



DB-DL-7815

Length: 895 Ø: 50
Cone Ø: d1 Ø 30 / d2 Ø 27
01215800A, 0034604605, 3754600005,
9744601005, 9744601205



DB-DL-8171

Length: 1687 Ø: 52
Cone Ø: d1 Ø 32 / d2 Ø 29
9493300603, 9493300703, 9493301503,
9493301603



DB-DL-8184

Length: 1095 Ø: 42
Cone Ø: d1 Ø 32 / d2 Ø 28,8
01217700A, 0014601305, 0014601405,
0024605005, 0034603205, 3754601505,
A0014601305, A0014601405, A0024605005



DB-DL-8185

Length: 711 Ø: 42
Cone Ø: d1 Ø 32 / d2 Ø 28,8
01213600A, 0014601105, 0024600405,
0034603105, A0014601105, A0024600405



DB-DL-8188

Length: 895 Ø: 40
Cone Ø: d1 Ø 28,6 / d2 Ø 23,9
01217200A, 0024604905, 0024605005,
0034605605



DB-DL-8327

Length: 1745 Ø: 48
Cone Ø: d1 Ø 32 / d2 Ø 29
01219800A, 9413300003, 9413300103,
9413300203, 9413300303, 9413300503



DB-DL-8640

Length: 1615 Ø: 50
Cone Ø: d1 Ø 32 / d2 Ø 29
6253301503, 6253301603, 6253302403,
6253302503, 9423300803, 9423302103,
9493300203, 9493300303, 9493300903



DB-DL-8644

Length: 894 Ø: 50
Cone Ø: d1 Ø 30 / d2 Ø 27
0034604705, 9744601105, 9744601305



DB-DL-8717

Length: 886 Ø: 38
Cone Ø: d1 Ø 30 / d2 Ø 27
0024601705, 0024607505, 0024607605,
0034604405



DB-DL-8731

Length: 846
Ø: 42
Cone Ø: d1 Ø 26 / d2 Ø 23,5
9704600805, 9704601005



DB-DL-9187

Length: 846 Ø: 42
Cone Ø: d1 Ø 26 / d2 Ø 23,5
9704601105, 9724602805, A9704601105,
A9724602805



DB-DL-12310

Length: 1532 Ø: 50
Cone Ø: d1 Ø 32 / d2 Ø 29
Thread: M27 x 1,5 LHT
9493301203, 9493301303, 9493301803,
9493302203, A9493301203, A9493301303,
A9493301803, A9493302203



DB-DL-12466

Length: 905 Ø: 38
Cone Ø: d1 Ø 32 / d2 Ø 29
0024605305, 0024605405, A0024605305,
A0024605405

No Image

DB-ES-5227

Length: 1588 Ø: 60
Cone Ø: d1 Ø 38 / d2 Ø 34,3
6253300903, 6253301203, 9443300203



DB-ES-8164

Length: 140
Cone Ø: d1 Ø 28,6 / d2 Ø 23,9
Thread: M28 x 1,5 RHT
0014604248, 0014605048, 0014608548,
0024600548



DB-ES-8387

Length: 55
Cone Ø: d1 Ø 10 / d2 Ø 10
Thread: M14 x 1,5 RHT
0009966845, 0009967045



DB-ES-8510

Length: 56
Cone Ø: d1 Ø 10 / d2 Ø 10
Thread: M12 x 1,75 LHT
0009965145, 0009965645, 0019963145



DB-ES-8530

Length: 115
Cone Ø: d1 Ø 28,6 / d2 Ø 23,9
Thread: M30 x 1,5 RHT
0014603848, 0014604848, 0014605148,
0014608648, 0014609948



DB-RK-8550

Ø: 75 Hole Distance: 152
Thick/Height: 24
0003502105, 0003504605



DB-RK-8626

Ø: 75 Hole Distance: 130
Thick/Height: 24
0003502205, 0003502505, 0003503405,
0003504505, GL11319



DB-RK-9294

Ø: 85 Hole Distance: 152
Thick/Height: 24
0003503105



DB-RK-10374

Ø: 85 Hole Distance: 152
Thick/Height: 24
0003504405



DB-SB-10385

Ø: 30 Thick/Height: 30
3093200073, 3143260153



DB-SB-10400

Length: 230
Thick/Height: 167,5 / 115
0003250696, 0003250896



DB-SB-10401

Length: 232
Thick/Height: 163,5 / 152,5
0003250596, 0003250796



DB-SB-10406

Ø: 80 Thick/Height: 46
0003238185



DB-SB-10407

Ø: 61 Thick/Height: 46
0003235985, 0003262481, 0003262981



DB-VB-3707

Length: 622 Ø: 46
Hole Ø 25 / 25 / 25
Hole Distance: 152 / 130 / 130
01337100A, 9423501005, 9423501505,
9443500005, 9473500105, 9473501005,
A3753500005, A9423501005, A9423501505,
A9443500005, A9473500105, A9473501005



DB-VB-7261

Length: 622 Ø: 46
Hole Ø 25 / 25 / 25
Hole Distance: 152 / 130 / 130
01337800A, 9443500305, 9443500505,
9443500605, 9473500705, 9473500905,
9483500405, 9483500305



DB-VB-10426

Length: 622 Ø: 46
Hole Ø 25 / 25 / 25
Hole Distance: 152 / 130 / 130
9443500405





ATEGO ...

712 ...	01/98→10/04	Stabiliser Mounting	DB-SB-10385	DB-SB-10385	1st FA	
	01/98→10/04	Stabiliser Mounting	DB-SB-10386	DB-SB-10386		
	01/98→10/04	Stabiliser Mounting	DB-SB-10386	DB-SB-10386	1st FA	
	01/98→10/04	Tie Rod	DB-ES-5214		Guide Rod	
	01/98→10/04	Tie Rod End	CV-ES-12461		for Steering Rod	
	01/98→10/04	Tie Rod End	CV-ES-12462		for Steering Rod	
714 K	01/98→10/04	Ball Head, gearshift linkage	DB-ES-8387			
	01/98→10/04	Centre Rod	DB-DL-5213		Push Rod, Leaf Spring Axle	
	01/98→10/04	Centre Rod	DB-DL-5405		Push Rod	
	01/98→10/04	Centre Rod	DB-DL-7815		Push Rod;Suspension Rod	
	01/98→10/04	Centre Rod	DB-DL-8731		Push Rod, Leaf Spring Axle	
	01/98→10/04	Stabiliser Mounting		DB-SB-10385		
	01/98→10/04	Stabiliser Mounting	DB-SB-10385	DB-SB-10385		
	01/98→10/04	Stabiliser Mounting	DB-SB-10385	DB-SB-10385	1st FA	
	01/98→10/04	Tie Rod	DB-ES-5214		Guide Rod	
	01/98→10/04	Tie Rod End	CV-ES-12461		for Steering Rod	
	01/98→10/04	Tie Rod End	CV-ES-12462		for Steering Rod	
	714, 714 L	01/98→10/04	Ball Head, gearshift linkage	DB-ES-8387		
		01/98→10/04	Centre Rod	DB-DL-5213		Push Rod
		01/98→10/04	Centre Rod	DB-DL-5213		Push Rod, Leaf Spring Axle
01/98→10/04		Centre Rod	DB-DL-5405		Push Rod	
01/98→10/04		Centre Rod	DB-DL-7815		Push Rod;Suspension Rod	
01/98→10/04		Centre Rod	DB-DL-8644		Push Rod	
01/98→10/04		Centre Rod	DB-DL-8731		Push Rod	
01/98→10/04		Centre Rod	DB-DL-9187		Push Rod	
01/98→10/04		Stabiliser Mounting		DB-SB-10385		
01/98→10/04		Stabiliser Mounting		DB-SB-10385	1st RA	
01/98→10/04		Stabiliser Mounting	DB-SB-10385	DB-SB-10385		
01/98→10/04		Stabiliser Mounting	DB-SB-10385	DB-SB-10385	1st FA	
01/98→10/04		Stabiliser Mounting	DB-SB-10386	DB-SB-10386		
01/98→10/04		Stabiliser Mounting	DB-SB-10386	DB-SB-10386	1st FA	
01/98→10/04		Suspension Arm Repair Kit		DB-RK-8550	for Wishbone (CV)	
01/98→10/04		Tie Rod	DB-ES-5214		Guide Rod	
01/98→10/04		Tie Rod End	CV-ES-12461		for Steering Rod	
01/98→10/04		Tie Rod End	CV-ES-12462		for Steering Rod	
01/98→10/04		Track Control Arm		DB-TC-12411	Control Arm	
01/98→10/04		Track Control Arm		DB-VB-10423	Wishbone (CV), 1st Drive Axle, →508306 05	
715,715 L		01/98→10/04	Ball Head, gearshift linkage	DB-ES-8387		
		01/98→10/04	Centre Rod	DB-DL-5213		Push Rod
		01/98→10/04	Centre Rod	DB-DL-5213		Push Rod, Leaf Spring Axle
		01/98→10/04	Centre Rod	DB-DL-5405		Push Rod
	01/98→10/04	Centre Rod	DB-DL-7815		Push Rod;Suspension Rod	
	01/98→10/04	Centre Rod	DB-DL-8644		Push Rod	
	01/98→10/04	Centre Rod	DB-DL-8731		Push Rod	
	01/98→10/04	Centre Rod	DB-DL-8731		Push Rod, Leaf Spring Axle	
	01/98→10/04	Centre Rod	DB-DL-9187		Push Rod	
	01/98→10/04	Stabiliser Mounting		DB-SB-10385		
	01/98→10/04	Stabiliser Mounting		DB-SB-10385	1st RA	
	01/98→10/04	Stabiliser Mounting		DB-SB-10407		
	01/98→10/04	Stabiliser Mounting	DB-SB-10385	DB-SB-10385		
	01/98→10/04	Stabiliser Mounting	DB-SB-10385	DB-SB-10385	1st FA	
	01/98→10/04	Stabiliser Mounting	DB-SB-10386	DB-SB-10386		
	01/98→10/04	Stabiliser Mounting	DB-SB-10386	DB-SB-10386	1st FA	
	01/98→10/04	Suspension Arm Repair Kit		DB-RK-8550	for Wishbone (CV)	
	01/98→10/04	Tie Rod	DB-ES-5214		Guide Rod	
	01/98→10/04	Tie Rod End	CV-ES-12461		for Steering Rod	
	01/98→10/04	Tie Rod End	CV-ES-12462		for Steering Rod	
	01/98→10/04	Track Control Arm		DB-TC-12411	Control Arm	
	01/98→10/04	Track Control Arm		DB-VB-10423	Wishbone (CV), 1st Drive Axle, →508306 05	
	717 K	01/98→10/04	Ball Head, gearshift linkage	DB-ES-8387		
		01/98→10/04	Centre Rod	DB-DL-5213		Push Rod, Leaf Spring Axle
01/98→10/04		Centre Rod	DB-DL-7815		Push Rod;Suspension Rod	
01/98→10/04		Centre Rod	DB-DL-8731		Push Rod, Leaf Spring Axle	

CV-ES-12461

Length: 120
 Cone Ø: d1 Ø 26 / d2 Ø 23,5
 Thread: M30 x 1,5 LHT
 0003300035, 3300148, 0003406213, 0013306635,
 0013308835, 0014604048, 0014604348,
 14606448, 0024600248, 3023300035,
 3023300135, 3023300235, 3023300335,
 3453307235, 3453307435, 3503307135,
 A0003300148, A0013306635, A0013308835,
 A0014604048, A0014604348, A0014606448,
 A0024600248, A3023300035, A3023300135,
 A3023300235, A3023300335, A3503307135



CV-ES-12462

Length: 120
 Cone Ø: d1 Ø 26 / d2 Ø 23,5
 Thread: M30 x 1,5 RHT
 0003300135, 0003300248, 0003303235,
 0003305835, 0003307335, 0003383410,
 004608348, 0004608348, 0004632229,
 0004633129, 0004633429, 0004633529,
 0013300135, 0013300235, 0013306735,
 0014603448, 0014604148, 0014604448,
 0014606348, 0014608348, 0014608448,
 0014609748, 0023301535, 3453307135,
 3503307035, 3503307335, 3643307135,
 5001832582, A0003300248, A0003303235,
 A0003307335, A0003383410, A0004608348,
 A0004632229, A0004633429, A0013300135,
 A0013300235, A0013306735, A0014603448,
 A0014604148, A0014604448, A0014606348,
 A0014608348, A0014608448, A0014609748,
 A0023301535



DB-DL-5213

Length: 846
 Ø: 42
 Cone Ø: d1 Ø 26 / d2 Ø 23,5
 01208200A, 9704600705, 9704600905



DB-DL-5405

Length: 890 Ø: 35
 Cone Ø: d1 Ø 28,6 / d2 Ø 23,9
 01215900A, 1460248, 0024604505, 0024604605,
 0034605005, 3752600637, 3754600405,
 A3752600637, A3754600405



DB-DL-7815

Length: 895 Ø: 50
 Cone Ø: d1 Ø 30 / d2 Ø 27
 01215800A, 0034604605, 3754600005,
 9744601005, 9744601205



DB-DL-8644

Length: 894 Ø: 50
 Cone Ø: d1 Ø 30 / d2 Ø 27
 0034604705, 9744601105, 9744601305



DB-DL-8731

Length: 846
 Ø: 42
 Cone Ø: d1 Ø 26 / d2 Ø 23,5
 9704600805, 9704601005



DB-DL-9187

Length: 846 Ø: 42
 Cone Ø: d1 Ø 26 / d2 Ø 23,5
 9704601105, 9724602805, A9704601105,
 A9724602805



DB-ES-5214

Length: 1640 Ø: 40
 Cone Ø: d1 Ø 26 / d2 Ø 23,5
 01218000A, 9703300003, 9703300103,
 9703300203, 9703300303, 9703300403



DB-ES-8387

Length: 55
 Cone Ø: d1 Ø 10 / d2 Ø 10
 Thread: M14 x 1,5 RHT
 0009966845, 0009967045



DB-RK-8550

Ø: 75 Hole Distance: 152
 Thick/Height: 24
 0003502105, 0003504605



DB-SB-10385

Ø: 30 Thick/Height: 30
 3093200073, 3143260153



DB-SB-10386

Ø: 38 Thick/Height: 38
 3183200073



DB-SB-10407

Ø: 61 Thick/Height: 46
 0003235985, 0003262481, 0003262981



DB-TC-12411

Length: 655 Ø: 40
 Hole Distance: 115 / 115
 9723500906



DB-VB-10423

Length: 761,7 Ø: 46
 Hole Ø 25 / 23 / 23
 Hole Distance: 152 / 130 / 130
 9743500005, 9743500405, 9743500505





ATEGO ...

717 K ...	01/98→10/04	Stabiliser Mounting		DB-SB-10385		
	01/98→10/04	Stabiliser Mounting	DB-SB-10385	DB-SB-10385		
	01/98→10/04	Stabiliser Mounting	DB-SB-10385	DB-SB-10385	1st FA	
	01/98→10/04	Tie Rod	DB-ES-5214		Guide Rod	
	01/98→10/04	Tie Rod End	CV-ES-12461		for Steering Rod	
	01/98→10/04	Tie Rod End	CV-ES-12462		for Steering Rod	
717, 717 L	01/98→10/04	Ball Head, gearshift linkage	DB-ES-8387			
	01/98→10/04	Centre Rod	DB-DL-5213		Push Rod	
	01/98→10/04	Centre Rod	DB-DL-5213		Push Rod, Leaf Spring Axle	
	01/98→10/04	Centre Rod	DB-DL-5405		Push Rod	
	01/98→10/04	Centre Rod	DB-DL-7815		Push Rod;Suspension Rod	
	01/98→10/04	Centre Rod	DB-DL-8644		Push Rod	
	01/98→10/04	Centre Rod	DB-DL-8731		Push Rod	
	01/98→10/04	Centre Rod	DB-DL-8731		Push Rod, Leaf Spring Axle	
	01/98→10/04	Centre Rod	DB-DL-9187		Push Rod	
	01/98→10/04	Stabiliser Mounting		DB-SB-10385		
	01/98→10/04	Stabiliser Mounting		DB-SB-10385	1st RA	
	01/98→10/04	Stabiliser Mounting	DB-SB-10385	DB-SB-10385		
	01/98→10/04	Stabiliser Mounting	DB-SB-10385	DB-SB-10385	1st FA	
	01/98→10/04	Stabiliser Mounting	DB-SB-10386	DB-SB-10386		
	01/98→10/04	Stabiliser Mounting	DB-SB-10386	DB-SB-10386	1st FA	
	01/98→10/04	Suspension Arm Repair Kit		DB-RK-8550	for Wishbone (CV)	
	01/98→10/04	Tie Rod	DB-ES-5214		Guide Rod	
	01/98→10/04	Tie Rod End	CV-ES-12461		for Steering Rod	
	01/98→10/04	Tie Rod End	CV-ES-12462		for Steering Rod	
	01/98→10/04	Track Control Arm		DB-TC-12411	Control Arm	
	01/98→10/04	Track Control Arm		DB-VB-10423	Wishbone (CV), 1st Drive Axle, →508306 05	
	812	01/98→10/04	Ball Head, gearshift linkage	DB-ES-8387		
		01/98→10/04	Centre Rod	DB-DL-5213		Push Rod, Leaf Spring Axle
		01/98→10/04	Centre Rod	DB-DL-5405		Push Rod
01/98→10/04		Centre Rod	DB-DL-7815		Push Rod;Suspension Rod	
01/98→10/04		Centre Rod	DB-DL-8644		Push Rod	
01/98→10/04		Centre Rod	DB-DL-8731		Push Rod, Leaf Spring Axle	
01/98→10/04		Centre Rod	DB-DL-9187		Push Rod	
01/98→10/04		Stabiliser Mounting		DB-SB-10385		
01/98→10/04		Stabiliser Mounting		DB-SB-10407		
01/98→10/04		Stabiliser Mounting	DB-SB-10385	DB-SB-10385		
01/98→10/04		Stabiliser Mounting	DB-SB-10385	DB-SB-10385	1st FA	
01/98→10/04		Stabiliser Mounting	DB-SB-10386	DB-SB-10386		
01/98→10/04		Stabiliser Mounting	DB-SB-10386	DB-SB-10386	1st FA	
01/98→10/04		Tie Rod	DB-ES-5214		Guide Rod	
01/98→10/04		Tie Rod End	CV-ES-12461		for Steering Rod	
01/98→10/04		Tie Rod End	CV-ES-12462		for Steering Rod	
814 K		01/98→10/04	Ball Head, gearshift linkage	DB-ES-8387		
		01/98→10/04	Ball Head, gearshift linkage	DB-ES-8500		
		01/98→10/04	Centre Rod	DB-DL-5213		Push Rod, Leaf Spring Axle
		01/98→10/04	Centre Rod	DB-DL-5405		Push Rod
		01/98→10/04	Centre Rod	DB-DL-7794		Push Rod, Leaf Spring Axle
		01/98→10/04	Centre Rod	DB-DL-7815		Push Rod;Suspension Rod
		01/98→10/04	Centre Rod	DB-DL-8731		Push Rod, Leaf Spring Axle
		01/98→10/04	Stabiliser Mounting		DB-SB-10385	
	01/98→10/04	Stabiliser Mounting	DB-SB-10385	DB-SB-10385		
	01/98→10/04	Stabiliser Mounting	DB-SB-10385	DB-SB-10385	1st FA	
	01/98→10/04	Tie Rod	DB-ES-5214		Guide Rod	
	01/98→10/04	Tie Rod End	CV-ES-12461		for Steering Rod	
	01/98→10/04	Tie Rod End	CV-ES-12462		for Steering Rod	
	814, 814 L	01/98→10/04	Ball Head, gearshift linkage	DB-ES-8387		
		01/98→10/04	Ball Head, gearshift linkage	DB-ES-8500		
		01/98→10/04	Centre Rod	DB-DL-5213		Push Rod
		01/98→10/04	Centre Rod	DB-DL-5213		Push Rod, Leaf Spring Axle
		01/98→10/04	Centre Rod	DB-DL-5405		Push Rod
01/98→10/04		Centre Rod	DB-DL-7794		Push Rod	
01/98→10/04		Centre Rod	DB-DL-7794		Push Rod, Leaf Spring Axle	

CV-ES-12461

Length: 120
 Cone Ø: d1 Ø 26 / d2 Ø 23,5
 Thread: M30 x 1,5 LHT
 0003300035, 3300148, 0003406213, 0013306635,
 0013308835, 0014604048, 0014604348,
 14606448, 0024600248, 3023300035,
 3023300135, 3023300235, 3023300335,
 3453307235, 3453307435, 3503307135,
 A0003300148, A0013306635, A0013308835,
 A0014604048, A0014604348, A0014606448,
 A0024600248, A3023300035, A3023300135,
 A3023300235, A3023300335, A3503307135



CV-ES-12462

Length: 120
 Cone Ø: d1 Ø 26 / d2 Ø 23,5
 Thread: M30 x 1,5 RHT
 0003300135, 0003300248, 0003303235,
 0003305835, 0003307335, 0003383410,
 004608348, 0004608348, 0004632229,
 0004633129, 0004633429, 0004633529,
 0013300135, 0013300235, 0013306735,
 0014603448, 0014604148, 0014604448,
 0014606348, 0014608348, 0014608448,
 0014609748, 0023301535, 3453307135,
 3503307035, 3503307335, 3643307135,
 5001832582, A0003300248, A0003303235,
 A0003307335, A0003383410, A0004608348,
 A0004632229, A0004633429, A0013300135,
 A0013300235, A0013306735, A0014603448,
 A0014604148, A0014604448, A0014606348,
 A0014608348, A0014608448, A0014609748,
 A0023301535



DB-DL-5213

Length: 846
 Ø: 42
 Cone Ø: d1 Ø 26 / d2 Ø 23,5
 01208200A, 9704600705, 9704600905



DB-DL-5405

Length: 890 Ø: 35
 Cone Ø: d1 Ø 28,6 / d2 Ø 23,9
 01215900A, 1460248, 0024604505, 0024604605,
 0034605005, 3752600637, 3754600405,
 A3752600637, A3754600405



DB-DL-7794

Length: 837 Ø: 40
 Cone Ø: d1 Ø 26 / d2 Ø 23,5
 9724601405, 9724601605



DB-DL-7815

Length: 895
 Ø: 50
 Cone Ø: d1 Ø 30 / d2 Ø 27
 01215800A, 34604605, 0034604605, 3754600005,
 9744601005, 9744601205



DB-DL-8644

Length: 894 Ø: 50
 Cone Ø: d1 Ø 30 / d2 Ø 27
 0034604705, 9744601105, 9744601305



DB-DL-8731

Length: 846
 Ø: 42
 Cone Ø: d1 Ø 26 / d2 Ø 23,5
 9704600805, 9704601005



DB-DL-9187

Length: 846 Ø: 42
 Cone Ø: d1 Ø 26 / d2 Ø 23,5
 9704601105, 9724602805, A9704601105,
 A9724602805



DB-ES-5214

Length: 1640 Ø: 40
 Cone Ø: d1 Ø 26 / d2 Ø 23,5
 01218000A, 9703300003, 9703300103,
 9703300203, 9703300303, 9703300403



DB-ES-8387

Length: 55
 Cone Ø: d1 Ø 10 / d2 Ø 10
 Thread: M14 x 1,5 RHT
 0009966845, 0009967045



DB-ES-8500

Length: 55
 Cone Ø: d1 Ø 12 / d2 Ø 10,8
 Thread: M14 x 1,5 RHT
 0002685989



DB-RK-8550

Ø: 75 Hole Distance: 152
 Thick/Height: 24
 0003502105, 0003504605



DB-SB-10385

Ø: 30 Thick/Height: 30
 3093200073, 3143260153



DB-SB-10386

Ø: 38 Thick/Height: 38
 3183200073



DB-SB-10407

Ø: 61 Thick/Height: 46
 0003235985, 0003262481, 0003262981



DB-TC-12411

Length: 655 Ø: 40
 Hole Distance: 115 / 115
 9723500906



DB-VB-10423

Length: 761,7 Ø: 46
 Hole Ø 25 / 23 / 23
 Hole Distance: 152 / 130 / 130
 9743500005, 9743500405, 9743500505



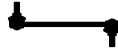

ATEGO ...

814, 814 L ...	01/98 → 10/04	Centre Rod	DB-DL-7815		Push Rod;Suspension Rod	
	01/98 → 10/04	Centre Rod	DB-DL-8644		Push Rod	
	01/98 → 10/04	Centre Rod	DB-DL-8731		Push Rod	
	01/98 → 10/04	Centre Rod	DB-DL-8731		Push Rod, Leaf Spring Axle	
	01/98 → 10/04	Centre Rod	DB-DL-9187		Push Rod	
	01/98 → 10/04	Stabiliser Mounting		DB-SB-10385		
	01/98 → 10/04	Stabiliser Mounting		DB-SB-10385	1st RA	
	01/98 → 10/04	Stabiliser Mounting	DB-SB-10385	DB-SB-10385		
	01/98 → 10/04	Stabiliser Mounting	DB-SB-10385	DB-SB-10385	1st FA	
	01/98 → 10/04	Stabiliser Mounting	DB-SB-10386	DB-SB-10386		
	01/98 → 10/04	Stabiliser Mounting	DB-SB-10386	DB-SB-10386	1st FA	
	01/98 → 10/04	Suspension Arm Repair Kit		DB-RK-8550	for Wishbone (CV)	
	01/98 → 10/04	Tie Rod	DB-ES-5214		Guide Rod	
	01/98 → 10/04	Tie Rod End	CV-ES-12461		for Steering Rod	
	01/98 → 10/04	Tie Rod End	CV-ES-12462		for Steering Rod	
	01/98 → 10/04	Track Control Arm		DB-TC-12411	Control Arm	
	01/98 → 10/04	Track Control Arm		DB-VB-10423	Wishbone (CV), 1st Drive Axle, →508306 05	
	815 F	01/98 → 10/04	Ball Head, gearshift linkage	DB-ES-8387		
		01/98 → 10/04	Centre Rod	DB-DL-5213		Push Rod, Leaf Spring Axle
		01/98 → 10/04	Centre Rod	DB-DL-5405		Push Rod
01/98 → 10/04		Centre Rod	DB-DL-7815		Push Rod;Suspension Rod	
01/98 → 10/04		Centre Rod	DB-DL-8731		Push Rod, Leaf Spring Axle	
01/98 → 10/04		Stabiliser Mounting		DB-SB-10385		
01/98 → 10/04		Stabiliser Mounting		DB-SB-10407		
01/98 → 10/04		Stabiliser Mounting	DB-SB-10385	DB-SB-10385		
01/98 → 10/04		Stabiliser Mounting	DB-SB-10385	DB-SB-10385	1st FA	
01/98 → 10/04		Tie Rod	DB-ES-5214		Guide Rod	
01/98 → 10/04		Tie Rod End	CV-ES-12461		for Steering Rod	
01/98 → 10/04		Tie Rod End	CV-ES-12462		for Steering Rod	
815 K	01/98 → 10/04	Ball Head, gearshift linkage	DB-ES-8387			
	01/98 → 10/04	Ball Head, gearshift linkage	DB-ES-8500			
	01/98 → 10/04	Centre Rod	DB-DL-5213		Push Rod, Leaf Spring Axle	
	01/98 → 10/04	Centre Rod	DB-DL-5405		Push Rod	
	01/98 → 10/04	Centre Rod	DB-DL-7794		Push Rod, Leaf Spring Axle	
	01/98 → 10/04	Centre Rod	DB-DL-7815		Push Rod;Suspension Rod	
	01/98 → 10/04	Centre Rod	DB-DL-8731		Push Rod, Leaf Spring Axle	
	01/98 → 10/04	Stabiliser Mounting		DB-SB-10385		
	01/98 → 10/04	Stabiliser Mounting		DB-SB-10407		
	01/98 → 10/04	Stabiliser Mounting	DB-SB-10385	DB-SB-10385		
	01/98 → 10/04	Stabiliser Mounting	DB-SB-10385	DB-SB-10385	1st FA	
	01/98 → 10/04	Tie Rod	DB-ES-5214		Guide Rod	
	01/98 → 10/04	Tie Rod End	CV-ES-12461		for Steering Rod	
	01/98 → 10/04	Tie Rod End	CV-ES-12462		for Steering Rod	
	815, 815 L	01/98 → 10/04	Ball Head, gearshift linkage	DB-ES-8387		
		01/98 → 10/04	Ball Head, gearshift linkage	DB-ES-8500		
01/98 → 10/04		Centre Rod	DB-DL-5213		Push Rod	
01/98 → 10/04		Centre Rod	DB-DL-5213		Push Rod, Leaf Spring Axle	
01/98 → 10/04		Centre Rod	DB-DL-5405		Push Rod	
01/98 → 10/04		Centre Rod	DB-DL-7794		Push Rod	
01/98 → 10/04		Centre Rod	DB-DL-7794		Push Rod, Leaf Spring Axle	
01/98 → 10/04		Centre Rod	DB-DL-7815		Push Rod;Suspension Rod	
01/98 → 10/04		Centre Rod	DB-DL-8644		Push Rod	
01/98 → 10/04		Centre Rod	DB-DL-8731		Push Rod	
01/98 → 10/04		Centre Rod	DB-DL-8731		Push Rod, Leaf Spring Axle	
01/98 → 10/04		Centre Rod	DB-DL-9187		Push Rod	
01/98 → 10/04		Stabiliser Mounting		DB-SB-10385		
01/98 → 10/04		Stabiliser Mounting		DB-SB-10385	1st RA	
01/98 → 10/04		Stabiliser Mounting		DB-SB-10407		
01/98 → 10/04		Stabiliser Mounting	DB-SB-10385	DB-SB-10385		
01/98 → 10/04		Stabiliser Mounting	DB-SB-10385	DB-SB-10385	1st FA	
01/98 → 10/04		Stabiliser Mounting	DB-SB-10386	DB-SB-10386		
01/98 → 10/04		Stabiliser Mounting	DB-SB-10386	DB-SB-10386	1st FA	
01/98 → 10/04		Suspension Arm Repair Kit		DB-RK-8550	for Wishbone (CV)	

CV-ES-12461

Length: 120
 Cone Ø: d1 Ø 26 / d2 Ø 23,5
 Thread: M30 x 1,5 LHT
 0003300035, 3300148, 0003406213, 0013306635,
 0013308835, 0014604048, 0014604348,
 14606448, 0024600248, 3023300035,
 3023300135, 3023300235, 3023300335,
 3453307235, 3453307435, 3503307135,
 A0003300148, A0013306635, A0013308835,
 A0014604048, A0014604348, A0014606448,
 A0024600248, A3023300035, A3023300135,
 A3023300235, A3023300335, A3503307135



CV-ES-12462

Length: 120
 Cone Ø: d1 Ø 26 / d2 Ø 23,5
 Thread: M30 x 1,5 RHT
 0003300135, 0003300248, 0003303235,
 0003305835, 0003307335, 0003383410,
 004608348, 0004608348, 0004632229,
 0004633129, 0004633429, 0004633529,
 0013300135, 0013300235, 0013306735,
 0014603448, 0014604148, 0014604448,
 0014606348, 0014608348, 0014608448,
 0014609748, 0023301535, 3453307135,
 3503307035, 3503307335, 3643307135,
 5001832582, A0003300248, A0003303235,
 A0003307335, A0003383410, A0004608348,
 A0004632229, A0004633429, A0013300135,
 A0013300235, A0013306735, A0014603448,
 A0014604148, A0014604448, A0014606348,
 A0014608348, A0014608448, A0014609748,
 A0023301535



DB-DL-5213

Length: 846
 Ø: 42
 Cone Ø: d1 Ø 26 / d2 Ø 23,5
 01208200A, 9704600705, 9704600905



DB-DL-5405

Length: 890 Ø: 35
 Cone Ø: d1 Ø 28,6 / d2 Ø 23,9
 01215900A, 1460248, 0024604505, 0024604605,
 0034605005, 3752600637, 3754600405,
 A3752600637, A3754600405



DB-DL-7794

Length: 837 Ø: 40
 Cone Ø: d1 Ø 26 / d2 Ø 23,5
 9724601405, 9724601605



DB-DL-7815

Length: 895
 Ø: 50
 Cone Ø: d1 Ø 30 / d2 Ø 27
 01215800A, 34604605, 0034604605, 3754600005,
 9744601005, 9744601205



DB-DL-8644

Length: 894 Ø: 50
 Cone Ø: d1 Ø 30 / d2 Ø 27
 0034604705, 9744601105, 9744601305



DB-DL-8731

Length: 846
 Ø: 42
 Cone Ø: d1 Ø 26 / d2 Ø 23,5
 9704600805, 9704601005



DB-DL-9187

Length: 846 Ø: 42
 Cone Ø: d1 Ø 26 / d2 Ø 23,5
 9704601105, 9724602805, A9704601105,
 A9724602805



DB-ES-5214

Length: 1640 Ø: 40
 Cone Ø: d1 Ø 26 / d2 Ø 23,5
 01218000A, 9703300003, 9703300103,
 9703300203, 9703300303, 9703300403



DB-ES-8387

Length: 55
 Cone Ø: d1 Ø 10 / d2 Ø 10
 Thread: M14 x 1,5 RHT
 0009966845, 0009967045



DB-ES-8500

Length: 55
 Cone Ø: d1 Ø 12 / d2 Ø 10,8
 Thread: M14 x 1,5 RHT
 0002685989



DB-RK-8550

Ø: 75 Hole Distance: 152
 Thick/Height: 24
 0003502105, 0003504605



DB-SB-10385

Ø: 30 Thick/Height: 30
 3093200073, 3143260153



DB-SB-10386

Ø: 38 Thick/Height: 38
 3183200073



DB-SB-10407

Ø: 61 Thick/Height: 46
 0003235985, 0003262481, 0003262981



DB-TC-12411

Length: 655 Ø: 40
 Hole Distance: 115 / 115
 9723500906



DB-VB-10423

Length: 761,7 Ø: 46
 Hole Ø 25 / 23 / 23
 Hole Distance: 152 / 130 / 130
 9743500005, 9743500405, 9743500505





ATEGO ...

815, 815 L ...	01/98 → 10/04	Tie Rod	DB-ES-5214		Guide Rod	
	01/98 → 10/04	Tie Rod End	CV-ES-12461		for Steering Rod	
	01/98 → 10/04	Tie Rod End	CV-ES-12462		for Steering Rod	
	01/98 → 10/04	Track Control Arm		DB-TC-12411	Control Arm	
	01/98 → 10/04	Track Control Arm		DB-VB-10423	Wishbone (CV), 1st Drive Axle, →508306 05	
817 K	01/98 → 10/04	Ball Head, gearshift linkage	DB-ES-8387			
	01/98 → 10/04	Ball Head, gearshift linkage	DB-ES-8500			
	01/98 → 10/04	Centre Rod	DB-DL-5213		Push Rod, Leaf Spring Axle	
	01/98 → 10/04	Centre Rod	DB-DL-5405		Push Rod	
	01/98 → 10/04	Centre Rod	DB-DL-7794		Push Rod, Leaf Spring Axle	
	01/98 → 10/04	Centre Rod	DB-DL-8731		Push Rod, Leaf Spring Axle	
	01/98 → 10/04	Stabiliser Mounting		DB-SB-10385		
	01/98 → 10/04	Stabiliser Mounting		DB-SB-10407		
	01/98 → 10/04	Stabiliser Mounting	DB-SB-10385	DB-SB-10385		
	01/98 → 10/04	Stabiliser Mounting	DB-SB-10385	DB-SB-10385	1st FA	
	01/98 → 10/04	Tie Rod	DB-ES-5214		Guide Rod	
	01/98 → 10/04	Tie Rod End	CV-ES-12461		for Steering Rod	
	01/98 → 10/04	Tie Rod End	CV-ES-12462		for Steering Rod	
	817, 817 L	01/98 → 10/04	Ball Head, gearshift linkage	DB-ES-8387		
		01/98 → 10/04	Ball Head, gearshift linkage	DB-ES-8500		
01/98 → 10/04		Centre Rod	DB-DL-5213		Push Rod	
01/98 → 10/04		Centre Rod	DB-DL-5213		Push Rod, Leaf Spring Axle	
01/98 → 10/04		Centre Rod	DB-DL-5405		Push Rod	
01/98 → 10/04		Centre Rod	DB-DL-7794		Push Rod	
01/98 → 10/04		Centre Rod	DB-DL-7794		Push Rod, Leaf Spring Axle	
01/98 → 10/04		Centre Rod	DB-DL-7815		Push Rod; Suspension Rod	
01/98 → 10/04		Centre Rod	DB-DL-8644		Push Rod	
01/98 → 10/04		Centre Rod	DB-DL-8731		Push Rod	
01/98 → 10/04		Centre Rod	DB-DL-8731		Push Rod, Leaf Spring Axle	
01/98 → 10/04		Centre Rod	DB-DL-9187		Push Rod	
01/98 → 10/04		Stabiliser Mounting		DB-SB-10385		
01/98 → 10/04		Stabiliser Mounting		DB-SB-10385	1st RA	
01/98 → 10/04		Stabiliser Mounting		DB-SB-10407		
01/98 → 10/04		Stabiliser Mounting	DB-SB-10385	DB-SB-10385		
01/98 → 10/04		Stabiliser Mounting	DB-SB-10385	DB-SB-10385	1st FA	
01/98 → 10/04		Stabiliser Mounting	DB-SB-10386	DB-SB-10386		
01/98 → 10/04		Stabiliser Mounting	DB-SB-10386	DB-SB-10386	1st FA	
01/98 → 10/04		Suspension Arm Repair Kit		DB-RK-8550	for Wishbone (CV)	
01/98 → 10/04		Tie Rod	DB-ES-5214		Guide Rod	
01/98 → 10/04		Tie Rod End	CV-ES-12461		for Steering Rod	
01/98 → 10/04		Tie Rod End	CV-ES-12462		for Steering Rod	
01/98 → 10/04		Track Control Arm		DB-TC-12411	Control Arm	
01/98 → 10/04		Track Control Arm		DB-VB-10423	Wishbone (CV), 1st Drive Axle, →508306 05	
823 K		01/98 → 10/04	Ball Head, gearshift linkage	DB-ES-8387		
		01/98 → 10/04	Ball Head, gearshift linkage	DB-ES-8500		
		01/98 → 10/04	Centre Rod	DB-DL-5213		Push Rod, Leaf Spring Axle
		01/98 → 10/04	Centre Rod	DB-DL-5405		Push Rod
		01/98 → 10/04	Centre Rod	DB-DL-7794		Push Rod, Leaf Spring Axle
	01/98 → 10/04	Centre Rod	DB-DL-8731		Push Rod, Leaf Spring Axle	
	01/98 → 10/04	Stabiliser Mounting		DB-SB-10385		
	01/98 → 10/04	Stabiliser Mounting		DB-SB-10407		
	01/98 → 10/04	Stabiliser Mounting	DB-SB-10385	DB-SB-10385		
	01/98 → 10/04	Stabiliser Mounting	DB-SB-10385	DB-SB-10385	1st FA	
	01/98 → 10/04	Tie Rod	DB-ES-5214		Guide Rod	
	01/98 → 10/04	Tie Rod End	CV-ES-12461		for Steering Rod	
	01/98 → 10/04	Tie Rod End	CV-ES-12462		for Steering Rod	
	823, 823 L	01/98 → 10/04	Ball Head, gearshift linkage	DB-ES-8387		
		01/98 → 10/04	Ball Head, gearshift linkage	DB-ES-8500		
01/98 → 10/04		Centre Rod	DB-DL-5213		Push Rod	
01/98 → 10/04		Centre Rod	DB-DL-5213		Push Rod, Leaf Spring Axle	
01/98 → 10/04		Centre Rod	DB-DL-5405		Push Rod	
01/98 → 10/04		Centre Rod	DB-DL-7794		Push Rod	
01/98 → 10/04		Centre Rod	DB-DL-7794		Push Rod, Leaf Spring Axle	

CV-ES-12461

Length: 120
Cone Ø: d1 Ø 26 / d2 Ø 23,5
Thread: M30 x 1,5 LHT
0003300035, 3300148, 0003406213, 0013306635,
0013308835, 0014604048, 0014604348,
14606448, 0024600248, 3023300035,
3023300135, 3023300235, 3023300335,
3453307235, 3453307435, 3503307135,
A0003300148, A0013306635, A0013308835,
A0014604048, A0014604348, A0014606448,
A0024600248, A3023300035, A3023300135,
A3023300235, A3023300335, A3503307135



CV-ES-12462

Length: 120
Cone Ø: d1 Ø 26 / d2 Ø 23,5
Thread: M30 x 1,5 RHT
0003300135, 0003300248, 0003303235,
0003305835, 0003307335, 0003383410,
004608348, 0004608348, 0004632229,
0004633129, 0004633429, 0004633529,
0013300135, 0013300235, 0013306735,
0014603448, 0014604148, 0014604448,
0014606348, 0014608348, 0014608448,
0014609748, 0023301535, 3453307135,
3503307035, 3503307335, 3643307135,
5001832582, A0003300248, A0003303235,
A0003307335, A0003383410, A0004608348,
A0004632229, A0004633429, A0013300135,
A0013300235, A0013306735, A0014603448,
A0014604148, A0014604448, A0014606348,
A0014608348, A0014608448, A0014609748,
A0023301535



DB-DL-5213

Length: 846
Ø: 42
Cone Ø: d1 Ø 26 / d2 Ø 23,5
01208200A, 9704600705, 9704600905



DB-DL-5405

Length: 890 Ø: 35
Cone Ø: d1 Ø 28,6 / d2 Ø 23,9
01215900A, 1460248, 0024604505, 0024604605,
0034605005, 3752600637, 3754600405,
A3752600637, A3754600405



DB-DL-7794

Length: 837 Ø: 40
Cone Ø: d1 Ø 26 / d2 Ø 23,5
9724601405, 9724601605



DB-DL-7815

Length: 895
Ø: 50
Cone Ø: d1 Ø 30 / d2 Ø 27
01215800A, 34604605, 0034604605, 3754600005,
9744601005, 9744601205



DB-DL-8644

Length: 894 Ø: 50
Cone Ø: d1 Ø 30 / d2 Ø 27
0034604705, 9744601105, 9744601305



DB-DL-8731

Length: 846
Ø: 42
Cone Ø: d1 Ø 26 / d2 Ø 23,5
9704600805, 9704601005



DB-DL-9187

Length: 846 Ø: 42
Cone Ø: d1 Ø 26 / d2 Ø 23,5
9704601105, 9724602805, A9704601105,
A9724602805



DB-ES-5214

Length: 1640 Ø: 40
Cone Ø: d1 Ø 26 / d2 Ø 23,5
01218000A, 9703300003, 9703300103,
9703300203, 9703300303, 9703300403



DB-ES-8387

Length: 55
Cone Ø: d1 Ø 10 / d2 Ø 10
Thread: M14 x 1,5 RHT
0009966845, 0009967045



DB-ES-8500

Length: 55
Cone Ø: d1 Ø 12 / d2 Ø 10,8
Thread: M14 x 1,5 RHT
0002685989



DB-RK-8550

Ø: 75 Hole Distance: 152
Thick/Height: 24
0003502105, 0003504605



DB-SB-10385

Ø: 30 Thick/Height: 30
3093200073, 3143260153



DB-SB-10386

Ø: 38 Thick/Height: 38
3183200073



DB-SB-10407

Ø: 61 Thick/Height: 46
0003235985, 0003262481, 0003262981



DB-TC-12411

Length: 655 Ø: 40
Hole Distance: 115 / 115
9723500906



DB-VB-10423

Length: 761,7 Ø: 46
Hole Ø 25 / 23 / 23
Hole Distance: 152 / 130 / 130
9743500005, 9743500405, 9743500505





ATEGO ...

823, 823 L ...	01/98 → 10/04	Centre Rod	DB-DL-7815		Push Rod;Suspension Rod	
	01/98 → 10/04	Centre Rod	DB-DL-8644		Push Rod	
	01/98 → 10/04	Centre Rod	DB-DL-8731		Push Rod	
	01/98 → 10/04	Centre Rod	DB-DL-8731		Push Rod, Leaf Spring Axle	
	01/98 → 10/04	Centre Rod	DB-DL-9187		Push Rod	
	01/98 → 10/04	Stabiliser Mounting		DB-SB-10385		
	01/98 → 10/04	Stabiliser Mounting		DB-SB-10385	1st RA	
	01/98 → 10/04	Stabiliser Mounting		DB-SB-10407		
	01/98 → 10/04	Stabiliser Mounting	DB-SB-10385	DB-SB-10385		
	01/98 → 10/04	Stabiliser Mounting	DB-SB-10385	DB-SB-10385	1st FA	
	01/98 → 10/04	Stabiliser Mounting	DB-SB-10386	DB-SB-10386		
	01/98 → 10/04	Stabiliser Mounting	DB-SB-10386	DB-SB-10386	1st FA	
	01/98 → 10/04	Suspension Arm Repair Kit		DB-RK-8550	for Wishbone (CV)	
	01/98 → 10/04	Tie Rod	DB-ES-5214		Guide Rod	
	01/98 → 10/04	Tie Rod End	CV-ES-12461		for Steering Rod	
	01/98 → 10/04	Tie Rod End	CV-ES-12462		for Steering Rod	
	01/98 → 10/04	Track Control Arm		DB-TC-12411	Control Arm	
	01/98 → 10/04	Track Control Arm		DB-VB-10423	Wishbone (CV), 1st Drive Axle, →508306 05	
	914 K	01/98 → 10/04	Centre Rod	DB-DL-5405		Push Rod
	914, 914 L	01/98 → 10/04	Centre Rod	DB-DL-5405		Push Rod
	917 AF	01/98 → 10/04	Ball Head, gearshift linkage	DB-ES-8387		
		01/98 → 10/04	Ball Head, gearshift linkage	DB-ES-8500		
		01/98 → 10/04	Centre Rod	DB-DL-5405		Push Rod
01/98 → 10/04		Centre Rod	DB-DL-9247		Push Rod	
01/98 → 10/04		Stabiliser Mounting		DB-SB-10407		
01/98 → 10/04		Stabiliser Mounting	DB-SB-10386	DB-SB-10386		
01/98 → 10/04		Stabiliser Mounting	DB-SB-10386	DB-SB-10386	1st FA	
01/98 → 10/04		Tie Rod End	CV-ES-12462		for Steering Rod	
917 K	01/98 → 10/04	Ball Head, gearshift linkage	DB-ES-8387			
	01/98 → 10/04	Ball Head, gearshift linkage	DB-ES-8500			
	01/98 → 10/04	Centre Rod	DB-DL-5405		Push Rod	
	01/98 → 10/04	Centre Rod	DB-DL-7794		Push Rod, Leaf Spring Axle	
	01/98 → 10/04	Centre Rod	DB-DL-7799		Push Rod, Leaf Spring Axle	
	01/98 → 10/04	Centre Rod	DB-DL-7815		Push Rod;Suspension Rod	
	01/98 → 10/04	Stabiliser Mounting		DB-SB-10386		
	01/98 → 10/04	Stabiliser Mounting		DB-SB-10407		
	01/98 → 10/04	Stabiliser Mounting	DB-SB-10386	DB-SB-10386		
	01/98 → 10/04	Stabiliser Mounting	DB-SB-10386	DB-SB-10386	1st FA	
	01/98 → 10/04	Tie Rod	DB-DL-8174		Guide Rod	
	01/98 → 10/04	Tie Rod	DB-ES-5214		Guide Rod	
	01/98 → 10/04	Tie Rod End	CV-ES-12461		for Steering Rod	
	01/98 → 10/04	Tie Rod End	CV-ES-12462		for Steering Rod	
	01/98 → 10/04	Tie Rod End	CV-ES-14162		for Steering Rod	
	01/98 → 10/04	Tie Rod End	CV-ES-14163		for Steering Rod	
	917, 917 L	01/98 → 10/04	Ball Head, gearshift linkage	DB-ES-8387		
		01/98 → 10/04	Ball Head, gearshift linkage	DB-ES-8500		
01/98 → 10/04		Centre Rod	DB-DL-5405		Push Rod	
01/98 → 10/04		Centre Rod	DB-DL-7794		Push Rod	
01/98 → 10/04		Centre Rod	DB-DL-7794		Push Rod, Leaf Spring Axle	
01/98 → 10/04		Centre Rod	DB-DL-7799		Push Rod, Leaf Spring Axle	
01/98 → 10/04		Centre Rod	DB-DL-9187		Push Rod	
01/98 → 10/04		Stabiliser Mounting		DB-SB-10385		
01/98 → 10/04		Stabiliser Mounting		DB-SB-10385	1st RA	
01/98 → 10/04		Stabiliser Mounting		DB-SB-10386		
01/98 → 10/04		Stabiliser Mounting		DB-SB-10407		
01/98 → 10/04		Stabiliser Mounting	DB-SB-10386	DB-SB-10386		
01/98 → 10/04		Stabiliser Mounting	DB-SB-10386	DB-SB-10386	1st FA	
01/98 → 10/04		Suspension Arm Repair Kit		DB-RK-8550	for Wishbone (CV)	
01/98 → 10/04		Tie Rod	DB-DL-8174		Guide Rod	
01/98 → 10/04		Tie Rod	DB-ES-5214		Guide Rod	
01/98 → 10/04		Tie Rod End	CV-ES-12461		for Steering Rod	
01/98 → 10/04		Tie Rod End	CV-ES-12462		for Steering Rod	
01/98 → 10/04		Tie Rod End	CV-ES-14162		for Steering Rod	

CV-ES-12461

Length: 120
Cone Ø: d1 Ø 26 / d2 Ø 23,5
Thread: M30 x 1,5 LHT
 0003300035, 3300148, 0003406213, 0013306635,
 0013308835, 0014604048, 0014604348,
 14606448, 0024600248, 3023300035,
 3023300135, 3023300235, 3023300335,
 3453307235, 3453307435, 3503307135,
 A0003300148, A0013306635, A0013308835,
 A0014604048, A0014604348, A0014606448,
 A0024600248, A3023300035, A3023300135,
 A3023300235, A3023300335, A3503307135



CV-ES-12462

Length: 120
Cone Ø: d1 Ø 26 / d2 Ø 23,5
Thread: M30 x 1,5 RHT
 0003300135, 0003300248, 0003303235,
 0003305835, 0003307335, 0003383410,
 0004608348, 004608348, 0004632229,
 0004633129, 0004633429, 0004633529,
 0013300135, 0013300235, 0013306735,
 0014603448, 0014604148, 0014604448,
 0014606348, 0014608348, 0014608448,
 0014609748, 0023301535, 3453307135,
 3503307035, 3503307335, 3643307135,
 5001832582, A0003300248, A0003303235,
 A0003307335, A0003383410, A0004608348,
 A0004632229, A0004633429, A0013300135,
 A0013300235, A0013306735, A0014603448,
 A0014604148, A0014604448, A0014606348,
 A0014608348, A0014608448, A0014609748,
 A0023301535



CV-ES-14162

Length: 125
Cone Ø: d1 Ø 30 / d2 Ø 27
Thread: M30 x 1,5 LHT
 4600648, 4601248, 4603448, 4603548,
 0004603548, 14600348, 14601448, 14602348,
 0014603748, 0014607848, 14607848, 002460
 0348



CV-ES-14163

Length: 125
Cone Ø: d1 Ø 30 / d2 Ø 27
Thread: M30 x 1,5 RHT
 0003305248, 0003387310, 0004600348,
 0004600948, 0004602848, 0004602948,
 0004608948, 0014600248, 0014600848,
 0014601248, 0014602248, 0014607748,
 0024600148, A0003387310, A0004600348,
 A0004602848, A0004602948, A0014600848,
 A0014601248, A0014602248, A0014607748



DB-DL-5405

Length: 890 Ø: 35
Cone Ø: d1 Ø 28,6 / d2 Ø 23,9
 01215900A, 1460248, 0024604505, 0024604605,
 0034605005, 3752600637, 3754600405,
 A3752600637, A3754600405



DB-DL-7794

Length: 837 Ø: 40
Cone Ø: d1 Ø 26 / d2 Ø 23,5
 9724601405, 9724601605



DB-DL-7799

Length: 895 Ø: 50
Cone Ø: d1 Ø 30 / d2 Ø 26
 0034605905, 3754600305, 9724601805,
 9724602005



DB-DL-7815

Length: 895 Ø: 50
Cone Ø: d1 Ø 30 / d2 Ø 27
 01215800A, 0034604605, 3754600005,
 9744601005, 9744601205



DB-DL-8174

Length: 1605 Ø: 40
Cone Ø: d1 Ø 30 / d2 Ø 27
 9753300203, 9753300303, 9753300803,
 9753301703, 9753302503



DB-DL-8644

Length: 894 Ø: 50
Cone Ø: d1 Ø 30 / d2 Ø 27
 0034604705, 9744601105, 9744601305



DB-DL-8731

Length: 846
 Ø: 42
Cone Ø: d1 Ø 26 / d2 Ø 23,5
 9704600805, 9704601005



DB-DL-9187

Length: 846 Ø: 42
Cone Ø: d1 Ø 26 / d2 Ø 23,5
 9704601105, 9724602805, A9704601105,
 A9724602805



DB-DL-9247

Length: 873 Ø: 40
Cone Ø: d1 Ø 26 / d2 Ø 23,5
 9724601005, 9724601205



DB-ES-5214

Length: 1640 Ø: 40
Cone Ø: d1 Ø 26 / d2 Ø 23,5
 01218000A, 9703300003, 9703300103,
 9703300203, 9703300303, 9703300403



DB-ES-8387

Length: 55
Cone Ø: d1 Ø 10 / d2 Ø 10
Thread: M14 x 1,5 RHT
 0009966845, 0009967045



DB-ES-8500

Length: 55
Cone Ø: d1 Ø 12 / d2 Ø 10,8
Thread: M14 x 1,5 RHT
 0002685989



DB-RK-8550

Ø: 75 Hole Distance: 152
 Thick/Height: 24
 0003502105, 0003504605



DB-SB-10385

Ø: 30 Thick/Height: 30
 3093200073, 3143260153



DB-SB-10386

Ø: 38 Thick/Height: 38
 3183200073



DB-SB-10407

Ø: 61 Thick/Height: 46
 0003235985, 0003262481, 0003262981



DB-TC-12411

Length: 655 Ø: 40
Hole Distance: 115 / 115
 9723500906



DB-VB-10423

Length: 761,7 Ø: 46
Hole Ø: 25 / 23 / 23
Hole Distance: 152 / 130 / 130
 9743500005, 9743500405, 9743500505





ATEGO ...

917, 917 L ...	01/98 → 10/04	Tie Rod End	CV-ES-14163		for Steering Rod
	01/98 → 10/04	Track Control Arm		DB-TC-12411	Control Arm
	01/98 → 10/04	Track Control Arm		DB-VB-10423	Wishbone (CV), 1st Drive Axle, →508306 05
923 K	01/98 → 10/04	Ball Head, gearshift linkage	DB-ES-8387		
	01/98 → 10/04	Ball Head, gearshift linkage	DB-ES-8500		
	01/98 → 10/04	Centre Rod	DB-DL-5405		Push Rod
	01/98 → 10/04	Centre Rod	DB-DL-7794		Push Rod, Leaf Spring Axle
	01/98 → 10/04	Centre Rod	DB-DL-7799		Push Rod, Leaf Spring Axle
	01/98 → 10/04	Stabiliser Mounting		DB-SB-10386	
	01/98 → 10/04	Stabiliser Mounting		DB-SB-10407	
	01/98 → 10/04	Stabiliser Mounting	DB-SB-10386	DB-SB-10386	
	01/98 → 10/04	Stabiliser Mounting	DB-SB-10386	DB-SB-10386	1st FA
	01/98 → 10/04	Tie Rod	DB-DL-8174		Guide Rod
	01/98 → 10/04	Tie Rod	DB-ES-5214		Guide Rod
	01/98 → 10/04	Tie Rod End	CV-ES-12461		for Steering Rod
	01/98 → 10/04	Tie Rod End	CV-ES-12462		for Steering Rod
	01/98 → 10/04	Tie Rod End	CV-ES-14162		for Steering Rod
	01/98 → 10/04	Tie Rod End	CV-ES-14163		for Steering Rod
923, 923 L	01/98 → 10/04	Ball Head, gearshift linkage	DB-ES-8387		
	01/98 → 10/04	Ball Head, gearshift linkage	DB-ES-8500		
	01/98 → 10/04	Centre Rod	DB-DL-5405		Push Rod
	01/98 → 10/04	Centre Rod	DB-DL-7794		Push Rod
	01/98 → 10/04	Centre Rod	DB-DL-7794		Push Rod, Leaf Spring Axle
	01/98 → 10/04	Centre Rod	DB-DL-7799		Push Rod, Leaf Spring Axle
	01/98 → 10/04	Centre Rod	DB-DL-9187		Push Rod
	01/98 → 10/04	Stabiliser Mounting		DB-SB-10385	
	01/98 → 10/04	Stabiliser Mounting		DB-SB-10385	1st RA
	01/98 → 10/04	Stabiliser Mounting		DB-SB-10386	
	01/98 → 10/04	Stabiliser Mounting		DB-SB-10407	
	01/98 → 10/04	Stabiliser Mounting	DB-SB-10386	DB-SB-10386	
	01/98 → 10/04	Stabiliser Mounting	DB-SB-10386	DB-SB-10386	1st FA
	01/98 → 10/04	Suspension Arm Repair Kit		DB-RK-8550	for Wishbone (CV)
	01/98 → 10/04	Tie Rod	DB-DL-8174		Guide Rod
	01/98 → 10/04	Tie Rod	DB-ES-5214		Guide Rod
	01/98 → 10/04	Tie Rod End	CV-ES-12461		for Steering Rod
	01/98 → 10/04	Tie Rod End	CV-ES-12462		for Steering Rod
	01/98 → 10/04	Tie Rod End	CV-ES-14162		for Steering Rod
	01/98 → 10/04	Tie Rod End	CV-ES-14163		for Steering Rod
	01/98 → 10/04	Track Control Arm		DB-TC-12411	Control Arm
	01/98 → 10/04	Track Control Arm		DB-VB-10423	Wishbone (CV), 1st Drive Axle, →508306 05
	925 AF	01/98 → 10/04	Ball Head, gearshift linkage	DB-ES-8387	
01/98 → 10/04		Ball Head, gearshift linkage	DB-ES-8500		
01/98 → 10/04		Centre Rod	DB-DL-5405		Push Rod
01/98 → 10/04		Centre Rod	DB-DL-9247		Push Rod
01/98 → 10/04		Stabiliser Mounting		DB-SB-10407	
01/98 → 10/04		Stabiliser Mounting	DB-SB-10386	DB-SB-10386	
01/98 → 10/04		Stabiliser Mounting	DB-SB-10386	DB-SB-10386	1st FA
01/98 → 10/04		Tie Rod End	CV-ES-12462		for Steering Rod

ATEGO 2

1015 K	10/04 →	Centre Rod	DB-DL-7794		Push Rod
	10/04 →	Centre Rod	DB-DL-7799		Push Rod
	10/04 →	Centre Rod	DB-DL-12298		for Steering Rod
	10/04 →	Centre Rod	DB-DL-12405		Coupling Rod
	10/04 →	Tie Rod	DB-DL-8174		Guide Rod
	10/04 →	Tie Rod	DB-DL-12304		
	10/04 →	Tie Rod	DB-ES-5214		Guide Rod
	10/04 →	Tie Rod End	CV-ES-12461		for Steering Rod
	10/04 →	Tie Rod End	CV-ES-12462		for Steering Rod
	10/04 →	Tie Rod End	CV-ES-14162		for Steering Rod
10/04 →	Tie Rod End	CV-ES-14163		for Steering Rod	

CV-ES-12461

Length: 120
 Cone Ø: d1 Ø 26 / d2 Ø 23,5
 Thread: M30 x 1,5 LHT
 0003300035, 3300148, 0003406213, 0013306635,
 0013308835, 0014604048, 0014604348,
 14606448, 0024600248, 3023300035,
 3023300135, 3023300235, 3023300335,
 3453307235, 3453307435, 3503307135,
 A0003300148, A0013306635, A0013308835,
 A0014604048, A0014604348, A0014606448,
 A0024600248, A3023300035, A3023300135,
 A3023300235, A3023300335, A3503307135



CV-ES-12462

Length: 120
 Cone Ø: d1 Ø 26 / d2 Ø 23,5
 Thread: M30 x 1,5 RHT
 0003300135, 0003300248, 0003303235,
 0003305835, 0003307335, 0003383410,
 0004608348, 004608348, 0004632229,
 0004633129, 0004633429, 0004633529,
 0013300135, 0013300235, 0013306735,
 0014603448, 0014604148, 0014604448,
 0014606348, 0014608348, 0014608448,
 0014609748, 0023301535, 3453307135,
 3503307035, 3503307335, 3643307135,
 5001832582, A0003300248, A0003303235,
 A0003307335, A0003383410, A0004608348,
 A0004632229, A0004633429, A0013300135,
 A0013300235, A0013306735, A0014603448,
 A0014604148, A0014604448, A0014606348,
 A0014608348, A0014608448, A0014609748,
 A0023301535



CV-ES-14162

Length: 125
 Cone Ø: d1 Ø 30 / d2 Ø 27
 Thread: M30 x 1,5 LHT
 4600648, 4601248, 4603448, 0004603548,
 4603548, 14600348, 14601448, 14602348, 001
 460 37 48, 14607848, 0014607848, 002 460 03 48



CV-ES-14163

Length: 125
 Cone Ø: d1 Ø 30 / d2 Ø 27
 Thread: M30 x 1,5 RHT
 0003305248, 0003387310, 0004600348,
 0004600948, 0004602848, 0004602948,
 0004608948, 0014600248, 0014600848,
 0014601248, 0014602248, 0014607748,
 0024600148, A0003387310, A0004600348,
 A0004602848, A0004602948, A0014600848,
 A0014601248, A0014602248, A0014607748



DB-DL-5405

Length: 890 Ø: 35
 Cone Ø: d1 Ø 28,6 / d2 Ø 23,9
 01215900A, 1460248, 0024604505, 0024604605,
 0034605005, 3752600637, 3754600405,
 A3752600637, A3754600405



DB-DL-7794

Length: 837 Ø: 40
 Cone Ø: d1 Ø 26 / d2 Ø 23,5
 9724601405, 9724601605



DB-DL-7799

Length: 895 Ø: 50
 Cone Ø: d1 Ø 30 / d2 Ø 26
 0034605905, 3754600305, 9724601805,
 9724602005



DB-DL-8174

Length: 1605 Ø: 40
 Cone Ø: d1 Ø 30 / d2 Ø 27
 9753300203, 9753300303, 9753300803,
 9753301703, 9753302503



DB-DL-9187

Length: 846 Ø: 42
 Cone Ø: d1 Ø 26 / d2 Ø 23,5
 9704601105, 9724602805, A9704601105,
 A9724602805



DB-DL-9247

Length: 873 Ø: 40
 Cone Ø: d1 Ø 26 / d2 Ø 23,5
 9724601005, 9724601205



DB-DL-12298

Length: 927 Ø: 50
 Cone Ø: d1 Ø 30 / d2 Ø 27
 0024602405, 0024603005



DB-DL-12304

Length: 1560 Ø: 40
 Cone Ø: d1 Ø 30 / d2 Ø 27
 Thread: M30 x 1,5 LHT / M30 x 1,5 RHT
 9753300603, 9753300703, 9753300903,
 A9753300603, A9753300703, A9753300903



DB-DL-12405

Length: 895 Ø: 50
 Cone Ø: d1 Ø 30 / d2 Ø 28,6
 Thread: M24 x 1,5 / M20 x 1,5
 9744602205, 9764600205, 9764600405,
 A9764600405



DB-ES-5214

Length: 1640 Ø: 40
 Cone Ø: d1 Ø 26 / d2 Ø 23,5
 01218000A, 9703300003, 9703300103,
 9703300203, 9703300303, 9703300403



DB-ES-8387

Length: 55
 Cone Ø: d1 Ø 10 / d2 Ø 10
 Thread: M14 x 1,5 RHT
 0009966845, 0009967045



DB-ES-8500

Length: 55
 Cone Ø: d1 Ø 12 / d2 Ø 10,8
 Thread: M14 x 1,5 RHT
 0002685989



DB-RK-8550

Ø: 75 Hole Distance: 152
 Thick/Height: 24
 0003502105, 0003504605



DB-SB-10385

Ø: 30 Thick/Height: 30
 3093200073, 3143260153



DB-SB-10386

Ø: 38 Thick/Height: 38
 3183200073



DB-SB-10407

Ø: 61 Thick/Height: 46
 0003235985, 0003262481, 0003262981



DB-TC-12411

Length: 655 Ø: 40
 Hole Distance: 115 / 115
 9723500906



DB-VB-10423

Length: 761,7 Ø: 46
 Hole Ø 25 / 23 / 23
 Hole Distance: 152 / 130 / 130
 9743500005, 9743500405, 9743500505





ATEGO 2 ...

1015 K, 1016 K	10/04 →	Ball Head, gearshift linkage	DB-ES-8387		
	10/04 →	Ball Head, gearshift linkage	DB-ES-8500		
	10/04 →	Centre Rod	DB-DL-7794		Push Rod, Leaf Spring Axle
	10/04 →	Centre Rod	DB-DL-7799		Push Rod, Leaf Spring Axle
	10/04 →	Centre Rod	DB-DL-12298		for Steering Rod
	10/04 →	Centre Rod	DB-DL-12405		Coupling Rod
	10/04 →	Stabiliser Mounting		DB-SB-10386	
	10/04 →	Stabiliser Mounting	DB-SB-10386	DB-SB-10386	
	10/04 →	Stabiliser Mounting	DB-SB-10386	DB-SB-10386	1st FA
	10/04 →	Tie Rod	DB-DL-8174		Guide Rod
	10/04 →	Tie Rod	DB-DL-12304		
	10/04 →	Tie Rod	DB-ES-5214		Guide Rod
	10/04 →	Tie Rod End	CV-ES-12461		for Steering Rod
	10/04 →	Tie Rod End	CV-ES-12462		for Steering Rod
	10/04 →	Tie Rod End	CV-ES-14162		for Steering Rod
	10/04 →	Tie Rod End	CV-ES-14163		for Steering Rod
	1015, 1015 L	10/04 →	Centre Rod	DB-DL-7794	
10/04 →		Centre Rod	DB-DL-7799		Push Rod
10/04 →		Centre Rod	DB-DL-9187		Push Rod
10/04 →		Centre Rod	DB-DL-12298		for Steering Rod
10/04 →		Centre Rod	DB-DL-12405		Coupling Rod
10/04 →		Suspension Arm Repair Kit		DB-RK-8550	for Wishbone (CV)
10/04 →		Tie Rod	DB-DL-8174		Guide Rod, 1st Front Axle
10/04 →		Tie Rod	DB-ES-5214		Guide Rod, 1st Front Axle
10/04 →		Tie Rod End	CV-ES-12461		for Steering Rod
10/04 →		Tie Rod End	CV-ES-12462		for Steering Rod
10/04 →		Tie Rod End	CV-ES-14162		for Steering Rod
10/04 →		Tie Rod End	CV-ES-14163		for Steering Rod
10/04 →		Track Control Arm		DB-TC-12411	Control Arm
10/04 →	Track Control Arm		DB-VB-10423	Wishbone (CV), 1st Drive Axle, →508306 05	
1016, 1016 L	10/04 →	Ball Head, gearshift linkage	DB-ES-8387		
	10/04 →	Ball Head, gearshift linkage	DB-ES-8500		
	10/04 →	Centre Rod	DB-DL-7794		Push Rod
	10/04 →	Centre Rod	DB-DL-7794		Push Rod, Leaf Spring Axle
	10/04 →	Centre Rod	DB-DL-7799		Push Rod
	10/04 →	Centre Rod	DB-DL-7799		Push Rod, Leaf Spring Axle
	10/04 →	Centre Rod	DB-DL-9187		Push Rod
	10/04 →	Centre Rod	DB-DL-12298		for Steering Rod
	10/04 →	Centre Rod	DB-DL-12405		Coupling Rod
	10/04 →	Stabiliser Mounting		DB-SB-10385	
	10/04 →	Stabiliser Mounting		DB-SB-10385	1st RA
	10/04 →	Stabiliser Mounting		DB-SB-10386	
	10/04 →	Stabiliser Mounting	DB-SB-10385	DB-SB-10385	1st FA
	10/04 →	Stabiliser Mounting	DB-SB-10386	DB-SB-10386	
	10/04 →	Stabiliser Mounting	DB-SB-10386	DB-SB-10386	1st FA
	10/04 →	Suspension Arm Repair Kit		DB-RK-8550	for Wishbone (CV)
	10/04 →	Tie Rod	DB-DL-8174		Guide Rod
	10/04 →	Tie Rod	DB-DL-8174		Guide Rod, 1st Front Axle
	10/04 →	Tie Rod	DB-ES-5214		Guide Rod
	10/04 →	Tie Rod	DB-ES-5214		Guide Rod, 1st Front Axle
	10/04 →	Tie Rod End	CV-ES-12461		for Steering Rod
	10/04 →	Tie Rod End	CV-ES-12462		for Steering Rod
	10/04 →	Tie Rod End	CV-ES-14162		for Steering Rod
10/04 →	Tie Rod End	CV-ES-14163		for Steering Rod	
10/04 →	Track Control Arm		DB-TC-12411	Control Arm	
10/04 →	Track Control Arm		DB-VB-10423	Wishbone (CV), 1st Drive Axle, →508306 05	
1017 AK	10/04 →	Centre Rod	DB-DL-9247		Push Rod
	10/04 →	Centre Rod	DB-DL-12298		for Steering Rod
	10/04 →	Centre Rod	DB-DL-12405		Coupling Rod
	10/04 →	Tie Rod End	CV-ES-12462		for Steering Rod

CV-ES-12461

Length: 120
Cone Ø: d1 Ø 26 / d2 Ø 23,5
Thread: M30 x 1,5 LHT
 0003300035, 3300148, 0003406213, 0013306635,
 0013308835, 0014604048, 0014604348,
 14606448, 0024600248, 3023300035,
 3023300135, 3023300235, 3023300335,
 3453307235, 3453307435, 3503307135,
 A0003300148, A0013306635, A0013308835,
 A0014604048, A0014604348, A0014606448,
 A0024600248, A3023300035, A3023300135,
 A3023300235, A3023300335, A3503307135



CV-ES-12462

Length: 120
Cone Ø: d1 Ø 26 / d2 Ø 23,5
Thread: M30 x 1,5 RHT
 0003300135, 0003300248, 0003303235,
 0003305835, 0003307335, 0003383410,
 0004608348, 004608348, 0004632229,
 0004633129, 0004633429, 0004633529,
 0013300135, 0013300235, 0013306735,
 0014603448, 0014604148, 0014604448,
 0014606348, 0014608348, 0014608448,
 0014609748, 0023301535, 3453307135,
 3503307035, 3503307335, 3643307135,
 5001832582, A0003300248, A0003303235,
 A0003307335, A0003383410, A0004608348,
 A0004632229, A0004633429, A0013300135,
 A0013300235, A0013306735, A0014603448,
 A0014604148, A0014604448, A0014606348,
 A0014608348, A0014608448, A0014609748,
 A0023301535



CV-ES-14162

Length: 125
Cone Ø: d1 Ø 30 / d2 Ø 27
Thread: M30 x 1,5 LHT
 4600648, 4601248, 4603448, 0004603548,
 14600348, 14601448, 14602348, 0014603748,
 0014607848, 0024600348



CV-ES-14163

Length: 125
Cone Ø: d1 Ø 30 / d2 Ø 27
Thread: M30 x 1,5 RHT
 0003305248, 0003387310, 0004600348,
 0004600948, 0004602848, 0004602948,
 0004608948, 0014600248, 0014600848,
 0014601248, 0014602248, 0014607748,
 0024600148, A0003387310, A0004600348,
 A0004602848, A0004602948, A0014600848,
 A0014601248, A0014602248, A0014607748



DB-DL-7794

Length: 837 Ø: 40
Cone Ø: d1 Ø 26 / d2 Ø 23,5
 9724601405, 9724601605



DB-DL-7799

Length: 895 Ø: 50
Cone Ø: d1 Ø 30 / d2 Ø 26
 0034605905, 3754600305, 9724601805,
 9724602005



DB-DL-8174

Length: 1605 Ø: 40
Cone Ø: d1 Ø 30 / d2 Ø 27
 9753300203, 9753300303, 9753300803,
 9753301703, 9753302503



DB-DL-9187

Length: 846 Ø: 42
Cone Ø: d1 Ø 26 / d2 Ø 23,5
 9704601105, 9724602805, A9704601105,
 A9724602805



DB-DL-9247

Length: 873 Ø: 40
Cone Ø: d1 Ø 26 / d2 Ø 23,5
 9724601005, 9724601205



DB-DL-12298

Length: 927 Ø: 50
Cone Ø: d1 Ø 30 / d2 Ø 27
 0024602405, 0024603005



DB-DL-12304

Length: 1560 Ø: 40
Cone Ø: d1 Ø 30 / d2 Ø 27
Thread: M30 x 1,5 LHT / M30 x 1,5 RHT
 9753300603, 9753300703, 9753300903,
 A9753300603, A9753300703, A9753300903



DB-DL-12405

Length: 895 Ø: 50
Cone Ø: d1 Ø 30 / d2 Ø 28,6
Thread: M24 x 1,5 / M20 x 1,5
 9744602205, 9764600205, 9764600405,
 A9764600405



DB-ES-5214

Length: 1640 Ø: 40
Cone Ø: d1 Ø 26 / d2 Ø 23,5
 01218000A, 9703300003, 9703300103,
 9703300203, 9703300303, 9703300403



DB-ES-8387

Length: 55
Cone Ø: d1 Ø 10 / d2 Ø 10
Thread: M14 x 1,5 RHT
 0009966845, 0009967045



DB-ES-8500

Length: 55
Cone Ø: d1 Ø 12 / d2 Ø 10,8
Thread: M14 x 1,5 RHT
 0002685989



DB-RK-8550

Ø: 75 **Hole Distance:** 152
Thick/Height: 24
 0003502105, 0003504605



DB-SB-10385

Ø: 30 **Thick/Height:** 30
 3093200073, 3143260153



DB-SB-10386

Ø: 38 **Thick/Height:** 38
 3183200073



DB-TC-12411

Length: 655 Ø: 40
Hole Distance: 115 / 115
 9723500906



DB-VB-10423

Length: 761,7 Ø: 46
Hole Ø: 25 / 23 / 23
Hole Distance: 152 / 130 / 130
 9743500005, 9743500405, 9743500505





ATEGO 2 ...

1017 K, 1018 K	10/04 →	Ball Head, gearshift linkage	DB-ES-8387			
	10/04 →	Ball Head, gearshift linkage	DB-ES-8500			
	10/04 →	Centre Rod	DB-DL-7794		Push Rod, Leaf Spring Axle	
	10/04 →	Centre Rod	DB-DL-7799		Push Rod, Leaf Spring Axle	
	10/04 →	Centre Rod	DB-DL-12405		Coupling Rod	
	10/04 →	Stabiliser Mounting		DB-SB-10386		
	10/04 →	Stabiliser Mounting	DB-SB-10386	DB-SB-10386		
	10/04 →	Stabiliser Mounting	DB-SB-10386	DB-SB-10386	1st FA	
	10/04 →	Tie Rod	DB-DL-8174		Guide Rod	
	10/04 →	Tie Rod	DB-DL-12304			
	10/04 →	Tie Rod	DB-ES-5214		Guide Rod	
	10/04 →	Tie Rod End	CV-ES-12461		for Steering Rod	
	10/04 →	Tie Rod End	CV-ES-12462		for Steering Rod	
	10/04 →	Tie Rod End	CV-ES-14162		for Steering Rod	
10/04 →	Tie Rod End	CV-ES-14163		for Steering Rod		
1018 A	10/04 →	Ball Head, gearshift linkage	DB-ES-8387			
	10/04 →	Centre Rod	DB-DL-8620		for Steering Rod	
	10/04 →	Centre Rod	DB-DL-9247		Push Rod	
	10/04 →	Centre Rod	DB-DL-12298		for Steering Rod	
	10/04 →	Centre Rod	DB-DL-12405		Coupling Rod	
	10/04 →	Stabiliser Mounting	DB-SB-10386	DB-SB-10386		
	10/04 →	Stabiliser Mounting	DB-SB-10386	DB-SB-10386	1st FA	
	10/04 →	Tie Rod	DB-DL-12311			
	10/04 →	Tie Rod End	CV-ES-12462		for Steering Rod	
	10/04 →	Tie Rod End	CV-ES-14163		for Steering Rod	
1018 AK	10/04 →	Centre Rod	DB-DL-9247		Push Rod	
	10/04 →	Centre Rod	DB-DL-12298		for Steering Rod	
	10/04 →	Centre Rod	DB-DL-12405		Coupling Rod	
	10/04 →	Tie Rod End	CV-ES-12462		for Steering Rod	
1018, 1018 L	10/04 →	Ball Head, gearshift linkage	DB-ES-8387			
	10/04 →	Ball Head, gearshift linkage	DB-ES-8500			
	10/04 →	Centre Rod	DB-DL-7794		Push Rod	
	10/04 →	Centre Rod	DB-DL-7794		Push Rod, Leaf Spring Axle	
	10/04 →	Centre Rod	DB-DL-7799		Push Rod, Leaf Spring Axle	
	10/04 →	Centre Rod	DB-DL-9187		Push Rod	
	10/04 →	Centre Rod	DB-DL-12405		Coupling Rod	
	10/04 →	Stabiliser Mounting		DB-SB-10385		
	10/04 →	Stabiliser Mounting		DB-SB-10385	1st RA	
	10/04 →	Stabiliser Mounting		DB-SB-10386		
	10/04 →	Stabiliser Mounting	DB-SB-10385	DB-SB-10385	1st FA	
	10/04 →	Stabiliser Mounting	DB-SB-10386	DB-SB-10386		
	10/04 →	Stabiliser Mounting	DB-SB-10386	DB-SB-10386	1st FA	
	10/04 →	Suspension Arm Repair Kit		DB-RK-8550	for Wishbone (CV)	
	10/04 →	Tie Rod	DB-DL-8174		Guide Rod	
	10/04 →	Tie Rod	DB-ES-5214		Guide Rod	
	10/04 →	Tie Rod End	CV-ES-12461		for Steering Rod	
	10/04 →	Tie Rod End	CV-ES-12462		for Steering Rod	
	10/04 →	Tie Rod End	CV-ES-14162		for Steering Rod	
	10/04 →	Tie Rod End	CV-ES-14163		for Steering Rod	
	10/04 →	Track Control Arm		DB-TC-12411	Control Arm	
	10/04 →	Track Control Arm		DB-VB-10423	Wishbone (CV), 1st Drive Axle, →508306 05	
	1022 A	10/04 →	Ball Head, gearshift linkage	DB-ES-8387		
		10/04 →	Centre Rod	DB-DL-8620		for Steering Rod
10/04 →		Centre Rod	DB-DL-9247		Push Rod	
10/04 →		Centre Rod	DB-DL-12298		for Steering Rod	
10/04 →		Centre Rod	DB-DL-12405		Coupling Rod	
10/04 →		Tie Rod	DB-DL-12311			
10/04 →		Tie Rod End	CV-ES-12462		for Steering Rod	
10/04 →		Tie Rod End	CV-ES-14163		for Steering Rod	
1022 AK	10/04 →	Centre Rod	DB-DL-9247		Push Rod	
	10/04 →	Centre Rod	DB-DL-12298		for Steering Rod	
	10/04 →	Centre Rod	DB-DL-12405		Coupling Rod	
	10/04 →	Tie Rod End	CV-ES-12462		for Steering Rod	

CV-ES-12461

Length: 120
 Cone Ø: d1 Ø 26 / d2 Ø 23,5
 Thread: M30 x 1,5 LHT
 0003300035, 3300148, 0003406213, 0013306635,
 0013308835, 0014604048, 0014604348,
 14606448, 0024600248, 3023300035,
 3023300135, 3023300235, 3023300335,
 3453307235, 3453307435, 3503307135,
 A0003300148, A0013306635, A0013308835,
 A0014604048, A0014604348, A0014606448,
 A0024600248, A3023300035, A3023300135,
 A3023300235, A3023300335, A3503307135



CV-ES-12462

Length: 120
 Cone Ø: d1 Ø 26 / d2 Ø 23,5
 Thread: M30 x 1,5 RHT
 0003300135, 0003300248, 0003303235,
 0003305835, 0003307335, 0003383410,
 0004608348, 004608348, 0004632229,
 0004633129, 0004633429, 0004633529,
 0013300135, 0013300235, 0013306735,
 0014603448, 0014604148, 0014604448,
 0014606348, 0014608348, 0014608448,
 0014609748, 0023301535, 3453307135,
 3503307035, 3503307335, 3643307135,
 5001832582, A0003300248, A0003303235,
 A0003307335, A0003383410, A0004608348,
 A0004632229, A0004633429, A0013300135,
 A0013300235, A0013306735, A0014603448,
 A0014604148, A0014604448, A0014606348,
 A0014608348, A0014608448, A0014609748,
 A0023301535



CV-ES-14162

Length: 125
 Cone Ø: d1 Ø 30 / d2 Ø 27
 Thread: M30 x 1,5 LHT
 4600648, 4601248, 4603448, 0004603548,
 4603548, 14600348, 14601448, 14602348, 001
 460 37 48, 14607848, 0014607848, 002 460 03 48



CV-ES-14163

Length: 125
 Cone Ø: d1 Ø 30 / d2 Ø 27
 Thread: M30 x 1,5 RHT
 0003305248, 0003387310, 0004600348,
 0004600948, 0004602848, 0004602948,
 0004608948, 0014600248, 0014600848,
 0014601248, 0014602248, 0014607748,
 0024600148, A0003387310, A0004600348,
 A0004602848, A0004602948, A0014600848,
 A0014601248, A0014602248, A0014607748



DB-DL-7794

Length: 837 Ø: 40
 Cone Ø: d1 Ø 26 / d2 Ø 23,5
 9724601405, 9724601605



DB-DL-7799

Length: 895
 Ø: 50
 Cone Ø: d1 Ø 30 / d2 Ø 26
 34605905, 0034605905, 3754600305,
 9724601805, 9724602005



DB-DL-8174

Length: 1605 Ø: 40
 Cone Ø: d1 Ø 30 / d2 Ø 27
 9753300203, 9753300303, 9753300803,
 9753301703, 9753302503



DB-DL-8620

Length: 884
 Ø: 50
 Cone Ø: d1 Ø 30 / d2 Ø 27
 Thread: M24 x 1,5 / M20 x 1,5
 9744600405, 9744600805, A9744600405,
 A9744600805



DB-DL-9187

Length: 846 Ø: 42
 Cone Ø: d1 Ø 26 / d2 Ø 23,5
 9704601105, 9724602805, A9704601105,
 A9724602805



DB-DL-9247

Length: 873 Ø: 40
 Cone Ø: d1 Ø 26 / d2 Ø 23,5
 9724601005, 9724601205



DB-DL-12298

Length: 927 Ø: 50
 Cone Ø: d1 Ø 30 / d2 Ø 27
 0024602405, 0024603005



DB-DL-12304

Length: 1560 Ø: 40
 Cone Ø: d1 Ø 30 / d2 Ø 27
 Thread: M30 x 1,5 LHT / M30 x 1,5 RHT
 9753300603, 9753300703, 9753300903,
 A9753300603, A9753300703, A9753300903



DB-DL-12311

Length: 1565 Ø: 60
 Cone Ø: d1 Ø 30 / d2 Ø 27
 9753300003, 9753300403, 9753301003,
 9753301903, A9753300003, A9753300403,
 A9753301003, A9753301903

No Image

DB-DL-12405

Length: 895 Ø: 50
 Cone Ø: d1 Ø 30 / d2 Ø 28,6
 Thread: M24 x 1,5 / M20 x 1,5
 9744600205, 9764600205, 9764600405,
 A9764600405



DB-ES-5214

Length: 1640 Ø: 40
 Cone Ø: d1 Ø 26 / d2 Ø 23,5
 01218000A, 9703300003, 9703300103,
 9703300203, 9703300303, 9703300403



DB-ES-8387

Length: 55
 Cone Ø: d1 Ø 10 / d2 Ø 10
 Thread: M14 x 1,5 RHT
 0009966845, 0009967045



DB-ES-8500

Length: 55
 Cone Ø: d1 Ø 12 / d2 Ø 10,8
 Thread: M14 x 1,5 RHT
 0002685989



DB-RK-8550

Ø: 75 Hole Distance: 152
 Thick/Height: 24
 0003502105, 0003504605



DB-SB-10385

Ø: 30 Thick/Height: 30
 3093200073, 3143260153



DB-SB-10386

Ø: 38 Thick/Height: 38
 3183200073



DB-TC-12411

Length: 655 Ø: 40
 Hole Distance: 115 / 115
 9723500906



DB-VB-10423

Length: 761,7 Ø: 46
 Hole Ø 25 / 23 / 23
 Hole Distance: 152 / 130 / 130
 9743500005, 9743500405, 9743500505



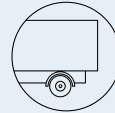

ATEGO 2 ...

1022 K	10/04 →	Ball Head, gearshift linkage	DB-ES-8387		
	10/04 →	Ball Head, gearshift linkage	DB-ES-8500		
	10/04 →	Centre Rod	DB-DL-7794		Push Rod, Leaf Spring Axle
	10/04 →	Centre Rod	DB-DL-7799		Push Rod, Leaf Spring Axle
	10/04 →	Centre Rod	DB-DL-12298		for Steering Rod
	10/04 →	Centre Rod	DB-DL-12405		Coupling Rod
	10/04 →	Stabiliser Mounting		DB-SB-10386	
	10/04 →	Stabiliser Mounting	DB-SB-10386	DB-SB-10386	
	10/04 →	Stabiliser Mounting	DB-SB-10386	DB-SB-10386	1st FA
	10/04 →	Tie Rod	DB-DL-8174		Guide Rod
	10/04 →	Tie Rod	DB-DL-12304		
	10/04 →	Tie Rod	DB-ES-5214		Guide Rod
	10/04 →	Tie Rod End	CV-ES-12461		for Steering Rod
	10/04 →	Tie Rod End	CV-ES-12462		for Steering Rod
	10/04 →	Tie Rod End	CV-ES-14162		for Steering Rod
	10/04 →	Tie Rod End	CV-ES-14163		for Steering Rod
1022 KO	10/04 →	Ball Head, gearshift linkage	DB-ES-8387		
	10/04 →	Centre Rod	DB-DL-7794		Push Rod
	10/04 →	Centre Rod	DB-DL-7799		Push Rod
	10/04 →	Centre Rod	DB-DL-12298		for Steering Rod
	10/04 →	Centre Rod	DB-DL-12405		Coupling Rod
	10/04 →	Tie Rod	DB-DL-8174		Guide Rod
	10/04 →	Tie Rod	DB-ES-5214		Guide Rod
	10/04 →	Tie Rod End	CV-ES-12461		for Steering Rod
	10/04 →	Tie Rod End	CV-ES-12462		for Steering Rod
	10/04 →	Tie Rod End	CV-ES-14162		for Steering Rod
10/04 →	Tie Rod End	CV-ES-14163		for Steering Rod	
1022, 1022 L	10/04 →	Ball Head, gearshift linkage	DB-ES-8387		
	10/04 →	Ball Head, gearshift linkage	DB-ES-8500		
	10/04 →	Centre Rod	DB-DL-7794		Push Rod
	10/04 →	Centre Rod	DB-DL-7794		Push Rod, Leaf Spring Axle
	10/04 →	Centre Rod	DB-DL-7799		Push Rod, Leaf Spring Axle
	10/04 →	Centre Rod	DB-DL-9187		Push Rod
	10/04 →	Centre Rod	DB-DL-12298		for Steering Rod
	10/04 →	Centre Rod	DB-DL-12405		Coupling Rod
	10/04 →	Stabiliser Mounting		DB-SB-10385	
	10/04 →	Stabiliser Mounting		DB-SB-10385	1st RA
	10/04 →	Stabiliser Mounting		DB-SB-10386	
	10/04 →	Stabiliser Mounting	DB-SB-10385	DB-SB-10385	1st FA
	10/04 →	Stabiliser Mounting	DB-SB-10386	DB-SB-10386	
	10/04 →	Stabiliser Mounting	DB-SB-10386	DB-SB-10386	1st FA
	10/04 →	Suspension Arm Repair Kit		DB-RK-8550	for Wishbone (CV)
	10/04 →	Tie Rod	DB-DL-8174		Guide Rod
	10/04 →	Tie Rod	DB-ES-5214		Guide Rod
	10/04 →	Tie Rod End	CV-ES-12461		for Steering Rod
	10/04 →	Tie Rod End	CV-ES-12462		for Steering Rod
	10/04 →	Tie Rod End	CV-ES-14162		for Steering Rod
10/04 →	Tie Rod End	CV-ES-14163		for Steering Rod	
10/04 →	Track Control Arm		DB-TC-12411	Control Arm	
10/04 →	Track Control Arm		DB-VB-10423	Wishbone (CV), 1st Drive Axle, →508306 05	
1023 A, 1024 A	10/04 →	Ball Head, gearshift linkage	DB-ES-8387		
	10/04 →	Centre Rod	DB-DL-8620		for Steering Rod
	10/04 →	Centre Rod	DB-DL-9247		Push Rod
	10/04 →	Centre Rod	DB-DL-12298		for Steering Rod
	10/04 →	Centre Rod	DB-DL-12405		Coupling Rod
	10/04 →	Stabiliser Mounting	DB-SB-10386	DB-SB-10386	
	10/04 →	Stabiliser Mounting	DB-SB-10386	DB-SB-10386	1st FA
	10/04 →	Tie Rod	DB-DL-12311		
	10/04 →	Tie Rod End	CV-ES-12462		for Steering Rod
	10/04 →	Tie Rod End	CV-ES-14163		for Steering Rod

CV-ES-12461

Length: 120
 Cone Ø: d1 Ø 26 / d2 Ø 23,5
 Thread: M30 x 1,5 LHT
 0003300035, 3300148, 0003406213, 0013306635,
 0013308835, 0014604048, 0014604348,
 14606448, 0024600248, 3023300035,
 3023300135, 3023300235, 3023300335,
 3453307235, 3453307435, 3503307135,
 A0003300148, A0013306635, A0013308835,
 A0014604048, A0014604348, A0014606448,
 A0024600248, A3023300035, A3023300135,
 A3023300235, A3023300335, A3503307135



CV-ES-12462

Length: 120
 Cone Ø: d1 Ø 26 / d2 Ø 23,5
 Thread: M30 x 1,5 RHT
 0003300135, 0003300248, 0003303235,
 0003305835, 0003307335, 0003383410,
 0004608348, 004608348, 0004632229,
 0004633129, 0004633429, 0004633529,
 0013300135, 0013300235, 0013306735,
 0014603448, 0014604148, 0014604448,
 0014606348, 0014608348, 0014608448,
 0014609748, 0023301535, 3453307135,
 3503307035, 3503307335, 3643307135,
 5001832582, A0003300248, A0003303235,
 A0003307335, A0003383410, A0004608348,
 A0004632229, A0004633429, A0013300135,
 A0013300235, A0013306735, A0014603448,
 A0014604148, A0014604448, A0014606348,
 A0014608348, A0014608448, A0014609748,
 A0023301535



CV-ES-14162

Length: 125
 Cone Ø: d1 Ø 30 / d2 Ø 27
 Thread: M30 x 1,5 LHT
 4600648, 4601248, 4603448, 0004603548,
 14600348, 14601448, 14602348, 0014603748,
 0014607848, 0024600348



CV-ES-14163

Length: 125
 Cone Ø: d1 Ø 30 / d2 Ø 27
 Thread: M30 x 1,5 RHT
 0003305248, 0003387310, 0004600348,
 0004600948, 0004602848, 0004602948,
 0004608948, 0014600248, 0014600848,
 0014601248, 0014602248, 0014607748,
 0024600148, A0003387310, A0004600348,
 A0004602848, A0004602948, A0014600848,
 A0014601248, A0014602248, A0014607748



DB-DL-7794

Length: 837 Ø: 40
 Cone Ø: d1 Ø 26 / d2 Ø 23,5
 9724601405, 9724601605



DB-DL-7799

Length: 895 Ø: 50
 Cone Ø: d1 Ø 30 / d2 Ø 26
 0034605905, 3754600305, 9724601805,
 9724602005



DB-DL-8174

Length: 1605 Ø: 40
 Cone Ø: d1 Ø 30 / d2 Ø 27
 9753300203, 9753300303, 9753300803,
 9753301703, 9753302503



DB-DL-8620

Length: 884
 Ø: 50
 Cone Ø: d1 Ø 30 / d2 Ø 27
 Thread: M24 x 1,5 / M20 x 1,5
 9744600405, 9744600805, A9744600405,
 A9744600805



DB-DL-9187

Length: 846 Ø: 42
 Cone Ø: d1 Ø 26 / d2 Ø 23,5
 9704601105, 9724602805, A9704601105,
 A9724602805



DB-DL-9247

Length: 873 Ø: 40
 Cone Ø: d1 Ø 26 / d2 Ø 23,5
 9724601005, 9724601205



DB-DL-12298

Length: 927 Ø: 50
 Cone Ø: d1 Ø 30 / d2 Ø 27
 0024602405, 0024603005



DB-DL-12304

Length: 1560 Ø: 40
 Cone Ø: d1 Ø 30 / d2 Ø 27
 Thread: M30 x 1,5 LHT / M30 x 1,5 RHT
 9753300603, 9753300703, 9753300903,
 A9753300603, A9753300703, A9753300903



DB-DL-12311

Length: 1565 Ø: 60
 Cone Ø: d1 Ø 30 / d2 Ø 27
 9753300003, 9753300403, 9753301003,
 9753301903, A9753300003, A9753300403,
 A9753301003, A9753301903

No Image

DB-DL-12405

Length: 895 Ø: 50
 Cone Ø: d1 Ø 30 / d2 Ø 28,6
 Thread: M24 x 1,5 / M20 x 1,5
 9744602205, 9764600205, 9764600405,
 A9764600405



DB-ES-5214

Length: 1640 Ø: 40
 Cone Ø: d1 Ø 26 / d2 Ø 23,5
 01218000A, 9703300003, 9703300103,
 9703300203, 9703300303, 9703300403



DB-ES-8387

Length: 55
 Cone Ø: d1 Ø 10 / d2 Ø 10
 Thread: M14 x 1,5 RHT
 0009966845, 0009967045



DB-ES-8500

Length: 55
 Cone Ø: d1 Ø 12 / d2 Ø 10,8
 Thread: M14 x 1,5 RHT
 0002685989



DB-RK-8550

Ø: 75 Hole Distance: 152
 Thick/Height: 24
 0003502105, 0003504605



DB-SB-10385

Ø: 30 Thick/Height: 30
 3093200073, 3143260153



DB-SB-10386

Ø: 38 Thick/Height: 38
 3183200073



DB-TC-12411

Length: 655 Ø: 40
 Hole Distance: 115 / 115
 9723500906



DB-VB-10423

Length: 761,7 Ø: 46
 Hole Ø 25 / 23 / 23
 Hole Distance: 152 / 130 / 130
 9743500005, 9743500405, 9743500505





ATEGO 2 ...

1023, 1023 L, 1024, 1024 L	10/04 →	Ball Head, gearshift linkage	DB-ES-8387			
	10/04 →	Ball Head, gearshift linkage	DB-ES-8500			
	10/04 →	Centre Rod	DB-DL-7794		Push Rod	
	10/04 →	Centre Rod	DB-DL-7794		Push Rod, Leaf Spring Axle	
	10/04 →	Centre Rod	DB-DL-7799		Push Rod, Leaf Spring Axle	
	10/04 →	Centre Rod	DB-DL-9187		Push Rod	
	10/04 →	Centre Rod	DB-DL-12298		for Steering Rod	
	10/04 →	Centre Rod	DB-DL-12405		Coupling Rod	
	10/04 →	Stabiliser Mounting		DB-SB-10385		
	10/04 →	Stabiliser Mounting		DB-SB-10385		1st RA
	10/04 →	Stabiliser Mounting		DB-SB-10386		
	10/04 →	Stabiliser Mounting	DB-SB-10385	DB-SB-10385		1st FA
	10/04 →	Stabiliser Mounting	DB-SB-10386	DB-SB-10386		
	10/04 →	Stabiliser Mounting	DB-SB-10386	DB-SB-10386		1st FA
	10/04 →	Suspension Arm Repair Kit		DB-RK-8550		for Wishbone (CV)
	10/04 →	Tie Rod	DB-DL-8174			Guide Rod
	10/04 →	Tie Rod	DB-ES-5214			Guide Rod
	10/04 →	Tie Rod End	CV-ES-12461			for Steering Rod
	10/04 →	Tie Rod End	CV-ES-12462			for Steering Rod
	10/04 →	Tie Rod End	CV-ES-14162			for Steering Rod
	10/04 →	Tie Rod End	CV-ES-14163			for Steering Rod
	10/04 →	Track Control Arm		DB-TC-12411		Control Arm
	10/04 →	Track Control Arm		DB-VB-10423		Wishbone (CV), 1st Drive Axle, →508306 05
	1024 AK	10/04 →	Centre Rod	DB-DL-9247		Push Rod
		10/04 →	Centre Rod	DB-DL-12298		for Steering Rod
10/04 →		Centre Rod	DB-DL-12405		Coupling Rod	
10/04 →		Tie Rod End	CV-ES-12462		for Steering Rod	
1024 K	10/04 →	Ball Head, gearshift linkage	DB-ES-8387			
	10/04 →	Ball Head, gearshift linkage	DB-ES-8500			
	10/04 →	Centre Rod	DB-DL-7794		Push Rod, Leaf Spring Axle	
	10/04 →	Centre Rod	DB-DL-7799		Push Rod, Leaf Spring Axle	
	10/04 →	Centre Rod	DB-DL-12298		for Steering Rod	
	10/04 →	Centre Rod	DB-DL-12405		Coupling Rod	
	10/04 →	Stabiliser Mounting		DB-SB-10386		
	10/04 →	Stabiliser Mounting	DB-SB-10386	DB-SB-10386		
	10/04 →	Stabiliser Mounting	DB-SB-10386	DB-SB-10386		1st FA
	10/04 →	Tie Rod	DB-DL-8174			Guide Rod
	10/04 →	Tie Rod	DB-DL-12304			
	10/04 →	Tie Rod	DB-ES-5214			Guide Rod
	10/04 →	Tie Rod End	CV-ES-12461			for Steering Rod
	10/04 →	Tie Rod End	CV-ES-12462			for Steering Rod
	10/04 →	Tie Rod End	CV-ES-14162			for Steering Rod
	10/04 →	Tie Rod End	CV-ES-14163			for Steering Rod
	1024, 1024 L	10/04 →	Centre Rod	DB-DL-7794		Push Rod
10/04 →		Centre Rod	DB-DL-7799		Push Rod	
10/04 →		Centre Rod	DB-DL-9187		Push Rod	
10/04 →		Centre Rod	DB-DL-12298		for Steering Rod	
10/04 →		Centre Rod	DB-DL-12405		Coupling Rod	
10/04 →		Tie Rod	DB-DL-8174			Guide Rod, 1st Front Axle
10/04 →		Tie Rod	DB-ES-5214			Guide Rod, 1st Front Axle
10/04 →		Tie Rod End	CV-ES-12461			for Steering Rod
10/04 →		Tie Rod End	CV-ES-12462			for Steering Rod
10/04 →		Tie Rod End	CV-ES-14162			for Steering Rod
10/04 →		Tie Rod End	CV-ES-14163			for Steering Rod
1026, 1026 L		10/04 →	Centre Rod	DB-DL-12298		for Steering Rod
	10/04 →	Centre Rod	DB-DL-12405		Coupling Rod	
1029, 1029 L	10/04 →	Centre Rod	DB-DL-12298		for Steering Rod	
	10/04 →	Centre Rod	DB-DL-12405		Coupling Rod	
1118 AF	01/11 →	Centre Rod	DB-DL-12298		for Steering Rod	
	01/11 →	Centre Rod	DB-DL-12405		Coupling Rod	

CV-ES-12461

Length: 120
Cone Ø: d1 Ø 26 / d2 Ø 23,5
Thread: M30 x 1,5 LHT
 0003300035, 3300148, 0003406213, 0013306635,
 0013308835, 0014604048, 0014604348,
 14606448, 0024600248, 3023300035,
 3023300135, 3023300235, 3023300335,
 3453307235, 3453307435, 3503307135,
 A0003300148, A0013306635, A0013308835,
 A0014604048, A0014604348, A0014606448,
 A0024600248, A3023300035, A3023300135,
 A3023300235, A3023300335, A3503307135



CV-ES-12462

Length: 120
Cone Ø: d1 Ø 26 / d2 Ø 23,5
Thread: M30 x 1,5 RHT
 0003300135, 0003300248, 0003303235,
 0003305835, 0003307335, 0003383410,
 0004608348, 004608348, 0004632229,
 0004633129, 0004633429, 0004633529,
 0013300135, 0013300235, 0013306735,
 0014603448, 0014604148, 0014604448,
 0014606348, 0014608348, 0014608448,
 0014609748, 0023301535, 3453307135,
 3503307035, 3503307335, 3643307135,
 5001832582, A0003300248, A0003303235,
 A0003307335, A0003383410, A0004608348,
 A0004632229, A0004633429, A0013300135,
 A0013300235, A0013306735, A0014603448,
 A0014604148, A0014604448, A0014606348,
 A0014608348, A0014608448, A0014609748,
 A0023301535



CV-ES-14162

Length: 125
Cone Ø: d1 Ø 30 / d2 Ø 27
Thread: M30 x 1,5 LHT
 4600648, 4601248, 4603448, 0004603548,
 14600348, 14601448, 14602348, 0014603748,
 0014607848, 0024600348



CV-ES-14163

Length: 125
Cone Ø: d1 Ø 30 / d2 Ø 27
Thread: M30 x 1,5 RHT
 0003305248, 0003387310, 0004600348,
 0004600948, 0004602848, 0004602948,
 0004608948, 0014600248, 0014600848,
 0014601248, 0014602248, 0014607748,
 0024600148, A0003387310, A0004600348,
 A0004602848, A0004602948, A0014600848,
 A0014601248, A0014602248, A0014607748



DB-DL-7794

Length: 837 Ø: 40
Cone Ø: d1 Ø 26 / d2 Ø 23,5
 9724601405, 9724601605



DB-DL-7799

Length: 895 Ø: 50
Cone Ø: d1 Ø 30 / d2 Ø 26
 0034605905, 3754600305, 9724601805,
 9724602005



DB-DL-8174

Length: 1605 Ø: 40
Cone Ø: d1 Ø 30 / d2 Ø 27
 9753300203, 9753300303, 9753300803,
 9753301703, 9753302503



DB-DL-9187

Length: 846 Ø: 42
Cone Ø: d1 Ø 26 / d2 Ø 23,5
 9704601105, 9724602805, A9704601105,
 A9724602805



DB-DL-9247

Length: 873 Ø: 40
Cone Ø: d1 Ø 26 / d2 Ø 23,5
 9724601005, 9724601205



DB-DL-12298

Length: 927 Ø: 50
Cone Ø: d1 Ø 30 / d2 Ø 27
 0024602405, 0024603005



DB-DL-12304

Length: 1560 Ø: 40
Cone Ø: d1 Ø 30 / d2 Ø 27
Thread: M30 x 1,5 LHT / M30 x 1,5 RHT
 9753300603, 9753300703, 9753300903,
 A9753300603, A9753300703, A9753300903



DB-DL-12405

Length: 895 Ø: 50
Cone Ø: d1 Ø 30 / d2 Ø 28,6
Thread: M24 x 1,5 / M20 x 1,5
 9744602205, 9764600205, 9764600405,
 A9764600405



DB-ES-5214

Length: 1640 Ø: 40
Cone Ø: d1 Ø 26 / d2 Ø 23,5
 01218000A, 9703300003, 9703300103,
 9703300203, 9703300303, 9703300403



DB-ES-8387

Length: 55
Cone Ø: d1 Ø 10 / d2 Ø 10
Thread: M14 x 1,5 RHT
 0009966845, 0009967045



DB-ES-8500

Length: 55
Cone Ø: d1 Ø 12 / d2 Ø 10,8
Thread: M14 x 1,5 RHT
 0002685989



DB-RK-8550

Ø: 75 **Hole Distance:** 152
Thick/Height: 24
 0003502105, 0003504605



DB-SB-10385

Ø: 30 **Thick/Height:** 30
 3093200073, 3143260153



DB-SB-10386

Ø: 38 **Thick/Height:** 38
 3183200073



DB-TC-12411

Length: 655 Ø: 40
Hole Distance: 115 / 115
 9723500906



DB-VB-10423

Length: 761,7 Ø: 46
Hole Ø: 25 / 23 / 23
Hole Distance: 152 / 130 / 130
 9743500005, 9743500405, 9743500505





ATEGO 2 ...

1215, 1215 L, 1216, 1216 L	10/04 →	Ball Head, gearshift linkage	DB-ES-8387		
	10/04 →	Ball Head, gearshift linkage	DB-ES-8500		
	10/04 →	Centre Rod	DB-DL-7794		Push Rod
	10/04 →	Centre Rod	DB-DL-7799		Push Rod
	10/04 →	Centre Rod	DB-DL-7799		Push Rod, Leaf Spring Axle
	10/04 →	Centre Rod	DB-DL-7815		Push Rod
	10/04 →	Centre Rod	DB-DL-7815		Push Rod, Leaf Spring Axle
	10/04 →	Centre Rod	DB-DL-8644		Push Rod
	10/04 →	Centre Rod	DB-DL-8644		Push Rod, Leaf Spring Axle
	10/04 →	Centre Rod	DB-DL-9187		Push Rod
	10/04 →	Centre Rod	DB-DL-12404		for Steering Rod
	10/04 →	Centre Rod	DB-DL-12405		Coupling Rod
	10/04 →	Centre Rod	DB-DL-12437		Push Rod
	10/04 →	Centre Rod	DB-DL-12475		Push Rod
	10/04 →	Stabiliser Mounting		DB-RK-9296	
	10/04 →	Stabiliser Mounting		DB-SB-10385	
	10/04 →	Stabiliser Mounting		DB-SB-10385	1st RA
	10/04 →	Stabiliser Mounting		DB-SB-10386	
	10/04 →	Stabiliser Mounting	DB-SB-10386	DB-SB-10386	
	10/04 →	Stabiliser Mounting	DB-SB-10386	DB-SB-10386	1st FA
	10/04 →	Suspension Arm Repair Kit		DB-RK-8550	for Wishbone (CV)
	10/04 →	Suspension Strut Repair Kit		DB-RK-8555	
	10/04 →	Tie Rod	DB-DL-8174		Guide Rod
	10/04 →	Tie Rod	DB-DL-12304		
	10/04 →	Tie Rod	DB-ES-5214		Guide Rod
	10/04 →	Tie Rod End	CV-ES-12461		for Steering Rod
	10/04 →	Tie Rod End	CV-ES-12462		for Steering Rod
	10/04 →	Tie Rod End	CV-ES-14162		for Steering Rod
	10/04 →	Tie Rod End	CV-ES-14163		for Steering Rod
	10/04 →	Track Control Arm		DB-TC-12411	Control Arm
	10/04 →	Track Control Arm		DB-VB-10423	Wishbone (CV), Air Suspension Axle
	1216 K	10/04 →	Ball Head, gearshift linkage	DB-ES-8387	
10/04 →		Ball Head, gearshift linkage	DB-ES-8500		
10/04 →		Centre Rod	DB-DL-7799		Push Rod, Leaf Spring Axle
10/04 →		Centre Rod	DB-DL-7815		Push Rod, Leaf Spring Axle
10/04 →		Centre Rod	DB-DL-8644		Push Rod, Leaf Spring Axle
10/04 →		Centre Rod	DB-DL-12405		Coupling Rod
10/04 →		Stabiliser Mounting		DB-SB-10386	
10/04 →		Stabiliser Mounting	DB-SB-10386	DB-SB-10386	
10/04 →		Stabiliser Mounting	DB-SB-10386	DB-SB-10386	1st FA
10/04 →		Tie Rod	DB-DL-8174		Guide Rod
10/04 →		Tie Rod	DB-DL-12304		
10/04 →		Tie Rod End	CV-ES-14162		for Steering Rod
10/04 →		Tie Rod End	CV-ES-14163		for Steering Rod
1216, 1216 L		10/04 →	Centre Rod	DB-DL-7794	
	10/04 →	Centre Rod	DB-DL-7799		Push Rod
	10/04 →	Centre Rod	DB-DL-7815		Push Rod
	10/04 →	Centre Rod	DB-DL-8644		Push Rod
	10/04 →	Centre Rod	DB-DL-9187		Push Rod
	10/04 →	Centre Rod	DB-DL-12298		for Steering Rod
	10/04 →	Centre Rod	DB-DL-12405		Coupling Rod
	10/04 →	Centre Rod	DB-DL-12475		Push Rod
	10/04 →	Tie Rod	DB-DL-8174		Guide Rod
	10/04 →	Tie Rod	DB-DL-12304		
	10/04 →	Tie Rod	DB-ES-5214		Guide Rod
	10/04 →	Tie Rod End	CV-ES-12461		for Steering Rod
	10/04 →	Tie Rod End	CV-ES-12462		for Steering Rod
	10/04 →	Tie Rod End	CV-ES-14162		for Steering Rod
	10/04 →	Tie Rod End	CV-ES-14163		for Steering Rod

CV-ES-12461

Length: 120
 Cone Ø: d1 Ø 26 / d2 Ø 23,5
 Thread: M30 x 1,5 LHT
 0003300035, 3300148, 0003406213, 0013306635,
 0013308835, 0014604048, 0014604348,
 14606448, 0024600248, 3023300035,
 3023300135, 3023300235, 3023300335,
 3453307235, 3453307435, 3503307135,
 A0003300148, A0013306635, A0013308835,
 A0014604048, A0014604348, A0014606448,
 A0024600248, A3023300035, A3023300135,
 A3023300235, A3023300335, A3503307135



CV-ES-12462

Length: 120
 Cone Ø: d1 Ø 26 / d2 Ø 23,5
 Thread: M30 x 1,5 RHT
 0003300135, 0003300248, 0003303235,
 0003305835, 0003307335, 0003383410,
 0004608348, 004608348, 0004632229,
 0004633129, 0004633429, 0004633529,
 0013300135, 0013300235, 0013306735,
 0014603448, 0014604148, 0014604448,
 0014606348, 0014608348, 0014608448,
 0014609748, 0023301535, 3453307135,
 3503307035, 3503307335, 3643307135,
 5001832582, A0003300248, A0003303235,
 A0003307335, A0003383410, A0004608348,
 A0004632229, A0004633429, A0013300135,
 A0013300235, A0013306735, A0014603448,
 A0014604148, A0014604448, A0014606348,
 A0014608348, A0014608448, A0014609748,
 A0023301535



CV-ES-14162

Length: 125
 Cone Ø: d1 Ø 30 / d2 Ø 27
 Thread: M30 x 1,5 LHT
 4600648, 4601248, 4603448, 0004603548,
 4603548, 14600348, 14601448, 14602348, 001
 460 37 48, 14607848, 0014607848, 002 460 03 48



CV-ES-14163

Length: 125
 Cone Ø: d1 Ø 30 / d2 Ø 27
 Thread: M30 x 1,5 RHT
 0003305248, 0003387310, 0004600348,
 0004600948, 0004602848, 0004602948,
 0004608948, 0014600248, 0014600848,
 0014601248, 0014602248, 0014607748,
 0024600148, A0003387310, A0004600348,
 A0004602848, A0004602948, A0014600848,
 A0014601248, A0014602248, A0014607748



DB-DL-7794

Length: 837 Ø: 40
 Cone Ø: d1 Ø 26 / d2 Ø 23,5
 9724601405, 9724601605



DB-DL-7799

Length: 895 Ø: 50
 Cone Ø: d1 Ø 30 / d2 Ø 26
 0034605905, 3754600305, 9724601805,
 9724602005



DB-DL-7815

Length: 895 Ø: 50
 Cone Ø: d1 Ø 30 / d2 Ø 27
 01215800A, 0034604605, 3754600005,
 9744601005, 9744601205



DB-DL-8174

Length: 1605 Ø: 40
 Cone Ø: d1 Ø 30 / d2 Ø 27
 9753300203, 9753300303, 9753300803,
 9753301703, 9753302503



DB-DL-8644

Length: 894 Ø: 50
 Cone Ø: d1 Ø 30 / d2 Ø 27
 0034604705, 9744601105, 9744601305

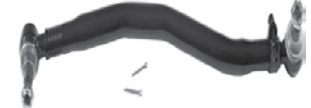

DB-DL-9187

Length: 846 Ø: 42
 Cone Ø: d1 Ø 26 / d2 Ø 23,5
 9704601105, 9724602805, A9704601105,
 A9724602805



DB-DL-12298

Length: 927 Ø: 50
 Cone Ø: d1 Ø 30 / d2 Ø 27
 0024602405, 0024603005



DB-DL-12304

Length: 1560 Ø: 40
 Cone Ø: d1 Ø 30 / d2 Ø 27
 Thread: M30 x 1,5 LHT / M30 x 1,5 RHT
 9753300603, 9753300703, 9753300903,
 A9753300603, A9753300703, A9753300903



DB-DL-12404

Length: 875 Ø: 50
 Cone Ø: d1 Ø 30/26 / d2 Ø 27/23,5
 9724600605



DB-DL-12405

Length: 895 Ø: 50
 Cone Ø: d1 Ø 30 / d2 Ø 28,6
 Thread: M24 x 1,5 / M20 x 1,5
 9744602205, 9764600205, 9764600405,
 A9764600405



DB-DL-12437

Length: 875 Ø: 50
 Cone Ø: d1 Ø 30 / d2 Ø 27
 9744600005, 9744600605, A9744600005,
 A9744600605



DB-DL-12475

Length: 888 Ø: 50
 Cone Ø: d1 Ø 30 / d2 Ø 27
 9744601505, A9744601505



No Image

DB-ES-5214

Length: 1640 Ø: 40
 Cone Ø: d1 Ø 26 / d2 Ø 23,5
 01218000A, 9703300003, 9703300103,
 9703300203, 9703300303, 9703300403



DB-ES-8387

Length: 55
 Cone Ø: d1 Ø 10 / d2 Ø 10
 Thread: M14 x 1,5 RHT
 0009966845, 0009967045



DB-ES-8500

Length: 55
 Cone Ø: d1 Ø 12 / d2 Ø 10,8
 Thread: M14 x 1,5 RHT
 0002685989



DB-RK-8550

Ø: 75 Hole Distance: 152
 Thick/Height: 24
 0003502105, 0003504605



DB-RK-8555

Ø: 67 Hole Distance: 130
 Thick/Height: 24
 01335600A, 0003502005, 0003504705



DB-RK-9296

Ø: 88 Hole Distance: 130
 Thick/Height: 24
 9423260050



DB-SB-10385

Ø: 30 Thick/Height: 30
 3093200073, 3143260153



DB-SB-10386

Ø: 38 Thick/Height: 38
 3183200073



DB-TC-12411

Length: 655 Ø: 40
 Hole Distance: 115 / 115
 9723500906



DB-VB-10423

Length: 761,7 Ø: 46
 Hole Ø 25 / 23 / 23
 Hole Distance: 152 / 130 / 130
 9743500005, 9743500405, 9743500505



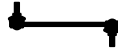

ATEGO 2 ...

1218 K	10/04 →	Ball Head, gearshift linkage	DB-ES-8387			
	10/04 →	Ball Head, gearshift linkage	DB-ES-8500			
	10/04 →	Centre Rod	DB-DL-7799		Push Rod, Leaf Spring Axle	
	10/04 →	Centre Rod	DB-DL-7815		Push Rod, Leaf Spring Axle	
	10/04 →	Centre Rod	DB-DL-8644		Push Rod, Leaf Spring Axle	
	10/04 →	Centre Rod	DB-DL-12298		for Steering Rod	
	10/04 →	Centre Rod	DB-DL-12405		Coupling Rod	
	10/04 →	Stabiliser Mounting		DB-SB-10386		
	10/04 →	Stabiliser Mounting	DB-SB-10386	DB-SB-10386		
	10/04 →	Stabiliser Mounting	DB-SB-10386	DB-SB-10386	1st FA	
	10/04 →	Tie Rod	DB-DL-8174		Guide Rod	
	10/04 →	Tie Rod	DB-DL-12304			
	10/04 →	Tie Rod End	CV-ES-14162		for Steering Rod	
	10/04 →	Tie Rod End	CV-ES-14163		for Steering Rod	
	1218, 1218 L	10/04 →	Ball Head, gearshift linkage	DB-ES-8387		
		10/04 →	Ball Head, gearshift linkage	DB-ES-8500		
10/04 →		Centre Rod	DB-DL-7794		Push Rod	
10/04 →		Centre Rod	DB-DL-7794		Push Rod, Leaf Spring Axle	
10/04 →		Centre Rod	DB-DL-7799		Push Rod	
10/04 →		Centre Rod	DB-DL-7799		Push Rod, Leaf Spring Axle	
10/04 →		Centre Rod	DB-DL-7815		Push Rod	
10/04 →		Centre Rod	DB-DL-7815		Push Rod, Leaf Spring Axle	
10/04 →		Centre Rod	DB-DL-8644		Push Rod	
10/04 →		Centre Rod	DB-DL-8644		Push Rod, Leaf Spring Axle	
10/04 →		Centre Rod	DB-DL-9187		Push Rod	
10/04 →		Centre Rod	DB-DL-12404		for Steering Rod	
10/04 →		Centre Rod	DB-DL-12405		Coupling Rod	
10/04 →		Centre Rod	DB-DL-12437		Push Rod	
10/04 →		Centre Rod	DB-DL-12475		Push Rod	
10/04 →		Stabiliser Mounting		DB-RK-9296		
10/04 →		Stabiliser Mounting		DB-SB-10385		
10/04 →		Stabiliser Mounting		DB-SB-10385	1st RA	
10/04 →		Stabiliser Mounting		DB-SB-10386		
10/04 →		Stabiliser Mounting	DB-SB-10386	DB-SB-10386		
10/04 →		Stabiliser Mounting	DB-SB-10386	DB-SB-10386	1st FA	
10/04 →		Suspension Arm Repair Kit		DB-RK-8550	for Wishbone (CV)	
10/04 →		Suspension Strut Repair Kit		DB-RK-8555		
10/04 →		Tie Rod	DB-DL-8174		Guide Rod	
10/04 →		Tie Rod	DB-DL-12304			
10/04 →		Tie Rod	DB-ES-5214		Guide Rod	
10/04 →		Tie Rod End	CV-ES-12461		for Steering Rod	
10/04 →		Tie Rod End	CV-ES-12462		for Steering Rod	
10/04 →		Tie Rod End	CV-ES-14162		for Steering Rod	
10/04 →		Tie Rod End	CV-ES-14163		for Steering Rod	
10/04 →		Track Control Arm		DB-TC-12411	Control Arm	
10/04 →		Track Control Arm		DB-VB-10423	Wishbone (CV), Air Suspension Axle	
1222 AF		10/04 →	Ball Head, gearshift linkage	DB-ES-8387		
	10/04 →	Ball Head, gearshift linkage	DB-ES-8500			
	10/04 →	Centre Rod	DB-DL-12298		for Steering Rod	
	10/04 →	Centre Rod	DB-DL-12405		Coupling Rod	
	10/04 →	Centre Rod	DB-DL-12475		Push Rod	
	10/04 →	Tie Rod	DB-DL-12311		1st FA, →504522 02	
	10/04 →	Tie Rod End	CV-ES-14163		for Steering Rod	
	1222 F	10/04 →	Ball Head, gearshift linkage	DB-ES-8387		
10/04 →		Ball Head, gearshift linkage	DB-ES-8500			
10/04 →		Centre Rod	DB-DL-7799		Push Rod	
10/04 →		Centre Rod	DB-DL-7815		Push Rod	
10/04 →		Centre Rod	DB-DL-8644		Push Rod	
10/04 →		Centre Rod	DB-DL-12298		for Steering Rod	
10/04 →		Centre Rod	DB-DL-12405		Coupling Rod	
10/04 →		Centre Rod	DB-DL-12475		Push Rod	
10/04 →		Tie Rod	DB-DL-8174		Guide Rod	
10/04 →		Tie Rod	DB-DL-12304			

CV-ES-12461

Length: 120
 Cone Ø: d1 Ø 26 / d2 Ø 23,5
 Thread: M30 x 1,5 LHT
 0003300035, 3300148, 0003406213, 0013306635,
 0013308835, 0014604048, 0014604348,
 14606448, 0024600248, 3023300035,
 3023300135, 3023300235, 3023300335,
 3453307235, 3453307435, 3503307135,
 A0003300148, A0013306635, A0013308835,
 A0014604048, A0014604348, A0014606448,
 A0024600248, A3023300035, A3023300135,
 A3023300235, A3023300335, A3503307135



CV-ES-12462

Length: 120
 Cone Ø: d1 Ø 26 / d2 Ø 23,5
 Thread: M30 x 1,5 RHT
 0003300135, 0003300248, 0003303235,
 0003305835, 0003307335, 0003383410,
 0004608348, 004608348, 0004632229,
 0004633129, 0004633429, 0004633529,
 0013300135, 0013300235, 0013306735,
 0014603448, 0014604148, 0014604448,
 0014606348, 0014608348, 0014608448,
 0014609748, 0023301535, 3453307135,
 3503307035, 3503307335, 3643307135,
 5001832582, A0003300248, A0003303235,
 A0003307335, A0003383410, A0004608348,
 A0004632229, A0004633429, A0013300135,
 A0013300235, A0013306735, A0014603448,
 A0014604148, A0014604448, A0014606348,
 A0014608348, A0014608448, A0014609748,
 A0023301535



CV-ES-14162

Length: 125
 Cone Ø: d1 Ø 30 / d2 Ø 27
 Thread: M30 x 1,5 LHT
 4600648, 4601248, 4603448, 4603548,
 0004603548, 14600348, 14601448, 14602348,
 0014603748, 0014607848, 14607848, 002460
 0348



CV-ES-14163

Length: 125
 Cone Ø: d1 Ø 30 / d2 Ø 27
 Thread: M30 x 1,5 RHT
 0003305248, 0003387310, 0004600348,
 0004600948, 0004602848, 0004602948,
 0004608948, 0014600248, 0014600848,
 0014601248, 0014602248, 0014607748,
 0024600148, A0003387310, A0004600348,
 A0004602848, A0004602948, A0014600848,
 A0014601248, A0014602248, A0014607748



DB-DL-7794

Length: 837 Ø: 40
 Cone Ø: d1 Ø 26 / d2 Ø 23,5
 9724601405, 9724601605



DB-DL-7799

Length: 895 Ø: 50
 Cone Ø: d1 Ø 30 / d2 Ø 26
 0034605905, 3754600305, 9724601805,
 9724602005



DB-DL-7815

Length: 895
 Ø: 50
 Cone Ø: d1 Ø 30 / d2 Ø 27
 01215800A, 34604605, 0034604605, 3754600005,
 9744601005, 9744601205



DB-DL-8174

Length: 1605 Ø: 40
 Cone Ø: d1 Ø 30 / d2 Ø 27
 9753300203, 9753300303, 9753300803,
 9753301703, 9753302503



DB-DL-8644

Length: 894 Ø: 50
 Cone Ø: d1 Ø 30 / d2 Ø 27
 0034604705, 9744601105, 9744601305

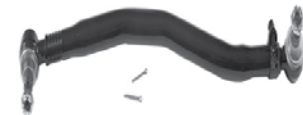

DB-DL-9187

Length: 846 Ø: 42
 Cone Ø: d1 Ø 26 / d2 Ø 23,5
 0104601105, 9724602805, A9704601105,
 A9724602805



DB-DL-12298

Length: 927 Ø: 50
 Cone Ø: d1 Ø 30 / d2 Ø 27
 0024602405, 0024603005



DB-DL-12304

Length: 1560 Ø: 40
 Cone Ø: d1 Ø 30 / d2 Ø 27
 Thread: M30 x 1,5 LHT / M30 x 1,5 RHT
 9753300603, 9753300703, 9753300903,
 A9753300603, A9753300703, A9753300903



DB-DL-12311

Length: 1565 Ø: 60
 Cone Ø: d1 Ø 30 / d2 Ø 27
 9753300003, 9753300403, 9753301003,
 9753301903, A9753300003, A9753300403,
 A9753301003, A9753301903

No Image

DB-DL-12404

Length: 875 Ø: 50
 Cone Ø: d1 Ø 30/26 / d2 Ø 27/23,5
 9724600605



DB-DL-12405

Length: 895 Ø: 50
 Cone Ø: d1 Ø 30 / d2 Ø 28,6
 Thread: M24 x 1,5 / M20 x 1,5
 9744602205, 9764600205, 9764600405,
 A9764600405



DB-DL-12437

Length: 875 Ø: 50
 Cone Ø: d1 Ø 30 / d2 Ø 27
 9744600005, 9744600605, A9744600005,
 A9744600605



DB-DL-12475

Length: 888 Ø: 50
 Cone Ø: d1 Ø 30 / d2 Ø 27
 9744601505, A9744601505



No Image

DB-ES-5214

Length: 1640 Ø: 40
 Cone Ø: d1 Ø 26 / d2 Ø 23,5
 01218000A, 9703300003, 9703300103,
 9703300203, 9703300303, 9703300403



DB-ES-8387

Length: 55
 Cone Ø: d1 Ø 10 / d2 Ø 10
 Thread: M14 x 1,5 RHT
 0009966845, 0009967045



DB-ES-8500

Length: 55
 Cone Ø: d1 Ø 12 / d2 Ø 10,8
 Thread: M14 x 1,5 RHT
 0002685989



DB-RK-8550

Ø: 75 Hole Distance: 152
 Thick/Height: 24
 0003502105, 0003504605



DB-RK-8555

Ø: 67 Hole Distance: 130
 Thick/Height: 24
 01335600A, 0003502005, 0003504705



DB-RK-9296

Ø: 88 Hole Distance: 130
 Thick/Height: 24
 9423260050



DB-SB-10385

Ø: 30 Thick/Height: 30
 3093200073, 3143260153



DB-SB-10386

Ø: 38 Thick/Height: 38
 3183200073



DB-TC-12411

Length: 655 Ø: 40
 Hole Distance: 115 / 115
 9723500906



DB-VB-10423

Length: 761,7 Ø: 46
 Hole Ø 25 / 23 / 23
 Hole Distance: 152 / 130 / 130
 9743500005, 9743500405, 9743500505





ATEGO 2 ...

1222 F ...	10/04 →	Tie Rod	DB-DL-12311		
	10/04 →	Tie Rod End	CV-ES-14162	for Steering Rod	
	10/04 →	Tie Rod End	CV-ES-14163	for Steering Rod	
1222 K	10/04 →	Ball Head, gearshift linkage	DB-ES-8387		
	10/04 →	Ball Head, gearshift linkage	DB-ES-8500		
	10/04 →	Centre Rod	DB-DL-7799	Push Rod, Leaf Spring Axle	
	10/04 →	Centre Rod	DB-DL-7815	Push Rod, Leaf Spring Axle	
	10/04 →	Centre Rod	DB-DL-8644	Push Rod, Leaf Spring Axle	
	10/04 →	Centre Rod	DB-DL-12298	for Steering Rod	
	10/04 →	Centre Rod	DB-DL-12405	Coupling Rod	
	10/04 →	Stabiliser Mounting	DB-SB-10386	DB-SB-10386	
	10/04 →	Stabiliser Mounting	DB-SB-10386	DB-SB-10386	1st FA
	10/04 →	Tie Rod	DB-DL-8174		Guide Rod
	10/04 →	Tie Rod	DB-DL-12304		
	10/04 →	Tie Rod End	CV-ES-14162		for Steering Rod
	10/04 →	Tie Rod End	CV-ES-14163		for Steering Rod
	1222, 1222 L	10/04 →	Ball Head, gearshift linkage	DB-ES-8387	
		10/04 →	Ball Head, gearshift linkage	DB-ES-8500	
10/04 →		Centre Rod	DB-DL-7794		Push Rod
10/04 →		Centre Rod	DB-DL-7794		Push Rod, Leaf Spring Axle
10/04 →		Centre Rod	DB-DL-7799		Push Rod
10/04 →		Centre Rod	DB-DL-7799		Push Rod, Leaf Spring Axle
10/04 →		Centre Rod	DB-DL-7815		Push Rod
10/04 →		Centre Rod	DB-DL-7815		Push Rod, Leaf Spring Axle
10/04 →		Centre Rod	DB-DL-8644		Push Rod
10/04 →		Centre Rod	DB-DL-8644		Push Rod, Leaf Spring Axle
10/04 →		Centre Rod	DB-DL-9187		Push Rod
10/04 →		Centre Rod	DB-DL-12298		for Steering Rod
10/04 →		Centre Rod	DB-DL-12404		for Steering Rod
10/04 →		Centre Rod	DB-DL-12405		Coupling Rod
10/04 →		Centre Rod	DB-DL-12437		Push Rod
10/04 →		Centre Rod	DB-DL-12475		Push Rod
10/04 →		Stabiliser Mounting		DB-RK-9296	
10/04 →		Stabiliser Mounting		DB-SB-10385	
10/04 →		Stabiliser Mounting		DB-SB-10385	1st RA
10/04 →		Stabiliser Mounting		DB-SB-10386	
10/04 →		Stabiliser Mounting	DB-SB-10386	DB-SB-10386	
10/04 →		Stabiliser Mounting	DB-SB-10386	DB-SB-10386	1st FA
10/04 →		Suspension Arm Repair Kit		DB-RK-8550	for Wishbone (CV)
10/04 →		Suspension Strut Repair Kit		DB-RK-8555	
10/04 →		Tie Rod	DB-DL-8174		Guide Rod
10/04 →		Tie Rod	DB-DL-12304		
10/04 →		Tie Rod	DB-ES-5214		Guide Rod
10/04 →		Tie Rod End	CV-ES-12461		for Steering Rod
10/04 →		Tie Rod End	CV-ES-12462		for Steering Rod
10/04 →		Tie Rod End	CV-ES-14162		for Steering Rod
10/04 →		Tie Rod End	CV-ES-14163		for Steering Rod
10/04 →		Track Control Arm		DB-TC-12411	Control Arm
10/04 →		Track Control Arm		DB-VB-10423	Wishbone (CV), Air Suspension Axle
1223, 1223 L, 1224, 1224 L		10/04 →	Ball Head, gearshift linkage	DB-ES-8387	
		10/04 →	Ball Head, gearshift linkage	DB-ES-8500	
	10/04 →	Centre Rod	DB-DL-7794		Push Rod
	10/04 →	Centre Rod	DB-DL-7794		Push Rod, Leaf Spring Axle
	10/04 →	Centre Rod	DB-DL-7799		Push Rod
	10/04 →	Centre Rod	DB-DL-7799		Push Rod, Leaf Spring Axle
	10/04 →	Centre Rod	DB-DL-7815		Push Rod
	10/04 →	Centre Rod	DB-DL-7815		Push Rod, Leaf Spring Axle
	10/04 →	Centre Rod	DB-DL-8644		Push Rod
	10/04 →	Centre Rod	DB-DL-8644		Push Rod, Leaf Spring Axle
	10/04 →	Centre Rod	DB-DL-9187		Push Rod
	10/04 →	Centre Rod	DB-DL-12298		for Steering Rod
	10/04 →	Centre Rod	DB-DL-12404		for Steering Rod
	10/04 →	Centre Rod	DB-DL-12405		Coupling Rod

CV-ES-12461

Length: 120
 Cone Ø: d1 Ø 26 / d2 Ø 23,5
 Thread: M30 x 1,5 LHT
 0003300035, 3300148, 0003406213, 0013306635,
 0013308835, 0014604048, 0014604348,
 14606448, 0024600248, 3023300035,
 3023300135, 3023300235, 3023300335,
 3453307235, 3453307435, 3503307135,
 A0003300148, A0013306635, A0013308835,
 A0014604048, A0014604348, A0014606448,
 A0024600248, A3023300035, A3023300135,
 A3023300235, A3023300335, A3503307135



CV-ES-12462

Length: 120
 Cone Ø: d1 Ø 26 / d2 Ø 23,5
 Thread: M30 x 1,5 RHT
 0003300135, 0003300248, 0003303235,
 0003305835, 0003307335, 0003383410,
 004608348, 0004608348, 0004632229,
 0004633129, 0004633429, 0004633529,
 0013300135, 0013300235, 0013306735,
 0014603448, 0014604148, 0014604448,
 0014606348, 0014608348, 0014608448,
 0014609748, 0023301535, 3453307135,
 3503307035, 3503307335, 3643307135,
 5001832582, A0003300248, A0003303235,
 A0003307335, A0003383410, A0004608348,
 A0004632229, A0004633429, A0013300135,
 A0013300235, A0013306735, A0014603448,
 A0014604148, A0014604448, A0014606348,
 A0014608348, A0014608448, A0014609748,
 A0023301535



CV-ES-14162

Length: 125
 Cone Ø: d1 Ø 30 / d2 Ø 27
 Thread: M30 x 1,5 LHT
 4600648, 4601248, 4603448, 0004603548,
 14600348, 14601448, 14602348, 0014603748,
 0014607848, 0024600348



CV-ES-14163

Length: 125
 Cone Ø: d1 Ø 30 / d2 Ø 27
 Thread: M30 x 1,5 RHT
 0003305248, 0003387310, 0004600348,
 0004600948, 0004602848, 0004602948,
 0004608948, 0014600248, 0014600848,
 0014601248, 0014602248, 0014607748,
 0024600148, A0003387310, A0004600348,
 A0004602848, A0004602948, A0014600848,
 A0014601248, A0014602248, A0014607748



DB-DL-7794

Length: 837 Ø: 40
 Cone Ø: d1 Ø 26 / d2 Ø 23,5
 9724601405, 9724601605



DB-DL-7799

Length: 895 Ø: 50
 Cone Ø: d1 Ø 30 / d2 Ø 26
 0034605905, 3754600305, 9724601805,
 9724602005



DB-DL-7815

Length: 895 Ø: 50
 Cone Ø: d1 Ø 30 / d2 Ø 27
 01215800A, 0034604605, 3754600005,
 9744601005, 9744601205



DB-DL-8174

Length: 1605 Ø: 40
 Cone Ø: d1 Ø 30 / d2 Ø 27
 9753300203, 9753300303, 9753300803,
 9753301703, 9753302503



DB-DL-8644

Length: 894 Ø: 50
 Cone Ø: d1 Ø 30 / d2 Ø 27
 0034604705, 9744601105, 9744601305

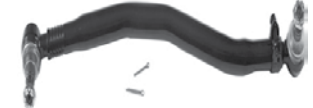

DB-DL-9187

Length: 846 Ø: 42
 Cone Ø: d1 Ø 26 / d2 Ø 23,5
 9704601105, 9724602805, A9704601105,
 A9724602805



DB-DL-12298

Length: 927 Ø: 50
 Cone Ø: d1 Ø 30 / d2 Ø 27
 0024602405, 0024603005



DB-DL-12304

Length: 1560 Ø: 40
 Cone Ø: d1 Ø 30 / d2 Ø 27
 Thread: M30 x 1,5 LHT / M30 x 1,5 RHT
 9753300603, 9753300703, 9753300903,
 A9753300603, A9753300703, A9753300903



DB-DL-12311

Length: 1565 Ø: 60
 Cone Ø: d1 Ø 30 / d2 Ø 27
 9753300003, 9753300403, 9753301003,
 9753301903, A9753300003, A9753300403,
 A9753301003, A9753301903



No Image

DB-DL-12404

Length: 875 Ø: 50
 Cone Ø: d1 Ø 30/26 / d2 Ø 27/23,5
 9724600605



DB-DL-12405

Length: 895 Ø: 50
 Cone Ø: d1 Ø 30 / d2 Ø 28,6
 Thread: M24 x 1,5 / M20 x 1,5
 9744602205, 9764600205, 9764600405,
 A9764600405



DB-DL-12437

Length: 875 Ø: 50
 Cone Ø: d1 Ø 30 / d2 Ø 27
 9744600005, 9744600605, A9744600005,
 A9744600605



DB-DL-12475

Length: 888 Ø: 50
 Cone Ø: d1 Ø 30 / d2 Ø 27
 9744601505, A9744601505



No Image

DB-ES-5214

Length: 1640 Ø: 40
 Cone Ø: d1 Ø 26 / d2 Ø 23,5
 01218000A, 9703300003, 9703300103,
 9703300203, 9703300303, 9703300403



DB-ES-8387

Length: 55
 Cone Ø: d1 Ø 10 / d2 Ø 10
 Thread: M14 x 1,5 RHT
 0009966845, 0009967045



DB-ES-8500

Length: 55
 Cone Ø: d1 Ø 12 / d2 Ø 10,8
 Thread: M14 x 1,5 RHT
 0002685989



DB-RK-8550

Ø: 75 Hole Distance: 152
 Thick/Height: 24
 0003502105, 0003504605



DB-RK-8555

Ø: 67 Hole Distance: 130
 Thick/Height: 24
 01335600A, 0003502005, 0003504705



DB-RK-9296

Ø: 88 Hole Distance: 130
 Thick/Height: 24
 9423260050



DB-SB-10385

Ø: 30 Thick/Height: 30
 3093200073, 3143260153



DB-SB-10386

Ø: 38 Thick/Height: 38
 3183200073



DB-TC-12411

Length: 655 Ø: 40
 Hole Distance: 115 / 115
 9723500906



DB-VB-10423

Length: 761,7 Ø: 46
 Hole Ø 25 / 23 / 23
 Hole Distance: 152 / 130 / 130
 9743500005, 9743500405, 9743500505



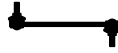

ATEGO 2 ...

1223, 1223 L, 1224, 1224 L ...	10/04 →	Centre Rod	DB-DL-12437		Push Rod	
	10/04 →	Centre Rod	DB-DL-12475		Push Rod	
	10/04 →	Stabiliser Mounting		DB-RK-9296		
	10/04 →	Stabiliser Mounting		DB-SB-10385		
	10/04 →	Stabiliser Mounting		DB-SB-10385	1st RA	
	10/04 →	Stabiliser Mounting		DB-SB-10386		
	10/04 →	Stabiliser Mounting	DB-SB-10386	DB-SB-10386		
	10/04 →	Stabiliser Mounting	DB-SB-10386	DB-SB-10386	1st FA	
	10/04 →	Suspension Arm Repair Kit		DB-RK-8550	for Wishbone (CV)	
	10/04 →	Suspension Strut Repair Kit		DB-RK-8555		
	10/04 →	Tie Rod	DB-DL-8174		Guide Rod	
	10/04 →	Tie Rod	DB-DL-12304			
	10/04 →	Tie Rod	DB-ES-5214		Guide Rod	
	10/04 →	Tie Rod End	CV-ES-12461		for Steering Rod	
	10/04 →	Tie Rod End	CV-ES-12462		for Steering Rod	
	10/04 →	Tie Rod End	CV-ES-14162		for Steering Rod	
	10/04 →	Tie Rod End	CV-ES-14163		for Steering Rod	
	10/04 →	Track Control Arm		DB-TC-12411	Control Arm	
	10/04 →	Track Control Arm		DB-VB-10423	Wishbone (CV), Air Suspension Axle	
	1224 K	10/04 →	Ball Head, gearshift linkage	DB-ES-8387		
		10/04 →	Ball Head, gearshift linkage	DB-ES-8500		
		10/04 →	Centre Rod			Push Rod, Leaf Spring Axle
		10/04 →	Centre Rod	DB-DL-7815		Push Rod, Leaf Spring Axle
		10/04 →	Centre Rod	DB-DL-8644		Push Rod, Leaf Spring Axle
		10/04 →	Centre Rod	DB-DL-12298		for Steering Rod
10/04 →		Centre Rod	DB-DL-12405		Coupling Rod	
10/04 →		Stabiliser Mounting	DB-SB-10386	DB-SB-10386		
10/04 →		Stabiliser Mounting	DB-SB-10386	DB-SB-10386	1st FA	
10/04 →		Tie Rod	DB-DL-8174		Guide Rod	
10/04 →		Tie Rod	DB-DL-12304			
10/04 →		Tie Rod End	CV-ES-14162		for Steering Rod	
10/04 →		Tie Rod End	CV-ES-14163		for Steering Rod	
1224, 1224 L		10/04 →	Centre Rod	DB-DL-7794		Push Rod
		10/04 →	Centre Rod	DB-DL-7799		Push Rod
	10/04 →	Centre Rod	DB-DL-7815		Push Rod	
	10/04 →	Centre Rod	DB-DL-8644		Push Rod	
	10/04 →	Centre Rod	DB-DL-9187		Push Rod	
	10/04 →	Centre Rod	DB-DL-12298		for Steering Rod	
	10/04 →	Centre Rod	DB-DL-12405		Coupling Rod	
	10/04 →	Centre Rod	DB-DL-12475		Push Rod	
	10/04 →	Tie Rod	DB-DL-8174		Guide Rod, 1st Front Axle	
	10/04 →	Tie Rod	DB-DL-12304		1st FA, →504310 24	
	10/04 →	Tie Rod	DB-ES-5214		Guide Rod, 1st Front Axle	
	10/04 →	Tie Rod End	CV-ES-12461		for Steering Rod	
	10/04 →	Tie Rod End	CV-ES-12462		for Steering Rod	
	10/04 →	Tie Rod End	CV-ES-14162		for Steering Rod	
	10/04 →	Tie Rod End	CV-ES-14163		for Steering Rod	
	1226 AF	10/04 →	Ball Head, gearshift linkage	DB-ES-8387		
		10/04 →	Ball Head, gearshift linkage	DB-ES-8500		
		10/04 →	Centre Rod	DB-DL-12298		for Steering Rod
10/04 →		Centre Rod	DB-DL-12405		Coupling Rod	
10/04 →		Centre Rod	DB-DL-12475		Push Rod	
10/04 →		Tie Rod	DB-DL-12311			
10/04 →		Tie Rod End	CV-ES-14163		for Steering Rod	
1226 F		10/04 →	Ball Head, gearshift linkage	DB-ES-8387		
	10/04 →	Ball Head, gearshift linkage	DB-ES-8500			
	10/04 →	Centre Rod	DB-DL-7799		Push Rod	
	10/04 →	Centre Rod	DB-DL-7815		Push Rod	
	10/04 →	Centre Rod	DB-DL-8644		Push Rod	
	10/04 →	Centre Rod	DB-DL-12298		for Steering Rod	
	10/04 →	Centre Rod	DB-DL-12405		Coupling Rod	
	10/04 →	Centre Rod	DB-DL-12475		Push Rod	
	10/04 →	Tie Rod	DB-DL-8174		Guide Rod	

CV-ES-12461

Length: 120
 Cone Ø: d1 Ø 26 / d2 Ø 23,5
 Thread: M30 x 1,5 LHT
 0003300035, 3300148, 0003406213, 0013306635,
 0013308835, 0014604048, 0014604348,
 14606448, 0024600248, 3023300035,
 3023300135, 3023300235, 3023300335,
 3453307235, 3453307435, 3503307135,
 A0003300148, A0013306635, A0013308835,
 A0014604048, A0014604348, A0014606448,
 A0024600248, A3023300035, A3023300135,
 A3023300235, A3023300335, A3503307135



CV-ES-12462

Length: 120
 Cone Ø: d1 Ø 26 / d2 Ø 23,5
 Thread: M30 x 1,5 RHT
 0003300135, 0003300248, 0003303235,
 0003305835, 0003307335, 0003383410,
 004608348, 0004608348, 0004632229,
 0004633129, 0004633429, 0004633529,
 0013300135, 0013300235, 0013306735,
 0014603448, 0014604148, 0014604448,
 0014606348, 0014608348, 0014608448,
 0014609748, 0023301535, 3453307135,
 3503307035, 3503307335, 3643307135,
 5001832582, A0003300248, A0003303235,
 A0003307335, A0003383410, A0004608348,
 A0004632229, A0004633429, A0013300135,
 A0013300235, A0013306735, A0014603448,
 A0014604148, A0014604448, A0014606348,
 A0014608348, A0014608448, A0014609748,
 A0023301535



CV-ES-14162

Length: 125
 Cone Ø: d1 Ø 30 / d2 Ø 27
 Thread: M30 x 1,5 LHT
 4600648, 4601248, 4603448, 0004603548,
 14600348, 14601448, 14602348, 0014603748,
 0014607848, 0024600348



CV-ES-14163

Length: 125
 Cone Ø: d1 Ø 30 / d2 Ø 27
 Thread: M30 x 1,5 RHT
 0003305248, 0003387310, 0004600348,
 0004600948, 0004602848, 0004602948,
 0004608948, 0014600248, 0014600848,
 0014601248, 0014602248, 0014607748,
 0024600148, A0003387310, A0004600348,
 A0004602848, A0004602948, A0014600848,
 A0014601248, A0014602248, A0014607748



DB-DL-7794

Length: 837 Ø: 40
 Cone Ø: d1 Ø 26 / d2 Ø 23,5
 9724601405, 9724601605



DB-DL-7799

Length: 895 Ø: 50
 Cone Ø: d1 Ø 30 / d2 Ø 26
 0034605905, 3754600305, 9724601805,
 9724602005



DB-DL-7815

Length: 895 Ø: 50
 Cone Ø: d1 Ø 30 / d2 Ø 27
 01215800A, 0034604605, 3754600005,
 9744601005, 9744601205



DB-DL-8174

Length: 1605 Ø: 40
 Cone Ø: d1 Ø 30 / d2 Ø 27
 9753300203, 9753300303, 9753300803,
 9753301703, 9753302503



DB-DL-8644

Length: 894 Ø: 50
 Cone Ø: d1 Ø 30 / d2 Ø 27
 0034604705, 9744601105, 9744601305

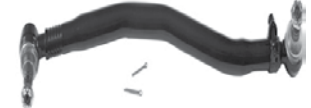

DB-DL-9187

Length: 846 Ø: 42
 Cone Ø: d1 Ø 26 / d2 Ø 23,5
 9704601105, 9724602805, A9704601105,
 A9724602805



DB-DL-12298

Length: 927 Ø: 50
 Cone Ø: d1 Ø 30 / d2 Ø 27
 0024602405, 0024603005



DB-DL-12304

Length: 1560 Ø: 40
 Cone Ø: d1 Ø 30 / d2 Ø 27
 Thread: M30 x 1,5 LHT / M30 x 1,5 RHT
 9753300603, 9753300703, 9753300903,
 A9753300603, A9753300703, A9753300903



DB-DL-12311

Length: 1565 Ø: 60
 Cone Ø: d1 Ø 30 / d2 Ø 27
 9753300003, 9753300403, 9753301003,
 9753301903, A9753300003, A9753300403,
 A9753301003, A9753301903

No Image

DB-DL-12405

Length: 895 Ø: 50
 Cone Ø: d1 Ø 30 / d2 Ø 28,6
 Thread: M24 x 1,5 / M20 x 1,5
 9744602205, 9764600205, 9764600405,
 A9764600405



DB-DL-12437

Length: 875 Ø: 50
 Cone Ø: d1 Ø 30 / d2 Ø 27
 9744600005, 9744600605, A9744600005,
 A9744600605



DB-DL-12475

Length: 888 Ø: 50
 Cone Ø: d1 Ø 30 / d2 Ø 27
 9744601505, A9744601505

No Image

DB-ES-5214

Length: 1640 Ø: 40
 Cone Ø: d1 Ø 26 / d2 Ø 23,5
 01218000A, 9703300003, 9703300103,
 9703300203, 9703300303, 9703300403



DB-ES-8387

Length: 55
 Cone Ø: d1 Ø 10 / d2 Ø 10
 Thread: M14 x 1,5 RHT
 0009966845, 0009967045



DB-ES-8500

Length: 55
 Cone Ø: d1 Ø 12 / d2 Ø 10,8
 Thread: M14 x 1,5 RHT
 0002685989



DB-RK-8550

Ø: 75 Hole Distance: 152
 Thick/Height: 24
 0003502105, 0003504605



DB-RK-8555

Ø: 67 Hole Distance: 130
 Thick/Height: 24
 01335600A, 0003502005, 0003504705



DB-RK-9296

Ø: 88 Hole Distance: 130
 Thick/Height: 24
 9423260050



DB-SB-10385

Ø: 30 Thick/Height: 30
 3093200073, 3143260153



DB-SB-10386

Ø: 38 Thick/Height: 38
 3183200073



DB-TC-12411

Length: 655 Ø: 40
 Hole Distance: 115 / 115
 9723500906



DB-VB-10423

Length: 761,7 Ø: 46
 Hole Ø 25 / 23 / 23
 Hole Distance: 152 / 130 / 130
 9743500005, 9743500405, 9743500505





ATEGO 2 ...

1226 F ...	10/04 →	Tie Rod	DB-DL-12304		
	10/04 →	Tie Rod End	CV-ES-14162	for Steering Rod	
	10/04 →	Tie Rod End	CV-ES-14163	for Steering Rod	
1226, 1226 L	10/04 →12/14	Tie Rod	DB-DL-8174	Guide Rod, 1st Front Axle	
	10/04 →	Ball Head, gearshift linkage	DB-ES-8387		
	10/04 →	Ball Head, gearshift linkage	DB-ES-8500		
	10/04 →	Centre Rod	DB-DL-7799	Push Rod	
	10/04 →	Centre Rod	DB-DL-7799	Push Rod, Leaf Spring Axle	
	10/04 →	Centre Rod	DB-DL-7815	Push Rod	
	10/04 →	Centre Rod	DB-DL-7815	Push Rod, Leaf Spring Axle	
	10/04 →	Centre Rod	DB-DL-8644	Push Rod	
	10/04 →	Centre Rod	DB-DL-8644	Push Rod, Leaf Spring Axle	
	10/04 →	Centre Rod	DB-DL-12298	for Steering Rod	
	10/04 →	Centre Rod	DB-DL-12404	for Steering Rod	
	10/04 →	Centre Rod	DB-DL-12405	Coupling Rod	
	10/04 →	Centre Rod	DB-DL-12437	Push Rod	
	10/04 →	Centre Rod	DB-DL-12475	Push Rod	
	10/04 →	Stabiliser Mounting		DB-RK-9296	
	10/04 →	Stabiliser Mounting		DB-SB-10385	
	10/04 →	Stabiliser Mounting		DB-SB-10385	1st RA
	10/04 →	Stabiliser Mounting		DB-SB-10386	
	10/04 →	Stabiliser Mounting	DB-SB-10386	DB-SB-10386	
	10/04 →	Stabiliser Mounting	DB-SB-10386	DB-SB-10386	1st FA
	10/04 →	Suspension Arm Repair Kit		DB-RK-8550	for Wishbone (CV)
	10/04 →	Suspension Strut Repair Kit		DB-RK-8555	
	10/04 →	Tie Rod	DB-DL-8174		Guide Rod
	10/04 →	Tie Rod	DB-DL-12304		
	10/04 →	Tie Rod End	CV-ES-14162		for Steering Rod
	10/04 →	Tie Rod End	CV-ES-14163		for Steering Rod
	10/04 →	Track Control Arm		DB-TC-12411	Control Arm
	10/04 →	Track Control Arm		DB-VB-10423	Wishbone (CV), Air Suspension Axle
	1228, 1228 L, 1229, 1229 L	10/04 →	Ball Head, gearshift linkage	DB-ES-8387	
		10/04 →	Ball Head, gearshift linkage	DB-ES-8500	
		10/04 →	Centre Rod	DB-DL-7799	Push Rod
		10/04 →	Centre Rod	DB-DL-7799	Push Rod, Leaf Spring Axle
		10/04 →	Centre Rod	DB-DL-7815	Push Rod
10/04 →		Centre Rod	DB-DL-7815	Push Rod, Leaf Spring Axle	
10/04 →		Centre Rod	DB-DL-8644	Push Rod	
10/04 →		Centre Rod	DB-DL-8644	Push Rod, Leaf Spring Axle	
10/04 →		Centre Rod	DB-DL-12298	for Steering Rod	
10/04 →		Centre Rod	DB-DL-12404	for Steering Rod	
10/04 →		Centre Rod	DB-DL-12405	Coupling Rod	
10/04 →		Centre Rod	DB-DL-12437	Push Rod	
10/04 →		Centre Rod	DB-DL-12475	Push Rod	
10/04 →		Stabiliser Mounting		DB-RK-9296	
10/04 →		Stabiliser Mounting		DB-SB-10385	
10/04 →		Stabiliser Mounting		DB-SB-10385	1st RA
10/04 →		Stabiliser Mounting		DB-SB-10386	
10/04 →		Stabiliser Mounting	DB-SB-10386	DB-SB-10386	
10/04 →		Stabiliser Mounting	DB-SB-10386	DB-SB-10386	1st FA
10/04 →		Suspension Arm Repair Kit		DB-RK-8550	for Wishbone (CV)
10/04 →		Suspension Strut Repair Kit		DB-RK-8555	
10/04 →		Tie Rod	DB-DL-8174		Guide Rod
10/04 →		Tie Rod	DB-DL-12304		
10/04 →		Tie Rod End	CV-ES-14162		for Steering Rod
10/04 →		Tie Rod End	CV-ES-14163		for Steering Rod
10/04 →		Track Control Arm		DB-TC-12411	Control Arm
10/04 →		Track Control Arm		DB-VB-10423	Wishbone (CV), Air Suspension Axle
1229, 1229 L		10/04 →	Centre Rod	DB-DL-7799	Push Rod
		10/04 →	Centre Rod	DB-DL-7815	Push Rod
		10/04 →	Centre Rod	DB-DL-8644	Push Rod
		10/04 →	Centre Rod	DB-DL-12298	for Steering Rod
		10/04 →	Centre Rod	DB-DL-12405	Coupling Rod

CV-ES-14162

Length: 125
Cone Ø: d1 Ø 30 / d2 Ø 27
Thread: M30 x 1,5 LHT
4600648, 4601248, 4603448, 0004603548,
4603548, 14600348, 14601448, 14602348, 001
460 37 48, 14607848, 0014607848, 002 460 03 48



CV-ES-14163

Length: 125
Cone Ø: d1 Ø 30 / d2 Ø 27
Thread: M30 x 1,5 RHT
0003305248, 0003387310, 0004600348,
0004600948, 0004602848, 0004602948,
0004608948, 0014600248, 0014600848,
0014601248, 0014602248, 0014607748,
0024600148, A0003387310, A0004600348,
A0004602848, A0004602948, A0014600848,
A0014601248, A0014602248, A0014607748



DB-DL-7799

Length: 895 Ø: 50
Cone Ø: d1 Ø 30 / d2 Ø 26
0034605905, 3754600305, 9724601805,
9724602005



DB-DL-7815

Length: 895 Ø: 50
Cone Ø: d1 Ø 30 / d2 Ø 27
01215800A, 0034604605, 3754600005,
9744601005, 9744601205



DB-DL-8174

Length: 1605 Ø: 40
Cone Ø: d1 Ø 30 / d2 Ø 27
9753300203, 9753300303, 9753300803,
9753301703, 9753302503



DB-DL-8644

Length: 894 Ø: 50
Cone Ø: d1 Ø 30 / d2 Ø 27
0034604705, 9744601105, 9744601305

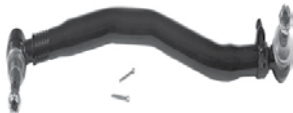

DB-DL-12298

Length: 927 Ø: 50
Cone Ø: d1 Ø 30 / d2 Ø 27
0024602405, 0024603005



DB-DL-12304

Length: 1560 Ø: 40
Cone Ø: d1 Ø 30 / d2 Ø 27
Thread: M30 x 1,5 LHT / M30 x 1,5 RHT
9753300603, 9753300703, 9753300903,
A9753300603, A9753300703, A9753300903



DB-DL-12404

Length: 875 Ø: 50
Cone Ø: d1 Ø 30/26 / d2 Ø 27/23,5
9724600605



DB-DL-12405

Length: 895 Ø: 50
Cone Ø: d1 Ø 30 / d2 Ø 28,6
Thread: M24 x 1,5 / M20 x 1,5
9744602205, 9764600205, 9764600405,
A9764600405



DB-DL-12437

Length: 875 Ø: 50
Cone Ø: d1 Ø 30 / d2 Ø 27
9744600005, 9744600605, A9744600005,
A9744600605



DB-DL-12475

Length: 888 Ø: 50
Cone Ø: d1 Ø 30 / d2 Ø 27
9744601505, A9744601505



No Image

DB-ES-8387

Length: 55
Cone Ø: d1 Ø 10 / d2 Ø 10
Thread: M14 x 1,5 RHT
0009966845, 0009967045



DB-ES-8500

Length: 55
Cone Ø: d1 Ø 12 / d2 Ø 10,8
Thread: M14 x 1,5 RHT
0002685989



DB-RK-8550

Ø: 75 Hole Distance: 152
Thick/Height: 24
0003502105, 0003504605



DB-RK-8555

Ø: 67 Hole Distance: 130
Thick/Height: 24
01335600A, 0003502005, 0003504705



DB-RK-9296

Ø: 88 Hole Distance: 130
Thick/Height: 24
9423260050



DB-SB-10385

Ø: 30 Thick/Height: 30
3093200073, 3143260153



DB-SB-10386

Ø: 38 Thick/Height: 38
3183200073



DB-TC-12411

Length: 655 Ø: 40
Hole Distance: 115 / 115
9723500906



DB-VB-10423

Length: 761,7 Ø: 46
Hole Ø 25 / 23 / 23
Hole Distance: 152 / 130 / 130
9743500005, 9743500405, 9743500505





ATEGO 2 ...

1229, 1229 L ...	10/04 →	Centre Rod	DB-DL-12475		Push Rod	
	10/04 →	Tie Rod	DB-DL-8174		Guide Rod, 1st Front Axle	
	10/04 →	Tie Rod	DB-DL-12304		1st FA, →504310 24	
	10/04 →	Tie Rod End	CV-ES-14162		for Steering Rod	
	10/04 →	Tie Rod End	CV-ES-14163		for Steering Rod	
1315	10/04 →	Ball Head, gearshift linkage	DB-ES-8510	DB-ES-8510		
	10/04 →	Centre Rod	DB-DL-12405		Coupling Rod	
1318 A	10/04 →	Ball Head, gearshift linkage	DB-ES-8387			
	10/04 →	Centre Rod	DB-DL-8620		for Steering Rod	
	10/04 →	Centre Rod	DB-DL-12298		for Steering Rod	
	10/04 →	Centre Rod	DB-DL-12405		Coupling Rod	
	10/04 →	Stabiliser Mounting	DB-SB-10386	DB-SB-10386		
	10/04 →	Stabiliser Mounting	DB-SB-10386	DB-SB-10386	1st FA	
	10/04 →	Tie Rod	DB-DL-12311			
	10/04 →	Tie Rod End	CV-ES-14163		for Steering Rod	
1318 AK	10/04 →	Ball Head, gearshift linkage	DB-ES-8387			
	10/04 →	Centre Rod	DB-DL-8620		for Steering Rod	
	10/04 →	Centre Rod	DB-DL-12298		for Steering Rod	
	10/04 →	Centre Rod	DB-DL-12405		Coupling Rod	
	10/04 →	Stabiliser Mounting	DB-SB-10386	DB-SB-10386		
	10/04 →	Stabiliser Mounting	DB-SB-10386	DB-SB-10386	1st FA	
	10/04 →	Tie Rod	DB-DL-12311			
	10/04 →	Tie Rod End	CV-ES-14163		for Steering Rod	
1318 K	10/04 →	Ball Head, gearshift linkage	DB-ES-8387			
	10/04 →	Ball Head, gearshift linkage	DB-ES-8500			
	10/04 →	Centre Rod	DB-DL-7799		Push Rod;Suspension Rod	
	10/04 →	Centre Rod	DB-DL-7815		Push Rod, Leaf Spring Axle	
	10/04 →	Centre Rod	DB-DL-8644		Push Rod, Leaf Spring Axle	
	10/04 →	Centre Rod	DB-DL-12405		Coupling Rod	
	10/04 →	Stabiliser Mounting		DB-SB-10386		
	10/04 →	Stabiliser Mounting	DB-SB-10386	DB-SB-10386		
	10/04 →	Stabiliser Mounting	DB-SB-10386	DB-SB-10386	1st FA	
	10/04 →	Tie Rod	DB-DL-8174		Guide Rod	
	10/04 →	Tie Rod	DB-DL-12304			
	10/04 →	Tie Rod End	CV-ES-14162		for Steering Rod	
	10/04 →	Tie Rod End	CV-ES-14163		for Steering Rod	
	1318, 1318 L	10/04 →	Ball Head, gearshift linkage	DB-ES-8387		
		10/04 →	Ball Head, gearshift linkage	DB-ES-8500		
10/04 →		Centre Rod	DB-DL-7799		Push Rod	
10/04 →		Centre Rod	DB-DL-7799		Push Rod, Leaf Spring Axle	
10/04 →		Centre Rod	DB-DL-7815		Push Rod	
10/04 →		Centre Rod	DB-DL-7815		Push Rod, Leaf Spring Axle	
10/04 →		Centre Rod	DB-DL-8644		Push Rod	
10/04 →		Centre Rod	DB-DL-8644		Push Rod, Leaf Spring Axle	
10/04 →		Centre Rod	DB-DL-12404		for Steering Rod	
10/04 →		Centre Rod	DB-DL-12405		Coupling Rod	
10/04 →		Centre Rod	DB-DL-12437		Push Rod	
10/04 →		Centre Rod	DB-DL-12475		Push Rod	
10/04 →		Stabiliser Mounting		DB-RK-9296		
10/04 →		Stabiliser Mounting		DB-SB-10385		
10/04 →		Stabiliser Mounting		DB-SB-10385	1st RA	
10/04 →		Stabiliser Mounting		DB-SB-10386		
10/04 →		Stabiliser Mounting	DB-SB-10386	DB-SB-10386		
10/04 →		Stabiliser Mounting	DB-SB-10386	DB-SB-10386	1st FA	
10/04 →		Suspension Arm Repair Kit		DB-RK-8550	for Wishbone (CV)	
10/04 →		Suspension Strut Repair Kit		DB-RK-8555		
10/04 →		Tie Rod	DB-DL-8174		Guide Rod	
10/04 →		Tie Rod	DB-DL-12304			
10/04 →		Tie Rod End	CV-ES-14162		for Steering Rod	
10/04 →		Tie Rod End	CV-ES-14163		for Steering Rod	
10/04 →		Track Control Arm		DB-TC-12411	Control Arm	
10/04 →		Track Control Arm		DB-VB-10423	Wishbone (CV), Air Suspension Axle	

CV-ES-14162

Length: 125
Cone Ø: d1 Ø 30 / d2 Ø 27
Thread: M30 x 1,5 LHT
4600648, 4601248, 4603448, 4603548,
0004603548, 14600348, 14601448, 14602348,
0014603748, 0014607848, 14607848, 002460
0348



CV-ES-14163

Length: 125
Cone Ø: d1 Ø 30 / d2 Ø 27
Thread: M30 x 1,5 RHT
0003305248, 0003387310, 0004600348,
0004600948, 0004602848, 0004602948,
0004608948, 0014600248, 0014600848,
0014601248, 0014602248, 0014607748,
0024600148, A0003387310, A0004600348,
A0004602848, A0004602948, A0014600848,
A0014601248, A0014602248, A0014607748



DB-DL-7799

Length: 895 Ø: 50
Cone Ø: d1 Ø 30 / d2 Ø 26
0034605905, 3754600305, 9724601805,
9724602005



DB-DL-7815

Length: 895 Ø: 50
Cone Ø: d1 Ø 30 / d2 Ø 27
01215800A, 0034604605, 3754600005,
9744601005, 9744601205



DB-DL-8174

Length: 1605 Ø: 40
Cone Ø: d1 Ø 30 / d2 Ø 27
9753300203, 9753300303, 9753300803,
9753301703, 9753302503



DB-DL-8620

Length: 884
Ø: 50
Cone Ø: d1 Ø 30 / d2 Ø 27
Thread: M24 x 1,5 / M20 x 1,5
9744600405, 9744600805, A9744600405,
A9744600805



DB-DL-8644

Length: 894 Ø: 50
Cone Ø: d1 Ø 30 / d2 Ø 27
0034604705, 9744601105, 9744601305

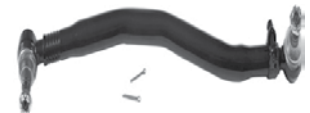

DB-DL-12298

Length: 927 Ø: 50
Cone Ø: d1 Ø 30 / d2 Ø 27
0024602405, 0024603005



DB-DL-12304

Length: 1560 Ø: 40
Cone Ø: d1 Ø 30 / d2 Ø 27
Thread: M30 x 1,5 LHT / M30 x 1,5 RHT
9753300603, 9753300703, 9753300903,
A9753300603, A9753300703, A9753300903



DB-DL-12311

Length: 1565 Ø: 60
Cone Ø: d1 Ø 30 / d2 Ø 27
9753300003, 9753300403, 9753301003,
9753301903, A9753300003, A9753300403,
A9753301003, A9753301903

No Image

DB-DL-12404

Length: 875 Ø: 50
Cone Ø: d1 Ø 30/26 / d2 Ø 27/23,5
9724600605



DB-DL-12405

Length: 895 Ø: 50
Cone Ø: d1 Ø 30 / d2 Ø 28,6
Thread: M24 x 1,5 / M20 x 1,5
9744602205, 9764600205, 9764600405,
A9764600405



DB-DL-12437

Length: 875 Ø: 50
Cone Ø: d1 Ø 30 / d2 Ø 27
9744600005, 9744600605, A9744600005,
A9744600605



DB-DL-12475

Length: 888 Ø: 50
Cone Ø: d1 Ø 30 / d2 Ø 27
9744601505, A9744601505

No Image

DB-ES-8387

Length: 55
Cone Ø: d1 Ø 10 / d2 Ø 10
Thread: M14 x 1,5 RHT
0009966845, 0009967045



DB-ES-8500

Length: 55
Cone Ø: d1 Ø 12 / d2 Ø 10,8
Thread: M14 x 1,5 RHT
0002685989



DB-ES-8510

Length: 56
Cone Ø: d1 Ø 10 / d2 Ø 10
Thread: M12 x 1,75 LHT
0009965145, 0009965645, 0019963145



DB-RK-8550

Ø: 75 Hole Distance: 152
Thick/Height: 24
0003502105, 0003504605



DB-RK-8555

Ø: 67
Hole Distance: 130
Thick/Height: 24
01335600A, 3502005, 0003502005, 3504705,
0003504705



DB-RK-9296

Ø: 88 Hole Distance: 130
Thick/Height: 24
9423260050



DB-SB-10385

Ø: 30 Thick/Height: 30
3093200073, 3143260153



DB-SB-10386

Ø: 38 Thick/Height: 38
3183200073



DB-TC-12411

Length: 655 Ø: 40
Hole Distance: 115 / 115
9723500906



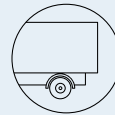

ATEGO 2 ...

1322 A	10/04 →	Ball Head, gearshift linkage	DB-ES-8387			
	10/04 →	Centre Rod	DB-DL-8620		for Steering Rod	
	10/04 →	Centre Rod	DB-DL-12298		for Steering Rod	
	10/04 →	Centre Rod	DB-DL-12405		Coupling Rod	
	10/04 →	Tie Rod	DB-DL-12311			
	10/04 →	Tie Rod End	CV-ES-14163		for Steering Rod	
1322 AF	10/04 →	Ball Head, gearshift linkage	DB-ES-8387			
	10/04 →	Ball Head, gearshift linkage	DB-ES-8500			
	10/04 →	Ball Head, gearshift linkage	DB-ES-8510			
	10/04 →	Centre Rod	DB-DL-12298		for Steering Rod	
	10/04 →	Centre Rod	DB-DL-12405		Coupling Rod	
	10/04 →	Centre Rod	DB-DL-12475		Push Rod	
	10/04 →	Tie Rod	DB-DL-12311			
	10/04 →	Tie Rod End	CV-ES-14163		for Steering Rod	
1322 AK	10/04 →	Centre Rod	DB-DL-12298		for Steering Rod	
	10/04 →	Centre Rod	DB-DL-12405		Coupling Rod	
	10/04 →	Tie Rod	DB-DL-12311			
	10/04 →	Tie Rod End	CV-ES-14163		for Steering Rod	
1322 F	10/04 →	Centre Rod	DB-DL-7799		Push Rod	
	10/04 →	Centre Rod	DB-DL-7815		Push Rod	
	10/04 →	Centre Rod	DB-DL-8644		Push Rod	
	10/04 →	Centre Rod	DB-DL-12298		for Steering Rod	
	10/04 →	Centre Rod	DB-DL-12405		Coupling Rod	
	10/04 →	Centre Rod	DB-DL-12475		Push Rod	
	10/04 →	Tie Rod	DB-DL-8174		Guide Rod, 1st Front Axle	
	10/04 →	Tie Rod	DB-DL-12304		1st FA, →504310 24	
	10/04 →	Tie Rod End	CV-ES-14162		for Steering Rod	
	10/04 →	Tie Rod End	CV-ES-14163		for Steering Rod	
1322 K	10/04 →	Ball Head, gearshift linkage	DB-ES-8387			
	10/04 →	Ball Head, gearshift linkage	DB-ES-8500			
	10/04 →	Centre Rod	DB-DL-7799		Push Rod,Suspension Rod	
	10/04 →	Centre Rod	DB-DL-7815		Push Rod, Leaf Spring Axle	
	10/04 →	Centre Rod	DB-DL-8644		Push Rod, Leaf Spring Axle	
	10/04 →	Centre Rod	DB-DL-12298		for Steering Rod	
	10/04 →	Centre Rod	DB-DL-12405		Coupling Rod	
	10/04 →	Stabiliser Mounting		DB-SB-10386		
	10/04 →	Stabiliser Mounting	DB-SB-10386	DB-SB-10386		
	10/04 →	Stabiliser Mounting	DB-SB-10386	DB-SB-10386	1st FA	
	10/04 →	Tie Rod	DB-DL-8174		Guide Rod	
	10/04 →	Tie Rod	DB-DL-12304			
	10/04 →	Tie Rod End	CV-ES-14162		for Steering Rod	
	10/04 →	Tie Rod End	CV-ES-14163		for Steering Rod	
	1322 LK0	10/04 →	Centre Rod	DB-DL-7799		Push Rod
10/04 →		Centre Rod	DB-DL-7815		Push Rod	
10/04 →		Centre Rod	DB-DL-8644		Push Rod	
10/04 →		Centre Rod	DB-DL-12298		for Steering Rod	
10/04 →		Centre Rod	DB-DL-12405		Coupling Rod	
10/04 →		Suspension Arm Repair Kit		DB-RK-8550	for Wishbone (CV)	
10/04 →		Tie Rod	DB-DL-8174		Guide Rod	
10/04 →		Tie Rod	DB-DL-12304			
10/04 →		Tie Rod End	CV-ES-14162		for Steering Rod	
10/04 →		Tie Rod End	CV-ES-14163		for Steering Rod	
10/04 →		Track Control Arm		DB-TC-12411	Control Arm	
10/04 →		Track Control Arm		DB-VB-10423	Wishbone (CV)	
1322 LS		10/04 →	Ball Head, gearshift linkage	DB-ES-8387		
		10/04 →	Ball Head, gearshift linkage	DB-ES-8500		
	10/04 →	Centre Rod	DB-DL-7799		Push Rod	
	10/04 →	Centre Rod	DB-DL-7815		Push Rod	
	10/04 →	Centre Rod	DB-DL-8644		Push Rod	
	10/04 →	Centre Rod	DB-DL-12298		for Steering Rod	
	10/04 →	Centre Rod	DB-DL-12405		Coupling Rod	
	10/04 →	Stabiliser Mounting		DB-RK-9296		
	10/04 →	Stabiliser Mounting		DB-SB-10385		

CV-ES-14162

Length: 125
Cone Ø: d1 Ø 30 / d2 Ø 27
Thread: M30 x 1,5 LHT
4600648, 4601248, 4603448, 0004603548,
4603548, 14600348, 14601448, 14602348, 001
460 37 48, 14607848, 0014607848, 002 460 03 48



CV-ES-14163

Length: 125
Cone Ø: d1 Ø 30 / d2 Ø 27
Thread: M30 x 1,5 RHT
0003305248, 0003387310, 0004600348,
0004600948, 0004602848, 0004602948,
0004608948, 0014600248, 0014600848,
0014601248, 0014602248, 0014607748,
0024600148, A0003387310, A0004600348,
A0004602848, A0004602948, A0014600848,
A0014601248, A0014602248, A0014607748



DB-DL-7799

Length: 895 Ø: 50
Cone Ø: d1 Ø 30 / d2 Ø 26
0034605905, 3754600305, 9724601805,
9724602005



DB-DL-7815

Length: 895 Ø: 50
Cone Ø: d1 Ø 30 / d2 Ø 27
01215800A, 0034604605, 3754600005,
9744601005, 9744601205



DB-DL-8174

Length: 1605 Ø: 40
Cone Ø: d1 Ø 30 / d2 Ø 27
9753300203, 9753300303, 9753300803,
9753301703, 9753302503



DB-DL-8620

Length: 884
Ø: 50
Cone Ø: d1 Ø 30 / d2 Ø 27
Thread: M24 x 1,5 / M20 x 1,5
9744600405, 9744600805, A9744600405,
A9744600805



DB-DL-8644

Length: 894 Ø: 50
Cone Ø: d1 Ø 30 / d2 Ø 27
0034604705, 9744601105, 9744601305

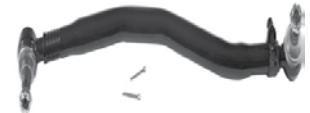

DB-DL-12298

Length: 927 Ø: 50
Cone Ø: d1 Ø 30 / d2 Ø 27
0024602405, 0024603005



DB-DL-12304

Length: 1560 Ø: 40
Cone Ø: d1 Ø 30 / d2 Ø 27
Thread: M30 x 1,5 LHT / M30 x 1,5 RHT
9753300603, 9753300703, 9753300903,
A9753300603, A9753300703, A9753300903



DB-DL-12311

Length: 1565 Ø: 60
Cone Ø: d1 Ø 30 / d2 Ø 27
9753300003, 9753300403, 9753301003,
9753301903, A9753300003, A9753300403,
A9753301003, A9753301903

No Image

DB-DL-12405

Length: 895 Ø: 50
Cone Ø: d1 Ø 30 / d2 Ø 28,6
Thread: M24 x 1,5 / M20 x 1,5
9744602205, 9764600205, 9764600405,
A9764600405



DB-DL-12475

Length: 888 Ø: 50
Cone Ø: d1 Ø 30 / d2 Ø 27
9744601505, A9744601505

No Image

DB-ES-8387

Length: 55
Cone Ø: d1 Ø 10 / d2 Ø 10
Thread: M14 x 1,5 RHT
0009966845, 0009967045



DB-ES-8500

Length: 55
Cone Ø: d1 Ø 12 / d2 Ø 10,8
Thread: M14 x 1,5 RHT
0002685989



DB-ES-8510

Length: 56
Cone Ø: d1 Ø 10 / d2 Ø 10
Thread: M12 x 1,75 LHT
0009965145, 0009965645, 0019963145



DB-RK-8550

Ø: 75 Hole Distance: 152
Thick/Height: 24
0003502105, 0003504605



DB-RK-9296

Ø: 88 Hole Distance: 130
Thick/Height: 24
9423260050



DB-SB-10385

Ø: 30 Thick/Height: 30
3093200073, 3143260153



DB-SB-10386

Ø: 38 Thick/Height: 38
3183200073



DB-TC-12411

Length: 655 Ø: 40
Hole Distance: 115 / 115
9723500906



DB-VB-10423

Length: 761,7 Ø: 46
Hole Ø 25 / 23 / 23
Hole Distance: 152 / 130 / 130
9743500005, 9743500405, 9743500505



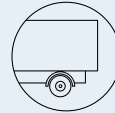

ATEGO 2 ...

1322 LS ...	10/04 →	Stabiliser Mounting		DB-SB-10385	1st RA	
	10/04 →	Stabiliser Mounting		DB-SB-10386		
	10/04 →	Stabiliser Mounting	DB-SB-10386	DB-SB-10386		
	10/04 →	Stabiliser Mounting	DB-SB-10386	DB-SB-10386	1st FA	
	10/04 →	Suspension Arm Repair Kit		DB-RK-8550	for Wishbone (CV)	
	10/04 →	Suspension Strut Repair Kit		DB-RK-8555		
	10/04 →	Tie Rod	DB-DL-8174		Guide Rod	
	10/04 →	Tie Rod	DB-DL-12304			
	10/04 →	Tie Rod End	CV-ES-14162		for Steering Rod	
	10/04 →	Tie Rod End	CV-ES-14163		for Steering Rod	
	10/04 →	Track Control Arm		DB-TC-12411	Control Arm	
	10/04 →	Track Control Arm		DB-VB-10423	Wishbone (CV), Air Suspension Axle	
	1322, 1322 L	10/04 →	Ball Head, gearshift linkage	DB-ES-8387		
		10/04 →	Ball Head, gearshift linkage	DB-ES-8500		
10/04 →		Centre Rod	DB-DL-7799		Push Rod	
10/04 →		Centre Rod	DB-DL-7799		Push Rod, Leaf Spring Axle	
10/04 →		Centre Rod	DB-DL-7815		Push Rod	
10/04 →		Centre Rod	DB-DL-7815		Push Rod, Leaf Spring Axle	
10/04 →		Centre Rod	DB-DL-8644		Push Rod	
10/04 →		Centre Rod	DB-DL-8644		Push Rod, Leaf Spring Axle	
10/04 →		Centre Rod	DB-DL-12298		for Steering Rod	
10/04 →		Centre Rod	DB-DL-12404		for Steering Rod	
10/04 →		Centre Rod	DB-DL-12405		Coupling Rod	
10/04 →		Centre Rod	DB-DL-12437		Push Rod	
10/04 →		Centre Rod	DB-DL-12475		Push Rod	
10/04 →		Stabiliser Mounting		DB-RK-9296		
10/04 →		Stabiliser Mounting		DB-SB-10385		
10/04 →		Stabiliser Mounting		DB-SB-10385	1st RA	
10/04 →		Stabiliser Mounting		DB-SB-10386		
10/04 →		Stabiliser Mounting	DB-SB-10386	DB-SB-10386		
10/04 →		Stabiliser Mounting	DB-SB-10386	DB-SB-10386	1st FA	
10/04 →		Suspension Arm Repair Kit		DB-RK-8550	for Wishbone (CV)	
10/04 →		Suspension Strut Repair Kit		DB-RK-8555		
10/04 →		Tie Rod	DB-DL-8174		Guide Rod	
10/04 →		Tie Rod	DB-DL-12304			
10/04 →		Tie Rod End	CV-ES-14162		for Steering Rod	
10/04 →		Tie Rod End	CV-ES-14163		for Steering Rod	
10/04 →		Track Control Arm		DB-TC-12411	Control Arm	
10/04 →		Track Control Arm		DB-VB-10423	Wishbone (CV), Air Suspension Axle	
1323 A, 1324 A		10/04 →	Ball Head, gearshift linkage	DB-ES-8387		
		10/04 →	Centre Rod	DB-DL-8620		for Steering Rod
		10/04 →	Centre Rod	DB-DL-12298		for Steering Rod
		10/04 →	Centre Rod	DB-DL-12405		Coupling Rod
		10/04 →	Stabiliser Mounting	DB-SB-10386	DB-SB-10386	
	10/04 →	Stabiliser Mounting	DB-SB-10386	DB-SB-10386	1st FA	
	10/04 →	Tie Rod	DB-DL-12311			
	10/04 →	Tie Rod End	CV-ES-14163		for Steering Rod	
1323 LS, 1324 LS	10/04 →	Ball Head, gearshift linkage	DB-ES-8387			
	10/04 →	Ball Head, gearshift linkage	DB-ES-8500			
	10/04 →	Centre Rod	DB-DL-7799		Push Rod	
	10/04 →	Centre Rod	DB-DL-7815		Push Rod	
	10/04 →	Centre Rod	DB-DL-8644		Push Rod	
	10/04 →	Centre Rod	DB-DL-12298		for Steering Rod	
	10/04 →	Centre Rod	DB-DL-12405		Coupling Rod	
	10/04 →	Stabiliser Mounting		DB-RK-9296		
	10/04 →	Stabiliser Mounting		DB-SB-10385		
	10/04 →	Stabiliser Mounting		DB-SB-10385	1st RA	
	10/04 →	Stabiliser Mounting		DB-SB-10386		
	10/04 →	Stabiliser Mounting	DB-SB-10386	DB-SB-10386		
	10/04 →	Stabiliser Mounting	DB-SB-10386	DB-SB-10386	1st FA	
	10/04 →	Suspension Arm Repair Kit		DB-RK-8550	for Wishbone (CV)	
	10/04 →	Suspension Strut Repair Kit		DB-RK-8555		
	10/04 →	Tie Rod	DB-DL-8174		Guide Rod	

CV-ES-14162

Length: 125
Cone Ø: d1 Ø 30 / d2 Ø 27
Thread: M30 x 1,5 LHT
4600648, 4601248, 4603448, 0004603548,
14600348, 14601448, 14602348, 0014603748,
0014607848, 0024600348



CV-ES-14163

Length: 125
Cone Ø: d1 Ø 30 / d2 Ø 27
Thread: M30 x 1,5 RHT
0003305248, 0003387310, 0004600348,
0004600948, 0004602848, 0004602948,
0004608948, 0014600248, 0014600848,
0014601248, 0014602248, 0014607748,
0024600148, A0003387310, A0004600348,
A0004602848, A0004602948, A0014600848,
A0014601248, A0014602248, A0014607748



DB-DL-7799

Length: 895 Ø: 50
Cone Ø: d1 Ø 30 / d2 Ø 26
0034605905, 3754600305, 9724601805,
9724602005



DB-DL-7815

Length: 895 Ø: 50
Cone Ø: d1 Ø 30 / d2 Ø 27
01215800A, 0034604605, 3754600005,
9744601005, 9744601205



DB-DL-8174

Length: 1605 Ø: 40
Cone Ø: d1 Ø 30 / d2 Ø 27
9753300203, 9753300303, 9753300803,
9753301703, 9753302503



DB-DL-8620

Length: 884
Ø: 50
Cone Ø: d1 Ø 30 / d2 Ø 27
Thread: M24 x 1,5 / M20 x 1,5
9744600405, 9744600805, A9744600405,
A9744600805



DB-DL-8644

Length: 894 Ø: 50
Cone Ø: d1 Ø 30 / d2 Ø 27
0034604705, 9744601105, 9744601305

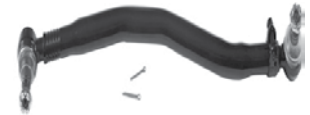

DB-DL-12298

Length: 927 Ø: 50
Cone Ø: d1 Ø 30 / d2 Ø 27
0024602405, 0024603005



DB-DL-12304

Length: 1560 Ø: 40
Cone Ø: d1 Ø 30 / d2 Ø 27
Thread: M30 x 1,5 LHT / M30 x 1,5 RHT
9753300603, 9753300703, 9753300903,
A9753300603, A9753300703, A9753300903



DB-DL-12311

Length: 1565 Ø: 60
Cone Ø: d1 Ø 30 / d2 Ø 27
9753300003, 9753300403, 9753301003,
9753301903, A9753300003, A9753300403,
A9753301003, A9753301903

No Image

DB-DL-12404

Length: 875 Ø: 50
Cone Ø: d1 Ø 30/26 / d2 Ø 27/23,5
9724600605



DB-DL-12405

Length: 895 Ø: 50
Cone Ø: d1 Ø 30 / d2 Ø 28,6
Thread: M24 x 1,5 / M20 x 1,5
9744602205, 9764600205, 9764600405,
A9764600405



DB-DL-12437

Length: 875 Ø: 50
Cone Ø: d1 Ø 30 / d2 Ø 27
9744600005, 9744600605, A9744600005,
A9744600605



DB-DL-12475

Length: 888 Ø: 50
Cone Ø: d1 Ø 30 / d2 Ø 27
9744601505, A9744601505

No Image

DB-ES-8387

Length: 55
Cone Ø: d1 Ø 10 / d2 Ø 10
Thread: M14 x 1,5 RHT
0009966845, 0009967045



DB-ES-8500

Length: 55
Cone Ø: d1 Ø 12 / d2 Ø 10,8
Thread: M14 x 1,5 RHT
0002685989



DB-RK-8550

Ø: 75 Hole Distance: 152
Thick/Height: 24
0003502105, 0003504605



DB-RK-8555

Ø: 67 Hole Distance: 130
Thick/Height: 24
01335600A, 0003502005, 0003504705



DB-RK-9296

Ø: 88 Hole Distance: 130
Thick/Height: 24
9423260050



DB-SB-10385

Ø: 30 Thick/Height: 30
3093200073, 3143260153



DB-SB-10386

Ø: 38 Thick/Height: 38
3183200073



DB-TC-12411

Length: 655 Ø: 40
Hole Distance: 115 / 115
9723500906



DB-VB-10423

Length: 761,7 Ø: 46
Hole Ø 25 / 23 / 23
Hole Distance: 152 / 130 / 130
9743500005, 9743500405, 9743500505





ATEGO 2 ...

1323 LS, 1324 LS ...	10/04 →	Tie Rod	DB-DL-12304		
	10/04 →	Tie Rod End	CV-ES-14162	for Steering Rod	
	10/04 →	Tie Rod End	CV-ES-14163	for Steering Rod	
	10/04 →	Track Control Arm		DB-TC-12411 Control Arm	
	10/04 →	Track Control Arm		DB-VB-10423 Wishbone (CV), Air Suspension Axle	
1323, 1323 L, 1324, 1324 L	10/04 →	Ball Head, gearshift linkage	DB-ES-8387		
	10/04 →	Ball Head, gearshift linkage	DB-ES-8500		
	10/04 →	Centre Rod	DB-DL-7799	Push Rod	
	10/04 →	Centre Rod	DB-DL-7799	Push Rod, Leaf Spring Axle	
	10/04 →	Centre Rod	DB-DL-7815	Push Rod	
	10/04 →	Centre Rod	DB-DL-7815	Push Rod, Leaf Spring Axle	
	10/04 →	Centre Rod	DB-DL-8644	Push Rod	
	10/04 →	Centre Rod	DB-DL-8644	Push Rod, Leaf Spring Axle	
	10/04 →	Centre Rod	DB-DL-12298	for Steering Rod	
	10/04 →	Centre Rod	DB-DL-12404	for Steering Rod	
	10/04 →	Centre Rod	DB-DL-12405	Coupling Rod	
	10/04 →	Centre Rod	DB-DL-12437	Push Rod	
	10/04 →	Centre Rod	DB-DL-12475	Push Rod	
	10/04 →	Stabiliser Mounting		DB-RK-9296	
	10/04 →	Stabiliser Mounting		DB-SB-10385	
	10/04 →	Stabiliser Mounting		DB-SB-10385 1st RA	
	10/04 →	Stabiliser Mounting		DB-SB-10386	
	10/04 →	Stabiliser Mounting	DB-SB-10386	DB-SB-10386	
	10/04 →	Stabiliser Mounting	DB-SB-10386	DB-SB-10386 1st FA	
	10/04 →	Suspension Arm Repair Kit		DB-RK-8550 for Wishbone (CV)	
	10/04 →	Suspension Strut Repair Kit		DB-RK-8555	
	10/04 →	Tie Rod	DB-DL-8174		Guide Rod
	10/04 →	Tie Rod	DB-DL-12304		
	10/04 →	Tie Rod End	CV-ES-14162		for Steering Rod
	10/04 →	Tie Rod End	CV-ES-14163		for Steering Rod
	10/04 →	Track Control Arm		DB-TC-12411	Control Arm
	10/04 →	Track Control Arm		DB-VB-10423	Wishbone (CV), Air Suspension Axle
	1324 AK	10/04 →	Ball Head, gearshift linkage	DB-ES-8387	
		10/04 →	Centre Rod	DB-DL-8620	for Steering Rod
		10/04 →	Centre Rod	DB-DL-12298	for Steering Rod
		10/04 →	Centre Rod	DB-DL-12405	Coupling Rod
		10/04 →	Stabiliser Mounting	DB-SB-10386	DB-SB-10386
		10/04 →	Stabiliser Mounting	DB-SB-10386	DB-SB-10386 1st FA
10/04 →		Tie Rod	DB-DL-12311		
10/04 →		Tie Rod End	CV-ES-14163	for Steering Rod	
1324 K	10/04 →	Ball Head, gearshift linkage	DB-ES-8387		
	10/04 →	Ball Head, gearshift linkage	DB-ES-8500		
	10/04 →	Centre Rod	DB-DL-7799	Push Rod,Suspension Rod	
	10/04 →	Centre Rod	DB-DL-7815	Push Rod, Leaf Spring Axle	
	10/04 →	Centre Rod	DB-DL-8644	Push Rod, Leaf Spring Axle	
	10/04 →	Centre Rod	DB-DL-12298	for Steering Rod	
	10/04 →	Centre Rod	DB-DL-12405	Coupling Rod	
	10/04 →	Stabiliser Mounting		DB-SB-10386	
	10/04 →	Stabiliser Mounting	DB-SB-10386	DB-SB-10386	
	10/04 →	Stabiliser Mounting	DB-SB-10386	DB-SB-10386 1st FA	
	10/04 →	Tie Rod	DB-DL-8174		Guide Rod
	10/04 →	Tie Rod	DB-DL-12304		
	10/04 →	Tie Rod End	CV-ES-14162		for Steering Rod
	10/04 →	Tie Rod End	CV-ES-14163		for Steering Rod
	1324 LK0	10/04 →	Centre Rod	DB-DL-7799	Push Rod
		10/04 →	Centre Rod	DB-DL-7815	Push Rod
		10/04 →	Centre Rod	DB-DL-8644	Push Rod
10/04 →		Centre Rod	DB-DL-12298	for Steering Rod	
10/04 →		Centre Rod	DB-DL-12405	Coupling Rod	
10/04 →		Suspension Arm Repair Kit		DB-RK-8550 for Wishbone (CV)	
10/04 →		Tie Rod	DB-DL-8174		Guide Rod
10/04 →		Tie Rod	DB-DL-12304		
10/04 →		Tie Rod End	CV-ES-14162		for Steering Rod

CV-ES-14162

Length: 125
Cone Ø: d1 Ø 30 / d2 Ø 27
Thread: M30 x 1,5 LHT
4600648, 4601248, 4603448, 0004603548,
14600348, 14601448, 14602348, 0014603748,
0014607848, 0024600348



CV-ES-14163

Length: 125
Cone Ø: d1 Ø 30 / d2 Ø 27
Thread: M30 x 1,5 RHT
0003305248, 0003387310, 0004600348,
0004600948, 0004602848, 0004602948,
0004608948, 0014600248, 0014600848,
0014601248, 0014602248, 0014607748,
0024600148, A0003387310, A0004600348,
A0004602848, A0004602948, A0014600848,
A0014601248, A0014602248, A0014607748



DB-DL-7799

Length: 895
Ø: 50
Cone Ø: d1 Ø 30 / d2 Ø 26
34605905, 0034605905, 3754600305,
9724601805, 9724602005



DB-DL-7815

Length: 895 Ø: 50
Cone Ø: d1 Ø 30 / d2 Ø 27
01215800A, 0034604605, 3754600005,
9744601005, 9744601205



DB-DL-8174

Length: 1605 Ø: 40
Cone Ø: d1 Ø 30 / d2 Ø 27
9753300203, 9753300303, 9753300803,
9753301703, 9753302503



DB-DL-8620

Length: 884
Ø: 50
Cone Ø: d1 Ø 30 / d2 Ø 27
Thread: M24 x 1,5 / M20 x 1,5
9744600405, 9744600805, A9744600405,
A9744600805



DB-DL-8644

Length: 894 Ø: 50
Cone Ø: d1 Ø 30 / d2 Ø 27
0034604705, 9744601105, 9744601305

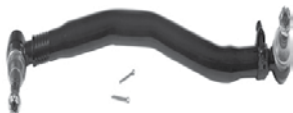

DB-DL-12298

Length: 927 Ø: 50
Cone Ø: d1 Ø 30 / d2 Ø 27
0024602405, 0024603005



DB-DL-12304

Length: 1560 Ø: 40
Cone Ø: d1 Ø 30 / d2 Ø 27
Thread: M30 x 1,5 LHT / M30 x 1,5 RHT
9753300603, 9753300703, 9753300903,
A9753300603, A9753300703, A9753300903



DB-DL-12311

Length: 1565 Ø: 60
Cone Ø: d1 Ø 30 / d2 Ø 27
9753300003, 9753300403, 9753301003,
9753301903, A9753300003, A9753300403,
A9753301003, A9753301903

No Image

DB-DL-12404

Length: 875 Ø: 50
Cone Ø: d1 Ø 30/26 / d2 Ø 27/23,5
9724600605



DB-DL-12405

Length: 895 Ø: 50
Cone Ø: d1 Ø 30 / d2 Ø 28,6
Thread: M24 x 1,5 / M20 x 1,5
9744602205, 9764600205, 9764600405,
A9764600405



DB-DL-12437

Length: 875 Ø: 50
Cone Ø: d1 Ø 30 / d2 Ø 27
9744600005, 9744600605, A9744600005,
A9744600605



DB-DL-12475

Length: 888 Ø: 50
Cone Ø: d1 Ø 30 / d2 Ø 27
9744601505, A9744601505

No Image

DB-ES-8387

Length: 55
Cone Ø: d1 Ø 10 / d2 Ø 10
Thread: M14 x 1,5 RHT
0009966845, 0009967045



DB-ES-8500

Length: 55
Cone Ø: d1 Ø 12 / d2 Ø 10,8
Thread: M14 x 1,5 RHT
0002685989



DB-RK-8550

Ø: 75 Hole Distance: 152
Thick/Height: 24
0003502105, 0003504605



DB-RK-8555

Ø: 67 Hole Distance: 130
Thick/Height: 24
01335600A, 0003502005, 0003504705



DB-RK-9296

Ø: 88 Hole Distance: 130
Thick/Height: 24
9423260050



DB-SB-10385

Ø: 30 Thick/Height: 30
3093200073, 3143260153



DB-SB-10386

Ø: 38 Thick/Height: 38
3183200073



DB-TC-12411

Length: 655 Ø: 40
Hole Distance: 115 / 115
9723500906



DB-VB-10423

Length: 761,7 Ø: 46
Hole Ø 25 / 23 / 23
Hole Distance: 152 / 130 / 130
9743500005, 9743500405, 9743500505





ATEGO 2 ...

1324 LK0 ...	10/04 →	Tie Rod End	CV-ES-14163		for Steering Rod
	10/04 →	Track Control Arm		DB-TC-12411	Control Arm
	10/04 →	Track Control Arm		DB-VB-10423	Wishbone (CV)
1324, 1324 L	10/04 →	Centre Rod	DB-DL-7799		Push Rod
	10/04 →	Centre Rod	DB-DL-7815		Push Rod
	10/04 →	Centre Rod	DB-DL-8644		Push Rod
	10/04 →	Centre Rod	DB-DL-12298		for Steering Rod
	10/04 →	Centre Rod	DB-DL-12405		Coupling Rod
	10/04 →	Centre Rod	DB-DL-12475		Push Rod
	10/04 →	Tie Rod	DB-DL-8174		Guide Rod, 1st Front Axle
	10/04 →	Tie Rod	DB-DL-12304		1st FA, →504310 24
	10/04 →	Tie Rod End	CV-ES-14162		for Steering Rod
	10/04 →	Tie Rod End	CV-ES-14163		for Steering Rod
1326 AF	10/04 →	Ball Head, gearshift linkage	DB-ES-8387		
	10/04 →	Ball Head, gearshift linkage	DB-ES-8500		
	10/04 →	Ball Head, gearshift linkage	DB-ES-8510		
	10/04 →	Centre Rod	DB-DL-12298		for Steering Rod
	10/04 →	Centre Rod	DB-DL-12405		Coupling Rod
	10/04 →	Centre Rod	DB-DL-12475		Push Rod
	10/04 →	Tie Rod	DB-DL-12311		
	10/04 →	Tie Rod End	CV-ES-14163		for Steering Rod
1326 F	10/04 →	Centre Rod	DB-DL-7799		Push Rod
	10/04 →	Centre Rod	DB-DL-7815		Push Rod
	10/04 →	Centre Rod	DB-DL-8644		Push Rod
	10/04 →	Centre Rod	DB-DL-12298		for Steering Rod
	10/04 →	Centre Rod	DB-DL-12405		Coupling Rod
	10/04 →	Centre Rod	DB-DL-12475		Push Rod
	10/04 →	Tie Rod	DB-DL-8174		Guide Rod, 1st Front Axle
	10/04 →	Tie Rod	DB-DL-12304		1st FA, →504310 24
	10/04 →	Tie Rod End	CV-ES-14162		for Steering Rod
	10/04 →	Tie Rod End	CV-ES-14163		for Steering Rod
1326 LS	10/04 →	Ball Head, gearshift linkage	DB-ES-8387		
	10/04 →	Ball Head, gearshift linkage	DB-ES-8500		
	10/04 →	Centre Rod	DB-DL-7799		Push Rod
	10/04 →	Centre Rod	DB-DL-7815		Push Rod
	10/04 →	Centre Rod	DB-DL-8644		Push Rod
	10/04 →	Centre Rod	DB-DL-12298		for Steering Rod
	10/04 →	Centre Rod	DB-DL-12405		Coupling Rod
	10/04 →	Stabiliser Mounting		DB-RK-9296	
	10/04 →	Stabiliser Mounting		DB-SB-10385	
	10/04 →	Stabiliser Mounting		DB-SB-10385	1st RA
	10/04 →	Stabiliser Mounting		DB-SB-10386	
	10/04 →	Stabiliser Mounting	DB-SB-10386	DB-SB-10386	
	10/04 →	Stabiliser Mounting	DB-SB-10386	DB-SB-10386	1st FA
	10/04 →	Suspension Arm Repair Kit		DB-RK-8550	for Wishbone (CV)
	10/04 →	Suspension Strut Repair Kit		DB-RK-8555	
	10/04 →	Tie Rod	DB-DL-8174		Guide Rod
	10/04 →	Tie Rod	DB-DL-12304		
	10/04 →	Tie Rod End	CV-ES-14162		for Steering Rod
	10/04 →	Tie Rod End	CV-ES-14163		for Steering Rod
	10/04 →	Track Control Arm		DB-TC-12411	Control Arm
10/04 →	Track Control Arm		DB-VB-10423	Wishbone (CV), Air Suspension Axle	
1326, 1326 L	10/04 →	Ball Head, gearshift linkage	DB-ES-8387		
	10/04 →	Ball Head, gearshift linkage	DB-ES-8500		
	10/04 →	Centre Rod	DB-DL-7799		Push Rod
	10/04 →	Centre Rod	DB-DL-7799		Push Rod, Leaf Spring Axle
	10/04 →	Centre Rod	DB-DL-7815		Push Rod
	10/04 →	Centre Rod	DB-DL-7815		Push Rod, Leaf Spring Axle
	10/04 →	Centre Rod	DB-DL-8644		Push Rod
	10/04 →	Centre Rod	DB-DL-8644		Push Rod, Leaf Spring Axle
	10/04 →	Centre Rod	DB-DL-12298		for Steering Rod
	10/04 →	Centre Rod	DB-DL-12404		for Steering Rod
	10/04 →	Centre Rod	DB-DL-12405		Coupling Rod

CV-ES-14162

Length: 125
Cone Ø: d1 Ø 30 / d2 Ø 27
Thread: M30 x 1,5 LHT
4600648, 4601248, 4603448, 0004603548,
4603548, 14600348, 14601448, 14602348, 001
460 37 48, 14607848, 0014607848, 002 460 03 48



CV-ES-14163

Length: 125
Cone Ø: d1 Ø 30 / d2 Ø 27
Thread: M30 x 1,5 RHT
0003305248, 0003387310, 0004600348,
0004600948, 0004602848, 0004602948,
0004608948, 0014600248, 0014600848,
0014601248, 0014602248, 0014607748,
0024600148, A0003387310, A0004600348,
A0004602848, A0004602948, A0014600848,
A0014601248, A0014602248, A0014607748



DB-DL-7799

Length: 895 Ø: 50
Cone Ø: d1 Ø 30 / d2 Ø 26
0034605905, 3754600305, 9724601805,
9724602005



DB-DL-7815

Length: 895 Ø: 50
Cone Ø: d1 Ø 30 / d2 Ø 27
01215800A, 0034604605, 3754600005,
9744601005, 9744601205



DB-DL-8174

Length: 1605 Ø: 40
Cone Ø: d1 Ø 30 / d2 Ø 27
9753300203, 9753300303, 9753300803,
9753301703, 9753302503



DB-DL-8644

Length: 894 Ø: 50
Cone Ø: d1 Ø 30 / d2 Ø 27
0034604705, 9744601105, 9744601305

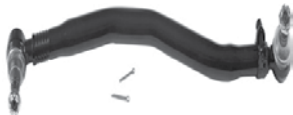

DB-DL-12298

Length: 927 Ø: 50
Cone Ø: d1 Ø 30 / d2 Ø 27
0024602405, 0024603005



DB-DL-12304

Length: 1560 Ø: 40
Cone Ø: d1 Ø 30 / d2 Ø 27
Thread: M30 x 1,5 LHT / M30 x 1,5 RHT
9753300603, 9753300703, 9753300903,
A9753300603, A9753300703, A9753300903



DB-DL-12311

Length: 1565 Ø: 60
Cone Ø: d1 Ø 30 / d2 Ø 27
9753300003, 9753300403, 9753301003,
9753301903, A9753300003, A9753300403,
A9753301003, A9753301903

No Image

DB-DL-12404

Length: 875 Ø: 50
Cone Ø: d1 Ø 30/26 / d2 Ø 27/23,5
9724600605



DB-DL-12405

Length: 895 Ø: 50
Cone Ø: d1 Ø 30 / d2 Ø 28,6
Thread: M24 x 1,5 / M20 x 1,5
9744602205, 9764600205, 9764600405,
A9764600405



DB-DL-12475

Length: 888 Ø: 50
Cone Ø: d1 Ø 30 / d2 Ø 27
9744601505, A9744601505

No Image

DB-ES-8387

Length: 55
Cone Ø: d1 Ø 10 / d2 Ø 10
Thread: M14 x 1,5 RHT
0009966845, 0009967045



DB-ES-8500

Length: 55
Cone Ø: d1 Ø 12 / d2 Ø 10,8
Thread: M14 x 1,5 RHT
0002685989



DB-ES-8510

Length: 56
Cone Ø: d1 Ø 10 / d2 Ø 10
Thread: M12 x 1,75 LHT
0009965145, 0009965645, 0019963145



DB-RK-8550

Ø: 75 Hole Distance: 152
Thick/Height: 24
0003502105, 0003504605



DB-RK-8555

Ø: 67 Hole Distance: 130
Thick/Height: 24
01335600A, 0003502005, 0003504705



DB-RK-9296

Ø: 88 Hole Distance: 130
Thick/Height: 24
9423260050



DB-SB-10385

Ø: 30 Thick/Height: 30
3093200073, 3143260153



DB-SB-10386

Ø: 38 Thick/Height: 38
3183200073



DB-TC-12411

Length: 655 Ø: 40
Hole Distance: 115 / 115
9723500906



DB-VB-10423

Length: 761,7 Ø: 46
Hole Ø 25 / 23 / 23
Hole Distance: 152 / 130 / 130
9743500005, 9743500405, 9743500505





ATEGO 2 ...

1326, 1326 L ...	10/04 →	Centre Rod	DB-DL-12437		Push Rod	
	10/04 →	Centre Rod	DB-DL-12475		Push Rod	
	10/04 →	Stabiliser Mounting		DB-RK-9296		
	10/04 →	Stabiliser Mounting		DB-SB-10385		
	10/04 →	Stabiliser Mounting		DB-SB-10385	1st RA	
	10/04 →	Stabiliser Mounting		DB-SB-10386		
	10/04 →	Stabiliser Mounting	DB-SB-10386	DB-SB-10386		
	10/04 →	Stabiliser Mounting	DB-SB-10386	DB-SB-10386	1st FA	
	10/04 →	Suspension Arm Repair Kit		DB-RK-8550	for Wishbone (CV)	
	10/04 →	Suspension Strut Repair Kit		DB-RK-8555		
	10/04 →	Tie Rod	DB-DL-8174		Guide Rod	
	10/04 →	Tie Rod	DB-DL-8174		Guide Rod, 1st Front Axle	
	10/04 →	Tie Rod	DB-DL-12304			
	10/04 →	Tie Rod End	CV-ES-14162		for Steering Rod	
	10/04 →	Tie Rod End	CV-ES-14163		for Steering Rod	
	10/04 →	Track Control Arm		DB-TC-12411	Control Arm	
	10/04 →	Track Control Arm		DB-VB-10423	Wishbone (CV), Air Suspension Axle	
	1328 LS, 1329 LS	10/04 →	Ball Head, gearshift linkage	DB-ES-8387		
		10/04 →	Ball Head, gearshift linkage	DB-ES-8500		
		10/04 →	Centre Rod	DB-DL-7799		Push Rod
		10/04 →	Centre Rod	DB-DL-7815		Push Rod
		10/04 →	Centre Rod	DB-DL-8644		Push Rod
		10/04 →	Centre Rod	DB-DL-12298		for Steering Rod
10/04 →		Centre Rod	DB-DL-12405		Coupling Rod	
10/04 →		Stabiliser Mounting		DB-RK-9296		
10/04 →		Stabiliser Mounting		DB-SB-10385		
10/04 →		Stabiliser Mounting		DB-SB-10385	1st RA	
10/04 →		Stabiliser Mounting		DB-SB-10386		
10/04 →		Stabiliser Mounting	DB-SB-10386	DB-SB-10386		
10/04 →		Stabiliser Mounting	DB-SB-10386	DB-SB-10386	1st FA	
10/04 →		Suspension Arm Repair Kit		DB-RK-8550	for Wishbone (CV)	
10/04 →		Suspension Strut Repair Kit		DB-RK-8555		
10/04 →		Tie Rod	DB-DL-8174		Guide Rod	
10/04 →		Tie Rod	DB-DL-12304			
10/04 →		Tie Rod End	CV-ES-14162		for Steering Rod	
10/04 →		Tie Rod End	CV-ES-14163		for Steering Rod	
10/04 →		Track Control Arm		DB-TC-12411	Control Arm	
10/04 →		Track Control Arm		DB-VB-10423	Wishbone (CV), Air Suspension Axle	
1328, 1328 L, 1329, 1329 L		10/04 →	Ball Head, gearshift linkage	DB-ES-8387		
		10/04 →	Ball Head, gearshift linkage	DB-ES-8500		
	10/04 →	Centre Rod	DB-DL-7799		Push Rod	
	10/04 →	Centre Rod	DB-DL-7799		Push Rod, Leaf Spring Axle	
	10/04 →	Centre Rod	DB-DL-7815		Push Rod	
	10/04 →	Centre Rod	DB-DL-7815		Push Rod, Leaf Spring Axle	
	10/04 →	Centre Rod	DB-DL-8644		Push Rod	
	10/04 →	Centre Rod	DB-DL-8644		Push Rod, Leaf Spring Axle	
	10/04 →	Centre Rod	DB-DL-12298		for Steering Rod	
	10/04 →	Centre Rod	DB-DL-12404		for Steering Rod	
	10/04 →	Centre Rod	DB-DL-12405		Coupling Rod	
	10/04 →	Centre Rod	DB-DL-12437		Push Rod	
	10/04 →	Centre Rod	DB-DL-12475		Push Rod	
	10/04 →	Stabiliser Mounting		DB-RK-9296		
	10/04 →	Stabiliser Mounting		DB-SB-10385		
	10/04 →	Stabiliser Mounting		DB-SB-10385	1st RA	
	10/04 →	Stabiliser Mounting		DB-SB-10386		
	10/04 →	Stabiliser Mounting	DB-SB-10386	DB-SB-10386		
	10/04 →	Stabiliser Mounting	DB-SB-10386	DB-SB-10386	1st FA	
	10/04 →	Suspension Arm Repair Kit		DB-RK-8550	for Wishbone (CV)	
	10/04 →	Suspension Strut Repair Kit		DB-RK-8555		
	10/04 →	Tie Rod	DB-DL-8174		Guide Rod	
	10/04 →	Tie Rod	DB-DL-12304			
	10/04 →	Tie Rod End	CV-ES-14162		for Steering Rod	
	10/04 →	Tie Rod End	CV-ES-14163		for Steering Rod	

CV-ES-14162

Length: 125
Cone Ø: d1 Ø 30 / d2 Ø 27
Thread: M30 x 1,5 LHT
4600648, 4601248, 4603448, 4603548,
0004603548, 14600348, 14601448, 14602348,
0014603748, 0014607848, 14607848, 002460
0348



CV-ES-14163

Length: 125
Cone Ø: d1 Ø 30 / d2 Ø 27
Thread: M30 x 1,5 RHT
0003305248, 0003387310, 0004600348,
0004600948, 0004602848, 0004602948,
0004608948, 0014600248, 0014600848,
0014601248, 0014602248, 0014607748,
0024600148, A0003387310, A0004600348,
A0004602848, A0004602948, A0014600848,
A0014601248, A0014602248, A0014607748



DB-DL-7799

Length: 895 Ø: 50
Cone Ø: d1 Ø 30 / d2 Ø 26
0034605905, 3754600305, 9724601805,
9724602005



DB-DL-7815

Length: 895
Ø: 50
Cone Ø: d1 Ø 30 / d2 Ø 27
01215800A, 34604605, 0034604605, 3754600005,
9744601005, 9744601205



DB-DL-8174

Length: 1605 Ø: 40
Cone Ø: d1 Ø 30 / d2 Ø 27
9753300203, 9753300303, 9753300803,
9753301703, 9753302503



DB-DL-8644

Length: 894 Ø: 50
Cone Ø: d1 Ø 30 / d2 Ø 27
0034604705, 9744601105, 9744601305

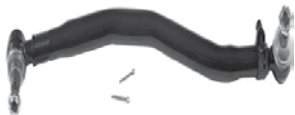

DB-DL-12298

Length: 927 Ø: 50
Cone Ø: d1 Ø 30 / d2 Ø 27
0024602405, 0024603005



DB-DL-12304

Length: 1560 Ø: 40
Cone Ø: d1 Ø 30 / d2 Ø 27
Thread: M30 x 1,5 LHT / M30 x 1,5 RHT
9753300603, 9753300703, 9753300903,
A9753300603, A9753300703, A9753300903



DB-DL-12404

Length: 875 Ø: 50
Cone Ø: d1 Ø 30/26 / d2 Ø 27/23,5
9724600605



DB-DL-12405

Length: 895 Ø: 50
Cone Ø: d1 Ø 30 / d2 Ø 28,6
Thread: M24 x 1,5 / M20 x 1,5
9744602205, 9764600205, 9764600405,
A9764600405



DB-DL-12437

Length: 875 Ø: 50
Cone Ø: d1 Ø 30 / d2 Ø 27
9744600005, 9744600605, A9744600005,
A9744600605



DB-DL-12475

Length: 888 Ø: 50
Cone Ø: d1 Ø 30 / d2 Ø 27
9744601505, A9744601505

No Image

DB-ES-8387

Length: 55
Cone Ø: d1 Ø 10 / d2 Ø 10
Thread: M14 x 1,5 RHT
0009966845, 0009967045



DB-ES-8500

Length: 55
Cone Ø: d1 Ø 12 / d2 Ø 10,8
Thread: M14 x 1,5 RHT
0002685989



DB-RK-8550

Ø: 75 Hole Distance: 152
Thick/Height: 24
0003502105, 0003504605



DB-RK-8555

Ø: 67 Hole Distance: 130
Thick/Height: 24
01335600A, 0003502005, 0003504705



DB-RK-9296

Ø: 88 Hole Distance: 130
Thick/Height: 24
9423260050



DB-SB-10385

Ø: 30 Thick/Height: 30
3093200073, 3143260153



DB-SB-10386

Ø: 38 Thick/Height: 38
3183200073



DB-TC-12411

Length: 655 Ø: 40
Hole Distance: 115 / 115
9723500906



DB-VB-10423

Length: 761,7 Ø: 46
Hole Ø 25 / 23 / 23
Hole Distance: 152 / 130 / 130
9743500005, 9743500405, 9743500505



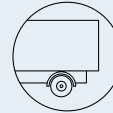

ATEGO 2 ...

1328, 1328 L, 1329, 1329 L ...	10/04 →	Track Control Arm		DB-TC-12411	Control Arm	
	10/04 →	Track Control Arm		DB-VB-10423	Wishbone (CV), Air Suspension Axle	
1329 AF	10/04 →	Ball Head, gearshift linkage	DB-ES-8387			
	10/04 →	Ball Head, gearshift linkage	DB-ES-8500			
	10/04 →	Ball Head, gearshift linkage	DB-ES-8510			
	10/04 →	Centre Rod	DB-DL-12298		for Steering Rod	
	10/04 →	Centre Rod	DB-DL-12405		Coupling Rod	
	10/04 →	Centre Rod	DB-DL-12475		Push Rod	
	10/04 →	Tie Rod	DB-DL-12311			
	10/04 →	Tie Rod End	CV-ES-14163		for Steering Rod	
1329 F	10/04 →	Centre Rod	DB-DL-7799		Push Rod	
	10/04 →	Centre Rod	DB-DL-7815		Push Rod	
	10/04 →	Centre Rod	DB-DL-8644		Push Rod	
	10/04 →	Centre Rod	DB-DL-12298		for Steering Rod	
	10/04 →	Centre Rod	DB-DL-12405		Coupling Rod	
	10/04 →	Centre Rod	DB-DL-12475		Push Rod	
	10/04 →	Tie Rod	DB-DL-8174		Guide Rod, 1st Front Axle	
	10/04 →	Tie Rod	DB-DL-12304		1st FA, →504310 24	
	10/04 →	Tie Rod End	CV-ES-14162		for Steering Rod	
	10/04 →	Tie Rod End	CV-ES-14163		for Steering Rod	
	1329, 1329 L	10/04 →	Centre Rod	DB-DL-7799		Push Rod
		10/04 →	Centre Rod	DB-DL-7815		Push Rod
10/04 →		Centre Rod	DB-DL-8644		Push Rod	
10/04 →		Centre Rod	DB-DL-12298		for Steering Rod	
10/04 →		Centre Rod	DB-DL-12405		Coupling Rod	
10/04 →		Centre Rod	DB-DL-12475		Push Rod	
10/04 →		Tie Rod	DB-DL-8174		Guide Rod, 1st Front Axle	
10/04 →		Tie Rod	DB-DL-12304		1st FA, →504310 24	
10/04 →		Tie Rod End	CV-ES-14162		for Steering Rod	
10/04 →		Tie Rod End	CV-ES-14163		for Steering Rod	
1418		10/04 →	Ball Head, gearshift linkage	DB-ES-8510	DB-ES-8510	
		10/04 →	Centre Rod	DB-DL-12405		Coupling Rod
1418 K	01/11 →	Centre Rod	DB-DL-12405		Coupling Rod	
1419	10/04 →	Ball Head, gearshift linkage	DB-ES-8510	DB-ES-8510		
	10/04 →	Centre Rod	DB-DL-12298		for Steering Rod	
1518 A	10/04 →	Centre Rod	DB-DL-12405		Coupling Rod	
	10/04 →	Ball Head, gearshift linkage	DB-ES-8387			
	10/04 →	Ball Head, gearshift linkage	DB-ES-8500			
	10/04 →	Centre Rod	DB-DL-8620		for Steering Rod	
	10/04 →	Centre Rod	DB-DL-12298		for Steering Rod	
	10/04 →	Centre Rod	DB-DL-12405		Coupling Rod	
	10/04 →	Stabiliser Mounting	DB-SB-10386	DB-SB-10386		
	10/04 →	Stabiliser Mounting	DB-SB-10386	DB-SB-10386	1st FA	
1518 AK	10/04 →	Tie Rod	DB-DL-12311			
	10/04 →	Tie Rod End	CV-ES-14163		for Steering Rod	
	10/04 →	Ball Head, gearshift linkage	DB-ES-8387			
	10/04 →	Ball Head, gearshift linkage	DB-ES-8500			
	10/04 →	Centre Rod	DB-DL-12298		for Steering Rod	
1518 K	10/04 →	Centre Rod	DB-DL-12405		Coupling Rod	
	10/04 →	Tie Rod	DB-DL-12311			
	10/04 →	Ball Head, gearshift linkage	DB-ES-8387			
	10/04 →	Ball Head, gearshift linkage	DB-ES-8500			
	10/04 →	Centre Rod	DB-DL-7815		Push Rod, Leaf Spring Axle	
	10/04 →	Centre Rod	DB-DL-8644		Push Rod, Leaf Spring Axle	
	10/04 →	Centre Rod	DB-DL-12405		Coupling Rod	
	10/04 →	Stabiliser Mounting		DB-SB-10386		
	10/04 →	Stabiliser Mounting	DB-SB-10386	DB-SB-10386		
	10/04 →	Stabiliser Mounting	DB-SB-10386	DB-SB-10386	1st FA	
	10/04 →	Tie Rod	DB-DL-8174		Guide Rod	
	10/04 →	Tie Rod	DB-DL-12304			
10/04 →	Tie Rod End	CV-ES-14162		for Steering Rod		
10/04 →	Tie Rod End	CV-ES-14163		for Steering Rod		

CV-ES-14162

Length: 125
Cone Ø: d1 Ø 30 / d2 Ø 27
Thread: M30 x 1,5 LHT
4600648, 4601248, 4603448, 0004603548,
14600348, 14601448, 14602348, 0014603748,
0014607848, 0024600348



CV-ES-14163

Length: 125
Cone Ø: d1 Ø 30 / d2 Ø 27
Thread: M30 x 1,5 RHT
0003305248, 0003387310, 0004600348,
0004600948, 0004602848, 0004602948,
0004608948, 0014600248, 0014600848,
0014601248, 0014602248, 0014607748,
0024600148, A0003387310, A0004600348,
A0004602848, A0004602948, A0014600848,
A0014601248, A0014602248, A0014607748



DB-DL-7799

Length: 895 Ø: 50
Cone Ø: d1 Ø 30 / d2 Ø 26
0034605905, 3754600305, 9724601805,
9724602005



DB-DL-7815

Length: 895
Ø: 50
Cone Ø: d1 Ø 30 / d2 Ø 27
01215800A, 34604605, 0034604605, 3754600005,
9744601005, 9744601205



DB-DL-8174

Length: 1605 Ø: 40
Cone Ø: d1 Ø 30 / d2 Ø 27
9753300203, 9753300303, 9753300803,
9753301703, 9753302503



DB-DL-8620

Length: 884
Ø: 50
Cone Ø: d1 Ø 30 / d2 Ø 27
Thread: M24 x 1,5 / M20 x 1,5
9744600405, 9744600805, A9744600405,
A9744600805



DB-DL-8644

Length: 894 Ø: 50
Cone Ø: d1 Ø 30 / d2 Ø 27
0034604705, 9744601105, 9744601305

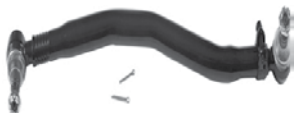

DB-DL-12298

Length: 927 Ø: 50
Cone Ø: d1 Ø 30 / d2 Ø 27
0024602405, 0024603005



DB-DL-12304

Length: 1560 Ø: 40
Cone Ø: d1 Ø 30 / d2 Ø 27
Thread: M30 x 1,5 LHT / M30 x 1,5 RHT
9753300603, 9753300703, 9753300903,
A9753300603, A9753300703, A9753300903



DB-DL-12311

Length: 1565 Ø: 60
Cone Ø: d1 Ø 30 / d2 Ø 27
9753300003, 9753300403, 9753301003,
9753301903, A9753300003, A9753300403,
A9753301003, A9753301903

No Image

DB-DL-12405

Length: 895 Ø: 50
Cone Ø: d1 Ø 30 / d2 Ø 28,6
Thread: M24 x 1,5 / M20 x 1,5
9744602205, 9764600205, 9764600405,
A9764600405



DB-DL-12475

Length: 888 Ø: 50
Cone Ø: d1 Ø 30 / d2 Ø 27
9744601505, A9744601505

No Image

DB-ES-8387

Length: 55
Cone Ø: d1 Ø 10 / d2 Ø 10
Thread: M14 x 1,5 RHT
0009966845, 0009967045



DB-ES-8500

Length: 55
Cone Ø: d1 Ø 12 / d2 Ø 10,8
Thread: M14 x 1,5 RHT
0002685989



DB-ES-8510

Length: 56
Cone Ø: d1 Ø 10 / d2 Ø 10
Thread: M12 x 1,75 LHT
0009965145, 0009965645, 0019963145



DB-SB-10386

Ø: 38 Thick/Height: 38
3183200073



DB-TC-12411

Length: 655 Ø: 40
Hole Distance: 115 / 115
9723500906



DB-VB-10423

Length: 761,7 Ø: 46
Hole Ø 25 / 23 / 23
Hole Distance: 152 / 130 / 130
9743500005, 9743500405, 9743500505





ATEGO 2 ...

1518, 1518 L	10/04 →	Ball Head, gearshift linkage	DB-ES-8387			
	10/04 →	Ball Head, gearshift linkage	DB-ES-8500			
	10/04 →	Centre Rod	DB-DL-7815		Push Rod	
	10/04 →	Centre Rod	DB-DL-7815		Push Rod, Leaf Spring Axle	
	10/04 →	Centre Rod	DB-DL-8644		Push Rod	
	10/04 →	Centre Rod	DB-DL-8644		Push Rod, Leaf Spring Axle	
	10/04 →	Centre Rod	DB-DL-12405		Coupling Rod	
	10/04 →	Centre Rod	DB-DL-12437		Push Rod	
	10/04 →	Stabiliser Mounting		DB-RK-9296		
	10/04 →	Stabiliser Mounting		DB-SB-10385		
	10/04 →	Stabiliser Mounting		DB-SB-10385	1st RA	
	10/04 →	Stabiliser Mounting		DB-SB-10386		
	10/04 →	Stabiliser Mounting	DB-SB-10386	DB-SB-10386		
	10/04 →	Stabiliser Mounting	DB-SB-10386	DB-SB-10386	1st FA	
	10/04 →	Suspension Arm Repair Kit		DB-RK-8550	for Wishbone (CV)	
	10/04 →	Suspension Strut Repair Kit		DB-RK-8555		
	10/04 →	Tie Rod	DB-DL-8174		Guide Rod	
	10/04 →	Tie Rod	DB-DL-12304		1st FA, →504310 24	
	10/04 →	Tie Rod End	CV-ES-14162		for Steering Rod	
	10/04 →	Tie Rod End	CV-ES-14163		for Steering Rod	
	10/04 →	Track Control Arm		DB-TC-12411	Control Arm	
	10/04 →	Track Control Arm		DB-VB-10423	Wishbone (CV), Air Suspension Axle	
	1522 A	10/04 →	Ball Head, gearshift linkage	DB-ES-8387		
		10/04 →	Ball Head, gearshift linkage	DB-ES-8500		
		10/04 →	Centre Rod	DB-DL-8620		for Steering Rod
		10/04 →	Centre Rod	DB-DL-12298		for Steering Rod
		10/04 →	Centre Rod	DB-DL-12405		Coupling Rod
		10/04 →	Tie Rod	DB-DL-12311		
		10/04 →	Tie Rod End	CV-ES-14163		for Steering Rod
	1522 AF	10/04 →	Ball Head, gearshift linkage	DB-ES-8387		
10/04 →		Ball Head, gearshift linkage	DB-ES-8500			
10/04 →		Centre Rod	DB-DL-12298		for Steering Rod	
10/04 →		Centre Rod	DB-DL-12405		Coupling Rod	
10/04 →		Centre Rod	DB-DL-12475		Push Rod	
10/04 →		Tie Rod	DB-DL-12311			
10/04 →		Tie Rod End	CV-ES-14163		for Steering Rod	
1522 AK	10/04 →	Ball Head, gearshift linkage	DB-ES-8387			
	10/04 →	Ball Head, gearshift linkage	DB-ES-8500			
	10/04 →	Centre Rod	DB-DL-12298		for Steering Rod	
	10/04 →	Centre Rod	DB-DL-12405		Coupling Rod	
	10/04 →	Tie Rod	DB-DL-12311			
	10/04 →	Tie Rod End	CV-ES-14163		for Steering Rod	
	10/04 →	Tie Rod End	CV-ES-14163		for Steering Rod	
1522 F	10/04 →	Ball Head, gearshift linkage	DB-ES-8387			
	10/04 →	Ball Head, gearshift linkage	DB-ES-8500			
	10/04 →	Centre Rod	DB-DL-7815		Push Rod	
	10/04 →	Centre Rod	DB-DL-8644		Push Rod	
	10/04 →	Centre Rod	DB-DL-12298		for Steering Rod	
	10/04 →	Centre Rod	DB-DL-12405		Coupling Rod	
	10/04 →	Tie Rod	DB-DL-8174		Guide Rod	
	10/04 →	Tie Rod	DB-DL-12304			
	10/04 →	Tie Rod End	CV-ES-14162		for Steering Rod	
	10/04 →	Tie Rod End	CV-ES-14163		for Steering Rod	
	10/04 →	Tie Rod End	CV-ES-14163		for Steering Rod	
	10/04 →	Tie Rod End	CV-ES-14163		for Steering Rod	
1522 K	10/04 →	Centre Rod	DB-DL-7815		Push Rod, Leaf Spring Axle	
	10/04 →	Centre Rod	DB-DL-8644		Push Rod, Leaf Spring Axle	
	10/04 →	Centre Rod	DB-DL-12298		for Steering Rod	
	10/04 →	Centre Rod	DB-DL-12405		Coupling Rod	
	10/04 →	Stabiliser Mounting		DB-SB-10386		
	10/04 →	Stabiliser Mounting	DB-SB-10386	DB-SB-10386		
	10/04 →	Tie Rod	DB-DL-8174		Guide Rod	
	10/04 →	Tie Rod	DB-DL-12304			
	10/04 →	Tie Rod End	CV-ES-14162		for Steering Rod	
	10/04 →	Tie Rod End	CV-ES-14163		for Steering Rod	
	10/04 →	Tie Rod End	CV-ES-14163		for Steering Rod	
	10/04 →	Tie Rod End	CV-ES-14163		for Steering Rod	

CV-ES-14162

Length: 125
Cone Ø: d1 Ø 30 / d2 Ø 27
Thread: M30 x 1,5 LHT
4600648, 4601248, 4603448, 0004603548,
4603548, 14600348, 14601448, 14602348, 001
460 37 48, 14607848, 0014607848, 002 460 03 48



CV-ES-14163

Length: 125
Cone Ø: d1 Ø 30 / d2 Ø 27
Thread: M30 x 1,5 RHT
0003305248, 0003387310, 0004600348,
0004600948, 0004602848, 0004602948,
0004608948, 0014600248, 0014600848,
0014601248, 0014602248, 0014607748,
0024600148, A0003387310, A0004600348,
A0004602848, A0004602948, A0014600848,
A0014601248, A0014602248, A0014607748



DB-DL-7815

Length: 895 Ø: 50
Cone Ø: d1 Ø 30 / d2 Ø 27
01215800A, 0034604605, 3754600005,
9744601005, 9744601205



DB-DL-8174

Length: 1605 Ø: 40
Cone Ø: d1 Ø 30 / d2 Ø 27
9753300203, 9753300303, 9753300803,
9753301703, 9753302503



DB-DL-8620

Length: 884
Ø: 50
Cone Ø: d1 Ø 30 / d2 Ø 27
Thread: M24 x 1,5 / M20 x 1,5
9744600405, 9744600805, A9744600405,
A9744600805



DB-DL-8644

Length: 894 Ø: 50
Cone Ø: d1 Ø 30 / d2 Ø 27
0034604705, 9744601105, 9744601305

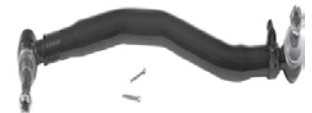

DB-DL-12298

Length: 927 Ø: 50
Cone Ø: d1 Ø 30 / d2 Ø 27
0024602405, 0024603005



DB-DL-12304

Length: 1560 Ø: 40
Cone Ø: d1 Ø 30 / d2 Ø 27
Thread: M30 x 1,5 LHT / M30 x 1,5 RHT
9753300603, 9753300703, 9753300903,
A9753300603, A9753300703, A9753300903



DB-DL-12311

Length: 1565 Ø: 60
Cone Ø: d1 Ø 30 / d2 Ø 27
9753300003, 9753300403, 9753301003,
9753301903, A9753300003, A9753300403,
A9753301003, A9753301903

No Image

DB-DL-12405

Length: 895 Ø: 50
Cone Ø: d1 Ø 30 / d2 Ø 28,6
Thread: M24 x 1,5 / M20 x 1,5
9744602205, 9764600205, 9764600405,
A9764600405



DB-DL-12437

Length: 875 Ø: 50
Cone Ø: d1 Ø 30 / d2 Ø 27
9744600005, 9744600605, A9744600005,
A9744600605



DB-DL-12475

Length: 888 Ø: 50
Cone Ø: d1 Ø 30 / d2 Ø 27
9744601505, A9744601505

No Image

DB-ES-8387

Length: 55
Cone Ø: d1 Ø 10 / d2 Ø 10
Thread: M14 x 1,5 RHT
0009966845, 0009967045



DB-ES-8500

Length: 55
Cone Ø: d1 Ø 12 / d2 Ø 10,8
Thread: M14 x 1,5 RHT
0002685989



DB-RK-8550

Ø: 75 Hole Distance: 152
Thick/Height: 24
0003502105, 0003504605



DB-RK-8555

Ø: 67 Hole Distance: 130
Thick/Height: 24
01335600A, 0003502005, 0003504705



DB-RK-9296

Ø: 88 Hole Distance: 130
Thick/Height: 24
9423260050



DB-SB-10385

Ø: 30 Thick/Height: 30
3093200073, 3143260153



DB-SB-10386

Ø: 38 Thick/Height: 38
3183200073



DB-TC-12411

Length: 655 Ø: 40
Hole Distance: 115 / 115
9723500906



DB-VB-10423

Length: 761,7 Ø: 46
Hole Ø 25 / 23 / 23
Hole Distance: 152 / 130 / 130
9743500005, 9743500405, 9743500505





ATEGO 2 ...

1522, 1522 L	10/04 →	Ball Head, gearshift linkage	DB-ES-8387			
	10/04 →	Ball Head, gearshift linkage	DB-ES-8500			
	10/04 →	Centre Rod	DB-DL-7815		Push Rod	
	10/04 →	Centre Rod	DB-DL-7815		Push Rod, Leaf Spring Axle	
	10/04 →	Centre Rod	DB-DL-8644		Push Rod	
	10/04 →	Centre Rod	DB-DL-8644		Push Rod, Leaf Spring Axle	
	10/04 →	Centre Rod	DB-DL-12298		for Steering Rod	
	10/04 →	Centre Rod	DB-DL-12405		Coupling Rod	
	10/04 →	Centre Rod	DB-DL-12437		Push Rod	
	10/04 →	Stabiliser Mounting		DB-RK-9296		
	10/04 →	Stabiliser Mounting		DB-SB-10385		
	10/04 →	Stabiliser Mounting		DB-SB-10385	1st RA	
	10/04 →	Stabiliser Mounting		DB-SB-10386		
	10/04 →	Stabiliser Mounting	DB-SB-10386	DB-SB-10386		
	10/04 →	Stabiliser Mounting	DB-SB-10386	DB-SB-10386	1st FA	
	10/04 →	Suspension Arm Repair Kit		DB-RK-8550	for Wishbone (CV)	
	10/04 →	Suspension Strut Repair Kit		DB-RK-8555		
	10/04 →	Tie Rod	DB-DL-8174		Guide Rod	
	10/04 →	Tie Rod	DB-DL-12304		1st FA, →504310 24	
	10/04 →	Tie Rod End	CV-ES-14162		for Steering Rod	
	10/04 →	Tie Rod End	CV-ES-14163		for Steering Rod	
	10/04 →	Track Control Arm		DB-TC-12411	Control Arm	
	10/04 →	Track Control Arm		DB-VB-10423	Wishbone (CV), Air Suspension Axle	
	1523 A, 1524 A	10/04 →	Ball Head, gearshift linkage	DB-ES-8387		
		10/04 →	Ball Head, gearshift linkage	DB-ES-8500		
		10/04 →	Centre Rod	DB-DL-8620		for Steering Rod
		10/04 →	Centre Rod	DB-DL-12298		for Steering Rod
		10/04 →	Centre Rod	DB-DL-12405		Coupling Rod
		10/04 →	Stabiliser Mounting	DB-SB-10386	DB-SB-10386	
		10/04 →	Stabiliser Mounting	DB-SB-10386	DB-SB-10386	1st FA
10/04 →		Tie Rod	DB-DL-12311			
10/04 →		Tie Rod End	CV-ES-14163		for Steering Rod	
1523 K, 1524 K		10/04 →	Ball Head, gearshift linkage	DB-ES-8387		
	10/04 →	Ball Head, gearshift linkage	DB-ES-8500			
	10/04 →	Centre Rod	DB-DL-7815		Push Rod, Leaf Spring Axle	
	10/04 →	Centre Rod	DB-DL-8644		Push Rod, Leaf Spring Axle	
	10/04 →	Centre Rod	DB-DL-12298		for Steering Rod	
	10/04 →	Centre Rod	DB-DL-12405		Coupling Rod	
	10/04 →	Stabiliser Mounting		DB-SB-10386		
	10/04 →	Stabiliser Mounting	DB-SB-10386	DB-SB-10386		
	10/04 →	Stabiliser Mounting	DB-SB-10386	DB-SB-10386	1st FA	
	10/04 →	Tie Rod	DB-DL-8174		Guide Rod	
	10/04 →	Tie Rod	DB-DL-12304			
	10/04 →	Tie Rod End	CV-ES-14162		for Steering Rod	
	10/04 →	Tie Rod End	CV-ES-14163		for Steering Rod	
	1523, 1523 L, 1524, 1524 L	10/04 →	Ball Head, gearshift linkage	DB-ES-8387		
10/04 →		Ball Head, gearshift linkage	DB-ES-8500			
10/04 →		Centre Rod	DB-DL-7815		Push Rod	
10/04 →		Centre Rod	DB-DL-7815		Push Rod, Leaf Spring Axle	
10/04 →		Centre Rod	DB-DL-8644		Push Rod	
10/04 →		Centre Rod	DB-DL-8644		Push Rod, Leaf Spring Axle	
10/04 →		Centre Rod	DB-DL-12298		for Steering Rod	
10/04 →		Centre Rod	DB-DL-12405		Coupling Rod	
10/04 →		Centre Rod	DB-DL-12437		Push Rod	
10/04 →		Stabiliser Mounting		DB-RK-9296		
10/04 →		Stabiliser Mounting		DB-SB-10385		
10/04 →		Stabiliser Mounting		DB-SB-10385	1st RA	
10/04 →		Stabiliser Mounting		DB-SB-10386		
10/04 →		Stabiliser Mounting	DB-SB-10386	DB-SB-10386		
10/04 →		Stabiliser Mounting	DB-SB-10386	DB-SB-10386	1st FA	
10/04 →		Suspension Arm Repair Kit		DB-RK-8550	for Wishbone (CV)	
10/04 →		Suspension Strut Repair Kit		DB-RK-8555		
10/04 →		Tie Rod	DB-DL-8174		Guide Rod	

CV-ES-14162

Length: 125
Cone Ø: d1 Ø 30 / d2 Ø 27
Thread: M30 x 1,5 LHT
4600648, 4601248, 4603448, 4603548,
0004603548, 14600348, 14601448, 14602348,
0014603748, 0014607848, 14607848, 002460
0348



CV-ES-14163

Length: 125
Cone Ø: d1 Ø 30 / d2 Ø 27
Thread: M30 x 1,5 RHT
0003305248, 0003387310, 0004600348,
0004600948, 0004602848, 0004602948,
0004608948, 0014600248, 0014600848,
0014601248, 0014602248, 0014607748,
0024600148, A0003387310, A0004600348,
A0004602848, A0004602948, A0014600848,
A0014601248, A0014602248, A0014607748



DB-DL-7815

Length: 895 Ø: 50
Cone Ø: d1 Ø 30 / d2 Ø 27
01215800A, 0034604605, 3754600005,
9744601005, 9744601205



DB-DL-8174

Length: 1605 Ø: 40
Cone Ø: d1 Ø 30 / d2 Ø 27
9753300203, 9753300303, 9753300803,
9753301703, 9753302503



DB-DL-8620

Length: 884
Ø: 50
Cone Ø: d1 Ø 30 / d2 Ø 27
Thread: M24 x 1,5 / M20 x 1,5
9744600405, 9744600805, A9744600405,
A9744600805



DB-DL-8644

Length: 894 Ø: 50
Cone Ø: d1 Ø 30 / d2 Ø 27
0034604705, 9744601105, 9744601305

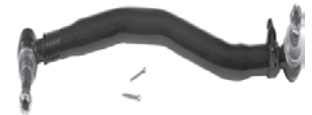

DB-DL-12298

Length: 927 Ø: 50
Cone Ø: d1 Ø 30 / d2 Ø 27
0024602405, 0024603005



DB-DL-12304

Length: 1560 Ø: 40
Cone Ø: d1 Ø 30 / d2 Ø 27
Thread: M30 x 1,5 LHT / M30 x 1,5 RHT
9753300603, 9753300703, 9753300903,
A9753300603, A9753300703, A9753300903



DB-DL-12311

Length: 1565 Ø: 60
Cone Ø: d1 Ø 30 / d2 Ø 27
9753300003, 9753300403, 9753301003,
9753301903, A9753300003, A9753300403,
A9753301003, A9753301903

No Image

DB-DL-12405

Length: 895 Ø: 50
Cone Ø: d1 Ø 30 / d2 Ø 28,6
Thread: M24 x 1,5 / M20 x 1,5
9744602205, 9764600205, 9764600405,
A9764600405



DB-DL-12437

Length: 875 Ø: 50
Cone Ø: d1 Ø 30 / d2 Ø 27
9744600005, 9744600605, A9744600005,
A9744600605



DB-ES-8387

Length: 55
Cone Ø: d1 Ø 10 / d2 Ø 10
Thread: M14 x 1,5 RHT
0009966845, 0009967045



DB-ES-8500

Length: 55
Cone Ø: d1 Ø 12 / d2 Ø 10,8
Thread: M14 x 1,5 RHT
0002685989



DB-RK-8550

Ø: 75 Hole Distance: 152
Thick/Height: 24
0003502105, 0003504605



DB-RK-8555

Ø: 67 Hole Distance: 130
Thick/Height: 24
01335600A, 0003502005, 0003504705



DB-RK-9296

Ø: 88 Hole Distance: 130
Thick/Height: 24
9423260050



DB-SB-10385

Ø: 30 Thick/Height: 30
3093200073, 3143260153



DB-SB-10386

Ø: 38 Thick/Height: 38
3183200073



DB-TC-12411

Length: 655 Ø: 40
Hole Distance: 115 / 115
9723500906



DB-VB-10423

Length: 761,7 Ø: 46
Hole Ø 25 / 23 / 23
Hole Distance: 152 / 130 / 130
9743500005, 9743500405, 9743500505





ATEGO 2 ...

1523, 1523 L, 1524, 1524 L ...	10/04 →	Tie Rod	DB-DL-12304		1st FA, →504310 24
	10/04 →	Tie Rod End	CV-ES-14162		for Steering Rod
	10/04 →	Tie Rod End	CV-ES-14163		for Steering Rod
	10/04 →	Track Control Arm		DB-TC-12411	Control Arm
	10/04 →	Track Control Arm		DB-VB-10423	Wishbone (CV), Air Suspension Axle
1524 AK	10/04 →	Ball Head, gearshift linkage	DB-ES-8387		
	10/04 →	Centre Rod	DB-DL-8620		for Steering Rod
	10/04 →	Centre Rod	DB-DL-12298		for Steering Rod
	10/04 →	Centre Rod	DB-DL-12405		Coupling Rod
	10/04 →	Stabiliser Mounting	DB-SB-10386	DB-SB-10386	
	10/04 →	Stabiliser Mounting	DB-SB-10386	DB-SB-10386	1st FA
	10/04 →	Tie Rod	DB-DL-12311		
1524, 1524 L	10/04 →	Centre Rod	DB-DL-7815		Push Rod
	10/04 →	Centre Rod	DB-DL-8644		Push Rod
	10/04 →	Centre Rod	DB-DL-12298		for Steering Rod
	10/04 →	Centre Rod	DB-DL-12405		Coupling Rod
	10/04 →	Tie Rod	DB-DL-8174		Guide Rod, 1st Front Axle
	10/04 →	Tie Rod	DB-DL-12304		1st FA, →504310 24
	10/04 →	Tie Rod End	CV-ES-14162		for Steering Rod
	10/04 →	Tie Rod End	CV-ES-14163		for Steering Rod
1526 AF	10/04 →	Ball Head, gearshift linkage	DB-ES-8387		
	10/04 →	Ball Head, gearshift linkage	DB-ES-8500		
	10/04 →	Centre Rod	DB-DL-12298		for Steering Rod
	10/04 →	Centre Rod	DB-DL-12405		Coupling Rod
	10/04 →	Centre Rod	DB-DL-12475		Push Rod
	10/04 →	Tie Rod	DB-DL-12311		
	10/04 →	Tie Rod End	CV-ES-14163		for Steering Rod
1526 AK	10/04 →	Ball Head, gearshift linkage	DB-ES-8387		
	10/04 →	Ball Head, gearshift linkage	DB-ES-8500		
	10/04 →	Centre Rod	DB-DL-8620		for Steering Rod
	10/04 →	Centre Rod	DB-DL-12298		for Steering Rod
	10/04 →	Centre Rod	DB-DL-12405		Coupling Rod
	10/04 →	Stabiliser Mounting	DB-SB-10386	DB-SB-10386	
	10/04 →	Stabiliser Mounting	DB-SB-10386	DB-SB-10386	1st FA
	10/04 →	Tie Rod	DB-DL-12311		
1526 K	10/04 →	Ball Head, gearshift linkage	DB-ES-8387		
	10/04 →	Ball Head, gearshift linkage	DB-ES-8500		
	10/04 →	Centre Rod	DB-DL-7815		Push Rod, Leaf Spring Axle
	10/04 →	Centre Rod	DB-DL-8644		Push Rod, Leaf Spring Axle
	10/04 →	Centre Rod	DB-DL-12298		for Steering Rod
	10/04 →	Centre Rod	DB-DL-12405		Coupling Rod
	10/04 →	Stabiliser Mounting		DB-SB-10386	
	10/04 →	Stabiliser Mounting	DB-SB-10386	DB-SB-10386	
	10/04 →	Stabiliser Mounting	DB-SB-10386	DB-SB-10386	1st FA
	10/04 →	Tie Rod	DB-DL-8174		Guide Rod
	10/04 →	Tie Rod	DB-DL-12304		
	10/04 →	Tie Rod End	CV-ES-14162		for Steering Rod
	10/04 →	Tie Rod End	CV-ES-14163		for Steering Rod
1526, 1526 L	10/04 →	Ball Head, gearshift linkage	DB-ES-8387		
	10/04 →	Ball Head, gearshift linkage	DB-ES-8500		
	10/04 →	Centre Rod	DB-DL-7815		Push Rod
	10/04 →	Centre Rod	DB-DL-7815		Push Rod, Leaf Spring Axle
	10/04 →	Centre Rod	DB-DL-8644		Push Rod
	10/04 →	Centre Rod	DB-DL-8644		Push Rod, Leaf Spring Axle
	10/04 →	Centre Rod	DB-DL-12298		for Steering Rod
	10/04 →	Centre Rod	DB-DL-12405		Coupling Rod
	10/04 →	Centre Rod	DB-DL-12437		Push Rod
	10/04 →	Stabiliser Mounting		DB-RK-9296	
	10/04 →	Stabiliser Mounting		DB-SB-10385	
	10/04 →	Stabiliser Mounting		DB-SB-10385	1st RA
	10/04 →	Stabiliser Mounting		DB-SB-10386	

CV-ES-14162

Length: 125
Cone Ø: d1 Ø 30 / d2 Ø 27
Thread: M30 x 1,5 LHT
4600648, 4601248, 4603448, 0004603548,
14600348, 14601448, 14602348, 0014603748,
0014607848, 0024600348



CV-ES-14163

Length: 125
Cone Ø: d1 Ø 30 / d2 Ø 27
Thread: M30 x 1,5 RHT
0003305248, 0003387310, 0004600348,
0004600948, 0004602848, 0004602948,
0004608948, 0014600248, 0014600848,
0014601248, 0014602248, 0014607748,
0024600148, A0003387310, A0004600348,
A0004602848, A0004602948, A0014600848,
A0014601248, A0014602248, A0014607748



DB-DL-7815

Length: 895 Ø: 50
Cone Ø: d1 Ø 30 / d2 Ø 27
01215800A, 0034604605, 3754600005,
9744601005, 9744601205



DB-DL-8174

Length: 1605 Ø: 40
Cone Ø: d1 Ø 30 / d2 Ø 27
9753300203, 9753300303, 9753300803,
9753301703, 9753302503



DB-DL-8620

Length: 884
Ø: 50
Cone Ø: d1 Ø 30 / d2 Ø 27
Thread: M24 x 1,5 / M20 x 1,5
9744600405, 9744600805, A9744600405,
A9744600805



DB-DL-8644

Length: 894 Ø: 50
Cone Ø: d1 Ø 30 / d2 Ø 27
0034604705, 9744601105, 9744601305

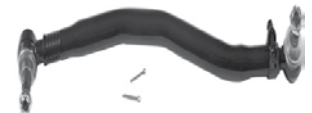

DB-DL-12298

Length: 927 Ø: 50
Cone Ø: d1 Ø 30 / d2 Ø 27
0024602405, 0024603005



DB-DL-12304

Length: 1560 Ø: 40
Cone Ø: d1 Ø 30 / d2 Ø 27
Thread: M30 x 1,5 LHT / M30 x 1,5 RHT
9753300603, 9753300703, 9753300903,
A9753300603, A9753300703, A9753300903



DB-DL-12311

Length: 1565 Ø: 60
Cone Ø: d1 Ø 30 / d2 Ø 27
9753300003, 9753300403, 9753301003,
9753301903, A9753300003, A9753300403,
A9753301003, A9753301903

No Image

DB-DL-12405

Length: 895 Ø: 50
Cone Ø: d1 Ø 30 / d2 Ø 28,6
Thread: M24 x 1,5 / M20 x 1,5
9744602205, 9764600205, 9764600405,
A9764600405



DB-DL-12437

Length: 875 Ø: 50
Cone Ø: d1 Ø 30 / d2 Ø 27
9744600005, 9744600605, A9744600005,
A9744600605



DB-DL-12475

Length: 888 Ø: 50
Cone Ø: d1 Ø 30 / d2 Ø 27
9744601505, A9744601505

No Image

DB-ES-8387

Length: 55
Cone Ø: d1 Ø 10 / d2 Ø 10
Thread: M14 x 1,5 RHT
0009966845, 0009967045



DB-ES-8500

Length: 55
Cone Ø: d1 Ø 12 / d2 Ø 10,8
Thread: M14 x 1,5 RHT
0002685989



DB-RK-9296

Ø: 88 Hole Distance: 130
Thick/Height: 24
9423260050



DB-SB-10385

Ø: 30 Thick/Height: 30
3093200073, 3143260153



DB-SB-10386

Ø: 38 Thick/Height: 38
3183200073



DB-TC-12411

Length: 655 Ø: 40
Hole Distance: 115 / 115
9723500906



DB-VB-10423

Length: 761,7 Ø: 46
Hole Ø 25 / 23 / 23
Hole Distance: 152 / 130 / 130
9743500005, 9743500405, 9743500505





ATEGO 2 ...

1526, 1526 L ...	10/04 →	Stabiliser Mounting	DB-SB-10386	DB-SB-10386	
	10/04 →	Stabiliser Mounting	DB-SB-10386	DB-SB-10386	1st FA
	10/04 →	Suspension Arm Repair Kit		DB-RK-8550	for Wishbone (CV)
	10/04 →	Suspension Strut Repair Kit		DB-RK-8555	
	10/04 →	Tie Rod	DB-DL-8174		Guide Rod
	10/04 →	Tie Rod	DB-DL-8174		Guide Rod, 1st Front Axle
	10/04 →	Tie Rod	DB-DL-12304		1st FA, →504310 24
	10/04 →	Tie Rod End	CV-ES-14162		for Steering Rod
	10/04 →	Tie Rod End	CV-ES-14163		for Steering Rod
	10/04 →	Track Control Arm		DB-TC-12411	Control Arm
10/04 →	Track Control Arm		DB-VB-10423	Wishbone (CV), Air Suspension Axle	
1528, 1528 L, 1529, 1529 L	10/04 →	Ball Head, gearshift linkage	DB-ES-8387		
	10/04 →	Ball Head, gearshift linkage	DB-ES-8500		
	10/04 →	Centre Rod	DB-DL-7815		Push Rod
	10/04 →	Centre Rod	DB-DL-7815		Push Rod, Leaf Spring Axle
	10/04 →	Centre Rod	DB-DL-8644		Push Rod
	10/04 →	Centre Rod	DB-DL-8644		Push Rod, Leaf Spring Axle
	10/04 →	Centre Rod	DB-DL-12298		for Steering Rod
	10/04 →	Centre Rod	DB-DL-12405		Coupling Rod
	10/04 →	Centre Rod	DB-DL-12437		Push Rod
	10/04 →	Stabiliser Mounting		DB-RK-9296	
	10/04 →	Stabiliser Mounting		DB-SB-10385	
	10/04 →	Stabiliser Mounting		DB-SB-10385	1st RA
	10/04 →	Stabiliser Mounting		DB-SB-10386	
	10/04 →	Stabiliser Mounting	DB-SB-10386	DB-SB-10386	
	10/04 →	Stabiliser Mounting	DB-SB-10386	DB-SB-10386	1st FA
	10/04 →	Suspension Arm Repair Kit		DB-RK-8550	for Wishbone (CV)
	10/04 →	Suspension Strut Repair Kit		DB-RK-8555	
	10/04 →	Tie Rod	DB-DL-8174		Guide Rod
	10/04 →	Tie Rod	DB-DL-12304		1st FA, →504310 24
	10/04 →	Tie Rod End	CV-ES-14162		for Steering Rod
	10/04 →	Tie Rod End	CV-ES-14163		for Steering Rod
	10/04 →	Track Control Arm		DB-TC-12411	Control Arm
	10/04 →	Track Control Arm		DB-VB-10423	Wishbone (CV), Air Suspension Axle
1529 AF	10/04 →	Ball Head, gearshift linkage	DB-ES-8387		
	10/04 →	Ball Head, gearshift linkage	DB-ES-8500		
	10/04 →	Centre Rod	DB-DL-12298		for Steering Rod
	10/04 →	Centre Rod	DB-DL-12405		Coupling Rod
	10/04 →	Centre Rod	DB-DL-12475		Push Rod
	10/04 →	Tie Rod	DB-DL-12311		
	10/04 →	Tie Rod End	CV-ES-14163		for Steering Rod
1529 AK	10/04 →	Ball Head, gearshift linkage	DB-ES-8387		
	10/04 →	Ball Head, gearshift linkage	DB-ES-8500		
	10/04 →	Centre Rod	DB-DL-8620		for Steering Rod
	10/04 →	Centre Rod	DB-DL-12298		for Steering Rod
	10/04 →	Centre Rod	DB-DL-12405		Coupling Rod
	10/04 →	Stabiliser Mounting	DB-SB-10386	DB-SB-10386	
	10/04 →	Stabiliser Mounting	DB-SB-10386	DB-SB-10386	1st FA
	10/04 →	Tie Rod	DB-DL-12311		
10/04 →	Tie Rod End	CV-ES-14163		for Steering Rod	
1529 F	10/04 →	Ball Head, gearshift linkage	DB-ES-8387		
	10/04 →	Ball Head, gearshift linkage	DB-ES-8500		
	10/04 →	Centre Rod	DB-DL-7815		Push Rod
	10/04 →	Centre Rod	DB-DL-8644		Push Rod
	10/04 →	Centre Rod	DB-DL-12298		for Steering Rod
	10/04 →	Centre Rod	DB-DL-12405		Coupling Rod
	10/04 →	Tie Rod	DB-DL-8174		Guide Rod
	10/04 →	Tie Rod	DB-DL-12304		
	10/04 →	Tie Rod End	CV-ES-14162		for Steering Rod
	10/04 →	Tie Rod End	CV-ES-14163		for Steering Rod

CV-ES-14162

Length: 125
Cone Ø: d1 Ø 30 / d2 Ø 27
Thread: M30 x 1,5 LHT
4600648, 4601248, 4603448, 0004603548,
4603548, 14600348, 14601448, 14602348, 001
460 37 48, 14607848, 0014607848, 002 460 03 48



CV-ES-14163

Length: 125
Cone Ø: d1 Ø 30 / d2 Ø 27
Thread: M30 x 1,5 RHT
0003305248, 0003387310, 0004600348,
0004600948, 0004602848, 0004602948,
0004608948, 0014600248, 0014600848,
0014601248, 0014602248, 0014607748,
0024600148, A0003387310, A0004600348,
A0004602848, A0004602948, A0014600848,
A0014601248, A0014602248, A0014607748



DB-DL-7815

Length: 895 Ø: 50
Cone Ø: d1 Ø 30 / d2 Ø 27
01215800A, 0034604605, 3754600005,
9744601005, 9744601205



DB-DL-8174

Length: 1605 Ø: 40
Cone Ø: d1 Ø 30 / d2 Ø 27
9753300203, 9753300303, 9753300803,
9753301703, 9753302503



DB-DL-8620

Length: 884
Ø: 50
Cone Ø: d1 Ø 30 / d2 Ø 27
Thread: M24 x 1,5 / M20 x 1,5
9744600405, 9744600805, A9744600405,
A9744600805



DB-DL-8644

Length: 894 Ø: 50
Cone Ø: d1 Ø 30 / d2 Ø 27
0034604705, 9744601105, 9744601305

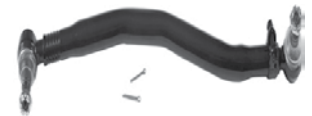

DB-DL-12298

Length: 927 Ø: 50
Cone Ø: d1 Ø 30 / d2 Ø 27
0024602405, 0024603005



DB-DL-12304

Length: 1560 Ø: 40
Cone Ø: d1 Ø 30 / d2 Ø 27
Thread: M30 x 1,5 LHT / M30 x 1,5 RHT
9753300603, 9753300703, 9753300903,
A9753300603, A9753300703, A9753300903



DB-DL-12311

Length: 1565 Ø: 60
Cone Ø: d1 Ø 30 / d2 Ø 27
9753300003, 9753300403, 9753301003,
9753301903, A9753300003, A9753300403,
A9753301003, A9753301903

No Image

DB-DL-12405

Length: 895 Ø: 50
Cone Ø: d1 Ø 30 / d2 Ø 28,6
Thread: M24 x 1,5 / M20 x 1,5
9744602205, 9764600205, 9764600405,
A9764600405



DB-DL-12437

Length: 875 Ø: 50
Cone Ø: d1 Ø 30 / d2 Ø 27
9744600005, 9744600605, A9744600005,
A9744600605



DB-DL-12475

Length: 888 Ø: 50
Cone Ø: d1 Ø 30 / d2 Ø 27
9744601505, A9744601505

No Image

DB-ES-8387

Length: 55
Cone Ø: d1 Ø 10 / d2 Ø 10
Thread: M14 x 1,5 RHT
0009966845, 0009967045



DB-ES-8500

Length: 55
Cone Ø: d1 Ø 12 / d2 Ø 10,8
Thread: M14 x 1,5 RHT
0002685989



DB-RK-8550

Ø: 75 Hole Distance: 152
Thick/Height: 24
0003502105, 0003504605



DB-RK-8555

Ø: 67 Hole Distance: 130
Thick/Height: 24
01335600A, 0003502005, 0003504705



DB-RK-9296

Ø: 88 Hole Distance: 130
Thick/Height: 24
9423260050



DB-SB-10385

Ø: 30 Thick/Height: 30
3093200073, 3143260153



DB-SB-10386

Ø: 38 Thick/Height: 38
3183200073



DB-TC-12411

Length: 655 Ø: 40
Hole Distance: 115 / 115
9723500906



DB-VB-10423

Length: 761,7 Ø: 46
Hole Ø 25 / 23 / 23
Hole Distance: 152 / 130 / 130
9743500005, 9743500405, 9743500505





ATEGO 2 ...

1529 K	10/04→	Ball Head, gearshift linkage	DB-ES-8387		
	10/04→	Ball Head, gearshift linkage	DB-ES-8500		
	10/04→	Centre Rod	DB-DL-7815		Push Rod, Leaf Spring Axle
	10/04→	Centre Rod	DB-DL-8644		Push Rod, Leaf Spring Axle
	10/04→	Centre Rod	DB-DL-12298		for Steering Rod
	10/04→	Centre Rod	DB-DL-12405		Coupling Rod
	10/04→	Stabiliser Mounting		DB-SB-10386	
	10/04→	Stabiliser Mounting	DB-SB-10386	DB-SB-10386	
	10/04→	Stabiliser Mounting	DB-SB-10386	DB-SB-10386	1st FA
	10/04→	Tie Rod	DB-DL-8174		Guide Rod
	10/04→	Tie Rod	DB-DL-12304		
	10/04→	Tie Rod End	CV-ES-14162		for Steering Rod
	10/04→	Tie Rod End	CV-ES-14163		for Steering Rod
	1529, 1529 L	10/04→	Centre Rod	DB-DL-7815	
10/04→		Centre Rod	DB-DL-8644		Push Rod
10/04→		Centre Rod	DB-DL-12298		for Steering Rod
10/04→		Centre Rod	DB-DL-12405		Coupling Rod
10/04→		Tie Rod	DB-DL-8174		Guide Rod, 1st Front Axle
10/04→		Tie Rod	DB-DL-12304		1st FA, →504310 24
10/04→		Tie Rod End	CV-ES-14162		for Steering Rod
10/04→		Tie Rod End	CV-ES-14163		for Steering Rod
1618	10/04→	Centre Rod	DB-DL-12405		Coupling Rod
1618 K	10/04→	Centre Rod	DB-DL-12405		Coupling Rod
1622	10/04→	Centre Rod	DB-DL-12298		for Steering Rod
	10/04→	Centre Rod	DB-DL-12405		Coupling Rod
1622 K	10/04→	Centre Rod	DB-DL-12298		for Steering Rod
	10/04→	Centre Rod	DB-DL-12405		Coupling Rod
1624	10/04→	Centre Rod	DB-DL-12298		for Steering Rod
	10/04→	Centre Rod	DB-DL-12405		Coupling Rod
1624 K	10/04→	Centre Rod	DB-DL-12298		for Steering Rod
	10/04→	Centre Rod	DB-DL-12405		Coupling Rod
1629	10/04→	Centre Rod	DB-DL-12298		for Steering Rod
	10/04→	Centre Rod	DB-DL-12405		Coupling Rod
1718	10/04→	Centre Rod	DB-DL-12298		for Steering Rod
	10/04→	Centre Rod	DB-DL-12405		Coupling Rod
1718 K	01/11→	Centre Rod	DB-DL-12405		Coupling Rod
1719	10/04→	Centre Rod	DB-DL-12298		for Steering Rod
	10/04→	Centre Rod	DB-DL-12405		Coupling Rod
1722	10/04→	Centre Rod	DB-DL-12298		for Steering Rod
	10/04→	Centre Rod	DB-DL-12405		Coupling Rod
1725	10/04→	Centre Rod	DB-DL-12298		for Steering Rod
	10/04→	Centre Rod	DB-DL-12405		Coupling Rod
1725 A	10/06→	Centre Rod	DB-DL-12298		for Steering Rod
	10/06→	Centre Rod	DB-DL-12405		Coupling Rod
	10/06→	Tie Rod	DB-DL-12311		
1725 K	01/11→	Centre Rod	DB-DL-12298		for Steering Rod
	01/11→	Centre Rod	DB-DL-12405		Coupling Rod
1725 S	01/07→	Centre Rod	DB-DL-12298		for Steering Rod
	01/07→	Centre Rod	DB-DL-12405		Coupling Rod
1728 S	01/07→	Centre Rod	DB-DL-12298		for Steering Rod
	01/07→	Centre Rod	DB-DL-12405		Coupling Rod
1924 L	10/04→	Centre Rod	DB-DL-7815		Push Rod
	10/04→	Centre Rod	DB-DL-8644		Push Rod
	10/04→	Centre Rod	DB-DL-12298		for Steering Rod
	10/04→	Centre Rod	DB-DL-12405		Coupling Rod
	10/04→	Suspension Arm Repair Kit		DB-RK-8550	for Wishbone (CV)
	10/04→	Tie Rod	DB-DL-8174		Guide Rod
	10/04→	Tie Rod	DB-DL-12304		
	10/04→	Tie Rod End	CV-ES-14162		for Steering Rod
	10/04→	Tie Rod End	CV-ES-14163		for Steering Rod
	10/04→	Track Control Arm		DB-TC-12411	Control Arm
	10/04→	Track Control Arm		DB-VB-10423	Wishbone (CV)
10/04→	Track Control Arm		DB-VB-10423	Wishbone (CV), Air Suspension Axle	

CV-ES-14162

Length: 125
Cone Ø: d1 Ø 30 / d2 Ø 27
Thread: M30 x 1,5 LHT
4600648, 4601248, 4603448, 0004603548,
14600348, 14601448, 14602348, 0014603748,
0014607848, 0024600348



CV-ES-14163

Length: 125
Cone Ø: d1 Ø 30 / d2 Ø 27
Thread: M30 x 1,5 RHT
0003305248, 0003387310, 0004600348,
0004600948, 0004602848, 0004602948,
0004608948, 0014600248, 0014600848,
0014601248, 0014602248, 0014607748,
0024600148, A0003387310, A0004600348,
A0004602848, A0004602948, A0014600848,
A0014601248, A0014602248, A0014607748



DB-DL-7815

Length: 895 Ø: 50
Cone Ø: d1 Ø 30 / d2 Ø 27
01215800A, 0034604605, 3754600005,
9744601005, 9744601205



DB-DL-8174

Length: 1605 Ø: 40
Cone Ø: d1 Ø 30 / d2 Ø 27
9753300203, 9753300303, 9753300803,
9753301703, 9753302503



DB-DL-8644

Length: 894 Ø: 50
Cone Ø: d1 Ø 30 / d2 Ø 27
0034604705, 9744601105, 9744601305

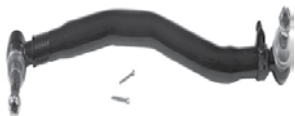

DB-DL-12298

Length: 927 Ø: 50
Cone Ø: d1 Ø 30 / d2 Ø 27
0024602405, 0024603005



DB-DL-12304

Length: 1560 Ø: 40
Cone Ø: d1 Ø 30 / d2 Ø 27
Thread: M30 x 1,5 LHT / M30 x 1,5 RHT
9753300603, 9753300703, 9753300903,
A9753300603, A9753300703, A9753300903



DB-DL-12311

Length: 1565 Ø: 60
Cone Ø: d1 Ø 30 / d2 Ø 27
9753300003, 9753300403, 9753301003,
9753301903, A9753300003, A9753300403,
A9753301003, A9753301903

No Image

DB-DL-12405

Length: 895 Ø: 50
Cone Ø: d1 Ø 30 / d2 Ø 28,6
Thread: M24 x 1,5 / M20 x 1,5
9744602205, 9764600205, 9764600405,
A9764600405



DB-ES-8387

Length: 55
Cone Ø: d1 Ø 10 / d2 Ø 10
Thread: M14 x 1,5 RHT
0009966845, 0009967045



DB-ES-8500

Length: 55
Cone Ø: d1 Ø 12 / d2 Ø 10,8
Thread: M14 x 1,5 RHT
0002685989



DB-RK-8550

Ø: 75 Hole Distance: 152
Thick/Height: 24
0003502105, 0003504605



DB-SB-10386

Ø: 38 Thick/Height: 38
3183200073



DB-TC-12411

Length: 655 Ø: 40
Hole Distance: 115 / 115
9723500906



DB-VB-10423

Length: 761,7 Ø: 46
Hole Ø 25 / 23 / 23
Hole Distance: 152 / 130 / 130
9743500005, 9743500405, 9743500505





ATEGO 2 ...

1926 L	10/04 →	Centre Rod	DB-DL-7815		Push Rod	
	10/04 →	Centre Rod	DB-DL-8644		Push Rod	
	10/04 →	Centre Rod	DB-DL-12298		for Steering Rod	
	10/04 →	Centre Rod	DB-DL-12405		Coupling Rod	
	10/04 →	Suspension Arm Repair Kit		DB-RK-8550	for Wishbone (CV)	
	10/04 →	Tie Rod	DB-DL-8174		Guide Rod	
	10/04 →	Tie Rod	DB-DL-12304			
	10/04 →	Tie Rod End	CV-ES-14162		for Steering Rod	
	10/04 →	Tie Rod End	CV-ES-14163		for Steering Rod	
	10/04 →	Track Control Arm		DB-TC-12411	Control Arm	
	10/04 →	Track Control Arm		DB-VB-10423	Wishbone (CV)	
	10/04 →	Track Control Arm		DB-VB-10423	Wishbone (CV), Air Suspension Axle	
	1929 L	10/04 →	Centre Rod	DB-DL-7815		Push Rod
		10/04 →	Centre Rod	DB-DL-8644		Push Rod
10/04 →		Centre Rod	DB-DL-12298		for Steering Rod	
10/04 →		Centre Rod	DB-DL-12405		Coupling Rod	
10/04 →		Suspension Arm Repair Kit		DB-RK-8550	for Wishbone (CV)	
10/04 →		Tie Rod	DB-DL-8174		Guide Rod	
10/04 →		Tie Rod	DB-DL-12304			
10/04 →		Tie Rod End	CV-ES-14162		for Steering Rod	
10/04 →		Tie Rod End	CV-ES-14163		for Steering Rod	
10/04 →		Track Control Arm		DB-TC-12411	Control Arm	
10/04 →		Track Control Arm		DB-VB-10423	Wishbone (CV)	
10/04 →		Track Control Arm		DB-VB-10423	Wishbone (CV), Air Suspension Axle	
2224 L		10/04 →	Centre Rod	DB-DL-7815		Push Rod
		10/04 →	Centre Rod	DB-DL-8644		Push Rod
	10/04 →	Centre Rod	DB-DL-12298		for Steering Rod	
	10/04 →	Centre Rod	DB-DL-12405		Coupling Rod	
	10/04 →	Suspension Arm Repair Kit		DB-RK-8550	for Wishbone (CV)	
	10/04 →	Tie Rod	DB-DL-8174		Guide Rod	
	10/04 →	Tie Rod End	CV-ES-14162		for Steering Rod	
	10/04 →	Tie Rod End	CV-ES-14163		for Steering Rod	
	10/04 →	Track Control Arm		DB-TC-12411	Control Arm	
	10/04 →	Track Control Arm		DB-VB-10423	Wishbone (CV)	
	10/04 →	Track Control Arm		DB-VB-10423	Wishbone (CV), Air Suspension Axle	
	2226 L	10/04 →	Centre Rod	DB-DL-7815		Push Rod
		10/04 →	Centre Rod	DB-DL-8644		Push Rod
		10/04 →	Centre Rod	DB-DL-12298		for Steering Rod
10/04 →		Centre Rod	DB-DL-12405		Coupling Rod	
10/04 →		Suspension Arm Repair Kit		DB-RK-8550	for Wishbone (CV)	
10/04 →		Tie Rod	DB-DL-8174		Guide Rod	
10/04 →		Tie Rod End	CV-ES-14162		for Steering Rod	
10/04 →		Tie Rod End	CV-ES-14163		for Steering Rod	
10/04 →		Track Control Arm		DB-TC-12411	Control Arm	
10/04 →		Track Control Arm		DB-VB-10423	Wishbone (CV)	
10/04 →		Track Control Arm		DB-VB-10423	Wishbone (CV), Air Suspension Axle	
2229 L		10/04 →	Centre Rod	DB-DL-7815		Push Rod
		10/04 →	Centre Rod	DB-DL-8644		Push Rod
		10/04 →	Centre Rod	DB-DL-12298		for Steering Rod
	10/04 →	Centre Rod	DB-DL-12405		Coupling Rod	
	10/04 →	Suspension Arm Repair Kit		DB-RK-8550	for Wishbone (CV)	
	10/04 →	Tie Rod	DB-DL-8174		Guide Rod	
	10/04 →	Tie Rod End	CV-ES-14162		for Steering Rod	
	10/04 →	Tie Rod End	CV-ES-14163		for Steering Rod	
	10/04 →	Track Control Arm		DB-TC-12411	Control Arm	
	10/04 →	Track Control Arm		DB-VB-10423	Wishbone (CV)	
	10/04 →	Track Control Arm		DB-VB-10423	Wishbone (CV), Air Suspension Axle	
	2422	10/04 →	Ball Head, gearshift linkage	DB-ES-8510	DB-ES-8510	
		10/04 →	Centre Rod	DB-DL-12298		for Steering Rod
		10/04 →	Centre Rod	DB-DL-12405		Coupling Rod
2425		10/04 →	Ball Head, gearshift linkage	DB-ES-8510	DB-ES-8510	
	10/04 →	Centre Rod	DB-DL-12298		for Steering Rod	
	10/04 →	Centre Rod	DB-DL-12405		Coupling Rod	

CV-ES-14162

Length: 125
Cone Ø: d1 Ø 30 / d2 Ø 27
Thread: M30 x 1,5 LHT
4600648, 4601248, 4603448, 0004603548,
14600348, 14601448, 14602348, 0014603748,
0014607848, 0024600348



CV-ES-14163

Length: 125
Cone Ø: d1 Ø 30 / d2 Ø 27
Thread: M30 x 1,5 RHT
0003305248, 0003387310, 0004600348,
0004600948, 0004602848, 0004602948,
0004608948, 0014600248, 0014600848,
0014601248, 0014602248, 0014607748,
0024600148, A0003387310, A0004600348,
A0004602848, A0004602948, A0014600848,
A0014601248, A0014602248, A0014607748



DB-DL-7815

Length: 895 Ø: 50
Cone Ø: d1 Ø 30 / d2 Ø 27
01215800A, 0034604605, 3754600005,
9744601005, 9744601205



DB-DL-8174

Length: 1605 Ø: 40
Cone Ø: d1 Ø 30 / d2 Ø 27
9753300203, 9753300303, 9753300803,
9753301703, 9753302503



DB-DL-8644

Length: 894 Ø: 50
Cone Ø: d1 Ø 30 / d2 Ø 27
0034604705, 9744601105, 9744601305



DB-DL-12298

Length: 927 Ø: 50
Cone Ø: d1 Ø 30 / d2 Ø 27
0024602405, 0024603005



DB-DL-12304

Length: 1560 Ø: 40
Cone Ø: d1 Ø 30 / d2 Ø 27
Thread: M30 x 1,5 LHT / M30 x 1,5 RHT
9753300603, 9753300703, 9753300903,
A9753300603, A9753300703, A9753300903



DB-DL-12405

Length: 895 Ø: 50
Cone Ø: d1 Ø 30 / d2 Ø 28,6
Thread: M24 x 1,5 / M20 x 1,5
9744602205, 9764600205, 9764600405,
A9764600405



DB-ES-8510

Length: 56
Cone Ø: d1 Ø 10 / d2 Ø 10
Thread: M12 x 1,75 LHT
0009965145, 0009965645, 0019963145



DB-RK-8550

Ø: 75 Hole Distance: 152
Thick/Height: 24
0003502105, 0003504605



DB-TC-12411

Length: 655 Ø: 40
Hole Distance: 115 / 115
9723500906



DB-VB-10423

Length: 761,7 Ø: 46
Hole Ø 25 / 23 / 23
Hole Distance: 152 / 130 / 130
9743500005, 9743500405, 9743500505





ATEGO 2 ...

2428	10/04 →	Ball Head, gearshift linkage	DB-ES-8510	DB-ES-8510		
	10/04 →	Centre Rod	DB-DL-12298		for Steering Rod	
	10/04 →	Centre Rod	DB-DL-12405		Coupling Rod	
2529 L	10/04 →	Bush, parabolic spring		DB-SB-10400		
	10/04 →	Bush, parabolic spring		DB-SB-10401		
	10/04 →	Centre Rod	DB-DL-5405		Push Rod	
	10/04 →	Centre Rod	DB-DL-12298		for Steering Rod	
	10/04 →	Centre Rod	DB-DL-12405		Coupling Rod	
	10/04 →	Suspension Arm Repair Kit		DB-RK-8550	for Wishbone (CV)	
	10/04 →	Tie Rod	DB-DL-8172		Guide Rod	
	10/04 →	Tie Rod	DB-DL-8388		Guide Rod	
	10/04 →	Tie Rod	DB-DL-8389			
	10/04 →	Track Control Arm		DB-VB-3707	Suspension Rod, Wishbone (CV)	
712, 713	10/04 →	Ball Head, gearshift linkage	DB-ES-8387			
	10/04 →	Centre Rod	DB-DL-5213		Push Rod, Leaf Spring Axle	
	10/04 →	Centre Rod	DB-DL-7815		Push Rod;Suspension Rod	
	10/04 →	Centre Rod	DB-DL-8644		Push Rod	
	10/04 →	Centre Rod	DB-DL-8731		Push Rod, Leaf Spring Axle	
	10/04 →	Centre Rod	DB-DL-9187		Push Rod	
	10/04 →	Centre Rod	DB-DL-12405		Coupling Rod	
	10/04 →	Stabiliser Mounting		DB-SB-10385		
	10/04 →	Stabiliser Mounting	DB-SB-10385	DB-SB-10385		
	10/04 →	Stabiliser Mounting	DB-SB-10385	DB-SB-10385	1st FA	
	10/04 →	Stabiliser Mounting	DB-SB-10386	DB-SB-10386		
	10/04 →	Stabiliser Mounting	DB-SB-10386	DB-SB-10386	1st FA	
	10/04 →	Tie Rod	DB-ES-5214		Guide Rod	
	10/04 →	Tie Rod End	CV-ES-12461		for Steering Rod	
	10/04 →	Tie Rod End	CV-ES-12462		for Steering Rod	
	715, 715 L, 716, 716 L	10/04 →	Ball Head, gearshift linkage	DB-ES-8387		
10/04 →		Centre Rod	DB-DL-5213		Push Rod	
10/04 →		Centre Rod	DB-DL-5213		Push Rod, Leaf Spring Axle	
10/04 →		Centre Rod	DB-DL-7815		Push Rod;Suspension Rod	
10/04 →		Centre Rod	DB-DL-8644		Push Rod	
10/04 →		Centre Rod	DB-DL-8731		Push Rod	
10/04 →		Centre Rod	DB-DL-8731		Push Rod, Leaf Spring Axle	
10/04 →		Centre Rod	DB-DL-9187		Push Rod	
10/04 →		Centre Rod	DB-DL-12405		Coupling Rod	
10/04 →		Stabiliser Mounting		DB-SB-10385		
10/04 →		Stabiliser Mounting		DB-SB-10385	1st RA	
10/04 →		Stabiliser Mounting	DB-SB-10385	DB-SB-10385		
10/04 →		Stabiliser Mounting	DB-SB-10385	DB-SB-10385	1st FA	
10/04 →		Stabiliser Mounting	DB-SB-10386	DB-SB-10386		
10/04 →		Stabiliser Mounting	DB-SB-10386	DB-SB-10386	1st FA	
10/04 →		Suspension Arm Repair Kit		DB-RK-8550	for Wishbone (CV)	
10/04 →		Tie Rod	DB-ES-5214		Guide Rod	
10/04 →		Tie Rod End	CV-ES-12461		for Steering Rod	
10/04 →		Tie Rod End	CV-ES-12462		for Steering Rod	
10/04 →		Track Control Arm		DB-TC-12411	Control Arm	
10/04 →		Track Control Arm		DB-VB-10423	Wishbone (CV), 1st Drive Axle, →508306 05	
812 K		10/04 →	Centre Rod	DB-DL-12405		Coupling Rod
812, 813		10/04 →	Ball Head, gearshift linkage	DB-ES-8387		
		10/04 →	Centre Rod	DB-DL-5213		Push Rod, Leaf Spring Axle
		10/04 →	Centre Rod	DB-DL-7815		Push Rod;Suspension Rod
		10/04 →	Centre Rod	DB-DL-8644		Push Rod
	10/04 →	Centre Rod	DB-DL-8731		Push Rod, Leaf Spring Axle	
	10/04 →	Centre Rod	DB-DL-9187		Push Rod	
	10/04 →	Centre Rod	DB-DL-12298		for Steering Rod	
	10/04 →	Centre Rod	DB-DL-12405		Coupling Rod	
	10/04 →	Stabiliser Mounting		DB-SB-10385		
	10/04 →	Stabiliser Mounting	DB-SB-10385	DB-SB-10385		
	10/04 →	Stabiliser Mounting	DB-SB-10385	DB-SB-10385	1st FA	
	10/04 →	Stabiliser Mounting	DB-SB-10386	DB-SB-10386		
	10/04 →	Stabiliser Mounting	DB-SB-10386	DB-SB-10386	1st FA	

CV-ES-12461

Length: 120
 Cone Ø: d1 Ø 26 / d2 Ø 23,5
 Thread: M30 x 1,5 LHT
 0003300035, 3300148, 0003406213, 0013306635,
 0013308835, 0014604048, 0014604348,
 14606448, 0024600248, 3023300035,
 3023300135, 3023300235, 3023300335,
 3453307235, 3453307435, 3503307135,
 A0003300148, A0013306635, A0013308835,
 A0014604048, A0014604348, A0014606448,
 A0024600248, A3023300035, A3023300135,
 A3023300235, A3023300335, A3503307135



CV-ES-12462

Length: 120
 Cone Ø: d1 Ø 26 / d2 Ø 23,5
 Thread: M30 x 1,5 RHT
 0003300135, 0003300248, 0003303235,
 0003305835, 0003307335, 0003383410,
 0004608348, 004608348, 0004632229,
 0004633129, 0004633429, 0004633529,
 0013300135, 0013300235, 0013306735,
 0014603448, 0014604148, 0014604448,
 0014606348, 0014608348, 0014608448,
 0014609748, 0023301535, 3453307135,
 3503307035, 3503307335, 3643307135,
 5001832582, A0003300248, A0003303235,
 A0003307335, A0003383410, A0004608348,
 A0004632229, A0004633429, A0013300135,
 A0013300235, A0013306735, A0014603448,
 A0014604148, A0014604448, A0014606348,
 A0014608348, A0014608448, A0014609748,
 A0023301535



DB-DL-5213

Length: 846
 Ø: 42
 Cone Ø: d1 Ø 26 / d2 Ø 23,5
 01208200A, 9704600705, 9704600905



DB-DL-5405

Length: 890 Ø: 35
 Cone Ø: d1 Ø 28,6 / d2 Ø 23,9
 01215900A, 1460248, 0024604505, 0024604605,
 0034605005, 3752600637, 3754600405,
 A3752600637, A3754600405



DB-DL-7815

Length: 895
 Ø: 50
 Cone Ø: d1 Ø 30 / d2 Ø 27
 01215800A, 34604605, 0034604605, 3754600005,
 9744601005, 9744601205



DB-DL-8172

Length: 1700 Ø: 52
 Cone Ø: d1 Ø 32 / d2 Ø 29
 01219700A, 9493300403, 9493300503,
 9493300803, 9493301403



DB-DL-8388

Length: 1735 Ø: 62
 Cone Ø: d1 Ø 32 / d2 Ø 28,8
 01219900A, 9453300003, 9453300103,
 9453300403, 9453300603, A9453300003



DB-DL-8389

Length: 1465 Ø: 40
 Cone Ø: d1 Ø 32 / d2 Ø 29
 9453300203, 9453300303, 9453300503



DB-DL-8644

Length: 894 Ø: 50
 Cone Ø: d1 Ø 30 / d2 Ø 27
 0034604705, 9744601105, 9744601305



DB-DL-8731

Length: 846
 Ø: 42
 Cone Ø: d1 Ø 26 / d2 Ø 23,5
 9704600805, 9704601005



DB-DL-9187

Length: 846 Ø: 42
 Cone Ø: d1 Ø 26 / d2 Ø 23,5
 9704601105, 9724602805, A9704601105,
 A9724602805



DB-DL-12298

Length: 927 Ø: 50
 Cone Ø: d1 Ø 30 / d2 Ø 27
 0024602405, 0024603005



DB-DL-12405

Length: 895 Ø: 50
 Cone Ø: d1 Ø 30 / d2 Ø 28,6
 Thread: M24 x 1,5 / M20 x 1,5
 9744602205, 9764600205, 9764600405,
 A9764600405



DB-ES-5214

Length: 1640 Ø: 40
 Cone Ø: d1 Ø 26 / d2 Ø 23,5
 01218000A, 9703300003, 9703300103,
 9703300203, 9703300303, 9703300403



DB-ES-8387

Length: 55
 Cone Ø: d1 Ø 10 / d2 Ø 10
 Thread: M14 x 1,5 RHT
 0009966845, 0009967045



DB-ES-8510

Length: 56
 Cone Ø: d1 Ø 10 / d2 Ø 10
 Thread: M12 x 1,75 LHT
 0009965145, 0009965645, 0019963145



DB-RK-8550

Ø: 75 Hole Distance: 152
 Thick/Height: 24
 0003502105, 0003504605



DB-SB-10385

Ø: 30 Thick/Height: 30
 3093200073, 3143260153



DB-SB-10386

Ø: 38 Thick/Height: 38
 3183200073



DB-SB-10400

Length: 230
 Thick/Height: 167,5 / 115
 0003250696, 0003250896



DB-SB-10401

Length: 232
 Thick/Height: 163,5 / 152,5
 0003250596, 0003250796



DB-TC-12411

Length: 655 Ø: 40
 Hole Distance: 115 / 115
 9723500906



DB-VB-3707

Length: 622 Ø: 46
 Hole Ø 25 / 25 / 25
 Hole Distance: 152 / 130 / 130
 01337100A, 9423501005, 9423501505,
 9443500005, 9473500105, 9473501005,
 A3753500005, A9423501005, A9423501505,
 A9443500005, A9473500105, A9473501005



DB-VB-10423

Length: 761,7 Ø: 46
 Hole Ø 25 / 23 / 23
 Hole Distance: 152 / 130 / 130
 9743500005, 9743500405, 9743500505





ATEGO 2 ...

812, 813 ...	10/04 →	Tie Rod	DB-ES-5214		Guide Rod	
	10/04 →	Tie Rod End	CV-ES-12461		for Steering Rod	
	10/04 →	Tie Rod End	CV-ES-12462		for Steering Rod	
815 F	10/04 →	Centre Rod	DB-DL-5213		Push Rod	
	10/04 →	Centre Rod	DB-DL-8731		Push Rod	
	10/04 →	Centre Rod	DB-DL-12298		for Steering Rod	
	10/04 →	Centre Rod	DB-DL-12405		Coupling Rod	
	10/04 →	Tie Rod	DB-ES-5214		Guide Rod, 1st Front Axle	
	10/04 →	Tie Rod End	CV-ES-12461		for Steering Rod	
	10/04 →	Tie Rod End	CV-ES-12462		for Steering Rod	
	815 K, 816 K	10/04 →	Ball Head, gearshift linkage	DB-ES-8387		
10/04 →		Ball Head, gearshift linkage	DB-ES-8500			
10/04 →		Centre Rod	DB-DL-5213		Push Rod, Leaf Spring Axle	
10/04 →		Centre Rod	DB-DL-7794		Push Rod, Leaf Spring Axle	
10/04 →		Centre Rod	DB-DL-8731		Push Rod, Leaf Spring Axle	
10/04 →		Centre Rod	DB-DL-12405		Coupling Rod	
10/04 →		Stabiliser Mounting		DB-SB-10385		
10/04 →		Stabiliser Mounting	DB-SB-10385	DB-SB-10385		
10/04 →		Stabiliser Mounting	DB-SB-10385	DB-SB-10385	1st FA	
10/04 →		Tie Rod	DB-ES-5214		Guide Rod	
10/04 →		Tie Rod End	CV-ES-12461		for Steering Rod	
10/04 →		Tie Rod End	CV-ES-12462		for Steering Rod	
815, 815 L, 816, 816 L		10/04 →	Ball Head, gearshift linkage	DB-ES-8387		
		10/04 →	Centre Rod	DB-DL-5213		Push Rod
		10/04 →	Centre Rod	DB-DL-5213		Push Rod, Leaf Spring Axle
	10/04 →	Centre Rod	DB-DL-7794		Push Rod	
	10/04 →	Centre Rod	DB-DL-7815		Push Rod; Suspension Rod	
	10/04 →	Centre Rod	DB-DL-8644		Push Rod	
	10/04 →	Centre Rod	DB-DL-8731		Push Rod	
	10/04 →	Centre Rod	DB-DL-8731		Push Rod, Leaf Spring Axle	
	10/04 →	Centre Rod	DB-DL-9187		Push Rod	
	10/04 →	Centre Rod	DB-DL-12405		Coupling Rod	
	10/04 →	Stabiliser Mounting		DB-SB-10385		
	10/04 →	Stabiliser Mounting		DB-SB-10385	1st RA	
	10/04 →	Stabiliser Mounting	DB-SB-10385	DB-SB-10385	1st FA	
	10/04 →	Stabiliser Mounting	DB-SB-10385	DB-SB-10385	1st FA	
	10/04 →	Stabiliser Mounting	DB-SB-10386	DB-SB-10386	1st FA	
	10/04 →	Stabiliser Mounting	DB-SB-10386	DB-SB-10386	1st FA	
	10/04 →	Suspension Arm Repair Kit		DB-RK-8550	for Wishbone (CV)	
	10/04 →	Tie Rod	DB-ES-5214		Guide Rod	
	10/04 →	Tie Rod End	CV-ES-12461		for Steering Rod	
	10/04 →	Tie Rod End	CV-ES-12462		for Steering Rod	
	10/04 →	Track Control Arm		DB-TC-12411	Control Arm	
	10/04 →	Track Control Arm		DB-VB-10423	Wishbone (CV), 1st Drive Axle, →508306 05	
	816, 816 L	10/04 →	Ball Head, gearshift linkage	DB-ES-8387		
		10/04 →	Centre Rod	DB-DL-5213		Push Rod
		10/04 →	Centre Rod	DB-DL-5213		Push Rod, Leaf Spring Axle
		10/04 →	Centre Rod	DB-DL-7794		Push Rod
		10/04 →	Centre Rod	DB-DL-7794		Push Rod, Leaf Spring Axle
		10/04 →	Centre Rod	DB-DL-8644		Push Rod
		10/04 →	Centre Rod	DB-DL-8731		Push Rod
		10/04 →	Centre Rod	DB-DL-8731		Push Rod, Leaf Spring Axle
10/04 →		Centre Rod	DB-DL-9187		Push Rod	
10/04 →		Centre Rod	DB-DL-12298		for Steering Rod	
10/04 →		Centre Rod	DB-DL-12405		Coupling Rod	
10/04 →		Stabiliser Mounting	DB-SB-10385	DB-SB-10385	1st FA	
10/04 →		Stabiliser Mounting	DB-SB-10386	DB-SB-10386	1st FA	
10/04 →		Suspension Arm Repair Kit		DB-RK-8550	for Wishbone (CV)	
10/04 →		Tie Rod	DB-ES-5214		Guide Rod	
10/04 →		Tie Rod End	CV-ES-12461		for Steering Rod	
10/04 →		Tie Rod End	CV-ES-12462		for Steering Rod	
10/04 →		Track Control Arm		DB-TC-12411	Control Arm	
10/04 →		Track Control Arm		DB-VB-10423	Wishbone (CV), 1st Drive Axle, →508306 05	

CV-ES-12461

Length: 120
 Cone Ø: d1 Ø 26 / d2 Ø 23,5
 Thread: M30 x 1,5 LHT
 0003300035, 3300148, 0003406213, 0013306635,
 0013308835, 0014604048, 0014604348,
 14606448, 0024600248, 3023300035,
 3023300135, 3023300235, 3023300335,
 3453307235, 3453307435, 3503307135,
 A0003300148, A0013306635, A0013308835,
 A0014604048, A0014604348, A0014606448,
 A0024600248, A3023300035, A3023300135,
 A3023300235, A3023300335, A3503307135



CV-ES-12462

Length: 120
 Cone Ø: d1 Ø 26 / d2 Ø 23,5
 Thread: M30 x 1,5 RHT
 0003300135, 0003300248, 0003303235,
 0003305835, 0003307335, 0003383410,
 0004608348, 004608348, 0004632229,
 0004633129, 0004633429, 0004633529,
 0013300135, 0013300235, 0013306735,
 0014603448, 0014604148, 0014604448,
 0014606348, 0014608348, 0014608448,
 0014609748, 0023301535, 3453307135,
 3503307035, 3503307335, 3643307135,
 5001832582, A0003300248, A0003303235,
 A0003307335, A0003383410, A0004608348,
 A0004632229, A0004633429, A0013300135,
 A0013300235, A0013306735, A0014603448,
 A0014604148, A0014604448, A0014606348,
 A0014608348, A0014608448, A0014609748,
 A0023301535



DB-DL-5213

Length: 846
 Ø: 42
 Cone Ø: d1 Ø 26 / d2 Ø 23,5
 01208200A, 9704600705, 9704600905



DB-DL-7794

Length: 837 Ø: 40
 Cone Ø: d1 Ø 26 / d2 Ø 23,5
 9724601405, 9724601605



DB-DL-7815

Length: 895 Ø: 50
 Cone Ø: d1 Ø 30 / d2 Ø 27
 01215800A, 0034604605, 3754600005,
 9744601005, 9744601205



DB-DL-8644

Length: 894 Ø: 50
 Cone Ø: d1 Ø 30 / d2 Ø 27
 0034604705, 9744601105, 9744601305



DB-DL-8731

Length: 846
 Ø: 42
 Cone Ø: d1 Ø 26 / d2 Ø 23,5
 9704600805, 9704601005



DB-DL-9187

Length: 846 Ø: 42
 Cone Ø: d1 Ø 26 / d2 Ø 23,5
 9704601105, 9724602805, A9704601105,
 A9724602805



DB-DL-12298

Length: 927 Ø: 50
 Cone Ø: d1 Ø 30 / d2 Ø 27
 0024602405, 0024603005



DB-DL-12405

Length: 895 Ø: 50
 Cone Ø: d1 Ø 30 / d2 Ø 28,6
 Thread: M24 x 1,5 / M20 x 1,5
 9744602205, 9764600205, 9764600405,
 A9764600405



DB-ES-5214

Length: 1640 Ø: 40
 Cone Ø: d1 Ø 26 / d2 Ø 23,5
 01218000A, 9703300003, 9703300103,
 9703300203, 9703300303, 9703300403



DB-ES-8387

Length: 55
 Cone Ø: d1 Ø 10 / d2 Ø 10
 Thread: M14 x 1,5 RHT
 0009966845, 0009967045



DB-ES-8500

Length: 55
 Cone Ø: d1 Ø 12 / d2 Ø 10,8
 Thread: M14 x 1,5 RHT
 0002685989



DB-RK-8550

Ø: 75 Hole Distance: 152
 Thick/Height: 24
 0003502105, 0003504605



DB-SB-10385

Ø: 30 Thick/Height: 30
 3093200073, 3143260153



DB-SB-10386

Ø: 38 Thick/Height: 38
 3183200073



DB-TC-12411

Length: 655 Ø: 40
 Hole Distance: 115 / 115
 9723500906



DB-VB-10423

Length: 761,7 Ø: 46
 Hole Ø 25 / 23 / 23
 Hole Distance: 152 / 130 / 130
 9743500005, 9743500405, 9743500505



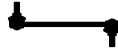

ATEGO 2 ...

818 K	10/04 →	Ball Head, gearshift linkage	DB-ES-8387			
	10/04 →	Ball Head, gearshift linkage	DB-ES-8500			
	10/04 →	Centre Rod	DB-DL-5213		Push Rod, Leaf Spring Axle	
	10/04 →	Centre Rod	DB-DL-7794		Push Rod, Leaf Spring Axle	
	10/04 →	Centre Rod	DB-DL-8731		Push Rod, Leaf Spring Axle	
	10/04 →	Centre Rod	DB-DL-12405		Coupling Rod	
	10/04 →	Stabiliser Mounting		DB-SB-10385		
	10/04 →	Stabiliser Mounting	DB-SB-10385	DB-SB-10385		
	10/04 →	Stabiliser Mounting	DB-SB-10385	DB-SB-10385	1st FA	
	10/04 →	Tie Rod	DB-ES-5214		Guide Rod	
	10/04 →	Tie Rod End	CV-ES-12461		for Steering Rod	
	10/04 →	Tie Rod End	CV-ES-12462		for Steering Rod	
	818, 818 L	10/04 →	Ball Head, gearshift linkage	DB-ES-8387		
		10/04 →	Ball Head, gearshift linkage	DB-ES-8500		
		10/04 →	Centre Rod	DB-DL-5213		Push Rod
		10/04 →	Centre Rod	DB-DL-5213		Push Rod, Leaf Spring Axle
10/04 →		Centre Rod	DB-DL-7794		Push Rod	
10/04 →		Centre Rod	DB-DL-7794		Push Rod, Leaf Spring Axle	
10/04 →		Centre Rod	DB-DL-7815		Push Rod;Suspension Rod	
10/04 →		Centre Rod	DB-DL-8644		Push Rod	
10/04 →		Centre Rod	DB-DL-8731		Push Rod	
10/04 →		Centre Rod	DB-DL-8731		Push Rod, Leaf Spring Axle	
10/04 →		Centre Rod	DB-DL-9187		Push Rod	
10/04 →		Centre Rod	DB-DL-12298		for Steering Rod	
10/04 →		Centre Rod	DB-DL-12405		Coupling Rod	
10/04 →		Stabiliser Mounting		DB-SB-10385		
10/04 →		Stabiliser Mounting		DB-SB-10385	1st RA	
10/04 →		Stabiliser Mounting	DB-SB-10385	DB-SB-10385		
10/04 →		Stabiliser Mounting	DB-SB-10385	DB-SB-10385	1st FA	
10/04 →		Stabiliser Mounting	DB-SB-10386	DB-SB-10386		
10/04 →		Stabiliser Mounting	DB-SB-10386	DB-SB-10386	1st FA	
10/04 →		Suspension Arm Repair Kit		DB-RK-8550	for Wishbone (CV)	
10/04 →		Tie Rod	DB-ES-5214		Guide Rod	
10/04 →		Tie Rod End	CV-ES-12461		for Steering Rod	
10/04 →		Tie Rod End	CV-ES-12462		for Steering Rod	
10/04 →		Track Control Arm		DB-TC-12411	Control Arm	
10/04 →		Track Control Arm		DB-VB-10423	Wishbone (CV), 1st Drive Axle, →508306 05	
822 F		10/04 →	Centre Rod	DB-DL-5213		Push Rod
		10/04 →	Centre Rod	DB-DL-8731		Push Rod
		10/04 →	Centre Rod	DB-DL-12298		for Steering Rod
		10/04 →	Centre Rod	DB-DL-12405		Coupling Rod
		10/04 →	Tie Rod	DB-ES-5214		Guide Rod, 1st Front Axle
		10/04 →	Tie Rod End	CV-ES-12461		for Steering Rod
		10/04 →	Tie Rod End	CV-ES-12462		for Steering Rod
	822 K	10/04 →	Ball Head, gearshift linkage	DB-ES-8387		
10/04 →		Centre Rod	DB-DL-5213		Push Rod, Leaf Spring Axle	
10/04 →		Centre Rod	DB-DL-7794		Push Rod, Leaf Spring Axle	
10/04 →		Centre Rod	DB-DL-8731		Push Rod, Leaf Spring Axle	
10/04 →		Centre Rod	DB-DL-12298		for Steering Rod	
10/04 →		Centre Rod	DB-DL-12405		Coupling Rod	
10/04 →		Stabiliser Mounting		DB-SB-10385		
10/04 →		Stabiliser Mounting	DB-SB-10385	DB-SB-10385		
10/04 →		Stabiliser Mounting	DB-SB-10385	DB-SB-10385	1st FA	
10/04 →		Tie Rod	DB-ES-5214		Guide Rod	
10/04 →		Tie Rod End	CV-ES-12461		for Steering Rod	
10/04 →		Tie Rod End	CV-ES-12462		for Steering Rod	
822, 822 L		10/04 →	Ball Head, gearshift linkage	DB-ES-8387		
		10/04 →	Centre Rod	DB-DL-5213		Push Rod
	10/04 →	Centre Rod	DB-DL-5213		Push Rod, Leaf Spring Axle	
	10/04 →	Centre Rod	DB-DL-7794		Push Rod	
	10/04 →	Centre Rod	DB-DL-7815		Push Rod;Suspension Rod	
	10/04 →	Centre Rod	DB-DL-8644		Push Rod	
	10/04 →	Centre Rod	DB-DL-8731		Push Rod	

CV-ES-12461

Length: 120
 Cone Ø: d1 Ø 26 / d2 Ø 23,5
 Thread: M30 x 1,5 LHT
 0003300035, 3300148, 0003406213, 0013306635,
 0013308835, 0014604048, 0014604348,
 14606448, 0024600248, 3023300035,
 3023300135, 3023300235, 3023300335,
 3453307235, 3453307435, 3503307135,
 A0003300148, A0013306635, A0013308835,
 A0014604048, A0014604348, A0014606448,
 A0024600248, A3023300035, A3023300135,
 A3023300235, A3023300335, A3503307135



CV-ES-12462

Length: 120
 Cone Ø: d1 Ø 26 / d2 Ø 23,5
 Thread: M30 x 1,5 RHT
 0003300135, 0003300248, 0003303235,
 0003305835, 0003307335, 0003383410,
 0004608348, 004608348, 0004632229,
 0004633129, 0004633429, 0004633529,
 0013300135, 0013300235, 0013306735,
 0014603448, 0014604148, 0014604448,
 0014606348, 0014608348, 0014608448,
 0014609748, 0023301535, 3453307135,
 3503307035, 3503307335, 3643307135,
 5001832582, A0003300248, A0003303235,
 A0003307335, A0003383410, A0004608348,
 A0004632229, A0004633429, A0013300135,
 A0013300235, A0013306735, A0014603448,
 A0014604148, A0014604448, A0014606348,
 A0014608348, A0014608448, A0014609748,
 A0023301535



DB-DL-5213

Length: 846
 Ø: 42
 Cone Ø: d1 Ø 26 / d2 Ø 23,5
 01208200A, 9704600705, 9704600905



DB-DL-7794

Length: 837 Ø: 40
 Cone Ø: d1 Ø 26 / d2 Ø 23,5
 9724601405, 9724601605



DB-DL-7815

Length: 895 Ø: 50
 Cone Ø: d1 Ø 30 / d2 Ø 27
 01215800A, 0034604605, 3754600005,
 9744601005, 9744601205



DB-DL-8644

Length: 894 Ø: 50
 Cone Ø: d1 Ø 30 / d2 Ø 27
 0034604705, 9744601105, 9744601305



DB-DL-8731

Length: 846
 Ø: 42
 Cone Ø: d1 Ø 26 / d2 Ø 23,5
 9704600805, 9704601005



DB-DL-9187

Length: 846 Ø: 42
 Cone Ø: d1 Ø 26 / d2 Ø 23,5
 9704601105, 9724602805, A9704601105,
 A9724602805



DB-DL-12298

Length: 927 Ø: 50
 Cone Ø: d1 Ø 30 / d2 Ø 27
 0024602405, 0024603005



DB-DL-12405

Length: 895 Ø: 50
 Cone Ø: d1 Ø 30 / d2 Ø 28,6
 Thread: M24 x 1,5 / M20 x 1,5
 9744602205, 9764600205, 9764600405,
 A9764600405



DB-ES-5214

Length: 1640 Ø: 40
 Cone Ø: d1 Ø 26 / d2 Ø 23,5
 01218000A, 9703300003, 9703300103,
 9703300203, 9703300303, 9703300403



DB-ES-8387

Length: 55
 Cone Ø: d1 Ø 10 / d2 Ø 10
 Thread: M14 x 1,5 RHT
 0009966845, 0009967045



DB-ES-8500

Length: 55
 Cone Ø: d1 Ø 12 / d2 Ø 10,8
 Thread: M14 x 1,5 RHT
 0002685989



DB-RK-8550

Ø: 75 Hole Distance: 152
 Thick/Height: 24
 0003502105, 0003504605



DB-SB-10385

Ø: 30 Thick/Height: 30
 3093200073, 3143260153



DB-SB-10386

Ø: 38 Thick/Height: 38
 3183200073



DB-TC-12411

Length: 655 Ø: 40
 Hole Distance: 115 / 115
 9723500906



DB-VB-10423

Length: 761,7 Ø: 46
 Hole Ø 25 / 23 / 23
 Hole Distance: 152 / 130 / 130
 9743500005, 9743500405, 9743500505





ATEGO 2 ...

822, 822 L ...	10/04 →	Centre Rod	DB-DL-8731		Push Rod, Leaf Spring Axle	
	10/04 →	Centre Rod	DB-DL-9187		Push Rod	
	10/04 →	Centre Rod	DB-DL-12298		for Steering Rod	
	10/04 →	Centre Rod	DB-DL-12405		Coupling Rod	
	10/04 →	Stabiliser Mounting		DB-SB-10385		
	10/04 →	Stabiliser Mounting		DB-SB-10385	1st RA	
	10/04 →	Stabiliser Mounting	DB-SB-10385	DB-SB-10385		
	10/04 →	Stabiliser Mounting	DB-SB-10385	DB-SB-10385	1st FA	
	10/04 →	Stabiliser Mounting	DB-SB-10386	DB-SB-10386		
	10/04 →	Stabiliser Mounting	DB-SB-10386	DB-SB-10386	1st FA	
	10/04 →	Suspension Arm Repair Kit		DB-RK-8550	for Wishbone (CV)	
	10/04 →	Tie Rod	DB-ES-5214		Guide Rod	
	10/04 →	Tie Rod End	CV-ES-12461		for Steering Rod	
	10/04 →	Tie Rod End	CV-ES-12462		for Steering Rod	
	823, 823 L, 824, 824 L	10/04 →	Track Control Arm		DB-TC-12411	Control Arm
10/04 →		Track Control Arm		DB-VB-10423	Wishbone (CV), 1st Drive Axle, →508306 05	
823, 823 L, 824, 824 L	10/04 →	Ball Head, gearshift linkage	DB-ES-8387			
	10/04 →	Ball Head, gearshift linkage	DB-ES-8500			
	10/04 →	Centre Rod	DB-DL-5213		Push Rod	
	10/04 →	Centre Rod	DB-DL-5213		Push Rod, Leaf Spring Axle	
	10/04 →	Centre Rod	DB-DL-7794		Push Rod	
	10/04 →	Centre Rod	DB-DL-7794		Push Rod, Leaf Spring Axle	
	10/04 →	Centre Rod	DB-DL-7815		Push Rod;Suspension Rod	
	10/04 →	Centre Rod	DB-DL-8644		Push Rod	
	10/04 →	Centre Rod	DB-DL-8731		Push Rod	
	10/04 →	Centre Rod	DB-DL-8731		Push Rod, Leaf Spring Axle	
	10/04 →	Centre Rod	DB-DL-9187		Push Rod	
	10/04 →	Centre Rod	DB-DL-12298		for Steering Rod	
	10/04 →	Centre Rod	DB-DL-12405		Coupling Rod	
	10/04 →	Stabiliser Mounting		DB-SB-10385		
	10/04 →	Stabiliser Mounting		DB-SB-10385	1st RA	
	10/04 →	Stabiliser Mounting	DB-SB-10385	DB-SB-10385		
	10/04 →	Stabiliser Mounting	DB-SB-10385	DB-SB-10385	1st FA	
	10/04 →	Stabiliser Mounting	DB-SB-10386	DB-SB-10386		
	10/04 →	Stabiliser Mounting	DB-SB-10386	DB-SB-10386	1st FA	
	10/04 →	Suspension Arm Repair Kit		DB-RK-8550	for Wishbone (CV)	
	10/04 →	Tie Rod	DB-ES-5214		Guide Rod	
	10/04 →	Tie Rod End	CV-ES-12461		for Steering Rod	
	10/04 →	Tie Rod End	CV-ES-12462		for Steering Rod	
	10/04 →	Track Control Arm		DB-TC-12411	Control Arm	
	10/04 →	Track Control Arm		DB-VB-10423	Wishbone (CV), 1st Drive Axle, →508306 05	
	824 K	10/04 →	Ball Head, gearshift linkage	DB-ES-8387		
		10/04 →	Centre Rod	DB-DL-5213		Push Rod, Leaf Spring Axle
		10/04 →	Centre Rod	DB-DL-7794		Push Rod
		10/04 →	Centre Rod	DB-DL-8731		Push Rod, Leaf Spring Axle
		10/04 →	Centre Rod	DB-DL-12298		for Steering Rod
10/04 →		Centre Rod	DB-DL-12405		Coupling Rod	
10/04 →		Stabiliser Mounting		DB-SB-10385		
10/04 →		Stabiliser Mounting	DB-SB-10385	DB-SB-10385		
10/04 →		Stabiliser Mounting	DB-SB-10385	DB-SB-10385	1st FA	
10/04 →		Tie Rod	DB-ES-5214		Guide Rod	
10/04 →		Tie Rod End	CV-ES-12461		for Steering Rod	
10/04 →		Tie Rod End	CV-ES-12462		for Steering Rod	
824, 824 L		10/04 →	Centre Rod	DB-DL-5213		Push Rod
		10/04 →	Centre Rod	DB-DL-7794		Push Rod
		10/04 →	Centre Rod	DB-DL-8731		Push Rod
	10/04 →	Centre Rod	DB-DL-9187		Push Rod	
	10/04 →	Centre Rod	DB-DL-12298		for Steering Rod	
	10/04 →	Centre Rod	DB-DL-12405		Coupling Rod	
	10/04 →	Tie Rod	DB-ES-5214		Guide Rod, 1st Front Axle	
	10/04 →	Tie Rod End	CV-ES-12461		for Steering Rod	
	10/04 →	Tie Rod End	CV-ES-12462		for Steering Rod	

CV-ES-12461

Length: 120
 Cone Ø: d1 Ø 26 / d2 Ø 23,5
 Thread: M30 x 1,5 LHT
 0003300035, 3300148, 0003406213, 0013306635,
 0013308835, 0014604048, 0014604348,
 14606448, 0024600248, 3023300035,
 3023300135, 3023300235, 3023300335,
 3453307235, 3453307435, 3503307135,
 A0003300148, A0013306635, A0013308835,
 A0014604048, A0014604348, A0014606448,
 A0024600248, A3023300035, A3023300135,
 A3023300235, A3023300335, A3503307135



CV-ES-12462

Length: 120
 Cone Ø: d1 Ø 26 / d2 Ø 23,5
 Thread: M30 x 1,5 RHT
 0003300135, 0003300248, 0003303235,
 0003305835, 0003307335, 0003383410,
 0004608348, 004608348, 0004632229,
 0004633129, 0004633429, 0004633529,
 0013300135, 0013300235, 0013306735,
 0014603448, 0014604148, 0014604448,
 0014606348, 0014608348, 0014608448,
 0014609748, 0023301535, 3453307135,
 3503307035, 3503307335, 3643307135,
 5001832582, A0003300248, A0003303235,
 A0003307335, A0003383410, A0004608348,
 A0004632229, A0004633429, A0013300135,
 A0013300235, A0013306735, A0014603448,
 A0014604148, A0014604448, A0014606348,
 A0014608348, A0014608448, A0014609748,
 A0023301535



DB-DL-5213

Length: 846
 Ø: 42
 Cone Ø: d1 Ø 26 / d2 Ø 23,5
 01208200A, 9704600705, 9704600905



DB-DL-7794

Length: 837 Ø: 40
 Cone Ø: d1 Ø 26 / d2 Ø 23,5
 9724601405, 9724601605



DB-DL-7815

Length: 895
 Ø: 50
 Cone Ø: d1 Ø 30 / d2 Ø 27
 01215800A, 34604605, 0034604605, 3754600005,
 9744601005, 9744601205



DB-DL-8644

Length: 894 Ø: 50
 Cone Ø: d1 Ø 30 / d2 Ø 27
 0034604705, 9744601105, 9744601305



DB-DL-8731

Length: 846
 Ø: 42
 Cone Ø: d1 Ø 26 / d2 Ø 23,5
 9704600805, 9704601005



DB-DL-9187

Length: 846 Ø: 42
 Cone Ø: d1 Ø 26 / d2 Ø 23,5
 9704601105, 9724602805, A9704601105,
 A9724602805



DB-DL-12298

Length: 927 Ø: 50
 Cone Ø: d1 Ø 30 / d2 Ø 27
 0024602405, 0024603005



DB-DL-12405

Length: 895 Ø: 50
 Cone Ø: d1 Ø 30 / d2 Ø 28,6
 Thread: M24 x 1,5 / M20 x 1,5
 9744602205, 9764600205, 9764600405,
 A9764600405



DB-ES-5214

Length: 1640 Ø: 40
 Cone Ø: d1 Ø 26 / d2 Ø 23,5
 01218000A, 9703300003, 9703300103,
 9703300203, 9703300303, 9703300403



DB-ES-8387

Length: 55
 Cone Ø: d1 Ø 10 / d2 Ø 10
 Thread: M14 x 1,5 RHT
 0009966845, 0009967045



DB-ES-8500

Length: 55
 Cone Ø: d1 Ø 12 / d2 Ø 10,8
 Thread: M14 x 1,5 RHT
 0002685989



DB-RK-8550

Ø: 75 Hole Distance: 152
 Thick/Height: 24
 0003502105, 0003504605



DB-SB-10385

Ø: 30 Thick/Height: 30
 3093200073, 3143260153



DB-SB-10386

Ø: 38 Thick/Height: 38
 3183200073



DB-TC-12411

Length: 655 Ø: 40
 Hole Distance: 115 / 115
 9723500906



DB-VB-10423

Length: 761,7 Ø: 46
 Hole Ø 25 / 23 / 23
 Hole Distance: 152 / 130 / 130
 9743500005, 9743500405, 9743500505





ATEGO 2 ...

826, 826 L	10/04 →	Centre Rod	DB-DL-12298		for Steering Rod	
	10/04 →	Centre Rod	DB-DL-12405		Coupling Rod	
829, 829 L	10/04 →	Centre Rod	DB-DL-12298		for Steering Rod	
	10/04 →	Centre Rod	DB-DL-12405		Coupling Rod	
915 K	10/04 →	Centre Rod	DB-DL-7794		Push Rod	
	10/04 →	Centre Rod	DB-DL-7799		Push Rod	
	10/04 →	Centre Rod	DB-DL-12298		for Steering Rod	
	10/04 →	Centre Rod	DB-DL-12405		Coupling Rod	
	10/04 →	Tie Rod	DB-DL-8174		Guide Rod, 1st Front Axle	
	10/04 →	Tie Rod	DB-ES-5214		Guide Rod, 1st Front Axle	
	10/04 →	Tie Rod End	CV-ES-12461		for Steering Rod	
	10/04 →	Tie Rod End	CV-ES-12462		for Steering Rod	
	10/04 →	Tie Rod End	CV-ES-14162		for Steering Rod	
	10/04 →	Tie Rod End	CV-ES-14163		for Steering Rod	
	915, 915 L, 916, 916 L	10/04 →	Ball Head, gearshift linkage	DB-ES-8387		
		10/04 →	Ball Head, gearshift linkage	DB-ES-8500		
10/04 →		Centre Rod	DB-DL-7794		Push Rod	
10/04 →		Centre Rod	DB-DL-7794		Push Rod, Leaf Spring Axle	
10/04 →		Centre Rod	DB-DL-7799		Push Rod, Leaf Spring Axle	
10/04 →		Centre Rod	DB-DL-9187		Push Rod	
10/04 →		Centre Rod	DB-DL-12405		Coupling Rod	
10/04 →		Stabiliser Mounting		DB-SB-10385		
10/04 →		Stabiliser Mounting		DB-SB-10385	1st RA	
10/04 →		Stabiliser Mounting		DB-SB-10386		
10/04 →		Stabiliser Mounting	DB-SB-10386	DB-SB-10386		
10/04 →		Stabiliser Mounting	DB-SB-10386	DB-SB-10386	1st FA	
10/04 →		Suspension Arm Repair Kit		DB-RK-8550	for Wishbone (CV)	
10/04 →		Tie Rod	DB-DL-8174		Guide Rod	
10/04 →		Tie Rod	DB-ES-5214		Guide Rod	
10/04 →		Tie Rod End	CV-ES-12461		for Steering Rod	
10/04 →		Tie Rod End	CV-ES-12462		for Steering Rod	
10/04 →		Tie Rod End	CV-ES-14162		for Steering Rod	
10/04 →		Tie Rod End	CV-ES-14163		for Steering Rod	
10/04 →		Track Control Arm		DB-TC-12411	Control Arm	
10/04 →		Track Control Arm		DB-VB-10423	Wishbone (CV), 1st Drive Axle, →508306 05	
916 K		10/04 →	Ball Head, gearshift linkage	DB-ES-8387		
		10/04 →	Ball Head, gearshift linkage	DB-ES-8500		
		10/04 →	Centre Rod	DB-DL-7794		Push Rod, Leaf Spring Axle
		10/04 →	Centre Rod	DB-DL-7799		Push Rod, Leaf Spring Axle
		10/04 →	Centre Rod	DB-DL-12405		Coupling Rod
		10/04 →	Stabiliser Mounting		DB-SB-10386	
		10/04 →	Stabiliser Mounting	DB-SB-10386	DB-SB-10386	
		10/04 →	Stabiliser Mounting	DB-SB-10386	DB-SB-10386	1st FA
		10/04 →	Tie Rod	DB-DL-8174		Guide Rod
		10/04 →	Tie Rod	DB-ES-5214		Guide Rod
		10/04 →	Tie Rod End	CV-ES-12461		for Steering Rod
	10/04 →	Tie Rod End	CV-ES-12462		for Steering Rod	
	10/04 →	Tie Rod End	CV-ES-14162		for Steering Rod	
	10/04 →	Tie Rod End	CV-ES-14163		for Steering Rod	
	916, 916 L	10/04 →	Centre Rod	DB-DL-7794		Push Rod
10/04 →		Centre Rod	DB-DL-7799		Push Rod	
10/04 →		Centre Rod	DB-DL-9187		Push Rod	
10/04 →		Centre Rod	DB-DL-12298		for Steering Rod	
10/04 →		Centre Rod	DB-DL-12405		Coupling Rod	
10/04 →		Tie Rod	DB-DL-8174		Guide Rod, 1st Front Axle	
10/04 →		Tie Rod	DB-ES-5214		Guide Rod, 1st Front Axle	
10/04 →		Tie Rod End	CV-ES-12461		for Steering Rod	
10/04 →		Tie Rod End	CV-ES-12462		for Steering Rod	
10/04 →		Tie Rod End	CV-ES-14162		for Steering Rod	
10/04 →		Tie Rod End	CV-ES-14163		for Steering Rod	

CV-ES-12461

Length: 120
Cone Ø: d1 Ø 26 / d2 Ø 23,5
Thread: M30 x 1,5 LHT
 0003300035, 3300148, 0003406213, 0013306635,
 0013308835, 0014604048, 0014604348,
 14606448, 0024600248, 3023300035,
 3023300135, 3023300235, 3023300335,
 3453307235, 3453307435, 3503307135,
 A0003300148, A0013306635, A0013308835,
 A0014604048, A0014604348, A0014606448,
 A0024600248, A3023300035, A3023300135,
 A3023300235, A3023300335, A3503307135



CV-ES-12462

Length: 120
Cone Ø: d1 Ø 26 / d2 Ø 23,5
Thread: M30 x 1,5 RHT
 0003300135, 0003300248, 0003303235,
 0003305835, 0003307335, 0003383410,
 0004608348, 004608348, 0004632229,
 0004633129, 0004633429, 0004633529,
 0013300135, 0013300235, 0013306735,
 0014603448, 0014604148, 0014604448,
 0014606348, 0014608348, 0014608448,
 0014609748, 0023301535, 3453307135,
 3503307035, 3503307335, 3643307135,
 5001832582, A0003300248, A0003303235,
 A0003307335, A0003383410, A0004608348,
 A0004632229, A0004633429, A0013300135,
 A0013300235, A0013306735, A0014603448,
 A0014604148, A0014604448, A0014606348,
 A0014608348, A0014608448, A0014609748,
 A0023301535



CV-ES-14162

Length: 125
Cone Ø: d1 Ø 30 / d2 Ø 27
Thread: M30 x 1,5 LHT
 4600648, 4601248, 4603448, 0004603548,
 4603548, 14600348, 14601448, 14602348, 001
 460 37 48, 14607848, 0014607848, 002 460 03 48



CV-ES-14163

Length: 125
Cone Ø: d1 Ø 30 / d2 Ø 27
Thread: M30 x 1,5 RHT
 0003305248, 0003387310, 0004600348,
 0004600948, 0004602848, 0004602948,
 0004608948, 0014600248, 0014600848,
 0014601248, 0014602248, 0014607748,
 0024600148, A0003387310, A0004600348,
 A0004602848, A0004602948, A0014600848,
 A0014601248, A0014602248, A0014607748



DB-DL-7794

Length: 837 Ø: 40
Cone Ø: d1 Ø 26 / d2 Ø 23,5
 9724601405, 9724601605



DB-DL-7799

Length: 895
Ø: 50
Cone Ø: d1 Ø 30 / d2 Ø 26
 34605905, 0034605905, 3754600305,
 9724601805, 9724602005



DB-DL-8174

Length: 1605 Ø: 40
Cone Ø: d1 Ø 30 / d2 Ø 27
 9753300203, 9753300303, 9753300803,
 9753301703, 9753302503



DB-DL-9187

Length: 846 Ø: 42
Cone Ø: d1 Ø 26 / d2 Ø 23,5
 9704601105, 9724602805, A9704601105,
 A9724602805



DB-DL-12298

Length: 927 Ø: 50
Cone Ø: d1 Ø 30 / d2 Ø 27
 0024602405, 0024603005



DB-DL-12405

Length: 895 Ø: 50
Cone Ø: d1 Ø 30 / d2 Ø 28,6
Thread: M24 x 1,5 / M20 x 1,5
 9744602205, 9764600205, 9764600405,
 A9764600405



DB-ES-5214

Length: 1640 Ø: 40
Cone Ø: d1 Ø 26 / d2 Ø 23,5
 01218000A, 9703300003, 9703300103,
 9703300203, 9703300303, 9703300403



DB-ES-8387

Length: 55
Cone Ø: d1 Ø 10 / d2 Ø 10
Thread: M14 x 1,5 RHT
 0009966845, 0009967045



DB-ES-8500

Length: 55
Cone Ø: d1 Ø 12 / d2 Ø 10,8
Thread: M14 x 1,5 RHT
 0002685989



DB-RK-8550

Ø: 75 **Hole Distance:** 152
Thick/Height: 24
 0003502105, 0003504605



DB-SB-10385

Ø: 30 **Thick/Height:** 30
 3093200073, 3143260153



DB-SB-10386

Ø: 38 **Thick/Height:** 38
 3183200073



DB-TC-12411

Length: 655 Ø: 40
Hole Distance: 115 / 115
 9723500906



DB-VB-10423

Length: 761,7 Ø: 46
Hole Ø: 25 / 23 / 23
Hole Distance: 152 / 130 / 130
 9743500005, 9743500405, 9743500505





ATEGO 2 ...

918 AF	10/04 →	Ball Head, gearshift linkage	DB-ES-8387			
	10/04 →	Ball Head, gearshift linkage	DB-ES-8500			
	10/04 →	Centre Rod	DB-DL-9247		Push Rod	
	10/04 →	Centre Rod	DB-DL-12298		for Steering Rod	
	10/04 →	Centre Rod	DB-DL-12405		Coupling Rod	
	10/04 →	Tie Rod End	CV-ES-12462		for Steering Rod	
918 K	10/04 →	Ball Head, gearshift linkage	DB-ES-8387			
	10/04 →	Ball Head, gearshift linkage	DB-ES-8500			
	10/04 →	Centre Rod	DB-DL-7794		Push Rod, Leaf Spring Axle	
	10/04 →	Centre Rod	DB-DL-7799		Push Rod, Leaf Spring Axle	
	10/04 →	Centre Rod	DB-DL-12405		Coupling Rod	
	10/04 →	Stabiliser Mounting		DB-SB-10386		
	10/04 →	Stabiliser Mounting	DB-SB-10386	DB-SB-10386		
	10/04 →	Stabiliser Mounting	DB-SB-10386	DB-SB-10386	1st FA	
	10/04 →	Tie Rod	DB-DL-8174		Guide Rod	
	10/04 →	Tie Rod	DB-ES-5214		Guide Rod	
	10/04 →	Tie Rod End	CV-ES-12461		for Steering Rod	
	10/04 →	Tie Rod End	CV-ES-12462		for Steering Rod	
	10/04 →	Tie Rod End	CV-ES-14162		for Steering Rod	
	10/04 →	Tie Rod End	CV-ES-14163		for Steering Rod	
	918, 918 L	10/04 →	Ball Head, gearshift linkage	DB-ES-8387		
		10/04 →	Ball Head, gearshift linkage	DB-ES-8500		
10/04 →		Centre Rod	DB-DL-7794		Push Rod	
10/04 →		Centre Rod	DB-DL-7794		Push Rod, Leaf Spring Axle	
10/04 →		Centre Rod	DB-DL-7799		Push Rod, Leaf Spring Axle	
10/04 →		Centre Rod	DB-DL-9187		Push Rod	
10/04 →		Centre Rod	DB-DL-12298		for Steering Rod	
10/04 →		Centre Rod	DB-DL-12405		Coupling Rod	
10/04 →		Stabiliser Mounting		DB-SB-10385		
10/04 →		Stabiliser Mounting		DB-SB-10385	1st RA	
10/04 →		Stabiliser Mounting		DB-SB-10386		
10/04 →		Stabiliser Mounting	DB-SB-10386	DB-SB-10386		
10/04 →		Stabiliser Mounting	DB-SB-10386	DB-SB-10386	1st FA	
10/04 →		Suspension Arm Repair Kit		DB-RK-8550	for Wishbone (CV)	
10/04 →		Tie Rod	DB-DL-8174		Guide Rod	
10/04 →		Tie Rod	DB-ES-5214		Guide Rod	
10/04 →		Tie Rod End	CV-ES-12461		for Steering Rod	
10/04 →		Tie Rod End	CV-ES-12462		for Steering Rod	
10/04 →		Tie Rod End	CV-ES-14162		for Steering Rod	
10/04 →		Tie Rod End	CV-ES-14163		for Steering Rod	
10/04 →		Track Control Arm		DB-TC-12411	Control Arm	
10/04 →		Track Control Arm		DB-VB-10423	Wishbone (CV), 1st Drive Axle, →508306 05	
922 AF		10/04 →	Ball Head, gearshift linkage	DB-ES-8387		
		10/04 →	Ball Head, gearshift linkage	DB-ES-8500		
		10/04 →	Centre Rod	DB-DL-9247		Push Rod
		10/04 →	Centre Rod	DB-DL-12298		for Steering Rod
	10/04 →	Centre Rod	DB-DL-12405		Coupling Rod	
	10/04 →	Tie Rod End	CV-ES-12462		for Steering Rod	
922 K	10/04 →	Ball Head, gearshift linkage	DB-ES-8387			
	10/04 →	Ball Head, gearshift linkage	DB-ES-8500			
	10/04 →	Centre Rod	DB-DL-7794		Push Rod, Leaf Spring Axle	
	10/04 →	Centre Rod	DB-DL-7799		Push Rod, Leaf Spring Axle	
	10/04 →	Centre Rod	DB-DL-12298		for Steering Rod	
	10/04 →	Centre Rod	DB-DL-12405		Coupling Rod	
	10/04 →	Stabiliser Mounting		DB-SB-10386		
	10/04 →	Stabiliser Mounting	DB-SB-10386	DB-SB-10386		
	10/04 →	Stabiliser Mounting	DB-SB-10386	DB-SB-10386	1st FA	
	10/04 →	Tie Rod	DB-DL-8174		Guide Rod	
	10/04 →	Tie Rod	DB-ES-5214		Guide Rod	
	10/04 →	Tie Rod End	CV-ES-12461		for Steering Rod	
	10/04 →	Tie Rod End	CV-ES-12462		for Steering Rod	
	10/04 →	Tie Rod End	CV-ES-14162		for Steering Rod	
10/04 →	Tie Rod End	CV-ES-14163		for Steering Rod		

CV-ES-12461

Length: 120
 Cone Ø: d1 Ø 26 / d2 Ø 23,5
 Thread: M30 x 1,5 LHT
 0003300035, 3300148, 0003406213, 0013306635,
 0013308835, 0014604048, 0014604348,
 14606448, 0024600248, 3023300035,
 3023300135, 3023300235, 3023300335,
 3453307235, 3453307435, 3503307135,
 A0003300148, A0013306635, A0013308835,
 A0014604048, A0014604348, A0014606448,
 A0024600248, A3023300035, A3023300135,
 A3023300235, A3023300335, A3503307135



CV-ES-12462

Length: 120
 Cone Ø: d1 Ø 26 / d2 Ø 23,5
 Thread: M30 x 1,5 RHT
 0003300135, 0003300248, 0003303235,
 0003305835, 0003307335, 0003383410,
 0004608348, 004608348, 0004632229,
 0004633129, 0004633429, 0004633529,
 0013300135, 0013300235, 0013306735,
 0014603448, 0014604148, 0014604448,
 0014606348, 0014608348, 0014608448,
 0014609748, 0023301535, 3453307135,
 3503307035, 3503307335, 3643307135,
 5001832582, A0003300248, A0003303235,
 A0003307335, A0003383410, A0004608348,
 A0004632229, A0004633429, A0013300135,
 A0013300235, A0013306735, A0014603448,
 A0014604148, A0014604448, A0014606348,
 A0014608348, A0014608448, A0014609748,
 A0023301535



CV-ES-14162

Length: 125
 Cone Ø: d1 Ø 30 / d2 Ø 27
 Thread: M30 x 1,5 LHT
 4600648, 4601248, 4603448, 0004603548,
 4603548, 14600348, 14601448, 14602348, 001
 460 37 48, 14607848, 0014607848, 002 460 03 48



CV-ES-14163

Length: 125
 Cone Ø: d1 Ø 30 / d2 Ø 27
 Thread: M30 x 1,5 RHT
 0003305248, 0003387310, 0004600348,
 0004600948, 0004602848, 0004602948,
 0004608948, 0014600248, 0014600848,
 0014601248, 0014602248, 0014607748,
 0024600148, A0003387310, A0004600348,
 A0004602848, A0004602948, A0014600848,
 A0014601248, A0014602248, A0014607748



DB-DL-7794

Length: 837 Ø: 40
 Cone Ø: d1 Ø 26 / d2 Ø 23,5
 9724601405, 9724601605



DB-DL-7799

Length: 895
 Ø: 50
 Cone Ø: d1 Ø 30 / d2 Ø 26
 34605905, 0034605905, 3754600305,
 9724601805, 9724602005



DB-DL-8174

Length: 1605 Ø: 40
 Cone Ø: d1 Ø 30 / d2 Ø 27
 9753300203, 9753300303, 9753300803,
 9753301703, 9753302503



DB-DL-9187

Length: 846 Ø: 42
 Cone Ø: d1 Ø 26 / d2 Ø 23,5
 9704601105, 9724602805, A9704601105,
 A9724602805



DB-DL-9247

Length: 873 Ø: 40
 Cone Ø: d1 Ø 26 / d2 Ø 23,5
 9724601005, 9724601205



DB-DL-12298

Length: 927 Ø: 50
 Cone Ø: d1 Ø 30 / d2 Ø 27
 0024602405, 0024603005



DB-DL-12405

Length: 895 Ø: 50
 Cone Ø: d1 Ø 30 / d2 Ø 28,6
 Thread: M24 x 1,5 / M20 x 1,5
 9744602205, 9764600205, 9764600405,
 A9764600405



DB-ES-5214

Length: 1640 Ø: 40
 Cone Ø: d1 Ø 26 / d2 Ø 23,5
 01218000A, 9703300003, 9703300103,
 9703300203, 9703300303, 9703300403



DB-ES-8387

Length: 55
 Cone Ø: d1 Ø 10 / d2 Ø 10
 Thread: M14 x 1,5 RHT
 0009966845, 0009967045



DB-ES-8500

Length: 55
 Cone Ø: d1 Ø 12 / d2 Ø 10,8
 Thread: M14 x 1,5 RHT
 0002685989



DB-RK-8550

Ø: 75 Hole Distance: 152
 Thick/Height: 24
 0003502105, 0003504605



DB-SB-10385

Ø: 30 Thick/Height: 30
 3093200073, 3143260153



DB-SB-10386

Ø: 38 Thick/Height: 38
 3183200073



DB-TC-12411

Length: 655 Ø: 40
 Hole Distance: 115 / 115
 9723500906



DB-VB-10423

Length: 761,7 Ø: 46
 Hole Ø 25 / 23 / 23
 Hole Distance: 152 / 130 / 130
 9743500005, 9743500405, 9743500505





ATEGO 2 ...

922, 922 L	10/04 →	Ball Head, gearshift linkage	DB-ES-8387			
	10/04 →	Ball Head, gearshift linkage	DB-ES-8500			
	10/04 →	Centre Rod	DB-DL-7794		Push Rod	
	10/04 →	Centre Rod	DB-DL-7794		Push Rod, Leaf Spring Axle	
	10/04 →	Centre Rod	DB-DL-7799		Push Rod, Leaf Spring Axle	
	10/04 →	Centre Rod	DB-DL-9187		Push Rod	
	10/04 →	Centre Rod	DB-DL-12298		for Steering Rod	
	10/04 →	Centre Rod	DB-DL-12405		Coupling Rod	
	10/04 →	Stabiliser Mounting		DB-SB-10385		
	10/04 →	Stabiliser Mounting		DB-SB-10385	1st RA	
	10/04 →	Stabiliser Mounting		DB-SB-10386		
	10/04 →	Stabiliser Mounting	DB-SB-10386	DB-SB-10386		
	10/04 →	Stabiliser Mounting	DB-SB-10386	DB-SB-10386	1st FA	
	10/04 →	Suspension Arm Repair Kit		DB-RK-8550	for Wishbone (CV)	
	10/04 →	Tie Rod	DB-DL-8174		Guide Rod	
	10/04 →	Tie Rod	DB-ES-5214		Guide Rod	
	10/04 →	Tie Rod End	CV-ES-12461		for Steering Rod	
	10/04 →	Tie Rod End	CV-ES-12462		for Steering Rod	
	10/04 →	Tie Rod End	CV-ES-14162		for Steering Rod	
	10/04 →	Tie Rod End	CV-ES-14163		for Steering Rod	
	10/04 →	Track Control Arm		DB-TC-12411	Control Arm	
	10/04 →	Track Control Arm		DB-VB-10423	Wishbone (CV), 1st Drive Axle, →508306 05	
	923, 923 L, 924, 924 L	10/04 →	Ball Head, gearshift linkage	DB-ES-8387		
		10/04 →	Ball Head, gearshift linkage	DB-ES-8500		
		10/04 →	Centre Rod	DB-DL-7794		Push Rod
		10/04 →	Centre Rod	DB-DL-7794		Push Rod, Leaf Spring Axle
		10/04 →	Centre Rod	DB-DL-7799		Push Rod, Leaf Spring Axle
		10/04 →	Centre Rod	DB-DL-9187		Push Rod
		10/04 →	Centre Rod	DB-DL-12298		for Steering Rod
		10/04 →	Centre Rod	DB-DL-12405		Coupling Rod
10/04 →		Stabiliser Mounting		DB-SB-10385		
10/04 →		Stabiliser Mounting		DB-SB-10385	1st RA	
10/04 →		Stabiliser Mounting		DB-SB-10386		
10/04 →		Stabiliser Mounting	DB-SB-10386	DB-SB-10386		
10/04 →		Stabiliser Mounting	DB-SB-10386	DB-SB-10386	1st FA	
10/04 →		Suspension Arm Repair Kit		DB-RK-8550	for Wishbone (CV)	
10/04 →		Tie Rod	DB-DL-8174		Guide Rod	
10/04 →		Tie Rod	DB-ES-5214		Guide Rod	
10/04 →		Tie Rod End	CV-ES-12461		for Steering Rod	
10/04 →		Tie Rod End	CV-ES-12462		for Steering Rod	
10/04 →		Tie Rod End	CV-ES-14162		for Steering Rod	
10/04 →		Tie Rod End	CV-ES-14163		for Steering Rod	
10/04 →		Track Control Arm		DB-TC-12411	Control Arm	
10/04 →		Track Control Arm		DB-VB-10423	Wishbone (CV), 1st Drive Axle, →508306 05	
924 K		10/04 →	Ball Head, gearshift linkage	DB-ES-8387		
		10/04 →	Ball Head, gearshift linkage	DB-ES-8500		
		10/04 →	Centre Rod	DB-DL-7794		Push Rod, Leaf Spring Axle
		10/04 →	Centre Rod	DB-DL-7799		Push Rod, Leaf Spring Axle
		10/04 →	Centre Rod	DB-DL-12298		for Steering Rod
		10/04 →	Centre Rod	DB-DL-12405		Coupling Rod
		10/04 →	Stabiliser Mounting		DB-SB-10386	
		10/04 →	Stabiliser Mounting	DB-SB-10386	DB-SB-10386	
	10/04 →	Stabiliser Mounting	DB-SB-10386	DB-SB-10386	1st FA	
	10/04 →	Tie Rod	DB-DL-8174		Guide Rod	
	10/04 →	Tie Rod	DB-ES-5214		Guide Rod	
	10/04 →	Tie Rod End	CV-ES-12461		for Steering Rod	
	10/04 →	Tie Rod End	CV-ES-12462		for Steering Rod	
	10/04 →	Tie Rod End	CV-ES-14162		for Steering Rod	
	10/04 →	Tie Rod End	CV-ES-14163		for Steering Rod	

CV-ES-12461

Length: 120
Cone Ø: d1 Ø 26 / d2 Ø 23,5
Thread: M30 x 1,5 LHT
 0003300035, 3300148, 0003406213, 0013306635,
 0013308835, 0014604048, 0014604348,
 14606448, 0024600248, 3023300035,
 3023300135, 3023300235, 3023300335,
 3453307235, 3453307435, 3503307135,
 A0003300148, A0013306635, A0013308835,
 A0014604048, A0014604348, A0014606448,
 A0024600248, A3023300035, A3023300135,
 A3023300235, A3023300335, A3503307135



CV-ES-12462

Length: 120
Cone Ø: d1 Ø 26 / d2 Ø 23,5
Thread: M30 x 1,5 RHT
 0003300135, 0003300248, 0003303235,
 0003305835, 0003307335, 0003383410,
 0004608348, 004608348, 0004632229,
 0004633129, 0004633429, 0004633529,
 0013300135, 0013300235, 0013306735,
 0014603448, 0014604148, 0014604448,
 0014606348, 0014608348, 0014608448,
 0014609748, 0023301535, 3453307135,
 3503307035, 3503307335, 3643307135,
 5001832582, A0003300248, A0003303235,
 A0003307335, A0003383410, A0004608348,
 A0004632229, A0004633429, A0013300135,
 A0013300235, A0013306735, A0014603448,
 A0014604148, A0014604448, A0014606348,
 A0014608348, A0014608448, A0014609748,
 A0023301535



CV-ES-14162

Length: 125
Cone Ø: d1 Ø 30 / d2 Ø 27
Thread: M30 x 1,5 LHT
 4600648, 4601248, 4603448, 0004603548,
 14600348, 14601448, 14602348, 0014603748,
 0014607848, 0024600348



CV-ES-14163

Length: 125
Cone Ø: d1 Ø 30 / d2 Ø 27
Thread: M30 x 1,5 RHT
 0003305248, 0003387310, 0004600348,
 0004600948, 0004602848, 0004602948,
 0004608948, 0014600248, 0014600848,
 0014601248, 0014602248, 0014607748,
 0024600148, A0003387310, A0004600348,
 A0004602848, A0004602948, A0014600848,
 A0014601248, A0014602248, A0014607748



DB-DL-7794

Length: 837 **Ø:** 40
Cone Ø: d1 Ø 26 / d2 Ø 23,5
 9724601405, 9724601605



DB-DL-7799

Length: 895 **Ø:** 50
Cone Ø: d1 Ø 30 / d2 Ø 26
 0034605905, 3754600305, 9724601805,
 9724602005



DB-DL-8174

Length: 1605 **Ø:** 40
Cone Ø: d1 Ø 30 / d2 Ø 27
 9753300203, 9753300303, 9753300803,
 9753301703, 9753302503



DB-DL-9187

Length: 846 **Ø:** 42
Cone Ø: d1 Ø 26 / d2 Ø 23,5
 9704601105, 9724602805, A9704601105,
 A9724602805



DB-DL-12298

Length: 927 **Ø:** 50
Cone Ø: d1 Ø 30 / d2 Ø 27
 0024602405, 0024603005



DB-DL-12405

Length: 895 **Ø:** 50
Cone Ø: d1 Ø 30 / d2 Ø 28,6
Thread: M24 x 1,5 / M20 x 1,5
 9744602205, 9764600205, 9764600405,
 A9764600405



DB-ES-5214

Length: 1640 **Ø:** 40
Cone Ø: d1 Ø 26 / d2 Ø 23,5
 01218000A, 9703300003, 9703300103,
 9703300203, 9703300303, 9703300403



DB-ES-8387

Length: 55
Cone Ø: d1 Ø 10 / d2 Ø 10
Thread: M14 x 1,5 RHT
 0009966845, 0009967045



DB-ES-8500

Length: 55
Cone Ø: d1 Ø 12 / d2 Ø 10,8
Thread: M14 x 1,5 RHT
 0002685989



DB-RK-8550

Ø: 75 **Hole Distance:** 152
Thick/Height: 24
 0003502105, 0003504605



DB-SB-10385

Ø: 30 **Thick/Height:** 30
 3093200073, 3143260153



DB-SB-10386

Ø: 38 **Thick/Height:** 38
 3183200073



DB-TC-12411

Length: 655 **Ø:** 40
Hole Distance: 115 / 115
 9723500906



DB-VB-10423

Length: 761,7 **Ø:** 46
Hole Ø: 25 / 23 / 23
Hole Distance: 152 / 130 / 130
 9743500005, 9743500405, 9743500505





ATEGO 2 ...

924, 924 L	10/04 →	Centre Rod	DB-DL-7794		Push Rod
	10/04 →	Centre Rod	DB-DL-7799		Push Rod
	10/04 →	Centre Rod	DB-DL-9187		Push Rod
	10/04 →	Centre Rod	DB-DL-12298		for Steering Rod
	10/04 →	Centre Rod	DB-DL-12405		Coupling Rod
	10/04 →	Tie Rod	DB-DL-8174		Guide Rod, 1st Front Axle
	10/04 →	Tie Rod	DB-ES-5214		Guide Rod, 1st Front Axle
	10/04 →	Tie Rod End	CV-ES-12461		for Steering Rod
	10/04 →	Tie Rod End	CV-ES-12462		for Steering Rod
	10/04 →	Tie Rod End	CV-ES-14162		for Steering Rod
	10/04 →	Tie Rod End	CV-ES-14163		for Steering Rod
926 AF	10/04 →	Ball Head, gearshift linkage	DB-ES-8387		
	10/04 →	Ball Head, gearshift linkage	DB-ES-8500		
	10/04 →	Centre Rod	DB-DL-9247		Push Rod
	10/04 →	Centre Rod	DB-DL-12298		for Steering Rod
	10/04 →	Centre Rod	DB-DL-12405		Coupling Rod
	10/04 →	Tie Rod End	CV-ES-12462		for Steering Rod
926, 926 L	10/04 →	Centre Rod	DB-DL-12298		for Steering Rod
	10/04 →	Centre Rod	DB-DL-12405		Coupling Rod
929, 929 L	10/04 →	Centre Rod	DB-DL-12298		for Steering Rod
	10/04 →	Centre Rod	DB-DL-12405		Coupling Rod

ATEGO 3

1016, 1016 L	04/13 →	Tie Rod End	CV-ES-12462		for Steering Rod
	04/13 →	Track Control Arm		DB-TC-12411	Control Arm
1018 A	04/13 →	Tie Rod End	CV-ES-12462		for Steering Rod
1018 AK	04/13 →	Tie Rod End	CV-ES-12462		for Steering Rod
1018, 1018 L	04/13 →	Tie Rod End	CV-ES-12462		for Steering Rod
	04/13 →	Track Control Arm		DB-TC-12411	Control Arm
1021 A	04/13 →	Tie Rod End	CV-ES-12462		for Steering Rod
1021 AK	04/13 →	Tie Rod End	CV-ES-12462		for Steering Rod
1021, 1021 L	04/13 →	Tie Rod End	CV-ES-12462		for Steering Rod
	04/13 →	Track Control Arm		DB-TC-12411	Control Arm
1023 A	04/13 →	Tie Rod End	CV-ES-12462		for Steering Rod
1023 AK	04/13 →	Tie Rod End	CV-ES-12462		for Steering Rod
1023, 1023 L	04/13 →	Tie Rod End	CV-ES-12462		for Steering Rod
	04/13 →	Track Control Arm		DB-TC-12411	Control Arm
1024 A	04/13 →	Tie Rod End	CV-ES-12462		for Steering Rod
1024 AK	04/13 →	Tie Rod End	CV-ES-12462		for Steering Rod
1024, 1024 L	04/13 →	Tie Rod End	CV-ES-12462		for Steering Rod
	04/13 →	Track Control Arm		DB-TC-12411	Control Arm
1216, 1216 L	04/13 →	Tie Rod End	CV-ES-14163		for Steering Rod
	04/13 →	Track Control Arm		DB-TC-12411	Control Arm
1218, 1218 L	04/13 →	Tie Rod End	CV-ES-14163		for Steering Rod
	04/13 →	Track Control Arm		DB-TC-12411	Control Arm
1221, 1221 L	04/13 →	Tie Rod End	CV-ES-14163		for Steering Rod
	04/13 →	Track Control Arm		DB-TC-12411	Control Arm
1223 AF	04/13 →	Tie Rod	DB-DL-12311		
	04/13 →	Tie Rod End	CV-ES-14163		for Steering Rod
1223, 1223 L	04/13 →	Tie Rod End	CV-ES-14163		for Steering Rod
	04/13 →	Track Control Arm		DB-TC-12411	Control Arm
1224, 1224 L	04/13 →	Tie Rod End	CV-ES-14163		for Steering Rod
	04/13 →	Track Control Arm		DB-TC-12411	Control Arm
1227 AF	04/13 →	Tie Rod	DB-DL-12311		
	04/13 →	Tie Rod End	CV-ES-14163		for Steering Rod
1227, 1227 L	04/13 →	Tie Rod End	CV-ES-14163		for Steering Rod
	04/13 →	Track Control Arm		DB-TC-12411	Control Arm
1230 AF	04/13 →	Tie Rod	DB-DL-12311		
	04/13 →	Tie Rod End	CV-ES-14163		for Steering Rod
1230, 1230 L	04/13 →	Tie Rod End	CV-ES-14163		for Steering Rod
	04/13 →	Track Control Arm		DB-TC-12411	Control Arm
1318 A	04/13 →	Tie Rod	DB-DL-12311		
	04/13 →	Tie Rod End	CV-ES-14163		for Steering Rod

CV-ES-12461

Length: 120
Cone Ø: d1 Ø 26 / d2 Ø 23,5
Thread: M30 x 1,5 LHT
 0003300035, 3300148, 0003406213, 0013306635,
 0013308835, 0014604048, 0014604348,
 14606448, 0024600248, 3023300035,
 3023300135, 3023300235, 3023300335,
 3453307235, 3453307435, 3503307135,
 A0003300148, A0013306635, A0013308835,
 A0014604048, A0014604348, A0014606448,
 A0024600248, A3023300035, A3023300135,
 A3023300235, A3023300335, A3503307135



CV-ES-12462

Length: 120
Cone Ø: d1 Ø 26 / d2 Ø 23,5
Thread: M30 x 1,5 RHT
 0003300135, 0003300248, 0003303235,
 0003305835, 0003307335, 0003383410,
 0004608348, 004608348, 0004632229,
 0004633129, 0004633429, 0004633529,
 0013300135, 0013300235, 0013306735,
 0014603448, 0014604148, 0014604448,
 0014606348, 0014608348, 0014608448,
 0014609748, 0023301535, 3453307135,
 3503307035, 3503307335, 3643307135,
 5001832582, A0003300248, A0003303235,
 A0003307335, A0003383410, A0004608348,
 A0004632229, A0004633429, A0013300135,
 A0013300235, A0013306735, A0014603448,
 A0014604148, A0014604448, A0014606348,
 A0014608348, A0014608448, A0014609748,
 A0023301535



CV-ES-14162

Length: 125
Cone Ø: d1 Ø 30 / d2 Ø 27
Thread: M30 x 1,5 LHT
 4600648, 4601248, 4603448, 0004603548,
 14600348, 14601448, 14602348, 0014603748,
 0014607848, 0024600348



CV-ES-14163

Length: 125
Cone Ø: d1 Ø 30 / d2 Ø 27
Thread: M30 x 1,5 RHT
 0003305248, 0003387310, 0004600348,
 0004600948, 0004602848, 0004602948,
 0004608948, 0014600248, 0014600848,
 0014601248, 0014602248, 0014607748,
 0024600148, A0003387310, A0004600348,
 A0004602848, A0004602948, A0014600848,
 A0014601248, A0014602248, A0014607748



DB-DL-7794

Length: 837 Ø: 40
Cone Ø: d1 Ø 26 / d2 Ø 23,5
 9724601405, 9724601605



DB-DL-7799

Length: 895 Ø: 50
Cone Ø: d1 Ø 30 / d2 Ø 26
 0034605905, 3754600305, 9724601805,
 9724602005



DB-DL-8174

Length: 1605 Ø: 40
Cone Ø: d1 Ø 30 / d2 Ø 27
 9753300203, 9753300303, 9753300803,
 9753301703, 9753302503



DB-DL-9187

Length: 846 Ø: 42
Cone Ø: d1 Ø 26 / d2 Ø 23,5
 9704601105, 9724602805, A9704601105,
 A9724602805



DB-DL-9247

Length: 873 Ø: 40
Cone Ø: d1 Ø 26 / d2 Ø 23,5
 9724601005, 9724601205



DB-DL-12298

Length: 927 Ø: 50
Cone Ø: d1 Ø 30 / d2 Ø 27
 0024602405, 0024603005



DB-DL-12311

Length: 1565 Ø: 60
Cone Ø: d1 Ø 30 / d2 Ø 27
 9753300003, 9753300403, 9753301003,
 9753301903, A9753300003, A9753300403,
 A9753301003, A9753301903

No Image

DB-DL-12405

Length: 895 Ø: 50
Cone Ø: d1 Ø 30 / d2 Ø 28,6
Thread: M24 x 1,5 / M20 x 1,5
 9744602205, 9764600205, 9764600405,
 A9764600405



DB-ES-5214

Length: 1640 Ø: 40
Cone Ø: d1 Ø 26 / d2 Ø 23,5
 01218000A, 9703300003, 9703300103,
 9703300203, 9703300303, 9703300403



DB-ES-8387

Length: 55
Cone Ø: d1 Ø 10 / d2 Ø 10
Thread: M14 x 1,5 RHT
 0009966845, 0009967045



DB-ES-8500

Length: 55
Cone Ø: d1 Ø 12 / d2 Ø 10,8
Thread: M14 x 1,5 RHT
 0002685989



DB-TC-12411

Length: 655 Ø: 40
Hole Distance: 115 / 115
 9723500906



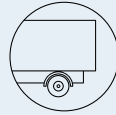

ATEGO 3 ...

1318 AK	04/13→	Tie Rod	DB-DL-12311	
	04/13→	Tie Rod End	CV-ES-14163	for Steering Rod
1318 K	04/13→	Tie Rod End	CV-ES-14163	for Steering Rod
1321 A	04/13→	Tie Rod	DB-DL-12311	
	04/13→	Tie Rod End	CV-ES-14163	for Steering Rod
1321 AK	04/13→	Tie Rod	DB-DL-12311	
	04/13→	Tie Rod End	CV-ES-14163	for Steering Rod
1321 K	04/13→	Tie Rod End	CV-ES-14163	for Steering Rod
1321 LS	04/13→	Tie Rod End	CV-ES-14163	for Steering Rod
1323 A	04/13→	Tie Rod	DB-DL-12311	
	04/13→	Tie Rod End	CV-ES-14163	for Steering Rod
1323 AF	04/13→	Tie Rod	DB-DL-12311	
	04/13→	Tie Rod End	CV-ES-14163	for Steering Rod
1323 AK	04/13→	Tie Rod	DB-DL-12311	
	04/13→	Tie Rod End	CV-ES-14163	for Steering Rod
1323 F	04/13→	Tie Rod End	CV-ES-14163	for Steering Rod
1323 K	04/13→	Tie Rod End	CV-ES-14163	for Steering Rod
1323 LS	04/13→	Tie Rod End	CV-ES-14163	for Steering Rod
1324 A	04/13→	Tie Rod	DB-DL-12311	
	04/13→	Tie Rod End	CV-ES-14163	for Steering Rod
1324 AK	04/13→	Tie Rod	DB-DL-12311	
	04/13→	Tie Rod End	CV-ES-14163	for Steering Rod
1324 K	04/13→	Tie Rod End	CV-ES-14163	for Steering Rod
1324 LS	04/13→	Tie Rod End	CV-ES-14163	for Steering Rod
1327 AF	04/13→	Tie Rod	DB-DL-12311	
	04/13→	Tie Rod End	CV-ES-14163	for Steering Rod
1327 AK	04/13→	Tie Rod	DB-DL-12311	
	04/13→	Tie Rod End	CV-ES-14163	for Steering Rod
1327 F	04/13→	Tie Rod End	CV-ES-14163	for Steering Rod
1327 K	04/13→	Tie Rod End	CV-ES-14163	for Steering Rod
1327 LS	04/13→	Tie Rod End	CV-ES-14163	for Steering Rod
1330 AF	04/13→	Tie Rod	DB-DL-12311	
	04/13→	Tie Rod End	CV-ES-14163	for Steering Rod
1330 AK	04/13→	Tie Rod	DB-DL-12311	
	04/13→	Tie Rod End	CV-ES-14163	for Steering Rod
1330 F	04/13→	Tie Rod End	CV-ES-14163	for Steering Rod
1330 K	04/13→	Tie Rod End	CV-ES-14163	for Steering Rod
1330 LS	04/13→	Tie Rod End	CV-ES-14163	for Steering Rod
1518 A	04/13→	Tie Rod	DB-DL-12311	
	04/13→	Tie Rod End	CV-ES-14163	for Steering Rod
1518 K	04/13→	Tie Rod End	CV-ES-14163	for Steering Rod
1521 A	04/13→	Tie Rod	DB-DL-12311	
	04/13→	Tie Rod End	CV-ES-14163	for Steering Rod
1521 AK	04/13→	Tie Rod	DB-DL-12311	
	04/13→	Tie Rod End	CV-ES-14163	for Steering Rod
1521 K	04/13→	Tie Rod End	CV-ES-14163	for Steering Rod
1523 A	04/13→	Tie Rod	DB-DL-12311	
	04/13→	Tie Rod End	CV-ES-14163	for Steering Rod
1523 AK	04/13→	Tie Rod	DB-DL-12311	
	04/13→	Tie Rod End	CV-ES-14163	for Steering Rod
1523 K	04/13→	Tie Rod End	CV-ES-14163	for Steering Rod
1524 A	04/13→	Tie Rod	DB-DL-12311	
	04/13→	Tie Rod End	CV-ES-14163	for Steering Rod
1524 AK	04/13→	Tie Rod	DB-DL-12311	
	04/13→	Tie Rod End	CV-ES-14163	for Steering Rod
1524 K	04/13→	Tie Rod End	CV-ES-14163	for Steering Rod
1527 AF	04/13→	Tie Rod	DB-DL-12311	
	04/13→	Tie Rod End	CV-ES-14163	for Steering Rod
1527 AK	04/13→	Tie Rod	DB-DL-12311	
	04/13→	Tie Rod End	CV-ES-14163	for Steering Rod
1527 F	04/13→	Tie Rod End	CV-ES-14163	for Steering Rod
1527 K	04/13→	Tie Rod End	CV-ES-14163	for Steering Rod

CV-ES-14163

Length: 125

Cone Ø: d1 Ø 30 / d2 Ø 27

Thread: M30 x 1,5 RHT

0003305248, 0003387310, 0004600348,
0004600948, 0004602848, 0004602948,
0004608948, 0014600248, 0014600848,
0014601248, 0014602248, 0014607748,
0024600148, A0003387310, A0004600348,
A0004602848, A0004602948, A0014600848,
A0014601248, A0014602248, A0014607748



DB-DL-12311

Length: 1565 Ø: 60

Cone Ø: d1 Ø 30 / d2 Ø 27

9753300003, 9753300403, 9753301003,
9753301903, A9753300003, A9753300403,
A9753301003, A9753301903

No Image



ATEGO 3 ...

1530 AF	04/13→	Tie Rod	DB-DL-12311	
	04/13→	Tie Rod End	CV-ES-14163	for Steering Rod
1530 AK	04/13→	Tie Rod	DB-DL-12311	
	04/13→	Tie Rod End	CV-ES-14163	for Steering Rod
1530 F	04/13→	Tie Rod End	CV-ES-14163	for Steering Rod
1530 K	04/13→	Tie Rod End	CV-ES-14163	for Steering Rod
716, 716 L	04/13→	Tie Rod End	CV-ES-12462	for Steering Rod
	04/13→	Track Control Arm		DB-TC-12411 Control Arm
718, 718 L	04/13→	Tie Rod End	CV-ES-12462	for Steering Rod
	04/13→	Track Control Arm		DB-TC-12411 Control Arm
721, 721 L	04/13→	Tie Rod End	CV-ES-12462	for Steering Rod
	04/13→	Track Control Arm		DB-TC-12411 Control Arm
723, 723 L	04/13→	Tie Rod End	CV-ES-12462	for Steering Rod
	04/13→	Track Control Arm		DB-TC-12411 Control Arm
816 K	04/13→	Tie Rod End	CV-ES-12462	for Steering Rod
816, 816 L	04/13→	Tie Rod End	CV-ES-12462	for Steering Rod
	04/13→	Track Control Arm		DB-TC-12411 Control Arm
818 K	04/13→	Tie Rod End	CV-ES-12462	for Steering Rod
818, 818 L	04/13→	Tie Rod End	CV-ES-12462	for Steering Rod
	04/13→	Track Control Arm		DB-TC-12411 Control Arm
821 K	04/13→	Tie Rod End	CV-ES-12462	for Steering Rod
821, 821 L	04/13→	Tie Rod End	CV-ES-12462	for Steering Rod
	04/13→	Track Control Arm		DB-TC-12411 Control Arm
823 K	04/13→	Tie Rod End	CV-ES-12462	for Steering Rod
823, 823 L	04/13→	Tie Rod End	CV-ES-12462	for Steering Rod
	04/13→	Track Control Arm		DB-TC-12411 Control Arm
824 K	04/13→	Tie Rod End	CV-ES-12462	for Steering Rod
824, 824 L	04/13→	Tie Rod End	CV-ES-12462	for Steering Rod
	04/13→	Track Control Arm		DB-TC-12411 Control Arm
916, 916 L	04/13→	Tie Rod End	CV-ES-12462	for Steering Rod
	04/13→	Track Control Arm		DB-TC-12411 Control Arm
918 AF	04/13→	Tie Rod End	CV-ES-12462	for Steering Rod
918, 918 L	04/13→	Tie Rod End	CV-ES-12462	for Steering Rod
	04/13→	Track Control Arm		DB-TC-12411 Control Arm
921, 921 L	04/13→	Tie Rod End	CV-ES-12462	for Steering Rod
	04/13→	Track Control Arm		DB-TC-12411 Control Arm
923 AF	04/13→	Tie Rod End	CV-ES-12462	for Steering Rod
923, 923 L	04/13→	Tie Rod End	CV-ES-12462	for Steering Rod
	04/13→	Track Control Arm		DB-TC-12411 Control Arm
924, 924 L	04/13→	Tie Rod End	CV-ES-12462	for Steering Rod
	04/13→	Track Control Arm		DB-TC-12411 Control Arm
927 AF	04/13→	Tie Rod End	CV-ES-12462	for Steering Rod

AXOR

1823	01/02→10/04	Bush, driver cab suspension	DB-SB-10384	
	01/02→10/04	Centre Rod	DB-DL-5230	Suspension Rod
	01/02→10/04	Centre Rod	DB-DL-5241	Suspension Rod
	01/02→10/04	Centre Rod	DB-DL-5405	Push Rod
	01/02→10/04	Centre Rod	DB-DL-7270	Push Rod;Suspension Rod
	01/02→10/04	Centre Rod	DB-DL-8184	Push Rod
	01/02→10/04	Centre Rod	DB-DL-8185	Push Rod
	01/02→10/04	Centre Rod	DB-DL-8188	Push Rod
	01/02→10/04	Centre Rod	DB-DL-9258	Push Rod
	01/02→10/04	Centre Rod	DB-DL-12300	for Steering Rod
	01/02→10/04	Rod Assembly	DB-DL-2178	Guide Rod
	01/02→10/04	Stabiliser Mounting	DB-SB-10410	
	01/02→10/04	Suspension Arm Repair Kit		DB-RK-8550 for Wishbone (CV)
	01/02→10/04	Suspension Arm Repair Kit		DB-RK-8626 for Wishbone (CV)
	01/02→10/04	Suspension Arm Repair Kit		DB-RK-10374 for Wishbone (CV)
	01/02→10/04	Suspension Arm Repair Kit		DB-RK-10375 for Wishbone (CV)
	01/02→10/04	Suspension Strut Repair Kit		MN-RK-8997
	01/02→10/04	Tie Rod	DB-DL-8171	Guide Rod
	01/02→10/04	Tie Rod	DB-DL-8327	Guide Rod

CV-ES-12462

Length: 120
 Cone Ø: d1 Ø 26 / d2 Ø 23,5
 Thread: M30 x 1,5 RHT
 0003300135, 0003300248, 0003303235,
 0003305835, 0003307335, 0003383410,
 0004608348, 0004608348, 0004632229,
 0004633129, 0004633429, 0004633529,
 0013300135, 0013300235, 0013306735,
 0014603448, 0014604148, 0014604448,
 0014606348, 0014608348, 0014608448,
 0014609748, 0023301535, 3453307135,
 3503307035, 3503307335, 3643307135,
 5001832582, A0003300248, A0003303235,
 A0003307335, A0003383410, A0004608348,
 A0004632229, A0004633429, A0013300135,
 A0013300235, A0013306735, A0014603448,
 A0014604148, A0014604448, A0014606348,
 A0014608348, A0014608448, A0014609748,
 A0023301535



CV-ES-14163

Length: 125
 Cone Ø: d1 Ø 30 / d2 Ø 27
 Thread: M30 x 1,5 RHT
 0003305248, 0003387310, 0004600348,
 0004600948, 0004602848, 0004602948,
 0004608948, 0014600248, 0014600848,
 0014601248, 0014602248, 0014607748,
 0024600148, A0003387310, A0004600348,
 A0004602848, A0004602948, A0014600848,
 A0014601248, A0014602248, A0014607748



DB-DL-2178

Length: 1735 Ø: 52
 Cone Ø: d1 Ø 32 / d2 Ø 29
 9423300003, 9423300103, 9423300203



DB-DL-5230

Length: 879 Ø: 42
 Cone Ø: d1 Ø 30 / d2 Ø 27
 01208600A, 0004607105, 0004607205,
 0014606705



DB-DL-5241

Length: 875 Ø: 40
 Cone Ø: d1 Ø 30 / d2 Ø 27
 01215300A, 0004609205, 0004609305,
 0014606905



DB-DL-5405

Length: 890 Ø: 35
 Cone Ø: d1 Ø 28,6 / d2 Ø 23,9
 01215900A, 1460248, 0024604505, 0024604605,
 0034605005, 3752600637, 3754600405,
 A3752600637, A3754600405



DB-DL-7270

Length: 875 Ø: 40
 Cone Ø: d1 Ø 28,6 / d2 Ø 23,9
 01208300A, 0024604705, 0024604805,
 0034604905, A0024604705



DB-DL-8171

Length: 1687 Ø: 52
 Cone Ø: d1 Ø 32 / d2 Ø 29
 9493300603, 9493300703, 9493301503,
 9493301603



DB-DL-8184

Length: 1095 Ø: 42
 Cone Ø: d1 Ø 32 / d2 Ø 28,8
 01217700A, 0014601305, 0014601405,
 0024600505, 0034603205, 3754601505,
 A0014601305, A0014601405, A0024600505



DB-DL-8185

Length: 711 Ø: 42
 Cone Ø: d1 Ø 32 / d2 Ø 28,8
 01213600A, 0014601105, 0024600405,
 0034603105, A0014601105, A0024600405



DB-DL-8188

Length: 895 Ø: 40
 Cone Ø: d1 Ø 28,6 / d2 Ø 23,9
 01217200A, 0024604905, 0024605005,
 0034605605



DB-DL-8327

Length: 1745 Ø: 48
 Cone Ø: d1 Ø 32 / d2 Ø 29
 01219800A, 9413300003, 9413300103,
 9413300203, 9413300303, 9413300503



DB-DL-9258

Length: 905
 Ø: 42
 Cone Ø: d1 Ø 28,6 / d2 Ø 23,9
 3754600605, 3754601105



DB-DL-12300

Length: 733 Ø: 36
 Cone Ø: d1 Ø 32 / d2 Ø 29
 0014601505, 0014607305, 0034603305,
 3754601605, A0014601505, A0034603305,
 A3754601605



DB-DL-12311

Length: 1565 Ø: 60
 Cone Ø: d1 Ø 30 / d2 Ø 27
 9753300003, 9753300403, 9753301003,
 9753301903, A9753300003, A9753300403,
 A9753301003, A9753301903

No Image

DB-RK-8550

Ø: 75 Hole Distance: 152
 Thick/Height: 24
 0003502105, 0003504605



DB-RK-8626

Ø: 75 Hole Distance: 130
 Thick/Height: 24
 0003502205, 0003502505, 0003503405,
 0003504505, GL11319



DB-RK-10374

Ø: 85 Hole Distance: 152
 Thick/Height: 24
 0003504405



DB-RK-10375

Ø: 100 Hole Distance: 152
 Thick/Height: 24
 0003502405, 0003503505, 0003504905



DB-SB-10384

Ø: 73 Thick/Height: 47
 9303170012, 9423171812



DB-SB-10410

Ø: 73 Hole Distance: 100
 Thick/Height: 24
 9413230050





AXOR ...

1823 ...	01/02→10/04	Tie Rod End	CV-ES-14162		for Steering Rod
	01/02→10/04	Tie Rod End	CV-ES-14163		for Steering Rod
	01/02→10/04	Tie Rod End	DB-ES-8164		for Push Rod
	01/02→10/04	Tie Rod End	DB-ES-8530		for Push Rod
	01/02→10/04	Track Control Arm		DB-VB-7798	Wishbone (CV)
1823 K	01/02→10/04	Bush, driver cab suspension	DB-SB-10384		
	01/02→10/04	Centre Rod	DB-DL-5405		Push Rod
	01/02→10/04	Centre Rod	DB-DL-7270		Push Rod;Suspension Rod
	01/02→10/04	Centre Rod	DB-DL-8184		Push Rod
	01/02→10/04	Centre Rod	DB-DL-8185		Push Rod
	01/02→10/04	Centre Rod	DB-DL-8188		Push Rod
	01/02→10/04	Centre Rod	DB-DL-9258		Push Rod
	01/02→10/04	Centre Rod	DB-DL-12300		for Steering Rod
	01/02→10/04	Rod Assembly	DB-DL-2178		Guide Rod
	01/02→10/04	Stabiliser Mounting	DB-SB-10410		
	01/02→10/04	Suspension Arm Repair Kit		DB-RK-8550	for Wishbone (CV)
	01/02→10/04	Suspension Arm Repair Kit		DB-RK-8626	for Wishbone (CV)
	01/02→10/04	Suspension Arm Repair Kit		DB-RK-10374	for Wishbone (CV)
	01/02→10/04	Suspension Arm Repair Kit		DB-RK-10375	for Wishbone (CV)
	01/02→10/04	Suspension Strut Repair Kit		MN-RK-8997	
	01/02→10/04	Tie Rod	DB-DL-8171		Guide Rod
	01/02→10/04	Tie Rod	DB-DL-8327		Guide Rod
	01/02→10/04	Tie Rod End	CV-ES-14162		for Steering Rod
	01/02→10/04	Tie Rod End	CV-ES-14163		for Steering Rod
	01/02→10/04	Tie Rod End	DB-ES-8164		for Push Rod
	01/02→10/04	Tie Rod End	DB-ES-8530		for Push Rod
01/02→10/04	Track Control Arm		DB-VB-7798	Wishbone (CV)	
1835 LS	01/02→10/04	Bush, driver cab suspension	DB-SB-10384		
	01/02→10/04	Centre Rod	DB-DL-5230		Suspension Rod
	01/02→10/04	Centre Rod	DB-DL-5241		Suspension Rod
	01/02→10/04	Centre Rod	DB-DL-5405		Push Rod
	01/02→10/04	Centre Rod	DB-DL-7270		Push Rod;Suspension Rod
	01/02→10/04	Centre Rod	DB-DL-8122		Push Rod
	01/02→10/04	Centre Rod	DB-DL-8184		Push Rod
	01/02→10/04	Centre Rod	DB-DL-8185		Push Rod
	01/02→10/04	Centre Rod	DB-DL-8188		Push Rod, Air Suspension Axle
	01/02→10/04	Centre Rod	DB-DL-12300		for Steering Rod
	01/02→10/04	Rod Assembly	DB-DL-2178		Guide Rod
	01/02→10/04	Stabiliser Mounting		DB-RK-9296	
	01/02→10/04	Stabiliser Mounting		DB-SB-10406	
	01/02→10/04	Stabiliser Mounting		DB-SB-10409	
	01/02→10/04	Stabiliser Mounting	DB-SB-10410		
	01/02→10/04	Suspension Arm Repair Kit		DB-RK-8550	for Wishbone (CV)
	01/02→10/04	Suspension Arm Repair Kit		DB-RK-8626	for Wishbone (CV)
	01/02→10/04	Suspension Arm Repair Kit		DB-RK-10374	for Wishbone (CV)
	01/02→10/04	Suspension Arm Repair Kit		DB-RK-10375	for Wishbone (CV)
	01/02→10/04	Suspension Strut Repair Kit		MN-RK-8997	
	01/02→10/04	Tie Rod	DB-DL-8327		Guide Rod
	01/02→10/04	Tie Rod End	CV-ES-14162		for Steering Rod
	01/02→10/04	Tie Rod End	CV-ES-14163		for Steering Rod
	01/02→10/04	Tie Rod End	DB-ES-8164		for Push Rod
	01/02→10/04	Tie Rod End	DB-ES-8530		for Push Rod
	01/02→10/04	Track Control Arm		DB-VB-7798	Wishbone (CV), Air Suspension Axle, * L 041976 *→
	1840 LS	01/02→10/04	Bush, driver cab suspension	DB-SB-10384	
01/02→10/04		Centre Rod	DB-DL-5230		Suspension Rod
01/02→10/04		Centre Rod	DB-DL-5241		Suspension Rod
01/02→10/04		Centre Rod	DB-DL-5405		Push Rod
01/02→10/04		Centre Rod	DB-DL-7270		Push Rod;Suspension Rod
01/02→10/04		Centre Rod	DB-DL-8122		Push Rod
01/02→10/04		Centre Rod	DB-DL-8184		Push Rod
01/02→10/04		Centre Rod	DB-DL-8185		Push Rod
01/02→10/04	Centre Rod	DB-DL-8188		Push Rod, Air Suspension Axle	

CV-ES-14162

Length: 125
Cone Ø: d1 Ø 30 / d2 Ø 27
Thread: M30 x 1,5 LHT
4600648, 4601248, 4603448, 0004603548,
14600348, 14601448, 14602348, 0014603748,
0014607848, 0024600348



CV-ES-14163

Length: 125
Cone Ø: d1 Ø 30 / d2 Ø 27
Thread: M30 x 1,5 RHT
0003305248, 0003387310, 0004600348,
0004600948, 0004602848, 0004602948,
0004608948, 0014600248, 0014600848,
0014601248, 0014602248, 0014607748,
0024600148, A0003387310, A0004600348,
A0004602848, A0004602948, A0014600848,
A0014601248, A0014602248, A0014607748



DB-DL-2178

Length: 1735 Ø: 52
Cone Ø: d1 Ø 32 / d2 Ø 29
9423300003, 9423300103, 9423300203



DB-DL-5230

Length: 879 Ø: 42
Cone Ø: d1 Ø 30 / d2 Ø 27
01208600A, 0004607105, 0004607205,
0014606705



DB-DL-5241

Length: 875 Ø: 40
Cone Ø: d1 Ø 30 / d2 Ø 27
01215300A, 0004609205, 0004609305,
0014606905



DB-DL-5405

Length: 890 Ø: 35
Cone Ø: d1 Ø 28,6 / d2 Ø 23,9
01215900A, 1460248, 0024604505, 0024604605,
0034605005, 3752600637, 3754600405,
A3752600637, A3754600405



DB-DL-7270

Length: 875 Ø: 40
Cone Ø: d1 Ø 28,6 / d2 Ø 23,9
01208300A, 0024604705, 0024604805,
0034604905, A0024604705



DB-DL-8122

Length: 875
Ø: 42
Cone Ø: d1 Ø 30 / d2 Ø 27
01215000A, 6174603205, 6174603305



DB-DL-8171

Length: 1687 Ø: 52
Cone Ø: d1 Ø 32 / d2 Ø 29
9493300603, 9493300703, 9493301503,
9493301603



DB-DL-8184

Length: 1095 Ø: 42
Cone Ø: d1 Ø 32 / d2 Ø 28,8
01217700A, 0014601305, 0014601405,
0024600505, 0034603205, 3754601505,
A0014601305, A0014601405, A0024600505



DB-DL-8185

Length: 711 Ø: 42
Cone Ø: d1 Ø 32 / d2 Ø 28,8
01213600A, 0014601105, 0024600405,
0034603105, A0014601105, A0024600405



DB-DL-8188

Length: 895 Ø: 40
Cone Ø: d1 Ø 28,6 / d2 Ø 23,9
01217200A, 0024604905, 0024605005,
0034605605



DB-DL-8327

Length: 1745 Ø: 48
Cone Ø: d1 Ø 32 / d2 Ø 29
01219800A, 9413300003, 9413300103,
9413300203, 9413300303, 9413300503



DB-DL-9258

Length: 905
Ø: 42
Cone Ø: d1 Ø 28,6 / d2 Ø 23,9
3754600605, 3754601105



DB-DL-12300

Length: 733 Ø: 36
Cone Ø: d1 Ø 32 / d2 Ø 29
0014601505, 0014607305, 0034603305,
3754601605, A0014601505, A0034603305,
A3754601605



DB-ES-8164

Length: 140
Cone Ø: d1 Ø 28,6 / d2 Ø 23,9
Thread: M28 x 1,5 RHT
0014604248, 0014605048, 0014608548,
0024600548



DB-ES-8530

Length: 115
Cone Ø: d1 Ø 28,6 / d2 Ø 23,9
Thread: M30 x 1,5 RHT
0014603848, 0014604848, 0014605148,
0014608648, 0014609948



DB-RK-8550

Ø: 75 Hole Distance: 152
Thick/Height: 24
0003502105, 0003504605



DB-RK-8626

Ø: 75 Hole Distance: 130
Thick/Height: 24
0003502205, 0003502505, 0003503405,
0003504505, GL11319



DB-RK-9296

Ø: 88 Hole Distance: 130
Thick/Height: 24
9423260050



DB-RK-10374

Ø: 85 Hole Distance: 152
Thick/Height: 24
0003504405



DB-RK-10375

Ø: 100 Hole Distance: 152
Thick/Height: 24
0003502405, 0003503505, 0003504905



DB-SB-10384

Ø: 73 Thick/Height: 47
9303170012, 9423171812



DB-SB-10406

Ø: 80 Thick/Height: 46
0003238185



DB-SB-10409

Ø: 77 Thick/Height: 56
0003265181



DB-SB-10410

Ø: 73 Hole Distance: 100
Thick/Height: 24
9413230050



DB-VB-7798

Length: 622 Ø: 48
Hole Ø 25 / 23 / 23
Hole Distance: 152 / 130 / 130
9423500505, 9423500805, 9423501205,
A9423501205



MN-RK-8997

Ø: 85
Hole Distance: 130
Thick/Height: 30
0003504805, 3504805





AXOR ...

1840 LS ...	01/02→10/04	Centre Rod	DB-DL-12300		for Steering Rod	
	01/02→10/04	Rod Assembly	DB-DL-2178		Guide Rod	
	01/02→10/04	Stabiliser Mounting		DB-RK-9296		
	01/02→10/04	Stabiliser Mounting		DB-SB-10406		
	01/02→10/04	Stabiliser Mounting		DB-SB-10409		
	01/02→10/04	Stabiliser Mounting	DB-SB-10410			
	01/02→10/04	Suspension Arm Repair Kit		DB-RK-8550	for Wishbone (CV)	
	01/02→10/04	Suspension Arm Repair Kit		DB-RK-8626	for Wishbone (CV)	
	01/02→10/04	Suspension Arm Repair Kit		DB-RK-10374	for Wishbone (CV)	
	01/02→10/04	Suspension Arm Repair Kit		DB-RK-10375	for Wishbone (CV)	
	01/02→10/04	Suspension Strut Repair Kit		MN-RK-8997		
	01/02→10/04	Tie Rod	DB-DL-8327		Guide Rod	
	01/02→10/04	Tie Rod End	CV-ES-14162		for Steering Rod	
	01/02→10/04	Tie Rod End	CV-ES-14163		for Steering Rod	
	01/02→10/04	Tie Rod End	DB-ES-8164		for Push Rod	
	01/02→10/04	Tie Rod End	DB-ES-8530		for Push Rod	
	01/02→10/04	Track Control Arm		DB-VB-7798	Wishbone (CV), Air Suspension Axle, * L 041976 *→	
	1843 LS	01/02→10/04	Bush, driver cab suspension	DB-SB-10384		
		01/02→10/04	Centre Rod	DB-DL-5230		Suspension Rod
		01/02→10/04	Centre Rod	DB-DL-5241		Suspension Rod
01/02→10/04		Centre Rod	DB-DL-5405		Push Rod	
01/02→10/04		Centre Rod	DB-DL-7270		Push Rod;Suspension Rod	
01/02→10/04		Centre Rod	DB-DL-8122		Push Rod	
01/02→10/04		Centre Rod	DB-DL-8184		Push Rod	
01/02→10/04		Centre Rod	DB-DL-8185		Push Rod	
01/02→10/04		Centre Rod	DB-DL-8188		Push Rod, Air Suspension Axle	
01/02→10/04		Centre Rod	DB-DL-12300		for Steering Rod	
01/02→10/04		Rod Assembly	DB-DL-2178		Guide Rod	
01/02→10/04		Stabiliser Mounting		DB-RK-9296		
01/02→10/04		Stabiliser Mounting		DB-SB-10406		
01/02→10/04		Stabiliser Mounting		DB-SB-10409		
01/02→10/04		Stabiliser Mounting	DB-SB-10410			
01/02→10/04		Suspension Arm Repair Kit		DB-RK-8550	for Wishbone (CV)	
01/02→10/04		Suspension Arm Repair Kit		DB-RK-8626	for Wishbone (CV)	
01/02→10/04		Suspension Arm Repair Kit		DB-RK-10374	for Wishbone (CV)	
01/02→10/04		Suspension Arm Repair Kit		DB-RK-10375	for Wishbone (CV)	
01/02→10/04		Suspension Strut Repair Kit		MN-RK-8997		
01/02→10/04	Tie Rod	DB-DL-8327		Guide Rod		
01/02→10/04	Tie Rod End	CV-ES-14162		for Steering Rod		
01/02→10/04	Tie Rod End	CV-ES-14163		for Steering Rod		
01/02→10/04	Tie Rod End	DB-ES-8164		for Push Rod		
01/02→10/04	Tie Rod End	DB-ES-8530		for Push Rod		
01/02→10/04	Track Control Arm		DB-VB-7798	Wishbone (CV), Air Suspension Axle, * L 041976 *→		
2523	01/02→10/04	Bush, driver cab suspension	DB-SB-10384			
	01/02→10/04	Bush, parabolic spring		DB-SB-10400		
	01/02→10/04	Centre Rod	DB-DL-5230		Suspension Rod	
	01/02→10/04	Centre Rod	DB-DL-5241		Suspension Rod	
	01/02→10/04	Centre Rod	DB-DL-5405		Push Rod	
	01/02→10/04	Centre Rod	DB-DL-7270		Push Rod;Suspension Rod	
	01/02→10/04	Centre Rod	DB-DL-8184		Push Rod	
	01/02→10/04	Centre Rod	DB-DL-8185		Push Rod	
	01/02→10/04	Centre Rod	DB-DL-8188		Push Rod	
	01/02→10/04	Centre Rod	DB-DL-12300		for Steering Rod	
	01/02→10/04	Rod Assembly	DB-DL-2178		Guide Rod	
	01/02→10/04	Stabiliser Mounting	DB-SB-10410			
	01/02→10/04	Suspension Arm Repair Kit		DB-RK-8550	for Wishbone (CV)	
	01/02→10/04	Suspension Arm Repair Kit		DB-RK-8626	for Wishbone (CV)	
	01/02→10/04	Suspension Arm Repair Kit		DB-RK-10374	for Wishbone (CV)	
	01/02→10/04	Suspension Arm Repair Kit		DB-RK-10375	for Wishbone (CV)	
	01/02→10/04	Suspension Strut Repair Kit		MN-RK-8997		
	01/02→10/04	Tie Rod	DB-DL-8327		Guide Rod	

CV-ES-14162

Length: 125
Cone Ø: d1 Ø 30 / d2 Ø 27
Thread: M30 x 1,5 LHT
4600648, 4601248, 4603448, 0004603548,
4603548, 14600348, 14601448, 14602348, 001
460 37 48, 14607848, 0014607848, 002 460 03 48



CV-ES-14163

Length: 125
Cone Ø: d1 Ø 30 / d2 Ø 27
Thread: M30 x 1,5 RHT
0003305248, 0003387310, 0004600348,
0004600948, 0004602848, 0004602948,
0004608948, 0014600248, 0014600848,
0014601248, 0014602248, 0014607748,
0024600148, A0003387310, A0004600348,
A0004602848, A0004602948, A0014600848,
A0014601248, A0014602248, A0014607748



DB-DL-2178

Length: 1735 Ø: 52
Cone Ø: d1 Ø 32 / d2 Ø 29
9423300003, 9423300103, 9423300203



DB-DL-5230

Length: 879 Ø: 42
Cone Ø: d1 Ø 30 / d2 Ø 27
01208600A, 0004607105, 0004607205,
0014606705



DB-DL-5241

Length: 875 Ø: 40
Cone Ø: d1 Ø 30 / d2 Ø 27
01215300A, 0004609205, 0004609305,
0014606905



DB-DL-5405

Length: 890 Ø: 35
Cone Ø: d1 Ø 28,6 / d2 Ø 23,9
01215900A, 1460248, 0024604505, 0024604605,
0034605005, 3752600637, 3754600405,
A3752600637, A3754600405



DB-DL-7270

Length: 875 Ø: 40
Cone Ø: d1 Ø 28,6 / d2 Ø 23,9
01208300A, 0024604705, 0024604805,
0034604905, A0024604705



DB-DL-8122

Length: 875
Ø: 42
Cone Ø: d1 Ø 30 / d2 Ø 27
01215000A, 6174603205, 6174603305



DB-DL-8184

Length: 1095 Ø: 42
Cone Ø: d1 Ø 32 / d2 Ø 28,8
01217700A, 0014601305, 0014601405,
0024600505, 0034603205, 3754601505,
A0014601305, A0014601405, A0024600505



DB-DL-8185

Length: 711 Ø: 42
Cone Ø: d1 Ø 32 / d2 Ø 28,8
01213600A, 0014601105, 0024600405,
0034603105, A0014601105, A0024600405



DB-DL-8188

Length: 895 Ø: 40
Cone Ø: d1 Ø 28,6 / d2 Ø 23,9
01217200A, 0024604905, 0024605005,
0034605605



DB-DL-8327

Length: 1745 Ø: 48
Cone Ø: d1 Ø 32 / d2 Ø 29
01219800A, 9413300003, 9413300103,
9413300203, 9413300303, 9413300503



DB-DL-12300

Length: 733 Ø: 36
Cone Ø: d1 Ø 32 / d2 Ø 29
0014601505, 0014607305, 0034603305,
3754601605, A0014601505, A0034603305,
A3754601605



DB-ES-8164

Length: 140
Cone Ø: d1 Ø 28,6 / d2 Ø 23,9
Thread: M28 x 1,5 RHT
0014604248, 0014605048, 0014608548,
0024600548



DB-ES-8530

Length: 115
Cone Ø: d1 Ø 28,6 / d2 Ø 23,9
Thread: M30 x 1,5 RHT
0014603848, 0014604848, 0014605148,
0014608648, 0014609948



DB-RK-8550

Ø: 75 Hole Distance: 152
Thick/Height: 24
0003502105, 0003504605



DB-RK-8626

Ø: 75 Hole Distance: 130
Thick/Height: 24
0003502205, 0003502505, 0003503405,
0003504505, GL11319



DB-RK-9296

Ø: 88 Hole Distance: 130
Thick/Height: 24
9423260050



DB-RK-10374

Ø: 85 Hole Distance: 152
Thick/Height: 24
0003504405



DB-RK-10375

Ø: 100 Hole Distance: 152
Thick/Height: 24
0003502405, 0003503505, 0003504905



DB-SB-10384

Ø: 73 Thick/Height: 47
9303170012, 9423171812



DB-SB-10400

Length: 230
Thick/Height: 167,5 / 115
0003250696, 0003250896



DB-SB-10406

Ø: 80 Thick/Height: 46
0003238185



DB-SB-10409

Ø: 77 Thick/Height: 56
0003265181



DB-SB-10410

Ø: 73 Hole Distance: 100
Thick/Height: 24
9413230050



DB-VB-7798

Length: 622 Ø: 48
Hole Ø 25 / 23 / 23
Hole Distance: 152 / 130 / 130
9423500505, 9423500805, 9423501205,
A9423501205



MN-RK-8997

Ø: 85
Hole Distance: 130
Thick/Height: 30
0003504805, 3504805



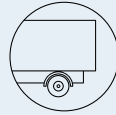

AXOR ...

2523 ...	01/02→10/04	Tie Rod End	CV-ES-14162		for Steering Rod	
	01/02→10/04	Tie Rod End	CV-ES-14163		for Steering Rod	
	01/02→10/04	Tie Rod End	DB-ES-8164		for Push Rod	
	01/02→10/04	Tie Rod End	DB-ES-8530		for Push Rod	
	01/02→10/04	Track Control Arm		DB-VB-7798	Wishbone (CV)	
2523 K	01/02→10/04	Bush, driver cab suspension	DB-SB-10384			
	01/02→10/04	Bush, parabolic spring		DB-SB-10400		
	01/02→10/04	Centre Rod	DB-DL-5405		Push Rod	
	01/02→10/04	Centre Rod	DB-DL-7270		Push Rod;Suspension Rod	
	01/02→10/04	Centre Rod	DB-DL-8184		Push Rod	
	01/02→10/04	Centre Rod	DB-DL-8185		Push Rod	
	01/02→10/04	Centre Rod	DB-DL-8188		Push Rod	
	01/02→10/04	Centre Rod	DB-DL-9258		Push Rod	
	01/02→10/04	Centre Rod	DB-DL-12300		for Steering Rod	
	01/02→10/04	Rod Assembly	DB-DL-2178		Guide Rod	
	01/02→10/04	Stabiliser Mounting	DB-SB-10410			
	01/02→10/04	Suspension Arm Repair Kit		DB-RK-8550	for Wishbone (CV)	
	01/02→10/04	Suspension Arm Repair Kit		DB-RK-8626	for Wishbone (CV)	
	01/02→10/04	Suspension Arm Repair Kit		DB-RK-10374	for Wishbone (CV)	
	01/02→10/04	Suspension Arm Repair Kit		DB-RK-10375	for Wishbone (CV)	
	01/02→10/04	Suspension Strut Repair Kit		MN-RK-8997		
	01/02→10/04	Tie Rod	DB-DL-8171		Guide Rod	
	01/02→10/04	Tie Rod	DB-DL-8327		Guide Rod	
	01/02→10/04	Tie Rod End	CV-ES-14162		for Steering Rod	
	01/02→10/04	Tie Rod End	CV-ES-14163		for Steering Rod	
	01/02→10/04	Tie Rod End	DB-ES-8164		for Push Rod	
	01/02→10/04	Tie Rod End	DB-ES-8530		for Push Rod	
	01/02→10/04	Track Control Arm		DB-VB-7798	Wishbone (CV)	
2528	01/02→10/04	Bush, driver cab suspension	DB-SB-10384			
	01/02→10/04	Bush, parabolic spring		DB-SB-10400		
	01/02→10/04	Centre Rod	DB-DL-5230		Suspension Rod	
	01/02→10/04	Centre Rod	DB-DL-5241		Suspension Rod	
	01/02→10/04	Centre Rod	DB-DL-5405		Push Rod	
	01/02→10/04	Centre Rod	DB-DL-7270		Push Rod;Suspension Rod	
	01/02→10/04	Centre Rod	DB-DL-8184		Push Rod	
	01/02→10/04	Centre Rod	DB-DL-8185		Push Rod	
	01/02→10/04	Centre Rod	DB-DL-8188		Push Rod	
	01/02→10/04	Centre Rod	DB-DL-9258		Push Rod	
	01/02→10/04	Centre Rod	DB-DL-12298		for Steering Rod	
	01/02→10/04	Centre Rod	DB-DL-12300		for Steering Rod	
	01/02→10/04	Centre Rod	DB-DL-12438		for Steering Rod	
	01/02→10/04	Rod Assembly	DB-DL-2178		Guide Rod	
	01/02→10/04	Stabiliser Mounting	DB-SB-10410			
	01/02→10/04	Suspension Arm Repair Kit		DB-RK-8550	for Wishbone (CV)	
	01/02→10/04	Suspension Arm Repair Kit		DB-RK-8626	for Wishbone (CV)	
	01/02→10/04	Suspension Arm Repair Kit		DB-RK-10374	for Wishbone (CV)	
	01/02→10/04	Suspension Arm Repair Kit		DB-RK-10375	for Wishbone (CV)	
	01/02→10/04	Suspension Strut Repair Kit		MN-RK-8997		
	01/02→10/04	Tie Rod	DB-DL-8327		Guide Rod	
	01/02→10/04	Tie Rod End	CV-ES-14162		for Steering Rod	
	01/02→10/04	Tie Rod End	CV-ES-14163		for Steering Rod	
	01/02→10/04	Tie Rod End	DB-ES-8164		for Push Rod	
	01/02→10/04	Tie Rod End	DB-ES-8530		for Push Rod	
	01/02→10/04	Track Control Arm		DB-VB-7798	Wishbone (CV)	
	2535 LS	01/02→10/04	Bush, driver cab suspension	DB-SB-10384		
		01/02→10/04	Centre Rod	DB-DL-5230		Suspension Rod
		01/02→10/04	Centre Rod	DB-DL-5241		Suspension Rod
		01/02→10/04	Centre Rod	DB-DL-5405		Push Rod
01/02→10/04		Centre Rod	DB-DL-7270		Push Rod;Suspension Rod	
01/02→10/04		Centre Rod	DB-DL-8122		Push Rod	
01/02→10/04		Centre Rod	DB-DL-8184		Push Rod	
01/02→10/04		Centre Rod	DB-DL-8185		Push Rod	
01/02→10/04		Centre Rod	DB-DL-8188		Push Rod, Air Suspension Axle	

CV-ES-14162

Length: 125
Cone Ø: d1 Ø 30 / d2 Ø 27
Thread: M30 x 1,5 LHT
4600648, 4601248, 4603448, 4603548,
0004603548, 14600348, 14601448, 14602348,
0014603748, 0014607848, 14607848, 002460
0348



CV-ES-14163

Length: 125
Cone Ø: d1 Ø 30 / d2 Ø 27
Thread: M30 x 1,5 RHT
0003305248, 0003387310, 0004600348,
0004600948, 0004602848, 0004602948,
0004608948, 0014600248, 0014600848,
0014601248, 0014602248, 0014607748,
0024600148, 0003387310, 0004600348,
A0004602848, A0004602948, A0014600848,
A0014601248, A0014602248, A0014607748



DB-DL-2178

Length: 1735 Ø: 52
Cone Ø: d1 Ø 32 / d2 Ø 29
9423300003, 9423300103, 9423300203



DB-DL-5230

Length: 879 Ø: 42
Cone Ø: d1 Ø 30 / d2 Ø 27
01208600A, 0004607105, 0004607205,
0014606705



DB-DL-5241

Length: 875 Ø: 40
Cone Ø: d1 Ø 30 / d2 Ø 27
01215300A, 0004609205, 0004609305,
0014606905



DB-DL-5405

Length: 890 Ø: 35
Cone Ø: d1 Ø 28,6 / d2 Ø 23,9
01215900A, 1460248, 0024604505, 0024604605,
0034605005, 3752600637, 3754600405,
A3752600637, A3754600405



DB-DL-7270

Length: 875 Ø: 40
Cone Ø: d1 Ø 28,6 / d2 Ø 23,9
01208300A, 0024604705, 0024604805,
0034604905, A0024604705



DB-DL-8122

Length: 875
Ø: 42
Cone Ø: d1 Ø 30 / d2 Ø 27
01215000A, 6174603205, 6174603305



DB-DL-8171

Length: 1687 Ø: 52
Cone Ø: d1 Ø 32 / d2 Ø 29
9493300603, 9493300703, 9493301503,
9493301603



DB-DL-8184

Length: 1095 Ø: 42
Cone Ø: d1 Ø 32 / d2 Ø 28,8
01217700A, 0014601305, 0014601405,
0024600505, 0034603205, 3754601505,
A0014601305, A0014601405, A0024600505



DB-DL-8185

Length: 711 Ø: 42
Cone Ø: d1 Ø 32 / d2 Ø 28,8
01213600A, 0014601105, 0024600405,
0034603105, A0014601105, A0024600405



DB-DL-8188

Length: 895 Ø: 40
Cone Ø: d1 Ø 28,6 / d2 Ø 23,9
01217200A, 0024604905, 0024605005,
0034605605



DB-DL-8327

Length: 1745 Ø: 48
Cone Ø: d1 Ø 32 / d2 Ø 29
01219800A, 9413300003, 9413300103,
9413300203, 9413300303, 9413300503



DB-DL-9258

Length: 905
Ø: 42
Cone Ø: d1 Ø 28,6 / d2 Ø 23,9
3754600605, 3754601105



DB-DL-12298

Length: 927 Ø: 50
Cone Ø: d1 Ø 30 / d2 Ø 27
0024602405, 0024603005



DB-DL-12300

Length: 733 Ø: 36
Cone Ø: d1 Ø 32 / d2 Ø 29
0014601505, 0014607305, 0034603305,
3754601605, A0014601505, A0034603305,
A3754601605



DB-DL-12438

Length: 743 Ø: 42
Cone Ø: d1 Ø 30 / d2 Ø 27
0024602505, 0024603105, A0024602505,
A0024603105



DB-ES-8164

Length: 140
Cone Ø: d1 Ø 28,6 / d2 Ø 23,9
Thread: M28 x 1,5 RHT
0014604248, 0014605048, 0014608548,
0024600548



DB-ES-8530

Length: 115
Cone Ø: d1 Ø 28,6 / d2 Ø 23,9
Thread: M30 x 1,5 RHT
0014603848, 0014604848, 0014605148,
0014608648, 0014609948



DB-RK-8550

Ø: 75 Hole Distance: 152
Thick/Height: 24
0003502105, 0003504605



DB-RK-8626

Ø: 75 Hole Distance: 130
Thick/Height: 24
0003502205, 0003502505, 0003503405,
0003504505, GL11319



DB-RK-10374

Ø: 85 Hole Distance: 152
Thick/Height: 24
0003504405



DB-RK-10375

Ø: 100 Hole Distance: 152
Thick/Height: 24
0003502405, 0003503505, 0003504905



DB-SB-10384

Ø: 73 Thick/Height: 47
9303170012, 9423171812



DB-SB-10400

Length: 230
Thick/Height: 167,5 / 115
0003250696, 0003250896



DB-SB-10410

Ø: 73 Hole Distance: 100
Thick/Height: 24
9413230050



DB-VB-7798

Length: 622 Ø: 48
Hole Ø 25 / 23 / 23
Hole Distance: 152 / 130 / 130
9423500505, 9423500805, 9423501205,
A9423501205



MN-RK-8997

Ø: 85
Hole Distance: 130
Thick/Height: 30
3504805, 0003504805



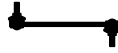

AXOR ...

2535 LS ...	01/02→10/04	Centre Rod	DB-DL-12300		for Steering Rod
	01/02→10/04	Stabiliser Mounting		DB-RK-9296	
	01/02→10/04	Stabiliser Mounting		DB-SB-10409	
	01/02→10/04	Suspension Arm Repair Kit		DB-RK-10374	for Wishbone (CV)
	01/02→10/04	Suspension Arm Repair Kit		DB-RK-10375	for Wishbone (CV)
	01/02→10/04	Suspension Strut Repair Kit		MN-RK-8997	
	01/02→10/04	Tie Rod	DB-DL-8327		Guide Rod
	01/02→10/04	Tie Rod End	DB-ES-8530		for Push Rod
01/02→10/04	Track Control Arm		DB-VB-7798		Wishbone (CV), Drive Axle; Air Suspension Axle, * L 041976 *→
2540 LS	01/02→10/04	Bush, driver cab suspension	DB-SB-10384		
	01/02→10/04	Centre Rod	DB-DL-5230		Suspension Rod
	01/02→10/04	Centre Rod	DB-DL-5241		Suspension Rod
	01/02→10/04	Centre Rod	DB-DL-5405		Push Rod
	01/02→10/04	Centre Rod	DB-DL-7270		Push Rod;Suspension Rod
	01/02→10/04	Centre Rod	DB-DL-8122		Push Rod
	01/02→10/04	Centre Rod	DB-DL-8184		Push Rod
	01/02→10/04	Centre Rod	DB-DL-8185		Push Rod
	01/02→10/04	Centre Rod	DB-DL-8188		Push Rod, Air Suspension Axle
	01/02→10/04	Centre Rod	DB-DL-12300		for Steering Rod
	01/02→10/04	Stabiliser Mounting		DB-RK-9296	
	01/02→10/04	Stabiliser Mounting		DB-SB-10409	
	01/02→10/04	Suspension Arm Repair Kit		DB-RK-10374	for Wishbone (CV)
	01/02→10/04	Suspension Arm Repair Kit		DB-RK-10375	for Wishbone (CV)
	01/02→10/04	Suspension Strut Repair Kit		MN-RK-8997	
	01/02→10/04	Tie Rod	DB-DL-8327		Guide Rod
	01/02→10/04	Tie Rod End	DB-ES-8530		for Push Rod
	01/02→10/04	Track Control Arm		DB-VB-7798	
2543 LS	01/02→10/04	Bush, driver cab suspension	DB-SB-10384		
	01/02→10/04	Centre Rod	DB-DL-5230		Suspension Rod
	01/02→10/04	Centre Rod	DB-DL-5241		Suspension Rod
	01/02→10/04	Centre Rod	DB-DL-5405		Push Rod
	01/02→10/04	Centre Rod	DB-DL-7270		Push Rod;Suspension Rod
	01/02→10/04	Centre Rod	DB-DL-8122		Push Rod
	01/02→10/04	Centre Rod	DB-DL-8184		Push Rod
	01/02→10/04	Centre Rod	DB-DL-8185		Push Rod
	01/02→10/04	Centre Rod	DB-DL-8188		Push Rod, Air Suspension Axle
	01/02→10/04	Centre Rod	DB-DL-12300		for Steering Rod
	01/02→10/04	Stabiliser Mounting		DB-RK-9296	
	01/02→10/04	Stabiliser Mounting		DB-SB-10409	
	01/02→10/04	Suspension Arm Repair Kit		DB-RK-10374	for Wishbone (CV)
	01/02→10/04	Suspension Arm Repair Kit		DB-RK-10375	for Wishbone (CV)
	01/02→10/04	Suspension Strut Repair Kit		MN-RK-8997	
	01/02→10/04	Tie Rod	DB-DL-8327		Guide Rod
	01/02→10/04	Tie Rod End	DB-ES-8530		for Push Rod
	01/02→10/04	Track Control Arm		DB-VB-7798	
2623 L	01/02→10/04	Bush, driver cab suspension	DB-SB-10384		
	01/02→10/04	Bush, parabolic spring		DB-SB-10400	
	01/02→10/04	Centre Rod	DB-DL-5230		Suspension Rod
	01/02→10/04	Centre Rod	DB-DL-5241		Suspension Rod
	01/02→10/04	Centre Rod	DB-DL-5405		Push Rod
	01/02→10/04	Centre Rod	DB-DL-7270		Push Rod;Suspension Rod
	01/02→10/04	Centre Rod	DB-DL-8184		Push Rod
	01/02→10/04	Centre Rod	DB-DL-8185		Push Rod
	01/02→10/04	Centre Rod	DB-DL-9258		Push Rod
	01/02→10/04	Centre Rod	DB-DL-12300		for Steering Rod
	01/02→10/04	Rod Assembly	DB-DL-2178		Guide Rod
	01/02→10/04	Stabiliser Mounting		DB-RK-9296	
	01/02→10/04	Stabiliser Mounting	DB-SB-10410		
	01/02→10/04	Suspension Arm Repair Kit		DB-RK-8550	for Wishbone (CV)
	01/02→10/04	Suspension Arm Repair Kit		DB-RK-8626	for Wishbone (CV)

DB-DL-2178

Length: 1735 Ø: 52
 Cone Ø: d1 Ø 32 / d2 Ø 29
 9423300003, 9423300103, 9423300203

**DB-DL-5230**

Length: 879 Ø: 42
 Cone Ø: d1 Ø 30 / d2 Ø 27
 01208600A, 0004607105, 0004607205,
 0014606705

**DB-DL-5241**

Length: 875 Ø: 40
 Cone Ø: d1 Ø 30 / d2 Ø 27
 01215300A, 0004609205, 0004609305,
 0014606905

**DB-DL-5405**

Length: 890 Ø: 35
 Cone Ø: d1 Ø 28,6 / d2 Ø 23,9
 01215900A, 1460248, 0024604505, 0024604605,
 0034605005, 3752600637, 3754600405,
 A3752600637, A3754600405

**DB-DL-7270**

Length: 875 Ø: 40
 Cone Ø: d1 Ø 28,6 / d2 Ø 23,9
 01208300A, 0024604705, 0024604805,
 0034604905, A0024604705

**DB-DL-8122**

Length: 875
 Ø: 42
 Cone Ø: d1 Ø 30 / d2 Ø 27
 01215000A, 6174603205, 6174603305

**DB-DL-8184**

Length: 1095 Ø: 42
 Cone Ø: d1 Ø 32 / d2 Ø 28,8
 01217700A, 0014601305, 0014601405,
 0024600505, 0034603205, 3754601505,
 A0014601305, A0014601405, A0024600505

**DB-DL-8185**

Length: 711 Ø: 42
 Cone Ø: d1 Ø 32 / d2 Ø 28,8
 01213600A, 0014601105, 0024600405,
 0034603105, A0014601105, A0024600405

**DB-DL-8188**

Length: 895 Ø: 40
 Cone Ø: d1 Ø 28,6 / d2 Ø 23,9
 01217200A, 0024604905, 0024605005,
 0034605605

**DB-DL-8327**

Length: 1745 Ø: 48
 Cone Ø: d1 Ø 32 / d2 Ø 29
 01219800A, 9413300003, 9413300103,
 9413300203, 9413300303, 9413300503

**DB-DL-9258**

Length: 905
 Ø: 42
 Cone Ø: d1 Ø 28,6 / d2 Ø 23,9
 3754600605, 3754601105

**DB-DL-12300**

Length: 733 Ø: 36
 Cone Ø: d1 Ø 32 / d2 Ø 29
 0014601505, 0014607305, 0034603305,
 3754601605, A0014601505, A0034603305,
 A3754601605

**DB-ES-8530**

Length: 115
 Cone Ø: d1 Ø 28,6 / d2 Ø 23,9
 Thread: M30 x 1,5 RHT
 0014603848, 0014604848, 0014605148,
 0014608648, 0014609948

**DB-RK-8550**

Ø: 75 Hole Distance: 152
 Thick/Height: 24
 0003502105, 0003504605

**DB-RK-8626**

Ø: 75 Hole Distance: 130
 Thick/Height: 24
 0003502205, 0003502505, 0003503405,
 0003504505, GL11319

**DB-RK-9296**

Ø: 88 Hole Distance: 130
 Thick/Height: 24
 9423260050

**DB-RK-10374**

Ø: 85 Hole Distance: 152
 Thick/Height: 24
 0003504405

**DB-RK-10375**

Ø: 100 Hole Distance: 152
 Thick/Height: 24
 0003502405, 0003503505, 0003504905

**DB-SB-10384**

Ø: 73 Thick/Height: 47
 9303170012, 9423171812

**DB-SB-10400**

Length: 230
 Thick/Height: 167,5 / 115
 0003250696, 0003250896

**DB-SB-10409**

Ø: 77 Thick/Height: 56
 0003265181

**DB-SB-10410**

Ø: 73 Hole Distance: 100
 Thick/Height: 24
 9413230050

**DB-VB-7798**

Length: 622 Ø: 48
 Hole Ø 25 / 23 / 23
 Hole Distance: 152 / 130 / 130
 9423500505, 9423500805, 9423501205,
 A9423501205

**MN-RK-8997**

Ø: 85
 Hole Distance: 130
 Thick/Height: 30
 0003504805, 3504805





AXOR ...

2623 L ...	01/02→10/04	Suspension Arm Repair Kit		DB-RK-10374	for Wishbone (CV)	
	01/02→10/04	Suspension Arm Repair Kit		DB-RK-10375	for Wishbone (CV)	
	01/02→10/04	Suspension Strut Repair Kit		DB-RK-8555		
	01/02→10/04	Suspension Strut Repair Kit		MN-RK-8997		
	01/02→10/04	Tie Rod	DB-DL-8327		Guide Rod	
	01/02→10/04	Tie Rod End	CV-ES-14162		for Steering Rod	
	01/02→10/04	Tie Rod End	CV-ES-14163		for Steering Rod	
	01/02→10/04	Tie Rod End	DB-ES-8530		for Push Rod	
	01/02→10/04	Track Control Arm		DB-VB-7790	Wishbone (CV)	
	01/02→10/04	Track Control Arm		DB-VB-7798	Wishbone (CV)	
	2628 B	01/02→10/04	Bush, driver cab suspension	DB-SB-10384		
		01/02→10/04	Bush, parabolic spring		DB-SB-10400	
		01/02→10/04	Centre Rod	DB-DL-5405		Push Rod
		01/02→10/04	Centre Rod	DB-DL-7270		Push Rod;Suspension Rod
01/02→10/04		Centre Rod	DB-DL-8184		Push Rod	
01/02→10/04		Centre Rod	DB-DL-8185		Push Rod	
01/02→10/04		Centre Rod	DB-DL-8188		Push Rod	
01/02→10/04		Centre Rod	DB-DL-9258		Push Rod	
01/02→10/04		Centre Rod	DB-DL-12300		for Steering Rod	
01/02→10/04		Stabiliser Mounting	DB-SB-10410			
01/02→10/04		Suspension Arm Repair Kit		DB-RK-8550	for Wishbone (CV)	
01/02→10/04		Suspension Arm Repair Kit		DB-RK-8626	for Wishbone (CV)	
01/02→10/04		Suspension Arm Repair Kit		DB-RK-10374	for Wishbone (CV)	
01/02→10/04		Suspension Arm Repair Kit		DB-RK-10375	for Wishbone (CV)	
01/02→10/04		Suspension Strut Repair Kit		MN-RK-8997		
01/02→10/04		Tie Rod	DB-DL-8171		Guide Rod	
01/02→10/04		Tie Rod	DB-DL-8327		Guide Rod	
01/02→10/04		Tie Rod End	DB-ES-8530		for Push Rod	
01/02→10/04		Track Control Arm		DB-DL-3475	Trailing Arm	
01/02→10/04		Track Control Arm		DB-VB-7261	Suspension Rod, Wishbone (CV), 1st RA;2nd RA	
01/02→10/04		Track Control Arm		DB-VB-7798	Wishbone (CV)	
2628 K		01/02→10/04	Bush, driver cab suspension	DB-SB-10384		
		01/02→10/04	Bush, parabolic spring		DB-SB-10400	
		01/02→10/04	Centre Rod	DB-DL-5405		Push Rod
		01/02→10/04	Centre Rod	DB-DL-7270		Push Rod;Suspension Rod
		01/02→10/04	Centre Rod	DB-DL-8184		Push Rod
		01/02→10/04	Centre Rod	DB-DL-8185		Push Rod
		01/02→10/04	Centre Rod	DB-DL-8188		Push Rod
	01/02→10/04	Centre Rod	DB-DL-9258		Push Rod	
	01/02→10/04	Centre Rod	DB-DL-12300		for Steering Rod	
	01/02→10/04	Stabiliser Mounting	DB-SB-10410			
	01/02→10/04	Suspension Arm Repair Kit		DB-RK-8550	for Wishbone (CV)	
	01/02→10/04	Suspension Arm Repair Kit		DB-RK-8626	for Wishbone (CV)	
	01/02→10/04	Suspension Arm Repair Kit		DB-RK-10374	for Wishbone (CV)	
	01/02→10/04	Suspension Arm Repair Kit		DB-RK-10375	for Wishbone (CV)	
	01/02→10/04	Suspension Strut Repair Kit		MN-RK-8997		
	01/02→10/04	Tie Rod	DB-DL-8171		Guide Rod	
	01/02→10/04	Tie Rod	DB-DL-8327		Guide Rod	
	01/02→10/04	Tie Rod End	DB-ES-8530		for Push Rod	
	01/02→10/04	Track Control Arm		DB-DL-3475	Trailing Arm	
	01/02→10/04	Track Control Arm		DB-VB-7261	Suspension Rod, Wishbone (CV), 1st RA;2nd RA	
	01/02→10/04	Track Control Arm		DB-VB-7798	Wishbone (CV)	
	2628 L	01/02→10/04	Bush, driver cab suspension	DB-SB-10384		
		01/02→10/04	Bush, parabolic spring		DB-SB-10400	
		01/02→10/04	Centre Rod	DB-DL-5230		Suspension Rod
		01/02→10/04	Centre Rod	DB-DL-5241		Suspension Rod
		01/02→10/04	Centre Rod	DB-DL-5405		Push Rod
		01/02→10/04	Centre Rod	DB-DL-7270		Push Rod;Suspension Rod
		01/02→10/04	Centre Rod	DB-DL-8184		Push Rod
01/02→10/04		Centre Rod	DB-DL-8185		Push Rod	
01/02→10/04		Centre Rod	DB-DL-9258		Push Rod	
01/02→10/04		Centre Rod	DB-DL-12300		for Steering Rod	
01/02→10/04		Rod Assembly	DB-DL-2178		Guide Rod	

CV-ES-14162

Length: 125
Cone Ø: d1 Ø 30 / d2 Ø 27
Thread: M30 x 1,5 LHT
4600648, 4601248, 4603448, 4603548,
0004603548, 14600348, 14601448, 14602348,
0014603748, 0014607848, 14607848, 002460
0348



CV-ES-14163

Length: 125
Cone Ø: d1 Ø 30 / d2 Ø 27
Thread: M30 x 1,5 RHT
0003305248, 0003387310, 0004600348,
0004600948, 0004602848, 0004602948,
0004608948, 0014600248, 0014600848,
0014601248, 0014602248, 0014607748,
0024600148, A0003387310, A0004600348,
A0004602848, A0004602948, A0014600848,
A0014601248, A0014602248, A0014607748



DB-DL-2178

Length: 1735 Ø: 52
Cone Ø: d1 Ø 32 / d2 Ø 29
9423300003, 9423300103, 9423300203



DB-DL-3475

Length: 565 Ø: 52
Hole Distance: 152 / 152
3753500006, 3753500206, 9473500805,
9483500006, 9483500805, 9483501205,
9483501305, 9483501905, 9483502005,
9483502405, A3753500006, A3753500206



DB-DL-5230

Length: 879 Ø: 42
Cone Ø: d1 Ø 30 / d2 Ø 27
01208600A, 0004607105, 0004607205,
0014606705



DB-DL-5241

Length: 875 Ø: 40
Cone Ø: d1 Ø 30 / d2 Ø 27
01215300A, 0004609205, 0004609305,
0014606905



DB-DL-5405

Length: 890 Ø: 35
Cone Ø: d1 Ø 28,6 / d2 Ø 23,9
01215900A, 1460248, 0024604505, 0024604605,
0034605005, 3752600637, 3754600405,
A3752600637, A3754600405



DB-DL-7270

Length: 875 Ø: 40
Cone Ø: d1 Ø 28,6 / d2 Ø 23,9
01208300A, 0024604705, 0024604805,
0034604905, A0024604705



DB-DL-8171

Length: 1687 Ø: 52
Cone Ø: d1 Ø 32 / d2 Ø 29
9493300603, 9493300703, 9493301503,
9493301603



DB-DL-8184

Length: 1095 Ø: 42
Cone Ø: d1 Ø 32 / d2 Ø 28,8
01217700A, 0014601305, 0014601405,
0024600505, 0034603205, 3754601505,
A0014601305, A0014601405, A0024600505



DB-DL-8185

Length: 711 Ø: 42
Cone Ø: d1 Ø 32 / d2 Ø 28,8
01213600A, 0014601105, 0024600405,
0034603105, A0014601105, A0024600405



DB-DL-8188

Length: 895 Ø: 40
Cone Ø: d1 Ø 28,6 / d2 Ø 23,9
01217200A, 0024604905, 0024605005,
0034605605



DB-DL-8327

Length: 1745 Ø: 48
Cone Ø: d1 Ø 32 / d2 Ø 29
01219800A, 9413300003, 9413300103,
9413300203, 9413300303, 9413300503



DB-DL-9258

Length: 905
Ø: 42
Cone Ø: d1 Ø 28,6 / d2 Ø 23,9
3754600605, 3754601105



DB-DL-12300

Length: 733 Ø: 36
Cone Ø: d1 Ø 32 / d2 Ø 29
0014601505, 0014607305, 0034603305,
3754601605, A0014601505, A0034603305,
A3754601605



DB-ES-8530

Length: 115
Cone Ø: d1 Ø 28,6 / d2 Ø 23,9
Thread: M30 x 1,5 RHT
0014603848, 0014604848, 0014605148,
0014608648, 0014609948



DB-RK-8550

Ø: 75 Hole Distance: 152
Thick/Height: 24
0003502105, 0003504605



DB-RK-8555

Ø: 67 Hole Distance: 130
Thick/Height: 24
01335600A, 0003502005, 0003504705



DB-RK-8626

Ø: 75 Hole Distance: 130
Thick/Height: 24
0003502205, 0003502505, 0003503405,
0003504505, GL11319



DB-RK-10374

Ø: 85 Hole Distance: 152
Thick/Height: 24
0003504405



DB-RK-10375

Ø: 100 Hole Distance: 152
Thick/Height: 24
0003502405, 0003503505, 0003504905



DB-SB-10384

Ø: 73 Thick/Height: 47
9303170012, 9423171812



DB-SB-10400

Length: 230
Thick/Height: 167,5 / 115
0003250696, 0003250896



DB-SB-10410

Ø: 73 Hole Distance: 100
Thick/Height: 24
9413230050



DB-VB-7261

Length: 622 Ø: 46
Hole Ø 25 / 25 / 25
Hole Distance: 152 / 130 / 130
01337800A, 9443500305, 9443500505,
9443500605, 9473500705, 9473500905,
9483500405, 9483503005



DB-VB-7790

Length: 622 Ø: 46
Hole Ø 25 / 23 / 23
Hole Distance: 152 / 130 / 130
01337000A, 3753500105, 9423500105,
9423500705, 9423501105, 9423501605,
9443500205



DB-VB-7798

Length: 622 Ø: 48
Hole Ø 25 / 23 / 23
Hole Distance: 152 / 130 / 130
9423500505, 9423500805, 9423501205,
A9423501205



MN-RK-8997

Ø: 85 Hole Distance: 130
Thick/Height: 30
0003504805



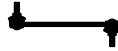

AXOR ...

2628 L ...	01/02→10/04	Stabiliser Mounting		DB-RK-9296	
	01/02→10/04	Stabiliser Mounting	DB-SB-10410		
	01/02→10/04	Suspension Arm Repair Kit		DB-RK-8550	for Wishbone (CV)
	01/02→10/04	Suspension Arm Repair Kit		DB-RK-8626	for Wishbone (CV)
	01/02→10/04	Suspension Arm Repair Kit		DB-RK-10374	for Wishbone (CV)
	01/02→10/04	Suspension Arm Repair Kit		DB-RK-10375	for Wishbone (CV)
	01/02→10/04	Suspension Strut Repair Kit		DB-RK-8555	
	01/02→10/04	Suspension Strut Repair Kit		MN-RK-8997	
	01/02→10/04	Tie Rod	DB-DL-8327		Guide Rod
	01/02→10/04	Tie Rod End	CV-ES-14162		for Steering Rod
	01/02→10/04	Tie Rod End	CV-ES-14163		for Steering Rod
	01/02→10/04	Tie Rod End	DB-ES-8530		for Push Rod
	01/02→10/04	Track Control Arm		DB-VB-7790	Wishbone (CV)
	01/02→10/04	Track Control Arm		DB-VB-7798	Wishbone (CV)
	3228 C	01/02→10/04	Bush, driver cab suspension	DB-SB-10384	
01/02→10/04		Bush, parabolic spring		DB-SB-10400	
01/02→10/04		Centre Rod	DB-DL-5230		Suspension Rod
01/02→10/04		Centre Rod	DB-DL-5241		Suspension Rod
01/02→10/04		Centre Rod	DB-DL-5405		Push Rod
01/02→10/04		Centre Rod	DB-DL-7270		Push Rod;Suspension Rod
01/02→10/04		Centre Rod	DB-DL-8184		Push Rod
01/02→10/04		Centre Rod	DB-DL-8185		Push Rod
01/02→10/04		Centre Rod	DB-DL-8188		Push Rod
01/02→10/04		Centre Rod	DB-DL-9258		Push Rod
01/02→10/04		Centre Rod	DB-DL-12300		for Steering Rod
01/02→10/04		Stabiliser Mounting	DB-SB-10410		
01/02→10/04		Suspension Arm Repair Kit		DB-RK-8550	for Wishbone (CV)
01/02→10/04		Suspension Arm Repair Kit		DB-RK-8626	for Wishbone (CV)
01/02→10/04		Suspension Arm Repair Kit		DB-RK-10374	for Wishbone (CV)
01/02→10/04		Suspension Arm Repair Kit		DB-RK-10375	for Wishbone (CV)
01/02→10/04		Suspension Strut Repair Kit		MN-RK-8997	
01/02→10/04		Tie Rod	DB-DL-8327		Guide Rod
01/02→10/04		Tie Rod End	DB-ES-8530		for Push Rod
01/02→10/04		Track Control Arm		DB-DL-3475	Trailing Arm
01/02→10/04		Track Control Arm		DB-VB-7798	Wishbone (CV)

AXOR 2

1823 AK, 1824 AK	10/04→	Ball Head, gearshift linkage	DB-ES-8510			
	10/04→	Centre Rod	DB-DL-8307		Push Rod, Leaf Spring Axle	
	10/04→	Centre Rod	DB-DL-8702		Push Rod, Leaf Spring Axle	
	10/04→	Centre Rod	DB-DL-12466		Push Rod	
	10/04→	Stabiliser Mounting		DB-SB-10406		
	10/04→	Tie Rod	DB-DL-12310			
	10/04→	Tie Rod	DB-ES-5227		Guide Rod	
	10/04→	Tie Rod	MN-DL-7834		Guide Rod	
	10/04→	Tie Rod End	DB-ES-5234		for Steering Rod	
	10/04→	Track Control Arm		DB-VB-7261	Suspension Rod, Wishbone (CV), 1st RA;2nd RA; Leaf Spring Axle	
	1823 K, 1823 KL, 1824 K	10/04→	Ball Head, gearshift linkage	DB-ES-8510		
		10/04→	Centre Rod	DB-DL-5230		Suspension Rod
		10/04→	Centre Rod	DB-DL-5241		Suspension Rod
10/04→		Centre Rod	DB-DL-5405		Push Rod, Leaf Spring Axle	
10/04→		Centre Rod	DB-DL-7270		Push Rod;Suspension Rod	
10/04→		Centre Rod	DB-DL-8184		Push Rod	
10/04→		Centre Rod	DB-DL-8185		Push Rod	
10/04→		Centre Rod	DB-DL-8188		Push Rod, Leaf Spring Axle	
10/04→		Centre Rod	DB-DL-8702		Push Rod, Leaf Spring Axle	
10/04→		Centre Rod	DB-DL-8717		Push Rod, Leaf Spring Axle	
10/04→		Centre Rod	DB-DL-12300		for Steering Rod	
10/04→		Centre Rod	DB-DL-12466		Push Rod	
10/04→		Stabiliser Mounting		DB-SB-10406		
10/04→		Suspension Arm Repair Kit		DB-RK-8550	for Wishbone (CV)	
10/04→		Tie Rod	DB-DL-8171		Guide Rod	



AXOR 2 ...

1823 K, 1823 KL, 1824 K ...	10/04 →	Tie Rod	DB-DL-8327		Guide Rod	
	10/04 →	Tie Rod	DB-DL-8640		Guide Rod	
	10/04 →	Tie Rod	DB-DL-12310			
	10/04 →	Tie Rod	DB-ES-5227		Guide Rod	
	10/04 →	Tie Rod End	DB-ES-8164		for Push Rod	
	10/04 →	Track Control Arm		DB-VB-7261		Suspension Rod, Wishbone (CV), 1st RA;2nd RA; Leaf Spring Axle
1823 LS, 1824 LS	10/04 →	Ball Head, gearshift linkage	DB-ES-8510			
	10/04 →	Centre Rod	DB-DL-5230		Suspension Rod	
	10/04 →	Centre Rod	DB-DL-5241		Suspension Rod	
	10/04 →	Centre Rod	DB-DL-5405		Push Rod	
	10/04 →	Centre Rod	DB-DL-7270		Push Rod;Suspension Rod	
	10/04 →	Centre Rod	DB-DL-8184		Push Rod	
	10/04 →	Centre Rod	DB-DL-8185		Push Rod	
	10/04 →	Centre Rod	DB-DL-8188		Push Rod, 1st FA;Leaf Spring Axle	
	10/04 →	Centre Rod	DB-DL-8717		Push Rod	
	10/04 →	Centre Rod	DB-DL-12300		for Steering Rod	
	10/04 →	Stabiliser Mounting		DB-RK-9296		
	10/04 →	Stabiliser Mounting		DB-SB-10406		
	10/04 →	Suspension Arm Repair Kit		DB-RK-8550		for Wishbone (CV)
	10/04 →	Suspension Arm Repair Kit		DB-RK-8626		for Wishbone (CV)
	10/04 →	Suspension Arm Repair Kit		DB-RK-8638		for Control Arm
	10/04 →	Suspension Arm Repair Kit		DB-RK-10374		for Wishbone (CV)
	10/04 →	Suspension Strut Repair Kit		DB-RK-9294		
	10/04 →	Suspension Strut Repair Kit		MN-RK-8997		
	10/04 →	Tie Rod	DB-DL-8171			Guide Rod
	10/04 →	Tie Rod	DB-DL-8327			Guide Rod
	10/04 →	Tie Rod	DB-DL-8640			Guide Rod
	10/04 →	Tie Rod	DB-DL-12310			
	10/04 →	Tie Rod	DB-ES-5227			Guide Rod
	10/04 →	Tie Rod End	CV-ES-0543			
	10/04 →	Track Control Arm		DB-VB-3707		Suspension Rod, Wishbone (CV), 1st RA; Air Suspension Axle, →* L 041975 *
	10/04 →	Track Control Arm		DB-VB-7798		Wishbone (CV), Air Suspension Axle
	10/04 →	Track Control Arm	DB-DL-5224			Control Arm, 1st FA;Air Suspension Axle
	10/04 →	Track Control Arm	DB-DL-9218	DB-DL-9218		Trailing Arm, 1st FA;Air Suspension Axle
	1823, 1823 L, 1824, 1824 L, LL	10/04 →	Ball Head, gearshift linkage	DB-ES-8510		
		10/04 →	Centre Rod	DB-DL-5230		Suspension Rod
		10/04 →	Centre Rod	DB-DL-5241		Suspension Rod
		10/04 →	Centre Rod	DB-DL-5405		Push Rod
		10/04 →	Centre Rod	DB-DL-5405		Push Rod, Leaf Spring Axle
10/04 →		Centre Rod	DB-DL-7270		Push Rod;Suspension Rod	
10/04 →		Centre Rod	DB-DL-8184		Push Rod	
10/04 →		Centre Rod	DB-DL-8185		Push Rod	
10/04 →		Centre Rod	DB-DL-8188		Push Rod	
10/04 →		Centre Rod	DB-DL-8188		Push Rod, 1st FA;Air Suspension Axle	
10/04 →		Centre Rod	DB-DL-8622		Push Rod	
10/04 →		Centre Rod	DB-DL-8702		Push Rod	
10/04 →		Centre Rod	DB-DL-8702		Push Rod, Leaf Spring Axle	
10/04 →		Centre Rod	DB-DL-8717		Push Rod	
10/04 →		Centre Rod	DB-DL-8717		Push Rod, Leaf Spring Axle	
10/04 →		Centre Rod	DB-DL-12300		for Steering Rod	
10/04 →		Centre Rod	DB-DL-12466		Push Rod	
10/04 →		Stabiliser Mounting		DB-RK-9296		
10/04 →		Stabiliser Mounting		DB-SB-10406		
10/04 →		Suspension Arm Repair Kit		DB-RK-8550		for Wishbone (CV)
10/04 →		Suspension Arm Repair Kit		DB-RK-8626		for Wishbone (CV)
10/04 →		Suspension Arm Repair Kit		DB-RK-8638		for Control Arm
10/04 →		Suspension Arm Repair Kit		DB-RK-10374		for Wishbone (CV)
10/04 →		Suspension Strut Repair Kit		DB-RK-9294		
10/04 →		Tie Rod	DB-DL-8171			Guide Rod
10/04 →		Tie Rod	DB-DL-8327			Guide Rod
10/04 →		Tie Rod	DB-DL-8388			Guide Rod

CV-ES-0543

Length: 125
Cone Ø: d1 Ø 32 / d2 Ø 29
Thread: M30 x 1,5 RHT
0004605748, 0004606048, 0004606848,
0004607048, 0014600448, 0014601148,
0014601748, 0014602448, 0014607648,
0014609648

**DB-DL-5224**

Length: 850 Ø: 60
Hole Distance: 100 / 100
01336100A, 9413300007

**DB-DL-5230**

Length: 879 Ø: 42
Cone Ø: d1 Ø 30 / d2 Ø 27
01208600A, 0004607105, 0004607205,
0014606705

**DB-DL-5241**

Length: 875 Ø: 40
Cone Ø: d1 Ø 30 / d2 Ø 27
01215300A, 0004609205, 0004609305,
0014606905

**DB-DL-5405**

Length: 890 Ø: 35
Cone Ø: d1 Ø 28,6 / d2 Ø 23,9
01215900A, 1460248, 0024604505, 0024604605,
0034605005, 3752600637, 3754600405,
A3752600637, A3754600405

**DB-DL-7270**

Length: 875 Ø: 40
Cone Ø: d1 Ø 28,6 / d2 Ø 23,9
01208300A, 0024604705, 0024604805,
0034604905, A0024604705

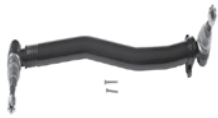
**DB-DL-8171**

Length: 1687 Ø: 52
Cone Ø: d1 Ø 32 / d2 Ø 29
9493300603, 9493300703, 9493301503,
9493301603

**DB-DL-8184**

Length: 1095 Ø: 42
Cone Ø: d1 Ø 32 / d2 Ø 28,8
01217700A, 0014601305, 0014601405,
0024605005, 0034603205, 3754601505,
A0014601305, A0014601405, A0024605005

**DB-DL-8185**

Length: 711 Ø: 42
Cone Ø: d1 Ø 32 / d2 Ø 28,8
01213600A, 0014601105, 0024600405,
0034603105, A0014601105, A0024600405

**DB-DL-8188**

Length: 895 Ø: 40
Cone Ø: d1 Ø 28,6 / d2 Ø 23,9
01217200A, 0024604905, 0024605005,
0034605605

**DB-DL-8327**

Length: 1745 Ø: 48
Cone Ø: d1 Ø 32 / d2 Ø 29
01219800A, 9413300003, 9413300103,
9413300203, 9413300303, 9413300503

**DB-DL-8388**

Length: 1735 Ø: 62
Cone Ø: d1 Ø 32 / d2 Ø 28,8
01219900A, 9453300003, 9453300103,
9453300403, 9453300603, A9453300003

**DB-DL-8622**

Length: 1558 Ø: 52
Cone Ø: d1 Ø 30 / d2 Ø 27
0014609005, 0014609105

**DB-DL-8640**

Length: 1615 Ø: 50
Cone Ø: d1 Ø 32 / d2 Ø 29
6253301503, 6253301603, 6253302403,
6253302503, 9423300803, 9423302103,
9493300203, 9493300303, 9493300903

**DB-DL-8702**

Length: 958 Ø: 38
Cone Ø: d1 Ø 32 / d2 Ø 30
0024606105, 0024606205, 0034604205

**DB-DL-8717**

Length: 886
Ø: 38
Cone Ø: d1 Ø 30 / d2 Ø 27
0024601705, 24601705, 0024607505, 24607505,
0024607605, 24607605, 0034604405

**DB-DL-9218**

Length: 754 Ø: 40
Hole Distance: 100
000360098524, 000390098524, 3753300111,
9413300011, A3753300111, SA50831601

**DB-DL-12300**

Length: 733 Ø: 36
Cone Ø: d1 Ø 32 / d2 Ø 29
0014601505, 0014607305, 0034603305,
3754601605, A0014601505, A0034603305,
A3754601605

**DB-DL-12310**

Length: 1532 Ø: 50
Cone Ø: d1 Ø 32 / d2 Ø 29
Thread: M27 x 1,5 LHT
9493301203, 9493301303, 9493301803,
9493302203, A9493301203, A9493301303,
A9493301803, A9493302203

**DB-DL-12466**

Length: 905 Ø: 38
Cone Ø: d1 Ø 32 / d2 Ø 29
0024605305, 0024605405, A0024605305,
A0024605405

No Image

DB-ES-5227

Length: 1588 Ø: 60
Cone Ø: d1 Ø 38 / d2 Ø 34,3
6253300903, 6253301203, 9443300203

**DB-ES-8164**

Length: 140
Cone Ø: d1 Ø 28,6 / d2 Ø 23,9
Thread: M28 x 1,5 RHT
0014604248, 0014605048, 0014608548,
0024600548

**DB-ES-8510**

Length: 56
Cone Ø: d1 Ø 10 / d2 Ø 10
Thread: M12 x 1,75 LHT
0009965145, 0009965645, 0019963145

**DB-RK-8550**

Ø: 75 Hole Distance: 152
Thick/Height: 24
0003502105, 0003504605

**DB-RK-8626**

Ø: 75 Hole Distance: 130
Thick/Height: 24
0003502205, 0003502505, 0003503405,
0003504505, GL11319

**DB-RK-8638**

Length: 100 Ø: 67
Hole Distance: 100
Thick/Height: 20
0003301411

**DB-RK-9294**

Ø: 85 Hole Distance: 152
Thick/Height: 24
0003503105

**DB-RK-9296**

Ø: 88 Hole Distance: 130
Thick/Height: 24
9423260050

**DB-RK-10374**

Ø: 85 Hole Distance: 152
Thick/Height: 24
0003504405

**DB-SB-10406**

Ø: 80 Thick/Height: 46
0003238185

**DB-VB-3707**

Length: 622 Ø: 46
Hole Ø 25 / 25 / 25
Hole Distance: 152 / 130 / 130
01337100A, 9423501005, 9423501505,
9443500005, 9473500105, 9473501005,
A375350005, A9423501005, A9423501505,
A9443500005, A9473500105, A9473501005

**DB-VB-7261**

Length: 622 Ø: 46
Hole Ø 25 / 25 / 25
Hole Distance: 152 / 130 / 130
01337800A, 9443500305, 9443500505,
9443500605, 9473500705, 9473500905,
9483500405, 9483503005

**DB-VB-7798**

Length: 622 Ø: 48
Hole Ø 25 / 23 / 23
Hole Distance: 152 / 130 / 130
9423500505, 9423500805, 9423501205,
A9423501205

**MN-RK-8997**

Ø: 85 Hole Distance: 130
Thick/Height: 30
0003504805





AXOR 2 ...

1823, 1823 L, 1824, 1824 L, LL ...	10/04 →	Tie Rod	DB-DL-8389	
	10/04 →	Tie Rod	DB-DL-8640	Guide Rod
	10/04 →	Tie Rod	DB-DL-12310	
	10/04 →	Tie Rod	DB-ES-5227	Guide Rod
	10/04 →	Tie Rod End	DB-ES-8164	for Push Rod
	10/04 →	Track Control Arm		DB-VB-3707 Suspension Rod, Wishbone (CV), 1st RA; Air Suspension Axle, →* L 041975 *
	10/04 →	Track Control Arm		DB-VB-7261 Suspension Rod, Wishbone (CV), 1st RA;2nd RA; Leaf Spring Axle
	10/04 →	Track Control Arm	DB-DL-5224	Control Arm, 1st FA;Air Suspension Axle
	10/04 →	Track Control Arm	DB-DL-9218	DB-DL-9218 Trailing Arm, 1st FA;Air Suspension Axle
	1826 AK	10/04 →	Ball Head, gearshift linkage	DB-ES-8510
10/04 →		Centre Rod	DB-DL-8307	Push Rod, Leaf Spring Axle
10/04 →		Centre Rod	DB-DL-8702	Push Rod, Leaf Spring Axle
10/04 →		Centre Rod	DB-DL-12466	Push Rod
10/04 →		Stabiliser Mounting		DB-SB-10406
10/04 →		Tie Rod	DB-DL-12310	
10/04 →		Tie Rod	DB-ES-5227	Guide Rod
10/04 →		Tie Rod	MN-DL-7834	Guide Rod
10/04 →		Tie Rod End	DB-ES-5234	for Steering Rod
10/04 →		Track Control Arm		DB-VB-7261 Suspension Rod, Wishbone (CV), 1st RA;2nd RA; Leaf Spring Axle
1826 K	10/04 →	Ball Head, gearshift linkage	DB-ES-8510	
	10/04 →	Centre Rod	DB-DL-5230	Suspension Rod
	10/04 →	Centre Rod	DB-DL-5241	Suspension Rod
	10/04 →	Centre Rod	DB-DL-5405	Push Rod, Leaf Spring Axle
	10/04 →	Centre Rod	DB-DL-7270	Push Rod;Suspension Rod
	10/04 →	Centre Rod	DB-DL-8184	Push Rod
	10/04 →	Centre Rod	DB-DL-8185	Push Rod
	10/04 →	Centre Rod	DB-DL-8188	Push Rod, Leaf Spring Axle
	10/04 →	Centre Rod	DB-DL-8702	Push Rod, Leaf Spring Axle
	10/04 →	Centre Rod	DB-DL-8717	Push Rod, Leaf Spring Axle
	10/04 →	Centre Rod	DB-DL-12300	for Steering Rod
	10/04 →	Centre Rod	DB-DL-12466	Push Rod
	10/04 →	Stabiliser Mounting		DB-SB-10406
	10/04 →	Suspension Arm Repair Kit		DB-RK-8550 for Wishbone (CV)
	10/04 →	Tie Rod	DB-DL-8171	Guide Rod
	10/04 →	Tie Rod	DB-DL-8327	Guide Rod
	10/04 →	Tie Rod	DB-DL-8640	Guide Rod
	10/04 →	Tie Rod	DB-DL-12310	
	10/04 →	Tie Rod	DB-ES-5227	Guide Rod
	10/04 →	Tie Rod End	DB-ES-8164	for Push Rod
10/04 →	Track Control Arm		DB-VB-7261 Suspension Rod, Wishbone (CV), 1st RA;2nd RA; Leaf Spring Axle	
1826 LS	10/04 →	Ball Head, gearshift linkage	DB-ES-8510	
	10/04 →	Centre Rod	DB-DL-5230	Suspension Rod
	10/04 →	Centre Rod	DB-DL-5241	Suspension Rod
	10/04 →	Centre Rod	DB-DL-5405	Push Rod
	10/04 →	Centre Rod	DB-DL-7270	Push Rod;Suspension Rod
	10/04 →	Centre Rod	DB-DL-8184	Push Rod
	10/04 →	Centre Rod	DB-DL-8185	Push Rod
	10/04 →	Centre Rod	DB-DL-8188	Push Rod, 1st FA;Leaf Spring Axle
	10/04 →	Centre Rod	DB-DL-8717	Push Rod
	10/04 →	Centre Rod	DB-DL-12300	for Steering Rod
	10/04 →	Stabiliser Mounting		DB-RK-9296
	10/04 →	Stabiliser Mounting		DB-SB-10406
	10/04 →	Suspension Arm Repair Kit		DB-RK-8550 for Wishbone (CV)
	10/04 →	Suspension Arm Repair Kit		DB-RK-8626 for Wishbone (CV)
	10/04 →	Suspension Arm Repair Kit		DB-RK-8638 for Control Arm
	10/04 →	Suspension Arm Repair Kit		DB-RK-10374 for Wishbone (CV)
	10/04 →	Suspension Strut Repair Kit		DB-RK-9294
	10/04 →	Suspension Strut Repair Kit		MN-RK-8997
	10/04 →	Tie Rod	DB-DL-8171	Guide Rod

DB-DL-5224

Length: 850 Ø: 60
Hole Distance: 100 / 100
01336100A, 9413300007

**DB-DL-5230**

Length: 879 Ø: 42
Cone Ø: d1 Ø 30 / d2 Ø 27
01208600A, 0004607105, 0004607205,
0014606705

**DB-DL-5241**

Length: 875 Ø: 40
Cone Ø: d1 Ø 30 / d2 Ø 27
01215900A, 0004609205, 0004609305,
0014606905

**DB-DL-5405**

Length: 890 Ø: 35
Cone Ø: d1 Ø 28,6 / d2 Ø 23,9
01215900A, 1460248, 0024604505, 0024604605,
0034605005, 3752600637, 3754600405,
A3752600637, A3754600405

**DB-DL-7270**

Length: 875 Ø: 40
Cone Ø: d1 Ø 28,6 / d2 Ø 23,9
01208300A, 0024604705, 0024604805,
0034604905, A0024604705

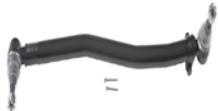
**DB-DL-8171**

Length: 1687 Ø: 52
Cone Ø: d1 Ø 32 / d2 Ø 29
9493300603, 9493300703, 9493301503,
9493301603

**DB-DL-8184**

Length: 1095 Ø: 42
Cone Ø: d1 Ø 32 / d2 Ø 28,8
01217700A, 0014601305, 0014601405,
0024600505, 0034603205, 3754601505,
A0014601305, A0014601405, A0024600505

**DB-DL-8185**

Length: 711 Ø: 42
Cone Ø: d1 Ø 32 / d2 Ø 28,8
01213600A, 0014601105, 0024600405,
0034603105, A0014601105, A0024600405

**DB-DL-8188**

Length: 895 Ø: 40
Cone Ø: d1 Ø 28,6 / d2 Ø 23,9
01217200A, 0024604905, 0024605005,
0034605605

**DB-DL-8307**

Length: 885 Ø: 38
Cone Ø: d1 Ø 32 / d2 Ø 30
01215500A, 0004604005, 0024605105,
0024605205, 0034604005

**DB-DL-8327**

Length: 1745 Ø: 48
Cone Ø: d1 Ø 32 / d2 Ø 29
01219800A, 9413300003, 9413300103,
9413300203, 9413300303, 9413300503

**DB-DL-8389**

Length: 1465 Ø: 40
Cone Ø: d1 Ø 32 / d2 Ø 29
9453300203, 9453300303, 9453300503

**DB-DL-8640**

Length: 1615 Ø: 50
Cone Ø: d1 Ø 32 / d2 Ø 29
6253301503, 6253301603, 6253302403,
6253302503, 9423300803, 9423302103,
9493300203, 9493300303, 9493300903

**DB-DL-8702**

Length: 958 Ø: 38
Cone Ø: d1 Ø 32 / d2 Ø 30
0024606105, 0024606205, 0034604205

**DB-DL-8717**

Length: 886
Ø: 38
Cone Ø: d1 Ø 30 / d2 Ø 27
0024601705, 24601705, 0024607505, 24607505,
0024607605, 24607605, 0034604405

**DB-DL-9218**

Length: 754 Ø: 40
Hole Distance: 100
000360098524, 000390098524, 3753300111,
9413300011, A3753300111, SA50831601

**DB-DL-12300**

Length: 733 Ø: 36
Cone Ø: d1 Ø 32 / d2 Ø 29
0014601505, 0014607305, 0034603305,
3754601605, A0014601505, A0034603305,
A3754601605

**DB-DL-12310**

Length: 1532 Ø: 50
Cone Ø: d1 Ø 32 / d2 Ø 29
Thread: M27 x 1,5 LHT
9493301203, 9493301303, 9493301803,
9493302203, A9493301203, A9493301303,
A9493301803, A9493302203

**DB-DL-12466**

Length: 905 Ø: 38
Cone Ø: d1 Ø 32 / d2 Ø 29
0024605305, 0024605405, A0024605305,
A0024605405

No Image

DB-ES-5227

Length: 1588 Ø: 60
Cone Ø: d1 Ø 38 / d2 Ø 34,3
6253300903, 6253301203, 9443300203

**DB-ES-5234**

Length: 135
Cone Ø: d1 Ø 38 / d2 Ø 34,3
Thread: M38 x 1,5 RHT
0004601748, 120322305, 2205000400

**DB-ES-8164**

Length: 140
Cone Ø: d1 Ø 28,6 / d2 Ø 23,9
Thread: M28 x 1,5 RHT
0014604248, 0014605048, 0014608548,
0024600548

**DB-ES-8510**

Length: 56
Cone Ø: d1 Ø 10 / d2 Ø 10
Thread: M12 x 1,75 LHT
0009965145, 0009965645, 0019963145

**DB-RK-8550**

Ø: 75 Hole Distance: 152
Thick/Height: 24
0003502105, 0003504605

**DB-RK-8626**

Ø: 75 Hole Distance: 130
Thick/Height: 24
0003502205, 0003502505, 0003503405,
0003504505, GL11319

**DB-RK-8638**

Length: 100 Ø: 67
Hole Distance: 100
Thick/Height: 20
0003301411

**DB-RK-9294**

Ø: 85 Hole Distance: 152
Thick/Height: 24
0003503105

**DB-RK-9296**

Ø: 88 Hole Distance: 130
Thick/Height: 24
9423260050

**DB-RK-10374**

Ø: 85 Hole Distance: 152
Thick/Height: 24
0003504405

**DB-SB-10406**

Ø: 80 Thick/Height: 46
0003238185

**DB-VB-3707**

Length: 622 Ø: 46
Hole Ø 25 / 25 / 25
Hole Distance: 152 / 130 / 130
01337100A, 9423501005, 9423501505,
9443500005, 9473500105, 9473501005,
A373500005, A9423501005, A9423501505,
A9443500005, A9473500105, A9473501005

**DB-VB-7261**

Length: 622 Ø: 46
Hole Ø 25 / 25 / 25
Hole Distance: 152 / 130 / 130
01337800A, 9443500305, 9443500505,
9443500605, 9473500705, 9473500905,
9483500405, 9483503005

**MN-DL-7834**

Length: 1588 Ø: 58
Cone Ø: d1 Ø 30 / d2 Ø 27
3463303903, 3463304903, 6253303203,
9443300503, 9443301303, 9443301703

**MN-RK-8997**

Ø: 85 Hole Distance: 130
Thick/Height: 30
0003504805





AXOR 2 ...

1826 LS ...	10/04 →	Tie Rod	DB-DL-8327		Guide Rod	
	10/04 →	Tie Rod	DB-DL-8640		Guide Rod	
	10/04 →	Tie Rod	DB-DL-12310			
	10/04 →	Tie Rod	DB-ES-5227		Guide Rod	
	10/04 →	Tie Rod End	CV-ES-0543			
	10/04 →	Track Control Arm		DB-VB-3707	Suspension Rod, Wishbone (CV), 1st RA; Air Suspension Axle, →* L 041975 *	
	10/04 →	Track Control Arm		DB-VB-7798	Wishbone (CV), Air Suspension Axle	
	10/04 →	Track Control Arm	DB-DL-5224		Control Arm, 1st FA; Air Suspension Axle	
	10/04 →	Track Control Arm	DB-DL-9218	DB-DL-9218	Trailing Arm, 1st FA; Air Suspension Axle	
	1826, 1826 L, LL	10/04 →	Ball Head, gearshift linkage	DB-ES-8510		
10/04 →		Centre Rod	DB-DL-5230		Suspension Rod	
10/04 →		Centre Rod	DB-DL-5241		Suspension Rod	
10/04 →		Centre Rod	DB-DL-5405		Push Rod	
10/04 →		Centre Rod	DB-DL-5405		Push Rod, Leaf Spring Axle	
10/04 →		Centre Rod	DB-DL-7270		Push Rod; Suspension Rod	
10/04 →		Centre Rod	DB-DL-8184		Push Rod	
10/04 →		Centre Rod	DB-DL-8185		Push Rod	
10/04 →		Centre Rod	DB-DL-8188		Push Rod	
10/04 →		Centre Rod	DB-DL-8188		Push Rod, 1st FA; Air Suspension Axle	
10/04 →		Centre Rod	DB-DL-8622		Push Rod	
10/04 →		Centre Rod	DB-DL-8702		Push Rod	
10/04 →		Centre Rod	DB-DL-8702		Push Rod, Leaf Spring Axle	
10/04 →		Centre Rod	DB-DL-8717		Push Rod	
10/04 →		Centre Rod	DB-DL-8717		Push Rod, Leaf Spring Axle	
10/04 →		Centre Rod	DB-DL-12300		for Steering Rod	
10/04 →		Centre Rod	DB-DL-12466		Push Rod	
10/04 →		Stabiliser Mounting		DB-RK-9296		
10/04 →		Stabiliser Mounting		DB-SB-10406		
10/04 →		Suspension Arm Repair Kit		DB-RK-8550	for Wishbone (CV)	
10/04 →		Suspension Arm Repair Kit		DB-RK-8626	for Wishbone (CV)	
10/04 →		Suspension Arm Repair Kit		DB-RK-8638	for Control Arm	
10/04 →		Suspension Arm Repair Kit		DB-RK-10374	for Wishbone (CV)	
10/04 →		Suspension Strut Repair Kit		DB-RK-9294		
10/04 →		Tie Rod	DB-DL-8171		Guide Rod	
10/04 →		Tie Rod	DB-DL-8327		Guide Rod	
10/04 →		Tie Rod	DB-DL-8640		Guide Rod	
10/04 →		Tie Rod	DB-DL-12310			
10/04 →		Tie Rod	DB-ES-5227		Guide Rod	
10/04 →		Tie Rod End	DB-ES-8164		for Push Rod	
10/04 →		Track Control Arm		DB-VB-3707	Suspension Rod, Wishbone (CV), 1st RA; Air Suspension Axle, →* L 041975 *	
10/04 →		Track Control Arm		DB-VB-7261	Suspension Rod, Wishbone (CV), 1st RA; 2nd RA; Leaf Spring Axle	
10/04 →		Track Control Arm	DB-DL-5224		Control Arm, 1st FA; Air Suspension Axle	
10/04 →		Track Control Arm	DB-DL-9218	DB-DL-9218	Trailing Arm, 1st FA; Air Suspension Axle	
1828 A, 1829 A		10/04 →	Ball Head, gearshift linkage	DB-ES-8510		
		10/04 →	Centre Rod	DB-DL-8184		Push Rod
		10/04 →	Centre Rod	DB-DL-8307		Push Rod, Leaf Spring Axle
		10/04 →	Centre Rod	DB-DL-8622		Push Rod
		10/04 →	Centre Rod	DB-DL-8702		Push Rod, Leaf Spring Axle
		10/04 →	Centre Rod	DB-DL-12466		Push Rod
	10/04 →	Stabiliser Mounting		DB-SB-10406		
	10/04 →	Tie Rod	DB-DL-12310			
	10/04 →	Tie Rod	DB-ES-5227		Guide Rod	
	10/04 →	Tie Rod	MN-DL-7834		Guide Rod	
	10/04 →	Tie Rod End	DB-ES-5234		for Steering Rod	
	10/04 →	Track Control Arm		DB-VB-7261	Suspension Rod, Wishbone (CV), 1st RA; 2nd RA; Leaf Spring Axle	
	1828 AK, 1829 AK	10/04 →	Ball Head, gearshift linkage	DB-ES-8510		
		10/04 →	Centre Rod	DB-DL-8307		Push Rod, Leaf Spring Axle
10/04 →		Centre Rod	DB-DL-8702		Push Rod, Leaf Spring Axle	
10/04 →		Centre Rod	DB-DL-12466		Push Rod	

CV-ES-0543

Length: 125
Cone Ø: d1 Ø 32 / d2 Ø 29
Thread: M30 x 1,5 RHT
0004605748, 0004606048, 0004606848,
0004607048, 0014600448, 0014601148,
0014601748, 0014602448, 0014607648,
0014609648



DB-DL-5224

Length: 850 Ø: 60
Hole Distance: 100 / 100
01336100A, 9413300007



DB-DL-5230

Length: 879 Ø: 42
Cone Ø: d1 Ø 30 / d2 Ø 27
01208600A, 0004607105, 0004607205,
0014606705



DB-DL-5241

Length: 875 Ø: 40
Cone Ø: d1 Ø 30 / d2 Ø 27
01215300A, 0004609205, 0004609305,
0014606905



DB-DL-5405

Length: 890 Ø: 35
Cone Ø: d1 Ø 28,6 / d2 Ø 23,9
01215900A, 1460248, 0024604505, 0024604605,
0034605005, 3752600637, 3754600405,
A3752600637, A3754600405



DB-DL-7270

Length: 875 Ø: 40
Cone Ø: d1 Ø 28,6 / d2 Ø 23,9
01208300A, 0024604705, 0024604805,
0034604905, A0024604705

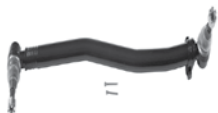

DB-DL-8171

Length: 1687 Ø: 52
Cone Ø: d1 Ø 32 / d2 Ø 29
9493300603, 9493300703, 9493301503,
9493301603



DB-DL-8184

Length: 1095 Ø: 42
Cone Ø: d1 Ø 32 / d2 Ø 28,8
01217700A, 0014601305, 0014601405,
0024605005, 0034603205, 3754601505,
A0014601305, A0014601405, A0024605005



DB-DL-8185

Length: 711 Ø: 42
Cone Ø: d1 Ø 32 / d2 Ø 28,8
01213600A, 0014601105, 0024600405,
0034603105, A0014601105, A0024600405



DB-DL-8188

Length: 895 Ø: 40
Cone Ø: d1 Ø 28,6 / d2 Ø 23,9
01217200A, 0024604905, 0024605005,
0034605605



DB-DL-8307

Length: 885 Ø: 38
Cone Ø: d1 Ø 32 / d2 Ø 30
01215500A, 0004604005, 0024605105,
0024605205, 0034604005



DB-DL-8327

Length: 1745 Ø: 48
Cone Ø: d1 Ø 32 / d2 Ø 29
01219800A, 9413300003, 9413300103,
9413300203, 9413300303, 9413300503



DB-DL-8622

Length: 1558 Ø: 52
Cone Ø: d1 Ø 30 / d2 Ø 27
0014609005, 0014609105



DB-DL-8640

Length: 1615 Ø: 50
Cone Ø: d1 Ø 32 / d2 Ø 29
6253301503, 6253301603, 6253302403,
6253302503, 9423300803, 9423302103,
9493300203, 9493300303, 9493300903



DB-DL-8702

Length: 958 Ø: 38
Cone Ø: d1 Ø 32 / d2 Ø 30
0024606105, 0024606205, 0034604205



DB-DL-8717

Length: 886 Ø: 38
Cone Ø: d1 Ø 30 / d2 Ø 27
0024601705, 0024607505, 0024607605,
0034604405



DB-DL-9218

Length: 754 Ø: 40
Hole Distance: 100
000360098524, 000390098524, 3753300111,
9413300011, A3753300111, SA50831601



DB-DL-12300

Length: 733 Ø: 36
Cone Ø: d1 Ø 32 / d2 Ø 29
0014601505, 0014607305, 0034603305,
3754601605, A0014601505, A0034603305,
A3754601605



DB-DL-12310

Length: 1532 Ø: 50
Cone Ø: d1 Ø 32 / d2 Ø 29
Thread: M27 x 1,5 LHT
9493301203, 9493301303, 9493301803,
9493302203, A9493301203, A9493301303,
A9493301803, A9493302203



DB-DL-12466

Length: 905 Ø: 38
Cone Ø: d1 Ø 32 / d2 Ø 29
0024605305, 0024605405, A0024605305,
A0024605405

No Image

DB-ES-5227

Length: 1588 Ø: 60
Cone Ø: d1 Ø 38 / d2 Ø 34,3
6253300903, 6253301203, 9443300203



DB-ES-5234

Length: 135
Cone Ø: d1 Ø 38 / d2 Ø 34,3
Thread: M38 x 1,5 RHT
0004601748, 120322305, 2205000400



DB-ES-8164

Length: 140
Cone Ø: d1 Ø 28,6 / d2 Ø 23,9
Thread: M28 x 1,5 RHT
0014604248, 0014605048, 0014608548,
0024600548



DB-ES-8510

Length: 56
Cone Ø: d1 Ø 10 / d2 Ø 10
Thread: M12 x 1,75 LHT
0009965145, 0009965645, 0019963145



DB-RK-8550

Ø: 75 Hole Distance: 152
Thick/Height: 24
0003502105, 0003504605



DB-RK-8626

Ø: 75 Hole Distance: 130
Thick/Height: 24
0003502205, 0003502505, 0003503405,
0003504505, GL11319



DB-RK-8638

Length: 100 Ø: 67
Hole Distance: 100
Thick/Height: 20
0003301411



DB-RK-9294

Ø: 85 Hole Distance: 152
Thick/Height: 24
0003503105



DB-RK-9296

Ø: 88 Hole Distance: 130
Thick/Height: 24
9423260050



DB-RK-10374

Ø: 85 Hole Distance: 152
Thick/Height: 24
0003504405



DB-SB-10406

Ø: 80 Thick/Height: 46
0003238185



DB-VB-3707

Length: 622 Ø: 46
Hole Ø 25 / 25 / 25
Hole Distance: 152 / 130 / 130
01337100A, 9423501005, 9423501505,
9443500005, 9473500105, 9473501005,
A3753500005, A9423501005, A9423501505,
A9443500005, A9473500105, A9473501005



DB-VB-7261

Length: 622 Ø: 46
Hole Ø 25 / 25 / 25
Hole Distance: 152 / 130 / 130
01337800A, 9443500305, 9443500505,
9443500605, 9473500705, 9473500905,
9483500405, 9483500505



DB-VB-7798

Length: 622 Ø: 48
Hole Ø 25 / 23 / 23
Hole Distance: 152 / 130 / 130
9423500505, 9423500805, 9423501205,
A9423501205



MN-DL-7834

Length: 1588 Ø: 58
Cone Ø: d1 Ø 30 / d2 Ø 27
3463303903, 3463304903, 6253303203,
9443300503, 9443301303, 9443301703





AXOR 2 ...

1828 AK, 1829 AK ...	10/04 →	Stabiliser Mounting		DB-SB-10406		
	10/04 →	Stabiliser Mounting		DB-SB-10409		
	10/04 →	Suspension Strut Repair Kit		DB-RK-8391		
	10/04 →	Tie Rod	DB-DL-12310			
	10/04 →	Tie Rod	DB-ES-5227		Guide Rod	
	10/04 →	Tie Rod	MN-DL-7834		Guide Rod	
	10/04 →	Tie Rod End	DB-ES-5234		for Steering Rod	
	10/04 →	Track Control Arm		DB-VB-7261	Suspension Rod, Wishbone (CV), 1st RA;2nd RA; Leaf Spring Axle	
	10/04 →	Track Control Arm		DB-VB-7798	Wishbone (CV)	
	1828 K, 1828 KL, 1829 K	10/04 →	Ball Head, gearshift linkage	DB-ES-8510		
10/04 →		Centre Rod	DB-DL-5230		Suspension Rod	
10/04 →		Centre Rod	DB-DL-5241		Suspension Rod	
10/04 →		Centre Rod	DB-DL-5405		Push Rod	
10/04 →		Centre Rod	DB-DL-5405		Push Rod, Leaf Spring Axle	
10/04 →		Centre Rod	DB-DL-7270		Push Rod;Suspension Rod	
10/04 →		Centre Rod	DB-DL-8184		Push Rod	
10/04 →		Centre Rod	DB-DL-8185		Push Rod	
10/04 →		Centre Rod	DB-DL-8188		Push Rod, Leaf Spring Axle	
10/04 →		Centre Rod	DB-DL-8702		Push Rod, Leaf Spring Axle	
10/04 →		Centre Rod	DB-DL-8717		Push Rod, Leaf Spring Axle	
10/04 →		Centre Rod	DB-DL-12300		for Steering Rod	
10/04 →		Centre Rod	DB-DL-12466		Push Rod	
10/04 →		Stabiliser Mounting		DB-SB-10406		
10/04 →		Stabiliser Mounting		DB-SB-10409		
10/04 →		Suspension Arm Repair Kit		DB-RK-8550	for Wishbone (CV)	
10/04 →		Suspension Strut Repair Kit		DB-RK-8391		
10/04 →		Tie Rod	DB-DL-8171		Guide Rod	
10/04 →		Tie Rod	DB-DL-8327		Guide Rod	
10/04 →		Tie Rod	DB-DL-8640		Guide Rod	
10/04 →		Tie Rod	DB-DL-12310			
10/04 →		Tie Rod	DB-ES-5227		Guide Rod	
10/04 →		Tie Rod End	DB-ES-8164		for Push Rod	
10/04 →		Track Control Arm		DB-VB-7261	Suspension Rod, Wishbone (CV), 1st RA;2nd RA; Leaf Spring Axle	
10/04 →		Track Control Arm		DB-VB-7798	Wishbone (CV)	
1828 LS		10/04 →	Centre Rod	DB-DL-5405		Push Rod
		10/04 →	Centre Rod	DB-DL-8188		Push Rod
		10/04 →	Centre Rod	DB-DL-8717		Push Rod
		10/04 →	Tie Rod	DB-DL-8171		Guide Rod
		10/04 →	Tie Rod	DB-DL-8327		Guide Rod
	10/04 →	Tie Rod	DB-DL-8640		Guide Rod	
	10/04 →	Track Control Arm		DB-VB-3707	Suspension Rod, Wishbone (CV)	
	10/04 →	Track Control Arm		DB-VB-7798	Wishbone (CV)	
	10/04 →	Track Control Arm	DB-DL-5224		Control Arm	
	10/04 →	Track Control Arm	DB-DL-9218	DB-DL-9218	Trailing Arm	
1828, 1828 L, 1829, 1829 L, LL	10/04 →	Ball Head, gearshift linkage	DB-ES-8510			
	10/04 →	Centre Rod	DB-DL-5230		Suspension Rod	
	10/04 →	Centre Rod	DB-DL-5241		Suspension Rod	
	10/04 →	Centre Rod	DB-DL-5405		Push Rod	
	10/04 →	Centre Rod	DB-DL-5405		Push Rod, Leaf Spring Axle	
	10/04 →	Centre Rod	DB-DL-7270		Push Rod;Suspension Rod	
	10/04 →	Centre Rod	DB-DL-8184		Push Rod	
	10/04 →	Centre Rod	DB-DL-8185		Push Rod	
	10/04 →	Centre Rod	DB-DL-8188		Push Rod	
	10/04 →	Centre Rod	DB-DL-8188		Push Rod, 1st FA;Air Suspension Axle	
	10/04 →	Centre Rod	DB-DL-8622		Push Rod	
	10/04 →	Centre Rod	DB-DL-8702		Push Rod	
	10/04 →	Centre Rod	DB-DL-8702		Push Rod, Leaf Spring Axle	
	10/04 →	Centre Rod	DB-DL-8717		Push Rod	
	10/04 →	Centre Rod	DB-DL-8717		Push Rod, Leaf Spring Axle	
	10/04 →	Centre Rod	DB-DL-12300		for Steering Rod	
	10/04 →	Stabiliser Mounting		DB-RK-9296		

DB-DL-5224

Length: 850 Ø: 60
 Hole Distance: 100 / 100
 01336100A, 941330007

**DB-DL-5230**

Length: 879 Ø: 42
 Cone Ø: d1 Ø 30 / d2 Ø 27
 01208600A, 0004607105, 0004607205,
 0014606705

**DB-DL-5241**

Length: 875 Ø: 40
 Cone Ø: d1 Ø 30 / d2 Ø 27
 01215900A, 0004609205, 0004609305,
 0014606905

**DB-DL-5405**

Length: 890 Ø: 35
 Cone Ø: d1 Ø 28,6 / d2 Ø 23,9
 01215900A, 1460248, 0024604505, 0024604605,
 0034605005, 3752600637, 3754600405,
 A3752600637, A3754600405

**DB-DL-7270**

Length: 875 Ø: 40
 Cone Ø: d1 Ø 28,6 / d2 Ø 23,9
 01208300A, 0024604705, 0024604805,
 0034604905, A0024604705

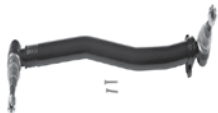
**DB-DL-8171**

Length: 1687 Ø: 52
 Cone Ø: d1 Ø 32 / d2 Ø 29
 9493300603, 9493300703, 9493301503,
 9493301603

**DB-DL-8184**

Length: 1095 Ø: 42
 Cone Ø: d1 Ø 32 / d2 Ø 28,8
 01217700A, 0014601305, 0014601405,
 0024600505, 0034603205, 3754601505,
 A0014601305, A0014601405, A0024600505

**DB-DL-8185**

Length: 711 Ø: 42
 Cone Ø: d1 Ø 32 / d2 Ø 28,8
 01213600A, 0014601105, 0024600405,
 0034603105, A0014601105, A0024600405

**DB-DL-8188**

Length: 895 Ø: 40
 Cone Ø: d1 Ø 28,6 / d2 Ø 23,9
 01217200A, 0024604905, 0024605005,
 0034605605

**DB-DL-8327**

Length: 1745 Ø: 48
 Cone Ø: d1 Ø 32 / d2 Ø 29
 01219800A, 9413300003, 9413300103,
 9413300203, 9413300303, 9413300503

**DB-DL-8622**

Length: 1558 Ø: 52
 Cone Ø: d1 Ø 30 / d2 Ø 27
 0014609005, 0014609105

**DB-DL-8640**

Length: 1615 Ø: 50
 Cone Ø: d1 Ø 32 / d2 Ø 29
 6253301503, 6253301603, 6253302403,
 6253302503, 9423300803, 9423302103,
 9493300203, 9493300303, 9493300903

**DB-DL-8702**

Length: 958 Ø: 38
 Cone Ø: d1 Ø 32 / d2 Ø 30
 0024606105, 0024606205, 0034604205

**DB-DL-8717**

Length: 886
 Ø: 38
 Cone Ø: d1 Ø 30 / d2 Ø 27
 0024601705, 24601705, 0024607505, 24607505,
 0024607605, 24607605, 0034604405

**DB-DL-9218**

Length: 754 Ø: 40
 Hole Distance: 100
 000360098524, 000390098524, 3753300111,
 9413300011, A3753300111, SA50831601

**DB-DL-12300**

Length: 733 Ø: 36
 Cone Ø: d1 Ø 32 / d2 Ø 29
 0014601505, 0014607305, 0034603305,
 3754601605, A0014601505, A0034603305,
 A3754601605

**DB-DL-12310**

Length: 1532 Ø: 50
 Cone Ø: d1 Ø 32 / d2 Ø 29
 Thread: M27 x 1,5 LHT
 9493301203, 9493301303, 9493301803,
 9493302203, A9493301203, A9493301303,
 A9493301803, A9493302203

**DB-DL-12466**

Length: 905 Ø: 38
 Cone Ø: d1 Ø 32 / d2 Ø 29
 0024605305, 0024605405, A0024605305,
 A0024605405



No Image

DB-ES-5227

Length: 1588 Ø: 60
 Cone Ø: d1 Ø 38 / d2 Ø 34,3
 6253300903, 6253301203, 9443300203

**DB-ES-5234**

Length: 135
 Cone Ø: d1 Ø 38 / d2 Ø 34,3
 Thread: M38 x 1,5 RHT
 0004601748, 120322305, 2205000400

**DB-ES-8164**

Length: 140
 Cone Ø: d1 Ø 28,6 / d2 Ø 23,9
 Thread: M28 x 1,5 RHT
 0014604248, 0014605048, 0014608548,
 0024600548

**DB-ES-8510**

Length: 56
 Cone Ø: d1 Ø 10 / d2 Ø 10
 Thread: M12 x 1,75 LHT
 0009965145, 0009965645, 0019963145

**DB-RK-8391**

Ø: 85 Hole Distance: 152
 Thick/Height: 24
 01336800A, 0003502705

**DB-RK-8550**

Ø: 75 Hole Distance: 152
 Thick/Height: 24
 0003502105, 0003504605

**DB-RK-9296**

Ø: 88 Hole Distance: 130
 Thick/Height: 24
 9423260050

**DB-SB-10406**

Ø: 80 Thick/Height: 46
 0003238185

**DB-SB-10409**

Ø: 77 Thick/Height: 56
 0003265181

**DB-VB-3707**

Length: 622 Ø: 46
 Hole Ø 25 / 25 / 25
 Hole Distance: 152 / 130 / 130
 01337100A, 9423501005, 9423501505,
 9443500005, 9473500105, 9473501005,
 A3753500005, A9423501005, A9423501505,
 A9443500005, A9473500105, A9473501005

**DB-VB-7261**

Length: 622 Ø: 46
 Hole Ø 25 / 25 / 25
 Hole Distance: 152 / 130 / 130
 01337800A, 9443500305, 9443500505,
 9443500605, 9473500705, 9473500905,
 9483500405, 9483500305

**DB-VB-7798**

Length: 622 Ø: 48
 Hole Ø 25 / 23 / 23
 Hole Distance: 152 / 130 / 130
 9423500505, 9423500805, 9423501205,
 A9423501205

**MN-DL-7834**

Length: 1588 Ø: 58
 Cone Ø: d1 Ø 30 / d2 Ø 27
 3463303903, 3463304903, 6253303203,
 9443300503, 9443301303, 9443301703





AXOR 2 ...

1828, 1828 L, 1829, 1829 L, LL ...	10/04 →	Stabiliser Mounting		DB-SB-10406		
	10/04 →	Suspension Arm Repair Kit		DB-RK-8550	for Wishbone (CV)	
	10/04 →	Suspension Arm Repair Kit		DB-RK-8626	for Wishbone (CV)	
	10/04 →	Suspension Arm Repair Kit		DB-RK-8638	for Control Arm	
	10/04 →	Suspension Arm Repair Kit		DB-RK-10374	for Wishbone (CV)	
	10/04 →	Suspension Strut Repair Kit		DB-RK-9294		
	10/04 →	Tie Rod	DB-DL-8171		Guide Rod	
	10/04 →	Tie Rod	DB-DL-8327		Guide Rod	
	10/04 →	Tie Rod	DB-DL-8640		Guide Rod	
	10/04 →	Tie Rod	DB-DL-12310			
	10/04 →	Tie Rod	DB-ES-5227		Guide Rod	
	10/04 →	Tie Rod End	DB-ES-8164		for Push Rod	
	10/04 →	Track Control Arm		DB-VB-3707	Suspension Rod, Wishbone (CV), 1st RA; Air Suspension Axle, →* L 041975 *	
	10/04 →	Track Control Arm		DB-VB-7261	Suspension Rod, Wishbone (CV), 1st RA;2nd RA; Leaf Spring Axle	
	10/04 →	Track Control Arm	DB-DL-5224		Control Arm, 1st FA;Air Suspension Axle	
	10/04 →	Track Control Arm	DB-DL-9218	DB-DL-9218	Trailing Arm, 1st FA;Air Suspension Axle	
	1829 LS	10/04 →	Ball Head, gearshift linkage	DB-ES-8510		
		10/04 →	Centre Rod	DB-DL-5230		Suspension Rod
		10/04 →	Centre Rod	DB-DL-5241		Suspension Rod
		10/04 →	Centre Rod	DB-DL-5405		Push Rod
		10/04 →	Centre Rod	DB-DL-7270		Push Rod;Suspension Rod
		10/04 →	Centre Rod	DB-DL-8184		Push Rod
		10/04 →	Centre Rod	DB-DL-8185		Push Rod
		10/04 →	Centre Rod	DB-DL-8188		Push Rod, 1st FA;Leaf Spring Axle
		10/04 →	Centre Rod	DB-DL-8717		Push Rod
10/04 →		Centre Rod	DB-DL-12300		for Steering Rod	
10/04 →		Stabiliser Mounting		DB-RK-9296		
10/04 →		Stabiliser Mounting		DB-SB-10406		
10/04 →		Suspension Arm Repair Kit		DB-RK-8550	for Wishbone (CV)	
10/04 →		Suspension Arm Repair Kit		DB-RK-8626	for Wishbone (CV)	
10/04 →		Suspension Arm Repair Kit		DB-RK-8638	for Control Arm	
10/04 →		Suspension Arm Repair Kit		DB-RK-10374	for Wishbone (CV)	
10/04 →		Suspension Strut Repair Kit		DB-RK-9294		
10/04 →		Suspension Strut Repair Kit		MN-RK-8997		
10/04 →		Tie Rod	DB-DL-8171		Guide Rod	
10/04 →		Tie Rod	DB-DL-8327		Guide Rod	
10/04 →		Tie Rod	DB-DL-8640		Guide Rod	
10/04 →		Tie Rod	DB-DL-12310			
10/04 →		Tie Rod	DB-ES-5227		Guide Rod	
10/04 →		Tie Rod End	CV-ES-0543			
10/04 →		Track Control Arm		DB-VB-3707	Suspension Rod, Wishbone (CV), 1st RA; Air Suspension Axle, →* L 041975 *	
10/04 →		Track Control Arm		DB-VB-7798	Wishbone (CV), Air Suspension Axle	
10/04 →		Track Control Arm	DB-DL-5224		Control Arm, 1st FA;Air Suspension Axle	
10/04 →		Track Control Arm	DB-DL-9218	DB-DL-9218	Trailing Arm, 1st FA;Air Suspension Axle	
1833 A		10/04 →	Ball Head, gearshift linkage	DB-ES-8510		
		10/04 →	Centre Rod	DB-DL-8184		Push Rod
		10/04 →	Centre Rod	DB-DL-8307		Push Rod, Leaf Spring Axle
		10/04 →	Centre Rod	DB-DL-8622		Push Rod
		10/04 →	Centre Rod	DB-DL-8702		Push Rod, Leaf Spring Axle
	10/04 →	Centre Rod	DB-DL-12466		Push Rod	
	10/04 →	Stabiliser Mounting		DB-SB-10406		
	10/04 →	Tie Rod	DB-DL-12310			
	10/04 →	Tie Rod	DB-ES-5227		Guide Rod	
	10/04 →	Tie Rod	MN-DL-7834		Guide Rod	
	10/04 →	Tie Rod End	DB-ES-5234		for Steering Rod	
	10/04 →	Track Control Arm		DB-VB-7261	Suspension Rod, Wishbone (CV), 1st RA;2nd RA; Leaf Spring Axle	

CV-ES-0543

Length: 125
 Cone Ø: d1 Ø 32 / d2 Ø 29
 Thread: M30 x 1,5 RHT
 0004605748, 0004606048, 0004606848,
 0004607048, 0014600448, 0014601148,
 0014601748, 0014602448, 0014607648,
 0014609648

**DB-DL-5224**

Length: 850 Ø: 60
 Hole Distance: 100 / 100
 01336100A, 9413300007

**DB-DL-5230**

Length: 879 Ø: 42
 Cone Ø: d1 Ø 30 / d2 Ø 27
 01208600A, 0004607105, 0004607205,
 0014606705

**DB-DL-5241**

Length: 875 Ø: 40
 Cone Ø: d1 Ø 30 / d2 Ø 27
 01215300A, 0004609205, 0004609305,
 0014606905

**DB-DL-5405**

Length: 890 Ø: 35
 Cone Ø: d1 Ø 28,6 / d2 Ø 23,9
 01215900A, 1460248, 0024604505, 0024604605,
 0034605005, 3752600637, 3754600405,
 A3752600637, A3754600405

**DB-DL-7270**

Length: 875 Ø: 40
 Cone Ø: d1 Ø 28,6 / d2 Ø 23,9
 01208300A, 0024604705, 0024604805,
 0034604905, A0024604705

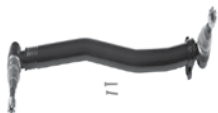
**DB-DL-8171**

Length: 1687 Ø: 52
 Cone Ø: d1 Ø 32 / d2 Ø 29
 9493300603, 9493300703, 9493301503,
 9493301603

**DB-DL-8184**

Length: 1095 Ø: 42
 Cone Ø: d1 Ø 32 / d2 Ø 28,8
 01217700A, 0014601305, 0014601405,
 0024600505, 0034603205, 3754601505,
 A0014601305, A0014601405, A0024600505

**DB-DL-8185**

Length: 711 Ø: 42
 Cone Ø: d1 Ø 32 / d2 Ø 28,8
 01213600A, 0014601105, 0024600405,
 0034603105, A0014601105, A0024600405

**DB-DL-8188**

Length: 895 Ø: 40
 Cone Ø: d1 Ø 28,6 / d2 Ø 23,9
 01217200A, 0024604905, 0024605005,
 0034605605

**DB-DL-8307**

Length: 885 Ø: 38
 Cone Ø: d1 Ø 32 / d2 Ø 30
 01215500A, 0004604005, 0024605105,
 0024605205, 0034604005

**DB-DL-8327**

Length: 1745 Ø: 48
 Cone Ø: d1 Ø 32 / d2 Ø 29
 01219800A, 9413300003, 9413300103,
 9413300203, 9413300303, 9413300503

**DB-DL-8622**

Length: 1558 Ø: 52
 Cone Ø: d1 Ø 30 / d2 Ø 27
 0014609005, 0014609105

**DB-DL-8640**

Length: 1615 Ø: 50
 Cone Ø: d1 Ø 32 / d2 Ø 29
 6253301503, 6253301603, 6253302403,
 6253302503, 9423300803, 9423302103,
 9493300203, 9493300303, 9493300903

**DB-DL-8702**

Length: 958 Ø: 38
 Cone Ø: d1 Ø 32 / d2 Ø 30
 0024606105, 0024606205, 0034604205

**DB-DL-8717**

Length: 886
 Ø: 38
 Cone Ø: d1 Ø 30 / d2 Ø 27
 0024601705, 24601705, 0024607505, 24607505,
 0024607605, 24607605, 0034604405

**DB-DL-9218**

Length: 754 Ø: 40
 Hole Distance: 100
 000360098524, 000390098524, 3753300111,
 9413300011, A3753300111, SA50831601

**DB-DL-12300**

Length: 733 Ø: 36
 Cone Ø: d1 Ø 32 / d2 Ø 29
 0014601505, 0014607305, 0034603305,
 3754601605, A0014601505, A0034603305,
 A3754601605

**DB-DL-12310**

Length: 1532 Ø: 50
 Cone Ø: d1 Ø 32 / d2 Ø 29
 Thread: M27 x 1,5 LHT
 9493301203, 9493301303, 9493301803,
 9493302203, A9493301203, A9493301303,
 A9493301803, A9493302203

**DB-DL-12466**

Length: 905 Ø: 38
 Cone Ø: d1 Ø 32 / d2 Ø 29
 0024605305, 0024605405, A0024605305,
 A0024605405

No Image**DB-ES-5227**

Length: 1588 Ø: 60
 Cone Ø: d1 Ø 38 / d2 Ø 34,3
 6253300903, 6253301203, 9443300203

**DB-ES-5234**

Length: 135
 Cone Ø: d1 Ø 38 / d2 Ø 34,3
 Thread: M38 x 1,5 RHT
 0004601748, 120322305, 2205000400

**DB-ES-8164**

Length: 140
 Cone Ø: d1 Ø 28,6 / d2 Ø 23,9
 Thread: M28 x 1,5 RHT
 0014604248, 0014605048, 0014608548,
 0024600548

**DB-ES-8510**

Length: 56
 Cone Ø: d1 Ø 10 / d2 Ø 10
 Thread: M12 x 1,75 LHT
 0009965145, 0009965645, 0019963145

**DB-RK-8550**

Ø: 75 Hole Distance: 152
 Thick/Height: 24
 0003502105, 0003504605

**DB-RK-8626**

Ø: 75 Hole Distance: 130
 Thick/Height: 24
 0003502205, 0003502505, 0003503405,
 0003504505, GL11319

**DB-RK-8638**

Length: 100 Ø: 67
 Hole Distance: 100
 Thick/Height: 20
 0003301411

**DB-RK-9294**

Ø: 85 Hole Distance: 152
 Thick/Height: 24
 0003503105

**DB-RK-9296**

Ø: 88 Hole Distance: 130
 Thick/Height: 24
 9423260050

**DB-RK-10374**

Ø: 85 Hole Distance: 152
 Thick/Height: 24
 0003504405

**DB-SB-10406**

Ø: 80 Thick/Height: 46
 0003238185

**DB-VB-3707**

Length: 622 Ø: 46
 Hole Ø 25 / 25 / 25
 Hole Distance: 152 / 130 / 130
 01337100A, 9423501005, 9423501505,
 9443500005, 9473500105, 9473501005,
 A3753500005, A9423501005, A9423501505,
 A9443500005, A9473500105, A9473501005

**DB-VB-7261**

Length: 622 Ø: 46
 Hole Ø 25 / 25 / 25
 Hole Distance: 152 / 130 / 130
 01337800A, 9443500305, 9443500505,
 9443500605, 9473500705, 9473500905,
 9483500405, 9483500305

**DB-VB-7798**

Length: 622 Ø: 48
 Hole Ø 25 / 23 / 23
 Hole Distance: 152 / 130 / 130
 9423500505, 9423500805, 9423501205,
 A9423501205

**MN-DL-7834**

Length: 1588 Ø: 58
 Cone Ø: d1 Ø 30 / d2 Ø 27
 3463303903, 3463304903, 6253303203,
 9443300503, 9443301303, 9443301703

**MN-RK-8997**

Ø: 85
 Hole Distance: 130
 Thick/Height: 30
 0003504805, 3504805





AXOR 2 ...

1833 AK	10/04 →	Ball Head, gearshift linkage	DB-ES-8510		
	10/04 →	Centre Rod	DB-DL-8307		Push Rod, Leaf Spring Axle
	10/04 →	Centre Rod	DB-DL-8702		Push Rod, Leaf Spring Axle
	10/04 →	Centre Rod	DB-DL-12466		Push Rod
	10/04 →	Stabiliser Mounting		DB-SB-10406	
	10/04 →	Tie Rod	DB-DL-12310		
	10/04 →	Tie Rod	DB-ES-5227		Guide Rod
	10/04 →	Tie Rod	MN-DL-7834		Guide Rod
	10/04 →	Tie Rod End	DB-ES-5234		for Steering Rod
	10/04 →	Track Control Arm		DB-VB-7261	Suspension Rod, Wishbone (CV), 1st RA;2nd RA; Leaf Spring Axle
1833 K	10/04 →	Ball Head, gearshift linkage	DB-ES-8510		
	10/04 →	Centre Rod	DB-DL-5230		Suspension Rod
	10/04 →	Centre Rod	DB-DL-5241		Suspension Rod
	10/04 →	Centre Rod	DB-DL-5405		Push Rod, Leaf Spring Axle
	10/04 →	Centre Rod	DB-DL-7270		Push Rod
	10/04 →	Centre Rod	DB-DL-8184		Push Rod
	10/04 →	Centre Rod	DB-DL-8185		Push Rod
	10/04 →	Centre Rod	DB-DL-8188		Push Rod, Leaf Spring Axle
	10/04 →	Centre Rod	DB-DL-8702		Push Rod, Leaf Spring Axle
	10/04 →	Centre Rod	DB-DL-8717		Push Rod, Leaf Spring Axle
	10/04 →	Centre Rod	DB-DL-12300		for Steering Rod
	10/04 →	Centre Rod	DB-DL-12466		Push Rod
	10/04 →	Stabiliser Mounting		DB-SB-10406	
	10/04 →	Suspension Arm Repair Kit		DB-RK-8550	for Wishbone (CV)
	10/04 →	Tie Rod	DB-DL-8171		Guide Rod
	10/04 →	Tie Rod	DB-DL-8327		Guide Rod
	10/04 →	Tie Rod	DB-DL-8640		Guide Rod
	10/04 →	Tie Rod	DB-DL-12310		
	10/04 →	Tie Rod	DB-ES-5227		Guide Rod
	10/04 →	Tie Rod End	DB-ES-8164		for Push Rod
10/04 →	Track Control Arm		DB-VB-7261	Suspension Rod, Wishbone (CV), 1st RA;2nd RA; Leaf Spring Axle	
1833 LS	10/04 →	Ball Head, gearshift linkage	DB-ES-8510		
	10/04 →	Centre Rod	DB-DL-5230		Suspension Rod
	10/04 →	Centre Rod	DB-DL-5241		Suspension Rod
	10/04 →	Centre Rod	DB-DL-5405		Push Rod
	10/04 →	Centre Rod	DB-DL-7270		Push Rod
	10/04 →	Centre Rod	DB-DL-8184		Push Rod
	10/04 →	Centre Rod	DB-DL-8185		Push Rod
	10/04 →	Centre Rod	DB-DL-8188		Push Rod, 1st FA;Leaf Spring Axle
	10/04 →	Centre Rod	DB-DL-8392		Push Rod
	10/04 →	Centre Rod	DB-DL-8717		Push Rod
	10/04 →	Centre Rod	DB-DL-12300		for Steering Rod
	10/04 →	Stabiliser Mounting		DB-RK-9296	
	10/04 →	Stabiliser Mounting		DB-SB-10406	
	10/04 →	Suspension Arm Repair Kit		DB-RK-8550	for Wishbone (CV)
	10/04 →	Suspension Arm Repair Kit		DB-RK-8626	for Wishbone (CV)
	10/04 →	Suspension Arm Repair Kit		DB-RK-8638	for Control Arm
	10/04 →	Suspension Arm Repair Kit		DB-RK-10374	for Wishbone (CV)
	10/04 →	Suspension Strut Repair Kit		DB-RK-9294	
	10/04 →	Suspension Strut Repair Kit		MN-RK-8997	
	10/04 →	Tie Rod	DB-DL-8171		Guide Rod
	10/04 →	Tie Rod	DB-DL-8327		Guide Rod
	10/04 →	Tie Rod	DB-DL-8640		Guide Rod
	10/04 →	Tie Rod	DB-DL-12310		
	10/04 →	Tie Rod	DB-ES-5227		Guide Rod
	10/04 →	Tie Rod End	DB-ES-8164		for Push Rod
	10/04 →	Tie Rod End	DB-ES-8530		for Push Rod
	10/04 →	Track Control Arm		DB-VB-3707	Suspension Rod, Wishbone (CV), 1st RA; Air Suspension Axle, →* L 041975 *
	10/04 →	Track Control Arm		DB-VB-7798	Wishbone (CV), Air Suspension Axle
	10/04 →	Track Control Arm	DB-DL-5224		Control Arm, 1st FA; Air Suspension Axle
	10/04 →	Track Control Arm	DB-DL-9218	DB-DL-9218	Trailing Arm, 1st FA; Air Suspension Axle

DB-DL-5224

Length: 850 Ø: 60
 Hole Distance: 100 / 100
 01336100A, 9413300007

**DB-DL-5230**

Length: 879 Ø: 42
 Cone Ø: d1 Ø 30 / d2 Ø 27
 01208600A, 0004607105, 0004607205,
 0014606705

**DB-DL-5241**

Length: 875 Ø: 40
 Cone Ø: d1 Ø 30 / d2 Ø 27
 01215300A, 0004609205, 0004609305,
 0014606905

**DB-DL-5405**

Length: 890 Ø: 35
 Cone Ø: d1 Ø 28,6 / d2 Ø 23,9
 01215900A, 1460248, 0024604505, 0024604605,
 0034605005, 3752600637, 3754600405,
 A3752600637, A3754600405

**DB-DL-7270**

Length: 875 Ø: 40
 Cone Ø: d1 Ø 28,6 / d2 Ø 23,9
 01208300A, 0024604705, 0024604805,
 0034604905, A0024604705

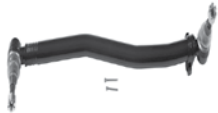
**DB-DL-8171**

Length: 1687 Ø: 52
 Cone Ø: d1 Ø 32 / d2 Ø 29
 9493300603, 9493300703, 9493301503,
 9493301603

**DB-DL-8184**

Length: 1095 Ø: 42
 Cone Ø: d1 Ø 32 / d2 Ø 28,8
 01217700A, 0014601305, 0014601405,
 0024600505, 0034603205, 3754601505,
 A0014601305, A0014601405, A0024600505

**DB-DL-8185**

Length: 711 Ø: 42
 Cone Ø: d1 Ø 32 / d2 Ø 28,8
 01213600A, 0014601105, 0024600405,
 0034603105, A0014601105, A0024600405

**DB-DL-8188**

Length: 895 Ø: 40
 Cone Ø: d1 Ø 28,6 / d2 Ø 23,9
 01217200A, 0024604905, 0024605005,
 0034605605

**DB-DL-8307**

Length: 885 Ø: 38
 Cone Ø: d1 Ø 32 / d2 Ø 30
 01215500A, 0004604005, 0024605105,
 0024605205, 0034604005

**DB-DL-8327**

Length: 1745 Ø: 48
 Cone Ø: d1 Ø 32 / d2 Ø 29
 01219800A, 9413300003, 9413300103,
 9413300203, 9413300303, 9413300503

**DB-DL-8392**

Length: 860 Ø: 40
 Cone Ø: d1 Ø 28,6 / d2 Ø 23,9
 0024609605, 0024609705, 0034605705

**DB-DL-8640**

Length: 1615 Ø: 50
 Cone Ø: d1 Ø 32 / d2 Ø 29
 6253301503, 6253301603, 6253302403,
 6253302503, 9423300803, 9423302103,
 9493300203, 9493300303, 9493300903

**DB-DL-8702**

Length: 958 Ø: 38
 Cone Ø: d1 Ø 32 / d2 Ø 30
 0024606105, 0024606205, 0034604205

**DB-DL-8717**

Length: 886 Ø: 38
 Cone Ø: d1 Ø 30 / d2 Ø 27
 0024601705, 0024607505, 0024607605,
 0034604405

**DB-DL-9218**

Length: 754 Ø: 40
 Hole Distance: 100
 000360098524, 000390098524, 3753300111,
 9413300011, A3753300111, SA50831601

**DB-DL-12300**

Length: 733 Ø: 36
 Cone Ø: d1 Ø 32 / d2 Ø 29
 0014601505, 0014607305, 0034603305,
 3754601605, A0014601505, A0034603305,
 A3754601605

**DB-DL-12310**

Length: 1532 Ø: 50
 Cone Ø: d1 Ø 32 / d2 Ø 29
 Thread: M27 x 1,5 LHT
 9493301203, 9493301303, 9493301803,
 9493302203, A9493301203, A9493301303,
 A9493301803, A9493302203

**DB-DL-12466**

Length: 905 Ø: 38
 Cone Ø: d1 Ø 32 / d2 Ø 29
 0024605305, 0024605405, A0024605305,
 A0024605405

No Image

DB-ES-5227

Length: 1588 Ø: 60
 Cone Ø: d1 Ø 38 / d2 Ø 34,3
 6253300903, 6253301203, 9443300203

**DB-ES-5234**

Length: 135
 Cone Ø: d1 Ø 38 / d2 Ø 34,3
 Thread: M38 x 1,5 RHT
 0004601748, 120322305, 2205000400

**DB-ES-8164**

Length: 140
 Cone Ø: d1 Ø 28,6 / d2 Ø 23,9
 Thread: M28 x 1,5 RHT
 0014604248, 0014605048, 0014608548,
 0024600548

**DB-ES-8510**

Length: 56
 Cone Ø: d1 Ø 10 / d2 Ø 10
 Thread: M12 x 1,75 LHT
 0009965145, 0009965645, 0019963145

**DB-ES-8530**

Length: 115
 Cone Ø: d1 Ø 28,6 / d2 Ø 23,9
 Thread: M30 x 1,5 RHT
 0014603848, 0014604848, 0014605148,
 0014608648, 0014609948

**DB-RK-8550**

Ø: 75 Hole Distance: 152
 Thick/Height: 24
 0003502105, 0003504605

**DB-RK-8626**

Ø: 75 Hole Distance: 130
 Thick/Height: 24
 0003502205, 0003502505, 0003503405,
 0003504505, GL11319

**DB-RK-8638**

Length: 100 Ø: 67
 Hole Distance: 100
 Thick/Height: 20
 0003301411

**DB-RK-9294**

Ø: 85 Hole Distance: 152
 Thick/Height: 24
 0003503105

**DB-RK-9296**

Ø: 88 Hole Distance: 130
 Thick/Height: 24
 9423260050

**DB-RK-10374**

Ø: 85 Hole Distance: 152
 Thick/Height: 24
 0003504405

**DB-SB-10406**

Ø: 80 Thick/Height: 46
 0003238185

**DB-VB-3707**

Length: 622 Ø: 46
 Hole Ø 25 / 25 / 25
 Hole Distance: 152 / 130 / 130
 01337100A, 9423501005, 9423501505,
 9443500005, 9473500105, 9473501005,
 A3753500005, A9423501005, A9423501505,
 A9443500005, A9473500105, A9473501005

**DB-VB-7261**

Length: 622 Ø: 46
 Hole Ø 25 / 25 / 25
 Hole Distance: 152 / 130 / 130
 01337800A, 9443500305, 9443500505,
 9443500605, 9473500705, 9473500905,
 9483500405, 9483500305

**DB-VB-7798**

Length: 622 Ø: 48
 Hole Ø 25 / 23 / 23
 Hole Distance: 152 / 130 / 130
 9423500505, 9423500805, 9423501205,
 A9423501205

**MN-DL-7834**

Length: 1588 Ø: 58
 Cone Ø: d1 Ø 30 / d2 Ø 27
 3463303903, 3463304903, 6253303203,
 9443300503, 9443301303, 9443301703

**MN-RK-8997**

Ø: 85 Hole Distance: 130
 Thick/Height: 30
 0003504805





AXOR 2 ...

1833, 1833 L, LL	10/04→	Ball Head, gearshift linkage	DB-ES-8510		
	10/04→	Centre Rod	DB-DL-5230	Suspension Rod	
	10/04→	Centre Rod	DB-DL-5241	Suspension Rod	
	10/04→	Centre Rod	DB-DL-5405	Push Rod	
	10/04→	Centre Rod	DB-DL-5405	Push Rod, Leaf Spring Axle	
	10/04→	Centre Rod	DB-DL-7270	Push Rod	
	10/04→	Centre Rod	DB-DL-8184	Push Rod	
	10/04→	Centre Rod	DB-DL-8185	Push Rod	
	10/04→	Centre Rod	DB-DL-8188	Push Rod	
	10/04→	Centre Rod	DB-DL-8188	Push Rod, 1st FA;Air Suspension Axle	
	10/04→	Centre Rod	DB-DL-8622	Push Rod	
	10/04→	Centre Rod	DB-DL-8702	Push Rod	
	10/04→	Centre Rod	DB-DL-8702	Push Rod, Leaf Spring Axle	
	10/04→	Centre Rod	DB-DL-8717	Push Rod	
	10/04→	Centre Rod	DB-DL-8717	Push Rod, Leaf Spring Axle	
	10/04→	Centre Rod	DB-DL-12300	for Steering Rod	
	10/04→	Centre Rod	DB-DL-12466	Push Rod	
	10/04→	Stabiliser Mounting		DB-RK-9296	
	10/04→	Stabiliser Mounting		DB-SB-10406	
	10/04→	Suspension Arm Repair Kit		DB-RK-8550	for Wishbone (CV)
	10/04→	Suspension Arm Repair Kit		DB-RK-8626	for Wishbone (CV)
	10/04→	Suspension Arm Repair Kit		DB-RK-8638	for Control Arm
	10/04→	Suspension Arm Repair Kit		DB-RK-10374	for Wishbone (CV)
	10/04→	Suspension Strut Repair Kit		DB-RK-9294	
	10/04→	Tie Rod	DB-DL-8171		Guide Rod
	10/04→	Tie Rod	DB-DL-8327		Guide Rod
	10/04→	Tie Rod	DB-DL-8640		Guide Rod
	10/04→	Tie Rod	DB-DL-12310		
	10/04→	Tie Rod	DB-ES-5227		Guide Rod
	10/04→	Tie Rod End	DB-ES-8164		for Push Rod
	10/04→	Track Control Arm		DB-VB-3707	Suspension Rod, Wishbone (CV), 1st RA; Air Suspension Axle, →* L 041975 *
	10/04→	Track Control Arm		DB-VB-7261	Suspension Rod, Wishbone (CV), 1st RA;2nd RA; Leaf Spring Axle
	10/04→	Track Control Arm	DB-DL-5224		Control Arm, 1st FA;Air Suspension Axle
10/04→	Track Control Arm	DB-DL-9218	DB-DL-9218	Trailing Arm, 1st FA;Air Suspension Axle	
1835 LS	01/11→	Centre Rod	DB-DL-5405	Push Rod, Leaf Spring Axle	
	01/11→	Centre Rod	DB-DL-8122	Push Rod	
	01/11→	Tie Rod	DB-DL-8327	Guide Rod	
	01/11→	Track Control Arm		DB-VB-7798 Wishbone (CV), Drive Axle;Air Suspension Axle	
1836 LS, LLS	10/04→	Bush, driver cab suspension	DB-SB-10384		
	10/04→	Centre Rod	DB-DL-5230	Suspension Rod	
	10/04→	Centre Rod	DB-DL-5241	Suspension Rod	
	10/04→	Centre Rod	DB-DL-5405	Push Rod	
	10/04→	Centre Rod	DB-DL-7270	Push Rod;Suspension Rod	
	10/04→	Centre Rod	DB-DL-8122	Push Rod	
	10/04→	Centre Rod	DB-DL-8184	Push Rod	
	10/04→	Centre Rod	DB-DL-8185	Push Rod	
	10/04→	Centre Rod	DB-DL-8188	Push Rod, Air Suspension Axle	
	10/04→	Centre Rod	DB-DL-12300	for Steering Rod	
	10/04→	Stabiliser Mounting		DB-RK-9296	
	10/04→	Stabiliser Mounting		DB-SB-10409	
	10/04→	Suspension Arm Repair Kit		DB-RK-10374	for Wishbone (CV)
	10/04→	Suspension Arm Repair Kit		DB-RK-10375	for Wishbone (CV)
	10/04→	Suspension Strut Repair Kit		MN-RK-8997	
	10/04→	Tie Rod	DB-DL-8327		Guide Rod
	10/04→	Tie Rod End	DB-ES-8164		for Push Rod
	10/04→	Tie Rod End	DB-ES-8530		for Push Rod
	10/04→	Track Control Arm		DB-VB-7798	Wishbone (CV), Air Suspension Axle
	1840 LS, LLS	10/04→	Bush, driver cab suspension	DB-SB-10384	
		10/04→	Centre Rod	DB-DL-5230	Suspension Rod
		10/04→	Centre Rod	DB-DL-5241	Suspension Rod
		10/04→	Centre Rod	DB-DL-5405	Push Rod

DB-DL-5224

Length: 850 Ø: 60
 Hole Distance: 100 / 100
 01336100A, 9413300007

**DB-DL-5230**

Length: 879 Ø: 42
 Cone Ø: d1 Ø 30 / d2 Ø 27
 01208600A, 0004607105, 0004607205,
 0014606705

**DB-DL-5241**

Length: 875 Ø: 40
 Cone Ø: d1 Ø 30 / d2 Ø 27
 01215300A, 0004609205, 0004609305,
 001460905

**DB-DL-5405**

Length: 890 Ø: 35
 Cone Ø: d1 Ø 28,6 / d2 Ø 23,9
 01215900A, 1460248, 0024604505, 0024604605,
 0034605005, 3752600637, 3754600405,
 A3752600637, A3754600405

**DB-DL-7270**

Length: 875 Ø: 40
 Cone Ø: d1 Ø 28,6 / d2 Ø 23,9
 01208300A, 0024604705, 0024604805,
 0034604905, A0024604705

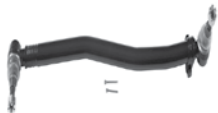
**DB-DL-8122**

Length: 875
 Ø: 42
 Cone Ø: d1 Ø 30 / d2 Ø 27
 01215000A, 6174603205, 6174603305

**DB-DL-8171**

Length: 1687 Ø: 52
 Cone Ø: d1 Ø 32 / d2 Ø 29
 9493300603, 9493300703, 9493301503,
 9493301603

**DB-DL-8184**

Length: 1095 Ø: 42
 Cone Ø: d1 Ø 32 / d2 Ø 28,8
 01217700A, 0014601305, 0014601405,
 002460505, 0034603205, 3754601505,
 A0014601305, A0014601405, A0024600505

**DB-DL-8185**

Length: 711 Ø: 42
 Cone Ø: d1 Ø 32 / d2 Ø 28,8
 01213600A, 0014601105, 0024600405,
 0034603105, A0014601105, A0024600405

**DB-DL-8188**

Length: 895 Ø: 40
 Cone Ø: d1 Ø 28,6 / d2 Ø 23,9
 01217200A, 0024604905, 0024605005,
 0034605605

**DB-DL-8327**

Length: 1745 Ø: 48
 Cone Ø: d1 Ø 32 / d2 Ø 29
 01219800A, 9413300003, 9413300103,
 9413300203, 9413300303, 9413300503

**DB-DL-8622**

Length: 1558 Ø: 52
 Cone Ø: d1 Ø 30 / d2 Ø 27
 0014609005, 0014609105

**DB-DL-8640**

Length: 1615 Ø: 50
 Cone Ø: d1 Ø 32 / d2 Ø 29
 6253301503, 6253301603, 6253302403,
 6253302503, 9423300803, 9423302103,
 9493300203, 9493300303, 9493300903

**DB-DL-8702**

Length: 958 Ø: 38
 Cone Ø: d1 Ø 32 / d2 Ø 30
 0024606105, 0024606205, 0034604205

**DB-DL-8717**

Length: 886
 Ø: 38
 Cone Ø: d1 Ø 30 / d2 Ø 27
 0024601705, 24601705, 0024607505, 24607505,
 0024607605, 24607605, 0034604405

**DB-DL-9218**

Length: 754 Ø: 40
 Hole Distance: 100
 000360098524, 000390098524, 3753300111,
 9413300011, A3753300111, SA50831601

**DB-DL-12300**

Length: 733 Ø: 36
 Cone Ø: d1 Ø 32 / d2 Ø 29
 0014601505, 0014607305, 0034603305,
 3754601605, A0014601505, A0034603305,
 A3754601605

**DB-DL-12310**

Length: 1532 Ø: 50
 Cone Ø: d1 Ø 32 / d2 Ø 29
 Thread: M27 x 1,5 LHT
 9493301203, 9493301303, 9493301803,
 9493302203, A9493301203, A9493301303,
 A9493301803, A9493302203

**DB-DL-12466**

Length: 905 Ø: 38
 Cone Ø: d1 Ø 32 / d2 Ø 29
 0024605305, 0024605405, A0024605305,
 A0024605405

No Image

DB-ES-5227

Length: 1588 Ø: 60
 Cone Ø: d1 Ø 38 / d2 Ø 34,3
 6253300903, 6253301203, 9443300203

**DB-ES-8164**

Length: 140
 Cone Ø: d1 Ø 28,6 / d2 Ø 23,9
 Thread: M28 x 1,5 RHT
 0014604248, 0014605048, 0014608548,
 002460548

**DB-ES-8510**

Length: 56
 Cone Ø: d1 Ø 10 / d2 Ø 10
 Thread: M12 x 1,75 LHT
 0009965145, 0009965645, 0019963145

**DB-ES-8530**

Length: 115
 Cone Ø: d1 Ø 28,6 / d2 Ø 23,9
 Thread: M30 x 1,5 RHT
 0014603848, 0014604848, 0014605148,
 0014608648, 0014609948

**DB-RK-8550**

Ø: 75 Hole Distance: 152
 Thick/Height: 24
 0003502105, 0003504605

**DB-RK-8626**

Ø: 75 Hole Distance: 130
 Thick/Height: 24
 0003502205, 0003502505, 0003503405,
 0003504505, GL11319

**DB-RK-8638**

Length: 100 Ø: 67
 Hole Distance: 100
 Thick/Height: 20
 0003301411

**DB-RK-9294**

Ø: 85 Hole Distance: 152
 Thick/Height: 24
 0003503105

**DB-RK-9296**

Ø: 88 Hole Distance: 130
 Thick/Height: 24
 9423260050

**DB-RK-10374**

Ø: 85 Hole Distance: 152
 Thick/Height: 24
 0003504405

**DB-RK-10375**

Ø: 100 Hole Distance: 152
 Thick/Height: 24
 0003502405, 0003503505, 0003504905

**DB-SB-10384**

Ø: 73 Thick/Height: 47
 9303170012, 9423171812

**DB-SB-10406**

Ø: 80 Thick/Height: 46
 0003238185

**DB-SB-10409**

Ø: 77 Thick/Height: 56
 0003265181

**DB-VB-3707**

Length: 622 Ø: 46
 Hole Ø 25 / 25 / 25
 Hole Distance: 152 / 130 / 130
 01337100A, 9423501005, 9423501505,
 9443500005, 9473500105, 9473501005,
 A3753500005, A9423501005, A9423501505,
 A9443500005, A9473500105, A9473501005

**DB-VB-7261**

Length: 622 Ø: 46
 Hole Ø 25 / 25 / 25
 Hole Distance: 152 / 130 / 130
 01337800A, 9443500305, 9443500505,
 9443500605, 9473500705, 9473500905,
 9483500405, 9483503005

**DB-VB-7798**

Length: 622 Ø: 48
 Hole Ø 25 / 23 / 23
 Hole Distance: 152 / 130 / 130
 9423500505, 9423500805, 9423501205,
 A9423501205

**MN-RK-8997**

Ø: 85
 Hole Distance: 130
 Thick/Height: 30
 0003504805, 3504805





AXOR 2 ...

1840 LS, LLS ...	10/04→	Centre Rod	DB-DL-7270		Push Rod;Suspension Rod
	10/04→	Centre Rod	DB-DL-8122		Push Rod
	10/04→	Centre Rod	DB-DL-8184		Push Rod
	10/04→	Centre Rod	DB-DL-8185		Push Rod
	10/04→	Centre Rod	DB-DL-8188		Push Rod, Air Suspension Axle
	10/04→	Centre Rod	DB-DL-12300		for Steering Rod
	10/04→	Stabiliser Mounting		DB-RK-9296	
	10/04→	Stabiliser Mounting		DB-SB-10409	
	10/04→	Suspension Arm Repair Kit		DB-RK-10374	for Wishbone (CV)
	10/04→	Suspension Arm Repair Kit		DB-RK-10375	for Wishbone (CV)
	10/04→	Suspension Strut Repair Kit		MN-RK-8997	
	10/04→	Tie Rod	DB-DL-8327		Guide Rod
	10/04→	Tie Rod	DB-DL-12310		
	10/04→	Tie Rod End	DB-ES-8164		for Push Rod
	10/04→	Tie Rod End	DB-ES-8530		for Push Rod
10/04→	Track Control Arm		DB-VB-7798	Wishbone (CV), Air Suspension Axle	
1843 LS, LLS	10/04→	Bush, driver cab suspension	DB-SB-10384		
	10/04→	Centre Rod	DB-DL-5230		Suspension Rod
	10/04→	Centre Rod	DB-DL-5241		Suspension Rod
	10/04→	Centre Rod	DB-DL-5405		Push Rod
	10/04→	Centre Rod	DB-DL-7270		Push Rod;Suspension Rod
	10/04→	Centre Rod	DB-DL-8122		Push Rod
	10/04→	Centre Rod	DB-DL-8184		Push Rod
	10/04→	Centre Rod	DB-DL-8185		Push Rod
	10/04→	Centre Rod	DB-DL-8188		Push Rod, Air Suspension Axle
	10/04→	Centre Rod	DB-DL-12300		for Steering Rod
	10/04→	Stabiliser Mounting		DB-RK-9296	
	10/04→	Stabiliser Mounting		DB-SB-10409	
	10/04→	Suspension Arm Repair Kit		DB-RK-10374	for Wishbone (CV)
	10/04→	Suspension Arm Repair Kit		DB-RK-10375	for Wishbone (CV)
	10/04→	Suspension Strut Repair Kit		MN-RK-8997	
10/04→	Tie Rod	DB-DL-8327		Guide Rod	
10/04→	Tie Rod End	DB-ES-8164		for Push Rod	
10/04→	Tie Rod End	DB-ES-8530		for Push Rod	
10/04→	Track Control Arm		DB-VB-7798	Wishbone (CV), Air Suspension Axle	
1933	10/04→	Bolt, wheel alignment	DB-ES-8498	DB-ES-8498	
	10/04→	Centre Rod	DB-DL-5405		Push Rod
1933 S	01/11→	Bolt, wheel alignment	DB-ES-8498	DB-ES-8498	
	01/11→	Centre Rod	DB-DL-5405		Push Rod, Leaf Spring Axle
2035 S, 2036 S, LS	01/11→	Ball Head, gearshift linkage	DB-ES-8510		
	01/11→	Bolt, wheel alignment	DB-ES-8498	DB-ES-8498	
	01/11→	Centre Rod	DB-DL-5405		Push Rod
	01/11→	Centre Rod	DB-DL-8122		Push Rod
2040 S, 2041 S, 2041 S, 2041 LS	01/11→	Ball Head, gearshift linkage	DB-ES-8510		
	01/11→	Bolt, wheel alignment	DB-ES-8498	DB-ES-8498	
	01/11→	Centre Rod	DB-DL-5405		Push Rod
	01/11→	Centre Rod	DB-DL-8122		Push Rod
	01/11→	Centre Rod	DB-DL-8122		Push Rod
2044 S	01/11→	Ball Head, gearshift linkage	DB-ES-8510		
	01/11→	Bolt, wheel alignment	DB-ES-8498	DB-ES-8498	
	01/11→	Centre Rod	DB-DL-5405		Push Rod
	01/11→	Centre Rod	DB-DL-8122		Push Rod
	01/11→	Centre Rod	DB-DL-8122		Push Rod
2436 LS, 2536 LS	10/04→	Centre Rod	DB-DL-8122		Push Rod
	10/04→	Centre Rod	DB-DL-8188		Push Rod, Air Suspension Axle
	10/04→	Track Control Arm		DB-VB-7798	Wishbone (CV), Drive Axle;Air Suspension Axle
2440 LS, 2540 LS	10/04→	Centre Rod	DB-DL-8122		Push Rod
	10/04→	Centre Rod	DB-DL-8188		Push Rod, Air Suspension Axle
	10/04→	Track Control Arm		DB-VB-7798	Wishbone (CV), Drive Axle;Air Suspension Axle
2443 LS, 2543 LS	10/04→	Centre Rod	DB-DL-8122		Push Rod
	10/04→	Centre Rod	DB-DL-8188		Push Rod, Air Suspension Axle
	10/04→	Track Control Arm		DB-VB-7798	Wishbone (CV), Drive Axle;Air Suspension Axle
2523	01/11→	Centre Rod	DB-DL-5405		Push Rod
	01/11→	Centre Rod	DB-DL-9258		Push Rod

DB-DL-5230

Length: 879 Ø: 42
 Cone Ø: d1 Ø 30 / d2 Ø 27
 01208600A, 0004607105, 0004607205,
 0014606705

**DB-DL-5241**

Length: 875 Ø: 40
 Cone Ø: d1 Ø 30 / d2 Ø 27
 01215300A, 0004609205, 0004609305,
 0014606905

**DB-DL-5405**

Length: 890 Ø: 35
 Cone Ø: d1 Ø 28,6 / d2 Ø 23,9
 01215900A, 1460248, 0024604505, 0024604605,
 0034605005, 3752600637, 3754600405,
 A3752600637, A3754600405

**DB-DL-7270**

Length: 875 Ø: 40
 Cone Ø: d1 Ø 28,6 / d2 Ø 23,9
 01208300A, 0024604705, 0024604805,
 0034604905, A0024604705

**DB-DL-8122**

Length: 875
 Ø: 42
 Cone Ø: d1 Ø 30 / d2 Ø 27
 01215000A, 6174603205, 6174603305

**DB-DL-8184**

Length: 1095 Ø: 42
 Cone Ø: d1 Ø 32 / d2 Ø 28,8
 01217700A, 0014601305, 0014601405,
 0024600505, 0034603205, 3754601505,
 A0014601305, A0014601405, A0024600505

**DB-DL-8185**

Length: 711 Ø: 42
 Cone Ø: d1 Ø 32 / d2 Ø 28,8
 01213600A, 0014601105, 0024600405,
 0034603105, A0014601105, A0024600405

**DB-DL-8188**

Length: 895 Ø: 40
 Cone Ø: d1 Ø 28,6 / d2 Ø 23,9
 01217200A, 0024604905, 0024605005,
 0034605605

**DB-DL-8327**

Length: 1745 Ø: 48
 Cone Ø: d1 Ø 32 / d2 Ø 29
 01219800A, 9413300003, 9413300103,
 9413300203, 9413300303, 9413300503

**DB-DL-9258**

Length: 905
 Ø: 42
 Cone Ø: d1 Ø 28,6 / d2 Ø 23,9
 3754600605, 3754601105

**DB-DL-12300**

Length: 733 Ø: 36
 Cone Ø: d1 Ø 32 / d2 Ø 29
 0014601505, 0014607305, 0034603305,
 3754601605, A0014601505, A0034603305,
 A3754601605

**DB-DL-12310**

Length: 1532 Ø: 50
 Cone Ø: d1 Ø 32 / d2 Ø 29
 Thread: M27 x 1,5 LHT
 9493301203, 9493301303, 9493301803,
 9493302203, A9493301203, A9493301303,
 A9493301803, A9493302203

**DB-ES-8164**

Length: 140
 Cone Ø: d1 Ø 28,6 / d2 Ø 23,9
 Thread: M28 x 1,5 RHT
 0014604248, 0014605048, 0014608548,
 0024600548

**DB-ES-8498****DB-ES-8510**

Length: 56
 Cone Ø: d1 Ø 10 / d2 Ø 10
 Thread: M12 x 1,75 LHT
 0009965145, 0009965645, 0019963145

**DB-ES-8530**

Length: 115
 Cone Ø: d1 Ø 28,6 / d2 Ø 23,9
 Thread: M30 x 1,5 RHT
 0014603848, 0014604848, 0014605148,
 0014608648, 0014609948

**DB-RK-9296**

Ø: 88 Hole Distance: 130
 Thick/Height: 24
 9423260050

**DB-RK-10374**

Ø: 85 Hole Distance: 152
 Thick/Height: 24
 0003504405

**DB-RK-10375**

Ø: 100 Hole Distance: 152
 Thick/Height: 24
 0003502405, 0003503505, 0003504905

**DB-SB-10384**

Ø: 73 Thick/Height: 47
 9303170012, 9423171812

**DB-SB-10409**

Ø: 77 Thick/Height: 56
 0003265181

**DB-VB-7798**

Length: 622 Ø: 48
 Hole Ø 25 / 23 / 23
 Hole Distance: 152 / 130 / 130
 9423500505, 9423500805, 9423501205,
 A9423501205

**MN-RK-8997**

Ø: 85 Hole Distance: 130
 Thick/Height: 30
 0003504805



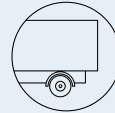

AXOR 2 ...

2528 K, 2528 KL	01/11→	Bush, driver cab suspension	DB-SB-10384	
	01/11→	Bush, parabolic spring		DB-SB-10400
	01/11→	Centre Rod	DB-DL-5405	Push Rod
	01/11→	Centre Rod	DB-DL-9258	Push Rod
	01/11→	Tie Rod	DB-DL-8171	Guide Rod
	01/11→	Tie Rod	DB-DL-8327	Guide Rod
2528 L, 2529 L	10/04→	Ball Head, gearshift linkage	DB-ES-8510	
	10/04→	Centre Rod	DB-DL-5230	Suspension Rod
	10/04→	Centre Rod	DB-DL-5241	Suspension Rod
	10/04→	Centre Rod	DB-DL-5405	Push Rod, 1st FA;Leaf Spring Axle
	10/04→	Centre Rod	DB-DL-7270	Push Rod;Suspension Rod
	10/04→	Centre Rod	DB-DL-8184	Push Rod
	10/04→	Centre Rod	DB-DL-8185	Push Rod
	10/04→	Centre Rod	DB-DL-8188	Push Rod, Air Suspension Axle
	10/04→	Centre Rod	DB-DL-8622	Push Rod
	10/04→	Centre Rod	DB-DL-8717	Push Rod, 1st FA;Leaf Spring Axle
	10/04→	Centre Rod	DB-DL-12300	for Steering Rod
	10/04→	Stabiliser Mounting		DB-SB-10406
	10/04→	Suspension Arm Repair Kit		DB-RK-8550 for Wishbone (CV)
	10/04→	Suspension Arm Repair Kit		DB-RK-8626 for Wishbone (CV)
	10/04→	Suspension Arm Repair Kit		DB-RK-8638 for Control Arm
	10/04→	Suspension Arm Repair Kit		DB-RK-10374 for Wishbone (CV)
	10/04→	Suspension Strut Repair Kit		DB-RK-8555
	10/04→	Suspension Strut Repair Kit		DB-RK-9294
	10/04→	Tie Rod		DB-DL-10209 Tag Axle;for vehicles with Hinged Trailing Axle
	10/04→	Tie Rod	DB-DL-8327	Guide Rod
	10/04→	Tie Rod	DB-DL-8640	Guide Rod
	10/04→	Tie Rod	DB-DL-12310	
	10/04→	Tie Rod	DB-ES-5227	Guide Rod
	10/04→	Tie Rod End	DB-ES-8164	for Push Rod
	10/04→	Track Control Arm		DB-VB-7261 Suspension Rod, Wishbone (CV), 1st RA;2nd RA; Air Suspension Axle
	10/04→	Track Control Arm		DB-VB-7790 Wishbone (CV), Tag Axle;Air Suspension Axle
	10/04→	Track Control Arm	DB-DL-5224	Control Arm, 1st FA;Air Suspension Axle
	10/04→	Track Control Arm	DB-DL-9218	DB-DL-9218 Trailing Arm, 1st FA;Air Suspension Axle
	10/04→	Track Control Arm	DB-VB-3707	DB-VB-3707 Suspension Rod, Wishbone (CV), 1st RA; Air Suspension Axle;1st FA;Leaf Spring Axle, →* L 041975 *
	2533, 2533 L	10/04→	Ball Head, gearshift linkage	DB-ES-8510
10/04→		Centre Rod	DB-DL-5230	Suspension Rod
10/04→		Centre Rod	DB-DL-5241	Suspension Rod
10/04→		Centre Rod	DB-DL-5405	Push Rod, 1st FA;Leaf Spring Axle
10/04→		Centre Rod	DB-DL-7270	Push Rod
10/04→		Centre Rod	DB-DL-8184	Push Rod
10/04→		Centre Rod	DB-DL-8185	Push Rod
10/04→		Centre Rod	DB-DL-8188	Push Rod, Air Suspension Axle
10/04→		Centre Rod	DB-DL-8622	Push Rod
10/04→		Centre Rod	DB-DL-8717	Push Rod, 1st FA;Leaf Spring Axle
10/04→		Centre Rod	DB-DL-12300	for Steering Rod
10/04→		Stabiliser Mounting		DB-RK-9296
10/04→		Stabiliser Mounting		DB-SB-10406
10/04→		Suspension Arm Repair Kit		DB-RK-8550 for Wishbone (CV)
10/04→		Suspension Arm Repair Kit		DB-RK-8626 for Wishbone (CV)
10/04→		Suspension Arm Repair Kit		DB-RK-8638 for Control Arm
10/04→		Suspension Arm Repair Kit		DB-RK-10374 for Wishbone (CV)
10/04→		Suspension Strut Repair Kit		DB-RK-8555
10/04→		Suspension Strut Repair Kit		DB-RK-9294
10/04→		Tie Rod		DB-DL-10209 Tag Axle;for vehicles with Hinged Trailing Axle
10/04→		Tie Rod	DB-DL-8327	Guide Rod
10/04→		Tie Rod	DB-DL-8640	Guide Rod
10/04→		Tie Rod	DB-DL-12310	
10/04→		Tie Rod	DB-ES-5227	Guide Rod
10/04→		Tie Rod End	DB-ES-8164	for Push Rod

DB-DL-5224

Length: 850 Ø: 60
Hole Distance: 100 / 100
01336100A, 941330007



DB-DL-5230

Length: 879 Ø: 42
Cone Ø: d1 Ø 30 / d2 Ø 27
01208600A, 0004607105, 0004607205,
0014606705



DB-DL-5241

Length: 875 Ø: 40
Cone Ø: d1 Ø 30 / d2 Ø 27
01215300A, 0004609205, 0004609305,
0014606905



DB-DL-5405

Length: 890 Ø: 35
Cone Ø: d1 Ø 28,6 / d2 Ø 23,9
01215300A, 1460248, 0024604505, 0024604605,
0034605005, 3752600637, 3754600405,
A375260637, A3754600405



DB-DL-7270

Length: 875 Ø: 40
Cone Ø: d1 Ø 28,6 / d2 Ø 23,9
01208300A, 0024604705, 0024604805,
0034604905, A0024604705



DB-DL-8171

Length: 1687 Ø: 52
Cone Ø: d1 Ø 32 / d2 Ø 29
9493300603, 9493300703, 9493301503,
9493301603



DB-DL-8184

Length: 1095 Ø: 42
Cone Ø: d1 Ø 32 / d2 Ø 28,8
01217700A, 0014601305, 0014601405,
0024600505, 0034603205, 3754601505,
A0014601305, A0014601405, A0024600505



DB-DL-8185

Length: 711 Ø: 42
Cone Ø: d1 Ø 32 / d2 Ø 28,8
01213600A, 0014601105, 0024600405,
0034603105, A0014601105, A0024600405



DB-DL-8188

Length: 895 Ø: 40
Cone Ø: d1 Ø 28,6 / d2 Ø 23,9
01217200A, 0024604905, 0024605005,
0034605605



DB-DL-8327

Length: 1745 Ø: 48
Cone Ø: d1 Ø 32 / d2 Ø 29
01219800A, 9413300003, 9413300103,
9413300203, 9413300303, 9413300503



DB-DL-8622

Length: 1558 Ø: 52
Cone Ø: d1 Ø 30 / d2 Ø 27
0014609005, 0014609105



DB-DL-8640

Length: 1615 Ø: 50
Cone Ø: d1 Ø 32 / d2 Ø 29
6253301503, 6253301603, 6253302403,
6253302503, 9423300803, 9423302103,
9493300203, 9493300303, 9493300903



DB-DL-8717

Length: 886
Ø: 38
Cone Ø: d1 Ø 30 / d2 Ø 27
0024601705, 24601705, 0024607505, 24607505,
0024607605, 24607605, 0034604405



DB-DL-9218

Length: 754 Ø: 40
Hole Distance: 100
000360098524, 000390098524, 3753300111,
9413300011, A3753300111, SA50831601



DB-DL-9258

Length: 905
Ø: 42
Cone Ø: d1 Ø 28,6 / d2 Ø 23,9
3754600605, 3754601105



DB-DL-10209

Length: 1281 Ø: 38
Cone Ø: d1 Ø 30 / d2 Ø 27
3574603505, 9423301003, 9423301703



DB-DL-12300

Length: 733 Ø: 36
Cone Ø: d1 Ø 32 / d2 Ø 29
0014601505, 0014607305, 0034603305,
3754601605, A0014601505, A0034603305,
A3754601605



DB-DL-12310

Length: 1532 Ø: 50
Cone Ø: d1 Ø 32 / d2 Ø 29
Thread: M27 x 1,5 LHT
9493301203, 9493301303, 9493301803,
9493302203, A9493301203, A9493301303,
A9493301803, A9493302203



DB-ES-5227

Length: 1588 Ø: 60
Cone Ø: d1 Ø 38 / d2 Ø 34,3
6253300903, 6253301203, 9443300203



DB-ES-8164

Length: 140
Cone Ø: d1 Ø 28,6 / d2 Ø 23,9
Thread: M28 x 1,5 RHT
0014604248, 0014605048, 0014608548,
0024600548



DB-ES-8510

Length: 56
Cone Ø: d1 Ø 10 / d2 Ø 10
Thread: M12 x 1,75 LHT
0009965145, 0009965645, 0019963145



DB-RK-8550

Ø: 75 Hole Distance: 152
Thick/Height: 24
0003502105, 0003504605



DB-RK-8555

Ø: 67 Hole Distance: 130
Thick/Height: 24
01335600A, 0003502005, 0003504705



DB-RK-8626

Ø: 75 Hole Distance: 130
Thick/Height: 24
0003502205, 0003502505, 0003503405,
0003504505, GL11319



DB-RK-8638

Length: 100 Ø: 67
Hole Distance: 100
Thick/Height: 20
0003301411



DB-RK-9294

Ø: 85 Hole Distance: 152
Thick/Height: 24
0003503105



DB-RK-9296

Ø: 88 Hole Distance: 130
Thick/Height: 24
9423260050



DB-RK-10374

Ø: 85 Hole Distance: 152
Thick/Height: 24
0003504405



DB-SB-10384

Ø: 73 Thick/Height: 47
9303170012, 9423171812



DB-SB-10400

Length: 230
Thick/Height: 167,5 / 115
0003250696, 0003250896



DB-SB-10406

Ø: 80 Thick/Height: 46
0003238185



DB-VB-3707

Length: 622 Ø: 46
Hole Ø 25 / 25 / 25
Hole Distance: 152 / 130 / 130
01337100A, 9423501005, 9423501505,
9443500005, 9473500105, 9473501005,
A3753500005, A9423501005, A9423501505,
A9443500005, A9473500105, A9473501005



DB-VB-7261

Length: 622 Ø: 46
Hole Ø 25 / 25 / 25
Hole Distance: 152 / 130 / 130
01337800A, 9443500305, 9443500505,
9443500605, 9473500705, 9473500905,
9483500405, 9483503005



DB-VB-7790

Length: 622 Ø: 46
Hole Ø 25 / 23 / 23
Hole Distance: 152 / 130 / 130
01337000A, 3753500105, 9423500105,
9423500705, 9423501105, 9423501605,
9443500205





AXOR 2 ...

2533, 2533 L ...	10/04 →	Track Control Arm		DB-VB-3707	Suspension Rod, Wishbone (CV), Drive Axle; Air Suspension Axle, →* L 041975 *
	10/04 →	Track Control Arm		DB-VB-7261	Suspension Rod, Wishbone (CV), 1st RA;2nd RA; Air Suspension Axle
	10/04 →	Track Control Arm		DB-VB-7790	Wishbone (CV), Tag Axle;Air Suspension Axle
	10/04 →	Track Control Arm	DB-DL-5224		Control Arm, 1st FA;Air Suspension Axle
	10/04 →	Track Control Arm	DB-DL-9218	DB-DL-9218	Trailing Arm, 1st FA;Air Suspension Axle
2535 L, 2536 L, 2536 LL	10/04 →	Centre Rod	DB-DL-5230		Suspension Rod
	10/04 →	Centre Rod	DB-DL-5241		Suspension Rod
	10/04 →	Centre Rod	DB-DL-7270		Push Rod;Suspension Rod
	10/04 →	Centre Rod	DB-DL-8122		Push Rod
	10/04 →	Centre Rod	DB-DL-8184		Push Rod
	10/04 →	Centre Rod	DB-DL-8185		Push Rod
	10/04 →	Centre Rod	DB-DL-8188		Push Rod, Air Suspension Axle
	10/04 →	Centre Rod	DB-DL-8717		Push Rod
	10/04 →	Centre Rod	DB-DL-9258		Push Rod, for vehicles with Part-Pneumatic Suspension
	10/04 →	Centre Rod	DB-DL-12300		for Steering Rod
	10/04 →	Stabiliser Mounting		DB-RK-9296	
	10/04 →	Stabiliser Mounting		DB-SB-10406	
	10/04 →	Stabiliser Mounting		DB-SB-10409	
	10/04 →	Stabiliser Mounting	DB-SB-10410		
	10/04 →	Suspension Arm Repair Kit		DB-RK-8550	for Wishbone (CV)
	10/04 →	Suspension Arm Repair Kit		DB-RK-8626	for Wishbone (CV)
	10/04 →	Suspension Arm Repair Kit		DB-RK-10374	for Wishbone (CV)
	10/04 →	Suspension Arm Repair Kit		DB-RK-10375	for Wishbone (CV)
	10/04 →	Suspension Arm Repair Kit	DB-RK-8638		for Control Arm
	10/04 →	Suspension Strut Repair Kit		DB-RK-8555	
	10/04 →	Suspension Strut Repair Kit		MN-RK-8997	
	10/04 →	Tie Rod		DB-DL-10209	Tag Axle;for vehicles with Hinged Trailing Axle
	10/04 →	Tie Rod	DB-DL-8327		Guide Rod
	10/04 →	Tie Rod	DB-DL-8640		Guide Rod
	10/04 →	Tie Rod End	DB-ES-8530		for Push Rod
	10/04 →	Track Control Arm		DB-VB-3707	Suspension Rod, Wishbone (CV), Drive Axle; Air Suspension Axle, →* L 041975 *
	10/04 →	Track Control Arm		DB-VB-7790	Wishbone (CV), Tag Axle;Air Suspension Axle
10/04 →	Track Control Arm	DB-DL-5224		Control Arm, 1st FA;Air Suspension Axle	
10/04 →	Track Control Arm	DB-DL-9218	DB-DL-9218	Trailing Arm, 1st FA;Air Suspension Axle	
2535 S, 2535 LS	10/04 →	Centre Rod	DB-DL-5405		Push Rod
	10/04 →	Centre Rod	DB-DL-8122		Push Rod
2540 L, LL	10/04 →	Centre Rod	DB-DL-5230		Suspension Rod
	10/04 →	Centre Rod	DB-DL-5241		Suspension Rod
	10/04 →	Centre Rod	DB-DL-7270		Push Rod;Suspension Rod
	10/04 →	Centre Rod	DB-DL-8122		Push Rod
	10/04 →	Centre Rod	DB-DL-8184		Push Rod
	10/04 →	Centre Rod	DB-DL-8185		Push Rod
	10/04 →	Centre Rod	DB-DL-8188		Push Rod, Air Suspension Axle
	10/04 →	Centre Rod	DB-DL-8717		Push Rod
	10/04 →	Centre Rod	DB-DL-9258		Push Rod, for vehicles with Part-Pneumatic Suspension
	10/04 →	Centre Rod	DB-DL-12300		for Steering Rod
	10/04 →	Stabiliser Mounting		DB-RK-9296	
	10/04 →	Stabiliser Mounting		DB-SB-10406	
	10/04 →	Stabiliser Mounting		DB-SB-10409	
	10/04 →	Stabiliser Mounting	DB-SB-10410		
	10/04 →	Suspension Arm Repair Kit		DB-RK-8550	for Wishbone (CV)
	10/04 →	Suspension Arm Repair Kit		DB-RK-8626	for Wishbone (CV)
	10/04 →	Suspension Arm Repair Kit		DB-RK-10374	for Wishbone (CV)
	10/04 →	Suspension Arm Repair Kit		DB-RK-10375	for Wishbone (CV)
	10/04 →	Suspension Arm Repair Kit	DB-RK-8638		for Control Arm
	10/04 →	Suspension Strut Repair Kit		DB-RK-8555	
	10/04 →	Suspension Strut Repair Kit		MN-RK-8997	
	10/04 →	Tie Rod		DB-DL-10209	Tag Axle;for vehicles with Hinged Trailing Axle

DB-DL-5224

Length: 850 Ø: 60
 Hole Distance: 100 / 100
 01336100A, 9413300007

**DB-DL-5230**

Length: 879 Ø: 42
 Cone Ø: d1 Ø 30 / d2 Ø 27
 01208600A, 0004607105, 0004607205,
 0014606705

**DB-DL-5241**

Length: 875 Ø: 40
 Cone Ø: d1 Ø 30 / d2 Ø 27
 01215300A, 0004609205, 0004609305,
 0014606905

**DB-DL-5405**

Length: 890 Ø: 35
 Cone Ø: d1 Ø 28,6 / d2 Ø 23,9
 01215900A, 1460248, 0024604505, 0024604605,
 0034605005, 3752600637, 3754600405,
 A3752600637, A3754600405

**DB-DL-7270**

Length: 875 Ø: 40
 Cone Ø: d1 Ø 28,6 / d2 Ø 23,9
 01208300A, 0024604705, 0024604805,
 0034604905, A0024604705

**DB-DL-8122**

Length: 875
 Ø: 42
 Cone Ø: d1 Ø 30 / d2 Ø 27
 01215000A, 6174603205, 6174603305

**DB-DL-8184**

Length: 1095 Ø: 42
 Cone Ø: d1 Ø 32 / d2 Ø 28,8
 01217700A, 0014601305, 0014601405,
 0024605005, 0034603205, 3754601505,
 A0014601305, A0014601405, A0024600505

**DB-DL-8185**

Length: 711 Ø: 42
 Cone Ø: d1 Ø 32 / d2 Ø 28,8
 01213600A, 0014601105, 0024600405,
 0034603105, A0014601105, A0024600405

**DB-DL-8188**

Length: 895 Ø: 40
 Cone Ø: d1 Ø 28,6 / d2 Ø 23,9
 01217200A, 0024604905, 0024605005,
 0034605605

**DB-DL-8327**

Length: 1745 Ø: 48
 Cone Ø: d1 Ø 32 / d2 Ø 29
 01219800A, 9413300003, 9413300103,
 9413300203, 9413300303, 9413300503

**DB-DL-8640**

Length: 1615 Ø: 50
 Cone Ø: d1 Ø 32 / d2 Ø 29
 6253301503, 6253301603, 6253302403,
 6253302503, 9423300803, 9423302103,
 9493300203, 9493300303, 9493300903

**DB-DL-8717**

Length: 886 Ø: 38
 Cone Ø: d1 Ø 30 / d2 Ø 27
 0024601705, 0024607505, 0024607605,
 0034604405

**DB-DL-9218**

Length: 754 Ø: 40
 Hole Distance: 100
 000360098524, 000390098524, 3753300111,
 9413300011, A3753300111, SA50831601

**DB-DL-9258**

Length: 905
 Ø: 42
 Cone Ø: d1 Ø 28,6 / d2 Ø 23,9
 3754600605, 3754601105

**DB-DL-10209**

Length: 1281 Ø: 38
 Cone Ø: d1 Ø 30 / d2 Ø 27
 3574603505, 9423301003, 9423301703

**DB-DL-12300**

Length: 733 Ø: 36
 Cone Ø: d1 Ø 32 / d2 Ø 29
 0014601505, 0014607305, 0034603305,
 3754601605, A0014601505, A0034603305,
 A3754601605

**DB-ES-8530**

Length: 115
 Cone Ø: d1 Ø 28,6 / d2 Ø 23,9
 Thread: M30 x 1,5 RHT
 0014603848, 0014604848, 0014605148,
 0014608648, 0014609948

**DB-RK-8550**

Ø: 75 Hole Distance: 152
 Thick/Height: 24
 0003502105, 0003504605

**DB-RK-8555**

Ø: 67 Hole Distance: 130
 Thick/Height: 24
 01335600A, 0003502005, 0003504705

**DB-RK-8626**

Ø: 75 Hole Distance: 130
 Thick/Height: 24
 0003502205, 0003502505, 0003503405,
 0003504505, GL11319

**DB-RK-8638**

Length: 100 Ø: 67
 Hole Distance: 100
 Thick/Height: 20
 0003301411

**DB-RK-9296**

Ø: 88 Hole Distance: 130
 Thick/Height: 24
 9423260050

**DB-RK-10374**

Ø: 85 Hole Distance: 152
 Thick/Height: 24
 0003504405

**DB-RK-10375**

Ø: 100 Hole Distance: 152
 Thick/Height: 24
 0003502405, 0003503505, 0003504905

**DB-SB-10406**

Ø: 80 Thick/Height: 46
 0003238185

**DB-SB-10409**

Ø: 77 Thick/Height: 56
 0003265181

**DB-SB-10410**

Ø: 73 Hole Distance: 100
 Thick/Height: 24
 9413230050

**DB-VB-3707**

Length: 622 Ø: 46
 Hole Ø 25 / 25 / 25
 Hole Distance: 152 / 130 / 130
 01337100A, 9423501005, 9423501505,
 9443500005, 9473500105, 9473501005,
 A3753500005, A9423501005, A9423501505,
 A9443500005, A9473500105, A9473501005

**DB-VB-7261**

Length: 622 Ø: 46
 Hole Ø 25 / 25 / 25
 Hole Distance: 152 / 130 / 130
 01337800A, 9443500305, 9443500505,
 9443500605, 9473500705, 9473500905,
 9483500405, 9483500305

**DB-VB-7790**

Length: 622 Ø: 46
 Hole Ø 25 / 23 / 23
 Hole Distance: 152 / 130 / 130
 01337000A, 3753500105, 9423500105,
 9423500705, 9423501105, 9423501605,
 9443500205

**MN-RK-8997**

Ø: 85 Hole Distance: 130
 Thick/Height: 30
 0003504805





AXOR 2 ...

2540 L, LL ...	10/04 →	Tie Rod	DB-DL-8327		Guide Rod	
	10/04 →	Tie Rod	DB-DL-8640		Guide Rod	
	10/04 →	Tie Rod End	DB-ES-8530		for Push Rod	
	10/04 →	Track Control Arm		DB-VB-3707	Suspension Rod, Wishbone (CV), Drive Axle; Air Suspension Axle, →* L 041975 *	
	10/04 →	Track Control Arm		DB-VB-7790	Wishbone (CV), Tag Axle	
	10/04 →	Track Control Arm	DB-DL-5224		Control Arm, 1st FA; Air Suspension Axle	
	10/04 →	Track Control Arm	DB-DL-9218	DB-DL-9218	Trailing Arm, 1st FA; Air Suspension Axle	
	2540 S, 2541 S, LS	10/04 →	Centre Rod	DB-DL-5405		Push Rod
10/04 →		Centre Rod	DB-DL-8122		Push Rod	
2543 L, LL	10/04 →	Centre Rod	DB-DL-5230		Suspension Rod	
	10/04 →	Centre Rod	DB-DL-5241		Suspension Rod	
	10/04 →	Centre Rod	DB-DL-7270		Push Rod; Suspension Rod	
	10/04 →	Centre Rod	DB-DL-8122		Push Rod	
	10/04 →	Centre Rod	DB-DL-8184		Push Rod	
	10/04 →	Centre Rod	DB-DL-8185		Push Rod	
	10/04 →	Centre Rod	DB-DL-8188		Push Rod, Air Suspension Axle	
	10/04 →	Centre Rod	DB-DL-8717		Push Rod	
	10/04 →	Centre Rod	DB-DL-9258		Push Rod, for vehicles with Part-Pneumatic Suspension	
	10/04 →	Centre Rod	DB-DL-12300		for Steering Rod	
	10/04 →	Stabiliser Mounting		DB-RK-9296		
	10/04 →	Stabiliser Mounting		DB-SB-10406		
	10/04 →	Stabiliser Mounting		DB-SB-10409		
	10/04 →	Stabiliser Mounting	DB-SB-10410			
	10/04 →	Suspension Arm Repair Kit		DB-RK-8550	for Wishbone (CV)	
	10/04 →	Suspension Arm Repair Kit		DB-RK-8626	for Wishbone (CV)	
	10/04 →	Suspension Arm Repair Kit		DB-RK-10374	for Wishbone (CV)	
	10/04 →	Suspension Arm Repair Kit		DB-RK-10375	for Wishbone (CV)	
	10/04 →	Suspension Arm Repair Kit	DB-RK-8638		for Control Arm	
	10/04 →	Suspension Strut Repair Kit		DB-RK-8555		
	10/04 →	Suspension Strut Repair Kit		MN-RK-8997		
	10/04 →	Tie Rod		DB-DL-10209	Tag Axle; for vehicles with Hinged Trailing Axle	
	10/04 →	Tie Rod	DB-DL-8327		Guide Rod	
	10/04 →	Tie Rod	DB-DL-8640		Guide Rod	
	10/04 →	Tie Rod End	DB-ES-8530		for Push Rod	
	10/04 →	Track Control Arm		DB-VB-3707	Suspension Rod, Wishbone (CV), Drive Axle; Air Suspension Axle, →* L 041975 *	
	10/04 →	Track Control Arm		DB-VB-7790	Wishbone (CV), Tag Axle	
	10/04 →	Track Control Arm	DB-DL-5224		Control Arm, 1st FA; Air Suspension Axle	
	10/04 →	Track Control Arm	DB-DL-9218	DB-DL-9218	Trailing Arm, 1st FA; Air Suspension Axle	
	2543 S, 2543 LS	10/04 →	Centre Rod	DB-DL-5405		Push Rod
		10/04 →	Centre Rod	DB-DL-8188		Push Rod
		10/04 →	Track Control Arm		DB-VB-3707	Suspension Rod, Wishbone (CV)
10/04 →		Track Control Arm		DB-VB-7798	Wishbone (CV)	
2628 B, 2629 B	10/04 →	Ball Head, gearshift linkage	DB-ES-8510			
	10/04 →	Bush, parabolic spring		DB-SB-10400		
	10/04 →	Bush, parabolic spring		DB-SB-10401		
	10/04 →	Centre Rod	DB-DL-5230		Suspension Rod	
	10/04 →	Centre Rod	DB-DL-5241		Suspension Rod	
	10/04 →	Centre Rod	DB-DL-5405		Push Rod, Leaf Spring Axle	
	10/04 →	Centre Rod	DB-DL-7270		Push Rod; Suspension Rod	
	10/04 →	Centre Rod	DB-DL-8184		Push Rod	
	10/04 →	Centre Rod	DB-DL-8185		Push Rod	
	10/04 →	Centre Rod	DB-DL-8188		Push Rod, Leaf Spring Axle	
	10/04 →	Centre Rod	DB-DL-8717		Push Rod, Leaf Spring Axle	
	10/04 →	Centre Rod	DB-DL-12300		for Steering Rod	
	10/04 →	Stabiliser Mounting		DB-SB-10406		
	10/04 →	Suspension Arm Repair Kit		DB-RK-8550	for Wishbone (CV)	
	10/04 →	Suspension Arm Repair Kit		DB-RK-8626	for Wishbone (CV)	
	10/04 →	Suspension Arm Repair Kit		DB-RK-10374	for Wishbone (CV)	
	10/04 →	Suspension Strut Repair Kit		DB-RK-9294		
	10/04 →	Tie Rod	DB-DL-8171		Guide Rod	

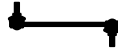

AXOR 2 ...

2628 B, 2629 B ...	10/04 →	Tie Rod	DB-DL-8327		Guide Rod	
	10/04 →	Tie Rod	DB-DL-8640		Guide Rod	
	10/04 →	Tie Rod	DB-DL-12310			
	10/04 →	Tie Rod End	DB-ES-8164		for Push Rod	
	10/04 →	Tie Rod End	DB-ES-8530		for Push Rod	
	10/04 →	Track Control Arm		DB-DL-3475	Trailing Arm	
	10/04 →	Track Control Arm		DB-VB-3707	Suspension Rod, Wishbone (CV)	
	10/04 →	Track Control Arm		DB-VB-7261	Suspension Rod, Wishbone (CV), 1st RA;2nd RA; Leaf Spring Axle	
	10/04 →	Track Control Arm		DB-VB-10426	Wishbone (CV), Leaf Spring Axle;Unit	
2628 K, 2629 K	10/04 →	Ball Head, gearshift linkage	DB-ES-8510			
	10/04 →	Bush, parabolic spring		DB-SB-10400		
	10/04 →	Bush, parabolic spring		DB-SB-10401		
	10/04 →	Centre Rod	DB-DL-5230		Suspension Rod	
	10/04 →	Centre Rod	DB-DL-5241		Suspension Rod	
	10/04 →	Centre Rod	DB-DL-5405		Push Rod	
	10/04 →	Centre Rod	DB-DL-5405		Push Rod, 1st FA;Leaf Spring Axle	
	10/04 →	Centre Rod	DB-DL-7270		Push Rod;Suspension Rod	
	10/04 →	Centre Rod	DB-DL-8184		Push Rod	
	10/04 →	Centre Rod	DB-DL-8185		Push Rod	
	10/04 →	Centre Rod	DB-DL-8188		Push Rod, 1st FA;Leaf Spring Axle	
	10/04 →	Centre Rod	DB-DL-8717		Push Rod, 1st FA;Leaf Spring Axle	
	10/04 →	Centre Rod	DB-DL-12300		for Steering Rod	
	10/04 →	Stabiliser Mounting		DB-SB-10406		
	10/04 →	Stabiliser Mounting		DB-SB-10409		
	10/04 →	Suspension Arm Repair Kit		DB-RK-8550	for Wishbone (CV)	
	10/04 →	Suspension Arm Repair Kit		DB-RK-8626	for Wishbone (CV)	
	10/04 →	Suspension Arm Repair Kit		DB-RK-10374	for Wishbone (CV)	
	10/04 →	Suspension Strut Repair Kit		DB-RK-8391		
	10/04 →	Suspension Strut Repair Kit		DB-RK-9294		
	10/04 →	Tie Rod	DB-DL-8171		Guide Rod	
	10/04 →	Tie Rod	DB-DL-8327		Guide Rod	
	10/04 →	Tie Rod	DB-DL-8640		Guide Rod	
	10/04 →	Tie Rod	DB-DL-12310			
	10/04 →	Tie Rod	DB-ES-5227		Guide Rod	
	10/04 →	Tie Rod End	DB-ES-8164		for Push Rod	
	10/04 →	Track Control Arm		DB-DL-3475	Trailing Arm	
	10/04 →	Track Control Arm		DB-VB-3707	Suspension Rod, Wishbone (CV)	
	10/04 →	Track Control Arm		DB-VB-7261	Suspension Rod, Wishbone (CV), 1st RA;2nd RA; Leaf Spring Axle	
	10/04 →	Track Control Arm		DB-VB-7798	Wishbone (CV)	
	10/04 →	Track Control Arm		DB-VB-10426	Wishbone (CV), Leaf Spring Axle;Unit	
	2628, 2629	10/04 →	Ball Head, gearshift linkage	DB-ES-8510		
		10/04 →	Bush, parabolic spring		DB-SB-10400	
10/04 →		Bush, parabolic spring		DB-SB-10401		
10/04 →		Centre Rod	DB-DL-5230		Suspension Rod	
10/04 →		Centre Rod	DB-DL-5241		Suspension Rod	
10/04 →		Centre Rod	DB-DL-5405		Push Rod, 1st FA;Leaf Spring Axle	
10/04 →		Centre Rod	DB-DL-7270		Push Rod;Suspension Rod	
10/04 →		Centre Rod	DB-DL-8184		Push Rod	
10/04 →		Centre Rod	DB-DL-8185		Push Rod	
10/04 →		Centre Rod	DB-DL-8188		Push Rod, 1st FA;Leaf Spring Axle	
10/04 →		Centre Rod	DB-DL-8622		Push Rod	
10/04 →		Centre Rod	DB-DL-8717		Push Rod, 1st FA;Leaf Spring Axle	
10/04 →		Centre Rod	DB-DL-12300		for Steering Rod	
10/04 →		Stabiliser Mounting		DB-SB-10406		
10/04 →		Suspension Arm Repair Kit		DB-RK-8550	for Wishbone (CV)	
10/04 →		Suspension Arm Repair Kit		DB-RK-8626	for Wishbone (CV)	
10/04 →		Suspension Arm Repair Kit		DB-RK-10374	for Wishbone (CV)	
10/04 →		Suspension Strut Repair Kit		DB-RK-9294		
10/04 →		Tie Rod	DB-DL-8171		Guide Rod	
10/04 →		Tie Rod	DB-DL-8327		Guide Rod	
10/04 →		Tie Rod	DB-DL-8640		Guide Rod	

DB-DL-3475

Length: 565 Ø: 52
Hole Distance: 152 / 152
3753500006, 3753500206, 9473500805,
9483500006, 9483500805, 9483501205,
9483501305, 9483501905, 9483502005,
9483502405, A3753500006, A3753500206



DB-DL-5230

Length: 879 Ø: 42
Cone Ø: d1 Ø 30 / d2 Ø 27
01208600A, 0004607105, 0004607205,
0014606705



DB-DL-5241

Length: 875 Ø: 40
Cone Ø: d1 Ø 30 / d2 Ø 27
01215300A, 0004609205, 0004609305,
0014606905



DB-DL-5405

Length: 890 Ø: 35
Cone Ø: d1 Ø 28,6 / d2 Ø 23,9
01215900A, 1460248, 0024604505, 0024604605,
0034605005, 3752600637, 3754600405,
A3752600637, A3754600405



DB-DL-7270

Length: 875 Ø: 40
Cone Ø: d1 Ø 28,6 / d2 Ø 23,9
01208300A, 0024604705, 0024604805,
0034604905, A0024604705



DB-DL-8171

Length: 1687 Ø: 52
Cone Ø: d1 Ø 32 / d2 Ø 29
9493300603, 9493300703, 9493301503,
9493301603



DB-DL-8184

Length: 1095 Ø: 42
Cone Ø: d1 Ø 32 / d2 Ø 28,8
01217700A, 0014601305, 0014601405,
0024600505, 0034603205, 3754601505,
A0014601305, A0014601405, A0024600505



DB-DL-8185

Length: 711 Ø: 42
Cone Ø: d1 Ø 32 / d2 Ø 28,8
01213600A, 0014601105, 0024600405,
0034603105, A0014601105, A0024600405



DB-DL-8188

Length: 895 Ø: 40
Cone Ø: d1 Ø 28,6 / d2 Ø 23,9
01217200A, 0024604905, 0024605005,
0034605605



DB-DL-8327

Length: 1745 Ø: 48
Cone Ø: d1 Ø 32 / d2 Ø 29
01219800A, 9413300003, 9413300103,
9413300203, 9413300303, 9413300503



DB-DL-8622

Length: 1558 Ø: 52
Cone Ø: d1 Ø 30 / d2 Ø 27
0014609005, 0014609105



DB-DL-8640

Length: 1615 Ø: 50
Cone Ø: d1 Ø 32 / d2 Ø 29
6253301503, 6253301603, 6253302403,
6253302503, 9423300803, 9423302103,
9493300203, 9493300303, 9493300903



DB-DL-8717

Length: 886
Ø: 38
Cone Ø: d1 Ø 30 / d2 Ø 27
0024601705, 24601705, 0024607505, 24607505,
0024607605, 24607605, 0034604405



DB-DL-12300

Length: 733 Ø: 36
Cone Ø: d1 Ø 32 / d2 Ø 29
0014601505, 0014607305, 0034603305,
3754601605, A0014601505, A0034603305,
A3754601605



DB-DL-12310

Length: 1532 Ø: 50
Cone Ø: d1 Ø 32 / d2 Ø 29
Thread: M27 x 1,5 LHT
9493301203, 9493301303, 9493301803,
9493302203, A9493301203, A9493301303,
A9493301803, A9493302203



DB-ES-5227

Length: 1588 Ø: 60
Cone Ø: d1 Ø 38 / d2 Ø 34,3
6253300903, 6253301203, 9443300203



DB-ES-8164

Length: 140
Cone Ø: d1 Ø 28,6 / d2 Ø 23,9
Thread: M28 x 1,5 RHT
0014604248, 0014605048, 0014608548,
0024600548



DB-ES-8510

Length: 56
Cone Ø: d1 Ø 10 / d2 Ø 10
Thread: M12 x 1,75 LHT
0009965145, 0009965645, 0019963145



DB-ES-8530

Length: 115
Cone Ø: d1 Ø 28,6 / d2 Ø 23,9
Thread: M30 x 1,5 RHT
0014603848, 0014604848, 0014605148,
0014608648, 0014609948



DB-RK-8391

Ø: 85 Hole Distance: 152
Thick/Height: 24
01336800A, 0003502705



DB-RK-8550

Ø: 75 Hole Distance: 152
Thick/Height: 24
0003502105, 0003504605



DB-RK-8626

Ø: 75 Hole Distance: 130
Thick/Height: 24
0003502205, 0003502505, 0003503405,
0003504505, 0003504605



DB-RK-9294

Ø: 85 Hole Distance: 152
Thick/Height: 24
0003503105



DB-RK-10374

Ø: 85 Hole Distance: 152
Thick/Height: 24
0003504405



DB-SB-10400

Length: 230
Thick/Height: 167,5 / 115
0003250696, 0003250896



DB-SB-10401

Length: 232
Thick/Height: 163,5 / 152,5
0003250596, 0003250796



DB-SB-10406

Ø: 80 Thick/Height: 46
0003238185



DB-SB-10409

Ø: 77 Thick/Height: 56
0003265181



DB-VB-3707

Length: 622 Ø: 46
Hole Ø 25 / 25 / 25
Hole Distance: 152 / 130 / 130
01337100A, 9423501005, 9423501505,
9443500005, 9473500105, 9473501005,
A3753500005, A9423501005, A9423501505,
A9443500005, A9473500105, A9473501005



DB-VB-7261

Length: 622 Ø: 46
Hole Ø 25 / 25 / 25
Hole Distance: 152 / 130 / 130
01337800A, 9443500305, 9443500505,
9443500605, 9473500705, 9473500905,
9483500405, 9483500305



DB-VB-7798

Length: 622 Ø: 48
Hole Ø 25 / 23 / 23
Hole Distance: 152 / 130 / 130
9423500505, 9423500805, 9423501205,
A9423501205



DB-VB-10426

Length: 622 Ø: 46
Hole Ø 25 / 25 / 25
Hole Distance: 152 / 130 / 130
9443500405





AXOR 2 ...

2628, 2629 ...	10/04 →	Tie Rod	DB-DL-12310		
	10/04 →	Tie Rod	DB-ES-5227	Guide Rod	
	10/04 →	Tie Rod End	DB-ES-8164	for Push Rod	
	10/04 →	Track Control Arm		DB-DL-3475 Trailing Arm	
	10/04 →	Track Control Arm		DB-VB-3707 Suspension Rod, Wishbone (CV)	
	10/04 →	Track Control Arm		DB-VB-7261 Suspension Rod, Wishbone (CV), 1st RA;2nd RA; Leaf Spring Axle	
	10/04 →	Track Control Arm		DB-VB-10426 Wishbone (CV), Leaf Spring Axle;Unit	
2633	10/04 →	Ball Head, gearshift linkage	DB-ES-8510		
	10/04 →	Bush, parabolic spring		DB-SB-10400	
	10/04 →	Bush, parabolic spring		DB-SB-10401	
	10/04 →	Centre Rod	DB-DL-5230	Suspension Rod	
	10/04 →	Centre Rod	DB-DL-5241	Suspension Rod	
	10/04 →	Centre Rod	DB-DL-5405	Push Rod, 1st FA;Leaf Spring Axle	
	10/04 →	Centre Rod	DB-DL-7270	Push Rod;Suspension Rod	
	10/04 →	Centre Rod	DB-DL-8184	Push Rod	
	10/04 →	Centre Rod	DB-DL-8185	Push Rod	
	10/04 →	Centre Rod	DB-DL-8188	Push Rod, 1st FA;Leaf Spring Axle	
	10/04 →	Centre Rod	DB-DL-8622	Push Rod	
	10/04 →	Centre Rod	DB-DL-8717	Push Rod, 1st FA;Leaf Spring Axle	
	10/04 →	Centre Rod	DB-DL-12300	for Steering Rod	
	10/04 →	Stabiliser Mounting		DB-SB-10406	
	10/04 →	Suspension Arm Repair Kit		DB-RK-8550 for Wishbone (CV)	
	10/04 →	Suspension Arm Repair Kit		DB-RK-8626 for Wishbone (CV)	
	10/04 →	Suspension Arm Repair Kit		DB-RK-10374 for Wishbone (CV)	
	10/04 →	Suspension Strut Repair Kit		DB-RK-9294	
	10/04 →	Tie Rod	DB-DL-8171	Guide Rod	
	10/04 →	Tie Rod	DB-DL-8327	Guide Rod	
	10/04 →	Tie Rod	DB-DL-8640	Guide Rod	
	10/04 →	Tie Rod	DB-DL-12310		
	10/04 →	Tie Rod	DB-ES-5227	Guide Rod	
	10/04 →	Tie Rod End	DB-ES-8164	for Push Rod	
	10/04 →	Track Control Arm		DB-DL-3475 Trailing Arm	
	10/04 →	Track Control Arm		DB-VB-3707 Suspension Rod, Wishbone (CV)	
	10/04 →	Track Control Arm		DB-VB-7261 Suspension Rod, Wishbone (CV), 1st RA;2nd RA; Leaf Spring Axle	
	10/04 →	Track Control Arm		DB-VB-10426 Wishbone (CV), Leaf Spring Axle;Unit	
	2633 B	10/04 →	Ball Head, gearshift linkage	DB-ES-8510	
		10/04 →	Bush, parabolic spring		DB-SB-10400
		10/04 →	Bush, parabolic spring		DB-SB-10401
		10/04 →	Centre Rod	DB-DL-5230	Suspension Rod
		10/04 →	Centre Rod	DB-DL-5241	Suspension Rod
10/04 →		Centre Rod	DB-DL-5405	Push Rod, Leaf Spring Axle	
10/04 →		Centre Rod	DB-DL-7270	Push Rod	
10/04 →		Centre Rod	DB-DL-8184	Push Rod	
10/04 →		Centre Rod	DB-DL-8185	Push Rod	
10/04 →		Centre Rod	DB-DL-8188	Push Rod, Leaf Spring Axle	
10/04 →		Centre Rod	DB-DL-8717	Push Rod, Leaf Spring Axle	
10/04 →		Centre Rod	DB-DL-12300	for Steering Rod	
10/04 →		Stabiliser Mounting		DB-SB-10406	
10/04 →		Suspension Arm Repair Kit		DB-RK-8550 for Wishbone (CV)	
10/04 →		Suspension Arm Repair Kit		DB-RK-8626 for Wishbone (CV)	
10/04 →		Suspension Arm Repair Kit		DB-RK-10374 for Wishbone (CV)	
10/04 →		Suspension Strut Repair Kit		DB-RK-9294	
10/04 →		Tie Rod	DB-DL-8171	Guide Rod	
10/04 →		Tie Rod	DB-DL-8327	Guide Rod	
10/04 →		Tie Rod	DB-DL-8640	Guide Rod	
10/04 →		Tie Rod	DB-DL-12310		
10/04 →		Tie Rod End	DB-ES-8164	for Push Rod	
10/04 →		Tie Rod End	DB-ES-8530	for Push Rod	
10/04 →		Track Control Arm		DB-DL-3475 Trailing Arm	
10/04 →		Track Control Arm		DB-VB-3707 Suspension Rod, Wishbone (CV)	

DB-DL-3475

Length: 565 Ø: 52
 Hole Distance: 152 / 152
 3753500006, 3753500206, 9473500805,
 9483500006, 9483500805, 9483501205,
 9483501305, 9483501905, 9483502005,
 9483502405, A3753500006, A3753500206

**DB-DL-5230**

Length: 879 Ø: 42
 Cone Ø: d1 Ø 30 / d2 Ø 27
 01208600A, 0004607105, 0004607205,
 0014606705

**DB-DL-5241**

Length: 875 Ø: 40
 Cone Ø: d1 Ø 30 / d2 Ø 27
 01215300A, 0004609205, 0004609305,
 0014606905

**DB-DL-5405**

Length: 890 Ø: 35
 Cone Ø: d1 Ø 28,6 / d2 Ø 23,9
 01215900A, 1460248, 0024604505, 0024604605,
 0034605005, 3752600637, 3754600405,
 A3752600637, A3754600405

**DB-DL-7270**

Length: 875 Ø: 40
 Cone Ø: d1 Ø 28,6 / d2 Ø 23,9
 01208300A, 0024604705, 0024604805,
 0034604905, A0024604705

**DB-DL-8171**

Length: 1687 Ø: 52
 Cone Ø: d1 Ø 32 / d2 Ø 29
 9493300603, 9493300703, 9493301503,
 9493301603

**DB-DL-8184**

Length: 1095 Ø: 42
 Cone Ø: d1 Ø 32 / d2 Ø 28,8
 01217700A, 0014601305, 0014601405,
 0024600505, 0034603205, 3754601505,
 A0014601305, A0014601405, A0024600505

**DB-DL-8185**

Length: 711 Ø: 42
 Cone Ø: d1 Ø 32 / d2 Ø 28,8
 01213600A, 0014601105, 0024600405,
 0034603105, A0014601105, A0024600405

**DB-DL-8188**

Length: 895 Ø: 40
 Cone Ø: d1 Ø 28,6 / d2 Ø 23,9
 01217200A, 0024604905, 0024605005,
 0034605605

**DB-DL-8327**

Length: 1745 Ø: 48
 Cone Ø: d1 Ø 32 / d2 Ø 29
 01219800A, 9413300003, 9413300103,
 9413300203, 9413300303, 9413300503

**DB-DL-8622**

Length: 1558 Ø: 52
 Cone Ø: d1 Ø 30 / d2 Ø 27
 0014609005, 0014609105

**DB-DL-8640**

Length: 1615 Ø: 50
 Cone Ø: d1 Ø 32 / d2 Ø 29
 6253301503, 6253301603, 6253302403,
 6253302503, 9423300803, 9423302103,
 9493300203, 9493300303, 9493300903

**DB-DL-8717**

Length: 886
 Ø: 38
 Cone Ø: d1 Ø 30 / d2 Ø 27
 0024601705, 24601705, 24607505, 0024607505,
 0024607605, 24607605, 0034604405

**DB-DL-12300**

Length: 733 Ø: 36
 Cone Ø: d1 Ø 32 / d2 Ø 29
 0014601505, 0014607305, 0034603305,
 3754601605, A0014601505, A0034603305,
 A3754601605

**DB-DL-12310**

Length: 1532 Ø: 50
 Cone Ø: d1 Ø 32 / d2 Ø 29
 Thread: M27 x 1,5 LHT
 9493301203, 9493301303, 9493301803,
 9493302203, A9493301203, A9493301303,
 A9493301803, A9493302203

**DB-ES-5227**

Length: 1588 Ø: 60
 Cone Ø: d1 Ø 38 / d2 Ø 34,3
 6253300903, 6253301203, 9443300203

**DB-ES-8164**

Length: 140
 Cone Ø: d1 Ø 28,6 / d2 Ø 23,9
 Thread: M28 x 1,5 RHT
 0014604248, 0014605048, 0014608548,
 0024600548

**DB-ES-8510**

Length: 56
 Cone Ø: d1 Ø 10 / d2 Ø 10
 Thread: M12 x 1,75 LHT
 0009965145, 0009965645, 0019963145

**DB-ES-8530**

Length: 115
 Cone Ø: d1 Ø 28,6 / d2 Ø 23,9
 Thread: M30 x 1,5 RHT
 0014603848, 0014604848, 0014605148,
 0014608648, 0014609948

**DB-RK-8550**

Ø: 75 Hole Distance: 152
 Thick/Height: 24
 0003502105, 0003504605

**DB-RK-8626**

Ø: 75 Hole Distance: 130
 Thick/Height: 24
 0003502205, 0003502505, 0003503405,
 0003504505, GL11319

**DB-RK-9294**

Ø: 85 Hole Distance: 152
 Thick/Height: 24
 0003503105

**DB-RK-10374**

Ø: 85 Hole Distance: 152
 Thick/Height: 24
 0003504405

**DB-SB-10400**

Length: 230
 Thick/Height: 167,5 / 115
 0003250696, 0003250896

**DB-SB-10401**

Length: 232
 Thick/Height: 163,5 / 152,5
 0003250596, 0003250796

**DB-SB-10406**

Ø: 80 Thick/Height: 46
 0003238185

**DB-VB-3707**

Length: 622 Ø: 46
 Hole Ø 25 / 25 / 25
 Hole Distance: 152 / 130 / 130
 01337100A, 9423501005, 9423501505,
 9443500005, 9473500105, 9473501005,
 A3753500005, A9423501005, A9423501505,
 A9443500005, A9473500105, A9473501005

**DB-VB-7261**

Length: 622 Ø: 46
 Hole Ø 25 / 25 / 25
 Hole Distance: 152 / 130 / 130
 01337800A, 9443500305, 9443500505,
 9443500605, 9473500705, 9473500905,
 9483500405, 9483503005

**DB-VB-10426**

Length: 622 Ø: 46
 Hole Ø 25 / 25 / 25
 Hole Distance: 152 / 130 / 130
 9443500405





AXOR 2 ...

2633 B ...	10/04 →	Track Control Arm		DB-VB-7261	Suspension Rod, Wishbone (CV), 1st RA;2nd RA; Leaf Spring Axle
	10/04 →	Track Control Arm		DB-VB-10426	Wishbone (CV), Leaf Spring Axle;Unit
2633 K	10/04 →	Ball Head, gearshift linkage	DB-ES-8510		
	10/04 →	Bush, parabolic spring		DB-SB-10400	
	10/04 →	Bush, parabolic spring		DB-SB-10401	
	10/04 →	Centre Rod	DB-DL-5230		Suspension Rod
	10/04 →	Centre Rod	DB-DL-5241		Suspension Rod
	10/04 →	Centre Rod	DB-DL-5405		Push Rod, 1st FA;Leaf Spring Axle
	10/04 →	Centre Rod	DB-DL-7270		Push Rod
	10/04 →	Centre Rod	DB-DL-8184		Push Rod
	10/04 →	Centre Rod	DB-DL-8185		Push Rod
	10/04 →	Centre Rod	DB-DL-8188		Push Rod, 1st FA;Leaf Spring Axle
	10/04 →	Centre Rod	DB-DL-8717		Push Rod, 1st FA;Leaf Spring Axle
	10/04 →	Centre Rod	DB-DL-12300		for Steering Rod
	10/04 →	Stabiliser Mounting		DB-SB-10406	
	10/04 →	Suspension Arm Repair Kit		DB-RK-8550	for Wishbone (CV)
	10/04 →	Suspension Arm Repair Kit		DB-RK-8626	for Wishbone (CV)
	10/04 →	Suspension Arm Repair Kit		DB-RK-10374	for Wishbone (CV)
	10/04 →	Suspension Strut Repair Kit		DB-RK-9294	
	10/04 →	Tie Rod	DB-DL-8171		Guide Rod
	10/04 →	Tie Rod	DB-DL-8327		Guide Rod
	10/04 →	Tie Rod	DB-DL-8640		Guide Rod
	10/04 →	Tie Rod	DB-DL-12310		
	10/04 →	Tie Rod	DB-ES-5227		Guide Rod
	10/04 →	Tie Rod End	DB-ES-8164		for Push Rod
	10/04 →	Track Control Arm		DB-DL-3475	Trailing Arm
	10/04 →	Track Control Arm		DB-VB-3707	Suspension Rod, Wishbone (CV)
	10/04 →	Track Control Arm		DB-VB-7261	Suspension Rod, Wishbone (CV), 1st RA;2nd RA; Leaf Spring Axle
	10/04 →	Track Control Arm		DB-VB-10426	Wishbone (CV), Leaf Spring Axle;Unit
2635 B	10/05 →	Bush, parabolic spring		DB-SB-10400	
	10/05 →	Bush, parabolic spring		DB-SB-10401	
	10/05 →	Centre Rod	DB-DL-8122		Push Rod
	10/05 →	Centre Rod	DB-DL-8717		Push Rod
	10/05 →	Centre Rod	DB-DL-9258		Push Rod
	10/05 →	Track Control Arm		DB-VB-7261	Suspension Rod, Wishbone (CV)
	10/05 →	Track Control Arm		DB-VB-10426	Wishbone (CV)
2636	10/04 →	Centre Rod	DB-DL-8122		Push Rod
	10/04 →	Centre Rod	DB-DL-8188		Push Rod
	10/04 →	Centre Rod	DB-DL-8717		Push Rod
	10/04 →	Centre Rod	DB-DL-9258		Push Rod
	10/04 →	Tie Rod		DB-DL-10209	
	10/04 →	Tie Rod	DB-DL-8640		Guide Rod
	10/04 →	Track Control Arm		DB-VB-3707	Suspension Rod, Wishbone (CV)
	10/04 →	Track Control Arm	DB-DL-5224		Control Arm
	10/04 →	Track Control Arm	DB-DL-9218	DB-DL-9218	Trailing Arm
2636 B	10/04 →	Bush, driver cab suspension	DB-SB-10384		
	10/04 →	Bush, parabolic spring		DB-SB-10400	
	10/04 →	Bush, parabolic spring		DB-SB-10401	
	10/04 →	Centre Rod	DB-DL-5230		Suspension Rod
	10/04 →	Centre Rod	DB-DL-5241		Suspension Rod
	10/04 →	Centre Rod	DB-DL-7270		Push Rod;Suspension Rod
	10/04 →	Centre Rod	DB-DL-8122		Push Rod
	10/04 →	Centre Rod	DB-DL-8184		Push Rod
	10/04 →	Centre Rod	DB-DL-8185		Push Rod
	10/04 →	Centre Rod	DB-DL-8717		Push Rod, Leaf Spring Axle
	10/04 →	Centre Rod	DB-DL-9258		Push Rod, for Leaf-Spring Suspension vehicles
	10/04 →	Centre Rod	DB-DL-12300		for Steering Rod
	10/04 →	Stabiliser Link	DB-DL-9254		Pressure Rod
	10/04 →	Stabiliser Mounting		DB-SB-10406	
	10/04 →	Stabiliser Mounting		DB-SB-10409	
	10/04 →	Suspension Arm Repair Kit		DB-RK-8550	for Wishbone (CV)



AXOR 2 ...

2636 B ...	10/04 →	Suspension Arm Repair Kit		DB-RK-8626	for Wishbone (CV)	
	10/04 →	Suspension Arm Repair Kit		DB-RK-10374	for Wishbone (CV)	
	10/04 →	Suspension Arm Repair Kit		DB-RK-10375	for Wishbone (CV)	
	10/04 →	Suspension Strut Repair Kit		DB-RK-8391		
	10/04 →	Tie Rod	DB-DL-8327		Guide Rod	
	10/04 →	Tie Rod	DB-DL-8640		Guide Rod	
	10/04 →	Tie Rod	DB-DL-12310			
	10/04 →	Tie Rod End	CV-ES-0543			
	10/04 →	Tie Rod End	CV-ES-0888			
	10/04 →	Track Control Arm		DB-DL-3475	Trailing Arm	
	10/04 →	Track Control Arm		DB-VB-3707	Suspension Rod, Wishbone (CV)	
	10/04 →	Track Control Arm		DB-VB-7261	Suspension Rod, Wishbone (CV), 1st RA;2nd RA; Leaf Spring Axle	
	10/04 →	Track Control Arm		DB-VB-10426	Wishbone (CV), Leaf Spring Axle;Unit	
	2636 K	10/04 →	Bush, parabolic spring		DB-SB-10400	
10/04 →		Bush, parabolic spring		DB-SB-10401		
10/04 →		Centre Rod	DB-DL-5230		Suspension Rod	
10/04 →		Centre Rod	DB-DL-5241		Suspension Rod	
10/04 →		Centre Rod	DB-DL-7270		Push Rod;Suspension Rod	
10/04 →		Centre Rod	DB-DL-8122		Push Rod	
10/04 →		Centre Rod	DB-DL-8184		Push Rod	
10/04 →		Centre Rod	DB-DL-8185		Push Rod	
10/04 →		Centre Rod	DB-DL-8717		Push Rod, Leaf Spring Axle	
10/04 →		Centre Rod	DB-DL-9258		Push Rod, for Leaf-Spring Suspension vehicles	
10/04 →		Centre Rod	DB-DL-12300		for Steering Rod	
10/04 →		Stabiliser Link	DB-DL-9254		Pressure Rod	
10/04 →		Stabiliser Mounting		DB-SB-10406		
10/04 →		Stabiliser Mounting		DB-SB-10409		
10/04 →		Suspension Arm Repair Kit		DB-RK-8550	for Wishbone (CV)	
10/04 →		Suspension Arm Repair Kit		DB-RK-8626	for Wishbone (CV)	
10/04 →		Suspension Arm Repair Kit		DB-RK-10374	for Wishbone (CV)	
10/04 →		Suspension Arm Repair Kit		DB-RK-10375	for Wishbone (CV)	
10/04 →		Suspension Strut Repair Kit		DB-RK-8391		
10/04 →		Tie Rod	DB-DL-8327		Guide Rod	
10/04 →		Tie Rod	DB-DL-8640		Guide Rod	
10/04 →		Tie Rod	DB-DL-12310			
10/04 →		Tie Rod End	CV-ES-0543			
10/04 →		Tie Rod End	CV-ES-0888			
10/04 →		Track Control Arm		DB-DL-3475	Trailing Arm	
10/04 →		Track Control Arm		DB-VB-3707	Suspension Rod, Wishbone (CV)	
10/04 →		Track Control Arm		DB-VB-7261	Suspension Rod, Wishbone (CV), 1st RA;2nd RA; Leaf Spring Axle	
10/04 →		Track Control Arm		DB-VB-10426	Wishbone (CV), Leaf Spring Axle;Unit	
2640		10/04 →	Centre Rod	DB-DL-8122		Push Rod
		10/04 →	Centre Rod	DB-DL-8188		Push Rod
		10/04 →	Centre Rod	DB-DL-8717		Push Rod
		10/04 →	Centre Rod	DB-DL-9258		Push Rod
		10/04 →	Tie Rod		DB-DL-10209	
		10/04 →	Tie Rod	DB-DL-8640		Guide Rod
	10/04 →	Track Control Arm		DB-VB-3707	Suspension Rod, Wishbone (CV)	
	10/04 →	Track Control Arm	DB-DL-5224		Control Arm	
	10/04 →	Track Control Arm	DB-DL-9218	DB-DL-9218	Trailing Arm	
	2640 B	10/04 →	Bush, driver cab suspension	DB-SB-10384		
10/04 →		Bush, parabolic spring		DB-SB-10400		
10/04 →		Bush, parabolic spring		DB-SB-10401		
10/04 →		Centre Rod	DB-DL-5230		Suspension Rod	
10/04 →		Centre Rod	DB-DL-5241		Suspension Rod	
10/04 →		Centre Rod	DB-DL-7270		Push Rod;Suspension Rod	
10/04 →		Centre Rod	DB-DL-8122		Push Rod	
10/04 →		Centre Rod	DB-DL-8184		Push Rod	
10/04 →		Centre Rod	DB-DL-8185		Push Rod	
10/04 →		Centre Rod	DB-DL-8717		Push Rod, Leaf Spring Axle	
10/04 →		Centre Rod	DB-DL-9258		Push Rod, for Leaf-Spring Suspension vehicles	

CV-ES-0543

Length: 125
 Cone Ø: d1 Ø 32 / d2 Ø 29
 Thread: M30 x 1,5 RHT
 0004605748, 0004606048, 0004606848,
 0004607048, 0014600448, 0014601148,
 0014601748, 0014602448, 0014607648,
 0014609648

**CV-ES-0888**

Length: 125
 Cone Ø: d1 Ø 32 / d2 Ø 29
 Thread: M30 x 1,5 LHT
 0004605848, 0004606148, 0004606948,
 0004607148, 0004609048, 0014600548,
 0014601348, 0014602548, 0014607948,
 0024600448

**DB-DL-3475**

Length: 565 Ø: 52
 Hole Distance: 152 / 152
 3753500006, 3753500206, 9473500805,
 9483500006, 9483500805, 9483501205,
 9483501305, 9483501905, 9483502005,
 9483502405, A3753500006, A3753500206

**DB-DL-5224**

Length: 850 Ø: 60
 Hole Distance: 100 / 100
 01336100A, 9413300007

**DB-DL-5230**

Length: 879 Ø: 42
 Cone Ø: d1 Ø 30 / d2 Ø 27
 01208600A, 0004607105, 0004607205,
 0014606705

**DB-DL-5241**

Length: 875 Ø: 40
 Cone Ø: d1 Ø 30 / d2 Ø 27
 01215300A, 0004609205, 0004609305,
 0014606905

**DB-DL-7270**

Length: 875 Ø: 40
 Cone Ø: d1 Ø 28,6 / d2 Ø 23,9
 01208300A, 0024604705, 0024604805,
 0034604905, A0024604705

**DB-DL-8122**

Length: 875
 Ø: 42
 Cone Ø: d1 Ø 30 / d2 Ø 27
 01215000A, 6174603205, 6174603305

**DB-DL-8184**

Length: 1095 Ø: 42
 Cone Ø: d1 Ø 32 / d2 Ø 28,8
 01217700A, 0014601305, 0014601405,
 0024600505, 0034603205, 3754601505,
 A0014601305, A0014601405, A0024600505

**DB-DL-8185**

Length: 711 Ø: 42
 Cone Ø: d1 Ø 32 / d2 Ø 28,8
 01213600A, 0014601105, 0024600405,
 0034603105, A0014601105, A0024600405

**DB-DL-8188**

Length: 895 Ø: 40
 Cone Ø: d1 Ø 28,6 / d2 Ø 23,9
 01217200A, 0024604905, 0024605005,
 0034605605

**DB-DL-8327**

Length: 1745 Ø: 48
 Cone Ø: d1 Ø 32 / d2 Ø 29
 01219800A, 9413300003, 9413300103,
 9413300203, 9413300303, 9413300503

**DB-DL-8640**

Length: 1615 Ø: 50
 Cone Ø: d1 Ø 32 / d2 Ø 29
 6253301503, 6253301603, 6253302403,
 6253302503, 9423300803, 9423302103,
 9493300203, 9493300303, 9493300903

**DB-DL-8717**

Length: 886
 Ø: 38
 Cone Ø: d1 Ø 30 / d2 Ø 27
 0024601705, 24601705, 0024607505, 24607505,
 0024607605, 24607605, 0034604405

**DB-DL-9218**

Length: 754 Ø: 40
 Hole Distance: 100
 000360098524, 000390098524, 3753300111,
 9413300011, A3753300111, SA50831601

**DB-DL-9254**

Length: 1815 Ø: 58
 0003220323, 0003220623, 3753220423

**DB-DL-9258**

Length: 905
 Ø: 42
 Cone Ø: d1 Ø 28,6 / d2 Ø 23,9
 3754600605, 3754601105

**DB-DL-10209**

Length: 1281 Ø: 38
 Cone Ø: d1 Ø 30 / d2 Ø 27
 3574603505, 9423301003, 9423301703

**DB-DL-12300**

Length: 733 Ø: 36
 Cone Ø: d1 Ø 32 / d2 Ø 29
 0014601505, 0014607305, 0034603305,
 3754601605, A0014601505, A0034603305,
 A3754601605

**DB-DL-12310**

Length: 1532 Ø: 50
 Cone Ø: d1 Ø 32 / d2 Ø 29
 Thread: M27 x 1,5 LHT
 9493301203, 9493301303, 9493301803,
 9493302203, A9493301203, A9493301303,
 A9493301803, A9493302203

**DB-RK-8391**

Ø: 85 Hole Distance: 152
 Thick/Height: 24
 01336800A, 0003502705

**DB-RK-8550**

Ø: 75 Hole Distance: 152
 Thick/Height: 24
 0003502105, 0003504605

**DB-RK-8626**

Ø: 75 Hole Distance: 130
 Thick/Height: 24
 0003502205, 0003502505, 0003503405,
 0003504505, GL11319

**DB-RK-10374**

Ø: 85 Hole Distance: 152
 Thick/Height: 24
 0003504405

**DB-RK-10375**

Ø: 100
 Hole Distance: 152
 Thick/Height: 24
 3502405, 0003502405, 3503505, 0003503505,
 0003504905, 3504905

**DB-SB-10384**

Ø: 73 Thick/Height: 47
 9303170012, 9423171812

**DB-SB-10400**

Length: 230
 Thick/Height: 167,5 / 115
 0003250696, 0003250896

**DB-SB-10401**

Length: 232
 Thick/Height: 163,5 / 152,5
 0003250596, 0003250796

**DB-SB-10406**

Ø: 80 Thick/Height: 46
 0003238185

**DB-SB-10409**

Ø: 77 Thick/Height: 56
 0003265181

**DB-VB-3707**

Length: 622 Ø: 46
 Hole Ø 25 / 25 / 25
 Hole Distance: 152 / 130 / 130
 01337100A, 9423501005, 9423501505,
 9443500005, 9473500105, 9473501005,
 A3753500005, A9423501005, A9423501505,
 A9443500005, A9473500105, A9473501005

**DB-VB-7261**

Length: 622 Ø: 46
 Hole Ø 25 / 25 / 25
 Hole Distance: 152 / 130 / 130
 01337800A, 9443500305, 9443500505,
 9443500605, 9473500705, 9473500905,
 9483500405, 9483503005

**DB-VB-10426**

Length: 622 Ø: 46
 Hole Ø 25 / 25 / 25
 Hole Distance: 152 / 130 / 130
 9443500405





AXOR 2 ...

2640 B ...	10/04 →	Centre Rod	DB-DL-12300		for Steering Rod	
	10/04 →	Stabiliser Link	DB-DL-9254		Pressure Rod	
	10/04 →	Stabiliser Mounting		DB-SB-10406		
	10/04 →	Stabiliser Mounting		DB-SB-10409		
	10/04 →	Suspension Arm Repair Kit		DB-RK-8550	for Wishbone (CV)	
	10/04 →	Suspension Arm Repair Kit		DB-RK-8626	for Wishbone (CV)	
	10/04 →	Suspension Arm Repair Kit		DB-RK-10374	for Wishbone (CV)	
	10/04 →	Suspension Arm Repair Kit		DB-RK-10375	for Wishbone (CV)	
	10/04 →	Suspension Strut Repair Kit		DB-RK-8391		
	10/04 →	Tie Rod	DB-DL-8327		Guide Rod	
	10/04 →	Tie Rod	DB-DL-8640		Guide Rod	
	10/04 →	Tie Rod	DB-DL-12310			
	10/04 →	Tie Rod End	CV-ES-0543			
	10/04 →	Tie Rod End	CV-ES-0888			
	10/04 →	Track Control Arm		DB-DL-3475	Trailing Arm	
	10/04 →	Track Control Arm		DB-VB-3707	Suspension Rod, Wishbone (CV)	
	10/04 →	Track Control Arm		DB-VB-7261	Suspension Rod, Wishbone (CV), 1st RA;2nd RA; Leaf Spring Axle	
	10/04 →	Track Control Arm		DB-VB-10426	Wishbone (CV), Leaf Spring Axle;Unit	
	2640 K	10/04 →	Bush, parabolic spring		DB-SB-10400	
		10/04 →	Bush, parabolic spring		DB-SB-10401	
10/04 →		Centre Rod	DB-DL-5230		Suspension Rod	
10/04 →		Centre Rod	DB-DL-5241		Suspension Rod	
10/04 →		Centre Rod	DB-DL-7270		Push Rod;Suspension Rod	
10/04 →		Centre Rod	DB-DL-8122		Push Rod	
10/04 →		Centre Rod	DB-DL-8184		Push Rod	
10/04 →		Centre Rod	DB-DL-8185		Push Rod	
10/04 →		Centre Rod	DB-DL-8717		Push Rod, Leaf Spring Axle	
10/04 →		Centre Rod	DB-DL-9258		Push Rod, for Leaf-Spring Suspension vehicles	
10/04 →		Centre Rod	DB-DL-12300		for Steering Rod	
10/04 →		Stabiliser Link	DB-DL-9254		Pressure Rod	
10/04 →		Stabiliser Mounting		DB-SB-10406		
10/04 →		Stabiliser Mounting		DB-SB-10409		
10/04 →		Suspension Arm Repair Kit		DB-RK-8550	for Wishbone (CV)	
10/04 →		Suspension Arm Repair Kit		DB-RK-8626	for Wishbone (CV)	
10/04 →		Suspension Arm Repair Kit		DB-RK-10374	for Wishbone (CV)	
10/04 →		Suspension Arm Repair Kit		DB-RK-10375	for Wishbone (CV)	
10/04 →		Suspension Strut Repair Kit		DB-RK-8391		
10/04 →		Tie Rod	DB-DL-8327		Guide Rod	
10/04 →		Tie Rod	DB-DL-8640		Guide Rod	
10/04 →		Tie Rod	DB-DL-12310			
10/04 →		Tie Rod End	CV-ES-0543			
10/04 →		Tie Rod End	CV-ES-0888			
10/04 →		Track Control Arm		DB-DL-3475	Trailing Arm	
10/04 →		Track Control Arm		DB-VB-3707	Suspension Rod, Wishbone (CV)	
10/04 →		Track Control Arm		DB-VB-7261	Suspension Rod, Wishbone (CV), 1st RA;2nd RA; Leaf Spring Axle	
10/04 →		Track Control Arm		DB-VB-10426	Wishbone (CV), Leaf Spring Axle;Unit	
2640 S, 2641 S, LS		10/04 →	Centre Rod	DB-DL-5405		Push Rod
		10/04 →	Centre Rod	DB-DL-8122		Push Rod
	10/04 →	Tie Rod	DB-DL-8171		Guide Rod	
	10/04 →	Track Control Arm		DB-VB-7261	Suspension Rod, Wishbone (CV)	
2643	10/04 →	Centre Rod	DB-DL-8122		Push Rod	
	10/04 →	Centre Rod	DB-DL-8188		Push Rod	
	10/04 →	Centre Rod	DB-DL-8717		Push Rod	
	10/04 →	Centre Rod	DB-DL-9258		Push Rod	
	10/04 →	Tie Rod		DB-DL-10209		
	10/04 →	Tie Rod	DB-DL-8640		Guide Rod	
	10/04 →	Track Control Arm		DB-VB-3707	Suspension Rod, Wishbone (CV)	
	10/04 →	Track Control Arm	DB-DL-5224		Control Arm	
	10/04 →	Track Control Arm	DB-DL-9218	DB-DL-9218	Trailing Arm	

CV-ES-0543

Length: 125
Cone Ø: d1 Ø 32 / d2 Ø 29
Thread: M30 x 1,5 RHT
0004605748, 0004606048, 0004606848,
0004607048, 0014600448, 0014601148,
0014601748, 0014602448, 0014607648,
0014609648



CV-ES-0888

Length: 125
Cone Ø: d1 Ø 32 / d2 Ø 29
Thread: M30 x 1,5 LHT
0004605848, 0004606148, 0004606948,
0004607148, 0004609048, 0014600548,
0014601348, 0014602548, 0014607948,
0024600448



DB-DL-3475

Length: 565 Ø: 52
Hole Distance: 152 / 152
3753500006, 3753500206, 9473500805,
9483500006, 9483500805, 9483501205,
9483501305, 9483501905, 9483502005,
9483502405, A3753500006, A3753500206



DB-DL-5224

Length: 850 Ø: 60
Hole Distance: 100 / 100
01336100A, 9413300007



DB-DL-5230

Length: 879 Ø: 42
Cone Ø: d1 Ø 30 / d2 Ø 27
01208600A, 0004607105, 0004607205,
0014606705



DB-DL-5241

Length: 875 Ø: 40
Cone Ø: d1 Ø 30 / d2 Ø 27
01215300A, 0004609205, 0004609305,
0014606905



DB-DL-5405

Length: 890 Ø: 35
Cone Ø: d1 Ø 28,6 / d2 Ø 23,9
01215900A, 1460248, 0024604505, 0024604605,
0034605005, 3752600637, 3754600405,
A3752600637, A3754600405



DB-DL-7270

Length: 875 Ø: 40
Cone Ø: d1 Ø 28,6 / d2 Ø 23,9
01208300A, 0024604705, 0024604805,
0034604905, A0024604705



DB-DL-8122

Length: 875
Ø: 42
Cone Ø: d1 Ø 30 / d2 Ø 27
01215000A, 6174603205, 6174603305



DB-DL-8171

Length: 1687 Ø: 52
Cone Ø: d1 Ø 32 / d2 Ø 29
9493300603, 9493300703, 9493301503,
9493301603



DB-DL-8184

Length: 1095 Ø: 42
Cone Ø: d1 Ø 32 / d2 Ø 28,8
01217700A, 0014601305, 0014601405,
0024600505, 0034603205, 3754601505,
A0014601305, A0014601405, A0024600505



DB-DL-8185

Length: 711 Ø: 42
Cone Ø: d1 Ø 32 / d2 Ø 28,8
01213600A, 0014601105, 0024600405,
0034603105, A0014601105, A0024600405



DB-DL-8188

Length: 895 Ø: 40
Cone Ø: d1 Ø 28,6 / d2 Ø 23,9
01217200A, 0024604905, 0024605005,
0034605605



DB-DL-8327

Length: 1745 Ø: 48
Cone Ø: d1 Ø 32 / d2 Ø 29
01219800A, 9413300003, 9413300103,
9413300203, 9413300303, 9413300503



DB-DL-8640

Length: 1615 Ø: 50
Cone Ø: d1 Ø 32 / d2 Ø 29
6253301503, 6253301603, 6253302403,
6253302503, 9423300803, 9423302103,
9493300203, 9493300303, 9493300903



DB-DL-8717

Length: 886
Ø: 38
Cone Ø: d1 Ø 30 / d2 Ø 27
0024601705, 24601705, 0024607505, 24607505,
0024607605, 24607605, 0034604405



DB-DL-9218

Length: 754 Ø: 40
Hole Distance: 100
000360098524, 000390098524, 3753300111,
9413300011, A3753300111, SA50831601



DB-DL-9254

Length: 1815 Ø: 58
0003220323, 0003220623, 3753220423



DB-DL-9258

Length: 905
Ø: 42
Cone Ø: d1 Ø 28,6 / d2 Ø 23,9
3754600605, 3754601105



DB-DL-10209

Length: 1281 Ø: 38
Cone Ø: d1 Ø 30 / d2 Ø 27
3574603505, 9423301003, 9423301703



DB-DL-12300

Length: 733 Ø: 36
Cone Ø: d1 Ø 32 / d2 Ø 29
0014601505, 0014607305, 0034603305,
3754601605, A0014601505, A0034603305,
A3754601605



DB-DL-12310

Length: 1532 Ø: 50
Cone Ø: d1 Ø 32 / d2 Ø 29
Thread: M27 x 1,5 LHT
9493301203, 9493301303, 9493301803,
9493302203, A9493301203, A9493301303,
A9493301803, A9493302203



DB-RK-8391

Ø: 85 Hole Distance: 152
Thick/Height: 24
01336800A, 0003502705



DB-RK-8550

Ø: 75 Hole Distance: 152
Thick/Height: 24
0003502105, 0003504605



DB-RK-8626

Ø: 75 Hole Distance: 130
Thick/Height: 24
0003502205, 0003502505, 0003503405,
0003504505, GL11319



DB-RK-10374

Ø: 85 Hole Distance: 152
Thick/Height: 24
0003504405



DB-RK-10375

Ø: 100 Hole Distance: 152
Thick/Height: 24
0003502405, 0003503505, 0003504905



DB-SB-10400

Length: 230
Thick/Height: 167,5 / 115
0003250696, 0003250896



DB-SB-10401

Length: 232
Thick/Height: 163,5 / 152,5
0003250596, 0003250796



DB-SB-10406

Ø: 80 Thick/Height: 46
0003238185



DB-SB-10409

Ø: 77 Thick/Height: 56
0003265181



DB-VB-3707

Length: 622 Ø: 46
Hole Ø 25 / 25 / 25
Hole Distance: 152 / 130 / 130
01337100A, 9423501005, 9423501505,
9443500005, 9473500105, 9473501005,
A373500005, A9423501005, A9423501505,
A9443500005, A9473500105, A9473501005



DB-VB-7261

Length: 622 Ø: 46
Hole Ø 25 / 25 / 25
Hole Distance: 152 / 130 / 130
01337800A, 9443500305, 9443500505,
9443500605, 9473500705, 9473500905,
9483500405, 9483500305



DB-VB-10426

Length: 622 Ø: 46
Hole Ø 25 / 25 / 25
Hole Distance: 152 / 130 / 130
9443500405



MERCEDES-BENZ



AXOR 2 ...

2643 B	10/04 →	Bush, driver cab suspension	DB-SB-10384		
	10/04 →	Bush, parabolic spring		DB-SB-10400	
	10/04 →	Bush, parabolic spring		DB-SB-10401	
	10/04 →	Centre Rod	DB-DL-5230	Suspension Rod	
	10/04 →	Centre Rod	DB-DL-5241	Suspension Rod	
	10/04 →	Centre Rod	DB-DL-7270	Push Rod;Suspension Rod	
	10/04 →	Centre Rod	DB-DL-8122	Push Rod	
	10/04 →	Centre Rod	DB-DL-8184	Push Rod	
	10/04 →	Centre Rod	DB-DL-8185	Push Rod	
	10/04 →	Centre Rod	DB-DL-8717	Push Rod, Leaf Spring Axle	
	10/04 →	Centre Rod	DB-DL-9258	Push Rod, for Leaf-Spring Suspension vehicles	
	10/04 →	Centre Rod	DB-DL-12300	for Steering Rod	
	10/04 →	Stabiliser Link	DB-DL-9254	Pressure Rod	
	10/04 →	Stabiliser Mounting		DB-SB-10406	
	10/04 →	Stabiliser Mounting		DB-SB-10409	
	10/04 →	Suspension Arm Repair Kit		DB-RK-8550 for Wishbone (CV)	
	10/04 →	Suspension Arm Repair Kit		DB-RK-8626 for Wishbone (CV)	
	10/04 →	Suspension Arm Repair Kit		DB-RK-10374 for Wishbone (CV)	
	10/04 →	Suspension Arm Repair Kit		DB-RK-10375 for Wishbone (CV)	
	10/04 →	Suspension Strut Repair Kit		DB-RK-8391	
	10/04 →	Tie Rod	DB-DL-8327	Guide Rod	
	10/04 →	Tie Rod	DB-DL-8640	Guide Rod	
	10/04 →	Tie Rod	DB-DL-12310		
	10/04 →	Tie Rod End	CV-ES-0543		
	10/04 →	Tie Rod End	CV-ES-0888		
	10/04 →	Track Control Arm		DB-DL-3475 Trailing Arm	
	10/04 →	Track Control Arm		DB-VB-3707 Suspension Rod, Wishbone (CV)	
	10/04 →	Track Control Arm		DB-VB-7261 Suspension Rod, Wishbone (CV), 1st RA;2nd RA; Leaf Spring Axle	
	10/04 →	Track Control Arm		DB-VB-10426 Wishbone (CV), Leaf Spring Axle;Unit	
	2643 K	10/04 →	Bush, parabolic spring		DB-SB-10400
		10/04 →	Bush, parabolic spring		DB-SB-10401
		10/04 →	Centre Rod	DB-DL-5230	Suspension Rod
		10/04 →	Centre Rod	DB-DL-5241	Suspension Rod
10/04 →		Centre Rod	DB-DL-7270	Push Rod;Suspension Rod	
10/04 →		Centre Rod	DB-DL-8122	Push Rod	
10/04 →		Centre Rod	DB-DL-8184	Push Rod	
10/04 →		Centre Rod	DB-DL-8185	Push Rod	
10/04 →		Centre Rod	DB-DL-8717	Push Rod, Leaf Spring Axle	
10/04 →		Centre Rod	DB-DL-9258	Push Rod, for Leaf-Spring Suspension vehicles	
10/04 →		Centre Rod	DB-DL-12300	for Steering Rod	
10/04 →		Stabiliser Link	DB-DL-9254	Pressure Rod	
10/04 →		Stabiliser Mounting		DB-SB-10406	
10/04 →		Stabiliser Mounting		DB-SB-10409	
10/04 →		Suspension Arm Repair Kit		DB-RK-8550 for Wishbone (CV)	
10/04 →		Suspension Arm Repair Kit		DB-RK-8626 for Wishbone (CV)	
10/04 →		Suspension Arm Repair Kit		DB-RK-10374 for Wishbone (CV)	
10/04 →		Suspension Arm Repair Kit		DB-RK-10375 for Wishbone (CV)	
10/04 →		Suspension Strut Repair Kit		DB-RK-8391	
10/04 →		Tie Rod	DB-DL-8327	Guide Rod	
10/04 →		Tie Rod	DB-DL-8640	Guide Rod	
10/04 →		Tie Rod	DB-DL-12310		
10/04 →		Tie Rod End	CV-ES-0543		
10/04 →		Tie Rod End	CV-ES-0888		
10/04 →		Track Control Arm		DB-DL-3475 Trailing Arm	
10/04 →		Track Control Arm		DB-VB-3707 Suspension Rod, Wishbone (CV)	
10/04 →		Track Control Arm		DB-VB-7261 Suspension Rod, Wishbone (CV), 1st RA;2nd RA; Leaf Spring Axle	
10/04 →		Track Control Arm		DB-VB-10426 Wishbone (CV), Leaf Spring Axle;Unit	

CV-ES-0543

Length: 125
Cone Ø: d1 Ø 32 / d2 Ø 29
Thread: M30 x 1,5 RHT
0004605748, 0004606048, 0004606848,
0004607048, 0014600448, 0014601148,
0014601748, 0014602448, 0014607648,
0014609648



CV-ES-0888

Length: 125
Cone Ø: d1 Ø 32 / d2 Ø 29
Thread: M30 x 1,5 LHT
0004605848, 0004606148, 0004606948,
0004607148, 0004609048, 0014600548,
0014601348, 0014602548, 0014607948,
0024600448



DB-DL-3475

Length: 565 Ø: 52
Hole Distance: 152 / 152
3753500006, 3753500206, 9473500805,
9483500006, 9483500805, 9483501205,
9483501305, 9483501905, 9483502005,
9483502405, A3753500006, A3753500206



DB-DL-5230

Length: 879 Ø: 42
Cone Ø: d1 Ø 30 / d2 Ø 27
01208600A, 0004607105, 0004607205,
0014606705



DB-DL-5241

Length: 875 Ø: 40
Cone Ø: d1 Ø 30 / d2 Ø 27
01215300A, 0004609205, 0004609305,
0014606905



DB-DL-7270

Length: 875 Ø: 40
Cone Ø: d1 Ø 28,6 / d2 Ø 23,9
01208300A, 0024604705, 0024604805,
0034604905, A0024604705



DB-DL-8122

Length: 875
Ø: 42
Cone Ø: d1 Ø 30 / d2 Ø 27
01215000A, 6174603205, 6174603305



DB-DL-8184

Length: 1095 Ø: 42
Cone Ø: d1 Ø 32 / d2 Ø 28,8
01217700A, 0014601305, 0014601405,
0024600505, 0034603205, 3754601505,
A0014601305, A0014601405, A0024600505



DB-DL-8185

Length: 711 Ø: 42
Cone Ø: d1 Ø 32 / d2 Ø 28,8
01213600A, 0014601105, 0024600405,
0034603105, A0014601105, A0024600405



DB-DL-8327

Length: 1745 Ø: 48
Cone Ø: d1 Ø 32 / d2 Ø 29
01219800A, 9413300003, 9413300103,
9413300203, 9413300303, 9413300503



DB-DL-8640

Length: 1615 Ø: 50
Cone Ø: d1 Ø 32 / d2 Ø 29
6253301503, 6253301603, 6253302403,
6253302503, 9423300803, 9423302103,
9493300203, 9493300303, 9493300903



DB-DL-8717

Length: 886
Ø: 38
Cone Ø: d1 Ø 30 / d2 Ø 27
0024601705, 24601705, 0024607505, 24607505,
0024607605, 24607605, 0034604405



DB-DL-9254

Length: 1815 Ø: 58
0003220323, 0003220623, 3753220423



DB-DL-9258

Length: 905
Ø: 42
Cone Ø: d1 Ø 28,6 / d2 Ø 23,9
3754600605, 3754601105



DB-DL-12300

Length: 733 Ø: 36
Cone Ø: d1 Ø 32 / d2 Ø 29
0014601505, 0014607305, 0034603305,
3754601605, A0014601505, A0034603305,
A3754601605



DB-DL-12310

Length: 1532 Ø: 50
Cone Ø: d1 Ø 32 / d2 Ø 29
Thread: M27 x 1,5 LHT
9493301203, 9493301303, 9493301803,
9493302203, A9493301203, A9493301303,
A9493301803, A9493302203



DB-RK-8391

Ø: 85 Hole Distance: 152
Thick/Height: 24
01336800A, 0003502705



DB-RK-8550

Ø: 75 Hole Distance: 152
Thick/Height: 24
0003502105, 0003504605



DB-RK-8626

Ø: 75 Hole Distance: 130
Thick/Height: 24
0003502205, 0003502505, 0003503405,
0003504505, GL11319



DB-RK-10374

Ø: 85 Hole Distance: 152
Thick/Height: 24
0003504405



DB-RK-10375

Ø: 100 Hole Distance: 152
Thick/Height: 24
0003502405, 0003503505, 0003504905



DB-SB-10384

Ø: 73 Thick/Height: 47
9303170012, 9423171812



DB-SB-10400

Length: 230
Thick/Height: 167,5 / 115
0003250696, 0003250896



DB-SB-10401

Length: 232
Thick/Height: 163,5 / 152,5
0003250596, 0003250796



DB-SB-10406

Ø: 80 Thick/Height: 46
0003238185



DB-SB-10409

Ø: 77 Thick/Height: 56
0003265181



DB-VB-3707

Length: 622 Ø: 46
Hole Ø 25 / 25 / 25
Hole Distance: 152 / 130 / 130
01337100A, 9423501005, 9423501505,
9443500005, 9473500105, 9473501005,
A3753500005, A9423501005, A9423501505,
A9443500005, A9473500105, A9473501005



DB-VB-7261

Length: 622 Ø: 46
Hole Ø 25 / 25 / 25
Hole Distance: 152 / 130 / 130
01337800A, 9443500305, 9443500505,
9443500605, 9473500705, 9473500905,
9483500405, 9483503005



DB-VB-10426

Length: 622 Ø: 46
Hole Ø 25 / 25 / 25
Hole Distance: 152 / 130 / 130
9443500405





AXOR 2 ...

2644 S, LS	01/11→	Bush, parabolic spring		DB-SB-10400	
	01/11→	Centre Rod	DB-DL-5405		Push Rod
	01/11→	Centre Rod	DB-DL-8122		Push Rod
	01/11→	Centre Rod	DB-DL-8188		Push Rod
	01/11→	Track Control Arm		DB-VB-3707	Suspension Rod, Wishbone (CV)
	01/11→	Track Control Arm		DB-VB-7261	Suspension Rod, Wishbone (CV)
	01/11→	Track Control Arm		DB-VB-7798	Wishbone (CV)
2828 K	10/04→	Tie Rod	DB-DL-8171		Guide Rod
	10/04→	Tie Rod End	DB-ES-8164		for Push Rod
	10/04→	Track Control Arm		DB-VB-7261	Suspension Rod, Wishbone (CV)
2831	01/11→	Tie Rod	DB-DL-8171		Guide Rod
	01/11→	Tie Rod End	DB-ES-8164		for Push Rod
	01/11→	Track Control Arm		DB-VB-7261	Suspension Rod, Wishbone (CV), 2nd RA
3028 B	01/11→	Bush, parabolic spring		DB-SB-10400	
	01/11→	Centre Rod	DB-DL-5405		Push Rod
	01/11→	Centre Rod	DB-DL-9258		Push Rod
	01/11→	Tie Rod	DB-DL-8171		Guide Rod
	01/11→	Tie Rod	DB-DL-8327		Guide Rod
	01/11→	Track Control Arm		DB-VB-7261	Suspension Rod, Wishbone (CV)
3028 K	01/11→	Bush, parabolic spring		DB-SB-10400	
	01/11→	Centre Rod	DB-DL-5405		Push Rod
	01/11→	Centre Rod	DB-DL-9258		Push Rod
	01/11→	Tie Rod	DB-DL-8171		Guide Rod
	01/11→	Tie Rod	DB-DL-8327		Guide Rod
	01/11→	Track Control Arm		DB-VB-7261	Suspension Rod, Wishbone (CV)
3228	01/11→	Bush, parabolic spring		DB-SB-10400	
	01/11→	Centre Rod	DB-DL-5405		Push Rod
	01/11→	Centre Rod	DB-DL-9258		Push Rod
3235	10/04→	Centre Rod	DB-DL-8122		Push Rod
	10/04→	Centre Rod	DB-DL-9258		Push Rod
3236 B	10/04→	Bush, driver cab suspension	DB-SB-10384		
	10/04→	Bush, parabolic spring		DB-SB-10401	
	10/04→	Centre Rod	DB-DL-8122		Push Rod
	10/04→	Centre Rod	DB-DL-8184		Push Rod, Leaf Spring Axle
	10/04→	Centre Rod	DB-DL-8185		Push Rod
	10/04→	Centre Rod	DB-DL-12300		for Steering Rod
	10/04→	Stabiliser Link	DB-DL-9254		Pressure Rod
	10/04→	Stabiliser Mounting		DB-SB-10406	
	10/04→	Stabiliser Mounting		DB-SB-10409	
	10/04→	Suspension Arm Repair Kit		DB-RK-8626	for Wishbone (CV)
	10/04→	Suspension Arm Repair Kit		DB-RK-10374	for Wishbone (CV)
	10/04→	Suspension Arm Repair Kit		DB-RK-10375	for Wishbone (CV)
	10/04→	Suspension Strut Repair Kit		DB-RK-8391	
	10/04→	Tie Rod	DB-DL-8172		Guide Rod
	10/04→	Tie Rod	DB-DL-8640		Guide Rod
	10/04→	Tie Rod	DB-DL-12310		
	10/04→	Tie Rod End	DB-ES-8323		Leaf Spring Axle
	10/04→	Track Control Arm		DB-DL-3475	Trailing Arm
	10/04→	Track Control Arm		DB-VB-3707	Suspension Rod, Wishbone (CV)
	10/04→	Track Control Arm		DB-VB-7261	Suspension Rod, Wishbone (CV), 1st RA;2nd RA; Leaf Spring Axle
	10/04→	Track Control Arm		DB-VB-10426	Wishbone (CV), Leaf Spring Axle;Unit
	3236 K	10/04→	Bush, parabolic spring		DB-SB-10401
10/04→		Centre Rod	DB-DL-8122		Push Rod
10/04→		Centre Rod	DB-DL-8184		Push Rod, Leaf Spring Axle
10/04→		Centre Rod	DB-DL-8185		Push Rod
10/04→		Centre Rod	DB-DL-12300		for Steering Rod
10/04→		Stabiliser Link	DB-DL-9254		Pressure Rod
10/04→		Stabiliser Mounting		DB-SB-10406	
10/04→		Stabiliser Mounting		DB-SB-10409	
10/04→		Suspension Arm Repair Kit		DB-RK-8626	for Wishbone (CV)
10/04→		Suspension Arm Repair Kit		DB-RK-10374	for Wishbone (CV)
10/04→		Suspension Arm Repair Kit		DB-RK-10375	for Wishbone (CV)

DB-DL-3475

Length: 565 Ø: 52
 Hole Distance: 152 / 152
 3753500006, 3753500206, 9473500805,
 9483500006, 9483500805, 9483501205,
 9483501305, 9483501905, 9483502005,
 9483502405, A3753500006, A3753500206

**DB-DL-5405**

Length: 890 Ø: 35
 Cone Ø: d1 Ø 28,6 / d2 Ø 23,9
 01215900A, 1460248, 0024604505, 0024604605,
 0034605005, 3752600637, 3754600405,
 A3752600637, A3754600405

**DB-DL-8122**

Length: 875
 Ø: 42
 Cone Ø: d1 Ø 30 / d2 Ø 27
 01215000A, 6174603205, 6174603305

**DB-DL-8171**

Length: 1687 Ø: 52
 Cone Ø: d1 Ø 32 / d2 Ø 29
 9493300603, 9493300703, 9493301503,
 9493301603

**DB-DL-8172**

Length: 1700 Ø: 52
 Cone Ø: d1 Ø 32 / d2 Ø 29
 01219700A, 9493300403, 9493300503,
 9493300803, 9493301403

**DB-DL-8184**

Length: 1095 Ø: 42
 Cone Ø: d1 Ø 32 / d2 Ø 28,8
 01217700A, 0014601305, 0014601405,
 0024600505, 0034603205, 3754601505,
 A0014601305, A0014601405, A0024600505

**DB-DL-8185**

Length: 711 Ø: 42
 Cone Ø: d1 Ø 32 / d2 Ø 28,8
 01213600A, 0014601105, 0024600405,
 0034603105, A0014601105, A0024600405

**DB-DL-8188**

Length: 895 Ø: 40
 Cone Ø: d1 Ø 28,6 / d2 Ø 23,9
 01217200A, 0024604905, 0024605005,
 0034605605

**DB-DL-8327**

Length: 1745 Ø: 48
 Cone Ø: d1 Ø 32 / d2 Ø 29
 01219800A, 9413300003, 9413300103,
 9413300203, 9413300303, 9413300503

**DB-DL-8640**

Length: 1615 Ø: 50
 Cone Ø: d1 Ø 32 / d2 Ø 29
 6253301503, 6253301603, 6253302403,
 6253302503, 9423300803, 9423302103,
 9493300203, 9493300303, 9493300903

**DB-DL-9254**

Length: 1815 Ø: 58
 0003220323, 0003220623, 3753220423

**DB-DL-9258**

Length: 905
 Ø: 42
 Cone Ø: d1 Ø 28,6 / d2 Ø 23,9
 3754600605, 3754601105

**DB-DL-12300**

Length: 733 Ø: 36
 Cone Ø: d1 Ø 32 / d2 Ø 29
 0014601505, 0014607305, 0034603305,
 3754601605, A0014601505, A0034603305,
 A3754601605

**DB-DL-12310**

Length: 1532 Ø: 50
 Cone Ø: d1 Ø 32 / d2 Ø 29
 Thread: M27 x 1,5 LHT
 9493301203, 9493301303, 9493301803,
 9493302203, A9493301203, A9493301303,
 A9493301803, A9493302203

**DB-ES-8164**

Length: 140
 Cone Ø: d1 Ø 28,6 / d2 Ø 23,9
 Thread: M28 x 1,5 RHT
 0014604248, 0014605048, 0014608548,
 0024600548

**DB-ES-8323**

Length: 75
 Cone Ø: d1 Ø 32 / d2 Ø 28,8
 Thread: M26 x 1,5 RHT
 0014601548, 0014601648, 0024600648,
 A0014601648, A0024600648

**DB-RK-8391**

Ø: 85 Hole Distance: 152
 Thick/Height: 24
 01336800A, 0003502705

**DB-RK-8626**

Ø: 75 Hole Distance: 130
 Thick/Height: 24
 0003502205, 0003502505, 0003503405,
 0003504505, GL11319

**DB-RK-10374**

Ø: 85 Hole Distance: 152
 Thick/Height: 24
 0003504405

**DB-RK-10375**

Ø: 100 Hole Distance: 152
 Thick/Height: 24
 0003502405, 0003503505, 0003504905

**DB-SB-10384**

Ø: 73 Thick/Height: 47
 9303170012, 9423171812

**DB-SB-10400**

Length: 230
 Thick/Height: 167,5 / 115
 0003250696, 0003250896

**DB-SB-10401**

Length: 232
 Thick/Height: 163,5 / 152,5
 0003250596, 0003250796

**DB-SB-10406**

Ø: 80 Thick/Height: 46
 0003238185

**DB-SB-10409**

Ø: 77 Thick/Height: 56
 0003265181

**DB-VB-3707**

Length: 622 Ø: 46
 Hole Ø 25 / 25 / 25
 Hole Distance: 152 / 130 / 130
 01337100A, 9423501005, 9423501505,
 9443500005, 9473500105, 9473501005,
 A3753500005, A9423501005, A9423501505,
 A9443500005, A9473500105, A9473501005

**DB-VB-7261**

Length: 622 Ø: 46
 Hole Ø 25 / 25 / 25
 Hole Distance: 152 / 130 / 130
 01337800A, 9443500305, 9443500505,
 9443500605, 9473500705, 9473500905,
 9483500405, 9483503005

**DB-VB-7798**

Length: 622 Ø: 48
 Hole Ø 25 / 23 / 23
 Hole Distance: 152 / 130 / 130
 9423500505, 9423500805, 9423501205,
 A9423501205

**DB-VB-10426**

Length: 622 Ø: 46
 Hole Ø 25 / 25 / 25
 Hole Distance: 152 / 130 / 130
 9443500405





AXOR 2 ...

3236 K ...	10/04 →	Suspension Strut Repair Kit		DB-RK-8391		
	10/04 →	Tie Rod	DB-DL-8172		Guide Rod	
	10/04 →	Tie Rod	DB-DL-8640		Guide Rod	
	10/04 →	Tie Rod	DB-DL-12310			
	10/04 →	Tie Rod End	DB-ES-8323		Leaf Spring Axle	
	10/04 →	Track Control Arm		DB-DL-3475	Trailing Arm	
	10/04 →	Track Control Arm		DB-VB-3707	Suspension Rod, Wishbone (CV)	
	10/04 →	Track Control Arm		DB-VB-7261	Suspension Rod, Wishbone (CV)	
	10/04 →	Track Control Arm		DB-VB-10426	Wishbone (CV), Leaf Spring Axle;Unit	
	3240	03/05 →	Centre Rod	DB-DL-5230		Suspension Rod
03/05 →		Centre Rod	DB-DL-5241		Suspension Rod	
03/05 →		Centre Rod	DB-DL-7270		Push Rod;Suspension Rod	
03/05 →		Centre Rod	DB-DL-8122		Push Rod	
03/05 →		Centre Rod	DB-DL-8184		Push Rod	
03/05 →		Centre Rod	DB-DL-8185		Push Rod	
03/05 →		Centre Rod	DB-DL-9258		Push Rod, for Leaf-Spring Suspension vehicles	
03/05 →		Centre Rod	DB-DL-12300		for Steering Rod	
03/05 →		Stabiliser Mounting		DB-SB-10409		
03/05 →		Stabiliser Mounting	DB-SB-10410			
03/05 →		Suspension Arm Repair Kit		DB-RK-8550	for Wishbone (CV)	
03/05 →		Suspension Arm Repair Kit		DB-RK-10375	for Wishbone (CV)	
03/05 →		Suspension Arm Repair Kit	DB-RK-8638		for Control Arm	
03/05 →		Suspension Strut Repair Kit		MN-RK-8997		
03/05 →		Tie Rod	DB-DL-8327		Guide Rod	
03/05 →		Tie Rod End	DB-ES-8164		for Push Rod	
03/05 →		Tie Rod End	DB-ES-8530		for Push Rod	
3240 B		10/04 →	Bush, driver cab suspension	DB-SB-10384		
	10/04 →	Bush, parabolic spring		DB-SB-10401		
	10/04 →	Centre Rod	DB-DL-8122		Push Rod	
	10/04 →	Centre Rod	DB-DL-8184		Push Rod, Leaf Spring Axle	
	10/04 →	Centre Rod	DB-DL-8185		Push Rod	
	10/04 →	Centre Rod	DB-DL-12300		for Steering Rod	
	10/04 →	Stabiliser Link	DB-DL-9254		Pressure Rod	
	10/04 →	Stabiliser Mounting		DB-SB-10406		
	10/04 →	Stabiliser Mounting		DB-SB-10409		
	10/04 →	Suspension Arm Repair Kit		DB-RK-8626	for Wishbone (CV)	
	10/04 →	Suspension Arm Repair Kit		DB-RK-10374	for Wishbone (CV)	
	10/04 →	Suspension Arm Repair Kit		DB-RK-10375	for Wishbone (CV)	
	10/04 →	Suspension Strut Repair Kit		DB-RK-8391		
	10/04 →	Tie Rod	DB-DL-8172		Guide Rod	
	10/04 →	Tie Rod	DB-DL-8640		Guide Rod	
	10/04 →	Tie Rod	DB-DL-12310			
	10/04 →	Tie Rod End	DB-ES-8323		Leaf Spring Axle	
	10/04 →	Track Control Arm		DB-DL-3475	Trailing Arm	
	10/04 →	Track Control Arm		DB-VB-3707	Suspension Rod, Wishbone (CV)	
	10/04 →	Track Control Arm		DB-VB-7261	Suspension Rod, Wishbone (CV), 1st RA;2nd RA; Leaf Spring Axle	
	10/04 →	Track Control Arm		DB-VB-10426	Wishbone (CV), Leaf Spring Axle;Unit	
	3240 K	10/04 →	Bush, parabolic spring		DB-SB-10401	
		10/04 →	Centre Rod	DB-DL-8122		Push Rod
		10/04 →	Centre Rod	DB-DL-8184		Push Rod, Leaf Spring Axle
		10/04 →	Centre Rod	DB-DL-8185		Push Rod
		10/04 →	Centre Rod	DB-DL-12300		for Steering Rod
10/04 →		Stabiliser Link	DB-DL-9254		Pressure Rod	
10/04 →		Stabiliser Mounting		DB-SB-10406		
10/04 →		Stabiliser Mounting		DB-SB-10409		
10/04 →		Suspension Arm Repair Kit		DB-RK-8626	for Wishbone (CV)	
10/04 →		Suspension Arm Repair Kit		DB-RK-10374	for Wishbone (CV)	
10/04 →		Suspension Arm Repair Kit		DB-RK-10375	for Wishbone (CV)	
10/04 →		Suspension Strut Repair Kit		DB-RK-8391		
10/04 →		Tie Rod	DB-DL-8172		Guide Rod	
10/04 →		Tie Rod	DB-DL-8640		Guide Rod	
10/04 →		Tie Rod	DB-DL-12310			

DB-DL-3475

Length: 565 Ø: 52
 Hole Distance: 152 / 152
 3753500006, 3753500206, 9473500805,
 9483500006, 9483500805, 9483501205,
 9483501305, 9483501905, 9483502005,
 9483502405, A3753500006, A3753500206

**DB-DL-5230**

Length: 879 Ø: 42
 Cone Ø: d1 Ø 30 / d2 Ø 27
 01208600A, 0004607105, 0004607205,
 0014606705

**DB-DL-5241**

Length: 875 Ø: 40
 Cone Ø: d1 Ø 30 / d2 Ø 27
 01215300A, 0004609205, 0004609305,
 0014606905

**DB-DL-7270**

Length: 875 Ø: 40
 Cone Ø: d1 Ø 28,6 / d2 Ø 23,9
 01208300A, 0024604705, 0024604805,
 0034604905, A0024604705

**DB-DL-8122**

Length: 875
 Ø: 42
 Cone Ø: d1 Ø 30 / d2 Ø 27
 01215000A, 6174603205, 6174603305

**DB-DL-8172**

Length: 1700 Ø: 52
 Cone Ø: d1 Ø 32 / d2 Ø 29
 01219700A, 9493300403, 9493300503,
 9493300803, 9493301403

**DB-DL-8184**

Length: 1095 Ø: 42
 Cone Ø: d1 Ø 32 / d2 Ø 28,8
 01217700A, 0014601305, 0014601405,
 0024600505, 0034603205, 3754601505,
 A0014601305, A0014601405, A0024600505

**DB-DL-8185**

Length: 711 Ø: 42
 Cone Ø: d1 Ø 32 / d2 Ø 28,8
 01213600A, 0014601105, 0024600405,
 0034603105, A0014601105, A0024600405

**DB-DL-8327**

Length: 1745 Ø: 48
 Cone Ø: d1 Ø 32 / d2 Ø 29
 01219800A, 9413300003, 9413300103,
 9413300203, 9413300303, 9413300503

**DB-DL-8640**

Length: 1615 Ø: 50
 Cone Ø: d1 Ø 32 / d2 Ø 29
 6253301503, 6253301603, 6253302403,
 6253302503, 9423300803, 9423302103,
 9493300203, 9493300303, 9493300903

**DB-DL-9254**

Length: 1815 Ø: 58
 0003220323, 0003220623, 3753220423

**DB-DL-9258**

Length: 905
 Ø: 42
 Cone Ø: d1 Ø 28,6 / d2 Ø 23,9
 3754600605, 3754601105

**DB-DL-12300**

Length: 733 Ø: 36
 Cone Ø: d1 Ø 32 / d2 Ø 29
 0014601505, 0014607305, 0034603305,
 3754601605, A0014601505, A0034603305,
 A3754601605

**DB-DL-12310**

Length: 1532 Ø: 50
 Cone Ø: d1 Ø 32 / d2 Ø 29
 Thread: M27 x 1,5 LHT
 9493301203, 9493301303, 9493301803,
 9493302203, A9493301203, A9493301303,
 A9493301803, A9493302203

**DB-ES-8164**

Length: 140
 Cone Ø: d1 Ø 28,6 / d2 Ø 23,9
 Thread: M28 x 1,5 RHT
 0014604248, 0014605048, 0014608548,
 0024600548

**DB-ES-8323**

Length: 75
 Cone Ø: d1 Ø 32 / d2 Ø 28,8
 Thread: M26 x 1,5 RHT
 0014601548, 0014601648, 0024600648,
 A0014601648, A0024600648

**DB-ES-8530**

Length: 115
 Cone Ø: d1 Ø 28,6 / d2 Ø 23,9
 Thread: M30 x 1,5 RHT
 0014603848, 0014604848, 0014605148,
 0014608648, 0014609948

**DB-RK-8391**

Ø: 85 Hole Distance: 152
 Thick/Height: 24
 01336800A, 0003502705

**DB-RK-8550**

Ø: 75 Hole Distance: 152
 Thick/Height: 24
 0003502105, 0003504605

**DB-RK-8626**

Ø: 75 Hole Distance: 130
 Thick/Height: 24
 0003502205, 0003502505, 0003503405,
 0003504505, GL11319

**DB-RK-8638**

Length: 100 Ø: 67
 Hole Distance: 100
 Thick/Height: 20
 0003301411

**DB-RK-10374**

Ø: 85 Hole Distance: 152
 Thick/Height: 24
 0003504405

**DB-RK-10375**

Ø: 100 Hole Distance: 152
 Thick/Height: 24
 0003502405, 0003503505, 0003504905

**DB-SB-10384**

Ø: 73 Thick/Height: 47
 9303170012, 9423171812

**DB-SB-10401**

Length: 232
 Thick/Height: 163,5 / 152,5
 0003250596, 0003250796

**DB-SB-10406**

Ø: 80 Thick/Height: 46
 0003238185

**DB-SB-10409**

Ø: 77 Thick/Height: 56
 0003265181

**DB-SB-10410**

Ø: 73 Hole Distance: 100
 Thick/Height: 24
 9413230050

**DB-VB-3707**

Length: 622 Ø: 46
 Hole Ø 25 / 25 / 25
 Hole Distance: 152 / 130 / 130
 01337100A, 9423501005, 9423501505,
 9443500005, 9473500105, 9473501005,
 A3753500005, A9423501005, A9423501505,
 A9443500005, A9473500105, A9473501005

**DB-VB-7261**

Length: 622 Ø: 46
 Hole Ø 25 / 25 / 25
 Hole Distance: 152 / 130 / 130
 01337800A, 9443500305, 9443500505,
 9443500605, 9473500705, 9473500905,
 9483500405, 9483500305

**DB-VB-10426**

Length: 622 Ø: 46
 Hole Ø 25 / 25 / 25
 Hole Distance: 152 / 130 / 130
 9443500405

**MN-RK-8997**

Ø: 85 Hole Distance: 130
 Thick/Height: 30
 0003504805



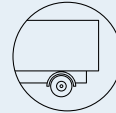

AXOR 2 ...

3240 K ...	10/04 →	Tie Rod End	DB-ES-8323		Leaf Spring Axle	
	10/04 →	Track Control Arm		DB-DL-3475	Trailing Arm	
	10/04 →	Track Control Arm		DB-VB-3707	Suspension Rod, Wishbone (CV)	
	10/04 →	Track Control Arm		DB-VB-7261	Suspension Rod, Wishbone (CV), 1st RA;2nd RA; Leaf Spring Axle	
	10/04 →	Track Control Arm		DB-VB-10426	Wishbone (CV), Leaf Spring Axle;Unit	
3243	10/04 →	Centre Rod	DB-DL-8122		Push Rod	
	10/04 →	Centre Rod	DB-DL-9258		Push Rod, for Leaf-Spring Suspension vehicles	
	10/04 →	Stabiliser Mounting		DB-SB-10409		
	10/04 →	Stabiliser Mounting	DB-SB-10410			
	10/04 →	Suspension Arm Repair Kit		DB-RK-8550	for Wishbone (CV)	
	10/04 →	Suspension Arm Repair Kit		DB-RK-10375	for Wishbone (CV)	
	10/04 →	Suspension Arm Repair Kit	DB-RK-8638		for Control Arm	
	10/04 →	Suspension Strut Repair Kit		MN-RK-8997		
	10/04 →	Tie Rod End	DB-ES-8530		for Push Rod	
3243 B	10/04 →	Bush, driver cab suspension	DB-SB-10384			
	10/04 →	Bush, parabolic spring		DB-SB-10401		
	10/04 →	Centre Rod	DB-DL-8122		Push Rod	
	10/04 →	Centre Rod	DB-DL-8184		Push Rod, Leaf Spring Axle	
	10/04 →	Centre Rod	DB-DL-8185		Push Rod	
	10/04 →	Centre Rod	DB-DL-12300		for Steering Rod	
	10/04 →	Stabiliser Link	DB-DL-9254		Pressure Rod	
	10/04 →	Stabiliser Mounting		DB-SB-10406		
	10/04 →	Stabiliser Mounting		DB-SB-10409		
	10/04 →	Suspension Arm Repair Kit		DB-RK-8626	for Wishbone (CV)	
	10/04 →	Suspension Arm Repair Kit		DB-RK-10374	for Wishbone (CV)	
	10/04 →	Suspension Arm Repair Kit		DB-RK-10375	for Wishbone (CV)	
	10/04 →	Suspension Strut Repair Kit		DB-RK-8391		
	10/04 →	Tie Rod	DB-DL-8172		Guide Rod	
	10/04 →	Tie Rod	DB-DL-8640		Guide Rod	
	10/04 →	Tie Rod	DB-DL-12310			
	10/04 →	Tie Rod End	DB-ES-8323		Leaf Spring Axle	
	10/04 →	Track Control Arm		DB-DL-3475	Trailing Arm	
	10/04 →	Track Control Arm		DB-VB-3707	Suspension Rod, Wishbone (CV)	
	10/04 →	Track Control Arm		DB-VB-7261	Suspension Rod, Wishbone (CV), 1st RA;2nd RA; Leaf Spring Axle	
	10/04 →	Track Control Arm		DB-VB-10426	Wishbone (CV), Leaf Spring Axle;Unit	
	3243 K	10/04 →	Bush, parabolic spring		DB-SB-10401	
		10/04 →	Centre Rod	DB-DL-8122		Push Rod
		10/04 →	Centre Rod	DB-DL-8184		Push Rod, Leaf Spring Axle
		10/04 →	Centre Rod	DB-DL-8185		Push Rod
		10/04 →	Centre Rod	DB-DL-12300		for Steering Rod
		10/04 →	Stabiliser Link	DB-DL-9254		Pressure Rod
10/04 →		Stabiliser Mounting		DB-SB-10406		
10/04 →		Stabiliser Mounting		DB-SB-10409		
10/04 →		Suspension Arm Repair Kit		DB-RK-8626	for Wishbone (CV)	
10/04 →		Suspension Arm Repair Kit		DB-RK-10374	for Wishbone (CV)	
10/04 →		Suspension Arm Repair Kit		DB-RK-10375	for Wishbone (CV)	
10/04 →		Suspension Strut Repair Kit		DB-RK-8391		
10/04 →		Tie Rod	DB-DL-8172		Guide Rod	
10/04 →		Tie Rod	DB-DL-8640		Guide Rod	
10/04 →		Tie Rod	DB-DL-12310			
10/04 →		Tie Rod End	DB-ES-8323		Leaf Spring Axle	
10/04 →		Track Control Arm		DB-DL-3475	Trailing Arm	
10/04 →		Track Control Arm		DB-VB-3707	Suspension Rod, Wishbone (CV)	
10/04 →		Track Control Arm		DB-VB-7261	Suspension Rod, Wishbone (CV), 1st RA;2nd RA; Leaf Spring Axle	
10/04 →		Track Control Arm		DB-VB-10426	Wishbone (CV), Leaf Spring Axle;Unit	
3335		10/04 →	Centre Rod	DB-DL-8122		Push Rod
		10/04 →	Centre Rod	DB-DL-8717		Push Rod, Leaf Spring Axle
		10/04 →	Centre Rod	DB-DL-9258		Push Rod, for Leaf-Spring Suspension vehicles
		10/04 →	Stabiliser Mounting		DB-SB-10406	
		10/04 →	Stabiliser Mounting		DB-SB-10409	

DB-DL-3475

Length: 565 Ø: 52
 Hole Distance: 152 / 152
 3753500006, 3753500206, 9473500805,
 9483500006, 9483500805, 9483501205,
 9483501305, 9483501905, 9483502005,
 9483502405, A3753500006, A3753500206

**DB-DL-8122**

Length: 875
 Ø: 42
 Cone Ø: d1 Ø 30 / d2 Ø 27
 01215000A, 6174603205, 6174603305

**DB-DL-8172**

Length: 1700 Ø: 52
 Cone Ø: d1 Ø 32 / d2 Ø 29
 01219700A, 9493300403, 9493300503,
 9493300803, 9493301403

**DB-DL-8184**

Length: 1095 Ø: 42
 Cone Ø: d1 Ø 32 / d2 Ø 28,8
 01217700A, 0014601305, 0014601405,
 0024600505, 0034603205, 3754601505,
 A0014601305, A0014601405, A0024600505

**DB-DL-8185**

Length: 711 Ø: 42
 Cone Ø: d1 Ø 32 / d2 Ø 28,8
 01213600A, 0014601105, 0024600405,
 0034603105, A0014601105, A0024600405

**DB-DL-8640**

Length: 1615 Ø: 50
 Cone Ø: d1 Ø 32 / d2 Ø 29
 6253301503, 6253301603, 6253302403,
 6253302503, 9423300803, 9423302103,
 9493300203, 9493300303, 9493300903

**DB-DL-8717**

Length: 886
 Ø: 38
 Cone Ø: d1 Ø 30 / d2 Ø 27
 0024601705, 24601705, 0024607505, 24607505,
 0024607605, 24607605, 0034604405

**DB-DL-9254**

Length: 1815 Ø: 58
 0003220323, 0003220623, 3753220423

**DB-DL-9258**

Length: 905
 Ø: 42
 Cone Ø: d1 Ø 28,6 / d2 Ø 23,9
 3754600605, 3754601105

**DB-DL-12300**

Length: 733 Ø: 36
 Cone Ø: d1 Ø 32 / d2 Ø 29
 0014601505, 0014607305, 0034603305,
 3754601605, A0014601505, A0034603305,
 A3754601605

**DB-DL-12310**

Length: 1532 Ø: 50
 Cone Ø: d1 Ø 32 / d2 Ø 29
 Thread: M27 x 1,5 LHT
 9493301203, 9493301303, 9493301803,
 9493302203, A9493301203, A9493301303,
 A9493301803, A9493302203

**DB-ES-8323**

Length: 75
 Cone Ø: d1 Ø 32 / d2 Ø 28,8
 Thread: M26 x 1,5 RHT
 0014601548, 0014601648, 0024600648,
 A0014601648, A0024600648

**DB-ES-8530**

Length: 115
 Cone Ø: d1 Ø 28,6 / d2 Ø 23,9
 Thread: M30 x 1,5 RHT
 0014603848, 0014604848, 0014605148,
 0014608648, 0014609948

**DB-RK-8391**

Ø: 85 Hole Distance: 152
 Thick/Height: 24
 01336800A, 0003502705

**DB-RK-8550**

Ø: 75 Hole Distance: 152
 Thick/Height: 24
 0003502105, 0003504605

**DB-RK-8626**

Ø: 75 Hole Distance: 130
 Thick/Height: 24
 0003502205, 0003502505, 0003503405,
 0003504505, GL11319

**DB-RK-8638**

Length: 100 Ø: 67
 Hole Distance: 100
 Thick/Height: 20
 0003301411

**DB-RK-10374**

Ø: 85 Hole Distance: 152
 Thick/Height: 24
 0003504405

**DB-RK-10375**

Ø: 100 Hole Distance: 152
 Thick/Height: 24
 0003502405, 0003503505, 0003504905

**DB-SB-10384**

Ø: 73 Thick/Height: 47
 9303170012, 9423171812

**DB-SB-10401**

Length: 232
 Thick/Height: 163,5 / 152,5
 0003250596, 0003250796

**DB-SB-10406**

Ø: 80 Thick/Height: 46
 0003238185

**DB-SB-10409**

Ø: 77 Thick/Height: 56
 0003265181

**DB-SB-10410**

Ø: 73 Hole Distance: 100
 Thick/Height: 24
 9413230050

**DB-VB-3707**

Length: 622 Ø: 46
 Hole Ø 25 / 25 / 25
 Hole Distance: 152 / 130 / 130
 01337100A, 9423501005, 9423501505,
 9443500005, 9473500105, 9473501005,
 A3753500005, A9423501005, A9423501505,
 A9443500005, A9473500105, A9473501005

**DB-VB-7261**

Length: 622 Ø: 46
 Hole Ø 25 / 25 / 25
 Hole Distance: 152 / 130 / 130
 01337800A, 9443500305, 9443500505,
 9443500605, 9473500705, 9473500905,
 9483500405, 9483503005

**DB-VB-10426**

Length: 622 Ø: 46
 Hole Ø 25 / 25 / 25
 Hole Distance: 152 / 130 / 130
 9443500405

**MN-RK-8997**

Ø: 85 Hole Distance: 130
 Thick/Height: 30
 0003504805





AXOR 2 ...

3335 ...	10/04→	Stabiliser Mounting	DB-SB-10410		
	10/04→	Suspension Arm Repair Kit		DB-RK-8550	for Wishbone (CV)
	10/04→	Suspension Arm Repair Kit		DB-RK-10375	for Wishbone (CV)
	10/04→	Suspension Arm Repair Kit	DB-RK-8638		for Control Arm
	10/04→	Suspension Strut Repair Kit		DB-RK-8710	
	10/04→	Suspension Strut Repair Kit		DB-RK-9291	
	10/04→	Suspension Strut Repair Kit		MN-RK-8997	
	10/04→	Tie Rod	DB-DL-8171		Guide Rod
	10/04→	Tie Rod	DB-DL-8327		Guide Rod
	10/04→	Tie Rod End	DB-ES-8530		for Push Rod
	10/04→	Track Control Arm		DB-VB-7261	Suspension Rod, Wishbone (CV), 1st RA;2nd RA; Leaf Spring Axle
	10/04→	Track Control Arm		DB-VB-9308	Suspension Rod, Wishbone (CV), 1st RA;2nd RA; Leaf Spring Axle
	3335 B	10/04→10/05	Centre Rod	DB-DL-8122	
10/04→10/05		Centre Rod	DB-DL-8717		Push Rod
10/04→10/05		Centre Rod	DB-DL-9258		Push Rod
10/04→10/05		Tie Rod	DB-DL-8171		Guide Rod
10/04→10/05		Tie Rod	DB-DL-8172		Guide Rod
10/04→10/05		Tie Rod	DB-DL-8327		Guide Rod
10/04→10/05		Tie Rod	DB-DL-12310		Guide Rod
10/04→10/05		Track Control Arm		DB-VB-7261	Suspension Rod, Wishbone (CV)
10/04→10/05		Track Control Arm		DB-VB-9307	Suspension Rod, Wishbone (CV)
3335 K	10/04→10/05	Track Control Arm		DB-VB-9308	Suspension Rod, Wishbone (CV)
	06/09→	Bush, parabolic spring		DB-SB-10401	
	06/09→	Centre Rod	DB-DL-8122		Push Rod
3335 S	06/09→	Tie Rod	DB-DL-8171		Guide Rod
	09/08→	Ball Head, gearshift linkage	DB-ES-8510		
3340 B	09/08→	Bush, parabolic spring		DB-SB-10400	
	09/08→	Bush, parabolic spring		DB-SB-10401	
	09/08→	Centre Rod	DB-DL-8122		Push Rod
	09/08→	Centre Rod	DB-DL-8188		Push Rod
	09/08→	Tie Rod	DB-DL-8171		Guide Rod
	09/08→	Tie Rod	DB-DL-8327		Guide Rod
	09/08→	Track Control Arm		DB-VB-7261	Suspension Rod, Wishbone (CV)
	09/08→	Track Control Arm		DB-VB-9308	Suspension Rod, Wishbone (CV)
	09/08→	Track Control Arm		DB-VB-9308	Suspension Rod, Wishbone (CV)
3340 K, 3341 K	10/04→10/05	Centre Rod	DB-DL-8122		Push Rod
	10/04→10/05	Centre Rod	DB-DL-8717		Push Rod
	10/04→10/05	Centre Rod	DB-DL-9258		Push Rod
	10/04→10/05	Tie Rod	DB-DL-8171		Guide Rod
	10/04→10/05	Tie Rod	DB-DL-8172		Guide Rod
	10/04→10/05	Tie Rod	DB-DL-8327		Guide Rod
	10/04→10/05	Tie Rod	DB-DL-12310		Guide Rod
	10/04→10/05	Track Control Arm		DB-VB-7261	Suspension Rod, Wishbone (CV)
	10/04→10/05	Track Control Arm		DB-VB-9307	Suspension Rod, Wishbone (CV)
	10/04→10/05	Track Control Arm		DB-VB-9308	Suspension Rod, Wishbone (CV)
	10/04→	Ball Head, gearshift linkage	DB-ES-8510	DB-ES-8510	
	10/04→	Bush, parabolic spring		DB-SB-10401	
	10/04→	Centre Rod	DB-DL-8122		Push Rod
10/04→	Centre Rod	DB-DL-8717		Push Rod, Leaf Spring Axle	
10/04→	Centre Rod	DB-DL-9258		Push Rod, for Leaf-Spring Suspension vehicles	
10/04→	Stabiliser Mounting		DB-SB-10406		
10/04→	Suspension Strut Repair Kit		DB-RK-8710		
10/04→	Suspension Strut Repair Kit		DB-RK-9291		
10/04→	Tie Rod	DB-DL-8171		Guide Rod, Leaf Spring Axle	
10/04→	Tie Rod	DB-DL-8172		Guide Rod, Leaf Spring Axle	
10/04→	Tie Rod	DB-DL-8327		Guide Rod, Leaf Spring Axle	
10/04→	Tie Rod	DB-DL-8640		Guide Rod	
10/04→	Tie Rod	DB-DL-12310		Guide Rod	
10/04→	Track Control Arm		DB-VB-7261	Suspension Rod, Wishbone (CV), 1st RA;2nd RA; Leaf Spring Axle	
10/04→	Track Control Arm		DB-VB-9307	Suspension Rod, Wishbone (CV), 1st RA;2nd RA; Leaf Spring Axle	
10/04→	Track Control Arm		DB-VB-9308	Suspension Rod, Wishbone (CV), 1st RA;2nd RA; Leaf Spring Axle	

DB-DL-8122

Length: 875
 Ø: 42
 Cone Ø: d1 Ø 30 / d2 Ø 27
 01215000A, 6174603205, 6174603305

**DB-DL-8171**

Length: 1687 Ø: 52
 Cone Ø: d1 Ø 32 / d2 Ø 29
 9493300603, 9493300703, 9493301503,
 9493301603

**DB-DL-8172**

Length: 1700 Ø: 52
 Cone Ø: d1 Ø 32 / d2 Ø 29
 01219700A, 9493300403, 9493300503,
 9493300803, 9493301403

**DB-DL-8188**

Length: 895 Ø: 40
 Cone Ø: d1 Ø 28,6 / d2 Ø 23,9
 01217200A, 0024604905, 0024605005,
 0034605605

**DB-DL-8327**

Length: 1745 Ø: 48
 Cone Ø: d1 Ø 32 / d2 Ø 29
 01219800A, 9413300003, 9413300103,
 9413300203, 9413300303, 9413300503

**DB-DL-8640**

Length: 1615 Ø: 50
 Cone Ø: d1 Ø 32 / d2 Ø 29
 6253301503, 6253301603, 6253302403,
 6253302503, 9423300803, 9423302103,
 9493300203, 9493300303, 9493300903

**DB-DL-8717**

Length: 886
 Ø: 38
 Cone Ø: d1 Ø 30 / d2 Ø 27
 0024601705, 24601705, 0024607505, 24607505,
 0024607605, 24607605, 0034604405

**DB-DL-9258**

Length: 905
 Ø: 42
 Cone Ø: d1 Ø 28,6 / d2 Ø 23,9
 3754600605, 3754601105

**DB-DL-12310**

Length: 1532 Ø: 50
 Cone Ø: d1 Ø 32 / d2 Ø 29
 Thread: M27 x 1,5 LHT
 9493301203, 9493301303, 9493301803,
 9493302203, A9493301203, A9493301303,
 A9493301803, A9493302203

**DB-ES-8510**

Length: 56
 Cone Ø: d1 Ø 10 / d2 Ø 10
 Thread: M12 x 1,75 LHT
 0009965145, 0009965645, 0019963145

**DB-ES-8530**

Length: 115
 Cone Ø: d1 Ø 28,6 / d2 Ø 23,9
 Thread: M30 x 1,5 RHT
 0014603848, 0014604848, 0014605148,
 0014608648, 0014609948

**DB-RK-8550**

Ø: 75 Hole Distance: 152
 Thick/Height: 24
 0003502105, 0003504605

**DB-RK-8638**

Length: 100 Ø: 67
 Hole Distance: 100
 Thick/Height: 20
 0003301411

**DB-RK-8710**

Ø: 85 Hole Distance: 130
 Thick/Height: 30
 0003503705

**DB-RK-9291**

Ø: 107,5 Hole Distance: 152
 Thick/Height: 30
 0003503605

**DB-RK-10375**

Ø: 100 Hole Distance: 152
 Thick/Height: 24
 0003502405, 0003503505, 0003504905

**DB-SB-10400**

Length: 230
 Thick/Height: 167,5 / 115
 0003250696, 0003250896

**DB-SB-10401**

Length: 232
 Thick/Height: 163,5 / 152,5
 0003250596, 0003250796

**DB-SB-10406**

Ø: 80 Thick/Height: 46
 0003238185

**DB-SB-10410**

Ø: 73 Hole Distance: 100
 Thick/Height: 24
 9413230050

**DB-VB-7261**

Length: 622 Ø: 46
 Hole Ø 25 / 25 / 25
 Hole Distance: 152 / 130 / 130
 01337800A, 9443500305, 9443500505,
 9443500605, 9473500705, 9473500905,
 9483500405, 9483500305

**DB-VB-9307**

Length: 667 Ø: 60
 Hole Ø 25 / 23 / 23
 Hole Distance: 152 / 130 / 130
 9483502805

**DB-VB-9308**

Length: 622 Ø: 46
 Hole Ø 25 / 25 / 25
 Hole Distance: 152 / 130 / 130
 9483502905

**MN-RK-8997**

Ø: 85 Hole Distance: 130
 Thick/Height: 30
 0003504805





AXOR 2 ...

3340 S, 3341 S	06/09 →	Ball Head, gearshift linkage	DB-ES-8510			
	06/09 →	Bush, parabolic spring		DB-SB-10400		
	06/09 →	Bush, parabolic spring		DB-SB-10401		
	06/09 →	Centre Rod	DB-DL-8122		Push Rod	
	06/09 →	Centre Rod	DB-DL-8188		Push Rod	
	06/09 →	Tie Rod	DB-DL-8171		Guide Rod	
	06/09 →	Tie Rod	DB-DL-8327		Guide Rod	
	06/09 →	Tie Rod	DB-DL-8640		Guide Rod	
	06/09 →	Tie Rod	DB-DL-12310			
	06/09 →	Track Control Arm		DB-VB-7261	Suspension Rod, Wishbone (CV)	
	06/09 →	Track Control Arm		DB-VB-9308	Suspension Rod, Wishbone (CV)	
	3340, 3341	10/04 →	Ball Head, gearshift linkage	DB-ES-8510	DB-ES-8510	
		10/04 →	Bush, parabolic spring		DB-SB-10401	
		10/04 →	Centre Rod	DB-DL-8122		Push Rod
10/04 →		Centre Rod	DB-DL-8717		Push Rod, Leaf Spring Axle	
10/04 →		Centre Rod	DB-DL-9258		Push Rod, for Leaf-Spring Suspension vehicles	
10/04 →		Stabiliser Mounting		DB-SB-10406		
10/04 →		Stabiliser Mounting		DB-SB-10409		
10/04 →		Stabiliser Mounting	DB-SB-10410			
10/04 →		Suspension Arm Repair Kit		DB-RK-8550	for Wishbone (CV)	
10/04 →		Suspension Arm Repair Kit		DB-RK-10375	for Wishbone (CV)	
10/04 →		Suspension Arm Repair Kit	DB-RK-8638		for Control Arm	
10/04 →		Suspension Strut Repair Kit		DB-RK-8710		
10/04 →		Suspension Strut Repair Kit		DB-RK-9291		
10/04 →		Suspension Strut Repair Kit		MN-RK-8997		
10/04 →		Tie Rod	DB-DL-8171		Guide Rod	
10/04 →		Tie Rod	DB-DL-8327		Guide Rod	
10/04 →		Tie Rod	DB-DL-8640		Guide Rod	
10/04 →		Tie Rod	DB-DL-12310			
10/04 →		Tie Rod End	DB-ES-8530		for Push Rod	
10/04 →		Track Control Arm		DB-VB-7261	Suspension Rod, Wishbone (CV), 1st RA;2nd RA; Leaf Spring Axle	
10/04 →		Track Control Arm		DB-VB-9308	Suspension Rod, Wishbone (CV), 1st RA;2nd RA; Leaf Spring Axle	
3343		10/04 →	Centre Rod	DB-DL-8122		Push Rod
		10/04 →	Centre Rod	DB-DL-8717		Push Rod, Leaf Spring Axle
		10/04 →	Centre Rod	DB-DL-9258		Push Rod, for Leaf-Spring Suspension vehicles
	10/04 →	Stabiliser Mounting		DB-SB-10406		
	10/04 →	Stabiliser Mounting		DB-SB-10409		
	10/04 →	Stabiliser Mounting	DB-SB-10410			
	10/04 →	Suspension Arm Repair Kit		DB-RK-8550	for Wishbone (CV)	
	10/04 →	Suspension Arm Repair Kit		DB-RK-10375	for Wishbone (CV)	
	10/04 →	Suspension Arm Repair Kit	DB-RK-8638		for Control Arm	
	10/04 →	Suspension Strut Repair Kit		DB-RK-8710		
	10/04 →	Suspension Strut Repair Kit		DB-RK-9291		
	10/04 →	Suspension Strut Repair Kit		MN-RK-8997		
	10/04 →	Tie Rod	DB-DL-8171		Guide Rod	
	10/04 →	Tie Rod	DB-DL-8327		Guide Rod	
	10/04 →	Tie Rod End	DB-ES-8530		for Push Rod	
	10/04 →	Track Control Arm		DB-VB-7261	Suspension Rod, Wishbone (CV), 1st RA;2nd RA; Leaf Spring Axle	
	10/04 →	Track Control Arm		DB-VB-9308	Suspension Rod, Wishbone (CV), 1st RA;2nd RA; Leaf Spring Axle	
	3343 B	10/04 →	Centre Rod	DB-DL-8122		Push Rod
10/04 →		Centre Rod	DB-DL-8717		Push Rod, Leaf Spring Axle	
10/04 →		Centre Rod	DB-DL-9258		Push Rod, for Leaf-Spring Suspension vehicles	
10/04 →		Stabiliser Mounting		DB-SB-10406		
10/04 →		Suspension Strut Repair Kit		DB-RK-8710		
10/04 →		Suspension Strut Repair Kit		DB-RK-9291		
10/04 →		Tie Rod	DB-DL-8171		Guide Rod, Leaf Spring Axle	
10/04 →		Tie Rod	DB-DL-8172		Guide Rod, Leaf Spring Axle	
10/04 →		Tie Rod	DB-DL-8327		Guide Rod, Leaf Spring Axle	
10/04 →		Tie Rod	DB-DL-8640		Guide Rod	

DB-DL-8122

Length: 875
 Ø: 42
 Cone Ø: d1 Ø 30 / d2 Ø 27
 01215000A, 6174603205, 6174603305

**DB-DL-8171**

Length: 1687 Ø: 52
 Cone Ø: d1 Ø 32 / d2 Ø 29
 9493300603, 9493300703, 9493301503,
 9493301603

**DB-DL-8172**

Length: 1700 Ø: 52
 Cone Ø: d1 Ø 32 / d2 Ø 29
 01219700A, 9493300403, 9493300503,
 9493300803, 9493301403

**DB-DL-8188**

Length: 895 Ø: 40
 Cone Ø: d1 Ø 28,6 / d2 Ø 23,9
 01217200A, 0024604905, 0024605005,
 0034605605

**DB-DL-8327**

Length: 1745 Ø: 48
 Cone Ø: d1 Ø 32 / d2 Ø 29
 01219800A, 9413300003, 9413300103,
 9413300203, 9413300303, 9413300503

**DB-DL-8640**

Length: 1615 Ø: 50
 Cone Ø: d1 Ø 32 / d2 Ø 29
 6253301503, 6253301603, 6253302403,
 6253302503, 9423300803, 9423302103,
 9493300203, 9493300303, 9493300903

**DB-DL-8717**

Length: 886
 Ø: 38
 Cone Ø: d1 Ø 30 / d2 Ø 27
 0024601705, 24601705, 24607505, 0024607505,
 24607605, 0024607605, 0034604405

**DB-DL-9258**

Length: 905
 Ø: 42
 Cone Ø: d1 Ø 28,6 / d2 Ø 23,9
 3754600605, 3754601105

**DB-DL-12310**

Length: 1532 Ø: 50
 Cone Ø: d1 Ø 32 / d2 Ø 29
 Thread: M27 x 1,5 LHT
 9493301203, 9493301303, 9493301803,
 9493302203, A9493301203, A9493301303,
 A9493301803, A9493302203

**DB-ES-8510**

Length: 56
 Cone Ø: d1 Ø 10 / d2 Ø 10
 Thread: M12 x 1,75 LHT
 0009965145, 0009965645, 0019963145

**DB-ES-8530**

Length: 115
 Cone Ø: d1 Ø 28,6 / d2 Ø 23,9
 Thread: M30 x 1,5 RHT
 0014603848, 0014604848, 0014605148,
 0014608648, 0014609948

**DB-RK-8550**

Ø: 75 Hole Distance: 152
 Thick/Height: 24
 0003502105, 0003504605

**DB-RK-8638**

Length: 100 Ø: 67
 Hole Distance: 100
 Thick/Height: 20
 0003301411

**DB-RK-8710**

Ø: 85 Hole Distance: 130
 Thick/Height: 30
 0003503705

**DB-RK-9291**

Ø: 107,5 Hole Distance: 152
 Thick/Height: 30
 0003503605

**DB-RK-10375**

Ø: 100 Hole Distance: 152
 Thick/Height: 24
 0003502405, 0003503505, 0003504905

**DB-SB-10400**

Length: 230
 Thick/Height: 167,5 / 115
 0003250696, 0003250896

**DB-SB-10401**

Length: 232
 Thick/Height: 163,5 / 152,5
 0003250596, 0003250796

**DB-SB-10406**

Ø: 80 Thick/Height: 46
 0003238185

**DB-SB-10409**

Ø: 77 Thick/Height: 56
 0003265181

**DB-SB-10410**

Ø: 73 Hole Distance: 100
 Thick/Height: 24
 9413230050

**DB-VB-7261**

Length: 622 Ø: 46
 Hole Ø 25 / 25 / 25
 Hole Distance: 152 / 130 / 130
 01337800A, 9443500305, 9443500505,
 9443500605, 9473500705, 9473500905,
 9483500405, 9483503005

**DB-VB-9308**

Length: 622 Ø: 46
 Hole Ø 25 / 25 / 25
 Hole Distance: 152 / 130 / 130
 9483502905





AXOR 2 ...

3343 B ...	10/04 →	Tie Rod	DB-DL-12310			
	10/04 →	Track Control Arm		DB-VB-7261	Suspension Rod, Wishbone (CV), 1st RA;2nd RA; Leaf Spring Axle	
	10/04 →	Track Control Arm		DB-VB-9307	Suspension Rod, Wishbone (CV), 1st RA;2nd RA; Leaf Spring Axle	
	10/04 →	Track Control Arm		DB-VB-9308	Suspension Rod, Wishbone (CV), 1st RA;2nd RA; Leaf Spring Axle	
3343 K	01/11 →	Ball Head, gearshift linkage	DB-ES-8510	DB-ES-8510		
	01/11 →	Bush, parabolic spring		DB-SB-10401		
	01/11 →	Centre Rod	DB-DL-8122		Push Rod	
	01/11 →	Tie Rod	DB-DL-8171		Guide Rod	
	01/11 →	Tie Rod	DB-DL-8640		Guide Rod	
3343 S	01/11 →	Ball Head, gearshift linkage	DB-ES-8510	DB-ES-8510		
	01/11 →	Bush, parabolic spring		DB-SB-10401		
	01/11 →	Centre Rod	DB-DL-8122		Push Rod	
	01/11 →	Tie Rod	DB-DL-8171		Guide Rod	
	01/11 →	Tie Rod	DB-DL-8640		Guide Rod	
3344 K	10/04 →	Tie Rod	DB-DL-12310			
	01/11 →	Ball Head, gearshift linkage	DB-ES-8510	DB-ES-8510		
	01/11 →	Bush, parabolic spring		DB-SB-10401		
	01/11 →	Centre Rod	DB-DL-8122		Push Rod	
	01/11 →	Tie Rod	DB-DL-8171		Guide Rod	
3535 K	06/09 →	Bush, parabolic spring		DB-SB-10401		
	06/09 →	Centre Rod	DB-DL-8122		Push Rod	
	06/09 →	Tie Rod	DB-DL-8171		Guide Rod	
	06/09 →	Tie Rod	DB-DL-8640		Guide Rod	
4135 B	10/05 →	Centre Rod	DB-DL-8122		Push Rod	
	10/05 →	Centre Rod	DB-DL-8184		Push Rod	
	10/05 →	Stabiliser Link	DB-DL-9254		Coupling Rod	
	10/05 →	Tie Rod	DB-DL-8171		Guide Rod	
	10/05 →	Tie Rod	DB-DL-8172		Guide Rod	
	10/05 →	Tie Rod	DB-DL-8390			
	10/05 →	Tie Rod	DB-DL-8640		Guide Rod	
	10/05 →	Tie Rod	DB-DL-12310			
	10/05 →	Tie Rod End	DB-ES-8323			
	10/05 →	Track Control Arm		DB-VB-7261	Suspension Rod, Wishbone (CV)	
	10/05 →	Track Control Arm		DB-VB-9307	Suspension Rod, Wishbone (CV)	
4135 K	06/09 →	Centre Rod	DB-DL-8122		Push Rod	
	06/09 →	Centre Rod	DB-DL-8184		Push Rod	
	06/09 →	Centre Rod	DB-DL-8184		Push Rod, Leaf Spring Axle	
	06/09 →	Centre Rod	DB-DL-12301		Push Rod, Leaf Spring Axle	
	06/09 →	Stabiliser Link	DB-DL-9254		Pressure Rod	
	06/09 →	Tie Rod	DB-DL-8171		Guide Rod	
	06/09 →	Tie Rod	DB-DL-8172		Guide Rod	
	06/09 →	Tie Rod	DB-DL-8390			
	06/09 →	Tie Rod	DB-DL-8640		Guide Rod	
	06/09 →	Tie Rod	DB-DL-12310			
	06/09 →	Tie Rod End	DB-ES-8323			
	06/09 →	Track Control Arm		DB-VB-7261	Suspension Rod, Wishbone (CV), 1st RA;2nd RA; Leaf Spring Axle	
	06/09 →	Track Control Arm		DB-VB-9307	Suspension Rod, Wishbone (CV), 1st RA;2nd RA; Leaf Spring Axle	
	06/09 →	Track Control Arm		DB-VB-9308	Suspension Rod, Wishbone (CV), 1st RA;2nd RA; Leaf Spring Axle	
	4140	01/11 →	Ball Head, gearshift linkage	DB-ES-8510	DB-ES-8510	
		01/11 →	Bush, parabolic spring		DB-SB-10401	
		01/11 →	Centre Rod	DB-DL-8122		Push Rod
01/11 →		Tie Rod	DB-DL-8171		Guide Rod	
01/11 →		Tie Rod	DB-DL-8640		Guide Rod	
01/11 →		Tie Rod	DB-DL-12310			

DB-DL-8122

Length: 875
Ø: 42
Cone Ø: d1 Ø 30 / d2 Ø 27
01215000A, 6174603205, 6174603305



DB-DL-8171

Length: 1687 Ø: 52
Cone Ø: d1 Ø 32 / d2 Ø 29
9493300603, 9493300703, 9493301503,
9493301603



DB-DL-8172

Length: 1700 Ø: 52
Cone Ø: d1 Ø 32 / d2 Ø 29
01219700A, 9493300403, 9493300503,
9493300803, 9493301403



DB-DL-8184

Length: 1095 Ø: 42
Cone Ø: d1 Ø 32 / d2 Ø 28,8
01217700A, 0014601305, 0014601405,
0024600505, 0034603205, 3754601505,
A0014601305, A0014601405, A0024600505



DB-DL-8390

Length: 1596 Ø: 50
Cone Ø: d1 Ø 32 / d2 Ø 29
9493301003, 9493301103, 9493301703



DB-DL-8640

Length: 1615 Ø: 50
Cone Ø: d1 Ø 32 / d2 Ø 29
6253301503, 6253301603, 6253302403,
6253302503, 9423300803, 9423302103,
9493300203, 9493300303, 9493300903



DB-DL-9254

Length: 1815 Ø: 58
0003220323, 0003220623, 3753220423



DB-DL-12301

Length: 716 Ø: 38
Cone Ø: d1 Ø 32 / d2 Ø 29
Thread: M30 x 1,5
0024608805, 0024608905, A0024608805,
A0024608905



DB-DL-12310

Length: 1532 Ø: 50
Cone Ø: d1 Ø 32 / d2 Ø 29
Thread: M27 x 1,5 LHT
9493301203, 9493301303, 9493301803,
9493302203, A9493301203, A9493301303,
A9493301803, A9493302203



DB-ES-8323

Length: 75
Cone Ø: d1 Ø 32 / d2 Ø 28,8
Thread: M26 x 1,5 RHT
0014601548, 0014601648, 0024600648,
A0014601648, A0024600648



DB-ES-8510

Length: 56
Cone Ø: d1 Ø 10 / d2 Ø 10
Thread: M12 x 1,75 LHT
0009965145, 0009965645, 0019963145



DB-SB-10401

Length: 232
Thick/Height: 163,5 / 152,5
0003250596, 0003250796



DB-VB-7261

Length: 622 Ø: 46
Hole Ø 25 / 25 / 25
Hole Distance: 152 / 130 / 130
01337800A, 9443500305, 9443500505,
9443500605, 9473500705, 9473500905,
9483500405, 9483500305



DB-VB-9307

Length: 667 Ø: 60
Hole Ø 25 / 23 / 23
Hole Distance: 152 / 130 / 130
9483502805



DB-VB-9308

Length: 622 Ø: 46
Hole Ø 25 / 25 / 25
Hole Distance: 152 / 130 / 130
9483502905





AXOR 2 ...

4140 B	01/11→	Centre Rod	DB-DL-8122	Push Rod
	01/11→	Centre Rod	DB-DL-8184	Push Rod
	01/11→	Stabiliser Link	DB-DL-9254	Pressure Rod
	01/11→	Tie Rod	DB-DL-8171	Guide Rod
	01/11→	Tie Rod	DB-DL-8172	Guide Rod
	01/11→	Tie Rod	DB-DL-8390	
	01/11→	Tie Rod	DB-DL-8640	Guide Rod
	01/11→	Tie Rod	DB-DL-12310	
	01/11→	Tie Rod End	DB-ES-8323	
	01/11→	Track Control Arm		DB-VB-7261 Suspension Rod, Wishbone (CV), 1st RA;2nd RA; Leaf Spring Axle
	01/11→	Track Control Arm		DB-VB-9307 Suspension Rod, Wishbone (CV), 1st RA;2nd RA; Leaf Spring Axle
	01/11→	Track Control Arm		DB-VB-9308 Suspension Rod, Wishbone (CV), 1st RA;2nd RA; Leaf Spring Axle
	4140 K	06/09→	Centre Rod	DB-DL-8122
06/09→		Centre Rod	DB-DL-8184	Push Rod
06/09→		Centre Rod	DB-DL-8184	Push Rod, Leaf Spring Axle
06/09→		Centre Rod	DB-DL-12301	Push Rod, Leaf Spring Axle
06/09→		Stabiliser Link	DB-DL-9254	Pressure Rod
06/09→		Tie Rod	DB-DL-8171	Guide Rod
06/09→		Tie Rod	DB-DL-8172	Guide Rod
06/09→		Tie Rod	DB-DL-8390	
06/09→		Tie Rod	DB-DL-8640	Guide Rod
06/09→		Tie Rod	DB-DL-12310	
06/09→		Tie Rod End	DB-ES-8323	
06/09→		Track Control Arm		DB-VB-7261 Suspension Rod, Wishbone (CV), 1st RA;2nd RA; Leaf Spring Axle
06/09→		Track Control Arm		DB-VB-9307 Suspension Rod, Wishbone (CV), 1st RA;2nd RA; Leaf Spring Axle
06/09→	Track Control Arm		DB-VB-9308 Suspension Rod, Wishbone (CV), 1st RA;2nd RA; Leaf Spring Axle	
4143 B	01/11→	Centre Rod	DB-DL-8122	Push Rod
	01/11→	Centre Rod	DB-DL-8184	Push Rod
	01/11→	Stabiliser Link	DB-DL-9254	Pressure Rod
	01/11→	Tie Rod	DB-DL-8171	Guide Rod
	01/11→	Tie Rod	DB-DL-8172	Guide Rod
	01/11→	Tie Rod	DB-DL-8390	
	01/11→	Tie Rod	DB-DL-8640	Guide Rod
	01/11→	Tie Rod	DB-DL-12310	
	01/11→	Tie Rod End	DB-ES-8323	
	01/11→	Track Control Arm		DB-VB-7261 Suspension Rod, Wishbone (CV), 1st RA;2nd RA; Leaf Spring Axle
	01/11→	Track Control Arm		DB-VB-9307 Suspension Rod, Wishbone (CV), 1st RA;2nd RA; Leaf Spring Axle
	01/11→	Track Control Arm		DB-VB-9308 Suspension Rod, Wishbone (CV), 1st RA;2nd RA; Leaf Spring Axle
	4143 K	06/09→	Centre Rod	DB-DL-8122
06/09→		Centre Rod	DB-DL-8184	Push Rod
06/09→		Centre Rod	DB-DL-8184	Push Rod, Leaf Spring Axle
06/09→		Centre Rod	DB-DL-12301	Push Rod, Leaf Spring Axle
06/09→		Stabiliser Link	DB-DL-9254	Pressure Rod
06/09→		Tie Rod	DB-DL-8171	Guide Rod
06/09→		Tie Rod	DB-DL-8172	Guide Rod
06/09→		Tie Rod	DB-DL-8390	
06/09→		Tie Rod	DB-DL-8640	Guide Rod
06/09→		Tie Rod	DB-DL-12310	
06/09→		Tie Rod End	DB-ES-8323	
06/09→		Track Control Arm		DB-VB-7261 Suspension Rod, Wishbone (CV), 1st RA;2nd RA; Leaf Spring Axle
06/09→		Track Control Arm		DB-VB-9307 Suspension Rod, Wishbone (CV), 1st RA;2nd RA; Leaf Spring Axle

DB-DL-8122

Length: 875
Ø: 42
Cone Ø: d1 Ø 30 / d2 Ø 27
01215000A, 6174603205, 6174603305



DB-DL-8171

Length: 1687 Ø: 52
Cone Ø: d1 Ø 32 / d2 Ø 29
9493300603, 9493300703, 9493301503,
9493301603



DB-DL-8172

Length: 1700 Ø: 52
Cone Ø: d1 Ø 32 / d2 Ø 29
01219700A, 9493300403, 9493300503,
9493300803, 9493301403



DB-DL-8184

Length: 1095 Ø: 42
Cone Ø: d1 Ø 32 / d2 Ø 28,8
01217700A, 0014601305, 0014601405,
0024600505, 0034603205, 3754601505,
A0014601305, A0014601405, A0024600505



DB-DL-8390

Length: 1596 Ø: 50
Cone Ø: d1 Ø 32 / d2 Ø 29
9493301003, 9493301103, 9493301703



DB-DL-8640

Length: 1615 Ø: 50
Cone Ø: d1 Ø 32 / d2 Ø 29
6253301503, 6253301603, 6253302403,
6253302503, 9423300803, 9423302103,
9493300203, 9493300303, 9493300903



DB-DL-9254

Length: 1815 Ø: 58
0003220323, 0003220623, 3753220423



DB-DL-12301

Length: 716 Ø: 38
Cone Ø: d1 Ø 32 / d2 Ø 29
Thread: M30 x 1,5
0024608805, 0024608905, A0024608805,
A0024608905



DB-DL-12310

Length: 1532 Ø: 50
Cone Ø: d1 Ø 32 / d2 Ø 29
Thread: M27 x 1,5 LHT
9493301203, 9493301303, 9493301803,
9493302203, A9493301203, A9493301303,
A9493301803, A9493302203



DB-ES-8323

Length: 75
Cone Ø: d1 Ø 32 / d2 Ø 28,8
Thread: M26 x 1,5 RHT
0014601548, 0014601648, 0024600648,
A0014601648, A0024600648



DB-VB-7261

Length: 622 Ø: 46
Hole Ø 25 / 25 / 25
Hole Distance: 152 / 130 / 130
01337800A, 9443500305, 9443500505,
9443500605, 9473500705, 9473500905,
9483500405, 9483503005



DB-VB-9307

Length: 667 Ø: 60
Hole Ø 25 / 23 / 23
Hole Distance: 152 / 130 / 130
9483502805



DB-VB-9308

Length: 622 Ø: 46
Hole Ø 25 / 25 / 25
Hole Distance: 152 / 130 / 130
9483502905





AXOR 2 ...

4143 K ...	06/09→	Track Control Arm		DB-VB-9308	Suspension Rod, Wishbone (CV), 1st RA;2nd RA; Leaf Spring Axle
	01/11→	Stabiliser Link	DB-DL-9254		Coupling Rod
	01/11→	Track Control Arm		DB-VB-7261	Suspension Rod, Wishbone (CV)
	01/11→	Track Control Arm		DB-VB-9307	Suspension Rod, Wishbone (CV)
	01/11→	Track Control Arm		DB-VB-9308	Suspension Rod, Wishbone (CV)
4144	01/11→	Ball Head, gearshift linkage	DB-ES-8510	DB-ES-8510	
	01/11→	Bush, parabolic spring		DB-SB-10401	
	01/11→	Centre Rod	DB-DL-8122		Push Rod
	01/11→	Tie Rod	DB-DL-8171		Guide Rod
	01/11→	Tie Rod	DB-DL-8640		Guide Rod
	01/11→	Tie Rod	DB-DL-12310		

CITARO (O 530)

Citaro BZ	01/02→	Stabiliser Link		DB-DL-7262	Coupling Rod
	01/02→	Stabiliser Link		DB-DL-7263	Coupling Rod
	01/02→	Stabiliser Link		DB-DL-12364	Coupling Rod
	01/02→	Stabiliser Link	DB-DL-7275		Coupling Rod
	01/02→	Stabiliser Link	DB-DL-7276		Coupling Rod
	01/02→	Tie Rod	DB-DL-9261		
	01/02→	Track Control Arm		DB-DL-7788	Trailing Arm
	01/02→	Track Control Arm		DB-DL-8393	for Steering Rod, Trailing Arm
	01/02→	Track Control Arm	DB-DL-9275	DB-DL-9275	Trailing Arm
Citaro G	01/98→	Stabiliser Link		DB-DL-7262	Coupling Rod
	01/98→	Stabiliser Link		DB-DL-7263	Coupling Rod
	01/98→	Stabiliser Link		DB-DL-12364	Coupling Rod
	01/98→	Stabiliser Link	DB-DL-7275		Coupling Rod
	01/98→	Stabiliser Link	DB-DL-7276		Coupling Rod
	01/98→	Tie Rod	DB-DL-9261		
	01/98→	Track Control Arm		DB-DL-7788	Trailing Arm
	01/98→	Track Control Arm		DB-DL-7788	Trailing Arm, Drive Axle
	01/98→	Track Control Arm		DB-DL-8393	for Steering Rod, Trailing Arm
01/98→	Track Control Arm	DB-DL-9275	DB-DL-9275	Trailing Arm	
Citaro G, Citaro GN3, Citaro LÜ	01/98→	Stabiliser Link		DB-DL-12364	Coupling Rod
Citaro G, Citaro LÜ	01/98→	Stabiliser Link		DB-DL-12364	Coupling Rod
Citaro GNG	04/00→	Stabiliser Link		DB-DL-7262	Coupling Rod
	04/00→	Stabiliser Link		DB-DL-7263	Coupling Rod
	04/00→	Stabiliser Link		DB-DL-12364	Coupling Rod
	04/00→	Stabiliser Link	DB-DL-7275		Coupling Rod
	04/00→	Stabiliser Link	DB-DL-7276		Coupling Rod
	04/00→	Tie Rod	DB-DL-9261		
	04/00→	Track Control Arm		DB-DL-7788	Trailing Arm
	04/00→	Track Control Arm		DB-DL-7788	Trailing Arm, Drive Axle
	04/00→	Track Control Arm		DB-DL-8393	for Steering Rod, Trailing Arm
	04/00→	Track Control Arm	DB-DL-9275	DB-DL-9275	Trailing Arm
Citaro N	01/98→	Stabiliser Link		DB-DL-7262	Coupling Rod
	01/98→	Stabiliser Link		DB-DL-7263	Coupling Rod
	01/98→	Stabiliser Link		DB-DL-12364	Coupling Rod
	01/98→	Stabiliser Link	DB-DL-7275		Coupling Rod
	01/98→	Stabiliser Link	DB-DL-7276		Coupling Rod
	01/98→	Tie Rod	DB-DL-9261		
	01/98→	Track Control Arm		DB-DL-7788	Trailing Arm, Drive Axle
	01/98→	Track Control Arm		DB-DL-8393	for Steering Rod, Trailing Arm
	01/98→	Track Control Arm	DB-DL-9275	DB-DL-9275	Trailing Arm
	01/99→	Track Control Arm		DB-DL-7788	Trailing Arm, Tag Axle;Rigid Axle
Citaro N, Citaro MUE	01/98→	Centre Rod	DB-DL-8122		Push Rod
	01/98→	Centre Rod	DB-DL-9251		Push Rod
	01/98→	Stabiliser Link		DB-DL-7262	Coupling Rod
	01/98→	Stabiliser Link		DB-DL-7263	Coupling Rod
	01/98→	Stabiliser Link		DB-DL-12364	Coupling Rod
	01/98→	Stabiliser Link	DB-DL-7275		Coupling Rod
	01/98→	Stabiliser Link	DB-DL-7276		Coupling Rod
	01/98→	Tie Rod	CV-DL-9082		

CV-DL-9082



DB-DL-7262

Length: 260
Ø: 36
Cone Ø: d1 Ø 26
Thread: M20 x 1,5
6283200189, 6283201289



DB-DL-7263

Length: 260
Ø: 36
Cone Ø: d1 Ø 26
Thread: M20 x 1,5
6283200389, 6283201389



DB-DL-7275



DB-DL-7276



DB-DL-7788

Length: 664
Ø: 48
Hole Distance: 130 / 130
6283330003



DB-DL-8122

Length: 875
Ø: 42
Cone Ø: d1 Ø 30 / d2 Ø 27
01215000A, 6174603205, 6174603305



DB-DL-8171

Length: 1687 Ø: 52
Cone Ø: d1 Ø 32 / d2 Ø 29
9493300603, 9493300703, 9493301503,
9493301603



DB-DL-8393

Length: 576
Ø: 48
Hole Distance: 130 / 130
6273500206, 6273500306, 628330905,
6283331705, 6443500306, A6273500206,
A6273500306, A6283330905, A6283331705,
A6443500306



DB-DL-8640

Length: 1615 Ø: 50
Cone Ø: d1 Ø 32 / d2 Ø 29
6253301503, 6253301603, 6253302403,
6253302503, 9423300803, 9423302103,
9493300203, 9493300303, 9493300903



DB-DL-9251



DB-DL-9254

Length: 1815 Ø: 58
0003220323, 0003220623, 3753220423



DB-DL-9261

Length: 1730
Ø: 62
Cone Ø: d1 Ø 26 / d2 Ø 23,5
3823300403, 6283300103



DB-DL-9275



DB-DL-12310

Length: 1532 Ø: 50
Cone Ø: d1 Ø 32 / d2 Ø 29
Thread: M27 x 1,5 LHT
9493301203, 9493301303, 9493301803,
9493302203, A9493301203, A9493301303,
A9493301803, A9493302203



DB-DL-12364

Length: 200 Ø: 32
Cone Ø: d1 Ø 30 / d2 Ø 27
0003201232, 6283201489, 6293200189,
6323200132, 6323200232, 6323200532,
A6323200132, A6323200532



DB-ES-8510

Length: 56
Cone Ø: d1 Ø 10 / d2 Ø 10
Thread: M12 x 1,75 LHT
0009965145, 0009965645, 0019963145



DB-SB-10401

Length: 232
Thick/Height: 163,5 / 152,5
0003250596, 0003250796



DB-VB-7261

Length: 622 Ø: 46
Hole Ø 25 / 25 / 25
Hole Distance: 152 / 130 / 130
01337800A, 9443500305, 9443500505,
9443500605, 9473500705, 9473500905,
9483500405, 9483503005



DB-VB-9307

Length: 667 Ø: 60
Hole Ø 25 / 23 / 23
Hole Distance: 152 / 130 / 130
9483502805



DB-VB-9308

Length: 622 Ø: 46
Hole Ø 25 / 25 / 25
Hole Distance: 152 / 130 / 130
9483502905





CITARO (O 530) ...

Citaro N, Citaro MUE ...	01/98 →	Tie Rod	DB-DL-9249		
	01/98 →	Tie Rod	DB-DL-9261		
	01/98 →	Track Control Arm		DB-DL-7788	Trailing Arm, Drive Axle
	01/98 →	Track Control Arm		DB-DL-8393	for Steering Rod, Trailing Arm
	01/98 →	Track Control Arm	DB-DL-9275	DB-DL-9275	Trailing Arm
Citaro NG	04/00 →	Stabiliser Link		DB-DL-7262	Coupling Rod
	04/00 →	Stabiliser Link		DB-DL-7263	Coupling Rod
	04/00 →	Stabiliser Link		DB-DL-12364	Coupling Rod
	04/00 →	Stabiliser Link	DB-DL-7275		Coupling Rod
	04/00 →	Stabiliser Link	DB-DL-7276		Coupling Rod
	04/00 →	Tie Rod	DB-DL-9261		
	04/00 →	Track Control Arm		DB-DL-7788	Trailing Arm, Drive Axle
	04/00 →	Track Control Arm		DB-DL-8393	for Steering Rod, Trailing Arm
	04/00 →	Track Control Arm	DB-DL-9275	DB-DL-9275	Trailing Arm
Citaro, Citaro MUE	01/98 →	Centre Rod	DB-DL-9251		Push Rod
	01/98 →	Stabiliser Link		DB-DL-7262	Coupling Rod
	01/98 →	Stabiliser Link		DB-DL-7263	Coupling Rod
	01/98 →	Stabiliser Link		DB-DL-12364	Coupling Rod
	01/98 →	Tie Rod	CV-DL-9082		
	01/98 →	Tie Rod	DB-DL-9249		
	01/98 →	Track Control Arm		DB-DL-7788	Trailing Arm
	01/98 →	Track Control Arm		DB-DL-8393	for Steering Rod, Trailing Arm

CONECTO (O 345)

CONECTO C, H, M, UE	11/01 →	Centre Rod	DB-DL-7795		Push Rod
	11/01 →	Centre Rod	DB-DL-9188		Push Rod
	11/01 →	Stabiliser Link		DB-DL-7262	Coupling Rod
	11/01 →	Stabiliser Link		DB-DL-7263	Coupling Rod
	11/01 →	Stabiliser Link		DB-DL-12364	Coupling Rod
	11/01 →	Track Control Arm		DB-DL-7788	Trailing Arm
	11/01 →	Track Control Arm		DB-DL-7788	Trailing Arm, Drive Axle
	11/01 →	Track Control Arm		DB-DL-8393	for Steering Rod, Trailing Arm
CONECTO C, H, UE	11/01 →	Centre Rod	DB-DL-7795		Push Rod
	11/01 →	Centre Rod	DB-DL-9188		Push Rod
	11/01 →	Stabiliser Link		DB-DL-7262	Coupling Rod
	11/01 →	Stabiliser Link		DB-DL-7263	Coupling Rod
	11/01 →	Stabiliser Link		DB-DL-12364	Coupling Rod
	11/01 →	Track Control Arm		DB-DL-7788	Trailing Arm
	11/01 →	Track Control Arm		DB-DL-7788	Trailing Arm, Drive Axle
	11/01 →	Track Control Arm		DB-DL-8393	for Steering Rod, Trailing Arm

ECONIC

1823 L, 1823 LL	03/98 →	Centre Rod	DB-DL-5230		Suspension Rod
	03/98 →	Centre Rod	DB-DL-5241		Suspension Rod
	03/98 →	Centre Rod	DB-DL-8184		Push Rod
	03/98 →	Centre Rod	DB-DL-8185		Push Rod
	03/98 →	Centre Rod	DB-DL-9269		Push Rod* 207575 * →
	03/98 →	Centre Rod	DB-DL-12300		for Steering Rod
	03/98 →	Rod Assembly	DB-DL-2178		Guide Rod
	03/98 →	Stabiliser Mounting		DB-SB-10406	
	03/98 →	Suspension Arm Repair Kit		DB-RK-8626	for Wishbone (CV)
	03/98 →	Suspension Arm Repair Kit		DB-RK-8638	for Control Arm
	03/98 →	Suspension Arm Repair Kit		DB-RK-10374	for Wishbone (CV)
	03/98 →	Suspension Strut Repair Kit		DB-RK-8555	
	03/98 →	Suspension Strut Repair Kit		DB-RK-9294	
	03/98 →	Tie Rod	DB-DL-8388		Guide Rod
	03/98 →	Tie Rod	DB-DL-8389		
	03/98 →	Tie Rod End	CV-ES-0543		
	03/98 →	Tie Rod End	CV-ES-0888		
	03/98 →	Track Control Arm		DB-VB-3707	Suspension Rod, Wishbone (CV), 1st RA; Air Suspension Axle, * V207575 * →
	03/98 →	Track Control Arm		DB-VB-7790	Wishbone (CV)
	03/98 →	Track Control Arm	DB-DL-5224		Control Arm, 1st FA; Air Suspension Axle
	03/98 →	Track Control Arm	DB-DL-9218	DB-DL-9218	Trailing Arm, 1st FA; Air Suspension Axle

CV-DL-9082



CV-ES-0543

Length: 125
Cone Ø: d1 Ø 32 / d2 Ø 29
Thread: M30 x 1,5 RHT
0004605748, 0004606048, 0004606848,
0004607048, 0014600448, 0014601148,
0014601748, 0014602448, 0014607648,
0014609648



CV-ES-0888

Length: 125
Cone Ø: d1 Ø 32 / d2 Ø 29
Thread: M30 x 1,5 LHT
0004605848, 0004606148, 0004606948,
0004607148, 0004609048, 0014600548,
0014601348, 0014602548, 0014607948,
0024600448



DB-DL-2178

Length: 1735 Ø: 52
Cone Ø: d1 Ø 32 / d2 Ø 29
9423300003, 9423300103, 9423300203



DB-DL-5224

Length: 850 Ø: 60
Hole Distance: 100 / 100
01336100A, 9413300007



DB-DL-5230

Length: 879 Ø: 42
Cone Ø: d1 Ø 30 / d2 Ø 27
01208600A, 0004607105, 0004607205,
0014606705



DB-DL-5241

Length: 875 Ø: 40
Cone Ø: d1 Ø 30 / d2 Ø 27
01215300A, 0004609205, 0004609305,
0014606905



DB-DL-7262

Length: 260
Ø: 36
Cone Ø: d1 Ø 26
Thread: M20 x 1,5
6283200189, 6283201289



DB-DL-7263

Length: 260
Ø: 36
Cone Ø: d1 Ø 26
Thread: M20 x 1,5
6283200389, 6283201389



DB-DL-7275



DB-DL-7276



DB-DL-7788

Length: 664
Ø: 48
Hole Distance: 130 / 130
6283330003



DB-DL-7795

Length: 920
Ø: 36
Cone Ø: d1 Ø 30 / d2 Ø 27
3574603205



DB-DL-8184

Length: 1095 Ø: 42
Cone Ø: d1 Ø 32 / d2 Ø 28,8
01217700A, 0014601305, 0014601405,
0024600505, 0034603205, 3754601505,
A0014601305, A0014601405, A0024600505



DB-DL-8185

Length: 711 Ø: 42
Cone Ø: d1 Ø 32 / d2 Ø 28,8
01213600A, 0014601105, 0024600405,
0034603105, A0014601105, A0024600405



DB-DL-8388

Length: 1735 Ø: 62
Cone Ø: d1 Ø 32 / d2 Ø 28,8
01219900A, 9453300003, 9453300103,
9453300403, 9453300603, A9453300003



DB-DL-8389

Length: 1465 Ø: 40
Cone Ø: d1 Ø 32 / d2 Ø 29
9453300203, 9453300303, 9453300503



DB-DL-8393

Length: 576
Ø: 48
Hole Distance: 130 / 130
6273500206, 6273500306, 6283330905,
6283331705, 6443500306, A6273500206,
A6273500306, A6283330905, A6283331705,
A6443500306



DB-DL-9188

Length: 1160
Ø: 38
Cone Ø: d1 Ø 30 / d2 Ø 27
3574603105



DB-DL-9218

Length: 754 Ø: 40
Hole Distance: 100
000360098524, 000390098524, 3753300111,
9413300011, A3753300111, SA50831601



DB-DL-9249



DB-DL-9251



DB-DL-9261

Length: 1730
Ø: 62
Cone Ø: d1 Ø 26 / d2 Ø 23,5
3823300403, 6283300103



DB-DL-9269

Length: 387
Ø: 36
Cone Ø: d1 Ø 32 / d2 Ø 29
9574600405, 9574600905



DB-DL-9275



DB-DL-12300

Length: 733 Ø: 36
Cone Ø: d1 Ø 32 / d2 Ø 29
0014601505, 0014607305, 0034603305,
3754601605, A0014601505, A0034603305,
A3754601605



DB-DL-12364

Length: 200 Ø: 32
Cone Ø: d1 Ø 30 / d2 Ø 27
0003201232, 6283201489, 6293200189,
6323200132, 6323200232, 6323200532,
A6323200132, A6323200532



DB-RK-8555

Ø: 67 Hole Distance: 130
Thick/Height: 24
01335600A, 0003502005, 0003504705



DB-RK-8626

Ø: 75 Hole Distance: 130
Thick/Height: 24
0003502205, 0003502505, 0003503405,
0003504505, GL11319



DB-RK-8638

Length: 100 Ø: 67
Hole Distance: 100
Thick/Height: 20
0003301411



DB-RK-9294

Ø: 85 Hole Distance: 152
Thick/Height: 24
0003503105



DB-RK-10374

Ø: 85 Hole Distance: 152
Thick/Height: 24
0003504405



DB-SB-10406

Ø: 80 Thick/Height: 46
0003238185



DB-VB-3707

Length: 622 Ø: 46
Hole Ø 25 / 25 / 25
Hole Distance: 152 / 130 / 130
01337100A, 9423501005, 9423501505,
9443500005, 9473500105, 9473501005,
A3753500005, A9423501005, A9423501505,
A9443500005, A9473500105, A9473501005



DB-VB-7790

Length: 622 Ø: 46
Hole Ø 25 / 23 / 23
Hole Distance: 152 / 130 / 130
01337000A, 3753500105, 9423500105,
9423500705, 9423501105, 9423501605,
9443500205





ECONIC ...

1824 L, 1824 LL	10/06→	Centre Rod	DB-DL-9269		Push Rod* 207575 *→
	10/06→	Stabiliser Mounting		DB-SB-10406	
	10/06→	Suspension Strut Repair Kit		DB-RK-8555	
	10/06→	Suspension Strut Repair Kit		DB-RK-9294	
	10/06→	Tie Rod	DB-DL-8388		Guide Rod
	10/06→	Tie Rod	DB-DL-8389		
	10/06→	Track Control Arm		DB-VB-3707	Suspension Rod, Wishbone (CV), 1st RA; Air Suspension Axle, * V207575 *→
	10/06→	Track Control Arm		DB-VB-7790	Wishbone (CV)
	10/06→	Track Control Arm	DB-DL-5224		Control Arm, 1st FA; Air Suspension Axle
	10/06→	Track Control Arm	DB-DL-9218	DB-DL-9218	Trailing Arm, 1st FA; Air Suspension Axle
1828 L	10/00→	Centre Rod	DB-DL-9269		Push Rod
	10/00→	Tie Rod	DB-DL-8388		Guide Rod
	10/00→	Tie Rod	DB-DL-8389		
	10/00→	Track Control Arm		DB-VB-3707	Suspension Rod, Wishbone (CV)
	10/00→	Track Control Arm		DB-VB-7790	Wishbone (CV)
	10/00→	Track Control Arm	DB-DL-5224		Control Arm
	10/00→	Track Control Arm	DB-DL-9218	DB-DL-9218	Trailing Arm
1828 L, 1828 LL	03/98→	Centre Rod	DB-DL-5230		Suspension Rod
	03/98→	Centre Rod	DB-DL-5241		Suspension Rod
	03/98→	Centre Rod	DB-DL-8184		Push Rod
	03/98→	Centre Rod	DB-DL-8185		Push Rod
	03/98→	Centre Rod	DB-DL-9269		Push Rod* 207575 *→
	03/98→	Centre Rod	DB-DL-12300		for Steering Rod
	03/98→	Rod Assembly	DB-DL-2178		Guide Rod
	03/98→	Stabiliser Mounting		DB-SB-10406	
	03/98→	Suspension Arm Repair Kit		DB-RK-8626	for Wishbone (CV)
	03/98→	Suspension Arm Repair Kit		DB-RK-8638	for Control Arm
	03/98→	Suspension Arm Repair Kit		DB-RK-10374	for Wishbone (CV)
	03/98→	Suspension Strut Repair Kit		DB-RK-8555	
	03/98→	Suspension Strut Repair Kit		DB-RK-9294	
	03/98→	Tie Rod	DB-DL-8388		Guide Rod
	03/98→	Tie Rod	DB-DL-8389		
	03/98→	Tie Rod End	CV-ES-0543		
	03/98→	Tie Rod End	CV-ES-0888		
	03/98→	Track Control Arm		DB-VB-3707	Suspension Rod, Wishbone (CV), 1st RA; Air Suspension Axle, * V207575 *→
	03/98→	Track Control Arm		DB-VB-7790	Wishbone (CV)
	03/98→	Track Control Arm	DB-DL-5224		Control Arm, 1st FA; Air Suspension Axle
	03/98→	Track Control Arm	DB-DL-9218	DB-DL-9218	Trailing Arm, 1st FA; Air Suspension Axle
	1828 LLS	10/00→	Centre Rod	DB-DL-9269	
10/00→		Stabiliser Mounting		DB-SB-10406	
10/00→		Suspension Strut Repair Kit		DB-RK-8555	
10/00→		Tie Rod	DB-DL-8388		Guide Rod, Air Suspension Axle
10/00→		Tie Rod	DB-DL-8389		
10/00→		Track Control Arm		DB-VB-3707	Suspension Rod, Wishbone (CV), Drive Axle; Air Suspension Axle, →* V207575 *
10/00→		Track Control Arm	DB-DL-5224		Control Arm, Air Suspension Axle
10/00→		Track Control Arm	DB-DL-9218	DB-DL-9218	Trailing Arm, Air Suspension Axle
1828 LS	10/04→	Centre Rod	DB-DL-9269		Push Rod
	10/04→	Tie Rod	DB-DL-8388		Guide Rod
	10/04→	Tie Rod	DB-DL-8389		
	10/04→	Track Control Arm		DB-VB-3707	Suspension Rod, Wishbone (CV)
	10/04→	Track Control Arm	DB-DL-5224		Control Arm
	10/04→	Track Control Arm	DB-DL-9218	DB-DL-9218	Trailing Arm
1829 L, 1829 LL	10/06→	Centre Rod	DB-DL-9269		Push Rod* 207575 *→
	10/06→	Stabiliser Mounting		DB-SB-10406	
	10/06→	Suspension Strut Repair Kit		DB-RK-8555	
	10/06→	Suspension Strut Repair Kit		DB-RK-9294	
	10/06→	Tie Rod	DB-DL-8388		Guide Rod
	10/06→	Tie Rod	DB-DL-8389		
	10/06→	Track Control Arm		DB-VB-3707	Suspension Rod, Wishbone (CV), 1st RA; Air Suspension Axle, * V207575 *→

CV-ES-0543

Length: 125
Cone Ø: d1 Ø 32 / d2 Ø 29
Thread: M30 x 1,5 RHT
0004605748, 0004606048, 0004606848,
0004607048, 0014600448, 0014601148,
0014601748, 0014602448, 0014607648,
0014609648



CV-ES-0888

Length: 125
Cone Ø: d1 Ø 32 / d2 Ø 29
Thread: M30 x 1,5 LHT
0004605848, 0004606148, 0004606948,
0004607148, 0004609048, 0014600548,
0014601348, 0014602548, 0014607948,
0024600448



DB-DL-2178

Length: 1735 Ø: 52
Cone Ø: d1 Ø 32 / d2 Ø 29
9423300003, 9423300103, 9423300203



DB-DL-5224

Length: 850 Ø: 60
Hole Distance: 100 / 100
01336100A, 9413300007



DB-DL-5230

Length: 879 Ø: 42
Cone Ø: d1 Ø 30 / d2 Ø 27
01208600A, 0004607105, 0004607205,
0014606705



DB-DL-5241

Length: 875 Ø: 40
Cone Ø: d1 Ø 30 / d2 Ø 27
01215300A, 0004609205, 0004609305,
0014606905



DB-DL-8184

Length: 1095 Ø: 42
Cone Ø: d1 Ø 32 / d2 Ø 28,8
01217700A, 0014601305, 0014601405,
0024600505, 0034603205, 3754601505,
A0014601305, A0014601405, A0024600505



DB-DL-8185

Length: 711 Ø: 42
Cone Ø: d1 Ø 32 / d2 Ø 28,8
01213600A, 0014601105, 0024600405,
0034603105, A0014601105, A0024600405



DB-DL-8388

Length: 1735 Ø: 62
Cone Ø: d1 Ø 32 / d2 Ø 28,8
01219900A, 9453300003, 9453300103,
9453300403, 9453300603, A9453300003



DB-DL-8389

Length: 1465 Ø: 40
Cone Ø: d1 Ø 32 / d2 Ø 29
9453300203, 9453300303, 9453300503



DB-DL-9218

Length: 754 Ø: 40
Hole Distance: 100
000360098524, 000390098524, 3753300111,
9413300011, A3753300111, SA50831601



DB-DL-9269

Length: 387
Ø: 36
Cone Ø: d1 Ø 32 / d2 Ø 29
9574600405, 9574600905



DB-DL-12300

Length: 733 Ø: 36
Cone Ø: d1 Ø 32 / d2 Ø 29
0014601505, 0014607305, 0034603305,
3754601605, A0014601505, A0034603305,
A3754601605



DB-RK-8555

Ø: 67 Hole Distance: 130
Thick/Height: 24
01335600A, 0003502005, 0003504705



DB-RK-8626

Ø: 75 Hole Distance: 130
Thick/Height: 24
0003502205, 0003502505, 0003503405,
0003504505, GL11319



DB-RK-8638

Length: 100 Ø: 67
Hole Distance: 100
Thick/Height: 20
0003301411



DB-RK-9294

Ø: 85 Hole Distance: 152
Thick/Height: 24
0003503105



DB-RK-10374

Ø: 85 Hole Distance: 152
Thick/Height: 24
0003504405



DB-SB-10406

Ø: 80 Thick/Height: 46
0003238185



DB-VB-3707

Length: 622 Ø: 46
Hole Ø 25 / 25 / 25
Hole Distance: 152 / 130 / 130
01337100A, 9423501005, 9423501505,
9443500005, 9473500105, 9473501005,
A3753500005, A9423501005, A9423501505,
A9443500005, A9473500105, A9473501005



DB-VB-7790

Length: 622 Ø: 46
Hole Ø 25 / 23 / 23
Hole Distance: 152 / 130 / 130
01337000A, 3753500105, 9423500105,
9423500705, 9423501105, 9423501605,
9443500205





ECONIC ...

1829 L, 1829 LL ...	10/06→	Track Control Arm		DB-VB-7790	Wishbone (CV)	
	10/06→	Track Control Arm	DB-DL-5224		Control Arm, 1st FA;Air Suspension Axle	
	10/06→	Track Control Arm	DB-DL-9218	DB-DL-9218	Trailing Arm, 1st FA;Air Suspension Axle	
1829 LS	10/07→	Centre Rod	DB-DL-9269		Push Rod	
	10/07→	Tie Rod	DB-DL-8388		Guide Rod	
	10/07→	Tie Rod	DB-DL-8389			
	10/07→	Track Control Arm		DB-VB-3707	Suspension Rod, Wishbone (CV)	
	10/07→	Track Control Arm	DB-DL-5224		Control Arm	
	10/07→	Track Control Arm	DB-DL-9218	DB-DL-9218	Trailing Arm	
1833 L, 1833 LL	10/06→	Centre Rod	DB-DL-9269		Push Rod* 207575 *→	
	10/06→	Stabiliser Mounting		DB-SB-10406		
	10/06→	Suspension Strut Repair Kit		DB-RK-8555		
	10/06→	Suspension Strut Repair Kit		DB-RK-9294		
	10/06→	Tie Rod	DB-DL-8388		Guide Rod	
	10/06→	Tie Rod	DB-DL-8389			
	10/06→	Track Control Arm		DB-VB-3707	Suspension Rod, Wishbone (CV), 1st RA; Air Suspension Axle, * V207575 *→	
	10/06→	Track Control Arm		DB-VB-7790	Wishbone (CV)	
	10/06→	Track Control Arm	DB-DL-5224		Control Arm, 1st FA;Air Suspension Axle	
	10/06→	Track Control Arm	DB-DL-9218	DB-DL-9218	Trailing Arm, 1st FA;Air Suspension Axle	
	1833 LS	10/07→	Centre Rod	DB-DL-9269		Push Rod
		10/07→	Tie Rod	DB-DL-8388		Guide Rod
10/07→		Tie Rod	DB-DL-8389			
10/07→		Track Control Arm		DB-VB-3707	Suspension Rod, Wishbone (CV)	
10/07→		Track Control Arm	DB-DL-5224		Control Arm	
10/07→		Track Control Arm	DB-DL-9218	DB-DL-9218	Trailing Arm	
2624 L	03/98→	Centre Rod	DB-DL-9269		Push Rod	
	03/98→	Tie Rod	DB-DL-8388		Guide Rod	
	03/98→	Tie Rod	DB-DL-8389			
	03/98→	Track Control Arm		DB-VB-3707	Suspension Rod, Wishbone (CV)	
	03/98→	Track Control Arm		DB-VB-7790	Wishbone (CV)	
	03/98→	Track Control Arm	DB-DL-5224		Control Arm	
2628 L	03/98→	Track Control Arm	DB-DL-9218	DB-DL-9218	Trailing Arm	
	10/00→	Centre Rod	DB-DL-9269		Push Rod	
	10/00→	Tie Rod	DB-DL-8388		Guide Rod	
	10/00→	Tie Rod	DB-DL-8389			
	10/00→	Track Control Arm		DB-VB-3707	Suspension Rod, Wishbone (CV)	
	10/00→	Track Control Arm		DB-VB-7790	Wishbone (CV)	
2628 LL	10/00→	Track Control Arm	DB-DL-5224		Control Arm	
	10/00→	Track Control Arm	DB-DL-9218	DB-DL-9218	Trailing Arm	
	01/98→	Centre Rod	DB-DL-5230		Suspension Rod	
	01/98→	Centre Rod	DB-DL-5241		Suspension Rod	
	01/98→	Centre Rod	DB-DL-7270		Push Rod;Suspension Rod	
	01/98→	Centre Rod	DB-DL-8184		Push Rod	
	01/98→	Centre Rod	DB-DL-8185		Push Rod	
	01/98→	Centre Rod	DB-DL-9269		Push Rod* 207575 *→	
	01/98→	Centre Rod	DB-DL-12300		for Steering Rod	
	01/98→	Stabiliser Mounting		DB-SB-10406		
	01/98→	Suspension Arm Repair Kit		DB-RK-8626	for Wishbone (CV)	
	01/98→	Suspension Arm Repair Kit		DB-RK-8638	for Control Arm	
	01/98→	Suspension Arm Repair Kit		DB-RK-10374	for Wishbone (CV)	
	01/98→	Suspension Strut Repair Kit		DB-RK-8555		
01/98→	Suspension Strut Repair Kit		DB-RK-9294			
01/98→	Tie Rod	DB-DL-8327		Guide Rod		
01/98→	Tie Rod End	CV-ES-0543				
01/98→	Tie Rod End	CV-ES-0888				
01/98→	Track Control Arm		DB-VB-3707	Suspension Rod, Wishbone (CV), 1st RA; Air Suspension Axle, * V207575 *→		
01/98→	Track Control Arm		DB-VB-3707	Suspension Rod, Wishbone (CV), Drive Axle; Air Suspension Axle		
01/98→	Track Control Arm		DB-VB-7790	Wishbone (CV), Leading Axle;Tag Axle; Air Suspension Axle		

CV-ES-0543

Length: 125
Cone Ø: d1 Ø 32 / d2 Ø 29
Thread: M30 x 1,5 RHT
0004605748, 0004606048, 0004606848,
0004607048, 0014600448, 0014601148,
0014601748, 0014602448, 0014607648,
0014609648



CV-ES-0888

Length: 125
Cone Ø: d1 Ø 32 / d2 Ø 29
Thread: M30 x 1,5 LHT
0004605848, 0004606148, 0004606948,
0004607148, 0004609048, 0014600548,
0014601348, 0014602548, 0014607948,
0024600448



DB-DL-5224

Length: 850 Ø: 60
Hole Distance: 100 / 100
01336100A, 9413300007



DB-DL-5230

Length: 879 Ø: 42
Cone Ø: d1 Ø 30 / d2 Ø 27
01208600A, 0004607105, 0004607205,
0014606705



DB-DL-5241

Length: 875 Ø: 40
Cone Ø: d1 Ø 30 / d2 Ø 27
01215300A, 0004609205, 0004609305,
0014606905



DB-DL-7270

Length: 875 Ø: 40
Cone Ø: d1 Ø 28,6 / d2 Ø 23,9
01208300A, 0024604705, 0024604805,
0034604905, A0024604705



DB-DL-8184

Length: 1095 Ø: 42
Cone Ø: d1 Ø 32 / d2 Ø 28,8
01217700A, 0014601305, 0014601405,
0024600505, 0034603205, 3754601505,
A0014601305, A0014601405, A0024600505



DB-DL-8185

Length: 711 Ø: 42
Cone Ø: d1 Ø 32 / d2 Ø 28,8
01213600A, 0014601105, 0024600405,
0034603105, A0014601105, A0024600405



DB-DL-8327

Length: 1745 Ø: 48
Cone Ø: d1 Ø 32 / d2 Ø 29
01219800A, 9413300003, 9413300103,
9413300203, 9413300303, 9413300503



DB-DL-8388

Length: 1735 Ø: 62
Cone Ø: d1 Ø 32 / d2 Ø 28,8
01219900A, 9453300003, 9453300103,
9453300403, 9453300603, A9453300003



DB-DL-8389

Length: 1465 Ø: 40
Cone Ø: d1 Ø 32 / d2 Ø 29
9453300203, 9453300303, 9453300503



DB-DL-9218

Length: 754 Ø: 40
Hole Distance: 100
000360098524, 000390098524, 3753300111,
9413300011, A3753300111, SA50831601



DB-DL-9269

Length: 387
Ø: 36
Cone Ø: d1 Ø 32 / d2 Ø 29
9574600405, 9574600905



DB-DL-12300

Length: 733 Ø: 36
Cone Ø: d1 Ø 32 / d2 Ø 29
0014601505, 0014607305, 0034603305,
3754601605, A0014601505, A0034603305,
A3754601605



DB-RK-8555

Ø: 67 Hole Distance: 130
Thick/Height: 24
01335600A, 0003502005, 0003504705



DB-RK-8626

Ø: 75 Hole Distance: 130
Thick/Height: 24
0003502205, 0003502505, 0003503405,
0003504505, GL11319



DB-RK-8638

Length: 100 Ø: 67
Hole Distance: 100
Thick/Height: 20
0003301411



DB-RK-9294

Ø: 85 Hole Distance: 152
Thick/Height: 24
0003503105



DB-RK-10374

Ø: 85 Hole Distance: 152
Thick/Height: 24
0003504405



DB-SB-10406

Ø: 80 Thick/Height: 46
0003238185



DB-VB-3707

Length: 622 Ø: 46
Hole Ø 25 / 25 / 25
Hole Distance: 152 / 130 / 130
01337100A, 9423501005, 9423501505,
9443500005, 9473500105, 9473501005,
A3753500005, A9423501005, A9423501505,
A9443500005, A9473500105, A9473501005



DB-VB-7790

Length: 622 Ø: 46
Hole Ø 25 / 23 / 23
Hole Distance: 152 / 130 / 130
01337000A, 3753500105, 9423500105,
9423500705, 9423501105, 9423501605,
9443500205





ECONIC ...

2628 LL ...	01/98→	Track Control Arm		DB-VB-7790	Wishbone (CV), Steering Axle; Air Suspension Axle	
	01/98→	Track Control Arm	DB-DL-5224		Control Arm, 1st FA;Air Suspension Axle	
	01/98→	Track Control Arm	DB-DL-5224		Control Arm, Air Suspension Axle	
	01/98→	Track Control Arm	DB-DL-9218	DB-DL-9218	Trailing Arm, 1st FA;Air Suspension Axle	
	01/98→	Track Control Arm	DB-DL-9218	DB-DL-9218	Trailing Arm, Air Suspension Axle	
	03/98→	Rod Assembly	DB-DL-2178		Guide Rod	
	03/98→	Suspension Arm Repair Kit		DB-RK-8550	for Wishbone (CV)	
	03/98→	Tie Rod	DB-DL-8388		Guide Rod	
	03/98→	Tie Rod	DB-DL-8389			
	03/98→	Track Control Arm		DB-VB-7790	Wishbone (CV)	
	03/98→	Track Control Arm	DB-DL-5224	DB-DL-5224	Trailing Arm	
	03/98→	Track Control Arm	DB-DL-9218	DB-DL-9218	Trailing Arm	
	2629 L, 2629 LL	10/01→	Centre Rod	DB-DL-9269		Push Rod* 207575 *→
		10/01→	Stabiliser Mounting		DB-SB-10406	
10/01→		Suspension Strut Repair Kit		DB-RK-8555		
10/01→		Suspension Strut Repair Kit		DB-RK-9294		
10/01→		Tie Rod	DB-DL-8389			
10/01→		Track Control Arm		DB-VB-3707	Suspension Rod, Wishbone (CV), 1st RA; Air Suspension Axle, →* V207575 *	
10/01→		Track Control Arm		DB-VB-3707	Suspension Rod, Wishbone (CV), Drive Axle; Air Suspension Axle	
10/01→		Track Control Arm		DB-VB-7790	Wishbone (CV), 1st RA;2nd RA	
10/01→		Track Control Arm		DB-VB-7790	Wishbone (CV), Steering Axle; Air Suspension Axle	
10/01→		Track Control Arm	DB-DL-5224		Control Arm, 1st FA;Air Suspension Axle	
10/01→		Track Control Arm	DB-DL-5224		Control Arm, Air Suspension Axle	
10/01→		Track Control Arm	DB-DL-9218	DB-DL-9218	Trailing Arm, 1st FA;Air Suspension Axle	
10/01→		Track Control Arm	DB-DL-9218	DB-DL-9218	Trailing Arm, Air Suspension Axle	
2633 L		10/01→	Track Control Arm		DB-VB-3707	Suspension Rod, Wishbone (CV)
	10/01→	Track Control Arm		DB-VB-7790	Wishbone (CV)	
	10/01→	Track Control Arm	DB-DL-5224		Control Arm	
	10/01→	Track Control Arm	DB-DL-9218	DB-DL-9218	Trailing Arm	
	10/01→	Track Control Arm	DB-DL-9218	DB-DL-9218	Trailing Arm	
2633 L, 2633 LL	10/07→	Centre Rod	DB-DL-9269		Push Rod* 207575 *→	
	10/07→	Stabiliser Mounting		DB-SB-10406		
	10/07→	Suspension Strut Repair Kit		DB-RK-8555		
	10/07→	Suspension Strut Repair Kit		DB-RK-9294		
	10/07→	Tie Rod	DB-DL-8389			
	10/07→	Track Control Arm		DB-VB-3707	Suspension Rod, Wishbone (CV), 1st RA; Air Suspension Axle, →* V207575 *	
	10/07→	Track Control Arm		DB-VB-7790	Wishbone (CV), 1st RA;2nd RA	
	10/07→	Track Control Arm	DB-DL-5224		Control Arm, 1st FA;Air Suspension Axle	
	10/07→	Track Control Arm	DB-DL-9218	DB-DL-9218	Trailing Arm, 1st FA;Air Suspension Axle	
	10/07→	Track Control Arm	DB-DL-9218	DB-DL-9218	Trailing Arm, 1st FA;Air Suspension Axle	
2633 LL	10/07→	Stabiliser Mounting		DB-SB-10406		
	10/07→	Suspension Strut Repair Kit		DB-RK-8555		
	10/07→	Suspension Strut Repair Kit		DB-RK-9294		
	10/07→	Track Control Arm		DB-VB-3707	Suspension Rod, Wishbone (CV), Drive Axle; Air Suspension Axle	
	10/07→	Track Control Arm		DB-VB-7790	Wishbone (CV), Steering Axle; Air Suspension Axle	
	10/07→	Track Control Arm	DB-DL-5224		Control Arm, Air Suspension Axle	
	10/07→	Track Control Arm	DB-DL-9218	DB-DL-9218	Trailing Arm, Air Suspension Axle	
	10/07→	Track Control Arm	DB-DL-9218	DB-DL-9218	Trailing Arm, Air Suspension Axle	
3233 L, 3233 LL	10/07→	Centre Rod	DB-DL-9269		Push Rod* 207575 *→	
	10/07→	Tie Rod	DB-DL-8388		Guide Rod, Air Suspension Axle	
	10/07→	Tie Rod	DB-DL-8389			
	10/07→	Track Control Arm		DB-VB-3707	Suspension Rod, Wishbone (CV), 1st RA;2nd RA, →* V207575 *	
	10/07→	Track Control Arm		DB-VB-7790	Wishbone (CV), Leading Axle; Air Suspension Axle	
	10/07→	Track Control Arm	DB-DL-5224		Control Arm, Air Suspension Axle	
	10/07→	Track Control Arm	DB-DL-9218	DB-DL-9218	Trailing Arm, Air Suspension Axle	

DB-DL-2178

Length: 1735 Ø: 52
Cone Ø: d1 Ø 32 / d2 Ø 29
9423300003, 9423300103, 9423300203



DB-RK-9294

Ø: 85 Hole Distance: 152
Thick/Height: 24
0003503105



DB-DL-5224

Length: 850 Ø: 60
Hole Distance: 100 / 100
01336100A, 9413300007



DB-SB-10406

Ø: 80 Thick/Height: 46
0003238185



DB-DL-8388

Length: 1735 Ø: 62
Cone Ø: d1 Ø 32 / d2 Ø 28,8
01219900A, 9453300003, 9453300103,
9453300403, 9453300603, A9453300003



DB-VB-3707

Length: 622 Ø: 46
Hole Ø 25 / 25 / 25
Hole Distance: 152 / 130 / 130
01337100A, 9423501005, 9423501505,
9443500005, 9473500105, 9473501005,
A3753500005, A9423501005, A9423501505,
A9443500005, A9473500105, A9473501005



DB-DL-8389

Length: 1465 Ø: 40
Cone Ø: d1 Ø 32 / d2 Ø 29
9453300203, 9453300303, 9453300503



DB-VB-7790

Length: 622 Ø: 46
Hole Ø 25 / 23 / 23
Hole Distance: 152 / 130 / 130
01337000A, 3753500105, 9423500105,
9423500705, 9423501105, 9423501605,
9443500205



DB-DL-9218

Length: 754 Ø: 40
Hole Distance: 100
000360098524, 000390098524, 3753300111,
9413300011, A3753300111, SA50831601



DB-DL-9269

Length: 387
Ø: 36
Cone Ø: d1 Ø 32 / d2 Ø 29
9574600405, 9574600905



DB-RK-8550

Ø: 75 Hole Distance: 152
Thick/Height: 24
0003502105, 0003504605



DB-RK-8555

Ø: 67 Hole Distance: 130
Thick/Height: 24
01335600A, 0003502005, 0003504705





INTEGRO (O 550)

Integro L	01/06→	Stabiliser Link		DB-DL-12364	Coupling Rod
	01/06→	Stabiliser Link	DB-DL-12363		Coupling Rod
	01/06→	Tie Rod End		MN-ES-8490	
	01/06→	Tie Rod End		MN-ES-8490	for vehicles with Hinged Trailing Axle
	01/06→	Track Control Arm		DB-DL-7788	Trailing Arm
	01/06→	Track Control Arm		DB-DL-7788	Trailing Arm, Tag Axle
	01/06→	Track Control Arm		DB-DL-8393	for Steering Rod, Trailing Arm
	01/06→	Track Control Arm		DB-TC-12376	Control Arm
Integro, Integro M	01/06→	Stabiliser Link		DB-DL-12364	Coupling Rod
	01/06→	Stabiliser Link	DB-DL-12363		Coupling Rod
	01/06→	Tie Rod End		MN-ES-8490	for vehicles with Hinged Trailing Axle
	01/06→	Track Control Arm		DB-DL-7788	Trailing Arm, Tag Axle
	01/06→	Track Control Arm		DB-TC-12376	Control Arm

INTOURO

Intouro, Intouro E, Intouro M, Intouro ME	01/05→	Stabiliser Link		DB-DL-12364	Coupling Rod
	01/05→	Stabiliser Link	DB-DL-12363		Coupling Rod
	01/05→	Track Control Arm		DB-TC-12376	Control Arm

LK/LN2

1114 A	02/87→12/98	Centre Rod	DB-DL-7832		Push Rod
	02/87→12/98	Stabiliser Mounting		DB-SB-10386	
	02/87→12/98	Stabiliser Mounting	DB-SB-10386	DB-SB-10386	
	02/87→12/98	Stabiliser Mounting	DB-SB-10386	DB-SB-10386	1st FA
	02/87→12/98	Tie Rod End	CV-ES-12461		for Steering Rod
	02/87→12/98	Tie Rod End	CV-ES-12462		for Steering Rod
1114 AK	02/87→12/98	Centre Rod	DB-DL-7832		Push Rod
	02/87→12/98	Centre Rod	DB-DL-10207		Push Rod* 5 426 402 *→
	02/87→12/98	Stabiliser Mounting		DB-SB-10385	
	02/87→12/98	Stabiliser Mounting		DB-SB-10385	→* 5 332 725 *
	02/87→12/98	Stabiliser Mounting		DB-SB-10385	1st RA
	02/87→12/98	Stabiliser Mounting		DB-SB-10386	
	02/87→12/98	Stabiliser Mounting	DB-SB-5272		
	02/87→12/98	Stabiliser Mounting	DB-SB-10386	DB-SB-10386	
	02/87→12/98	Stabiliser Mounting	DB-SB-10386	DB-SB-10386	1st FA
	02/87→12/98	Tie Rod End	CV-ES-12461		for Steering Rod
1114 K	03/84→12/98	Centre Rod	DB-DL-5215		Push Rod
	03/84→12/98	Centre Rod	DB-DL-5219		Push Rod
	03/84→12/98	Centre Rod	DB-DL-7832		Push Rod
	03/84→12/98	Stabiliser Mounting		DB-SB-10385	
	03/84→12/98	Stabiliser Mounting		DB-SB-10385	→* 5 260 362 *
	03/84→12/98	Stabiliser Mounting		DB-SB-10385	→* 5 332 725 *
	03/84→12/98	Stabiliser Mounting		DB-SB-10385	1st RA
	03/84→12/98	Stabiliser Mounting	DB-SB-5274		
	03/84→12/98	Stabiliser Mounting	DB-SB-10385	DB-SB-10385	1st FA
	03/84→12/98	Stabiliser Mounting	DB-SB-10386	DB-SB-10386	
	03/84→12/98	Stabiliser Mounting	DB-SB-10386	DB-SB-10386	* 5 260 363 *→
	03/84→12/98	Stabiliser Mounting	DB-SB-10386	DB-SB-10386	1st FA
	03/84→12/98	Tie Rod End	CV-ES-12461		for Steering Rod
	03/84→12/98	Tie Rod End	CV-ES-12462		for Steering Rod
1114 S	03/84→12/98	Centre Rod	DB-DL-5219		Push Rod
	03/84→12/98	Stabiliser Mounting		DB-SB-10385	
	03/84→12/98	Stabiliser Mounting		DB-SB-10385	→* 5 332 725 *
	03/84→12/98	Stabiliser Mounting		DB-SB-10385	1st RA
	03/84→12/98	Stabiliser Mounting	DB-SB-5274		
	03/84→12/98	Stabiliser Mounting	DB-SB-10385	DB-SB-10385	1st FA
	03/84→12/98	Stabiliser Mounting	DB-SB-10386	DB-SB-10386	
	03/84→12/98	Stabiliser Mounting	DB-SB-10386	DB-SB-10386	1st FA
1114,1114 L	01/84→12/98	Centre Rod	DB-DL-5215		Push Rod
	01/84→12/98	Centre Rod	DB-DL-5215		Push Rod→* 5 424 630 *
	01/84→12/98	Centre Rod	DB-DL-5219		Push Rod
	01/84→12/98	Centre Rod	DB-DL-7832		Push Rod* 5 424 631 *→

CV-ES-12461

Length: 120
 Cone Ø: d1 Ø 26 / d2 Ø 23,5
 Thread: M30 x 1,5 LHT
 0003300035, 3300148, 0003406213, 0013306635,
 0013308835, 0014604048, 0014604348,
 14606448, 0024600248, 3023300035,
 3023300135, 3023300235, 3023300335,
 3453307235, 3453307435, 3503307135,
 A0003300148, A0013306635, A0013308835,
 A0014604048, A0014604348, A0014606448,
 A0024600248, A3023300035, A3023300135,
 A3023300235, A3023300335, A3503307135



CV-ES-12462

Length: 120
 Cone Ø: d1 Ø 26 / d2 Ø 23,5
 Thread: M30 x 1,5 RHT
 0003300135, 0003300248, 0003303235,
 0003305835, 0003307335, 0003383410,
 0004608348, 004608348, 0004632229,
 0004633129, 0004633429, 0004633529,
 0013300135, 0013300235, 0013306735,
 0014603448, 0014604148, 0014604448,
 0014606348, 0014608348, 0014608448,
 0014609748, 0023301535, 3453307135,
 3503307035, 3503307335, 3643307135,
 5001832582, A0003300248, A0003303235,
 A0003307335, A0003383410, A0004608348,
 A0004632229, A0004633429, A0013300135,
 A0013300235, A0013306735, A0014603448,
 A0014604148, A0014604448, A0014606348,
 A0014608348, A0014608448, A0014609748,
 A0023301535



DB-DL-5215

Length: 780
 Ø: 40
 Cone Ø: d1 Ø 26 / d2 Ø 23,5
 6764600105, 6764600605, 6764601105,
 6764601505



DB-DL-5219

Length: 785
 Ø: 40
 Cone Ø: d1 Ø 26 / d2 Ø 22
 01212200A, 6754601005, 6754601605,
 6754602205, 6754602805



DB-DL-7788

Length: 664
 Ø: 48
 Hole Distance: 130 / 130
 6283330003



DB-DL-7832

Length: 783
 Ø: 42
 Cone Ø: d1 Ø 26 / d2 Ø 23,5
 6764601905, 6764602105



DB-DL-8393

Length: 576
 Ø: 48
 Hole Distance: 130 / 130
 6273500206, 6273500306, 6283330905,
 6283331705, 6443500306, A6273500206,
 A6273500306, A6283330905, A6283331705,
 A6443500306



DB-DL-10207

Length: 780
 Ø: 40
 Cone Ø: d1 Ø 26 / d2 Ø 23,5
 6744600405



DB-DL-12363

Length: 148
 Ø: 31
 Cone Ø: d1 Ø 30 / d2 Ø 27
 0003200132, 3200132, 3200532, 0003200532,
 0003200832, 3200832, 0003201132, 3201132,
 6323200332



DB-DL-12364

Length: 200 Ø: 32
 Cone Ø: d1 Ø 30 / d2 Ø 27
 0003201232, 6283201489, 6293200189,
 6323200132, 6323200232, 6323200532,
 A6323200132, A6323200532



DB-SB-5272

Thick/Height: 57
 01331400A, 6753231785



DB-SB-5274

Ø: 64
 Thick/Height: 60
 01307500A, 6753231885



DB-SB-10385

Ø: 30 Thick/Height: 30
 3093200073, 3143260153



DB-SB-10386

Ø: 38 Thick/Height: 38
 3183200073



DB-TC-12376

Length: 628
 Ø: 46
 Hole Distance: 130 / 130
 4103500906, 6293500106, 6293501206,
 6293502806, 6323500006



MN-ES-8490





LK/LN2 ...

1114,1114 L ...	01/84 →12/98	Stabiliser Mounting		DB-SB-10385		
	01/84 →12/98	Stabiliser Mounting		DB-SB-10385	→* 5 296 594 *	
	01/84 →12/98	Stabiliser Mounting		DB-SB-10385	→* 5 332 725 *	
	01/84 →12/98	Stabiliser Mounting		DB-SB-10385	1st RA	
	01/84 →12/98	Stabiliser Mounting		DB-SB-10386		
	01/84 →12/98	Stabiliser Mounting		DB-SB-10386	* 5 296 595 * →	
	01/84 →12/98	Stabiliser Mounting	DB-SB-5274			
	01/84 →12/98	Stabiliser Mounting	DB-SB-10385	DB-SB-10385		
	01/84 →12/98	Stabiliser Mounting	DB-SB-10385	DB-SB-10385	1st FA	
	01/84 →12/98	Stabiliser Mounting	DB-SB-10386	DB-SB-10386		
	01/84 →12/98	Stabiliser Mounting	DB-SB-10386	DB-SB-10386	1st FA	
	01/84 →12/98	Tie Rod End	CV-ES-12461		for Steering Rod	
	01/84 →12/98	Tie Rod End	CV-ES-12462		for Steering Rod	
	1117 A	06/87 →12/98	Centre Rod	DB-DL-7832		Push Rod
06/87 →12/98		Centre Rod	DB-DL-10207		Push Rod	
06/87 →12/98		Centre Rod	DB-DL-10207		Push Rod* 5 426 402 * →	
06/87 →12/98		Stabiliser Mounting		DB-SB-10385		
06/87 →12/98		Stabiliser Mounting		DB-SB-10385	→* 5 332 725 *	
06/87 →12/98		Stabiliser Mounting		DB-SB-10385	1st RA	
06/87 →12/98		Stabiliser Mounting		DB-SB-10386		
06/87 →12/98		Stabiliser Mounting	DB-SB-5272			
06/87 →12/98		Stabiliser Mounting	DB-SB-10386	DB-SB-10386		
06/87 →12/98		Stabiliser Mounting	DB-SB-10386	DB-SB-10386	1st FA	
06/87 →12/98		Tie Rod End	CV-ES-12461		for Steering Rod	
06/87 →12/98		Tie Rod End	CV-ES-12462		for Steering Rod	
1117 AK		04/84 →12/98	Centre Rod	DB-DL-10207		Push Rod
		04/84 →12/98	Stabiliser Mounting		DB-SB-10386	
	04/84 →12/98	Stabiliser Mounting	DB-SB-10386	DB-SB-10386		
	04/84 →12/98	Stabiliser Mounting	DB-SB-10386	DB-SB-10386	1st FA	
1117 K	04/84 →12/98	Centre Rod	DB-DL-5215		Push Rod	
	04/84 →12/98	Centre Rod	DB-DL-5219		Push Rod	
	04/84 →12/98	Centre Rod	DB-DL-7832		Push Rod	
	04/84 →12/98	Stabiliser Mounting		DB-SB-10386		
	04/84 →12/98	Stabiliser Mounting	DB-SB-10386	DB-SB-10386		
	04/84 →12/98	Stabiliser Mounting	DB-SB-10386	DB-SB-10386	1st FA	
	04/84 →12/98	Tie Rod End	CV-ES-12461		for Steering Rod	
	04/84 →12/98	Tie Rod End	CV-ES-12462		for Steering Rod	
1117 LO	03/96 →12/98	Centre Rod	DB-DL-5215		Push Rod	
	03/96 →12/98	Centre Rod	DB-DL-5219		Push Rod	
	03/96 →12/98	Stabiliser Mounting		DB-SB-10386		
	03/96 →12/98	Stabiliser Mounting	DB-SB-10385	DB-SB-10385		
	03/96 →12/98	Stabiliser Mounting	DB-SB-10386	DB-SB-10386		
	03/96 →12/98	Stabiliser Mounting	DB-SB-10386	DB-SB-10386	1st FA	
	03/96 →12/98	Tie Rod End	CV-ES-12461		for Steering Rod	
1117 O,1117 LO	01/84 →12/98	Centre Rod	DB-DL-5215		Push Rod	
	01/84 →12/98	Centre Rod	DB-DL-5219		Push Rod	
	01/84 →12/98	Stabiliser Mounting		DB-SB-10385		
	01/84 →12/98	Stabiliser Mounting		DB-SB-10385	→* 5 296 594 *	
	01/84 →12/98	Stabiliser Mounting		DB-SB-10385	→* 5 332 725 *	
	01/84 →12/98	Stabiliser Mounting		DB-SB-10385	1st RA	
	01/84 →12/98	Stabiliser Mounting		DB-SB-10386		
	01/84 →12/98	Stabiliser Mounting		DB-SB-10386	* 5 296 595 * →	
	01/84 →12/98	Stabiliser Mounting	DB-SB-5274			
	01/84 →12/98	Stabiliser Mounting	DB-SB-10385	DB-SB-10385	1st FA	
	01/84 →12/98	Stabiliser Mounting	DB-SB-10386	DB-SB-10386		
	01/84 →12/98	Stabiliser Mounting	DB-SB-10386	DB-SB-10386	1st FA	
	01/84 →12/98	Stabiliser Mounting	DB-SB-10386	DB-SB-10386	1st FA	
	01/84 →12/98	Tie Rod End	CV-ES-12461		for Steering Rod	
	1117 S	03/96 →12/98	Centre Rod	DB-DL-5215		Push Rod
		03/96 →12/98	Centre Rod	DB-DL-5219		Push Rod
03/96 →12/98		Stabiliser Mounting		DB-SB-10385		
03/96 →12/98		Stabiliser Mounting		DB-SB-10386		
03/96 →12/98		Stabiliser Mounting	DB-SB-5274			
03/96 →12/98		Stabiliser Mounting	DB-SB-10385	DB-SB-10385		

CV-ES-12461

Length: 120

Cone Ø: d1 Ø 26 / d2 Ø 23,5

Thread: M30 x 1,5 LHT

0003300035, 3300148, 0003406213, 0013306635,
0013308835, 0014604048, 0014604348,
14606448, 0024600248, 3023300035,
3023300135, 3023300235, 3023300335,
3453307235, 3453307435, 3503307135,
A0003300148, A0013306635, A0013308835,
A0014604048, A0014604348, A0014606448,
A0024600248, A3023300035, A3023300135,
A3023300235, A3023300335, A3503307135



CV-ES-12462

Length: 120

Cone Ø: d1 Ø 26 / d2 Ø 23,5

Thread: M30 x 1,5 RHT

0003300135, 0003300248, 0003303235,
0003305835, 0003307335, 0003383410,
0004608348, 004608348, 0004632229,
0004633129, 0004633429, 0004633529,
0013300135, 0013300235, 0013306735,
0014603448, 0014604148, 0014604448,
0014606348, 0014608348, 0014608448,
0014609748, 0023301535, 3453307135,
3503307035, 3503307335, 3643307135,
5001832582, A0003300248, A0003303235,
A0003307335, A0003383410, A0004608348,
A0004632229, A0004633429, A0013300135,
A0013300235, A0013306735, A0014603448,
A0014604148, A0014604448, A0014606348,
A0014608348, A0014608448, A0014609748,
A0023301535



DB-DL-5215

Length: 780

Ø: 40

Cone Ø: d1 Ø 26 / d2 Ø 23,5

6764600105, 6764600605, 6764601105,
6764601505



DB-DL-5219

Length: 785

Ø: 40

Cone Ø: d1 Ø 26 / d2 Ø 22

01212200A, 6754601005, 6754601605,
6754602205, 6754602805



DB-DL-7832

Length: 783

Ø: 42

Cone Ø: d1 Ø 26 / d2 Ø 23,5

6764601905, 6764602105



DB-DL-10207

Length: 780

Ø: 40

Cone Ø: d1 Ø 26 / d2 Ø 23,5

6744600405



DB-SB-5272

Thick/Height: 57

01331400A, 6753231785



DB-SB-5274

Ø: 64

Thick/Height: 60

01307500A, 6753231885



DB-SB-10385

Ø: 30 Thick/Height: 30

3093200073, 3143260153



DB-SB-10386

Ø: 38 Thick/Height: 38

3183200073





LK/LN2 ...

1117 S ...	03/96→12/98	Stabiliser Mounting	DB-SB-10385	DB-SB-10385	1st FA	
	03/96→12/98	Stabiliser Mounting	DB-SB-10386	DB-SB-10386		
	03/96→12/98	Stabiliser Mounting	DB-SB-10386	DB-SB-10386	1st FA	
	03/96→12/98	Tie Rod End	CV-ES-12461		for Steering Rod	
	03/96→12/98	Tie Rod End	CV-ES-12462		for Steering Rod	
1117 S,1117 LS	01/84→12/98	Centre Rod	DB-DL-5219		Push Rod	
	01/84→12/98	Stabiliser Mounting		DB-SB-10385		
	01/84→12/98	Stabiliser Mounting		DB-SB-10385	→* 5 296 594 *	
	01/84→12/98	Stabiliser Mounting		DB-SB-10385	→* 5 332 725 *	
	01/84→12/98	Stabiliser Mounting		DB-SB-10385	1st RA	
	01/84→12/98	Stabiliser Mounting		DB-SB-10386		
	01/84→12/98	Stabiliser Mounting		DB-SB-10386	* 5 296 595 *→	
	01/84→12/98	Stabiliser Mounting	DB-SB-5274			
	01/84→12/98	Stabiliser Mounting	DB-SB-10385	DB-SB-10385		
	01/84→12/98	Stabiliser Mounting	DB-SB-10385	DB-SB-10385	1st FA	
	01/84→12/98	Stabiliser Mounting	DB-SB-10386	DB-SB-10386		
	01/84→12/98	Stabiliser Mounting	DB-SB-10386	DB-SB-10386	1st FA	
	01/84→12/98	Tie Rod End	CV-ES-12461		for Steering Rod	
	1117,1117 L	01/84→12/98	Centre Rod	DB-DL-5215		Push Rod
01/84→12/98		Centre Rod	DB-DL-5215		Push Rod→* 5 424 630 *	
01/84→12/98		Centre Rod	DB-DL-5219		Push Rod	
01/84→12/98		Centre Rod	DB-DL-7832		Push Rod* 5 424 631 *→	
01/84→12/98		Stabiliser Mounting		DB-SB-10385		
01/84→12/98		Stabiliser Mounting		DB-SB-10385	→* 5 296 594 *	
01/84→12/98		Stabiliser Mounting		DB-SB-10385	→* 5 332 725 *	
01/84→12/98		Stabiliser Mounting		DB-SB-10385	1st RA	
01/84→12/98		Stabiliser Mounting		DB-SB-10386		
01/84→12/98		Stabiliser Mounting		DB-SB-10386	* 5 296 595 *→	
01/84→12/98		Stabiliser Mounting	DB-SB-5274			
01/84→12/98		Stabiliser Mounting	DB-SB-10385	DB-SB-10385		
01/84→12/98		Stabiliser Mounting	DB-SB-10385	DB-SB-10385	1st FA	
01/84→12/98		Stabiliser Mounting	DB-SB-10386	DB-SB-10386		
01/84→12/98		Stabiliser Mounting	DB-SB-10386	DB-SB-10386	1st FA	
01/84→12/98		Tie Rod End	CV-ES-12461		for Steering Rod	
01/84→12/98		Tie Rod End	CV-ES-12462		for Steering Rod	
1120 AF		02/87→12/98	Centre Rod	DB-DL-7832		Push Rod
		02/87→12/98	Centre Rod	DB-DL-10207		Push Rod* 5 426 402 *→
		02/87→12/98	Stabiliser Mounting		DB-SB-10385	
	02/87→12/98	Stabiliser Mounting		DB-SB-10385	→* 5 332 725 *	
	02/87→12/98	Stabiliser Mounting		DB-SB-10385	1st RA	
	02/87→12/98	Stabiliser Mounting	DB-SB-10386	DB-SB-10386		
	02/87→12/98	Stabiliser Mounting	DB-SB-10386	DB-SB-10386	1st FA	
	02/87→12/98	Tie Rod End	CV-ES-12461		for Steering Rod	
	02/87→12/98	Tie Rod End	CV-ES-12462		for Steering Rod	
	1120 F	02/90→12/98	Centre Rod	DB-DL-5215		Push Rod* 5 426 402 *→
02/90→12/98		Centre Rod	DB-DL-5219		Push Rod	
02/90→12/98		Centre Rod	DB-DL-5219		Push Rod→* 5 426 401 *	
02/90→12/98		Stabiliser Mounting		DB-SB-10385		
02/90→12/98		Stabiliser Mounting		DB-SB-10385	→* 5 332 725 *	
02/90→12/98		Stabiliser Mounting		DB-SB-10385	→* 5 400 707 *	
02/90→12/98		Stabiliser Mounting		DB-SB-10385	1st RA	
02/90→12/98		Stabiliser Mounting		DB-SB-10386		
02/90→12/98		Stabiliser Mounting		DB-SB-10386	* 5 400 708 *→	
02/90→12/98		Stabiliser Mounting	DB-SB-5274			
02/90→12/98		Stabiliser Mounting	DB-SB-10385	DB-SB-10385		
02/90→12/98		Stabiliser Mounting	DB-SB-10385	DB-SB-10385	1st FA	
02/90→12/98		Stabiliser Mounting	DB-SB-10386	DB-SB-10386		
02/90→12/98		Stabiliser Mounting	DB-SB-10386	DB-SB-10386	1st FA	
02/90→12/98		Tie Rod End	CV-ES-12461		for Steering Rod	
02/90→12/98		Tie Rod End	CV-ES-12462		for Steering Rod	

CV-ES-12461

Length: 120

Cone Ø: d1 Ø 26 / d2 Ø 23,5

Thread: M30 x 1,5 LHT

0003300035, 3300148, 0003406213, 0013306635,
0013308835, 0014604048, 0014604348,
14606448, 0024600248, 3023300035,
3023300135, 3023300235, 3023300335,
3453307235, 3453307435, 3503307135,
A0003300148, A0013306635, A0013308835,
A0014604048, A0014604348, A0014606448,
A0024600248, A3023300035, A3023300135,
A3023300235, A3023300335, A3503307135



CV-ES-12462

Length: 120

Cone Ø: d1 Ø 26 / d2 Ø 23,5

Thread: M30 x 1,5 RHT

0003300135, 0003300248, 0003303235,
0003305835, 0003307335, 0003383410,
0004608348, 004608348, 0004632229,
0004633129, 0004633429, 0004633529,
0013300135, 0013300235, 0013306735,
0014603448, 0014604148, 0014604448,
0014606348, 0014608348, 0014608448,
0014609748, 0023301535, 3453307135,
3503307035, 3503307335, 3643307135,
5001832582, A0003300248, A0003303235,
A0003307335, A0003383410, A0004608348,
A0004632229, A0004633429, A0013300135,
A0013300235, A0013306735, A0014603448,
A0014604148, A0014604448, A0014606348,
A0014608348, A0014608448, A0014609748,
A0023301535



DB-DL-5215

Length: 780

Ø: 40

Cone Ø: d1 Ø 26 / d2 Ø 23,5

6764600105, 6764600605, 6764601105,
6764601505



DB-DL-5219

Length: 785

Ø: 40

Cone Ø: d1 Ø 26 / d2 Ø 22

01212200A, 6754601005, 6754601605,
6754602205, 6754602805



DB-DL-7832

Length: 783

Ø: 42

Cone Ø: d1 Ø 26 / d2 Ø 23,5

6764601905, 6764602105



DB-DL-10207

Length: 780

Ø: 40

Cone Ø: d1 Ø 26 / d2 Ø 23,5

6744600405



DB-SB-5274

Ø: 64

Thick/Height: 60

01307500A, 6753231885



DB-SB-10385

Ø: 30 Thick/Height: 30

3093200073, 3143260153



DB-SB-10386

Ø: 38 Thick/Height: 38

3183200073





LK/LN2 ...

1120 L	08/84 → 12/98	Centre Rod	DB-DL-5215		Push Rod
	08/84 → 12/98	Centre Rod	DB-DL-5219		Push Rod
	08/84 → 12/98	Stabiliser Mounting		DB-SB-10385	
	08/84 → 12/98	Stabiliser Mounting		DB-SB-10385	→* 5 296 594 *
	08/84 → 12/98	Stabiliser Mounting		DB-SB-10385	→* 5 332 725 *
	08/84 → 12/98	Stabiliser Mounting		DB-SB-10385	1st RA
	08/84 → 12/98	Stabiliser Mounting	DB-SB-5274		
	08/84 → 12/98	Stabiliser Mounting	DB-SB-10385	DB-SB-10385	1st FA
	08/84 → 12/98	Stabiliser Mounting	DB-SB-10386	DB-SB-10386	
	08/84 → 12/98	Stabiliser Mounting	DB-SB-10386	DB-SB-10386	* 5 296 595 * →
	08/84 → 12/98	Stabiliser Mounting	DB-SB-10386	DB-SB-10386	1st FA
	08/84 → 12/98	Tie Rod End	CV-ES-12461		for Steering Rod
	08/84 → 12/98	Tie Rod End	CV-ES-12462		for Steering Rod
	1120 O,1120 LO	01/84 → 12/98	Centre Rod	DB-DL-5215	
01/84 → 12/98		Centre Rod	DB-DL-5219		Push Rod
01/84 → 12/98		Stabiliser Mounting		DB-SB-10385	
01/84 → 12/98		Stabiliser Mounting		DB-SB-10385	→* 5 296 594 *
01/84 → 12/98		Stabiliser Mounting		DB-SB-10385	→* 5 332 725 *
01/84 → 12/98		Stabiliser Mounting		DB-SB-10385	1st RA
01/84 → 12/98		Stabiliser Mounting		DB-SB-10386	
01/84 → 12/98		Stabiliser Mounting		DB-SB-10386	* 5 296 595 * →
01/84 → 12/98		Stabiliser Mounting	DB-SB-5274		
01/84 → 12/98		Stabiliser Mounting	DB-SB-10385	DB-SB-10385	
01/84 → 12/98		Stabiliser Mounting	DB-SB-10385	DB-SB-10385	1st FA
01/84 → 12/98		Stabiliser Mounting	DB-SB-10386	DB-SB-10386	
01/84 → 12/98		Stabiliser Mounting	DB-SB-10386	DB-SB-10386	1st FA
01/84 → 12/98		Tie Rod End	CV-ES-12461		for Steering Rod
01/84 → 12/98	Tie Rod End	CV-ES-12462		for Steering Rod	
1120 S,1120 LS	01/84 → 12/98	Centre Rod	DB-DL-5219		Push Rod
	01/84 → 12/98	Stabiliser Mounting		DB-SB-10385	
	01/84 → 12/98	Stabiliser Mounting		DB-SB-10385	→* 5 296 594 *
	01/84 → 12/98	Stabiliser Mounting		DB-SB-10385	→* 5 332 725 *
	01/84 → 12/98	Stabiliser Mounting		DB-SB-10385	1st RA
	01/84 → 12/98	Stabiliser Mounting		DB-SB-10386	
	01/84 → 12/98	Stabiliser Mounting		DB-SB-10386	* 5 296 595 * →
	01/84 → 12/98	Stabiliser Mounting	DB-SB-5274		
	01/84 → 12/98	Stabiliser Mounting	DB-SB-10385	DB-SB-10385	
	01/84 → 12/98	Stabiliser Mounting	DB-SB-10385	DB-SB-10385	1st FA
	01/84 → 12/98	Stabiliser Mounting	DB-SB-10386	DB-SB-10386	
	01/84 → 12/98	Stabiliser Mounting	DB-SB-10386	DB-SB-10386	1st FA
	01/84 → 12/98	Tie Rod End	CV-ES-12461		for Steering Rod
	01/84 → 12/98	Tie Rod End	CV-ES-12462		for Steering Rod
1120,1120 L	01/84 → 12/98	Centre Rod	DB-DL-5215		Push Rod
	01/84 → 12/98	Centre Rod	DB-DL-5219		Push Rod
	01/84 → 12/98	Stabiliser Mounting		DB-SB-10385	
	01/84 → 12/98	Stabiliser Mounting		DB-SB-10385	→* 5 296 594 *
	01/84 → 12/98	Stabiliser Mounting		DB-SB-10385	→* 5 332 725 *
	01/84 → 12/98	Stabiliser Mounting		DB-SB-10385	1st RA
	01/84 → 12/98	Stabiliser Mounting		DB-SB-10386	
	01/84 → 12/98	Stabiliser Mounting		DB-SB-10386	* 5 296 595 * →
	01/84 → 12/98	Stabiliser Mounting	DB-SB-5274		
	01/84 → 12/98	Stabiliser Mounting	DB-SB-10385	DB-SB-10385	
	01/84 → 12/98	Stabiliser Mounting	DB-SB-10385	DB-SB-10385	1st FA
	01/84 → 12/98	Stabiliser Mounting	DB-SB-10386	DB-SB-10386	
	01/84 → 12/98	Stabiliser Mounting	DB-SB-10386	DB-SB-10386	1st FA
	01/84 → 12/98	Tie Rod End	CV-ES-12461		for Steering Rod
01/84 → 12/98	Tie Rod End	CV-ES-12462		for Steering Rod	
1124 AF	03/92 → 12/98	Centre Rod	DB-DL-7832		Push Rod
	03/92 → 12/98	Centre Rod	DB-DL-10207		Push Rod
	03/92 → 12/98	Centre Rod	DB-DL-10207		Push Rod* 5 426 402 * →
	03/92 → 12/98	Stabiliser Mounting		DB-SB-10385	
	03/92 → 12/98	Stabiliser Mounting		DB-SB-10385	→* 5 332 725 *
	03/92 → 12/98	Stabiliser Mounting		DB-SB-10385	1st RA

CV-ES-12461

Length: 120

Cone Ø: d1 Ø 26 / d2 Ø 23,5

Thread: M30 x 1,5 LHT

0003300035, 3300148, 0003406213, 0013306635,
0013308835, 0014604048, 0014604348,
14606448, 0024600248, 3023300035,
3023300135, 3023300235, 3023300335,
3453307235, 3453307435, 3503307135,
A0003300148, A0013306635, A0013308835,
A0014604048, A0014604348, A0014606448,
A0024600248, A3023300035, A3023300135,
A3023300235, A3023300335, A3503307135



DB-SB-5274

Ø: 64

Thick/Height: 60

01307500A, 6753231885



DB-SB-10385

Ø: 30 Thick/Height: 30

3093200073, 3143260153



CV-ES-12462

Length: 120

Cone Ø: d1 Ø 26 / d2 Ø 23,5

Thread: M30 x 1,5 RHT

0003300135, 0003300248, 0003303235,
0003305835, 0003307335, 0003383410,
0004608348, 004608348, 0004632229,
0004633129, 0004633429, 0004633529,
0013300135, 0013300235, 0013306735,
0014603448, 0014604148, 0014604448,
0014606348, 0014608348, 0014608448,
0014609748, 0023301535, 3453307135,
3503307035, 3503307335, 3643307135,
5001832582, A0003300248, A0003303235,
A0003307335, A0003383410, A0004608348,
A0004632229, A0004633429, A0013300135,
A0013300235, A0013306735, A0014603448,
A0014604148, A0014604448, A0014606348,
A0014608348, A0014608448, A0014609748,
A0023301535



DB-SB-10386

Ø: 38 Thick/Height: 38

3183200073



DB-DL-5215

Length: 780

Ø: 40

Cone Ø: d1 Ø 26 / d2 Ø 23,5

6764600105, 6764600605, 6764601105,
6764601505



DB-DL-5219

Length: 785

Ø: 40

Cone Ø: d1 Ø 26 / d2 Ø 22

01212200A, 6754601005, 6754601605,
6754602205, 6754602805



DB-DL-7832

Length: 783

Ø: 42

Cone Ø: d1 Ø 26 / d2 Ø 23,5

6764601905, 6764602105



DB-DL-10207

Length: 780

Ø: 40

Cone Ø: d1 Ø 26 / d2 Ø 23,5

6744600405





LK/LN2 ...

1124 AF ...	03/92→12/98	Stabiliser Mounting		DB-SB-10386	
	03/92→12/98	Stabiliser Mounting	DB-SB-10386	DB-SB-10386	
	03/92→12/98	Stabiliser Mounting	DB-SB-10386	DB-SB-10386	1st FA
	03/92→12/98	Tie Rod End	CV-ES-12461		for Steering Rod
	03/92→12/98	Tie Rod End	CV-ES-12462		for Steering Rod
1124 F	03/92→12/98	Centre Rod	DB-DL-5215		Push Rod
	03/92→12/98	Centre Rod	DB-DL-5215		Push Rod* 5 426 402 *→
	03/92→12/98	Centre Rod	DB-DL-5219		Push Rod
	03/92→12/98	Centre Rod	DB-DL-5219		Push Rod→* 5 426 401 *
	03/92→12/98	Stabiliser Mounting		DB-SB-10385	
	03/92→12/98	Stabiliser Mounting		DB-SB-10385	→* 5 332 725 *
	03/92→12/98	Stabiliser Mounting		DB-SB-10385	→* 5 400 707 *
	03/92→12/98	Stabiliser Mounting		DB-SB-10385	1st RA
	03/92→12/98	Stabiliser Mounting		DB-SB-10386	
	03/92→12/98	Stabiliser Mounting		DB-SB-10386	* 5 400 708 *→
	03/92→12/98	Stabiliser Mounting	DB-SB-5274		
	03/92→12/98	Stabiliser Mounting	DB-SB-10385	DB-SB-10385	
	03/92→12/98	Stabiliser Mounting	DB-SB-10385	DB-SB-10385	1st FA
	03/92→12/98	Stabiliser Mounting	DB-SB-10386	DB-SB-10386	
	03/92→12/98	Stabiliser Mounting	DB-SB-10386	DB-SB-10386	1st FA
03/92→12/98	Tie Rod End	CV-ES-12461		for Steering Rod	
03/92→12/98	Tie Rod End	CV-ES-12462		for Steering Rod	
1214 A	01/84→12/98	Tie Rod	DB-DL-8632		
	01/84→12/98	Tie Rod End	CV-ES-12461		for Steering Rod
	01/84→12/98	Tie Rod End	CV-ES-12462		for Steering Rod
	01/84→12/98	Tie Rod End	CV-ES-12461		for Steering Rod
1217 KO	03/94→12/98	Centre Rod	DB-DL-5216		Push Rod
	03/94→12/98	Centre Rod	DB-DL-8121		Push Rod
	03/94→12/98	Tie Rod End	CV-ES-12461		for Steering Rod
	03/94→12/98	Tie Rod End	CV-ES-12462		for Steering Rod
1314	07/84→12/98	Centre Rod	DB-DL-5215		Push Rod* 5 423 426 *→
	07/84→12/98	Centre Rod	DB-DL-5215		Push Rod→* 5 424 630 *
	07/84→12/98	Centre Rod	DB-DL-5219		Push Rod→* 5 423 425 *
	07/84→12/98	Centre Rod	DB-DL-7832		Push Rod
	07/84→12/98	Centre Rod	DB-DL-7832		Push Rod* 5 424 631 *→* K 055 088 *
	07/84→12/98	Centre Rod	DB-DL-8176		Push Rod* K 055 089 *→
	07/84→12/98	Centre Rod	DB-DL-12440		Suspension Rod
	07/84→12/98	Stabiliser Mounting		DB-SB-10385	
	07/84→12/98	Stabiliser Mounting		DB-SB-10385	→* 5 332 725 *
	07/84→12/98	Stabiliser Mounting		DB-SB-10385	1st RA
	07/84→12/98	Stabiliser Mounting	DB-SB-5274		
	07/84→12/98	Stabiliser Mounting	DB-SB-10385	DB-SB-10385	1st FA
	07/84→12/98	Stabiliser Mounting	DB-SB-10386	DB-SB-10386	
	07/84→12/98	Stabiliser Mounting	DB-SB-10386	DB-SB-10386	1st FA
	07/84→12/98	Tie Rod End	CV-ES-12461		for Steering Rod
07/84→12/98	Tie Rod End	CV-ES-12462		for Steering Rod	
1314 AK	06/87→12/98	Centre Rod	DB-DL-7832		Push Rod
	06/87→12/98	Stabiliser Mounting		DB-SB-10385	
	06/87→12/98	Stabiliser Mounting		DB-SB-10385	→* 5 332 725 *
	06/87→12/98	Stabiliser Mounting		DB-SB-10385	1st RA
	06/87→12/98	Stabiliser Mounting	DB-SB-5272		
	06/87→12/98	Stabiliser Mounting	DB-SB-10386	DB-SB-10386	
	06/87→12/98	Stabiliser Mounting	DB-SB-10386	DB-SB-10386	1st FA
	06/87→12/98	Tie Rod End	CV-ES-12461		for Steering Rod
	06/87→12/98	Tie Rod End	CV-ES-12462		for Steering Rod
	06/87→12/98	Tie Rod End	CV-ES-12461		for Steering Rod
1314 K	07/84→12/98	Centre Rod	DB-DL-5215		Push Rod* 5 423 426 *→
	07/84→12/98	Centre Rod	DB-DL-5215		Push Rod→* 5 424 630 *
	07/84→12/98	Centre Rod	DB-DL-5219		Push Rod→* 5 423 425 *
	07/84→12/98	Centre Rod	DB-DL-7832		Push Rod* 5 424 631 *→* K 055 088 *
	07/84→12/98	Centre Rod	DB-DL-8176		Push Rod* K 055 089 *→
	07/84→12/98	Centre Rod	DB-DL-12440		Suspension Rod
	07/84→12/98	Stabiliser Mounting		DB-SB-10385	
	07/84→12/98	Stabiliser Mounting		DB-SB-10385	→* 5 260 362 *
	07/84→12/98	Stabiliser Mounting		DB-SB-10385	→* 5 332 725 *
	07/84→12/98	Stabiliser Mounting		DB-SB-10385	

CV-ES-12461

Length: 120

Cone Ø: d1 Ø 26 / d2 Ø 23,5

Thread: M30 x 1,5 LHT

0003300035, 3300148, 0003406213, 0013306635,
0013308835, 0014604048, 0014604348,
14606448, 0024600248, 3023300035,
3023300135, 3023300235, 3023300335,
3453307235, 3453307435, 3503307135,
A0003300148, A0013306635, A0013308835,
A0014604048, A0014604348, A0014606448,
A0024600248, A3023300035, A3023300135,
A3023300235, A3023300335, A3503307135



CV-ES-12462

Length: 120

Cone Ø: d1 Ø 26 / d2 Ø 23,5

Thread: M30 x 1,5 RHT

0003300135, 0003300248, 0003303235,
0003305835, 0003307335, 0003383410,
004608348, 0004608348, 0004632229,
0004633129, 0004633429, 0004633529,
0013300135, 0013300235, 0013306735,
0014603448, 0014604148, 0014604448,
0014606348, 0014608348, 0014608448,
0014609748, 0023301535, 3453307135,
3503307035, 3503307335, 3643307135,
5001832582, A0003300248, A0003303235,
A0003307335, A0003383410, A0004608348,
A0004632229, A0004633429, A0013300135,
A0013300235, A0013306735, A0014603448,
A0014604148, A0014604448, A0014606348,
A0014608348, A0014608448, A0014609748,
A0023301535



DB-DL-5215

Length: 780

Ø: 40

Cone Ø: d1 Ø 26 / d2 Ø 23,5

6764600105, 6764600605, 6764601105,
6764601505



DB-DL-5216

Length: 890

Ø: 42

Cone Ø: d1 Ø 26 / d2 Ø 23,5

01215700A, 3834600605, 3834601405,
3834602305, 3834604405



DB-DL-5219

Length: 785

Ø: 40

Cone Ø: d1 Ø 26 / d2 Ø 22

01212200A, 6754601005, 6754601605,
6754602205, 6754602805



DB-DL-7832

Length: 783

Ø: 42

Cone Ø: d1 Ø 26 / d2 Ø 23,5

6764601905, 6764602105



DB-DL-8121

Length: 895

Ø: 40

Cone Ø: d1 Ø 22 / d2 Ø 19,9

01215600A, 3834600805, 3834601605,
3834602405, 3834604505



DB-DL-8176

Length: 783

Ø: 42

Cone Ø: d1 Ø 26 / d2 Ø 23,5

6764603105



DB-DL-8632

Length: 1635

Ø: 60

Cone Ø: d1 Ø 30 / d2 Ø 27

3853301303, 3853302103, 3853302203



DB-DL-12440

Length: 783

Ø: 42

Cone Ø: d1 Ø 26 / d2 Ø 23,5

Thread: M30 x 1,5 RHT

6764602005, 6764602205, 6764603205



DB-SB-5272

Thick/Height: 57

01331400A, 6753231785



DB-SB-5274

Ø: 64

Thick/Height: 60

01307500A, 6753231885



DB-SB-10385

Ø: 30 Thick/Height: 30

3093200073, 3143260153



DB-SB-10386

Ø: 38 Thick/Height: 38

3183200073



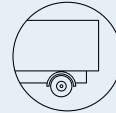
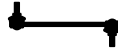

LK/LN2 ...

1314 K ...	07/84 → 12/98	Stabiliser Mounting		DB-SB-10385	1st RA	
	07/84 → 12/98	Stabiliser Mounting	DB-SB-5275			
	07/84 → 12/98	Stabiliser Mounting	DB-SB-10385	DB-SB-10385	1st FA	
	07/84 → 12/98	Stabiliser Mounting	DB-SB-10386	DB-SB-10386		
	07/84 → 12/98	Stabiliser Mounting	DB-SB-10386	DB-SB-10386	* 5 260 363 * →	
	07/84 → 12/98	Stabiliser Mounting	DB-SB-10386	DB-SB-10386	1st FA	
	07/84 → 12/98	Tie Rod End	CV-ES-12461		for Steering Rod	
	07/84 → 12/98	Tie Rod End	CV-ES-12462		for Steering Rod	
1314 KO	07/84 → 12/98	Centre Rod	DB-DL-5215		Push Rod → * 5 426 401 *	
	07/84 → 12/98	Centre Rod	DB-DL-7832		Push Rod	
	07/84 → 12/98	Centre Rod	DB-DL-7832		Push Rod* 5 426 402 * → * K 055 088 *	
	07/84 → 12/98	Centre Rod	DB-DL-8176		Push Rod* K 055 089 * →	
	07/84 → 12/98	Centre Rod	DB-DL-12440		Suspension Rod	
	07/84 → 12/98	Stabiliser Mounting		DB-SB-10385		
	07/84 → 12/98	Stabiliser Mounting		DB-SB-10385	→ * 5 332 725 *	
	07/84 → 12/98	Stabiliser Mounting		DB-SB-10385	1st RA	
	07/84 → 12/98	Stabiliser Mounting	DB-SB-10385	DB-SB-10385	1st FA	
	07/84 → 12/98	Stabiliser Mounting	DB-SB-10386	DB-SB-10386		
	07/84 → 12/98	Tie Rod End	CV-ES-12461		for Steering Rod	
	1317 AK	08/84 → 12/98	Centre Rod	DB-DL-7832		Push Rod
		08/84 → 12/98	Stabiliser Mounting		DB-SB-10385	
		08/84 → 12/98	Stabiliser Mounting		DB-SB-10385	→ * 5 332 725 *
08/84 → 12/98		Stabiliser Mounting		DB-SB-10385	1st RA	
08/84 → 12/98		Stabiliser Mounting	DB-SB-10385	DB-SB-10385	1st FA	
08/84 → 12/98		Stabiliser Mounting	DB-SB-10386	DB-SB-10386		
08/84 → 12/98		Stabiliser Mounting	DB-SB-10386	DB-SB-10386	1st FA	
08/84 → 12/98		Tie Rod End	CV-ES-12461		for Steering Rod	
08/84 → 12/98		Tie Rod End	CV-ES-12462		for Steering Rod	
1317 K		07/84 → 12/98	Centre Rod	DB-DL-5215		Push Rod
		07/84 → 12/98	Centre Rod	DB-DL-5215		Push Rod* 5 423 426 * →
		07/84 → 12/98	Centre Rod	DB-DL-5215		Push Rod → * 5 424 630 *
		07/84 → 12/98	Centre Rod	DB-DL-5219		Push Rod → * 5 423 425 *
		07/84 → 12/98	Centre Rod	DB-DL-7832		Push Rod* 5 424 631 * → * K 055 088 *
	07/84 → 12/98	Centre Rod	DB-DL-8176		Push Rod	
	07/84 → 12/98	Centre Rod	DB-DL-8176		Push Rod* K 055 089 * →	
	07/84 → 12/98	Centre Rod	DB-DL-12440		Suspension Rod	
	07/84 → 12/98	Stabiliser Mounting		DB-SB-10385		
	07/84 → 12/98	Stabiliser Mounting		DB-SB-10385	→ * 5 260 362 *	
	07/84 → 12/98	Stabiliser Mounting		DB-SB-10385	→ * 5 332 725 *	
	07/84 → 12/98	Stabiliser Mounting		DB-SB-10385	1st RA	
	07/84 → 12/98	Stabiliser Mounting		DB-SB-10386		
	07/84 → 12/98	Stabiliser Mounting		DB-SB-10386	* 5 260 363 * →	
	07/84 → 12/98	Stabiliser Mounting	DB-SB-10385	DB-SB-10385	1st FA	
	07/84 → 12/98	Stabiliser Mounting	DB-SB-10386	DB-SB-10386		
	07/84 → 12/98	Stabiliser Mounting	DB-SB-10386	DB-SB-10386	1st FA	
	07/84 → 12/98	Tie Rod End	CV-ES-12461		for Steering Rod	
	1317 KO	03/94 → 12/98	Centre Rod	DB-DL-5215		Push Rod → * 5 426 401 *
		03/94 → 12/98	Centre Rod	DB-DL-7832		Push Rod
		03/94 → 12/98	Centre Rod	DB-DL-7832		Push Rod* 5 426 402 * → * K 055 088 *
03/94 → 12/98		Centre Rod	DB-DL-8176		Push Rod	
03/94 → 12/98		Centre Rod	DB-DL-8176		Push Rod* K 055 089 * →	
03/94 → 12/98		Centre Rod	DB-DL-12440		Suspension Rod	
03/94 → 12/98		Stabiliser Mounting		DB-SB-10385		
03/94 → 12/98		Stabiliser Mounting		DB-SB-10385	→ * 5 332 725 *	
03/94 → 12/98		Stabiliser Mounting		DB-SB-10385	1st RA	
03/94 → 12/98		Stabiliser Mounting	DB-SB-10385	DB-SB-10385	1st FA	
03/94 → 12/98		Stabiliser Mounting	DB-SB-10385	DB-SB-10385	1st FA	
03/94 → 12/98		Tie Rod End	CV-ES-12461		for Steering Rod	
03/96 → 12/98		Stabiliser Mounting	DB-SB-5274			

CV-ES-12461

Length: 120

Cone Ø: d1 Ø 26 / d2 Ø 23,5

Thread: M30 x 1,5 LHT

0003300035, 3300148, 0003406213, 0013306635,
0013308835, 0014604048, 0014604348,
14606448, 0024600248, 3023300035,
3023300135, 3023300235, 3023300335,
3453307235, 3453307435, 3503307135,
A0003300148, A0013306635, A0013308835,
A0014604048, A0014604348, A0014606448,
A0024600248, A3023300035, A3023300135,
A3023300235, A3023300335, A3503307135



CV-ES-12462

Length: 120

Cone Ø: d1 Ø 26 / d2 Ø 23,5

Thread: M30 x 1,5 RHT

0003300135, 0003300248, 0003303235,
0003305835, 0003307335, 0003383410,
0004608348, 004608348, 0004632229,
0004633129, 0004633429, 0004633529,
0013300135, 0013300235, 0013306735,
0014603448, 0014604148, 0014604448,
0014606348, 0014608348, 0014608448,
0014609748, 0023301535, 3453307135,
3503307035, 3503307335, 3643307135,
5001832582, A0003300248, A0003303235,
A0003307335, A0003383410, A0004608348,
A0004632229, A0004633429, A0013300135,
A0013300235, A0013306735, A0014603448,
A0014604148, A0014604448, A0014606348,
A0014608348, A0014608448, A0014609748,
A0023301535



DB-DL-5215

Length: 780

Ø: 40

Cone Ø: d1 Ø 26 / d2 Ø 23,5

6764600105, 6764600605, 6764601105,
6764601505



DB-DL-5219

Length: 785

Ø: 40

Cone Ø: d1 Ø 26 / d2 Ø 22

01212200A, 6754601005, 6754601605,
6754602205, 6754602805



DB-DL-7832

Length: 783

Ø: 42

Cone Ø: d1 Ø 26 / d2 Ø 23,5

6764601905, 6764602105



DB-DL-8176

Length: 783

Ø: 42

Cone Ø: d1 Ø 26 / d2 Ø 23,5

6764603105



DB-DL-12440

Length: 783

Ø: 42

Cone Ø: d1 Ø 26 / d2 Ø 23,5

Thread: M30 x 1,5 RHT

6764602005, 6764602205, 6764603205



DB-SB-5274

Ø: 64

Thick/Height: 60

01307500A, 6753231885



DB-SB-5275

Thick/Height: 60

01329400A, 6753231285



DB-SB-10385

Ø: 30 Thick/Height: 30

3093200073, 3143260153



DB-SB-10386

Ø: 38 Thick/Height: 38

3183200073



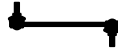

LK/LN2 ...

1317 LS	03/96→12/98	Centre Rod	DB-DL-8176		Push Rod
	03/96→12/98	Centre Rod	DB-DL-12440		Suspension Rod
	03/96→12/98	Stabiliser Mounting		DB-SB-10386	
	03/96→12/98	Stabiliser Mounting	DB-SB-5274	DB-SB-5274	
	03/96→12/98	Stabiliser Mounting	DB-SB-10386	DB-SB-10386	
	03/96→12/98	Stabiliser Mounting	DB-SB-10386	DB-SB-10386	1st FA
	03/96→12/98	Tie Rod End	CV-ES-12461		for Steering Rod
	03/96→12/98	Tie Rod End	CV-ES-12462		for Steering Rod
1317 S,1317 LS	01/84→12/98	Centre Rod	DB-DL-5215		Push Rod
	01/84→12/98	Centre Rod	DB-DL-5215		Push Rod* 5 423 426 *→
	01/84→12/98	Centre Rod	DB-DL-5215		Push Rod→* 5 424 630 *
	01/84→12/98	Centre Rod	DB-DL-5219		Push Rod→* 5 423 425 *
	01/84→12/98	Centre Rod	DB-DL-7832		Push Rod* 5 424 631 *→* K 055 088 *
	01/84→12/98	Centre Rod	DB-DL-8176		Push Rod
	01/84→12/98	Centre Rod	DB-DL-8176		Push Rod* K 055 089 *→
	01/84→12/98	Centre Rod	DB-DL-12440		Suspension Rod
	01/84→12/98	Stabiliser Mounting		DB-SB-10385	
	01/84→12/98	Stabiliser Mounting		DB-SB-10385	→* 5 296 594 *
	01/84→12/98	Stabiliser Mounting		DB-SB-10385	→* 5 332 725 *
	01/84→12/98	Stabiliser Mounting		DB-SB-10385	1st RA
	01/84→12/98	Stabiliser Mounting		DB-SB-10386	
	01/84→12/98	Stabiliser Mounting		DB-SB-10386	* 5 296 595 *→
	01/84→12/98	Stabiliser Mounting	DB-SB-5274		
	01/84→12/98	Stabiliser Mounting	DB-SB-10385	DB-SB-10385	
	01/84→12/98	Stabiliser Mounting	DB-SB-10385	DB-SB-10385	1st FA
	01/84→12/98	Stabiliser Mounting	DB-SB-10386	DB-SB-10386	
	01/84→12/98	Stabiliser Mounting	DB-SB-10386	DB-SB-10386	1st FA
	01/84→12/98	Tie Rod End	CV-ES-12461		for Steering Rod
01/84→12/98	Tie Rod End	CV-ES-12462		for Steering Rod	
1317,1317 L	01/84→12/98	Centre Rod	DB-DL-5215		Push Rod
	01/84→12/98	Centre Rod	DB-DL-5215		Push Rod* 5 423 426 *→
	01/84→12/98	Centre Rod	DB-DL-5215		Push Rod→* 5 424 630 *
	01/84→12/98	Centre Rod	DB-DL-5219		Push Rod→* 5 423 425 *
	01/84→12/98	Centre Rod	DB-DL-7832		Push Rod* 5 424 631 *→* K 055 088 *
	01/84→12/98	Centre Rod	DB-DL-8176		Push Rod
	01/84→12/98	Centre Rod	DB-DL-8176		Push Rod* K 055 089 *→
	01/84→12/98	Centre Rod	DB-DL-12440		Suspension Rod
	01/84→12/98	Stabiliser Mounting		DB-SB-10385	
	01/84→12/98	Stabiliser Mounting		DB-SB-10385	→* 5 296 594 *
	01/84→12/98	Stabiliser Mounting		DB-SB-10385	→* 5 332 725 *
	01/84→12/98	Stabiliser Mounting		DB-SB-10385	1st RA
	01/84→12/98	Stabiliser Mounting		DB-SB-10386	
	01/84→12/98	Stabiliser Mounting		DB-SB-10386	* 5 296 595 *→
	01/84→12/98	Stabiliser Mounting	DB-SB-5274		
	01/84→12/98	Stabiliser Mounting	DB-SB-10385	DB-SB-10385	
	01/84→12/98	Stabiliser Mounting	DB-SB-10385	DB-SB-10385	1st FA
	01/84→12/98	Stabiliser Mounting	DB-SB-10386	DB-SB-10386	
	01/84→12/98	Stabiliser Mounting	DB-SB-10386	DB-SB-10386	1st FA
	01/84→12/98	Tie Rod End	CV-ES-12461		for Steering Rod
01/84→12/98	Tie Rod End	CV-ES-12462		for Steering Rod	
03/96→12/98	Centre Rod	DB-DL-5215		Push Rod* 5 426 402 *→	
03/96→12/98	Centre Rod	DB-DL-5219		Push Rod→* 5 426 401 *	
1320 AK	12/92→12/98	Centre Rod	DB-DL-7832		Push Rod
	12/92→12/98	Stabiliser Mounting		DB-SB-10386	
	12/92→12/98	Stabiliser Mounting	DB-SB-10386	DB-SB-10386	
	12/92→12/98	Stabiliser Mounting	DB-SB-10386	DB-SB-10386	1st FA
1320 L	12/92→12/98	Centre Rod	DB-DL-5215		Push Rod* 5 423 426 *→
	12/92→12/98	Centre Rod	DB-DL-5215		Push Rod→* 5 424 630 *
	12/92→12/98	Centre Rod	DB-DL-5219		Push Rod→* 5 423 425 *
	12/92→12/98	Centre Rod	DB-DL-7832		Push Rod* 5 424 631 *→* K 055 088 *
	12/92→12/98	Centre Rod	DB-DL-8176		Push Rod* K 055 089 *→
	12/92→12/98	Centre Rod	DB-DL-12440		Suspension Rod
	12/92→12/98	Stabiliser Mounting		DB-SB-10385	
	12/92→12/98	Stabiliser Mounting		DB-SB-10385	

CV-ES-12461

Length: 120

Cone Ø: d1 Ø 26 / d2 Ø 23,5

Thread: M30 x 1,5 LHT

0003300035, 3300148, 0003406213, 0013306635,
0013308835, 0014604048, 0014604348,
14606448, 0024600248, 3023300035,
3023300135, 3023300235, 3023300335,
3453307235, 3453307435, 3503307135,
A0003300148, A0013306635, A0013308835,
A0014604048, A0014604348, A0014606448,
A0024600248, A3023300035, A3023300135,
A3023300235, A3023300335, A3503307135



CV-ES-12462

Length: 120

Cone Ø: d1 Ø 26 / d2 Ø 23,5

Thread: M30 x 1,5 RHT

0003300135, 0003300248, 0003303235,
0003305835, 0003307335, 0003383410,
0004608348, 004608348, 0004632229,
0004633129, 0004633429, 0004633529,
0013300135, 0013300235, 0013306735,
0014603448, 0014604148, 0014604448,
0014606348, 0014608348, 0014608448,
0014609748, 0023301535, 3453307135,
3503307035, 3503307335, 3643307135,
5001832582, A0003300248, A0003303235,
A0003307335, A0003383410, A0004608348,
A0004632229, A0004633429, A0013300135,
A0013300235, A0013306735, A0014603448,
A0014604148, A0014604448, A0014606348,
A0014608348, A0014608448, A0014609748,
A0023301535



DB-DL-5215

Length: 780

Ø: 40

Cone Ø: d1 Ø 26 / d2 Ø 23,5

6764600105, 6764600605, 6764601105,
6764601505



DB-DL-5219

Length: 785

Ø: 40

Cone Ø: d1 Ø 26 / d2 Ø 22

01212200A, 6754601005, 6754601605,
6754602205, 6754602805



DB-DL-7832

Length: 783

Ø: 42

Cone Ø: d1 Ø 26 / d2 Ø 23,5

6764601905, 6764602105



DB-DL-8176

Length: 783

Ø: 42

Cone Ø: d1 Ø 26 / d2 Ø 23,5

6764603105



DB-DL-12440

Length: 783

Ø: 42

Cone Ø: d1 Ø 26 / d2 Ø 23,5

Thread: M30 x 1,5 RHT

6764602005, 6764602205, 6764603205



DB-SB-5274

Ø: 64

Thick/Height: 60

01307500A, 6753231885



DB-SB-10385

Ø: 30 Thick/Height: 30

3093200073, 3143260153



DB-SB-10386

Ø: 38 Thick/Height: 38

3183200073





LK/LN2 ...

1320 L ...	12/92→12/98	Stabiliser Mounting		DB-SB-10385	→* 5 296 594 *	
	12/92→12/98	Stabiliser Mounting		DB-SB-10385	→* 5 332 725 *	
	12/92→12/98	Stabiliser Mounting		DB-SB-10385	1st RA	
	12/92→12/98	Stabiliser Mounting	DB-SB-5274			
	12/92→12/98	Stabiliser Mounting	DB-SB-5275			
	12/92→12/98	Stabiliser Mounting	DB-SB-10385	DB-SB-10385	1st FA	
	12/92→12/98	Stabiliser Mounting	DB-SB-10386	DB-SB-10386		
	12/92→12/98	Stabiliser Mounting	DB-SB-10386	DB-SB-10386	* 5 296 595 *→	
	12/92→12/98	Stabiliser Mounting	DB-SB-10386	DB-SB-10386	1st FA	
	12/92→12/98	Tie Rod End	CV-ES-12461		for Steering Rod	
	12/92→12/98	Tie Rod End	CV-ES-12462		for Steering Rod	
	1320 S,1320 LS	01/84→12/98	Centre Rod	DB-DL-5215		Push Rod
01/84→12/98		Centre Rod	DB-DL-5215		Push Rod* 5 423 426 *→	
01/84→12/98		Centre Rod	DB-DL-5215		Push Rod* 5 426 402 *→	
01/84→12/98		Centre Rod	DB-DL-5215		Push Rod→* 5 424 630 *	
01/84→12/98		Centre Rod	DB-DL-5219		Push Rod→* 5 423 425 *	
01/84→12/98		Centre Rod	DB-DL-5219		Push Rod→* 5 426 401 *	
01/84→12/98		Centre Rod	DB-DL-7832		Push Rod* 5 424 631 *→* K 055 088 *	
01/84→12/98		Centre Rod	DB-DL-8176		Push Rod	
01/84→12/98		Centre Rod	DB-DL-8176		Push Rod* K 055 089 *→	
01/84→12/98		Centre Rod	DB-DL-12440		Suspension Rod	
01/84→12/98		Stabiliser Mounting		DB-SB-10385		
01/84→12/98		Stabiliser Mounting		DB-SB-10385	→* 5 296 594 *	
01/84→12/98		Stabiliser Mounting		DB-SB-10385	→* 5 332 725 *	
01/84→12/98		Stabiliser Mounting		DB-SB-10385	1st RA	
01/84→12/98		Stabiliser Mounting		DB-SB-10386		
01/84→12/98		Stabiliser Mounting		DB-SB-10386	* 5 296 595 *→	
01/84→12/98		Stabiliser Mounting	DB-SB-5274			
01/84→12/98		Stabiliser Mounting	DB-SB-10385	DB-SB-10385		
01/84→12/98		Stabiliser Mounting	DB-SB-10385	DB-SB-10385	1st FA	
01/84→12/98		Stabiliser Mounting	DB-SB-10386	DB-SB-10386		
01/84→12/98		Stabiliser Mounting	DB-SB-10386	DB-SB-10386	1st FA	
01/84→12/98		Tie Rod End	CV-ES-12461		for Steering Rod	
01/84→12/98		Tie Rod End	CV-ES-12462		for Steering Rod	
1320,1320 L		01/84→12/98	Centre Rod	DB-DL-5215		Push Rod
		01/84→12/98	Centre Rod	DB-DL-5215		Push Rod* 5 423 426 *→
		01/84→12/98	Centre Rod	DB-DL-5215		Push Rod* 5 426 402 *→
		01/84→12/98	Centre Rod	DB-DL-5215		Push Rod→* 5 424 630 *
		01/84→12/98	Centre Rod	DB-DL-5219		Push Rod→* 5 423 425 *
	01/84→12/98	Centre Rod	DB-DL-5219		Push Rod→* 5 426 401 *	
	01/84→12/98	Centre Rod	DB-DL-7832		Push Rod	
	01/84→12/98	Centre Rod	DB-DL-7832		Push Rod* 5 424 631 *→* K 055 088 *	
	01/84→12/98	Centre Rod	DB-DL-8176		Push Rod	
	01/84→12/98	Centre Rod	DB-DL-8176		Push Rod* K 055 089 *→	
	01/84→12/98	Centre Rod	DB-DL-12440		Suspension Rod	
	01/84→12/98	Stabiliser Mounting		DB-SB-10385		
	01/84→12/98	Stabiliser Mounting		DB-SB-10385	→* 5 296 594 *	
	01/84→12/98	Stabiliser Mounting		DB-SB-10385	→* 5 332 725 *	
	01/84→12/98	Stabiliser Mounting		DB-SB-10385	1st RA	
	01/84→12/98	Stabiliser Mounting		DB-SB-10386		
	01/84→12/98	Stabiliser Mounting		DB-SB-10386	* 5 296 595 *→	
	01/84→12/98	Stabiliser Mounting	DB-SB-5274			
	01/84→12/98	Stabiliser Mounting	DB-SB-5275			
	01/84→12/98	Stabiliser Mounting	DB-SB-10385	DB-SB-10385		
	01/84→12/98	Stabiliser Mounting	DB-SB-10385	DB-SB-10385	1st FA	
	01/84→12/98	Stabiliser Mounting	DB-SB-10386	DB-SB-10386		
	01/84→12/98	Stabiliser Mounting	DB-SB-10386	DB-SB-10386	* 5 296 595 *→	
	01/84→12/98	Stabiliser Mounting	DB-SB-10386	DB-SB-10386	1st FA	
	01/84→12/98	Tie Rod End	CV-ES-12461		for Steering Rod	
	01/84→12/98	Tie Rod End	CV-ES-12462		for Steering Rod	

CV-ES-12461

Length: 120

Cone Ø: d1 Ø 26 / d2 Ø 23,5

Thread: M30 x 1,5 LHT

0003300035, 3300148, 0003406213, 0013306635,
0013308835, 0014604048, 0014604348,
14606448, 0024600248, 3023300035,
3023300135, 3023300235, 3023300335,
3453307235, 3453307435, 3503307135,
A0003300148, A0013306635, A0013308835,
A0014604048, A0014604348, A0014606448,
A0024600248, A3023300035, A3023300135,
A3023300235, A3023300335, A3503307135



CV-ES-12462

Length: 120

Cone Ø: d1 Ø 26 / d2 Ø 23,5

Thread: M30 x 1,5 RHT

0003300135, 0003300248, 0003303235,
0003305835, 0003307335, 0003383410,
0004608348, 004608348, 0004632229,
0004633129, 0004633429, 0004633529,
0013300135, 0013300235, 0013306735,
0014603448, 0014604148, 0014604448,
0014606348, 0014608348, 0014608448,
0014609748, 0023301535, 3453307135,
3503307035, 3503307335, 3643307135,
5001832582, A0003300248, A0003303235,
A0003307335, A0003383410, A0004608348,
A0004632229, A0004633429, A0013300135,
A0013300235, A0013306735, A0014603448,
A0014604148, A0014604448, A0014606348,
A0014608348, A0014608448, A0014609748,
A0023301535



DB-DL-5215

Length: 780

Ø: 40

Cone Ø: d1 Ø 26 / d2 Ø 23,5

6764600105, 6764600605, 6764601105,
6764601505



DB-DL-5219

Length: 785

Ø: 40

Cone Ø: d1 Ø 26 / d2 Ø 22

01212200A, 6754601005, 6754601605,
6754602205, 6754602805



DB-DL-7832

Length: 783

Ø: 42

Cone Ø: d1 Ø 26 / d2 Ø 23,5

6764601905, 6764602105



DB-DL-8176

Length: 783

Ø: 42

Cone Ø: d1 Ø 26 / d2 Ø 23,5

6764603105



DB-DL-12440

Length: 783

Ø: 42

Cone Ø: d1 Ø 26 / d2 Ø 23,5

Thread: M30 x 1,5 RHT

6764602005, 6764602205, 6764603205



DB-SB-5274

Ø: 64

Thick/Height: 60

01307500A, 6753231885



DB-SB-5275

Thick/Height: 60

01329400A, 6753231285



DB-SB-10385

Ø: 30 Thick/Height: 30

3093200073, 3143260153



DB-SB-10386

Ø: 38 Thick/Height: 38

3183200073





LK/LN2 ...

1324 L	01/91→12/98	Centre Rod	DB-DL-5215		Push Rod	
	01/91→12/98	Centre Rod	DB-DL-5215		Push Rod→* 5 424 630 *	
	01/91→12/98	Centre Rod	DB-DL-7832		Push Rod	
	01/91→12/98	Centre Rod	DB-DL-7832		Push Rod* 5 424 631 *→* K 055 088 *	
	01/91→12/98	Centre Rod	DB-DL-8176		Push Rod* K 055 089 *→	
	01/91→12/98	Centre Rod	DB-DL-12440		Suspension Rod	
	01/91→12/98	Stabiliser Mounting		DB-SB-10386		
	01/91→12/98	Stabiliser Mounting	DB-SB-5275			
	01/91→12/98	Stabiliser Mounting	DB-SB-10386	DB-SB-10386		
	01/91→12/98	Stabiliser Mounting	DB-SB-10386	DB-SB-10386	1st FA	
	01/91→12/98	Tie Rod End	CV-ES-12461		for Steering Rod	
	01/91→12/98	Tie Rod End	CV-ES-12462		for Steering Rod	
	1324 S,1324 LS	01/84→12/98	Centre Rod	DB-DL-5215		Push Rod
		01/84→12/98	Centre Rod	DB-DL-5215		Push Rod→* 5 424 630 *
01/84→12/98		Centre Rod	DB-DL-7832		Push Rod* 5 424 631 *→* K 055 088 *	
01/84→12/98		Centre Rod	DB-DL-8176		Push Rod* K 055 089 *→	
01/84→12/98		Centre Rod	DB-DL-12440		Suspension Rod	
01/84→12/98		Stabiliser Mounting		DB-SB-10386		
01/84→12/98		Stabiliser Mounting	DB-SB-5274			
01/84→12/98		Stabiliser Mounting	DB-SB-10385	DB-SB-10385		
01/84→12/98		Stabiliser Mounting	DB-SB-10385	DB-SB-10385	1st FA	
01/84→12/98		Stabiliser Mounting	DB-SB-10386	DB-SB-10386		
01/84→12/98		Stabiliser Mounting	DB-SB-10386	DB-SB-10386	1st FA	
01/84→12/98		Tie Rod End	CV-ES-12461		for Steering Rod	
01/84→12/98		Tie Rod End	CV-ES-12462		for Steering Rod	
1324,1324 L		01/84→12/98	Centre Rod	DB-DL-5215		Push Rod
	01/84→12/98	Centre Rod	DB-DL-5215		Push Rod* 5 423 426 *→	
	01/84→12/98	Centre Rod	DB-DL-5215		Push Rod→* 5 424 630 *	
	01/84→12/98	Centre Rod	DB-DL-5219		Push Rod→* 5 423 425 *	
	01/84→12/98	Centre Rod	DB-DL-7832		Push Rod	
	01/84→12/98	Centre Rod	DB-DL-7832		Push Rod* 5 424 631 *→* K 055 088 *	
	01/84→12/98	Centre Rod	DB-DL-8176		Push Rod	
	01/84→12/98	Centre Rod	DB-DL-8176		Push Rod* K 055 089 *→	
	01/84→12/98	Centre Rod	DB-DL-12440		Suspension Rod	
	01/84→12/98	Stabiliser Mounting		DB-SB-10385		
	01/84→12/98	Stabiliser Mounting		DB-SB-10385	→* 5 296 594 *	
	01/84→12/98	Stabiliser Mounting		DB-SB-10385	→* 5 332 725 *	
	01/84→12/98	Stabiliser Mounting		DB-SB-10385	1st RA	
	01/84→12/98	Stabiliser Mounting		DB-SB-10386		
	01/84→12/98	Stabiliser Mounting		DB-SB-10386	* 5 296 595 *→	
	01/84→12/98	Stabiliser Mounting	DB-SB-5274			
	01/84→12/98	Stabiliser Mounting	DB-SB-5275			
	01/84→12/98	Stabiliser Mounting	DB-SB-10385	DB-SB-10385		
	01/84→12/98	Stabiliser Mounting	DB-SB-10385	DB-SB-10385	1st FA	
	01/84→12/98	Stabiliser Mounting	DB-SB-10386	DB-SB-10386		
	01/84→12/98	Stabiliser Mounting	DB-SB-10386	DB-SB-10386	1st FA	
	01/84→12/98	Tie Rod End	CV-ES-12461		for Steering Rod	
01/84→12/98	Tie Rod End	CV-ES-12462		for Steering Rod		
1514 K	01/89→12/98	Centre Rod	DB-DL-7832		Push Rod	
	01/89→12/98	Centre Rod	DB-DL-7832		Push Rod→* K 055 088 *	
	01/89→12/98	Centre Rod	DB-DL-8176		Push Rod* K 055 089 *→	
	01/89→12/98	Centre Rod	DB-DL-12440		Suspension Rod	
	01/89→12/98	Stabiliser Mounting		DB-SB-10385		
	01/89→12/98	Stabiliser Mounting		DB-SB-10385	→* 5 332 725 *	
	01/89→12/98	Stabiliser Mounting		DB-SB-10385	1st RA	
	01/89→12/98	Stabiliser Mounting		DB-SB-10386		
	01/89→12/98	Stabiliser Mounting	DB-SB-10386	DB-SB-10386		
	01/89→12/98	Stabiliser Mounting	DB-SB-10386	DB-SB-10386	1st FA	
	01/89→12/98	Tie Rod End	CV-ES-12461		for Steering Rod	
	01/89→12/98	Tie Rod End	CV-ES-12462		for Steering Rod	

CV-ES-12461

Length: 120

Cone Ø: d1 Ø 26 / d2 Ø 23,5

Thread: M30 x 1,5 LHT

0003300035, 3300148, 0003406213, 0013306635,
0013308835, 0014604048, 0014604348,
14606448, 0024600248, 3023300035,
3023300135, 3023300235, 3023300335,
3453307235, 3453307435, 3503307135,
A0003300148, A0013306635, A0013308835,
A0014604048, A0014604348, A0014606448,
A0024600248, A3023300035, A3023300135,
A3023300235, A3023300335, A3503307135



CV-ES-12462

Length: 120

Cone Ø: d1 Ø 26 / d2 Ø 23,5

Thread: M30 x 1,5 RHT

0003300135, 0003300248, 0003303235,
0003305835, 0003307335, 0003383410,
004608348, 0004608348, 0004632229,
0004633129, 0004633429, 0004633529,
0013300135, 0013300235, 0013306735,
0014603448, 0014604148, 0014604448,
0014606348, 0014608348, 0014608448,
0014609748, 0023301535, 3453307135,
3503307035, 3503307335, 3643307135,
5001832582, A0003300248, A0003303235,
A0003307335, A0003383410, A0004608348,
A0004632229, A0004633429, A0013300135,
A0013300235, A0013306735, A0014603448,
A0014604148, A0014604448, A0014606348,
A0014608348, A0014608448, A0014609748,
A0023301535



DB-DL-5215

Length: 780

Ø: 40

Cone Ø: d1 Ø 26 / d2 Ø 23,5

6764600105, 6764600605, 6764601105,
6764601505



DB-DL-5219

Length: 785

Ø: 40

Cone Ø: d1 Ø 26 / d2 Ø 22

01212200A, 6754601005, 6754601605,
6754602205, 6754602805



DB-DL-7832

Length: 783

Ø: 42

Cone Ø: d1 Ø 26 / d2 Ø 23,5

6764601905, 6764602105



DB-DL-8176

Length: 783

Ø: 42

Cone Ø: d1 Ø 26 / d2 Ø 23,5

6764603105



DB-DL-12440

Length: 783

Ø: 42

Cone Ø: d1 Ø 26 / d2 Ø 23,5

Thread: M30 x 1,5 RHT

6764602005, 6764602205, 6764603205



DB-SB-5274

Ø: 64

Thick/Height: 60

01307500A, 6753231885



DB-SB-5275

Thick/Height: 60

01329400A, 6753231285



DB-SB-10385

Ø: 30 Thick/Height: 30

3093200073, 3143260153



DB-SB-10386

Ø: 38 Thick/Height: 38

3183200073





LK/LN2 ...

1514,1514 L	01/84 →12/98	Centre Rod	DB-DL-7832		Push Rod
	01/84 →12/98	Centre Rod	DB-DL-7832		Push Rod →* K 055 088 *
	01/84 →12/98	Centre Rod	DB-DL-8176		Push Rod* K 055 089 * →
	01/84 →12/98	Centre Rod	DB-DL-12440		Suspension Rod
	01/84 →12/98	Stabiliser Mounting		DB-SB-10385	
	01/84 →12/98	Stabiliser Mounting		DB-SB-10385	→* 5 296 594 *
	01/84 →12/98	Stabiliser Mounting		DB-SB-10385	→* 5 332 725 *
	01/84 →12/98	Stabiliser Mounting		DB-SB-10385	1st RA
	01/84 →12/98	Stabiliser Mounting		DB-SB-10386	
	01/84 →12/98	Stabiliser Mounting	DB-SB-5274		
	01/84 →12/98	Stabiliser Mounting	DB-SB-10385	DB-SB-10385	1st FA
	01/84 →12/98	Stabiliser Mounting	DB-SB-10386	DB-SB-10386	
	01/84 →12/98	Stabiliser Mounting	DB-SB-10386	DB-SB-10386	1st FA
	01/84 →12/98	Tie Rod End	CV-ES-12461		for Steering Rod
	01/84 →12/98	Tie Rod End	CV-ES-12462		for Steering Rod
1517 K	01/89 →12/98	Centre Rod	DB-DL-7832		Push Rod
	01/89 →12/98	Centre Rod	DB-DL-7832		Push Rod →* K 055 088 *
	01/89 →12/98	Centre Rod	DB-DL-8176		Push Rod
	01/89 →12/98	Centre Rod	DB-DL-8176		Push Rod* K 055 089 * →
	01/89 →12/98	Centre Rod	DB-DL-12440		Suspension Rod
	01/89 →12/98	Stabiliser Mounting		DB-SB-10386	
	01/89 →12/98	Stabiliser Mounting	DB-SB-10386	DB-SB-10386	
	01/89 →12/98	Stabiliser Mounting	DB-SB-10386	DB-SB-10386	1st FA
	01/89 →12/98	Tie Rod End	CV-ES-12461		for Steering Rod
	1517,1517 L	01/84 →12/98	Centre Rod	DB-DL-7832	
01/84 →12/98		Centre Rod	DB-DL-7832		Push Rod →* K 055 088 *
01/84 →12/98		Centre Rod	DB-DL-8176		Push Rod
01/84 →12/98		Centre Rod	DB-DL-8176		Push Rod* K 055 089 * →
01/84 →12/98		Centre Rod	DB-DL-12440		Suspension Rod
01/84 →12/98		Stabiliser Mounting		DB-SB-10385	
01/84 →12/98		Stabiliser Mounting		DB-SB-10385	→* 5 296 594 *
01/84 →12/98		Stabiliser Mounting		DB-SB-10385	→* 5 332 725 *
01/84 →12/98		Stabiliser Mounting		DB-SB-10385	1st RA
01/84 →12/98		Stabiliser Mounting		DB-SB-10386	
01/84 →12/98		Stabiliser Mounting	DB-SB-10386	DB-SB-10386	* 5 296 595 * →
01/84 →12/98		Stabiliser Mounting	DB-SB-10385	DB-SB-10385	1st FA
01/84 →12/98		Stabiliser Mounting	DB-SB-10386	DB-SB-10386	
01/84 →12/98		Stabiliser Mounting	DB-SB-10386	DB-SB-10386	1st FA
01/84 →12/98		Tie Rod End	CV-ES-12461		for Steering Rod
1520,1520 L	01/84 →12/98	Centre Rod	DB-DL-7832		Push Rod
	01/84 →12/98	Centre Rod	DB-DL-7832		Push Rod →* K 055 088 *
	01/84 →12/98	Centre Rod	DB-DL-8176		Push Rod
	01/84 →12/98	Centre Rod	DB-DL-8176		Push Rod* K 055 089 * →
	01/84 →12/98	Centre Rod	DB-DL-12440		Suspension Rod
	01/84 →12/98	Stabiliser Mounting		DB-SB-10385	
	01/84 →12/98	Stabiliser Mounting		DB-SB-10385	→* 5 332 725 *
	01/84 →12/98	Stabiliser Mounting		DB-SB-10385	1st RA
	01/84 →12/98	Stabiliser Mounting		DB-SB-10386	
	01/84 →12/98	Stabiliser Mounting	DB-SB-10385	DB-SB-10385	1st FA
	01/84 →12/98	Stabiliser Mounting	DB-SB-10386	DB-SB-10386	
	01/84 →12/98	Stabiliser Mounting	DB-SB-10386	DB-SB-10386	1st FA
	01/84 →12/98	Stabiliser Mounting	DB-SB-10386	DB-SB-10386	1st FA
	01/84 →12/98	Tie Rod End	CV-ES-12461		for Steering Rod
	1524,1524 L	01/84 →12/98	Centre Rod	DB-DL-7832	
01/84 →12/98		Centre Rod	DB-DL-7832		Push Rod →* K 055 088 *
01/84 →12/98		Centre Rod	DB-DL-8176		Push Rod
01/84 →12/98		Centre Rod	DB-DL-8176		Push Rod* K 055 089 * →
01/84 →12/98		Centre Rod	DB-DL-12440		Suspension Rod
01/84 →12/98		Stabiliser Mounting		DB-SB-10386	
01/84 →12/98		Stabiliser Mounting	DB-SB-10385	DB-SB-10385	
01/84 →12/98		Stabiliser Mounting	DB-SB-10385	DB-SB-10385	1st FA
01/84 →12/98		Stabiliser Mounting	DB-SB-10386	DB-SB-10386	1st FA
01/84 →12/98		Tie Rod End	CV-ES-12461		for Steering Rod

CV-ES-12461

Length: 120

Cone Ø: d1 Ø 26 / d2 Ø 23,5

Thread: M30 x 1,5 LHT

0003300035, 3300148, 0003406213, 0013306635,
0013308835, 0014604048, 0014604348,
14606448, 0024600248, 3023300035,
3023300135, 3023300235, 3023300335,
3453307235, 3453307435, 3503307135,
A0003300148, A0013306635, A0013308835,
A0014604048, A0014604348, A0014606448,
A0024600248, A3023300035, A3023300135,
A3023300235, A3023300335, A3503307135



DB-SB-10385

Ø: 30 Thick/Height: 30
3093200073, 3143260153



DB-SB-10386

Ø: 38 Thick/Height: 38
3183200073



CV-ES-12462

Length: 120

Cone Ø: d1 Ø 26 / d2 Ø 23,5

Thread: M30 x 1,5 RHT

0003300135, 0003300248, 0003303235,
0003305835, 0003307335, 0003383410,
0004608348, 004608348, 0004632229,
0004633129, 0004633429, 0004633529,
0013300135, 0013300235, 0013306735,
0014603448, 0014604148, 0014604448,
0014606348, 0014608348, 0014608448,
0014609748, 0023301535, 3453307135,
3503307035, 3503307335, 3643307135,
5001832582, A0003300248, A0003303235,
A0003307335, A0003383410, A0004608348,
A0004632229, A0004633429, A0013300135,
A0013300235, A0013306735, A0014603448,
A0014604148, A0014604448, A0014606348,
A0014608348, A0014608448, A0014609748,
A0023301535



DB-DL-7832

Length: 783

Ø: 42

Cone Ø: d1 Ø 26 / d2 Ø 23,5

6764601905, 6764602105



DB-DL-8176

Length: 783

Ø: 42

Cone Ø: d1 Ø 26 / d2 Ø 23,5

6764603105



DB-DL-12440

Length: 783

Ø: 42

Cone Ø: d1 Ø 26 / d2 Ø 23,5

Thread: M30 x 1,5 RHT

6764602005, 6764602205, 6764603205



DB-SB-5274

Ø: 64

Thick/Height: 60

01307500A, 6753231885





LK/LN2 ...

1720	01/84 → 12/98	Centre Rod	DB-DL-7832		Push Rod
	01/84 → 12/98	Centre Rod	DB-DL-7832		Push Rod → * K 055 088 *
	01/84 → 12/98	Centre Rod	DB-DL-8176		Push Rod* K 055 089 * →
	01/84 → 12/98	Centre Rod	DB-DL-12440		Suspension Rod
	01/84 → 12/98	Stabiliser Mounting		DB-SB-10386	
	01/84 → 12/98	Stabiliser Mounting	DB-SB-10386	DB-SB-10386	
	01/84 → 12/98	Stabiliser Mounting	DB-SB-10386	DB-SB-10386	1st FA
	01/84 → 12/98	Tie Rod End	CV-ES-12461		for Steering Rod
1723, 1724	01/84 → 12/98	Centre Rod	DB-DL-7832		Push Rod
	01/84 → 12/98	Centre Rod	DB-DL-7832		Push Rod → * K 055 088 *
	01/84 → 12/98	Centre Rod	DB-DL-8176		Push Rod* K 055 089 * →
	01/84 → 12/98	Centre Rod	DB-DL-12440		Suspension Rod
	01/84 → 12/98	Stabiliser Mounting	DB-SB-10385	DB-SB-10385	
	01/84 → 12/98	Stabiliser Mounting	DB-SB-10385	DB-SB-10385	1st FA
	01/84 → 12/98	Stabiliser Mounting	DB-SB-10386	DB-SB-10386	
	01/84 → 12/98	Stabiliser Mounting	DB-SB-10386	DB-SB-10386	1st FA
2020 L	01/84 → 12/98	Centre Rod	DB-DL-5215		Push Rod* 5 423 426 * →
	01/84 → 12/98	Centre Rod	DB-DL-5215		Push Rod → * 5 424 630 *
	01/84 → 12/98	Centre Rod	DB-DL-5219		Push Rod → * 5 423 425 *
	01/84 → 12/98	Centre Rod	DB-DL-7832		Push Rod
	01/84 → 12/98	Centre Rod	DB-DL-7832		Push Rod* 5 424 631 * → * K 055 088 *
	01/84 → 12/98	Centre Rod	DB-DL-7832		Push Rod → * K 055 088 *
	01/84 → 12/98	Centre Rod	DB-DL-8176		Push Rod* K 055 089 * →
	01/84 → 12/98	Centre Rod	DB-DL-12440		Suspension Rod
	01/84 → 12/98	Stabiliser Mounting		DB-SB-10385	
	01/84 → 12/98	Stabiliser Mounting		DB-SB-10385	→ * 5 296 594 *
	01/84 → 12/98	Stabiliser Mounting		DB-SB-10385	→ * 5 332 725 *
	01/84 → 12/98	Stabiliser Mounting		DB-SB-10385	1st RA
	01/84 → 12/98	Stabiliser Mounting	DB-SB-5274		
	01/84 → 12/98	Stabiliser Mounting	DB-SB-10385	DB-SB-10385	1st FA
	01/84 → 12/98	Stabiliser Mounting	DB-SB-10386	DB-SB-10386	
	01/84 → 12/98	Stabiliser Mounting	DB-SB-10386	DB-SB-10386	* 5 296 595 * →
01/84 → 12/98	Stabiliser Mounting	DB-SB-10386	DB-SB-10386	1st FA	
01/84 → 12/98	Tie Rod End	CV-ES-12461		for Steering Rod	
2024 L	01/84 → 12/98	Centre Rod	DB-DL-7832		Push Rod
	01/84 → 12/98	Centre Rod	DB-DL-7832		Push Rod → * K 055 088 *
	01/84 → 12/98	Centre Rod	DB-DL-8176		Push Rod
	01/84 → 12/98	Centre Rod	DB-DL-8176		Push Rod* K 055 089 * →
	01/84 → 12/98	Centre Rod	DB-DL-12440		Suspension Rod
	01/84 → 12/98	Stabiliser Mounting		DB-SB-10386	
	01/84 → 12/98	Stabiliser Mounting	DB-SB-10386	DB-SB-10386	
	01/84 → 12/98	Stabiliser Mounting	DB-SB-10386	DB-SB-10386	1st FA
709	01/84 → 12/98	Tie Rod End	CV-ES-12461		for Steering Rod
	03/84 → 12/98	Ball Head, gearshift linkage	DB-ES-8491		
	03/84 → 12/98	Ball Head, gearshift linkage	DB-ES-8492		
	03/84 → 12/98	Centre Rod	DB-DL-0280		Push Rod
	03/84 → 12/98	Centre Rod	DB-DL-6235		Push Rod
	03/84 → 12/98	Stabiliser Mounting		DB-SB-10385	
	03/84 → 12/98	Stabiliser Mounting		DB-SB-10385	* 5 225 566 * →
	03/84 → 12/98	Stabiliser Mounting		DB-SB-10385	→ * 5 225 565 *
	03/84 → 12/98	Stabiliser Mounting		DB-SB-10385	→ * 5 332 725 *
	03/84 → 12/98	Stabiliser Mounting		DB-SB-10385	1st RA
	03/84 → 12/98	Stabiliser Mounting	DB-SB-5267		
	03/84 → 12/98	Stabiliser Mounting	DB-SB-5268		
	03/84 → 12/98	Stabiliser Mounting	DB-SB-5268		1st FA
	03/84 → 12/98	Stabiliser Mounting	DB-SB-10385	DB-SB-10385	
	03/84 → 12/98	Stabiliser Mounting	DB-SB-10385	DB-SB-10385	1st FA
	03/84 → 12/98	Tie Rod End	CV-ES-2774		
	03/84 → 12/98	Tie Rod End	DB-ES-0830		
	03/84 → 12/98	Tie Rod End	DB-ES-1281		

CV-ES-2774

Length: 95
Cone Ø: d1 Ø 20 / d2 Ø 18
Thread: M24 x 1,5 RHT
0003300635, 0003308535, 0004607248,
0004633229, 0024601648



CV-ES-12461

Length: 120
Cone Ø: d1 Ø 26 / d2 Ø 23,5
Thread: M30 x 1,5 LHT
0003300035, 3300148, 0003406213, 0013306635,
0013308835, 0014604048, 0014604348,
14606448, 0024600248, 3023300035,
3023300135, 3023300235, 3023300335,
3453307235, 3453307435, 3503307135,
A0003300148, A0013306635, A0013308835,
A0014604048, A0014604348, A0014606448,
A0024600248, A3023300035, A3023300135,
A3023300235, A3023300335, A3503307135



DB-DL-0280

6734600305, 6734600705



DB-DL-5215

Length: 780
Ø: 40
Cone Ø: d1 Ø 26 / d2 Ø 23,5
6764600105, 6764600605, 6764601105,
6764601505



DB-DL-5219

Length: 785
Ø: 40
Cone Ø: d1 Ø 26 / d2 Ø 22
01212200A, 6754601005, 6754601605,
6754602205, 6754602805



DB-DL-6235

Length: 725
Ø: 36
Cone Ø: d1 Ø 22 / d2 Ø 19,9
6734600605



DB-DL-7832

Length: 783
Ø: 42
Cone Ø: d1 Ø 26 / d2 Ø 23,5
6764601905, 6764602105



DB-DL-8176

Length: 783
Ø: 42
Cone Ø: d1 Ø 26 / d2 Ø 23,5
6764603105



DB-DL-12440

Length: 783
Ø: 42
Cone Ø: d1 Ø 26 / d2 Ø 23,5
Thread: M30 x 1,5 RHT
6764602005, 6764602205, 6764603205



DB-ES-0830

Length: 95
Cone Ø: d1 Ø 20 / d2 Ø 18
Thread: M24 x 1,5 LHT
0003300235, 0003300735, 0003308635,
0004607348



DB-ES-1281

Length: 115
Cone Ø: d1 Ø 22 / d2 Ø 19,9
Thread: M30 x 1,5 RHT
0003303135, 0003308135



DB-ES-8491

Length: 60
Cone Ø: d1 Ø 10 / d2 Ø 10
Thread: M12 x 1,75 LHT
0009966745



DB-ES-8492

Length: 60
Cone Ø: d1 Ø 10 / d2 Ø 10
Thread: M12 x 1,75 RHT
0009966645, 3752680189, A3752680189



DB-SB-5267

Thick/Height: 60
01321500A, 6733230485



DB-SB-5268

Length: 55
Thick/Height: 60
01307400A, 99905014



DB-SB-5274

Ø: 64
Thick/Height: 60
01307500A, 6753231885



DB-SB-10385

Ø: 30 Thick/Height: 30
3093200073, 3143260153



DB-SB-10386

Ø: 38 Thick/Height: 38
3183200073



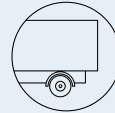
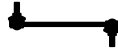

LK/LN2 ...

709 K	03/84 → 10/90	Ball Head, gearshift linkage	DB-ES-8491			
	03/84 → 10/90	Ball Head, gearshift linkage	DB-ES-8492			
	03/84 → 10/90	Centre Rod	DB-DL-0280		Push Rod	
	03/84 → 10/90	Centre Rod	DB-DL-6235		Push Rod	
	03/84 → 10/90	Stabiliser Mounting		DB-SB-10385		
	03/84 → 10/90	Stabiliser Mounting		DB-SB-10385	* 5 225 566 * →	
	03/84 → 10/90	Stabiliser Mounting		DB-SB-10385	→* 5 225 565 *	
	03/84 → 10/90	Stabiliser Mounting		DB-SB-10385	→* 5 332 725 *	
	03/84 → 10/90	Stabiliser Mounting		DB-SB-10385	1st RA	
	03/84 → 10/90	Stabiliser Mounting	DB-SB-5268			
	03/84 → 10/90	Stabiliser Mounting	DB-SB-5268		1st FA	
	03/84 → 10/90	Stabiliser Mounting	DB-SB-10385	DB-SB-10385		
	03/84 → 10/90	Stabiliser Mounting	DB-SB-10385	DB-SB-10385	1st FA	
	711	03/94 → 12/98	Ball Head, gearshift linkage	DB-ES-8491		
		03/94 → 12/98	Ball Head, gearshift linkage	DB-ES-8492		
		03/94 → 12/98	Centre Rod	DB-DL-0280		Push Rod
		03/94 → 12/98	Centre Rod	DB-DL-6235		Push Rod
03/94 → 12/98		Stabiliser Mounting		DB-SB-10385		
03/94 → 12/98		Stabiliser Mounting		DB-SB-10385	→* 5 225 565 *	
03/94 → 12/98		Stabiliser Mounting		DB-SB-10385	→* 5 332 725 *	
03/94 → 12/98		Stabiliser Mounting		DB-SB-10385	1st RA	
03/94 → 12/98		Stabiliser Mounting	DB-SB-5268			
03/94 → 12/98		Stabiliser Mounting	DB-SB-5268		1st FA	
03/94 → 12/98		Stabiliser Mounting	DB-SB-10385	DB-SB-10385		
03/94 → 12/98		Stabiliser Mounting	DB-SB-10385	DB-SB-10385	1st FA	
03/94 → 12/98		Tie Rod End	CV-ES-2774			
03/94 → 12/98		Tie Rod End	DB-ES-0830			
03/96 → 12/98		Ball Head, gearshift linkage	DB-ES-8387			
809		03/84 → 12/98	Ball Head, gearshift linkage	DB-ES-8491		
		03/84 → 12/98	Ball Head, gearshift linkage	DB-ES-8492		
	03/84 → 12/98	Centre Rod	DB-DL-0280		Push Rod	
	03/84 → 12/98	Centre Rod	DB-DL-6235		Push Rod	
	03/84 → 12/98	Stabiliser Mounting		DB-SB-10385		
	03/84 → 12/98	Stabiliser Mounting		DB-SB-10385	→* 5 332 725 *	
	03/84 → 12/98	Stabiliser Mounting		DB-SB-10385	1st RA	
	03/84 → 12/98	Stabiliser Mounting	DB-SB-5268			
	03/84 → 12/98	Stabiliser Mounting	DB-SB-5268		1st FA	
	03/84 → 12/98	Stabiliser Mounting	DB-SB-10385	DB-SB-10385		
	03/84 → 12/98	Stabiliser Mounting	DB-SB-10385	DB-SB-10385	1st FA	
	03/84 → 12/98	Stabiliser Mounting	DB-SB-10386	DB-SB-10386		
	03/84 → 12/98	Stabiliser Mounting	DB-SB-10386	DB-SB-10386	1st FA	
	03/84 → 12/98	Tie Rod End	DB-ES-1281			
	809 K	03/84 → 12/98	Ball Head, gearshift linkage	DB-ES-8491		
		03/84 → 12/98	Ball Head, gearshift linkage	DB-ES-8492		
		03/84 → 12/98	Centre Rod	DB-DL-0280		Push Rod
03/84 → 12/98		Centre Rod	DB-DL-6235		Push Rod	
03/84 → 12/98		Stabiliser Mounting		DB-SB-10385		
03/84 → 12/98		Stabiliser Mounting		DB-SB-10385	→* 5 332 725 *	
03/84 → 12/98		Stabiliser Mounting		DB-SB-10385	1st RA	
03/84 → 12/98		Stabiliser Mounting	DB-SB-5268			
03/84 → 12/98		Stabiliser Mounting	DB-SB-5268		1st FA	
03/84 → 12/98		Stabiliser Mounting	DB-SB-10385	DB-SB-10385		
03/84 → 12/98		Stabiliser Mounting	DB-SB-10385	DB-SB-10385	1st FA	
03/84 → 12/98		Stabiliser Mounting	DB-SB-10386	DB-SB-10386		
03/84 → 12/98		Stabiliser Mounting	DB-SB-10386	DB-SB-10386	1st FA	
03/84 → 12/98		Tie Rod End	DB-ES-1281			
811		03/94 → 12/98	Ball Head, gearshift linkage	DB-ES-8491		
		03/94 → 12/98	Ball Head, gearshift linkage	DB-ES-8492		
		03/94 → 12/98	Centre Rod	DB-DL-0280		Push Rod
	03/94 → 12/98	Centre Rod	DB-DL-6235		Push Rod	
	03/94 → 12/98	Stabiliser Mounting		DB-SB-10385		
	03/94 → 12/98	Stabiliser Mounting		DB-SB-10385	→* 5 332 725 *	
	03/94 → 12/98	Stabiliser Mounting		DB-SB-10385	1st RA	
	03/94 → 12/98	Stabiliser Mounting	DB-SB-5268			
	03/94 → 12/98	Stabiliser Mounting	DB-SB-5268		1st FA	
	03/94 → 12/98	Stabiliser Mounting	DB-SB-10385	DB-SB-10385		
	03/94 → 12/98	Stabiliser Mounting	DB-SB-10385	DB-SB-10385	1st FA	
	03/94 → 12/98	Tie Rod End	DB-ES-1281			

CV-ES-2774

Length: 95
Cone Ø: d1 Ø 20 / d2 Ø 18
Thread: M24 x 1,5 RHT
0003300635, 0003308535, 0004607248,
0004633229, 0024601648



DB-SB-5268

Length: 55
Thick/Height: 60
01307400A, 99905014



DB-DL-0280

6734600305, 6734600705



DB-SB-10385

Ø: 30 Thick/Height: 30
3093200073, 3143260153



DB-DL-6235

Length: 725
Ø: 36
Cone Ø: d1 Ø 22 / d2 Ø 19,9
6734600605



DB-SB-10386

Ø: 38 Thick/Height: 38
3183200073



DB-ES-0830

Length: 95
Cone Ø: d1 Ø 20 / d2 Ø 18
Thread: M24 x 1,5 LHT
0003300235, 0003300735, 0003308635,
0004607348



DB-ES-1281

Length: 115
Cone Ø: d1 Ø 22 / d2 Ø 19,9
Thread: M30 x 1,5 RHT
0003303135, 0003308135



DB-ES-8387

Length: 55
Cone Ø: d1 Ø 10 / d2 Ø 10
Thread: M14 x 1,5 RHT
0009966845, 0009967045



DB-ES-8491

Length: 60
Cone Ø: d1 Ø 10 / d2 Ø 10
Thread: M12 x 1,75 LHT
0009966745



DB-ES-8492

Length: 60
Cone Ø: d1 Ø 10 / d2 Ø 10
Thread: M12 x 1,75 RHT
0009966645, 3752680189, A3752680189





LK/LN2 ...

811 ...	03/94 →12/98	Stabiliser Mounting	DB-SB-10385	DB-SB-10385		
	03/94 →12/98	Stabiliser Mounting	DB-SB-10385	DB-SB-10385	1st FA	
	03/94 →12/98	Tie Rod End	DB-ES-1281			
	03/96 →12/98	Ball Head, gearshift linkage	DB-ES-8387			
811 K	03/94 →12/98	Ball Head, gearshift linkage	DB-ES-8491			
	03/94 →12/98	Ball Head, gearshift linkage	DB-ES-8492			
	03/94 →12/98	Centre Rod	DB-DL-0280		Push Rod	
	03/94 →12/98	Centre Rod	DB-DL-6235		Push Rod	
	03/94 →12/98	Stabiliser Mounting		DB-SB-10385		
	03/94 →12/98	Stabiliser Mounting		DB-SB-10385	→* 5 332 725 *	
	03/94 →12/98	Stabiliser Mounting		DB-SB-10385	1st RA	
	03/94 →12/98	Stabiliser Mounting	DB-SB-5268			
	03/94 →12/98	Stabiliser Mounting	DB-SB-5268		1st FA	
	03/94 →12/98	Stabiliser Mounting	DB-SB-10385	DB-SB-10385		
	03/94 →12/98	Stabiliser Mounting	DB-SB-10385	DB-SB-10385	1st FA	
	03/96 →12/98	Ball Head, gearshift linkage	DB-ES-8387			
	814 F	05/86 →12/98	Ball Head, gearshift linkage	DB-ES-8387		
05/86 →12/98		Ball Head, gearshift linkage	DB-ES-8491			
05/86 →12/98		Ball Head, gearshift linkage	DB-ES-8492			
05/86 →12/98		Stabiliser Mounting		DB-SB-5269		
05/86 →12/98		Stabiliser Mounting		DB-SB-5270		
05/86 →12/98		Stabiliser Mounting		DB-SB-10385		
05/86 →12/98		Stabiliser Mounting		DB-SB-10385	→* 5 332 725 *	
05/86 →12/98		Stabiliser Mounting		DB-SB-10385	1st RA	
05/86 →12/98		Stabiliser Mounting	DB-SB-5268		→* 5 282 994 *	
05/86 →12/98		Stabiliser Mounting	DB-SB-5268		→* 5 502 947 *	
05/86 →12/98		Stabiliser Mounting	DB-SB-5268		1st FA	
05/86 →12/98		Stabiliser Mounting	DB-SB-10385	DB-SB-10385	1st FA	
05/86 →12/98		Tie Rod End	CV-ES-12461		for Steering Rod	
03/94 →12/98		Centre Rod	DB-DL-0280		Push Rod	
03/94 →12/98		Centre Rod	DB-DL-6235		Push Rod	
03/94 →12/98		Stabiliser Mounting	DB-SB-5268			
03/94 →12/98		Stabiliser Mounting	DB-SB-10385	DB-SB-10385		
814 K		03/84 →12/98	Ball Head, gearshift linkage	DB-ES-8387		
		03/84 →12/98	Ball Head, gearshift linkage	DB-ES-8491		
		03/84 →12/98	Ball Head, gearshift linkage	DB-ES-8492		
	03/84 →12/98	Stabiliser Mounting		DB-SB-10385		
	03/84 →12/98	Stabiliser Mounting		DB-SB-10385	→* 5 332 725 *	
	03/84 →12/98	Stabiliser Mounting		DB-SB-10385	1st RA	
	03/84 →12/98	Stabiliser Mounting	DB-SB-5268		* 5 308 589 * →	
	03/84 →12/98	Stabiliser Mounting	DB-SB-5268		→* 5 300 676 *	
	03/84 →12/98	Stabiliser Mounting	DB-SB-5268		1st FA	
	03/84 →12/98	Stabiliser Mounting	DB-SB-5274			
	03/84 →12/98	Stabiliser Mounting	DB-SB-10385	DB-SB-10385	1st FA	
	03/84 →12/98	Tie Rod End	DB-ES-1281			
	03/94 →12/98	Centre Rod	DB-DL-0280		Push Rod	
	03/94 →12/98	Centre Rod	DB-DL-6235		Push Rod	
	03/94 →12/98	Stabiliser Mounting	DB-SB-5268			
	03/94 →12/98	Stabiliser Mounting	DB-SB-5274	DB-SB-5274		
	03/94 →12/98	Stabiliser Mounting	DB-SB-10385	DB-SB-10385		
	814 LO	03/96 →12/98	Ball Head, gearshift linkage	DB-ES-8387		
		03/96 →12/98	Ball Head, gearshift linkage	DB-ES-8491		
03/96 →12/98		Ball Head, gearshift linkage	DB-ES-8492			
03/96 →12/98		Centre Rod	DB-DL-0280		Push Rod	
03/96 →12/98		Centre Rod	DB-DL-6235		Push Rod	
03/96 →12/98		Stabiliser Mounting		DB-SB-10385		
03/96 →12/98		Stabiliser Mounting		DB-SB-10386		
03/96 →12/98		Stabiliser Mounting	DB-SB-10385	DB-SB-10385		
814 O, 814 LO	03/96 →12/98	Stabiliser Mounting	DB-SB-10385	DB-SB-10385	1st FA	
	01/84 →12/98	Ball Head, gearshift linkage	DB-ES-8387			
	01/84 →12/98	Ball Head, gearshift linkage	DB-ES-8491			
	01/84 →12/98	Ball Head, gearshift linkage	DB-ES-8492			
	01/84 →12/98	Centre Rod	DB-DL-0280		Push Rod	

CV-ES-12461

Length: 120
Cone Ø: d1 Ø 26 / d2 Ø 23,5
Thread: M30 x 1,5 LHT
0003300035, 3300148, 0003406213, 0013306635,
0013308835, 0014604048, 0014604348,
14606448, 0024600248, 3023300035,
3023300135, 3023300235, 3023300335,
3453307235, 3453307435, 3503307135,
A0003300148, A0013306635, A0013308835,
A0014604048, A0014604348, A0014606448,
A0024600248, A3023300035, A3023300135,
A3023300235, A3023300335, A3503307135



DB-DL-0280

6734600305, 6734600705



DB-DL-6235

Length: 725
Ø: 36
Cone Ø: d1 Ø 22 / d2 Ø 19,9
6734600605



DB-ES-1281

Length: 115
Cone Ø: d1 Ø 22 / d2 Ø 19,9
Thread: M30 x 1,5 RHT
0003303135, 0003308135



DB-ES-8387

Length: 55
Cone Ø: d1 Ø 10 / d2 Ø 10
Thread: M14 x 1,5 RHT
0009966845, 0009967045



DB-ES-8491

Length: 60
Cone Ø: d1 Ø 10 / d2 Ø 10
Thread: M12 x 1,75 LHT
0009966745



DB-ES-8492

Length: 60
Cone Ø: d1 Ø 10 / d2 Ø 10
Thread: M12 x 1,75 RHT
0009966645, 3752680189, A3752680189



DB-SB-5268

Length: 55
Thick/Height: 60
01307400A, 99905014



DB-SB-5269

Ø: 58
Thick/Height: 47
01328600A, 99902563



DB-SB-5270

Ø: 54
Thick/Height: 47
01328700A, 99902538



DB-SB-5274

Ø: 64
Thick/Height: 60
01307500A, 6753231885



DB-SB-10385

Ø: 30 Thick/Height: 30
3093200073, 3143260153



DB-SB-10386

Ø: 38 Thick/Height: 38
3183200073



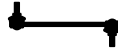

LK/LN2 ...

814 0, 814 LO ...	01/84 →12/98	Stabiliser Mounting		DB-SB-10385	
	01/84 →12/98	Stabiliser Mounting		DB-SB-10385	→* 5 332 725 *
	01/84 →12/98	Stabiliser Mounting		DB-SB-10385	1st RA
	01/84 →12/98	Stabiliser Mounting	DB-SB-5268		
	01/84 →12/98	Stabiliser Mounting	DB-SB-5268		1st FA
	01/84 →12/98	Stabiliser Mounting	DB-SB-10385	DB-SB-10385	1st FA
814 S	03/84 →12/98	Ball Head, gearshift linkage	DB-ES-8387		
	03/84 →12/98	Ball Head, gearshift linkage	DB-ES-8491		
	03/84 →12/98	Ball Head, gearshift linkage	DB-ES-8492		
	03/84 →12/98	Stabiliser Mounting		DB-SB-10385	
	03/84 →12/98	Stabiliser Mounting		DB-SB-10385	→* 5 332 725 *
	03/84 →12/98	Stabiliser Mounting		DB-SB-10385	1st RA
	03/84 →12/98	Stabiliser Mounting	DB-SB-5268		* 5 309 145 *→
	03/84 →12/98	Stabiliser Mounting	DB-SB-5268		→* 5 301 189 *
	03/84 →12/98	Stabiliser Mounting	DB-SB-5268		1st FA
	03/84 →12/98	Stabiliser Mounting	DB-SB-5274		
	03/84 →12/98	Stabiliser Mounting	DB-SB-10385	DB-SB-10385	1st FA
	03/84 →12/98	Tie Rod End	CV-ES-12461		for Steering Rod
	03/94 →12/98	Stabiliser Mounting	DB-SB-5268		
	03/94 →12/98	Stabiliser Mounting	DB-SB-5274	DB-SB-5274	
03/94 →12/98	Stabiliser Mounting	DB-SB-10385	DB-SB-10385		
03/96 →12/98	Centre Rod	DB-DL-0280		Push Rod	
03/96 →12/98	Centre Rod	DB-DL-6235		Push Rod	
814,814 L	01/84 →12/98	Ball Head, gearshift linkage	DB-ES-8387		
	01/84 →12/98	Ball Head, gearshift linkage	DB-ES-8491		
	01/84 →12/98	Ball Head, gearshift linkage	DB-ES-8492		
	01/84 →12/98	Stabiliser Mounting		DB-SB-10385	
	01/84 →12/98	Stabiliser Mounting		DB-SB-10385	→* 5 332 725 *
	01/84 →12/98	Stabiliser Mounting		DB-SB-10385	1st RA
	01/84 →12/98	Stabiliser Mounting		DB-SB-10386	
	01/84 →12/98	Stabiliser Mounting	DB-SB-5268		
	01/84 →12/98	Stabiliser Mounting	DB-SB-5268		1st FA
	01/84 →12/98	Stabiliser Mounting	DB-SB-5274	DB-SB-5274	
	01/84 →12/98	Stabiliser Mounting	DB-SB-10385	DB-SB-10385	
	01/84 →12/98	Stabiliser Mounting	DB-SB-10385	DB-SB-10385	1st FA
	01/84 →12/98	Tie Rod End	CV-ES-12461		for Steering Rod
	814,814L	01/84 →12/98	Stabiliser Mounting	DB-SB-5268	
01/84 →12/98		Stabiliser Mounting	DB-SB-5268		→* 5 300 676 *
01/84 →12/98		Stabiliser Mounting	DB-SB-5274		
03/96 →12/98		Centre Rod	DB-DL-0280		Push Rod
03/96 →12/98		Centre Rod	DB-DL-6235		Push Rod
817 F	03/84 →12/98	Stabiliser Mounting		DB-SB-5269	
	03/84 →12/98	Stabiliser Mounting		DB-SB-10385	
	03/84 →12/98	Stabiliser Mounting		DB-SB-10385	→* 5 332 725 *
	03/84 →12/98	Stabiliser Mounting		DB-SB-10385	1st RA
	03/84 →12/98	Stabiliser Mounting	DB-SB-5268		→* 5 282 994 *
	03/84 →12/98	Stabiliser Mounting	DB-SB-5268		1st FA
	03/84 →12/98	Stabiliser Mounting	DB-SB-10385	DB-SB-10385	
	03/84 →12/98	Stabiliser Mounting	DB-SB-10385	DB-SB-10385	1st FA
	03/84 →12/98	Tie Rod End	CV-ES-12461		for Steering Rod
817 K	01/86 →12/98	Stabiliser Mounting		DB-SB-10385	
	01/86 →12/98	Stabiliser Mounting		DB-SB-10385	1st RA
	01/86 →12/98	Stabiliser Mounting	DB-SB-5268		
	01/86 →12/98	Stabiliser Mounting	DB-SB-5268		1st FA
	01/86 →12/98	Stabiliser Mounting	DB-SB-10385	DB-SB-10385	
	01/86 →12/98	Stabiliser Mounting	DB-SB-10385	DB-SB-10385	1st FA
	01/86 →12/98	Tie Rod End	CV-ES-12461		for Steering Rod
817 LO	03/96 →12/98	Stabiliser Mounting		DB-SB-10385	
	03/96 →12/98	Stabiliser Mounting	DB-SB-10385	DB-SB-10385	
	03/96 →12/98	Stabiliser Mounting	DB-SB-10385	DB-SB-10385	1st FA
	03/96 →12/98	Tie Rod End	CV-ES-12461		for Steering Rod

CV-ES-12461

Length: 120
Cone Ø: d1 Ø 26 / d2 Ø 23,5
Thread: M30 x 1,5 LHT
0003300035, 3300148, 0003406213, 0013306635,
0013308835, 0014604048, 0014604348,
14606448, 0024600248, 3023300035,
3023300135, 3023300235, 3023300335,
3453307235, 3453307435, 3503307135,
A0003300148, A0013306635, A0013308835,
A0014604048, A0014604348, A0014606448,
A0024600248, A3023300035, A3023300135,
A3023300235, A3023300335, A3503307135



DB-DL-0280

6734600305, 6734600705



DB-DL-6235

Length: 725
Ø: 36
Cone Ø: d1 Ø 22 / d2 Ø 19,9
6734600605



DB-ES-8387

Length: 55
Cone Ø: d1 Ø 10 / d2 Ø 10
Thread: M14 x 1,5 RHT
0009966845, 0009967045



DB-ES-8491

Length: 60
Cone Ø: d1 Ø 10 / d2 Ø 10
Thread: M12 x 1,75 LHT
0009966745



DB-ES-8492

Length: 60
Cone Ø: d1 Ø 10 / d2 Ø 10
Thread: M12 x 1,75 RHT
0009966645, 3752680189, A3752680189



DB-SB-5268

Length: 55
Thick/Height: 60
01307400A, 99905014



DB-SB-5269

Ø: 58
Thick/Height: 47
01328600A, 99902563



DB-SB-5274

Ø: 64
Thick/Height: 60
01307500A, 6753231885



DB-SB-10385

Ø: 30 Thick/Height: 30
3093200073, 3143260153



DB-SB-10386

Ø: 38 Thick/Height: 38
3183200073



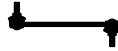

LK/LN2 ...

817 0, 817 LO	01/84 → 12/98	Stabiliser Mounting		DB-SB-10385		
	01/84 → 12/98	Stabiliser Mounting		DB-SB-10385	→* 5 332 725 *	
	01/84 → 12/98	Stabiliser Mounting		DB-SB-10385	1st RA	
	01/84 → 12/98	Stabiliser Mounting	DB-SB-10385	DB-SB-10385		
	01/84 → 12/98	Stabiliser Mounting	DB-SB-10385	DB-SB-10385	1st FA	
	01/84 → 12/98	Tie Rod End	CV-ES-12461		for Steering Rod	
817 S, 817 LS	01/84 → 12/98	Stabiliser Link		VL-DL-8518	Coupling Rod, Control Arm	
	01/84 → 12/98	Stabiliser Link		VL-DL-8543	Coupling Rod, Control Arm	
	01/84 → 12/98	Stabiliser Mounting		DB-SB-10385		
	01/84 → 12/98	Stabiliser Mounting		DB-SB-10385	→* 5 332 725 *	
	01/84 → 12/98	Stabiliser Mounting		DB-SB-10385	1st RA	
	01/84 → 12/98	Stabiliser Mounting	DB-SB-5268			
	01/84 → 12/98	Stabiliser Mounting	DB-SB-5268		* 5 309 145 * →	
	01/84 → 12/98	Stabiliser Mounting	DB-SB-5268		→* 5 301 189 *	
	01/84 → 12/98	Stabiliser Mounting	DB-SB-5268		1st FA	
	01/84 → 12/98	Stabiliser Mounting	DB-SB-5274			
	01/84 → 12/98	Stabiliser Mounting	DB-SB-10385	DB-SB-10385		
	01/84 → 12/98	Stabiliser Mounting	DB-SB-10385	DB-SB-10385	1st FA	
	01/84 → 12/98	Tie Rod End	CV-ES-12461		for Steering Rod	
	03/96 → 12/98	Centre Rod	DB-DL-0280		Push Rod	
Centre Rod		DB-DL-6235		Push Rod		
817, 817 L	01/84 → 12/98	Centre Rod	DB-DL-7832		Push Rod	
	01/84 → 12/98	Stabiliser Mounting		DB-SB-10385		
	01/84 → 12/98	Stabiliser Mounting		DB-SB-10385	→* 5 332 725 *	
	01/84 → 12/98	Stabiliser Mounting		DB-SB-10385	1st RA	
	01/84 → 12/98	Stabiliser Mounting	DB-SB-5268			
	01/84 → 12/98	Stabiliser Mounting	DB-SB-5268		* 5 308 589 * →	
	01/84 → 12/98	Stabiliser Mounting	DB-SB-5268		→* 5 300 676 *	
	01/84 → 12/98	Stabiliser Mounting	DB-SB-5268		1st FA	
	01/84 → 12/98	Stabiliser Mounting	DB-SB-5274			
	01/84 → 12/98	Stabiliser Mounting	DB-SB-10385	DB-SB-10385		
	01/84 → 12/98	Stabiliser Mounting	DB-SB-10385	DB-SB-10385	1st FA	
	01/84 → 12/98	Tie Rod End	CV-ES-12461		for Steering Rod	
	914	03/84 → 12/98	Ball Head, gearshift linkage	DB-ES-8387		
		03/84 → 12/98	Ball Head, gearshift linkage	DB-ES-8491		
03/84 → 12/98		Ball Head, gearshift linkage	DB-ES-8492			
03/84 → 12/98		Centre Rod	DB-DL-5219		Push Rod	
03/84 → 12/98		Stabiliser Mounting		DB-SB-10385		
03/84 → 12/98		Stabiliser Mounting		DB-SB-10385	→* 5 332 725 *	
03/84 → 12/98		Stabiliser Mounting		DB-SB-10385	1st RA	
03/84 → 12/98		Stabiliser Mounting		DB-SB-10386		
03/84 → 12/98		Stabiliser Mounting	DB-SB-5268		* 5 308 589 * →	
03/84 → 12/98		Stabiliser Mounting	DB-SB-5268		→* 5 300 676 *	
03/84 → 12/98		Stabiliser Mounting	DB-SB-5268		1st FA	
03/84 → 12/98		Stabiliser Mounting	DB-SB-5274			
03/84 → 12/98		Stabiliser Mounting	DB-SB-10385	DB-SB-10385	1st FA	
03/84 → 12/98		Stabiliser Mounting	DB-SB-10386	DB-SB-10386		
03/84 → 12/98	Stabiliser Mounting	DB-SB-10386	DB-SB-10386	1st FA		
03/84 → 12/98	Tie Rod End	CV-ES-12461		for Steering Rod		
03/84 → 12/98	Tie Rod End	CV-ES-12462		for Steering Rod		
914 AK	02/87 → 12/98	Ball Head, gearshift linkage	DB-ES-8387			
	02/87 → 12/98	Ball Head, gearshift linkage	DB-ES-8491			
	02/87 → 12/98	Ball Head, gearshift linkage	DB-ES-8492			
	02/87 → 12/98	Centre Rod	DB-DL-7832		Push Rod	
	02/87 → 12/98	Centre Rod	DB-DL-10207		Push Rod* 5 426 402 * →	
	02/87 → 12/98	Stabiliser Mounting		DB-SB-10385		
	02/87 → 12/98	Stabiliser Mounting		DB-SB-10385	→* 5 332 725 *	
	02/87 → 12/98	Stabiliser Mounting		DB-SB-10385	1st RA	
	02/87 → 12/98	Stabiliser Mounting	DB-SB-5272			
	02/87 → 12/98	Stabiliser Mounting	DB-SB-10385	DB-SB-10385	1st FA	
	02/87 → 12/98	Stabiliser Mounting	DB-SB-10386	DB-SB-10386		
	02/87 → 12/98	Tie Rod End	CV-ES-12461		for Steering Rod	
	02/87 → 12/98	Tie Rod End	CV-ES-12462		for Steering Rod	

CV-ES-12461

Length: 120
 Cone Ø: d1 Ø 26 / d2 Ø 23,5
 Thread: M30 x 1,5 LHT
 0003300035, 3300148, 0003406213, 0013306635,
 0013308835, 0014604048, 0014604348,
 14606448, 0024600248, 3023300035,
 3023300135, 3023300235, 3023300335,
 3453307235, 3453307435, 3503307135,
 A0003300148, A0013306635, A0013308835,
 A0014604048, A0014604348, A0014606448,
 A0024600248, A3023300035, A3023300135,
 A3023300235, A3023300335, A3503307135



CV-ES-12462

Length: 120
 Cone Ø: d1 Ø 26 / d2 Ø 23,5
 Thread: M30 x 1,5 RHT
 0003300135, 0003300248, 0003303235,
 0003305835, 0003307335, 0003383410,
 0004608348, 004608348, 0004632229,
 0004633129, 0004633429, 0004633529,
 0013300135, 0013300235, 0013306735,
 0014603448, 0014604148, 0014604448,
 0014606348, 0014608348, 0014608448,
 0014609748, 0023301535, 3453307135,
 3503307035, 3503307335, 3643307135,
 5001832582, A0003300248, A0003303235,
 A0003307335, A0003383410, A0004608348,
 A0004632229, A0004633429, A0013300135,
 A0013300235, A0013306735, A0014603448,
 A0014604148, A0014604448, A0014606348,
 A0014608348, A0014608448, A0014609748,
 A0023301535



DB-DL-0280

6734600305, 6734600705



DB-DL-5219

Length: 785
 Ø: 40
 Cone Ø: d1 Ø 26 / d2 Ø 22
 01212200A, 6754601005, 6754601605,
 6754602205, 6754602805



DB-DL-6235

Length: 725
 Ø: 36
 Cone Ø: d1 Ø 22 / d2 Ø 19,9
 6734600605



DB-DL-7832

Length: 783
 Ø: 42
 Cone Ø: d1 Ø 26 / d2 Ø 23,5
 6764601905, 6764602105



DB-DL-10207

Length: 780
 Ø: 40
 Cone Ø: d1 Ø 26 / d2 Ø 23,5
 6744600405



DB-ES-8387

Length: 55
 Cone Ø: d1 Ø 10 / d2 Ø 10
 Thread: M14 x 1,5 RHT
 0009966845, 0009967045



DB-ES-8491

Length: 60
 Cone Ø: d1 Ø 10 / d2 Ø 10
 Thread: M12 x 1,75 LHT
 0009966745



DB-ES-8492

Length: 60
 Cone Ø: d1 Ø 10 / d2 Ø 10
 Thread: M12 x 1,75 RHT
 0009966645, 3752680189, A3752680189



DB-SB-5268

Length: 55
 Thick/Height: 60
 01307400A, 99905014



DB-SB-5272

Thick/Height: 57
 01331400A, 6753231785



DB-SB-5274

Ø: 64
 Thick/Height: 60
 01307500A, 6753231885



DB-SB-10385

Ø: 30 Thick/Height: 30
 3093200073, 3143260153



DB-SB-10386

Ø: 38 Thick/Height: 38
 3183200073



VL-DL-8518



VL-DL-8543



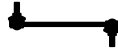

LK/LN2 ...

914 K	03/84→12/98	Ball Head, gearshift linkage	DB-ES-8387		
	03/84→12/98	Ball Head, gearshift linkage	DB-ES-8491		
	03/84→12/98	Ball Head, gearshift linkage	DB-ES-8492		
	03/84→12/98	Stabiliser Mounting		DB-SB-5269	
	03/84→12/98	Stabiliser Mounting		DB-SB-10385	
	03/84→12/98	Stabiliser Mounting		DB-SB-10385	→* 5 332 725 *
	03/84→12/98	Stabiliser Mounting		DB-SB-10385	1st RA
	03/84→12/98	Stabiliser Mounting	DB-SB-5268		* 5 308 589 *→
	03/84→12/98	Stabiliser Mounting	DB-SB-5268		→* 5 300 676 *
	03/84→12/98	Stabiliser Mounting	DB-SB-5268		1st FA
	03/84→12/98	Stabiliser Mounting	DB-SB-5274		
	03/84→12/98	Stabiliser Mounting	DB-SB-10385	DB-SB-10385	1st FA
	03/84→12/98	Tie Rod End	CV-ES-12461		for Steering Rod
914 KO	01/87→12/98	Ball Head, gearshift linkage	DB-ES-8387		
	01/87→12/98	Ball Head, gearshift linkage	DB-ES-8491		
	01/87→12/98	Ball Head, gearshift linkage	DB-ES-8492		
	01/87→12/98	Stabiliser Mounting		DB-SB-5269	
	01/87→12/98	Stabiliser Mounting		DB-SB-10385	
	01/87→12/98	Stabiliser Mounting		DB-SB-10385	→* 5 332 725 *
	01/87→12/98	Stabiliser Mounting		DB-SB-10385	1st RA
	01/87→12/98	Stabiliser Mounting	DB-SB-5268		→* 5 502 947 *
	01/87→12/98	Stabiliser Mounting	DB-SB-5268		1st FA
	01/87→12/98	Stabiliser Mounting	DB-SB-10385	DB-SB-10385	1st FA
917	03/94→12/98	Stabiliser Mounting		DB-SB-10385	
	03/94→12/98	Stabiliser Mounting		DB-SB-10385	→* 5 332 725 *
	03/94→12/98	Stabiliser Mounting		DB-SB-10385	1st RA
	03/94→12/98	Stabiliser Mounting	DB-SB-5268		
	03/94→12/98	Stabiliser Mounting	DB-SB-5268		1st FA
	03/94→12/98	Stabiliser Mounting	DB-SB-10385	DB-SB-10385	
	03/94→12/98	Stabiliser Mounting	DB-SB-10385	DB-SB-10385	1st FA
	03/94→12/98	Stabiliser Mounting	DB-SB-10386	DB-SB-10386	
	03/94→12/98	Stabiliser Mounting	DB-SB-10386	DB-SB-10386	1st FA
	03/94→12/98	Tie Rod End	CV-ES-12461		for Steering Rod
917 AF	02/87→12/98	Centre Rod	DB-DL-7832		Push Rod
	02/87→12/98	Centre Rod	DB-DL-10207		Push Rod
	02/87→12/98	Centre Rod	DB-DL-10207		Push Rod* 5 426 402 *→
	02/87→12/98	Stabiliser Mounting		DB-SB-10385	
	02/87→12/98	Stabiliser Mounting		DB-SB-10385	→* 5 332 725 *
	02/87→12/98	Stabiliser Mounting		DB-SB-10385	1st RA
	02/87→12/98	Stabiliser Mounting		DB-SB-10386	
	02/87→12/98	Stabiliser Mounting	DB-SB-10385	DB-SB-10385	1st FA
	02/87→12/98	Stabiliser Mounting	DB-SB-10386	DB-SB-10386	
	02/87→12/98	Stabiliser Mounting	DB-SB-10386	DB-SB-10386	1st FA
	02/87→12/98	Tie Rod End	CV-ES-12461		for Steering Rod
	02/87→12/98	Tie Rod End	CV-ES-12462		for Steering Rod
	917 AK	03/94→12/98	Centre Rod	DB-DL-10207	
03/94→12/98		Stabiliser Mounting	DB-SB-10385	DB-SB-10385	
03/94→12/98		Stabiliser Mounting	DB-SB-10385	DB-SB-10385	1st FA
03/94→12/98		Stabiliser Mounting	DB-SB-10386	DB-SB-10386	1st FA
917 K	03/94→12/98	Stabiliser Mounting		DB-SB-5269	
	03/94→12/98	Stabiliser Mounting		DB-SB-10385	
	03/94→12/98	Stabiliser Mounting		DB-SB-10385	1st RA
	03/94→12/98	Stabiliser Mounting	DB-SB-5268		
	03/94→12/98	Stabiliser Mounting	DB-SB-5268		1st FA
	03/94→12/98	Stabiliser Mounting	DB-SB-10385	DB-SB-10385	
	03/94→12/98	Stabiliser Mounting	DB-SB-10385	DB-SB-10385	1st FA
	03/94→12/98	Stabiliser Mounting	DB-SB-10386	DB-SB-10386	
	03/94→12/98	Tie Rod End	CV-ES-12461		for Steering Rod
	03/96→12/98	Stabiliser Mounting	DB-SB-10386	DB-SB-10386	1st FA

CV-ES-12461

Length: 120

Cone Ø: d1 Ø 26 / d2 Ø 23,5

Thread: M30 x 1,5 LHT

0003300035, 3300148, 0003406213, 0013306635,
0013308835, 0014604048, 0014604348,
14606448, 0024600248, 3023300035,
3023300135, 3023300235, 3023300335,
3453307235, 3453307435, 3503307135,
A0003300148, A0013306635, A0013308835,
A0014604048, A0014604348, A0014606448,
A0024600248, A3023300035, A3023300135,
A3023300235, A3023300335, A3503307135



CV-ES-12462

Length: 120

Cone Ø: d1 Ø 26 / d2 Ø 23,5

Thread: M30 x 1,5 RHT

0003300135, 0003300248, 0003303235,
0003305835, 0003307335, 0003383410,
0004608348, 004608348, 0004632229,
0004633129, 0004633429, 0004633529,
0013300135, 0013300235, 0013306735,
0014603448, 0014604148, 0014604448,
0014606348, 0014608348, 0014608448,
0014609748, 0023301535, 3453307135,
3503307035, 3503307335, 3643307135,
5001832582, A0003300248, A0003303235,
A0003307335, A0003383410, A0004608348,
A0004632229, A0004633429, A0013300135,
A0013300235, A0013306735, A0014603448,
A0014604148, A0014604448, A0014606348,
A0014608348, A0014608448, A0014609748,
A0023301535



DB-DL-7832

Length: 783

Ø: 42

Cone Ø: d1 Ø 26 / d2 Ø 23,5

6764601905, 6764602105



DB-DL-10207

Length: 780

Ø: 40

Cone Ø: d1 Ø 26 / d2 Ø 23,5

6744600405



DB-ES-8387

Length: 55

Cone Ø: d1 Ø 10 / d2 Ø 10

Thread: M14 x 1,5 RHT

0009966845, 0009967045



DB-ES-8491

Length: 60

Cone Ø: d1 Ø 10 / d2 Ø 10

Thread: M12 x 1,75 LHT

0009966745



DB-ES-8492

Length: 60

Cone Ø: d1 Ø 10 / d2 Ø 10

Thread: M12 x 1,75 RHT

0009966645, 3752680189, A3752680189



DB-SB-5268

Length: 55

Thick/Height: 60

01307400A, 99905014



DB-SB-5269

Ø: 58

Thick/Height: 47

01328600A, 99902563



DB-SB-5274

Ø: 64

Thick/Height: 60

01307500A, 6753231885



DB-SB-10385

Ø: 30 Thick/Height: 30

3093200073, 3143260153



DB-SB-10386

Ø: 38 Thick/Height: 38

3183200073





LK/LN2 ...

917 KO	03/94 → 12/98	Centre Rod	DB-DL-5215		Push Rod
	03/94 → 12/98	Stabiliser Mounting		DB-SB-5269	
	03/94 → 12/98	Stabiliser Mounting		DB-SB-10385	
	03/94 → 12/98	Stabiliser Mounting		DB-SB-10385	1st RA
	03/94 → 12/98	Stabiliser Mounting	DB-SB-10385	DB-SB-10385	
	03/94 → 12/98	Stabiliser Mounting	DB-SB-10385	DB-SB-10385	1st FA
	03/94 → 12/98	Tie Rod End	CV-ES-12461		for Steering Rod
0 1114 ,0 1114 L	01/84 → 12/98	Centre Rod	DB-DL-5215		Push Rod
	01/84 → 12/98	Centre Rod	DB-DL-5219		Push Rod
	01/84 → 12/98	Stabiliser Mounting		DB-SB-10385	
	01/84 → 12/98	Stabiliser Mounting		DB-SB-10385	→* 5 296 594 *
	01/84 → 12/98	Stabiliser Mounting		DB-SB-10385	→* 5 332 725 *
	01/84 → 12/98	Stabiliser Mounting		DB-SB-10385	1st RA
	01/84 → 12/98	Stabiliser Mounting		DB-SB-10386	* 5 296 595 * →
	01/84 → 12/98	Stabiliser Mounting	DB-SB-5274		
	01/84 → 12/98	Stabiliser Mounting	DB-SB-10385	DB-SB-10385	
	01/84 → 12/98	Stabiliser Mounting	DB-SB-10385	DB-SB-10385	1st FA
	01/84 → 12/98	Stabiliser Mounting	DB-SB-10386	DB-SB-10386	
	01/84 → 12/98	Stabiliser Mounting	DB-SB-10386	DB-SB-10386	1st FA
	01/84 → 12/98	Tie Rod End	CV-ES-12461		for Steering Rod
	01/84 → 12/98	Tie Rod End	CV-ES-12462		for Steering Rod
	0 814, 0 814 L	01/84 → 12/98	Ball Head, gearshift linkage	DB-ES-8387	
01/84 → 12/98		Ball Head, gearshift linkage	DB-ES-8491		
01/84 → 12/98		Ball Head, gearshift linkage	DB-ES-8492		
01/84 → 12/98		Centre Rod	DB-DL-0280		Push Rod
01/84 → 12/98		Centre Rod	DB-DL-6235		Push Rod
01/84 → 12/98		Stabiliser Mounting		DB-SB-10385	
01/84 → 12/98		Stabiliser Mounting		DB-SB-10385	→* 5 332 725 *
01/84 → 12/98		Stabiliser Mounting		DB-SB-10385	1st RA
01/84 → 12/98		Stabiliser Mounting	DB-SB-5268		
01/84 → 12/98		Stabiliser Mounting	DB-SB-10385	DB-SB-10385	
01/84 → 12/98		Stabiliser Mounting	DB-SB-10385	DB-SB-10385	1st FA

LP

LP 1013	11/76 → 12/84	Stabiliser Mounting		DB-SB-10385	
	11/76 → 12/84	Stabiliser Mounting		DB-SB-10385	1st RA
	11/76 → 12/84	Stabiliser Mounting	DB-SB-10385	DB-SB-10385	1st FA
LP 1013, LPL 1013	11/76 → 12/84	Stabiliser Mounting		DB-SB-10385	
	11/76 → 12/84	Stabiliser Mounting		DB-SB-10385	→* 4 462 009 *
	11/76 → 12/84	Stabiliser Mounting		DB-SB-10385	1st RA
	11/76 → 12/84	Stabiliser Mounting		DB-SB-10386	
	11/76 → 12/84	Stabiliser Mounting	DB-SB-10385	DB-SB-10385	1st FA
LP 1113, LPL 1113	01/80 → 12/84	Centre Rod	DB-DL-1179		Push Rod
	01/80 → 12/84	Stabiliser Mounting		DB-SB-10385	
	01/80 → 12/84	Stabiliser Mounting		DB-SB-10385	→* 4 462 009 *
	01/80 → 12/84	Stabiliser Mounting		DB-SB-10385	1st RA
	01/80 → 12/84	Stabiliser Mounting		DB-SB-10386	
	01/80 → 12/84	Stabiliser Mounting	DB-SB-10385	DB-SB-10385	1st FA
LP 608, LPL 608	09/63 → 12/84	Stabiliser Mounting		DB-SB-10385	
	09/63 → 12/84	Stabiliser Mounting		DB-SB-10385	* 4 282 708 * →
	09/63 → 12/84	Stabiliser Mounting		DB-SB-10385	* 4 491 915 * →* 4 770 200 *
	09/63 → 12/84	Stabiliser Mounting		DB-SB-10385	* 4 770 201 * →
	09/63 → 12/84	Stabiliser Mounting		DB-SB-10385	→* 4 282 707 *
	09/63 → 12/84	Stabiliser Mounting		DB-SB-10385	1st RA
	09/63 → 12/84	Stabiliser Mounting	DB-SB-10385	DB-SB-10385	
	09/63 → 12/84	Stabiliser Mounting	DB-SB-10385	DB-SB-10385	1st FA
	09/63 → 12/84	Suspension Arm Repair Kit		CV-RK-8118	for Drag Link
	09/63 → 12/84	Suspension Strut Repair Kit		DF-RK-8671	
	LP 709, LPL 709	09/63 → 12/84	Stabiliser Mounting		DB-SB-10385
09/63 → 12/84		Stabiliser Mounting		DB-SB-10385	* 4 282 708 * →
09/63 → 12/84		Stabiliser Mounting		DB-SB-10385	* 4 491 915 * →* 4 770 200 *
09/63 → 12/84		Stabiliser Mounting		DB-SB-10385	* 4 770 201 * →
09/63 → 12/84		Stabiliser Mounting		DB-SB-10385	→* 4 282 707 *

CV-ES-12461

Length: 120
 Cone Ø: d1 Ø 26 / d2 Ø 23,5
 Thread: M30 x 1,5 LHT
 0003300035, 3300148, 0003406213, 0013306635,
 0013308835, 0014604048, 0014604348,
 14606448, 0024600248, 3023300035,
 3023300135, 3023300235, 3023300335,
 3453307235, 3453307435, 3503307135,
 A0003300148, A0013306635, A0013308835,
 A0014604048, A0014604348, A0014606448,
 A0024600248, A3023300035, A3023300135,
 A3023300235, A3023300335, A3503307135



CV-ES-12462

Length: 120
 Cone Ø: d1 Ø 26 / d2 Ø 23,5
 Thread: M30 x 1,5 RHT
 0003300135, 0003300248, 0003303235,
 0003305835, 0003307335, 0003383410,
 0004608348, 004608348, 0004632229,
 0004633129, 0004633429, 0004633529,
 0013300135, 0013300235, 0013306735,
 0014603448, 0014604148, 0014604448,
 0014606348, 0014608348, 0014608448,
 0014609748, 0023301535, 3453307135,
 3503307035, 3503307335, 3643307135,
 5001832582, A0003300248, A0003303235,
 A0003307335, A0003383410, A0004608348,
 A0004632229, A0004633429, A0013300135,
 A0013300235, A0013306735, A0014603448,
 A0014604148, A0014604448, A0014606348,
 A0014608348, A0014608448, A0014609748,
 A0023301535



CV-RK-8118

Ø: 85
 Hole Distance: 130
 Thick/Height: 30
 0003500506, 3500506



DB-DL-0280

6734600305, 6734600705



DB-DL-1179

Length: 533
 Ø: 36
 Cone Ø: d1 Ø 22 / d2 Ø 19,9
 3164600605, 3164600805



DB-DL-5215

Length: 780
 Ø: 40
 Cone Ø: d1 Ø 26 / d2 Ø 23,5
 6764600105, 6764600605, 6764601105,
 6764601505



DB-DL-5219

Length: 785
 Ø: 40
 Cone Ø: d1 Ø 26 / d2 Ø 22
 01212200A, 6754601005, 6754601605,
 6754602205, 6754602805



DB-DL-6235

Length: 725
 Ø: 36
 Cone Ø: d1 Ø 22 / d2 Ø 19,9
 6734600605



DB-ES-8387

Length: 55
 Cone Ø: d1 Ø 10 / d2 Ø 10
 Thread: M14 x 1,5 RHT
 0009966845, 0009967045



DB-ES-8491

Length: 60
 Cone Ø: d1 Ø 10 / d2 Ø 10
 Thread: M12 x 1,75 LHT
 0009966745



DB-ES-8492

Length: 60
 Cone Ø: d1 Ø 10 / d2 Ø 10
 Thread: M12 x 1,75 RHT
 0009966645, 3752680189, A3752680189



DB-SB-5268

Length: 55
 Thick/Height: 60
 01307400A, 99905014



DB-SB-5269

Ø: 58
 Thick/Height: 47
 01328600A, 99902563



DB-SB-5274

Ø: 64
 Thick/Height: 60
 01307500A, 6753231885



DB-SB-10385

Ø: 30 Thick/Height: 30
 3093200073, 3143260153



DB-SB-10386

Ø: 38 Thick/Height: 38
 3183200073



DF-RK-8671



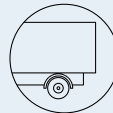

LP ...

LP 709, LPL 709 ...	09/63→12/84	Stabiliser Mounting		DB-SB-10385	1st RA
	09/63→12/84	Stabiliser Mounting	DB-SB-10385	DB-SB-10385	
	09/63→12/84	Stabiliser Mounting	DB-SB-10385	DB-SB-10385	1st FA
	09/63→12/84	Suspension Arm Repair Kit		CV-RK-8118	for Drag Link
	09/63→12/84	Suspension Strut Repair Kit		DF-RK-8671	
LP 808, LPL 808	09/63→12/84	Stabiliser Mounting		DB-SB-10385	
	09/63→12/84	Stabiliser Mounting		DB-SB-10385	* 4 282 708 *→
	09/63→12/84	Stabiliser Mounting		DB-SB-10385	* 8 000 001 *→
	09/63→12/84	Stabiliser Mounting		DB-SB-10385	→* 4 282 707 *
	09/63→12/84	Stabiliser Mounting		DB-SB-10385	1st RA
	09/63→12/84	Stabiliser Mounting	DB-SB-10385	DB-SB-10385	1st FA
	09/63→12/84	Suspension Arm Repair Kit		CV-RK-8118	for Drag Link
LP 809, LPL 808, LPL 809	09/63→12/84	Suspension Strut Repair Kit		DF-RK-8671	
	09/63→12/84	Stabiliser Mounting		DB-SB-10385	
LP 811	09/63→12/84	Stabiliser Mounting		DB-SB-10385	* 4 282 708 *→
	09/63→12/84	Stabiliser Mounting		DB-SB-10385	* 8 000 001 *→
	09/63→12/84	Stabiliser Mounting		DB-SB-10385	→* 4 282 707 *
	09/63→12/84	Stabiliser Mounting		DB-SB-10385	1st RA
	09/63→12/84	Stabiliser Mounting	DB-SB-10385	DB-SB-10385	→* 4 770 200 *
	09/63→12/84	Stabiliser Mounting	DB-SB-10385	DB-SB-10385	1st FA
	09/63→12/84	Suspension Arm Repair Kit		CV-RK-8118	for Drag Link
	09/63→12/84	Suspension Strut Repair Kit		DF-RK-8671	
LP 813, LPL 813	10/69→02/73	Stabiliser Mounting		DB-SB-10385	
	10/69→02/73	Stabiliser Mounting		DB-SB-10385	* 4 282 708 *→
	10/69→02/73	Stabiliser Mounting		DB-SB-10385	* 8 000 001 *→
	10/69→02/73	Stabiliser Mounting		DB-SB-10385	→* 4 282 707 *
	10/69→02/73	Stabiliser Mounting		DB-SB-10385	1st RA
LP 911 B	09/63→12/84	Stabiliser Mounting		DB-SB-10385	1st FA
	09/63→12/84	Stabiliser Mounting		DB-SB-10385	* 4 282 708 *→
	09/63→12/84	Stabiliser Mounting		DB-SB-10385	* 8 000 001 *→
	09/63→12/84	Stabiliser Mounting		DB-SB-10385	→* 4 282 707 *
	09/63→12/84	Stabiliser Mounting		DB-SB-10385	→* 4 462 009 *
	09/63→12/84	Stabiliser Mounting		DB-SB-10385	1st RA
LP 913, LPL 913	09/63→12/84	Stabiliser Mounting		DB-SB-10385	* 4 282 708 *→
	09/63→12/84	Stabiliser Mounting		DB-SB-10385	* 4 654 296 *→
	09/63→12/84	Stabiliser Mounting		DB-SB-10385	* 8 000 001 *→
	09/63→12/84	Stabiliser Mounting		DB-SB-10385	→* 4 282 707 *
	09/63→12/84	Stabiliser Mounting		DB-SB-10385	→* 4 282 707 *
	09/63→12/84	Stabiliser Mounting		DB-SB-10385	→* 4 462 009 *
	09/63→12/84	Stabiliser Mounting		DB-SB-10385	1st RA
	09/63→12/84	Stabiliser Mounting	DB-SB-10385	DB-SB-10385	1st FA
LPK 1013	09/63→12/84	Stabiliser Mounting		DB-SB-10385	
	11/76→12/84	Stabiliser Mounting		DB-SB-10385	1st RA
	11/76→12/84	Stabiliser Mounting	DB-SB-10385	DB-SB-10385	1st FA
LPK 608	10/69→10/77	Stabiliser Mounting		DB-SB-10385	
	10/69→10/77	Stabiliser Mounting		DB-SB-10385	* 4 282 708 *→
	10/69→10/77	Stabiliser Mounting		DB-SB-10385	→* 4 282 707 *
	10/69→10/77	Stabiliser Mounting		DB-SB-10385	→* 4 770 200 *
	10/69→10/77	Stabiliser Mounting		DB-SB-10385	1st RA
	10/69→10/77	Stabiliser Mounting	DB-SB-10385	DB-SB-10385	
	10/69→10/77	Stabiliser Mounting	DB-SB-10385	DB-SB-10385	1st FA
	10/69→10/77	Suspension Arm Repair Kit		CV-RK-8118	for Drag Link
	10/69→10/77	Suspension Strut Repair Kit		DF-RK-8671	
LPK 709	11/77→12/84	Stabiliser Mounting		DB-SB-10385	
	11/77→12/84	Stabiliser Mounting		DB-SB-10385	* 4 282 708 *→
	11/77→12/84	Stabiliser Mounting		DB-SB-10385	→* 4 282 707 *
	11/77→12/84	Stabiliser Mounting		DB-SB-10385	→* 4 770 200 *
	11/77→12/84	Stabiliser Mounting		DB-SB-10385	1st RA
	11/77→12/84	Stabiliser Mounting	DB-SB-10385	DB-SB-10385	

CV-RK-8118

Ø: 85

Hole Distance: 130

Thick/Height: 30

0003500506, 3500506



DB-DL-9208

Length: 260

Ø: 24

Cone Ø: d1 Ø 18 / d2 Ø 16,2

Thread: M14 x 1,5

3603200189, 3603200789, 3603201089



DB-ES-1084

Length: 106

Cone Ø: d1 Ø 22 / d2 Ø 20

Thread: M18 x 1,5 RHT / M24 x 1,5 RHT

0003301335, 0003307635, 0003309835,
0013300035



DB-SB-10385

Ø: 30 Thick/Height: 30

3093200073, 3143260153



DB-SB-10386

Ø: 38 Thick/Height: 38

3183200073



DF-RK-8671





LP ...

LPK 709 ...	11/77→12/84	Stabiliser Mounting	DB-SB-10385	DB-SB-10385	1st FA
	11/77→12/84	Suspension Arm Repair Kit		CV-RK-8118	for Drag Link
	11/77→12/84	Suspension Strut Repair Kit		DF-RK-8671	
LPK 808	10/69→10/77	Stabiliser Mounting		DB-SB-10385	
	10/69→10/77	Stabiliser Mounting		DB-SB-10385	* 4 282 708 *→
	10/69→10/77	Stabiliser Mounting		DB-SB-10385	* 8 000 001 *→
	10/69→10/77	Stabiliser Mounting		DB-SB-10385	→* 4 282 707 *
	10/69→10/77	Stabiliser Mounting		DB-SB-10385	1st RA
	10/69→10/77	Stabiliser Mounting	DB-SB-10385	DB-SB-10385	1st FA
	10/69→10/77	Suspension Arm Repair Kit		CV-RK-8118	for Drag Link
	10/69→10/77	Suspension Strut Repair Kit		DF-RK-8671	
LPK 809	11/77→12/84	Stabiliser Mounting		DB-SB-10385	
	11/77→12/84	Stabiliser Mounting		DB-SB-10385	* 4 282 708 *→
	11/77→12/84	Stabiliser Mounting		DB-SB-10385	* 8 000 001 *→
	11/77→12/84	Stabiliser Mounting		DB-SB-10385	→* 4 282 707 *
	11/77→12/84	Stabiliser Mounting		DB-SB-10385	1st RA
	11/77→12/84	Stabiliser Mounting	DB-SB-10385	DB-SB-10385	1st FA
	11/77→12/84	Suspension Arm Repair Kit		CV-RK-8118	for Drag Link
	11/77→12/84	Suspension Strut Repair Kit		DF-RK-8671	
LPK 813	03/73→12/84	Stabiliser Mounting		DB-SB-10385	
	03/73→12/84	Stabiliser Mounting		DB-SB-10385	* 4 282 708 *→
	03/73→12/84	Stabiliser Mounting		DB-SB-10385	* 8 000 001 *→
	03/73→12/84	Stabiliser Mounting		DB-SB-10385	→* 4 282 707 *
	03/73→12/84	Stabiliser Mounting		DB-SB-10385	1st RA
	03/73→12/84	Stabiliser Mounting	DB-SB-10385	DB-SB-10385	1st FA
LPK 913	01/67→12/84	Stabiliser Mounting		DB-SB-10385	
	01/67→12/84	Stabiliser Mounting		DB-SB-10385	* 4 282 708 *→
	01/67→12/84	Stabiliser Mounting		DB-SB-10385	* 8 000 001 *→
	01/67→12/84	Stabiliser Mounting		DB-SB-10385	→* 4 282 707 *
	01/67→12/84	Stabiliser Mounting		DB-SB-10385	1st RA
	01/67→12/84	Stabiliser Mounting	DB-SB-10385	DB-SB-10385	1st FA
LPKF 608	09/63→12/84	Stabiliser Mounting		DB-SB-10385	
	09/63→12/84	Stabiliser Mounting		DB-SB-10385	* 4 282 708 *→
	09/63→12/84	Stabiliser Mounting		DB-SB-10385	→* 4 282 707 *
	09/63→12/84	Stabiliser Mounting		DB-SB-10385	1st RA
	09/63→12/84	Stabiliser Mounting	DB-SB-10385	DB-SB-10385	1st FA
	09/63→12/84	Suspension Arm Repair Kit		CV-RK-8118	for Drag Link
	09/63→12/84	Suspension Strut Repair Kit		DF-RK-8671	
LPKF 709	11/77→12/84	Stabiliser Mounting		DB-SB-10385	
	11/77→12/84	Stabiliser Mounting		DB-SB-10385	* 4 282 708 *→
	11/77→12/84	Stabiliser Mounting		DB-SB-10385	→* 4 282 707 *
	11/77→12/84	Stabiliser Mounting		DB-SB-10385	1st RA
	11/77→12/84	Stabiliser Mounting	DB-SB-10385	DB-SB-10385	1st FA
	11/77→12/84	Suspension Arm Repair Kit		CV-RK-8118	for Drag Link
	11/77→12/84	Suspension Strut Repair Kit		DF-RK-8671	
LPKF 808, LPKF 809	10/69→10/77	Stabiliser Mounting		DB-SB-10385	
	10/69→10/77	Stabiliser Mounting		DB-SB-10385	* 0 658 978 *→* 4 282 707 *
	10/69→10/77	Stabiliser Mounting	DB-SB-10385	DB-SB-10385	1st FA
	10/69→10/77	Stabiliser Mounting	DB-SB-10385	DB-SB-10385	1st RA
	10/69→10/77	Suspension Arm Repair Kit		CV-RK-8118	for Drag Link
	10/69→10/77	Suspension Strut Repair Kit		DF-RK-8671	
LPKO 608	02/66→07/77	Stabiliser Mounting		DB-SB-10385	
	02/66→07/77	Stabiliser Mounting		DB-SB-10385	* 4 282 708 *→
	02/66→07/77	Stabiliser Mounting		DB-SB-10385	→* 4 282 707 *
	02/66→07/77	Stabiliser Mounting		DB-SB-10385	1st RA
	02/66→07/77	Stabiliser Mounting	DB-SB-10385	DB-SB-10385	1st FA
LPKO 709	02/66→07/77	Stabiliser Mounting		DB-SB-10385	
	02/66→07/77	Stabiliser Mounting		DB-SB-10385	* 4 282 708 *→
	02/66→07/77	Stabiliser Mounting		DB-SB-10385	→* 4 282 707 *
	02/66→07/77	Stabiliser Mounting		DB-SB-10385	1st RA
	02/66→07/77	Stabiliser Mounting	DB-SB-10385	DB-SB-10385	1st FA

CV-RK-8118

Ø: 85
Hole Distance: 130
Thick/Height: 30
0003500506, 3500506



DB-SB-10385

Ø: 30 Thick/Height: 30
3093200073, 3143260153



DB-SB-10386

Ø: 38 Thick/Height: 38
3183200073



DF-RK-8671



LP ...

LPO 608	10/69→10/77	Stabiliser Mounting		DB-SB-10385	
	10/69→10/77	Stabiliser Mounting		DB-SB-10385	* 4 282 708 *→
	10/69→10/77	Stabiliser Mounting		DB-SB-10385	→* 4 282 707 *
	10/69→10/77	Stabiliser Mounting		DB-SB-10385	1st RA
	10/69→10/77	Stabiliser Mounting	DB-SB-10385	DB-SB-10385	1st FA
	10/69→10/77	Suspension Arm Repair Kit		CV-RK-8118	for Drag Link
	10/69→10/77	Suspension Strut Repair Kit		DF-RK-8671	
LPO 709	11/77→12/84	Stabiliser Mounting		DB-SB-10385	
	11/77→12/84	Stabiliser Mounting		DB-SB-10385	* 4 282 708 *→
	11/77→12/84	Stabiliser Mounting		DB-SB-10385	→* 4 282 707 *
	11/77→12/84	Stabiliser Mounting		DB-SB-10385	1st RA
	11/77→12/84	Stabiliser Mounting	DB-SB-10385	DB-SB-10385	1st FA
	11/77→12/84	Suspension Arm Repair Kit		CV-RK-8118	for Drag Link
11/77→12/84	Suspension Strut Repair Kit		DF-RK-8671		
LPO 808, LPO 809	09/67→10/77	Stabiliser Mounting		DB-SB-10385	
	09/67→10/77	Stabiliser Mounting		DB-SB-10385	* 0 658 978 *→* 4 282 707 *
	09/67→10/77	Stabiliser Mounting	DB-SB-10385	DB-SB-10385	
	09/67→10/77	Stabiliser Mounting	DB-SB-10385	DB-SB-10385	1st FA
LPO 811	10/69→02/73	Stabiliser Mounting		DB-SB-10385	
	10/69→02/73	Stabiliser Mounting		DB-SB-10385	1st RA
	10/69→02/73	Stabiliser Mounting	DB-SB-10385	DB-SB-10385	1st FA
LPO 813	10/69→	Stabiliser Mounting		DB-SB-10385	
	10/69→	Stabiliser Mounting		DB-SB-10385	1st RA
	10/69→	Stabiliser Mounting	DB-SB-10385	DB-SB-10385	1st FA
LPS 608, LPLS 608	09/63→12/84	Stabiliser Mounting		DB-SB-10385	
	09/63→12/84	Stabiliser Mounting		DB-SB-10385	* 4 282 708 *→
	09/63→12/84	Stabiliser Mounting		DB-SB-10385	→* 4 282 707 *
	09/63→12/84	Stabiliser Mounting		DB-SB-10385	1st RA
	09/63→12/84	Stabiliser Mounting	DB-SB-10385	DB-SB-10385	1st FA
	09/63→12/84	Suspension Arm Repair Kit		CV-RK-8118	for Drag Link
	09/63→12/84	Suspension Strut Repair Kit		DF-RK-8671	
LPS 709, LPLS 709	09/63→12/84	Stabiliser Mounting		DB-SB-10385	
	09/63→12/84	Stabiliser Mounting		DB-SB-10385	* 4 282 708 *→
	09/63→12/84	Stabiliser Mounting		DB-SB-10385	→* 4 282 707 *
	09/63→12/84	Stabiliser Mounting		DB-SB-10385	1st RA
	09/63→12/84	Stabiliser Mounting	DB-SB-10385	DB-SB-10385	1st FA
	09/63→12/84	Suspension Arm Repair Kit		CV-RK-8118	for Drag Link
	09/63→12/84	Suspension Strut Repair Kit		DF-RK-8671	
LPS 811	10/69→02/73	Stabiliser Mounting		DB-SB-10385	
	10/69→02/73	Stabiliser Mounting		DB-SB-10385	1st RA
	10/69→02/73	Stabiliser Mounting	DB-SB-10385	DB-SB-10385	1st FA
LPS 813, LPLS 813	09/63→12/84	Stabiliser Mounting		DB-SB-10385	
	09/63→12/84	Stabiliser Mounting		DB-SB-10385	1st RA
	09/63→12/84	Stabiliser Mounting	DB-SB-10385	DB-SB-10385	1st FA
LPS 911 B	01/67→03/77	Stabiliser Link		DB-DL-9208	Coupling Rod
	01/67→03/77	Tie Rod End		DB-ES-1084	
LPS 913	10/69→12/84	Stabiliser Mounting		DB-SB-10385	
	10/69→12/84	Stabiliser Mounting		DB-SB-10385	1st RA
	10/69→12/84	Stabiliser Mounting	DB-SB-10385	DB-SB-10385	1st FA

MB-TRAC

1100	03/79→08/87	Tie Rod End		DB-ES-8570	→* 114457 *
	03/79→08/87	Tie Rod End		DF-ES-12429	for Steering Rod
1300	03/76→08/87	Tie Rod End		DB-ES-8570	→* 114457 *
	03/76→08/87	Tie Rod End		DF-ES-12429	for Steering Rod
1300 Turbo, 1400 Turbo	02/82→12/91	Tie Rod End		DB-ES-8570	→* 114457 *
	02/82→12/91	Tie Rod End		DF-ES-12429	for Steering Rod
1500	07/80→12/87	Tie Rod End		DB-ES-8570	→* 114457 *
	07/80→12/87	Tie Rod End		DF-ES-12429	for Steering Rod

CV-RK-8118

Ø: 85

Hole Distance: 130

Thick/Height: 30

0003500506, 3500506



DB-DL-9208

Length: 260

Ø: 24

Cone Ø: d1 Ø 18 / d2 Ø 16,2

Thread: M14 x 1,5

3603200189, 3603200789, 3603201089



DB-ES-1084

Length: 106

Cone Ø: d1 Ø 22 / d2 Ø 20

Thread: M18 x 1,5 RHT / M24 x 1,5 RHT

0003301335, 0003307635, 0003309835,

0013300035



DB-ES-8570

Length: 75

Cone Ø: d1 Ø 26 / d2 Ø 23,5

Thread: M22 x 1,5 RHT

0004632429, 4632429, 0004632529, 4632529



DB-SB-10385

Ø: 30 Thick/Height: 30

3093200073, 3143260153



DF-ES-12429



DF-RK-8671





MK

1222	07/89→08/94	Stabiliser Mounting		DB-SB-10407	
	07/89→08/94	Suspension Arm Repair Kit	DB-RK-5303		
	07/89→08/94	Tie Rod End	CV-ES-12461		for Steering Rod
	07/89→08/94	Tie Rod End	CV-ES-12462		for Steering Rod
	07/89→08/94	Tie Rod End	CV-ES-14163		for Steering Rod
1222 A, 1222 LA	09/89→07/94	Centre Rod	DB-DL-5239		Push Rod
	09/89→07/94	Stabiliser Mounting		DB-SB-10407	
	09/89→07/94	Tie Rod	DB-DL-8632		
	09/89→07/94	Tie Rod End	CV-ES-12461		for Steering Rod
	09/89→07/94	Tie Rod End	CV-ES-12462		for Steering Rod
1222 AF	09/89→09/93	Centre Rod	DB-DL-5239		Push Rod
	09/89→09/93	Stabiliser Mounting		DB-SB-10407	
	09/89→09/93	Suspension Arm Repair Kit		DB-RK-10378	
	09/89→09/93	Tie Rod	DB-DL-8632		
	09/89→09/93	Tie Rod End	CV-ES-12461		for Steering Rod
1222 F	07/89→08/94	Stabiliser Mounting		DB-SB-10407	
	07/89→08/94	Suspension Arm Repair Kit		DB-RK-10378	
	07/89→08/94	Suspension Arm Repair Kit	DB-RK-5303		
	07/89→08/94	Tie Rod End	CV-ES-12461		for Steering Rod
	07/89→08/94	Tie Rod End	CV-ES-12462		for Steering Rod
1222 S, 1222 LS	07/89→08/94	Tie Rod End	CV-ES-14163		for Steering Rod
	07/89→08/94	Stabiliser Mounting		DB-SB-10407	
	07/89→08/94	Suspension Arm Repair Kit	DB-RK-5303		
	07/89→08/94	Tie Rod End	CV-ES-12461		for Steering Rod
	07/89→08/94	Tie Rod End	CV-ES-12462		for Steering Rod
1224 AF	07/89→08/94	Tie Rod End	CV-ES-14163		for Steering Rod
	02/93→09/96	Centre Rod	DB-DL-5239		Push Rod
	02/93→09/96	Stabiliser Mounting		DB-SB-10407	
	02/93→09/96	Suspension Arm Repair Kit		DB-RK-10378	
	02/93→09/96	Tie Rod	DB-DL-8632		
1224 F	02/93→09/96	Tie Rod End	CV-ES-12461		for Steering Rod
	02/93→09/96	Tie Rod End	CV-ES-12462		for Steering Rod
	07/89→08/94	Tie Rod End	CV-ES-12461		for Steering Rod
	07/89→08/94	Tie Rod End	CV-ES-12462		for Steering Rod
1226 AF	02/90→09/96	Centre Rod	DB-DL-5239		Push Rod
	02/90→09/96	Stabiliser Mounting		DB-SB-10407	
	02/90→09/96	Suspension Arm Repair Kit		DB-RK-10378	
	02/90→09/96	Tie Rod	DB-DL-8632		
	02/90→09/96	Tie Rod End	CV-ES-12461		for Steering Rod
	02/90→09/96	Tie Rod End	CV-ES-12462		for Steering Rod
1227 A	01/92→07/92	Centre Rod	DB-DL-5239		Push Rod
	01/92→07/92	Stabiliser Mounting		DB-SB-10407	
	01/92→07/92	Tie Rod	DB-DL-8632		
	01/92→07/92	Tie Rod End	CV-ES-12461		for Steering Rod
	01/92→07/92	Tie Rod End	CV-ES-12462		for Steering Rod
1227 AF, 1227 LAF	01/92→07/92	Ball Head, gearshift linkage	DB-ES-8500		
	01/92→07/92	Centre Rod	DB-DL-5239		Push Rod
	01/92→07/92	Tie Rod	DB-DL-8632		
	01/92→07/92	Tie Rod End	CV-ES-12461		for Steering Rod
	01/92→07/92	Tie Rod End	CV-ES-12462		for Steering Rod
1231 AF	01/92→09/96	Centre Rod	DB-DL-5239		Push Rod
	01/92→09/96	Tie Rod	DB-DL-8632		
	01/92→09/96	Tie Rod End	CV-ES-12461		for Steering Rod
	01/92→09/96	Tie Rod End	CV-ES-12462		for Steering Rod
1234 AF	01/92→09/96	Tie Rod End	CV-ES-12462		for Steering Rod
	01/92→09/96	Ball Head, gearshift linkage	DB-ES-8500		
	01/92→09/96	Centre Rod	DB-DL-5239		Push Rod
	01/92→09/96	Stabiliser Mounting		DB-SB-10407	
	01/92→09/96	Suspension Arm Repair Kit		DB-RK-10378	
	01/92→09/96	Tie Rod	DB-DL-8632		
	01/92→09/96	Tie Rod End	CV-ES-12461		for Steering Rod
01/92→09/96	Tie Rod End	CV-ES-12462		for Steering Rod	

CV-ES-12461

Length: 120

Cone Ø: d1 Ø 26 / d2 Ø 23,5

Thread: M30 x 1,5 LHT

0003300035, 3300148, 0003406213, 0013306635,
0013308835, 0014604048, 0014604348,
14606448, 0024600248, 3023300035,
3023300135, 3023300235, 3023300335,
3453307235, 3453307435, 3503307135,
A0003300148, A0013306635, A0013308835,
A0014604048, A0014604348, A0014606448,
A0024600248, A3023300035, A3023300135,
A3023300235, A3023300335, A3503307135



CV-ES-12462

Length: 120

Cone Ø: d1 Ø 26 / d2 Ø 23,5

Thread: M30 x 1,5 RHT

0003300135, 0003300248, 0003303235,
0003305835, 0003307335, 0003383410,
0004608348, 0004608348, 0004632229,
0004633129, 0004633429, 0004633529,
0013300135, 0013300235, 0013306735,
0014603448, 0014604148, 0014604448,
0014606348, 0014608348, 0014608448,
0014609748, 0023301535, 3453307135,
3503307035, 3503307335, 3643307135,
5001832582, A0003300248, A0003303235,
A0003307335, A0003383410, A0004608348,
A0004632229, A0004633429, A0013300135,
A0013300235, A0013306735, A0014603448,
A0014604148, A0014604448, A0014606348,
A0014608348, A0014608448, A0014609748,
A0023301535



CV-ES-14163

Length: 125

Cone Ø: d1 Ø 30 / d2 Ø 27

Thread: M30 x 1,5 RHT

0003305248, 0003387310, 0004600348,
0004600948, 0004602848, 0004602948,
0004608948, 0014600248, 0014600848,
0014601248, 0014602248, 0014607748,
0024600148, A0003387310, A0004600348,
A0004602848, A0004602948, A0014600848,
A0014601248, A0014602248, A0014607748



DB-DL-5239

Length: 862

Ø: 42

Cone Ø: d1 Ø 30 / d2 Ø 27

01214500A, 6174602405, 6174603405



DB-DL-8632

Length: 1635

Ø: 60

Cone Ø: d1 Ø 30 / d2 Ø 27

3853301303, 3853302103, 3853302203



DB-ES-8500

Length: 55

Cone Ø: d1 Ø 12 / d2 Ø 10,8

Thread: M14 x 1,5 RHT

0002685989



DB-RK-5303

Ø: 37

01304400A, 6253200611



DB-RK-10378

Ø: 86

6203200028



DB-SB-10407

Ø: 61 Thick/Height: 46

0003235985, 0003262481, 0003262981





MK ...

1417	07/89→09/96	Centre Rod	DB-DL-5412		Push Rod
	07/89→09/96	Stabiliser Mounting		DB-SB-10407	
	07/89→09/96	Suspension Arm Repair Kit		DB-RK-8564	Wishbone (CV)
	07/89→09/96	Suspension Arm Repair Kit		MN-RK-9387	
	07/89→09/96	Suspension Arm Repair Kit	DB-RK-5303		
	07/89→09/96	Tie Rod End	CV-ES-12461		for Steering Rod
	07/89→09/96	Tie Rod End	CV-ES-12462		for Steering Rod
1417 A	07/89→09/96	Tie Rod End	CV-ES-14163		for Steering Rod
	09/89→09/96	Centre Rod	DB-DL-5239		Push Rod
	09/89→09/96	Centre Rod	DB-DL-5412		Push Rod
	09/89→09/96	Stabiliser Mounting		DB-SB-10407	
	09/89→09/96	Suspension Arm Repair Kit		DB-RK-8564	Wishbone (CV)
	09/89→09/96	Suspension Arm Repair Kit		MN-RK-9387	
	09/89→09/96	Tie Rod	DB-DL-8632		
1417 AK	09/89→09/96	Tie Rod End	CV-ES-12461		for Steering Rod
	09/89→09/96	Tie Rod End	CV-ES-12462		for Steering Rod
	09/89→09/96	Centre Rod	DB-DL-5239		Push Rod
	09/89→09/96	Centre Rod	DB-DL-5412		Push Rod
	09/89→09/96	Stabiliser Mounting		DB-SB-10407	
	09/89→09/96	Suspension Arm Repair Kit		DB-RK-8564	Wishbone (CV)
	09/89→09/96	Suspension Arm Repair Kit		DB-RK-10378	
1417 K	09/89→09/96	Suspension Arm Repair Kit		MN-RK-9387	
	09/89→09/96	Tie Rod	DB-DL-8632		
	09/89→09/96	Tie Rod End	CV-ES-12461		for Steering Rod
	09/89→09/96	Tie Rod End	CV-ES-12462		for Steering Rod
	07/89→09/96	Centre Rod	DB-DL-5412		Push Rod
	07/89→09/96	Stabiliser Mounting		DB-SB-10407	
	07/89→09/96	Suspension Arm Repair Kit		DB-RK-10378	
1420 AK	07/89→09/96	Tie Rod End	CV-ES-12461		for Steering Rod
	07/89→09/96	Tie Rod End	CV-ES-12462		for Steering Rod
	07/89→09/96	Tie Rod End	CV-ES-14163		for Steering Rod
	09/89→09/96	Centre Rod	DB-DL-5239		Push Rod
	09/89→09/96	Centre Rod	DB-DL-5412		Push Rod
	09/89→09/96	Tie Rod	DB-DL-8632		
	09/89→09/96	Tie Rod End	CV-ES-12461		for Steering Rod
1420 LS	09/89→09/96	Tie Rod End	CV-ES-12462		for Steering Rod
	02/90→09/96	Centre Rod	DB-DL-5207		Push Rod
	02/90→09/96	Centre Rod	DB-DL-5412		Push Rod
	02/90→09/96	Centre Rod	DB-DL-7831		Push Rod
	02/90→09/96	Centre Rod	DB-DL-8138		Push Rod
	02/90→09/96	Centre Rod	DB-DL-8618		Push Rod
	02/90→09/96	Centre Rod	DB-DL-12309		Coupling Rod
	02/90→09/96	Stabiliser Mounting		DB-SB-10407	
	02/90→09/96	Suspension Arm Repair Kit		DB-RK-5284	→* K 097 019 *
	02/90→09/96	Suspension Arm Repair Kit		DB-RK-5284	1st RA
	02/90→09/96	Suspension Arm Repair Kit		DB-RK-8564	Wishbone (CV)
	02/90→09/96	Suspension Arm Repair Kit		DB-RK-12372	for Wishbone (CV)K063070→
	02/90→09/96	Suspension Arm Repair Kit		DF-RK-9336	
	02/90→09/96	Suspension Arm Repair Kit		DF-RK-9336	* K 063 070 *→
	02/90→09/96	Suspension Arm Repair Kit		MN-RK-9387	
	02/90→09/96	Suspension Arm Repair Kit		MN-RK-9387	→* 5 926 392 *
	02/90→09/96	Suspension Arm Repair Kit		SC-RK-8688	for Drag Link
	02/90→09/96	Tie Rod	DB-DL-8640		Guide Rod
	02/90→09/96	Tie Rod	DB-ES-5209		
	02/90→09/96	Tie Rod End	CV-ES-12461		for Steering Rod
	02/90→09/96	Tie Rod End	CV-ES-12462		for Steering Rod
	02/90→09/96	Tie Rod End	CV-ES-14163		for Steering Rod
	02/90→09/96	Track Control Arm		DB-DL-5220	Trailing Arm
1420,1420 L	12/87→09/96	Centre Rod	DB-DL-5412		Push Rod
	12/87→09/96	Stabiliser Mounting		DB-SB-10407	
	12/87→09/96	Suspension Arm Repair Kit		DB-RK-5284	→* K 097 019 *
	12/87→09/96	Suspension Arm Repair Kit		DB-RK-5284	1st RA
	12/87→09/96	Suspension Arm Repair Kit		DB-RK-8564	Wishbone (CV)

CV-ES-12461

Length: 120
 Cone Ø: d1 Ø 26 / d2 Ø 23,5
 Thread: M30 x 1,5 LHT
 0003300035, 3300148, 0003406213, 0013306635,
 0013308835, 0014604048, 0014604348,
 14606448, 0024600248, 3023300035,
 3023300135, 3023300235, 3023300335,
 3453307235, 3453307435, 3503307135,
 A0003300148, A0013306635, A0013308835,
 A0014604048, A0014604348, A0014606448,
 A0024600248, A3023300035, A3023300135,
 A3023300235, A3023300335, A3503307135



CV-ES-12462

Length: 120
 Cone Ø: d1 Ø 26 / d2 Ø 23,5
 Thread: M30 x 1,5 RHT
 0003300135, 0003300248, 0003303235,
 0003305835, 0003307335, 0003383410,
 004608348, 0004608348, 0004632229,
 0004633129, 0004633429, 0004633529,
 0013300135, 0013300235, 0013306735,
 0014603448, 0014604148, 0014604448,
 0014606348, 0014608348, 0014608448,
 0014609748, 0023301535, 3453307135,
 3503307035, 3503307335, 3643307135,
 5001832582, A0003300248, A0003303235,
 A0003307335, A0003383410, A0004608348,
 A0004632229, A0004633429, A0013300135,
 A0013300235, A0013306735, A0014603448,
 A0014604148, A0014604448, A0014606348,
 A0014608348, A0014608448, A0014609748,
 A0023301535



CV-ES-14163

Length: 125
 Cone Ø: d1 Ø 30 / d2 Ø 27
 Thread: M30 x 1,5 RHT
 0003305248, 0003387310, 0004600348,
 0004600948, 0004602848, 0004602948,
 0004608948, 0014600248, 0014600848,
 0014601248, 0014602248, 0014607748,
 0024600148, A0003387310, A0004600348,
 A0004602848, A0004602948, A0014600848,
 A0014601248, A0014602248, A0014607748



DB-DL-5207

Length: 875 Ø: 42
 Cone Ø: d1 Ø 30 / d2 Ø 27
 01215100A, 6174603505, 6174603605



DB-DL-5220

Length: 522
 Ø: 52
 Hole Distance: 151
 01335200A, 3813500606, 6523500306,
 6533500106



DB-DL-5239

Length: 862
 Ø: 42
 Cone Ø: d1 Ø 30 / d2 Ø 27
 01214500A, 6174602405, 6174603405



DB-DL-5412

Length: 840
 Ø: 48
 Cone Ø: d1 Ø 32 / d2 Ø 30
 01214400A, 0014600305, 14600305, 0014600405,
 14600405



DB-DL-7831

Length: 870
 Ø: 42
 Cone Ø: d1 Ø 30 / d2 Ø 27
 01215200A, 6254602505



DB-DL-8138

Length: 1130
 Ø: 40
 Cone Ø: d1 Ø 32 / d2 Ø 28,8
 4606605, 0004606605



DB-DL-8618

Length: 680
 Ø: 42
 Cone Ø: d1 Ø 32 / d2 Ø 28,8
 0004604305, 4604305, 6254604805



DB-DL-8632

Length: 1635
 Ø: 60
 Cone Ø: d1 Ø 30 / d2 Ø 27
 3853301303, 3853302103, 3853302203



DB-DL-8640

Length: 1615 Ø: 50
 Cone Ø: d1 Ø 32 / d2 Ø 29
 6253301503, 6253301603, 6253302403,
 6253302503, 9423300803, 9423302103,
 9493300203, 9493300303, 9493300903



DB-DL-12309

Length: 685 Ø: 40
 Cone Ø: d1 Ø 32 / d2 Ø 28,8
 0004606005, 0004606305



DB-ES-5209

Length: 1670 Ø: 50
 Cone Ø: d1 Ø 30 / d2 Ø 27
 6203300503, 6203300603



DB-RK-5284

Ø: 65
 01303900A, 6523200511



DB-RK-5303

Ø: 37
 01304400A, 6253200611



DB-RK-8564

Ø: 90
 01302200A, 0003500105, 3500105, 0003500405,
 3500405, 0005861833, 5861833, 81432706047



DB-RK-10378

Ø: 86
 6203200028



DB-RK-12372

Ø: 85
 Hole Distance: 152
 Thick/Height: 24
 003501805, A003501805



DB-SB-10407

Ø: 61 Thick/Height: 46
 0003235985, 0003262481, 0003262981



DF-RK-9336

Ø: 108
 0003501705, 3501705



MN-RK-9387

Ø: 90
 0003500105, 81432706047



SC-RK-8688

Length: 95
 Ø: 95
 0003501905, 3501905





MK ...

1420,1420 L ...	12/87→09/96	Suspension Arm Repair Kit		DB-RK-12372	for Wishbone (CV)K063070→
	12/87→09/96	Suspension Arm Repair Kit		DF-RK-9336	
	12/87→09/96	Suspension Arm Repair Kit		DF-RK-9336	* K 063 070 *→
	12/87→09/96	Suspension Arm Repair Kit		MN-RK-9387	
	12/87→09/96	Suspension Arm Repair Kit		MN-RK-9387	→* 5 926 392 *
	12/87→09/96	Suspension Arm Repair Kit		SC-RK-8688	for Drag Link
	12/87→09/96	Suspension Arm Repair Kit	DB-RK-5303		
	12/87→09/96	Tie Rod	DB-DL-8640		Guide Rod
	12/87→09/96	Tie Rod	DB-ES-5209		
	12/87→09/96	Tie Rod End	CV-ES-12461		for Steering Rod
	12/87→09/96	Tie Rod End	CV-ES-12462		for Steering Rod
	12/87→09/96	Tie Rod End	CV-ES-14163		for Steering Rod
	12/87→09/96	Track Control Arm		DB-DL-5220	Trailing Arm
	1422	02/93→08/94	Centre Rod	DB-DL-5412	
02/93→08/94		Stabiliser Mounting		DB-SB-10407	
02/93→08/94		Suspension Arm Repair Kit		DF-RK-9336	
02/93→08/94		Suspension Arm Repair Kit	DB-RK-5303		
02/93→08/94		Tie Rod	DB-DL-8640		Guide Rod
02/93→08/94		Tie Rod End	CV-ES-12461		for Steering Rod
02/93→08/94		Tie Rod End	CV-ES-12462		for Steering Rod
02/93→08/94		Tie Rod End	CV-ES-14163		for Steering Rod
1422 F	07/89→08/94	Centre Rod	DB-DL-5412		Push Rod
	07/89→08/94	Centre Rod	DB-DL-7831		Push Rod
	07/89→08/94	Centre Rod	DB-DL-8138		Push Rod
	07/89→08/94	Centre Rod	DB-DL-8618		Push Rod
	07/89→08/94	Centre Rod	DB-DL-12309		Coupling Rod
	07/89→08/94	Stabiliser Mounting		DB-SB-10407	
	07/89→08/94	Suspension Arm Repair Kit		DB-RK-10378	
	07/89→08/94	Suspension Arm Repair Kit	DB-RK-5303		
	07/89→08/94	Tie Rod	DB-DL-8640		Guide Rod
	07/89→08/94	Tie Rod	DB-ES-5209		
	07/89→08/94	Tie Rod End	CV-ES-12461		for Steering Rod
	07/89→08/94	Tie Rod End	CV-ES-12462		for Steering Rod
	07/89→08/94	Tie Rod End	CV-ES-14163		for Steering Rod
	1422 LS	02/93→08/94	Centre Rod	DB-DL-5412	
02/93→08/94		Stabiliser Mounting		DB-SB-10407	
02/93→08/94		Suspension Arm Repair Kit		DB-RK-5284	
02/93→08/94		Suspension Arm Repair Kit		DB-RK-5284	1st RA
02/93→08/94		Suspension Arm Repair Kit		DB-RK-8564	Wishbone (CV)
02/93→08/94		Suspension Arm Repair Kit		DB-RK-12372	for Wishbone (CV)K063070→
02/93→08/94		Suspension Arm Repair Kit		DF-RK-9336	
02/93→08/94		Suspension Arm Repair Kit		DF-RK-9336	* K 063 070 *→
02/93→08/94		Suspension Arm Repair Kit		MN-RK-9387	
02/93→08/94		Suspension Arm Repair Kit		MN-RK-9387	→* 5 926 392 *
02/93→08/94		Suspension Arm Repair Kit		SC-RK-8688	for Drag Link
02/93→08/94		Suspension Arm Repair Kit	DB-RK-5303		
02/93→08/94		Tie Rod End	CV-ES-12461		for Steering Rod
02/93→08/94		Tie Rod End	CV-ES-12462		for Steering Rod
1422 S,1422 LS	02/93→08/94	Track Control Arm		DB-DL-5220	Trailing Arm
	12/87→09/96	Centre Rod	DB-DL-5412		Push Rod
	12/87→09/96	Stabiliser Mounting		DB-SB-10407	
	12/87→09/96	Suspension Arm Repair Kit		DB-RK-5284	
	12/87→09/96	Suspension Arm Repair Kit		DB-RK-5284	1st RA
	12/87→09/96	Suspension Arm Repair Kit		DB-RK-8564	Wishbone (CV)
	12/87→09/96	Suspension Arm Repair Kit		DB-RK-12372	for Wishbone (CV)K063070→
	12/87→09/96	Suspension Arm Repair Kit		DF-RK-9336	
	12/87→09/96	Suspension Arm Repair Kit		DF-RK-9336	* K 063 070 *→
	12/87→09/96	Suspension Arm Repair Kit		MN-RK-9387	
	12/87→09/96	Suspension Arm Repair Kit		MN-RK-9387	→* 5 926 392 *
	12/87→09/96	Suspension Arm Repair Kit		SC-RK-8688	for Drag Link
	12/87→09/96	Suspension Arm Repair Kit	DB-RK-5303		
	12/87→09/96	Tie Rod End	CV-ES-12461		for Steering Rod
12/87→09/96	Tie Rod End	CV-ES-12462		for Steering Rod	
12/87→09/96	Track Control Arm		DB-DL-5220	Trailing Arm	

CV-ES-12461

Length: 120
 Cone Ø: d1 Ø 26 / d2 Ø 23,5
 Thread: M30 x 1,5 LHT
 0003300035, 3300148, 0003406213, 0013306635,
 0013308835, 0014604048, 0014604348,
 14606448, 0024600248, 3023300035,
 3023300135, 3023300235, 3023300335,
 3453307235, 3453307435, 3503307135,
 A0003300148, A0013306635, A0013308835,
 A0014604048, A0014604348, A0014606448,
 A0024600248, A3023300035, A3023300135,
 A3023300235, A3023300335, A3503307135



CV-ES-12462

Length: 120
 Cone Ø: d1 Ø 26 / d2 Ø 23,5
 Thread: M30 x 1,5 RHT
 0003300135, 0003300248, 0003303235,
 0003305835, 0003307335, 0003383410,
 0004608348, 004608348, 0004632229,
 0004633129, 0004633429, 0004633529,
 0013300135, 0013300235, 0013306735,
 0014603448, 0014604148, 0014604448,
 0014606348, 0014608348, 0014608448,
 0014609748, 0023301535, 3453307135,
 3503307035, 3503307335, 3643307135,
 5001832582, A0003300248, A0003303235,
 A0003307335, A0003383410, A0004608348,
 A0004632229, A0004633429, A0013300135,
 A0013300235, A0013306735, A0014603448,
 A0014604148, A0014604448, A0014606348,
 A0014608348, A0014608448, A0014609748,
 A0023301535



CV-ES-14163

Length: 125
 Cone Ø: d1 Ø 30 / d2 Ø 27
 Thread: M30 x 1,5 RHT
 0003305248, 0003387310, 0004600348,
 0004600948, 0004602848, 0004602948,
 0004608948, 0014600248, 0014600848,
 0014601248, 0014602248, 0014607748,
 0024600148, A0003387310, A0004600348,
 A0004602848, A0004602948, A0014600848,
 A0014601248, A0014602248, A0014607748



DB-DL-5220

Length: 522
 Ø: 52
 Hole Distance: 151
 01335200A, 3813500606, 6523500306,
 6533500106



DB-DL-5412

Length: 840
 Ø: 48
 Cone Ø: d1 Ø 32 / d2 Ø 30
 01214400A, 14600305, 0014600305, 0014600405,
 14600405



DB-DL-7831

Length: 870
 Ø: 42
 Cone Ø: d1 Ø 30 / d2 Ø 27
 01215200A, 6254602505



DB-DL-8138

Length: 1130
 Ø: 40
 Cone Ø: d1 Ø 32 / d2 Ø 28,8
 0004606605, 4606605



DB-DL-8618

Length: 680
 Ø: 42
 Cone Ø: d1 Ø 32 / d2 Ø 28,8
 0004604305, 4604305, 6254604805



DB-DL-8640

Length: 1615 Ø: 50
 Cone Ø: d1 Ø 32 / d2 Ø 29
 6253301503, 6253301603, 6253302403,
 6253302503, 9423300803, 9423302103,
 9493300203, 9493300303, 9493300903



DB-DL-12309

Length: 685 Ø: 40
 Cone Ø: d1 Ø 32 / d2 Ø 28,8
 0004606005, 0004606305



DB-ES-5209

Length: 1670 Ø: 50
 Cone Ø: d1 Ø 30 / d2 Ø 27
 6203300503, 6203300603



DB-RK-5284

Ø: 65
 01303900A, 6523200511



DB-RK-5303

Ø: 37
 01304400A, 6253200611



DB-RK-8564

Ø: 90
 01302200A, 0003500105, 3500105, 0003500405,
 3500405, 5861833, 0005861833, 81432706047



DB-RK-10378

Ø: 86
 6203200028



DB-RK-12372

Ø: 85
 Hole Distance: 152
 Thick/Height: 24
 003501805, A003501805



DB-SB-10407

Ø: 61 Thick/Height: 46
 0003235985, 0003262481, 0003262981



DF-RK-9336

Ø: 108
 3501705, 0003501705



MN-RK-9387

Ø: 90
 0003500105, 81432706047



SC-RK-8688

Length: 95
 Ø: 95
 0003501905, 3501905





MK ...

1422,1422 L	12/87→09/96	Centre Rod	DB-DL-5412		Push Rod
	12/87→09/96	Centre Rod	DB-DL-7831		Push Rod
	12/87→09/96	Centre Rod	DB-DL-8138		Push Rod
	12/87→09/96	Centre Rod	DB-DL-8618		Push Rod
	12/87→09/96	Centre Rod	DB-DL-12309		Coupling Rod
	12/87→09/96	Stabiliser Mounting		DB-SB-10407	
	12/87→09/96	Suspension Arm Repair Kit		DB-RK-5284	
	12/87→09/96	Suspension Arm Repair Kit		DB-RK-5284	1st RA
	12/87→09/96	Suspension Arm Repair Kit		DB-RK-8564	Wishbone (CV)
	12/87→09/96	Suspension Arm Repair Kit		DB-RK-12372	for Wishbone (CV)
	12/87→09/96	Suspension Arm Repair Kit		DF-RK-9336	
	12/87→09/96	Suspension Arm Repair Kit		DF-RK-9336	* K 063 070 *→
	12/87→09/96	Suspension Arm Repair Kit		MN-RK-9387	
	12/87→09/96	Suspension Arm Repair Kit		MN-RK-9387	→* 5 926 392 *
	12/87→09/96	Suspension Arm Repair Kit		SC-RK-8688	for Drag Link
	12/87→09/96	Suspension Arm Repair Kit	DB-RK-5282		
	12/87→09/96	Suspension Arm Repair Kit	DB-RK-5303		
	12/87→09/96	Suspension Arm Repair Kit	DB-RK-10372	DB-RK-10372	for Control ArmK063070→
	12/87→09/96	Tie Rod	DB-DL-8640		Guide Rod
	12/87→09/96	Tie Rod	DB-ES-5209		
	12/87→09/96	Tie Rod End	CV-ES-12461		for Steering Rod
	12/87→09/96	Tie Rod End	CV-ES-12462		for Steering Rod
	12/87→09/96	Tie Rod End	CV-ES-14163		for Steering Rod
	12/87→09/96	Track Control Arm		DB-DL-5220	Trailing Arm
1424	07/89→09/96	Centre Rod	DB-DL-5412		Push Rod
	07/89→09/96	Suspension Arm Repair Kit		DB-RK-8564	Wishbone (CV)
	07/89→09/96	Suspension Arm Repair Kit		MN-RK-9387	
	07/89→09/96	Tie Rod End	CV-ES-12461		for Steering Rod
	07/89→09/96	Tie Rod End	CV-ES-12462		for Steering Rod
1424 S,1424 LS	12/87→09/96	Centre Rod	DB-DL-5231		Push Rod* K 072 178 *→
	12/87→09/96	Centre Rod	DB-DL-5412		Push Rod* K 016 738 *→* K 072 177 *
	12/87→09/96	Centre Rod	DB-DL-7831		Push Rod
	12/87→09/96	Centre Rod	DB-DL-8138		Push Rod
	12/87→09/96	Centre Rod	DB-DL-8618		Push Rod
	12/87→09/96	Centre Rod	DB-DL-8672		Push Rod→* 1 K 016737 *
	12/87→09/96	Centre Rod	DB-DL-12309		Coupling Rod
	12/87→09/96	Stabiliser Mounting		DB-SB-10407	
	12/87→09/96	Suspension Arm Repair Kit		DB-RK-5284	
	12/87→09/96	Suspension Arm Repair Kit		DB-RK-5284	→* K 097 019 *
	12/87→09/96	Suspension Arm Repair Kit		DB-RK-5284	1st RA
	12/87→09/96	Suspension Arm Repair Kit		DB-RK-8564	Wishbone (CV)
	12/87→09/96	Suspension Arm Repair Kit		DB-RK-12372	for Wishbone (CV)K063070→
	12/87→09/96	Suspension Arm Repair Kit		DF-RK-9336	
	12/87→09/96	Suspension Arm Repair Kit		DF-RK-9336	* K 063 070 *→
	12/87→09/96	Suspension Arm Repair Kit		MN-RK-9387	
	12/87→09/96	Suspension Arm Repair Kit		MN-RK-9387	→* 5 926 392 *
	12/87→09/96	Suspension Arm Repair Kit		SC-RK-8688	for Drag Link
	12/87→09/96	Suspension Arm Repair Kit	DB-RK-5303		
	12/87→09/96	Tie Rod	DB-DL-8640		Guide Rod
	12/87→09/96	Tie Rod	DB-ES-5209		
	12/87→09/96	Tie Rod End	CV-ES-12461		for Steering Rod
	12/87→09/96	Tie Rod End	CV-ES-12462		for Steering Rod
	12/87→09/96	Track Control Arm		DB-DL-5220	Trailing Arm
1424,1424 L	12/87→09/96	Centre Rod	DB-DL-5231		Push Rod* K 072 178 *→
	12/87→09/96	Centre Rod	DB-DL-5412		Push Rod* K 016 738 *→* K 072 177 *
	12/87→09/96	Centre Rod	DB-DL-7831		Push Rod
	12/87→09/96	Centre Rod	DB-DL-8138		Push Rod
	12/87→09/96	Centre Rod	DB-DL-8618		Push Rod
	12/87→09/96	Centre Rod	DB-DL-8672		Push Rod→* 1 K 016737 *
	12/87→09/96	Centre Rod	DB-DL-12309		Coupling Rod
	12/87→09/96	Stabiliser Mounting		DB-SB-10407	
	12/87→09/96	Suspension Arm Repair Kit		DB-RK-5284	
	12/87→09/96	Suspension Arm Repair Kit		DB-RK-5284	→* K 097 019 *

CV-ES-12461

Length: 120
Cone Ø: d1 Ø 26 / d2 Ø 23,5
Thread: M30 x 1,5 LHT
 0003300035, 3300148, 0003406213, 0013306635,
 0013308835, 0014604048, 0014604348,
 14606448, 0024600248, 3023300035,
 3023300135, 3023300235, 3023300335,
 3453307235, 3453307435, 3503307135,
 A0003300148, A0013306635, A0013308835,
 A0014604048, A0014604348, A0014606448,
 A0024600248, A3023300035, A3023300135,
 A3023300235, A3023300335, A3503307135



CV-ES-12462

Length: 120
Cone Ø: d1 Ø 26 / d2 Ø 23,5
Thread: M30 x 1,5 RHT
 0003300135, 0003300248, 0003303235,
 0003305835, 0003307335, 0003383410,
 0004608348, 004608348, 0004632229,
 0004633129, 0004633429, 0004633529,
 0013300135, 0013300235, 0013306735,
 0014603448, 0014604148, 0014604448,
 0014606348, 0014608348, 0014608448,
 0014609748, 0023301535, 3453307135,
 3503307035, 3503307335, 3643307135,
 5001832582, A0003300248, A0003303235,
 A0003307335, A0003383410, A0004608348,
 A0004632229, A0004633429, A0013300135,
 A0013300235, A0013306735, A0014603448,
 A0014604148, A0014604448, A0014606348,
 A0014608348, A0014608448, A0014609748,
 A0023301535



CV-ES-14163

Length: 125
Cone Ø: d1 Ø 30 / d2 Ø 27
Thread: M30 x 1,5 RHT
 0003305248, 0003387310, 0004600348,
 0004600948, 0004602848, 0004602948,
 0004608948, 0014600248, 0014600848,
 0014601248, 0014602248, 0014607748,
 0024600148, A0003387310, A0004600348,
 A0004602848, A0004602948, A0014600848,
 A0014601248, A0014602248, A0014607748



DB-DL-5220

Length: 522
Ø: 52
Hole Distance: 151
 01335200A, 3813500606, 6523500306,
 6533500106



DB-DL-5231

Length: 840
Ø: 52
Cone Ø: d1 Ø 32 / d2 Ø 29
 01208500A, 0014602905, 14602905, 0014603005,
 14603005, A0014602905



DB-DL-5412

Length: 840
Ø: 48
Cone Ø: d1 Ø 32 / d2 Ø 30
 01214400A, 0014600305, 14600305, 0014600405,
 14600405



DB-DL-7831

Length: 870
Ø: 42
Cone Ø: d1 Ø 30 / d2 Ø 27
 01215200A, 6254602505



DB-DL-8138

Length: 1130
Ø: 40
Cone Ø: d1 Ø 32 / d2 Ø 28,8
 0004606605, 4606605



DB-DL-8618

Length: 680
Ø: 42
Cone Ø: d1 Ø 32 / d2 Ø 28,8
 0004604305, 4604305, 6254604805



DB-DL-8640

Length: 1615 **Ø:** 50
Cone Ø: d1 Ø 32 / d2 Ø 29
 6253301503, 6253301603, 6253302403,
 6253302503, 9423300803, 9423302103,
 9493300203, 9493300303, 9493300903



DB-DL-8672

Length: 860
Ø: 48
Cone Ø: d1 Ø 30 / d2 Ø 27
 0014609705, 14609705



DB-DL-12309

Length: 685
Ø: 40
Cone Ø: d1 Ø 32 / d2 Ø 28,8
 4606005, 0004606005, 4606305, 0004606305



DB-ES-5209

Length: 1670 **Ø:** 50
Cone Ø: d1 Ø 30 / d2 Ø 27
 6203300503, 6203300603



DB-RK-5282

Ø: 59
 01303800A, 6553200111



DB-RK-5284

Ø: 65
 01303900A, 6523200511



DB-RK-5303

Ø: 37
 01304400A, 6253200611



DB-RK-8564

Ø: 90
 01302200A, 0003500105, 3500105, 0003500405,
 3500405, 0005861833, 5861833, 81432706047



DB-RK-10372

Ø: 56
Hole Distance: 90
Thick/Height: 20
 0003302511, 0003302611



DB-RK-12372

Ø: 85
Hole Distance: 152
Thick/Height: 24
 003501805, A003501805



DB-SB-10407

Ø: 61 **Thick/Height:** 46
 0003235985, 0003262481, 0003262981



DF-RK-9336

Ø: 108
 0003501705, 3501705



MN-RK-9387

Ø: 90
 0003500105, 81432706047



SC-RK-8688

Length: 95
Ø: 95
 0003501905, 3501905





MK ...

1424,1424 L ...	12/87→09/96	Suspension Arm Repair Kit		DB-RK-5284	1st RA
	12/87→09/96	Suspension Arm Repair Kit		DB-RK-8564	Wishbone (CV)
	12/87→09/96	Suspension Arm Repair Kit		DB-RK-12372	for Wishbone (CV)K063070→
	12/87→09/96	Suspension Arm Repair Kit		DF-RK-9336	
	12/87→09/96	Suspension Arm Repair Kit		DF-RK-9336	* K 063 070 *→
	12/87→09/96	Suspension Arm Repair Kit		MN-RK-9387	
	12/87→09/96	Suspension Arm Repair Kit		MN-RK-9387	→* 5 926 392 *
	12/87→09/96	Suspension Arm Repair Kit		SC-RK-8688	for Drag Link
	12/87→09/96	Suspension Arm Repair Kit	DB-RK-5282		
	12/87→09/96	Suspension Arm Repair Kit	DB-RK-5303		
	12/87→09/96	Tie Rod	DB-DL-8640		Guide Rod
	12/87→09/96	Tie Rod	DB-ES-5209		
	12/87→09/96	Tie Rod End	CV-ES-12461		for Steering Rod
	12/87→09/96	Tie Rod End	CV-ES-12462		for Steering Rod
	12/87→09/96	Track Control Arm		DB-DL-5220	Trailing Arm
1426 S,1426 LS	12/87→09/96	Centre Rod	DB-DL-5412		Push Rod
	12/87→09/96	Stabiliser Mounting		DB-SB-10407	
	12/87→09/96	Suspension Arm Repair Kit		DB-RK-5284	
	12/87→09/96	Suspension Arm Repair Kit		DB-RK-5284	1st RA
	12/87→09/96	Suspension Arm Repair Kit		DB-RK-8564	Wishbone (CV)
	12/87→09/96	Suspension Arm Repair Kit		DB-RK-10378	
	12/87→09/96	Suspension Arm Repair Kit		DB-RK-12372	for Wishbone (CV)K063070→
	12/87→09/96	Suspension Arm Repair Kit		DF-RK-9336	
	12/87→09/96	Suspension Arm Repair Kit		DF-RK-9336	* K 063 070 *→
	12/87→09/96	Suspension Arm Repair Kit		MN-RK-9387	
	12/87→09/96	Suspension Arm Repair Kit		MN-RK-9387	→* 5 926 392 *
	12/87→09/96	Suspension Arm Repair Kit		SC-RK-8688	for Drag Link
	12/87→09/96	Suspension Arm Repair Kit	DB-RK-5303		
	12/87→09/96	Tie Rod End	CV-ES-12461		for Steering Rod
	12/87→09/96	Tie Rod End	CV-ES-12462		for Steering Rod
12/87→09/96	Tie Rod End	CV-ES-14163		for Steering Rod	
12/87→09/96	Track Control Arm		DB-DL-5220	Trailing Arm	
1427	02/93→09/96	Centre Rod	DB-DL-5231		Push Rod* K 072 178 *→
	02/93→09/96	Centre Rod	DB-DL-5412		Push Rod* K 016 738 *→* K 072 177 *
	02/93→09/96	Tie Rod	DB-DL-8640		Guide Rod
	02/93→09/96	Tie Rod End	CV-ES-12461		for Steering Rod
	02/93→09/96	Tie Rod End	CV-ES-12462		for Steering Rod
1427 F	02/93→09/96	Centre Rod	DB-DL-5231		Push Rod* K 072 178 *→
	02/93→09/96	Centre Rod	DB-DL-5412		Push Rod* K 016 738 *→* K 072 177 *
	02/93→09/96	Centre Rod	DB-DL-8672		Push Rod→* 1 K 016737 *
	02/93→09/96	Stabiliser Mounting		DB-SB-10407	
	02/93→09/96	Suspension Arm Repair Kit		DB-RK-10378	
	02/93→09/96	Suspension Arm Repair Kit	DB-RK-5303		
	02/93→09/96	Tie Rod	DB-DL-8640		Guide Rod
	02/93→09/96	Tie Rod	DB-ES-5209		
	02/93→09/96	Tie Rod End	CV-ES-12461		for Steering Rod
	02/93→09/96	Tie Rod End	CV-ES-12462		for Steering Rod
1427 L	12/87→09/96	Centre Rod	DB-DL-5231		Push Rod* K 072 178 *→
	12/87→09/96	Centre Rod	DB-DL-5412		Push Rod* K 016 738 *→* K 072 177 *
	12/87→09/96	Suspension Arm Repair Kit		DB-RK-5284	→* K 097 019 *
	12/87→09/96	Suspension Arm Repair Kit		DB-RK-5284	1st RA
	12/87→09/96	Suspension Arm Repair Kit		DB-RK-8564	Wishbone (CV)
	12/87→09/96	Suspension Arm Repair Kit		DB-RK-12372	for Wishbone (CV)K063070→
	12/87→09/96	Suspension Arm Repair Kit		DF-RK-9336	
	12/87→09/96	Suspension Arm Repair Kit		DF-RK-9336	* K 063 070 *→
	12/87→09/96	Suspension Arm Repair Kit		MN-RK-9387	
	12/87→09/96	Suspension Arm Repair Kit		MN-RK-9387	→* 5 926 392 *
	12/87→09/96	Suspension Arm Repair Kit		SC-RK-8688	for Drag Link
	12/87→09/96	Suspension Arm Repair Kit	DB-RK-5282		
	12/87→09/96	Tie Rod	DB-DL-8640		Guide Rod
	12/87→09/96	Tie Rod	DB-ES-5209		
	12/87→09/96	Tie Rod End	CV-ES-12461		for Steering Rod
12/87→09/96	Tie Rod End	CV-ES-12462		for Steering Rod	
12/87→09/96	Track Control Arm		DB-DL-5220	Trailing Arm	

CV-ES-12461

Length: 120
Cone Ø: d1 Ø 26 / d2 Ø 23,5
Thread: M30 x 1,5 LHT
 0003300035, 3300148, 0003406213, 0013306635,
 0013308835, 0014604048, 0014604348,
 14606448, 0024600248, 3023300035,
 3023300135, 3023300235, 3023300335,
 3453307235, 3453307435, 3503307135,
 A0003300148, A0013306635, A0013308835,
 A0014604048, A0014604348, A0014606448,
 A0024600248, A3023300035, A3023300135,
 A3023300235, A3023300335, A3503307135



CV-ES-12462

Length: 120
Cone Ø: d1 Ø 26 / d2 Ø 23,5
Thread: M30 x 1,5 RHT
 0003300135, 0003300248, 0003303235,
 0003305835, 0003307335, 0003383410,
 004608348, 0004608348, 0004632229,
 0004633129, 0004633429, 0004633529,
 0013300135, 0013300235, 0013306735,
 0014603448, 0014604148, 0014604448,
 0014606348, 0014608348, 0014608448,
 0014609748, 0023301535, 3453307135,
 3503307035, 3503307335, 3643307135,
 5001832582, A0003300248, A0003303235,
 A0003307335, A0003383410, A0004608348,
 A0004632229, A0004633429, A0013300135,
 A0013300235, A0013306735, A0014603448,
 A0014604148, A0014604448, A0014606348,
 A0014608348, A0014608448, A0014609748,
 A0023301535



CV-ES-14163

Length: 125
Cone Ø: d1 Ø 30 / d2 Ø 27
Thread: M30 x 1,5 RHT
 0003305248, 0003387310, 0004600348,
 0004600948, 0004602848, 0004602948,
 0004608948, 0014600248, 0014600848,
 0014601248, 0014602248, 0014607748,
 0024600148, A0003387310, A0004600348,
 A0004602848, A0004602948, A0014600848,
 A0014601248, A0014602248, A0014607748



DB-DL-5220

Length: 522
Ø: 52
Hole Distance: 151
 01335200A, 3813500606, 6523500306,
 6533500106



DB-DL-5231

Length: 840
Ø: 52
Cone Ø: d1 Ø 32 / d2 Ø 29
 01208500A, 0014602905, 14602905, 0014603005,
 14603005, A0014602905



DB-DL-5412

Length: 840
Ø: 48
Cone Ø: d1 Ø 32 / d2 Ø 30
 01214400A, 0014600305, 14600305, 0014600405,
 14600405



DB-DL-8640

Length: 1615 **Ø:** 50
Cone Ø: d1 Ø 32 / d2 Ø 29
 6253301503, 6253301603, 6253302403,
 6253302503, 9423300803, 9423302103,
 9493300203, 9493300303, 9493300903



DB-DL-8672

Length: 860
Ø: 48
Cone Ø: d1 Ø 30 / d2 Ø 27
 0014609705, 14609705



DB-ES-5209

Length: 1670 **Ø:** 50
Cone Ø: d1 Ø 30 / d2 Ø 27
 6203300503, 6203300603



DB-RK-5282

Ø: 59
 01303800A, 6553200111



DB-RK-5284

Ø: 65
 01303900A, 6523200511



DB-RK-5303

Ø: 37
 01304400A, 6253200611



DB-RK-8564

Ø: 90
 01302200A, 0003500105, 3500105, 0003500405,
 3500405, 0005861833, 5861833, 81432706047



DB-RK-10378

Ø: 86
 6203200028



DB-RK-12372

Ø: 85
Hole Distance: 152
Thick/Height: 24
 003501805, A003501805



DB-SB-10407

Ø: 61 **Thick/Height:** 46
 0003235985, 0003262481, 0003262981



DF-RK-9336

Ø: 108
 0003501705, 3501705



MN-RK-9387

Ø: 90
 0003500105, 81432706047



SC-RK-8688

Length: 95
Ø: 95
 0003501905, 3501905





MK ...

1427 LS	02/93→09/96	Centre Rod	DB-DL-5231	Push Rod* K 072 178 *→	
	02/93→09/96	Centre Rod	DB-DL-5412	Push Rod* K 016 738 *→* K 072 177 *	
	02/93→09/96	Centre Rod	DB-DL-7831	Push Rod	
	02/93→09/96	Centre Rod	DB-DL-8138	Push Rod	
	02/93→09/96	Centre Rod	DB-DL-8618	Push Rod	
	02/93→09/96	Centre Rod	DB-DL-12309	Coupling Rod	
	02/93→09/96	Suspension Arm Repair Kit	DB-RK-5284	→* K 097 019 *	
	02/93→09/96	Suspension Arm Repair Kit	DB-RK-5284	1st RA	
	02/93→09/96	Suspension Arm Repair Kit	DB-RK-8564	Wishbone (CV)	
	02/93→09/96	Suspension Arm Repair Kit	DB-RK-12372	for Wishbone (CV)K063070→	
	02/93→09/96	Suspension Arm Repair Kit	DF-RK-9336		
	02/93→09/96	Suspension Arm Repair Kit	DF-RK-9336	* K 063 070 *→	
	02/93→09/96	Suspension Arm Repair Kit	MN-RK-9387		
	02/93→09/96	Suspension Arm Repair Kit	MN-RK-9387	→* 5 926 392 *	
	02/93→09/96	Suspension Arm Repair Kit	SC-RK-8688	for Drag Link	
	02/93→09/96	Tie Rod	DB-DL-8640	Guide Rod	
	02/93→09/96	Tie Rod	DB-ES-5209		
	02/93→09/96	Tie Rod End	CV-ES-12461	for Steering Rod	
	02/93→09/96	Tie Rod End	CV-ES-12462	for Steering Rod	
	02/93→09/96	Track Control Arm	DB-DL-5220	Trailing Arm	
	1427 S, 1427 LS	02/93→09/96	Centre Rod	DB-DL-5231	Push Rod* K 072 178 *→
		02/93→09/96	Centre Rod	DB-DL-5412	Push Rod* K 016 738 *→* K 072 177 *
		02/93→09/96	Centre Rod	DB-DL-7831	Push Rod
02/93→09/96		Centre Rod	DB-DL-8138	Push Rod	
02/93→09/96		Centre Rod	DB-DL-8618	Push Rod	
02/93→09/96		Centre Rod	DB-DL-12309	Coupling Rod	
02/93→09/96		Suspension Arm Repair Kit	DB-RK-5284	→* K 097 019 *	
02/93→09/96		Suspension Arm Repair Kit	DB-RK-5284	1st RA	
02/93→09/96		Suspension Arm Repair Kit	DB-RK-8564	Wishbone (CV)	
02/93→09/96		Suspension Arm Repair Kit	DB-RK-12372	for Wishbone (CV)K063070→	
02/93→09/96		Suspension Arm Repair Kit	DF-RK-9336		
02/93→09/96		Suspension Arm Repair Kit	DF-RK-9336	* K 063 070 *→	
02/93→09/96		Suspension Arm Repair Kit	MN-RK-9387		
02/93→09/96		Suspension Arm Repair Kit	MN-RK-9387	→* 5 926 392 *	
02/93→09/96		Suspension Arm Repair Kit	SC-RK-8688	for Drag Link	
02/93→09/96		Tie Rod	DB-DL-8640	Guide Rod	
02/93→09/96		Tie Rod	DB-ES-5209		
02/93→09/96		Tie Rod End	CV-ES-12461	for Steering Rod	
02/93→09/96		Tie Rod End	CV-ES-12462	for Steering Rod	
02/93→09/96		Track Control Arm	DB-DL-5220	Trailing Arm	
1429 AF		01/92→09/96	Centre Rod	DB-DL-5239	Push Rod
		01/92→09/96	Tie Rod	DB-DL-8632	
		01/92→09/96	Tie Rod End	CV-ES-12461	for Steering Rod
	01/92→09/96	Tie Rod End	CV-ES-12462	for Steering Rod	
	1431	12/87→08/96	Centre Rod	DB-DL-5412	Push Rod
12/87→08/96	Tie Rod	DB-DL-8640	Guide Rod		
12/87→08/96	Tie Rod End	CV-ES-12461	for Steering Rod		
12/87→08/96	Tie Rod End	CV-ES-12462	for Steering Rod		
1431 F	12/87→08/96	Centre Rod	DB-DL-5412	Push Rod	
	12/87→08/96	Centre Rod	DB-DL-7831	Push Rod	
	12/87→08/96	Centre Rod	DB-DL-8138	Push Rod	
	12/87→08/96	Centre Rod	DB-DL-8618	Push Rod	
	12/87→08/96	Centre Rod	DB-DL-12309	Coupling Rod	
	12/87→08/96	Tie Rod	DB-DL-8640	Guide Rod	
	12/87→08/96	Tie Rod	DB-ES-5209		
	12/87→08/96	Tie Rod End	CV-ES-12461	for Steering Rod	
	12/87→08/96	Tie Rod End	CV-ES-12462	for Steering Rod	
	1624 S	12/87→09/96	Centre Rod	DB-DL-5231	Push Rod* K 072 178 *→
	12/87→09/96	Centre Rod	DB-DL-5412	Push Rod* K 016 738 *→* K 072 177 *	
12/87→09/96	Tie Rod	DB-DL-8640	Guide Rod		
12/87→09/96	Tie Rod End	CV-ES-12461	for Steering Rod		
12/87→09/96	Tie Rod End	CV-ES-12462	for Steering Rod		

CV-ES-12461

Length: 120
 Cone Ø: d1 Ø 26 / d2 Ø 23,5
 Thread: M30 x 1,5 LHT
 0003300035, 3300148, 0003406213, 0013306635,
 0013308835, 0014604048, 0014604348,
 14606448, 0024600248, 3023300035,
 3023300135, 3023300235, 3023300335,
 3453307235, 3453307435, 3503307135,
 A0003300148, A0013306635, A0013308835,
 A0014604048, A0014604348, A0014606448,
 A0024600248, A3023300035, A3023300135,
 A3023300235, A3023300335, A3503307135



CV-ES-12462

Length: 120
 Cone Ø: d1 Ø 26 / d2 Ø 23,5
 Thread: M30 x 1,5 RHT
 0003300135, 0003300248, 0003303235,
 0003305835, 0003307335, 0003383410,
 004608348, 0004608348, 0004632229,
 0004633129, 0004633429, 0004633529,
 0013300135, 0013300235, 0013306735,
 0014603448, 0014604148, 0014604448,
 0014606348, 0014608348, 0014608448,
 0014609748, 0023301535, 3453307135,
 3503307035, 3503307335, 3643307135,
 5001832582, A0003300248, A0003303235,
 A0003307335, A0003383410, A0004608348,
 A0004632229, A0004633429, A0013300135,
 A0013300235, A0013306735, A0014603448,
 A0014604148, A0014604448, A0014606348,
 A0014608348, A0014608448, A0014609748,
 A0023301535



DB-DL-5220

Length: 522
 Ø: 52
 Hole Distance: 151
 01335200A, 3813500606, 6523500306,
 6533500106



DB-DL-5231

Length: 840
 Ø: 52
 Cone Ø: d1 Ø 32 / d2 Ø 29
 01208500A, 14602905, 0014602905, 0014603005,
 14603005, A0014602905



DB-DL-5239

Length: 862
 Ø: 42
 Cone Ø: d1 Ø 30 / d2 Ø 27
 01214500A, 6174602405, 6174603405



DB-DL-5412

Length: 840
 Ø: 48
 Cone Ø: d1 Ø 32 / d2 Ø 30
 01214400A, 0014600305, 14600305, 0014600405,
 14600405



DB-DL-7831

Length: 870
 Ø: 42
 Cone Ø: d1 Ø 30 / d2 Ø 27
 01215200A, 6254602505



DB-DL-8138

Length: 1130
 Ø: 40
 Cone Ø: d1 Ø 32 / d2 Ø 28,8
 0004606605, 4606605



DB-DL-8618

Length: 680
 Ø: 42
 Cone Ø: d1 Ø 32 / d2 Ø 28,8
 0004604305, 4604305, 6254604805



DB-DL-8632

Length: 1635
 Ø: 60
 Cone Ø: d1 Ø 30 / d2 Ø 27
 3853301303, 3853302103, 3853302203



DB-DL-8640

Length: 1615 Ø: 50
 Cone Ø: d1 Ø 32 / d2 Ø 29
 6253301503, 6253301603, 6253302403,
 6253302503, 9423300803, 9423302103,
 9493300203, 9493300303, 9493300903



DB-DL-12309

Length: 685 Ø: 40
 Cone Ø: d1 Ø 32 / d2 Ø 28,8
 0004606005, 0004606305



DB-ES-5209

Length: 1670 Ø: 50
 Cone Ø: d1 Ø 30 / d2 Ø 27
 6203300503, 6203300603



DB-RK-5284

Ø: 65
 01303900A, 6523200511



DB-RK-8564

Ø: 90
 01302200A, 0003500105, 3500105, 0003500405,
 3500405, 5861833, 0005861833, 81432706047



DB-RK-12372

Ø: 85
 Hole Distance: 152
 Thick/Height: 24
 003501805, A003501805



DF-RK-9336

Ø: 108
 0003501705, 3501705



MN-RK-9387

Ø: 90
 0003500105, 81432706047



SC-RK-8688

Length: 95
 Ø: 95
 0003501905, 3501905





MK ...

1627 AF	01/92→09/96	Centre Rod	DB-DL-5239		Push Rod	
	01/92→09/96	Tie Rod	DB-DL-8632			
	01/92→09/96	Tie Rod End	CV-ES-12461		for Steering Rod	
	01/92→09/96	Tie Rod End	CV-ES-12462		for Steering Rod	
1717 AK	09/89→08/94	Centre Rod	DB-DL-5239		Push Rod	
	09/89→08/94	Centre Rod	DB-DL-5412		Push Rod	
	09/89→08/94	Stabiliser Mounting		DB-SB-10407		
	09/89→08/94	Suspension Arm Repair Kit		DB-RK-8564	Wishbone (CV)	
	09/89→08/94	Suspension Arm Repair Kit		MN-RK-9387		
	09/89→08/94	Tie Rod	DB-DL-8632			
	09/89→08/94	Tie Rod End	CV-ES-12461		for Steering Rod	
	09/89→08/94	Tie Rod End	CV-ES-12462		for Steering Rod	
	09/89→08/94	Tie Rod End	CV-ES-14163		for Steering Rod	
	1717 K	09/89→08/94	Centre Rod	DB-DL-5412		Push Rod
09/89→08/94		Centre Rod	DB-DL-8672		Push Rod* 1 5 593345 *→	
09/89→08/94		Stabiliser Mounting		DB-SB-10407		
09/89→08/94		Suspension Arm Repair Kit		DB-RK-8564	Wishbone (CV)	
09/89→08/94		Suspension Arm Repair Kit		MN-RK-9387		
09/89→08/94		Suspension Arm Repair Kit	DB-RK-5303			
09/89→08/94		Tie Rod End	CV-ES-12461		for Steering Rod	
09/89→08/94		Tie Rod End	CV-ES-12462		for Steering Rod	
09/89→08/94		Tie Rod End	CV-ES-14163		for Steering Rod	
1717,1717 L		12/87→09/96	Centre Rod	DB-DL-5412		Push Rod
	12/87→09/96	Centre Rod	DB-DL-7831		Push Rod	
	12/87→09/96	Centre Rod	DB-DL-8131		Push Rod	
	12/87→09/96	Centre Rod	DB-DL-8138		Push Rod	
	12/87→09/96	Centre Rod	DB-DL-8618		Push Rod	
	12/87→09/96	Centre Rod	DB-DL-8672		Push Rod* 1 5 593345 *→	
	12/87→09/96	Centre Rod	DB-DL-12309		Coupling Rod	
	12/87→09/96	Stabiliser Mounting		DB-SB-10407		
	12/87→09/96	Suspension Arm Repair Kit		DB-RK-5284		
	12/87→09/96	Suspension Arm Repair Kit		DB-RK-5284	1st RA	
	12/87→09/96	Suspension Arm Repair Kit		DB-RK-8564	Wishbone (CV)	
	12/87→09/96	Suspension Arm Repair Kit		DB-RK-12372	for Wishbone (CV)K063070→	
	12/87→09/96	Suspension Arm Repair Kit		DF-RK-9336		
	12/87→09/96	Suspension Arm Repair Kit		DF-RK-9336	* K 063 070 *→	
	12/87→09/96	Suspension Arm Repair Kit		MN-RK-9387		
	12/87→09/96	Suspension Arm Repair Kit		MN-RK-9387	→* 5 926 392 *	
	12/87→09/96	Suspension Arm Repair Kit	DB-RK-5282			
	12/87→09/96	Suspension Arm Repair Kit	DB-RK-5303			
	12/87→09/96	Tie Rod	DB-DL-8640		Guide Rod	
	12/87→09/96	Tie Rod	DB-ES-5209			
	12/87→09/96	Tie Rod End	CV-ES-12461		for Steering Rod	
	12/87→09/96	Tie Rod End	CV-ES-12462		for Steering Rod	
	12/87→09/96	Tie Rod End	CV-ES-14163		for Steering Rod	
	12/87→09/96	Track Control Arm		DB-DL-5220	Trailing Arm	
	1720 L	12/88→08/94	Centre Rod	DB-DL-5412		Push Rod
		12/88→08/94	Stabiliser Mounting	DB-SB-5258		1st FA
		12/88→08/94	Stabiliser Mounting	DB-SB-5258	DB-SB-5258	→* 5 903 513 *
		12/88→08/94	Suspension Arm Repair Kit		DB-RK-5284	
		12/88→08/94	Suspension Arm Repair Kit		DB-RK-5284	1st RA
		12/88→08/94	Suspension Arm Repair Kit		DB-RK-8564	Wishbone (CV)
12/88→08/94		Suspension Arm Repair Kit		DB-RK-12372	for Wishbone (CV)K063070→	
12/88→08/94		Suspension Arm Repair Kit		DF-RK-9336		
12/88→08/94		Suspension Arm Repair Kit		DF-RK-9336	* K 063 070 *→	
12/88→08/94		Suspension Arm Repair Kit		MN-RK-9387		
12/88→08/94		Suspension Arm Repair Kit		MN-RK-9387	→* 5 926 392 *	
12/88→08/94		Suspension Arm Repair Kit		SC-RK-8688	for Drag Link	
12/88→08/94		Suspension Arm Repair Kit	DB-RK-5282			
12/88→08/94		Tie Rod End	CV-ES-12461		for Steering Rod	
12/88→08/94		Tie Rod End	CV-ES-12462		for Steering Rod	
12/88→08/94		Track Control Arm		DB-DL-5220	Trailing Arm	

CV-ES-12461

Length: 120
 Cone Ø: d1 Ø 26 / d2 Ø 23,5
 Thread: M30 x 1,5 LHT
 0003300035, 3300148, 0003406213, 0013306635, 0013308835, 0014604048, 0014604348, 14606448, 0024600248, 3023300035, 3023300135, 3023300235, 3023300335, 3453307235, 3453307435, 3503307135, A0003300148, A0013306635, A0013308835, A0014604048, A0014604348, A0014606448, A0024600248, A3023300035, A3023300135, A3023300235, A3023300335, A3503307135



CV-ES-12462

Length: 120
 Cone Ø: d1 Ø 26 / d2 Ø 23,5
 Thread: M30 x 1,5 RHT
 0003300135, 0003300248, 0003303235, 0003305835, 0003307335, 0003383410, 004608348, 0004608348, 0004632229, 0004633129, 0004633429, 0004633529, 0013300135, 0013300235, 0013306735, 0014603448, 0014604148, 0014604448, 0014606348, 0014608348, 0014608448, 0014609748, 0023301535, 3453307135, 3503307035, 3503307335, 3643307135, 5001832582, A0003300248, A0003303235, A0003307335, A0003383410, A0004608348, A0004632229, A0004633429, A0013300135, A0013300235, A0013306735, A0014603448, A0014604148, A0014604448, A0014606348, A0014608348, A0014608448, A0014609748, A0023301535



CV-ES-14163

Length: 125
 Cone Ø: d1 Ø 30 / d2 Ø 27
 Thread: M30 x 1,5 RHT
 0003305248, 0003387310, 0004600348, 0004600948, 0004602848, 0004602948, 0004608948, 0014600248, 0014600848, 0014601248, 0014602248, 0014607748, 0024600148, A0003387310, A0004600348, A0004602848, A0004602948, A0014600848, A0014601248, A0014602248, A0014607748



DB-DL-5220

Length: 522
 Ø: 52
 Hole Distance: 151
 01335200A, 3813500606, 6523500306, 6533500106



DB-DL-5239

Length: 862
 Ø: 42
 Cone Ø: d1 Ø 30 / d2 Ø 27
 01214500A, 6174602405, 6174603405



DB-DL-5412

Length: 840
 Ø: 48
 Cone Ø: d1 Ø 32 / d2 Ø 30
 01214400A, 0014600305, 14600305, 0014600405, 14600405



DB-DL-7831

Length: 870
 Ø: 42
 Cone Ø: d1 Ø 30 / d2 Ø 27
 01215200A, 6254602505



DB-DL-8131

Length: 1115 Ø: 52
 Cone Ø: d1 Ø 32 / d2 Ø 28,8
 0004604405, 6254605005



DB-DL-8138

Length: 1130
 Ø: 40
 Cone Ø: d1 Ø 32 / d2 Ø 28,8
 0004606605, 4606605



DB-DL-8618

Length: 680
 Ø: 42
 Cone Ø: d1 Ø 32 / d2 Ø 28,8
 0004604305, 4604305, 6254604805



DB-DL-8632

Length: 1635
 Ø: 60
 Cone Ø: d1 Ø 30 / d2 Ø 27
 3853301303, 3853302103, 3853302203



DB-DL-8640

Length: 1615 Ø: 50
 Cone Ø: d1 Ø 32 / d2 Ø 29
 6253301503, 6253301603, 6253302403, 6253302503, 9423300803, 9423302103, 9493300203, 9493300303, 9493300903



DB-DL-8672

Length: 860
 Ø: 48
 Cone Ø: d1 Ø 30 / d2 Ø 27
 0014609705, 14609705



DB-DL-12309

Length: 685
 Ø: 40
 Cone Ø: d1 Ø 32 / d2 Ø 28,8
 0004606005, 4606005, 4606305, 0004606305



DB-ES-5209

Length: 1670 Ø: 50
 Cone Ø: d1 Ø 30 / d2 Ø 27
 6203300503, 6203300603



DB-RK-5282

Ø: 59
 01303800A, 6553200111



DB-RK-5284

Ø: 65
 01303900A, 6523200511



DB-RK-5303

Ø: 37
 01304400A, 6253200611



DB-RK-8564

Ø: 90
 01302200A, 3500105, 0003500105, 0003500405, 3500405, 0005861833, 5861833, 81432706047



DB-RK-12372

Ø: 85
 Hole Distance: 152
 Thick/Height: 24
 003501805, A003501805



DB-SB-5258

Ø: 70
 Thick/Height: 62
 01311400A, 3873230285



DB-SB-10407

Ø: 61 Thick/Height: 46
 0003235985, 0003262481, 0003262981



DF-RK-9336

Ø: 108
 0003501705, 3501705



MN-RK-9387

Ø: 90
 0003500105, 81432706047



SC-RK-8688

Length: 95
 Ø: 95
 0003501905, 3501905





MK ...

1720 S	02/90→08/94	Centre Rod	DB-DL-5412		Push Rod
	02/90→08/94	Centre Rod	DB-DL-8672		Push Rod* 1 5 593345 *→
	02/90→08/94	Stabiliser Mounting		DB-SB-10407	
	02/90→08/94	Suspension Arm Repair Kit	DB-RK-5303		
	02/90→08/94	Tie Rod End	CV-ES-12461		for Steering Rod
	02/90→08/94	Tie Rod End	CV-ES-12462		for Steering Rod
	02/90→08/94	Tie Rod End	CV-ES-14163		for Steering Rod
1720,1720 L	12/87→09/96	Centre Rod	DB-DL-5231		Push Rod* K 072 178 *→
	12/87→09/96	Centre Rod	DB-DL-5412		Push Rod* K 016 738 *→* K 072 177 *
	12/87→09/96	Centre Rod	DB-DL-5412		Push Rod* K 017 164 *→* K 072 177 *
	12/87→09/96	Centre Rod	DB-DL-8672		Push Rod* 1 5 593345 *→* 1 K 016737 *
	12/87→09/96	Centre Rod	DB-DL-10216		Push Rod
	12/87→09/96	Stabiliser Mounting		DB-SB-10407	
	12/87→09/96	Stabiliser Mounting	DB-SB-5258		1st FA
	12/87→09/96	Stabiliser Mounting	DB-SB-5258	DB-SB-5258	→* 5 903 513 *
	12/87→09/96	Suspension Arm Repair Kit		DB-RK-5284	
	12/87→09/96	Suspension Arm Repair Kit		DB-RK-5284	→* K 097 019 *
	12/87→09/96	Suspension Arm Repair Kit		DB-RK-5284	1st RA
	12/87→09/96	Suspension Arm Repair Kit		DB-RK-8564	Wishbone (CV)
	12/87→09/96	Suspension Arm Repair Kit		DB-RK-12372	for Wishbone (CV)K063070→
	12/87→09/96	Suspension Arm Repair Kit		DF-RK-9336	
	12/87→09/96	Suspension Arm Repair Kit		DF-RK-9336	* K 063 070 *→
	12/87→09/96	Suspension Arm Repair Kit		MN-RK-9387	
	12/87→09/96	Suspension Arm Repair Kit		MN-RK-9387	→* 5 926 392 *
	12/87→09/96	Suspension Arm Repair Kit		SC-RK-8688	for Drag Link
	12/87→09/96	Suspension Arm Repair Kit	DB-RK-5282		
	12/87→09/96	Suspension Arm Repair Kit	DB-RK-5303		
	12/87→09/96	Tie Rod	DB-DL-8640		Guide Rod
	12/87→09/96	Tie Rod	DB-ES-5209		
	12/87→09/96	Tie Rod End	CV-ES-12461		for Steering Rod
	12/87→09/96	Tie Rod End	CV-ES-12462		for Steering Rod
	12/87→09/96	Tie Rod End	CV-ES-14163		for Steering Rod
12/87→09/96	Track Control Arm		DB-DL-5220	Trailing Arm	
1722	08/88→08/94	Centre Rod	DB-DL-5412		Push Rod
	08/88→08/94	Tie Rod End	CV-ES-12461		for Steering Rod
	08/88→08/94	Tie Rod End	CV-ES-12462		for Steering Rod
	08/88→08/94	Tie Rod End	CV-ES-14163		for Steering Rod
	12/88→08/94	Centre Rod	DB-DL-5207		Push Rod
	12/88→08/94	Centre Rod	DB-DL-8672		Push Rod* 1 5 593345 *→
	12/88→08/94	Stabiliser Mounting		DB-SB-10407	
	12/88→08/94	Stabiliser Mounting	DB-SB-5258	DB-SB-5258	
	12/88→08/94	Suspension Arm Repair Kit		CV-RK-8118	for Drag Link
	12/88→08/94	Suspension Arm Repair Kit		DF-RK-9336	
	12/88→08/94	Suspension Arm Repair Kit	DB-RK-5283		
	12/88→08/94	Suspension Arm Repair Kit	DB-RK-5303		
	12/88→08/94	Suspension Strut Repair Kit		DF-RK-8671	
12/88→08/94	Track Control Arm		DB-DL-5220	Trailing Arm	
1722 AK	12/88→08/94	Centre Rod	DB-DL-5207		Push Rod
	12/88→08/94	Centre Rod	DB-DL-5239		Push Rod
	12/88→08/94	Centre Rod	DB-DL-5412		Push Rod
	12/88→08/94	Stabiliser Mounting		DB-SB-10407	
	12/88→08/94	Tie Rod	DB-DL-8632		
	12/88→08/94	Tie Rod End	CV-ES-12461		for Steering Rod
	12/88→08/94	Tie Rod End	CV-ES-12462		for Steering Rod
1722 K	12/88→08/94	Tie Rod End	CV-ES-14163		for Steering Rod
	12/88→08/94	Centre Rod	DB-DL-5207		Push Rod
	12/88→08/94	Centre Rod	DB-DL-5412		Push Rod
	12/88→08/94	Centre Rod	DB-DL-8672		Push Rod* 1 593345 *→
	12/88→08/94	Stabiliser Mounting		DB-SB-10407	
	12/88→08/94	Suspension Arm Repair Kit	DB-RK-5303		
	12/88→08/94	Tie Rod End	CV-ES-12461		for Steering Rod
12/88→08/94	Tie Rod End	CV-ES-12462		for Steering Rod	
12/88→08/94	Tie Rod End	CV-ES-14163		for Steering Rod	

CV-ES-12461

Length: 120
Cone Ø: d1 Ø 26 / d2 Ø 23,5
Thread: M30 x 1,5 LHT
0003300035, 3300148, 0003406213, 0013306635,
0013308835, 0014604048, 0014604348,
14606448, 0024600248, 3023300035,
3023300135, 3023300235, 3023300335,
3453307235, 3453307435, 3503307135,
A0003300148, A0013306635, A0013308835,
A0014604048, A0014604348, A0014606448,
A0024600248, A3023300035, A3023300135,
A3023300235, A3023300335, A3503307135



CV-ES-12462

Length: 120
Cone Ø: d1 Ø 26 / d2 Ø 23,5
Thread: M30 x 1,5 RHT
0003300135, 0003300248, 0003303235,
0003305835, 0003307335, 0003383410,
0004608348, 004608348, 0004632229,
0004633129, 0004633429, 0004633529,
0013300135, 0013300235, 0013306735,
0014603448, 0014604148, 0014604448,
0014606348, 0014608348, 0014608448,
0014609748, 0023301535, 3453307135,
3503307035, 3503307335, 3643307135,
5001832582, A0003300248, A0003303235,
A0003307335, A0003383410, A0004608348,
A0004632229, A0004633429, A0013300135,
A0013300235, A0013306735, A0014603448,
A0014604148, A0014604448, A0014606348,
A0014608348, A0014608448, A0014609748,
A0023301535



CV-ES-14163

Length: 125
Cone Ø: d1 Ø 30 / d2 Ø 27
Thread: M30 x 1,5 RHT
0003305248, 0003387310, 0004600348,
0004600948, 0004602848, 0004602948,
0004608948, 0014600248, 0014600848,
0014601248, 0014602248, 0014607748,
0024600148, A0003387310, A0004600348,
A0004602848, A0004602948, A0014600848,
A0014601248, A0014602248, A0014607748



CV-RK-8118

Ø: 85
Hole Distance: 130
Thick/Height: 30
3500506, 0003500506



DB-DL-5207

Length: 875 Ø: 42
Cone Ø: d1 Ø 30 / d2 Ø 27
01215100A, 6174603505, 6174603605



DB-DL-5220

Length: 522
Ø: 52
Hole Distance: 151
01335200A, 3813500606, 6523500306,
6533500106



DB-DL-5231

Length: 840
Ø: 52
Cone Ø: d1 Ø 32 / d2 Ø 29
01208500A, 14602905, 0014602905, 0014603005,
14603005, A0014602905



DB-DL-5239

Length: 862
Ø: 42
Cone Ø: d1 Ø 30 / d2 Ø 27
01214500A, 6174602405, 6174603405



DB-DL-5412

Length: 840
Ø: 48
Cone Ø: d1 Ø 32 / d2 Ø 30
01214400A, 14600305, 0014600305, 0014600405,
14600405



DB-DL-8632

Length: 1635
Ø: 60
Cone Ø: d1 Ø 30 / d2 Ø 27
3853301303, 3853302103, 3853302203



DB-DL-8640

Length: 1615 Ø: 50
Cone Ø: d1 Ø 32 / d2 Ø 29
6253301503, 6253301603, 6253302403,
6253302503, 9423300803, 9423302103,
9493300203, 9493300303, 9493300903



DB-DL-8672

Length: 860
Ø: 48
Cone Ø: d1 Ø 30 / d2 Ø 27
0014609705, 14609705



DB-DL-10216

Length: 1190
Ø: 40
Cone Ø: d1 Ø 32 / d2 Ø 29
0004604905



DB-ES-5209

Length: 1670 Ø: 50
Cone Ø: d1 Ø 30 / d2 Ø 27
6203300503, 6203300603



DB-RK-5282

Ø: 59
01303800A, 6553200111



DB-RK-5283

Ø: 70
01319900A, 6203200628



DB-RK-5284

Ø: 65
01303800A, 6523200511



DB-RK-5303

Ø: 37
01304400A, 6253200611



DB-RK-8564

Ø: 90
01302200A, 0003500105, 3500105, 0003500405,
3500405, 5861833, 0005861833, 81432706047



DB-RK-12372

Ø: 85
Hole Distance: 152
Thick/Height: 24
003501805, A003501805



DB-SB-5258

Ø: 70
Thick/Height: 62
01311400A, 3873230285



DB-SB-10407

Ø: 61 Thick/Height: 46
0003235985, 0003262481, 0003262981



DF-RK-8671



DF-RK-9336

Ø: 108
3501705, 0003501705



MN-RK-9387

Ø: 90
0003500105, 81432706047



SC-RK-8688

Length: 95
Ø: 95
0003501905, 3501905



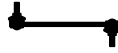

MK ...

1722 L	12/88→08/94	Centre Rod	DB-DL-5207		Push Rod
	12/88→08/94	Centre Rod	DB-DL-5412		Push Rod
	12/88→08/94	Centre Rod	DB-DL-7831		Push Rod
	12/88→08/94	Centre Rod	DB-DL-8138		Push Rod
	12/88→08/94	Centre Rod	DB-DL-8618		Push Rod
	12/88→08/94	Centre Rod	DB-DL-8672		Push Rod* 1 5 593345 *→
	12/88→08/94	Centre Rod	DB-DL-8672		Push Rod* 1 5 593345 *→* 1 K 072177 *
	12/88→08/94	Centre Rod	DB-DL-8735		Push Rod
	12/88→08/94	Centre Rod	DB-DL-12309		Coupling Rod
	12/88→08/94	Stabiliser Mounting		DB-SB-10407	
	12/88→08/94	Stabiliser Mounting	DB-SB-5258		1st FA
	12/88→08/94	Stabiliser Mounting	DB-SB-5258	DB-SB-5258	→* 5 903 513 *
	12/88→08/94	Suspension Arm Repair Kit		CV-RK-8118	for Drag Link
	12/88→08/94	Suspension Arm Repair Kit		DB-RK-5284	
	12/88→08/94	Suspension Arm Repair Kit		DB-RK-5284	1st RA
	12/88→08/94	Suspension Arm Repair Kit		DB-RK-8564	Wishbone (CV)
	12/88→08/94	Suspension Arm Repair Kit		DB-RK-12372	for Wishbone (CV)K063070→
	12/88→08/94	Suspension Arm Repair Kit		DF-RK-9336	
	12/88→08/94	Suspension Arm Repair Kit		DF-RK-9336	* K 063 070 *→
	12/88→08/94	Suspension Arm Repair Kit		MN-RK-9387	
	12/88→08/94	Suspension Arm Repair Kit		MN-RK-9387	→* 5 926 392 *
	12/88→08/94	Suspension Arm Repair Kit		SC-RK-8688	for Drag Link
	12/88→08/94	Suspension Arm Repair Kit	DB-RK-5282		
	12/88→08/94	Suspension Arm Repair Kit	DB-RK-5283		
	12/88→08/94	Suspension Arm Repair Kit	DB-RK-5303		
	12/88→08/94	Suspension Strut Repair Kit		DF-RK-8671	
	12/88→08/94	Tie Rod	DB-DL-8640		Guide Rod
	12/88→08/94	Tie Rod	DB-ES-5209		
	12/88→08/94	Tie Rod End	CV-ES-12461		for Steering Rod
	12/88→08/94	Tie Rod End	CV-ES-12462		for Steering Rod
	12/88→08/94	Tie Rod End	CV-ES-14163		for Steering Rod
	12/88→08/94	Track Control Arm		DB-DL-5220	Trailing Arm
1722 S	12/88→08/94	Centre Rod	DB-DL-5207		Push Rod
	12/88→08/94	Centre Rod	DB-DL-5412		Push Rod
	12/88→08/94	Centre Rod	DB-DL-8672		Push Rod* 1 593345 *→
	12/88→08/94	Stabiliser Mounting		DB-SB-10407	
	12/88→08/94	Tie Rod End	CV-ES-12461		for Steering Rod
12/88→08/94	Tie Rod End	CV-ES-12462		for Steering Rod	
12/88→08/94	Tie Rod End	CV-ES-14163		for Steering Rod	
1722, 1722 L, 1722 LL	12/87→09/96	Centre Rod	DB-DL-5412		Push Rod
	12/87→09/96	Centre Rod	DB-DL-7831		Push Rod
	12/87→09/96	Centre Rod	DB-DL-8138		Push Rod
	12/87→09/96	Centre Rod	DB-DL-8618		Push Rod
	12/87→09/96	Centre Rod	DB-DL-8735		Push Rod
	12/87→09/96	Centre Rod	DB-DL-12309		Coupling Rod
	12/87→09/96	Stabiliser Mounting	DB-SB-5258		1st FA
	12/87→09/96	Stabiliser Mounting	DB-SB-5258	DB-SB-5258	→* 5 903 513 *
	12/87→09/96	Suspension Arm Repair Kit		DB-RK-5284	
	12/87→09/96	Suspension Arm Repair Kit		DB-RK-5284	1st RA
	12/87→09/96	Suspension Arm Repair Kit		DB-RK-8564	Wishbone (CV)
	12/87→09/96	Suspension Arm Repair Kit		DB-RK-12372	for Wishbone (CV)K063070→
	12/87→09/96	Suspension Arm Repair Kit		DF-RK-9336	
	12/87→09/96	Suspension Arm Repair Kit		DF-RK-9336	* K 063 070 *→
	12/87→09/96	Suspension Arm Repair Kit		MN-RK-9387	
	12/87→09/96	Suspension Arm Repair Kit		MN-RK-9387	→* 5 926 392 *
	12/87→09/96	Suspension Arm Repair Kit		SC-RK-8688	for Drag Link
	12/87→09/96	Suspension Arm Repair Kit	DB-RK-5282		
	12/87→09/96	Tie Rod	DB-DL-8640		Guide Rod
	12/87→09/96	Tie Rod	DB-ES-5209		
	12/87→09/96	Tie Rod End	CV-ES-12461		for Steering Rod
	12/87→09/96	Tie Rod End	CV-ES-12462		for Steering Rod
	12/87→09/96	Tie Rod End	CV-ES-14163		for Steering Rod
	12/87→09/96	Track Control Arm		DB-DL-5220	Trailing Arm

CV-ES-12461

Length: 120
 Cone Ø: d1 Ø 26 / d2 Ø 23,5
 Thread: M30 x 1,5 LHT
 0003300035, 3300148, 0003406213, 0013306635,
 0013308835, 0014604048, 0014604348,
 14606448, 0024600248, 3023300035,
 3023300135, 3023300235, 3023300335,
 3453307235, 3453307435, 3503307135,
 A0003300148, A0013306635, A0013308835,
 A0014604048, A0014604348, A0014606448,
 A0024600248, A3023300035, A3023300135,
 A3023300235, A3023300335, A3503307135



CV-ES-12462

Length: 120
 Cone Ø: d1 Ø 26 / d2 Ø 23,5
 Thread: M30 x 1,5 RHT
 0003300135, 0003300248, 0003303235,
 0003305835, 0003307335, 0003383410,
 0004608348, 004608348, 0004632229,
 0004633129, 0004633429, 0004633529,
 0013300135, 0013300235, 0013306735,
 0014603448, 0014604148, 0014604448,
 0014606348, 0014608348, 0014608448,
 0014609748, 0023301535, 3453307135,
 3503307035, 3503307335, 3643307135,
 5001832582, A0003300248, A0003303235,
 A0003307335, A0003383410, A0004608348,
 A0004632229, A0004633429, A0013300135,
 A0013300235, A0013306735, A0014603448,
 A0014604148, A0014604448, A0014606348,
 A0014608348, A0014608448, A0014609748,
 A0023301535



CV-ES-14163

Length: 125
 Cone Ø: d1 Ø 30 / d2 Ø 27
 Thread: M30 x 1,5 RHT
 0003305248, 0003387310, 0004600348,
 0004600948, 0004602848, 0004602948,
 0004608948, 0014600248, 0014600848,
 0014601248, 0014602248, 0014607748,
 0024600148, A0003387310, A0004600348,
 A0004602848, A0004602948, A0014600848,
 A0014601248, A0014602248, A0014607748



CV-RK-8118

Ø: 85
 Hole Distance: 130
 Thick/Height: 30
 0003500506, 3500506



DB-DL-5207

Length: 875 Ø: 42
 Cone Ø: d1 Ø 30 / d2 Ø 27
 01215100A, 6174603505, 6174603605



DB-DL-5220

Length: 522
 Ø: 52
 Hole Distance: 151
 01335200A, 3813500606, 6523500306,
 6533500106



DB-DL-5412

Length: 840
 Ø: 48
 Cone Ø: d1 Ø 32 / d2 Ø 30
 01214400A, 0014600305, 14600305, 0014600405,
 14600405



DB-DL-7831

Length: 870
 Ø: 42
 Cone Ø: d1 Ø 30 / d2 Ø 27
 01215200A, 6254602505



DB-DL-8138

Length: 1130
 Ø: 40
 Cone Ø: d1 Ø 32 / d2 Ø 28,8
 4606605, 0004606605



DB-DL-8618

Length: 680
 Ø: 42
 Cone Ø: d1 Ø 32 / d2 Ø 28,8
 0004604305, 4604305, 6254604805



DB-DL-8640

Length: 1615 Ø: 50
 Cone Ø: d1 Ø 32 / d2 Ø 29
 6253301503, 6253301603, 6253302403,
 6253302503, 9423300803, 9423302103,
 9493300203, 9493300303, 9493300903



DB-DL-8672

Length: 860
 Ø: 48
 Cone Ø: d1 Ø 30 / d2 Ø 27
 0014609705, 14609705



DB-DL-8735

Length: 825
 Ø: 42
 Cone Ø: d1 Ø 30 / d2 Ø 27
 Thread: M24 x 1,5
 0004601005, 4601005, 0004601105, 4601105



DB-DL-12309

Length: 685
 Ø: 40
 Cone Ø: d1 Ø 32 / d2 Ø 28,8
 0004606005, 4606005, 4606305, 0004606305



DB-ES-5209

Length: 1670 Ø: 50
 Cone Ø: d1 Ø 30 / d2 Ø 27
 6203300503, 6203300603



DB-RK-5282

Ø: 59
 01303800A, 6553200111



DB-RK-5283

Ø: 70
 01319900A, 6203200628



DB-RK-5284

Ø: 65
 01303900A, 6523200511



DB-RK-5303

Ø: 37
 01304400A, 6253200611



DB-RK-8564

Ø: 90
 01302200A, 0003500105, 3500105, 0003500405,
 3500405, 0005861833, 5861833, 81432706047



DB-RK-12372

Ø: 85
 Hole Distance: 152
 Thick/Height: 24
 003501805, A003501805



DB-SB-5258

Ø: 70
 Thick/Height: 62
 01311400A, 3873230285



DB-SB-10407

Ø: 61 Thick/Height: 46
 0003235985, 0003262481, 0003262981



DF-RK-8671



DF-RK-9336

Ø: 108
 0003501705, 3501705



MN-RK-9387

Ø: 90
 0003500105, 81432706047



SC-RK-8688

Length: 95
 Ø: 95
 0003501905, 3501905





MK ...

1722,1722 L, 1722 LL	12/87→09/96	Centre Rod	DB-DL-5207		Push Rod	
	12/87→09/96	Centre Rod	DB-DL-8672		Push Rod* 1 5 593345 *→	
	12/87→09/96	Stabiliser Mounting		DB-SB-10407		
	12/87→09/96	Suspension Arm Repair Kit		CV-RK-8118	for Drag Link	
	12/87→09/96	Suspension Arm Repair Kit	DB-RK-5283			
	12/87→09/96	Suspension Arm Repair Kit	DB-RK-5303			
	12/87→09/96	Suspension Strut Repair Kit		DF-RK-8671		
1726 AK	06/89→08/94	Centre Rod	DB-DL-5412		Push Rod	
	06/89→08/94	Stabiliser Mounting		DB-SB-10407		
	06/89→08/94	Tie Rod	DB-DL-8632			
	06/89→08/94	Tie Rod End	CV-ES-12461		for Steering Rod	
	06/89→08/94	Tie Rod End	CV-ES-12462		for Steering Rod	
	06/89→08/94	Tie Rod End	CV-ES-14163		for Steering Rod	
1726 K	12/88→08/94	Centre Rod	DB-DL-5412		Push Rod	
	12/88→08/94	Centre Rod	DB-DL-8672		Push Rod	
	12/88→08/94	Stabiliser Mounting		DB-SB-10407		
	12/88→08/94	Stabiliser Mounting	DB-SB-5258	DB-SB-5258		
	12/88→08/94	Suspension Arm Repair Kit	DB-RK-5283			
	12/88→08/94	Suspension Arm Repair Kit	DB-RK-5303			
	12/88→08/94	Tie Rod End	CV-ES-12461		for Steering Rod	
	12/88→08/94	Tie Rod End	CV-ES-12462		for Steering Rod	
	12/88→08/94	Tie Rod End	CV-ES-14163		for Steering Rod	
	1726 L, 1726 LL	12/88→08/94	Centre Rod	DB-DL-5412		Push Rod
12/88→08/94		Centre Rod	DB-DL-7831		Push Rod	
12/88→08/94		Centre Rod	DB-DL-8138		Push Rod	
12/88→08/94		Centre Rod	DB-DL-8618		Push Rod	
12/88→08/94		Centre Rod	DB-DL-8672		Push Rod	
12/88→08/94		Centre Rod	DB-DL-8735		Push Rod	
12/88→08/94		Centre Rod	DB-DL-12309		Coupling Rod	
12/88→08/94		Stabiliser Mounting		DB-SB-10407		
12/88→08/94		Stabiliser Mounting	DB-SB-5258		1st FA	
12/88→08/94		Stabiliser Mounting	DB-SB-5258	DB-SB-5258	→* 5 903 513 *	
12/88→08/94		Suspension Arm Repair Kit		CV-RK-8118	for Drag Link	
12/88→08/94		Suspension Arm Repair Kit		DB-RK-5284		
12/88→08/94		Suspension Arm Repair Kit		DB-RK-5284	1st RA	
12/88→08/94		Suspension Arm Repair Kit		DB-RK-8564	Wishbone (CV)	
12/88→08/94		Suspension Arm Repair Kit		DB-RK-12372	for Wishbone (CV)K063070→	
12/88→08/94		Suspension Arm Repair Kit		DF-RK-9336		
12/88→08/94		Suspension Arm Repair Kit		DF-RK-9336	* K 063 070 *→	
12/88→08/94		Suspension Arm Repair Kit		MN-RK-9387		
12/88→08/94		Suspension Arm Repair Kit		MN-RK-9387	→* 5 926 392 *	
12/88→08/94		Suspension Arm Repair Kit		SC-RK-8688	for Drag Link	
12/88→08/94		Suspension Arm Repair Kit	DB-RK-5282			
12/88→08/94		Suspension Arm Repair Kit	DB-RK-5283			
12/88→08/94		Suspension Arm Repair Kit	DB-RK-5303			
12/88→08/94		Suspension Strut Repair Kit		DF-RK-8671		
12/88→08/94		Tie Rod	DB-DL-8640		Guide Rod	
12/88→08/94		Tie Rod	DB-ES-5209			
12/88→08/94		Tie Rod End	CV-ES-12461		for Steering Rod	
12/88→08/94		Tie Rod End	CV-ES-12462		for Steering Rod	
12/88→08/94		Tie Rod End	CV-ES-14163		for Steering Rod	
12/88→08/94		Track Control Arm		DB-DL-5220	Trailing Arm	
1726 LL		12/87→09/96	Centre Rod	DB-DL-5412		Push Rod
		12/87→09/96	Centre Rod	DB-DL-7831		Push Rod
		12/87→09/96	Centre Rod	DB-DL-8138		Push Rod
	12/87→09/96	Centre Rod	DB-DL-8618		Push Rod	
	12/87→09/96	Centre Rod	DB-DL-12309		Coupling Rod	
	12/87→09/96	Stabiliser Mounting	DB-SB-5258		1st FA	
	12/87→09/96	Stabiliser Mounting	DB-SB-5258	DB-SB-5258	→* 5 903 513 *	
	12/87→09/96	Suspension Arm Repair Kit		DB-RK-5284		
	12/87→09/96	Suspension Arm Repair Kit		DB-RK-5284	1st RA	
	12/87→09/96	Suspension Arm Repair Kit		DB-RK-8564	Wishbone (CV)	
	12/87→09/96	Suspension Arm Repair Kit		DB-RK-12372	for Wishbone (CV)K063070→	

CV-ES-12461

Length: 120
 Cone Ø: d1 Ø 26 / d2 Ø 23,5
 Thread: M30 x 1,5 LHT
 0003300035, 3300148, 0003406213, 0013306635,
 0013308835, 0014604048, 0014604348,
 14606448, 0024600248, 3023300035,
 3023300135, 3023300235, 3023300335,
 3453307235, 3453307435, 3503307135,
 A0003300148, A0013306635, A0013308835,
 A0014604048, A0014604348, A0014606448,
 A0024600248, A3023300035, A3023300135,
 A3023300235, A3023300335, A3503307135



CV-ES-12462

Length: 120
 Cone Ø: d1 Ø 26 / d2 Ø 23,5
 Thread: M30 x 1,5 RHT
 0003300135, 0003300248, 0003303235,
 0003305835, 0003307335, 0003383410,
 004608348, 0004608348, 0004632229,
 0004633129, 0004633429, 0004633529,
 0013300135, 0013300235, 0013306735,
 0014603448, 0014604148, 0014604448,
 0014606348, 0014608348, 0014608448,
 0014609748, 0023301535, 3453307135,
 3503307035, 3503307335, 3643307135,
 5001832582, A0003300248, A0003303235,
 A0003307335, A0003383410, A0004608348,
 A0004632229, A0004633429, A0013300135,
 A0013300235, A0013306735, A0014603448,
 A0014604148, A0014604448, A0014606348,
 A0014608348, A0014608448, A0014609748,
 A0023301535



CV-ES-14163

Length: 125
 Cone Ø: d1 Ø 30 / d2 Ø 27
 Thread: M30 x 1,5 RHT
 0003305248, 0003387310, 0004600348,
 0004600948, 0004602848, 0004602948,
 0004608948, 0014600248, 0014600848,
 0014601248, 0014602248, 0014607748,
 0024600148, A0003387310, A0004600348,
 A0004602848, A0004602948, A0014600848,
 A0014601248, A0014602248, A0014607748



CV-RK-8118

Ø: 85
 Hole Distance: 130
 Thick/Height: 30
 0003500506, 35005506



DB-DL-5207

Length: 875 Ø: 42
 Cone Ø: d1 Ø 30 / d2 Ø 27
 01215100A, 6174603505, 6174603605



DB-DL-5220

Length: 522
 Ø: 52
 Hole Distance: 151
 01335200A, 3813500606, 6523500306,
 6533500106



DB-DL-5412

Length: 840
 Ø: 48
 Cone Ø: d1 Ø 32 / d2 Ø 30
 01214400A, 0014600305, 14600305, 0014600405,
 14600405



DB-DL-7831

Length: 870
 Ø: 42
 Cone Ø: d1 Ø 30 / d2 Ø 27
 01215200A, 6254602505



DB-DL-8138

Length: 1130
 Ø: 40
 Cone Ø: d1 Ø 32 / d2 Ø 28,8
 4606605, 0004606605



DB-DL-8618

Length: 680
 Ø: 42
 Cone Ø: d1 Ø 32 / d2 Ø 28,8
 4604305, 0004604305, 6254604805



DB-DL-8632

Length: 1635
 Ø: 60
 Cone Ø: d1 Ø 30 / d2 Ø 27
 3853301303, 3853302103, 3853302203



DB-DL-8640

Length: 1615 Ø: 50
 Cone Ø: d1 Ø 32 / d2 Ø 29
 6253301503, 6253301603, 6253302403,
 6253302503, 9423300803, 9423302103,
 9493300203, 9493300303, 9493300903



DB-DL-8672

Length: 860
 Ø: 48
 Cone Ø: d1 Ø 30 / d2 Ø 27
 0014609705, 14609705



DB-DL-8735

Length: 825
 Ø: 42
 Cone Ø: d1 Ø 30 / d2 Ø 27
 Thread: M24 x 1,5
 0004601005, 4601005, 0004601105, 4601105



DB-DL-12309

Length: 685 Ø: 40
 Cone Ø: d1 Ø 32 / d2 Ø 28,8
 0004606005, 0004606305



DB-ES-5209

Length: 1670 Ø: 50
 Cone Ø: d1 Ø 30 / d2 Ø 27
 6203300503, 6203300603



DB-RK-5282

Ø: 59
 01303800A, 6553200111



DB-RK-5283

Ø: 70
 01319900A, 6203200628



DB-RK-5284

Ø: 65
 01303900A, 6523200511



DB-RK-5303

Ø: 37
 01304400A, 6253200611



DB-RK-8564

Ø: 90
 01302200A, 0003500105, 3500105, 0003500405,
 3500405, 0005861833, 5861833, 81432706047



DB-RK-12372

Ø: 85
 Hole Distance: 152
 Thick/Height: 24
 003501805, A003501805



DB-SB-5258

Ø: 70
 Thick/Height: 62
 01311400A, 3873230285



DB-SB-10407

Ø: 61 Thick/Height: 46
 0003235985, 0003262481, 0003262981



DF-RK-8671



DF-RK-9336

Ø: 108
 0003501705, 3501705



MN-RK-9387

Ø: 90
 0003500105, 81432706047



SC-RK-8688

Length: 95
 Ø: 95
 0003501905, 3501905





MK ...

1726 LL ...	12/87→09/96	Suspension Arm Repair Kit		DF-RK-9336		
	12/87→09/96	Suspension Arm Repair Kit		DF-RK-9336	* K 063 070 *→	
	12/87→09/96	Suspension Arm Repair Kit		MN-RK-9387		
	12/87→09/96	Suspension Arm Repair Kit		MN-RK-9387	→* 5 926 392 *	
	12/87→09/96	Suspension Arm Repair Kit		SC-RK-8688	for Drag Link	
	12/87→09/96	Suspension Arm Repair Kit	DB-RK-5282			
	12/87→09/96	Tie Rod	DB-DL-8640		Guide Rod	
	12/87→09/96	Tie Rod	DB-ES-5209			
	12/87→09/96	Tie Rod End	CV-ES-12461		for Steering Rod	
	12/87→09/96	Tie Rod End	CV-ES-12462		for Steering Rod	
	12/87→09/96	Track Control Arm		DB-DL-5220	Trailing Arm	
	1726 S,1726 LS	12/87→09/96	Centre Rod	DB-DL-5412		Push Rod
		12/87→09/96	Centre Rod	DB-DL-8672		Push Rod
		12/87→09/96	Stabiliser Mounting		DB-SB-10407	
		12/87→09/96	Stabiliser Mounting	DB-SB-5258		1st FA
12/87→09/96		Stabiliser Mounting	DB-SB-5258	DB-SB-5258	→* 5 903 513 *	
12/87→09/96		Suspension Arm Repair Kit		DB-RK-5284		
12/87→09/96		Suspension Arm Repair Kit		DB-RK-5284	1st RA	
12/87→09/96		Suspension Arm Repair Kit		DB-RK-8564	Wishbone (CV)	
12/87→09/96		Suspension Arm Repair Kit		DB-RK-12372	for Wishbone (CV)K063070→	
12/87→09/96		Suspension Arm Repair Kit		DF-RK-9336		
12/87→09/96		Suspension Arm Repair Kit		DF-RK-9336	* K 063 070 *→	
12/87→09/96		Suspension Arm Repair Kit		MN-RK-9387		
12/87→09/96		Suspension Arm Repair Kit		MN-RK-9387	→* 5 926 392 *	
12/87→09/96		Suspension Arm Repair Kit		SC-RK-8688	for Drag Link	
1726,1726 L, 1726 LL		12/87→09/96	Suspension Arm Repair Kit	DB-RK-5303		
	12/87→09/96	Tie Rod End	CV-ES-12461		for Steering Rod	
	12/87→09/96	Tie Rod End	CV-ES-12462		for Steering Rod	
	12/87→09/96	Tie Rod End	CV-ES-14163		for Steering Rod	
	12/87→09/96	Track Control Arm		DB-DL-5220	Trailing Arm	
	12/87→09/96	Centre Rod	DB-DL-5412		Push Rod	
	12/87→09/96	Centre Rod	DB-DL-7831		Push Rod	
	12/87→09/96	Centre Rod	DB-DL-8138		Push Rod	
	12/87→09/96	Centre Rod	DB-DL-8618		Push Rod	
	12/87→09/96	Centre Rod	DB-DL-8672		Push Rod	
	12/87→09/96	Centre Rod	DB-DL-8735		Push Rod	
	12/87→09/96	Centre Rod	DB-DL-12309		Coupling Rod	
	12/87→09/96	Stabiliser Mounting		DB-SB-10407		
	12/87→09/96	Stabiliser Mounting	DB-SB-5258		1st FA	
	12/87→09/96	Stabiliser Mounting	DB-SB-5258	DB-SB-5258	→* 5 903 513 *	
12/87→09/96	Suspension Arm Repair Kit		CV-RK-8118	for Drag Link		
12/87→09/96	Suspension Arm Repair Kit		DB-RK-5284			
12/87→09/96	Suspension Arm Repair Kit		DB-RK-5284	1st RA		
12/87→09/96	Suspension Arm Repair Kit		DB-RK-8564	Wishbone (CV)		
12/87→09/96	Suspension Arm Repair Kit		DB-RK-12372	for Wishbone (CV)K063070→		
12/87→09/96	Suspension Arm Repair Kit		DF-RK-9336			
12/87→09/96	Suspension Arm Repair Kit		DF-RK-9336	* K 063 070 *→		
12/87→09/96	Suspension Arm Repair Kit		MN-RK-9387			
12/87→09/96	Suspension Arm Repair Kit		MN-RK-9387	→* 5 926 392 *		
12/87→09/96	Suspension Arm Repair Kit		SC-RK-8688	for Drag Link		
12/87→09/96	Suspension Arm Repair Kit	DB-RK-5282				
12/87→09/96	Suspension Arm Repair Kit	DB-RK-5283				
12/87→09/96	Suspension Arm Repair Kit	DB-RK-5303				
12/87→09/96	Suspension Strut Repair Kit		DF-RK-8671			
12/87→09/96	Tie Rod	DB-DL-8640		Guide Rod		
12/87→09/96	Tie Rod	DB-ES-5209				
12/87→09/96	Tie Rod End	CV-ES-12461		for Steering Rod		
12/87→09/96	Tie Rod End	CV-ES-12462		for Steering Rod		
12/87→09/96	Tie Rod End	CV-ES-14163		for Steering Rod		
12/87→09/96	Track Control Arm		DB-DL-5220	Trailing Arm		

CV-ES-12461

Length: 120
Cone Ø: d1 Ø 26 / d2 Ø 23,5
Thread: M30 x 1,5 LHT
0003300035, 3300148, 0003406213, 0013306635,
0013308835, 0014604048, 0014604348,
14606448, 0024600248, 3023300035,
3023300135, 3023300235, 3023300335,
3453307235, 3453307435, 3503307135,
A0003300148, A0013306635, A0013308835,
A0014604048, A0014604348, A0014606448,
A0024600248, A3023300035, A3023300135,
A3023300235, A3023300335, A3503307135



CV-ES-12462

Length: 120
Cone Ø: d1 Ø 26 / d2 Ø 23,5
Thread: M30 x 1,5 RHT
0003300135, 0003300248, 0003303235,
0003305835, 0003307335, 0003383410,
0004608348, 004608348, 0004632229,
0004633129, 0004633429, 0004633529,
0013300135, 0013300235, 0013306735,
0014603448, 0014604148, 0014604448,
0014606348, 0014608348, 0014608448,
0014609748, 0023301535, 3453307135,
3503307035, 3503307335, 3643307135,
5001832582, A0003300248, A0003303235,
A0003307335, A0003383410, A0004608348,
A0004632229, A0004633429, A0013300135,
A0013300235, A0013306735, A0014603448,
A0014604148, A0014604448, A0014606348,
A0014608348, A0014608448, A0014609748,
A0023301535



CV-ES-14163

Length: 125
Cone Ø: d1 Ø 30 / d2 Ø 27
Thread: M30 x 1,5 RHT
0003305248, 0003387310, 0004600348,
0004600948, 0004602848, 0004602948,
0004608948, 0014600248, 0014600848,
0014601248, 0014602248, 0014607748,
0024600148, A0003387310, A0004600348,
A0004602848, A0004602948, A0014600848,
A0014601248, A0014602248, A0014607748



CV-RK-8118

Ø: 85
Hole Distance: 130
Thick/Height: 30
0003500506, 3500506



DB-DL-5220

Length: 522
Ø: 52
Hole Distance: 151
01335200A, 3813500606, 6523500306,
6533500106



DB-DL-5412

Length: 840
Ø: 48
Cone Ø: d1 Ø 32 / d2 Ø 30
01214400A, 0014600305, 14600305, 0014600405,
14600405



DB-DL-7831

Length: 870
Ø: 42
Cone Ø: d1 Ø 30 / d2 Ø 27
01215200A, 6254602505



DB-DL-8138

Length: 1130
Ø: 40
Cone Ø: d1 Ø 32 / d2 Ø 28,8
0004606605, 4606605



DB-DL-8618

Length: 680
Ø: 42
Cone Ø: d1 Ø 32 / d2 Ø 28,8
4604305, 0004604305, 6254604805



DB-DL-8640

Length: 1615 Ø: 50
Cone Ø: d1 Ø 32 / d2 Ø 29
6253301503, 6253301603, 6253302403,
6253302503, 9423300803, 9423302103,
9493300203, 9493300303, 9493300903



DB-DL-8672

Length: 860
Ø: 48
Cone Ø: d1 Ø 30 / d2 Ø 27
14609705, 0014609705



DB-DL-8735

Length: 825
Ø: 42
Cone Ø: d1 Ø 30 / d2 Ø 27
Thread: M24 x 1,5
4601005, 0004601005, 0004601105, 4601105



DB-DL-12309

Length: 685 Ø: 40
Cone Ø: d1 Ø 32 / d2 Ø 28,8
0004606005, 0004606305



DB-ES-5209

Length: 1670 Ø: 50
Cone Ø: d1 Ø 30 / d2 Ø 27
6203300503, 6203300603



DB-RK-5282

Ø: 59
01303800A, 6553200111



DB-RK-5283

Ø: 70
01319900A, 6203200628



DB-RK-5284

Ø: 65
01303900A, 6523200511



DB-RK-5303

Ø: 37
01304400A, 6253200611



DB-RK-8564

Ø: 90
01302200A, 0003500105, 3500105, 0003500405,
3500405, 0005861833, 5861833, 81432706047



DB-RK-12372

Ø: 85
Hole Distance: 152
Thick/Height: 24
003501805, A003501805



DB-SB-5258

Ø: 70
Thick/Height: 62
01311400A, 3873230285



DB-SB-10407

Ø: 61 Thick/Height: 46
0003235985, 0003262481, 0003262981



DF-RK-8671



DF-RK-9336

Ø: 108
3501705, 0003501705



MN-RK-9387

Ø: 90
0003500105, 81432706047



SC-RK-8688

Length: 95
Ø: 95
0003501905, 3501905



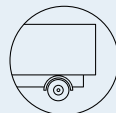

MK ...

1727 L	12/88→08/94	Centre Rod	DB-DL-5412		Push Rod	
	12/88→08/94	Centre Rod	DB-DL-7831		Push Rod	
	12/88→08/94	Centre Rod	DB-DL-8138		Push Rod	
	12/88→08/94	Centre Rod	DB-DL-8618		Push Rod	
	12/88→08/94	Centre Rod	DB-DL-8672		Push Rod	
	12/88→08/94	Centre Rod	DB-DL-12309		Coupling Rod	
	12/88→08/94	Stabiliser Mounting		DB-SB-10407		
	12/88→08/94	Stabiliser Mounting	DB-SB-5258		1st FA	
	12/88→08/94	Stabiliser Mounting	DB-SB-5258	DB-SB-5258	→* 5 903 513 *	
	12/88→08/94	Suspension Arm Repair Kit		DB-RK-5284		
	12/88→08/94	Suspension Arm Repair Kit		DB-RK-5284	1st RA	
	12/88→08/94	Suspension Arm Repair Kit		DB-RK-8564	Wishbone (CV)	
	12/88→08/94	Suspension Arm Repair Kit		DB-RK-12372	for Wishbone (CV)K063070→	
	12/88→08/94	Suspension Arm Repair Kit		DF-RK-9336		
	12/88→08/94	Suspension Arm Repair Kit		DF-RK-9336	* K 063 070 *→	
	12/88→08/94	Suspension Arm Repair Kit		MN-RK-9387		
	12/88→08/94	Suspension Arm Repair Kit		MN-RK-9387	→* 5 926 392 *	
	12/88→08/94	Suspension Arm Repair Kit		SC-RK-8688	for Drag Link	
	12/88→08/94	Suspension Arm Repair Kit	DB-RK-5282			
	12/88→08/94	Suspension Arm Repair Kit	DB-RK-5283			
	12/88→08/94	Suspension Arm Repair Kit	DB-RK-5303			
	12/88→08/94	Tie Rod	DB-DL-8640		Guide Rod	
	12/88→08/94	Tie Rod	DB-ES-5209			
	12/88→08/94	Tie Rod End	CV-ES-12461		for Steering Rod	
	12/88→08/94	Tie Rod End	CV-ES-12462		for Steering Rod	
	12/88→08/94	Tie Rod End	CV-ES-14163		for Steering Rod	
	12/88→08/94	Track Control Arm		DB-DL-5220	Trailing Arm	
	1729	12/87→09/96	Centre Rod	DB-DL-5412		Push Rod
		12/87→09/96	Centre Rod	DB-DL-7831		Push Rod
		12/87→09/96	Centre Rod	DB-DL-8138		Push Rod
12/87→09/96		Centre Rod	DB-DL-8618		Push Rod	
12/87→09/96		Centre Rod	DB-DL-8735		Push Rod	
12/87→09/96		Centre Rod	DB-DL-12309		Coupling Rod	
12/87→09/96		Tie Rod	DB-DL-8640		Guide Rod	
12/87→09/96		Tie Rod	DB-ES-5209			
12/87→09/96		Tie Rod End	CV-ES-12461		for Steering Rod	
12/87→09/96		Tie Rod End	CV-ES-12462		for Steering Rod	
12/87→09/96	Tie Rod End	CV-ES-14163		for Steering Rod		
1729 LS	12/87→09/96	Centre Rod	DB-DL-5412		Push Rod	
	12/87→09/96	Stabiliser Mounting	DB-SB-5258		1st FA	
	12/87→09/96	Stabiliser Mounting	DB-SB-5258	DB-SB-5258	→* 5 903 513 *	
	12/87→09/96	Suspension Arm Repair Kit		DB-RK-5284		
	12/87→09/96	Suspension Arm Repair Kit		DB-RK-5284	1st RA	
	12/87→09/96	Suspension Arm Repair Kit		DB-RK-8564	Wishbone (CV)	
	12/87→09/96	Suspension Arm Repair Kit		DB-RK-12372	for Wishbone (CV)K063070→	
	12/87→09/96	Suspension Arm Repair Kit		DF-RK-9336		
	12/87→09/96	Suspension Arm Repair Kit		DF-RK-9336	* K 063 070 *→	
	12/87→09/96	Suspension Arm Repair Kit		MN-RK-9387		
	12/87→09/96	Suspension Arm Repair Kit		MN-RK-9387	→* 5 926 392 *	
	12/87→09/96	Suspension Arm Repair Kit		SC-RK-8688	for Drag Link	
	12/87→09/96	Tie Rod End	CV-ES-12461		for Steering Rod	
	12/87→09/96	Tie Rod End	CV-ES-12462		for Steering Rod	
12/87→09/96	Track Control Arm		DB-DL-5220	Trailing Arm		
1733 S,1733 LS	12/87→09/96	Ball Head, gearshift linkage	DB-ES-8387			
	12/87→09/96	Ball Head, gearshift linkage	DB-ES-8492			
	12/87→09/96	Ball Head, gearshift linkage	DB-ES-8500			
	12/87→09/96	Centre Rod	DB-DL-5231		Push Rod* K 072 178 *→	
	12/87→09/96	Centre Rod	DB-DL-5412		Push Rod* K 017 164 *→	
	12/87→09/96	Centre Rod	DB-DL-5412		Push Rod* K 017 164 *→* K 072 177 *	
	12/87→09/96	Centre Rod	DB-DL-8672		Push Rod→* 1 K 017163 *	
	12/87→09/96	Stabiliser Mounting		DB-SB-10407		
	12/87→09/96	Stabiliser Mounting	DB-SB-5258		1st FA	
	12/87→09/96	Stabiliser Mounting	DB-SB-5258	DB-SB-5258	→* 5 903 513 *	

CV-ES-12461

Length: 120
Cone Ø: d1 Ø 26 / d2 Ø 23,5
Thread: M30 x 1,5 LHT
 0003300035, 3300148, 0003406213, 0013306635, 0013308835, 0014604048, 0014604348, 14606448, 0024600248, 3023300035, 3023300135, 3023300235, 3023300335, 3453307235, 3453307435, 3503307135, A0003300148, A0013306635, A0013308835, A0014604048, A0014604348, A0014606448, A0024600248, A3023300035, A3023300135, A3023300235, A3023300335, A3503307135



CV-ES-12462

Length: 120
Cone Ø: d1 Ø 26 / d2 Ø 23,5
Thread: M30 x 1,5 RHT
 0003300135, 0003300248, 0003303235, 0003305835, 0003307335, 0003383410, 0004608348, 004608348, 0004632229, 0004633129, 0004633429, 0004633529, 0013300135, 0013300235, 0013306735, 0014603448, 0014604148, 0014604448, 0014606348, 0014608348, 0014608448, 0014609748, 0023301535, 3453307135, 3503307035, 3503307335, 3643307135, 5001832582, A0003300248, A0003303235, A0003307335, A0003383410, A0004608348, A0004632229, A0004633429, A0013300135, A0013300235, A0013306735, A0014603448, A0014604148, A0014604448, A0014606348, A0014608348, A0014608448, A0014609748, A0023301535



CV-ES-14163

Length: 125
Cone Ø: d1 Ø 30 / d2 Ø 27
Thread: M30 x 1,5 RHT
 0003305248, 0003387310, 0004600348, 0004600948, 0004602848, 0004602948, 0004608948, 0014600248, 0014600848, 0014601248, 0014602248, 0014607748, 0024600148, A0003387310, A0004600348, A0004602848, A0004602948, A0014600848, A0014601248, A0014602248, A0014607748



DB-DL-5220

Length: 522
Ø: 52
Hole Distance: 151
 01335200A, 3813500606, 6523500306, 6533500106



DB-DL-5231

Length: 840
Ø: 52
Cone Ø: d1 Ø 32 / d2 Ø 29
 01208500A, 0014602905, 14602905, 0014603005, 14603005, A0014602905



DB-DL-5412

Length: 840
Ø: 48
Cone Ø: d1 Ø 32 / d2 Ø 30
 01214400A, 0014600305, 14600305, 0014600405, 14600405



DB-DL-7831

Length: 870
Ø: 42
Cone Ø: d1 Ø 30 / d2 Ø 27
 01215200A, 6254602505



DB-DL-8138

Length: 1130
Ø: 40
Cone Ø: d1 Ø 32 / d2 Ø 28,8
 0004606605, 4606605



DB-DL-8618

Length: 680
Ø: 42
Cone Ø: d1 Ø 32 / d2 Ø 28,8
 0004604305, 4604305, 6254604805



DB-DL-8640

Length: 1615 **Ø:** 50
Cone Ø: d1 Ø 32 / d2 Ø 29
 6253301503, 6253301603, 6253302403, 6253302503, 9423300803, 9423302103, 9493300203, 9493300303, 9493300903



DB-DL-8672

Length: 860
Ø: 48
Cone Ø: d1 Ø 30 / d2 Ø 27
 0014609705, 14609705



DB-DL-8735

Length: 825
Ø: 42
Cone Ø: d1 Ø 30 / d2 Ø 27
Thread: M24 x 1,5
 0004601005, 4601005, 4601105, 0004601105



DB-DL-12309

Length: 685 **Ø:** 40
Cone Ø: d1 Ø 32 / d2 Ø 28,8
 0004606005, 0004606305



DB-ES-5209

Length: 1670 **Ø:** 50
Cone Ø: d1 Ø 30 / d2 Ø 27
 6203300503, 6203300603



DB-ES-8387

Length: 55
Cone Ø: d1 Ø 10 / d2 Ø 10
Thread: M14 x 1,5 RHT
 0009966845, 0009967045



DB-ES-8492

Length: 60
Cone Ø: d1 Ø 10 / d2 Ø 10
Thread: M12 x 1,75 RHT
 0009966645, 3752680189, A3752680189



DB-ES-8500

Length: 55
Cone Ø: d1 Ø 12 / d2 Ø 10,8
Thread: M14 x 1,5 RHT
 0002685989



DB-RK-5282

Ø: 59
 01303800A, 6553200111



DB-RK-5283

Ø: 70
 01319900A, 6203200628



DB-RK-5284

Ø: 65
 01303900A, 6523200511



DB-RK-5303

Ø: 37
 01304400A, 6253200611



DB-RK-8564

Ø: 90
 01302200A, 0003500105, 3500105, 0003500405, 3500405, 5861833, 0005861833, 81432706047



DB-RK-12372

Ø: 85
Hole Distance: 152
Thick/Height: 24
 003501805, A003501805



DB-SB-5258

Ø: 70
Thick/Height: 62
 01311400A, 3873230285



DB-SB-10407

Ø: 61 **Thick/Height:** 46
 0003235985, 0003262481, 0003262981



DF-RK-9336

Ø: 108
 3501705, 0003501705



MN-RK-9387

Ø: 90
 0003500105, 81432706047



SC-RK-8688

Length: 95
Ø: 95
 0003501905, 3501905





MK ...

1733 S,1733 LS ...	12/87→09/96	Suspension Arm Repair Kit		CV-RK-8118	for Drag Link	
	12/87→09/96	Suspension Arm Repair Kit		DB-RK-5284	→* K 097 019 *	
	12/87→09/96	Suspension Arm Repair Kit		DB-RK-5284	1st RA	
	12/87→09/96	Suspension Arm Repair Kit		DB-RK-8564	Wishbone (CV)	
	12/87→09/96	Suspension Arm Repair Kit		DB-RK-10378		
	12/87→09/96	Suspension Arm Repair Kit		DB-RK-12372	for Wishbone (CV)K063070→	
	12/87→09/96	Suspension Arm Repair Kit		DF-RK-9336		
	12/87→09/96	Suspension Arm Repair Kit		DF-RK-9336	* K 063 070 *→	
	12/87→09/96	Suspension Arm Repair Kit		MN-RK-9387		
	12/87→09/96	Suspension Arm Repair Kit		MN-RK-9387	→* 5 926 392 *	
	12/87→09/96	Suspension Arm Repair Kit		SC-RK-8688	for Drag Link	
	12/87→09/96	Suspension Arm Repair Kit	DB-RK-5303			
	12/87→09/96	Suspension Strut Repair Kit		DF-RK-8671		
	12/87→09/96	Tie Rod	DB-DL-8640		Guide Rod	
	12/87→09/96	Tie Rod End	CV-ES-12461		for Steering Rod	
	12/87→09/96	Tie Rod End	CV-ES-12462		for Steering Rod	
	12/87→09/96	Tie Rod End	CV-ES-14163		for Steering Rod	
	12/87→09/96	Track Control Arm		DB-DL-5220	Trailing Arm	
	1733,1733 L, 1734 L	12/87→09/96	Ball Head, gearshift linkage	DB-ES-8387		
		12/87→09/96	Ball Head, gearshift linkage	DB-ES-8492		
		12/87→09/96	Ball Head, gearshift linkage	DB-ES-8500		
		12/87→09/96	Centre Rod	DB-DL-5231		Push Rod* K 072 178 *→
		12/87→09/96	Centre Rod	DB-DL-5412		Push Rod* K 017 164 *→
		12/87→09/96	Centre Rod	DB-DL-5412		Push Rod* K 017 164 *→* K 072 177 *
		12/87→09/96	Centre Rod	DB-DL-7831		Push Rod
12/87→09/96		Centre Rod	DB-DL-8131		Push Rod	
12/87→09/96		Centre Rod	DB-DL-8138		Push Rod	
12/87→09/96		Centre Rod	DB-DL-8618		Push Rod	
12/87→09/96		Centre Rod	DB-DL-8672		Push Rod→* 1 K 017163 *	
12/87→09/96		Centre Rod	DB-DL-8735		Push Rod	
12/87→09/96		Centre Rod	DB-DL-10216		Push Rod	
12/87→09/96		Centre Rod	DB-DL-12309		Coupling Rod	
12/87→09/96		Stabiliser Mounting		DB-SB-10407		
12/87→09/96		Stabiliser Mounting	DB-SB-5257			
12/87→09/96		Stabiliser Mounting	DB-SB-5258		1st FA	
12/87→09/96		Stabiliser Mounting	DB-SB-5258	DB-SB-5258	→* 5 903 513 *	
12/87→09/96		Suspension Arm Repair Kit		DB-RK-5284		
12/87→09/96		Suspension Arm Repair Kit		DB-RK-5284	→* K 097 019 *	
12/87→09/96		Suspension Arm Repair Kit		DB-RK-5284	1st RA	
12/87→09/96		Suspension Arm Repair Kit		DB-RK-8564	Wishbone (CV)	
12/87→09/96		Suspension Arm Repair Kit		DB-RK-12372	for Wishbone (CV)K063070→	
12/87→09/96		Suspension Arm Repair Kit		DF-RK-9336		
12/87→09/96		Suspension Arm Repair Kit		DF-RK-9336	* K 063 070 *→	
12/87→09/96		Suspension Arm Repair Kit		MN-RK-9387		
12/87→09/96		Suspension Arm Repair Kit		MN-RK-9387	→* 5 926 392 *	
12/87→09/96		Suspension Arm Repair Kit		SC-RK-8688	for Drag Link	
12/87→09/96		Suspension Arm Repair Kit	DB-RK-5282			
12/87→09/96		Suspension Arm Repair Kit	DB-RK-5303			
12/87→09/96		Tie Rod	DB-DL-8640		Guide Rod	
12/87→09/96		Tie Rod	DB-ES-5209			
12/87→09/96		Tie Rod End	CV-ES-12461		for Steering Rod	
12/87→09/96		Tie Rod End	CV-ES-12462		for Steering Rod	
12/87→09/96		Tie Rod End	CV-ES-14163		for Steering Rod	
12/87→09/96		Track Control Arm		DB-DL-5220	Trailing Arm	
1820 AK		07/93→09/96	Centre Rod	DB-DL-5239		Push Rod
		07/93→09/96	Centre Rod	DB-DL-5412		Push Rod
		07/93→09/96	Stabiliser Mounting		DB-SB-10407	
		07/93→09/96	Suspension Arm Repair Kit		DB-RK-8564	Wishbone (CV)
	07/93→09/96	Suspension Arm Repair Kit		MN-RK-9387		
	07/93→09/96	Tie Rod	DB-DL-8632			
	07/93→09/96	Tie Rod End	CV-ES-12461		for Steering Rod	
	07/93→09/96	Tie Rod End	CV-ES-12462		for Steering Rod	
07/93→09/96	Tie Rod End	CV-ES-14163		for Steering Rod		

CV-ES-12461

Length: 120
Cone Ø: d1 Ø 26 / d2 Ø 23,5
Thread: M30 x 1,5 LHT
0003300035, 3300148, 0003406213, 0013306635,
0013308835, 0014604048, 0014604348,
14606448, 0024600248, 3023300035,
3023300135, 3023300235, 3023300335,
3453307235, 3453307435, 3503307135,
A0003300148, A0013306635, A0013308835,
A0014604048, A0014604348, A0014606448,
A0024600248, A3023300035, A3023300135,
A3023300235, A3023300335, A3503307135



CV-ES-12462

Length: 120
Cone Ø: d1 Ø 26 / d2 Ø 23,5
Thread: M30 x 1,5 RHT
0003300135, 0003300248, 0003300235,
0003305835, 0003307335, 0003383410,
0004608348, 0004608348, 0004632229,
0004633129, 0004633429, 0004633529,
0013300135, 0013300235, 0013306735,
0014603448, 0014604148, 0014604448,
0014606348, 0014608348, 0014608448,
0014609748, 0023301535, 3453307135,
3503307035, 3503307335, 3643307135,
5001832582, A0003300248, A0003303235,
A0003307335, A0003383410, A0004608348,
A0004632229, A0004633429, A0013300135,
A0013300235, A0013306735, A0014603448,
A0014604148, A0014604448, A0014606348,
A0014608348, A0014608448, A0014609748,
A023301535



CV-ES-14163

Length: 125
Cone Ø: d1 Ø 30 / d2 Ø 27
Thread: M30 x 1,5 RHT
0003305248, 0003387310, 0004600348,
0004600948, 0004602848, 0004602948,
0004608948, 0014600248, 0014600848,
0014601248, 0014602248, 0014607748,
0024600148, A0003387310, A0004600348,
A0004602848, A0004602948, A0014600848,
A0014601248, A0014602248, A0014607748



CV-RK-8118

Ø: 85
Hole Distance: 130
Thick/Height: 30
0003500506, 3500506



DB-DL-5220

Length: 522
Ø: 52
Hole Distance: 151
01335200A, 3813500606, 6523500306,
6533500106



DB-DL-5231

Length: 840
Ø: 52
Cone Ø: d1 Ø 32 / d2 Ø 29
01208500A, 0014602905, 14602905, 0014603005,
14603005, A0014602905



DB-DL-5239

Length: 862
Ø: 42
Cone Ø: d1 Ø 30 / d2 Ø 27
01214500A, 6174602405, 6174603405



DB-DL-5412

Length: 840
Ø: 48
Cone Ø: d1 Ø 32 / d2 Ø 30
01214400A, 0014600305, 14600305, 0014600405,
14600405



DB-DL-7831

Length: 870
Ø: 42
Cone Ø: d1 Ø 30 / d2 Ø 27
01215200A, 6254602505



DB-DL-8131

Length: 1115 Ø: 52
Cone Ø: d1 Ø 32 / d2 Ø 28,8
0004604405, 6254605005



DB-DL-8138

Length: 1130
Ø: 40
Cone Ø: d1 Ø 32 / d2 Ø 28,8
0004606605, 4606605



DB-DL-8618

Length: 680
Ø: 42
Cone Ø: d1 Ø 32 / d2 Ø 28,8
0004604305, 4604305, 6254604805



DB-DL-8632

Length: 1635
Ø: 60
Cone Ø: d1 Ø 30 / d2 Ø 27
3853301303, 3853302103, 3853302203



DB-DL-8640

Length: 1615 Ø: 50
Cone Ø: d1 Ø 32 / d2 Ø 29
6253301503, 6253301603, 6253302403,
6253302503, 9423300803, 9423302103,
9493300203, 9493300303, 9493300903



DB-DL-8672

Length: 860
Ø: 48
Cone Ø: d1 Ø 30 / d2 Ø 27
0014609705, 14609705



DB-DL-8735

Length: 825
Ø: 42
Cone Ø: d1 Ø 30 / d2 Ø 27
Thread: M24 x 1,5
0004601005, 4601005, 0004601105, 4601105



DB-DL-10216

Length: 1190
Ø: 40
Cone Ø: d1 Ø 32 / d2 Ø 29
0004604905



DB-DL-12309

Length: 685
Ø: 40
Cone Ø: d1 Ø 32 / d2 Ø 28,8
4606005, 0004606005, 0004606305, 4606305



DB-ES-5209

Length: 1670 Ø: 50
Cone Ø: d1 Ø 30 / d2 Ø 27
6203300503, 6203300603



DB-ES-8387

Length: 55
Cone Ø: d1 Ø 10 / d2 Ø 10
Thread: M14 x 1,5 RHT
0009966845, 0009967045



DB-ES-8492

Length: 60
Cone Ø: d1 Ø 10 / d2 Ø 10
Thread: M12 x 1,75 RHT
0009966845, 3752680189, A3752680189



DB-ES-8500

Length: 55
Cone Ø: d1 Ø 12 / d2 Ø 10,8
Thread: M14 x 1,5 RHT
0002685989



DB-RK-5282

Ø: 59
01303800A, 6553200111



DB-RK-5284

Ø: 65
01303900A, 6523200511



DB-RK-5303

Ø: 37
01304400A, 6253200611



DB-RK-8564

Ø: 90
01302200A, 0003500105, 3500105, 0003500405,
3500405, 0005861833, 5861833, 81432706047



DB-RK-10378

Ø: 86
6203200028



DB-RK-12372

Ø: 85
Hole Distance: 152
Thick/Height: 24
003501805, A003501805



DB-SB-5257

Ø: 60
Thick/Height: 60,5
01304700A, 6533260381



DB-SB-5258

Ø: 70
Thick/Height: 62
01311400A, 3873230285



DB-SB-10407

Ø: 61 Thick/Height: 46
0003235985, 0003262481, 0003262981



DF-RK-8671



DF-RK-9336

Ø: 108
0003501705, 3501705



MN-RK-9387

Ø: 90
0003500105, 81432706047



SC-RK-8688

Length: 95
Ø: 95
3501905, 0003501905





MK ...

1820 K	05/92→09/96	Centre Rod	DB-DL-5231	Push Rod* K 072 178 *→	
	05/92→09/96	Centre Rod	DB-DL-5412	Push Rod* K 016 738 *→* K 072 177 *	
	05/92→09/96	Centre Rod	DB-DL-8672	Push Rod* 1 5 593345 *→	
	05/92→09/96	Stabiliser Mounting		DB-SB-10407	
	05/92→09/96	Suspension Arm Repair Kit		DB-RK-8564 Wishbone (CV)	
	05/92→09/96	Suspension Arm Repair Kit		MN-RK-9387	
	05/92→09/96	Suspension Arm Repair Kit	DB-RK-5303		
	05/92→09/96	Tie Rod End	CV-ES-12461	for Steering Rod	
	05/92→09/96	Tie Rod End	CV-ES-12462	for Steering Rod	
	05/92→09/96	Tie Rod End	CV-ES-14163	for Steering Rod	
1820,1820 L	12/87→09/96	Centre Rod	DB-DL-5231	Push Rod* K 072 178 *→	
	12/87→09/96	Centre Rod	DB-DL-5412	Push Rod* K 016 738 *→* K 072 177 *	
	12/87→09/96	Centre Rod	DB-DL-5412	Push Rod* K 017 164 *→* K 072 177 *	
	12/87→09/96	Centre Rod	DB-DL-5412	Push Rod→* K 072 177 *	
	12/87→09/96	Centre Rod	DB-DL-7831	Push Rod	
	12/87→09/96	Centre Rod	DB-DL-8138	Push Rod	
	12/87→09/96	Centre Rod	DB-DL-8618	Push Rod	
	12/87→09/96	Centre Rod	DB-DL-8672	Push Rod* 1 5 593345 *→* 1 K 016737 *	
	12/87→09/96	Centre Rod	DB-DL-10216	Push Rod	
	12/87→09/96	Centre Rod	DB-DL-12309	Coupling Rod	
	12/87→09/96	Stabiliser Mounting		DB-SB-10407	
	12/87→09/96	Suspension Arm Repair Kit		DB-RK-5284 →* K 097 019 *	
	12/87→09/96	Suspension Arm Repair Kit		DB-RK-5284 1st RA	
	12/87→09/96	Suspension Arm Repair Kit		DB-RK-8564 Wishbone (CV)	
	12/87→09/96	Suspension Arm Repair Kit		DB-RK-12372 for Wishbone (CV)K063070→	
	12/87→09/96	Suspension Arm Repair Kit		DF-RK-9336	
	12/87→09/96	Suspension Arm Repair Kit		DF-RK-9336 * K 063 070 *→	
	12/87→09/96	Suspension Arm Repair Kit		MN-RK-9387	
	12/87→09/96	Suspension Arm Repair Kit		MN-RK-9387 →* 5 926 392 *	
	12/87→09/96	Suspension Arm Repair Kit	DB-RK-5282		
	12/87→09/96	Suspension Arm Repair Kit	DB-RK-5303		
	12/87→09/96	Tie Rod	DB-DL-8640	Guide Rod	
	12/87→09/96	Tie Rod	DB-ES-5209		
	12/87→09/96	Tie Rod End	CV-ES-12461	for Steering Rod	
	12/87→09/96	Tie Rod End	CV-ES-12462	for Steering Rod	
	12/87→09/96	Tie Rod End	CV-ES-14163	for Steering Rod	
	12/87→09/96	Track Control Arm		DB-DL-5220 Trailing Arm	
	1824	12/88→09/96	Centre Rod	DB-DL-5412	Push Rod
		12/88→09/96	Tie Rod End	CV-ES-12461	for Steering Rod
		12/88→09/96	Tie Rod End	CV-ES-12462	for Steering Rod
		12/88→09/96	Tie Rod End	CV-ES-14163	for Steering Rod
		08/92→09/96	Centre Rod	DB-DL-8735	Push Rod
		08/92→09/96	Tie Rod	DB-DL-8640	Guide Rod
01/94→09/96		Ball Head, gearshift linkage	DB-ES-8387		
01/94→09/96		Ball Head, gearshift linkage	DB-ES-8492		
01/94→09/96		Ball Head, gearshift linkage	DB-ES-8500		
01/94→09/96		Centre Rod	DB-DL-5231	Push Rod* K 072 178 *→	
01/94→09/96		Centre Rod	DB-DL-5412	Push Rod* K 016 738 *→* K 072 177 *	
01/94→09/96		Centre Rod	DB-DL-8672	Push Rod→* 1 K 016737 *	
01/94→09/96		Stabiliser Mounting		DB-SB-10407	
01/94→09/96		Suspension Arm Repair Kit		DF-RK-9336	
01/94→09/96		Suspension Arm Repair Kit	DB-RK-5303		
01/94→09/96		Track Control Arm		DB-DL-5220 Trailing Arm	
1824 AK		08/92→09/96	Ball Head, gearshift linkage	DB-ES-8500	
		08/92→09/96	Centre Rod	DB-DL-5239	Push Rod
		08/92→09/96	Centre Rod	DB-DL-5412	Push Rod
		08/92→09/96	Centre Rod	DB-DL-10216	Push Rod
	08/92→09/96	Stabiliser Mounting		DB-SB-10407	
	08/92→09/96	Tie Rod	DB-DL-8632		
	08/92→09/96	Tie Rod End	CV-ES-12461	for Steering Rod	
	08/92→09/96	Tie Rod End	CV-ES-12462	for Steering Rod	
08/92→09/96	Tie Rod End	CV-ES-14163	for Steering Rod		

CV-ES-12461

Length: 120
Cone Ø: d1 Ø 26 / d2 Ø 23,5
Thread: M30 x 1,5 LHT
0003300035, 3300148, 0003406213, 0013306635, 0013308835, 0014604048, 0014604348, 14606448, 0024600248, 3023300035, 3023300135, 3023300235, 3023300335, 3453307235, 3453307435, 3503307135, A0003300148, A0013306635, A0013308835, A0014604048, A0014604348, A0014606448, A0024600248, A3023300035, A3023300135, A3023300235, A3023300335, A3503307135



CV-ES-12462

Length: 120
Cone Ø: d1 Ø 26 / d2 Ø 23,5
Thread: M30 x 1,5 RHT
0003300135, 0003300248, 0003303235, 0003305835, 0003307335, 0003383410, 0004608348, 004608348, 0004632229, 0004633129, 0004633429, 0004633529, 0013300135, 0013300235, 0013306735, 0014603448, 0014604148, 0014604448, 0014606348, 0014608348, 0014608448, 0014609748, 0023301535, 3453307135, 3503307035, 3503307335, 3643307135, 5001832582, A0003300248, A0003303235, A0003307335, A0003383410, A0004608348, A0004632229, A0004633429, A0013300135, A0013300235, A0013306735, A0014603448, A0014604148, A0014604448, A0014606348, A0014608348, A0014608448, A0014609748, A0023301535



CV-ES-14163

Length: 125
Cone Ø: d1 Ø 30 / d2 Ø 27
Thread: M30 x 1,5 RHT
0003305248, 0003387310, 0004600348, 0004600948, 0004602848, 0004602948, 0004608948, 0014600248, 0014600848, 0014601248, 0014602248, 0014607748, 0024600148, A0003387310, A0004600348, A0004602848, A0004602948, A0014600848, A0014601248, A0014602248, A0014607748



DB-DL-5220

Length: 522
Ø: 52
Hole Distance: 151
01335200A, 3813500606, 6523500306, 6533500106



DB-DL-5231

Length: 840
Ø: 52
Cone Ø: d1 Ø 32 / d2 Ø 29
01208500A, 14602905, 0014602905, 0014603005, 14603005, A0014602905



DB-DL-5239

Length: 862
Ø: 42
Cone Ø: d1 Ø 30 / d2 Ø 27
01214500A, 6174602405, 6174603405



DB-DL-5412

Length: 840
Ø: 48
Cone Ø: d1 Ø 32 / d2 Ø 30
01214400A, 14600305, 0014600305, 14600405, 0014600405



DB-DL-7831

Length: 870
Ø: 42
Cone Ø: d1 Ø 30 / d2 Ø 27
01215200A, 6254602505



DB-DL-8138

Length: 1130
Ø: 40
Cone Ø: d1 Ø 32 / d2 Ø 28,8
0004606605, 4606605



DB-DL-8618

Length: 680
Ø: 42
Cone Ø: d1 Ø 32 / d2 Ø 28,8
0004604305, 4604305, 6254604805



DB-DL-8632

Length: 1635
Ø: 60
Cone Ø: d1 Ø 30 / d2 Ø 27
3853301303, 3853302103, 3853302203



DB-DL-8640

Length: 1615 **Ø:** 50
Cone Ø: d1 Ø 32 / d2 Ø 29
6253301503, 6253301603, 6253302403, 6253302503, 9423300803, 9423302103, 9493300203, 9493300303, 9493300903



DB-DL-8672

Length: 860
Ø: 48
Cone Ø: d1 Ø 30 / d2 Ø 27
14609705, 0014609705



DB-DL-8735

Length: 825
Ø: 42
Cone Ø: d1 Ø 30 / d2 Ø 27
Thread: M24 x 1,5
4601005, 0004601005, 0004601105, 4601105



DB-DL-10216

Length: 1190
Ø: 40
Cone Ø: d1 Ø 32 / d2 Ø 29
0004604905



DB-DL-12309

Length: 685 **Ø:** 40
Cone Ø: d1 Ø 32 / d2 Ø 28,8
0004606005, 0004606305



DB-ES-5209

Length: 1670 **Ø:** 50
Cone Ø: d1 Ø 30 / d2 Ø 27
6203300503, 6203300603



DB-ES-8387

Length: 55
Cone Ø: d1 Ø 10 / d2 Ø 10
Thread: M14 x 1,5 RHT
0009966845, 0009967045



DB-ES-8492

Length: 60
Cone Ø: d1 Ø 10 / d2 Ø 10
Thread: M12 x 1,75 RHT
0009966645, 3752680189, A3752680189



DB-ES-8500

Length: 55
Cone Ø: d1 Ø 12 / d2 Ø 10,8
Thread: M14 x 1,5 RHT
0002685989



DB-RK-5282

Ø: 59
01303800A, 6553200111



DB-RK-5284

Ø: 65
01303900A, 6523200511



DB-RK-5303

Ø: 37
01304400A, 6253200611



DB-RK-8564

Ø: 90
01302200A, 0003500105, 3500105, 0003500405, 3500405, 0005861833, 5861833, 81432706047



DB-RK-12372

Ø: 85
Hole Distance: 152
Thick/Height: 24
0003501805, A003501805



DB-SB-10407

Ø: 61 **Thick/Height:** 46
0003235985, 0003262481, 0003262981



DF-RK-9336

Ø: 108
0003501705, 3501705



MN-RK-9387

Ø: 90
0003500105, 81432706047



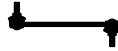

MK ...

1824 K	08/92→09/96	Ball Head, gearshift linkage	DB-ES-8387			
	08/92→09/96	Ball Head, gearshift linkage	DB-ES-8492			
	08/92→09/96	Ball Head, gearshift linkage	DB-ES-8500			
	08/92→09/96	Centre Rod	DB-DL-5231		Push Rod* K 072 178 *→	
	08/92→09/96	Centre Rod	DB-DL-5412		Push Rod* K 016 738 *→* K 072 177 *	
	08/92→09/96	Centre Rod	DB-DL-5412		Push Rod→* K 072 177 *	
	08/92→09/96	Centre Rod	DB-DL-8672		Push Rod→* 1 K 016737 *	
	08/92→09/96	Stabiliser Mounting		DB-SB-10407		
	08/92→09/96	Suspension Arm Repair Kit	DB-RK-5303			
	08/92→09/96	Tie Rod	DB-DL-8640		Guide Rod	
	08/92→09/96	Tie Rod End	CV-ES-12461		for Steering Rod	
	08/92→09/96	Tie Rod End	CV-ES-12462		for Steering Rod	
	08/92→09/96	Tie Rod End	CV-ES-14163		for Steering Rod	
	1824,1824 L	12/87→09/96	Ball Head, gearshift linkage	DB-ES-8387		
12/87→09/96		Ball Head, gearshift linkage	DB-ES-8492			
12/87→09/96		Ball Head, gearshift linkage	DB-ES-8500			
12/87→09/96		Centre Rod	DB-DL-5231		Push Rod* K 072 178 *→	
12/87→09/96		Centre Rod	DB-DL-5412		Push Rod* K 016 738 *→* K 072 177 *	
12/87→09/96		Centre Rod	DB-DL-7831		Push Rod	
12/87→09/96		Centre Rod	DB-DL-8138		Push Rod	
12/87→09/96		Centre Rod	DB-DL-8618		Push Rod	
12/87→09/96		Centre Rod	DB-DL-8672		Push Rod→* 1 K 016737 *	
12/87→09/96		Centre Rod	DB-DL-8735		Push Rod	
12/87→09/96		Centre Rod	DB-DL-12309		Coupling Rod	
12/87→09/96		Stabiliser Mounting		DB-SB-10407		
12/87→09/96		Stabiliser Mounting	DB-SB-5258		1st FA	
12/87→09/96		Stabiliser Mounting	DB-SB-5258	DB-SB-5258	→* 5 903 513 *	
12/87→09/96		Suspension Arm Repair Kit		DB-RK-5284	→* K 097 019 *	
12/87→09/96		Suspension Arm Repair Kit		DB-RK-5284	1st RA	
12/87→09/96		Suspension Arm Repair Kit		DB-RK-8564	Wishbone (CV)	
12/87→09/96		Suspension Arm Repair Kit		DB-RK-12372	for Wishbone (CV)K063070→	
12/87→09/96		Suspension Arm Repair Kit		DF-RK-9336		
12/87→09/96		Suspension Arm Repair Kit		DF-RK-9336	* K 063 070 *→	
12/87→09/96		Suspension Arm Repair Kit		MN-RK-9387		
12/87→09/96		Suspension Arm Repair Kit		MN-RK-9387	→* 5 926 392 *	
12/87→09/96		Suspension Arm Repair Kit	DB-RK-5282			
12/87→09/96		Suspension Arm Repair Kit	DB-RK-5303			
12/87→09/96		Tie Rod	DB-DL-8640		Guide Rod	
12/87→09/96		Tie Rod	DB-ES-5209			
12/87→09/96		Tie Rod End	CV-ES-12461		for Steering Rod	
12/87→09/96		Tie Rod End	CV-ES-12462		for Steering Rod	
12/87→09/96		Track Control Arm		DB-DL-5220	Trailing Arm	
1827 AK		08/92→09/96	Ball Head, gearshift linkage	DB-ES-8500		
		08/92→09/96	Centre Rod	DB-DL-5239		Push Rod
		08/92→09/96	Centre Rod	DB-DL-5412		Push Rod
		08/92→09/96	Centre Rod	DB-DL-10216		Push Rod
		08/92→09/96	Tie Rod	DB-DL-8632		
	08/92→09/96	Tie Rod End	CV-ES-12461		for Steering Rod	
	08/92→09/96	Tie Rod End	CV-ES-12462		for Steering Rod	
1827 K	01/94→09/96	Ball Head, gearshift linkage	DB-ES-8387			
	01/94→09/96	Ball Head, gearshift linkage	DB-ES-8492			
	01/94→09/96	Ball Head, gearshift linkage	DB-ES-8500			
	01/94→09/96	Centre Rod	DB-DL-5231		Push Rod* K 072 178 *→	
	01/94→09/96	Centre Rod	DB-DL-5412		Push Rod* K 016 738 *→* K 072 177 *	
	01/94→09/96	Centre Rod	DB-DL-5412		Push Rod→* K 072 177 *	
	01/94→09/96	Tie Rod	DB-DL-8640		Guide Rod	
	01/94→09/96	Tie Rod End	CV-ES-12461		for Steering Rod	
	01/94→09/96	Tie Rod End	CV-ES-12462		for Steering Rod	
01/94→09/96	Tie Rod End	CV-ES-14163		for Steering Rod		

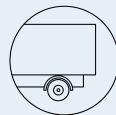

MK ...

1827 S,1827 LS	12/87→09/96	Ball Head, gearshift linkage	DB-ES-8387		
	12/87→09/96	Ball Head, gearshift linkage	DB-ES-8492		
	12/87→09/96	Ball Head, gearshift linkage	DB-ES-8500		
	12/87→09/96	Centre Rod	DB-DL-5231		Push Rod* K 072 178 *→
	12/87→09/96	Centre Rod	DB-DL-5412		Push Rod* K 017 164 *→* K 072 177 *
	12/87→09/96	Centre Rod	DB-DL-8672		Push Rod→* 1 K 016737 *
	12/87→09/96	Stabiliser Mounting		DB-SB-10407	
	12/87→09/96	Stabiliser Mounting	DB-SB-5258		1st FA
	12/87→09/96	Stabiliser Mounting	DB-SB-5258	DB-SB-5258	→* 5 903 513 *
	12/87→09/96	Suspension Arm Repair Kit		DB-RK-5284	→* K 097 019 *
	12/87→09/96	Suspension Arm Repair Kit		DB-RK-5284	1st RA
	12/87→09/96	Suspension Arm Repair Kit		DB-RK-8564	Wishbone (CV)
	12/87→09/96	Suspension Arm Repair Kit		DB-RK-12372	for Wishbone (CV)K063070→
	12/87→09/96	Suspension Arm Repair Kit		DF-RK-9336	
	12/87→09/96	Suspension Arm Repair Kit		DF-RK-9336	* K 063 070 *→
	12/87→09/96	Suspension Arm Repair Kit		MN-RK-9387	
	12/87→09/96	Suspension Arm Repair Kit		MN-RK-9387	→* 5 926 392 *
	12/87→09/96	Suspension Arm Repair Kit	DB-RK-5303		
	12/87→09/96	Tie Rod	DB-DL-8640		Guide Rod
	12/87→09/96	Tie Rod End	CV-ES-12461		for Steering Rod
	12/87→09/96	Tie Rod End	CV-ES-12462		for Steering Rod
	12/87→09/96	Tie Rod End	CV-ES-14163		for Steering Rod
	12/87→09/96	Track Control Arm		DB-DL-5220	Trailing Arm
1827,1827 L	12/87→09/96	Ball Head, gearshift linkage	DB-ES-8387		
	12/87→09/96	Ball Head, gearshift linkage	DB-ES-8492		
	12/87→09/96	Ball Head, gearshift linkage	DB-ES-8500		
	12/87→09/96	Centre Rod	DB-DL-5231		Push Rod* K 072 178 *→
	12/87→09/96	Centre Rod	DB-DL-5241		Suspension Rod
	12/87→09/96	Centre Rod	DB-DL-5412		Push Rod* K 016 738 *→
	12/87→09/96	Centre Rod	DB-DL-5412		Push Rod* K 016 738 *→* K 072 177 *
	12/87→09/96	Centre Rod	DB-DL-5412		Push Rod* K 017 164 *→* K 072 177 *
	12/87→09/96	Centre Rod	DB-DL-7270		Push Rod;Suspension Rod
	12/87→09/96	Centre Rod	DB-DL-7831		Push Rod
	12/87→09/96	Centre Rod	DB-DL-8138		Push Rod
	12/87→09/96	Centre Rod	DB-DL-8618		Push Rod
	12/87→09/96	Centre Rod	DB-DL-8672		Push Rod→* 1 K 016737 *
	12/87→09/96	Centre Rod	DB-DL-8735		Push Rod
	12/87→09/96	Centre Rod	DB-DL-12309		Coupling Rod
	12/87→09/96	Stabiliser Mounting		DB-SB-10407	
	12/87→09/96	Stabiliser Mounting	DB-SB-5258		1st FA
	12/87→09/96	Stabiliser Mounting	DB-SB-5258	DB-SB-5258	→* 5 903 513 *
	12/87→09/96	Suspension Arm Repair Kit		DB-RK-5284	→* K 097 019 *
	12/87→09/96	Suspension Arm Repair Kit		DB-RK-5284	1st RA
	12/87→09/96	Suspension Arm Repair Kit		DB-RK-8550	for Wishbone (CV)
	12/87→09/96	Suspension Arm Repair Kit		DB-RK-8564	Wishbone (CV)
	12/87→09/96	Suspension Arm Repair Kit		DB-RK-12372	for Wishbone (CV)K063070→
	12/87→09/96	Suspension Arm Repair Kit		DF-RK-9336	
	12/87→09/96	Suspension Arm Repair Kit		DF-RK-9336	* K 063 070 *→
	12/87→09/96	Suspension Arm Repair Kit		MN-RK-9387	
	12/87→09/96	Suspension Arm Repair Kit		MN-RK-9387	→* 5 926 392 *
	12/87→09/96	Suspension Arm Repair Kit	DB-RK-5282		
	12/87→09/96	Suspension Arm Repair Kit	DB-RK-5303		
	12/87→09/96	Tie Rod	DB-DL-8640		Guide Rod
	12/87→09/96	Tie Rod	DB-ES-5209		
	12/87→09/96	Tie Rod End	CV-ES-12461		for Steering Rod
	12/87→09/96	Tie Rod End	CV-ES-12462		for Steering Rod
	12/87→09/96	Tie Rod End	CV-ES-14163		for Steering Rod
	12/87→09/96	Track Control Arm		DB-DL-5220	Trailing Arm
1831 K	12/88→08/94	Centre Rod	DB-DL-5412		Push Rod
	12/88→08/94	Tie Rod End	CV-ES-12461		for Steering Rod
	12/88→08/94	Tie Rod End	CV-ES-12462		for Steering Rod
	12/88→08/94	Tie Rod End	CV-ES-14163		for Steering Rod



MK ...

1831 S,1831 LS	12/87→09/96	Ball Head, gearshift linkage	DB-ES-8387		
	12/87→09/96	Ball Head, gearshift linkage	DB-ES-8492		
	12/87→09/96	Ball Head, gearshift linkage	DB-ES-8500		
	12/87→09/96	Centre Rod	DB-DL-5231		Push Rod* K 072 178 *→
	12/87→09/96	Centre Rod	DB-DL-5412		Push Rod* K 017 164 *→* K 072 177 *
	12/87→09/96	Centre Rod	DB-DL-8672		Push Rod→* 1 K 016737 *
	12/87→09/96	Stabiliser Mounting		DB-SB-10407	
	12/87→09/96	Stabiliser Mounting	DB-SB-5258		1st FA
	12/87→09/96	Stabiliser Mounting	DB-SB-5258	DB-SB-5258	→* 5 903 513 *
	12/87→09/96	Suspension Arm Repair Kit		DB-RK-5284	→* K 097 019 *
	12/87→09/96	Suspension Arm Repair Kit		DB-RK-5284	1st RA
	12/87→09/96	Suspension Arm Repair Kit		DB-RK-8564	Wishbone (CV)
	12/87→09/96	Suspension Arm Repair Kit		DB-RK-12372	for Wishbone (CV)K063070→
	12/87→09/96	Suspension Arm Repair Kit		DF-RK-9336	
	12/87→09/96	Suspension Arm Repair Kit		DF-RK-9336	* K 063 070 *→
	12/87→09/96	Suspension Arm Repair Kit		MN-RK-9387	
	12/87→09/96	Suspension Arm Repair Kit		MN-RK-9387	→* 5 926 392 *
	12/87→09/96	Suspension Arm Repair Kit	DB-RK-5303		
	12/87→09/96	Tie Rod	DB-DL-8640		Guide Rod
	12/87→09/96	Tie Rod End	CV-ES-12461		for Steering Rod
	12/87→09/96	Tie Rod End	CV-ES-12462		for Steering Rod
	12/87→09/96	Tie Rod End	CV-ES-14163		for Steering Rod
	12/87→09/96	Track Control Arm		DB-DL-5220	Trailing Arm
	1831,1831 L	12/87→09/96	Ball Head, gearshift linkage	DB-ES-8387	
12/87→09/96		Ball Head, gearshift linkage	DB-ES-8492		
12/87→09/96		Ball Head, gearshift linkage	DB-ES-8500		
12/87→09/96		Centre Rod	DB-DL-5217		Push Rod
12/87→09/96		Centre Rod	DB-DL-5231		Push Rod* K 072 178 *→
12/87→09/96		Centre Rod	DB-DL-5412		Push Rod* K 017 164 *→* K 072 177 *
12/87→09/96		Centre Rod	DB-DL-7831		Push Rod
12/87→09/96		Centre Rod	DB-DL-8138		Push Rod
12/87→09/96		Centre Rod	DB-DL-8618		Push Rod
12/87→09/96		Centre Rod	DB-DL-8672		Push Rod→* 1 K 016737 *
12/87→09/96		Centre Rod	DB-DL-8735		Push Rod
12/87→09/96		Centre Rod	DB-DL-10216		Push Rod
12/87→09/96		Centre Rod	DB-DL-12309		Coupling Rod
12/87→09/96		Stabiliser Mounting		DB-SB-10407	
12/87→09/96		Stabiliser Mounting	DB-SB-5258		1st FA
12/87→09/96		Stabiliser Mounting	DB-SB-5258	DB-SB-5258	→* 5 903 513 *
12/87→09/96		Suspension Arm Repair Kit		DB-RK-5284	→* K 097 019 *
12/87→09/96		Suspension Arm Repair Kit		DB-RK-5284	1st RA
12/87→09/96		Suspension Arm Repair Kit		DB-RK-8564	Wishbone (CV)
12/87→09/96		Suspension Arm Repair Kit		DB-RK-12372	for Wishbone (CV)K063070→
12/87→09/96		Suspension Arm Repair Kit		DF-RK-9336	
12/87→09/96		Suspension Arm Repair Kit		DF-RK-9336	* K 063 070 *→
12/87→09/96		Suspension Arm Repair Kit		MN-RK-9387	
12/87→09/96		Suspension Arm Repair Kit		MN-RK-9387	→* 5 926 392 *
12/87→09/96		Suspension Arm Repair Kit	DB-RK-5282		
12/87→09/96		Suspension Arm Repair Kit	DB-RK-5303		
12/87→09/96		Tie Rod	DB-DL-8640		Guide Rod
12/87→09/96		Tie Rod	DB-ES-5209		
12/87→09/96		Tie Rod End	CV-ES-12461		for Steering Rod
12/87→09/96		Tie Rod End	CV-ES-12462		for Steering Rod
12/87→09/96		Tie Rod End	CV-ES-14163		for Steering Rod
12/87→09/96		Track Control Arm		DB-DL-5220	Trailing Arm
1834 S,1834 LS	12/87→09/96	Ball Head, gearshift linkage	DB-ES-8387		
	12/87→09/96	Ball Head, gearshift linkage	DB-ES-8492		
	12/87→09/96	Ball Head, gearshift linkage	DB-ES-8500		
	12/87→09/96	Centre Rod	DB-DL-5231		Push Rod* K 072 178 *→
	12/87→09/96	Centre Rod	DB-DL-5412		Push Rod* K 017 164 *→
	12/87→09/96	Centre Rod	DB-DL-5412		Push Rod* K 017 164 *→* K 072 177 *
	12/87→09/96	Centre Rod	DB-DL-8672		Push Rod→* 1 K 017163 *
12/87→09/96	Stabiliser Mounting		DB-SB-10407		

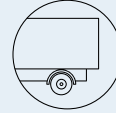

MK ...

1834 S,1834 LS ...	12/87→09/96	Stabiliser Mounting	DB-SB-5258		1st FA	
	12/87→09/96	Stabiliser Mounting	DB-SB-5258	DB-SB-5258	→* 5 903 513 *	
	12/87→09/96	Suspension Arm Repair Kit		CV-RK-8118	for Drag Link	
	12/87→09/96	Suspension Arm Repair Kit		DB-RK-5284	→* K 097 019 *	
	12/87→09/96	Suspension Arm Repair Kit		DB-RK-5284	1st RA	
	12/87→09/96	Suspension Arm Repair Kit		DB-RK-8564	Wishbone (CV)	
	12/87→09/96	Suspension Arm Repair Kit		DB-RK-12372	for Wishbone (CV)K063070→	
	12/87→09/96	Suspension Arm Repair Kit		DF-RK-9336		
	12/87→09/96	Suspension Arm Repair Kit		DF-RK-9336	* K 063 070 *→	
	12/87→09/96	Suspension Arm Repair Kit		MN-RK-9387		
	12/87→09/96	Suspension Arm Repair Kit		MN-RK-9387	→* 5 926 392 *	
	12/87→09/96	Suspension Arm Repair Kit		SC-RK-8688	for Drag Link	
	12/87→09/96	Suspension Arm Repair Kit	DB-RK-5303			
	12/87→09/96	Suspension Strut Repair Kit		DF-RK-8671		
	12/87→09/96	Tie Rod	DB-DL-8640		Guide Rod	
	12/87→09/96	Tie Rod End	CV-ES-12461		for Steering Rod	
	12/87→09/96	Tie Rod End	CV-ES-12462		for Steering Rod	
	12/87→09/96	Tie Rod End	CV-ES-14163		for Steering Rod	
	12/87→09/96	Track Control Arm		DB-DL-5220	Trailing Arm	
	1834,1834 L	12/87→09/96	Ball Head, gearshift linkage	DB-ES-8387		
		12/87→09/96	Ball Head, gearshift linkage	DB-ES-8492		
		12/87→09/96	Ball Head, gearshift linkage	DB-ES-8500		
		12/87→09/96	Centre Rod	DB-DL-5231		Push Rod* K 072 178 *→
		12/87→09/96	Centre Rod	DB-DL-5412		Push Rod* K 017 164 *→
		12/87→09/96	Centre Rod	DB-DL-5412		Push Rod* K 017 164 *→* K 072 177 *
		12/87→09/96	Centre Rod	DB-DL-7831		Push Rod
12/87→09/96		Centre Rod	DB-DL-8131		Push Rod	
12/87→09/96		Centre Rod	DB-DL-8138		Push Rod	
12/87→09/96		Centre Rod	DB-DL-8618		Push Rod	
12/87→09/96		Centre Rod	DB-DL-8672		Push Rod→* 1 K 017163 *	
12/87→09/96		Centre Rod	DB-DL-8735		Push Rod	
12/87→09/96		Centre Rod	DB-DL-10216		Push Rod	
12/87→09/96		Centre Rod	DB-DL-12309		Coupling Rod	
12/87→09/96		Stabiliser Mounting		DB-SB-10407		
12/87→09/96		Stabiliser Mounting	DB-SB-5257			
12/87→09/96		Stabiliser Mounting	DB-SB-5258		1st FA	
12/87→09/96		Stabiliser Mounting	DB-SB-5258	DB-SB-5258	→* 5 903 513 *	
12/87→09/96		Suspension Arm Repair Kit		DB-RK-5284	→* K 097 019 *	
12/87→09/96		Suspension Arm Repair Kit		DB-RK-5284	1st RA	
12/87→09/96		Suspension Arm Repair Kit		DB-RK-8564	Wishbone (CV)	
12/87→09/96		Suspension Arm Repair Kit		DB-RK-12372	for Wishbone (CV)K063070→	
12/87→09/96		Suspension Arm Repair Kit		DF-RK-9336		
12/87→09/96		Suspension Arm Repair Kit		DF-RK-9336	* K 063 070 *→	
12/87→09/96		Suspension Arm Repair Kit		MN-RK-9387		
12/87→09/96		Suspension Arm Repair Kit		MN-RK-9387	→* 5 926 392 *	
12/87→09/96		Suspension Arm Repair Kit		SC-RK-8688	for Drag Link	
12/87→09/96		Suspension Arm Repair Kit	DB-RK-5282			
12/87→09/96		Suspension Arm Repair Kit	DB-RK-5303			
12/87→09/96		Tie Rod	DB-DL-8640		Guide Rod	
12/87→09/96		Tie Rod	DB-ES-5209			
12/87→09/96		Tie Rod End	CV-ES-12461		for Steering Rod	
12/87→09/96		Tie Rod End	CV-ES-12462		for Steering Rod	
12/87→09/96		Tie Rod End	CV-ES-14163		for Steering Rod	
12/87→09/96		Track Control Arm		DB-DL-5220	Trailing Arm	
1926		12/87→09/96	Centre Rod	DB-DL-5412		Push Rod
		12/87→09/96	Centre Rod	DB-DL-8735		Push Rod
		12/87→09/96	Tie Rod	DB-DL-8640		Guide Rod
		12/87→09/96	Tie Rod End	CV-ES-12461		for Steering Rod
		12/87→09/96	Tie Rod End	CV-ES-12462		for Steering Rod
12/87→09/96		Tie Rod End	CV-ES-14163		for Steering Rod	

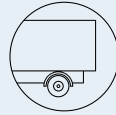

MK ...

2320 L	12/87→09/96	Centre Rod	DB-DL-5412		Push Rod	
	12/87→09/96	Suspension Arm Repair Kit		DB-RK-5284	→* K 097 019 *	
	12/87→09/96	Suspension Arm Repair Kit		DB-RK-5284	1st RA	
	12/87→09/96	Suspension Arm Repair Kit		DB-RK-8564	Wishbone (CV)	
	12/87→09/96	Suspension Arm Repair Kit		DB-RK-12372	for Wishbone (CV)K063070→	
	12/87→09/96	Suspension Arm Repair Kit		DF-RK-9336		
	12/87→09/96	Suspension Arm Repair Kit		DF-RK-9336	* K 063 070 *→	
	12/87→09/96	Suspension Arm Repair Kit		MN-RK-9387		
	12/87→09/96	Suspension Arm Repair Kit		MN-RK-9387	→* 5 926 392 *	
	12/87→09/96	Suspension Arm Repair Kit		SC-RK-8688	for Drag Link	
	12/87→09/96	Tie Rod	DB-DL-8640		Guide Rod	
	12/87→09/96	Tie Rod	DB-ES-5209			
	12/87→09/96	Tie Rod End	CV-ES-12461		for Steering Rod	
	12/87→09/96	Tie Rod End	CV-ES-12462		for Steering Rod	
	12/87→09/96	Track Control Arm		DB-DL-5220	Trailing Arm	
2327 L	12/87→09/96	Centre Rod	DB-DL-5231		Push Rod* K 072 178 *→	
	12/87→09/96	Centre Rod	DB-DL-5412		Push Rod* K 016 738 *→* K 072 177 *	
	12/87→09/96	Centre Rod	DB-DL-7831		Push Rod	
	12/87→09/96	Centre Rod	DB-DL-8138		Push Rod	
	12/87→09/96	Centre Rod	DB-DL-8618		Push Rod	
	12/87→09/96	Centre Rod	DB-DL-12309		Coupling Rod	
	12/87→09/96	Suspension Arm Repair Kit		DB-RK-5284	→* K 097 019 *	
	12/87→09/96	Suspension Arm Repair Kit		DB-RK-5284	1st RA	
	12/87→09/96	Suspension Arm Repair Kit		DB-RK-8564	Wishbone (CV)	
	12/87→09/96	Suspension Arm Repair Kit		DB-RK-12372	for Wishbone (CV)K063070→	
	12/87→09/96	Suspension Arm Repair Kit		DF-RK-9336		
	12/87→09/96	Suspension Arm Repair Kit		DF-RK-9336	* K 063 070 *→	
	12/87→09/96	Suspension Arm Repair Kit		MN-RK-9387		
	12/87→09/96	Suspension Arm Repair Kit		MN-RK-9387	→* 5 926 392 *	
	12/87→09/96	Suspension Arm Repair Kit		SC-RK-8688	for Drag Link	
	12/87→09/96	Suspension Arm Repair Kit	DB-RK-5282			
	12/87→09/96	Tie Rod	DB-DL-8640		Guide Rod	
	12/87→09/96	Tie Rod	DB-ES-5209			
	12/87→09/96	Tie Rod End	CV-ES-12461		for Steering Rod	
	12/87→09/96	Tie Rod End	CV-ES-12462		for Steering Rod	
	12/87→09/96	Track Control Arm		DB-DL-5220	Trailing Arm	
	2420,2420 L	12/87→09/96	Centre Rod	DB-DL-5412		Push Rod
		12/87→09/96	Centre Rod	DB-DL-8672		Push Rod→* 1 K 072177 *
		12/87→09/96	Centre Rod	DB-DL-8735		Push Rod
12/87→09/96		Stabiliser Mounting		DB-SB-10407		
12/87→09/96		Stabiliser Mounting	DB-SB-5258	DB-SB-5258		
12/87→09/96		Suspension Arm Repair Kit		DB-RK-5284		
12/87→09/96		Suspension Arm Repair Kit		DB-RK-5284	1st RA	
12/87→09/96		Suspension Arm Repair Kit		DB-RK-8564	Wishbone (CV)	
12/87→09/96		Suspension Arm Repair Kit		DB-RK-12372	for Wishbone (CV)K063070→	
12/87→09/96		Suspension Arm Repair Kit		DF-RK-9336		
12/87→09/96		Suspension Arm Repair Kit		DF-RK-9336	* K 063 070 *→	
12/87→09/96		Suspension Arm Repair Kit		DF-RK-9336	Lifting Axle, * K 063 070 *→	
12/87→09/96		Suspension Arm Repair Kit		MN-RK-9387		
12/87→09/96		Suspension Arm Repair Kit		MN-RK-9387	→* 5 926 392 *	
12/87→09/96		Suspension Arm Repair Kit		MN-RK-9387	Lifting Axle, →* 5 926 392 *	
12/87→09/96		Suspension Arm Repair Kit		SC-RK-8688	for Drag Link	
12/87→09/96		Suspension Arm Repair Kit	DB-RK-5282			
12/87→09/96		Suspension Arm Repair Kit	DB-RK-5303			
12/87→09/96		Tie Rod	DB-DL-8640		Guide Rod	
12/87→09/96		Tie Rod	DB-ES-5209			
12/87→09/96		Tie Rod End	CV-ES-12461		for Steering Rod	
12/87→09/96		Tie Rod End	CV-ES-14163		for Steering Rod	
12/87→09/96		Track Control Arm		DB-DL-5220	Trailing Arm	
12/87→09/96		Track Control Arm		DB-DL-9164	Trailing Arm	
12/87→09/96		Track Control Arm		DB-DL-9221	Trailing Arm	
12/87→09/96		Track Control Arm		DB-VB-10421	Wishbone (CV);Trailing Arm* 5 926 393 *→	

CV-ES-12461

Length: 120
Cone Ø: d1 Ø 26 / d2 Ø 23,5
Thread: M30 x 1,5 LHT
0003300035, 3300148, 0003406213, 0013306635, 0013308835, 0014604048, 0014604348, 14606448, 0024600248, 3023300035, 3023300135, 3023300235, 3023300335, 3453307235, 3453307435, 3503307135, A0003300148, A0013306635, A0013308835, A0014604048, A0014604348, A0014606448, A0024600248, A3023300035, A3023300135, A3023300235, A3023300335, A3503307135



CV-ES-12462

Length: 120
Cone Ø: d1 Ø 26 / d2 Ø 23,5
Thread: M30 x 1,5 RHT
0003300135, 0003300248, 0003303235, 0003305835, 0003307335, 0003383410, 0004608348, 004608348, 0004632229, 0004633129, 0004633429, 0004633529, 0013300135, 0013300235, 0013306735, 0014603448, 0014604148, 0014604448, 0014606348, 0014608348, 0014608448, 0014609748, 0023301535, 3453307135, 3503307035, 3503307335, 3643307135, 5001832582, A0003300248, A0003303235, A0003307335, A0003383410, A0004608348, A0004632229, A0004633429, A0013300135, A0013300235, A0013306735, A0014603448, A0014604148, A0014604448, A0014606348, A0014608348, A0014608448, A0014609748, A0023301535



CV-ES-14163

Length: 125
Cone Ø: d1 Ø 30 / d2 Ø 27
Thread: M30 x 1,5 RHT
0003305248, 0003387310, 0004600348, 0004600948, 0004602848, 0004602948, 0004608948, 0014600248, 0014600848, 0014601248, 0014602248, 0014607748, 0024600148, A0003387310, A0004600348, A0004602848, A0004602948, A0014600848, A0014601248, A0014602248, A0014607748



DB-DL-5220

Length: 522
Ø: 52
Hole Distance: 151
01335200A, 3813500606, 6523500306, 6533500106



DB-DL-5231

Length: 840
Ø: 52
Cone Ø: d1 Ø 32 / d2 Ø 29
01208500A, 0014602905, 14602905, 0014603005, 14603005, A0014602905



DB-DL-5412

Length: 840
Ø: 48
Cone Ø: d1 Ø 32 / d2 Ø 30
01214400A, 0014600305, 14600305, 14600405, 0014600405



DB-DL-7831

Length: 870
Ø: 42
Cone Ø: d1 Ø 30 / d2 Ø 27
01215200A, 6254602505



DB-DL-8138

Length: 1130
Ø: 40
Cone Ø: d1 Ø 32 / d2 Ø 28,8
0004606605, 4606605



DB-DL-8618

Length: 680
Ø: 42
Cone Ø: d1 Ø 32 / d2 Ø 28,8
0004604305, 4604305, 6254604805



DB-DL-8640

Length: 1615 Ø: 50
Cone Ø: d1 Ø 32 / d2 Ø 29
6253301503, 6253301603, 6253302403, 6253302503, 9423300803, 9423302103, 9493300203, 9493300303, 9493300903



DB-DL-8672

Length: 860
Ø: 48
Cone Ø: d1 Ø 30 / d2 Ø 27
0014609705, 14609705



DB-DL-8735

Length: 825
Ø: 42
Cone Ø: d1 Ø 30 / d2 Ø 27
Thread: M24 x 1,5
0004601005, 4601005, 0004601105, 4601105



DB-DL-9164

Length: 500
Ø: 50
Hole Distance: 152 / 152
3853500006, 6533500006



DB-DL-9221

Length: 652
Ø: 52
Hole Distance: 152
6543500406, 6543500506, 6543520005



DB-DL-12309

Length: 685 Ø: 40
Cone Ø: d1 Ø 32 / d2 Ø 28,8
0004606005, 0004606305



DB-ES-5209

Length: 1670 Ø: 50
Cone Ø: d1 Ø 30 / d2 Ø 27
6203300503, 6203300603



DB-RK-5282

Ø: 59
01303800A, 6553200111



DB-RK-5284

Ø: 65
01303900A, 6523200511



DB-RK-5303

Ø: 37
01304400A, 6253200611



DB-RK-8564

Ø: 90
01302200A, 0003500105, 3500105, 0003500405, 3500405, 0005861833, 5861833, 81432706047



DB-RK-12372

Ø: 85
Hole Distance: 152
Thick/Height: 24
003501805, A003501805



DB-SB-5258

Ø: 70
Thick/Height: 62
01311400A, 3873230285



DB-SB-10407

Ø: 61 Thick/Height: 46
0003235985, 0003262481, 0003262981



DB-VB-10421

Length: 623
Ø: 56
Hole Distance: 152 / 152
6533500405



DF-RK-9336

Ø: 108
0003501705, 3501705



MN-RK-9387

Ø: 90
0003500105, 81432706047



SC-RK-8688

Length: 95
Ø: 95
0003501905, 3501905





MK ...

2422	09/89→08/94	Centre Rod	DB-DL-5412		Push Rod	
	09/89→08/94	Centre Rod	DB-DL-8672		Push Rod→* 1 K 072177 *	
	09/89→08/94	Stabiliser Mounting		DB-SB-10407		
	09/89→08/94	Suspension Arm Repair Kit	DB-RK-5303			
	09/89→08/94	Tie Rod End	CV-ES-14163		for Steering Rod	
	09/89→08/94	Track Control Arm		DB-DL-7839	Trailing Arm	
2422 , 2422 L	12/87→09/96	Centre Rod	DB-DL-5412		Push Rod	
	12/87→09/96	Centre Rod	DB-DL-8735		Push Rod	
	12/87→09/96	Centre Rod	DB-DL-12309		Coupling Rod	
	12/87→09/96	Suspension Arm Repair Kit		DB-RK-5284		
	12/87→09/96	Suspension Arm Repair Kit		DB-RK-5284	1st RA	
	12/87→09/96	Suspension Arm Repair Kit		DB-RK-8564	Wishbone (CV)	
	12/87→09/96	Suspension Arm Repair Kit		DF-RK-9336		
	12/87→09/96	Suspension Arm Repair Kit		DF-RK-9336	* K 063 070 *→	
	12/87→09/96	Suspension Arm Repair Kit		MN-RK-9387		
	12/87→09/96	Suspension Arm Repair Kit		MN-RK-9387	→* 5 926 392 *	
	12/87→09/96	Suspension Arm Repair Kit		SC-RK-8688	for Drag Link	
	12/87→09/96	Suspension Arm Repair Kit	DB-RK-5282			
	12/87→09/96	Tie Rod	DB-DL-8640		Guide Rod	
	12/87→09/96	Tie Rod	DB-ES-5209			
	12/87→09/96	Tie Rod End	CV-ES-12461		for Steering Rod	
	12/87→09/96	Tie Rod End	CV-ES-12462		for Steering Rod	
	12/87→09/96	Tie Rod End	CV-ES-14163		for Steering Rod	
	12/87→09/96	Track Control Arm		DB-DL-5220	Trailing Arm	
	09/89→08/94	Centre Rod	DB-DL-7831		Push Rod	
	09/89→08/94	Centre Rod	DB-DL-8138		Push Rod	
	09/89→08/94	Centre Rod	DB-DL-8618		Push Rod	
	09/89→08/94	Stabiliser Mounting	DB-SB-5258		1st FA	
	09/89→08/94	Stabiliser Mounting	DB-SB-5258	DB-SB-5258	→* 5 903 513 *	
09/89→08/94	Suspension Arm Repair Kit		DB-RK-12372	for Wishbone (CV), Lifting Axle, K063070→		
2422 B	09/89→08/94	Centre Rod	DB-DL-5412		Push Rod	
	09/89→08/94	Centre Rod	DB-DL-8672		Push Rod	
	09/89→08/94	Centre Rod	DB-DL-8672		Push Rod→* 1 K 072177 *	
	09/89→08/94	Stabiliser Mounting		DB-SB-5258	1st RA	
	09/89→08/94	Stabiliser Mounting		DB-SB-10407		
	09/89→08/94	Stabiliser Mounting	DB-SB-5258	DB-SB-5258		
2422 K	09/89→08/94	Centre Rod	DB-DL-5412		Push Rod	
	09/89→08/94	Centre Rod	DB-DL-8672		Push Rod	
	09/89→08/94	Centre Rod	DB-DL-8672		Push Rod→* 1 K 072177 *	
	09/89→08/94	Stabiliser Mounting		DB-SB-5258	1st RA	
	09/89→08/94	Stabiliser Mounting		DB-SB-10407		
	09/89→08/94	Stabiliser Mounting	DB-SB-5258	DB-SB-5258		
2422 L	09/89→08/94	Track Control Arm		DB-DL-7839	Trailing Arm	
	12/87→09/96	Centre Rod	DB-DL-8735		Push Rod	
	12/87→09/96	Suspension Arm Repair Kit		DB-RK-5284		
	12/87→09/96	Suspension Arm Repair Kit		DB-RK-5284	1st RA	
	12/87→09/96	Suspension Arm Repair Kit		DB-RK-8564	Wishbone (CV)	
	12/87→09/96	Suspension Arm Repair Kit		DB-RK-12372	for Wishbone (CV)K063070→	
2422, 2422 L	12/87→09/96	Suspension Arm Repair Kit		DF-RK-9336		
	12/87→09/96	Suspension Arm Repair Kit		DF-RK-9336	* K 063 070 *→	
	12/87→09/96	Suspension Arm Repair Kit		MN-RK-9387		
	12/87→09/96	Suspension Arm Repair Kit		MN-RK-9387	→* 5 926 392 *	
	12/87→09/96	Suspension Arm Repair Kit	DB-RK-5282			
	12/87→09/96	Tie Rod	DB-DL-8640		Guide Rod	
	12/87→09/96	Tie Rod End	CV-ES-12461		for Steering Rod	
	12/87→09/96	Track Control Arm		DB-DL-9221	Trailing Arm	
	09/89→08/94	Suspension Arm Repair Kit		DB-RK-12372	for Wishbone (CV)K063070→	
	2422,2422 L	12/87→09/96	Centre Rod	DB-DL-8672		Push Rod
		12/87→09/96	Centre Rod	DB-DL-8672		Push Rod→* 1 K 072177 *
		12/87→09/96	Stabiliser Mounting		DB-SB-10407	
		12/87→09/96	Stabiliser Mounting	DB-SB-5258	DB-SB-5258	
12/87→09/96		Suspension Arm Repair Kit		DB-RK-12372	for Wishbone (CV)	

CV-ES-12461

Length: 120
Cone Ø: d1 Ø 26 / d2 Ø 23,5
Thread: M30 x 1,5 LHT
 0003300035, 3300148, 0003406213, 0013306635,
 0013308835, 0014604048, 0014604348,
 14606448, 0024600248, 3023300035,
 3023300135, 3023300235, 3023300335,
 3453307235, 3453307435, 3503307135,
 A0003300148, A0013306635, A0013308835,
 A0014604048, A0014604348, A0014606448,
 A0024600248, A3023300035, A3023300135,
 A3023300235, A3023300335, A3503307135

**CV-ES-12462**

Length: 120
Cone Ø: d1 Ø 26 / d2 Ø 23,5
Thread: M30 x 1,5 RHT
 0003300135, 0003300248, 0003303235,
 0003305835, 0003307335, 0003383410,
 0004608348, 004608348, 0004632229,
 0004633129, 0004633429, 0004633529,
 0013300135, 0013300235, 0013306735,
 0014603448, 0014604148, 0014604448,
 0014606348, 0014608348, 0014608448,
 0014609748, 0023301535, 3453307135,
 3503307035, 3503307335, 3643307135,
 5001832582, A0003300248, A0003303235,
 A0003307335, A0003383410, A0004608348,
 A0004632229, A0004633429, A0013300135,
 A0013300235, A0013306735, A0014603448,
 A0014604148, A0014604448, A0014606348,
 A0014608348, A0014608448, A0014609748,
 A0023301535

**CV-ES-14163**

Length: 125
Cone Ø: d1 Ø 30 / d2 Ø 27
Thread: M30 x 1,5 RHT
 0003305248, 0003387310, 0004600348,
 0004600948, 0004602848, 0004602948,
 0004608948, 0014600248, 0014600848,
 0014601248, 0014602248, 0014607748,
 0024600148, A0003387310, A0004600348,
 A0004602848, A0004602948, A0014600848,
 A0014601248, A0014602248, A0014607748

**DB-DL-5220**

Length: 522
Ø: 52
Hole Distance: 151
 01335200A, 3813500606, 6523500306,
 6533500106

**DB-DL-5412**

Length: 840
Ø: 48
Cone Ø: d1 Ø 32 / d2 Ø 30
 01214400A, 0014600305, 14600305, 0014600405,
 14600405

**DB-DL-7831**

Length: 870
Ø: 42
Cone Ø: d1 Ø 30 / d2 Ø 27
 01215200A, 6254602505

**DB-DL-7839**

Length: 585
Ø: 50
Hole Distance: 152 / 152
 3953500206, 6593500106, 6593502406

**DB-DL-8138**

Length: 1130
Ø: 40
Cone Ø: d1 Ø 32 / d2 Ø 28,8
 0004606605, 4606605

**DB-DL-8618**

Length: 680
Ø: 42
Cone Ø: d1 Ø 32 / d2 Ø 28,8
 0004604305, 4604305, 6254604805

**DB-DL-8640**

Length: 1615 **Ø:** 50
Cone Ø: d1 Ø 32 / d2 Ø 29
 6253301503, 6253301603, 6253302403,
 6253302503, 9423300803, 9423302103,
 9493300203, 9493300303, 9493300903

**DB-DL-8672**

Length: 860
Ø: 48
Cone Ø: d1 Ø 30 / d2 Ø 27
 0014609705, 14609705

**DB-DL-8735**

Length: 825
Ø: 42
Cone Ø: d1 Ø 30 / d2 Ø 27
Thread: M24 x 1,5
 0004601005, 4601005, 0004601105, 4601105

**DB-DL-9221**

Length: 652
Ø: 52
Hole Distance: 152
 6543500406, 6543500506, 6543520005

**DB-DL-12309**

Length: 685 **Ø:** 40
Cone Ø: d1 Ø 32 / d2 Ø 28,8
 0004606005, 0004606305

**DB-ES-5209**

Length: 1670 **Ø:** 50
Cone Ø: d1 Ø 30 / d2 Ø 27
 6203300503, 6203300603

**DB-RK-5282**

Ø: 59
 01303800A, 6553200111

**DB-RK-5284**

Ø: 65
 01303900A, 6523200511

**DB-RK-5303**

Ø: 37
 01304400A, 6253200611

**DB-RK-8564**

Ø: 90
 01302200A, 0003500105, 3500105, 0003500405,
 3500405, 0005861833, 5861833, 81432706047

**DB-RK-12372**

Ø: 85
Hole Distance: 152
Thick/Height: 24
 003501805, A003501805

**DB-SB-5258**

Ø: 70
Thick/Height: 62
 01311400A, 3873230285

**DB-SB-10407**

Ø: 61 **Thick/Height:** 46
 0003235985, 0003262481, 0003262981

**DF-RK-9336**

Ø: 108
 0003501705, 3501705

**MN-RK-9387**

Ø: 90
 0003500105, 81432706047

**SC-RK-8688**

Length: 95
Ø: 95
 0003501905, 3501905



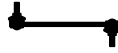

MK ...

2422,2422 L ...	12/87→09/96	Suspension Arm Repair Kit		DF-RK-9336	Lifting Axle, * K 063 070 *→	
	12/87→09/96	Suspension Arm Repair Kit		MN-RK-9387	Lifting Axle, →* 5 926 392 *	
	12/87→09/96	Suspension Arm Repair Kit	DB-RK-5303			
	12/87→09/96	Track Control Arm		DB-DL-9164	Trailing Arm	
	12/87→09/96	Track Control Arm		DB-VB-10421	Wishbone (CV);Trailing Arm* 5 926 393 *→	
2426	12/87→09/96	Centre Rod	DB-DL-5412		Push Rod	
	12/87→09/96	Centre Rod	DB-DL-7831		Push Rod	
	12/87→09/96	Centre Rod	DB-DL-8138		Push Rod	
	12/87→09/96	Centre Rod	DB-DL-8618		Push Rod	
	12/87→09/96	Centre Rod	DB-DL-8735		Push Rod	
	12/87→09/96	Centre Rod	DB-DL-12309		Coupling Rod	
	12/87→09/96	Tie Rod	DB-DL-8640		Guide Rod	
	12/87→09/96	Tie Rod	DB-ES-5209			
	12/87→09/96	Tie Rod End	CV-ES-12461		for Steering Rod	
	12/87→09/96	Tie Rod End	CV-ES-12462		for Steering Rod	
	12/87→09/96	Tie Rod End	CV-ES-14163		for Steering Rod	
	01/90→08/94	Centre Rod	DB-DL-8672		Push Rod	
	01/90→08/94	Centre Rod	DB-DL-8672		Push Rod→* 1 K972177 *	
	01/90→08/94	Stabiliser Mounting		DB-SB-10407		
	01/90→08/94	Suspension Arm Repair Kit	DB-RK-5303			
01/90→08/94	Track Control Arm		DB-DL-7839	Trailing Arm		
2426 B	02/90→08/94	Centre Rod	DB-DL-5412		Push Rod	
	02/90→08/94	Centre Rod	DB-DL-8672		Push Rod	
	02/90→08/94	Centre Rod	DB-DL-8672		Push Rod→* 1 K 072177 *	
	02/90→08/94	Stabiliser Mounting		DB-SB-5258	1st RA	
	02/90→08/94	Stabiliser Mounting		DB-SB-10407		
	02/90→08/94	Stabiliser Mounting	DB-SB-5258	DB-SB-5258		
	02/90→08/94	Suspension Arm Repair Kit	DB-RK-5303			
	02/90→08/94	Tie Rod End	CV-ES-14163		for Steering Rod	
	02/90→08/94	Track Control Arm		DB-DL-7839	Trailing Arm	
	2426 L	12/87→09/96	Centre Rod	DB-DL-5412		Push Rod
12/87→09/96		Centre Rod	DB-DL-7831		Push Rod	
12/87→09/96		Centre Rod	DB-DL-8138		Push Rod	
12/87→09/96		Centre Rod	DB-DL-8618		Push Rod	
12/87→09/96		Centre Rod	DB-DL-8735		Push Rod	
12/87→09/96		Centre Rod	DB-DL-12309		Coupling Rod	
12/87→09/96		Stabiliser Mounting	DB-SB-5258		1st FA	
12/87→09/96		Stabiliser Mounting	DB-SB-5258	DB-SB-5258	→* 5 903 513 *	
12/87→09/96		Suspension Arm Repair Kit		DB-RK-5284		
12/87→09/96		Suspension Arm Repair Kit		DB-RK-5284	1st RA	
12/87→09/96		Suspension Arm Repair Kit		DB-RK-8564	Wishbone (CV)	
12/87→09/96		Suspension Arm Repair Kit		DB-RK-12372	for Wishbone (CV)K063070→	
12/87→09/96		Suspension Arm Repair Kit		DF-RK-9336		
12/87→09/96		Suspension Arm Repair Kit		DF-RK-9336	* K 063 070 *→	
12/87→09/96		Suspension Arm Repair Kit		MN-RK-9387		
12/87→09/96		Suspension Arm Repair Kit		MN-RK-9387	→* 5 926 392 *	
12/87→09/96		Suspension Arm Repair Kit		SC-RK-8688	for Drag Link	
12/87→09/96		Suspension Arm Repair Kit	DB-RK-5282			
12/87→09/96		Tie Rod	DB-DL-8640		Guide Rod	
12/87→09/96		Tie Rod	DB-ES-5209			
12/87→09/96		Tie Rod End	CV-ES-12461		for Steering Rod	
12/87→09/96		Tie Rod End	CV-ES-12462		for Steering Rod	
12/87→09/96		Tie Rod End	CV-ES-14163		for Steering Rod	
12/87→09/96		Track Control Arm		DB-DL-5220	Trailing Arm	
02/90→08/94		Stabiliser Mounting	DB-SB-5257			
02/90→08/94		Suspension Arm Repair Kit	DB-RK-5303			
02/90→08/94		Track Control Arm		DB-DL-9221	Trailing Arm	
2426, 2426 L		02/90→08/94	Centre Rod	DB-DL-5412		Push Rod
		02/90→08/94	Centre Rod	DB-DL-7831		Push Rod
		02/90→08/94	Centre Rod	DB-DL-8138		Push Rod
	02/90→08/94	Centre Rod	DB-DL-8618		Push Rod	
	02/90→08/94	Centre Rod	DB-DL-8735		Push Rod	
02/90→08/94	Centre Rod	DB-DL-12309		Coupling Rod		

CV-ES-12461

Length: 120
Cone Ø: d1 Ø 26 / d2 Ø 23,5
Thread: M30 x 1,5 LHT
0003300035, 3300148, 0003406213, 0013306635,
0013308835, 0014604048, 0014604348,
14606448, 0024600248, 3023300035,
3023300135, 3023300235, 3023300335,
3453307235, 3453307435, 3503307135,
A0003300148, A0013306635, A0013308835,
A0014604048, A0014604348, A0014606448,
A0024600248, A3023300035, A3023300135,
A3023300235, A3023300335, A3503307135



CV-ES-12462

Length: 120
Cone Ø: d1 Ø 26 / d2 Ø 23,5
Thread: M30 x 1,5 RHT
0003300135, 0003300248, 0003303235,
0003305835, 0003307335, 0003383410,
0004608348, 004608348, 0004632229,
0004633129, 0004633429, 0004633529,
0013300135, 0013300235, 0013306735,
0014603448, 0014604148, 0014604448,
0014606348, 0014608348, 0014608448,
0014609748, 0023301535, 3453307135,
3503307035, 3503307335, 3643307135,
5001832582, A0003300248, A0003303235,
A0003307335, A0003383410, A0004608348,
A0004632229, A0004633429, A0013300135,
A0013300235, A0013306735, A0014603448,
A0014604148, A0014604448, A0014606348,
A0014608348, A0014608448, A0014609748,
A0023301535



CV-ES-14163

Length: 125
Cone Ø: d1 Ø 30 / d2 Ø 27
Thread: M30 x 1,5 RHT
0003305248, 0003387310, 0004600348,
0004600948, 0004602848, 0004602948,
0004608948, 0014600248, 0014600848,
0014601248, 0014602248, 0014607748,
0024600148, A0003387310, A0004600348,
A0004602848, A0004602948, A0014600848,
A0014601248, A0014602248, A0014607748



DB-DL-5220

Length: 522
Ø: 52
Hole Distance: 151
01335200A, 3813500606, 6523500306,
6533500106



DB-DL-5412

Length: 840
Ø: 48
Cone Ø: d1 Ø 32 / d2 Ø 30
01214400A, 14600305, 0014600305, 0014600405,
14600405



DB-DL-7831

Length: 870
Ø: 42
Cone Ø: d1 Ø 30 / d2 Ø 27
01215200A, 6254602505



DB-DL-7839

Length: 585
Ø: 50
Hole Distance: 152 / 152
3953500206, 6593500106, 6593502406



DB-DL-8138

Length: 1130
Ø: 40
Cone Ø: d1 Ø 32 / d2 Ø 28,8
4606605, 0004606605



DB-DL-8618

Length: 680
Ø: 42
Cone Ø: d1 Ø 32 / d2 Ø 28,8
0004604305, 4604305, 6254604805



DB-DL-8640

Length: 1615 Ø: 50
Cone Ø: d1 Ø 32 / d2 Ø 29
6253301503, 6253301603, 6253302403,
6253302503, 9423300803, 9423302103,
9493300203, 9493300303, 9493300903



DB-DL-8672

Length: 860
Ø: 48
Cone Ø: d1 Ø 30 / d2 Ø 27
14609705, 0014609705



DB-DL-8735

Length: 825
Ø: 42
Cone Ø: d1 Ø 30 / d2 Ø 27
Thread: M24 x 1,5
0004601005, 4601005, 0004601105, 4601105



DB-DL-9164

Length: 500
Ø: 50
Hole Distance: 152 / 152
3853500006, 6533500006



DB-DL-9221

Length: 652
Ø: 52
Hole Distance: 152
6543500406, 6543500506, 6543520005



DB-DL-12309

Length: 685 Ø: 40
Cone Ø: d1 Ø 32 / d2 Ø 28,8
0004606005, 0004606305



DB-ES-5209

Length: 1670 Ø: 50
Cone Ø: d1 Ø 30 / d2 Ø 27
6203300503, 6203300603



DB-RK-5282

Ø: 59
01303800A, 6553200111



DB-RK-5284

Ø: 65
01303900A, 6523200511



DB-RK-5303

Ø: 37
01304400A, 6253200611



DB-RK-8564

Ø: 90
01302200A, 0003500105, 3500105, 0003500405,
3500405, 0005861833, 5861833, 81432706047



DB-RK-12372

Ø: 85
Hole Distance: 152
Thick/Height: 24
003501805, A003501805



DB-SB-5257

Ø: 60
Thick/Height: 60,5
01304700A, 6533260381



DB-SB-5258

Ø: 70
Thick/Height: 62
01311400A, 3873230285



DB-SB-10407

Ø: 61 Thick/Height: 46
0003235985, 0003262481, 0003262981



DB-VB-10421

Length: 623
Ø: 56
Hole Distance: 152 / 152
6533500405



DF-RK-9336

Ø: 108
0003501705, 3501705



MN-RK-9387

Ø: 90
0003500105, 81432706047



SC-RK-8688

Length: 95
Ø: 95
0003501905, 3501905



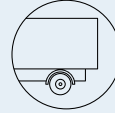

MK ...

2426, 2426 L ...	02/90→08/94	Stabiliser Mounting	DB-SB-5257			
	02/90→08/94	Stabiliser Mounting	DB-SB-5258		1st FA	
	02/90→08/94	Stabiliser Mounting	DB-SB-5258	DB-SB-5258	→* 5 903 513 *	
	02/90→08/94	Suspension Arm Repair Kit		DB-RK-5284		
	02/90→08/94	Suspension Arm Repair Kit		DB-RK-5284	1st RA	
	02/90→08/94	Suspension Arm Repair Kit		DB-RK-8564	Wishbone (CV)	
	02/90→08/94	Suspension Arm Repair Kit		DB-RK-12372	for Wishbone (CV)K063070→	
	02/90→08/94	Suspension Arm Repair Kit		DF-RK-9336		
	02/90→08/94	Suspension Arm Repair Kit		DF-RK-9336	* K 063 070 *→	
	02/90→08/94	Suspension Arm Repair Kit		MN-RK-9387		
	02/90→08/94	Suspension Arm Repair Kit		MN-RK-9387	→* 5 926 392 *	
	02/90→08/94	Suspension Arm Repair Kit		SC-RK-8688	for Drag Link	
	02/90→08/94	Suspension Arm Repair Kit	DB-RK-5282			
	02/90→08/94	Suspension Arm Repair Kit	DB-RK-5303			
	02/90→08/94	Tie Rod	DB-DL-8640		Guide Rod	
	02/90→08/94	Tie Rod	DB-ES-5209			
	02/90→08/94	Tie Rod End	CV-ES-12461		for Steering Rod	
	02/90→08/94	Tie Rod End	CV-ES-12462		for Steering Rod	
	02/90→08/94	Tie Rod End	CV-ES-14163		for Steering Rod	
	02/90→08/94	Track Control Arm		DB-DL-5220	Trailing Arm	
	02/90→08/94	Track Control Arm		DB-DL-9221	Trailing Arm	
	2427 B	02/90→08/94	Centre Rod	DB-DL-5412		Push Rod
02/90→08/94		Stabiliser Mounting		DB-SB-5258	1st RA	
02/90→08/94		Stabiliser Mounting	DB-SB-5258	DB-SB-5258		
02/90→08/94		Track Control Arm		DB-DL-7839	Trailing Arm	
2427 L	12/87→09/96	Centre Rod	DB-DL-8735		Push Rod	
	12/87→09/96	Suspension Arm Repair Kit		DB-RK-5284		
	12/87→09/96	Suspension Arm Repair Kit		DB-RK-5284	1st RA	
	12/87→09/96	Suspension Arm Repair Kit		DB-RK-8564	Wishbone (CV)	
	12/87→09/96	Suspension Arm Repair Kit		DB-RK-12372	for Wishbone (CV)K063070→	
	12/87→09/96	Suspension Arm Repair Kit		DF-RK-9336		
	12/87→09/96	Suspension Arm Repair Kit		DF-RK-9336	* K 063 070 *→	
	12/87→09/96	Suspension Arm Repair Kit		MN-RK-9387		
	12/87→09/96	Suspension Arm Repair Kit		MN-RK-9387	→* 5 926 392 *	
	12/87→09/96	Suspension Arm Repair Kit	DB-RK-5282			
12/87→09/96	Tie Rod	DB-DL-8640		Guide Rod		
12/87→09/96	Tie Rod End	CV-ES-12461		for Steering Rod		
12/87→09/96	Track Control Arm		DB-DL-9221	Trailing Arm		
2429	12/87→09/96	Centre Rod	DB-DL-5412		Push Rod	
	12/87→09/96	Centre Rod	DB-DL-7831		Push Rod	
	12/87→09/96	Centre Rod	DB-DL-8138		Push Rod	
	12/87→09/96	Centre Rod	DB-DL-8618		Push Rod	
	12/87→09/96	Centre Rod	DB-DL-8735		Push Rod	
	12/87→09/96	Centre Rod	DB-DL-12309		Coupling Rod	
	12/87→09/96	Tie Rod	DB-DL-8640		Guide Rod	
	12/87→09/96	Tie Rod	DB-ES-5209			
	12/87→09/96	Tie Rod End	CV-ES-12461		for Steering Rod	
	12/87→09/96	Tie Rod End	CV-ES-12462		for Steering Rod	
	12/87→09/96	Tie Rod End	CV-ES-14163		for Steering Rod	
	2431	12/87→09/96	Ball Head, gearshift linkage	DB-ES-8387		
		12/87→09/96	Ball Head, gearshift linkage	DB-ES-8492		
		12/87→09/96	Ball Head, gearshift linkage	DB-ES-8500		
12/87→09/96		Centre Rod	DB-DL-5231		Push Rod* K 072 178 *→	
12/87→09/96		Centre Rod	DB-DL-5412		Push Rod* K 017 164 *→* K 072 177 *	
12/87→09/96		Centre Rod	DB-DL-7831		Push Rod	
12/87→09/96		Centre Rod	DB-DL-8735		Push Rod	
12/87→09/96		Tie Rod	DB-DL-8640		Guide Rod	
12/87→09/96		Tie Rod End	CV-ES-12461		for Steering Rod	
12/87→09/96		Tie Rod End	CV-ES-12462		for Steering Rod	
12/87→09/96	Tie Rod End	CV-ES-14163		for Steering Rod		

CV-ES-12461

Length: 120
Cone Ø: d1 Ø 26 / d2 Ø 23,5
Thread: M30 x 1,5 LHT
0003300035, 3300148, 0003406213, 0013306635, 0013308835, 0014604048, 0014604348, 14606448, 0024600248, 3023300035, 3023300135, 3023300235, 3023300335, 3453307235, 3453307435, 3503307135, A0003300148, A0013306635, A0013308835, A0014604048, A0014604348, A0014606448, A0024600248, A3023300035, A3023300135, A3023300235, A3023300335, A3503307135



CV-ES-12462

Length: 120
Cone Ø: d1 Ø 26 / d2 Ø 23,5
Thread: M30 x 1,5 RHT
0003300135, 0003300248, 0003303235, 0003305835, 0003307335, 0003383410, 0004608348, 004608348, 0004632229, 0004633129, 0004633429, 0004633529, 0013300135, 0013300235, 0013306735, 0014603448, 0014604148, 0014604448, 0014606348, 0014608348, 0014608448, 0014609748, 0023301535, 3453307135, 3503307035, 3503307335, 3643307135, 5001832582, A0003300248, A0003303235, A0003307335, A0003383410, A0004608348, A0004632229, A0004633429, A0013300135, A0013300235, A0013306735, A0014603448, A0014604148, A0014604448, A0014606348, A0014608348, A0014608448, A0014609748, A0023301535



CV-ES-14163

Length: 125
Cone Ø: d1 Ø 30 / d2 Ø 27
Thread: M30 x 1,5 RHT
0003305248, 0003387310, 0004600348, 0004600948, 0004602848, 0004602948, 0004608948, 0014600248, 0014600848, 0014601248, 0014602248, 0014607748, 0024600148, A0003387310, A0004600348, A0004602848, A0004602948, A0014600848, A0014601248, A0014602248, A0014607748



DB-DL-5220

Length: 522
Ø: 52
Hole Distance: 151
01335200A, 3813500606, 6523500306, 6533500106



DB-DL-5231

Length: 840
Ø: 52
Cone Ø: d1 Ø 32 / d2 Ø 29
01208500A, 0014602905, 14602905, 0014603005, 14603005, A0014602905



DB-DL-5412

Length: 840
Ø: 48
Cone Ø: d1 Ø 32 / d2 Ø 30
01214400A, 0014600305, 14600305, 14600405, 0014600405



DB-DL-7831

Length: 870
Ø: 42
Cone Ø: d1 Ø 30 / d2 Ø 27
01215200A, 6254602505



DB-DL-7839

Length: 585
Ø: 50
Hole Distance: 152 / 152
3953500206, 6593500106, 6593502406



DB-DL-8138

Length: 1130
Ø: 40
Cone Ø: d1 Ø 32 / d2 Ø 28,8
0004606605, 4606605



DB-DL-8618

Length: 680
Ø: 42
Cone Ø: d1 Ø 32 / d2 Ø 28,8
0004604305, 4604305, 6254604805



DB-DL-8640

Length: 1615 Ø: 50
Cone Ø: d1 Ø 32 / d2 Ø 29
6253301503, 6253301603, 6253302403, 6253302503, 9423300803, 9423302103, 9493300203, 9493300303, 9493300903



DB-DL-8735

Length: 825
Ø: 42
Cone Ø: d1 Ø 30 / d2 Ø 27
Thread: M24 x 1,5
0004601005, 4601005, 4601105, 0004601105



DB-DL-9221

Length: 652
Ø: 52
Hole Distance: 152
6543500406, 6543500506, 6543520005



DB-DL-12309

Length: 685 Ø: 40
Cone Ø: d1 Ø 32 / d2 Ø 28,8
0004606005, 0004606305



DB-ES-5209

Length: 1670 Ø: 50
Cone Ø: d1 Ø 30 / d2 Ø 27
6203300503, 6203300603



DB-ES-8387

Length: 55
Cone Ø: d1 Ø 10 / d2 Ø 10
Thread: M14 x 1,5 RHT
0009966845, 0009967045



DB-ES-8492

Length: 60
Cone Ø: d1 Ø 10 / d2 Ø 10
Thread: M12 x 1,75 RHT
0009966645, 3752680189, A3752680189



DB-ES-8500

Length: 55
Cone Ø: d1 Ø 12 / d2 Ø 10,8
Thread: M14 x 1,5 RHT
0002685989



DB-RK-5282

Ø: 59
01303800A, 6553200111



DB-RK-5284

Ø: 65
01303900A, 6523200511



DB-RK-5303

Ø: 37
01304400A, 6253200611



DB-RK-8564

Ø: 90
01302200A, 0003500105, 3500105, 0003500405, 3500405, 0005861833, 5861833, 81432706047



DB-RK-12372

Ø: 85
Hole Distance: 152
Thick/Height: 24
003501805, A003501805



DB-SB-5257

Ø: 60
Thick/Height: 60,5
01304700A, 6533260381



DB-SB-5258

Ø: 70
Thick/Height: 62
01311400A, 3873230285



DF-RK-9336

Ø: 108
0003501705, 3501705



MN-RK-9387

Ø: 90
0003500105, 81432706047



SC-RK-8688

Length: 95
Ø: 95
3501905, 0003501905



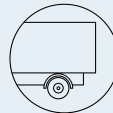

MK ...

2433 K	09/89→07/92	Ball Head, gearshift linkage	DB-ES-8387			
	09/89→07/92	Ball Head, gearshift linkage	DB-ES-8500			
	09/89→07/92	Centre Rod	DB-DL-5412		Push Rod	
	09/89→07/92	Centre Rod	DB-DL-8672		Push Rod→* 1 K 072177 *	
	09/89→07/92	Centre Rod	DB-DL-10213		Push Rod* K 072 178 *→	
	09/89→07/92	Stabiliser Mounting		DB-SB-5258	1st RA	
	09/89→07/92	Stabiliser Mounting		DB-SB-10407		
	09/89→07/92	Stabiliser Mounting	DB-SB-5258	DB-SB-5258		
	09/89→07/92	Suspension Arm Repair Kit	DB-RK-5303			
	09/89→07/92	Tie Rod End	CV-ES-14163		for Steering Rod	
	09/89→07/92	Track Control Arm		DB-DL-7839	Trailing Arm	
	2433 L	12/87→09/96	Centre Rod	DB-DL-8735		Push Rod
		12/87→09/96	Suspension Arm Repair Kit		DB-RK-5284	
12/87→09/96		Suspension Arm Repair Kit		DB-RK-5284	1st RA	
12/87→09/96		Suspension Arm Repair Kit		DB-RK-8564	Wishbone (CV)	
12/87→09/96		Suspension Arm Repair Kit		DB-RK-12372	for Wishbone (CV)K063070→	
12/87→09/96		Suspension Arm Repair Kit		DF-RK-9336		
12/87→09/96		Suspension Arm Repair Kit		DF-RK-9336	* K 063 070 *→	
12/87→09/96		Suspension Arm Repair Kit		MN-RK-9387		
12/87→09/96		Suspension Arm Repair Kit		MN-RK-9387	→* 5 926 392 *	
12/87→09/96		Suspension Arm Repair Kit	DB-RK-5282			
12/87→09/96		Tie Rod	DB-DL-8640		Guide Rod	
12/87→09/96		Tie Rod End	CV-ES-12461		for Steering Rod	
2433 S		12/87→09/96	Track Control Arm		DB-DL-9221	Trailing Arm
	12/87→09/96	Ball Head, gearshift linkage	DB-ES-8387			
	12/87→09/96	Ball Head, gearshift linkage	DB-ES-8492			
	12/87→09/96	Ball Head, gearshift linkage	DB-ES-8500			
	12/87→09/96	Centre Rod	DB-DL-5412		Push Rod* K 017 164 *→	
	12/87→09/96	Tie Rod	DB-DL-8640		Guide Rod	
	12/87→09/96	Tie Rod End	CV-ES-12461		for Steering Rod	
	12/87→09/96	Tie Rod End	CV-ES-12462		for Steering Rod	
	12/87→09/96	Tie Rod End	CV-ES-14163		for Steering Rod	
	2433 S,2433 LS	12/87→09/96	Ball Head, gearshift linkage	DB-ES-8387		
		12/87→09/96	Ball Head, gearshift linkage	DB-ES-8492		
		12/87→09/96	Ball Head, gearshift linkage	DB-ES-8500		
		12/87→09/96	Centre Rod	DB-DL-10216		Push Rod
12/87→09/96		Stabiliser Mounting	DB-SB-5257			
12/87→09/96		Suspension Arm Repair Kit		DB-RK-5284	→* K 097 019 *	
12/87→09/96		Suspension Arm Repair Kit		DB-RK-5284	1st RA	
12/87→09/96		Suspension Arm Repair Kit		DB-RK-8564	Wishbone (CV)	
12/87→09/96		Suspension Arm Repair Kit		DB-RK-12372	for Wishbone (CV)K063070→	
12/87→09/96		Suspension Arm Repair Kit		DF-RK-9336		
12/87→09/96		Suspension Arm Repair Kit		DF-RK-9336	* K 063 070 *→	
12/87→09/96		Suspension Arm Repair Kit		MN-RK-9387		
12/87→09/96		Suspension Arm Repair Kit		MN-RK-9387	→* 5 926 392 *	
12/87→09/96		Suspension Arm Repair Kit	DB-RK-5282			
12/87→09/96		Tie Rod	DB-DL-8640		Guide Rod	
12/87→09/96		Tie Rod End	CV-ES-12461		for Steering Rod	
12/87→09/96		Tie Rod End	CV-ES-14163		for Steering Rod	
2433,2433 L, 2434 L		12/87→09/96	Track Control Arm		DB-DL-9221	Trailing Arm
	12/87→09/96	Ball Head, gearshift linkage	DB-ES-8387			
	12/87→09/96	Ball Head, gearshift linkage	DB-ES-8492			
	12/87→09/96	Ball Head, gearshift linkage	DB-ES-8500			
	12/87→09/96	Centre Rod	DB-DL-5217		Push Rod	
	12/87→09/96	Centre Rod	DB-DL-5231		Push Rod* K 072 178 *→	
	12/87→09/96	Centre Rod	DB-DL-5241		Suspension Rod	
	12/87→09/96	Centre Rod	DB-DL-5412		Push Rod* K 017 164 *→	
	12/87→09/96	Centre Rod	DB-DL-5412		Push Rod* K 017 164 *→* K 072 177 *	
	12/87→09/96	Centre Rod	DB-DL-7270		Push Rod;Suspension Rod	
	12/87→09/96	Centre Rod	DB-DL-7831		Push Rod	
	12/87→09/96	Centre Rod	DB-DL-8131		Push Rod	
	12/87→09/96	Centre Rod	DB-DL-8138		Push Rod	
12/87→09/96	Centre Rod	DB-DL-8618		Push Rod		

CV-ES-12461

Length: 120
Cone Ø: d1 Ø 26 / d2 Ø 23,5
Thread: M30 x 1,5 LHT
0003300035, 3300148, 0003406213, 0013306635, 0013308835, 0014604048, 0014604348, 14606448, 0024600248, 3023300035, 3023300135, 3023300235, 3023300335, 3453307235, 3453307435, 3503307135, A0003300148, A0013306635, A0013308835, A0014604048, A0014604348, A0014606448, A0024600248, A3023300035, A3023300135, A3023300235, A3023300335, A3503307135



CV-ES-12462

Length: 120
Cone Ø: d1 Ø 26 / d2 Ø 23,5
Thread: M30 x 1,5 RHT
0003300135, 0003300248, 0003303235, 0003305835, 0003307335, 0003383410, 0004608348, 004608348, 0004632229, 0004633129, 0004633429, 0004633529, 0013300135, 0013300235, 0013306735, 0014603448, 0014604148, 0014604448, 0014606348, 0014608348, 0014608448, 0014609748, 0023301535, 3453307135, 3503307035, 3503307335, 3643307135, 5001832582, A0003300248, A0003303235, A0003307335, A0003383410, A0004608348, A0004632229, A0004633429, A0013300135, A0013300235, A0013306735, A0014603448, A0014604148, A0014604448, A0014606348, A0014608348, A0014608448, A0014609748, A0023301535



CV-ES-14163

Length: 125
Cone Ø: d1 Ø 30 / d2 Ø 27
Thread: M30 x 1,5 RHT
0003305248, 0003387310, 0004600348, 0004600948, 0004602848, 0004602948, 0004608948, 0014600248, 0014600848, 0014601248, 0014602248, 0014607748, 0024600148, A0003387310, A0004600348, A0004602848, A0004602948, A0014600848, A0014601248, A0014602248, A0014607748



DB-DL-5217

Length: 862 Ø: 40
Cone Ø: d1 Ø 30 / d2 Ø 27
01214700A, 6204600405, 6204600805, 6204602905, 6204603005



DB-DL-5231

Length: 840
Ø: 52
Cone Ø: d1 Ø 32 / d2 Ø 29
01208500A, 0014602905, 14602905, 0014603005, 14603005, A0014602905



DB-DL-5241

Length: 875 Ø: 40
Cone Ø: d1 Ø 30 / d2 Ø 27
01215300A, 0004609205, 0004609305, 0014606905



DB-DL-5412

Length: 840
Ø: 48
Cone Ø: d1 Ø 32 / d2 Ø 30
01214400A, 0014600305, 14600305, 0014600405, 14600405



DB-DL-7270

Length: 875 Ø: 40
Cone Ø: d1 Ø 28,6 / d2 Ø 23,9
01208300A, 0024604705, 0024604805, 0034604905, A0024604705



DB-DL-7831

Length: 870 Ø: 42
Cone Ø: d1 Ø 30 / d2 Ø 27
01215200A, 6254602505



DB-DL-7839

Length: 585 Ø: 50
Hole Distance: 152 / 152
3953500206, 6593500106, 6593502406



DB-DL-8131

Length: 1115 Ø: 52
Cone Ø: d1 Ø 32 / d2 Ø 28,8
0004604405, 6254605005



DB-DL-8138

Length: 1130
Ø: 40
Cone Ø: d1 Ø 32 / d2 Ø 28,8
4606605, 0004606605



DB-DL-8618

Length: 680 Ø: 42
Cone Ø: d1 Ø 32 / d2 Ø 28,8
4604305, 0004604305, 6254604805



DB-DL-8640

Length: 1615 Ø: 50
Cone Ø: d1 Ø 32 / d2 Ø 29
6253301503, 6253301603, 6253302403, 6253302503, 9423300803, 9423302103, 9493300203, 9493300303, 9493300903



DB-DL-8672

Length: 860 Ø: 48
Cone Ø: d1 Ø 30 / d2 Ø 27
14609705, 0014609705



DB-DL-8735

Length: 825 Ø: 42
Cone Ø: d1 Ø 30 / d2 Ø 27
Thread: M24 x 1,5
0004601005, 4601005, 0004601105, 4601105



DB-DL-9221

Length: 652 Ø: 52
Hole Distance: 152
6543500406, 6543500506, 6543520005



DB-DL-10213

Length: 860 Ø: 52
Cone Ø: d1 Ø 32 / d2 Ø 29
0014602505, 0014602705



DB-DL-10216

Length: 1190 Ø: 40
Cone Ø: d1 Ø 32 / d2 Ø 29
0004604905



DB-ES-8387

Length: 55
Cone Ø: d1 Ø 10 / d2 Ø 10
Thread: M14 x 1,5 RHT
0009966845, 0009967045



DB-ES-8492

Length: 60
Cone Ø: d1 Ø 10 / d2 Ø 10
Thread: M12 x 1,75 RHT
0009966645, 3752680189, A3752680189



DB-ES-8500

Length: 55
Cone Ø: d1 Ø 12 / d2 Ø 10,8
Thread: M14 x 1,5 RHT
0002685989



DB-RK-5282

Ø: 59
01303800A, 6553200111



DB-RK-5284

Ø: 65
01303900A, 6523200511



DB-RK-5303

Ø: 37
01304400A, 6253200611



DB-RK-8564

Ø: 90
01302200A, 0003500105, 3500105, 3500405, 0003500405, 5861833, 0005861833, 81432706047



DB-RK-12372

Ø: 85
Hole Distance: 152
Thick/Height: 24
003501805, A003501805



DB-SB-5257

Ø: 60
Thick/Height: 60,5
01304700A, 6533260381



DB-SB-5258

Ø: 70
Thick/Height: 62
01311400A, 3873230285



DB-SB-10407

Ø: 61 Thick/Height: 46
0003235985, 0003262481, 0003262981



DF-RK-9336

Ø: 108
0003501705, 3501705



MN-RK-9387

Ø: 90
0003500105, 81432706047





MK ...

2433,2433 L, 2434 L ...	12/87→09/96	Centre Rod	DB-DL-8735		Push Rod
	12/87→09/96	Centre Rod	DB-DL-10216		Push Rod
	12/87→09/96	Centre Rod	DB-DL-12309		Coupling Rod
	12/87→09/96	Stabiliser Mounting		DB-SB-10407	
	12/87→09/96	Stabiliser Mounting	DB-SB-5258		1st FA
	12/87→09/96	Stabiliser Mounting	DB-SB-5258	DB-SB-5258	
	12/87→09/96	Stabiliser Mounting	DB-SB-5258	DB-SB-5258	→* 5 903 513 *
	12/87→09/96	Suspension Arm Repair Kit		DB-RK-5284	→* K 097 019 *
	12/87→09/96	Suspension Arm Repair Kit		DB-RK-5284	1st RA
	12/87→09/96	Suspension Arm Repair Kit		DB-RK-8550	for Wishbone (CV)
	12/87→09/96	Suspension Arm Repair Kit		DB-RK-8564	Wishbone (CV)
	12/87→09/96	Suspension Arm Repair Kit		DB-RK-12372	for Wishbone (CV), Lifting Axle, K063070 →
	12/87→09/96	Suspension Arm Repair Kit		DF-RK-9336	
	12/87→09/96	Suspension Arm Repair Kit		DF-RK-9336	* K 063 070 * →
	12/87→09/96	Suspension Arm Repair Kit		DF-RK-9336	Lifting Axle, * K 063 070 * →
	12/87→09/96	Suspension Arm Repair Kit		MN-RK-9387	
	12/87→09/96	Suspension Arm Repair Kit		MN-RK-9387	→* 5 926 392 *
	12/87→09/96	Suspension Arm Repair Kit		MN-RK-9387	Lifting Axle, →* 5 926 392 *
	12/87→09/96	Suspension Arm Repair Kit		SC-RK-8688	for Drag Link
	12/87→09/96	Suspension Arm Repair Kit	DB-RK-5282		
	12/87→09/96	Suspension Arm Repair Kit	DB-RK-5303		
	12/87→09/96	Tie Rod	DB-DL-8640		Guide Rod
	12/87→09/96	Tie Rod	DB-ES-5209		
	12/87→09/96	Tie Rod End	CV-ES-12461		for Steering Rod
	12/87→09/96	Tie Rod End	CV-ES-12462		for Steering Rod
	12/87→09/96	Tie Rod End	CV-ES-14163		for Steering Rod
	12/87→09/96	Track Control Arm		DB-DL-5220	Trailing Arm
	12/87→09/96	Track Control Arm		DB-DL-9164	Trailing Arm
	12/87→09/96	Track Control Arm		DB-VB-10421	Wishbone (CV); Trailing Arm* 5 926 393 * →
	2522 L	12/87→09/96	Centre Rod	DB-DL-8735	
12/87→09/96		Suspension Arm Repair Kit		DB-RK-5284	
12/87→09/96		Suspension Arm Repair Kit		DB-RK-5284	1st RA
12/87→09/96		Suspension Arm Repair Kit		DB-RK-8564	Wishbone (CV)
12/87→09/96		Suspension Arm Repair Kit		DB-RK-12372	for Wishbone (CV)K063070 →
12/87→09/96		Suspension Arm Repair Kit		DF-RK-9336	
12/87→09/96		Suspension Arm Repair Kit		DF-RK-9336	* K 063 070 * →
12/87→09/96		Suspension Arm Repair Kit		MN-RK-9387	
12/87→09/96		Suspension Arm Repair Kit		MN-RK-9387	→* 5 926 392 *
12/87→09/96		Suspension Arm Repair Kit	DB-RK-5282		
12/87→09/96		Tie Rod	DB-DL-8640		Guide Rod
12/87→09/96		Tie Rod End	CV-ES-12461		for Steering Rod
12/87→09/96		Track Control Arm		DB-DL-9221	Trailing Arm
2524	06/92→09/96	Centre Rod	DB-DL-5412		Push Rod
	06/92→09/96	Centre Rod	DB-DL-8672		Push Rod →* 1 K 072177 *
	06/92→09/96	Centre Rod	DB-DL-10213		Push Rod
	06/92→09/96	Centre Rod	DB-DL-10213		Push Rod* K 072 178 * →
	06/92→09/96	Stabiliser Mounting		DB-SB-10407	
	06/92→09/96	Stabiliser Mounting	DB-SB-5258	DB-SB-5258	
	06/92→09/96	Suspension Arm Repair Kit	DB-RK-5303		
	06/92→09/96	Tie Rod End	CV-ES-14163		for Steering Rod
	06/92→09/96	Track Control Arm		DB-DL-7839	Trailing Arm
	06/92→09/96	Track Control Arm		DB-DL-7839	Trailing Arm
2524 K	06/92→09/96	Ball Head, gearshift linkage	DB-ES-8387		
	06/92→09/96	Ball Head, gearshift linkage	DB-ES-8492		
	06/92→09/96	Centre Rod	DB-DL-5412		Push Rod
	06/92→09/96	Centre Rod	DB-DL-8672		Push Rod →* 1 K 072177 *
	06/92→09/96	Centre Rod	DB-DL-10213		Push Rod* K 072 178 * →
	06/92→09/96	Stabiliser Mounting		DB-SB-5258	1st RA
	06/92→09/96	Stabiliser Mounting		DB-SB-10407	
	06/92→09/96	Stabiliser Mounting	DB-SB-5258	DB-SB-5258	
	06/92→09/96	Tie Rod End	CV-ES-14163		for Steering Rod
	06/92→09/96	Track Control Arm		DB-DL-7839	Trailing Arm
	06/92→09/96	Track Control Arm		DB-DL-7839	Trailing Arm

CV-ES-12461

Length: 120
Cone Ø: d1 Ø 26 / d2 Ø 23,5
Thread: M30 x 1,5 LHT
0003300035, 3300148, 0003406213, 0013306635,
0013308835, 0014604048, 0014604348,
14606448, 0024600248, 3023300035,
3023300135, 3023300235, 3023300335,
3453307235, 3453307435, 3503307135,
A0003300148, A0013306635, A0013308835,
A0014604048, A0014604348, A0014606448,
A0024600248, A3023300035, A3023300135,
A3023300235, A3023300335, A3503307135



CV-ES-12462

Length: 120
Cone Ø: d1 Ø 26 / d2 Ø 23,5
Thread: M30 x 1,5 RHT
0003300135, 0003300248, 0003303235,
0003305835, 0003307335, 0003383410,
0004608348, 004608348, 0004632229,
0004633129, 0004633429, 0004633529,
0013300135, 0013300235, 0013306735,
0014603448, 0014604148, 0014604448,
0014606348, 0014608348, 0014608448,
0014609748, 0023301535, 3453307135,
3503307035, 3503307335, 3643307135,
5001832582, A0003300248, A0003303235,
A0003307335, A0003383410, A0004608348,
A0004632229, A0004633429, A0013300135,
A0013300235, A0013306735, A0014603448,
A0014604148, A0014604448, A0014606348,
A0014608348, A0014608448, A0014609748,
A0023301535



CV-ES-14163

Length: 125
Cone Ø: d1 Ø 30 / d2 Ø 27
Thread: M30 x 1,5 RHT
0003305248, 0003387310, 0004600348,
0004600948, 0004602848, 0004602948,
0004608948, 0014600248, 0014600848,
0014601248, 0014602248, 0014607748,
0024600148, A0003387310, A0004600348,
A0004602848, A0004602948, A0014600848,
A0014601248, A0014602248, A0014607748



DB-DL-5220

Length: 522
Ø: 52
Hole Distance: 151
01335200A, 3813500606, 6523500306,
6533500106



DB-DL-5412

Length: 840
Ø: 48
Cone Ø: d1 Ø 32 / d2 Ø 30
01214400A, 0014600305, 14600305, 0014600405,
14600405



DB-DL-7839

Length: 585
Ø: 50
Hole Distance: 152 / 152
3953500206, 6593500106, 6593502406



DB-DL-8640

Length: 1615 Ø: 50
Cone Ø: d1 Ø 32 / d2 Ø 29
6253301503, 6253301603, 6253302403,
6253302503, 9423300803, 9423302103,
9493300203, 9493300303, 9493300903



DB-DL-8672

Length: 860
Ø: 48
Cone Ø: d1 Ø 30 / d2 Ø 27
0014609705, 14609705



DB-DL-8735

Length: 825
Ø: 42
Cone Ø: d1 Ø 30 / d2 Ø 27
Thread: M24 x 1,5
0004601005, 4601005, 0004601105, 4601105



DB-DL-9164

Length: 500
Ø: 50
Hole Distance: 152 / 152
3853500006, 6533500006



DB-DL-9221

Length: 652
Ø: 52
Hole Distance: 152
6543500406, 6543500506, 6543520005



DB-DL-10213

Length: 860
Ø: 52
Cone Ø: d1 Ø 32 / d2 Ø 29
0014602505, 0014602705



DB-DL-10216

Length: 1190
Ø: 40
Cone Ø: d1 Ø 32 / d2 Ø 29
0004604905



DB-DL-12309

Length: 685 Ø: 40
Cone Ø: d1 Ø 32 / d2 Ø 28,8
0004606005, 0004606305



DB-ES-5209

Length: 1670 Ø: 50
Cone Ø: d1 Ø 30 / d2 Ø 27
6203300503, 6203300603



DB-ES-8387

Length: 55
Cone Ø: d1 Ø 10 / d2 Ø 10
Thread: M14 x 1,5 RHT
0009966845, 0009967045



DB-ES-8492

Length: 60
Cone Ø: d1 Ø 10 / d2 Ø 10
Thread: M12 x 1,75 RHT
0009966645, 3752680189, A3752680189



DB-RK-5282

Ø: 59
01303800A, 6553200111



DB-RK-5284

Ø: 65
01303900A, 6523200511



DB-RK-5303

Ø: 37
01304400A, 6253200611



DB-RK-8550

Ø: 75 Hole Distance: 152
Thick/Height: 24
0003502105, 0003504605



DB-RK-8564

Ø: 90
01302200A, 0003500105, 3500105, 0003500405,
3500405, 0005861833, 5861833, 81432706047



DB-RK-12372

Ø: 85
Hole Distance: 152
Thick/Height: 24
003501805, A003501805



DB-SB-5258

Ø: 70
Thick/Height: 62
01311400A, 3873230285



DB-SB-10407

Ø: 61 Thick/Height: 46
0003235985, 0003262481, 0003262981



DB-VB-10421

Length: 623
Ø: 56
Hole Distance: 152 / 152
6533500405



DF-RK-9336

Ø: 108
0003501705, 3501705



MN-RK-9387

Ø: 90
0003500105, 81432706047



SC-RK-8688

Length: 95
Ø: 95
0003501905, 3501905





MK ...

2524 L	12/87→09/96	Ball Head, gearshift linkage	DB-ES-8387		
	12/87→09/96	Ball Head, gearshift linkage	DB-ES-8492		
	12/87→09/96	Ball Head, gearshift linkage	DB-ES-8500		
	12/87→09/96	Centre Rod	DB-DL-5231		Push Rod* K 072 178 *→
	12/87→09/96	Centre Rod	DB-DL-5412		Push Rod* K 016 738 *→* K 072 177 *
	12/87→09/96	Centre Rod	DB-DL-8735		Push Rod
	12/87→09/96	Stabiliser Mounting	DB-SB-5258		1st FA
	12/87→09/96	Stabiliser Mounting	DB-SB-5258	DB-SB-5258	→* 5 903 513 *
	12/87→09/96	Suspension Arm Repair Kit		DB-RK-5284	
	12/87→09/96	Suspension Arm Repair Kit		DB-RK-5284	→* K 097 019 *
	12/87→09/96	Suspension Arm Repair Kit		DB-RK-5284	1st RA
	12/87→09/96	Suspension Arm Repair Kit		DB-RK-8564	Wishbone (CV)
	12/87→09/96	Suspension Arm Repair Kit		DB-RK-12372	for Wishbone (CV), Lifting Axle, K063070→
	12/87→09/96	Suspension Arm Repair Kit		DB-RK-12372	for Wishbone (CV)K063070→
	12/87→09/96	Suspension Arm Repair Kit		DF-RK-9336	
	12/87→09/96	Suspension Arm Repair Kit		DF-RK-9336	* K 063 070 *→
	12/87→09/96	Suspension Arm Repair Kit		DF-RK-9336	Lifting Axle, * K 063 070 *→
	12/87→09/96	Suspension Arm Repair Kit		MN-RK-9387	
	12/87→09/96	Suspension Arm Repair Kit		MN-RK-9387	→* 5 926 392 *
	12/87→09/96	Suspension Arm Repair Kit		MN-RK-9387	Lifting Axle, →* 5 926 392 *
	12/87→09/96	Suspension Arm Repair Kit		SC-RK-8688	for Drag Link
	12/87→09/96	Suspension Arm Repair Kit	DB-RK-5282		
	12/87→09/96	Tie Rod	DB-DL-8640		Guide Rod
	12/87→09/96	Tie Rod	DB-ES-5209		
	12/87→09/96	Tie Rod End	CV-ES-12461		for Steering Rod
12/87→09/96	Tie Rod End	CV-ES-12462		for Steering Rod	
12/87→09/96	Track Control Arm		DB-DL-5220	Trailing Arm	
12/87→09/96	Track Control Arm		DB-VB-10421	Wishbone (CV);Trailing Arm* 5 926 393 *→	
2524,2524 L	12/87→09/96	Centre Rod	DB-DL-5231		Push Rod* K 072 178 *→
	12/87→09/96	Centre Rod	DB-DL-5241		Suspension Rod
	12/87→09/96	Centre Rod	DB-DL-5412		Push Rod* K 016 738 *→
	12/87→09/96	Centre Rod	DB-DL-5412		Push Rod* K 016 738 *→* K 072 177 *
	12/87→09/96	Centre Rod	DB-DL-7270		Push Rod;Suspension Rod
	12/87→09/96	Centre Rod	DB-DL-8735		Push Rod
	12/87→09/96	Centre Rod	DB-DL-10216		Push Rod
	12/87→09/96	Centre Rod	DB-DL-12309		Coupling Rod
	12/87→09/96	Stabiliser Mounting		DB-SB-10407	
	12/87→09/96	Stabiliser Mounting	DB-SB-5257		
	12/87→09/96	Stabiliser Mounting	DB-SB-5258	DB-SB-5258	
	12/87→09/96	Suspension Arm Repair Kit		DB-RK-5284	
	12/87→09/96	Suspension Arm Repair Kit		DB-RK-5284	→* K 097 019 *
	12/87→09/96	Suspension Arm Repair Kit		DB-RK-5284	1st RA
	12/87→09/96	Suspension Arm Repair Kit		DB-RK-8550	for Wishbone (CV)
	12/87→09/96	Suspension Arm Repair Kit		DB-RK-8564	Wishbone (CV)
	12/87→09/96	Suspension Arm Repair Kit		DB-RK-12372	for Wishbone (CV)
	12/87→09/96	Suspension Arm Repair Kit		DB-RK-12372	for Wishbone (CV), Lifting Axle, K063070→
	12/87→09/96	Suspension Arm Repair Kit		DB-RK-12372	for Wishbone (CV)K063070→
	12/87→09/96	Suspension Arm Repair Kit		DF-RK-9336	
	12/87→09/96	Suspension Arm Repair Kit		DF-RK-9336	* K 063 070 *→
	12/87→09/96	Suspension Arm Repair Kit		DF-RK-9336	Lifting Axle, * K 063 070 *→
	12/87→09/96	Suspension Arm Repair Kit		MN-RK-9387	
	12/87→09/96	Suspension Arm Repair Kit		MN-RK-9387	→* 5 926 392 *
	12/87→09/96	Suspension Arm Repair Kit		MN-RK-9387	Lifting Axle, →* 5 926 392 *
	12/87→09/96	Suspension Arm Repair Kit		SC-RK-8688	for Drag Link
	12/87→09/96	Suspension Arm Repair Kit	DB-RK-5282		
	12/87→09/96	Suspension Arm Repair Kit	DB-RK-5303		
	12/87→09/96	Tie Rod	DB-DL-8640		Guide Rod
	12/87→09/96	Tie Rod	DB-ES-5209		
	12/87→09/96	Tie Rod End	CV-ES-12461		for Steering Rod
	12/87→09/96	Tie Rod End	CV-ES-14163		for Steering Rod
	12/87→09/96	Track Control Arm		DB-DL-5220	Trailing Arm
	12/87→09/96	Track Control Arm		DB-DL-9164	Trailing Arm
12/87→09/96	Track Control Arm		DB-DL-9221	Trailing Arm	
12/87→09/96	Track Control Arm		DB-VB-10421	Wishbone (CV);Trailing Arm* 5 926 393 *→	

CV-ES-12461

Length: 120
Cone Ø: d1 Ø 26 / d2 Ø 23,5
Thread: M30 x 1,5 LHT
0003300035, 3300148, 0003406213, 0013306635, 0013308835, 0014604048, 0014604348, 14606448, 0024600248, 3023300035, 3023300135, 3023300235, 3023300335, 3453307235, 3453307435, 3503307135, A0003300148, A0013306635, A0013308835, A0014604048, A0014604348, A0014606448, A0024600248, A3023300035, A3023300135, A3023300235, A3023300335, A3503307135



CV-ES-12462

Length: 120
Cone Ø: d1 Ø 26 / d2 Ø 23,5
Thread: M30 x 1,5 RHT
0003300135, 0003300248, 0003303235, 0003305835, 0003307335, 0003383410, 0004608348, 0004608348, 0004632229, 0004633129, 0004633429, 0004633529, 0013300135, 0013300235, 0013306735, 0014603448, 0014604148, 0014604448, 0014606348, 0014608348, 0014608448, 0014609748, 0023301535, 3453307135, 3503307035, 3503307335, 3643307135, 5001832582, A0003300248, A0003303235, A0003307335, A0003383410, A0004608348, A0004632229, A0004633429, A0013300135, A0013300235, A0013306735, A0014603448, A0014604148, A0014604448, A0014606348, A0014608348, A0014608448, A0014609748, A0023301535



CV-ES-14163

Length: 125
Cone Ø: d1 Ø 30 / d2 Ø 27
Thread: M30 x 1,5 RHT
0003305248, 0003387310, 0004600348, 0004600948, 0004602848, 0004602948, 0004608948, 0014600248, 0014600848, 0014601248, 0014602248, 0014607748, 0024600148, A0003387310, A0004600348, A0004602848, A0004602948, A0014600848, A0014601248, A0014602248, A0014607748



DB-DL-5220

Length: 522
Ø: 52
Hole Distance: 151
01335200A, 3813500606, 6523500306, 6533500106



DB-DL-5231

Length: 840
Ø: 52
Cone Ø: d1 Ø 32 / d2 Ø 29
01208500A, 14602905, 0014602905, 0014603005, 14603005, A0014602905



DB-DL-5241

Length: 875
Ø: 40
Cone Ø: d1 Ø 30 / d2 Ø 27
01215300A, 0004609205, 0004609305, 0014606905



DB-DL-5412

Length: 840
Ø: 48
Cone Ø: d1 Ø 32 / d2 Ø 30
01214400A, 0014600305, 14600305, 0014600405, 14600405



DB-DL-7270

Length: 875
Ø: 40
Cone Ø: d1 Ø 28,6 / d2 Ø 23,9
01208300A, 0024604705, 0024604805, 0034604905, A0024604705



DB-DL-8640

Length: 1615
Ø: 50
Cone Ø: d1 Ø 32 / d2 Ø 29
6253301503, 6253301603, 6253302403, 6253302503, 9423300803, 9423302103, 9493300203, 9493300303, 9493300903



DB-DL-8735

Length: 825
Ø: 42
Cone Ø: d1 Ø 30 / d2 Ø 27
Thread: M24 x 1,5
0004601005, 4601005, 0004601105, 4601105



DB-DL-9164

Length: 500
Ø: 50
Hole Distance: 152 / 152
3853500006, 6533500006



DB-DL-9221

Length: 652
Ø: 52
Hole Distance: 152
6543500406, 6543500506, 6543520005



DB-DL-10216

Length: 1190
Ø: 40
Cone Ø: d1 Ø 32 / d2 Ø 29
0004604905



DB-DL-12309

Length: 685
Ø: 40
Cone Ø: d1 Ø 32 / d2 Ø 28,8
4606005, 0004606005, 4606305, 0004606305



DB-ES-5209

Length: 1670
Ø: 50
Cone Ø: d1 Ø 30 / d2 Ø 27
6203300503, 6203300603



DB-ES-8387

Length: 55
Cone Ø: d1 Ø 10 / d2 Ø 10
Thread: M14 x 1,5 RHT
0009966845, 0009967045



DB-ES-8492

Length: 60
Cone Ø: d1 Ø 10 / d2 Ø 10
Thread: M12 x 1,75 RHT
0009966645, 3752680189, A3752680189



DB-ES-8500

Length: 55
Cone Ø: d1 Ø 12 / d2 Ø 10,8
Thread: M14 x 1,5 RHT
0002685989



DB-RK-5282

Ø: 59
01303800A, 6553200111



DB-RK-5284

Ø: 65
01303900A, 6523200511



DB-RK-5303

Ø: 37
01304400A, 6253200611



DB-RK-8550

Ø: 75
Hole Distance: 152
Thick/Height: 24
0003502105, 0003504605



DB-RK-8564

Ø: 90
01302200A, 0003500105, 3500105, 0003500405, 3500405, 0005861833, 5861833, 8143270607



DB-RK-12372

Ø: 85
Hole Distance: 152
Thick/Height: 24
003501805, A003501805



DB-SB-5257

Ø: 60
Thick/Height: 60,5
01304700A, 6533260381



DB-SB-5258

Ø: 70
Thick/Height: 62
01311400A, 3873260285



DB-SB-10407

Ø: 61
Thick/Height: 46
0003235985, 0003262481, 0003262981



DB-VB-10421

Length: 623
Ø: 56
Hole Distance: 152 / 152
6533500405



DF-RK-9336

Ø: 108
3501705, 0003501705



MN-RK-9387

Ø: 90
0003500105, 8143270607



SC-RK-8688

Length: 95
Ø: 95
0003501905, 3501905





MK ...

2527	10/93→09/96	Ball Head, gearshift linkage	DB-ES-8387		
	10/93→09/96	Ball Head, gearshift linkage	DB-ES-8492		
	10/93→09/96	Ball Head, gearshift linkage	DB-ES-8500		
	10/93→09/96	Centre Rod	DB-DL-5231		Push Rod* K 072 178 *→
	10/93→09/96	Centre Rod	DB-DL-5412		Push Rod* K 017 164 *→* K 072 177 *
	10/93→09/96	Centre Rod	DB-DL-7831		Push Rod
	10/93→09/96	Centre Rod	DB-DL-8138		Push Rod
	10/93→09/96	Centre Rod	DB-DL-8618		Push Rod
	10/93→09/96	Centre Rod	DB-DL-8672		Push Rod→* 1 K 072177 *
	10/93→09/96	Centre Rod	DB-DL-10213		Push Rod* K 072 178 *→
	10/93→09/96	Centre Rod	DB-DL-12309		Coupling Rod
	10/93→09/96	Stabiliser Mounting		DB-SB-10407	
	10/93→09/96	Suspension Arm Repair Kit		DB-RK-12372	for Wishbone (CV), Lifting Axle, K063070→
	10/93→09/96	Suspension Arm Repair Kit		DB-RK-12372	for Wishbone (CV)K063070→
	10/93→09/96	Suspension Arm Repair Kit	DB-RK-5303		
	10/93→09/96	Tie Rod	DB-DL-8640		Guide Rod
	10/93→09/96	Tie Rod	DB-ES-5209		
	10/93→09/96	Tie Rod End	CV-ES-12461		for Steering Rod
	10/93→09/96	Tie Rod End	CV-ES-12462		for Steering Rod
	10/93→09/96	Tie Rod End	CV-ES-14163		for Steering Rod
	10/93→09/96	Track Control Arm		DB-DL-5220	Trailing Arm
	10/93→09/96	Track Control Arm		DB-DL-7839	Trailing Arm
	01/94→09/96	Centre Rod	DB-DL-5241		Suspension Rod
	01/94→09/96	Centre Rod	DB-DL-5412		Push Rod* K 016 738 *→
	01/94→09/96	Centre Rod	DB-DL-5412		Push Rod* K 016 738 *→* K 072 177 *
	01/94→09/96	Centre Rod	DB-DL-7270		Push Rod;Suspension Rod
	01/94→09/96	Centre Rod	DB-DL-8735		Push Rod
	01/94→09/96	Centre Rod	DB-DL-10216		Push Rod
	01/94→09/96	Stabiliser Mounting		DB-SB-5258	1st RA
	01/94→09/96	Stabiliser Mounting	DB-SB-5257		
	01/94→09/96	Stabiliser Mounting	DB-SB-5258	DB-SB-5258	
	01/94→09/96	Suspension Arm Repair Kit		DB-RK-5284	→* K 097 019 *
	01/94→09/96	Suspension Arm Repair Kit		DB-RK-5284	1st RA
	01/94→09/96	Suspension Arm Repair Kit		DB-RK-8550	for Wishbone (CV)
	01/94→09/96	Suspension Arm Repair Kit		DB-RK-8564	Wishbone (CV)
	01/94→09/96	Suspension Arm Repair Kit		DF-RK-9336	
	01/94→09/96	Suspension Arm Repair Kit		DF-RK-9336	* K 063 070 *→
	01/94→09/96	Suspension Arm Repair Kit		DF-RK-9336	Lifting Axle, * K 063 070 *→
	01/94→09/96	Suspension Arm Repair Kit		MN-RK-9387	
	01/94→09/96	Suspension Arm Repair Kit		MN-RK-9387	→* 5 926 392 *
01/94→09/96	Suspension Arm Repair Kit		MN-RK-9387	Lifting Axle, →* 5 926 392 *	
01/94→09/96	Suspension Arm Repair Kit		SC-RK-8688	for Drag Link	
01/94→09/96	Suspension Arm Repair Kit	DB-RK-5282			
01/94→09/96	Track Control Arm		DB-DL-9221	Trailing Arm	
01/94→09/96	Track Control Arm		DB-VB-10421	Wishbone (CV);Trailing Arm* 5 926 393 *→	
2527 B	03/91→09/96	Ball Head, gearshift linkage	DB-ES-8387		
	03/91→09/96	Ball Head, gearshift linkage	DB-ES-8492		
	03/91→09/96	Ball Head, gearshift linkage	DB-ES-8500		
	03/91→09/96	Centre Rod	DB-DL-5412		Push Rod
	03/91→09/96	Centre Rod	DB-DL-8672		Push Rod→* 1 K 072177 *
	03/91→09/96	Centre Rod	DB-DL-10213		Push Rod* K 072 178 *→
	03/91→09/96	Stabiliser Mounting		DB-SB-5258	1st RA
	03/91→09/96	Stabiliser Mounting		DB-SB-10407	
	03/91→09/96	Stabiliser Mounting	DB-SB-5258	DB-SB-5258	
	03/91→09/96	Suspension Arm Repair Kit	DB-RK-5303		
	03/91→09/96	Tie Rod End	CV-ES-14163		for Steering Rod
	03/91→09/96	Track Control Arm		DB-DL-7839	Trailing Arm
2527 K	10/93→09/96	Ball Head, gearshift linkage	DB-ES-8387		
	10/93→09/96	Ball Head, gearshift linkage	DB-ES-8492		
	10/93→09/96	Ball Head, gearshift linkage	DB-ES-8500		
	10/93→09/96	Centre Rod	DB-DL-5412		Push Rod
	10/93→09/96	Centre Rod	DB-DL-8672		Push Rod→* 1 K 072177 *
	10/93→09/96	Centre Rod	DB-DL-10213		Push Rod* K 072 178 *→

CV-ES-12461

Length: 120
 Cone Ø: d1 Ø 26 / d2 Ø 23,5
 Thread: M30 x 1,5 LHT
 0003300035, 3300148, 0003406213, 0013306635,
 0013308835, 0014604048, 0014604348,
 14606448, 0024600248, 3023300035,
 3023300135, 3023300235, 3023300335,
 3453307235, 3453307435, 3503307135,
 A0003300148, A0013306635, A0013308835,
 A0014604048, A0014604348, A0014606448,
 A0024600248, A3023300035, A3023300135,
 A3023300235, A3023300335, A3503307135



CV-ES-12462

Length: 120
 Cone Ø: d1 Ø 26 / d2 Ø 23,5
 Thread: M30 x 1,5 RHT
 0003300135, 0003300248, 0003303235,
 0003305835, 0003307335, 0003383410,
 0004608348, 0004608348, 0004632229,
 0004633129, 0004633429, 0004633529,
 0013300135, 0013300235, 0013306735,
 0014603448, 0014604148, 0014604448,
 0014606348, 0014608348, 0014608448,
 0014609748, 0023301535, 3453307135,
 3503307035, 3503307335, 3643307135,
 5001832582, A0003300248, A0003303235,
 A0003307335, A0003383410, A0004608348,
 A0004632229, A0004633429, A0013300135,
 A0013300235, A0013306735, A0014603448,
 A0014604148, A0014604448, A0014606348,
 A0014608348, A0014608448, A0014609748,
 A0023301535



CV-ES-14163

Length: 125
 Cone Ø: d1 Ø 30 / d2 Ø 27
 Thread: M30 x 1,5 RHT
 0003305248, 0003387310, 0004600348,
 0004600948, 0004602848, 0004602948,
 0004608948, 0014600248, 0014600848,
 0014601248, 0014602248, 0014607748,
 0024600148, A0003387310, A0004600348,
 A0004602848, A0004602948, A0014600848,
 A0014601248, A0014602248, A0014607748



DB-DL-5220

Length: 522 Ø: 52
 Hole Distance: 151
 01335200A, 3813500606, 6523500306,
 6533500106



DB-DL-5231

Length: 840 Ø: 52
 Cone Ø: d1 Ø 32 / d2 Ø 29
 01208500A, 0014602905, 14602905, 0014603005,
 14603005, A0014602905



DB-DL-5241

Length: 875 Ø: 40
 Cone Ø: d1 Ø 30 / d2 Ø 27
 01215300A, 0004609205, 0004609305,
 0014606905



DB-DL-5412

Length: 840 Ø: 48
 Cone Ø: d1 Ø 32 / d2 Ø 30
 01214400A, 0014600305, 14600305, 0014600405,
 14600405



DB-DL-7270

Length: 875 Ø: 40
 Cone Ø: d1 Ø 28,6 / d2 Ø 23,9
 01208300A, 0024604705, 0024604805,
 0034604905, A0024604705



DB-DL-7831

Length: 870 Ø: 42
 Cone Ø: d1 Ø 30 / d2 Ø 27
 01215200A, 6254602505



DB-DL-7839

Length: 585 Ø: 50
 Hole Distance: 152 / 152
 3953500206, 6593500106, 6593502406



DB-DL-8138

Length: 1130 Ø: 40
 Cone Ø: d1 Ø 32 / d2 Ø 28,8
 4606605, 0004606605



DB-DL-8618

Length: 680 Ø: 42
 Cone Ø: d1 Ø 32 / d2 Ø 28,8
 4604305, 0004604305, 62546024805



DB-DL-8640

Length: 1615 Ø: 50
 Cone Ø: d1 Ø 32 / d2 Ø 29
 6253301503, 6253301603, 6253302403,
 6253302503, 9423300803, 9423302103,
 9493300203, 9493300303, 9493300903



DB-DL-8672

Length: 860 Ø: 48
 Cone Ø: d1 Ø 30 / d2 Ø 27
 14609705, 0014609705



DB-DL-8735

Length: 825 Ø: 42
 Cone Ø: d1 Ø 30 / d2 Ø 27
 Thread: M24 x 1,5
 0004601005, 4601005, 0004601105, 4601105

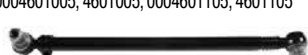

DB-DL-9221

Length: 652 Ø: 52
 Hole Distance: 152
 6543500406, 6543500506, 6543520005



DB-DL-10213

Length: 860 Ø: 52
 Cone Ø: d1 Ø 32 / d2 Ø 29
 0014602505, 0014602705



DB-DL-10216

Length: 1190
 Ø: 40
 Cone Ø: d1 Ø 32 / d2 Ø 29
 0004604905



DB-DL-12309

Length: 685 Ø: 40
 Cone Ø: d1 Ø 32 / d2 Ø 28,8
 0004606005, 0004606305



DB-ES-5209

Length: 1670 Ø: 50
 Cone Ø: d1 Ø 30 / d2 Ø 27
 6203300503, 6203300603



DB-ES-8387

Length: 55
 Cone Ø: d1 Ø 10 / d2 Ø 10
 Thread: M14 x 1,5 RHT
 0009966845, 0009967045



DB-ES-8492

Length: 60
 Cone Ø: d1 Ø 10 / d2 Ø 10
 Thread: M12 x 1,75 RHT
 0009966645, 3752680189, A3752680189



DB-ES-8500

Length: 55
 Cone Ø: d1 Ø 12 / d2 Ø 10,8
 Thread: M14 x 1,5 RHT
 0002685989



DB-RK-5282

Ø: 59
 01303800A, 6553200111



DB-RK-5284

Ø: 65
 01303900A, 6523200511



DB-RK-5303

Ø: 37
 01304400A, 6253200611



DB-RK-8550

Ø: 75 Hole Distance: 152
 Thick/Height: 24
 0003502105, 0003504605



DB-RK-8564

Ø: 90
 01302200A, 0003500105, 3500105, 0003500405,
 3500405, 0005861833, 5861833, 81432706047



DB-RK-12372

Ø: 85
 Hole Distance: 152
 Thick/Height: 24
 003501805, A003501805



DB-SB-5257

Ø: 60
 Thick/Height: 60,5
 01304700A, 6533260381



DB-SB-5258

Ø: 70
 Thick/Height: 62
 01311400A, 3873230285



DB-SB-10407

Ø: 61 Thick/Height: 46
 0003235985, 0003262481, 0003262981



DB-VB-10421

Length: 623
 Ø: 56
 Hole Distance: 152 / 152
 6533500405



DF-RK-9336

Ø: 108
 0003501705, 3501705



MN-RK-9387

Ø: 90
 0003500105, 81432706047



SC-RK-8688

Length: 95 Ø: 95
 0003501905, 3501905





MK ...

2527 K ...	10/93→09/96	Stabiliser Mounting		DB-SB-5258	1st RA	
	10/93→09/96	Stabiliser Mounting		DB-SB-10407		
	10/93→09/96	Stabiliser Mounting	DB-SB-5258	DB-SB-5258		
	10/93→09/96	Suspension Arm Repair Kit	DB-RK-5303			
	10/93→09/96	Tie Rod End	CV-ES-14163		for Steering Rod	
	10/93→09/96	Track Control Arm		DB-DL-7839	Trailing Arm	
2527 L	12/87→09/96	Ball Head, gearshift linkage	DB-ES-8387			
	12/87→09/96	Ball Head, gearshift linkage	DB-ES-8492			
	12/87→09/96	Ball Head, gearshift linkage	DB-ES-8500			
	12/87→09/96	Centre Rod	DB-DL-5231		Push Rod* K 072 178 *→	
	12/87→09/96	Centre Rod	DB-DL-5241		Suspension Rod	
	12/87→09/96	Centre Rod	DB-DL-5412		Push Rod* K 017 164 *→* K 072 177 *	
	12/87→09/96	Centre Rod	DB-DL-7270		Push Rod;Suspension Rod	
	12/87→09/96	Centre Rod	DB-DL-7831		Push Rod	
	12/87→09/96	Centre Rod	DB-DL-8138		Push Rod	
	12/87→09/96	Centre Rod	DB-DL-8618		Push Rod	
	12/87→09/96	Centre Rod	DB-DL-8735		Push Rod	
	12/87→09/96	Centre Rod	DB-DL-12309		Coupling Rod	
	12/87→09/96	Stabiliser Mounting	DB-SB-5258		1st FA	
	12/87→09/96	Stabiliser Mounting	DB-SB-5258	DB-SB-5258	→* 5 903 513 *	
	12/87→09/96	Suspension Arm Repair Kit		DB-RK-5284	→* K 097 019 *	
	12/87→09/96	Suspension Arm Repair Kit		DB-RK-5284	1st RA	
	12/87→09/96	Suspension Arm Repair Kit		DB-RK-8550	for Wishbone (CV)	
	12/87→09/96	Suspension Arm Repair Kit		DB-RK-8564	Wishbone (CV)	
	12/87→09/96	Suspension Arm Repair Kit		DB-RK-12372	for Wishbone (CV)K063070→	
	12/87→09/96	Suspension Arm Repair Kit		DF-RK-9336		
	12/87→09/96	Suspension Arm Repair Kit		DF-RK-9336	* K 063 070 *→	
	12/87→09/96	Suspension Arm Repair Kit		MN-RK-9387		
	12/87→09/96	Suspension Arm Repair Kit		MN-RK-9387	→* 5 926 392 *	
	12/87→09/96	Suspension Arm Repair Kit	DB-RK-5282			
	12/87→09/96	Tie Rod	DB-DL-8640		Guide Rod	
	12/87→09/96	Tie Rod	DB-ES-5209			
	12/87→09/96	Tie Rod End	CV-ES-12461		for Steering Rod	
	12/87→09/96	Tie Rod End	CV-ES-12462		for Steering Rod	
	12/87→09/96	Tie Rod End	CV-ES-14163		for Steering Rod	
	12/87→09/96	Track Control Arm		DB-DL-5220	Trailing Arm	
	03/91→09/96	Stabiliser Mounting	DB-SB-5257			
	03/91→09/96	Suspension Arm Repair Kit		DB-RK-5284		
	03/91→09/96	Track Control Arm		DB-DL-9221	Trailing Arm	
	09/92→09/96	Centre Rod	DB-DL-5412		Push Rod* K 016 738 *→	
	09/92→09/96	Centre Rod	DB-DL-8672		Push Rod* 1 5 593345 *→* 1 K 072177 *	
	09/92→09/96	Centre Rod	DB-DL-8672		Push Rod→* 1 K 072177 *	
	09/92→09/96	Centre Rod	DB-DL-10216		Push Rod	
	09/92→09/96	Stabiliser Mounting		DB-SB-10407		
	09/92→09/96	Stabiliser Mounting	DB-SB-5258	DB-SB-5258		
	09/92→09/96	Suspension Arm Repair Kit		DB-RK-12372	for Wishbone (CV), Lifting Axle, K063070→	
	09/92→09/96	Suspension Arm Repair Kit		DF-RK-9336	Lifting Axle, * K 063 070 *→	
	09/92→09/96	Suspension Arm Repair Kit		MN-RK-9387	Lifting Axle, →* 5 926 392 *	
	09/92→09/96	Suspension Arm Repair Kit		SC-RK-8688	for Drag Link	
	09/92→09/96	Track Control Arm		DB-DL-9164	Trailing Arm	
	09/92→09/96	Track Control Arm		DB-VB-10421	Wishbone (CV);Trailing Arm* 5 926 393 *→	
	01/94→09/96	Centre Rod	DB-DL-5412		Push Rod* K 016 738 *→* K 072 177 *	
	2531 B	12/87→09/96	Ball Head, gearshift linkage	DB-ES-8387		
		12/87→09/96	Ball Head, gearshift linkage	DB-ES-8492		
		12/87→09/96	Ball Head, gearshift linkage	DB-ES-8500		
		12/87→09/96	Centre Rod	DB-DL-5412		Push Rod
		12/87→09/96	Centre Rod	DB-DL-10213		Push Rod* K 072 178 *→
		12/87→09/96	Stabiliser Mounting		DB-SB-5258	1st RA
12/87→09/96	Stabiliser Mounting	DB-SB-5258	DB-SB-5258			
12/87→09/96	Track Control Arm		DB-DL-7839	Trailing Arm		

CV-ES-12461

Length: 120
Cone Ø: d1 Ø 26 / d2 Ø 23,5
Thread: M30 x 1,5 LHT
0003300035, 3300148, 0003406213, 0013306635,
0013308835, 0014604048, 0014604348,
14606448, 0024600248, 3023300035,
3023300135, 3023300235, 3023300335,
3453307235, 3453307435, 3503307135,
A0003300148, A0013306635, A0013308835,
A0014604048, A0014604348, A0014606448,
A0024600248, A3023300035, A3023300135,
A3023300235, A3023300335, A3503307135



CV-ES-12462

Length: 120
Cone Ø: d1 Ø 26 / d2 Ø 23,5
Thread: M30 x 1,5 RHT
0003300135, 0003300248, 0003303235,
0003305835, 0003307335, 0003383410,
0004608348, 0004608348, 0004632229,
0004633129, 0004633429, 0004633529,
0013300135, 0013300235, 0013306735,
0014603448, 0014604148, 0014604448,
0014606348, 0014608348, 0014608448,
0014609748, 0023301535, 3453307135,
3503307035, 3503307335, 3643307135,
5001832582, A0003300248, A0003303235,
A0003307335, A0003383410, A0004608348,
A0004632229, A0004633429, A0013300135,
A0013300235, A0013306735, A0014603448,
A0014604148, A0014604448, A0014606348,
A0014608348, A0014608448, A0014609748,
A0023301535



CV-ES-14163

Length: 125
Cone Ø: d1 Ø 30 / d2 Ø 27
Thread: M30 x 1,5 RHT
0003305248, 0003387310, 0004600348,
0004600948, 0004602848, 0004602948,
0004608948, 0014600248, 0014600848,
0014601248, 0014602248, 0014607748,
0024600148, A0003387310, A0004600348,
A0004602848, A0004602948, A0014600848,
A0014601248, A0014602248, A0014607748



DB-DL-5220

Length: 522 Ø: 52
Hole Distance: 151
01335200A, 3813500606, 6523500306,
6533500106



DB-DL-5231

Length: 840 Ø: 52
Cone Ø: d1 Ø 32 / d2 Ø 29
01208500A, 0014602905, 14602905, 0014603005,
14603005, A0014602905



DB-DL-5241

Length: 875 Ø: 40
Cone Ø: d1 Ø 30 / d2 Ø 27
01215300A, 0004609205, 0004609305,
0014606905



DB-DL-5412

Length: 840 Ø: 48
Cone Ø: d1 Ø 32 / d2 Ø 30
01214400A, 0014600305, 14600305, 14600405,
0014600405



DB-DL-7270

Length: 875 Ø: 40
Cone Ø: d1 Ø 28,6 / d2 Ø 23,9
01208300A, 0024604705, 0024604805,
0034604905, A0024604705



DB-DL-7831

Length: 870 Ø: 42
Cone Ø: d1 Ø 30 / d2 Ø 27
01215200A, 6254602505



DB-DL-7839

Length: 585 Ø: 50
Hole Distance: 152 / 152
3953500206, 6593500106, 6593502406



DB-DL-8138

Length: 1130 Ø: 40
Cone Ø: d1 Ø 32 / d2 Ø 28,8
0004606605, 4606605



DB-DL-8618

Length: 680 Ø: 42
Cone Ø: d1 Ø 32 / d2 Ø 28,8
0004604305, 4604305, 6254604805



DB-DL-8640

Length: 1615 Ø: 50
Cone Ø: d1 Ø 32 / d2 Ø 29
6253301503, 6253301603, 6253302403,
6253302503, 9423300803, 9423302103,
9493300203, 9493300303, 9493300903



DB-DL-8672

Length: 860 Ø: 48
Cone Ø: d1 Ø 30 / d2 Ø 27
0014609705, 14609705



DB-DL-8735

Length: 825 Ø: 42
Cone Ø: d1 Ø 30 / d2 Ø 27
Thread: M24 x 1,5
0004601005, 4601005, 0004601105, 4601105



DB-DL-9164

Length: 500 Ø: 50
Hole Distance: 152 / 152
3853500006, 6533500006



DB-DL-9221

Length: 652 Ø: 52
Hole Distance: 152
6543500406, 6543500506, 6543520005



DB-DL-10213

Length: 860 Ø: 52
Cone Ø: d1 Ø 32 / d2 Ø 29
0014602505, 0014602705



DB-DL-10216

Length: 1190 Ø: 40
Cone Ø: d1 Ø 32 / d2 Ø 29
0004604905



DB-DL-12309

Length: 685 Ø: 40
Cone Ø: d1 Ø 32 / d2 Ø 28,8
0004606005, 4606005, 4606305, 0004606305



DB-ES-5209

Length: 1670 Ø: 50
Cone Ø: d1 Ø 30 / d2 Ø 27
6203300503, 6203300603



DB-ES-8387

Length: 55
Cone Ø: d1 Ø 10 / d2 Ø 10
Thread: M14 x 1,5 RHT
0009966845, 0009967045



DB-ES-8492

Length: 60
Cone Ø: d1 Ø 10 / d2 Ø 10
Thread: M12 x 1,75 RHT
0009966845, 3752680189, A3752680189



DB-ES-8500

Length: 55
Cone Ø: d1 Ø 12 / d2 Ø 10,8
Thread: M14 x 1,5 RHT
0002685989



DB-RK-5282

Ø: 59
01303800A, 6553200111



DB-RK-5284

Ø: 65
01303900A, 6523200511



DB-RK-5303

Ø: 37
01304400A, 6253200611



DB-RK-8550

Ø: 75 Hole Distance: 152
Thick/Height: 24
0003502105, 0003504605



DB-RK-8564

Ø: 90
01302200A, 3500105, 0003500105, 0003500405,
3500405, 0005861833, 5861833, 81432706047



DB-RK-12372

Ø: 85
Hole Distance: 152
Thick/Height: 24
003501805, A003501805



DB-SB-5257

Ø: 60
Thick/Height: 60,5
01304700A, 653320381



DB-SB-5258

Ø: 70
Thick/Height: 62
01311400A, 3873230285



DB-SB-10407

Ø: 61 Thick/Height: 46
0003235985, 0003262481, 0003262981



DB-VB-10421

Length: 623
Ø: 56
Hole Distance: 152 / 152
6533500405



DF-RK-9336

Ø: 108
0003501705, 3501705



MN-RK-9387

Ø: 90
0003500105, 81432706047



SC-RK-8688

Length: 95 Ø: 95
0003501905, 3501905





MK ...

2531 L	12/87→09/96	Ball Head, gearshift linkage	DB-ES-8387		
	12/87→09/96	Ball Head, gearshift linkage	DB-ES-8492		
	12/87→09/96	Ball Head, gearshift linkage	DB-ES-8500		
	12/87→09/96	Centre Rod	DB-DL-5217		Push Rod
	12/87→09/96	Centre Rod	DB-DL-5231		Push Rod* K 072 178 *→
	12/87→09/96	Centre Rod	DB-DL-5412		Push Rod* K 017 164 *→* K 072 177 *
	12/87→09/96	Centre Rod	DB-DL-7831		Push Rod
	12/87→09/96	Centre Rod	DB-DL-8138		Push Rod
	12/87→09/96	Centre Rod	DB-DL-8618		Push Rod
	12/87→09/96	Centre Rod	DB-DL-8735		Push Rod
	12/87→09/96	Centre Rod	DB-DL-10216		Push Rod
	12/87→09/96	Centre Rod	DB-DL-12309		Coupling Rod
	12/87→09/96	Stabiliser Mounting	DB-SB-5258		1st FA
	12/87→09/96	Stabiliser Mounting	DB-SB-5258	DB-SB-5258	→* 5 903 513 *
	12/87→09/96	Suspension Arm Repair Kit		DB-RK-5284	→* K 097 019 *
	12/87→09/96	Suspension Arm Repair Kit		DB-RK-5284	1st RA
	12/87→09/96	Suspension Arm Repair Kit		DB-RK-8564	Wishbone (CV)
	12/87→09/96	Suspension Arm Repair Kit		DB-RK-12372	for Wishbone (CV)K063070→
	12/87→09/96	Suspension Arm Repair Kit		DF-RK-9336	
	12/87→09/96	Suspension Arm Repair Kit		DF-RK-9336	* K 063 070 *→
	12/87→09/96	Suspension Arm Repair Kit		MN-RK-9387	
	12/87→09/96	Suspension Arm Repair Kit		MN-RK-9387	→* 5 926 392 *
	12/87→09/96	Suspension Arm Repair Kit	DB-RK-5282		
	12/87→09/96	Tie Rod	DB-DL-8640		Guide Rod
	12/87→09/96	Tie Rod	DB-ES-5209		
	12/87→09/96	Tie Rod End	CV-ES-12461		for Steering Rod
	12/87→09/96	Tie Rod End	CV-ES-12462		for Steering Rod
	12/87→09/96	Track Control Arm		DB-DL-5220	Trailing Arm
	12/87→09/96	Track Control Arm		DB-DL-9221	Trailing Arm
	2531,2531 L	12/87→09/96	Ball Head, gearshift linkage	DB-ES-8387	
12/87→09/96		Ball Head, gearshift linkage	DB-ES-8492		
12/87→09/96		Ball Head, gearshift linkage	DB-ES-8500		
12/87→09/96		Centre Rod	DB-DL-5217		Push Rod
12/87→09/96		Centre Rod	DB-DL-5231		Push Rod
12/87→09/96		Centre Rod	DB-DL-5231		Push Rod* K 072 178 *→
12/87→09/96		Centre Rod	DB-DL-5241		Suspension Rod
12/87→09/96		Centre Rod	DB-DL-5412		Push Rod* K 016 738 *→* K 072 177 *
12/87→09/96		Centre Rod	DB-DL-5412		Push Rod* K 017 164 *→* K 072 177 *
12/87→09/96		Centre Rod	DB-DL-7270		Push Rod;Suspension Rod
12/87→09/96		Centre Rod	DB-DL-7831		Push Rod
12/87→09/96		Centre Rod	DB-DL-8131		Push Rod
12/87→09/96		Centre Rod	DB-DL-8138		Push Rod
12/87→09/96		Centre Rod	DB-DL-8618		Push Rod
12/87→09/96		Centre Rod	DB-DL-8735		Push Rod
12/87→09/96		Centre Rod	DB-DL-10213		Push Rod
12/87→09/96		Centre Rod	DB-DL-10213		Push Rod* K 072 178 *→
12/87→09/96		Centre Rod	DB-DL-10216		Push Rod
12/87→09/96		Centre Rod	DB-DL-12309		Coupling Rod
12/87→09/96		Stabiliser Mounting		DB-SB-10407	
12/87→09/96		Stabiliser Mounting	DB-SB-5257		
12/87→09/96		Stabiliser Mounting	DB-SB-5258		1st FA
12/87→09/96		Stabiliser Mounting	DB-SB-5258	DB-SB-5258	
12/87→09/96		Stabiliser Mounting	DB-SB-5258	DB-SB-5258	→* 5 903 513 *
12/87→09/96		Suspension Arm Repair Kit		DB-RK-5284	→* K 097 019 *
12/87→09/96		Suspension Arm Repair Kit		DB-RK-5284	1st RA
12/87→09/96		Suspension Arm Repair Kit		DB-RK-8550	for Wishbone (CV)
12/87→09/96		Suspension Arm Repair Kit		DB-RK-8564	Wishbone (CV)
12/87→09/96		Suspension Arm Repair Kit	DB-RK-12372		for Wishbone (CV), Lifting Axle, K063070→
12/87→09/96		Suspension Arm Repair Kit		DF-RK-9336	
12/87→09/96	Suspension Arm Repair Kit		DF-RK-9336	* K 063 070 *→	
12/87→09/96	Suspension Arm Repair Kit		DF-RK-9336	Lifting Axle, * K 063 070 *→	
12/87→09/96	Suspension Arm Repair Kit		MN-RK-9387		
12/87→09/96	Suspension Arm Repair Kit		MN-RK-9387	→* 5 926 392 *	

CV-ES-12461

Length: 120
 Cone Ø: d1 Ø 26 / d2 Ø 23,5
 Thread: M30 x 1,5 LHT
 0003300035, 3300148, 0003406213, 0013306635, 0013308835, 0014604048, 0014604348, 14606448, 0024600248, 3023300035, 3023300135, 3023300235, 3023300335, 3453307235, 3453307435, 3503307135, A0003300148, A0013306635, A0013308835, A0014604048, A0014604348, A0014606448, A0024600248, A3023300035, A3023300135, A3023300235, A3023300335, A3503307135



CV-ES-12462

Length: 120
 Cone Ø: d1 Ø 26 / d2 Ø 23,5
 Thread: M30 x 1,5 RHT
 0003300135, 0003300248, 0003303235, 0003305835, 0003307335, 0003383410, 0004608348, 004608348, 0004632229, 0004633129, 0004633429, 0004633529, 0013300135, 0013300235, 0013306735, 0014603448, 0014604148, 0014604448, 0014606348, 0014608348, 0014608448, 0014609748, 0023301535, 3453307135, 3503307035, 3503307335, 3643307135, 5001832582, A0003300248, A0003303235, A0003307335, A0003383410, A0004608348, A0004632229, A0004633429, A0013300135, A0013300235, A0013306735, A0014603448, A0014604148, A0014604448, A0014606348, A0014608348, A0014608448, A0014609748, A0023301535



DB-DL-5217

Length: 862 Ø: 40
 Cone Ø: d1 Ø 30 / d2 Ø 27
 01214700A, 6204600405, 6204600805, 6204602905, 6204603005



DB-DL-5220

Length: 522
 Ø: 52
 Hole Distance: 151
 01335200A, 3813500606, 6523500306, 6533500106



DB-DL-5231

Length: 840
 Ø: 52
 Cone Ø: d1 Ø 32 / d2 Ø 29
 01208500A, 0014602905, 14602905, 14603005, 0014603005, A0014602905



DB-DL-5241

Length: 875 Ø: 40
 Cone Ø: d1 Ø 30 / d2 Ø 27
 01215300A, 0004609205, 0004609305, 0014606905



DB-DL-5412

Length: 840
 Ø: 48
 Cone Ø: d1 Ø 32 / d2 Ø 30
 01214400A, 14600305, 0014600305, 14600405, 0014600405



DB-DL-7270

Length: 875 Ø: 40
 Cone Ø: d1 Ø 28,6 / d2 Ø 23,9
 01208300A, 0024604705, 0024604805, 0034604905, A0024604705



DB-DL-7831

Length: 870
 Ø: 42
 Cone Ø: d1 Ø 30 / d2 Ø 27
 01215200A, 6254602505



DB-DL-8131

Length: 1115
 Ø: 52
 Cone Ø: d1 Ø 32 / d2 Ø 28,8
 4604405, 0004604405, 6254605005



DB-DL-8138

Length: 1130
 Ø: 40
 Cone Ø: d1 Ø 32 / d2 Ø 28,8
 0004606605, 4606605



DB-DL-8618

Length: 680
 Ø: 42
 Cone Ø: d1 Ø 32 / d2 Ø 28,8
 0004604305, 4604305, 6254604805



DB-DL-8640

Length: 1615 Ø: 50
 Cone Ø: d1 Ø 32 / d2 Ø 29
 6253301503, 6253301603, 6253302403, 6253302503, 9423300803, 9423302103, 9493300203, 9493300303, 9493300903



DB-DL-8735

Length: 825
 Ø: 42
 Cone Ø: d1 Ø 30 / d2 Ø 27
 Thread: M24 x 1,5
 0004601005, 4601005, 0004601105, 4601105



DB-DL-9221

Length: 652
 Ø: 52
 Hole Distance: 152
 6543500406, 6543500506, 6543520005



DB-DL-10213

Length: 860
 Ø: 52
 Cone Ø: d1 Ø 32 / d2 Ø 29
 0014602505, 0014602705



DB-DL-10216

Length: 1190
 Ø: 40
 Cone Ø: d1 Ø 32 / d2 Ø 29
 0004604905



DB-DL-12309

Length: 685 Ø: 40
 Cone Ø: d1 Ø 32 / d2 Ø 28,8
 0004606005, 0004606305



DB-ES-5209

Length: 1670 Ø: 50
 Cone Ø: d1 Ø 30 / d2 Ø 27
 6203300503, 6203300603



DB-ES-8387

Length: 55
 Cone Ø: d1 Ø 10 / d2 Ø 10
 Thread: M14 x 1,5 RHT
 0009966845, 0009967045



DB-ES-8492

Length: 60
 Cone Ø: d1 Ø 10 / d2 Ø 10
 Thread: M12 x 1,75 RHT
 0009966645, 3752680189, A3752680189



DB-ES-8500

Length: 55
 Cone Ø: d1 Ø 12 / d2 Ø 10,8
 Thread: M14 x 1,5 RHT
 0002685989



DB-RK-5282

Ø: 59
 01303800A, 6553200111



DB-RK-5284

Ø: 65
 01303900A, 6523200511



DB-RK-8550

Ø: 75 Hole Distance: 152
 Thick/Height: 24
 0003502105, 0003504605



DB-RK-8564

Ø: 90
 01302200A, 0003500105, 3500105, 3500405, 0003500405, 5861833, 0005861833, 81432706047



DB-RK-12372

Ø: 85
 Hole Distance: 152
 Thick/Height: 24
 003501805, A003501805



DB-SB-5257

Ø: 60
 Thick/Height: 60,5
 01304700A, 6533260381



DB-SB-5258

Ø: 70
 Thick/Height: 62
 01311400A, 3873230285



DB-SB-10407

Ø: 61 Thick/Height: 46
 0003235985, 0003262481, 0003262981



DF-RK-9336

Ø: 108
 0003501705, 3501705



MN-RK-9387

Ø: 90
 0003500105, 81432706047





MK ...

2531,2531 L ...	12/87→09/96	Suspension Arm Repair Kit		MN-RK-9387	Lifting Axle, →* 5 926 392 *	
	12/87→09/96	Suspension Arm Repair Kit		SC-RK-8688	for Drag Link	
	12/87→09/96	Suspension Arm Repair Kit	DB-RK-5282			
	12/87→09/96	Tie Rod	DB-DL-8640		Guide Rod	
	12/87→09/96	Tie Rod	DB-ES-5209			
	12/87→09/96	Tie Rod End	CV-ES-12461		for Steering Rod	
	12/87→09/96	Tie Rod End	CV-ES-12462		for Steering Rod	
	12/87→09/96	Tie Rod End	CV-ES-14163		for Steering Rod	
	12/87→09/96	Track Control Arm		DB-DL-5220	Trailing Arm	
	12/87→09/96	Track Control Arm		DB-DL-7839	Trailing Arm	
	12/87→09/96	Track Control Arm		DB-DL-9164	Trailing Arm	
	12/87→09/96	Track Control Arm		DB-DL-9221	Trailing Arm	
	12/87→09/96	Track Control Arm		DB-VB-10421	Wishbone (CV);Trailing Arm* 5 926 393 *→	
2534 K	01/91→09/96	Ball Head, gearshift linkage	DB-ES-8387			
	01/91→09/96	Ball Head, gearshift linkage	DB-ES-8500			
	01/91→09/96	Centre Rod	DB-DL-5412		Push Rod	
	01/91→09/96	Centre Rod	DB-DL-8672		Push Rod→* 1 K 072177 *	
	01/91→09/96	Centre Rod	DB-DL-10213		Push Rod* K 072 178 *→	
	01/91→09/96	Stabiliser Mounting		DB-SB-5258	1st RA	
	01/91→09/96	Stabiliser Mounting		DB-SB-10407		
	01/91→09/96	Stabiliser Mounting	DB-SB-5258	DB-SB-5258		
	01/91→09/96	Suspension Arm Repair Kit	DB-RK-5303			
	01/91→09/96	Tie Rod End	CV-ES-14163		for Steering Rod	
	01/91→09/96	Track Control Arm		DB-DL-7839	Trailing Arm	
2534 L	12/87→09/96	Ball Head, gearshift linkage	DB-ES-8387			
	12/87→09/96	Ball Head, gearshift linkage	DB-ES-8492			
	12/87→09/96	Ball Head, gearshift linkage	DB-ES-8500			
	12/87→09/96	Centre Rod	DB-DL-7831		Push Rod	
	12/87→09/96	Centre Rod	DB-DL-8138		Push Rod	
	12/87→09/96	Centre Rod	DB-DL-8618		Push Rod	
	12/87→09/96	Centre Rod	DB-DL-8735		Push Rod	
	12/87→09/96	Centre Rod	DB-DL-10216		Push Rod	
	12/87→09/96	Centre Rod	DB-DL-12309		Coupling Rod	
	12/87→09/96	Suspension Arm Repair Kit		DB-RK-5284	→* K 097 019 *	
	12/87→09/96	Suspension Arm Repair Kit		DB-RK-5284	1st RA	
	12/87→09/96	Suspension Arm Repair Kit		DB-RK-8564	Wishbone (CV)	
	12/87→09/96	Suspension Arm Repair Kit		DB-RK-12372	for Wishbone (CV)K063070→	
	12/87→09/96	Suspension Arm Repair Kit		DF-RK-9336		
	12/87→09/96	Suspension Arm Repair Kit		DF-RK-9336	* K 063 070 *→	
	12/87→09/96	Suspension Arm Repair Kit		MN-RK-9387		
	12/87→09/96	Suspension Arm Repair Kit		MN-RK-9387	→* 5 926 392 *	
	12/87→09/96	Suspension Arm Repair Kit	DB-RK-5282			
	12/87→09/96	Tie Rod	DB-DL-8640		Guide Rod	
	12/87→09/96	Tie Rod	DB-ES-5209			
	12/87→09/96	Tie Rod End	CV-ES-12461		for Steering Rod	
	12/87→09/96	Track Control Arm		DB-DL-9221	Trailing Arm	
	2534 S,2534 LS	12/87→09/96	Ball Head, gearshift linkage	DB-ES-8387		
		12/87→09/96	Ball Head, gearshift linkage	DB-ES-8492		
		12/87→09/96	Ball Head, gearshift linkage	DB-ES-8500		
		12/87→09/96	Centre Rod	DB-DL-10216		Push Rod
		12/87→09/96	Stabiliser Mounting	DB-SB-5257		
12/87→09/96		Suspension Arm Repair Kit		DB-RK-5284	→* K 097 019 *	
12/87→09/96		Suspension Arm Repair Kit		DB-RK-5284	1st RA	
12/87→09/96		Suspension Arm Repair Kit		DB-RK-8564	Wishbone (CV)	
12/87→09/96		Suspension Arm Repair Kit		DB-RK-12372	for Wishbone (CV)K063070→	
12/87→09/96		Suspension Arm Repair Kit		DF-RK-9336		
12/87→09/96		Suspension Arm Repair Kit		DF-RK-9336	* K 063 070 *→	
12/87→09/96		Suspension Arm Repair Kit		MN-RK-9387		
12/87→09/96		Suspension Arm Repair Kit		MN-RK-9387	→* 5 926 392 *	
12/87→09/96		Suspension Arm Repair Kit	DB-RK-5282			
12/87→09/96		Tie Rod	DB-DL-8640		Guide Rod	
12/87→09/96		Tie Rod End	CV-ES-12461		for Steering Rod	
12/87→09/96		Tie Rod End	CV-ES-14163		for Steering Rod	
12/87→09/96		Track Control Arm		DB-DL-9221	Trailing Arm	

CV-ES-12461

Length: 120
Cone Ø: d1 Ø 26 / d2 Ø 23,5
Thread: M30 x 1,5 LHT
0003300035, 3300148, 0003406213, 0013306635,
0013308835, 0014604048, 0014604348,
14606448, 0024600248, 3023300035,
3023300135, 3023300235, 3023300335,
3453307235, 3453307435, 3503307135,
A0003300148, A0013306635, A0013308835,
A0014604048, A0014604348, A0014606448,
A0024600248, A3023300035, A3023300135,
A3023300235, A3023300335, A3503307135



CV-ES-12462

Length: 120
Cone Ø: d1 Ø 26 / d2 Ø 23,5
Thread: M30 x 1,5 RHT
0003300135, 0003300248, 0003303235,
0003305835, 0003307335, 0003383410,
0004608348, 004608348, 0004632229,
0004633129, 0004633429, 0004633529,
0013300135, 0013300235, 0013306735,
0014603448, 0014604148, 0014604448,
0014606348, 0014608348, 0014608448,
0014609748, 0023301535, 3453307135,
3503307035, 3503307335, 3643307135,
5001832582, A0003300248, A0003303235,
A000330735, A0003383410, A0004608348,
A0004632229, A0004633429, A0013300135,
A0013300235, A0013306735, A0014603448,
A0014604148, A0014604448, A0014606348,
A0014608348, A0014608448, A0014609748,
A0023301535



CV-ES-14163

Length: 125
Cone Ø: d1 Ø 30 / d2 Ø 27
Thread: M30 x 1,5 RHT
0003305248, 0003387310, 0004600348,
0004600948, 0004602848, 0004602948,
0004608948, 0014600248, 0014600848,
0014601248, 0014602248, 0014607748,
0024600148, A0003387310, A0004600348,
A0004602848, A0004602948, A0014600848,
A0014601248, A0014602248, A0014607748



DB-DL-5220

Length: 522
Ø: 52
Hole Distance: 151
01335200A, 3813500606, 65233500306,
6533500106



DB-DL-5412

Length: 840
Ø: 48
Cone Ø: d1 Ø 32 / d2 Ø 30
01214400A, 0014600305, 14600305, 0014600405,
14600405



DB-DL-7831

Length: 870
Ø: 42
Cone Ø: d1 Ø 30 / d2 Ø 27
01215200A, 6254602505



DB-DL-7839

Length: 585
Ø: 50
Hole Distance: 152 / 152
3953500206, 6593500106, 6593502406



DB-DL-8138

Length: 1130
Ø: 40
Cone Ø: d1 Ø 32 / d2 Ø 28,8
0004606605, 4606605



DB-DL-8618

Length: 680
Ø: 42
Cone Ø: d1 Ø 32 / d2 Ø 28,8
0004604305, 4604305, 6254604805



DB-DL-8640

Length: 1615 Ø: 50
Cone Ø: d1 Ø 32 / d2 Ø 29
6253301503, 6253301603, 6253302403,
6253302503, 9423300803, 9423302103,
9493300203, 9493300303, 9493300903



DB-DL-8672

Length: 860
Ø: 48
Cone Ø: d1 Ø 30 / d2 Ø 27
0014609705, 14609705



DB-DL-8735

Length: 825
Ø: 42
Cone Ø: d1 Ø 30 / d2 Ø 27
Thread: M24 x 1,5
0004601005, 4601005, 0004601105, 4601105



DB-DL-9164

Length: 500
Ø: 50
Hole Distance: 152 / 152
3853500006, 6533500006



DB-DL-9221

Length: 652
Ø: 52
Hole Distance: 152
6543500406, 6543500506, 6543520005



DB-DL-10213

Length: 860
Ø: 52
Cone Ø: d1 Ø 32 / d2 Ø 29
0014602505, 0014602705



DB-DL-10216

Length: 1190
Ø: 40
Cone Ø: d1 Ø 32 / d2 Ø 29
0004604905



DB-DL-12309

Length: 685
Ø: 40
Cone Ø: d1 Ø 32 / d2 Ø 28,8
0004606005, 4606005, 4606305, 0004606305



DB-ES-5209

Length: 1670 Ø: 50
Cone Ø: d1 Ø 30 / d2 Ø 27
6203300503, 6203300603



DB-ES-8387

Length: 55
Cone Ø: d1 Ø 10 / d2 Ø 10
Thread: M14 x 1,5 RHT
0009966845, 0009967045



DB-ES-8492

Length: 60
Cone Ø: d1 Ø 10 / d2 Ø 10
Thread: M12 x 1,75 RHT
0009966645, 3752680189, A3752680189



DB-ES-8500

Length: 55
Cone Ø: d1 Ø 12 / d2 Ø 10,8
Thread: M14 x 1,5 RHT
0002685989



DB-RK-5282

Ø: 59
01303800A, 6553200111



DB-RK-5284

Ø: 65
01303900A, 6523200511



DB-RK-5303

Ø: 37
01304400A, 6253200611



DB-RK-8564

Ø: 90
01302200A, 0003500105, 3500105, 3500405,
0003500405, 5861833, 0005861833,
81432706047



DB-RK-12372

Ø: 85
Hole Distance: 152
Thick/Height: 24
003501805, A003501805



DB-SB-5257

Ø: 60
Thick/Height: 60,5
01304700A, 6533260381



DB-SB-5258

Ø: 70
Thick/Height: 62
01311400A, 3873230285



DB-SB-10407

Ø: 61 Thick/Height: 46
0003235985, 0003262481, 0003262981



DB-VB-10421

Length: 623
Ø: 56
Hole Distance: 152 / 152
6533500405



DF-RK-9336

Ø: 108
0003501705, 3501705



MN-RK-9387

Ø: 90
0003500105, 81432706047



SC-RK-8688

Length: 95
Ø: 95
0003501905, 3501905





MK ...

2534,2534 L

12/87→09/96	Ball Head, gearshift linkage	DB-ES-8387		
12/87→09/96	Ball Head, gearshift linkage	DB-ES-8492		
12/87→09/96	Ball Head, gearshift linkage	DB-ES-8500		
12/87→09/96	Centre Rod	DB-DL-5217		Push Rod
12/87→09/96	Centre Rod	DB-DL-5231		Push Rod* K 072 178 *→
12/87→09/96	Centre Rod	DB-DL-5241		Suspension Rod
12/87→09/96	Centre Rod	DB-DL-5412		Push Rod* K 017 164 *→
12/87→09/96	Centre Rod	DB-DL-5412		Push Rod* K 017 164 *→* K 072 177 *
12/87→09/96	Centre Rod	DB-DL-5412		Push Rod→* K 072 177 *
12/87→09/96	Centre Rod	DB-DL-7270		Push Rod;Suspension Rod
12/87→09/96	Centre Rod	DB-DL-7831		Push Rod
12/87→09/96	Centre Rod	DB-DL-8131		Push Rod
12/87→09/96	Centre Rod	DB-DL-8138		Push Rod
12/87→09/96	Centre Rod	DB-DL-8618		Push Rod
12/87→09/96	Centre Rod	DB-DL-8735		Push Rod
12/87→09/96	Centre Rod	DB-DL-10216		Push Rod
12/87→09/96	Centre Rod	DB-DL-12309		Coupling Rod
12/87→09/96	Stabiliser Mounting		DB-SB-10407	
12/87→09/96	Stabiliser Mounting	DB-SB-5258	DB-SB-5258	
12/87→09/96	Suspension Arm Repair Kit		DB-RK-5284	→* K 097 019 *
12/87→09/96	Suspension Arm Repair Kit		DB-RK-5284	1st RA
12/87→09/96	Suspension Arm Repair Kit		DB-RK-8550	for Wishbone (CV)
12/87→09/96	Suspension Arm Repair Kit		DB-RK-8564	Wishbone (CV)
12/87→09/96	Suspension Arm Repair Kit		DB-RK-12372	for Wishbone (CV), Lifting Axle, K063070→
12/87→09/96	Suspension Arm Repair Kit		DB-RK-12372	for Wishbone (CV)K063070→
12/87→09/96	Suspension Arm Repair Kit		DF-RK-9336	
12/87→09/96	Suspension Arm Repair Kit		DF-RK-9336	* K 063 070 *→
12/87→09/96	Suspension Arm Repair Kit		DF-RK-9336	Lifting Axle, * K 063 070 *→
12/87→09/96	Suspension Arm Repair Kit		MN-RK-9387	
12/87→09/96	Suspension Arm Repair Kit		MN-RK-9387	→* 5 926 392 *
12/87→09/96	Suspension Arm Repair Kit		MN-RK-9387	Lifting Axle, →* 5 926 392 *
12/87→09/96	Suspension Arm Repair Kit		SC-RK-8688	for Drag Link
12/87→09/96	Suspension Arm Repair Kit	DB-RK-5282		
12/87→09/96	Suspension Arm Repair Kit	DB-RK-5303		
12/87→09/96	Tie Rod	DB-DL-8640		Guide Rod
12/87→09/96	Tie Rod	DB-ES-5209		
12/87→09/96	Tie Rod End	CV-ES-12461		for Steering Rod
12/87→09/96	Tie Rod End	CV-ES-12462		for Steering Rod
12/87→09/96	Tie Rod End	CV-ES-14163		for Steering Rod
12/87→09/96	Track Control Arm		DB-DL-5220	Trailing Arm
12/87→09/96	Track Control Arm		DB-DL-9164	Trailing Arm
12/87→09/96	Track Control Arm		DB-VB-10421	Wishbone (CV);Trailing Arm* 5 926 393 *→

3231 L

12/87→09/96	Ball Head, gearshift linkage	DB-ES-8387		
12/87→09/96	Ball Head, gearshift linkage	DB-ES-8492		
12/87→09/96	Ball Head, gearshift linkage	DB-ES-8500		
12/87→09/96	Centre Rod	DB-DL-5231		Push Rod* K 072 178 *→
12/87→09/96	Centre Rod	DB-DL-5241		Suspension Rod
12/87→09/96	Centre Rod	DB-DL-5412		Push Rod* K 017 164 *→* K 072 177 *
12/87→09/96	Centre Rod	DB-DL-7270		Push Rod;Suspension Rod
12/87→09/96	Centre Rod	DB-DL-7831		Push Rod
12/87→09/96	Centre Rod	DB-DL-8138		Push Rod
12/87→09/96	Centre Rod	DB-DL-8618		Push Rod
12/87→09/96	Centre Rod	DB-DL-8735		Push Rod
12/87→09/96	Centre Rod	DB-DL-12309		Coupling Rod
12/87→09/96	Stabiliser Mounting	DB-SB-5258	DB-SB-5258	
12/87→09/96	Suspension Arm Repair Kit		DB-RK-5284	→* K 097 019 *
12/87→09/96	Suspension Arm Repair Kit		DB-RK-5284	1st RA
12/87→09/96	Suspension Arm Repair Kit		DB-RK-8550	for Wishbone (CV)
12/87→09/96	Suspension Arm Repair Kit		DB-RK-8564	Wishbone (CV)
12/87→09/96	Suspension Arm Repair Kit		DB-RK-12372	for Wishbone (CV), Lifting Axle, K063070→
12/87→09/96	Suspension Arm Repair Kit		DB-RK-12372	for Wishbone (CV)K063070→
12/87→09/96	Suspension Arm Repair Kit		DF-RK-9336	
12/87→09/96	Suspension Arm Repair Kit		DF-RK-9336	* K 063 070 *→

CV-ES-12461

Length: 120
 Cone Ø: d1 Ø 26 / d2 Ø 23,5
 Thread: M30 x 1,5 LHT
 0003300035, 3300148, 0003406213, 0013306635,
 0013308835, 0014604048, 0014604348,
 14606448, 0024600248, 3023300035,
 3023300135, 3023300235, 3023300335,
 3453307235, 3453307435, 3503307135,
 A0003300148, A0013306635, A0013308835,
 A0014604048, A0014604348, A0014606448,
 A0024600248, A3023300035, A3023300135,
 A3023300235, A3023300335, A3503307135



CV-ES-12462

Length: 120
 Cone Ø: d1 Ø 26 / d2 Ø 23,5
 Thread: M30 x 1,5 RHT
 0003300135, 0003300248, 0003303235,
 0003305835, 0003307335, 0003383410,
 004608348, 0004608348, 0004632229,
 0004633129, 0004633429, 0004633529,
 0013300135, 0013300235, 0013306735,
 0014603448, 0014604148, 0014604448,
 0014606348, 0014608348, 0014608448,
 0014609748, 0023301535, 3453307135,
 3503307035, 3503307335, 3643307135,
 5001832582, A0003300248, A0003303235,
 A0003307335, A0003383410, A0004608348,
 A0004632229, A0004633429, A0013300135,
 A0013300235, A0013306735, A0014603448,
 A0014604148, A0014604448, A0014606348,
 A0014608348, A0014608448, A0014609748,
 A0023301535



CV-ES-14163

Length: 125
 Cone Ø: d1 Ø 30 / d2 Ø 27
 Thread: M30 x 1,5 RHT
 0003305248, 0003387310, 0004600348,
 0004600948, 0004602848, 0004602948,
 0004608948, 0014600248, 0014600848,
 0014601248, 0014602248, 0014607748,
 0024600148, A0003387310, A0004600348,
 A0004602848, A0004602948, A0014600848,
 A0014601248, A0014602248, A0014607748



DB-DL-5217

Length: 862 Ø: 40
 Cone Ø: d1 Ø 30 / d2 Ø 27
 01214700A, 6204600405, 6204600805,
 6204602905, 6204603005



DB-DL-5220

Length: 522
 Ø: 52
 Hole Distance: 151
 01335200A, 3813500606, 6523500306,
 6533500106



DB-DL-5231

Length: 840
 Ø: 52
 Cone Ø: d1 Ø 32 / d2 Ø 29
 01208500A, 14602905, 0014602905, 0014603005,
 14603005, A0014602905



DB-DL-5241

Length: 875 Ø: 40
 Cone Ø: d1 Ø 30 / d2 Ø 27
 01215300A, 0004609205, 0004609305,
 0014606905



DB-DL-5412

Length: 840
 Ø: 48
 Cone Ø: d1 Ø 32 / d2 Ø 30
 01214400A, 0014600305, 14600305, 0014600405,
 14600405



DB-DL-7270

Length: 875 Ø: 40
 Cone Ø: d1 Ø 28,6 / d2 Ø 29,9
 01208300A, 0024604705, 0024604805,
 0034604905, A0024604705



DB-DL-7831

Length: 870
 Ø: 42
 Cone Ø: d1 Ø 30 / d2 Ø 27
 01215200A, 6254602505



DB-DL-8131

Length: 1115 Ø: 52
 Cone Ø: d1 Ø 32 / d2 Ø 28,8
 0004604405, 6254605005



DB-DL-8138

Length: 1130
 Ø: 40
 Cone Ø: d1 Ø 32 / d2 Ø 28,8
 0004606605, 4606605



DB-DL-8618

Length: 680
 Ø: 42
 Cone Ø: d1 Ø 32 / d2 Ø 28,8
 0004604305, 4604305, 6254604805



DB-DL-8640

Length: 1615 Ø: 50
 Cone Ø: d1 Ø 32 / d2 Ø 29
 6253301503, 6253301603, 6253302403,
 6253302503, 9423300803, 9423302103,
 9493300203, 9493300303, 9493300903



DB-DL-8735

Length: 825
 Ø: 42
 Cone Ø: d1 Ø 30 / d2 Ø 27
 Thread: M24 x 1,5
 0004601005, 4601005, 0004601105, 4601105



DB-DL-9164

Length: 500
 Ø: 50
 Hole Distance: 152 / 152
 3853500006, 6533500006



DB-DL-10216

Length: 1190
 Ø: 40
 Cone Ø: d1 Ø 32 / d2 Ø 29
 0004604905



DB-DL-12309

Length: 685 Ø: 40
 Cone Ø: d1 Ø 32 / d2 Ø 28,8
 0004606005, 0004606305



DB-ES-5209

Length: 1670 Ø: 50
 Cone Ø: d1 Ø 30 / d2 Ø 27
 6203300503, 6203300603



DB-ES-8387

Length: 55
 Cone Ø: d1 Ø 10 / d2 Ø 10
 Thread: M14 x 1,5 RHT
 0009966845, 0009967045



DB-ES-8492

Length: 60
 Cone Ø: d1 Ø 10 / d2 Ø 10
 Thread: M12 x 1,75 RHT
 0009966645, 3752680189, A3752680189



DB-ES-8500

Length: 55
 Cone Ø: d1 Ø 12 / d2 Ø 10,8
 Thread: M14 x 1,5 RHT
 0002685989



DB-RK-5282

Ø: 59
 01303800A, 6553200111



DB-RK-5284

Ø: 65
 01303900A, 6523200511



DB-RK-5303

Ø: 37
 01304400A, 6253200611



DB-RK-8550

Ø: 75 Hole Distance: 152
 Thick/Height: 24
 0003502105, 0003504605



DB-RK-8564

Ø: 90
 01302200A, 3500105, 0003500105, 0003500405,
 3500405, 0005861833, 5861833, 81432706047



DB-RK-12372

Ø: 85
 Hole Distance: 152
 Thick/Height: 24
 003501805, A003501805



DB-SB-5258

Ø: 70
 Thick/Height: 62
 01311400A, 3873230285



DB-SB-10407

Ø: 61 Thick/Height: 46
 0003235985, 0003262481, 0003262981



DB-VB-10421

Length: 623
 Ø: 56
 Hole Distance: 152 / 152
 6533500405



DF-RK-9336

Ø: 108
 0003501705, 3501705



MN-RK-9387

Ø: 90
 0003500105, 81432706047



SC-RK-8688

Length: 95
 Ø: 95
 0003501905, 3501905





MK ...

3231 L ...	12/87→09/96	Suspension Arm Repair Kit		DF-RK-9336	Lifting Axle, * K 063 070 *→
	12/87→09/96	Suspension Arm Repair Kit		MN-RK-9387	
	12/87→09/96	Suspension Arm Repair Kit		MN-RK-9387	→* 5 926 392 *
	12/87→09/96	Suspension Arm Repair Kit		MN-RK-9387	Lifting Axle, →* 5 926 392 *
	12/87→09/96	Suspension Arm Repair Kit		SC-RK-8688	for Drag Link
	12/87→09/96	Suspension Arm Repair Kit	DB-RK-5282		
	12/87→09/96	Tie Rod	DB-DL-8640		Guide Rod
	12/87→09/96	Tie Rod	DB-ES-5209		
	12/87→09/96	Track Control Arm		DB-DL-5220	Trailing Arm
12/87→09/96	Track Control Arm		DB-VB-10421	Wishbone (CV);Trailing Arm* 5 926 393 *→	

NG

1013	02/76→12/84	Centre Rod	DB-DL-8121		Push Rod
	02/76→12/84	Tie Rod End	CV-ES-12461		for Steering Rod
	02/76→12/84	Tie Rod End	CV-ES-12462		for Steering Rod
1013 A	02/76→12/86	Centre Rod	DB-DL-8676		Push Rod
	02/76→12/86	Tie Rod End	CV-ES-12461		for Steering Rod
	02/76→12/86	Tie Rod End	CV-ES-12462		for Steering Rod
1013 AK	02/76→12/84	Centre Rod	DB-DL-8676		Push Rod
	02/76→12/84	Tie Rod End	CV-ES-12461		for Steering Rod
	02/76→12/84	Tie Rod End	CV-ES-12462		for Steering Rod
1013 K	02/76→12/84	Centre Rod	DB-DL-8121		Push Rod
	02/76→12/84	Tie Rod End	CV-ES-12461		for Steering Rod
	02/76→12/84	Tie Rod End	CV-ES-12462		for Steering Rod
1013 KO	02/76→12/84	Centre Rod	DB-DL-5216		Push Rod
	02/76→12/84	Centre Rod	DB-DL-8121		Push Rod
	02/76→12/84	Centre Rod	DB-DL-8121		Push Rod→* 4 640 759 *
	02/76→12/84	Tie Rod End	CV-ES-12461		for Steering Rod
	02/76→12/84	Tie Rod End	CV-ES-12462		for Steering Rod
1013 S	02/76→12/84	Centre Rod	DB-DL-8121		Push Rod
	02/76→12/84	Tie Rod End	CV-ES-12461		for Steering Rod
	02/76→12/84	Tie Rod End	CV-ES-12462		for Steering Rod
1017	11/75→02/91	Centre Rod	DB-DL-8121		Push Rod
	11/75→02/91	Tie Rod End	CV-ES-12461		for Steering Rod
	11/75→02/91	Tie Rod End	CV-ES-12462		for Steering Rod
1017 A	11/75→02/91	Centre Rod	DB-DL-8676		Push Rod
	11/75→02/91	Tie Rod End	CV-ES-12461		for Steering Rod
	11/75→02/91	Tie Rod End	CV-ES-12462		for Steering Rod
1017 AF	11/75→09/85	Centre Rod	DB-DL-8676		Push Rod
	11/75→09/85	Tie Rod End	CV-ES-12461		for Steering Rod
	11/75→09/85	Tie Rod End	CV-ES-12462		for Steering Rod
1017 AK	02/76→12/84	Centre Rod	DB-DL-8676		Push Rod
	02/76→12/84	Tie Rod End	CV-ES-12461		for Steering Rod
	02/76→12/84	Tie Rod End	CV-ES-12462		for Steering Rod
1017 AS	04/77→09/85	Centre Rod	DB-DL-8676		Push Rod
	04/77→09/85	Tie Rod End	CV-ES-12461		for Steering Rod
	04/77→09/85	Tie Rod End	CV-ES-12462		for Steering Rod
1017 K	02/76→12/84	Centre Rod	DB-DL-8121		Push Rod
	02/76→12/84	Tie Rod End	CV-ES-12461		for Steering Rod
	02/76→12/84	Tie Rod End	CV-ES-12462		for Steering Rod
1017 KO,1017 F	08/73→09/96	Centre Rod	DB-DL-5216		Push Rod
	08/73→09/96	Centre Rod	DB-DL-8121		Push Rod
	08/73→09/96	Centre Rod	DB-DL-8121		Push Rod→* 0 640 759 *
	08/73→09/96	Tie Rod End	CV-ES-12461		for Steering Rod
	08/73→09/96	Tie Rod End	CV-ES-12462		for Steering Rod
1017 S,1017 LS	08/73→09/96	Centre Rod	DB-DL-8121		Push Rod
	08/73→09/96	Suspension Arm Repair Kit		CV-RK-8118	for Drag Link
	08/73→09/96	Suspension Arm Repair Kit		DB-RK-8380	for Drag Link
	08/73→09/96	Suspension Arm Repair Kit		DB-RK-8564	Wishbone (CV)
	08/73→09/96	Suspension Strut Repair Kit		DF-RK-8671	
	08/73→09/96	Tie Rod End	CV-ES-12461		for Steering Rod
	08/73→09/96	Tie Rod End	CV-ES-12462		for Steering Rod
08/73→09/96	Track Control Arm		DB-DL-5220	Trailing Arm	

CV-ES-12461

Length: 120
Cone Ø: d1 Ø 26 / d2 Ø 23,5
Thread: M30 x 1,5 LHT
0003300035, 3300148, 0003406213, 0013306635,
0013308835, 0014604048, 0014604348,
14606448, 0024600248, 3023300035,
3023300135, 3023300235, 3023300335,
3453307235, 3453307435, 3503307135,
A0003300148, A0013306635, A0013308835,
A0014604048, A0014604348, A0014606448,
A0024600248, A3023300035, A3023300135,
A3023300235, A3023300335, A3503307135



CV-ES-12462

Length: 120
Cone Ø: d1 Ø 26 / d2 Ø 23,5
Thread: M30 x 1,5 RHT
0003300135, 0003300248, 0003303235,
0003305835, 0003307335, 0003383410,
0004608348, 004608348, 0004632229,
0004633129, 0004633429, 0004633529,
0013300135, 0013300235, 0013306735,
0014603448, 0014604148, 0014604448,
0014606348, 0014608348, 0014608448,
0014609748, 0023301535, 3453307135,
3503307035, 3503307335, 3643307135,
5001832582, A0003300248, A0003303235,
A0003307335, A0003383410, A0004608348,
A0004632229, A0004633429, A0013300135,
A0013300235, A0013306735, A0014603448,
A0014604148, A0014604448, A0014606348,
A0014608348, A0014608448, A0014609748,
A0023301535



CV-RK-8118

Ø: 85
Hole Distance: 130
Thick/Height: 30
0003500506, 3500506



DB-DL-5216

Length: 890
Ø: 42
Cone Ø: d1 Ø 26 / d2 Ø 23,5
01215700A, 3834600605, 3834601405,
3834602305, 3834604405



DB-DL-5220

Length: 522
Ø: 52
Hole Distance: 151
01335200A, 3813500606, 6523500306,
6533500106



DB-DL-8121

Length: 895
Ø: 40
Cone Ø: d1 Ø 22 / d2 Ø 19,9
01215600A, 3834600805, 3834601605,
3834602405, 3834604505



DB-DL-8640

Length: 1615 Ø: 50
Cone Ø: d1 Ø 32 / d2 Ø 29
6253301503, 6253301603, 6253302403,
6253302503, 9423300803, 9423302103,
9493300203, 9493300303, 9493300903



DB-DL-8676

Length: 865
Ø: 42
Cone Ø: d1 Ø 26 / d2 Ø 23,5
3854600805, 3854602005, 3854603405



DB-ES-5209

Length: 1670 Ø: 50
Cone Ø: d1 Ø 30 / d2 Ø 27
6203300503, 6203300603



DB-RK-5282

Ø: 59
01303800A, 6553200111



DB-RK-8380

Ø: 80
0005861035, 5861035



DB-RK-8564

Ø: 90
01302200A, 0003500105, 3500105, 0003500405,
3500405, 0005861833, 5861833, 81432706047



DB-VB-10421

Length: 623
Ø: 56
Hole Distance: 152 / 152
6533500405



DF-RK-8671



DF-RK-9336

Ø: 108
0003501705, 3501705



MN-RK-9387

Ø: 90
0003500105, 81432706047



SC-RK-8688

Length: 95
Ø: 95
0003501905, 3501905



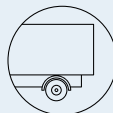

NG ...

1019 AF	01/79→12/82	Centre Rod	DB-DL-8676		Push Rod
	01/79→12/82	Tie Rod End	CV-ES-12461		for Steering Rod
	01/79→12/82	Tie Rod End	CV-ES-12462		for Steering Rod
1019 F	01/79→12/82	Centre Rod	DB-DL-5216		Push Rod
	01/79→12/82	Tie Rod End	CV-ES-12461		for Steering Rod
	01/79→12/82	Tie Rod End	CV-ES-12462		for Steering Rod
1213	09/75→05/86	Centre Rod	DB-DL-5216		Push Rod
	09/75→05/86	Centre Rod	DB-DL-8121		Push Rod
	09/75→05/86	Tie Rod End	CV-ES-12461		for Steering Rod
	09/75→05/86	Tie Rod End	CV-ES-12462		for Steering Rod
1213 A	09/75→05/86	Centre Rod	DB-DL-8676		Push Rod
	09/75→05/86	Tie Rod End	CV-ES-12461		for Steering Rod
	09/75→05/86	Tie Rod End	CV-ES-12462		for Steering Rod
1213 AK	09/75→05/86	Centre Rod	DB-DL-8676		Push Rod
	09/75→05/86	Tie Rod End	CV-ES-12461		for Steering Rod
	09/75→05/86	Tie Rod End	CV-ES-12462		for Steering Rod
1213 AKO	09/75→05/86	Centre Rod	DB-DL-8676		Push Rod
	09/75→05/86	Tie Rod End	CV-ES-12461		for Steering Rod
	09/75→05/86	Tie Rod End	CV-ES-12462		for Steering Rod
1213 AS	09/75→05/86	Centre Rod	DB-DL-8676		Push Rod
	09/75→05/86	Tie Rod End	CV-ES-12461		for Steering Rod
	09/75→05/86	Tie Rod End	CV-ES-12462		for Steering Rod
1213 K	09/75→05/86	Centre Rod	DB-DL-5216		Push Rod
	09/75→05/86	Centre Rod	DB-DL-8121		Push Rod
	09/75→05/86	Tie Rod End	CV-ES-12461		for Steering Rod
	09/75→05/86	Tie Rod End	CV-ES-12462		for Steering Rod
1213 KO	09/75→05/86	Centre Rod	DB-DL-5216		Push Rod
	09/75→05/86	Centre Rod	DB-DL-8121		Push Rod
	09/75→05/86	Tie Rod End	CV-ES-12461		for Steering Rod
1213 S	09/75→05/86	Tie Rod End	CV-ES-12462		for Steering Rod
	09/75→05/86	Centre Rod	DB-DL-5216		Push Rod
	09/75→05/86	Centre Rod	DB-DL-8121		Push Rod
	09/75→05/86	Tie Rod End	CV-ES-12461		for Steering Rod
1217 A	09/75→05/86	Tie Rod End	CV-ES-12462		for Steering Rod
	09/75→09/85	Centre Rod	DB-DL-8676		Push Rod
	09/75→09/85	Tie Rod End	CV-ES-12461		for Steering Rod
1217 AK	09/75→09/85	Tie Rod End	CV-ES-12462		for Steering Rod
	09/75→09/85	Centre Rod	DB-DL-8676		Push Rod
	09/75→09/85	Tie Rod End	CV-ES-12461		for Steering Rod
1217 AS	09/75→09/85	Tie Rod End	CV-ES-12462		for Steering Rod
	09/75→09/85	Centre Rod	DB-DL-8676		Push Rod
	09/75→09/85	Tie Rod End	CV-ES-12461		for Steering Rod
1217 CA	09/75→09/85	Tie Rod End	CV-ES-12462		for Steering Rod
	05/82→10/90	Tie Rod	DB-DL-8632		Push Rod
	05/82→10/90	Tie Rod End	CV-ES-12461		for Steering Rod
1217 K	05/82→10/90	Tie Rod End	CV-ES-12462		for Steering Rod
	09/75→12/84	Centre Rod	DB-DL-5216		Push Rod
	09/75→12/84	Centre Rod	DB-DL-8121		Push Rod
1217 KO	09/75→12/84	Tie Rod End	CV-ES-12461		for Steering Rod
	09/75→12/84	Tie Rod End	CV-ES-12462		for Steering Rod
	09/75→09/85	Centre Rod	DB-DL-5216		Push Rod
	09/75→09/85	Centre Rod	DB-DL-8121		Push Rod
1217 S,1217 LS	09/75→09/85	Tie Rod End	CV-ES-12461		for Steering Rod
	09/75→09/85	Tie Rod End	CV-ES-12462		for Steering Rod
	08/73→09/96	Centre Rod	DB-DL-5216		Push Rod
	08/73→09/96	Centre Rod	DB-DL-8121		Push Rod
	08/73→09/96	Suspension Arm Repair Kit		CV-RK-8118	for Drag Link
	08/73→09/96	Suspension Arm Repair Kit		DB-RK-8380	Wishbone (CV)
	08/73→09/96	Suspension Arm Repair Kit		DB-RK-8564	Wishbone (CV)
08/73→09/96	Suspension Strut Repair Kit		DF-RK-8671		
1217 K	08/73→09/96	Tie Rod End	CV-ES-12461		for Steering Rod
	08/73→09/96	Tie Rod End	CV-ES-12462		for Steering Rod
	08/73→09/96	Track Control Arm		DB-DL-5220	Trailing Arm

CV-ES-12461

Length: 120

Cone Ø: d1 Ø 26 / d2 Ø 23,5

Thread: M30 x 1,5 LHT

0003300035, 3300148, 0003406213, 0013306635, 0013308835, 0014604048, 0014604348, 14606448, 0024600248, 3023300035, 3023300135, 3023300235, 3023300335, 3453307235, 3453307435, 3503307135, A0003300148, A0013306635, A0013308835, A0014604048, A0014604348, A0014606448, A0024600248, A3023300035, A3023300135, A3023300235, A3023300335, A3503307135



CV-ES-12462

Length: 120

Cone Ø: d1 Ø 26 / d2 Ø 23,5

Thread: M30 x 1,5 RHT

0003300135, 0003300248, 0003303235, 0003305835, 0003307335, 0003383410, 004608348, 0004608348, 0004632229, 0004633129, 0004633429, 0004633529, 0013300135, 0013300235, 0013306735, 0014603448, 0014604148, 0014604448, 0014606348, 0014608348, 0014608448, 0014609748, 0023301535, 3453307135, 3503307035, 3503307335, 3643307135, 5001832582, A0003300248, A0003303235, A0003307335, A0003383410, A0004608348, A0004632229, A0004633429, A0013300135, A0013300235, A0013306735, A0014603448, A0014604148, A0014604448, A0014606348, A0014608348, A0014608448, A0014609748, A0023301535



CV-RK-8118

Ø: 85

Hole Distance: 130

Thick/Height: 30

0003500506, 3500506



DB-DL-5216

Length: 890

Ø: 42

Cone Ø: d1 Ø 26 / d2 Ø 23,5

01215700A, 3834600605, 3834601405, 3834602305, 3834604405



DB-DL-5220

Length: 522

Ø: 52

Hole Distance: 151

01335200A, 3813500606, 6523500306, 6533500106



DB-DL-8121

Length: 895

Ø: 40

Cone Ø: d1 Ø 22 / d2 Ø 19,9

01215600A, 3834600805, 3834601605, 3834602405, 3834604505



DB-DL-8632

Length: 1635

Ø: 60

Cone Ø: d1 Ø 30 / d2 Ø 27

3853301303, 3853302103, 3853302203



DB-DL-8676

Length: 865

Ø: 42

Cone Ø: d1 Ø 26 / d2 Ø 23,5

3854600805, 3854602005, 3854603405



DB-RK-8380

Ø: 80

0005861035, 5861035



DB-RK-8564

Ø: 90

01302200A, 0003500105, 3500105, 0003500405, 3500405, 0005861833, 5861833, 8143270607



DF-RK-8671





NG ...

1217,1217 L	08/73→09/96	Centre Rod	DB-DL-5216	Push Rod
	08/73→09/96	Centre Rod	DB-DL-8121	Push Rod
	08/73→09/96	Suspension Arm Repair Kit	DB-RK-8380	Wishbone (CV)
	08/73→09/96	Tie Rod End	CV-ES-12461	for Steering Rod
	08/73→09/96	Tie Rod End	CV-ES-12462	for Steering Rod
	08/73→09/96	Track Control Arm	DB-DL-5220	Trailing Arm
1219	09/75→09/84	Centre Rod	DB-DL-5216	Push Rod
	09/75→09/84	Centre Rod	DB-DL-8121	Push Rod
	09/75→09/84	Tie Rod End	CV-ES-12461	for Steering Rod
	09/75→09/84	Tie Rod End	CV-ES-12462	for Steering Rod
1219 A	09/75→12/82	Centre Rod	DB-DL-8676	Push Rod
	09/75→12/82	Tie Rod End	CV-ES-12461	for Steering Rod
	09/75→12/82	Tie Rod End	CV-ES-12462	for Steering Rod
1219 AF	09/75→09/84	Centre Rod	DB-DL-8676	Push Rod
	09/75→09/84	Tie Rod End	CV-ES-12461	for Steering Rod
	09/75→09/84	Tie Rod End	CV-ES-12462	for Steering Rod
1219 AK	09/75→12/84	Centre Rod	DB-DL-8676	Push Rod
	09/75→12/84	Tie Rod End	CV-ES-12461	for Steering Rod
	09/75→12/84	Tie Rod End	CV-ES-12462	for Steering Rod
1219 F	09/75→09/84	Centre Rod	DB-DL-5216	Push Rod
	09/75→09/84	Centre Rod	DB-DL-8121	Push Rod
	09/75→09/84	Tie Rod End	CV-ES-12461	for Steering Rod
	09/75→09/84	Tie Rod End	CV-ES-12462	for Steering Rod
1219 K	09/75→09/84	Centre Rod	DB-DL-5216	Push Rod
	09/75→09/84	Centre Rod	DB-DL-8121	Push Rod
	09/75→09/84	Tie Rod End	CV-ES-12461	for Steering Rod
	09/75→09/84	Tie Rod End	CV-ES-12462	for Steering Rod
1219 S	09/75→09/84	Centre Rod	DB-DL-5216	Push Rod
	09/75→09/84	Centre Rod	DB-DL-8121	Push Rod
	09/75→09/84	Tie Rod End	CV-ES-12461	for Steering Rod
	09/75→09/84	Tie Rod End	CV-ES-12462	for Steering Rod
1222	07/82→02/90	Centre Rod	DB-DL-5239	Push Rod* 5 217 090 *→
	07/82→02/90	Suspension Arm Repair Kit	DB-RK-8380	for Drag Link
	07/82→02/90	Tie Rod	DB-DL-8632	
	07/82→02/90	Tie Rod End	CV-ES-12461	for Steering Rod
	07/82→02/90	Tie Rod End	CV-ES-12462	for Steering Rod
	07/82→02/90	Tie Rod End	CV-ES-14163	for Steering Rod
	07/82→02/90	Track Control Arm	DB-DL-5220	Trailing Arm
1222 A	05/82→10/90	Centre Rod	DB-DL-5239	Push Rod* 5 217 090 *→
	05/82→10/90	Tie Rod	DB-DL-8632	
	05/82→10/90	Tie Rod End	CV-ES-12461	for Steering Rod
	05/82→10/90	Tie Rod End	CV-ES-12462	for Steering Rod
	05/82→10/90	Tie Rod End	CV-ES-14163	for Steering Rod
1222 AF	05/82→12/91	Centre Rod	DB-DL-5239	Push Rod* 5 217 090 *→
	05/82→12/91	Tie Rod	DB-DL-8632	
	05/82→12/91	Tie Rod End	CV-ES-12461	for Steering Rod
	05/82→12/91	Tie Rod End	CV-ES-12462	for Steering Rod
	05/82→12/91	Tie Rod End	CV-ES-14163	for Steering Rod
1222 F	05/82→12/91	Tie Rod End	CV-ES-12461	for Steering Rod
	05/82→12/91	Tie Rod End	CV-ES-12462	for Steering Rod
1222 S	07/82→02/90	Tie Rod End	CV-ES-12461	for Steering Rod
	07/82→02/90	Tie Rod End	CV-ES-12462	for Steering Rod
	07/82→02/90	Tie Rod End	CV-ES-14163	for Steering Rod
1225 AF	05/82→12/91	Centre Rod	DB-DL-5239	Push Rod
	05/82→12/91	Centre Rod	DB-DL-5239	Push Rod* 5 217 090 *→
	05/82→12/91	Tie Rod	DB-DL-8632	
	05/82→12/91	Tie Rod End	CV-ES-12461	for Steering Rod
	05/82→12/91	Tie Rod End	CV-ES-12462	for Steering Rod
	05/82→12/91	Tie Rod End	CV-ES-14163	for Steering Rod
1228 AF	05/82→12/91	Centre Rod	DB-DL-5239	Push Rod
	05/82→12/91	Tie Rod	DB-DL-8632	
	05/82→12/91	Tie Rod End	CV-ES-12461	for Steering Rod
	05/82→12/91	Tie Rod End	CV-ES-12462	for Steering Rod
	05/82→12/91	Tie Rod End	CV-ES-14163	for Steering Rod

CV-ES-12461

Length: 120

Cone Ø: d1 Ø 26 / d2 Ø 23,5

Thread: M30 x 1,5 LHT

0003300035, 3300148, 0003406213, 0013306635,
0013308835, 0014604048, 0014604348,
14606448, 0024600248, 3023300035,
3023300135, 3023300235, 3023300335,
3453307235, 3453307435, 3503307135,
A0003300148, A0013306635, A0013308835,
A0014604048, A0014604348, A0014606448,
A0024600248, A3023300035, A3023300135,
A3023300235, A3023300335, A3503307135



CV-ES-12462

Length: 120

Cone Ø: d1 Ø 26 / d2 Ø 23,5

Thread: M30 x 1,5 RHT

0003300135, 0003300248, 0003303235,
0003305835, 0003307335, 0003383410,
0004608348, 004608348, 0004632229,
0004633129, 0004633429, 0004633529,
0013300135, 0013300235, 0013306735,
0014603448, 0014604148, 0014604448,
0014606348, 0014608348, 0014608448,
0014609748, 0023301535, 3453307135,
3503307035, 3503307335, 3643307135,
5001832582, A0003300248, A0003303235,
A0003307335, A0003383410, A0004608348,
A0004632229, A0004633429, A0013300135,
A0013300235, A0013306735, A0014603448,
A0014604148, A0014604448, A0014606348,
A0014608348, A0014608448, A0014609748,
A0023301535



CV-ES-14163

Length: 125

Cone Ø: d1 Ø 30 / d2 Ø 27

Thread: M30 x 1,5 RHT

0003305248, 0003387310, 0004600348,
0004600948, 0004602848, 0004602948,
0004608948, 0014600248, 0014600848,
0014601248, 0014602248, 0014607748,
0024600148, A0003387310, A0004600348,
A0004602848, A0004602948, A0014600848,
A0014601248, A0014602248, A0014607748



DB-DL-5216

Length: 890

Ø: 42

Cone Ø: d1 Ø 26 / d2 Ø 23,5

01215700A, 3834600605, 3834601405,
3834602305, 3834604405



DB-DL-5220

Length: 522

Ø: 52

Hole Distance: 151

01335200A, 3813500606, 6523500306,
6533500106



DB-DL-5239

Length: 862

Ø: 42

Cone Ø: d1 Ø 30 / d2 Ø 27

01214500A, 6174602405, 6174603405



DB-DL-8121

Length: 895

Ø: 40

Cone Ø: d1 Ø 22 / d2 Ø 19,9

01215600A, 3834600805, 3834601605,
3834602405, 3834604505



DB-DL-8632

Length: 1635

Ø: 60

Cone Ø: d1 Ø 30 / d2 Ø 27

3853301303, 3853302103, 3853302203



DB-DL-8676

Length: 865

Ø: 42

Cone Ø: d1 Ø 26 / d2 Ø 23,5

3854600805, 3854602005, 3854603405



DB-RK-8380

Ø: 80

0005861035, 5861035



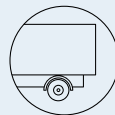

NG ...

1413	09/75→12/84	Centre Rod	DB-DL-5216	Push Rod
	09/75→12/84	Centre Rod	DB-DL-5216	Push Rod* 4 215 306 *→
	09/75→12/84	Centre Rod	DB-DL-8121	Push Rod→* 4 215 305 *
	09/75→12/84	Tie Rod End	CV-ES-12461	for Steering Rod
	09/75→12/84	Tie Rod End	CV-ES-12462	for Steering Rod
1413 A	09/75→12/84	Centre Rod	DB-DL-5216	Push Rod
	09/75→12/84	Centre Rod	DB-DL-8676	Push Rod
	09/75→12/84	Tie Rod End	CV-ES-12461	for Steering Rod
	09/75→12/84	Tie Rod End	CV-ES-12462	for Steering Rod
1413 AK	09/75→12/84	Centre Rod	DB-DL-5216	Push Rod
	09/75→12/84	Centre Rod	DB-DL-8676	Push Rod
	09/75→12/84	Tie Rod End	CV-ES-12461	for Steering Rod
1413 AKO	09/75→12/84	Centre Rod	DB-DL-5216	Push Rod
	09/75→12/84	Centre Rod	DB-DL-8676	Push Rod
	09/75→12/84	Tie Rod End	CV-ES-12461	for Steering Rod
	09/75→12/84	Tie Rod End	CV-ES-12462	for Steering Rod
1413 K	09/75→12/84	Centre Rod	DB-DL-5216	Push Rod
	09/75→12/84	Centre Rod	DB-DL-5216	Push Rod* 4 215 306 *→
	09/75→12/84	Centre Rod	DB-DL-8121	Push Rod→* 4 215 305 *
	09/75→12/84	Tie Rod End	CV-ES-12461	for Steering Rod
	09/75→12/84	Tie Rod End	CV-ES-12462	for Steering Rod
1413 KO	09/75→12/84	Centre Rod	DB-DL-5216	Push Rod
	09/75→12/84	Centre Rod	DB-DL-5216	Push Rod* 4 215 306 *→
	09/75→12/84	Centre Rod	DB-DL-8121	Push Rod→* 4 215 305 *
	09/75→12/84	Tie Rod End	CV-ES-12461	for Steering Rod
1414	04/84→03/91	Centre Rod	DB-DL-5207	Push Rod
	04/84→03/91	Centre Rod	DB-DL-8122	Push Rod
	04/84→03/91	Tie Rod End	CV-ES-12461	for Steering Rod
	04/84→03/91	Tie Rod End	CV-ES-12462	for Steering Rod
1414 K	04/84→03/91	Centre Rod	DB-DL-5207	Push Rod
	04/84→03/91	Centre Rod	DB-DL-8122	Push Rod
	04/84→03/91	Tie Rod End	CV-ES-12461	for Steering Rod
	04/84→03/91	Tie Rod End	CV-ES-12462	for Steering Rod
1417	05/75→12/84	Centre Rod	DB-DL-5216	Push Rod
	05/75→12/84	Centre Rod	DB-DL-5216	Push Rod* 4 215 306 *→
	05/75→12/84	Centre Rod	DB-DL-8121	Push Rod→* 4 215 305 *
	05/75→12/84	Tie Rod End	CV-ES-12461	for Steering Rod
	05/75→12/84	Tie Rod End	CV-ES-12462	for Steering Rod
1417 A	05/75→12/84	Centre Rod	DB-DL-5216	Push Rod
	05/75→12/84	Centre Rod	DB-DL-8676	Push Rod
	05/75→12/84	Tie Rod End	CV-ES-12461	for Steering Rod
	05/75→12/84	Tie Rod End	CV-ES-12462	for Steering Rod
1417 AK	05/75→12/84	Centre Rod	DB-DL-5216	Push Rod
	05/75→12/84	Centre Rod	DB-DL-8676	Push Rod
	05/75→12/84	Tie Rod End	CV-ES-12461	for Steering Rod
	05/75→12/84	Tie Rod End	CV-ES-12462	for Steering Rod
	05/75→12/84	Tie Rod End	CV-ES-12462	for Steering Rod
1417 AKO	05/75→12/84	Centre Rod	DB-DL-5216	Push Rod
	05/75→12/84	Centre Rod	DB-DL-8676	Push Rod
	05/75→12/84	Tie Rod End	CV-ES-12461	for Steering Rod
	05/75→12/84	Tie Rod End	CV-ES-12462	for Steering Rod
1417 C	04/84→03/91	Centre Rod	DB-DL-5207	Push Rod
	04/84→03/91	Centre Rod	DB-DL-8122	Push Rod
	04/84→03/91	Tie Rod End	CV-ES-12461	for Steering Rod
	04/84→03/91	Tie Rod End	CV-ES-12462	for Steering Rod
1417 CA	04/84→03/91	Centre Rod	DB-DL-5239	Push Rod* 5 217 090 *→
	04/84→03/91	Tie Rod	DB-DL-8632	
	04/84→03/91	Tie Rod End	CV-ES-12461	for Steering Rod
	04/84→03/91	Tie Rod End	CV-ES-12462	for Steering Rod
	04/84→03/91	Tie Rod End	CV-ES-14163	for Steering Rod

CV-ES-12461

Length: 120

Cone Ø: d1 Ø 26 / d2 Ø 23,5

Thread: M30 x 1,5 LHT

0003300035, 3300148, 0003406213, 0013306635,
0013308835, 0014604048, 0014604348,
14606448, 0024600248, 3023300035,
3023300135, 3023300235, 3023300335,
3453307235, 3453307435, 3503307135,
A0003300148, A0013306635, A0013308835,
A0014604048, A0014604348, A0014606448,
A0024600248, A3023300035, A3023300135,
A3023300235, A3023300335, A3503307135



CV-ES-12462

Length: 120

Cone Ø: d1 Ø 26 / d2 Ø 23,5

Thread: M30 x 1,5 RHT

0003300135, 0003300248, 0003303235,
0003305835, 0003307335, 0003383410,
004608348, 0004608348, 0004632229,
0004633129, 0004633429, 0004633529,
0013300135, 0013300235, 0013306735,
0014603448, 0014604148, 0014604448,
0014606348, 0014608348, 0014608448,
0014609748, 0023301535, 3453307135,
3503307035, 3503307335, 3643307135,
5001832582, A0003300248, A0003303235,
A0003307335, A0003383410, A0004608348,
A0004632229, A0004633429, A0013300135,
A0013300235, A0013306735, A0014603448,
A0014604148, A0014604448, A0014606348,
A0014608348, A0014608448, A0014609748,
A0023301535



CV-ES-14163

Length: 125

Cone Ø: d1 Ø 30 / d2 Ø 27

Thread: M30 x 1,5 RHT

0003305248, 0003387310, 0004600348,
0004600948, 0004602848, 0004602948,
0004608948, 0014600248, 0014600848,
0014601248, 0014602248, 0014607748,
0024600148, A0003387310, A0004600348,
A0004602848, A0004602948, A0014600848,
A0014601248, A0014602248, A0014607748



DB-DL-5207

Length: 875 Ø: 42

Cone Ø: d1 Ø 30 / d2 Ø 27

01215100A, 6174603505, 6174603605



DB-DL-5216

Length: 890

Ø: 42

Cone Ø: d1 Ø 26 / d2 Ø 23,5

01215700A, 3834600605, 3834601405,
3834602305, 3834604405



DB-DL-5239

Length: 862

Ø: 42

Cone Ø: d1 Ø 30 / d2 Ø 27

01214500A, 6174602405, 6174603405



DB-DL-8121

Length: 895

Ø: 40

Cone Ø: d1 Ø 22 / d2 Ø 19,9

01215600A, 3834600805, 3834601605,
3834602405, 3834604505



DB-DL-8122

Length: 875

Ø: 42

Cone Ø: d1 Ø 30 / d2 Ø 27

01215000A, 6174603205, 6174603305



DB-DL-8632

Length: 1635

Ø: 60

Cone Ø: d1 Ø 30 / d2 Ø 27

3853301303, 3853302103, 3853302203



DB-DL-8676

Length: 865

Ø: 42

Cone Ø: d1 Ø 26 / d2 Ø 23,5

3854600805, 3854602005, 3854603405





NG ...

1417 CAK	04/84→03/91	Centre Rod	DB-DL-5239		Push Rod* 5 217 090 *→
	04/84→03/91	Tie Rod	DB-DL-8632		
	04/84→03/91	Tie Rod End	CV-ES-12461		for Steering Rod
	04/84→03/91	Tie Rod End	CV-ES-12462		for Steering Rod
	04/84→03/91	Tie Rod End	CV-ES-14163		for Steering Rod
1417 CK	04/84→03/91	Centre Rod	DB-DL-5207		Push Rod
	04/84→03/91	Centre Rod	DB-DL-8122		Push Rod
	04/84→03/91	Tie Rod End	CV-ES-12461		for Steering Rod
	04/84→03/91	Tie Rod End	CV-ES-12462		for Steering Rod
1417 K	05/75→12/84	Centre Rod	DB-DL-5216		Push Rod
	05/75→12/84	Centre Rod	DB-DL-5216		Push Rod* 4 215 306 *→
	05/75→12/84	Centre Rod	DB-DL-8121		Push Rod→* 4 215 305 *
	05/75→12/84	Tie Rod End	CV-ES-12461		for Steering Rod
	05/75→12/84	Tie Rod End	CV-ES-12462		for Steering Rod
1417 KO	05/75→12/84	Centre Rod	DB-DL-5216		Push Rod
	05/75→12/84	Centre Rod	DB-DL-5216		Push Rod* 4 215 306 *→
	05/75→12/84	Centre Rod	DB-DL-8121		Push Rod→* 4 215 305 *
	05/75→12/84	Tie Rod End	CV-ES-12461		for Steering Rod
1419 AK	05/75→12/84	Centre Rod	DB-DL-5216		Push Rod
	05/75→12/84	Tie Rod End	CV-ES-12461		for Steering Rod
	05/75→12/84	Tie Rod End	CV-ES-12462		for Steering Rod
1419 AS	05/75→12/82	Centre Rod	DB-DL-5216		Push Rod
	05/75→12/82	Tie Rod End	CV-ES-12461		for Steering Rod
	05/75→12/82	Tie Rod End	CV-ES-12462		for Steering Rod
1419 C,1419 CL	08/73→09/96	Centre Rod	DB-DL-5207		Push Rod
	08/73→09/96	Centre Rod	DB-DL-8122		Push Rod
	08/73→09/96	Suspension Arm Repair Kit		DB-RK-8380	Wishbone (CV)
	08/73→09/96	Suspension Arm Repair Kit		DB-RK-8564	Wishbone (CV)
	08/73→09/96	Suspension Arm Repair Kit		MN-RK-9387	
	08/73→09/96	Suspension Arm Repair Kit		SC-RK-8688	for Drag Link
	08/73→09/96	Tie Rod End	CV-ES-12461		for Steering Rod
	08/73→09/96	Tie Rod End	CV-ES-12462		for Steering Rod
	08/73→09/96	Track Control Arm		DB-DL-5220	Trailing Arm
1419 F	05/75→12/82	Centre Rod	DB-DL-5216		Push Rod
	05/75→12/82	Tie Rod End	CV-ES-12461		for Steering Rod
	05/75→12/82	Tie Rod End	CV-ES-12462		for Steering Rod
1419 K	05/75→12/82	Centre Rod	DB-DL-5216		Push Rod
	05/75→12/82	Tie Rod End	CV-ES-12461		for Steering Rod
	05/75→12/82	Tie Rod End	CV-ES-12462		for Steering Rod
1419 S,1419 LS	08/73→09/96	Centre Rod	DB-DL-5216		Push Rod
	08/73→09/96	Suspension Arm Repair Kit		DB-RK-8380	Wishbone (CV)
	08/73→09/96	Suspension Arm Repair Kit		DB-RK-8564	Wishbone (CV)
	08/73→09/96	Tie Rod End	CV-ES-12461		for Steering Rod
	08/73→09/96	Tie Rod End	CV-ES-12462		for Steering Rod
1419,1419 L	08/73→09/96	Track Control Arm		DB-DL-5220	Trailing Arm
	08/73→09/96	Centre Rod	DB-DL-5216		Push Rod
	08/73→09/96	Suspension Arm Repair Kit		DB-RK-8380	Wishbone (CV)
	08/73→09/96	Suspension Arm Repair Kit		DB-RK-8564	Wishbone (CV)
	08/73→09/96	Tie Rod End	CV-ES-12461		for Steering Rod
	08/73→09/96	Tie Rod End	CV-ES-12462		for Steering Rod
1420 LS	07/85→03/91	Centre Rod	DB-DL-5207		Push Rod
	07/85→03/91	Centre Rod	DB-DL-8122		Push Rod
	07/85→03/91	Suspension Arm Repair Kit		DB-RK-8380	Wishbone (CV)
	07/85→03/91	Suspension Arm Repair Kit		DB-RK-8564	Wishbone (CV)
	07/85→03/91	Suspension Arm Repair Kit		MN-RK-9387	
	07/85→03/91	Tie Rod End	CV-ES-12461		for Steering Rod
	07/85→03/91	Tie Rod End	CV-ES-12462		for Steering Rod
	07/85→03/91	Track Control Arm		DB-DL-5220	Trailing Arm

CV-ES-12461

Length: 120
 Cone Ø: d1 Ø 26 / d2 Ø 23,5
 Thread: M30 x 1,5 LHT
 0003300035, 3300148, 0003406213, 0013306635,
 0013308835, 0014604048, 0014604348,
 14606448, 0024600248, 3023300035,
 3023300135, 3023300235, 3023300335,
 3453307235, 3453307435, 3503307135,
 A0003300148, A0013306635, A0013308835,
 A0014604048, A0014604348, A0014606448,
 A0024600248, A3023300035, A3023300135,
 A3023300235, A3023300335, A3503307135



CV-ES-12462

Length: 120
 Cone Ø: d1 Ø 26 / d2 Ø 23,5
 Thread: M30 x 1,5 RHT
 0003300135, 0003300248, 0003303235,
 0003305835, 0003307335, 0003383410,
 0004608348, 004608348, 0004632229,
 0004633129, 0004633429, 0004633529,
 0013300135, 0013300235, 0013306735,
 0014603448, 0014604148, 0014604448,
 0014606348, 0014608348, 0014608448,
 0014609748, 0023301535, 3453307135,
 3503307035, 3503307335, 3643307135,
 5001832582, A0003300248, A0003303235,
 A0003307335, A0003383410, A0004608348,
 A0004632229, A0004633429, A0013300135,
 A0013300235, A0013306735, A0014603448,
 A0014604148, A0014604448, A0014606348,
 A0014608348, A0014608448, A0014609748,
 A0023301535



CV-ES-14163

Length: 125
 Cone Ø: d1 Ø 30 / d2 Ø 27
 Thread: M30 x 1,5 RHT
 0003305248, 0003387310, 0004600348,
 0004600948, 0004602848, 0004602948,
 0004608948, 0014600248, 0014600848,
 0014601248, 0014602248, 0014607748,
 0024600148, A0003387310, A0004600348,
 A0004602848, A0004602948, A0014600848,
 A0014601248, A0014602248, A0014607748



DB-DL-5207

Length: 875 Ø: 42
 Cone Ø: d1 Ø 30 / d2 Ø 27
 01215100A, 6174603505, 6174603605



DB-DL-5216

Length: 890
 Ø: 42
 Cone Ø: d1 Ø 26 / d2 Ø 23,5
 01215700A, 3834600605, 3834601405,
 3834602305, 3834604405



DB-DL-5220

Length: 522
 Ø: 52
 Hole Distance: 151
 01335200A, 3813500606, 6523500306,
 6533500106



DB-DL-5239

Length: 862
 Ø: 42
 Cone Ø: d1 Ø 30 / d2 Ø 27
 01214500A, 6174602405, 6174603405



DB-DL-8121

Length: 895
 Ø: 40
 Cone Ø: d1 Ø 22 / d2 Ø 19,9
 01215600A, 3834600805, 3834601605,
 3834602405, 3834604505



DB-DL-8122

Length: 875
 Ø: 42
 Cone Ø: d1 Ø 30 / d2 Ø 27
 01215000A, 6174603205, 6174603305



DB-DL-8632

Length: 1635
 Ø: 60
 Cone Ø: d1 Ø 30 / d2 Ø 27
 3853301303, 3853302103, 3853302203



DB-RK-8380

Ø: 80
 0005861035, 5861035



DB-RK-8564

Ø: 90
 01302200A, 0003500105, 3500105, 0003500405,
 3500405, 0005861833, 5861833, 81432706047



MN-RK-9387

Ø: 90
 0003500105, 81432706047



SC-RK-8688

Length: 95
 Ø: 95
 0003501905, 3501905



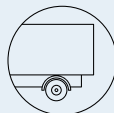

NG ...

1420,1420 L	08/73→09/96	Centre Rod	DB-DL-5207		Push Rod	
	08/73→09/96	Centre Rod	DB-DL-8122		Push Rod	
	08/73→09/96	Suspension Arm Repair Kit		DB-RK-8380	Wishbone (CV)	
	08/73→09/96	Suspension Arm Repair Kit		DB-RK-8564	Wishbone (CV)	
	08/73→09/96	Suspension Arm Repair Kit		MN-RK-9387		
	08/73→09/96	Suspension Arm Repair Kit		SC-RK-8688	for Drag Link	
	08/73→09/96	Tie Rod End	CV-ES-12461		for Steering Rod	
	08/73→09/96	Tie Rod End	CV-ES-12462		for Steering Rod	
	08/73→09/96	Track Control Arm		DB-DL-5220	Trailing Arm	
1422 F	05/82→10/90	Centre Rod	DB-DL-5207		Push Rod	
	05/82→10/90	Centre Rod	DB-DL-8122		Push Rod	
	05/82→10/90	Tie Rod End	CV-ES-12461		for Steering Rod	
	05/82→10/90	Tie Rod End	CV-ES-12462		for Steering Rod	
1422 S, 1422 LS	08/73→09/96	Centre Rod	DB-DL-5207		Push Rod	
	08/73→09/96	Centre Rod	DB-DL-8122		Push Rod	
	08/73→09/96	Suspension Arm Repair Kit		DB-RK-8380	Wishbone (CV)	
	08/73→09/96	Suspension Arm Repair Kit		DB-RK-8564	Wishbone (CV)	
	08/73→09/96	Suspension Arm Repair Kit		MN-RK-9387		
	08/73→09/96	Tie Rod End	CV-ES-12461		for Steering Rod	
	08/73→09/96	Tie Rod End	CV-ES-12462		for Steering Rod	
	08/73→09/96	Track Control Arm		DB-DL-5220	Trailing Arm	
	1422,1422 L	08/73→09/96	Centre Rod	DB-DL-5207		Push Rod
08/73→09/96		Centre Rod	DB-DL-8122		Push Rod	
08/73→09/96		Suspension Arm Repair Kit		CV-RK-8118	for Drag Link	
08/73→09/96		Suspension Arm Repair Kit		DB-RK-8380	Wishbone (CV)	
08/73→09/96		Suspension Arm Repair Kit		DB-RK-8564	Wishbone (CV)	
08/73→09/96		Suspension Arm Repair Kit		MN-RK-9387		
08/73→09/96		Suspension Strut Repair Kit		DF-RK-8671		
08/73→09/96		Tie Rod	DB-ES-5209			
08/73→09/96		Tie Rod End	CV-ES-12461		for Steering Rod	
08/73→09/96		Tie Rod End	CV-ES-12462		for Steering Rod	
08/73→09/96		Track Control Arm		DB-DL-5220	Trailing Arm	
1424 F		07/75→01/87	Centre Rod	DB-DL-5216		Push Rod
		07/75→01/87	Centre Rod	DB-DL-5216		Push Rod* 4 215 306 *→
	07/75→01/87	Centre Rod	DB-DL-8121		Push Rod→* 4 215 305 *	
	07/75→01/87	Tie Rod End	CV-ES-12461		for Steering Rod	
	07/75→01/87	Tie Rod End	CV-ES-12462		for Steering Rod	
	1424 K	07/75→01/87	Centre Rod	DB-DL-5216		Push Rod
07/75→01/87		Centre Rod	DB-DL-5216		Push Rod* 4 215 306 *→	
07/75→01/87		Centre Rod	DB-DL-8121		Push Rod→* 4 215 305 *	
07/75→01/87		Tie Rod End	CV-ES-12461		for Steering Rod	
07/75→01/87		Tie Rod End	CV-ES-12462		for Steering Rod	
1424 S,1424 LS	08/73→09/96	Centre Rod	DB-DL-5216		Push Rod	
	08/73→09/96	Centre Rod	DB-DL-5216		Push Rod* 4 215 306 *→	
	08/73→09/96	Centre Rod	DB-DL-8121		Push Rod→* 4 215 305 *	
	08/73→09/96	Suspension Arm Repair Kit		CV-RK-8118	for Drag Link	
	08/73→09/96	Suspension Arm Repair Kit		DB-RK-8380	Wishbone (CV)	
	08/73→09/96	Suspension Arm Repair Kit		DB-RK-8564	Wishbone (CV)	
	08/73→09/96	Suspension Strut Repair Kit		DF-RK-8671		
	08/73→09/96	Tie Rod End	CV-ES-12461		for Steering Rod	
	08/73→09/96	Tie Rod End	CV-ES-12462		for Steering Rod	
	08/73→09/96	Track Control Arm		DB-DL-5220	Trailing Arm	
1424,1424 L	08/73→09/96	Centre Rod	DB-DL-5216		Push Rod	
	08/73→09/96	Centre Rod	DB-DL-5216		Push Rod* 4 215 306 *→	
	08/73→09/96	Centre Rod	DB-DL-8121		Push Rod→* 4 215 305 *	
	08/73→09/96	Tie Rod End	CV-ES-12461		for Steering Rod	
	08/73→09/96	Tie Rod End	CV-ES-12462		for Steering Rod	
	1425 AF	08/73→09/96	Centre Rod	DB-DL-5239		Push Rod* 5 217 090 *→
08/73→09/96		Tie Rod	DB-DL-8632			
08/73→09/96		Tie Rod End	CV-ES-12461		for Steering Rod	
08/73→09/96		Tie Rod End	CV-ES-12462		for Steering Rod	
08/73→09/96		Tie Rod End	CV-ES-14163		for Steering Rod	

CV-ES-12461

Length: 120
Cone Ø: d1 Ø 26 / d2 Ø 23,5
Thread: M30 x 1,5 LHT
0003300035, 3300148, 0003406213, 0013306635,
0013308835, 0014604048, 0014604348,
14606448, 0024600248, 3023300035,
3023300135, 3023300235, 3023300335,
3453307235, 3453307435, 3503307135,
A0003300148, A0013306635, A0013308835,
A0014604048, A0014604348, A0014606448,
A0024600248, A3023300035, A3023300135,
A3023300235, A3023300335, A3503307135



CV-ES-12462

Length: 120
Cone Ø: d1 Ø 26 / d2 Ø 23,5
Thread: M30 x 1,5 RHT
0003300135, 0003300248, 0003303235,
0003305835, 0003307335, 0003383410,
0004608348, 004608348, 0004632229,
0004633129, 0004633429, 0004633529,
0013300135, 0013300235, 0013306735,
0014603448, 0014604148, 0014604448,
0014606348, 0014608348, 0014608448,
0014609748, 0023301535, 3453307135,
3503307035, 3503307335, 3643307135,
5001832582, A0003300248, A0003303235,
A0003307335, A0003383410, A0004608348,
A0004632229, A0004633429, A0013300135,
A0013300235, A0013306735, A0014603448,
A0014604148, A0014604448, A0014606348,
A0014608348, A0014608448, A0014609748,
A0023301535



CV-ES-14163

Length: 125
Cone Ø: d1 Ø 30 / d2 Ø 27
Thread: M30 x 1,5 RHT
0003305248, 0003387310, 0004600348,
0004600948, 0004602848, 0004602948,
0004608948, 0014600248, 0014600848,
0014601248, 0014602248, 0014607748,
0024600148, A0003387310, A0004600348,
A0004602848, A0004602948, A0014600848,
A0014601248, A0014602248, A0014607748



CV-RK-8118

Ø: 85
Hole Distance: 130
Thick/Height: 30
3500506, 0003500506



DB-DL-5207

Length: 875 **Ø:** 42
Cone Ø: d1 Ø 30 / d2 Ø 27
01215100A, 6174603505, 6174603605



DB-DL-5216

Length: 890
Ø: 42
Cone Ø: d1 Ø 26 / d2 Ø 23,5
01215700A, 3834600605, 3834601405,
3834602305, 3834604405



DB-DL-5220

Length: 522
Ø: 52
Hole Distance: 151
01335200A, 3813500606, 6523500306,
6533500106



DB-DL-5239

Length: 862
Ø: 42
Cone Ø: d1 Ø 30 / d2 Ø 27
01214500A, 6174602405, 6174603405



DB-DL-8121

Length: 895
Ø: 40
Cone Ø: d1 Ø 22 / d2 Ø 19,9
01215600A, 3834600805, 3834601605,
3834602405, 3834604505



DB-DL-8122

Length: 875
Ø: 42
Cone Ø: d1 Ø 30 / d2 Ø 27
01215000A, 6174603205, 6174603305



DB-DL-8632

Length: 1635
Ø: 60
Cone Ø: d1 Ø 30 / d2 Ø 27
3853301303, 3853302103, 3853302203



DB-ES-5209

Length: 1670 **Ø:** 50
Cone Ø: d1 Ø 30 / d2 Ø 27
6203300503, 6203300603



DB-RK-8380

Ø: 80
0005861035, 5861035



DB-RK-8564

Ø: 90
01302200A, 0003500105, 3500105, 0003500405,
3500405, 5861833, 0005861833, 81432706047



DF-RK-8671



MN-RK-9387

Ø: 90
0003500105, 81432706047



SC-RK-8688

Length: 95
Ø: 95
0003501905, 3501905





NG ...

1425 S,1425 LS	08/73→09/96	Centre Rod	DB-DL-5207		Push Rod
	08/73→09/96	Centre Rod	DB-DL-8122		Push Rod
	08/73→09/96	Suspension Arm Repair Kit		CV-RK-8118	for Drag Link
	08/73→09/96	Suspension Arm Repair Kit		DB-RK-8380	Wishbone (CV)
	08/73→09/96	Suspension Arm Repair Kit		DB-RK-8564	Wishbone (CV)
	08/73→09/96	Suspension Arm Repair Kit		MN-RK-9387	
	08/73→09/96	Suspension Strut Repair Kit		DF-RK-8671	
	08/73→09/96	Tie Rod End	CV-ES-12461		for Steering Rod
	08/73→09/96	Tie Rod End	CV-ES-12462		for Steering Rod
1428 AF	08/73→09/96	Track Control Arm		DB-DL-5220	Trailing Arm
	08/73→09/96	Centre Rod	DB-DL-5239		Push Rod
	08/73→09/96	Centre Rod	DB-DL-5239		Push Rod* 5 217 090 *→
	08/73→09/96	Tie Rod	DB-DL-8632		
	08/73→09/96	Tie Rod End	CV-ES-12461		for Steering Rod
	08/73→09/96	Tie Rod End	CV-ES-12462		for Steering Rod
1428 F	08/73→09/96	Tie Rod End	CV-ES-14163		for Steering Rod
	05/82→12/91	Tie Rod End	CV-ES-12461		for Steering Rod
1429 AF	05/82→12/91	Tie Rod End	CV-ES-12462		for Steering Rod
	08/73→09/96	Centre Rod	DB-DL-5239		Push Rod
1613 K	08/73→09/96	Tie Rod	DB-DL-8632		
	08/73→09/96	Tie Rod End	CV-ES-12461		for Steering Rod
	08/73→09/96	Tie Rod End	CV-ES-12462		for Steering Rod
	08/73→09/96	Tie Rod End	CV-ES-14163		for Steering Rod
1613 KO	08/73→09/96	Tie Rod End	CV-ES-14163		for Steering Rod
	01/75→12/84	Centre Rod	DB-DL-5216		Push Rod
	01/75→12/84	Tie Rod End	CV-ES-12461		for Steering Rod
1613 K0	01/75→12/84	Tie Rod End	CV-ES-12462		for Steering Rod
	01/75→12/84	Centre Rod	DB-DL-5216		Push Rod
	01/75→12/84	Tie Rod End	CV-ES-12461		for Steering Rod
1613,1613 L	01/75→12/84	Tie Rod End	CV-ES-12462		for Steering Rod
	08/73→09/96	Centre Rod	DB-DL-5216		Push Rod
	08/73→09/96	Suspension Arm Repair Kit		CV-RK-8118	for Drag Link
	08/73→09/96	Suspension Arm Repair Kit		DB-RK-8380	Wishbone (CV)
	08/73→09/96	Suspension Arm Repair Kit		DB-RK-8564	Wishbone (CV)
	08/73→09/96	Suspension Strut Repair Kit		DF-RK-8671	
	08/73→09/96	Tie Rod End	CV-ES-12461		for Steering Rod
1614	08/73→09/96	Tie Rod End	CV-ES-12462		for Steering Rod
	08/73→09/96	Track Control Arm		DB-DL-5220	Trailing Arm
	04/84→03/91	Centre Rod	DB-DL-5207		Push Rod* 5 259 613 *→
	04/84→03/91	Centre Rod	DB-DL-8122		Push Rod* 5 259 613 *→
	04/84→03/91	Centre Rod	DB-DL-8672		Push Rod* 1 5 259613 *→
	04/84→03/91	Tie Rod End	CV-ES-12461		for Steering Rod
	04/84→03/91	Tie Rod End	CV-ES-12462		for Steering Rod
	04/84→03/91	Tie Rod End	CV-ES-14163		for Steering Rod
	04/84→03/91	Track Control Arm		DB-DL-5220	Trailing Arm
	1614 K	04/84→03/91	Centre Rod	DB-DL-5207	
04/84→03/91		Centre Rod	DB-DL-8122		Push Rod* 5 259 613 *→
04/84→03/91		Centre Rod	DB-DL-8672		Push Rod* 1 5 259613 *→
04/84→03/91		Suspension Arm Repair Kit		DB-RK-8564	Wishbone (CV)
04/84→03/91		Tie Rod End	CV-ES-12461		for Steering Rod
04/84→03/91		Tie Rod End	CV-ES-12462		for Steering Rod
04/84→03/91		Tie Rod End	CV-ES-14163		for Steering Rod
1617 AK	01/75→07/85	Centre Rod	DB-DL-5216		Push Rod
	01/75→07/85	Tie Rod End	CV-ES-12461		for Steering Rod
	01/75→07/85	Tie Rod End	CV-ES-12462		for Steering Rod
1617 C,1617 CL	08/73→09/96	Centre Rod	DB-DL-5207		Push Rod* 5 259 613 *→
	08/73→09/96	Centre Rod	DB-DL-8122		Push Rod* 5 259 613 *→
	08/73→09/96	Centre Rod	DB-DL-8672		Push Rod* 1 5 259613 *→
	08/73→09/96	Suspension Arm Repair Kit		CV-RK-8118	for Drag Link
	08/73→09/96	Suspension Arm Repair Kit		DB-RK-8380	Wishbone (CV)
	08/73→09/96	Suspension Arm Repair Kit		DB-RK-8564	Wishbone (CV)
	08/73→09/96	Suspension Strut Repair Kit		DF-RK-8671	
	08/73→09/96	Tie Rod	DB-ES-5209		
	08/73→09/96	Tie Rod End	CV-ES-12461		for Steering Rod

CV-ES-12461

Length: 120
 Cone Ø: d1 Ø 26 / d2 Ø 23,5
 Thread: M30 x 1,5 LHT
 0003300035, 3300148, 0003406213, 0013306635,
 0013308835, 0014604048, 0014604348,
 14606448, 0024600248, 3023300035,
 3023300135, 3023300235, 3023300335,
 3453307235, 3453307435, 3503307135,
 A0003300148, A0013306635, A0013308835,
 A0014604048, A0014604348, A0014606448,
 A0024600248, A3023300035, A3023300135,
 A3023300235, A3023300335, A3503307135



CV-ES-12462

Length: 120
 Cone Ø: d1 Ø 26 / d2 Ø 23,5
 Thread: M30 x 1,5 RHT
 0003300135, 0003300248, 0003303235,
 0003305835, 0003307335, 0003383410,
 0004608348, 004608348, 0004632229,
 0004633129, 0004633429, 0004633529,
 0013300135, 0013300235, 0013306735,
 0014603448, 0014604148, 0014604448,
 0014606348, 0014608348, 0014608448,
 0014609748, 0023301535, 3453307135,
 3503307035, 3503307335, 3643307135,
 5001832582, A0003300248, A0003303235,
 A0003307335, A0003383410, A0004608348,
 A0004632229, A0004633429, A0013300135,
 A0013300235, A0013306735, A0014603448,
 A0014604148, A0014604448, A0014606348,
 A0014608348, A0014608448, A0014609748,
 A0023301535



CV-ES-14163

Length: 125
 Cone Ø: d1 Ø 30 / d2 Ø 27
 Thread: M30 x 1,5 RHT
 0003305248, 0003387310, 0004600348,
 0004600948, 0004602848, 0004602948,
 0004608948, 0014600248, 0014600848,
 0014601248, 0014602248, 0014607748,
 0024600148, A0003387310, A0004600348,
 A0004602848, A0004602948, A0014600848,
 A0014601248, A0014602248, A0014607748



CV-RK-8118

Ø: 85
 Hole Distance: 130
 Thick/Height: 30
 0003500506, 3500506



DB-DL-5207

Length: 875 Ø: 42
 Cone Ø: d1 Ø 30 / d2 Ø 27
 01215100A, 6174603505, 6174603605



DB-DL-5216

Length: 890
 Ø: 42
 Cone Ø: d1 Ø 26 / d2 Ø 23,5
 01215700A, 3834600605, 3834601405,
 3834602305, 3834604405



DB-DL-5220

Length: 522
 Ø: 52
 Hole Distance: 151
 01335200A, 3813500606, 6523500306,
 6533500106



DB-DL-5239

Length: 862
 Ø: 42
 Cone Ø: d1 Ø 30 / d2 Ø 27
 01214500A, 6174602405, 6174603405



DB-DL-8122

Length: 875
 Ø: 42
 Cone Ø: d1 Ø 30 / d2 Ø 27
 01215000A, 6174603205, 6174603305



DB-DL-8632

Length: 1635
 Ø: 60
 Cone Ø: d1 Ø 30 / d2 Ø 27
 3853301303, 3853302103, 3853302203



DB-DL-8672

Length: 860
 Ø: 48
 Cone Ø: d1 Ø 30 / d2 Ø 27
 0014609705, 14609705



DB-ES-5209

Length: 1670 Ø: 50
 Cone Ø: d1 Ø 30 / d2 Ø 27
 6203300503, 6203300603



DB-RK-8380

Ø: 80
 0005861035, 5861035



DB-RK-8564

Ø: 90
 01302200A, 0003500105, 3500105, 0003500405,
 3500405, 5861833, 0005861833, 81432706047



DF-RK-8671



MN-RK-9387

Ø: 90
 0003500105, 81432706047



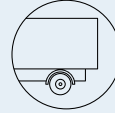
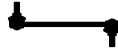

NG ...

1617 C,1617 CL ...	08/73→09/96	Tie Rod End	CV-ES-12462		for Steering Rod
	08/73→09/96	Tie Rod End	CV-ES-14163		for Steering Rod
	08/73→09/96	Track Control Arm		DB-DL-5220	Trailing Arm
1617 CAK	04/84→03/91	Centre Rod	DB-DL-5239		Push Rod* 5 180 857 *→
	04/84→03/91	Suspension Arm Repair Kit		DB-RK-8564	Wishbone (CV)
	04/84→03/91	Tie Rod	DB-DL-8632		
	04/84→03/91	Tie Rod End	CV-ES-12461		for Steering Rod
1617 CK	04/84→03/91	Tie Rod End	CV-ES-12462		for Steering Rod
	04/84→03/91	Centre Rod	DB-DL-5207		Push Rod* 5 259 613 *→
	04/84→03/91	Centre Rod	DB-DL-8122		Push Rod* 5 259 613 *→
	04/84→03/91	Centre Rod	DB-DL-8672		Push Rod* 1 5 259613 *→
1617 CS	04/84→03/91	Suspension Arm Repair Kit		DB-RK-8564	Wishbone (CV)
	04/84→03/91	Tie Rod End	CV-ES-12461		for Steering Rod
	04/84→03/91	Tie Rod End	CV-ES-12462		for Steering Rod
	04/84→03/91	Tie Rod End	CV-ES-14163		for Steering Rod
1617 K	04/84→03/91	Centre Rod	DB-DL-5207		Push Rod* 5 259 613 *→
	04/84→03/91	Centre Rod	DB-DL-8122		Push Rod* 5 259 613 *→
	04/84→03/91	Centre Rod	DB-DL-8672		Push Rod* 1 5 259613 *→
	04/84→03/91	Suspension Arm Repair Kit		DB-RK-8564	Wishbone (CV)
1617 KO	04/84→03/91	Tie Rod End	CV-ES-12461		for Steering Rod
	04/84→03/91	Tie Rod End	CV-ES-12462		for Steering Rod
	04/84→03/91	Tie Rod End	CV-ES-14163		for Steering Rod
	01/75→07/85	Centre Rod	DB-DL-5216		Push Rod
1617 K	01/75→07/85	Tie Rod End	CV-ES-12461		for Steering Rod
	01/75→07/85	Tie Rod End	CV-ES-12462		for Steering Rod
	01/75→07/85	Tie Rod End	CV-ES-12466		for Steering Rod
1617 S	01/75→07/85	Centre Rod	DB-DL-5216		Push Rod
	01/75→07/85	Tie Rod End	CV-ES-12461		for Steering Rod
	01/75→07/85	Tie Rod End	CV-ES-12462		for Steering Rod
1617,1617 L	01/75→07/85	Tie Rod End	CV-ES-14163		for Steering Rod
	08/73→09/96	Centre Rod	DB-DL-5216		Push Rod
	08/73→09/96	Suspension Arm Repair Kit		DB-RK-8380	Wishbone (CV)
	08/73→09/96	Suspension Arm Repair Kit		DB-RK-8564	Wishbone (CV)
	08/73→09/96	Tie Rod End	CV-ES-12461		for Steering Rod
	08/73→09/96	Tie Rod End	CV-ES-12462		for Steering Rod
1619 AK	08/73→09/96	Track Control Arm		DB-DL-5220	Trailing Arm
	11/74→12/82	Centre Rod	DB-DL-5216		Push Rod
	11/74→12/82	Centre Rod	DB-DL-8676		Push Rod
	11/74→12/82	Tie Rod End	CV-ES-12461		for Steering Rod
1619 C,1619 CL	11/74→12/82	Tie Rod End	CV-ES-12462		for Steering Rod
	08/73→09/96	Centre Rod	DB-DL-5207		Push Rod* 5 259 613 *→
	08/73→09/96	Centre Rod	DB-DL-8122		Push Rod* 5 259 613 *→
	08/73→09/96	Centre Rod	DB-DL-8672		Push Rod* 1 5 259613 *→
	08/73→09/96	Suspension Arm Repair Kit		DB-RK-8380	Wishbone (CV)
	08/73→09/96	Tie Rod	DB-ES-5209		
	08/73→09/96	Tie Rod End	CV-ES-12461		for Steering Rod
	08/73→09/96	Tie Rod End	CV-ES-12462		for Steering Rod
1619 K	08/73→09/96	Tie Rod End	CV-ES-14163		for Steering Rod
	08/73→09/96	Track Control Arm		DB-DL-5220	Trailing Arm
	11/74→12/82	Centre Rod	DB-DL-5216		Push Rod
1619 KO	11/74→12/82	Tie Rod End	CV-ES-12461		for Steering Rod
	11/74→12/82	Tie Rod End	CV-ES-12462		for Steering Rod
	11/74→01/87	Centre Rod	DB-DL-5216		Push Rod
1619 S	11/74→01/87	Tie Rod End	CV-ES-12461		for Steering Rod
	11/74→01/87	Tie Rod End	CV-ES-12462		for Steering Rod
	11/74→12/84	Centre Rod	DB-DL-5216		Push Rod
1619,1619 L	11/74→12/84	Tie Rod End	CV-ES-12461		for Steering Rod
	11/74→12/84	Tie Rod End	CV-ES-12462		for Steering Rod
	08/73→09/96	Centre Rod	DB-DL-5216		Push Rod
	08/73→09/96	Suspension Arm Repair Kit		DB-RK-8380	Wishbone (CV)
1619,1619 L	08/73→09/96	Suspension Arm Repair Kit		DB-RK-8564	Wishbone (CV)
	08/73→09/96	Tie Rod End	CV-ES-12461		for Steering Rod

CV-ES-12461

Length: 120
Cone Ø: d1 Ø 26 / d2 Ø 23,5
Thread: M30 x 1,5 LHT
0003300035, 3300148, 0003406213, 0013306635,
0013308835, 0014604048, 0014604348,
14606448, 0024600248, 3023300035,
3023300135, 3023300235, 3023300335,
3453307235, 3453307435, 3503307135,
A0003300148, A0013306635, A0013308835,
A0014604048, A0014604348, A0014606448,
A0024600248, A3023300035, A3023300135,
A3023300235, A3023300335, A3503307135



CV-ES-12462

Length: 120
Cone Ø: d1 Ø 26 / d2 Ø 23,5
Thread: M30 x 1,5 RHT
0003300135, 0003300248, 0003303235,
0003305835, 0003307335, 0003383410,
0004608348, 004608348, 0004632229,
0004633129, 0004633429, 0004633529,
0013300135, 0013300235, 0013306735,
0014603448, 0014604148, 0014604448,
0014606348, 0014608348, 0014608448,
0014609748, 0023301535, 3453307135,
3503307035, 3503307335, 3643307135,
5001832582, A0003300248, A0003303235,
A0003307335, A0003383410, A0004608348,
A0004632229, A0004633429, A0013300135,
A0013300235, A0013306735, A0014603448,
A0014604148, A0014604448, A0014606348,
A0014608348, A0014608448, A0014609748,
A0023301535



CV-ES-14163

Length: 125
Cone Ø: d1 Ø 30 / d2 Ø 27
Thread: M30 x 1,5 RHT
0003305248, 0003387310, 0004600348,
0004600948, 0004602848, 0004602948,
0004608948, 0014600248, 0014600848,
0014601248, 0014602248, 0014607748,
0024600148, A0003387310, A0004600348,
A0004602848, A0004602948, A0014600848,
A0014601248, A0014602248, A0014607748



DB-DL-5207

Length: 875 Ø: 42
Cone Ø: d1 Ø 30 / d2 Ø 27
01215100A, 6174603505, 6174603605



DB-DL-5216

Length: 890
Ø: 42
Cone Ø: d1 Ø 26 / d2 Ø 23,5
01215700A, 3834600605, 3834601405,
3834602305, 3834604405



DB-DL-5220

Length: 522
Ø: 52
Hole Distance: 151
01335200A, 3813500606, 6523500306,
6533500106



DB-DL-5239

Length: 862
Ø: 42
Cone Ø: d1 Ø 30 / d2 Ø 27
01214500A, 6174602405, 6174603405



DB-DL-8122

Length: 875
Ø: 42
Cone Ø: d1 Ø 30 / d2 Ø 27
01215000A, 6174603205, 6174603305



DB-DL-8632

Length: 1635
Ø: 60
Cone Ø: d1 Ø 30 / d2 Ø 27
3853301303, 3853302103, 3853302203



DB-DL-8672

Length: 860
Ø: 48
Cone Ø: d1 Ø 30 / d2 Ø 27
14609705, 0014609705



DB-DL-8676

Length: 865
Ø: 42
Cone Ø: d1 Ø 26 / d2 Ø 23,5
3854600805, 3854602005, 3854603405



DB-ES-5209

Length: 1670 Ø: 50
Cone Ø: d1 Ø 30 / d2 Ø 27
6203300503, 6203300603



DB-RK-8380

Ø: 80
0005861035, 5861035



DB-RK-8564

Ø: 90
01302200A, 0003500105, 3500105, 0003500405,
3500405, 5861833, 0005861833, 81432706047



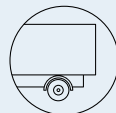

NG ...

1619,1619 L ...	08/73→09/96	Tie Rod End	CV-ES-12462		for Steering Rod
	08/73→09/96	Track Control Arm		DB-DL-5220	Trailing Arm
1620,1620 L	08/73→09/96	Centre Rod	DB-DL-5207		Push Rod* 5 259 613 *→
	08/73→09/96	Centre Rod	DB-DL-8122		Push Rod* 5 259 613 *→
	08/73→09/96	Centre Rod	DB-DL-8672		Push Rod* 1 5 259613 *→
	08/73→09/96	Suspension Arm Repair Kit		DB-RK-8380	Wishbone (CV)
	08/73→09/96	Tie Rod	DB-ES-5209		
	08/73→09/96	Tie Rod End	CV-ES-12461		for Steering Rod
	08/73→09/96	Tie Rod End	CV-ES-12462		for Steering Rod
	08/73→09/96	Tie Rod End	CV-ES-14163		for Steering Rod
1622 AK	08/73→09/96	Track Control Arm		DB-DL-5220	Trailing Arm
	05/82→10/89	Centre Rod	DB-DL-5207		Push Rod
	05/82→10/89	Centre Rod	DB-DL-5239		Push Rod* 5 180 857 *→
	05/82→10/89	Centre Rod	DB-DL-10216		Push Rod
	05/82→10/89	Suspension Arm Repair Kit		DB-RK-8564	Wishbone (CV)
	05/82→10/89	Tie Rod	DB-DL-8632		
	05/82→10/89	Tie Rod End	CV-ES-12461		for Steering Rod
	05/82→10/89	Tie Rod End	CV-ES-12462		for Steering Rod
	05/82→10/89	Tie Rod End	CV-ES-14163		for Steering Rod
1622 K	05/82→10/89	Centre Rod	DB-DL-5207		Push Rod* 5 259 613 *→
	05/82→10/89	Centre Rod	DB-DL-8122		Push Rod* 5 259 613 *→
	05/82→10/89	Centre Rod	DB-DL-8672		Push Rod* 1 5 259613 *→
	05/82→10/89	Suspension Arm Repair Kit		DB-RK-8564	Wishbone (CV)
	05/82→10/89	Tie Rod End	CV-ES-12461		for Steering Rod
	05/82→10/89	Tie Rod End	CV-ES-12462		for Steering Rod
1622 S	05/82→10/89	Tie Rod End	CV-ES-14163		for Steering Rod
	05/82→03/91	Centre Rod	DB-DL-5207		Push Rod* 5 259 613 *→
	05/82→03/91	Centre Rod	DB-DL-8122		Push Rod* 5 259 613 *→
	05/82→03/91	Centre Rod	DB-DL-8672		Push Rod* 1 5 259613 *→
	05/82→03/91	Suspension Arm Repair Kit		DB-RK-8564	Wishbone (CV)
1622,1622 L	05/82→03/91	Tie Rod End	CV-ES-12461		for Steering Rod
	05/82→03/91	Tie Rod End	CV-ES-12462		for Steering Rod
	05/82→03/91	Tie Rod End	CV-ES-14163		for Steering Rod
	08/73→09/96	Centre Rod	DB-DL-5207		Push Rod* 5 259 613 *→
	08/73→09/96	Centre Rod	DB-DL-7831		Push Rod
	08/73→09/96	Centre Rod	DB-DL-8122		Push Rod* 5 259 613 *→
	08/73→09/96	Centre Rod	DB-DL-8138		Push Rod
	08/73→09/96	Centre Rod	DB-DL-8618		Push Rod
	08/73→09/96	Centre Rod	DB-DL-8672		Push Rod* 1 5 259613 *→
	08/73→09/96	Centre Rod	DB-DL-10216		Push Rod
	08/73→09/96	Centre Rod	DB-DL-12309		Coupling Rod
	08/73→09/96	Suspension Arm Repair Kit		DB-RK-8380	Wishbone (CV)
	08/73→09/96	Suspension Arm Repair Kit		DB-RK-8564	Wishbone (CV)
	08/73→09/96	Tie Rod	DB-DL-8640		Guide Rod
	08/73→09/96	Tie Rod	DB-ES-5209		
	08/73→09/96	Tie Rod End	CV-ES-12461		for Steering Rod
	08/73→09/96	Tie Rod End	CV-ES-12462		for Steering Rod
	08/73→09/96	Tie Rod End	CV-ES-14163		for Steering Rod
	08/73→09/96	Track Control Arm		DB-DL-5220	Trailing Arm
	1624 K	07/75→08/82	Centre Rod	DB-DL-5216	
07/75→08/82		Tie Rod End	CV-ES-12461		for Steering Rod
07/75→08/82		Tie Rod End	CV-ES-12462		for Steering Rod
1624 S,1624 LS	08/73→09/96	Centre Rod	DB-DL-5216		Push Rod
	08/73→09/96	Suspension Arm Repair Kit		DB-RK-8380	Wishbone (CV)
	08/73→09/96	Suspension Arm Repair Kit		DB-RK-8564	Wishbone (CV)
	08/73→09/96	Tie Rod End	CV-ES-12461		for Steering Rod
	08/73→09/96	Tie Rod End	CV-ES-12462		for Steering Rod
	08/73→09/96	Track Control Arm		DB-DL-5220	Trailing Arm
1624,1624 L	08/73→09/96	Centre Rod	DB-DL-5216		Push Rod
	08/73→09/96	Suspension Arm Repair Kit		DB-RK-8380	Wishbone (CV)
	08/73→09/96	Tie Rod End	CV-ES-12461		for Steering Rod
	08/73→09/96	Tie Rod End	CV-ES-12462		for Steering Rod
	08/73→09/96	Track Control Arm		DB-DL-5220	Trailing Arm

CV-ES-12461

Length: 120
Cone Ø: d1 Ø 26 / d2 Ø 23,5
Thread: M30 x 1,5 LHT
0003300035, 3300148, 0003406213, 0013306635,
0013308835, 0014604048, 0014604348,
14606448, 0024600248, 3023300035,
3023300135, 3023300235, 3023300335,
3453307235, 3453307435, 3503307135,
A0003300148, A0013306635, A0013308835,
A0014604048, A0014604348, A0014606448,
A0024600248, A3023300035, A3023300135,
A3023300235, A3023300335, A3503307135



CV-ES-12462

Length: 120
Cone Ø: d1 Ø 26 / d2 Ø 23,5
Thread: M30 x 1,5 RHT
0003300135, 0003300248, 0003303235,
0003305835, 0003307335, 0003383410,
0004608348, 004608348, 0004632229,
0004633129, 0004633429, 0004633529,
0013300135, 0013300235, 0013306735,
0014603448, 0014604148, 0014604448,
0014606348, 0014608348, 0014608448,
0014609748, 0023301535, 3453307135,
3503307035, 3503307335, 3643307135,
5001832582, A0003300248, A0003303235,
A0003307335, A0003383410, A0004608348,
A0004632229, A0004633429, A0013300135,
A0013300235, A0013306735, A0014603448,
A0014604148, A0014604448, A0014606348,
A0014608348, A0014608448, A0014609748,
A0023301535



CV-ES-14163

Length: 125
Cone Ø: d1 Ø 30 / d2 Ø 27
Thread: M30 x 1,5 RHT
0003305248, 0003387310, 0004600348,
0004600948, 0004602848, 0004602948,
0004608948, 0014600248, 0014600848,
0014601248, 0014602248, 0014607748,
0024600148, A0003387310, A0004600348,
A0004602848, A0004602948, A0014600848,
A0014601248, A0014602248, A0014607748



DB-DL-5207

Length: 875 Ø: 42
Cone Ø: d1 Ø 30 / d2 Ø 27
01215100A, 6174603505, 6174603605



DB-DL-5216

Length: 890
Ø: 42
Cone Ø: d1 Ø 26 / d2 Ø 23,5
01215700A, 3834600605, 3834601405,
3834602305, 3834604405



DB-DL-5220

Length: 522
Ø: 52
Hole Distance: 151
01335200A, 3813500606, 6523500306,
6533500106



DB-DL-5239

Length: 862
Ø: 42
Cone Ø: d1 Ø 30 / d2 Ø 27
01214500A, 6174602405, 6174603405



DB-DL-7831

Length: 870
Ø: 42
Cone Ø: d1 Ø 30 / d2 Ø 27
01215200A, 6254602505



DB-DL-8122

Length: 875
Ø: 42
Cone Ø: d1 Ø 30 / d2 Ø 27
01215000A, 6174603205, 6174603305



DB-DL-8138

Length: 1130
Ø: 40
Cone Ø: d1 Ø 32 / d2 Ø 28,8
0004606605, 4606605



DB-DL-8618

Length: 680
Ø: 42
Cone Ø: d1 Ø 32 / d2 Ø 28,8
0004604305, 4604305, 6254604805



DB-DL-8632

Length: 1635
Ø: 60
Cone Ø: d1 Ø 30 / d2 Ø 27
3853301303, 3853302103, 3853302203



DB-DL-8640

Length: 1615 Ø: 50
Cone Ø: d1 Ø 32 / d2 Ø 29
6253301503, 6253301603, 6253302403,
6253302503, 9423300803, 9423302103,
9493300203, 9493300303, 9493300903



DB-DL-8672

Length: 860
Ø: 48
Cone Ø: d1 Ø 30 / d2 Ø 27
0014609705, 14609705



DB-DL-10216

Length: 1190
Ø: 40
Cone Ø: d1 Ø 32 / d2 Ø 29
0004604905



DB-DL-12309

Length: 685 Ø: 40
Cone Ø: d1 Ø 32 / d2 Ø 28,8
0004606005, 0004606305



DB-ES-5209

Length: 1670 Ø: 50
Cone Ø: d1 Ø 30 / d2 Ø 27
6203300503, 6203300603



DB-RK-8380

Ø: 80
5861035, 0005861035



DB-RK-8564

Ø: 90
01302200A, 0003500105, 3500105, 0003500405,
3500405, 0005861833, 5861833, 81432706047



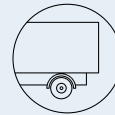

NG ...

1625 AK	10/80→11/89	Centre Rod	DB-DL-5207		Push Rod
	10/80→11/89	Centre Rod	DB-DL-5239		Push Rod* 5 180 857 *→
	10/80→11/89	Suspension Arm Repair Kit		DB-RK-8564	Wishbone (CV)
	10/80→11/89	Tie Rod	DB-DL-8632		
	10/80→11/89	Tie Rod End	CV-ES-12461		for Steering Rod
	10/80→11/89	Tie Rod End	CV-ES-12462		for Steering Rod
	10/80→11/89	Tie Rod End	CV-ES-14163		for Steering Rod
	10/80→11/89	Track Control Arm		DB-DL-5220	Trailing Arm
1625 K	05/80→11/89	Centre Rod	DB-DL-5207		Push Rod
	05/80→11/89	Centre Rod	DB-DL-8672		Push Rod* 1 5 158233 *→
	05/80→11/89	Tie Rod End	CV-ES-12461		for Steering Rod
	05/80→11/89	Tie Rod End	CV-ES-12462		for Steering Rod
	05/80→11/89	Tie Rod End	CV-ES-14163		for Steering Rod
1625 S,1625 LS	08/73→09/96	Centre Rod	DB-DL-5207		Push Rod
	08/73→09/96	Centre Rod	DB-DL-8672		Push Rod* 1 5 158233 *→
	08/73→09/96	Suspension Arm Repair Kit		DB-RK-8380	Wishbone (CV)
	08/73→09/96	Suspension Arm Repair Kit		DB-RK-8564	Wishbone (CV)
	08/73→09/96	Tie Rod End	CV-ES-12461		for Steering Rod
	08/73→09/96	Tie Rod End	CV-ES-12462		for Steering Rod
	08/73→09/96	Tie Rod End	CV-ES-14163		for Steering Rod
	08/73→09/96	Track Control Arm		DB-DL-5220	Trailing Arm
1625,1625 L	08/73→09/96	Centre Rod	DB-DL-5207		Push Rod
	08/73→09/96	Centre Rod	DB-DL-8672		Push Rod* 1 5 158233 *→
	08/73→09/96	Suspension Arm Repair Kit		DB-RK-8380	Wishbone (CV)
	08/73→09/96	Suspension Arm Repair Kit		DB-RK-8564	Wishbone (CV)
	08/73→09/96	Tie Rod	DB-ES-5209		
	08/73→09/96	Tie Rod End	CV-ES-12461		for Steering Rod
	08/73→09/96	Tie Rod End	CV-ES-12462		for Steering Rod
	08/73→09/96	Tie Rod End	CV-ES-14163		for Steering Rod
	08/73→09/96	Track Control Arm		DB-DL-5220	Trailing Arm
	1626 AK	08/73→12/80	Centre Rod	DB-DL-10216	
08/73→12/80		Stabiliser Mounting	DB-SB-5259		
08/73→12/80		Tie Rod	MN-DL-7834		Guide Rod
08/73→12/80		Tie Rod End	CV-ES-14163		for Steering Rod
1626 AS	05/74→12/80	Centre Rod	DB-DL-10216		Push Rod
	05/74→12/80	Stabiliser Mounting	DB-SB-5259		
	05/74→12/80	Tie Rod	MN-DL-7834		Guide Rod
	05/74→12/80	Tie Rod End	CV-ES-12461		for Steering Rod
	05/74→12/80	Tie Rod End	CV-ES-14163		for Steering Rod
1626 K	08/73→12/80	Centre Rod	DB-DL-10140		Push Rod* 4 118 555 *→* 4 127 150 *
	08/73→12/80	Centre Rod	DB-DL-10140		Push Rod* 4 129 898 *→* 4 298 136 *
	08/73→12/80	Tie Rod End	CV-ES-12461		for Steering Rod
	08/73→12/80	Tie Rod End	CV-ES-14163		for Steering Rod
1626 S,1626 LS	08/73→09/96	Centre Rod	DB-DL-10140		Push Rod* 4 118 555 *→* 4 127 150 *
	08/73→09/96	Centre Rod	DB-DL-10140		Push Rod* 4 129 898 *→* 4 298 136 *
	08/73→09/96	Suspension Arm Repair Kit		CV-RK-8118	for Drag Link
	08/73→09/96	Suspension Arm Repair Kit		DB-RK-8564	Wishbone (CV)
	08/73→09/96	Suspension Strut Repair Kit		DF-RK-8671	
	08/73→09/96	Tie Rod End	CV-ES-12461		for Steering Rod
	08/73→09/96	Tie Rod End	CV-ES-14163		for Steering Rod
1626,1626 L	08/73→09/96	Centre Rod	DB-DL-10140		Push Rod* 4 118 555 *→* 4 127 150 *
	08/73→09/96	Centre Rod	DB-DL-10140		Push Rod* 4 129 898 *→* 4 298 136 *
	08/73→09/96	Suspension Arm Repair Kit		DB-RK-8564	Wishbone (CV)
	08/73→09/96	Tie Rod End	CV-ES-12461		for Steering Rod
	08/73→09/96	Tie Rod End	CV-ES-14163		for Steering Rod
1628 A	01/80→05/89	Centre Rod	DB-DL-5217		Push Rod
	01/80→05/89	Tie Rod	MN-DL-7834		Guide Rod
1628 S,1628 LS	08/73→09/96	Centre Rod	DB-DL-10216		Push Rod
	08/73→09/96	Suspension Arm Repair Kit		CV-RK-8118	for Drag Link
	08/73→09/96	Suspension Arm Repair Kit		DB-RK-8564	Wishbone (CV)
	08/73→09/96	Suspension Arm Repair Kit		DB-RK-10378	
	08/73→09/96	Suspension Arm Repair Kit	DB-RK-5280		
	08/73→09/96	Suspension Strut Repair Kit		DF-RK-8671	

CV-ES-12461

Length: 120
Cone Ø: d1 Ø 26 / d2 Ø 23,5
Thread: M30 x 1,5 LHT
0003300035, 3300148, 0003406213, 0013306635,
0013308835, 0014604048, 0014604348,
14606448, 0024600248, 3023300035,
3023300135, 3023300235, 3023300335,
3453307235, 3453307435, 3503307135,
A0003300148, A0013306635, A0013308835,
A0014604048, A0014604348, A0014606448,
A0024600248, A3023300035, A3023300135,
A3023300235, A3023300335, A3503307135



CV-ES-12462

Length: 120
Cone Ø: d1 Ø 26 / d2 Ø 23,5
Thread: M30 x 1,5 RHT
0003300135, 0003300248, 0003303235,
0003305835, 0003307335, 0003383410,
0004608348, 004608348, 0004632229,
0004633129, 0004633429, 0004633529,
0013300135, 0013300235, 0013306735,
0014603448, 0014604148, 0014604448,
0014606348, 0014608348, 0014608448,
0014609748, 0023301535, 3453307135,
3503307035, 3503307335, 3643307135,
5001832582, A0003300248, A0003303235,
A0003307335, A0003383410, A0004608348,
A0004632229, A0004633429, A0013300135,
A0013300235, A0013306735, A0014603448,
A0014604148, A0014604448, A0014606348,
A0014608348, A0014608448, A0014609748,
A0023301535



CV-ES-14163

Length: 125
Cone Ø: d1 Ø 30 / d2 Ø 27
Thread: M30 x 1,5 RHT
0003305248, 0003387310, 0004600348,
0004600948, 0004602848, 0004602948,
0004608948, 0014600248, 0014600848,
0014601248, 0014602248, 0014607748,
0024600148, A0003387310, A0004600348,
A0004602848, A0004602948, A0014600848,
A0014601248, A0014602248, A0014607748



CV-RK-8118

Ø: 85
Hole Distance: 130
Thick/Height: 30
0003500506, 3500506



DB-DL-5207

Length: 875 Ø: 42
Cone Ø: d1 Ø 30 / d2 Ø 27
01215100A, 6174603505, 6174603605



DB-DL-5217

Length: 862 Ø: 40
Cone Ø: d1 Ø 30 / d2 Ø 27
01214700A, 6204600405, 6204600805,
6204602905, 6204603005



DB-DL-5220

Length: 522
Ø: 52
Hole Distance: 151
01335200A, 3813500606, 6523500306,
6533500106



DB-DL-5239

Length: 862
Ø: 42
Cone Ø: d1 Ø 30 / d2 Ø 27
01214500A, 6174602405, 6174603405



DB-DL-8632

Length: 1635
Ø: 60
Cone Ø: d1 Ø 30 / d2 Ø 27
3853301303, 3853302103, 3853302203



DB-DL-8672

Length: 860
Ø: 48
Cone Ø: d1 Ø 30 / d2 Ø 27
0014609705, 14609705



DB-DL-10140

Length: 865
Ø: 40
Cone Ø: d1 Ø 26 / d2 Ø 23,5
3874600605, 3874600805, 3874604405,
3874604505



DB-DL-10216

Length: 1190
Ø: 40
Cone Ø: d1 Ø 32 / d2 Ø 29
0004604905



DB-ES-5209

Length: 1670 Ø: 50
Cone Ø: d1 Ø 30 / d2 Ø 27
6203300503, 6203300603



DB-RK-5280

Ø: 86
01303000A, 6213200428



DB-RK-8380

Ø: 80
5861035, 0005861035



DB-RK-8564

Ø: 90
01302200A, 0003500105, 3500105, 0003500405,
3500405, 0005861833, 5861833, 81432706047



DB-RK-10378

Ø: 86
6203200028



DB-SB-5259

Ø: 44
Thick/Height: 25
01317200A, 0003232150, 3232150



DF-RK-8671



MN-DL-7834

Length: 1588 Ø: 58
Cone Ø: d1 Ø 30 / d2 Ø 27
3463303903, 3463304903, 6253303203,
9443300503, 9443301303, 9443301703



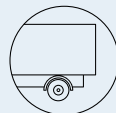

NG ...

1628 S,1628 LS ...	08/73→09/96	Tie Rod End	CV-ES-12461		for Steering Rod
	08/73→09/96	Tie Rod End	CV-ES-14163		for Steering Rod
	08/73→09/96	Track Control Arm		DB-DL-7840	Suspension Rod, Trailing Arm
1628,1628 L	08/73→09/96	Centre Rod	DB-DL-5239		Push Rod* 5 180 857 *→
	08/73→09/96	Centre Rod	DB-DL-10216		Push Rod
	08/73→09/96	Suspension Arm Repair Kit		DB-RK-8564	Wishbone (CV)
	08/73→09/96	Suspension Arm Repair Kit	DB-RK-5280		
	08/73→09/96	Suspension Arm Repair Kit	DB-RK-5282		
	08/73→09/96	Tie Rod	DB-DL-8632		
	08/73→09/96	Tie Rod	DB-ES-5209		
	08/73→09/96	Tie Rod End	CV-ES-12461		for Steering Rod
	08/73→09/96	Tie Rod End	CV-ES-12462		for Steering Rod
	08/73→09/96	Tie Rod End	CV-ES-14163		for Steering Rod
	08/73→09/96	Track Control Arm		DB-DL-5220	Trailing Arm
1632 AK	08/73→08/82	Centre Rod	DB-DL-10216		Push Rod
	08/73→08/82	Stabiliser Mounting	DB-SB-5259		
	08/73→08/82	Tie Rod	MN-DL-7834		Guide Rod
	08/73→08/82	Tie Rod End	CV-ES-12461		for Steering Rod
	08/73→08/82	Tie Rod End	CV-ES-14163		for Steering Rod
1632 AS	05/74→09/83	Centre Rod	DB-DL-10216		Push Rod
	05/74→09/83	Stabiliser Mounting	DB-SB-5259		
	05/74→09/83	Tie Rod End	CV-ES-12461		for Steering Rod
	05/74→09/83	Tie Rod End	CV-ES-14163		for Steering Rod
1632 K	08/73→08/82	Centre Rod	DB-DL-10140		Push Rod* 4 118 555 *→* 4 127 150 *
	08/73→08/82	Centre Rod	DB-DL-10140		Push Rod* 4 129 898 *→* 4 298 136 *
	08/73→08/82	Tie Rod End	CV-ES-12461		for Steering Rod
	08/73→08/82	Tie Rod End	CV-ES-14163		for Steering Rod
1632 S,1632 LS	08/73→09/96	Centre Rod	DB-DL-10140		Push Rod* 4 118 555 *→* 4 127 150 *
	08/73→09/96	Centre Rod	DB-DL-10140		Push Rod* 4 129 898 *→* 4 298 136 *
	08/73→09/96	Suspension Arm Repair Kit		CV-RK-8118	for Drag Link
	08/73→09/96	Suspension Arm Repair Kit		DB-RK-8564	Wishbone (CV)
	08/73→09/96	Suspension Strut Repair Kit		DF-RK-8671	
	08/73→09/96	Tie Rod End	CV-ES-12461		for Steering Rod
	08/73→09/96	Tie Rod End	CV-ES-14163		for Steering Rod
	08/73→09/96	Tie Rod End	CV-ES-14163		for Steering Rod
	08/73→09/96	Tie Rod End	CV-ES-14163		for Steering Rod
1632,1632 L	08/73→09/96	Centre Rod	DB-DL-10140		Push Rod* 4 118 555 *→* 4 127 150 *
	08/73→09/96	Centre Rod	DB-DL-10140		Push Rod* 4 129 898 *→* 4 298 136 *
	08/73→09/96	Suspension Arm Repair Kit		DB-RK-8564	Wishbone (CV)
	08/73→09/96	Tie Rod End	CV-ES-12461		for Steering Rod
	08/73→09/96	Tie Rod End	CV-ES-14163		for Steering Rod
1633 S,1633 LS	08/73→09/96	Suspension Arm Repair Kit		CV-RK-8118	for Drag Link
	08/73→09/96	Suspension Arm Repair Kit		DB-RK-10378	
	08/73→09/96	Suspension Arm Repair Kit	DB-RK-5280		
	08/73→09/96	Suspension Strut Repair Kit		DF-RK-8671	
	08/73→09/96	Tie Rod End	CV-ES-12461		for Steering Rod
	08/73→09/96	Tie Rod End	CV-ES-14163		for Steering Rod
	08/73→09/96	Track Control Arm		DB-DL-7840	Suspension Rod, Trailing Arm
	08/73→09/96	Track Control Arm		DB-DL-7840	Suspension Rod, Trailing Arm
1633,1633 L	08/73→09/96	Centre Rod	DB-DL-10216		Push Rod
	08/73→09/96	Suspension Arm Repair Kit		DB-RK-8564	Wishbone (CV)
	08/73→09/96	Suspension Arm Repair Kit	DB-RK-5280		
	08/73→09/96	Suspension Arm Repair Kit	DB-RK-5282		
	08/73→09/96	Tie Rod	DB-ES-5209		
	08/73→09/96	Tie Rod End	CV-ES-12461		for Steering Rod
	08/73→09/96	Tie Rod End	CV-ES-14163		for Steering Rod
	08/73→09/96	Tie Rod End	CV-ES-14163		for Steering Rod
	08/73→09/96	Tie Rod End	CV-ES-14163		for Steering Rod
1635 K	02/86→07/89	Stabiliser Mounting	DB-SB-5258	DB-SB-5258	
	02/86→07/89	Suspension Arm Repair Kit		CV-RK-8118	for Drag Link
	02/86→07/89	Suspension Arm Repair Kit		DB-RK-10378	
	02/86→07/89	Suspension Arm Repair Kit	DB-RK-5283		
	02/86→07/89	Suspension Strut Repair Kit		DF-RK-8671	
	02/86→07/89	Tie Rod End	CV-ES-14163		for Steering Rod
1635 S,1635 LS	08/73→09/96	Centre Rod	DB-DL-10216		Push Rod
	08/73→09/96	Suspension Arm Repair Kit		CV-RK-8118	for Drag Link
	08/73→09/96	Suspension Arm Repair Kit		DB-RK-8564	Wishbone (CV)
	08/73→09/96	Suspension Arm Repair Kit		DB-RK-10378	

CV-ES-12461

Length: 120
Cone Ø: d1 Ø 26 / d2 Ø 23,5
Thread: M30 x 1,5 LHT
0003300035, 3300148, 0003406213, 0013306635,
0013308835, 0014604048, 0014604348,
14606448, 0024600248, 3023300035,
3023300135, 3023300235, 3023300335,
3453307235, 3453307435, 3503307135,
A0003300148, A0013306635, A0013308835,
A0014604048, A0014604348, A0014606448,
A0024600248, A3023300035, A3023300135,
A3023300235, A3023300335, A3503307135



CV-ES-12462

Length: 120
Cone Ø: d1 Ø 26 / d2 Ø 23,5
Thread: M30 x 1,5 RHT
0003300135, 0003300248, 0003303235,
0003305835, 0003307335, 0003383410,
0004608348, 004608348, 0004632229,
0004633129, 0004633429, 0004633529,
0013300135, 0013300235, 0013306735,
0014603448, 0014604148, 0014604448,
0014606348, 0014608348, 0014608448,
0014609748, 0023301535, 3453307135,
3503307035, 3503307335, 3643307135,
5001832582, A0003300248, A0003303235,
A0003307335, A0003383410, A0004608348,
A0004632229, A0004633429, A0013300135,
A0013300235, A0013306735, A0014603448,
A0014604148, A0014604448, A0014606348,
A0014608348, A0014608448, A0014609748,
A0023301535



CV-ES-14163

Length: 125
Cone Ø: d1 Ø 30 / d2 Ø 27
Thread: M30 x 1,5 RHT
0003305248, 0003387310, 0004600348,
0004600948, 0004602848, 0004602948,
0004608948, 0014600248, 0014600848,
0014601248, 0014602248, 0014607748,
0024600148, A0003387310, A0004600348,
A0004602848, A0004602948, A0014600848,
A0014601248, A0014602248, A0014607748



CV-RK-8118

Ø: 85
Hole Distance: 130
Thick/Height: 30
3500506, 0003500506



DB-DL-5220

Length: 522
Ø: 52
Hole Distance: 151
01335200A, 3813500606, 6523500306,
6533500106



DB-DL-5239

Length: 862
Ø: 42
Cone Ø: d1 Ø 30 / d2 Ø 27
01214500A, 6174602405, 6174603405



DB-DL-7840

Length: 595
Ø: 62
Hole Distance: 152 / 152
6203500006, 6203500106, 6203500306,
6553500306



DB-DL-8632

Length: 1635
Ø: 60
Cone Ø: d1 Ø 30 / d2 Ø 27
3853301303, 3853302103, 3853302203



DB-DL-10140

Length: 865
Ø: 40
Cone Ø: d1 Ø 26 / d2 Ø 23,5
3874600605, 3874600805, 3874604405,
3874604505



DB-DL-10216

Length: 1190
Ø: 40
Cone Ø: d1 Ø 32 / d2 Ø 29
0004604905



DB-ES-5209

Length: 1670 **Ø:** 50
Cone Ø: d1 Ø 30 / d2 Ø 27
6203300503, 6203300603



DB-RK-5280

Ø: 86
01303000A, 6213200428



DB-RK-5282

Ø: 59
01303800A, 6553200111



DB-RK-5283

Ø: 70
01319900A, 6203200628



DB-RK-8564

Ø: 90
01302200A, 0003500105, 3500105, 0003500405,
3500405, 5861833, 0005861833, 81432706047



DB-RK-10378

Ø: 86
6203200028



DB-SB-5258

Ø: 70
Thick/Height: 62
01311400A, 3873230285



DB-SB-5259

Ø: 44
Thick/Height: 25
01317200A, 0003232150, 3232150



DF-RK-8671



MN-DL-7834

Length: 1588 **Ø:** 58
Cone Ø: d1 Ø 30 / d2 Ø 27
3463303903, 3463304903, 6253303203,
9443300503, 9443301303, 9443301703





NG ...

1635 S,1635 LS ...	08/73→09/96	Suspension Arm Repair Kit	DB-RK-5280		
	08/73→09/96	Suspension Strut Repair Kit		DF-RK-8671	
	08/73→09/96	Tie Rod End	CV-ES-12461		for Steering Rod
	08/73→09/96	Tie Rod End	CV-ES-14163		for Steering Rod
	08/73→09/96	Track Control Arm		DB-DL-7840	Suspension Rod, Trailing Arm
1635,1635 L	08/73→09/96	Suspension Arm Repair Kit		CV-RK-8118	for Drag Link
	08/73→09/96	Suspension Arm Repair Kit	DB-RK-5282		
	08/73→09/96	Suspension Strut Repair Kit		DF-RK-8671	
	08/73→09/96	Tie Rod	DB-ES-5209		
	08/73→09/96	Tie Rod End	CV-ES-12461		for Steering Rod
	08/73→09/96	Tie Rod End	CV-ES-14163		for Steering Rod
1636 S,1636 LS	08/73→09/96	Suspension Arm Repair Kit		CV-RK-8118	for Drag Link
	08/73→09/96	Suspension Arm Repair Kit		DB-RK-8564	Wishbone (CV)
	08/73→09/96	Suspension Arm Repair Kit		DB-RK-10378	
	08/73→09/96	Suspension Arm Repair Kit	DB-RK-5280		
	08/73→09/96	Suspension Strut Repair Kit		DF-RK-8671	
	08/73→09/96	Tie Rod End	CV-ES-14163		for Steering Rod
	08/73→09/96	Track Control Arm		DB-DL-7840	Suspension Rod, Trailing Arm
1636,1636 L	08/73→09/96	Centre Rod	DB-DL-10216		Push Rod
	08/73→09/96	Suspension Arm Repair Kit		DB-RK-8564	Wishbone (CV)
	08/73→09/96	Suspension Arm Repair Kit	DB-RK-5280		
	08/73→09/96	Suspension Arm Repair Kit	DB-RK-5282		
	08/73→09/96	Tie Rod	DB-ES-5209		
	08/73→09/96	Tie Rod End	CV-ES-12461		for Steering Rod
	08/73→09/96	Tie Rod End	CV-ES-14163		for Steering Rod
	08/73→09/96	Tie Rod End	CV-ES-14163		for Steering Rod
1638	11/80→12/86	Stabiliser Mounting	DB-SB-5258	DB-SB-5258	
	11/80→12/86	Suspension Arm Repair Kit		DB-RK-10378	
	11/80→12/86	Suspension Arm Repair Kit	DB-RK-5283		
	11/80→12/86	Tie Rod End	CV-ES-12461		for Steering Rod
	11/80→12/86	Tie Rod End	CV-ES-14163		for Steering Rod
1638 S,1638 LS	08/73→09/96	Suspension Arm Repair Kit		CV-RK-8118	for Drag Link
	08/73→09/96	Suspension Arm Repair Kit		DB-RK-8564	Wishbone (CV)
	08/73→09/96	Suspension Arm Repair Kit		DB-RK-10378	
	08/73→09/96	Suspension Arm Repair Kit	DB-RK-5280		
	08/73→09/96	Suspension Strut Repair Kit		DF-RK-8671	
	08/73→09/96	Tie Rod End	CV-ES-14163		for Steering Rod
1644	08/73→09/96	Track Control Arm		DB-DL-7840	Suspension Rod, Trailing Arm
	06/86→08/89	Stabiliser Mounting	DB-SB-5258	DB-SB-5258	
	06/86→08/89	Suspension Arm Repair Kit		CV-RK-8118	for Drag Link
	06/86→08/89	Suspension Arm Repair Kit		DB-RK-10378	
	06/86→08/89	Suspension Arm Repair Kit	DB-RK-5283		
	06/86→08/89	Suspension Strut Repair Kit		DF-RK-8671	
	06/86→08/89	Tie Rod	DB-ES-5209		
	06/86→08/89	Tie Rod End	CV-ES-12461		for Steering Rod
	06/86→08/89	Tie Rod End	CV-ES-14163		for Steering Rod
	06/86→08/89	Track Control Arm		DB-DL-7840	Suspension Rod, Trailing Arm
1644 S,1644 LS	08/73→09/96	Centre Rod	DB-DL-10216		Push Rod
	08/73→09/96	Suspension Arm Repair Kit		CV-RK-8118	for Drag Link
	08/73→09/96	Suspension Arm Repair Kit		DB-RK-8564	Wishbone (CV)
	08/73→09/96	Suspension Arm Repair Kit		DB-RK-10378	
	08/73→09/96	Suspension Arm Repair Kit	DB-RK-5280		
	08/73→09/96	Suspension Strut Repair Kit		DF-RK-8671	
	08/73→09/96	Tie Rod End	CV-ES-12461		for Steering Rod
	08/73→09/96	Tie Rod End	CV-ES-14163		for Steering Rod
	08/73→09/96	Track Control Arm		DB-DL-7840	Suspension Rod, Trailing Arm
1719	09/73→08/82	Tie Rod End	CV-ES-12461		for Steering Rod
	09/73→08/82	Tie Rod End	CV-ES-14163		for Steering Rod
1719 AK	09/73→08/82	Centre Rod	DB-DL-10216		Push Rod
	09/73→08/82	Tie Rod	MN-DL-7834		Guide Rod
	09/73→08/82	Tie Rod End	CV-ES-12461		for Steering Rod
	09/73→08/82	Tie Rod End	CV-ES-14163		for Steering Rod
1719 K	09/73→08/82	Tie Rod End	CV-ES-12461		for Steering Rod
	09/73→08/82	Tie Rod End	CV-ES-14163		for Steering Rod

CV-ES-12461

Length: 120
Cone Ø: d1 Ø 26 / d2 Ø 23,5
Thread: M30 x 1,5 LHT
0003300035, 3300148, 0003406213, 0013306635,
0013308835, 0014604048, 0014604348,
14606448, 0024600248, 3023300035,
3023300135, 3023300235, 3023300335,
3453307235, 3453307435, 3503307135,
A0003300148, A0013306635, A0013308835,
A0014604048, A0014604348, A0014606448,
A0024600248, A3023300035, A3023300135,
A3023300235, A3023300335, A3503307135



CV-ES-14163

Length: 125
Cone Ø: d1 Ø 30 / d2 Ø 27
Thread: M30 x 1,5 RHT
0003305248, 0003387310, 0004600348,
0004600948, 0004602848, 0004602948,
0004608948, 0014600248, 0014600848,
0014601248, 0014602248, 0014607748,
0024600148, A0003387310, A0004600348,
A0004602848, A0004602948, A0014600848,
A0014601248, A0014602248, A0014607748



CV-RK-8118

Ø: 85
Hole Distance: 130
Thick/Height: 30
0003500506, 3500506



DB-DL-7840

Length: 595
Ø: 62
Hole Distance: 152 / 152
6203500006, 6203500106, 6203500306,
6553500306



DB-DL-10216

Length: 1190
Ø: 40
Cone Ø: d1 Ø 32 / d2 Ø 29
0004604905



DB-ES-5209

Length: 1670 Ø: 50
Cone Ø: d1 Ø 30 / d2 Ø 27
6203300503, 6203300603



DB-RK-5280

Ø: 86
01303000A, 6213200428



DB-RK-5282

Ø: 59
01303800A, 6553200111



DB-RK-5283

Ø: 70
01319900A, 6203200628



DB-RK-8564

Ø: 90
01302200A, 0003500105, 3500105, 0003500405,
3500405, 0005861833, 5861833, 81432706047



DB-RK-10378

Ø: 86
6203200028



DB-SB-5258

Ø: 70
Thick/Height: 62
01311400A, 3873230285



DF-RK-8671



MN-DL-7834

Length: 1588 Ø: 58
Cone Ø: d1 Ø 30 / d2 Ø 27
3463303903, 3463304903, 6253303203,
9443300503, 9443301303, 9443301703



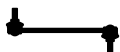

NG ...

1719 S	09/73→08/82	Tie Rod End	CV-ES-12461		for Steering Rod
	09/73→08/82	Tie Rod End	CV-ES-14163		for Steering Rod
1814	04/84→03/91	Centre Rod	DB-DL-5207		Push Rod
	04/84→03/91	Centre Rod	DB-DL-8122		Push Rod
	04/84→03/91	Tie Rod End	CV-ES-12461		for Steering Rod
	04/84→03/91	Tie Rod End	CV-ES-12462		for Steering Rod
1919	05/74→08/82	Tie Rod End	CV-ES-12461		for Steering Rod
	05/74→08/82	Tie Rod End	CV-ES-14163		for Steering Rod
1919 AK	05/74→08/82	Tie Rod	MN-DL-7834		Guide Rod
	05/74→08/82	Tie Rod End	CV-ES-14163		for Steering Rod
1919 K	05/74→08/82	Tie Rod End	CV-ES-12461		for Steering Rod
	05/74→08/82	Tie Rod End	CV-ES-14163		for Steering Rod
1919 S	05/74→08/82	Tie Rod End	CV-ES-12461		for Steering Rod
	05/74→08/82	Tie Rod End	CV-ES-14163		for Steering Rod
1922	10/81→10/90	Centre Rod	DB-DL-5241		Suspension Rod
	10/81→10/90	Centre Rod	DB-DL-7270		Push Rod;Suspension Rod
	10/81→10/90	Centre Rod	DB-DL-10216		Push Rod
	10/81→10/90	Stabiliser Mounting	DB-SB-5258	DB-SB-5258	
	10/81→10/90	Suspension Arm Repair Kit		DB-RK-8550	for Wishbone (CV)
	10/81→10/90	Suspension Arm Repair Kit		DB-RK-10378	
	10/81→10/90	Suspension Arm Repair Kit	DB-RK-5283		
	10/81→10/90	Tie Rod End	CV-ES-12461		for Steering Rod
	10/81→10/90	Tie Rod End	CV-ES-14163		for Steering Rod
1922 AK	10/81→03/91	Centre Rod	DB-DL-5217		Push Rod* 5 184 732 *-→* 5 211 262 *
	10/81→03/91	Centre Rod	DB-DL-10216		Push Rod
	10/81→03/91	Suspension Arm Repair Kit		DB-RK-10378	
	10/81→03/91	Tie Rod	MN-DL-7834		Guide Rod
	10/81→03/91	Tie Rod End	CV-ES-12461		for Steering Rod
	10/81→03/91	Tie Rod End	CV-ES-14163		for Steering Rod
	10/81→03/91	Tie Rod End	CV-ES-14163		for Steering Rod
1922 K	10/81→03/91	Centre Rod	DB-DL-10216		Push Rod
	10/81→03/91	Stabiliser Mounting	DB-SB-5258	DB-SB-5258	
	10/81→03/91	Suspension Arm Repair Kit		DB-RK-10378	
	10/81→03/91	Suspension Arm Repair Kit	DB-RK-5283		
	10/81→03/91	Tie Rod End	CV-ES-12461		for Steering Rod
	10/81→03/91	Tie Rod End	CV-ES-14163		for Steering Rod
	10/81→03/91	Tie Rod End	CV-ES-14163		for Steering Rod
1922 S	10/81→03/91	Stabiliser Mounting	DB-SB-5258	DB-SB-5258	
	10/81→03/91	Suspension Arm Repair Kit		DB-RK-10378	
	10/81→03/91	Suspension Arm Repair Kit	DB-RK-5283		
	10/81→03/91	Tie Rod End	CV-ES-14163		for Steering Rod
1926	05/74→12/80	Stabiliser Mounting	DB-SB-5259		
	05/74→12/80	Tie Rod End	CV-ES-12461		for Steering Rod
	05/74→12/80	Tie Rod End	CV-ES-14163		for Steering Rod
1926 A	05/74→12/80	Centre Rod	DB-DL-10216		Push Rod
	05/74→12/80	Stabiliser Mounting	DB-SB-5259		
	05/74→12/80	Tie Rod	MN-DL-7834		Guide Rod
	05/74→12/80	Tie Rod End	CV-ES-12461		for Steering Rod
	05/74→12/80	Tie Rod End	CV-ES-14163		for Steering Rod
	05/74→12/80	Tie Rod End	CV-ES-14163		for Steering Rod
1926 AK	08/73→12/80	Centre Rod	DB-DL-10216		Push Rod
	08/73→12/80	Stabiliser Mounting	DB-SB-5259		
	08/73→12/80	Tie Rod	MN-DL-7834		Guide Rod
	08/73→12/80	Tie Rod End	CV-ES-12461		for Steering Rod
	08/73→12/80	Tie Rod End	CV-ES-14163		for Steering Rod
	08/73→12/80	Tie Rod End	CV-ES-14163		for Steering Rod
1926 AS	05/74→12/80	Centre Rod	DB-DL-10216		Push Rod
	05/74→12/80	Stabiliser Mounting	DB-SB-5259		
	05/74→12/80	Tie Rod	MN-DL-7834		Guide Rod
	05/74→12/80	Tie Rod End	CV-ES-12461		for Steering Rod
	05/74→12/80	Tie Rod End	CV-ES-14163		for Steering Rod
	05/74→12/80	Tie Rod End	CV-ES-14163		for Steering Rod
1926 K	08/73→12/80	Stabiliser Mounting	DB-SB-5259		
	08/73→12/80	Tie Rod End	CV-ES-12461		for Steering Rod
	08/73→12/80	Tie Rod End	CV-ES-14163		for Steering Rod

CV-ES-12461

Length: 120
Cone Ø: d1 Ø 26 / d2 Ø 23,5
Thread: M30 x 1,5 LHT
 0003300035, 3300148, 0003406213, 0013306635,
 0013308835, 0014604048, 0014604348,
 14606448, 0024600248, 3023300035,
 3023300135, 3023300235, 3023300335,
 3453307235, 3453307435, 3503307135,
 A0003300148, A0013306635, A0013308835,
 A0014604048, A0014604348, A0014606448,
 A0024600248, A3023300035, A3023300135,
 A3023300235, A3023300335, A3503307135



CV-ES-12462

Length: 120
Cone Ø: d1 Ø 26 / d2 Ø 23,5
Thread: M30 x 1,5 RHT
 0003300135, 0003300248, 0003303235,
 0003305835, 0003307335, 0003383410,
 0004608348, 004608348, 0004632229,
 0004633129, 0004633429, 0004633529,
 0013300135, 0013300235, 0013306735,
 0014603448, 0014604148, 0014604448,
 0014606348, 0014608348, 0014608448,
 0014609748, 0023301535, 3453307135,
 3503307035, 3503307335, 3643307135,
 5001832582, A0003300248, A0003303235,
 A0003307335, A0003383410, A0004608348,
 A0004632229, A0004633429, A0013300135,
 A0013300235, A0013306735, A0014603448,
 A0014604148, A0014604448, A0014606348,
 A0014608348, A0014608448, A0014609748,
 A0023301535



CV-ES-14163

Length: 125
Cone Ø: d1 Ø 30 / d2 Ø 27
Thread: M30 x 1,5 RHT
 0003305248, 0003387310, 0004600348,
 0004600948, 0004602848, 0004602948,
 0004608948, 0014600248, 0014600848,
 0014601248, 0014602248, 0014607748,
 0024600148, A0003387310, A0004600348,
 A0004602848, A0004602948, A0014600848,
 A0014601248, A0014602248, A0014607748



DB-DL-5207

Length: 875 Ø: 42
Cone Ø: d1 Ø 30 / d2 Ø 27
 01215100A, 6174603505, 6174603605



DB-DL-5217

Length: 862 Ø: 40
Cone Ø: d1 Ø 30 / d2 Ø 27
 01214700A, 6204600405, 6204600805,
 6204602905, 6204603005



DB-DL-5241

Length: 875 Ø: 40
Cone Ø: d1 Ø 30 / d2 Ø 27
 01215300A, 0004609205, 0004609305,
 0014606905



DB-DL-7270

Length: 875 Ø: 40
Cone Ø: d1 Ø 28,6 / d2 Ø 23,9
 01208300A, 0024604705, 0024604805,
 0034604905, A0024604705



DB-DL-8122

Length: 875
Ø: 42
Cone Ø: d1 Ø 30 / d2 Ø 27
 01215000A, 6174603205, 6174603305



DB-DL-10216

Length: 1190
Ø: 40
Cone Ø: d1 Ø 32 / d2 Ø 29
 0004604905



DB-RK-5283

Ø: 70
 01319900A, 6203200628



DB-RK-8550

Ø: 75 Hole Distance: 152
Thick/Height: 24
 0003502105, 0003504605



DB-RK-10378

Ø: 86
 6203200028



DB-SB-5258

Ø: 70
Thick/Height: 62
 01311400A, 3873230285



DB-SB-5259

Ø: 44
Thick/Height: 25
 01317200A, 0003232150, 3232150



MN-DL-7834

Length: 1588 Ø: 58
Cone Ø: d1 Ø 30 / d2 Ø 27
 3463303903, 3463304903, 6253303203,
 9443300503, 9443301303, 9443301703





NG ...

1926 S,1926 LS	08/73→09/96	Suspension Arm Repair Kit		CV-RK-8118	for Drag Link
	08/73→09/96	Suspension Arm Repair Kit		DB-RK-8564	Wishbone (CV)
	08/73→09/96	Suspension Strut Repair Kit		DF-RK-8671	
	08/73→09/96	Tie Rod End	CV-ES-12461		for Steering Rod
	08/73→09/96	Tie Rod End	CV-ES-14163		for Steering Rod
1928 A	01/80→03/91	Centre Rod	DB-DL-5217		Push Rod* 5 184 732 *→* 5 211 262 *
	01/80→03/91	Centre Rod	DB-DL-10216		Push Rod
	01/80→03/91	Suspension Arm Repair Kit		DB-RK-10378	
	01/80→03/91	Tie Rod	MN-DL-7834		Guide Rod
	01/80→03/91	Tie Rod End	CV-ES-12461		for Steering Rod
	01/80→03/91	Tie Rod End	CV-ES-14163		for Steering Rod
1928 AK	01/80→03/91	Tie Rod End	DB-ES-5234		for Steering Rod
	01/80→03/91	Centre Rod	DB-DL-5217		Push Rod* 5 184 732 *→* 5 211 262 *
	01/80→03/91	Centre Rod	DB-DL-10216		Push Rod
	01/80→03/91	Suspension Arm Repair Kit		DB-RK-10378	
	01/80→03/91	Tie Rod	MN-DL-7834		Guide Rod
1928 AS	01/80→03/91	Tie Rod End	CV-ES-12461		for Steering Rod
	01/80→03/91	Tie Rod End	CV-ES-14163		for Steering Rod
	01/80→03/91	Centre Rod	DB-DL-5217		Push Rod* 5 184 732 *→* 5 211 262 *
	01/80→03/91	Centre Rod	DB-DL-10216		Push Rod
	01/80→03/91	Suspension Arm Repair Kit		DB-RK-10378	
1928 K	01/80→03/91	Tie Rod	MN-DL-7834		Guide Rod
	01/80→03/91	Tie Rod End	CV-ES-12461		for Steering Rod
	01/80→03/91	Tie Rod End	CV-ES-14163		for Steering Rod
	01/80→03/91	Centre Rod	DB-DL-5217		Push Rod
	01/80→03/91	Suspension Arm Repair Kit		DB-RK-10378	
1928 S,1928 LS	01/80→03/91	Tie Rod End	CV-ES-14163		for Steering Rod
	08/73→09/96	Centre Rod	DB-DL-10216		Push Rod
	08/73→09/96	Suspension Arm Repair Kit		CV-RK-8118	for Drag Link
	08/73→09/96	Suspension Arm Repair Kit		DB-RK-8564	Wishbone (CV)
	08/73→09/96	Suspension Arm Repair Kit		DB-RK-10378	
	08/73→09/96	Suspension Arm Repair Kit	DB-RK-5280		
	08/73→09/96	Suspension Strut Repair Kit		DF-RK-8671	
	08/73→09/96	Tie Rod End	CV-ES-12461		for Steering Rod
	08/73→09/96	Tie Rod End	CV-ES-14163		for Steering Rod
	08/73→09/96	Track Control Arm		DB-DL-7840	Suspension Rod, Trailing Arm
1928,1928 L	08/73→09/96	Centre Rod	DB-DL-5412		Push Rod
	08/73→09/96	Centre Rod	DB-DL-10216		Push Rod
	08/73→09/96	Suspension Arm Repair Kit	DB-RK-5282		
	08/73→09/96	Tie Rod	DB-ES-5209		
	08/73→09/96	Tie Rod End	CV-ES-12461		for Steering Rod
	08/73→09/96	Tie Rod End	CV-ES-14163		for Steering Rod
1932	05/74→03/83	Stabiliser Mounting	DB-SB-5259		
	05/74→03/83	Tie Rod End	CV-ES-12461		for Steering Rod
	05/74→03/83	Tie Rod End	CV-ES-14163		for Steering Rod
1932 A	05/74→03/83	Centre Rod	DB-DL-10216		Push Rod
	05/74→03/83	Stabiliser Mounting	DB-SB-5259		
	05/74→03/83	Tie Rod	MN-DL-7834		Guide Rod
	05/74→03/83	Tie Rod End	CV-ES-12461		for Steering Rod
	05/74→03/83	Tie Rod End	CV-ES-14163		for Steering Rod
1932 AK	08/73→09/83	Centre Rod	DB-DL-10216		Push Rod
	08/73→09/83	Stabiliser Mounting	DB-SB-5259		
	08/73→09/83	Tie Rod	MN-DL-7834		Guide Rod
	08/73→09/83	Tie Rod End	CV-ES-12461		for Steering Rod
	08/73→09/83	Tie Rod End	CV-ES-14163		for Steering Rod
1932 AS	05/74→12/82	Centre Rod	DB-DL-10216		Push Rod
	05/74→12/82	Stabiliser Mounting	DB-SB-5259		
	05/74→12/82	Tie Rod	MN-DL-7834		Guide Rod
	05/74→12/82	Tie Rod End	CV-ES-12461		for Steering Rod
1932 K	05/74→12/82	Tie Rod End	CV-ES-14163		for Steering Rod
	08/73→08/82	Stabiliser Mounting	DB-SB-5259		
	08/73→08/82	Tie Rod End	CV-ES-12461		for Steering Rod
	08/73→08/82	Tie Rod End	CV-ES-14163		for Steering Rod

CV-ES-12461

Length: 120
 Cone Ø: d1 Ø 26 / d2 Ø 23,5
 Thread: M30 x 1,5 LHT
 0003300035, 3300148, 0003406213, 0013306635,
 0013308835, 0014604048, 0014604348,
 14606448, 0024600248, 3023300035,
 3023300135, 3023300235, 3023300335,
 3453307235, 3453307435, 3503307135,
 A0003300148, A0013306635, A0013308835,
 A0014604048, A0014604348, A0014606448,
 A0024600248, A3023300035, A3023300135,
 A3023300235, A3023300335, A3503307135



CV-ES-14163

Length: 125
 Cone Ø: d1 Ø 30 / d2 Ø 27
 Thread: M30 x 1,5 RHT
 0003305248, 0003387310, 0004600348,
 0004600948, 0004602848, 0004602948,
 0004608948, 0014600248, 0014600848,
 0014601248, 0014602248, 0014607748,
 0024600148, A0003387310, A0004600348,
 A0004602848, A0004602948, A0014600848,
 A0014601248, A0014602248, A0014607748



CV-RK-8118

Ø: 85
 Hole Distance: 130
 Thick/Height: 30
 0003500506, 3500506



DB-DL-5217

Length: 862 Ø: 40
 Cone Ø: d1 Ø 30 / d2 Ø 27
 01214700A, 6204600405, 6204600805,
 6204602905, 6204603005



DB-DL-5412

Length: 840
 Ø: 48
 Cone Ø: d1 Ø 32 / d2 Ø 30
 01214400A, 0014600305, 14600305, 14600405,
 0014600405



DB-DL-7840

Length: 595
 Ø: 62
 Hole Distance: 152 / 152
 6203500006, 6203500106, 6203500306,
 6553500306



DB-DL-10216

Length: 1190
 Ø: 40
 Cone Ø: d1 Ø 32 / d2 Ø 29
 0004604905



DB-ES-5209

Length: 1670 Ø: 50
 Cone Ø: d1 Ø 30 / d2 Ø 27
 6203300503, 6203300603



DB-ES-5234

Length: 135
 Cone Ø: d1 Ø 38 / d2 Ø 34,3
 Thread: M38 x 1,5 RHT
 0004601748, 120322305, 2205000400



DB-RK-5280

Ø: 86
 01303000A, 6213200428



DB-RK-5282

Ø: 59
 01303800A, 6553200111



DB-RK-8564

Ø: 90
 01302200A, 0003500105, 3500105, 0003500405,
 3500405, 5861833, 0005861833, 81432706047



DB-RK-10378

Ø: 86
 6203200028



DB-SB-5259

Ø: 44
 Thick/Height: 25
 01317200A, 0003232150, 3232150



DF-RK-8671



MN-DL-7834

Length: 1588 Ø: 58
 Cone Ø: d1 Ø 30 / d2 Ø 27
 3463303903, 3463304903, 6253303203,
 9443300503, 9443301303, 9443301703





NG ...

1932 S,1932 LS	08/73→09/96	Suspension Arm Repair Kit		DB-RK-8564	Wishbone (CV)
	08/73→09/96	Tie Rod End	CV-ES-12461		for Steering Rod
	08/73→09/96	Tie Rod End	CV-ES-14163		for Steering Rod
1933	11/80→03/91	Centre Rod	DB-DL-10216		Push Rod
	11/80→03/91	Stabiliser Mounting	DB-SB-5258	DB-SB-5258	
	11/80→03/91	Suspension Arm Repair Kit		DB-RK-10378	
	11/80→03/91	Suspension Arm Repair Kit	DB-RK-5283		
	11/80→03/91	Tie Rod End	CV-ES-12461		for Steering Rod
	11/80→03/91	Tie Rod End	CV-ES-14163		for Steering Rod
1933 S,1933 LS	08/73→09/96	Centre Rod	DB-DL-10216		Push Rod
	08/73→09/96	Suspension Arm Repair Kit		CV-RK-8118	for Drag Link
	08/73→09/96	Suspension Arm Repair Kit		DB-RK-8564	Wishbone (CV)
	08/73→09/96	Suspension Arm Repair Kit		DB-RK-10378	
	08/73→09/96	Suspension Arm Repair Kit	DB-RK-5280		
	08/73→09/96	Suspension Strut Repair Kit		DF-RK-8671	
	08/73→09/96	Tie Rod End	CV-ES-12461		for Steering Rod
	08/73→09/96	Tie Rod End	CV-ES-14163		for Steering Rod
	08/73→09/96	Track Control Arm		DB-DL-7840	Suspension Rod, Trailing Arm
1935	02/86→09/89	Centre Rod	DB-DL-10216		Push Rod
	02/86→09/89	Stabiliser Mounting	DB-SB-5258	DB-SB-5258	
	02/86→09/89	Suspension Arm Repair Kit		DB-RK-10378	
	02/86→09/89	Suspension Arm Repair Kit	DB-RK-5283		
	02/86→09/89	Tie Rod End	CV-ES-12461		for Steering Rod
	02/86→09/89	Tie Rod End	CV-ES-14163		for Steering Rod
1935 AK	09/87→03/91	Centre Rod	DB-DL-5217		Push Rod
	09/87→03/91	Centre Rod	DB-DL-10216		Push Rod
	09/87→03/91	Suspension Arm Repair Kit		DB-RK-10378	
	09/87→03/91	Tie Rod	MN-DL-7834		Guide Rod
	09/87→03/91	Tie Rod End	CV-ES-12461		for Steering Rod
1935 AS	09/87→03/91	Tie Rod End	CV-ES-14163		for Steering Rod
	09/87→03/91	Centre Rod	DB-DL-5217		Push Rod
	09/87→03/91	Centre Rod	DB-DL-10216		Push Rod
	09/87→03/91	Tie Rod	MN-DL-7834		Guide Rod
	09/87→03/91	Tie Rod End	CV-ES-12461		for Steering Rod
1935 S,1935 LS	09/87→03/91	Tie Rod End	CV-ES-14163		for Steering Rod
	08/73→09/96	Centre Rod	DB-DL-10216		Push Rod
	08/73→09/96	Suspension Arm Repair Kit		CV-RK-8118	for Drag Link
	08/73→09/96	Suspension Arm Repair Kit		DB-RK-8564	Wishbone (CV)
	08/73→09/96	Suspension Arm Repair Kit		DB-RK-10378	
	08/73→09/96	Suspension Arm Repair Kit	DB-RK-5280		
	08/73→09/96	Suspension Strut Repair Kit		DF-RK-8671	
	08/73→09/96	Tie Rod End	CV-ES-12461		for Steering Rod
	08/73→09/96	Tie Rod End	CV-ES-14163		for Steering Rod
1936	08/73→09/96	Track Control Arm		DB-DL-7840	Suspension Rod, Trailing Arm
	10/81→03/91	Centre Rod	DB-DL-5217		Push Rod
	10/81→03/91	Centre Rod	DB-DL-10216		Push Rod
	10/81→03/91	Stabiliser Mounting	DB-SB-5258	DB-SB-5258	
	10/81→03/91	Suspension Arm Repair Kit		DB-RK-10378	
	10/81→03/91	Suspension Arm Repair Kit	DB-RK-5283		
	10/81→03/91	Tie Rod End	CV-ES-12461		for Steering Rod
	10/81→03/91	Tie Rod End	CV-ES-14163		for Steering Rod
	10/81→03/91	Centre Rod	DB-DL-5217		Push Rod
	10/81→03/91	Centre Rod	DB-DL-10216		Push Rod
1936 AK	10/81→03/91	Suspension Arm Repair Kit		DB-RK-10378	
	10/81→03/91	Tie Rod	MN-DL-7834		Guide Rod
	10/81→03/91	Tie Rod End	CV-ES-12461		for Steering Rod
	10/81→03/91	Tie Rod End	CV-ES-14163		for Steering Rod
	10/81→03/91	Tie Rod End	DB-ES-5234		for Steering Rod
	10/81→03/91	Centre Rod	DB-DL-5217		Push Rod* 5 184 732 *→* 5 211 262 *
	10/81→03/91	Centre Rod	DB-DL-10216		Push Rod
1936 AS	10/81→03/91	Suspension Arm Repair Kit		DB-RK-10378	
	10/81→03/91	Centre Rod	DB-DL-5217		Push Rod* 5 184 732 *→* 5 211 262 *
	10/81→03/91	Centre Rod	DB-DL-10216		Push Rod
	10/81→03/91	Tie Rod	MN-DL-7834		Guide Rod

CV-ES-12461

Length: 120
Cone Ø: d1 Ø 26 / d2 Ø 23,5
Thread: M30 x 1,5 LHT
 0003300035, 3300148, 0003406213, 0013306635,
 0013308835, 0014604048, 0014604348,
 14606448, 0024600248, 3023300035,
 3023300135, 3023300235, 3023300335,
 3453307235, 3453307435, 3503307135,
 A0003300148, A0013306635, A0013308835,
 A0014604048, A0014604348, A0014606448,
 A0024600248, A3023300035, A3023300135,
 A3023300235, A3023300335, A3503307135



CV-ES-14163

Length: 125
Cone Ø: d1 Ø 30 / d2 Ø 27
Thread: M30 x 1,5 RHT
 0003305248, 0003387310, 0004600348,
 0004600948, 0004602848, 0004602948,
 0004608948, 0014600248, 0014600848,
 0014601248, 0014602248, 0014607748,
 0024600148, A0003387310, A0004600348,
 A0004602848, A0004602948, A0014600848,
 A0014601248, A0014602248, A0014607748



CV-RK-8118

Ø: 85
Hole Distance: 130
Thick/Height: 30
 0003500506, 3500506



DB-DL-5217

Length: 862 **Ø:** 40
Cone Ø: d1 Ø 30 / d2 Ø 27
 01214700A, 6204600405, 6204600805,
 6204602905, 6204603005



DB-DL-7840

Length: 595
Ø: 62
Hole Distance: 152 / 152
 6203500006, 6203500106, 6203500306,
 6553500306



DB-DL-10216

Length: 1190
Ø: 40
Cone Ø: d1 Ø 32 / d2 Ø 29
 0004604905



DB-ES-5234

Length: 135
Cone Ø: d1 Ø 38 / d2 Ø 34,3
Thread: M38 x 1,5 RHT
 0004601748, 120322305, 2205000400



DB-RK-5280

Ø: 86
 01303000A, 6213200428



DB-RK-5283

Ø: 70
 01319900A, 6203200628



DB-RK-8564

Ø: 90
 01302200A, 0003500105, 3500105, 0003500405,
 3500405, 0005861833, 5861833, 81432706047



DB-RK-10378

Ø: 86
 6203200028



DB-SB-5258

Ø: 70
Thick/Height: 62
 01311400A, 3873230285



DF-RK-8671



MN-DL-7834

Length: 1588 **Ø:** 58
Cone Ø: d1 Ø 30 / d2 Ø 27
 3463303903, 3463304903, 6253303203,
 9443300503, 9443301303, 9443301703





NG ...

1936 AS ...	10/81→03/91	Tie Rod End	CV-ES-12461		for Steering Rod
	10/81→03/91	Tie Rod End	CV-ES-14163		for Steering Rod
1936 K	10/81→03/91	Stabiliser Mounting	DB-SB-5258	DB-SB-5258	
	10/81→03/91	Suspension Arm Repair Kit		DB-RK-10378	
	10/81→03/91	Suspension Arm Repair Kit	DB-RK-5283		
	10/81→03/91	Tie Rod End	CV-ES-14163		for Steering Rod
1936 S,1936 LS	08/73→09/96	Centre Rod	DB-DL-10216		Push Rod
	08/73→09/96	Suspension Arm Repair Kit		CV-RK-8118	for Drag Link
	08/73→09/96	Suspension Arm Repair Kit		DB-RK-8564	Wishbone (CV)
	08/73→09/96	Suspension Arm Repair Kit		DB-RK-10378	
	08/73→09/96	Suspension Strut Repair Kit		DF-RK-8671	
	08/73→09/96	Tie Rod End	CV-ES-12461		for Steering Rod
	08/73→09/96	Tie Rod End	CV-ES-14163		for Steering Rod
1938	08/73→09/96	Track Control Arm		DB-DL-7840	Suspension Rod, Trailing Arm
	11/80→06/90	Centre Rod	DB-DL-10216		Push Rod
	11/80→06/90	Stabiliser Mounting	DB-SB-5258	DB-SB-5258	
	11/80→06/90	Suspension Arm Repair Kit		DB-RK-10378	
	11/80→06/90	Suspension Arm Repair Kit	DB-RK-5283		
	11/80→06/90	Tie Rod End	CV-ES-12461		for Steering Rod
1938 S,1938 LS	11/80→06/90	Tie Rod End	CV-ES-14163		for Steering Rod
	08/73→09/96	Centre Rod	DB-DL-10216		Push Rod
	08/73→09/96	Suspension Arm Repair Kit		CV-RK-8118	for Drag Link
	08/73→09/96	Suspension Arm Repair Kit		DB-RK-8564	Wishbone (CV)
	08/73→09/96	Suspension Arm Repair Kit		DB-RK-10378	
	08/73→09/96	Suspension Arm Repair Kit	DB-RK-5280		
1944	08/73→09/96	Suspension Strut Repair Kit		DF-RK-8671	
	08/73→09/96	Tie Rod End	CV-ES-12461		for Steering Rod
	08/73→09/96	Tie Rod End	CV-ES-14163		for Steering Rod
	08/73→09/96	Track Control Arm		DB-DL-7840	Suspension Rod, Trailing Arm
	10/85→12/89	Centre Rod	DB-DL-10216		Push Rod
	10/85→12/89	Stabiliser Mounting	DB-SB-5258	DB-SB-5258	
	10/85→12/89	Suspension Arm Repair Kit		DB-RK-10378	
1944 S,1944 LS	10/85→12/89	Suspension Arm Repair Kit	DB-RK-5283		
	10/85→12/89	Tie Rod End	CV-ES-12461		for Steering Rod
	10/85→12/89	Tie Rod End	CV-ES-14163		for Steering Rod
	08/73→09/96	Centre Rod	DB-DL-10216		Push Rod
	08/73→09/96	Suspension Arm Repair Kit		CV-RK-8118	for Drag Link
	08/73→09/96	Suspension Arm Repair Kit		DB-RK-8564	Wishbone (CV)
2025 S	08/73→09/96	Suspension Arm Repair Kit		DB-RK-10378	
	08/73→09/96	Suspension Arm Repair Kit	DB-RK-5280		
	08/73→09/96	Suspension Strut Repair Kit		DF-RK-8671	
	08/73→09/96	Tie Rod End	CV-ES-12461		for Steering Rod
	08/73→09/96	Tie Rod End	CV-ES-14163		for Steering Rod
	08/73→09/96	Track Control Arm		DB-DL-7840	Suspension Rod, Trailing Arm
	08/83→03/91	Tie Rod End	CV-ES-12461		for Steering Rod
2026 S	08/83→03/91	Tie Rod End	CV-ES-14163		for Steering Rod
	10/76→10/80	Centre Rod	DB-DL-10140		Push Rod
	10/76→10/80	Centre Rod	DB-DL-10140		Push Rod→* 4 298 136 *
	10/76→10/80	Stabiliser Mounting	DB-SB-5259		
	10/76→10/80	Tie Rod End	CV-ES-12461		for Steering Rod
	10/76→10/80	Tie Rod End	CV-ES-14163		for Steering Rod
2028 A	01/80→06/89	Centre Rod	DB-DL-5217		Push Rod
	01/80→06/89	Centre Rod	DB-DL-10216		Push Rod
	01/80→06/89	Tie Rod	DB-ES-5209		
	01/80→06/89	Tie Rod	DB-ES-5227		Guide Rod
	01/80→06/89	Tie Rod	MN-DL-7834		Guide Rod
	01/80→06/89	Tie Rod End	CV-ES-12461		for Steering Rod
	01/80→06/89	Tie Rod End	DB-ES-5234		for Steering Rod
	01/80→06/89	Track Control Arm		DB-DL-6227	Suspension Rod, Trailing Arm
	01/80→06/89	Centre Rod	DB-DL-10216		Push Rod
2028 LS	01/80→06/89	Suspension Arm Repair Kit		CV-RK-8118	for Drag Link
	01/80→06/89	Suspension Arm Repair Kit		DB-RK-8564	Wishbone (CV)
	01/80→06/89	Suspension Arm Repair Kit	DB-RK-5280		

CV-ES-12461

Length: 120
 Cone Ø: d1 Ø 26 / d2 Ø 23,5
 Thread: M30 x 1,5 LHT
 0003300035, 3300148, 0003406213, 0013306635,
 0013308835, 0014604048, 0014604348,
 14606448, 0024600248, 3023300035,
 3023300135, 3023300235, 3023300335,
 3453307235, 3453307435, 3503307135,
 A0003300148, A0013306635, A0013308835,
 A0014604048, A0014604348, A0014606448,
 A0024600248, A3023300035, A3023300135,
 A3023300235, A3023300335, A3503307135



CV-ES-14163

Length: 125
 Cone Ø: d1 Ø 30 / d2 Ø 27
 Thread: M30 x 1,5 RHT
 0003305248, 0003387310, 0004600348,
 0004600948, 0004602848, 0004602948,
 0004608948, 0014600248, 0014600848,
 0014601248, 0014602248, 0014607748,
 0024600148, A0003387310, A0004600348,
 A0004602848, A0004602948, A0014600848,
 A0014601248, A0014602248, A0014607748



CV-RK-8118

Ø: 85
 Hole Distance: 130
 Thick/Height: 30
 0003500506, 3500506



DB-DL-5217

Length: 862 Ø: 40
 Cone Ø: d1 Ø 30 / d2 Ø 27
 01214700A, 6204600405, 6204600805,
 6204602905, 6204603005



DB-DL-6227

Length: 629
 Ø: 58
 Hole Distance: 152 / 152
 6593501506, 6593503806



DB-DL-7840

Length: 595
 Ø: 62
 Hole Distance: 152 / 152
 6203500006, 6203500106, 6203500306,
 6553500306



DB-DL-10140

Length: 865
 Ø: 40
 Cone Ø: d1 Ø 26 / d2 Ø 23,5
 3874600605, 3874600805, 3874604405,
 3874604505



DB-DL-10216

Length: 1190
 Ø: 40
 Cone Ø: d1 Ø 32 / d2 Ø 29
 0004604905



DB-ES-5209

Length: 1670 Ø: 50
 Cone Ø: d1 Ø 30 / d2 Ø 27
 6203300503, 6203300603



DB-ES-5227

Length: 1588 Ø: 60
 Cone Ø: d1 Ø 38 / d2 Ø 34,3
 6253300903, 6253301203, 9443300203



DB-ES-5234

Length: 135
 Cone Ø: d1 Ø 38 / d2 Ø 34,3
 Thread: M38 x 1,5 RHT
 0004601748, 120322305, 2205000400



DB-RK-5280

Ø: 86
 01303000A, 6213200428



DB-RK-5283

Ø: 70
 01319900A, 6203200628



DB-RK-8564

Ø: 90
 01302200A, 0003500105, 3500105, 0003500405,
 3500405, 0005861833, 5861833, 81432706047



DB-RK-10378

Ø: 86
 6203200028



DB-SB-5258

Ø: 70
 Thick/Height: 62
 01311400A, 3873230285



DB-SB-5259

Ø: 44
 Thick/Height: 25
 01317200A, 0003232150, 3232150



DF-RK-8671



MN-DL-7834

Length: 1588 Ø: 58
 Cone Ø: d1 Ø 30 / d2 Ø 27
 3463303903, 3463304903, 6253303203,
 9443300503, 9443301303, 9443301703





NG ...

2028 LS ...	01/80→06/89	Suspension Strut Repair Kit		DF-RK-8671	
	01/80→06/89	Tie Rod End	CV-ES-12461		for Steering Rod
	01/80→06/89	Tie Rod End	CV-ES-14163		for Steering Rod
	01/80→06/89	Track Control Arm		DB-DL-7840	Suspension Rod, Trailing Arm
2032 S	08/75→09/83	Centre Rod	DB-DL-10140		Push Rod
	08/75→09/83	Centre Rod	DB-DL-10140		Push Rod→* 4 298 136 *
	08/75→09/83	Stabiliser Mounting	DB-SB-5259		
	08/75→09/83	Tie Rod End	CV-ES-12461		for Steering Rod
	08/75→09/83	Tie Rod End	CV-ES-14163		for Steering Rod
2033 LS	12/81→05/87	Suspension Arm Repair Kit		CV-RK-8118	for Drag Link
	12/81→05/87	Suspension Arm Repair Kit		DB-RK-8564	Wishbone (CV)
	12/81→05/87	Suspension Arm Repair Kit	DB-RK-5280		
	12/81→05/87	Suspension Strut Repair Kit		DF-RK-8671	
	12/81→05/87	Tie Rod End	CV-ES-12461		for Steering Rod
	12/81→05/87	Tie Rod End	CV-ES-14163		for Steering Rod
	12/81→05/87	Track Control Arm		DB-DL-7840	Suspension Rod, Trailing Arm
2035 S,2035 LS	08/73→09/96	Suspension Arm Repair Kit		CV-RK-8118	for Drag Link
	08/73→09/96	Suspension Arm Repair Kit		DB-RK-10378	
	08/73→09/96	Suspension Arm Repair Kit	DB-RK-5280		
	08/73→09/96	Suspension Strut Repair Kit		DF-RK-8671	
	08/73→09/96	Tie Rod End	CV-ES-12461		for Steering Rod
	08/73→09/96	Tie Rod End	CV-ES-14163		for Steering Rod
	08/73→09/96	Track Control Arm		DB-DL-7840	Suspension Rod, Trailing Arm
2036 A	01/80→06/89	Centre Rod	DB-DL-5217		Push Rod
	01/80→06/89	Centre Rod	DB-DL-10216		Push Rod
	01/80→06/89	Tie Rod	DB-ES-5209		
	01/80→06/89	Tie Rod	DB-ES-5227		Guide Rod
	01/80→06/89	Tie Rod	MN-DL-7834		Guide Rod
	01/80→06/89	Tie Rod End	CV-ES-12461		for Steering Rod
	01/80→06/89	Tie Rod End	DB-ES-5234		for Steering Rod
	01/80→06/89	Track Control Arm		DB-DL-6227	Suspension Rod, Trailing Arm
2036 LS	03/84→03/91	Suspension Arm Repair Kit		CV-RK-8118	for Drag Link
	03/84→03/91	Suspension Arm Repair Kit		DB-RK-8564	Wishbone (CV)
	03/84→03/91	Suspension Arm Repair Kit	DB-RK-5280		
	03/84→03/91	Suspension Strut Repair Kit		DF-RK-8671	
	03/84→03/91	Tie Rod End	CV-ES-12461		for Steering Rod
	03/84→03/91	Tie Rod End	CV-ES-14163		for Steering Rod
2219	06/76→01/87	Centre Rod	DB-DL-5216		Push Rod
	06/76→01/87	Suspension Strut Repair Kit		CV-RK-7850	
	06/76→01/87	Tie Rod End	CV-ES-12461		for Steering Rod
	06/76→01/87	Tie Rod End	CV-ES-12462		for Steering Rod
2219 C,2219 CL	08/73→09/96	Centre Rod	DB-DL-8672		Push Rod* 1 4 914207 *→
	08/73→09/96	Stabiliser Mounting	DB-SB-5258	DB-SB-5258	
	08/73→09/96	Suspension Arm Repair Kit		CV-RK-8118	for Drag Link
	08/73→09/96	Suspension Arm Repair Kit		DB-RK-8380	for Drag Link
	08/73→09/96	Suspension Arm Repair Kit		DB-RK-8564	Wishbone (CV)
	08/73→09/96	Suspension Arm Repair Kit		MN-RK-9387	
	08/73→09/96	Suspension Arm Repair Kit		MN-RK-9387	Lifting Axle
	08/73→09/96	Suspension Arm Repair Kit		SC-RK-8688	for Drag Link
	08/73→09/96	Suspension Arm Repair Kit		SC-RK-8688	for Drag Link, Lifting Axle
	08/73→09/96	Suspension Strut Repair Kit		DF-RK-8671	
	08/73→09/96	Tie Rod	DB-ES-5209		
	08/73→09/96	Tie Rod End	CV-ES-12461		for Steering Rod
	08/73→09/96	Tie Rod End	CV-ES-14163		for Steering Rod
	08/73→09/96	Track Control Arm		DB-DL-5220	Trailing Arm
	08/73→09/96	Track Control Arm		DB-DL-9164	Trailing Arm
	2219 K	06/76→01/87	Centre Rod	DB-DL-5216	
06/76→01/87		Suspension Strut Repair Kit		CV-RK-7850	
06/76→01/87		Tie Rod End	CV-ES-12461		for Steering Rod
06/76→01/87		Tie Rod End	CV-ES-12462		for Steering Rod

CV-ES-12461

Length: 120
Cone Ø: d1 Ø 26 / d2 Ø 23,5
Thread: M30 x 1,5 LHT
0003300035, 3300148, 0003406213, 0013306635,
0013308835, 0014604048, 0014604348,
14606448, 0024600248, 3023300035,
3023300135, 3023300235, 3023300335,
3453307235, 3453307435, 3503307135,
A0003300148, A0013306635, A0013308835,
A0014604048, A0014604348, A0014606448,
A0024600248, A3023300035, A3023300135,
A3023300235, A3023300335, A3503307135



CV-ES-12462

Length: 120
Cone Ø: d1 Ø 26 / d2 Ø 23,5
Thread: M30 x 1,5 RHT
0003300135, 0003300248, 0003303235,
0003305835, 0003307335, 0003383410,
0004608348, 004608348, 0004632229,
0004633129, 0004633429, 0004633529,
0013300135, 0013300235, 0013306735,
0014603448, 0014604148, 0014604448,
0014606348, 0014608348, 0014608448,
0014609748, 0023301535, 3453307135,
3503307035, 3503307335, 3643307135,
5001832582, A0003300248, A0003303235,
A0003307335, A0003383410, A0004608348,
A0004632229, A0004633429, A0013300135,
A0013300235, A0013306735, A0014603448,
A0014604148, A0014604448, A0014606348,
A0014608348, A0014608448, A0014609748,
A0023301535



CV-ES-14163

Length: 125
Cone Ø: d1 Ø 30 / d2 Ø 27
Thread: M30 x 1,5 RHT
0003305248, 0003387310, 0004600348,
0004600948, 0004602848, 0004602948,
0004608948, 0014600248, 0014600848,
0014601248, 0014602248, 0014607748,
0024600148, A0003387310, A0004600348,
A0004602848, A0004602948, A0014600848,
A0014601248, A0014602248, A0014607748



CV-RK-7850

Ø: 85
Thick/Height: 171
0003501013, 3501013



CV-RK-8118

Ø: 85
Hole Distance: 130
Thick/Height: 30
0003500506, 3500506



DB-DL-5216

Length: 890
Ø: 42
Cone Ø: d1 Ø 26 / d2 Ø 23,5
01215700A, 3834600605, 3834601405,
3834602305, 3834604405



DB-DL-5217

Length: 862 Ø: 40
Cone Ø: d1 Ø 30 / d2 Ø 27
01214700A, 6204600405, 6204600805,
6204602905, 6204603005



DB-DL-5220

Length: 522
Ø: 52
Hole Distance: 151
01335200A, 3813500606, 6523500306,
6533500106



DB-DL-6227

Length: 629
Ø: 58
Hole Distance: 152 / 152
6593501506, 6593503806



DB-DL-7840

Length: 595
Ø: 62
Hole Distance: 152 / 152
6203500006, 6203500106, 6203500306,
6553500306



DB-DL-8672

Length: 860
Ø: 48
Cone Ø: d1 Ø 30 / d2 Ø 27
0014609705, 14609705



DB-DL-9164

Length: 500
Ø: 50
Hole Distance: 152 / 152
3853500006, 6533500006



DB-DL-10140

Length: 865
Ø: 40
Cone Ø: d1 Ø 26 / d2 Ø 23,5
3874600605, 3874600805, 3874604405,
3874604505



DB-DL-10216

Length: 1190
Ø: 40
Cone Ø: d1 Ø 32 / d2 Ø 29
0004604905



DB-ES-5209

Length: 1670 Ø: 50
Cone Ø: d1 Ø 30 / d2 Ø 27
6203300503, 6203300603



DB-ES-5227

Length: 1588 Ø: 60
Cone Ø: d1 Ø 38 / d2 Ø 34,3
6253300903, 6253301203, 9443300203



DB-ES-5234

Length: 135
Cone Ø: d1 Ø 38 / d2 Ø 34,3
Thread: M38 x 1,5 RHT
0004601748, 120322305, 2205000400



DB-RK-5280

Ø: 86
01303000A, 6213200428



DB-RK-8380

Ø: 80
0005861035, 5861035



DB-RK-8564

Ø: 90
01302200A, 0003500105, 3500105, 0003500405,
3500405, 0005861833, 5861833, 81432706047



DB-RK-10378

Ø: 86
6203200028



DB-SB-5258

Ø: 70
Thick/Height: 62
01311400A, 3873230285



DB-SB-5259

Ø: 44
Thick/Height: 25
01317200A, 0003232150, 3232150



DF-RK-8671



MN-DL-7834

Length: 1588 Ø: 58
Cone Ø: d1 Ø 30 / d2 Ø 27
3463303903, 3463304903, 6253303203,
9443300503, 9443301303, 9443301703



MN-RK-9387

Ø: 90
0003500105, 81432706047



SC-RK-8688

Length: 95
Ø: 95
3501905, 0003501905





NG ...

2219 KO	06/76→01/87	Centre Rod	DB-DL-5216		Push Rod	
	06/76→01/87	Suspension Strut Repair Kit		CV-RK-7850		
	06/76→01/87	Tie Rod End	CV-ES-12461		for Steering Rod	
	06/76→01/87	Tie Rod End	CV-ES-12462		for Steering Rod	
2219,2219 L	08/73→09/96	Centre Rod	DB-DL-5216		Push Rod	
	08/73→09/96	Suspension Arm Repair Kit		CV-RK-8118	for Drag Link	
	08/73→09/96	Suspension Arm Repair Kit		DB-RK-8380	for Drag Link	
	08/73→09/96	Suspension Arm Repair Kit		DB-RK-8564	Wishbone (CV)	
	08/73→09/96	Suspension Strut Repair Kit		DF-RK-8671		
	08/73→09/96	Tie Rod End	CV-ES-12461		for Steering Rod	
	08/73→09/96	Tie Rod End	CV-ES-12462		for Steering Rod	
	08/73→09/96	Tie Rod End	CV-ES-14163		for Steering Rod	
	08/73→09/96	Track Control Arm		DB-DL-5220	Trailing Arm	
	08/73→09/96	Track Control Arm		DB-DL-9164	Trailing Arm	
	08/73→09/96	Track Control Arm		DB-DL-9164	Trailing Arm, Lifting Axle	
	2220,2220 L	08/73→09/96	Centre Rod	DB-DL-8672		Push Rod* 1 4 914207 *→
08/73→09/96		Stabiliser Mounting	DB-SB-5258	DB-SB-5258		
08/73→09/96		Suspension Arm Repair Kit		CV-RK-8118	for Drag Link	
08/73→09/96		Suspension Arm Repair Kit		DB-RK-8380	for Drag Link	
08/73→09/96		Suspension Arm Repair Kit		DB-RK-8564	Wishbone (CV)	
08/73→09/96		Suspension Arm Repair Kit		MN-RK-9387		
08/73→09/96		Suspension Arm Repair Kit		MN-RK-9387	Lifting Axle	
08/73→09/96		Suspension Arm Repair Kit		SC-RK-8688	for Drag Link	
08/73→09/96		Suspension Arm Repair Kit		SC-RK-8688	for Drag Link, Lifting Axle	
08/73→09/96		Suspension Strut Repair Kit		DF-RK-8671		
08/73→09/96		Tie Rod	DB-ES-5209			
08/73→09/96		Tie Rod End	CV-ES-12461		for Steering Rod	
08/73→09/96		Tie Rod End	CV-ES-14163		for Steering Rod	
08/73→09/96		Track Control Arm		DB-DL-5220	Trailing Arm	
08/73→09/96		Track Control Arm		DB-DL-9164	Trailing Arm	
2222		05/82→03/91	Centre Rod	DB-DL-5217		Push Rod
		05/82→03/91	Centre Rod	DB-DL-8672		Push Rod* 1 4 914207 *→
	05/82→03/91	Centre Rod	DB-DL-10216		Push Rod	
	05/82→03/91	Suspension Arm Repair Kit		CV-RK-8118	for Drag Link	
	05/82→03/91	Suspension Strut Repair Kit		DF-RK-8671		
	05/82→03/91	Tie Rod End	CV-ES-12461		for Steering Rod	
	05/82→03/91	Tie Rod End	CV-ES-14163		for Steering Rod	
	05/82→03/91	Track Control Arm		DB-DL-7839	Trailing Arm	
2222 B	05/82→03/91	Centre Rod	DB-DL-8672		Push Rod* 1 4 914207 *→	
	05/82→03/91	Suspension Arm Repair Kit		CV-RK-8118	for Drag Link	
	05/82→03/91	Suspension Strut Repair Kit		DF-RK-8671		
	05/82→03/91	Tie Rod End	CV-ES-14163		for Steering Rod	
	05/82→03/91	Track Control Arm		DB-DL-7839	Trailing Arm	
2222 K	05/82→10/89	Centre Rod	DB-DL-5239		Push Rod* 5 180 857 *→	
	05/82→10/89	Centre Rod	DB-DL-10216		Push Rod	
	05/82→10/89	Tie Rod	DB-DL-8632			
	05/82→03/91	Centre Rod	DB-DL-8672		Push Rod* 1 4 914207 *→	
	05/82→03/91	Suspension Arm Repair Kit		CV-RK-8118	for Drag Link	
	05/82→03/91	Suspension Strut Repair Kit		DF-RK-8671		
	05/82→03/91	Tie Rod End	CV-ES-12461		for Steering Rod	
	05/82→03/91	Tie Rod End	CV-ES-12462		for Steering Rod	
	05/82→03/91	Tie Rod End	CV-ES-14163		for Steering Rod	
2222 L	05/82→03/91	Track Control Arm		DB-DL-7839	Trailing Arm	
	08/73→09/96	Centre Rod	DB-DL-5207		Push Rod* 5 259 613 *→	
	08/73→09/96	Centre Rod	DB-DL-7831		Push Rod	
	08/73→09/96	Centre Rod	DB-DL-8122		Push Rod* 5 259 613 *→	
	08/73→09/96	Centre Rod	DB-DL-8138		Push Rod	
	08/73→09/96	Centre Rod	DB-DL-8618		Push Rod	
	08/73→09/96	Centre Rod	DB-DL-10216		Push Rod	
	08/73→09/96	Centre Rod	DB-DL-12309		Coupling Rod	
	08/73→09/96	Suspension Arm Repair Kit		DB-RK-8380	Wishbone (CV)	
	08/73→09/96	Tie Rod	DB-DL-8640		Guide Rod	
	08/73→09/96	Tie Rod	DB-ES-5209			

CV-ES-12461

Length: 120
Cone Ø: d1 Ø 26 / d2 Ø 23,5
Thread: M30 x 1,5 LHT
0003300035, 3300148, 0003406213, 0013306635,
0013308835, 0014604048, 0014604348,
14606448, 0024600248, 3023300035,
3023300135, 3023300235, 3023300335,
3453307235, 3453307435, 3503307135,
A0003300148, A0013306635, A0013308835,
A0014604048, A0014604348, A0014606448,
A0024600248, A3023300035, A3023300135,
A3023300235, A3023300335, A3503307135



CV-ES-12462

Length: 120
Cone Ø: d1 Ø 26 / d2 Ø 23,5
Thread: M30 x 1,5 RHT
0003300135, 0003300248, 0003303235,
0003305835, 0003307335, 0003383410,
0004608348, 004608348, 0004632229,
0004633129, 0004633429, 0004633529,
0013300135, 0013300235, 0013306735,
0014603448, 0014604148, 0014604448,
0014606348, 0014608348, 0014608448,
0014609748, 0023301535, 3453307135,
3503307035, 3503307335, 3643307135,
5001832582, A0003300248, A0003303235,
A0003307335, A0003383410, A0004608348,
A0004632229, A0004633429, A0013300135,
A0013300235, A0013306735, A0014603448,
A0014604148, A0014604448, A0014606348,
A0014608348, A0014608448, A0014609748,
A0023301535



CV-ES-14163

Length: 125
Cone Ø: d1 Ø 30 / d2 Ø 27
Thread: M30 x 1,5 RHT
0003305248, 0003387310, 0004600348,
0004600948, 0004602848, 0004602948,
0004608948, 0014600248, 0014600848,
0014601248, 0014602248, 0014607748,
0024600148, A0003387310, A0004600348,
A0004602848, A0004602948, A0014600848,
A0014601248, A0014602248, A0014607748



CV-RK-7850

Ø: 85
Thick/Height: 171
0003501013, 3501013



CV-RK-8118

Ø: 85
Hole Distance: 130
Thick/Height: 30
0003500506, 3500506



DB-DL-5207

Length: 875 Ø: 42
Cone Ø: d1 Ø 30 / d2 Ø 27
01215100A, 6174603505, 6174603605



DB-DL-5216

Length: 890
Ø: 42
Cone Ø: d1 Ø 26 / d2 Ø 23,5
01215700A, 3834600605, 3834601405,
3834602305, 3834604405



DB-DL-5217

Length: 862 Ø: 40
Cone Ø: d1 Ø 30 / d2 Ø 27
01214700A, 6204600405, 6204600805,
6204602905, 6204603005



DB-DL-5220

Length: 522
Ø: 52
Hole Distance: 151
01335200A, 3813500606, 6523500306,
6533500106



DB-DL-5239

Length: 862
Ø: 42
Cone Ø: d1 Ø 30 / d2 Ø 27
01214500A, 6174602405, 6174603405



DB-DL-7831

Length: 870
Ø: 42
Cone Ø: d1 Ø 30 / d2 Ø 27
01215200A, 6254602505



DB-DL-7839

Length: 585
Ø: 50
Hole Distance: 152 / 152
3953500206, 6593500106, 6593502406



DB-DL-8122

Length: 875
Ø: 42
Cone Ø: d1 Ø 30 / d2 Ø 27
01215000A, 6174603205, 6174603305



DB-DL-8138

Length: 1130
Ø: 40
Cone Ø: d1 Ø 32 / d2 Ø 28,8
0004606605, 4606605



DB-DL-8618

Length: 680
Ø: 42
Cone Ø: d1 Ø 32 / d2 Ø 28,8
0004604305, 4604305, 6254604805



DB-DL-8632

Length: 1635
Ø: 60
Cone Ø: d1 Ø 30 / d2 Ø 27
3853301303, 3853302103, 3853302203



DB-DL-8640

Length: 1615 Ø: 50
Cone Ø: d1 Ø 32 / d2 Ø 29
6253301503, 6253301603, 6253302403,
6253302503, 9423300803, 9423302103,
9493300203, 9493300303, 9493300903



DB-DL-8672

Length: 860
Ø: 48
Cone Ø: d1 Ø 30 / d2 Ø 27
0014609705, 14609705



DB-DL-9164

Length: 500
Ø: 50
Hole Distance: 152 / 152
3853500006, 6533500006



DB-DL-10216

Length: 1190
Ø: 40
Cone Ø: d1 Ø 32 / d2 Ø 29
0004604905



DB-DL-12309

Length: 685 Ø: 40
Cone Ø: d1 Ø 32 / d2 Ø 28,8
0004606005, 0004606305



DB-ES-5209

Length: 1670 Ø: 50
Cone Ø: d1 Ø 30 / d2 Ø 27
6203300503, 6203300603



DB-RK-8380

Ø: 80
0005861035, 5861035



DB-RK-8564

Ø: 90
01302200A, 0003500105, 3500105, 0003500405,
3500405, 0005861833, 5861833, 81432706047



DB-SB-5258

Ø: 70
Thick/Height: 62
01311400A, 3873230285



DF-RK-8671



MN-RK-9387

Ø: 90
0003500105, 81432706047



SC-RK-8688

Length: 95
Ø: 95
0003501905, 3501905





NG ...

2222 L ...	08/73→09/96	Tie Rod End	CV-ES-12461		for Steering Rod
	08/73→09/96	Tie Rod End	CV-ES-12462		for Steering Rod
	08/73→09/96	Tie Rod End	CV-ES-14163		for Steering Rod
	08/73→09/96	Track Control Arm		DB-DL-5220	Trailing Arm
2222,2222 L	08/73→09/96	Centre Rod	DB-DL-7831		Push Rod
	08/73→09/96	Centre Rod	DB-DL-8138		Push Rod
	08/73→09/96	Centre Rod	DB-DL-8618		Push Rod
	08/73→09/96	Centre Rod	DB-DL-8672		Push Rod* 1 4 914207 *→
	08/73→09/96	Centre Rod	DB-DL-10216		Push Rod
	08/73→09/96	Centre Rod	DB-DL-12309		Coupling Rod
	08/73→09/96	Stabiliser Mounting	DB-SB-5258	DB-SB-5258	
	08/73→09/96	Suspension Arm Repair Kit		CV-RK-8118	for Drag Link
	08/73→09/96	Suspension Arm Repair Kit		DB-RK-8380	for Drag Link
	08/73→09/96	Suspension Arm Repair Kit		DB-RK-8564	Wishbone (CV)
	08/73→09/96	Suspension Arm Repair Kit		MN-RK-9387	
	08/73→09/96	Suspension Arm Repair Kit		MN-RK-9387	Lifting Axle
	08/73→09/96	Suspension Arm Repair Kit		SC-RK-8688	for Drag Link
	08/73→09/96	Suspension Arm Repair Kit		SC-RK-8688	for Drag Link, Lifting Axle
	08/73→09/96	Suspension Strut Repair Kit		DF-RK-8671	
	08/73→09/96	Tie Rod	DB-DL-8640		Guide Rod
	08/73→09/96	Tie Rod	DB-ES-5209		
	08/73→09/96	Tie Rod End	CV-ES-12461		for Steering Rod
	08/73→09/96	Tie Rod End	CV-ES-14163		for Steering Rod
	08/73→09/96	Track Control Arm		DB-DL-5220	Trailing Arm
08/73→09/96	Track Control Arm		DB-DL-9164	Trailing Arm	
08/73→09/96	Track Control Arm		DB-DL-9164	Trailing Arm, Lifting Axle	
2224	04/76→12/82	Centre Rod	DB-DL-5216		Push Rod
	04/76→12/82	Suspension Strut Repair Kit		CV-RK-7850	
	04/76→12/82	Tie Rod End	CV-ES-12461		for Steering Rod
	04/76→12/82	Tie Rod End	CV-ES-12462		for Steering Rod
2224 B	05/75→03/84	Centre Rod	DB-DL-5216		Push Rod
	05/75→03/84	Suspension Strut Repair Kit		CV-RK-7850	
	05/75→03/84	Tie Rod End	CV-ES-12461		for Steering Rod
	05/75→03/84	Tie Rod End	CV-ES-12462		for Steering Rod
2224 K	04/76→12/82	Centre Rod	DB-DL-5216		Push Rod
	04/76→12/82	Suspension Strut Repair Kit		CV-RK-7850	
	04/76→12/82	Tie Rod End	CV-ES-12461		for Steering Rod
	04/76→12/82	Tie Rod End	CV-ES-12462		for Steering Rod
2224 S	07/76→12/82	Centre Rod	DB-DL-5216		Push Rod
	07/76→12/82	Suspension Strut Repair Kit		CV-RK-7850	
	07/76→12/82	Tie Rod End	CV-ES-12461		for Steering Rod
	07/76→12/82	Tie Rod End	CV-ES-12462		for Steering Rod
2225	04/85→03/91	Centre Rod	DB-DL-8672		Push Rod* 1 4 914207 *→
	04/85→03/91	Suspension Arm Repair Kit		CV-RK-8118	for Drag Link
	04/85→03/91	Suspension Strut Repair Kit		DF-RK-8671	
	04/85→03/91	Tie Rod End	CV-ES-12461		for Steering Rod
	04/85→03/91	Tie Rod End	CV-ES-12462		for Steering Rod
	04/85→03/91	Tie Rod End	CV-ES-14163		for Steering Rod
	04/85→03/91	Track Control Arm		DB-DL-7839	Trailing Arm
	04/85→03/91	Track Control Arm		DB-DL-9164	Trailing Arm
	04/85→03/91	Track Control Arm		DB-DL-9164	Trailing Arm
2225 B	08/83→03/91	Centre Rod	DB-DL-8672		Push Rod* 1 4 914207 *→
	08/83→03/91	Suspension Arm Repair Kit		CV-RK-8118	for Drag Link
	08/83→03/91	Suspension Arm Repair Kit		DB-RK-8380	Wishbone (CV)
	08/83→03/91	Suspension Strut Repair Kit		DF-RK-8671	
	08/83→03/91	Tie Rod End	CV-ES-12461		for Steering Rod
	08/83→03/91	Tie Rod End	CV-ES-12462		for Steering Rod
	08/83→03/91	Tie Rod End	CV-ES-14163		for Steering Rod
	08/83→03/91	Track Control Arm		DB-DL-5220	Trailing Arm
	08/83→03/91	Track Control Arm		DB-DL-7839	Trailing Arm
2225 L	08/73→09/96	Suspension Arm Repair Kit		DB-RK-8380	Wishbone (CV)
	08/73→09/96	Tie Rod	DB-ES-5209		
	08/73→09/96	Tie Rod End	CV-ES-12461		for Steering Rod
	08/73→09/96	Tie Rod End	CV-ES-12462		for Steering Rod

CV-ES-12461

Length: 120
Cone Ø: d1 Ø 26 / d2 Ø 23,5
Thread: M30 x 1,5 LHT
0003300035, 3300148, 0003406213, 0013306635,
0013308835, 0014604048, 0014604348,
14606448, 0024600248, 3023300035,
3023300135, 3023300235, 3023300335,
3453307235, 3453307435, 3503307135,
A0003300148, A0013306635, A0013308835,
A0014604048, A0014604348, A0014606448,
A0024600248, A3023300035, A3023300135,
A3023300235, A3023300335, A3503307135



CV-ES-12462

Length: 120
Cone Ø: d1 Ø 26 / d2 Ø 23,5
Thread: M30 x 1,5 RHT
0003300135, 0003300248, 0003303235,
0003305835, 0003307335, 0003383410,
0004608348, 004608348, 0004632229,
0004633129, 0004633429, 0004633529,
0013300135, 0013300235, 0013306735,
0014603448, 0014604148, 0014604448,
0014606348, 0014608348, 0014608448,
0014609748, 0023301535, 3453307135,
3503307035, 3503307335, 3643307135,
5001832582, A0003300248, A0003303235,
A0003307335, A0003383410, A0004608348,
A0004632229, A0004633429, A0013300135,
A0013300235, A0013306735, A0014603448,
A0014604148, A0014604448, A0014606348,
A0014608348, A0014608448, A0014609748,
A0023301535



CV-ES-14163

Length: 125
Cone Ø: d1 Ø 30 / d2 Ø 27
Thread: M30 x 1,5 RHT
0003305248, 0003387310, 0004600348,
0004600948, 0004602848, 0004602948,
0004608948, 0014600248, 0014600848,
0014601248, 0014602248, 0014607748,
0024600148, A0003387310, A0004600348,
A0004602848, A0004602948, A0014600848,
A0014601248, A0014602248, A0014607748



CV-RK-7850

Ø: 85
Thick/Height: 171
0003501013, 3501013



CV-RK-8118

Ø: 85
Hole Distance: 130
Thick/Height: 30
0003500506, 3500506



DB-DL-5216

Length: 890
Ø: 42
Cone Ø: d1 Ø 26 / d2 Ø 23,5
01215700A, 3834600605, 3834601405,
3834602305, 3834604405



DB-DL-5220

Length: 522
Ø: 52
Hole Distance: 151
01335200A, 3813500606, 6523500306,
6533500106



DB-DL-7831

Length: 870
Ø: 42
Cone Ø: d1 Ø 30 / d2 Ø 27
01215200A, 6254602505



DB-DL-7839

Length: 585
Ø: 50
Hole Distance: 152 / 152
3953500206, 6593500106, 6593502406



DB-DL-8138

Length: 1130
Ø: 40
Cone Ø: d1 Ø 32 / d2 Ø 28,8
0004606605, 4606605



DB-DL-8618

Length: 680
Ø: 42
Cone Ø: d1 Ø 32 / d2 Ø 28,8
0004604305, 4604305, 6254604805



DB-DL-8640

Length: 1615 **Ø:** 50
Cone Ø: d1 Ø 32 / d2 Ø 29
6253301503, 6253301603, 6253302403,
6253302503, 9423300803, 9423302103,
9493300203, 9493300303, 9493300903



DB-DL-8672

Length: 860
Ø: 48
Cone Ø: d1 Ø 30 / d2 Ø 27
0014609705, 14609705



DB-DL-9164

Length: 500
Ø: 50
Hole Distance: 152 / 152
3853500006, 6533500006



DB-DL-10216

Length: 1190
Ø: 40
Cone Ø: d1 Ø 32 / d2 Ø 29
0004604905



DB-DL-12309

Length: 685
Ø: 40
Cone Ø: d1 Ø 32 / d2 Ø 28,8
4606005, 0004606005, 0004606305, 4606305



DB-ES-5209

Length: 1670 **Ø:** 50
Cone Ø: d1 Ø 30 / d2 Ø 27
6203300503, 6203300603



DB-RK-8380

Ø: 80
0005861035, 5861035



DB-RK-8564

Ø: 90
01302200A, 3500105, 0003500105, 0003500405,
3500405, 0005861833, 5861833, 81432706047



DB-SB-5258

Ø: 70
Thick/Height: 62
01311400A, 3873230285



DF-RK-8671



MN-RK-9387

Ø: 90
0003500105, 81432706047



SC-RK-8688

Length: 95
Ø: 95
0003501905, 3501905





NG ...

2225 L ...	08/73→09/96	Tie Rod End	CV-ES-14163		for Steering Rod
	08/73→09/96	Track Control Arm		DB-DL-5220	Trailing Arm
2226	09/75→12/80	Centre Rod	DB-DL-10140		Push Rod* 4 118 555 *→* 4 127 150 *
	09/75→12/80	Centre Rod	DB-DL-10140		Push Rod* 4 129 898 *→* 4 298 136 *
	09/75→12/80	Stabiliser Mounting	DB-SB-5259		
	09/75→12/80	Suspension Arm Repair Kit		CV-RK-8118	for Drag Link
	09/75→12/80	Suspension Strut Repair Kit		DF-RK-8671	
	09/75→12/80	Tie Rod End	CV-ES-12461		for Steering Rod
	09/75→12/80	Tie Rod End	CV-ES-14163		for Steering Rod
	09/75→12/80	Track Control Arm		DB-DL-7839	Trailing Arm
	09/75→12/80	Track Control Arm		DB-DL-7839	Trailing Arm* 4 472 129 *→
	09/75→12/80	Track Control Arm		DB-DL-9226	Trailing Arm
2226 S,2226 LS	09/75→12/80	Track Control Arm		DB-DL-9226	Trailing Arm→* 4 426 005 *
	09/75→12/80	Track Control Arm		DB-DL-9226	Trailing Arm→* 4 431 027 *
	08/73→09/96	Centre Rod	DB-DL-10140		Push Rod
	08/73→09/96	Centre Rod	DB-DL-10140		Push Rod* 4 118 555 *→* 4 127 150 *
	08/73→09/96	Centre Rod	DB-DL-10140		Push Rod* 4 129 898 *→* 4 298 136 *
	08/73→09/96	Centre Rod	DB-DL-10140		Push Rod→* 4 298 136 *
	08/73→09/96	Suspension Arm Repair Kit		CV-RK-8118	for Drag Link
	08/73→09/96	Suspension Arm Repair Kit		DB-RK-8564	Wishbone (CV)
	08/73→09/96	Suspension Strut Repair Kit		DF-RK-8671	
	08/73→09/96	Tie Rod End	CV-ES-12461		for Steering Rod
2226,2226 L	08/73→09/96	Tie Rod End	CV-ES-14163		for Steering Rod
	08/73→09/96	Track Control Arm		DB-DL-7839	Trailing Arm
	08/73→09/96	Track Control Arm		DB-DL-7839	Trailing Arm* 4 472 129 *→
	08/73→09/96	Track Control Arm		DB-DL-9226	Trailing Arm
	08/73→09/96	Track Control Arm		DB-DL-9226	Trailing Arm→* 4 450 302 *
	08/73→09/96	Centre Rod	DB-DL-10140		Push Rod
	08/73→09/96	Centre Rod	DB-DL-10140		Push Rod* 4 118 555 *→* 4 127 150 *
	08/73→09/96	Centre Rod	DB-DL-10140		Push Rod* 4 129 898 *→* 4 298 136 *
	08/73→09/96	Centre Rod	DB-DL-10140		Push Rod→* 4 298 136 *
	08/73→09/96	Suspension Arm Repair Kit		CV-RK-8118	for Drag Link
2228	08/73→09/96	Suspension Arm Repair Kit		DB-RK-8564	Wishbone (CV)
	08/73→09/96	Suspension Strut Repair Kit		DF-RK-8671	
	08/73→09/96	Tie Rod End	CV-ES-12461		for Steering Rod
	08/73→09/96	Tie Rod End	CV-ES-14163		for Steering Rod
	12/79→03/91	Centre Rod	DB-DL-10216		Push Rod
	12/79→03/91	Stabiliser Mounting	DB-SB-5258	DB-SB-5258	
	12/79→03/91	Suspension Arm Repair Kit	DB-RK-5283		
	12/79→03/91	Tie Rod End	CV-ES-12461		for Steering Rod
	12/79→03/91	Tie Rod End	CV-ES-14163		for Steering Rod
	12/79→03/91	Track Control Arm		DB-DL-7839	Trailing Arm
2228 S	12/79→03/91	Track Control Arm		DB-DL-7840	Suspension Rod, Trailing Arm
	12/79→03/91	Track Control Arm		DB-DS-6088	Suspension Rod, Trailing Arm
	12/79→03/91	Centre Rod	DB-DL-10216		Push Rod
	12/79→03/91	Stabiliser Mounting	DB-SB-5258	DB-SB-5258	
	12/79→03/91	Suspension Arm Repair Kit	DB-RK-5283		
	12/79→03/91	Tie Rod End	CV-ES-12461		for Steering Rod
	12/79→03/91	Tie Rod End	CV-ES-14163		for Steering Rod
	12/79→03/91	Track Control Arm		DB-DL-7839	Trailing Arm
	12/79→03/91	Track Control Arm		DB-DL-7840	Suspension Rod, Trailing Arm
	2228,2228 L	08/73→09/96	Centre Rod	DB-DL-5241	
08/73→09/96		Centre Rod	DB-DL-7270		Push Rod;Suspension Rod
08/73→09/96		Centre Rod	DB-DL-10216		Push Rod
08/73→09/96		Stabiliser Mounting	DB-SB-5258	DB-SB-5258	
08/73→09/96		Suspension Arm Repair Kit		CV-RK-8118	for Drag Link
08/73→09/96		Suspension Arm Repair Kit		DB-RK-8550	for Wishbone (CV)
08/73→09/96		Suspension Arm Repair Kit		DB-RK-8564	Wishbone (CV)
08/73→09/96		Suspension Arm Repair Kit	DB-RK-5280		
08/73→09/96		Suspension Arm Repair Kit	DB-RK-5282		
08/73→09/96		Suspension Arm Repair Kit	DB-RK-5283		
08/73→09/96		Suspension Strut Repair Kit		DF-RK-8671	
08/73→09/96		Tie Rod	DB-ES-5209		

CV-ES-12461

Length: 120
 Cone Ø: d1 Ø 26 / d2 Ø 23,5
 Thread: M30 x 1,5 LHT
 0003300035, 3300148, 0003406213, 0013306635,
 0013308835, 0014604048, 0014604348,
 14606448, 0024600248, 3023300035,
 3023300135, 3023300235, 3023300335,
 3453307235, 3453307435, 3503307135,
 A0003300148, A0013306635, A0013308835,
 A0014604048, A0014604348, A0014606448,
 A0024600248, A3023300035, A3023300135,
 A3023300235, A3023300335, A3503307135



CV-ES-14163

Length: 125
 Cone Ø: d1 Ø 30 / d2 Ø 27
 Thread: M30 x 1,5 RHT
 0003305248, 0003387310, 0004600348,
 0004600948, 0004602848, 0004602948,
 0004608948, 0014600248, 0014600848,
 0014601248, 0014602248, 0014607748,
 0024600148, A0003387310, A0004600348,
 A0004602848, A0004602948, A0014600848,
 A0014601248, A0014602248, A0014607748



CV-RK-8118

Ø: 85
 Hole Distance: 130
 Thick/Height: 30
 0003500506, 3500506



DB-DL-5220

Length: 522
 Ø: 52
 Hole Distance: 151
 01335200A, 3813500606, 6523500306,
 6533500106



DB-DL-5241

Length: 875 Ø: 40
 Cone Ø: d1 Ø 30 / d2 Ø 27
 01215300A, 0004609205, 0004609305,
 0014606905



DB-DL-7270

Length: 875 Ø: 40
 Cone Ø: d1 Ø 28,6 / d2 Ø 23,9
 01208300A, 0024604705, 0024604805,
 0034604905, A0024604705



DB-DL-7839

Length: 585
 Ø: 50
 Hole Distance: 152 / 152
 3953500206, 6593500106, 6593502406



DB-DL-7840

Length: 595
 Ø: 62
 Hole Distance: 152 / 152
 6203500006, 6203500106, 6203500306,
 6553500306



DB-DL-9226

Length: 628
 Ø: 50
 Hole Distance: 152 / 152
 3953201532



DB-DL-10140

Length: 865
 Ø: 40
 Cone Ø: d1 Ø 26 / d2 Ø 23,5
 3874600605, 3874600805, 3874604405,
 3874604505



DB-DL-10216

Length: 1190
 Ø: 40
 Cone Ø: d1 Ø 32 / d2 Ø 29
 0004604905



DB-DS-6088

Length: 585
 Ø: 50
 Hole Distance: 152 / 152
 3953500706, 6593500406



DB-ES-5209

Length: 1670 Ø: 50
 Cone Ø: d1 Ø 30 / d2 Ø 27
 6203300503, 6203300603



DB-RK-5280

Ø: 86
 01303000A, 6213200428



DB-RK-5282

Ø: 59
 01303800A, 6553200111



DB-RK-5283

Ø: 70
 01319900A, 6203200628



DB-RK-8550

Ø: 75 Hole Distance: 152
 Thick/Height: 24
 0003502105, 0003504605



DB-RK-8564

Ø: 90
 01302200A, 0003500105, 3500105, 3500405,
 0003500405, 0005861833, 5861833,
 81432706047



DB-SB-5258

Ø: 70
 Thick/Height: 62
 01311400A, 3873230285



DB-SB-5259

Ø: 44
 Thick/Height: 25
 01317200A, 0003232150, 3232150



DF-RK-8671





NG ...

2228,2228 L ...	08/73→09/96	Tie Rod End	CV-ES-12461		for Steering Rod	
	08/73→09/96	Tie Rod End	CV-ES-12462		for Steering Rod	
	08/73→09/96	Tie Rod End	CV-ES-14163		for Steering Rod	
	08/73→09/96	Track Control Arm		DB-DL-7839	Trailing Arm	
2232	05/74→09/83	Centre Rod	DB-DL-10140		Push Rod* 4 118 555 *→* 4 127 150 *	
	05/74→09/83	Centre Rod	DB-DL-10140		Push Rod* 4 129 898 *→* 4 298 136 *	
	05/74→09/83	Stabiliser Mounting	DB-SB-5259			
	05/74→09/83	Suspension Arm Repair Kit		CV-RK-8118	for Drag Link	
	05/74→09/83	Suspension Arm Repair Kit		DB-RK-8564	Wishbone (CV)	
	05/74→09/83	Suspension Strut Repair Kit		DF-RK-8671		
	05/74→09/83	Tie Rod End	CV-ES-12461		for Steering Rod	
	05/74→09/83	Tie Rod End	CV-ES-14163		for Steering Rod	
	05/74→09/83	Track Control Arm		DB-DL-7839	Trailing Arm	
	05/74→09/83	Track Control Arm		DB-DL-7839	Trailing Arm* 4 472 129 *→	
	05/74→09/83	Track Control Arm		DB-DL-9226	Trailing Arm	
	05/74→09/83	Track Control Arm		DB-DL-9226	Trailing Arm→* 4 426 005 *	
	05/74→09/83	Track Control Arm		DB-DL-9226	Trailing Arm→* 4 431 027 *	
	2232 S,2232 LS	08/73→09/96	Centre Rod	DB-DL-10140		Push Rod
08/73→09/96		Centre Rod	DB-DL-10140		Push Rod* 4 118 555 *→* 4 127 150 *	
08/73→09/96		Centre Rod	DB-DL-10140		Push Rod* 4 129 898 *→* 4 298 136 *	
08/73→09/96		Centre Rod	DB-DL-10140		Push Rod→* 4 298 136 *	
08/73→09/96		Suspension Arm Repair Kit		CV-RK-8118	for Drag Link	
08/73→09/96		Suspension Arm Repair Kit		DB-RK-8564	Wishbone (CV)	
08/73→09/96		Suspension Strut Repair Kit		DF-RK-8671		
08/73→09/96		Tie Rod End	CV-ES-12461		for Steering Rod	
08/73→09/96		Tie Rod End	CV-ES-14163		for Steering Rod	
08/73→09/96		Track Control Arm		DB-DL-7839	Trailing Arm	
08/73→09/96		Track Control Arm		DB-DL-7839	Trailing Arm* 4 472 129 *→	
08/73→09/96		Track Control Arm		DB-DL-9226	Trailing Arm	
08/73→09/96		Track Control Arm		DB-DL-9226	Trailing Arm→* 4 453 073 *	
2232,2232 L		08/73→09/96	Centre Rod	DB-DL-10140		Push Rod
	08/73→09/96	Centre Rod	DB-DL-10140		Push Rod* 4 118 555 *→* 4 127 150 *	
	08/73→09/96	Centre Rod	DB-DL-10140		Push Rod* 4 129 898 *→* 4 298 136 *	
	08/73→09/96	Centre Rod	DB-DL-10140		Push Rod→* 4 298 136 *	
	08/73→09/96	Suspension Arm Repair Kit		CV-RK-8118	for Drag Link	
	08/73→09/96	Suspension Arm Repair Kit		DB-RK-8564	Wishbone (CV)	
	08/73→09/96	Suspension Strut Repair Kit		DF-RK-8671		
	08/73→09/96	Tie Rod End	CV-ES-12461		for Steering Rod	
	08/73→09/96	Tie Rod End	CV-ES-14163		for Steering Rod	
	2233	11/80→05/87	Centre Rod	DB-DL-10216		Push Rod
11/80→05/87		Stabiliser Mounting	DB-SB-5258	DB-SB-5258		
11/80→05/87		Suspension Arm Repair Kit	DB-RK-5283			
11/80→05/87		Tie Rod	DB-ES-5209			
11/80→05/87		Tie Rod End	CV-ES-12461		for Steering Rod	
11/80→05/87		Tie Rod End	CV-ES-14163		for Steering Rod	
11/80→05/87		Tie Rod End	DB-ES-5234		for Steering Rod	
11/80→05/87		Track Control Arm		DB-DL-7839	Trailing Arm	
11/80→05/87		Track Control Arm		DB-DS-6088	Suspension Rod, Trailing Arm	
2233 S		11/80→05/87	Stabiliser Mounting	DB-SB-5258	DB-SB-5258	
		11/80→05/87	Suspension Arm Repair Kit	DB-RK-5283		
		11/80→05/87	Tie Rod End	CV-ES-14163		for Steering Rod
	11/80→05/87	Track Control Arm		DB-DL-7839	Trailing Arm	
	11/80→05/87	Track Control Arm		DB-DS-6088	Suspension Rod, Trailing Arm	
2233,2233 L	08/73→09/96	Centre Rod	DB-DL-5241		Suspension Rod	
	08/73→09/96	Centre Rod	DB-DL-7270		Push Rod,Suspension Rod	
	08/73→09/96	Centre Rod	DB-DL-10216		Push Rod	
	08/73→09/96	Suspension Arm Repair Kit		CV-RK-8118	for Drag Link	
	08/73→09/96	Suspension Arm Repair Kit		DB-RK-8550	for Wishbone (CV)	
	08/73→09/96	Suspension Arm Repair Kit		DB-RK-8564	Wishbone (CV)	
	08/73→09/96	Suspension Arm Repair Kit		DB-RK-10378		
	08/73→09/96	Suspension Arm Repair Kit	DB-RK-5280			
	08/73→09/96	Suspension Arm Repair Kit	DB-RK-5282			
	08/73→09/96	Suspension Strut Repair Kit		DF-RK-8671		

CV-ES-12461

Length: 120
Cone Ø: d1 Ø 26 / d2 Ø 23,5
Thread: M30 x 1,5 LHT
0003300035, 3300148, 0003406213, 0013306635,
0013308835, 0014604048, 0014604348,
14606448, 0024600248, 3023300035,
3023300135, 3023300235, 3023300335,
3453307235, 3453307435, 3503307135,
A0003300148, A0013306635, A0013308835,
A0014604048, A0014604348, A0014606448,
A0024600248, A3023300035, A3023300135,
A3023300235, A3023300335, A3503307135



CV-ES-12462

Length: 120
Cone Ø: d1 Ø 26 / d2 Ø 23,5
Thread: M30 x 1,5 RHT
0003300135, 0003300248, 0003303235,
0003305835, 0003307335, 0003383410,
0004608348, 004608348, 0004632229,
0004633129, 0004633429, 0004633529,
0013300135, 0013300235, 0013306735,
0014603448, 0014604148, 0014604448,
0014606348, 0014608348, 0014608448,
0014609748, 0023301535, 3453307135,
3503307035, 3503307335, 3643307135,
5001832582, A0003300248, A0003303235,
A0003307335, A0003383410, A0004608348,
A0004632229, A0004633429, A0013300135,
A0013300235, A0013306735, A0014603448,
A0014604148, A0014604448, A0014606348,
A0014608348, A0014608448, A0014609748,
A0023301535



CV-ES-14163

Length: 125
Cone Ø: d1 Ø 30 / d2 Ø 27
Thread: M30 x 1,5 RHT
0003305248, 0003387310, 0004600348,
0004600948, 0004602848, 0004602948,
0004608948, 0014600248, 0014600848,
0014601248, 0014602248, 0014607748,
0024600148, A0003387310, A0004600348,
A0004602848, A0004602948, A0014600848,
A0014601248, A0014602248, A0014607748



CV-RK-8118

Ø: 85
Hole Distance: 130
Thick/Height: 30
0003500506, 3500506



DB-DL-5241

Length: 875 Ø: 40
Cone Ø: d1 Ø 30 / d2 Ø 27
01215300A, 0004609205, 0004609305,
0014606905



DB-DL-7270

Length: 875 Ø: 40
Cone Ø: d1 Ø 28,6 / d2 Ø 23,9
01208300A, 0024604705, 0024604805,
0034604905, A0024604705



DB-DL-7839

Length: 585
Ø: 50
Hole Distance: 152 / 152
3953500206, 6593500106, 6593502406



DB-DL-9226

Length: 628
Ø: 50
Hole Distance: 152 / 152
3953201532



DB-DL-10140

Length: 865
Ø: 40
Cone Ø: d1 Ø 26 / d2 Ø 23,5
3874600605, 3874600805, 3874604405,
3874604505



DB-DL-10216

Length: 1190
Ø: 40
Cone Ø: d1 Ø 32 / d2 Ø 29
0004604905



DB-DS-6088

Length: 585
Ø: 50
Hole Distance: 152 / 152
3953500706, 6593500406



DB-ES-5209

Length: 1670 Ø: 50
Cone Ø: d1 Ø 30 / d2 Ø 27
6203300503, 6203300603



DB-ES-5234

Length: 135
Cone Ø: d1 Ø 38 / d2 Ø 34,3
Thread: M38 x 1,5 RHT
0004601748, 120322305, 2205000400



DB-RK-5280

Ø: 86
01303000A, 6213200428



DB-RK-5282

Ø: 59
01303800A, 6553200111



DB-RK-5283

Ø: 70
01319900A, 6203200628



DB-RK-8550

Ø: 75 Hole Distance: 152
Thick/Height: 24
0003502105, 0003504605



DB-RK-8564

Ø: 90
01302200A, 0003500105, 3500105, 0003500405,
3500405, 0005861833, 5861833, 81432706047



DB-RK-10378

Ø: 86
6203200028



DB-SB-5258

Ø: 70
Thick/Height: 62
01311400A, 3873230285



DB-SB-5259

Ø: 44
Thick/Height: 25
01317200A, 3232150, 0003232150



DF-RK-8671





NG ...

2233,2233 L ...	08/73→09/96	Tie Rod	DB-ES-5209			
	08/73→09/96	Tie Rod End	CV-ES-12461		for Steering Rod	
	08/73→09/96	Tie Rod End	CV-ES-14163		for Steering Rod	
2235 K	03/86→07/89	Stabiliser Mounting	DB-SB-5258	DB-SB-5258		
	03/86→07/89	Suspension Arm Repair Kit		DB-RK-7267	for Drag Link	
	03/86→07/89	Suspension Arm Repair Kit	DB-RK-5283			
	03/86→07/89	Tie Rod End	CV-ES-14163		for Steering Rod	
	03/86→07/89	Track Control Arm		DB-DL-7839	Trailing Arm	
	03/86→07/89	Track Control Arm		DB-DS-6088	Suspension Rod, Trailing Arm	
2235 S, 2235 LS	08/73→09/96	Centre Rod	DB-DL-10216		Push Rod	
	08/73→09/96	Stabiliser Mounting	DB-SB-5258	DB-SB-5258		
	08/73→09/96	Suspension Arm Repair Kit		DB-RK-7267	for Drag Link	
	08/73→09/96	Suspension Arm Repair Kit		DB-RK-10378		
	08/73→09/96	Suspension Arm Repair Kit	DB-RK-5282			
	08/73→09/96	Suspension Arm Repair Kit	DB-RK-5283			
	08/73→09/96	Tie Rod	DB-ES-5209			
	08/73→09/96	Tie Rod End	CV-ES-12461		for Steering Rod	
	08/73→09/96	Track Control Arm		DB-DL-7839	Trailing Arm	
	08/73→09/96	Track Control Arm		DB-DS-6088	Suspension Rod, Trailing Arm	
	2235,2235 L	08/73→09/96	Centre Rod	DB-DL-5241		Suspension Rod
		08/73→09/96	Centre Rod	DB-DL-7270		Push Rod;Suspension Rod
		08/73→09/96	Centre Rod	DB-DL-7831		Push Rod
		08/73→09/96	Centre Rod	DB-DL-8138		Push Rod
08/73→09/96		Centre Rod	DB-DL-8618		Push Rod	
08/73→09/96		Centre Rod	DB-DL-10216		Push Rod	
08/73→09/96		Suspension Arm Repair Kit		CV-RK-8118	for Drag Link	
08/73→09/96		Suspension Arm Repair Kit		DB-RK-7267	for Drag Link	
08/73→09/96		Suspension Arm Repair Kit		DB-RK-8550	for Wishbone (CV)	
08/73→09/96		Suspension Arm Repair Kit		DB-RK-8564	Wishbone (CV)	
08/73→09/96		Suspension Arm Repair Kit	DB-RK-5280			
08/73→09/96		Suspension Arm Repair Kit	DB-RK-5282			
08/73→09/96		Suspension Strut Repair Kit		DF-RK-8671		
08/73→09/96		Tie Rod	DB-ES-5209			
08/73→09/96		Tie Rod End	CV-ES-12461		for Steering Rod	
08/73→09/96		Tie Rod End	CV-ES-14163		for Steering Rod	
08/73→09/96		Tie Rod End	DB-ES-5234		for Steering Rod	
08/73→09/96		Track Control Arm		DB-DL-7839	Trailing Arm	
08/73→09/96		Track Control Arm		DB-DS-6088	Suspension Rod, Trailing Arm	
2236		09/82→03/91	Centre Rod	DB-DL-5241		Suspension Rod
		09/82→03/91	Centre Rod	DB-DL-7270		Push Rod;Suspension Rod
		09/82→03/91	Centre Rod	DB-DL-10216		Push Rod
		09/82→03/91	Stabiliser Mounting	DB-SB-5258	DB-SB-5258	
		09/82→03/91	Suspension Arm Repair Kit		DB-RK-8550	for Wishbone (CV)
		09/82→03/91	Suspension Arm Repair Kit	DB-RK-5283		
		09/82→03/91	Tie Rod End	CV-ES-12461		for Steering Rod
		09/82→03/91	Tie Rod End	CV-ES-14163		for Steering Rod
	09/82→03/91	Tie Rod End	DB-ES-5234		for Steering Rod	
	09/82→03/91	Track Control Arm		DB-DL-7839	Trailing Arm	
2236 S	12/84→03/91	Stabiliser Mounting	DB-SB-5258	DB-SB-5258		
	12/84→03/91	Suspension Arm Repair Kit	DB-RK-5280			
	12/84→03/91	Suspension Arm Repair Kit	DB-RK-5283			
	12/84→03/91	Tie Rod End	CV-ES-14163		for Steering Rod	
	12/84→03/91	Track Control Arm		DB-DL-7839	Trailing Arm	
	12/84→03/91	Track Control Arm		DB-DL-7840	Suspension Rod, Trailing Arm	
	12/84→03/91	Track Control Arm		DB-DS-6088	Suspension Rod, Trailing Arm	
2238 S	01/81→12/86	Stabiliser Mounting	DB-SB-5258	DB-SB-5258		
	01/81→12/86	Suspension Arm Repair Kit	DB-RK-5283			
	01/81→12/86	Tie Rod End	CV-ES-14163		for Steering Rod	
	01/81→12/86	Track Control Arm		DB-DL-7839	Trailing Arm	
	01/81→12/86	Track Control Arm		DB-DS-6088	Suspension Rod, Trailing Arm	
	01/81→12/86	Track Control Arm		DB-DS-6088	Suspension Rod, Trailing Arm	
2238,2238 L	08/73→09/96	Centre Rod	DB-DL-5241		Suspension Rod	
	08/73→09/96	Centre Rod	DB-DL-7270		Push Rod;Suspension Rod	
	08/73→09/96	Centre Rod	DB-DL-10216		Push Rod	
	08/73→09/96	Suspension Arm Repair Kit		CV-RK-8118	for Drag Link	
	08/73→09/96	Suspension Arm Repair Kit		DB-RK-8550	for Wishbone (CV)	
	08/73→09/96	Suspension Arm Repair Kit		DB-RK-8564	Wishbone (CV)	

CV-ES-12461

Length: 120
 Cone Ø: d1 Ø 26 / d2 Ø 23,5
 Thread: M30 x 1,5 LHT
 0003300035, 3300148, 0003406213, 0013306635,
 0013308835, 0014604048, 0014604348,
 14606448, 0024600248, 3023300035,
 3023300135, 3023300235, 3023300335,
 3453307235, 3453307435, 3503307135,
 A0003300148, A0013306635, A0013308835,
 A0014604048, A0014604348, A0014606448,
 A0024600248, A3023300035, A3023300135,
 A3023300235, A3023300335, A3503307135



CV-ES-14163

Length: 125
 Cone Ø: d1 Ø 30 / d2 Ø 27
 Thread: M30 x 1,5 RHT
 0003305248, 0003387310, 0004600348,
 0004600948, 0004602848, 0004602948,
 0004608948, 0014600248, 0014600848,
 0014601248, 0014602248, 0014607748,
 0024600148, A0003387310, A0004600348,
 A0004602848, A0004602948, A0014600848,
 A0014601248, A0014602248, A0014607748



CV-RK-8118

Ø: 85
 Hole Distance: 130
 Thick/Height: 30
 0003500506, 3500506



DB-DL-5241

Length: 875 Ø: 40
 Cone Ø: d1 Ø 30 / d2 Ø 27
 01215300A, 0004609205, 0004609305,
 0014606905



DB-DL-7270

Length: 875 Ø: 40
 Cone Ø: d1 Ø 28,6 / d2 Ø 23,9
 01208300A, 0024604705, 0024604805,
 0034604905, A0024604705



DB-DL-7831

Length: 870
 Ø: 42
 Cone Ø: d1 Ø 30 / d2 Ø 27
 01215200A, 6254602505



DB-DL-7839

Length: 585
 Ø: 50
 Hole Distance: 152 / 152
 3953500206, 6593500106, 6593502406



DB-DL-7840

Length: 595
 Ø: 62
 Hole Distance: 152 / 152
 6203500006, 6203500106, 6203500306,
 6553500306



DB-DL-8138

Length: 1130
 Ø: 40
 Cone Ø: d1 Ø 32 / d2 Ø 28,8
 4606605, 0004606605



DB-DL-8618

Length: 680
 Ø: 42
 Cone Ø: d1 Ø 32 / d2 Ø 28,8
 4604305, 0004604305, 6254604805



DB-DL-10216

Length: 1190
 Ø: 40
 Cone Ø: d1 Ø 32 / d2 Ø 29
 0004604905



DB-DS-6088

Length: 585
 Ø: 50
 Hole Distance: 152 / 152
 3953500706, 6593500406



DB-ES-5209

Length: 1670 Ø: 50
 Cone Ø: d1 Ø 30 / d2 Ø 27
 6203300503, 6203300603



DB-ES-5234

Length: 135
 Cone Ø: d1 Ø 38 / d2 Ø 34,3
 Thread: M38 x 1,5 RHT
 0004601748, 120322305, 2205000400



DB-RK-5280

Ø: 86
 01303000A, 6213200428



DB-RK-5282

Ø: 59
 01303800A, 6553200111



DB-RK-5283

Ø: 70
 01319900A, 6203200628



DB-RK-7267

Ø: 95
 Hole Distance: 152
 Thick/Height: 24
 01302100A, 0003500413, 3500413, 5861235,
 0005861235, 81432706069



DB-RK-8550

Ø: 75 Hole Distance: 152
 Thick/Height: 24
 0003502105, 0003504605



DB-RK-8564

Ø: 90
 01302200A, 0003500105, 3500105, 0003500405,
 3500405, 0005861833, 5861833, 81432706047



DB-RK-10378

Ø: 86
 6203200028



DB-SB-5258

Ø: 70
 Thick/Height: 62
 01311400A, 3873230285



DF-RK-8671





NG ...

2238,2238 L ...	08/73→09/96	Suspension Arm Repair Kit		DB-RK-10378		
	08/73→09/96	Suspension Arm Repair Kit	DB-RK-5280			
	08/73→09/96	Suspension Strut Repair Kit		DF-RK-8671		
	08/73→09/96	Tie Rod End	CV-ES-12461		for Steering Rod	
	08/73→09/96	Tie Rod End	CV-ES-14163		for Steering Rod	
2244 S	10/85→07/89	Stabiliser Mounting	DB-SB-5258	DB-SB-5258		
	10/85→07/89	Suspension Arm Repair Kit		DB-RK-7267	for Drag Link	
	10/85→07/89	Suspension Arm Repair Kit	DB-RK-5283			
	10/85→07/89	Tie Rod End	CV-ES-14163		for Steering Rod	
	10/85→07/89	Track Control Arm		DB-DL-7839	Trailing Arm	
	10/85→07/89	Track Control Arm		DB-DL-7840	Suspension Rod, Trailing Arm	
2244,2244 L	08/73→09/96	Centre Rod	DB-DL-5241		Suspension Rod	
	08/73→09/96	Centre Rod	DB-DL-7270		Push Rod;Suspension Rod	
	08/73→09/96	Centre Rod	DB-DL-10216		Push Rod	
	08/73→09/96	Suspension Arm Repair Kit		CV-RK-8118	for Drag Link	
	08/73→09/96	Suspension Arm Repair Kit		DB-RK-8550	for Wishbone (CV)	
	08/73→09/96	Suspension Arm Repair Kit		DB-RK-8564	Wishbone (CV)	
	08/73→09/96	Suspension Arm Repair Kit	DB-RK-5280			
	08/73→09/96	Suspension Strut Repair Kit		DF-RK-8671		
	08/73→09/96	Tie Rod	DB-ES-5209			
	08/73→09/96	Tie Rod End	CV-ES-12461		for Steering Rod	
	08/73→09/96	Tie Rod End	CV-ES-14163		for Steering Rod	
	08/73→09/96	Track Control Arm		DB-DL-7839	Trailing Arm	
	2422	08/73→09/96	Centre Rod	DB-DL-5207		Push Rod* 5 259 613 *→
		08/73→09/96	Centre Rod	DB-DL-8122		Push Rod* 5 259 613 *→
08/73→09/96		Centre Rod	DB-DL-10216		Push Rod	
08/73→09/96		Tie Rod End	CV-ES-12461		for Steering Rod	
08/73→09/96		Tie Rod End	CV-ES-12462		for Steering Rod	
08/73→09/96		Tie Rod End	CV-ES-14163		for Steering Rod	
10/81→10/90		Centre Rod	DB-DL-5241		Suspension Rod	
10/81→10/90		Centre Rod	DB-DL-7270		Push Rod;Suspension Rod	
10/81→10/90		Suspension Arm Repair Kit		DB-RK-8550	for Wishbone (CV)	
2422 K		10/81→03/91	Centre Rod	DB-DL-10216		Push Rod
	10/81→03/91	Tie Rod End	CV-ES-12461		for Steering Rod	
2428	08/73→09/96	Centre Rod	DB-DL-5412		Push Rod	
	08/73→09/96	Centre Rod	DB-DL-10216		Push Rod	
	08/73→09/96	Tie Rod End	CV-ES-12461		for Steering Rod	
2433	10/80→09/96	Centre Rod	DB-DL-5241		Suspension Rod	
	10/80→09/96	Centre Rod	DB-DL-7270		Push Rod;Suspension Rod	
	10/80→09/96	Centre Rod	DB-DL-10216		Push Rod	
	10/80→09/96	Suspension Arm Repair Kit		DB-RK-8550	for Wishbone (CV)	
	10/80→09/96	Tie Rod End	CV-ES-12461		for Steering Rod	
2438	10/80→09/96	Tie Rod End	CV-ES-14163		for Steering Rod	
	08/73→09/96	Centre Rod	DB-DL-5241		Suspension Rod	
	08/73→09/96	Centre Rod	DB-DL-7270		Push Rod;Suspension Rod	
	08/73→09/96	Centre Rod	DB-DL-10216		Push Rod	
	08/73→09/96	Suspension Arm Repair Kit		DB-RK-8550	for Wishbone (CV)	
2438 L	08/73→09/96	Tie Rod End	CV-ES-12461		for Steering Rod	
	08/73→09/96	Tie Rod End	CV-ES-14163		for Steering Rod	
	11/80→06/90	Centre Rod	DB-DL-10216		Push Rod	
2444 LS	11/80→06/90	Tie Rod End	CV-ES-12461		for Steering Rod	
	11/80→06/90	Tie Rod End	CV-ES-14163		for Steering Rod	
	08/73→09/96	Centre Rod	DB-DL-10216		Push Rod	
2528 A	08/73→09/96	Tie Rod End	CV-ES-12461		for Steering Rod	
	08/73→09/96	Track Control Arm		DB-DL-7840	Suspension Rod, Trailing Arm	
	01/80→03/91	Centre Rod	DB-DL-5217		Push Rod* 5 184 732 *→* 5 211 262 *	
	01/80→03/91	Centre Rod	DB-DL-10216		Push Rod	
2528 A	01/80→03/91	Tie Rod	MN-DL-7834		Guide Rod	
	01/80→03/91	Tie Rod End	CV-ES-12461		for Steering Rod	
	01/80→03/91	Tie Rod End	CV-ES-14163		for Steering Rod	
	01/80→03/91	Tie Rod End	DB-ES-5234		for Steering Rod	
	01/80→03/91	Tie Rod End	DB-ES-5234		for Steering Rod	

CV-ES-12461

Length: 120
Cone Ø: d1 Ø 26 / d2 Ø 23,5
Thread: M30 x 1,5 LHT
 0003300035, 3300148, 0003406213, 0013306635, 0013308835, 0014604048, 0014604348, 14606448, 0024600248, 3023300035, 3023300135, 3023300235, 3023300335, 3453307235, 3453307435, 3503307135, A0003300148, A0013306635, A0013308835, A0014604048, A0014604348, A0014606448, A0024600248, A3023300035, A3023300135, A3023300235, A3023300335, A3503307135



CV-ES-12462

Length: 120
Cone Ø: d1 Ø 26 / d2 Ø 23,5
Thread: M30 x 1,5 RHT
 0003300135, 0003300248, 0003303235, 0003305835, 0003307335, 0003383410, 0004608348, 004608348, 0004632229, 0004633129, 0004633429, 0004633529, 0013300135, 0013300235, 0013306735, 0014603448, 0014604148, 0014604448, 0014606348, 0014608348, 0014608448, 0014609748, 0023301535, 3453307135, 3503307035, 3503307335, 3643307135, 5001832582, A0003300248, A0003303235, A0003307335, A0003383410, A0004608348, A0004632229, A0004633429, A0013300135, A0013300235, A0013306735, A0014603448, A0014604148, A0014604448, A0014606348, A0014608348, A0014608448, A0014609748, A0023301535



CV-ES-14163

Length: 125
Cone Ø: d1 Ø 30 / d2 Ø 27
Thread: M30 x 1,5 RHT
 0003305248, 0003387310, 0004600348, 0004600948, 0004602848, 0004602948, 0004608948, 0014600248, 0014600848, 0014601248, 0014602248, 0014607748, 0024600148, A0003387310, A0004600348, A0004602848, A0004602948, A0014600848, A0014601248, A0014602248, A0014607748



CV-RK-8118

Ø: 85
Hole Distance: 130
Thick/Height: 30
 3500506, 0003500506



DB-DL-5207

Length: 875 **Ø:** 42
Cone Ø: d1 Ø 30 / d2 Ø 27
 01215100A, 6174603505, 6174603605



DB-DL-5217

Length: 862 **Ø:** 40
Cone Ø: d1 Ø 30 / d2 Ø 27
 01214700A, 6204600405, 6204600805, 6204602905, 6204603005



DB-DL-5241

Length: 875 **Ø:** 40
Cone Ø: d1 Ø 30 / d2 Ø 27
 01215300A, 0004609205, 0004609305, 0014606905



DB-DL-5412

Length: 840
Ø: 48
Cone Ø: d1 Ø 32 / d2 Ø 30
 01214400A, 0014600305, 14600305, 0014600405, 14600405



DB-DL-7270

Length: 875 **Ø:** 40
Cone Ø: d1 Ø 28,6 / d2 Ø 23,9
 01208300A, 0024604705, 0024604805, 0034604905, A0024604705



DB-DL-7839

Length: 585
Ø: 50
Hole Distance: 152 / 152
 3953500206, 6593500106, 6593502406



DB-DL-7840

Length: 595
Ø: 62
Hole Distance: 152 / 152
 6203500006, 6203500106, 6203500306, 653500306



DB-DL-8122

Length: 875
Ø: 42
Cone Ø: d1 Ø 30 / d2 Ø 27
 01215000A, 6174603205, 6174603305



DB-DL-10216

Length: 1190
Ø: 40
Cone Ø: d1 Ø 32 / d2 Ø 29
 0004604905



DB-ES-5209

Length: 1670 **Ø:** 50
Cone Ø: d1 Ø 30 / d2 Ø 27
 6203300503, 6203300603



DB-ES-5234

Length: 135
Cone Ø: d1 Ø 38 / d2 Ø 34,3
Thread: M38 x 1,5 RHT
 0004601748, 120322305, 2205000400



DB-RK-5280

Ø: 86
 01303000A, 6213200428



DB-RK-5283

Ø: 70
 01319900A, 6203200628



DB-RK-7267

Ø: 95
Hole Distance: 152
Thick/Height: 24
 01302100A, 0003500413, 3500413, 0005861235, 5861235, 8143270609



DB-RK-8550

Ø: 75 **Hole Distance:** 152
Thick/Height: 24
 0003502105, 0003504605



DB-RK-8564

Ø: 90
 01302200A, 0003500105, 3500105, 0003500405, 3500405, 0005861833, 5861833, 81432706047



DB-RK-10378

Ø: 86
 6203200028



DB-SB-5258

Ø: 70
Thick/Height: 62
 01311400A, 3873230285



DF-RK-8671



MN-DL-7834

Length: 1588 **Ø:** 88
Cone Ø: d1 Ø 30 / d2 Ø 27
 3463303903, 3463304903, 6253303203, 9443300503, 9443301303, 9443301703





NG ...

2528 AK	01/80→03/91	Centre Rod	DB-DL-5217		Push Rod* 5 184 732 *→* 5 211 262 *	
	01/80→03/91	Centre Rod	DB-DL-10216		Push Rod	
	01/80→03/91	Tie Rod	MN-DL-7834		Guide Rod	
	01/80→03/91	Tie Rod End	CV-ES-12461		for Steering Rod	
2536 AK	10/81→03/91	Centre Rod	DB-DL-5217		Push Rod	
	10/81→03/91	Centre Rod	DB-DL-5217		Push Rod* 5 184 732 *→* 5 211 262 *	
	10/81→03/91	Centre Rod	DB-DL-10216		Push Rod	
	10/81→03/91	Tie Rod	MN-DL-7834		Guide Rod	
	10/81→03/91	Tie Rod End	CV-ES-12461		for Steering Rod	
2626	10/81→03/91	Tie Rod End	DB-ES-5234		for Steering Rod	
	06/75→03/81	Stabiliser Mounting	DB-SB-5259			
	06/75→03/81	Suspension Arm Repair Kit		CV-RK-8118	for Drag Link	
	06/75→03/81	Suspension Arm Repair Kit		DB-RK-7267	for Drag Link	
	06/75→03/81	Suspension Strut Repair Kit		DF-RK-8671		
	06/75→03/81	Tie Rod End	CV-ES-12461		for Steering Rod	
	06/75→03/81	Tie Rod End	CV-ES-14163		for Steering Rod	
	06/75→03/81	Track Control Arm		DB-DL-7839	Trailing Arm	
2626 A	06/75→03/81	Track Control Arm		DB-DL-9226	Trailing Arm	
	06/75→03/81	Centre Rod	DB-DL-10216		Push Rod	
	06/75→03/81	Stabiliser Mounting	DB-SB-5259			
	06/75→03/81	Suspension Arm Repair Kit		CV-RK-8118	for Drag Link	
	06/75→03/81	Suspension Arm Repair Kit		DB-RK-7267	for Drag Link	
	06/75→03/81	Suspension Strut Repair Kit		DF-RK-8671		
	06/75→03/81	Tie Rod	MN-DL-7834		Guide Rod	
	06/75→03/81	Tie Rod End	CV-ES-12461		for Steering Rod	
	06/75→03/81	Tie Rod End	CV-ES-14163		for Steering Rod	
	06/75→03/81	Track Control Arm		DB-DL-7839	Trailing Arm	
	06/75→03/81	Track Control Arm		DB-DL-9257	Trailing Arm	
	06/75→03/81	Track Control Arm		DB-DL-9257	Trailing Arm→* 1 4 423552 *	
	2626 AB	05/74→12/80	Centre Rod	DB-DL-10216		Push Rod
		05/74→12/80	Suspension Arm Repair Kit		CV-RK-8118	for Drag Link
05/74→12/80		Suspension Arm Repair Kit		DB-RK-7267	for Drag Link	
05/74→12/80		Suspension Strut Repair Kit		DF-RK-8671		
05/74→12/80		Tie Rod	MN-DL-7834		Guide Rod	
05/74→12/80		Tie Rod End	CV-ES-12461		for Steering Rod	
05/74→12/80		Tie Rod End	CV-ES-14163		for Steering Rod	
05/74→12/80		Track Control Arm		DB-DL-7839	Trailing Arm	
05/74→12/80		Track Control Arm		DB-DL-9257	Trailing Arm→* 1 4 406809 *	
2626 AK	08/73→12/81	Centre Rod	DB-DL-10216		Push Rod	
	08/73→12/81	Stabiliser Mounting	DB-SB-5259			
	08/73→12/81	Suspension Arm Repair Kit		CV-RK-8118	for Drag Link	
	08/73→12/81	Suspension Arm Repair Kit		DB-RK-7267	for Drag Link	
	08/73→12/81	Suspension Strut Repair Kit		DF-RK-8671		
	08/73→12/81	Tie Rod	MN-DL-7834		Guide Rod	
	08/73→12/81	Tie Rod End	CV-ES-12461		for Steering Rod	
	08/73→12/81	Tie Rod End	CV-ES-14163		for Steering Rod	
	08/73→12/81	Track Control Arm		DB-DL-7839	Trailing Arm	
2626 AS	08/73→12/81	Track Control Arm		DB-DL-9257	Trailing Arm→* 1 4 405201 *	
	06/75→03/81	Centre Rod	DB-DL-10216		Push Rod	
	06/75→03/81	Stabiliser Mounting	DB-SB-5259			
	06/75→03/81	Suspension Arm Repair Kit		CV-RK-8118	for Drag Link	
	06/75→03/81	Suspension Arm Repair Kit		DB-RK-7267	for Drag Link	
	06/75→03/81	Suspension Strut Repair Kit		DF-RK-8671		
	06/75→03/81	Tie Rod	MN-DL-7834		Guide Rod	
	06/75→03/81	Tie Rod End	CV-ES-12461		for Steering Rod	
	06/75→03/81	Tie Rod End	CV-ES-14163		for Steering Rod	
	06/75→03/81	Track Control Arm		DB-DL-7839	Trailing Arm	
2626 B	06/75→03/81	Track Control Arm		DB-DL-9257	Trailing Arm→* 1 4 426005 *	
	05/74→12/80	Stabiliser Mounting	DB-SB-5259			
	05/74→12/80	Suspension Arm Repair Kit		CV-RK-8118	for Drag Link	
	05/74→12/80	Suspension Arm Repair Kit		DB-RK-7267	for Drag Link	
	05/74→12/80	Suspension Strut Repair Kit		DF-RK-8671		
	05/74→12/80	Tie Rod End	CV-ES-12461		for Steering Rod	
	05/74→12/80	Tie Rod End	CV-ES-14163		for Steering Rod	
05/74→12/80	Track Control Arm		DB-DL-7839	Trailing Arm		

CV-ES-12461

Length: 120
 Cone Ø: d1 Ø 26 / d2 Ø 23,5
 Thread: M30 x 1,5 LHT
 0003300035, 3300148, 0003406213, 0013306635,
 0013308835, 0014604048, 0014604348,
 14606448, 0024600248, 3023300035,
 3023300135, 3023300235, 3023300335,
 3453307235, 3453307435, 3503307135,
 A0003300148, A0013306635, A0013308835,
 A0014604048, A0014604348, A0014606448,
 A0024600248, A3023300035, A3023300135,
 A3023300235, A3023300335, A3503307135



CV-ES-14163

Length: 125
 Cone Ø: d1 Ø 30 / d2 Ø 27
 Thread: M30 x 1,5 RHT
 0003305248, 0003387310, 0004600348,
 0004600948, 0004602848, 0004602948,
 0004608948, 0014600248, 0014600848,
 0014601248, 0014602248, 0014607748,
 0024600148, A0003387310, A0004600348,
 A0004602848, A0004602948, A0014600848,
 A0014601248, A0014602248, A0014607748



CV-RK-8118

Ø: 85
 Hole Distance: 130
 Thick/Height: 30
 3500506, 0003500506



DB-DL-5217

Length: 862 Ø: 40
 Cone Ø: d1 Ø 30 / d2 Ø 27
 01214700A, 6204600405, 6204600805,
 6204602905, 6204603005



DB-DL-7839

Length: 585
 Ø: 50
 Hole Distance: 152 / 152
 3953500206, 6593500106, 6593502406



DB-DL-9226

Length: 628
 Ø: 50
 Hole Distance: 152 / 152
 3953201532



DB-DL-9257

Length: 638
 Ø: 50
 Hole Distance: 152 / 152
 3953201432



DB-DL-10216

Length: 1190
 Ø: 40
 Cone Ø: d1 Ø 32 / d2 Ø 29
 0004604905



DB-ES-5234

Length: 135
 Cone Ø: d1 Ø 38 / d2 Ø 34,3
 Thread: M38 x 1,5 RHT
 0004601748, 120322305, 2205000400



DB-RK-7267

Ø: 95
 Hole Distance: 152
 Thick/Height: 24
 01302100A, 0003500413, 3500413, 0005861235,
 5861235, 81432706069



DB-SB-5259

Ø: 44
 Thick/Height: 25
 01317200A, 0003232150, 3232150



DF-RK-8671



MN-DL-7834

Length: 1588 Ø: 58
 Cone Ø: d1 Ø 30 / d2 Ø 27
 3463303903, 3463304903, 6253303203,
 9443300503, 9443301303, 9443301703





NG ...

2626 K	08/73→03/81	Centre Rod	DB-DL-10216		Push Rod	
	08/73→03/81	Stabiliser Mounting	DB-SB-5259			
	08/73→03/81	Suspension Arm Repair Kit		CV-RK-8118	for Drag Link	
	08/73→03/81	Suspension Arm Repair Kit		DB-RK-7267	for Drag Link	
	08/73→03/81	Suspension Strut Repair Kit		DF-RK-8671		
	08/73→03/81	Tie Rod	MN-DL-7834		Guide Rod	
	08/73→03/81	Tie Rod End	CV-ES-12461		for Steering Rod	
	08/73→03/81	Tie Rod End	CV-ES-14163		for Steering Rod	
	08/73→03/81	Track Control Arm		DB-DL-7839	Trailing Arm	
	08/73→03/81	Track Control Arm		DB-DL-9226	Trailing Arm	
2626 S	06/75→03/81	Stabiliser Mounting	DB-SB-5259			
	06/75→03/81	Suspension Arm Repair Kit		CV-RK-8118	for Drag Link	
	06/75→03/81	Suspension Arm Repair Kit		DB-RK-7267	for Drag Link	
	06/75→03/81	Suspension Strut Repair Kit		DF-RK-8671		
	06/75→03/81	Tie Rod End	CV-ES-12461		for Steering Rod	
	06/75→03/81	Tie Rod End	CV-ES-14163		for Steering Rod	
	06/75→03/81	Track Control Arm		DB-DL-7839	Trailing Arm	
	06/75→03/81	Track Control Arm		DB-DL-9226	Trailing Arm	
2628	02/80→03/91	Centre Rod	DB-DL-5241		Suspension Rod	
	02/80→03/91	Centre Rod	DB-DL-7270		Push Rod;Suspension Rod	
	02/80→03/91	Centre Rod	DB-DL-7831		Push Rod	
	02/80→03/91	Centre Rod	DB-DL-8131		Push Rod	
	02/80→03/91	Centre Rod	DB-DL-8618		Push Rod	
	02/80→03/91	Centre Rod	DB-DL-10216		Push Rod	
	02/80→03/91	Suspension Arm Repair Kit		DB-RK-7267	for Drag Link	
	02/80→03/91	Suspension Arm Repair Kit		DB-RK-8550	for Wishbone (CV)	
	02/80→03/91	Tie Rod	DB-ES-5227		Guide Rod	
	02/80→03/91	Tie Rod End	CV-ES-12461		for Steering Rod	
	02/80→03/91	Tie Rod End	CV-ES-14163		for Steering Rod	
	02/80→03/91	Tie Rod End	DB-ES-5234		for Steering Rod	
	02/80→03/91	Track Control Arm		DB-DL-6197	Suspension Rod, Trailing Arm	
	02/80→03/91	Track Control Arm		DB-DL-6198	Suspension Rod, Trailing Arm	
	02/80→03/91	Track Control Arm		DB-DL-6227	Suspension Rod, Trailing Arm	
	02/80→03/91	Track Control Arm		DB-DS-6088	Suspension Rod, Trailing Arm	
	2628 A	02/80→03/91	Centre Rod	DB-DL-5217		Push Rod
		02/80→03/91	Centre Rod	DB-DL-5217		Push Rod* 5 184 732 *→
02/80→03/91		Centre Rod	DB-DL-7831		Push Rod	
02/80→03/91		Centre Rod	DB-DL-8131		Push Rod	
02/80→03/91		Centre Rod	DB-DL-8618		Push Rod	
02/80→03/91		Centre Rod	DB-DL-10216		Push Rod	
02/80→03/91		Suspension Arm Repair Kit		DB-RK-7267	for Drag Link	
02/80→03/91		Tie Rod	DB-DL-8640		Guide Rod	
02/80→03/91		Tie Rod	DB-ES-5209			
02/80→03/91		Tie Rod	DB-ES-5227		Guide Rod	
02/80→03/91		Tie Rod	MN-DL-7834		Guide Rod	
02/80→03/91		Tie Rod End	CV-ES-12461		for Steering Rod	
02/80→03/91		Tie Rod End	CV-ES-14163		for Steering Rod	
02/80→03/91		Tie Rod End	DB-ES-5234		for Steering Rod	
02/80→03/91		Track Control Arm		DB-DL-6197	Suspension Rod, Trailing Arm	
02/80→03/91		Track Control Arm		DB-DL-6198	Suspension Rod, Trailing Arm	
02/80→03/91		Track Control Arm		DB-DL-6227	Suspension Rod, Trailing Arm	
02/80→03/91		Track Control Arm		DB-DS-6088	Suspension Rod, Trailing Arm	
2628 AK		02/80→03/91	Centre Rod	DB-DL-5217		Push Rod* 5 184 732 *→
		02/80→03/91	Centre Rod	DB-DL-10216		Push Rod
	02/80→03/91	Suspension Arm Repair Kit		DB-RK-7267	for Drag Link	
	02/80→03/91	Tie Rod	DB-ES-5227		Guide Rod	
	02/80→03/91	Tie Rod	MN-DL-7834		Guide Rod	
	02/80→03/91	Tie Rod End	CV-ES-12461		for Steering Rod	
	02/80→03/91	Tie Rod End	CV-ES-14163		for Steering Rod	
	02/80→03/91	Track Control Arm		DB-DL-6197	Suspension Rod, Trailing Arm	
	02/80→03/91	Track Control Arm		DB-DL-6198	Suspension Rod, Trailing Arm	
	02/80→03/91	Track Control Arm		DB-DL-6227	Suspension Rod, Trailing Arm	
	02/80→03/91	Track Control Arm		DB-DS-6088	Suspension Rod, Trailing Arm	

CV-ES-12461

Length: 120
 Cone Ø: d1 Ø 26 / d2 Ø 23,5
 Thread: M30 x 1,5 LHT
 0003300035, 3300148, 0003406213, 0013306635,
 0013308835, 0014604048, 0014604348,
 14606448, 0024600248, 3023300035,
 3023300135, 3023300235, 3023300335,
 3453307235, 3453307435, 3503307135,
 A0003300148, A0013306635, A0013308835,
 A0014604048, A0014604348, A0014606448,
 A0024600248, A3023300035, A3023300135,
 A3023300235, A3023300335, A3503307135



CV-ES-14163

Length: 125
 Cone Ø: d1 Ø 30 / d2 Ø 27
 Thread: M30 x 1,5 RHT
 0003305248, 0003387310, 0004600348,
 0004600948, 0004602848, 0004602948,
 0004608948, 0014600248, 0014600848,
 0014601248, 0014602248, 0014607748,
 0024600148, A0003387310, A0004600348,
 A0004602848, A0004602948, A0014600848,
 A0014601248, A0014602248, A0014607748



CV-RK-8118

Ø: 85
 Hole Distance: 130
 Thick/Height: 30
 0003500506, 3500506



DB-DL-5217

Length: 862 Ø: 40
 Cone Ø: d1 Ø 30 / d2 Ø 27
 01214700A, 6204600405, 6204600805,
 6204602905, 6204603005



DB-DL-5241

Length: 875 Ø: 40
 Cone Ø: d1 Ø 30 / d2 Ø 27
 01215300A, 0004609205, 0004609305,
 0014606905



DB-DL-6197

Length: 579
 Ø: 50
 Hole Distance: 152 / 152
 6593501206, 6593503506



DB-DL-6198

Length: 579
 Ø: 58
 Hole Distance: 152 / 152
 3953500006, 6593501106



DB-DL-6227

Length: 629
 Ø: 58
 Hole Distance: 152 / 152
 6593501506, 6593503806



DB-DL-7270

Length: 875 Ø: 40
 Cone Ø: d1 Ø 28,6 / d2 Ø 23,9
 01208300A, 0024604705, 0024604805,
 0034604905, A0024604705



DB-DL-7831

Length: 870
 Ø: 42
 Cone Ø: d1 Ø 30 / d2 Ø 27
 01215200A, 6254602505



DB-DL-7839

Length: 585
 Ø: 50
 Hole Distance: 152 / 152
 3953500206, 6593500106, 6593502406



DB-DL-8131

Length: 1115 Ø: 52
 Cone Ø: d1 Ø 32 / d2 Ø 28,8
 0004604405, 6254605005



DB-DL-8618

Length: 680
 Ø: 42
 Cone Ø: d1 Ø 32 / d2 Ø 28,8
 0004604305, 4604305, 6254604805



DB-DL-8640

Length: 1615 Ø: 50
 Cone Ø: d1 Ø 32 / d2 Ø 29
 6253301503, 6253301603, 6253302403,
 6253302503, 9423300803, 9423302103,
 9493300203, 9493300303, 9493300903



DB-DL-9226

Length: 628
 Ø: 50
 Hole Distance: 152 / 152
 3953201532



DB-DL-10216

Length: 1190
 Ø: 40
 Cone Ø: d1 Ø 32 / d2 Ø 29
 0004604905



DB-DS-6088

Length: 585
 Ø: 50
 Hole Distance: 152 / 152
 3953500706, 6593500406



DB-ES-5209

Length: 1670 Ø: 50
 Cone Ø: d1 Ø 30 / d2 Ø 27
 6203300503, 6203300603



DB-ES-5227

Length: 1588 Ø: 60
 Cone Ø: d1 Ø 38 / d2 Ø 34,3
 6253300903, 6253301203, 9443300203



DB-ES-5234

Length: 135
 Cone Ø: d1 Ø 38 / d2 Ø 34,3
 Thread: M38 x 1,5 RHT
 0004601748, 120322305, 2205000400



DB-RK-7267

Ø: 95
 Hole Distance: 152
 Thick/Height: 24
 01302100A, 0003500413, 3500413, 0005861235,
 5861235, 8143270609



DB-RK-8550

Ø: 75 Hole Distance: 152
 Thick/Height: 24
 0003502105, 0003504605



DB-SB-5259

Ø: 44
 Thick/Height: 25
 01317200A, 0003232150, 3232150



DF-RK-8671



MN-DL-7834

Length: 1588 Ø: 58
 Cone Ø: d1 Ø 30 / d2 Ø 27
 3463303903, 3463304903, 6253303203,
 9443300503, 9443301303, 9443301703





NG ...

2628 AS	02/80→03/91	Centre Rod	DB-DL-5217		Push Rod* 5 184 732 *→
	02/80→03/91	Centre Rod	DB-DL-10216		Push Rod
	02/80→03/91	Suspension Arm Repair Kit		DB-RK-7267	for Drag Link
	02/80→03/91	Tie Rod	DB-ES-5227		Guide Rod
	02/80→03/91	Tie Rod	MN-DL-7834		Guide Rod
	02/80→03/91	Tie Rod End	CV-ES-12461		for Steering Rod
	02/80→03/91	Tie Rod End	CV-ES-14163		for Steering Rod
	02/80→03/91	Track Control Arm		DB-DL-6197	Suspension Rod, Trailing Arm
	02/80→03/91	Track Control Arm		DB-DL-6198	Suspension Rod, Trailing Arm
	02/80→03/91	Track Control Arm		DB-DL-6227	Suspension Rod, Trailing Arm
02/80→03/91	Track Control Arm		DB-DS-6088	Suspension Rod, Trailing Arm	
2628 B	02/80→08/89	Stabiliser Mounting	DB-SB-5258	DB-SB-5258	
	02/80→08/89	Suspension Arm Repair Kit		DB-RK-7267	for Drag Link
	02/80→08/89	Suspension Arm Repair Kit	DB-RK-5283		
	02/80→08/89	Tie Rod	DB-ES-5227		Guide Rod
	02/80→08/89	Tie Rod End	CV-ES-14163		for Steering Rod
	02/80→08/89	Track Control Arm		DB-DL-6197	Suspension Rod, Trailing Arm
	02/80→08/89	Track Control Arm		DB-DL-6198	Suspension Rod, Trailing Arm
	02/80→08/89	Track Control Arm		DB-DL-6227	Suspension Rod, Trailing Arm
2628 K	02/80→03/91	Centre Rod	DB-DL-10216		Push Rod
	02/80→03/91	Suspension Arm Repair Kit		DB-RK-7267	for Drag Link
	02/80→03/91	Tie Rod	DB-ES-5227		Guide Rod
	02/80→03/91	Tie Rod End	CV-ES-12461		for Steering Rod
	02/80→03/91	Tie Rod End	CV-ES-14163		for Steering Rod
	02/80→03/91	Track Control Arm		DB-DL-6197	Suspension Rod, Trailing Arm
	02/80→03/91	Track Control Arm		DB-DL-6198	Suspension Rod, Trailing Arm
	02/80→03/91	Track Control Arm		DB-DL-6227	Suspension Rod, Trailing Arm
2628 S	02/80→03/91	Stabiliser Mounting	DB-SB-5258	DB-SB-5258	
	02/80→03/91	Suspension Arm Repair Kit		DB-RK-7267	for Drag Link
	02/80→03/91	Suspension Arm Repair Kit	DB-RK-5283		
	02/80→03/91	Tie Rod	DB-ES-5227		Guide Rod
	02/80→03/91	Tie Rod End	CV-ES-14163		for Steering Rod
	02/80→03/91	Track Control Arm		DB-DL-6197	Suspension Rod, Trailing Arm
	02/80→03/91	Track Control Arm		DB-DL-6198	Suspension Rod, Trailing Arm
	02/80→03/91	Track Control Arm		DB-DL-6227	Suspension Rod, Trailing Arm
2632	05/74→09/83	Centre Rod	DB-DL-10216		Push Rod
	05/74→09/83	Stabiliser Mounting	DB-SB-5259		
	05/74→09/83	Suspension Arm Repair Kit		CV-RK-8118	for Drag Link
	05/74→09/83	Suspension Arm Repair Kit		DB-RK-7267	for Drag Link
	05/74→09/83	Suspension Strut Repair Kit		DF-RK-8671	
	05/74→09/83	Tie Rod End	CV-ES-12461		for Steering Rod
	05/74→09/83	Tie Rod End	CV-ES-14163		for Steering Rod
	05/74→09/83	Track Control Arm		DB-DL-7839	Trailing Arm
2632 A	05/74→09/83	Centre Rod	DB-DL-10216		Push Rod
	05/74→09/83	Stabiliser Mounting	DB-SB-5259		
	05/74→09/83	Suspension Arm Repair Kit		CV-RK-8118	for Drag Link
	05/74→09/83	Suspension Arm Repair Kit		DB-RK-7267	for Drag Link
	05/74→09/83	Suspension Strut Repair Kit		DF-RK-8671	
	05/74→09/83	Tie Rod	MN-DL-7834		Guide Rod
	05/74→09/83	Tie Rod End	CV-ES-12461		for Steering Rod
	05/74→09/83	Tie Rod End	CV-ES-14163		for Steering Rod
2632 AK	08/73→09/83	Centre Rod	DB-DL-10216		Push Rod
	08/73→09/83	Stabiliser Mounting	DB-SB-5259		
	08/73→09/83	Suspension Arm Repair Kit		CV-RK-8118	for Drag Link
	08/73→09/83	Suspension Arm Repair Kit		DB-RK-7267	for Drag Link
	08/73→09/83	Suspension Strut Repair Kit		DF-RK-8671	
	08/73→09/83	Tie Rod	MN-DL-7834		Guide Rod
	08/73→09/83	Track Control Arm		DB-DL-7839	Trailing Arm
	08/73→09/83	Track Control Arm		DB-DL-9257	Trailing Arm→* 1 4 423552 *

CV-ES-12461

Length: 120
 Cone Ø: d1 Ø 26 / d2 Ø 23,5
 Thread: M30 x 1,5 LHT
 0003300035, 3300148, 0003406213, 0013306635,
 0013308835, 0014604048, 0014604348,
 14606448, 0024600248, 3023300035,
 3023300135, 3023300235, 3023300335,
 3453307235, 3453307435, 3503307135,
 A0003300148, A0013306635, A0013308835,
 A0014604048, A0014604348, A0014606448,
 A0024600248, A3023300035, A3023300135,
 A3023300235, A3023300335, A3503307135



CV-ES-14163

Length: 125
 Cone Ø: d1 Ø 30 / d2 Ø 27
 Thread: M30 x 1,5 RHT
 0003305248, 0003387310, 0004600348,
 0004600948, 0004602848, 0004602948,
 0004608948, 0014600248, 0014600848,
 0014601248, 0014602248, 0014607748,
 0024600148, A0003387310, A0004600348,
 A0004602848, A0004602948, A0014600848,
 A0014601248, A0014602248, A0014607748



CV-RK-8118

Ø: 85
 Hole Distance: 130
 Thick/Height: 30
 0003500506, 3500506



DB-DL-5217

Length: 862 Ø: 40
 Cone Ø: d1 Ø 30 / d2 Ø 27
 01214700A, 6204600405, 6204600805,
 6204602905, 6204603005



DB-DL-6197

Length: 579
 Ø: 50
 Hole Distance: 152 / 152
 6593501206, 6593503506



DB-DL-6198

Length: 579
 Ø: 58
 Hole Distance: 152 / 152
 3953500006, 6593501106



DB-DL-6227

Length: 629
 Ø: 58
 Hole Distance: 152 / 152
 6593501506, 6593503806



DB-DL-7839

Length: 585
 Ø: 50
 Hole Distance: 152 / 152
 3953500206, 6593500106, 6593502406



DB-DL-9226

Length: 628
 Ø: 50
 Hole Distance: 152 / 152
 3953201532



DB-DL-9257

Length: 638
 Ø: 50
 Hole Distance: 152 / 152
 3953201432



DB-DL-10216

Length: 1190
 Ø: 40
 Cone Ø: d1 Ø 32 / d2 Ø 29
 0004604905



DB-DS-6088

Length: 585
 Ø: 50
 Hole Distance: 152 / 152
 3953500706, 6593500406



DB-ES-5227

Length: 1588 Ø: 60
 Cone Ø: d1 Ø 38 / d2 Ø 34,3
 6253300903, 6253301203, 9443300203



DB-RK-5283

Ø: 70
 01319900A, 6203200628



DB-RK-7267

Ø: 95
 Hole Distance: 152
 Thick/Height: 24
 01302100A, 3500413, 0003500413, 0005861235,
 5861235, 81432706069



DB-SB-5258

Ø: 70
 Thick/Height: 62
 01311400A, 3873230285



DB-SB-5259

Ø: 44
 Thick/Height: 25
 01317200A, 0003232150, 3232150



DF-RK-8671



MN-DL-7834

Length: 1588 Ø: 58
 Cone Ø: d1 Ø 30 / d2 Ø 27
 3463303903, 3463304903, 6253303203,
 9443300503, 9443301303, 9443301703





NG ...

2632 AK ...	08/73→09/83	Tie Rod End	CV-ES-12461		for Steering Rod	
	08/73→09/83	Tie Rod End	CV-ES-14163		for Steering Rod	
	08/73→09/83	Track Control Arm		DB-DL-7839	Trailing Arm	
	08/73→09/83	Track Control Arm		DB-DL-9257	Trailing Arm→* 1 4 405201 *	
2632 AS	05/74→09/83	Centre Rod	DB-DL-10216		Push Rod	
	05/74→09/83	Stabiliser Mounting	DB-SB-5259			
	05/74→09/83	Suspension Arm Repair Kit		CV-RK-8118	for Drag Link	
	05/74→09/83	Suspension Arm Repair Kit		DB-RK-7267	for Drag Link	
	05/74→09/83	Suspension Strut Repair Kit		DF-RK-8671		
	05/74→09/83	Tie Rod	MN-DL-7834		Guide Rod	
	05/74→09/83	Tie Rod End	CV-ES-12461		for Steering Rod	
	05/74→09/83	Tie Rod End	CV-ES-14163		for Steering Rod	
	05/74→09/83	Track Control Arm		DB-DL-7839	Trailing Arm	
	05/74→09/83	Track Control Arm		DB-DL-9257	Trailing Arm→* 1 4 426005 *	
2632 K	08/73→09/83	Stabiliser Mounting	DB-SB-5259			
	08/73→09/83	Suspension Arm Repair Kit		CV-RK-8118	for Drag Link	
	08/73→09/83	Suspension Arm Repair Kit		DB-RK-7267	for Drag Link	
	08/73→09/83	Suspension Strut Repair Kit		DF-RK-8671		
	08/73→09/83	Tie Rod End	CV-ES-12461		for Steering Rod	
	08/73→09/83	Tie Rod End	CV-ES-14163		for Steering Rod	
	08/73→09/83	Track Control Arm		DB-DL-7839	Trailing Arm	
	08/73→09/83	Track Control Arm		DB-DL-9226	Trailing Arm	
2632 S	05/74→09/83	Stabiliser Mounting	DB-SB-5259			
	05/74→09/83	Suspension Arm Repair Kit		CV-RK-8118	for Drag Link	
	05/74→09/83	Suspension Arm Repair Kit		DB-RK-7267	for Drag Link	
	05/74→09/83	Suspension Strut Repair Kit		DF-RK-8671		
	05/74→09/83	Tie Rod End	CV-ES-12461		for Steering Rod	
	05/74→09/83	Tie Rod End	CV-ES-14163		for Steering Rod	
	05/74→09/83	Track Control Arm		DB-DL-7839	Trailing Arm	
2633	05/74→09/83	Track Control Arm		DB-DL-9226	Trailing Arm	
	05/82→05/87	Centre Rod	DB-DL-5241		Suspension Rod	
	05/82→05/87	Centre Rod	DB-DL-7270		Push Rod;Suspension Rod	
	05/82→05/87	Centre Rod	DB-DL-10216		Push Rod	
	05/82→05/87	Stabiliser Mounting	DB-SB-5258	DB-SB-5258		
	05/82→05/87	Suspension Arm Repair Kit		DB-RK-7267	for Drag Link	
	05/82→05/87	Suspension Arm Repair Kit		DB-RK-8550	for Wishbone (CV)	
	05/82→05/87	Suspension Arm Repair Kit	DB-RK-5283			
	05/82→05/87	Tie Rod	DB-ES-5227		Guide Rod	
	05/82→05/87	Tie Rod End	CV-ES-12461		for Steering Rod	
	05/82→05/87	Tie Rod End	CV-ES-14163		for Steering Rod	
	05/82→05/87	Track Control Arm		DB-DL-6197	Suspension Rod, Trailing Arm	
	05/82→05/87	Track Control Arm		DB-DL-6198	Suspension Rod, Trailing Arm	
	05/82→05/87	Track Control Arm		DB-DL-6227	Suspension Rod, Trailing Arm	
	05/82→05/87	Track Control Arm		DB-DS-6088	Suspension Rod, Trailing Arm	
	2633 S	05/82→05/87	Centre Rod	DB-DL-10216		Push Rod
05/82→05/87		Stabiliser Mounting	DB-SB-5258	DB-SB-5258		
05/82→05/87		Suspension Arm Repair Kit		DB-RK-7267	for Drag Link	
05/82→05/87		Suspension Arm Repair Kit	DB-RK-5283			
05/82→05/87		Tie Rod	DB-ES-5227		Guide Rod	
05/82→05/87		Tie Rod End	CV-ES-12461		for Steering Rod	
05/82→05/87		Tie Rod End	CV-ES-14163		for Steering Rod	
05/82→05/87		Track Control Arm		DB-DL-6197	Suspension Rod, Trailing Arm	
05/82→05/87		Track Control Arm		DB-DL-6198	Suspension Rod, Trailing Arm	
05/82→05/87		Track Control Arm		DB-DL-6227	Suspension Rod, Trailing Arm	
05/82→05/87		Track Control Arm		DB-DS-6088	Suspension Rod, Trailing Arm	
2635		04/86→03/91	Centre Rod	DB-DL-5241		Suspension Rod
		04/86→03/91	Centre Rod	DB-DL-7270		Push Rod;Suspension Rod
		04/86→03/91	Centre Rod	DB-DL-7831		Push Rod
	04/86→03/91	Centre Rod	DB-DL-8131		Push Rod	
	04/86→03/91	Centre Rod	DB-DL-8138		Push Rod	
	04/86→03/91	Centre Rod	DB-DL-8618		Push Rod	
	04/86→03/91	Centre Rod	DB-DL-10216		Push Rod	
	04/86→03/91	Stabiliser Mounting	DB-SB-5258	DB-SB-5258		

CV-ES-12461

Length: 120
Cone Ø: d1 Ø 26 / d2 Ø 23,5
Thread: M30 x 1,5 LHT
0003300035, 3300148, 0003406213, 0013306635,
0013308835, 0014604048, 0014604348,
14606448, 0024600248, 3023300035,
3023300135, 3023300235, 3023300335,
3453307235, 3453307435, 3503307135,
A0003300148, A0013306635, A0013308835,
A0014604048, A0014604348, A0014606448,
A0024600248, A3023300035, A3023300135,
A3023300235, A3023300335, A3503307135



CV-ES-14163

Length: 125
Cone Ø: d1 Ø 30 / d2 Ø 27
Thread: M30 x 1,5 RHT
0003305248, 0003387310, 0004600348,
0004600948, 0004602848, 0004602948,
0004608948, 0014600248, 0014600848,
0014601248, 0014602248, 0014607748,
0024600148, A0003387310, A0004600348,
A0004602848, A0004602948, A0014600848,
A0014601248, A0014602248, A0014607748



CV-RK-8118

Ø: 85
Hole Distance: 130
Thick/Height: 30
0003500506, 3500506



DB-DL-5241

Length: 875 Ø: 40
Cone Ø: d1 Ø 30 / d2 Ø 27
01215300A, 0004609205, 0004609305,
0014606905



DB-DL-6197

Length: 579
Ø: 50
Hole Distance: 152 / 152
6593501206, 6593503506



DB-DL-6198

Length: 579
Ø: 58
Hole Distance: 152 / 152
3953500006, 6593501106



DB-DL-6227

Length: 629
Ø: 58
Hole Distance: 152 / 152
6593501506, 6593503806



DB-DL-7270

Length: 875 Ø: 40
Cone Ø: d1 Ø 28,6 / d2 Ø 23,9
01208300A, 0024604705, 0024604805,
0034604905, A0024604705



DB-DL-7831

Length: 870
Ø: 42
Cone Ø: d1 Ø 30 / d2 Ø 27
01215200A, 6254602505



DB-DL-7839

Length: 585
Ø: 50
Hole Distance: 152 / 152
3953500206, 6593500106, 6593502406



DB-DL-8131

Length: 1115 Ø: 52
Cone Ø: d1 Ø 32 / d2 Ø 28,8
0004604405, 6254605005



DB-DL-8138

Length: 1130
Ø: 40
Cone Ø: d1 Ø 32 / d2 Ø 28,8
0004606605, 4606605



DB-DL-8618

Length: 680
Ø: 42
Cone Ø: d1 Ø 32 / d2 Ø 28,8
0004604305, 4604305, 6254604805



DB-DL-9226

Length: 628
Ø: 50
Hole Distance: 152 / 152
3953201532



DB-DL-9257

Length: 638
Ø: 50
Hole Distance: 152 / 152
3953201432



DB-DL-10216

Length: 1190
Ø: 40
Cone Ø: d1 Ø 32 / d2 Ø 29
0004604905



DB-DS-6088

Length: 585
Ø: 50
Hole Distance: 152 / 152
3953500706, 6593500406



DB-ES-5227

Length: 1588 Ø: 60
Cone Ø: d1 Ø 38 / d2 Ø 34,3
6253300903, 6253301203, 9443300203



DB-RK-5283

Ø: 70
01319900A, 6203200628



DB-RK-7267

Ø: 95
Hole Distance: 152
Thick/Height: 24
01302100A, 0003500413, 3500413, 0005861235,
5861235, 8143270609



DB-RK-8550

Ø: 75 Hole Distance: 152
Thick/Height: 24
0003502105, 0003504605



DB-SB-5258

Ø: 70
Thick/Height: 62
01311400A, 3873230285



DB-SB-5259

Ø: 44
Thick/Height: 25
01317200A, 0003232150, 3232150



DF-RK-8671



MN-DL-7834

Length: 1588 Ø: 58
Cone Ø: d1 Ø 30 / d2 Ø 27
3463303903, 3463304903, 6253303203,
9443300503, 9443301303, 9443301703





NG ...

2635 ...	04/86→03/91	Suspension Arm Repair Kit		DB-RK-7267	for Drag Link
	04/86→03/91	Suspension Arm Repair Kit		DB-RK-8550	for Wishbone (CV)
	04/86→03/91	Suspension Arm Repair Kit	DB-RK-5283		
	04/86→03/91	Tie Rod	DB-DL-8640		Guide Rod
	04/86→03/91	Tie Rod	DB-ES-5209		
	04/86→03/91	Tie Rod	DB-ES-5227		Guide Rod
	04/86→03/91	Tie Rod End	CV-ES-12461		for Steering Rod
	04/86→03/91	Tie Rod End	CV-ES-14163		for Steering Rod
	04/86→03/91	Track Control Arm		DB-DL-6197	Suspension Rod, Trailing Arm
	04/86→03/91	Track Control Arm		DB-DL-6198	Suspension Rod, Trailing Arm
	04/86→03/91	Track Control Arm		DB-DL-6227	Suspension Rod, Trailing Arm
2635 A	09/87→03/91	Centre Rod	DB-DL-5217		Push Rod
	09/87→03/91	Centre Rod	DB-DL-7831		Push Rod
	09/87→03/91	Centre Rod	DB-DL-10216		Push Rod
	09/87→03/91	Suspension Arm Repair Kit		DB-RK-7267	for Drag Link
	09/87→03/91	Tie Rod	DB-ES-5209		
	09/87→03/91	Tie Rod	DB-ES-5227		Guide Rod
	09/87→03/91	Tie Rod	MN-DL-7834		Guide Rod
	09/87→03/91	Tie Rod End	CV-ES-12461		for Steering Rod
	09/87→03/91	Tie Rod End	CV-ES-14163		for Steering Rod
	09/87→03/91	Tie Rod End	DB-ES-5234		for Steering Rod
	09/87→03/91	Track Control Arm		DB-DL-6197	Suspension Rod, Trailing Arm
09/87→03/91	Track Control Arm		DB-DL-6198	Suspension Rod, Trailing Arm	
2635 AK	09/87→03/91	Centre Rod	DB-DL-5217		Push Rod
	09/87→03/91	Centre Rod	DB-DL-10216		Push Rod
	09/87→03/91	Suspension Arm Repair Kit		DB-RK-7267	for Drag Link
	09/87→03/91	Tie Rod	DB-ES-5227		Guide Rod
	09/87→03/91	Tie Rod	MN-DL-7834		Guide Rod
	09/87→03/91	Tie Rod End	CV-ES-12461		for Steering Rod
	09/87→03/91	Tie Rod End	CV-ES-14163		for Steering Rod
	09/87→03/91	Track Control Arm		DB-DL-6197	Suspension Rod, Trailing Arm
	09/87→03/91	Track Control Arm		DB-DL-6198	Suspension Rod, Trailing Arm
2635 AS	09/87→03/91	Centre Rod	DB-DL-5217		Push Rod
	09/87→03/91	Centre Rod	DB-DL-10216		Push Rod
	09/87→03/91	Suspension Arm Repair Kit		DB-RK-7267	for Drag Link
	09/87→03/91	Tie Rod	DB-ES-5227		Guide Rod
	09/87→03/91	Tie Rod	MN-DL-7834		Guide Rod
	09/87→03/91	Tie Rod End	CV-ES-12461		for Steering Rod
	09/87→03/91	Tie Rod End	CV-ES-14163		for Steering Rod
	09/87→03/91	Track Control Arm		DB-DL-6197	Suspension Rod, Trailing Arm
	09/87→03/91	Track Control Arm		DB-DL-6198	Suspension Rod, Trailing Arm
2635 S	04/86→03/91	Stabiliser Mounting	DB-SB-5258	DB-SB-5258	
	04/86→03/91	Suspension Arm Repair Kit		DB-RK-7267	for Drag Link
	04/86→03/91	Suspension Arm Repair Kit	DB-RK-5283		
	04/86→03/91	Tie Rod	DB-ES-5227		Guide Rod
	04/86→03/91	Tie Rod End	CV-ES-14163		for Steering Rod
	04/86→03/91	Track Control Arm		DB-DL-6197	Suspension Rod, Trailing Arm
	04/86→03/91	Track Control Arm		DB-DL-6198	Suspension Rod, Trailing Arm
	04/86→03/91	Track Control Arm		DB-DL-6227	Suspension Rod, Trailing Arm
2636	11/81→03/91	Centre Rod	DB-DL-5217		Push Rod
	11/81→03/91	Centre Rod	DB-DL-5241		Suspension Rod
	11/81→03/91	Centre Rod	DB-DL-7270		Push Rod;Suspension Rod
	11/81→03/91	Centre Rod	DB-DL-7831		Push Rod
	11/81→03/91	Centre Rod	DB-DL-8131		Push Rod
	11/81→03/91	Centre Rod	DB-DL-8618		Push Rod
	11/81→03/91	Centre Rod	DB-DL-10216		Push Rod
	11/81→03/91	Suspension Arm Repair Kit		DB-RK-7267	for Drag Link
	11/81→03/91	Suspension Arm Repair Kit		DB-RK-8550	for Wishbone (CV)
	11/81→03/91	Suspension Arm Repair Kit		DB-RK-9297	Wishbone (CV)
	11/81→03/91	Tie Rod	DB-DL-8640		Guide Rod
	11/81→03/91	Tie Rod	DB-ES-5209		
	11/81→03/91	Tie Rod	DB-ES-5227		Guide Rod
	11/81→03/91	Tie Rod End	CV-ES-12461		for Steering Rod

CV-ES-12461

Length: 120
 Cone Ø: d1 Ø 26 / d2 Ø 23,5
 Thread: M30 x 1,5 LHT
 0003300035, 3300148, 0003406213, 0013306635,
 0013308835, 0014604048, 0014604348,
 14606448, 0024600248, 3023300035,
 3023300135, 3023300235, 3023300335,
 3453307235, 3453307435, 3503307135,
 A0003300148, A0013306635, A0013308835,
 A0014604048, A0014604348, A0014606448,
 A0024600248, A3023300035, A3023300135,
 A3023300235, A3023300335, A3503307135



CV-ES-14163

Length: 125
 Cone Ø: d1 Ø 30 / d2 Ø 27
 Thread: M30 x 1,5 RHT
 0003305248, 0003387310, 0004600348,
 0004600948, 0004602848, 0004602948,
 0004608948, 0014600248, 0014600848,
 0014601248, 0014602248, 0014607748,
 0024600148, A0003387310, A0004600348,
 A0004602848, A0004602948, A0014600848,
 A0014601248, A0014602248, A0014607748



DB-DL-5217

Length: 862 Ø: 40
 Cone Ø: d1 Ø 30 / d2 Ø 27
 01214700A, 6204600405, 6204600805,
 6204602905, 6204603005



DB-DL-5241

Length: 875 Ø: 40
 Cone Ø: d1 Ø 30 / d2 Ø 27
 01215300A, 0004609205, 0004609305,
 0014606905



DB-DL-6197

Length: 579
 Ø: 50
 Hole Distance: 152 / 152
 6593501206, 6593503506



DB-DL-6198

Length: 579
 Ø: 58
 Hole Distance: 152 / 152
 3953500006, 6593501106



DB-DL-6227

Length: 629
 Ø: 58
 Hole Distance: 152 / 152
 6593501506, 6593503806



DB-DL-7270

Length: 875 Ø: 40
 Cone Ø: d1 Ø 28,6 / d2 Ø 23,9
 01208300A, 0024604705, 0024604805,
 0034604905, A0024604705



DB-DL-7831

Length: 870
 Ø: 42
 Cone Ø: d1 Ø 30 / d2 Ø 27
 01215200A, 6254602505



DB-DL-8131

Length: 1115 Ø: 52
 Cone Ø: d1 Ø 32 / d2 Ø 28,8
 0004604405, 6254605005



DB-DL-8618

Length: 680
 Ø: 42
 Cone Ø: d1 Ø 32 / d2 Ø 28,8
 0004604305, 4604305, 6254604805



DB-DL-8640

Length: 1615 Ø: 50
 Cone Ø: d1 Ø 32 / d2 Ø 29
 6253301503, 6253301603, 6253302403,
 6253302503, 9423300803, 9423302103,
 9493300203, 9493300303, 9493300903



DB-DL-10216

Length: 1190
 Ø: 40
 Cone Ø: d1 Ø 32 / d2 Ø 29
 0004604905



DB-ES-5209

Length: 1670 Ø: 50
 Cone Ø: d1 Ø 30 / d2 Ø 27
 6203300503, 6203300603



DB-ES-5227

Length: 1588 Ø: 60
 Cone Ø: d1 Ø 38 / d2 Ø 34,3
 6253300903, 6253301203, 9443300203



DB-ES-5234

Length: 135
 Cone Ø: d1 Ø 38 / d2 Ø 34,3
 Thread: M38 x 1,5 RHT
 0004601748, 120322305, 2205000400



DB-RK-5283

Ø: 70
 01319900A, 6203200628



DB-RK-7267

Ø: 95
 Hole Distance: 152
 Thick/Height: 24
 01302100A, 0003500413, 3500413, 0005861235,
 5861235, 81432706069



DB-RK-8550

Ø: 75 Hole Distance: 152
 Thick/Height: 24
 0003502105, 0003504605



DB-RK-9297

Ø: 90
 0003500805, 3500805



DB-SB-5258

Ø: 70
 Thick/Height: 62
 01311400A, 3873230285



MN-DL-7834

Length: 1588 Ø: 58
 Cone Ø: d1 Ø 30 / d2 Ø 27
 3463303903, 3463304903, 6253303203,
 9443300503, 9443301303, 9443301703





NG ...

2636 ...	11/81→03/91	Tie Rod End	CV-ES-14163		for Steering Rod	
	11/81→03/91	Track Control Arm		DB-DL-6197	Suspension Rod, Trailing Arm	
	11/81→03/91	Track Control Arm		DB-DL-6198	Suspension Rod, Trailing Arm	
	11/81→03/91	Track Control Arm		DB-DL-6227	Suspension Rod, Trailing Arm	
	11/81→03/91	Track Control Arm		DB-DS-6088	Suspension Rod, Trailing Arm	
2636 A	11/81→03/91	Centre Rod	DB-DL-5217		Push Rod	
	11/81→03/91	Centre Rod	DB-DL-5217		Push Rod* 5 184 732 *→	
	11/81→03/91	Centre Rod	DB-DL-7831		Push Rod	
	11/81→03/91	Centre Rod	DB-DL-10216		Push Rod	
	11/81→03/91	Suspension Arm Repair Kit		DB-RK-7267	for Drag Link	
	11/81→03/91	Tie Rod	DB-ES-5209			
	11/81→03/91	Tie Rod	DB-ES-5227		Guide Rod	
	11/81→03/91	Tie Rod	MN-DL-7834		Guide Rod	
	11/81→03/91	Tie Rod End	CV-ES-12461		for Steering Rod	
	11/81→03/91	Tie Rod End	CV-ES-14163		for Steering Rod	
	11/81→03/91	Tie Rod End	DB-ES-5234		for Steering Rod	
	11/81→03/91	Track Control Arm		DB-DL-6197	Suspension Rod, Trailing Arm	
	11/81→03/91	Track Control Arm		DB-DL-6198	Suspension Rod, Trailing Arm	
	11/81→03/91	Track Control Arm		DB-DL-6227	Suspension Rod, Trailing Arm	
11/81→03/91	Track Control Arm		DB-DS-6088	Suspension Rod, Trailing Arm		
2636 AK	11/81→03/91	Centre Rod	DB-DL-5217		Push Rod* 5 184 732 *→	
	11/81→03/91	Centre Rod	DB-DL-10216		Push Rod	
	11/81→03/91	Suspension Arm Repair Kit		DB-RK-7267	for Drag Link	
	11/81→03/91	Tie Rod	DB-ES-5227		Guide Rod	
	11/81→03/91	Tie Rod	MN-DL-7834		Guide Rod	
	11/81→03/91	Tie Rod End	CV-ES-12461		for Steering Rod	
	11/81→03/91	Tie Rod End	CV-ES-14163		for Steering Rod	
	11/81→03/91	Track Control Arm		DB-DL-6197	Suspension Rod, Trailing Arm	
	11/81→03/91	Track Control Arm		DB-DL-6198	Suspension Rod, Trailing Arm	
	11/81→03/91	Track Control Arm		DB-DL-6227	Suspension Rod, Trailing Arm	
	11/81→03/91	Track Control Arm		DB-DS-6088	Suspension Rod, Trailing Arm	
	2636 AS	11/81→03/91	Centre Rod	DB-DL-5217		Push Rod* 5 184 732 *→
		11/81→03/91	Centre Rod	DB-DL-10216		Push Rod
		11/81→03/91	Suspension Arm Repair Kit		DB-RK-7267	for Drag Link
11/81→03/91		Tie Rod	DB-ES-5227		Guide Rod	
11/81→03/91		Tie Rod	MN-DL-7834		Guide Rod	
11/81→03/91		Tie Rod End	CV-ES-12461		for Steering Rod	
11/81→03/91		Tie Rod End	CV-ES-14163		for Steering Rod	
11/81→03/91		Track Control Arm		DB-DL-6197	Suspension Rod, Trailing Arm	
11/81→03/91		Track Control Arm		DB-DL-6198	Suspension Rod, Trailing Arm	
11/81→03/91		Track Control Arm		DB-DL-6227	Suspension Rod, Trailing Arm	
11/81→03/91		Track Control Arm		DB-DS-6088	Suspension Rod, Trailing Arm	
2636 K		11/81→03/91	Centre Rod	DB-DL-7831		Push Rod
		11/81→03/91	Centre Rod	DB-DL-8131		Push Rod
		11/81→03/91	Centre Rod	DB-DL-8618		Push Rod
	11/81→03/91	Centre Rod	DB-DL-10216		Push Rod	
	11/81→03/91	Stabiliser Mounting	DB-SB-5258	DB-SB-5258		
	11/81→03/91	Suspension Arm Repair Kit		DB-RK-7267	for Drag Link	
	11/81→03/91	Suspension Arm Repair Kit	DB-RK-5283			
	11/81→03/91	Tie Rod	DB-ES-5227		Guide Rod	
	11/81→03/91	Tie Rod End	CV-ES-12461		for Steering Rod	
	11/81→03/91	Tie Rod End	CV-ES-14163		for Steering Rod	
	11/81→03/91	Track Control Arm		DB-DL-6197	Suspension Rod, Trailing Arm	
	11/81→03/91	Track Control Arm		DB-DL-6198	Suspension Rod, Trailing Arm	
	11/81→03/91	Track Control Arm		DB-DL-6227	Suspension Rod, Trailing Arm	
	11/81→03/91	Track Control Arm		DB-DS-6088	Suspension Rod, Trailing Arm	
2636 S	11/81→03/91	Centre Rod	DB-DL-10216		Push Rod	
	11/81→03/91	Stabiliser Mounting	DB-SB-5258	DB-SB-5258		
	11/81→03/91	Suspension Arm Repair Kit		DB-RK-7267	for Drag Link	
	11/81→03/91	Suspension Arm Repair Kit	DB-RK-5283			
	11/81→03/91	Tie Rod	DB-ES-5227		Guide Rod	
	11/81→03/91	Tie Rod End	CV-ES-12461		for Steering Rod	
	11/81→03/91	Tie Rod End	CV-ES-14163		for Steering Rod	

CV-ES-12461

Length: 120
 Cone Ø: d1 Ø 26 / d2 Ø 23,5
 Thread: M30 x 1,5 LHT
 0003300035, 3300148, 0003406213, 0013306635,
 0013308835, 0014604048, 0014604348,
 14606448, 0024600248, 3023300035,
 3023300135, 3023300235, 3023300335,
 3453307235, 3453307435, 3503307135,
 A0003300148, A0013306635, A0013308835,
 A0014604048, A0014604348, A0014606448,
 A0024600248, A3023300035, A3023300135,
 A3023300235, A3023300335, A3503307135



CV-ES-14163

Length: 125
 Cone Ø: d1 Ø 30 / d2 Ø 27
 Thread: M30 x 1,5 RHT
 0003305248, 0003387310, 0004600348,
 0004600948, 0004602848, 0004602948,
 0004608948, 0014600248, 0014600848,
 0014601248, 0014602248, 0014607748,
 0024600148, A0003387310, A0004600348,
 A0004602848, A0004602948, A0014600848,
 A0014601248, A0014602248, A0014607748



DB-DL-5217

Length: 862 Ø: 40
 Cone Ø: d1 Ø 30 / d2 Ø 27
 01214700A, 6204600405, 6204600805,
 6204602905, 6204603005



DB-DL-6197

Length: 579
 Ø: 50
 Hole Distance: 152 / 152
 6593501206, 6593503506



DB-DL-6198

Length: 579
 Ø: 58
 Hole Distance: 152 / 152
 3953500006, 6593501106



DB-DL-6227

Length: 629
 Ø: 58
 Hole Distance: 152 / 152
 6593501506, 6593503806



DB-DL-7831

Length: 870
 Ø: 42
 Cone Ø: d1 Ø 30 / d2 Ø 27
 01215200A, 6254602505



DB-DL-8131

Length: 1115 Ø: 52
 Cone Ø: d1 Ø 32 / d2 Ø 28,8
 0004604405, 6254605005



DB-DL-8618

Length: 680
 Ø: 42
 Cone Ø: d1 Ø 32 / d2 Ø 28,8
 0004604305, 4604305, 6254604805



DB-DL-10216

Length: 1190
 Ø: 40
 Cone Ø: d1 Ø 32 / d2 Ø 29
 0004604905



DB-DS-6088

Length: 585
 Ø: 50
 Hole Distance: 152 / 152
 3953500706, 6593500406



DB-ES-5209

Length: 1670 Ø: 50
 Cone Ø: d1 Ø 30 / d2 Ø 27
 6203300503, 6203300603



DB-ES-5227

Length: 1588 Ø: 60
 Cone Ø: d1 Ø 38 / d2 Ø 34,3
 6253300903, 6253301203, 9443300203



DB-ES-5234

Length: 135
 Cone Ø: d1 Ø 38 / d2 Ø 34,3
 Thread: M38 x 1,5 RHT
 0004601748, 120322305, 2205000400



DB-RK-5283

Ø: 70
 01319900A, 6203200628



DB-RK-7267

Ø: 95
 Hole Distance: 152
 Thick/Height: 24
 01302100A, 0003500413, 3500413, 0005861235,
 5861235, 81432706069



DB-SB-5258

Ø: 70
 Thick/Height: 62
 01311400A, 3873230285



MN-DL-7834

Length: 1588 Ø: 58
 Cone Ø: d1 Ø 30 / d2 Ø 27
 3463303903, 3463304903, 6253303203,
 9443300503, 9443301303, 9443301703





NG ...

2636 S ...	11/81→03/91	Track Control Arm		DB-DL-6197	Suspension Rod, Trailing Arm	
	11/81→03/91	Track Control Arm		DB-DL-6198	Suspension Rod, Trailing Arm	
	11/81→03/91	Track Control Arm		DB-DL-6227	Suspension Rod, Trailing Arm	
	11/81→03/91	Track Control Arm		DB-DS-6088	Suspension Rod, Trailing Arm	
2638	01/81→12/86	Centre Rod	DB-DL-5241		Suspension Rod	
	01/81→12/86	Centre Rod	DB-DL-7270		Push Rod;Suspension Rod	
	01/81→12/86	Centre Rod	DB-DL-10216		Push Rod	
	01/81→12/86	Suspension Arm Repair Kit		DB-RK-8550	for Wishbone (CV)	
	01/81→12/86	Tie Rod End	CV-ES-12461		for Steering Rod	
	01/81→12/86	Tie Rod End	CV-ES-14163		for Steering Rod	
2638 S	01/81→12/86	Centre Rod	DB-DL-10216		Push Rod	
	01/81→12/86	Stabiliser Mounting	DB-SB-5258	DB-SB-5258		
	01/81→12/86	Suspension Arm Repair Kit		DB-RK-7267	for Drag Link	
	01/81→12/86	Suspension Arm Repair Kit	DB-RK-5283			
	01/81→12/86	Tie Rod	DB-ES-5227		Guide Rod	
	01/81→12/86	Tie Rod End	CV-ES-12461		for Steering Rod	
	01/81→12/86	Tie Rod End	CV-ES-14163		for Steering Rod	
	01/81→12/86	Track Control Arm		DB-DL-6197	Suspension Rod, Trailing Arm	
	01/81→12/86	Track Control Arm		DB-DL-6198	Suspension Rod, Trailing Arm	
	01/81→12/86	Track Control Arm		DB-DS-6088	Suspension Rod, Trailing Arm	
	2644	08/73→09/96	Centre Rod	DB-DL-5241		Suspension Rod
		08/73→09/96	Centre Rod	DB-DL-7270		Push Rod;Suspension Rod
		08/73→09/96	Centre Rod	DB-DL-10216		Push Rod
		08/73→09/96	Suspension Arm Repair Kit		DB-RK-8550	for Wishbone (CV)
08/73→09/96		Tie Rod End	CV-ES-12461		for Steering Rod	
08/73→09/96		Tie Rod End	CV-ES-14163		for Steering Rod	
2644 S	10/85→02/90	Centre Rod	DB-DL-7831		Push Rod	
	10/85→02/90	Centre Rod	DB-DL-8131		Push Rod	
	10/85→02/90	Centre Rod	DB-DL-8138		Push Rod	
	10/85→02/90	Centre Rod	DB-DL-8618		Push Rod	
	10/85→02/90	Centre Rod	DB-DL-10216		Push Rod	
	10/85→02/90	Stabiliser Mounting	DB-SB-5258	DB-SB-5258		
	10/85→02/90	Suspension Arm Repair Kit		DB-RK-7267	for Drag Link	
	10/85→02/90	Suspension Arm Repair Kit	DB-RK-5283			
	10/85→02/90	Tie Rod	DB-ES-5209			
	10/85→02/90	Tie Rod	DB-ES-5227		Guide Rod	
	10/85→02/90	Tie Rod End	CV-ES-12461		for Steering Rod	
	10/85→02/90	Tie Rod End	CV-ES-14163		for Steering Rod	
	10/85→02/90	Track Control Arm		DB-DL-6197	Suspension Rod, Trailing Arm	
	10/85→02/90	Track Control Arm		DB-DL-6198	Suspension Rod, Trailing Arm	
	10/85→02/90	Track Control Arm		DB-DL-6227	Suspension Rod, Trailing Arm	
	10/85→02/90	Track Control Arm		DB-DL-7840	Suspension Rod, Trailing Arm	
3025 B	08/83→03/91	Tie Rod End	CV-ES-14163		for Steering Rod	
	08/83→03/91	Track Control Arm		DB-DL-7839	Trailing Arm	
	12/85→07/87	Stabiliser Mounting		DB-SB-10407		
	12/85→07/87	Tie Rod	DB-DL-8640		Guide Rod	
	12/85→07/87	Tie Rod	DB-ES-5227		Guide Rod	
	12/85→07/87	Tie Rod End	DF-ES-7777			
3025 K	04/85→03/91	Tie Rod End	CV-ES-14163		for Steering Rod	
	04/85→03/91	Track Control Arm		DB-DL-7839	Trailing Arm	
	12/85→07/87	Stabiliser Mounting		DB-SB-10407		
	12/85→07/87	Tie Rod	DB-DL-8640		Guide Rod	
	12/85→07/87	Tie Rod	DB-ES-5227		Guide Rod	
	12/85→07/87	Tie Rod End	DF-ES-7777			
3028	02/80→03/91	Centre Rod	DB-DL-5241		Suspension Rod	
	02/80→03/91	Centre Rod	DB-DL-7270		Push Rod;Suspension Rod	
	02/80→03/91	Centre Rod	DB-DL-10216		Push Rod	
	02/80→03/91	Suspension Arm Repair Kit		DB-RK-8550	for Wishbone (CV)	
	02/80→03/91	Tie Rod End	CV-ES-12461		for Steering Rod	
02/80→03/91	Tie Rod End	CV-ES-14163		for Steering Rod		

CV-ES-12461

Length: 120
Cone Ø: d1 Ø 26 / d2 Ø 23,5
Thread: M30 x 1,5 LHT
0003300035, 3300148, 0003406213, 0013306635,
0013308835, 0014604048, 0014604348,
14606448, 0024600248, 3023300035,
3023300135, 3023300235, 3023300335,
3453307235, 3453307435, 3503307135,
A0003300148, A0013306635, A0013308835,
A0014604048, A0014604348, A0014606448,
A0024600248, A3023300035, A3023300135,
A3023300235, A3023300335, A3503307135



CV-ES-14163

Length: 125
Cone Ø: d1 Ø 30 / d2 Ø 27
Thread: M30 x 1,5 RHT
0003305248, 0003387310, 0004600348,
0004600948, 0004602848, 0004602948,
0004608948, 0014600248, 0014600848,
0014601248, 0014602248, 0014607748,
0024600148, A0003387310, A0004600348,
A0004602848, A0004602948, A0014600848,
A0014601248, A0014602248, A0014607748



DB-DL-5241

Length: 875 Ø: 40
Cone Ø: d1 Ø 30 / d2 Ø 27
01215300A, 0004609205, 0004609305,
0014606905



DB-DL-6197

Length: 579
Ø: 50
Hole Distance: 152 / 152
6593501206, 6593503506



DB-DL-6198

Length: 579
Ø: 58
Hole Distance: 152 / 152
3953500006, 6593501106



DB-DL-6227

Length: 629
Ø: 58
Hole Distance: 152 / 152
6593501506, 6593503806



DB-DL-7270

Length: 875 Ø: 40
Cone Ø: d1 Ø 28,6 / d2 Ø 23,9
01208300A, 0024604705, 0024604805,
0034604905, A0024604705



DB-DL-7831

Length: 870
Ø: 42
Cone Ø: d1 Ø 30 / d2 Ø 27
01215200A, 6254602505



DB-DL-7839

Length: 585
Ø: 50
Hole Distance: 152 / 152
3953500206, 6593500106, 6593502406



DB-DL-7840

Length: 595
Ø: 62
Hole Distance: 152 / 152
6203500006, 6203500106, 6203500306,
6553500306



DB-DL-8131

Length: 1115
Ø: 52
Cone Ø: d1 Ø 32 / d2 Ø 28,8
4604405, 0004604405, 6254605005



DB-DL-8138

Length: 1130
Ø: 40
Cone Ø: d1 Ø 32 / d2 Ø 28,8
0004606605, 4606605



DB-DL-8618

Length: 680
Ø: 42
Cone Ø: d1 Ø 32 / d2 Ø 28,8
0004604305, 4604305, 6254604805



DB-DL-8640

Length: 1615 Ø: 50
Cone Ø: d1 Ø 32 / d2 Ø 29
6253301503, 6253301603, 6253302403,
6253302503, 9423300803, 9423302103,
9493300203, 9493300303, 9493300903



DB-DL-10216

Length: 1190
Ø: 40
Cone Ø: d1 Ø 32 / d2 Ø 29
0004604905



DB-DS-6088

Length: 585
Ø: 50
Hole Distance: 152 / 152
3953500706, 6593500406



DB-ES-5209

Length: 1670 Ø: 50
Cone Ø: d1 Ø 30 / d2 Ø 27
6203300503, 6203300603



DB-ES-5227

Length: 1588 Ø: 60
Cone Ø: d1 Ø 38 / d2 Ø 34,3
6253300903, 6253301203, 9443300203



DB-RK-5283

Ø: 70
01319900A, 6203200628



DB-RK-7267

Ø: 95
Hole Distance: 152
Thick/Height: 24
01302100A, 0003500413, 3500413, 0005861235,
5861235, 81432706069



DB-RK-8550

Ø: 75 Hole Distance: 152
Thick/Height: 24
0003502105, 0003504605



DB-SB-5258

Ø: 70
Thick/Height: 62
01311400A, 3873230285



DB-SB-10407

Ø: 61 Thick/Height: 46
0003235985, 0003262481, 0003262981



DF-ES-7777

Length: 85
Cone Ø: d1 Ø 38 / d2 Ø 34,3
Thread: M26 x 1,5 RHT
6244600348





NG ...

3028 B	12/85→07/87	Centre Rod	DB-DL-7831	Push Rod	
	12/85→07/87	Centre Rod	DB-DL-7831	Push Rod* 5 401 092 *→	
	12/85→07/87	Centre Rod	DB-DL-10216	Push Rod	
	12/85→07/87	Stabiliser Mounting		DB-SB-10407	
	12/85→07/87	Suspension Arm Repair Kit	DB-RK-5307		
	12/85→07/87	Tie Rod	DB-ES-5227	Guide Rod	
	12/85→07/87	Tie Rod End	CV-ES-12461	for Steering Rod	
	12/85→07/87	Tie Rod End	CV-ES-14163	for Steering Rod	
	12/85→07/87	Tie Rod End	DF-ES-7777		
	12/85→07/87	Track Control Arm		DB-DL-7839 Trailing Arm	
	12/85→07/87	Track Control Arm		DB-DS-6088 Suspension Rod, Trailing Arm	
	3028 K	12/85→07/87	Centre Rod	DB-DL-7831	Push Rod
		12/85→07/87	Centre Rod	DB-DL-7831	Push Rod* 5 401 092 *→
		12/85→07/87	Centre Rod	DB-DL-8131	Push Rod
12/85→07/87		Centre Rod	DB-DL-8618	Push Rod	
12/85→07/87		Centre Rod	DB-DL-10216	Push Rod	
12/85→07/87		Stabiliser Mounting		DB-SB-10407	
12/85→07/87		Suspension Arm Repair Kit		DB-RK-5281	
12/85→07/87		Suspension Arm Repair Kit	DB-RK-5307		
12/85→07/87		Tie Rod	DB-DL-8640	Guide Rod	
12/85→07/87		Tie Rod	DB-ES-5227	Guide Rod	
12/85→07/87		Tie Rod End	CV-ES-12461	for Steering Rod	
12/85→07/87		Tie Rod End	CV-ES-14163	for Steering Rod	
12/85→07/87		Tie Rod End	DF-ES-7777		
12/85→07/87		Track Control Arm		DB-DL-7839 Trailing Arm	
12/85→07/87		Track Control Arm		DB-DS-6088 Suspension Rod, Trailing Arm	
3033		05/82→05/87	Centre Rod	DB-DL-5241	Suspension Rod
		05/82→05/87	Centre Rod	DB-DL-7270	Push Rod;Suspension Rod
	05/82→05/87	Centre Rod	DB-DL-10216	Push Rod	
	05/82→05/87	Suspension Arm Repair Kit		DB-RK-8550 for Wishbone (CV)	
	05/82→05/87	Tie Rod End	CV-ES-12461	for Steering Rod	
	05/82→05/87	Tie Rod End	CV-ES-14163	for Steering Rod	
3036	11/81→03/91	Centre Rod	DB-DL-5241	Suspension Rod	
	11/81→03/91	Centre Rod	DB-DL-7270	Push Rod;Suspension Rod	
	11/81→03/91	Centre Rod	DB-DL-10216	Push Rod	
	11/81→03/91	Suspension Arm Repair Kit		DB-RK-8550 for Wishbone (CV)	
	11/81→03/91	Tie Rod End	CV-ES-12461	for Steering Rod	
	11/81→03/91	Tie Rod End	CV-ES-14163	for Steering Rod	
3038	01/81→12/86	Centre Rod	DB-DL-5241	Suspension Rod	
	01/81→12/86	Centre Rod	DB-DL-7270	Push Rod;Suspension Rod	
	01/81→12/86	Centre Rod	DB-DL-10216	Push Rod	
	01/81→12/86	Suspension Arm Repair Kit		DB-RK-8550 for Wishbone (CV)	
	01/81→12/86	Tie Rod End	CV-ES-12461	for Steering Rod	
	01/81→12/86	Tie Rod End	CV-ES-14163	for Steering Rod	
3228 B	07/87→03/91	Stabiliser Mounting		DB-SB-10407	
	07/87→03/91	Tie Rod	DB-DL-8640	Guide Rod	
	07/87→03/91	Tie Rod	DB-ES-5227	Guide Rod	
	07/87→03/91	Tie Rod End	CV-ES-14163	for Steering Rod	
	07/87→03/91	Tie Rod End	DF-ES-7777		
	3228 K	07/87→03/91	Centre Rod	DB-DL-7831	Push Rod
07/87→03/91		Centre Rod	DB-DL-7831	Push Rod* 5 401 092 *→	
07/87→03/91		Centre Rod	DB-DL-8131	Push Rod	
07/87→03/91		Centre Rod	DB-DL-8618	Push Rod	
07/87→03/91		Centre Rod	DB-DL-10216	Push Rod	
07/87→03/91		Stabiliser Mounting		DB-SB-10407	
07/87→03/91		Suspension Arm Repair Kit		DB-RK-5281	
07/87→03/91		Suspension Arm Repair Kit	DB-RK-5307		
07/87→03/91		Tie Rod	DB-DL-8640	Guide Rod	
07/87→03/91		Tie Rod	DB-ES-5227	Guide Rod	
07/87→03/91		Tie Rod End	CV-ES-12461	for Steering Rod	
07/87→03/91		Tie Rod End	CV-ES-14163	for Steering Rod	
07/87→03/91		Tie Rod End	DF-ES-7777		
07/87→03/91		Track Control Arm		DB-DL-7839 Trailing Arm	
07/87→03/91		Track Control Arm		DB-DS-6088 Suspension Rod, Trailing Arm	

CV-ES-12461

Length: 120
 Cone Ø: d1 Ø 26 / d2 Ø 23,5
 Thread: M30 x 1,5 LHT
 0003300035, 3300148, 0003406213, 0013306635,
 0013308835, 0014604048, 0014604348,
 14606448, 0024600248, 3023300035,
 3023300135, 3023300235, 3023300335,
 3453307235, 3453307435, 3503307135,
 A0003300148, A0013306635, A0013308835,
 A0014604048, A0014604348, A0014606448,
 A0024600248, A3023300035, A3023300135,
 A3023300235, A3023300335, A3503307135



CV-ES-14163

Length: 125
 Cone Ø: d1 Ø 30 / d2 Ø 27
 Thread: M30 x 1,5 RHT
 0003305248, 0003387310, 0004600348,
 0004600948, 0004602848, 0004602948,
 0004608948, 0014600248, 0014600848,
 0014601248, 0014602248, 0014607748,
 0024600148, A0003387310, A0004600348,
 A0004602848, A0004602948, A0014600848,
 A0014601248, A0014602248, A0014607748



DB-DL-5241

Length: 875 Ø: 40
 Cone Ø: d1 Ø 30 / d2 Ø 27
 01215300A, 0004609205, 0004609305,
 0014606905



DB-DL-7270

Length: 875 Ø: 40
 Cone Ø: d1 Ø 28,6 / d2 Ø 23,9
 01208300A, 0024604705, 0024604805,
 0034604905, A0024604705



DB-DL-7831

Length: 870
 Ø: 42
 Cone Ø: d1 Ø 30 / d2 Ø 27
 01215200A, 6254602505



DB-DL-7839

Length: 585
 Ø: 50
 Hole Distance: 152 / 152
 3953500206, 6593500106, 6593502406



DB-DL-8131

Length: 1115
 Ø: 52
 Cone Ø: d1 Ø 32 / d2 Ø 28,8
 4604405, 0004604405, 6254605005



DB-DL-8618

Length: 680
 Ø: 42
 Cone Ø: d1 Ø 32 / d2 Ø 28,8
 0004604305, 4604305, 6254604805



DB-DL-8640

Length: 1615 Ø: 50
 Cone Ø: d1 Ø 32 / d2 Ø 29
 6253301503, 6253301603, 6253302403,
 6253302503, 9423300803, 9423302103,
 9493300203, 9493300303, 9493300903



DB-DL-10216

Length: 1190
 Ø: 40
 Cone Ø: d1 Ø 32 / d2 Ø 29
 0004604905



DB-DS-6088

Length: 585
 Ø: 50
 Hole Distance: 152 / 152
 3953500706, 6593500406



DB-ES-5227

Length: 1588 Ø: 60
 Cone Ø: d1 Ø 38 / d2 Ø 34,3
 6253300903, 6253301203, 9443300203



DB-RK-5281

Ø: 86
 01303700A, 6253200111



DB-RK-5307

Ø: 70
 01303500A, 6473200028



DB-RK-8550

Ø: 75 Hole Distance: 152
 Thick/Height: 24
 0003502105, 0003504605



DB-SB-10407

Ø: 61 Thick/Height: 46
 0003235985, 0003262481, 0003262981



DF-ES-7777

Length: 85
 Cone Ø: d1 Ø 38 / d2 Ø 34,3
 Thread: M26 x 1,5 RHT
 6244600348



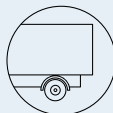

NG ...

3235	07/88→08/94	Ball Head, gearshift linkage	DB-ES-8387			
	07/88→08/94	Ball Head, gearshift linkage	DB-ES-8491			
	07/88→08/94	Ball Head, gearshift linkage	DB-ES-8492			
	07/88→08/94	Ball Head, gearshift linkage	DB-ES-8500			
	07/88→08/94	Centre Rod	DB-DL-5241		Suspension Rod	
	07/88→08/94	Centre Rod	DB-DL-7270		Push Rod;Suspension Rod	
	07/88→08/94	Centre Rod	DB-DL-7831		Push Rod	
	07/88→08/94	Centre Rod	DB-DL-8131		Push Rod	
	07/88→08/94	Centre Rod	DB-DL-8138		Push Rod	
	07/88→08/94	Centre Rod	DB-DL-8618		Push Rod	
	07/88→08/94	Centre Rod	DB-DL-12309		Coupling Rod	
	07/88→08/94	Suspension Arm Repair Kit		DB-RK-8550	for Wishbone (CV)	
	07/88→08/94	Tie Rod	DB-DL-8640		Guide Rod	
	07/88→08/94	Tie Rod End	CV-ES-12461		for Steering Rod	
	07/88→08/94	Tie Rod End	CV-ES-14163		for Steering Rod	
3250 A	09/85→08/94	Centre Rod	DB-DL-5217		Push Rod	
	09/85→08/94	Centre Rod	DB-DL-10216		Push Rod	
	09/85→08/94	Stabiliser Mounting		DB-SB-10407		
	09/85→08/94	Suspension Arm Repair Kit		DB-RK-5281		
	09/85→08/94	Suspension Arm Repair Kit		DB-RK-7267	for Drag Link	
	09/85→08/94	Tie Rod	DB-ES-5209			
	09/85→08/94	Tie Rod	DB-ES-5227		Guide Rod	
	09/85→08/94	Tie Rod	MN-DL-7834		Guide Rod	
	09/85→08/94	Tie Rod End	CV-ES-12461		for Steering Rod	
	09/85→08/94	Tie Rod End	CV-ES-14163		for Steering Rod	
	09/85→08/94	Tie Rod End	DB-ES-5234		for Steering Rod	
	09/85→08/94	Track Control Arm		DB-DL-6227	Suspension Rod, Trailing Arm	
	3250 AF	09/85→08/94	Stabiliser Mounting		DB-SB-10407	
		09/85→08/94	Suspension Arm Repair Kit		DB-RK-5281	
		09/85→08/94	Suspension Arm Repair Kit		DB-RK-7267	for Drag Link
09/85→08/94		Tie Rod	DB-ES-5227		Guide Rod	
09/85→08/94		Tie Rod End	CV-ES-14163		for Steering Rod	
09/85→08/94		Tie Rod End	DB-ES-5234		for Steering Rod	
09/85→08/94		Track Control Arm		DB-DL-6227	Suspension Rod, Trailing Arm	
3328		02/80→03/91	Centre Rod	DB-DL-7831		Push Rod
		02/80→03/91	Centre Rod	DB-DL-8131		Push Rod
		02/80→03/91	Centre Rod	DB-DL-8618		Push Rod
		02/80→03/91	Centre Rod	DB-DL-10216		Push Rod
		02/80→03/91	Suspension Arm Repair Kit		DB-RK-7267	for Drag Link
		02/80→03/91	Tie Rod	DB-ES-5227		Guide Rod
		02/80→03/91	Tie Rod End	CV-ES-12461		for Steering Rod
		02/80→03/91	Tie Rod End	CV-ES-14163		for Steering Rod
	02/80→03/91	Tie Rod End	DB-ES-5234		for Steering Rod	
	02/80→03/91	Track Control Arm		DB-DL-6197	Suspension Rod, Trailing Arm	
	02/80→03/91	Track Control Arm		DB-DL-6198	Suspension Rod, Trailing Arm	
	02/80→03/91	Track Control Arm		DB-DL-6227	Suspension Rod, Trailing Arm	
	02/80→03/91	Track Control Arm		DB-DS-6088	Suspension Rod, Trailing Arm	
	3328 B	02/80→03/91	Centre Rod	DB-DL-5217		Push Rod
		02/80→03/91	Centre Rod	DB-DL-5217		Push Rod* 5 184 732 *→
02/80→03/91		Centre Rod	DB-DL-7831		Push Rod	
02/80→03/91		Centre Rod	DB-DL-10216		Push Rod	
02/80→03/91		Suspension Arm Repair Kit		DB-RK-7267	for Drag Link	
02/80→03/91		Tie Rod	DB-ES-5209			
02/80→03/91		Tie Rod	DB-ES-5227		Guide Rod	
02/80→03/91		Tie Rod	MN-DL-7834		Guide Rod	
02/80→03/91		Tie Rod End	CV-ES-12461		for Steering Rod	
02/80→03/91		Tie Rod End	CV-ES-14163		for Steering Rod	
02/80→03/91		Tie Rod End	DB-ES-5234		for Steering Rod	
02/80→03/91		Track Control Arm		DB-DL-6197	Suspension Rod, Trailing Arm	
02/80→03/91		Track Control Arm		DB-DL-6198	Suspension Rod, Trailing Arm	
02/80→03/91		Track Control Arm		DB-DL-6227	Suspension Rod, Trailing Arm	
02/80→03/91		Track Control Arm		DB-DS-6088	Suspension Rod, Trailing Arm	
07/82→07/87	Centre Rod	DB-DL-7831		Push Rod* 5 401 092 *→		

CV-ES-12461

Length: 120
Cone Ø: d1 Ø 26 / d2 Ø 23,5
Thread: M30 x 1,5 LHT
0003300035, 3300148, 0003406213, 0013306635,
0013308835, 0014604048, 0014604348,
14606448, 0024600248, 3023300035,
3023300135, 3023300235, 3023300335,
3453307235, 3453307435, 3503307135,
A0003300148, A0013306635, A0013308835,
A0014604048, A0014604348, A0014606448,
A0024600248, A3023300035, A3023300135,
A3023300235, A3023300335, A3503307135



CV-ES-14163

Length: 125
Cone Ø: d1 Ø 30 / d2 Ø 27
Thread: M30 x 1,5 RHT
0003305248, 0003387310, 0004600348,
0004600948, 0004602848, 0004602948,
0004608948, 0014600248, 0014600848,
0014601248, 0014602248, 0014607748,
0024600148, A0003387310, A0004600348,
A0004602848, A0004602948, A0014600848,
A0014601248, A0014602248, A0014607748



DB-DL-5217

Length: 862 Ø: 40
Cone Ø: d1 Ø 30 / d2 Ø 27
01214700A, 6204600405, 6204600805,
6204602905, 6204603005



DB-DL-5241

Length: 875 Ø: 40
Cone Ø: d1 Ø 30 / d2 Ø 27
01215300A, 0004609205, 0004609305,
0014606905



DB-DL-6197

Length: 579
Ø: 50
Hole Distance: 152 / 152
6593501206, 6593503506



DB-DL-6198

Length: 579
Ø: 58
Hole Distance: 152 / 152
3953500006, 6593501106



DB-DL-6227

Length: 629
Ø: 58
Hole Distance: 152 / 152
6593501506, 6593503806



DB-DL-7270

Length: 875 Ø: 40
Cone Ø: d1 Ø 28,6 / d2 Ø 23,9
01208300A, 0024604705, 0024604805,
0034604905, A0024604705



DB-DL-7831

Length: 870
Ø: 42
Cone Ø: d1 Ø 30 / d2 Ø 27
01215200A, 6254602505



DB-DL-8131

Length: 1115
Ø: 52
Cone Ø: d1 Ø 32 / d2 Ø 28,8
4604405, 0004604405, 6254605005



DB-DL-8138

Length: 1130
Ø: 40
Cone Ø: d1 Ø 32 / d2 Ø 28,8
0004606605, 4606605



DB-DL-8618

Length: 680
Ø: 42
Cone Ø: d1 Ø 32 / d2 Ø 28,8
0004604305, 4604305, 6254604805



DB-DL-8640

Length: 1615 Ø: 50
Cone Ø: d1 Ø 32 / d2 Ø 29
6253301503, 6253301603, 6253302403,
6253302503, 9423300803, 9423302103,
9493300203, 9493300303, 9493300903



DB-DL-10216

Length: 1190
Ø: 40
Cone Ø: d1 Ø 32 / d2 Ø 29
0004604905



DB-DL-12309

Length: 685 Ø: 40
Cone Ø: d1 Ø 32 / d2 Ø 28,8
0004606005, 0004606305



DB-DS-6088

Length: 585
Ø: 50
Hole Distance: 152 / 152
3953500706, 6593500406



DB-ES-5209

Length: 1670 Ø: 50
Cone Ø: d1 Ø 30 / d2 Ø 27
6203300503, 6203300603



DB-ES-5227

Length: 1588 Ø: 60
Cone Ø: d1 Ø 38 / d2 Ø 34,3
6253300903, 6253301203, 9443300203



DB-ES-5234

Length: 135
Cone Ø: d1 Ø 38 / d2 Ø 34,3
Thread: M38 x 1,5 RHT
0004601748, 120322305, 2205000400



DB-ES-8387

Length: 55
Cone Ø: d1 Ø 10 / d2 Ø 10
Thread: M14 x 1,5 RHT
0009966845, 0009967045



DB-ES-8491

Length: 60
Cone Ø: d1 Ø 10 / d2 Ø 10
Thread: M12 x 1,75 LHT
0009966745



DB-ES-8492

Length: 60
Cone Ø: d1 Ø 10 / d2 Ø 10
Thread: M12 x 1,75 RHT
0009966645, 3752680189, A3752680189



DB-ES-8500

Length: 55
Cone Ø: d1 Ø 12 / d2 Ø 10,8
Thread: M14 x 1,5 RHT
0002685989



DB-RK-5281

Ø: 86
01303700A, 6253200111



DB-RK-7267

Ø: 95
Hole Distance: 152
Thick/Height: 24
01302100A, 0003500413, 3500413, 0005861235,
5861235, 81432706069



DB-RK-8550

Ø: 75 Hole Distance: 152
Thick/Height: 24
0003502105, 0003504605



DB-SB-10407

Ø: 61 Thick/Height: 46
0003235985, 0003262481, 0003262981



MN-DL-7834

Length: 1588 Ø: 58
Cone Ø: d1 Ø 30 / d2 Ø 27
3463303903, 3463304903, 6253303203,
9443300503, 9443301303, 9443301703



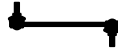

NG ...

3328 B ...	07/82→07/87	Stabiliser Mounting		DB-SB-10407	
	07/82→07/87	Tie Rod	DB-DL-8640		Guide Rod
	07/82→07/87	Tie Rod End	DF-ES-7777		
	07/82→07/87	Centre Rod	DB-DL-7831		Push Rod
3328 K	07/82→07/87	Centre Rod	DB-DL-7831		Push Rod* 5 401 092 *→
	07/82→07/87	Centre Rod	DB-DL-10216		Push Rod
	07/82→07/87	Stabiliser Mounting		DB-SB-10407	
	07/82→07/87	Suspension Arm Repair Kit		DB-RK-5281	
	07/82→07/87	Suspension Arm Repair Kit		DB-RK-7267	for Drag Link
	07/82→07/87	Suspension Arm Repair Kit	DB-RK-5307		
	07/82→07/87	Tie Rod	DB-DL-8640		Guide Rod
	07/82→07/87	Tie Rod	DB-ES-5227		Guide Rod
	07/82→07/87	Tie Rod End	CV-ES-12461		for Steering Rod
	07/82→07/87	Tie Rod End	CV-ES-14163		for Steering Rod
	07/82→07/87	Tie Rod End	DF-ES-7777		
	07/82→07/87	Track Control Arm		DB-DL-6197	Suspension Rod, Trailing Arm
	07/82→07/87	Track Control Arm		DB-DL-6198	Suspension Rod, Trailing Arm
	3333	12/82→11/91	Centre Rod	DB-DL-10216	
12/82→11/91		Stabiliser Mounting	DB-SB-5258	DB-SB-5258	
12/82→11/91		Suspension Arm Repair Kit		DB-RK-7267	for Drag Link
12/82→11/91		Suspension Arm Repair Kit	DB-RK-5283		
12/82→11/91		Tie Rod	DB-ES-5227		Guide Rod
12/82→11/91		Tie Rod End	CV-ES-12461		for Steering Rod
12/82→11/91		Tie Rod End	CV-ES-14163		for Steering Rod
12/82→11/91		Track Control Arm		DB-DL-6197	Suspension Rod, Trailing Arm
12/82→11/91		Track Control Arm		DB-DL-6198	Suspension Rod, Trailing Arm
12/82→11/91		Track Control Arm		DB-DL-6227	Suspension Rod, Trailing Arm
12/82→11/91		Track Control Arm		DB-DS-6088	Suspension Rod, Trailing Arm
3333 B		12/82→11/91	Centre Rod	DB-DL-10216	
	12/82→11/91	Stabiliser Mounting	DB-SB-5258	DB-SB-5258	
	12/82→11/91	Suspension Arm Repair Kit		DB-RK-7267	for Drag Link
	12/82→11/91	Suspension Arm Repair Kit	DB-RK-5283		
	12/82→11/91	Tie Rod	DB-ES-5227		Guide Rod
	12/82→11/91	Tie Rod End	CV-ES-12461		for Steering Rod
	12/82→11/91	Tie Rod End	CV-ES-14163		for Steering Rod
	12/82→11/91	Track Control Arm		DB-DL-6197	Suspension Rod, Trailing Arm
	12/82→11/91	Track Control Arm		DB-DL-6198	Suspension Rod, Trailing Arm
	12/82→11/91	Track Control Arm		DB-DL-6227	Suspension Rod, Trailing Arm
	12/82→11/91	Track Control Arm		DB-DS-6088	Suspension Rod, Trailing Arm
	3333 K	12/82→11/91	Centre Rod	DB-DL-10216	
12/82→11/91		Stabiliser Mounting	DB-SB-5258	DB-SB-5258	
12/82→11/91		Suspension Arm Repair Kit		DB-RK-7267	for Drag Link
12/82→11/91		Suspension Arm Repair Kit	DB-RK-5283		
12/82→11/91		Tie Rod	DB-ES-5227		Guide Rod
12/82→11/91		Tie Rod End	CV-ES-12461		for Steering Rod
12/82→11/91		Tie Rod End	CV-ES-14163		for Steering Rod
12/82→11/91		Track Control Arm		DB-DL-6197	Suspension Rod, Trailing Arm
12/82→11/91		Track Control Arm		DB-DL-6198	Suspension Rod, Trailing Arm
12/82→11/91		Track Control Arm		DB-DL-6227	Suspension Rod, Trailing Arm
12/82→11/91		Track Control Arm		DB-DS-6088	Suspension Rod, Trailing Arm
3335		04/86→03/91	Centre Rod	DB-DL-5241	
	04/86→03/91	Centre Rod	DB-DL-7270		Push Rod;Suspension Rod
	04/86→03/91	Centre Rod	DB-DL-7831		Push Rod
	04/86→03/91	Centre Rod	DB-DL-8131		Push Rod
	04/86→03/91	Centre Rod	DB-DL-8138		Push Rod
	04/86→03/91	Centre Rod	DB-DL-8618		Push Rod
	04/86→03/91	Centre Rod	DB-DL-10216		Push Rod
	04/86→03/91	Suspension Arm Repair Kit		DB-RK-7267	for Drag Link
	04/86→03/91	Suspension Arm Repair Kit		DB-RK-8550	for Wishbone (CV)
	04/86→03/91	Tie Rod	DB-DL-8640		Guide Rod
	04/86→03/91	Tie Rod	DB-ES-5209		
	04/86→03/91	Tie Rod	DB-ES-5227		Guide Rod
	04/86→03/91	Tie Rod End	CV-ES-12461		for Steering Rod

CV-ES-12461

Length: 120
 Cone Ø: d1 Ø 26 / d2 Ø 23,5
 Thread: M30 x 1,5 LHT
 0003300035, 3300148, 0003406213, 0013306635,
 0013308835, 0014604048, 0014604348,
 14606448, 0024600248, 3023300035,
 3023300135, 3023300235, 3023300335,
 3453307235, 3453307435, 3503307135,
 A0003300148, A0013306635, A0013308835,
 A0014604048, A0014604348, A0014606448,
 A0024600248, A3023300035, A3023300135,
 A3023300235, A3023300335, A3503307135



CV-ES-14163

Length: 125
 Cone Ø: d1 Ø 30 / d2 Ø 27
 Thread: M30 x 1,5 RHT
 0003305248, 0003387310, 0004600348,
 0004600948, 0004602848, 0004602948,
 0004608948, 0014600248, 0014600848,
 0014601248, 0014602248, 0014607748,
 0024600148, A0003387310, A0004600348,
 A0004602848, A0004602948, A0014600848,
 A0014601248, A0014602248, A0014607748



DB-DL-5241

Length: 875 Ø: 40
 Cone Ø: d1 Ø 30 / d2 Ø 27
 01215300A, 0004609205, 0004609305,
 0014606905



DB-DL-6197

Length: 579
 Ø: 50
 Hole Distance: 152 / 152
 6593501206, 6593503506



DB-DL-6198

Length: 579
 Ø: 58
 Hole Distance: 152 / 152
 3953500006, 6593501106



DB-DL-6227

Length: 629
 Ø: 58
 Hole Distance: 152 / 152
 6593501506, 6593503806



DB-DL-7270

Length: 875 Ø: 40
 Cone Ø: d1 Ø 28,6 / d2 Ø 23,9
 01208300A, 0024604705, 0024604805,
 0034604905, A0024604705



DB-DL-7831

Length: 870
 Ø: 42
 Cone Ø: d1 Ø 30 / d2 Ø 27
 01215200A, 6254602505



DB-DL-8131

Length: 1115 Ø: 52
 Cone Ø: d1 Ø 32 / d2 Ø 28,8
 0004604405, 6254605005



DB-DL-8138

Length: 1130
 Ø: 40
 Cone Ø: d1 Ø 32 / d2 Ø 28,8
 0004606605, 4606605



DB-DL-8618

Length: 680
 Ø: 42
 Cone Ø: d1 Ø 32 / d2 Ø 28,8
 0004604305, 4604305, 6254604805



DB-DL-8640

Length: 1615 Ø: 50
 Cone Ø: d1 Ø 32 / d2 Ø 29
 6253301503, 6253301603, 6253302403,
 6253302503, 9423300803, 9423302103,
 9493300203, 9493300303, 9493300903



DB-DL-10216

Length: 1190
 Ø: 40
 Cone Ø: d1 Ø 32 / d2 Ø 29
 0004604905



DB-DS-6088

Length: 585
 Ø: 50
 Hole Distance: 152 / 152
 3953500706, 6593500406



DB-ES-5209

Length: 1670 Ø: 50
 Cone Ø: d1 Ø 30 / d2 Ø 27
 6203300503, 6203300603



DB-ES-5227

Length: 1588 Ø: 60
 Cone Ø: d1 Ø 38 / d2 Ø 34,3
 6253300903, 6253301203, 9443300203



DB-RK-5281

Ø: 86
 01303700A, 6253200111



DB-RK-5283

Ø: 70
 01319900A, 6203200628



DB-RK-5307

Ø: 70
 01303500A, 6473200028



DB-RK-7267

Ø: 95
 Hole Distance: 152
 Thick/Height: 24
 01302100A, 0003500413, 3500413, 0005861235,
 5861235, 81432706069



DB-RK-8550

Ø: 75 Hole Distance: 152
 Thick/Height: 24
 0003502105, 0003504605



DB-SB-5258

Ø: 70
 Thick/Height: 62
 01311400A, 3873230285



DB-SB-10407

Ø: 61 Thick/Height: 46
 0003235985, 0003262481, 0003262981



DF-ES-7777

Length: 85
 Cone Ø: d1 Ø 38 / d2 Ø 34,3
 Thread: M26 x 1,5 RHT
 6244600348





NG ...

3335 ...	04/86→03/91	Tie Rod End	CV-ES-14163		for Steering Rod
	04/86→03/91	Track Control Arm		DB-DL-6197	Suspension Rod, Trailing Arm
	04/86→03/91	Track Control Arm		DB-DL-6198	Suspension Rod, Trailing Arm
	04/86→03/91	Track Control Arm		DB-DL-6227	Suspension Rod, Trailing Arm
3335 A	04/86→03/91	Centre Rod	DB-DL-5217		Push Rod
	04/86→03/91	Centre Rod	DB-DL-7831		Push Rod
	04/86→03/91	Centre Rod	DB-DL-10216		Push Rod
	04/86→03/91	Suspension Arm Repair Kit		DB-RK-7267	for Drag Link
	04/86→03/91	Tie Rod	DB-ES-5209		
	04/86→03/91	Tie Rod	DB-ES-5227		Guide Rod
	04/86→03/91	Tie Rod	MN-DL-7834		Guide Rod
	04/86→03/91	Tie Rod End	CV-ES-12461		for Steering Rod
	04/86→03/91	Tie Rod End	CV-ES-14163		for Steering Rod
	04/86→03/91	Tie Rod End	DB-ES-5234		for Steering Rod
	04/86→03/91	Track Control Arm		DB-DL-6197	Suspension Rod, Trailing Arm
	04/86→03/91	Track Control Arm		DB-DL-6198	Suspension Rod, Trailing Arm
	3336	12/82→11/91	Centre Rod	DB-DL-5217	
12/82→11/91		Centre Rod	DB-DL-7831		Push Rod
12/82→11/91		Centre Rod	DB-DL-8131		Push Rod
12/82→11/91		Centre Rod	DB-DL-8618		Push Rod
12/82→11/91		Centre Rod	DB-DL-10216		Push Rod
12/82→11/91		Stabiliser Mounting	DB-SB-5258	DB-SB-5258	
12/82→11/91		Suspension Arm Repair Kit		DB-RK-7267	for Drag Link
12/82→11/91		Suspension Arm Repair Kit		DB-RK-9297	Wishbone (CV)
12/82→11/91		Suspension Arm Repair Kit	DB-RK-5283		
12/82→11/91		Tie Rod	DB-DL-8640		Guide Rod
12/82→11/91		Tie Rod	DB-ES-5209		
12/82→11/91		Tie Rod	DB-ES-5227		Guide Rod
12/82→11/91		Tie Rod	MN-DL-7834		Guide Rod
12/82→11/91		Tie Rod End	CV-ES-12461		for Steering Rod
12/82→11/91		Tie Rod End	CV-ES-14163		for Steering Rod
12/82→11/91		Tie Rod End	DB-ES-5234		for Steering Rod
12/82→11/91		Track Control Arm		DB-DL-6197	Suspension Rod, Trailing Arm
12/82→11/91		Track Control Arm		DB-DL-6198	Suspension Rod, Trailing Arm
12/82→11/91		Track Control Arm		DB-DL-6227	Suspension Rod, Trailing Arm
12/82→11/91		Track Control Arm		DB-DS-6088	Suspension Rod, Trailing Arm
3336 A	11/81→03/91	Centre Rod	DB-DL-5217		Push Rod
	11/81→03/91	Centre Rod	DB-DL-5217		Push Rod* 5 184 732 *→
	11/81→03/91	Centre Rod	DB-DL-7831		Push Rod
	11/81→03/91	Centre Rod	DB-DL-10216		Push Rod
	11/81→03/91	Suspension Arm Repair Kit		DB-RK-7267	for Drag Link
	11/81→03/91	Tie Rod	DB-ES-5209		
	11/81→03/91	Tie Rod	DB-ES-5227		Guide Rod
	11/81→03/91	Tie Rod	MN-DL-7834		Guide Rod
	11/81→03/91	Tie Rod End	CV-ES-12461		for Steering Rod
	11/81→03/91	Tie Rod End	CV-ES-14163		for Steering Rod
	11/81→03/91	Tie Rod End	DB-ES-5234		for Steering Rod
	11/81→03/91	Track Control Arm		DB-DL-6197	Suspension Rod, Trailing Arm
	11/81→03/91	Track Control Arm		DB-DL-6198	Suspension Rod, Trailing Arm
	11/81→03/91	Track Control Arm		DB-DL-6227	Suspension Rod, Trailing Arm
11/81→03/91	Track Control Arm		DB-DS-6088	Suspension Rod, Trailing Arm	
3336 AK	09/86→11/91	Centre Rod	DB-DL-5217		Push Rod
	09/86→11/91	Centre Rod	DB-DL-5217		Push Rod* 5 184 732 *→
	09/86→11/91	Centre Rod	DB-DL-7831		Push Rod
	09/86→11/91	Centre Rod	DB-DL-10216		Push Rod
	09/86→11/91	Suspension Arm Repair Kit		DB-RK-7267	for Drag Link
	09/86→11/91	Tie Rod	DB-ES-5209		
	09/86→11/91	Tie Rod	DB-ES-5227		Guide Rod
	09/86→11/91	Tie Rod	MN-DL-7834		Guide Rod
	09/86→11/91	Tie Rod End	CV-ES-12461		for Steering Rod
	09/86→11/91	Tie Rod End	CV-ES-14163		for Steering Rod
	09/86→11/91	Tie Rod End	DB-ES-5234		for Steering Rod
	09/86→11/91	Track Control Arm		DB-DL-6197	Suspension Rod, Trailing Arm

CV-ES-12461

Length: 120
 Cone Ø: d1 Ø 26 / d2 Ø 23,5
 Thread: M30 x 1,5 LHT
 0003300035, 3300148, 0003406213, 0013306635,
 0013308835, 0014604048, 0014604348,
 14606448, 0024600248, 3023300035,
 3023300135, 3023300235, 3023300335,
 3453307235, 3453307435, 3503307135,
 A0003300148, A0013306635, A0013308835,
 A0014604048, A0014604348, A0014606448,
 A0024600248, A3023300035, A3023300135,
 A3023300235, A3023300335, A3503307135



CV-ES-14163

Length: 125
 Cone Ø: d1 Ø 30 / d2 Ø 27
 Thread: M30 x 1,5 RHT
 0003305248, 0003387310, 0004600348,
 0004600948, 0004602848, 0004602948,
 0004608948, 0014600248, 0014600848,
 0014601248, 0014602248, 0014607748,
 0024600148, A0003387310, A0004600348,
 A0004602848, A0004602948, A0014600848,
 A0014601248, A0014602248, A0014607748



DB-DL-5217

Length: 862 Ø: 40
 Cone Ø: d1 Ø 30 / d2 Ø 27
 01214700A, 6204600405, 6204600805,
 6204602905, 6204603005



DB-DL-6197

Length: 579
 Ø: 50
 Hole Distance: 152 / 152
 6593501206, 6593503506



DB-DL-6198

Length: 579
 Ø: 58
 Hole Distance: 152 / 152
 3953500006, 6593501106



DB-DL-6227

Length: 629
 Ø: 58
 Hole Distance: 152 / 152
 6593501506, 6593503806



DB-DL-7831

Length: 870
 Ø: 42
 Cone Ø: d1 Ø 30 / d2 Ø 27
 01215200A, 6254602505



DB-DL-8131

Length: 1115
 Ø: 52
 Cone Ø: d1 Ø 32 / d2 Ø 28,8
 4604405, 0004604405, 6254605005



DB-DL-8618

Length: 680
 Ø: 42
 Cone Ø: d1 Ø 32 / d2 Ø 28,8
 0004604305, 4604305, 6254604805



DB-DL-8640

Length: 1615 Ø: 50
 Cone Ø: d1 Ø 32 / d2 Ø 29
 6253301503, 6253301603, 6253302403,
 6253302503, 9423300803, 9423302103,
 9493300203, 9493300303, 9493300903



DB-DL-10216

Length: 1190
 Ø: 40
 Cone Ø: d1 Ø 32 / d2 Ø 29
 0004604905



DB-DS-6088

Length: 585
 Ø: 50
 Hole Distance: 152 / 152
 3953500706, 6593500406



DB-ES-5209

Length: 1670 Ø: 50
 Cone Ø: d1 Ø 30 / d2 Ø 27
 6203300503, 6203300603



DB-ES-5227

Length: 1588 Ø: 60
 Cone Ø: d1 Ø 38 / d2 Ø 34,3
 6253300903, 6253301203, 9443300203



DB-ES-5234

Length: 135
 Cone Ø: d1 Ø 38 / d2 Ø 34,3
 Thread: M38 x 1,5 RHT
 0004601748, 120322305, 2205000400



DB-RK-5283

Ø: 70
 01319900A, 6203200628



DB-RK-7267

Ø: 95
 Hole Distance: 152
 Thick/Height: 24
 01302100A, 0003500413, 3500413, 0005861235,
 5861235, 81432706069



DB-RK-9297

Ø: 90
 0003500805, 3500805



DB-SB-5258

Ø: 70
 Thick/Height: 62
 01311400A, 3873230285



MN-DL-7834

Length: 1588 Ø: 58
 Cone Ø: d1 Ø 30 / d2 Ø 27
 3463303903, 3463304903, 6253303203,
 9443300503, 9443301303, 9443301703





NG ...

3336 AK ...	09/86→11/91	Track Control Arm		DB-DL-6198	Suspension Rod, Trailing Arm	
	09/86→11/91	Track Control Arm		DB-DL-6227	Suspension Rod, Trailing Arm	
	09/86→11/91	Track Control Arm		DB-DS-6088	Suspension Rod, Trailing Arm	
3336 B	12/82→11/91	Centre Rod	DB-DL-10216		Push Rod	
	12/82→11/91	Suspension Arm Repair Kit		DB-RK-7267	for Drag Link	
	12/82→11/91	Tie Rod	DB-ES-5227		Guide Rod	
	12/82→11/91	Tie Rod End	CV-ES-12461		for Steering Rod	
	12/82→11/91	Tie Rod End	CV-ES-14163		for Steering Rod	
	12/82→11/91	Track Control Arm		DB-DL-6197	Suspension Rod, Trailing Arm	
	12/82→11/91	Track Control Arm		DB-DL-6198	Suspension Rod, Trailing Arm	
	12/82→11/91	Track Control Arm		DB-DL-6227	Suspension Rod, Trailing Arm	
	12/82→11/91	Track Control Arm		DB-DS-6088	Suspension Rod, Trailing Arm	
3336 K	12/82→11/91	Centre Rod	DB-DL-7831		Push Rod	
	12/82→11/91	Centre Rod	DB-DL-8131		Push Rod	
	12/82→11/91	Centre Rod	DB-DL-8618		Push Rod	
	12/82→11/91	Centre Rod	DB-DL-10216		Push Rod	
	12/82→11/91	Stabiliser Mounting	DB-SB-5258	DB-SB-5258		
	12/82→11/91	Suspension Arm Repair Kit		DB-RK-7267	for Drag Link	
	12/82→11/91	Suspension Arm Repair Kit	DB-RK-5283			
	12/82→11/91	Tie Rod	DB-ES-5227		Guide Rod	
	12/82→11/91	Tie Rod End	CV-ES-12461		for Steering Rod	
	12/82→11/91	Tie Rod End	CV-ES-14163		for Steering Rod	
	12/82→11/91	Track Control Arm		DB-DL-6197	Suspension Rod, Trailing Arm	
	12/82→11/91	Track Control Arm		DB-DL-6198	Suspension Rod, Trailing Arm	
	12/82→11/91	Track Control Arm		DB-DL-6227	Suspension Rod, Trailing Arm	
	12/82→11/91	Track Control Arm		DB-DS-6088	Suspension Rod, Trailing Arm	
	3336 S	12/82→11/91	Centre Rod	DB-DL-10216		Push Rod
12/82→11/91		Stabiliser Mounting	DB-SB-5258	DB-SB-5258		
12/82→11/91		Suspension Arm Repair Kit		DB-RK-7267	for Drag Link	
12/82→11/91		Suspension Arm Repair Kit	DB-RK-5283			
12/82→11/91		Tie Rod	DB-ES-5227		Guide Rod	
12/82→11/91		Tie Rod End	CV-ES-12461		for Steering Rod	
12/82→11/91		Tie Rod End	CV-ES-14163		for Steering Rod	
12/82→11/91		Track Control Arm		DB-DL-6197	Suspension Rod, Trailing Arm	
12/82→11/91		Track Control Arm		DB-DL-6198	Suspension Rod, Trailing Arm	
12/82→11/91		Track Control Arm		DB-DL-6227	Suspension Rod, Trailing Arm	
12/82→11/91		Track Control Arm		DB-DS-6088	Suspension Rod, Trailing Arm	
3338		01/81→12/86	Centre Rod	DB-DL-10216		Push Rod
	01/81→12/86	Suspension Arm Repair Kit		DB-RK-7267	for Drag Link	
	01/81→12/86	Tie Rod	DB-ES-5227		Guide Rod	
	01/81→12/86	Tie Rod End	CV-ES-12461		for Steering Rod	
	01/81→12/86	Tie Rod End	CV-ES-14163		for Steering Rod	
	01/81→12/86	Track Control Arm		DB-DL-6197	Suspension Rod, Trailing Arm	
	01/81→12/86	Track Control Arm		DB-DL-6198	Suspension Rod, Trailing Arm	
	01/81→12/86	Track Control Arm		DB-DS-6088	Suspension Rod, Trailing Arm	
	01/81→12/86	Track Control Arm				
3528	07/82→07/87	Centre Rod	DB-DL-7831		Push Rod	
	07/82→07/87	Centre Rod	DB-DL-7831		Push Rod* 5 401 092 *→	
	07/82→07/87	Centre Rod	DB-DL-10216		Push Rod	
	07/82→07/87	Suspension Arm Repair Kit		DB-RK-7267	for Drag Link	
	07/82→07/87	Tie Rod	DB-DL-8640		Guide Rod	
	07/82→07/87	Tie Rod	DB-ES-5227		Guide Rod	
	07/82→07/87	Tie Rod End	CV-ES-12461		for Steering Rod	
	07/82→07/87	Tie Rod End	CV-ES-14163		for Steering Rod	
	07/82→07/87	Tie Rod End	DF-ES-7777			
	07/82→07/87	Track Control Arm		DB-DL-6197	Suspension Rod, Trailing Arm	
	07/82→07/87	Track Control Arm		DB-DL-6198	Suspension Rod, Trailing Arm	
	3528 B	07/87→09/89	Centre Rod	DB-DL-7831		Push Rod
		07/87→09/89	Centre Rod	DB-DL-7831		Push Rod* 5 401 092 *→
		07/87→09/89	Centre Rod	DB-DL-10216		Push Rod
07/87→09/89		Stabiliser Mounting		DB-SB-10407		
07/87→09/89		Suspension Arm Repair Kit		DB-RK-5281		
07/87→09/89		Suspension Arm Repair Kit		DB-RK-7267	for Drag Link	
07/87→09/89	Suspension Arm Repair Kit	DB-RK-5307				

CV-ES-12461

Length: 120
 Cone Ø: d1 Ø 26 / d2 Ø 23,5
 Thread: M30 x 1,5 LHT
 0003300035, 3300148, 0003406213, 0013306635,
 0013308835, 0014604048, 0014604348,
 14606448, 0024600248, 3023300035,
 3023300135, 3023300235, 3023300335,
 3453307235, 3453307435, 3503307135,
 A0003300148, A0013306635, A0013308835,
 A0014604048, A0014604348, A0014606448,
 A0024600248, A3023300035, A3023300135,
 A3023300235, A3023300335, A3503307135



CV-ES-14163

Length: 125
 Cone Ø: d1 Ø 30 / d2 Ø 27
 Thread: M30 x 1,5 RHT
 0003305248, 0003387310, 0004600348,
 0004600948, 0004602848, 0004602948,
 0004608948, 0014600248, 0014600848,
 0014601248, 0014602248, 0014607748,
 0024600148, A0003387310, A0004600348,
 A0004602848, A0004602948, A0014600848,
 A0014601248, A0014602248, A0014607748



DB-DL-6197

Length: 579
 Ø: 50
 Hole Distance: 152 / 152
 6593501206, 6593503506



DB-DL-6198

Length: 579
 Ø: 58
 Hole Distance: 152 / 152
 3953500006, 6593501106



DB-DL-6227

Length: 629
 Ø: 58
 Hole Distance: 152 / 152
 6593501506, 6593503806



DB-DL-7831

Length: 870
 Ø: 42
 Cone Ø: d1 Ø 30 / d2 Ø 27
 01215200A, 6254602505



DB-DL-8131

Length: 1115
 Ø: 52
 Cone Ø: d1 Ø 32 / d2 Ø 28,8
 4604405, 0004604405, 6254605005



DB-DL-8618

Length: 680
 Ø: 42
 Cone Ø: d1 Ø 32 / d2 Ø 28,8
 4604305, 0004604305, 6254604805



DB-DL-8640

Length: 1615 Ø: 50
 Cone Ø: d1 Ø 32 / d2 Ø 29
 6253301503, 6253301603, 6253302403,
 6253302503, 9423300803, 9423302103,
 9493300203, 9493300303, 9493300903



DB-DL-10216

Length: 1190
 Ø: 40
 Cone Ø: d1 Ø 32 / d2 Ø 29
 0004604905



DB-DS-6088

Length: 585
 Ø: 50
 Hole Distance: 152 / 152
 3953500706, 6593500406



DB-ES-5227

Length: 1588 Ø: 60
 Cone Ø: d1 Ø 38 / d2 Ø 34,3
 6253300903, 6253301203, 9443300203



DB-RK-5281

Ø: 86
 01303700A, 6253200111



DB-RK-5283

Ø: 70
 01319900A, 6203200628



DB-RK-5307

Ø: 70
 01303500A, 6473200028



DB-RK-7267

Ø: 95
 Hole Distance: 152
 Thick/Height: 24
 01302100A, 0003500413, 3500413, 0005861235,
 5861235, 81432706069



DB-SB-5258

Ø: 70
 Thick/Height: 62
 01311400A, 3873230285



DB-SB-10407

Ø: 61 Thick/Height: 46
 0003235985, 0003262481, 0003262981



DF-ES-7777

Length: 85
 Cone Ø: d1 Ø 38 / d2 Ø 34,3
 Thread: M26 x 1,5 RHT
 6244600348





NG ...

3528 B ...	07/87→09/89	Tie Rod	DB-DL-8640		Guide Rod	
	07/87→09/89	Tie Rod	DB-ES-5227		Guide Rod	
	07/87→09/89	Tie Rod End	CV-ES-12461		for Steering Rod	
	07/87→09/89	Tie Rod End	CV-ES-14163		for Steering Rod	
	07/87→09/89	Tie Rod End	DF-ES-7777			
	07/87→09/89	Track Control Arm		DB-DL-6197	Suspension Rod, Trailing Arm	
	07/87→09/89	Track Control Arm		DB-DL-6198	Suspension Rod, Trailing Arm	
	3528 K	07/82→07/87	Centre Rod	DB-DL-7831		Push Rod* 5 401 092 *→
07/82→07/87		Tie Rod	DB-DL-8640		Guide Rod	
07/82→07/87		Tie Rod End	DF-ES-7777			
07/82→09/89		Centre Rod	DB-DL-7831		Push Rod	
07/82→09/89		Centre Rod	DB-DL-10216		Push Rod	
07/82→09/89		Suspension Arm Repair Kit		DB-RK-7267	for Drag Link	
07/82→09/89		Tie Rod	DB-ES-5227		Guide Rod	
07/82→09/89		Tie Rod End	CV-ES-12461		for Steering Rod	
07/82→09/89		Tie Rod End	CV-ES-14163		for Steering Rod	
07/82→09/89		Track Control Arm		DB-DL-6197	Suspension Rod, Trailing Arm	
07/82→09/89		Track Control Arm		DB-DL-6198	Suspension Rod, Trailing Arm	
07/87→09/89		Centre Rod	DB-DL-5217		Push Rod	
07/87→09/89		Centre Rod	DB-DL-5217		Push Rod* 5 184 732 *→	
07/87→09/89		Tie Rod	DB-ES-5209			
07/87→09/89		Tie Rod	MN-DL-7834		Guide Rod	
07/87→09/89		Tie Rod End	DB-ES-5234		for Steering Rod	
07/87→09/89		Track Control Arm		DB-DL-6227	Suspension Rod, Trailing Arm	
07/87→09/89		Track Control Arm		DB-DS-6088	Suspension Rod, Trailing Arm	
3535 AK		09/87→02/90	Centre Rod	DB-DL-5217		Push Rod
		09/87→02/90	Centre Rod	DB-DL-5217		Push Rod* 5 184 732 *→
	09/87→02/90	Centre Rod	DB-DL-7831		Push Rod	
	09/87→02/90	Centre Rod	DB-DL-8131		Push Rod	
	09/87→02/90	Centre Rod	DB-DL-8618		Push Rod	
	09/87→02/90	Centre Rod	DB-DL-10216		Push Rod	
	09/87→02/90	Suspension Arm Repair Kit		DB-RK-7267	for Drag Link	
	09/87→02/90	Tie Rod	DB-DL-8640		Guide Rod	
	09/87→02/90	Tie Rod	DB-ES-5209			
	09/87→02/90	Tie Rod	DB-ES-5227		Guide Rod	
	09/87→02/90	Tie Rod	MN-DL-7834		Guide Rod	
	09/87→02/90	Tie Rod End	CV-ES-12461		for Steering Rod	
	09/87→02/90	Tie Rod End	CV-ES-14163		for Steering Rod	
	09/87→02/90	Tie Rod End	DB-ES-5234		for Steering Rod	
	09/87→02/90	Track Control Arm		DB-DL-6197	Suspension Rod, Trailing Arm	
	09/87→02/90	Track Control Arm		DB-DL-6198	Suspension Rod, Trailing Arm	
	09/87→02/90	Track Control Arm		DB-DL-6227	Suspension Rod, Trailing Arm	
	09/87→02/90	Track Control Arm		DB-DS-6088	Suspension Rod, Trailing Arm	
	3535 K	09/87→01/89	Centre Rod	DB-DL-7831		Push Rod
		09/87→01/89	Centre Rod	DB-DL-7831		Push Rod* 5 401 092 *→
09/87→01/89		Centre Rod	DB-DL-10216		Push Rod	
09/87→01/89		Stabiliser Mounting		DB-SB-10407		
09/87→01/89		Suspension Arm Repair Kit		DB-RK-5281		
09/87→01/89		Suspension Arm Repair Kit		DB-RK-7267	for Drag Link	
09/87→01/89		Suspension Arm Repair Kit	DB-RK-5307			
09/87→01/89		Tie Rod	DB-DL-8640		Guide Rod	
09/87→01/89		Tie Rod	DB-ES-5227		Guide Rod	
09/87→01/89		Tie Rod End	CV-ES-12461		for Steering Rod	
09/87→01/89		Tie Rod End	CV-ES-14163		for Steering Rod	
09/87→01/89		Tie Rod End	DF-ES-7777			
09/87→01/89		Track Control Arm		DB-DL-6197	Suspension Rod, Trailing Arm	
09/87→01/89		Track Control Arm		DB-DL-6198	Suspension Rod, Trailing Arm	
09/87→01/89		Track Control Arm		DB-DL-7839	Trailing Arm	
09/87→01/89		Track Control Arm		DB-DS-6088	Suspension Rod, Trailing Arm	

CV-ES-12461

Length: 120
 Cone Ø: d1 Ø 26 / d2 Ø 23,5
 Thread: M30 x 1,5 LHT
 0003300035, 3300148, 0003406213, 0013306635,
 0013308835, 0014604048, 0014604348,
 14606448, 0024600248, 3023300035,
 3023300135, 3023300235, 3023300335,
 3453307235, 3453307435, 3503307135,
 A0003300148, A0013306635, A0013308835,
 A0014604048, A0014604348, A0014606448,
 A0024600248, A3023300035, A3023300135,
 A3023300235, A3023300335, A3503307135



CV-ES-14163

Length: 125
 Cone Ø: d1 Ø 30 / d2 Ø 27
 Thread: M30 x 1,5 RHT
 0003305248, 0003387310, 0004600348,
 0004600948, 0004602848, 0004602948,
 0004608948, 0014600248, 0014600848,
 0014601248, 0014602248, 0014607748,
 0024600148, A0003387310, A0004600348,
 A0004602848, A0004602948, A0014600848,
 A0014601248, A0014602248, A0014607748



DB-DL-5217

Length: 862 Ø: 40
 Cone Ø: d1 Ø 30 / d2 Ø 27
 01214700A, 6204600405, 6204600805,
 6204602905, 6204603005



DB-DL-6197

Length: 579
 Ø: 50
 Hole Distance: 152 / 152
 6593501206, 6593503506



DB-DL-6198

Length: 579
 Ø: 58
 Hole Distance: 152 / 152
 3953500006, 6593501106



DB-DL-6227

Length: 629
 Ø: 58
 Hole Distance: 152 / 152
 6593501506, 6593503806



DB-DL-7831

Length: 870
 Ø: 42
 Cone Ø: d1 Ø 30 / d2 Ø 27
 01215200A, 6254602505



DB-DL-7839

Length: 585
 Ø: 50
 Hole Distance: 152 / 152
 3953500206, 6593500106, 6593502406



DB-DL-8131

Length: 1115
 Ø: 52
 Cone Ø: d1 Ø 32 / d2 Ø 28,8
 4604405, 0004604405, 6254605005



DB-DL-8618

Length: 680
 Ø: 42
 Cone Ø: d1 Ø 32 / d2 Ø 28,8
 0004604305, 4604305, 6254604805



DB-DL-8640

Length: 1615 Ø: 50
 Cone Ø: d1 Ø 32 / d2 Ø 29
 6253301503, 6253301603, 6253302403,
 6253302503, 9423300803, 9423302103,
 9493300203, 9493300303, 9493300903



DB-DL-10216

Length: 1190
 Ø: 40
 Cone Ø: d1 Ø 32 / d2 Ø 29
 0004604905



DB-DS-6088

Length: 585
 Ø: 50
 Hole Distance: 152 / 152
 3953500706, 6593500406



DB-ES-5209

Length: 1670 Ø: 50
 Cone Ø: d1 Ø 30 / d2 Ø 27
 6203300503, 6203300603



DB-ES-5227

Length: 1588 Ø: 60
 Cone Ø: d1 Ø 38 / d2 Ø 34,3
 6253300903, 6253301203, 9443300203



DB-ES-5234

Length: 135
 Cone Ø: d1 Ø 38 / d2 Ø 34,3
 Thread: M38 x 1,5 RHT
 0004601748, 120322305, 2205000400



DB-RK-5281

Ø: 86
 01303700A, 6253200111



DB-RK-5307

Ø: 70
 01303500A, 6473200028



DB-RK-7267

Ø: 95
 Hole Distance: 152
 Thick/Height: 24
 01302100A, 0003500413, 3500413, 5861235,
 0005861235, 81432706069



DB-SB-10407

Ø: 61 Thick/Height: 46
 0003235985, 0003262481, 0003262981



DF-ES-7777

Length: 85
 Cone Ø: d1 Ø 38 / d2 Ø 34,3
 Thread: M26 x 1,5 RHT
 6244600348



MN-DL-7834

Length: 1588 Ø: 58
 Cone Ø: d1 Ø 30 / d2 Ø 27
 3463303903, 3463304903, 6253303203,
 9443300503, 9443301303, 9443301703





NG ...

3536 K	12/82→11/91	Centre Rod	DB-DL-10216		Push Rod	
	12/82→11/91	Suspension Arm Repair Kit		DB-RK-7267	for Drag Link	
	12/82→11/91	Tie Rod	DB-ES-5227		Guide Rod	
	12/82→11/91	Tie Rod End	CV-ES-12461		for Steering Rod	
	12/82→11/91	Tie Rod End	CV-ES-14163		for Steering Rod	
	12/82→11/91	Track Control Arm		DB-DL-6197	Suspension Rod, Trailing Arm	
	12/82→11/91	Track Control Arm		DB-DL-6198	Suspension Rod, Trailing Arm	
	12/82→11/91	Track Control Arm		DB-DL-6227	Suspension Rod, Trailing Arm	
3544	12/82→11/91	Track Control Arm		DB-DS-6088	Suspension Rod, Trailing Arm	
	08/73→09/96	Centre Rod	DB-DL-5241		Suspension Rod	
	08/73→09/96	Centre Rod	DB-DL-7270		Push Rod;Suspension Rod	
	08/73→09/96	Centre Rod	DB-DL-10216		Push Rod	
	08/73→09/96	Suspension Arm Repair Kit		DB-RK-8550	for Wishbone (CV)	
	08/73→09/96	Tie Rod End	CV-ES-12461		for Steering Rod	
3544 S	08/73→09/96	Tie Rod End	CV-ES-14163		for Steering Rod	
	08/73→09/96	Centre Rod	DB-DL-7831		Push Rod	
	08/73→09/96	Centre Rod	DB-DL-8131		Push Rod	
	08/73→09/96	Centre Rod	DB-DL-8138		Push Rod	
	08/73→09/96	Centre Rod	DB-DL-8618		Push Rod	
	08/73→09/96	Centre Rod	DB-DL-10216		Push Rod	
	08/73→09/96	Suspension Arm Repair Kit		DB-RK-7267	for Drag Link	
	08/73→09/96	Tie Rod	DB-ES-5209			
	08/73→09/96	Tie Rod	DB-ES-5227		Guide Rod	
	08/73→09/96	Tie Rod End	CV-ES-12461		for Steering Rod	
	08/73→09/96	Tie Rod End	CV-ES-14163		for Steering Rod	
	08/73→09/96	Track Control Arm		DB-DL-6197	Suspension Rod, Trailing Arm	
	08/73→09/96	Track Control Arm		DB-DL-6198	Suspension Rod, Trailing Arm	
	08/73→09/96	Track Control Arm		DB-DL-6227	Suspension Rod, Trailing Arm	
	08/73→09/96	Track Control Arm		DB-DL-7840	Suspension Rod, Trailing Arm	
	3836 AK	11/81→03/91	Centre Rod	DB-DL-5217		Push Rod* 5 184 732 *→
		11/81→03/91	Centre Rod	DB-DL-10216		Push Rod
		11/81→03/91	Suspension Arm Repair Kit		DB-RK-7267	for Drag Link
11/81→03/91		Tie Rod	DB-ES-5227		Guide Rod	
11/81→03/91		Tie Rod	MN-DL-7834		Guide Rod	
11/81→03/91		Tie Rod End	CV-ES-12461		for Steering Rod	
11/81→03/91		Tie Rod End	CV-ES-14163		for Steering Rod	
11/81→03/91		Track Control Arm		DB-DL-6197	Suspension Rod, Trailing Arm	
11/81→03/91		Track Control Arm		DB-DL-6198	Suspension Rod, Trailing Arm	
11/81→03/91		Track Control Arm		DB-DL-6227	Suspension Rod, Trailing Arm	
11/81→03/91		Track Control Arm		DB-DS-6088	Suspension Rod, Trailing Arm	
3850 A		09/85→08/94	Centre Rod	DB-DL-5217		Push Rod
		09/85→08/94	Centre Rod	DB-DL-10216		Push Rod
	09/85→08/94	Stabiliser Mounting		DB-SB-10407		
	09/85→08/94	Suspension Arm Repair Kit		DB-RK-7267	for Drag Link	
	09/85→08/94	Tie Rod	DB-ES-5209			
	09/85→08/94	Tie Rod	DB-ES-5227		Guide Rod	
	09/85→08/94	Tie Rod	MN-DL-7834		Guide Rod	
	09/85→08/94	Tie Rod End	CV-ES-12461		for Steering Rod	
	09/85→08/94	Tie Rod End	CV-ES-14163		for Steering Rod	
	09/85→08/94	Tie Rod End	DB-ES-5234		for Steering Rod	
	09/85→08/94	Track Control Arm		DB-DL-6227	Suspension Rod, Trailing Arm	
	O 100					
	City	01/94→	Tie Rod	ME-AX-2734		
01/94→		Tie Rod	ME-AX-2735			
01/94→		Tie Rod End	ME-ES-1760			
O 301						
O 301	02/86→05/87	Stabiliser Mounting		DB-SB-5270		
	02/86→05/87	Stabiliser Mounting	DB-SB-10385	DB-SB-10385		
	02/86→05/87	Tie Bar Bush		DB-SB-5312		
	02/86→05/87	Tie Rod End	CV-ES-12461		for Steering Rod	

CV-ES-12461

Length: 120
 Cone Ø: d1 Ø 26 / d2 Ø 23,5
 Thread: M30 x 1,5 LHT
 0003300035, 3300148, 0003406213, 0013306635,
 0013308835, 0014604048, 0014604348,
 14606448, 0024600248, 3023300035,
 3023300135, 3023300235, 3023300335,
 3453307235, 3453307435, 3503307135,
 A0003300148, A0013306635, A0013308835,
 A0014604048, A0014604348, A0014606448,
 A0024600248, A3023300035, A3023300135,
 A3023300235, A3023300335, A3503307135



CV-ES-14163

Length: 125
 Cone Ø: d1 Ø 30 / d2 Ø 27
 Thread: M30 x 1,5 RHT
 0003305248, 0003387310, 0004600348,
 0004600948, 0004602848, 0004602948,
 0004608948, 0014600248, 0014600848,
 0014601248, 0014602248, 0014607748,
 0024600148, A0003387310, A0004600348,
 A0004602848, A0004602948, A0014600848,
 A0014601248, A0014602248, A0014607748



DB-DL-5217

Length: 862 Ø: 40
 Cone Ø: d1 Ø 30 / d2 Ø 27
 01214700A, 6204600405, 6204600805,
 6204602905, 6204603005



DB-DL-5241

Length: 875 Ø: 40
 Cone Ø: d1 Ø 30 / d2 Ø 27
 01215300A, 0004609205, 0004609305,
 0014606905



DB-DL-6197

Length: 579
 Ø: 50
 Hole Distance: 152 / 152
 6593501206, 6593503506



DB-DL-6198

Length: 579
 Ø: 58
 Hole Distance: 152 / 152
 3953500006, 6593501106



DB-DL-6227

Length: 629
 Ø: 58
 Hole Distance: 152 / 152
 6593501506, 6593503806



DB-DL-7270

Length: 875 Ø: 40
 Cone Ø: d1 Ø 28,6 / d2 Ø 23,9
 01208300A, 0024604705, 0024604805,
 0034604905, A0024604705



DB-DL-7831

Length: 870
 Ø: 42
 Cone Ø: d1 Ø 30 / d2 Ø 27
 01215200A, 6254602505



DB-DL-7840

Length: 595
 Ø: 62
 Hole Distance: 152 / 152
 6203500006, 6203500106, 6203500306,
 6553500306



DB-DL-8131

Length: 1115 Ø: 52
 Cone Ø: d1 Ø 32 / d2 Ø 28,8
 0004604405, 6254605005



DB-DL-8138

Length: 1130
 Ø: 40
 Cone Ø: d1 Ø 32 / d2 Ø 28,8
 0004606605, 4606605



DB-DL-8618

Length: 680
 Ø: 42
 Cone Ø: d1 Ø 32 / d2 Ø 28,8
 0004604305, 4604305, 6254604805



DB-DL-10216

Length: 1190
 Ø: 40
 Cone Ø: d1 Ø 32 / d2 Ø 29
 0004604905



DB-DS-6088

Length: 585
 Ø: 50
 Hole Distance: 152 / 152
 3953500706, 6593500406



DB-ES-5209

Length: 1670 Ø: 50
 Cone Ø: d1 Ø 30 / d2 Ø 27
 6203300503, 6203300603



DB-ES-5227

Length: 1588 Ø: 60
 Cone Ø: d1 Ø 38 / d2 Ø 34,3
 6253300903, 6253301203, 9443300203



DB-ES-5234

Length: 135
 Cone Ø: d1 Ø 38 / d2 Ø 34,3
 Thread: M38 x 1,5 RHT
 0004601748, 120322305, 2205000400



DB-RK-7267

Ø: 95
 Hole Distance: 152
 Thick/Height: 24
 01302100A, 0003500413, 3500413, 0005861235,
 5861235, 81432706069



DB-RK-8550

Ø: 75 Hole Distance: 152
 Thick/Height: 24
 0003502105, 0003504605



DB-SB-5270

Ø: 54
 Thick/Height: 47
 01328700A, 99902538



DB-SB-5312

Length: 100
 Ø: 97
 Thick/Height: 40
 01330000A, 3173330964, 3173331164,
 3173331164S



DB-SB-10385

Ø: 30 Thick/Height: 30
 3093200073, 3143260153



DB-SB-10407

Ø: 61 Thick/Height: 46
 0003235985, 0003262481, 0003262981



ME-AX-2734

Length: 1236
 Ø: 35
 Cone Ø: d1 Ø 18 / d2 Ø 16,2
 6314600705



ME-AX-2735

Length: 300
 Ø: 26
 Cone Ø: d1 Ø 20 / d2 Ø 18,2
 6313300503



ME-ES-1760

Length: 92
 Cone Ø: d1 Ø 18,2 / d2 Ø 16,2
 Thread: M18 x 1,5 LHT
 0004606548, 6313300310, 6313380310



MN-DL-7834

Length: 1588 Ø: 58
 Cone Ø: d1 Ø 30 / d2 Ø 27
 3463303903, 3463304903, 6253303203,
 9443300503, 9443301303, 9443301703



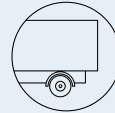

O 302

0 302	11/64→11/75	Tie Bar Bush	DB-SB-5312	DB-SB-5312	
	11/64→11/75	Tie Rod End	DB-ES-2558		
	11/64→11/75	Tie Rod End	DB-ES-2559		

O 303

0 303	10/74→06/83	Tie Bar Bush	DB-SB-5312	DB-SB-5312	
	10/74→09/92	Tie Rod End	CV-ES-12461		for Steering Rod
	10/74→09/92	Tie Rod End	DB-ES-0834		
	10/74→09/92	Tie Rod End	DB-ES-2558		
	10/74→09/92	Tie Rod End	DB-ES-2559		
	10/74→	Tie Rod End	CV-ES-12462		for Steering Rod
	01/80→09/92	Tie Bar Bush	DB-SB-5312		
09/87→09/92	Track Control Arm		DB-DL-3405	Trailing Arm	

O 305

0 305 G	02/78→05/87	Tie Bar Bush	DB-SB-5312	DB-SB-5312	
	02/78→05/87	Tie Rod End	DB-ES-2558		
	02/78→05/87	Tie Rod End	DB-ES-2559		
0 305 ST	01/69→05/87	Tie Bar Bush	DB-SB-5312	DB-SB-5312	
	01/69→05/87	Tie Rod End	DB-ES-2558		
	01/69→05/87	Tie Rod End	DB-ES-2559		
	04/73→05/87	Stabiliser Mounting	DB-SB-9302		* 0 047 201 *→
	04/73→05/87	Stabiliser Mounting	DB-SB-9302		* 0 047 240 *→
	04/73→05/87	Stabiliser Mounting	DB-SB-9302		1st FA

O 307

0 307	04/73→08/87	Stabiliser Mounting	DB-SB-9302		* 0 047 201 *→
	04/73→08/87	Stabiliser Mounting	DB-SB-9302		* 0 047 240 *→
	04/73→08/87	Stabiliser Mounting	DB-SB-9302		1st FA
	04/73→08/87	Tie Bar Bush	DB-SB-5312	DB-SB-5312	
	04/73→08/87	Tie Rod End	DB-ES-2558		
	04/73→08/87	Tie Rod End	DB-ES-2559		

O 309

0 309 B	01/68→02/89	Tie Rod	DB-DL-9143		
	01/68→02/89	Tie Rod End	DB-ES-2753		
	01/68→02/89	Tie Rod End	ME-ES-0643	ME-ES-0643	
0 309 D	01/68→12/88	Tie Rod End	ME-ES-0643	ME-ES-0643	
	01/68→02/89	Tie Rod	DB-DL-9143		
	01/68→02/89	Tie Rod End	DB-ES-2753		
	01/70→02/89	Stabiliser Mounting	DB-SB-10386	DB-SB-10386	
	01/70→02/89	Tie Rod End	DB-ES-2752		
	05/77→02/89	Stabiliser Mounting		DB-SB-10386	

O 317

0 317	01/66→01/76	Tie Bar Bush	DB-SB-5312	DB-SB-5312	
	01/66→01/76	Tie Rod End	DB-ES-2558		
	01/66→01/76	Tie Rod End	DB-ES-2559		

O 340

0 340	01/91→06/95	Stabiliser Mounting	DB-SB-9302		
	01/91→06/95	Stabiliser Mounting	DB-SB-9302		1st FA
	01/91→06/95	Tie Bar Bush		DB-SB-5312	
	01/91→06/95	Tie Bar Bush	DB-SB-5312		1st FA
	01/91→06/95	Track Control Arm		DB-DL-3405	Trailing Arm
	01/91→	Tie Rod End	CV-ES-12461		for Steering Rod
	01/91→	Tie Rod End	CV-ES-12462		for Steering Rod
	Tourismo	08/92→08/95	Stabiliser Mounting	DB-SB-9302	
08/92→08/95		Stabiliser Mounting	DB-SB-9302		1st FA
08/92→08/95		Tie Bar Bush		DB-SB-5312	
08/92→08/95		Tie Bar Bush	DB-SB-5312		1st FA
08/92→08/95		Tie Rod End	CV-ES-12461		for Steering Rod
08/92→08/95		Tie Rod End	CV-ES-12462		for Steering Rod
08/92→08/95		Track Control Arm		DB-DL-3405	Trailing Arm

CV-ES-12461

Length: 120

Cone Ø: d1 Ø 26 / d2 Ø 23,5

Thread: M30 x 1,5 LHT

0003300035, 3300148, 0003406213, 0013306635,
0013308835, 0014604048, 0014604348,
14606448, 0024600248, 3023300035,
3023300135, 3023300235, 3023300335,
3453307235, 3453307435, 3503307135,
A0003300148, A0013306635, A0013308835,
A0014604048, A0014604348, A0014606448,
A0024600248, A3023300035, A3023300135,
A3023300235, A3023300335, A3503307135



CV-ES-12462

Length: 120

Cone Ø: d1 Ø 26 / d2 Ø 23,5

Thread: M30 x 1,5 RHT

0003300135, 0003300248, 0003303235,
0003305835, 0003307335, 0003383410,
0004608348, 0004608348, 0004632229,
0004633129, 0004633429, 0004633529,
0013300135, 0013300235, 0013306735,
0014603448, 0014604148, 0014604448,
0014606348, 0014608348, 0014608448,
0014609748, 0023301535, 3453307135,
3503307035, 3503307335, 3643307135,
5001832582, A0003300248, A0003303235,
A0003307335, A0003383410, A0004608348,
A0004632229, A0004633429, A0013300135,
A0013300235, A0013306735, A0014603448,
A0014604148, A0014604448, A0014606348,
A0014608348, A0014608448, A0014609748,
A0023301535



DB-DL-3405

Length: 585

Ø: 56

3173500606, 3573303411



DB-DL-9143

Length: 1476

Ø: 40

Cone Ø: d1 Ø 18 / d2 Ø 16,2

3093301203, 3093301303, 3093301403,
3093301603, 3093301703, 3093301803,
3093301903, 3093302003, 3093302103



DB-ES-0834

Length: 101

Cone Ø: d1 Ø 22 / d2 Ø 20

Thread: M28 x 1,5 RHT

0003301435, 0003301535, 0003309335,
0003309535, 0023301135



DB-ES-2558

Length: 150

Cone Ø: d1 Ø 26 / d2 Ø 23,5

Thread: M35 x 1,5 RHT

0003384929, 0013302635



DB-ES-2559

Length: 150

Cone Ø: d1 Ø 26 / d2 Ø 23,5

Thread: M35 x 1,5 LHT

0003302935, 0003304135



DB-ES-2752

Length: 160

Cone Ø: d1 Ø 18 / d2 Ø 16,2

Thread: M24 x 1,5 RHT

0003302735, 0003307035



DB-ES-2753

Length: 160

Cone Ø: d1 Ø 18 / d2 Ø 16,2

Thread: M24 x 1,5 LHT

0003302635, 0003306935



DB-SB-5312

Length: 100

Ø: 97

Thick/Height: 40

01330000A, 3173330964, 3173331164,
3173331164S



DB-SB-9302

Ø: 82

Thick/Height: 80

3013260081



DB-SB-10386

Ø: 38

Thick/Height: 38

3183200073



ME-ES-0643

Length: 92

Cone Ø: d1 Ø 18 / d2 Ø 16,2

Thread: M22 x 1,5 RHT

0003305035, 3305035, 0004602148, 4602148,
4604148, 4604548, 4608548, 3103300435,
3103301335





O 402

O 402	02/86→12/91	Stabiliser Mounting		DB-SB-5270	
	02/86→12/91	Stabiliser Mounting	DB-SB-10385	DB-SB-10385	
	02/86→12/91	Tie Bar Bush		DB-SB-5312	
	02/86→12/91	Tie Rod End	CV-ES-12461		for Steering Rod

O 403

O 403 SHD	01/03→	Centre Rod	DB-DL-12375		for Steering Rod
	09/03→	Tie Rod	DB-DL-8728		
	09/03→	Tie Rod	DB-DL-9211		
	09/03→	Track Control Arm	DB-VB-3700		Control Arm
	09/03→	Track Control Arm	DB-VB-3701		Control Arm
	09/03→	Track Control Arm	DB-VB-3702		Control Arm

O 404

O 404		Centre Rod	DB-DL-12375		for Steering Rod
		Tie Rod End	CV-ES-12461		for Steering Rod
		Tie Rod End	CV-ES-12462		for Steering Rod
	09/91→01/92	Track Control Arm	DB-VB-3701		Control Arm
	09/91→10/99	Ball Joint	DB-ES-7782		Push Rod
	09/91→10/99	Ball Joint	DB-ES-7782		Push Rod, 1st FA
	09/91→10/99	Centre Rod	DB-DL-7775		Push Rod
	09/91→10/99	Drag Link End	DB-ES-7783	DB-ES-7783	
	09/91→10/99	Drag Link End	DB-ES-7784	DB-ES-7784	
	09/91→10/99	Suspension Arm Repair Kit		DB-RK-8635	for Drag Link
	09/91→10/99	Suspension Arm Repair Kit	DB-RK-8674		for Wishbone (CV)
	09/91→10/99	Suspension Arm Repair Kit	DB-RK-8674		for Wishbone (CV), 1st FA
	09/91→10/99	Tie Rod	DB-DL-8728		
	09/91→10/99	Tie Rod	DB-DL-9211		
	09/91→10/99	Track Control Arm		DB-VB-3702	Control Arm
	09/91→10/99	Track Control Arm	DB-VB-3700		Control Arm
	09/91→10/99	Track Control Arm	DB-VB-3701	DB-VB-3701	Wishbone (CV);Trailing Arm
	09/91→10/99	Track Control Arm	DB-VB-3701	DB-VB-3701	Wishbone (CV);Trailing Arm, 1st FA

O 405

O 405 G,O 405 GN,O 405 GTD	11/85→	Centre Rod	CV-DL-0546		Push Rod
	11/85→	Centre Rod	DB-DL-3228		Push Rod
	11/85→	Centre Rod	DB-DL-7775		Push Rod
	11/85→	Centre Rod	DB-DL-7775		Push Rod→* 0 079 427 *
	11/85→	Centre Rod	DB-DL-7795		Push Rod
	11/85→	Centre Rod	DB-DL-9188		Push Rod
	11/85→	Centre Rod	DB-DL-9188		Push Rod* 0 079 428 *→
	11/85→	Centre Rod	MN-DL-7786		Push Rod
	11/85→	Centre Rod	MN-DL-7786		Push Rod→* 0 079 427 *
	11/85→	Suspension Arm	DB-DL-3461		Push Rod
	11/85→	Suspension Arm	DB-DL-3461		Push Rod* 0 079 428 *→
	11/85→	Suspension Arm Repair Kit		DB-RK-8725	for Drag Link
	11/85→	Suspension Arm Repair Kit		DB-RK-9262	for Drag Link
	11/85→	Suspension Arm Repair Kit		DF-RK-8503	for Control Arm→* 0 079 427 *
	11/85→	Suspension Arm Repair Kit		MN-RK-7280	for Drag Link
	11/85→	Suspension Arm Repair Kit	DB-RK-9262	DB-RK-9262	for Drag Link
	11/85→	Suspension Arm Repair Kit	DF-RK-8503	DF-RK-8503	for Control Arm, 1st FA
	11/85→	Suspension Arm Repair Kit	MN-RK-9392		for Control Arm, 1st FA
	11/85→	Suspension Arm Repair Kit	MN-RK-9392		for Control Arm→* 0 079 427 *
	11/85→	Tie Bar Bush	DB-SB-5312	DB-SB-5312	
	11/85→	Tie Rod End	CV-ES-12462		for Steering Rod
	11/85→	Tie Rod End	MN-ES-8611		
	11/85→	Tie Rod End	MN-ES-8611		→* 0 079 427 *
	11/85→	Track control arm		CV-TC-12384	Push Rod, Trailing Arm, 1st RA, 70876→
	11/85→	Track Control Arm		DB-DL-3405	Trailing Arm
	11/85→	Track Control Arm		MN-DL-7797	Suspension Rod, Control Arm;Trailing Arm
	11/85→	Track Control Arm	DB-DL-8652	DB-DL-8652	Suspension Rod, Trailing Arm
	11/85→	Track Control Arm	DB-DL-9275	DB-DL-9275	Trailing Arm
	11/85→	Track Control Arm	DB-DL-9275	DB-DL-9275	Trailing Arm* 0 079 428 *→

CV-DL-0546

Length: 990 Ø: 36
 Cone Ø: d1 Ø 26 / d2 Ø 23,5
 3574601005, 3574601105

**CV-ES-12461**

Length: 120
 Cone Ø: d1 Ø 26 / d2 Ø 23,5
 Thread: M30 x 1,5 LHT
 0003300135, 3300148, 0003406213, 0013306635,
 0013308835, 0014604048, 0014604348,
 14606448, 0024600248, 3023300035,
 3023300135, 3023300235, 3023300335,
 3453307235, 3453307435, 3503307135,
 A0003300148, A0013306635, A0013308835,
 A0014604048, A0014604348, A0014606448,
 A0024600248, A3023300035, A3023300135,
 A3023300235, A3023300335, A3503307135

**CV-ES-12462**

Length: 120
 Cone Ø: d1 Ø 26 / d2 Ø 23,5
 Thread: M30 x 1,5 RHT
 0003300135, 0003300248, 0003303235,
 0003305835, 0003307335, 0003383410,
 0004608348, 004608348, 0004632229,
 0004633129, 0004633429, 0004633529,
 0013300135, 0013300235, 0013306735,
 0014603448, 0014604148, 0014604448,
 0014606348, 0014608348, 0014608448,
 0014609748, 0023301535, 3453307135,
 3503307035, 3503307335, 3643307135,
 5001832582, A0003300248, A0003303235,
 A0003307335, A0003383410, A0004608348,
 A0004632229, A0004633429, A0013300135,
 A0013300235, A0013306735, A0014603448,
 A0014604148, A0014604448, A0014606348,
 A0014608348, A0014608448, A0014609748,
 A0023301535

**CV-TC-12384**

Length: 585 Ø: 56
 Hole Distance: 130
 3573500306

**DB-DL-3228**

Length: 1066 Ø: 40
 Cone Ø: d1 Ø 26 / d2 Ø 23,5
 01217600A, 3574601405, 3574601505

**DB-DL-3405**

Length: 585 Ø: 56
 3173500606, 3573303411

**DB-DL-3461**

Length: 625 Ø: 36
 Hole Distance: 90 / 90
 3573330405, 6713330105, A6713330105

**DB-DL-7775**

Length: 1000 Ø: 38
 Cone Ø: d1 Ø 26 / d2 Ø 23,5
 4254600105, 4254600205, 4254600305,
 4254600405, 4374600105, 4524600405

**DB-DL-7795**

Length: 920 Ø: 36
 Cone Ø: d1 Ø 30 / d2 Ø 27
 3574603205

**DB-DL-8652**

Length: 713 Ø: 56
 Hole Distance: 130 / 130
 3573301911, 3573303311

**DB-DL-8728**

Length: 506 Ø: 30
 Cone Ø: d1 Ø 30 / d2 Ø 27
 3563300103, 6133300103

**DB-DL-9188**

Length: 1160 Ø: 38
 Cone Ø: d1 Ø 30 / d2 Ø 27
 3574603105

**DB-DL-9211**

Length: 697 Ø: 32
 Cone Ø: d1 Ø 30 / d2 Ø 27
 3563300003, 6133300003

**DB-DL-9275****DB-DL-12375**

Length: 1708 Ø: 56
 Cone Ø: d1 Ø 30 / d2 Ø 27
 3564630015, 6134630015

**DB-ES-7782**

Length: 120
 Cone Ø: d1 Ø 26 / d2 Ø 23,5
 Thread: M24 x 1,5 RHT
 3300827, 0003300827, 0003330827, 3330827

**DB-ES-7783**

Length: 125
 Cone Ø: d1 Ø 30 / d2 Ø 27
 Thread: M24 x 1,5 RHT
 0004607748, 4607748, 0014602148, 14602148

**DB-ES-7784**

Length: 125
 Cone Ø: d1 Ø 30 / d2 Ø 27
 Thread: M24 x 1,5 LHT
 0004607848, 4607848, 0014602048, 14602048

**DB-RK-8635**

Ø: 75
 Hole Distance: 130
 Thick/Height: 24
 0003501305, 3501305

**DB-RK-8674**

Ø: 67
 Hole Distance: 115
 Thick/Height: 24
 0003501005, 3501005

**DB-RK-8725**

Ø: 87
 Thick/Height: 70
 0003301611, 3301611

**DB-RK-9262**

Ø: 87
 Hole Distance: 130
 Thick/Height: 30
 0003300080, 3300080

**DB-SB-5270**

Ø: 54
 Thick/Height: 47
 01328700A, 99902538

**DB-SB-5312**

Length: 100
 Ø: 97
 Thick/Height: 40
 01330000A, 3173330964, 3173331164,
 3173331164S

**DB-SB-10385**

Ø: 30 Thick/Height: 30
 3093200073, 3143260153

**DB-VB-3700**

Length: 800 Ø: 48
 Hole Distance: 126 / 126
 3563301510, 6133300110

**DB-VB-3701**

Length: 901 Ø: 48
 Hole Distance: 126 / 126
 3563301410, 6133300010

**DB-VB-3702**

Length: 507 Ø: 46
 Hole Distance: 115 / 115
 3563331304, 6133330004, 6133330104

**DF-RK-8503**

Ø: 75
 Hole Distance: 130
 Thick/Height: 24
 0003300207, 3300207

**MN-DL-7786**

Length: 1245
 Ø: 60
 Cone Ø: d1 Ø 30
 81466106375, 81466106684, 81466116016,
 3574602005, 3574602305

**MN-DL-7797**

Length: 750
 Ø: 48
 Hole Distance: 130 / 130
 81432206099, 81432206100, 3573330205

**MN-ES-8611****MN-RK-7280**

Ø: 75
 Hole Distance: 115
 Thick/Height: 24
 689748, 0003300707, 3300707

**MN-RK-9392**

Ø: 85
 Thick/Height: 250
 0003300107, 3300107





O 405 ...

O 405 G, O 405 GN, O 405 GTD,
O 405 GNTD, O 405 GNDE

	09/91→	Centre Rod	CV-DL-0546		Push Rod
	09/91→	Centre Rod	DB-DL-3228		Push Rod
	09/91→	Centre Rod	DB-DL-7775		Push Rod
	09/91→	Centre Rod	DB-DL-7775		Push Rod→* 0 079 427 *
	09/91→	Centre Rod	DB-DL-7795		Push Rod
	09/91→	Centre Rod	DB-DL-9188		Push Rod
	09/91→	Centre Rod	DB-DL-9188		Push Rod* 0 079 428 *→
	09/91→	Centre Rod	MN-DL-7786		Push Rod
	09/91→	Centre Rod	MN-DL-7786		Push Rod→* 0 079 427 *
	09/91→	Suspension Arm	DB-DL-3461		Push Rod
	09/91→	Suspension Arm	DB-DL-3461		Push Rod* 0 079 428 *→
	09/91→	Suspension Arm Repair Kit		DB-RK-8725	for Drag Link
	09/91→	Suspension Arm Repair Kit		DB-RK-9262	for Drag Link
	09/91→	Suspension Arm Repair Kit		DF-RK-8503	for Control Arm→* 0 079 427 *
	09/91→	Suspension Arm Repair Kit		MN-RK-7280	for Drag Link
	09/91→	Suspension Arm Repair Kit	DB-RK-9262	DB-RK-9262	for Drag Link
	09/91→	Suspension Arm Repair Kit	DF-RK-8503	DF-RK-8503	for Control Arm, 1st FA
	09/91→	Suspension Arm Repair Kit	MN-RK-9392		for Control Arm, 1st FA
	09/91→	Suspension Arm Repair Kit	MN-RK-9392		for Control Arm→* 0 079 427 *
	09/91→	Tie Bar Bush	DB-SB-5312	DB-SB-5312	
	09/91→	Tie Rod End	MN-ES-8611		
	09/91→	Tie Rod End	MN-ES-8611		→* 0 079 427 *
	09/91→	Track control arm		CV-TC-12384	Push Rod, Trailing Arm, 1st RA, 70876→
	09/91→	Track Control Arm		DB-DL-3405	Trailing Arm
	09/91→	Track Control Arm		MN-DL-7797	Suspension Rod, Control Arm; Trailing Arm
	09/91→	Track Control Arm	DB-DL-8652	DB-DL-8652	Suspension Rod, Trailing Arm
	09/91→	Track Control Arm	DB-DL-9275	DB-DL-9275	Trailing Arm
	09/91→	Track Control Arm	DB-DL-9275	DB-DL-9275	Trailing Arm* 0 079 428 *→
O 405 G, O 405 GTD	01/86→	Centre Rod	CV-DL-0546		Push Rod
	01/86→	Centre Rod	DB-DL-3228		Push Rod
	01/86→	Suspension Arm Repair Kit		DB-RK-8725	for Drag Link
	01/86→	Tie Bar Bush	DB-SB-5312	DB-SB-5312	
	01/86→	Tie Rod End	CV-ES-12462		for Steering Rod
	01/86→	Track control arm		CV-TC-12384	Push Rod, Trailing Arm, 1st RA, 70876→
	01/86→	Track Control Arm		DB-DL-3405	Trailing Arm
	01/86→	Track Control Arm	DB-DL-8652	DB-DL-8652	Suspension Rod, Trailing Arm
O 405 GT	11/91→	Track control arm		CV-TC-12384	Push Rod, Trailing Arm, 1st RA, 70876→
	11/91→	Track control arm		CV-TC-12384	Push Rod, Trailing Arm, Drive Axle, 70876→
O 405 GTZ		Track control arm		CV-TC-12384	Push Rod, Trailing Arm, 1st RA, 70876→
		Track control arm		CV-TC-12384	Push Rod, Trailing Arm, Drive Axle, 70876→
O 405 N, O 405 NH	11/85→	Track control arm		CV-TC-12384	Push Rod, Trailing Arm, Drive Axle, 70876→
O 405 ST	11/85→	Centre Rod	CV-DL-0546		Push Rod
	11/85→	Centre Rod	DB-DL-3228		Push Rod
	11/85→	Suspension Arm Repair Kit		DB-RK-8725	for Drag Link
	11/85→	Tie Bar Bush	DB-SB-5312	DB-SB-5312	
	11/85→	Tie Rod	DB-DL-9211		
	11/85→	Tie Rod End	DB-ES-2558		
	11/85→	Tie Rod End	DB-ES-2559		
	11/85→	Track control arm		CV-TC-12384	Push Rod, Trailing Arm 70876→
	11/85→	Track Control Arm		DB-DL-3405	Trailing Arm
	11/85→	Track Control Arm	DB-DL-8652	DB-DL-8652	Suspension Rod, Trailing Arm
O 405 ST, O 405 N	12/84→	Centre Rod	CV-DL-0546		Push Rod
	12/84→	Centre Rod	DB-DL-3228		Push Rod
	12/84→	Centre Rod	DB-DL-7775		Push Rod
	12/84→	Centre Rod	DB-DL-7775		Push Rod→* 0 079 427 *
	12/84→	Centre Rod	DB-DL-7795		Push Rod
	12/84→	Centre Rod	DB-DL-9188		Push Rod
	12/84→	Centre Rod	DB-DL-9188		Push Rod* 0 079 428 *→
	12/84→	Centre Rod	MN-DL-7786		Push Rod
	12/84→	Centre Rod	MN-DL-7786		Push Rod→* 0 079 427 *
	12/84→	Suspension Arm	DB-DL-3461		Push Rod
	12/84→	Suspension Arm Repair Kit		DB-RK-8725	for Drag Link
	12/84→	Suspension Arm Repair Kit		DF-RK-8503	for Control Arm→* 0 079 427 *

CV-DL-0546

Length: 990
Ø: 36
Cone Ø: d1 Ø 26 / d2 Ø 23,5
3574601005, 3574601105



CV-ES-12462

Length: 120
Cone Ø: d1 Ø 26 / d2 Ø 23,5
Thread: M30 x 1,5 RHT
0003300135, 0003300248, 00033003235,
00033005835, 00033007335, 0003383410,
0004608348, 0004608348, 0004632229,
0004633129, 0004633429, 0004633529,
0013300135, 0013300235, 0013306735,
0014603448, 0014604148, 0014604448,
0014606348, 0014608348, 0014608448,
0014609748, 0023301535, 3453307135,
3503307035, 3503307335, 3643307135,
5001832582, A0003300248, A0003303235,
A0003307335, A0003383410, A0004608348,
A0004632229, A0004633429, A0013300135,
A0013300235, A0013306735, A0014603448,
A0014604148, A0014604448, A0014606348,
A0014608348, A0014608448, A0014609748,
A0023301535



CV-TC-12384

Length: 585
Ø: 56
Hole Distance: 130
3573500306



DB-DL-3228

Length: 1066
Ø: 40
Cone Ø: d1 Ø 26 / d2 Ø 23,5
01217600A, 3574601405, 3574601505



DB-DL-3405

Length: 585
Ø: 56
3173500606, 3573303411



DB-DL-3461

Length: 625
Ø: 36
Hole Distance: 90 / 90
3573330405, 6713330105, A6713330105



DB-DL-7775

Length: 1000
Ø: 38
Cone Ø: d1 Ø 26 / d2 Ø 23,5
4254600105, 4254600205, 4254600305,
4254600405, 4374600105, 4524600405



DB-DL-7795

Length: 920
Ø: 36
Cone Ø: d1 Ø 30 / d2 Ø 27
3574603205



DB-DL-8652

Length: 713
Ø: 56
Hole Distance: 130 / 130
3573301911, 3573303311



DB-DL-9188

Length: 1160
Ø: 38
Cone Ø: d1 Ø 30 / d2 Ø 27
3574603105



DB-DL-9211

Length: 697
Ø: 32
Cone Ø: d1 Ø 30 / d2 Ø 27
3563300003, 6133300003



DB-DL-9275



DB-ES-2558

Length: 150
Cone Ø: d1 Ø 26 / d2 Ø 23,5
Thread: M35 x 1,5 RHT
0003384929, 0013302635



DB-ES-2559

Length: 150
Cone Ø: d1 Ø 26 / d2 Ø 23,5
Thread: M35 x 1,5 LHT
0003302935, 0003304135



DB-RK-8725

Ø: 87
Thick/Height: 70
0003301611, 3301611



DB-RK-9262

Ø: 87
Hole Distance: 130
Thick/Height: 30
0003300080, 3300080



DB-SB-5312

Length: 100
Ø: 97
Thick/Height: 40
01330000A, 317330964, 3173331164,
3173331164S



DF-RK-8503

Ø: 75
Hole Distance: 130
Thick/Height: 24
0003300207, 3300207



MN-DL-7786

Length: 1245
Ø: 60
Cone Ø: d1 Ø 30
81466106375, 81466106684, 81466116016,
3574602005, 3574602305



MN-DL-7797

Length: 750
Ø: 48
Hole Distance: 130 / 130
81432206099, 81432206100, 3573330205



MN-ES-8611



MN-RK-7280

Ø: 75
Hole Distance: 115
Thick/Height: 24
689748, 0003300707, 3300707



MN-RK-9392

Ø: 85
Thick/Height: 250
0003300107, 3300107



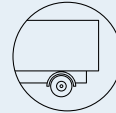

O 405 ...

0 405 ST,0 405 N ...	12/84→	Suspension Arm Repair Kit		MN-RK-7280	for Drag Link
	12/84→	Suspension Arm Repair Kit	DB-RK-9262	DB-RK-9262	for Drag Link
	12/84→	Suspension Arm Repair Kit	DF-RK-8503	DF-RK-8503	for Control Arm, 1st FA
	12/84→	Suspension Arm Repair Kit	MN-RK-9392		for Control Arm
	12/84→	Suspension Arm Repair Kit	MN-RK-9392		for Control Arm, 1st FA
	12/84→	Suspension Arm Repair Kit	MN-RK-9392		for Control Arm→* 0 079 427 *
	12/84→	Tie Bar Bush	DB-SB-5312		
	12/84→	Tie Bar Bush	DB-SB-5312		1st FA
	12/84→	Tie Rod End	MN-ES-8611		
	12/84→	Tie Rod End	MN-ES-8611		→* 0 079 427 *
	12/84→	Track control arm		CV-TC-12384	Push Rod, Trailing Arm70876→
	12/84→	Track Control Arm		DB-DL-3405	Trailing Arm
	12/84→	Track Control Arm		MN-DL-7797	Suspension Rod, Control Arm;Trailing Arm
	12/84→	Track Control Arm	DB-DL-8652	DB-DL-8652	Suspension Rod, Trailing Arm
	12/84→	Track Control Arm	DB-DL-9275	DB-DL-9275	Trailing Arm

O 407

0 407	03/87→11/01	Centre Rod	DB-DL-3228		Push Rod
	03/87→11/01	Suspension Arm	DB-DL-3461		Push Rod
	03/87→11/01	Suspension Arm Repair Kit		DB-RK-8725	for Drag Link
	03/87→11/01	Suspension Arm Repair Kit	DB-RK-9262	DB-RK-9262	for Drag Link
	03/87→11/01	Tie Bar Bush	DB-SB-5312		
	03/87→11/01	Tie Bar Bush	DB-SB-5312		1st FA
	03/87→11/01	Tie Rod End	DB-ES-2558		
	03/87→11/01	Tie Rod End	DB-ES-2559		
	03/87→11/01	Track control arm		CV-TC-12384	Push Rod, Trailing Arm70876→
	03/87→11/01	Track Control Arm		DB-DL-3405	Trailing Arm
	03/87→11/01	Track Control Arm	DB-DL-8652	DB-DL-8652	Suspension Rod, Trailing Arm

O 408

0 408	01/91→12/98	Centre Rod	DB-DL-3228		Push Rod
	01/91→12/98	Suspension Arm	DB-DL-3461		Push Rod
	01/91→12/98	Suspension Arm Repair Kit		DB-RK-8725	for Drag Link
	01/91→12/98	Suspension Arm Repair Kit	DB-RK-9262	DB-RK-9262	for Drag Link
	01/91→12/98	Tie Bar Bush	DB-SB-5312		
	01/91→12/98	Tie Bar Bush	DB-SB-5312		1st FA
	01/91→12/98	Tie Rod End	DB-ES-2558		
	01/91→12/98	Tie Rod End	DB-ES-2559		
	01/91→12/98	Track control arm		CV-TC-12384	Push Rod, Trailing Arm70876→
	01/91→12/98	Track Control Arm		DB-DL-3405	Trailing Arm
	01/91→12/98	Track Control Arm	DB-DL-8652	DB-DL-8652	Suspension Rod, Trailing Arm

OH Series

1525	01/70→	Tie Rod End	RV-ES-12331		
------	--------	-------------	--------------------	--	--

SK

1728, 1729, 1729 L	07/87→09/96	Ball Head, gearshift linkage	DB-ES-8387		
	07/87→09/96	Ball Head, gearshift linkage	DB-ES-8491		
	07/87→09/96	Ball Head, gearshift linkage	DB-ES-8492		
	07/87→09/96	Ball Head, gearshift linkage	DB-ES-8500		
	07/87→09/96	Centre Rod	DB-DL-5217		Push Rod
	07/87→09/96	Centre Rod	DB-DL-7831		Push Rod
	07/87→09/96	Centre Rod	DB-DL-8131		Push Rod
	07/87→09/96	Centre Rod	DB-DL-8138		Push Rod
	07/87→09/96	Centre Rod	DB-DL-8618		Push Rod
	07/87→09/96	Centre Rod	DB-DL-10216		Push Rod
	07/87→09/96	Centre Rod	DB-DL-12308		Coupling Rod
	07/87→09/96	Centre Rod	DB-DL-12309		Coupling Rod
	07/87→09/96	Suspension Arm Repair Kit		DB-RK-12372	for Wishbone (CV)K063070→
	07/87→09/96	Suspension Arm Repair Kit		DF-RK-9336	
	07/87→09/96	Suspension Arm Repair Kit		DF-RK-9336	* K 063 070 *→
	07/87→09/96	Suspension Arm Repair Kit	DB-RK-5280		
	07/87→09/96	Suspension Arm Repair Kit	DB-RK-5282		
	07/87→09/96	Tie Rod	DB-DL-8640		Guide Rod
	07/87→09/96	Tie Rod	DB-ES-5209		

CV-TC-12384

Length: 585
 Ø: 56
 Hole Distance: 130
 3573500306

**DB-DL-3228**

Length: 1066
 Ø: 40
 Cone Ø: d1 Ø 26 / d2 Ø 23,5
 01217600A, 3574601405, 3574601505

**DB-DL-3405**

Length: 585
 Ø: 56
 3173500606, 3573303411

**DB-DL-3461**

Length: 625
 Ø: 36
 Hole Distance: 90 / 90
 3573330405, 6713330105, A6713330105

**DB-DL-5217**

Length: 862 Ø: 40
 Cone Ø: d1 Ø 30 / d2 Ø 27
 01214700A, 6204600405, 6204600805,
 6204602905, 6204603005

**DB-DL-7831**

Length: 870
 Ø: 42
 Cone Ø: d1 Ø 30 / d2 Ø 27
 01215200A, 6254602505

**DB-DL-8131**

Length: 1115 Ø: 52
 Cone Ø: d1 Ø 32 / d2 Ø 28,8
 0004604405, 6254605005

**DB-DL-8138**

Length: 1130
 Ø: 40
 Cone Ø: d1 Ø 32 / d2 Ø 28,8
 0004606605, 4606605

**DB-DL-8618**

Length: 680
 Ø: 42
 Cone Ø: d1 Ø 32 / d2 Ø 28,8
 4604305, 0004604305, 6254604805

**DB-DL-8640**

Length: 1615 Ø: 50
 Cone Ø: d1 Ø 32 / d2 Ø 29
 6253301503, 6253301603, 6253302403,
 6253302503, 9423300803, 9423302103,
 9493300203, 9493300303, 9493300903

**DB-DL-8652**

Length: 713
 Ø: 56
 Hole Distance: 130 / 130
 3573301911, 3573303311

**DB-DL-9275****DB-DL-10216**

Length: 1190
 Ø: 40
 Cone Ø: d1 Ø 32 / d2 Ø 29
 0004604905

**DB-DL-12308**

Length: 885
 Ø: 42
 Cone Ø: d1 Ø 30 / d2 Ø 27
 0004600705, 4600705

**DB-DL-12309**

Length: 685 Ø: 40
 Cone Ø: d1 Ø 32 / d2 Ø 28,8
 0004606005, 0004606305

**DB-ES-2558**

Length: 150
 Cone Ø: d1 Ø 26 / d2 Ø 23,5
 Thread: M35 x 1,5 RHT
 0003384929, 0013302635

**DB-ES-2559**

Length: 150
 Cone Ø: d1 Ø 26 / d2 Ø 23,5
 Thread: M35 x 1,5 LHT
 0003302935, 0003304135

**DB-ES-5209**

Length: 1670 Ø: 50
 Cone Ø: d1 Ø 30 / d2 Ø 27
 6203300503, 6203300603

**DB-ES-8387**

Length: 55
 Cone Ø: d1 Ø 10 / d2 Ø 10
 Thread: M14 x 1,5 RHT
 0009966845, 0009967045

**DB-ES-8491**

Length: 60
 Cone Ø: d1 Ø 10 / d2 Ø 10
 Thread: M12 x 1,75 LHT
 0009966745

**DB-ES-8492**

Length: 60
 Cone Ø: d1 Ø 10 / d2 Ø 10
 Thread: M12 x 1,75 RHT
 0009966645, 3752680189, A3752680189

**DB-ES-8500**

Length: 55
 Cone Ø: d1 Ø 12 / d2 Ø 10,8
 Thread: M14 x 1,5 RHT
 0002685989

**DB-RK-5280**

Ø: 86
 01303000A, 6213200428

**DB-RK-5282**

Ø: 59
 01303800A, 6553200111

**DB-RK-8725**

Ø: 87
 Thick/Height: 70
 0003301611, 3301611

**DB-RK-9262**

Ø: 87
 Hole Distance: 130
 Thick/Height: 30
 0003300080, 3300080

**DB-RK-12372**

Ø: 85
 Hole Distance: 152
 Thick/Height: 24
 003501805, A003501805

**DB-SB-5312**

Length: 100
 Ø: 97
 Thick/Height: 40
 01330000A, 3173330964, 3173331164,
 3173331164S

**DF-RK-8503**

Ø: 75
 Hole Distance: 130
 Thick/Height: 24
 0003300207, 3300207

**DF-RK-9336**

Ø: 108
 0003501705, 3501705

**MN-DL-7797**

Length: 750
 Ø: 48
 Hole Distance: 130 / 130
 81432206099, 81432206100, 3573330205

**MN-ES-8611****MN-RK-7280**

Ø: 75
 Hole Distance: 115
 Thick/Height: 24
 689748, 0003300707, 3300707

**MN-RK-9392**

Ø: 85
 Thick/Height: 250
 0003300107, 3300107

**RV-ES-12331**

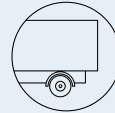

SK ...

1728, 1729, 1729 L ...	07/87→09/96	Tie Rod	DB-ES-5227		Guide Rod	
	07/87→09/96	Tie Rod End	CV-ES-12461		for Steering Rod	
	07/87→09/96	Tie Rod End	CV-ES-14163		for Steering Rod	
	07/87→09/96	Track Control Arm		DB-DL-7840	Suspension Rod, Trailing Arm	
	07/87→09/96	Track Control Arm		DB-DL-7840	Suspension Rod, Trailing Arm* 5 922 799 *→	
	07/87→09/96	Track Control Arm		DB-VB-7776	Wishbone (CV);Trailing Arm* 5 926 393 *→	
1729 AK	07/88→09/93	Centre Rod	DB-DL-5217		Push Rod	
	07/88→09/93	Centre Rod	DB-DL-10216		Push Rod	
	07/88→09/93	Suspension Arm Repair Kit		DB-RK-10378		
	07/88→09/93	Tie Rod	DB-ES-5227		Guide Rod	
	07/88→09/93	Tie Rod	MN-DL-7834		Guide Rod	
	07/88→09/93	Tie Rod End	CV-ES-12461		for Steering Rod	
1729 K	07/88→08/94	Centre Rod	DB-DL-5217		Push Rod	
	07/88→08/94	Centre Rod	DB-DL-7831		Push Rod	
	07/88→08/94	Centre Rod	DB-DL-7831		Push Rod* K 189 672 *→	
	07/88→08/94	Centre Rod	DB-DL-8131		Push Rod	
	07/88→08/94	Centre Rod	DB-DL-8138		Push Rod	
	07/88→08/94	Centre Rod	DB-DL-8618		Push Rod	
	07/88→08/94	Centre Rod	DB-DL-12309		Coupling Rod	
	07/88→08/94	Stabiliser Mounting	DB-SB-5258	DB-SB-5258		
	07/88→08/94	Suspension Arm Repair Kit		DB-RK-10378		
	07/88→08/94	Suspension Arm Repair Kit	DB-RK-5283			
	07/88→08/94	Tie Rod	DB-DL-8640		Guide Rod	
	07/88→08/94	Tie Rod	DB-ES-5209			
	07/88→08/94	Tie Rod	DB-ES-5227		Guide Rod	
	07/88→08/94	Tie Rod End	CV-ES-12461		for Steering Rod	
	07/88→08/94	Tie Rod End	CV-ES-14163		for Steering Rod	
	1729 S,1729 LS	07/87→09/96	Centre Rod	DB-DL-5217		Push Rod
		07/87→09/96	Centre Rod	DB-DL-7831		Push Rod
		07/87→09/96	Centre Rod	DB-DL-7831		Push Rod* K 189 672 *→
		07/87→09/96	Centre Rod	DB-DL-8131		Push Rod
07/87→09/96		Centre Rod	DB-DL-8138		Push Rod	
07/87→09/96		Centre Rod	DB-DL-8618		Push Rod	
07/87→09/96		Suspension Arm Repair Kit		CV-RK-8118	for Drag Link	
07/87→09/96		Suspension Arm Repair Kit		DB-RK-8564	Wishbone (CV)	
07/87→09/96		Suspension Arm Repair Kit		DB-RK-10378		
07/87→09/96		Suspension Arm Repair Kit		DB-RK-12372	for Wishbone (CV)K063070→	
07/87→09/96		Suspension Arm Repair Kit		DF-RK-9336		
07/87→09/96		Suspension Arm Repair Kit		DF-RK-9336	* K 063 070 *→	
07/87→09/96		Suspension Arm Repair Kit	DB-RK-5280			
07/87→09/96		Suspension Strut Repair Kit		DF-RK-8671		
07/87→09/96		Tie Rod	DB-DL-8640		Guide Rod	
07/87→09/96		Tie Rod	DB-ES-5209			
07/87→09/96		Tie Rod	DB-ES-5227		Guide Rod	
07/87→09/96		Tie Rod End	CV-ES-12461		for Steering Rod	
07/87→09/96		Tie Rod End	CV-ES-14163		for Steering Rod	
07/87→09/96		Track Control Arm		DB-DL-7840	Suspension Rod, Trailing Arm	
07/87→09/96		Track Control Arm		DB-VB-7776	Wishbone (CV);Trailing Arm* 5 926 393 *→	
1735 AK		08/89→08/94	Centre Rod	DB-DL-5217		Push Rod
	08/89→08/94	Centre Rod	DB-DL-10216		Push Rod	
	08/89→08/94	Suspension Arm Repair Kit		DB-RK-10378		
	08/89→08/94	Tie Rod	DB-ES-5227		Guide Rod	
	08/89→08/94	Tie Rod	MN-DL-7834		Guide Rod	
	08/89→08/94	Tie Rod End	CV-ES-12461		for Steering Rod	
1735 K	07/88→08/94	Centre Rod	DB-DL-5217		Push Rod	
	07/88→08/94	Centre Rod	DB-DL-7831		Push Rod	
	07/88→08/94	Centre Rod	DB-DL-7831		Push Rod* K 189 672 *→	
	07/88→08/94	Centre Rod	DB-DL-8131		Push Rod	
	07/88→08/94	Centre Rod	DB-DL-8138		Push Rod	
	07/88→08/94	Centre Rod	DB-DL-8618		Push Rod	
	07/88→08/94	Stabiliser Mounting	DB-SB-5258	DB-SB-5258		
	07/88→08/94	Suspension Arm Repair Kit		DB-RK-10378		
	07/88→08/94	Suspension Arm Repair Kit	DB-RK-5280			

CV-ES-12461

Length: 120
 Cone Ø: d1 Ø 26 / d2 Ø 23,5
 Thread: M30 x 1,5 LHT
 0003300035, 3300148, 0003406213, 0013306635,
 0013308835, 0014604048, 0014604348,
 14606448, 0024600248, 3023300035,
 3023300135, 3023300235, 3023300335,
 3453307235, 3453307435, 3503307135,
 A0003300148, A0013306635, A0013308835,
 A0014604048, A0014604348, A0014606448,
 A0024600248, A3023300035, A3023300135,
 A3023300235, A3023300335, A3503307135



CV-ES-14163

Length: 125
 Cone Ø: d1 Ø 30 / d2 Ø 27
 Thread: M30 x 1,5 RHT
 0003305248, 0003387310, 0004600348,
 0004600948, 0004602848, 0004602948,
 0004608948, 0014600248, 0014600848,
 0014601248, 0014602248, 0014607748,
 0024600148, A0003387310, A0004600348,
 A0004602848, A0004602948, A0014600848,
 A0014601248, A0014602248, A0014607748



CV-RK-8118

Ø: 85
 Hole Distance: 130
 Thick/Height: 30
 3500506, 0003500506



DB-DL-5217

Length: 862 Ø: 40
 Cone Ø: d1 Ø 30 / d2 Ø 27
 01214700A, 6204600405, 6204600805,
 6204602905, 6204603005



DB-DL-7831

Length: 870
 Ø: 42
 Cone Ø: d1 Ø 30 / d2 Ø 27
 01215200A, 6254602505



DB-DL-7840

Length: 595
 Ø: 62
 Hole Distance: 152 / 152
 6203500006, 6203500106, 6203500306,
 6553500306



DB-DL-8131

Length: 1115 Ø: 52
 Cone Ø: d1 Ø 32 / d2 Ø 28,8
 0004604405, 6254605005



DB-DL-8138

Length: 1130
 Ø: 40
 Cone Ø: d1 Ø 32 / d2 Ø 28,8
 0004606605, 4606605



DB-DL-8618

Length: 680
 Ø: 42
 Cone Ø: d1 Ø 32 / d2 Ø 28,8
 0004604305, 4604305, 6254604805



DB-DL-8640

Length: 1615 Ø: 50
 Cone Ø: d1 Ø 32 / d2 Ø 29
 6253301503, 6253301603, 6253302403,
 6253302503, 9423300803, 9423302103,
 9493300203, 9493300303, 9493300903



DB-DL-10216

Length: 1190
 Ø: 40
 Cone Ø: d1 Ø 32 / d2 Ø 29
 0004604905



DB-DL-12309

Length: 685 Ø: 40
 Cone Ø: d1 Ø 32 / d2 Ø 28,8
 0004606005, 0004606305



DB-ES-5209

Length: 1670 Ø: 50
 Cone Ø: d1 Ø 30 / d2 Ø 27
 6203300503, 6203300603



DB-ES-5227

Length: 1588 Ø: 60
 Cone Ø: d1 Ø 38 / d2 Ø 34,3
 6253300903, 6253301203, 9443300203



DB-RK-5280

Ø: 86
 01303000A, 6213200428



DB-RK-5283

Ø: 70
 01319900A, 6203200628



DB-RK-8564

Ø: 90
 01302200A, 0003500105, 3500105, 0003500405,
 3500405, 0005861833, 5861833, 81432706047



DB-RK-10378

Ø: 86
 6203200028



DB-RK-12372

Ø: 85
 Hole Distance: 152
 Thick/Height: 24
 003501805, A003501805



DB-SB-5258

Ø: 70
 Thick/Height: 62
 01311400A, 3873230285



DB-VB-7776

Length: 622 Ø: 56
 Hole Distance: 152 / 152
 6533500205, 6583500205



DF-RK-8671



DF-RK-9336

Ø: 108
 0003501705, 3501705



MN-DL-7834

Length: 1588 Ø: 58
 Cone Ø: d1 Ø 30 / d2 Ø 27
 3463303903, 3463304903, 6253303203,
 9443300503, 9443301303, 9443301703





SK ...

1735 K ...	07/88→08/94	Suspension Arm Repair Kit	DB-RK-5283	
	07/88→08/94	Tie Rod	DB-DL-8640	Guide Rod
	07/88→08/94	Tie Rod	DB-ES-5227	Guide Rod
	07/88→08/94	Tie Rod End	CV-ES-12461	for Steering Rod
	07/88→08/94	Tie Rod End	CV-ES-14163	for Steering Rod
1735 L	07/88→08/94	Ball Head, gearshift linkage	DB-ES-8387	
	07/88→08/94	Ball Head, gearshift linkage	DB-ES-8491	
	07/88→08/94	Ball Head, gearshift linkage	DB-ES-8492	
	07/88→08/94	Ball Head, gearshift linkage	DB-ES-8500	
	07/88→08/94	Centre Rod	DB-DL-5217	Push Rod
	07/88→08/94	Centre Rod	DB-DL-7831	Push Rod
	07/88→08/94	Centre Rod	DB-DL-8131	Push Rod
	07/88→08/94	Centre Rod	DB-DL-8138	Push Rod
	07/88→08/94	Centre Rod	DB-DL-8618	Push Rod
	07/88→08/94	Centre Rod	DB-DL-12308	Coupling Rod
	07/88→08/94	Centre Rod	DB-DL-12309	Coupling Rod
	07/88→08/94	Suspension Arm Repair Kit		DB-RK-12372 for Wishbone (CV)K063070→
	07/88→08/94	Suspension Arm Repair Kit		DF-RK-9336
	07/88→08/94	Suspension Arm Repair Kit		DF-RK-9336 * K 063 070 *→
	07/88→08/94	Suspension Arm Repair Kit	DB-RK-5280	
	07/88→08/94	Suspension Arm Repair Kit	DB-RK-5282	
	07/88→08/94	Tie Rod	DB-DL-8640	Guide Rod
	07/88→08/94	Tie Rod	DB-ES-5209	
	07/88→08/94	Tie Rod	DB-ES-5227	Guide Rod
	07/88→08/94	Tie Rod End	CV-ES-12461	for Steering Rod
	07/88→08/94	Tie Rod End	CV-ES-14163	for Steering Rod
	07/88→08/94	Track Control Arm		DB-DL-7840 Suspension Rod, Trailing Arm
	07/88→08/94	Track Control Arm		DB-DL-7840 Suspension Rod, Trailing Arm* 5 922 799 *→
07/88→08/94	Track Control Arm		DB-VB-7776 Wishbone (CV);Trailing Arm* 5 926 393 *→	
1735 S,1735 LS	07/87→09/96	Ball Head, gearshift linkage	DB-ES-8387	
	07/87→09/96	Ball Head, gearshift linkage	DB-ES-8491	
	07/87→09/96	Ball Head, gearshift linkage	DB-ES-8492	
	07/87→09/96	Ball Head, gearshift linkage	DB-ES-8500	
	07/87→09/96	Centre Rod	DB-DL-5217	Push Rod
	07/87→09/96	Centre Rod	DB-DL-7831	Push Rod
	07/87→09/96	Centre Rod	DB-DL-7831	Push Rod* K 189 672 *→
	07/87→09/96	Centre Rod	DB-DL-8131	Push Rod
	07/87→09/96	Centre Rod	DB-DL-8138	Push Rod
	07/87→09/96	Centre Rod	DB-DL-8618	Push Rod
	07/87→09/96	Centre Rod	DB-DL-12309	Coupling Rod
	07/87→09/96	Suspension Arm Repair Kit		CV-RK-8118 for Drag Link
	07/87→09/96	Suspension Arm Repair Kit		DB-RK-8564 Wishbone (CV)
	07/87→09/96	Suspension Arm Repair Kit		DB-RK-10378
	07/87→09/96	Suspension Arm Repair Kit		DB-RK-12372 for Wishbone (CV)K063070→
	07/87→09/96	Suspension Arm Repair Kit		DF-RK-9336
	07/87→09/96	Suspension Arm Repair Kit		DF-RK-9336 * K 063 070 *→
	07/87→09/96	Suspension Arm Repair Kit	DB-RK-5280	
	07/87→09/96	Suspension Strut Repair Kit		DF-RK-8671
	07/87→09/96	Tie Rod	DB-DL-8640	Guide Rod
	07/87→09/96	Tie Rod	DB-ES-5209	
	07/87→09/96	Tie Rod	DB-ES-5227	Guide Rod
	07/87→09/96	Tie Rod End	CV-ES-12461	for Steering Rod
	07/87→09/96	Tie Rod End	CV-ES-14163	for Steering Rod
	07/87→09/96	Track Control Arm		DB-DL-7840 Suspension Rod, Trailing Arm
	07/87→09/96	Track Control Arm		DB-VB-7776 Wishbone (CV);Trailing Arm* 5 926 393 *→
	1735,1735 L	07/87→09/96	Ball Head, gearshift linkage	DB-ES-8387
07/87→09/96		Ball Head, gearshift linkage	DB-ES-8491	
07/87→09/96		Ball Head, gearshift linkage	DB-ES-8492	
07/87→09/96		Ball Head, gearshift linkage	DB-ES-8500	
07/87→09/96		Centre Rod	DB-DL-5217	Push Rod
07/87→09/96		Centre Rod	DB-DL-5233	Push Rod* K 016 738 *→* K 033 740 *
07/87→09/96		Centre Rod	DB-DL-7831	Push Rod
07/87→09/96	Centre Rod	DB-DL-8131	Push Rod	

CV-ES-12461

Length: 120
 Cone Ø: d1 Ø 26 / d2 Ø 23,5
 Thread: M30 x 1,5 LHT
 0003300035, 3300148, 0003406213, 0013306635,
 0013308835, 0014604048, 0014604348,
 14606448, 0024600248, 3023300035,
 3023300135, 3023300235, 3023300335,
 3453307235, 3453307435, 3503307135,
 A0003300148, A0013306635, A0013308835,
 A0014604048, A0014604348, A0014606448,
 A0024600248, A3023300035, A3023300135,
 A3023300235, A3023300335, A3503307135



CV-ES-14163

Length: 125
 Cone Ø: d1 Ø 30 / d2 Ø 27
 Thread: M30 x 1,5 RHT
 0003305248, 0003387310, 0004600348,
 0004600948, 0004602848, 0004602948,
 0004608948, 0014600248, 0014600848,
 0014601248, 0014602248, 0014607748,
 0024600148, A0003387310, A0004600348,
 A0004602848, A0004602948, A0014600848,
 A0014601248, A0014602248, A0014607748



CV-RK-8118

Ø: 85
 Hole Distance: 130
 Thick/Height: 30
 0003500506, 3500506



DB-DL-5217

Length: 862 Ø: 40
 Cone Ø: d1 Ø 30 / d2 Ø 27
 01214700A, 6204600405, 6204600805,
 6204602905, 6204603005



DB-DL-5233

Length: 895
 Ø: 48
 Cone Ø: d1 Ø 30 / d2 Ø 27
 01217300A, 4609805, 0004609805, 0004609905,
 4609905



DB-DL-7831

Length: 870
 Ø: 42
 Cone Ø: d1 Ø 30 / d2 Ø 27
 01215200A, 6254602505



DB-DL-7840

Length: 595
 Ø: 62
 Hole Distance: 152 / 152
 6203500006, 6203500106, 6203500306,
 6553500306



DB-DL-8131

Length: 1115 Ø: 52
 Cone Ø: d1 Ø 32 / d2 Ø 28,8
 0004604405, 6254605005



DB-DL-8138

Length: 1130
 Ø: 40
 Cone Ø: d1 Ø 32 / d2 Ø 28,8
 0004606605, 4606605



DB-DL-8618

Length: 680
 Ø: 42
 Cone Ø: d1 Ø 32 / d2 Ø 28,8
 0004604305, 4604305, 6254604805



DB-DL-8640

Length: 1615 Ø: 50
 Cone Ø: d1 Ø 32 / d2 Ø 29
 6253301503, 6253301603, 6253302403,
 6253302503, 9423300803, 9423302103,
 9493300203, 9493300303, 9493300903



DB-DL-12308

Length: 885
 Ø: 42
 Cone Ø: d1 Ø 30 / d2 Ø 27
 0004600705, 4600705



DB-DL-12309

Length: 685 Ø: 40
 Cone Ø: d1 Ø 32 / d2 Ø 28,8
 0004606005, 0004606305



DB-ES-5209

Length: 1670 Ø: 50
 Cone Ø: d1 Ø 30 / d2 Ø 27
 6203300503, 6203300603



DB-ES-5227

Length: 1588 Ø: 60
 Cone Ø: d1 Ø 38 / d2 Ø 34,3
 6253300903, 6253301203, 9443300203



DB-ES-8387

Length: 55
 Cone Ø: d1 Ø 10 / d2 Ø 10
 Thread: M14 x 1,5 RHT
 0009966845, 0009967045



DB-ES-8491

Length: 60
 Cone Ø: d1 Ø 10 / d2 Ø 10
 Thread: M12 x 1,75 LHT
 0009966745



DB-ES-8492

Length: 60
 Cone Ø: d1 Ø 10 / d2 Ø 10
 Thread: M12 x 1,75 RHT
 0009966645, 3752680189, A3752680189



DB-ES-8500

Length: 55
 Cone Ø: d1 Ø 12 / d2 Ø 10,8
 Thread: M14 x 1,5 RHT
 0002685989



DB-RK-5280

Ø: 86
 01303000A, 6213200428



DB-RK-5282

Ø: 59
 01303800A, 6553200111



DB-RK-5283

Ø: 70
 01319900A, 6203200628



DB-RK-8564

Ø: 90
 01302200A, 3500105, 0003500105, 3500405,
 0003500405, 0005861833, 5861833,
 81432706047



DB-RK-10378

Ø: 86
 6203200028



DB-RK-12372

Ø: 85
 Hole Distance: 152
 Thick/Height: 24
 003501805, A003501805



DB-VB-7776

Length: 622 Ø: 56
 Hole Distance: 152 / 152
 6533500205, 6583500205



DF-RK-8671



DF-RK-9336

Ø: 108
 0003501705, 3501705





SK ...

1735,1735 L ...	07/87→09/96	Centre Rod	DB-DL-8138		Push Rod	
	07/87→09/96	Centre Rod	DB-DL-8618		Push Rod	
	07/87→09/96	Centre Rod	DB-DL-12308		Coupling Rod	
	07/87→09/96	Centre Rod	DB-DL-12309		Coupling Rod	
	07/87→09/96	Suspension Arm Repair Kit		DB-RK-12372	for Wishbone (CV)K063070→	
	07/87→09/96	Suspension Arm Repair Kit		DF-RK-9336		
	07/87→09/96	Suspension Arm Repair Kit		DF-RK-9336	* K 063 070 *→	
	07/87→09/96	Suspension Arm Repair Kit	DB-RK-5280			
	07/87→09/96	Suspension Arm Repair Kit	DB-RK-5282			
	07/87→09/96	Tie Rod	DB-DL-8640		Guide Rod	
	07/87→09/96	Tie Rod	DB-ES-5209			
	07/87→09/96	Tie Rod	DB-ES-5227		Guide Rod	
	07/87→09/96	Tie Rod End	CV-ES-12461		for Steering Rod	
	07/87→09/96	Tie Rod End	CV-ES-14163		for Steering Rod	
	07/87→09/96	Track Control Arm		DB-DL-7840	Suspension Rod, Trailing Arm	
	07/87→09/96	Track Control Arm		DB-DL-7840	Suspension Rod, Trailing Arm* 5 922 799 *→	
07/87→09/96	Track Control Arm		DB-VB-7776	Wishbone (CV);Trailing Arm* 5 926 393 *→		
1748 S,1748 LS	07/87→09/96	Ball Head, gearshift linkage	DB-ES-8387			
	07/87→09/96	Ball Head, gearshift linkage	DB-ES-8491			
	07/87→09/96	Ball Head, gearshift linkage	DB-ES-8492			
	07/87→09/96	Ball Head, gearshift linkage	DB-ES-8500			
	07/87→09/96	Centre Rod	DB-DL-5217	DB-DL-5217	Push Rod	
	07/87→09/96	Centre Rod	DB-DL-7831		Push Rod	
	07/87→09/96	Centre Rod	DB-DL-7831		Push Rod* K 189 672 *→* K 226 467 *	
	07/87→09/96	Centre Rod	DB-DL-8131		Push Rod	
	07/87→09/96	Centre Rod	DB-DL-8138		Push Rod	
	07/87→09/96	Centre Rod	DB-DL-8618		Push Rod	
	07/87→09/96	Centre Rod	DB-DL-10216		Push Rod	
	07/87→09/96	Centre Rod	DB-DL-12309		Coupling Rod	
	07/87→09/96	Suspension Arm Repair Kit		CV-RK-8118	for Drag Link	
	07/87→09/96	Suspension Arm Repair Kit		DB-RK-10378		
	07/87→09/96	Suspension Arm Repair Kit		DB-RK-12372	for Wishbone (CV)	
	07/87→09/96	Suspension Arm Repair Kit		DF-RK-9336		
	07/87→09/96	Suspension Arm Repair Kit	DB-RK-5280			
	07/87→09/96	Suspension Strut Repair Kit		DF-RK-8671		
	07/87→09/96	Tie Rod	DB-DL-8640		Guide Rod	
	07/87→09/96	Tie Rod	DB-ES-5209			
	07/87→09/96	Tie Rod	DB-ES-5227		Guide Rod	
	07/87→09/96	Tie Rod	MN-DL-7834		Guide Rod	
	07/87→09/96	Tie Rod End	CV-ES-12461		for Steering Rod	
	07/87→09/96	Tie Rod End	CV-ES-14163		for Steering Rod	
	07/87→09/96	Track Control Arm		DB-DL-7840	Suspension Rod, Trailing Arm	
	07/87→09/96	Track Control Arm		DB-VB-7776	Wishbone (CV);Trailing Arm* 5 926 393 *→	
	1748,1748 L	07/87→09/96	Ball Head, gearshift linkage	DB-ES-8387		
		07/87→09/96	Ball Head, gearshift linkage	DB-ES-8491		
07/87→09/96		Ball Head, gearshift linkage	DB-ES-8492			
07/87→09/96		Ball Head, gearshift linkage	DB-ES-8500			
07/87→09/96		Centre Rod	DB-DL-5217		Push Rod	
07/87→09/96		Centre Rod	DB-DL-5233		Push Rod* K 017 164 *→	
07/87→09/96		Centre Rod	DB-DL-7831		Push Rod	
07/87→09/96		Centre Rod	DB-DL-7831		Push Rod* K 189 672 *→* K 226 467 *	
07/87→09/96		Centre Rod	DB-DL-7831		Push Rod→* K 226 467 *	
07/87→09/96		Centre Rod	DB-DL-8131		Push Rod	
07/87→09/96		Centre Rod	DB-DL-8138		Push Rod	
07/87→09/96		Centre Rod	DB-DL-8618		Push Rod	
07/87→09/96		Centre Rod	DB-DL-12308		Coupling Rod	
07/87→09/96		Suspension Arm Repair Kit		DB-RK-12372	for Wishbone (CV)	
07/87→09/96		Suspension Arm Repair Kit		DF-RK-9336		
07/87→09/96		Suspension Arm Repair Kit	DB-RK-5280			
07/87→09/96		Suspension Arm Repair Kit	DB-RK-5282			
07/87→09/96		Tie Rod	DB-DL-8640		Guide Rod	
07/87→09/96		Tie Rod	DB-ES-5209			
07/87→09/96		Tie Rod	DB-ES-5227		Guide Rod	

CV-ES-12461

Length: 120
Cone Ø: d1 Ø 26 / d2 Ø 23,5
Thread: M30 x 1,5 LHT
0003300035, 3300148, 0003406213, 0013306635, 0013308835, 0014604048, 0014604348, 14606448, 0024600248, 3023300035, 3023300135, 3023300235, 3023300335, 3453307235, 3453307435, 3503307135, A0003300148, A0013306635, A0013308835, A0014604048, A0014604348, A0014606448, A0024600248, A3023300035, A3023300135, A3023300235, A3023300335, A3503307135



CV-ES-14163

Length: 125
Cone Ø: d1 Ø 30 / d2 Ø 27
Thread: M30 x 1,5 RHT
0003305248, 0003387310, 0004600348, 0004600948, 0004602848, 0004602948, 0004608948, 0014600248, 0014600848, 0014601248, 0014602248, 0014607748, 0024600148, A0003387310, A0004600348, A0004602848, A0004602948, A0014600848, A0014601248, A0014602248, A0014607748



CV-RK-8118

Ø: 85
Hole Distance: 130
Thick/Height: 30
0003500506, 3500506



DB-DL-5217

Length: 862 Ø: 40
Cone Ø: d1 Ø 30 / d2 Ø 27
01214700A, 6204600405, 6204600805, 6204602905, 6204603005



DB-DL-5233

Length: 895 Ø: 48
Cone Ø: d1 Ø 30 / d2 Ø 27
01217300A, 0004609805, 0004609905



DB-DL-7831

Length: 870
Ø: 42
Cone Ø: d1 Ø 30 / d2 Ø 27
01215200A, 6254602505



DB-DL-7840

Length: 595
Ø: 62
Hole Distance: 152 / 152
6203500006, 6203500106, 6203500306, 6553500306



DB-DL-8131

Length: 1115 Ø: 52
Cone Ø: d1 Ø 32 / d2 Ø 28,8
0004604405, 6254605005



DB-DL-8138

Length: 1130
Ø: 40
Cone Ø: d1 Ø 32 / d2 Ø 28,8
0004606605, 4606605



DB-DL-8618

Length: 680
Ø: 42
Cone Ø: d1 Ø 32 / d2 Ø 28,8
0004604305, 4604305, 6254604805



DB-DL-8640

Length: 1615 Ø: 50
Cone Ø: d1 Ø 32 / d2 Ø 29
6253301503, 6253301603, 6253302403, 6253302503, 9423300803, 9423302103, 9493300203, 9493300303, 9493300903



DB-DL-10216

Length: 1190
Ø: 40
Cone Ø: d1 Ø 32 / d2 Ø 29
0004604905



DB-DL-12308

Length: 885
Ø: 42
Cone Ø: d1 Ø 30 / d2 Ø 27
0004600705, 4600705



DB-DL-12309

Length: 685 Ø: 40
Cone Ø: d1 Ø 32 / d2 Ø 28,8
0004606005, 0004606305



DB-ES-5209

Length: 1670 Ø: 50
Cone Ø: d1 Ø 30 / d2 Ø 27
6203300503, 6203300603



DB-ES-5227

Length: 1588 Ø: 60
Cone Ø: d1 Ø 38 / d2 Ø 34,3
6253300903, 6253301203, 9443300203



DB-ES-8387

Length: 55
Cone Ø: d1 Ø 10 / d2 Ø 10
Thread: M14 x 1,5 RHT
0009966845, 0009967045



DB-ES-8491

Length: 60
Cone Ø: d1 Ø 10 / d2 Ø 10
Thread: M12 x 1,75 LHT
0009966745



DB-ES-8492

Length: 60
Cone Ø: d1 Ø 10 / d2 Ø 10
Thread: M12 x 1,75 RHT
0009966645, 3752680189, A3752680189



DB-ES-8500

Length: 55
Cone Ø: d1 Ø 12 / d2 Ø 10,8
Thread: M14 x 1,5 RHT
0002685989



DB-RK-5280

Ø: 86
01303000A, 6213200428



DB-RK-5282

Ø: 59
01303800A, 6553200111



DB-RK-10378

Ø: 86
6203200028



DB-RK-12372

Ø: 85
Hole Distance: 152
Thick/Height: 24
003501805, A003501805



DB-VB-7776

Length: 622 Ø: 56
Hole Distance: 152 / 152
6533500205, 6583500205



DF-RK-8671



DF-RK-9336

Ø: 108
0003501705, 3501705



MN-DL-7834

Length: 1588 Ø: 58
Cone Ø: d1 Ø 30 / d2 Ø 27
3463303903, 3463304903, 6253303203, 9443300503, 9443301303, 9443301703





SK ...

1748,1748 L ...	07/87→09/96	Tie Rod End	CV-ES-12461		for Steering Rod
	07/87→09/96	Tie Rod End	CV-ES-14163		for Steering Rod
	07/87→09/96	Track Control Arm		DB-DL-7840	Suspension Rod, Trailing Arm
	07/87→09/96	Track Control Arm		DB-VB-7776	Wishbone (CV);Trailing Arm* 5 926 393 *→
1831 AK	05/91→09/96	Ball Head, gearshift linkage	DB-ES-8500		
	05/91→09/96	Centre Rod	DB-DL-5217		Push Rod
	05/91→09/96	Centre Rod	DB-DL-10216		Push Rod
	05/91→09/96	Tie Rod	DB-ES-5209		
	05/91→09/96	Tie Rod	DB-ES-5227		Guide Rod
	05/91→09/96	Tie Rod	MN-DL-7834		Guide Rod
	05/91→09/96	Tie Rod End	CV-ES-12461		for Steering Rod
	05/91→09/96	Tie Rod End	DB-ES-5234		for Steering Rod
1831 K	07/92→09/96	Ball Head, gearshift linkage	DB-ES-8387		
	07/92→09/96	Ball Head, gearshift linkage	DB-ES-8492		
	07/92→09/96	Ball Head, gearshift linkage	DB-ES-8500		
	07/92→09/96	Centre Rod	DB-DL-5217		Push Rod
	07/92→09/96	Centre Rod	DB-DL-7831		Push Rod
	07/92→09/96	Centre Rod	DB-DL-7831		Push Rod* K 189 672 *→* K 226 467 *
	07/92→09/96	Centre Rod	DB-DL-8131		Push Rod
	07/92→09/96	Centre Rod	DB-DL-8618		Push Rod
	07/92→09/96	Stabiliser Mounting	DB-SB-5258	DB-SB-5258	
	07/92→09/96	Suspension Arm Repair Kit	DB-RK-5283		
	07/92→09/96	Tie Rod	DB-DL-8640		Guide Rod
	07/92→09/96	Tie Rod	DB-ES-5227		Guide Rod
	07/92→09/96	Tie Rod End	CV-ES-12461		for Steering Rod
	1831 S,1831 LS	07/87→09/96	Ball Head, gearshift linkage	DB-ES-8387	
07/87→09/96		Ball Head, gearshift linkage	DB-ES-8492		
07/87→09/96		Ball Head, gearshift linkage	DB-ES-8500		
07/87→09/96		Centre Rod	DB-DL-5217		Push Rod
07/87→09/96		Centre Rod	DB-DL-5241		Suspension Rod
07/87→09/96		Centre Rod	DB-DL-7831		Push Rod
07/87→09/96		Centre Rod	DB-DL-7831		Push Rod* K 189 672 *→* K 226 467 *
07/87→09/96		Centre Rod	DB-DL-8131		Push Rod
07/87→09/96		Centre Rod	DB-DL-8618		Push Rod
07/87→09/96		Suspension Arm Repair Kit		DB-RK-12372	for Wishbone (CV)K063070→
07/87→09/96		Suspension Arm Repair Kit		DF-RK-9336	
07/87→09/96		Suspension Arm Repair Kit		DF-RK-9336	* K 063 070 *→
07/87→09/96		Suspension Arm Repair Kit	DB-RK-5280		
07/87→09/96		Suspension Arm Repair Kit	DB-RK-10372	DB-RK-10372	for Control ArmK063070→
07/87→09/96		Tie Rod	DB-DL-8640		Guide Rod
07/87→09/96		Tie Rod	DB-ES-5209		
07/87→09/96		Tie Rod	DB-ES-5227		Guide Rod
07/87→09/96		Tie Rod End	CV-ES-12461		for Steering Rod
07/87→09/96		Track Control Arm		DB-DL-5220	Trailing Arm
07/87→09/96		Track Control Arm		DB-DL-7840	Suspension Rod, Trailing Arm
07/87→09/96	Track Control Arm		DB-VB-7776	Wishbone (CV);Trailing Arm	
1831,1831 L	07/87→09/96	Ball Head, gearshift linkage	DB-ES-8387		
	07/87→09/96	Ball Head, gearshift linkage	DB-ES-8492		
	07/87→09/96	Ball Head, gearshift linkage	DB-ES-8500		
	07/87→09/96	Centre Rod	DB-DL-5217		Push Rod
	07/87→09/96	Centre Rod	DB-DL-7831		Push Rod
	07/87→09/96	Centre Rod	DB-DL-7831		Push Rod* K 189 672 *→* K 226 467 *
	07/87→09/96	Centre Rod	DB-DL-7831		Push Rod→* K 226 467 *
	07/87→09/96	Centre Rod	DB-DL-8131		Push Rod
	07/87→09/96	Centre Rod	DB-DL-8618		Push Rod
	07/87→09/96	Centre Rod	DB-DL-12308		Coupling Rod
	07/87→09/96	Suspension Arm Repair Kit		DB-RK-12372	for Wishbone (CV)K063070→
	07/87→09/96	Suspension Arm Repair Kit		DF-RK-9336	
	07/87→09/96	Suspension Arm Repair Kit		DF-RK-9336	* K 063 070 *→
	07/87→09/96	Suspension Arm Repair Kit	DB-RK-5280		
	07/87→09/96	Suspension Arm Repair Kit	DB-RK-5282		
	07/87→09/96	Suspension Arm Repair Kit	DB-RK-10372	DB-RK-10372	for Control ArmK063070→
	07/87→09/96	Tie Rod	DB-DL-8640		Guide Rod

CV-ES-12461

Length: 120
 Cone Ø: d1 Ø 26 / d2 Ø 23,5
 Thread: M30 x 1,5 LHT
 0003300035, 3300148, 0003406213, 0013306635,
 0013308835, 0014604048, 0014604348,
 14606448, 0024600248, 3023300035,
 3023300135, 3023300235, 3023300335,
 3453307235, 3453307435, 3503307135,
 A0003300148, A0013306635, A0013308835,
 A0014604048, A0014604348, A0014606448,
 A0024600248, A3023300035, A3023300135,
 A3023300235, A3023300335, A3503307135

**CV-ES-14163**

Length: 125
 Cone Ø: d1 Ø 30 / d2 Ø 27
 Thread: M30 x 1,5 RHT
 0003305248, 0003387310, 0004600348,
 0004600948, 0004602848, 0004602948,
 0004608948, 0014600248, 0014600848,
 0014601248, 0014602248, 0014607748,
 0024600148, A0003387310, A0004600348,
 A0004602848, A0004602948, A0014600848,
 A0014601248, A0014602248, A0014607748

**DB-DL-5217**

Length: 862 Ø: 40
 Cone Ø: d1 Ø 30 / d2 Ø 27
 01214700A, 6204600405, 6204600805,
 6204602905, 6204603005

**DB-DL-5220**

Length: 522
 Ø: 52
 Hole Distance: 151
 01335200A, 3813500606, 6523500306,
 6533500106

**DB-DL-5241**

Length: 875 Ø: 40
 Cone Ø: d1 Ø 30 / d2 Ø 27
 01215300A, 0004609205, 0004609305,
 0014606905

**DB-DL-7831**

Length: 870
 Ø: 42
 Cone Ø: d1 Ø 30 / d2 Ø 27
 01215200A, 6254602505

**DB-DL-7840**

Length: 595
 Ø: 62
 Hole Distance: 152 / 152
 6203500006, 6203500106, 6203500306,
 6533500306

**DB-DL-8131**

Length: 1115 Ø: 52
 Cone Ø: d1 Ø 32 / d2 Ø 28,8
 0004604405, 6254605005

**DB-DL-8618**

Length: 680
 Ø: 42
 Cone Ø: d1 Ø 32 / d2 Ø 28,8
 0004604305, 4604305, 6254604805

**DB-DL-8640**

Length: 1615 Ø: 50
 Cone Ø: d1 Ø 32 / d2 Ø 29
 6253301503, 6253301603, 6253302403,
 6253302503, 9423300803, 9423302103,
 9493300203, 9493300303, 9493300903

**DB-DL-10216**

Length: 1190
 Ø: 40
 Cone Ø: d1 Ø 32 / d2 Ø 29
 0004604905

**DB-DL-12308**

Length: 885
 Ø: 42
 Cone Ø: d1 Ø 30 / d2 Ø 27
 0004600705, 4600705

**DB-ES-5209**

Length: 1670 Ø: 50
 Cone Ø: d1 Ø 30 / d2 Ø 27
 6203300503, 6203300603

**DB-ES-5227**

Length: 1588 Ø: 60
 Cone Ø: d1 Ø 38 / d2 Ø 34,3
 6253300903, 6253301203, 9443300203

**DB-ES-5234**

Length: 135
 Cone Ø: d1 Ø 38 / d2 Ø 34,3
 Thread: M38 x 1,5 RHT
 0004601748, 120322305, 2205000400

**DB-ES-8387**

Length: 55
 Cone Ø: d1 Ø 10 / d2 Ø 10
 Thread: M14 x 1,5 RHT
 0009966845, 0009967045

**DB-ES-8492**

Length: 60
 Cone Ø: d1 Ø 10 / d2 Ø 10
 Thread: M12 x 1,75 RHT
 0009966645, 3752680189, A3752680189

**DB-ES-8500**

Length: 55
 Cone Ø: d1 Ø 12 / d2 Ø 10,8
 Thread: M14 x 1,5 RHT
 0002685989

**DB-RK-5280**

Ø: 86
 01303000A, 6123200428

**DB-RK-5282**

Ø: 59
 01303800A, 6553200111

**DB-RK-5283**

Ø: 70
 01319900A, 6203200628

**DB-RK-10372**

Ø: 56
 Hole Distance: 90
 Thick/Height: 20
 0003302511, 0003302611

**DB-RK-12372**

Ø: 85
 Hole Distance: 152
 Thick/Height: 24
 003501805, A003501805

**DB-SB-5258**

Ø: 70
 Thick/Height: 62
 01311400A, 3873230285

**DB-VB-7776**

Length: 622 Ø: 56
 Hole Distance: 152 / 152
 6533500205, 6583500205

**DF-RK-9336**

Ø: 108
 0003501705, 3501705

**MN-DL-7834**

Length: 1588 Ø: 58
 Cone Ø: d1 Ø 30 / d2 Ø 27
 3463303903, 3463304903, 6253303203,
 9443300503, 9443301303, 9443301703





SK ...

1831,1831 L ...	07/87→09/96	Tie Rod	DB-ES-5209		
	07/87→09/96	Tie Rod	DB-ES-5227	Guide Rod	
	07/87→09/96	Tie Rod End	CV-ES-12461	for Steering Rod	
	07/87→09/96	Track Control Arm		DB-DL-5220 Trailing Arm	
	07/87→09/96	Track Control Arm		DB-DL-7840 Suspension Rod, Trailing Arm	
	07/87→09/96	Track Control Arm		DB-VB-7776 Wishbone (CV);Trailing Arm	
1834 AK	07/88→09/93	Centre Rod	DB-DL-5217	Push Rod	
	07/88→09/93	Centre Rod	DB-DL-10216	Push Rod	
	07/88→09/93	Tie Rod	DB-ES-5227	Guide Rod	
	07/88→09/93	Tie Rod	MN-DL-7834	Guide Rod	
	07/88→09/93	Tie Rod End	CV-ES-12461	for Steering Rod	
	1834 S,1834 LS	07/87→09/96	Ball Head, gearshift linkage	DB-ES-8387	
07/87→09/96		Ball Head, gearshift linkage	DB-ES-8492		
07/87→09/96		Ball Head, gearshift linkage	DB-ES-8500		
07/87→09/96		Centre Rod	DB-DL-5217	Push Rod	
07/87→09/96		Centre Rod	DB-DL-5241	Suspension Rod	
07/87→09/96		Centre Rod	DB-DL-7831	Push Rod	
07/87→09/96		Centre Rod	DB-DL-7831	Push Rod* K 189 672 *→* K 226 467 *	
07/87→09/96		Centre Rod	DB-DL-8131	Push Rod	
07/87→09/96		Centre Rod	DB-DL-8618	Push Rod	
07/87→09/96		Suspension Arm Repair Kit		DB-RK-12372 for Wishbone (CV)K063070→	
07/87→09/96		Suspension Arm Repair Kit		DF-RK-9336	
07/87→09/96		Suspension Arm Repair Kit		DF-RK-9336 * K 063 070 *→	
07/87→09/96		Suspension Arm Repair Kit	DB-RK-5280		
07/87→09/96		Tie Rod	DB-DL-8640	Guide Rod	
07/87→09/96		Tie Rod	DB-ES-5209	Guide Rod	
07/87→09/96		Tie Rod	DB-ES-5227	Guide Rod	
07/87→09/96		Tie Rod End	CV-ES-12461	for Steering Rod	
07/87→09/96		Track Control Arm		DB-DL-5220 Trailing Arm	
07/87→09/96		Track Control Arm		DB-DL-7840 Suspension Rod, Trailing Arm	
07/87→09/96		Track Control Arm		DB-VB-7776 Wishbone (CV);Trailing Arm	
1834,1834 L		07/87→09/96	Ball Head, gearshift linkage	DB-ES-8387	
		07/87→09/96	Ball Head, gearshift linkage	DB-ES-8492	
		07/87→09/96	Ball Head, gearshift linkage	DB-ES-8500	
	07/87→09/96	Centre Rod	DB-DL-5217	Push Rod	
	07/87→09/96	Centre Rod	DB-DL-5412	Push Rod* K 016 738 *→	
	07/87→09/96	Centre Rod	DB-DL-7831	Push Rod	
	07/87→09/96	Centre Rod	DB-DL-7831	Push Rod* K 189 672 *→* K 226 467 *	
	07/87→09/96	Centre Rod	DB-DL-7831	Push Rod→* K 226 467 *	
	07/87→09/96	Centre Rod	DB-DL-8131	Push Rod	
	07/87→09/96	Centre Rod	DB-DL-8138	Push Rod	
	07/87→09/96	Centre Rod	DB-DL-8618	Push Rod	
	07/87→09/96	Centre Rod	DB-DL-10216	Push Rod	
	07/87→09/96	Centre Rod	DB-DL-12308	Coupling Rod	
	07/87→09/96	Centre Rod	DB-DL-12309	Coupling Rod	
	07/87→09/96	Suspension Arm Repair Kit		DB-RK-12372 for Wishbone (CV)	
	07/87→09/96	Suspension Arm Repair Kit		DF-RK-9336	
	07/87→09/96	Suspension Arm Repair Kit		DF-RK-9336 * K 063 070 *→	
	07/87→09/96	Suspension Arm Repair Kit	DB-RK-5280		
	07/87→09/96	Suspension Arm Repair Kit	DB-RK-5282		
	07/87→09/96	Tie Rod	DB-DL-8640	Guide Rod	
	07/87→09/96	Tie Rod	DB-ES-5209	Guide Rod	
	07/87→09/96	Tie Rod	DB-ES-5227	Guide Rod	
	07/87→09/96	Tie Rod End	CV-ES-12461	for Steering Rod	
	07/87→09/96	Track Control Arm		DB-DL-7840 Suspension Rod, Trailing Arm	
	07/87→09/96	Track Control Arm		DB-VB-7776 Wishbone (CV);Trailing Arm	
	1838 AK	12/92→09/96	Ball Head, gearshift linkage	DB-ES-8387	
		12/92→09/96	Ball Head, gearshift linkage	DB-ES-8491	
12/92→09/96		Ball Head, gearshift linkage	DB-ES-8492		
12/92→09/96		Ball Head, gearshift linkage	DB-ES-8500		
12/92→09/96		Centre Rod	DB-DL-5217	Push Rod	
12/92→09/96		Centre Rod	DB-DL-7831	Push Rod	
12/92→09/96		Centre Rod	DB-DL-8131	Push Rod	

CV-ES-12461

Length: 120
 Cone Ø: d1 Ø 26 / d2 Ø 23,5
 Thread: M30 x 1,5 LHT
 0003300035, 3300148, 0003406213, 0013306635,
 0013308835, 0014604048, 0014604348,
 14606448, 0024600248, 3023300035,
 3023300135, 3023300235, 3023300335,
 3453307235, 3453307435, 3503307135,
 A0003300148, A0013306635, A0013308835,
 A0014604048, A0014604348, A0014606448,
 A0024600248, A3023300035, A3023300135,
 A3023300235, A3023300335, A3503307135



DB-DL-5217

Length: 862 Ø: 40
 Cone Ø: d1 Ø 30 / d2 Ø 27
 01214700A, 6204600405, 6204600805,
 6204602905, 6204603005



DB-DL-5220

Length: 522
 Ø: 52
 Hole Distance: 151
 01335200A, 3813500606, 6523500306,
 6533500106



DB-DL-5241

Length: 875 Ø: 40
 Cone Ø: d1 Ø 30 / d2 Ø 27
 01215300A, 0004609205, 0004609305,
 0014606905



DB-DL-5412

Length: 840
 Ø: 48
 Cone Ø: d1 Ø 32 / d2 Ø 30
 01214400A, 0014600305, 14600305, 0014600405,
 14600405



DB-DL-7831

Length: 870
 Ø: 42
 Cone Ø: d1 Ø 30 / d2 Ø 27
 01215200A, 6254602505



DB-DL-7840

Length: 595
 Ø: 62
 Hole Distance: 152 / 152
 6203500006, 6203500106, 6203500306,
 6553500306



DB-DL-8131

Length: 1115 Ø: 52
 Cone Ø: d1 Ø 32 / d2 Ø 28,8
 0004604405, 6254605005



DB-DL-8138

Length: 1130
 Ø: 40
 Cone Ø: d1 Ø 32 / d2 Ø 28,8
 0004606605, 4606605



DB-DL-8618

Length: 680
 Ø: 42
 Cone Ø: d1 Ø 32 / d2 Ø 28,8
 0004604305, 4604305, 6254604805



DB-DL-8640

Length: 1615 Ø: 50
 Cone Ø: d1 Ø 32 / d2 Ø 29
 6253301503, 6253301603, 6253302403,
 6253302503, 9423300803, 9423302103,
 9493300203, 9493300303, 9493300903



DB-DL-10216

Length: 1190
 Ø: 40
 Cone Ø: d1 Ø 32 / d2 Ø 29
 0004604905



DB-DL-12308

Length: 885
 Ø: 42
 Cone Ø: d1 Ø 30 / d2 Ø 27
 0004600705, 4600705



DB-DL-12309

Length: 685 Ø: 40
 Cone Ø: d1 Ø 32 / d2 Ø 28,8
 0004606005, 0004606305



DB-ES-5209

Length: 1670 Ø: 50
 Cone Ø: d1 Ø 30 / d2 Ø 27
 6203300503, 6203300603



DB-ES-5227

Length: 1588 Ø: 60
 Cone Ø: d1 Ø 38 / d2 Ø 34,3
 6253300903, 6253301203, 9443300203



DB-ES-8387

Length: 55
 Cone Ø: d1 Ø 10 / d2 Ø 10
 Thread: M14 x 1,5 RHT
 0009966845, 0009967045



DB-ES-8491

Length: 60
 Cone Ø: d1 Ø 10 / d2 Ø 10
 Thread: M12 x 1,75 LHT
 0009966745



DB-ES-8492

Length: 60
 Cone Ø: d1 Ø 10 / d2 Ø 10
 Thread: M12 x 1,75 RHT
 0009966645, 3752680189, A3752680189



DB-ES-8500

Length: 55
 Cone Ø: d1 Ø 12 / d2 Ø 10,8
 Thread: M14 x 1,5 RHT
 0002685989



DB-RK-5280

Ø: 86
 01303000A, 6213200428



DB-RK-5282

Ø: 59
 01303800A, 6553200111



DB-RK-12372

Ø: 85
 Hole Distance: 152
 Thick/Height: 24
 003501805, A003501805



DB-VB-7776

Length: 622 Ø: 56
 Hole Distance: 152 / 152
 6533500205, 6583500205



DF-RK-9336

Ø: 108
 3501705, 0003501705



MN-DL-7834

Length: 1588 Ø: 58
 Cone Ø: d1 Ø 30 / d2 Ø 27
 3463303903, 3463304903, 6253303203,
 9443300503, 9443301303, 9443301703





SK ...

1838 AK ...	12/92→09/96	Centre Rod	DB-DL-8138		Push Rod
	12/92→09/96	Centre Rod	DB-DL-8618		Push Rod
	12/92→09/96	Centre Rod	DB-DL-10216		Push Rod
	12/92→09/96	Tie Rod	DB-DL-8640		Guide Rod
	12/92→09/96	Tie Rod	DB-ES-5209		
	12/92→09/96	Tie Rod	DB-ES-5227		Guide Rod
	12/92→09/96	Tie Rod	MN-DL-7834		Guide Rod
	12/92→09/96	Tie Rod End	CV-ES-12461		for Steering Rod
	12/92→09/96	Tie Rod End	DB-ES-5234		for Steering Rod
1838 K	12/90→09/96	Ball Head, gearshift linkage	DB-ES-8387		
	12/90→09/96	Ball Head, gearshift linkage	DB-ES-8491		
	12/90→09/96	Ball Head, gearshift linkage	DB-ES-8492		
	12/90→09/96	Ball Head, gearshift linkage	DB-ES-8500		
	12/90→09/96	Centre Rod	DB-DL-5217		Push Rod
	12/90→09/96	Centre Rod	DB-DL-7831		Push Rod
	12/90→09/96	Centre Rod	DB-DL-7831		Push Rod* K 189 672 *→* K 226 467 *
	12/90→09/96	Centre Rod	DB-DL-8131		Push Rod
	12/90→09/96	Centre Rod	DB-DL-8618		Push Rod
	12/90→09/96	Stabiliser Mounting	DB-SB-5258	DB-SB-5258	
	12/90→09/96	Suspension Arm Repair Kit	DB-RK-5283		
	12/90→09/96	Tie Rod	DB-DL-8640		Guide Rod
	12/90→09/96	Tie Rod	DB-ES-5227		Guide Rod
	12/90→09/96	Tie Rod End	CV-ES-12461		for Steering Rod
	1838 S,1838 LS	07/87→09/96	Ball Head, gearshift linkage	DB-ES-8387	
07/87→09/96		Ball Head, gearshift linkage	DB-ES-8491		
07/87→09/96		Ball Head, gearshift linkage	DB-ES-8492		
07/87→09/96		Ball Head, gearshift linkage	DB-ES-8500		
07/87→09/96		Centre Rod	DB-DL-5217		Push Rod
07/87→09/96		Centre Rod	DB-DL-5241		Suspension Rod
07/87→09/96		Centre Rod	DB-DL-7831		Push Rod
07/87→09/96		Centre Rod	DB-DL-7831		Push Rod* K 189 672 *→* K 226 467 *
07/87→09/96		Centre Rod	DB-DL-8131		Push Rod
07/87→09/96		Centre Rod	DB-DL-8138		Push Rod
07/87→09/96		Centre Rod	DB-DL-8618		Push Rod
07/87→09/96		Centre Rod	DB-DL-12309		Coupling Rod
07/87→09/96		Suspension Arm Repair Kit		DB-RK-12372	for Wishbone (CV)
07/87→09/96		Suspension Arm Repair Kit		DF-RK-9336	
07/87→09/96		Suspension Arm Repair Kit		SC-RK-8688	for Drag Link
07/87→09/96		Suspension Arm Repair Kit	DB-RK-5280		
07/87→09/96		Tie Rod	DB-DL-8640		Guide Rod
07/87→09/96		Tie Rod	DB-ES-5209		
07/87→09/96		Tie Rod	DB-ES-5227		Guide Rod
07/87→09/96		Tie Rod End	CV-ES-12461		for Steering Rod
07/87→09/96		Track Control Arm		DB-DL-5220	Trailing Arm
07/87→09/96		Track Control Arm		DB-DL-7840	Suspension Rod, Trailing Arm
07/87→09/96		Track Control Arm		DB-VB-7776	Wishbone (CV);Trailing Arm* 5 926 393 *→
07/87→09/96	Track Control Arm		DB-VB-10421	Wishbone (CV);Trailing Arm	
1838,1838 L	07/87→09/96	Ball Head, gearshift linkage	DB-ES-8387		
	07/87→09/96	Ball Head, gearshift linkage	DB-ES-8491		
	07/87→09/96	Ball Head, gearshift linkage	DB-ES-8492		
	07/87→09/96	Ball Head, gearshift linkage	DB-ES-8500		
	07/87→09/96	Centre Rod	DB-DL-5217		Push Rod
	07/87→09/96	Centre Rod	DB-DL-7831		Push Rod
	07/87→09/96	Centre Rod	DB-DL-7831		Push Rod* K 189 672 *→* K 226 467 *
	07/87→09/96	Centre Rod	DB-DL-7831		Push Rod→* K 226 467 *
	07/87→09/96	Centre Rod	DB-DL-8131		Push Rod
	07/87→09/96	Centre Rod	DB-DL-8138		Push Rod
	07/87→09/96	Centre Rod	DB-DL-8618		Push Rod
	07/87→09/96	Centre Rod	DB-DL-9256		Push Rod
	07/87→09/96	Centre Rod	DB-DL-12308		Coupling Rod
	07/87→09/96	Centre Rod	DB-DL-12309		Coupling Rod
	07/87→09/96	Suspension Arm Repair Kit		DB-RK-10378	
	07/87→09/96	Suspension Arm Repair Kit		DB-RK-12372	for Wishbone (CV)

CV-ES-12461

Length: 120
Cone Ø: d1 Ø 26 / d2 Ø 23,5
Thread: M30 x 1,5 LHT
0003300035, 3300148, 0003406213, 0013306635,
0013308835, 0014604048, 0014604348,
14606448, 0024600248, 3023300035,
3023300135, 3023300235, 3023300335,
3453307235, 3453307435, 3503307135,
A0003300148, A0013306635, A0013308835,
A0014604048, A0014604348, A0014606448,
A0024600248, A3023300035, A3023300135,
A3023300235, A3023300335, A3503307135



DB-DL-5217

Length: 862 Ø: 40
Cone Ø: d1 Ø 30 / d2 Ø 27
01214700A, 6204600405, 6204600805,
6204602905, 6204603005



DB-DL-5220

Length: 522
Ø: 52
Hole Distance: 151
01335200A, 3813500606, 6523500306,
6533500106



DB-DL-5241

Length: 875 Ø: 40
Cone Ø: d1 Ø 30 / d2 Ø 27
01215300A, 0004609205, 0004609305,
0014606905



DB-DL-7831

Length: 870
Ø: 42
Cone Ø: d1 Ø 30 / d2 Ø 27
01215200A, 6254602505



DB-DL-7840

Length: 595
Ø: 62
Hole Distance: 152 / 152
6203500006, 6203500106, 6203500306,
6533500306



DB-DL-8131

Length: 1115 Ø: 52
Cone Ø: d1 Ø 32 / d2 Ø 28,8
0004604405, 6254605005



DB-DL-8138

Length: 1130
Ø: 40
Cone Ø: d1 Ø 32 / d2 Ø 28,8
0004606605, 4606605



DB-DL-8618

Length: 680
Ø: 42
Cone Ø: d1 Ø 32 / d2 Ø 28,8
0004604305, 4604305, 6254604805



DB-DL-8640

Length: 1615 Ø: 50
Cone Ø: d1 Ø 32 / d2 Ø 29
6253301503, 6253301603, 6253302403,
6253302503, 9423300803, 9423302103,
9493300203, 9493300303, 9493300903



DB-DL-9256

Length: 905
Ø: 48
Cone Ø: d1 Ø 32 / d2 Ø 29
0014604205, 14604205



DB-DL-10216

Length: 1190
Ø: 40
Cone Ø: d1 Ø 32 / d2 Ø 29
0004604905



DB-DL-12308

Length: 885
Ø: 42
Cone Ø: d1 Ø 30 / d2 Ø 27
0004600705, 4600705



DB-DL-12309

Length: 685
Ø: 40
Cone Ø: d1 Ø 32 / d2 Ø 28,8
4606005, 0004606005, 4606305, 0004606305



DB-ES-5209

Length: 1670 Ø: 50
Cone Ø: d1 Ø 30 / d2 Ø 27
6203300503, 6203300603



DB-ES-5227

Length: 1588 Ø: 60
Cone Ø: d1 Ø 38 / d2 Ø 34,3
6253300903, 6253301203, 9443300203



DB-ES-5234

Length: 135
Cone Ø: d1 Ø 38 / d2 Ø 34,3
Thread: M38 x 1,5 RHT
0004601748, 120322305, 2205000400



DB-ES-8387

Length: 55
Cone Ø: d1 Ø 10 / d2 Ø 10
Thread: M14 x 1,5 RHT
0009966845, 0009967045



DB-ES-8491

Length: 60
Cone Ø: d1 Ø 10 / d2 Ø 10
Thread: M12 x 1,75 LHT
0009966745



DB-ES-8492

Length: 60
Cone Ø: d1 Ø 10 / d2 Ø 10
Thread: M12 x 1,75 RHT
0009966645, 3752680189, A3752680189



DB-ES-8500

Length: 55
Cone Ø: d1 Ø 12 / d2 Ø 10,8
Thread: M14 x 1,5 RHT
0002685989



DB-RK-5280

Ø: 86
01303000A, 6213200428



DB-RK-5283

Ø: 70
01319900A, 6203200628



DB-RK-10378

Ø: 86
6203200028



DB-RK-12372

Ø: 85
Hole Distance: 182
Thick/Height: 24
003501805, A003501805



DB-SB-5258

Ø: 70
Thick/Height: 62
01311400A, 3873230285



DB-VB-7776

Length: 622 Ø: 56
Hole Distance: 152 / 152
6533500205, 6583500205



DB-VB-10421

Length: 623
Ø: 56
Hole Distance: 152 / 152
6533500405



DF-RK-9336

Ø: 108
3501705, 0003501705



MN-DL-7834

Length: 1588 Ø: 58
Cone Ø: d1 Ø 30 / d2 Ø 27
3463303903, 3463304903, 6253303203,
9443300503, 9443301303, 9443301703



SC-RK-8688

Length: 95
Ø: 95
0003501905, 3501905





SK ...

1838,1838 L ...	07/87→09/96	Suspension Arm Repair Kit		DF-RK-9336		
	07/87→09/96	Suspension Arm Repair Kit	DB-RK-5280			
	07/87→09/96	Suspension Arm Repair Kit	DB-RK-5282			
	07/87→09/96	Tie Rod	DB-DL-8640		Guide Rod	
	07/87→09/96	Tie Rod	DB-ES-5209			
	07/87→09/96	Tie Rod	DB-ES-5227		Guide Rod	
	07/87→09/96	Tie Rod End	CV-ES-12461		for Steering Rod	
	07/87→09/96	Tie Rod End	CV-ES-14163		for Steering Rod	
	07/87→09/96	Track Control Arm		DB-DL-7840	Suspension Rod, Trailing Arm	
	07/87→09/96	Track Control Arm		DB-VB-7776	Wishbone (CV);Trailing Arm* 5 926 393 *→	
1840 LS	07/91→07/92	Ball Head, gearshift linkage	DB-ES-8387			
	07/91→07/92	Ball Head, gearshift linkage	DB-ES-8491			
	07/91→07/92	Ball Head, gearshift linkage	DB-ES-8492			
	07/91→07/92	Ball Head, gearshift linkage	DB-ES-8500			
	07/91→07/92	Centre Rod	DB-DL-5217		Push Rod	
	07/91→07/92	Centre Rod	DB-DL-7831		Push Rod	
	07/91→07/92	Centre Rod	DB-DL-7831		Push Rod* K 189 672 *→* K 226 467 *	
	07/91→07/92	Centre Rod	DB-DL-8131		Push Rod	
	07/91→07/92	Centre Rod	DB-DL-8138		Push Rod	
	07/91→07/92	Centre Rod	DB-DL-8618		Push Rod	
	07/91→07/92	Centre Rod	DB-DL-12309		Coupling Rod	
	07/91→07/92	Suspension Arm Repair Kit		DB-RK-12372	for Wishbone (CV)	
	07/91→07/92	Suspension Arm Repair Kit		DF-RK-9336		
	07/91→07/92	Suspension Arm Repair Kit	DB-RK-5280			
	07/91→07/92	Tie Rod	DB-DL-8640		Guide Rod	
	07/91→07/92	Tie Rod	DB-ES-5209			
	07/91→07/92	Tie Rod	DB-ES-5227		Guide Rod	
	07/91→07/92	Tie Rod End	CV-ES-12461		for Steering Rod	
	07/91→07/92	Track Control Arm		DB-DL-5220	Trailing Arm	
	07/91→07/92	Track Control Arm		DB-DL-7840	Suspension Rod, Trailing Arm	
	07/91→07/92	Track Control Arm		DB-VB-7776	Wishbone (CV);Trailing Arm* 5 926 393 *→	
	1844 S,1844 LS	07/87→09/96	Ball Head, gearshift linkage	DB-ES-8387		
07/87→09/96		Ball Head, gearshift linkage	DB-ES-8491			
07/87→09/96		Ball Head, gearshift linkage	DB-ES-8492			
07/87→09/96		Ball Head, gearshift linkage	DB-ES-8500			
07/87→09/96		Centre Rod	DB-DL-5217	DB-DL-5217	Push Rod	
07/87→09/96		Centre Rod	DB-DL-7831		Push Rod	
07/87→09/96		Centre Rod	DB-DL-7831		Push Rod* K 189 672 *→* K 226 467 *	
07/87→09/96		Centre Rod	DB-DL-8131		Push Rod	
07/87→09/96		Centre Rod	DB-DL-8138		Push Rod	
07/87→09/96		Centre Rod	DB-DL-8618		Push Rod	
07/87→09/96		Centre Rod	DB-DL-12309		Coupling Rod	
07/87→09/96		Suspension Arm Repair Kit		DB-RK-12372	for Wishbone (CV)	
07/87→09/96		Suspension Arm Repair Kit		DF-RK-9336		
07/87→09/96		Tie Rod	DB-DL-8640		Guide Rod	
07/87→09/96		Tie Rod	DB-ES-5209			
07/87→09/96		Tie Rod	DB-ES-5227		Guide Rod	
07/87→09/96		Tie Rod End	CV-ES-12461		for Steering Rod	
07/87→09/96		Track Control Arm		DB-DL-7840	Suspension Rod, Trailing Arm	
07/87→09/96		Track Control Arm		DB-VB-7776	Wishbone (CV);Trailing Arm* 5 926 393 *→	
1844,1844 L		07/87→09/96	Ball Head, gearshift linkage	DB-ES-8387		
		07/87→09/96	Ball Head, gearshift linkage	DB-ES-8491		
		07/87→09/96	Ball Head, gearshift linkage	DB-ES-8492		
	07/87→09/96	Ball Head, gearshift linkage	DB-ES-8500			
	07/87→09/96	Centre Rod	DB-DL-5217	DB-DL-5217	Push Rod	
	07/87→09/96	Centre Rod	DB-DL-5233		Push Rod* K 017 164 *→	
	07/87→09/96	Centre Rod	DB-DL-7831		Push Rod	
	07/87→09/96	Centre Rod	DB-DL-7831		Push Rod* K 189 672 *→* K 226 467 *	
	07/87→09/96	Centre Rod	DB-DL-7831		Push Rod→* K 226 467 *	
	07/87→09/96	Centre Rod	DB-DL-8131		Push Rod	
	07/87→09/96	Centre Rod	DB-DL-8138		Push Rod	
	07/87→09/96	Centre Rod	DB-DL-8618		Push Rod	
	07/87→09/96	Centre Rod	DB-DL-9256		Push Rod	

CV-ES-12461

Length: 120
 Cone Ø: d1 Ø 26 / d2 Ø 23,5
 Thread: M30 x 1,5 LHT
 0003300035, 3300148, 0003406213, 0013306635,
 0013308835, 0014604048, 0014604348,
 14606448, 0024600248, 3023300035,
 3023300135, 3023300235, 3023300335,
 3453307235, 3453307435, 3503307135,
 A0003300148, A0013306635, A0013308835,
 A0014604048, A0014604348, A0014606448,
 A0024600248, A3023300035, A3023300135,
 A3023300235, A3023300335, A3503307135



CV-ES-14163

Length: 125
 Cone Ø: d1 Ø 30 / d2 Ø 27
 Thread: M30 x 1,5 RHT
 0003305248, 0003387310, 0004600348,
 0004600948, 0004602848, 0004602948,
 0004608948, 0014600248, 0014600848,
 0014601248, 0014602248, 0014607748,
 0024600148, A0003387310, A0004600348,
 A0004602848, A0004602948, A0014600848,
 A0014601248, A0014602248, A0014607748



DB-DL-5217

Length: 862 Ø: 40
 Cone Ø: d1 Ø 30 / d2 Ø 27
 01214700A, 6204600405, 6204600805,
 6204602905, 6204603005



DB-DL-5220

Length: 522
 Ø: 52
 Hole Distance: 151
 01335200A, 3813500606, 6523500306,
 6533500106



DB-DL-5233

Length: 895 Ø: 48
 Cone Ø: d1 Ø 30 / d2 Ø 27
 01217300A, 0004609805, 0004609905



DB-DL-7831

Length: 870
 Ø: 42
 Cone Ø: d1 Ø 30 / d2 Ø 27
 01215200A, 6254602505



DB-DL-7840

Length: 595
 Ø: 62
 Hole Distance: 152 / 152
 6203500006, 6203500106, 6203500306,
 6533500306



DB-DL-8131

Length: 1115
 Ø: 52
 Cone Ø: d1 Ø 32 / d2 Ø 28,8
 4604405, 0004604405, 6254605005



DB-DL-8138

Length: 1130
 Ø: 40
 Cone Ø: d1 Ø 32 / d2 Ø 28,8
 0004606605, 4606605



DB-DL-8618

Length: 680
 Ø: 42
 Cone Ø: d1 Ø 32 / d2 Ø 28,8
 0004604305, 4604305, 6254604805



DB-DL-8640

Length: 1615 Ø: 50
 Cone Ø: d1 Ø 32 / d2 Ø 29
 6253301503, 6253301603, 6253302403,
 6253302503, 9423300803, 9423302103,
 9493300203, 9493300303, 9493300903



DB-DL-9256

Length: 905
 Ø: 48
 Cone Ø: d1 Ø 32 / d2 Ø 29
 0014604205, 14604205



DB-DL-12309

Length: 685
 Ø: 40
 Cone Ø: d1 Ø 32 / d2 Ø 28,8
 0004606005, 4606005, 4606305, 0004606305



DB-ES-5209

Length: 1670 Ø: 50
 Cone Ø: d1 Ø 30 / d2 Ø 27
 6203300503, 6203300603



DB-ES-5227

Length: 1588 Ø: 60
 Cone Ø: d1 Ø 38 / d2 Ø 34,3
 6253300903, 6253301203, 9443300203



DB-ES-8387

Length: 55
 Cone Ø: d1 Ø 10 / d2 Ø 10
 Thread: M14 x 1,5 RHT
 0009966845, 0009967045



DB-ES-8491

Length: 60
 Cone Ø: d1 Ø 10 / d2 Ø 10
 Thread: M12 x 1,75 LHT
 0009966745



DB-ES-8492

Length: 60
 Cone Ø: d1 Ø 10 / d2 Ø 10
 Thread: M12 x 1,75 RHT
 0009966645, 3752680189, A3752680189



DB-ES-8500

Length: 55
 Cone Ø: d1 Ø 12 / d2 Ø 10,8
 Thread: M14 x 1,5 RHT
 0002685989



DB-RK-5280

Ø: 86
 01303000A, 6213200428



DB-RK-5282

Ø: 59
 01303800A, 6553200111



DB-RK-12372

Ø: 85
 Hole Distance: 152
 Thick/Height: 24
 003501805, A003501805



DB-VB-7776

Length: 622 Ø: 56
 Hole Distance: 152 / 152
 6533500205, 6583500205



DF-RK-9336

Ø: 108
 0003501705, 3501705



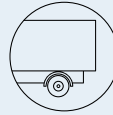

SK ...

1844,1844 L ...	07/87→09/96	Centre Rod	DB-DL-10216	Push Rod	
	07/87→09/96	Centre Rod	DB-DL-12308	Coupling Rod	
	07/87→09/96	Centre Rod	DB-DL-12309	Coupling Rod	
	07/87→09/96	Suspension Arm Repair Kit		DB-RK-12372 for Wishbone (CV)	
	07/87→09/96	Suspension Arm Repair Kit		DF-RK-9336	
	07/87→09/96	Suspension Arm Repair Kit	DB-RK-5280		
	07/87→09/96	Suspension Arm Repair Kit	DB-RK-5282		
	07/87→09/96	Suspension Arm Repair Kit	DB-RK-10372	DB-RK-10372 for Control ArmK063070→	
	07/87→09/96	Tie Rod	DB-DL-8640	Guide Rod	
	07/87→09/96	Tie Rod	DB-ES-5209		
	07/87→09/96	Tie Rod	DB-ES-5227	Guide Rod	
	07/87→09/96	Tie Rod	MN-DL-7834	Guide Rod	
	07/87→09/96	Tie Rod End	CV-ES-12461	for Steering Rod	
	07/87→09/96	Tie Rod End	CV-ES-14163	for Steering Rod	
	07/87→09/96	Tie Rod End	DB-ES-5234	for Steering Rod	
	07/87→09/96	Track Control Arm		DB-DL-7840 Suspension Rod, Trailing Arm	
	07/87→09/96	Track Control Arm		DB-VB-7776 Wishbone (CV);Trailing Arm* 5 926 393 *→	
	1850 K	07/88→08/94	Tie Rod	DB-DL-8640	Guide Rod
		07/88→08/94	Tie Rod	DB-ES-5227	Guide Rod
		07/88→08/94	Tie Rod End	CV-ES-14163	for Steering Rod
1850 LAS	07/87→09/96	Ball Head, gearshift linkage	DB-ES-8387		
	07/87→09/96	Ball Head, gearshift linkage	DB-ES-8491		
	07/87→09/96	Ball Head, gearshift linkage	DB-ES-8492		
	07/87→09/96	Ball Head, gearshift linkage	DB-ES-8500		
	07/87→09/96	Centre Rod	DB-DL-5217	Push Rod	
	07/87→09/96	Centre Rod	DB-DL-7831	Push Rod	
	07/87→09/96	Centre Rod	DB-DL-7831	Push Rod* K 189 672 *→* K 226 467 *	
	07/87→09/96	Centre Rod	DB-DL-8131	Push Rod	
	07/87→09/96	Centre Rod	DB-DL-8138	Push Rod	
	07/87→09/96	Centre Rod	DB-DL-8618	Push Rod	
	07/87→09/96	Centre Rod	DB-DL-10216	Push Rod	
	07/87→09/96	Centre Rod	DB-DL-12309	Coupling Rod	
	07/87→09/96	Suspension Arm Repair Kit		DB-RK-12372 for Wishbone (CV)	
	07/87→09/96	Suspension Arm Repair Kit		DF-RK-9336	
	07/87→09/96	Tie Rod	DB-DL-8640	Guide Rod	
	07/87→09/96	Tie Rod	DB-ES-5209		
	07/87→09/96	Tie Rod	DB-ES-5227	Guide Rod	
	07/87→09/96	Tie Rod	MN-DL-7834	Guide Rod	
	07/87→09/96	Tie Rod End	CV-ES-12461	for Steering Rod	
	07/87→09/96	Track Control Arm		DB-DL-7840 Suspension Rod, Trailing Arm	
	07/87→09/96	Track Control Arm		DB-VB-7776 Wishbone (CV);Trailing Arm* 5 926 393 *→	
	1850 S,1850 LS	07/87→09/96	Ball Head, gearshift linkage	DB-ES-8387	
		07/87→09/96	Ball Head, gearshift linkage	DB-ES-8491	
		07/87→09/96	Ball Head, gearshift linkage	DB-ES-8492	
		07/87→09/96	Ball Head, gearshift linkage	DB-ES-8500	
07/87→09/96		Centre Rod	DB-DL-5217	DB-DL-5217 Push Rod	
07/87→09/96		Centre Rod	DB-DL-7831	Push Rod	
07/87→09/96		Centre Rod	DB-DL-7831	Push Rod* K 189 672 *→* K 226 467 *	
07/87→09/96		Centre Rod	DB-DL-8131	Push Rod	
07/87→09/96		Centre Rod	DB-DL-8138	Push Rod	
07/87→09/96		Centre Rod	DB-DL-8618	Push Rod	
07/87→09/96		Centre Rod	DB-DL-10216	Push Rod	
07/87→09/96		Centre Rod	DB-DL-12309	Coupling Rod	
07/87→09/96		Suspension Arm Repair Kit		DB-RK-12372 for Wishbone (CV)	
07/87→09/96		Suspension Arm Repair Kit		DF-RK-9336	
07/87→09/96		Suspension Arm Repair Kit	DB-RK-5280		
07/87→09/96		Tie Rod	DB-DL-8640	Guide Rod	
07/87→09/96		Tie Rod	DB-ES-5209		
07/87→09/96		Tie Rod	DB-ES-5227	Guide Rod	
07/87→09/96		Tie Rod	MN-DL-7834	Guide Rod	
07/87→09/96		Tie Rod End	CV-ES-12461	for Steering Rod	
07/87→09/96		Tie Rod End	CV-ES-14163	for Steering Rod	
07/87→09/96		Track Control Arm		DB-DL-7840 Suspension Rod, Trailing Arm	
07/87→09/96		Track Control Arm		DB-VB-7776 Wishbone (CV);Trailing Arm* 5 926 393 *→	

CV-ES-12461

Length: 120
Cone Ø: d1 Ø 26 / d2 Ø 23,5
Thread: M30 x 1,5 LHT
0003300035, 3300148, 0003406213, 0013306635, 0013308835, 0014604048, 0014604348, 14606448, 0024600248, 3023300035, 3023300135, 3023300235, 3023300335, 3453307235, 3453307435, 3503307135, A0003300148, A0013306635, A0013308835, A0014604048, A0014604348, A0014606448, A0024600248, A3023300035, A3023300135, A3023300235, A3023300335, A3503307135



CV-ES-14163

Length: 125
Cone Ø: d1 Ø 30 / d2 Ø 27
Thread: M30 x 1,5 RHT
0003305248, 0003387310, 0004600348, 0004600948, 0004602848, 0004602948, 0004608948, 0014600248, 0014600848, 0014601248, 0014602248, 0014607748, 0024600148, A0003387310, A0004600348, A0004602848, A0004602948, A0014600848, A0014601248, A0014602248, A0014607748



DB-DL-5217

Length: 862 Ø: 40
Cone Ø: d1 Ø 30 / d2 Ø 27
01214700A, 6204600405, 6204600805, 6204602905, 6204603005



DB-DL-7831

Length: 870
Ø: 42
Cone Ø: d1 Ø 30 / d2 Ø 27
01215200A, 6254602505



DB-DL-7840

Length: 595
Ø: 62
Hole Distance: 152 / 152
6203500006, 6203500106, 6203500306, 6553500306



DB-DL-8131

Length: 1115 Ø: 52
Cone Ø: d1 Ø 32 / d2 Ø 28,8
0004604405, 6254605005



DB-DL-8138

Length: 1130
Ø: 40
Cone Ø: d1 Ø 32 / d2 Ø 28,8
4606605, 0004606605



DB-DL-8618

Length: 680
Ø: 42
Cone Ø: d1 Ø 32 / d2 Ø 28,8
0004604305, 4604305, 6254604805



DB-DL-8640

Length: 1615 Ø: 50
Cone Ø: d1 Ø 32 / d2 Ø 29
6253301503, 6253301603, 6253302403, 6253302503, 9423300803, 9423302103, 9493300203, 9493300303, 9493300903



DB-DL-10216

Length: 1190
Ø: 40
Cone Ø: d1 Ø 32 / d2 Ø 29
0004604905



DB-DL-12308

Length: 885
Ø: 42
Cone Ø: d1 Ø 30 / d2 Ø 27
0004600705, 4600705



DB-DL-12309

Length: 685 Ø: 40
Cone Ø: d1 Ø 32 / d2 Ø 28,8
0004606005, 0004606305



DB-ES-5209

Length: 1670 Ø: 50
Cone Ø: d1 Ø 30 / d2 Ø 27
6203300503, 6203300603



DB-ES-5227

Length: 1588 Ø: 60
Cone Ø: d1 Ø 38 / d2 Ø 34,3
6253300903, 6253301203, 9443300203



DB-ES-5234

Length: 135
Cone Ø: d1 Ø 38 / d2 Ø 34,3
Thread: M38 x 1,5 RHT
0004601748, 120322305, 2205000400



DB-ES-8387

Length: 55
Cone Ø: d1 Ø 10 / d2 Ø 10
Thread: M14 x 1,5 RHT
0009966845, 0009967045



DB-ES-8491

Length: 60
Cone Ø: d1 Ø 10 / d2 Ø 10
Thread: M12 x 1,75 LHT
0009966745



DB-ES-8492

Length: 60
Cone Ø: d1 Ø 10 / d2 Ø 10
Thread: M12 x 1,75 RHT
0009966645, 3752680189, A3752680189



DB-ES-8500

Length: 55
Cone Ø: d1 Ø 12 / d2 Ø 10,8
Thread: M14 x 1,5 RHT
0002685989



DB-RK-5280

Ø: 86
01303000A, 6213200428



DB-RK-5282

Ø: 59
01303800A, 6553200111



DB-RK-10372

Ø: 56
Hole Distance: 90
Thick/Height: 20
0003302511, 0003302611



DB-RK-12372

Ø: 85
Hole Distance: 152
Thick/Height: 24
003501805, A003501805



DB-VB-7776

Length: 622 Ø: 56
Hole Distance: 152 / 152
6533500205, 6583500205



DF-RK-9336

Ø: 108
0003501705, 3501705



MN-DL-7834

Length: 1588 Ø: 58
Cone Ø: d1 Ø 30 / d2 Ø 27
3463303903, 3463304903, 6253303203, 9443300503, 9443301303, 9443301703



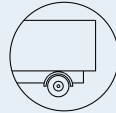

SK ...

1850,1850 L	07/87→09/96	Ball Head, gearshift linkage	DB-ES-8387		
	07/87→09/96	Ball Head, gearshift linkage	DB-ES-8491		
	07/87→09/96	Ball Head, gearshift linkage	DB-ES-8492		
	07/87→09/96	Ball Head, gearshift linkage	DB-ES-8500		
	07/87→09/96	Centre Rod	DB-DL-5217		Push Rod
	07/87→09/96	Centre Rod	DB-DL-5233		Push Rod* K 017 164 *→
	07/87→09/96	Centre Rod	DB-DL-7831		Push Rod
	07/87→09/96	Centre Rod	DB-DL-7831		Push Rod* K 189 672 *→* K 226 467 *
	07/87→09/96	Centre Rod	DB-DL-7831		Push Rod→* K 226 467 *
	07/87→09/96	Centre Rod	DB-DL-8131		Push Rod
	07/87→09/96	Centre Rod	DB-DL-8138		Push Rod
	07/87→09/96	Centre Rod	DB-DL-8618		Push Rod
	07/87→09/96	Centre Rod	DB-DL-10216		Push Rod
	07/87→09/96	Centre Rod	DB-DL-12308		Coupling Rod
	07/87→09/96	Suspension Arm Repair Kit		DB-RK-12372	for Wishbone (CV)
	07/87→09/96	Suspension Arm Repair Kit		DF-RK-9336	
	07/87→09/96	Suspension Arm Repair Kit	DB-RK-5280		
	07/87→09/96	Suspension Arm Repair Kit	DB-RK-5282		
	07/87→09/96	Tie Rod	DB-DL-8640		Guide Rod
	07/87→09/96	Tie Rod	DB-ES-5209		
	07/87→09/96	Tie Rod	DB-ES-5227		Guide Rod
	07/87→09/96	Tie Rod	MN-DL-7834		Guide Rod
	07/87→09/96	Tie Rod End	CV-ES-12461		for Steering Rod
	07/87→09/96	Tie Rod End	CV-ES-14163		for Steering Rod
	07/87→09/96	Tie Rod End	DB-ES-5234		for Steering Rod
	07/87→09/96	Track Control Arm		DB-DL-7840	Suspension Rod, Trailing Arm
	07/87→09/96	Track Control Arm		DB-VB-7776	Wishbone (CV);Trailing Arm* 5 926 393 *→
1853 AK	01/96→09/96	Ball Head, gearshift linkage	DB-ES-8387		
	01/96→09/96	Ball Head, gearshift linkage	DB-ES-8491		
	01/96→09/96	Ball Head, gearshift linkage	DB-ES-8492		
	01/96→09/96	Ball Head, gearshift linkage	DB-ES-8500		
	01/96→09/96	Centre Rod	DB-DL-5217		Push Rod
	01/96→09/96	Centre Rod	DB-DL-7831		Push Rod
	01/96→09/96	Centre Rod	DB-DL-8131		Push Rod
	01/96→09/96	Centre Rod	DB-DL-8138		Push Rod
	01/96→09/96	Centre Rod	DB-DL-8618		Push Rod
	01/96→09/96	Centre Rod	DB-DL-10216		Push Rod
	01/96→09/96	Tie Rod	DB-DL-8640		Guide Rod
	01/96→09/96	Tie Rod	DB-ES-5209		
	01/96→09/96	Tie Rod	DB-ES-5227		Guide Rod
	01/96→09/96	Tie Rod	MN-DL-7834		Guide Rod
	01/96→09/96	Tie Rod End	CV-ES-12461		for Steering Rod
	01/96→09/96	Tie Rod End	DB-ES-5234		for Steering Rod
	1853 S,1853 LS	07/87→09/96	Ball Head, gearshift linkage	DB-ES-8387	
07/87→09/96		Ball Head, gearshift linkage	DB-ES-8491		
07/87→09/96		Ball Head, gearshift linkage	DB-ES-8492		
07/87→09/96		Ball Head, gearshift linkage	DB-ES-8500		
07/87→09/96		Centre Rod	DB-DL-5217	DB-DL-5217	Push Rod
07/87→09/96		Centre Rod	DB-DL-7831		Push Rod
07/87→09/96		Centre Rod	DB-DL-7831		Push Rod* K 189 672 *→* K 226 467 *
07/87→09/96		Centre Rod	DB-DL-8131		Push Rod
07/87→09/96		Centre Rod	DB-DL-8138		Push Rod
07/87→09/96		Centre Rod	DB-DL-8618		Push Rod
07/87→09/96		Centre Rod	DB-DL-10216		Push Rod
07/87→09/96		Centre Rod	DB-DL-12309		Coupling Rod
07/87→09/96		Suspension Arm Repair Kit		DB-RK-12372	for Wishbone (CV)
07/87→09/96		Suspension Arm Repair Kit		DF-RK-9336	
07/87→09/96		Suspension Arm Repair Kit	DB-RK-5280		
07/87→09/96		Tie Rod	DB-DL-8640		Guide Rod
07/87→09/96		Tie Rod	DB-ES-5209		
07/87→09/96		Tie Rod	DB-ES-5227		Guide Rod
07/87→09/96		Tie Rod	MN-DL-7834		Guide Rod
07/87→09/96		Tie Rod End	CV-ES-12461		for Steering Rod

CV-ES-12461

Length: 120
Cone Ø: d1 Ø 26 / d2 Ø 23,5
Thread: M30 x 1,5 LHT
0003300035, 3300148, 0003406213, 0013306635,
0013308835, 0014604048, 0014604348,
14606448, 0024600248, 3023300035,
3023300135, 3023300235, 3023300335,
3453307235, 3453307435, 3503307135,
A0003300148, A0013306635, A0013308835,
A0014604048, A0014604348, A0014606448,
A0024600248, A3023300035, A3023300135,
A3023300235, A3023300335, A3503307135



CV-ES-14163

Length: 125
Cone Ø: d1 Ø 30 / d2 Ø 27
Thread: M30 x 1,5 RHT
0003305248, 0003387310, 0004600348,
0004600948, 0004602848, 0004602948,
0004608948, 0014600248, 0014600848,
0014601248, 0014602248, 0014607748,
0024600148, A0003387310, A0004600348,
A0004602848, A0004602948, A0014600848,
A0014601248, A0014602248, A0014607748



DB-DL-5217

Length: 862 Ø: 40
Cone Ø: d1 Ø 30 / d2 Ø 27
01214700A, 6204600405, 6204600805,
6204602905, 6204603005



DB-DL-5233

Length: 895 Ø: 48
Cone Ø: d1 Ø 30 / d2 Ø 27
01217300A, 0004609805, 0004609905



DB-DL-7831

Length: 870
Ø: 42
Cone Ø: d1 Ø 30 / d2 Ø 27
01215200A, 6254602505



DB-DL-7840

Length: 595
Ø: 62
Hole Distance: 152 / 152
6203500006, 6203500106, 6203500306,
6553500306



DB-DL-8131

Length: 1115
Ø: 52
Cone Ø: d1 Ø 32 / d2 Ø 28,8
4604405, 0004604405, 6254605005



DB-DL-8138

Length: 1130
Ø: 40
Cone Ø: d1 Ø 32 / d2 Ø 28,8
0004606605, 4606605



DB-DL-8618

Length: 680
Ø: 42
Cone Ø: d1 Ø 32 / d2 Ø 28,8
0004604305, 4604305, 6254604805



DB-DL-8640

Length: 1615 Ø: 50
Cone Ø: d1 Ø 32 / d2 Ø 29
6253301503, 6253301603, 6253302403,
6253302503, 9423300803, 9423302103,
9493300203, 9493300303, 9493300903



DB-DL-10216

Length: 1190
Ø: 40
Cone Ø: d1 Ø 32 / d2 Ø 29
0004604905



DB-DL-12308

Length: 885
Ø: 42
Cone Ø: d1 Ø 30 / d2 Ø 27
0004600705, 4600705



DB-DL-12309

Length: 685
Ø: 40
Cone Ø: d1 Ø 32 / d2 Ø 28,8
4606005, 0004606005, 0004606305, 4606305



DB-ES-5209

Length: 1670 Ø: 50
Cone Ø: d1 Ø 30 / d2 Ø 27
6203300503, 6203300603



DB-ES-5227

Length: 1588 Ø: 60
Cone Ø: d1 Ø 38 / d2 Ø 34,3
6253300903, 6253301203, 9443300203



DB-ES-5234

Length: 135
Cone Ø: d1 Ø 38 / d2 Ø 34,3
Thread: M38 x 1,5 RHT
0004601748, 120322305, 2205000400



DB-ES-8387

Length: 55
Cone Ø: d1 Ø 10 / d2 Ø 10
Thread: M14 x 1,5 RHT
0009966845, 0009967045



DB-ES-8491

Length: 60
Cone Ø: d1 Ø 10 / d2 Ø 10
Thread: M12 x 1,75 LHT
0009966745



DB-ES-8492

Length: 60
Cone Ø: d1 Ø 10 / d2 Ø 10
Thread: M12 x 1,75 RHT
0009966645, 3752680189, A3752680189



DB-ES-8500

Length: 55
Cone Ø: d1 Ø 12 / d2 Ø 10,8
Thread: M14 x 1,5 RHT
0002685989



DB-RK-5280

Ø: 86
01303000A, 6213200428



DB-RK-5282

Ø: 59
01303800A, 6553200111



DB-RK-12372

Ø: 85
Hole Distance: 152
Thick/Height: 24
003501805, A003501805



DB-VB-7776

Length: 622 Ø: 56
Hole Distance: 152 / 152
6533500205, 6583500205



DF-RK-9336

Ø: 108
0003501705, 3501705



MN-DL-7834

Length: 1588 Ø: 58
Cone Ø: d1 Ø 30 / d2 Ø 27
3463303903, 3463304903, 6253303203,
9443300503, 9443301303, 9443301703





SK ...

1853 S,1853 LS ...	07/87→09/96	Tie Rod End	CV-ES-14163		for Steering Rod	
	07/87→09/96	Track Control Arm		DB-DL-7840	Suspension Rod, Trailing Arm	
	07/87→09/96	Track Control Arm		DB-VB-7776	Wishbone (CV);Trailing Arm* 5 926 393 *→	
1853,1853 L	07/87→09/96	Ball Head, gearshift linkage	DB-ES-8387			
	07/87→09/96	Ball Head, gearshift linkage	DB-ES-8491			
	07/87→09/96	Ball Head, gearshift linkage	DB-ES-8492			
	07/87→09/96	Ball Head, gearshift linkage	DB-ES-8500			
	07/87→09/96	Centre Rod	DB-DL-5217		Push Rod	
	07/87→09/96	Centre Rod	DB-DL-5233		Push Rod* K 017 164 *→	
	07/87→09/96	Centre Rod	DB-DL-7831		Push Rod	
	07/87→09/96	Centre Rod	DB-DL-7831		Push Rod* K 189 672 *→* K 226 467 *	
	07/87→09/96	Centre Rod	DB-DL-7831		Push Rod→* K 226 467 *	
	07/87→09/96	Centre Rod	DB-DL-8131		Push Rod	
	07/87→09/96	Centre Rod	DB-DL-8138		Push Rod	
	07/87→09/96	Centre Rod	DB-DL-8618		Push Rod	
	07/87→09/96	Centre Rod	DB-DL-12308		Coupling Rod	
	07/87→09/96	Suspension Arm Repair Kit		DB-RK-12372	for Wishbone (CV)	
	07/87→09/96	Suspension Arm Repair Kit		DF-RK-9336		
	07/87→09/96	Suspension Arm Repair Kit	DB-RK-5280			
	07/87→09/96	Suspension Arm Repair Kit	DB-RK-5282			
	07/87→09/96	Tie Rod	DB-DL-8640		Guide Rod	
	07/87→09/96	Tie Rod	DB-ES-5209			
	07/87→09/96	Tie Rod	DB-ES-5227		Guide Rod	
	07/87→09/96	Tie Rod End	CV-ES-12461		for Steering Rod	
	07/87→09/96	Tie Rod End	CV-ES-14163		for Steering Rod	
	07/87→09/96	Track Control Arm		DB-DL-7840	Suspension Rod, Trailing Arm	
	07/87→09/96	Track Control Arm		DB-VB-7776	Wishbone (CV);Trailing Arm* 5 926 393 *→	
	1922	05/89→08/94	Ball Head, gearshift linkage	DB-ES-8387		
05/89→08/94		Ball Head, gearshift linkage	DB-ES-8492			
05/89→08/94		Ball Head, gearshift linkage	DB-ES-8500			
05/89→08/94		Centre Rod	DB-DL-5217		Push Rod	
05/89→08/94		Centre Rod	DB-DL-7831		Push Rod	
05/89→08/94		Centre Rod	DB-DL-8131		Push Rod	
05/89→08/94		Centre Rod	DB-DL-8138		Push Rod	
05/89→08/94		Centre Rod	DB-DL-8618		Push Rod	
05/89→08/94		Stabiliser Mounting	DB-SB-5258	DB-SB-5258		
05/89→08/94		Suspension Arm Repair Kit		DB-RK-10378		
05/89→08/94		Suspension Arm Repair Kit	DB-RK-5283			
05/89→08/94		Tie Rod	DB-DL-8640		Guide Rod	
05/89→08/94		Tie Rod	DB-ES-5209			
05/89→08/94		Tie Rod	DB-ES-5227		Guide Rod	
05/89→08/94		Tie Rod End	CV-ES-12461		for Steering Rod	
05/89→08/94		Tie Rod End	CV-ES-14163		for Steering Rod	
1922 AK		08/89→08/94	Centre Rod	DB-DL-5217		Push Rod
		08/89→08/94	Centre Rod	DB-DL-10216		Push Rod
		08/89→08/94	Stabiliser Mounting	DB-SB-5258	DB-SB-5258	
		08/89→08/94	Suspension Arm Repair Kit		DB-RK-10378	
	08/89→08/94	Suspension Arm Repair Kit	DB-RK-5283			
	08/89→08/94	Tie Rod	DB-ES-5209			
	08/89→08/94	Tie Rod	DB-ES-5227		Guide Rod	
	08/89→08/94	Tie Rod	MN-DL-7834		Guide Rod	
	08/89→08/94	Tie Rod End	CV-ES-12461		for Steering Rod	
	08/89→08/94	Tie Rod End	DB-ES-5234		for Steering Rod	
	1922 K	05/89→08/94	Centre Rod	DB-DL-5217		Push Rod
		05/89→08/94	Centre Rod	DB-DL-7831		Push Rod
05/89→08/94		Centre Rod	DB-DL-8131		Push Rod	
05/89→08/94		Centre Rod	DB-DL-8138		Push Rod	
05/89→08/94		Centre Rod	DB-DL-8618		Push Rod	
05/89→08/94		Centre Rod	DB-DL-10216		Push Rod	
05/89→08/94		Stabiliser Mounting	DB-SB-5258	DB-SB-5258		
05/89→08/94		Suspension Arm Repair Kit		DB-RK-10378		
05/89→08/94		Suspension Arm Repair Kit	DB-RK-5283			
05/89→08/94		Tie Rod	DB-DL-8640		Guide Rod	

CV-ES-12461

Length: 120
 Cone Ø: d1 Ø 26 / d2 Ø 23,5
 Thread: M30 x 1,5 LHT
 0003300035, 3300148, 0003406213, 0013306635,
 0013308835, 0014604048, 0014604348,
 14606448, 0024600248, 3023300035,
 3023300135, 3023300235, 3023300335,
 3453307235, 3453307435, 3503307135,
 A0003300148, A0013306635, A0013308835,
 A0014604048, A0014604348, A0014606448,
 A0024600248, A3023300035, A3023300135,
 A3023300235, A3023300335, A3503307135



CV-ES-14163

Length: 125
 Cone Ø: d1 Ø 30 / d2 Ø 27
 Thread: M30 x 1,5 RHT
 0003305248, 0003387310, 0004600348,
 0004600948, 0004602848, 0004602948,
 0004608948, 0014600248, 0014600848,
 0014601248, 0014602248, 0014607748,
 0024600148, A0003387310, A0004600348,
 A0004602848, A0004602948, A0014600848,
 A0014601248, A0014602248, A0014607748



DB-DL-5217

Length: 862 Ø: 40
 Cone Ø: d1 Ø 30 / d2 Ø 27
 01214700A, 6204600405, 6204600805,
 6204602905, 6204603005



DB-DL-5233

Length: 895 Ø: 48
 Cone Ø: d1 Ø 30 / d2 Ø 27
 01217300A, 0004609805, 0004609905



DB-DL-7831

Length: 870
 Ø: 42
 Cone Ø: d1 Ø 30 / d2 Ø 27
 01215200A, 6254602505



DB-DL-7840

Length: 595
 Ø: 62
 Hole Distance: 152 / 152
 6203500006, 6203500106, 6203500306,
 6553500306



DB-DL-8131

Length: 1115 Ø: 52
 Cone Ø: d1 Ø 32 / d2 Ø 28,8
 0004604405, 6254605005



DB-DL-8138

Length: 1130
 Ø: 40
 Cone Ø: d1 Ø 32 / d2 Ø 28,8
 0004606605, 4606605



DB-DL-8618

Length: 680
 Ø: 42
 Cone Ø: d1 Ø 32 / d2 Ø 28,8
 0004604305, 4604305, 6254604805



DB-DL-8640

Length: 1615 Ø: 50
 Cone Ø: d1 Ø 32 / d2 Ø 29
 6253301503, 6253301603, 6253302403,
 6253302503, 9423300803, 9423302103,
 9493300203, 9493300303, 9493300903



DB-DL-10216

Length: 1190
 Ø: 40
 Cone Ø: d1 Ø 32 / d2 Ø 29
 0004604905



DB-DL-12308

Length: 885
 Ø: 42
 Cone Ø: d1 Ø 30 / d2 Ø 27
 0004600705, 4600705



DB-ES-5209

Length: 1670 Ø: 50
 Cone Ø: d1 Ø 30 / d2 Ø 27
 6203300503, 6203300603



DB-ES-5227

Length: 1588 Ø: 60
 Cone Ø: d1 Ø 38 / d2 Ø 34,3
 6253300903, 6253301203, 9443300203



DB-ES-5234

Length: 135
 Cone Ø: d1 Ø 38 / d2 Ø 34,3
 Thread: M38 x 1,5 RHT
 0004601748, 120322305, 2205000400



DB-ES-8387

Length: 55
 Cone Ø: d1 Ø 10 / d2 Ø 10
 Thread: M14 x 1,5 RHT
 0009966845, 0009967045



DB-ES-8491

Length: 60
 Cone Ø: d1 Ø 10 / d2 Ø 10
 Thread: M12 x 1,75 LHT
 0009966745



DB-ES-8492

Length: 60
 Cone Ø: d1 Ø 10 / d2 Ø 10
 Thread: M12 x 1,75 RHT
 0009966645, 3752680189, A3752680189



DB-ES-8500

Length: 55
 Cone Ø: d1 Ø 12 / d2 Ø 10,8
 Thread: M14 x 1,5 RHT
 0002685989



DB-RK-5280

Ø: 86
 01303000A, 6213200428



DB-RK-5282

Ø: 59
 01303800A, 6553200111



DB-RK-5283

Ø: 70
 01319900A, 6203200628



DB-RK-10378

Ø: 86
 6203200028



DB-RK-12372

Ø: 85
 Hole Distance: 152
 Thick/Height: 24
 003501805, A003501805



DB-SB-5258

Ø: 70
 Thick/Height: 62
 01311400A, 3873230285



DB-VB-7776

Length: 622 Ø: 56
 Hole Distance: 152 / 152
 6533500205, 6583500205



DF-RK-9336

Ø: 108
 0003501705, 3501705



MN-DL-7834

Length: 1588 Ø: 58
 Cone Ø: d1 Ø 30 / d2 Ø 27
 3463303903, 3463304903, 6253303203,
 9443300503, 9443301303, 9443301703





SK ...

1922 K ...	05/89→08/94	Tie Rod	DB-ES-5227		Guide Rod
	05/89→08/94	Tie Rod End	CV-ES-12461		for Steering Rod
	05/89→08/94	Tie Rod End	CV-ES-14163		for Steering Rod
1922 S	05/89→08/94	Ball Head, gearshift linkage	DB-ES-8387		
	05/89→08/94	Ball Head, gearshift linkage	DB-ES-8492		
	05/89→08/94	Ball Head, gearshift linkage	DB-ES-8500		
	05/89→08/94	Centre Rod	DB-DL-5217		Push Rod
	05/89→08/94	Centre Rod	DB-DL-7831		Push Rod
	05/89→08/94	Centre Rod	DB-DL-8131		Push Rod
	05/89→08/94	Centre Rod	DB-DL-8618		Push Rod
	05/89→08/94	Suspension Arm Repair Kit		DB-RK-10378	
	05/89→08/94	Tie Rod	DB-DL-8640		Guide Rod
	05/89→08/94	Tie Rod	DB-ES-5209		
	05/89→08/94	Tie Rod	DB-ES-5227		Guide Rod
	05/89→08/94	Tie Rod End	CV-ES-14163		for Steering Rod
1929 A	07/88→08/94	Centre Rod	DB-DL-5217		Push Rod
	07/88→08/94	Centre Rod	DB-DL-5241		Suspension Rod
	07/88→08/94	Centre Rod	DB-DL-7270		Push Rod;Suspension Rod
	07/88→08/94	Centre Rod	DB-DL-7831		Push Rod
	07/88→08/94	Centre Rod	DB-DL-8131		Push Rod
	07/88→08/94	Centre Rod	DB-DL-8138		Push Rod
	07/88→08/94	Centre Rod	DB-DL-8618		Push Rod
	07/88→08/94	Centre Rod	DB-DL-10216		Push Rod
	07/88→08/94	Centre Rod	DB-DL-12309		Coupling Rod
	07/88→08/94	Stabiliser Mounting	DB-SB-5258	DB-SB-5258	
	07/88→08/94	Suspension Arm Repair Kit		DB-RK-8550	for Wishbone (CV)
	07/88→08/94	Suspension Arm Repair Kit		DB-RK-10378	
	07/88→08/94	Suspension Arm Repair Kit	DB-RK-5283		
	07/88→08/94	Tie Rod	DB-DL-8640		Guide Rod
	07/88→08/94	Tie Rod	DB-ES-5209		
	07/88→08/94	Tie Rod	DB-ES-5227		Guide Rod
	07/88→08/94	Tie Rod	MN-DL-7834		Guide Rod
	07/88→08/94	Tie Rod End	CV-ES-12461		for Steering Rod
	07/88→08/94	Tie Rod End	DB-ES-5234		for Steering Rod
	1929 AK	07/88→08/94	Centre Rod	DB-DL-5217	
07/88→08/94		Centre Rod	DB-DL-10216		Push Rod
07/88→08/94		Suspension Arm Repair Kit		DB-RK-10378	
07/88→08/94		Tie Rod	DB-ES-5227		Guide Rod
07/88→08/94		Tie Rod	MN-DL-7834		Guide Rod
07/88→08/94		Tie Rod End	CV-ES-12461		for Steering Rod
1929 AS	07/88→08/94	Centre Rod	DB-DL-5217		Push Rod
	07/88→08/94	Centre Rod	DB-DL-7831		Push Rod
	07/88→08/94	Centre Rod	DB-DL-8131		Push Rod
	07/88→08/94	Centre Rod	DB-DL-8618		Push Rod
	07/88→08/94	Centre Rod	DB-DL-10216		Push Rod
	07/88→08/94	Tie Rod	DB-DL-8640		Guide Rod
	07/88→08/94	Tie Rod	DB-ES-5209		
	07/88→08/94	Tie Rod	DB-ES-5227		Guide Rod
	07/88→08/94	Tie Rod	MN-DL-7834		Guide Rod
	07/88→08/94	Tie Rod End	CV-ES-12461		for Steering Rod
	07/88→08/94	Tie Rod End	DB-ES-5234		for Steering Rod
1929 K	07/88→08/94	Centre Rod	DB-DL-5217		Push Rod
	07/88→08/94	Centre Rod	DB-DL-7831		Push Rod
	07/88→08/94	Centre Rod	DB-DL-8131		Push Rod
	07/88→08/94	Centre Rod	DB-DL-8138		Push Rod
	07/88→08/94	Centre Rod	DB-DL-8618		Push Rod
	07/88→08/94	Stabiliser Mounting	DB-SB-5258	DB-SB-5258	
	07/88→08/94	Suspension Arm Repair Kit		DB-RK-10378	
	07/88→08/94	Suspension Arm Repair Kit	DB-RK-5283		
	07/88→08/94	Tie Rod	DB-DL-8640		Guide Rod
	07/88→08/94	Tie Rod	DB-ES-5227		Guide Rod
	07/88→08/94	Tie Rod End	CV-ES-12461		for Steering Rod
	07/88→08/94	Tie Rod End	CV-ES-14163		for Steering Rod

CV-ES-12461

Length: 120
Cone Ø: d1 Ø 26 / d2 Ø 23,5
Thread: M30 x 1,5 LHT
 0003300035, 3300148, 0003406213, 0013306635,
 0013308835, 0014604048, 0014604348,
 14606448, 0024600248, 3023300035,
 3023300135, 3023300235, 3023300335,
 3453307235, 3453307435, 3503307135,
 A0003300148, A0013306635, A0013308835,
 A0014604048, A0014604348, A0014606448,
 A0024600248, A3023300035, A3023300135,
 A3023300235, A3023300335, A3503307135



CV-ES-14163

Length: 125
Cone Ø: d1 Ø 30 / d2 Ø 27
Thread: M30 x 1,5 RHT
 0003305248, 0003387310, 0004600348,
 0004600948, 0004602848, 0004602948,
 0004608948, 0014600248, 0014600848,
 0014601248, 0014602248, 0014607748,
 0024600148, A0003387310, A0004600348,
 A0004602848, A0004602948, A0014600848,
 A0014601248, A0014602248, A0014607748



DB-DL-5217

Length: 862 Ø: 40
Cone Ø: d1 Ø 30 / d2 Ø 27
 01214700A, 6204600405, 6204600805,
 6204602905, 6204603005



DB-DL-5241

Length: 875 Ø: 40
Cone Ø: d1 Ø 30 / d2 Ø 27
 01215300A, 0004609205, 0004609305,
 0014606905



DB-DL-7270

Length: 875 Ø: 40
Cone Ø: d1 Ø 28,6 / d2 Ø 23,9
 01208300A, 0024604705, 0024604805,
 0034604905, A0024604705



DB-DL-7831

Length: 870
 Ø: 42
Cone Ø: d1 Ø 30 / d2 Ø 27
 01215200A, 6254602505



DB-DL-8131

Length: 1115 Ø: 52
Cone Ø: d1 Ø 32 / d2 Ø 28,8
 0004604405, 6254605005



DB-DL-8138

Length: 1130
 Ø: 40
Cone Ø: d1 Ø 32 / d2 Ø 28,8
 0004606605, 4606605



DB-DL-8618

Length: 680
 Ø: 42
Cone Ø: d1 Ø 32 / d2 Ø 28,8
 0004604305, 4604305, 6254604805



DB-DL-8640

Length: 1615 Ø: 50
Cone Ø: d1 Ø 32 / d2 Ø 29
 6253301503, 6253301603, 6253302403,
 6253302503, 9423300803, 9423302103,
 9493300203, 9493300303, 9493300903



DB-DL-10216

Length: 1190
 Ø: 40
Cone Ø: d1 Ø 32 / d2 Ø 29
 0004604905



DB-DL-12309

Length: 685 Ø: 40
Cone Ø: d1 Ø 32 / d2 Ø 28,8
 0004606005, 0004606305



DB-ES-5209

Length: 1670 Ø: 50
Cone Ø: d1 Ø 30 / d2 Ø 27
 6203300503, 6203300603



DB-ES-5227

Length: 1588 Ø: 60
Cone Ø: d1 Ø 38 / d2 Ø 34,3
 6253300903, 6253301203, 9443300203



DB-ES-5234

Length: 135
Cone Ø: d1 Ø 38 / d2 Ø 34,3
Thread: M38 x 1,5 RHT
 0004601748, 120322305, 2205000400



DB-ES-8387

Length: 55
Cone Ø: d1 Ø 10 / d2 Ø 10
Thread: M14 x 1,5 RHT
 0009966845, 0009967045



DB-ES-8492

Length: 60
Cone Ø: d1 Ø 10 / d2 Ø 10
Thread: M12 x 1,75 RHT
 0009966645, 3752680189, A3752680189



DB-ES-8500

Length: 55
Cone Ø: d1 Ø 12 / d2 Ø 10,8
Thread: M14 x 1,5 RHT
 0002685989



DB-RK-5283

Ø: 70
 01319900A, 6203200628



DB-RK-8550

Ø: 75 Hole Distance: 152
 Thick/Height: 24
 0003502105, 0003504605



DB-RK-10378

Ø: 86
 6203200028



DB-SB-5258

Ø: 70
 Thick/Height: 62
 01311400A, 3873230285



MN-DL-7834

Length: 1588 Ø: 58
Cone Ø: d1 Ø 30 / d2 Ø 27
 3463303903, 3463304903, 6253303203,
 9443300503, 9443301303, 9443301703



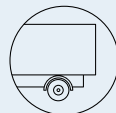

SK ...

1929 S	07/88→08/94	Centre Rod	DB-DL-5217		Push Rod	
	07/88→08/94	Centre Rod	DB-DL-7831		Push Rod	
	07/88→08/94	Centre Rod	DB-DL-8131		Push Rod	
	07/88→08/94	Centre Rod	DB-DL-8618		Push Rod	
	07/88→08/94	Tie Rod	DB-DL-8640		Guide Rod	
	07/88→08/94	Tie Rod	DB-ES-5209			
	07/88→08/94	Tie Rod	DB-ES-5227		Guide Rod	
	07/88→08/94	Tie Rod End	CV-ES-12461		for Steering Rod	
	07/88→08/94	Tie Rod End	CV-ES-14163		for Steering Rod	
	1929,1929 L	07/87→09/96	Centre Rod	DB-DL-5217		Push Rod
07/87→09/96		Centre Rod	DB-DL-5233		Push Rod* K 017 164 *→* K 040 717 *	
07/87→09/96		Centre Rod	DB-DL-7831		Push Rod	
07/87→09/96		Centre Rod	DB-DL-8131		Push Rod	
07/87→09/96		Centre Rod	DB-DL-8138		Push Rod	
07/87→09/96		Centre Rod	DB-DL-8618		Push Rod	
07/87→09/96		Centre Rod	DB-DL-12308		Coupling Rod	
07/87→09/96		Suspension Arm Repair Kit		CV-RK-8118	for Drag Link	
07/87→09/96		Suspension Arm Repair Kit		DB-RK-8564	Wishbone (CV)	
07/87→09/96		Suspension Arm Repair Kit		DB-RK-12372	for Wishbone (CV)K063070→	
07/87→09/96		Suspension Arm Repair Kit		DF-RK-9336		
07/87→09/96		Suspension Arm Repair Kit		DF-RK-9336	* K 063 070 *→	
07/87→09/96		Suspension Arm Repair Kit	DB-RK-5282			
07/87→09/96		Suspension Strut Repair Kit		DF-RK-8671		
07/87→09/96		Tie Rod	DB-DL-8640		Guide Rod	
07/87→09/96		Tie Rod	DB-ES-5209			
07/87→09/96		Tie Rod	DB-ES-5227		Guide Rod	
07/87→09/96		Tie Rod End	CV-ES-12461		for Steering Rod	
07/87→09/96		Tie Rod End	CV-ES-14163		for Steering Rod	
07/87→09/96		Track Control Arm		DB-DL-7840	Suspension Rod, Trailing Arm	
07/87→09/96		Track Control Arm		DB-DL-7840	Suspension Rod, Trailing Arm* 5 922 799 *→	
07/87→09/96		Track Control Arm		DB-VB-7776	Wishbone (CV);Trailing Arm* 5 926 393 *→	
1935	05/89→08/94	Ball Head, gearshift linkage	DB-ES-8387			
	05/89→08/94	Ball Head, gearshift linkage	DB-ES-8491			
	05/89→08/94	Ball Head, gearshift linkage	DB-ES-8492			
	05/89→08/94	Ball Head, gearshift linkage	DB-ES-8500			
	05/89→08/94	Centre Rod	DB-DL-5217		Push Rod	
	05/89→08/94	Centre Rod	DB-DL-5241		Suspension Rod	
	05/89→08/94	Centre Rod	DB-DL-7270		Push Rod;Suspension Rod	
	05/89→08/94	Centre Rod	DB-DL-7831		Push Rod	
	05/89→08/94	Centre Rod	DB-DL-8131		Push Rod	
	05/89→08/94	Centre Rod	DB-DL-8138		Push Rod	
	05/89→08/94	Centre Rod	DB-DL-8618		Push Rod	
	05/89→08/94	Centre Rod	DB-DL-10216		Push Rod	
	05/89→08/94	Centre Rod	DB-DL-12309		Coupling Rod	
	05/89→08/94	Stabiliser Mounting	DB-SB-5258	DB-SB-5258		
	05/89→08/94	Suspension Arm Repair Kit		DB-RK-8550	for Wishbone (CV)	
	05/89→08/94	Suspension Arm Repair Kit		DB-RK-10378		
	05/89→08/94	Suspension Arm Repair Kit	DB-RK-5283			
	05/89→08/94	Tie Rod	DB-DL-8640		Guide Rod	
	05/89→08/94	Tie Rod	DB-ES-5209			
	05/89→08/94	Tie Rod	DB-ES-5227		Guide Rod	
	05/89→08/94	Tie Rod	MN-DL-7834		Guide Rod	
	05/89→08/94	Tie Rod End	CV-ES-12461		for Steering Rod	
	05/89→08/94	Tie Rod End	CV-ES-14163		for Steering Rod	
	05/89→08/94	Tie Rod End	DB-ES-5234		for Steering Rod	
	1935 AK	05/89→08/94	Centre Rod	DB-DL-5217		Push Rod
		05/89→08/94	Centre Rod	DB-DL-8618		Push Rod
		05/89→08/94	Centre Rod	DB-DL-10216		Push Rod
05/89→08/94		Stabiliser Mounting	DB-SB-5258	DB-SB-5258		
05/89→08/94		Suspension Arm Repair Kit		DB-RK-10378		
05/89→08/94		Suspension Arm Repair Kit	DB-RK-5283			
05/89→08/94		Tie Rod	DB-DL-8640		Guide Rod	
05/89→08/94		Tie Rod	DB-ES-5209			
05/89→08/94		Tie Rod	DB-ES-5227		Guide Rod	

CV-ES-12461

Length: 120
 Cone Ø: d1 Ø 26 / d2 Ø 23,5
 Thread: M30 x 1,5 LHT
 0003300035, 3300148, 0003406213, 0013306635,
 0013308835, 0014604048, 0014604348,
 14606448, 0024600248, 3023300035,
 3023300135, 3023300235, 3023300335,
 3453307235, 3453307435, 3503307135,
 A0003300148, A0013306635, A0013308835,
 A0014604048, A0014604348, A0014606448,
 A0024600248, A3023300035, A3023300135,
 A3023300235, A3023300335, A3503307135

**CV-ES-14163**

Length: 125
 Cone Ø: d1 Ø 30 / d2 Ø 27
 Thread: M30 x 1,5 RHT
 0003305248, 0003387310, 0004600348,
 0004600948, 0004602848, 0004602948,
 0004608948, 0014600248, 0014600848,
 0014601248, 0014602248, 0014607748,
 0024600148, A0003387310, A0004600348,
 A0004602848, A0004602948, A0014600848,
 A0014601248, A0014602248, A0014607748

**CV-RK-8118**

Ø: 85
 Hole Distance: 130
 Thick/Height: 30
 0003500506, 3500506

**DB-DL-5217**

Length: 862 Ø: 40
 Cone Ø: d1 Ø 30 / d2 Ø 27
 01214700A, 6204600405, 6204600805,
 6204602905, 6204603005

**DB-DL-5233**

Length: 895
 Ø: 48
 Cone Ø: d1 Ø 30 / d2 Ø 27
 01217300A, 4609805, 0004609805, 4609905,
 0004609905

**DB-DL-5241**

Length: 875 Ø: 40
 Cone Ø: d1 Ø 30 / d2 Ø 27
 01215300A, 0004609205, 0004609305,
 0014606905

**DB-DL-7270**

Length: 875 Ø: 40
 Cone Ø: d1 Ø 28,6 / d2 Ø 23,9
 01208300A, 0024604705, 0024604805,
 0034604905, A0024604705

**DB-DL-7831**

Length: 870 Ø: 42
 Cone Ø: d1 Ø 30 / d2 Ø 27
 01215200A, 6254602505

**DB-DL-7840**

Length: 595
 Ø: 62
 Hole Distance: 152 / 152
 6203500006, 6203500106, 6203500306,
 6553500306

**DB-DL-8131**

Length: 1115 Ø: 52
 Cone Ø: d1 Ø 32 / d2 Ø 28,8
 4604405, 0004604405, 6254605005

**DB-DL-8138**

Length: 1130 Ø: 40
 Cone Ø: d1 Ø 32 / d2 Ø 28,8
 0004606605, 4606605

**DB-DL-8618**

Length: 680 Ø: 42
 Cone Ø: d1 Ø 32 / d2 Ø 28,8
 0004604305, 4604305, 6254604805

**DB-DL-8640**

Length: 1615 Ø: 50
 Cone Ø: d1 Ø 32 / d2 Ø 29
 6253301503, 6253301603, 6253302403,
 6253302503, 9423300803, 9423302103,
 9493300203, 9493300303, 9493300903

**DB-DL-10216**

Length: 1190 Ø: 40
 Cone Ø: d1 Ø 32 / d2 Ø 29
 0004604905

**DB-DL-12308**

Length: 885
 Ø: 42
 Cone Ø: d1 Ø 30 / d2 Ø 27
 0004600705, 4600705

**DB-DL-12309**

Length: 685 Ø: 40
 Cone Ø: d1 Ø 32 / d2 Ø 28,8
 0004606005, 0004606305

**DB-ES-5209**

Length: 1670 Ø: 50
 Cone Ø: d1 Ø 30 / d2 Ø 27
 6203300503, 6203300603

**DB-ES-5227**

Length: 1588 Ø: 60
 Cone Ø: d1 Ø 38 / d2 Ø 34,3
 6253300903, 6253301203, 9443300203

**DB-ES-5234**

Length: 135
 Cone Ø: d1 Ø 38 / d2 Ø 34,3
 Thread: M38 x 1,5 RHT
 0004601748, 120322305, 2205000400

**DB-ES-8387**

Length: 55
 Cone Ø: d1 Ø 10 / d2 Ø 10
 Thread: M14 x 1,5 RHT
 0009966845, 0009967045

**DB-ES-8491**

Length: 60
 Cone Ø: d1 Ø 10 / d2 Ø 10
 Thread: M12 x 1,75 LHT
 0009966745

**DB-ES-8492**

Length: 60
 Cone Ø: d1 Ø 10 / d2 Ø 10
 Thread: M12 x 1,75 RHT
 0009966645, 3752680189, A3752680189

**DB-ES-8500**

Length: 55
 Cone Ø: d1 Ø 12 / d2 Ø 10,8
 Thread: M14 x 1,5 RHT
 0002685989

**DB-RK-5282**

Ø: 59
 01303800A, 6553200111

**DB-RK-5283**

Ø: 70
 01319900A, 6203200628

**DB-RK-8550**

Length: 1588 Hole Distance: 152
 Thick/Height: 24
 0003502105, 0003504605

**DB-RK-8564**

Ø: 90
 01302200A, 3500105, 0003500105, 0003500405,
 3500405, 0005861833, 5861833, 81432706047

**DB-RK-10378**

Ø: 86
 6203200028

**DB-RK-12372**

Ø: 85 Hole Distance: 152
 Thick/Height: 24
 003501805, A003501805

**DB-SB-5258**

Ø: 70 Thick/Height: 62
 01311400A, 3873230285

**DB-VB-7776**

Length: 622 Ø: 56
 Hole Distance: 152 / 152
 6533500205, 6583500205

**DF-RK-8671****DF-RK-9336**

Ø: 108
 3501705, 0003501705

**MN-DL-7834**

Length: 1588 Ø: 58
 Cone Ø: d1 Ø 30 / d2 Ø 27
 3463303903, 3463304903, 6253303203,
 9443300503, 9443301303, 9443301703





SK ...

1935 AK ...	05/89→08/94	Tie Rod	DB-ES-5227		Guide Rod	
	05/89→08/94	Tie Rod	MN-DL-7834		Guide Rod	
	05/89→08/94	Tie Rod End	CV-ES-12461		for Steering Rod	
	05/89→08/94	Tie Rod End	DB-ES-5234		for Steering Rod	
1935 AS	05/89→08/94	Centre Rod	DB-DL-5217		Push Rod	
	05/89→08/94	Centre Rod	DB-DL-10216		Push Rod	
	05/89→08/94	Suspension Arm Repair Kit		DB-RK-10378		
	05/89→08/94	Tie Rod	DB-ES-5227		Guide Rod	
	05/89→08/94	Tie Rod	MN-DL-7834		Guide Rod	
1935 K	05/89→08/94	Tie Rod End	CV-ES-12461		for Steering Rod	
	05/89→08/94	Centre Rod	DB-DL-5217		Push Rod	
	05/89→08/94	Centre Rod	DB-DL-7831		Push Rod	
	05/89→08/94	Centre Rod	DB-DL-8131		Push Rod	
	05/89→08/94	Centre Rod	DB-DL-8138		Push Rod	
	05/89→08/94	Centre Rod	DB-DL-8618		Push Rod	
	05/89→08/94	Stabiliser Mounting	DB-SB-5258	DB-SB-5258		
	05/89→08/94	Suspension Arm Repair Kit		DB-RK-10378		
	05/89→08/94	Suspension Arm Repair Kit	DB-RK-5283			
	05/89→08/94	Tie Rod	DB-DL-8640		Guide Rod	
	05/89→08/94	Tie Rod	DB-ES-5227		Guide Rod	
	05/89→08/94	Tie Rod End	CV-ES-12461		for Steering Rod	
	05/89→08/94	Tie Rod End	CV-ES-14163		for Steering Rod	
	1935 S	05/89→08/94	Ball Head, gearshift linkage	DB-ES-8387		
		05/89→08/94	Ball Head, gearshift linkage	DB-ES-8491		
05/89→08/94		Ball Head, gearshift linkage	DB-ES-8492			
05/89→08/94		Ball Head, gearshift linkage	DB-ES-8500			
05/89→08/94		Centre Rod	DB-DL-5217		Push Rod	
05/89→08/94		Centre Rod	DB-DL-7831		Push Rod	
05/89→08/94		Centre Rod	DB-DL-8131		Push Rod	
05/89→08/94		Centre Rod	DB-DL-8138		Push Rod	
05/89→08/94		Centre Rod	DB-DL-8618		Push Rod	
05/89→08/94		Stabiliser Mounting	DB-SB-5258	DB-SB-5258		
05/89→08/94		Suspension Arm Repair Kit	DB-RK-5283			
05/89→08/94		Tie Rod	DB-DL-8640		Guide Rod	
05/89→08/94		Tie Rod	DB-ES-5209			
05/89→08/94		Tie Rod	DB-ES-5227		Guide Rod	
05/89→08/94		Tie Rod End	CV-ES-12461		for Steering Rod	
05/89→08/94		Tie Rod End	CV-ES-14163		for Steering Rod	
1945 AK		07/88→08/94	Centre Rod	DB-DL-5217		Push Rod
		07/88→08/94	Centre Rod	DB-DL-10216		Push Rod
	07/88→08/94	Tie Rod	DB-ES-5227		Guide Rod	
	07/88→08/94	Tie Rod	MN-DL-7834		Guide Rod	
	07/88→08/94	Tie Rod End	CV-ES-12461		for Steering Rod	
1948	09/88→07/92	Ball Head, gearshift linkage	DB-ES-8387			
	09/88→07/92	Ball Head, gearshift linkage	DB-ES-8491			
	09/88→07/92	Ball Head, gearshift linkage	DB-ES-8492			
	09/88→07/92	Ball Head, gearshift linkage	DB-ES-8500			
	09/88→07/92	Centre Rod	DB-DL-5217		Push Rod	
	09/88→07/92	Centre Rod	DB-DL-5233		Push Rod* K 017 164 *→	
	09/88→07/92	Centre Rod	DB-DL-7831		Push Rod	
	09/88→07/92	Centre Rod	DB-DL-7831		Push Rod→* K 226 467 *	
	09/88→07/92	Centre Rod	DB-DL-8131		Push Rod	
	09/88→07/92	Centre Rod	DB-DL-8138		Push Rod	
	09/88→07/92	Centre Rod	DB-DL-8618		Push Rod	
	09/88→07/92	Suspension Arm Repair Kit		DB-RK-10378		
	09/88→07/92	Tie Rod	DB-DL-8640		Guide Rod	
	09/88→07/92	Tie Rod	DB-ES-5209			
	09/88→07/92	Tie Rod	DB-ES-5227		Guide Rod	
	09/88→07/92	Tie Rod End	CV-ES-12461		for Steering Rod	
	09/88→07/92	Tie Rod End	CV-ES-14163		for Steering Rod	

CV-ES-12461

Length: 120
Cone Ø: d1 Ø 26 / d2 Ø 23,5
Thread: M30 x 1,5 LHT
 0003300035, 3300148, 0003406213, 0013306635,
 0013308835, 0014604048, 0014604348,
 14606448, 0024600248, 3023300035,
 3023300135, 3023300235, 3023300335,
 3453307235, 3453307435, 3503307135,
 A0003300148, A0013306635, A0013308835,
 A0014604048, A0014604348, A0014606448,
 A0024600248, A3023300035, A3023300135,
 A3023300235, A3023300335, A3503307135



CV-ES-14163

Length: 125
Cone Ø: d1 Ø 30 / d2 Ø 27
Thread: M30 x 1,5 RHT
 0003305248, 0003387310, 0004600348,
 0004600948, 0004602848, 0004602948,
 0004608948, 0014600248, 0014600848,
 0014601248, 0014602248, 0014607748,
 0024600148, A0003387310, A0004600348,
 A0004602848, A0004602948, A0014600848,
 A0014601248, A0014602248, A0014607748



DB-DL-5217

Length: 862 Ø: 40
Cone Ø: d1 Ø 30 / d2 Ø 27
 01214700A, 6204600405, 6204600805,
 6204602905, 6204603005



DB-DL-5233

Length: 895 Ø: 48
Cone Ø: d1 Ø 30 / d2 Ø 27
 01217300A, 0004609805, 0004609905



DB-DL-7831

Length: 870
 Ø: 42
Cone Ø: d1 Ø 30 / d2 Ø 27
 01215200A, 6254602505



DB-DL-8131

Length: 1115 Ø: 52
Cone Ø: d1 Ø 32 / d2 Ø 28,8
 0004604405, 6254605005



DB-DL-8138

Length: 1130
 Ø: 40
Cone Ø: d1 Ø 32 / d2 Ø 28,8
 0004606605, 4606605



DB-DL-8618

Length: 680
 Ø: 42
Cone Ø: d1 Ø 32 / d2 Ø 28,8
 0004604305, 4604305, 6254604805



DB-DL-8640

Length: 1615 Ø: 50
Cone Ø: d1 Ø 32 / d2 Ø 29
 6253301503, 6253301603, 6253302403,
 6253302503, 9423300803, 9423302103,
 9493300203, 9493300303, 9493300903



DB-DL-10216

Length: 1190 Ø: 40
Cone Ø: d1 Ø 32 / d2 Ø 29
 0004604905



DB-ES-5209

Length: 1670 Ø: 50
Cone Ø: d1 Ø 30 / d2 Ø 27
 6203300503, 6203300603



DB-ES-5227

Length: 1588 Ø: 60
Cone Ø: d1 Ø 38 / d2 Ø 34,3
 6253300903, 6253301203, 9443300203



DB-ES-5234

Length: 135
Cone Ø: d1 Ø 38 / d2 Ø 34,3
Thread: M38 x 1,5 RHT
 0004601748, 120322305, 2205000400



DB-ES-8387

Length: 55
Cone Ø: d1 Ø 10 / d2 Ø 10
Thread: M14 x 1,5 RHT
 0009966845, 0009967045



DB-ES-8491

Length: 60
Cone Ø: d1 Ø 10 / d2 Ø 10
Thread: M12 x 1,75 LHT
 0009966745



DB-ES-8492

Length: 60
Cone Ø: d1 Ø 10 / d2 Ø 10
Thread: M12 x 1,75 RHT
 0009966645, 3752680189, A3752680189



DB-ES-8500

Length: 55
Cone Ø: d1 Ø 12 / d2 Ø 10,8
Thread: M14 x 1,5 RHT
 0002685989



DB-RK-5283

Ø: 70
 01319900A, 6203200628



DB-RK-10378

Ø: 86
 6203200028



DB-SB-5258

Ø: 70
Thick/Height: 62
 01311400A, 3873230285



MN-DL-7834

Length: 1588 Ø: 58
Cone Ø: d1 Ø 30 / d2 Ø 27
 3463303903, 3463304903, 6253303203,
 9443300503, 9443301303, 9443301703



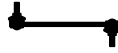

SK ...

2024	02/93→09/96	Ball Head, gearshift linkage	DB-ES-8387			
	02/93→09/96	Ball Head, gearshift linkage	DB-ES-8492			
	02/93→09/96	Ball Head, gearshift linkage	DB-ES-8500			
	02/93→09/96	Centre Rod	DB-DL-5217		Push Rod	
	02/93→09/96	Centre Rod	DB-DL-5233		Push Rod* K 016 738 *→	
	02/93→09/96	Centre Rod	DB-DL-7831		Push Rod	
	02/93→09/96	Centre Rod	DB-DL-7831		Push Rod→* K 226 467 *	
	02/93→09/96	Centre Rod	DB-DL-8131		Push Rod	
	02/93→09/96	Centre Rod	DB-DL-8618		Push Rod	
	02/93→09/96	Suspension Arm Repair Kit		DB-RK-10378		
	02/93→09/96	Tie Rod	DB-DL-8640		Guide Rod	
	02/93→09/96	Tie Rod	DB-ES-5209			
	02/93→09/96	Tie Rod	DB-ES-5227		Guide Rod	
	02/93→09/96	Tie Rod End	CV-ES-12461		for Steering Rod	
	2024 AK	02/93→09/96	Ball Head, gearshift linkage	DB-ES-8387		
02/93→09/96		Ball Head, gearshift linkage	DB-ES-8500			
02/93→09/96		Centre Rod	DB-DL-5217		Push Rod	
02/93→09/96		Centre Rod	DB-DL-10216		Push Rod	
02/93→09/96		Stabiliser Mounting	DB-SB-5258	DB-SB-5258		
02/93→09/96		Suspension Arm Repair Kit	DB-RK-5283			
02/93→09/96		Tie Rod	DB-ES-5209			
02/93→09/96		Tie Rod	DB-ES-5227		Guide Rod	
02/93→09/96		Tie Rod	MN-DL-7834		Guide Rod	
02/93→09/96		Tie Rod End	CV-ES-12461		for Steering Rod	
02/93→09/96		Tie Rod End	DB-ES-5234		for Steering Rod	
2024 K		02/93→09/96	Ball Head, gearshift linkage	DB-ES-8387		
	02/93→09/96	Ball Head, gearshift linkage	DB-ES-8492			
	02/93→09/96	Ball Head, gearshift linkage	DB-ES-8500			
	02/93→09/96	Centre Rod	DB-DL-5217		Push Rod	
	02/93→09/96	Centre Rod	DB-DL-7831		Push Rod	
	02/93→09/96	Centre Rod	DB-DL-7831		Push Rod* K 189 672 *→* K 226 467 *	
	02/93→09/96	Centre Rod	DB-DL-8131		Push Rod	
	02/93→09/96	Centre Rod	DB-DL-8618		Push Rod	
	02/93→09/96	Stabiliser Mounting	DB-SB-5258	DB-SB-5258		
	02/93→09/96	Suspension Arm Repair Kit		DB-RK-10378		
	02/93→09/96	Suspension Arm Repair Kit	DB-RK-5283			
	02/93→09/96	Tie Rod	DB-DL-8640		Guide Rod	
	02/93→09/96	Tie Rod	DB-ES-5209			
	02/93→09/96	Tie Rod	DB-ES-5227		Guide Rod	
	02/93→09/96	Tie Rod End	CV-ES-12461		for Steering Rod	
2027 AK	02/93→09/96	Ball Head, gearshift linkage	DB-ES-8387			
	02/93→09/96	Ball Head, gearshift linkage	DB-ES-8500			
	02/93→09/96	Centre Rod	DB-DL-5217		Push Rod	
	02/93→09/96	Centre Rod	DB-DL-10216		Push Rod	
	02/93→09/96	Tie Rod	DB-ES-5209			
	02/93→09/96	Tie Rod	DB-ES-5227		Guide Rod	
	02/93→09/96	Tie Rod	MN-DL-7834		Guide Rod	
	02/93→09/96	Tie Rod End	CV-ES-12461		for Steering Rod	
	02/93→09/96	Tie Rod End	DB-ES-5234		for Steering Rod	
	2031	03/92→09/96	Ball Head, gearshift linkage	DB-ES-8387		
		03/92→09/96	Ball Head, gearshift linkage	DB-ES-8492		
		03/92→09/96	Ball Head, gearshift linkage	DB-ES-8500		
03/92→09/96		Centre Rod	DB-DL-5217		Push Rod	
03/92→09/96		Centre Rod	DB-DL-7831		Push Rod	
03/92→09/96		Centre Rod	DB-DL-7831		Push Rod→* K 226 467 *	
03/92→09/96		Centre Rod	DB-DL-8131		Push Rod	
03/92→09/96		Centre Rod	DB-DL-8138		Push Rod	
03/92→09/96		Centre Rod	DB-DL-8618		Push Rod	
03/92→09/96		Stabiliser Mounting	DB-SB-5258	DB-SB-5258		
03/92→09/96		Suspension Arm Repair Kit		DB-RK-10378		
03/92→09/96		Suspension Arm Repair Kit	DB-RK-5283			
03/92→09/96		Tie Rod	DB-DL-8640		Guide Rod	
03/92→09/96		Tie Rod	DB-ES-5209			

CV-ES-12461

Length: 120
 Cone Ø: d1 Ø 26 / d2 Ø 23,5
 Thread: M30 x 1,5 LHT
 0003300035, 3300148, 0003406213, 0013306635,
 0013308835, 0014604048, 0014604348,
 14606448, 0024600248, 3023300035,
 3023300135, 3023300235, 3023300335,
 3453307235, 3453307435, 3503307135,
 A0003300148, A0013306635, A0013308835,
 A0014604048, A0014604348, A0014606448,
 A0024600248, A3023300035, A3023300135,
 A3023300235, A3023300335, A3503307135



DB-DL-5217

Length: 862 Ø: 40
 Cone Ø: d1 Ø 30 / d2 Ø 27
 01214700A, 6204600405, 6204600805,
 6204602905, 6204603005



DB-DL-5233

Length: 895 Ø: 48
 Cone Ø: d1 Ø 30 / d2 Ø 27
 01217300A, 0004609805, 0004609905



DB-DL-7831

Length: 870
 Ø: 42
 Cone Ø: d1 Ø 30 / d2 Ø 27
 01215200A, 6254602505



DB-DL-8131

Length: 1115 Ø: 52
 Cone Ø: d1 Ø 32 / d2 Ø 28,8
 0004604405, 6254605005



DB-DL-8138

Length: 1130
 Ø: 40
 Cone Ø: d1 Ø 32 / d2 Ø 28,8
 0004606605, 4606605



DB-DL-8618

Length: 680
 Ø: 42
 Cone Ø: d1 Ø 32 / d2 Ø 28,8
 0004604305, 4604305, 6254604805



DB-DL-8640

Length: 1615 Ø: 50
 Cone Ø: d1 Ø 32 / d2 Ø 29
 6253301503, 6253301603, 6253302403,
 6253302503, 9423300803, 9423302103,
 9493300203, 9493300303, 9493300903



DB-DL-10216

Length: 1190
 Ø: 40
 Cone Ø: d1 Ø 32 / d2 Ø 29
 0004604905



DB-ES-5209

Length: 1670 Ø: 50
 Cone Ø: d1 Ø 30 / d2 Ø 27
 6203300503, 6203300603



DB-ES-5227

Length: 1588 Ø: 60
 Cone Ø: d1 Ø 38 / d2 Ø 34,3
 6253300903, 6253301203, 9443300203



DB-ES-5234

Length: 135
 Cone Ø: d1 Ø 38 / d2 Ø 34,3
 Thread: M38 x 1,5 RHT
 0004601748, 120322305, 2205000400



DB-ES-8387

Length: 55
 Cone Ø: d1 Ø 10 / d2 Ø 10
 Thread: M14 x 1,5 RHT
 0009966845, 0009967045



DB-ES-8492

Length: 60
 Cone Ø: d1 Ø 10 / d2 Ø 10
 Thread: M12 x 1,75 RHT
 0009966645, 3752680189, A3752680189



DB-ES-8500

Length: 55
 Cone Ø: d1 Ø 12 / d2 Ø 10,8
 Thread: M14 x 1,5 RHT
 0002685989



DB-RK-5283

Ø: 70
 01319900A, 6203200628



DB-RK-10378

Ø: 86
 6203200028



DB-SB-5258

Ø: 70
 Thick/Height: 62
 01311400A, 3873230285



MN-DL-7834

Length: 1588 Ø: 58
 Cone Ø: d1 Ø 30 / d2 Ø 27
 3463303903, 3463304903, 6253303203,
 9443300503, 9443301303, 9443301703





SK ...

2031 ...	03/92→09/96	Tie Rod	DB-ES-5227		Guide Rod	
	03/92→09/96	Tie Rod End	CV-ES-12461		for Steering Rod	
2031 A	03/92→09/96	Ball Head, gearshift linkage	DB-ES-8387			
	03/92→09/96	Ball Head, gearshift linkage	DB-ES-8500			
	03/92→09/96	Centre Rod	DB-DL-5217		Push Rod	
	03/92→09/96	Centre Rod	DB-DL-5217		Push Rod→* K 040 469 *	
	03/92→09/96	Centre Rod	DB-DL-9263		Push Rod* K 040 470 *→	
	03/92→09/96	Centre Rod	DB-DL-10216		Push Rod	
	03/92→09/96	Stabiliser Mounting	DB-SB-5258	DB-SB-5258		
	03/92→09/96	Suspension Arm Repair Kit		DB-RK-10378		
	03/92→09/96	Suspension Arm Repair Kit	DB-RK-5283			
	03/92→09/96	Tie Rod	DB-ES-5209			
	03/92→09/96	Tie Rod	DB-ES-5227		Guide Rod	
	03/92→09/96	Tie Rod	MN-DL-7834		Guide Rod	
	03/92→09/96	Tie Rod End	CV-ES-12461		for Steering Rod	
	03/92→09/96	Tie Rod End	DB-ES-5234		for Steering Rod	
2031 AS	03/92→09/96	Ball Head, gearshift linkage	DB-ES-8387			
	03/92→09/96	Ball Head, gearshift linkage	DB-ES-8500			
	03/92→09/96	Centre Rod	DB-DL-5217		Push Rod	
	03/92→09/96	Centre Rod	DB-DL-5217		Push Rod→* K 040 469 *	
	03/92→09/96	Centre Rod	DB-DL-9263		Push Rod* K 040 470 *→	
	03/92→09/96	Centre Rod	DB-DL-10216		Push Rod	
	03/92→09/96	Stabiliser Mounting	DB-SB-5258	DB-SB-5258		
	03/92→09/96	Suspension Arm Repair Kit		DB-RK-10378		
	03/92→09/96	Suspension Arm Repair Kit	DB-RK-5283			
	03/92→09/96	Tie Rod	DB-ES-5209			
	03/92→09/96	Tie Rod	DB-ES-5227		Guide Rod	
	03/92→09/96	Tie Rod	MN-DL-7834		Guide Rod	
	03/92→09/96	Tie Rod End	CV-ES-12461		for Steering Rod	
	03/92→09/96	Tie Rod End	DB-ES-5234		for Steering Rod	
2031 K	03/92→09/96	Ball Head, gearshift linkage	DB-ES-8387			
	03/92→09/96	Ball Head, gearshift linkage	DB-ES-8492			
	03/92→09/96	Ball Head, gearshift linkage	DB-ES-8500			
	03/92→09/96	Centre Rod	DB-DL-5217		Push Rod	
	03/92→09/96	Centre Rod	DB-DL-7831		Push Rod	
	03/92→09/96	Centre Rod	DB-DL-7831		Push Rod* K 189 672 *→* K 226 467 *	
	03/92→09/96	Centre Rod	DB-DL-8131		Push Rod	
	03/92→09/96	Centre Rod	DB-DL-8618		Push Rod	
	03/92→09/96	Tie Rod	DB-DL-8640		Guide Rod	
	03/92→09/96	Tie Rod	DB-ES-5227		Guide Rod	
	03/92→09/96	Tie Rod End	CV-ES-12461		for Steering Rod	
	2031 S	03/92→09/96	Ball Head, gearshift linkage	DB-ES-8387		
		03/92→09/96	Ball Head, gearshift linkage	DB-ES-8492		
		03/92→09/96	Ball Head, gearshift linkage	DB-ES-8500		
03/92→09/96		Centre Rod	DB-DL-5217		Push Rod	
03/92→09/96		Centre Rod	DB-DL-5233		Push Rod	
03/92→09/96		Centre Rod	DB-DL-7831		Push Rod	
03/92→09/96		Centre Rod	DB-DL-8131		Push Rod	
03/92→09/96		Centre Rod	DB-DL-8618		Push Rod	
03/92→09/96		Stabiliser Mounting	DB-SB-5258		1st FA	
03/92→09/96		Stabiliser Mounting	DB-SB-5258	DB-SB-5258		
03/92→09/96		Tie Rod	DB-DL-8640		Guide Rod	
03/92→09/96		Tie Rod	DB-ES-5209			
03/92→09/96		Tie Rod	DB-ES-5227		Guide Rod	
03/92→09/96		Tie Rod End	CV-ES-0543			
03/92→09/96		Tie Rod End	CV-ES-0888			
03/92→09/96		Tie Rod End	CV-ES-14163		for Steering Rod	
2038		11/91→09/96	Centre Rod	DB-DL-9256		Push Rod
	11/91→09/96	Stabiliser Mounting	DB-SB-5258		1st FA	
	11/91→09/96	Stabiliser Mounting	DB-SB-5258	DB-SB-5258		
	11/91→09/96	Suspension Arm Repair Kit		DB-RK-10378		
	11/91→09/96	Suspension Arm Repair Kit	DB-RK-5283			
	11/91→	Ball Head, gearshift linkage	DB-ES-8387			

CV-ES-0543

Length: 125
Cone Ø: d1 Ø 32 / d2 Ø 29
Thread: M30 x 1,5 RHT
0004605748, 0004606048, 0004606848,
0004607048, 0014600448, 0014601148,
0014601748, 0014602448, 0014607648,
0014609648



CV-ES-0888

Length: 125
Cone Ø: d1 Ø 32 / d2 Ø 29
Thread: M30 x 1,5 LHT
0004605848, 0004606148, 0004606948,
0004607148, 0004609048, 0014600548,
0014601348, 0014602548, 0014607948,
0024600448



CV-ES-12461

Length: 120
Cone Ø: d1 Ø 26 / d2 Ø 23,5
Thread: M30 x 1,5 LHT
0003300035, 3300148, 0003406213, 0013306635,
0013308835, 0014604048, 0014604348,
14606448, 0024600248, 3023300035,
3023300135, 3023300235, 3023300335,
3453307235, 3453307435, 3503307135,
A0003300148, A0013306635, A0013308835,
A0014604048, A0014604348, A0014606448,
A0024600248, A3023300035, A3023300135,
A3023300235, A3023300335, A3503307135



CV-ES-14163

Length: 125
Cone Ø: d1 Ø 30 / d2 Ø 27
Thread: M30 x 1,5 RHT
0003305248, 0003387310, 0004600348,
0004600948, 0004602848, 0004602948,
0004608948, 0014600248, 0014600848,
0014601248, 0014602248, 0014607748,
0024600148, A0003387310, A0004600348,
A0004602848, A0004602948, A0014600848,
A0014601248, A0014602248, A0014607748



DB-DL-5217

Length: 862 Ø: 40
Cone Ø: d1 Ø 30 / d2 Ø 27
01214700A, 6204600405, 6204600805,
6204602905, 6204603005



DB-DL-5233

Length: 895
Ø: 48
Cone Ø: d1 Ø 30 / d2 Ø 27
01217300A, 0004609805, 4609805, 4609905,
0004609905



DB-DL-7831

Length: 870
Ø: 42
Cone Ø: d1 Ø 30 / d2 Ø 27
01215200A, 6254602505



DB-DL-8131

Length: 1115 Ø: 52
Cone Ø: d1 Ø 32 / d2 Ø 28,8
0004604405, 6254605005



DB-DL-8618

Length: 680
Ø: 42
Cone Ø: d1 Ø 32 / d2 Ø 28,8
0004604305, 4604305, 6254604805



DB-DL-8640

Length: 1615 Ø: 50
Cone Ø: d1 Ø 32 / d2 Ø 29
6253301503, 6253301603, 6253302403,
6253302503, 9423300803, 9423302103,
9493300203, 9493300303, 9493300903



DB-DL-9256

Length: 905
Ø: 48
Cone Ø: d1 Ø 32 / d2 Ø 29
0014604205, 14604205



DB-DL-9263

Length: 870
Ø: 42
Cone Ø: d1 Ø 32 / d2 Ø 27
0014600505, 14600505, 14600605, 0014600605



DB-DL-10216

Length: 1190
Ø: 40
Cone Ø: d1 Ø 32 / d2 Ø 29
0004604905



DB-ES-5209

Length: 1670 Ø: 50
Cone Ø: d1 Ø 30 / d2 Ø 27
6203300503, 6203300603



DB-ES-5227

Length: 1588 Ø: 60
Cone Ø: d1 Ø 38 / d2 Ø 34,3
6253300903, 6253301203, 9443300203



DB-ES-5234

Length: 135
Cone Ø: d1 Ø 38 / d2 Ø 34,3
Thread: M38 x 1,5 RHT
0004601748, 120322305, 2205000400



DB-ES-8387

Length: 55
Cone Ø: d1 Ø 10 / d2 Ø 10
Thread: M14 x 1,5 RHT
0009966845, 0009967045



DB-ES-8492

Length: 60
Cone Ø: d1 Ø 10 / d2 Ø 10
Thread: M12 x 1,75 RHT
0009966645, 3752680189, A3752680189



DB-ES-8500

Length: 55
Cone Ø: d1 Ø 12 / d2 Ø 10,8
Thread: M14 x 1,5 RHT
0002685989



DB-RK-5283

Ø: 70
01319900A, 6203200628



DB-RK-10378

Ø: 86
6203200028



DB-SB-5258

Ø: 70
Thick/Height: 62
01311400A, 3873230285



MN-DL-7834

Length: 1588 Ø: 58
Cone Ø: d1 Ø 30 / d2 Ø 27
3463303903, 3463304903, 6253303203,
9443300503, 9443301303, 9443301703





SK ...

2038 ...	11/91→	Ball Head, gearshift linkage	DB-ES-8491		
	11/91→	Ball Head, gearshift linkage	DB-ES-8492		
	11/91→	Ball Head, gearshift linkage	DB-ES-8500		
	11/91→	Centre Rod	DB-DL-5217		Push Rod
	11/91→	Centre Rod	DB-DL-5233		Push Rod* K 017 164 *→
	11/91→	Centre Rod	DB-DL-7831		Push Rod
	11/91→	Centre Rod	DB-DL-7831		Push Rod→* K 226 467 *
	11/91→	Centre Rod	DB-DL-8131		Push Rod
	11/91→	Centre Rod	DB-DL-8138		Push Rod
	11/91→	Centre Rod	DB-DL-8618		Push Rod
	11/91→	Centre Rod	DB-DL-10216		Push Rod
	11/91→	Tie Rod	DB-DL-8640		Guide Rod
	11/91→	Tie Rod	DB-ES-5209		
	11/91→	Tie Rod	DB-ES-5227		Guide Rod
	11/91→	Tie Rod	MN-DL-7834		Guide Rod
11/91→	Tie Rod End	CV-ES-12461		for Steering Rod	
11/91→	Tie Rod End	CV-ES-14163		for Steering Rod	
11/91→	Tie Rod End	DB-ES-5234		for Steering Rod	
2038 AS	12/92→09/96	Ball Head, gearshift linkage	DB-ES-8491		
	12/92→09/96	Ball Head, gearshift linkage	DB-ES-8492		
	12/92→09/96	Ball Head, gearshift linkage	DB-ES-8500		
	12/92→09/96	Centre Rod	DB-DL-5217		Push Rod
	12/92→09/96	Centre Rod	DB-DL-5217		Push Rod→* K 040 469 *
	12/92→09/96	Centre Rod	DB-DL-9263		Push Rod* K 040 470 *→
	12/92→09/96	Centre Rod	DB-DL-10216		Push Rod
	12/92→09/96	Stabiliser Mounting	DB-SB-5258	DB-SB-5258	
	12/92→09/96	Suspension Arm Repair Kit		DB-RK-10378	
	12/92→09/96	Suspension Arm Repair Kit	DB-RK-5283		
	12/92→09/96	Tie Rod	DB-ES-5227		Guide Rod
	12/92→09/96	Tie Rod	MN-DL-7834		Guide Rod
12/92→09/96	Tie Rod End	CV-ES-12461		for Steering Rod	
2038 S	11/91→09/96	Ball Head, gearshift linkage	DB-ES-8387		
	11/91→09/96	Ball Head, gearshift linkage	DB-ES-8491		
	11/91→09/96	Ball Head, gearshift linkage	DB-ES-8492		
	11/91→09/96	Ball Head, gearshift linkage	DB-ES-8500		
	11/91→09/96	Centre Rod	DB-DL-5217		Push Rod
	11/91→09/96	Centre Rod	DB-DL-5233		Push Rod* K 017 164 *→
	11/91→09/96	Centre Rod	DB-DL-7831		Push Rod
	11/91→09/96	Centre Rod	DB-DL-8131		Push Rod
	11/91→09/96	Centre Rod	DB-DL-8618		Push Rod
	11/91→09/96	Stabiliser Mounting	DB-SB-5258		1st FA
	11/91→09/96	Stabiliser Mounting	DB-SB-5258	DB-SB-5258	
	11/91→09/96	Tie Rod	DB-DL-8640		Guide Rod
	11/91→09/96	Tie Rod	DB-ES-5209		
	11/91→09/96	Tie Rod	DB-ES-5227		Guide Rod
	11/91→09/96	Tie Rod End	CV-ES-0543		
	11/91→09/96	Tie Rod End	CV-ES-0888		
	11/91→09/96	Tie Rod End	CV-ES-14163		for Steering Rod
	2044	01/92→09/96	Ball Head, gearshift linkage	DB-ES-8387	
01/92→09/96		Ball Head, gearshift linkage	DB-ES-8491		
01/92→09/96		Ball Head, gearshift linkage	DB-ES-8492		
01/92→09/96		Ball Head, gearshift linkage	DB-ES-8500		
01/92→09/96		Centre Rod	DB-DL-5217		Push Rod
01/92→09/96		Centre Rod	DB-DL-5233		Push Rod* K 017 164 *→
01/92→09/96		Centre Rod	DB-DL-7831		Push Rod
01/92→09/96		Centre Rod	DB-DL-7831		Push Rod→* K 226 467 *
01/92→09/96		Centre Rod	DB-DL-8131		Push Rod
01/92→09/96		Centre Rod	DB-DL-8138		Push Rod
01/92→09/96		Centre Rod	DB-DL-8618		Push Rod
01/92→09/96		Centre Rod	DB-DL-10216		Push Rod
01/92→09/96		Stabiliser Mounting	DB-SB-5258		1st FA
01/92→09/96		Stabiliser Mounting	DB-SB-5258	DB-SB-5258	
01/92→09/96		Suspension Arm Repair Kit	DB-RK-5283		

CV-ES-0543

Length: 125
 Cone Ø: d1 Ø 32 / d2 Ø 29
 Thread: M30 x 1,5 RHT
 0004605748, 0004606048, 0004606848,
 0004607048, 0014600448, 0014601148,
 0014601748, 0014602448, 0014607648,
 0014609648



CV-ES-0888

Length: 125
 Cone Ø: d1 Ø 32 / d2 Ø 29
 Thread: M30 x 1,5 LHT
 0004605848, 0004606148, 0004606948,
 0004607148, 0004609048, 0014600548,
 0014601348, 0014602548, 0014607948,
 0024600448



CV-ES-12461

Length: 120
 Cone Ø: d1 Ø 26 / d2 Ø 23,5
 Thread: M30 x 1,5 LHT
 0003300035, 3300148, 0003406213, 0013306635,
 0013308835, 0014604048, 0014604348,
 14606448, 0024600248, 3023300035,
 3023300135, 3023300235, 3023300335,
 3453307235, 3453307435, 3503307135,
 A0003300148, A0013306635, A0013308835,
 A0014604048, A0014604348, A0014606448,
 A0024600248, A3023300035, A3023300135,
 A3023300235, A3023300335, A3503307135



CV-ES-14163

Length: 125
 Cone Ø: d1 Ø 30 / d2 Ø 27
 Thread: M30 x 1,5 RHT
 0003305248, 0003387310, 0004600348,
 0004600948, 0004602848, 0004602948,
 0004608948, 0014600248, 0014600848,
 0014601248, 0014602248, 0014607748,
 0024600148, A0003387310, A0004600348,
 A0004602848, A0004602948, A0014600848,
 A0014601248, A0014602248, A0014607748



DB-DL-5217

Length: 862 Ø: 40
 Cone Ø: d1 Ø 30 / d2 Ø 27
 01214700A, 6204600405, 6204600805,
 6204602905, 6204603005



DB-DL-5233

Length: 895 Ø: 48
 Cone Ø: d1 Ø 30 / d2 Ø 27
 01217300A, 0004609805, 0004609905



DB-DL-7831

Length: 870
 Ø: 42
 Cone Ø: d1 Ø 30 / d2 Ø 27
 01215200A, 6254602505



DB-DL-8131

Length: 1115
 Ø: 52
 Cone Ø: d1 Ø 32 / d2 Ø 28,8
 4604405, 0004604405, 6254605005



DB-DL-8138

Length: 1130
 Ø: 40
 Cone Ø: d1 Ø 32 / d2 Ø 28,8
 0004606605, 4606605



DB-DL-8618

Length: 680
 Ø: 42
 Cone Ø: d1 Ø 32 / d2 Ø 28,8
 0004604305, 4604305, 6254604805



DB-DL-8640

Length: 1615 Ø: 50
 Cone Ø: d1 Ø 32 / d2 Ø 29
 6253301503, 6253301603, 6253302403,
 6253302503, 9423300803, 9423302103,
 9493300203, 9493300303, 9493300903



DB-DL-9263

Length: 870
 Ø: 42
 Cone Ø: d1 Ø 32 / d2 Ø 27
 0014600505, 14600505, 14600605, 0014600605



DB-DL-10216

Length: 1190
 Ø: 40
 Cone Ø: d1 Ø 32 / d2 Ø 29
 0004604905



DB-ES-5209

Length: 1670 Ø: 50
 Cone Ø: d1 Ø 30 / d2 Ø 27
 6203300503, 6203300603



DB-ES-5227

Length: 1588 Ø: 60
 Cone Ø: d1 Ø 38 / d2 Ø 34,3
 6253300903, 6253301203, 9443300203



DB-ES-5234

Length: 135
 Cone Ø: d1 Ø 38 / d2 Ø 34,3
 Thread: M38 x 1,5 RHT
 0004601748, 120322305, 2205000400



DB-ES-8387

Length: 55
 Cone Ø: d1 Ø 10 / d2 Ø 10
 Thread: M14 x 1,5 RHT
 0009966845, 0009967045



DB-ES-8491

Length: 60
 Cone Ø: d1 Ø 10 / d2 Ø 10
 Thread: M12 x 1,75 LHT
 0009966745



DB-ES-8492

Length: 60
 Cone Ø: d1 Ø 10 / d2 Ø 10
 Thread: M12 x 1,75 RHT
 0009966645, 3752680189, A3752680189



DB-ES-8500

Length: 55
 Cone Ø: d1 Ø 12 / d2 Ø 10,8
 Thread: M14 x 1,5 RHT
 0002685989



DB-RK-5283

Ø: 70
 01319900A, 6203200628



DB-RK-10378

Ø: 86
 6203200028



DB-SB-5258

Ø: 70
 Thick/Height: 62
 01311400A, 3873230285



MN-DL-7834

Length: 1588 Ø: 58
 Cone Ø: d1 Ø 30 / d2 Ø 27
 3463303903, 3463304903, 6253303203,
 9443300503, 9443301303, 9443301703





SK ...

2044 ...	01/92→09/96	Tie Rod	DB-DL-8640		Guide Rod
	01/92→09/96	Tie Rod	DB-ES-5209		
	01/92→09/96	Tie Rod	DB-ES-5227		Guide Rod
	01/92→09/96	Tie Rod	MN-DL-7834		Guide Rod
	01/92→09/96	Tie Rod End	CV-ES-12461		for Steering Rod
	01/92→09/96	Tie Rod End	CV-ES-14163		for Steering Rod
	01/92→09/96	Tie Rod End	DB-ES-5234		for Steering Rod
2044 AS	01/94→09/96	Ball Head, gearshift linkage	DB-ES-8491		
	01/94→09/96	Ball Head, gearshift linkage	DB-ES-8492		
	01/94→09/96	Ball Head, gearshift linkage	DB-ES-8500		
	01/94→09/96	Centre Rod	DB-DL-5217		Push Rod
	01/94→09/96	Centre Rod	DB-DL-5217		Push Rod→* K 040 469 *
	01/94→09/96	Centre Rod	DB-DL-9263		Push Rod* K 040 470 *→
	01/94→09/96	Centre Rod	DB-DL-10216		Push Rod
	01/94→09/96	Tie Rod	DB-ES-5227		Guide Rod
	01/94→09/96	Tie Rod	MN-DL-7834		Guide Rod
	01/94→09/96	Tie Rod End	CV-ES-12461		for Steering Rod
	2044 S	01/92→09/96	Ball Head, gearshift linkage	DB-ES-8387	
01/92→09/96		Ball Head, gearshift linkage	DB-ES-8491		
01/92→09/96		Ball Head, gearshift linkage	DB-ES-8492		
01/92→09/96		Ball Head, gearshift linkage	DB-ES-8500		
01/92→09/96		Centre Rod	DB-DL-5217		Push Rod
01/92→09/96		Centre Rod	DB-DL-5233		Push Rod* K 017 164 *→
01/92→09/96		Centre Rod	DB-DL-7831		Push Rod
01/92→09/96		Centre Rod	DB-DL-8131		Push Rod
01/92→09/96		Centre Rod	DB-DL-8618		Push Rod
01/92→09/96		Stabiliser Mounting	DB-SB-5258		1st FA
01/92→09/96		Stabiliser Mounting	DB-SB-5258	DB-SB-5258	
01/92→09/96		Tie Rod	DB-DL-8640		Guide Rod
01/92→09/96		Tie Rod	DB-ES-5209		
01/92→09/96		Tie Rod	DB-ES-5227		Guide Rod
01/92→09/96		Tie Rod End	CV-ES-14163		for Steering Rod
2050	01/91→09/96	Ball Head, gearshift linkage	DB-ES-8387		
	01/91→09/96	Ball Head, gearshift linkage	DB-ES-8491		
	01/91→09/96	Ball Head, gearshift linkage	DB-ES-8492		
	01/91→09/96	Ball Head, gearshift linkage	DB-ES-8500		
	01/91→09/96	Centre Rod	DB-DL-5217		Push Rod
	01/91→09/96	Centre Rod	DB-DL-5233		Push Rod* K 017 164 *→
	01/91→09/96	Centre Rod	DB-DL-7831		Push Rod
	01/91→09/96	Centre Rod	DB-DL-7831		Push Rod→* K 226 467 *
	01/91→09/96	Centre Rod	DB-DL-8131		Push Rod
	01/91→09/96	Centre Rod	DB-DL-8138		Push Rod
	01/91→09/96	Centre Rod	DB-DL-8618		Push Rod
	01/91→09/96	Suspension Arm Repair Kit		DB-RK-10378	
	01/91→09/96	Tie Rod	DB-DL-8640		Guide Rod
	01/91→09/96	Tie Rod	DB-ES-5209		
	01/91→09/96	Tie Rod	DB-ES-5227		Guide Rod
	01/91→09/96	Tie Rod End	CV-ES-12461		for Steering Rod
	01/91→09/96	Tie Rod End	CV-ES-14163		for Steering Rod
2050 S	01/91→09/96	Ball Head, gearshift linkage	DB-ES-8387		
	01/91→09/96	Ball Head, gearshift linkage	DB-ES-8491		
	01/91→09/96	Ball Head, gearshift linkage	DB-ES-8492		
	01/91→09/96	Ball Head, gearshift linkage	DB-ES-8500		
	01/91→09/96	Centre Rod	DB-DL-5217		Push Rod
	01/91→09/96	Centre Rod	DB-DL-5233		Push Rod* K 017 164 *→
	01/91→09/96	Centre Rod	DB-DL-7831		Push Rod
	01/91→09/96	Centre Rod	DB-DL-8131		Push Rod
	01/91→09/96	Centre Rod	DB-DL-8618		Push Rod
	01/91→09/96	Stabiliser Mounting	DB-SB-5258		1st FA
	01/91→09/96	Stabiliser Mounting	DB-SB-5258	DB-SB-5258	
	01/91→09/96	Tie Rod	DB-DL-8640		Guide Rod
	01/91→09/96	Tie Rod	DB-ES-5209		
	01/91→09/96	Tie Rod	DB-ES-5227		Guide Rod
	01/91→09/96	Tie Rod End	CV-ES-14163		for Steering Rod

CV-ES-12461

Length: 120
 Cone Ø: d1 Ø 26 / d2 Ø 23,5
 Thread: M30 x 1,5 LHT
 0003300035, 3300148, 0003406213, 0013306635,
 0013308835, 0014604048, 0014604348,
 14606448, 0024600248, 3023300035,
 3023300135, 3023300235, 3023300335,
 3453307235, 3453307435, 3503307135,
 A0003300148, A0013306635, A0013308835,
 A0014604048, A0014604348, A0014606448,
 A0024600248, A3023300035, A3023300135,
 A3023300235, A3023300335, A3503307135



CV-ES-14163

Length: 125
 Cone Ø: d1 Ø 30 / d2 Ø 27
 Thread: M30 x 1,5 RHT
 0003305248, 0003387310, 0004600348,
 0004600948, 0004602848, 0004602948,
 0004608948, 0014600248, 0014600848,
 0014601248, 0014602248, 0014607748,
 0024600148, A0003387310, A0004600348,
 A0004602848, A0004602948, A0014600848,
 A0014601248, A0014602248, A0014607748



DB-DL-5217

Length: 862 Ø: 40
 Cone Ø: d1 Ø 30 / d2 Ø 27
 01214700A, 6204600405, 6204600805,
 6204602905, 6204603005



DB-DL-5233

Length: 895
 Ø: 48
 Cone Ø: d1 Ø 30 / d2 Ø 27
 01217300A, 4609805, 0004609805, 0004609905,
 4609905



DB-DL-7831

Length: 870
 Ø: 42
 Cone Ø: d1 Ø 30 / d2 Ø 27
 01215200A, 6254602505



DB-DL-8131

Length: 1115 Ø: 52
 Cone Ø: d1 Ø 32 / d2 Ø 28,8
 0004604405, 6254605005



DB-DL-8138

Length: 1130
 Ø: 40
 Cone Ø: d1 Ø 32 / d2 Ø 28,8
 0004606605, 4606605



DB-DL-8618

Length: 680
 Ø: 42
 Cone Ø: d1 Ø 32 / d2 Ø 28,8
 0004604305, 4604305, 6254604805



DB-DL-8640

Length: 1615 Ø: 50
 Cone Ø: d1 Ø 32 / d2 Ø 29
 6253301503, 6253301603, 6253302403,
 6253302503, 9423300803, 9423302103,
 9493300203, 9493300303, 9493300903



DB-DL-9263

Length: 870
 Ø: 42
 Cone Ø: d1 Ø 32 / d2 Ø 27
 14600505, 0014600505, 0014600605, 14600605



DB-DL-10216

Length: 1190
 Ø: 40
 Cone Ø: d1 Ø 32 / d2 Ø 29
 0004604905



DB-ES-5209

Length: 1670 Ø: 50
 Cone Ø: d1 Ø 30 / d2 Ø 27
 6203300503, 6203300603



DB-ES-5227

Length: 1588 Ø: 60
 Cone Ø: d1 Ø 38 / d2 Ø 34,3
 6253300903, 6253301203, 9443300203



DB-ES-5234

Length: 135
 Cone Ø: d1 Ø 38 / d2 Ø 34,3
 Thread: M38 x 1,5 RHT
 0004601748, 120322305, 2205000400



DB-ES-8387

Length: 55
 Cone Ø: d1 Ø 10 / d2 Ø 10
 Thread: M14 x 1,5 RHT
 0009966845, 0009967045



DB-ES-8491

Length: 60
 Cone Ø: d1 Ø 10 / d2 Ø 10
 Thread: M12 x 1,75 LHT
 0009966745



DB-ES-8492

Length: 60
 Cone Ø: d1 Ø 10 / d2 Ø 10
 Thread: M12 x 1,75 RHT
 0009966645, 3752680189, A3752680189



DB-ES-8500

Length: 55
 Cone Ø: d1 Ø 12 / d2 Ø 10,8
 Thread: M14 x 1,5 RHT
 0002685989



DB-RK-10378

Ø: 86
 6203200028



DB-SB-5258

Ø: 70
 Thick/Height: 62
 01311400A, 3873230285



MN-DL-7834

Length: 1588 Ø: 58
 Cone Ø: d1 Ø 30 / d2 Ø 27
 3463303903, 3463304903, 6253303203,
 9443300503, 9443301303, 9443301703





SK ...

2055 AF	01/92→09/96	Ball Head, gearshift linkage	DB-ES-8387		
	01/92→09/96	Ball Head, gearshift linkage	DB-ES-8491		
	01/92→09/96	Ball Head, gearshift linkage	DB-ES-8492		
	01/92→09/96	Ball Head, gearshift linkage	DB-ES-8500		
	01/92→09/96	Centre Rod	DB-DL-5217		Push Rod
	01/92→09/96	Centre Rod	DB-DL-5233		Push Rod* K 017 164 *→
	01/92→09/96	Centre Rod	DB-DL-7831		Push Rod
	01/92→09/96	Centre Rod	DB-DL-7831		Push Rod→* K 226 467 *
	01/92→09/96	Centre Rod	DB-DL-8131		Push Rod
	01/92→09/96	Centre Rod	DB-DL-8618		Push Rod
	01/92→09/96	Tie Rod	DB-DL-8640		Guide Rod
	01/92→09/96	Tie Rod	DB-ES-5209		
	01/92→09/96	Tie Rod	DB-ES-5227		Guide Rod
	01/92→09/96	Tie Rod End	CV-ES-12461		for Steering Rod
	01/92→09/96	Tie Rod End	DB-ES-5234		for Steering Rod
2422 L	07/87→09/96	Centre Rod	DB-DL-5217		Push Rod
	07/87→09/96	Centre Rod	DB-DL-7831		Push Rod
	07/87→09/96	Centre Rod	DB-DL-8131		Push Rod
	07/87→09/96	Centre Rod	DB-DL-8138		Push Rod
	07/87→09/96	Centre Rod	DB-DL-8618		Push Rod
	07/87→09/96	Tie Rod	DB-DL-8640		Guide Rod
	07/87→09/96	Tie Rod	DB-ES-5209		
	07/87→09/96	Tie Rod	DB-ES-5227		Guide Rod
	07/87→09/96	Tie Rod End	CV-ES-12461		for Steering Rod
	07/87→09/96	Tie Rod End	CV-ES-14163		for Steering Rod
2429	07/87→09/96	Tie Rod End	CV-ES-12461		for Steering Rod
	07/87→09/96	Tie Rod End	CV-ES-14163		for Steering Rod
	07/88→08/94	Centre Rod	DB-DL-5217		Push Rod
	07/88→08/94	Centre Rod	DB-DL-5233		Push Rod* 5 937 288 *→
	07/88→08/94	Centre Rod	DB-DL-7831		Push Rod
	07/88→08/94	Centre Rod	DB-DL-7831		Push Rod→* K 226 467 *
	07/88→08/94	Centre Rod	DB-DL-8131		Push Rod
	07/88→08/94	Centre Rod	DB-DL-8138		Push Rod
	07/88→08/94	Centre Rod	DB-DL-8138		Push Rod
	07/88→08/94	Centre Rod	DB-DL-8618		Push Rod
	07/88→08/94	Suspension Arm Repair Kit	DB-RK-6111	DB-RK-6111	Trailing Arm
	07/88→08/94	Tie Rod	DB-DL-8640		Guide Rod
	07/88→08/94	Tie Rod	DB-ES-5209		
07/88→08/94	Track Control Arm		DB-DL-7839	Trailing Arm	
07/88→08/94	Track Control Arm		DB-DS-6088	Suspension Rod, Trailing Arm	
2429 K	07/88→08/94	Centre Rod	DB-DL-5217		Push Rod
	07/88→08/94	Centre Rod	DB-DL-5233		Push Rod* 5 937 288 *→
	07/88→08/94	Centre Rod	DB-DL-7831		Push Rod
	07/88→08/94	Centre Rod	DB-DL-8131		Push Rod
	07/88→08/94	Centre Rod	DB-DL-8618		Push Rod
	07/88→08/94	Stabiliser Mounting	DB-SB-5258	DB-SB-5258	
	07/88→08/94	Suspension Arm Repair Kit		DB-RK-7267	for Drag Link
	07/88→08/94	Suspension Arm Repair Kit	DB-RK-5283		
	07/88→08/94	Tie Rod	DB-DL-8640		Guide Rod
	07/88→08/94	Tie Rod	DB-ES-5209		
	07/88→08/94	Tie Rod End	CV-ES-12461		for Steering Rod
	07/88→08/94	Tie Rod End	CV-ES-14163		for Steering Rod
	07/88→08/94	Track Control Arm		DB-DL-7839	Trailing Arm
	07/88→08/94	Track Control Arm		DB-DS-6088	Suspension Rod, Trailing Arm
	2429 S	07/88→08/94	Centre Rod	DB-DL-5217	
07/88→08/94		Centre Rod	DB-DL-5233		Push Rod* 5 937 288 *→
07/88→08/94		Centre Rod	DB-DL-7831		Push Rod
07/88→08/94		Centre Rod	DB-DL-7831		Push Rod→* K 226 467 *
07/88→08/94		Centre Rod	DB-DL-8131		Push Rod
07/88→08/94		Centre Rod	DB-DL-8138		Push Rod
07/88→08/94		Centre Rod	DB-DL-8618		Push Rod
07/88→08/94		Stabiliser Mounting	DB-SB-5258	DB-SB-5258	
07/88→08/94		Suspension Arm Repair Kit	DB-RK-5283		
07/88→08/94		Suspension Arm Repair Kit	DB-RK-6111	DB-RK-6111	Trailing Arm
07/88→08/94		Tie Rod	DB-DL-8640		Guide Rod

CV-ES-12461

Length: 120
Cone Ø: d1 Ø 26 / d2 Ø 23,5
Thread: M30 x 1,5 LHT
0003300035, 3300148, 0003406213, 0013306635,
0013308835, 0014604048, 0014604348,
14606448, 0024600248, 3023300035,
3023300135, 3023300235, 3023300335,
3453307235, 3453307435, 3503307135,
A0003300148, A0013306635, A0013308835,
A0014604048, A0014604348, A0014606448,
A0024600248, A3023300035, A3023300135,
A3023300235, A3023300335, A3503307135



CV-ES-14163

Length: 125
Cone Ø: d1 Ø 30 / d2 Ø 27
Thread: M30 x 1,5 RHT
0003305248, 0003387310, 0004600348,
0004600948, 0004602848, 0004602948,
0004608948, 0014600248, 0014600848,
0014601248, 0014602248, 0014607748,
0024600148, A0003387310, A0004600348,
A0004602848, A0004602948, A0014600848,
A0014601248, A0014602248, A0014607748



DB-DL-5217

Length: 862 Ø: 40
Cone Ø: d1 Ø 30 / d2 Ø 27
01214700A, 6204600405, 6204600805,
6204602905, 6204603005



DB-DL-5233

Length: 895 Ø: 48
Cone Ø: d1 Ø 30 / d2 Ø 27
01217300A, 0004609805, 0004609905



DB-DL-7831

Length: 870
Ø: 42
Cone Ø: d1 Ø 30 / d2 Ø 27
01215200A, 6254602505



DB-DL-7839

Length: 585
Ø: 50
Hole Distance: 152 / 152
3953500206, 6593500106, 6593502406



DB-DL-8131

Length: 1115 Ø: 52
Cone Ø: d1 Ø 32 / d2 Ø 28,8
0004604405, 6254605005



DB-DL-8138

Length: 1130
Ø: 40
Cone Ø: d1 Ø 32 / d2 Ø 28,8
0004606605, 4606605



DB-DL-8618

Length: 680
Ø: 42
Cone Ø: d1 Ø 32 / d2 Ø 28,8
0004604305, 4604305, 6254604805



DB-DL-8640

Length: 1615 Ø: 50
Cone Ø: d1 Ø 32 / d2 Ø 29
6253301503, 6253301603, 6253302403,
6253302503, 9423300803, 9423302103,
9493300203, 9493300303, 9493300903



DB-DS-6088

Length: 585
Ø: 50
Hole Distance: 152 / 152
3953500706, 6593500406



DB-ES-5209

Length: 1670 Ø: 50
Cone Ø: d1 Ø 30 / d2 Ø 27
6203300503, 6203300603



DB-ES-5227

Length: 1588 Ø: 60
Cone Ø: d1 Ø 38 / d2 Ø 34,3
6253300903, 6253301203, 9443300203



DB-ES-5234

Length: 135
Cone Ø: d1 Ø 38 / d2 Ø 34,3
Thread: M38 x 1,5 RHT
0004601748, 120322305, 2205000400



DB-ES-8387

Length: 55
Cone Ø: d1 Ø 10 / d2 Ø 10
Thread: M14 x 1,5 RHT
0009966845, 0009967045



DB-ES-8491

Length: 60
Cone Ø: d1 Ø 10 / d2 Ø 10
Thread: M12 x 1,75 LHT
0009966745



DB-ES-8492

Length: 60
Cone Ø: d1 Ø 10 / d2 Ø 10
Thread: M12 x 1,75 RHT
0009966645, 3752680189, A3752680189



DB-ES-8500

Length: 55
Cone Ø: d1 Ø 12 / d2 Ø 10,8
Thread: M14 x 1,5 RHT
0002685989



DB-RK-5283

Ø: 70
01319900A, 6203200628



DB-RK-6111

Ø: 85
Hole Distance: 152
Thick/Height: 24
0003500613, 0005861135



DB-RK-7267

Ø: 95
Hole Distance: 152
Thick/Height: 24
01302100A, 0003500413, 3500413, 0005861235,
5861235, 81432706069



DB-SB-5258

Ø: 70
Thick/Height: 62
01311400A, 3873230285





SK ...

2429 S ...	07/88→08/94	Tie Rod	DB-ES-5209		
	07/88→08/94	Tie Rod End	CV-ES-12461	for Steering Rod	
	07/88→08/94	Tie Rod End	CV-ES-14163	for Steering Rod	
	07/88→08/94	Track Control Arm		DB-DL-7839 Trailing Arm	
	07/88→08/94	Track Control Arm		DB-DS-6088 Suspension Rod, Trailing Arm	
2429 S,2429 LS	07/87→09/96	Centre Rod	DB-DL-5217	Push Rod	
	07/87→09/96	Centre Rod	DB-DL-7831	Push Rod	
	07/87→09/96	Centre Rod	DB-DL-8131	Push Rod	
	07/87→09/96	Centre Rod	DB-DL-8618	Push Rod	
	07/87→09/96	Suspension Arm Repair Kit		DB-RK-8564 Wishbone (CV)	
	07/87→09/96	Suspension Arm Repair Kit		DB-RK-10378	
	07/87→09/96	Suspension Arm Repair Kit		DF-RK-9336	
	07/87→09/96	Suspension Arm Repair Kit		DF-RK-9336 * K 063 070 *→	
	07/87→09/96	Suspension Arm Repair Kit	DB-RK-5280		
	07/87→09/96	Tie Rod	DB-DL-8640	Guide Rod	
	07/87→09/96	Tie Rod End	CV-ES-12461	for Steering Rod	
	07/87→09/96	Tie Rod End	CV-ES-14163	for Steering Rod	
	07/87→09/96	Track Control Arm		DB-DL-7840 Suspension Rod, Trailing Arm	
	07/87→09/96	Track Control Arm		DB-VB-7776 Wishbone (CV);Trailing Arm* 5 926 393 *→	
	2429, 2429 L	07/87→09/96	Centre Rod	DB-DL-5217	Push Rod
07/87→09/96		Centre Rod	DB-DL-5233	Push Rod* K 017 164 *→* K 040 717 *	
07/87→09/96		Centre Rod	DB-DL-7831	Push Rod	
07/87→09/96		Centre Rod	DB-DL-8131	Push Rod	
07/87→09/96		Centre Rod	DB-DL-8138	Push Rod	
07/87→09/96		Centre Rod	DB-DL-8618	Push Rod	
07/87→09/96		Centre Rod	DB-DL-12308	Coupling Rod	
07/87→09/96		Centre Rod	DB-DL-12309	Coupling Rod	
07/87→09/96		Suspension Arm Repair Kit		DB-RK-12372 for Wishbone (CV)	
07/87→09/96		Suspension Arm Repair Kit		DF-RK-9336	
07/87→09/96		Suspension Arm Repair Kit		DF-RK-9336 * K 063 070 *→	
07/87→09/96		Suspension Arm Repair Kit	DB-RK-5282		
07/87→09/96		Tie Rod	DB-DL-8640	Guide Rod	
07/87→09/96		Tie Rod	DB-ES-5209		
07/87→09/96		Tie Rod	DB-ES-5227	Guide Rod	
07/87→09/96		Tie Rod End	CV-ES-12461	for Steering Rod	
07/87→09/96		Tie Rod End	CV-ES-14163	for Steering Rod	
07/87→09/96		Track Control Arm		DB-DL-7840 Suspension Rod, Trailing Arm	
07/87→09/96		Track Control Arm		DB-DL-7840 Suspension Rod, Trailing Arm* 5 922 799 *→	
07/87→09/96		Track Control Arm		DB-VB-7776 Wishbone (CV);Trailing Arm* 5 926 393 *→	
2429,2429 L		07/87→09/96	Centre Rod	DB-DL-10216	Push Rod
		07/87→09/96	Suspension Arm Repair Kit		CV-RK-8118 for Drag Link
		07/87→09/96	Suspension Arm Repair Kit		DB-RK-8564 Wishbone (CV)
		07/87→09/96	Suspension Arm Repair Kit		DB-RK-12372 for Wishbone (CV)K063070→
		07/87→09/96	Suspension Arm Repair Kit		DF-RK-9336 Lifting Axle, * K 063 070 *→
	07/87→09/96	Suspension Arm Repair Kit		MN-RK-9387	
	07/87→09/96	Suspension Arm Repair Kit		MN-RK-9387 →* 5 926 392 *	
	07/87→09/96	Suspension Arm Repair Kit		MN-RK-9387 Lifting Axle, →* 5 926 392 *	
	07/87→09/96	Suspension Arm Repair Kit	DB-RK-5280		
	07/87→09/96	Suspension Strut Repair Kit		DF-RK-8671	
	07/87→09/96	Track Control Arm		DB-VB-7776 Wishbone (CV);Trailing Arm, Lifting Axle	
	2434 L	07/87→09/96	Centre Rod	DB-DL-5217	Push Rod
		07/87→09/96	Centre Rod	DB-DL-7831	Push Rod
		07/87→09/96	Centre Rod	DB-DL-8131	Push Rod
		07/87→09/96	Centre Rod	DB-DL-8138	Push Rod
07/87→09/96		Centre Rod	DB-DL-8618	Push Rod	
07/87→09/96		Centre Rod	DB-DL-10216	Push Rod	
07/87→09/96		Centre Rod	DB-DL-12308	Coupling Rod	
07/87→09/96		Suspension Arm Repair Kit		DB-RK-8564 Wishbone (CV)	
07/87→09/96		Suspension Arm Repair Kit		DB-RK-12372 for Wishbone (CV)	
07/87→09/96		Suspension Arm Repair Kit		DF-RK-9336	
07/87→09/96		Suspension Arm Repair Kit		DF-RK-9336 * K 063 070 *→	
07/87→09/96		Suspension Arm Repair Kit		DF-RK-9336 Lifting Axle, * K 063 070 *→	
07/87→09/96		Suspension Arm Repair Kit		MN-RK-9387	

CV-ES-12461

Length: 120
Cone Ø: d1 Ø 26 / d2 Ø 23,5
Thread: M30 x 1,5 LHT
0003300035, 3300148, 0003406213, 0013306635, 0013308835, 0014604048, 0014604348, 14606448, 0024600248, 3023300035, 3023300135, 3023300235, 3023300335, 3453307235, 3453307435, 3503307135, A0003300148, A0013306635, A0013308835, A0014604048, A0014604348, A0014606448, A0024600248, A3023300035, A3023300135, A3023300235, A3023300335, A3503307135



CV-ES-14163

Length: 125
Cone Ø: d1 Ø 30 / d2 Ø 27
Thread: M30 x 1,5 RHT
0003305248, 0003387310, 0004600348, 0004600948, 0004602848, 0004602948, 0004608948, 0014600248, 0014600848, 0014601248, 0014602248, 0014607748, 0024600148, A0003387310, A0004600348, A0004602848, A0004602948, A0014600848, A0014601248, A0014602248, A0014607748



CV-RK-8118

Ø: 85
Hole Distance: 130
Thick/Height: 30
0003500506, 3500506



DB-DL-5217

Length: 862 **Ø:** 40
Cone Ø: d1 Ø 30 / d2 Ø 27
01214700A, 6204600405, 6204600805, 6204602905, 6204603005



DB-DL-5233

Length: 895
Ø: 48
Cone Ø: d1 Ø 30 / d2 Ø 27
01217300A, 4609805, 0004609805, 0004609905, 4609905



DB-DL-7831

Length: 870
Ø: 42
Cone Ø: d1 Ø 30 / d2 Ø 27
01215200A, 6254602505



DB-DL-7839

Length: 585
Ø: 50
Hole Distance: 152 / 152
3953500206, 6593500106, 6593502406



DB-DL-7840

Length: 595
Ø: 62
Hole Distance: 152 / 152
6203500006, 6203500106, 6203500306, 6553500306



DB-DL-8131

Length: 1115 **Ø:** 52
Cone Ø: d1 Ø 32 / d2 Ø 28,8
0004604405, 6254605005



DB-DL-8138

Length: 1130
Ø: 40
Cone Ø: d1 Ø 32 / d2 Ø 28,8
0004606605, 4606605



DB-DL-8618

Length: 680
Ø: 42
Cone Ø: d1 Ø 32 / d2 Ø 28,8
0004604305, 4604305, 6254604805



DB-DL-8640

Length: 1615 **Ø:** 50
Cone Ø: d1 Ø 32 / d2 Ø 29
6253301503, 6253301603, 6253302403, 6253302503, 9423300803, 9423302103, 9493300203, 9493300303, 9493300903



DB-DL-10216

Length: 1190
Ø: 40
Cone Ø: d1 Ø 32 / d2 Ø 29
0004604905



DB-DL-12308

Length: 885
Ø: 42
Cone Ø: d1 Ø 30 / d2 Ø 27
4600705, 0004600705



DB-DL-12309

Length: 685
Ø: 40
Cone Ø: d1 Ø 32 / d2 Ø 28,8
4606005, 0004606005, 0004606305, 4606305



DB-DS-6088

Length: 585
Ø: 50
Hole Distance: 152 / 152
3953500706, 6593500406



DB-ES-5209

Length: 1670 **Ø:** 50
Cone Ø: d1 Ø 30 / d2 Ø 27
6203300503, 6203300603



DB-ES-5227

Length: 1588 **Ø:** 60
Cone Ø: d1 Ø 38 / d2 Ø 34,3
6253300903, 6253301203, 9443300203



DB-RK-5280

Ø: 86
01303000A, 6213200428



DB-RK-5282

Ø: 59
01303800A, 6553200111



DB-RK-8564

Ø: 90
01302200A, 0003500105, 3500105, 0003500405, 3500405, 0005861833, 5861833, 81432706047



DB-RK-10378

Ø: 86
6203200028



DB-RK-12372

Ø: 85
Hole Distance: 152
Thick/Height: 24
003501805, A003501805



DB-VB-7776

Length: 622 **Ø:** 56
Hole Distance: 152 / 152
6533500205, 6583500205



DF-RK-8671



DF-RK-9336

Ø: 108
0003501705, 3501705



MN-RK-9387

Ø: 90
0003500105, 81432706047





SK ...

2434 L ...	07/87→09/96	Suspension Arm Repair Kit		MN-RK-9387	→* 5 926 392 *	
	07/87→09/96	Suspension Arm Repair Kit		MN-RK-9387	Lifting Axle, →* 5 926 392 *	
	07/87→09/96	Suspension Arm Repair Kit	DB-RK-5282			
	07/87→09/96	Suspension Arm Repair Kit	DB-RK-10372	DB-RK-10372	for Control Arm, Lifting Axle, K063070→	
	07/87→09/96	Tie Rod	DB-DL-8640		Guide Rod	
	07/87→09/96	Tie Rod	DB-ES-5209			
	07/87→09/96	Tie Rod End	CV-ES-12461		for Steering Rod	
	07/87→09/96	Track Control Arm		DB-DL-7840	Suspension Rod, Trailing Arm	
	07/87→09/96	Track Control Arm		DB-DL-7840	Suspension Rod, Trailing Arm* 5 922 799 *→	
	07/87→09/96	Track Control Arm		DB-VB-7776	Wishbone (CV);Trailing Arm* 5 926 393 *→	
07/87→09/96	Track Control Arm		DB-VB-7776	Wishbone (CV);Trailing Arm, Lifting Axle		
2435	07/87→09/96	Ball Head, gearshift linkage	DB-ES-8387			
	07/87→09/96	Ball Head, gearshift linkage	DB-ES-8491			
	07/87→09/96	Ball Head, gearshift linkage	DB-ES-8492			
	07/87→09/96	Ball Head, gearshift linkage	DB-ES-8500			
	07/87→09/96	Centre Rod	DB-DL-5217		Push Rod	
	07/87→09/96	Centre Rod	DB-DL-5233		Push Rod* K 016 738 *→* K 033 740 *	
	07/87→09/96	Centre Rod	DB-DL-7831		Push Rod	
	07/87→09/96	Centre Rod	DB-DL-8131		Push Rod	
	07/87→09/96	Centre Rod	DB-DL-8138		Push Rod	
	07/87→09/96	Centre Rod	DB-DL-8618		Push Rod	
	07/87→09/96	Centre Rod	DB-DL-10216		Push Rod	
	07/87→09/96	Centre Rod	DB-DL-12308		Coupling Rod	
	07/87→09/96	Centre Rod	DB-DL-12309		Coupling Rod	
	07/87→09/96	Suspension Arm Repair Kit		DB-RK-12372	for Wishbone (CV)K063070→	
	07/87→09/96	Suspension Arm Repair Kit		DF-RK-9336		
	07/87→09/96	Suspension Arm Repair Kit		DF-RK-9336	* K 063 070 *→	
	07/87→09/96	Suspension Arm Repair Kit	DB-RK-5282			
	07/87→09/96	Tie Rod	DB-DL-8640		Guide Rod	
	07/87→09/96	Tie Rod	DB-ES-5209			
	07/87→09/96	Tie Rod	DB-ES-5227		Guide Rod	
	07/87→09/96	Tie Rod	MN-DL-7834		Guide Rod	
	07/87→09/96	Tie Rod End	CV-ES-12461		for Steering Rod	
	07/87→09/96	Tie Rod End	DB-ES-5234		for Steering Rod	
	07/87→09/96	Track Control Arm		DB-DL-7840	Suspension Rod, Trailing Arm	
	07/87→09/96	Track Control Arm		DB-DL-7840	Suspension Rod, Trailing Arm* 5 922 799 *→	
	07/87→09/96	Track Control Arm		DB-VB-7776	Wishbone (CV);Trailing Arm* 5 926 393 *→	
	07/88→08/94	Centre Rod	DB-DL-5233		Push Rod* 5 937 288 *→	
	07/88→08/94	Centre Rod	DB-DL-5241		Suspension Rod	
	07/88→08/94	Centre Rod	DB-DL-7270		Push Rod;Suspension Rod	
	07/88→08/94	Centre Rod	DB-DL-7831		Push Rod→* K 226 467 *	
	07/88→08/94	Stabiliser Mounting	DB-SB-5258	DB-SB-5258		
	07/88→08/94	Suspension Arm Repair Kit		DB-RK-7267	for Drag Link	
	07/88→08/94	Suspension Arm Repair Kit		DB-RK-8550	for Wishbone (CV)	
	07/88→08/94	Suspension Arm Repair Kit	DB-RK-5283			
	07/88→08/94	Track Control Arm		DB-DL-7839	Trailing Arm	
	07/88→08/94	Track Control Arm		DB-DS-6088	Suspension Rod, Trailing Arm	
	2435 K	07/88→08/94	Centre Rod	DB-DL-5217		Push Rod
		07/88→08/94	Centre Rod	DB-DL-5233		Push Rod* 5 937 288 *→
		07/88→08/94	Centre Rod	DB-DL-7831		Push Rod
		07/88→08/94	Centre Rod	DB-DL-8131		Push Rod
07/88→08/94		Centre Rod	DB-DL-8138		Push Rod	
07/88→08/94		Centre Rod	DB-DL-8618		Push Rod	
07/88→08/94		Centre Rod	DB-DL-12309		Coupling Rod	
07/88→08/94		Suspension Arm Repair Kit		DB-RK-7267	for Drag Link	
07/88→08/94		Tie Rod	DB-DL-8640		Guide Rod	
07/88→08/94		Tie Rod	DB-ES-5209			
07/88→08/94		Tie Rod End	CV-ES-12461		for Steering Rod	
07/88→08/94		Tie Rod End	CV-ES-14163		for Steering Rod	
07/88→08/94		Track Control Arm		DB-DL-7839	Trailing Arm	
07/88→08/94		Track Control Arm		DB-DS-6088	Suspension Rod, Trailing Arm	

CV-ES-12461

Length: 120
 Cone Ø: d1 Ø 26 / d2 Ø 23,5
 Thread: M30 x 1,5 LHT
 0003300035, 3300148, 0003406213, 0013306635,
 0013308835, 0014604048, 0014604348,
 14606448, 0024600248, 3023300035,
 3023300135, 3023300235, 3023300335,
 3453307235, 3453307435, 3503307135,
 A0003300148, A0013306635, A0013308835,
 A0014604048, A0014604348, A0014606448,
 A0024600248, A3023300035, A3023300135,
 A3023300235, A3023300335, A3503307135



CV-ES-14163

Length: 125
 Cone Ø: d1 Ø 30 / d2 Ø 27
 Thread: M30 x 1,5 RHT
 0003305248, 0003387310, 0004600348,
 0004600948, 0004602848, 0004602948,
 0004608948, 0014600248, 0014600848,
 0014601248, 0014602248, 0014607748,
 0024600148, A0003387310, A0004600348,
 A0004602848, A0004602948, A0014600848,
 A0014601248, A0014602248, A0014607748



DB-DL-5217

Length: 862 Ø: 40
 Cone Ø: d1 Ø 30 / d2 Ø 27
 01214700A, 6204600405, 6204600805,
 6204602905, 6204603005



DB-DL-5233

Length: 895 Ø: 48
 Cone Ø: d1 Ø 30 / d2 Ø 27
 01217300A, 0004609805, 0004609905



DB-DL-5241

Length: 875 Ø: 40
 Cone Ø: d1 Ø 30 / d2 Ø 27
 01215300A, 0004609205, 0004609305,
 0014606905



DB-DL-7270

Length: 875 Ø: 40
 Cone Ø: d1 Ø 28,6 / d2 Ø 23,9
 01208300A, 0024604705, 0024604805,
 0034604905, A0024604705



DB-DL-7831

Length: 870
 Ø: 42
 Cone Ø: d1 Ø 30 / d2 Ø 27
 01215200A, 6254602505



DB-DL-7839

Length: 585
 Ø: 50
 Hole Distance: 152 / 152
 3953500206, 6593500106, 6593502406



DB-DL-7840

Length: 595
 Ø: 62
 Hole Distance: 152 / 152
 6203500006, 6203500106, 6203500306,
 6553500306



DB-DL-8131

Length: 1115 Ø: 52
 Cone Ø: d1 Ø 32 / d2 Ø 28,8
 0004604405, 6254605005



DB-DL-8138

Length: 1130
 Ø: 40
 Cone Ø: d1 Ø 32 / d2 Ø 28,8
 0004606605, 4606605



DB-DL-8618

Length: 680
 Ø: 42
 Cone Ø: d1 Ø 32 / d2 Ø 28,8
 0004604305, 4604305, 6254604805



DB-DL-8640

Length: 1615 Ø: 50
 Cone Ø: d1 Ø 32 / d2 Ø 29
 6253301503, 6253301603, 6253302403,
 6253302503, 9423300803, 9423302103,
 9493300203, 9493300303, 9493300903



DB-DL-10216

Length: 1190
 Ø: 40
 Cone Ø: d1 Ø 32 / d2 Ø 29
 0004604905



DB-DL-12308

Length: 885
 Ø: 42
 Cone Ø: d1 Ø 30 / d2 Ø 27
 0004600705, 4600705



DB-DL-12309

Length: 685 Ø: 40
 Cone Ø: d1 Ø 32 / d2 Ø 28,8
 0004606005, 0004606305



DB-DS-6088

Length: 585
 Ø: 50
 Hole Distance: 152 / 152
 3953500706, 6593500406



DB-ES-5209

Length: 1670 Ø: 50
 Cone Ø: d1 Ø 30 / d2 Ø 27
 6203300503, 6203300603



DB-ES-5227

Length: 1588 Ø: 60
 Cone Ø: d1 Ø 38 / d2 Ø 34,3
 6253300903, 6253301203, 9443300203



DB-ES-5234

Length: 135
 Cone Ø: d1 Ø 38 / d2 Ø 34,3
 Thread: M38 x 1,5 RHT
 0004601748, 120322305, 2205000400



DB-ES-8387

Length: 55
 Cone Ø: d1 Ø 10 / d2 Ø 10
 Thread: M14 x 1,5 RHT
 0009966845, 0009967045



DB-ES-8491

Length: 60
 Cone Ø: d1 Ø 10 / d2 Ø 10
 Thread: M12 x 1,75 LHT
 0009966745



DB-ES-8492

Length: 60
 Cone Ø: d1 Ø 10 / d2 Ø 10
 Thread: M12 x 1,75 RHT
 0009966645, 3752680189, A3752680189



DB-ES-8500

Length: 55
 Cone Ø: d1 Ø 12 / d2 Ø 10,8
 Thread: M14 x 1,5 RHT
 0002685989



DB-RK-5282

Ø: 59
 01303800A, 6553200111



DB-RK-5283

Ø: 70
 01319900A, 6203200628



DB-RK-7267

Ø: 95
 Hole Distance: 152
 Thick/Height: 24
 01302100A, 0003500413, 3500413, 0005861235,
 5861235, 81432706069



DB-RK-8550

Ø: 75 Hole Distance: 152
 Thick/Height: 24
 0003502105, 0003504605



DB-RK-10372

Ø: 56
 Hole Distance: 90
 Thick/Height: 20
 0003302511, 0003302611



DB-RK-12372

Ø: 85
 Hole Distance: 152
 Thick/Height: 24
 003501805, A003501805



DB-SB-5258

Ø: 70
 Thick/Height: 62
 01311400A, 3873230285



DB-VB-7776

Length: 622 Ø: 56
 Hole Distance: 152 / 152
 6533500205, 6583500205



DF-RK-9336

Ø: 108
 0003501705, 3501705



MN-DL-7834

Length: 1588 Ø: 58
 Cone Ø: d1 Ø 30 / d2 Ø 27
 3463303903, 3463304903, 6253303203,
 9443300503, 9443301303, 9443301703



MN-RK-9387

Ø: 90
 0003500105, 81432706047





SK ...

2435 LS	07/87→09/96	Ball Head, gearshift linkage	DB-ES-8387			
	07/87→09/96	Ball Head, gearshift linkage	DB-ES-8491			
	07/87→09/96	Ball Head, gearshift linkage	DB-ES-8492			
	07/87→09/96	Ball Head, gearshift linkage	DB-ES-8500			
	07/87→09/96	Centre Rod	DB-DL-5217		Push Rod	
	07/87→09/96	Centre Rod	DB-DL-7831		Push Rod	
	07/87→09/96	Centre Rod	DB-DL-8131		Push Rod	
	07/87→09/96	Centre Rod	DB-DL-8138		Push Rod	
	07/87→09/96	Centre Rod	DB-DL-8618		Push Rod	
	07/87→09/96	Centre Rod	DB-DL-10216		Push Rod	
	07/87→09/96	Centre Rod	DB-DL-12308		Coupling Rod	
	07/87→09/96	Suspension Arm Repair Kit		DB-RK-8564	Wishbone (CV)	
	07/87→09/96	Suspension Arm Repair Kit		DB-RK-12372	for Wishbone (CV)K063070→	
	07/87→09/96	Suspension Arm Repair Kit		DF-RK-9336		
	07/87→09/96	Suspension Arm Repair Kit		DF-RK-9336	* K 063 070 *→	
	07/87→09/96	Suspension Arm Repair Kit		DF-RK-9336	Lifting Axle, * K 063 070 *→	
	07/87→09/96	Suspension Arm Repair Kit		MN-RK-9387		
	07/87→09/96	Suspension Arm Repair Kit		MN-RK-9387	→* 5 926 392 *	
	07/87→09/96	Suspension Arm Repair Kit		MN-RK-9387	Lifting Axle, →* 5 926 392 *	
	07/87→09/96	Suspension Arm Repair Kit	DB-RK-5282			
	07/87→09/96	Tie Rod	DB-DL-8640		Guide Rod	
	07/87→09/96	Tie Rod	DB-ES-5209			
	07/87→09/96	Tie Rod End	CV-ES-12461		for Steering Rod	
	07/87→09/96	Track Control Arm		DB-DL-7840	Suspension Rod, Trailing Arm	
	07/87→09/96	Track Control Arm		DB-DL-7840	Suspension Rod, Trailing Arm* 5 922 799 *→	
	07/87→09/96	Track Control Arm		DB-VB-7776	Wishbone (CV);Trailing Arm* 5 926 393 *→	
07/87→09/96	Track Control Arm		DB-VB-7776	Wishbone (CV);Trailing Arm, Lifting Axle		
2435 S	07/88→08/94	Centre Rod	DB-DL-5217		Push Rod	
	07/88→08/94	Centre Rod	DB-DL-5233		Push Rod* 5 937 288 *→	
	07/88→08/94	Centre Rod	DB-DL-7831		Push Rod	
	07/88→08/94	Centre Rod	DB-DL-7831		Push Rod→* K 226 467 *	
	07/88→08/94	Centre Rod	DB-DL-8131		Push Rod	
	07/88→08/94	Centre Rod	DB-DL-8138		Push Rod	
	07/88→08/94	Centre Rod	DB-DL-8618		Push Rod	
	07/88→08/94	Stabiliser Mounting	DB-SB-5258	DB-SB-5258		
	07/88→08/94	Suspension Arm Repair Kit	DB-RK-5283			
	07/88→08/94	Suspension Arm Repair Kit	DB-RK-6111	DB-RK-6111	Trailing Arm	
	07/88→08/94	Tie Rod	DB-DL-8640		Guide Rod	
	07/88→08/94	Tie Rod	DB-ES-5209			
	07/88→08/94	Tie Rod End	CV-ES-12461		for Steering Rod	
	07/88→08/94	Tie Rod End	CV-ES-14163		for Steering Rod	
	07/88→08/94	Track Control Arm		DB-DL-7839	Trailing Arm	
	07/88→08/94	Track Control Arm		DB-DS-6088	Suspension Rod, Trailing Arm	
	2435 S,2435 LS	07/87→09/96	Ball Head, gearshift linkage	DB-ES-8387		
		07/87→09/96	Ball Head, gearshift linkage	DB-ES-8491		
07/87→09/96		Ball Head, gearshift linkage	DB-ES-8492			
07/87→09/96		Ball Head, gearshift linkage	DB-ES-8500			
07/87→09/96		Centre Rod	DB-DL-5217		Push Rod	
07/87→09/96		Centre Rod	DB-DL-7831		Push Rod	
07/87→09/96		Centre Rod	DB-DL-8131		Push Rod	
07/87→09/96		Centre Rod	DB-DL-8618		Push Rod	
07/87→09/96		Centre Rod	DB-DL-9215		Push Rod	
07/87→09/96		Centre Rod	DB-DL-12308		Coupling Rod	
07/87→09/96		Stabiliser Mounting	DB-SB-5258	DB-SB-5258		
07/87→09/96		Suspension Arm Repair Kit		DB-RK-8564	Wishbone (CV)	
07/87→09/96		Suspension Arm Repair Kit		DB-RK-10378		
07/87→09/96		Suspension Arm Repair Kit		DF-RK-9336		
07/87→09/96		Suspension Arm Repair Kit		DF-RK-9336	* K 063 070 *→	
07/87→09/96		Suspension Arm Repair Kit	DB-RK-5280			
07/87→09/96		Suspension Arm Repair Kit	DB-RK-5283			
07/87→09/96		Tie Rod	DB-DL-8640		Guide Rod	
07/87→09/96		Tie Rod End	CV-ES-12461		for Steering Rod	
07/87→09/96		Tie Rod End	CV-ES-14163		for Steering Rod	

CV-ES-12461

Length: 120
 Cone Ø: d1 Ø 26 / d2 Ø 23,5
 Thread: M30 x 1,5 LHT
 0003300035, 3300148, 0003406213, 0013306635,
 0013308835, 0014604048, 0014604348,
 14606448, 0024600248, 3023300035,
 3023300135, 3023300235, 3023300335,
 3453307235, 3453307435, 3503307135,
 A0003300148, A0013306635, A0013308835,
 A0014604048, A0014604348, A0014606448,
 A0024600248, A3023300035, A3023300135,
 A3023300235, A3023300335, A3503307135



CV-ES-14163

Length: 125
 Cone Ø: d1 Ø 30 / d2 Ø 27
 Thread: M30 x 1,5 RHT
 0003305248, 0003387310, 0004600348,
 0004600948, 0004602848, 0004602948,
 0004608948, 0014600248, 0014600848,
 0014601248, 0014602248, 0014607748,
 0024600148, A0003387310, A0004600348,
 A0004602848, A0004602948, A0014600848,
 A0014601248, A0014602248, A0014607748



DB-DL-5217

Length: 862 Ø: 40
 Cone Ø: d1 Ø 30 / d2 Ø 27
 01214700A, 6204600405, 6204600805,
 6204602905, 6204603005



DB-DL-5233

Length: 895 Ø: 48
 Cone Ø: d1 Ø 30 / d2 Ø 27
 01217300A, 0004609805, 0004609905



DB-DL-7831

Length: 870
 Ø: 42
 Cone Ø: d1 Ø 30 / d2 Ø 27
 01215200A, 6254602505



DB-DL-7839

Length: 585
 Ø: 50
 Hole Distance: 152 / 152
 3953500206, 6593500106, 6593502406



DB-DL-7840

Length: 595
 Ø: 62
 Hole Distance: 152 / 152
 6203500006, 6203500106, 6203500306,
 6553500306



DB-DL-8131

Length: 1115
 Ø: 52
 Cone Ø: d1 Ø 32 / d2 Ø 28,8
 4604405, 0004604405, 6254605005



DB-DL-8138

Length: 1130
 Ø: 40
 Cone Ø: d1 Ø 32 / d2 Ø 28,8
 0004606605, 4606605



DB-DL-8618

Length: 680
 Ø: 42
 Cone Ø: d1 Ø 32 / d2 Ø 28,8
 0004604305, 4604305, 6254604805



DB-DL-8640

Length: 1615 Ø: 50
 Cone Ø: d1 Ø 32 / d2 Ø 29
 6253301503, 6253301603, 6253302403,
 6253302503, 9423300803, 9423302103,
 9493300203, 9493300303, 9493300903



DB-DL-9215

Length: 975
 Ø: 42
 Cone Ø: d1 Ø 30 / d2 Ø 27
 3964603005, 3964604805



DB-DL-10216

Length: 1190
 Ø: 40
 Cone Ø: d1 Ø 32 / d2 Ø 29
 0004604905



DB-DL-12308

Length: 885
 Ø: 42
 Cone Ø: d1 Ø 30 / d2 Ø 27
 0004600705, 4600705



DB-DS-6088

Length: 585
 Ø: 50
 Hole Distance: 152 / 152
 3953500706, 6593500406



DB-ES-5209

Length: 1670 Ø: 50
 Cone Ø: d1 Ø 30 / d2 Ø 27
 6203300503, 6203300603



DB-ES-8387

Length: 55
 Cone Ø: d1 Ø 10 / d2 Ø 10
 Thread: M14 x 1,5 RHT
 0009966845, 0009967045



DB-ES-8491

Length: 60
 Cone Ø: d1 Ø 10 / d2 Ø 10
 Thread: M12 x 1,75 LHT
 0009966745



DB-ES-8492

Length: 60
 Cone Ø: d1 Ø 10 / d2 Ø 10
 Thread: M12 x 1,75 RHT
 0009966645, 3752680189, A3752680189



DB-ES-8500

Length: 55
 Cone Ø: d1 Ø 12 / d2 Ø 10,8
 Thread: M14 x 1,5 RHT
 0002685989



DB-RK-5280

Ø: 86
 01303000A, 6213200428



DB-RK-5282

Ø: 59
 01303800A, 6553200111



DB-RK-5283

Ø: 70
 01319900A, 6203200628



DB-RK-6111

Ø: 85
 Hole Distance: 152
 Thick/Height: 24
 0003500613, 0005861135



DB-RK-8564

Ø: 90
 01302200A, 0003500105, 3500105, 0003500405,
 3500405, 0005861833, 5861833, 81432706047



DB-RK-10378

Ø: 86
 6203200028



DB-RK-12372

Ø: 85
 Hole Distance: 152
 Thick/Height: 24
 003501805, A003501805



DB-SB-5258

Ø: 70
 Thick/Height: 62
 01311400A, 3873230285



DB-VB-7776

Length: 622 Ø: 86
 Hole Distance: 152 / 152
 6533500205, 6583500205



DF-RK-9336

Ø: 108
 0003501705, 3501705



MN-RK-9387

Ø: 90
 0003500105, 81432706047





SK ...

2435 S,2435 LS ...	07/87→09/96	Track Control Arm		DB-DL-7839	Trailing Arm
	07/87→09/96	Track Control Arm		DB-DL-7840	Suspension Rod, Trailing Arm
	07/87→09/96	Track Control Arm		DB-VB-7776	Wishbone (CV);Trailing Arm* 5 926 393 *→
2435,2435 L	07/87→09/96	Ball Head, gearshift linkage	DB-ES-8387		
	07/87→09/96	Ball Head, gearshift linkage	DB-ES-8491		
	07/87→09/96	Ball Head, gearshift linkage	DB-ES-8492		
	07/87→09/96	Ball Head, gearshift linkage	DB-ES-8500		
	07/87→09/96	Centre Rod	DB-DL-5217		Push Rod
	07/87→09/96	Centre Rod	DB-DL-5241		Suspension Rod
	07/87→09/96	Centre Rod	DB-DL-7270		Push Rod;Suspension Rod
	07/87→09/96	Centre Rod	DB-DL-7831		Push Rod
	07/87→09/96	Centre Rod	DB-DL-8131		Push Rod
	07/87→09/96	Centre Rod	DB-DL-8138		Push Rod
	07/87→09/96	Centre Rod	DB-DL-8618		Push Rod
	07/87→09/96	Centre Rod	DB-DL-10216		Push Rod
	07/87→09/96	Centre Rod	DB-DL-12308		Coupling Rod
	07/87→09/96	Centre Rod	DB-DL-12309		Coupling Rod
	07/87→09/96	Stabiliser Mounting	DB-SB-5258	DB-SB-5258	
	07/87→09/96	Suspension Arm Repair Kit		CV-RK-8118	for Drag Link
	07/87→09/96	Suspension Arm Repair Kit		DB-RK-8550	for Wishbone (CV)
	07/87→09/96	Suspension Arm Repair Kit		DB-RK-8564	Wishbone (CV)
	07/87→09/96	Suspension Arm Repair Kit		DB-RK-10378	
	07/87→09/96	Suspension Arm Repair Kit		DB-RK-12372	for Wishbone (CV), Lifting Axle
	07/87→09/96	Suspension Arm Repair Kit		DF-RK-9336	
	07/87→09/96	Suspension Arm Repair Kit		DF-RK-9336	* K 063 070 *→
	07/87→09/96	Suspension Arm Repair Kit		DF-RK-9336	Lifting Axle, * K 063 070 *→
	07/87→09/96	Suspension Arm Repair Kit		MN-RK-9387	
	07/87→09/96	Suspension Arm Repair Kit		MN-RK-9387	→* 5 926 392 *
	07/87→09/96	Suspension Arm Repair Kit		MN-RK-9387	Lifting Axle, →* 5 926 392 *
	07/87→09/96	Suspension Arm Repair Kit	DB-RK-5280		
	07/87→09/96	Suspension Arm Repair Kit	DB-RK-5282		
	07/87→09/96	Suspension Arm Repair Kit	DB-RK-5283		
	07/87→09/96	Suspension Strut Repair Kit		DF-RK-8671	
	07/87→09/96	Tie Rod	DB-DL-8640		Guide Rod
	07/87→09/96	Tie Rod	DB-ES-5209		
	07/87→09/96	Tie Rod End	CV-ES-12461		for Steering Rod
07/87→09/96	Tie Rod End	CV-ES-14163		for Steering Rod	
07/87→09/96	Track Control Arm		DB-DL-7840	Suspension Rod, Trailing Arm	
07/87→09/96	Track Control Arm		DB-DL-7840	Suspension Rod, Trailing Arm* 5 922 799 *→	
07/87→09/96	Track Control Arm		DB-VB-7776	Wishbone (CV);Trailing Arm* 5 926 393 *→	
07/87→09/96	Track Control Arm		DB-VB-7776	Wishbone (CV);Trailing Arm, Lifting Axle	
2448	07/88→07/92	Ball Head, gearshift linkage	DB-ES-8387		
	07/88→07/92	Ball Head, gearshift linkage	DB-ES-8491		
	07/88→07/92	Ball Head, gearshift linkage	DB-ES-8492		
	07/88→07/92	Ball Head, gearshift linkage	DB-ES-8500		
	07/88→07/92	Centre Rod	DB-DL-5217		Push Rod
	07/88→07/92	Centre Rod	DB-DL-5233		Push Rod* 5 937 288 *→
	07/88→07/92	Centre Rod	DB-DL-7831		Push Rod
	07/88→07/92	Centre Rod	DB-DL-8131		Push Rod
	07/88→07/92	Centre Rod	DB-DL-8138		Push Rod
	07/88→07/92	Centre Rod	DB-DL-8618		Push Rod
	07/88→07/92	Centre Rod	DB-DL-10216		Push Rod
	07/88→07/92	Centre Rod	DB-DL-12309		Coupling Rod
	07/88→07/92	Tie Rod	DB-DL-8640		Guide Rod
	07/88→07/92	Tie Rod	DB-ES-5209		
	07/88→07/92	Tie Rod End	CV-ES-12461		for Steering Rod
	07/88→07/92	Track Control Arm		DB-DL-7839	Trailing Arm
	07/88→07/92	Track Control Arm		DB-DS-6088	Suspension Rod, Trailing Arm
	2448 LS	07/88→07/92	Ball Head, gearshift linkage	DB-ES-8387	
07/88→07/92		Ball Head, gearshift linkage	DB-ES-8491		
07/88→07/92		Ball Head, gearshift linkage	DB-ES-8492		
07/88→07/92		Ball Head, gearshift linkage	DB-ES-8500		
07/88→07/92		Centre Rod	DB-DL-5217		Push Rod

CV-ES-12461

Length: 120
 Cone Ø: d1 Ø 26 / d2 Ø 23,5
 Thread: M30 x 1,5 LHT
 0003300035, 3300148, 0003406213, 0013306635,
 0013308835, 0014604048, 0014604348,
 14606448, 0024600248, 3023300035,
 3023300135, 3023300235, 3023300335,
 3453307235, 3453307435, 3503307135,
 A0003300148, A0013306635, A0013308835,
 A0014604048, A0014604348, A0014606448,
 A0024600248, A3023300035, A3023300135,
 A3023300235, A3023300335, A3503307135



CV-ES-14163

Length: 125
 Cone Ø: d1 Ø 30 / d2 Ø 27
 Thread: M30 x 1,5 RHT
 0003305248, 0003387310, 0004600348,
 0004600948, 0004602848, 0004602948,
 0004608948, 0014600248, 0014600848,
 0014601248, 0014602248, 0014607748,
 0024600148, A0003387310, A0004600348,
 A0004602848, A0004602948, A0014600848,
 A0014601248, A0014602248, A0014607748



CV-RK-8118

Ø: 85
 Hole Distance: 130
 Thick/Height: 30
 0003500506, 3500506



DB-DL-5217

Length: 862 Ø: 40
 Cone Ø: d1 Ø 30 / d2 Ø 27
 01214700A, 6204600405, 6204600805,
 6204602905, 6204603005



DB-DL-5233

Length: 895
 Ø: 48
 Cone Ø: d1 Ø 30 / d2 Ø 27
 01217300A, 4609805, 0004609805, 4609905,
 0004609905



DB-DL-5241

Length: 875 Ø: 40
 Cone Ø: d1 Ø 30 / d2 Ø 27
 01215300A, 0004609205, 0004609305,
 0014606905



DB-DL-7270

Length: 875 Ø: 40
 Cone Ø: d1 Ø 28,6 / d2 Ø 23,9
 01208300A, 0024604705, 0024604805,
 0034604905, A0024604705



DB-DL-7831

Length: 870
 Ø: 42
 Cone Ø: d1 Ø 30 / d2 Ø 27
 01215200A, 6254602505



DB-DL-7839

Length: 585
 Ø: 50
 Hole Distance: 152 / 152
 3953500206, 6593500106, 6593502406



DB-DL-7840

Length: 595
 Ø: 62
 Hole Distance: 152 / 152
 6203500006, 6203500106, 6203500306,
 6553500306



DB-DL-8131

Length: 1115 Ø: 52
 Cone Ø: d1 Ø 32 / d2 Ø 28,8
 0004604405, 6254605005



DB-DL-8138

Length: 1130
 Ø: 40
 Cone Ø: d1 Ø 32 / d2 Ø 28,8
 0004606605, 4606605



DB-DL-8618

Length: 680
 Ø: 42
 Cone Ø: d1 Ø 32 / d2 Ø 28,8
 4604305, 0004604305, 6254604805



DB-DL-8640

Length: 1615 Ø: 50
 Cone Ø: d1 Ø 32 / d2 Ø 29
 6253301503, 6253301603, 6253302403,
 6253302503, 9423300803, 9423302103,
 9493300203, 9493300303, 9493300903



DB-DL-10216

Length: 1190
 Ø: 40
 Cone Ø: d1 Ø 32 / d2 Ø 29
 0004604905



DB-DL-12308

Length: 885
 Ø: 42
 Cone Ø: d1 Ø 30 / d2 Ø 27
 0004600705, 4600705



DB-DL-12309

Length: 685 Ø: 40
 Cone Ø: d1 Ø 32 / d2 Ø 28,8
 0004606005, 0004606305



DB-DS-6088

Length: 585
 Ø: 50
 Hole Distance: 152 / 152
 3953500706, 6593500406



DB-ES-5209

Length: 1670 Ø: 50
 Cone Ø: d1 Ø 30 / d2 Ø 27
 6203300503, 6203300603



DB-ES-8387

Length: 55
 Cone Ø: d1 Ø 10 / d2 Ø 10
 Thread: M14 x 1,5 RHT
 0009966845, 0009967045



DB-ES-8491

Length: 60
 Cone Ø: d1 Ø 10 / d2 Ø 10
 Thread: M12 x 1,75 LHT
 0009966745



DB-ES-8492

Length: 60
 Cone Ø: d1 Ø 10 / d2 Ø 10
 Thread: M12 x 1,75 RHT
 0009966645, 3752680189, A3752680189



DB-ES-8500

Length: 55
 Cone Ø: d1 Ø 12 / d2 Ø 10,8
 Thread: M14 x 1,5 RHT
 0002685989



DB-RK-5280

Ø: 86
 01303000A, 6213200428



DB-RK-5282

Ø: 59
 01303800A, 6553200111



DB-RK-5283

Ø: 70
 01319900A, 6203200628



DB-RK-8550

Ø: 75 Hole Distance: 152
 Thick/Height: 24
 0003502105, 0003504605



DB-RK-8564

Ø: 90
 01302200A, 0003500105, 3500105, 3500405,
 0003500405, 0005861833, 5861833,
 81432706047



DB-RK-10378

Ø: 86
 6203200028



DB-RK-12372

Ø: 85
 Hole Distance: 152
 Thick/Height: 24
 0003501805, A003501805



DB-SB-5258

Ø: 70
 Thick/Height: 62
 01311400A, 3873230285



DB-VB-7776

Length: 622 Ø: 56
 Hole Distance: 152 / 152
 6533500205, 6583500205



DF-RK-8671



DF-RK-9336

Ø: 108
 0003501705, 3501705



MN-RK-9387

Ø: 90
 0003500105, 81432706047





SK ...

2448 LS ...	07/88→07/92	Centre Rod	DB-DL-5233		Push Rod* 5 937 288 *→
	07/88→07/92	Centre Rod	DB-DL-7831		Push Rod
	07/88→07/92	Centre Rod	DB-DL-7831		Push Rod* K 189 672 *→* K 226 467 *
	07/88→07/92	Centre Rod	DB-DL-8131		Push Rod
	07/88→07/92	Centre Rod	DB-DL-8138		Push Rod
	07/88→07/92	Centre Rod	DB-DL-8618		Push Rod
	07/88→07/92	Centre Rod	DB-DL-9215		Push Rod
	07/88→07/92	Centre Rod	DB-DL-10216		Push Rod
	07/88→07/92	Centre Rod	DB-DL-12308		Coupling Rod
	07/88→07/92	Centre Rod	DB-DL-12309		Coupling Rod
	07/88→07/92	Suspension Arm Repair Kit		DB-RK-8564	Wishbone (CV)
	07/88→07/92	Suspension Arm Repair Kit		DB-RK-12372	for Wishbone (CV), Lifting Axle, K063070→
	07/88→07/92	Suspension Arm Repair Kit		DF-RK-9336	
	07/88→07/92	Suspension Arm Repair Kit		DF-RK-9336	* K 063 070 *→
	07/88→07/92	Suspension Arm Repair Kit		DF-RK-9336	Lifting Axle, * K 063 070 *→
	07/88→07/92	Suspension Arm Repair Kit		MN-RK-9387	
	07/88→07/92	Suspension Arm Repair Kit		MN-RK-9387	→* 5 926 392 *
	07/88→07/92	Suspension Arm Repair Kit		MN-RK-9387	Lifting Axle, →* 5 926 392 *
	07/88→07/92	Suspension Arm Repair Kit	DB-RK-5282		
	07/88→07/92	Tie Rod	DB-DL-8640		Guide Rod
	07/88→07/92	Tie Rod	DB-ES-5209		
	07/88→07/92	Tie Rod End	CV-ES-12461		for Steering Rod
	07/88→07/92	Track Control Arm		DB-DL-7839	Trailing Arm
	07/88→07/92	Track Control Arm		DB-DL-7840	Suspension Rod, Trailing Arm
	07/88→07/92	Track Control Arm		DB-DL-7840	Suspension Rod, Trailing Arm* 5 922 799 *→
	07/88→07/92	Track Control Arm		DB-VB-7776	Wishbone (CV);Trailing Arm* 5 926 393 *→
07/88→07/92	Track Control Arm		DB-VB-7776	Wishbone (CV);Trailing Arm, Lifting Axle	
2448 S	07/88→07/92	Ball Head, gearshift linkage	DB-ES-8387		
	07/88→07/92	Ball Head, gearshift linkage	DB-ES-8491		
	07/88→07/92	Ball Head, gearshift linkage	DB-ES-8492		
	07/88→07/92	Ball Head, gearshift linkage	DB-ES-8500		
	07/88→07/92	Centre Rod	DB-DL-5217		Push Rod
	07/88→07/92	Centre Rod	DB-DL-5233		Push Rod* 5 937 288 *→
	07/88→07/92	Centre Rod	DB-DL-7831		Push Rod
	07/88→07/92	Centre Rod	DB-DL-8131		Push Rod
	07/88→07/92	Centre Rod	DB-DL-8138		Push Rod
	07/88→07/92	Centre Rod	DB-DL-8618		Push Rod
	07/88→07/92	Centre Rod	DB-DL-10216		Push Rod
	07/88→07/92	Centre Rod	DB-DL-12309		Coupling Rod
	07/88→07/92	Stabiliser Mounting	DB-SB-5258	DB-SB-5258	
	07/88→07/92	Suspension Arm Repair Kit	DB-RK-5283		
	07/88→07/92	Suspension Arm Repair Kit	DB-RK-6111	DB-RK-6111	Trailing Arm
	07/88→07/92	Tie Rod	DB-DL-8640		Guide Rod
	07/88→07/92	Tie Rod	DB-ES-5209		
	07/88→07/92	Tie Rod End	CV-ES-12461		for Steering Rod
	07/88→07/92	Track Control Arm		DB-DL-7839	Trailing Arm
	07/88→07/92	Track Control Arm		DB-DL-7840	Suspension Rod, Trailing Arm
07/88→07/92	Track Control Arm		DB-DS-6088	Suspension Rod, Trailing Arm	
2448,2448 L	07/87→09/96	Ball Head, gearshift linkage	DB-ES-8387		
	07/87→09/96	Ball Head, gearshift linkage	DB-ES-8491		
	07/87→09/96	Ball Head, gearshift linkage	DB-ES-8492		
	07/87→09/96	Ball Head, gearshift linkage	DB-ES-8500		
	07/87→09/96	Centre Rod	DB-DL-5217		Push Rod
	07/87→09/96	Centre Rod	DB-DL-5233		Push Rod* K 017 164 *→
	07/87→09/96	Centre Rod	DB-DL-7831		Push Rod
	07/87→09/96	Centre Rod	DB-DL-7831		Push Rod* K 189 672 *→* K 226 467 *
	07/87→09/96	Centre Rod	DB-DL-7831		Push Rod→* K 226 467 *
	07/87→09/96	Centre Rod	DB-DL-8131		Push Rod
	07/87→09/96	Centre Rod	DB-DL-8138		Push Rod
	07/87→09/96	Centre Rod	DB-DL-8618		Push Rod
	07/87→09/96	Centre Rod	DB-DL-10216		Push Rod
	07/87→09/96	Centre Rod	DB-DL-12308		Coupling Rod
	07/87→09/96	Centre Rod	DB-DL-12309		Coupling Rod

CV-ES-12461

Length: 120
 Cone Ø: d1 Ø 26 / d2 Ø 23,5
 Thread: M30 x 1,5 LHT
 0003300035, 3300148, 0003406213, 0013306635,
 0013308835, 0014604048, 0014604348,
 14606448, 0024600248, 3023300035,
 3023300135, 3023300235, 3023300335,
 3453307235, 3453307435, 3503307135,
 A0003300148, A0013306635, A0013308835,
 A0014604048, A0014604348, A0014606448,
 A0024600248, A3023300035, A3023300135,
 A3023300235, A3023300335, A3503307135



DB-DL-5217

Length: 862 Ø: 40
 Cone Ø: d1 Ø 30 / d2 Ø 27
 01214700A, 6204600405, 6204600805,
 6204602905, 6204603005



DB-DL-5233

Length: 895 Ø: 48
 Cone Ø: d1 Ø 30 / d2 Ø 27
 01217300A, 0004609805, 0004609905



DB-DL-7831

Length: 870
 Ø: 42
 Cone Ø: d1 Ø 30 / d2 Ø 27
 01215200A, 6254602505



DB-DL-7839

Length: 585
 Ø: 50
 Hole Distance: 152 / 152
 3953500206, 6593500106, 6593502406



DB-DL-7840

Length: 595
 Ø: 62
 Hole Distance: 152 / 152
 6203500006, 6203500106, 6203500306,
 6553500306



DB-DL-8131

Length: 1115 Ø: 52
 Cone Ø: d1 Ø 32 / d2 Ø 28,8
 0004604405, 6254605005



DB-DL-8138

Length: 1130
 Ø: 40
 Cone Ø: d1 Ø 32 / d2 Ø 28,8
 4606605, 0004606605



DB-DL-8618

Length: 680
 Ø: 42
 Cone Ø: d1 Ø 32 / d2 Ø 28,8
 0004604305, 4604305, 6254604805



DB-DL-8640

Length: 1615 Ø: 50
 Cone Ø: d1 Ø 32 / d2 Ø 29
 6253301503, 6253301603, 6253302403,
 6253302503, 9423300803, 9423302103,
 9493300203, 9493300303, 9493300903



DB-DL-9215

Length: 975
 Ø: 42
 Cone Ø: d1 Ø 30 / d2 Ø 27
 3964603005, 3964604805



DB-DL-10216

Length: 1190
 Ø: 40
 Cone Ø: d1 Ø 32 / d2 Ø 29
 0004604905



DB-DL-12308

Length: 885
 Ø: 42
 Cone Ø: d1 Ø 30 / d2 Ø 27
 0004600705, 4600705



DB-DL-12309

Length: 685 Ø: 40
 Cone Ø: d1 Ø 32 / d2 Ø 28,8
 0004606005, 0004606305



DB-DS-6088

Length: 585
 Ø: 50
 Hole Distance: 152 / 152
 3953500706, 6593500406



DB-ES-5209

Length: 1670 Ø: 50
 Cone Ø: d1 Ø 30 / d2 Ø 27
 6203300503, 6203300603



DB-ES-8387

Length: 55
 Cone Ø: d1 Ø 10 / d2 Ø 10
 Thread: M14 x 1,5 RHT
 0009966845, 0009967045



DB-ES-8491

Length: 60
 Cone Ø: d1 Ø 10 / d2 Ø 10
 Thread: M12 x 1,75 LHT
 0009966745



DB-ES-8492

Length: 60
 Cone Ø: d1 Ø 10 / d2 Ø 10
 Thread: M12 x 1,75 RHT
 0009966645, 3752680189, A3752680189



DB-ES-8500

Length: 55
 Cone Ø: d1 Ø 12 / d2 Ø 10,8
 Thread: M14 x 1,5 RHT
 0002685989



DB-RK-5282

Ø: 59
 01303800A, 6553200111



DB-RK-5283

Ø: 70
 01319900A, 6203200628



DB-RK-6111

Ø: 85
 Hole Distance: 152
 Thick/Height: 24
 0003500613, 0005861135



DB-RK-8564

Ø: 90
 01302200A, 0003500105, 3500105, 3500405,
 0003500405, 0005861833, 5861833,
 81432706047



DB-RK-12372

Ø: 85
 Hole Distance: 152
 Thick/Height: 24
 003501805, A003501805



DB-SB-5258

Ø: 70
 Thick/Height: 62
 01311400A, 3873230285



DB-VB-7776

Length: 622 Ø: 56
 Hole Distance: 152 / 152
 6533500205, 6583500205



DF-RK-9336

Ø: 108
 3501705, 0003501705



MN-RK-9387

Ø: 90
 0003500105, 81432706047





SK ...

2448,2448 L ...	07/87→09/96	Suspension Arm Repair Kit		CV-RK-8118	for Drag Link	
	07/87→09/96	Suspension Arm Repair Kit		DB-RK-8564	Wishbone (CV)	
	07/87→09/96	Suspension Arm Repair Kit		DB-RK-10378		
	07/87→09/96	Suspension Arm Repair Kit		DB-RK-12372	for Wishbone (CV), Lifting Axle, K063070→	
	07/87→09/96	Suspension Arm Repair Kit		DF-RK-9336		
	07/87→09/96	Suspension Arm Repair Kit		DF-RK-9336	* K 063 070 *→	
	07/87→09/96	Suspension Arm Repair Kit		DF-RK-9336	Lifting Axle, * K 063 070 *→	
	07/87→09/96	Suspension Arm Repair Kit		MN-RK-9387		
	07/87→09/96	Suspension Arm Repair Kit		MN-RK-9387	→* 5 926 392 *	
	07/87→09/96	Suspension Arm Repair Kit		MN-RK-9387	Lifting Axle, →* 5 926 392 *	
	07/87→09/96	Suspension Arm Repair Kit	DB-RK-5280			
	07/87→09/96	Suspension Arm Repair Kit	DB-RK-5282			
	07/87→09/96	Suspension Strut Repair Kit		DF-RK-8671		
	07/87→09/96	Tie Rod	DB-DL-8640		Guide Rod	
	07/87→09/96	Tie Rod	DB-ES-5209			
	07/87→09/96	Tie Rod End	CV-ES-12461		for Steering Rod	
	07/87→09/96	Tie Rod End	CV-ES-14163		for Steering Rod	
	07/87→09/96	Track Control Arm		DB-DL-7840	Suspension Rod, Trailing Arm	
	07/87→09/96	Track Control Arm		DB-DL-7840	Suspension Rod, Trailing Arm* 5 922 799 *→	
	07/87→09/96	Track Control Arm		DB-VB-7776	Wishbone (CV);Trailing Arm* 5 926 393 *→	
07/87→09/96	Track Control Arm		DB-VB-7776	Wishbone (CV);Trailing Arm, Lifting Axle		
2531	05/91→09/96	Ball Head, gearshift linkage	DB-ES-8500			
	05/91→09/96	Centre Rod	DB-DL-5217		Push Rod	
	05/91→09/96	Centre Rod	DB-DL-10216		Push Rod	
	05/91→09/96	Tie Rod	DB-ES-5209			
	05/91→09/96	Tie Rod	DB-ES-5227		Guide Rod	
	05/91→09/96	Tie Rod	MN-DL-7834		Guide Rod	
	05/91→09/96	Tie Rod End	CV-ES-12461		for Steering Rod	
	05/91→09/96	Tie Rod End	DB-ES-5234		for Steering Rod	
2531, 2531 L	07/87→09/96	Ball Head, gearshift linkage	DB-ES-8387			
	07/87→09/96	Ball Head, gearshift linkage	DB-ES-8492			
	07/87→09/96	Ball Head, gearshift linkage	DB-ES-8500			
	07/87→09/96	Centre Rod	DB-DL-5217		Push Rod	
	07/87→09/96	Centre Rod	DB-DL-5217		Push Rod→* K 040 469 *	
	07/87→09/96	Centre Rod	DB-DL-7831		Push Rod	
	07/87→09/96	Centre Rod	DB-DL-7831		Push Rod* K 189 672 *→* K 226 467 *	
	07/87→09/96	Centre Rod	DB-DL-7831		Push Rod→* K 226 467 *	
	07/87→09/96	Centre Rod	DB-DL-8131		Push Rod	
	07/87→09/96	Centre Rod	DB-DL-8618		Push Rod	
	07/87→09/96	Centre Rod	DB-DL-9263		Push Rod* K 040 470 *→	
	07/87→09/96	Centre Rod	DB-DL-10216		Push Rod	
	07/87→09/96	Centre Rod	DB-DL-12308		Coupling Rod	
	07/87→09/96	Suspension Arm Repair Kit		DB-RK-12372	for Wishbone (CV)K063070→	
	07/87→09/96	Suspension Arm Repair Kit		DF-RK-9336		
	07/87→09/96	Suspension Arm Repair Kit		DF-RK-9336	* K 063 070 *→	
	07/87→09/96	Suspension Arm Repair Kit	DB-RK-5282			
	07/87→09/96	Tie Rod	DB-DL-8640		Guide Rod	
	07/87→09/96	Tie Rod	DB-ES-5209			
	07/87→09/96	Tie Rod	DB-ES-5227		Guide Rod	
	07/87→09/96	Tie Rod	MN-DL-7834		Guide Rod	
	07/87→09/96	Tie Rod End	CV-ES-12461		for Steering Rod	
	07/87→09/96	Tie Rod End	DB-ES-5234		for Steering Rod	
	07/87→09/96	Track Control Arm		DB-DL-7840	Suspension Rod, Trailing Arm	
	07/87→09/96	Track Control Arm		DB-VB-7776	Wishbone (CV);Trailing Arm	
	2534, 2534 L	07/87→09/96	Ball Head, gearshift linkage	DB-ES-8387		
		07/87→09/96	Ball Head, gearshift linkage	DB-ES-8492		
07/87→09/96		Ball Head, gearshift linkage	DB-ES-8500			
07/87→09/96		Centre Rod	DB-DL-5217		Push Rod	
07/87→09/96		Centre Rod	DB-DL-5412		Push Rod* K 016 738 *→	
07/87→09/96		Centre Rod	DB-DL-7831		Push Rod	
07/87→09/96		Centre Rod	DB-DL-7831		Push Rod* K 189 672 *→* K 226 467 *	
07/87→09/96		Centre Rod	DB-DL-7831		Push Rod→* K 226 467 *	
07/87→09/96	Centre Rod	DB-DL-8131		Push Rod		

CV-ES-12461

Length: 120
 Cone Ø: d1 Ø 26 / d2 Ø 23,5
 Thread: M30 x 1,5 LHT
 0003300035, 3300148, 0003406213, 0013306635,
 0013308835, 0014604048, 0014604348,
 14606448, 0024600248, 3023300035,
 3023300135, 3023300235, 3023300335,
 3453307235, 3453307435, 3503307135,
 A0003300148, A0013306635, A0013308835,
 A0014604048, A0014604348, A0014606448,
 A0024600248, A3023300035, A3023300135,
 A3023300235, A3023300335, A3503307135



CV-ES-14163

Length: 125
 Cone Ø: d1 Ø 30 / d2 Ø 27
 Thread: M30 x 1,5 RHT
 0003305248, 0003387310, 0004600348,
 0004600948, 0004602848, 0004602948,
 0004608948, 0014600248, 0014600848,
 0014601248, 0014602248, 0014607748,
 0024600148, A0003387310, A0004600348,
 A0004602848, A0004602948, A0014600848,
 A0014601248, A0014602248, A0014607748



CV-RK-8118

Ø: 85
 Hole Distance: 130
 Thick/Height: 30
 0003500506, 3500506



DB-DL-5217

Length: 862 Ø: 40
 Cone Ø: d1 Ø 30 / d2 Ø 27
 01214700A, 6204600405, 6204600805,
 6204602905, 6204603005



DB-DL-5412

Length: 840
 Ø: 48
 Cone Ø: d1 Ø 32 / d2 Ø 30
 01214400A, 0014600305, 14600305, 0014600405,
 14600405



DB-DL-7831

Length: 870
 Ø: 42
 Cone Ø: d1 Ø 30 / d2 Ø 27
 01215200A, 6254602505



DB-DL-7840

Length: 595
 Ø: 62
 Hole Distance: 152 / 152
 6203500006, 6203500106, 6203500306,
 653500306



DB-DL-8131

Length: 1115 Ø: 52
 Cone Ø: d1 Ø 32 / d2 Ø 28,8
 0004604405, 6254605005



DB-DL-8618

Length: 680
 Ø: 42
 Cone Ø: d1 Ø 32 / d2 Ø 28,8
 0004604305, 4604305, 6254604805



DB-DL-8640

Length: 1615 Ø: 50
 Cone Ø: d1 Ø 32 / d2 Ø 29
 6253301503, 6253301603, 6253302403,
 6253302503, 9423300803, 9423302103,
 9493300203, 9493300303, 9493300903



DB-DL-9263

Length: 870
 Ø: 42
 Cone Ø: d1 Ø 32 / d2 Ø 27
 0014600505, 14600505, 0014600605, 14600605



DB-DL-10216

Length: 1190
 Ø: 40
 Cone Ø: d1 Ø 32 / d2 Ø 29
 0004604905



DB-DL-12308

Length: 885
 Ø: 42
 Cone Ø: d1 Ø 30 / d2 Ø 27
 4600705, 0004600705



DB-ES-5209

Length: 1670 Ø: 50
 Cone Ø: d1 Ø 30 / d2 Ø 27
 6203300503, 6203300603



DB-ES-5227

Length: 1588 Ø: 60
 Cone Ø: d1 Ø 38 / d2 Ø 34,3
 6253300903, 6253301203, 9443300203



DB-ES-5234

Length: 135
 Cone Ø: d1 Ø 38 / d2 Ø 34,3
 Thread: M38 x 1,5 RHT
 0004601748, 120322305, 2205000400



DB-ES-8387

Length: 55
 Cone Ø: d1 Ø 10 / d2 Ø 10
 Thread: M14 x 1,5 RHT
 0009966845, 0009967045



DB-ES-8492

Length: 60
 Cone Ø: d1 Ø 10 / d2 Ø 10
 Thread: M12 x 1,75 RHT
 0009966645, 3752680189, A3752680189



DB-ES-8500

Length: 55
 Cone Ø: d1 Ø 12 / d2 Ø 10,8
 Thread: M14 x 1,5 RHT
 0002685989



DB-RK-5280

Ø: 86
 01303000A, 6213200428



DB-RK-5282

Ø: 59
 01303800A, 6553200111



DB-RK-8564

Ø: 90
 01302200A, 0003500105, 3500105, 0003500405,
 3500405, 0005861833, 5861833, 81432706047



DB-RK-10378

Ø: 86
 6203200028



DB-RK-12372

Ø: 85
 Hole Distance: 152
 Thick/Height: 24
 003501805, A003501805



DB-VB-7776

Length: 622 Ø: 56
 Hole Distance: 152 / 152
 6533500205, 6583500205



DF-RK-8671



DF-RK-9336

Ø: 108
 0003501705, 3501705



MN-DL-7834

Length: 1588 Ø: 58
 Cone Ø: d1 Ø 30 / d2 Ø 27
 3463303903, 3463304903, 6253303203,
 9443300503, 9443301303, 9443301703



MN-RK-9387

Ø: 90
 0003500105, 81432706047





SK ...

2534, 2534 L ...	07/87→09/96	Centre Rod	DB-DL-8138		Push Rod
	07/87→09/96	Centre Rod	DB-DL-8618		Push Rod
	07/87→09/96	Centre Rod	DB-DL-10216		Push Rod
	07/87→09/96	Centre Rod	DB-DL-12308		Coupling Rod
	07/87→09/96	Centre Rod	DB-DL-12309		Coupling Rod
	07/87→09/96	Suspension Arm Repair Kit		DB-RK-12372	for Wishbone (CV)K063070→
	07/87→09/96	Suspension Arm Repair Kit		DF-RK-9336	
	07/87→09/96	Suspension Arm Repair Kit		DF-RK-9336	* K 063 070 *→
	07/87→09/96	Suspension Arm Repair Kit	DB-RK-5282		
	07/87→09/96	Tie Rod	DB-DL-8640		Guide Rod
	07/87→09/96	Tie Rod	DB-ES-5209		
	07/87→09/96	Tie Rod	DB-ES-5227		Guide Rod
	07/87→09/96	Tie Rod End	CV-ES-12461		for Steering Rod
	07/87→09/96	Track Control Arm		DB-DL-7840	Suspension Rod, Trailing Arm
	07/87→09/96	Track Control Arm		DB-VB-7776	Wishbone (CV);Trailing Arm
	2538	03/91→09/96	Ball Head, gearshift linkage	DB-ES-8387	
03/91→09/96		Ball Head, gearshift linkage	DB-ES-8491		
03/91→09/96		Ball Head, gearshift linkage	DB-ES-8492		
03/91→09/96		Ball Head, gearshift linkage	DB-ES-8500		
03/91→09/96		Centre Rod	DB-DL-5217		Push Rod
03/91→09/96		Centre Rod	DB-DL-5233		Push Rod* 5 937 288 *→
03/91→09/96		Centre Rod	DB-DL-5233		Push Rod* K 017 164 *→
03/91→09/96		Centre Rod	DB-DL-7831		Push Rod
03/91→09/96		Centre Rod	DB-DL-8131		Push Rod
03/91→09/96		Centre Rod	DB-DL-8138		Push Rod
03/91→09/96		Centre Rod	DB-DL-8618		Push Rod
03/91→09/96		Centre Rod	DB-DL-9256		Push Rod
03/91→09/96		Centre Rod	DB-DL-10216		Push Rod
03/91→09/96		Centre Rod	DB-DL-12309		Coupling Rod
03/91→09/96		Stabiliser Mounting	DB-SB-5258	DB-SB-5258	
03/91→09/96		Suspension Arm Repair Kit		DF-RK-9336	
03/91→09/96		Suspension Arm Repair Kit	DB-RK-5280		
03/91→09/96		Suspension Arm Repair Kit	DB-RK-5283		
03/91→09/96		Suspension Arm Repair Kit	DB-RK-6111	DB-RK-6111	Trailing Arm
03/91→09/96		Tie Rod	DB-DL-8640		Guide Rod
03/91→09/96		Tie Rod	DB-ES-5209		
03/91→09/96		Tie Rod End	CV-ES-12461		for Steering Rod
03/91→09/96		Tie Rod End	CV-ES-14163		for Steering Rod
03/91→09/96		Track Control Arm		DB-DL-7839	Trailing Arm
03/91→09/96		Track Control Arm		DB-DL-7840	Suspension Rod, Trailing Arm
03/91→09/96		Track Control Arm		DB-DS-6088	Suspension Rod, Trailing Arm
2538 K, 2538 LK	03/91→09/96	Ball Head, gearshift linkage	DB-ES-8387		
	03/91→09/96	Ball Head, gearshift linkage	DB-ES-8491		
	03/91→09/96	Ball Head, gearshift linkage	DB-ES-8492		
	03/91→09/96	Ball Head, gearshift linkage	DB-ES-8500		
	03/91→09/96	Centre Rod	DB-DL-5217		Push Rod
	03/91→09/96	Centre Rod	DB-DL-5233		Push Rod* 5 937 288 *→
	03/91→09/96	Centre Rod	DB-DL-7831		Push Rod
	03/91→09/96	Centre Rod	DB-DL-8131		Push Rod
	03/91→09/96	Centre Rod	DB-DL-8138		Push Rod
	03/91→09/96	Centre Rod	DB-DL-8618		Push Rod
	03/91→09/96	Stabiliser Mounting	DB-SB-5258	DB-SB-5258	
	03/91→09/96	Suspension Arm Repair Kit		DB-RK-7267	for Drag Link
	03/91→09/96	Suspension Arm Repair Kit	DB-RK-5283		
	03/91→09/96	Tie Rod	DB-DL-8640		Guide Rod
	03/91→09/96	Tie Rod	DB-ES-5209		
	03/91→09/96	Tie Rod End	CV-ES-12461		for Steering Rod
	03/91→09/96	Tie Rod End	CV-ES-14163		for Steering Rod
	03/91→09/96	Track Control Arm		DB-DL-7839	Trailing Arm
	03/91→09/96	Track Control Arm		DB-DS-6088	Suspension Rod, Trailing Arm

CV-ES-12461

Length: 120
 Cone Ø: d1 Ø 26 / d2 Ø 23,5
 Thread: M30 x 1,5 LHT
 0003300035, 3300148, 0003406213, 0013306635,
 0013308835, 0014604048, 0014604348,
 14606448, 0024600248, 3023300035,
 3023300135, 3023300235, 3023300335,
 3453307235, 3453307435, 3503307135,
 A0003300148, A0013306635, A0013308835,
 A0014604048, A0014604348, A0014606448,
 A0024600248, A3023300035, A3023300135,
 A3023300235, A3023300335, A3503307135



CV-ES-14163

Length: 125
 Cone Ø: d1 Ø 30 / d2 Ø 27
 Thread: M30 x 1,5 RHT
 0003305248, 0003387310, 0004600348,
 0004600948, 0004602848, 0004602948,
 0004608948, 0014600248, 0014600848,
 0014601248, 0014602248, 0014607748,
 0024600148, A0003387310, A0004600348,
 A0004602848, A0004602948, A0014600848,
 A0014601248, A0014602248, A0014607748



DB-DL-5217

Length: 862 Ø: 40
 Cone Ø: d1 Ø 30 / d2 Ø 27
 01214700A, 6204600405, 6204600805,
 6204602905, 6204603005



DB-DL-5233

Length: 895 Ø: 48
 Cone Ø: d1 Ø 30 / d2 Ø 27
 01217300A, 0004609805, 0004609905



DB-DL-7831

Length: 870
 Ø: 42
 Cone Ø: d1 Ø 30 / d2 Ø 27
 01215200A, 6254602505



DB-DL-7839

Length: 585
 Ø: 50
 Hole Distance: 152 / 152
 3953500206, 6593500106, 6593502406



DB-DL-7840

Length: 595
 Ø: 62
 Hole Distance: 152 / 152
 6203500006, 6203500106, 6203500306,
 6553500306



DB-DL-8131

Length: 1115 Ø: 52
 Cone Ø: d1 Ø 32 / d2 Ø 28,8
 0004604405, 6254605005



DB-DL-8138

Length: 1130
 Ø: 40
 Cone Ø: d1 Ø 32 / d2 Ø 28,8
 0004606605, 4606605



DB-DL-8618

Length: 680
 Ø: 42
 Cone Ø: d1 Ø 32 / d2 Ø 28,8
 0004604305, 4604305, 6254604805



DB-DL-8640

Length: 1615 Ø: 50
 Cone Ø: d1 Ø 32 / d2 Ø 29
 6253301503, 6253301603, 6253302403,
 6253302503, 9423300803, 9423302103,
 9493300203, 9493300303, 9493300903



DB-DL-9256

Length: 905
 Ø: 48
 Cone Ø: d1 Ø 32 / d2 Ø 29
 14604205, 0014604205



DB-DL-10216

Length: 1190
 Ø: 40
 Cone Ø: d1 Ø 32 / d2 Ø 29
 0004604905



DB-DL-12308

Length: 885
 Ø: 42
 Cone Ø: d1 Ø 30 / d2 Ø 27
 0004600705, 4600705



DB-DL-12309

Length: 685 Ø: 40
 Cone Ø: d1 Ø 32 / d2 Ø 28,8
 0004606005, 0004606305



DB-DS-6088

Length: 585
 Ø: 50
 Hole Distance: 152 / 152
 3953500706, 6593500406



DB-ES-5209

Length: 1670 Ø: 50
 Cone Ø: d1 Ø 30 / d2 Ø 27
 6203300503, 6203300603



DB-ES-5227

Length: 1588 Ø: 60
 Cone Ø: d1 Ø 38 / d2 Ø 34,3
 6253300903, 6253301203, 9443300203



DB-ES-8387

Length: 55
 Cone Ø: d1 Ø 10 / d2 Ø 10
 Thread: M14 x 1,5 RHT
 0009966845, 0009967045



DB-ES-8491

Length: 60
 Cone Ø: d1 Ø 10 / d2 Ø 10
 Thread: M12 x 1,75 LHT
 0009966745



DB-ES-8492

Length: 60
 Cone Ø: d1 Ø 10 / d2 Ø 10
 Thread: M12 x 1,75 RHT
 0009966645, 3752680189, A3752680189



DB-ES-8500

Length: 55
 Cone Ø: d1 Ø 12 / d2 Ø 10,8
 Thread: M14 x 1,5 RHT
 0002685989



DB-RK-5280

Ø: 86
 01303000A, 6213200428



DB-RK-5282

Ø: 59
 01303800A, 6553200111



DB-RK-5283

Ø: 70
 01319900A, 6203200628



DB-RK-6111

Ø: 85
 Hole Distance: 152
 Thick/Height: 24
 0003500613, 0005861135



DB-RK-7267

Ø: 95
 Hole Distance: 152
 Thick/Height: 24
 01302100A, 3500413, 0003500413, 0005861235,
 5861235, 81432706069



DB-RK-12372

Ø: 85
 Hole Distance: 152
 Thick/Height: 24
 003501805, A003501805



DB-SB-5258

Ø: 70
 Thick/Height: 62
 01311400A, 387320285



DB-VB-7776

Length: 622 Ø: 56
 Hole Distance: 152 / 152
 6533500205, 6583500205



DF-RK-9336

Ø: 108
 3501705, 0003501705





SK ...

2538 S	03/91→09/96	Ball Head, gearshift linkage	DB-ES-8387			
	03/91→09/96	Ball Head, gearshift linkage	DB-ES-8491			
	03/91→09/96	Ball Head, gearshift linkage	DB-ES-8492			
	03/91→09/96	Ball Head, gearshift linkage	DB-ES-8500			
	03/91→09/96	Centre Rod	DB-DL-5217		Push Rod	
	03/91→09/96	Centre Rod	DB-DL-5233		Push Rod* 5 937 288 *→	
	03/91→09/96	Centre Rod	DB-DL-7831		Push Rod	
	03/91→09/96	Centre Rod	DB-DL-8131		Push Rod	
	03/91→09/96	Centre Rod	DB-DL-8618		Push Rod	
	03/91→09/96	Stabiliser Mounting	DB-SB-5258	DB-SB-5258		
	03/91→09/96	Suspension Arm Repair Kit	DB-RK-5280			
	03/91→09/96	Suspension Arm Repair Kit	DB-RK-5283			
	03/91→09/96	Tie Rod	DB-DL-8640		Guide Rod	
	03/91→09/96	Tie Rod	DB-ES-5209			
	03/91→09/96	Tie Rod End	CV-ES-12461		for Steering Rod	
	03/91→09/96	Tie Rod End	CV-ES-14163		for Steering Rod	
	03/91→09/96	Track Control Arm		DB-DL-7839	Trailing Arm	
	03/91→09/96	Track Control Arm		DB-DS-6088	Suspension Rod, Trailing Arm	
	2538 S,2538 LS	07/87→09/96	Ball Head, gearshift linkage	DB-ES-8387		
		07/87→09/96	Ball Head, gearshift linkage	DB-ES-8491		
07/87→09/96		Ball Head, gearshift linkage	DB-ES-8492			
07/87→09/96		Ball Head, gearshift linkage	DB-ES-8500			
07/87→09/96		Centre Rod	DB-DL-5217		Push Rod	
07/87→09/96		Centre Rod	DB-DL-5233		Push Rod* 5 937 288 *→	
07/87→09/96		Centre Rod	DB-DL-7831		Push Rod	
07/87→09/96		Centre Rod	DB-DL-8131		Push Rod	
07/87→09/96		Centre Rod	DB-DL-8618		Push Rod	
07/87→09/96		Centre Rod	DB-DL-9215		Push Rod	
07/87→09/96		Stabiliser Mounting	DB-SB-5258	DB-SB-5258		
07/87→09/96		Suspension Arm Repair Kit		DB-RK-8564	Wishbone (CV)	
07/87→09/96		Suspension Arm Repair Kit		DB-RK-10378		
07/87→09/96		Suspension Arm Repair Kit		DF-RK-9336		
07/87→09/96		Suspension Arm Repair Kit		DF-RK-9336	* K 063 070 *→	
07/87→09/96		Suspension Arm Repair Kit	DB-RK-5280			
07/87→09/96		Suspension Arm Repair Kit	DB-RK-5283			
07/87→09/96		Tie Rod	DB-DL-8640		Guide Rod	
07/87→09/96		Tie Rod	DB-ES-5209			
07/87→09/96		Tie Rod End	CV-ES-12461		for Steering Rod	
07/87→09/96	Tie Rod End	CV-ES-14163		for Steering Rod		
07/87→09/96	Track Control Arm		DB-DL-7839	Trailing Arm		
07/87→09/96	Track Control Arm		DB-DL-7840	Suspension Rod, Trailing Arm		
07/87→09/96	Track Control Arm		DB-DS-6088	Suspension Rod, Trailing Arm		
07/87→09/96	Track Control Arm		DB-VB-7776	Wishbone (CV);Trailing Arm* 5 926 393 *→		
2538,2538 L	07/87→09/96	Ball Head, gearshift linkage	DB-ES-8387			
	07/87→09/96	Ball Head, gearshift linkage	DB-ES-8491			
	07/87→09/96	Ball Head, gearshift linkage	DB-ES-8492			
	07/87→09/96	Ball Head, gearshift linkage	DB-ES-8500			
	07/87→09/96	Centre Rod	DB-DL-5217		Push Rod	
	07/87→09/96	Centre Rod	DB-DL-5233		Push Rod	
	07/87→09/96	Centre Rod	DB-DL-5233		Push Rod* 5 937 288 *→	
	07/87→09/96	Centre Rod	DB-DL-5233		Push Rod* K 016 738 *→	
	07/87→09/96	Centre Rod	DB-DL-5233		Push Rod* K 017 164 *→	
	07/87→09/96	Centre Rod	DB-DL-5241		Suspension Rod	
	07/87→09/96	Centre Rod	DB-DL-7270		Push Rod;Suspension Rod	
	07/87→09/96	Centre Rod	DB-DL-7831		Push Rod	
	07/87→09/96	Centre Rod	DB-DL-7831		Push Rod* K 189 672 *→* K 226 467 *	
	07/87→09/96	Centre Rod	DB-DL-7831		Push Rod→* K 226 467 *	
	07/87→09/96	Centre Rod	DB-DL-8131		Push Rod	
	07/87→09/96	Centre Rod	DB-DL-8138		Push Rod	
	07/87→09/96	Centre Rod	DB-DL-8618		Push Rod	
	07/87→09/96	Centre Rod	DB-DL-9256		Push Rod	
	07/87→09/96	Centre Rod	DB-DL-10216		Push Rod	
	07/87→09/96	Centre Rod	DB-DL-12308		Coupling Rod	

CV-ES-12461

Length: 120
 Cone Ø: d1 Ø 26 / d2 Ø 23,5
 Thread: M30 x 1,5 LHT
 0003300035, 3300148, 0003406213, 0013306635,
 0013308835, 0014604048, 0014604348,
 14606448, 0024600248, 3023300035,
 3023300135, 3023300235, 3023300335,
 3453307235, 3453307435, 3503307135,
 A0003300148, A0013306635, A0013308835,
 A0014604048, A0014604348, A0014606448,
 A0024600248, A3023300035, A3023300135,
 A3023300235, A3023300335, A3503307135



CV-ES-14163

Length: 125
 Cone Ø: d1 Ø 30 / d2 Ø 27
 Thread: M30 x 1,5 RHT
 0003305248, 0003387310, 0004600348,
 0004600948, 0004602848, 0004602948,
 0004608948, 0014600248, 0014600848,
 0014601248, 0014602248, 0014607748,
 0024600148, A0003387310, A0004600348,
 A0004602848, A0004602948, A0014600848,
 A0014601248, A0014602248, A0014607748



DB-DL-5217

Length: 862 Ø: 40
 Cone Ø: d1 Ø 30 / d2 Ø 27
 01214700A, 6204600405, 6204600805,
 6204602905, 6204603005



DB-DL-5233

Length: 895
 Ø: 48
 Cone Ø: d1 Ø 30 / d2 Ø 27
 01217300A, 4609805, 0004609805, 0004609905,
 4609905



DB-DL-5241

Length: 875 Ø: 40
 Cone Ø: d1 Ø 30 / d2 Ø 27
 01215300A, 0004609205, 0004609305,
 0014606905



DB-DL-7270

Length: 875 Ø: 40
 Cone Ø: d1 Ø 28,6 / d2 Ø 23,9
 01208300A, 0024604705, 0024604805,
 0034604905, A0024604705



DB-DL-7831

Length: 870
 Ø: 42
 Cone Ø: d1 Ø 30 / d2 Ø 27
 01215200A, 6254602505



DB-DL-7839

Length: 585
 Ø: 50
 Hole Distance: 152 / 152
 3953500206, 6593500106, 6593502406



DB-DL-7840

Length: 595
 Ø: 62
 Hole Distance: 152 / 152
 6203500006, 6203500106, 6203500306,
 6553500306



DB-DL-8131

Length: 1115 Ø: 52
 Cone Ø: d1 Ø 32 / d2 Ø 28,8
 0004604405, 6254605005



DB-DL-8138

Length: 1130
 Ø: 40
 Cone Ø: d1 Ø 32 / d2 Ø 28,8
 0004606605, 4606605



DB-DL-8618

Length: 680
 Ø: 42
 Cone Ø: d1 Ø 32 / d2 Ø 28,8
 0004604305, 4604305, 6254604805



DB-DL-8640

Length: 1615 Ø: 50
 Cone Ø: d1 Ø 32 / d2 Ø 29
 6253301503, 6253301603, 6253302403,
 6253302503, 9423300803, 9423302103,
 9493300203, 9493300303, 9493300903



DB-DL-9215

Length: 975
 Ø: 42
 Cone Ø: d1 Ø 30 / d2 Ø 27
 3964603005, 3964604805



DB-DL-9256

Length: 905
 Ø: 48
 Cone Ø: d1 Ø 32 / d2 Ø 29
 0014604205, 14604205



DB-DL-10216

Length: 1190
 Ø: 40
 Cone Ø: d1 Ø 32 / d2 Ø 29
 0004604905



DB-DL-12308

Length: 885
 Ø: 42
 Cone Ø: d1 Ø 30 / d2 Ø 27
 0004600705, 4600705



DB-DS-6088

Length: 585
 Ø: 50
 Hole Distance: 152 / 152
 3953500706, 6593500406



DB-ES-5209

Length: 1670 Ø: 50
 Cone Ø: d1 Ø 30 / d2 Ø 27
 6203300503, 6203300603



DB-ES-8387

Length: 55
 Cone Ø: d1 Ø 10 / d2 Ø 10
 Thread: M14 x 1,5 RHT
 0009966845, 0009967045



DB-ES-8491

Length: 60
 Cone Ø: d1 Ø 10 / d2 Ø 10
 Thread: M12 x 1,75 LHT
 0009966745



DB-ES-8492

Length: 60
 Cone Ø: d1 Ø 10 / d2 Ø 10
 Thread: M12 x 1,75 RHT
 0009966645, 3752680189, A3752680189



DB-ES-8500

Length: 55
 Cone Ø: d1 Ø 12 / d2 Ø 10,8
 Thread: M14 x 1,5 RHT
 0002685989



DB-RK-5280

Ø: 86
 01303000A, 6213200428



DB-RK-5283

Ø: 70
 01319900A, 6203200628



DB-RK-8564

Ø: 90
 01302200A, 0003500105, 3500105, 0003500405,
 3500405, 5861833, 0005861833, 81432706047



DB-RK-10378

Ø: 86
 6203200028



DB-SB-5258

Ø: 70
 Thick/Height: 62
 01311400A, 3873230285



DB-VB-7776

Length: 622 Ø: 56
 Hole Distance: 152 / 152
 6533500205, 6583500205



DF-RK-9336

Ø: 108
 0003501705, 3501705





SK ...

2538,2538 L ...	07/87→09/96	Centre Rod	DB-DL-12309		Coupling Rod
	07/87→09/96	Stabiliser Mounting	DB-SB-5258	DB-SB-5258	
	07/87→09/96	Suspension Arm Repair Kit		DB-RK-7267	for Drag Link
	07/87→09/96	Suspension Arm Repair Kit		DB-RK-8550	for Wishbone (CV)
	07/87→09/96	Suspension Arm Repair Kit		DB-RK-8564	Wishbone (CV)
	07/87→09/96	Suspension Arm Repair Kit		DB-RK-12372	for Wishbone (CV)
	07/87→09/96	Suspension Arm Repair Kit		DB-RK-12372	for Wishbone (CV), Lifting Axle, K063070→
	07/87→09/96	Suspension Arm Repair Kit		DF-RK-9336	
	07/87→09/96	Suspension Arm Repair Kit		DF-RK-9336	* K 063 070 *→
	07/87→09/96	Suspension Arm Repair Kit		DF-RK-9336	Lifting Axle, * K 063 070 *→
	07/87→09/96	Suspension Arm Repair Kit		MN-RK-9387	
	07/87→09/96	Suspension Arm Repair Kit		MN-RK-9387	→* 5 926 392 *
	07/87→09/96	Suspension Arm Repair Kit		MN-RK-9387	Lifting Axle, →* 5 926 392 *
	07/87→09/96	Suspension Arm Repair Kit	DB-RK-5280		
	07/87→09/96	Suspension Arm Repair Kit	DB-RK-5282		
	07/87→09/96	Suspension Arm Repair Kit	DB-RK-5283		
	07/87→09/96	Tie Rod	DB-DL-8640		Guide Rod
	07/87→09/96	Tie Rod	DB-ES-5209		
	07/87→09/96	Tie Rod End	CV-ES-12461		for Steering Rod
	07/87→09/96	Tie Rod End	CV-ES-14163		for Steering Rod
	07/87→09/96	Track Control Arm		DB-DL-7839	Trailing Arm
	07/87→09/96	Track Control Arm		DB-DL-7840	Suspension Rod, Trailing Arm
	07/87→09/96	Track Control Arm		DB-DL-7840	Suspension Rod, Trailing Arm* 5 922 799 *→
	07/87→09/96	Track Control Arm		DB-DS-6088	Suspension Rod, Trailing Arm
	07/87→09/96	Track Control Arm		DB-VB-7776	Wishbone (CV);Trailing Arm* 5 926 393 *→
07/87→09/96	Track Control Arm		DB-VB-7776	Wishbone (CV);Trailing Arm, Lifting Axle	
2544	01/94→09/96	Ball Head, gearshift linkage	DB-ES-8387		
	01/94→09/96	Ball Head, gearshift linkage	DB-ES-8491		
	01/94→09/96	Ball Head, gearshift linkage	DB-ES-8492		
	01/94→09/96	Ball Head, gearshift linkage	DB-ES-8500		
	01/94→09/96	Centre Rod	DB-DL-5217		Push Rod
	01/94→09/96	Centre Rod	DB-DL-5233		Push Rod* 5 937 288 *→
	01/94→09/96	Centre Rod	DB-DL-7831		Push Rod
	01/94→09/96	Centre Rod	DB-DL-8131		Push Rod
	01/94→09/96	Centre Rod	DB-DL-8618		Push Rod
	01/94→09/96	Suspension Arm Repair Kit	DB-RK-6111	DB-RK-6111	Trailing Arm
	01/94→09/96	Tie Rod	DB-DL-8640		Guide Rod
	01/94→09/96	Tie Rod	DB-ES-5209		
	01/94→09/96	Tie Rod End	CV-ES-12461		for Steering Rod
	01/94→09/96	Track Control Arm		DB-DL-7839	Trailing Arm
	01/94→09/96	Track Control Arm		DB-DS-6088	Suspension Rod, Trailing Arm
2544 LS	01/92→09/96	Ball Head, gearshift linkage	DB-ES-8387		
	01/92→09/96	Ball Head, gearshift linkage	DB-ES-8491		
	01/92→09/96	Ball Head, gearshift linkage	DB-ES-8492		
	01/92→09/96	Ball Head, gearshift linkage	DB-ES-8500		
	01/92→09/96	Centre Rod	DB-DL-5217		Push Rod
	01/92→09/96	Centre Rod	DB-DL-8618		Push Rod
	01/92→09/96	Suspension Arm Repair Kit		DF-RK-9336	
	01/92→09/96	Suspension Arm Repair Kit		DF-RK-9336	* K 063 070 *→
	01/92→09/96	Tie Rod	DB-DL-8640		Guide Rod
	01/92→09/96	Tie Rod End	CV-ES-12461		for Steering Rod
	01/92→09/96	Track Control Arm		DB-DL-7840	Suspension Rod, Trailing Arm
	01/92→09/96	Track Control Arm		DB-VB-7776	Wishbone (CV);Trailing Arm* 5 926 393 *→
	2544 S	07/88→08/94	Centre Rod	DB-DL-5217	
07/88→08/94		Centre Rod	DB-DL-5233		Push Rod* 5 937 288 *→
07/88→08/94		Centre Rod	DB-DL-7831		Push Rod
07/88→08/94		Centre Rod	DB-DL-7831		Push Rod→* K 226 467 *
07/88→08/94		Centre Rod	DB-DL-8131		Push Rod
07/88→08/94		Centre Rod	DB-DL-8138		Push Rod
07/88→08/94		Centre Rod	DB-DL-8618		Push Rod
07/88→08/94		Suspension Arm Repair Kit	DB-RK-6111	DB-RK-6111	Trailing Arm
07/88→08/94		Tie Rod	DB-DL-8640		Guide Rod
07/88→08/94		Tie Rod	DB-ES-5209		

CV-ES-12461

Length: 120
 Cone Ø: d1 Ø 26 / d2 Ø 23,5
 Thread: M30 x 1,5 LHT
 0003300035, 3300148, 0003406213, 0013306635,
 0013308835, 0014604048, 0014604348,
 14606448, 0024600248, 3023300035,
 3023300135, 3023300235, 3023300335,
 3453307235, 3453307435, 3503307135,
 A0003300148, A0013306635, A0013308835,
 A0014604048, A0014604348, A0014606448,
 A0024600248, A3023300035, A3023300135,
 A3023300235, A3023300335, A3503307135



CV-ES-14163

Length: 125
 Cone Ø: d1 Ø 30 / d2 Ø 27
 Thread: M30 x 1,5 RHT
 0003305248, 0003387310, 0004600348,
 0004600948, 0004602848, 0004602948,
 0004608948, 0014600248, 0014600848,
 0014601248, 0014602248, 0014607748,
 0024600148, A0003387310, A0004600348,
 A0004602848, A0004602948, A0014600848,
 A0014601248, A0014602248, A0014607748



DB-DL-5217

Length: 862 Ø: 40
 Cone Ø: d1 Ø 30 / d2 Ø 27
 01214700A, 6204600405, 6204600805,
 6204602905, 6204603005



DB-DL-5233

Length: 895 Ø: 48
 Cone Ø: d1 Ø 30 / d2 Ø 27
 01217300A, 0004609805, 0004609905



DB-DL-7831

Length: 870
 Ø: 42
 Cone Ø: d1 Ø 30 / d2 Ø 27
 01215200A, 6254602505



DB-DL-7839

Length: 585
 Ø: 50
 Hole Distance: 152 / 152
 3953500206, 6593500106, 6593502406



DB-DL-7840

Length: 595
 Ø: 62
 Hole Distance: 152 / 152
 6203500006, 6203500106, 6203500306,
 6553500306



DB-DL-8131

Length: 1115 Ø: 52
 Cone Ø: d1 Ø 32 / d2 Ø 28,8
 0004604405, 6254605005



DB-DL-8138

Length: 1130
 Ø: 40
 Cone Ø: d1 Ø 32 / d2 Ø 28,8
 0004606605, 4606605



DB-DL-8618

Length: 680
 Ø: 42
 Cone Ø: d1 Ø 32 / d2 Ø 28,8
 4604305, 0004604305, 6254604805



DB-DL-8640

Length: 1615 Ø: 50
 Cone Ø: d1 Ø 32 / d2 Ø 29
 6253301503, 6253301603, 6253302403,
 6253302503, 9423300803, 9423302103,
 9493300203, 9493300303, 9493300903



DB-DL-12309

Length: 685 Ø: 40
 Cone Ø: d1 Ø 32 / d2 Ø 28,8
 0004606005, 0004606305



DB-DS-6088

Length: 585
 Ø: 50
 Hole Distance: 152 / 152
 3953500706, 6593500406



DB-ES-5209

Length: 1670 Ø: 50
 Cone Ø: d1 Ø 30 / d2 Ø 27
 6203300503, 6203300603



DB-ES-8387

Length: 55
 Cone Ø: d1 Ø 10 / d2 Ø 10
 Thread: M14 x 1,5 RHT
 0009966845, 0009967045



DB-ES-8491

Length: 60
 Cone Ø: d1 Ø 10 / d2 Ø 10
 Thread: M12 x 1,75 LHT
 0009966745



DB-ES-8492

Length: 60
 Cone Ø: d1 Ø 10 / d2 Ø 10
 Thread: M12 x 1,75 RHT
 0009966645, 3752680189, A3752680189



DB-ES-8500

Length: 55
 Cone Ø: d1 Ø 12 / d2 Ø 10,8
 Thread: M14 x 1,5 RHT
 0002685989



DB-RK-5280

Ø: 86
 01303000A, 6213200428



DB-RK-5282

Ø: 59
 01303800A, 6553200111



DB-RK-5283

Ø: 70
 01319900A, 6203200628



DB-RK-6111

Ø: 85
 Hole Distance: 152
 Thick/Height: 24
 0003500613, 0005861135



DB-RK-7267

Ø: 95
 Hole Distance: 152
 Thick/Height: 24
 01302100A, 0003500413, 3500413, 0005861235,
 5861235, 81432706069



DB-RK-8550

Ø: 75 Hole Distance: 152
 Thick/Height: 24
 0003502105, 0003504605



DB-RK-8564

Ø: 90
 01302200A, 0003500105, 3500105, 3500405,
 0003500405, 5861833, 0005861833,
 81432706047



DB-RK-12372

Ø: 85
 Hole Distance: 152
 Thick/Height: 24
 003501805, A003501805



DB-SB-5258

Ø: 70
 Thick/Height: 62
 01311400A, 3873230285



DB-VB-7776

Length: 622 Ø: 56
 Hole Distance: 152 / 152
 6533500205, 6583500205



DF-RK-9336

Ø: 108
 3501705, 0003501705



MN-RK-9387

Ø: 90
 0003500105, 81432706047





SK ...

2544 S ...	07/88→08/94	Tie Rod End	CV-ES-12461		for Steering Rod	
	07/88→08/94	Track Control Arm		DB-DL-7839	Trailing Arm	
	07/88→08/94	Track Control Arm		DB-DS-6088	Suspension Rod, Trailing Arm	
2544 S, LS	01/92→09/96	Ball Head, gearshift linkage	DB-ES-8387			
	01/92→09/96	Ball Head, gearshift linkage	DB-ES-8491			
	01/92→09/96	Ball Head, gearshift linkage	DB-ES-8492			
	01/92→09/96	Ball Head, gearshift linkage	DB-ES-8500			
	01/92→09/96	Centre Rod	DB-DL-5217	DB-DL-5217	Push Rod	
	01/92→09/96	Centre Rod	DB-DL-5233		Push Rod* 5 937 288 *→	
	01/92→09/96	Centre Rod	DB-DL-7831		Push Rod	
	01/92→09/96	Centre Rod	DB-DL-7831		Push Rod* K 189 672 *→* K 226 467 *	
	01/92→09/96	Centre Rod	DB-DL-8131		Push Rod	
	01/92→09/96	Centre Rod	DB-DL-8138		Push Rod	
	01/92→09/96	Centre Rod	DB-DL-8618		Push Rod	
	01/92→09/96	Stabiliser Mounting	DB-SB-5258	DB-SB-5258		
	01/92→09/96	Suspension Arm Repair Kit		DB-RK-12372	for Wishbone (CV)	
	01/92→09/96	Suspension Arm Repair Kit		DF-RK-9336		
	01/92→09/96	Suspension Arm Repair Kit	DB-RK-5280			
	01/92→09/96	Suspension Arm Repair Kit	DB-RK-5283			
	01/92→09/96	Tie Rod	DB-DL-8640		Guide Rod	
	01/92→09/96	Tie Rod	DB-ES-5209			
	01/92→09/96	Tie Rod	DB-ES-5227		Guide Rod	
	01/92→09/96	Tie Rod End	CV-ES-12461		for Steering Rod	
	01/92→09/96	Tie Rod End	CV-ES-14163		for Steering Rod	
	01/92→09/96	Track Control Arm		DB-DL-7839	Trailing Arm	
	01/92→09/96	Track Control Arm		DB-DL-7840	Suspension Rod, Trailing Arm	
	01/92→09/96	Track Control Arm		DB-VB-7776	Wishbone (CV);Trailing Arm* 5 926 393 *→	
	2544, 2544 L	07/87→09/96	Ball Head, gearshift linkage	DB-ES-8387		
		07/87→09/96	Ball Head, gearshift linkage	DB-ES-8491		
		07/87→09/96	Ball Head, gearshift linkage	DB-ES-8492		
07/87→09/96		Ball Head, gearshift linkage	DB-ES-8500			
07/87→09/96		Centre Rod	DB-DL-5241		Suspension Rod	
07/87→09/96		Centre Rod	DB-DL-7270		Push Rod;Suspension Rod	
07/87→09/96		Centre Rod	DB-DL-7831		Push Rod	
07/87→09/96		Centre Rod	DB-DL-7831		Push Rod* K 189 672 *→* K 226 467 *	
07/87→09/96		Centre Rod	DB-DL-8131		Push Rod	
07/87→09/96		Centre Rod	DB-DL-8138		Push Rod	
07/87→09/96		Centre Rod	DB-DL-8618		Push Rod	
07/87→09/96		Centre Rod	DB-DL-9256		Push Rod	
07/87→09/96		Centre Rod	DB-DL-10216		Push Rod	
07/87→09/96		Centre Rod	DB-DL-12308		Coupling Rod	
07/87→09/96		Centre Rod	DB-DL-12309		Coupling Rod	
07/87→09/96		Suspension Arm Repair Kit		DB-RK-8550	for Wishbone (CV)	
07/87→09/96		Suspension Arm Repair Kit		DB-RK-8564	Wishbone (CV)	
07/87→09/96		Suspension Arm Repair Kit		DB-RK-12372	for Wishbone (CV), Lifting Axle, K063070→	
07/87→09/96		Suspension Arm Repair Kit		DF-RK-9336		
07/87→09/96		Suspension Arm Repair Kit		DF-RK-9336	* K 063 070 *→	
07/87→09/96		Suspension Arm Repair Kit		DF-RK-9336	Lifting Axle, * K 063 070 *→	
07/87→09/96		Suspension Arm Repair Kit		MN-RK-9387		
07/87→09/96		Suspension Arm Repair Kit		MN-RK-9387	→* 5 926 392 *	
07/87→09/96		Suspension Arm Repair Kit		MN-RK-9387	Lifting Axle, →* 5 926 392 *	
07/87→09/96		Suspension Arm Repair Kit	DB-RK-5282			
07/87→09/96		Tie Rod	DB-DL-8640		Guide Rod	
07/87→09/96		Tie Rod	DB-ES-5209			
07/87→09/96		Tie Rod	DB-ES-5227		Guide Rod	
07/87→09/96		Tie Rod End	CV-ES-12461		for Steering Rod	
07/87→09/96		Tie Rod End	CV-ES-14163		for Steering Rod	
07/87→09/96		Track Control Arm		DB-DL-7840	Suspension Rod, Trailing Arm	
07/87→09/96		Track Control Arm		DB-DL-7840	Suspension Rod, Trailing Arm* 5 922 799 *→	
07/87→09/96		Track Control Arm		DB-VB-7776	Wishbone (CV);Trailing Arm* 5 926 393 *→	
07/87→09/96	Track Control Arm		DB-VB-7776	Wishbone (CV);Trailing Arm, Lifting Axle		
01/92→09/96	Centre Rod	DB-DL-5217	DB-DL-5217	Push Rod		



SK ...

2544,2544 L	07/87→09/96	Centre Rod	DB-DL-5217		Push Rod	
	07/87→09/96	Centre Rod	DB-DL-5233		Push Rod* 5 937 288 *→	
	07/87→09/96	Centre Rod	DB-DL-5233		Push Rod* K 016 738 *→	
	07/87→09/96	Centre Rod	DB-DL-5233		Push Rod* K 017 164 *→	
	07/87→09/96	Centre Rod	DB-DL-7831		Push Rod→* K 226 467 *	
	07/87→09/96	Stabiliser Mounting	DB-SB-5258	DB-SB-5258		
	07/87→09/96	Suspension Arm Repair Kit	DB-RK-5280			
	07/87→09/96	Suspension Arm Repair Kit	DB-RK-5283			
	07/87→09/96	Tie Rod	MN-DL-7834		Guide Rod	
	07/87→09/96	Tie Rod End	DB-ES-5234		for Steering Rod	
	07/87→09/96	Track Control Arm		DB-DL-7839	Trailing Arm	
	2550	07/87→09/96	Centre Rod	DB-DL-5217		Push Rod
		07/87→09/96	Centre Rod	DB-DL-7831		Push Rod
		07/87→09/96	Centre Rod	DB-DL-8131		Push Rod
07/87→09/96		Centre Rod	DB-DL-8138		Push Rod	
07/87→09/96		Centre Rod	DB-DL-8618		Push Rod	
07/87→09/96		Centre Rod	DB-DL-12309		Coupling Rod	
07/87→09/96		Tie Rod	DB-DL-8640		Guide Rod	
07/87→09/96		Tie Rod	DB-ES-5209			
07/87→09/96		Tie Rod	DB-ES-5227		Guide Rod	
07/87→09/96		Tie Rod End	CV-ES-12461		for Steering Rod	
01/91→09/96		Ball Head, gearshift linkage	DB-ES-8387			
01/91→09/96		Ball Head, gearshift linkage	DB-ES-8491			
01/91→09/96		Ball Head, gearshift linkage	DB-ES-8492			
01/91→09/96		Ball Head, gearshift linkage	DB-ES-8500			
01/91→09/96		Centre Rod	DB-DL-5233		Push Rod* 5 937 288 *→	
01/91→09/96		Centre Rod	DB-DL-10216		Push Rod	
01/91→09/96		Suspension Arm Repair Kit	DB-RK-6111	DB-RK-6111	Trailing Arm	
01/91→09/96		Track Control Arm		DB-DL-7839	Trailing Arm	
01/91→09/96		Track Control Arm		DB-DS-6088	Suspension Rod, Trailing Arm	
2550 K		07/87→09/96	Ball Head, gearshift linkage	DB-ES-8387		
	07/87→09/96	Ball Head, gearshift linkage	DB-ES-8491			
	07/87→09/96	Ball Head, gearshift linkage	DB-ES-8492			
	07/87→09/96	Ball Head, gearshift linkage	DB-ES-8500			
	07/87→09/96	Centre Rod	DB-DL-5217		Push Rod	
	07/87→09/96	Centre Rod	DB-DL-5233		Push Rod* 5 937 288 *→	
	07/87→09/96	Centre Rod	DB-DL-7831		Push Rod	
	07/87→09/96	Centre Rod	DB-DL-8131		Push Rod	
	07/87→09/96	Centre Rod	DB-DL-8138		Push Rod	
	07/87→09/96	Centre Rod	DB-DL-8618		Push Rod	
	07/87→09/96	Suspension Arm Repair Kit		DB-RK-7267	for Drag Link	
	07/87→09/96	Tie Rod	DB-DL-8640		Guide Rod	
	07/87→09/96	Tie Rod	DB-ES-5209			
	07/87→09/96	Tie Rod End	CV-ES-12461		for Steering Rod	
	07/87→09/96	Track Control Arm		DB-DL-7839	Trailing Arm	
	07/87→09/96	Track Control Arm		DB-DS-6088	Suspension Rod, Trailing Arm	
	2550 S, 2550 LS	01/91→09/96	Ball Head, gearshift linkage	DB-ES-8387		
		01/91→09/96	Ball Head, gearshift linkage	DB-ES-8491		
		01/91→09/96	Ball Head, gearshift linkage	DB-ES-8492		
		01/91→09/96	Ball Head, gearshift linkage	DB-ES-8500		
01/91→09/96		Centre Rod	DB-DL-5217		Push Rod	
01/91→09/96		Centre Rod	DB-DL-5233		Push Rod* 5 937 288 *→	
01/91→09/96		Centre Rod	DB-DL-7831		Push Rod	
01/91→09/96		Centre Rod	DB-DL-8131		Push Rod	
01/91→09/96		Centre Rod	DB-DL-8138		Push Rod	
01/91→09/96		Centre Rod	DB-DL-8618		Push Rod	
01/91→09/96		Centre Rod	DB-DL-10216		Push Rod	
01/91→09/96		Centre Rod	DB-DL-12309		Coupling Rod	
01/91→09/96		Stabiliser Mounting	DB-SB-5258	DB-SB-5258		
01/91→09/96		Suspension Arm Repair Kit		DF-RK-9336		
01/91→09/96		Suspension Arm Repair Kit		DF-RK-9336	* K 063 070 *→	
01/91→09/96		Suspension Arm Repair Kit	DB-RK-5283			
01/91→09/96		Tie Rod	DB-DL-8640		Guide Rod	

CV-ES-12461

Length: 120
 Cone Ø: d1 Ø 26 / d2 Ø 23,5
 Thread: M30 x 1,5 LHT
 0003300035, 3300148, 0003406213, 0013306635,
 0013308835, 0014604048, 0014604348,
 14606448, 0024600248, 3023300035,
 3023300135, 3023300235, 3023300335,
 3453307235, 3453307435, 3503307135,
 A0003300148, A0013306635, A0013308835,
 A0014604048, A0014604348, A0014606448,
 A0024600248, A3023300035, A3023300135,
 A3023300235, A3023300335, A3503307135



DB-DL-5217

Length: 862 Ø: 40
 Cone Ø: d1 Ø 30 / d2 Ø 27
 01214700A, 6204600405, 6204600805,
 6204602905, 6204603005



DB-DL-5233

Length: 895
 Ø: 48
 Cone Ø: d1 Ø 30 / d2 Ø 27
 01217300A, 4609805, 0004609805, 4609905,
 0004609905



DB-DL-7831

Length: 870
 Ø: 42
 Cone Ø: d1 Ø 30 / d2 Ø 27
 01215200A, 6254602505



DB-DL-7839

Length: 585
 Ø: 50
 Hole Distance: 152 / 152
 3953500206, 6593500106, 6593502406



DB-DL-8131

Length: 1115 Ø: 52
 Cone Ø: d1 Ø 32 / d2 Ø 28,8
 0004604405, 6254605005



DB-DL-8138

Length: 1130
 Ø: 40
 Cone Ø: d1 Ø 32 / d2 Ø 28,8
 0004606605, 4606605



DB-DL-8618

Length: 680
 Ø: 42
 Cone Ø: d1 Ø 32 / d2 Ø 28,8
 4604305, 0004604305, 6254604805



DB-DL-8640

Length: 1615 Ø: 50
 Cone Ø: d1 Ø 32 / d2 Ø 29
 6253301503, 6253301603, 6253302403,
 6253302503, 9423300803, 9423302103,
 9493300203, 9493300303, 9493300903



DB-DL-10216

Length: 1190
 Ø: 40
 Cone Ø: d1 Ø 32 / d2 Ø 29
 0004604905



DB-DL-12309

Length: 685 Ø: 40
 Cone Ø: d1 Ø 32 / d2 Ø 28,8
 0004606005, 0004606305



DB-DS-6088

Length: 585
 Ø: 50
 Hole Distance: 152 / 152
 3953500706, 6593500406



DB-ES-5209

Length: 1670 Ø: 50
 Cone Ø: d1 Ø 30 / d2 Ø 27
 6203300503, 6203300603



DB-ES-5227

Length: 1588 Ø: 60
 Cone Ø: d1 Ø 38 / d2 Ø 34,3
 6253300903, 6253301203, 9443300203



DB-ES-5234

Length: 135
 Cone Ø: d1 Ø 38 / d2 Ø 34,3
 Thread: M38 x 1,5 RHT
 0004601748, 120322305, 2205000400



DB-ES-8387

Length: 55
 Cone Ø: d1 Ø 10 / d2 Ø 10
 Thread: M14 x 1,5 RHT
 0009966845, 0009967045



DB-ES-8491

Length: 60
 Cone Ø: d1 Ø 10 / d2 Ø 10
 Thread: M12 x 1,75 LHT
 0009966745



DB-ES-8492

Length: 60
 Cone Ø: d1 Ø 10 / d2 Ø 10
 Thread: M12 x 1,75 RHT
 0009966645, 3752680189, A3752680189



DB-ES-8500

Length: 55
 Cone Ø: d1 Ø 12 / d2 Ø 10,8
 Thread: M14 x 1,5 RHT
 0002685989



DB-RK-5280

Ø: 86
 01303000A, 6213200428



DB-RK-5283

Ø: 70
 01319900A, 6203200628



DB-RK-6111

Ø: 85
 Hole Distance: 152
 Thick/Height: 24
 0003500613, 0005861135



DB-RK-7267

Ø: 95
 Hole Distance: 152
 Thick/Height: 24
 01302100A, 0003500413, 3500413, 0005861235,
 5861235, 81432706069



DB-SB-5258

Ø: 70
 Thick/Height: 62
 01311400A, 3873230285



DF-RK-9336

Ø: 108
 3501705, 0003501705



MN-DL-7834

Length: 1588 Ø: 58
 Cone Ø: d1 Ø 30 / d2 Ø 27
 3463303903, 3463304903, 6253303203,
 9443300503, 9443301303, 9443301703





SK ...

2550 S, 2550 LS ...	01/91→09/96	Tie Rod	DB-ES-5209			
	01/91→09/96	Tie Rod End	CV-ES-12461		for Steering Rod	
	01/91→09/96	Track Control Arm		DB-DL-7839	Trailing Arm	
	01/91→09/96	Track Control Arm		DB-DL-7840	Suspension Rod, Trailing Arm	
	01/91→09/96	Track Control Arm		DB-DS-6088	Suspension Rod, Trailing Arm	
	01/91→09/96	Track Control Arm		DB-VB-7776	Wishbone (CV);Trailing Arm* 5 926 393 *→	
2550,2550 L	07/87→09/96	Ball Head, gearshift linkage	DB-ES-8387			
	07/87→09/96	Ball Head, gearshift linkage	DB-ES-8491			
	07/87→09/96	Ball Head, gearshift linkage	DB-ES-8492			
	07/87→09/96	Ball Head, gearshift linkage	DB-ES-8500			
	07/87→09/96	Centre Rod	DB-DL-5217		Push Rod	
	07/87→09/96	Centre Rod	DB-DL-5233		Push Rod* K 017 164 *→	
	07/87→09/96	Centre Rod	DB-DL-7831		Push Rod	
	07/87→09/96	Centre Rod	DB-DL-7831		Push Rod* K 189 672 *→* K 226 467 *	
	07/87→09/96	Centre Rod	DB-DL-7831		Push Rod→* K 226 467 *	
	07/87→09/96	Centre Rod	DB-DL-8131		Push Rod	
	07/87→09/96	Centre Rod	DB-DL-8138		Push Rod	
	07/87→09/96	Centre Rod	DB-DL-8618		Push Rod	
	07/87→09/96	Centre Rod	DB-DL-10216		Push Rod	
	07/87→09/96	Centre Rod	DB-DL-12308		Coupling Rod	
	07/87→09/96	Centre Rod	DB-DL-12309		Coupling Rod	
	07/87→09/96	Stabiliser Mounting	DB-SB-5258	DB-SB-5258		
	07/87→09/96	Suspension Arm Repair Kit		DB-RK-8564	Wishbone (CV)	
	07/87→09/96	Suspension Arm Repair Kit		DB-RK-12372	for Wishbone (CV), Lifting Axle, K063070→	
	07/87→09/96	Suspension Arm Repair Kit		DF-RK-9336		
	07/87→09/96	Suspension Arm Repair Kit		DF-RK-9336	* K 063 070 *→	
	07/87→09/96	Suspension Arm Repair Kit		DF-RK-9336	Lifting Axle, * K 063 070 *→	
	07/87→09/96	Suspension Arm Repair Kit		MN-RK-9387		
	07/87→09/96	Suspension Arm Repair Kit		MN-RK-9387	→* 5 926 392 *	
	07/87→09/96	Suspension Arm Repair Kit		MN-RK-9387	Lifting Axle, →* 5 926 392 *	
	07/87→09/96	Suspension Arm Repair Kit	DB-RK-5280			
	07/87→09/96	Suspension Arm Repair Kit	DB-RK-5282			
	07/87→09/96	Suspension Arm Repair Kit	DB-RK-5283			
	07/87→09/96	Tie Rod	DB-DL-8640		Guide Rod	
	07/87→09/96	Tie Rod	DB-ES-5209			
	07/87→09/96	Tie Rod	DB-ES-5227		Guide Rod	
	07/87→09/96	Tie Rod End	CV-ES-12461		for Steering Rod	
	07/87→09/96	Tie Rod End	CV-ES-14163		for Steering Rod	
	07/87→09/96	Track Control Arm		DB-DL-7840	Suspension Rod, Trailing Arm	
	07/87→09/96	Track Control Arm		DB-DL-7840	Suspension Rod, Trailing Arm* 5 922 799 *→	
	07/87→09/96	Track Control Arm		DB-VB-7776	Wishbone (CV);Trailing Arm* 5 926 393 *→	
	07/87→09/96	Track Control Arm		DB-VB-7776	Wishbone (CV);Trailing Arm, Lifting Axle	
2553 S, 2553 LS	01/96→09/96	Ball Head, gearshift linkage	DB-ES-8387			
	01/96→09/96	Ball Head, gearshift linkage	DB-ES-8491			
	01/96→09/96	Ball Head, gearshift linkage	DB-ES-8492			
	01/96→09/96	Ball Head, gearshift linkage	DB-ES-8500			
	01/96→09/96	Centre Rod	DB-DL-5217	DB-DL-5217	Push Rod	
	01/96→09/96	Centre Rod	DB-DL-5233		Push Rod* 5 937 288 *→	
	01/96→09/96	Centre Rod	DB-DL-7831		Push Rod	
	01/96→09/96	Centre Rod	DB-DL-7831		Push Rod* K 189 672 *→* K 226 467 *	
	01/96→09/96	Centre Rod	DB-DL-8131		Push Rod	
	01/96→09/96	Centre Rod	DB-DL-8138		Push Rod	
	01/96→09/96	Centre Rod	DB-DL-8618		Push Rod	
	01/96→09/96	Centre Rod	DB-DL-10216		Push Rod	
	01/96→09/96	Centre Rod	DB-DL-12309		Coupling Rod	
	01/96→09/96	Stabiliser Mounting	DB-SB-5258	DB-SB-5258		
	01/96→09/96	Suspension Arm Repair Kit		DB-RK-12372	for Wishbone (CV)	
	01/96→09/96	Suspension Arm Repair Kit		DF-RK-9336		
	01/96→09/96	Suspension Arm Repair Kit	DB-RK-5283			
	01/96→09/96	Tie Rod	DB-DL-8640		Guide Rod	
	01/96→09/96	Tie Rod	DB-ES-5209			
	01/96→09/96	Tie Rod	DB-ES-5227		Guide Rod	
	01/96→09/96	Tie Rod End	CV-ES-12461		for Steering Rod	

CV-ES-12461

Length: 120
 Cone Ø: d1 Ø 26 / d2 Ø 23,5
 Thread: M30 x 1,5 LHT
 0003300035, 3300148, 0003406213, 0013306635,
 0013308835, 0014604048, 0014604348,
 14606448, 0024600248, 3023300035,
 3023300135, 3023300235, 3023300335,
 3453307235, 3453307435, 3503307135,
 A0003300148, A0013306635, A0013308835,
 A0014604048, A0014604348, A0014606448,
 A0024600248, A3023300035, A3023300135,
 A3023300235, A3023300335, A3503307135



CV-ES-14163

Length: 125
 Cone Ø: d1 Ø 30 / d2 Ø 27
 Thread: M30 x 1,5 RHT
 0003305248, 0003387310, 0004600348,
 0004600948, 0004602848, 0004602948,
 0004608948, 0014600248, 0014600848,
 0014601248, 0014602248, 0014607748,
 0024600148, A0003387310, A0004600348,
 A0004602848, A0004602948, A0014600848,
 A0014601248, A0014602248, A0014607748



DB-DL-5217

Length: 862 Ø: 40
 Cone Ø: d1 Ø 30 / d2 Ø 27
 01214700A, 6204600405, 6204600805,
 6204602905, 6204603005



DB-DL-5233

Length: 895 Ø: 48
 Cone Ø: d1 Ø 30 / d2 Ø 27
 01217300A, 0004609805, 0004609905



DB-DL-7831

Length: 870
 Ø: 42
 Cone Ø: d1 Ø 30 / d2 Ø 27
 01215200A, 6254602505



DB-DL-7839

Length: 585
 Ø: 50
 Hole Distance: 152 / 152
 3953500206, 6593500106, 6593502406



DB-DL-7840

Length: 595
 Ø: 62
 Hole Distance: 152 / 152
 6203500006, 6203500106, 6203500306,
 6553500306



DB-DL-8131

Length: 1115 Ø: 52
 Cone Ø: d1 Ø 32 / d2 Ø 28,8
 0004604405, 6254605005



DB-DL-8138

Length: 1130
 Ø: 40
 Cone Ø: d1 Ø 32 / d2 Ø 28,8
 4606605, 0004606605



DB-DL-8618

Length: 680
 Ø: 42
 Cone Ø: d1 Ø 32 / d2 Ø 28,8
 0004604305, 4604305, 6254604805



DB-DL-8640

Length: 1615 Ø: 50
 Cone Ø: d1 Ø 32 / d2 Ø 29
 6253301503, 6253301603, 6253302403,
 6253302503, 9423300803, 9423302103,
 9493300203, 9493300303, 9493300903



DB-DL-10216

Length: 1190
 Ø: 40
 Cone Ø: d1 Ø 32 / d2 Ø 29
 0004604905



DB-DL-12308

Length: 885
 Ø: 42
 Cone Ø: d1 Ø 30 / d2 Ø 27
 0004600705, 4600705



DB-DL-12309

Length: 685 Ø: 40
 Cone Ø: d1 Ø 32 / d2 Ø 28,8
 0004606005, 0004606305



DB-DS-6088

Length: 585
 Ø: 50
 Hole Distance: 152 / 152
 3953500706, 6593500406



DB-ES-5209

Length: 1670 Ø: 50
 Cone Ø: d1 Ø 30 / d2 Ø 27
 6203300503, 6203300603



DB-ES-5227

Length: 1588 Ø: 60
 Cone Ø: d1 Ø 38 / d2 Ø 34,3
 6253300903, 6253301203, 9443300203



DB-ES-8387

Length: 55
 Cone Ø: d1 Ø 10 / d2 Ø 10
 Thread: M14 x 1,5 RHT
 0009966845, 0009967045



DB-ES-8491

Length: 60
 Cone Ø: d1 Ø 10 / d2 Ø 10
 Thread: M12 x 1,75 LHT
 0009966745



DB-ES-8492

Length: 60
 Cone Ø: d1 Ø 10 / d2 Ø 10
 Thread: M12 x 1,75 RHT
 0009966645, 3752680189, A3752680189



DB-ES-8500

Length: 55
 Cone Ø: d1 Ø 12 / d2 Ø 10,8
 Thread: M14 x 1,5 RHT
 0002685989



DB-RK-5280

Ø: 86
 01303000A, 6213200428



DB-RK-5282

Ø: 59
 01303800A, 6553200111



DB-RK-5283

Ø: 70
 01319900A, 6203200628



DB-RK-8564

Ø: 90
 01302200A, 0003500105, 3500105, 0003500405,
 3500405, 0005861833, 5861833, 81432706047



DB-RK-12372

Ø: 85
 Hole Distance: 152
 Thick/Height: 24
 003501805, A003501805



DB-SB-5258

Ø: 70
 Thick/Height: 62
 01311400A, 3873230285



DB-VB-7776

Length: 622 Ø: 56
 Hole Distance: 152 / 152
 6533500205, 6583500205



DF-RK-9336

Ø: 108
 0003501705, 3501705



MN-RK-9387

Ø: 90
 0003500105, 81432706047





SK ...

2553 S, 2553 LS ...	01/96→09/96	Track Control Arm		DB-DL-7839	Trailing Arm	
	01/96→09/96	Track Control Arm		DB-DL-7840	Suspension Rod, Trailing Arm	
	01/96→09/96	Track Control Arm		DB-DS-6088	Suspension Rod, Trailing Arm	
	01/96→09/96	Track Control Arm		DB-VB-7776	Wishbone (CV);Trailing Arm* 5 926 393 *→	
2553,2553 L	07/87→09/96	Ball Head, gearshift linkage	DB-ES-8387			
	07/87→09/96	Ball Head, gearshift linkage	DB-ES-8491			
	07/87→09/96	Ball Head, gearshift linkage	DB-ES-8492			
	07/87→09/96	Ball Head, gearshift linkage	DB-ES-8500			
	07/87→09/96	Centre Rod	DB-DL-5217		Push Rod	
	07/87→09/96	Centre Rod	DB-DL-5233		Push Rod* K 016 738 *→	
	07/87→09/96	Centre Rod	DB-DL-5233		Push Rod* K 017 164 *→	
	07/87→09/96	Centre Rod	DB-DL-7831		Push Rod	
	07/87→09/96	Centre Rod	DB-DL-7831		Push Rod* K 189 672 *→* K 226 467 *	
	07/87→09/96	Centre Rod	DB-DL-7831		Push Rod→* K 226 467 *	
	07/87→09/96	Centre Rod	DB-DL-8131		Push Rod	
	07/87→09/96	Centre Rod	DB-DL-8138		Push Rod	
	07/87→09/96	Centre Rod	DB-DL-8618		Push Rod	
	07/87→09/96	Centre Rod	DB-DL-10216		Push Rod	
	07/87→09/96	Centre Rod	DB-DL-12308		Coupling Rod	
	07/87→09/96	Centre Rod	DB-DL-12309		Coupling Rod	
	07/87→09/96	Suspension Arm Repair Kit		DB-RK-8564	Wishbone (CV)	
	07/87→09/96	Suspension Arm Repair Kit		DB-RK-12372	for Wishbone (CV), Lifting Axle, K063070→	
	07/87→09/96	Suspension Arm Repair Kit		DF-RK-9336		
	07/87→09/96	Suspension Arm Repair Kit		DF-RK-9336	* K 063 070 *→	
	07/87→09/96	Suspension Arm Repair Kit		DF-RK-9336	Lifting Axle, * K 063 070 *→	
	07/87→09/96	Suspension Arm Repair Kit		MN-RK-9387		
	07/87→09/96	Suspension Arm Repair Kit		MN-RK-9387	→* 5 926 392 *	
	07/87→09/96	Suspension Arm Repair Kit		MN-RK-9387	Lifting Axle, →* 5 926 392 *	
	07/87→09/96	Suspension Arm Repair Kit	DB-RK-5280			
	07/87→09/96	Suspension Arm Repair Kit	DB-RK-5282			
	07/87→09/96	Tie Rod	DB-DL-8640		Guide Rod	
	07/87→09/96	Tie Rod	DB-ES-5209			
	07/87→09/96	Tie Rod End	CV-ES-12461		for Steering Rod	
	07/87→09/96	Tie Rod End	CV-ES-14163		for Steering Rod	
	07/87→09/96	Track Control Arm		DB-DL-7840	Suspension Rod, Trailing Arm	
	07/87→09/96	Track Control Arm		DB-DL-7840	Suspension Rod, Trailing Arm* 5 922 799 *→	
	07/87→09/96	Track Control Arm		DB-VB-7776	Wishbone (CV);Trailing Arm* 5 926 393 *→	
07/87→09/96	Track Control Arm		DB-VB-7776	Wishbone (CV);Trailing Arm, Lifting Axle		
2629	07/88→08/94	Centre Rod	DB-DL-5217		Push Rod	
	07/88→08/94	Centre Rod	DB-DL-5233		Push Rod* 5 937 288 *→	
	07/88→08/94	Centre Rod	DB-DL-7831		Push Rod	
	07/88→08/94	Centre Rod	DB-DL-8131		Push Rod	
	07/88→08/94	Centre Rod	DB-DL-8618		Push Rod	
	07/88→08/94	Centre Rod	DB-DL-10216		Push Rod	
	07/88→08/94	Stabiliser Mounting		DB-SB-5258		
	07/88→08/94	Suspension Arm Repair Kit		DB-RK-7267	for Drag Link	
	07/88→08/94	Suspension Arm Repair Kit	DB-RK-5283			
	07/88→08/94	Tie Rod	DB-DL-8640		Guide Rod	
	07/88→08/94	Tie Rod	DB-ES-5209			
	07/88→08/94	Tie Rod	DB-ES-5227		Guide Rod	
	07/88→08/94	Tie Rod End	CV-ES-12461		for Steering Rod	
	07/88→08/94	Tie Rod End	CV-ES-14163		for Steering Rod	
	07/88→08/94	Track Control Arm		DB-DL-6197	Suspension Rod, Trailing Arm	
	07/88→08/94	Track Control Arm		DB-DL-6198	Suspension Rod, Trailing Arm	
	07/88→08/94	Track Control Arm		DB-DL-6227	Suspension Rod, Trailing Arm	
	2629 A	07/88→08/94	Centre Rod	DB-DL-5217		Push Rod
		07/88→08/94	Centre Rod	DB-DL-7831		Push Rod
		07/88→08/94	Centre Rod	DB-DL-8131		Push Rod
		07/88→08/94	Centre Rod	DB-DL-8618		Push Rod
07/88→08/94		Centre Rod	DB-DL-10216		Push Rod	
07/88→08/94		Stabiliser Mounting	DB-SB-5258	DB-SB-5258		
07/88→08/94		Suspension Arm Repair Kit		DB-RK-7267	for Drag Link	
07/88→08/94		Suspension Arm Repair Kit	DB-RK-5283			

CV-ES-12461

Length: 120
 Cone Ø: d1 Ø 26 / d2 Ø 23,5
 Thread: M30 x 1,5 LHT
 0003300035, 3300148, 0003406213, 0013306635,
 0013308835, 0014604048, 0014604348,
 14606448, 0024600248, 3023300035,
 3023300135, 3023300235, 3023300335,
 3453307235, 3453307435, 3503307135,
 A0003300148, A0013306635, A0013308835,
 A0014604048, A0014604348, A0014606448,
 A0024600248, A3023300035, A3023300135,
 A3023300235, A3023300335, A3503307135



CV-ES-14163

Length: 125
 Cone Ø: d1 Ø 30 / d2 Ø 27
 Thread: M30 x 1,5 RHT
 0003305248, 0003387310, 0004600348,
 0004600948, 0004602848, 0004602948,
 0004608948, 0014600248, 0014600848,
 0014601248, 0014602248, 0014607748,
 0024600148, A0003387310, A0004600348,
 A0004600948, A0004602848, A0014600848,
 A0014601248, A0014602248, A0014607748



DB-DL-5217

Length: 862 Ø: 40
 Cone Ø: d1 Ø 30 / d2 Ø 27
 01214700A, 6204600405, 6204600805,
 6204602905, 6204603005



DB-DL-5233

Length: 895 Ø: 48
 Cone Ø: d1 Ø 30 / d2 Ø 27
 01217300A, 0004609805, 0004609905



DB-DL-6197

Length: 579 Ø: 50
 Hole Distance: 152 / 152
 6593501206, 6593503506



DB-DL-6198

Length: 579 Ø: 58
 Hole Distance: 152 / 152
 3953500006, 6593501106



DB-DL-6227

Length: 629 Ø: 58
 Hole Distance: 152 / 152
 6593501506, 6593503806



DB-DL-7831

Length: 870 Ø: 42
 Cone Ø: d1 Ø 30 / d2 Ø 27
 01215200A, 6254602505



DB-DL-7839

Length: 585
 Ø: 50
 Hole Distance: 152 / 152
 3953500206, 6593500106, 6593502406



DB-DL-7840

Length: 595
 Ø: 62
 Hole Distance: 152 / 152
 6203500006, 6203500106, 6203500306,
 6553500306



DB-DL-8131

Length: 1115 Ø: 52
 Cone Ø: d1 Ø 32 / d2 Ø 28,8
 0004604405, 6254605005



DB-DL-8138

Length: 1130
 Ø: 40
 Cone Ø: d1 Ø 32 / d2 Ø 28,8
 0004606605, 4606605



DB-DL-8618

Length: 680
 Ø: 42
 Cone Ø: d1 Ø 32 / d2 Ø 28,8
 0004604305, 4604305, 6254604805



DB-DL-8640

Length: 1615 Ø: 50
 Cone Ø: d1 Ø 32 / d2 Ø 29
 6253301503, 6253301603, 6253302403,
 6253302503, 9423300803, 9423302103,
 9493300203, 9493300303, 9493300903



DB-DL-10216

Length: 1190
 Ø: 40
 Cone Ø: d1 Ø 32 / d2 Ø 29
 0004604905



DB-DL-12308

Length: 885
 Ø: 42
 Cone Ø: d1 Ø 30 / d2 Ø 27
 0004600705, 4600705



DB-DL-12309

Length: 685
 Ø: 40
 Cone Ø: d1 Ø 32 / d2 Ø 28,8
 4606005, 0004606005, 0004606305, 4606305



DB-DS-6088

Length: 585
 Ø: 50
 Hole Distance: 152 / 152
 3953500706, 6593500406



DB-ES-5209

Length: 1670 Ø: 50
 Cone Ø: d1 Ø 30 / d2 Ø 27
 6203300503, 6203300603



DB-ES-5227

Length: 1588 Ø: 60
 Cone Ø: d1 Ø 38 / d2 Ø 34,3
 6253300903, 6253301203, 9443300203



DB-ES-8387

Length: 55
 Cone Ø: d1 Ø 10 / d2 Ø 10
 Thread: M14 x 1,5 RHT
 0009966845, 0009967045



DB-ES-8491

Length: 60
 Cone Ø: d1 Ø 10 / d2 Ø 10
 Thread: M12 x 1,75 LHT
 0009966745



DB-ES-8492

Length: 60
 Cone Ø: d1 Ø 10 / d2 Ø 10
 Thread: M12 x 1,75 RHT
 0009966645, 3752680189, A3752680189



DB-ES-8500

Length: 55
 Cone Ø: d1 Ø 12 / d2 Ø 10,8
 Thread: M14 x 1,5 RHT
 0002685989



DB-RK-5280

Ø: 86
 01303000A, 6213200428



DB-RK-5282

Ø: 59
 01303800A, 6553200111



DB-RK-5283

Ø: 70
 01319900A, 6203200628



DB-RK-7267

Ø: 95
 Hole Distance: 152
 Thick/Height: 24
 01302100A, 0003500413, 3500413, 0005861235,
 5861235, 81432706069



DB-RK-8564

Ø: 90
 01302200A, 0003500105, 3500105, 0003500405,
 3500405, 0005861833, 5861833, 81432706047



DB-RK-12372

Ø: 85
 Hole Distance: 152
 Thick/Height: 24
 003501805, A003501805



DB-SB-5258

Ø: 70
 Thick/Height: 62
 01311400A, 387320285



DB-VB-7776

Length: 622 Ø: 56
 Hole Distance: 152 / 152
 6533500205, 6583500205



DF-RK-9336

Ø: 108
 3501705, 0003501705



MN-RK-9387

Ø: 90
 0003500105, 81432706047



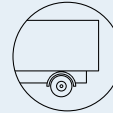
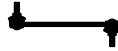

SK ...

2629 A ...	07/88→08/94	Tie Rod	DB-DL-8640		Guide Rod	
	07/88→08/94	Tie Rod	DB-ES-5209			
	07/88→08/94	Tie Rod	DB-ES-5227		Guide Rod	
	07/88→08/94	Tie Rod	MN-DL-7834		Guide Rod	
	07/88→08/94	Tie Rod End	CV-ES-12461		for Steering Rod	
	07/88→08/94	Tie Rod End	CV-ES-14163		for Steering Rod	
	07/88→08/94	Tie Rod End	DB-ES-5234		for Steering Rod	
	07/88→08/94	Track Control Arm		DB-DL-6197	Suspension Rod, Trailing Arm	
	07/88→08/94	Track Control Arm		DB-DL-6198	Suspension Rod, Trailing Arm	
	07/88→08/94	Track Control Arm		DB-DL-6227	Suspension Rod, Trailing Arm	
2629 AK	07/88→08/94	Centre Rod	DB-DL-5217		Push Rod	
	07/88→08/94	Centre Rod	DB-DL-10216		Push Rod	
	07/88→08/94	Suspension Arm Repair Kit		DB-RK-7267	for Drag Link	
	07/88→08/94	Tie Rod	DB-ES-5227		Guide Rod	
	07/88→08/94	Tie Rod	MN-DL-7834		Guide Rod	
	07/88→08/94	Tie Rod End	CV-ES-12461		for Steering Rod	
	07/88→08/94	Tie Rod End	CV-ES-14163		for Steering Rod	
	07/88→08/94	Track Control Arm		DB-DL-6197	Suspension Rod, Trailing Arm	
	07/88→08/94	Track Control Arm		DB-DL-6198	Suspension Rod, Trailing Arm	
	07/88→08/94	Track Control Arm		DB-DL-6227	Suspension Rod, Trailing Arm	
2629 AS	07/88→08/94	Centre Rod	DB-DL-5217		Push Rod	
	07/88→08/94	Centre Rod	DB-DL-10216		Push Rod	
	07/88→08/94	Suspension Arm Repair Kit		DB-RK-7267	for Drag Link	
	07/88→08/94	Tie Rod	DB-ES-5227		Guide Rod	
	07/88→08/94	Tie Rod	MN-DL-7834		Guide Rod	
	07/88→08/94	Tie Rod End	CV-ES-12461		for Steering Rod	
	07/88→08/94	Tie Rod End	CV-ES-14163		for Steering Rod	
	07/88→08/94	Track Control Arm		DB-DL-6197	Suspension Rod, Trailing Arm	
	07/88→08/94	Track Control Arm		DB-DL-6198	Suspension Rod, Trailing Arm	
	07/88→08/94	Track Control Arm		DB-DL-6227	Suspension Rod, Trailing Arm	
2629 B	07/88→08/94	Centre Rod	DB-DL-5217		Push Rod	
	07/88→08/94	Centre Rod	DB-DL-5233		Push Rod* 5 937 288 *→	
	07/88→08/94	Centre Rod	DB-DL-7831		Push Rod	
	07/88→08/94	Centre Rod	DB-DL-8131		Push Rod	
	07/88→08/94	Centre Rod	DB-DL-8618		Push Rod	
	07/88→08/94	Stabiliser Mounting	DB-SB-5258	DB-SB-5258		
	07/88→08/94	Suspension Arm Repair Kit		DB-RK-7267	for Drag Link	
	07/88→08/94	Suspension Arm Repair Kit	DB-RK-5283			
	07/88→08/94	Tie Rod	DB-DL-8640		Guide Rod	
	07/88→08/94	Tie Rod	DB-ES-5209			
	07/88→08/94	Tie Rod	DB-ES-5227		Guide Rod	
	07/88→08/94	Tie Rod End	CV-ES-12461		for Steering Rod	
	07/88→08/94	Tie Rod End	CV-ES-14163		for Steering Rod	
	07/88→08/94	Track Control Arm		DB-DL-6197	Suspension Rod, Trailing Arm	
	07/88→08/94	Track Control Arm		DB-DL-6198	Suspension Rod, Trailing Arm	
	07/88→08/94	Track Control Arm		DB-DL-6227	Suspension Rod, Trailing Arm	
	2629 K	07/88→08/94	Centre Rod	DB-DL-5217		Push Rod
		07/88→08/94	Centre Rod	DB-DL-5233		Push Rod* 5 937 288 *→
07/88→08/94		Centre Rod	DB-DL-7831		Push Rod	
07/88→08/94		Centre Rod	DB-DL-8131		Push Rod	
07/88→08/94		Centre Rod	DB-DL-8618		Push Rod	
07/88→08/94		Stabiliser Mounting	DB-SB-5258	DB-SB-5258		
07/88→08/94		Suspension Arm Repair Kit		DB-RK-7267	for Drag Link	
07/88→08/94		Suspension Arm Repair Kit	DB-RK-5283			
07/88→08/94		Tie Rod	DB-DL-8640		Guide Rod	
07/88→08/94		Tie Rod	DB-ES-5209			
07/88→08/94		Tie Rod	DB-ES-5227		Guide Rod	
07/88→08/94		Tie Rod End	CV-ES-12461		for Steering Rod	
07/88→08/94		Tie Rod End	CV-ES-14163		for Steering Rod	
07/88→08/94		Track Control Arm		DB-DL-6197	Suspension Rod, Trailing Arm	
07/88→08/94		Track Control Arm		DB-DL-6198	Suspension Rod, Trailing Arm	
07/88→08/94	Track Control Arm		DB-DL-6227	Suspension Rod, Trailing Arm		

CV-ES-12461

Length: 120
 Cone Ø: d1 Ø 26 / d2 Ø 23,5
 Thread: M30 x 1,5 LHT
 0003300035, 3300148, 0003406213, 0013306635,
 0013308835, 0014604048, 0014604348,
 14606448, 0024600248, 3023300035,
 3023300135, 3023300235, 3023300335,
 3453307235, 3453307435, 3503307135,
 A0003300148, A0013306635, A0013308835,
 A0014604048, A0014604348, A0014606448,
 A0024600248, A3023300035, A3023300135,
 A3023300235, A3023300335, A3503307135



CV-ES-14163

Length: 125
 Cone Ø: d1 Ø 30 / d2 Ø 27
 Thread: M30 x 1,5 RHT
 0003305248, 0003387310, 0004600348,
 0004600948, 0004602848, 0004602948,
 0004608948, 0014600248, 0014600848,
 0014601248, 0014602248, 0014607748,
 0024600148, A0003387310, A0004600348,
 A0004602848, A0004602948, A0014600848,
 A0014601248, A0014602248, A0014607748



DB-DL-5217

Length: 862 Ø: 40
 Cone Ø: d1 Ø 30 / d2 Ø 27
 01214700A, 6204600405, 6204600805,
 6204602905, 6204603005



DB-DL-5233

Length: 895 Ø: 48
 Cone Ø: d1 Ø 30 / d2 Ø 27
 01217300A, 0004609805, 0004609905



DB-DL-6197

Length: 579
 Ø: 50
 Hole Distance: 152 / 152
 6593501206, 6593503506



DB-DL-6198

Length: 579
 Ø: 58
 Hole Distance: 152 / 152
 3953500006, 6593501106



DB-DL-6227

Length: 629
 Ø: 58
 Hole Distance: 152 / 152
 6593501506, 6593503806



DB-DL-7831

Length: 870
 Ø: 42
 Cone Ø: d1 Ø 30 / d2 Ø 27
 01215200A, 6254602505



DB-DL-8131

Length: 1115 Ø: 52
 Cone Ø: d1 Ø 32 / d2 Ø 28,8
 0004604405, 6254605005



DB-DL-8618

Length: 680
 Ø: 42
 Cone Ø: d1 Ø 32 / d2 Ø 28,8
 0004604305, 4604305, 6254604805



DB-DL-8640

Length: 1615 Ø: 50
 Cone Ø: d1 Ø 32 / d2 Ø 29
 6253301503, 6253301603, 6253302403,
 6253302503, 9423300803, 9423302103,
 9493300203, 9493300303, 9493300903



DB-DL-10216

Length: 1190
 Ø: 40
 Cone Ø: d1 Ø 32 / d2 Ø 29
 0004604905



DB-ES-5209

Length: 1670 Ø: 50
 Cone Ø: d1 Ø 30 / d2 Ø 27
 6203300503, 6203300603



DB-ES-5227

Length: 1588 Ø: 60
 Cone Ø: d1 Ø 38 / d2 Ø 34,3
 6253300903, 6253301203, 9443300203



DB-ES-5234

Length: 135
 Cone Ø: d1 Ø 38 / d2 Ø 34,3
 Thread: M38 x 1,5 RHT
 0004601748, 120322305, 2205000400



DB-RK-5283

Ø: 70
 01319900A, 6203200628



DB-RK-7267

Ø: 95
 Hole Distance: 152
 Thick/Height: 24
 01302100A, 0003500413, 3500413, 0005861235,
 5861235, 81432706069



DB-SB-5258

Ø: 70
 Thick/Height: 62
 01311400A, 3873230285



MN-DL-7834

Length: 1588 Ø: 58
 Cone Ø: d1 Ø 30 / d2 Ø 27
 3463303903, 3463304903, 6253303203,
 9443300503, 9443301303, 9443301703





SK ...

2629 S	07/88→08/94	Centre Rod	DB-DL-5217		Push Rod
	07/88→08/94	Centre Rod	DB-DL-5233		Push Rod* 5 937 288 *→
	07/88→08/94	Centre Rod	DB-DL-7831		Push Rod
	07/88→08/94	Centre Rod	DB-DL-8131		Push Rod
	07/88→08/94	Centre Rod	DB-DL-8618		Push Rod
	07/88→08/94	Stabiliser Mounting	DB-SB-5258	DB-SB-5258	
	07/88→08/94	Suspension Arm Repair Kit		DB-RK-7267	for Drag Link
	07/88→08/94	Suspension Arm Repair Kit	DB-RK-5283		
	07/88→08/94	Tie Rod	DB-DL-8640		Guide Rod
	07/88→08/94	Tie Rod	DB-ES-5209		
	07/88→08/94	Tie Rod	DB-ES-5227		Guide Rod
	07/88→08/94	Tie Rod End	CV-ES-12461		for Steering Rod
	07/88→08/94	Tie Rod End	CV-ES-14163		for Steering Rod
	07/88→08/94	Track Control Arm		DB-DL-6197	Suspension Rod, Trailing Arm
	07/88→08/94	Track Control Arm		DB-DL-6198	Suspension Rod, Trailing Arm
07/88→08/94	Track Control Arm		DB-DL-6227	Suspension Rod, Trailing Arm	
2631	06/92→09/96	Ball Head, gearshift linkage	DB-ES-8387		
	06/92→09/96	Ball Head, gearshift linkage	DB-ES-8492		
	06/92→09/96	Ball Head, gearshift linkage	DB-ES-8500		
	06/92→09/96	Centre Rod	DB-DL-5217		Push Rod
	06/92→09/96	Centre Rod	DB-DL-5233		Push Rod* 5 937 288 *→
	06/92→09/96	Centre Rod	DB-DL-7831		Push Rod
	06/92→09/96	Centre Rod	DB-DL-8131		Push Rod
	06/92→09/96	Centre Rod	DB-DL-8138		Push Rod
	06/92→09/96	Centre Rod	DB-DL-8618		Push Rod
	06/92→09/96	Stabiliser Mounting	DB-SB-5258	DB-SB-5258	
	06/92→09/96	Suspension Arm Repair Kit		DB-RK-7267	for Drag Link
	06/92→09/96	Suspension Arm Repair Kit	DB-RK-5283		
	06/92→09/96	Tie Rod	DB-DL-8640		Guide Rod
	06/92→09/96	Tie Rod	DB-ES-5209		
	06/92→09/96	Tie Rod	DB-ES-5227		Guide Rod
	06/92→09/96	Tie Rod End	CV-ES-0543		
	06/92→09/96	Tie Rod End	CV-ES-0888		
	06/92→09/96	Tie Rod End	CV-ES-14163		for Steering Rod
	06/92→09/96	Track Control Arm		DB-DL-6197	Suspension Rod, Trailing Arm
	06/92→09/96	Track Control Arm		DB-DL-6198	Suspension Rod, Trailing Arm
06/92→09/96	Track Control Arm		DB-DL-6227	Suspension Rod, Trailing Arm	
2631 A	06/92→09/96	Ball Head, gearshift linkage	DB-ES-8500		
	06/92→09/96	Centre Rod	DB-DL-5217		Push Rod
	06/92→09/96	Centre Rod	DB-DL-10216		Push Rod
	06/92→09/96	Suspension Arm Repair Kit		DB-RK-7267	for Drag Link
	06/92→09/96	Tie Rod	DB-ES-5227		Guide Rod
	06/92→09/96	Tie Rod	MN-DL-7834		Guide Rod
	06/92→09/96	Tie Rod End	CV-ES-12461		for Steering Rod
	06/92→09/96	Track Control Arm		DB-DL-6197	Suspension Rod, Trailing Arm
	06/92→09/96	Track Control Arm		DB-DL-6198	Suspension Rod, Trailing Arm
06/92→09/96	Track Control Arm		DB-DL-6227	Suspension Rod, Trailing Arm	
2631 AK, 2634 AK	06/92→09/96	Ball Head, gearshift linkage	DB-ES-8500		
	06/92→09/96	Centre Rod	DB-DL-5217		Push Rod
	06/92→09/96	Centre Rod	DB-DL-10216		Push Rod
	06/92→09/96	Suspension Arm Repair Kit		DB-RK-7267	for Drag Link
	06/92→09/96	Tie Rod	DB-ES-5227		Guide Rod
	06/92→09/96	Tie Rod	MN-DL-7834		Guide Rod
	06/92→09/96	Tie Rod End	CV-ES-12461		for Steering Rod
	06/92→09/96	Track Control Arm		DB-DL-6197	Suspension Rod, Trailing Arm
	06/92→09/96	Track Control Arm		DB-DL-6198	Suspension Rod, Trailing Arm
06/92→09/96	Track Control Arm		DB-DL-6227	Suspension Rod, Trailing Arm	
2631 AS	06/92→09/96	Ball Head, gearshift linkage	DB-ES-8500		
	06/92→09/96	Centre Rod	DB-DL-5217		Push Rod
	06/92→09/96	Centre Rod	DB-DL-10216		Push Rod
	06/92→09/96	Suspension Arm Repair Kit		DB-RK-7267	for Drag Link
	06/92→09/96	Tie Rod	DB-ES-5227		Guide Rod
	06/92→09/96	Tie Rod	MN-DL-7834		Guide Rod

CV-ES-0543

Length: 125
Cone Ø: d1 Ø 32 / d2 Ø 29
Thread: M30 x 1,5 RHT
0004605748, 0004606048, 0004606848,
0004607048, 0014600448, 0014601148,
0014601748, 0014602448, 0014607648,
0014609648



CV-ES-0888

Length: 125
Cone Ø: d1 Ø 32 / d2 Ø 29
Thread: M30 x 1,5 LHT
0004605848, 0004606148, 0004606948,
0004607148, 0004609048, 0014600548,
0014601348, 0014602548, 0014607948,
0024600448



CV-ES-12461

Length: 120
Cone Ø: d1 Ø 26 / d2 Ø 23,5
Thread: M30 x 1,5 LHT
0003300035, 3300148, 0003406213, 0013306635,
0013308835, 0014604048, 0014604348,
14606448, 0024600248, 3023300035,
3023300135, 3023300235, 3023300335,
3453307235, 3453307435, 3503307135,
A0003300148, A0013306635, A0013308835,
A0014604048, A0014604348, A0014606448,
A0024600248, A3023300035, A3023300135,
A3023300235, A3023300335, A3503307135



CV-ES-14163

Length: 125
Cone Ø: d1 Ø 30 / d2 Ø 27
Thread: M30 x 1,5 RHT
0003305248, 0003387310, 0004600348,
0004600948, 0004602848, 0004602948,
0004608948, 0014600248, 0014600848,
0014601248, 0014602248, 0014607748,
0024600148, A0003387310, A0004600348,
A0004602848, A0004602948, A0014600848,
A0014601248, A0014602248, A0014607748



DB-DL-5217

Length: 862 Ø: 40
Cone Ø: d1 Ø 30 / d2 Ø 27
01214700A, 6204600405, 6204600805,
6204602905, 6204603005



DB-DL-5233

Length: 895 Ø: 48
Cone Ø: d1 Ø 30 / d2 Ø 27
01217300A, 0004609805, 0004609905



DB-DL-6197

Length: 579
Ø: 50
Hole Distance: 152 / 152
6593501206, 6593503506



DB-DL-6198

Length: 579
Ø: 58
Hole Distance: 152 / 152
3953500006, 6593501106



DB-DL-6227

Length: 629
Ø: 58
Hole Distance: 152 / 152
6593501506, 6593503806



DB-DL-7831

Length: 870
Ø: 42
Cone Ø: d1 Ø 30 / d2 Ø 27
01215200A, 6254602505



DB-DL-8131

Length: 1115 Ø: 52
Cone Ø: d1 Ø 32 / d2 Ø 28,8
0004604405, 6254605005



DB-DL-8138

Length: 1130
Ø: 40
Cone Ø: d1 Ø 32 / d2 Ø 28,8
0004606605, 4606605



DB-DL-8618

Length: 680
Ø: 42
Cone Ø: d1 Ø 32 / d2 Ø 28,8
4604305, 0004604305, 6254604805



DB-DL-8640

Length: 1615 Ø: 50
Cone Ø: d1 Ø 32 / d2 Ø 29
6253301503, 6253301603, 6253302403,
6253302503, 9423300803, 9423302103,
9493300203, 9493300303, 9493300903



DB-DL-10216

Length: 1190
Ø: 40
Cone Ø: d1 Ø 32 / d2 Ø 29
0004604905



DB-ES-5209

Length: 1670 Ø: 50
Cone Ø: d1 Ø 30 / d2 Ø 27
6203300503, 6203300603



DB-ES-5227

Length: 1588 Ø: 60
Cone Ø: d1 Ø 38 / d2 Ø 34,3
6253300903, 6253301203, 9443300203



DB-ES-8387

Length: 55
Cone Ø: d1 Ø 10 / d2 Ø 10
Thread: M14 x 1,5 RHT
0009966845, 0009967045



DB-ES-8492

Length: 60
Cone Ø: d1 Ø 10 / d2 Ø 10
Thread: M12 x 1,75 RHT
0009966645, 3752680189, A3752680189



DB-ES-8500

Length: 55
Cone Ø: d1 Ø 12 / d2 Ø 10,8
Thread: M14 x 1,5 RHT
0002685989



DB-RK-5283

Ø: 70
01319900A, 6203200628



DB-RK-7267

Ø: 95
Hole Distance: 152
Thick/Height: 24
01302100A, 3500413, 0003500413, 5861235,
0005861235, 81432706069



DB-SB-5258

Ø: 70
Thick/Height: 62
01311400A, 3873230285



MN-DL-7834

Length: 1588 Ø: 58
Cone Ø: d1 Ø 30 / d2 Ø 27
3463303903, 3463304903, 6253303203,
9443300503, 9443301303, 9443301703





SK ...

2631 AS ...	06/92→09/96	Tie Rod End	CV-ES-12461		for Steering Rod
	06/92→09/96	Track Control Arm		DB-DL-6197	Suspension Rod, Trailing Arm
	06/92→09/96	Track Control Arm		DB-DL-6198	Suspension Rod, Trailing Arm
	06/92→09/96	Track Control Arm		DB-DL-6227	Suspension Rod, Trailing Arm
2631 B	06/92→09/96	Ball Head, gearshift linkage	DB-ES-8387		
	06/92→09/96	Ball Head, gearshift linkage	DB-ES-8492		
	06/92→09/96	Ball Head, gearshift linkage	DB-ES-8500		
	06/92→09/96	Centre Rod	DB-DL-5217		Push Rod
	06/92→09/96	Centre Rod	DB-DL-5233		Push Rod* 5 937 288 *→
	06/92→09/96	Centre Rod	DB-DL-7831		Push Rod
	06/92→09/96	Centre Rod	DB-DL-8131		Push Rod
	06/92→09/96	Centre Rod	DB-DL-8618		Push Rod
	06/92→09/96	Suspension Arm Repair Kit		DB-RK-7267	for Drag Link
	06/92→09/96	Tie Rod	DB-DL-8640		Guide Rod
	06/92→09/96	Tie Rod	DB-ES-5209		
	06/92→09/96	Tie Rod	DB-ES-5227		Guide Rod
	06/92→09/96	Tie Rod End	CV-ES-0543		
	06/92→09/96	Tie Rod End	CV-ES-0888		
	06/92→09/96	Tie Rod End	CV-ES-14163		for Steering Rod
	06/92→09/96	Track Control Arm		DB-DL-6197	Suspension Rod, Trailing Arm
	06/92→09/96	Track Control Arm		DB-DL-6198	Suspension Rod, Trailing Arm
06/92→09/96	Track Control Arm		DB-DL-6227	Suspension Rod, Trailing Arm	
2631 K	07/88→08/94	Ball Head, gearshift linkage	DB-ES-8387		
	07/88→08/94	Ball Head, gearshift linkage	DB-ES-8492		
	07/88→08/94	Ball Head, gearshift linkage	DB-ES-8500		
	07/88→08/94	Centre Rod	DB-DL-5217		Push Rod
	07/88→08/94	Centre Rod	DB-DL-5233		Push Rod* 5 937 288 *→
	07/88→08/94	Centre Rod	DB-DL-7831		Push Rod
	07/88→08/94	Centre Rod	DB-DL-8131		Push Rod
	07/88→08/94	Centre Rod	DB-DL-8138		Push Rod
	07/88→08/94	Centre Rod	DB-DL-8618		Push Rod
	07/88→08/94	Suspension Arm Repair Kit		DB-RK-7267	for Drag Link
	07/88→08/94	Tie Rod	DB-DL-8640		Guide Rod
	07/88→08/94	Tie Rod	DB-ES-5209		
	07/88→08/94	Tie Rod	DB-ES-5227		Guide Rod
	07/88→08/94	Tie Rod End	CV-ES-12461		for Steering Rod
	07/88→08/94	Track Control Arm		DB-DL-6197	Suspension Rod, Trailing Arm
	07/88→08/94	Track Control Arm		DB-DL-6198	Suspension Rod, Trailing Arm
	07/88→08/94	Track Control Arm		DB-DL-6227	Suspension Rod, Trailing Arm
2631 S	06/92→09/96	Ball Head, gearshift linkage	DB-ES-8387		
	06/92→09/96	Ball Head, gearshift linkage	DB-ES-8492		
	06/92→09/96	Ball Head, gearshift linkage	DB-ES-8500		
	06/92→09/96	Centre Rod	DB-DL-5217		Push Rod
	06/92→09/96	Centre Rod	DB-DL-5233		Push Rod* 5 937 288 *→
	06/92→09/96	Centre Rod	DB-DL-7831		Push Rod
	06/92→09/96	Centre Rod	DB-DL-8131		Push Rod
	06/92→09/96	Centre Rod	DB-DL-8618		Push Rod
	06/92→09/96	Stabiliser Mounting	DB-SB-5258	DB-SB-5258	
	06/92→09/96	Suspension Arm Repair Kit		DB-RK-7267	for Drag Link
	06/92→09/96	Suspension Arm Repair Kit	DB-RK-5283		
	06/92→09/96	Tie Rod	DB-DL-8640		Guide Rod
	06/92→09/96	Tie Rod	DB-ES-5209		
	06/92→09/96	Tie Rod	DB-ES-5227		Guide Rod
	06/92→09/96	Tie Rod End	CV-ES-14163		for Steering Rod
	06/92→09/96	Track Control Arm		DB-DL-6197	Suspension Rod, Trailing Arm
	06/92→09/96	Track Control Arm		DB-DL-6198	Suspension Rod, Trailing Arm
06/92→09/96	Track Control Arm		DB-DL-6227	Suspension Rod, Trailing Arm	
2634	06/92→09/96	Ball Head, gearshift linkage	DB-ES-8387		
	06/92→09/96	Ball Head, gearshift linkage	DB-ES-8492		
	06/92→09/96	Ball Head, gearshift linkage	DB-ES-8500		
	06/92→09/96	Centre Rod	DB-DL-5217		Push Rod
	06/92→09/96	Centre Rod	DB-DL-5233		Push Rod* 5 937 288 *→
	06/92→09/96	Centre Rod	DB-DL-7831		Push Rod

CV-ES-0543

Length: 125
Cone Ø: d1 Ø 32 / d2 Ø 29
Thread: M30 x 1,5 RHT
0004605748, 0004606048, 0004606848,
0004607048, 0014600448, 0014601148,
0014601748, 0014602448, 0014607648,
0014609648



CV-ES-0888

Length: 125
Cone Ø: d1 Ø 32 / d2 Ø 29
Thread: M30 x 1,5 LHT
0004605848, 0004606148, 0004606948,
0004607148, 0004609048, 0014600548,
0014601348, 0014602548, 0014607948,
0024600448



CV-ES-12461

Length: 120
Cone Ø: d1 Ø 26 / d2 Ø 23,5
Thread: M30 x 1,5 LHT
0003300035, 3300148, 0003406213, 0013306635,
0013308835, 0014604048, 0014604348,
14606448, 0024600248, 3023300035,
3023300135, 3023300235, 3023300335,
3453307235, 3453307435, 3503307135,
A0003300148, A0013306635, A0013308835,
A0014604048, A0014604348, A0014606448,
A0024600248, A3023300035, A3023300135,
A3023300235, A3023300335, A3503307135



CV-ES-14163

Length: 125
Cone Ø: d1 Ø 30 / d2 Ø 27
Thread: M30 x 1,5 RHT
0003305248, 0003387310, 0004600348,
0004600948, 0004602848, 0004602948,
0004608948, 0014600248, 0014600848,
0014601248, 0014602248, 0014607748,
0024600148, A0003387310, A0004600348,
A0004602848, A0004602948, A0014600848,
A0014601248, A0014602248, A0014607748



DB-DL-5217

Length: 862 Ø: 40
Cone Ø: d1 Ø 30 / d2 Ø 27
01214700A, 6204600405, 6204600805,
6204602905, 6204603005



DB-DL-5233

Length: 895 Ø: 48
Cone Ø: d1 Ø 30 / d2 Ø 27
01217300A, 0004609805, 0004609905



DB-DL-6197

Length: 579
Ø: 50
Hole Distance: 152 / 152
6593501206, 6593503506



DB-DL-6198

Length: 579
Ø: 58
Hole Distance: 152 / 152
3953500006, 6593501106



DB-DL-6227

Length: 629
Ø: 58
Hole Distance: 152 / 152
6593501506, 6593503806



DB-DL-7831

Length: 870
Ø: 42
Cone Ø: d1 Ø 30 / d2 Ø 27
01215200A, 6254602505



DB-DL-8131

Length: 1115 Ø: 52
Cone Ø: d1 Ø 32 / d2 Ø 28,8
0004604405, 6254605005



DB-DL-8138

Length: 1130
Ø: 40
Cone Ø: d1 Ø 32 / d2 Ø 28,8
0004606605, 4606605



DB-DL-8618

Length: 680
Ø: 42
Cone Ø: d1 Ø 32 / d2 Ø 28,8
4604305, 0004604305, 6254604805



DB-DL-8640

Length: 1615 Ø: 50
Cone Ø: d1 Ø 32 / d2 Ø 29
6253301503, 6253301603, 6253302403,
6253302503, 9423300803, 9423302103,
9493300203, 9493300303, 9493300903



DB-ES-5209

Length: 1670 Ø: 50
Cone Ø: d1 Ø 30 / d2 Ø 27
6203300503, 6203300603



DB-ES-5227

Length: 1588 Ø: 60
Cone Ø: d1 Ø 38 / d2 Ø 34,3
6253300903, 6253301203, 9443300203



DB-ES-8387

Length: 55
Cone Ø: d1 Ø 10 / d2 Ø 10
Thread: M14 x 1,5 RHT
0009966845, 0009967045



DB-ES-8492

Length: 60
Cone Ø: d1 Ø 10 / d2 Ø 10
Thread: M12 x 1,75 RHT
0009966645, 3752680189, A3752680189



DB-ES-8500

Length: 55
Cone Ø: d1 Ø 12 / d2 Ø 10,8
Thread: M14 x 1,5 RHT
0002685989



DB-RK-5283

Ø: 70
01319900A, 6203200628



DB-RK-7267

Ø: 95
Hole Distance: 152
Thick/Height: 24
01302100A, 0003500413, 3500413, 5861235,
0005861235, 81432706069



DB-SB-5258

Ø: 70
Thick/Height: 62
01311400A, 3873230285



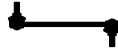

SK ...

2634 ...	06/92→09/96	Centre Rod	DB-DL-8131		Push Rod	
	06/92→09/96	Centre Rod	DB-DL-8618		Push Rod	
	06/92→09/96	Suspension Arm Repair Kit		DB-RK-7267	for Drag Link	
	06/92→09/96	Tie Rod	DB-DL-8640		Guide Rod	
	06/92→09/96	Tie Rod	DB-ES-5209			
	06/92→09/96	Tie Rod	DB-ES-5227		Guide Rod	
	06/92→09/96	Tie Rod End	CV-ES-0543			
	06/92→09/96	Tie Rod End	CV-ES-0888			
	06/92→09/96	Tie Rod End	CV-ES-14163		for Steering Rod	
	06/92→09/96	Track Control Arm		DB-DL-6197	Suspension Rod, Trailing Arm	
	06/92→09/96	Track Control Arm		DB-DL-6198	Suspension Rod, Trailing Arm	
	06/92→09/96	Track Control Arm		DB-DL-6227	Suspension Rod, Trailing Arm	
	2634 S	06/92→09/96	Ball Head, gearshift linkage	DB-ES-8387		
		06/92→09/96	Ball Head, gearshift linkage	DB-ES-8492		
06/92→09/96		Ball Head, gearshift linkage	DB-ES-8500			
06/92→09/96		Centre Rod	DB-DL-5217		Push Rod	
06/92→09/96		Centre Rod	DB-DL-5233		Push Rod* 5 937 288 *→	
06/92→09/96		Centre Rod	DB-DL-7831		Push Rod	
06/92→09/96		Centre Rod	DB-DL-8131		Push Rod	
06/92→09/96		Centre Rod	DB-DL-8618		Push Rod	
06/92→09/96		Suspension Arm Repair Kit		DB-RK-7267	for Drag Link	
06/92→09/96		Tie Rod	DB-DL-8640		Guide Rod	
06/92→09/96		Tie Rod	DB-ES-5209			
06/92→09/96		Tie Rod	DB-ES-5227		Guide Rod	
06/92→09/96		Tie Rod End	CV-ES-14163		for Steering Rod	
06/92→09/96		Track Control Arm		DB-DL-6197	Suspension Rod, Trailing Arm	
06/92→09/96		Track Control Arm		DB-DL-6198	Suspension Rod, Trailing Arm	
06/92→09/96		Track Control Arm		DB-DL-6227	Suspension Rod, Trailing Arm	
2635		07/88→08/94	Centre Rod	DB-DL-5217		Push Rod
		07/88→08/94	Centre Rod	DB-DL-5233		Push Rod* 5 937 287 *→
	07/88→08/94	Centre Rod	DB-DL-7831		Push Rod	
	07/88→08/94	Centre Rod	DB-DL-8131		Push Rod	
	07/88→08/94	Centre Rod	DB-DL-8138		Push Rod	
	07/88→08/94	Centre Rod	DB-DL-8618		Push Rod	
	07/88→08/94	Centre Rod	DB-DL-10216		Push Rod	
	07/88→08/94	Centre Rod	DB-DL-12309		Coupling Rod	
	07/88→08/94	Stabiliser Mounting	DB-SB-5258	DB-SB-5258		
	07/88→08/94	Suspension Arm Repair Kit		DB-RK-7267	for Drag Link	
	07/88→08/94	Suspension Arm Repair Kit	DB-RK-5283			
	07/88→08/94	Tie Rod	DB-DL-8640		Guide Rod	
	07/88→08/94	Tie Rod	DB-ES-5209			
	07/88→08/94	Tie Rod	DB-ES-5227		Guide Rod	
	07/88→08/94	Tie Rod End	CV-ES-12461		for Steering Rod	
	07/88→08/94	Tie Rod End	CV-ES-14163		for Steering Rod	
	01/91→08/94	Track Control Arm		DB-DL-6197	Suspension Rod, Trailing Arm	
	01/91→08/94	Track Control Arm		DB-DL-6198	Suspension Rod, Trailing Arm	
	01/91→08/94	Track Control Arm		DB-DL-6227	Suspension Rod, Trailing Arm	
	2635 A	02/90→08/94	Centre Rod	DB-DL-5217		Push Rod
		02/90→08/94	Centre Rod	DB-DL-10216		Push Rod
02/90→08/94		Suspension Arm Repair Kit		DB-RK-7267	for Drag Link	
02/90→08/94		Tie Rod	DB-DL-8640		Guide Rod	
02/90→08/94		Tie Rod	DB-ES-5209			
02/90→08/94		Tie Rod	DB-ES-5227		Guide Rod	
02/90→08/94		Tie Rod	MN-DL-7834		Guide Rod	
02/90→08/94		Tie Rod End	CV-ES-12461		for Steering Rod	
02/90→08/94		Tie Rod End	CV-ES-14163		for Steering Rod	
02/90→08/94		Tie Rod End	DB-ES-5234		for Steering Rod	
02/90→08/94		Track Control Arm		DB-DL-6197	Suspension Rod, Trailing Arm	
02/90→08/94		Track Control Arm		DB-DL-6198	Suspension Rod, Trailing Arm	
02/90→08/94		Track Control Arm		DB-DL-6227	Suspension Rod, Trailing Arm	

CV-ES-0543

Length: 125
Cone Ø: d1 Ø 32 / d2 Ø 29
Thread: M30 x 1,5 RHT
0004605748, 0004606048, 0004606848,
0004607048, 0014600448, 0014601148,
0014601748, 0014602448, 0014607648,
0014609648



CV-ES-0888

Length: 125
Cone Ø: d1 Ø 32 / d2 Ø 29
Thread: M30 x 1,5 LHT
0004605848, 0004606148, 0004606948,
0004607148, 0004609048, 0014600548,
0014601348, 0014602548, 0014607948,
0024600448



CV-ES-12461

Length: 120
Cone Ø: d1 Ø 26 / d2 Ø 23,5
Thread: M30 x 1,5 LHT
0003300035, 3300148, 0003406213, 0013306635,
0013308835, 0014604048, 0014604348,
14606448, 0024600248, 3023300035,
3023300135, 3023300235, 3023300335,
3453307235, 3453307435, 3503307135,
A0003300148, A0013306635, A0013308835,
A0014604048, A0014604348, A0014606448,
A0024600248, A3023300035, A3023300135,
A3023300235, A3023300335, A3503307135



CV-ES-14163

Length: 125
Cone Ø: d1 Ø 30 / d2 Ø 27
Thread: M30 x 1,5 RHT
0003305248, 0003387310, 0004600348,
0004600948, 0004602848, 0004602948,
0004608948, 0014600248, 0014600848,
0014601248, 0014602248, 0014607748,
0024600148, A0003387310, A0004600348,
A0004602848, A0004602948, A0014600848,
A0014601248, A0014602248, A0014607748



DB-DL-5217

Length: 862 Ø: 40
Cone Ø: d1 Ø 30 / d2 Ø 27
01214700A, 6204600405, 6204600805,
6204602905, 6204603005



DB-DL-5233

Length: 895
Ø: 48
Cone Ø: d1 Ø 30 / d2 Ø 27
01217300A, 0004609805, 4609805, 4609905,
0004609905



DB-DL-6197

Length: 579
Ø: 50
Hole Distance: 152 / 152
6593501206, 6593503506



DB-DL-6198

Length: 579
Ø: 58
Hole Distance: 152 / 152
3953500006, 6593501106



DB-DL-6227

Length: 629
Ø: 58
Hole Distance: 152 / 152
6593501506, 6593503806



DB-DL-7831

Length: 870
Ø: 42
Cone Ø: d1 Ø 30 / d2 Ø 27
01215200A, 6254602505



DB-DL-8131

Length: 1115
Ø: 52
Cone Ø: d1 Ø 32 / d2 Ø 28,8
4604405, 0004604405, 6254605005



DB-DL-8138

Length: 1130
Ø: 40
Cone Ø: d1 Ø 32 / d2 Ø 28,8
0004606605, 4606605



DB-DL-8618

Length: 680
Ø: 42
Cone Ø: d1 Ø 32 / d2 Ø 28,8
0004604305, 4604305, 6254604805



DB-DL-8640

Length: 1615 Ø: 50
Cone Ø: d1 Ø 32 / d2 Ø 29
6253301503, 6253301603, 6253302403,
6253302503, 9423300803, 9423302103,
9493300203, 9493300303, 9493300903



DB-DL-10216

Length: 1190
Ø: 40
Cone Ø: d1 Ø 32 / d2 Ø 29
0004604905



DB-DL-12309

Length: 685 Ø: 40
Cone Ø: d1 Ø 32 / d2 Ø 28,8
0004606005, 0004606305



DB-ES-5209

Length: 1670 Ø: 50
Cone Ø: d1 Ø 30 / d2 Ø 27
6203300503, 6203300603



DB-ES-5227

Length: 1588 Ø: 60
Cone Ø: d1 Ø 38 / d2 Ø 34,3
6253300903, 6253301203, 9443300203



DB-ES-5234

Length: 135
Cone Ø: d1 Ø 38 / d2 Ø 34,3
Thread: M38 x 1,5 RHT
0004601748, 120322305, 2205000400



DB-ES-8387

Length: 55
Cone Ø: d1 Ø 10 / d2 Ø 10
Thread: M14 x 1,5 RHT
0009966845, 0009967045



DB-ES-8492

Length: 60
Cone Ø: d1 Ø 10 / d2 Ø 10
Thread: M12 x 1,75 RHT
0009966645, 3752680189, A3752680189



DB-ES-8500

Length: 55
Cone Ø: d1 Ø 12 / d2 Ø 10,8
Thread: M14 x 1,5 RHT
0002685989



DB-RK-5283

Ø: 70
01319900A, 6203200628



DB-RK-7267

Ø: 95
Hole Distance: 152
Thick/Height: 24
01302100A, 3500413, 0003500413, 5861235,
0005861235, 81432706069



DB-SB-5258

Ø: 70
Thick/Height: 62
01311400A, 3873230285



MN-DL-7834

Length: 1588 Ø: 58
Cone Ø: d1 Ø 30 / d2 Ø 27
3463303903, 3463304903, 6253303203,
9443300503, 9443301303, 9443301703





SK ...

2635 AK	02/90→08/94	Centre Rod	DB-DL-5217		Push Rod
	02/90→08/94	Centre Rod	DB-DL-10216		Push Rod
	02/90→08/94	Suspension Arm Repair Kit		DB-RK-7267	for Drag Link
	02/90→08/94	Tie Rod	DB-ES-5209		
	02/90→08/94	Tie Rod	DB-ES-5227		Guide Rod
	02/90→08/94	Tie Rod	MN-DL-7834		Guide Rod
	02/90→08/94	Tie Rod End	CV-ES-12461		for Steering Rod
	02/90→08/94	Tie Rod End	CV-ES-14163		for Steering Rod
	02/90→08/94	Tie Rod End	DB-ES-5234		for Steering Rod
	02/90→08/94	Track Control Arm		DB-DL-6197	Suspension Rod, Trailing Arm
	02/90→08/94	Track Control Arm		DB-DL-6198	Suspension Rod, Trailing Arm
	02/90→08/94	Track Control Arm		DB-DL-6227	Suspension Rod, Trailing Arm
	2635 AS	02/90→09/96	Centre Rod	DB-DL-5217	
02/90→09/96		Centre Rod	DB-DL-10216		Push Rod
02/90→09/96		Suspension Arm Repair Kit		DB-RK-7267	for Drag Link
02/90→09/96		Tie Rod	DB-ES-5227		Guide Rod
02/90→09/96		Tie Rod	MN-DL-7834		Guide Rod
02/90→09/96		Tie Rod End	CV-ES-12461		for Steering Rod
02/90→09/96		Tie Rod End	CV-ES-14163		for Steering Rod
02/90→09/96		Track Control Arm		DB-DL-6197	Suspension Rod, Trailing Arm
02/90→09/96		Track Control Arm		DB-DL-6198	Suspension Rod, Trailing Arm
02/90→09/96		Track Control Arm		DB-DL-6227	Suspension Rod, Trailing Arm
2635 K	07/88→08/94	Centre Rod	DB-DL-5217		Push Rod
	07/88→08/94	Centre Rod	DB-DL-5233		Push Rod* 5 937 287 *→
	07/88→08/94	Centre Rod	DB-DL-7831		Push Rod
	07/88→08/94	Centre Rod	DB-DL-8131		Push Rod
	07/88→08/94	Centre Rod	DB-DL-8618		Push Rod
	07/88→08/94	Stabiliser Mounting	DB-SB-5258	DB-SB-5258	
	07/88→08/94	Suspension Arm Repair Kit		DB-RK-7267	for Drag Link
	07/88→08/94	Suspension Arm Repair Kit	DB-RK-5283		
	07/88→08/94	Tie Rod	DB-DL-8640		Guide Rod
	07/88→08/94	Tie Rod	DB-ES-5209		
	07/88→08/94	Tie Rod	DB-ES-5227		Guide Rod
	07/88→08/94	Tie Rod End	CV-ES-12461		for Steering Rod
	07/88→08/94	Tie Rod End	CV-ES-14163		for Steering Rod
	07/88→08/94	Track Control Arm		DB-DL-6197	Suspension Rod, Trailing Arm
	07/88→08/94	Track Control Arm		DB-DL-6198	Suspension Rod, Trailing Arm
	07/88→08/94	Track Control Arm		DB-DL-6227	Suspension Rod, Trailing Arm
	2635 S	07/88→08/94	Ball Head, gearshift linkage	DB-ES-8387	
07/88→08/94		Ball Head, gearshift linkage	DB-ES-8491		
07/88→08/94		Ball Head, gearshift linkage	DB-ES-8492		
07/88→08/94		Ball Head, gearshift linkage	DB-ES-8500		
07/88→08/94		Centre Rod	DB-DL-5217		Push Rod
07/88→08/94		Centre Rod	DB-DL-5233		Push Rod* 5 937 287 *→
07/88→08/94		Centre Rod	DB-DL-7831		Push Rod
07/88→08/94		Centre Rod	DB-DL-8131		Push Rod
07/88→08/94		Centre Rod	DB-DL-8618		Push Rod
07/88→08/94		Stabiliser Mounting	DB-SB-5258	DB-SB-5258	
07/88→08/94		Suspension Arm Repair Kit		DB-RK-7267	for Drag Link
07/88→08/94		Suspension Arm Repair Kit	DB-RK-5283		
07/88→08/94		Tie Rod	DB-DL-8640		Guide Rod
07/88→08/94		Tie Rod	DB-ES-5209		
07/88→08/94		Tie Rod	DB-ES-5227		Guide Rod
07/88→08/94		Tie Rod End	CV-ES-12461		for Steering Rod
07/88→08/94		Tie Rod End	CV-ES-14163		for Steering Rod
07/88→08/94		Track Control Arm		DB-DL-6197	Suspension Rod, Trailing Arm
07/88→08/94		Track Control Arm		DB-DL-6198	Suspension Rod, Trailing Arm
07/88→08/94		Track Control Arm		DB-DL-6227	Suspension Rod, Trailing Arm
2638 A, LA	09/91→09/96	Ball Head, gearshift linkage	DB-ES-8491		
	09/91→09/96	Ball Head, gearshift linkage	DB-ES-8492		
	09/91→09/96	Centre Rod	DB-DL-5217		Push Rod
	09/91→09/96	Suspension Arm Repair Kit		DB-RK-7267	for Drag Link
	09/91→09/96	Tie Rod	DB-DL-8640		Guide Rod

CV-ES-12461

Length: 120
 Cone Ø: d1 Ø 26 / d2 Ø 23,5
 Thread: M30 x 1,5 LHT
 0003300035, 3300148, 0003406213, 0013306635,
 0013308835, 0014604048, 0014604348,
 14606448, 0024600248, 3023300035,
 3023300135, 3023300235, 3023300335,
 3453307235, 3453307435, 3503307135,
 A0003300148, A0013306635, A0013308835,
 A0014604048, A0014604348, A0014606448,
 A0024600248, A3023300035, A3023300135,
 A3023300235, A3023300335, A3503307135



CV-ES-14163

Length: 125
 Cone Ø: d1 Ø 30 / d2 Ø 27
 Thread: M30 x 1,5 RHT
 0003305248, 0003387310, 0004600348,
 0004600948, 0004602848, 0004602948,
 0004608948, 0014600248, 0014600848,
 0014601248, 0014602248, 0014607748,
 0024600148, A0003387310, A0004600348,
 A0004602848, A0004602948, A0014600848,
 A0014601248, A0014602248, A0014607748



DB-DL-5217

Length: 862 Ø: 40
 Cone Ø: d1 Ø 30 / d2 Ø 27
 01214700A, 6204600405, 6204600805,
 6204602905, 6204603005



DB-DL-5233

Length: 895 Ø: 48
 Cone Ø: d1 Ø 30 / d2 Ø 27
 01217300A, 0004609805, 0004609905



DB-DL-6197

Length: 579
 Ø: 50
 Hole Distance: 152 / 152
 6593501206, 6593503506



DB-DL-6198

Length: 579
 Ø: 58
 Hole Distance: 152 / 152
 3953500006, 6593501106



DB-DL-6227

Length: 629
 Ø: 58
 Hole Distance: 152 / 152
 6593501506, 6593503806



DB-DL-7831

Length: 870
 Ø: 42
 Cone Ø: d1 Ø 30 / d2 Ø 27
 01215200A, 6254602505



DB-DL-8131

Length: 1115 Ø: 52
 Cone Ø: d1 Ø 32 / d2 Ø 28,8
 0004604405, 6254605005



DB-DL-8618

Length: 680
 Ø: 42
 Cone Ø: d1 Ø 32 / d2 Ø 28,8
 0004604305, 4604305, 6254604805



DB-DL-8640

Length: 1615 Ø: 50
 Cone Ø: d1 Ø 32 / d2 Ø 29
 6253301503, 6253301603, 6253302403,
 6253302503, 9423300803, 9423302103,
 9493300203, 9493300303, 9493300903



DB-DL-10216

Length: 1190
 Ø: 40
 Cone Ø: d1 Ø 32 / d2 Ø 29
 0004604905



DB-ES-5209

Length: 1670 Ø: 50
 Cone Ø: d1 Ø 30 / d2 Ø 27
 6203300503, 6203300603



DB-ES-5227

Length: 1588 Ø: 60
 Cone Ø: d1 Ø 38 / d2 Ø 34,3
 6253300903, 6253301203, 9443300203



DB-ES-5234

Length: 135
 Cone Ø: d1 Ø 38 / d2 Ø 34,3
 Thread: M38 x 1,5 RHT
 0004601748, 120322305, 2205000400



DB-ES-8387

Length: 55
 Cone Ø: d1 Ø 10 / d2 Ø 10
 Thread: M14 x 1,5 RHT
 0009966845, 0009967045



DB-ES-8491

Length: 60
 Cone Ø: d1 Ø 10 / d2 Ø 10
 Thread: M12 x 1,75 LHT
 0009966745



DB-ES-8492

Length: 60
 Cone Ø: d1 Ø 10 / d2 Ø 10
 Thread: M12 x 1,75 RHT
 0009966645, 3752680189, A3752680189



DB-ES-8500

Length: 55
 Cone Ø: d1 Ø 12 / d2 Ø 10,8
 Thread: M14 x 1,5 RHT
 0002685989



DB-RK-5283

Ø: 70
 01319900A, 6203200628



DB-RK-7267

Ø: 95
 Hole Distance: 152
 Thick/Height: 24
 01302100A, 0003500413, 3500413, 0005861235,
 5861235, 81432706069



DB-SB-5258

Ø: 70
 Thick/Height: 62
 01311400A, 3873230285



MN-DL-7834

Length: 1588 Ø: 58
 Cone Ø: d1 Ø 30 / d2 Ø 27
 3463303903, 3463304903, 6253303203,
 9443300503, 9443301303, 9443301703





SK ...

2638 A, LA ...	09/91→09/96	Tie Rod	DB-ES-5227		Guide Rod	
	09/91→09/96	Tie Rod	MN-DL-7834		Guide Rod	
	09/91→09/96	Tie Rod End	CV-ES-12461		for Steering Rod	
	09/91→09/96	Track Control Arm		DB-DL-6197	Suspension Rod, Trailing Arm	
	09/91→09/96	Track Control Arm		DB-DL-6198	Suspension Rod, Trailing Arm	
	09/91→09/96	Track Control Arm		DB-DL-6227	Suspension Rod, Trailing Arm	
2638 AK	09/91→09/96	Ball Head, gearshift linkage	DB-ES-8491			
	09/91→09/96	Ball Head, gearshift linkage	DB-ES-8492			
	09/91→09/96	Centre Rod	DB-DL-5217		Push Rod	
	09/91→09/96	Centre Rod	DB-DL-10216		Push Rod	
	09/91→09/96	Suspension Arm Repair Kit		DB-RK-7267	for Drag Link	
	09/91→09/96	Tie Rod	DB-ES-5209			
	09/91→09/96	Tie Rod	DB-ES-5227		Guide Rod	
	09/91→09/96	Tie Rod	MN-DL-7834		Guide Rod	
	09/91→09/96	Tie Rod End	CV-ES-12461		for Steering Rod	
	09/91→09/96	Tie Rod End	CV-ES-14163		for Steering Rod	
	09/91→09/96	Tie Rod End	DB-ES-5234		for Steering Rod	
	09/91→09/96	Track Control Arm		DB-DL-6197	Suspension Rod, Trailing Arm	
	09/91→09/96	Track Control Arm		DB-DL-6198	Suspension Rod, Trailing Arm	
	09/91→09/96	Track Control Arm		DB-DL-6227	Suspension Rod, Trailing Arm	
2638 AS	07/92→09/96	Ball Head, gearshift linkage	DB-ES-8491			
	07/92→09/96	Ball Head, gearshift linkage	DB-ES-8492			
	07/92→09/96	Centre Rod	DB-DL-5217		Push Rod	
	07/92→09/96	Centre Rod	DB-DL-10216		Push Rod	
	07/92→09/96	Suspension Arm Repair Kit		DB-RK-7267	for Drag Link	
	07/92→09/96	Tie Rod	DB-ES-5227		Guide Rod	
	07/92→09/96	Tie Rod	MN-DL-7834		Guide Rod	
	07/92→09/96	Tie Rod End	CV-ES-12461		for Steering Rod	
	07/92→09/96	Tie Rod End	CV-ES-14163		for Steering Rod	
	07/92→09/96	Track Control Arm		DB-DL-6197	Suspension Rod, Trailing Arm	
	07/92→09/96	Track Control Arm		DB-DL-6198	Suspension Rod, Trailing Arm	
	07/92→09/96	Track Control Arm		DB-DL-6227	Suspension Rod, Trailing Arm	
	2638 K	09/91→09/96	Ball Head, gearshift linkage	DB-ES-8387		
		09/91→09/96	Ball Head, gearshift linkage	DB-ES-8491		
09/91→09/96		Ball Head, gearshift linkage	DB-ES-8492			
09/91→09/96		Ball Head, gearshift linkage	DB-ES-8500			
09/91→09/96		Centre Rod	DB-DL-5217		Push Rod	
09/91→09/96		Centre Rod	DB-DL-5233		Push Rod* 5 937 287 *→	
09/91→09/96		Centre Rod	DB-DL-5233		Push Rod* 5 937 288 *→	
09/91→09/96		Centre Rod	DB-DL-5241		Suspension Rod	
09/91→09/96		Centre Rod	DB-DL-7270		Push Rod;Suspension Rod	
09/91→09/96		Centre Rod	DB-DL-7831		Push Rod	
09/91→09/96		Centre Rod	DB-DL-8131		Push Rod	
09/91→09/96		Centre Rod	DB-DL-8618		Push Rod	
09/91→09/96		Stabiliser Mounting	DB-SB-5258	DB-SB-5258		
09/91→09/96		Suspension Arm Repair Kit		DB-RK-7267	for Drag Link	
09/91→09/96		Suspension Arm Repair Kit		DB-RK-8550	for Wishbone (CV)	
09/91→09/96		Suspension Arm Repair Kit	DB-RK-5283			
09/91→09/96		Tie Rod	DB-DL-8640		Guide Rod	
09/91→09/96		Tie Rod	DB-ES-5209			
09/91→09/96		Tie Rod	DB-ES-5227		Guide Rod	
09/91→09/96		Tie Rod End	CV-ES-12461		for Steering Rod	
09/91→09/96		Track Control Arm		DB-DL-6197	Suspension Rod, Trailing Arm	
09/91→09/96		Track Control Arm		DB-DL-6198	Suspension Rod, Trailing Arm	
09/91→09/96		Track Control Arm		DB-DL-6227	Suspension Rod, Trailing Arm	
2638 S		09/91→09/96	Ball Head, gearshift linkage	DB-ES-8387		
		09/91→09/96	Ball Head, gearshift linkage	DB-ES-8491		
		09/91→09/96	Ball Head, gearshift linkage	DB-ES-8492		
		09/91→09/96	Ball Head, gearshift linkage	DB-ES-8500		
		09/91→09/96	Centre Rod	DB-DL-5217		Push Rod
	09/91→09/96	Centre Rod	DB-DL-7831		Push Rod	
	09/91→09/96	Centre Rod	DB-DL-8131		Push Rod	
09/91→09/96	Centre Rod	DB-DL-8618		Push Rod		

CV-ES-12461

Length: 120
 Cone Ø: d1 Ø 26 / d2 Ø 23,5
 Thread: M30 x 1,5 LHT
 0003300035, 3300148, 0003406213, 0013306635,
 0013308835, 0014604048, 0014604348,
 14606448, 0024600248, 3023300035,
 3023300135, 3023300235, 3023300335,
 3453307235, 3453307435, 3503307135,
 A0003300148, A0013306635, A0013308835,
 A0014604048, A0014604348, A0014606448,
 A0024600248, A3023300035, A3023300135,
 A3023300235, A3023300335, A3503307135



CV-ES-14163

Length: 125
 Cone Ø: d1 Ø 30 / d2 Ø 27
 Thread: M30 x 1,5 RHT
 0003305248, 0003387310, 0004600348,
 0004600948, 0004602848, 0004602948,
 0004608948, 0014600248, 0014600848,
 0014601248, 0014602248, 0014607748,
 0024600148, A0003387310, A0004600348,
 A0004602848, A0004602948, A0014600848,
 A0014601248, A0014602248, A0014607748



DB-DL-5217

Length: 862 Ø: 40
 Cone Ø: d1 Ø 30 / d2 Ø 27
 01214700A, 6204600405, 6204600805,
 6204602905, 6204603005



DB-DL-5233

Length: 895 Ø: 48
 Cone Ø: d1 Ø 30 / d2 Ø 27
 01217300A, 0004609805, 0004609905



DB-DL-5241

Length: 875 Ø: 40
 Cone Ø: d1 Ø 30 / d2 Ø 27
 01215300A, 0004609205, 0004609305,
 0014606905



DB-DL-6197

Length: 579
 Ø: 50
 Hole Distance: 152 / 152
 6593501206, 6593503506



DB-DL-6198

Length: 579
 Ø: 58
 Hole Distance: 152 / 152
 3953500006, 6593501106



DB-DL-6227

Length: 629
 Ø: 58
 Hole Distance: 152 / 152
 6593501506, 6593503806



DB-DL-7270

Length: 875 Ø: 40
 Cone Ø: d1 Ø 28,6 / d2 Ø 23,9
 01208300A, 0024604705, 0024604805,
 0034604905, A0024604705



DB-DL-7831

Length: 870
 Ø: 42
 Cone Ø: d1 Ø 30 / d2 Ø 27
 01215200A, 6254602505



DB-DL-8131

Length: 1115
 Ø: 52
 Cone Ø: d1 Ø 32 / d2 Ø 28,8
 4604405, 0004604405, 6254605005



DB-DL-8618

Length: 680
 Ø: 42
 Cone Ø: d1 Ø 32 / d2 Ø 28,8
 4604305, 0004604305, 6254604805



DB-DL-8640

Length: 1615 Ø: 50
 Cone Ø: d1 Ø 32 / d2 Ø 29
 6253301503, 6253301603, 6253302403,
 6253302503, 9423300803, 9423302103,
 9493300203, 9493300303, 9493300903



DB-DL-10216

Length: 1190
 Ø: 40
 Cone Ø: d1 Ø 32 / d2 Ø 29
 0004604905



DB-ES-5209

Length: 1670 Ø: 50
 Cone Ø: d1 Ø 30 / d2 Ø 27
 6203300503, 6203300603



DB-ES-5227

Length: 1588 Ø: 60
 Cone Ø: d1 Ø 38 / d2 Ø 34,3
 6253300903, 6253301203, 9443300203



DB-ES-5234

Length: 135
 Cone Ø: d1 Ø 38 / d2 Ø 34,3
 Thread: M38 x 1,5 RHT
 0004601748, 120322305, 2205000400



DB-ES-8387

Length: 55
 Cone Ø: d1 Ø 10 / d2 Ø 10
 Thread: M14 x 1,5 RHT
 0009966845, 0009967045



DB-ES-8491

Length: 60
 Cone Ø: d1 Ø 10 / d2 Ø 10
 Thread: M12 x 1,75 LHT
 0009966745



DB-ES-8492

Length: 60
 Cone Ø: d1 Ø 10 / d2 Ø 10
 Thread: M12 x 1,75 RHT
 0009966645, 3752680189, A3752680189



DB-ES-8500

Length: 55
 Cone Ø: d1 Ø 12 / d2 Ø 10,8
 Thread: M14 x 1,5 RHT
 0002685989



DB-RK-5283

Ø: 70
 01319900A, 6203200628



DB-RK-7267

Ø: 95
 Hole Distance: 152
 Thick/Height: 24
 01302100A, 0003500413, 3500413, 0005861235,
 5861235, 81432706069



DB-RK-8550

Ø: 75 Hole Distance: 152
 Thick/Height: 24
 0003502105, 0003504605



DB-SB-5258

Ø: 70
 Thick/Height: 62
 01311400A, 3873230285



MN-DL-7834

Length: 1588 Ø: 58
 Cone Ø: d1 Ø 30 / d2 Ø 27
 3463303903, 3463304903, 6253303203,
 9443300503, 9443301303, 9443301703





SK ...

2638 S ...	09/91→09/96	Stabiliser Mounting	DB-SB-5258	DB-SB-5258		
	09/91→09/96	Suspension Arm Repair Kit		DB-RK-7267	for Drag Link	
	09/91→09/96	Suspension Arm Repair Kit	DB-RK-5283			
	09/91→09/96	Tie Rod	DB-DL-8640		Guide Rod	
	09/91→09/96	Tie Rod	DB-ES-5209			
	09/91→09/96	Tie Rod	DB-ES-5227		Guide Rod	
	09/91→09/96	Tie Rod End	CV-ES-0543			
	09/91→09/96	Tie Rod End	CV-ES-0888			
	09/91→09/96	Track Control Arm		DB-DL-6197	Suspension Rod, Trailing Arm	
	09/91→09/96	Track Control Arm		DB-DL-6198	Suspension Rod, Trailing Arm	
	09/91→09/96	Track Control Arm		DB-DL-6227	Suspension Rod, Trailing Arm	
	2638, 2638 L	09/91→09/96	Ball Head, gearshift linkage	DB-ES-8387		
		09/91→09/96	Ball Head, gearshift linkage	DB-ES-8491		
09/91→09/96		Ball Head, gearshift linkage	DB-ES-8492			
09/91→09/96		Ball Head, gearshift linkage	DB-ES-8500			
09/91→09/96		Centre Rod	DB-DL-5217		Push Rod	
09/91→09/96		Centre Rod	DB-DL-5233		Push Rod* 5 937 288 *→	
09/91→09/96		Centre Rod	DB-DL-5241		Suspension Rod	
09/91→09/96		Centre Rod	DB-DL-7270		Push Rod;Suspension Rod	
09/91→09/96		Centre Rod	DB-DL-7831		Push Rod	
09/91→09/96		Centre Rod	DB-DL-8131		Push Rod	
09/91→09/96		Centre Rod	DB-DL-8138		Push Rod	
09/91→09/96		Centre Rod	DB-DL-8618		Push Rod	
09/91→09/96		Centre Rod	DB-DL-9263		Push Rod	
09/91→09/96		Centre Rod	DB-DL-10216		Push Rod	
09/91→09/96		Centre Rod	DB-DL-12309		Coupling Rod	
09/91→09/96		Stabiliser Mounting	DB-SB-5258	DB-SB-5258		
09/91→09/96		Suspension Arm Repair Kit		DB-RK-7267	for Drag Link	
09/91→09/96		Suspension Arm Repair Kit		DB-RK-8550	for Wishbone (CV)	
09/91→09/96		Suspension Arm Repair Kit	DB-RK-5283			
09/91→09/96		Tie Rod	DB-DL-8640		Guide Rod	
09/91→09/96		Tie Rod	DB-ES-5209			
09/91→09/96		Tie Rod	DB-ES-5227		Guide Rod	
09/91→09/96		Tie Rod End	CV-ES-12461		for Steering Rod	
09/91→09/96		Tie Rod End	CV-ES-14163		for Steering Rod	
09/91→09/96		Track Control Arm		DB-DL-6197	Suspension Rod, Trailing Arm	
09/91→09/96		Track Control Arm		DB-DL-6198	Suspension Rod, Trailing Arm	
09/91→09/96		Track Control Arm		DB-DL-6227	Suspension Rod, Trailing Arm	
2644 A		01/92→09/96	Ball Head, gearshift linkage	DB-ES-8491		
		01/92→09/96	Ball Head, gearshift linkage	DB-ES-8492		
		01/92→09/96	Centre Rod	DB-DL-5217		Push Rod
	01/92→09/96	Suspension Arm Repair Kit		DB-RK-7267	for Drag Link	
	01/92→09/96	Tie Rod	DB-DL-8640		Guide Rod	
	01/92→09/96	Tie Rod	DB-ES-5227		Guide Rod	
	01/92→09/96	Tie Rod	MN-DL-7834		Guide Rod	
	01/92→09/96	Tie Rod End	CV-ES-12461		for Steering Rod	
	01/92→09/96	Track Control Arm		DB-DL-6197	Suspension Rod, Trailing Arm	
	01/92→09/96	Track Control Arm		DB-DL-6198	Suspension Rod, Trailing Arm	
	01/92→09/96	Track Control Arm		DB-DL-6227	Suspension Rod, Trailing Arm	
	2644 S	01/92→09/96	Ball Head, gearshift linkage	DB-ES-8387		
01/92→09/96		Ball Head, gearshift linkage	DB-ES-8491			
01/92→09/96		Ball Head, gearshift linkage	DB-ES-8492			
01/92→09/96		Ball Head, gearshift linkage	DB-ES-8500			
01/92→09/96		Centre Rod	DB-DL-5217		Push Rod	
01/92→09/96		Centre Rod	DB-DL-5233		Push Rod* 5 937 288 *→	
01/92→09/96		Centre Rod	DB-DL-7831		Push Rod	
01/92→09/96		Centre Rod	DB-DL-8131		Push Rod	
01/92→09/96		Centre Rod	DB-DL-8138		Push Rod	
01/92→09/96		Centre Rod	DB-DL-8618		Push Rod	
01/92→09/96		Centre Rod	DB-DL-10216		Push Rod	
01/92→09/96		Centre Rod	DB-DL-12309		Coupling Rod	
01/92→09/96		Stabiliser Mounting	DB-SB-5258	DB-SB-5258		
01/92→09/96		Suspension Arm Repair Kit		DB-RK-7267	for Drag Link	

CV-ES-0543

Length: 125
Cone Ø: d1 Ø 32 / d2 Ø 29
Thread: M30 x 1,5 RHT
0004605748, 0004606048, 0004606848,
0004607048, 0014600448, 0014601148,
0014601748, 0014602448, 0014607648,
0014609648



CV-ES-0888

Length: 125
Cone Ø: d1 Ø 32 / d2 Ø 29
Thread: M30 x 1,5 LHT
0004605848, 0004606148, 0004606948,
0004607148, 0004609048, 0014600548,
0014601348, 0014602548, 0014607948,
0024600448



CV-ES-12461

Length: 120
Cone Ø: d1 Ø 26 / d2 Ø 23,5
Thread: M30 x 1,5 LHT
0003300035, 3300148, 0003406213, 0013306635,
0013308835, 0014604048, 0014604348,
14606448, 0024600248, 3023300035,
3023300135, 3023300235, 3023300335,
3453307235, 3453307435, 3503307135,
A0003300148, A0013306635, A0013308835,
A0014604048, A0014604348, A0014606448,
A0024600248, A3023300035, A3023300135,
A3023300235, A3023300335, A3503307135



CV-ES-14163

Length: 125
Cone Ø: d1 Ø 30 / d2 Ø 27
Thread: M30 x 1,5 RHT
00033005248, 0003387310, 0004600348,
0004600948, 0004602848, 0004602948,
0004608948, 0014600248, 0014600848,
0014601248, 0014602248, 0014607748,
0024600148, A0003387310, A0004600348,
A0004602848, A0004602948, A0014600848,
A0014601248, A0014602248, A0014607748



DB-DL-5217

Length: 862 Ø: 40
Cone Ø: d1 Ø 30 / d2 Ø 27
01214700A, 6204600405, 6204600805,
6204602905, 6204603005



DB-DL-5233

Length: 895 Ø: 48
Cone Ø: d1 Ø 30 / d2 Ø 27
01217300A, 0004609805, 0004609905



DB-DL-5241

Length: 875 Ø: 40
Cone Ø: d1 Ø 30 / d2 Ø 27
01215300A, 0004609205, 0004609305,
0014606905



DB-DL-6197

Length: 579
Ø: 50
Hole Distance: 152 / 152
6593501206, 6593503506



DB-DL-6198

Length: 579
Ø: 58
Hole Distance: 152 / 152
3953500006, 6593501106



DB-DL-6227

Length: 629
Ø: 58
Hole Distance: 152 / 152
6593501506, 6593503806



DB-DL-7270

Length: 875 Ø: 40
Cone Ø: d1 Ø 28,6 / d2 Ø 23,9
01208300A, 0024604705, 0024604805,
0034604905, A0024604705



DB-DL-7831

Length: 870
Ø: 42
Cone Ø: d1 Ø 30 / d2 Ø 27
01215200A, 6254602505



DB-DL-8131

Length: 1115
Ø: 52
Cone Ø: d1 Ø 32 / d2 Ø 28,8
4604405, 0004604405, 6254605005



DB-DL-8138

Length: 1130
Ø: 40
Cone Ø: d1 Ø 32 / d2 Ø 28,8
4606605, 0004606605



DB-DL-8618

Length: 680
Ø: 42
Cone Ø: d1 Ø 32 / d2 Ø 28,8
0004604305, 4604305, 6254604805



DB-DL-8640

Length: 1615 Ø: 50
Cone Ø: d1 Ø 32 / d2 Ø 29
6253301503, 6253301603, 6253302403,
6253302503, 9423300803, 9423302103,
9493300203, 9493300303, 9493300903



DB-DL-9263

Length: 870
Ø: 42
Cone Ø: d1 Ø 32 / d2 Ø 27
0014600505, 14600505, 0014600605, 14600605



DB-DL-10216

Length: 1190
Ø: 40
Cone Ø: d1 Ø 32 / d2 Ø 29
0004604905



DB-DL-12309

Length: 685
Ø: 40
Cone Ø: d1 Ø 32 / d2 Ø 28,8
4606005, 0004606005, 0004606305, 4606305



DB-ES-5209

Length: 1670 Ø: 50
Cone Ø: d1 Ø 30 / d2 Ø 27
6203300503, 6203300603



DB-ES-5227

Length: 1588 Ø: 60
Cone Ø: d1 Ø 38 / d2 Ø 34,3
6253300903, 6253301203, 9443300203



DB-ES-8387

Length: 55
Cone Ø: d1 Ø 10 / d2 Ø 10
Thread: M14 x 1,5 RHT
0009966845, 0009967045



DB-ES-8491

Length: 60
Cone Ø: d1 Ø 10 / d2 Ø 10
Thread: M12 x 1,75 LHT
000996745



DB-ES-8492

Length: 60
Cone Ø: d1 Ø 10 / d2 Ø 10
Thread: M12 x 1,75 RHT
0009966645, 3752680189, A3752680189



DB-ES-8500

Length: 55
Cone Ø: d1 Ø 12 / d2 Ø 10,8
Thread: M14 x 1,5 RHT
0002685989



DB-RK-5283

Ø: 70
01319900A, 6203200628



DB-RK-7267

Ø: 95
Hole Distance: 152
Thick/Height: 24
01302100A, 0003500413, 3500413, 5861235,
0005861235, 81432706069



DB-RK-8550

Ø: 75 Hole Distance: 152
Thick/Height: 24
0003502105, 0003504605



DB-SB-5258

Ø: 70
Thick/Height: 62
01311400A, 3873230285



MN-DL-7834

Length: 1588 Ø: 58
Cone Ø: d1 Ø 30 / d2 Ø 27
3463303903, 3463304903, 6253303203,
9443300503, 9443301303, 9443301703





SK ...

2644 S ...	01/92→09/96	Suspension Arm Repair Kit	DB-RK-5283		
	01/92→09/96	Tie Rod	DB-DL-8640	Guide Rod	
	01/92→09/96	Tie Rod	DB-ES-5209		
	01/92→09/96	Tie Rod	DB-ES-5227	Guide Rod	
	01/92→09/96	Tie Rod End	CV-ES-12461	for Steering Rod	
	01/92→09/96	Track Control Arm		DB-DL-6197 Suspension Rod, Trailing Arm	
	01/92→09/96	Track Control Arm		DB-DL-6198 Suspension Rod, Trailing Arm	
2644, 2644 L	01/92→09/96	Track Control Arm		DB-DL-6227 Suspension Rod, Trailing Arm	
	01/92→09/96	Ball Head, gearshift linkage	DB-ES-8387		
	01/92→09/96	Ball Head, gearshift linkage	DB-ES-8491		
	01/92→09/96	Ball Head, gearshift linkage	DB-ES-8492		
	01/92→09/96	Ball Head, gearshift linkage	DB-ES-8500		
	01/92→09/96	Centre Rod	DB-DL-5217	Push Rod	
	01/92→09/96	Centre Rod	DB-DL-5233	Push Rod* 5 937 288 *→	
	01/92→09/96	Centre Rod	DB-DL-5241	Suspension Rod	
	01/92→09/96	Centre Rod	DB-DL-7270	Push Rod;Suspension Rod	
	01/92→09/96	Centre Rod	DB-DL-7831	Push Rod	
	01/92→09/96	Centre Rod	DB-DL-8131	Push Rod	
	01/92→09/96	Centre Rod	DB-DL-8138	Push Rod	
	01/92→09/96	Centre Rod	DB-DL-8618	Push Rod	
	01/92→09/96	Centre Rod	DB-DL-9263	Push Rod	
	01/92→09/96	Centre Rod	DB-DL-10216	Push Rod	
	01/92→09/96	Centre Rod	DB-DL-12309	Coupling Rod	
	01/92→09/96	Stabiliser Mounting	DB-SB-5258	DB-SB-5258	
	01/92→09/96	Suspension Arm Repair Kit		DB-RK-7267 for Drag Link	
	01/92→09/96	Suspension Arm Repair Kit		DB-RK-8550 for Wishbone (CV)	
	01/92→09/96	Suspension Arm Repair Kit	DB-RK-5283		
	01/92→09/96	Tie Rod	DB-DL-8640	Guide Rod	
	01/92→09/96	Tie Rod	DB-ES-5209		
	01/92→09/96	Tie Rod	DB-ES-5227	Guide Rod	
	01/92→09/96	Tie Rod End	CV-ES-12461	for Steering Rod	
	01/92→09/96	Tie Rod End	CV-ES-14163	for Steering Rod	
	01/92→09/96	Track Control Arm		DB-DL-6197 Suspension Rod, Trailing Arm	
	01/92→09/96	Track Control Arm		DB-DL-6198 Suspension Rod, Trailing Arm	
01/92→09/96	Track Control Arm		DB-DL-6227 Suspension Rod, Trailing Arm		
2645 AS	02/90→09/96	Centre Rod	DB-DL-5217	Push Rod	
	02/90→09/96	Centre Rod	DB-DL-10216	Push Rod	
	02/90→09/96	Suspension Arm Repair Kit		DB-RK-7267 for Drag Link	
	02/90→09/96	Tie Rod	DB-ES-5227	Guide Rod	
	02/90→09/96	Tie Rod	MN-DL-7834	Guide Rod	
	02/90→09/96	Tie Rod End	CV-ES-12461	for Steering Rod	
	02/90→09/96	Track Control Arm		DB-DL-6197 Suspension Rod, Trailing Arm	
	02/90→09/96	Track Control Arm		DB-DL-6198 Suspension Rod, Trailing Arm	
	02/90→09/96	Track Control Arm		DB-DL-6227 Suspension Rod, Trailing Arm	
	2648 AK	02/90→08/94	Centre Rod	DB-DL-5217	Push Rod
02/90→08/94		Centre Rod	DB-DL-10216	Push Rod	
02/90→08/94		Suspension Arm Repair Kit		DB-RK-7267 for Drag Link	
02/90→08/94		Tie Rod	DB-ES-5209		
02/90→08/94		Tie Rod	DB-ES-5227	Guide Rod	
02/90→08/94		Tie Rod	MN-DL-7834	Guide Rod	
02/90→08/94		Tie Rod End	CV-ES-12461	for Steering Rod	
02/90→08/94		Tie Rod End	DB-ES-5234	for Steering Rod	
02/90→08/94		Track Control Arm		DB-DL-6197 Suspension Rod, Trailing Arm	
02/90→08/94		Track Control Arm		DB-DL-6198 Suspension Rod, Trailing Arm	
02/90→08/94		Track Control Arm		DB-DL-6227 Suspension Rod, Trailing Arm	
2648 AS		07/88→08/94	Centre Rod	DB-DL-5217	Push Rod
		07/88→08/94	Centre Rod	DB-DL-10216	Push Rod
	07/88→08/94	Suspension Arm Repair Kit		DB-RK-7267 for Drag Link	
	07/88→08/94	Tie Rod	DB-ES-5227	Guide Rod	
	07/88→08/94	Tie Rod	MN-DL-7834	Guide Rod	
	07/88→08/94	Tie Rod End	CV-ES-12461	for Steering Rod	
	07/88→08/94	Track Control Arm		DB-DL-6197 Suspension Rod, Trailing Arm	
	07/88→08/94	Track Control Arm		DB-DL-6198 Suspension Rod, Trailing Arm	
07/88→08/94	Track Control Arm		DB-DL-6227 Suspension Rod, Trailing Arm		

CV-ES-12461

Length: 120
 Cone Ø: d1 Ø 26 / d2 Ø 23,5
 Thread: M30 x 1,5 LHT
 0003300035, 3300148, 0003406213, 0013306635,
 0013308835, 0014604048, 0014604348,
 14606448, 0024600248, 3023300035,
 3023300135, 3023300235, 3023300335,
 3453307235, 3453307435, 3503307135,
 A0003300148, A0013306635, A0013308835,
 A0014604048, A0014604348, A0014606448,
 A0024600248, A3023300035, A3023300135,
 A3023300235, A3023300335, A3503307135



CV-ES-14163

Length: 125
 Cone Ø: d1 Ø 30 / d2 Ø 27
 Thread: M30 x 1,5 RHT
 0003305248, 0003387310, 0004600348,
 0004600948, 0004602848, 0004602948,
 0004608948, 0014600248, 0014600848,
 0014601248, 0014602248, 0014607748,
 0024600148, A0003387310, A0004600348,
 A0004602848, A0004602948, A0014600848,
 A0014601248, A0014602248, A0014607748



DB-DL-5217

Length: 862 Ø: 40
 Cone Ø: d1 Ø 30 / d2 Ø 27
 01214700A, 6204600405, 6204600805,
 6204602905, 6204603005



DB-DL-5233

Length: 895 Ø: 48
 Cone Ø: d1 Ø 30 / d2 Ø 27
 01217300A, 0004609805, 0004609905



DB-DL-5241

Length: 875 Ø: 40
 Cone Ø: d1 Ø 30 / d2 Ø 27
 01215300A, 0004609205, 0004609305,
 0014606905



DB-DL-6197

Length: 579
 Ø: 50
 Hole Distance: 152 / 152
 6593501206, 6593503506



DB-DL-6198

Length: 579
 Ø: 58
 Hole Distance: 152 / 152
 3953500006, 6593501106



DB-DL-6227

Length: 629
 Ø: 58
 Hole Distance: 152 / 152
 6593501506, 6593503806



DB-DL-7270

Length: 875 Ø: 40
 Cone Ø: d1 Ø 28,6 / d2 Ø 23,9
 01208300A, 0024604705, 0024604805,
 0034604905, A0024604705



DB-DL-7831

Length: 870
 Ø: 42
 Cone Ø: d1 Ø 30 / d2 Ø 27
 01215200A, 6254602505



DB-DL-8131

Length: 1115 Ø: 52
 Cone Ø: d1 Ø 32 / d2 Ø 28,8
 0004604405, 6254605005



DB-DL-8138

Length: 1130
 Ø: 40
 Cone Ø: d1 Ø 32 / d2 Ø 28,8
 0004606605, 4606605



DB-DL-8618

Length: 680
 Ø: 42
 Cone Ø: d1 Ø 32 / d2 Ø 28,8
 0004604305, 4604305, 6254604805



DB-DL-8640

Length: 1615 Ø: 50
 Cone Ø: d1 Ø 32 / d2 Ø 29
 6253301503, 6253301603, 6253302403,
 6253302503, 9423300803, 9423302103,
 9493300203, 9493300303, 9493300903



DB-DL-9263

Length: 870
 Ø: 42
 Cone Ø: d1 Ø 32 / d2 Ø 27
 0014600505, 14600505, 0014600605, 14600605



DB-DL-10216

Length: 1190
 Ø: 40
 Cone Ø: d1 Ø 32 / d2 Ø 29
 0004604905



DB-DL-12309

Length: 685 Ø: 40
 Cone Ø: d1 Ø 32 / d2 Ø 28,8
 0004606005, 0004606305



DB-ES-5209

Length: 1670 Ø: 50
 Cone Ø: d1 Ø 30 / d2 Ø 27
 6203300503, 6203300603



DB-ES-5227

Length: 1588 Ø: 60
 Cone Ø: d1 Ø 38 / d2 Ø 34,3
 6253300903, 6253301203, 9443300203



DB-ES-5234

Length: 135
 Cone Ø: d1 Ø 38 / d2 Ø 34,3
 Thread: M38 x 1,5 RHT
 0004601748, 120322305, 2205000400



DB-ES-8387

Length: 55
 Cone Ø: d1 Ø 10 / d2 Ø 10
 Thread: M14 x 1,5 RHT
 0009966845, 0009967045



DB-ES-8491

Length: 60
 Cone Ø: d1 Ø 10 / d2 Ø 10
 Thread: M12 x 1,75 LHT
 0009966745



DB-ES-8492

Length: 60
 Cone Ø: d1 Ø 10 / d2 Ø 10
 Thread: M12 x 1,75 RHT
 0009966645, 3752680189, A3752680189



DB-ES-8500

Length: 55
 Cone Ø: d1 Ø 12 / d2 Ø 10,8
 Thread: M14 x 1,5 RHT
 0002685989



DB-RK-5283

Ø: 70
 013119900A, 6203200628



DB-RK-7267

Ø: 95
 Hole Distance: 152
 Thick/Height: 24
 01302100A, 3500413, 0003500413, 0005861235,
 5861235, 81432706069



DB-RK-8550

Ø: 75 Hole Distance: 152
 Thick/Height: 24
 0003502105, 0003504605



DB-SB-5258

Ø: 70
 Thick/Height: 62
 01311400A, 3873230285



MN-DL-7834

Length: 1588 Ø: 58
 Cone Ø: d1 Ø 30 / d2 Ø 27
 3463303903, 3463304903, 6253303203,
 9443300503, 9443301303, 9443301703





SK ...

2648 S	12/88→07/92	Ball Head, gearshift linkage	DB-ES-8387		
	12/88→07/92	Ball Head, gearshift linkage	DB-ES-8491		
	12/88→07/92	Ball Head, gearshift linkage	DB-ES-8492		
	12/88→07/92	Ball Head, gearshift linkage	DB-ES-8500		
	12/88→07/92	Centre Rod	DB-DL-5217		Push Rod
	12/88→07/92	Centre Rod	DB-DL-5233		Push Rod* 5 937 288 *→
	12/88→07/92	Centre Rod	DB-DL-5241		Suspension Rod
	12/88→07/92	Centre Rod	DB-DL-7270		Push Rod;Suspension Rod
	12/88→07/92	Centre Rod	DB-DL-7831		Push Rod
	12/88→07/92	Centre Rod	DB-DL-7831		Push Rod→* K 226 467 *
	12/88→07/92	Centre Rod	DB-DL-8131		Push Rod
	12/88→07/92	Centre Rod	DB-DL-8138		Push Rod
	12/88→07/92	Centre Rod	DB-DL-8618		Push Rod
	12/88→07/92	Centre Rod	DB-DL-10216		Push Rod
	12/88→07/92	Centre Rod	DB-DL-12309		Coupling Rod
	12/88→07/92	Stabiliser Mounting	DB-SB-5258	DB-SB-5258	
	12/88→07/92	Suspension Arm Repair Kit		DB-RK-7267	for Drag Link
	12/88→07/92	Suspension Arm Repair Kit		DB-RK-8550	for Wishbone (CV)
	12/88→07/92	Suspension Arm Repair Kit	DB-RK-5283		
	12/88→07/92	Tie Rod	DB-DL-8640		Guide Rod
	12/88→07/92	Tie Rod	DB-ES-5209		
	12/88→07/92	Tie Rod	DB-ES-5227		Guide Rod
	12/88→07/92	Tie Rod End	CV-ES-12461		for Steering Rod
	12/88→07/92	Tie Rod End	CV-ES-14163		for Steering Rod
	12/88→07/92	Track Control Arm		DB-DL-6197	Suspension Rod, Trailing Arm
	12/88→07/92	Track Control Arm		DB-DL-6198	Suspension Rod, Trailing Arm
	12/88→07/92	Track Control Arm		DB-DL-6227	Suspension Rod, Trailing Arm
2650 A	07/87→09/96	Ball Head, gearshift linkage	DB-ES-8500		
	07/87→09/96	Centre Rod	DB-DL-5217		Push Rod
	07/87→09/96	Centre Rod	DB-DL-10216		Push Rod
	07/87→09/96	Suspension Arm Repair Kit		DB-RK-7267	for Drag Link
	07/87→09/96	Tie Rod	DB-ES-5227		Guide Rod
	07/87→09/96	Tie Rod	MN-DL-7834		Guide Rod
	07/87→09/96	Tie Rod End	CV-ES-12461		for Steering Rod
	07/87→09/96	Track Control Arm		DB-DL-6197	Suspension Rod, Trailing Arm
	07/87→09/96	Track Control Arm		DB-DL-6198	Suspension Rod, Trailing Arm
07/87→09/96	Track Control Arm		DB-DL-6227	Suspension Rod, Trailing Arm	
2650 AK	07/88→08/94	Ball Head, gearshift linkage	DB-ES-8491		
	07/88→08/94	Ball Head, gearshift linkage	DB-ES-8492		
	07/88→08/94	Centre Rod	DB-DL-5217		Push Rod
	07/88→08/94	Centre Rod	DB-DL-10216		Push Rod
	07/88→08/94	Suspension Arm Repair Kit		DB-RK-7267	for Drag Link
	07/88→08/94	Tie Rod	DB-ES-5209		
	07/88→08/94	Tie Rod	DB-ES-5227		Guide Rod
	07/88→08/94	Tie Rod	MN-DL-7834		Guide Rod
	07/88→08/94	Tie Rod End	CV-ES-12461		for Steering Rod
	07/88→08/94	Tie Rod End	DB-ES-5234		for Steering Rod
	07/88→08/94	Track Control Arm		DB-DL-6197	Suspension Rod, Trailing Arm
	07/88→08/94	Track Control Arm		DB-DL-6198	Suspension Rod, Trailing Arm
07/88→08/94	Track Control Arm		DB-DL-6227	Suspension Rod, Trailing Arm	
2650 AS	01/94→09/96	Ball Head, gearshift linkage	DB-ES-8491		
	01/94→09/96	Ball Head, gearshift linkage	DB-ES-8492		
	01/94→09/96	Centre Rod	DB-DL-5217		Push Rod
	01/94→09/96	Centre Rod	DB-DL-10216		Push Rod
	01/94→09/96	Suspension Arm Repair Kit		DB-RK-7267	for Drag Link
	01/94→09/96	Tie Rod	DB-ES-5227		Guide Rod
	01/94→09/96	Tie Rod	MN-DL-7834		Guide Rod
	01/94→09/96	Tie Rod End	CV-ES-12461		for Steering Rod
	01/94→09/96	Track Control Arm		DB-DL-6197	Suspension Rod, Trailing Arm
	01/94→09/96	Track Control Arm		DB-DL-6198	Suspension Rod, Trailing Arm
	01/94→09/96	Track Control Arm		DB-DL-6227	Suspension Rod, Trailing Arm

CV-ES-12461

Length: 120
 Cone Ø: d1 Ø 26 / d2 Ø 23,5
 Thread: M30 x 1,5 LHT
 0003300035, 3300148, 0003406213, 0013306635,
 0013308835, 0014604048, 0014604348,
 14606448, 0024600248, 3023300035,
 3023300135, 3023300235, 3023300335,
 3453307235, 3453307435, 3503307135,
 A0003300148, A0013306635, A0013308835,
 A0014604048, A0014604348, A0014606448,
 A0024600248, A3023300035, A3023300135,
 A3023300235, A3023300335, A3503307135



CV-ES-14163

Length: 125
 Cone Ø: d1 Ø 30 / d2 Ø 27
 Thread: M30 x 1,5 RHT
 0003305248, 0003387310, 0004600348,
 0004600948, 0004602848, 0004602948,
 0004608948, 0014600248, 0014600848,
 0014601248, 0014602248, 0014607748,
 0024600148, A0003387310, A0004600348,
 A0004602848, A0004602948, A0014600848,
 A0014601248, A0014602248, A0014607748



DB-DL-5217

Length: 862 Ø: 40
 Cone Ø: d1 Ø 30 / d2 Ø 27
 01214700A, 6204600405, 6204600805,
 6204602905, 6204603005



DB-DL-5233

Length: 895 Ø: 48
 Cone Ø: d1 Ø 30 / d2 Ø 27
 01217300A, 0004609805, 0004609905



DB-DL-5241

Length: 875 Ø: 40
 Cone Ø: d1 Ø 30 / d2 Ø 27
 01215300A, 0004609205, 0004609305,
 0014606905



DB-DL-6197

Length: 579
 Ø: 50
 Hole Distance: 152 / 152
 6593501206, 6593503506



DB-DL-6198

Length: 579
 Ø: 58
 Hole Distance: 152 / 152
 3953500006, 6593501106



DB-DL-6227

Length: 629
 Ø: 58
 Hole Distance: 152 / 152
 6593501506, 6593503806



DB-DL-7270

Length: 875 Ø: 40
 Cone Ø: d1 Ø 28,6 / d2 Ø 23,9
 01208300A, 0024604705, 0024604805,
 0034604905, A0024604705



DB-DL-7831

Length: 870
 Ø: 42
 Cone Ø: d1 Ø 30 / d2 Ø 27
 01215200A, 6254602505



DB-DL-8131

Length: 1115 Ø: 52
 Cone Ø: d1 Ø 32 / d2 Ø 28,8
 0004604405, 6254605005



DB-DL-8138

Length: 1130
 Ø: 40
 Cone Ø: d1 Ø 32 / d2 Ø 28,8
 0004606605, 4606605



DB-DL-8618

Length: 680
 Ø: 42
 Cone Ø: d1 Ø 32 / d2 Ø 28,8
 0004604305, 4604305, 6254604805



DB-DL-8640

Length: 1615 Ø: 50
 Cone Ø: d1 Ø 32 / d2 Ø 29
 6253301503, 6253301603, 6253302403,
 6253302503, 9423300803, 9423302103,
 9493300203, 9493300303, 9493300903



DB-DL-10216

Length: 1190
 Ø: 40
 Cone Ø: d1 Ø 32 / d2 Ø 29
 0004604905



DB-DL-12309

Length: 685 Ø: 40
 Cone Ø: d1 Ø 32 / d2 Ø 28,8
 0004606005, 0004606305



DB-ES-5209

Length: 1670 Ø: 50
 Cone Ø: d1 Ø 30 / d2 Ø 27
 6203300503, 6203300603



DB-ES-5227

Length: 1588 Ø: 60
 Cone Ø: d1 Ø 38 / d2 Ø 34,3
 6253300903, 6253301203, 9443300203



DB-ES-5234

Length: 135
 Cone Ø: d1 Ø 38 / d2 Ø 34,3
 Thread: M38 x 1,5 RHT
 0004601748, 120322305, 2205000400



DB-ES-8387

Length: 55
 Cone Ø: d1 Ø 10 / d2 Ø 10
 Thread: M14 x 1,5 RHT
 0009966845, 0009967045



DB-ES-8491

Length: 60
 Cone Ø: d1 Ø 10 / d2 Ø 10
 Thread: M12 x 1,75 LHT
 0009966745



DB-ES-8492

Length: 60
 Cone Ø: d1 Ø 10 / d2 Ø 10
 Thread: M12 x 1,75 RHT
 0009966645, 3752680189, A3752680189



DB-ES-8500

Length: 55
 Cone Ø: d1 Ø 12 / d2 Ø 10,8
 Thread: M14 x 1,5 RHT
 0002685989



DB-RK-5283

Ø: 70
 01319900A, 6203200628



DB-RK-7267

Ø: 95
 Hole Distance: 152
 Thick/Height: 24
 01302100A, 3500413, 0003500413, 0005861235,
 5861235, 81432706069



DB-RK-8550

Ø: 75 Hole Distance: 152
 Thick/Height: 24
 0003502105, 0003504605



DB-SB-5258

Ø: 70
 Thick/Height: 62
 01311400A, 3873230285



MN-DL-7834

Length: 1588 Ø: 58
 Cone Ø: d1 Ø 30 / d2 Ø 27
 3463303903, 3463304903, 6253303203,
 9443300503, 9443301303, 9443301703





SK ...

2650 K	07/88→08/94	Centre Rod	DB-DL-5217		Push Rod
	07/88→08/94	Centre Rod	DB-DL-5233		Push Rod* 5 937 287 *→
	07/88→08/94	Centre Rod	DB-DL-7831		Push Rod
	07/88→08/94	Centre Rod	DB-DL-8131		Push Rod
	07/88→08/94	Centre Rod	DB-DL-8618		Push Rod
	07/88→08/94	Suspension Arm Repair Kit		DB-RK-7267	for Drag Link
	07/88→08/94	Tie Rod	DB-DL-8640		Guide Rod
	07/88→08/94	Tie Rod	DB-ES-5209		
	07/88→08/94	Tie Rod	DB-ES-5227		Guide Rod
	07/88→08/94	Tie Rod End	CV-ES-12461		for Steering Rod
	07/88→08/94	Track Control Arm		DB-DL-6197	Suspension Rod, Trailing Arm
	07/88→08/94	Track Control Arm		DB-DL-6198	Suspension Rod, Trailing Arm
	07/88→08/94	Track Control Arm		DB-DL-6227	Suspension Rod, Trailing Arm
	2650 S	07/92→09/96	Ball Head, gearshift linkage	DB-ES-8387	
07/92→09/96		Ball Head, gearshift linkage	DB-ES-8491		
07/92→09/96		Ball Head, gearshift linkage	DB-ES-8492		
07/92→09/96		Ball Head, gearshift linkage	DB-ES-8500		
07/92→09/96		Centre Rod	DB-DL-5217		Push Rod
07/92→09/96		Centre Rod	DB-DL-5233		Push Rod* 5 937 288 *→
07/92→09/96		Centre Rod	DB-DL-5241		Suspension Rod
07/92→09/96		Centre Rod	DB-DL-7270		Push Rod;Suspension Rod
07/92→09/96		Centre Rod	DB-DL-7831		Push Rod
07/92→09/96		Centre Rod	DB-DL-7831		Push Rod→* K 226 467 *
07/92→09/96		Centre Rod	DB-DL-8131		Push Rod
07/92→09/96		Centre Rod	DB-DL-8138		Push Rod
07/92→09/96		Centre Rod	DB-DL-8618		Push Rod
07/92→09/96		Centre Rod	DB-DL-10216		Push Rod
07/92→09/96		Centre Rod	DB-DL-12309		Coupling Rod
07/92→09/96		Stabiliser Mounting	DB-SB-5258	DB-SB-5258	
07/92→09/96		Suspension Arm Repair Kit		DB-RK-7267	for Drag Link
07/92→09/96		Suspension Arm Repair Kit		DB-RK-8550	for Wishbone (CV)
07/92→09/96		Suspension Arm Repair Kit	DB-RK-5283		
07/92→09/96		Tie Rod	DB-DL-8640		Guide Rod
07/92→09/96		Tie Rod	DB-ES-5209		
07/92→09/96		Tie Rod	DB-ES-5227		Guide Rod
07/92→09/96		Tie Rod End	CV-ES-12461		for Steering Rod
07/92→09/96		Tie Rod End	CV-ES-14163		for Steering Rod
07/92→09/96		Track Control Arm		DB-DL-6197	Suspension Rod, Trailing Arm
07/92→09/96		Track Control Arm		DB-DL-6198	Suspension Rod, Trailing Arm
07/92→09/96		Track Control Arm		DB-DL-6227	Suspension Rod, Trailing Arm
2650, 2650 L		07/92→09/96	Ball Head, gearshift linkage	DB-ES-8387	
	07/92→09/96	Ball Head, gearshift linkage	DB-ES-8491		
	07/92→09/96	Ball Head, gearshift linkage	DB-ES-8492		
	07/92→09/96	Ball Head, gearshift linkage	DB-ES-8500		
	07/92→09/96	Centre Rod	DB-DL-5217		Push Rod
	07/92→09/96	Centre Rod	DB-DL-5233		Push Rod* 5 937 288 *→
	07/92→09/96	Centre Rod	DB-DL-5233		Push Rod* K 017 164 *→
	07/92→09/96	Centre Rod	DB-DL-5241		Suspension Rod
	07/92→09/96	Centre Rod	DB-DL-7270		Push Rod;Suspension Rod
	07/92→09/96	Centre Rod	DB-DL-7831		Push Rod
	07/92→09/96	Centre Rod	DB-DL-7831		Push Rod→* K 226 467 *
	07/92→09/96	Centre Rod	DB-DL-8131		Push Rod
	07/92→09/96	Centre Rod	DB-DL-8138		Push Rod
	07/92→09/96	Centre Rod	DB-DL-8618		Push Rod
	07/92→09/96	Centre Rod	DB-DL-9263		Push Rod
	07/92→09/96	Centre Rod	DB-DL-10216		Push Rod
	07/92→09/96	Centre Rod	DB-DL-12308		Coupling Rod
	07/92→09/96	Centre Rod	DB-DL-12309		Coupling Rod
	07/92→09/96	Stabiliser Mounting	DB-SB-5258	DB-SB-5258	
	07/92→09/96	Suspension Arm Repair Kit		DB-RK-7267	for Drag Link
	07/92→09/96	Suspension Arm Repair Kit		DB-RK-8550	for Wishbone (CV)
	07/92→09/96	Suspension Arm Repair Kit		DB-RK-12372	for Wishbone (CV)
	07/92→09/96	Suspension Arm Repair Kit		DF-RK-9336	

CV-ES-12461

Length: 120
 Cone Ø: d1 Ø 26 / d2 Ø 23,5
 Thread: M30 x 1,5 LHT
 0003300035, 3300148, 0003406213, 0013306635,
 0013308835, 0014604048, 0014604348,
 14606448, 0024600248, 3023300035,
 3023300135, 3023300235, 3023300335,
 3453307235, 3453307435, 3503307135,
 A0003300148, A0013306635, A0013308835,
 A0014604048, A0014604348, A0014606448,
 A0024600248, A3023300035, A3023300135,
 A3023300235, A3023300335, A3503307135



CV-ES-14163

Length: 125
 Cone Ø: d1 Ø 30 / d2 Ø 27
 Thread: M30 x 1,5 RHT
 0003305248, 0003387310, 0004600348,
 0004600948, 0004602848, 0004602948,
 0004608948, 0014600248, 0014600848,
 0014601248, 0014602248, 0014607748,
 0024600148, A0003387310, A0004600348,
 A0004602848, A0004602948, A0014600848,
 A0014601248, A0014602248, A0014607748



DB-DL-5217

Length: 862 Ø: 40
 Cone Ø: d1 Ø 30 / d2 Ø 27
 01214700A, 6204600405, 6204600805,
 6204602905, 6204603005



DB-DL-5233

Length: 895 Ø: 48
 Cone Ø: d1 Ø 30 / d2 Ø 27
 01217300A, 0004609805, 0004609905



DB-DL-5241

Length: 875 Ø: 40
 Cone Ø: d1 Ø 30 / d2 Ø 27
 01215300A, 0004609205, 0004609305,
 0014606905



DB-DL-6197

Length: 579
 Ø: 50
 Hole Distance: 152 / 152
 6593501206, 6593503506



DB-DL-6198

Length: 579
 Ø: 58
 Hole Distance: 152 / 152
 3953500006, 6593501106



DB-DL-6227

Length: 629
 Ø: 58
 Hole Distance: 152 / 152
 6593501506, 6593503806



DB-DL-7270

Length: 875 Ø: 40
 Cone Ø: d1 Ø 28,6 / d2 Ø 23,9
 01208300A, 0024604705, 0024604805,
 0034604905, A0024604705



DB-DL-7831

Length: 870
 Ø: 42
 Cone Ø: d1 Ø 30 / d2 Ø 27
 01215200A, 6254602505



DB-DL-8131

Length: 1115 Ø: 52
 Cone Ø: d1 Ø 32 / d2 Ø 28,8
 0004604405, 6254605005



DB-DL-8138

Length: 1130
 Ø: 40
 Cone Ø: d1 Ø 32 / d2 Ø 28,8
 4606605, 0004606605



DB-DL-8618

Length: 680
 Ø: 42
 Cone Ø: d1 Ø 32 / d2 Ø 28,8
 4604305, 0004604305, 6254604805



DB-DL-8640

Length: 1615 Ø: 50
 Cone Ø: d1 Ø 32 / d2 Ø 29
 6253301503, 6253301603, 6253302403,
 6253302503, 9423300803, 9423302103,
 9493300203, 9493300303, 9493300903



DB-DL-9263

Length: 870
 Ø: 42
 Cone Ø: d1 Ø 32 / d2 Ø 27
 14600505, 0014600505, 0014600605, 14600605



DB-DL-10216

Length: 1190
 Ø: 40
 Cone Ø: d1 Ø 32 / d2 Ø 29
 0004604905



DB-DL-12308

Length: 885
 Ø: 42
 Cone Ø: d1 Ø 30 / d2 Ø 27
 0004600705, 4600705



DB-DL-12309

Length: 685
 Ø: 40
 Cone Ø: d1 Ø 32 / d2 Ø 28,8
 0004606005, 4606005, 4606305, 0004606305



DB-ES-5209

Length: 1670 Ø: 50
 Cone Ø: d1 Ø 30 / d2 Ø 27
 6203300503, 6203300603



DB-ES-5227

Length: 1588 Ø: 60
 Cone Ø: d1 Ø 38 / d2 Ø 34,3
 6253300903, 6253301203, 9443300203



DB-ES-8387

Length: 55
 Cone Ø: d1 Ø 10 / d2 Ø 10
 Thread: M14 x 1,5 RHT
 0009966845, 0009967045



DB-ES-8491

Length: 60
 Cone Ø: d1 Ø 10 / d2 Ø 10
 Thread: M12 x 1,75 LHT
 0009966745



DB-ES-8492

Length: 60
 Cone Ø: d1 Ø 10 / d2 Ø 10
 Thread: M12 x 1,75 RHT
 0009966645, 3752680189, A3752680189



DB-ES-8500

Length: 55
 Cone Ø: d1 Ø 12 / d2 Ø 10,8
 Thread: M14 x 1,5 RHT
 0002685989



DB-RK-5283

Ø: 70
 01319900A, 6203200628



DB-RK-7267

Ø: 95
 Hole Distance: 152
 Thick/Height: 24
 01302100A, 0003500413, 3500413, 0005861235,
 5861235, 81432706069



DB-RK-8550

Ø: 75 Hole Distance: 152
 Thick/Height: 24
 0003502105, 0003504605



DB-RK-12372

Ø: 85
 Hole Distance: 152
 Thick/Height: 24
 003501805, A003501805



DB-SB-5258

Ø: 70
 Thick/Height: 62
 01311400A, 3873230285



DF-RK-9336

Ø: 108
 0003501705, 3501705





SK ...

2650, 2650 L ...	07/92→09/96	Suspension Arm Repair Kit	DB-RK-5282		
	07/92→09/96	Suspension Arm Repair Kit	DB-RK-5283		
	07/92→09/96	Tie Rod	DB-DL-8640	Guide Rod	
	07/92→09/96	Tie Rod	DB-ES-5209		
	07/92→09/96	Tie Rod	DB-ES-5227	Guide Rod	
	07/92→09/96	Tie Rod End	CV-ES-12461	for Steering Rod	
	07/92→09/96	Tie Rod End	CV-ES-14163	for Steering Rod	
	07/92→09/96	Track Control Arm		DB-DL-6197 Suspension Rod, Trailing Arm	
	07/92→09/96	Track Control Arm		DB-DL-6198 Suspension Rod, Trailing Arm	
	07/92→09/96	Track Control Arm		DB-DL-6227 Suspension Rod, Trailing Arm	
	07/92→09/96	Track Control Arm		DB-VB-7776 Wishbone (CV);Trailing Arm* 5 926 393 *→	
	2653 AK	07/92→09/96	Ball Head, gearshift linkage	DB-ES-8491	
		07/92→09/96	Ball Head, gearshift linkage	DB-ES-8492	
07/92→09/96		Centre Rod	DB-DL-5217	Push Rod	
07/92→09/96		Centre Rod	DB-DL-10216	Push Rod	
07/92→09/96		Suspension Arm Repair Kit		DB-RK-7267 for Drag Link	
07/92→09/96		Tie Rod	DB-ES-5209		
07/92→09/96		Tie Rod	DB-ES-5227	Guide Rod	
07/92→09/96		Tie Rod	MN-DL-7834	Guide Rod	
07/92→09/96		Tie Rod End	CV-ES-12461	for Steering Rod	
07/92→09/96		Tie Rod End	DB-ES-5234	for Steering Rod	
07/92→09/96		Track Control Arm		DB-DL-6197 Suspension Rod, Trailing Arm	
07/92→09/96		Track Control Arm		DB-DL-6198 Suspension Rod, Trailing Arm	
07/92→09/96		Track Control Arm		DB-DL-6227 Suspension Rod, Trailing Arm	
2653, 2653 L	09/95→09/96	Ball Head, gearshift linkage	DB-ES-8387		
	09/95→09/96	Ball Head, gearshift linkage	DB-ES-8491		
	09/95→09/96	Ball Head, gearshift linkage	DB-ES-8492		
	09/95→09/96	Ball Head, gearshift linkage	DB-ES-8500		
	09/95→09/96	Centre Rod	DB-DL-5217	Push Rod	
	09/95→09/96	Centre Rod	DB-DL-5233	Push Rod* 5 937 288 *→	
	09/95→09/96	Centre Rod	DB-DL-5241	Suspension Rod	
	09/95→09/96	Centre Rod	DB-DL-7270	Push Rod;Suspension Rod	
	09/95→09/96	Centre Rod	DB-DL-7831	Push Rod	
	09/95→09/96	Centre Rod	DB-DL-7831	Push Rod→* K 226 467 *	
	09/95→09/96	Centre Rod	DB-DL-8131	Push Rod	
	09/95→09/96	Centre Rod	DB-DL-8138	Push Rod	
	09/95→09/96	Centre Rod	DB-DL-8618	Push Rod	
	09/95→09/96	Centre Rod	DB-DL-9263	Push Rod	
	09/95→09/96	Centre Rod	DB-DL-10216	Push Rod	
	09/95→09/96	Suspension Arm Repair Kit		DB-RK-7267 for Drag Link	
	09/95→09/96	Suspension Arm Repair Kit		DB-RK-8550 for Wishbone (CV)	
	09/95→09/96	Tie Rod	DB-DL-8640	Guide Rod	
	09/95→09/96	Tie Rod	DB-ES-5209		
	09/95→09/96	Tie Rod	DB-ES-5227	Guide Rod	
	09/95→09/96	Tie Rod End	CV-ES-12461	for Steering Rod	
	09/95→09/96	Track Control Arm		DB-DL-6197 Suspension Rod, Trailing Arm	
	09/95→09/96	Track Control Arm		DB-DL-6198 Suspension Rod, Trailing Arm	
	09/95→09/96	Track Control Arm		DB-DL-6227 Suspension Rod, Trailing Arm	
	3050	01/94→09/96	Ball Head, gearshift linkage	DB-ES-8387	
		01/94→09/96	Ball Head, gearshift linkage	DB-ES-8491	
		01/94→09/96	Ball Head, gearshift linkage	DB-ES-8492	
01/94→09/96		Ball Head, gearshift linkage	DB-ES-8500		
01/94→09/96		Centre Rod	DB-DL-5217	Push Rod	
01/94→09/96		Centre Rod	DB-DL-10216	Push Rod	
01/94→09/96		Stabiliser Mounting		DB-SB-10407	
01/94→09/96		Suspension Arm Repair Kit		DB-RK-7267 for Drag Link	
01/94→09/96		Tie Rod	DB-DL-8640	Guide Rod	
01/94→09/96		Tie Rod	DB-ES-5209		
01/94→09/96		Tie Rod	DB-ES-5227	Guide Rod	
01/94→09/96		Tie Rod End	CV-ES-12461	for Steering Rod	
01/94→09/96		Tie Rod End	DB-ES-5234	for Steering Rod	
01/94→09/96		Track Control Arm		DB-DL-6197 Suspension Rod, Trailing Arm	
01/94→09/96		Track Control Arm		DB-DL-6198 Suspension Rod, Trailing Arm	
01/94→09/96		Track Control Arm		DB-DL-6227 Suspension Rod, Trailing Arm	

CV-ES-12461

Length: 120
 Cone Ø: d1 Ø 26 / d2 Ø 23,5
 Thread: M30 x 1,5 LHT
 0003300035, 3300148, 0003406213, 0013306635,
 0013308835, 0014604048, 0014604348,
 14606448, 0024600248, 3023300035,
 3023300135, 3023300235, 3023300335,
 3453307235, 3453307435, 3503307135,
 A0003300148, A0013306635, A0013308835,
 A0014604048, A0014604348, A0014606448,
 A0024600248, A3023300035, A3023300135,
 A3023300235, A3023300335, A3503307135



CV-ES-14163

Length: 125
 Cone Ø: d1 Ø 30 / d2 Ø 27
 Thread: M30 x 1,5 RHT
 0003305248, 0003387310, 0004600348,
 0004600948, 0004602848, 0004602948,
 0004608948, 0014600248, 0014600848,
 0014601248, 0014602248, 0014607748,
 0024600148, A0003387310, A0004600348,
 A0004602848, A0004602948, A0014600848,
 A0014601248, A0014602248, A0014607748



DB-DL-5217

Length: 862 Ø: 40
 Cone Ø: d1 Ø 30 / d2 Ø 27
 01214700A, 6204600405, 6204600805,
 6204602905, 6204603005



DB-DL-5233

Length: 895 Ø: 48
 Cone Ø: d1 Ø 30 / d2 Ø 27
 01217300A, 0004609805, 0004609905



DB-DL-5241

Length: 875 Ø: 40
 Cone Ø: d1 Ø 30 / d2 Ø 27
 01215300A, 0004609205, 0004609305,
 0014606905



DB-DL-6197

Length: 579
 Ø: 50
 Hole Distance: 152 / 152
 6593501206, 6593503506



DB-DL-6198

Length: 579
 Ø: 58
 Hole Distance: 152 / 152
 3953500006, 6593501106



DB-DL-6227

Length: 629
 Ø: 58
 Hole Distance: 152 / 152
 6593501506, 6593503806



DB-DL-7270

Length: 875 Ø: 40
 Cone Ø: d1 Ø 28,6 / d2 Ø 23,9
 01208300A, 0024604705, 0024604805,
 0034604905, A0024604705



DB-DL-7831

Length: 870
 Ø: 42
 Cone Ø: d1 Ø 30 / d2 Ø 27
 01215200A, 6254602505



DB-DL-8131

Length: 1115 Ø: 52
 Cone Ø: d1 Ø 32 / d2 Ø 28,8
 0004604405, 6254605005



DB-DL-8138

Length: 1130
 Ø: 40
 Cone Ø: d1 Ø 32 / d2 Ø 28,8
 0004606605, 4606605



DB-DL-8618

Length: 680
 Ø: 42
 Cone Ø: d1 Ø 32 / d2 Ø 28,8
 0004604305, 4604305, 6254604805



DB-DL-8640

Length: 1615 Ø: 50
 Cone Ø: d1 Ø 32 / d2 Ø 29
 6253301503, 6253301603, 6253302403,
 6253302503, 9423300803, 9423302103,
 9493300203, 9493300303, 9493300903



DB-DL-9263

Length: 870
 Ø: 42
 Cone Ø: d1 Ø 32 / d2 Ø 27
 14600505, 0014600505, 14600605, 0014600605



DB-DL-10216

Length: 1190
 Ø: 40
 Cone Ø: d1 Ø 32 / d2 Ø 29
 0004604905



DB-ES-5209

Length: 1670 Ø: 50
 Cone Ø: d1 Ø 30 / d2 Ø 27
 6203300503, 6203300603



DB-ES-5227

Length: 1588 Ø: 60
 Cone Ø: d1 Ø 38 / d2 Ø 34,3
 6253300903, 6253301203, 9443300203



DB-ES-5234

Length: 135
 Cone Ø: d1 Ø 38 / d2 Ø 34,3
 Thread: M38 x 1,5 RHT
 0004601748, 120322305, 2205000400



DB-ES-8387

Length: 55
 Cone Ø: d1 Ø 10 / d2 Ø 10
 Thread: M14 x 1,5 RHT
 0009966845, 0009967045



DB-ES-8491

Length: 60
 Cone Ø: d1 Ø 10 / d2 Ø 10
 Thread: M12 x 1,75 LHT
 0009966745



DB-ES-8492

Length: 60
 Cone Ø: d1 Ø 10 / d2 Ø 10
 Thread: M12 x 1,75 RHT
 0009966645, 3752680189, A3752680189



DB-ES-8500

Length: 55
 Cone Ø: d1 Ø 12 / d2 Ø 10,8
 Thread: M14 x 1,5 RHT
 0002685989



DB-RK-5282

Ø: 59
 01303800A, 6553200111



DB-RK-5283

Ø: 70
 01319900A, 6203200628



DB-RK-7267

Ø: 95
 Hole Distance: 152
 Thick/Height: 24
 01302100A, 0003500413, 3500413, 0005861235,
 5861235, 8143270609



DB-RK-8550

Ø: 75 Hole Distance: 152
 Thick/Height: 24
 0003502105, 0003504605



DB-SB-10407

Ø: 61 Thick/Height: 46
 0003235985, 0003262481, 0003262981



DB-VB-7776

Length: 622 Ø: 56
 Hole Distance: 152 / 152
 6533500205, 6583500205



MN-DL-7834

Length: 1588 Ø: 58
 Cone Ø: d1 Ø 30 / d2 Ø 27
 3463303903, 3463304903, 6253303203,
 9443300503, 9443301303, 9443301703





SK ...

3053 S	12/93→09/96	Ball Head, gearshift linkage	DB-ES-8387			
	12/93→09/96	Ball Head, gearshift linkage	DB-ES-8491			
	12/93→09/96	Ball Head, gearshift linkage	DB-ES-8492			
	12/93→09/96	Ball Head, gearshift linkage	DB-ES-8500			
	12/93→09/96	Centre Rod	DB-DL-5217		Push Rod	
	12/93→09/96	Centre Rod	DB-DL-10216		Push Rod	
	12/93→09/96	Stabiliser Mounting		DB-SB-10407		
	12/93→09/96	Suspension Arm Repair Kit		DB-RK-7267	for Drag Link	
	12/93→09/96	Suspension Arm Repair Kit	DB-RK-5280			
	12/93→09/96	Tie Rod	DB-DL-8640		Guide Rod	
	12/93→09/96	Tie Rod	DB-ES-5209			
	12/93→09/96	Tie Rod	DB-ES-5227		Guide Rod	
	12/93→09/96	Tie Rod End	CV-ES-12461		for Steering Rod	
	12/93→09/96	Tie Rod End	DB-ES-5234		for Steering Rod	
	3229	12/93→09/96	Track Control Arm		DB-DL-6197	Suspension Rod, Trailing Arm
12/93→09/96		Track Control Arm		DB-DL-6198	Suspension Rod, Trailing Arm	
12/93→09/96		Track Control Arm		DB-DL-6227	Suspension Rod, Trailing Arm	
09/89→08/94		Centre Rod	DB-DL-9263		Push Rod	
09/89→08/94		Centre Rod	DB-DL-9263		Push Rod* 5 946 137 *→	
09/89→08/94		Centre Rod	DB-DL-12309		Coupling Rod	
09/89→08/94		Stabiliser Mounting		DB-SB-10407		
09/89→08/94		Suspension Arm Repair Kit	DB-RK-5303			
09/89→08/94		Suspension Arm Repair Kit	DB-RK-6111	DB-RK-6111	Trailing Arm	
09/89→08/94		Tie Rod	DB-DL-8640		Guide Rod	
09/89→08/94		Tie Rod	DB-ES-5227		Guide Rod	
09/89→08/94		Tie Rod End	CV-ES-14163		for Steering Rod	
09/89→08/94		Tie Rod End	DB-ES-8617			
09/89→08/94		Track Control Arm		DB-DL-7839	Trailing Arm	
3229 B		09/89→07/92	Centre Rod	DB-DL-9263		Push Rod
	09/89→07/92	Centre Rod	DB-DL-9263		Push Rod* 5 946 137 *→	
	09/89→07/92	Centre Rod	DB-DL-12309		Coupling Rod	
	09/89→07/92	Stabiliser Mounting		DB-SB-10407		
	09/89→07/92	Suspension Arm Repair Kit	DB-RK-5303			
	09/89→07/92	Suspension Arm Repair Kit	DB-RK-6111	DB-RK-6111	Trailing Arm	
	09/89→07/92	Tie Rod	DB-DL-8640		Guide Rod	
	09/89→07/92	Tie Rod	DB-ES-5227		Guide Rod	
	09/89→07/92	Tie Rod End	CV-ES-14163		for Steering Rod	
	09/89→07/92	Tie Rod End	DB-ES-8617			
	09/89→07/92	Track Control Arm		DB-DL-7839	Trailing Arm	
	3229 K	09/89→01/92	Centre Rod	DB-DL-9263		Push Rod
		09/89→01/92	Centre Rod	DB-DL-9263		Push Rod* 5 946 137 *→
		09/89→01/92	Centre Rod	DB-DL-12309		Coupling Rod
		09/89→01/92	Stabiliser Mounting		DB-SB-10407	
09/89→01/92		Suspension Arm Repair Kit	DB-RK-5303			
09/89→01/92		Suspension Arm Repair Kit	DB-RK-6111	DB-RK-6111	Trailing Arm	
09/89→01/92		Tie Rod	DB-DL-8640		Guide Rod	
09/89→01/92		Tie Rod	DB-ES-5227		Guide Rod	
09/89→01/92		Tie Rod End	CV-ES-14163		for Steering Rod	
09/89→01/92		Tie Rod End	DB-ES-8617			
09/89→01/92		Track Control Arm		DB-DL-7839	Trailing Arm	
3233 B		10/90→07/92	Ball Head, gearshift linkage	DB-ES-8387		
		10/90→07/92	Ball Head, gearshift linkage	DB-ES-8492		
		10/90→07/92	Ball Head, gearshift linkage	DB-ES-8500		
		10/90→07/92	Centre Rod	DB-DL-12309		Coupling Rod
	10/90→07/92	Stabiliser Mounting		DB-SB-10407		
	10/90→07/92	Suspension Arm Repair Kit	CV-RK-1583	CV-RK-1583	Trailing Arm	
	10/90→07/92	Suspension Arm Repair Kit	DB-RK-5303			
	10/90→07/92	Suspension Arm Repair Kit	DB-RK-6111	DB-RK-6111	Trailing Arm	
	10/90→07/92	Tie Rod	DB-DL-8640		Guide Rod	
	10/90→07/92	Tie Rod	DB-ES-5227		Guide Rod	
	10/90→07/92	Tie Rod End	CV-ES-14163		for Steering Rod	
	10/90→07/92	Tie Rod End	DB-ES-8323			
	10/90→07/92	Tie Rod End	DB-ES-8617			
	10/90→07/92	Track Control Arm		DB-DL-7839	Trailing Arm	

CV-ES-12461

Length: 120
 Cone Ø: d1 Ø 26 / d2 Ø 23,5
 Thread: M30 x 1,5 LHT
 0003300035, 3300148, 0003406213, 0013306635,
 0013308835, 0014604048, 0014604348,
 14606448, 0024600248, 3023300035,
 3023300135, 3023300235, 3023300335,
 3453307235, 3453307435, 3503307135,
 A0003300148, A0013306635, A0013308835,
 A0014604048, A0014604348, A0014606448,
 A0024600248, A3023300035, A3023300135,
 A3023300235, A3023300335, A3503307135



CV-ES-14163

Length: 125
 Cone Ø: d1 Ø 30 / d2 Ø 27
 Thread: M30 x 1,5 RHT
 0003305248, 0003387310, 0004600348,
 0004600948, 0004602848, 0004602948,
 0004608948, 0014600248, 0014600848,
 0014601248, 0014602248, 0014607748,
 0024600148, A0003387310, A0004600348,
 A0004602848, A0004602948, A0014600848,
 A0014601248, A0014602248, A0014607748



CV-RK-1583

Ø: 80
 Hole Distance: 152
 Thick/Height: 24
 0005861433



DB-DL-5217

Length: 862 Ø: 40
 Cone Ø: d1 Ø 30 / d2 Ø 27
 01214700A, 6204600405, 6204600805,
 6204602905, 6204603005



DB-DL-6197

Length: 579
 Ø: 50
 Hole Distance: 152 / 152
 6593501206, 6593503506



DB-DL-6198

Length: 579
 Ø: 58
 Hole Distance: 152 / 152
 3953500006, 6593501106



DB-DL-6227

Length: 629
 Ø: 58
 Hole Distance: 152 / 152
 6593501506, 6593503806



DB-DL-7839

Length: 585
 Ø: 50
 Hole Distance: 152 / 152
 3953500206, 6593500106, 6593502406



DB-DL-8640

Length: 1615 Ø: 50
 Cone Ø: d1 Ø 32 / d2 Ø 29
 6253301503, 6253301603, 6253302403,
 6253302503, 9423300803, 9423302103,
 9493300203, 9493300303, 9493300903



DB-DL-9263

Length: 870
 Ø: 42
 Cone Ø: d1 Ø 32 / d2 Ø 27
 14600505, 0014600505, 0014600605, 14600605



DB-DL-10216

Length: 1190
 Ø: 40
 Cone Ø: d1 Ø 32 / d2 Ø 29
 0004604905



DB-DL-12309

Length: 685 Ø: 40
 Cone Ø: d1 Ø 32 / d2 Ø 28,8
 0004606005, 0004606305



DB-ES-5209

Length: 1670 Ø: 50
 Cone Ø: d1 Ø 30 / d2 Ø 27
 6203300503, 6203300603



DB-ES-5227

Length: 1588 Ø: 60
 Cone Ø: d1 Ø 38 / d2 Ø 34,3
 6253300903, 6253301203, 9443300203



DB-ES-5234

Length: 135
 Cone Ø: d1 Ø 38 / d2 Ø 34,3
 Thread: M38 x 1,5 RHT
 0004601748, 120322305, 2205000400



DB-ES-8323

Length: 75
 Cone Ø: d1 Ø 32 / d2 Ø 28,8
 Thread: M26 x 1,5 RHT
 0014601548, 0014601648, 0024600648,
 A0014601648, A0024600648



DB-ES-8387

Length: 55
 Cone Ø: d1 Ø 10 / d2 Ø 10
 Thread: M14 x 1,5 RHT
 0009966845, 0009967045



DB-ES-8491

Length: 60
 Cone Ø: d1 Ø 10 / d2 Ø 10
 Thread: M12 x 1,75 LHT
 0009966745



DB-ES-8492

Length: 60
 Cone Ø: d1 Ø 10 / d2 Ø 10
 Thread: M12 x 1,75 RHT
 0009966645, 3752680189, A3752680189



DB-ES-8500

Length: 55
 Cone Ø: d1 Ø 12 / d2 Ø 10,8
 Thread: M14 x 1,5 RHT
 0002685989



DB-ES-8617

Length: 155
 Cone Ø: d1 Ø 32 / d2 Ø 28,8
 Thread: M30 x 1,5 RHT
 0004604848, 4604848, 0014600648, 14600648



DB-RK-5280

Ø: 86
 01303000A, 6213200428



DB-RK-5303

Ø: 37
 01304400A, 6253200611



DB-RK-6111

Ø: 85
 Hole Distance: 152
 Thick/Height: 24
 0003500613, 0005861135



DB-RK-7267

Ø: 95
 Hole Distance: 152
 Thick/Height: 24
 01302100A, 0003500413, 3500413, 0005861235,
 5861235, 8143270609



DB-SB-10407

Ø: 61 Thick/Height: 46
 0003235985, 0003262481, 0003262981





SK ...

3233 K	10/90→07/92	Ball Head, gearshift linkage	DB-ES-8387		
	10/90→07/92	Ball Head, gearshift linkage	DB-ES-8492		
	10/90→07/92	Ball Head, gearshift linkage	DB-ES-8500		
	10/90→07/92	Centre Rod	DB-DL-12309		Coupling Rod
	10/90→07/92	Stabiliser Mounting		DB-SB-10407	
	10/90→07/92	Suspension Arm Repair Kit	DB-RK-5303		
	10/90→07/92	Suspension Arm Repair Kit	DB-RK-6111	DB-RK-6111	Trailing Arm
	10/90→07/92	Tie Rod	DB-DL-8640		Guide Rod
	10/90→07/92	Tie Rod	DB-ES-5227		Guide Rod
	10/90→07/92	Tie Rod End	CV-ES-14163		for Steering Rod
	10/90→07/92	Tie Rod End	DB-ES-8323		
	10/90→07/92	Tie Rod End	DB-ES-8617		
	10/90→07/92	Track Control Arm		DB-DL-7839	Trailing Arm
	3234 B	02/92→09/96	Ball Head, gearshift linkage	DB-ES-8387	
02/92→09/96		Ball Head, gearshift linkage	DB-ES-8492		
02/92→09/96		Ball Head, gearshift linkage	DB-ES-8500		
02/92→09/96		Centre Rod	DB-DL-12309		Coupling Rod
02/92→09/96		Stabiliser Mounting		DB-SB-10407	
02/92→09/96		Suspension Arm Repair Kit	DB-RK-5303		
02/92→09/96		Suspension Arm Repair Kit	DB-RK-6111	DB-RK-6111	Trailing Arm
02/92→09/96		Tie Rod	DB-DL-8640		Guide Rod
02/92→09/96		Tie Rod	DB-ES-5227		Guide Rod
02/92→09/96		Tie Rod End	CV-ES-14163		for Steering Rod
02/92→09/96		Tie Rod End	DB-ES-8323		
02/92→09/96		Tie Rod End	DB-ES-8617		
02/92→09/96		Track Control Arm		DB-DL-7839	Trailing Arm
3234 K		02/92→09/96	Ball Head, gearshift linkage	DB-ES-8387	
	02/92→09/96	Ball Head, gearshift linkage	DB-ES-8492		
	02/92→09/96	Ball Head, gearshift linkage	DB-ES-8500		
	02/92→09/96	Centre Rod	DB-DL-12309		Coupling Rod
	02/92→09/96	Stabiliser Mounting		DB-SB-10407	
	02/92→09/96	Suspension Arm Repair Kit	DB-RK-5303		
	02/92→09/96	Suspension Arm Repair Kit	DB-RK-6111	DB-RK-6111	Trailing Arm
	02/92→09/96	Tie Rod	DB-DL-8640		Guide Rod
	02/92→09/96	Tie Rod	DB-ES-5227		Guide Rod
	02/92→09/96	Tie Rod End	CV-ES-14163		for Steering Rod
	02/92→09/96	Tie Rod End	DB-ES-8323		
	02/92→09/96	Tie Rod End	DB-ES-8617		
	02/92→09/96	Track Control Arm		DB-DL-7839	Trailing Arm
	3235	07/88→08/94	Centre Rod	DB-DL-5217	
07/88→08/94		Centre Rod	DB-DL-5233		Push Rod* 5 937 288 *→
07/88→08/94		Centre Rod	DB-DL-7831		Push Rod
07/88→08/94		Centre Rod	DB-DL-7831		Push Rod→* K 226 467 *
07/88→08/94		Centre Rod	DB-DL-8131		Push Rod
07/88→08/94		Centre Rod	DB-DL-8138		Push Rod
07/88→08/94		Centre Rod	DB-DL-8618		Push Rod
07/88→08/94		Centre Rod	DB-DL-12309		Coupling Rod
07/88→08/94		Tie Rod	DB-DL-8640		Guide Rod
07/88→08/94		Tie Rod	DB-ES-5209		
07/88→08/94		Tie Rod End	CV-ES-12461		for Steering Rod
07/88→08/94		Tie Rod End	CV-ES-14163		for Steering Rod
07/88→08/94		Track Control Arm		DB-DL-7839	Trailing Arm
07/88→08/94		Track Control Arm		DB-DS-6088	Suspension Rod, Trailing Arm
10/88→07/92		Centre Rod	DB-DL-8131		Push Rod→* 5 940 186 *
10/88→07/92		Centre Rod	DB-DL-8138		Push Rod* 5 940 187 *→
10/88→07/92		Centre Rod	DB-DL-10216		Push Rod
10/88→07/92		Stabiliser Mounting		DB-SB-10407	
10/88→07/92		Suspension Arm Repair Kit		DB-RK-5281	
10/88→07/92		Suspension Arm Repair Kit	DB-RK-5307		
10/88→07/92		Suspension Arm Repair Kit	DB-RK-6111	DB-RK-6111	Trailing Arm
10/88→07/92		Tie Rod	DB-ES-5227		Guide Rod

CV-ES-12461

Length: 120
Cone Ø: d1 Ø 26 / d2 Ø 23,5
Thread: M30 x 1,5 LHT
0003300035, 3300148, 0003406213, 0013306635, 0013308835, 0014604048, 0014604348, 14606448, 0024600248, 3023300035, 3023300135, 3023300235, 3023300335, 3453307235, 3453307435, 3503307135, A0003300148, A0013306635, A0013308835, A0014604048, A0014604348, A0014606448, A0024600248, A3023300035, A3023300135, A3023300235, A3023300335, A3503307135



CV-ES-14163

Length: 125
Cone Ø: d1 Ø 30 / d2 Ø 27
Thread: M30 x 1,5 RHT
0003305248, 0003387310, 0004600348, 0004600948, 0004602848, 0004602948, 0004608948, 0014600248, 0014600848, 0014601248, 0014602248, 0014607748, 0024600148, A0003387310, A0004600348, A0004602848, A0004602948, A0014600848, A0014601248, A0014602248, A0014607748



DB-DL-5217

Length: 862 Ø: 40
Cone Ø: d1 Ø 30 / d2 Ø 27
01214700A, 6204600405, 6204600805, 6204602905, 6204603005



DB-DL-5233

Length: 895
Ø: 48
Cone Ø: d1 Ø 30 / d2 Ø 27
01217300A, 4609805, 0004609805, 0004609905, 4609905



DB-DL-7831

Length: 870
Ø: 42
Cone Ø: d1 Ø 30 / d2 Ø 27
01215200A, 6254602505



DB-DL-7839

Length: 585
Ø: 50
Hole Distance: 152 / 152
3953500206, 6593500106, 6593502406



DB-DL-8131

Length: 1115 Ø: 52
Cone Ø: d1 Ø 32 / d2 Ø 28,8
0004604405, 6254605005



DB-DL-8138

Length: 1130
Ø: 40
Cone Ø: d1 Ø 32 / d2 Ø 28,8
4606605, 0004606605



DB-DL-8618

Length: 680
Ø: 42
Cone Ø: d1 Ø 32 / d2 Ø 28,8
4604305, 0004604305, 6254604805



DB-DL-8640

Length: 1615 Ø: 50
Cone Ø: d1 Ø 32 / d2 Ø 29
6253301503, 6253301603, 6253302403, 6253302503, 9423300803, 9423302103, 9493300203, 9493300303, 9493300903



DB-DL-10216

Length: 1190
Ø: 40
Cone Ø: d1 Ø 32 / d2 Ø 29
0004604905



DB-DL-12309

Length: 685 Ø: 40
Cone Ø: d1 Ø 32 / d2 Ø 28,8
0004606005, 0004606305



DB-DS-6088

Length: 585
Ø: 50
Hole Distance: 152 / 152
3953500706, 6593500406



DB-ES-5209

Length: 1670 Ø: 50
Cone Ø: d1 Ø 30 / d2 Ø 27
6203300503, 6203300603



DB-ES-5227

Length: 1588 Ø: 60
Cone Ø: d1 Ø 38 / d2 Ø 34,3
6253300903, 6253301203, 9443300203



DB-ES-8323

Length: 75
Cone Ø: d1 Ø 32 / d2 Ø 28,8
Thread: M26 x 1,5 RHT
0014601548, 0014601648, 0024600648, A0014601648, A0024600648



DB-ES-8387

Length: 55
Cone Ø: d1 Ø 10 / d2 Ø 10
Thread: M14 x 1,5 RHT
0009966845, 0009967045



DB-ES-8492

Length: 60
Cone Ø: d1 Ø 10 / d2 Ø 10
Thread: M12 x 1,75 RHT
0009966645, 3752680189, A3752680189



DB-ES-8500

Length: 55
Cone Ø: d1 Ø 12 / d2 Ø 10,8
Thread: M14 x 1,5 RHT
0002685989



DB-ES-8617

Length: 155
Cone Ø: d1 Ø 32 / d2 Ø 28,8
Thread: M30 x 1,5 RHT
0004604848, 4604848, 0014600648, 14600648



DB-RK-5281

Ø: 86
01303700A, 6253200111



DB-RK-5303

Ø: 37
01304400A, 6253200611



DB-RK-5307

Ø: 70
01303500A, 6473200028



DB-RK-6111

Ø: 85
Hole Distance: 152
Thick/Height: 24
0003500613, 0005861135



DB-SB-10407

Ø: 61 Thick/Height: 46
0003235985, 0003262481, 0003262981





SK ...

3235 K	07/87→07/92	Centre Rod	DB-DL-7831		Push Rod
	07/87→07/92	Centre Rod	DB-DL-7831		Push Rod* 5 401 092 *→
	07/87→07/92	Centre Rod	DB-DL-8131		Push Rod
	07/87→07/92	Centre Rod	DB-DL-8131		Push Rod→* 5 940 186 *
	07/87→07/92	Centre Rod	DB-DL-8138		Push Rod
	07/87→07/92	Centre Rod	DB-DL-8138		Push Rod* 5 940 187 *→
	07/87→07/92	Centre Rod	DB-DL-8618		Push Rod
	07/87→07/92	Centre Rod	DB-DL-10216		Push Rod
	07/87→07/92	Centre Rod	DB-DL-12309		Coupling Rod
	07/87→07/92	Stabiliser Mounting		DB-SB-10407	
	07/87→07/92	Suspension Arm Repair Kit		DB-RK-5281	
	07/87→07/92	Suspension Arm Repair Kit	DB-RK-5307		
	07/87→07/92	Suspension Arm Repair Kit	DB-RK-6111	DB-RK-6111	Trailing Arm
	07/87→07/92	Tie Rod	DB-DL-8640		Guide Rod
	07/87→07/92	Tie Rod	DB-ES-5209		
	07/87→07/92	Tie Rod	DB-ES-5227		Guide Rod
	07/87→07/92	Tie Rod End	CV-ES-12461		for Steering Rod
	07/87→07/92	Tie Rod End	CV-ES-14163		for Steering Rod
	07/87→07/92	Tie Rod End	DF-ES-7777		
	07/87→07/92	Track Control Arm		DB-DL-7839	Trailing Arm
07/87→07/92	Track Control Arm		DB-DS-6088	Suspension Rod, Trailing Arm	
3235 L	07/87→09/96	Centre Rod	DB-DL-5217		Push Rod
	07/87→09/96	Centre Rod	DB-DL-7831		Push Rod
	07/87→09/96	Centre Rod	DB-DL-8131		Push Rod
	07/87→09/96	Centre Rod	DB-DL-8138		Push Rod
	07/87→09/96	Centre Rod	DB-DL-8618		Push Rod
	07/87→09/96	Centre Rod	DB-DL-10216		Push Rod
	07/87→09/96	Centre Rod	DB-DL-12308		Coupling Rod
	07/87→09/96	Centre Rod	DB-DL-12309		Coupling Rod
	07/87→09/96	Suspension Arm Repair Kit		DB-RK-8564	Wishbone (CV)
	07/87→09/96	Suspension Arm Repair Kit		DB-RK-12372	for Wishbone (CV), Lifting Axle, K063070→
	07/87→09/96	Suspension Arm Repair Kit		DF-RK-9336	
	07/87→09/96	Suspension Arm Repair Kit		DF-RK-9336	* K 063 070 *→
	07/87→09/96	Suspension Arm Repair Kit		DF-RK-9336	Lifting Axle, * K 063 070 *→
	07/87→09/96	Suspension Arm Repair Kit		MN-RK-9387	
	07/87→09/96	Suspension Arm Repair Kit		MN-RK-9387	→* 5 926 392 *
	07/87→09/96	Suspension Arm Repair Kit		MN-RK-9387	Lifting Axle, →* 5 926 392 *
	07/87→09/96	Suspension Arm Repair Kit	DB-RK-5282		
	07/87→09/96	Tie Rod	DB-DL-8640		Guide Rod
	07/87→09/96	Tie Rod	DB-ES-5209		
	07/87→09/96	Tie Rod End	CV-ES-12461		for Steering Rod
	07/87→09/96	Tie Rod End	CV-ES-14163		for Steering Rod
	07/87→09/96	Track Control Arm		DB-DL-7840	Suspension Rod, Trailing Arm
	07/87→09/96	Track Control Arm		DB-DL-7840	Suspension Rod, Trailing Arm* 5 922 799 *→
	07/87→09/96	Track Control Arm		DB-VB-7776	Wishbone (CV);Trailing Arm* 5 926 393 *→
07/87→09/96	Track Control Arm		DB-VB-7776	Wishbone (CV);Trailing Arm, Lifting Axle	
3236 A	07/87→09/96	Centre Rod	DB-DL-5217		Push Rod
	07/87→09/96	Centre Rod	DB-DL-10216		Push Rod
	07/87→09/96	Stabiliser Mounting		DB-SB-10407	
	07/87→09/96	Suspension Arm Repair Kit		DB-RK-7267	for Drag Link
	07/87→09/96	Tie Rod	DB-ES-5209		
	07/87→09/96	Tie Rod	DB-ES-5227		Guide Rod
	07/87→09/96	Tie Rod End	CV-ES-12461		for Steering Rod
	07/87→09/96	Tie Rod End	DB-ES-5234		for Steering Rod
	07/87→09/96	Track Control Arm		DB-DL-6227	Suspension Rod, Trailing Arm
	3238	10/90→09/96	Ball Head, gearshift linkage	DB-ES-8387	
10/90→09/96		Ball Head, gearshift linkage	DB-ES-8491		
10/90→09/96		Ball Head, gearshift linkage	DB-ES-8492		
10/90→09/96		Ball Head, gearshift linkage	DB-ES-8500		
10/90→09/96		Centre Rod	DB-DL-7831		Push Rod
10/90→09/96		Centre Rod	DB-DL-7831		Push Rod→* K 003 418 *
10/90→09/96		Centre Rod	DB-DL-7831		Push Rod→* K 009 191 *
10/90→09/96		Centre Rod	DB-DL-8131		Push Rod



SK ...

3238 ...	10/90→09/96	Centre Rod	DB-DL-8131		Push Rod→* 5 940 186 *	
	10/90→09/96	Centre Rod	DB-DL-8138		Push Rod	
	10/90→09/96	Centre Rod	DB-DL-8138		Push Rod* 5 940 187 *→	
	10/90→09/96	Centre Rod	DB-DL-8618		Push Rod	
	10/90→09/96	Centre Rod	DB-DL-8618		Push Rod→* K 003 418 *	
	10/90→09/96	Centre Rod	DB-DL-8618		Push Rod→* K 009 191 *	
	10/90→09/96	Centre Rod	DB-DL-9256		Push Rod	
	10/90→09/96	Centre Rod	DB-DL-9256		Push Rod* K 003 419 *→	
	10/90→09/96	Centre Rod	DB-DL-9256		Push Rod* K 009 192 *→	
	10/90→09/96	Centre Rod	DB-DL-10216		Push Rod	
	10/90→09/96	Centre Rod	DB-DL-12309		Coupling Rod	
	10/90→09/96	Stabiliser Mounting		DB-SB-10407		
	10/90→09/96	Suspension Arm Repair Kit		DB-RK-5281		
	10/90→09/96	Suspension Arm Repair Kit	DB-RK-5307			
	10/90→09/96	Suspension Arm Repair Kit	DB-RK-6111	DB-RK-6111	Trailing Arm	
	10/90→09/96	Tie Rod	DB-DL-8640		Guide Rod	
	10/90→09/96	Tie Rod	DB-ES-5209			
	10/90→09/96	Tie Rod	DB-ES-5227		Guide Rod	
	10/90→09/96	Tie Rod End	CV-ES-12461		for Steering Rod	
	10/90→09/96	Tie Rod End	CV-ES-14163		for Steering Rod	
	10/90→09/96	Tie Rod End	DB-ES-5234		for Steering Rod	
	10/90→09/96	Tie Rod End	DB-ES-8323			
	10/90→09/96	Track Control Arm		DB-DL-7839	Trailing Arm	
	10/90→09/96	Track Control Arm		DB-DS-6088	Suspension Rod, Trailing Arm	
	03/91→09/96	Centre Rod	DB-DL-5217		Push Rod	
	3238 L	07/87→09/96	Ball Head, gearshift linkage	DB-ES-8387		
		07/87→09/96	Ball Head, gearshift linkage	DB-ES-8491		
		07/87→09/96	Ball Head, gearshift linkage	DB-ES-8492		
		07/87→09/96	Ball Head, gearshift linkage	DB-ES-8500		
		07/87→09/96	Centre Rod	DB-DL-7831		Push Rod
07/87→09/96		Centre Rod	DB-DL-7831		Push Rod* K 189 672 *→* K 226 467 *	
07/87→09/96		Centre Rod	DB-DL-8131		Push Rod	
07/87→09/96		Centre Rod	DB-DL-8138		Push Rod	
07/87→09/96		Centre Rod	DB-DL-8618		Push Rod	
07/87→09/96		Centre Rod	DB-DL-10216		Push Rod	
07/87→09/96		Centre Rod	DB-DL-12308		Coupling Rod	
07/87→09/96		Centre Rod	DB-DL-12309		Coupling Rod	
07/87→09/96		Suspension Arm Repair Kit		DB-RK-8564	Wishbone (CV)	
07/87→09/96		Suspension Arm Repair Kit		DB-RK-12372	for Wishbone (CV), Lifting Axle, k→	
07/87→09/96		Suspension Arm Repair Kit		DF-RK-9336		
07/87→09/96		Suspension Arm Repair Kit		DF-RK-9336	* K 063 070 *→	
07/87→09/96		Suspension Arm Repair Kit		DF-RK-9336	Lifting Axle, * K 063 070 *→	
07/87→09/96		Suspension Arm Repair Kit		MN-RK-9387		
07/87→09/96		Suspension Arm Repair Kit		MN-RK-9387	→* 5 926 392 *	
07/87→09/96		Suspension Arm Repair Kit		MN-RK-9387	Lifting Axle, →* 5 926 392 *	
07/87→09/96		Suspension Arm Repair Kit	DB-RK-5282			
07/87→09/96		Tie Rod	DB-DL-8640		Guide Rod	
07/87→09/96		Tie Rod	DB-ES-5209			
07/87→09/96		Tie Rod End	CV-ES-12461		for Steering Rod	
07/87→09/96		Tie Rod End	CV-ES-14163		for Steering Rod	
07/87→09/96		Track Control Arm		DB-DL-7840	Suspension Rod, Trailing Arm	
07/87→09/96		Track Control Arm		DB-DL-7840	Suspension Rod, Trailing Arm* 5 922 799 *→	
07/87→09/96		Track Control Arm		DB-VB-7776	Wishbone (CV);Trailing Arm* 5 926 393 *→	
07/87→09/96		Track Control Arm		DB-VB-7776	Wishbone (CV);Trailing Arm, Lifting Axle	
3238, 3238 L		10/90→09/96	Ball Head, gearshift linkage	DB-ES-8387		
	10/90→09/96	Ball Head, gearshift linkage	DB-ES-8491			
	10/90→09/96	Ball Head, gearshift linkage	DB-ES-8492			
	10/90→09/96	Ball Head, gearshift linkage	DB-ES-8500			
	10/90→09/96	Centre Rod	DB-DL-7831		Push Rod	
	10/90→09/96	Centre Rod	DB-DL-7831		Push Rod→* K 003 418 *	
	10/90→09/96	Centre Rod	DB-DL-7831		Push Rod→* K 009 191 *	
	10/90→09/96	Centre Rod	DB-DL-8131		Push Rod	
10/90→09/96	Centre Rod	DB-DL-8131		Push Rod→* 5 940 186 *		



SK ...

3238, 3238 L ...	10/90→09/96	Centre Rod	DB-DL-8138		Push Rod	
	10/90→09/96	Centre Rod	DB-DL-8138		Push Rod* 5 940 187 *→	
	10/90→09/96	Centre Rod	DB-DL-8618		Push Rod	
	10/90→09/96	Centre Rod	DB-DL-8618		Push Rod→* K 003 418 *	
	10/90→09/96	Centre Rod	DB-DL-8618		Push Rod→* K 009 191 *	
	10/90→09/96	Centre Rod	DB-DL-9256		Push Rod	
	10/90→09/96	Centre Rod	DB-DL-9256		Push Rod* K 003 419 *→	
	10/90→09/96	Centre Rod	DB-DL-9256		Push Rod* K 009 192 *→	
	10/90→09/96	Centre Rod	DB-DL-10216		Push Rod	
	10/90→09/96	Centre Rod	DB-DL-12309		Coupling Rod	
	10/90→09/96	Stabiliser Mounting		DB-SB-10407		
	10/90→09/96	Suspension Arm Repair Kit		DB-RK-5281		
	10/90→09/96	Suspension Arm Repair Kit	DB-RK-5307			
	10/90→09/96	Tie Rod	DB-DL-8640		Guide Rod	
	10/90→09/96	Tie Rod	DB-ES-5209			
	10/90→09/96	Tie Rod	DB-ES-5227		Guide Rod	
	10/90→09/96	Tie Rod End	CV-ES-12461		for Steering Rod	
	10/90→09/96	Tie Rod End	CV-ES-14163		for Steering Rod	
	10/90→09/96	Tie Rod End	DB-ES-5234		for Steering Rod	
	10/90→09/96	Tie Rod End	DB-ES-8323			
	10/90→09/96	Track Control Arm		DB-DL-7839	Trailing Arm	
	10/90→09/96	Track Control Arm		DB-DS-6088	Suspension Rod, Trailing Arm	
	01/94→09/96	Centre Rod	DB-DL-5233		Push Rod* K 016 738 *→	
	01/94→09/96	Centre Rod	DB-DL-7831		Push Rod→* K 226 467 *	
	01/94→09/96	Suspension Arm Repair Kit	DB-RK-6111	DB-RK-6111	Trailing Arm	
	3244	01/94→09/96	Ball Head, gearshift linkage	DB-ES-8387		
		01/94→09/96	Ball Head, gearshift linkage	DB-ES-8491		
		01/94→09/96	Ball Head, gearshift linkage	DB-ES-8492		
		01/94→09/96	Ball Head, gearshift linkage	DB-ES-8500		
		01/94→09/96	Centre Rod	DB-DL-7831		Push Rod
		01/94→09/96	Centre Rod	DB-DL-7831		Push Rod→* K 003 418 *
		01/94→09/96	Centre Rod	DB-DL-7831		Push Rod→* K 009 191 *
		01/94→09/96	Centre Rod	DB-DL-8131		Push Rod
01/94→09/96		Centre Rod	DB-DL-8131		Push Rod→* 5 940 186 *	
01/94→09/96		Centre Rod	DB-DL-8138		Push Rod	
01/94→09/96		Centre Rod	DB-DL-8138		Push Rod* 5 940 187 *→	
01/94→09/96		Centre Rod	DB-DL-8618		Push Rod	
01/94→09/96		Centre Rod	DB-DL-8618		Push Rod→* K 003 418 *	
01/94→09/96		Centre Rod	DB-DL-8618		Push Rod→* K 009 191 *	
01/94→09/96		Centre Rod	DB-DL-9256		Push Rod	
01/94→09/96		Centre Rod	DB-DL-9256		Push Rod* K 003 419 *→	
01/94→09/96		Centre Rod	DB-DL-9256		Push Rod* K 009 192 *→	
01/94→09/96		Centre Rod	DB-DL-10216		Push Rod	
01/94→09/96		Centre Rod	DB-DL-12309		Coupling Rod	
01/94→09/96		Suspension Arm Repair Kit	DB-RK-6111	DB-RK-6111	Trailing Arm	
01/94→09/96		Tie Rod	DB-DL-8640		Guide Rod	
01/94→09/96		Tie Rod	DB-ES-5209			
01/94→09/96		Tie Rod	DB-ES-5227		Guide Rod	
01/94→09/96		Tie Rod End	CV-ES-12461		for Steering Rod	
01/94→09/96		Tie Rod End	DB-ES-5234		for Steering Rod	
01/94→09/96		Tie Rod End	DB-ES-8323			
01/94→09/96		Track Control Arm		DB-DL-7839	Trailing Arm	
01/94→09/96		Track Control Arm		DB-DS-6088	Suspension Rod, Trailing Arm	
3244 L		07/87→09/96	Ball Head, gearshift linkage	DB-ES-8387		
		07/87→09/96	Ball Head, gearshift linkage	DB-ES-8491		
		07/87→09/96	Ball Head, gearshift linkage	DB-ES-8492		
		07/87→09/96	Ball Head, gearshift linkage	DB-ES-8500		
		07/87→09/96	Centre Rod	DB-DL-5241		Suspension Rod
	07/87→09/96	Centre Rod	DB-DL-7270		Push Rod;Suspension Rod	
	07/87→09/96	Centre Rod	DB-DL-7831		Push Rod	
	07/87→09/96	Centre Rod	DB-DL-7831		Push Rod* K 189 672 *→* K 226 467 *	
	07/87→09/96	Centre Rod	DB-DL-8131		Push Rod	
07/87→09/96	Centre Rod	DB-DL-8138		Push Rod		

CV-ES-12461

Length: 120
Cone Ø: d1 Ø 26 / d2 Ø 23,5
Thread: M30 x 1,5 LHT
 0003300035, 3300148, 0003406213, 0013306635, 0013308835, 0014604048, 0014604348, 14606448, 0024600248, 3023300035, 3023300135, 3023300235, 3023300335, 3453307235, 3453307435, 3503307135, A0003300148, A0013306635, A0013308835, A0014604048, A0014604348, A0014606448, A0024600248, A3023300035, A3023300135, A3023300235, A3023300335, A3503307135

**CV-ES-14163**

Length: 125
Cone Ø: d1 Ø 30 / d2 Ø 27
Thread: M30 x 1,5 RHT
 0003305248, 0003387310, 0004600348, 0004600948, 0004602848, 0004602948, 0004608948, 0014600248, 0014600848, 0014601248, 0014602248, 0014607748, 0024600148, A0003387310, A0004600348, A0004602848, A0004602948, A0014600848, A0014601248, A0014602248, A0014607748

**DB-DL-5233**

Length: 895 Ø: 48
Cone Ø: d1 Ø 30 / d2 Ø 27
 01217300A, 0004609805, 0004609905

**DB-DL-5241**

Length: 875 Ø: 40
Cone Ø: d1 Ø 30 / d2 Ø 27
 01215300A, 0004609205, 0004609305, 0014606905

**DB-DL-7270**

Length: 875 Ø: 40
Cone Ø: d1 Ø 28,6 / d2 Ø 23,9
 01208300A, 0024604705, 0024604805, 0034604905, A0024604705

**DB-DL-7831**

Length: 870
 Ø: 42
Cone Ø: d1 Ø 30 / d2 Ø 27
 01215200A, 6254602505

**DB-DL-7839**

Length: 585
 Ø: 50
Hole Distance: 152 / 152
 3953500206, 6593500106, 6593502406

**DB-DL-8131**

Length: 1115 Ø: 52
Cone Ø: d1 Ø 32 / d2 Ø 28,8
 0004604405, 6254605005

**DB-DL-8138**

Length: 1130
 Ø: 40
Cone Ø: d1 Ø 32 / d2 Ø 28,8
 4606605, 0004606605

**DB-DL-8618**

Length: 680
 Ø: 42
Cone Ø: d1 Ø 32 / d2 Ø 28,8
 0004604305, 4604305, 6254604805

**DB-DL-8640**

Length: 1615 Ø: 50
Cone Ø: d1 Ø 32 / d2 Ø 29
 6253301503, 6253301603, 6253302403, 6253302503, 9423300803, 9423302103, 9493300203, 9493300303, 9493300903

**DB-DL-9256**

Length: 905
 Ø: 48
Cone Ø: d1 Ø 32 / d2 Ø 29
 0014604205, 14604205

**DB-DL-10216**

Length: 1190
 Ø: 40
Cone Ø: d1 Ø 32 / d2 Ø 29
 0004604905

**DB-DL-12309**

Length: 685 Ø: 40
Cone Ø: d1 Ø 32 / d2 Ø 28,8
 0004606005, 0004606305

**DB-DS-6088**

Length: 585
 Ø: 50
Hole Distance: 152 / 152
 3953500706, 6593500406

**DB-ES-5209**

Length: 1670 Ø: 50
Cone Ø: d1 Ø 30 / d2 Ø 27
 6203300503, 6203300603

**DB-ES-5227**

Length: 1588 Ø: 60
Cone Ø: d1 Ø 38 / d2 Ø 34,3
 6253300903, 6253301203, 9443300203

**DB-ES-5234**

Length: 135
Cone Ø: d1 Ø 38 / d2 Ø 34,3
Thread: M38 x 1,5 RHT
 0004601748, 120322305, 2205000400

**DB-ES-8323**

Length: 75
Cone Ø: d1 Ø 32 / d2 Ø 28,8
Thread: M26 x 1,5 RHT
 0014601548, 0014601648, 0024600648, A0014601648, A0024600648

**DB-ES-8387**

Length: 55
Cone Ø: d1 Ø 10 / d2 Ø 10
Thread: M14 x 1,5 RHT
 0009966845, 0009967045

**DB-ES-8491**

Length: 60
Cone Ø: d1 Ø 10 / d2 Ø 10
Thread: M12 x 1,75 LHT
 0009966745

**DB-ES-8492**

Length: 60
Cone Ø: d1 Ø 10 / d2 Ø 10
Thread: M12 x 1,75 RHT
 0009966645, 3752680189, A3752680189

**DB-ES-8500**

Length: 55
Cone Ø: d1 Ø 12 / d2 Ø 10,8
Thread: M14 x 1,5 RHT
 0002685989

**DB-RK-5281**

Ø: 86
 01303700A, 6253200111

**DB-RK-5307**

Ø: 70
 01303500A, 6473200028

**DB-RK-6111**

Ø: 85
Hole Distance: 152
Thick/Height: 24
 0003500613, 0005861135

**DB-SB-10407**

Ø: 61 **Thick/Height:** 46
 0003235985, 0003262481, 0003262981



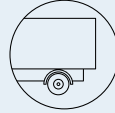

SK ...

3244 L ...	07/87→09/96	Centre Rod	DB-DL-8618		Push Rod
	07/87→09/96	Centre Rod	DB-DL-12308		Coupling Rod
	07/87→09/96	Suspension Arm Repair Kit		DB-RK-8550	for Wishbone (CV)
	07/87→09/96	Suspension Arm Repair Kit		DB-RK-8564	Wishbone (CV)
	07/87→09/96	Suspension Arm Repair Kit		DB-RK-12372	for Wishbone (CV)K063070→
	07/87→09/96	Suspension Arm Repair Kit		DF-RK-9336	
	07/87→09/96	Suspension Arm Repair Kit		DF-RK-9336	* K 063 070 *→
	07/87→09/96	Suspension Arm Repair Kit		DF-RK-9336	Lifting Axle, * K 063 070 *→
	07/87→09/96	Suspension Arm Repair Kit		MN-RK-9387	
	07/87→09/96	Suspension Arm Repair Kit		MN-RK-9387	→* 5 926 392 *
	07/87→09/96	Suspension Arm Repair Kit		MN-RK-9387	Lifting Axle, →* 5 926 392 *
	07/87→09/96	Suspension Arm Repair Kit	DB-RK-5282		
	07/87→09/96	Tie Rod	DB-DL-8640		Guide Rod
	07/87→09/96	Tie Rod	DB-ES-5209		
	07/87→09/96	Tie Rod End	CV-ES-14163		for Steering Rod
	07/87→09/96	Track Control Arm		DB-DL-7840	Suspension Rod, Trailing Arm
	07/87→09/96	Track Control Arm		DB-DL-7840	Suspension Rod, Trailing Arm* 5 922 799 *→
	07/87→09/96	Track Control Arm		DB-VB-7776	Wishbone (CV);Trailing Arm* 5 926 393 *→
07/87→09/96	Track Control Arm		DB-VB-7776	Wishbone (CV);Trailing Arm, Lifting Axle	
3248	07/87→09/96	Ball Head, gearshift linkage	DB-ES-8387		
	07/87→09/96	Ball Head, gearshift linkage	DB-ES-8491		
	07/87→09/96	Ball Head, gearshift linkage	DB-ES-8492		
	07/87→09/96	Ball Head, gearshift linkage	DB-ES-8500		
	07/87→09/96	Centre Rod	DB-DL-5217		Push Rod
	07/87→09/96	Centre Rod	DB-DL-5233		Push Rod* 5 937 288 *→
	07/87→09/96	Centre Rod	DB-DL-5233		Push Rod* K 017 164 *→
	07/87→09/96	Centre Rod	DB-DL-7831		Push Rod
	07/87→09/96	Centre Rod	DB-DL-7831		Push Rod→* K 226 467 *
	07/87→09/96	Centre Rod	DB-DL-8131		Push Rod
	07/87→09/96	Centre Rod	DB-DL-8138		Push Rod
	07/87→09/96	Centre Rod	DB-DL-8618		Push Rod
	07/87→09/96	Centre Rod	DB-DL-10216		Push Rod
	07/87→09/96	Centre Rod	DB-DL-12309		Coupling Rod
	07/87→09/96	Suspension Arm Repair Kit	DB-RK-6111	DB-RK-6111	Trailing Arm
	07/87→09/96	Tie Rod	DB-DL-8640		Guide Rod
	07/87→09/96	Tie Rod	DB-ES-5209		
	07/87→09/96	Tie Rod End	CV-ES-12461		for Steering Rod
	07/87→09/96	Tie Rod End	CV-ES-14163		for Steering Rod
	07/87→09/96	Track Control Arm		DB-DL-7839	Trailing Arm
07/87→09/96	Track Control Arm		DB-DS-6088	Suspension Rod, Trailing Arm	
3250 L	07/87→09/96	Ball Head, gearshift linkage	DB-ES-8387		
	07/87→09/96	Ball Head, gearshift linkage	DB-ES-8491		
	07/87→09/96	Ball Head, gearshift linkage	DB-ES-8492		
	07/87→09/96	Ball Head, gearshift linkage	DB-ES-8500		
	07/87→09/96	Centre Rod	DB-DL-5217		Push Rod
	07/87→09/96	Centre Rod	DB-DL-7831		Push Rod
	07/87→09/96	Centre Rod	DB-DL-7831		Push Rod* K 189 672 *→* K 226 467 *
	07/87→09/96	Centre Rod	DB-DL-8131		Push Rod
	07/87→09/96	Centre Rod	DB-DL-8138		Push Rod
	07/87→09/96	Centre Rod	DB-DL-8618		Push Rod
	07/87→09/96	Centre Rod	DB-DL-10216		Push Rod
	07/87→09/96	Centre Rod	DB-DL-12308		Coupling Rod
	07/87→09/96	Centre Rod	DB-DL-12309		Coupling Rod
	07/87→09/96	Suspension Arm Repair Kit		DB-RK-8564	Wishbone (CV)
	07/87→09/96	Suspension Arm Repair Kit		DB-RK-12372	for Wishbone (CV), Lifting Axle, K063070→
	07/87→09/96	Suspension Arm Repair Kit		DF-RK-9336	
	07/87→09/96	Suspension Arm Repair Kit		DF-RK-9336	* K 063 070 *→
	07/87→09/96	Suspension Arm Repair Kit		DF-RK-9336	Lifting Axle, * K 063 070 *→
	07/87→09/96	Suspension Arm Repair Kit		MN-RK-9387	
	07/87→09/96	Suspension Arm Repair Kit		MN-RK-9387	→* 5 926 392 *
	07/87→09/96	Suspension Arm Repair Kit		MN-RK-9387	Lifting Axle, →* 5 926 392 *
	07/87→09/96	Suspension Arm Repair Kit	DB-RK-5282		
	07/87→09/96	Tie Rod	DB-DL-8640		Guide Rod

CV-ES-12461

Length: 120
Cone Ø: d1 Ø 26 / d2 Ø 23,5
Thread: M30 x 1,5 LHT
 0003300035, 3300148, 0003406213, 0013306635, 0013308835, 0014604048, 0014604348, 14606448, 0024600248, 3023300035, 3023300135, 3023300235, 3023300335, 3453307235, 3453307435, 3503307135, A0003300148, A0013306635, A0013308835, A0014604048, A0014604348, A0014606448, A0024600248, A3023300035, A3023300135, A3023300235, A3023300335, A3503307135



CV-ES-14163

Length: 125
Cone Ø: d1 Ø 30 / d2 Ø 27
Thread: M30 x 1,5 RHT
 0003305248, 0003387310, 0004600348, 0004600948, 0004602848, 0004602948, 0004608948, 0014600248, 0014600848, 0014601248, 0014602248, 0014607748, 0024600148, A0003387310, A0004600348, A0004602848, A0004602948, A0014600848, A0014601248, A0014602248, A0014607748



DB-DL-5217

Length: 862 Ø: 40
Cone Ø: d1 Ø 30 / d2 Ø 27
 01214700A, 6204600405, 6204600805, 6204602905, 6204603005



DB-DL-5233

Length: 895 Ø: 48
Cone Ø: d1 Ø 30 / d2 Ø 27
 01217300A, 0004609805, 0004609905



DB-DL-7831

Length: 870
Ø: 42
Cone Ø: d1 Ø 30 / d2 Ø 27
 01215200A, 6254602505



DB-DL-7839

Length: 585
Ø: 50
Hole Distance: 152 / 152
 3953500206, 6593500106, 6593502406



DB-DL-7840

Length: 595
Ø: 62
Hole Distance: 152 / 152
 6203500006, 6203500106, 6203500306, 6533500306



DB-DL-8131

Length: 1115 Ø: 52
Cone Ø: d1 Ø 32 / d2 Ø 28,8
 0004604405, 6254605005



DB-DL-8138

Length: 1130
Ø: 40
Cone Ø: d1 Ø 32 / d2 Ø 28,8
 0004606605, 4606605



DB-DL-8618

Length: 680
Ø: 42
Cone Ø: d1 Ø 32 / d2 Ø 28,8
 0004604305, 4604305, 6254604805



DB-DL-8640

Length: 1615 Ø: 50
Cone Ø: d1 Ø 32 / d2 Ø 29
 6253301503, 6253301603, 6253302403, 6253302503, 9423300803, 9423302103, 9493300203, 9493300303, 9493300903



DB-DL-10216

Length: 1190
Ø: 40
Cone Ø: d1 Ø 32 / d2 Ø 29
 0004604905



DB-DL-12308

Length: 885
Ø: 42
Cone Ø: d1 Ø 30 / d2 Ø 27
 4600705, 0004600705



DB-DL-12309

Length: 685 Ø: 40
Cone Ø: d1 Ø 32 / d2 Ø 28,8
 0004606005, 0004606305



DB-DS-6088

Length: 585
Ø: 50
Hole Distance: 152 / 152
 3953500706, 6593500406



DB-ES-5209

Length: 1670 Ø: 50
Cone Ø: d1 Ø 30 / d2 Ø 27
 6203300503, 6203300603



DB-ES-8387

Length: 55
Cone Ø: d1 Ø 10 / d2 Ø 10
Thread: M14 x 1,5 RHT
 0009966845, 0009967045



DB-ES-8491

Length: 60
Cone Ø: d1 Ø 10 / d2 Ø 10
Thread: M12 x 1,75 LHT
 0009966745



DB-ES-8492

Length: 60
Cone Ø: d1 Ø 10 / d2 Ø 10
Thread: M12 x 1,75 RHT
 0009966645, 3752680189, A3752680189



DB-ES-8500

Length: 55
Cone Ø: d1 Ø 12 / d2 Ø 10,8
Thread: M14 x 1,5 RHT
 0002685989



DB-RK-5282

Ø: 59
 01303800A, 6553200111



DB-RK-6111

Ø: 85
Hole Distance: 152
Thick/Height: 24
 0003500613, 0005861135



DB-RK-8550

Ø: 75 **Hole Distance:** 152
Thick/Height: 24
 0003502105, 0003504605



DB-RK-8564

Ø: 90
 01302200A, 3500105, 0003500105, 3500405, 0003500405, 0005861833, 5861833, 81432706047



DB-RK-12372

Ø: 85
Hole Distance: 152
Thick/Height: 24
 003501805, A003501805



DB-VB-7776

Length: 622 **Ø:** 56
Hole Distance: 152 / 152
 6533500205, 6583500205



DF-RK-9336

Ø: 108
 3501705, 0003501705



MN-RK-9387

Ø: 90
 0003500105, 81432706047





SK ...

3250 L ...	07/87→09/96	Tie Rod	DB-ES-5209		
	07/87→09/96	Tie Rod End	CV-ES-12461		for Steering Rod
	07/87→09/96	Track Control Arm		DB-DL-7840	Suspension Rod, Trailing Arm
	07/87→09/96	Track Control Arm		DB-DL-7840	Suspension Rod, Trailing Arm* 5 922 799 *→
	07/87→09/96	Track Control Arm		DB-VB-7776	Wishbone (CV);Trailing Arm* 5 926 393 *→
	07/87→09/96	Track Control Arm		DB-VB-7776	Wishbone (CV);Trailing Arm, Lifting Axle
3253, 3253 L	01/96→09/96	Ball Head, gearshift linkage	DB-ES-8387		
	01/96→09/96	Ball Head, gearshift linkage	DB-ES-8491		
	01/96→09/96	Ball Head, gearshift linkage	DB-ES-8492		
	01/96→09/96	Ball Head, gearshift linkage	DB-ES-8500		
	01/96→09/96	Centre Rod	DB-DL-5217		Push Rod
	01/96→09/96	Centre Rod	DB-DL-5233		Push Rod* K 017 164 *→
	01/96→09/96	Centre Rod	DB-DL-7831		Push Rod
	01/96→09/96	Centre Rod	DB-DL-7831		Push Rod* K 189 672 *→* K 226 467 *
	01/96→09/96	Centre Rod	DB-DL-7831		Push Rod→* K 003 418 *
	01/96→09/96	Centre Rod	DB-DL-7831		Push Rod→* K 009 191 *
	01/96→09/96	Centre Rod	DB-DL-7831		Push Rod→* K 226 467 *
	01/96→09/96	Centre Rod	DB-DL-8131		Push Rod
	01/96→09/96	Centre Rod	DB-DL-8131		Push Rod→* 5 940 186 *
	01/96→09/96	Centre Rod	DB-DL-8138		Push Rod
	01/96→09/96	Centre Rod	DB-DL-8138		Push Rod* 5 940 187 *→
	01/96→09/96	Centre Rod	DB-DL-8618		Push Rod
	01/96→09/96	Centre Rod	DB-DL-8618		Push Rod→* K 003 418 *
	01/96→09/96	Centre Rod	DB-DL-8618		Push Rod→* K 009 191 *
	01/96→09/96	Centre Rod	DB-DL-9256		Push Rod
	01/96→09/96	Centre Rod	DB-DL-9256		Push Rod* K 003 419 *→
	01/96→09/96	Centre Rod	DB-DL-9256		Push Rod* K 009 192 *→
	01/96→09/96	Centre Rod	DB-DL-10216		Push Rod
	01/96→09/96	Centre Rod	DB-DL-12308		Coupling Rod
	01/96→09/96	Centre Rod	DB-DL-12309		Coupling Rod
	01/96→09/96	Stabiliser Mounting		DB-SB-10407	
	01/96→09/96	Suspension Arm Repair Kit		DB-RK-5281	
	01/96→09/96	Suspension Arm Repair Kit		DB-RK-8564	Wishbone (CV)
	01/96→09/96	Suspension Arm Repair Kit		DB-RK-12372	for Wishbone (CV), Lifting Axle, K063070→
	01/96→09/96	Suspension Arm Repair Kit		DF-RK-9336	
	01/96→09/96	Suspension Arm Repair Kit		DF-RK-9336	* K 063 070 *→
	01/96→09/96	Suspension Arm Repair Kit		DF-RK-9336	Lifting Axle, * K 063 070 *→
	01/96→09/96	Suspension Arm Repair Kit		MN-RK-9387	
	01/96→09/96	Suspension Arm Repair Kit		MN-RK-9387	→* 5 926 392 *
	01/96→09/96	Suspension Arm Repair Kit		MN-RK-9387	Lifting Axle, →* 5 926 392 *
	01/96→09/96	Suspension Arm Repair Kit	DB-RK-5282		
	01/96→09/96	Suspension Arm Repair Kit	DB-RK-5307		
	01/96→09/96	Tie Rod	DB-DL-8640		Guide Rod
	01/96→09/96	Tie Rod	DB-ES-5209		
	01/96→09/96	Tie Rod	DB-ES-5227		Guide Rod
	01/96→09/96	Tie Rod End	CV-ES-12461		for Steering Rod
	01/96→09/96	Tie Rod End	DB-ES-5234		for Steering Rod
	01/96→09/96	Tie Rod End	DB-ES-8323		
	01/96→09/96	Track Control Arm		DB-DL-7839	Trailing Arm
	01/96→09/96	Track Control Arm		DB-DL-7840	Suspension Rod, Trailing Arm
	01/96→09/96	Track Control Arm		DB-DL-7840	Suspension Rod, Trailing Arm* 5 922 799 *→
	01/96→09/96	Track Control Arm		DB-DS-6088	Suspension Rod, Trailing Arm
	01/96→09/96	Track Control Arm		DB-VB-7776	Wishbone (CV);Trailing Arm* 5 926 393 *→
01/96→09/96	Track Control Arm		DB-VB-7776	Wishbone (CV);Trailing Arm, Lifting Axle	
3255	07/87→09/96	Ball Head, gearshift linkage	DB-ES-8387		
	07/87→09/96	Ball Head, gearshift linkage	DB-ES-8491		
	07/87→09/96	Ball Head, gearshift linkage	DB-ES-8492		
	07/87→09/96	Ball Head, gearshift linkage	DB-ES-8500		
	07/87→09/96	Centre Rod	DB-DL-5217		Push Rod
	07/87→09/96	Centre Rod	DB-DL-5233		Push Rod* 5 937 288 *→
	07/87→09/96	Centre Rod	DB-DL-7831		Push Rod
07/87→09/96	Centre Rod	DB-DL-8131		Push Rod	
07/87→09/96	Centre Rod	DB-DL-8138		Push Rod	

CV-ES-12461

Length: 120
Cone Ø: d1 Ø 26 / d2 Ø 23,5
Thread: M30 x 1,5 LHT
 0003300035, 3300148, 0003406213, 0013306635,
 0013308835, 0014604048, 0014604348,
 14606448, 0024600248, 3023300035,
 3023300135, 3023300235, 3023300335,
 3453307235, 3453307435, 3503307135,
 A0003300148, A0013306635, A0013308835,
 A0014604048, A0014604348, A0014606448,
 A0024600248, A3023300035, A3023300135,
 A3023300235, A3023300335, A3503307135



DB-DL-5217

Length: 862 **Ø:** 40
Cone Ø: d1 Ø 30 / d2 Ø 27
 01214700A, 6204600405, 6204600805,
 6204602905, 6204603005



DB-DL-5233

Length: 895 **Ø:** 48
Cone Ø: d1 Ø 30 / d2 Ø 27
 01217300A, 0004609805, 0004609905



DB-DL-7831

Length: 870
Ø: 42
Cone Ø: d1 Ø 30 / d2 Ø 27
 01215200A, 6254602505



DB-DL-7839

Length: 585
Ø: 50
Hole Distance: 152 / 152
 3953500206, 6593500106, 6593502406



DB-DL-7840

Length: 595
Ø: 62
Hole Distance: 152 / 152
 6203500006, 6203500106, 6203500306,
 6553500306



DB-DL-8131

Length: 1115 **Ø:** 52
Cone Ø: d1 Ø 32 / d2 Ø 28,8
 0004604405, 6254605005



DB-DL-8138

Length: 1130
Ø: 40
Cone Ø: d1 Ø 32 / d2 Ø 28,8
 0004606605, 4606605



DB-DL-8618

Length: 680
Ø: 42
Cone Ø: d1 Ø 32 / d2 Ø 28,8
 0004604305, 4604305, 6254604805



DB-DL-8640

Length: 1615 **Ø:** 50
Cone Ø: d1 Ø 32 / d2 Ø 29
 6253301503, 6253301603, 6253302403,
 6253302503, 9423300803, 9423302103,
 9493300203, 9493300303, 9493300903



DB-DL-9256

Length: 905
Ø: 48
Cone Ø: d1 Ø 32 / d2 Ø 29
 14604205, 0014604205



DB-DL-10216

Length: 1190
Ø: 40
Cone Ø: d1 Ø 32 / d2 Ø 29
 0004604905



DB-DL-12308

Length: 885
Ø: 42
Cone Ø: d1 Ø 30 / d2 Ø 27
 4600705, 0004600705



DB-DL-12309

Length: 685 **Ø:** 40
Cone Ø: d1 Ø 32 / d2 Ø 28,8
 0004606005, 0004606305



DB-DS-6088

Length: 585
Ø: 50
Hole Distance: 152 / 152
 3953500706, 6593500406



DB-ES-5209

Length: 1670 **Ø:** 50
Cone Ø: d1 Ø 30 / d2 Ø 27
 6203300503, 6203300603



DB-ES-5227

Length: 1588 **Ø:** 60
Cone Ø: d1 Ø 38 / d2 Ø 34,3
 6253300903, 6253301203, 9443300203



DB-ES-5234

Length: 135
Cone Ø: d1 Ø 38 / d2 Ø 34,3
Thread: M38 x 1,5 RHT
 0004601748, 120322305, 2205000400



DB-ES-8323

Length: 75
Cone Ø: d1 Ø 32 / d2 Ø 28,8
Thread: M26 x 1,5 RHT
 0014601548, 0014601648, 0024600648,
 A0014601648, A0024600648



DB-ES-8387

Length: 55
Cone Ø: d1 Ø 10 / d2 Ø 10
Thread: M14 x 1,5 RHT
 0009966845, 0009967045



DB-ES-8491

Length: 60
Cone Ø: d1 Ø 10 / d2 Ø 10
Thread: M12 x 1,75 LHT
 0009966745



DB-ES-8492

Length: 60
Cone Ø: d1 Ø 10 / d2 Ø 10
Thread: M12 x 1,75 RHT
 0009966645, 3752680189, A3752680189



DB-ES-8500

Length: 55
Cone Ø: d1 Ø 12 / d2 Ø 10,8
Thread: M14 x 1,5 RHT
 0002685989



DB-RK-5281

Ø: 86
 01303700A, 6253200111



DB-RK-5282

Ø: 59
 01303800A, 6553200111



DB-RK-5307

Ø: 70
 01303500A, 6473200028



DB-RK-8564

Ø: 90
 01302200A, 0003500105, 3500105, 3500405,
 0003500405, 0005861833, 5861833,
 81432706047



DB-RK-12372

Ø: 85
Hole Distance: 152
Thick/Height: 24
 003501805, A003501805



DB-SB-10407

Ø: 61 **Thick/Height:** 46
 0003235985, 0003262481, 0003262981



DB-VB-7776

Length: 622 **Ø:** 56
Hole Distance: 152 / 152
 6533500205, 6583500205



DF-RK-9336

Ø: 108
 0003501705, 3501705



MN-RK-9387

Ø: 90
 0003500105, 81432706047





SK ...

3255 ...	07/87→09/96	Centre Rod	DB-DL-8618	Push Rod	
	07/87→09/96	Centre Rod	DB-DL-10216	Push Rod	
	07/87→09/96	Centre Rod	DB-DL-12309	Coupling Rod	
	07/87→09/96	Tie Rod	DB-DL-8640	Guide Rod	
	07/87→09/96	Tie Rod	DB-ES-5209		
	07/87→09/96	Tie Rod End	CV-ES-12461	for Steering Rod	
	07/87→09/96	Tie Rod End	CV-ES-14163	for Steering Rod	
	07/87→09/96	Track Control Arm		DB-DL-7839 Trailing Arm	
	07/87→09/96	Track Control Arm		DB-DS-6088 Suspension Rod, Trailing Arm	
	3529	07/88→08/94	Centre Rod	DB-DL-5217	Push Rod
07/88→08/94		Centre Rod	DB-DL-5233	Push Rod* 5 937 288 *→	
07/88→08/94		Centre Rod	DB-DL-7831	Push Rod	
07/88→08/94		Centre Rod	DB-DL-8131	Push Rod	
07/88→08/94		Centre Rod	DB-DL-8618	Push Rod	
07/88→08/94		Centre Rod	DB-DL-10216	Push Rod	
07/88→08/94		Suspension Arm Repair Kit		DB-RK-7267 for Drag Link	
07/88→08/94		Tie Rod	DB-DL-8640	Guide Rod	
07/88→08/94		Tie Rod	DB-ES-5209		
07/88→08/94		Tie Rod	DB-ES-5227	Guide Rod	
07/88→08/94		Tie Rod End	CV-ES-12461	for Steering Rod	
07/88→08/94		Track Control Arm		DB-DL-6197 Suspension Rod, Trailing Arm	
07/88→08/94		Track Control Arm		DB-DL-6198 Suspension Rod, Trailing Arm	
07/88→08/94		Track Control Arm		DB-DL-6227 Suspension Rod, Trailing Arm	
3534 K		10/93→09/96	Ball Head, gearshift linkage	DB-ES-8387	
	10/93→09/96	Ball Head, gearshift linkage	DB-ES-8492		
	10/93→09/96	Ball Head, gearshift linkage	DB-ES-8500		
	10/93→09/96	Centre Rod	DB-DL-7831	Push Rod	
	10/93→09/96	Centre Rod	DB-DL-7831	Push Rod→* K 144 404 *	
	10/93→09/96	Centre Rod	DB-DL-8131	Push Rod	
	10/93→09/96	Centre Rod	DB-DL-8138	Push Rod	
	10/93→09/96	Centre Rod	DB-DL-8618	Push Rod	
	10/93→09/96	Centre Rod	DB-DL-8618	Push Rod→* K 144 404 *	
	10/93→09/96	Centre Rod	DB-DL-9256	Push Rod	
	10/93→09/96	Centre Rod	DB-DL-9256	Push Rod* K 144 405 *→	
	10/93→09/96	Centre Rod	DB-DL-12309	Coupling Rod	
	10/93→09/96	Stabiliser Mounting		DB-SB-10407	
	10/93→09/96	Suspension Arm Repair Kit		DB-RK-7267 for Drag Link	
	10/93→09/96	Suspension Arm Repair Kit	DB-RK-5307		
	10/93→09/96	Tie Rod	DB-DL-8640	Guide Rod	
	10/93→09/96	Tie Rod	DB-ES-5227	Guide Rod	
	10/93→09/96	Tie Rod End	CV-ES-14163	for Steering Rod	
	10/93→09/96	Tie Rod End	DB-ES-8323		
	10/93→09/96	Tie Rod End	DB-ES-8617		
	10/93→09/96	Track Control Arm		DB-DL-6197 Suspension Rod, Trailing Arm	
	10/93→09/96	Track Control Arm		DB-DL-6198 Suspension Rod, Trailing Arm	
	10/93→09/96	Track Control Arm		DB-DL-6227 Suspension Rod, Trailing Arm	
	3535	07/88→08/94	Centre Rod	DB-DL-5217	Push Rod
		07/88→08/94	Centre Rod	DB-DL-5233	Push Rod* 5 937 287 *→
07/88→08/94		Centre Rod	DB-DL-7831	Push Rod	
07/88→08/94		Centre Rod	DB-DL-8131	Push Rod	
07/88→08/94		Centre Rod	DB-DL-8138	Push Rod	
07/88→08/94		Centre Rod	DB-DL-8618	Push Rod	
07/88→08/94		Centre Rod	DB-DL-10216	Push Rod	
07/88→08/94		Centre Rod	DB-DL-12309	Coupling Rod	
07/88→08/94		Suspension Arm Repair Kit		DB-RK-7267 for Drag Link	
07/88→08/94		Tie Rod	DB-DL-8640	Guide Rod	
07/88→08/94		Tie Rod	DB-ES-5209		
07/88→08/94		Tie Rod	DB-ES-5227	Guide Rod	
07/88→08/94		Tie Rod	MN-DL-7834	Guide Rod	
07/88→08/94		Tie Rod End	CV-ES-12461	for Steering Rod	
07/88→08/94		Tie Rod End	CV-ES-14163	for Steering Rod	
07/88→08/94		Tie Rod End	DB-ES-5234	for Steering Rod	

CV-ES-12461

Length: 120
Cone Ø: d1 Ø 26 / d2 Ø 23,5
Thread: M30 x 1,5 LHT
 0003300035, 3300148, 0003406213, 0013306635,
 0013308835, 0014604048, 0014604348,
 14606448, 0024600248, 3023300035,
 3023300135, 3023300235, 3023300335,
 3453307235, 3453307435, 3503307135,
 A0003300148, A0013306635, A0013308835,
 A0014604048, A0014604348, A0014606448,
 A0024600248, A3023300035, A3023300135,
 A3023300235, A3023300335, A3503307135



CV-ES-14163

Length: 125
Cone Ø: d1 Ø 30 / d2 Ø 27
Thread: M30 x 1,5 RHT
 0003305248, 0003387310, 0004600348,
 0004600948, 0004602848, 0004602948,
 0004608948, 0014600248, 0014600848,
 0014601248, 0014602248, 0014607748,
 0024600148, A0003387310, A0004600348,
 A0004602848, A0004602948, A0014600848,
 A0014601248, A0014602248, A0014607748



DB-DL-5217

Length: 862 Ø: 40
Cone Ø: d1 Ø 30 / d2 Ø 27
 01214700A, 6204600405, 6204600805,
 6204602905, 6204603005



DB-DL-5233

Length: 895 Ø: 48
Cone Ø: d1 Ø 30 / d2 Ø 27
 01217300A, 0004609805, 0004609905



DB-DL-6197

Length: 579
 Ø: 50
Hole Distance: 152 / 152
 6593501206, 6593503506



DB-DL-6198

Length: 579
 Ø: 58
Hole Distance: 152 / 152
 3953500006, 6593501106



DB-DL-6227

Length: 629
 Ø: 58
Hole Distance: 152 / 152
 6593501506, 6593503806



DB-DL-7831

Length: 870
 Ø: 42
Cone Ø: d1 Ø 30 / d2 Ø 27
 01215200A, 6254602505



DB-DL-7839

Length: 585
 Ø: 50
Hole Distance: 152 / 152
 3953500206, 6593500106, 6593502406



DB-DL-8131

Length: 1115 Ø: 52
Cone Ø: d1 Ø 32 / d2 Ø 28,8
 0004604405, 6254605005



DB-DL-8138

Length: 1130
 Ø: 40
Cone Ø: d1 Ø 32 / d2 Ø 28,8
 0004606605, 4606605



DB-DL-8618

Length: 680
 Ø: 42
Cone Ø: d1 Ø 32 / d2 Ø 28,8
 0004604305, 4604305, 6254604805



DB-DL-8640

Length: 1615 Ø: 50
Cone Ø: d1 Ø 32 / d2 Ø 29
 6253301503, 6253301603, 6253302403,
 6253302503, 9423300803, 9423302103,
 9493300203, 9493300303, 9493300903



DB-DL-9256

Length: 905
 Ø: 48
Cone Ø: d1 Ø 32 / d2 Ø 29
 0014604205, 14604205



DB-DL-10216

Length: 1190
 Ø: 40
Cone Ø: d1 Ø 32 / d2 Ø 29
 0004604905



DB-DL-12309

Length: 685 Ø: 40
Cone Ø: d1 Ø 32 / d2 Ø 28,8
 0004606005, 0004606305



DB-DS-6088

Length: 585
 Ø: 50
Hole Distance: 152 / 152
 3953500706, 6593500406



DB-ES-5209

Length: 1670 Ø: 50
Cone Ø: d1 Ø 30 / d2 Ø 27
 6203300503, 6203300603



DB-ES-5227

Length: 1588 Ø: 60
Cone Ø: d1 Ø 38 / d2 Ø 34,3
 6253300903, 6253301203, 9443300203



DB-ES-5234

Length: 135
Cone Ø: d1 Ø 38 / d2 Ø 34,3
Thread: M38 x 1,5 RHT
 0004601748, 120322305, 2205000400



DB-ES-8323

Length: 75
Cone Ø: d1 Ø 32 / d2 Ø 28,8
Thread: M26 x 1,5 RHT
 14601548, 0014601548, 14601648, 0014601648,
 0024600648, 24600648, A0014601648,
 A0024600648



DB-ES-8387

Length: 55
Cone Ø: d1 Ø 10 / d2 Ø 10
Thread: M14 x 1,5 RHT
 0009966845, 0009967045



DB-ES-8492

Length: 60
Cone Ø: d1 Ø 10 / d2 Ø 10
Thread: M12 x 1,75 RHT
 0009966645, 3752680189, A3752680189



DB-ES-8500

Length: 55
Cone Ø: d1 Ø 12 / d2 Ø 10,8
Thread: M14 x 1,5 RHT
 0002685989



DB-ES-8617

Length: 155
Cone Ø: d1 Ø 32 / d2 Ø 28,8
Thread: M30 x 1,5 RHT
 0004604848, 4604848, 0014600648, 14600648



DB-RK-5307

Ø: 70
 01303500A, 6473200028



DB-RK-7267

Ø: 95
Hole Distance: 152
Thick/Height: 24
 01302100A, 3500413, 0003500413, 0005861235,
 5861235, 81432706069



DB-SB-10407

Ø: 61 Thick/Height: 46
 0003235985, 0003262481, 0003262981



MN-DL-7834

Length: 1588 Ø: 58
Cone Ø: d1 Ø 30 / d2 Ø 27
 3463303903, 3463304903, 6253303203,
 9443300503, 9443301303, 9443301703



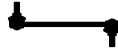

SK ...

3535 AK	02/90→08/94	Centre Rod	DB-DL-5217		Push Rod	
	02/90→08/94	Centre Rod	DB-DL-10216		Push Rod	
	02/90→08/94	Stabiliser Mounting		DB-SB-10407		
	02/90→08/94	Suspension Arm Repair Kit		DB-RK-7267	for Drag Link	
	02/90→08/94	Suspension Arm Repair Kit	DB-RK-5307			
	02/90→08/94	Tie Rod	DB-ES-5209			
	02/90→08/94	Tie Rod	DB-ES-5227		Guide Rod	
	02/90→08/94	Tie Rod End	CV-ES-12461		for Steering Rod	
	02/90→08/94	Tie Rod End	DB-ES-5234		for Steering Rod	
	02/90→08/94	Track Control Arm		DB-DL-6197	Suspension Rod, Trailing Arm	
	02/90→08/94	Track Control Arm		DB-DL-6198	Suspension Rod, Trailing Arm	
	02/90→08/94	Track Control Arm		DB-DL-6227	Suspension Rod, Trailing Arm	
	3535 B	10/88→08/94	Centre Rod	DB-DL-7831		Push Rod
		10/88→08/94	Centre Rod	DB-DL-8131		Push Rod
		10/88→08/94	Centre Rod	DB-DL-8131		Push Rod→* 5 940 186 *
10/88→08/94		Centre Rod	DB-DL-8138		Push Rod	
10/88→08/94		Centre Rod	DB-DL-8138		Push Rod* 5 940 187 *→	
10/88→08/94		Centre Rod	DB-DL-8618		Push Rod	
10/88→08/94		Centre Rod	DB-DL-12309		Coupling Rod	
10/88→08/94		Stabiliser Mounting		DB-SB-10407		
10/88→08/94		Suspension Arm Repair Kit		DB-RK-5281		
10/88→08/94		Suspension Arm Repair Kit		DB-RK-7267	for Drag Link	
10/88→08/94		Suspension Arm Repair Kit	DB-RK-5307			
10/88→08/94		Tie Rod	DB-DL-8640		Guide Rod	
10/88→08/94		Tie Rod	DB-ES-5227		Guide Rod	
10/88→08/94		Tie Rod End	CV-ES-14163		for Steering Rod	
10/88→08/94		Track Control Arm		DB-DL-6197	Suspension Rod, Trailing Arm	
10/88→08/94		Track Control Arm		DB-DL-6198	Suspension Rod, Trailing Arm	
3535 K		07/87→09/96	Centre Rod	DB-DL-5217		Push Rod
		07/87→09/96	Centre Rod	DB-DL-7831		Push Rod
	07/87→09/96	Centre Rod	DB-DL-8131		Push Rod	
	07/87→09/96	Centre Rod	DB-DL-8618		Push Rod	
	07/87→09/96	Centre Rod	DB-DL-10216		Push Rod	
	07/87→09/96	Centre Rod	DB-DL-12309		Coupling Rod	
	07/87→09/96	Suspension Arm Repair Kit		DB-RK-7267	for Drag Link	
	07/87→09/96	Tie Rod	DB-DL-8640		Guide Rod	
	07/87→09/96	Tie Rod	DB-ES-5209			
	07/87→09/96	Tie Rod	DB-ES-5227		Guide Rod	
	07/87→09/96	Tie Rod	MN-DL-7834		Guide Rod	
	07/87→09/96	Tie Rod End	CV-ES-14163		for Steering Rod	
	07/87→09/96	Track Control Arm		DB-DL-6197	Suspension Rod, Trailing Arm	
	07/87→09/96	Track Control Arm		DB-DL-6198	Suspension Rod, Trailing Arm	
	07/87→09/96	Track Control Arm		DB-DL-6227	Suspension Rod, Trailing Arm	
	10/88→08/94	Centre Rod	DB-DL-8131		Push Rod→* 5 940 186 *	
	10/88→08/94	Centre Rod	DB-DL-8138		Push Rod	
	10/88→08/94	Centre Rod	DB-DL-8138		Push Rod* 5 940 187 *→	
	10/88→08/94	Stabiliser Mounting		DB-SB-10407		
	10/88→08/94	Suspension Arm Repair Kit		DB-RK-5281		
	10/88→08/94	Suspension Arm Repair Kit	DB-RK-5307			
	03/91→08/94	Tie Rod End	CV-ES-12461		for Steering Rod	
	3535 S	07/88→08/94	Centre Rod	DB-DL-5217		Push Rod
		07/88→08/94	Centre Rod	DB-DL-5233		Push Rod* 5 937 287 *→
		07/88→08/94	Centre Rod	DB-DL-7831		Push Rod
		07/88→08/94	Centre Rod	DB-DL-8131		Push Rod
		07/88→08/94	Centre Rod	DB-DL-8618		Push Rod
07/88→08/94		Suspension Arm Repair Kit		DB-RK-7267	for Drag Link	
07/88→08/94		Tie Rod	DB-DL-8640		Guide Rod	
07/88→08/94		Tie Rod	DB-ES-5209			
07/88→08/94		Tie Rod	DB-ES-5227		Guide Rod	
07/88→08/94		Tie Rod End	CV-ES-12461		for Steering Rod	
07/88→08/94		Tie Rod End	CV-ES-14163		for Steering Rod	
07/88→08/94		Track Control Arm		DB-DL-6197	Suspension Rod, Trailing Arm	
07/88→08/94		Track Control Arm		DB-DL-6198	Suspension Rod, Trailing Arm	
07/88→08/94		Track Control Arm		DB-DL-6227	Suspension Rod, Trailing Arm	

CV-ES-12461

Length: 120
 Cone Ø: d1 Ø 26 / d2 Ø 23,5
 Thread: M30 x 1,5 LHT
 0003300035, 3300148, 0003406213, 0013306635,
 0013308835, 0014604048, 0014604348,
 14606448, 0024600248, 3023300035,
 3023300135, 3023300235, 3023300335,
 3453307235, 3453307435, 3503307135,
 A0003300148, A0013306635, A0013308835,
 A0014604048, A0014604348, A0014606448,
 A0024600248, A3023300035, A3023300135,
 A3023300235, A3023300335, A3503307135



CV-ES-14163

Length: 125
 Cone Ø: d1 Ø 30 / d2 Ø 27
 Thread: M30 x 1,5 RHT
 0003305248, 0003387310, 0004600348,
 0004600948, 0004602848, 0004602948,
 0004608948, 0014600248, 0014600848,
 0014601248, 0014602248, 0014607748,
 0024600148, A0003387310, A0004600348,
 A0004602848, A0004602948, A0014600848,
 A0014601248, A0014602248, A0014607748



DB-DL-5217

Length: 862 Ø: 40
 Cone Ø: d1 Ø 30 / d2 Ø 27
 01214700A, 6204600405, 6204600805,
 6204602905, 6204603005



DB-DL-5233

Length: 895 Ø: 48
 Cone Ø: d1 Ø 30 / d2 Ø 27
 01217300A, 0004609805, 0004609905



DB-DL-6197

Length: 579
 Ø: 50
 Hole Distance: 152 / 152
 6593501206, 6593503506



DB-DL-6198

Length: 579
 Ø: 58
 Hole Distance: 152 / 152
 3953500006, 6593501106



DB-DL-6227

Length: 629
 Ø: 58
 Hole Distance: 152 / 152
 6593501506, 6593503806



DB-DL-7831

Length: 870
 Ø: 42
 Cone Ø: d1 Ø 30 / d2 Ø 27
 01215200A, 6254602505



DB-DL-8131

Length: 1115 Ø: 52
 Cone Ø: d1 Ø 32 / d2 Ø 28,8
 0004604405, 6254605005



DB-DL-8138

Length: 1130
 Ø: 40
 Cone Ø: d1 Ø 32 / d2 Ø 28,8
 0004606605, 4606605



DB-DL-8618

Length: 680
 Ø: 42
 Cone Ø: d1 Ø 32 / d2 Ø 28,8
 0004604305, 4604305, 6254604805



DB-DL-8640

Length: 1615 Ø: 50
 Cone Ø: d1 Ø 32 / d2 Ø 29
 6253301503, 6253301603, 6253302403,
 6253302503, 9423300803, 9423302103,
 9493300203, 9493300303, 9493300903



DB-DL-10216

Length: 1190
 Ø: 40
 Cone Ø: d1 Ø 32 / d2 Ø 29
 0004604905



DB-DL-12309

Length: 685
 Ø: 40
 Cone Ø: d1 Ø 32 / d2 Ø 28,8
 0004606005, 4606005, 4606305, 0004606305



DB-ES-5209

Length: 1670 Ø: 50
 Cone Ø: d1 Ø 30 / d2 Ø 27
 6203300503, 6203300603



DB-ES-5227

Length: 1588 Ø: 60
 Cone Ø: d1 Ø 38 / d2 Ø 34,3
 6253300903, 6253301203, 9443300203



DB-ES-5234

Length: 135
 Cone Ø: d1 Ø 38 / d2 Ø 34,3
 Thread: M38 x 1,5 RHT
 0004601748, 120322305, 2205000400



DB-RK-5281

Ø: 86
 01303700A, 6253200111



DB-RK-5307

Ø: 70
 01303500A, 6473200028



DB-RK-7267

Ø: 95
 Hole Distance: 152
 Thick/Height: 24
 01302100A, 0003500413, 3500413, 0005861235,
 5861235, 81432706069



DB-SB-10407

Ø: 61 Thick/Height: 46
 0003235985, 0003262481, 0003262981



MN-DL-7834

Length: 1588 Ø: 58
 Cone Ø: d1 Ø 30 / d2 Ø 27
 3463303903, 3463304903, 6253303203,
 9443300503, 9443301303, 9443301703





SK ...

3538	03/91→09/96	Ball Head, gearshift linkage	DB-ES-8387			
	03/91→09/96	Ball Head, gearshift linkage	DB-ES-8491			
	03/91→09/96	Ball Head, gearshift linkage	DB-ES-8492			
	03/91→09/96	Ball Head, gearshift linkage	DB-ES-8500			
	03/91→09/96	Centre Rod	DB-DL-5241		Suspension Rod	
	03/91→09/96	Centre Rod	DB-DL-7270		Push Rod;Suspension Rod	
	03/91→09/96	Centre Rod	DB-DL-7831		Push Rod	
	03/91→09/96	Centre Rod	DB-DL-7831		Push Rod→* 5 952 761 *	
	03/91→09/96	Centre Rod	DB-DL-8131		Push Rod	
	03/91→09/96	Centre Rod	DB-DL-8131		Push Rod→* 5 940 186 *	
	03/91→09/96	Centre Rod	DB-DL-8138		Push Rod	
	03/91→09/96	Centre Rod	DB-DL-8138		Push Rod* 5 940 187 *→	
	03/91→09/96	Centre Rod	DB-DL-8618		Push Rod	
	03/91→09/96	Centre Rod	DB-DL-8618		Push Rod→* 5 952 761 *	
	03/91→09/96	Centre Rod	DB-DL-9256		Push Rod	
	03/91→09/96	Centre Rod	DB-DL-9256		Push Rod* 5 952 762 *→	
	03/91→09/96	Centre Rod	DB-DL-12309		Coupling Rod	
	03/91→09/96	Suspension Arm Repair Kit		DB-RK-7267	for Drag Link	
	03/91→09/96	Suspension Arm Repair Kit		DB-RK-8550	for Wishbone (CV)	
	03/91→09/96	Tie Rod	DB-DL-8640		Guide Rod	
	03/91→09/96	Tie Rod	DB-ES-5227		Guide Rod	
	03/91→09/96	Tie Rod End	CV-ES-12461		for Steering Rod	
	03/91→09/96	Tie Rod End	DB-ES-8323			
	03/91→09/96	Track Control Arm		DB-DL-6197	Suspension Rod, Trailing Arm	
	03/91→09/96	Track Control Arm		DB-DL-6198	Suspension Rod, Trailing Arm	
	03/91→09/96	Track Control Arm		DB-DL-6227	Suspension Rod, Trailing Arm	
	09/91→09/96	Centre Rod	DB-DL-5217		Push Rod	
	09/91→09/96	Centre Rod	DB-DL-5233		Push Rod* 5 937 288 *→	
	09/91→09/96	Centre Rod	DB-DL-9263		Push Rod	
	09/91→09/96	Centre Rod	DB-DL-10216		Push Rod	
09/91→09/96	Tie Rod	DB-ES-5209				
3538 AK	03/91→09/96	Ball Head, gearshift linkage	DB-ES-8387			
	03/91→09/96	Ball Head, gearshift linkage	DB-ES-8491			
	03/91→09/96	Ball Head, gearshift linkage	DB-ES-8492			
	03/91→09/96	Ball Head, gearshift linkage	DB-ES-8500			
	03/91→09/96	Centre Rod	DB-DL-5217		Push Rod	
	03/91→09/96	Centre Rod	DB-DL-5241		Suspension Rod	
	03/91→09/96	Centre Rod	DB-DL-7270		Push Rod;Suspension Rod	
	03/91→09/96	Centre Rod	DB-DL-7831		Push Rod	
	03/91→09/96	Centre Rod	DB-DL-8138		Push Rod	
	03/91→09/96	Centre Rod	DB-DL-8618		Push Rod	
	03/91→09/96	Centre Rod	DB-DL-10216		Push Rod	
	03/91→09/96	Drag Link End	DB-ES-8529			
	03/91→09/96	Stabiliser Mounting		DB-SB-10407		
	03/91→09/96	Suspension Arm Repair Kit		DB-RK-7267	for Drag Link	
	03/91→09/96	Suspension Arm Repair Kit		DB-RK-8550	for Wishbone (CV)	
	03/91→09/96	Suspension Arm Repair Kit	DB-RK-5307			
	03/91→09/96	Tie Rod	DB-DL-8640		Guide Rod	
	03/91→09/96	Tie Rod	DB-ES-5209			
	03/91→09/96	Tie Rod	DB-ES-5227		Guide Rod	
	03/91→09/96	Tie Rod End	CV-ES-12461		for Steering Rod	
	03/91→09/96	Tie Rod End	DB-ES-5234		for Steering Rod	
	03/91→09/96	Tie Rod End	DB-ES-8323			
	03/91→09/96	Track Control Arm		DB-DL-6197	Suspension Rod, Trailing Arm	
	03/91→09/96	Track Control Arm		DB-DL-6198	Suspension Rod, Trailing Arm	
	03/91→09/96	Track Control Arm		DB-DL-6227	Suspension Rod, Trailing Arm	
	3538 K	03/91→09/96	Ball Head, gearshift linkage	DB-ES-8387		
		03/91→09/96	Ball Head, gearshift linkage	DB-ES-8491		
		03/91→09/96	Ball Head, gearshift linkage	DB-ES-8492		
		03/91→09/96	Ball Head, gearshift linkage	DB-ES-8500		
		03/91→09/96	Centre Rod	DB-DL-5241		Suspension Rod
03/91→09/96		Centre Rod	DB-DL-7270		Push Rod;Suspension Rod	
03/91→09/96	Centre Rod	DB-DL-7831		Push Rod		

CV-ES-12461

Length: 120
 Cone Ø: d1 Ø 26 / d2 Ø 23,5
 Thread: M30 x 1,5 LHT
 0003300035, 3300148, 0003406213, 0013306635,
 0013308835, 0014604048, 0014604348,
 14606448, 0024600248, 3023300035,
 3023300135, 3023300235, 3023300335,
 3453307235, 3453307435, 3503307135,
 A0003300148, A0013306635, A0013308835,
 A0014604048, A0014604348, A0014606448,
 A0024600248, A3023300035, A3023300135,
 A3023300235, A3023300335, A3503307135



DB-DL-5217

Length: 862 Ø: 40
 Cone Ø: d1 Ø 30 / d2 Ø 27
 01214700A, 620460405, 6204600805,
 6204602905, 6204603005



DB-DL-5233

Length: 895
 Ø: 48
 Cone Ø: d1 Ø 30 / d2 Ø 27
 01217300A, 4609805, 0004609805, 0004609905,
 4609905



DB-DL-5241

Length: 875 Ø: 40
 Cone Ø: d1 Ø 30 / d2 Ø 27
 01215300A, 0004609205, 0004609305,
 0014606905



DB-DL-6197

Length: 579
 Ø: 50
 Hole Distance: 152 / 152
 6593501206, 6593503506



DB-DL-6198

Length: 579
 Ø: 58
 Hole Distance: 152 / 152
 3953500006, 6593501106



DB-DL-6227

Length: 629
 Ø: 58
 Hole Distance: 152 / 152
 6593501506, 6593503806



DB-DL-7270

Length: 875 Ø: 40
 Cone Ø: d1 Ø 28,6 / d2 Ø 23,9
 01208300A, 0024604705, 0024604805,
 0034604905, A0024604705



DB-DL-7831

Length: 870
 Ø: 42
 Cone Ø: d1 Ø 30 / d2 Ø 27
 01215200A, 6254602505



DB-DL-8131

Length: 1115 Ø: 52
 Cone Ø: d1 Ø 32 / d2 Ø 28,8
 0004604405, 6254605005



DB-DL-8138

Length: 1130
 Ø: 40
 Cone Ø: d1 Ø 32 / d2 Ø 28,8
 0004606605, 4606605



DB-DL-8618

Length: 680
 Ø: 42
 Cone Ø: d1 Ø 32 / d2 Ø 28,8
 0004604305, 4604305, 6254604805



DB-DL-8640

Length: 1615 Ø: 50
 Cone Ø: d1 Ø 32 / d2 Ø 29
 6253301503, 6253301603, 6253302403,
 6253302503, 9423300803, 9423302103,
 9493300203, 9493300303, 9493300903



DB-DL-9256

Length: 905
 Ø: 48
 Cone Ø: d1 Ø 32 / d2 Ø 29
 0014604205, 14604205



DB-DL-9263

Length: 870
 Ø: 42
 Cone Ø: d1 Ø 32 / d2 Ø 27
 14600505, 0014600505, 0014600605, 14600605



DB-DL-10216

Length: 1190
 Ø: 40
 Cone Ø: d1 Ø 32 / d2 Ø 29
 0004604905



DB-DL-12309

Length: 685 Ø: 40
 Cone Ø: d1 Ø 32 / d2 Ø 28,8
 0004606005, 0004606305



DB-ES-5209

Length: 1670 Ø: 50
 Cone Ø: d1 Ø 30 / d2 Ø 27
 6203300503, 6203300603



DB-ES-5227

Length: 1588 Ø: 60
 Cone Ø: d1 Ø 38 / d2 Ø 34,3
 6253300903, 6253301203, 9443300203



DB-ES-5234

Length: 135
 Cone Ø: d1 Ø 38 / d2 Ø 34,3
 Thread: M38 x 1,5 RHT
 0004601748, 120322305, 2205000400



DB-ES-8323

Length: 75
 Cone Ø: d1 Ø 32 / d2 Ø 28,8
 Thread: M26 x 1,5 RHT
 0014601548, 0014601648, 0024600648,
 A0014601648, A0024600648



DB-ES-8387

Length: 55
 Cone Ø: d1 Ø 10 / d2 Ø 10
 Thread: M14 x 1,5 RHT
 0009966845, 0009967045



DB-ES-8491

Length: 60
 Cone Ø: d1 Ø 10 / d2 Ø 10
 Thread: M12 x 1,75 LHT
 0009966745



DB-ES-8492

Length: 60
 Cone Ø: d1 Ø 10 / d2 Ø 10
 Thread: M12 x 1,75 RHT
 0009966645, 3752680189, A3752680189



DB-ES-8500

Length: 55
 Cone Ø: d1 Ø 12 / d2 Ø 10,8
 Thread: M14 x 1,5 RHT
 0002685989



DB-ES-8529

Length: 145
 Cone Ø: d1 Ø 32 / d2 Ø 28,8
 Thread: M30 x 1,5 RHT
 0014602948, 14602948, 3714607148,
 A3714607148



DB-RK-5307

Ø: 70
 01303500A, 6473200028



DB-RK-7267

Ø: 95
 Hole Distance: 152
 Thick/Height: 24
 01302100A, 3500413, 0003500413, 0005861235,
 5861235, 81432706069



DB-RK-8550

Ø: 75 Hole Distance: 152
 Thick/Height: 24
 0003502105, 0003504605



DB-SB-10407

Ø: 61 Thick/Height: 46
 0003235985, 0003262481, 0003262981



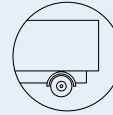

SK ...

3538 K ...	03/91→09/96	Centre Rod	DB-DL-7831		Push Rod→* 5 952 761 *	
	03/91→09/96	Centre Rod	DB-DL-7831		Push Rod→* K 003 418 *	
	03/91→09/96	Centre Rod	DB-DL-8131		Push Rod	
	03/91→09/96	Centre Rod	DB-DL-8131		Push Rod→* 5 940 186 *	
	03/91→09/96	Centre Rod	DB-DL-8138		Push Rod	
	03/91→09/96	Centre Rod	DB-DL-8138		Push Rod* 5 940 187 *→	
	03/91→09/96	Centre Rod	DB-DL-8618		Push Rod	
	03/91→09/96	Centre Rod	DB-DL-8618		Push Rod→* 5 952 761 *	
	03/91→09/96	Centre Rod	DB-DL-8618		Push Rod→* K 003 418 *	
	03/91→09/96	Centre Rod	DB-DL-9256		Push Rod	
	03/91→09/96	Centre Rod	DB-DL-9256		Push Rod* 5 952 762 *→	
	03/91→09/96	Centre Rod	DB-DL-9256		Push Rod* K 003 419 *→	
	03/91→09/96	Centre Rod	DB-DL-12309		Coupling Rod	
	03/91→09/96	Stabiliser Mounting		DB-SB-10407		
	03/91→09/96	Suspension Arm Repair Kit		DB-RK-7267	for Drag Link	
	03/91→09/96	Suspension Arm Repair Kit		DB-RK-8550	for Wishbone (CV)	
	03/91→09/96	Suspension Arm Repair Kit	DB-RK-5307			
	03/91→09/96	Tie Rod	DB-DL-8640		Guide Rod	
	03/91→09/96	Tie Rod	DB-ES-5227		Guide Rod	
	03/91→09/96	Tie Rod End	CV-ES-14163		for Steering Rod	
	03/91→09/96	Tie Rod End	DB-ES-8323			
	03/91→09/96	Track Control Arm		DB-DL-6197	Suspension Rod, Trailing Arm	
	03/91→09/96	Track Control Arm		DB-DL-6198	Suspension Rod, Trailing Arm	
	03/91→09/96	Track Control Arm		DB-DL-6227	Suspension Rod, Trailing Arm	
	3544	01/92→09/96	Ball Head, gearshift linkage	DB-ES-8387		
01/92→09/96		Ball Head, gearshift linkage	DB-ES-8491			
01/92→09/96		Ball Head, gearshift linkage	DB-ES-8492			
01/92→09/96		Ball Head, gearshift linkage	DB-ES-8500			
01/92→09/96		Centre Rod	DB-DL-5217		Push Rod	
01/92→09/96		Centre Rod	DB-DL-5233		Push Rod* 5 937 288 *→	
01/92→09/96		Centre Rod	DB-DL-7831		Push Rod	
01/92→09/96		Centre Rod	DB-DL-8131		Push Rod	
01/92→09/96		Centre Rod	DB-DL-8138		Push Rod	
01/92→09/96		Centre Rod	DB-DL-8618		Push Rod	
01/92→09/96		Centre Rod	DB-DL-10216		Push Rod	
01/92→09/96		Centre Rod	DB-DL-12309		Coupling Rod	
01/92→09/96		Suspension Arm Repair Kit		DB-RK-7267	for Drag Link	
01/92→09/96		Tie Rod	DB-DL-8640		Guide Rod	
01/92→09/96		Tie Rod	DB-ES-5209			
01/92→09/96		Tie Rod	DB-ES-5227		Guide Rod	
01/92→09/96		Tie Rod End	CV-ES-12461		for Steering Rod	
01/92→09/96		Tie Rod End	CV-ES-14163		for Steering Rod	
01/92→09/96		Track Control Arm		DB-DL-6197	Suspension Rod, Trailing Arm	
01/92→09/96		Track Control Arm		DB-DL-6198	Suspension Rod, Trailing Arm	
01/92→09/96		Track Control Arm		DB-DL-6227	Suspension Rod, Trailing Arm	
3544 AK		03/91→09/96	Ball Head, gearshift linkage	DB-ES-8387		
		03/91→09/96	Ball Head, gearshift linkage	DB-ES-8491		
		03/91→09/96	Ball Head, gearshift linkage	DB-ES-8492		
		03/91→09/96	Ball Head, gearshift linkage	DB-ES-8500		
	03/91→09/96	Centre Rod	DB-DL-5217		Push Rod	
	03/91→09/96	Centre Rod	DB-DL-5241		Suspension Rod	
	03/91→09/96	Centre Rod	DB-DL-7270		Push Rod;Suspension Rod	
	03/91→09/96	Centre Rod	DB-DL-10216		Push Rod	
	03/91→09/96	Suspension Arm Repair Kit		DB-RK-7267	for Drag Link	
	03/91→09/96	Suspension Arm Repair Kit		DB-RK-8550	for Wishbone (CV)	
	03/91→09/96	Tie Rod	DB-ES-5209			
	03/91→09/96	Tie Rod	DB-ES-5227		Guide Rod	
	03/91→09/96	Tie Rod End	CV-ES-12461		for Steering Rod	
	03/91→09/96	Tie Rod End	DB-ES-5234		for Steering Rod	
	03/91→09/96	Tie Rod End	DB-ES-8323			
	03/91→09/96	Track Control Arm		DB-DL-6197	Suspension Rod, Trailing Arm	
	03/91→09/96	Track Control Arm		DB-DL-6198	Suspension Rod, Trailing Arm	
	03/91→09/96	Track Control Arm		DB-DL-6227	Suspension Rod, Trailing Arm	

CV-ES-12461

Length: 120
 Cone Ø: d1 Ø 26 / d2 Ø 23,5
 Thread: M30 x 1,5 LHT
 0003300035, 3300148, 0003406213, 0013306635,
 0013308835, 0014604048, 0014604348,
 14606448, 0024600248, 3023300035,
 3023300135, 3023300235, 3023300335,
 3453307235, 3453307435, 3503307135,
 A0003300148, A0013306635, A0013308835,
 A0014604048, A0014604348, A0014606448,
 A0024600248, A3023300035, A3023300135,
 A3023300235, A3023300335, A3503307135



CV-ES-14163

Length: 125
 Cone Ø: d1 Ø 30 / d2 Ø 27
 Thread: M30 x 1,5 RHT
 0003305248, 0003387310, 0004600348,
 0004600948, 0004602848, 0004602948,
 0004608948, 0014600248, 0014600848,
 0014601248, 0014602248, 0014607748,
 0024600148, A0003387310, A0004600348,
 A0004602848, A0004602948, A0014600848,
 A0014601248, A0014602248, A0014607748



DB-DL-5217

Length: 862 Ø: 40
 Cone Ø: d1 Ø 30 / d2 Ø 27
 01214700A, 6204600405, 6204600805,
 6204602905, 6204603005



DB-DL-5233

Length: 895
 Ø: 48
 Cone Ø: d1 Ø 30 / d2 Ø 27
 01217300A, 0004609805, 4609805, 4609905,
 0004609905



DB-DL-5241

Length: 875 Ø: 40
 Cone Ø: d1 Ø 30 / d2 Ø 27
 01215300A, 0004609205, 0004609305,
 0014606905



DB-DL-6197

Length: 579
 Ø: 50
 Hole Distance: 152 / 152
 6593501206, 6593503506



DB-DL-6198

Length: 579
 Ø: 58
 Hole Distance: 152 / 152
 3953500006, 6593501106



DB-DL-6227

Length: 629
 Ø: 58
 Hole Distance: 152 / 152
 6593501506, 6593503806



DB-DL-7270

Length: 875 Ø: 40
 Cone Ø: d1 Ø 28,6 / d2 Ø 23,9
 01208300A, 0024604705, 0024604805,
 0034604905, A0024604705



DB-DL-7831

Length: 870
 Ø: 42
 Cone Ø: d1 Ø 30 / d2 Ø 27
 01215200A, 6254602505



DB-DL-8131

Length: 1115 Ø: 52
 Cone Ø: d1 Ø 32 / d2 Ø 28,8
 0004604405, 6254605005



DB-DL-8138

Length: 1130
 Ø: 40
 Cone Ø: d1 Ø 32 / d2 Ø 28,8
 0004606605, 4606605



DB-DL-8618

Length: 680
 Ø: 42
 Cone Ø: d1 Ø 32 / d2 Ø 28,8
 0004604305, 4604305, 6254604805



DB-DL-8640

Length: 1615 Ø: 50
 Cone Ø: d1 Ø 32 / d2 Ø 29
 6253301503, 6253301603, 6253302403,
 6253302503, 9423300803, 9423302103,
 9493300203, 9493300303, 9493300903



DB-DL-9256

Length: 905
 Ø: 48
 Cone Ø: d1 Ø 32 / d2 Ø 29
 0014604205, 14604205



DB-DL-10216

Length: 1190
 Ø: 40
 Cone Ø: d1 Ø 32 / d2 Ø 29
 0004604905



DB-DL-12309

Length: 685 Ø: 40
 Cone Ø: d1 Ø 32 / d2 Ø 28,8
 0004606005, 0004606305



DB-ES-5209

Length: 1670 Ø: 50
 Cone Ø: d1 Ø 30 / d2 Ø 27
 6203300503, 6203300603



DB-ES-5227

Length: 1588 Ø: 60
 Cone Ø: d1 Ø 38 / d2 Ø 34,3
 6253300903, 6253301203, 9443300203



DB-ES-5234

Length: 135
 Cone Ø: d1 Ø 38 / d2 Ø 34,3
 Thread: M38 x 1,5 RHT
 0004601748, 120322305, 2205000400



DB-ES-8323

Length: 75
 Cone Ø: d1 Ø 32 / d2 Ø 28,8
 Thread: M26 x 1,5 RHT
 0014601548, 0014601648, 0024600648,
 A0014601648, A0024600648



DB-ES-8387

Length: 55
 Cone Ø: d1 Ø 10 / d2 Ø 10
 Thread: M14 x 1,5 RHT
 0009966845, 0009967045



DB-ES-8491

Length: 60
 Cone Ø: d1 Ø 10 / d2 Ø 10
 Thread: M12 x 1,75 LHT
 0009966745



DB-ES-8492

Length: 60
 Cone Ø: d1 Ø 10 / d2 Ø 10
 Thread: M12 x 1,75 RHT
 0009966645, 3752680189, A3752680189



DB-ES-8500

Length: 55
 Cone Ø: d1 Ø 12 / d2 Ø 10,8
 Thread: M14 x 1,5 RHT
 0002685989



DB-RK-5307

Ø: 70
 01303500A, 6473200028



DB-RK-7267

Ø: 95
 Hole Distance: 152
 Thick/Height: 24
 01302100A, 0003500413, 3500413, 0005861235,
 5861235, 81432706069



DB-RK-8550

Ø: 75 Hole Distance: 152
 Thick/Height: 24
 0003502105, 0003504605



DB-SB-10407

Ø: 61 Thick/Height: 46
 0003235985, 0003262481, 0003262981





SK ...

3544 K	03/91→09/96	Ball Head, gearshift linkage	DB-ES-8387		
	03/91→09/96	Ball Head, gearshift linkage	DB-ES-8491		
	03/91→09/96	Ball Head, gearshift linkage	DB-ES-8492		
	03/91→09/96	Ball Head, gearshift linkage	DB-ES-8500		
	03/91→09/96	Centre Rod	DB-DL-7831		Push Rod
	03/91→09/96	Centre Rod	DB-DL-7831		Push Rod→* K 003 418 *
	03/91→09/96	Centre Rod	DB-DL-8131		Push Rod
	03/91→09/96	Centre Rod	DB-DL-8131		Push Rod→* 5 940 186 *
	03/91→09/96	Centre Rod	DB-DL-8138		Push Rod
	03/91→09/96	Centre Rod	DB-DL-8138		Push Rod* 5 940 187 *→
	03/91→09/96	Centre Rod	DB-DL-8618		Push Rod
	03/91→09/96	Centre Rod	DB-DL-8618		Push Rod→* K 003 418 *
	03/91→09/96	Centre Rod	DB-DL-9256		Push Rod
	03/91→09/96	Centre Rod	DB-DL-9256		Push Rod* K 003 419 *→
	03/91→09/96	Centre Rod	DB-DL-12309		Coupling Rod
	03/91→09/96	Suspension Arm Repair Kit		DB-RK-7267	for Drag Link
	03/91→09/96	Tie Rod	DB-DL-8640		Guide Rod
	03/91→09/96	Tie Rod	DB-ES-5227		Guide Rod
	03/91→09/96	Tie Rod End	DB-ES-8323		
	03/91→09/96	Track Control Arm		DB-DL-6197	Suspension Rod, Trailing Arm
03/91→09/96	Track Control Arm		DB-DL-6198	Suspension Rod, Trailing Arm	
03/91→09/96	Track Control Arm		DB-DL-6227	Suspension Rod, Trailing Arm	
3548	05/92→09/96	Ball Head, gearshift linkage	DB-ES-8387		
	05/92→09/96	Ball Head, gearshift linkage	DB-ES-8500		
	05/92→09/96	Centre Rod	DB-DL-5217		Push Rod
	05/92→09/96	Centre Rod	DB-DL-10216		Push Rod
	05/92→09/96	Suspension Arm Repair Kit		DB-RK-7267	for Drag Link
	05/92→09/96	Tie Rod	DB-DL-8640		Guide Rod
	05/92→09/96	Tie Rod	DB-ES-5209		
	05/92→09/96	Tie Rod	DB-ES-5227		Guide Rod
	05/92→09/96	Tie Rod End	CV-ES-12461		for Steering Rod
	05/92→09/96	Tie Rod End	DB-ES-5234		for Steering Rod
	05/92→09/96	Tie Rod End	DB-ES-8323		
	05/92→09/96	Track Control Arm		DB-DL-6197	Suspension Rod, Trailing Arm
	05/92→09/96	Track Control Arm		DB-DL-6198	Suspension Rod, Trailing Arm
3550	05/92→09/96	Ball Head, gearshift linkage	DB-ES-8387		
	05/92→09/96	Ball Head, gearshift linkage	DB-ES-8491		
	05/92→09/96	Ball Head, gearshift linkage	DB-ES-8492		
	05/92→09/96	Ball Head, gearshift linkage	DB-ES-8500		
	05/92→09/96	Centre Rod	DB-DL-5217		Push Rod
	05/92→09/96	Centre Rod	DB-DL-5233		Push Rod* 5 937 288 *→
	05/92→09/96	Centre Rod	DB-DL-5241		Suspension Rod
	05/92→09/96	Centre Rod	DB-DL-7270		Push Rod,Suspension Rod
	05/92→09/96	Centre Rod	DB-DL-7831		Push Rod
	05/92→09/96	Centre Rod	DB-DL-7831		Push Rod→* 5 952 761 *
	05/92→09/96	Centre Rod	DB-DL-7831		Push Rod→* K 226 467 *
	05/92→09/96	Centre Rod	DB-DL-8131		Push Rod
	05/92→09/96	Centre Rod	DB-DL-8131		Push Rod→* 5 940 186 *
	05/92→09/96	Centre Rod	DB-DL-8138		Push Rod
	05/92→09/96	Centre Rod	DB-DL-8138		Push Rod* 5 940 187 *→
	05/92→09/96	Centre Rod	DB-DL-8618		Push Rod
	05/92→09/96	Centre Rod	DB-DL-8618		Push Rod→* 5 952 761 *
	05/92→09/96	Centre Rod	DB-DL-9256		Push Rod
	05/92→09/96	Centre Rod	DB-DL-9256		Push Rod* 5 952 762 *→
	05/92→09/96	Centre Rod	DB-DL-10216		Push Rod
	05/92→09/96	Centre Rod	DB-DL-12309		Coupling Rod
	05/92→09/96	Suspension Arm Repair Kit		DB-RK-7267	for Drag Link
	05/92→09/96	Suspension Arm Repair Kit		DB-RK-8550	for Wishbone (CV)
	05/92→09/96	Tie Rod	DB-DL-8640		Guide Rod
	05/92→09/96	Tie Rod	DB-ES-5209		
	05/92→09/96	Tie Rod	DB-ES-5227		Guide Rod
	05/92→09/96	Tie Rod End	CV-ES-12461		for Steering Rod
	05/92→09/96	Tie Rod End	CV-ES-14163		for Steering Rod

CV-ES-12461

Length: 120
 Cone Ø: d1 Ø 26 / d2 Ø 23,5
 Thread: M30 x 1,5 LHT
 0003300035, 3300148, 0003406213, 0013306635,
 0013308835, 0014604048, 0014604348,
 14606448, 0024600248, 3023300035,
 3023300135, 3023300235, 3023300335,
 3453307235, 3453307435, 3503307135,
 A0003300148, A0013306635, A0013308835,
 A0014604048, A0014604348, A0014606448,
 A0024600248, A3023300035, A3023300135,
 A3023300235, A3023300335, A3503307135

**CV-ES-14163**

Length: 125
 Cone Ø: d1 Ø 30 / d2 Ø 27
 Thread: M30 x 1,5 RHT
 0003305248, 0003387310, 0004600348,
 0004600948, 0004602848, 0004602948,
 0004608948, 0014600248, 0014600848,
 0014601248, 0014602248, 0014607748,
 0024600148, A0003387310, A0004600348,
 A0004602848, A0004602948, A0014600848,
 A0014601248, A0014602248, A0014607748

**DB-DL-5217**

Length: 862 Ø: 40
 Cone Ø: d1 Ø 30 / d2 Ø 27
 01214700A, 6204600405, 6204600805,
 6204602905, 6204603005

**DB-DL-5233**

Length: 895 Ø: 48
 Cone Ø: d1 Ø 30 / d2 Ø 27
 01217300A, 0004609805, 0004609905

**DB-DL-5241**

Length: 875 Ø: 40
 Cone Ø: d1 Ø 30 / d2 Ø 27
 01215300A, 0004609205, 0004609305,
 0014606905

**DB-DL-6197**

Length: 579
 Ø: 50
 Hole Distance: 152 / 152
 6593501206, 6593503506

**DB-DL-6198**

Length: 579
 Ø: 58
 Hole Distance: 152 / 152
 3953500006, 6593501106

**DB-DL-6227**

Length: 629
 Ø: 58
 Hole Distance: 152 / 152
 6593501506, 6593503806

**DB-DL-7270**

Length: 875 Ø: 40
 Cone Ø: d1 Ø 28,6 / d2 Ø 23,9
 01208300A, 0024604705, 0024604805,
 0034604905, A0024604705

**DB-DL-7831**

Length: 870
 Ø: 42
 Cone Ø: d1 Ø 30 / d2 Ø 27
 01215200A, 6254602505

**DB-DL-8131**

Length: 1115 Ø: 52
 Cone Ø: d1 Ø 32 / d2 Ø 28,8
 0004604405, 6254605005

**DB-DL-8138**

Length: 1130
 Ø: 40
 Cone Ø: d1 Ø 32 / d2 Ø 28,8
 0004606605, 4606605

**DB-DL-8618**

Length: 680
 Ø: 42
 Cone Ø: d1 Ø 32 / d2 Ø 28,8
 4604305, 0004604305, 6254604805

**DB-DL-8640**

Length: 1615 Ø: 50
 Cone Ø: d1 Ø 32 / d2 Ø 29
 6253301503, 6253301603, 6253302403,
 6253302503, 9423300803, 9423302103,
 9493300203, 9493300303, 9493300903

**DB-DL-9256**

Length: 905
 Ø: 48
 Cone Ø: d1 Ø 32 / d2 Ø 29
 0014604205, 14604205

**DB-DL-10216**

Length: 1190
 Ø: 40
 Cone Ø: d1 Ø 32 / d2 Ø 29
 0004604905

**DB-DL-12309**

Length: 685 Ø: 40
 Cone Ø: d1 Ø 32 / d2 Ø 28,8
 0004606005, 0004606305

**DB-ES-5209**

Length: 1670 Ø: 50
 Cone Ø: d1 Ø 30 / d2 Ø 27
 6203300503, 6203300603

**DB-ES-5227**

Length: 1588 Ø: 60
 Cone Ø: d1 Ø 38 / d2 Ø 34,3
 6253300903, 6253301203, 9443300203

**DB-ES-5234**

Length: 135
 Cone Ø: d1 Ø 38 / d2 Ø 34,3
 Thread: M38 x 1,5 RHT
 0004601748, 120322305, 2205000400

**DB-ES-8323**

Length: 75
 Cone Ø: d1 Ø 32 / d2 Ø 28,8
 Thread: M26 x 1,5 RHT
 0014601548, 0014601648, 0024600648,
 A0014601648, A0024600648

**DB-ES-8387**

Length: 55
 Cone Ø: d1 Ø 10 / d2 Ø 10
 Thread: M14 x 1,5 RHT
 0009966845, 0009967045

**DB-ES-8491**

Length: 60
 Cone Ø: d1 Ø 10 / d2 Ø 10
 Thread: M12 x 1,75 LHT
 0009966745

**DB-ES-8492**

Length: 60
 Cone Ø: d1 Ø 10 / d2 Ø 10
 Thread: M12 x 1,75 RHT
 0009966645, 3752680189, A3752680189

**DB-ES-8500**

Length: 55
 Cone Ø: d1 Ø 12 / d2 Ø 10,8
 Thread: M14 x 1,5 RHT
 0002685989

**DB-RK-7267**

Ø: 95
 Hole Distance: 152
 Thick/Height: 24
 01302100A, 0003500413, 3500413, 0005861235,
 5861235, 8143270609

**DB-RK-8550**

Ø: 75 Hole Distance: 152
 Thick/Height: 24
 0003502105, 0003504605



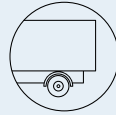

SK ...

3550 ...	05/92→09/96	Tie Rod End	DB-ES-5234		for Steering Rod	
	05/92→09/96	Tie Rod End	DB-ES-8323			
	05/92→09/96	Track Control Arm		DB-DL-6197	Suspension Rod, Trailing Arm	
	05/92→09/96	Track Control Arm		DB-DL-6198	Suspension Rod, Trailing Arm	
	05/92→09/96	Track Control Arm		DB-DL-6227	Suspension Rod, Trailing Arm	
3550 K	03/91→09/96	Ball Head, gearshift linkage	DB-ES-8387			
	03/91→09/96	Ball Head, gearshift linkage	DB-ES-8491			
	03/91→09/96	Ball Head, gearshift linkage	DB-ES-8492			
	03/91→09/96	Ball Head, gearshift linkage	DB-ES-8500			
	03/91→09/96	Centre Rod	DB-DL-5217		Push Rod	
	03/91→09/96	Centre Rod	DB-DL-5241		Suspension Rod	
	03/91→09/96	Centre Rod	DB-DL-7270		Push Rod;Suspension Rod	
	03/91→09/96	Centre Rod	DB-DL-7831		Push Rod	
	03/91→09/96	Centre Rod	DB-DL-8138		Push Rod	
	03/91→09/96	Centre Rod	DB-DL-8618		Push Rod	
	03/91→09/96	Centre Rod	DB-DL-10216		Push Rod	
	03/91→09/96	Drag Link End	DB-ES-8529			
	03/91→09/96	Suspension Arm Repair Kit		DB-RK-7267	for Drag Link	
	03/91→09/96	Suspension Arm Repair Kit		DB-RK-8550	for Wishbone (CV)	
	03/91→09/96	Tie Rod	DB-DL-8640		Guide Rod	
	03/91→09/96	Tie Rod	DB-ES-5209			
	03/91→09/96	Tie Rod	DB-ES-5227		Guide Rod	
	03/91→09/96	Tie Rod End	CV-ES-12461		for Steering Rod	
	03/91→09/96	Tie Rod End	DB-ES-5234		for Steering Rod	
	03/91→09/96	Tie Rod End	DB-ES-8323			
	03/91→09/96	Track Control Arm		DB-DL-6197	Suspension Rod, Trailing Arm	
	03/91→09/96	Track Control Arm		DB-DL-6198	Suspension Rod, Trailing Arm	
	03/91→09/96	Track Control Arm		DB-DL-6227	Suspension Rod, Trailing Arm	
	3550 S, 3553 S	05/92→09/96	Ball Head, gearshift linkage	DB-ES-8387		
		05/92→09/96	Ball Head, gearshift linkage	DB-ES-8491		
		05/92→09/96	Ball Head, gearshift linkage	DB-ES-8492		
		05/92→09/96	Ball Head, gearshift linkage	DB-ES-8500		
05/92→09/96		Centre Rod	DB-DL-5217		Push Rod	
05/92→09/96		Centre Rod	DB-DL-10216		Push Rod	
05/92→09/96		Stabiliser Mounting		DB-SB-10407		
05/92→09/96		Suspension Arm Repair Kit		DB-RK-7267	for Drag Link	
05/92→09/96		Suspension Arm Repair Kit	DB-RK-5280			
05/92→09/96		Tie Rod	DB-DL-8640		Guide Rod	
05/92→09/96		Tie Rod	DB-ES-5209			
05/92→09/96		Tie Rod	DB-ES-5227		Guide Rod	
05/92→09/96		Tie Rod End	CV-ES-12461		for Steering Rod	
05/92→09/96		Tie Rod End	DB-ES-5234		for Steering Rod	
05/92→09/96		Tie Rod End	DB-ES-8323			
05/92→09/96		Track Control Arm		DB-DL-6197	Suspension Rod, Trailing Arm	
05/92→09/96		Track Control Arm		DB-DL-6198	Suspension Rod, Trailing Arm	
05/92→09/96		Track Control Arm		DB-DL-6227	Suspension Rod, Trailing Arm	
3553 S		04/92→	Ball Head, gearshift linkage	DB-ES-8387		
		04/92→	Ball Head, gearshift linkage	DB-ES-8500		
		04/92→	Centre Rod	DB-DL-5217		Push Rod
	04/92→	Centre Rod	DB-DL-10216		Push Rod	
	04/92→	Stabiliser Mounting		DB-SB-10407		
	04/92→	Suspension Arm Repair Kit		DB-RK-7267	for Drag Link	
	04/92→	Suspension Arm Repair Kit	DB-RK-5280			
	04/92→	Tie Rod	DB-DL-8640		Guide Rod	
	04/92→	Tie Rod	DB-ES-5209			
	04/92→	Tie Rod	DB-ES-5227		Guide Rod	
	04/92→	Tie Rod End	CV-ES-12461		for Steering Rod	
	04/92→	Tie Rod End	DB-ES-5234		for Steering Rod	
	04/92→	Tie Rod End	DB-ES-8323			
	04/92→	Track Control Arm		DB-DL-6197	Suspension Rod, Trailing Arm	
	04/92→	Track Control Arm		DB-DL-6198	Suspension Rod, Trailing Arm	

CV-ES-12461

Length: 120
 Cone Ø: d1 Ø 26 / d2 Ø 23,5
 Thread: M30 x 1,5 LHT
 0003300035, 3300148, 0003406213, 0013306635,
 0013308835, 0014604048, 0014604348,
 14606448, 0024600248, 3023300035,
 3023300135, 3023300235, 3023300335,
 3453307235, 3453307435, 3503307135,
 A0003300148, A0013306635, A0013308835,
 A0014604048, A0014604348, A0014606448,
 A0024600248, A3023300035, A3023300135,
 A3023300235, A3023300335, A3503307135



DB-DL-5217

Length: 862 Ø: 40
 Cone Ø: d1 Ø 30 / d2 Ø 27
 01214700A, 6204600405, 6204600805,
 6204602905, 6204603005



DB-DL-5241

Length: 875 Ø: 40
 Cone Ø: d1 Ø 30 / d2 Ø 27
 01215300A, 0004609205, 0004609305,
 0014606905



DB-DL-6197

Length: 579
 Ø: 50
 Hole Distance: 152 / 152
 6593501206, 6593503506



DB-DL-6198

Length: 579
 Ø: 58
 Hole Distance: 152 / 152
 3953500006, 6593501106



DB-DL-6227

Length: 629
 Ø: 58
 Hole Distance: 152 / 152
 6593501506, 6593503806



DB-DL-7270

Length: 875 Ø: 40
 Cone Ø: d1 Ø 28,6 / d2 Ø 23,9
 01208300A, 0024604705, 0024604805,
 0034604905, A0024604705



DB-DL-7831

Length: 870
 Ø: 42
 Cone Ø: d1 Ø 30 / d2 Ø 27
 01215200A, 6254602505



DB-DL-8138

Length: 1130
 Ø: 40
 Cone Ø: d1 Ø 32 / d2 Ø 28,8
 4606605, 0004606605



DB-DL-8618

Length: 680
 Ø: 42
 Cone Ø: d1 Ø 32 / d2 Ø 28,8
 0004604305, 4604305, 6254604805



DB-DL-8640

Length: 1615 Ø: 50
 Cone Ø: d1 Ø 32 / d2 Ø 29
 6253301503, 6253301603, 6253302403,
 6253302503, 9423300803, 9423302103,
 9493300203, 9493300303, 9493300903



DB-DL-10216

Length: 1190
 Ø: 40
 Cone Ø: d1 Ø 32 / d2 Ø 29
 0004604905



DB-ES-5209

Length: 1670 Ø: 50
 Cone Ø: d1 Ø 30 / d2 Ø 27
 6203300503, 6203300603



DB-ES-5227

Length: 1588 Ø: 60
 Cone Ø: d1 Ø 38 / d2 Ø 34,3
 6253300903, 6253301203, 9443300203



DB-ES-5234

Length: 135
 Cone Ø: d1 Ø 38 / d2 Ø 34,3
 Thread: M38 x 1,5 RHT
 0004601748, 120322305, 2205000400



DB-ES-8323

Length: 75
 Cone Ø: d1 Ø 32 / d2 Ø 28,8
 Thread: M26 x 1,5 RHT
 0014601548, 0014601648, 0024600648,
 A0014601648, A0024600648



DB-ES-8387

Length: 55
 Cone Ø: d1 Ø 10 / d2 Ø 10
 Thread: M14 x 1,5 RHT
 0009966845, 0009967045



DB-ES-8491

Length: 60
 Cone Ø: d1 Ø 10 / d2 Ø 10
 Thread: M12 x 1,75 LHT
 0009966745



DB-ES-8492

Length: 60
 Cone Ø: d1 Ø 10 / d2 Ø 10
 Thread: M12 x 1,75 RHT
 0009966645, 3752680189, A3752680189



DB-ES-8500

Length: 55
 Cone Ø: d1 Ø 12 / d2 Ø 10,8
 Thread: M14 x 1,5 RHT
 0002685989



DB-ES-8529

Length: 145
 Cone Ø: d1 Ø 32 / d2 Ø 28,8
 Thread: M30 x 1,5 RHT
 0014602948, 14602948, 3714607148,
 A3714607148



DB-RK-5280

Ø: 86
 01303000A, 6213200428



DB-RK-7267

Ø: 95
 Hole Distance: 152
 Thick/Height: 24
 01302100A, 0003500413, 3500413, 0005861235,
 5861235, 81432706069



DB-RK-8550

Ø: 75 Hole Distance: 152
 Thick/Height: 24
 0003502105, 0003504605



DB-SB-10407

Ø: 61 Thick/Height: 46
 0003235985, 0003262481, 0003262981





SK ...

3553, 3553 L	01/94→09/96	Ball Head, gearshift linkage	DB-ES-8387	
	01/94→09/96	Ball Head, gearshift linkage	DB-ES-8491	
	01/94→09/96	Ball Head, gearshift linkage	DB-ES-8492	
	01/94→09/96	Ball Head, gearshift linkage	DB-ES-8500	
	01/94→09/96	Centre Rod	DB-DL-5217	Push Rod
	01/94→09/96	Centre Rod	DB-DL-5233	Push Rod* 5 937 288 *→
	01/94→09/96	Centre Rod	DB-DL-5241	Suspension Rod
	01/94→09/96	Centre Rod	DB-DL-7270	Push Rod;Suspension Rod
	01/94→09/96	Centre Rod	DB-DL-7831	Push Rod
	01/94→09/96	Centre Rod	DB-DL-7831	Push Rod→* K 226 467 *
	01/94→09/96	Centre Rod	DB-DL-8131	Push Rod
	01/94→09/96	Centre Rod	DB-DL-8138	Push Rod
	01/94→09/96	Centre Rod	DB-DL-8618	Push Rod
	01/94→09/96	Centre Rod	DB-DL-10216	Push Rod
	01/94→09/96	Centre Rod	DB-DL-12309	Coupling Rod
	01/94→09/96	Suspension Arm Repair Kit		DB-RK-7267 for Drag Link
	01/94→09/96	Suspension Arm Repair Kit		DB-RK-8550 for Wishbone (CV)
	01/94→09/96	Tie Rod	DB-DL-8640	Guide Rod
	01/94→09/96	Tie Rod	DB-ES-5209	
	01/94→09/96	Tie Rod	DB-ES-5227	Guide Rod
	01/94→09/96	Tie Rod End	CV-ES-12461	for Steering Rod
	01/94→09/96	Track Control Arm		DB-DL-6197 Suspension Rod, Trailing Arm
	01/94→09/96	Track Control Arm		DB-DL-6198 Suspension Rod, Trailing Arm
	01/94→09/96	Track Control Arm		DB-DL-6227 Suspension Rod, Trailing Arm
4050 A	07/87→	Centre Rod	DB-DL-5217	Push Rod
	07/87→	Stabiliser Mounting		DB-SB-10407
	07/87→	Suspension Arm Repair Kit		DB-RK-7267 for Drag Link
	07/87→	Tie Rod	DB-ES-5209	
	07/87→	Tie Rod	DB-ES-5227	Guide Rod
	07/87→	Tie Rod End	DB-ES-5234	for Steering Rod
	07/87→	Tie Rod End	DB-ES-8617	
	07/87→	Tie Rod End	SC-ES-5764	
4844	12/91→08/94	Ball Head, gearshift linkage	DB-ES-8491	
	12/91→08/94	Ball Head, gearshift linkage	DB-ES-8492	
	12/91→08/94	Centre Rod	DB-DL-5217	Push Rod
	12/91→08/94	Centre Rod	DB-DL-10216	Push Rod
	12/91→08/94	Suspension Arm Repair Kit		DB-RK-7267 for Drag Link
	12/91→08/94	Tie Rod	DB-DL-8640	Guide Rod
	12/91→08/94	Tie Rod	DB-ES-5209	
	12/91→08/94	Tie Rod	DB-ES-5227	Guide Rod
	12/91→08/94	Tie Rod	MN-DL-7834	Guide Rod
	12/91→08/94	Tie Rod End	CV-ES-12461	for Steering Rod
	12/91→08/94	Tie Rod End	DB-ES-5234	for Steering Rod
	12/91→08/94	Track Control Arm		DB-DL-6197 Suspension Rod, Trailing Arm
	12/91→08/94	Track Control Arm		DB-DL-6198 Suspension Rod, Trailing Arm
12/91→08/94	Track Control Arm		DB-DL-6227 Suspension Rod, Trailing Arm	
4844 K	03/91→09/96	Ball Head, gearshift linkage	DB-ES-8387	
	03/91→09/96	Ball Head, gearshift linkage	DB-ES-8491	
	03/91→09/96	Ball Head, gearshift linkage	DB-ES-8492	
	03/91→09/96	Ball Head, gearshift linkage	DB-ES-8500	
	03/91→09/96	Centre Rod	DB-DL-5217	Push Rod
	03/91→09/96	Centre Rod	DB-DL-5241	Suspension Rod
	03/91→09/96	Centre Rod	DB-DL-7270	Push Rod;Suspension Rod
	03/91→09/96	Centre Rod	DB-DL-10216	Push Rod
	03/91→09/96	Suspension Arm Repair Kit		DB-RK-7267 for Drag Link
	03/91→09/96	Suspension Arm Repair Kit		DB-RK-8550 for Wishbone (CV)
	03/91→09/96	Tie Rod	DB-DL-8640	Guide Rod
	03/91→09/96	Tie Rod	DB-ES-5209	
	03/91→09/96	Tie Rod	DB-ES-5227	Guide Rod
	03/91→09/96	Tie Rod End	CV-ES-12461	for Steering Rod
	03/91→09/96	Tie Rod End	DB-ES-5234	for Steering Rod
	03/91→09/96	Tie Rod End	DB-ES-8323	
	03/91→09/96	Track Control Arm		DB-DL-6197 Suspension Rod, Trailing Arm

CV-ES-12461

Length: 120
 Cone Ø: d1 Ø 26 / d2 Ø 23,5
 Thread: M30 x 1,5 LHT
 0003300035, 3300148, 0003406213, 0013306635,
 0013308835, 0014604048, 0014604348,
 14606448, 0024600248, 3023300035,
 3023300135, 3023300235, 3023300335,
 3453307235, 3453307435, 3503307135,
 A0003300148, A0013306635, A0013308835,
 A0014604048, A0014604348, A0014606448,
 A0024600248, A3023300035, A3023300135,
 A3023300235, A3023300335, A3503307135



DB-DL-5217

Length: 862 Ø: 40
 Cone Ø: d1 Ø 30 / d2 Ø 27
 01214700A, 6204600405, 6204600805,
 6204602905, 6204603005



DB-DL-5233

Length: 895
 Ø: 48
 Cone Ø: d1 Ø 30 / d2 Ø 27
 01217300A, 0004609805, 4609805, 4609905,
 0004609905



DB-DL-5241

Length: 875 Ø: 40
 Cone Ø: d1 Ø 30 / d2 Ø 27
 01215300A, 0004609205, 0004609305,
 0014606905



DB-DL-6197

Length: 579
 Ø: 50
 Hole Distance: 152 / 152
 6593501206, 6593503506



DB-DL-6198

Length: 579
 Ø: 58
 Hole Distance: 152 / 152
 3953500006, 6593501106



DB-DL-6227

Length: 629
 Ø: 58
 Hole Distance: 152 / 152
 6593501506, 6593503806



DB-DL-7270

Length: 875 Ø: 40
 Cone Ø: d1 Ø 28,6 / d2 Ø 23,9
 01208300A, 0024604705, 0024604805,
 0034604905, A0024604705



DB-DL-7831

Length: 870
 Ø: 42
 Cone Ø: d1 Ø 30 / d2 Ø 27
 01215200A, 6254602505



DB-DL-8131

Length: 1115
 Ø: 52
 Cone Ø: d1 Ø 32 / d2 Ø 28,8
 4604405, 0004604405, 6254605005



DB-DL-8138

Length: 1130
 Ø: 40
 Cone Ø: d1 Ø 32 / d2 Ø 28,8
 0004606605, 4606605



DB-DL-8618

Length: 680
 Ø: 42
 Cone Ø: d1 Ø 32 / d2 Ø 28,8
 0004604305, 4604305, 6254604805



DB-DL-8640

Length: 1615 Ø: 50
 Cone Ø: d1 Ø 32 / d2 Ø 29
 6253301503, 6253301603, 6253302403,
 6253302503, 9423300803, 9423302103,
 9493300203, 9493300303, 9493300903



DB-DL-10216

Length: 1190
 Ø: 40
 Cone Ø: d1 Ø 32 / d2 Ø 29
 0004604905



DB-DL-12309

Length: 685
 Ø: 40
 Cone Ø: d1 Ø 32 / d2 Ø 28,8
 0004606005, 4606005, 4606305, 0004606305



DB-ES-5209

Length: 1670 Ø: 50
 Cone Ø: d1 Ø 30 / d2 Ø 27
 6203300503, 6203300603



DB-ES-5227

Length: 1588 Ø: 60
 Cone Ø: d1 Ø 38 / d2 Ø 34,3
 6253300903, 6253301203, 9443300203



DB-ES-5234

Length: 135
 Cone Ø: d1 Ø 38 / d2 Ø 34,3
 Thread: M38 x 1,5 RHT
 0004601748, 120322305, 2205000400



DB-ES-8323

Length: 75
 Cone Ø: d1 Ø 32 / d2 Ø 28,8
 Thread: M26 x 1,5 RHT
 0014601548, 0014601648, 0024600648,
 A0014601648, A0024600648



DB-ES-8387

Length: 55
 Cone Ø: d1 Ø 10 / d2 Ø 10
 Thread: M14 x 1,5 RHT
 0009966845, 0009967045



DB-ES-8491

Length: 60
 Cone Ø: d1 Ø 10 / d2 Ø 10
 Thread: M12 x 1,75 LHT
 0009966745



DB-ES-8492

Length: 60
 Cone Ø: d1 Ø 10 / d2 Ø 10
 Thread: M12 x 1,75 RHT
 0009966645, 3752680189, A3752680189



DB-ES-8500

Length: 55
 Cone Ø: d1 Ø 12 / d2 Ø 10,8
 Thread: M14 x 1,5 RHT
 0002685989



DB-ES-8617

Length: 155
 Cone Ø: d1 Ø 32 / d2 Ø 28,8
 Thread: M30 x 1,5 RHT
 0004604848, 4604848, 0014600648, 14600648



DB-RK-7267

Ø: 95
 Hole Distance: 152
 Thick/Height: 24
 01302100A, 0003500413, 3500413, 0005861235,
 5861235, 81432706069



DB-RK-8550

Ø: 75 Hole Distance: 152
 Thick/Height: 24
 0003502105, 0003504605



DB-SB-10407

Ø: 61 Thick/Height: 46
 0003235985, 0003262481, 0003262981



MN-DL-7834

Length: 1588 Ø: 58
 Cone Ø: d1 Ø 30 / d2 Ø 27
 3463303903, 3463304903, 6253303203,
 9443300503, 9443301303, 94433017030



SC-ES-5764

Length: 95
 Cone Ø: d1 Ø 30 / d2 Ø 27
 Thread: M26 x 1,5 RHT
 0004604948





SK ...

4844 K ...	03/91→09/96	Track Control Arm		DB-DL-6198	Suspension Rod, Trailing Arm
	03/91→09/96	Track Control Arm		DB-DL-6227	Suspension Rod, Trailing Arm
4850 A	07/87→	Suspension Arm Repair Kit		DB-RK-7267	for Drag Link
	07/87→	Tie Rod	DB-ES-5227		Guide Rod
	07/87→	Tie Rod End	DB-ES-5234		for Steering Rod
	07/87→	Tie Rod End	SC-ES-5764		

TOURINO (O 510)

TOURINO	10/03→	Suspension Arm Repair Kit	DB-RK-9298	DB-RK-9298	for Drag Link;for Control Arm
---------	--------	---------------------------	-------------------	-------------------	-------------------------------

TOURISMO (O 350)

Tourismo	08/95→	Tie Rod	DB-DL-8728		
	08/95→	Tie Rod	DB-DL-9211		
	08/95→	Track Control Arm		DB-TC-12376	Control Arm
	08/95→	Track Control Arm	DB-VB-3700		Control Arm
	08/95→	Track Control Arm	DB-VB-3701		Control Arm
Tourismo 15 RHD	01/03→	Stabiliser Link		DB-DL-12364	Coupling Rod
	01/03→	Stabiliser Link	DB-DL-12363		Coupling Rod
	01/03→	Track Control Arm		DB-TC-12376	Control Arm
Tourismo 15 SHD	01/03→	Stabiliser Link		DB-DL-12364	Coupling Rod
	01/03→	Stabiliser Link	DB-DL-12363		Coupling Rod
	01/03→	Track Control Arm		DB-TC-12376	Control Arm
Tourismo 16 RHD	01/03→	Stabiliser Link		DB-DL-12364	Coupling Rod
	01/03→	Stabiliser Link	DB-DL-12363		Coupling Rod
	01/03→	Tie Rod End		MN-ES-8490	
	01/03→	Track Control Arm		DB-DL-7788	Trailing Arm
	01/03→	Track Control Arm		DB-DL-8393	for Steering Rod, Trailing Arm
	01/03→	Track Control Arm		DB-TC-12376	Control Arm
	01/03→	Track Control Arm		DB-DL-12364	Coupling Rod
Tourismo 17 RHD	01/03→	Stabiliser Link	DB-DL-12363		Coupling Rod
	01/03→	Stabiliser Link		MN-ES-8490	
	01/03→	Track Control Arm		DB-DL-7788	Trailing Arm
	01/03→	Track Control Arm		DB-DL-8393	for Steering Rod, Trailing Arm
	01/03→	Track Control Arm		DB-TC-12376	Control Arm
Tourismo RHD, SHD	08/95→	Centre Rod	DB-DL-12375		for Steering Rod
	08/95→	Tie Rod	DB-DL-8728		
	08/95→	Tie Rod	DB-DL-9211		
	08/95→	Track Control Arm		DB-TC-12376	Control Arm
	08/95→	Track Control Arm	DB-VB-3700		Control Arm
	08/95→	Track Control Arm	DB-VB-3701		Control Arm

TOURO (O 500)

O 500 GL, GLE	01/01→	Tie Rod End	RV-ES-12331		
O 500 RSD	01/01→	Stabiliser Link	DB-DL-12363		Coupling Rod
O 500 U	01/01→	Stabiliser Link	DB-DL-12363		Coupling Rod
	01/01→	Tie Rod End	RV-ES-12331		
Touro	10/01→	Stabiliser Link		DB-DL-12364	Coupling Rod
	10/01→	Stabiliser Link	DB-DL-12363		Coupling Rod

TRAVEGO (O 580)

O 580-15 RH	10/99→	Stabiliser Link		DB-DL-12364	Coupling Rod
	10/99→	Stabiliser Link	DB-DL-12363		Coupling Rod
	10/99→	Track Control Arm		DB-TC-12376	Control Arm
O 580-15 RH/RHD	10/99→	Stabiliser Link		DB-DL-12364	Coupling Rod
	10/99→	Stabiliser Link	DB-DL-12363		Coupling Rod
	10/99→	Track Control Arm		DB-TC-12376	Control Arm
O 580-15 RHD	10/99→	Stabiliser Link		DB-DL-12364	Coupling Rod
	10/99→	Stabiliser Link	DB-DL-12363		Coupling Rod
	10/99→	Track Control Arm		DB-TC-12376	Control Arm
O 580-15 SHD	10/99→	Stabiliser Link		DB-DL-12364	Coupling Rod
	10/99→	Stabiliser Link	DB-DL-12363		Coupling Rod
	10/99→	Track Control Arm		DB-TC-12376	Control Arm

DB-DL-6198

Length: 579
 Ø: 58
 Hole Distance: 152 / 152
 3953500006, 6593501106

**DB-DL-6227**

Length: 629
 Ø: 58
 Hole Distance: 152 / 152
 6593501506, 6593503806

**DB-DL-7788**

Length: 664
 Ø: 48
 Hole Distance: 130 / 130
 6283330003

**DB-DL-8393**

Length: 576
 Ø: 48
 Hole Distance: 130 / 130
 6273500206, 6273500306, 6283330905,
 6283331705, 6443500306, A6273500206,
 A6273500306, A6283330905, A6283331705,
 A6443500306

**DB-DL-8728**

Length: 506
 Ø: 30
 Cone Ø: d1 Ø 30 / d2 Ø 27
 3563300103, 6133300103

**DB-DL-9211**

Length: 697
 Ø: 32
 Cone Ø: d1 Ø 30 / d2 Ø 27
 3563300003, 6133300003

**DB-DL-12363**

Length: 148
 Ø: 31
 Cone Ø: d1 Ø 30 / d2 Ø 27
 0003200132, 3200132, 0003200532, 3200532,
 3200832, 0003200832, 0003201132, 3201132,
 6323200332

**DB-DL-12364**

Length: 200
 Ø: 32
 Cone Ø: d1 Ø 30 / d2 Ø 27
 0003201232, 6283201489, 6293200189,
 6323200132, 6323200232, 6323200532,
 A6323200132, A6323200532

**DB-DL-12375**

Length: 1708
 Ø: 56
 Cone Ø: d1 Ø 30 / d2 Ø 27
 3564630015, 6134630015

**DB-ES-5227**

Length: 1588 Ø: 60
 Cone Ø: d1 Ø 38 / d2 Ø 34,3
 6253300903, 6253301203, 9443300203

**DB-ES-5234**

Length: 135
 Cone Ø: d1 Ø 38 / d2 Ø 34,3
 Thread: M38 x 1,5 RHT
 0004601748, 120322305, 2205000400

**DB-RK-7267**

Ø: 95
 Hole Distance: 152
 Thick/Height: 24
 01302100A, 0003500413, 3500413, 0005861235,
 5861235, 81432706069

**DB-RK-9298**

Ø: 67
 Hole Distance: 115
 Thick/Height: 24
 4443330127

**DB-TC-12376**

Length: 628
 Ø: 46
 Hole Distance: 130 / 130
 4103500906, 6293500106, 6293501206,
 6293502806, 6323500006

**DB-VB-3700**

Length: 800
 Ø: 48
 Hole Distance: 126 / 126
 3563301510, 6133300110

**DB-VB-3701**

Length: 901
 Ø: 48
 Hole Distance: 126 / 126
 3563301410, 6133300010

**MN-ES-8490****RV-ES-12331****SC-ES-5764**

Length: 95
 Cone Ø: d1 Ø 30 / d2 Ø 27
 Thread: M26 x 1,5 RHT
 0004604948





TRAVEGO (O 580) ...

O 580-16 RHD	10/99→	Stabiliser Link		DB-DL-12364	Coupling Rod
	10/99→	Stabiliser Link	DB-DL-12363		Coupling Rod
	10/99→	Tie Rod End		MN-ES-8490	
	10/99→	Track Control Arm		DB-DL-7788	Trailing Arm
	10/99→	Track Control Arm		DB-DL-8393	for Steering Rod, Trailing Arm
	10/99→	Track Control Arm		DB-TC-12376	Control Arm
O 580-16 RHD, O 580-17 RHD	10/99→	Stabiliser Link		DB-DL-12364	Coupling Rod
	10/99→	Stabiliser Link	DB-DL-12363		Coupling Rod
	10/99→	Tie Rod End		MN-ES-8490	for vehicles with Hinged Trailing Axle
	10/99→	Track Control Arm		DB-DL-7788	Trailing Arm, Tag Axle
	10/99→	Track Control Arm		DB-DL-8393	for Steering Rod, Trailing Arm
	10/99→	Track Control Arm		DB-TC-12376	Control Arm
O 580-17 RHD	10/99→	Stabiliser Link		DB-DL-12364	Coupling Rod
	10/99→	Stabiliser Link	DB-DL-12363		Coupling Rod
	10/99→	Tie Rod End		MN-ES-8490	for vehicles with Hinged Trailing Axle
	10/99→	Track Control Arm		DB-DL-7788	Trailing Arm, Tag Axle
	10/99→	Track Control Arm		DB-DL-8393	for Steering Rod, Trailing Arm
	10/99→	Track Control Arm		DB-TC-12376	Control Arm
O 580-17 SHD	10/99→	Stabiliser Link		DB-DL-12364	Coupling Rod
	10/99→	Stabiliser Link	DB-DL-12363		Coupling Rod
	10/99→	Track Control Arm		DB-TC-12376	Control Arm

UNIMOG

U 100, U 110, U 1100L	01/77→05/88	Tie Rod	DB-DL-9225		
	01/77→05/88	Tie Rod	DB-DL-9225		* 010350 *→
U 1000	01/77→05/88	Centre Rod	DB-DL-9194		Suspension Rod
	01/77→	Tie Rod	DB-DL-9193		
	01/88→	Centre Rod	DB-DL-9194		Push Rod
U 1000T	01/77→12/82	Centre Rod	DB-DL-9194		Suspension Rod
	01/77→12/82	Tie Rod	DB-DL-9193		
U 1150,U 1150L	05/88→	Tie Rod	DB-DL-9225		
U 1200	02/82→05/88	Centre Rod	DB-DL-9194		Suspension Rod
	02/82→	Tie Rod	DB-DL-9193		
	01/88→	Centre Rod	DB-DL-9194		Push Rod
U 1200T	01/83→05/88	Centre Rod	DB-DL-9194		Suspension Rod
	01/83→	Tie Rod	DB-DL-9193		
	01/88→	Centre Rod	DB-DL-9194		Push Rod
U 125, U 1100L	01/77→01/88	Tie Rod	DB-DL-9225		
U 1250	01/77→01/88	Tie Rod	DB-DL-9225		* 010350 *→
	12/84→05/88	Centre Rod	DB-DL-9194		Suspension Rod
	12/84→05/88	Tie Rod	DB-DL-9193		
U 1250,U 1250L	01/88→	Centre Rod	DB-DL-9194		Push Rod
	01/88→	Tie Rod	DB-DL-9193		
U 1250L	05/88→	Centre Rod	DB-DL-9194		Push Rod
	05/88→	Tie Rod	DB-DL-9193		
U 1300	01/77→12/84	Centre Rod	DB-DL-7775		Push Rod
U 1300 L	01/77→05/88	Centre Rod	DB-DL-7775		Push Rod
U 1300,U 1300L	01/77→05/88	Centre Rod	DB-DL-7775		Push Rod
U 1350L	05/88→	Centre Rod	DB-DL-7775		Push Rod
U 1400	01/88→	Centre Rod	DB-DL-9194		Push Rod
	01/88→	Tie Rod	DB-DL-9193		
U 1450,U 1450L	01/88→	Centre Rod	DB-DL-9194		Push Rod
	01/88→	Tie Rod	DB-DL-9193		
U 1500	01/77→05/88	Centre Rod	DB-DL-7775		Push Rod
U 1500T	01/77→05/88	Centre Rod	DB-DL-7775		Push Rod
U 1550	01/86→05/88	Tie Rod	DB-DL-9193		
U 1550 L	02/86→05/88	Centre Rod	DB-DL-7775		Suspension Rod
U 1550L	05/88→	Centre Rod	DB-DL-7775		Push Rod
U 1600	01/88→	Centre Rod	DB-DL-9194		Push Rod
	01/88→	Stabiliser Mounting	DB-SB-10386	DB-SB-10386	
U 1650,U 1650L	01/88→	Centre Rod	DB-DL-9194		Push Rod
	01/88→	Stabiliser Mounting	DB-SB-10386	DB-SB-10386	
U 1700, U 1700 L	05/78→	Centre Rod	DB-DL-7775		Push Rod

DB-DL-7775

Length: 1000

Ø: 38

Cone Ø: d1 Ø 26 / d2 Ø 23,5
4254600105, 4254600205, 4254600305,
4254600405, 4374600105, 4524600405



DB-DL-7788

Length: 664

Ø: 48

Hole Distance: 130 / 130
6283330003



DB-DL-8393

Length: 576

Ø: 48

Hole Distance: 130 / 130
6273500206, 6273500306, 6283330905,
6283331705, 6443500306, A6273500206,
A6273500306, A6283330905, A6283331705,
A6443500306



DB-DL-9193

Length: 1170

Ø: 46

Cone Ø: d1 Ø 26 / d2 Ø 23,5
4243300303



DB-DL-9194

Length: 882

Ø: 38

Cone Ø: d1 Ø 26 / d2 Ø 23,5
4274600005, 4274600105, 4274600305,
4274600405



DB-DL-9225

Length: 1132 Ø: 46

Cone Ø: d1 Ø 22 / d2 Ø 20
4163300003



DB-DL-12363

Length: 148 Ø: 31

Cone Ø: d1 Ø 30 / d2 Ø 27
0003200132, 0003200532, 0003200832,
0003201132, 6323200332



DB-DL-12364

Length: 200 Ø: 32

Cone Ø: d1 Ø 30 / d2 Ø 27
0003201232, 6283201489, 6293200189,
6323200132, 6323200232, 6323200532,
A6323200132, A6323200532



DB-SB-10386

Ø: 38 Thick/Height: 38
3183200073



DB-TC-12376

Length: 628

Ø: 46

Hole Distance: 130 / 130
4103500906, 6293500106, 6293501206,
6293502806, 6323500006



MN-ES-8490





UNIMOG ...

U 1700L	05/78→09/88	Centre Rod	DB-DL-7775	Push Rod
U 1700T	09/88→	Centre Rod	DB-DL-7775	Push Rod
U 1750,U 1750L	09/88→	Centre Rod	DB-DL-7775	Push Rod
U 1800	04/92→	Centre Rod	DB-DL-7775	Push Rod
U 1800T	04/92→	Centre Rod	DB-DL-7775	Suspension Rod
U 1850,U 1850L	04/92→	Centre Rod	DB-DL-7775	Push Rod
U 2100	09/89→	Centre Rod	DB-DL-7775	Push Rod
U 2100T	09/89→	Centre Rod	DB-DL-7775	Suspension Rod
U 2150	09/89→	Centre Rod	DB-DL-7775	Push Rod
U 2150,U 2150L	09/89→	Centre Rod	DB-DL-7775	Push Rod
U 216	05/13→	Tie Rod End	CV-ES-12461	for Steering Rod
	05/13→	Tie Rod End	CV-ES-12462	for Steering Rod
U 218	05/13→	Tie Rod End	CV-ES-12461	for Steering Rod
	05/13→	Tie Rod End	CV-ES-12462	for Steering Rod
U 2400	05/91→	Centre Rod	DB-DL-7775	Push Rod
U 2400TG	07/93→	Centre Rod	DB-DL-7775	Push Rod
U 2450,U 2450L	05/91→	Centre Rod	DB-DL-7775	Push Rod
U 2450L	07/93→	Centre Rod	DB-DL-7775	Push Rod
U 3000	09/02→	Centre Rod	DB-DL-7775	Push Rod
U 318	05/13→	Tie Rod End	CV-ES-12461	for Steering Rod
	05/13→	Tie Rod End	CV-ES-12462	for Steering Rod
U 4000	09/02→	Centre Rod	DB-DL-7775	Push Rod
U 423	05/13→	Tie Rod End	CV-ES-12461	for Steering Rod
	05/13→	Tie Rod End	CV-ES-12462	for Steering Rod
U 423 L	05/13→	Tie Rod End	CV-ES-12461	for Steering Rod
	05/13→	Tie Rod End	CV-ES-12462	for Steering Rod
U 427, U 427 L	05/13→	Tie Rod End	CV-ES-12461	for Steering Rod
	05/13→	Tie Rod End	CV-ES-12462	for Steering Rod
U 430, U 430 L	05/13→	Tie Rod End	CV-ES-12461	for Steering Rod
	05/13→	Tie Rod End	CV-ES-12462	for Steering Rod
U 5000	09/02→	Centre Rod	DB-DL-7775	Push Rod
U 52, U 60, U 600,U 600L	01/77→05/88	Centre Rod	DB-DL-6140	Push Rod
U 527, U 527 L	05/13→	Tie Rod End	CV-ES-12461	for Steering Rod
	05/13→	Tie Rod End	CV-ES-12462	for Steering Rod
U 530, U 530 L	05/13→	Tie Rod End	CV-ES-12461	for Steering Rod
	05/13→	Tie Rod End	CV-ES-12462	for Steering Rod
U 54	04/66→03/72	Tie Rod	DB-DL-9225	* 003544 *→
U 65, U 70	01/62→01/88	Tie Rod	DB-DL-9225	* 020559 *→
U 66, U 72	03/69→01/88	Tie Rod	DB-DL-9225	* 003544 *→
U 72 ,U 80	01/69→01/77	Tie Rod	DB-DL-9225	
	01/69→01/77	Tie Rod	DB-DL-9225	* 000070 *→
U 80, U 84, U 90	05/69→01/88	Tie Rod	DB-DL-9225	
	05/69→01/88	Tie Rod	DB-DL-9225	* 010350 *→
U 800	01/77→03/90	Tie Rod	DB-DL-9225	
	01/77→03/90	Tie Rod	DB-DL-9225	* 003544 *→
U 800L	01/77→03/90	Tie Rod	DB-DL-9225	
	01/77→03/90	Tie Rod	DB-DL-9225	* 000070 *→
U 900	01/77→	Tie Rod	DB-DL-9225	
	01/77→	Tie Rod	DB-DL-9225	* 020559 *→

ZETROS

1833 A	09/08→	Stabiliser Mounting		DB-SB-10406	
	09/08→	Tie Rod	DB-ES-5227		Guide Rod, Drive Axle
2733 A	09/08→	Bush, parabolic spring		DB-SB-10401	
	09/08→	Tie Rod	DB-ES-5227		Guide Rod, Drive Axle
	09/08→	Track Control Arm		DB-VB-9307	Suspension Rod, Wishbone (CV), 1st RA;2nd RA

CV-ES-12461

Length: 120

Cone Ø: d1 Ø 26 / d2 Ø 23,5

Thread: M30 x 1,5 LHT

0003300035, 3300148, 0003406213, 0013306635,
0013308835, 0014604048, 0014604348,
14606448, 0024600248, 3023300035,
3023300135, 3023300235, 3023300335,
3453307235, 3453307435, 3503307135,
A0003300148, A0013306635, A0013308835,
A0014604048, A0014604348, A0014606448,
A0024600248, A3023300035, A3023300135,
A3023300235, A3023300335, A3503307135



CV-ES-12462

Length: 120

Cone Ø: d1 Ø 26 / d2 Ø 23,5

Thread: M30 x 1,5 RHT

0003300135, 0003300248, 0003303235,
0003305835, 0003307335, 0003383410,
0004608348, 004608348, 0004632229,
0004633129, 0004633429, 0004633529,
0013300135, 0013300235, 0013306735,
0014603448, 0014604148, 0014604448,
0014606348, 0014608348, 0014608448,
0014609748, 0023301535, 3453307135,
3503307035, 3503307335, 3643307135,
5001832582, A0003300248, A0003303235,
A0003307335, A0003383410, A0004608348,
A0004632229, A0004633429, A0013300135,
A0013300235, A0013306735, A0014603448,
A0014604148, A0014604448, A0014606348,
A0014608348, A0014608448, A0014609748,
A0023301535



DB-DL-6140

Length: 885

Ø: 40

Cone Ø: d1 Ø 30 / d2 Ø 27

6204600005, 6204602005



DB-DL-7775

Length: 1000

Ø: 38

Cone Ø: d1 Ø 26 / d2 Ø 23,5

4254600105, 4254600205, 4254600305,

4254600405, 4374600105, 4524600405



DB-DL-9225

Length: 1132 Ø: 46

Cone Ø: d1 Ø 22 / d2 Ø 20

4163300003



DB-ES-5227

Length: 1588 Ø: 60

Cone Ø: d1 Ø 38 / d2 Ø 34,3

6253300903, 6253301203, 9443300203



DB-SB-10401

Length: 232

Thick/Height: 163,5 / 152,5

0003250596, 0003250796



DB-SB-10406

Ø: 80 Thick/Height: 46

0003238185



DB-VB-9307

Length: 667 Ø: 60

Hole Ø 25 / 23 / 23

Hole Distance: 152 / 130 / 130

9483502805





Centroliner

N 4420	01/99 →	Tie Rod	MN-DL-8734		
	01/99 →	Tie Rod	MN-DL-10268		
	01/99 →	Track Control Arm		MN-DL-10283	Trailing Arm
	01/99 →	Track Control Arm		MN-DL-10286	Trailing Arm
	01/99 →	Track Control Arm	MN-DL-9368	MN-DL-9368	Trailing Arm
N 4421	01/99 →	Tie Rod	MN-DL-8734		
	01/99 →	Tie Rod	MN-DL-10268		
	01/99 →	Track Control Arm		MN-DL-10283	Trailing Arm
	01/99 →	Track Control Arm		MN-DL-10286	Trailing Arm
	01/99 →	Track Control Arm	MN-DL-9368	MN-DL-9368	Trailing Arm
N 4516	10/98 →	Centre Rod	MN-DL-7804		Push Rod
	10/98 →	Centre Rod	MN-DL-7808		Push Rod
	10/98 →	Suspension Strut Repair Kit		CV-RK-5311	
	10/98 →	Tie Rod	MN-DL-8621		
	10/98 →	Track Control Arm		MN-DL-7272	Trailing Arm
	10/98 →	Track Control Arm		MN-DL-8733	Trailing Arm
	10/98 →	Track Control Arm		MN-TC-12400	Control Arm
N 4522	10/98 →	Suspension Strut Repair Kit		CV-RK-5311	
	10/98 →	Track Control Arm		MN-TC-12400	Control Arm

Cityliner

N 1216 HD	09/06 →	Suspension Strut Repair Kit		CV-RK-5311	
	09/06 →	Tie Rod	MN-DL-10268		
	09/06 →	Tie Rod	MN-DL-10269		
	09/06 →	Track Control Arm		MN-DL-10283	Trailing Arm
	09/06 →	Track Control Arm		MN-DL-10286	Trailing Arm
N 1216 HDC	09/06 →	Suspension Strut Repair Kit		CV-RK-5311	

Starliner

N 5218 SHD	05/05 →	Suspension Strut Repair Kit		CV-RK-5311	
	05/05 →	Tie Rod	MN-DL-10268		
	05/05 →	Tie Rod	MN-DL-10269		
	05/05 →	Track Control Arm		MN-DL-10283	Trailing Arm

Tourliner

N 2216 SHD	01/03 →	Suspension Strut Repair Kit		CV-RK-5311	
	01/03 →	Tie Rod	MN-DL-8734		
	01/03 →	Tie Rod	MN-DL-10268		
	01/03 →	Track Control Arm		MN-DL-10283	Trailing Arm
	01/03 →	Track Control Arm	MN-DL-9368		Control Arm
	01/03 →	Track Control Arm	MN-DL-9369		Control Arm
	06/06 →	Track Control Arm		MN-DL-10286	Trailing Arm
N 2216 SHDL	01/03 →	Suspension Strut Repair Kit		CV-RK-5311	
	01/03 →	Tie Rod	MN-DL-8734		
	01/03 →	Tie Rod	MN-DL-10268		
	01/03 →	Track Control Arm		MN-DL-10283	Trailing Arm
	01/03 →	Track Control Arm		MN-DL-10286	Trailing Arm
	01/03 →	Track Control Arm	MN-DL-9368		Control Arm
	01/03 →	Track Control Arm	MN-DL-9369		Control Arm

Trendliner

N 3516 Ü	09/04 →	Suspension Strut Repair Kit		CV-RK-5311	
	09/04 →	Tie Rod	MN-DL-10268		
	09/04 →	Tie Rod	MN-DL-10269		
	09/04 →	Track Control Arm		MN-DL-10283	Trailing Arm
	09/04 →	Track Control Arm		MN-DL-10286	Trailing Arm
	09/04 →	Track Control Arm	MN-DL-9368		Control Arm
	09/04 →	Track Control Arm	MN-DL-9369		Control Arm
N 3516/3 ÜL	09/04 →	Suspension Strut Repair Kit		CV-RK-5311	
	09/04 →	Tie Rod	MN-DL-10268		
	09/04 →	Tie Rod	MN-DL-10269		
	09/04 →	Track Control Arm		MN-DL-10283	Trailing Arm
	09/04 →	Track Control Arm		MN-DL-10286	Trailing Arm
	09/04 →	Track Control Arm	MN-DL-9368		Control Arm
	09/04 →	Track Control Arm	MN-DL-9369		Control Arm

CV-RK-5311

11013547, 070550504, 521155208



MN-DL-7272



MN-DL-7804



MN-DL-7808



MN-DL-8621



MN-DL-8733



MN-DL-8734



MN-DL-9368



MN-DL-9369



MN-DL-10268

Length: 661

Ø: 38

Cone Ø: d1 Ø 30 / d2 Ø 27

81467116770, 81467116772, 81467116874,
81467116875, 81467116876



MN-DL-10269

Length: 429

Ø: 36

Cone Ø: d1 Ø 30 / d2 Ø 27

81467116886, 81467116897, 81467116898,
81467116899



MN-DL-10283



MN-DL-10286

Length: 570

Ø: 48

Hole Distance: 130 / 130

81432206151, 81432206183, 81432206276



MN-TC-12400

Length: 413

Hole Distance: 80 / 80

Thick/Height: 35

81432206215



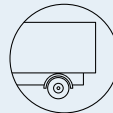

Ares

Ares		Tie Rod	RV-DL-12381	
------	--	---------	-------------	--

C

C 210.19	12/83→05/91	Ball Head, gearshift linkage	CV-ES-2121	
	12/83→05/91	Centre Rod	RV-DL-0905	Push Rod
	12/83→05/91	Tie Rod End	CV-ES-14162	for Steering Rod
	12/83→05/91	Tie Rod End	CV-ES-14163	for Steering Rod
C 230ti.19	05/90→07/92	Ball Head, gearshift linkage	CV-ES-2121	
	05/90→07/92	Centre Rod	RV-DL-0905	Push Rod
	05/90→07/92	Centre Rod	RV-DL-7539	Coupling Rod
	05/90→07/92	Suspension Strut Repair Kit		DF-RK-8671
	05/90→07/92	Tie Rod End	CV-ES-0912	
	05/90→07/92	Tie Rod End	CV-ES-0914	for Steering Rod
	05/90→07/92	Tie Rod End	CV-ES-14162	for Steering Rod
	05/90→07/92	Tie Rod End	CV-ES-14163	for Steering Rod
C 260.19	10/82→05/91	Ball Head, gearshift linkage	CV-ES-2121	
	10/82→05/91	Centre Rod	RV-DL-0905	Push Rod
	10/82→05/91	Centre Rod	RV-DL-7539	Coupling Rod
	10/82→05/91	Tie Rod End	CV-ES-0912	
	10/82→05/91	Tie Rod End	CV-ES-0914	for Steering Rod
	10/82→05/91	Tie Rod End	CV-ES-14162	for Steering Rod
	10/82→05/91	Tie Rod End	CV-ES-14163	for Steering Rod
C 260.19,C 280.19	10/82→10/98	Ball Head, gearshift linkage	CV-ES-2121	
	10/82→10/98	Centre Rod	RV-DL-0905	Push Rod
	10/82→10/98	Centre Rod	RV-DL-7539	Coupling Rod
	10/82→10/98	Suspension Strut Repair Kit		DF-RK-8671
	10/82→10/98	Tie Rod End	CV-ES-0912	
	10/82→10/98	Tie Rod End	CV-ES-0914	for Steering Rod
	10/82→10/98	Tie Rod End	CV-ES-14162	for Steering Rod
	10/82→10/98	Tie Rod End	CV-ES-14163	for Steering Rod
C 260.26	10/82→05/91	Ball Head, gearshift linkage	CV-ES-2121	
	10/82→05/91	Centre Rod	RV-DL-0905	Push Rod
	10/82→05/91	Centre Rod	RV-DL-7539	Coupling Rod
	10/82→05/91	Tie Rod End	CV-ES-0912	
	10/82→05/91	Tie Rod End	CV-ES-0914	for Steering Rod
	10/82→05/91	Tie Rod End	CV-ES-14162	for Steering Rod
	10/82→05/91	Tie Rod End	CV-ES-14163	for Steering Rod
C 280.19	07/92→03/93	Ball Head, gearshift linkage	CV-ES-2121	
	07/92→03/93	Centre Rod	RV-DL-0905	Push Rod
	07/92→03/93	Centre Rod	RV-DL-7539	Coupling Rod
	07/92→03/93	Suspension Strut Repair Kit		DF-RK-8671
	07/92→03/93	Tie Rod End	CV-ES-0912	
	07/92→03/93	Tie Rod End	CV-ES-0914	for Steering Rod
	07/92→03/93	Tie Rod End	CV-ES-14162	for Steering Rod
	07/92→03/93	Tie Rod End	CV-ES-14163	for Steering Rod
C 290.19,C 300.19	10/82→10/98	Ball Head, gearshift linkage	CV-ES-2121	
	10/82→10/98	Centre Rod	RV-DL-0905	Push Rod
	10/82→10/98	Centre Rod	RV-DL-7539	Coupling Rod
	10/82→10/98	Suspension Strut Repair Kit		DF-RK-8671
	10/82→10/98	Tie Rod End	CV-ES-0912	
	10/82→10/98	Tie Rod End	CV-ES-0914	for Steering Rod
	10/82→10/98	Tie Rod End	CV-ES-14162	for Steering Rod
	10/82→10/98	Tie Rod End	CV-ES-14163	for Steering Rod
C 290.19/T	05/86→05/91	Ball Head, gearshift linkage	CV-ES-2121	
	05/86→05/91	Centre Rod	RV-DL-0905	Push Rod
	05/86→05/91	Centre Rod	RV-DL-7539	Coupling Rod
	05/86→05/91	Tie Rod End	CV-ES-0912	
	05/86→05/91	Tie Rod End	CV-ES-0914	for Steering Rod
	05/86→05/91	Tie Rod End	CV-ES-14162	for Steering Rod
	05/86→05/91	Tie Rod End	CV-ES-14163	for Steering Rod
	05/86→05/91	Tie Rod End	CV-ES-14163	for Steering Rod

CV-ES-0912

Length: 125
Cone Ø: d1 Ø 30 / d2 Ø 27
Thread: M38 x 1,5 LHT
3401206, 5001832579



RV-DL-0905

Length: 840
Ø: 52
Cone Ø: d1 Ø 30 / d2 Ø 27
5000787472, 5010130483



CV-ES-0914

Length: 125
Cone Ø: d1 Ø 30 / d2 Ø 27
Thread: M38 x 1,5 RHT
3401207, 5001832580



RV-DL-7539

Length: 1690
Ø: 48
Cone Ø: d1 Ø 30 / d2 Ø 27
5000786902, 5010145077



CV-ES-2121

Length: 85
Cone Ø: d1 Ø 12 / d2 Ø 10,8
Thread: M14 x 1,5 RHT
23162046, 5000516214, 5010144543,
5010245591



RV-DL-12381

Length: 776
Ø: 38
Cone Ø: d1 Ø 26 / d2 Ø 23,5
5010393015



CV-ES-14162

Length: 125
Cone Ø: d1 Ø 30 / d2 Ø 27
Thread: M30 x 1,5 LHT
3401170, 5000288361, 5001832581,
5001858759, 5001858774



CV-ES-14163

Length: 125
Cone Ø: d1 Ø 30 / d2 Ø 27
Thread: M30 x 1,5 RHT
0003406169, 0003406236, 0003406251,
0003406254, 0003406260, 0003406261,
5000288360, 5000590236, 5000804824,
5001858773, 7420937674, 7701011412



DF-RK-8671

Ø: 80
Hole Distance: 145
Thick/Height: 30
5001014345





C ...

C 290.26,C 300.26	10/82→10/98	Ball Head, gearshift linkage	CV-ES-2121		
	10/82→10/98	Centre Rod	RV-DL-0905	Push Rod	
	10/82→10/98	Centre Rod	RV-DL-7539	Coupling Rod	
	10/82→10/98	Tie Rod End	CV-ES-0912		
	10/82→10/98	Tie Rod End	CV-ES-0914	for Steering Rod	
	10/82→10/98	Tie Rod End	CV-ES-14162	for Steering Rod	
	10/82→10/98	Tie Rod End	CV-ES-14163	for Steering Rod	
C 300.19	04/87→10/98	Ball Head, gearshift linkage	CV-ES-2121		
	04/87→10/98	Centre Rod	RV-DL-0905	Push Rod	
	04/87→10/98	Centre Rod	RV-DL-7539	Coupling Rod	
	04/87→10/98	Suspension Strut Repair Kit		DF-RK-8671	
	04/87→10/98	Tie Rod End	CV-ES-0912		
	04/87→10/98	Tie Rod End	CV-ES-0914	for Steering Rod	
	04/87→10/98	Tie Rod End	CV-ES-14162	for Steering Rod	
C 300.24	04/87→10/98	Ball Head, gearshift linkage	CV-ES-2121		
	04/87→10/98	Centre Rod	RV-DL-0905	Push Rod	
	04/87→10/98	Centre Rod	RV-DL-7539	Coupling Rod	
	04/87→10/98	Suspension Strut Repair Kit		DF-RK-8671	
	04/87→10/98	Tie Rod End	CV-ES-0912		
	04/87→10/98	Tie Rod End	CV-ES-0914	for Steering Rod	
	04/87→10/98	Tie Rod End	CV-ES-14162	for Steering Rod	
C 300.26	04/87→10/98	Ball Head, gearshift linkage	CV-ES-2121		
	04/87→10/98	Centre Rod	RV-DL-0905	Push Rod	
	04/87→10/98	Centre Rod	RV-DL-7539	Coupling Rod	
	04/87→10/98	Suspension Strut Repair Kit		DF-RK-8671	
	04/87→10/98	Tie Rod End	CV-ES-0912		
	04/87→10/98	Tie Rod End	CV-ES-0914	for Steering Rod	
	04/87→10/98	Tie Rod End	CV-ES-14162	for Steering Rod	
C 340.19/T C 340ti.17/T	07/90→10/98	Tie Rod End	CV-ES-14163	for Steering Rod	
	07/90→10/98	Ball Head, gearshift linkage	CV-ES-2121		
	07/90→10/98	Centre Rod	RV-DL-0905	Push Rod	
	07/90→10/98	Suspension Strut Repair Kit		DF-RK-8671	
	07/90→10/98	Tie Rod End	CV-ES-14162	for Steering Rod	
	07/90→10/98	Tie Rod End	CV-ES-14163	for Steering Rod	
	C 340ti.19/T	07/90→10/98	Ball Head, gearshift linkage	CV-ES-2121	
07/90→10/98		Centre Rod	RV-DL-0905	Push Rod	
07/90→10/98		Suspension Strut Repair Kit		DF-RK-8671	
07/90→10/98		Tie Rod End	CV-ES-14162	for Steering Rod	
07/90→10/98		Tie Rod End	CV-ES-14163	for Steering Rod	
CBH 280.26		04/86→10/92	Ball Head, gearshift linkage	CV-ES-2121	
		04/86→10/92	Centre Rod	RV-DL-7539	Coupling Rod
	04/86→10/92	Suspension Strut Repair Kit		DF-RK-8671	
	04/86→10/92	Tie Rod End	CV-ES-0912		
	04/86→10/92	Tie Rod End	CV-ES-0914	for Steering Rod	
	04/86→10/92	Tie Rod End	CV-ES-14162	for Steering Rod	
	04/86→10/92	Tie Rod End	CV-ES-14163	for Steering Rod	
CBH 280.26/T	12/88→10/92	Centre Rod	RV-DL-8136	Push Rod	
	04/86→10/92	Ball Head, gearshift linkage	CV-ES-2121		
	04/86→10/92	Centre Rod	RV-DL-7539	Coupling Rod	
	04/86→10/92	Suspension Strut Repair Kit		DF-RK-8671	
	04/86→10/92	Tie Rod End	CV-ES-0912		
	04/86→10/92	Tie Rod End	CV-ES-0914	for Steering Rod	
	04/86→10/92	Tie Rod End	CV-ES-14162	for Steering Rod	
CBH 280.34	04/86→10/92	Tie Rod End	CV-ES-14163	for Steering Rod	
	04/86→10/92	Tie Rod End	CV-ES-14163	for Steering Rod	
	12/88→10/92	Centre Rod	RV-DL-8136	Push Rod	
	04/86→10/92	Ball Head, gearshift linkage	CV-ES-2121		
	04/86→10/92	Centre Rod	RV-DL-7539	Coupling Rod	
	04/86→10/92	Suspension Strut Repair Kit		DF-RK-8671	
	04/86→10/92	Tie Rod End	CV-ES-0912		

CV-ES-0912

Length: 125
Cone Ø: d1 Ø 30 / d2 Ø 27
Thread: M38 x 1,5 LHT
3401206, 5001832579



RV-DL-0905

Length: 840
Ø: 52
Cone Ø: d1 Ø 30 / d2 Ø 27
5000787472, 5010130483



CV-ES-0914

Length: 125
Cone Ø: d1 Ø 30 / d2 Ø 27
Thread: M38 x 1,5 RHT
3401207, 5001832580



RV-DL-7539

Length: 1690
Ø: 48
Cone Ø: d1 Ø 30 / d2 Ø 27
5000786902, 5010145077



CV-ES-2121

Length: 85
Cone Ø: d1 Ø 12 / d2 Ø 10,8
Thread: M14 x 1,5 RHT
23162046, 5000516214, 5010144543,
5010245591



RV-DL-8136

Length: 725
Ø: 42
Cone Ø: d1 Ø 30 / d2 Ø 27
5010130383



CV-ES-14162

Length: 125
Cone Ø: d1 Ø 30 / d2 Ø 27
Thread: M30 x 1,5 LHT
3401170, 5000288361, 5001832581,
5001858759, 5001858774



CV-ES-14163

Length: 125
Cone Ø: d1 Ø 30 / d2 Ø 27
Thread: M30 x 1,5 RHT
0003406169, 0003406236, 0003406251,
0003406254, 0003406260, 0003406261,
5000288360, 5000590236, 5000804824,
5001858773, 7420937674, 7701011412



DF-RK-8671

Ø: 80
Hole Distance: 145
Thick/Height: 30
5001014345





C ...

CBH 280.34 ...	04/86→10/92	Tie Rod End	CV-ES-14162		for Steering Rod
	04/86→10/92	Tie Rod End	CV-ES-14163		for Steering Rod
	12/88→10/92	Centre Rod	RV-DL-8136		Push Rod
CBH 280.34/T	04/86→10/92	Ball Head, gearshift linkage	CV-ES-2121		
	04/86→10/92	Centre Rod	RV-DL-7539		Coupling Rod
	04/86→10/92	Suspension Strut Repair Kit		DF-RK-8671	
	04/86→10/92	Tie Rod End	CV-ES-0912		
	04/86→10/92	Tie Rod End	CV-ES-0914		for Steering Rod
	04/86→10/92	Tie Rod End	CV-ES-14162		for Steering Rod
	04/86→10/92	Tie Rod End	CV-ES-14163		for Steering Rod
	12/88→10/92	Centre Rod	RV-DL-8136		Push Rod
	CBH 320.24	10/92→10/98	Ball Head, gearshift linkage	CV-ES-2121	
10/92→10/98		Centre Rod	RV-DL-7539		Coupling Rod
10/92→10/98		Suspension Strut Repair Kit		DF-RK-8671	
10/92→10/98		Tie Rod End	CV-ES-0912		
10/92→10/98		Tie Rod End	CV-ES-0914		for Steering Rod
10/92→10/98		Tie Rod End	CV-ES-14162		for Steering Rod
10/92→10/98		Tie Rod End	CV-ES-14163		for Steering Rod
10/92→10/98		Track Control Arm		RV-DL-8126	Trailing Arm
CBH 320.24/T		10/92→10/98	Ball Head, gearshift linkage	CV-ES-2121	
	10/92→10/98	Centre Rod	RV-DL-7539		Coupling Rod
	10/92→10/98	Suspension Strut Repair Kit		DF-RK-8671	
	10/92→10/98	Tie Rod End	CV-ES-0912		
	10/92→10/98	Tie Rod End	CV-ES-0914		for Steering Rod
	10/92→10/98	Tie Rod End	CV-ES-14162		for Steering Rod
	10/92→10/98	Tie Rod End	CV-ES-14163		for Steering Rod
CBH 320.26	10/92→10/98	Track Control Arm		RV-DL-8126	Trailing Arm
	10/92→06/98	Centre Rod	RV-DL-8136		Push Rod
	10/92→10/98	Ball Head, gearshift linkage	CV-ES-2121		
	10/92→10/98	Centre Rod	RV-DL-7539		Coupling Rod
	10/92→10/98	Suspension Strut Repair Kit		DF-RK-8671	
	10/92→10/98	Tie Rod End	CV-ES-0912		
	10/92→10/98	Tie Rod End	CV-ES-0914		for Steering Rod
CBH 320.26/T	10/92→10/98	Tie Rod End	CV-ES-14162		for Steering Rod
	10/92→10/98	Tie Rod End	CV-ES-14163		for Steering Rod
	10/92→10/98	Track Control Arm		RV-DL-8126	Trailing Arm
	10/92→06/98	Centre Rod	RV-DL-8136		Push Rod
	10/92→10/98	Ball Head, gearshift linkage	CV-ES-2121		
	10/92→10/98	Centre Rod	RV-DL-7539		Coupling Rod
	10/92→10/98	Suspension Strut Repair Kit		DF-RK-8671	
	10/92→10/98	Tie Rod End	CV-ES-0912		
	10/92→10/98	Tie Rod End	CV-ES-0914		for Steering Rod
CBH 320.34	10/92→10/98	Tie Rod End	CV-ES-14162		for Steering Rod
	10/92→10/98	Tie Rod End	CV-ES-14163		for Steering Rod
	10/92→10/98	Track Control Arm		RV-DL-8126	Trailing Arm
	10/92→06/98	Centre Rod	RV-DL-8136		Push Rod
	10/92→10/98	Ball Head, gearshift linkage	CV-ES-2121		
	10/92→10/98	Centre Rod	RV-DL-7539		Coupling Rod
	10/92→10/98	Suspension Strut Repair Kit		DF-RK-8671	
	10/92→10/98	Tie Rod End	CV-ES-0912		
	10/92→10/98	Tie Rod End	CV-ES-0914		for Steering Rod
CBH 320.34/T	10/92→10/98	Tie Rod End	CV-ES-14162		for Steering Rod
	10/92→10/98	Tie Rod End	CV-ES-14163		for Steering Rod
	10/92→10/98	Track Control Arm		RV-DL-8126	Trailing Arm
	10/92→06/98	Centre Rod	RV-DL-8136		Push Rod
	10/92→10/98	Ball Head, gearshift linkage	CV-ES-2121		
	10/92→10/98	Centre Rod	RV-DL-7539		Coupling Rod
	10/92→10/98	Suspension Strut Repair Kit		DF-RK-8671	
	10/92→10/98	Tie Rod End	CV-ES-0912		
	10/92→10/98	Tie Rod End	CV-ES-0914		for Steering Rod

CV-ES-0912

Length: 125
Cone Ø: d1 Ø 30 / d2 Ø 27
Thread: M38 x 1,5 LHT
3401206, 5001832579



RV-DL-7539

Length: 1690
Ø: 48
Cone Ø: d1 Ø 30 / d2 Ø 27
5000786902, 5010145077



CV-ES-0914

Length: 125
Cone Ø: d1 Ø 30 / d2 Ø 27
Thread: M38 x 1,5 RHT
3401207, 5001832580



RV-DL-8126

Length: 575
Ø: 50
Hole Distance: 145 / 145
5010268035



CV-ES-2121

Length: 85
Cone Ø: d1 Ø 12 / d2 Ø 10,8
Thread: M14 x 1,5 RHT
23162046, 5000516214, 5010144543,
5010245591



RV-DL-8136

Length: 725
Ø: 42
Cone Ø: d1 Ø 30 / d2 Ø 27
5010130383



CV-ES-14162

Length: 125
Cone Ø: d1 Ø 30 / d2 Ø 27
Thread: M30 x 1,5 LHT
3401170, 5000288361, 5001832581,
5001858759, 5001858774



CV-ES-14163

Length: 125
Cone Ø: d1 Ø 30 / d2 Ø 27
Thread: M30 x 1,5 RHT
0003406169, 0003406236, 0003406251,
0003406254, 0003406260, 0003406261,
5000288360, 5000590236, 5000804824,
5001858773, 7420937674, 7701011412



DF-RK-8671

Ø: 80
Hole Distance: 145
Thick/Height: 30
5001014345





C ...

CBH 340.26	02/88→10/92	Suspension Strut Repair Kit		DF-RK-8671	
	02/88→10/92	Tie Rod End	CV-ES-14163		for Steering Rod
CBH 350.26	05/90→01/93	Ball Head, gearshift linkage	CV-ES-2121		
	05/90→01/93	Centre Rod	RV-DL-7539		Coupling Rod
	05/90→01/93	Tie Rod End	CV-ES-0912		
	05/90→01/93	Tie Rod End	CV-ES-0914		for Steering Rod
	05/90→01/93	Tie Rod End	CV-ES-14162		for Steering Rod
	05/90→01/93	Tie Rod End	CV-ES-14163		for Steering Rod
CBH 350.34	05/90→01/93	Ball Head, gearshift linkage	CV-ES-2121		
	05/90→01/93	Centre Rod	RV-DL-7539		Coupling Rod
	05/90→01/93	Tie Rod End	CV-ES-0912		
	05/90→01/93	Tie Rod End	CV-ES-0914		for Steering Rod
	05/90→01/93	Tie Rod End	CV-ES-14162		for Steering Rod
	05/90→01/93	Tie Rod End	CV-ES-14163		for Steering Rod
CBH 380.26	01/90→10/92	Ball Head, gearshift linkage	CV-ES-2121		
	01/90→10/92	Centre Rod	RV-DL-7539		Coupling Rod
	01/90→10/92	Tie Rod End	CV-ES-0912		
	01/90→10/92	Tie Rod End	CV-ES-0914		for Steering Rod
	01/90→10/92	Tie Rod End	CV-ES-14162		for Steering Rod
	01/90→10/92	Tie Rod End	CV-ES-14163		for Steering Rod
CBH 380.34	01/90→10/92	Ball Head, gearshift linkage	CV-ES-2121		
	01/90→10/92	Centre Rod	RV-DL-7539		Coupling Rod
	01/90→10/92	Tie Rod End	CV-ES-0912		
	01/90→10/92	Tie Rod End	CV-ES-0914		for Steering Rod
	01/90→10/92	Tie Rod End	CV-ES-14162		for Steering Rod
	01/90→10/92	Tie Rod End	CV-ES-14163		for Steering Rod
CBH 385.24	10/92→06/98	Centre Rod	RV-DL-8136		Push Rod
	10/92→10/98	Ball Head, gearshift linkage	CV-ES-2121		
	10/92→10/98	Centre Rod	RV-DL-7539		Coupling Rod
	10/92→10/98	Tie Rod End	CV-ES-0912		
	10/92→10/98	Tie Rod End	CV-ES-0914		for Steering Rod
	10/92→10/98	Tie Rod End	CV-ES-14162		for Steering Rod
	10/92→10/98	Tie Rod End	CV-ES-14163		for Steering Rod
	10/92→10/98	Track Control Arm		RV-DL-8126	Trailing Arm
CBH 385.26	10/92→06/98	Centre Rod	RV-DL-8136		Push Rod
	10/92→10/98	Ball Head, gearshift linkage	CV-ES-2121		
	10/92→10/98	Centre Rod	RV-DL-7539		Coupling Rod
	10/92→10/98	Tie Rod End	CV-ES-0912		
	10/92→10/98	Tie Rod End	CV-ES-0914		for Steering Rod
	10/92→10/98	Tie Rod End	CV-ES-14162		for Steering Rod
	10/92→10/98	Tie Rod End	CV-ES-14163		for Steering Rod
	10/92→10/98	Track Control Arm		RV-DL-8126	Trailing Arm
CBH 385.26/T	10/92→06/98	Centre Rod	RV-DL-8136		Push Rod
	10/92→10/98	Ball Head, gearshift linkage	CV-ES-2121		
	10/92→10/98	Centre Rod	RV-DL-7539		Coupling Rod
	10/92→10/98	Tie Rod End	CV-ES-0912		
	10/92→10/98	Tie Rod End	CV-ES-0914		for Steering Rod
	10/92→10/98	Tie Rod End	CV-ES-14162		for Steering Rod
	10/92→10/98	Tie Rod End	CV-ES-14163		for Steering Rod
	10/92→10/98	Track Control Arm		RV-DL-8126	Trailing Arm
CBH 385.34	10/92→06/98	Centre Rod	RV-DL-8136		Push Rod
	10/92→10/98	Ball Head, gearshift linkage	CV-ES-2121		
	10/92→10/98	Centre Rod	RV-DL-7539		Coupling Rod
	10/92→10/98	Suspension Strut Repair Kit		DF-RK-8671	
	10/92→10/98	Tie Rod End	CV-ES-0912		
	10/92→10/98	Tie Rod End	CV-ES-0914		for Steering Rod
	10/92→10/98	Tie Rod End	CV-ES-14162		for Steering Rod
	10/92→10/98	Tie Rod End	CV-ES-14163		for Steering Rod
CBH 385.34/T	10/92→10/98	Track Control Arm		RV-DL-8126	Trailing Arm
	10/92→06/98	Centre Rod	RV-DL-8136		Push Rod
	10/92→10/98	Ball Head, gearshift linkage	CV-ES-2121		
	10/92→10/98	Centre Rod	RV-DL-7539		Coupling Rod
CBH 385.34/T	10/92→10/98	Suspension Strut Repair Kit		DF-RK-8671	
	10/92→10/98	Centre Rod	RV-DL-8136		Push Rod
	10/92→10/98	Ball Head, gearshift linkage	CV-ES-2121		
	10/92→10/98	Centre Rod	RV-DL-7539		Coupling Rod

CV-ES-0912

Length: 125
Cone Ø: d1 Ø 30 / d2 Ø 27
Thread: M38 x 1,5 LHT
3401206, 5001832579



RV-DL-7539

Length: 1690
Ø: 48
Cone Ø: d1 Ø 30 / d2 Ø 27
5000786902, 5010145077



CV-ES-0914

Length: 125
Cone Ø: d1 Ø 30 / d2 Ø 27
Thread: M38 x 1,5 RHT
3401207, 5001832580



RV-DL-8126

Length: 575
Ø: 50
Hole Distance: 145 / 145
5010268035



CV-ES-2121

Length: 85
Cone Ø: d1 Ø 12 / d2 Ø 10,8
Thread: M14 x 1,5 RHT
23162046, 5000516214, 5010144543,
5010245591



RV-DL-8136

Length: 725
Ø: 42
Cone Ø: d1 Ø 30 / d2 Ø 27
5010130383



CV-ES-14162

Length: 125
Cone Ø: d1 Ø 30 / d2 Ø 27
Thread: M30 x 1,5 LHT
3401170, 5000288361, 5001832581,
5001858759, 5001858774



CV-ES-14163

Length: 125
Cone Ø: d1 Ø 30 / d2 Ø 27
Thread: M30 x 1,5 RHT
0003406169, 0003406236, 0003406251,
0003406254, 0003406260, 0003406261,
5000288360, 5000590236, 5000804824,
5001858773, 7420937674, 7701011412



DF-RK-8671

Ø: 80
Hole Distance: 145
Thick/Height: 30
5001014345





C ...

CBH 385.34/T ...	10/92→10/98	Tie Rod End	CV-ES-0912	
	10/92→10/98	Tie Rod End	CV-ES-0914	for Steering Rod
	10/92→10/98	Tie Rod End	CV-ES-14162	for Steering Rod
	10/92→10/98	Tie Rod End	CV-ES-14163	for Steering Rod
	10/92→10/98	Track Control Arm		RV-DL-8126 Trailing Arm
CCH 300.26	09/90→03/93	Suspension Strut Repair Kit		DF-RK-8671
	09/90→03/93	Tie Rod End	CV-ES-14163	for Steering Rod
CCH 300.30	09/90→03/93	Tie Rod End	CV-ES-14163	for Steering Rod
CLM 280.19/T	04/86→10/92	Ball Head, gearshift linkage	CV-ES-2121	
	04/86→10/92	Centre Rod	RV-DL-7539	Coupling Rod
	04/86→10/92	Tie Rod End	CV-ES-0912	
	04/86→10/92	Tie Rod End	CV-ES-0914	for Steering Rod
	04/86→10/92	Tie Rod End	CV-ES-14162	for Steering Rod
CLM 320.19/T	04/86→10/92	Tie Rod End	CV-ES-14163	for Steering Rod
	10/92→10/98	Ball Head, gearshift linkage	CV-ES-2121	
	10/92→10/98	Centre Rod	RV-DL-7539	Coupling Rod
	10/92→10/98	Tie Rod End	CV-ES-0912	
	10/92→10/98	Tie Rod End	CV-ES-0914	for Steering Rod
CLM 320.25/T	10/92→10/98	Tie Rod End	CV-ES-14162	for Steering Rod
	10/92→10/98	Tie Rod End	CV-ES-14163	for Steering Rod
	10/92→10/98	Ball Head, gearshift linkage	CV-ES-2121	
	10/92→10/98	Centre Rod	RV-DL-7539	Coupling Rod
	10/92→10/98	Tie Rod End	CV-ES-0912	
CLM 380.19/T	10/92→10/98	Tie Rod End	CV-ES-0914	for Steering Rod
	10/92→10/98	Tie Rod End	CV-ES-14162	for Steering Rod
	10/92→10/98	Tie Rod End	CV-ES-14163	for Steering Rod
	10/92→10/98	Track Control Arm		RV-DL-8126 Trailing Arm
	05/91→10/92	Ball Head, gearshift linkage	CV-ES-2121	
CLM 385.19/T	05/91→10/92	Centre Rod	RV-DL-7539	Coupling Rod
	05/91→10/92	Tie Rod End	CV-ES-0912	
	05/91→10/92	Tie Rod End	CV-ES-0914	for Steering Rod
	05/91→10/92	Tie Rod End	CV-ES-14162	for Steering Rod
	05/91→10/92	Tie Rod End	CV-ES-14163	for Steering Rod
CLM 385.22/T	10/92→10/98	Ball Head, gearshift linkage	CV-ES-2121	
	10/92→10/98	Centre Rod	RV-DL-7539	Coupling Rod
	10/92→10/98	Tie Rod End	CV-ES-0912	
	10/92→10/98	Tie Rod End	CV-ES-0914	for Steering Rod
	10/92→10/98	Tie Rod End	CV-ES-14162	for Steering Rod
CLM 385.25/T	10/92→10/98	Tie Rod End	CV-ES-14163	for Steering Rod
	10/92→10/98	Track Control Arm		RV-DL-8126 Trailing Arm
	10/92→10/98	Ball Head, gearshift linkage	CV-ES-2121	
	10/92→10/98	Centre Rod	RV-DL-7539	Coupling Rod
	10/92→10/98	Tie Rod End	CV-ES-0912	
CLR 230.19	10/92→10/98	Tie Rod End	CV-ES-0914	for Steering Rod
	10/92→10/98	Tie Rod End	CV-ES-14162	for Steering Rod
	10/92→10/98	Tie Rod End	CV-ES-14163	for Steering Rod
	10/92→10/98	Track Control Arm		RV-DL-8126 Trailing Arm
	09/90→10/98	Tie Rod End	CV-ES-14163	for Steering Rod

D-Serie

10 P 210	01/13→	Tie Rod	RV-DL-12465	
	01/13→	Tie Rod End	CV-ES-14163	for Steering Rod
10 P 240	01/13→	Tie Rod	RV-DL-12465	
	01/13→	Tie Rod End	CV-ES-14163	for Steering Rod
12 P 210	01/13→	Tie Rod	RV-DL-12465	
	01/13→	Tie Rod End	CV-ES-14163	for Steering Rod

CV-ES-0912

Length: 125
Cone Ø: d1 Ø 30 / d2 Ø 27
Thread: M38 x 1,5 LHT
3401206, 5001832579



RV-DL-7539

Length: 1690
Ø: 48
Cone Ø: d1 Ø 30 / d2 Ø 27
5000786902, 5010145077



CV-ES-0914

Length: 125
Cone Ø: d1 Ø 30 / d2 Ø 27
Thread: M38 x 1,5 RHT
3401207, 5001832580



RV-DL-8126

Length: 575
Ø: 50
Hole Distance: 145 / 145
5010268035



CV-ES-2121

Length: 85
Cone Ø: d1 Ø 12 / d2 Ø 10,8
Thread: M14 x 1,5 RHT
23162046, 5000516214, 5010144543,
5010245591



RV-DL-12465

Length: 1580
Ø: 40
Cone Ø: d1 Ø 30 / d2 Ø 27
Thread: M30 x 1,5 LHT / M30 x 1,5
RHT
5010566051



CV-ES-14162

Length: 125
Cone Ø: d1 Ø 30 / d2 Ø 27
Thread: M30 x 1,5 LHT
3401170, 5000288361, 5001832581,
5001858759, 5001858774



CV-ES-14163

Length: 125
Cone Ø: d1 Ø 30 / d2 Ø 27
Thread: M30 x 1,5 RHT
0003406169, 0003406236, 0003406251,
0003406254, 0003406260, 0003406261,
5000288360, 5000590236, 5000804824,
5001858773, 7420937674, 7701011412



DF-RK-8671

Ø: 80
Hole Distance: 145
Thick/Height: 30
5001014345



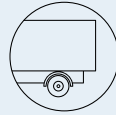

D-Serie ...

12 P 240	01/13→	Tie Rod	RV-DL-12465	
	01/13→	Tie Rod End	CV-ES-14163	for Steering Rod
12 P 250	01/13→	Tie Rod	RV-DL-12334	
	01/13→	Tie Rod	RV-DL-12465	
	01/13→	Tie Rod End	CV-ES-14163	for Steering Rod
12 P 280	01/13→	Tie Rod	RV-DL-12334	
	01/13→	Tie Rod End	CV-ES-14163	for Steering Rod
13 P 210, 13 KP 210	01/13→	Tie Rod	RV-DL-12465	
	01/13→	Tie Rod End	CV-ES-14163	for Steering Rod
13 P 240, 13 KP 240	01/13→	Tie Rod	RV-DL-12465	
	01/13→	Tie Rod End	CV-ES-14163	for Steering Rod
13 P 250, 13 KP 250	01/13→	Tie Rod	RV-DL-12334	
	01/13→	Tie Rod	RV-DL-12465	
	01/13→	Tie Rod End	CV-ES-14163	for Steering Rod
13 P 280, 13 KP 280	01/13→	Tie Rod	RV-DL-12334	
	01/13→	Tie Rod End	CV-ES-14163	for Steering Rod
14 P 210, 14 KP 210	01/13→	Tie Rod	RV-DL-12465	
	01/13→	Tie Rod End	CV-ES-14163	for Steering Rod
14 P 240, 14 KP 240	01/13→	Tie Rod	RV-DL-12465	
	01/13→	Tie Rod End	CV-ES-14163	for Steering Rod
14 P 250, 14 KP 250	01/13→	Tie Rod	RV-DL-12334	
	01/13→	Tie Rod	RV-DL-12465	
	01/13→	Tie Rod End	CV-ES-14163	for Steering Rod
	01/13→	Tie Rod End	CV-ES-14163	for Steering Rod
14 P 280, 14 KP 280	01/13→	Tie Rod	RV-DL-12334	
	01/13→	Tie Rod End	CV-ES-14163	for Steering Rod
16 P 210, 16 KP 210	01/13→	Tie Rod	RV-DL-12465	
	01/13→	Tie Rod End	CV-ES-14163	for Steering Rod
16 P 240, 16 KP 240	01/13→	Tie Rod	RV-DL-12465	
	01/13→	Tie Rod End	CV-ES-14163	for Steering Rod
16 P 250, 16 KP 250	01/13→	Tie Rod	RV-DL-12334	
	01/13→	Tie Rod	RV-DL-12465	
	01/13→	Tie Rod End	CV-ES-14163	for Steering Rod
16 P 280, 16 KP 280	01/13→	Tie Rod	RV-DL-12334	
	01/13→	Tie Rod End	CV-ES-14163	for Steering Rod
18 P 250	01/13→	Tie Rod	RV-DL-12334	
	01/13→	Tie Rod	RV-DL-12465	
	01/13→	Tie Rod End	CV-ES-14163	for Steering Rod
18 P 250, 18 KP 250	01/13→	Tie Rod	RV-DL-12334	
	01/13→	Tie Rod	RV-DL-12465	
	01/13→	Tie Rod End	CV-ES-14163	for Steering Rod
18 P 280	01/13→	Tie Rod	RV-DL-12334	
	01/13→	Tie Rod End	CV-ES-14163	for Steering Rod
18 P 280, 18 KP 280	01/13→	Tie Rod	RV-DL-12334	
	01/13→	Tie Rod End	CV-ES-14163	for Steering Rod
18 P 320	01/13→	Tie Rod	RV-DL-12334	
	01/13→	Tie Rod End	CV-ES-14163	for Steering Rod
18 P 320, 18 KP 320	01/13→	Tie Rod	RV-DL-12334	
	01/13→	Tie Rod End	CV-ES-14163	for Steering Rod
18 T 280	01/13→	Tie Rod	RV-DL-12334	
	01/13→	Tie Rod End	CV-ES-14163	for Steering Rod
18 T 320	01/13→	Tie Rod	RV-DL-12334	
	01/13→	Tie Rod End	CV-ES-14163	for Steering Rod
25 P 250	01/13→	Tie Rod	RV-DL-12334	
	01/13→	Tie Rod End	CV-ES-14163	for Steering Rod
25 P 280	01/13→	Tie Rod	RV-DL-12334	
	01/13→	Tie Rod End	CV-ES-14163	for Steering Rod
25 P 320	01/13→	Tie Rod	RV-DL-12334	
	01/13→	Tie Rod End	CV-ES-14163	for Steering Rod
26 P 250	01/13→	Tie Rod	RV-DL-12334	
	01/13→	Tie Rod End	CV-ES-14163	for Steering Rod
26 P 250, 26 KP 250	01/13→	Tie Rod	RV-DL-12334	
	01/13→	Tie Rod End	CV-ES-14163	for Steering Rod

CV-ES-14163

Length: 125

Cone Ø: d1 Ø 30 / d2 Ø 27

Thread: M30 x 1,5 RHT

0003406169, 0003406236, 0003406251,
0003406254, 0003406260, 0003406261,
5000288360, 5000590236, 5000804824,
5001858773, 7420937674, 7701011412



RV-DL-12334

Length: 1686

Ø: 60

Cone Ø: d1 Ø 30 / d2 Ø 27

21560963, 5001868366, 5010587034,
5010587038, 7421560963, 7422163637



RV-DL-12465

Length: 1580

Ø: 40

Cone Ø: d1 Ø 30 / d2 Ø 27

Thread: M30 x 1,5 LHT / M30 x 1,5
RHT

5010566051





D-Serie ...

26 P 280	01/13→	Tie Rod	RV-DL-12334	
	01/13→	Tie Rod End	CV-ES-14163	for Steering Rod
26 P 280, 26 KP 280	01/13→	Tie Rod	RV-DL-12334	
	01/13→	Tie Rod End	CV-ES-14163	for Steering Rod
26 P 320	01/13→	Tie Rod	RV-DL-12334	
	01/13→	Tie Rod End	CV-ES-14163	for Steering Rod
26 P 320, 26 KP 320	01/13→	Tie Rod	RV-DL-12334	
	01/13→	Tie Rod End	CV-ES-14163	for Steering Rod

FR1

FR1	01/83→	Track Control Arm	RV-DL-7282	Trailing Arm
-----	--------	-------------------	-------------------	--------------

G

G 170.11	05/83→02/90	Ball Head, gearshift linkage	CV-ES-2121	
	05/83→02/90	Centre Rod	RV-DL-0900	Push Rod
	05/83→02/90	Tie Rod End	CV-ES-0912	
	05/83→02/90	Tie Rod End	CV-ES-0914	for Steering Rod
	05/83→02/90	Tie Rod End	CV-ES-14162	for Steering Rod
	05/83→02/90	Tie Rod End	CV-ES-14163	for Steering Rod
G 170.13	05/83→02/90	Ball Head, gearshift linkage	CV-ES-2121	
	05/83→02/90	Centre Rod	RV-DL-0900	Push Rod
	05/83→02/90	Tie Rod End	CV-ES-0912	
	05/83→02/90	Tie Rod End	CV-ES-0914	for Steering Rod
	05/83→02/90	Tie Rod End	CV-ES-14162	for Steering Rod
	05/83→02/90	Tie Rod End	CV-ES-14163	for Steering Rod
G 170.15	05/83→02/90	Ball Head, gearshift linkage	CV-ES-2121	
	05/83→02/90	Centre Rod	RV-DL-0900	Push Rod
	05/83→02/90	Tie Rod End	CV-ES-0912	
	05/83→02/90	Tie Rod End	CV-ES-0914	for Steering Rod
	05/83→02/90	Tie Rod End	CV-ES-14162	for Steering Rod
	05/83→02/90	Tie Rod End	CV-ES-14163	for Steering Rod
G 170.16	05/83→02/90	Ball Head, gearshift linkage	CV-ES-2121	
	05/83→02/90	Centre Rod	RV-DL-0900	Push Rod
	05/83→02/90	Tie Rod End	CV-ES-0912	
	05/83→02/90	Tie Rod End	CV-ES-0914	for Steering Rod
	05/83→02/90	Tie Rod End	CV-ES-14162	for Steering Rod
	05/83→02/90	Tie Rod End	CV-ES-14163	for Steering Rod
G 170.17	05/83→02/90	Ball Head, gearshift linkage	CV-ES-2121	
	05/83→02/90	Centre Rod	RV-DL-0900	Push Rod
	05/83→02/90	Tie Rod End	CV-ES-0912	
	05/83→02/90	Tie Rod End	CV-ES-0914	for Steering Rod
	05/83→02/90	Tie Rod End	CV-ES-14162	for Steering Rod
	05/83→02/90	Tie Rod End	CV-ES-14163	for Steering Rod
G 200.13	05/90→09/91	Ball Head, gearshift linkage	CV-ES-2121	
	05/90→09/91	Centre Rod	RV-DL-0900	Push Rod
	05/90→09/91	Tie Rod End	CV-ES-0912	
	05/90→09/91	Tie Rod End	CV-ES-0914	for Steering Rod
	05/90→09/91	Tie Rod End	CV-ES-14162	for Steering Rod
	05/90→09/91	Tie Rod End	CV-ES-14163	for Steering Rod
G 200.15	05/90→09/91	Ball Head, gearshift linkage	CV-ES-2121	
	05/90→09/91	Centre Rod	RV-DL-0900	Push Rod
	05/90→09/91	Tie Rod End	CV-ES-0912	
	05/90→09/91	Tie Rod End	CV-ES-0914	for Steering Rod
	05/90→09/91	Tie Rod End	CV-ES-14162	for Steering Rod
	05/90→09/91	Tie Rod End	CV-ES-14163	for Steering Rod
G 200.16	05/90→09/91	Ball Head, gearshift linkage	CV-ES-2121	
	05/90→09/91	Centre Rod	RV-DL-0900	Push Rod
	05/90→09/91	Tie Rod End	CV-ES-0912	
	05/90→09/91	Tie Rod End	CV-ES-0914	for Steering Rod
	05/90→09/91	Tie Rod End	CV-ES-14162	for Steering Rod
	05/90→09/91	Tie Rod End	CV-ES-14163	for Steering Rod

CV-ES-0912

Length: 125
Cone Ø: d1 Ø 30 / d2 Ø 27
Thread: M38 x 1,5 LHT
3401206, 5001832579



RV-DL-7282

Length: 690
Ø: 46
Hole Distance: 122 / 122
5000790218, 5000869573, 5010207727



CV-ES-0914

Length: 125
Cone Ø: d1 Ø 30 / d2 Ø 27
Thread: M38 x 1,5 RHT
3401207, 5001832580



RV-DL-12334

Length: 1686
Ø: 60
Cone Ø: d1 Ø 30 / d2 Ø 27
21560963, 5001868366, 5010587034,
5010587038, 7421560963, 7422163637



CV-ES-2121

Length: 85
Cone Ø: d1 Ø 12 / d2 Ø 10,8
Thread: M14 x 1,5 RHT
23162046, 5000516214, 5010144543,
5010245591



RV-ES-8691

Length: 106
Cone Ø: d1 Ø 20 / d2 Ø 18
Thread: M24 x 1,5 LHT
7700658834



CV-ES-14162

Length: 125
Cone Ø: d1 Ø 30 / d2 Ø 27
Thread: M30 x 1,5 LHT
3401170, 5000288361, 5001832581,
5001858759, 5001858774



CV-ES-14163

Length: 125
Cone Ø: d1 Ø 30 / d2 Ø 27
Thread: M30 x 1,5 RHT
0003406169, 0003406236, 0003406251,
0003406254, 0003406260, 0003406261,
5000288360, 5000590236, 5000804824,
5001858773, 7420937674, 7701011412



RV-DL-0900

Length: 990
Ø: 52
Cone Ø: d1 Ø 30 / d2 Ø 27
5000725267, 5010144552





G ...

G 200.17	05/90→09/91	Ball Head, gearshift linkage	CV-ES-2121	
	05/90→09/91	Centre Rod	RV-DL-0900	Push Rod
	05/90→09/91	Tie Rod End	CV-ES-0912	
	05/90→09/91	Tie Rod End	CV-ES-0914	for Steering Rod
	05/90→09/91	Tie Rod End	CV-ES-14162	for Steering Rod
	05/90→09/91	Tie Rod End	CV-ES-14163	for Steering Rod
	05/90→09/91	Tie Rod End	RV-ES-8691	
G 200.18	05/90→09/91	Ball Head, gearshift linkage	CV-ES-2121	
	05/90→09/91	Centre Rod	RV-DL-0900	Push Rod
	05/90→09/91	Tie Rod End	CV-ES-0912	
	05/90→09/91	Tie Rod End	CV-ES-0914	for Steering Rod
	05/90→09/91	Tie Rod End	CV-ES-14162	for Steering Rod
	05/90→09/91	Tie Rod End	CV-ES-14163	for Steering Rod
	05/90→09/91	Tie Rod End	RV-ES-8691	
G 210.16	11/83→02/90	Ball Head, gearshift linkage	CV-ES-2121	
	11/83→02/90	Centre Rod	RV-DL-0900	Push Rod
	11/83→02/90	Tie Rod End	CV-ES-0912	
	11/83→02/90	Tie Rod End	CV-ES-0914	for Steering Rod
	11/83→02/90	Tie Rod End	CV-ES-14162	for Steering Rod
	11/83→02/90	Tie Rod End	CV-ES-14163	for Steering Rod
	11/83→02/90	Tie Rod End	RV-ES-8691	
G 210.17 BOM	11/83→02/90	Ball Head, gearshift linkage	CV-ES-2121	
	11/83→02/90	Centre Rod	RV-DL-0900	Push Rod
	11/83→02/90	Tie Rod End	CV-ES-0912	
	11/83→02/90	Tie Rod End	CV-ES-0914	for Steering Rod
	11/83→02/90	Tie Rod End	CV-ES-14162	for Steering Rod
	11/83→02/90	Tie Rod End	CV-ES-14163	for Steering Rod
	11/83→02/90	Tie Rod End	RV-ES-8691	
G 210.18 BOM	11/83→02/90	Ball Head, gearshift linkage	CV-ES-2121	
	11/83→02/90	Centre Rod	RV-DL-0900	Push Rod
	11/83→02/90	Tie Rod End	CV-ES-0912	
	11/83→02/90	Tie Rod End	CV-ES-0914	for Steering Rod
	11/83→02/90	Tie Rod End	CV-ES-14162	for Steering Rod
	11/83→02/90	Tie Rod End	CV-ES-14163	for Steering Rod
	11/83→02/90	Tie Rod End	RV-ES-8691	
G 210.19	11/83→02/90	Ball Head, gearshift linkage	CV-ES-2121	
	11/83→02/90	Centre Rod	RV-DL-0900	Push Rod
	11/83→02/90	Tie Rod End	CV-ES-0912	
	11/83→02/90	Tie Rod End	CV-ES-0914	for Steering Rod
	11/83→02/90	Tie Rod End	CV-ES-14162	for Steering Rod
	11/83→02/90	Tie Rod End	CV-ES-14163	for Steering Rod
	11/83→02/90	Tie Rod End	RV-ES-8691	
G 210.19 BOM	11/83→02/90	Ball Head, gearshift linkage	CV-ES-2121	
	11/83→02/90	Centre Rod	RV-DL-0900	Push Rod
	11/83→02/90	Tie Rod End	CV-ES-0912	
	11/83→02/90	Tie Rod End	CV-ES-0914	for Steering Rod
	11/83→02/90	Tie Rod End	CV-ES-14162	for Steering Rod
	11/83→02/90	Tie Rod End	CV-ES-14163	for Steering Rod
	11/83→02/90	Tie Rod End	RV-ES-8691	
G 220.17 BOM	03/91→09/91	Tie Rod End	RV-ES-8691	
G 220.19 BOM	03/91→09/91	Tie Rod End	RV-ES-8691	
G 230.11	01/85→05/90	Ball Head, gearshift linkage	CV-ES-2121	
	01/85→05/90	Centre Rod	RV-DL-0900	Push Rod
	01/85→05/90	Tie Rod End	CV-ES-0912	
	01/85→05/90	Tie Rod End	CV-ES-0914	for Steering Rod
	01/85→05/90	Tie Rod End	CV-ES-14162	for Steering Rod
	01/85→05/90	Tie Rod End	CV-ES-14163	for Steering Rod
	01/85→05/90	Tie Rod End	RV-ES-8691	
G 230.13	01/85→05/90	Ball Head, gearshift linkage	CV-ES-2121	
	01/85→05/90	Centre Rod	RV-DL-0900	Push Rod
	01/85→05/90	Tie Rod End	CV-ES-0912	
	01/85→05/90	Tie Rod End	CV-ES-0914	for Steering Rod
	01/85→05/90	Tie Rod End	CV-ES-14162	for Steering Rod

CV-ES-0912

Length: 125

Cone Ø: d1 Ø 30 / d2 Ø 27

Thread: M38 x 1,5 LHT

3401206, 5001832579



RV-ES-8691

Length: 106

Cone Ø: d1 Ø 20 / d2 Ø 18

Thread: M24 x 1,5 LHT

7700658834



CV-ES-0914

Length: 125

Cone Ø: d1 Ø 30 / d2 Ø 27

Thread: M38 x 1,5 RHT

3401207, 5001832580



CV-ES-2121

Length: 85

Cone Ø: d1 Ø 12 / d2 Ø 10,8

Thread: M14 x 1,5 RHT

23162046, 5000516214, 5010144543,
5010245591



CV-ES-14162

Length: 125

Cone Ø: d1 Ø 30 / d2 Ø 27

Thread: M30 x 1,5 LHT

3401170, 5000288361, 5001832581,
5001858759, 5001858774



CV-ES-14163

Length: 125

Cone Ø: d1 Ø 30 / d2 Ø 27

Thread: M30 x 1,5 RHT

0003406169, 0003406236, 0003406251,
0003406254, 0003406260, 0003406261,
5000288360, 5000590236, 5000804824,
5001858773, 7420937674, 7701011412



RV-DL-0900

Length: 990

Ø: 52

Cone Ø: d1 Ø 30 / d2 Ø 27

5000725267, 5010144552



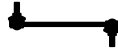

G ...

G 230.13 ...	01/85→05/90	Tie Rod End	CV-ES-14163		for Steering Rod
	01/85→05/90	Tie Rod End	RV-ES-8691		
G 230.13 SP	01/85→08/91	Ball Head, gearshift linkage	CV-ES-2121		
	01/85→08/91	Centre Rod	RV-DL-0900		Push Rod
	01/85→08/91	Tie Rod End	CV-ES-0912		
	01/85→08/91	Tie Rod End	CV-ES-0914		for Steering Rod
	01/85→08/91	Tie Rod End	CV-ES-14162		for Steering Rod
	01/85→08/91	Tie Rod End	CV-ES-14163		for Steering Rod
	01/85→08/91	Tie Rod End	RV-ES-8691		
G 230.15	01/85→05/90	Ball Head, gearshift linkage	CV-ES-2121		
	01/85→05/90	Centre Rod	RV-DL-0900		Push Rod
	01/85→05/90	Tie Rod End	CV-ES-0912		
	01/85→05/90	Tie Rod End	CV-ES-0914		for Steering Rod
	01/85→05/90	Tie Rod End	CV-ES-14162		for Steering Rod
	01/85→05/90	Tie Rod End	CV-ES-14163		for Steering Rod
G 230.15/T	01/85→05/90	Ball Head, gearshift linkage	CV-ES-2121		
	01/85→05/90	Centre Rod	RV-DL-0900		Push Rod
	01/85→05/90	Tie Rod End	CV-ES-0912		
	01/85→05/90	Tie Rod End	CV-ES-0914		for Steering Rod
	01/85→05/90	Tie Rod End	CV-ES-14162		for Steering Rod
	01/85→05/90	Tie Rod End	CV-ES-14163		for Steering Rod
G 230.16	01/85→05/90	Ball Head, gearshift linkage	CV-ES-2121		
	01/85→05/90	Centre Rod	RV-DL-0900		Push Rod
	01/85→05/90	Tie Rod End	CV-ES-0912		
	01/85→05/90	Tie Rod End	CV-ES-0914		for Steering Rod
	01/85→05/90	Tie Rod End	CV-ES-14162		for Steering Rod
	01/85→05/90	Tie Rod End	CV-ES-14163		for Steering Rod
G 230.17	01/85→05/90	Ball Head, gearshift linkage	CV-ES-2121		
	01/85→05/90	Centre Rod	RV-DL-0900		Push Rod
	01/85→05/90	Tie Rod End	CV-ES-0912		
	01/85→05/90	Tie Rod End	CV-ES-0914		for Steering Rod
	01/85→05/90	Tie Rod End	CV-ES-14162		for Steering Rod
	01/85→05/90	Tie Rod End	CV-ES-14163		for Steering Rod
G 230.17/T	01/85→05/90	Ball Head, gearshift linkage	CV-ES-2121		
	01/85→05/90	Centre Rod	RV-DL-0900		Push Rod
	01/85→05/90	Tie Rod End	CV-ES-0912		
	01/85→05/90	Tie Rod End	CV-ES-0914		for Steering Rod
	01/85→05/90	Tie Rod End	CV-ES-14162		for Steering Rod
	01/85→05/90	Tie Rod End	CV-ES-14163		for Steering Rod
G 230.19	01/85→05/90	Ball Head, gearshift linkage	CV-ES-2121		
	01/85→05/90	Centre Rod	RV-DL-0900		Push Rod
	01/85→05/90	Tie Rod End	CV-ES-0912		
	01/85→05/90	Tie Rod End	CV-ES-0914		for Steering Rod
	01/85→05/90	Tie Rod End	CV-ES-14162		for Steering Rod
	01/85→05/90	Tie Rod End	CV-ES-14163		for Steering Rod
G 230ti.13	02/90→08/91	Ball Head, gearshift linkage	CV-ES-2121		
	02/90→08/91	Centre Rod	RV-DL-0900		Push Rod
	02/90→08/91	Tie Rod End	CV-ES-0912		
	02/90→08/91	Tie Rod End	CV-ES-0914		for Steering Rod
	02/90→08/91	Tie Rod End	CV-ES-14162		for Steering Rod
	02/90→08/91	Tie Rod End	CV-ES-14163		for Steering Rod
G 230ti.15	02/90→08/91	Ball Head, gearshift linkage	CV-ES-2121		
	02/90→08/91	Centre Rod	RV-DL-0900		Push Rod
	02/90→08/91	Tie Rod End	CV-ES-0912		
	02/90→08/91	Tie Rod End	CV-ES-0914		for Steering Rod
	02/90→08/91	Tie Rod End	CV-ES-14162		for Steering Rod

CV-ES-0912

Length: 125

Cone Ø: d1 Ø 30 / d2 Ø 27

Thread: M38 x 1,5 LHT

3401206, 5001832579



RV-ES-8691

Length: 106

Cone Ø: d1 Ø 20 / d2 Ø 18

Thread: M24 x 1,5 LHT

7700658834



CV-ES-0914

Length: 125

Cone Ø: d1 Ø 30 / d2 Ø 27

Thread: M38 x 1,5 RHT

3401207, 5001832580



CV-ES-2121

Length: 85

Cone Ø: d1 Ø 12 / d2 Ø 10,8

Thread: M14 x 1,5 RHT

23162046, 5000516214, 5010144543,
5010245591



CV-ES-14162

Length: 125

Cone Ø: d1 Ø 30 / d2 Ø 27

Thread: M30 x 1,5 LHT

3401170, 5000288361, 5001832581,
5001858759, 5001858774



CV-ES-14163

Length: 125

Cone Ø: d1 Ø 30 / d2 Ø 27

Thread: M30 x 1,5 RHT

0003406169, 0003406236, 0003406251,
0003406254, 0003406260, 0003406261,
5000288360, 5000590236, 5000804824,
5001858773, 7420937674, 7701011412



RV-DL-0900

Length: 990

Ø: 52

Cone Ø: d1 Ø 30 / d2 Ø 27

5000725267, 5010144552





G ...

G 230ti.15 ...	02/90→08/91	Tie Rod End	CV-ES-14163		for Steering Rod
	02/90→08/91	Tie Rod End	RV-ES-8691		
G 230ti.16	02/90→08/91	Ball Head, gearshift linkage	CV-ES-2121		
	02/90→08/91	Centre Rod	RV-DL-0900		Push Rod
	02/90→08/91	Tie Rod End	CV-ES-0912		
	02/90→08/91	Tie Rod End	CV-ES-0914		for Steering Rod
	02/90→08/91	Tie Rod End	CV-ES-14162		for Steering Rod
	02/90→08/91	Tie Rod End	CV-ES-14163		for Steering Rod
	02/90→08/91	Tie Rod End	RV-ES-8691		
G 230ti.17	02/90→08/91	Ball Head, gearshift linkage	CV-ES-2121		
	02/90→08/91	Centre Rod	RV-DL-0900		Push Rod
	02/90→08/91	Tie Rod End	CV-ES-0912		
	02/90→08/91	Tie Rod End	CV-ES-0914		for Steering Rod
	02/90→08/91	Tie Rod End	CV-ES-14162		for Steering Rod
	02/90→08/91	Tie Rod End	CV-ES-14163		for Steering Rod
	02/90→08/91	Tie Rod End	RV-ES-8691		
G 230ti.18	02/90→08/91	Ball Head, gearshift linkage	CV-ES-2121		
	02/90→08/91	Centre Rod	RV-DL-0900		Push Rod
	02/90→08/91	Tie Rod End	CV-ES-0912		
	02/90→08/91	Tie Rod End	CV-ES-0914		for Steering Rod
	02/90→08/91	Tie Rod End	CV-ES-14162		for Steering Rod
	02/90→08/91	Tie Rod End	CV-ES-14163		for Steering Rod
G 230ti.19	02/90→08/91	Ball Head, gearshift linkage	CV-ES-2121		
	02/90→08/91	Centre Rod	RV-DL-0900		Push Rod
	02/90→08/91	Tie Rod End	CV-ES-0912		
	02/90→08/91	Tie Rod End	CV-ES-0914		for Steering Rod
	02/90→08/91	Tie Rod End	CV-ES-14162		for Steering Rod
	02/90→08/91	Tie Rod End	CV-ES-14163		for Steering Rod
	02/90→08/91	Tie Rod End	RV-ES-8691		
G 260.15/T	10/82→05/90	Ball Head, gearshift linkage	CV-ES-2121		
	10/82→05/90	Centre Rod	RV-DL-0900		Push Rod
	10/82→05/90	Tie Rod End	CV-ES-0912		
	10/82→05/90	Tie Rod End	CV-ES-0914		for Steering Rod
	10/82→05/90	Tie Rod End	CV-ES-14162		for Steering Rod
	10/82→05/90	Tie Rod End	CV-ES-14163		for Steering Rod
G 260.16	10/82→05/90	Ball Head, gearshift linkage	CV-ES-2121		
	10/82→05/90	Centre Rod	RV-DL-0900		Push Rod
	10/82→05/90	Tie Rod End	CV-ES-0912		
	10/82→05/90	Tie Rod End	CV-ES-0914		for Steering Rod
	10/82→05/90	Tie Rod End	CV-ES-14162		for Steering Rod
	10/82→05/90	Tie Rod End	CV-ES-14163		for Steering Rod
	10/82→05/90	Tie Rod End	RV-ES-8691		
G 260.17	10/82→05/90	Ball Head, gearshift linkage	CV-ES-2121		
	10/82→05/90	Centre Rod	RV-DL-0900		Push Rod
	10/82→05/90	Tie Rod End	CV-ES-0912		
	10/82→05/90	Tie Rod End	CV-ES-0914		for Steering Rod
	10/82→05/90	Tie Rod End	CV-ES-14162		for Steering Rod
	10/82→05/90	Tie Rod End	CV-ES-14163		for Steering Rod
	10/82→09/91	Tie Rod End	RV-ES-8691		
G 260.17/T	10/82→05/90	Ball Head, gearshift linkage	CV-ES-2121		
	10/82→05/90	Centre Rod	RV-DL-0900		Push Rod
	10/82→05/90	Tie Rod End	CV-ES-0912		
	10/82→05/90	Tie Rod End	CV-ES-0914		for Steering Rod
	10/82→05/90	Tie Rod End	CV-ES-14162		for Steering Rod
	10/82→05/90	Tie Rod End	CV-ES-14163		for Steering Rod
G 260.19	10/82→05/90	Ball Head, gearshift linkage	CV-ES-2121		
	10/82→05/90	Centre Rod	RV-DL-0900		Push Rod
	10/82→05/90	Tie Rod End	CV-ES-0912		
	10/82→05/90	Tie Rod End	CV-ES-0914		for Steering Rod
	10/82→05/90	Tie Rod End	CV-ES-14162		for Steering Rod

CV-ES-0912

Length: 125

Cone Ø: d1 Ø 30 / d2 Ø 27

Thread: M38 x 1,5 LHT

3401206, 5001832579



RV-ES-8691

Length: 106

Cone Ø: d1 Ø 20 / d2 Ø 18

Thread: M24 x 1,5 LHT

7700658834



CV-ES-0914

Length: 125

Cone Ø: d1 Ø 30 / d2 Ø 27

Thread: M38 x 1,5 RHT

3401207, 5001832580



CV-ES-2121

Length: 85

Cone Ø: d1 Ø 12 / d2 Ø 10,8

Thread: M14 x 1,5 RHT

23162046, 5000516214, 5010144543,
5010245591



CV-ES-14162

Length: 125

Cone Ø: d1 Ø 30 / d2 Ø 27

Thread: M30 x 1,5 LHT

3401170, 5000288361, 5001832581,
5001858759, 5001858774



CV-ES-14163

Length: 125

Cone Ø: d1 Ø 30 / d2 Ø 27

Thread: M30 x 1,5 RHT

0003406169, 0003406236, 0003406251,
0003406254, 0003406260, 0003406261,
5000288360, 5000590236, 5000804824,
5001858773, 7420937674, 7701011412



RV-DL-0900

Length: 990

Ø: 52

Cone Ø: d1 Ø 30 / d2 Ø 27

5000725267, 5010144552





G ...

G 260.19 ...	10/82→05/90	Tie Rod End	CV-ES-14163		for Steering Rod
	10/82→05/90	Tie Rod End	RV-ES-8691		
G 260.19/T	10/82→05/90	Ball Head, gearshift linkage	CV-ES-2121		
	10/82→05/90	Centre Rod	RV-DL-0900		Push Rod
	10/82→05/90	Tie Rod End	CV-ES-0912		
	10/82→05/90	Tie Rod End	CV-ES-0914		for Steering Rod
	10/82→05/90	Tie Rod End	CV-ES-14162		for Steering Rod
	10/82→05/90	Tie Rod End	CV-ES-14163		for Steering Rod
	10/82→05/90	Tie Rod End	RV-ES-8691		
G 260.22/T	10/82→05/90	Ball Head, gearshift linkage	CV-ES-2121		
	10/82→05/90	Centre Rod	RV-DL-0900		Push Rod
	10/82→05/90	Tie Rod End	CV-ES-0912		
	10/82→05/90	Tie Rod End	CV-ES-0914		for Steering Rod
	10/82→05/90	Tie Rod End	CV-ES-14162		for Steering Rod
	10/82→05/90	Tie Rod End	CV-ES-14163		for Steering Rod
	10/82→05/90	Tie Rod End	RV-ES-8691		
G 260.24 CIT	10/82→05/90	Ball Head, gearshift linkage	CV-ES-2121		
	10/82→05/90	Centre Rod	RV-DL-0900		Push Rod
	10/82→05/90	Tie Rod End	CV-ES-0912		
	10/82→05/90	Tie Rod End	CV-ES-0914		for Steering Rod
	10/82→05/90	Tie Rod End	CV-ES-14162		for Steering Rod
	10/82→05/90	Tie Rod End	CV-ES-14163		for Steering Rod
G 280.13	01/90→09/91	Tie Rod End	RV-ES-12446		
G 280.15	01/90→09/91	Tie Rod End	RV-ES-12446		
G 280.15/T	01/90→09/91	Tie Rod End	RV-ES-12446		
G 280.16	01/90→09/91	Tie Rod End	RV-ES-12446		
G 280.18	01/90→09/91	Tie Rod End	RV-ES-12446		
G 280.19	01/90→09/91	Tie Rod End	RV-ES-12446		
G 280.24	01/90→09/91	Tie Rod End	RV-ES-12446		
G 280.26	01/90→09/91	Tie Rod End	RV-ES-12446		
G 290.17/TD	11/85→12/89	Ball Head, gearshift linkage	CV-ES-2121		
	11/85→12/89	Centre Rod	RV-DL-0900		Push Rod
	11/85→12/89	Tie Rod End	CV-ES-0912		
	11/85→12/89	Tie Rod End	CV-ES-0914		for Steering Rod
	11/85→12/89	Tie Rod End	CV-ES-14162		for Steering Rod
	11/85→12/89	Tie Rod End	CV-ES-14163		for Steering Rod
G 290.19	11/85→12/89	Ball Head, gearshift linkage	CV-ES-2121		
	11/85→12/89	Centre Rod	RV-DL-0900		Push Rod
	11/85→12/89	Tie Rod End	CV-ES-0912		
	11/85→12/89	Tie Rod End	CV-ES-0914		for Steering Rod
	11/85→12/89	Tie Rod End	CV-ES-14162		for Steering Rod
	11/85→12/89	Tie Rod End	CV-ES-14163		for Steering Rod
G 290.19/T	11/85→12/89	Ball Head, gearshift linkage	CV-ES-2121		
	11/85→12/89	Centre Rod	RV-DL-0900		Push Rod
	11/85→12/89	Tie Rod End	CV-ES-0912		
	11/85→12/89	Tie Rod End	CV-ES-0914		for Steering Rod
	11/85→12/89	Tie Rod End	CV-ES-14162		for Steering Rod
	11/85→12/89	Tie Rod End	CV-ES-14163		for Steering Rod
G 290.22/TD	11/85→12/89	Ball Head, gearshift linkage	CV-ES-2121		
	11/85→12/89	Centre Rod	RV-DL-0900		Push Rod
	11/85→12/89	Tie Rod End	CV-ES-0912		
	11/85→12/89	Tie Rod End	CV-ES-0914		for Steering Rod
	11/85→12/89	Tie Rod End	CV-ES-14162		for Steering Rod
	11/85→12/89	Tie Rod End	CV-ES-14163		for Steering Rod
G 290.24	11/85→12/89	Ball Head, gearshift linkage	CV-ES-2121		
	11/85→12/89	Centre Rod	RV-DL-0900		Push Rod
	11/85→12/89	Tie Rod End	CV-ES-0912		
	11/85→12/89	Tie Rod End	CV-ES-0914		for Steering Rod
	11/85→12/89	Tie Rod End	CV-ES-14162		for Steering Rod
	11/85→12/89	Tie Rod End	CV-ES-14163		for Steering Rod

CV-ES-0912

Length: 125
Cone Ø: d1 Ø 30 / d2 Ø 27
Thread: M38 x 1,5 LHT
3401206, 5001832579



RV-ES-8691

Length: 106
Cone Ø: d1 Ø 20 / d2 Ø 18
Thread: M24 x 1,5 LHT
7700658834



CV-ES-0914

Length: 125
Cone Ø: d1 Ø 30 / d2 Ø 27
Thread: M38 x 1,5 RHT
3401207, 5001832580



RV-ES-12446

Length: 170
Cone Ø: d1 Ø 30 / d2 Ø 27
5000288362



CV-ES-2121

Length: 85
Cone Ø: d1 Ø 12 / d2 Ø 10,8
Thread: M14 x 1,5 RHT
23162046, 5000516214, 5010144543,
5010245591



CV-ES-14162

Length: 125
Cone Ø: d1 Ø 30 / d2 Ø 27
Thread: M30 x 1,5 LHT
3401170, 5000288361, 5001832581,
5001858759, 5001858774



CV-ES-14163

Length: 125
Cone Ø: d1 Ø 30 / d2 Ø 27
Thread: M30 x 1,5 RHT
0003406169, 0003406236, 0003406251,
0003406254, 0003406260, 0003406261,
5000288360, 5000590236, 5000804824,
5001858773, 7420937674, 7701011412



RV-DL-0900

Length: 990
Ø: 52
Cone Ø: d1 Ø 30 / d2 Ø 27
5000725267, 5010144552





G ...

G 290.24 CIT	11/85→12/89	Ball Head, gearshift linkage	CV-ES-2121	
	11/85→12/89	Centre Rod	RV-DL-0900	Push Rod
	11/85→12/89	Tie Rod End	CV-ES-0912	
	11/85→12/89	Tie Rod End	CV-ES-0914	for Steering Rod
	11/85→12/89	Tie Rod End	CV-ES-14162	for Steering Rod
	11/85→12/89	Tie Rod End	CV-ES-14163	for Steering Rod
G 290.26	11/85→12/89	Ball Head, gearshift linkage	CV-ES-2121	
	11/85→12/89	Centre Rod	RV-DL-0900	Push Rod
	11/85→12/89	Tie Rod End	CV-ES-0912	
	11/85→12/89	Tie Rod End	CV-ES-0914	for Steering Rod
	11/85→12/89	Tie Rod End	CV-ES-14162	for Steering Rod
	11/85→12/89	Tie Rod End	CV-ES-14163	for Steering Rod
G 300.13	01/90→08/91	Tie Rod End	RV-ES-8691	
G 300.15	01/90→08/91	Tie Rod End	RV-ES-8691	
G 300.15/T	01/90→08/91	Tie Rod End	RV-ES-8691	
G 300.16	01/90→08/91	Tie Rod End	RV-ES-8691	
G 300.17	01/90→08/91	Tie Rod End	RV-ES-8691	
G 300.19	01/90→08/91	Tie Rod End	RV-ES-8691	
G 300.19/T	01/90→08/91	Tie Rod End	RV-ES-8691	
G 300.24	01/90→08/91	Tie Rod End	RV-ES-8691	
G 300.25	01/90→08/91	Tie Rod End	RV-ES-8691	
G 300.26	01/90→08/91	Tie Rod End	RV-ES-8691	
G 300.26 CIT	01/90→08/91	Tie Rod End	RV-ES-8691	
G 300.26/T	01/90→08/91	Tie Rod End	RV-ES-8691	
G 320.19	11/88→05/90	Ball Head, gearshift linkage	CV-ES-2121	
	11/88→05/90	Centre Rod	RV-DL-0900	Push Rod
	11/88→05/90	Tie Rod End	CV-ES-0912	
	11/88→05/90	Tie Rod End	CV-ES-0914	for Steering Rod
	11/88→05/90	Tie Rod End	CV-ES-14162	for Steering Rod
	11/88→05/90	Tie Rod End	CV-ES-14163	for Steering Rod
G 320.19 T	11/88→05/90	Ball Head, gearshift linkage	CV-ES-2121	
	11/88→05/90	Centre Rod	RV-DL-0900	Push Rod
	11/88→05/90	Centre Rod	RV-DL-8177	Push Rod
	11/88→05/90	Tie Rod End	CV-ES-0912	
	11/88→05/90	Tie Rod End	CV-ES-0914	for Steering Rod
	11/88→05/90	Tie Rod End	CV-ES-14162	for Steering Rod
G 320.24	11/88→05/90	Ball Head, gearshift linkage	CV-ES-2121	
	11/88→05/90	Centre Rod	RV-DL-0900	Push Rod
	11/88→05/90	Tie Rod End	CV-ES-0912	
	11/88→05/90	Tie Rod End	CV-ES-0914	for Steering Rod
	11/88→05/90	Tie Rod End	CV-ES-14162	for Steering Rod
	11/88→05/90	Tie Rod End	CV-ES-14163	for Steering Rod
G 330.13	02/90→08/91	Tie Rod End	RV-ES-8691	
G 330.15	02/90→08/91	Tie Rod End	RV-ES-8691	
G 330.16	02/90→08/91	Tie Rod End	RV-ES-8691	
G 330.17	02/90→08/91	Tie Rod End	RV-ES-8691	
G 330.17/T	02/90→08/91	Tie Rod End	RV-ES-8691	
G 330.19	02/90→08/91	Tie Rod End	RV-ES-8691	
G 330.24	02/90→08/91	Tie Rod End	RV-ES-8691	
G 330.26	02/90→08/91	Tie Rod End	RV-ES-8691	
G 340ti.19/T,G 330.19/T	02/90→08/91	Ball Head, gearshift linkage	CV-ES-2121	
	02/90→08/91	Centre Rod	RV-DL-0900	Push Rod
	02/90→08/91	Tie Rod End	CV-ES-0912	
	02/90→08/91	Tie Rod End	CV-ES-0914	for Steering Rod
	02/90→08/91	Tie Rod End	CV-ES-14162	for Steering Rod
	02/90→08/91	Tie Rod End	CV-ES-14163	for Steering Rod
G 340ti.19/T,G 330.19/T,G 330.17/T	01/90→08/91	Ball Head, gearshift linkage	CV-ES-2121	
	01/90→08/91	Centre Rod	RV-DL-0900	Push Rod
	01/90→08/91	Tie Rod End	CV-ES-0912	
	01/90→08/91	Tie Rod End	CV-ES-0914	for Steering Rod
	01/90→08/91	Tie Rod End	CV-ES-14162	for Steering Rod

CV-ES-0912

Length: 125
Cone Ø: d1 Ø 30 / d2 Ø 27
Thread: M38 x 1,5 LHT
3401206, 5001832579



RV-DL-8177

Length: 1012
Ø: 52
Cone Ø: d1 Ø 30 / d2 Ø 27
5010130451, 7485114925



CV-ES-0914

Length: 125
Cone Ø: d1 Ø 30 / d2 Ø 27
Thread: M38 x 1,5 RHT
3401207, 5001832580



RV-ES-8691

Length: 106
Cone Ø: d1 Ø 20 / d2 Ø 18
Thread: M24 x 1,5 LHT
7700658834



CV-ES-2121

Length: 85
Cone Ø: d1 Ø 12 / d2 Ø 10,8
Thread: M14 x 1,5 RHT
23162046, 5000516214, 5010144543,
5010245591



CV-ES-14162

Length: 125
Cone Ø: d1 Ø 30 / d2 Ø 27
Thread: M30 x 1,5 LHT
3401170, 5000288361, 5001832581,
5001858759, 5001858774



CV-ES-14163

Length: 125
Cone Ø: d1 Ø 30 / d2 Ø 27
Thread: M30 x 1,5 RHT
0003406169, 0003406236, 0003406251,
0003406254, 0003406260, 0003406261,
5000288360, 5000590236, 5000804824,
5001858773, 7420937674, 7701011412



RV-DL-0900

Length: 990
Ø: 52
Cone Ø: d1 Ø 30 / d2 Ø 27
5000725267, 5010144552





G ...

G 340ti.19/T,G 330.19/T, G 330.17/T ...	01/90→08/91	Tie Rod End	CV-ES-14163		for Steering Rod
	01/90→08/91	Tie Rod End	RV-ES-8691		

Iliade

FRH, GTX, GTXE, RTX, TX	01/97→	Suspension Arm Repair Kit	DB-RK-8366	DB-RK-8366	for Control Arm;for Drag Link
	01/97→	Tie Rod	RV-DL-12381		
	01/97→	Track Control Arm		RV-DL-7282	Trailing Arm
GT, GTC, GTE	04/98→	Suspension Arm Repair Kit	DB-RK-8366	DB-RK-8366	for Control Arm;for Drag Link
	04/98→	Tie Rod	RV-DL-12381		
	04/98→	Track Control Arm		RV-DL-7282	Trailing Arm

Kerax

260.18	06/97→	Ball Head, gearshift linkage	CV-ES-2121			
	06/97→	Ball Head, gearshift linkage	DF-ES-9335			
	06/97→	Centre Rod	RV-DL-0886		Push Rod	
	06/97→	Centre Rod	RV-DL-0887		Coupling Rod	
	06/97→	Centre Rod	RV-DL-2181		Coupling Rod	
	06/97→	Centre Rod	RV-DL-8156		Push Rod	
	06/97→	Suspension Strut Repair Kit		DF-RK-8671		
	06/97→	Suspension Strut Repair Kit		RV-RK-8648		
	06/97→	Tie Rod End	CV-ES-14162		for Steering Rod	
	06/97→	Tie Rod End	CV-ES-14163		for Steering Rod	
	06/97→	Tie Rod End	RV-ES-12331			
	06/97→	Track Control Arm		RV-TC-12339	Suspension Rod, Trailing Arm	
	260.18/B	06/97→	Ball Head, gearshift linkage	CV-ES-2121		
		06/97→	Ball Head, gearshift linkage	DF-ES-9335		
06/97→		Centre Rod	RV-DL-0886		Push Rod	
06/97→		Centre Rod	RV-DL-0887		Coupling Rod	
06/97→		Centre Rod	RV-DL-2181		Coupling Rod	
06/97→		Centre Rod	RV-DL-8156		Push Rod	
06/97→		Suspension Strut Repair Kit		DF-RK-8671		
06/97→		Suspension Strut Repair Kit		RV-RK-8648		
06/97→		Tie Rod	RV-DL-8313		Guide Rod	
06/97→		Tie Rod End	CV-ES-14162		for Steering Rod	
06/97→		Tie Rod End	CV-ES-14163		for Steering Rod	
06/97→		Tie Rod End	RV-ES-12331			
06/97→		Track Control Arm		RV-TC-12339	Suspension Rod, Trailing Arm	
270.18		01/01→	Ball Head, gearshift linkage	CV-ES-2121		
	01/01→	Centre Rod	RV-DL-0886		Push Rod	
	01/01→	Centre Rod	RV-DL-0887		Coupling Rod	
	01/01→	Centre Rod	RV-DL-2181		Coupling Rod	
	01/01→	Centre Rod	RV-DL-8156		Push Rod	
	01/01→	Tie Rod	RV-DL-8313		Guide Rod	
	01/01→	Tie Rod End	CV-ES-14162		for Steering Rod	
	01/01→	Tie Rod End	CV-ES-14163		for Steering Rod	
	01/01→	Tie Rod End	RV-ES-12331			
	01/01→	Track Control Arm		RV-TC-12339	Suspension Rod, Trailing Arm	
	300.18/B	06/97→	Ball Head, gearshift linkage	CV-ES-2121		
		06/97→	Ball Head, gearshift linkage	DF-ES-9335		
		06/97→	Centre Rod	RV-DL-0886		Push Rod
		06/97→	Centre Rod	RV-DL-0887		Coupling Rod
06/97→		Centre Rod	RV-DL-2181		Coupling Rod	
06/97→		Centre Rod	RV-DL-8156		Push Rod	
06/97→		Suspension Strut Repair Kit		DF-RK-8671		
06/97→		Suspension Strut Repair Kit		RV-RK-8648		
06/97→		Tie Rod	RV-DL-8313		Guide Rod	
06/97→		Tie Rod End	CV-ES-14162		for Steering Rod	
06/97→		Tie Rod End	CV-ES-14163		for Steering Rod	
06/97→		Tie Rod End	RV-ES-12331			
06/97→		Track Control Arm		RV-TC-12339	Suspension Rod, Trailing Arm	
300.26/A,300.26/B		06/97→	Ball Head, gearshift linkage	CV-ES-2121		
	06/97→	Ball Head, gearshift linkage	DF-ES-9335			
	06/97→	Centre Rod	RV-DL-0886		Push Rod	
	06/97→	Centre Rod	RV-DL-0887		Coupling Rod	

CV-ES-2121

Length: 85
Cone Ø: d1 Ø 12 / d2 Ø 10,8
Thread: M14 x 1,5 RHT
23162046, 5000516214, 5010144543,
5010245591



CV-ES-14162

Length: 125
Cone Ø: d1 Ø 30 / d2 Ø 27
Thread: M30 x 1,5 LHT
3401170, 5000288361, 5001832581,
5001858759, 5001858774



CV-ES-14163

Length: 125
Cone Ø: d1 Ø 30 / d2 Ø 27
Thread: M30 x 1,5 RHT
0003406169, 0003406236, 0003406251,
0003406254, 0003406260, 0003406261,
5000288360, 5000590236, 5000804824,
5001858773, 7420937674, 7701011412



DB-RK-8366

Ø: 85
Hole Distance: 130
Thick/Height: 30
5000333285, 5001850588, 5010393047



DF-ES-9335

Length: 85
Cone Ø: d1 Ø 12 / d2 Ø 10,75
Thread: M14 x 1,5 RHT
23162046, 5000516214, 5010144543,
5010245591



DF-RK-8671

Ø: 80
Hole Distance: 145
Thick/Height: 30
5001014345



RV-DL-0886

Length: 945
Ø: 52
Cone Ø: d1 Ø 30 / d2 Ø 27
5010229242, 5010488052



RV-DL-0887

Length: 1720
Ø: 48
Cone Ø: d1 Ø 30 / d2 Ø 27
5010308082



RV-DL-2181

Length: 1650
Ø: 40
Cone Ø: d1 Ø 30 / d2 Ø 27
5010145581, 5010308215



RV-DL-7282

Length: 690
Ø: 46
Hole Distance: 122 / 122
5000790218, 5000869573, 5010207727



RV-DL-8156

Length: 934
Ø: 52
Cone Ø: d1 Ø 30 / d2 Ø 27
5010229243, 5010488053



RV-DL-8313

Length: 1752
Ø: 48
Cone Ø: d1 Ø 30 / d2 Ø 27
5010098467, 5010145584, 5010439631



RV-DL-12381

Length: 776
Ø: 38
Cone Ø: d1 Ø 26 / d2 Ø 23,5
5010393015



RV-ES-8691

Length: 106
Cone Ø: d1 Ø 20 / d2 Ø 18
Thread: M24 x 1,5 LHT
7700658834



RV-ES-12331

Length: 140
Cone Ø: d1 Ø 30 / d2 Ø 27
Thread: M32 x 1,5 RHT / M24 x 1,5 RHT
0014607248, 014607248, 5001866165,
5001867774, 7485134391



RV-RK-8648

Ø: 85
Hole Distance: 152
Thick/Height: 35
5001842337



RV-TC-12339

Length: 515
Hole Distance: 13 / 130
7420532931, 7421051046





Kerax ...

300.26/A,300.26/B ...	06/97→	Centre Rod	RV-DL-2181		Coupling Rod	
	06/97→	Centre Rod	RV-DL-8156		Push Rod	
	06/97→	Suspension Strut Repair Kit		DF-RK-8671		
	06/97→	Suspension Strut Repair Kit		RV-RK-8648		
	06/97→	Tie Rod	RV-DL-8313		Guide Rod	
	06/97→	Tie Rod End	CV-ES-14162		for Steering Rod	
	06/97→	Tie Rod End	CV-ES-14163		for Steering Rod	
	06/97→	Tie Rod End	RV-ES-12331			
	06/97→	Track Control Arm		RV-DL-7971	Trailing Arm	
	06/97→	Track Control Arm		RV-DL-8159	Trailing Arm, Leaf Spring Axle	
	06/97→	Track Control Arm		RV-TC-12339	Suspension Rod, Trailing Arm	
	11/00→	Track Control Arm		RV-DL-8324	Trailing Arm, Leaf Spring Axle	
	300.26/B	06/97→	Ball Head, gearshift linkage	CV-ES-2121		
06/97→		Ball Head, gearshift linkage	DF-ES-9335			
06/97→		Centre Rod	RV-DL-0886		Push Rod	
06/97→		Centre Rod	RV-DL-0887		Coupling Rod	
06/97→		Centre Rod	RV-DL-2181		Coupling Rod	
06/97→		Centre Rod	RV-DL-8156		Push Rod	
06/97→		Suspension Strut Repair Kit		DF-RK-8671		
06/97→		Suspension Strut Repair Kit		RV-RK-8648		
06/97→		Tie Rod	RV-DL-8313		Guide Rod	
06/97→		Tie Rod End	CV-ES-14162		for Steering Rod	
06/97→		Tie Rod End	CV-ES-14163		for Steering Rod	
06/97→		Tie Rod End	RV-ES-12331			
06/97→		Track Control Arm		RV-DL-7971	Trailing Arm	
06/97→		Track Control Arm		RV-TC-12339	Suspension Rod, Trailing Arm	
320.18		01/01→	Ball Head, gearshift linkage	CV-ES-2121		
		01/01→	Centre Rod	RV-DL-0886		Push Rod
	01/01→	Centre Rod	RV-DL-0887		Coupling Rod	
	01/01→	Centre Rod	RV-DL-2181		Coupling Rod	
	01/01→	Centre Rod	RV-DL-8156		Push Rod	
	01/01→	Tie Rod	RV-DL-8313		Guide Rod	
	01/01→	Tie Rod End	CV-ES-14162		for Steering Rod	
	01/01→	Tie Rod End	CV-ES-14163		for Steering Rod	
	01/01→	Tie Rod End	RV-ES-12331			
	01/01→	Track Control Arm		RV-TC-12339	Suspension Rod, Trailing Arm	
	320.26	01/01→	Ball Head, gearshift linkage	CV-ES-2121		
		01/01→	Ball Head, gearshift linkage	DF-ES-9335		
01/01→		Centre Rod	RV-DL-0886		Push Rod	
01/01→		Centre Rod	RV-DL-0887		Coupling Rod	
01/01→		Centre Rod	RV-DL-2181		Coupling Rod	
01/01→		Centre Rod	RV-DL-8156		Push Rod	
01/01→		Suspension Strut Repair Kit		RV-RK-8648		
01/01→		Tie Rod	RV-DL-8313		Guide Rod	
01/01→		Tie Rod End	CV-ES-14162		for Steering Rod	
01/01→		Tie Rod End	CV-ES-14163		for Steering Rod	
01/01→		Tie Rod End	RV-ES-12331			
01/01→		Track Control Arm		RV-DL-8159	Trailing Arm, Leaf Spring Axle	
01/01→		Track Control Arm		RV-DL-8324	Trailing Arm, Leaf Spring Axle	
01/01→		Track Control Arm		RV-TC-12339	Suspension Rod, Trailing Arm	
340.18	06/97→	Ball Head, gearshift linkage	CV-ES-2121			
	06/97→	Ball Head, gearshift linkage	DF-ES-9335			
	06/97→	Centre Rod	RV-DL-0886		Push Rod	
	06/97→	Centre Rod	RV-DL-0887		Coupling Rod	
	06/97→	Centre Rod	RV-DL-2181		Coupling Rod	
	06/97→	Centre Rod	RV-DL-8156		Push Rod	
	06/97→	Suspension Strut Repair Kit		DF-RK-8671		
	06/97→	Suspension Strut Repair Kit		RV-RK-8648		
	06/97→	Tie Rod	RV-DL-8313		Guide Rod	
	06/97→	Tie Rod End	CV-ES-14162		for Steering Rod	
	06/97→	Tie Rod End	CV-ES-14163		for Steering Rod	
	06/97→	Tie Rod End	RV-ES-12331			
	06/97→	Track Control Arm		RV-TC-12339	Suspension Rod, Trailing Arm	

CV-ES-2121

Length: 85
Cone Ø: d1 Ø 12 / d2 Ø 10,8
Thread: M14 x 1,5 RHT
23162046, 5000516214, 5010144543,
5010245591



CV-ES-14162

Length: 125
Cone Ø: d1 Ø 30 / d2 Ø 27
Thread: M30 x 1,5 LHT
3401170, 5000288361, 5001832581,
5001858759, 5001858774



CV-ES-14163

Length: 125
Cone Ø: d1 Ø 30 / d2 Ø 27
Thread: M30 x 1,5 RHT
0003406169, 0003406236, 0003406251,
0003406254, 0003406260, 0003406261,
5000288360, 5000590236, 5000804824,
5001858773, 7420937674, 7701011412



DF-ES-9335

Length: 85
Cone Ø: d1 Ø 12 / d2 Ø 10,75
Thread: M14 x 1,5 RHT
23162046, 5000516214, 5010144543,
5010245591



DF-RK-8671

Ø: 80
Hole Distance: 145
Thick/Height: 30
5001014345



RV-DL-0886

Length: 945
Ø: 52
Cone Ø: d1 Ø 30 / d2 Ø 27
5010229242, 5010488052



RV-DL-0887

Length: 1720
Ø: 48
Cone Ø: d1 Ø 30 / d2 Ø 27
5010308082



RV-DL-2181

Length: 1650
Ø: 40
Cone Ø: d1 Ø 30 / d2 Ø 27
5010145581, 5010308215



RV-DL-7971

Length: 575
Ø: 50
Hole Distance: 152 / 152
5010094840



RV-DL-8156

Length: 934
Ø: 52
Cone Ø: d1 Ø 30 / d2 Ø 27
5010229243, 5010488053



RV-DL-8159

Length: 574
Ø: 50
Hole Distance: 152 / 152
5010389262



RV-DL-8313

Length: 1752
Ø: 48
Cone Ø: d1 Ø 30 / d2 Ø 27
5010098467, 5010145584, 5010439631



RV-DL-8324

Length: 575
Ø: 50
Hole Distance: 152 / 152
5010467915



RV-ES-12331

Length: 140
Cone Ø: d1 Ø 30 / d2 Ø 27
Thread: M32 x 1,5 RHT / M24 x 1,5 RHT
0014607248, 014607248, 5001866165,
5001867774, 7485134391



RV-RK-8648

Ø: 85
Hole Distance: 152
Thick/Height: 35
5001842337



RV-TC-12339

Length: 515
Hole Distance: 13 / 130
7420532931, 7421051046





Kerax ...

340.18/B	06/97→	Ball Head, gearshift linkage	CV-ES-2121		
	06/97→	Ball Head, gearshift linkage	DF-ES-9335		
	06/97→	Centre Rod	RV-DL-0886		Push Rod
	06/97→	Centre Rod	RV-DL-0887		Coupling Rod
	06/97→	Centre Rod	RV-DL-2181		Coupling Rod
	06/97→	Centre Rod	RV-DL-8156		Push Rod
	06/97→	Suspension Strut Repair Kit		DF-RK-8671	
	06/97→	Suspension Strut Repair Kit		RV-RK-8648	
	06/97→	Tie Rod	RV-DL-8313		Guide Rod
	06/97→	Tie Rod End	CV-ES-14162		for Steering Rod
	06/97→	Tie Rod End	CV-ES-14163		for Steering Rod
	06/97→	Tie Rod End	RV-ES-12331		
	06/97→	Track Control Arm		RV-TC-12339	Suspension Rod, Trailing Arm
	340.26	06/97→01/01	Ball Head, gearshift linkage	CV-ES-2121	
06/97→01/01		Ball Head, gearshift linkage	DF-ES-9335		
06/97→01/01		Centre Rod	RV-DL-0886		Push Rod
06/97→01/01		Centre Rod	RV-DL-0887		Coupling Rod
06/97→01/01		Centre Rod	RV-DL-2181		Coupling Rod
06/97→01/01		Centre Rod	RV-DL-8156		Push Rod
06/97→01/01		Suspension Strut Repair Kit		DF-RK-8671	
06/97→01/01		Suspension Strut Repair Kit		RV-RK-8648	
06/97→01/01		Tie Rod End	CV-ES-14162		for Steering Rod
06/97→01/01		Tie Rod End	CV-ES-14163		for Steering Rod
06/97→01/01		Tie Rod End	RV-ES-12331		
06/97→01/01		Track Control Arm		RV-DL-7971	Trailing Arm
06/97→01/01		Track Control Arm		RV-DL-8159	Trailing Arm, Leaf Spring Axle
06/97→01/01		Track Control Arm		RV-DL-8324	Trailing Arm, Leaf Spring Axle
06/97→01/01	Track Control Arm		RV-TC-12339	Suspension Rod, Trailing Arm	
340.26/A,340.26/B	06/97→	Ball Head, gearshift linkage	CV-ES-2121		
	06/97→	Ball Head, gearshift linkage	DF-ES-9335		
	06/97→	Centre Rod	RV-DL-0886		Push Rod
	06/97→	Centre Rod	RV-DL-0887		Coupling Rod
	06/97→	Centre Rod	RV-DL-2181		Coupling Rod
	06/97→	Centre Rod	RV-DL-8156		Push Rod
	06/97→	Suspension Strut Repair Kit		DF-RK-8671	
	06/97→	Suspension Strut Repair Kit		RV-RK-8648	
	06/97→	Tie Rod	RV-DL-8313		Guide Rod
	06/97→	Tie Rod End	CV-ES-14162		for Steering Rod
	06/97→	Tie Rod End	CV-ES-14163		for Steering Rod
	06/97→	Tie Rod End	RV-ES-12331		
	06/97→	Track Control Arm		RV-DL-7971	Trailing Arm
	06/97→	Track Control Arm		RV-DL-8159	Trailing Arm, Leaf Spring Axle
06/97→	Track Control Arm		RV-TC-12339	Suspension Rod, Trailing Arm	
11/00→	Track Control Arm		RV-DL-8324	Trailing Arm, Leaf Spring Axle	
340.26/B	06/97→	Ball Head, gearshift linkage	CV-ES-2121		
	06/97→	Ball Head, gearshift linkage	DF-ES-9335		
	06/97→	Centre Rod	RV-DL-0886		Push Rod
	06/97→	Centre Rod	RV-DL-0887		Coupling Rod
	06/97→	Centre Rod	RV-DL-2181		Coupling Rod
	06/97→	Centre Rod	RV-DL-8156		Push Rod
	06/97→	Suspension Strut Repair Kit		DF-RK-8671	
	06/97→	Suspension Strut Repair Kit		RV-RK-8648	
	06/97→	Tie Rod	RV-DL-8313		Guide Rod
	06/97→	Tie Rod End	CV-ES-14162		for Steering Rod
	06/97→	Tie Rod End	CV-ES-14163		for Steering Rod
	06/97→	Tie Rod End	RV-ES-12331		
	06/97→	Track Control Arm		RV-DL-7971	Trailing Arm
	06/97→	Track Control Arm		RV-TC-12339	Suspension Rod, Trailing Arm
340.32/A	06/97→03/98	Tie Rod End	IV-ES-8515		
	06/97→	Ball Head, gearshift linkage	CV-ES-2121		
	06/97→	Ball Head, gearshift linkage	DF-ES-9335		
	06/97→	Centre Rod	RV-DL-0886		Push Rod
	06/97→	Centre Rod	RV-DL-0887		Coupling Rod

CV-ES-2121

Length: 85
Cone Ø: d1 Ø 12 / d2 Ø 10,8
Thread: M14 x 1,5 RHT
23162046, 5000516214, 5010144543,
5010245591



CV-ES-14162

Length: 125
Cone Ø: d1 Ø 30 / d2 Ø 27
Thread: M30 x 1,5 LHT
3401170, 5000288361, 5001832581,
5001858759, 5001858774



CV-ES-14163

Length: 125
Cone Ø: d1 Ø 30 / d2 Ø 27
Thread: M30 x 1,5 RHT
0003406169, 0003406236, 0003406251,
0003406254, 0003406260, 0003406261,
5000288360, 5000590236, 5000804824,
5001858773, 7420937674, 7701011412



DF-ES-9335

Length: 85
Cone Ø: d1 Ø 12 / d2 Ø 10,75
Thread: M14 x 1,5 RHT
23162046, 5000516214, 5010144543,
5010245591



DF-RK-8671

Ø: 80
Hole Distance: 145
Thick/Height: 30
5001014345



IV-ES-8515



RV-DL-0886

Length: 945
Ø: 52
Cone Ø: d1 Ø 30 / d2 Ø 27
5010229242, 5010488052



RV-DL-0887

Length: 1720
Ø: 48
Cone Ø: d1 Ø 30 / d2 Ø 27
5010308082



RV-DL-2181

Length: 1650
Ø: 40
Cone Ø: d1 Ø 30 / d2 Ø 27
5010145581, 5010308215



RV-DL-7971

Length: 575
Ø: 50
Hole Distance: 152 / 152
5010094840



RV-DL-8156

Length: 934
Ø: 52
Cone Ø: d1 Ø 30 / d2 Ø 27
5010229243, 5010488053



RV-DL-8159

Length: 574
Ø: 50
Hole Distance: 152 / 152
5010389262



RV-DL-8313

Length: 1752
Ø: 48
Cone Ø: d1 Ø 30 / d2 Ø 27
5010098467, 5010145584, 5010439631



RV-DL-8324

Length: 575
Ø: 50
Hole Distance: 152 / 152
5010467915



RV-ES-12331

Length: 140
Cone Ø: d1 Ø 30 / d2 Ø 27
Thread: M32 x 1,5 RHT / M24 x 1,5 RHT
0014607248, 014607248, 5001866165,
5001867774, 7485134391



RV-RK-8648

Ø: 85
Hole Distance: 152
Thick/Height: 35
5001842337



RV-TC-12339

Length: 515
Hole Distance: 13 / 130
7420532931, 7421051046



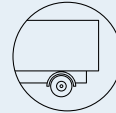

Kerax ...

340.32/A ...	06/97→	Centre Rod	RV-DL-2181		Coupling Rod
	06/97→	Centre Rod	RV-DL-8156		Push Rod
	06/97→	Centre Rod	RV-DL-8300		Push Rod
	06/97→	Suspension Strut Repair Kit		DF-RK-8671	
	06/97→	Suspension Strut Repair Kit		RV-RK-8648	
	06/97→	Tie Rod	RV-DL-8313		Guide Rod
	06/97→	Tie Rod	RV-DL-8313		Guide Rod, 1st FA;2nd FA
	06/97→	Tie Rod End	CV-ES-14162		for Steering Rod
	06/97→	Tie Rod End	CV-ES-14163		for Steering Rod
	06/97→	Tie Rod End	DB-ES-8323		
	06/97→	Tie Rod End	RV-ES-12331		
	06/97→	Track Control Arm		RV-DL-7971	Trailing Arm
	06/97→	Track Control Arm		RV-DL-8159	Trailing Arm, Leaf Spring Axle
	06/97→	Track Control Arm		RV-TC-12339	Suspension Rod, Trailing Arm
11/00→	Track Control Arm		RV-DL-8324	Trailing Arm, Leaf Spring Axle	
350.34	01/03→	Ball Head, gearshift linkage	CV-ES-2121		
	01/03→	Ball Head, gearshift linkage	DF-ES-9335		
	01/03→	Centre Rod	RV-DL-0886		Push Rod
	01/03→	Centre Rod	RV-DL-0887		Coupling Rod
	01/03→	Centre Rod	RV-DL-2181		Coupling Rod
	01/03→	Centre Rod	RV-DL-8156		Push Rod
	01/03→	Suspension Strut Repair Kit		RV-RK-8648	
	01/03→	Tie Rod End	CV-ES-14162		for Steering Rod
	01/03→	Tie Rod End	CV-ES-14163		for Steering Rod
	01/03→	Tie Rod End	RV-ES-12331		
01/03→	Track Control Arm		RV-TC-12339	Suspension Rod, Trailing Arm	
370.18	01/01→	Ball Head, gearshift linkage	CV-ES-2121		
	01/01→	Ball Head, gearshift linkage	DF-ES-9335		
	01/01→	Centre Rod	RV-DL-0886		Push Rod
	01/01→	Centre Rod	RV-DL-0887		Coupling Rod
	01/01→	Centre Rod	RV-DL-2181		Coupling Rod
	01/01→	Centre Rod	RV-DL-8156		Push Rod
	01/01→	Centre Rod	RV-DL-10245		Push Rod
	01/01→	Suspension Arm Repair Kit		VL-RK-9497	for Drag Link
	01/01→	Suspension Strut Repair Kit		MN-RK-8501	
	01/01→	Suspension Strut Repair Kit		RV-RK-8648	
	01/01→	Tie Rod	RV-DL-8313		Guide Rod
	01/01→	Tie Rod End	CV-ES-14162		for Steering Rod
	01/01→	Tie Rod End	CV-ES-14163		for Steering Rod
	01/01→	Tie Rod End	RV-ES-12331		
	01/01→	Track Control Arm		RV-TC-12339	Suspension Rod, Trailing Arm
	01/01→	Track Control Arm		RV-VB-8191	Wishbone (CV)
	370.26	01/01→	Ball Head, gearshift linkage	CV-ES-2121	
01/01→		Ball Head, gearshift linkage	DF-ES-9335		
01/01→		Centre Rod	RV-DL-0886		Push Rod
01/01→		Centre Rod	RV-DL-0887		Coupling Rod
01/01→		Centre Rod	RV-DL-2181		Coupling Rod
01/01→		Centre Rod	RV-DL-8156		Push Rod
01/01→		Suspension Arm Repair Kit		VL-RK-9497	for Drag Link
01/01→		Suspension Strut Repair Kit		MN-RK-8501	
01/01→		Suspension Strut Repair Kit		RV-RK-8648	
01/01→		Tie Rod	RV-DL-8313		Guide Rod
01/01→		Tie Rod	RV-DL-12329		
01/01→		Tie Rod End	CV-ES-14162		for Steering Rod
01/01→		Tie Rod End	CV-ES-14163		for Steering Rod
01/01→		Tie Rod End	RV-ES-12331		
01/01→		Track Control Arm		RV-DL-8159	Trailing Arm, Leaf Spring Axle
01/01→		Track Control Arm		RV-DL-8324	Trailing Arm, Leaf Spring Axle
01/01→		Track Control Arm		RV-TC-12339	Suspension Rod, Trailing Arm
01/01→		Track Control Arm		RV-TC-12340	Trailing Arm
01/01→		Track Control Arm		RV-VB-8191	Wishbone (CV)
10/05→		Centre Rod	RV-DL-10245		Push Rod

CV-ES-2121

Length: 85
Cone Ø: d1 Ø 12 / d2 Ø 10,8
Thread: M14 x 1,5 RHT
23162046, 5000516214, 5010144543,
5010245591



CV-ES-14162

Length: 125
Cone Ø: d1 Ø 30 / d2 Ø 27
Thread: M30 x 1,5 LHT
3401170, 5000288361, 5001832581,
5001858759, 5001858774



CV-ES-14163

Length: 125
Cone Ø: d1 Ø 30 / d2 Ø 27
Thread: M30 x 1,5 RHT
0003406169, 0003406236, 0003406251,
0003406254, 0003406260, 0003406261,
5000288360, 5000590236, 5000804824,
5001858773, 7420937674, 7701011412



DB-ES-8323

Length: 75
Cone Ø: d1 Ø 32 / d2 Ø 28,8
Thread: M26 x 1,5 RHT
5001830480, 5001845430



DF-ES-9335

Length: 85
Cone Ø: d1 Ø 12 / d2 Ø 10,75
Thread: M14 x 1,5 RHT
23162046, 5000516214, 5010144543,
5010245591



DF-RK-8671

Ø: 80
Hole Distance: 145
Thick/Height: 30
5001014345



MN-RK-8501

Ø: 75
Hole Distance: 115
Thick/Height: 24
7420547286



RV-DL-0886

Length: 945
Ø: 52
Cone Ø: d1 Ø 30 / d2 Ø 27
5010229242, 5010488052



RV-DL-0887

Length: 1720
Ø: 48
Cone Ø: d1 Ø 30 / d2 Ø 27
5010308082



RV-DL-2181

Length: 1650
Ø: 40
Cone Ø: d1 Ø 30 / d2 Ø 27
5010145581, 5010308215



RV-DL-7971

Length: 575
Ø: 50
Hole Distance: 152 / 152
5010094840



RV-DL-8156

Length: 934
Ø: 52
Cone Ø: d1 Ø 30 / d2 Ø 27
5010229243, 5010488053



RV-DL-8159

Length: 574
Ø: 50
Hole Distance: 152 / 152
5010389262



RV-DL-8300

Length: 1125
Ø: 50
Cone Ø: d1 Ø 30 / d2 Ø 27
5010383528, 5010488096



RV-DL-8313

Length: 1752
Ø: 48
Cone Ø: d1 Ø 30 / d2 Ø 27
5010098467, 5010145584, 5010439631



RV-DL-8324

Length: 575
Ø: 50
Hole Distance: 152 / 152
5010467915



RV-DL-10245

Length: 893
Ø: 62
Cone Ø: d1 Ø 30 / d2 Ø 27
7420761145



RV-DL-12329

Length: 1694
Ø: 42
Cone Ø: d1 Ø 30
7420713858



RV-ES-12331

Length: 140
Cone Ø: d1 Ø 30 / d2 Ø 27
Thread: M32 x 1,5 RHT / M24 x 1,5 RHT
014607248, 0014607248, 5001866165,
5001867774, 7485134391



RV-RK-8648

Ø: 85
Hole Distance: 152
Thick/Height: 35
5001842337



RV-TC-12339

Length: 515
Hole Distance: 13 / 130
7420532931, 7421051046



RV-TC-12340

Length: 510
Hole Distance: 115 / 115
7420443044



RV-VB-8191

Length: 662,4
Ø: 48
Hole Distance: 115 / 115
7420741703, RVVB8191



VL-RK-9497

Ø: 95
Hole Distance: 130
Thick/Height: 35
7420702095



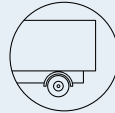
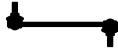

Kerax ...

370.26 ...	10/05 →	Track Control Arm		RV-VB-8191	Wishbone (CV), 1st RA;2nd RA; Leaf Spring Axle;Unit
	10/05 →	Track Control Arm		VL-VB-7787	Wishbone (CV), 1st RA;2nd RA; Leaf Spring Axle;Unit
370.32	01/01 →	Ball Head, gearshift linkage	CV-ES-2121		
	01/01 →	Ball Head, gearshift linkage	DF-ES-9335		
	01/01 →	Centre Rod	RV-DL-0886		Push Rod
	01/01 →	Centre Rod	RV-DL-0887		Coupling Rod
	01/01 →	Centre Rod	RV-DL-2181		Coupling Rod
	01/01 →	Centre Rod	RV-DL-8156		Push Rod
	01/01 →	Centre Rod	RV-DL-8300		Push Rod
	01/01 →	Centre Rod	RV-DL-12468		for Steering Rod
	01/01 →	Suspension Arm Repair Kit		VL-RK-9497	for Drag Link
	01/01 →	Suspension Strut Repair Kit		MN-RK-8501	
	01/01 →	Suspension Strut Repair Kit		RV-RK-8648	
	01/01 →	Tie Rod	RV-DL-8313		Guide Rod, 1st FA;2nd FA
	01/01 →	Tie Rod	RV-DL-12328		
	01/01 →	Tie Rod	RV-DL-12329		
	01/01 →	Tie Rod End	CV-ES-14162		for Steering Rod
	01/01 →	Tie Rod End	CV-ES-14163		for Steering Rod
	01/01 →	Tie Rod End	DB-ES-8323		
	01/01 →	Track Control Arm		RV-DL-8159	Trailing Arm, Leaf Spring Axle
	01/01 →	Track Control Arm		RV-DL-8324	Trailing Arm, Leaf Spring Axle
	01/01 →	Track Control Arm		RV-TC-12339	Suspension Rod, Trailing Arm
	01/01 →	Track Control Arm		RV-TC-12340	Trailing Arm
	01/01 →	Track Control Arm		RV-VB-8191	Wishbone (CV)
	10/05 →	Centre Rod	RV-DL-12317		Push Rod
	10/05 →	Track Control Arm		RV-DL-10299	Trailing Arm, 1st RA;2nd RA; Leaf Spring Axle;Unit
	10/05 →	Track Control Arm		RV-VB-8191	Wishbone (CV), 1st RA;2nd RA; Leaf Spring Axle;Unit
	10/05 →	Track Control Arm		VL-VB-7787	Wishbone (CV), 1st RA;2nd RA; Leaf Spring Axle;Unit
	385.18	06/97 →	Ball Head, gearshift linkage	CV-ES-2121	
06/97 →		Centre Rod	RV-DL-0886		Push Rod
06/97 →		Centre Rod	RV-DL-0887		Coupling Rod
06/97 →		Centre Rod	RV-DL-2181		Coupling Rod
06/97 →		Centre Rod	RV-DL-8156		Push Rod
06/97 →		Suspension Strut Repair Kit		DF-RK-8671	
06/97 →		Tie Rod	RV-DL-8313		Guide Rod
06/97 →		Tie Rod End	CV-ES-14162		for Steering Rod
06/97 →		Tie Rod End	CV-ES-14163		for Steering Rod
06/97 →		Track Control Arm		RV-TC-12339	Suspension Rod, Trailing Arm
385.18/B	06/97 →	Ball Head, gearshift linkage	CV-ES-2121		
	06/97 →	Centre Rod	RV-DL-0886		Push Rod
	06/97 →	Centre Rod	RV-DL-0887		Coupling Rod
	06/97 →	Centre Rod	RV-DL-2181		Coupling Rod
	06/97 →	Centre Rod	RV-DL-8156		Push Rod
	06/97 →	Suspension Strut Repair Kit		DF-RK-8671	
	06/97 →	Tie Rod	RV-DL-8313		Guide Rod
	06/97 →	Tie Rod End	CV-ES-14162		for Steering Rod
	06/97 →	Tie Rod End	CV-ES-14163		for Steering Rod
	06/97 →	Track Control Arm		RV-TC-12339	Suspension Rod, Trailing Arm
385.18T	06/97 →	Ball Head, gearshift linkage	CV-ES-2121		
	06/97 →	Ball Head, gearshift linkage	DF-ES-9335		
	06/97 →	Centre Rod	RV-DL-0886		Push Rod
	06/97 →	Centre Rod	RV-DL-0887		Coupling Rod
	06/97 →	Centre Rod	RV-DL-2181		Coupling Rod
	06/97 →	Centre Rod	RV-DL-8156		Push Rod
	06/97 →	Suspension Strut Repair Kit		DF-RK-8671	
	06/97 →	Suspension Strut Repair Kit		RV-RK-8648	
	06/97 →	Tie Rod	RV-DL-8313		Guide Rod
06/97 →	Tie Rod End	CV-ES-14162		for Steering Rod	

CV-ES-2121

Length: 85
Cone Ø: d1 Ø 12 / d2 Ø 10,8
Thread: M14 x 1,5 RHT
23162046, 5000516214, 5010144543,
5010245591



CV-ES-14162

Length: 125
Cone Ø: d1 Ø 30 / d2 Ø 27
Thread: M30 x 1,5 LHT
3401170, 5000288361, 5001832581,
5001858759, 5001858774



CV-ES-14163

Length: 125
Cone Ø: d1 Ø 30 / d2 Ø 27
Thread: M30 x 1,5 RHT
0003406169, 0003406236, 0003406251,
0003406254, 0003406260, 0003406261,
5000288360, 5000590236, 5000804824,
5001858773, 7420937674, 7701011412



DB-ES-8323

Length: 75
Cone Ø: d1 Ø 32 / d2 Ø 28,8
Thread: M26 x 1,5 RHT
5001830480, 5001845430



DF-ES-9335

Length: 85
Cone Ø: d1 Ø 12 / d2 Ø 10,75
Thread: M14 x 1,5 RHT
23162046, 5000516214, 5010144543,
5010245591



DF-RK-8671

Ø: 80
Hole Distance: 145
Thick/Height: 30
5001014345



MN-RK-8501

Ø: 75
Hole Distance: 115
Thick/Height: 24
7420547286



RV-DL-0886

Length: 945
Ø: 52
Cone Ø: d1 Ø 30 / d2 Ø 27
5010229242, 5010488052



RV-DL-0887

Length: 1720
Ø: 48
Cone Ø: d1 Ø 30 / d2 Ø 27
5010308082



RV-DL-2181

Length: 1650
Ø: 40
Cone Ø: d1 Ø 30 / d2 Ø 27
5010145581, 5010308215



RV-DL-8156

Length: 934
Ø: 52
Cone Ø: d1 Ø 30 / d2 Ø 27
5010229243, 5010488053



RV-DL-8159

Length: 574
Ø: 50
Hole Distance: 152 / 152
5010389262



RV-DL-8300

Length: 1125
Ø: 50
Cone Ø: d1 Ø 30 / d2 Ø 27
5010383528, 5010488096



RV-DL-8313

Length: 1752
Ø: 48
Cone Ø: d1 Ø 30 / d2 Ø 27
5010098467, 5010145584, 5010439631



RV-DL-8324

Length: 575
Ø: 50
Hole Distance: 152 / 152
5010467915



RV-DL-10299

Length: 510
Ø: 21
21051052, 7420864583, 7421051052



RV-DL-12317

Length: 866
Ø: 60
7420847206, 7421560950



RV-DL-12328

Length: 1608
Ø: 42
Cone Ø: d1 Ø 30
7420713860



RV-DL-12329

Length: 1694
Ø: 42
Cone Ø: d1 Ø 30
7420713858



RV-DL-12468

Length: 866
Ø: 60
Cone Ø: d1 Ø 30 / d2 Ø 27
20847191, 7420847190, 7421560945



RV-RK-8648

Ø: 85
Hole Distance: 152
Thick/Height: 35
5001842337



RV-TC-12339

Length: 515
Hole Distance: 13 / 130
7420532931, 7421051046



RV-TC-12340

Length: 510
Hole Distance: 115 / 115
7420443044



RV-VB-8191

Length: 662,4
Ø: 48
Hole Distance: 115 / 115
7420741703, RVVB8191



VL-RK-9497

Ø: 95
Hole Distance: 130
Thick/Height: 35
7420702095



VL-VB-7787

Length: 671
Ø: 58
Hole Distance: 130 / 130
7420829503





Kerax ...

385.18T ...	06/97→	Tie Rod End	CV-ES-14163		for Steering Rod	
	06/97→	Track Control Arm		RV-DL-7971	Trailing Arm	
	06/97→	Track Control Arm		RV-TC-12339	Suspension Rod, Trailing Arm	
385.26	06/97→	Ball Head, gearshift linkage	CV-ES-2121			
	06/97→	Ball Head, gearshift linkage	DF-ES-9335			
	06/97→	Centre Rod	RV-DL-0886		Push Rod	
	06/97→	Centre Rod	RV-DL-0887		Coupling Rod	
	06/97→	Centre Rod	RV-DL-2181		Coupling Rod	
	06/97→	Centre Rod	RV-DL-8156		Push Rod	
	06/97→	Suspension Strut Repair Kit		DF-RK-8671		
	06/97→	Suspension Strut Repair Kit		RV-RK-8648		
	06/97→	Tie Rod	RV-DL-8313		Guide Rod	
	06/97→	Tie Rod End	CV-ES-14162		for Steering Rod	
	06/97→	Tie Rod End	CV-ES-14163		for Steering Rod	
	06/97→	Track Control Arm		RV-DL-7971	Trailing Arm	
	06/97→	Track Control Arm		RV-TC-12339	Suspension Rod, Trailing Arm	
	385.26/A,385.26/B	06/97→	Ball Head, gearshift linkage	CV-ES-2121		
		06/97→	Centre Rod	RV-DL-0886		Push Rod
06/97→		Centre Rod	RV-DL-0887		Coupling Rod	
06/97→		Centre Rod	RV-DL-2181		Coupling Rod	
06/97→		Centre Rod	RV-DL-8156		Push Rod	
06/97→		Suspension Strut Repair Kit		DF-RK-8671		
06/97→		Suspension Strut Repair Kit		RV-RK-8648		
06/97→		Tie Rod	RV-DL-8313		Guide Rod	
06/97→		Tie Rod End	CV-ES-14162		for Steering Rod	
06/97→		Tie Rod End	CV-ES-14163		for Steering Rod	
06/97→		Track Control Arm		RV-DL-7971	Trailing Arm	
06/97→		Track Control Arm		RV-DL-8159	Trailing Arm, Leaf Spring Axle	
06/97→		Track Control Arm		RV-TC-12339	Suspension Rod, Trailing Arm	
11/00→		Track Control Arm		RV-DL-8324	Trailing Arm, Leaf Spring Axle	
385.26/A,385.26/B,385.26/C		06/97→	Ball Head, gearshift linkage	CV-ES-2121		
	06/97→	Ball Head, gearshift linkage	DF-ES-9335			
	06/97→	Centre Rod	RV-DL-0886		Push Rod	
	06/97→	Centre Rod	RV-DL-0887		Coupling Rod	
	06/97→	Centre Rod	RV-DL-2181		Coupling Rod	
	06/97→	Centre Rod	RV-DL-8156		Push Rod	
	06/97→	Suspension Strut Repair Kit		DF-RK-8671		
	06/97→	Suspension Strut Repair Kit		RV-RK-8648		
	06/97→	Tie Rod	RV-DL-8313		Guide Rod	
	06/97→	Tie Rod End	CV-ES-14162		for Steering Rod	
	06/97→	Tie Rod End	CV-ES-14163		for Steering Rod	
	06/97→	Track Control Arm		RV-DL-7971	Trailing Arm	
	06/97→	Track Control Arm		RV-TC-12339	Suspension Rod, Trailing Arm	
	385.26/B	06/97→	Ball Head, gearshift linkage	CV-ES-2121		
		06/97→	Ball Head, gearshift linkage	DF-ES-9335		
06/97→		Centre Rod	RV-DL-0886		Push Rod	
06/97→		Centre Rod	RV-DL-0887		Coupling Rod	
06/97→		Centre Rod	RV-DL-2181		Coupling Rod	
06/97→		Centre Rod	RV-DL-8156		Push Rod	
06/97→		Suspension Strut Repair Kit		DF-RK-8671		
06/97→		Suspension Strut Repair Kit		RV-RK-8648		
06/97→		Tie Rod	RV-DL-8313		Guide Rod	
06/97→		Tie Rod End	CV-ES-14162		for Steering Rod	
06/97→		Tie Rod End	CV-ES-14163		for Steering Rod	
06/97→		Track Control Arm		RV-DL-7971	Trailing Arm	
06/97→		Track Control Arm		RV-TC-12339	Suspension Rod, Trailing Arm	
385.26T		06/97→	Ball Head, gearshift linkage	CV-ES-2121		
		06/97→	Ball Head, gearshift linkage	DF-ES-9335		
	06/97→	Centre Rod	RV-DL-0886		Push Rod	
	06/97→	Centre Rod	RV-DL-0887		Coupling Rod	
	06/97→	Centre Rod	RV-DL-2181		Coupling Rod	
	06/97→	Centre Rod	RV-DL-8156		Push Rod	
	06/97→	Suspension Strut Repair Kit		DF-RK-8671		

CV-ES-2121

Length: 85
Cone Ø: d1 Ø 12 / d2 Ø 10,8
Thread: M14 x 1,5 RHT
23162046, 5000516214, 5010144543,
5010245591



CV-ES-14162

Length: 125
Cone Ø: d1 Ø 30 / d2 Ø 27
Thread: M30 x 1,5 LHT
3401170, 5000288361, 5001832581,
5001858759, 5001858774



CV-ES-14163

Length: 125
Cone Ø: d1 Ø 30 / d2 Ø 27
Thread: M30 x 1,5 RHT
0003406169, 0003406236, 0003406251,
0003406254, 0003406260, 0003406261,
5000288360, 5000590236, 5000804824,
5001858773, 7420937674, 7701011412



DF-ES-9335

Length: 85
Cone Ø: d1 Ø 12 / d2 Ø 10,75
Thread: M14 x 1,5 RHT
23162046, 5000516214, 5010144543,
5010245591



DF-RK-8671

Ø: 80
Hole Distance: 145
Thick/Height: 30
5001014345



RV-DL-0886

Length: 945
Ø: 52
Cone Ø: d1 Ø 30 / d2 Ø 27
5010229242, 5010488052



RV-DL-0887

Length: 1720
Ø: 48
Cone Ø: d1 Ø 30 / d2 Ø 27
5010308082



RV-DL-2181

Length: 1650
Ø: 40
Cone Ø: d1 Ø 30 / d2 Ø 27
5010145581, 5010308215



RV-DL-7971

Length: 575
Ø: 50
Hole Distance: 152 / 152
5010094840



RV-DL-8156

Length: 934
Ø: 52
Cone Ø: d1 Ø 30 / d2 Ø 27
5010229243, 5010488053



RV-DL-8159

Length: 574
Ø: 50
Hole Distance: 152 / 152
5010389262



RV-DL-8313

Length: 1752
Ø: 48
Cone Ø: d1 Ø 30 / d2 Ø 27
5010098467, 5010145584, 5010439631



RV-DL-8324

Length: 575
Ø: 50
Hole Distance: 152 / 152
5010467915



RV-RK-8648

Ø: 85
Hole Distance: 152
Thick/Height: 35
5001842337



RV-TC-12339

Length: 515
Hole Distance: 13 / 130
7420532931, 7421051046





Kerax ...

385.26T ...	06/97→	Suspension Strut Repair Kit		RV-RK-8648	
	06/97→	Tie Rod	RV-DL-8313		Guide Rod
	06/97→	Tie Rod End	CV-ES-14162		for Steering Rod
	06/97→	Tie Rod End	CV-ES-14163		for Steering Rod
	06/97→	Track Control Arm		RV-DL-7971	Trailing Arm
	06/97→	Track Control Arm		RV-TC-12339	Suspension Rod, Trailing Arm
385.32/A,385.32/B	06/97→03/98	Tie Rod End	IV-ES-8515		
	06/97→	Ball Head, gearshift linkage	CV-ES-2121		
	06/97→	Centre Rod	RV-DL-0886		Push Rod
	06/97→	Centre Rod	RV-DL-0887		Coupling Rod
	06/97→	Centre Rod	RV-DL-2181		Coupling Rod
	06/97→	Centre Rod	RV-DL-8156		Push Rod
	06/97→	Centre Rod	RV-DL-8300		Push Rod
	06/97→	Suspension Strut Repair Kit		DF-RK-8671	
	06/97→	Suspension Strut Repair Kit		RV-RK-8648	
	06/97→	Tie Rod	RV-DL-8313		Guide Rod, 1st FA;2nd FA
	06/97→	Tie Rod End	CV-ES-14162		for Steering Rod
	06/97→	Tie Rod End	CV-ES-14163		for Steering Rod
	06/97→	Tie Rod End	DB-ES-8323		
	06/97→	Track Control Arm		RV-DL-7971	Trailing Arm
	06/97→	Track Control Arm		RV-DL-8159	Trailing Arm, Leaf Spring Axle
	06/97→	Track Control Arm		RV-TC-12339	Suspension Rod, Trailing Arm
11/00→	Track Control Arm		RV-DL-8324	Trailing Arm, Leaf Spring Axle	
385.32/A,385.32/B,385.32/C	06/97→03/98	Tie Rod End	IV-ES-8515		
	06/97→	Ball Head, gearshift linkage	CV-ES-2121		
	06/97→	Ball Head, gearshift linkage	DF-ES-9335		
	06/97→	Centre Rod	RV-DL-0886		Push Rod
	06/97→	Centre Rod	RV-DL-0887		Coupling Rod
	06/97→	Centre Rod	RV-DL-2181		Coupling Rod
	06/97→	Centre Rod	RV-DL-8156		Push Rod
	06/97→	Tie Rod	RV-DL-8313		Guide Rod
	06/97→	Tie Rod End	CV-ES-14162		for Steering Rod
	06/97→	Tie Rod End	CV-ES-14163		for Steering Rod
	06/97→	Track Control Arm		RV-DL-7971	Trailing Arm
	06/97→	Track Control Arm		RV-TC-12339	Suspension Rod, Trailing Arm
	04/98→	Tie Rod End	DB-ES-8323		
	385.32/B	06/97→03/98	Tie Rod End	IV-ES-8515	
06/97→		Ball Head, gearshift linkage	CV-ES-2121		
06/97→		Ball Head, gearshift linkage	DF-ES-9335		
06/97→		Centre Rod	RV-DL-0886		Push Rod
06/97→		Centre Rod	RV-DL-0887		Coupling Rod
06/97→		Centre Rod	RV-DL-2181		Coupling Rod
06/97→		Centre Rod	RV-DL-8156		Push Rod
06/97→		Suspension Strut Repair Kit		DF-RK-8671	
06/97→		Suspension Strut Repair Kit		RV-RK-8648	
06/97→		Tie Rod	RV-DL-8313		Guide Rod
06/97→		Tie Rod End	CV-ES-14162		for Steering Rod
06/97→		Tie Rod End	CV-ES-14163		for Steering Rod
06/97→		Track Control Arm		RV-DL-7971	Trailing Arm
06/97→		Track Control Arm		RV-TC-12339	Suspension Rod, Trailing Arm
04/98→		Tie Rod End	DB-ES-8323		
400.18		01/00→	Ball Head, gearshift linkage	CV-ES-2121	
	01/00→	Centre Rod	RV-DL-0886		Push Rod
	01/00→	Centre Rod	RV-DL-0887		Coupling Rod
	01/00→	Centre Rod	RV-DL-2181		Coupling Rod
	01/00→	Centre Rod	RV-DL-8156		Push Rod
	01/00→	Tie Rod	RV-DL-8313		Guide Rod
	01/00→	Tie Rod End	CV-ES-14162		for Steering Rod
	01/00→	Tie Rod End	CV-ES-14163		for Steering Rod
	01/00→	Track Control Arm		RV-TC-12339	Suspension Rod, Trailing Arm

CV-ES-2121

Length: 85
Cone Ø: d1 Ø 12 / d2 Ø 10,8
Thread: M14 x 1,5 RHT
23162046, 5000516214, 5010144543,
5010245591



CV-ES-14162

Length: 125
Cone Ø: d1 Ø 30 / d2 Ø 27
Thread: M30 x 1,5 LHT
3401170, 5000288361, 5001832581,
5001858759, 5001858774



CV-ES-14163

Length: 125
Cone Ø: d1 Ø 30 / d2 Ø 27
Thread: M30 x 1,5 RHT
0003406169, 0003406236, 0003406251,
0003406254, 0003406260, 0003406261,
5000288360, 5000590236, 5000804824,
5001858773, 7420937674, 7701011412



DB-ES-8323

Length: 75
Cone Ø: d1 Ø 32 / d2 Ø 28,8
Thread: M26 x 1,5 RHT
5001830480, 5001845430



DF-ES-9335

Length: 85
Cone Ø: d1 Ø 12 / d2 Ø 10,75
Thread: M14 x 1,5 RHT
23162046, 5000516214, 5010144543,
5010245591



DF-RK-8671

Ø: 80
Hole Distance: 145
Thick/Height: 30
5001014345



IV-ES-8515



RV-DL-0886

Length: 945
Ø: 52
Cone Ø: d1 Ø 30 / d2 Ø 27
5010229242, 5010488052



RV-DL-0887

Length: 1720
Ø: 48
Cone Ø: d1 Ø 30 / d2 Ø 27
5010308082



RV-DL-2181

Length: 1650
Ø: 40
Cone Ø: d1 Ø 30 / d2 Ø 27
5010145581, 5010308215



RV-DL-7971

Length: 575
Ø: 50
Hole Distance: 152 / 152
5010094840



RV-DL-8156

Length: 934
Ø: 52
Cone Ø: d1 Ø 30 / d2 Ø 27
5010229243, 5010488053



RV-DL-8159

Length: 574
Ø: 50
Hole Distance: 152 / 152
5010389262



RV-DL-8300

Length: 1125
Ø: 50
Cone Ø: d1 Ø 30 / d2 Ø 27
5010383528, 5010488096



RV-DL-8313

Length: 1752
Ø: 48
Cone Ø: d1 Ø 30 / d2 Ø 27
5010098467, 5010145584, 5010439631



RV-DL-8324

Length: 575
Ø: 50
Hole Distance: 152 / 152
5010467915



RV-RK-8648

Ø: 85
Hole Distance: 152
Thick/Height: 35
5001842337



RV-TC-12339

Length: 515
Hole Distance: 13 / 130
7420532931, 7421051046





Kerax ...

400.18T	01/00→	Ball Head, gearshift linkage	CV-ES-2121			
	01/00→	Centre Rod	RV-DL-0886		Push Rod	
	01/00→	Centre Rod	RV-DL-0887		Coupling Rod	
	01/00→	Centre Rod	RV-DL-2181		Coupling Rod	
	01/00→	Centre Rod	RV-DL-8156		Push Rod	
	01/00→	Tie Rod	RV-DL-8313		Guide Rod	
	01/00→	Tie Rod End	CV-ES-14162		for Steering Rod	
	01/00→	Tie Rod End	CV-ES-14163		for Steering Rod	
400.26	01/00→	Track Control Arm		RV-TC-12339	Suspension Rod, Trailing Arm	
	09/98→	Ball Head, gearshift linkage	CV-ES-2121			
	09/98→	Centre Rod	RV-DL-0886		Push Rod	
	09/98→	Centre Rod	RV-DL-0887		Coupling Rod	
	09/98→	Centre Rod	RV-DL-2181		Coupling Rod	
	09/98→	Centre Rod	RV-DL-8156		Push Rod	
	09/98→	Tie Rod	RV-DL-8313		Guide Rod	
	09/98→	Tie Rod End	CV-ES-14162		for Steering Rod	
	09/98→	Tie Rod End	CV-ES-14163		for Steering Rod	
	09/98→	Track Control Arm		RV-DL-7971	Trailing Arm	
	09/98→	Track Control Arm		RV-DL-8159	Trailing Arm, Leaf Spring Axle	
	09/98→	Track Control Arm		RV-DL-8324	Trailing Arm, Leaf Spring Axle	
	09/98→	Track Control Arm		RV-TC-12339	Suspension Rod, Trailing Arm	
	400.26/A,400.26/B,400.26/C	01/00→	Ball Head, gearshift linkage	CV-ES-2121		
01/00→		Centre Rod	RV-DL-0886		Push Rod	
01/00→		Centre Rod	RV-DL-0887		Coupling Rod	
01/00→		Centre Rod	RV-DL-2181		Coupling Rod	
01/00→		Centre Rod	RV-DL-8156		Push Rod	
01/00→		Tie Rod	RV-DL-8313		Guide Rod	
01/00→		Tie Rod End	CV-ES-14162		for Steering Rod	
01/00→		Tie Rod End	CV-ES-14163		for Steering Rod	
01/00→		Track Control Arm		RV-DL-7971	Trailing Arm	
01/00→		Track Control Arm		RV-DL-8159	Trailing Arm, Leaf Spring Axle	
01/00→		Track Control Arm		RV-TC-12339	Suspension Rod, Trailing Arm	
01/00→		Track Control Arm		RV-DL-8324	Trailing Arm, Leaf Spring Axle	
400.26/B		11/00→	Track Control Arm		RV-DL-8324	Trailing Arm, Leaf Spring Axle
		01/00→	Ball Head, gearshift linkage	CV-ES-2121		
	01/00→	Centre Rod	RV-DL-0886		Push Rod	
	01/00→	Centre Rod	RV-DL-0887		Coupling Rod	
	01/00→	Centre Rod	RV-DL-2181		Coupling Rod	
	01/00→	Centre Rod	RV-DL-8156		Push Rod	
	01/00→	Tie Rod	RV-DL-8313		Guide Rod	
	01/00→	Tie Rod End	CV-ES-14162		for Steering Rod	
	01/00→	Tie Rod End	CV-ES-14163		for Steering Rod	
	01/00→	Track Control Arm		RV-DL-7971	Trailing Arm	
	01/00→	Track Control Arm		RV-DL-8159	Trailing Arm, Leaf Spring Axle	
	01/00→	Track Control Arm		RV-TC-12339	Suspension Rod, Trailing Arm	
	01/00→	Track Control Arm		RV-DL-8324	Trailing Arm, Leaf Spring Axle	
	400.26T	11/00→	Track Control Arm		RV-DL-8324	Trailing Arm, Leaf Spring Axle
01/00→		Ball Head, gearshift linkage	CV-ES-2121			
01/00→		Centre Rod	RV-DL-0886		Push Rod	
01/00→		Centre Rod	RV-DL-0887		Coupling Rod	
01/00→		Centre Rod	RV-DL-2181		Coupling Rod	
01/00→		Centre Rod	RV-DL-8156		Push Rod	
01/00→		Tie Rod	RV-DL-8313		Guide Rod	
01/00→		Tie Rod End	CV-ES-14162		for Steering Rod	
01/00→		Tie Rod End	CV-ES-14163		for Steering Rod	
01/00→		Track Control Arm		RV-DL-7971	Trailing Arm	
01/00→		Track Control Arm		RV-DL-8159	Trailing Arm, Leaf Spring Axle	
01/00→		Track Control Arm		RV-TC-12339	Suspension Rod, Trailing Arm	
01/00→		Track Control Arm		RV-DL-8324	Trailing Arm, Leaf Spring Axle	
400.32/A,400.32/B,400.32/C		11/00→	Track Control Arm		RV-DL-8324	Trailing Arm, Leaf Spring Axle
	01/00→	Ball Head, gearshift linkage	CV-ES-2121			
	01/00→	Centre Rod	RV-DL-0886		Push Rod	
	01/00→	Centre Rod	RV-DL-0887		Coupling Rod	
	01/00→	Centre Rod	RV-DL-2181		Coupling Rod	
	01/00→	Centre Rod	RV-DL-8156		Push Rod	
01/00→	Centre Rod	RV-DL-8300		Push Rod		

CV-ES-2121

Length: 85
Cone Ø: d1 Ø 12 / d2 Ø 10,8
Thread: M14 x 1,5 RHT
23162046, 5000516214, 5010144543,
5010245591



CV-ES-14162

Length: 125
Cone Ø: d1 Ø 30 / d2 Ø 27
Thread: M30 x 1,5 LHT
3401170, 5000288361, 5001832581,
5001858759, 5001858774



CV-ES-14163

Length: 125
Cone Ø: d1 Ø 30 / d2 Ø 27
Thread: M30 x 1,5 RHT
0003406169, 0003406236, 0003406251,
0003406254, 0003406260, 0003406261,
5000288360, 5000590236, 5000804824,
5001858773, 7420937674, 7701011412



RV-DL-0886

Length: 945
Ø: 52
Cone Ø: d1 Ø 30 / d2 Ø 27
5010229242, 5010488052



RV-DL-0887

Length: 1720
Ø: 48
Cone Ø: d1 Ø 30 / d2 Ø 27
5010308082



RV-DL-2181

Length: 1650
Ø: 40
Cone Ø: d1 Ø 30 / d2 Ø 27
5010145581, 5010308215



RV-DL-7971

Length: 575
Ø: 50
Hole Distance: 152 / 152
5010094840



RV-DL-8156

Length: 934
Ø: 52
Cone Ø: d1 Ø 30 / d2 Ø 27
5010229243, 5010488053



RV-DL-8159

Length: 574
Ø: 50
Hole Distance: 152 / 152
5010389262



RV-DL-8300

Length: 1125
Ø: 50
Cone Ø: d1 Ø 30 / d2 Ø 27
5010383528, 5010488096



RV-DL-8313

Length: 1752
Ø: 48
Cone Ø: d1 Ø 30 / d2 Ø 27
5010098467, 5010145584, 5010439631



RV-DL-8324

Length: 575
Ø: 50
Hole Distance: 152 / 152
5010467915



RV-TC-12339

Length: 515
Hole Distance: 13 / 130
7420532931, 7421051046





Kerax ...

400.32/A,400.32/B,400.32/C ...	01/00→	Tie Rod	RV-DL-8313		Guide Rod, 1st FA;2nd FA
	01/00→	Tie Rod End	CV-ES-14162		for Steering Rod
	01/00→	Tie Rod End	CV-ES-14163		for Steering Rod
	01/00→	Tie Rod End	DB-ES-8323		
	01/00→	Track Control Arm		RV-DL-7971	Trailing Arm
	01/00→	Track Control Arm		RV-DL-8159	Trailing Arm, Leaf Spring Axle
	01/00→	Track Control Arm		RV-TC-12339	Suspension Rod, Trailing Arm
	11/00→	Track Control Arm		RV-DL-8324	Trailing Arm, Leaf Spring Axle
400.32/B	01/00→	Ball Head, gearshift linkage	CV-ES-2121		
	01/00→	Centre Rod	RV-DL-0886		Push Rod
	01/00→	Centre Rod	RV-DL-0887		Coupling Rod
	01/00→	Centre Rod	RV-DL-2181		Coupling Rod
	01/00→	Centre Rod	RV-DL-8156		Push Rod
	01/00→	Centre Rod	RV-DL-8300		Push Rod
	01/00→	Tie Rod	RV-DL-8313		Guide Rod
	01/00→	Tie Rod	RV-DL-8313		Guide Rod, 1st FA;2nd FA
	01/00→	Tie Rod End	CV-ES-14162		for Steering Rod
	01/00→	Tie Rod End	CV-ES-14163		for Steering Rod
	01/00→	Tie Rod End	DB-ES-8323		
	01/00→	Track Control Arm		RV-DL-7971	Trailing Arm
	01/00→	Track Control Arm		RV-DL-8159	Trailing Arm, Leaf Spring Axle
	01/00→	Track Control Arm		RV-TC-12339	Suspension Rod, Trailing Arm
	11/00→	Track Control Arm		RV-DL-8324	Trailing Arm, Leaf Spring Axle
410.18	10/05→	Centre Rod	RV-DL-10245		Push Rod
	10/05→	Suspension Arm Repair Kit		VL-RK-9497	for Drag Link
	10/05→	Suspension Strut Repair Kit		MN-RK-8501	
	10/05→	Tie Rod End	RV-ES-12331		
	10/05→	Track Control Arm		RV-TC-12339	Suspension Rod, Trailing Arm
	10/05→	Track Control Arm		RV-VB-8191	Wishbone (CV)
410.26	10/05→	Centre Rod	RV-DL-10245		Push Rod
	10/05→	Suspension Arm Repair Kit		VL-RK-9497	for Drag Link
	10/05→	Suspension Strut Repair Kit		MN-RK-8501	
	10/05→	Tie Rod	RV-DL-12329		
	10/05→	Tie Rod End	RV-ES-12331		
	10/05→	Track Control Arm		RV-TC-12339	Suspension Rod, Trailing Arm
	10/05→	Track Control Arm		RV-TC-12340	Trailing Arm
	10/05→	Track Control Arm		RV-VB-8191	Wishbone (CV), 1st RA;2nd RA; Leaf Spring Axle;Unit
410.32	10/05→	Track Control Arm		VL-VB-7787	Wishbone (CV), 1st RA;2nd RA; Leaf Spring Axle;Unit
	10/05→	Centre Rod	RV-DL-12317		Push Rod
	10/05→	Centre Rod	RV-DL-12468		for Steering Rod
	10/05→	Suspension Arm Repair Kit		VL-RK-9497	for Drag Link
	10/05→	Suspension Strut Repair Kit		MN-RK-8501	
	10/05→	Tie Rod	RV-DL-12328		
	10/05→	Tie Rod	RV-DL-12329		
	10/05→	Tie Rod End	DB-ES-8323		
	10/05→	Track Control Arm		RV-DL-10299	Trailing Arm, 1st RA;2nd RA; Leaf Spring Axle;Unit
	10/05→	Track Control Arm		RV-TC-12339	Suspension Rod, Trailing Arm
	10/05→	Track Control Arm		RV-TC-12340	Trailing Arm
	10/05→	Track Control Arm		RV-VB-8191	Wishbone (CV), 1st RA;2nd RA; Leaf Spring Axle;Unit
420.18	10/05→	Track Control Arm		VL-VB-7787	Wishbone (CV), 1st RA;2nd RA; Leaf Spring Axle;Unit
	01/01→	Ball Head, gearshift linkage	CV-ES-2121		
	01/01→	Ball Head, gearshift linkage	DF-ES-9335		
	01/01→	Centre Rod	RV-DL-0886		Push Rod
	01/01→	Centre Rod	RV-DL-0887		Coupling Rod
	01/01→	Centre Rod	RV-DL-2181		Coupling Rod
	01/01→	Centre Rod	RV-DL-8156		Push Rod
	01/01→	Suspension Strut Repair Kit		RV-RK-8648	
	01/01→	Tie Rod	RV-DL-8313		Guide Rod

CV-ES-2121

Length: 85
Cone Ø: d1 Ø 12 / d2 Ø 10,8
Thread: M14 x 1,5 RHT
23162046, 5000516214, 5010144543,
5010245591



CV-ES-14162

Length: 125
Cone Ø: d1 Ø 30 / d2 Ø 27
Thread: M30 x 1,5 LHT
3401170, 5000288361, 5001832581,
5001858759, 5001858774



CV-ES-14163

Length: 125
Cone Ø: d1 Ø 30 / d2 Ø 27
Thread: M30 x 1,5 RHT
0003406169, 0003406236, 0003406251,
0003406254, 0003406260, 0003406261,
5000288360, 5000590236, 5000804824,
5001858773, 7420937674, 7701011412



DB-ES-8323

Length: 75
Cone Ø: d1 Ø 32 / d2 Ø 28,8
Thread: M26 x 1,5 RHT
5001830480, 5001845430



DF-ES-9335

Length: 85
Cone Ø: d1 Ø 12 / d2 Ø 10,75
Thread: M14 x 1,5 RHT
23162046, 5000516214, 5010144543,
5010245591



MN-RK-8501

Ø: 75
Hole Distance: 115
Thick/Height: 24
7420547286



RV-DL-0886

Length: 945
Ø: 52
Cone Ø: d1 Ø 30 / d2 Ø 27
5010229242, 5010488052



RV-DL-0887

Length: 1720
Ø: 48
Cone Ø: d1 Ø 30 / d2 Ø 27
5010308082



RV-DL-2181

Length: 1650
Ø: 40
Cone Ø: d1 Ø 30 / d2 Ø 27
5010145581, 5010308215



RV-DL-7971

Length: 575
Ø: 50
Hole Distance: 152 / 152
5010094840



RV-DL-8156

Length: 934
Ø: 52
Cone Ø: d1 Ø 30 / d2 Ø 27
5010229243, 5010488053



RV-DL-8159

Length: 574
Ø: 50
Hole Distance: 152 / 152
5010389262



RV-DL-8300

Length: 1125
Ø: 50
Cone Ø: d1 Ø 30 / d2 Ø 27
5010383528, 5010488096



RV-DL-8313

Length: 1752
Ø: 48
Cone Ø: d1 Ø 30 / d2 Ø 27
5010098467, 5010145584, 5010439631



RV-DL-8324

Length: 575
Ø: 50
Hole Distance: 152 / 152
5010467915



RV-DL-10245

Length: 893
Ø: 62
Cone Ø: d1 Ø 30 / d2 Ø 27
7420761145



RV-DL-10299

Length: 510
Ø: 21
21051052, 7420864583, 7421051052



RV-DL-12317

Length: 866
Ø: 60
7420847206, 7421560950



RV-DL-12328

Length: 1608
Ø: 42
Cone Ø: d1 Ø 30
7420713860



RV-DL-12329

Length: 1694
Ø: 42
Cone Ø: d1 Ø 30
7420713858



RV-DL-12468

Length: 866
Ø: 60
Cone Ø: d1 Ø 30 / d2 Ø 27
20847191, 7420847190, 7421560945



RV-ES-12331

Length: 140
Cone Ø: d1 Ø 30 / d2 Ø 27
Thread: M32 x 1,5 RHT / M24 x 1,5 RHT
0014607248, 014607248, 5001866165,
5001867774, 7485134391



RV-RK-8648

Ø: 85
Hole Distance: 152
Thick/Height: 35
5001842337



RV-TC-12339

Length: 515
Hole Distance: 13 / 130
7420532931, 7421051046



RV-TC-12340

Length: 510
Hole Distance: 115 / 115
7420443044



RV-VB-8191

Length: 662,4
Ø: 48
Hole Distance: 115 / 115
7420741703, RWW8191



VL-RK-9497

Ø: 95
Hole Distance: 130
Thick/Height: 35
7420702095



VL-VB-7787

Length: 671
Ø: 58
Hole Distance: 130 / 130
7420829503





Kerax ...

420.18 ...	01/01→	Tie Rod End	CV-ES-14162		for Steering Rod	
	01/01→	Tie Rod End	CV-ES-14163		for Steering Rod	
	01/01→	Track Control Arm		RV-TC-12339	Suspension Rod, Trailing Arm	
420.26	01/01→	Ball Head, gearshift linkage	CV-ES-2121			
	01/01→	Ball Head, gearshift linkage	DF-ES-9335			
	01/01→	Centre Rod	RV-DL-0886		Push Rod	
	01/01→	Centre Rod	RV-DL-0887		Coupling Rod	
	01/01→	Centre Rod	RV-DL-2181		Coupling Rod	
	01/01→	Centre Rod	RV-DL-8156		Push Rod	
	01/01→	Centre Rod	RV-DL-8300		Push Rod	
	01/01→	Suspension Strut Repair Kit		RV-RK-8648		
	01/01→	Tie Rod	RV-DL-8313		Guide Rod	
	01/01→	Tie Rod	RV-DL-8313		Guide Rod, 1st FA;2nd FA	
	01/01→	Tie Rod End	CV-ES-14162		for Steering Rod	
	01/01→	Tie Rod End	CV-ES-14163		for Steering Rod	
	01/01→	Tie Rod End	DB-ES-8323			
	01/01→	Track Control Arm		RV-DL-8159	Trailing Arm, Leaf Spring Axle	
	01/01→	Track Control Arm		RV-DL-8324	Trailing Arm, Leaf Spring Axle	
01/01→	Track Control Arm		RV-TC-12339	Suspension Rod, Trailing Arm		
420.32	10/01→	Ball Head, gearshift linkage	CV-ES-2121			
	10/01→	Ball Head, gearshift linkage	DF-ES-9335			
	10/01→	Centre Rod	RV-DL-0886		Push Rod	
	10/01→	Centre Rod	RV-DL-0887		Coupling Rod	
	10/01→	Centre Rod	RV-DL-2181		Coupling Rod	
	10/01→	Centre Rod	RV-DL-8156		Push Rod	
	10/01→	Centre Rod	RV-DL-8300		Push Rod	
	10/01→	Suspension Strut Repair Kit		RV-RK-8648		
	10/01→	Tie Rod	RV-DL-8313		Guide Rod, 1st FA;2nd FA	
	10/01→	Tie Rod End	CV-ES-14162		for Steering Rod	
	10/01→	Tie Rod End	CV-ES-14163		for Steering Rod	
	10/01→	Tie Rod End	DB-ES-8323			
	10/01→	Track Control Arm		RV-DL-8159	Trailing Arm, Leaf Spring Axle	
	10/01→	Track Control Arm		RV-DL-8324	Trailing Arm, Leaf Spring Axle	
	10/01→	Track Control Arm		RV-TC-12339	Suspension Rod, Trailing Arm	
420.34	01/01→	Ball Head, gearshift linkage	CV-ES-2121			
	01/01→	Ball Head, gearshift linkage	DF-ES-9335			
	01/01→	Centre Rod	RV-DL-0886		Push Rod	
	01/01→	Centre Rod	RV-DL-0887		Coupling Rod	
	01/01→	Centre Rod	RV-DL-2181		Coupling Rod	
	01/01→	Centre Rod	RV-DL-8156		Push Rod	
	01/01→	Suspension Strut Repair Kit		RV-RK-8648		
	01/01→	Tie Rod	RV-DL-8313		Guide Rod	
	01/01→	Tie Rod End	CV-ES-14162		for Steering Rod	
	01/01→	Tie Rod End	CV-ES-14163		for Steering Rod	
	01/01→	Track Control Arm		RV-DL-8159	Trailing Arm, Leaf Spring Axle	
	01/01→	Track Control Arm		RV-DL-8324	Trailing Arm, Leaf Spring Axle	
	01/01→	Track Control Arm		RV-TC-12339	Suspension Rod, Trailing Arm	
	450.18	10/05→	Centre Rod	RV-DL-10245		Push Rod
		10/05→	Suspension Arm Repair Kit		VL-RK-9497	for Drag Link
10/05→		Suspension Strut Repair Kit		MN-RK-8501		
10/05→		Tie Rod End	RV-ES-12331			
10/05→		Track Control Arm		RV-TC-12339	Suspension Rod, Trailing Arm	
10/05→		Track Control Arm		RV-VB-8191	Wishbone (CV)	
10/05→		Track Control Arm		RV-TC-12339	Suspension Rod, Trailing Arm	
450.26	10/05→	Centre Rod	RV-DL-10245		Push Rod	
	10/05→	Suspension Arm Repair Kit		VL-RK-9497	for Drag Link	
	10/05→	Suspension Strut Repair Kit		MN-RK-8501		
	10/05→	Tie Rod	RV-DL-12329			
	10/05→	Tie Rod End	RV-ES-12331			
	10/05→	Track Control Arm		RV-TC-12339	Suspension Rod, Trailing Arm	
	10/05→	Track Control Arm		RV-TC-12340	Trailing Arm	
	10/05→	Track Control Arm		RV-VB-8191	Wishbone (CV), 1st RA;2nd RA; Leaf Spring Axle;Unit	
	10/05→	Track Control Arm		VL-VB-7787	Wishbone (CV), 1st RA;2nd RA; Leaf Spring Axle;Unit	

CV-ES-2121

Length: 85
Cone Ø: d1 Ø 12 / d2 Ø 10,8
Thread: M14 x 1,5 RHT
23162046, 5000516214, 5010144543,
5010245591



CV-ES-14162

Length: 125
Cone Ø: d1 Ø 30 / d2 Ø 27
Thread: M30 x 1,5 LHT
3401170, 5000288361, 5001832581,
5001858759, 5001858774



CV-ES-14163

Length: 125
Cone Ø: d1 Ø 30 / d2 Ø 27
Thread: M30 x 1,5 RHT
0003406169, 0003406236, 0003406251,
0003406254, 0003406260, 0003406261,
5000288360, 5000590236, 5000804824,
5001858773, 7420937674, 7701011412



DB-ES-8323

Length: 75
Cone Ø: d1 Ø 32 / d2 Ø 28,8
Thread: M26 x 1,5 RHT
5001830480, 5001845430



DF-ES-9335

Length: 85
Cone Ø: d1 Ø 12 / d2 Ø 10,75
Thread: M14 x 1,5 RHT
23162046, 5000516214, 5010144543,
5010245591



MN-RK-8501

Ø: 75
Hole Distance: 115
Thick/Height: 24
7420547286



RV-DL-0886

Length: 945
Ø: 52
Cone Ø: d1 Ø 30 / d2 Ø 27
5010229242, 5010488052



RV-DL-0887

Length: 1720
Ø: 48
Cone Ø: d1 Ø 30 / d2 Ø 27
5010308082



RV-DL-2181

Length: 1650
Ø: 40
Cone Ø: d1 Ø 30 / d2 Ø 27
5010145581, 5010308215



RV-DL-8156

Length: 934
Ø: 52
Cone Ø: d1 Ø 30 / d2 Ø 27
5010229243, 5010488053



RV-DL-8159

Length: 574
Ø: 50
Hole Distance: 152 / 152
5010389262



RV-DL-8300

Length: 1125
Ø: 50
Cone Ø: d1 Ø 30 / d2 Ø 27
5010383528, 5010488096



RV-DL-8313

Length: 1752
Ø: 48
Cone Ø: d1 Ø 30 / d2 Ø 27
5010098467, 5010145584, 5010439631



RV-DL-8324

Length: 575
Ø: 50
Hole Distance: 152 / 152
5010467915



RV-DL-10245

Length: 893
Ø: 62
Cone Ø: d1 Ø 30 / d2 Ø 27
7420761145



RV-DL-12329

Length: 1694
Ø: 42
Cone Ø: d1 Ø 30
7420713858



RV-ES-12331

Length: 140
Cone Ø: d1 Ø 30 / d2 Ø 27
Thread: M32 x 1,5 RHT / M24 x 1,5 RHT
0014607248, 014607248, 5001866165,
5001867774, 7485134391



RV-RK-8648

Ø: 85
Hole Distance: 152
Thick/Height: 35
5001842337



RV-TC-12339

Length: 515
Hole Distance: 13 / 130
7420532931, 7421051046



RV-TC-12340

Length: 510
Hole Distance: 115 / 115
7420443044



RV-VB-8191

Length: 662,4
Ø: 48
Hole Distance: 115 / 115
7420741703, RVVB8191



VL-RK-9497

Ø: 95
Hole Distance: 130
Thick/Height: 35
7420702095



VL-VB-7787

Length: 671
Ø: 58
Hole Distance: 130 / 130
7420829503



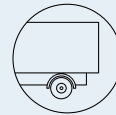

Kerax ...

450.32	10/05→	Centre Rod	RV-DL-12317		Push Rod
	10/05→	Centre Rod	RV-DL-12468		for Steering Rod
	10/05→	Suspension Arm Repair Kit		VL-RK-9497	for Drag Link
	10/05→	Suspension Strut Repair Kit		MN-RK-8501	
	10/05→	Tie Rod	RV-DL-12328		
	10/05→	Tie Rod	RV-DL-12329		
	10/05→	Tie Rod End	DB-ES-8323		
	10/05→	Track Control Arm		RV-DL-10299	Trailing Arm, 1st RA;2nd RA; Leaf Spring Axle;Unit
	10/05→	Track Control Arm		RV-TC-12339	Suspension Rod, Trailing Arm
	10/05→	Track Control Arm		RV-TC-12340	Trailing Arm
	10/05→	Track Control Arm		RV-VB-8191	Wishbone (CV), 1st RA;2nd RA; Leaf Spring Axle;Unit
	10/05→	Track Control Arm		VL-VB-7787	Wishbone (CV), 1st RA;2nd RA; Leaf Spring Axle;Unit
460.32	05/06→	Centre Rod	RV-DL-12317		Push Rod
	05/06→	Centre Rod	RV-DL-12468		for Steering Rod
	05/06→	Suspension Arm Repair Kit		VL-RK-9497	for Drag Link
	05/06→	Tie Rod	RV-DL-10243		
	05/06→	Tie Rod	RV-DL-12328		
	05/06→	Tie Rod	RV-DL-12329		
	05/06→	Tie Rod End	DB-ES-8323		
	05/06→	Track Control Arm		RV-DL-10299	Trailing Arm, 1st RA;2nd RA; Leaf Spring Axle;Unit
05/06→	Track Control Arm		RV-TC-12339	Suspension Rod, Trailing Arm	
05/06→	Track Control Arm		VL-VB-7787	Wishbone (CV), 1st RA;2nd RA; Leaf Spring Axle;Unit	
500.32	05/06→	Centre Rod	RV-DL-12317		Push Rod
	05/06→	Centre Rod	RV-DL-12468		for Steering Rod
	05/06→	Suspension Arm Repair Kit		VL-RK-9497	for Drag Link
	05/06→	Tie Rod	RV-DL-10243		
	05/06→	Tie Rod	RV-DL-12328		
	05/06→	Tie Rod	RV-DL-12329		
	05/06→	Tie Rod End	DB-ES-8323		
	05/06→	Track Control Arm		RV-DL-10299	Trailing Arm, 1st RA;2nd RA; Leaf Spring Axle;Unit
05/06→	Track Control Arm		RV-TC-12339	Suspension Rod, Trailing Arm	
05/06→	Track Control Arm		VL-VB-7787	Wishbone (CV), 1st RA;2nd RA; Leaf Spring Axle;Unit	

Magnum

AE 380.18	09/90→06/92	Tie Rod End	RV-ES-12331		
AE 380.18T	09/90→06/92	Tie Rod End	RV-ES-12331		
AE 380.26	09/90→06/92	Tie Rod End	RV-ES-12331		
AE 380.26T	09/90→06/92	Tie Rod End	RV-ES-12331		
AE 385ti.18	02/92→10/96	Ball Head, gearshift linkage	CV-ES-2121		
	02/92→10/96	Suspension Strut Repair Kit		DF-RK-8671	
	02/92→10/96	Tie Rod End	CV-ES-14162		for Steering Rod
	02/92→10/96	Tie Rod End	CV-ES-14163		for Steering Rod
	02/92→10/96	Tie Rod End	RV-ES-12331		
AE 385ti.18T	02/92→10/96	Ball Head, gearshift linkage	CV-ES-2121		
	02/92→10/96	Ball Head, gearshift linkage	DF-ES-9335		
	02/92→10/96	Centre Rod	RV-DL-0902		Push Rod
	02/92→10/96	Centre Rod	RV-DL-8316		Push Rod
	02/92→10/96	Suspension Strut Repair Kit		DF-RK-8671	
	02/92→10/96	Tie Rod End	CV-ES-14162		for Steering Rod
	02/92→10/96	Tie Rod End	CV-ES-14163		for Steering Rod
02/92→10/96	Tie Rod End	RV-ES-12331			
AE 385ti.19	02/92→10/96	Ball Head, gearshift linkage	CV-ES-2121		
	02/92→10/96	Suspension Strut Repair Kit		DF-RK-8671	
	02/92→10/96	Tie Rod End	CV-ES-14162		for Steering Rod
02/92→10/96	Tie Rod End	CV-ES-14163		for Steering Rod	

CV-ES-2121

Length: 85
Cone Ø: d1 Ø 12 / d2 Ø 10,8
Thread: M14 x 1,5 RHT
23162046, 5000516214, 5010144543,
5010245591



CV-ES-14162

Length: 125
Cone Ø: d1 Ø 30 / d2 Ø 27
Thread: M30 x 1,5 LHT
3401170, 5000288361, 5001832581,
5001858759, 5001858774



CV-ES-14163

Length: 125
Cone Ø: d1 Ø 30 / d2 Ø 27
Thread: M30 x 1,5 RHT
0003406169, 0003406236, 0003406251,
0003406254, 0003406260, 0003406261,
5000288360, 5000590236, 5000804824,
5001858773, 7420937674, 7701011412



DB-ES-8323

Length: 75
Cone Ø: d1 Ø 32 / d2 Ø 28,8
Thread: M26 x 1,5 RHT
5001830480, 5001845430



DF-ES-9335

Length: 85
Cone Ø: d1 Ø 12 / d2 Ø 10,75
Thread: M14 x 1,5 RHT
23162046, 5000516214, 5010144543,
5010245591



DF-RK-8671

Ø: 80
Hole Distance: 145
Thick/Height: 30
5001014345



MN-RK-8501

Ø: 75
Hole Distance: 115
Thick/Height: 24
7420547286



RV-DL-0902

Length: 720
Ø: 40
Cone Ø: d1 Ø 30 / d2 Ø 27
5010060764, 5010557243



RV-DL-8316

Length: 735
Ø: 50
Cone Ø: d1 Ø 30 / d2 Ø 27
5010383203, 5010488836, 5010557523



RV-DL-10243

Length: 1726
Ø: 60
Cone Ø: d1 Ø 30 / d2 Ø 27
Thread: M24 x 1,5 RHT
5001868363, 5010587004, 5010600822,
7421560957



RV-DL-10299

Length: 510
Ø: 21
21051052, 7420864583, 7421051052



RV-DL-12317

Length: 866
Ø: 60
7420847206, 7421560950



RV-DL-12328

Length: 1608
Ø: 42
Cone Ø: d1 Ø 30
7420713860



RV-DL-12329

Length: 1694
Ø: 42
Cone Ø: d1 Ø 30
7420713858



RV-DL-12468

Length: 866
Ø: 60
Cone Ø: d1 Ø 30 / d2 Ø 27
20847191, 7420847190, 7421560945



RV-ES-12331

Length: 140
Cone Ø: d1 Ø 30 / d2 Ø 27
Thread: M32 x 1,5 RHT / M24 x 1,5 RHT
014607248, 0014607248, 5001866165,
5001867774, 7485134391



RV-TC-12339

Length: 515
Hole Distance: 13 / 130
7420532931, 7421051046



RV-TC-12340

Length: 510
Hole Distance: 115 / 115
7420443044



RV-VB-8191

Length: 662,4
Ø: 48
Hole Distance: 115 / 115
7420741703, RVVB8191



VL-RK-9497

Ø: 95
Hole Distance: 130
Thick/Height: 35
7420702095



VL-VB-7787

Length: 671
Ø: 58
Hole Distance: 130 / 130
7420829503





Magnum ...

AE 385ti.19T	02/92→10/96	Ball Head, gearshift linkage	CV-ES-2121		
	02/92→10/96	Ball Head, gearshift linkage	DF-ES-9335		
	02/92→10/96	Centre Rod	RV-DL-0902		Push Rod
	02/92→10/96	Centre Rod	RV-DL-8316		Push Rod
	02/92→10/96	Suspension Strut Repair Kit		DF-RK-8671	
	02/92→10/96	Tie Rod End	CV-ES-14162		for Steering Rod
	02/92→10/96	Tie Rod End	CV-ES-14163		for Steering Rod
AE 385ti.24	02/92→10/96	Ball Head, gearshift linkage	CV-ES-2121		
	02/92→10/96	Suspension Strut Repair Kit		DF-RK-8671	
	02/92→10/96	Tie Rod End	CV-ES-14162		for Steering Rod
	02/92→10/96	Tie Rod End	CV-ES-14163		for Steering Rod
AE 385ti.26	02/92→10/96	Ball Head, gearshift linkage	CV-ES-2121		
	02/92→10/96	Ball Head, gearshift linkage	DF-ES-9335		
	02/92→10/96	Centre Rod	RV-DL-8316		Push Rod
	02/92→10/96	Suspension Strut Repair Kit		DF-RK-8671	
	02/92→10/96	Tie Rod End	CV-ES-14162		for Steering Rod
	02/92→10/96	Tie Rod End	CV-ES-14163		for Steering Rod
	02/92→10/96	Tie Rod End	RV-ES-12331		
AE 390.18	09/96→	Ball Head, gearshift linkage	CV-ES-2121		
	09/96→	Ball Head, gearshift linkage	DF-ES-9335		
	09/96→	Centre Rod	RV-DL-0902		Push Rod
	09/96→	Centre Rod	RV-DL-2181		Coupling Rod
	09/96→	Centre Rod	RV-DL-8316		Push Rod
	09/96→	Suspension Strut Repair Kit		DF-RK-8671	
	09/96→	Tie Rod End	CV-ES-14162		for Steering Rod
	09/96→	Tie Rod End	CV-ES-14163		for Steering Rod
	09/96→	Tie Rod End	RV-ES-12331		
	09/96→	Tie Rod End	SC-ES-7279		for Steering Rod
AE 390.18T	07/99→	Tie Rod	RV-DL-8314		Guide Rod
	09/96→	Ball Head, gearshift linkage	CV-ES-2121		
	09/96→	Ball Head, gearshift linkage	DF-ES-9335		
	09/96→	Centre Rod	RV-DL-0902		Push Rod
	09/96→	Centre Rod	RV-DL-2181		Coupling Rod
	09/96→	Centre Rod	RV-DL-8316		Push Rod
	09/96→	Suspension Strut Repair Kit		DF-RK-8671	
	09/96→	Tie Rod	RV-DL-8314		Guide Rod
	09/96→	Tie Rod End	CV-ES-14162		for Steering Rod
	09/96→	Tie Rod End	CV-ES-14163		for Steering Rod
AE 390.19	09/96→	Tie Rod End	RV-ES-12331		
	09/96→	Ball Head, gearshift linkage	CV-ES-2121		
	09/96→	Ball Head, gearshift linkage	DF-ES-9335		
	09/96→	Centre Rod	RV-DL-0902		Push Rod
	09/96→	Centre Rod	RV-DL-2181		Coupling Rod
	09/96→	Centre Rod	RV-DL-8316		Push Rod
	09/96→	Suspension Strut Repair Kit		DF-RK-8671	
	09/96→	Tie Rod End	CV-ES-14162		for Steering Rod
	09/96→	Tie Rod End	CV-ES-14163		for Steering Rod
	09/96→	Tie Rod End	SC-ES-7279		for Steering Rod
AE 390.19T	07/99→	Tie Rod	RV-DL-8314		Guide Rod
	09/96→	Ball Head, gearshift linkage	CV-ES-2121		
	09/96→	Ball Head, gearshift linkage	DF-ES-9335		
	09/96→	Centre Rod	RV-DL-0902		Push Rod
	09/96→	Centre Rod	RV-DL-2181		Coupling Rod
	09/96→	Centre Rod	RV-DL-8316		Push Rod
	09/96→	Suspension Strut Repair Kit		DF-RK-8671	
	09/96→	Tie Rod End	CV-ES-14162		for Steering Rod
	09/96→	Tie Rod End	CV-ES-14163		for Steering Rod
	09/96→	Tie Rod End	RV-ES-12331		
AE 390.26	09/96→	Ball Head, gearshift linkage	CV-ES-2121		
	09/96→	Ball Head, gearshift linkage	DF-ES-9335		
	09/96→	Centre Rod	RV-DL-0902		Push Rod
	09/96→	Centre Rod	RV-DL-2181		Coupling Rod
	09/96→	Centre Rod	RV-DL-8316		Push Rod
	09/96→	Suspension Strut Repair Kit		DF-RK-8671	
	09/96→	Tie Rod End	CV-ES-14162		for Steering Rod

CV-ES-2121

Length: 85
Cone Ø: d1 Ø 12 / d2 Ø 10,8
Thread: M14 x 1,5 RHT
23162046, 5000516214, 5010144543,
5010245591



CV-ES-14162

Length: 125
Cone Ø: d1 Ø 30 / d2 Ø 27
Thread: M30 x 1,5 LHT
3401170, 5000288361, 5001832581,
5001858759, 5001858774



CV-ES-14163

Length: 125
Cone Ø: d1 Ø 30 / d2 Ø 27
Thread: M30 x 1,5 RHT
0003406169, 0003406236, 0003406251,
0003406254, 0003406260, 0003406261,
5000288360, 5000590236, 5000804824,
5001858773, 7420937674, 7701011412



DF-ES-9335

Length: 85
Cone Ø: d1 Ø 12 / d2 Ø 10,75
Thread: M14 x 1,5 RHT
23162046, 5000516214, 5010144543,
5010245591



DF-RK-8671

Ø: 80
Hole Distance: 145
Thick/Height: 30
5001014345



RV-DL-0902

Length: 720
Ø: 40
Cone Ø: d1 Ø 30 / d2 Ø 27
5010060764, 5010557243



RV-DL-2181

Length: 1650
Ø: 40
Cone Ø: d1 Ø 30 / d2 Ø 27
5010145581, 5010308215



RV-DL-8314

Length: 1758
Ø: 52
Cone Ø: d1 Ø 30 / d2 Ø 27
5010439021, 5010566063



RV-DL-8316

Length: 735
Ø: 50
Cone Ø: d1 Ø 30 / d2 Ø 27
5010383203, 5010488836, 5010557523



RV-ES-12331

Length: 140
Cone Ø: d1 Ø 30 / d2 Ø 27
Thread: M32 x 1,5 RHT / M24 x 1,5 RHT
0014607248, 014607248, 5001866165,
5001867774, 7485134391



SC-ES-7279

Length: 150
Cone Ø: d1 Ø 30 / d2 Ø 27
Thread: M30 x 1,5 RHT
5001852452, 5001858763



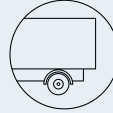

Magnum ...

AE 390.26 ...	09/96 →	Tie Rod End	CV-ES-14162		for Steering Rod
	09/96 →	Tie Rod End	CV-ES-14163		for Steering Rod
	09/96 →	Tie Rod End	RV-ES-12331		
	09/96 →	Tie Rod End	SC-ES-7279		for Steering Rod
	07/99 →	Tie Rod	RV-DL-8314		Guide Rod
AE 420ti.18	10/92 →12/96	Ball Head, gearshift linkage	CV-ES-2121		
	10/92 →12/96	Ball Head, gearshift linkage	DF-ES-9335		
	10/92 →12/96	Centre Rod	RV-DL-0902		Push Rod
	10/92 →12/96	Centre Rod	RV-DL-2181		Coupling Rod
	10/92 →12/96	Centre Rod	RV-DL-8316		Push Rod
	10/92 →12/96	Suspension Strut Repair Kit		DF-RK-8671	
	10/92 →12/96	Tie Rod End	CV-ES-14162		for Steering Rod
	10/92 →12/96	Tie Rod End	CV-ES-14163		for Steering Rod
	10/92 →12/96	Tie Rod End	RV-ES-12331		
AE 420ti.18T	10/92 →12/96	Ball Head, gearshift linkage	CV-ES-2121		
	10/92 →12/96	Ball Head, gearshift linkage	DF-ES-9335		
	10/92 →12/96	Centre Rod	RV-DL-0902		Push Rod
	10/92 →12/96	Centre Rod	RV-DL-2181		Coupling Rod
	10/92 →12/96	Centre Rod	RV-DL-8316		Push Rod
	10/92 →12/96	Suspension Strut Repair Kit		DF-RK-8671	
	10/92 →12/96	Tie Rod End	CV-ES-14162		for Steering Rod
	10/92 →12/96	Tie Rod End	CV-ES-14163		for Steering Rod
	10/92 →12/96	Tie Rod End	RV-ES-12331		
AE 420ti.19	10/92 →12/96	Ball Head, gearshift linkage	CV-ES-2121		
	10/92 →12/96	Ball Head, gearshift linkage	DF-ES-9335		
	10/92 →12/96	Centre Rod	RV-DL-0902		Push Rod
	10/92 →12/96	Centre Rod	RV-DL-2181		Coupling Rod
	10/92 →12/96	Centre Rod	RV-DL-8316		Push Rod
	10/92 →12/96	Suspension Strut Repair Kit		DF-RK-8671	
	10/92 →12/96	Tie Rod End	CV-ES-14162		for Steering Rod
AE 420ti.19T	10/92 →12/96	Ball Head, gearshift linkage	CV-ES-2121		
	10/92 →12/96	Ball Head, gearshift linkage	DF-ES-9335		
	10/92 →12/96	Centre Rod	RV-DL-0902		Push Rod
	10/92 →12/96	Centre Rod	RV-DL-2181		Coupling Rod
	10/92 →12/96	Centre Rod	RV-DL-8316		Push Rod
	10/92 →12/96	Suspension Strut Repair Kit		DF-RK-8671	
	10/92 →12/96	Tie Rod End	CV-ES-14162		for Steering Rod
AE 420ti.19T	10/92 →12/96	Ball Head, gearshift linkage	CV-ES-2121		
	10/92 →12/96	Ball Head, gearshift linkage	DF-ES-9335		
	10/92 →12/96	Centre Rod	RV-DL-0902		Push Rod
	10/92 →12/96	Centre Rod	RV-DL-2181		Coupling Rod
	10/92 →12/96	Centre Rod	RV-DL-8316		Push Rod
	10/92 →12/96	Suspension Strut Repair Kit		DF-RK-8671	
	10/92 →12/96	Tie Rod End	CV-ES-14162		for Steering Rod
AE 420ti.22T	10/92 →10/96	Ball Head, gearshift linkage	CV-ES-2121		
	10/92 →10/96	Ball Head, gearshift linkage	DF-ES-9335		
	10/92 →10/96	Centre Rod	RV-DL-0902		Push Rod
	10/92 →10/96	Centre Rod	RV-DL-2181		Coupling Rod
	10/92 →10/96	Centre Rod	RV-DL-8316		Push Rod
	10/92 →10/96	Suspension Strut Repair Kit		DF-RK-8671	
	10/92 →10/96	Tie Rod End	CV-ES-14162		for Steering Rod
AE 420ti.24	10/92 →10/96	Tie Rod End	CV-ES-14163		for Steering Rod
	10/92 →12/96	Ball Head, gearshift linkage	CV-ES-2121		
	10/92 →12/96	Ball Head, gearshift linkage	DF-ES-9335		
	10/92 →12/96	Centre Rod	RV-DL-0902		Push Rod
	10/92 →12/96	Centre Rod	RV-DL-2181		Coupling Rod
	10/92 →12/96	Centre Rod	RV-DL-8316		Push Rod
	10/92 →12/96	Suspension Strut Repair Kit		DF-RK-8671	
AE 420ti.24T	10/92 →12/96	Tie Rod End	CV-ES-14162		for Steering Rod
	10/92 →12/96	Tie Rod End	CV-ES-14163		for Steering Rod
	10/92 →12/96	Ball Head, gearshift linkage	CV-ES-2121		
	10/92 →12/96	Ball Head, gearshift linkage	DF-ES-9335		
	10/92 →12/96	Centre Rod	RV-DL-0902		Push Rod
	10/92 →12/96	Centre Rod	RV-DL-2181		Coupling Rod
	10/92 →12/96	Centre Rod	RV-DL-8316		Push Rod
AE 420ti.24T	10/92 →12/96	Suspension Strut Repair Kit		DF-RK-8671	
	10/92 →12/96	Tie Rod End	CV-ES-14162		for Steering Rod
	10/92 →12/96	Tie Rod End	CV-ES-14163		for Steering Rod
	10/92 →12/96	Tie Rod End	RV-ES-12331		

CV-ES-2121

Length: 85
Cone Ø: d1 Ø 12 / d2 Ø 10,8
Thread: M14 x 1,5 RHT
23162046, 5000516214, 5010144543,
5010245591



RV-DL-2181

Length: 1650
Ø: 40
Cone Ø: d1 Ø 30 / d2 Ø 27
5010145581, 5010308215



CV-ES-14162

Length: 125
Cone Ø: d1 Ø 30 / d2 Ø 27
Thread: M30 x 1,5 LHT
3401170, 5000288361, 5001832581,
5001858759, 5001858774



RV-DL-8314

Length: 1758
Ø: 52
Cone Ø: d1 Ø 30 / d2 Ø 27
5010439021, 5010566063



CV-ES-14163

Length: 125
Cone Ø: d1 Ø 30 / d2 Ø 27
Thread: M30 x 1,5 RHT
0003406169, 0003406236, 0003406251,
0003406254, 0003406260, 0003406261,
5000288360, 5000590236, 5000804824,
5001858773, 7420937674, 7701011412



RV-DL-8316

Length: 735
Ø: 50
Cone Ø: d1 Ø 30 / d2 Ø 27
5010383203, 5010488836, 5010557523



DF-ES-9335

Length: 85
Cone Ø: d1 Ø 12 / d2 Ø 10,75
Thread: M14 x 1,5 RHT
23162046, 5000516214, 5010144543,
5010245591



RV-ES-12331

Length: 140
Cone Ø: d1 Ø 30 / d2 Ø 27
Thread: M32 x 1,5 RHT / M24 x 1,5 RHT
0014607248, 014607248, 5001866165,
5001867774, 7485134391



DF-RK-8671

Ø: 80
Hole Distance: 145
Thick/Height: 30
5001014345



SC-ES-7279

Length: 150
Cone Ø: d1 Ø 30 / d2 Ø 27
Thread: M30 x 1,5 RHT
5001852452, 5001858763



RV-DL-0902

Length: 720
Ø: 40
Cone Ø: d1 Ø 30 / d2 Ø 27
5010060764, 5010557243





Magnum ...

AE 420ti.26	10/92→12/96	Ball Head, gearshift linkage	CV-ES-2121		
	10/92→12/96	Ball Head, gearshift linkage	DF-ES-9335		
	10/92→12/96	Centre Rod	RV-DL-0902		Push Rod
	10/92→12/96	Centre Rod	RV-DL-2181		Coupling Rod
	10/92→12/96	Centre Rod	RV-DL-8316		Push Rod
	10/92→12/96	Suspension Strut Repair Kit		DF-RK-8671	
	10/92→12/96	Tie Rod End	CV-ES-14162		for Steering Rod
	10/92→12/96	Tie Rod End	CV-ES-14163		for Steering Rod
	10/92→12/96	Tie Rod End	RV-ES-12331		
AE 420ti.26T	10/92→12/96	Ball Head, gearshift linkage	CV-ES-2121		
	10/92→12/96	Ball Head, gearshift linkage	DF-ES-9335		
	10/92→12/96	Centre Rod	RV-DL-0902		Push Rod
	10/92→12/96	Centre Rod	RV-DL-2181		Coupling Rod
	10/92→12/96	Centre Rod	RV-DL-8316		Push Rod
	10/92→12/96	Suspension Strut Repair Kit		DF-RK-8671	
	10/92→12/96	Tie Rod End	CV-ES-14162		for Steering Rod
	10/92→12/96	Tie Rod End	CV-ES-14163		for Steering Rod
	10/92→12/96	Tie Rod End	RV-ES-12331		
AE 430.18	09/96→	Ball Head, gearshift linkage	CV-ES-2121		
	09/96→	Ball Head, gearshift linkage	DF-ES-9335		
	09/96→	Centre Rod	RV-DL-0902		Push Rod
	09/96→	Centre Rod	RV-DL-2181		Coupling Rod
	09/96→	Centre Rod	RV-DL-8316		Push Rod
	09/96→	Suspension Strut Repair Kit		DF-RK-8671	
	09/96→	Tie Rod End	CV-ES-14162		for Steering Rod
	09/96→	Tie Rod End	CV-ES-14163		for Steering Rod
	09/96→	Tie Rod End	RV-ES-12331		
AE 430.18T	07/99→	Tie Rod	RV-DL-8314		Guide Rod
	09/96→	Ball Head, gearshift linkage	CV-ES-2121		
	09/96→	Ball Head, gearshift linkage	DF-ES-9335		
	09/96→	Centre Rod	RV-DL-0902		Push Rod
	09/96→	Centre Rod	RV-DL-2181		Coupling Rod
	09/96→	Centre Rod	RV-DL-8316		Push Rod
	09/96→	Suspension Strut Repair Kit		DF-RK-8671	
	09/96→	Tie Rod	RV-DL-8314		Guide Rod
	09/96→	Tie Rod End	CV-ES-14162		for Steering Rod
09/96→	Tie Rod End	CV-ES-14163		for Steering Rod	
AE 430.19	09/96→	Tie Rod End	RV-ES-12331		
	09/96→	Ball Head, gearshift linkage	CV-ES-2121		
	09/96→	Ball Head, gearshift linkage	DF-ES-9335		
	09/96→	Centre Rod	RV-DL-0902		Push Rod
	09/96→	Centre Rod	RV-DL-2181		Coupling Rod
	09/96→	Centre Rod	RV-DL-8316		Push Rod
	09/96→	Suspension Strut Repair Kit		DF-RK-8671	
	09/96→	Tie Rod End	CV-ES-14162		for Steering Rod
	09/96→	Tie Rod End	CV-ES-14163		for Steering Rod
09/96→	Tie Rod End	SC-ES-7279		for Steering Rod	
AE 430.19T	07/99→	Tie Rod	RV-DL-8314		Guide Rod
	09/96→	Ball Head, gearshift linkage	CV-ES-2121		
	09/96→	Ball Head, gearshift linkage	DF-ES-9335		
	09/96→	Centre Rod	RV-DL-0902		Push Rod
	09/96→	Centre Rod	RV-DL-2181		Coupling Rod
	09/96→	Centre Rod	RV-DL-8316		Push Rod
	09/96→	Suspension Strut Repair Kit		DF-RK-8671	
	09/96→	Tie Rod End	CV-ES-14162		for Steering Rod
	09/96→	Tie Rod End	CV-ES-14163		for Steering Rod
AE 430.26	09/96→	Tie Rod End	RV-ES-12331		
	09/96→	Ball Head, gearshift linkage	CV-ES-2121		
	09/96→	Ball Head, gearshift linkage	DF-ES-9335		
	09/96→	Centre Rod	RV-DL-0902		Push Rod
	09/96→	Centre Rod	RV-DL-2181		Coupling Rod
	09/96→	Centre Rod	RV-DL-8316		Push Rod
	09/96→	Suspension Strut Repair Kit		DF-RK-8671	
	09/96→	Tie Rod End	CV-ES-14162		for Steering Rod
	09/96→	Tie Rod End	CV-ES-14163		for Steering Rod

CV-ES-2121

Length: 85
Cone Ø: d1 Ø 12 / d2 Ø 10,8
Thread: M14 x 1,5 RHT
23162046, 5000516214, 5010144543,
5010245591



CV-ES-14162

Length: 125
Cone Ø: d1 Ø 30 / d2 Ø 27
Thread: M30 x 1,5 LHT
3401170, 5000288361, 5001832581,
5001858759, 5001858774



CV-ES-14163

Length: 125
Cone Ø: d1 Ø 30 / d2 Ø 27
Thread: M30 x 1,5 RHT
0003406169, 0003406236, 0003406251,
0003406254, 0003406260, 0003406261,
5000288360, 5000590236, 5000804824,
5001858773, 7420937674, 7701011412



DF-ES-9335

Length: 85
Cone Ø: d1 Ø 12 / d2 Ø 10,75
Thread: M14 x 1,5 RHT
23162046, 5000516214, 5010144543,
5010245591



DF-RK-8671

Ø: 80
Hole Distance: 145
Thick/Height: 30
5001014345



RV-DL-0902

Length: 720
Ø: 40
Cone Ø: d1 Ø 30 / d2 Ø 27
5010060764, 5010557243



RV-DL-2181

Length: 1650
Ø: 40
Cone Ø: d1 Ø 30 / d2 Ø 27
5010145581, 5010308215



RV-DL-8314

Length: 1758
Ø: 52
Cone Ø: d1 Ø 30 / d2 Ø 27
5010439021, 5010566063



RV-DL-8316

Length: 735
Ø: 50
Cone Ø: d1 Ø 30 / d2 Ø 27
5010383203, 5010488836, 5010557523



RV-ES-12331

Length: 140
Cone Ø: d1 Ø 30 / d2 Ø 27
Thread: M32 x 1,5 RHT / M24 x 1,5 RHT
0014607248, 014607248, 5001866165,
5001867774, 7485134391



SC-ES-7279

Length: 150
Cone Ø: d1 Ø 30 / d2 Ø 27
Thread: M30 x 1,5 RHT
5001852452, 5001858763





Magnum ...

AE 430.26 ...	09/96 →	Tie Rod End	CV-ES-14163		for Steering Rod	
	09/96 →	Tie Rod End	RV-ES-12331			
	09/96 →	Tie Rod End	SC-ES-7279		for Steering Rod	
	07/99 →	Tie Rod	RV-DL-8314		Guide Rod	
AE 430.26T	01/97 →	Ball Head, gearshift linkage	CV-ES-2121			
	01/97 →	Ball Head, gearshift linkage	DF-ES-9335			
	01/97 →	Centre Rod	RV-DL-0902		Push Rod	
	01/97 →	Centre Rod	RV-DL-2181		Coupling Rod	
	01/97 →	Centre Rod	RV-DL-8316		Push Rod	
	01/97 →	Suspension Strut Repair Kit		DF-RK-8671		
	01/97 →	Tie Rod	RV-DL-8314		Guide Rod	
	01/97 →	Tie Rod	RV-DL-12318			
	01/97 →	Tie Rod End	CV-ES-14162		for Steering Rod	
	01/97 →	Tie Rod End	CV-ES-14163		for Steering Rod	
	01/97 →	Tie Rod End	RV-ES-12331			
	01/97 →	Tie Rod End	SC-ES-7279		for Steering Rod	
	AE 470.18	11/96 →	Ball Head, gearshift linkage	CV-ES-2121		
		11/96 →	Ball Head, gearshift linkage	DF-ES-9335		
11/96 →		Centre Rod	RV-DL-0902		Push Rod	
11/96 →		Centre Rod	RV-DL-2181		Coupling Rod	
11/96 →		Centre Rod	RV-DL-8316		Push Rod	
11/96 →		Suspension Strut Repair Kit		DF-RK-8671		
11/96 →		Tie Rod End	CV-ES-14162		for Steering Rod	
11/96 →		Tie Rod End	CV-ES-14163		for Steering Rod	
11/96 →		Tie Rod End	RV-ES-12331			
11/96 →		Tie Rod End	SC-ES-7279		for Steering Rod	
07/99 →		Tie Rod	RV-DL-8314		Guide Rod	
AE 470.18T		11/96 →	Ball Head, gearshift linkage	CV-ES-2121		
		11/96 →	Ball Head, gearshift linkage	DF-ES-9335		
		11/96 →	Centre Rod	RV-DL-0902		Push Rod
	11/96 →	Centre Rod	RV-DL-2181		Coupling Rod	
	11/96 →	Centre Rod	RV-DL-8316		Push Rod	
	11/96 →	Suspension Strut Repair Kit		DF-RK-8671		
	11/96 →	Tie Rod	RV-DL-8314		Guide Rod	
	11/96 →	Tie Rod End	CV-ES-14162		for Steering Rod	
	11/96 →	Tie Rod End	CV-ES-14163		for Steering Rod	
	11/96 →	Tie Rod End	RV-ES-12331			
AE 470.19	11/96 →	Ball Head, gearshift linkage	CV-ES-2121			
	11/96 →	Ball Head, gearshift linkage	DF-ES-9335			
	11/96 →	Centre Rod	RV-DL-0902		Push Rod	
	11/96 →	Centre Rod	RV-DL-2181		Coupling Rod	
	11/96 →	Centre Rod	RV-DL-8316		Push Rod	
	11/96 →	Suspension Strut Repair Kit		DF-RK-8671		
	11/96 →	Tie Rod End	CV-ES-14162		for Steering Rod	
	11/96 →	Tie Rod End	CV-ES-14163		for Steering Rod	
	11/96 →	Tie Rod End	SC-ES-7279		for Steering Rod	
AE 470.19T	07/99 →	Tie Rod	RV-DL-8314		Guide Rod	
	11/96 →	Ball Head, gearshift linkage	CV-ES-2121			
	11/96 →	Ball Head, gearshift linkage	DF-ES-9335			
	11/96 →	Centre Rod	RV-DL-0902		Push Rod	
	11/96 →	Centre Rod	RV-DL-2181		Coupling Rod	
	11/96 →	Centre Rod	RV-DL-8316		Push Rod	
	11/96 →	Suspension Strut Repair Kit		DF-RK-8671		
	11/96 →	Tie Rod End	CV-ES-14162		for Steering Rod	
	11/96 →	Tie Rod End	CV-ES-14163		for Steering Rod	
AE 470.26	01/97 →	Ball Head, gearshift linkage	CV-ES-2121			
	01/97 →	Ball Head, gearshift linkage	DF-ES-9335			
	01/97 →	Centre Rod	RV-DL-0902		Push Rod	
	01/97 →	Centre Rod	RV-DL-2181		Coupling Rod	
	01/97 →	Centre Rod	RV-DL-8316		Push Rod	
	01/97 →	Suspension Strut Repair Kit		DF-RK-8671		
	01/97 →	Tie Rod End	CV-ES-14162		for Steering Rod	
	01/97 →	Tie Rod End	CV-ES-14163		for Steering Rod	

CV-ES-2121

Length: 85
Cone Ø: d1 Ø 12 / d2 Ø 10,8
Thread: M14 x 1,5 RHT
23162046, 5000516214, 5010144543,
5010245591



CV-ES-14162

Length: 125
Cone Ø: d1 Ø 30 / d2 Ø 27
Thread: M30 x 1,5 LHT
3401170, 5000288361, 5001832581,
5001858759, 5001858774



CV-ES-14163

Length: 125
Cone Ø: d1 Ø 30 / d2 Ø 27
Thread: M30 x 1,5 RHT
0003406169, 0003406236, 0003406251,
0003406254, 0003406260, 0003406261,
5000288360, 5000590236, 5000804824,
5001858773, 7420937674, 7701011412



DF-ES-9335

Length: 85
Cone Ø: d1 Ø 12 / d2 Ø 10,75
Thread: M14 x 1,5 RHT
23162046, 5000516214, 5010144543,
5010245591



DF-RK-8671

Ø: 80
Hole Distance: 145
Thick/Height: 30
5001014345



RV-DL-0902

Length: 720
Ø: 40
Cone Ø: d1 Ø 30 / d2 Ø 27
5010060764, 5010557243



RV-DL-2181

Length: 1650
Ø: 40
Cone Ø: d1 Ø 30 / d2 Ø 27
5010145581, 5010308215



RV-DL-8314

Length: 1758
Ø: 52
Cone Ø: d1 Ø 30 / d2 Ø 27
5010439021, 5010566063



RV-DL-8316

Length: 735
Ø: 50
Cone Ø: d1 Ø 30 / d2 Ø 27
5010383203, 5010488836, 5010557523



RV-DL-12318

Length: 1650
Ø: 40
Cone Ø: d1 Ø 26 / d2 Ø 23,5
5010566157



RV-ES-12331

Length: 140
Cone Ø: d1 Ø 30 / d2 Ø 27
Thread: M32 x 1,5 RHT / M24 x 1,5 RHT
0014607248, 014607248, 5001866165,
5001867774, 7485134391



SC-ES-7279

Length: 150
Cone Ø: d1 Ø 30 / d2 Ø 27
Thread: M30 x 1,5 RHT
5001852452, 5001858763





Magnum ...

AE 470.26 ...	01/97→	Tie Rod End	RV-ES-12331	
	01/97→	Tie Rod End	SC-ES-7279	for Steering Rod
	07/99→	Tie Rod	RV-DL-8314	Guide Rod
AE 470.26T	01/98→	Ball Head, gearshift linkage	CV-ES-2121	
	01/98→	Ball Head, gearshift linkage	DF-ES-9335	
	01/98→	Centre Rod	RV-DL-0902	Push Rod
	01/98→	Centre Rod	RV-DL-2181	Coupling Rod
	01/98→	Centre Rod	RV-DL-8316	Push Rod
	01/98→	Suspension Strut Repair Kit		DF-RK-8671
	01/98→	Tie Rod	RV-DL-8314	Guide Rod
	01/98→	Tie Rod End	CV-ES-14162	for Steering Rod
	01/98→	Tie Rod End	CV-ES-14163	for Steering Rod
	01/98→	Tie Rod End	RV-ES-12331	
	01/98→	Tie Rod End	SC-ES-7279	for Steering Rod
AE 500.18	09/90→	Tie Rod End	RV-ES-12331	
AE 500.18T	09/90→	Tie Rod End	RV-ES-12331	
AE 500.26	09/90→	Tie Rod End	RV-ES-12331	
AE 500.26T	09/90→	Tie Rod End	RV-ES-12331	
AE 520.18	10/92→05/96	Ball Head, gearshift linkage	CV-ES-2121	
	10/92→05/96	Ball Head, gearshift linkage	DF-ES-9335	
	10/92→05/96	Centre Rod	RV-DL-8316	Push Rod
	10/92→05/96	Suspension Strut Repair Kit		DF-RK-8671
	10/92→05/96	Tie Rod End	CV-ES-14162	for Steering Rod
	10/92→05/96	Tie Rod End	CV-ES-14163	for Steering Rod
	10/92→05/96	Tie Rod End	RV-ES-12331	
AE 520.18T	10/92→05/96	Ball Head, gearshift linkage	CV-ES-2121	
	10/92→05/96	Ball Head, gearshift linkage	DF-ES-9335	
	10/92→05/96	Centre Rod	RV-DL-0902	Push Rod
	10/92→05/96	Centre Rod	RV-DL-8316	Push Rod
	10/92→05/96	Suspension Strut Repair Kit		DF-RK-8671
	10/92→05/96	Tie Rod End	CV-ES-14162	for Steering Rod
	10/92→05/96	Tie Rod End	CV-ES-14163	for Steering Rod
	10/92→05/96	Tie Rod End	RV-ES-12331	
AE 520.19	10/92→05/96	Ball Head, gearshift linkage	CV-ES-2121	
	10/92→05/96	Ball Head, gearshift linkage	DF-ES-9335	
	10/92→05/96	Centre Rod	RV-DL-8316	Push Rod
	10/92→05/96	Suspension Strut Repair Kit		DF-RK-8671
	10/92→05/96	Tie Rod End	CV-ES-14162	for Steering Rod
	10/92→05/96	Tie Rod End	CV-ES-14163	for Steering Rod
AE 520.19T	10/92→05/96	Ball Head, gearshift linkage	CV-ES-2121	
	10/92→05/96	Ball Head, gearshift linkage	DF-ES-9335	
	10/92→05/96	Centre Rod	RV-DL-0902	Push Rod
	10/92→05/96	Centre Rod	RV-DL-8316	Push Rod
	10/92→05/96	Suspension Strut Repair Kit		DF-RK-8671
	10/92→05/96	Tie Rod End	CV-ES-14162	for Steering Rod
	10/92→05/96	Tie Rod End	CV-ES-14163	for Steering Rod
AE 520.22T	10/92→05/96	Ball Head, gearshift linkage	CV-ES-2121	
	10/92→05/96	Centre Rod	RV-DL-0902	Push Rod
	10/92→05/96	Suspension Strut Repair Kit		DF-RK-8671
	10/92→05/96	Tie Rod End	CV-ES-14162	for Steering Rod
	10/92→05/96	Tie Rod End	CV-ES-14163	for Steering Rod
	10/92→05/96	Tie Rod End	RV-ES-12331	
AE 520.24	10/92→05/96	Ball Head, gearshift linkage	CV-ES-2121	
	10/92→05/96	Suspension Strut Repair Kit		DF-RK-8671
	10/92→05/96	Tie Rod End	CV-ES-14162	for Steering Rod
	10/92→05/96	Tie Rod End	CV-ES-14163	for Steering Rod
AE 520.24T	10/92→05/96	Ball Head, gearshift linkage	CV-ES-2121	
	10/92→05/96	Centre Rod	RV-DL-0902	Push Rod
	10/92→05/96	Suspension Strut Repair Kit		DF-RK-8671
	10/92→05/96	Tie Rod End	CV-ES-14162	for Steering Rod
	10/92→05/96	Tie Rod End	CV-ES-14163	for Steering Rod
	10/92→05/96	Tie Rod End	RV-ES-12331	

CV-ES-2121

Length: 85
Cone Ø: d1 Ø 12 / d2 Ø 10,8
Thread: M14 x 1,5 RHT
23162046, 5000516214, 5010144543,
5010245591



CV-ES-14162

Length: 125
Cone Ø: d1 Ø 30 / d2 Ø 27
Thread: M30 x 1,5 LHT
3401170, 5000288361, 5001832581,
5001858759, 5001858774



CV-ES-14163

Length: 125
Cone Ø: d1 Ø 30 / d2 Ø 27
Thread: M30 x 1,5 RHT
0003406169, 0003406236, 0003406251,
0003406254, 0003406260, 0003406261,
5000288360, 5000590236, 5000804824,
5001858773, 7420937674, 7701011412



DF-ES-9335

Length: 85
Cone Ø: d1 Ø 12 / d2 Ø 10,75
Thread: M14 x 1,5 RHT
23162046, 5000516214, 5010144543,
5010245591



DF-RK-8671

Ø: 80
Hole Distance: 145
Thick/Height: 30
5001014345



RV-DL-0902

Length: 720
Ø: 40
Cone Ø: d1 Ø 30 / d2 Ø 27
5010060764, 5010557243



RV-DL-2181

Length: 1650
Ø: 40
Cone Ø: d1 Ø 30 / d2 Ø 27
5010145581, 5010308215



RV-DL-8314

Length: 1758
Ø: 52
Cone Ø: d1 Ø 30 / d2 Ø 27
5010439021, 5010566063



RV-DL-8316

Length: 735
Ø: 50
Cone Ø: d1 Ø 30 / d2 Ø 27
5010383203, 5010488836, 5010557523



RV-ES-12331

Length: 140
Cone Ø: d1 Ø 30 / d2 Ø 27
Thread: M32 x 1,5 RHT / M24 x 1,5 RHT
0014607248, 014607248, 5001866165,
5001867774, 7485134391



SC-ES-7279

Length: 150
Cone Ø: d1 Ø 30 / d2 Ø 27
Thread: M30 x 1,5 RHT
5001852452, 5001858763





Magnum ...

AE 520.26	10/92→	Ball Head, gearshift linkage	CV-ES-2121			
	10/92→	Ball Head, gearshift linkage	DF-ES-9335			
	10/92→	Centre Rod	RV-DL-8316		Push Rod	
	10/92→	Suspension Strut Repair Kit		DF-RK-8671		
	10/92→	Tie Rod End	CV-ES-14162		for Steering Rod	
	10/92→	Tie Rod End	CV-ES-14163		for Steering Rod	
	10/92→	Tie Rod End	RV-ES-12331			
AE 520.26T	10/92→05/96	Ball Head, gearshift linkage	CV-ES-2121			
	10/92→05/96	Ball Head, gearshift linkage	DF-ES-9335			
	10/92→05/96	Centre Rod	RV-DL-0902		Push Rod	
	10/92→05/96	Centre Rod	RV-DL-8316		Push Rod	
	10/92→05/96	Suspension Strut Repair Kit		DF-RK-8671		
	10/92→05/96	Tie Rod End	CV-ES-14162		for Steering Rod	
	10/92→05/96	Tie Rod End	CV-ES-14163		for Steering Rod	
AE 560.18	04/96→	Ball Head, gearshift linkage	CV-ES-2121			
	04/96→	Ball Head, gearshift linkage	DF-ES-9335			
	04/96→	Centre Rod	RV-DL-0902		Push Rod	
	04/96→	Centre Rod	RV-DL-2181		Coupling Rod	
	04/96→	Centre Rod	RV-DL-8316		Push Rod	
	04/96→	Suspension Strut Repair Kit		DF-RK-8671		
	04/96→	Tie Rod End	CV-ES-14162		for Steering Rod	
	04/96→	Tie Rod End	CV-ES-14163		for Steering Rod	
	04/96→	Tie Rod End	RV-ES-12331			
	04/96→	Tie Rod End	SC-ES-7279		for Steering Rod	
AE 560.18T	04/96→	Ball Head, gearshift linkage	CV-ES-2121			
	04/96→	Ball Head, gearshift linkage	DF-ES-9335			
	04/96→	Centre Rod	RV-DL-0902		Push Rod	
	04/96→	Centre Rod	RV-DL-2181		Coupling Rod	
	04/96→	Centre Rod	RV-DL-8316		Push Rod	
	04/96→	Suspension Strut Repair Kit		DF-RK-8671		
	04/96→	Tie Rod End	CV-ES-14162		for Steering Rod	
	04/96→	Tie Rod End	CV-ES-14163		for Steering Rod	
	04/96→	Tie Rod End	RV-ES-12331			
	04/96→	Tie Rod End	SC-ES-7279		for Steering Rod	
AE 560.19	04/96→	Ball Head, gearshift linkage	CV-ES-2121			
	04/96→	Ball Head, gearshift linkage	DF-ES-9335			
	04/96→	Centre Rod	RV-DL-0902		Push Rod	
	04/96→	Centre Rod	RV-DL-2181		Coupling Rod	
	04/96→	Centre Rod	RV-DL-8316		Push Rod	
	04/96→	Suspension Strut Repair Kit		DF-RK-8671		
	04/96→	Tie Rod End	CV-ES-14162		for Steering Rod	
	04/96→	Tie Rod End	CV-ES-14163		for Steering Rod	
	04/96→	Tie Rod End	SC-ES-7279		for Steering Rod	
	AE 560.19T	04/96→	Ball Head, gearshift linkage	CV-ES-2121		
04/96→		Ball Head, gearshift linkage	DF-ES-9335			
04/96→		Centre Rod	RV-DL-0902		Push Rod	
04/96→		Centre Rod	RV-DL-2181		Coupling Rod	
04/96→		Centre Rod	RV-DL-8316		Push Rod	
04/96→		Suspension Strut Repair Kit		DF-RK-8671		
04/96→		Tie Rod End	CV-ES-14162		for Steering Rod	
04/96→		Tie Rod End	CV-ES-14163		for Steering Rod	
AE 560.26		04/96→	Ball Head, gearshift linkage	CV-ES-2121		
		04/96→	Ball Head, gearshift linkage	DF-ES-9335		
	04/96→	Centre Rod	RV-DL-0902		Push Rod	
	04/96→	Centre Rod	RV-DL-2181		Coupling Rod	
	04/96→	Centre Rod	RV-DL-8316		Push Rod	
	04/96→	Suspension Strut Repair Kit		DF-RK-8671		
	04/96→	Tie Rod End	CV-ES-14162		for Steering Rod	
	04/96→	Tie Rod End	CV-ES-14163		for Steering Rod	
	04/96→	Tie Rod End	RV-ES-12331			
	04/96→	Tie Rod End	SC-ES-7279		for Steering Rod	
AE 560.26T	01/97→	Ball Head, gearshift linkage	CV-ES-2121			
	01/97→	Ball Head, gearshift linkage	DF-ES-9335			
	01/97→	Centre Rod	RV-DL-0902		Push Rod	

CV-ES-2121

Length: 85
Cone Ø: d1 Ø 12 / d2 Ø 10,8
Thread: M14 x 1,5 RHT
23162046, 5000516214, 5010144543,
5010245591



RV-DL-2181

Length: 1650
Ø: 40
Cone Ø: d1 Ø 30 / d2 Ø 27
5010145581, 5010308215



CV-ES-14162

Length: 125
Cone Ø: d1 Ø 30 / d2 Ø 27
Thread: M30 x 1,5 LHT
3401170, 5000288361, 5001832581,
5001858759, 5001858774



RV-DL-8316

Length: 735
Ø: 50
Cone Ø: d1 Ø 30 / d2 Ø 27
5010383203, 5010488836, 5010557523



CV-ES-14163

Length: 125
Cone Ø: d1 Ø 30 / d2 Ø 27
Thread: M30 x 1,5 RHT
0003406169, 0003406236, 0003406251,
0003406254, 0003406260, 0003406261,
5000288360, 5000590236, 5000804824,
5001858773, 7420937674, 7701011412



RV-ES-12331

Length: 140
Cone Ø: d1 Ø 30 / d2 Ø 27
Thread: M32 x 1,5 RHT / M24 x 1,5 RHT
0014607248, 014607248, 5001866165,
5001867774, 7485134391



DF-ES-9335

Length: 85
Cone Ø: d1 Ø 12 / d2 Ø 10,75
Thread: M14 x 1,5 RHT
23162046, 5000516214, 5010144543,
5010245591



SC-ES-7279

Length: 150
Cone Ø: d1 Ø 30 / d2 Ø 27
Thread: M30 x 1,5 RHT
5001852452, 5001858763



DF-RK-8671

Ø: 80
Hole Distance: 145
Thick/Height: 30
5001014345



RV-DL-0902

Length: 720
Ø: 40
Cone Ø: d1 Ø 30 / d2 Ø 27
5010060764, 5010557243





Magnum ...

AE 560.26T ...	01/97→	Centre Rod	RV-DL-2181		Coupling Rod
	01/97→	Centre Rod	RV-DL-8316		Push Rod
	01/97→	Suspension Strut Repair Kit		DF-RK-8671	
	01/97→	Tie Rod	RV-DL-12318		
	01/97→	Tie Rod End	CV-ES-14162		for Steering Rod
	01/97→	Tie Rod End	CV-ES-14163		for Steering Rod
	01/97→	Tie Rod End	RV-ES-12331		
	01/97→	Tie Rod End	SC-ES-7279		for Steering Rod
DXi 12 440.18	10/04→04/06	Centre Rod	RV-DL-10244		Push Rod, Leaf Spring Axle
	10/04→04/06	Centre Rod	RV-DL-12319		for Steering Rod
	10/04→04/06	Tie Rod	RV-DL-10243		
	10/04→04/06	Tie Rod End	RV-ES-12331		
DXi 12 440.18 T	10/04→04/06	Centre Rod	RV-DL-10244		Push Rod, Leaf Spring Axle
	10/04→04/06	Centre Rod	RV-DL-12319		for Steering Rod
	10/04→04/06	Tie Rod	RV-DL-10243		
	10/04→04/06	Tie Rod End	RV-ES-12331		
DXi 12 440.24	10/04→04/06	Centre Rod	RV-DL-10244		Push Rod, Leaf Spring Axle
	10/04→04/06	Tie Rod	RV-DL-10243		
	10/04→04/06	Tie Rod End	RV-ES-12331		
DXi 12 440.26	10/04→04/06	Centre Rod	RV-DL-10244		Push Rod, Leaf Spring Axle
	10/04→04/06	Tie Rod	RV-DL-10243		
	10/04→04/06	Tie Rod End	RV-ES-12331		
DXi 12 440.26 T	10/04→04/06	Centre Rod	RV-DL-10244		Push Rod
	10/04→04/06	Centre Rod	RV-DL-10244		Push Rod, Leaf Spring Axle
	10/04→04/06	Tie Rod	RV-DL-10243		
	10/04→04/06	Tie Rod End	RV-ES-12331		
DXi 12 480.18	10/04→04/06	Centre Rod	RV-DL-10244		Push Rod, Leaf Spring Axle
	10/04→04/06	Tie Rod	RV-DL-10243		
	10/04→04/06	Tie Rod End	RV-ES-12331		
DXi 12 480.18 T	10/04→04/06	Centre Rod	RV-DL-10244		Push Rod, Leaf Spring Axle
	10/04→04/06	Tie Rod	RV-DL-10243		
	10/04→04/06	Tie Rod End	RV-ES-12331		
DXi 12 480.24	10/04→04/06	Centre Rod	RV-DL-10244		Push Rod, Leaf Spring Axle
	10/04→04/06	Tie Rod	RV-DL-10243		
	10/04→04/06	Tie Rod End	RV-ES-12331		
DXi 12 480.26	10/04→04/06	Centre Rod	RV-DL-10244		Push Rod, Leaf Spring Axle
	10/04→04/06	Tie Rod	RV-DL-10243		
	10/04→04/06	Tie Rod End	RV-ES-12331		
DXi 12 480.26 T	10/04→04/06	Centre Rod	RV-DL-10244		Push Rod
	10/04→04/06	Centre Rod	RV-DL-10244		Push Rod, Leaf Spring Axle
	10/04→04/06	Tie Rod	RV-DL-10243		
	10/04→04/06	Tie Rod End	RV-ES-12331		
DXi 13 440.19	03/09→	Centre Rod	RV-DL-10244		Push Rod, Leaf Spring Axle
	03/09→	Centre Rod	RV-DL-12319		for Steering Rod
	03/09→	Centre Rod	RV-DL-12478		Push Rod
	03/09→	Tie Rod	RV-DL-10243		
	03/09→	Tie Rod End	RV-ES-12331		
DXi 13 460.18 T	05/06→	Centre Rod	RV-DL-10244		Push Rod, Leaf Spring Axle
	05/06→	Centre Rod	RV-DL-12319		for Steering Rod
	05/06→	Tie Rod	RV-DL-10243		
	05/06→	Tie Rod End	RV-ES-12331		
DXi 13 460.24	05/06→	Centre Rod	RV-DL-10244		Push Rod
	05/06→	Centre Rod	RV-DL-12478		Push Rod
	05/06→	Tie Rod	RV-DL-10243		
	05/06→	Tie Rod End	RV-ES-12331		
DXi 13 460.25	05/06→	Centre Rod	RV-DL-10244		Push Rod
	05/06→	Centre Rod	RV-DL-12478		Push Rod
	05/06→	Tie Rod	RV-DL-10243		
	05/06→	Tie Rod End	RV-ES-12331		
DXi 13 460.26	05/06→	Centre Rod	RV-DL-10244		Push Rod
	05/06→	Centre Rod	RV-DL-12478		Push Rod
	05/06→	Tie Rod	RV-DL-10243		
	05/06→	Tie Rod End	RV-ES-12331		

CV-ES-14162

Length: 125
Cone Ø: d1 Ø 30 / d2 Ø 27
Thread: M30 x 1,5 LHT
3401170, 5000288361, 5001832581,
5001858759, 5001858774



RV-DL-10244

Length: 700
Ø: 50
Cone Ø: d1 Ø 30 / d2 Ø 27
5001868374, 5010630637, 5010630638,
7421560825



CV-ES-14163

Length: 125
Cone Ø: d1 Ø 30 / d2 Ø 27
Thread: M30 x 1,5 RHT
0003406169, 0003406236, 0003406251,
0003406254, 0003406260, 0003406261,
5000288360, 5000590236, 5000804824,
5001858773, 7420937674, 7701011412



RV-DL-12318

Length: 1650
Ø: 40
Cone Ø: d1 Ø 26 / d2 Ø 23,5
5010566157



DF-RK-8671

Ø: 80
Hole Distance: 145
Thick/Height: 30
5001014345



RV-DL-12319

Length: 697
Ø: 50
Cone Ø: d1 Ø 30
25379258, 5001868377, 5010630649,
5010630650, 7421560838



RV-DL-2181

Length: 1650
Ø: 40
Cone Ø: d1 Ø 30 / d2 Ø 27
5010145581, 5010308215



RV-DL-12478

Length: 696
Ø: 52
Cone Ø: d1 Ø 30
50 01 868 376, 50 10 630 648

No Image

RV-DL-8316

Length: 735
Ø: 50
Cone Ø: d1 Ø 30 / d2 Ø 27
5010383203, 5010488836, 5010557523



RV-ES-12331

Length: 140
Cone Ø: d1 Ø 30 / d2 Ø 27
Thread: M32 x 1,5 RHT / M24 x 1,5 RHT
0014607248, 014607248, 5001866165,
5001867774, 7485134391



RV-DL-10243

Length: 1726
Ø: 60
Cone Ø: d1 Ø 30 / d2 Ø 27
Thread: M24 x 1,5 RHT
5001868363, 5010587004, 5010600822,
7421560957



SC-ES-7279

Length: 150
Cone Ø: d1 Ø 30 / d2 Ø 27
Thread: M30 x 1,5 RHT
5001852452, 5001858763



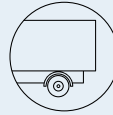
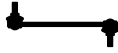

Magnum ...

DXi 13 460.26 T	05/06→	Centre Rod	RV-DL-10244	Push Rod, Leaf Spring Axle
	05/06→	Tie Rod	RV-DL-10243	
	05/06→	Tie Rod End	RV-ES-12331	
DXi 13 480.19	03/09→	Centre Rod	RV-DL-12478	Push Rod
	03/09→	Tie Rod	RV-DL-10243	
	03/09→	Tie Rod End	RV-ES-12331	
DXi 13 480.26	03/09→	Centre Rod	RV-DL-10244	Push Rod, Leaf Spring Axle
	03/09→	Centre Rod	RV-DL-12478	Push Rod
	03/09→	Tie Rod	RV-DL-10243	
	03/09→	Tie Rod End	RV-ES-12331	
DXi 13 500.18 T	05/06→	Centre Rod	RV-DL-10244	Push Rod, Leaf Spring Axle
	05/06→	Centre Rod	RV-DL-12319	for Steering Rod
	05/06→	Tie Rod	RV-DL-10243	
	05/06→	Tie Rod End	RV-ES-12331	
DXi 13 500.24	05/06→	Centre Rod	RV-DL-10244	Push Rod
	05/06→	Centre Rod	RV-DL-12478	Push Rod
	05/06→	Tie Rod	RV-DL-10243	
	05/06→	Tie Rod End	RV-ES-12331	
DXi 13 500.25	05/06→	Centre Rod	RV-DL-10244	Push Rod
	05/06→	Centre Rod	RV-DL-12478	Push Rod
	05/06→	Tie Rod	RV-DL-10243	
	05/06→	Tie Rod End	RV-ES-12331	
DXi 13 500.26	05/06→	Centre Rod	RV-DL-10244	Push Rod
	05/06→	Centre Rod	RV-DL-12478	Push Rod
	05/06→	Tie Rod	RV-DL-10243	
	05/06→	Tie Rod End	RV-ES-12331	
DXi 13 500.26 T	05/06→	Centre Rod	RV-DL-10244	Push Rod, Leaf Spring Axle
	05/06→	Tie Rod	RV-DL-10243	
	05/06→	Tie Rod End	RV-ES-12331	
DXi 13 520.18	08/09→	Centre Rod	RV-DL-10244	Push Rod, Leaf Spring Axle
	08/09→	Centre Rod	RV-DL-12319	for Steering Rod
	08/09→	Tie Rod	RV-DL-10243	
	08/09→	Tie Rod End	RV-ES-12331	
DXi 13 520.19	08/09→	Centre Rod	RV-DL-10244	Push Rod, Leaf Spring Axle
	08/09→	Centre Rod	RV-DL-12319	for Steering Rod
	08/09→	Centre Rod	RV-DL-12478	Push Rod
	08/09→	Tie Rod	RV-DL-10243	
	08/09→	Tie Rod End	RV-ES-12331	
DXi 13 520.24	08/09→	Tie Rod	RV-DL-10243	
	08/09→	Tie Rod End	RV-ES-12331	
DXi 13 520.25	08/09→	Tie Rod	RV-DL-10243	
	08/09→	Tie Rod End	RV-ES-12331	
DXi 13 520.26	08/09→	Centre Rod	RV-DL-10244	Push Rod, Leaf Spring Axle
	08/09→	Tie Rod	RV-DL-10243	
	08/09→	Tie Rod End	RV-ES-12331	
E.TECH 400.18	05/00→	Ball Head, gearshift linkage	CV-ES-2121	
	05/00→	Centre Rod	RV-DL-0902	Push Rod
	05/00→	Centre Rod	RV-DL-2181	Coupling Rod
	05/00→	Centre Rod	RV-DL-8316	Push Rod
	05/00→	Tie Rod	RV-DL-8314	Guide Rod, Air Suspension Axle
	05/00→	Tie Rod	RV-DL-12318	
	05/00→	Tie Rod End	CV-ES-14162	for Steering Rod
	05/00→	Tie Rod End	CV-ES-14163	for Steering Rod
	05/00→	Tie Rod End	SC-ES-7279	for Steering Rod
E.TECH 400.18T	05/00→	Ball Head, gearshift linkage	CV-ES-2121	
	05/00→	Centre Rod	RV-DL-0902	Push Rod
	05/00→	Centre Rod	RV-DL-2181	Coupling Rod
	05/00→	Centre Rod	RV-DL-8316	Push Rod
	05/00→	Tie Rod	RV-DL-8314	Guide Rod
	05/00→	Tie Rod	RV-DL-12318	
	05/00→	Tie Rod End	CV-ES-12461	for Steering Rod
	05/00→	Tie Rod End	CV-ES-12462	for Steering Rod
	05/00→	Tie Rod End	CV-ES-14162	for Steering Rod

CV-ES-2121

Length: 85
Cone Ø: d1 Ø 12 / d2 Ø 10,8
Thread: M14 x 1,5 RHT
23162046, 5000516214, 5010144543,
5010245591



CV-ES-12461

Length: 120
Cone Ø: d1 Ø 26 / d2 Ø 23,5
Thread: M30 x 1,5 LHT
0003406213, 3406218, 5000242467,
5000242488, 5000295215, 5000295336,
5000588470, 5000805280, 5000806187,
5000814347, 5000820879, 5000823654,
5001834533, 5001850550, 5001852263,
5001859984



CV-ES-12462

Length: 120
Cone Ø: d1 Ø 26 / d2 Ø 23,5
Thread: M30 x 1,5 RHT
0003406212, 0003406253, 5000242159,
5000295214, 5000812483, 5001831473,
5001850549, 5001852264, 5001859985,
7701016946



CV-ES-14162

Length: 125
Cone Ø: d1 Ø 30 / d2 Ø 27
Thread: M30 x 1,5 LHT
3401170, 5000288361, 5001832581,
5001858759, 5001858774



CV-ES-14163

Length: 125
Cone Ø: d1 Ø 30 / d2 Ø 27
Thread: M30 x 1,5 RHT
0003406169, 0003406236, 0003406251,
0003406254, 0003406260, 0003406261,
5000288360, 5000590236, 5000804824,
5001858773, 7420937674, 7701011412



RV-DL-0902

Length: 720
Ø: 40
Cone Ø: d1 Ø 30 / d2 Ø 27
5010060764, 5010557243



RV-DL-2181

Length: 1650
Ø: 40
Cone Ø: d1 Ø 30 / d2 Ø 27
5010145581, 5010308215



RV-DL-8314

Length: 1758
Ø: 52
Cone Ø: d1 Ø 30 / d2 Ø 27
5010439021, 5010566063



RV-DL-8316

Length: 735
Ø: 50
Cone Ø: d1 Ø 30 / d2 Ø 27
5010383203, 5010488836, 5010557523



RV-DL-10243

Length: 1726
Ø: 60
Cone Ø: d1 Ø 30 / d2 Ø 27
Thread: M24 x 1,5 RHT
5001868363, 5010587004, 5010600822,
7421560957



RV-DL-10244

Length: 700
Ø: 50
Cone Ø: d1 Ø 30 / d2 Ø 27
5001868374, 5010630637, 5010630638,
7421560825



RV-DL-12318

Length: 1650
Ø: 40
Cone Ø: d1 Ø 26 / d2 Ø 23,5
5010566157



RV-DL-12319

Length: 697
Ø: 50
Cone Ø: d1 Ø 30
25379258, 5001868377, 5010630649,
5010630650, 7421560838



RV-DL-12478

Length: 696
Ø: 52
Cone Ø: d1 Ø 30
50 01 868 376, 50 10 630 648

No Image

RV-ES-12331

Length: 140
Cone Ø: d1 Ø 30 / d2 Ø 27
Thread: M32 x 1,5 RHT / M24 x 1,5 RHT
0014607248, 014607248, 5001866165,
5001867774, 7485134391



SC-ES-7279

Length: 150
Cone Ø: d1 Ø 30 / d2 Ø 27
Thread: M30 x 1,5 RHT
5001852452, 5001858763





Magnum ...

E.TECH 400.18T ...	05/00→	Tie Rod End	CV-ES-14163	for Steering Rod
	05/00→	Tie Rod End	SC-ES-7279	for Steering Rod
E.TECH 400.24	05/00→	Ball Head, gearshift linkage	CV-ES-2121	
	05/00→	Centre Rod	RV-DL-0902	Push Rod
	05/00→	Centre Rod	RV-DL-2181	Coupling Rod
	05/00→	Centre Rod	RV-DL-8316	Push Rod
	05/00→	Tie Rod	RV-DL-8314	Guide Rod, Air Suspension Axle
	05/00→	Tie Rod	RV-DL-12318	
	05/00→	Tie Rod End	CV-ES-14162	for Steering Rod
	05/00→	Tie Rod End	CV-ES-14163	for Steering Rod
	05/00→	Tie Rod End	SC-ES-7279	for Steering Rod
E.TECH 400.26	05/00→	Ball Head, gearshift linkage	CV-ES-2121	
	05/00→	Centre Rod	RV-DL-0902	Push Rod
	05/00→	Centre Rod	RV-DL-2181	Coupling Rod
	05/00→	Centre Rod	RV-DL-8316	Push Rod
	05/00→	Tie Rod	RV-DL-8314	Guide Rod, Air Suspension Axle
	05/00→	Tie Rod	RV-DL-12318	
	05/00→	Tie Rod End	CV-ES-14162	for Steering Rod
	05/00→	Tie Rod End	CV-ES-14163	for Steering Rod
	05/00→	Tie Rod End	SC-ES-7279	for Steering Rod
E.TECH 440.18	05/00→	Ball Head, gearshift linkage	CV-ES-2121	
	05/00→	Centre Rod	RV-DL-0902	Push Rod
	05/00→	Centre Rod	RV-DL-2181	Coupling Rod
	05/00→	Centre Rod	RV-DL-8316	Push Rod
	05/00→	Tie Rod	RV-DL-8314	Guide Rod, Air Suspension Axle
	05/00→	Tie Rod	RV-DL-12318	
	05/00→	Tie Rod End	CV-ES-14162	for Steering Rod
	05/00→	Tie Rod End	CV-ES-14163	for Steering Rod
	05/00→	Tie Rod End	SC-ES-7279	for Steering Rod
E.TECH 440.18T	05/00→	Ball Head, gearshift linkage	CV-ES-2121	
	05/00→	Centre Rod	RV-DL-0902	Push Rod
	05/00→	Centre Rod	RV-DL-2181	Coupling Rod
	05/00→	Centre Rod	RV-DL-8316	Push Rod
	05/00→	Tie Rod	RV-DL-8314	Guide Rod
	05/00→	Tie Rod	RV-DL-12318	
	05/00→	Tie Rod End	CV-ES-12461	for Steering Rod
	05/00→	Tie Rod End	CV-ES-12462	for Steering Rod
	05/00→	Tie Rod End	CV-ES-14162	for Steering Rod
	05/00→	Tie Rod End	CV-ES-14163	for Steering Rod
05/00→	Tie Rod End	SC-ES-7279	for Steering Rod	
E.TECH 440.24	05/00→	Ball Head, gearshift linkage	CV-ES-2121	
	05/00→	Centre Rod	RV-DL-0902	Push Rod
	05/00→	Centre Rod	RV-DL-2181	Coupling Rod
	05/00→	Centre Rod	RV-DL-8316	Push Rod
	05/00→	Tie Rod	RV-DL-8314	Guide Rod, Air Suspension Axle
	05/00→	Tie Rod	RV-DL-12318	
	05/00→	Tie Rod End	CV-ES-14162	for Steering Rod
	05/00→	Tie Rod End	CV-ES-14163	for Steering Rod
	05/00→	Tie Rod End	SC-ES-7279	for Steering Rod
	05/00→	Tie Rod End	SC-ES-7279	for Steering Rod
E.TECH 440.26	05/00→	Ball Head, gearshift linkage	CV-ES-2121	
	05/00→	Centre Rod	RV-DL-0902	Push Rod
	05/00→	Centre Rod	RV-DL-2181	Coupling Rod
	05/00→	Centre Rod	RV-DL-8316	Push Rod
	05/00→	Tie Rod	RV-DL-8314	Guide Rod, Air Suspension Axle
	05/00→	Tie Rod	RV-DL-12318	
	05/00→	Tie Rod End	CV-ES-14162	for Steering Rod
	05/00→	Tie Rod End	CV-ES-14163	for Steering Rod
	05/00→	Tie Rod End	SC-ES-7279	for Steering Rod
E.TECH 440.26T	05/00→	Ball Head, gearshift linkage	CV-ES-2121	
	05/00→	Centre Rod	RV-DL-0902	Push Rod
	05/00→	Centre Rod	RV-DL-2181	Coupling Rod
	05/00→	Centre Rod	RV-DL-8316	Push Rod
	05/00→	Tie Rod	RV-DL-8314	Guide Rod

CV-ES-2121

Length: 85
Cone Ø: d1 Ø 12 / d2 Ø 10,8
Thread: M14 x 1,5 RHT
23162046, 5000516214, 5010144543,
5010245591



CV-ES-12461

Length: 120
Cone Ø: d1 Ø 26 / d2 Ø 23,5
Thread: M30 x 1,5 LHT
0003406213, 3406218, 5000242467,
5000242488, 5000295215, 5000295336,
5000588470, 5000805280, 5000806187,
5000814347, 5000820879, 5000823654,
5001834533, 5001850550, 5001852263,
5001859984



CV-ES-12462

Length: 120
Cone Ø: d1 Ø 26 / d2 Ø 23,5
Thread: M30 x 1,5 RHT
0003406212, 0003406253, 5000242159,
5000295214, 5000812483, 5001831473,
5001850549, 5001852264, 5001859985,
7701016946



CV-ES-14162

Length: 125
Cone Ø: d1 Ø 30 / d2 Ø 27
Thread: M30 x 1,5 LHT
3401170, 5000288361, 5001832581,
5001858759, 5001858774



CV-ES-14163

Length: 125
Cone Ø: d1 Ø 30 / d2 Ø 27
Thread: M30 x 1,5 RHT
0003406169, 0003406236, 0003406251,
0003406254, 0003406260, 0003406261,
5000288360, 5000590236, 5000804824,
5001858773, 7420937674, 7701011412



RV-DL-0902

Length: 720
Ø: 40
Cone Ø: d1 Ø 30 / d2 Ø 27
5010060764, 5010557243



RV-DL-2181

Length: 1650
Ø: 40
Cone Ø: d1 Ø 30 / d2 Ø 27
5010145581, 5010308215



RV-DL-8314

Length: 1758
Ø: 52
Cone Ø: d1 Ø 30 / d2 Ø 27
5010439021, 5010566063



RV-DL-8316

Length: 735
Ø: 50
Cone Ø: d1 Ø 30 / d2 Ø 27
5010383203, 5010488836, 5010557523



RV-DL-12318

Length: 1650
Ø: 40
Cone Ø: d1 Ø 26 / d2 Ø 23,5
5010566157



SC-ES-7279

Length: 150
Cone Ø: d1 Ø 30 / d2 Ø 27
Thread: M30 x 1,5 RHT
5001852452, 5001858763





Magnum ...

E.TECH 440.26T ...	05/00→	Tie Rod	RV-DL-8314	Guide Rod, Air Suspension Axle	
	05/00→	Tie Rod	RV-DL-12318		
	05/00→	Tie Rod End	CV-ES-12461	for Steering Rod	
	05/00→	Tie Rod End	CV-ES-12462	for Steering Rod	
	05/00→	Tie Rod End	CV-ES-14162	for Steering Rod	
	05/00→	Tie Rod End	CV-ES-14163	for Steering Rod	
	05/00→	Tie Rod End	SC-ES-7279	for Steering Rod	
E.TECH 480.18	05/00→	Ball Head, gearshift linkage	CV-ES-2121		
	05/00→	Centre Rod	RV-DL-0902	Push Rod	
	05/00→	Centre Rod	RV-DL-2181	Coupling Rod	
	05/00→	Centre Rod	RV-DL-8316	Push Rod	
	05/00→	Tie Rod	RV-DL-8314	Guide Rod, Air Suspension Axle	
	05/00→	Tie Rod	RV-DL-12318		
	05/00→	Tie Rod End	CV-ES-14162	for Steering Rod	
	05/00→	Tie Rod End	CV-ES-14163	for Steering Rod	
E.TECH 480.18T	05/00→	Ball Head, gearshift linkage	CV-ES-2121		
	05/00→	Centre Rod	RV-DL-0902	Push Rod	
	05/00→	Centre Rod	RV-DL-2181	Coupling Rod	
	05/00→	Centre Rod	RV-DL-8316	Push Rod	
	05/00→	Tie Rod	RV-DL-8314	Guide Rod	
	05/00→	Tie Rod	RV-DL-12318		
	05/00→	Tie Rod End	CV-ES-12461	for Steering Rod	
	05/00→	Tie Rod End	CV-ES-12462	for Steering Rod	
	05/00→	Tie Rod End	CV-ES-14162	for Steering Rod	
	05/00→	Tie Rod End	CV-ES-14163	for Steering Rod	
	05/00→	Tie Rod End	SC-ES-7279	for Steering Rod	
	E.TECH 480.24	05/00→	Ball Head, gearshift linkage	CV-ES-2121	
		05/00→	Centre Rod	RV-DL-0902	Push Rod
		05/00→	Centre Rod	RV-DL-2181	Coupling Rod
05/00→		Centre Rod	RV-DL-8316	Push Rod	
05/00→		Tie Rod	RV-DL-8314	Guide Rod, Air Suspension Axle	
05/00→		Tie Rod	RV-DL-12318		
05/00→		Tie Rod End	CV-ES-14162	for Steering Rod	
05/00→		Tie Rod End	CV-ES-14163	for Steering Rod	
05/00→		Tie Rod End	SC-ES-7279	for Steering Rod	
E.TECH 480.26		05/00→	Ball Head, gearshift linkage	CV-ES-2121	
	05/00→	Centre Rod	RV-DL-0902	Push Rod	
	05/00→	Centre Rod	RV-DL-2181	Coupling Rod	
	05/00→	Centre Rod	RV-DL-8316	Push Rod	
	05/00→	Tie Rod	RV-DL-8314	Guide Rod, Air Suspension Axle	
	05/00→	Tie Rod	RV-DL-12318		
	05/00→	Tie Rod End	CV-ES-14162	for Steering Rod	
	05/00→	Tie Rod End	CV-ES-14163	for Steering Rod	
E.TECH 480.26T	05/00→	Ball Head, gearshift linkage	CV-ES-2121		
	05/00→	Centre Rod	RV-DL-0902	Push Rod	
	05/00→	Centre Rod	RV-DL-2181	Coupling Rod	
	05/00→	Centre Rod	RV-DL-8316	Push Rod	
	05/00→	Tie Rod	RV-DL-8314	Guide Rod	
	05/00→	Tie Rod	RV-DL-8314	Guide Rod, Air Suspension Axle	
	05/00→	Tie Rod	RV-DL-12318		
	05/00→	Tie Rod End	CV-ES-12461	for Steering Rod	
	05/00→	Tie Rod End	CV-ES-12462	for Steering Rod	
	05/00→	Tie Rod End	CV-ES-14162	for Steering Rod	
	05/00→	Tie Rod End	CV-ES-14163	for Steering Rod	
	05/00→	Tie Rod End	SC-ES-7279	for Steering Rod	

CV-ES-2121

Length: 85
Cone Ø: d1 Ø 12 / d2 Ø 10,8
Thread: M14 x 1,5 RHT
23162046, 5000516214, 5010144543,
5010245591



CV-ES-12461

Length: 120
Cone Ø: d1 Ø 26 / d2 Ø 23,5
Thread: M30 x 1,5 LHT
0003406213, 3406218, 5000242467,
5000242488, 5000295215, 5000295336,
5000588470, 5000805280, 5000806187,
5000814347, 5000820879, 5000823654,
5001834533, 5001850550, 5001852263,
5001859984



CV-ES-12462

Length: 120
Cone Ø: d1 Ø 26 / d2 Ø 23,5
Thread: M30 x 1,5 RHT
0003406212, 0003406253, 5000242159,
5000295214, 5000812483, 5001831473,
5001850549, 5001852264, 5001859985,
7701016946



CV-ES-14162

Length: 125
Cone Ø: d1 Ø 30 / d2 Ø 27
Thread: M30 x 1,5 LHT
3401170, 5000288361, 5001832581,
5001858759, 5001858774



CV-ES-14163

Length: 125
Cone Ø: d1 Ø 30 / d2 Ø 27
Thread: M30 x 1,5 RHT
0003406169, 0003406236, 0003406251,
0003406254, 0003406260, 0003406261,
5000288360, 5000590236, 5000804824,
5001858773, 7420937674, 7701011412



RV-DL-0902

Length: 720
Ø: 40
Cone Ø: d1 Ø 30 / d2 Ø 27
5010060764, 5010557243



RV-DL-2181

Length: 1650
Ø: 40
Cone Ø: d1 Ø 30 / d2 Ø 27
5010145581, 5010308215



RV-DL-8314

Length: 1758
Ø: 52
Cone Ø: d1 Ø 30 / d2 Ø 27
5010439021, 5010566063



RV-DL-8316

Length: 735
Ø: 50
Cone Ø: d1 Ø 30 / d2 Ø 27
5010383203, 5010488836, 5010557523



RV-DL-12318

Length: 1650
Ø: 40
Cone Ø: d1 Ø 26 / d2 Ø 23,5
5010566157



SC-ES-7279

Length: 150
Cone Ø: d1 Ø 30 / d2 Ø 27
Thread: M30 x 1,5 RHT
5001852452, 5001858763





Major

R 340ti.16/T	05/91→04/93	Centre Rod	RV-DL-8177	Push Rod
	05/91→05/93	Centre Rod	RV-DL-0074	Push Rod
	05/91→10/96	Ball Head, gearshift linkage	CV-ES-2121	
	05/91→10/96	Centre Rod	RV-DL-2181	Coupling Rod
	05/91→10/96	Tie Rod End	CV-ES-0912	
	05/91→10/96	Tie Rod End	CV-ES-0914	for Steering Rod
	05/91→10/96	Tie Rod End	CV-ES-14162	for Steering Rod
	05/91→10/96	Tie Rod End	CV-ES-14163	for Steering Rod
	05/91→10/96	Tie Rod End	RV-ES-12445	
	05/91→10/96	Tie Rod End	RV-ES-12446	
	01/93→10/96	Tie Rod	RV-DL-8313	Guide Rod
R 340ti.17	05/91→04/93	Centre Rod	RV-DL-8177	Push Rod
	05/91→05/93	Centre Rod	RV-DL-0074	Push Rod
	05/91→10/96	Ball Head, gearshift linkage	CV-ES-2121	
	05/91→10/96	Centre Rod	RV-DL-2181	Coupling Rod
	05/91→10/96	Tie Rod End	CV-ES-0912	
	05/91→10/96	Tie Rod End	CV-ES-0914	for Steering Rod
	05/91→10/96	Tie Rod End	CV-ES-14162	for Steering Rod
	05/91→10/96	Tie Rod End	CV-ES-14163	for Steering Rod
	05/91→10/96	Tie Rod End	RV-ES-12445	
	05/91→10/96	Tie Rod End	RV-ES-12446	
	01/93→10/96	Tie Rod	RV-DL-8313	Guide Rod
R 340ti.18	05/91→04/93	Centre Rod	RV-DL-8177	Push Rod
	05/91→05/93	Centre Rod	RV-DL-0074	Push Rod
	05/91→10/96	Ball Head, gearshift linkage	CV-ES-2121	
	05/91→10/96	Centre Rod	RV-DL-2181	Coupling Rod
	05/91→10/96	Tie Rod End	CV-ES-0912	
	05/91→10/96	Tie Rod End	CV-ES-0914	for Steering Rod
	05/91→10/96	Tie Rod End	CV-ES-14162	for Steering Rod
	05/91→10/96	Tie Rod End	CV-ES-14163	for Steering Rod
	05/91→10/96	Tie Rod End	RV-ES-12445	
	05/91→10/96	Tie Rod End	RV-ES-12446	
	01/93→10/96	Tie Rod	RV-DL-8313	Guide Rod
R 340ti.18/T	05/91→04/93	Centre Rod	RV-DL-8177	Push Rod
	05/91→05/93	Centre Rod	RV-DL-0074	Push Rod
	05/91→10/96	Ball Head, gearshift linkage	CV-ES-2121	
	05/91→10/96	Centre Rod	RV-DL-2181	Coupling Rod
	05/91→10/96	Tie Rod End	CV-ES-0912	
	05/91→10/96	Tie Rod End	CV-ES-0914	for Steering Rod
	05/91→10/96	Tie Rod End	CV-ES-14162	for Steering Rod
	05/91→10/96	Tie Rod End	CV-ES-14163	for Steering Rod
	05/91→10/96	Tie Rod End	RV-ES-12445	
	05/91→10/96	Tie Rod End	RV-ES-12446	
	01/93→10/96	Tie Rod	RV-DL-8313	Guide Rod
R 340ti.19	05/91→04/93	Centre Rod	RV-DL-8177	Push Rod
	05/91→05/93	Centre Rod	RV-DL-0074	Push Rod
	05/91→10/96	Ball Head, gearshift linkage	CV-ES-2121	
	05/91→10/96	Centre Rod	RV-DL-2181	Coupling Rod
	05/91→10/96	Tie Rod End	CV-ES-0912	
	05/91→10/96	Tie Rod End	CV-ES-0914	for Steering Rod
	05/91→10/96	Tie Rod End	CV-ES-14162	for Steering Rod
	05/91→10/96	Tie Rod End	CV-ES-14163	for Steering Rod
	05/91→10/96	Tie Rod End	RV-ES-12445	
	05/91→10/96	Tie Rod End	RV-ES-12446	
	01/93→10/96	Tie Rod	RV-DL-8313	Guide Rod
R 340ti.19/T	05/91→04/93	Centre Rod	RV-DL-8177	Push Rod
	05/91→05/93	Centre Rod	RV-DL-0074	Push Rod
	05/91→10/96	Ball Head, gearshift linkage	CV-ES-2121	
	05/91→10/96	Centre Rod	RV-DL-2181	Coupling Rod
	05/91→10/96	Tie Rod End	CV-ES-0912	

CV-ES-0912

Length: 125
Cone Ø: d1 Ø 30 / d2 Ø 27
Thread: M38 x 1,5 LHT
3401206, 5001832579



RV-DL-0882

Length: 1040
Ø: 62
Cone Ø: d1 Ø 30 / d2 Ø 27
5010130740, 5010239387



CV-ES-0914

Length: 125
Cone Ø: d1 Ø 30 / d2 Ø 27
Thread: M38 x 1,5 RHT
3401207, 5001832580



RV-DL-2181

Length: 1650
Ø: 40
Cone Ø: d1 Ø 30 / d2 Ø 27
5010145581, 5010308215



CV-ES-2121

Length: 85
Cone Ø: d1 Ø 12 / d2 Ø 10,8
Thread: M14 x 1,5 RHT
23162046, 5000516214, 5010144543,
5010245591



RV-DL-8177

Length: 1012
Ø: 52
Cone Ø: d1 Ø 30 / d2 Ø 27
5010130451, 7485114925



CV-ES-14162

Length: 125
Cone Ø: d1 Ø 30 / d2 Ø 27
Thread: M30 x 1,5 LHT
3401170, 5000288361, 5001832581,
5001858759, 5001858774



RV-DL-8313

Length: 1752
Ø: 48
Cone Ø: d1 Ø 30 / d2 Ø 27
5010098467, 5010145584, 5010439631



CV-ES-14163

Length: 125
Cone Ø: d1 Ø 30 / d2 Ø 27
Thread: M30 x 1,5 RHT
0003406169, 0003406236, 0003406251,
0003406254, 0003406260, 0003406261,
5000288360, 5000590236, 5000804824,
5001858773, 7420937674, 7701011412



RV-ES-12445

Length: 170
Cone Ø: d1 Ø 30 / d2 Ø 27
5000288363



RV-ES-12446

Length: 170
Cone Ø: d1 Ø 30 / d2 Ø 27
5000288362



RV-DL-0074

Length: 1012
Ø: 52
Cone Ø: d1 Ø 30 / d2 Ø 27
5010130453





Major ...

R 340ti.19/T ...	05/91→10/96	Tie Rod End	CV-ES-0914	for Steering Rod
	05/91→10/96	Tie Rod End	CV-ES-14162	for Steering Rod
	05/91→10/96	Tie Rod End	CV-ES-14163	for Steering Rod
	05/91→10/96	Tie Rod End	RV-ES-12445	
	05/91→10/96	Tie Rod End	RV-ES-12446	
	01/93→10/96	Tie Rod	RV-DL-8313	Guide Rod
R 340ti.24	05/91→04/93	Centre Rod	RV-DL-8177	Push Rod
	05/91→05/93	Centre Rod	RV-DL-0074	Push Rod
	05/91→10/96	Ball Head, gearshift linkage	CV-ES-2121	
	05/91→10/96	Centre Rod	RV-DL-2181	Coupling Rod
	05/91→10/96	Tie Rod End	CV-ES-0912	
	05/91→10/96	Tie Rod End	CV-ES-0914	for Steering Rod
	05/91→10/96	Tie Rod End	CV-ES-14162	for Steering Rod
	05/91→10/96	Tie Rod End	CV-ES-14163	for Steering Rod
	05/91→10/96	Tie Rod End	RV-ES-12445	
	05/91→10/96	Tie Rod End	RV-ES-12446	
	01/93→10/96	Tie Rod	RV-DL-8313	Guide Rod
	05/93→10/96	Centre Rod	RV-DL-0882	Push Rod
	R 340ti.26	05/91→04/93	Centre Rod	RV-DL-8177
05/91→05/93		Centre Rod	RV-DL-0074	Push Rod
05/91→10/96		Ball Head, gearshift linkage	CV-ES-2121	
05/91→10/96		Centre Rod	RV-DL-2181	Coupling Rod
05/91→10/96		Tie Rod End	CV-ES-0912	
05/91→10/96		Tie Rod End	CV-ES-0914	for Steering Rod
05/91→10/96		Tie Rod End	CV-ES-14162	for Steering Rod
05/91→10/96		Tie Rod End	CV-ES-14163	for Steering Rod
05/91→10/96		Tie Rod End	RV-ES-12445	
05/91→10/96		Tie Rod End	RV-ES-12446	
01/93→10/96		Tie Rod	RV-DL-8313	Guide Rod
05/93→10/96		Centre Rod	RV-DL-0882	Push Rod
R 350.17		05/91→12/92	Ball Head, gearshift linkage	CV-ES-2121
	05/91→12/92	Centre Rod	RV-DL-0074	Push Rod
	05/91→12/92	Centre Rod	RV-DL-2181	Coupling Rod
	05/91→12/92	Centre Rod	RV-DL-8177	Push Rod
	05/91→12/92	Tie Rod End	CV-ES-0912	
	05/91→12/92	Tie Rod End	CV-ES-0914	for Steering Rod
	05/91→12/92	Tie Rod End	CV-ES-14162	for Steering Rod
	05/91→12/92	Tie Rod End	CV-ES-14163	for Steering Rod
	05/91→12/92	Tie Rod End	RV-ES-12446	
R 350.17/T	05/91→12/92	Ball Head, gearshift linkage	CV-ES-2121	
	05/91→12/92	Centre Rod	RV-DL-0074	Push Rod
	05/91→12/92	Centre Rod	RV-DL-2181	Coupling Rod
	05/91→12/92	Centre Rod	RV-DL-8177	Push Rod
	05/91→12/92	Tie Rod End	CV-ES-0912	
	05/91→12/92	Tie Rod End	CV-ES-0914	for Steering Rod
	05/91→12/92	Tie Rod End	CV-ES-14162	for Steering Rod
	05/91→12/92	Tie Rod End	CV-ES-14163	for Steering Rod
	05/91→12/92	Tie Rod End	RV-ES-12446	
R 350.18	05/91→12/92	Ball Head, gearshift linkage	CV-ES-2121	
	05/91→12/92	Centre Rod	RV-DL-0074	Push Rod
	05/91→12/92	Centre Rod	RV-DL-2181	Coupling Rod
	05/91→12/92	Centre Rod	RV-DL-8177	Push Rod
	05/91→12/92	Tie Rod End	CV-ES-0912	
	05/91→12/92	Tie Rod End	CV-ES-0914	for Steering Rod
	05/91→12/92	Tie Rod End	CV-ES-14162	for Steering Rod
	05/91→12/92	Tie Rod End	RV-ES-12446	
R 350.18/T	05/91→12/92	Ball Head, gearshift linkage	CV-ES-2121	
	05/91→12/92	Centre Rod	RV-DL-0074	Push Rod
	05/91→12/92	Centre Rod	RV-DL-2181	Coupling Rod
	05/91→12/92	Centre Rod	RV-DL-8177	Push Rod
	05/91→12/92	Tie Rod End	CV-ES-0912	
	05/91→12/92	Tie Rod End	CV-ES-0914	for Steering Rod

CV-ES-0912

Length: 125
Cone Ø: d1 Ø 30 / d2 Ø 27
Thread: M38 x 1,5 LHT
3401206, 5001832579



RV-DL-0882

Length: 1040
Ø: 62
Cone Ø: d1 Ø 30 / d2 Ø 27
5010130740, 5010239387



CV-ES-0914

Length: 125
Cone Ø: d1 Ø 30 / d2 Ø 27
Thread: M38 x 1,5 RHT
3401207, 5001832580



RV-DL-2181

Length: 1650
Ø: 40
Cone Ø: d1 Ø 30 / d2 Ø 27
5010145581, 5010308215



CV-ES-2121

Length: 85
Cone Ø: d1 Ø 12 / d2 Ø 10,8
Thread: M14 x 1,5 RHT
23162046, 5000516214, 5010144543,
5010245591



RV-DL-8177

Length: 1012
Ø: 52
Cone Ø: d1 Ø 30 / d2 Ø 27
5010130451, 7485114925



CV-ES-14162

Length: 125
Cone Ø: d1 Ø 30 / d2 Ø 27
Thread: M30 x 1,5 LHT
3401170, 5000288361, 5001832581,
5001858759, 5001858774



RV-DL-8313

Length: 1752
Ø: 48
Cone Ø: d1 Ø 30 / d2 Ø 27
5010098467, 5010145584, 5010439631



CV-ES-14163

Length: 125
Cone Ø: d1 Ø 30 / d2 Ø 27
Thread: M30 x 1,5 RHT
0003406169, 0003406236, 0003406251,
0003406254, 0003406260, 0003406261,
5000288360, 5000590236, 5000804824,
5001858773, 7420937674, 7701011412



RV-ES-12445

Length: 170
Cone Ø: d1 Ø 30 / d2 Ø 27
5000288363



RV-DL-0074

Length: 1012
Ø: 52
Cone Ø: d1 Ø 30 / d2 Ø 27
5010130453



RV-ES-12446

Length: 170
Cone Ø: d1 Ø 30 / d2 Ø 27
5000288362





Major ...

R 350.18/T ...	05/91→12/92	Tie Rod End	CV-ES-14162	for Steering Rod
	05/91→12/92	Tie Rod End	CV-ES-14163	for Steering Rod
	05/91→12/92	Tie Rod End	RV-ES-12446	
R 350.19	05/91→12/92	Ball Head, gearshift linkage	CV-ES-2121	
	05/91→12/92	Centre Rod	RV-DL-0074	Push Rod
	05/91→12/92	Centre Rod	RV-DL-2181	Coupling Rod
	05/91→12/92	Centre Rod	RV-DL-8177	Push Rod
	05/91→12/92	Tie Rod End	CV-ES-0912	
	05/91→12/92	Tie Rod End	CV-ES-0914	for Steering Rod
	05/91→12/92	Tie Rod End	CV-ES-14162	for Steering Rod
	05/91→12/92	Tie Rod End	CV-ES-14163	for Steering Rod
	05/91→12/92	Tie Rod End	RV-ES-12446	
R 350.19/T	05/91→12/92	Ball Head, gearshift linkage	CV-ES-2121	
	05/91→12/92	Centre Rod	RV-DL-0074	Push Rod
	05/91→12/92	Centre Rod	RV-DL-2181	Coupling Rod
	05/91→12/92	Centre Rod	RV-DL-8177	Push Rod
	05/91→12/92	Tie Rod End	CV-ES-0912	
	05/91→12/92	Tie Rod End	CV-ES-0914	for Steering Rod
	05/91→12/92	Tie Rod End	CV-ES-14162	for Steering Rod
	05/91→12/92	Tie Rod End	CV-ES-14163	for Steering Rod
	05/91→12/92	Tie Rod End	RV-ES-12446	
R 350.19/TB	05/91→12/92	Ball Head, gearshift linkage	CV-ES-2121	
	05/91→12/92	Centre Rod	RV-DL-0074	Push Rod
	05/91→12/92	Centre Rod	RV-DL-2181	Coupling Rod
	05/91→12/92	Centre Rod	RV-DL-8177	Push Rod
	05/91→12/92	Tie Rod End	CV-ES-0912	
	05/91→12/92	Tie Rod End	CV-ES-0914	for Steering Rod
	05/91→12/92	Tie Rod End	CV-ES-14162	for Steering Rod
	05/91→12/92	Tie Rod End	CV-ES-14163	for Steering Rod
	05/91→12/92	Tie Rod End	RV-ES-12446	
R 350.24	05/91→10/92	Ball Head, gearshift linkage	CV-ES-2121	
	05/91→10/92	Centre Rod	RV-DL-0074	Push Rod
	05/91→10/92	Centre Rod	RV-DL-2181	Coupling Rod
	05/91→10/92	Centre Rod	RV-DL-8177	Push Rod
	05/91→10/92	Tie Rod End	CV-ES-0912	
	05/91→10/92	Tie Rod End	CV-ES-0914	for Steering Rod
	05/91→10/92	Tie Rod End	CV-ES-14162	for Steering Rod
	05/91→10/92	Tie Rod End	CV-ES-14163	for Steering Rod
R 350.26	05/91→12/92	Ball Head, gearshift linkage	CV-ES-2121	
	05/91→12/92	Centre Rod	RV-DL-0074	Push Rod
	05/91→12/92	Centre Rod	RV-DL-2181	Coupling Rod
	05/91→12/92	Centre Rod	RV-DL-8177	Push Rod
	05/91→12/92	Tie Rod End	CV-ES-0912	
	05/91→12/92	Tie Rod End	CV-ES-0914	for Steering Rod
	05/91→12/92	Tie Rod End	CV-ES-14162	for Steering Rod
	05/91→12/92	Tie Rod End	CV-ES-14163	for Steering Rod
R 380.22/T	05/91→12/92	Ball Head, gearshift linkage	CV-ES-2121	
	05/91→12/92	Centre Rod	RV-DL-0074	Push Rod
	05/91→12/92	Centre Rod	RV-DL-2181	Coupling Rod
	05/91→12/92	Centre Rod	RV-DL-8177	Push Rod
	05/91→12/92	Tie Rod End	CV-ES-0912	
	05/91→12/92	Tie Rod End	CV-ES-0914	for Steering Rod
	05/91→12/92	Tie Rod End	CV-ES-14162	for Steering Rod
	05/91→12/92	Tie Rod End	CV-ES-14163	for Steering Rod
	05/91→12/92	Tie Rod End	RV-ES-12446	
R 380.25	05/91→12/92	Ball Head, gearshift linkage	CV-ES-2121	
	05/91→12/92	Centre Rod	RV-DL-0074	Push Rod
	05/91→12/92	Centre Rod	RV-DL-2181	Coupling Rod
	05/91→12/92	Centre Rod	RV-DL-8177	Push Rod
	05/91→12/92	Tie Rod End	CV-ES-0912	
	05/91→12/92	Tie Rod End	CV-ES-0914	for Steering Rod
	05/91→12/92	Tie Rod End	CV-ES-14162	for Steering Rod
	05/91→12/92	Tie Rod End	CV-ES-14163	for Steering Rod

CV-ES-0912

Length: 125
Cone Ø: d1 Ø 30 / d2 Ø 27
Thread: M38 x 1,5 LHT
3401206, 5001832579



RV-DL-2181

Length: 1650
Ø: 40
Cone Ø: d1 Ø 30 / d2 Ø 27
5010145581, 5010308215



CV-ES-0914

Length: 125
Cone Ø: d1 Ø 30 / d2 Ø 27
Thread: M38 x 1,5 RHT
3401207, 5001832580



RV-DL-8177

Length: 1012
Ø: 52
Cone Ø: d1 Ø 30 / d2 Ø 27
5010130451, 7485114925



CV-ES-2121

Length: 85
Cone Ø: d1 Ø 12 / d2 Ø 10,8
Thread: M14 x 1,5 RHT
23162046, 5000516214, 5010144543,
5010245591



RV-ES-12446

Length: 170
Cone Ø: d1 Ø 30 / d2 Ø 27
5000288362



CV-ES-14162

Length: 125
Cone Ø: d1 Ø 30 / d2 Ø 27
Thread: M30 x 1,5 LHT
3401170, 5000288361, 5001832581,
5001858759, 5001858774



CV-ES-14163

Length: 125
Cone Ø: d1 Ø 30 / d2 Ø 27
Thread: M30 x 1,5 RHT
0003406169, 0003406236, 0003406251,
0003406254, 0003406260, 0003406261,
5000288360, 5000590236, 5000804824,
5001858773, 7420937674, 7701011412



RV-DL-0074

Length: 1012
Ø: 52
Cone Ø: d1 Ø 30 / d2 Ø 27
5010130453





Major ...

R 385ti.17,R 380.17	05/91→04/93	Centre Rod	RV-DL-8177	Push Rod
	05/91→05/93	Centre Rod	RV-DL-0074	Push Rod
	05/91→10/96	Ball Head, gearshift linkage	CV-ES-2121	
	05/91→10/96	Centre Rod	RV-DL-2181	Coupling Rod
	05/91→10/96	Tie Rod End	CV-ES-0912	
	05/91→10/96	Tie Rod End	CV-ES-0914	for Steering Rod
	05/91→10/96	Tie Rod End	CV-ES-14162	for Steering Rod
	05/91→10/96	Tie Rod End	CV-ES-14163	for Steering Rod
	01/93→10/96	Tie Rod	RV-DL-8313	Guide Rod
	05/93→10/96	Centre Rod	RV-DL-0882	Push Rod
R 385ti.18,R 380.18	05/91→04/93	Centre Rod	RV-DL-8177	Push Rod
	05/91→05/93	Centre Rod	RV-DL-0074	Push Rod
	05/91→10/96	Ball Head, gearshift linkage	CV-ES-2121	
	05/91→10/96	Centre Rod	RV-DL-2181	Coupling Rod
	05/91→10/96	Tie Rod End	CV-ES-0912	
	05/91→10/96	Tie Rod End	CV-ES-0914	for Steering Rod
	05/91→10/96	Tie Rod End	CV-ES-14162	for Steering Rod
	05/91→10/96	Tie Rod End	CV-ES-14163	for Steering Rod
	01/93→10/96	Tie Rod	RV-DL-8313	Guide Rod
	05/93→10/96	Centre Rod	RV-DL-0882	Push Rod
R 385ti.18/T,R 380.18/T	05/91→04/93	Centre Rod	RV-DL-8177	Push Rod
	05/91→05/93	Centre Rod	RV-DL-0074	Push Rod
	05/91→10/96	Ball Head, gearshift linkage	CV-ES-2121	
	05/91→10/96	Centre Rod	RV-DL-2181	Coupling Rod
	05/91→10/96	Tie Rod End	CV-ES-0912	
	05/91→10/96	Tie Rod End	CV-ES-0914	for Steering Rod
	05/91→10/96	Tie Rod End	CV-ES-14162	for Steering Rod
	05/91→10/96	Tie Rod End	CV-ES-14163	for Steering Rod
	05/91→10/96	Tie Rod End	RV-ES-12445	
	05/91→10/96	Tie Rod End	RV-ES-12446	
R 385ti.19,R 380.19	01/93→10/96	Tie Rod	RV-DL-8313	Guide Rod
	05/91→04/93	Centre Rod	RV-DL-8177	Push Rod
	05/91→05/93	Centre Rod	RV-DL-0074	Push Rod
	05/91→10/96	Ball Head, gearshift linkage	CV-ES-2121	
	05/91→10/96	Centre Rod	RV-DL-2181	Coupling Rod
	05/91→10/96	Tie Rod End	CV-ES-0912	
	05/91→10/96	Tie Rod End	CV-ES-0914	for Steering Rod
	05/91→10/96	Tie Rod End	CV-ES-14162	for Steering Rod
	05/91→10/96	Tie Rod End	CV-ES-14163	for Steering Rod
	01/93→10/96	Tie Rod	RV-DL-8313	Guide Rod
R 385ti.19/T,R 380.19/T	05/93→10/96	Centre Rod	RV-DL-0882	Push Rod
	05/91→04/93	Centre Rod	RV-DL-8177	Push Rod
	05/91→05/93	Centre Rod	RV-DL-0074	Push Rod
	05/91→10/96	Ball Head, gearshift linkage	CV-ES-2121	
	05/91→10/96	Centre Rod	RV-DL-2181	Coupling Rod
	05/91→10/96	Tie Rod End	CV-ES-0912	
	05/91→10/96	Tie Rod End	CV-ES-0914	for Steering Rod
	05/91→10/96	Tie Rod End	CV-ES-14162	for Steering Rod
	05/91→10/96	Tie Rod End	CV-ES-14163	for Steering Rod
	05/91→10/96	Tie Rod End	RV-ES-12445	
R 385ti.22/T,R 380.19/TB	05/91→10/96	Tie Rod End	RV-ES-12446	
	01/93→10/96	Tie Rod	RV-DL-8313	Guide Rod
	05/91→04/93	Centre Rod	RV-DL-8177	Push Rod
	05/91→05/93	Centre Rod	RV-DL-0074	Push Rod
	05/91→10/96	Ball Head, gearshift linkage	CV-ES-2121	
	05/91→10/96	Centre Rod	RV-DL-2181	Coupling Rod
	05/91→10/96	Tie Rod End	CV-ES-0912	
	05/91→10/96	Tie Rod End	CV-ES-0914	for Steering Rod
	05/91→10/96	Tie Rod End	CV-ES-14162	for Steering Rod
	05/91→10/96	Tie Rod End	CV-ES-14163	for Steering Rod

CV-ES-0912

Length: 125
Cone Ø: d1 Ø 30 / d2 Ø 27
Thread: M38 x 1,5 LHT
3401206, 5001832579



RV-DL-0882

Length: 1040
Ø: 62
Cone Ø: d1 Ø 30 / d2 Ø 27
5010130740, 5010239387



CV-ES-0914

Length: 125
Cone Ø: d1 Ø 30 / d2 Ø 27
Thread: M38 x 1,5 RHT
3401207, 5001832580



RV-DL-2181

Length: 1650
Ø: 40
Cone Ø: d1 Ø 30 / d2 Ø 27
5010145581, 5010308215



CV-ES-2121

Length: 85
Cone Ø: d1 Ø 12 / d2 Ø 10,8
Thread: M14 x 1,5 RHT
23162046, 5000516214, 5010144543,
5010245591



RV-DL-8177

Length: 1012
Ø: 52
Cone Ø: d1 Ø 30 / d2 Ø 27
5010130451, 7485114925



CV-ES-14162

Length: 125
Cone Ø: d1 Ø 30 / d2 Ø 27
Thread: M30 x 1,5 LHT
3401170, 5000288361, 5001832581,
5001858759, 5001858774



RV-DL-8313

Length: 1752
Ø: 48
Cone Ø: d1 Ø 30 / d2 Ø 27
5010098467, 5010145584, 5010439631



CV-ES-14163

Length: 125
Cone Ø: d1 Ø 30 / d2 Ø 27
Thread: M30 x 1,5 RHT
0003406169, 0003406236, 0003406251,
0003406254, 0003406260, 0003406261,
5000288360, 5000590236, 5000804824,
5001858773, 7420937674, 7701011412



RV-ES-12445

Length: 170
Cone Ø: d1 Ø 30 / d2 Ø 27
5000288363



RV-DL-0074

Length: 1012
Ø: 52
Cone Ø: d1 Ø 30 / d2 Ø 27
5010130453



RV-ES-12446

Length: 170
Cone Ø: d1 Ø 30 / d2 Ø 27
5000288362





Major ...

R 385ti.24,R 380.24	05/91→04/93	Centre Rod	RV-DL-8177	Push Rod
	05/91→05/93	Centre Rod	RV-DL-0074	Push Rod
	05/91→10/96	Ball Head, gearshift linkage	CV-ES-2121	
	05/91→10/96	Centre Rod	RV-DL-2181	Coupling Rod
	05/91→10/96	Tie Rod End	CV-ES-0912	
	05/91→10/96	Tie Rod End	CV-ES-0914	for Steering Rod
	05/91→10/96	Tie Rod End	CV-ES-14162	for Steering Rod
	05/91→10/96	Tie Rod End	CV-ES-14163	for Steering Rod
	01/93→10/96	Tie Rod	RV-DL-8313	Guide Rod
	05/93→10/96	Centre Rod	RV-DL-0882	Push Rod
R 385ti.25,R 380.25	05/91→04/93	Centre Rod	RV-DL-8177	Push Rod
	05/91→05/93	Centre Rod	RV-DL-0074	Push Rod
	05/91→10/96	Ball Head, gearshift linkage	CV-ES-2121	
	05/91→10/96	Centre Rod	RV-DL-2181	Coupling Rod
	05/91→10/96	Tie Rod End	CV-ES-0912	
	05/91→10/96	Tie Rod End	CV-ES-0914	for Steering Rod
	05/91→10/96	Tie Rod End	CV-ES-14162	for Steering Rod
	05/91→10/96	Tie Rod End	CV-ES-14163	for Steering Rod
	01/93→10/96	Tie Rod	RV-DL-8313	Guide Rod
	05/93→10/96	Centre Rod	RV-DL-0882	Push Rod
R 385ti.25/T,R 380.25/T	05/91→04/93	Centre Rod	RV-DL-8177	Push Rod
	05/91→05/93	Centre Rod	RV-DL-0074	Push Rod
	05/91→10/96	Ball Head, gearshift linkage	CV-ES-2121	
	05/91→10/96	Centre Rod	RV-DL-2181	Coupling Rod
	05/91→10/96	Tie Rod End	CV-ES-0912	
	05/91→10/96	Tie Rod End	CV-ES-0914	for Steering Rod
	05/91→10/96	Tie Rod End	CV-ES-14162	for Steering Rod
	05/91→10/96	Tie Rod End	CV-ES-14163	for Steering Rod
	01/93→10/96	Tie Rod	RV-DL-8313	Guide Rod
	05/93→10/96	Centre Rod	RV-DL-0882	Push Rod
R 385ti.26	12/91→04/93	Centre Rod	RV-DL-8177	Push Rod
	12/91→05/93	Centre Rod	RV-DL-0074	Push Rod
	12/91→10/96	Ball Head, gearshift linkage	CV-ES-2121	
	12/91→10/96	Centre Rod	RV-DL-2181	Coupling Rod
	12/91→10/96	Tie Rod End	CV-ES-0912	
	12/91→10/96	Tie Rod End	CV-ES-0914	for Steering Rod
	12/91→10/96	Tie Rod End	CV-ES-14162	for Steering Rod
	12/91→10/96	Tie Rod End	CV-ES-14163	for Steering Rod
	01/93→10/96	Tie Rod	RV-DL-8313	Guide Rod
	05/93→10/96	Centre Rod	RV-DL-0882	Push Rod
R 385ti.26,R 380.26	05/91→04/93	Centre Rod	RV-DL-8177	Push Rod
	05/91→05/93	Centre Rod	RV-DL-0074	Push Rod
	05/91→10/96	Ball Head, gearshift linkage	CV-ES-2121	
	05/91→10/96	Centre Rod	RV-DL-2181	Coupling Rod
	05/91→10/96	Tie Rod End	CV-ES-0912	
	05/91→10/96	Tie Rod End	CV-ES-0914	for Steering Rod
	05/91→10/96	Tie Rod End	CV-ES-14162	for Steering Rod
	05/91→10/96	Tie Rod End	CV-ES-14163	for Steering Rod
	01/93→10/96	Tie Rod	RV-DL-8313	Guide Rod
	05/93→10/96	Centre Rod	RV-DL-0882	Push Rod
R 385ti.26/T,R 380.26/T	05/91→04/93	Centre Rod	RV-DL-8177	Push Rod
	05/91→05/93	Centre Rod	RV-DL-0074	Push Rod
	05/91→10/96	Ball Head, gearshift linkage	CV-ES-2121	
	05/91→10/96	Centre Rod	RV-DL-2181	Coupling Rod
	05/91→10/96	Tie Rod End	CV-ES-0912	
	05/91→10/96	Tie Rod End	CV-ES-0914	for Steering Rod
	05/91→10/96	Tie Rod End	CV-ES-14162	for Steering Rod
	05/91→10/96	Tie Rod End	CV-ES-14163	for Steering Rod
	01/93→10/96	Tie Rod	RV-DL-8313	Guide Rod
	05/93→10/96	Centre Rod	RV-DL-0882	Push Rod
R 420ti.18/T	10/92→04/93	Centre Rod	RV-DL-8177	Push Rod
	10/92→05/93	Centre Rod	RV-DL-0074	Push Rod
	10/92→10/96	Ball Head, gearshift linkage	CV-ES-2121	
	10/92→10/96	Centre Rod	RV-DL-2181	Coupling Rod
	10/92→10/96	Tie Rod End	CV-ES-0912	

CV-ES-0912

Length: 125
Cone Ø: d1 Ø 30 / d2 Ø 27
Thread: M38 x 1,5 LHT
3401206, 5001832579



RV-DL-0882

Length: 1040
Ø: 62
Cone Ø: d1 Ø 30 / d2 Ø 27
5010130740, 5010239387



CV-ES-0914

Length: 125
Cone Ø: d1 Ø 30 / d2 Ø 27
Thread: M38 x 1,5 RHT
3401207, 5001832580



RV-DL-2181

Length: 1650
Ø: 40
Cone Ø: d1 Ø 30 / d2 Ø 27
5010145581, 5010308215



CV-ES-2121

Length: 85
Cone Ø: d1 Ø 12 / d2 Ø 10,8
Thread: M14 x 1,5 RHT
23162046, 5000516214, 5010144543,
5010245591



RV-DL-8177

Length: 1012
Ø: 52
Cone Ø: d1 Ø 30 / d2 Ø 27
5010130451, 7485114925



CV-ES-14162

Length: 125
Cone Ø: d1 Ø 30 / d2 Ø 27
Thread: M30 x 1,5 LHT
3401170, 5000288361, 5001832581,
5001858759, 5001858774



RV-DL-8313

Length: 1752
Ø: 48
Cone Ø: d1 Ø 30 / d2 Ø 27
5010098467, 5010145584, 5010439631



CV-ES-14163

Length: 125
Cone Ø: d1 Ø 30 / d2 Ø 27
Thread: M30 x 1,5 RHT
0003406169, 0003406236, 0003406251,
0003406254, 0003406260, 0003406261,
5000288360, 5000590236, 5000804824,
5001858773, 7420937674, 7701011412



RV-DL-0074

Length: 1012
Ø: 52
Cone Ø: d1 Ø 30 / d2 Ø 27
5010130453





Major ...

R 420ti.18/T ...	10/92→10/96	Tie Rod End	CV-ES-0914	for Steering Rod
	10/92→10/96	Tie Rod End	CV-ES-14162	for Steering Rod
	10/92→10/96	Tie Rod End	CV-ES-14163	for Steering Rod
	10/92→10/96	Tie Rod End	RV-ES-12445	
	10/92→10/96	Tie Rod End	RV-ES-12446	
	01/93→10/96	Tie Rod	RV-DL-8313	Guide Rod
R 420ti.19/T	10/92→04/93	Centre Rod	RV-DL-8177	Push Rod
	10/92→05/93	Centre Rod	RV-DL-0074	Push Rod
	10/92→10/96	Ball Head, gearshift linkage	CV-ES-2121	
	10/92→10/96	Centre Rod	RV-DL-2181	Coupling Rod
	10/92→10/96	Tie Rod End	CV-ES-0912	
	10/92→10/96	Tie Rod End	CV-ES-0914	for Steering Rod
	10/92→10/96	Tie Rod End	CV-ES-14162	for Steering Rod
	10/92→10/96	Tie Rod End	CV-ES-14163	for Steering Rod
	10/92→10/96	Tie Rod End	RV-ES-12445	
	10/92→10/96	Tie Rod End	RV-ES-12446	
R 420ti.22/T	10/92→04/93	Centre Rod	RV-DL-8177	Push Rod
	10/92→05/93	Centre Rod	RV-DL-0074	Push Rod
	10/92→10/96	Ball Head, gearshift linkage	CV-ES-2121	
	10/92→10/96	Centre Rod	RV-DL-2181	Coupling Rod
	10/92→10/96	Tie Rod End	CV-ES-0912	
	10/92→10/96	Tie Rod End	CV-ES-0914	for Steering Rod
	10/92→10/96	Tie Rod End	CV-ES-14162	for Steering Rod
	10/92→10/96	Tie Rod End	CV-ES-14163	for Steering Rod
	10/92→10/96	Tie Rod End	RV-ES-12445	
	10/92→10/96	Tie Rod End	RV-ES-12446	
R 420ti.24/TS	04/92→04/93	Centre Rod	RV-DL-8177	Push Rod
	04/92→05/93	Centre Rod	RV-DL-0074	Push Rod
	04/92→10/96	Ball Head, gearshift linkage	CV-ES-2121	
	04/92→10/96	Centre Rod	RV-DL-2181	Coupling Rod
	04/92→10/96	Tie Rod End	CV-ES-0912	
	04/92→10/96	Tie Rod End	CV-ES-0914	for Steering Rod
	04/92→10/96	Tie Rod End	CV-ES-14162	for Steering Rod
	04/92→10/96	Tie Rod End	CV-ES-14163	for Steering Rod
	04/92→10/96	Tie Rod End	RV-ES-12445	
	04/92→10/96	Tie Rod End	RV-ES-12446	
R 420ti.26/TS	04/92→04/93	Centre Rod	RV-DL-8177	Push Rod
	04/92→05/93	Centre Rod	RV-DL-0074	Push Rod
	04/92→10/96	Ball Head, gearshift linkage	CV-ES-2121	
	04/92→10/96	Centre Rod	RV-DL-2181	Coupling Rod
	04/92→10/96	Tie Rod End	CV-ES-0912	
	04/92→10/96	Tie Rod End	CV-ES-0914	for Steering Rod
	04/92→10/96	Tie Rod End	CV-ES-14162	for Steering Rod
	04/92→10/96	Tie Rod End	CV-ES-14163	for Steering Rod
	04/92→10/96	Tie Rod End	RV-ES-12445	
	04/92→10/96	Tie Rod End	RV-ES-12446	
R 420ti.35/TS	04/92→04/93	Centre Rod	RV-DL-8177	Push Rod
	04/92→05/93	Centre Rod	RV-DL-0074	Push Rod
	04/92→10/96	Ball Head, gearshift linkage	CV-ES-2121	
	04/92→10/96	Centre Rod	RV-DL-2181	Coupling Rod
	04/92→10/96	Stabiliser Link	RV-DL-10249	Pressure Rod
	04/92→10/96	Tie Rod End	CV-ES-0912	
	04/92→10/96	Tie Rod End	CV-ES-0914	for Steering Rod
	04/92→10/96	Tie Rod End	CV-ES-14162	for Steering Rod
	04/92→10/96	Tie Rod End	CV-ES-14163	for Steering Rod
	01/93→10/96	Tie Rod	RV-DL-8313	Guide Rod

CV-ES-0912

Length: 125
Cone Ø: d1 Ø 30 / d2 Ø 27
Thread: M38 x 1,5 LHT
3401206, 5001832579



RV-DL-2181

Length: 1650
Ø: 40
Cone Ø: d1 Ø 30 / d2 Ø 27
5010145581, 5010308215



CV-ES-0914

Length: 125
Cone Ø: d1 Ø 30 / d2 Ø 27
Thread: M38 x 1,5 RHT
3401207, 5001832580



RV-DL-8177

Length: 1012
Ø: 52
Cone Ø: d1 Ø 30 / d2 Ø 27
5010130451, 7485114925



CV-ES-2121

Length: 85
Cone Ø: d1 Ø 12 / d2 Ø 10,8
Thread: M14 x 1,5 RHT
23162046, 5000516214, 5010144543,
5010245591



RV-DL-8313

Length: 1752
Ø: 48
Cone Ø: d1 Ø 30 / d2 Ø 27
5010098467, 5010145584, 5010439631



CV-ES-14162

Length: 125
Cone Ø: d1 Ø 30 / d2 Ø 27
Thread: M30 x 1,5 LHT
3401170, 5000288361, 5001832581,
5001858759, 5001858774



RV-DL-10249

Length: 440
Ø: 36
Cone Ø: d1 Ø 26 / d2 Ø 23,5
0000758006, 5000874575, 5010065789



CV-ES-14163

Length: 125
Cone Ø: d1 Ø 30 / d2 Ø 27
Thread: M30 x 1,5 RHT
0003406169, 0003406236, 0003406251,
0003406254, 0003406260, 0003406261,
5000288360, 5000590236, 5000804824,
5001858773, 7420937674, 7701011412



RV-ES-12445

Length: 170
Cone Ø: d1 Ø 30 / d2 Ø 27
5000288363



RV-DL-0074

Length: 1012
Ø: 52
Cone Ø: d1 Ø 30 / d2 Ø 27
5010130453



RV-ES-12446

Length: 170
Cone Ø: d1 Ø 30 / d2 Ø 27
5000288362





Manager

G 200.13	09/91→03/93	Ball Head, gearshift linkage	CV-ES-2121	
	09/91→03/93	Centre Rod	RV-DL-0900	Push Rod
	09/91→03/93	Centre Rod	RV-DL-8198	Push Rod
	09/91→03/93	Tie Rod End	CV-ES-0912	
	09/91→03/93	Tie Rod End	CV-ES-0914	for Steering Rod
	09/91→03/93	Tie Rod End	CV-ES-14162	for Steering Rod
	09/91→03/93	Tie Rod End	CV-ES-14163	for Steering Rod
	09/91→03/93	Tie Rod End	RV-ES-8691	
G 200.15	09/91→03/93	Ball Head, gearshift linkage	CV-ES-2121	
	09/91→03/93	Centre Rod	RV-DL-0900	Push Rod
	09/91→03/93	Centre Rod	RV-DL-8198	Push Rod
	09/91→03/93	Tie Rod End	CV-ES-0912	
	09/91→03/93	Tie Rod End	CV-ES-0914	for Steering Rod
	09/91→03/93	Tie Rod End	CV-ES-14162	for Steering Rod
	09/91→03/93	Tie Rod End	CV-ES-14163	for Steering Rod
	09/91→03/93	Tie Rod End	RV-ES-8691	
G 200.16	09/91→03/93	Ball Head, gearshift linkage	CV-ES-2121	
	09/91→03/93	Centre Rod	RV-DL-0900	Push Rod
	09/91→03/93	Tie Rod End	CV-ES-0912	
	09/91→03/93	Tie Rod End	CV-ES-0914	for Steering Rod
	09/91→03/93	Tie Rod End	CV-ES-14162	for Steering Rod
	09/91→03/93	Tie Rod End	CV-ES-14163	for Steering Rod
	09/91→03/93	Tie Rod End	RV-ES-8691	
G 200.17	09/91→03/93	Ball Head, gearshift linkage	CV-ES-2121	
	09/91→03/93	Centre Rod	RV-DL-0900	Push Rod
	09/91→03/93	Tie Rod End	CV-ES-0912	
	09/91→03/93	Tie Rod End	CV-ES-0914	for Steering Rod
	09/91→03/93	Tie Rod End	CV-ES-14162	for Steering Rod
	09/91→03/93	Tie Rod End	CV-ES-14163	for Steering Rod
	09/91→03/93	Tie Rod End	RV-ES-8691	
G 200.18	09/91→03/93	Ball Head, gearshift linkage	CV-ES-2121	
	09/91→03/93	Centre Rod	RV-DL-0900	Push Rod
	09/91→03/93	Tie Rod End	CV-ES-0912	
	09/91→03/93	Tie Rod End	CV-ES-0914	for Steering Rod
	09/91→03/93	Tie Rod End	CV-ES-14162	for Steering Rod
	09/91→03/93	Tie Rod End	CV-ES-14163	for Steering Rod
G 210.16	05/92→10/96	Ball Head, gearshift linkage	CV-ES-2121	
	05/92→10/96	Centre Rod	RV-DL-0900	Push Rod
	05/92→10/96	Tie Rod End	CV-ES-0912	
	05/92→10/96	Tie Rod End	CV-ES-0914	for Steering Rod
	05/92→10/96	Tie Rod End	CV-ES-14162	for Steering Rod
	05/92→10/96	Tie Rod End	CV-ES-14163	for Steering Rod
	05/92→10/96	Tie Rod End	RV-ES-8691	
	05/92→10/96	Tie Rod End	RV-ES-8691	
G 210.18	05/92→10/96	Ball Head, gearshift linkage	CV-ES-2121	
	05/92→10/96	Centre Rod	RV-DL-0900	Push Rod
	05/92→10/96	Tie Rod End	CV-ES-0912	
	05/92→10/96	Tie Rod End	CV-ES-0914	for Steering Rod
	05/92→10/96	Tie Rod End	CV-ES-14162	for Steering Rod
	05/92→10/96	Tie Rod End	CV-ES-14163	for Steering Rod
	05/92→10/96	Tie Rod End	RV-ES-8691	
	05/92→10/96	Tie Rod End	RV-ES-8691	
G 220.17 BOM	09/91→10/96	Ball Head, gearshift linkage	CV-ES-2121	
	09/91→10/96	Centre Rod	RV-DL-0900	Push Rod
	09/91→10/96	Tie Rod End	CV-ES-0912	
	09/91→10/96	Tie Rod End	CV-ES-0914	for Steering Rod
	09/91→10/96	Tie Rod End	CV-ES-14162	for Steering Rod
	09/91→10/96	Tie Rod End	CV-ES-14163	for Steering Rod
	09/91→10/96	Tie Rod End	RV-ES-8691	
G 220.19 BOM	09/91→10/96	Ball Head, gearshift linkage	CV-ES-2121	
	09/91→10/96	Centre Rod	RV-DL-0900	Push Rod
	09/91→10/96	Tie Rod End	CV-ES-0912	
	09/91→10/96	Tie Rod End	CV-ES-0914	for Steering Rod
	09/91→10/96	Tie Rod End	CV-ES-14162	for Steering Rod

CV-ES-0912

Length: 125
Cone Ø: d1 Ø 30 / d2 Ø 27
Thread: M38 x 1,5 LHT
3401206, 5001832579



RV-DL-8198

Length: 981
Ø: 52
Cone Ø: d1 Ø 30 / d2 Ø 27
5010094585, 7485114919



CV-ES-0914

Length: 125
Cone Ø: d1 Ø 30 / d2 Ø 27
Thread: M38 x 1,5 RHT
3401207, 5001832580



RV-ES-8691

Length: 106
Cone Ø: d1 Ø 20 / d2 Ø 18
Thread: M24 x 1,5 LHT
7700658834



CV-ES-2121

Length: 85
Cone Ø: d1 Ø 12 / d2 Ø 10,8
Thread: M14 x 1,5 RHT
23162046, 5000516214, 5010144543,
5010245591



CV-ES-14162

Length: 125
Cone Ø: d1 Ø 30 / d2 Ø 27
Thread: M30 x 1,5 LHT
3401170, 5000288361, 5001832581,
5001858759, 5001858774



CV-ES-14163

Length: 125
Cone Ø: d1 Ø 30 / d2 Ø 27
Thread: M30 x 1,5 RHT
0003406169, 0003406236, 0003406251,
0003406254, 0003406260, 0003406261,
5000288360, 5000590236, 5000804824,
5001858773, 7420937674, 7701011412



RV-DL-0900

Length: 990
Ø: 52
Cone Ø: d1 Ø 30 / d2 Ø 27
5000725267, 5010144552





Manager ...

G 220.19 BOM ...	09/91→10/96	Tie Rod End	CV-ES-14163		for Steering Rod
	09/91→10/96	Tie Rod End	RV-ES-8691		
G 230.13 SP	09/91→03/93	Ball Head, gearshift linkage	CV-ES-2121		
	09/91→03/93	Centre Rod	RV-DL-0900		Push Rod
	09/91→03/93	Tie Rod End	CV-ES-0912		
	09/91→03/93	Tie Rod End	CV-ES-0914		for Steering Rod
	09/91→03/93	Tie Rod End	CV-ES-14162		for Steering Rod
	09/91→03/93	Tie Rod End	CV-ES-14163		for Steering Rod
	09/91→03/93	Tie Rod End	RV-ES-8691		
G 230ti.13	09/91→03/93	Ball Head, gearshift linkage	CV-ES-2121		
	09/91→03/93	Centre Rod	RV-DL-0900		Push Rod
	09/91→03/93	Tie Rod End	CV-ES-0912		
	09/91→03/93	Tie Rod End	CV-ES-0914		for Steering Rod
	09/91→03/93	Tie Rod End	CV-ES-14162		for Steering Rod
	09/91→03/93	Tie Rod End	CV-ES-14163		for Steering Rod
	09/91→03/93	Tie Rod End	RV-ES-8691		
G 230ti.15	09/91→03/93	Ball Head, gearshift linkage	CV-ES-2121		
	09/91→03/93	Centre Rod	RV-DL-0900		Push Rod
	09/91→03/93	Tie Rod End	CV-ES-0912		
	09/91→03/93	Tie Rod End	CV-ES-0914		for Steering Rod
	09/91→03/93	Tie Rod End	CV-ES-14162		for Steering Rod
	09/91→03/93	Tie Rod End	CV-ES-14163		for Steering Rod
G 230ti.16	09/91→10/96	Ball Head, gearshift linkage	CV-ES-2121		
	09/91→10/96	Centre Rod	RV-DL-0900		Push Rod
	09/91→10/96	Tie Rod End	CV-ES-0912		
	09/91→10/96	Tie Rod End	CV-ES-0914		for Steering Rod
	09/91→10/96	Tie Rod End	CV-ES-14162		for Steering Rod
	09/91→10/96	Tie Rod End	CV-ES-14163		for Steering Rod
G 230ti.17	09/91→10/96	Ball Head, gearshift linkage	CV-ES-2121		
	09/91→10/96	Centre Rod	RV-DL-0900		Push Rod
	09/91→10/96	Tie Rod End	CV-ES-0912		
	09/91→10/96	Tie Rod End	CV-ES-0914		for Steering Rod
	09/91→10/96	Tie Rod End	CV-ES-14162		for Steering Rod
	09/91→10/96	Tie Rod End	CV-ES-14163		for Steering Rod
G 230ti.18	05/92→10/96	Ball Head, gearshift linkage	CV-ES-2121		
	05/92→10/96	Centre Rod	RV-DL-0900		Push Rod
	05/92→10/96	Tie Rod End	CV-ES-0912		
	05/92→10/96	Tie Rod End	CV-ES-0914		for Steering Rod
	05/92→10/96	Tie Rod End	CV-ES-14162		for Steering Rod
	05/92→10/96	Tie Rod End	CV-ES-14163		for Steering Rod
	05/92→10/96	Tie Rod End	RV-ES-8691		
G 230ti.19	09/91→10/96	Ball Head, gearshift linkage	CV-ES-2121		
	09/91→10/96	Centre Rod	RV-DL-0900		Push Rod
	09/91→10/96	Tie Rod End	CV-ES-0912		
	09/91→10/96	Tie Rod End	CV-ES-0914		for Steering Rod
	09/91→10/96	Tie Rod End	CV-ES-14162		for Steering Rod
	09/91→10/96	Tie Rod End	CV-ES-14163		for Steering Rod
	09/91→10/96	Tie Rod End	RV-ES-8691		
G 270.13 SP	03/93→10/96	Ball Head, gearshift linkage	CV-ES-2121		
	03/93→10/96	Centre Rod	RV-DL-0900		Push Rod
	03/93→10/96	Tie Rod End	CV-ES-0912		
	03/93→10/96	Tie Rod End	CV-ES-0914		for Steering Rod
	03/93→10/96	Tie Rod End	CV-ES-14162		for Steering Rod
	03/93→10/96	Tie Rod End	CV-ES-14163		for Steering Rod
G 270.14 SP	03/93→10/96	Ball Head, gearshift linkage	CV-ES-2121		
	03/93→10/96	Centre Rod	RV-DL-0900		Push Rod
	03/93→10/96	Tie Rod End	CV-ES-0912		
	03/93→10/96	Tie Rod End	CV-ES-0914		for Steering Rod
	03/93→10/96	Tie Rod End	CV-ES-14162		for Steering Rod
	03/93→10/96	Tie Rod End	CV-ES-14163		for Steering Rod

CV-ES-0912

Length: 125

Cone Ø: d1 Ø 30 / d2 Ø 27

Thread: M38 x 1,5 LHT

3401206, 5001832579



RV-ES-8691

Length: 106

Cone Ø: d1 Ø 20 / d2 Ø 18

Thread: M24 x 1,5 LHT

7700658834



CV-ES-0914

Length: 125

Cone Ø: d1 Ø 30 / d2 Ø 27

Thread: M38 x 1,5 RHT

3401207, 5001832580



CV-ES-2121

Length: 85

Cone Ø: d1 Ø 12 / d2 Ø 10,8

Thread: M14 x 1,5 RHT

23162046, 5000516214, 5010144543,
5010245591



CV-ES-14162

Length: 125

Cone Ø: d1 Ø 30 / d2 Ø 27

Thread: M30 x 1,5 LHT

3401170, 5000288361, 5001832581,
5001858759, 5001858774



CV-ES-14163

Length: 125

Cone Ø: d1 Ø 30 / d2 Ø 27

Thread: M30 x 1,5 RHT

0003406169, 0003406236, 0003406251,
0003406254, 0003406260, 0003406261,
5000288360, 5000590236, 5000804824,
5001858773, 7420937674, 7701011412



RV-DL-0900

Length: 990

Ø: 52

Cone Ø: d1 Ø 30 / d2 Ø 27

5000725267, 5010144552





Manager ...

G 270.18,G 270.17	11/92→10/96	Ball Head, gearshift linkage	CV-ES-2121	
	11/92→10/96	Centre Rod	RV-DL-0900	Push Rod
	11/92→10/96	Tie Rod End	CV-ES-0912	
	11/92→10/96	Tie Rod End	CV-ES-0914	for Steering Rod
	11/92→10/96	Tie Rod End	CV-ES-14162	for Steering Rod
	11/92→10/96	Tie Rod End	CV-ES-14163	for Steering Rod
	11/92→10/96	Tie Rod End	RV-ES-8691	
G 280.13,G 270.13	09/91→10/96	Ball Head, gearshift linkage	CV-ES-2121	
	09/91→10/96	Centre Rod	RV-DL-0900	Push Rod
	09/91→10/96	Tie Rod End	CV-ES-0912	
	09/91→10/96	Tie Rod End	CV-ES-0914	for Steering Rod
	09/91→10/96	Tie Rod End	CV-ES-14162	for Steering Rod
	09/91→10/96	Tie Rod End	CV-ES-14163	for Steering Rod
	09/91→10/96	Tie Rod End	RV-ES-8691	
G 280.15,G 270.15	09/91→10/96	Ball Head, gearshift linkage	CV-ES-2121	
	09/91→10/96	Centre Rod	RV-DL-0900	Push Rod
	09/91→10/96	Tie Rod End	CV-ES-0912	
	09/91→10/96	Tie Rod End	CV-ES-0914	for Steering Rod
	09/91→10/96	Tie Rod End	CV-ES-14162	for Steering Rod
	09/91→10/96	Tie Rod End	CV-ES-14163	for Steering Rod
	09/91→10/96	Tie Rod End	RV-ES-8691	
G 280.15/T,G 270.15/T	09/91→10/96	Ball Head, gearshift linkage	CV-ES-2121	
	09/91→10/96	Centre Rod	RV-DL-0900	Push Rod
	09/91→10/96	Tie Rod End	CV-ES-0912	
	09/91→10/96	Tie Rod End	CV-ES-0914	for Steering Rod
	09/91→10/96	Tie Rod End	CV-ES-14162	for Steering Rod
	09/91→10/96	Tie Rod End	CV-ES-14163	for Steering Rod
	09/91→10/96	Tie Rod End	RV-ES-8691	
G 280.16	09/91→03/93	Ball Head, gearshift linkage	CV-ES-2121	
	09/91→03/93	Centre Rod	RV-DL-0900	Push Rod
	09/91→03/93	Tie Rod End	CV-ES-0912	
	09/91→03/93	Tie Rod End	CV-ES-0914	for Steering Rod
	09/91→03/93	Tie Rod End	CV-ES-14162	for Steering Rod
	09/91→03/93	Tie Rod End	CV-ES-14163	for Steering Rod
	09/91→03/93	Tie Rod End	RV-ES-8691	
G 280.16,G 270.16	09/91→10/96	Ball Head, gearshift linkage	CV-ES-2121	
	09/91→10/96	Centre Rod	RV-DL-0900	Push Rod
	09/91→10/96	Tie Rod End	CV-ES-0912	
	09/91→10/96	Tie Rod End	CV-ES-0914	for Steering Rod
	09/91→10/96	Tie Rod End	CV-ES-14162	for Steering Rod
	09/91→10/96	Tie Rod End	CV-ES-14163	for Steering Rod
	09/91→10/96	Tie Rod End	RV-ES-8691	
G 280.17,G 270.18	09/91→10/96	Ball Head, gearshift linkage	CV-ES-2121	
	09/91→10/96	Centre Rod	RV-DL-0900	Push Rod
	09/91→10/96	Tie Rod End	CV-ES-0912	
	09/91→10/96	Tie Rod End	CV-ES-0914	for Steering Rod
	09/91→10/96	Tie Rod End	CV-ES-14162	for Steering Rod
	09/91→10/96	Tie Rod End	CV-ES-14163	for Steering Rod
	09/91→10/96	Tie Rod End	RV-ES-8691	
G 280.17/T,G 270.17/T	09/91→10/96	Ball Head, gearshift linkage	CV-ES-2121	
	09/91→10/96	Centre Rod	RV-DL-0900	Push Rod
	09/91→10/96	Tie Rod End	CV-ES-0912	
	09/91→10/96	Tie Rod End	CV-ES-0914	for Steering Rod
	09/91→10/96	Tie Rod End	CV-ES-14162	for Steering Rod
	09/91→10/96	Tie Rod End	CV-ES-14163	for Steering Rod
	09/91→10/96	Tie Rod End	RV-ES-8691	
G 280.18,G 270.18,G 270.17	09/91→10/96	Ball Head, gearshift linkage	CV-ES-2121	
	09/91→10/96	Centre Rod	RV-DL-0900	Push Rod
	09/91→10/96	Tie Rod End	CV-ES-0912	
	09/91→10/96	Tie Rod End	CV-ES-0914	for Steering Rod
	09/91→10/96	Tie Rod End	CV-ES-14162	for Steering Rod
	09/91→10/96	Tie Rod End	CV-ES-14163	for Steering Rod
	09/91→10/96	Tie Rod End	RV-ES-8691	

CV-ES-0912

Length: 125

Cone Ø: d1 Ø 30 / d2 Ø 27

Thread: M38 x 1,5 LHT

3401206, 5001832579



RV-ES-8691

Length: 106

Cone Ø: d1 Ø 20 / d2 Ø 18

Thread: M24 x 1,5 LHT

7700658834



CV-ES-0914

Length: 125

Cone Ø: d1 Ø 30 / d2 Ø 27

Thread: M38 x 1,5 RHT

3401207, 5001832580



CV-ES-2121

Length: 85

Cone Ø: d1 Ø 12 / d2 Ø 10,8

Thread: M14 x 1,5 RHT

23162046, 5000516214, 5010144543,
5010245591



CV-ES-14162

Length: 125

Cone Ø: d1 Ø 30 / d2 Ø 27

Thread: M30 x 1,5 LHT

3401170, 5000288361, 5001832581,
5001858759, 5001858774



CV-ES-14163

Length: 125

Cone Ø: d1 Ø 30 / d2 Ø 27

Thread: M30 x 1,5 RHT

0003406169, 0003406236, 0003406251,
0003406254, 0003406260, 0003406261,
5000288360, 5000590236, 5000804824,
5001858773, 7420937674, 7701011412



RV-DL-0900

Length: 990

Ø: 52

Cone Ø: d1 Ø 30 / d2 Ø 27

5000725267, 5010144552





Manager ...

G 280.19	09/91→03/93	Ball Head, gearshift linkage	CV-ES-2121	
	09/91→03/93	Centre Rod	RV-DL-0900	Push Rod
	09/91→03/93	Tie Rod End	CV-ES-0912	
	09/91→03/93	Tie Rod End	CV-ES-0914	for Steering Rod
	09/91→03/93	Tie Rod End	CV-ES-14162	for Steering Rod
	09/91→03/93	Tie Rod End	CV-ES-14163	for Steering Rod
	09/91→03/93	Tie Rod End	RV-ES-8691	
G 280.19,G 270.19	09/91→10/96	Ball Head, gearshift linkage	CV-ES-2121	
	09/91→10/96	Centre Rod	RV-DL-0900	Push Rod
	09/91→10/96	Tie Rod End	CV-ES-0912	
	09/91→10/96	Tie Rod End	CV-ES-0914	for Steering Rod
	09/91→10/96	Tie Rod End	CV-ES-14162	for Steering Rod
	09/91→10/96	Tie Rod End	CV-ES-14163	for Steering Rod
	09/91→10/96	Tie Rod End	RV-ES-8691	
G 280.24	09/91→03/93	Ball Head, gearshift linkage	CV-ES-2121	
	09/91→03/93	Centre Rod	RV-DL-0900	Push Rod
	09/91→03/93	Centre Rod	RV-DL-8198	Push Rod
	09/91→03/93	Tie Rod End	CV-ES-0912	
	09/91→03/93	Tie Rod End	CV-ES-0914	for Steering Rod
	09/91→03/93	Tie Rod End	CV-ES-14162	for Steering Rod
	09/91→03/93	Tie Rod End	CV-ES-14163	for Steering Rod
	09/91→03/93	Tie Rod End	RV-ES-8691	
G 280.26,G 270.26	09/91→10/96	Ball Head, gearshift linkage	CV-ES-2121	
	09/91→10/96	Centre Rod	RV-DL-0900	Push Rod
	09/91→10/96	Centre Rod	RV-DL-8198	Push Rod
	09/91→10/96	Tie Rod End	CV-ES-0912	
	09/91→10/96	Tie Rod End	CV-ES-0914	for Steering Rod
	09/91→10/96	Tie Rod End	CV-ES-14162	for Steering Rod
	09/91→10/96	Tie Rod End	CV-ES-14163	for Steering Rod
	09/91→10/96	Tie Rod End	RV-ES-8691	
G 300.13	09/91→10/96	Ball Head, gearshift linkage	CV-ES-2121	
	09/91→10/96	Centre Rod	RV-DL-0900	Push Rod
	09/91→10/96	Tie Rod End	CV-ES-0912	
	09/91→10/96	Tie Rod End	CV-ES-0914	for Steering Rod
	09/91→10/96	Tie Rod End	CV-ES-14162	for Steering Rod
	09/91→10/96	Tie Rod End	CV-ES-14163	for Steering Rod
	09/91→10/96	Tie Rod End	RV-ES-8691	
G 300.15	09/91→10/96	Ball Head, gearshift linkage	CV-ES-2121	
	09/91→10/96	Centre Rod	RV-DL-0900	Push Rod
	09/91→10/96	Tie Rod End	CV-ES-0912	
	09/91→10/96	Tie Rod End	CV-ES-0914	for Steering Rod
	09/91→10/96	Tie Rod End	CV-ES-14162	for Steering Rod
	09/91→10/96	Tie Rod End	CV-ES-14163	for Steering Rod
	09/91→10/96	Tie Rod End	RV-ES-8691	
G 300.15/T	09/91→10/96	Ball Head, gearshift linkage	CV-ES-2121	
	09/91→10/96	Centre Rod	RV-DL-0900	Push Rod
	09/91→10/96	Tie Rod End	CV-ES-0912	
	09/91→10/96	Tie Rod End	CV-ES-0914	for Steering Rod
	09/91→10/96	Tie Rod End	CV-ES-14162	for Steering Rod
	09/91→10/96	Tie Rod End	CV-ES-14163	for Steering Rod
	09/91→10/96	Tie Rod End	RV-ES-8691	
G 300.16	09/91→10/96	Ball Head, gearshift linkage	CV-ES-2121	
	09/91→10/96	Centre Rod	RV-DL-0900	Push Rod
	09/91→10/96	Tie Rod End	CV-ES-0912	
	09/91→10/96	Tie Rod End	CV-ES-0914	for Steering Rod
	09/91→10/96	Tie Rod End	CV-ES-14162	for Steering Rod
	09/91→10/96	Tie Rod End	CV-ES-14163	for Steering Rod
	09/91→10/96	Tie Rod End	RV-ES-8691	
G 300.17	09/91→10/96	Ball Head, gearshift linkage	CV-ES-2121	
	09/91→10/96	Centre Rod	RV-DL-0900	Push Rod
	09/91→10/96	Tie Rod End	CV-ES-0912	
	09/91→10/96	Tie Rod End	CV-ES-0914	for Steering Rod
	09/91→10/96	Tie Rod End	CV-ES-14162	for Steering Rod

CV-ES-0912

Length: 125
Cone Ø: d1 Ø 30 / d2 Ø 27
Thread: M38 x 1,5 LHT
3401206, 5001832579



RV-DL-8198

Length: 981
Ø: 52
Cone Ø: d1 Ø 30 / d2 Ø 27
5010094585, 7485114919



CV-ES-0914

Length: 125
Cone Ø: d1 Ø 30 / d2 Ø 27
Thread: M38 x 1,5 RHT
3401207, 5001832580



RV-ES-8691

Length: 106
Cone Ø: d1 Ø 20 / d2 Ø 18
Thread: M24 x 1,5 LHT
7700658834



CV-ES-2121

Length: 85
Cone Ø: d1 Ø 12 / d2 Ø 10,8
Thread: M14 x 1,5 RHT
23162046, 5000516214, 5010144543,
5010245591



CV-ES-14162

Length: 125
Cone Ø: d1 Ø 30 / d2 Ø 27
Thread: M30 x 1,5 LHT
3401170, 5000288361, 5001832581,
5001858759, 5001858774



CV-ES-14163

Length: 125
Cone Ø: d1 Ø 30 / d2 Ø 27
Thread: M30 x 1,5 RHT
0003406169, 0003406236, 0003406251,
0003406254, 0003406260, 0003406261,
5000288360, 5000590236, 5000804824,
5001858773, 7420937674, 7701011412



RV-DL-0900

Length: 990
Ø: 52
Cone Ø: d1 Ø 30 / d2 Ø 27
5000725267, 5010144552





Manager ...

G 300.17 ...	09/91→10/96	Tie Rod End	CV-ES-14163		for Steering Rod
	09/91→10/96	Tie Rod End	RV-ES-8691		
G 300.17/T	09/92→10/96	Ball Head, gearshift linkage	CV-ES-2121		
	09/92→10/96	Centre Rod	RV-DL-0900		Push Rod
	09/92→10/96	Tie Rod End	CV-ES-0912		
	09/92→10/96	Tie Rod End	CV-ES-0914		for Steering Rod
	09/92→10/96	Tie Rod End	CV-ES-14162		for Steering Rod
	09/92→10/96	Tie Rod End	CV-ES-14163		for Steering Rod
	09/92→10/96	Tie Rod End	RV-ES-8691		
G 300.18	09/92→10/96	Ball Head, gearshift linkage	CV-ES-2121		
	09/92→10/96	Centre Rod	RV-DL-0900		Push Rod
	09/92→10/96	Tie Rod End	CV-ES-0912		
	09/92→10/96	Tie Rod End	CV-ES-0914		for Steering Rod
	09/92→10/96	Tie Rod End	CV-ES-14162		for Steering Rod
	09/92→10/96	Tie Rod End	CV-ES-14163		for Steering Rod
	09/92→10/96	Tie Rod End	RV-ES-8691		
G 300.19	09/91→10/96	Ball Head, gearshift linkage	CV-ES-2121		
	09/91→10/96	Centre Rod	RV-DL-0900		Push Rod
	09/91→10/96	Tie Rod End	CV-ES-0912		
	09/91→10/96	Tie Rod End	CV-ES-0914		for Steering Rod
	09/91→10/96	Tie Rod End	CV-ES-14162		for Steering Rod
	09/91→10/96	Tie Rod End	CV-ES-14163		for Steering Rod
G 300.19/T	09/91→10/96	Ball Head, gearshift linkage	CV-ES-2121		
	09/91→10/96	Centre Rod	RV-DL-0900		Push Rod
	09/91→10/96	Tie Rod End	CV-ES-0912		
	09/91→10/96	Tie Rod End	CV-ES-0914		for Steering Rod
	09/91→10/96	Tie Rod End	CV-ES-14162		for Steering Rod
	09/91→10/96	Tie Rod End	CV-ES-14163		for Steering Rod
G 300.24	09/91→10/96	Ball Head, gearshift linkage	CV-ES-2121		
	09/91→10/96	Centre Rod	RV-DL-0900		Push Rod
	09/91→10/96	Centre Rod	RV-DL-8198		Push Rod
	09/91→10/96	Tie Rod End	CV-ES-0912		
	09/91→10/96	Tie Rod End	CV-ES-0914		for Steering Rod
	09/91→10/96	Tie Rod End	CV-ES-14162		for Steering Rod
	09/91→10/96	Tie Rod End	CV-ES-14163		for Steering Rod
	09/91→10/96	Tie Rod End	RV-ES-8691		
G 300.25	09/91→10/96	Ball Head, gearshift linkage	CV-ES-2121		
	09/91→10/96	Centre Rod	RV-DL-0900		Push Rod
	09/91→10/96	Centre Rod	RV-DL-8198		Push Rod
	09/91→10/96	Tie Rod End	CV-ES-0912		
	09/91→10/96	Tie Rod End	CV-ES-0914		for Steering Rod
	09/91→10/96	Tie Rod End	CV-ES-14162		for Steering Rod
	09/91→10/96	Tie Rod End	CV-ES-14163		for Steering Rod
	09/91→10/96	Tie Rod End	RV-ES-8691		
G 300.26	09/91→10/96	Ball Head, gearshift linkage	CV-ES-2121		
	09/91→10/96	Centre Rod	RV-DL-0900		Push Rod
	09/91→10/96	Centre Rod	RV-DL-8198		Push Rod
	09/91→10/96	Tie Rod End	CV-ES-0912		
	09/91→10/96	Tie Rod End	CV-ES-0914		for Steering Rod
	09/91→10/96	Tie Rod End	CV-ES-14162		for Steering Rod
	09/91→10/96	Tie Rod End	CV-ES-14163		for Steering Rod
	09/91→10/96	Tie Rod End	RV-ES-8691		
	G 300.26 CIT	09/91→10/96	Ball Head, gearshift linkage	CV-ES-2121	
09/91→10/96		Centre Rod	RV-DL-0900		Push Rod
09/91→10/96		Centre Rod	RV-DL-8198		Push Rod
09/91→10/96		Tie Rod End	CV-ES-0912		
09/91→10/96		Tie Rod End	CV-ES-0914		for Steering Rod
09/91→10/96		Tie Rod End	CV-ES-14162		for Steering Rod
09/91→10/96		Tie Rod End	CV-ES-14163		for Steering Rod
09/91→10/96		Tie Rod End	RV-ES-8691		

CV-ES-0912

Length: 125
Cone Ø: d1 Ø 30 / d2 Ø 27
Thread: M38 x 1,5 LHT
3401206, 5001832579



RV-DL-8198

Length: 981
Ø: 52
Cone Ø: d1 Ø 30 / d2 Ø 27
5010094585, 7485114919



CV-ES-0914

Length: 125
Cone Ø: d1 Ø 30 / d2 Ø 27
Thread: M38 x 1,5 RHT
3401207, 5001832580



RV-ES-8691

Length: 106
Cone Ø: d1 Ø 20 / d2 Ø 18
Thread: M24 x 1,5 LHT
7700658834



CV-ES-2121

Length: 85
Cone Ø: d1 Ø 12 / d2 Ø 10,8
Thread: M14 x 1,5 RHT
23162046, 5000516214, 5010144543,
5010245591



CV-ES-14162

Length: 125
Cone Ø: d1 Ø 30 / d2 Ø 27
Thread: M30 x 1,5 LHT
3401170, 5000288361, 5001832581,
5001858759, 5001858774



CV-ES-14163

Length: 125
Cone Ø: d1 Ø 30 / d2 Ø 27
Thread: M30 x 1,5 RHT
0003406169, 0003406236, 0003406251,
0003406254, 0003406260, 0003406261,
5000288360, 5000590236, 5000804824,
5001858773, 7420937674, 7701011412



RV-DL-0900

Length: 990
Ø: 52
Cone Ø: d1 Ø 30 / d2 Ø 27
5000725267, 5010144552





Manager ...

G 300.26/T	09/91→10/96	Ball Head, gearshift linkage	CV-ES-2121	
	09/91→10/96	Centre Rod	RV-DL-0900	Push Rod
	09/91→10/96	Centre Rod	RV-DL-8198	Push Rod
	09/91→10/96	Tie Rod End	CV-ES-0912	
	09/91→10/96	Tie Rod End	CV-ES-0914	for Steering Rod
	09/91→10/96	Tie Rod End	CV-ES-14162	for Steering Rod
	09/91→10/96	Tie Rod End	CV-ES-14163	for Steering Rod
	09/91→10/96	Tie Rod End	RV-ES-8691	
G 330.13	09/91→03/93	Ball Head, gearshift linkage	CV-ES-2121	
	09/91→03/93	Centre Rod	RV-DL-0900	Push Rod
	09/91→03/93	Tie Rod End	CV-ES-0912	
	09/91→03/93	Tie Rod End	CV-ES-0914	for Steering Rod
	09/91→03/93	Tie Rod End	CV-ES-14162	for Steering Rod
	09/91→03/93	Tie Rod End	CV-ES-14163	for Steering Rod
	09/91→03/93	Tie Rod End	RV-ES-8691	
G 330.15	09/91→03/93	Ball Head, gearshift linkage	CV-ES-2121	
	09/91→03/93	Centre Rod	RV-DL-0900	Push Rod
	09/91→03/93	Tie Rod End	CV-ES-0912	
	09/91→03/93	Tie Rod End	CV-ES-0914	for Steering Rod
	09/91→03/93	Tie Rod End	CV-ES-14162	for Steering Rod
	09/91→03/93	Tie Rod End	CV-ES-14163	for Steering Rod
G 330.17	09/91→03/93	Ball Head, gearshift linkage	CV-ES-2121	
	09/91→03/93	Centre Rod	RV-DL-0900	Push Rod
	09/91→03/93	Tie Rod End	CV-ES-0912	
	09/91→03/93	Tie Rod End	CV-ES-0914	for Steering Rod
	09/91→03/93	Tie Rod End	CV-ES-14162	for Steering Rod
	09/91→03/93	Tie Rod End	CV-ES-14163	for Steering Rod
	09/91→03/93	Tie Rod End	RV-ES-8691	
G 330.18	09/91→03/93	Ball Head, gearshift linkage	CV-ES-2121	
	09/91→03/93	Centre Rod	RV-DL-0900	Push Rod
	09/91→03/93	Tie Rod End	CV-ES-0912	
	09/91→03/93	Tie Rod End	CV-ES-0914	for Steering Rod
	09/91→03/93	Tie Rod End	CV-ES-14162	for Steering Rod
	09/91→03/93	Tie Rod End	CV-ES-14163	for Steering Rod
G 330.19	09/91→03/93	Ball Head, gearshift linkage	CV-ES-2121	
	09/91→03/93	Centre Rod	RV-DL-0900	Push Rod
	09/91→03/93	Tie Rod End	CV-ES-0912	
	09/91→03/93	Tie Rod End	CV-ES-0914	for Steering Rod
	09/91→03/93	Tie Rod End	CV-ES-14162	for Steering Rod
	09/91→03/93	Tie Rod End	CV-ES-14163	for Steering Rod
	09/91→03/93	Tie Rod End	RV-ES-8691	
G 330.24	09/91→03/93	Ball Head, gearshift linkage	CV-ES-2121	
	09/91→03/93	Centre Rod	RV-DL-0900	Push Rod
	09/91→03/93	Centre Rod	RV-DL-8198	Push Rod
	09/91→03/93	Tie Rod End	CV-ES-0912	
	09/91→03/93	Tie Rod End	CV-ES-0914	for Steering Rod
	09/91→03/93	Tie Rod End	CV-ES-14162	for Steering Rod
	09/91→03/93	Tie Rod End	CV-ES-14163	for Steering Rod
	09/91→03/93	Tie Rod End	RV-ES-8691	
G 330.26	09/91→03/93	Ball Head, gearshift linkage	CV-ES-2121	
	09/91→03/93	Centre Rod	RV-DL-0900	Push Rod
	09/91→03/93	Centre Rod	RV-DL-8198	Push Rod
	09/91→03/93	Tie Rod End	CV-ES-0912	
	09/91→03/93	Tie Rod End	CV-ES-0914	for Steering Rod
	09/91→03/93	Tie Rod End	CV-ES-14162	for Steering Rod
	09/91→03/93	Tie Rod End	CV-ES-14163	for Steering Rod
	09/91→03/93	Tie Rod End	RV-ES-8691	
G 340ti.16,G 330.16	09/91→10/96	Ball Head, gearshift linkage	CV-ES-2121	
	09/91→10/96	Centre Rod	RV-DL-0900	Push Rod
	09/91→10/96	Tie Rod End	CV-ES-0912	
	09/91→10/96	Tie Rod End	CV-ES-0914	for Steering Rod

CV-ES-0912

Length: 125
Cone Ø: d1 Ø 30 / d2 Ø 27
Thread: M38 x 1,5 LHT
3401206, 5001832579



RV-DL-8198

Length: 981
Ø: 52
Cone Ø: d1 Ø 30 / d2 Ø 27
5010094585, 7485114919



CV-ES-0914

Length: 125
Cone Ø: d1 Ø 30 / d2 Ø 27
Thread: M38 x 1,5 RHT
3401207, 5001832580



RV-ES-8691

Length: 106
Cone Ø: d1 Ø 20 / d2 Ø 18
Thread: M24 x 1,5 LHT
7700658834



CV-ES-2121

Length: 85
Cone Ø: d1 Ø 12 / d2 Ø 10,8
Thread: M14 x 1,5 RHT
23162046, 5000516214, 5010144543,
5010245591



CV-ES-14162

Length: 125
Cone Ø: d1 Ø 30 / d2 Ø 27
Thread: M30 x 1,5 LHT
3401170, 5000288361, 5001832581,
5001858759, 5001858774



CV-ES-14163

Length: 125
Cone Ø: d1 Ø 30 / d2 Ø 27
Thread: M30 x 1,5 RHT
0003406169, 0003406236, 0003406251,
0003406254, 0003406260, 0003406261,
5000288360, 5000590236, 5000804824,
5001858773, 7420937674, 7701011412



RV-DL-0900

Length: 990
Ø: 52
Cone Ø: d1 Ø 30 / d2 Ø 27
5000725267, 5010144552





Manager ...

G 340ti.16,G 330.16 ...	09/91→10/96	Tie Rod End	CV-ES-14162	for Steering Rod
	09/91→10/96	Tie Rod End	CV-ES-14163	for Steering Rod
	09/91→10/96	Tie Rod End	RV-ES-8691	
G 340ti.17,G 330.19	09/91→10/96	Ball Head, gearshift linkage	CV-ES-2121	
	09/91→10/96	Centre Rod	RV-DL-0900	Push Rod
	09/91→10/96	Tie Rod End	CV-ES-0912	
	09/91→10/96	Tie Rod End	CV-ES-0914	for Steering Rod
	09/91→10/96	Tie Rod End	CV-ES-14162	for Steering Rod
	09/91→10/96	Tie Rod End	CV-ES-14163	for Steering Rod
	09/91→10/96	Tie Rod End	RV-ES-8691	
G 340ti.17/T,G 330.17/T	09/91→10/96	Ball Head, gearshift linkage	CV-ES-2121	
	09/91→10/96	Centre Rod	RV-DL-0900	Push Rod
	09/91→10/96	Tie Rod End	CV-ES-0912	
	09/91→10/96	Tie Rod End	CV-ES-0914	for Steering Rod
	09/91→10/96	Tie Rod End	CV-ES-14162	for Steering Rod
	09/91→10/96	Tie Rod End	CV-ES-14163	for Steering Rod
	09/91→10/96	Tie Rod End	RV-ES-8691	
G 340ti.18,G 330.18	09/91→10/96	Ball Head, gearshift linkage	CV-ES-2121	
	09/91→10/96	Centre Rod	RV-DL-0900	Push Rod
	09/91→10/96	Tie Rod End	CV-ES-0912	
	09/91→10/96	Tie Rod End	CV-ES-0914	for Steering Rod
	09/91→10/96	Tie Rod End	CV-ES-14162	for Steering Rod
	09/91→10/96	Tie Rod End	CV-ES-14163	for Steering Rod
	09/91→10/96	Tie Rod End	RV-ES-8691	
G 340ti.18/T	02/92→10/96	Ball Head, gearshift linkage	CV-ES-2121	
	02/92→10/96	Centre Rod	RV-DL-0900	Push Rod
	02/92→10/96	Tie Rod End	CV-ES-0912	
	02/92→10/96	Tie Rod End	CV-ES-0914	for Steering Rod
	02/92→10/96	Tie Rod End	CV-ES-14162	for Steering Rod
	02/92→10/96	Tie Rod End	CV-ES-14163	for Steering Rod
	02/92→10/96	Tie Rod End	RV-ES-8691	
G 340ti.19,G 330.19	09/91→10/96	Ball Head, gearshift linkage	CV-ES-2121	
	09/91→10/96	Centre Rod	RV-DL-0900	Push Rod
	09/91→10/96	Tie Rod End	CV-ES-0912	
	09/91→10/96	Tie Rod End	CV-ES-0914	for Steering Rod
	09/91→10/96	Tie Rod End	CV-ES-14162	for Steering Rod
	09/91→10/96	Tie Rod End	CV-ES-14163	for Steering Rod
G 340ti.19/T,G 330.19/T	09/91→10/96	Ball Head, gearshift linkage	CV-ES-2121	
	09/91→10/96	Centre Rod	RV-DL-0900	Push Rod
	09/91→10/96	Tie Rod End	CV-ES-0912	
	09/91→10/96	Tie Rod End	CV-ES-0914	for Steering Rod
	09/91→10/96	Tie Rod End	CV-ES-14162	for Steering Rod
	09/91→10/96	Tie Rod End	CV-ES-14163	for Steering Rod
G 340ti.19/T,G 330.19/T,G 330.17/T	09/91→10/96	Ball Head, gearshift linkage	CV-ES-2121	
	09/91→10/96	Centre Rod	RV-DL-0900	Push Rod
	09/91→10/96	Tie Rod End	CV-ES-0912	
	09/91→10/96	Tie Rod End	CV-ES-0914	for Steering Rod
	09/91→10/96	Tie Rod End	CV-ES-14162	for Steering Rod
	09/91→10/96	Tie Rod End	CV-ES-14163	for Steering Rod
	09/91→10/96	Tie Rod End	RV-ES-8691	
	09/91→10/96	Tie Rod End	RV-ES-8691	
G 340ti.26,G 330.26	10/91→10/96	Ball Head, gearshift linkage	CV-ES-2121	
	10/91→10/96	Centre Rod	RV-DL-0900	Push Rod
	10/91→10/96	Centre Rod	RV-DL-8198	Push Rod
	10/91→10/96	Tie Rod End	CV-ES-0912	
	10/91→10/96	Tie Rod End	CV-ES-0914	for Steering Rod
	10/91→10/96	Tie Rod End	CV-ES-14162	for Steering Rod
	10/91→10/96	Tie Rod End	CV-ES-14163	for Steering Rod
	10/91→10/96	Tie Rod End	RV-ES-8691	

CV-ES-0912

Length: 125
Cone Ø: d1 Ø 30 / d2 Ø 27
Thread: M38 x 1,5 LHT
3401206, 5001832579



RV-DL-8198

Length: 981
Ø: 52
Cone Ø: d1 Ø 30 / d2 Ø 27
5010094585, 7485114919



CV-ES-0914

Length: 125
Cone Ø: d1 Ø 30 / d2 Ø 27
Thread: M38 x 1,5 RHT
3401207, 5001832580



RV-ES-8691

Length: 106
Cone Ø: d1 Ø 20 / d2 Ø 18
Thread: M24 x 1,5 LHT
7700658834



CV-ES-2121

Length: 85
Cone Ø: d1 Ø 12 / d2 Ø 10,8
Thread: M14 x 1,5 RHT
23162046, 5000516214, 5010144543,
5010245591



CV-ES-14162

Length: 125
Cone Ø: d1 Ø 30 / d2 Ø 27
Thread: M30 x 1,5 LHT
3401170, 5000288361, 5001832581,
5001858759, 5001858774



CV-ES-14163

Length: 125
Cone Ø: d1 Ø 30 / d2 Ø 27
Thread: M30 x 1,5 RHT
0003406169, 0003406236, 0003406251,
0003406254, 0003406260, 0003406261,
5000288360, 5000590236, 5000804824,
5001858773, 7420937674, 7701011412



RV-DL-0900

Length: 990
Ø: 52
Cone Ø: d1 Ø 30 / d2 Ø 27
5000725267, 5010144552





Maxter

G 230ti.19	10/92→05/95	Centre Rod	RV-DL-8156	Push Rod
	10/92→05/95	Tie Rod	RV-DL-8313	Guide Rod
	10/92→05/95	Tie Rod End	CV-ES-14163	for Steering Rod
	10/92→05/95	Tie Rod End	RV-ES-8691	
G 260.19	02/96→06/97	Centre Rod	RV-DL-8156	Push Rod
	02/96→06/97	Tie Rod	RV-DL-8313	Guide Rod
	02/96→06/97	Tie Rod End	CV-ES-14163	for Steering Rod
	02/96→06/97	Tie Rod End	RV-ES-8691	
G 270.19	01/93→10/96	Centre Rod	RV-DL-8156	Push Rod
	01/93→10/96	Tie Rod	RV-DL-8313	Guide Rod
	01/93→10/96	Tie Rod End	CV-ES-14163	for Steering Rod
	01/93→10/96	Tie Rod End	RV-ES-8691	
G 280.18	10/92→03/93	Centre Rod	RV-DL-8156	Push Rod
	10/92→03/93	Tie Rod	RV-DL-8313	Guide Rod
	10/92→03/93	Tie Rod End	CV-ES-14163	for Steering Rod
G 280.18/T	10/92→03/93	Centre Rod	RV-DL-8156	Push Rod
	10/92→03/93	Tie Rod	RV-DL-8313	Guide Rod
	10/92→03/93	Tie Rod End	CV-ES-14163	for Steering Rod
G 300.18	10/92→10/96	Ball Head, gearshift linkage	CV-ES-2121	
	10/92→10/96	Centre Rod	RV-DL-0886	Push Rod
	10/92→10/96	Centre Rod	RV-DL-8156	Push Rod
	10/92→10/96	Tie Rod	RV-DL-8313	Guide Rod
	10/92→10/96	Tie Rod End	CV-ES-14162	for Steering Rod
	10/92→10/96	Tie Rod End	CV-ES-14163	for Steering Rod
	10/92→10/96	Tie Rod End	RV-ES-8691	
G 300.19	10/92→06/97	Ball Head, gearshift linkage	CV-ES-2121	
	10/92→06/97	Centre Rod	RV-DL-0886	Push Rod
	10/92→06/97	Centre Rod	RV-DL-8156	Push Rod
	10/92→06/97	Tie Rod	RV-DL-8313	Guide Rod
	10/92→06/97	Tie Rod End	CV-ES-14162	for Steering Rod
	10/92→06/97	Tie Rod End	CV-ES-14163	for Steering Rod
	10/92→06/97	Tie Rod End	RV-ES-8691	
G 300.19/T	10/92→10/96	Ball Head, gearshift linkage	CV-ES-2121	
	10/92→10/96	Centre Rod	RV-DL-0886	Push Rod
	10/92→10/96	Centre Rod	RV-DL-8156	Push Rod
	10/92→10/96	Tie Rod	RV-DL-8313	Guide Rod
	10/92→10/96	Tie Rod End	CV-ES-14162	for Steering Rod
	10/92→10/96	Tie Rod End	CV-ES-14163	for Steering Rod
	10/92→10/96	Tie Rod End	RV-ES-8691	
G 300.26	10/92→10/96	Centre Rod	RV-DL-8300	Push Rod
	10/92→06/97	Ball Head, gearshift linkage	CV-ES-2121	
	10/92→06/97	Centre Rod	RV-DL-0886	Push Rod
	10/92→06/97	Centre Rod	RV-DL-8156	Push Rod
	10/92→06/97	Tie Rod	RV-DL-8313	Guide Rod
	10/92→06/97	Tie Rod End	CV-ES-14162	for Steering Rod
	10/92→06/97	Tie Rod End	CV-ES-14163	for Steering Rod
	10/92→06/97	Tie Rod End	RV-ES-8691	
	10/92→06/97	Track Control Arm	RV-DL-7971	Trailing Arm
G 340ti.18/T	10/92→06/97	Ball Head, gearshift linkage	CV-ES-2121	
	10/92→06/97	Centre Rod	RV-DL-0886	Push Rod
	10/92→06/97	Tie Rod End	CV-ES-14162	for Steering Rod
	10/92→06/97	Tie Rod End	CV-ES-14163	for Steering Rod
	10/92→06/97	Tie Rod End	RV-ES-8691	
G 340ti.19	10/92→06/97	Ball Head, gearshift linkage	CV-ES-2121	
	10/92→06/97	Centre Rod	RV-DL-0886	Push Rod
	10/92→06/97	Centre Rod	RV-DL-8156	Push Rod
	10/92→06/97	Tie Rod	RV-DL-8313	Guide Rod
	10/92→06/97	Tie Rod End	CV-ES-14162	for Steering Rod
	10/92→06/97	Tie Rod End	CV-ES-14163	for Steering Rod

CV-ES-2121

Length: 85

Cone Ø: d1 Ø 12 / d2 Ø 10,8

Thread: M14 x 1,5 RHT

23162046, 5000516214, 5010144543,
5010245591



RV-DL-8300

Length: 1125

Ø: 50

Cone Ø: d1 Ø 30 / d2 Ø 27

5010383528, 5010488096



CV-ES-14162

Length: 125

Cone Ø: d1 Ø 30 / d2 Ø 27

Thread: M30 x 1,5 LHT

3401170, 5000288361, 5001832581,
5001858759, 5001858774



RV-DL-8313

Length: 1752

Ø: 48

Cone Ø: d1 Ø 30 / d2 Ø 27

5010098467, 5010145584, 5010439631



CV-ES-14163

Length: 125

Cone Ø: d1 Ø 30 / d2 Ø 27

Thread: M30 x 1,5 RHT

0003406169, 0003406236, 0003406251,
0003406254, 0003406260, 0003406261,
5000288360, 5000590236, 5000804824,
5001858773, 7420937674, 7701011412



RV-ES-8691

Length: 106

Cone Ø: d1 Ø 20 / d2 Ø 18

Thread: M24 x 1,5 LHT

7700658834



RV-DL-0886

Length: 945

Ø: 52

Cone Ø: d1 Ø 30 / d2 Ø 27

5010229242, 5010488052



RV-DL-7971

Length: 575

Ø: 50

Hole Distance: 152 / 152

5010094840



RV-DL-8156

Length: 934

Ø: 52

Cone Ø: d1 Ø 30 / d2 Ø 27

5010229243, 5010488053





Maxter ...

G 340ti.19/T	10/92→06/97	Ball Head, gearshift linkage	CV-ES-2121		
	10/92→06/97	Centre Rod	RV-DL-0886		Push Rod
	10/92→06/97	Centre Rod	RV-DL-8156		Push Rod
	10/92→06/97	Tie Rod	RV-DL-8313		Guide Rod
	10/92→06/97	Tie Rod End	CV-ES-14162		for Steering Rod
	10/92→06/97	Tie Rod End	CV-ES-14163		for Steering Rod
	10/92→06/97	Tie Rod End	RV-ES-8691		
G 340ti.25/A,G 340ti.25/B	10/92→06/97	Ball Head, gearshift linkage	CV-ES-2121		
	10/92→06/97	Centre Rod	RV-DL-0886		Push Rod
	10/92→06/97	Centre Rod	RV-DL-8156		Push Rod
	10/92→06/97	Tie Rod	RV-DL-8313		Guide Rod
	10/92→06/97	Tie Rod End	CV-ES-14162		for Steering Rod
	10/92→06/97	Tie Rod End	CV-ES-14163		for Steering Rod
	10/92→06/97	Tie Rod End	RV-ES-8691		
G 340ti.26	10/92→06/97	Track Control Arm		RV-DL-7971	Trailing Arm
	10/92→06/97	Ball Head, gearshift linkage	CV-ES-2121		
	10/92→06/97	Centre Rod	RV-DL-0886		Push Rod
	10/92→06/97	Centre Rod	RV-DL-8156		Push Rod
	10/92→06/97	Tie Rod	RV-DL-8313		Guide Rod
	10/92→06/97	Tie Rod End	CV-ES-14162		for Steering Rod
	10/92→06/97	Tie Rod End	CV-ES-14163		for Steering Rod
G 340ti.26,G 340ti.26/B	10/92→06/97	Tie Rod End	RV-ES-8691		
	10/92→06/97	Track Control Arm		RV-DL-7971	Trailing Arm
	10/92→06/97	Ball Head, gearshift linkage	CV-ES-2121		
	10/92→06/97	Centre Rod	RV-DL-0886		Push Rod
	10/92→06/97	Centre Rod	RV-DL-8156		Push Rod
	10/92→06/97	Tie Rod	RV-DL-8313		Guide Rod
	10/92→06/97	Tie Rod End	CV-ES-14162		for Steering Rod
G 340ti.26/B	10/92→06/97	Tie Rod End	CV-ES-14163		for Steering Rod
	10/92→06/97	Tie Rod End	RV-ES-8691		
	10/92→06/97	Track Control Arm		RV-DL-7971	Trailing Arm
	10/92→06/97	Ball Head, gearshift linkage	CV-ES-2121		
	10/92→06/97	Centre Rod	RV-DL-0886		Push Rod
	10/92→06/97	Centre Rod	RV-DL-8156		Push Rod
	10/92→06/97	Tie Rod	RV-DL-8313		Guide Rod
G 340ti.26/C	10/92→06/97	Tie Rod End	CV-ES-14162		for Steering Rod
	10/92→06/97	Tie Rod End	CV-ES-14163		for Steering Rod
	10/92→06/97	Tie Rod End	RV-ES-8691		
	10/92→06/97	Track Control Arm		RV-DL-7971	Trailing Arm
	10/92→06/97	Centre Rod	RV-DL-0886		Push Rod
	10/92→06/97	Tie Rod End	CV-ES-14163		for Steering Rod
	10/92→06/97	Tie Rod End	RV-ES-8691		
G 340ti.32,G 340ti.32/B	10/92→06/97	Track Control Arm		RV-DL-7971	Trailing Arm
	10/92→06/97	Ball Head, gearshift linkage	CV-ES-2121		
	10/92→06/97	Centre Rod	RV-DL-0886		Push Rod
	10/92→06/97	Centre Rod	RV-DL-8156		Push Rod
	10/92→06/97	Centre Rod	RV-DL-8300		Push Rod
	10/92→06/97	Tie Rod	RV-DL-8313		Guide Rod
	10/92→06/97	Tie Rod End	CV-ES-14162		for Steering Rod
	10/92→06/97	Tie Rod End	CV-ES-14163		for Steering Rod
	10/92→06/97	Tie Rod End	RV-ES-8691		
	10/92→06/97	Track Control Arm		RV-DL-7971	Trailing Arm
G 340ti.32/A,G 340ti.32/B, G 340ti.32/C	10/92→06/97	Ball Head, gearshift linkage	CV-ES-2121		
	10/92→06/97	Centre Rod	RV-DL-0886		Push Rod
	10/92→06/97	Centre Rod	RV-DL-8156		Push Rod
	10/92→06/97	Centre Rod	RV-DL-8300		Push Rod
	10/92→06/97	Tie Rod	RV-DL-8313		Guide Rod
	10/92→06/97	Tie Rod End	CV-ES-14162		for Steering Rod
	10/92→06/97	Tie Rod End	CV-ES-14163		for Steering Rod
	10/92→06/97	Tie Rod End	RV-ES-8691		
	10/92→06/97	Track Control Arm		RV-DL-7971	Trailing Arm
	10/92→06/97	Track Control Arm		RV-DL-7971	Trailing Arm

CV-ES-2121

Length: 85

Cone Ø: d1 Ø 12 / d2 Ø 10,8

Thread: M14 x 1,5 RHT

23162046, 5000516214, 5010144543,
5010245591



RV-DL-8300

Length: 1125

Ø: 50

Cone Ø: d1 Ø 30 / d2 Ø 27

5010383528, 5010488096



CV-ES-14162

Length: 125

Cone Ø: d1 Ø 30 / d2 Ø 27

Thread: M30 x 1,5 LHT

3401170, 5000288361, 5001832581,
5001858759, 5001858774



RV-DL-8313

Length: 1752

Ø: 48

Cone Ø: d1 Ø 30 / d2 Ø 27

5010098467, 5010145584, 5010439631



CV-ES-14163

Length: 125

Cone Ø: d1 Ø 30 / d2 Ø 27

Thread: M30 x 1,5 RHT

0003406169, 0003406236, 0003406251,
0003406254, 0003406260, 0003406261,
5000288360, 5000590236, 5000804824,
5001858773, 7420937674, 7701011412



RV-ES-8691

Length: 106

Cone Ø: d1 Ø 20 / d2 Ø 18

Thread: M24 x 1,5 LHT

7700658834



RV-DL-0886

Length: 945

Ø: 52

Cone Ø: d1 Ø 30 / d2 Ø 27

5010229242, 5010488052



RV-DL-7971

Length: 575

Ø: 50

Hole Distance: 152 / 152

5010094840



RV-DL-8156

Length: 934

Ø: 52

Cone Ø: d1 Ø 30 / d2 Ø 27

5010229243, 5010488053





Maxter ...

G 340ti.34	10/92→06/97	Ball Head, gearshift linkage	CV-ES-2121		
	10/92→06/97	Centre Rod	RV-DL-0886		Push Rod
	10/92→06/97	Centre Rod	RV-DL-8156		Push Rod
	10/92→06/97	Tie Rod	RV-DL-8313		Guide Rod
	10/92→06/97	Tie Rod End	CV-ES-14162		for Steering Rod
	10/92→06/97	Tie Rod End	CV-ES-14163		for Steering Rod
	10/92→06/97	Tie Rod End	RV-ES-8691		
	10/92→06/97	Track Control Arm		RV-DL-7971	Trailing Arm
G 340ti.40	10/92→06/97	Ball Head, gearshift linkage	CV-ES-2121		
	10/92→06/97	Centre Rod	RV-DL-0886		Push Rod
	10/92→06/97	Centre Rod	RV-DL-8156		Push Rod
	10/92→06/97	Centre Rod	RV-DL-8300		Push Rod
	10/92→06/97	Tie Rod	RV-DL-8313		Guide Rod
	10/92→06/97	Tie Rod End	CV-ES-14162		for Steering Rod
	10/92→06/97	Tie Rod End	CV-ES-14163		for Steering Rod
	10/92→06/97	Tie Rod End	RV-ES-8691		
10/92→06/97	Track Control Arm		RV-DL-7971	Trailing Arm	

Midliner

M 140.12/C	05/89→03/93	Ball Head, gearshift linkage	CV-ES-2121		
	05/89→03/93	Centre Rod	RV-DL-0904		Push Rod
	05/89→03/93	Centre Rod	RV-DL-0909		Coupling Rod
	05/89→03/93	Tie Rod	RV-DL-8170		
	05/89→03/93	Tie Rod	RV-DL-8317		
	05/89→03/93	Tie Rod End	CV-ES-0912		
	05/89→03/93	Tie Rod End	CV-ES-0914		for Steering Rod
	05/89→03/93	Tie Rod End	CV-ES-12461		for Steering Rod
	05/89→03/93	Tie Rod End	CV-ES-12462		for Steering Rod
M 140.13/C	04/89→03/93	Ball Head, gearshift linkage	CV-ES-2121		
	04/89→03/93	Centre Rod	RV-DL-0904		Push Rod
	04/89→03/93	Centre Rod	RV-DL-0909		Coupling Rod
	04/89→03/93	Tie Rod	RV-DL-8170		
	04/89→03/93	Tie Rod	RV-DL-8317		
	04/89→03/93	Tie Rod End	CV-ES-0912		
	04/89→03/93	Tie Rod End	CV-ES-0914		for Steering Rod
	04/89→03/93	Tie Rod End	CV-ES-12461		for Steering Rod
	04/89→03/93	Tie Rod End	CV-ES-12462		for Steering Rod
M 150.09/C	11/92→10/96	Ball Head, gearshift linkage	CV-ES-2121		
	11/92→10/96	Centre Rod	RV-DL-0904		Push Rod
	11/92→10/96	Centre Rod	RV-DL-0907		Push Rod
	11/92→10/96	Centre Rod	RV-DL-0909		Coupling Rod
	11/92→10/96	Centre Rod	RV-DL-10246		Push Rod
	11/92→10/96	Tie Rod	RV-DL-8199		
	11/92→10/96	Tie Rod End	CV-ES-0912		
	11/92→10/96	Tie Rod End	CV-ES-0914		for Steering Rod
	11/92→10/96	Tie Rod End	CV-ES-12461		for Steering Rod
M 150.09/C SP	11/92→10/96	Ball Head, gearshift linkage	CV-ES-2121		
	11/92→10/96	Centre Rod	RV-DL-0904		Push Rod
	11/92→10/96	Centre Rod	RV-DL-0907		Push Rod
	11/92→10/96	Centre Rod	RV-DL-0909		Coupling Rod
	11/92→10/96	Centre Rod	RV-DL-10246		Push Rod
	11/92→10/96	Tie Rod	RV-DL-8199		
	11/92→10/96	Tie Rod End	CV-ES-0912		
	11/92→10/96	Tie Rod End	CV-ES-0914		for Steering Rod
	11/92→10/96	Tie Rod End	CV-ES-12461		for Steering Rod
M 150.11/C	11/92→10/96	Ball Head, gearshift linkage	CV-ES-2121		
	11/92→10/96	Centre Rod	RV-DL-0904		Push Rod
	11/92→10/96	Centre Rod	RV-DL-0907		Push Rod
	11/92→10/96	Centre Rod	RV-DL-0909		Coupling Rod

CV-ES-0912

Length: 125
Cone Ø: d1 Ø 30 / d2 Ø 27
Thread: M38 x 1,5 LHT
3401206, 5001832579



CV-ES-0914

Length: 125
Cone Ø: d1 Ø 30 / d2 Ø 27
Thread: M38 x 1,5 RHT
3401207, 5001832580



CV-ES-2121

Length: 85
Cone Ø: d1 Ø 12 / d2 Ø 10,8
Thread: M14 x 1,5 RHT
23162046, 5000516214, 5010144543,
5010245591



CV-ES-12461

Length: 120
Cone Ø: d1 Ø 26 / d2 Ø 23,5
Thread: M30 x 1,5 LHT
0003406213, 3406218, 5000242467,
5000242488, 5000295215, 5000295336,
5000588470, 5000805280, 5000806187,
5000814347, 5000820879, 5000823654,
5001834533, 5001850550, 5001852263,
5001859984



CV-ES-12462

Length: 120
Cone Ø: d1 Ø 26 / d2 Ø 23,5
Thread: M30 x 1,5 RHT
0003406212, 0003406253, 5000242159,
5000295214, 5000812483, 5001831473,
5001850549, 5001852264, 5001859985,
7701016946



CV-ES-14162

Length: 125
Cone Ø: d1 Ø 30 / d2 Ø 27
Thread: M30 x 1,5 LHT
3401170, 5000288361, 5001832581,
5001858759, 5001858774



CV-ES-14163

Length: 125
Cone Ø: d1 Ø 30 / d2 Ø 27
Thread: M30 x 1,5 RHT
0003406169, 0003406236, 0003406251,
0003406254, 0003406260, 0003406261,
5000288360, 5000590236, 5000804824,
5001858773, 7420937674, 7701011412



RV-DL-0886

Length: 945
Ø: 52
Cone Ø: d1 Ø 30 / d2 Ø 27
5010229242, 5010488052



RV-DL-0904

Length: 872
Ø: 40
Cone Ø: d1 Ø 26 / d2 Ø 23,5
5010130393



RV-DL-0907

Length: 900
Ø: 40
Cone Ø: d1 Ø 22 / d2 Ø 20
5010037602, 5010130456



RV-DL-0909

Length: 1528
Ø: 40
Cone Ø: d1 Ø 26 / d2 Ø 23,5
5000613837



RV-DL-7971

Length: 575
Ø: 50
Hole Distance: 152 / 152
5010094840



RV-DL-8156

Length: 934
Ø: 52
Cone Ø: d1 Ø 30 / d2 Ø 27
5010229243, 5010488053



RV-DL-8170

Length: 1404
Ø: 34
Cone Ø: d1 Ø 22 / d2 Ø 20
5000350120, 5000541224, 5010097562,
7485114941



RV-DL-8199

Length: 1470
Ø: 36
Cone Ø: d1 Ø 26 / d2 Ø 23,5
5010308214, 5010439984



RV-DL-8300

Length: 1125
Ø: 50
Cone Ø: d1 Ø 30 / d2 Ø 27
5010383528, 5010488096



RV-DL-8313

Length: 1752
Ø: 48
Cone Ø: d1 Ø 30 / d2 Ø 27
5010098467, 5010145584, 5010439631



RV-DL-8317

Length: 1415
Ø: 30
Cone Ø: d1 Ø 20 / d2 Ø 18
5000446681, 5010224899



RV-DL-10246

Length: 895
Ø: 40
Cone Ø: d1 Ø 26 / d2 Ø 23,5
5010039426, 5010130386, 7485114920



RV-ES-8691

Length: 106
Cone Ø: d1 Ø 20 / d2 Ø 18
Thread: M24 x 1,5 LHT
7700658834





Midliner ...

M 150.11/C ...	11/92→10/96	Centre Rod	RV-DL-10246		Push Rod
	11/92→10/96	Tie Rod	RV-DL-8199		
	11/92→10/96	Tie Rod End	CV-ES-0912		
	11/92→10/96	Tie Rod End	CV-ES-0914		for Steering Rod
	11/92→10/96	Tie Rod End	CV-ES-12461		for Steering Rod
	11/92→10/96	Tie Rod End	CV-ES-12462		for Steering Rod
M 150.11/C SP	11/92→10/96	Ball Head, gearshift linkage	CV-ES-2121		
	11/92→10/96	Centre Rod	RV-DL-0904		Push Rod
	11/92→10/96	Centre Rod	RV-DL-0907		Push Rod
	11/92→10/96	Centre Rod	RV-DL-0909		Coupling Rod
	11/92→10/96	Centre Rod	RV-DL-10246		Push Rod
	11/92→10/96	Tie Rod	RV-DL-8199		
	11/92→10/96	Tie Rod End	CV-ES-0912		
	11/92→10/96	Tie Rod End	CV-ES-0914		for Steering Rod
	11/92→10/96	Tie Rod End	CV-ES-12461		for Steering Rod
	11/92→10/96	Tie Rod End	CV-ES-12462		for Steering Rod
	M 150.12/C	11/92→01/00	Ball Head, gearshift linkage	CV-ES-2121	
11/92→01/00		Centre Rod	RV-DL-0904		Push Rod
11/92→01/00		Centre Rod	RV-DL-0907		Push Rod
11/92→01/00		Centre Rod	RV-DL-0909		Coupling Rod
11/92→01/00		Tie Rod	RV-DL-8170		
11/92→01/00		Tie Rod	RV-DL-8317		
11/92→01/00		Tie Rod End	CV-ES-0912		
11/92→01/00		Tie Rod End	CV-ES-0914		for Steering Rod
11/92→01/00		Tie Rod End	CV-ES-12461		for Steering Rod
11/92→01/00		Tie Rod End	CV-ES-12462		for Steering Rod
02/98→01/00		Centre Rod	RV-DL-8186		Push Rod
07/99→01/00		Tie Rod	RV-DL-8312		
M 150.12/C BTP		11/92→10/96	Ball Head, gearshift linkage	CV-ES-2121	
	11/92→10/96	Centre Rod	RV-DL-0904		Push Rod
	11/92→10/96	Centre Rod	RV-DL-0907		Push Rod
	11/92→10/96	Centre Rod	RV-DL-0909		Coupling Rod
	11/92→10/96	Tie Rod	RV-DL-8170		
	11/92→10/96	Tie Rod	RV-DL-8317		
	11/92→10/96	Tie Rod End	CV-ES-0912		
	11/92→10/96	Tie Rod End	CV-ES-0914		for Steering Rod
	11/92→10/96	Tie Rod End	CV-ES-12461		for Steering Rod
	11/92→10/96	Tie Rod End	CV-ES-12462		for Steering Rod
	M 150.13/C	11/92→01/00	Ball Head, gearshift linkage	CV-ES-2121	
11/92→01/00		Centre Rod	RV-DL-0904		Push Rod
11/92→01/00		Centre Rod	RV-DL-0907		Push Rod
11/92→01/00		Centre Rod	RV-DL-0909		Coupling Rod
11/92→01/00		Tie Rod	RV-DL-8170		
11/92→01/00		Tie Rod	RV-DL-8317		
11/92→01/00		Tie Rod End	CV-ES-0912		
11/92→01/00		Tie Rod End	CV-ES-0914		for Steering Rod
11/92→01/00		Tie Rod End	CV-ES-12461		for Steering Rod
11/92→01/00		Tie Rod End	CV-ES-12462		for Steering Rod
02/98→01/00		Centre Rod	RV-DL-8186		Push Rod
07/99→01/00		Tie Rod	RV-DL-8312		
M 150.13/C BTP		11/92→10/96	Ball Head, gearshift linkage	CV-ES-2121	
	11/92→10/96	Centre Rod	RV-DL-0904		Push Rod
	11/92→10/96	Centre Rod	RV-DL-0907		Push Rod
	11/92→10/96	Centre Rod	RV-DL-0909		Coupling Rod
	11/92→10/96	Tie Rod	RV-DL-8170		
	11/92→10/96	Tie Rod	RV-DL-8317		
	11/92→10/96	Tie Rod End	CV-ES-0912		
	11/92→10/96	Tie Rod End	CV-ES-0914		for Steering Rod
	11/92→10/96	Tie Rod End	CV-ES-12461		for Steering Rod
	11/92→10/96	Tie Rod End	CV-ES-12462		for Steering Rod

CV-ES-0912

Length: 125
Cone Ø: d1 Ø 30 / d2 Ø 27
Thread: M38 x 1,5 LHT
3401206, 5001832579



RV-DL-0904

Length: 872
Ø: 40
Cone Ø: d1 Ø 26 / d2 Ø 23,5
5010130393



RV-DL-8312

Length: 1560
Ø: 52
Cone Ø: d1 Ø 30 / d2 Ø 27
5010439023, 5010566062



CV-ES-0914

Length: 125
Cone Ø: d1 Ø 30 / d2 Ø 27
Thread: M38 x 1,5 RHT
3401207, 5001832580



RV-DL-0907

Length: 900
Ø: 40
Cone Ø: d1 Ø 22 / d2 Ø 20
5010037602, 5010130456



RV-DL-8317

Length: 1415
Ø: 30
Cone Ø: d1 Ø 20 / d2 Ø 18
5000446681, 5010224899



CV-ES-2121

Length: 85
Cone Ø: d1 Ø 12 / d2 Ø 10,8
Thread: M14 x 1,5 RHT
23162046, 5000516214, 5010144543,
5010245591



RV-DL-0909

Length: 1528
Ø: 40
Cone Ø: d1 Ø 26 / d2 Ø 23,5
5000613837



RV-DL-10246

Length: 895
Ø: 40
Cone Ø: d1 Ø 26 / d2 Ø 23,5
5010039426, 5010130386, 7485114920



CV-ES-12461

Length: 120
Cone Ø: d1 Ø 26 / d2 Ø 23,5
Thread: M30 x 1,5 LHT
0003406213, 3406218, 5000242467,
5000242488, 5000295215, 5000295336,
5000588470, 5000805280, 5000806187,
5000814347, 5000820879, 5000823654,
5001834533, 5001850550, 5001852263,
5001859984



RV-DL-8170

Length: 1404
Ø: 34
Cone Ø: d1 Ø 22 / d2 Ø 20
5000350120, 5000541224, 5010097562,
7485114941



CV-ES-12462

Length: 120
Cone Ø: d1 Ø 26 / d2 Ø 23,5
Thread: M30 x 1,5 RHT
0003406212, 0003406253, 5000242159,
5000295214, 5000812483, 5001831473,
5001850549, 5001852264, 5001859985,
7701016946



RV-DL-8186

Length: 895
Ø: 40
Cone Ø: d1 Ø 22 / d2 Ø 20
5010383097, 7485114938



RV-DL-8199

Length: 1470
Ø: 36
Cone Ø: d1 Ø 26 / d2 Ø 23,5
5010308214, 5010439984





Midliner ...

M 150.14/C BOM	11/92→10/96	Ball Head, gearshift linkage	CV-ES-2121	
	11/92→10/96	Centre Rod	RV-DL-0904	Push Rod
	11/92→10/96	Centre Rod	RV-DL-0907	Push Rod
	11/92→10/96	Centre Rod	RV-DL-0909	Coupling Rod
	11/92→10/96	Tie Rod	RV-DL-8170	
	11/92→10/96	Tie Rod	RV-DL-8317	
	11/92→10/96	Tie Rod End	CV-ES-0912	
	11/92→10/96	Tie Rod End	CV-ES-0914	for Steering Rod
	11/92→10/96	Tie Rod End	CV-ES-12461	for Steering Rod
	11/92→10/96	Tie Rod End	CV-ES-12462	for Steering Rod
M 150.14/C CIT	11/92→10/96	Ball Head, gearshift linkage	CV-ES-2121	
	11/92→10/96	Centre Rod	RV-DL-0904	Push Rod
	11/92→10/96	Centre Rod	RV-DL-0907	Push Rod
	11/92→10/96	Centre Rod	RV-DL-0909	Coupling Rod
	11/92→10/96	Tie Rod	RV-DL-8170	
	11/92→10/96	Tie Rod	RV-DL-8317	
	11/92→10/96	Tie Rod End	CV-ES-0912	
	11/92→10/96	Tie Rod End	CV-ES-0914	for Steering Rod
	11/92→10/96	Tie Rod End	CV-ES-12461	for Steering Rod
	11/92→10/96	Tie Rod End	CV-ES-12462	for Steering Rod
M 160.12/C	05/89→03/93	Ball Head, gearshift linkage	CV-ES-2121	
	05/89→03/93	Centre Rod	RV-DL-0904	Push Rod
	05/89→03/93	Centre Rod	RV-DL-0909	Coupling Rod
	05/89→03/93	Tie Rod	RV-DL-8170	
	05/89→03/93	Tie Rod	RV-DL-8317	
	05/89→03/93	Tie Rod End	CV-ES-0912	
	05/89→03/93	Tie Rod End	CV-ES-0914	for Steering Rod
	05/89→03/93	Tie Rod End	CV-ES-12461	for Steering Rod
	05/89→03/93	Tie Rod End	CV-ES-12462	for Steering Rod
	05/89→03/93	Tie Rod End	RV-ES-8691	
M 160.13/C	05/89→03/93	Ball Head, gearshift linkage	CV-ES-2121	
	05/89→03/93	Centre Rod	RV-DL-0904	Push Rod
	05/89→03/93	Centre Rod	RV-DL-0909	Coupling Rod
	05/89→03/93	Tie Rod	RV-DL-8170	
	05/89→03/93	Tie Rod	RV-DL-8317	
	05/89→03/93	Tie Rod End	CV-ES-0912	
	05/89→03/93	Tie Rod End	CV-ES-0914	for Steering Rod
	05/89→03/93	Tie Rod End	CV-ES-12461	for Steering Rod
	05/89→03/93	Tie Rod End	CV-ES-12462	for Steering Rod
	05/89→03/93	Tie Rod End	RV-ES-8691	
M 160.14/C BOM	05/89→03/93	Ball Head, gearshift linkage	CV-ES-2121	
	05/89→03/93	Centre Rod	RV-DL-0904	Push Rod
	05/89→03/93	Centre Rod	RV-DL-0909	Coupling Rod
	05/89→03/93	Tie Rod	RV-DL-8170	
	05/89→03/93	Tie Rod	RV-DL-8317	
	05/89→03/93	Tie Rod End	CV-ES-0912	
	05/89→03/93	Tie Rod End	CV-ES-0914	for Steering Rod
	05/89→03/93	Tie Rod End	CV-ES-12461	for Steering Rod
	05/89→03/93	Tie Rod End	CV-ES-12462	for Steering Rod
	05/89→03/93	Tie Rod End	RV-ES-8691	
M 160.14/C CIT	05/89→03/93	Ball Head, gearshift linkage	CV-ES-2121	
	05/89→03/93	Centre Rod	RV-DL-0904	Push Rod
	05/89→03/93	Centre Rod	RV-DL-0909	Coupling Rod
	05/89→03/93	Tie Rod	RV-DL-8170	
	05/89→03/93	Tie Rod	RV-DL-8317	
	05/89→03/93	Tie Rod End	CV-ES-0912	
	05/89→03/93	Tie Rod End	CV-ES-0914	for Steering Rod
	05/89→03/93	Tie Rod End	CV-ES-12461	for Steering Rod
	05/89→03/93	Tie Rod End	CV-ES-12462	for Steering Rod
	05/89→03/93	Tie Rod End	RV-ES-8691	

CV-ES-0912

Length: 125
Cone Ø: d1 Ø 30 / d2 Ø 27
Thread: M38 x 1,5 LHT
3401206, 5001832579



RV-DL-0904

Length: 872
Ø: 40
Cone Ø: d1 Ø 26 / d2 Ø 23,5
5010130393



CV-ES-0914

Length: 125
Cone Ø: d1 Ø 30 / d2 Ø 27
Thread: M38 x 1,5 RHT
3401207, 5001832580



RV-DL-0907

Length: 900
Ø: 40
Cone Ø: d1 Ø 22 / d2 Ø 20
5010037602, 5010130456



CV-ES-2121

Length: 85
Cone Ø: d1 Ø 12 / d2 Ø 10,8
Thread: M14 x 1,5 RHT
23162046, 5000516214, 5010144543,
5010245591



RV-DL-0909

Length: 1528
Ø: 40
Cone Ø: d1 Ø 26 / d2 Ø 23,5
5000613837



CV-ES-12461

Length: 120
Cone Ø: d1 Ø 26 / d2 Ø 23,5
Thread: M30 x 1,5 LHT
0003406213, 3406218, 5000242467,
5000242488, 5000295215, 5000295336,
5000588470, 5000805280, 5000806187,
5000814347, 5000820879, 5000823654,
5001834533, 5001850550, 5001852263,
5001859984



RV-DL-8170

Length: 1404
Ø: 34
Cone Ø: d1 Ø 22 / d2 Ø 20
5000350120, 5000541224, 5010097562,
7485114941



CV-ES-12462

Length: 120
Cone Ø: d1 Ø 26 / d2 Ø 23,5
Thread: M30 x 1,5 RHT
0003406212, 0003406253, 5000242159,
5000295214, 5000812483, 5001831473,
5001850549, 5001852264, 5001859985,
7701016946



RV-DL-8317

Length: 1415
Ø: 30
Cone Ø: d1 Ø 20 / d2 Ø 18
5000446681, 5010224899



RV-ES-8691

Length: 106
Cone Ø: d1 Ø 20 / d2 Ø 18
Thread: M24 x 1,5 LHT
7700658834





Midliner ...

M 160.15/D	05/89→03/93	Ball Head, gearshift linkage	CV-ES-2121	
	05/89→03/93	Centre Rod	RV-DL-0904	Push Rod
	05/89→03/93	Centre Rod	RV-DL-0909	Coupling Rod
	05/89→03/93	Centre Rod	RV-DL-10246	Push Rod
	05/89→03/93	Tie Rod	RV-DL-8170	
	05/89→03/93	Tie Rod	RV-DL-8317	
	05/89→03/93	Tie Rod End	CV-ES-0912	
	05/89→03/93	Tie Rod End	CV-ES-0914	for Steering Rod
	05/89→03/93	Tie Rod End	CV-ES-12461	for Steering Rod
	05/89→03/93	Tie Rod End	CV-ES-12462	for Steering Rod
M 180.10/C	05/89→03/93	Tie Rod End	RV-ES-8691	
	11/92→10/96	Ball Head, gearshift linkage	CV-ES-2121	
	11/92→10/96	Centre Rod	RV-DL-0904	Push Rod
	11/92→10/96	Centre Rod	RV-DL-0907	Push Rod
	11/92→10/96	Centre Rod	RV-DL-0909	Coupling Rod
	11/92→10/96	Centre Rod	RV-DL-10246	Push Rod
	11/92→10/96	Tie Rod	RV-DL-8199	
	11/92→10/96	Tie Rod End	CV-ES-0912	
	11/92→10/96	Tie Rod End	CV-ES-0914	for Steering Rod
	11/92→10/96	Tie Rod End	CV-ES-12461	for Steering Rod
M 180.11/C	11/92→10/96	Tie Rod End	CV-ES-12462	for Steering Rod
	11/92→10/96	Ball Head, gearshift linkage	CV-ES-2121	
	11/92→10/96	Centre Rod	RV-DL-0904	Push Rod
	11/92→10/96	Centre Rod	RV-DL-0907	Push Rod
	11/92→10/96	Centre Rod	RV-DL-0909	Coupling Rod
	11/92→10/96	Centre Rod	RV-DL-10246	Push Rod
	11/92→10/96	Tie Rod	RV-DL-8199	
	11/92→10/96	Tie Rod End	CV-ES-0912	
	11/92→10/96	Tie Rod End	CV-ES-0914	for Steering Rod
	11/92→10/96	Tie Rod End	CV-ES-12461	for Steering Rod
M 180.11/C SP	11/92→10/96	Tie Rod End	CV-ES-12462	for Steering Rod
	11/92→10/96	Ball Head, gearshift linkage	CV-ES-2121	
	11/92→10/96	Centre Rod	RV-DL-0904	Push Rod
	11/92→10/96	Centre Rod	RV-DL-0907	Push Rod
	11/92→10/96	Centre Rod	RV-DL-0909	Coupling Rod
	11/92→10/96	Centre Rod	RV-DL-10246	Push Rod
	11/92→10/96	Tie Rod	RV-DL-8199	
	11/92→10/96	Tie Rod End	CV-ES-0912	
	11/92→10/96	Tie Rod End	CV-ES-0914	for Steering Rod
	11/92→10/96	Tie Rod End	CV-ES-12461	for Steering Rod
M 180.12/C	11/92→10/96	Tie Rod End	CV-ES-12462	for Steering Rod
	11/92→01/00	Ball Head, gearshift linkage	CV-ES-2121	
	11/92→01/00	Centre Rod	RV-DL-0904	Push Rod
	11/92→01/00	Centre Rod	RV-DL-0907	Push Rod
	11/92→01/00	Centre Rod	RV-DL-0909	Coupling Rod
	11/92→01/00	Tie Rod	RV-DL-8170	
	11/92→01/00	Tie Rod	RV-DL-8317	
	11/92→01/00	Tie Rod End	CV-ES-0912	
	11/92→01/00	Tie Rod End	CV-ES-0914	for Steering Rod
	11/92→01/00	Tie Rod End	CV-ES-12461	for Steering Rod
M 180.12/C BTP	11/92→01/00	Tie Rod End	CV-ES-12462	for Steering Rod
	02/98→01/00	Centre Rod	RV-DL-8186	Push Rod
	07/99→01/00	Tie Rod	RV-DL-8312	
	11/92→10/96	Ball Head, gearshift linkage	CV-ES-2121	
	11/92→10/96	Centre Rod	RV-DL-0904	Push Rod
	11/92→10/96	Centre Rod	RV-DL-0907	Push Rod
	11/92→10/96	Centre Rod	RV-DL-0909	Coupling Rod
	11/92→10/96	Centre Rod	RV-DL-10246	Push Rod
	11/92→10/96	Tie Rod	RV-DL-8170	
	11/92→10/96	Tie Rod	RV-DL-8317	
M 180.12/C BTP	11/92→10/96	Tie Rod End	CV-ES-0912	
	11/92→10/96	Tie Rod End	CV-ES-0914	for Steering Rod
	11/92→10/96	Tie Rod End	CV-ES-12461	for Steering Rod
	11/92→10/96	Tie Rod End	CV-ES-12462	for Steering Rod
	11/92→10/96	Tie Rod End	CV-ES-12461	for Steering Rod
	11/92→10/96	Tie Rod End	CV-ES-12462	for Steering Rod

CV-ES-0912

Length: 125
Cone Ø: d1 Ø 30 / d2 Ø 27
Thread: M38 x 1,5 LHT
3401206, 5001832579



RV-DL-0904

Length: 872
Ø: 40
Cone Ø: d1 Ø 26 / d2 Ø 23,5
5010130393



RV-DL-8312

Length: 1560
Ø: 52
Cone Ø: d1 Ø 30 / d2 Ø 27
5010439023, 5010566062



CV-ES-0914

Length: 125
Cone Ø: d1 Ø 30 / d2 Ø 27
Thread: M38 x 1,5 RHT
3401207, 5001832580



RV-DL-0907

Length: 900
Ø: 40
Cone Ø: d1 Ø 22 / d2 Ø 20
5010037602, 5010130456



RV-DL-8317

Length: 1415
Ø: 30
Cone Ø: d1 Ø 20 / d2 Ø 18
5000446681, 5010224899



CV-ES-2121

Length: 85
Cone Ø: d1 Ø 12 / d2 Ø 10,8
Thread: M14 x 1,5 RHT
23162046, 5000516214, 5010144543,
5010245591



RV-DL-0909

Length: 1528
Ø: 40
Cone Ø: d1 Ø 26 / d2 Ø 23,5
5000613837



RV-DL-10246

Length: 895
Ø: 40
Cone Ø: d1 Ø 26 / d2 Ø 23,5
5010039426, 5010130386, 7485114920



CV-ES-12461

Length: 120
Cone Ø: d1 Ø 26 / d2 Ø 23,5
Thread: M30 x 1,5 LHT
0003406213, 3406218, 5000242467,
5000242488, 5000295215, 5000295336,
5000588470, 5000805280, 5000806187,
5000814347, 5000820879, 5000823654,
5001834533, 5001850550, 5001852263,
5001859984



RV-DL-8170

Length: 1404
Ø: 34
Cone Ø: d1 Ø 22 / d2 Ø 20
5000350120, 5000541224, 5010097562,
7485114941



RV-ES-8691

Length: 106
Cone Ø: d1 Ø 20 / d2 Ø 18
Thread: M24 x 1,5 LHT
7700658834



CV-ES-12462

Length: 120
Cone Ø: d1 Ø 26 / d2 Ø 23,5
Thread: M30 x 1,5 RHT
0003406212, 0003406253, 5000242159,
5000295214, 5000812483, 5001831473,
5001850549, 5001852264, 5001859985,
7701016946



RV-DL-8186

Length: 895
Ø: 40
Cone Ø: d1 Ø 22 / d2 Ø 20
5010383097, 7485114938



RV-DL-8199

Length: 1470
Ø: 36
Cone Ø: d1 Ø 26 / d2 Ø 23,5
5010308214, 5010439984



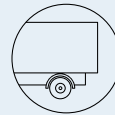

Midliner ...

M 180.13 SP	11/92→10/96	Ball Head, gearshift linkage	CV-ES-2121	
	11/92→10/96	Centre Rod	RV-DL-0904	Push Rod
	11/92→10/96	Centre Rod	RV-DL-0907	Push Rod
	11/92→10/96	Centre Rod	RV-DL-0909	Coupling Rod
	11/92→10/96	Centre Rod	RV-DL-10246	Push Rod
	11/92→10/96	Tie Rod	RV-DL-8199	
	11/92→10/96	Tie Rod End	CV-ES-0912	
	11/92→10/96	Tie Rod End	CV-ES-0914	for Steering Rod
	11/92→10/96	Tie Rod End	CV-ES-12461	for Steering Rod
	11/92→10/96	Tie Rod End	CV-ES-12462	for Steering Rod
M 180.13/C	11/92→10/96	Centre Rod	RV-DL-10246	Push Rod
	11/92→10/96	Tie Rod	RV-DL-8199	
	11/92→01/00	Ball Head, gearshift linkage	CV-ES-2121	
	11/92→01/00	Centre Rod	RV-DL-0904	Push Rod
	11/92→01/00	Centre Rod	RV-DL-0907	Push Rod
	11/92→01/00	Centre Rod	RV-DL-0909	Coupling Rod
	11/92→01/00	Tie Rod	RV-DL-8170	
	11/92→01/00	Tie Rod	RV-DL-8317	
	11/92→01/00	Tie Rod End	CV-ES-0912	
	11/92→01/00	Tie Rod End	CV-ES-0914	for Steering Rod
	11/92→01/00	Tie Rod End	CV-ES-12461	for Steering Rod
	11/92→01/00	Tie Rod End	CV-ES-12462	for Steering Rod
	02/98→01/00	Centre Rod	RV-DL-8186	Push Rod
	07/99→01/00	Tie Rod	RV-DL-8312	
M 180.13/C BTP	11/92→10/96	Ball Head, gearshift linkage	CV-ES-2121	
	11/92→10/96	Centre Rod	RV-DL-0904	Push Rod
	11/92→10/96	Centre Rod	RV-DL-0907	Push Rod
	11/92→10/96	Centre Rod	RV-DL-0909	Coupling Rod
	11/92→10/96	Tie Rod	RV-DL-8170	
	11/92→10/96	Tie Rod	RV-DL-8317	
	11/92→10/96	Tie Rod End	CV-ES-0912	
	11/92→10/96	Tie Rod End	CV-ES-0914	for Steering Rod
	11/92→10/96	Tie Rod End	CV-ES-12461	for Steering Rod
	11/92→10/96	Tie Rod End	CV-ES-12462	for Steering Rod
M 180.15/D	11/92→10/96	Centre Rod	RV-DL-10246	Push Rod
	11/92→10/96	Tie Rod	RV-DL-8199	
	11/92→01/00	Ball Head, gearshift linkage	CV-ES-2121	
	11/92→01/00	Centre Rod	RV-DL-0904	Push Rod
	11/92→01/00	Centre Rod	RV-DL-0907	Push Rod
	11/92→01/00	Centre Rod	RV-DL-0909	Coupling Rod
	11/92→01/00	Tie Rod	RV-DL-8170	
	11/92→01/00	Tie Rod	RV-DL-8317	
	11/92→01/00	Tie Rod End	CV-ES-0912	
	11/92→01/00	Tie Rod End	CV-ES-0914	for Steering Rod
	11/92→01/00	Tie Rod End	CV-ES-12461	for Steering Rod
	11/92→01/00	Tie Rod End	CV-ES-12462	for Steering Rod
	02/98→01/00	Centre Rod	RV-DL-8186	Push Rod
	07/99→01/00	Tie Rod	RV-DL-8312	
M 180.15/D BTP	11/92→10/96	Ball Head, gearshift linkage	CV-ES-2121	
	11/92→10/96	Centre Rod	RV-DL-0904	Push Rod
	11/92→10/96	Centre Rod	RV-DL-0907	Push Rod
	11/92→10/96	Centre Rod	RV-DL-0909	Coupling Rod
	11/92→10/96	Tie Rod	RV-DL-8170	
	11/92→10/96	Tie Rod	RV-DL-8317	
	11/92→10/96	Tie Rod End	CV-ES-0912	
	11/92→10/96	Tie Rod End	CV-ES-0914	for Steering Rod
	11/92→10/96	Tie Rod End	CV-ES-12461	for Steering Rod
	11/92→10/96	Tie Rod End	CV-ES-12462	for Steering Rod
M 180.16/D	11/92→01/00	Ball Head, gearshift linkage	CV-ES-2121	
	11/92→01/00	Centre Rod	RV-DL-0904	Push Rod
	11/92→01/00	Centre Rod	RV-DL-0907	Push Rod
	11/92→01/00	Centre Rod	RV-DL-0909	Coupling Rod
	11/92→01/00	Tie Rod	RV-DL-8170	

CV-ES-0912

Length: 125
Cone Ø: d1 Ø 30 / d2 Ø 27
Thread: M38 x 1,5 LHT
3401206, 5001832579



RV-DL-0904

Length: 872
Ø: 40
Cone Ø: d1 Ø 26 / d2 Ø 23,5
5010130393



RV-DL-8312

Length: 1560
Ø: 52
Cone Ø: d1 Ø 30 / d2 Ø 27
5010439023, 5010566062



CV-ES-0914

Length: 125
Cone Ø: d1 Ø 30 / d2 Ø 27
Thread: M38 x 1,5 RHT
3401207, 5001832580



RV-DL-0907

Length: 900
Ø: 40
Cone Ø: d1 Ø 22 / d2 Ø 20
5010037602, 5010130456



RV-DL-8317

Length: 1415
Ø: 30
Cone Ø: d1 Ø 20 / d2 Ø 18
5000446681, 5010224899



CV-ES-2121

Length: 85
Cone Ø: d1 Ø 12 / d2 Ø 10,8
Thread: M14 x 1,5 RHT
23162046, 5000516214, 5010144543,
5010245591



RV-DL-0909

Length: 1528
Ø: 40
Cone Ø: d1 Ø 26 / d2 Ø 23,5
5000613837



RV-DL-10246

Length: 895
Ø: 40
Cone Ø: d1 Ø 26 / d2 Ø 23,5
5010039426, 5010130386, 7485114920



CV-ES-12461

Length: 120
Cone Ø: d1 Ø 26 / d2 Ø 23,5
Thread: M30 x 1,5 LHT
0003406213, 3406218, 5000242467,
5000242488, 5000295215, 5000295336,
5000588470, 5000805280, 5000806187,
5000814347, 5000820879, 5000823654,
5001834533, 5001850550, 5001852263,
5001859984



RV-DL-8170

Length: 1404
Ø: 34
Cone Ø: d1 Ø 22 / d2 Ø 20
5000350120, 5000541224, 5010097562,
7485114941



CV-ES-12462

Length: 120
Cone Ø: d1 Ø 26 / d2 Ø 23,5
Thread: M30 x 1,5 RHT
0003406212, 0003406253, 5000242159,
5000295214, 5000812483, 5001831473,
5001850549, 5001852264, 5001859985,
7701016946



RV-DL-8186

Length: 895
Ø: 40
Cone Ø: d1 Ø 22 / d2 Ø 20
5010383097, 7485114938



RV-DL-8199

Length: 1470
Ø: 36
Cone Ø: d1 Ø 26 / d2 Ø 23,5
5010308214, 5010439984





Midliner ...

M 180.16/D ...	11/92→01/00	Tie Rod	RV-DL-8317	
	11/92→01/00	Tie Rod End	CV-ES-0912	
	11/92→01/00	Tie Rod End	CV-ES-0914	for Steering Rod
	11/92→01/00	Tie Rod End	CV-ES-12461	for Steering Rod
	11/92→01/00	Tie Rod End	CV-ES-12462	for Steering Rod
	02/98→01/00	Centre Rod	RV-DL-8186	Push Rod
	07/99→01/00	Tie Rod	RV-DL-8312	
M 200.10/C	05/88→03/93	Ball Head, gearshift linkage	CV-ES-2121	
	05/88→03/93	Centre Rod	RV-DL-0904	Push Rod
	05/88→03/93	Centre Rod	RV-DL-0909	Coupling Rod
	05/88→03/93	Tie Rod	RV-DL-8170	
	05/88→03/93	Tie Rod	RV-DL-8317	
	05/88→03/93	Tie Rod End	CV-ES-0912	
	05/88→03/93	Tie Rod End	CV-ES-0914	for Steering Rod
	05/88→03/93	Tie Rod End	CV-ES-12461	for Steering Rod
	05/88→03/93	Tie Rod End	CV-ES-12462	for Steering Rod
	05/88→03/93	Tie Rod End	RV-ES-8691	
M 200.12/C	05/88→03/93	Ball Head, gearshift linkage	CV-ES-2121	
	05/88→03/93	Centre Rod	RV-DL-0904	Push Rod
	05/88→03/93	Centre Rod	RV-DL-0909	Coupling Rod
	05/88→03/93	Tie Rod	RV-DL-8170	
	05/88→03/93	Tie Rod	RV-DL-8317	
	05/88→03/93	Tie Rod End	CV-ES-0912	
	05/88→03/93	Tie Rod End	CV-ES-0914	for Steering Rod
	05/88→03/93	Tie Rod End	CV-ES-12461	for Steering Rod
	05/88→03/93	Tie Rod End	CV-ES-12462	for Steering Rod
	05/88→03/93	Tie Rod End	RV-ES-8691	
M 200.13/C	05/88→03/93	Ball Head, gearshift linkage	CV-ES-2121	
	05/88→03/93	Centre Rod	RV-DL-0904	Push Rod
	05/88→03/93	Centre Rod	RV-DL-0909	Coupling Rod
	05/88→03/93	Tie Rod	RV-DL-8170	
	05/88→03/93	Tie Rod	RV-DL-8317	
	05/88→03/93	Tie Rod End	CV-ES-0912	
	05/88→03/93	Tie Rod End	CV-ES-0914	for Steering Rod
	05/88→03/93	Tie Rod End	CV-ES-12461	for Steering Rod
	05/88→03/93	Tie Rod End	CV-ES-12462	for Steering Rod
	05/88→03/93	Tie Rod End	RV-ES-8691	
M 200.14/C BOM	05/88→03/93	Ball Head, gearshift linkage	CV-ES-2121	
	05/88→03/93	Centre Rod	RV-DL-0904	Push Rod
	05/88→03/93	Centre Rod	RV-DL-0909	Coupling Rod
	05/88→03/93	Tie Rod	RV-DL-8170	
	05/88→03/93	Tie Rod	RV-DL-8317	
	05/88→03/93	Tie Rod End	CV-ES-0912	
	05/88→03/93	Tie Rod End	CV-ES-0914	for Steering Rod
	05/88→03/93	Tie Rod End	CV-ES-12461	for Steering Rod
	05/88→03/93	Tie Rod End	CV-ES-12462	for Steering Rod
	05/88→03/93	Tie Rod End	RV-ES-8691	
M 200.14/C CIT	05/88→03/93	Ball Head, gearshift linkage	CV-ES-2121	
	05/88→03/93	Centre Rod	RV-DL-0904	Push Rod
	05/88→03/93	Centre Rod	RV-DL-0909	Coupling Rod
	05/88→03/93	Tie Rod	RV-DL-8170	
	05/88→03/93	Tie Rod	RV-DL-8317	
	05/88→03/93	Tie Rod End	CV-ES-0912	
	05/88→03/93	Tie Rod End	CV-ES-0914	for Steering Rod
	05/88→03/93	Tie Rod End	CV-ES-12461	for Steering Rod
	05/88→03/93	Tie Rod End	CV-ES-12462	for Steering Rod
	05/88→03/93	Tie Rod End	RV-ES-8691	
M 200.15/D	05/88→03/93	Ball Head, gearshift linkage	CV-ES-2121	
	05/88→03/93	Centre Rod	RV-DL-0904	Push Rod
	05/88→03/93	Centre Rod	RV-DL-0909	Coupling Rod
	05/88→03/93	Tie Rod	RV-DL-8170	
	05/88→03/93	Tie Rod	RV-DL-8317	
	05/88→03/93	Tie Rod End	CV-ES-0912	
	05/88→03/93	Tie Rod End	CV-ES-0914	for Steering Rod

CV-ES-0912

Length: 125
Cone Ø: d1 Ø 30 / d2 Ø 27
Thread: M38 x 1,5 LHT
3401206, 5001832579



RV-DL-0904

Length: 872
Ø: 40
Cone Ø: d1 Ø 26 / d2 Ø 23,5
5010130393



RV-ES-8691

Length: 106
Cone Ø: d1 Ø 20 / d2 Ø 18
Thread: M24 x 1,5 LHT
7700658834



CV-ES-0914

Length: 125
Cone Ø: d1 Ø 30 / d2 Ø 27
Thread: M38 x 1,5 RHT
3401207, 5001832580



RV-DL-0909

Length: 1528
Ø: 40
Cone Ø: d1 Ø 26 / d2 Ø 23,5
5000613837



CV-ES-2121

Length: 85
Cone Ø: d1 Ø 12 / d2 Ø 10,8
Thread: M14 x 1,5 RHT
23162046, 5000516214, 5010144543,
5010245591



RV-DL-8170

Length: 1404
Ø: 34
Cone Ø: d1 Ø 22 / d2 Ø 20
5000350120, 5000541224, 5010097562,
7485114941



CV-ES-12461

Length: 120
Cone Ø: d1 Ø 26 / d2 Ø 23,5
Thread: M30 x 1,5 LHT
0003406213, 3406218, 5000242467,
5000242488, 5000295215, 5000295336,
5000588470, 5000805280, 5000806187,
5000814347, 5000820879, 5000823654,
5001834533, 5001850550, 5001852263,
5001859984



RV-DL-8186

Length: 895
Ø: 40
Cone Ø: d1 Ø 22 / d2 Ø 20
5010383097, 7485114938



CV-ES-12462

Length: 120
Cone Ø: d1 Ø 26 / d2 Ø 23,5
Thread: M30 x 1,5 RHT
0003406212, 0003406253, 5000242159,
5000295214, 5000812483, 5001831473,
5001850549, 5001852264, 5001859985,
7701016946



RV-DL-8312

Length: 1560
Ø: 52
Cone Ø: d1 Ø 30 / d2 Ø 27
5010439023, 5010566062



RV-DL-8317

Length: 1415
Ø: 30
Cone Ø: d1 Ø 20 / d2 Ø 18
5000446681, 5010224899





Midliner ...

M 200.15/D ...	05/88→03/93	Tie Rod End	CV-ES-0914	for Steering Rod	
	05/88→03/93	Tie Rod End	CV-ES-12461	for Steering Rod	
	05/88→03/93	Tie Rod End	CV-ES-12462	for Steering Rod	
	05/88→03/93	Tie Rod End	RV-ES-8691		
M 200.16/D	05/88→03/93	Ball Head, gearshift linkage	CV-ES-2121		
	05/88→03/93	Centre Rod	RV-DL-0904	Push Rod	
	05/88→03/93	Centre Rod	RV-DL-0909	Coupling Rod	
	05/88→03/93	Tie Rod	RV-DL-8170		
	05/88→03/93	Tie Rod	RV-DL-8317		
	05/88→03/93	Tie Rod End	CV-ES-0912		
	05/88→03/93	Tie Rod End	CV-ES-0914	for Steering Rod	
	05/88→03/93	Tie Rod End	CV-ES-12461	for Steering Rod	
	05/88→03/93	Tie Rod End	CV-ES-12462	for Steering Rod	
	05/88→03/93	Tie Rod End	RV-ES-8691		
M 210.12/C	05/92→01/00	Ball Head, gearshift linkage	CV-ES-2121		
	05/92→01/00	Centre Rod	RV-DL-0904	Push Rod	
	05/92→01/00	Centre Rod	RV-DL-0907	Push Rod	
	05/92→01/00	Centre Rod	RV-DL-0909	Coupling Rod	
	05/92→01/00	Tie Rod	RV-DL-8170		
	05/92→01/00	Tie Rod	RV-DL-8317		
	05/92→01/00	Tie Rod End	CV-ES-0912		
	05/92→01/00	Tie Rod End	CV-ES-0914	for Steering Rod	
	05/92→01/00	Tie Rod End	CV-ES-12461	for Steering Rod	
	05/92→01/00	Tie Rod End	CV-ES-12462	for Steering Rod	
	02/98→01/00	Centre Rod	RV-DL-8186	Push Rod	
	07/99→01/00	Tie Rod	RV-DL-8312		
	M 210.13/C	05/92→01/00	Ball Head, gearshift linkage	CV-ES-2121	
05/92→01/00		Centre Rod	RV-DL-0904	Push Rod	
05/92→01/00		Centre Rod	RV-DL-0907	Push Rod	
05/92→01/00		Centre Rod	RV-DL-0909	Coupling Rod	
05/92→01/00		Tie Rod	RV-DL-8170		
05/92→01/00		Tie Rod	RV-DL-8317		
05/92→01/00		Tie Rod End	CV-ES-0912		
05/92→01/00		Tie Rod End	CV-ES-0914	for Steering Rod	
05/92→01/00		Tie Rod End	CV-ES-12461	for Steering Rod	
05/92→01/00		Tie Rod End	CV-ES-12462	for Steering Rod	
02/98→01/00		Centre Rod	RV-DL-8186	Push Rod	
07/99→01/00		Tie Rod	RV-DL-8312		
M 210.13/C SP		05/92→10/96	Ball Head, gearshift linkage	CV-ES-2121	
	05/92→10/96	Centre Rod	RV-DL-0904	Push Rod	
	05/92→10/96	Centre Rod	RV-DL-0907	Push Rod	
	05/92→10/96	Centre Rod	RV-DL-0909	Coupling Rod	
	05/92→10/96	Tie Rod	RV-DL-8170		
	05/92→10/96	Tie Rod	RV-DL-8317		
	05/92→10/96	Tie Rod End	CV-ES-0912		
	05/92→10/96	Tie Rod End	CV-ES-0914	for Steering Rod	
	05/92→10/96	Tie Rod End	CV-ES-12461	for Steering Rod	
	05/92→10/96	Tie Rod End	CV-ES-12462	for Steering Rod	
	M 210.14/C BOM	05/92→10/96	Ball Head, gearshift linkage	CV-ES-2121	
		05/92→10/96	Centre Rod	RV-DL-0904	Push Rod
		05/92→10/96	Centre Rod	RV-DL-0907	Push Rod
05/92→10/96		Centre Rod	RV-DL-0909	Coupling Rod	
05/92→10/96		Tie Rod	RV-DL-8170		
05/92→10/96		Tie Rod	RV-DL-8317		
05/92→10/96		Tie Rod End	CV-ES-0912		
05/92→10/96		Tie Rod End	CV-ES-0914	for Steering Rod	
05/92→10/96		Tie Rod End	CV-ES-12461	for Steering Rod	
05/92→10/96		Tie Rod End	CV-ES-12462	for Steering Rod	
M 210.14/D	05/96→01/00	Ball Head, gearshift linkage	CV-ES-2121		
	05/96→01/00	Centre Rod	RV-DL-0904	Push Rod	
	05/96→01/00	Centre Rod	RV-DL-0907	Push Rod	
	05/96→01/00	Centre Rod	RV-DL-0909	Coupling Rod	
	05/96→01/00	Centre Rod	RV-DL-10246	Push Rod	

CV-ES-0912

Length: 125
Cone Ø: d1 Ø 30 / d2 Ø 27
Thread: M38 x 1,5 LHT
3401206, 5001832579



RV-DL-0904

Length: 872
Ø: 40
Cone Ø: d1 Ø 26 / d2 Ø 23,5
5010130393



RV-DL-8317

Length: 1415
Ø: 30
Cone Ø: d1 Ø 20 / d2 Ø 18
5000446681, 5010224899



CV-ES-0914

Length: 125
Cone Ø: d1 Ø 30 / d2 Ø 27
Thread: M38 x 1,5 RHT
3401207, 5001832580



RV-DL-0907

Length: 900
Ø: 40
Cone Ø: d1 Ø 22 / d2 Ø 20
5010037602, 5010130456



RV-DL-10246

Length: 895
Ø: 40
Cone Ø: d1 Ø 26 / d2 Ø 23,5
5010039426, 5010130386, 7485114920



CV-ES-2121

Length: 85
Cone Ø: d1 Ø 12 / d2 Ø 10,8
Thread: M14 x 1,5 RHT
23162046, 5000516214, 5010144543,
5010245591



RV-DL-0909

Length: 1528
Ø: 40
Cone Ø: d1 Ø 26 / d2 Ø 23,5
5000613837



RV-ES-8691

Length: 106
Cone Ø: d1 Ø 20 / d2 Ø 18
Thread: M24 x 1,5 LHT
7700658834



CV-ES-12461

Length: 120
Cone Ø: d1 Ø 26 / d2 Ø 23,5
Thread: M30 x 1,5 LHT
0003406213, 3406218, 5000242467,
5000242488, 5000295215, 5000295336,
5000588470, 5000805280, 5000806187,
5000814347, 5000820879, 5000823654,
5001834533, 5001850550, 5001852263,
5001859984



RV-DL-8170

Length: 1404
Ø: 34
Cone Ø: d1 Ø 22 / d2 Ø 20
5000350120, 5000541224, 5010097562,
7485114941



CV-ES-12462

Length: 120
Cone Ø: d1 Ø 26 / d2 Ø 23,5
Thread: M30 x 1,5 RHT
0003406212, 0003406253, 5000242159,
5000295214, 5000812483, 5001831473,
5001850549, 5001852264, 5001859985,
7701016946



RV-DL-8186

Length: 895
Ø: 40
Cone Ø: d1 Ø 22 / d2 Ø 20
5010383097, 7485114938



RV-DL-8312

Length: 1560
Ø: 52
Cone Ø: d1 Ø 30 / d2 Ø 27
5010439023, 5010566062





Midliner ...

M 210.14/D ...	05/96→01/00	Stabiliser Link	RV-DL-12326	RV-DL-12326	Suspension Rod	
	05/96→01/00	Stabiliser Link	RV-DL-12327	RV-DL-12327	Suspension Rod	
	05/96→01/00	Tie Rod	RV-DL-8199			
	05/96→01/00	Tie Rod End	CV-ES-0912			
	05/96→01/00	Tie Rod End	CV-ES-0914		for Steering Rod	
	05/96→01/00	Tie Rod End	CV-ES-12461		for Steering Rod	
	05/96→01/00	Tie Rod End	CV-ES-12462		for Steering Rod	
M 210.15/D	05/92→01/00	Ball Head, gearshift linkage	CV-ES-2121			
	05/92→01/00	Centre Rod	RV-DL-0904		Push Rod	
	05/92→01/00	Centre Rod	RV-DL-0907		Push Rod	
	05/92→01/00	Centre Rod	RV-DL-0909		Coupling Rod	
	05/92→01/00	Tie Rod	RV-DL-8170			
	05/92→01/00	Tie Rod	RV-DL-8317			
	05/92→01/00	Tie Rod End	CV-ES-0912			
	05/92→01/00	Tie Rod End	CV-ES-0914		for Steering Rod	
	05/92→01/00	Tie Rod End	CV-ES-12461		for Steering Rod	
	05/92→01/00	Tie Rod End	CV-ES-12462		for Steering Rod	
	02/98→01/00	Centre Rod	RV-DL-8186		Push Rod	
	07/99→01/00	Tie Rod	RV-DL-8312			
	M 210.15/D CIT	05/92→10/96	Ball Head, gearshift linkage	CV-ES-2121		
		05/92→10/96	Centre Rod	RV-DL-0904		Push Rod
05/92→10/96		Centre Rod	RV-DL-0907		Push Rod	
05/92→10/96		Centre Rod	RV-DL-0909		Coupling Rod	
05/92→10/96		Tie Rod	RV-DL-8170			
05/92→10/96		Tie Rod	RV-DL-8317			
05/92→10/96		Tie Rod End	CV-ES-0912			
05/92→10/96		Tie Rod End	CV-ES-0914		for Steering Rod	
05/92→10/96		Tie Rod End	CV-ES-12461		for Steering Rod	
M 210.16/D	05/92→01/00	Ball Head, gearshift linkage	CV-ES-2121			
	05/92→01/00	Centre Rod	RV-DL-0904		Push Rod	
	05/92→01/00	Centre Rod	RV-DL-0907		Push Rod	
	05/92→01/00	Centre Rod	RV-DL-0909		Coupling Rod	
	05/92→01/00	Stabiliser Link	RV-DL-12326	RV-DL-12326	Suspension Rod	
	05/92→01/00	Stabiliser Link	RV-DL-12327	RV-DL-12327	Suspension Rod	
	05/92→01/00	Tie Rod	RV-DL-8170			
	05/92→01/00	Tie Rod	RV-DL-8317			
	05/92→01/00	Tie Rod End	CV-ES-0912			
	05/92→01/00	Tie Rod End	CV-ES-0914		for Steering Rod	
	05/92→01/00	Tie Rod End	CV-ES-12461		for Steering Rod	
	05/92→01/00	Tie Rod End	CV-ES-12462		for Steering Rod	
	05/96→01/00	Centre Rod	RV-DL-10246		Push Rod	
	05/96→01/00	Tie Rod	RV-DL-8199			
02/98→01/00	Centre Rod	RV-DL-8186		Push Rod		
07/99→01/00	Tie Rod	RV-DL-8312				
M 210.16/D CIT	05/92→10/96	Ball Head, gearshift linkage	CV-ES-2121			
	05/92→10/96	Centre Rod	RV-DL-0904		Push Rod	
	05/92→10/96	Centre Rod	RV-DL-0907		Push Rod	
	05/92→10/96	Centre Rod	RV-DL-0909		Coupling Rod	
	05/92→10/96	Tie Rod	RV-DL-8170			
	05/92→10/96	Tie Rod	RV-DL-8317			
	05/92→10/96	Tie Rod End	CV-ES-0912			
	05/92→10/96	Tie Rod End	CV-ES-0914		for Steering Rod	
	05/92→10/96	Tie Rod End	CV-ES-12461		for Steering Rod	
M 230.10/C	05/89→07/92	Ball Head, gearshift linkage	CV-ES-2121			
	05/89→07/92	Centre Rod	RV-DL-0904		Push Rod	
	05/89→07/92	Centre Rod	RV-DL-0909		Coupling Rod	
	05/89→07/92	Tie Rod End	CV-ES-0912			
	05/89→07/92	Tie Rod End	CV-ES-0914		for Steering Rod	
	05/89→07/92	Tie Rod End	CV-ES-12461		for Steering Rod	
	05/89→07/92	Tie Rod End	RV-ES-8691		for Steering Rod	

CV-ES-0912

Length: 125
 Cone Ø: d1 Ø 30 / d2 Ø 27
 Thread: M38 x 1,5 LHT
 3401206, 5001832579

**RV-DL-0904**

Length: 872
 Ø: 40
 Cone Ø: d1 Ø 26 / d2 Ø 23,5
 5010130393

**RV-DL-8312**

Length: 1560
 Ø: 52
 Cone Ø: d1 Ø 30 / d2 Ø 27
 5010439023, 5010566062

**CV-ES-0914**

Length: 125
 Cone Ø: d1 Ø 30 / d2 Ø 27
 Thread: M38 x 1,5 RHT
 3401207, 5001832580

**RV-DL-0907**

Length: 900
 Ø: 40
 Cone Ø: d1 Ø 22 / d2 Ø 20
 5010037602, 5010130456

**RV-DL-8317**

Length: 1415
 Ø: 30
 Cone Ø: d1 Ø 20 / d2 Ø 18
 5000446681, 5010224899

**CV-ES-2121**

Length: 85
 Cone Ø: d1 Ø 12 / d2 Ø 10,8
 Thread: M14 x 1,5 RHT
 23162046, 5000516214, 5010144543,
 5010245591

**RV-DL-0909**

Length: 1528
 Ø: 40
 Cone Ø: d1 Ø 26 / d2 Ø 23,5
 5000613837

**RV-DL-10246**

Length: 895
 Ø: 40
 Cone Ø: d1 Ø 26 / d2 Ø 23,5
 5010039426, 5010130386, 7485114920

**CV-ES-12461**

Length: 120
 Cone Ø: d1 Ø 26 / d2 Ø 23,5
 Thread: M30 x 1,5 LHT
 0003406213, 3406218, 5000242467,
 5000242488, 5000295215, 5000295336,
 5000588470, 5000805280, 5000806187,
 5000814347, 5000820879, 5000823654,
 5001834533, 5001850550, 5001852263,
 5001859984

**RV-DL-8170**

Length: 1404
 Ø: 34
 Cone Ø: d1 Ø 22 / d2 Ø 20
 5000350120, 5000541224, 5010097562,
 7485114941

**RV-DL-12326**

Length: 280
 Ø: 28
 Cone Ø: d1 Ø 20
 5010238594, 5010253255

**CV-ES-12462**

Length: 120
 Cone Ø: d1 Ø 26 / d2 Ø 23,5
 Thread: M30 x 1,5 RHT
 0003406212, 0003406253, 5000242159,
 5000295214, 5000812483, 5001831473,
 5001850549, 5001852264, 5001859985,
 7701016946

**RV-DL-8186**

Length: 895
 Ø: 40
 Cone Ø: d1 Ø 22 / d2 Ø 20
 5010383097, 7485114938

**RV-DL-12327**

Length: 280
 Ø: 28
 Cone Ø: d1 Ø 20
 5010253256

**RV-DL-8199**

Length: 1470
 Ø: 36
 Cone Ø: d1 Ø 26 / d2 Ø 23,5
 5010308214, 5010439984

**RV-ES-8691**

Length: 106
 Cone Ø: d1 Ø 20 / d2 Ø 18
 Thread: M24 x 1,5 LHT
 7700658834



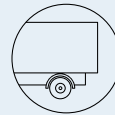

Midliner ...

M 230.12/C	05/92→10/96	Ball Head, gearshift linkage	CV-ES-2121	
	05/92→10/96	Centre Rod	RV-DL-0904	Push Rod
	05/92→10/96	Centre Rod	RV-DL-0909	Coupling Rod
	05/92→10/96	Tie Rod	RV-DL-8170	
	05/92→10/96	Tie Rod	RV-DL-8317	
	05/92→10/96	Tie Rod End	CV-ES-0912	
	05/92→10/96	Tie Rod End	CV-ES-0914	for Steering Rod
	05/92→10/96	Tie Rod End	CV-ES-12461	for Steering Rod
	05/92→10/96	Tie Rod End	CV-ES-12462	for Steering Rod
	05/92→10/96	Tie Rod End	RV-ES-8691	
M 230.12/D	05/89→07/92	Ball Head, gearshift linkage	CV-ES-2121	
	05/89→07/92	Centre Rod	RV-DL-0904	Push Rod
	05/89→07/92	Centre Rod	RV-DL-0909	Coupling Rod
	05/89→07/92	Tie Rod End	CV-ES-0912	
	05/89→07/92	Tie Rod End	CV-ES-0914	for Steering Rod
	05/89→07/92	Tie Rod End	CV-ES-12461	for Steering Rod
	05/89→07/92	Tie Rod End	CV-ES-12462	for Steering Rod
	05/89→07/92	Tie Rod End	RV-ES-8691	
M 230.13/C	05/92→10/96	Ball Head, gearshift linkage	CV-ES-2121	
	05/92→10/96	Centre Rod	RV-DL-0904	Push Rod
	05/92→10/96	Centre Rod	RV-DL-0909	Coupling Rod
	05/92→10/96	Tie Rod	RV-DL-8170	
	05/92→10/96	Tie Rod	RV-DL-8317	
	05/92→10/96	Tie Rod End	CV-ES-0912	
	05/92→10/96	Tie Rod End	CV-ES-0914	for Steering Rod
	05/92→10/96	Tie Rod End	CV-ES-12461	for Steering Rod
	05/92→10/96	Tie Rod End	CV-ES-12462	for Steering Rod
05/92→10/96	Tie Rod End	RV-ES-8691		
M 230.13/C, M 230.13/D	05/89→10/96	Ball Head, gearshift linkage	CV-ES-2121	
	05/89→10/96	Centre Rod	RV-DL-0904	Push Rod
	05/89→10/96	Centre Rod	RV-DL-0909	Coupling Rod
	05/89→10/96	Tie Rod	RV-DL-8170	
	05/89→10/96	Tie Rod	RV-DL-8317	
	05/89→10/96	Tie Rod End	CV-ES-0912	
	05/89→10/96	Tie Rod End	CV-ES-0914	for Steering Rod
	05/89→10/96	Tie Rod End	CV-ES-12461	for Steering Rod
	05/89→10/96	Tie Rod End	CV-ES-12462	for Steering Rod
05/89→10/96	Tie Rod End	RV-ES-8691		
M 230.13/D	05/89→07/92	Ball Head, gearshift linkage	CV-ES-2121	
	05/89→07/92	Centre Rod	RV-DL-0904	Push Rod
	05/89→07/92	Centre Rod	RV-DL-0909	Coupling Rod
	05/89→07/92	Tie Rod End	CV-ES-0912	
	05/89→07/92	Tie Rod End	CV-ES-0914	for Steering Rod
	05/89→07/92	Tie Rod End	CV-ES-12461	for Steering Rod
	05/89→07/92	Tie Rod End	CV-ES-12462	for Steering Rod
05/89→07/92	Tie Rod End	RV-ES-8691		
M 230.13C/T	05/89→10/96	Ball Head, gearshift linkage	CV-ES-2121	
	05/89→10/96	Centre Rod	RV-DL-0904	Push Rod
	05/89→10/96	Centre Rod	RV-DL-0909	Coupling Rod
	05/89→10/96	Tie Rod	RV-DL-8170	
	05/89→10/96	Tie Rod	RV-DL-8317	
	05/89→10/96	Tie Rod End	CV-ES-0912	
	05/89→10/96	Tie Rod End	CV-ES-0914	for Steering Rod
	05/89→10/96	Tie Rod End	CV-ES-12461	for Steering Rod
	05/89→10/96	Tie Rod End	CV-ES-12462	for Steering Rod
05/89→10/96	Tie Rod End	RV-ES-8691		
M 230.15/D	05/89→10/96	Ball Head, gearshift linkage	CV-ES-2121	
	05/89→10/96	Centre Rod	RV-DL-0904	Push Rod
	05/89→10/96	Centre Rod	RV-DL-0909	Coupling Rod
	05/89→10/96	Tie Rod	RV-DL-8170	
	05/89→10/96	Tie Rod	RV-DL-8317	
	05/89→10/96	Tie Rod End	CV-ES-0912	
	05/89→10/96	Tie Rod End	CV-ES-0914	for Steering Rod

CV-ES-0912

Length: 125
Cone Ø: d1 Ø 30 / d2 Ø 27
Thread: M38 x 1,5 LHT
3401206, 5001832579



RV-DL-0904

Length: 872
Ø: 40
Cone Ø: d1 Ø 26 / d2 Ø 23,5
5010130393



CV-ES-0914

Length: 125
Cone Ø: d1 Ø 30 / d2 Ø 27
Thread: M38 x 1,5 RHT
3401207, 5001832580



RV-DL-0909

Length: 1528
Ø: 40
Cone Ø: d1 Ø 26 / d2 Ø 23,5
5000613837



CV-ES-2121

Length: 85
Cone Ø: d1 Ø 12 / d2 Ø 10,8
Thread: M14 x 1,5 RHT
23162046, 5000516214, 5010144543,
5010245591



RV-DL-8170

Length: 1404
Ø: 34
Cone Ø: d1 Ø 22 / d2 Ø 20
5000350120, 5000541224, 5010097562,
7485114941



CV-ES-12461

Length: 120
Cone Ø: d1 Ø 26 / d2 Ø 23,5
Thread: M30 x 1,5 LHT
0003406213, 3406218, 5000242467,
5000242488, 5000295215, 5000295336,
5000588470, 5000805280, 5000806187,
5000814347, 5000820879, 5000823654,
5001834533, 5001850550, 5001852263,
5001859984



RV-DL-8317

Length: 1415
Ø: 30
Cone Ø: d1 Ø 20 / d2 Ø 18
5000446681, 5010224899



CV-ES-12462

Length: 120
Cone Ø: d1 Ø 26 / d2 Ø 23,5
Thread: M30 x 1,5 RHT
0003406212, 0003406253, 5000242159,
5000295214, 5000812483, 5001831473,
5001850549, 5001852264, 5001859985,
7701016946



RV-ES-8691

Length: 106
Cone Ø: d1 Ø 20 / d2 Ø 18
Thread: M24 x 1,5 LHT
7700658834





Midliner ...

M 230.15/D ...	05/89→10/96	Tie Rod End	CV-ES-12461		for Steering Rod	
	05/89→10/96	Tie Rod End	CV-ES-12462		for Steering Rod	
	05/89→10/96	Tie Rod End	RV-ES-8691			
M 230.15/D CIT	05/89→07/92	Ball Head, gearshift linkage	CV-ES-2121			
	05/89→07/92	Centre Rod	RV-DL-0904		Push Rod	
	05/89→07/92	Centre Rod	RV-DL-0909		Coupling Rod	
	05/89→07/92	Tie Rod End	CV-ES-0912			
	05/89→07/92	Tie Rod End	CV-ES-0914		for Steering Rod	
	05/89→07/92	Tie Rod End	CV-ES-12461		for Steering Rod	
	05/89→07/92	Tie Rod End	CV-ES-12462		for Steering Rod	
	05/89→07/92	Tie Rod End	RV-ES-8691			
M 230.16/D	05/89→10/96	Ball Head, gearshift linkage	CV-ES-2121			
	05/89→10/96	Centre Rod	RV-DL-0904		Push Rod	
	05/89→10/96	Centre Rod	RV-DL-0909		Coupling Rod	
	05/89→10/96	Tie Rod	RV-DL-8170			
	05/89→10/96	Tie Rod	RV-DL-8317			
	05/89→10/96	Tie Rod End	CV-ES-0912			
	05/89→10/96	Tie Rod End	CV-ES-0914		for Steering Rod	
	05/89→10/96	Tie Rod End	CV-ES-12461		for Steering Rod	
	05/89→10/96	Tie Rod End	CV-ES-12462		for Steering Rod	
	05/89→10/96	Tie Rod End	RV-ES-8691			
	M 230.16/D CIT	05/89→07/92	Ball Head, gearshift linkage	CV-ES-2121		
05/89→07/92		Centre Rod	RV-DL-0904		Push Rod	
05/89→07/92		Centre Rod	RV-DL-0909		Coupling Rod	
05/89→07/92		Tie Rod End	CV-ES-0912			
05/89→07/92		Tie Rod End	CV-ES-0914		for Steering Rod	
05/89→07/92		Tie Rod End	CV-ES-12461		for Steering Rod	
05/89→07/92		Tie Rod End	CV-ES-12462		for Steering Rod	
05/89→07/92		Tie Rod End	RV-ES-8691			
M 230.16D/T	05/89→10/96	Ball Head, gearshift linkage	CV-ES-2121			
	05/89→10/96	Centre Rod	RV-DL-0904		Push Rod	
	05/89→10/96	Centre Rod	RV-DL-0909		Coupling Rod	
	05/89→10/96	Stabiliser Link	RV-DL-12326	RV-DL-12326	Suspension Rod	
	05/89→10/96	Stabiliser Link	RV-DL-12327	RV-DL-12327	Suspension Rod	
	05/89→10/96	Tie Rod	RV-DL-8170			
	05/89→10/96	Tie Rod	RV-DL-8317			
	05/89→10/96	Tie Rod End	CV-ES-0912			
	05/89→10/96	Tie Rod End	CV-ES-0914		for Steering Rod	
	05/89→10/96	Tie Rod End	CV-ES-12461		for Steering Rod	
	05/89→10/96	Tie Rod End	CV-ES-12462		for Steering Rod	
	05/89→10/96	Tie Rod End	RV-ES-8691			
	M 250.13/C	05/96→01/00	Ball Head, gearshift linkage	CV-ES-2121		
		05/96→01/00	Centre Rod	RV-DL-0904		Push Rod
05/96→01/00		Centre Rod	RV-DL-0907		Push Rod	
05/96→01/00		Centre Rod	RV-DL-0909		Coupling Rod	
05/96→01/00		Stabiliser Link	RV-DL-12326	RV-DL-12326	Suspension Rod	
05/96→01/00		Stabiliser Link	RV-DL-12327	RV-DL-12327	Suspension Rod	
05/96→01/00		Tie Rod	RV-DL-8170			
05/96→01/00		Tie Rod	RV-DL-8317			
05/96→01/00		Tie Rod End	CV-ES-0912			
05/96→01/00		Tie Rod End	CV-ES-0914		for Steering Rod	
05/96→01/00		Tie Rod End	CV-ES-12461		for Steering Rod	
05/96→01/00		Tie Rod End	CV-ES-12462		for Steering Rod	
02/98→01/00		Centre Rod	RV-DL-8186		Push Rod	
07/99→01/00		Tie Rod	RV-DL-8312			
M 250.15/C, M 250.15/D		05/96→01/00	Ball Head, gearshift linkage	CV-ES-2121		
		05/96→01/00	Centre Rod	RV-DL-0904		Push Rod
		05/96→01/00	Centre Rod	RV-DL-0907		Push Rod
	05/96→01/00	Centre Rod	RV-DL-0909		Coupling Rod	
	05/96→01/00	Stabiliser Link	RV-DL-12326	RV-DL-12326	Suspension Rod	
	05/96→01/00	Stabiliser Link	RV-DL-12327	RV-DL-12327	Suspension Rod	
	05/96→01/00	Tie Rod	RV-DL-8170			
	05/96→01/00	Tie Rod	RV-DL-8317			
	05/96→01/00	Tie Rod	RV-DL-8312			

CV-ES-0912

Length: 125
 Cone Ø: d1 Ø 30 / d2 Ø 27
 Thread: M38 x 1,5 LHT
 3401206, 5001832579

**RV-DL-0904**

Length: 872
 Ø: 40
 Cone Ø: d1 Ø 26 / d2 Ø 23,5
 5010130393

**RV-DL-8317**

Length: 1415
 Ø: 30
 Cone Ø: d1 Ø 20 / d2 Ø 18
 5000446681, 5010224899

**CV-ES-0914**

Length: 125
 Cone Ø: d1 Ø 30 / d2 Ø 27
 Thread: M38 x 1,5 RHT
 3401207, 5001832580

**RV-DL-0907**

Length: 900
 Ø: 40
 Cone Ø: d1 Ø 22 / d2 Ø 20
 5010037602, 5010130456

**RV-DL-12326**

Length: 280
 Ø: 28
 Cone Ø: d1 Ø 20
 5010238594, 5010253255

**CV-ES-2121**

Length: 85
 Cone Ø: d1 Ø 12 / d2 Ø 10,8
 Thread: M14 x 1,5 RHT
 23162046, 5000516214, 5010144543,
 5010245591

**RV-DL-0909**

Length: 1528
 Ø: 40
 Cone Ø: d1 Ø 26 / d2 Ø 23,5
 5000613837

**RV-DL-12327**

Length: 280
 Ø: 28
 Cone Ø: d1 Ø 20
 5010253256

**CV-ES-12461**

Length: 120
 Cone Ø: d1 Ø 26 / d2 Ø 23,5
 Thread: M30 x 1,5 LHT
 0003406213, 3406218, 5000242467,
 5000242488, 5000295215, 5000295336,
 5000588470, 5000805280, 5000806187,
 5000814347, 5000820879, 5000823654,
 5001834533, 5001850550, 5001852263,
 5001859984

**RV-DL-8170**

Length: 1404
 Ø: 34
 Cone Ø: d1 Ø 22 / d2 Ø 20
 5000350120, 5000541224, 5010097562,
 7485114941

**RV-ES-8691**

Length: 106
 Cone Ø: d1 Ø 20 / d2 Ø 18
 Thread: M24 x 1,5 LHT
 7700658834

**CV-ES-12462**

Length: 120
 Cone Ø: d1 Ø 26 / d2 Ø 23,5
 Thread: M30 x 1,5 RHT
 0003406212, 0003406253, 5000242159,
 5000295214, 5000812483, 5001831473,
 5001850549, 5001852264, 5001859985,
 7701016946

**RV-DL-8186**

Length: 895
 Ø: 40
 Cone Ø: d1 Ø 22 / d2 Ø 20
 5010383097, 7485114938

**RV-DL-8312**

Length: 1560
 Ø: 52
 Cone Ø: d1 Ø 30 / d2 Ø 27
 5010439023, 5010566062





Midliner ...

M 250.15/C, M 250.15/D ...	05/96→01/00	Tie Rod End	CV-ES-0912			
	05/96→01/00	Tie Rod End	CV-ES-0914		for Steering Rod	
	05/96→01/00	Tie Rod End	CV-ES-12461		for Steering Rod	
	05/96→01/00	Tie Rod End	CV-ES-12462		for Steering Rod	
	02/98→01/00	Centre Rod	RV-DL-8186		Push Rod	
	07/99→01/00	Tie Rod	RV-DL-8312			
M 250.15C/T	05/96→01/00	Ball Head, gearshift linkage	CV-ES-2121			
	05/96→01/00	Centre Rod	RV-DL-0904		Push Rod	
	05/96→01/00	Centre Rod	RV-DL-0907		Push Rod	
	05/96→01/00	Centre Rod	RV-DL-0909		Coupling Rod	
	05/96→01/00	Stabiliser Link	RV-DL-12326	RV-DL-12326	Suspension Rod	
	05/96→01/00	Stabiliser Link	RV-DL-12327	RV-DL-12327	Suspension Rod	
	05/96→01/00	Tie Rod	RV-DL-8170			
	05/96→01/00	Tie Rod	RV-DL-8317			
	05/96→01/00	Tie Rod End	CV-ES-0912			
	05/96→01/00	Tie Rod End	CV-ES-0914		for Steering Rod	
	05/96→01/00	Tie Rod End	CV-ES-12461		for Steering Rod	
	05/96→01/00	Tie Rod End	CV-ES-12462		for Steering Rod	
	02/98→01/00	Centre Rod	RV-DL-8186		Push Rod	
	07/99→01/00	Tie Rod	RV-DL-8312			
	M 250.16/D	05/96→01/00	Ball Head, gearshift linkage	CV-ES-2121		
05/96→01/00		Centre Rod	RV-DL-0904		Push Rod	
05/96→01/00		Centre Rod	RV-DL-0907		Push Rod	
05/96→01/00		Centre Rod	RV-DL-0909		Coupling Rod	
05/96→01/00		Tie Rod	RV-DL-8170			
05/96→01/00		Tie Rod	RV-DL-8317			
05/96→01/00		Tie Rod End	CV-ES-0912			
05/96→01/00		Tie Rod End	CV-ES-0914		for Steering Rod	
05/96→01/00		Tie Rod End	CV-ES-12461		for Steering Rod	
05/96→01/00		Tie Rod End	CV-ES-12462		for Steering Rod	
02/98→01/00		Centre Rod	RV-DL-8186		Push Rod	
07/99→01/00		Tie Rod	RV-DL-8312			
ME 160.13		05/89→03/93	Ball Head, gearshift linkage	CV-ES-2121		
		05/89→03/93	Centre Rod	RV-DL-0904		Push Rod
		05/89→03/93	Centre Rod	RV-DL-0909		Coupling Rod
	05/89→03/93	Tie Rod End	CV-ES-0912			
	05/89→03/93	Tie Rod End	CV-ES-0914		for Steering Rod	
	05/89→03/93	Tie Rod End	CV-ES-12461		for Steering Rod	
	05/89→03/93	Tie Rod End	CV-ES-12462		for Steering Rod	
ME 160.15	05/89→03/93	Ball Head, gearshift linkage	CV-ES-2121			
	05/89→03/93	Centre Rod	RV-DL-0904		Push Rod	
	05/89→03/93	Centre Rod	RV-DL-0909		Coupling Rod	
	05/89→03/93	Centre Rod	RV-DL-10246		Push Rod	
	05/89→03/93	Tie Rod	RV-DL-8199			
	05/89→03/93	Tie Rod End	CV-ES-0912			
	05/89→03/93	Tie Rod End	CV-ES-0914		for Steering Rod	
	05/89→03/93	Tie Rod End	CV-ES-12461		for Steering Rod	
	05/89→03/93	Tie Rod End	CV-ES-12462		for Steering Rod	
ME 180.15	05/89→03/93	Ball Head, gearshift linkage	CV-ES-2121			
	05/89→03/93	Centre Rod	RV-DL-0904		Push Rod	
	05/89→03/93	Centre Rod	RV-DL-0907		Push Rod	
	05/89→03/93	Centre Rod	RV-DL-0909		Coupling Rod	
	05/89→03/93	Centre Rod	RV-DL-10246		Push Rod	
	05/89→03/93	Tie Rod	RV-DL-8199			
	05/89→03/93	Tie Rod End	CV-ES-0912			
	05/89→03/93	Tie Rod End	CV-ES-0914		for Steering Rod	
	05/89→03/93	Tie Rod End	CV-ES-12461		for Steering Rod	
S 100.06/A	01/86→08/89	Centre Rod	RV-DL-8160		Push Rod	
	01/86→09/90	Ball Head, gearshift linkage	CV-ES-2121			
	01/86→09/90	Centre Rod	RV-DL-0907		Push Rod	
	01/86→09/90	Tie Rod	RV-DL-8170			
	01/86→09/90	Tie Rod	RV-DL-8317			

CV-ES-0912

Length: 125
Cone Ø: d1 Ø 30 / d2 Ø 27
Thread: M38 x 1,5 LHT
3401206, 5001832579



RV-DL-0904

Length: 872
Ø: 40
Cone Ø: d1 Ø 26 / d2 Ø 23,5
5010130393



RV-DL-8199

Length: 1470
Ø: 36
Cone Ø: d1 Ø 26 / d2 Ø 23,5
5010308214, 5010439984



CV-ES-0914

Length: 125
Cone Ø: d1 Ø 30 / d2 Ø 27
Thread: M38 x 1,5 RHT
3401207, 5001832580



RV-DL-0907

Length: 900
Ø: 40
Cone Ø: d1 Ø 22 / d2 Ø 20
5010037602, 5010130456



RV-DL-8312

Length: 1560
Ø: 52
Cone Ø: d1 Ø 30 / d2 Ø 27
5010439023, 5010566062



CV-ES-2121

Length: 85
Cone Ø: d1 Ø 12 / d2 Ø 10,8
Thread: M14 x 1,5 RHT
23162046, 5000516214, 5010144543,
5010245591



RV-DL-0909

Length: 1528
Ø: 40
Cone Ø: d1 Ø 26 / d2 Ø 23,5
5000613837



RV-DL-8317

Length: 1415
Ø: 30
Cone Ø: d1 Ø 20 / d2 Ø 18
5000446681, 5010224899



CV-ES-12461

Length: 120
Cone Ø: d1 Ø 26 / d2 Ø 23,5
Thread: M30 x 1,5 LHT
0003406213, 3406218, 5000242467,
5000242488, 5000295215, 5000295336,
5000588470, 5000805280, 5000806187,
5000814347, 5000820879, 5000823654,
5001834533, 5001850550, 5001852263,
5001859984



RV-DL-8160

Length: 877
Ø: 36
Cone Ø: d1 Ø 20 / d2 Ø 18
5010037411, 5010037576



RV-DL-10246

Length: 895
Ø: 40
Cone Ø: d1 Ø 26 / d2 Ø 23,5
5010039426, 5010130386, 7485114920



CV-ES-12462

Length: 120
Cone Ø: d1 Ø 26 / d2 Ø 23,5
Thread: M30 x 1,5 RHT
0003406212, 0003406253, 5000242159,
5000295214, 5000812483, 5001831473,
5001850549, 5001852264, 5001859985,
7701016946



RV-DL-8170

Length: 1404
Ø: 34
Cone Ø: d1 Ø 22 / d2 Ø 20
5000350120, 5000541224, 5010097562,
7485114941



RV-DL-12326

Length: 280
Ø: 28
Cone Ø: d1 Ø 20
5010238594, 5010253255



RV-DL-8186

Length: 895
Ø: 40
Cone Ø: d1 Ø 22 / d2 Ø 20
5010383097, 7485114938



RV-DL-12327

Length: 280
Ø: 28
Cone Ø: d1 Ø 20
5010253256





Midliner ...

S 100.07/A	01/86→08/89	Centre Rod	RV-DL-8160	Push Rod
	01/86→09/90	Ball Head, gearshift linkage	CV-ES-2121	
	01/86→09/90	Centre Rod	RV-DL-0907	Push Rod
	01/86→09/90	Tie Rod	RV-DL-8170	
	01/86→09/90	Tie Rod	RV-DL-8317	
S 100.08/A	01/86→08/89	Centre Rod	RV-DL-8160	Push Rod
	01/86→09/90	Ball Head, gearshift linkage	CV-ES-2121	
	01/86→09/90	Centre Rod	RV-DL-0907	Push Rod
	01/86→09/90	Tie Rod	RV-DL-8170	
	01/86→09/90	Tie Rod	RV-DL-8317	
S 100.09/A BOM	01/86→09/90	Ball Head, gearshift linkage	CV-ES-2121	
	01/86→09/90	Centre Rod	RV-DL-0907	Push Rod
	01/86→09/90	Tie Rod	RV-DL-8170	
	01/86→09/90	Tie Rod	RV-DL-8317	
S 100.09/A CIT	01/86→09/90	Ball Head, gearshift linkage	CV-ES-2121	
	01/86→09/90	Centre Rod	RV-DL-0907	Push Rod
	01/86→09/90	Tie Rod	RV-DL-8170	
	01/86→09/90	Tie Rod	RV-DL-8317	
S 110.06/A	06/85→09/89	Centre Rod	RV-DL-8160	Push Rod
	06/85→09/90	Ball Head, gearshift linkage	CV-ES-2121	
	06/85→09/90	Centre Rod	RV-DL-0907	Push Rod
	06/85→09/90	Tie Rod	RV-DL-8317	
S 110.07/A	06/85→09/89	Centre Rod	RV-DL-8160	Push Rod
	06/85→09/90	Ball Head, gearshift linkage	CV-ES-2121	
	06/85→09/90	Centre Rod	RV-DL-0907	Push Rod
	06/85→09/90	Tie Rod	RV-DL-8317	
S 110.08/A	06/85→09/89	Centre Rod	RV-DL-8160	Push Rod
	06/85→09/90	Ball Head, gearshift linkage	CV-ES-2121	
	06/85→09/90	Centre Rod	RV-DL-0907	Push Rod
	06/85→09/90	Tie Rod	RV-DL-8317	
S 120.06/A	09/90→11/92	Centre Rod	RV-DL-0907	Push Rod
	09/90→11/92	Tie Rod	RV-DL-8170	
	09/90→11/92	Tie Rod	RV-DL-8317	
S 120.06/A,S 120.07/A	09/90→10/94	Centre Rod	RV-DL-0907	Push Rod
	09/90→10/94	Tie Rod	RV-DL-8170	
	09/90→10/94	Tie Rod	RV-DL-8317	
S 120.07/A	09/90→10/94	Centre Rod	RV-DL-0907	Push Rod
	09/90→10/94	Tie Rod	RV-DL-8170	
	09/90→10/94	Tie Rod	RV-DL-8317	
S 120.08/A	09/90→10/94	Centre Rod	RV-DL-0907	Push Rod
	09/90→10/94	Tie Rod	RV-DL-8170	
	09/90→10/94	Tie Rod	RV-DL-8317	
S 120.09/A	11/92→10/94	Centre Rod	RV-DL-0907	Push Rod
	11/92→10/94	Tie Rod	RV-DL-8170	
	11/92→10/94	Tie Rod	RV-DL-8317	
S 120.09/B	11/92→10/94	Centre Rod	RV-DL-0907	Push Rod
	11/92→10/94	Tie Rod	RV-DL-8170	
	11/92→10/94	Tie Rod	RV-DL-8317	
S 120.09/B BOM	09/90→10/94	Centre Rod	RV-DL-0907	Push Rod
	09/90→10/94	Tie Rod	RV-DL-8170	
	09/90→10/94	Tie Rod	RV-DL-8317	
S 120.09/B CIT	09/90→11/92	Centre Rod	RV-DL-0907	Push Rod
	09/90→11/92	Tie Rod	RV-DL-8170	
	09/90→11/92	Tie Rod	RV-DL-8317	
S 130.06	09/83→01/90	Ball Head, gearshift linkage	CV-ES-2121	
	09/83→01/90	Centre Rod	RV-DL-0907	Push Rod
	09/83→01/90	Centre Rod	RV-DL-10246	Push Rod
	09/83→01/90	Tie Rod	RV-DL-8170	
	09/83→01/90	Tie Rod	RV-DL-8199	
	09/83→01/90	Tie Rod	RV-DL-8317	
	09/83→01/90	Tie Rod End	CV-ES-0912	for Steering Rod
	09/83→01/90	Tie Rod End	CV-ES-12462	for Steering Rod
	02/86→09/89	Centre Rod	RV-DL-8160	Push Rod

CV-ES-0912

Length: 125
Cone Ø: d1 Ø 30 / d2 Ø 27
Thread: M38 x 1,5 LHT
3401206, 5001832579



RV-DL-8170

Length: 1404
Ø: 34
Cone Ø: d1 Ø 22 / d2 Ø 20
5000350120, 5000541224, 5010097562,
7485114941



CV-ES-0914

Length: 125
Cone Ø: d1 Ø 30 / d2 Ø 27
Thread: M38 x 1,5 RHT
3401207, 5001832580



RV-DL-8199

Length: 1470
Ø: 36
Cone Ø: d1 Ø 26 / d2 Ø 23,5
5010308214, 5010439984



CV-ES-2121

Length: 85
Cone Ø: d1 Ø 12 / d2 Ø 10,8
Thread: M14 x 1,5 RHT
23162046, 5000516214, 5010144543,
5010245591



RV-DL-8317

Length: 1415
Ø: 30
Cone Ø: d1 Ø 20 / d2 Ø 18
5000446681, 5010224899



CV-ES-12462

Length: 120
Cone Ø: d1 Ø 26 / d2 Ø 23,5
Thread: M30 x 1,5 RHT
0003406212, 0003406253, 5000242159,
5000295214, 5000812483, 5001831473,
5001850549, 5001852264, 5001859985,
7701016946



RV-DL-10246

Length: 895
Ø: 40
Cone Ø: d1 Ø 26 / d2 Ø 23,5
5010039426, 5010130386, 7485114920



RV-DL-0907

Length: 900
Ø: 40
Cone Ø: d1 Ø 22 / d2 Ø 20
5010037602, 5010130456



RV-DL-8160

Length: 877
Ø: 36
Cone Ø: d1 Ø 20 / d2 Ø 18
5010037411, 5010037576





Midliner ...

S 130.07	09/83→01/90	Ball Head, gearshift linkage	CV-ES-2121	
	09/83→01/90	Centre Rod	RV-DL-0907	Push Rod
	09/83→01/90	Centre Rod	RV-DL-10246	Push Rod
	09/83→01/90	Tie Rod	RV-DL-8170	
	09/83→01/90	Tie Rod	RV-DL-8199	
	09/83→01/90	Tie Rod	RV-DL-8317	
	09/83→01/90	Tie Rod End	CV-ES-0912	
	09/83→01/90	Tie Rod End	CV-ES-0914	for Steering Rod
	09/83→01/90	Tie Rod End	CV-ES-12462	for Steering Rod
S 130.08/A	02/86→09/89	Centre Rod	RV-DL-8160	Push Rod
	09/83→01/90	Ball Head, gearshift linkage	CV-ES-2121	
	09/83→01/90	Centre Rod	RV-DL-0907	Push Rod
	09/83→01/90	Centre Rod	RV-DL-10246	Push Rod
	09/83→01/90	Tie Rod	RV-DL-8170	
	09/83→01/90	Tie Rod	RV-DL-8199	
	09/83→01/90	Tie Rod	RV-DL-8317	
	09/83→01/90	Tie Rod End	CV-ES-0912	
	09/83→01/90	Tie Rod End	CV-ES-0914	for Steering Rod
S 130.08/A,S 130.08/B	09/83→01/90	Tie Rod End	CV-ES-12462	for Steering Rod
	02/86→09/89	Centre Rod	RV-DL-8160	Push Rod
	09/83→01/90	Ball Head, gearshift linkage	CV-ES-2121	
	09/83→01/90	Centre Rod	RV-DL-0907	Push Rod
	09/83→01/90	Centre Rod	RV-DL-10246	Push Rod
	09/83→01/90	Tie Rod	RV-DL-8170	
	09/83→01/90	Tie Rod	RV-DL-8199	
	09/83→01/90	Tie Rod	RV-DL-8317	
	09/83→01/90	Tie Rod End	CV-ES-0912	
S 130.08/B	09/83→01/90	Tie Rod End	CV-ES-0914	for Steering Rod
	09/83→01/90	Tie Rod End	CV-ES-12462	for Steering Rod
	02/86→09/89	Centre Rod	RV-DL-8160	Push Rod
	09/83→01/90	Ball Head, gearshift linkage	CV-ES-2121	
	09/83→01/90	Centre Rod	RV-DL-0907	Push Rod
	09/83→01/90	Centre Rod	RV-DL-10246	Push Rod
	09/83→01/90	Tie Rod	RV-DL-8170	
	09/83→01/90	Tie Rod	RV-DL-8199	
	09/83→01/90	Tie Rod	RV-DL-8317	
S 130.08/R	09/83→01/90	Tie Rod End	CV-ES-0912	
	09/83→01/90	Tie Rod End	CV-ES-0914	for Steering Rod
	09/83→01/90	Tie Rod End	CV-ES-12462	for Steering Rod
	02/86→09/89	Centre Rod	RV-DL-8160	Push Rod
	09/83→01/90	Ball Head, gearshift linkage	CV-ES-2121	
	09/83→01/90	Centre Rod	RV-DL-0907	Push Rod
	09/83→01/90	Centre Rod	RV-DL-10246	Push Rod
	09/83→01/90	Tie Rod	RV-DL-8170	
	09/83→01/90	Tie Rod	RV-DL-8199	
S 130.09/B	09/83→01/90	Tie Rod	RV-DL-8317	
	09/83→01/90	Tie Rod End	CV-ES-0912	
	09/83→01/90	Tie Rod End	CV-ES-0914	for Steering Rod
	09/83→01/90	Tie Rod End	CV-ES-12462	for Steering Rod
	02/86→09/89	Centre Rod	RV-DL-8160	Push Rod
	09/83→01/90	Ball Head, gearshift linkage	CV-ES-2121	
	09/83→01/90	Centre Rod	RV-DL-0907	Push Rod
	09/83→01/90	Centre Rod	RV-DL-10246	Push Rod
	09/83→01/90	Tie Rod	RV-DL-8170	

CV-ES-0912

Length: 125
Cone Ø: d1 Ø 30 / d2 Ø 27
Thread: M38 x 1,5 LHT
3401206, 5001832579



RV-DL-8170

Length: 1404
Ø: 34
Cone Ø: d1 Ø 22 / d2 Ø 20
5000350120, 5000541224, 5010097562,
7485114941



CV-ES-0914

Length: 125
Cone Ø: d1 Ø 30 / d2 Ø 27
Thread: M38 x 1,5 RHT
3401207, 5001832580



RV-DL-8199

Length: 1470
Ø: 36
Cone Ø: d1 Ø 26 / d2 Ø 23,5
5010308214, 5010439984



CV-ES-2121

Length: 85
Cone Ø: d1 Ø 12 / d2 Ø 10,8
Thread: M14 x 1,5 RHT
23162046, 5000516214, 5010144543,
5010245591



RV-DL-8317

Length: 1415
Ø: 30
Cone Ø: d1 Ø 20 / d2 Ø 18
5000446681, 5010224899



CV-ES-12462

Length: 120
Cone Ø: d1 Ø 26 / d2 Ø 23,5
Thread: M30 x 1,5 RHT
0003406212, 0003406253, 5000242159,
5000295214, 5000812483, 5001831473,
5001850549, 5001852264, 5001859985,
7701016946



RV-DL-10246

Length: 895
Ø: 40
Cone Ø: d1 Ø 26 / d2 Ø 23,5
5010039426, 5010130386, 7485114920



RV-DL-0907

Length: 900
Ø: 40
Cone Ø: d1 Ø 22 / d2 Ø 20
5010037602, 5010130456



RV-DL-8160

Length: 877
Ø: 36
Cone Ø: d1 Ø 20 / d2 Ø 18
5010037411, 5010037576





Midliner ...

S 130.11 ...	09/83→01/90	Ball Head, gearshift linkage	CV-ES-2121		
	09/83→01/90	Centre Rod	RV-DL-0907		Push Rod
	09/83→01/90	Centre Rod	RV-DL-10246		Push Rod
	09/83→01/90	Tie Rod	RV-DL-8170		
	09/83→01/90	Tie Rod	RV-DL-8199		
	09/83→01/90	Tie Rod	RV-DL-8317		
	09/83→01/90	Tie Rod End	CV-ES-0912		
	09/83→01/90	Tie Rod End	CV-ES-0914		for Steering Rod
	09/83→01/90	Tie Rod End	CV-ES-12462		for Steering Rod
S 130.11/B	02/86→09/89	Centre Rod	RV-DL-8160		Push Rod
	09/83→01/90	Ball Head, gearshift linkage	CV-ES-2121		
	09/83→01/90	Centre Rod	RV-DL-0907		Push Rod
	09/83→01/90	Centre Rod	RV-DL-10246		Push Rod
	09/83→01/90	Tie Rod	RV-DL-8170		
	09/83→01/90	Tie Rod	RV-DL-8199		
	09/83→01/90	Tie Rod	RV-DL-8317		
	09/83→01/90	Tie Rod End	CV-ES-0912		
	09/83→01/90	Tie Rod End	CV-ES-0914		for Steering Rod
S 130.13/B	09/83→01/90	Tie Rod End	CV-ES-12462		for Steering Rod
	02/86→09/89	Centre Rod	RV-DL-8160		Push Rod
	09/83→01/90	Ball Head, gearshift linkage	CV-ES-2121		
	09/83→01/90	Centre Rod	RV-DL-0907		Push Rod
	09/83→01/90	Centre Rod	RV-DL-10246		Push Rod
	09/83→01/90	Tie Rod	RV-DL-8170		
	09/83→01/90	Tie Rod	RV-DL-8199		
	09/83→01/90	Tie Rod	RV-DL-8317		
	09/83→01/90	Tie Rod End	CV-ES-0912		
S 135.08/A	09/83→01/90	Tie Rod End	CV-ES-0914		for Steering Rod
	09/83→01/90	Tie Rod End	CV-ES-12462		for Steering Rod
	02/86→09/89	Centre Rod	RV-DL-8160		Push Rod
	02/94→05/96	Centre Rod	RV-DL-0907		Push Rod
	02/94→05/96	Tie Rod	RV-DL-8170		
S 135.08/A,S 150.08/A	02/94→05/96	Tie Rod	RV-DL-8317		
	05/96→01/00	Centre Rod	RV-DL-0907		Push Rod
	05/96→01/00	Stabiliser Link	RV-DL-12326	RV-DL-12326	Suspension Rod
	05/96→01/00	Stabiliser Link	RV-DL-12327	RV-DL-12327	Suspension Rod
	05/96→01/00	Tie Rod	RV-DL-8170		
S 135.09/B,S 150.09/B	05/96→01/00	Tie Rod	RV-DL-8317		
	02/98→01/00	Centre Rod	RV-DL-8186		Push Rod
	05/96→01/00	Centre Rod	RV-DL-0907		Push Rod
	05/96→01/00	Stabiliser Link	RV-DL-12326	RV-DL-12326	Suspension Rod
	05/96→01/00	Stabiliser Link	RV-DL-12327	RV-DL-12327	Suspension Rod
	05/96→01/00	Tie Rod	RV-DL-8170		
S 140.07/A	05/96→01/00	Tie Rod	RV-DL-8317		
	02/98→01/00	Centre Rod	RV-DL-8186		Push Rod
	01/90→09/93	Ball Head, gearshift linkage	CV-ES-2121		
	01/90→09/93	Centre Rod	RV-DL-0907		Push Rod
	01/90→09/93	Centre Rod	RV-DL-8186		Push Rod
S 140.08/A,S 140.08/B	01/90→09/93	Tie Rod	RV-DL-8170		
	01/90→09/93	Tie Rod	RV-DL-8317		
	01/90→09/93	Ball Head, gearshift linkage	CV-ES-2121		
	01/90→09/93	Centre Rod	RV-DL-0907		Push Rod
S 140.08/B	01/90→09/93	Tie Rod	RV-DL-8170		
	01/90→09/93	Tie Rod	RV-DL-8317		
	01/90→09/93	Ball Head, gearshift linkage	CV-ES-2121		
	01/90→09/93	Centre Rod	RV-DL-0907		Push Rod
	01/90→09/93	Centre Rod	RV-DL-8186		Push Rod
S 140.09/B	01/90→09/93	Tie Rod	RV-DL-8170		
	01/90→09/93	Tie Rod	RV-DL-8317		
	01/90→09/93	Ball Head, gearshift linkage	CV-ES-2121		
	01/90→09/93	Centre Rod	RV-DL-0907		Push Rod

CV-ES-0912

Length: 125
Cone Ø: d1 Ø 30 / d2 Ø 27
Thread: M38 x 1,5 LHT
3401206, 5001832579



RV-DL-8170

Length: 1404
Ø: 34
Cone Ø: d1 Ø 22 / d2 Ø 20
5000350120, 5000541224, 5010097562,
7485114941



RV-DL-12327

Length: 280
Ø: 28
Cone Ø: d1 Ø 20
5010253256



CV-ES-0914

Length: 125
Cone Ø: d1 Ø 30 / d2 Ø 27
Thread: M38 x 1,5 RHT
3401207, 5001832580



RV-DL-8186

Length: 895
Ø: 40
Cone Ø: d1 Ø 22 / d2 Ø 20
5010383097, 7485114938



CV-ES-2121

Length: 85
Cone Ø: d1 Ø 12 / d2 Ø 10,8
Thread: M14 x 1,5 RHT
23162046, 5000516214, 5010144543,
5010245591



RV-DL-8199

Length: 1470
Ø: 36
Cone Ø: d1 Ø 26 / d2 Ø 23,5
5010308214, 5010439984



CV-ES-12462

Length: 120
Cone Ø: d1 Ø 26 / d2 Ø 23,5
Thread: M30 x 1,5 RHT
0003406212, 0003406253, 5000242159,
5000295214, 5000812483, 5001831473,
5001850549, 5001852264, 5001859985,
7701016946



RV-DL-8317

Length: 1415
Ø: 30
Cone Ø: d1 Ø 20 / d2 Ø 18
5000446681, 5010224899



RV-DL-0907

Length: 900
Ø: 40
Cone Ø: d1 Ø 22 / d2 Ø 20
5010037602, 5010130456



RV-DL-10246

Length: 895
Ø: 40
Cone Ø: d1 Ø 26 / d2 Ø 23,5
5010039426, 5010130386, 7485114920



RV-DL-8160

Length: 877
Ø: 36
Cone Ø: d1 Ø 20 / d2 Ø 18
5010037411, 5010037576



RV-DL-12326

Length: 280
Ø: 28
Cone Ø: d1 Ø 20
5010238594, 5010253255





Midliner ...

S 150.08/A	11/92→01/00	Ball Head, gearshift linkage	CV-ES-2121	
	11/92→01/00	Centre Rod	RV-DL-0904	Push Rod
	11/92→01/00	Centre Rod	RV-DL-0907	Push Rod
	11/92→01/00	Centre Rod	RV-DL-0909	Coupling Rod
	11/92→01/00	Centre Rod	RV-DL-8186	Push Rod
	11/92→01/00	Tie Rod	RV-DL-8170	
	11/92→01/00	Tie Rod	RV-DL-8317	
	11/92→01/00	Tie Rod End	CV-ES-0912	
	11/92→01/00	Tie Rod End	CV-ES-0914	for Steering Rod
	11/92→01/00	Tie Rod End	CV-ES-12461	for Steering Rod
	11/92→01/00	Tie Rod End	CV-ES-12462	for Steering Rod
	07/99→01/00	Tie Rod	RV-DL-8312	
	S 150.08/A,S 150.08/B	11/92→05/96	Ball Head, gearshift linkage	CV-ES-2121
11/92→05/96		Centre Rod	RV-DL-0904	Push Rod
11/92→05/96		Centre Rod	RV-DL-0907	Push Rod
11/92→05/96		Centre Rod	RV-DL-0909	Coupling Rod
11/92→05/96		Centre Rod	RV-DL-8186	Push Rod
11/92→05/96		Tie Rod	RV-DL-8170	
11/92→05/96		Tie Rod	RV-DL-8317	
11/92→05/96		Tie Rod End	CV-ES-0912	
11/92→05/96		Tie Rod End	CV-ES-0914	for Steering Rod
11/92→05/96		Tie Rod End	CV-ES-12461	for Steering Rod
11/92→05/96		Tie Rod End	CV-ES-12462	for Steering Rod
07/99→01/00		Tie Rod	RV-DL-8312	
S 150.08/B		11/92→05/96	Ball Head, gearshift linkage	CV-ES-2121
	11/92→05/96	Centre Rod	RV-DL-0904	Push Rod
	11/92→05/96	Centre Rod	RV-DL-0907	Push Rod
	11/92→05/96	Centre Rod	RV-DL-0909	Coupling Rod
	11/92→05/96	Centre Rod	RV-DL-8186	Push Rod
	11/92→05/96	Tie Rod	RV-DL-8170	
	11/92→05/96	Tie Rod	RV-DL-8317	
	11/92→05/96	Tie Rod End	CV-ES-0912	
	11/92→05/96	Tie Rod End	CV-ES-0914	for Steering Rod
	11/92→05/96	Tie Rod End	CV-ES-12461	for Steering Rod
	11/92→05/96	Tie Rod End	CV-ES-12462	for Steering Rod
	07/99→01/00	Tie Rod	RV-DL-8312	
	S 150.08TI	05/83→09/90	Ball Head, gearshift linkage	CV-ES-2121
05/83→09/90		Centre Rod	RV-DL-0904	Push Rod
05/83→09/90		Centre Rod	RV-DL-0907	Push Rod
05/83→09/90		Centre Rod	RV-DL-8186	Push Rod
05/83→09/90		Tie Rod	RV-DL-8170	
05/83→09/90		Tie Rod	RV-DL-8199	
05/83→09/90		Tie Rod	RV-DL-8317	
05/83→09/90		Tie Rod End	CV-ES-0912	
05/83→09/90		Tie Rod End	CV-ES-0914	for Steering Rod
05/83→09/90		Tie Rod End	CV-ES-12461	for Steering Rod
05/83→09/90		Tie Rod End	CV-ES-12462	for Steering Rod
07/99→01/00		Tie Rod	RV-DL-8312	
S 150.08TI/R		05/86→09/90	Ball Head, gearshift linkage	CV-ES-2121
	05/86→09/90	Centre Rod	RV-DL-0904	Push Rod
	05/86→09/90	Centre Rod	RV-DL-0907	Push Rod
	05/86→09/90	Centre Rod	RV-DL-8186	Push Rod
	05/86→09/90	Tie Rod	RV-DL-8170	
	05/86→09/90	Tie Rod	RV-DL-8199	
	05/86→09/90	Tie Rod	RV-DL-8317	
	05/86→09/90	Tie Rod End	CV-ES-0912	
	05/86→09/90	Tie Rod End	CV-ES-0914	for Steering Rod
	05/86→09/90	Tie Rod End	CV-ES-12461	for Steering Rod
	05/86→09/90	Tie Rod End	CV-ES-12462	for Steering Rod
	07/99→01/00	Tie Rod	RV-DL-8312	
	S 150.09/B	11/92→01/00	Ball Head, gearshift linkage	CV-ES-2121
11/92→01/00		Centre Rod	RV-DL-0904	Push Rod
11/92→01/00		Centre Rod	RV-DL-0907	Push Rod
11/92→01/00		Centre Rod	RV-DL-0909	Coupling Rod
11/92→01/00		Centre Rod	RV-DL-8186	Push Rod
11/92→01/00		Tie Rod	RV-DL-8170	
11/92→01/00		Tie Rod	RV-DL-8317	

CV-ES-0912

Length: 125
Cone Ø: d1 Ø 30 / d2 Ø 27
Thread: M38 x 1,5 LHT
3401206, 5001832579



RV-DL-0904

Length: 872
Ø: 40
Cone Ø: d1 Ø 26 / d2 Ø 23,5
5010130393



RV-DL-8312

Length: 1560
Ø: 52
Cone Ø: d1 Ø 30 / d2 Ø 27
5010439023, 5010566062



CV-ES-0914

Length: 125
Cone Ø: d1 Ø 30 / d2 Ø 27
Thread: M38 x 1,5 RHT
3401207, 5001832580



RV-DL-0907

Length: 900
Ø: 40
Cone Ø: d1 Ø 22 / d2 Ø 20
5010037602, 5010130456



RV-DL-8317

Length: 1415
Ø: 30
Cone Ø: d1 Ø 20 / d2 Ø 18
5000446681, 5010224899



CV-ES-2121

Length: 85
Cone Ø: d1 Ø 12 / d2 Ø 10,8
Thread: M14 x 1,5 RHT
23162046, 5000516214, 5010144543,
5010245591



RV-DL-0909

Length: 1528
Ø: 40
Cone Ø: d1 Ø 26 / d2 Ø 23,5
5000613837



CV-ES-12461

Length: 120
Cone Ø: d1 Ø 26 / d2 Ø 23,5
Thread: M30 x 1,5 LHT
0003406213, 3406218, 5000242467,
5000242488, 5000295215, 5000295336,
5000588470, 5000805280, 5000806187,
5000814347, 5000820879, 5000823654,
5001834533, 5001850550, 5001852263,
5001859984



RV-DL-8170

Length: 1404
Ø: 34
Cone Ø: d1 Ø 22 / d2 Ø 20
5000350120, 5000541224, 5010097562,
7485114941



CV-ES-12462

Length: 120
Cone Ø: d1 Ø 26 / d2 Ø 23,5
Thread: M30 x 1,5 RHT
0003406212, 0003406253, 5000242159,
5000295214, 5000812483, 5001831473,
5001850549, 5001852264, 5001859985,
7701016946



RV-DL-8186

Length: 895
Ø: 40
Cone Ø: d1 Ø 22 / d2 Ø 20
5010383097, 7485114938



RV-DL-8199

Length: 1470
Ø: 36
Cone Ø: d1 Ø 26 / d2 Ø 23,5
5010308214, 5010439984





Midliner ...

S 150.09/B ...	11/92→01/00	Tie Rod End	CV-ES-0912	
	11/92→01/00	Tie Rod End	CV-ES-0914	for Steering Rod
	11/92→01/00	Tie Rod End	CV-ES-12461	for Steering Rod
	11/92→01/00	Tie Rod End	CV-ES-12462	for Steering Rod
	07/99→01/00	Tie Rod	RV-DL-8312	
S 150.09/B,S 135.09/B	05/96→01/00	Ball Head, gearshift linkage	CV-ES-2121	
	05/96→01/00	Centre Rod	RV-DL-0904	Push Rod
	05/96→01/00	Centre Rod	RV-DL-0907	Push Rod
	05/96→01/00	Centre Rod	RV-DL-0909	Coupling Rod
	05/96→01/00	Centre Rod	RV-DL-8186	Push Rod
	05/96→01/00	Stabiliser Link	RV-DL-12326	RV-DL-12326 Suspension Rod
	05/96→01/00	Stabiliser Link	RV-DL-12327	RV-DL-12327 Suspension Rod
	05/96→01/00	Tie Rod	RV-DL-8170	
	05/96→01/00	Tie Rod	RV-DL-8317	
	05/96→01/00	Tie Rod End	CV-ES-0912	
	05/96→01/00	Tie Rod End	CV-ES-0914	for Steering Rod
	05/96→01/00	Tie Rod End	CV-ES-12461	for Steering Rod
	05/96→01/00	Tie Rod End	CV-ES-12462	for Steering Rod
	07/99→01/00	Tie Rod	RV-DL-8312	
	S 150.09TI	05/83→09/90	Ball Head, gearshift linkage	CV-ES-2121
05/83→09/90		Centre Rod	RV-DL-0904	Push Rod
05/83→09/90		Centre Rod	RV-DL-0907	Push Rod
05/83→09/90		Centre Rod	RV-DL-8186	Push Rod
05/83→09/90		Tie Rod	RV-DL-8170	
05/83→09/90		Tie Rod	RV-DL-8199	
05/83→09/90		Tie Rod	RV-DL-8317	
05/83→09/90		Tie Rod End	CV-ES-0912	
05/83→09/90		Tie Rod End	CV-ES-0914	for Steering Rod
05/83→09/90		Tie Rod End	CV-ES-12461	for Steering Rod
05/83→09/90		Tie Rod End	CV-ES-12462	for Steering Rod
S 150.11TI	05/86→09/90	Ball Head, gearshift linkage	CV-ES-2121	
	05/86→09/90	Centre Rod	RV-DL-0904	Push Rod
	05/86→09/90	Centre Rod	RV-DL-0907	Push Rod
	05/86→09/90	Centre Rod	RV-DL-8186	Push Rod
	05/86→09/90	Tie Rod	RV-DL-8170	
	05/86→09/90	Tie Rod	RV-DL-8199	
	05/86→09/90	Tie Rod	RV-DL-8317	
	05/86→09/90	Tie Rod End	CV-ES-0912	
	05/86→09/90	Tie Rod End	CV-ES-0914	for Steering Rod
	05/86→09/90	Tie Rod End	CV-ES-12461	for Steering Rod
	05/86→09/90	Tie Rod End	CV-ES-12462	for Steering Rod
S 150.13TI	04/86→09/90	Ball Head, gearshift linkage	CV-ES-2121	
	04/86→09/90	Centre Rod	RV-DL-0904	Push Rod
	04/86→09/90	Centre Rod	RV-DL-0907	Push Rod
	04/86→09/90	Centre Rod	RV-DL-8186	Push Rod
	04/86→09/90	Tie Rod	RV-DL-8170	
	04/86→09/90	Tie Rod	RV-DL-8199	
	04/86→09/90	Tie Rod	RV-DL-8317	
	04/86→09/90	Tie Rod End	CV-ES-0912	
	04/86→09/90	Tie Rod End	CV-ES-0914	for Steering Rod
	04/86→09/90	Tie Rod End	CV-ES-12461	for Steering Rod
	04/86→09/90	Tie Rod End	CV-ES-12462	for Steering Rod
S 150.14TI BOM	05/86→09/90	Ball Head, gearshift linkage	CV-ES-2121	
	05/86→09/90	Centre Rod	RV-DL-0904	Push Rod
	05/86→09/90	Centre Rod	RV-DL-0907	Push Rod
	05/86→09/90	Centre Rod	RV-DL-8186	Push Rod
	05/86→09/90	Tie Rod	RV-DL-8170	
	05/86→09/90	Tie Rod	RV-DL-8199	
	05/86→09/90	Tie Rod	RV-DL-8317	
	05/86→09/90	Tie Rod End	CV-ES-0912	
	05/86→09/90	Tie Rod End	CV-ES-0914	for Steering Rod
	05/86→09/90	Tie Rod End	CV-ES-12461	for Steering Rod
	05/86→09/90	Tie Rod End	CV-ES-12462	for Steering Rod

CV-ES-0912

Length: 125
Cone Ø: d1 Ø 30 / d2 Ø 27
Thread: M38 x 1,5 LHT
3401206, 5001832579



RV-DL-0904

Length: 872
Ø: 40
Cone Ø: d1 Ø 26 / d2 Ø 23,5
5010130393



RV-DL-8312

Length: 1560
Ø: 52
Cone Ø: d1 Ø 30 / d2 Ø 27
5010439023, 5010566062



CV-ES-0914

Length: 125
Cone Ø: d1 Ø 30 / d2 Ø 27
Thread: M38 x 1,5 RHT
3401207, 5001832580



RV-DL-0907

Length: 900
Ø: 40
Cone Ø: d1 Ø 22 / d2 Ø 20
5010037602, 5010130456



RV-DL-8317

Length: 1415
Ø: 30
Cone Ø: d1 Ø 20 / d2 Ø 18
5000446681, 5010224899



CV-ES-2121

Length: 85
Cone Ø: d1 Ø 12 / d2 Ø 10,8
Thread: M14 x 1,5 RHT
23162046, 5000516214, 5010144543,
5010245591



RV-DL-0909

Length: 1528
Ø: 40
Cone Ø: d1 Ø 26 / d2 Ø 23,5
5000613837



RV-DL-12326

Length: 280
Ø: 28
Cone Ø: d1 Ø 20
5010238594, 5010253255



CV-ES-12461

Length: 120
Cone Ø: d1 Ø 26 / d2 Ø 23,5
Thread: M30 x 1,5 LHT
0003406213, 3406218, 5000242467,
5000242488, 5000295215, 5000295336,
5000588470, 5000805280, 5000806187,
5000814347, 5000820879, 5000823654,
5001834533, 5001850550, 5001852263,
5001859984



RV-DL-8170

Length: 1404
Ø: 34
Cone Ø: d1 Ø 22 / d2 Ø 20
5000350120, 5000541224, 5010097562,
7485114941



RV-DL-12327

Length: 280
Ø: 28
Cone Ø: d1 Ø 20
5010253256



CV-ES-12462

Length: 120
Cone Ø: d1 Ø 26 / d2 Ø 23,5
Thread: M30 x 1,5 RHT
0003406212, 0003406253, 5000242159,
5000295214, 5000812483, 5001831473,
5001850549, 5001852264, 5001859985,
7701016946



RV-DL-8186

Length: 895
Ø: 40
Cone Ø: d1 Ø 22 / d2 Ø 20
5010383097, 7485114938



RV-DL-8199

Length: 1470
Ø: 36
Cone Ø: d1 Ø 26 / d2 Ø 23,5
5010308214, 5010439984





Midliner ...

S 160.08/A,S 160.08/B	01/90→09/93	Tie Rod	RV-DL-8170	
	01/90→09/93	Tie Rod	RV-DL-8317	
S 160.08/B	01/90→09/93	Tie Rod	RV-DL-8170	
	01/90→09/93	Tie Rod	RV-DL-8317	
S 160.09/B	01/90→09/93	Tie Rod	RV-DL-8170	
	01/90→09/93	Tie Rod	RV-DL-8317	
S 160.09/B SP	01/90→09/93	Tie Rod	RV-DL-8170	
	01/90→09/93	Tie Rod	RV-DL-8317	
S 170.11TI	10/87→05/89	Ball Head, gearshift linkage	CV-ES-2121	
	10/87→05/89	Centre Rod	RV-DL-10246	Push Rod
	10/87→05/89	Tie Rod	RV-DL-8199	
	10/87→05/89	Tie Rod End	CV-ES-0912	
	10/87→05/89	Tie Rod End	CV-ES-0914	for Steering Rod
	10/87→05/89	Tie Rod End	CV-ES-12461	for Steering Rod
	10/87→05/89	Tie Rod End	CV-ES-12462	for Steering Rod
S 170.11TI/R	10/87→05/89	Ball Head, gearshift linkage	CV-ES-2121	
	10/87→05/89	Centre Rod	RV-DL-10246	Push Rod
	10/87→05/89	Tie Rod	RV-DL-8199	
	10/87→05/89	Tie Rod End	CV-ES-0912	
	10/87→05/89	Tie Rod End	CV-ES-0914	for Steering Rod
	10/87→05/89	Tie Rod End	CV-ES-12461	for Steering Rod
	10/87→05/89	Tie Rod End	CV-ES-12462	for Steering Rod
S 170.13TI	10/83→03/93	Centre Rod	RV-DL-10246	Push Rod
	10/83→03/93	Tie Rod	RV-DL-8199	
	10/83→03/93	Tie Rod End	CV-ES-12461	for Steering Rod
	10/83→03/93	Tie Rod End	CV-ES-12462	for Steering Rod
S 170.13TI,S 170 SP	10/83→03/93	Ball Head, gearshift linkage	CV-ES-2121	
	10/83→03/93	Centre Rod	RV-DL-10246	Push Rod
	10/83→03/93	Tie Rod	RV-DL-8199	
	10/83→03/93	Tie Rod End	CV-ES-0912	
	10/83→03/93	Tie Rod End	CV-ES-0914	for Steering Rod
	10/83→03/93	Tie Rod End	CV-ES-12461	for Steering Rod
	10/83→03/93	Tie Rod End	CV-ES-12462	for Steering Rod
S 170.13TI,S 170.13TI/R	10/83→05/89	Ball Head, gearshift linkage	CV-ES-2121	
	10/83→05/89	Centre Rod	RV-DL-10246	Push Rod
	10/83→05/89	Tie Rod	RV-DL-8199	
	10/83→05/89	Tie Rod End	CV-ES-0912	
	10/83→05/89	Tie Rod End	CV-ES-0914	for Steering Rod
	10/83→05/89	Tie Rod End	CV-ES-12461	for Steering Rod
	10/83→05/89	Tie Rod End	CV-ES-12462	for Steering Rod
S 170.13TI/T	10/84→05/89	Ball Head, gearshift linkage	CV-ES-2121	
	10/84→05/89	Centre Rod	RV-DL-10246	Push Rod
	10/84→05/89	Tie Rod	RV-DL-8199	
	10/84→05/89	Tie Rod End	CV-ES-0912	
	10/84→05/89	Tie Rod End	CV-ES-0914	for Steering Rod
	10/84→05/89	Tie Rod End	CV-ES-12461	for Steering Rod
	10/84→05/89	Tie Rod End	CV-ES-12462	for Steering Rod
S 170.14TI	10/83→05/89	Ball Head, gearshift linkage	CV-ES-2121	
	10/83→05/89	Centre Rod	RV-DL-10246	Push Rod
	10/83→05/89	Tie Rod	RV-DL-8199	
	10/83→05/89	Tie Rod End	CV-ES-0912	
	10/83→05/89	Tie Rod End	CV-ES-0914	for Steering Rod
	10/83→05/89	Tie Rod End	CV-ES-12461	for Steering Rod
	10/83→05/89	Tie Rod End	CV-ES-12462	for Steering Rod
S 170.14TI/R	10/87→05/89	Ball Head, gearshift linkage	CV-ES-2121	
	10/87→05/89	Centre Rod	RV-DL-10246	Push Rod
	10/87→05/89	Tie Rod	RV-DL-8199	
	10/87→05/89	Tie Rod End	CV-ES-0912	
	10/87→05/89	Tie Rod End	CV-ES-0914	for Steering Rod
	10/87→05/89	Tie Rod End	CV-ES-12461	for Steering Rod
	10/87→05/89	Tie Rod End	CV-ES-12462	for Steering Rod
S 170.15TI	10/82→09/93	Tie Rod End	CV-ES-12461	for Steering Rod
	10/82→09/93	Tie Rod End	CV-ES-12462	for Steering Rod

CV-ES-0912

Length: 125
Cone Ø: d1 Ø 30 / d2 Ø 27
Thread: M38 x 1,5 LHT
3401206, 5001832579



RV-DL-8170

Length: 1404
Ø: 34
Cone Ø: d1 Ø 22 / d2 Ø 20
5000350120, 5000541224, 5010097562,
7485114941



CV-ES-0914

Length: 125
Cone Ø: d1 Ø 30 / d2 Ø 27
Thread: M38 x 1,5 RHT
3401207, 5001832580



RV-DL-8199

Length: 1470
Ø: 36
Cone Ø: d1 Ø 26 / d2 Ø 23,5
5010308214, 5010439984



CV-ES-2121

Length: 85
Cone Ø: d1 Ø 12 / d2 Ø 10,8
Thread: M14 x 1,5 RHT
23162046, 5000516214, 5010144543,
5010245591



RV-DL-8317

Length: 1415
Ø: 30
Cone Ø: d1 Ø 20 / d2 Ø 18
5000446681, 5010224899



CV-ES-12461

Length: 120
Cone Ø: d1 Ø 26 / d2 Ø 23,5
Thread: M30 x 1,5 LHT
0003406213, 3406218, 5000242467,
5000242488, 5000295215, 5000295336,
5000588470, 5000805280, 5000806187,
5000814347, 5000820879, 5000823654,
5001834533, 5001850550, 5001852263,
5001859984



RV-DL-10246

Length: 895
Ø: 40
Cone Ø: d1 Ø 26 / d2 Ø 23,5
5010039426, 5010130386, 7485114920



CV-ES-12462

Length: 120
Cone Ø: d1 Ø 26 / d2 Ø 23,5
Thread: M30 x 1,5 RHT
0003406212, 0003406253, 5000242159,
5000295214, 5000812483, 5001831473,
5001850549, 5001852264, 5001859985,
7701016946





Midliner ...

S 180.08/A	11/92→01/00	Ball Head, gearshift linkage	CV-ES-2121			
	11/92→01/00	Centre Rod	RV-DL-0904		Push Rod	
	11/92→01/00	Centre Rod	RV-DL-0907		Push Rod	
	11/92→01/00	Centre Rod	RV-DL-0909		Coupling Rod	
	11/92→01/00	Centre Rod	RV-DL-8186		Push Rod	
	11/92→01/00	Tie Rod	RV-DL-8170			
	11/92→01/00	Tie Rod	RV-DL-8317			
	11/92→01/00	Tie Rod End	CV-ES-0912			
	11/92→01/00	Tie Rod End	CV-ES-0914		for Steering Rod	
	11/92→01/00	Tie Rod End	CV-ES-12461		for Steering Rod	
	11/92→01/00	Tie Rod End	CV-ES-12462		for Steering Rod	
	07/99→01/00	Tie Rod	RV-DL-8312			
	S 180.08/A,S 180.08/B	11/92→10/96	Ball Head, gearshift linkage	CV-ES-2121		
		11/92→10/96	Centre Rod	RV-DL-0904		Push Rod
11/92→10/96		Centre Rod	RV-DL-0907		Push Rod	
11/92→10/96		Centre Rod	RV-DL-0909		Coupling Rod	
11/92→10/96		Centre Rod	RV-DL-8186		Push Rod	
11/92→10/96		Tie Rod	RV-DL-8170			
11/92→10/96		Tie Rod	RV-DL-8317			
11/92→10/96		Tie Rod End	CV-ES-0912			
11/92→10/96		Tie Rod End	CV-ES-0914		for Steering Rod	
11/92→10/96		Tie Rod End	CV-ES-12461		for Steering Rod	
11/92→10/96		Tie Rod End	CV-ES-12462		for Steering Rod	
S 180.09/B		11/92→01/00	Ball Head, gearshift linkage	CV-ES-2121		
		11/92→01/00	Centre Rod	RV-DL-0904		Push Rod
		11/92→01/00	Centre Rod	RV-DL-0907		Push Rod
	11/92→01/00	Centre Rod	RV-DL-0909		Coupling Rod	
	11/92→01/00	Centre Rod	RV-DL-8186		Push Rod	
	11/92→01/00	Tie Rod	RV-DL-8170			
	11/92→01/00	Tie Rod	RV-DL-8317			
	11/92→01/00	Tie Rod End	CV-ES-0912			
	11/92→01/00	Tie Rod End	CV-ES-0914		for Steering Rod	
	11/92→01/00	Tie Rod End	CV-ES-12461		for Steering Rod	
	11/92→01/00	Tie Rod End	CV-ES-12462		for Steering Rod	
	07/99→01/00	Tie Rod	RV-DL-8312			
	S 180.09/B SP	11/92→10/96	Ball Head, gearshift linkage	CV-ES-2121		
		11/92→10/96	Centre Rod	RV-DL-0904		Push Rod
11/92→10/96		Centre Rod	RV-DL-0907		Push Rod	
11/92→10/96		Centre Rod	RV-DL-0909		Coupling Rod	
11/92→10/96		Centre Rod	RV-DL-8186		Push Rod	
11/92→10/96		Stabiliser Link	RV-DL-12326	RV-DL-12326	Suspension Rod	
11/92→10/96		Stabiliser Link	RV-DL-12327	RV-DL-12327	Suspension Rod	
11/92→10/96		Tie Rod	RV-DL-8170			
11/92→10/96		Tie Rod	RV-DL-8317			
11/92→10/96		Tie Rod End	CV-ES-0912			
11/92→10/96		Tie Rod End	CV-ES-0914		for Steering Rod	
11/92→10/96		Tie Rod End	CV-ES-12461		for Steering Rod	
11/92→10/96		Tie Rod End	CV-ES-12462		for Steering Rod	
S 210.08/A		04/95→01/00	Ball Head, gearshift linkage	CV-ES-2121		
	04/95→01/00	Centre Rod	RV-DL-0904		Push Rod	
	04/95→01/00	Centre Rod	RV-DL-0907		Push Rod	
	04/95→01/00	Centre Rod	RV-DL-0909		Coupling Rod	
	04/95→01/00	Centre Rod	RV-DL-8186		Push Rod	
	04/95→01/00	Tie Rod	RV-DL-8170			
	04/95→01/00	Tie Rod	RV-DL-8317			
	04/95→01/00	Tie Rod End	CV-ES-0912			
	04/95→01/00	Tie Rod End	CV-ES-0914		for Steering Rod	
	04/95→01/00	Tie Rod End	CV-ES-12461		for Steering Rod	
	04/95→01/00	Tie Rod End	CV-ES-12462		for Steering Rod	
	07/99→01/00	Tie Rod	RV-DL-8312			

CV-ES-0912

Length: 125
Cone Ø: d1 Ø 30 / d2 Ø 27
Thread: M38 x 1,5 LHT
3401206, 5001832579



RV-DL-0904

Length: 872
Ø: 40
Cone Ø: d1 Ø 26 / d2 Ø 23,5
5010130393



RV-DL-8317

Length: 1415
Ø: 30
Cone Ø: d1 Ø 20 / d2 Ø 18
5000446681, 5010224899



CV-ES-0914

Length: 125
Cone Ø: d1 Ø 30 / d2 Ø 27
Thread: M38 x 1,5 RHT
3401207, 5001832580



RV-DL-0907

Length: 900
Ø: 40
Cone Ø: d1 Ø 22 / d2 Ø 20
5010037602, 5010130456



RV-DL-12326

Length: 280
Ø: 28
Cone Ø: d1 Ø 20
5010238594, 5010253255



CV-ES-2121

Length: 85
Cone Ø: d1 Ø 12 / d2 Ø 10,8
Thread: M14 x 1,5 RHT
23162046, 5000516214, 5010144543,
5010245591



RV-DL-0909

Length: 1528
Ø: 40
Cone Ø: d1 Ø 26 / d2 Ø 23,5
5000613837



RV-DL-12327

Length: 280
Ø: 28
Cone Ø: d1 Ø 20
5010253256



CV-ES-12461

Length: 120
Cone Ø: d1 Ø 26 / d2 Ø 23,5
Thread: M30 x 1,5 LHT
0003406213, 3406218, 5000242467,
5000242488, 5000295215, 5000295336,
5000588470, 5000805280, 5000806187,
5000814347, 5000820879, 5000823654,
5001834533, 5001850550, 5001852263,
5001859984



RV-DL-8170

Length: 1404
Ø: 34
Cone Ø: d1 Ø 22 / d2 Ø 20
5000350120, 5000541224, 5010097562,
7485114941



CV-ES-12462

Length: 120
Cone Ø: d1 Ø 26 / d2 Ø 23,5
Thread: M30 x 1,5 RHT
0003406212, 0003406253, 5000242159,
5000295214, 5000812483, 5001831473,
5001850549, 5001852264, 5001859985,
7701016946



RV-DL-8186

Length: 895
Ø: 40
Cone Ø: d1 Ø 22 / d2 Ø 20
5010383097, 7485114938



RV-DL-8312

Length: 1560
Ø: 52
Cone Ø: d1 Ø 30 / d2 Ø 27
5010439023, 5010566062



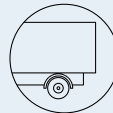

Midliner ...

S 210.09/B	04/95→01/00	Ball Head, gearshift linkage	CV-ES-2121	
	04/95→01/00	Centre Rod	RV-DL-0904	Push Rod
	04/95→01/00	Centre Rod	RV-DL-0907	Push Rod
	04/95→01/00	Centre Rod	RV-DL-0909	Coupling Rod
	04/95→01/00	Centre Rod	RV-DL-8186	Push Rod
	04/95→01/00	Tie Rod	RV-DL-8170	
	04/95→01/00	Tie Rod	RV-DL-8317	
	04/95→01/00	Tie Rod End	CV-ES-0912	
	04/95→01/00	Tie Rod End	CV-ES-0914	for Steering Rod
	04/95→01/00	Tie Rod End	CV-ES-12461	for Steering Rod
	04/95→01/00	Tie Rod End	CV-ES-12462	for Steering Rod
S 220.11TI	07/99→01/00	Tie Rod	RV-DL-8312	
	09/87→09/90	Ball Head, gearshift linkage	CV-ES-2121	
	09/87→09/90	Centre Rod	RV-DL-0904	Push Rod
	09/87→09/90	Centre Rod	RV-DL-0907	Push Rod
	09/87→09/90	Centre Rod	RV-DL-0909	Coupling Rod
	09/87→09/90	Centre Rod	RV-DL-10246	Push Rod
	09/87→09/90	Tie Rod	RV-DL-8199	
	09/87→09/90	Tie Rod End	CV-ES-0912	
	09/87→09/90	Tie Rod End	CV-ES-0914	for Steering Rod
S 220.13TI	09/87→09/90	Tie Rod End	CV-ES-12461	for Steering Rod
	09/87→09/90	Tie Rod End	CV-ES-12462	for Steering Rod
	09/87→09/90	Tie Rod End	CV-ES-12462	for Steering Rod
	09/87→09/90	Ball Head, gearshift linkage	CV-ES-2121	
	09/87→09/90	Centre Rod	RV-DL-0904	Push Rod
	09/87→09/90	Centre Rod	RV-DL-0907	Push Rod
	09/87→09/90	Centre Rod	RV-DL-0909	Coupling Rod
	09/87→09/90	Centre Rod	RV-DL-10246	Push Rod
	09/87→09/90	Tie Rod	RV-DL-8199	
S 220.13TI/T	09/87→09/90	Tie Rod End	CV-ES-0912	
	09/87→09/90	Tie Rod End	CV-ES-0914	for Steering Rod
	09/87→09/90	Tie Rod End	CV-ES-12461	for Steering Rod
	09/87→09/90	Tie Rod End	CV-ES-12462	for Steering Rod
	09/87→09/90	Ball Head, gearshift linkage	CV-ES-2121	
	09/87→09/90	Centre Rod	RV-DL-0904	Push Rod
	09/87→09/90	Centre Rod	RV-DL-0907	Push Rod
	09/87→09/90	Centre Rod	RV-DL-0909	Coupling Rod
	09/87→09/90	Centre Rod	RV-DL-10246	Push Rod
S 220.14TI	09/87→09/90	Tie Rod	RV-DL-8199	
	09/87→09/90	Tie Rod End	CV-ES-0912	
	09/87→09/90	Tie Rod End	CV-ES-0914	for Steering Rod
	09/87→09/90	Tie Rod End	CV-ES-12461	for Steering Rod
	09/87→09/90	Tie Rod End	CV-ES-12462	for Steering Rod
	09/87→09/90	Ball Head, gearshift linkage	CV-ES-2121	
	09/87→09/90	Centre Rod	RV-DL-0904	Push Rod
	09/87→09/90	Centre Rod	RV-DL-0907	Push Rod
	09/87→09/90	Centre Rod	RV-DL-0909	Coupling Rod
S 220.14TI/T	09/87→09/90	Centre Rod	RV-DL-10246	Push Rod
	09/87→09/90	Tie Rod	RV-DL-8199	
	09/87→09/90	Tie Rod End	CV-ES-0912	
	09/87→09/90	Tie Rod End	CV-ES-0914	for Steering Rod
	09/87→09/90	Tie Rod End	CV-ES-12461	for Steering Rod
	09/87→09/90	Tie Rod End	CV-ES-12462	for Steering Rod
	09/87→09/90	Ball Head, gearshift linkage	CV-ES-2121	
	09/87→09/90	Centre Rod	RV-DL-0904	Push Rod
	09/87→09/90	Centre Rod	RV-DL-0907	Push Rod
09/87→09/90	Centre Rod	RV-DL-0909	Coupling Rod	
S 220.14TI/T	09/87→09/90	Centre Rod	RV-DL-10246	Push Rod
	09/87→09/90	Tie Rod	RV-DL-8199	
	09/87→09/90	Tie Rod End	CV-ES-0912	
	09/87→09/90	Tie Rod End	CV-ES-0914	for Steering Rod
	09/87→09/90	Tie Rod End	CV-ES-12461	for Steering Rod
	09/87→09/90	Tie Rod End	CV-ES-12462	for Steering Rod
	09/87→09/90	Ball Head, gearshift linkage	CV-ES-2121	
	09/87→09/90	Centre Rod	RV-DL-0904	Push Rod
	09/87→09/90	Centre Rod	RV-DL-0907	Push Rod
09/87→09/90	Centre Rod	RV-DL-0909	Coupling Rod	

CV-ES-0912

Length: 125
Cone Ø: d1 Ø 30 / d2 Ø 27
Thread: M38 x 1,5 LHT
3401206, 5001832579



RV-DL-0904

Length: 872
Ø: 40
Cone Ø: d1 Ø 26 / d2 Ø 23,5
5010130393



RV-DL-8312

Length: 1560
Ø: 52
Cone Ø: d1 Ø 30 / d2 Ø 27
5010439023, 5010566062



CV-ES-0914

Length: 125
Cone Ø: d1 Ø 30 / d2 Ø 27
Thread: M38 x 1,5 RHT
3401207, 5001832580



RV-DL-0907

Length: 900
Ø: 40
Cone Ø: d1 Ø 22 / d2 Ø 20
5010037602, 5010130456



RV-DL-8317

Length: 1415
Ø: 30
Cone Ø: d1 Ø 20 / d2 Ø 18
5000446681, 5010224899



CV-ES-2121

Length: 85
Cone Ø: d1 Ø 12 / d2 Ø 10,8
Thread: M14 x 1,5 RHT
23162046, 5000516214, 5010144543,
5010245591



RV-DL-0909

Length: 1528
Ø: 40
Cone Ø: d1 Ø 26 / d2 Ø 23,5
5000613837



RV-DL-10246

Length: 895
Ø: 40
Cone Ø: d1 Ø 26 / d2 Ø 23,5
5010039426, 5010130386, 7485114920



CV-ES-12461

Length: 120
Cone Ø: d1 Ø 26 / d2 Ø 23,5
Thread: M30 x 1,5 LHT
0003406213, 3406218, 5000242467,
5000242488, 5000295215, 5000295336,
5000588470, 5000805280, 5000806187,
5000814347, 5000820879, 5000823654,
5001834533, 5001850550, 5001852263,
5001859984



RV-DL-8170

Length: 1404
Ø: 34
Cone Ø: d1 Ø 22 / d2 Ø 20
5000350120, 5000541224, 5010097562,
7485114941



CV-ES-12462

Length: 120
Cone Ø: d1 Ø 26 / d2 Ø 23,5
Thread: M30 x 1,5 RHT
0003406212, 0003406253, 5000242159,
5000295214, 5000812483, 5001831473,
5001850549, 5001852264, 5001859985,
7701016946



RV-DL-8186

Length: 895
Ø: 40
Cone Ø: d1 Ø 22 / d2 Ø 20
5010383097, 7485114938



RV-DL-8199

Length: 1470
Ø: 36
Cone Ø: d1 Ø 26 / d2 Ø 23,5
5010308214, 5010439984





Midlum

135.08/B,150.08/B	01/00→	Ball Head, gearshift linkage	CV-ES-2121		
	01/00→	Centre Rod	RV-DL-2181		Coupling Rod
	01/00→	Centre Rod	RV-DL-7539		Coupling Rod
	01/00→	Centre Rod	RV-DL-12448		for Steering Rod
	01/00→	Stabiliser Link	RV-DL-12326	RV-DL-12326	Suspension Rod
	01/00→	Stabiliser Link	RV-DL-12327	RV-DL-12327	Suspension Rod
	01/00→	Tie Rod End	CV-ES-0912		
	01/00→	Tie Rod End	CV-ES-0914		for Steering Rod
	01/00→	Tie Rod End	CV-ES-12461		for Steering Rod
	01/00→	Tie Rod End	CV-ES-12462		for Steering Rod
	01/00→	Tie Rod End	CV-ES-14162		for Steering Rod
	01/00→	Tie Rod End	CV-ES-14163		for Steering Rod
	135.09/B,150.09/B	01/00→	Ball Head, gearshift linkage	CV-ES-2121	
01/00→		Centre Rod	RV-DL-2181		Coupling Rod
01/00→		Centre Rod	RV-DL-7539		Coupling Rod
01/00→		Centre Rod	RV-DL-12448		for Steering Rod
01/00→		Stabiliser Link	RV-DL-12326	RV-DL-12326	Suspension Rod
01/00→		Stabiliser Link	RV-DL-12327	RV-DL-12327	Suspension Rod
01/00→		Tie Rod End	CV-ES-0912		
01/00→		Tie Rod End	CV-ES-0914		for Steering Rod
01/00→		Tie Rod End	CV-ES-12461		for Steering Rod
01/00→		Tie Rod End	CV-ES-12462		for Steering Rod
01/00→		Tie Rod End	CV-ES-14162		for Steering Rod
01/00→		Tie Rod End	CV-ES-14163		for Steering Rod
135.10/B,150.10/B		01/00→	Ball Head, gearshift linkage	CV-ES-2121	
	01/00→	Centre Rod	RV-DL-2181		Coupling Rod
	01/00→	Centre Rod	RV-DL-7539		Coupling Rod
	01/00→	Centre Rod	RV-DL-12448		for Steering Rod
	01/00→	Stabiliser Link	RV-DL-12326	RV-DL-12326	Suspension Rod
	01/00→	Stabiliser Link	RV-DL-12327	RV-DL-12327	Suspension Rod
	01/00→	Tie Rod End	CV-ES-0912		
	01/00→	Tie Rod End	CV-ES-0914		for Steering Rod
	01/00→	Tie Rod End	CV-ES-12461		for Steering Rod
	01/00→	Tie Rod End	CV-ES-12462		for Steering Rod
	01/00→	Tie Rod End	CV-ES-14162		for Steering Rod
	01/00→	Tie Rod End	CV-ES-14163		for Steering Rod
	150.08/B	10/01→	Ball Head, gearshift linkage	CV-ES-2121	
10/01→		Ball Head, gearshift linkage	DF-ES-9335		
10/01→		Centre Rod	RV-DL-2181		Coupling Rod
10/01→		Centre Rod	RV-DL-7539		Coupling Rod
10/01→		Centre Rod	RV-DL-8308		Push Rod
10/01→		Centre Rod	RV-DL-12448		for Steering Rod
10/01→		Stabiliser Link	RV-DL-12326	RV-DL-12326	Suspension Rod
10/01→		Stabiliser Link	RV-DL-12327	RV-DL-12327	Suspension Rod
10/01→		Tie Rod	RV-DL-8310		
10/01→		Tie Rod End	CV-ES-0912		
10/01→		Tie Rod End	CV-ES-0914		for Steering Rod
10/01→		Tie Rod End	CV-ES-12461		for Steering Rod
10/01→		Tie Rod End	CV-ES-12462		for Steering Rod
10/01→		Tie Rod End	CV-ES-14162		for Steering Rod
10/01→		Tie Rod End	CV-ES-14163		for Steering Rod
150.10/B		10/01→	Ball Head, gearshift linkage	CV-ES-2121	
	10/01→	Ball Head, gearshift linkage	DF-ES-9335		
	10/01→	Centre Rod	RV-DL-2181		Coupling Rod
	10/01→	Centre Rod	RV-DL-7539		Coupling Rod
	10/01→	Centre Rod	RV-DL-8308		Push Rod
	10/01→	Centre Rod	RV-DL-12448		for Steering Rod
	10/01→	Stabiliser Link	RV-DL-12326	RV-DL-12326	Suspension Rod
	10/01→	Stabiliser Link	RV-DL-12327	RV-DL-12327	Suspension Rod
	10/01→	Tie Rod	RV-DL-8310		
	10/01→	Tie Rod End	CV-ES-0912		
	10/01→	Tie Rod End	CV-ES-0914		for Steering Rod

CV-ES-0912

Length: 125
Cone Ø: d1 Ø 30 / d2 Ø 27
Thread: M38 x 1,5 LHT
3401206, 5001832579



CV-ES-0914

Length: 125
Cone Ø: d1 Ø 30 / d2 Ø 27
Thread: M38 x 1,5 RHT
3401207, 5001832580



CV-ES-2121

Length: 85
Cone Ø: d1 Ø 12 / d2 Ø 10,8
Thread: M14 x 1,5 RHT
23162046, 5000516214, 5010144543,
5010245591



CV-ES-12461

Length: 120
Cone Ø: d1 Ø 26 / d2 Ø 23,5
Thread: M30 x 1,5 LHT

0003406213, 3406218, 5000242467,
5000242488, 5000295215, 5000295336,
5000588470, 5000805280, 5000806187,
5000814347, 5000820879, 5000823654,
5001834533, 5001850550, 5001852263,
5001859984



CV-ES-12462

Length: 120
Cone Ø: d1 Ø 26 / d2 Ø 23,5
Thread: M30 x 1,5 RHT

0003406212, 0003406253, 5000242159,
5000295214, 5000812483, 5001831473,
5001850549, 5001852264, 5001859985,
7701016946



CV-ES-14162

Length: 125
Cone Ø: d1 Ø 30 / d2 Ø 27
Thread: M30 x 1,5 LHT
3401170, 5000288361, 5001832581,
5001858759, 5001858774



CV-ES-14163

Length: 125
Cone Ø: d1 Ø 30 / d2 Ø 27
Thread: M30 x 1,5 RHT
0003406169, 0003406236, 0003406251,
0003406254, 0003406260, 0003406261,
5000288360, 5000590236, 5000804824,
5001858773, 7420937674, 7701011412



DF-ES-9335

Length: 85
Cone Ø: d1 Ø 12 / d2 Ø 10,75
Thread: M14 x 1,5 RHT
23162046, 5000516214, 5010144543,
5010245591



RV-DL-2181

Length: 1650
Ø: 40
Cone Ø: d1 Ø 30 / d2 Ø 27
5010145581, 5010308215



RV-DL-7539

Length: 1690
Ø: 48
Cone Ø: d1 Ø 30 / d2 Ø 27
5000786902, 5010145077



RV-DL-8308

Length: 883
Ø: 42
Cone Ø: d1 Ø 22 / d2 Ø 20
5010294831, 5010488165



RV-DL-8309

Length: 891
Ø: 42
Cone Ø: d1 Ø 22 / d2 Ø 20
5010557423



RV-DL-8310

Length: 1500
Ø: 38
Cone Ø: d1 Ø 26 / d2 Ø 23,5
5010395796, 5010566049



RV-DL-12326

Length: 280
Ø: 28
Cone Ø: d1 Ø 20
5010238594, 5010253255



RV-DL-12327

Length: 280
Ø: 28
Cone Ø: d1 Ø 20
5010253256



RV-DL-12448

Length: 900
Ø: 50
Cone Ø: d1 Ø 30 / d2 Ø 27
5010488084, 5010488639, 5010488759,
5010557341



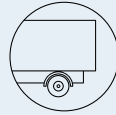

Midlum ...

150.10/B ...	10/01→	Tie Rod End	CV-ES-12461		for Steering Rod
	10/01→	Tie Rod End	CV-ES-12462		for Steering Rod
	10/01→	Tie Rod End	CV-ES-14162		for Steering Rod
	10/01→	Tie Rod End	CV-ES-14163		for Steering Rod
	10/02→	Centre Rod	RV-DL-8309		Push Rod
150.12/B	01/00→	Ball Head, gearshift linkage	CV-ES-2121		
	01/00→	Ball Head, gearshift linkage	DF-ES-9335		
	01/00→	Centre Rod	RV-DL-2181		Coupling Rod
	01/00→	Centre Rod	RV-DL-7539		Coupling Rod
	01/00→	Centre Rod	RV-DL-8308		Push Rod
	01/00→	Centre Rod	RV-DL-12448		for Steering Rod
	01/00→	Stabiliser Link	RV-DL-12326	RV-DL-12326	Suspension Rod
	01/00→	Stabiliser Link	RV-DL-12327	RV-DL-12327	Suspension Rod
	01/00→	Tie Rod	RV-DL-8310		
	01/00→	Tie Rod End	CV-ES-0912		
	01/00→	Tie Rod End	CV-ES-0914		for Steering Rod
	01/00→	Tie Rod End	CV-ES-12461		for Steering Rod
	01/00→	Tie Rod End	CV-ES-12462		for Steering Rod
	01/00→	Tie Rod End	CV-ES-14162		for Steering Rod
	01/00→	Tie Rod End	CV-ES-14163		for Steering Rod
	10/02→	Centre Rod	RV-DL-8309		Push Rod
	160.08	05/06→	Ball Head, gearshift linkage	DF-ES-9335	
05/06→		Centre Rod	RV-DL-8309		Push Rod
05/06→		Centre Rod	RV-DL-12448		for Steering Rod
05/06→		Centre Rod	RV-DL-12480		Push Rod
05/06→		Tie Rod	RV-DL-8310		
05/06→		Tie Rod End	CV-ES-12461		for Steering Rod
05/06→		Tie Rod End	CV-ES-12462		for Steering Rod
05/06→		Tie Rod End	CV-ES-14163		for Steering Rod
160.10	05/06→	Ball Head, gearshift linkage	DF-ES-9335		
	05/06→	Centre Rod	RV-DL-8309		Push Rod
	05/06→	Centre Rod	RV-DL-12448		for Steering Rod
	05/06→	Centre Rod	RV-DL-12480		Push Rod
	05/06→	Tie Rod	RV-DL-8310		
	05/06→	Tie Rod End	CV-ES-12461		for Steering Rod
	05/06→	Tie Rod End	CV-ES-12462		for Steering Rod
160.12	05/06→	Ball Head, gearshift linkage	DF-ES-9335		
	05/06→	Centre Rod	RV-DL-8309		Push Rod
	05/06→	Centre Rod	RV-DL-12448		for Steering Rod
	05/06→	Centre Rod	RV-DL-12480		Push Rod
	05/06→	Tie Rod	RV-DL-8310		
	05/06→	Tie Rod End	CV-ES-12461		for Steering Rod
	05/06→	Tie Rod End	CV-ES-12462		for Steering Rod
180.08/B	05/06→	Tie Rod End	CV-ES-14163		for Steering Rod
	01/00→	Ball Head, gearshift linkage	CV-ES-2121		
	01/00→	Centre Rod	RV-DL-2181		Coupling Rod
	01/00→	Centre Rod	RV-DL-7539		Coupling Rod
	01/00→	Centre Rod	RV-DL-12448		for Steering Rod
	01/00→	Stabiliser Link	RV-DL-12326	RV-DL-12326	Suspension Rod
	01/00→	Stabiliser Link	RV-DL-12327	RV-DL-12327	Suspension Rod
	01/00→	Tie Rod End	CV-ES-0912		
	01/00→	Tie Rod End	CV-ES-0914		for Steering Rod
	01/00→	Tie Rod End	CV-ES-12461		for Steering Rod
	01/00→	Tie Rod End	CV-ES-12462		for Steering Rod
	01/00→	Tie Rod End	CV-ES-14162		for Steering Rod
	01/00→	Tie Rod End	CV-ES-14163		for Steering Rod
	10/01→	Ball Head, gearshift linkage	DF-ES-9335		
10/01→	Centre Rod	RV-DL-8308		Push Rod	
10/01→	Tie Rod	RV-DL-8310			
10/02→	Centre Rod	RV-DL-8309		Push Rod	

CV-ES-0912

Length: 125
Cone Ø: d1 Ø 30 / d2 Ø 27
Thread: M38 x 1,5 LHT
3401206, 5001832579



CV-ES-0914

Length: 125
Cone Ø: d1 Ø 30 / d2 Ø 27
Thread: M38 x 1,5 RHT
3401207, 5001832580



CV-ES-2121

Length: 85
Cone Ø: d1 Ø 12 / d2 Ø 10,8
Thread: M14 x 1,5 RHT
23162046, 5000516214, 5010144543,
5010245591



CV-ES-12461

Length: 120
Cone Ø: d1 Ø 26 / d2 Ø 23,5
Thread: M30 x 1,5 LHT

0003406213, 3406218, 5000242467,
5000242488, 5000295215, 5000295336,
5000588470, 5000805280, 5000806187,
5000814347, 5000820879, 5000823654,
5001834533, 5001850550, 5001852263,
5001859984



CV-ES-12462

Length: 120
Cone Ø: d1 Ø 26 / d2 Ø 23,5
Thread: M30 x 1,5 RHT

0003406212, 0003406253, 5000242159,
5000295214, 5000812483, 5001831473,
5001850549, 5001852264, 5001859985,
7701016946



CV-ES-14162

Length: 125
Cone Ø: d1 Ø 30 / d2 Ø 27
Thread: M30 x 1,5 LHT
3401170, 5000288361, 5001832581,
5001858759, 5001858774



CV-ES-14163

Length: 125
Cone Ø: d1 Ø 30 / d2 Ø 27
Thread: M30 x 1,5 RHT
0003406169, 0003406236, 0003406251,
0003406254, 0003406260, 0003406261,
5000288360, 5000590236, 5000804824,
5001858773, 7420937674, 7701011412



DF-ES-9335

Length: 85
Cone Ø: d1 Ø 12 / d2 Ø 10,75
Thread: M14 x 1,5 RHT
23162046, 5000516214, 5010144543,
5010245591



RV-DL-2181

Length: 1650
Ø: 40
Cone Ø: d1 Ø 30 / d2 Ø 27
5010145581, 5010308215



RV-DL-7539

Length: 1690
Ø: 48
Cone Ø: d1 Ø 30 / d2 Ø 27
5000786902, 5010145077



RV-DL-8308

Length: 883
Ø: 42
Cone Ø: d1 Ø 22 / d2 Ø 20
5010294831, 5010488165



RV-DL-8309

Length: 891
Ø: 42
Cone Ø: d1 Ø 22 / d2 Ø 20
5010557423



RV-DL-8310

Length: 1500
Ø: 38
Cone Ø: d1 Ø 26 / d2 Ø 23,5
5010395796, 5010566049



RV-DL-12326

Length: 280
Ø: 28
Cone Ø: d1 Ø 20
5010238594, 5010253255



RV-DL-12327

Length: 280
Ø: 28
Cone Ø: d1 Ø 20
5010253256



RV-DL-12448

Length: 900
Ø: 50
Cone Ø: d1 Ø 30 / d2 Ø 27
5010488084, 5010488639, 5010488759,
5010557341



RV-DL-12480

Length: 922
Ø: 42
Cone Ø: d1 Ø 26 / d2 Ø 23,5
50 10 305 365, 50 10 630 255





Midlum ...

180.09/B	01/00→	Ball Head, gearshift linkage	CV-ES-2121			
	01/00→	Centre Rod	RV-DL-2181		Coupling Rod	
	01/00→	Centre Rod	RV-DL-7539		Coupling Rod	
	01/00→	Centre Rod	RV-DL-12448		for Steering Rod	
	01/00→	Stabiliser Link	RV-DL-12326	RV-DL-12326	Suspension Rod	
	01/00→	Stabiliser Link	RV-DL-12327	RV-DL-12327	Suspension Rod	
	01/00→	Tie Rod End	CV-ES-0912			
	01/00→	Tie Rod End	CV-ES-0914		for Steering Rod	
	01/00→	Tie Rod End	CV-ES-12461		for Steering Rod	
	01/00→	Tie Rod End	CV-ES-12462		for Steering Rod	
	01/00→	Tie Rod End	CV-ES-14162		for Steering Rod	
	01/00→	Tie Rod End	CV-ES-14163		for Steering Rod	
	180.10/B	01/00→	Ball Head, gearshift linkage	CV-ES-2121		
		01/00→	Centre Rod	RV-DL-2181		Coupling Rod
01/00→		Centre Rod	RV-DL-7539		Coupling Rod	
01/00→		Centre Rod	RV-DL-12448		for Steering Rod	
01/00→		Stabiliser Link	RV-DL-12326	RV-DL-12326	Suspension Rod	
01/00→		Stabiliser Link	RV-DL-12327	RV-DL-12327	Suspension Rod	
01/00→		Tie Rod	RV-DL-12321			
01/00→		Tie Rod End	CV-ES-0912			
01/00→		Tie Rod End	CV-ES-0914		for Steering Rod	
01/00→		Tie Rod End	CV-ES-12461		for Steering Rod	
01/00→		Tie Rod End	CV-ES-12462		for Steering Rod	
01/00→		Tie Rod End	CV-ES-14162		for Steering Rod	
01/00→		Tie Rod End	CV-ES-14163		for Steering Rod	
10/01→		Ball Head, gearshift linkage	DF-ES-9335			
10/01→		Centre Rod	RV-DL-8308		Push Rod	
10/01→		Tie Rod	RV-DL-8310			
10/02→		Centre Rod	RV-DL-8309		Push Rod	
180.12		10/01→11/01	Tie Rod	SC-DL-8137		
	10/01→	Ball Head, gearshift linkage	CV-ES-2121			
	10/01→	Ball Head, gearshift linkage	DF-ES-9335			
	10/01→	Centre Rod	RV-DL-2181		Coupling Rod	
	10/01→	Centre Rod	RV-DL-7539		Coupling Rod	
	10/01→	Centre Rod	RV-DL-8190		Push Rod	
	10/01→	Centre Rod	RV-DL-12448		for Steering Rod	
	10/01→	Tie Rod	RV-DL-12321			
	10/01→	Tie Rod	RV-DL-12465			
	10/01→	Tie Rod End	CV-ES-0912			
	10/01→	Tie Rod End	CV-ES-0914		for Steering Rod	
	10/01→	Tie Rod End	CV-ES-12461		for Steering Rod	
	10/01→	Tie Rod End	CV-ES-12462		for Steering Rod	
	10/01→	Tie Rod End	CV-ES-14162		for Steering Rod	
	10/01→	Tie Rod End	CV-ES-14163		for Steering Rod	
	180.12/B	01/00→	Ball Head, gearshift linkage	CV-ES-2121		
		01/00→	Centre Rod	RV-DL-2181		Coupling Rod
01/00→		Centre Rod	RV-DL-7539		Coupling Rod	
01/00→		Centre Rod	RV-DL-12448		for Steering Rod	
01/00→		Stabiliser Link	RV-DL-12326	RV-DL-12326	Suspension Rod	
01/00→		Stabiliser Link	RV-DL-12327	RV-DL-12327	Suspension Rod	
01/00→		Tie Rod End	CV-ES-0912			
01/00→		Tie Rod End	CV-ES-0914		for Steering Rod	
01/00→		Tie Rod End	CV-ES-12461		for Steering Rod	
01/00→		Tie Rod End	CV-ES-12462		for Steering Rod	
01/00→		Tie Rod End	CV-ES-14162		for Steering Rod	
01/00→		Tie Rod End	CV-ES-14163		for Steering Rod	
180.12/B, 180.12/C		10/01→	Ball Head, gearshift linkage	CV-ES-2121		
		10/01→	Ball Head, gearshift linkage	DF-ES-9335		
	10/01→	Centre Rod	RV-DL-2181		Coupling Rod	
	10/01→	Centre Rod	RV-DL-7539		Coupling Rod	
	10/01→	Centre Rod	RV-DL-8306		Push Rod	
	10/01→	Centre Rod	RV-DL-8308		Push Rod	
	10/01→	Centre Rod	RV-DL-12448		for Steering Rod	

CV-ES-0912

Length: 125
Cone Ø: d1 Ø 30 / d2 Ø 27
Thread: M38 x 1,5 LHT
3401206, 5001832579



CV-ES-0914

Length: 125
Cone Ø: d1 Ø 30 / d2 Ø 27
Thread: M38 x 1,5 RHT
3401207, 5001832580



CV-ES-2121

Length: 85
Cone Ø: d1 Ø 12 / d2 Ø 10,8
Thread: M14 x 1,5 RHT
23162046, 5000516214, 5010144543,
5010245591



CV-ES-12461

Length: 120
Cone Ø: d1 Ø 26 / d2 Ø 23,5
Thread: M30 x 1,5 LHT

0003406213, 3406218, 5000242467,
5000242488, 5000295215, 5000295336,
5000588470, 5000805280, 5000806187,
5000814347, 5000820879, 5000823654,
5001834533, 5001850550, 5001852263,
5001859984



CV-ES-12462

Length: 120
Cone Ø: d1 Ø 26 / d2 Ø 23,5
Thread: M30 x 1,5 RHT

0003406212, 0003406253, 5000242159,
5000295214, 5000812483, 5001831473,
5001850549, 5001852264, 5001859985,
7701016946



CV-ES-14162

Length: 125
Cone Ø: d1 Ø 30 / d2 Ø 27
Thread: M30 x 1,5 LHT
3401170, 5000288361, 5001832581,
5001858759, 5001858774



CV-ES-14163

Length: 125
Cone Ø: d1 Ø 30 / d2 Ø 27
Thread: M30 x 1,5 RHT
0003406169, 0003406236, 0003406251,
0003406254, 0003406260, 0003406261,
5000288360, 5000590236, 5000804824,
5001858773, 7420937674, 7701011412



DF-ES-9335

Length: 85
Cone Ø: d1 Ø 12 / d2 Ø 10,75
Thread: M14 x 1,5 RHT
23162046, 5000516214, 5010144543,
5010245591



RV-DL-2181

Length: 1650
Ø: 40
Cone Ø: d1 Ø 30 / d2 Ø 27
5010145581, 5010308215



RV-DL-7539

Length: 1690
Ø: 48
Cone Ø: d1 Ø 30 / d2 Ø 27
5000786902, 5010145077



RV-DL-8190

Length: 946
Ø: 42
Cone Ø: d1 Ø 26 / d2 Ø 23,5
5010294709, 5010305367, 5010488167



RV-DL-8306

Length: 940
Ø: 40
Cone Ø: d1 Ø 26 / d2 Ø 23,5
5010488166



RV-DL-8308

Length: 883
Ø: 42
Cone Ø: d1 Ø 22 / d2 Ø 20
5010294831, 5010488165



RV-DL-8309

Length: 891
Ø: 42
Cone Ø: d1 Ø 22 / d2 Ø 20
5010557423



RV-DL-8310

Length: 1500
Ø: 38
Cone Ø: d1 Ø 26 / d2 Ø 23,5
5010395796, 5010566049



RV-DL-12321

Length: 1575
Ø: 38
Cone Ø: d1 Ø 26 / d2 Ø 23,5
5010395797, 5010566050



RV-DL-12326

Length: 280
Ø: 28
Cone Ø: d1 Ø 20
5010238594, 5010253255



RV-DL-12327

Length: 280
Ø: 28
Cone Ø: d1 Ø 20
5010253256



RV-DL-12448

Length: 900
Ø: 50
Cone Ø: d1 Ø 30 / d2 Ø 27
5010488084, 5010488639, 5010488759,
5010557341



RV-DL-12465

Length: 1580
Ø: 40
Cone Ø: d1 Ø 30 / d2 Ø 27
Thread: M30 x 1,5 LHT / M30 x 1,5
RHT
5010566051



SC-DL-8137

Length: 1736
Ø: 40
Cone Ø: d1 Ø 30 / d2 Ø 27
5000613598





Midlum ...

180.12/B, 180.12/C ...	10/01→	Stabiliser Link	RV-DL-12326	RV-DL-12326	Suspension Rod
	10/01→	Stabiliser Link	RV-DL-12327	RV-DL-12327	Suspension Rod
	10/01→	Tie Rod	RV-DL-8310		
	10/01→	Tie Rod	RV-DL-12321		
	10/01→	Tie Rod End	CV-ES-0912		
	10/01→	Tie Rod End	CV-ES-0914		for Steering Rod
	10/01→	Tie Rod End	CV-ES-12461		for Steering Rod
	10/01→	Tie Rod End	CV-ES-12462		for Steering Rod
	10/01→	Tie Rod End	CV-ES-14162		for Steering Rod
	10/01→	Tie Rod End	CV-ES-14163		for Steering Rod
190.08	10/02→	Centre Rod	RV-DL-8309		Push Rod
	05/06→	Ball Head, gearshift linkage	DF-ES-9335		
	05/06→	Centre Rod	RV-DL-8309		Push Rod
	05/06→	Centre Rod	RV-DL-12448		for Steering Rod
	05/06→	Centre Rod	RV-DL-12480		Push Rod
	05/06→	Tie Rod	RV-DL-8310		
	05/06→	Tie Rod End	CV-ES-12461		for Steering Rod
	05/06→	Tie Rod End	CV-ES-12462		for Steering Rod
190.10	05/06→	Tie Rod End	CV-ES-14163		for Steering Rod
	05/06→	Ball Head, gearshift linkage	DF-ES-9335		
	05/06→	Centre Rod	RV-DL-8309		Push Rod
	05/06→	Centre Rod	RV-DL-12448		for Steering Rod
	05/06→	Centre Rod	RV-DL-12480		Push Rod
	05/06→	Tie Rod	RV-DL-8310		
	05/06→	Tie Rod End	CV-ES-12461		for Steering Rod
190.12	05/06→	Tie Rod End	CV-ES-12462		for Steering Rod
	05/06→	Tie Rod End	CV-ES-14163		for Steering Rod
	05/06→	Ball Head, gearshift linkage	DF-ES-9335		
	05/06→	Centre Rod	RV-DL-8309		Push Rod
	05/06→	Centre Rod	RV-DL-12448		for Steering Rod
	05/06→	Centre Rod	RV-DL-12480		Push Rod
	05/06→	Tie Rod	RV-DL-8310		
190.13	05/06→	Tie Rod	RV-DL-12321		
	05/06→	Tie Rod End	CV-ES-12461		for Steering Rod
	05/06→	Tie Rod End	CV-ES-12462		for Steering Rod
	05/06→	Tie Rod End	CV-ES-14163		for Steering Rod
	05/06→	Ball Head, gearshift linkage	DF-ES-9335		
	05/06→	Centre Rod	RV-DL-8190		Push Rod
	05/06→	Centre Rod	RV-DL-12448		for Steering Rod
190.14	05/06→	Centre Rod	RV-DL-12480		Push Rod
	05/06→	Tie Rod End	CV-ES-12461		for Steering Rod
	05/06→	Tie Rod End	CV-ES-12462		for Steering Rod
	05/06→	Tie Rod End	CV-ES-14163		for Steering Rod
	05/06→	Ball Head, gearshift linkage	DF-ES-9335		
	05/06→	Centre Rod	RV-DL-8190		Push Rod
	05/06→	Centre Rod	RV-DL-12448		for Steering Rod
190.16	05/06→	Centre Rod	RV-DL-12480		Push Rod
	05/06→	Tie Rod End	CV-ES-12461		for Steering Rod
	05/06→	Tie Rod End	CV-ES-12462		for Steering Rod
	05/06→	Tie Rod End	CV-ES-14163		for Steering Rod
	05/06→	Ball Head, gearshift linkage	DF-ES-9335		
	05/06→	Centre Rod	RV-DL-8190		Push Rod
	05/06→	Centre Rod	RV-DL-12448		for Steering Rod
210.08/B	05/06→	Centre Rod	RV-DL-12480		Push Rod
	01/00→	Tie Rod End	CV-ES-12461		for Steering Rod
	01/00→	Tie Rod End	CV-ES-12462		for Steering Rod
	01/00→	Tie Rod End	CV-ES-14163		for Steering Rod
	01/00→	Ball Head, gearshift linkage	CV-ES-2121		
	01/00→	Centre Rod	RV-DL-2181		Coupling Rod
	01/00→	Centre Rod	RV-DL-7539		Coupling Rod
	01/00→	Centre Rod	RV-DL-8653		Push Rod
	01/00→	Centre Rod	RV-DL-12448		for Steering Rod
	01/00→	Stabiliser Link	RV-DL-12326	RV-DL-12326	Suspension Rod

CV-ES-0912

Length: 125
Cone Ø: d1 Ø 30 / d2 Ø 27
Thread: M38 x 1,5 LHT
3401206, 5001832579



CV-ES-0914

Length: 125
Cone Ø: d1 Ø 30 / d2 Ø 27
Thread: M38 x 1,5 RHT
3401207, 5001832580



CV-ES-2121

Length: 85
Cone Ø: d1 Ø 12 / d2 Ø 10,8
Thread: M14 x 1,5 RHT
23162046, 5000516214, 5010144543,
5010245591



CV-ES-12461

Length: 120
Cone Ø: d1 Ø 26 / d2 Ø 23,5
Thread: M30 x 1,5 LHT

0003406213, 3406218, 5000242467,
5000242488, 5000295215, 5000295336,
5000588470, 5000805280, 5000806187,
5000814347, 5000820879, 5000823654,
5001834533, 5001850550, 5001852263,
5001859984



CV-ES-12462

Length: 120
Cone Ø: d1 Ø 26 / d2 Ø 23,5
Thread: M30 x 1,5 RHT

0003406212, 0003406253, 5000242159,
5000295214, 5000812483, 5001831473,
5001850549, 5001852264, 5001859985,
7701016946



CV-ES-14162

Length: 125
Cone Ø: d1 Ø 30 / d2 Ø 27
Thread: M30 x 1,5 LHT
3401170, 5000288361, 5001832581,
5001858759, 5001858774



CV-ES-14163

Length: 125
Cone Ø: d1 Ø 30 / d2 Ø 27
Thread: M30 x 1,5 RHT
0003406169, 0003406236, 0003406251,
0003406254, 0003406260, 0003406261,
5000288360, 5000590236, 5000804824,
5001858773, 7420937674, 7701011412



DF-ES-9335

Length: 85
Cone Ø: d1 Ø 12 / d2 Ø 10,75
Thread: M14 x 1,5 RHT
23162046, 5000516214, 5010144543,
5010245591



RV-DL-2181

Length: 1650
Ø: 40
Cone Ø: d1 Ø 30 / d2 Ø 27
5010145581, 5010308215



RV-DL-7539

Length: 1690
Ø: 48
Cone Ø: d1 Ø 30 / d2 Ø 27
5000786902, 5010145077



RV-DL-8190

Length: 946
Ø: 42
Cone Ø: d1 Ø 26 / d2 Ø 23,5
5010294709, 5010305367, 5010488167



RV-DL-8309

Length: 891
Ø: 42
Cone Ø: d1 Ø 22 / d2 Ø 20
5010557423



RV-DL-8310

Length: 1500
Ø: 38
Cone Ø: d1 Ø 26 / d2 Ø 23,5
5010395796, 5010566049



RV-DL-8653

Length: 940
Ø: 42
Cone Ø: d1 Ø 26 / d2 Ø 23,5
5010488146



RV-DL-12321

Length: 1575
Ø: 38
Cone Ø: d1 Ø 26 / d2 Ø 23,5
5010395797, 5010566050



RV-DL-12326

Length: 280
Ø: 28
Cone Ø: d1 Ø 20
5010238594, 5010253255



RV-DL-12327

Length: 280
Ø: 28
Cone Ø: d1 Ø 20
5010253256



RV-DL-12448

Length: 900
Ø: 50
Cone Ø: d1 Ø 30 / d2 Ø 27
5010488084, 5010488639, 5010488759,
5010557341



RV-DL-12480

Length: 922
Ø: 42
Cone Ø: d1 Ø 26 / d2 Ø 23,5
50 10 305 365, 50 10 630 255



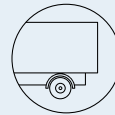

Midlum ...

210.08/B ...	01/00→	Stabiliser Link	RV-DL-12327	RV-DL-12327	Suspension Rod	
	01/00→	Tie Rod End	CV-ES-0912			
	01/00→	Tie Rod End	CV-ES-0914		for Steering Rod	
	01/00→	Tie Rod End	CV-ES-12461		for Steering Rod	
	01/00→	Tie Rod End	CV-ES-12462		for Steering Rod	
	01/00→	Tie Rod End	CV-ES-14162		for Steering Rod	
	01/00→	Tie Rod End	CV-ES-14163		for Steering Rod	
210.08/B, 220.08/B	01/00→	Ball Head, gearshift linkage	CV-ES-2121			
	01/00→	Centre Rod	RV-DL-2181		Coupling Rod	
	01/00→	Centre Rod	RV-DL-7539		Coupling Rod	
	01/00→	Centre Rod	RV-DL-8308		Push Rod	
	01/00→	Centre Rod	RV-DL-12448		for Steering Rod	
	01/00→	Stabiliser Link	RV-DL-12326	RV-DL-12326	Suspension Rod	
	01/00→	Stabiliser Link	RV-DL-12327	RV-DL-12327	Suspension Rod	
	01/00→	Tie Rod	RV-DL-8310			
	01/00→	Tie Rod End	CV-ES-0912			
	01/00→	Tie Rod End	CV-ES-0914		for Steering Rod	
	01/00→	Tie Rod End	CV-ES-12461		for Steering Rod	
	01/00→	Tie Rod End	CV-ES-12462		for Steering Rod	
	01/00→	Tie Rod End	CV-ES-14162		for Steering Rod	
	01/00→	Tie Rod End	CV-ES-14163		for Steering Rod	
	10/02→	Centre Rod	RV-DL-8309		Push Rod	
	210.09/B	01/00→	Ball Head, gearshift linkage	CV-ES-2121		
		01/00→	Centre Rod	RV-DL-2181		Coupling Rod
01/00→		Centre Rod	RV-DL-7539		Coupling Rod	
01/00→		Centre Rod	RV-DL-8653		Push Rod	
01/00→		Centre Rod	RV-DL-12448		for Steering Rod	
01/00→		Stabiliser Link	RV-DL-12326	RV-DL-12326	Suspension Rod	
01/00→		Stabiliser Link	RV-DL-12327	RV-DL-12327	Suspension Rod	
01/00→		Tie Rod End	CV-ES-0912			
01/00→		Tie Rod End	CV-ES-0914		for Steering Rod	
01/00→		Tie Rod End	CV-ES-12461		for Steering Rod	
01/00→		Tie Rod End	CV-ES-12462		for Steering Rod	
01/00→		Tie Rod End	CV-ES-14162		for Steering Rod	
01/00→		Tie Rod End	CV-ES-14163		for Steering Rod	
210.10/B		01/00→	Ball Head, gearshift linkage	CV-ES-2121		
	01/00→	Centre Rod	RV-DL-2181		Coupling Rod	
	01/00→	Centre Rod	RV-DL-7539		Coupling Rod	
	01/00→	Centre Rod	RV-DL-8653		Push Rod	
	01/00→	Centre Rod	RV-DL-12448		for Steering Rod	
	01/00→	Stabiliser Link	RV-DL-12326	RV-DL-12326	Suspension Rod	
	01/00→	Stabiliser Link	RV-DL-12327	RV-DL-12327	Suspension Rod	
	01/00→	Tie Rod End	CV-ES-0912			
	01/00→	Tie Rod End	CV-ES-0914		for Steering Rod	
	01/00→	Tie Rod End	CV-ES-12461		for Steering Rod	
	01/00→	Tie Rod End	CV-ES-12462		for Steering Rod	
	01/00→	Tie Rod End	CV-ES-14162		for Steering Rod	
	01/00→	Tie Rod End	CV-ES-14163		for Steering Rod	
	210.10/B, 220.10/B	01/00→	Ball Head, gearshift linkage	CV-ES-2121		
01/00→		Centre Rod	RV-DL-2181		Coupling Rod	
01/00→		Centre Rod	RV-DL-7539		Coupling Rod	
01/00→		Centre Rod	RV-DL-8308		Push Rod	
01/00→		Centre Rod	RV-DL-12448		for Steering Rod	
01/00→		Stabiliser Link	RV-DL-12326	RV-DL-12326	Suspension Rod	
01/00→		Stabiliser Link	RV-DL-12327	RV-DL-12327	Suspension Rod	
01/00→		Tie Rod	RV-DL-8310			
01/00→		Tie Rod End	CV-ES-0912			
01/00→		Tie Rod End	CV-ES-0914		for Steering Rod	
01/00→		Tie Rod End	CV-ES-12461		for Steering Rod	
01/00→		Tie Rod End	CV-ES-12462		for Steering Rod	
01/00→		Tie Rod End	CV-ES-14162		for Steering Rod	
01/00→		Tie Rod End	CV-ES-14163		for Steering Rod	
10/02→	Centre Rod	RV-DL-8309		Push Rod		

CV-ES-0912

Length: 125
Cone Ø: d1 Ø 30 / d2 Ø 27
Thread: M38 x 1,5 LHT
3401206, 5001832579



CV-ES-0914

Length: 125
Cone Ø: d1 Ø 30 / d2 Ø 27
Thread: M38 x 1,5 RHT
3401207, 5001832580



CV-ES-2121

Length: 85
Cone Ø: d1 Ø 12 / d2 Ø 10,8
Thread: M14 x 1,5 RHT
23162046, 5000516214, 5010144543,
5010245591



CV-ES-12461

Length: 120
Cone Ø: d1 Ø 26 / d2 Ø 23,5
Thread: M30 x 1,5 LHT
0003406213, 3406218, 5000242467,
5000242488, 5000295215, 5000295336,
5000588470, 5000805280, 5000806187,
5000814347, 5000820879, 5000823654,
5001834533, 5001850550, 5001852263,
5001859984



CV-ES-12462

Length: 120
Cone Ø: d1 Ø 26 / d2 Ø 23,5
Thread: M30 x 1,5 RHT
0003406212, 0003406253, 5000242159,
5000295214, 5000812483, 5001831473,
5001850549, 5001852264, 5001859985,
7701016946



CV-ES-14162

Length: 125
Cone Ø: d1 Ø 30 / d2 Ø 27
Thread: M30 x 1,5 LHT
3401170, 5000288361, 5001832581,
5001858759, 5001858774



CV-ES-14163

Length: 125
Cone Ø: d1 Ø 30 / d2 Ø 27
Thread: M30 x 1,5 RHT
0003406169, 0003406236, 0003406251,
0003406254, 0003406260, 0003406261,
5000288360, 5000590236, 5000804824,
5001858773, 7420937674, 7701011412



RV-DL-2181

Length: 1650
Ø: 40
Cone Ø: d1 Ø 30 / d2 Ø 27
5010145581, 5010308215



RV-DL-7539

Length: 1690
Ø: 48
Cone Ø: d1 Ø 30 / d2 Ø 27
5000786902, 5010145077



RV-DL-8308

Length: 883
Ø: 42
Cone Ø: d1 Ø 22 / d2 Ø 20
5010294831, 5010488165



RV-DL-8309

Length: 891
Ø: 42
Cone Ø: d1 Ø 22 / d2 Ø 20
5010557423



RV-DL-8310

Length: 1500
Ø: 38
Cone Ø: d1 Ø 26 / d2 Ø 23,5
5010395796, 5010566049



RV-DL-8653

Length: 940
Ø: 42
Cone Ø: d1 Ø 26 / d2 Ø 23,5
5010488146



RV-DL-12326

Length: 280
Ø: 28
Cone Ø: d1 Ø 20
5010238594, 5010253255



RV-DL-12327

Length: 280
Ø: 28
Cone Ø: d1 Ø 20
5010253256



RV-DL-12448

Length: 900
Ø: 50
Cone Ø: d1 Ø 30 / d2 Ø 27
5010488084, 5010488639, 5010488759,
5010557341





Midlum ...

210.12/C	01/00→	Ball Head, gearshift linkage	CV-ES-2121		
	01/00→	Centre Rod	RV-DL-2181		Coupling Rod
	01/00→	Centre Rod	RV-DL-7539		Coupling Rod
	01/00→	Centre Rod	RV-DL-8653		Push Rod
	01/00→	Centre Rod	RV-DL-12448		for Steering Rod
	01/00→	Stabiliser Link	RV-DL-12326	RV-DL-12326	Suspension Rod
	01/00→	Stabiliser Link	RV-DL-12327	RV-DL-12327	Suspension Rod
	01/00→	Tie Rod End	CV-ES-0912		
	01/00→	Tie Rod End	CV-ES-0914		for Steering Rod
	01/00→	Tie Rod End	CV-ES-12461		for Steering Rod
	01/00→	Tie Rod End	CV-ES-12462		for Steering Rod
	01/00→	Tie Rod End	CV-ES-14162		for Steering Rod
	01/00→	Tie Rod End	CV-ES-14163		for Steering Rod
210.12/C, 220.12/C	01/00→	Ball Head, gearshift linkage	CV-ES-2121		
	01/00→	Centre Rod	RV-DL-2181		Coupling Rod
	01/00→	Centre Rod	RV-DL-7539		Coupling Rod
	01/00→	Centre Rod	RV-DL-8306		Push Rod
	01/00→	Centre Rod	RV-DL-12448		for Steering Rod
	01/00→	Tie Rod	RV-DL-12321		
	01/00→	Tie Rod End	CV-ES-0912		
	01/00→	Tie Rod End	CV-ES-0914		for Steering Rod
	01/00→	Tie Rod End	CV-ES-12461		for Steering Rod
	01/00→	Tie Rod End	CV-ES-12462		for Steering Rod
	01/00→	Tie Rod End	CV-ES-14162		for Steering Rod
	01/00→	Tie Rod End	CV-ES-14163		for Steering Rod
	210.13/C	01/00→	Ball Head, gearshift linkage	CV-ES-2121	
01/00→		Centre Rod	RV-DL-2181		Coupling Rod
01/00→		Centre Rod	RV-DL-7539		Coupling Rod
01/00→		Centre Rod	RV-DL-8653		Push Rod
01/00→		Centre Rod	RV-DL-12448		for Steering Rod
01/00→		Stabiliser Link	RV-DL-12326	RV-DL-12326	Suspension Rod
01/00→		Stabiliser Link	RV-DL-12327	RV-DL-12327	Suspension Rod
01/00→		Tie Rod End	CV-ES-0912		
01/00→		Tie Rod End	CV-ES-0914		for Steering Rod
01/00→		Tie Rod End	CV-ES-12461		for Steering Rod
01/00→		Tie Rod End	CV-ES-12462		for Steering Rod
01/00→		Tie Rod End	CV-ES-14162		for Steering Rod
01/00→		Tie Rod End	CV-ES-14163		for Steering Rod
210.13/C, 220.13/C, 220.13/D	01/00→11/01	Tie Rod	SC-DL-8137		
	01/00→	Ball Head, gearshift linkage	CV-ES-2121		
	01/00→	Centre Rod	RV-DL-2181		Coupling Rod
	01/00→	Centre Rod	RV-DL-7539		Coupling Rod
	01/00→	Centre Rod	RV-DL-8190		Push Rod
	01/00→	Centre Rod	RV-DL-12448		for Steering Rod
	01/00→	Tie Rod	RV-DL-12465		
	01/00→	Tie Rod End	CV-ES-0912		
	01/00→	Tie Rod End	CV-ES-0914		for Steering Rod
	01/00→	Tie Rod End	CV-ES-12461		for Steering Rod
	01/00→	Tie Rod End	CV-ES-12462		for Steering Rod
	01/00→	Tie Rod End	CV-ES-14162		for Steering Rod
	01/00→	Tie Rod End	CV-ES-14163		for Steering Rod
210.14/C, 220.14/C, 220.14/D	01/00→11/01	Tie Rod	SC-DL-8137		
	01/00→	Ball Head, gearshift linkage	CV-ES-2121		
	01/00→	Centre Rod	RV-DL-2181		Coupling Rod
	01/00→	Centre Rod	RV-DL-7539		Coupling Rod
	01/00→	Centre Rod	RV-DL-8190		Push Rod
	01/00→	Centre Rod	RV-DL-12448		for Steering Rod
	01/00→	Tie Rod	RV-DL-12465		
	01/00→	Tie Rod End	CV-ES-0912		
	01/00→	Tie Rod End	CV-ES-0914		for Steering Rod
	01/00→	Tie Rod End	CV-ES-12461		for Steering Rod
	01/00→	Tie Rod End	CV-ES-12462		for Steering Rod
	01/00→	Tie Rod End	CV-ES-14162		for Steering Rod
	01/00→	Tie Rod End	CV-ES-14163		for Steering Rod

CV-ES-0912

Length: 125
Cone Ø: d1 Ø 30 / d2 Ø 27
Thread: M38 x 1,5 LHT
3401206, 5001832579



CV-ES-0914

Length: 125
Cone Ø: d1 Ø 30 / d2 Ø 27
Thread: M38 x 1,5 RHT
3401207, 5001832580



CV-ES-2121

Length: 85
Cone Ø: d1 Ø 12 / d2 Ø 10,8
Thread: M14 x 1,5 RHT
23162046, 5000516214, 5010144543,
5010245591



CV-ES-12461

Length: 120
Cone Ø: d1 Ø 26 / d2 Ø 23,5
Thread: M30 x 1,5 LHT
0003406213, 3406218, 5000242467,
5000242488, 5000295215, 5000295336,
5000588470, 5000805280, 5000806187,
5000814347, 5000820879, 5000823654,
5001834533, 5001850550, 5001852263,
5001859984



CV-ES-12462

Length: 120
Cone Ø: d1 Ø 26 / d2 Ø 23,5
Thread: M30 x 1,5 RHT
0003406212, 0003406253, 5000242159,
5000295214, 5000812483, 5001831473,
5001850549, 5001852264, 5001859985,
7701016946



CV-ES-14162

Length: 125
Cone Ø: d1 Ø 30 / d2 Ø 27
Thread: M30 x 1,5 LHT
3401170, 5000288361, 5001832581,
5001858759, 5001858774



CV-ES-14163

Length: 125
Cone Ø: d1 Ø 30 / d2 Ø 27
Thread: M30 x 1,5 RHT
0003406169, 0003406236, 0003406251,
0003406254, 0003406260, 0003406261,
5000288360, 5000590236, 5000804824,
5001858773, 7420937674, 7701011412



RV-DL-2181

Length: 1650
Ø: 40
Cone Ø: d1 Ø 30 / d2 Ø 27
5010145581, 5010308215



RV-DL-7539

Length: 1690
Ø: 48
Cone Ø: d1 Ø 30 / d2 Ø 27
5000786902, 5010145077



RV-DL-8190

Length: 946
Ø: 42
Cone Ø: d1 Ø 26 / d2 Ø 23,5
5010294709, 5010305367, 5010488167



RV-DL-8306

Length: 940
Ø: 40
Cone Ø: d1 Ø 26 / d2 Ø 23,5
5010488166



RV-DL-8653

Length: 940
Ø: 42
Cone Ø: d1 Ø 26 / d2 Ø 23,5
5010488146



RV-DL-12321

Length: 1575
Ø: 38
Cone Ø: d1 Ø 26 / d2 Ø 23,5
5010395797, 5010566050



RV-DL-12326

Length: 280
Ø: 28
Cone Ø: d1 Ø 20
5010238594, 5010253255



RV-DL-12327

Length: 280
Ø: 28
Cone Ø: d1 Ø 20
5010253256



RV-DL-12448

Length: 900
Ø: 50
Cone Ø: d1 Ø 30 / d2 Ø 27
5010488084, 5010488639, 5010488759,
5010557341



RV-DL-12465

Length: 1580
Ø: 40
Cone Ø: d1 Ø 30 / d2 Ø 27
Thread: M30 x 1,5 LHT / M30 x 1,5
RHT
5010566051



SC-DL-8137

Length: 1736
Ø: 40
Cone Ø: d1 Ø 30 / d2 Ø 27
5000613598





Midlum ...

210.15/C	01/00→	Ball Head, gearshift linkage	CV-ES-2121		
	01/00→	Centre Rod	RV-DL-2181		Coupling Rod
	01/00→	Centre Rod	RV-DL-7539		Coupling Rod
	01/00→	Centre Rod	RV-DL-8653		Push Rod
	01/00→	Centre Rod	RV-DL-12448		for Steering Rod
	01/00→	Stabiliser Link	RV-DL-12326	RV-DL-12326	Suspension Rod
	01/00→	Stabiliser Link	RV-DL-12327	RV-DL-12327	Suspension Rod
	01/00→	Tie Rod End	CV-ES-0912		
	01/00→	Tie Rod End	CV-ES-0914		for Steering Rod
	01/00→	Tie Rod End	CV-ES-12461		for Steering Rod
	01/00→	Tie Rod End	CV-ES-12462		for Steering Rod
	01/00→	Tie Rod End	CV-ES-14162		for Steering Rod
	01/00→	Tie Rod End	CV-ES-14163		for Steering Rod
	210.16/C, 220.16/C, 22.16/D	01/00→11/01	Tie Rod	SC-DL-8137	
01/00→		Ball Head, gearshift linkage	CV-ES-2121		
01/00→		Centre Rod	RV-DL-2181		Coupling Rod
01/00→		Centre Rod	RV-DL-7539		Coupling Rod
01/00→		Centre Rod	RV-DL-8190		Push Rod
01/00→		Centre Rod	RV-DL-12448		for Steering Rod
01/00→		Tie Rod	RV-DL-12465		
01/00→		Tie Rod End	CV-ES-0912		
01/00→		Tie Rod End	CV-ES-0914		for Steering Rod
01/00→		Tie Rod End	CV-ES-12461		for Steering Rod
01/00→		Tie Rod End	CV-ES-12462		for Steering Rod
01/00→		Tie Rod End	CV-ES-14162		for Steering Rod
01/00→		Tie Rod End	CV-ES-14163		for Steering Rod
220.08		05/06→	Ball Head, gearshift linkage	DF-ES-9335	
	05/06→	Centre Rod	RV-DL-8309		Push Rod
	05/06→	Centre Rod	RV-DL-12448		for Steering Rod
	05/06→	Centre Rod	RV-DL-12480		Push Rod
	05/06→	Tie Rod	RV-DL-8310		
	05/06→	Tie Rod End	CV-ES-12461		for Steering Rod
	05/06→	Tie Rod End	CV-ES-12462		for Steering Rod
	05/06→	Tie Rod End	CV-ES-14163		for Steering Rod
220.10	05/06→	Ball Head, gearshift linkage	DF-ES-9335		
	05/06→	Centre Rod	RV-DL-8309		Push Rod
	05/06→	Centre Rod	RV-DL-12448		for Steering Rod
	05/06→	Centre Rod	RV-DL-12480		Push Rod
	05/06→	Tie Rod	RV-DL-8310		
	05/06→	Tie Rod End	CV-ES-12461		for Steering Rod
	05/06→	Tie Rod End	CV-ES-12462		for Steering Rod
	05/06→	Tie Rod End	CV-ES-14163		for Steering Rod
220.12	10/01→	Ball Head, gearshift linkage	CV-ES-2121		
	10/01→	Ball Head, gearshift linkage	DF-ES-9335		
	10/01→	Centre Rod	RV-DL-2181		Coupling Rod
	10/01→	Centre Rod	RV-DL-7539		Coupling Rod
	10/01→	Centre Rod	RV-DL-12322		for Steering Rod
	10/01→	Centre Rod	RV-DL-12448		for Steering Rod
	10/01→	Centre Rod	RV-DL-12480		Push Rod
	10/01→	Tie Rod	RV-DL-12321		
	10/01→	Tie Rod	RV-DL-12465		
	10/01→	Tie Rod	RV-DL-12467		
	10/01→	Tie Rod End	CV-ES-0912		
	10/01→	Tie Rod End	CV-ES-0914		for Steering Rod
	10/01→	Tie Rod End	CV-ES-12461		for Steering Rod
	10/01→	Tie Rod End	CV-ES-12462		for Steering Rod
	10/01→	Tie Rod End	CV-ES-14162		for Steering Rod
	10/01→	Tie Rod End	CV-ES-14163		for Steering Rod
	05/06→	Centre Rod	RV-DL-8309		Push Rod
	05/06→	Tie Rod	RV-DL-8310		

CV-ES-0912

Length: 125
Cone Ø: d1 Ø 30 / d2 Ø 27
Thread: M38 x 1,5 LHT
3401206, 5001832579



CV-ES-0914

Length: 125
Cone Ø: d1 Ø 30 / d2 Ø 27
Thread: M38 x 1,5 RHT
3401207, 5001832580



CV-ES-2121

Length: 85
Cone Ø: d1 Ø 12 / d2 Ø 10,8
Thread: M14 x 1,5 RHT
23162046, 5000516214, 5010144543,
5010245591



CV-ES-12461

Length: 120
Cone Ø: d1 Ø 26 / d2 Ø 23,5
Thread: M30 x 1,5 LHT

0003406213, 3406218, 5000242467,
5000242488, 5000295215, 5000295336,
5000588470, 5000805280, 5000806187,
5000814347, 5000820879, 5000823654,
5001834533, 5001850550, 5001852263,
5001859984



CV-ES-12462

Length: 120
Cone Ø: d1 Ø 26 / d2 Ø 23,5
Thread: M30 x 1,5 RHT

0003406212, 0003406253, 5000242159,
5000295214, 5000812483, 5001831473,
5001850549, 5001852264, 5001859985,
7701016946



CV-ES-14162

Length: 125
Cone Ø: d1 Ø 30 / d2 Ø 27
Thread: M30 x 1,5 LHT
3401170, 5000288361, 5001832581,
5001858759, 5001858774



CV-ES-14163

Length: 125
Cone Ø: d1 Ø 30 / d2 Ø 27
Thread: M30 x 1,5 RHT
0003406169, 0003406236, 0003406251,
0003406254, 0003406260, 0003406261,
5000288360, 5000590236, 5000804824,
5001858773, 7420937674, 7701011412



DF-ES-9335

Length: 85
Cone Ø: d1 Ø 12 / d2 Ø 10,75
Thread: M14 x 1,5 RHT
23162046, 5000516214, 5010144543,
5010245591



RV-DL-2181

Length: 1650
Ø: 40
Cone Ø: d1 Ø 30 / d2 Ø 27
5010145581, 5010308215



RV-DL-7539

Length: 1690
Ø: 48
Cone Ø: d1 Ø 30 / d2 Ø 27
5000786902, 5010145077



RV-DL-8190

Length: 946
Ø: 42
Cone Ø: d1 Ø 26 / d2 Ø 23,5
5010294709, 5010305367, 5010488167



RV-DL-8309

Length: 891
Ø: 42
Cone Ø: d1 Ø 22 / d2 Ø 20
5010557423



RV-DL-8310

Length: 1500
Ø: 38
Cone Ø: d1 Ø 26 / d2 Ø 23,5
5010395796, 5010566049



RV-DL-8653

Length: 940
Ø: 42
Cone Ø: d1 Ø 26 / d2 Ø 23,5
5010488146



RV-DL-12321

Length: 1575
Ø: 38
Cone Ø: d1 Ø 26 / d2 Ø 23,5
5010395797, 5010566050



RV-DL-12322

Length: 922
Ø: 42
Cone Ø: d1 Ø 26 / d2 Ø 23,5
Thread: M30 x 1,5 RHT
5010499243, 5010517082



RV-DL-12326

Length: 280
Ø: 28
Cone Ø: d1 Ø 20
5010238594, 5010253255



RV-DL-12327

Length: 280
Ø: 28
Cone Ø: d1 Ø 20
5010253256



RV-DL-12448

Length: 900
Ø: 50
Cone Ø: d1 Ø 30 / d2 Ø 27
5010488084, 5010488639, 5010488759,
5010557341



RV-DL-12465

Length: 1580
Ø: 40
Cone Ø: d1 Ø 30 / d2 Ø 27
Thread: M30 x 1,5 LHT / M30 x 1,5
RHT
5010566051



RV-DL-12467

Length: 1376
Ø: 52
Cone Ø: d1 Ø 30 / d2 Ø 27
5010439078



RV-DL-12480

Length: 922
Ø: 42
Cone Ø: d1 Ø 26 / d2 Ø 23,5
50 10 305 365, 50 10 630 255



SC-DL-8137

Length: 1736
Ø: 40
Cone Ø: d1 Ø 30 / d2 Ø 27
5000613598





Midlum ...

220.13	05/06→	Ball Head, gearshift linkage	DF-ES-9335	
	05/06→	Centre Rod	RV-DL-8190	Push Rod
	05/06→	Centre Rod	RV-DL-12448	for Steering Rod
	05/06→	Centre Rod	RV-DL-12480	Push Rod
	05/06→	Tie Rod	RV-DL-12465	
	05/06→	Tie Rod End	CV-ES-12461	for Steering Rod
	05/06→	Tie Rod End	CV-ES-12462	for Steering Rod
	05/06→	Tie Rod End	CV-ES-14163	for Steering Rod
220.14	10/01→	Ball Head, gearshift linkage	CV-ES-2121	
	10/01→	Ball Head, gearshift linkage	DF-ES-9335	
	10/01→	Centre Rod	RV-DL-2181	Coupling Rod
	10/01→	Centre Rod	RV-DL-7539	Coupling Rod
	10/01→	Centre Rod	RV-DL-12322	for Steering Rod
	10/01→	Centre Rod	RV-DL-12448	for Steering Rod
	10/01→	Centre Rod	RV-DL-12480	Push Rod
	10/01→	Tie Rod	RV-DL-12465	
	10/01→	Tie Rod	RV-DL-12467	
	10/01→	Tie Rod End	CV-ES-0912	
	10/01→	Tie Rod End	CV-ES-0914	for Steering Rod
	10/01→	Tie Rod End	CV-ES-12461	for Steering Rod
	10/01→	Tie Rod End	CV-ES-12462	for Steering Rod
	10/01→	Tie Rod End	CV-ES-14162	for Steering Rod
	10/01→	Tie Rod End	CV-ES-14163	for Steering Rod
	05/06→	Centre Rod	RV-DL-8190	Push Rod
220.15	10/01→11/01	Tie Rod	SC-DL-8137	
	10/01→	Ball Head, gearshift linkage	CV-ES-2121	
	10/01→	Ball Head, gearshift linkage	DF-ES-9335	
	10/01→	Centre Rod	RV-DL-2181	Coupling Rod
	10/01→	Centre Rod	RV-DL-7539	Coupling Rod
	10/01→	Centre Rod	RV-DL-8190	Push Rod
	10/01→	Centre Rod	RV-DL-12448	for Steering Rod
	10/01→	Tie Rod	RV-DL-12321	
	10/01→	Tie Rod	RV-DL-12465	
	10/01→	Tie Rod End	CV-ES-0912	
	10/01→	Tie Rod End	CV-ES-0914	for Steering Rod
	10/01→	Tie Rod End	CV-ES-12461	for Steering Rod
	10/01→	Tie Rod End	CV-ES-14162	for Steering Rod
	10/01→	Tie Rod End	CV-ES-14163	for Steering Rod
220.16	10/01→	Ball Head, gearshift linkage	CV-ES-2121	
	10/01→	Ball Head, gearshift linkage	DF-ES-9335	
	10/01→	Centre Rod	RV-DL-2181	Coupling Rod
	10/01→	Centre Rod	RV-DL-7539	Coupling Rod
	10/01→	Centre Rod	RV-DL-12448	for Steering Rod
	10/01→	Centre Rod	RV-DL-12480	Push Rod
	10/01→	Tie Rod	RV-DL-12465	
	10/01→	Tie Rod	RV-DL-12467	
	10/01→	Tie Rod End	CV-ES-0912	
	10/01→	Tie Rod End	CV-ES-0914	for Steering Rod
	10/01→	Tie Rod End	CV-ES-12461	for Steering Rod
	10/01→	Tie Rod End	CV-ES-14162	for Steering Rod
	10/01→	Tie Rod End	CV-ES-14163	for Steering Rod
	05/06→	Centre Rod	RV-DL-8190	Push Rod
220.18/D	10/01→	Ball Head, gearshift linkage	CV-ES-2121	
	10/01→	Ball Head, gearshift linkage	DF-ES-9335	
	10/01→	Centre Rod	RV-DL-2181	Coupling Rod
	10/01→	Centre Rod	RV-DL-7539	Coupling Rod
	10/01→	Centre Rod	RV-DL-12448	for Steering Rod
	10/01→	Tie Rod End	CV-ES-0912	
	10/01→	Tie Rod End	CV-ES-0914	for Steering Rod
	10/01→	Tie Rod End	CV-ES-12461	for Steering Rod
	10/01→	Tie Rod End	CV-ES-12462	for Steering Rod
	10/01→	Tie Rod End	CV-ES-14162	for Steering Rod
	10/01→	Tie Rod End	CV-ES-14163	for Steering Rod
	10/01→	Tie Rod End	CV-ES-14163	for Steering Rod

CV-ES-0912

Length: 125
Cone Ø: d1 Ø 30 / d2 Ø 27
Thread: M38 x 1,5 LHT
3401206, 5001832579



CV-ES-0914

Length: 125
Cone Ø: d1 Ø 30 / d2 Ø 27
Thread: M38 x 1,5 RHT
3401207, 5001832580



CV-ES-2121

Length: 85
Cone Ø: d1 Ø 12 / d2 Ø 10,8
Thread: M14 x 1,5 RHT
23162046, 5000516214, 5010144543,
5010245591



CV-ES-12461

Length: 120
Cone Ø: d1 Ø 26 / d2 Ø 23,5
Thread: M30 x 1,5 LHT
0003406213, 3406218, 5000242467,
5000242488, 5000295215, 5000295336,
5000588470, 5000805280, 5000806187,
5000814347, 5000820879, 5000823654,
5001834533, 5001850550, 5001852263,
5001859984



CV-ES-12462

Length: 120
Cone Ø: d1 Ø 26 / d2 Ø 23,5
Thread: M30 x 1,5 RHT
0003406212, 0003406253, 5000242159,
5000295214, 5000812483, 5001831473,
5001850549, 5001852264, 5001859985,
7701016946



CV-ES-14162

Length: 125
Cone Ø: d1 Ø 30 / d2 Ø 27
Thread: M30 x 1,5 LHT
3401170, 5000288361, 5001832581,
5001858759, 5001858774



CV-ES-14163

Length: 125
Cone Ø: d1 Ø 30 / d2 Ø 27
Thread: M30 x 1,5 RHT
0003406169, 0003406236, 0003406251,
0003406254, 0003406260, 0003406261,
5000288360, 5000590236, 5000804824,
5001858773, 7420937674, 7701011412



DF-ES-9335

Length: 85
Cone Ø: d1 Ø 12 / d2 Ø 10,75
Thread: M14 x 1,5 RHT
23162046, 5000516214, 5010144543,
5010245591



RV-DL-2181

Length: 1650
Ø: 40
Cone Ø: d1 Ø 30 / d2 Ø 27
5010145581, 5010308215



RV-DL-7539

Length: 1690
Ø: 48
Cone Ø: d1 Ø 30 / d2 Ø 27
5000786902, 5010145077



RV-DL-8190

Length: 946
Ø: 42
Cone Ø: d1 Ø 26 / d2 Ø 23,5
5010294709, 5010305367, 5010488167



RV-DL-12321

Length: 1575
Ø: 38
Cone Ø: d1 Ø 26 / d2 Ø 23,5
5010395797, 5010566050



RV-DL-12322

Length: 922
Ø: 42
Cone Ø: d1 Ø 26 / d2 Ø 23,5
Thread: M30 x 1,5 RHT
5010499243, 5010517082



RV-DL-12448

Length: 900
Ø: 50
Cone Ø: d1 Ø 30 / d2 Ø 27
5010488084, 5010488639, 5010488759,
5010557341



RV-DL-12465

Length: 1580
Ø: 40
Cone Ø: d1 Ø 30 / d2 Ø 27
Thread: M30 x 1,5 LHT / M30 x 1,5
RHT
5010566051



RV-DL-12467

Length: 1376
Ø: 52
Cone Ø: d1 Ø 30 / d2 Ø 27
5010439078



RV-DL-12480

Length: 922
Ø: 42
Cone Ø: d1 Ø 26 / d2 Ø 23,5
50 10 305 365, 50 10 630 255



SC-DL-8137

Length: 1736
Ø: 40
Cone Ø: d1 Ø 30 / d2 Ø 27
5000613598





Midlum ...

240.12	05/06→	Ball Head, gearshift linkage	DF-ES-9335		
	05/06→	Centre Rod	RV-DL-12448		for Steering Rod
	05/06→	Centre Rod	RV-DL-12480		Push Rod
	05/06→	Tie Rod	RV-DL-10243		
	05/06→	Tie Rod	RV-DL-12334		
	05/06→	Tie Rod	RV-DL-12465		
	05/06→	Tie Rod End	CV-ES-12461		for Steering Rod
	05/06→	Tie Rod End	CV-ES-12462		for Steering Rod
	05/06→	Tie Rod End	CV-ES-14163		for Steering Rod
240.13	05/06→	Ball Head, gearshift linkage	DF-ES-9335		
	05/06→	Centre Rod	RV-DL-8190		Push Rod
	05/06→	Centre Rod	RV-DL-12448		for Steering Rod
	05/06→	Centre Rod	RV-DL-12480		Push Rod
	05/06→	Tie Rod	RV-DL-10243		
	05/06→	Tie Rod	RV-DL-12334		
	05/06→	Tie Rod	RV-DL-12465		
	05/06→	Tie Rod End	CV-ES-12461		for Steering Rod
	05/06→	Tie Rod End	CV-ES-12462		for Steering Rod
05/06→	Tie Rod End	CV-ES-14163		for Steering Rod	
240.14	05/06→	Ball Head, gearshift linkage	DF-ES-9335		
	05/06→	Centre Rod	RV-DL-8190		Push Rod
	05/06→	Centre Rod	RV-DL-12448		for Steering Rod
	05/06→	Centre Rod	RV-DL-12480		Push Rod
	05/06→	Tie Rod	RV-DL-10243		
	05/06→	Tie Rod	RV-DL-12334		
	05/06→	Tie Rod	RV-DL-12465		
	05/06→	Tie Rod End	CV-ES-12461		for Steering Rod
	05/06→	Tie Rod End	CV-ES-12462		for Steering Rod
05/06→	Tie Rod End	CV-ES-14163		for Steering Rod	
240.15	05/06→	Ball Head, gearshift linkage	DF-ES-9335		
	05/06→	Centre Rod	RV-DL-12448		for Steering Rod
	05/06→	Centre Rod	RV-DL-12480		Push Rod
	05/06→	Tie Rod	RV-DL-10243		
	05/06→	Tie Rod	RV-DL-12334		
	05/06→	Tie Rod	RV-DL-12465		
	05/06→	Tie Rod End	CV-ES-12461		for Steering Rod
	05/06→	Tie Rod End	CV-ES-12462		for Steering Rod
	05/06→	Tie Rod End	CV-ES-14163		for Steering Rod
240.16	05/06→	Ball Head, gearshift linkage	DF-ES-9335		
	05/06→	Centre Rod	RV-DL-8190		Push Rod
	05/06→	Centre Rod	RV-DL-12448		for Steering Rod
	05/06→	Centre Rod	RV-DL-12480		Push Rod
	05/06→	Tie Rod	RV-DL-10243		
	05/06→	Tie Rod	RV-DL-12334		
	05/06→	Tie Rod	RV-DL-12465		
	05/06→	Tie Rod End	CV-ES-12461		for Steering Rod
	05/06→	Tie Rod End	CV-ES-12462		for Steering Rod
05/06→	Tie Rod End	CV-ES-14163		for Steering Rod	
240.18	05/06→	Ball Head, gearshift linkage	DF-ES-9335		
	05/06→	Centre Rod	RV-DL-12448		for Steering Rod
	05/06→	Centre Rod	RV-DL-12480		Push Rod
	05/06→	Tie Rod	RV-DL-10243		
	05/06→	Tie Rod	RV-DL-12334		
	05/06→	Tie Rod	RV-DL-12465		
	05/06→	Tie Rod End	CV-ES-12461		for Steering Rod
	05/06→	Tie Rod End	CV-ES-12462		for Steering Rod
	05/06→	Tie Rod End	CV-ES-14163		for Steering Rod
250.12/C	01/00→	Ball Head, gearshift linkage	CV-ES-2121		
	01/00→	Centre Rod	RV-DL-2181		Coupling Rod
	01/00→	Centre Rod	RV-DL-7539		Coupling Rod
	01/00→	Centre Rod	RV-DL-12448		for Steering Rod
	01/00→	Stabiliser Link	RV-DL-12326	RV-DL-12326	Suspension Rod
	01/00→	Stabiliser Link	RV-DL-12327	RV-DL-12327	Suspension Rod
	01/00→	Tie Rod End	CV-ES-0912		

CV-ES-0912

Length: 125
Cone Ø: d1 Ø 30 / d2 Ø 27
Thread: M38 x 1,5 LHT
3401206, 5001832579



CV-ES-2121

Length: 85
Cone Ø: d1 Ø 12 / d2 Ø 10,8
Thread: M14 x 1,5 RHT
23162046, 5000516214, 5010144543,
5010245591



CV-ES-12461

Length: 120
Cone Ø: d1 Ø 26 / d2 Ø 23,5
Thread: M30 x 1,5 LHT
0003406213, 3406218, 5000242467,
5000242488, 5000295215, 5000295336,
5000588470, 5000805280, 5000806187,
5000814347, 5000820879, 5000823654,
5001834533, 5001850550, 5001852263,
5001859984



CV-ES-12462

Length: 120
Cone Ø: d1 Ø 26 / d2 Ø 23,5
Thread: M30 x 1,5 RHT
0003406212, 0003406253, 5000242159,
5000295214, 5000812483, 5001831473,
5001850549, 5001852264, 5001859985,
7701016946



CV-ES-14163

Length: 125
Cone Ø: d1 Ø 30 / d2 Ø 27
Thread: M30 x 1,5 RHT
0003406169, 0003406236, 0003406251,
0003406254, 0003406260, 0003406261,
5000288360, 5000590236, 5000804824,
5001858773, 7420937674, 7701011412



DF-ES-9335

Length: 85
Cone Ø: d1 Ø 12 / d2 Ø 10,75
Thread: M14 x 1,5 RHT
23162046, 5000516214, 5010144543,
5010245591



RV-DL-2181

Length: 1650
Ø: 40
Cone Ø: d1 Ø 30 / d2 Ø 27
5010145581, 5010308215



RV-DL-7539

Length: 1690
Ø: 48
Cone Ø: d1 Ø 30 / d2 Ø 27
5000786902, 5010145077



RV-DL-8190

Length: 946
Ø: 42
Cone Ø: d1 Ø 26 / d2 Ø 23,5
5010294709, 5010305367, 5010488167



RV-DL-10243

Length: 1726
Ø: 60
Cone Ø: d1 Ø 30 / d2 Ø 27
Thread: M24 x 1,5 RHT
5001868363, 5010587004, 5010600822,
7421560957



RV-DL-12326

Length: 280
Ø: 28
Cone Ø: d1 Ø 20
5010238594, 5010253255



RV-DL-12327

Length: 280
Ø: 28
Cone Ø: d1 Ø 20
5010253256



RV-DL-12334

Length: 1686
Ø: 60
Cone Ø: d1 Ø 30 / d2 Ø 27
21560963, 5001868366, 5010587034,
5010587038, 7421560963, 7422163637



RV-DL-12448

Length: 900
Ø: 50
Cone Ø: d1 Ø 30 / d2 Ø 27
5010488084, 5010488639, 5010488759,
5010557341



RV-DL-12465

Length: 1580
Ø: 40
Cone Ø: d1 Ø 30 / d2 Ø 27
Thread: M30 x 1,5 LHT / M30 x 1,5
RHT
5010566051



RV-DL-12480

Length: 922
Ø: 42
Cone Ø: d1 Ø 26 / d2 Ø 23,5
50 10 305 365, 50 10 630 255



CV-ES-0912

Length: 125
Cone Ø: d1 Ø 30 / d2 Ø 27
Thread: M38 x 1,5 LHT
3401206, 5001832579



CV-ES-0914

Length: 125
Cone Ø: d1 Ø 30 / d2 Ø 27
Thread: M38 x 1,5 RHT
3401207, 5001832580



CV-ES-2121

Length: 85
Cone Ø: d1 Ø 12 / d2 Ø 10,8
Thread: M14 x 1,5 RHT
23162046, 5000516214, 5010144543,
5010245591



CV-ES-12461

Length: 120
Cone Ø: d1 Ø 26 / d2 Ø 23,5
Thread: M30 x 1,5 LHT
0003406213, 3406218, 5000242467,
5000242488, 5000295215, 5000295336,
5000588470, 5000805280, 5000806187,
5000814347, 5000820879, 5000823654,
5001834533, 5001850550, 5001852263,
5001859984



CV-ES-12462

Length: 120
Cone Ø: d1 Ø 26 / d2 Ø 23,5
Thread: M30 x 1,5 RHT
0003406212, 0003406253, 5000242159,
5000295214, 5000812483, 5001831473,
5001850549, 5001852264, 5001859985,
7701016946



CV-ES-14162

Length: 125
Cone Ø: d1 Ø 30 / d2 Ø 27
Thread: M30 x 1,5 LHT
3401170, 5000288361, 5001832581,
5001858759, 5001858774



CV-ES-14163

Length: 125
Cone Ø: d1 Ø 30 / d2 Ø 27
Thread: M30 x 1,5 RHT
0003406169, 0003406236, 0003406251,
0003406254, 0003406260, 0003406261,
5000288360, 5000590236, 5000804824,
5001858773, 7420937674, 7701011412



RV-DL-2181

Length: 1650
Ø: 40
Cone Ø: d1 Ø 30 / d2 Ø 27
5010145581, 5010308215



RV-DL-7539

Length: 1690
Ø: 48
Cone Ø: d1 Ø 30 / d2 Ø 27
5000786902, 5010145077



RV-DL-12326

Length: 280
Ø: 28
Cone Ø: d1 Ø 20
5010238594, 5010253255



RV-DL-12327

Length: 280
Ø: 28
Cone Ø: d1 Ø 20
5010253256



RV-DL-12448

Length: 900
Ø: 50
Cone Ø: d1 Ø 30 / d2 Ø 27
5010488084, 5010488639, 5010488759,
5010557341





Midlum ...

250.16/CT ...	01/00→	Tie Rod End	CV-ES-14162		for Steering Rod
	01/00→	Tie Rod End	CV-ES-14163		for Steering Rod
270.12/C	10/01→11/01	Tie Rod	SC-DL-8137		
	10/01→	Ball Head, gearshift linkage	CV-ES-2121		
	10/01→	Ball Head, gearshift linkage	DF-ES-9335		
	10/01→	Centre Rod	RV-DL-2181		Coupling Rod
	10/01→	Centre Rod	RV-DL-7539		Coupling Rod
	10/01→	Centre Rod	RV-DL-8190		Push Rod
	10/01→	Centre Rod	RV-DL-12448		for Steering Rod
	10/01→	Tie Rod	RV-DL-12465		
	10/01→	Tie Rod End	CV-ES-0912		
	10/01→	Tie Rod End	CV-ES-0914		for Steering Rod
	10/01→	Tie Rod End	CV-ES-12461		for Steering Rod
	10/01→	Tie Rod End	CV-ES-12462		for Steering Rod
	10/01→	Tie Rod End	CV-ES-14162		for Steering Rod
	10/01→	Tie Rod End	CV-ES-14163		for Steering Rod
270.13/C, 270.13/D	10/01→11/01	Tie Rod	SC-DL-8137		
	10/01→	Ball Head, gearshift linkage	CV-ES-2121		
	10/01→	Ball Head, gearshift linkage	DF-ES-9335		
	10/01→	Centre Rod	RV-DL-2181		Coupling Rod
	10/01→	Centre Rod	RV-DL-7539		Coupling Rod
	10/01→	Centre Rod	RV-DL-8190		Push Rod
	10/01→	Centre Rod	RV-DL-12448		for Steering Rod
	10/01→	Tie Rod	RV-DL-12465		
	10/01→	Tie Rod End	CV-ES-0912		
	10/01→	Tie Rod End	CV-ES-0914		for Steering Rod
	10/01→	Tie Rod End	CV-ES-12461		for Steering Rod
	10/01→	Tie Rod End	CV-ES-12462		for Steering Rod
	10/01→	Tie Rod End	CV-ES-14162		for Steering Rod
	10/01→	Tie Rod End	CV-ES-14163		for Steering Rod
270.14/C, 270.14/D	10/01→11/01	Tie Rod	SC-DL-8137		
	10/01→	Ball Head, gearshift linkage	CV-ES-2121		
	10/01→	Ball Head, gearshift linkage	DF-ES-9335		
	10/01→	Centre Rod	RV-DL-2181		Coupling Rod
	10/01→	Centre Rod	RV-DL-7539		Coupling Rod
	10/01→	Centre Rod	RV-DL-8190		Push Rod
	10/01→	Centre Rod	RV-DL-12448		for Steering Rod
	10/01→	Tie Rod	RV-DL-12465		
	10/01→	Tie Rod End	CV-ES-0912		
	10/01→	Tie Rod End	CV-ES-0914		for Steering Rod
	10/01→	Tie Rod End	CV-ES-12461		for Steering Rod
	10/01→	Tie Rod End	CV-ES-12462		for Steering Rod
	10/01→	Tie Rod End	CV-ES-14162		for Steering Rod
	10/01→	Tie Rod End	CV-ES-14163		for Steering Rod
270.16/B	10/01→11/01	Tie Rod	SC-DL-8137		
	10/01→	Ball Head, gearshift linkage	CV-ES-2121		
	10/01→	Ball Head, gearshift linkage	DF-ES-9335		
	10/01→	Centre Rod	RV-DL-2181		Coupling Rod
	10/01→	Centre Rod	RV-DL-7539		Coupling Rod
	10/01→	Centre Rod	RV-DL-8190		Push Rod
	10/01→	Centre Rod	RV-DL-12448		for Steering Rod
	10/01→	Tie Rod	RV-DL-12465		
	10/01→	Tie Rod End	CV-ES-0912		
	10/01→	Tie Rod End	CV-ES-0914		for Steering Rod
	10/01→	Tie Rod End	CV-ES-12461		for Steering Rod
	10/01→	Tie Rod End	CV-ES-12462		for Steering Rod
	10/01→	Tie Rod End	CV-ES-14162		for Steering Rod
	10/01→	Tie Rod End	CV-ES-14163		for Steering Rod
270.16/C, 270.16/D	10/01→11/01	Tie Rod	SC-DL-8137		
	10/01→	Ball Head, gearshift linkage	CV-ES-2121		
	10/01→	Ball Head, gearshift linkage	DF-ES-9335		
	10/01→	Centre Rod	RV-DL-2181		Coupling Rod
	10/01→	Centre Rod	RV-DL-7539		Coupling Rod

CV-ES-0912

Length: 125
Cone Ø: d1 Ø 30 / d2 Ø 27
Thread: M38 x 1,5 LHT
3401206, 5001832579



CV-ES-0914

Length: 125
Cone Ø: d1 Ø 30 / d2 Ø 27
Thread: M38 x 1,5 RHT
3401207, 5001832580



CV-ES-2121

Length: 85
Cone Ø: d1 Ø 12 / d2 Ø 10,8
Thread: M14 x 1,5 RHT
23162046, 5000516214, 5010144543,
5010245591



CV-ES-12461

Length: 120
Cone Ø: d1 Ø 26 / d2 Ø 23,5
Thread: M30 x 1,5 LHT
0003406213, 3406218, 5000242467,
5000242488, 5000295215, 5000295336,
5000588470, 5000805280, 5000806187,
5000814347, 5000820879, 5000823654,
5001834533, 5001850550, 5001852263,
5001859984



CV-ES-12462

Length: 120
Cone Ø: d1 Ø 26 / d2 Ø 23,5
Thread: M30 x 1,5 RHT
0003406212, 0003406253, 5000242159,
5000295214, 5000812483, 5001831473,
5001850549, 5001852264, 5001859985,
7701016946



CV-ES-14162

Length: 125
Cone Ø: d1 Ø 30 / d2 Ø 27
Thread: M30 x 1,5 LHT
3401170, 5000288361, 5001832581,
5001858759, 5001858774



CV-ES-14163

Length: 125
Cone Ø: d1 Ø 30 / d2 Ø 27
Thread: M30 x 1,5 RHT
0003406169, 0003406236, 0003406251,
0003406254, 0003406260, 0003406261,
5000288360, 5000590236, 5000804824,
5001858773, 7420937674, 7701011412



DF-ES-9335

Length: 85
Cone Ø: d1 Ø 12 / d2 Ø 10,75
Thread: M14 x 1,5 RHT
23162046, 5000516214, 5010144543,
5010245591



RV-DL-2181

Length: 1650
Ø: 40
Cone Ø: d1 Ø 30 / d2 Ø 27
5010145581, 5010308215



RV-DL-7539

Length: 1690
Ø: 48
Cone Ø: d1 Ø 30 / d2 Ø 27
5000786902, 5010145077



RV-DL-8190

Length: 946
Ø: 42
Cone Ø: d1 Ø 26 / d2 Ø 23,5
5010294709, 5010305367, 5010488167



RV-DL-12448

Length: 900
Ø: 50
Cone Ø: d1 Ø 30 / d2 Ø 27
5010488084, 5010488639, 5010488759,
5010557341



RV-DL-12465

Length: 1580
Ø: 40
Cone Ø: d1 Ø 30 / d2 Ø 27
Thread: M30 x 1,5 LHT / M30 x 1,5
RHT
5010566051



SC-DL-8137

Length: 1736
Ø: 40
Cone Ø: d1 Ø 30 / d2 Ø 27
5000613598





Midlum ...

270.16/C, 270.16/D ...	10/01→	Centre Rod	RV-DL-8190	Push Rod
	10/01→	Centre Rod	RV-DL-12448	for Steering Rod
	10/01→	Tie Rod	RV-DL-12465	
	10/01→	Tie Rod End	CV-ES-0912	
	10/01→	Tie Rod End	CV-ES-0914	for Steering Rod
	10/01→	Tie Rod End	CV-ES-12461	for Steering Rod
	10/01→	Tie Rod End	CV-ES-12462	for Steering Rod
	10/01→	Tie Rod End	CV-ES-14162	for Steering Rod
	10/01→	Tie Rod End	CV-ES-14163	for Steering Rod
270.18/D	10/01→	Ball Head, gearshift linkage	CV-ES-2121	
	10/01→	Ball Head, gearshift linkage	DF-ES-9335	
	10/01→	Centre Rod	RV-DL-2181	Coupling Rod
	10/01→	Centre Rod	RV-DL-7539	Coupling Rod
	10/01→	Centre Rod	RV-DL-12448	for Steering Rod
	10/01→	Tie Rod End	CV-ES-0912	
	10/01→	Tie Rod End	CV-ES-0914	for Steering Rod
	10/01→	Tie Rod End	CV-ES-12461	for Steering Rod
	10/01→	Tie Rod End	CV-ES-12462	for Steering Rod
	10/01→	Tie Rod End	CV-ES-14162	for Steering Rod
280.12	05/06→	Ball Head, gearshift linkage	DF-ES-9335	
	05/06→	Centre Rod	RV-DL-12448	for Steering Rod
	05/06→	Centre Rod	RV-DL-12480	Push Rod
	05/06→	Tie Rod	RV-DL-10243	
	05/06→	Tie Rod	RV-DL-12334	
	05/06→	Tie Rod	RV-DL-12465	
	05/06→	Tie Rod End	CV-ES-12461	for Steering Rod
	05/06→	Tie Rod End	CV-ES-12462	for Steering Rod
	05/06→	Tie Rod End	CV-ES-14163	for Steering Rod
280.13	05/06→	Ball Head, gearshift linkage	DF-ES-9335	
	05/06→	Centre Rod	RV-DL-8190	Push Rod
	05/06→	Centre Rod	RV-DL-12448	for Steering Rod
	05/06→	Centre Rod	RV-DL-12480	Push Rod
	05/06→	Tie Rod	RV-DL-10243	
	05/06→	Tie Rod	RV-DL-12334	
	05/06→	Tie Rod	RV-DL-12465	
	05/06→	Tie Rod End	CV-ES-12461	for Steering Rod
	05/06→	Tie Rod End	CV-ES-12462	for Steering Rod
280.14	05/06→	Ball Head, gearshift linkage	DF-ES-9335	
	05/06→	Centre Rod	RV-DL-8190	Push Rod
	05/06→	Centre Rod	RV-DL-12448	for Steering Rod
	05/06→	Centre Rod	RV-DL-12480	Push Rod
	05/06→	Tie Rod	RV-DL-10243	
	05/06→	Tie Rod	RV-DL-12334	
	05/06→	Tie Rod	RV-DL-12465	
	05/06→	Tie Rod End	CV-ES-12461	for Steering Rod
	05/06→	Tie Rod End	CV-ES-12462	for Steering Rod
280.16	05/06→	Ball Head, gearshift linkage	DF-ES-9335	
	05/06→	Centre Rod	RV-DL-8190	Push Rod
	05/06→	Centre Rod	RV-DL-12448	for Steering Rod
	05/06→	Centre Rod	RV-DL-12480	Push Rod
	05/06→	Tie Rod	RV-DL-10243	
	05/06→	Tie Rod	RV-DL-12334	
	05/06→	Tie Rod	RV-DL-12465	
	05/06→	Tie Rod End	CV-ES-12461	for Steering Rod
	05/06→	Tie Rod End	CV-ES-12462	for Steering Rod
280.18	05/06→	Ball Head, gearshift linkage	DF-ES-9335	
	05/06→	Centre Rod	RV-DL-12448	for Steering Rod
	05/06→	Centre Rod	RV-DL-12480	Push Rod
	05/06→	Tie Rod	RV-DL-10243	

CV-ES-0912

Length: 125
Cone Ø: d1 Ø 30 / d2 Ø 27
Thread: M38 x 1,5 RHT
3401206, 5001832579



CV-ES-0914

Length: 125
Cone Ø: d1 Ø 30 / d2 Ø 27
Thread: M38 x 1,5 RHT
3401207, 5001832580



CV-ES-2121

Length: 85
Cone Ø: d1 Ø 12 / d2 Ø 10,8
Thread: M14 x 1,5 RHT
23162046, 5000516214, 5010144543,
5010245591



CV-ES-12461

Length: 120
Cone Ø: d1 Ø 26 / d2 Ø 23,5
Thread: M30 x 1,5 LHT
0003406213, 3406218, 5000242467,
5000242488, 5000295215, 5000295336,
5000588470, 5000805280, 5000806187,
5000814347, 5000820879, 5000823654,
5001834533, 5001850550, 5001852263,
5001859984



CV-ES-12462

Length: 120
Cone Ø: d1 Ø 26 / d2 Ø 23,5
Thread: M30 x 1,5 RHT
0003406212, 0003406253, 5000242159,
5000295214, 5000812483, 5001831473,
5001850549, 5001852264, 5001859985,
7701016946



CV-ES-14162

Length: 125
Cone Ø: d1 Ø 30 / d2 Ø 27
Thread: M30 x 1,5 LHT
3401170, 5000288361, 5001832581,
5001858759, 5001858774



CV-ES-14163

Length: 125
Cone Ø: d1 Ø 30 / d2 Ø 27
Thread: M30 x 1,5 RHT
0003406169, 0003406236, 0003406251,
0003406254, 0003406260, 0003406261,
5000288360, 5000590236, 5000804824,
5001858773, 7420937674, 7701011412



DF-ES-9335

Length: 85
Cone Ø: d1 Ø 12 / d2 Ø 10,75
Thread: M14 x 1,5 RHT
23162046, 5000516214, 5010144543,
5010245591



RV-DL-2181

Length: 1650
Ø: 40
Cone Ø: d1 Ø 30 / d2 Ø 27
5010145581, 5010308215



RV-DL-7539

Length: 1690
Ø: 48
Cone Ø: d1 Ø 30 / d2 Ø 27
5000786902, 5010145077



RV-DL-8190

Length: 946
Ø: 42
Cone Ø: d1 Ø 26 / d2 Ø 23,5
5010294709, 5010305367, 5010488167



RV-DL-10243

Length: 1726
Ø: 60
Cone Ø: d1 Ø 30 / d2 Ø 27
Thread: M24 x 1,5 RHT
5001868363, 5010587004, 5010600822,
7421560957



RV-DL-12334

Length: 1686
Ø: 60
Cone Ø: d1 Ø 30 / d2 Ø 27
21560963, 5001868366, 5010587034,
5010587038, 7421560963, 7422163637



RV-DL-12448

Length: 900
Ø: 50
Cone Ø: d1 Ø 30 / d2 Ø 27
5010488084, 5010488639, 5010488759,
5010557341



RV-DL-12465

Length: 1580
Ø: 40
Cone Ø: d1 Ø 30 / d2 Ø 27
Thread: M30 x 1,5 LHT / M30 x 1,5
RHT
5010566051



RV-DL-12480

Length: 922
Ø: 42
Cone Ø: d1 Ø 26 / d2 Ø 23,5
50 10 305 365, 50 10 630 255





Midlum ...

280.18 ...	05/06 →	Tie Rod	RV-DL-12334	
	05/06 →	Tie Rod End	CV-ES-12461	for Steering Rod
	05/06 →	Tie Rod End	CV-ES-12462	for Steering Rod
	05/06 →	Tie Rod End	CV-ES-14163	for Steering Rod

Premium

Distribution 210.16	04/96 →	Ball Head, gearshift linkage	CV-ES-2121		for vehicles without Pneumatic Suspension	
	04/96 →	Ball Head, gearshift linkage	DF-ES-9335			
	04/96 →	Ball Head, gearshift linkage	IV-ES-12273			
	04/96 →	Bush, parabolic spring		VL-SB-5356		
	04/96 →	Centre Rod	RV-DL-0887		Coupling Rod	
	04/96 →	Centre Rod	RV-DL-0908		Push Rod, for vehicles without Pneumatic Suspension	
	04/96 →	Centre Rod	RV-DL-0919		Push Rod, for Pneumatic Suspension vehicles	
	04/96 →	Centre Rod	RV-DL-8299		Push Rod, Leaf Spring Axle	
	04/96 →	Suspension Strut Repair Kit		MN-RK-8501		
	04/96 →	Tie Rod	RV-DL-8302			
	04/96 →	Tie Rod	RV-DL-8313		Guide Rod, Leaf Spring Axle	
	04/96 →	Tie Rod	RV-DL-8314		Guide Rod, Air Suspension Axle	
	04/96 →	Tie Rod	RV-DL-8318		Guide Rod, Air Suspension Axle	
	04/96 →	Tie Rod	RV-DL-12334			
	04/96 →	Tie Rod End	CV-ES-14162		for Steering Rod	
	04/96 →	Tie Rod End	CV-ES-14163		for Steering Rod	
	04/96 →	Tie Rod End	SC-ES-7279		for Steering Rod	
	04/96 →	Track Control Arm		RV-VB-8191	Wishbone (CV)	
	Distribution 210.18D, 220.18	04/96 →	Ball Head, gearshift linkage	CV-ES-2121		for vehicles without Pneumatic Suspension
		04/96 →	Ball Head, gearshift linkage	DF-ES-9335		
04/96 →		Ball Head, gearshift linkage	IV-ES-12273			
04/96 →		Bush, parabolic spring		VL-SB-5356		
04/96 →		Centre Rod	RV-DL-0887		Coupling Rod	
04/96 →		Centre Rod	RV-DL-0908		Push Rod, for vehicles without Pneumatic Suspension	
04/96 →		Centre Rod	RV-DL-0919		Push Rod, for Pneumatic Suspension vehicles	
04/96 →		Centre Rod	RV-DL-8299		Push Rod, Leaf Spring Axle	
04/96 →		Suspension Strut Repair Kit		MN-RK-8501		
04/96 →		Tie Rod	RV-DL-8302			
04/96 →		Tie Rod	RV-DL-8313		Guide Rod, Leaf Spring Axle	
04/96 →		Tie Rod	RV-DL-8314		Guide Rod, Air Suspension Axle	
04/96 →		Tie Rod	RV-DL-8318		Guide Rod, Air Suspension Axle	
04/96 →		Tie Rod	RV-DL-12334			
04/96 →		Tie Rod End	CV-ES-14162		for Steering Rod	
04/96 →		Tie Rod End	CV-ES-14163		for Steering Rod	
04/96 →		Tie Rod End	SC-ES-7279		for Steering Rod	
04/96 →		Track Control Arm		RV-VB-8191	Wishbone (CV)	
Distribution 210.19D		04/96 →	Ball Head, gearshift linkage	IV-ES-12273		
		04/96 →	Tie Rod	RV-DL-8313		Guide Rod, Leaf Spring Axle
	04/96 →	Tie Rod	RV-DL-8314		Guide Rod, for Pneumatic Suspension vehicles	
	04/96 →	Tie Rod	RV-DL-8318		Guide Rod, for Pneumatic Suspension vehicles	
	04/96 →	Tie Rod End	CV-ES-14162		for Steering Rod	
	04/96 →	Tie Rod End	CV-ES-14163		for Steering Rod	
Distribution 250.16	04/96 →	Ball Head, gearshift linkage	CV-ES-2121		for vehicles without Pneumatic Suspension	
	04/96 →	Ball Head, gearshift linkage	DF-ES-9335			
	04/96 →	Ball Head, gearshift linkage	IV-ES-12273			
	04/96 →	Bush, parabolic spring		VL-SB-5356		
	04/96 →	Centre Rod	RV-DL-0887		Coupling Rod	
	04/96 →	Centre Rod	RV-DL-0908		Push Rod, for vehicles without Pneumatic Suspension	
	04/96 →	Centre Rod	RV-DL-0919		Push Rod, for Pneumatic Suspension vehicles	
	04/96 →	Centre Rod	RV-DL-8299		Push Rod, Leaf Spring Axle	
	04/96 →	Suspension Strut Repair Kit		MN-RK-8501		
	04/96 →	Tie Rod	RV-DL-8302			
	04/96 →	Tie Rod	RV-DL-8313		Guide Rod, Leaf Spring Axle	
	04/96 →	Tie Rod	RV-DL-8314		Guide Rod, Air Suspension Axle	

CV-ES-2121

Length: 85
Cone Ø: d1 Ø 12 / d2 Ø 10,8
Thread: M14 x 1,5 RHT
23162046, 5000516214, 5010144543,
5010245591



DF-ES-9335

Length: 85
Cone Ø: d1 Ø 12 / d2 Ø 10,75
Thread: M14 x 1,5 RHT
23162046, 5000516214, 5010144543,
5010245591



RV-DL-8299

Length: 827
Ø: 52
Cone Ø: d1 Ø 30 / d2 Ø 27
5010294720



RV-VB-8191

Length: 662,4
Ø: 48
Hole Distance: 115 / 115
7420741703, RVVB8191



CV-ES-12461

Length: 120
Cone Ø: d1 Ø 26 / d2 Ø 23,5
Thread: M30 x 1,5 LHT
0003406213, 3406218, 5000242467,
5000242488, 5000295215, 5000295336,
5000588470, 5000805280, 5000806187,
5000814347, 5000820879, 5000823654,
5001834533, 5001850550, 5001852263,
5001859984



IV-ES-12273

Length: 36
Thread: M10 x 1,5 RHT
5010245365



RV-DL-8302

Length: 1570
Ø: 48
Cone Ø: d1 Ø 30 / d2 Ø 27
5010308083



SC-ES-7279

Length: 150
Cone Ø: d1 Ø 30 / d2 Ø 27
Thread: M30 x 1,5 RHT
5001852452, 5001858763



CV-ES-12462

Length: 120
Cone Ø: d1 Ø 26 / d2 Ø 23,5
Thread: M30 x 1,5 RHT
0003406212, 0003406253, 5000242159,
5000295214, 5000812483, 5001831473,
5001850549, 5001852264, 5001859985,
7701016946



MN-RK-8501

Ø: 75
Hole Distance: 115
Thick/Height: 24
7420547286



RV-DL-8313

Length: 1752
Ø: 48
Cone Ø: d1 Ø 30 / d2 Ø 27
5010098467, 5010145584, 5010439631



VL-SB-5356

Thick/Height: 150
7420390836



CV-ES-14162

Length: 125
Cone Ø: d1 Ø 30 / d2 Ø 27
Thread: M30 x 1,5 LHT
3401170, 5000288361, 5001832581,
5001858759, 5001858774



RV-DL-0887

Length: 1720
Ø: 48
Cone Ø: d1 Ø 30 / d2 Ø 27
5010308082



RV-DL-8314

Length: 1758
Ø: 52
Cone Ø: d1 Ø 30 / d2 Ø 27
5010439021, 5010566063



CV-ES-14163

Length: 125
Cone Ø: d1 Ø 30 / d2 Ø 27
Thread: M30 x 1,5 RHT
0003406169, 0003406236, 0003406251,
0003406254, 0003406260, 0003406261,
5000288360, 5000590236, 5000804824,
5001858773, 7420937674, 7701011412



RV-DL-0908

Length: 845
Ø: 52
Cone Ø: d1 Ø 30 / d2 Ø 27
5010294288



RV-DL-8318

Length: 1720
Ø: 52
Cone Ø: d1 Ø 30 / d2 Ø 27
5010439022, 5010566064



RV-DL-0919

Length: 870
Ø: 62
Cone Ø: d1 Ø 30 / d2 Ø 27
5010294289



RV-DL-12334

Length: 1686
Ø: 60
Cone Ø: d1 Ø 30 / d2 Ø 27
21560963, 5001868366, 5010587034,
5010587038, 7421560963, 7422163637





Premium ...

Distribution 250.16 ...	04/96 →	Tie Rod	RV-DL-8318		Guide Rod, Air Suspension Axle	
	04/96 →	Tie Rod	RV-DL-12334			
	04/96 →	Tie Rod End	CV-ES-14162		for Steering Rod	
	04/96 →	Tie Rod End	CV-ES-14163		for Steering Rod	
	04/96 →	Tie Rod End	SC-ES-7279		for Steering Rod	
	04/96 →	Track Control Arm		RV-VB-8191		Wishbone (CV)
Distribution 250.18D	04/96 →	Ball Head, gearshift linkage	CV-ES-2121		for vehicles without Pneumatic Suspension	
	04/96 →	Ball Head, gearshift linkage	DF-ES-9335			
	04/96 →	Ball Head, gearshift linkage	IV-ES-12273			
	04/96 →	Bush, parabolic spring		VL-SB-5356		
	04/96 →	Centre Rod	RV-DL-0887		Coupling Rod	
	04/96 →	Centre Rod	RV-DL-0908		Push Rod, for vehicles without Pneumatic Suspension	
	04/96 →	Centre Rod	RV-DL-0919		Push Rod, for Pneumatic Suspension vehicles	
	04/96 →	Centre Rod	RV-DL-8299		Push Rod, Leaf Spring Axle	
	04/96 →	Suspension Strut Repair Kit		MN-RK-8501		
	04/96 →	Tie Rod	RV-DL-8302			
	04/96 →	Tie Rod	RV-DL-8313		Guide Rod, Leaf Spring Axle	
	04/96 →	Tie Rod	RV-DL-8314		Guide Rod, Air Suspension Axle	
	04/96 →	Tie Rod	RV-DL-8318		Guide Rod, Air Suspension Axle	
	04/96 →	Tie Rod	RV-DL-12334			
	04/96 →	Tie Rod End	CV-ES-14162		for Steering Rod	
	04/96 →	Tie Rod End	CV-ES-14163		for Steering Rod	
	04/96 →	Tie Rod End	SC-ES-7279		for Steering Rod	
	04/96 →	Track Control Arm		RV-VB-8191		Wishbone (CV)
	Distribution 250.19	04/96 →	Ball Head, gearshift linkage	CV-ES-2121		for vehicles without Pneumatic Suspension
04/96 →		Ball Head, gearshift linkage	DF-ES-9335			
04/96 →		Ball Head, gearshift linkage	IV-ES-12273			
04/96 →		Bush, parabolic spring		VL-SB-5356		
04/96 →		Centre Rod	RV-DL-0887		Coupling Rod	
04/96 →		Centre Rod	RV-DL-0908		Push Rod, for vehicles without Pneumatic Suspension	
04/96 →		Centre Rod	RV-DL-0919		Push Rod, for Pneumatic Suspension vehicles	
04/96 →		Centre Rod	RV-DL-8299		Push Rod, Leaf Spring Axle	
04/96 →		Suspension Strut Repair Kit		MN-RK-8501		
04/96 →		Tie Rod	RV-DL-8302			
04/96 →		Tie Rod	RV-DL-8313		Guide Rod, Leaf Spring Axle	
04/96 →		Tie Rod	RV-DL-8314		Guide Rod, Air Suspension Axle	
04/96 →		Tie Rod	RV-DL-8318		Guide Rod, Air Suspension Axle	
04/96 →		Tie Rod	RV-DL-12334			
04/96 →		Tie Rod End	CV-ES-14162		for Steering Rod	
04/96 →		Tie Rod End	CV-ES-14163		for Steering Rod	
04/96 →		Tie Rod End	SC-ES-7279		for Steering Rod	
04/96 →		Track Control Arm		RV-VB-8191		Wishbone (CV)
Distribution 260.16		04/96 →	Ball Head, gearshift linkage	CV-ES-2121		for vehicles without Pneumatic Suspension
	04/96 →	Ball Head, gearshift linkage	DF-ES-9335			
	04/96 →	Ball Head, gearshift linkage	IV-ES-12273			
	04/96 →	Bush, parabolic spring		VL-SB-5356		
	04/96 →	Centre Rod	RV-DL-0887		Coupling Rod	
	04/96 →	Centre Rod	RV-DL-0908		Push Rod, for vehicles without Pneumatic Suspension	
	04/96 →	Centre Rod	RV-DL-0919		Push Rod, for Pneumatic Suspension vehicles	
	04/96 →	Centre Rod	RV-DL-8299		Push Rod, Leaf Spring Axle	
	04/96 →	Tie Rod	RV-DL-8302			
	04/96 →	Tie Rod	RV-DL-8313		Guide Rod, Leaf Spring Axle	
	04/96 →	Tie Rod	RV-DL-8314		Guide Rod, Air Suspension Axle	
	04/96 →	Tie Rod	RV-DL-8318		Guide Rod, Air Suspension Axle	
	04/96 →	Tie Rod	RV-DL-12334			
	04/96 →	Tie Rod End	CV-ES-14162		for Steering Rod	
	04/96 →	Tie Rod End	CV-ES-14163		for Steering Rod	

CV-ES-2121

Length: 85
Cone Ø: d1 Ø 12 / d2 Ø 10,8
Thread: M14 x 1,5 RHT
23162046, 5000516214, 5010144543,
5010245591



CV-ES-14162

Length: 125
Cone Ø: d1 Ø 30 / d2 Ø 27
Thread: M30 x 1,5 LHT
3401170, 5000288361, 5001832581,
5001858759, 5001858774



CV-ES-14163

Length: 125
Cone Ø: d1 Ø 30 / d2 Ø 27
Thread: M30 x 1,5 RHT
0003406169, 0003406236, 0003406251,
0003406254, 0003406260, 0003406261,
5000288360, 5000590236, 5000804824,
5001858773, 7420937674, 7701011412



DF-ES-9335

Length: 85
Cone Ø: d1 Ø 12 / d2 Ø 10,75
Thread: M14 x 1,5 RHT
23162046, 5000516214, 5010144543,
5010245591



IV-ES-12273

Length: 36
Thread: M10 x 1,5 RHT
5010245365



MN-RK-8501

Ø: 75
Hole Distance: 115
Thick/Height: 24
7420547286



RV-DL-0887

Length: 1720
Ø: 48
Cone Ø: d1 Ø 30 / d2 Ø 27
5010308082



RV-DL-0908

Length: 845
Ø: 52
Cone Ø: d1 Ø 30 / d2 Ø 27
5010294288



RV-DL-0919

Length: 870
Ø: 62
Cone Ø: d1 Ø 30 / d2 Ø 27
5010294289



RV-DL-8299

Length: 827
Ø: 52
Cone Ø: d1 Ø 30 / d2 Ø 27
5010294720



RV-DL-8302

Length: 1570
Ø: 48
Cone Ø: d1 Ø 30 / d2 Ø 27
5010308083



RV-DL-8313

Length: 1752
Ø: 48
Cone Ø: d1 Ø 30 / d2 Ø 27
5010098467, 5010145584, 5010439631



RV-DL-8314

Length: 1758
Ø: 52
Cone Ø: d1 Ø 30 / d2 Ø 27
5010439021, 5010566063



RV-DL-8318

Length: 1720
Ø: 52
Cone Ø: d1 Ø 30 / d2 Ø 27
5010439022, 5010566064



RV-DL-12334

Length: 1686
Ø: 60
Cone Ø: d1 Ø 30 / d2 Ø 27
21560963, 5001868366, 5010587034,
5010587038, 7421560963, 7422163637



RV-VB-8191

Length: 662,4
Ø: 48
Hole Distance: 115 / 115
7420741703, RVVB8191



SC-ES-7279

Length: 150
Cone Ø: d1 Ø 30 / d2 Ø 27
Thread: M30 x 1,5 RHT
5001852452, 5001858763



VL-SB-5356

Thick/Height: 150
7420390836





Premium ...

Distribution 260.18	04/96 →	Ball Head, gearshift linkage	CV-ES-2121		for vehicles without Pneumatic Suspension
	04/96 →	Ball Head, gearshift linkage	DF-ES-9335		
	04/96 →	Ball Head, gearshift linkage	IV-ES-12273		
	04/96 →	Bush, parabolic spring		VL-SB-5356	
	04/96 →	Centre Rod	RV-DL-0887		Coupling Rod
	04/96 →	Centre Rod	RV-DL-0908		Push Rod, for vehicles without Pneumatic Suspension
	04/96 →	Centre Rod	RV-DL-0919		Push Rod, for Pneumatic Suspension vehicles
	04/96 →	Centre Rod	RV-DL-8299		Push Rod, Leaf Spring Axle
	04/96 →	Tie Rod	RV-DL-8302		
	04/96 →	Tie Rod	RV-DL-8313		Guide Rod, Leaf Spring Axle
	04/96 →	Tie Rod	RV-DL-8314		Guide Rod, Air Suspension Axle
	04/96 →	Tie Rod	RV-DL-8318		Guide Rod, Air Suspension Axle
	04/96 →	Tie Rod	RV-DL-12334		
	04/96 →	Tie Rod End	CV-ES-14162		for Steering Rod
04/96 →	Tie Rod End	CV-ES-14163		for Steering Rod	
Distribution 260.19	04/96 →	Ball Head, gearshift linkage	CV-ES-2121		for vehicles without Pneumatic Suspension
	04/96 →	Ball Head, gearshift linkage	DF-ES-9335		
	04/96 →	Ball Head, gearshift linkage	IV-ES-12273		
	04/96 →	Bush, parabolic spring		VL-SB-5356	
	04/96 →	Centre Rod	RV-DL-0887		Coupling Rod
	04/96 →	Centre Rod	RV-DL-0908		Push Rod, for vehicles without Pneumatic Suspension
	04/96 →	Centre Rod	RV-DL-0919		Push Rod, for Pneumatic Suspension vehicles
	04/96 →	Centre Rod	RV-DL-8299		Push Rod, Leaf Spring Axle
	04/96 →	Tie Rod	RV-DL-8302		
	04/96 →	Tie Rod	RV-DL-8313		Guide Rod, Leaf Spring Axle
	04/96 →	Tie Rod	RV-DL-8314		Guide Rod, Air Suspension Axle
	04/96 →	Tie Rod	RV-DL-8318		Guide Rod, Air Suspension Axle
	04/96 →	Tie Rod	RV-DL-12334		
	04/96 →	Tie Rod End	CV-ES-14162		for Steering Rod
04/96 →	Tie Rod End	CV-ES-14163		for Steering Rod	
Distribution 270.18	08/00 →	Ball Head, gearshift linkage	CV-ES-2121		for vehicles without Pneumatic Suspension
	08/00 →	Ball Head, gearshift linkage	DF-ES-9335		
	08/00 →	Ball Head, gearshift linkage	IV-ES-12273		
	08/00 →	Bush, parabolic spring		VL-SB-5356	
	08/00 →	Centre Rod	RV-DL-0887		Coupling Rod
	08/00 →	Centre Rod	RV-DL-0908		Push Rod, for vehicles without Pneumatic Suspension
	08/00 →	Centre Rod	RV-DL-0919		Push Rod, for Pneumatic Suspension vehicles
	08/00 →	Centre Rod	RV-DL-8299		Push Rod, Leaf Spring Axle
	08/00 →	Suspension Strut Repair Kit		MN-RK-8501	
	08/00 →	Tie Rod	RV-DL-8302		
	08/00 →	Tie Rod	RV-DL-8313		Guide Rod, Leaf Spring Axle
	08/00 →	Tie Rod	RV-DL-8314		Guide Rod, Air Suspension Axle
	08/00 →	Tie Rod	RV-DL-8318		Guide Rod, Air Suspension Axle
	08/00 →	Tie Rod	RV-DL-12334		
08/00 →	Tie Rod End	CV-ES-14162		for Steering Rod	
08/00 →	Tie Rod End	CV-ES-14163		for Steering Rod	
08/00 →	Tie Rod End	SC-ES-7279		for Steering Rod	
08/00 →	Track Control Arm		RV-VB-8191	Wishbone (CV)	
Distribution 300.16D	04/96 →	Ball Head, gearshift linkage	CV-ES-2121		for vehicles without Pneumatic Suspension
	04/96 →	Ball Head, gearshift linkage	DF-ES-9335		
	04/96 →	Ball Head, gearshift linkage	IV-ES-12273		
	04/96 →	Bush, parabolic spring		VL-SB-5356	
	04/96 →	Centre Rod	RV-DL-0887		Coupling Rod
	04/96 →	Centre Rod	RV-DL-0908		Push Rod, for vehicles without Pneumatic Suspension
	04/96 →	Centre Rod	RV-DL-0919		Push Rod, for Pneumatic Suspension vehicles
	04/96 →	Centre Rod	RV-DL-8299		Push Rod, Leaf Spring Axle
	04/96 →	Suspension Strut Repair Kit		MN-RK-8501	
	04/96 →	Tie Rod	RV-DL-8302		
04/96 →	Tie Rod	RV-DL-8313		Guide Rod, Leaf Spring Axle	

CV-ES-2121

Length: 85
Cone Ø: d1 Ø 12 / d2 Ø 10,8
Thread: M14 x 1,5 RHT
23162046, 5000516214, 5010144543,
5010245591



CV-ES-14162

Length: 125
Cone Ø: d1 Ø 30 / d2 Ø 27
Thread: M30 x 1,5 LHT
3401170, 5000288361, 5001832581,
5001858759, 5001858774



CV-ES-14163

Length: 125
Cone Ø: d1 Ø 30 / d2 Ø 27
Thread: M30 x 1,5 RHT
0003406169, 0003406236, 0003406251,
0003406254, 0003406260, 0003406261,
5000288360, 5000590236, 5000804824,
5001858773, 7420937674, 7701011412



DF-ES-9335

Length: 85
Cone Ø: d1 Ø 12 / d2 Ø 10,75
Thread: M14 x 1,5 RHT
23162046, 5000516214, 5010144543,
5010245591



IV-ES-12273

Length: 36
Thread: M10 x 1,5 RHT
5010245365



MN-RK-8501

Ø: 75
Hole Distance: 115
Thick/Height: 24
7420547286



RV-DL-0887

Length: 1720
Ø: 48
Cone Ø: d1 Ø 30 / d2 Ø 27
5010308082



RV-DL-0908

Length: 845
Ø: 52
Cone Ø: d1 Ø 30 / d2 Ø 27
5010294288



RV-DL-0919

Length: 870
Ø: 62
Cone Ø: d1 Ø 30 / d2 Ø 27
5010294289



RV-DL-8299

Length: 827
Ø: 52
Cone Ø: d1 Ø 30 / d2 Ø 27
5010294720



RV-DL-8302

Length: 1570
Ø: 48
Cone Ø: d1 Ø 30 / d2 Ø 27
5010308083



RV-DL-8313

Length: 1752
Ø: 48
Cone Ø: d1 Ø 30 / d2 Ø 27
5010098467, 5010145584, 5010439631



RV-DL-8314

Length: 1758
Ø: 52
Cone Ø: d1 Ø 30 / d2 Ø 27
5010439021, 5010566063



RV-DL-8318

Length: 1720
Ø: 52
Cone Ø: d1 Ø 30 / d2 Ø 27
5010439022, 5010566064



RV-DL-12334

Length: 1686
Ø: 60
Cone Ø: d1 Ø 30 / d2 Ø 27
21560963, 5001868366, 5010587034,
5010587038, 7421560963, 7422163637



RV-VB-8191

Length: 662,4
Ø: 48
Hole Distance: 115 / 115
7420741703, RVVB8191



SC-ES-7279

Length: 150
Cone Ø: d1 Ø 30 / d2 Ø 27
Thread: M30 x 1,5 RHT
5001852452, 5001858763



VL-SB-5356

Thick/Height: 150
7420390836





Premium ...

Distribution 300.16D ...	04/96 →	Tie Rod	RV-DL-8314		Guide Rod, Air Suspension Axle	
	04/96 →	Tie Rod	RV-DL-8318		Guide Rod, Air Suspension Axle	
	04/96 →	Tie Rod	RV-DL-12334			
	04/96 →	Tie Rod End	CV-ES-14162		for Steering Rod	
	04/96 →	Tie Rod End	CV-ES-14163		for Steering Rod	
	04/96 →	Tie Rod End	SC-ES-7279		for Steering Rod	
	04/96 →	Track Control Arm		RV-VB-8191		Wishbone (CV)
Distribution 300.16T	04/96 →	Ball Head, gearshift linkage	CV-ES-2121		for vehicles without Pneumatic Suspension	
	04/96 →	Ball Head, gearshift linkage	DF-ES-9335			
	04/96 →	Ball Head, gearshift linkage	IV-ES-12273			
	04/96 →	Bush, parabolic spring		VL-SB-5356		
	04/96 →	Centre Rod	RV-DL-0887		Coupling Rod	
	04/96 →	Centre Rod	RV-DL-0901		Push Rod, for vehicles without Pneumatic Suspension	
	04/96 →	Centre Rod	RV-DL-0919		Push Rod, for Pneumatic Suspension vehicles	
	04/96 →	Suspension Strut Repair Kit		MN-RK-8501		
	04/96 →	Tie Rod	RV-DL-8314		Guide Rod	
	04/96 →	Tie Rod	RV-DL-12334			
	04/96 →	Tie Rod End	CV-ES-14162		for Steering Rod	
	04/96 →	Tie Rod End	CV-ES-14163		for Steering Rod	
	04/96 →	Tie Rod End	SC-ES-7279		for Steering Rod	
	04/96 →	Track Control Arm		RV-VB-8191		Wishbone (CV)
	Distribution 300.18D	04/96 →	Ball Head, gearshift linkage	CV-ES-2121		for vehicles without Pneumatic Suspension
04/96 →		Ball Head, gearshift linkage	DF-ES-9335			
04/96 →		Ball Head, gearshift linkage	IV-ES-12273			
04/96 →		Bush, parabolic spring		VL-SB-5356		
04/96 →		Centre Rod	RV-DL-0887		Coupling Rod	
04/96 →		Centre Rod	RV-DL-0908		Push Rod, for vehicles without Pneumatic Suspension	
04/96 →		Centre Rod	RV-DL-0919		Push Rod, for Pneumatic Suspension vehicles	
04/96 →		Centre Rod	RV-DL-8299		Push Rod, Leaf Spring Axle	
04/96 →		Suspension Strut Repair Kit		MN-RK-8501		
04/96 →		Tie Rod	RV-DL-8302			
04/96 →		Tie Rod	RV-DL-8313		Guide Rod, Leaf Spring Axle	
04/96 →		Tie Rod	RV-DL-8314		Guide Rod, Air Suspension Axle	
04/96 →		Tie Rod	RV-DL-8318		Guide Rod, Air Suspension Axle	
04/96 →		Tie Rod	RV-DL-12334			
04/96 →		Tie Rod End	CV-ES-14162		for Steering Rod	
04/96 →		Tie Rod End	CV-ES-14163		for Steering Rod	
04/96 →		Tie Rod End	SC-ES-7279		for Steering Rod	
04/96 →		Track Control Arm		RV-VB-8191		Wishbone (CV)
Distribution 300.18D/T		04/96 →	Ball Head, gearshift linkage	CV-ES-2121		for vehicles without Pneumatic Suspension
		04/96 →	Ball Head, gearshift linkage	IV-ES-12273		
	04/96 →	Bush, parabolic spring		VL-SB-5356		
	04/96 →	Centre Rod	RV-DL-0887		Coupling Rod	
	04/96 →	Centre Rod	RV-DL-0901		Push Rod, for vehicles without Pneumatic Suspension	
	04/96 →	Centre Rod	RV-DL-0919		Push Rod, for Pneumatic Suspension vehicles	
	04/96 →	Suspension Strut Repair Kit		MN-RK-8501		
	04/96 →	Tie Rod	RV-DL-8313		Guide Rod, Leaf Spring Axle	
	04/96 →	Tie Rod	RV-DL-12334			
	04/96 →	Tie Rod End	CV-ES-14162		for Steering Rod	
	04/96 →	Tie Rod End	CV-ES-14163		for Steering Rod	
	04/96 →	Tie Rod End	SC-ES-7279		for Steering Rod	
	04/96 →	Track Control Arm		RV-VB-8191		Wishbone (CV)
	07/99 →	Tie Rod	RV-DL-8314		Guide Rod, Air Suspension Axle	
	Distribution 300.19	04/96 →	Ball Head, gearshift linkage	CV-ES-2121		for vehicles without Pneumatic Suspension
04/96 →		Ball Head, gearshift linkage	DF-ES-9335			
04/96 →		Ball Head, gearshift linkage	IV-ES-12273			
04/96 →		Bush, parabolic spring		VL-SB-5356		
04/96 →		Centre Rod	RV-DL-0887		Coupling Rod	
04/96 →		Centre Rod	RV-DL-0908		Push Rod, for vehicles without Pneumatic Suspension	

CV-ES-2121

Length: 85
Cone Ø: d1 Ø 12 / d2 Ø 10,8
Thread: M14 x 1,5 RHT
23162046, 5000516214, 5010144543,
5010245591



CV-ES-14162

Length: 125
Cone Ø: d1 Ø 30 / d2 Ø 27
Thread: M30 x 1,5 LHT
3401170, 5000288361, 5001832581,
5001858759, 5001858774



CV-ES-14163

Length: 125
Cone Ø: d1 Ø 30 / d2 Ø 27
Thread: M30 x 1,5 RHT
0003406169, 0003406236, 0003406251,
0003406254, 0003406260, 0003406261,
5000288360, 5000590236, 5000804824,
5001858773, 7420937674, 7701011412



DF-ES-9335

Length: 85
Cone Ø: d1 Ø 12 / d2 Ø 10,75
Thread: M14 x 1,5 RHT
23162046, 5000516214, 5010144543,
5010245591



IV-ES-12273

Length: 36
Thread: M10 x 1,5 RHT
5010245365



MN-RK-8501

Ø: 75
Hole Distance: 115
Thick/Height: 24
7420547286



RV-DL-0887

Length: 1720
Ø: 48
Cone Ø: d1 Ø 30 / d2 Ø 27
5010308082



RV-DL-0901

Length: 810
Ø: 50
Cone Ø: d1 Ø 30 / d2 Ø 27
5010294287



RV-DL-0908

Length: 845
Ø: 52
Cone Ø: d1 Ø 30 / d2 Ø 27
5010294288



RV-DL-0919

Length: 870
Ø: 62
Cone Ø: d1 Ø 30 / d2 Ø 27
5010294289



RV-DL-8299

Length: 827
Ø: 52
Cone Ø: d1 Ø 30 / d2 Ø 27
5010294720



RV-DL-8302

Length: 1570
Ø: 48
Cone Ø: d1 Ø 30 / d2 Ø 27
5010308083



RV-DL-8313

Length: 1752
Ø: 48
Cone Ø: d1 Ø 30 / d2 Ø 27
5010098467, 5010145584, 5010439631



RV-DL-8314

Length: 1758
Ø: 52
Cone Ø: d1 Ø 30 / d2 Ø 27
5010439021, 5010566063



RV-DL-8318

Length: 1720
Ø: 52
Cone Ø: d1 Ø 30 / d2 Ø 27
5010439022, 5010566064



RV-DL-12334

Length: 1686
Ø: 60
Cone Ø: d1 Ø 30 / d2 Ø 27
21560963, 5001868366, 5010587034,
5010587038, 7421560963, 7422163637



RV-VB-8191

Length: 662,4
Ø: 48
Hole Distance: 115 / 115
7420741703, RVVB8191



SC-ES-7279

Length: 150
Cone Ø: d1 Ø 30 / d2 Ø 27
Thread: M30 x 1,5 RHT
5001852452, 5001858763



VL-SB-5356

Thick/Height: 150
7420390836





Premium ...

Distribution 300.19 ...	04/96→	Centre Rod	RV-DL-0919		Push Rod, for Pneumatic Suspension vehicles
	04/96→	Centre Rod	RV-DL-8299		Push Rod, Leaf Spring Axle
	04/96→	Suspension Strut Repair Kit		MN-RK-8501	
	04/96→	Tie Rod	RV-DL-8302		
	04/96→	Tie Rod	RV-DL-8313		Guide Rod
	04/96→	Tie Rod	RV-DL-8314		Guide Rod, Air Suspension Axle
	04/96→	Tie Rod	RV-DL-8318		Guide Rod, Air Suspension Axle
	04/96→	Tie Rod	RV-DL-12334		
	04/96→	Tie Rod End	CV-ES-14162		for Steering Rod
	04/96→	Tie Rod End	CV-ES-14163		for Steering Rod
	04/96→	Tie Rod End	SC-ES-7279		for Steering Rod
	04/96→	Track Control Arm		RV-VB-8191	Wishbone (CV)
	Distribution 300.19D/T	04/96→	Ball Head, gearshift linkage	CV-ES-2121	
04/96→		Ball Head, gearshift linkage	DF-ES-9335		
04/96→		Ball Head, gearshift linkage	IV-ES-12273		
04/96→		Bush, parabolic spring		VL-SB-5356	
04/96→		Centre Rod	RV-DL-0887		Coupling Rod
04/96→		Centre Rod	RV-DL-0901		Push Rod, for vehicles without Pneumatic Suspension
04/96→		Centre Rod	RV-DL-0919		Push Rod, for Pneumatic Suspension vehicles
04/96→		Suspension Strut Repair Kit		MN-RK-8501	
04/96→		Tie Rod	RV-DL-8314		Guide Rod
04/96→		Tie Rod	RV-DL-12334		
04/96→		Tie Rod End	CV-ES-14162		for Steering Rod
04/96→		Tie Rod End	CV-ES-14163		for Steering Rod
04/96→		Tie Rod End	SC-ES-7279		for Steering Rod
04/96→	Track Control Arm		RV-VB-8191	Wishbone (CV)	
Distribution 300.26D	04/96→	Ball Head, gearshift linkage	CV-ES-2121		for vehicles without Pneumatic Suspension
	04/96→	Ball Head, gearshift linkage	DF-ES-9335		
	04/96→	Ball Head, gearshift linkage	IV-ES-12273		
	04/96→	Bush, parabolic spring		VL-SB-5356	
	04/96→	Centre Rod	RV-DL-0883		Push Rod
	04/96→	Centre Rod	RV-DL-0887		Coupling Rod
	04/96→	Suspension Strut Repair Kit		MN-RK-8501	
	04/96→	Tie Rod	RV-DL-8313		Guide Rod, Leaf Spring Axle
	04/96→	Tie Rod	RV-DL-12334		
	04/96→	Tie Rod End		MN-ES-8490	for vehicles with Hinged Trailing Axle
	04/96→	Tie Rod End	CV-ES-14162		for Steering Rod
	04/96→	Tie Rod End	CV-ES-14163		for Steering Rod
	04/96→	Tie Rod End	IV-ES-12272		for Steering Rod
	04/96→	Tie Rod End	SC-ES-7279		for Steering Rod
	04/96→	Track Control Arm		RV-VB-8191	Wishbone (CV)
	07/99→	Tie Rod	RV-DL-8314		Guide Rod, Air Suspension Axle
	Distribution 320.18	08/00→	Ball Head, gearshift linkage	CV-ES-2121	
08/00→		Ball Head, gearshift linkage	DF-ES-9335		
08/00→		Ball Head, gearshift linkage	IV-ES-12273		
08/00→		Bush, parabolic spring		VL-SB-5356	
08/00→		Centre Rod	RV-DL-0887		Coupling Rod
08/00→		Centre Rod	RV-DL-0901		Push Rod, for vehicles without Pneumatic Suspension
08/00→		Centre Rod	RV-DL-0919		Push Rod, for Pneumatic Suspension vehicles
08/00→		Suspension Strut Repair Kit		MN-RK-8501	
08/00→		Tie Rod	RV-DL-8314		Guide Rod
08/00→		Tie Rod	RV-DL-8318		Guide Rod
08/00→		Tie Rod	RV-DL-12334		
08/00→		Tie Rod End	CV-ES-14162		for Steering Rod
08/00→		Tie Rod End	CV-ES-14163		for Steering Rod
08/00→		Tie Rod End	SC-ES-7279		for Steering Rod
08/00→		Track Control Arm		RV-VB-8191	Wishbone (CV)
Distribution 320.18 D	08/00→	Ball Head, gearshift linkage	CV-ES-2121		for vehicles without Pneumatic Suspension
	08/00→	Ball Head, gearshift linkage	DF-ES-9335		
	08/00→	Ball Head, gearshift linkage	IV-ES-12273		
	08/00→	Bush, parabolic spring		VL-SB-5356	

CV-ES-2121

Length: 85
Cone Ø: d1 Ø 12 / d2 Ø 10,8
Thread: M14 x 1,5 RHT
23162046, 5000516214, 5010144543,
5010245591



MN-ES-8490

Length: 90
Cone Ø: d1 Ø 30 / d2 Ø 27
Thread: M26 x 1,5 RHT
0014606948, 14606948, 5001849880



RV-DL-8299

Length: 827
Ø: 52
Cone Ø: d1 Ø 30 / d2 Ø 27
5010294720



RV-VB-8191

Length: 662,4
Ø: 48
Hole Distance: 115 / 115
7420741703, RVVB8191



CV-ES-14162

Length: 125
Cone Ø: d1 Ø 30 / d2 Ø 27
Thread: M30 x 1,5 LHT
3401170, 5000288361, 5001832581,
5001858759, 5001858774



MN-RK-8501

Ø: 75
Hole Distance: 115
Thick/Height: 24
7420547286



RV-DL-8302

Length: 1570
Ø: 48
Cone Ø: d1 Ø 30 / d2 Ø 27
5010308083



SC-ES-7279

Length: 150
Cone Ø: d1 Ø 30 / d2 Ø 27
Thread: M30 x 1,5 RHT
5001852452, 5001858763



CV-ES-14163

Length: 125
Cone Ø: d1 Ø 30 / d2 Ø 27
Thread: M30 x 1,5 RHT
0003406169, 0003406236, 0003406251,
0003406254, 0003406260, 0003406261,
5000288360, 5000590236, 5000804824,
5001858773, 7420937674, 7701011412



RV-DL-0883

Length: 847
Ø: 52
Cone Ø: d1 Ø 30 / d2 Ø 27
5010294502



RV-DL-8313

Length: 1752
Ø: 48
Cone Ø: d1 Ø 30 / d2 Ø 27
5010098467, 5010145584, 5010439631



VL-SB-5356

Thick/Height: 150
7420390836



DF-ES-9335

Length: 85
Cone Ø: d1 Ø 12 / d2 Ø 10,75
Thread: M14 x 1,5 RHT
23162046, 5000516214, 5010144543,
5010245591



RV-DL-0887

Length: 1720
Ø: 48
Cone Ø: d1 Ø 30 / d2 Ø 27
5010308082



RV-DL-8314

Length: 1758
Ø: 52
Cone Ø: d1 Ø 30 / d2 Ø 27
5010439021, 5010566063



IV-ES-12272

Length: 75
Cone Ø: d1 Ø 30 / d2 Ø 27
Thread: M26 x 1,5 RHT
5001849879



RV-DL-0901

Length: 810
Ø: 50
Cone Ø: d1 Ø 30 / d2 Ø 27
5010294287



RV-DL-8318

Length: 1720
Ø: 52
Cone Ø: d1 Ø 30 / d2 Ø 27
5010439022, 5010566064



IV-ES-12273

Length: 36
Thread: M10 x 1,5 RHT
5010245365



RV-DL-0919

Length: 870
Ø: 62
Cone Ø: d1 Ø 30 / d2 Ø 27
5010294289



RV-DL-12334

Length: 1686
Ø: 60
Cone Ø: d1 Ø 30 / d2 Ø 27
21560963, 5001868366, 5010587034,
5010587038, 7421560963, 7422163637





Premium ...

Distribution 320.18 D ...	08/00→	Centre Rod	RV-DL-0887		Coupling Rod
	08/00→	Centre Rod	RV-DL-0908		Push Rod, for vehicles without Pneumatic Suspension
	08/00→	Centre Rod	RV-DL-0919		Push Rod, for Pneumatic Suspension vehicles
	08/00→	Centre Rod	RV-DL-8299		Push Rod, Leaf Spring Axle
	08/00→	Suspension Strut Repair Kit		MN-RK-8501	
	08/00→	Tie Rod	RV-DL-8302		
	08/00→	Tie Rod	RV-DL-8313		Guide Rod, Leaf Spring Axle
	08/00→	Tie Rod	RV-DL-8314		Guide Rod, Air Suspension Axle
	08/00→	Tie Rod	RV-DL-8318		Guide Rod, Air Suspension Axle
	08/00→	Tie Rod	RV-DL-12334		
	08/00→	Tie Rod End	CV-ES-14162		for Steering Rod
	08/00→	Tie Rod End	CV-ES-14163		for Steering Rod
	08/00→	Tie Rod End	SC-ES-7279		for Steering Rod
	08/00→	Track Control Arm		RV-VB-8191	Wishbone (CV)
Distribution 320.24D	08/00→	Ball Head, gearshift linkage	CV-ES-2121		for vehicles without Pneumatic Suspension
	08/00→	Ball Head, gearshift linkage	DF-ES-9335		
	08/00→	Ball Head, gearshift linkage	IV-ES-12273		
	08/00→	Bush, parabolic spring		VL-SB-5356	
	08/00→	Centre Rod	RV-DL-0883		Push Rod
	08/00→	Centre Rod	RV-DL-0887		Coupling Rod
	08/00→	Suspension Strut Repair Kit		MN-RK-8501	
	08/00→	Tie Rod	RV-DL-8313		Guide Rod, Leaf Spring Axle
	08/00→	Tie Rod	RV-DL-8314		Guide Rod, Air Suspension Axle
	08/00→	Tie Rod	RV-DL-12334		
	08/00→	Tie Rod End		MN-ES-8490	for vehicles with Hinged Trailing Axle
	08/00→	Tie Rod End	CV-ES-14162		for Steering Rod
	08/00→	Tie Rod End	CV-ES-14163		for Steering Rod
	08/00→	Tie Rod End	IV-ES-12272		for Steering Rod
08/00→	Tie Rod End	SC-ES-7279		for Steering Rod	
08/00→	Track Control Arm		RV-VB-8191	Wishbone (CV)	
Distribution 320.26D	08/00→	Ball Head, gearshift linkage	CV-ES-2121		for vehicles without Pneumatic Suspension
	08/00→	Ball Head, gearshift linkage	DF-ES-9335		
	08/00→	Ball Head, gearshift linkage	IV-ES-12273		
	08/00→	Bush, parabolic spring		VL-SB-5356	
	08/00→	Centre Rod	RV-DL-0883		Push Rod
	08/00→	Centre Rod	RV-DL-0887		Coupling Rod
	08/00→	Suspension Strut Repair Kit		MN-RK-8501	
	08/00→	Tie Rod		RV-DL-8318	Guide Rod
	08/00→	Tie Rod	RV-DL-8313		Guide Rod, Leaf Spring Axle
	08/00→	Tie Rod	RV-DL-8314		Guide Rod, Air Suspension Axle
	08/00→	Tie Rod	RV-DL-12334		
	08/00→	Tie Rod End		MN-ES-8490	for vehicles with Hinged Trailing Axle
	08/00→	Tie Rod End	CV-ES-14162		for Steering Rod
	08/00→	Tie Rod End	CV-ES-14163		for Steering Rod
08/00→	Tie Rod End	IV-ES-12272		for Steering Rod	
08/00→	Tie Rod End	SC-ES-7279		for Steering Rod	
08/00→	Track Control Arm		RV-VB-8191	Wishbone (CV)	
Distribution 340.18D	04/96→	Ball Head, gearshift linkage	CV-ES-2121		for vehicles without Pneumatic Suspension
	04/96→	Ball Head, gearshift linkage	DF-ES-9335		
	04/96→	Ball Head, gearshift linkage	IV-ES-12273		
	04/96→	Bush, parabolic spring		VL-SB-5356	
	04/96→	Centre Rod	RV-DL-0887		Coupling Rod
	04/96→	Centre Rod	RV-DL-0908		Push Rod, for vehicles without Pneumatic Suspension
	04/96→	Centre Rod	RV-DL-0919		Push Rod, for Pneumatic Suspension vehicles
	04/96→	Centre Rod	RV-DL-8299		Push Rod, Leaf Spring Axle
	04/96→	Suspension Strut Repair Kit		MN-RK-8501	
	04/96→	Tie Rod	RV-DL-8302		
	04/96→	Tie Rod	RV-DL-8313		Guide Rod, Leaf Spring Axle
	04/96→	Tie Rod	RV-DL-8314		Guide Rod, Air Suspension Axle
	04/96→	Tie Rod	RV-DL-8318		Guide Rod, Air Suspension Axle
	04/96→	Tie Rod	RV-DL-12334		

CV-ES-2121

Length: 85
Cone Ø: d1 Ø 12 / d2 Ø 10,8
Thread: M14 x 1,5 RHT
23162046, 5000516214, 5010144543,
5010245591



MN-ES-8490

Length: 90
Cone Ø: d1 Ø 30 / d2 Ø 27
Thread: M26 x 1,5 RHT
0014606948, 14606948, 5001849880



RV-DL-8299

Length: 827
Ø: 52
Cone Ø: d1 Ø 30 / d2 Ø 27
5010294720



RV-VB-8191

Length: 662,4
Ø: 48
Hole Distance: 115 / 115
7420741703, RVVB8191



CV-ES-14162

Length: 125
Cone Ø: d1 Ø 30 / d2 Ø 27
Thread: M30 x 1,5 LHT
3401170, 5000288361, 5001832581,
5001858759, 5001858774



MN-RK-8501

Ø: 75
Hole Distance: 115
Thick/Height: 24
7420547286



RV-DL-8302

Length: 1570
Ø: 48
Cone Ø: d1 Ø 30 / d2 Ø 27
5010308083



SC-ES-7279

Length: 150
Cone Ø: d1 Ø 30 / d2 Ø 27
Thread: M30 x 1,5 RHT
5001852452, 5001858763



CV-ES-14163

Length: 125
Cone Ø: d1 Ø 30 / d2 Ø 27
Thread: M30 x 1,5 RHT
0003406169, 0003406236, 0003406251,
0003406254, 0003406260, 0003406261,
5000288360, 5000590236, 5000804824,
5001858773, 7420937674, 7701011412



RV-DL-0883

Length: 847
Ø: 52
Cone Ø: d1 Ø 30 / d2 Ø 27
5010294502



RV-DL-8313

Length: 1752
Ø: 48
Cone Ø: d1 Ø 30 / d2 Ø 27
5010098467, 5010145584, 5010439631



VL-SB-5356

Thick/Height: 150
7420390836



DF-ES-9335

Length: 85
Cone Ø: d1 Ø 12 / d2 Ø 10,75
Thread: M14 x 1,5 RHT
23162046, 5000516214, 5010144543,
5010245591



RV-DL-0887

Length: 1720
Ø: 48
Cone Ø: d1 Ø 30 / d2 Ø 27
5010308082



RV-DL-8314

Length: 1758
Ø: 52
Cone Ø: d1 Ø 30 / d2 Ø 27
5010439021, 5010566063



IV-ES-12272

Length: 75
Cone Ø: d1 Ø 30 / d2 Ø 27
Thread: M26 x 1,5 RHT
5001849879



RV-DL-0908

Length: 845
Ø: 52
Cone Ø: d1 Ø 30 / d2 Ø 27
5010294288



RV-DL-8318

Length: 1720
Ø: 52
Cone Ø: d1 Ø 30 / d2 Ø 27
5010439022, 5010566064



IV-ES-12273

Length: 36
Thread: M10 x 1,5 RHT
5010245365



RV-DL-0919

Length: 870
Ø: 62
Cone Ø: d1 Ø 30 / d2 Ø 27
5010294289



RV-DL-12334

Length: 1686
Ø: 60
Cone Ø: d1 Ø 30 / d2 Ø 27
21560963, 5001868366, 5010587034,
5010587038, 7421560963, 7422163637





Premium ...

Distribution 340.18D ...	04/96 →	Tie Rod End	CV-ES-14162		for Steering Rod	
	04/96 →	Tie Rod End	CV-ES-14163		for Steering Rod	
	04/96 →	Tie Rod End	SC-ES-7279		for Steering Rod	
	04/96 →	Track Control Arm		RV-VB-8191	Wishbone (CV)	
Distribution 340.18D/T	04/96 →	Ball Head, gearshift linkage	CV-ES-2121		for vehicles without Pneumatic Suspension	
	04/96 →	Ball Head, gearshift linkage	IV-ES-12273			
	04/96 →	Bush, parabolic spring		VL-SB-5356		
	04/96 →	Centre Rod	RV-DL-0887		Coupling Rod	
	04/96 →	Centre Rod	RV-DL-0901		Push Rod, for vehicles without Pneumatic Suspension	
	04/96 →	Centre Rod	RV-DL-0919		Push Rod, for Pneumatic Suspension vehicles	
	04/96 →	Suspension Strut Repair Kit		MN-RK-8501		
	04/96 →	Tie Rod	RV-DL-12334			
	04/96 →	Tie Rod End	CV-ES-14162		for Steering Rod	
	04/96 →	Tie Rod End	CV-ES-14163		for Steering Rod	
	04/96 →	Tie Rod End	SC-ES-7279		for Steering Rod	
	04/96 →	Track Control Arm		RV-VB-8191	Wishbone (CV)	
	Distribution 340.19D	04/96 →	Ball Head, gearshift linkage	CV-ES-2121		for vehicles without Pneumatic Suspension
		04/96 →	Ball Head, gearshift linkage	DF-ES-9335		
04/96 →		Ball Head, gearshift linkage	IV-ES-12273			
04/96 →		Bush, parabolic spring		VL-SB-5356		
04/96 →		Centre Rod	RV-DL-0887		Coupling Rod	
04/96 →		Centre Rod	RV-DL-0908		Push Rod, for vehicles without Pneumatic Suspension	
04/96 →		Centre Rod	RV-DL-0919		Push Rod, for Pneumatic Suspension vehicles	
04/96 →		Centre Rod	RV-DL-8299		Push Rod, Leaf Spring Axle	
04/96 →		Suspension Strut Repair Kit		MN-RK-8501		
04/96 →		Tie Rod	RV-DL-8302			
04/96 →		Tie Rod	RV-DL-8313		Guide Rod, Leaf Spring Axle	
04/96 →		Tie Rod	RV-DL-8314		Guide Rod, Air Suspension Axle	
04/96 →		Tie Rod	RV-DL-8318		Guide Rod, Air Suspension Axle	
04/96 →		Tie Rod	RV-DL-12334			
04/96 →		Tie Rod End	CV-ES-14162		for Steering Rod	
04/96 →		Tie Rod End	CV-ES-14163		for Steering Rod	
04/96 →		Tie Rod End	SC-ES-7279		for Steering Rod	
04/96 →		Track Control Arm		RV-VB-8191	Wishbone (CV)	
Distribution 340.19D/T		04/96 →	Ball Head, gearshift linkage	CV-ES-2121		for vehicles without Pneumatic Suspension
		04/96 →	Ball Head, gearshift linkage	DF-ES-9335		
	04/96 →	Ball Head, gearshift linkage	IV-ES-12273			
	04/96 →	Bush, parabolic spring		VL-SB-5356		
	04/96 →	Centre Rod	RV-DL-0887		Coupling Rod	
	04/96 →	Centre Rod	RV-DL-0901		Push Rod, for vehicles without Pneumatic Suspension	
	04/96 →	Centre Rod	RV-DL-0919		Push Rod, for Pneumatic Suspension vehicles	
	04/96 →	Suspension Strut Repair Kit		MN-RK-8501		
	04/96 →	Tie Rod	RV-DL-8314		Guide Rod	
	04/96 →	Tie Rod	RV-DL-12334			
	04/96 →	Tie Rod End	CV-ES-14162		for Steering Rod	
	04/96 →	Tie Rod End	CV-ES-14163		for Steering Rod	
	04/96 →	Tie Rod End	SC-ES-7279		for Steering Rod	
	04/96 →	Track Control Arm		RV-VB-8191	Wishbone (CV)	
Distribution 340.26D	04/96 →	Ball Head, gearshift linkage	CV-ES-2121		for vehicles without Pneumatic Suspension	
	04/96 →	Ball Head, gearshift linkage	DF-ES-9335			
	04/96 →	Ball Head, gearshift linkage	IV-ES-12273			
	04/96 →	Bush, parabolic spring		VL-SB-5356		
	04/96 →	Centre Rod	RV-DL-0883		Push Rod	
	04/96 →	Centre Rod	RV-DL-0887		Coupling Rod	
	04/96 →	Suspension Strut Repair Kit		MN-RK-8501		
	04/96 →	Tie Rod	RV-DL-8313		Guide Rod, Leaf Spring Axle	
	04/96 →	Tie Rod	RV-DL-12334			
	04/96 →	Tie Rod End		MN-ES-8490	for vehicles with Hinged Trailing Axle	
	04/96 →	Tie Rod End	CV-ES-14162		for Steering Rod	
	04/96 →	Tie Rod End	CV-ES-14163		for Steering Rod	

CV-ES-2121

Length: 85
Cone Ø: d1 Ø 12 / d2 Ø 10,8
Thread: M14 x 1,5 RHT
23162046, 5000516214, 5010144543,
5010245591



CV-ES-14162

Length: 125
Cone Ø: d1 Ø 30 / d2 Ø 27
Thread: M30 x 1,5 LHT
3401170, 5000288361, 5001832581,
5001858759, 5001858774



CV-ES-14163

Length: 125
Cone Ø: d1 Ø 30 / d2 Ø 27
Thread: M30 x 1,5 RHT
0003406169, 0003406236, 0003406251,
0003406254, 0003406260, 0003406261,
5000288360, 5000590236, 5000804824,
5001858773, 7420937674, 7701011412



DF-ES-9335

Length: 85
Cone Ø: d1 Ø 12 / d2 Ø 10,75
Thread: M14 x 1,5 RHT
23162046, 5000516214, 5010144543,
5010245591



IV-ES-12273

Length: 36
Thread: M10 x 1,5 RHT
5010245365



MN-ES-8490

Length: 90
Cone Ø: d1 Ø 30 / d2 Ø 27
Thread: M26 x 1,5 RHT
14606948, 0014606948, 5001849880



MN-RK-8501

Ø: 75
Hole Distance: 115
Thick/Height: 24
7420547286



RV-DL-0883

Length: 847
Ø: 52
Cone Ø: d1 Ø 30 / d2 Ø 27
5010294502



RV-DL-0887

Length: 1720
Ø: 48
Cone Ø: d1 Ø 30 / d2 Ø 27
5010308082



RV-DL-0901

Length: 810
Ø: 50
Cone Ø: d1 Ø 30 / d2 Ø 27
5010294287



RV-DL-0908

Length: 845
Ø: 52
Cone Ø: d1 Ø 30 / d2 Ø 27
5010294288



RV-DL-0919

Length: 870
Ø: 62
Cone Ø: d1 Ø 30 / d2 Ø 27
5010294289



RV-DL-8299

Length: 827
Ø: 52
Cone Ø: d1 Ø 30 / d2 Ø 27
5010294720



RV-DL-8302

Length: 1570
Ø: 48
Cone Ø: d1 Ø 30 / d2 Ø 27
5010308083



RV-DL-8313

Length: 1752
Ø: 48
Cone Ø: d1 Ø 30 / d2 Ø 27
5010098467, 5010145584, 5010439631



RV-DL-8314

Length: 1758
Ø: 52
Cone Ø: d1 Ø 30 / d2 Ø 27
5010439021, 5010566063



RV-DL-8318

Length: 1720
Ø: 52
Cone Ø: d1 Ø 30 / d2 Ø 27
5010439022, 5010566064



RV-DL-12334

Length: 1686
Ø: 60
Cone Ø: d1 Ø 30 / d2 Ø 27
21560963, 5001868366, 5010587034,
5010587038, 7421560963, 7422163637



RV-VB-8191

Length: 662,4
Ø: 48
Hole Distance: 115 / 115
7420741703, RVVB8191



SC-ES-7279

Length: 150
Cone Ø: d1 Ø 30 / d2 Ø 27
Thread: M30 x 1,5 RHT
5001852452, 5001858763



VL-SB-5356

Thick/Height: 150
7420390836





Premium ...

Distribution 340.26D ...	04/96→	Tie Rod End	IV-ES-12272		for Steering Rod
	04/96→	Tie Rod End	SC-ES-7279		for Steering Rod
	04/96→	Track Control Arm		RV-VB-8191	Wishbone (CV)
	07/99→	Tie Rod	RV-DL-8314		Guide Rod, Air Suspension Axle
Distribution 370.18	08/00→	Ball Head, gearshift linkage	CV-ES-2121		for vehicles without Pneumatic Suspension
	08/00→	Ball Head, gearshift linkage	DF-ES-9335		
	08/00→	Ball Head, gearshift linkage	IV-ES-12273		
	08/00→	Bush, parabolic spring		VL-SB-5356	
	08/00→	Centre Rod	RV-DL-0887		Coupling Rod
	08/00→	Centre Rod	RV-DL-0901		Push Rod, for vehicles without Pneumatic Suspension
	08/00→	Centre Rod	RV-DL-0919		Push Rod, for Pneumatic Suspension vehicles
	08/00→	Suspension Strut Repair Kit		MN-RK-8501	
	08/00→	Tie Rod	RV-DL-8314		Guide Rod
	08/00→	Tie Rod	RV-DL-8318		Guide Rod
	08/00→	Tie Rod	RV-DL-12334		
	08/00→	Tie Rod End	CV-ES-14162		for Steering Rod
	08/00→	Tie Rod End	CV-ES-14163		for Steering Rod
	08/00→	Tie Rod End	SC-ES-7279		for Steering Rod
	08/00→	Track Control Arm		RV-VB-8191	Wishbone (CV)
	Distribution 370.18D	08/00→	Ball Head, gearshift linkage	CV-ES-2121	
08/00→		Ball Head, gearshift linkage	DF-ES-9335		
08/00→		Ball Head, gearshift linkage	IV-ES-12273		
08/00→		Bush, parabolic spring		VL-SB-5356	
08/00→		Centre Rod	RV-DL-0887		Coupling Rod
08/00→		Centre Rod	RV-DL-0908		Push Rod, for vehicles without Pneumatic Suspension
08/00→		Centre Rod	RV-DL-0919		Push Rod, for Pneumatic Suspension vehicles
08/00→		Centre Rod	RV-DL-8299		Push Rod, Leaf Spring Axle
08/00→		Tie Rod	RV-DL-8302		
08/00→		Tie Rod	RV-DL-8313		Guide Rod, Leaf Spring Axle
08/00→		Tie Rod	RV-DL-8314		Guide Rod, Air Suspension Axle
08/00→		Tie Rod	RV-DL-8318		Guide Rod, Air Suspension Axle
08/00→		Tie Rod	RV-DL-12334		
08/00→		Tie Rod End	CV-ES-14162		for Steering Rod
08/00→		Tie Rod End	CV-ES-14163		for Steering Rod
08/00→		Tie Rod End	SC-ES-7279		for Steering Rod
Distribution 370.24D	08/00→	Ball Head, gearshift linkage	CV-ES-2121		for vehicles without Pneumatic Suspension
	08/00→	Ball Head, gearshift linkage	DF-ES-9335		
	08/00→	Ball Head, gearshift linkage	IV-ES-12273		
	08/00→	Bush, parabolic spring		VL-SB-5356	
	08/00→	Centre Rod	RV-DL-0883		Push Rod
	08/00→	Centre Rod	RV-DL-0887		Coupling Rod
	08/00→	Suspension Strut Repair Kit		MN-RK-8501	
	08/00→	Tie Rod	RV-DL-8313		Guide Rod, Leaf Spring Axle
	08/00→	Tie Rod	RV-DL-8314		Guide Rod, Air Suspension Axle
	08/00→	Tie Rod	RV-DL-12334		
	08/00→	Tie Rod End		MN-ES-8490	for vehicles with Hinged Trailing Axle
	08/00→	Tie Rod End	CV-ES-14162		for Steering Rod
	08/00→	Tie Rod End	CV-ES-14163		for Steering Rod
	08/00→	Tie Rod End	IV-ES-12272		for Steering Rod
	08/00→	Tie Rod End	SC-ES-7279		for Steering Rod
	08/00→	Track Control Arm		RV-VB-8191	Wishbone (CV)
Distribution 370.26D	08/00→	Ball Head, gearshift linkage	CV-ES-2121		for vehicles without Pneumatic Suspension
	08/00→	Ball Head, gearshift linkage	DF-ES-9335		
	08/00→	Ball Head, gearshift linkage	IV-ES-12273		
	08/00→	Bush, parabolic spring		VL-SB-5356	
	08/00→	Centre Rod	RV-DL-0883		Push Rod
	08/00→	Centre Rod	RV-DL-0887		Coupling Rod
	08/00→	Suspension Strut Repair Kit		MN-RK-8501	
	08/00→	Tie Rod		RV-DL-8318	Guide Rod
08/00→	Tie Rod	RV-DL-8313		Guide Rod, Leaf Spring Axle	
08/00→	Tie Rod	RV-DL-8314		Guide Rod, Air Suspension Axle	

CV-ES-2121

Length: 85
Cone Ø: d1 Ø 12 / d2 Ø 10,8
Thread: M14 x 1,5 RHT
23162046, 5000516214, 5010144543,
5010245591



MN-ES-8490

Length: 90
Cone Ø: d1 Ø 30 / d2 Ø 27
Thread: M26 x 1,5 RHT
0014606948, 14606948, 5001849880



RV-DL-0919

Length: 870
Ø: 62
Cone Ø: d1 Ø 30 / d2 Ø 27
5010294289



RV-DL-12334

Length: 1686
Ø: 60
Cone Ø: d1 Ø 30 / d2 Ø 27
21560963, 5001868366, 5010587034,
5010587038, 7421560963, 7422163637



CV-ES-14162

Length: 125
Cone Ø: d1 Ø 30 / d2 Ø 27
Thread: M30 x 1,5 LHT
3401170, 5000288361, 5001832581,
5001858759, 5001858774



MN-RK-8501

Ø: 75
Hole Distance: 115
Thick/Height: 24
7420547286



RV-DL-8299

Length: 827
Ø: 52
Cone Ø: d1 Ø 30 / d2 Ø 27
5010294720



RV-VB-8191

Length: 662,4
Ø: 48
Hole Distance: 115 / 115
7420741703, RVVB8191



CV-ES-14163

Length: 125
Cone Ø: d1 Ø 30 / d2 Ø 27
Thread: M30 x 1,5 RHT
0003406169, 0003406236, 0003406251,
0003406254, 0003406260, 0003406261,
5000288360, 5000590236, 5000804824,
5001858773, 7420937674, 7701011412



RV-DL-0883

Length: 847
Ø: 52
Cone Ø: d1 Ø 30 / d2 Ø 27
5010294502



RV-DL-8302

Length: 1570
Ø: 48
Cone Ø: d1 Ø 30 / d2 Ø 27
5010308083



SC-ES-7279

Length: 150
Cone Ø: d1 Ø 30 / d2 Ø 27
Thread: M30 x 1,5 RHT
5001852452, 5001858763



DF-ES-9335

Length: 85
Cone Ø: d1 Ø 12 / d2 Ø 10,75
Thread: M14 x 1,5 RHT
23162046, 5000516214, 5010144543,
5010245591



RV-DL-0887

Length: 1720
Ø: 48
Cone Ø: d1 Ø 30 / d2 Ø 27
5010308082



RV-DL-8313

Length: 1752
Ø: 48
Cone Ø: d1 Ø 30 / d2 Ø 27
5010098467, 5010145584, 5010439631



VL-SB-5356

Thick/Height: 150
7420390836



IV-ES-12272

Length: 75
Cone Ø: d1 Ø 30 / d2 Ø 27
Thread: M26 x 1,5 RHT
5001849879



RV-DL-0901

Length: 810
Ø: 50
Cone Ø: d1 Ø 30 / d2 Ø 27
5010294287



RV-DL-8314

Length: 1758
Ø: 52
Cone Ø: d1 Ø 30 / d2 Ø 27
5010439021, 5010566063



IV-ES-12273

Length: 36
Thread: M10 x 1,5 RHT
5010245365



RV-DL-0908

Length: 845
Ø: 52
Cone Ø: d1 Ø 30 / d2 Ø 27
5010294288



RV-DL-8318

Length: 1720
Ø: 52
Cone Ø: d1 Ø 30 / d2 Ø 27
5010439022, 5010566064





Premium ...

Distribution 370.26D ...	08/00→	Tie Rod	RV-DL-12334			
	08/00→	Tie Rod End		MN-ES-8490	for vehicles with Hinged Trailing Axle	
	08/00→	Tie Rod End	CV-ES-14162		for Steering Rod	
	08/00→	Tie Rod End	CV-ES-14163		for Steering Rod	
	08/00→	Tie Rod End	IV-ES-12272		for Steering Rod	
	08/00→	Tie Rod End	SC-ES-7279		for Steering Rod	
	08/00→	Track Control Arm		RV-VB-8191	Wishbone (CV)	
Distribution 400.18D	01/00→	Ball Head, gearshift linkage	CV-ES-2121		for vehicles without Pneumatic Suspension	
	01/00→	Ball Head, gearshift linkage	IV-ES-12273			
	01/00→	Centre Rod	RV-DL-0887		Coupling Rod	
	01/00→	Centre Rod	RV-DL-0908		Push Rod, for vehicles without Pneumatic Suspension	
	01/00→	Centre Rod	RV-DL-0919		Push Rod, for Pneumatic Suspension vehicles	
	01/00→	Suspension Strut Repair Kit		MN-RK-8501		
	01/00→	Tie Rod	RV-DL-8313		Guide Rod	
	01/00→	Tie Rod	RV-DL-8314		Guide Rod	
	01/00→	Tie Rod	RV-DL-12334			
	01/00→	Tie Rod End	CV-ES-14162		for Steering Rod	
	01/00→	Tie Rod End	CV-ES-14163		for Steering Rod	
	01/00→	Tie Rod End	SC-ES-7279		for Steering Rod	
	01/00→	Track Control Arm		RV-VB-8191	Wishbone (CV)	
	Distribution 400.18D/T	01/00→	Ball Head, gearshift linkage	CV-ES-2121		for vehicles without Pneumatic Suspension
01/00→		Ball Head, gearshift linkage	IV-ES-12273			
01/00→		Centre Rod	RV-DL-0887		Coupling Rod	
01/00→		Centre Rod	RV-DL-0901		Push Rod, for vehicles without Pneumatic Suspension	
01/00→		Centre Rod	RV-DL-0919		Push Rod, for Pneumatic Suspension vehicles	
01/00→		Suspension Strut Repair Kit		MN-RK-8501		
01/00→		Tie Rod	RV-DL-12334			
01/00→		Tie Rod End	CV-ES-14162		for Steering Rod	
01/00→		Tie Rod End	CV-ES-14163		for Steering Rod	
01/00→		Tie Rod End	SC-ES-7279		for Steering Rod	
01/00→		Track Control Arm		RV-VB-8191	Wishbone (CV)	
Distribution 420.18		08/00→	Ball Head, gearshift linkage	CV-ES-2121		for vehicles without Pneumatic Suspension
		08/00→	Ball Head, gearshift linkage	IV-ES-12273		
		08/00→	Centre Rod	RV-DL-0887		Coupling Rod
	08/00→	Centre Rod	RV-DL-0901		Push Rod, for vehicles without Pneumatic Suspension	
	08/00→	Centre Rod	RV-DL-0919		Push Rod, for Pneumatic Suspension vehicles	
	08/00→	Suspension Strut Repair Kit		MN-RK-8501		
	08/00→	Tie Rod	RV-DL-12334			
	08/00→	Tie Rod End	CV-ES-14162		for Steering Rod	
	08/00→	Tie Rod End	CV-ES-14163		for Steering Rod	
	08/00→	Tie Rod End	SC-ES-7279		for Steering Rod	
	08/00→	Track Control Arm		RV-VB-8191	Wishbone (CV)	
	Distribution 420.18D	08/00→	Ball Head, gearshift linkage	CV-ES-2121		for vehicles without Pneumatic Suspension
		08/00→	Ball Head, gearshift linkage	IV-ES-12273		
		08/00→	Centre Rod	RV-DL-0887		Coupling Rod
08/00→		Centre Rod	RV-DL-0908		Push Rod, for vehicles without Pneumatic Suspension	
08/00→		Centre Rod	RV-DL-0919		Push Rod, for Pneumatic Suspension vehicles	
08/00→		Suspension Strut Repair Kit		MN-RK-8501		
08/00→		Tie Rod	RV-DL-8313		Guide Rod	
08/00→		Tie Rod	RV-DL-8314		Guide Rod	
08/00→		Tie Rod	RV-DL-12334			
08/00→		Tie Rod End	CV-ES-14162		for Steering Rod	
08/00→		Tie Rod End	CV-ES-14163		for Steering Rod	
08/00→		Tie Rod End	SC-ES-7279		for Steering Rod	
08/00→		Track Control Arm		RV-VB-8191	Wishbone (CV)	
Route 300.16		09/96→	Ball Head, gearshift linkage	CV-ES-2121		for vehicles without Pneumatic Suspension
	09/96→	Ball Head, gearshift linkage	DF-ES-9335			
	09/96→	Ball Head, gearshift linkage	IV-ES-12273			
	09/96→	Centre Rod	RV-DL-0887		Coupling Rod	

CV-ES-2121

Length: 85
Cone Ø: d1 Ø 12 / d2 Ø 10,8
Thread: M14 x 1,5 RHT
23162046, 5000516214, 5010144543,
5010245591



MN-ES-8490

Length: 90
Cone Ø: d1 Ø 30 / d2 Ø 27
Thread: M26 x 1,5 RHT
0014606948, 14606948, 5001849880



RV-DL-8313

Length: 1752
Ø: 48
Cone Ø: d1 Ø 30 / d2 Ø 27
5010098467, 5010145584, 5010439631



CV-ES-14162

Length: 125
Cone Ø: d1 Ø 30 / d2 Ø 27
Thread: M30 x 1,5 LHT
3401170, 5000288361, 5001832581,
5001858759, 5001858774



MN-RK-8501

Ø: 75
Hole Distance: 115
Thick/Height: 24
7420547286



RV-DL-8314

Length: 1758
Ø: 52
Cone Ø: d1 Ø 30 / d2 Ø 27
5010439021, 5010566063



CV-ES-14163

Length: 125
Cone Ø: d1 Ø 30 / d2 Ø 27
Thread: M30 x 1,5 RHT
0003406169, 0003406236, 0003406251,
0003406254, 0003406260, 0003406261,
5000288360, 5000590236, 5000804824,
5001858773, 7420937674, 7701011412



RV-DL-0887

Length: 1720
Ø: 48
Cone Ø: d1 Ø 30 / d2 Ø 27
5010308082



RV-DL-12334

Length: 1686
Ø: 60
Cone Ø: d1 Ø 30 / d2 Ø 27
21560963, 5001868366, 5010587034,
5010587038, 7421560963, 7422163637



DF-ES-9335

Length: 85
Cone Ø: d1 Ø 12 / d2 Ø 10,75
Thread: M14 x 1,5 RHT
23162046, 5000516214, 5010144543,
5010245591



RV-DL-0901

Length: 810
Ø: 50
Cone Ø: d1 Ø 30 / d2 Ø 27
5010294287



RV-VB-8191

Length: 662,4
Ø: 48
Hole Distance: 115 / 115
7420741703, RVVB8191



IV-ES-12272

Length: 75
Cone Ø: d1 Ø 30 / d2 Ø 27
Thread: M26 x 1,5 RHT
5001849879



RV-DL-0908

Length: 845
Ø: 52
Cone Ø: d1 Ø 30 / d2 Ø 27
5010294288



SC-ES-7279

Length: 150
Cone Ø: d1 Ø 30 / d2 Ø 27
Thread: M30 x 1,5 RHT
5001852452, 5001858763



IV-ES-12273

Length: 36
Thread: M10 x 1,5 RHT
5010245365



RV-DL-0919

Length: 870
Ø: 62
Cone Ø: d1 Ø 30 / d2 Ø 27
5010294289





Premium ...

Route 300.16 ...	09/96 →	Centre Rod	RV-DL-0908		Push Rod, for vehicles without Pneumatic Suspension
	09/96 →	Centre Rod	RV-DL-0919		Push Rod, for Pneumatic Suspension vehicles
	09/96 →	Tie Rod	RV-DL-8313		Guide Rod
	09/96 →	Tie Rod	RV-DL-10243		
	09/96 →	Tie Rod	RV-DL-12334		
	09/96 →	Tie Rod End	CV-ES-14162		for Steering Rod
	09/96 →	Tie Rod End	CV-ES-14163		for Steering Rod
	09/96 →	Tie Rod End	SC-ES-7279		for Steering Rod
Route 300.18	09/96 →	Ball Head, gearshift linkage	CV-ES-2121		for vehicles without Pneumatic Suspension
	09/96 →	Ball Head, gearshift linkage	DF-ES-9335		
	09/96 →	Ball Head, gearshift linkage	IV-ES-12273		
	09/96 →	Centre Rod	RV-DL-0887		Coupling Rod
	09/96 →	Centre Rod	RV-DL-0908		Push Rod, for vehicles without Pneumatic Suspension
	09/96 →	Centre Rod	RV-DL-0919		Push Rod, for Pneumatic Suspension vehicles
	09/96 →	Suspension Strut Repair Kit		MN-RK-8501	
	09/96 →	Tie Rod	RV-DL-8313		Guide Rod
	09/96 →	Tie Rod	RV-DL-8314		Guide Rod
	09/96 →	Tie Rod	RV-DL-10243		
	09/96 →	Tie Rod	RV-DL-12334		
	09/96 →	Tie Rod End	CV-ES-14162		for Steering Rod
	09/96 →	Tie Rod End	CV-ES-14163		for Steering Rod
	09/96 →	Tie Rod End	SC-ES-7279		for Steering Rod
	09/96 →	Track Control Arm		RV-VB-8191	Wishbone (CV)
	Route 300.18T	09/96 →	Ball Head, gearshift linkage	CV-ES-2121	
09/96 →		Ball Head, gearshift linkage	DF-ES-9335		
09/96 →		Ball Head, gearshift linkage	IV-ES-12273		
09/96 →		Centre Rod	RV-DL-0887		Coupling Rod
09/96 →		Centre Rod	RV-DL-0901		Push Rod, for vehicles without Pneumatic Suspension
09/96 →		Centre Rod	RV-DL-0919		Push Rod, for Pneumatic Suspension vehicles
09/96 →		Tie Rod	RV-DL-10243		
09/96 →		Tie Rod	RV-DL-12334		
09/96 →		Tie Rod End	CV-ES-14162		for Steering Rod
09/96 →		Tie Rod End	CV-ES-14163		for Steering Rod
09/96 →	Tie Rod End	SC-ES-7279		for Steering Rod	
Route 300.19	09/96 →	Ball Head, gearshift linkage	CV-ES-2121		for vehicles without Pneumatic Suspension
	09/96 →	Ball Head, gearshift linkage	DF-ES-9335		
	09/96 →	Ball Head, gearshift linkage	IV-ES-12273		
	09/96 →	Centre Rod	RV-DL-0887		Coupling Rod
	09/96 →	Centre Rod	RV-DL-0908		Push Rod, for vehicles without Pneumatic Suspension
	09/96 →	Centre Rod	RV-DL-0919		Push Rod, for Pneumatic Suspension vehicles
	09/96 →	Tie Rod	RV-DL-8313		Guide Rod
	09/96 →	Tie Rod	RV-DL-10243		
	09/96 →	Tie Rod	RV-DL-12334		
	09/96 →	Tie Rod End	CV-ES-14162		for Steering Rod
	09/96 →	Tie Rod End	CV-ES-14163		for Steering Rod
	09/96 →	Tie Rod End	SC-ES-7279		for Steering Rod
Route 300.19T	09/96 →	Ball Head, gearshift linkage	CV-ES-2121		for vehicles without Pneumatic Suspension
	09/96 →	Ball Head, gearshift linkage	DF-ES-9335		
	09/96 →	Ball Head, gearshift linkage	IV-ES-12273		
	09/96 →	Centre Rod	RV-DL-0887		Coupling Rod
	09/96 →	Centre Rod	RV-DL-0901		Push Rod, for vehicles without Pneumatic Suspension
	09/96 →	Centre Rod	RV-DL-0919		Push Rod, for Pneumatic Suspension vehicles
	09/96 →	Tie Rod	RV-DL-8314		Guide Rod
	09/96 →	Tie Rod	RV-DL-10243		
	09/96 →	Tie Rod	RV-DL-12334		
	09/96 →	Tie Rod End	CV-ES-14162		for Steering Rod
	09/96 →	Tie Rod End	CV-ES-14163		for Steering Rod
	09/96 →	Tie Rod End	SC-ES-7279		for Steering Rod

CV-ES-2121

Length: 85
Cone Ø: d1 Ø 12 / d2 Ø 10,8
Thread: M14 x 1,5 RHT
23162046, 5000516214, 5010144543,
5010245591



CV-ES-14162

Length: 125
Cone Ø: d1 Ø 30 / d2 Ø 27
Thread: M30 x 1,5 LHT
3401170, 5000288361, 5001832581,
5001858759, 5001858774



CV-ES-14163

Length: 125
Cone Ø: d1 Ø 30 / d2 Ø 27
Thread: M30 x 1,5 RHT
0003406169, 0003406236, 0003406251,
0003406254, 0003406260, 0003406261,
5000288360, 5000590236, 5000804824,
5001858773, 7420937674, 7701011412



DF-ES-9335

Length: 85
Cone Ø: d1 Ø 12 / d2 Ø 10,75
Thread: M14 x 1,5 RHT
23162046, 5000516214, 5010144543,
5010245591



IV-ES-12273

Length: 36
Thread: M10 x 1,5 RHT
5010245365



MN-RK-8501

Ø: 75
Hole Distance: 115
Thick/Height: 24
7420547286



RV-DL-0887

Length: 1720
Ø: 48
Cone Ø: d1 Ø 30 / d2 Ø 27
5010308082



RV-DL-0901

Length: 810
Ø: 50
Cone Ø: d1 Ø 30 / d2 Ø 27
5010294287



RV-DL-0908

Length: 845
Ø: 52
Cone Ø: d1 Ø 30 / d2 Ø 27
5010294288



RV-DL-0919

Length: 870
Ø: 62
Cone Ø: d1 Ø 30 / d2 Ø 27
5010294289



RV-DL-8313

Length: 1752
Ø: 48
Cone Ø: d1 Ø 30 / d2 Ø 27
5010098467, 5010145584, 5010439631



RV-DL-8314

Length: 1758
Ø: 52
Cone Ø: d1 Ø 30 / d2 Ø 27
5010439021, 5010566063



RV-DL-10243

Length: 1726
Ø: 60
Cone Ø: d1 Ø 30 / d2 Ø 27
Thread: M24 x 1,5 RHT
5001868363, 5010587004, 5010600822,
7421560957



RV-DL-12334

Length: 1686
Ø: 60
Cone Ø: d1 Ø 30 / d2 Ø 27
21560963, 5001868366, 5010587034,
5010587038, 7421560963, 7422163637



RV-VB-8191

Length: 662,4
Ø: 48
Hole Distance: 115 / 115
7420741703, RVVB8191



SC-ES-7279

Length: 150
Cone Ø: d1 Ø 30 / d2 Ø 27
Thread: M30 x 1,5 RHT
5001852452, 5001858763





Premium ...

Route 320.18	08/00→	Ball Head, gearshift linkage	CV-ES-2121		for vehicles without Pneumatic Suspension	
	08/00→	Ball Head, gearshift linkage	DF-ES-9335			
	08/00→	Ball Head, gearshift linkage	IV-ES-12273			
	08/00→	Centre Rod	RV-DL-0887		Coupling Rod	
	08/00→	Centre Rod	RV-DL-0901		Push Rod, for vehicles without Pneumatic Suspension	
	08/00→	Centre Rod	RV-DL-0908		Push Rod, for vehicles without Pneumatic Suspension	
	08/00→	Centre Rod	RV-DL-0919		Push Rod, for Pneumatic Suspension vehicles	
	08/00→	Centre Rod	RV-DL-8299		Push Rod, Leaf Spring Axle	
	08/00→	Tie Rod	RV-DL-8302			
	08/00→	Tie Rod	RV-DL-8313		Guide Rod, Leaf Spring Axle	
	08/00→	Tie Rod	RV-DL-8314		Guide Rod	
	08/00→	Tie Rod	RV-DL-8314		Guide Rod, Air Suspension Axle	
	08/00→	Tie Rod	RV-DL-8318		Guide Rod, Air Suspension Axle	
	08/00→	Tie Rod	RV-DL-10243			
	08/00→	Tie Rod	RV-DL-12334			
	08/00→	Tie Rod End	CV-ES-14162		for Steering Rod	
	08/00→	Tie Rod End	CV-ES-14163		for Steering Rod	
08/00→	Tie Rod End	SC-ES-7279		for Steering Rod		
Route 340.18	04/96→	Ball Head, gearshift linkage	CV-ES-2121		for vehicles without Pneumatic Suspension	
	04/96→	Ball Head, gearshift linkage	DF-ES-9335			
	04/96→	Ball Head, gearshift linkage	IV-ES-12273			
	04/96→	Centre Rod	RV-DL-0887		Coupling Rod	
	04/96→	Centre Rod	RV-DL-0908		Push Rod, for vehicles without Pneumatic Suspension	
	04/96→	Centre Rod	RV-DL-0919		Push Rod, for Pneumatic Suspension vehicles	
	04/96→	Centre Rod	RV-DL-8299		Push Rod, Leaf Spring Axle	
	04/96→	Suspension Strut Repair Kit		MN-RK-8501		
	04/96→	Tie Rod	RV-DL-8302			
	04/96→	Tie Rod	RV-DL-8313		Guide Rod, Leaf Spring Axle	
	04/96→	Tie Rod	RV-DL-8314		Guide Rod, Air Suspension Axle	
	04/96→	Tie Rod	RV-DL-8318		Guide Rod, Air Suspension Axle	
	04/96→	Tie Rod	RV-DL-10243			
	04/96→	Tie Rod	RV-DL-12334			
	04/96→	Tie Rod End	CV-ES-14162		for Steering Rod	
	04/96→	Tie Rod End	CV-ES-14163		for Steering Rod	
	04/96→	Tie Rod End	SC-ES-7279		for Steering Rod	
04/96→	Track Control Arm		RV-VB-8191	Wishbone (CV)		
Route 340.18T	04/96→	Ball Head, gearshift linkage	CV-ES-2121		for vehicles without Pneumatic Suspension	
	04/96→	Ball Head, gearshift linkage	DF-ES-9335			
	04/96→	Ball Head, gearshift linkage	IV-ES-12273			
	04/96→	Centre Rod	RV-DL-0887		Coupling Rod	
	04/96→	Centre Rod	RV-DL-0901		Push Rod, for vehicles without Pneumatic Suspension	
	04/96→	Centre Rod	RV-DL-0919		Push Rod, for Pneumatic Suspension vehicles	
	04/96→	Suspension Strut Repair Kit		MN-RK-8501		
	04/96→	Tie Rod	RV-DL-8314		Guide Rod	
	04/96→	Tie Rod	RV-DL-10243			
	04/96→	Tie Rod	RV-DL-12334			
	04/96→	Tie Rod End	CV-ES-14162		for Steering Rod	
	04/96→	Tie Rod End	CV-ES-14163		for Steering Rod	
	04/96→	Tie Rod End	SC-ES-7279		for Steering Rod	
	04/96→	Track Control Arm		RV-VB-8191	Wishbone (CV)	
	Route 340.19	04/96→	Ball Head, gearshift linkage	CV-ES-2121		for vehicles without Pneumatic Suspension
		04/96→	Ball Head, gearshift linkage	DF-ES-9335		
		04/96→	Ball Head, gearshift linkage	IV-ES-12273		
04/96→		Centre Rod	RV-DL-0887		Coupling Rod	
04/96→		Centre Rod	RV-DL-0908		Push Rod, for vehicles without Pneumatic Suspension	
04/96→		Centre Rod	RV-DL-0919		Push Rod, for Pneumatic Suspension vehicles	
04/96→		Centre Rod	RV-DL-8299		Push Rod, Leaf Spring Axle	
04/96→	Suspension Strut Repair Kit		MN-RK-8501			

CV-ES-2121

Length: 85
Cone Ø: d1 Ø 12 / d2 Ø 10,8
Thread: M14 x 1,5 RHT
23162046, 5000516214, 5010144543,
5010245591



CV-ES-14162

Length: 125
Cone Ø: d1 Ø 30 / d2 Ø 27
Thread: M30 x 1,5 LHT
3401170, 5000288361, 5001832581,
5001858759, 5001858774



CV-ES-14163

Length: 125
Cone Ø: d1 Ø 30 / d2 Ø 27
Thread: M30 x 1,5 RHT
0003406169, 0003406236, 0003406251,
0003406254, 0003406260, 0003406261,
5000288360, 5000590236, 5000804824,
5001858773, 7420937674, 7701011412



DF-ES-9335

Length: 85
Cone Ø: d1 Ø 12 / d2 Ø 10,75
Thread: M14 x 1,5 RHT
23162046, 5000516214, 5010144543,
5010245591



IV-ES-12273

Length: 36
Thread: M10 x 1,5 RHT
5010245365



MN-RK-8501

Ø: 75
Hole Distance: 115
Thick/Height: 24
7420547286



RV-DL-0887

Length: 1720
Ø: 48
Cone Ø: d1 Ø 30 / d2 Ø 27
5010308082



RV-DL-0901

Length: 810
Ø: 50
Cone Ø: d1 Ø 30 / d2 Ø 27
5010294287



RV-DL-0908

Length: 845
Ø: 52
Cone Ø: d1 Ø 30 / d2 Ø 27
5010294288



RV-DL-0919

Length: 870
Ø: 62
Cone Ø: d1 Ø 30 / d2 Ø 27
5010294289



RV-DL-8299

Length: 827
Ø: 52
Cone Ø: d1 Ø 30 / d2 Ø 27
5010294720



RV-DL-8302

Length: 1570
Ø: 48
Cone Ø: d1 Ø 30 / d2 Ø 27
5010308083



RV-DL-8313

Length: 1752
Ø: 48
Cone Ø: d1 Ø 30 / d2 Ø 27
5010098467, 5010145584, 5010439631



RV-DL-8314

Length: 1758
Ø: 52
Cone Ø: d1 Ø 30 / d2 Ø 27
5010439021, 5010566063



RV-DL-8318

Length: 1720
Ø: 52
Cone Ø: d1 Ø 30 / d2 Ø 27
5010439022, 5010566064



RV-DL-10243

Length: 1726
Ø: 60
Cone Ø: d1 Ø 30 / d2 Ø 27
Thread: M24 x 1,5 RHT
5001868363, 5010587004, 5010600822,
7421560957



RV-DL-12334

Length: 1686
Ø: 60
Cone Ø: d1 Ø 30 / d2 Ø 27
21560963, 5001868366, 5010587034,
5010587038, 7421560963, 7422163637



RV-VB-8191

Length: 662,4
Ø: 48
Hole Distance: 115 / 115
7420741703, RVVB8191



SC-ES-7279

Length: 150
Cone Ø: d1 Ø 30 / d2 Ø 27
Thread: M30 x 1,5 RHT
5001852452, 5001858763





Premium ...

Route 340.19 ...	04/96 →	Tie Rod	RV-DL-8302		
	04/96 →	Tie Rod	RV-DL-8313	Guide Rod, Leaf Spring Axle	
	04/96 →	Tie Rod	RV-DL-8314	Guide Rod, Air Suspension Axle	
	04/96 →	Tie Rod	RV-DL-8318	Guide Rod, Air Suspension Axle	
	04/96 →	Tie Rod	RV-DL-10243		
	04/96 →	Tie Rod	RV-DL-12334		
	04/96 →	Tie Rod End	CV-ES-14162	for Steering Rod	
	04/96 →	Tie Rod End	CV-ES-14163	for Steering Rod	
	04/96 →	Tie Rod End	SC-ES-7279	for Steering Rod	
Route 340.19T	04/96 →	Track Control Arm		RV-VB-8191 Wishbone (CV)	
	04/96 →	Ball Head, gearshift linkage	CV-ES-2121	for vehicles without Pneumatic Suspension	
	04/96 →	Ball Head, gearshift linkage	DF-ES-9335		
	04/96 →	Ball Head, gearshift linkage	IV-ES-12273		
	04/96 →	Centre Rod	RV-DL-0887	Coupling Rod	
	04/96 →	Centre Rod	RV-DL-0901	Push Rod, for vehicles without Pneumatic Suspension	
	04/96 →	Centre Rod	RV-DL-0919	Push Rod, for Pneumatic Suspension vehicles	
	04/96 →	Suspension Strut Repair Kit		MN-RK-8501	
	04/96 →	Tie Rod	RV-DL-8314	Guide Rod	
	04/96 →	Tie Rod	RV-DL-10243		
	04/96 →	Tie Rod	RV-DL-12334		
	04/96 →	Tie Rod End	CV-ES-14162	for Steering Rod	
	04/96 →	Tie Rod End	CV-ES-14163	for Steering Rod	
	04/96 →	Tie Rod End	SC-ES-7279	for Steering Rod	
	04/96 →	Track Control Arm		RV-VB-8191 Wishbone (CV)	
	Route 340.24	04/96 →	Ball Head, gearshift linkage	CV-ES-2121	for vehicles without Pneumatic Suspension
		04/96 →	Ball Head, gearshift linkage	DF-ES-9335	
04/96 →		Ball Head, gearshift linkage	IV-ES-12273		
04/96 →		Centre Rod	RV-DL-0883	Push Rod	
04/96 →		Centre Rod	RV-DL-0887	Coupling Rod	
04/96 →		Centre Rod	RV-DL-8299	Suspension Rod	
04/96 →		Suspension Strut Repair Kit		MN-RK-8501	
04/96 →		Tie Rod	RV-DL-8313	Guide Rod	
04/96 →		Tie Rod	RV-DL-10243		
04/96 →		Tie Rod	RV-DL-12334		
04/96 →		Tie Rod End	CV-ES-14162	for Steering Rod	
04/96 →		Tie Rod End	CV-ES-14163	for Steering Rod	
04/96 →		Tie Rod End	SC-ES-7279	for Steering Rod	
04/96 →		Track Control Arm		RV-VB-8191 Wishbone (CV)	
Route 340.26	04/96 →	Ball Head, gearshift linkage	CV-ES-2121	for vehicles without Pneumatic Suspension	
	04/96 →	Ball Head, gearshift linkage	DF-ES-9335		
	04/96 →	Ball Head, gearshift linkage	IV-ES-12273		
	04/96 →	Centre Rod	RV-DL-0883	Push Rod	
	04/96 →	Centre Rod	RV-DL-0887	Coupling Rod	
	04/96 →	Suspension Strut Repair Kit		MN-RK-8501	
	04/96 →	Tie Rod	RV-DL-8313	Guide Rod	
	04/96 →	Tie Rod	RV-DL-8314	Guide Rod	
	04/96 →	Tie Rod	RV-DL-10243		
	04/96 →	Tie Rod	RV-DL-12334		
	04/96 →	Tie Rod End		MN-ES-8490 for vehicles with Hinged Trailing Axle	
	04/96 →	Tie Rod End	CV-ES-14162	for Steering Rod	
	04/96 →	Tie Rod End	CV-ES-14163	for Steering Rod	
	04/96 →	Tie Rod End	IV-ES-12272	for Steering Rod	
	04/96 →	Tie Rod End	SC-ES-7279	for Steering Rod	
	04/96 →	Track Control Arm		RV-VB-8191 Wishbone (CV)	
	Route 370.18	08/00 →	Ball Head, gearshift linkage	CV-ES-2121	for vehicles without Pneumatic Suspension
		08/00 →	Ball Head, gearshift linkage	DF-ES-9335	
08/00 →		Ball Head, gearshift linkage	IV-ES-12273		
08/00 →		Centre Rod	RV-DL-0887	Coupling Rod	
08/00 →		Centre Rod	RV-DL-0901	Push Rod, for vehicles without Pneumatic Suspension	
08/00 →		Centre Rod	RV-DL-0908	Push Rod, for vehicles without Pneumatic Suspension	

CV-ES-2121

Length: 85
Cone Ø: d1 Ø 12 / d2 Ø 10,8
Thread: M14 x 1,5 RHT
23162046, 5000516214, 5010144543,
5010245591



MN-ES-8490

Length: 90
Cone Ø: d1 Ø 30 / d2 Ø 27
Thread: M26 x 1,5 RHT
14606948, 0014606948, 5001849880



RV-DL-0919

Length: 870
Ø: 62
Cone Ø: d1 Ø 30 / d2 Ø 27
5010294289



RV-DL-10243

Length: 1726
Ø: 60
Cone Ø: d1 Ø 30 / d2 Ø 27
Thread: M24 x 1,5 RHT
5001868363, 5010587004, 5010600822,
7421560957



CV-ES-14162

Length: 125
Cone Ø: d1 Ø 30 / d2 Ø 27
Thread: M30 x 1,5 LHT
3401170, 5000288361, 5001832581,
5001858759, 5001858774



MN-RK-8501

Ø: 75
Hole Distance: 115
Thick/Height: 24
7420547286



RV-DL-8299

Length: 827
Ø: 52
Cone Ø: d1 Ø 30 / d2 Ø 27
5010294720



RV-DL-12334

Length: 1686
Ø: 60
Cone Ø: d1 Ø 30 / d2 Ø 27
21560963, 5001868366, 5010587034,
5010587038, 7421560963, 7422163637



CV-ES-14163

Length: 125
Cone Ø: d1 Ø 30 / d2 Ø 27
Thread: M30 x 1,5 RHT
0003406169, 0003406236, 0003406251,
0003406254, 0003406260, 0003406261,
5000288360, 5000590236, 5000804824,
5001858773, 7420937674, 7701011412



RV-DL-0883

Length: 847
Ø: 52
Cone Ø: d1 Ø 30 / d2 Ø 27
5010294502



RV-DL-8302

Length: 1570
Ø: 48
Cone Ø: d1 Ø 30 / d2 Ø 27
5010308083



RV-VB-8191

Length: 662,4
Ø: 48
Hole Distance: 115 / 115
7420741703, RVVB8191



DF-ES-9335

Length: 85
Cone Ø: d1 Ø 12 / d2 Ø 10,75
Thread: M14 x 1,5 RHT
23162046, 5000516214, 5010144543,
5010245591



RV-DL-0887

Length: 1720
Ø: 48
Cone Ø: d1 Ø 30 / d2 Ø 27
5010308082



RV-DL-8313

Length: 1752
Ø: 48
Cone Ø: d1 Ø 30 / d2 Ø 27
5010098467, 5010145584, 5010439631



SC-ES-7279

Length: 150
Cone Ø: d1 Ø 30 / d2 Ø 27
Thread: M30 x 1,5 RHT
5001852452, 5001858763



IV-ES-12272

Length: 75
Cone Ø: d1 Ø 30 / d2 Ø 27
Thread: M26 x 1,5 RHT
5001849879



RV-DL-0901

Length: 810
Ø: 50
Cone Ø: d1 Ø 30 / d2 Ø 27
5010294287



RV-DL-8314

Length: 1758
Ø: 52
Cone Ø: d1 Ø 30 / d2 Ø 27
5010439021, 5010566063



IV-ES-12273

Length: 36
Thread: M10 x 1,5 RHT
5010245365



RV-DL-0908

Length: 845
Ø: 52
Cone Ø: d1 Ø 30 / d2 Ø 27
5010294288



RV-DL-8318

Length: 1720
Ø: 52
Cone Ø: d1 Ø 30 / d2 Ø 27
5010439022, 5010566064





Premium ...

Route 370.18 ...	08/00→	Centre Rod	RV-DL-0919		Push Rod, for Pneumatic Suspension vehicles
	08/00→	Centre Rod	RV-DL-8299		Push Rod, Leaf Spring Axle
	08/00→	Suspension Strut Repair Kit		MN-RK-8501	
	08/00→	Tie Rod	RV-DL-8302		
	08/00→	Tie Rod	RV-DL-8313		Guide Rod, Leaf Spring Axle
	08/00→	Tie Rod	RV-DL-8314		Guide Rod
	08/00→	Tie Rod	RV-DL-8314		Guide Rod, Air Suspension Axle
	08/00→	Tie Rod	RV-DL-8318		Guide Rod
	08/00→	Tie Rod	RV-DL-8318		Guide Rod, Air Suspension Axle
	08/00→	Tie Rod	RV-DL-10243		
	08/00→	Tie Rod	RV-DL-12334		
	08/00→	Tie Rod End	CV-ES-14162		for Steering Rod
	08/00→	Tie Rod End	CV-ES-14163		for Steering Rod
	08/00→	Tie Rod End	SC-ES-7279		for Steering Rod
	Route 370.24	08/00→	Track Control Arm		RV-VB-8191
08/00→		Ball Head, gearshift linkage	CV-ES-2121		for vehicles without Pneumatic Suspension
08/00→		Ball Head, gearshift linkage	DF-ES-9335		
08/00→		Ball Head, gearshift linkage	IV-ES-12273		
08/00→		Centre Rod	RV-DL-0883		Push Rod
08/00→		Centre Rod	RV-DL-0887		Coupling Rod
08/00→		Suspension Strut Repair Kit		MN-RK-8501	
08/00→		Tie Rod	RV-DL-8313		Guide Rod, Leaf Spring Axle
08/00→		Tie Rod	RV-DL-8314		Guide Rod, Air Suspension Axle
08/00→		Tie Rod	RV-DL-10243		
08/00→		Tie Rod	RV-DL-12334		
08/00→		Tie Rod End		MN-ES-8490	for vehicles with Hinged Trailing Axle
08/00→		Tie Rod End	CV-ES-14162		for Steering Rod
08/00→		Tie Rod End	CV-ES-14163		for Steering Rod
08/00→		Tie Rod End	IV-ES-12272		for Steering Rod
08/00→	Tie Rod End	SC-ES-7279		for Steering Rod	
Route 370.26	08/00→	Track Control Arm		RV-VB-8191	Wishbone (CV)
	08/00→	Ball Head, gearshift linkage	CV-ES-2121		for vehicles without Pneumatic Suspension
	08/00→	Ball Head, gearshift linkage	DF-ES-9335		
	08/00→	Ball Head, gearshift linkage	IV-ES-12273		
	08/00→	Centre Rod	RV-DL-0883		Push Rod
	08/00→	Centre Rod	RV-DL-0887		Coupling Rod
	08/00→	Suspension Strut Repair Kit		MN-RK-8501	
	08/00→	Tie Rod	RV-DL-8313		Guide Rod, Leaf Spring Axle
	08/00→	Tie Rod	RV-DL-8314		Guide Rod, Air Suspension Axle
	08/00→	Tie Rod	RV-DL-10243		
	08/00→	Tie Rod	RV-DL-12334		
	08/00→	Tie Rod End		MN-ES-8490	for vehicles with Hinged Trailing Axle
	08/00→	Tie Rod End	CV-ES-14162		for Steering Rod
	08/00→	Tie Rod End	CV-ES-14163		for Steering Rod
	08/00→	Tie Rod End	IV-ES-12272		for Steering Rod
08/00→	Tie Rod End	SC-ES-7279		for Steering Rod	
Route 385.18,400.18	04/96→	Track Control Arm		RV-VB-8191	Wishbone (CV)
	04/96→	Ball Head, gearshift linkage	CV-ES-2121		for vehicles without Pneumatic Suspension
	04/96→	Ball Head, gearshift linkage	DF-ES-9335		
	04/96→	Ball Head, gearshift linkage	IV-ES-12273		
	04/96→	Centre Rod	RV-DL-0887		Coupling Rod
	04/96→	Centre Rod	RV-DL-0908		Push Rod, for vehicles without Pneumatic Suspension
	04/96→	Centre Rod	RV-DL-0919		Push Rod, for Pneumatic Suspension vehicles
	04/96→	Suspension Strut Repair Kit		MN-RK-8501	
	04/96→	Tie Rod	RV-DL-8313		Guide Rod
	04/96→	Tie Rod	RV-DL-8314		Guide Rod
	04/96→	Tie Rod	RV-DL-10243		
	04/96→	Tie Rod	RV-DL-12334		
	04/96→	Tie Rod End	CV-ES-14162		for Steering Rod
	04/96→	Tie Rod End	CV-ES-14163		for Steering Rod
	04/96→	Tie Rod End	SC-ES-7279		for Steering Rod

CV-ES-2121

Length: 85
Cone Ø: d1 Ø 12 / d2 Ø 10,8
Thread: M14 x 1,5 RHT
23162046, 5000516214, 5010144543,
5010245591



MN-ES-8490

Length: 90
Cone Ø: d1 Ø 30 / d2 Ø 27
Thread: M26 x 1,5 RHT
14606948, 0014606948, 5001849880



RV-DL-8299

Length: 827
Ø: 52
Cone Ø: d1 Ø 30 / d2 Ø 27
5010294720



RV-DL-12334

Length: 1686
Ø: 60
Cone Ø: d1 Ø 30 / d2 Ø 27
21560963, 5001868366, 5010587034,
5010587038, 7421560963, 7422163637



CV-ES-14162

Length: 125
Cone Ø: d1 Ø 30 / d2 Ø 27
Thread: M30 x 1,5 LHT
3401170, 5000288361, 5001832581,
5001858759, 5001858774



MN-RK-8501

Ø: 75
Hole Distance: 115
Thick/Height: 24
7420547286



RV-DL-8302

Length: 1570
Ø: 48
Cone Ø: d1 Ø 30 / d2 Ø 27
5010308083



RV-VB-8191

Length: 662,4
Ø: 48
Hole Distance: 115 / 115
7420741703, RVVB8191



CV-ES-14163

Length: 125
Cone Ø: d1 Ø 30 / d2 Ø 27
Thread: M30 x 1,5 RHT
0003406169, 0003406236, 0003406251,
0003406254, 0003406260, 0003406261,
5000288360, 5000590236, 5000804824,
5001858773, 7420937674, 7701011412



RV-DL-0883

Length: 847
Ø: 52
Cone Ø: d1 Ø 30 / d2 Ø 27
5010294502



RV-DL-8313

Length: 1752
Ø: 48
Cone Ø: d1 Ø 30 / d2 Ø 27
5010098467, 5010145584, 5010439631



SC-ES-7279

Length: 150
Cone Ø: d1 Ø 30 / d2 Ø 27
Thread: M30 x 1,5 RHT
5001852452, 5001858763



DF-ES-9335

Length: 85
Cone Ø: d1 Ø 12 / d2 Ø 10,75
Thread: M14 x 1,5 RHT
23162046, 5000516214, 5010144543,
5010245591



RV-DL-0887

Length: 1720
Ø: 48
Cone Ø: d1 Ø 30 / d2 Ø 27
5010308082



RV-DL-8314

Length: 1758
Ø: 52
Cone Ø: d1 Ø 30 / d2 Ø 27
5010439021, 5010566063



IV-ES-12272

Length: 75
Cone Ø: d1 Ø 30 / d2 Ø 27
Thread: M26 x 1,5 RHT
5001849879



RV-DL-0908

Length: 845
Ø: 52
Cone Ø: d1 Ø 30 / d2 Ø 27
5010294288



RV-DL-8318

Length: 1720
Ø: 52
Cone Ø: d1 Ø 30 / d2 Ø 27
5010439022, 5010566064



IV-ES-12273

Length: 36
Thread: M10 x 1,5 RHT
5010245365



RV-DL-0919

Length: 870
Ø: 62
Cone Ø: d1 Ø 30 / d2 Ø 27
5010294289



RV-DL-10243

Length: 1726
Ø: 60
Cone Ø: d1 Ø 30 / d2 Ø 27
Thread: M24 x 1,5 RHT
5001868363, 5010587004, 5010600822,
7421560957





Premium ...

Route 385.18T,400.18T	04/96 →	Ball Head, gearshift linkage	CV-ES-2121		for vehicles without Pneumatic Suspension
	04/96 →	Ball Head, gearshift linkage	DF-ES-9335		
	04/96 →	Ball Head, gearshift linkage	IV-ES-12273		
	04/96 →	Centre Rod	RV-DL-0887		Coupling Rod
	04/96 →	Centre Rod	RV-DL-0901		Push Rod, for vehicles without Pneumatic Suspension
	04/96 →	Centre Rod	RV-DL-0919		Push Rod, for Pneumatic Suspension vehicles
	04/96 →	Suspension Strut Repair Kit		MN-RK-8501	
	04/96 →	Tie Rod	RV-DL-8314		Guide Rod
	04/96 →	Tie Rod	RV-DL-10243		
	04/96 →	Tie Rod	RV-DL-12334		
	04/96 →	Tie Rod End	CV-ES-14162		for Steering Rod
	04/96 →	Tie Rod End	CV-ES-14163		for Steering Rod
	04/96 →	Tie Rod End	SC-ES-7279		for Steering Rod
	04/96 →	Track Control Arm		RV-VB-8191	Wishbone (CV)
	Route 385.19,400.19	04/96 →	Ball Head, gearshift linkage	CV-ES-2121	
04/96 →		Ball Head, gearshift linkage	DF-ES-9335		
04/96 →		Ball Head, gearshift linkage	IV-ES-12273		
04/96 →		Centre Rod	RV-DL-0887		Coupling Rod
04/96 →		Centre Rod	RV-DL-0908		Push Rod, for vehicles without Pneumatic Suspension
04/96 →		Centre Rod	RV-DL-0919		Push Rod, for Pneumatic Suspension vehicles
04/96 →		Centre Rod	RV-DL-8299		Push Rod, Leaf Spring Axle
04/96 →		Suspension Strut Repair Kit		MN-RK-8501	
04/96 →		Tie Rod	RV-DL-8302		
04/96 →		Tie Rod	RV-DL-8313		Guide Rod, Leaf Spring Axle
04/96 →		Tie Rod	RV-DL-8314		Guide Rod, Air Suspension Axle
04/96 →		Tie Rod	RV-DL-8318		Guide Rod, Air Suspension Axle
04/96 →		Tie Rod	RV-DL-10243		
04/96 →		Tie Rod	RV-DL-12334		
04/96 →		Tie Rod End	CV-ES-14162		for Steering Rod
04/96 →	Tie Rod End	CV-ES-14163		for Steering Rod	
04/96 →	Tie Rod End	SC-ES-7279		for Steering Rod	
04/96 →	Track Control Arm		RV-VB-8191	Wishbone (CV)	
Route 385.19T,400.19T	04/96 →	Ball Head, gearshift linkage	CV-ES-2121		for vehicles without Pneumatic Suspension
	04/96 →	Ball Head, gearshift linkage	DF-ES-9335		
	04/96 →	Ball Head, gearshift linkage	IV-ES-12273		
	04/96 →	Centre Rod	RV-DL-0887		Coupling Rod
	04/96 →	Centre Rod	RV-DL-0901		Push Rod, for vehicles without Pneumatic Suspension
	04/96 →	Centre Rod	RV-DL-0919		Push Rod, for Pneumatic Suspension vehicles
	04/96 →	Suspension Strut Repair Kit		MN-RK-8501	
	04/96 →	Tie Rod	RV-DL-8314		Guide Rod
	04/96 →	Tie Rod	RV-DL-10243		
	04/96 →	Tie Rod	RV-DL-12334		
	04/96 →	Tie Rod End	CV-ES-14162		for Steering Rod
	04/96 →	Tie Rod End	CV-ES-14163		for Steering Rod
	04/96 →	Tie Rod End	SC-ES-7279		for Steering Rod
	04/96 →	Track Control Arm		RV-VB-8191	Wishbone (CV)
	Route 385.24,400.24	04/96 →	Ball Head, gearshift linkage	CV-ES-2121	
04/96 →		Ball Head, gearshift linkage	DF-ES-9335		
04/96 →		Ball Head, gearshift linkage	IV-ES-12273		
04/96 →		Centre Rod	RV-DL-0883		Push Rod
04/96 →		Centre Rod	RV-DL-0887		Coupling Rod
04/96 →		Centre Rod	RV-DL-8299		Suspension Rod
04/96 →		Suspension Strut Repair Kit		MN-RK-8501	
04/96 →		Tie Rod	RV-DL-8313		Guide Rod
04/96 →		Tie Rod	RV-DL-8314		Guide Rod
04/96 →		Tie Rod	RV-DL-10243		
04/96 →		Tie Rod	RV-DL-12334		
04/96 →		Tie Rod End	CV-ES-14162		for Steering Rod
04/96 →		Tie Rod End	CV-ES-14163		for Steering Rod
04/96 →		Tie Rod End	SC-ES-7279		for Steering Rod
04/96 →		Track Control Arm		RV-VB-8191	Wishbone (CV)

CV-ES-2121

Length: 85
Cone Ø: d1 Ø 12 / d2 Ø 10,8
Thread: M14 x 1,5 RHT
23162046, 5000516214, 5010144543,
5010245591



CV-ES-14162

Length: 125
Cone Ø: d1 Ø 30 / d2 Ø 27
Thread: M30 x 1,5 LHT
3401170, 5000288361, 5001832581,
5001858759, 5001858774



CV-ES-14163

Length: 125
Cone Ø: d1 Ø 30 / d2 Ø 27
Thread: M30 x 1,5 RHT
0003406169, 0003406236, 0003406251,
0003406254, 0003406260, 0003406261,
5000288360, 5000590236, 5000804824,
5001858773, 7420937674, 7701011412



DF-ES-9335

Length: 85
Cone Ø: d1 Ø 12 / d2 Ø 10,75
Thread: M14 x 1,5 RHT
23162046, 5000516214, 5010144543,
5010245591



IV-ES-12273

Length: 36
Thread: M10 x 1,5 RHT
5010245365



MN-RK-8501

Ø: 75
Hole Distance: 115
Thick/Height: 24
7420547286



RV-DL-0883

Length: 847
Ø: 52
Cone Ø: d1 Ø 30 / d2 Ø 27
5010294502



RV-DL-0887

Length: 1720
Ø: 48
Cone Ø: d1 Ø 30 / d2 Ø 27
5010308082



RV-DL-0901

Length: 810
Ø: 50
Cone Ø: d1 Ø 30 / d2 Ø 27
5010294287



RV-DL-0908

Length: 845
Ø: 52
Cone Ø: d1 Ø 30 / d2 Ø 27
5010294288



RV-DL-0919

Length: 870
Ø: 62
Cone Ø: d1 Ø 30 / d2 Ø 27
5010294289



RV-DL-8299

Length: 827
Ø: 52
Cone Ø: d1 Ø 30 / d2 Ø 27
5010294720



RV-DL-8302

Length: 1570
Ø: 48
Cone Ø: d1 Ø 30 / d2 Ø 27
5010308083



RV-DL-8313

Length: 1752
Ø: 48
Cone Ø: d1 Ø 30 / d2 Ø 27
5010098467, 5010145584, 5010439631



RV-DL-8314

Length: 1758
Ø: 52
Cone Ø: d1 Ø 30 / d2 Ø 27
5010439021, 5010566063



RV-DL-8318

Length: 1720
Ø: 52
Cone Ø: d1 Ø 30 / d2 Ø 27
5010439022, 5010566064



RV-DL-10243

Length: 1726
Ø: 60
Cone Ø: d1 Ø 30 / d2 Ø 27
Thread: M24 x 1,5 RHT
5001868363, 5010587004, 5010600822,
7421560957



RV-DL-12334

Length: 1686
Ø: 60
Cone Ø: d1 Ø 30 / d2 Ø 27
21560963, 5001868366, 5010587034,
5010587038, 7421560963, 7422163637



RV-VB-8191

Length: 662,4
Ø: 48
Hole Distance: 115 / 115
7420741703, RVVB8191



SC-ES-7279

Length: 150
Cone Ø: d1 Ø 30 / d2 Ø 27
Thread: M30 x 1,5 RHT
5001852452, 5001858763





Premium ...

Route 385.24T,400.24T	09/96→	Ball Head, gearshift linkage	CV-ES-2121		for vehicles without Pneumatic Suspension	
	09/96→	Ball Head, gearshift linkage	DF-ES-9335			
	09/96→	Ball Head, gearshift linkage	IV-ES-12273			
	09/96→	Centre Rod	RV-DL-0883		Push Rod	
	09/96→	Centre Rod	RV-DL-0887		Coupling Rod	
	09/96→	Tie Rod	RV-DL-8313		Guide Rod	
	09/96→	Tie Rod	RV-DL-8314		Guide Rod	
	09/96→	Tie Rod	RV-DL-10243			
	09/96→	Tie Rod	RV-DL-12334			
	09/96→	Tie Rod End	CV-ES-14162		for Steering Rod	
	09/96→	Tie Rod End	CV-ES-14163		for Steering Rod	
	09/96→	Tie Rod End	SC-ES-7279		for Steering Rod	
	07/99→	Tie Rod	RV-DL-8318		Guide Rod, Air Suspension Axle	
Route 385.26	04/96→	Ball Head, gearshift linkage	CV-ES-2121		for vehicles without Pneumatic Suspension	
	04/96→	Ball Head, gearshift linkage	DF-ES-9335			
	04/96→	Ball Head, gearshift linkage	IV-ES-12273			
	04/96→	Centre Rod	RV-DL-0883		Push Rod	
	04/96→	Centre Rod	RV-DL-0887		Coupling Rod	
	04/96→	Suspension Strut Repair Kit		MN-RK-8501		
	04/96→	Tie Rod	RV-DL-8313		Guide Rod	
	04/96→	Tie Rod	RV-DL-10243			
	04/96→	Tie Rod	RV-DL-12334			
	04/96→	Tie Rod End		MN-ES-8490	for vehicles with Hinged Trailing Axle	
	04/96→	Tie Rod End	CV-ES-14162		for Steering Rod	
	04/96→	Tie Rod End	CV-ES-14163		for Steering Rod	
	04/96→	Tie Rod End	IV-ES-12272		for Steering Rod	
	04/96→	Tie Rod End	SC-ES-7279		for Steering Rod	
	04/96→	Track Control Arm		RV-VB-8191	Wishbone (CV)	
Route 385.26,400.26	04/96→	Ball Head, gearshift linkage	CV-ES-2121		for vehicles without Pneumatic Suspension	
	04/96→	Ball Head, gearshift linkage	DF-ES-9335			
	04/96→	Ball Head, gearshift linkage	IV-ES-12273			
	04/96→	Centre Rod	RV-DL-0883		Push Rod	
	04/96→	Centre Rod	RV-DL-0887		Coupling Rod	
	04/96→	Centre Rod	RV-DL-8299		Suspension Rod	
	04/96→	Suspension Strut Repair Kit		MN-RK-8501		
	04/96→	Tie Rod	RV-DL-8313		Guide Rod, Leaf Spring Axle	
	04/96→	Tie Rod	RV-DL-10243			
	04/96→	Tie Rod	RV-DL-12334			
	04/96→	Tie Rod End	CV-ES-14162		for Steering Rod	
	04/96→	Tie Rod End	CV-ES-14163		for Steering Rod	
	04/96→	Tie Rod End	SC-ES-7279		for Steering Rod	
	04/96→	Track Control Arm		RV-VB-8191	Wishbone (CV)	
	07/99→	Tie Rod	RV-DL-8314		Guide Rod, Air Suspension Axle	
	Route 420.18	08/00→	Ball Head, gearshift linkage	CV-ES-2121		for vehicles without Pneumatic Suspension
		08/00→	Ball Head, gearshift linkage	DF-ES-9335		
08/00→		Ball Head, gearshift linkage	IV-ES-12273			
08/00→		Centre Rod	RV-DL-0887		Coupling Rod	
08/00→		Centre Rod	RV-DL-0908		Push Rod, for vehicles without Pneumatic Suspension	
08/00→		Centre Rod	RV-DL-0919		Push Rod, for Pneumatic Suspension vehicles	
08/00→		Centre Rod	RV-DL-8299		Push Rod, Leaf Spring Axle	
08/00→		Suspension Strut Repair Kit		MN-RK-8501		
08/00→		Tie Rod	RV-DL-8302			
08/00→		Tie Rod	RV-DL-8313		Guide Rod, Leaf Spring Axle	
08/00→		Tie Rod	RV-DL-8314		Guide Rod, Air Suspension Axle	
08/00→		Tie Rod	RV-DL-8318		Guide Rod, Air Suspension Axle	
08/00→		Tie Rod	RV-DL-10243			
08/00→		Tie Rod	RV-DL-12334			
08/00→		Tie Rod End	CV-ES-14162		for Steering Rod	
08/00→		Tie Rod End	CV-ES-14163		for Steering Rod	
08/00→		Tie Rod End	SC-ES-7279		for Steering Rod	
08/00→		Track Control Arm		RV-VB-8191	Wishbone (CV)	

CV-ES-2121

Length: 85
Cone Ø: d1 Ø 12 / d2 Ø 10,8
Thread: M14 x 1,5 RHT
23162046, 5000516214, 5010144543,
5010245591



MN-ES-8490

Length: 90
Cone Ø: d1 Ø 30 / d2 Ø 27
Thread: M26 x 1,5 RHT
0014606948, 14606948, 5001849880



RV-DL-8299

Length: 827
Ø: 52
Cone Ø: d1 Ø 30 / d2 Ø 27
5010294720



RV-DL-12334

Length: 1686
Ø: 60
Cone Ø: d1 Ø 30 / d2 Ø 27
21560963, 5001868366, 5010587034,
5010587038, 7421560963, 7422163637



CV-ES-14162

Length: 125
Cone Ø: d1 Ø 30 / d2 Ø 27
Thread: M30 x 1,5 LHT
3401170, 5000288361, 5001832581,
5001858759, 5001858774



MN-RK-8501

Ø: 75
Hole Distance: 115
Thick/Height: 24
7420547286



RV-DL-8302

Length: 1570
Ø: 48
Cone Ø: d1 Ø 30 / d2 Ø 27
5010308083



RV-VB-8191

Length: 662,4
Ø: 48
Hole Distance: 115 / 115
7420741703, RRVB8191



CV-ES-14163

Length: 125
Cone Ø: d1 Ø 30 / d2 Ø 27
Thread: M30 x 1,5 RHT
0003406169, 0003406236, 0003406251,
0003406254, 0003406260, 0003406261,
5000288360, 5000590236, 5000804824,
5001858773, 7420937674, 7701011412



RV-DL-0883

Length: 847
Ø: 52
Cone Ø: d1 Ø 30 / d2 Ø 27
5010294502



RV-DL-8313

Length: 1752
Ø: 48
Cone Ø: d1 Ø 30 / d2 Ø 27
5010098467, 5010145584, 5010439631



SC-ES-7279

Length: 150
Cone Ø: d1 Ø 30 / d2 Ø 27
Thread: M30 x 1,5 RHT
5001852452, 5001858763



DF-ES-9335

Length: 85
Cone Ø: d1 Ø 12 / d2 Ø 10,75
Thread: M14 x 1,5 RHT
23162046, 5000516214, 5010144543,
5010245591



RV-DL-0887

Length: 1720
Ø: 48
Cone Ø: d1 Ø 30 / d2 Ø 27
5010308082



RV-DL-8314

Length: 1758
Ø: 52
Cone Ø: d1 Ø 30 / d2 Ø 27
5010439021, 5010566063



IV-ES-12272

Length: 75
Cone Ø: d1 Ø 30 / d2 Ø 27
Thread: M26 x 1,5 RHT
5001849879



RV-DL-0908

Length: 845
Ø: 52
Cone Ø: d1 Ø 30 / d2 Ø 27
5010294288



RV-DL-8318

Length: 1720
Ø: 52
Cone Ø: d1 Ø 30 / d2 Ø 27
5010439022, 5010566064



IV-ES-12273

Length: 36
Thread: M10 x 1,5 RHT
5010245365



RV-DL-0919

Length: 870
Ø: 62
Cone Ø: d1 Ø 30 / d2 Ø 27
5010294289



RV-DL-10243

Length: 1726
Ø: 60
Cone Ø: d1 Ø 30 / d2 Ø 27
Thread: M24 x 1,5 RHT
5001868363, 5010587004, 5010600822,
7421560957





Premium ...

Route 420.18T	08/00→	Ball Head, gearshift linkage	CV-ES-2121		for vehicles without Pneumatic Suspension
	08/00→	Ball Head, gearshift linkage	DF-ES-9335		
	08/00→	Ball Head, gearshift linkage	IV-ES-12273		
	08/00→	Centre Rod	RV-DL-0887		Coupling Rod
	08/00→	Centre Rod	RV-DL-0901		Push Rod, for vehicles without Pneumatic Suspension
	08/00→	Centre Rod	RV-DL-0919		Push Rod, for Pneumatic Suspension vehicles
	08/00→	Suspension Strut Repair Kit		MN-RK-8501	
	08/00→	Tie Rod	RV-DL-8314		Guide Rod
	08/00→	Tie Rod	RV-DL-8318		Guide Rod
	08/00→	Tie Rod	RV-DL-10243		
	08/00→	Tie Rod	RV-DL-12334		
	08/00→	Tie Rod End	CV-ES-14162		for Steering Rod
	08/00→	Tie Rod End	CV-ES-14163		for Steering Rod
	08/00→	Tie Rod End	SC-ES-7279		for Steering Rod
	Route 420.24	08/00→	Track Control Arm		RV-VB-8191
08/00→		Ball Head, gearshift linkage	CV-ES-2121		for vehicles without Pneumatic Suspension
08/00→		Ball Head, gearshift linkage	DF-ES-9335		
08/00→		Ball Head, gearshift linkage	IV-ES-12273		
08/00→		Centre Rod	RV-DL-0883		Push Rod
08/00→		Centre Rod	RV-DL-0887		Coupling Rod
08/00→		Suspension Strut Repair Kit		MN-RK-8501	
08/00→		Tie Rod	RV-DL-8313		Guide Rod, Leaf Spring Axle
08/00→		Tie Rod	RV-DL-8314		Guide Rod
08/00→		Tie Rod	RV-DL-8314		Guide Rod, Air Suspension Axle
08/00→		Tie Rod	RV-DL-10243		
08/00→		Tie Rod	RV-DL-12334		
08/00→		Tie Rod End		MN-ES-8490	for vehicles with Hinged Trailing Axle
08/00→		Tie Rod End	CV-ES-14162		for Steering Rod
08/00→		Tie Rod End	CV-ES-14163		for Steering Rod
08/00→	Tie Rod End	IV-ES-12272		for Steering Rod	
08/00→	Tie Rod End	SC-ES-7279		for Steering Rod	
Route 420.25	08/00→	Track Control Arm		RV-VB-8191	Wishbone (CV)
	08/00→	Ball Head, gearshift linkage	CV-ES-2121		for vehicles without Pneumatic Suspension
	08/00→	Ball Head, gearshift linkage	DF-ES-9335		
	08/00→	Ball Head, gearshift linkage	IV-ES-12273		
	08/00→	Centre Rod	RV-DL-0883		Push Rod
	08/00→	Centre Rod	RV-DL-0887		Coupling Rod
	08/00→	Suspension Strut Repair Kit		MN-RK-8501	
	08/00→	Tie Rod		RV-DL-8318	Guide Rod, Leading Axle
	08/00→	Tie Rod	RV-DL-8314		Guide Rod
	08/00→	Tie Rod	RV-DL-10243		
	08/00→	Tie Rod	RV-DL-12334		
	08/00→	Tie Rod End	CV-ES-14162		for Steering Rod
	08/00→	Tie Rod End	CV-ES-14163		for Steering Rod
	08/00→	Tie Rod End	SC-ES-7279		for Steering Rod
	Route 420.26	08/00→	Track Control Arm		RV-VB-8191
08/00→		Ball Head, gearshift linkage	CV-ES-2121		for vehicles without Pneumatic Suspension
08/00→		Ball Head, gearshift linkage	DF-ES-9335		
08/00→		Ball Head, gearshift linkage	IV-ES-12273		
08/00→		Centre Rod	RV-DL-0883		Push Rod
08/00→		Centre Rod	RV-DL-0887		Coupling Rod
08/00→		Suspension Strut Repair Kit		MN-RK-8501	
08/00→		Tie Rod	RV-DL-8313		Guide Rod, Leaf Spring Axle
08/00→		Tie Rod	RV-DL-8314		Guide Rod, Air Suspension Axle
08/00→		Tie Rod	RV-DL-10243		
08/00→		Tie Rod	RV-DL-12334		
08/00→		Tie Rod End		MN-ES-8490	for vehicles with Hinged Trailing Axle
08/00→		Tie Rod End	CV-ES-14162		for Steering Rod
08/00→		Tie Rod End	CV-ES-14163		for Steering Rod
08/00→		Tie Rod End	IV-ES-12272		for Steering Rod
08/00→	Tie Rod End	SC-ES-7279		for Steering Rod	
08/00→	Track Control Arm		RV-VB-8191	Wishbone (CV)	

CV-ES-2121

Length: 85
Cone Ø: d1 Ø 12 / d2 Ø 10,8
Thread: M14 x 1,5 RHT
23162046, 5000516214, 5010144543,
5010245591



MN-ES-8490

Length: 90
Cone Ø: d1 Ø 30 / d2 Ø 27
Thread: M26 x 1,5 RHT
14606948, 0014606948, 5001849880



RV-DL-8313

Length: 1752
Ø: 48
Cone Ø: d1 Ø 30 / d2 Ø 27
5010098467, 5010145584, 5010439631



SC-ES-7279

Length: 150
Cone Ø: d1 Ø 30 / d2 Ø 27
Thread: M30 x 1,5 RHT
5001852452, 5001858763



CV-ES-14162

Length: 125
Cone Ø: d1 Ø 30 / d2 Ø 27
Thread: M30 x 1,5 LHT
3401170, 5000288361, 5001832581,
5001858759, 5001858774



MN-RK-8501

Ø: 75
Hole Distance: 115
Thick/Height: 24
7420547286



RV-DL-8314

Length: 1758
Ø: 52
Cone Ø: d1 Ø 30 / d2 Ø 27
5010439021, 5010566063



CV-ES-14163

Length: 125
Cone Ø: d1 Ø 30 / d2 Ø 27
Thread: M30 x 1,5 RHT
0003406169, 0003406236, 0003406251,
0003406254, 0003406260, 0003406261,
5000288360, 5000590236, 5000804824,
5001858773, 7420937674, 7701011412



RV-DL-0883

Length: 847
Ø: 52
Cone Ø: d1 Ø 30 / d2 Ø 27
5010294502



RV-DL-8318

Length: 1720
Ø: 52
Cone Ø: d1 Ø 30 / d2 Ø 27
5010439022, 5010566064



DF-ES-9335

Length: 85
Cone Ø: d1 Ø 12 / d2 Ø 10,75
Thread: M14 x 1,5 RHT
23162046, 5000516214, 5010144543,
5010245591



RV-DL-0887

Length: 1720
Ø: 48
Cone Ø: d1 Ø 30 / d2 Ø 27
5010308082



RV-DL-10243

Length: 1726
Ø: 60
Cone Ø: d1 Ø 30 / d2 Ø 27
Thread: M24 x 1,5 RHT
5001868363, 5010587004, 5010600822,
7421560957



IV-ES-12272

Length: 75
Cone Ø: d1 Ø 30 / d2 Ø 27
Thread: M26 x 1,5 RHT
5001849879



RV-DL-0901

Length: 810
Ø: 50
Cone Ø: d1 Ø 30 / d2 Ø 27
5010294287



RV-DL-12334

Length: 1686
Ø: 60
Cone Ø: d1 Ø 30 / d2 Ø 27
21560963, 5001868366, 5010587034,
5010587038, 7421560963, 7422163637



IV-ES-12273

Length: 36
Thread: M10 x 1,5 RHT
5010245365



RV-DL-0919

Length: 870
Ø: 62
Cone Ø: d1 Ø 30 / d2 Ø 27
5010294289



RV-VB-8191

Length: 662,4
Ø: 48
Hole Distance: 115 / 115
7420741703, RVVB8191





Premium 2

Distribution 240.18 D	05/06→	Centre Rod	RV-DL-8415		Push Rod	
	05/06→	Centre Rod	RV-DL-12480		Push Rod	
	05/06→	Suspension Strut Repair Kit		MN-RK-8501		
	05/06→	Tie Rod	RV-DL-10243			
	05/06→	Tie Rod	RV-DL-12334			
	05/06→	Tie Rod	RV-DL-12337			
	05/06→	Tie Rod End	RV-ES-12331			
	05/06→	Tie Rod End	SC-ES-7279			for Steering Rod
Distribution 270.19	05/06→	Track Control Arm		RV-VB-8191	Wishbone (CV)	
	10/06→	Centre Rod	RV-DL-8415		Push Rod	
	10/06→	Centre Rod	RV-DL-12480		Push Rod	
	10/06→	Tie Rod	RV-DL-10243			
	10/06→	Tie Rod	RV-DL-12334			
	10/06→	Tie Rod	RV-DL-12337			
	10/06→	Tie Rod End	RV-ES-12331			
Distribution 280.18 D	10/05→	Ball Head, gearshift linkage	DF-ES-9335			
	10/05→	Bush, parabolic spring		VL-SB-5356		
	10/05→	Centre Rod	RV-DL-8415		Push Rod	
	10/05→	Centre Rod	RV-DL-12480		Push Rod	
	10/05→	Suspension Strut Repair Kit		MN-RK-8501		
	10/05→	Tie Rod	RV-DL-8314		Guide Rod	
	10/05→	Tie Rod	RV-DL-10243			
	10/05→	Tie Rod	RV-DL-12334			
	10/05→	Tie Rod	RV-DL-12337			
	10/05→	Tie Rod End	RV-ES-12331			
	10/05→	Tie Rod End	SC-ES-7279			for Steering Rod
	10/05→	Track Control Arm		RV-VB-8191		Wishbone (CV)
Distribution 280.26	10/05→	Ball Head, gearshift linkage	DF-ES-9335			
	10/05→	Bush, parabolic spring		VL-SB-5356		
	10/05→	Centre Rod	RV-DL-12480		Push Rod	
	10/05→	Suspension Strut Repair Kit		MN-RK-8501		
	10/05→	Tie Rod	RV-DL-8314		Guide Rod	
	10/05→	Tie Rod	RV-DL-10243			
	10/05→	Tie Rod	RV-DL-12334			
	10/05→	Tie Rod	RV-DL-12338			
	10/05→	Tie Rod End		RV-ES-9432		
	10/05→	Tie Rod End	RV-ES-12331			
	10/05→	Tie Rod End	RV-ES-12442			
	10/05→	Tie Rod End	SC-ES-7279			for Steering Rod
	10/05→	Track Control Arm		RV-VB-8191		Wishbone (CV)
Distribution 310.18	10/06→	Centre Rod	RV-DL-8415		Push Rod	
	10/06→	Centre Rod	RV-DL-12480		Push Rod	
	10/06→	Tie Rod	RV-DL-10243			
	10/06→	Tie Rod	RV-DL-12334			
	10/06→	Tie Rod	RV-DL-12337			
	10/06→	Tie Rod End	RV-ES-12331			
Distribution 310.26	10/06→	Centre Rod	RV-DL-12480		Push Rod	
	10/06→	Tie Rod	RV-DL-10243			
	10/06→	Tie Rod	RV-DL-12334			
	10/06→	Tie Rod	RV-DL-12338			
	10/06→	Tie Rod End		RV-ES-9432		
	10/06→	Tie Rod End	RV-ES-12331			
	10/06→	Tie Rod End	RV-ES-12442			
Distribution 320.18	05/06→	Bush, parabolic spring		VL-SB-5356		
	05/06→	Centre Rod	RV-DL-12480		Push Rod	
	05/06→	Suspension Strut Repair Kit		MN-RK-8501		
	05/06→	Tie Rod	RV-DL-10243			
	05/06→	Tie Rod	RV-DL-12334			
	05/06→	Tie Rod	RV-DL-12337			
	05/06→	Tie Rod End	RV-ES-12331			
	05/06→	Tie Rod End	SC-ES-7279			for Steering Rod
05/06→	Track Control Arm		RV-VB-8191		Wishbone (CV)	

DF-ES-9335

Length: 85
Cone Ø: d1 Ø 12 / d2 Ø 10,75
Thread: M14 x 1,5 RHT
23162046, 5000516214, 5010144543,
5010245591



MN-RK-8501

Ø: 75
Hole Distance: 115
Thick/Height: 24
7420547286



RV-DL-8314

Length: 1758
Ø: 52
Cone Ø: d1 Ø 30 / d2 Ø 27
5010439021, 5010566063



RV-DL-8415

Length: 825
Ø: 62
Cone Ø: d1 Ø 30 / d2 Ø 27
25379293, 5001868384, 5010630822,
5010630823, 7421560882



RV-DL-10243

Length: 1726
Ø: 60
Cone Ø: d1 Ø 30 / d2 Ø 27
Thread: M24 x 1,5 RHT
5001868363, 5010587004, 5010600822,
7421560957



RV-DL-12334

Length: 1686
Ø: 60
Cone Ø: d1 Ø 30 / d2 Ø 27
21560963, 5001868366, 5010587034,
5010587038, 7421560963, 7422163637



RV-DL-12337

Length: 1676
Ø: 40
Cone Ø: d1 Ø 30 / d2 Ø 27
Thread: M30 x 1,5 RHT
21560968, 25370845, 5001868367,
5010587050, 5010587053, 7421560968



RV-DL-12338

Length: 1719
Ø: 40
Cone Ø: d1 Ø 30 / d2 Ø 27
Thread: M30 x 1,5 RHT
21560965, 25370844, 5001868404,
5010587049, 5010587052, 7421560965



RV-DL-12480

Length: 922
Ø: 42
Cone Ø: d1 Ø 26 / d2 Ø 23,5
50 10 305 365, 50 10 630 255



RV-ES-9432

Length: 120
Cone Ø: d1 Ø 28 / d2 Ø 23,9
Thread: M26 x 1,5 RHT
7403193731



RV-ES-12331

Length: 140
Cone Ø: d1 Ø 30 / d2 Ø 27
Thread: M32 x 1,5 RHT / M24 x 1,5 RHT
0014607248, 014607248, 5001866165,
5001867774, 7485134391



RV-ES-12442

Length: 88
Cone Ø: d1 Ø 28,6
Thread: M26 x 1,5 RHT
7403987648



RV-VB-8191

Length: 662,4
Ø: 48
Hole Distance: 115 / 115
7420741703, RVVB8191



SC-ES-7279

Length: 150
Cone Ø: d1 Ø 30 / d2 Ø 27
Thread: M30 x 1,5 RHT
5001852452, 5001858763



VL-SB-5356

Thick/Height: 150
7420390836





Premium 2 ...

Distribution 320.18 D	10/05→	Bush, parabolic spring		VL-SB-5356		
	10/05→	Centre Rod	RV-DL-8415		Push Rod	
	10/05→	Centre Rod	RV-DL-12480		Push Rod	
	10/05→	Suspension Strut Repair Kit		MN-RK-8501		
	10/05→	Tie Rod	RV-DL-8314		Guide Rod	
	10/05→	Tie Rod	RV-DL-10243			
	10/05→	Tie Rod	RV-DL-12334			
	10/05→	Tie Rod	RV-DL-12337			
	10/05→	Tie Rod End	RV-ES-12331			
	10/05→	Tie Rod End	SC-ES-7279		for Steering Rod	
	10/05→	Track Control Arm		RV-VB-8191	Wishbone (CV)	
	Distribution 320.26	10/05→	Bush, parabolic spring		VL-SB-5356	
		10/05→	Centre Rod	RV-DL-12480		Push Rod
		10/05→	Suspension Strut Repair Kit		MN-RK-8501	
10/05→		Tie Rod	RV-DL-8314		Guide Rod	
10/05→		Tie Rod	RV-DL-10243			
10/05→		Tie Rod	RV-DL-12334			
10/05→		Tie Rod	RV-DL-12338			
10/05→		Tie Rod End		RV-ES-9432		
10/05→		Tie Rod End	RV-ES-12331			
10/05→		Tie Rod End	RV-ES-12442			
10/05→		Tie Rod End	SC-ES-7279		for Steering Rod	
10/05→		Track Control Arm		RV-VB-8191	Wishbone (CV)	
Distribution 340.18		10/06→	Centre Rod	RV-DL-8415		Push Rod
		10/06→	Centre Rod	RV-DL-12480		Push Rod
	10/06→	Tie Rod	RV-DL-10243			
	10/06→	Tie Rod	RV-DL-12334			
	10/06→	Tie Rod	RV-DL-12337			
	10/06→	Tie Rod End	RV-ES-12331			
Distribution 340.19	10/06→	Centre Rod	RV-DL-12480		Push Rod	
	10/06→	Tie Rod	RV-DL-10243			
	10/06→	Tie Rod	RV-DL-12334			
	10/06→	Tie Rod	RV-DL-12337			
	10/06→	Tie Rod End	RV-ES-12331			
Distribution 340.26	10/06→	Centre Rod	RV-DL-12480		Push Rod	
	10/06→	Tie Rod	RV-DL-10243			
	10/06→	Tie Rod	RV-DL-12334			
	10/06→	Tie Rod	RV-DL-12338			
	10/06→	Tie Rod End		RV-ES-9432		
	10/06→	Tie Rod End	RV-ES-12331			
	10/06→	Tie Rod End	RV-ES-12442			
Distribution 370.18 D	10/05→	Ball Head, gearshift linkage	DF-ES-9335			
	10/05→	Bush, parabolic spring		VL-SB-5356		
	10/05→	Centre Rod	RV-DL-8415		Push Rod, Leaf Spring Axle	
	10/05→	Tie Rod	RV-DL-8314		Guide Rod	
	10/05→	Tie Rod	RV-DL-10243			
	10/05→	Tie Rod	RV-DL-12334			
	10/05→	Tie Rod	RV-DL-12337			
	10/05→	Tie Rod	RV-DL-12338			
	10/05→	Tie Rod End	RV-ES-12331			
	10/05→	Tie Rod End	SC-ES-7279		for Steering Rod	
	Distribution 370.26	10/05→	Bush, parabolic spring		VL-SB-5356	
		10/05→	Centre Rod	RV-DL-8415		Push Rod, Leaf Spring Axle
		10/05→	Suspension Strut Repair Kit		MN-RK-8501	
10/05→		Tie Rod	RV-DL-8314		Guide Rod	
10/05→		Tie Rod	RV-DL-10243			
10/05→		Tie Rod	RV-DL-12334			
10/05→		Tie Rod	RV-DL-12338			
10/05→		Tie Rod End		RV-ES-9432		
10/05→		Tie Rod End	RV-ES-12331			
10/05→		Tie Rod End	RV-ES-12442			
10/05→		Tie Rod End	SC-ES-7279		for Steering Rod	
10/05→		Track Control Arm		RV-VB-8191	Wishbone (CV)	

DF-ES-9335

Length: 85
Cone Ø: d1 Ø 12 / d2 Ø 10,75
Thread: M14 x 1,5 RHT
23162046, 5000516214, 5010144543,
5010245591



MN-RK-8501

Ø: 75
Hole Distance: 115
Thick/Height: 24
7420547286



RV-DL-8314

Length: 1758
Ø: 52
Cone Ø: d1 Ø 30 / d2 Ø 27
5010439021, 5010566063



RV-DL-8415

Length: 825
Ø: 62
Cone Ø: d1 Ø 30 / d2 Ø 27
25379293, 5001868384, 5010630822,
5010630823, 7421560882



RV-DL-10243

Length: 1726
Ø: 60
Cone Ø: d1 Ø 30 / d2 Ø 27
Thread: M24 x 1,5 RHT
5001868363, 5010587004, 5010600822,
7421560957



RV-DL-12334

Length: 1686
Ø: 60
Cone Ø: d1 Ø 30 / d2 Ø 27
21560963, 5001868366, 5010587034,
5010587038, 7421560963, 7422163637



RV-DL-12337

Length: 1676
Ø: 40
Cone Ø: d1 Ø 30 / d2 Ø 27
Thread: M30 x 1,5 RHT
21560968, 25370845, 5001868367,
5010587050, 5010587053, 7421560968



RV-DL-12338

Length: 1719
Ø: 40
Cone Ø: d1 Ø 30 / d2 Ø 27
Thread: M30 x 1,5 RHT
21560965, 25370844, 5001868404,
5010587049, 5010587052, 7421560965



RV-DL-12480

Length: 922
Ø: 42
Cone Ø: d1 Ø 26 / d2 Ø 23,5
50 10 305 365, 50 10 630 255



RV-ES-9432

Length: 120
Cone Ø: d1 Ø 28 / d2 Ø 23,9
Thread: M26 x 1,5 RHT
7403193731



RV-ES-12331

Length: 140
Cone Ø: d1 Ø 30 / d2 Ø 27
Thread: M32 x 1,5 RHT / M24 x 1,5 RHT
0014607248, 014607248, 5001866165,
5001867774, 7485134391



RV-ES-12442

Length: 88
Cone Ø: d1 Ø 28,6
Thread: M26 x 1,5 RHT
7403987648



RV-VB-8191

Length: 662,4
Ø: 48
Hole Distance: 115 / 115
7420741703, RVVB8191



SC-ES-7279

Length: 150
Cone Ø: d1 Ø 30 / d2 Ø 27
Thread: M30 x 1,5 RHT
5001852452, 5001858763



VL-SB-5356

Thick/Height: 150
7420390836



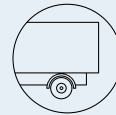

Premium 2 ...

Distribution 380.18	10/06→	Centre Rod	RV-DL-8415		Push Rod, Leaf Spring Axle	
	10/06→	Tie Rod	RV-DL-10243			
	10/06→	Tie Rod	RV-DL-12334			
	10/06→	Tie Rod	RV-DL-12337			
	10/06→	Tie Rod	RV-DL-12338			
	10/06→	Tie Rod End	RV-ES-12331			
Distribution 380.19	10/06→	Centre Rod	RV-DL-8415		Push Rod, Leaf Spring Axle	
	10/06→	Tie Rod	RV-DL-12334			
	10/06→	Tie Rod	RV-DL-12337			
	10/06→	Tie Rod End	RV-ES-12331			
Distribution 380.26	10/06→	Centre Rod	RV-DL-8415		Push Rod, Leaf Spring Axle	
	10/06→	Tie Rod	RV-DL-10243			
	10/06→	Tie Rod	RV-DL-12338			
	10/06→	Tie Rod End		RV-ES-9432		
	10/06→	Tie Rod End	RV-ES-12331			
	10/06→	Tie Rod End	RV-ES-12442			
Distribution 410.18 D	10/05→	Ball Head, gearshift linkage	DF-ES-9335			
	10/05→	Bush, parabolic spring		VL-SB-5356		
	10/05→	Centre Rod	RV-DL-8415		Push Rod, Leaf Spring Axle	
	10/05→	Suspension Strut Repair Kit		MN-RK-8501		
	10/05→	Tie Rod	RV-DL-8314		Guide Rod	
	10/05→	Tie Rod	RV-DL-10243			
	10/05→	Tie Rod	RV-DL-12334			
	10/05→	Tie Rod	RV-DL-12337			
	10/05→	Tie Rod	RV-DL-12338			
	10/05→	Tie Rod End	RV-ES-12331			
	10/05→	Tie Rod End	SC-ES-7279		for Steering Rod	
	10/05→	Track Control Arm		RV-VB-8191	Wishbone (CV)	
	Distribution 410.26	10/05→	Ball Head, gearshift linkage	DF-ES-9335		
		10/05→	Bush, parabolic spring		VL-SB-5356	
10/05→		Centre Rod	RV-DL-8415		Push Rod, Leaf Spring Axle	
10/05→		Suspension Strut Repair Kit		MN-RK-8501		
10/05→		Tie Rod	RV-DL-8314		Guide Rod	
10/05→		Tie Rod	RV-DL-10243			
10/05→		Tie Rod	RV-DL-12334			
10/05→		Tie Rod	RV-DL-12338			
10/05→		Tie Rod End		RV-ES-9432		
10/05→		Tie Rod End	RV-ES-12331			
10/05→		Tie Rod End	RV-ES-12442			
10/05→		Tie Rod End	SC-ES-7279		for Steering Rod	
10/05→		Track Control Arm		RV-VB-8191	Wishbone (CV)	
Distribution 430.18		10/06→	Centre Rod	RV-DL-8415		Push Rod, Leaf Spring Axle
	10/06→	Tie Rod	RV-DL-10243			
	10/06→	Tie Rod	RV-DL-12334			
	10/06→	Tie Rod	RV-DL-12337			
	10/06→	Tie Rod	RV-DL-12338			
	10/06→	Tie Rod End	RV-ES-12331			
Distribution 430.19	10/06→	Centre Rod	RV-DL-8415		Push Rod, Leaf Spring Axle	
	10/06→	Tie Rod	RV-DL-12334			
	10/06→	Tie Rod	RV-DL-12337			
	10/06→	Tie Rod End	RV-ES-12331			
Distribution 430.26	10/06→	Centre Rod	RV-DL-8415		Push Rod, Leaf Spring Axle	
	10/06→	Tie Rod	RV-DL-10243			
	10/06→	Tie Rod	RV-DL-12338			
	10/06→	Tie Rod End		RV-ES-9432		
	10/06→	Tie Rod End	RV-ES-12331			
	10/06→	Tie Rod End	RV-ES-12442			
Distribution 450.18 D	10/05→	Ball Head, gearshift linkage	DF-ES-9335			
	10/05→	Bush, parabolic spring		VL-SB-5356		
	10/05→	Centre Rod	RV-DL-8415		Push Rod, Leaf Spring Axle	
	10/05→	Suspension Strut Repair Kit		MN-RK-8501		
	10/05→	Tie Rod	RV-DL-8314		Guide Rod	
	10/05→	Tie Rod	RV-DL-12334			

DF-ES-9335

Length: 85
Cone Ø: d1 Ø 12 / d2 Ø 10,75
Thread: M14 x 1,5 RHT
23162046, 5000516214, 5010144543,
5010245591



MN-RK-8501

Ø: 75
Hole Distance: 115
Thick/Height: 24
7420547286



RV-DL-8314

Length: 1758
Ø: 52
Cone Ø: d1 Ø 30 / d2 Ø 27
5010439021, 5010566063



RV-DL-8415

Length: 825
Ø: 62
Cone Ø: d1 Ø 30 / d2 Ø 27
25379293, 5001868384, 5010630822,
5010630823, 7421560882



RV-DL-10243

Length: 1726
Ø: 60
Cone Ø: d1 Ø 30 / d2 Ø 27
Thread: M24 x 1,5 RHT
5001868363, 5010587004, 5010600822,
7421560957



RV-DL-12334

Length: 1686
Ø: 60
Cone Ø: d1 Ø 30 / d2 Ø 27
21560963, 5001868366, 5010587034,
5010587038, 7421560963, 7422163637



RV-DL-12337

Length: 1676
Ø: 40
Cone Ø: d1 Ø 30 / d2 Ø 27
Thread: M30 x 1,5 RHT
21560968, 25370845, 5001868367,
5010587050, 5010587053, 7421560968



RV-DL-12338

Length: 1719
Ø: 40
Cone Ø: d1 Ø 30 / d2 Ø 27
Thread: M30 x 1,5 RHT
21560965, 25370844, 5001868404,
5010587049, 5010587052, 7421560965



RV-ES-9432

Length: 120
Cone Ø: d1 Ø 28 / d2 Ø 23,9
Thread: M26 x 1,5 RHT
7403193731



RV-ES-12331

Length: 140
Cone Ø: d1 Ø 30 / d2 Ø 27
Thread: M32 x 1,5 RHT / M24 x 1,5 RHT
0014607248, 014607248, 5001866165,
5001867774, 7485134391



RV-ES-12442

Length: 88
Cone Ø: d1 Ø 28,6
Thread: M26 x 1,5 RHT
7403987648



RV-VB-8191

Length: 662,4
Ø: 48
Hole Distance: 115 / 115
7420741703, RVVB8191



SC-ES-7279

Length: 150
Cone Ø: d1 Ø 30 / d2 Ø 27
Thread: M30 x 1,5 RHT
5001852452, 5001858763



VL-SB-5356

Thick/Height: 150
7420390836



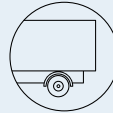

Premium 2 ...

Distribution 450.18 D ...	10/05→	Tie Rod	RV-DL-12337	
	10/05→	Tie Rod	RV-DL-12338	
	10/05→	Tie Rod End	RV-ES-12331	
	10/05→	Tie Rod End	SC-ES-7279	for Steering Rod
	10/05→	Track Control Arm		RV-VB-8191 Wishbone (CV)
Distribution 460.19	10/06→	Centre Rod	RV-DL-8415	Push Rod, Leaf Spring Axle
	10/06→	Tie Rod	RV-DL-10243	
	10/06→	Tie Rod	RV-DL-12334	
	10/06→	Tie Rod	RV-DL-12337	
	10/06→	Tie Rod	RV-DL-12338	
	10/06→	Tie Rod End	RV-ES-12331	
Lander 270.18, Lander 270.19	10/06→	Centre Rod	RV-DL-8415	Push Rod
	10/06→	Centre Rod	RV-DL-12480	Push Rod
	10/06→	Tie Rod	RV-DL-10243	
	10/06→	Tie Rod	RV-DL-12334	
	10/06→	Tie Rod	RV-DL-12337	
	10/06→	Tie Rod	RV-DL-12338	
	10/06→	Tie Rod End	RV-ES-12331	
Lander 310.19	10/06→	Centre Rod	RV-DL-8415	Push Rod
	10/06→	Centre Rod	RV-DL-12480	Push Rod
	10/06→	Tie Rod	RV-DL-10243	
	10/06→	Tie Rod	RV-DL-12334	
	10/06→	Tie Rod	RV-DL-12337	
	10/06→	Tie Rod	RV-DL-12338	
Lander 310.26	10/06→	Centre Rod	RV-DL-8415	Push Rod
	10/06→	Centre Rod	RV-DL-12480	Push Rod
	10/06→	Tie Rod	RV-DL-10243	
	10/06→	Tie Rod	RV-DL-12334	
	10/06→	Tie Rod	RV-DL-12337	
	10/06→	Tie Rod	RV-DL-12338	
	10/06→	Tie Rod End	RV-ES-12331	
	10/06→	Track Control Arm		RV-TC-12340 Trailing Arm
Lander 340.18, Lander 340.19	10/06→	Centre Rod	RV-DL-8415	Push Rod
	10/06→	Centre Rod	RV-DL-12480	Push Rod
	10/06→	Tie Rod	RV-DL-10243	
	10/06→	Tie Rod	RV-DL-12334	
	10/06→	Tie Rod	RV-DL-12337	
	10/06→	Tie Rod	RV-DL-12338	
	10/06→	Tie Rod End	RV-ES-12331	
	10/06→	Track Control Arm		RV-TC-12340 Trailing Arm
	10/06→	Track Control Arm		RV-VB-8191 Wishbone (CV), 1st RA;2nd RA; Leaf Spring Axle;Unit
	Lander 340.26	10/06→	Centre Rod	RV-DL-8415
10/06→		Centre Rod	RV-DL-12480	Push Rod
10/06→		Tie Rod	RV-DL-10243	
10/06→		Tie Rod	RV-DL-12334	
10/06→		Tie Rod	RV-DL-12337	
10/06→		Tie Rod	RV-DL-12338	
10/06→		Tie Rod End	RV-ES-12331	
10/06→		Track Control Arm		RV-TC-12340 Trailing Arm
Lander 380.19	10/06→	Centre Rod	RV-DL-8415	Push Rod
	10/06→	Centre Rod	RV-DL-8415	Push Rod, Leaf Spring Axle
	10/06→	Tie Rod	RV-DL-12337	
	10/06→	Tie Rod	RV-DL-12338	
	10/06→	Track Control Arm		RV-TC-12340 Trailing Arm
Lander 380.26	10/06→	Centre Rod	RV-DL-8415	Push Rod, Leaf Spring Axle
	10/06→	Tie Rod	RV-DL-12337	
	10/06→	Tie Rod	RV-DL-12338	
	10/06→	Track Control Arm		RV-TC-12340 Trailing Arm
Lander 380.26	10/06→	Track Control Arm		RV-VB-8191 Wishbone (CV), 1st RA;2nd RA; Leaf Spring Axle;Unit

RV-DL-8415

Length: 825

Ø: 62

Cone Ø: d1 Ø 30 / d2 Ø 27

25379293, 5001868384, 5010630822,
5010630823, 7421560882



RV-DL-12480

Length: 922

Ø: 42

Cone Ø: d1 Ø 26 / d2 Ø 23,5

50 10 305 365, 50 10 630 255



RV-DL-10243

Length: 1726

Ø: 60

Cone Ø: d1 Ø 30 / d2 Ø 27

Thread: M24 x 1,5 RHT

5001868363, 5010587004, 5010600822,
7421560957



RV-ES-12331

Length: 140

Cone Ø: d1 Ø 30 / d2 Ø 27

Thread: M32 x 1,5 RHT / M24 x 1,5 RHT

014607248, 0014607248, 5001866165,
5001867774, 7485134391



RV-DL-12334

Length: 1686

Ø: 60

Cone Ø: d1 Ø 30 / d2 Ø 27

21560963, 5001868366, 5010587034,
5010587038, 7421560963, 7422163637



RV-TC-12340

Length: 510

Hole Distance: 115 / 115

7420443044



RV-DL-12337

Length: 1676

Ø: 40

Cone Ø: d1 Ø 30 / d2 Ø 27

Thread: M30 x 1,5 RHT

21560968, 25370845, 5001868367,
5010587050, 5010587053, 7421560968



RV-VB-8191

Length: 662,4

Ø: 48

Hole Distance: 115 / 115

7420741703, RWVB8191



RV-DL-12338

Length: 1719

Ø: 40

Cone Ø: d1 Ø 30 / d2 Ø 27

Thread: M30 x 1,5 RHT

21560965, 25370844, 5001868404,
5010587049, 5010587052, 7421560965



SC-ES-7279

Length: 150

Cone Ø: d1 Ø 30 / d2 Ø 27

Thread: M30 x 1,5 RHT

5001852452, 5001858763





Premium 2 ...

Lander 380.32	10/06→	Tie Rod	RV-DL-12337	
	10/06→	Tie Rod	RV-DL-12338	
	10/06→	Track Control Arm		RV-TC-12340 Trailing Arm
	10/06→	Track Control Arm		RV-VB-8191 Wishbone (CV), 1st RA;2nd RA; Leaf Spring Axle;Unit
Lander 430.18	10/06→	Centre Rod	RV-DL-8415	Push Rod
	10/06→	Centre Rod	RV-DL-8415	Push Rod, Leaf Spring Axle
	10/06→	Tie Rod	RV-DL-12337	
	10/06→	Tie Rod	RV-DL-12338	
Lander 430.26	10/06→	Centre Rod	RV-DL-8415	Push Rod
	10/06→	Centre Rod	RV-DL-8415	Push Rod, Leaf Spring Axle
	10/06→	Tie Rod	RV-DL-12337	
	10/06→	Tie Rod	RV-DL-12338	
	10/06→	Track Control Arm		RV-TC-12340 Trailing Arm
	10/06→	Track Control Arm		RV-VB-8191 Wishbone (CV), 1st RA;2nd RA; Leaf Spring Axle;Unit
Lander 430.32	10/06→	Tie Rod	RV-DL-12337	
	10/06→	Tie Rod	RV-DL-12338	
	10/06→	Track Control Arm		RV-TC-12340 Trailing Arm
	10/06→	Track Control Arm		RV-VB-8191 Wishbone (CV), 1st RA;2nd RA; Leaf Spring Axle;Unit
Lander 440.32	10/05→	Tie Rod	RV-DL-12337	
	10/05→	Tie Rod	RV-DL-12338	
	10/05→	Track Control Arm		RV-TC-12340 Trailing Arm
	10/05→	Track Control Arm		RV-VB-8191 Wishbone (CV), 1st RA;2nd RA; Leaf Spring Axle;Unit
Lander 460.18	10/06→	Centre Rod	RV-DL-8415	Push Rod
	10/06→	Centre Rod	RV-DL-8415	Push Rod, Leaf Spring Axle
	10/06→	Tie Rod	RV-DL-12337	
	10/06→	Tie Rod	RV-DL-12338	
Lander 460.26	10/06→	Centre Rod	RV-DL-8415	Push Rod
	10/06→	Centre Rod	RV-DL-8415	Push Rod, Leaf Spring Axle
	10/06→	Tie Rod	RV-DL-12337	
	10/06→	Tie Rod	RV-DL-12338	
	10/06→	Track Control Arm		RV-TC-12340 Trailing Arm
	10/06→	Track Control Arm		RV-VB-8191 Wishbone (CV), 1st RA;2nd RA; Leaf Spring Axle;Unit
Lander 460.32	10/06→	Tie Rod	RV-DL-12337	
	10/06→	Tie Rod	RV-DL-12338	
	10/06→	Track Control Arm		RV-TC-12340 Trailing Arm
	10/06→	Track Control Arm		RV-VB-8191 Wishbone (CV), 1st RA;2nd RA; Leaf Spring Axle;Unit
Route 330.18 T	10/05→	Centre Rod	RV-DL-8415	Push Rod, Leaf Spring Axle
	10/05→	Tie Rod	RV-DL-12334	
	10/05→	Tie Rod End	RV-ES-12331	
Route 380.18	10/06→	Centre Rod	RV-DL-8415	Push Rod, Leaf Spring Axle
	10/06→	Tie Rod	RV-DL-10243	
	10/06→	Tie Rod	RV-DL-12334	
	10/06→	Tie Rod	RV-DL-12337	
	10/06→	Tie Rod	RV-DL-12338	
Route 380.19	10/06→	Centre Rod	RV-DL-8415	Push Rod, Leaf Spring Axle
	10/06→	Tie Rod	RV-DL-12334	
Route 380.26	10/06→	Centre Rod	RV-DL-8415	Push Rod, Leaf Spring Axle
	10/06→	Tie Rod	RV-DL-10243	
	10/06→	Tie Rod	RV-DL-12338	
	10/06→	Tie Rod End		RV-ES-9432
	10/06→	Tie Rod End	RV-ES-12442	
Route 410.18	10/05→	Ball Head, gearshift linkage	DF-ES-9335	
	10/05→	Centre Rod	RV-DL-8415	Push Rod, Leaf Spring Axle
	10/05→	Suspension Strut Repair Kit		MN-RK-8501
	10/05→	Tie Rod	RV-DL-8314	Guide Rod
	10/05→	Tie Rod	RV-DL-10243	
	10/05→	Tie Rod	RV-DL-12334	

DF-ES-9335

Length: 85
Cone Ø: d1 Ø 12 / d2 Ø 10,75
Thread: M14 x 1,5 RHT
23162046, 5000516214, 5010144543,
5010245591



RV-DL-12337

Length: 1676
Ø: 40
Cone Ø: d1 Ø 30 / d2 Ø 27
Thread: M30 x 1,5 RHT
21560968, 25370845, 5001868367,
5010587050, 5010587053, 7421560968



RV-VB-8191

Length: 662,4
Ø: 48
Hole Distance: 115 / 115
7420741703, RVVB8191



MN-RK-8501

Ø: 75
Hole Distance: 115
Thick/Height: 24
7420547286



RV-DL-12338

Length: 1719
Ø: 40
Cone Ø: d1 Ø 30 / d2 Ø 27
Thread: M30 x 1,5 RHT
21560965, 25370844, 5001868404,
5010587049, 5010587052, 7421560965



RV-DL-8314

Length: 1758
Ø: 52
Cone Ø: d1 Ø 30 / d2 Ø 27
5010439021, 5010566063



RV-ES-9432

Length: 120
Cone Ø: d1 Ø 28 / d2 Ø 23,9
Thread: M26 x 1,5 RHT
7403193731



RV-DL-8415

Length: 825
Ø: 62
Cone Ø: d1 Ø 30 / d2 Ø 27
25379293, 5001868384, 5010630822,
5010630823, 7421560882



RV-ES-12331

Length: 140
Cone Ø: d1 Ø 30 / d2 Ø 27
Thread: M32 x 1,5 RHT / M24 x 1,5 RHT
0014607248, 014607248, 5001866165,
5001867774, 7485134391



RV-DL-10243

Length: 1726
Ø: 60
Cone Ø: d1 Ø 30 / d2 Ø 27
Thread: M24 x 1,5 RHT
5001868363, 5010587004, 5010600822,
7421560957



RV-ES-12442

Length: 88
Cone Ø: d1 Ø 28,6
Thread: M26 x 1,5 RHT
7403987648



RV-DL-12334

Length: 1686
Ø: 60
Cone Ø: d1 Ø 30 / d2 Ø 27
21560963, 5001868366, 5010587034,
5010587038, 7421560963, 7422163637



RV-TC-12340

Length: 510
Hole Distance: 115 / 115
7420443044





Premium 2 ...

Route 410.18 ...	10/05→	Tie Rod	RV-DL-12337	
	10/05→	Tie Rod End	SC-ES-7279	for Steering Rod
	10/05→	Track Control Arm		RV-VB-8191 Wishbone (CV)
Route 410.18 D	10/05→	Ball Head, gearshift linkage	DF-ES-9335	
	10/05→	Centre Rod	RV-DL-8415	Push Rod, Leaf Spring Axle
	10/05→	Suspension Strut Repair Kit		MN-RK-8501
	10/05→	Tie Rod	RV-DL-8314	Guide Rod
	10/05→	Tie Rod	RV-DL-10243	
	10/05→	Tie Rod	RV-DL-12334	
	10/05→	Tie Rod	RV-DL-12337	
	10/05→	Tie Rod	RV-DL-12338	
	10/05→	Tie Rod End	SC-ES-7279	for Steering Rod
	10/05→	Track Control Arm		RV-VB-8191 Wishbone (CV)
Route 410.24	10/05→	Ball Head, gearshift linkage	DF-ES-9335	
	10/05→	Centre Rod	RV-DL-8415	Push Rod, Leaf Spring Axle
	10/05→	Suspension Strut Repair Kit		MN-RK-8501
	10/05→	Tie Rod	RV-DL-8314	Guide Rod
	10/05→	Tie Rod	RV-DL-10243	
	10/05→	Tie Rod	RV-DL-12334	
	10/05→	Tie Rod	RV-DL-12338	
	10/05→	Tie Rod End		RV-ES-9432
	10/05→	Tie Rod End	RV-ES-12442	
	10/05→	Tie Rod End	SC-ES-7279	for Steering Rod
Route 410.25	10/05→	Ball Head, gearshift linkage	DF-ES-9335	
	10/05→	Centre Rod	RV-DL-8415	Push Rod
	10/05→	Centre Rod	RV-DL-8415	Push Rod, Leaf Spring Axle
	10/05→	Suspension Strut Repair Kit		MN-RK-8501
	10/05→	Tie Rod	RV-DL-8314	Guide Rod
	10/05→	Tie Rod	RV-DL-10243	
	10/05→	Tie Rod	RV-DL-12334	
	10/05→	Tie Rod	RV-DL-12338	
	10/05→	Tie Rod End		RV-ES-9432
	10/05→	Tie Rod End	RV-ES-12442	
Route 410.26	10/05→	Tie Rod End	SC-ES-7279	for Steering Rod
	10/05→	Track Control Arm		RV-VB-8191 Wishbone (CV)
	10/05→	Ball Head, gearshift linkage	DF-ES-9335	
	10/05→	Centre Rod	RV-DL-8415	Push Rod, Leaf Spring Axle
	10/05→	Suspension Strut Repair Kit		MN-RK-8501
	10/05→	Tie Rod	RV-DL-8314	Guide Rod
	10/05→	Tie Rod	RV-DL-10243	
	10/05→	Tie Rod	RV-DL-12334	
	10/05→	Tie Rod	RV-DL-12338	
	10/05→	Tie Rod End		RV-ES-9432
Route 430.18	10/06→	Centre Rod	RV-DL-8415	Push Rod, Leaf Spring Axle
	10/06→	Tie Rod	RV-DL-10243	
	10/06→	Tie Rod	RV-DL-12334	
	10/06→	Tie Rod	RV-DL-12337	
	10/06→	Tie Rod	RV-DL-12338	
Route 430.19	10/06→	Centre Rod	RV-DL-8415	Push Rod, Leaf Spring Axle
	10/06→	Tie Rod	RV-DL-12334	
	10/06→	Tie Rod	RV-DL-12337	
Route 430.26	10/06→	Centre Rod	RV-DL-8415	Push Rod
	10/06→	Centre Rod	RV-DL-8415	Push Rod, Leaf Spring Axle
	10/06→	Tie Rod	RV-DL-10243	
	10/06→	Tie Rod	RV-DL-12334	
	10/06→	Tie Rod	RV-DL-12338	
	10/06→	Tie Rod End		RV-ES-9432
10/06→	Tie Rod End	RV-ES-12442		

DF-ES-9335

Length: 85
Cone Ø: d1 Ø 12 / d2 Ø 10,75
Thread: M14 x 1,5 RHT
23162046, 5000516214, 5010144543,
5010245591



RV-DL-12337

Length: 1676
Ø: 40
Cone Ø: d1 Ø 30 / d2 Ø 27
Thread: M30 x 1,5 RHT
21560968, 25370845, 5001868367,
5010587050, 5010587053, 7421560968



MN-RK-8501

Ø: 75
Hole Distance: 115
Thick/Height: 24
7420547286



RV-DL-12338

Length: 1719
Ø: 40
Cone Ø: d1 Ø 30 / d2 Ø 27
Thread: M30 x 1,5 RHT
21560965, 25370844, 5001868404,
5010587049, 5010587052, 7421560965



RV-DL-8314

Length: 1758
Ø: 52
Cone Ø: d1 Ø 30 / d2 Ø 27
5010439021, 5010566063



RV-ES-9432

Length: 120
Cone Ø: d1 Ø 28 / d2 Ø 23,9
Thread: M26 x 1,5 RHT
7403193731



RV-DL-8415

Length: 825
Ø: 62
Cone Ø: d1 Ø 30 / d2 Ø 27
25379293, 5001868384, 5010630822,
5010630823, 7421560882



RV-ES-12442

Length: 88
Cone Ø: d1 Ø 28,6
Thread: M26 x 1,5 RHT
7403987648



RV-DL-10243

Length: 1726
Ø: 60
Cone Ø: d1 Ø 30 / d2 Ø 27
Thread: M24 x 1,5 RHT
5001868363, 5010587004, 5010600822,
7421560957



RV-VB-8191

Length: 662,4
Ø: 48
Hole Distance: 115 / 115
7420741703, RNVB8191



RV-DL-12334

Length: 1686
Ø: 60
Cone Ø: d1 Ø 30 / d2 Ø 27
21560963, 5001868366, 5010587034,
5010587038, 7421560963, 7422163637



SC-ES-7279

Length: 150
Cone Ø: d1 Ø 30 / d2 Ø 27
Thread: M30 x 1,5 RHT
5001852452, 5001858763





Premium 2 ...

Route 450.18	10/05 →	Ball Head, gearshift linkage	DF-ES-9335		
	10/05 →	Centre Rod	RV-DL-8415		Push Rod, Leaf Spring Axle
	10/05 →	Suspension Strut Repair Kit		MN-RK-8501	
	10/05 →	Tie Rod	RV-DL-8314		Guide Rod
	10/05 →	Tie Rod	RV-DL-10243		
	10/05 →	Tie Rod	RV-DL-12334		
	10/05 →	Tie Rod	RV-DL-12337		
	10/05 →	Tie Rod	RV-DL-12338		
	10/05 →	Tie Rod End	SC-ES-7279		for Steering Rod
	10/05 →	Track Control Arm		RV-VB-8191	Wishbone (CV)
Route 450.18 D	10/05 →	Ball Head, gearshift linkage	DF-ES-9335		
	10/05 →	Centre Rod	RV-DL-8415		Push Rod, Leaf Spring Axle
	10/05 →	Suspension Strut Repair Kit		MN-RK-8501	
	10/05 →	Tie Rod	RV-DL-8314		Guide Rod
	10/05 →	Tie Rod	RV-DL-10243		
	10/05 →	Tie Rod	RV-DL-12334		
	10/05 →	Tie Rod	RV-DL-12337		
	10/05 →	Tie Rod	RV-DL-12338		
	10/05 →	Tie Rod End	CV-ES-14163		for Steering Rod
	10/05 →	Tie Rod End	SC-ES-7279		for Steering Rod
10/05 →	Track Control Arm		RV-VB-8191	Wishbone (CV)	
Route 450.24	10/05 →	Ball Head, gearshift linkage	DF-ES-9335		
	10/05 →	Centre Rod	RV-DL-8415		Push Rod, Leaf Spring Axle
	10/05 →	Suspension Strut Repair Kit		MN-RK-8501	
	10/05 →	Tie Rod	RV-DL-8314		Guide Rod
	10/05 →	Tie Rod	RV-DL-10243		
	10/05 →	Tie Rod	RV-DL-12334		
	10/05 →	Tie Rod	RV-DL-12338		
	10/05 →	Tie Rod End		RV-ES-9432	
	10/05 →	Tie Rod End	RV-ES-12442		
	10/05 →	Tie Rod End	SC-ES-7279		for Steering Rod
10/05 →	Track Control Arm		RV-VB-8191	Wishbone (CV)	
Route 450.25	10/05 →	Ball Head, gearshift linkage	DF-ES-9335		
	10/05 →	Centre Rod	RV-DL-8415		Push Rod
	10/05 →	Centre Rod	RV-DL-8415		Push Rod, Leaf Spring Axle
	10/05 →	Suspension Strut Repair Kit		MN-RK-8501	
	10/05 →	Tie Rod	RV-DL-8314		Guide Rod
	10/05 →	Tie Rod	RV-DL-10243		
	10/05 →	Tie Rod	RV-DL-12334		
	10/05 →	Tie Rod	RV-DL-12338		
	10/05 →	Tie Rod End		RV-ES-9432	
	10/05 →	Tie Rod End	RV-ES-12442		
10/05 →	Tie Rod End	SC-ES-7279		for Steering Rod	
10/05 →	Track Control Arm		RV-VB-8191	Wishbone (CV)	
Route 450.26	10/05 →	Ball Head, gearshift linkage	DF-ES-9335		
	10/05 →	Centre Rod	RV-DL-8415		Push Rod, Leaf Spring Axle
	10/05 →	Suspension Strut Repair Kit		MN-RK-8501	
	10/05 →	Tie Rod	RV-DL-8314		Guide Rod
	10/05 →	Tie Rod	RV-DL-10243		
	10/05 →	Tie Rod	RV-DL-12334		
	10/05 →	Tie Rod	RV-DL-12338		
	10/05 →	Tie Rod End		RV-ES-9432	
	10/05 →	Tie Rod End	RV-ES-12442		
	10/05 →	Tie Rod End	SC-ES-7279		for Steering Rod
10/05 →	Track Control Arm		RV-VB-8191	Wishbone (CV)	
Route 460.18	10/06 →	Centre Rod	RV-DL-8415		Push Rod, Leaf Spring Axle
	10/06 →	Tie Rod	RV-DL-10243		
	10/06 →	Tie Rod	RV-DL-12334		
	10/06 →	Tie Rod	RV-DL-12337		
	10/06 →	Tie Rod	RV-DL-12338		

CV-ES-14163

Length: 125
Cone Ø: d1 Ø 30 / d2 Ø 27
Thread: M30 x 1,5 RHT
0003406169, 0003406236, 0003406251,
0003406254, 0003406260, 0003406261,
5000288360, 5000590236, 5000804824,
5001858773, 7420937674, 7701011412



DF-ES-9335

Length: 85
Cone Ø: d1 Ø 12 / d2 Ø 10,75
Thread: M14 x 1,5 RHT
23162046, 5000516214, 5010144543,
5010245591



MN-RK-8501

Ø: 75
Hole Distance: 115
Thick/Height: 24
7420547286



RV-DL-8314

Length: 1758
Ø: 52
Cone Ø: d1 Ø 30 / d2 Ø 27
5010439021, 5010566063



RV-DL-8415

Length: 825
Ø: 62
Cone Ø: d1 Ø 30 / d2 Ø 27
25379293, 5001868384, 5010630822,
5010630823, 7421560882



RV-DL-10243

Length: 1726
Ø: 60
Cone Ø: d1 Ø 30 / d2 Ø 27
Thread: M24 x 1,5 RHT
5001868363, 5010587004, 5010600822,
7421560957



RV-DL-12334

Length: 1686
Ø: 60
Cone Ø: d1 Ø 30 / d2 Ø 27
21560963, 5001868366, 5010587034,
5010587038, 7421560963, 7422163637



RV-DL-12337

Length: 1676
Ø: 40
Cone Ø: d1 Ø 30 / d2 Ø 27
Thread: M30 x 1,5 RHT
21560968, 25370845, 5001868367,
5010587050, 5010587053, 7421560968



RV-DL-12338

Length: 1719
Ø: 40
Cone Ø: d1 Ø 30 / d2 Ø 27
Thread: M30 x 1,5 RHT
21560965, 25370844, 5001868404,
5010587049, 5010587052, 7421560965



RV-ES-9432

Length: 120
Cone Ø: d1 Ø 28 / d2 Ø 23,9
Thread: M26 x 1,5 RHT
7403193731



RV-ES-12442

Length: 88
Cone Ø: d1 Ø 28,6
Thread: M26 x 1,5 RHT
7403987648



RV-VB-8191

Length: 662,4
Ø: 48
Hole Distance: 115 / 115
7420741703, RVVB8191



SC-ES-7279

Length: 150
Cone Ø: d1 Ø 30 / d2 Ø 27
Thread: M30 x 1,5 RHT
5001852452, 5001858763





Premium 2 ...

Route 460.26	10/06→	Centre Rod	RV-DL-8415		Push Rod
	10/06→	Centre Rod	RV-DL-8415		Push Rod, Leaf Spring Axle
	10/06→	Tie Rod	RV-DL-10243		
	10/06→	Tie Rod	RV-DL-12334		
	10/06→	Tie Rod	RV-DL-12338		
	10/06→	Tie Rod End		RV-ES-9432	
	10/06→	Tie Rod End	RV-ES-12442		

R

R 310.16	10/80→03/89	Ball Head, gearshift linkage	CV-ES-2121		
	10/80→03/89	Centre Rod	RV-DL-0074		Push Rod
	10/80→03/89	Centre Rod	RV-DL-2181		Coupling Rod
	10/80→03/89	Centre Rod	RV-DL-8177		Push Rod
	10/80→03/89	Stabiliser Link	RV-DL-10249		Pressure Rod
	10/80→03/89	Suspension Strut Repair Kit		DF-RK-8671	
	10/80→03/89	Tie Rod End	CV-ES-0912		
	10/80→03/89	Tie Rod End	CV-ES-0914		for Steering Rod
	10/80→03/89	Tie Rod End	CV-ES-14162		for Steering Rod
	10/80→03/89	Tie Rod End	CV-ES-14163		for Steering Rod
	10/80→03/89	Tie Rod End	RV-ES-12445		
	10/80→03/89	Tie Rod End	RV-ES-12446		
	R 310.16/T	10/80→03/89	Ball Head, gearshift linkage	CV-ES-2121	
10/80→03/89		Centre Rod	RV-DL-0074		Push Rod
10/80→03/89		Centre Rod	RV-DL-2181		Coupling Rod
10/80→03/89		Centre Rod	RV-DL-8177		Push Rod
10/80→03/89		Stabiliser Link	RV-DL-10249		Pressure Rod
10/80→03/89		Suspension Strut Repair Kit		DF-RK-8671	
10/80→03/89		Tie Rod End	CV-ES-0912		
10/80→03/89		Tie Rod End	CV-ES-0914		for Steering Rod
10/80→03/89		Tie Rod End	CV-ES-14162		for Steering Rod
10/80→03/89		Tie Rod End	CV-ES-14163		for Steering Rod
10/80→03/89		Tie Rod End	RV-ES-12445		
10/80→03/89		Tie Rod End	RV-ES-12446		
R 310.17		10/80→03/89	Ball Head, gearshift linkage	CV-ES-2121	
	10/80→03/89	Centre Rod	RV-DL-0074		Push Rod
	10/80→03/89	Centre Rod	RV-DL-2181		Coupling Rod
	10/80→03/89	Centre Rod	RV-DL-8177		Push Rod
	10/80→03/89	Stabiliser Link	RV-DL-10249		Pressure Rod
	10/80→03/89	Suspension Strut Repair Kit		DF-RK-8671	
	10/80→03/89	Tie Rod End	CV-ES-0912		
	10/80→03/89	Tie Rod End	CV-ES-0914		for Steering Rod
	10/80→03/89	Tie Rod End	CV-ES-14162		for Steering Rod
	10/80→03/89	Tie Rod End	CV-ES-14163		for Steering Rod
	10/80→03/89	Tie Rod End	RV-ES-12445		
	10/80→03/89	Tie Rod End	RV-ES-12446		
	R 310.17/T	10/80→03/89	Ball Head, gearshift linkage	CV-ES-2121	
10/80→03/89		Centre Rod	RV-DL-0074		Push Rod
10/80→03/89		Centre Rod	RV-DL-2181		Coupling Rod
10/80→03/89		Centre Rod	RV-DL-8177		Push Rod
10/80→03/89		Stabiliser Link	RV-DL-10249		Pressure Rod
10/80→03/89		Suspension Strut Repair Kit		DF-RK-8671	
10/80→03/89		Tie Rod End	CV-ES-0912		
10/80→03/89		Tie Rod End	CV-ES-0914		for Steering Rod
10/80→03/89		Tie Rod End	CV-ES-14162		for Steering Rod
10/80→03/89		Tie Rod End	CV-ES-14163		for Steering Rod
10/80→03/89		Tie Rod End	RV-ES-12445		
10/80→03/89		Tie Rod End	RV-ES-12446		
R 310.19		10/80→03/89	Ball Head, gearshift linkage	CV-ES-2121	
	10/80→03/89	Centre Rod	RV-DL-0074		Push Rod
	10/80→03/89	Centre Rod	RV-DL-2181		Coupling Rod
	10/80→03/89	Centre Rod	RV-DL-8177		Push Rod
	10/80→03/89	Stabiliser Link	RV-DL-10249		Pressure Rod
	10/80→03/89	Suspension Strut Repair Kit		DF-RK-8671	

CV-ES-0912

Length: 125
Cone Ø: d1 Ø 30 / d2 Ø 27
Thread: M38 x 1,5 LHT
3401206, 5001832579



RV-DL-0074

Length: 1012
Ø: 52
Cone Ø: d1 Ø 30 / d2 Ø 27
5010130453



RV-DL-12334

Length: 1686
Ø: 60
Cone Ø: d1 Ø 30 / d2 Ø 27
21560963, 5001868366, 5010587034,
5010587038, 7421560963, 7422163637



CV-ES-0914

Length: 125
Cone Ø: d1 Ø 30 / d2 Ø 27
Thread: M38 x 1,5 RHT
3401207, 5001832580



RV-DL-2181

Length: 1650
Ø: 40
Cone Ø: d1 Ø 30 / d2 Ø 27
5010145581, 5010308215



RV-DL-12338

Length: 1719
Ø: 40
Cone Ø: d1 Ø 30 / d2 Ø 27
Thread: M30 x 1,5 RHT
21560965, 25370844, 5001868404,
5010587049, 5010587052, 7421560965



CV-ES-2121

Length: 85
Cone Ø: d1 Ø 12 / d2 Ø 10,8
Thread: M14 x 1,5 RHT
23162046, 5000516214, 5010144543,
5010245591



RV-DL-8177

Length: 1012
Ø: 52
Cone Ø: d1 Ø 30 / d2 Ø 27
5010130451, 7485114925



RV-ES-9432

Length: 120
Cone Ø: d1 Ø 28 / d2 Ø 23,9
Thread: M26 x 1,5 RHT
7403193731



CV-ES-14162

Length: 125
Cone Ø: d1 Ø 30 / d2 Ø 27
Thread: M30 x 1,5 LHT
3401170, 5000288361, 5001832581,
5001858759, 5001858774



RV-DL-8415

Length: 825
Ø: 62
Cone Ø: d1 Ø 30 / d2 Ø 27
25379293, 5001868384, 5010630822,
5010630823, 7421560882



RV-ES-12442

Length: 88
Cone Ø: d1 Ø 28,6
Thread: M26 x 1,5 RHT
7403987648



CV-ES-14163

Length: 125
Cone Ø: d1 Ø 30 / d2 Ø 27
Thread: M30 x 1,5 RHT
0003406169, 0003406236, 0003406251,
0003406254, 0003406260, 0003406261,
5000288360, 5000590236, 5000804824,
5001858773, 7420937674, 7701011412



RV-DL-10243

Length: 1726
Ø: 60
Cone Ø: d1 Ø 30 / d2 Ø 27
Thread: M24 x 1,5 RHT
5001868363, 5010587004, 5010600822,
7421560957



RV-ES-12445

Length: 170
Cone Ø: d1 Ø 30 / d2 Ø 27
5000288363



DF-RK-8671

Ø: 80
Hole Distance: 145
Thick/Height: 30
5001014345



RV-DL-10249

Length: 440
Ø: 36
Cone Ø: d1 Ø 26 / d2 Ø 23,5
0000758006, 5000874575, 5010065789



RV-ES-12446

Length: 170
Cone Ø: d1 Ø 30 / d2 Ø 27
5000288362





R ...

R 310.19 ...	10/80→03/89	Tie Rod End	CV-ES-0912		
	10/80→03/89	Tie Rod End	CV-ES-0914	for Steering Rod	
	10/80→03/89	Tie Rod End	CV-ES-14162	for Steering Rod	
	10/80→03/89	Tie Rod End	CV-ES-14163	for Steering Rod	
	10/80→03/89	Tie Rod End	RV-ES-12445		
	10/80→03/89	Tie Rod End	RV-ES-12446		
R 310.19/T	10/80→03/89	Ball Head, gearshift linkage	CV-ES-2121		
	10/80→03/89	Centre Rod	RV-DL-0074	Push Rod	
	10/80→03/89	Centre Rod	RV-DL-2181	Coupling Rod	
	10/80→03/89	Centre Rod	RV-DL-8177	Push Rod	
	10/80→03/89	Stabiliser Link	RV-DL-10249	Pressure Rod	
	10/80→03/89	Suspension Strut Repair Kit		DF-RK-8671	
	10/80→03/89	Tie Rod End	CV-ES-0912		
	10/80→03/89	Tie Rod End	CV-ES-0914	for Steering Rod	
	10/80→03/89	Tie Rod End	CV-ES-14162	for Steering Rod	
	10/80→03/89	Tie Rod End	CV-ES-14163	for Steering Rod	
	10/80→03/89	Tie Rod End	RV-ES-12445		
	10/80→03/89	Tie Rod End	RV-ES-12446		
	R 310.22	10/80→03/89	Ball Head, gearshift linkage	CV-ES-2121	
		10/80→03/89	Centre Rod	RV-DL-0074	Push Rod
10/80→03/89		Centre Rod	RV-DL-2181	Coupling Rod	
10/80→03/89		Centre Rod	RV-DL-8177	Push Rod	
10/80→03/89		Stabiliser Link	RV-DL-10249	Pressure Rod	
10/80→03/89		Suspension Strut Repair Kit		DF-RK-8671	
10/80→03/89		Tie Rod End	CV-ES-0912		
10/80→03/89		Tie Rod End	CV-ES-0914	for Steering Rod	
10/80→03/89		Tie Rod End	CV-ES-14162	for Steering Rod	
10/80→03/89		Tie Rod End	CV-ES-14163	for Steering Rod	
10/80→03/89		Tie Rod End	RV-ES-12445		
10/80→03/89		Tie Rod End	RV-ES-12446		
R 310.22/T		10/80→03/89	Ball Head, gearshift linkage	CV-ES-2121	
		10/80→03/89	Centre Rod	RV-DL-0074	Push Rod
	10/80→03/89	Centre Rod	RV-DL-2181	Coupling Rod	
	10/80→03/89	Centre Rod	RV-DL-8177	Push Rod	
	10/80→03/89	Stabiliser Link	RV-DL-10249	Pressure Rod	
	10/80→03/89	Suspension Strut Repair Kit		DF-RK-8671	
	10/80→03/89	Tie Rod End	CV-ES-0912		
	10/80→03/89	Tie Rod End	CV-ES-0914	for Steering Rod	
	10/80→03/89	Tie Rod End	CV-ES-14162	for Steering Rod	
	10/80→03/89	Tie Rod End	CV-ES-14163	for Steering Rod	
	10/80→03/89	Tie Rod End	RV-ES-12445		
	10/80→03/89	Tie Rod End	RV-ES-12446		
	R 330.17	05/88→05/91	Ball Head, gearshift linkage	CV-ES-2121	
		05/88→05/91	Centre Rod	RV-DL-0074	Push Rod
05/88→05/91		Centre Rod	RV-DL-2181	Coupling Rod	
05/88→05/91		Centre Rod	RV-DL-8177	Push Rod	
05/88→05/91		Suspension Strut Repair Kit		DF-RK-8671	
05/88→05/91		Tie Rod End	CV-ES-0912		
05/88→05/91		Tie Rod End	CV-ES-0914	for Steering Rod	
05/88→05/91		Tie Rod End	CV-ES-14162	for Steering Rod	
05/88→05/91		Tie Rod End	CV-ES-14163	for Steering Rod	
05/88→05/91		Tie Rod End	RV-ES-12445		
05/88→05/91		Tie Rod End	RV-ES-12446		
R 330.17/T		05/88→05/91	Ball Head, gearshift linkage	CV-ES-2121	
		05/88→05/91	Centre Rod	RV-DL-0074	Push Rod
		05/88→05/91	Centre Rod	RV-DL-2181	Coupling Rod
	05/88→05/91	Centre Rod	RV-DL-8177	Push Rod	
	05/88→05/91	Suspension Strut Repair Kit		DF-RK-8671	
	05/88→05/91	Tie Rod End	CV-ES-0912		
	05/88→05/91	Tie Rod End	CV-ES-0914	for Steering Rod	
	05/88→05/91	Tie Rod End	CV-ES-14162	for Steering Rod	
	05/88→05/91	Tie Rod End	CV-ES-14163	for Steering Rod	
	05/88→05/91	Tie Rod End	RV-ES-12445		

CV-ES-0912

Length: 125
Cone Ø: d1 Ø 30 / d2 Ø 27
Thread: M38 x 1,5 LHT
3401206, 5001832579



RV-DL-0074

Length: 1012
Ø: 52
Cone Ø: d1 Ø 30 / d2 Ø 27
5010130453



CV-ES-0914

Length: 125
Cone Ø: d1 Ø 30 / d2 Ø 27
Thread: M38 x 1,5 RHT
3401207, 5001832580



RV-DL-2181

Length: 1650
Ø: 40
Cone Ø: d1 Ø 30 / d2 Ø 27
5010145581, 5010308215



CV-ES-2121

Length: 85
Cone Ø: d1 Ø 12 / d2 Ø 10,8
Thread: M14 x 1,5 RHT
23162046, 5000516214, 5010144543,
5010245591



RV-DL-8177

Length: 1012
Ø: 52
Cone Ø: d1 Ø 30 / d2 Ø 27
5010130451, 7485114925



CV-ES-14162

Length: 125
Cone Ø: d1 Ø 30 / d2 Ø 27
Thread: M30 x 1,5 LHT
3401170, 5000288361, 5001832581,
5001858759, 5001858774



RV-DL-10249

Length: 440
Ø: 36
Cone Ø: d1 Ø 26 / d2 Ø 23,5
0000758006, 5000874575, 5010065789



CV-ES-14163

Length: 125
Cone Ø: d1 Ø 30 / d2 Ø 27
Thread: M30 x 1,5 RHT
0003406169, 0003406236, 0003406251,
0003406254, 0003406260, 0003406261,
5000288360, 5000590236, 5000804824,
5001858773, 7420937674, 7701011412



RV-ES-12445

Length: 170
Cone Ø: d1 Ø 30 / d2 Ø 27
5000288363



RV-ES-12446

Length: 170
Cone Ø: d1 Ø 30 / d2 Ø 27
5000288362



DF-RK-8671

Ø: 80
Hole Distance: 145
Thick/Height: 30
5001014345





R ...

R 330.19	05/88→05/91	Ball Head, gearshift linkage	CV-ES-2121			
	05/88→05/91	Centre Rod	RV-DL-0074		Push Rod	
	05/88→05/91	Centre Rod	RV-DL-2181		Coupling Rod	
	05/88→05/91	Centre Rod	RV-DL-8177		Push Rod	
	05/88→05/91	Suspension Strut Repair Kit		DF-RK-8671		
	05/88→05/91	Tie Rod End	CV-ES-0912			
	05/88→05/91	Tie Rod End	CV-ES-0914		for Steering Rod	
	05/88→05/91	Tie Rod End	CV-ES-14162		for Steering Rod	
	05/88→05/91	Tie Rod End	CV-ES-14163		for Steering Rod	
	05/88→05/91	Tie Rod End	RV-ES-12445			
	05/88→05/91	Tie Rod End	RV-ES-12446			
	R 330.19/T	05/88→05/91	Ball Head, gearshift linkage	CV-ES-2121		
		05/88→05/91	Centre Rod	RV-DL-0074		Push Rod
05/88→05/91		Centre Rod	RV-DL-2181		Coupling Rod	
05/88→05/91		Centre Rod	RV-DL-8177		Push Rod	
05/88→05/91		Suspension Strut Repair Kit		DF-RK-8671		
05/88→05/91		Tie Rod End	CV-ES-0912			
05/88→05/91		Tie Rod End	CV-ES-0914		for Steering Rod	
05/88→05/91		Tie Rod End	CV-ES-14162		for Steering Rod	
05/88→05/91		Tie Rod End	CV-ES-14163		for Steering Rod	
05/88→05/91		Tie Rod End	RV-ES-12445			
05/88→05/91		Tie Rod End	RV-ES-12446			
R 330.24		05/88→05/91	Ball Head, gearshift linkage	CV-ES-2121		
		05/88→05/91	Centre Rod	RV-DL-0074		Push Rod
	05/88→05/91	Centre Rod	RV-DL-2181		Coupling Rod	
	05/88→05/91	Centre Rod	RV-DL-8177		Push Rod	
	05/88→05/91	Suspension Strut Repair Kit		DF-RK-8671		
	05/88→05/91	Tie Rod End	CV-ES-0912			
	05/88→05/91	Tie Rod End	CV-ES-0914		for Steering Rod	
	05/88→05/91	Tie Rod End	CV-ES-14162		for Steering Rod	
	05/88→05/91	Tie Rod End	CV-ES-14163		for Steering Rod	
	05/88→05/91	Tie Rod End	RV-ES-12445			
	05/88→05/91	Tie Rod End	RV-ES-12446			
	R 340.17	03/86→01/90	Ball Head, gearshift linkage	CV-ES-2121		
		03/86→01/90	Centre Rod	RV-DL-0074		Push Rod
03/86→01/90		Centre Rod	RV-DL-2181		Coupling Rod	
03/86→01/90		Centre Rod	RV-DL-8177		Push Rod	
03/86→01/90		Suspension Strut Repair Kit		DF-RK-8671		
03/86→01/90		Tie Rod End	CV-ES-0912			
03/86→01/90		Tie Rod End	CV-ES-0914		for Steering Rod	
03/86→01/90		Tie Rod End	CV-ES-14162		for Steering Rod	
03/86→01/90		Tie Rod End	CV-ES-14163		for Steering Rod	
03/86→01/90		Tie Rod End	RV-ES-12445			
03/86→01/90		Tie Rod End	RV-ES-12446			
R 340.17/T		03/86→01/90	Ball Head, gearshift linkage	CV-ES-2121		
		03/86→01/90	Centre Rod	RV-DL-0074		Push Rod
	03/86→01/90	Centre Rod	RV-DL-2181		Coupling Rod	
	03/86→01/90	Centre Rod	RV-DL-8177		Push Rod	
	03/86→01/90	Suspension Strut Repair Kit		DF-RK-8671		
	03/86→01/90	Tie Rod End	CV-ES-0912			
	03/86→01/90	Tie Rod End	CV-ES-0914		for Steering Rod	
	03/86→01/90	Tie Rod End	CV-ES-14162		for Steering Rod	
	03/86→01/90	Tie Rod End	CV-ES-14163		for Steering Rod	
	03/86→01/90	Tie Rod End	RV-ES-12445			
	03/86→01/90	Tie Rod End	RV-ES-12446			
	R 340.19	03/86→01/90	Ball Head, gearshift linkage	CV-ES-2121		
		03/86→01/90	Centre Rod	RV-DL-0074		Push Rod
03/86→01/90		Centre Rod	RV-DL-2181		Coupling Rod	
03/86→01/90		Centre Rod	RV-DL-8177		Push Rod	
03/86→01/90		Suspension Strut Repair Kit		DF-RK-8671		
03/86→01/90		Tie Rod End	CV-ES-0912			
03/86→01/90		Tie Rod End	CV-ES-14162		for Steering Rod	

CV-ES-0912

Length: 125
Cone Ø: d1 Ø 30 / d2 Ø 27
Thread: M38 x 1,5 LHT
3401206, 5001832579



RV-DL-0074

Length: 1012
Ø: 52
Cone Ø: d1 Ø 30 / d2 Ø 27
5010130453



CV-ES-0914

Length: 125
Cone Ø: d1 Ø 30 / d2 Ø 27
Thread: M38 x 1,5 RHT
3401207, 5001832580



RV-DL-2181

Length: 1650
Ø: 40
Cone Ø: d1 Ø 30 / d2 Ø 27
5010145581, 5010308215



CV-ES-2121

Length: 85
Cone Ø: d1 Ø 12 / d2 Ø 10,8
Thread: M14 x 1,5 RHT
23162046, 5000516214, 5010144543,
5010245591



RV-DL-8177

Length: 1012
Ø: 52
Cone Ø: d1 Ø 30 / d2 Ø 27
5010130451, 7485114925



CV-ES-14162

Length: 125
Cone Ø: d1 Ø 30 / d2 Ø 27
Thread: M30 x 1,5 LHT
3401170, 5000288361, 5001832581,
5001858759, 5001858774



RV-ES-12445

Length: 170
Cone Ø: d1 Ø 30 / d2 Ø 27
5000288363



CV-ES-14163

Length: 125
Cone Ø: d1 Ø 30 / d2 Ø 27
Thread: M30 x 1,5 RHT
0003406169, 0003406236, 0003406251,
0003406254, 0003406260, 0003406261,
5000288360, 5000590236, 5000804824,
5001858773, 7420937674, 7701011412



RV-ES-12446

Length: 170
Cone Ø: d1 Ø 30 / d2 Ø 27
5000288362



DF-RK-8671

Ø: 80
Hole Distance: 145
Thick/Height: 30
5001014345



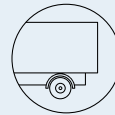

R ...

R 340.19 ...	03/86→01/90	Tie Rod End	CV-ES-14163		for Steering Rod
	03/86→01/90	Tie Rod End	RV-ES-12445		
	03/86→01/90	Tie Rod End	RV-ES-12446		
R 340.19/T	03/86→01/90	Ball Head, gearshift linkage	CV-ES-2121		
	03/86→01/90	Centre Rod	RV-DL-0074		Push Rod
	03/86→01/90	Centre Rod	RV-DL-2181		Coupling Rod
	03/86→01/90	Centre Rod	RV-DL-8177		Push Rod
	03/86→01/90	Suspension Strut Repair Kit		DF-RK-8671	
	03/86→01/90	Tie Rod End	CV-ES-0912		
	03/86→01/90	Tie Rod End	CV-ES-0914		for Steering Rod
	03/86→01/90	Tie Rod End	CV-ES-14162		for Steering Rod
	03/86→01/90	Tie Rod End	CV-ES-14163		for Steering Rod
	03/86→01/90	Tie Rod End	RV-ES-12445		
	03/86→01/90	Tie Rod End	RV-ES-12446		
R 340.24	03/86→01/90	Ball Head, gearshift linkage	CV-ES-2121		
	03/86→01/90	Centre Rod	RV-DL-0074		Push Rod
	03/86→01/90	Centre Rod	RV-DL-2181		Coupling Rod
	03/86→01/90	Centre Rod	RV-DL-8177		Push Rod
	03/86→01/90	Suspension Strut Repair Kit		DF-RK-8671	
	03/86→01/90	Tie Rod End	CV-ES-0912		
	03/86→01/90	Tie Rod End	CV-ES-0914		for Steering Rod
	03/86→01/90	Tie Rod End	CV-ES-14162		for Steering Rod
	03/86→01/90	Tie Rod End	CV-ES-14163		for Steering Rod
	03/86→01/90	Tie Rod End	RV-ES-12445		
	03/86→01/90	Tie Rod End	RV-ES-12446		
R 340ti.16/T	01/90→05/91	Ball Head, gearshift linkage	CV-ES-2121		
	01/90→05/91	Centre Rod	RV-DL-0074		Push Rod
	01/90→05/91	Centre Rod	RV-DL-2181		Coupling Rod
	01/90→05/91	Centre Rod	RV-DL-8177		Push Rod
	01/90→05/91	Suspension Strut Repair Kit		DF-RK-8671	
	01/90→05/91	Tie Rod End	CV-ES-0912		
	01/90→05/91	Tie Rod End	CV-ES-0914		for Steering Rod
	01/90→05/91	Tie Rod End	CV-ES-14162		for Steering Rod
	01/90→05/91	Tie Rod End	CV-ES-14163		for Steering Rod
	01/90→05/91	Tie Rod End	RV-ES-12445		
	01/90→05/91	Tie Rod End	RV-ES-12446		
R 340ti.17	01/90→05/91	Ball Head, gearshift linkage	CV-ES-2121		
	01/90→05/91	Centre Rod	RV-DL-0074		Push Rod
	01/90→05/91	Centre Rod	RV-DL-2181		Coupling Rod
	01/90→05/91	Centre Rod	RV-DL-8177		Push Rod
	01/90→05/91	Suspension Strut Repair Kit		DF-RK-8671	
	01/90→05/91	Tie Rod End	CV-ES-0912		
	01/90→05/91	Tie Rod End	CV-ES-0914		for Steering Rod
	01/90→05/91	Tie Rod End	CV-ES-14162		for Steering Rod
	01/90→05/91	Tie Rod End	CV-ES-14163		for Steering Rod
	01/90→05/91	Tie Rod End	RV-ES-12445		
	01/90→05/91	Tie Rod End	RV-ES-12446		
R 340ti.18	01/90→05/91	Ball Head, gearshift linkage	CV-ES-2121		
	01/90→05/91	Centre Rod	RV-DL-0074		Push Rod
	01/90→05/91	Centre Rod	RV-DL-2181		Coupling Rod
	01/90→05/91	Centre Rod	RV-DL-8177		Push Rod
	01/90→05/91	Suspension Strut Repair Kit		DF-RK-8671	
	01/90→05/91	Tie Rod End	CV-ES-0912		
	01/90→05/91	Tie Rod End	CV-ES-0914		for Steering Rod
	01/90→05/91	Tie Rod End	CV-ES-14162		for Steering Rod
	01/90→05/91	Tie Rod End	CV-ES-14163		for Steering Rod
	01/90→05/91	Tie Rod End	RV-ES-12445		
	01/90→05/91	Tie Rod End	RV-ES-12446		
R 340ti.18/T	01/90→05/91	Ball Head, gearshift linkage	CV-ES-2121		
	01/90→05/91	Centre Rod	RV-DL-0074		Push Rod
	01/90→05/91	Centre Rod	RV-DL-2181		Coupling Rod
	01/90→05/91	Centre Rod	RV-DL-8177		Push Rod
	01/90→05/91	Suspension Strut Repair Kit		DF-RK-8671	

CV-ES-0912

Length: 125
Cone Ø: d1 Ø 30 / d2 Ø 27
Thread: M38 x 1,5 LHT
3401206, 5001832579



RV-DL-0074

Length: 1012
Ø: 52
Cone Ø: d1 Ø 30 / d2 Ø 27
5010130453



CV-ES-0914

Length: 125
Cone Ø: d1 Ø 30 / d2 Ø 27
Thread: M38 x 1,5 RHT
3401207, 5001832580



RV-DL-2181

Length: 1650
Ø: 40
Cone Ø: d1 Ø 30 / d2 Ø 27
5010145581, 5010308215



CV-ES-2121

Length: 85
Cone Ø: d1 Ø 12 / d2 Ø 10,8
Thread: M14 x 1,5 RHT
23162046, 5000516214, 5010144543,
5010245591



RV-DL-8177

Length: 1012
Ø: 52
Cone Ø: d1 Ø 30 / d2 Ø 27
5010130451, 7485114925



CV-ES-14162

Length: 125
Cone Ø: d1 Ø 30 / d2 Ø 27
Thread: M30 x 1,5 LHT
3401170, 5000288361, 5001832581,
5001858759, 5001858774



RV-ES-12445

Length: 170
Cone Ø: d1 Ø 30 / d2 Ø 27
5000288363



CV-ES-14163

Length: 125
Cone Ø: d1 Ø 30 / d2 Ø 27
Thread: M30 x 1,5 RHT
0003406169, 0003406236, 0003406251,
0003406254, 0003406260, 0003406261,
5000288360, 5000590236, 5000804824,
5001858773, 7420937674, 7701011412



RV-ES-12446

Length: 170
Cone Ø: d1 Ø 30 / d2 Ø 27
5000288362



DF-RK-8671

Ø: 80
Hole Distance: 145
Thick/Height: 30
5001014345





R ...

R 340ti.18/T ...	01/90→05/91	Tie Rod End	CV-ES-0912		
	01/90→05/91	Tie Rod End	CV-ES-0914	for Steering Rod	
	01/90→05/91	Tie Rod End	CV-ES-14162	for Steering Rod	
	01/90→05/91	Tie Rod End	CV-ES-14163	for Steering Rod	
	01/90→05/91	Tie Rod End	RV-ES-12445		
	01/90→05/91	Tie Rod End	RV-ES-12446		
R 340ti.19	01/90→05/91	Ball Head, gearshift linkage	CV-ES-2121		
	01/90→05/91	Centre Rod	RV-DL-0074	Push Rod	
	01/90→05/91	Centre Rod	RV-DL-2181	Coupling Rod	
	01/90→05/91	Centre Rod	RV-DL-8177	Push Rod	
	01/90→05/91	Suspension Strut Repair Kit		DF-RK-8671	
	01/90→05/91	Tie Rod End	CV-ES-0912		
	01/90→05/91	Tie Rod End	CV-ES-0914	for Steering Rod	
	01/90→05/91	Tie Rod End	CV-ES-14162	for Steering Rod	
	01/90→05/91	Tie Rod End	CV-ES-14163	for Steering Rod	
	01/90→05/91	Tie Rod End	RV-ES-12445		
	01/90→05/91	Tie Rod End	RV-ES-12446		
	R 340ti.19/T	01/90→05/91	Ball Head, gearshift linkage	CV-ES-2121	
		01/90→05/91	Centre Rod	RV-DL-0074	Push Rod
01/90→05/91		Centre Rod	RV-DL-2181	Coupling Rod	
01/90→05/91		Centre Rod	RV-DL-8177	Push Rod	
01/90→05/91		Suspension Strut Repair Kit		DF-RK-8671	
01/90→05/91		Tie Rod End	CV-ES-0912		
01/90→05/91		Tie Rod End	CV-ES-0914	for Steering Rod	
01/90→05/91		Tie Rod End	CV-ES-14162	for Steering Rod	
01/90→05/91		Tie Rod End	CV-ES-14163	for Steering Rod	
01/90→05/91		Tie Rod End	RV-ES-12445		
01/90→05/91		Tie Rod End	RV-ES-12446		
R 340ti.24		01/90→05/91	Ball Head, gearshift linkage	CV-ES-2121	
		01/90→05/91	Centre Rod	RV-DL-0074	Push Rod
	01/90→05/91	Centre Rod	RV-DL-2181	Coupling Rod	
	01/90→05/91	Centre Rod	RV-DL-8177	Push Rod	
	01/90→05/91	Suspension Strut Repair Kit		DF-RK-8671	
	01/90→05/91	Tie Rod End	CV-ES-0912		
	01/90→05/91	Tie Rod End	CV-ES-0914	for Steering Rod	
	01/90→05/91	Tie Rod End	CV-ES-14162	for Steering Rod	
	01/90→05/91	Tie Rod End	CV-ES-14163	for Steering Rod	
	01/90→05/91	Tie Rod End	RV-ES-12445		
	01/90→05/91	Tie Rod End	RV-ES-12446		
	R 340ti.26	01/90→05/91	Ball Head, gearshift linkage	CV-ES-2121	
		01/90→05/91	Centre Rod	RV-DL-0074	Push Rod
01/90→05/91		Centre Rod	RV-DL-2181	Coupling Rod	
01/90→05/91		Centre Rod	RV-DL-8177	Push Rod	
01/90→05/91		Suspension Strut Repair Kit		DF-RK-8671	
01/90→05/91		Tie Rod End	CV-ES-0912		
01/90→05/91		Tie Rod End	CV-ES-0914	for Steering Rod	
01/90→05/91		Tie Rod End	CV-ES-14162	for Steering Rod	
01/90→05/91		Tie Rod End	CV-ES-14163	for Steering Rod	
01/90→05/91		Tie Rod End	RV-ES-12445		
01/90→05/91		Tie Rod End	RV-ES-12446		
R 350.17		01/90→05/91	Ball Head, gearshift linkage	CV-ES-2121	
		01/90→05/91	Centre Rod	RV-DL-0074	Push Rod
	01/90→05/91	Centre Rod	RV-DL-2181	Coupling Rod	
	01/90→05/91	Centre Rod	RV-DL-8177	Push Rod	
	01/90→05/91	Suspension Strut Repair Kit		DF-RK-8671	
	01/90→05/91	Tie Rod End	CV-ES-0912		
	01/90→05/91	Tie Rod End	CV-ES-0914	for Steering Rod	
	01/90→05/91	Tie Rod End	CV-ES-14162	for Steering Rod	
	01/90→05/91	Tie Rod End	CV-ES-14163	for Steering Rod	
	01/90→05/91	Tie Rod End	RV-ES-12445		
	01/90→05/91	Tie Rod End	RV-ES-12446		

CV-ES-0912

Length: 125
Cone Ø: d1 Ø 30 / d2 Ø 27
Thread: M38 x 1,5 LHT
3401206, 5001832579



RV-DL-0074

Length: 1012
Ø: 52
Cone Ø: d1 Ø 30 / d2 Ø 27
5010130453



CV-ES-0914

Length: 125
Cone Ø: d1 Ø 30 / d2 Ø 27
Thread: M38 x 1,5 RHT
3401207, 5001832580



RV-DL-2181

Length: 1650
Ø: 40
Cone Ø: d1 Ø 30 / d2 Ø 27
5010145581, 5010308215



CV-ES-2121

Length: 85
Cone Ø: d1 Ø 12 / d2 Ø 10,8
Thread: M14 x 1,5 RHT
23162046, 5000516214, 5010144543,
5010245591



RV-DL-8177

Length: 1012
Ø: 52
Cone Ø: d1 Ø 30 / d2 Ø 27
5010130451, 7485114925



CV-ES-14162

Length: 125
Cone Ø: d1 Ø 30 / d2 Ø 27
Thread: M30 x 1,5 LHT
3401170, 5000288361, 5001832581,
5001858759, 5001858774



RV-ES-12445

Length: 170
Cone Ø: d1 Ø 30 / d2 Ø 27
5000288363



CV-ES-14163

Length: 125
Cone Ø: d1 Ø 30 / d2 Ø 27
Thread: M30 x 1,5 RHT
0003406169, 0003406236, 0003406251,
0003406254, 0003406260, 0003406261,
5000288360, 5000590236, 5000804824,
5001858773, 7420937674, 7701011412



RV-ES-12446

Length: 170
Cone Ø: d1 Ø 30 / d2 Ø 27
5000288362



DF-RK-8671

Ø: 80
Hole Distance: 145
Thick/Height: 30
5001014345





R ...

R 350.17/T	01/90→05/91	Ball Head, gearshift linkage	CV-ES-2121			
	01/90→05/91	Centre Rod	RV-DL-0074		Push Rod	
	01/90→05/91	Centre Rod	RV-DL-2181		Coupling Rod	
	01/90→05/91	Centre Rod	RV-DL-8177		Push Rod	
	01/90→05/91	Suspension Strut Repair Kit		DF-RK-8671		
	01/90→05/91	Tie Rod End	CV-ES-0912			
	01/90→05/91	Tie Rod End	CV-ES-0914		for Steering Rod	
	01/90→05/91	Tie Rod End	CV-ES-14162		for Steering Rod	
	01/90→05/91	Tie Rod End	CV-ES-14163		for Steering Rod	
	01/90→05/91	Tie Rod End	RV-ES-12445			
	01/90→05/91	Tie Rod End	RV-ES-12446			
	R 350.18	01/90→05/91	Ball Head, gearshift linkage	CV-ES-2121		
		01/90→05/91	Centre Rod	RV-DL-0074		Push Rod
01/90→05/91		Centre Rod	RV-DL-2181		Coupling Rod	
01/90→05/91		Centre Rod	RV-DL-8177		Push Rod	
01/90→05/91		Suspension Strut Repair Kit		DF-RK-8671		
01/90→05/91		Tie Rod End	CV-ES-0912			
01/90→05/91		Tie Rod End	CV-ES-0914		for Steering Rod	
01/90→05/91		Tie Rod End	CV-ES-14162		for Steering Rod	
01/90→05/91		Tie Rod End	CV-ES-14163		for Steering Rod	
01/90→05/91		Tie Rod End	RV-ES-12445			
01/90→05/91		Tie Rod End	RV-ES-12446			
R 350.18/T		01/90→05/91	Ball Head, gearshift linkage	CV-ES-2121		
		01/90→05/91	Centre Rod	RV-DL-0074		Push Rod
	01/90→05/91	Centre Rod	RV-DL-2181		Coupling Rod	
	01/90→05/91	Centre Rod	RV-DL-8177		Push Rod	
	01/90→05/91	Suspension Strut Repair Kit		DF-RK-8671		
	01/90→05/91	Tie Rod End	CV-ES-0912			
	01/90→05/91	Tie Rod End	CV-ES-0914		for Steering Rod	
	01/90→05/91	Tie Rod End	CV-ES-14162		for Steering Rod	
	01/90→05/91	Tie Rod End	CV-ES-14163		for Steering Rod	
	01/90→05/91	Tie Rod End	RV-ES-12445			
	01/90→05/91	Tie Rod End	RV-ES-12446			
	R 350.19	01/90→05/91	Ball Head, gearshift linkage	CV-ES-2121		
		01/90→05/91	Centre Rod	RV-DL-0074		Push Rod
01/90→05/91		Centre Rod	RV-DL-2181		Coupling Rod	
01/90→05/91		Centre Rod	RV-DL-8177		Push Rod	
01/90→05/91		Suspension Strut Repair Kit		DF-RK-8671		
01/90→05/91		Tie Rod End	CV-ES-0912			
01/90→05/91		Tie Rod End	CV-ES-0914		for Steering Rod	
01/90→05/91		Tie Rod End	CV-ES-14162		for Steering Rod	
01/90→05/91		Tie Rod End	CV-ES-14163		for Steering Rod	
01/90→05/91		Tie Rod End	RV-ES-12445			
01/90→05/91		Tie Rod End	RV-ES-12446			
R 350.19/T		01/90→05/91	Ball Head, gearshift linkage	CV-ES-2121		
		01/90→05/91	Centre Rod	RV-DL-0074		Push Rod
	01/90→05/91	Centre Rod	RV-DL-2181		Coupling Rod	
	01/90→05/91	Centre Rod	RV-DL-8177		Push Rod	
	01/90→05/91	Suspension Strut Repair Kit		DF-RK-8671		
	01/90→05/91	Tie Rod End	CV-ES-0912			
	01/90→05/91	Tie Rod End	CV-ES-0914		for Steering Rod	
	01/90→05/91	Tie Rod End	CV-ES-14162		for Steering Rod	
	01/90→05/91	Tie Rod End	CV-ES-14163		for Steering Rod	
	01/90→05/91	Tie Rod End	RV-ES-12445			
	01/90→05/91	Tie Rod End	RV-ES-12446			
	R 350.19/TB	01/90→05/91	Ball Head, gearshift linkage	CV-ES-2121		
		01/90→05/91	Centre Rod	RV-DL-0074		Push Rod
01/90→05/91		Centre Rod	RV-DL-2181		Coupling Rod	
01/90→05/91		Centre Rod	RV-DL-8177		Push Rod	
01/90→05/91		Suspension Strut Repair Kit		DF-RK-8671		
01/90→05/91		Tie Rod End	CV-ES-0912			
01/90→05/91		Tie Rod End	CV-ES-14162		for Steering Rod	

CV-ES-0912

Length: 125
Cone Ø: d1 Ø 30 / d2 Ø 27
Thread: M38 x 1,5 LHT
3401206, 5001832579



RV-DL-0074

Length: 1012
Ø: 52
Cone Ø: d1 Ø 30 / d2 Ø 27
5010130453



CV-ES-0914

Length: 125
Cone Ø: d1 Ø 30 / d2 Ø 27
Thread: M38 x 1,5 RHT
3401207, 5001832580



RV-DL-2181

Length: 1650
Ø: 40
Cone Ø: d1 Ø 30 / d2 Ø 27
5010145581, 5010308215



CV-ES-2121

Length: 85
Cone Ø: d1 Ø 12 / d2 Ø 10,8
Thread: M14 x 1,5 RHT
23162046, 5000516214, 5010144543,
5010245591



RV-DL-8177

Length: 1012
Ø: 52
Cone Ø: d1 Ø 30 / d2 Ø 27
5010130451, 7485114925



CV-ES-14162

Length: 125
Cone Ø: d1 Ø 30 / d2 Ø 27
Thread: M30 x 1,5 LHT
3401170, 5000288361, 5001832581,
5001858759, 5001858774



RV-ES-12445

Length: 170
Cone Ø: d1 Ø 30 / d2 Ø 27
5000288363



CV-ES-14163

Length: 125
Cone Ø: d1 Ø 30 / d2 Ø 27
Thread: M30 x 1,5 RHT
0003406169, 0003406236, 0003406251,
0003406254, 0003406260, 0003406261,
5000288360, 5000590236, 5000804824,
5001858773, 7420937674, 7701011412



RV-ES-12446

Length: 170
Cone Ø: d1 Ø 30 / d2 Ø 27
5000288362



DF-RK-8671

Ø: 80
Hole Distance: 145
Thick/Height: 30
5001014345





R ...

R 350.19/TB ...	01/90→05/91	Tie Rod End	CV-ES-14163		for Steering Rod
	01/90→05/91	Tie Rod End	RV-ES-12445		
	01/90→05/91	Tie Rod End	RV-ES-12446		
R 350.24	01/90→05/91	Ball Head, gearshift linkage	CV-ES-2121		
	01/90→05/91	Centre Rod	RV-DL-0074		Push Rod
	01/90→05/91	Centre Rod	RV-DL-2181		Coupling Rod
	01/90→05/91	Centre Rod	RV-DL-8177		Push Rod
	01/90→05/91	Suspension Strut Repair Kit		DF-RK-8671	
	01/90→05/91	Tie Rod End	CV-ES-0912		
	01/90→05/91	Tie Rod End	CV-ES-0914		for Steering Rod
	01/90→05/91	Tie Rod End	CV-ES-14162		for Steering Rod
	01/90→05/91	Tie Rod End	CV-ES-14163		for Steering Rod
	01/90→05/91	Tie Rod End	RV-ES-12445		
	01/90→05/91	Tie Rod End	RV-ES-12446		
	R 350.26	01/90→05/91	Ball Head, gearshift linkage	CV-ES-2121	
01/90→05/91		Centre Rod	RV-DL-0074		Push Rod
01/90→05/91		Centre Rod	RV-DL-2181		Coupling Rod
01/90→05/91		Centre Rod	RV-DL-8177		Push Rod
01/90→05/91		Suspension Strut Repair Kit		DF-RK-8671	
01/90→05/91		Tie Rod End	CV-ES-0912		
01/90→05/91		Tie Rod End	CV-ES-0914		for Steering Rod
01/90→05/91		Tie Rod End	CV-ES-14162		for Steering Rod
01/90→05/91		Tie Rod End	CV-ES-14163		for Steering Rod
01/90→05/91		Tie Rod End	RV-ES-12445		
01/90→05/91		Tie Rod End	RV-ES-12446		
R 360.19/T		01/90→05/91	Tie Rod End	CV-ES-14163	
	01/90→05/91	Tie Rod End	RV-ES-12446		
R 360.26/T	01/90→05/91	Tie Rod End	CV-ES-14163		for Steering Rod
	01/90→05/91	Tie Rod End	RV-ES-12446		
R 365.17	10/87→05/90	Ball Head, gearshift linkage	CV-ES-2121		
	10/87→05/90	Centre Rod	RV-DL-0074		Push Rod
	10/87→05/90	Centre Rod	RV-DL-2181		Coupling Rod
	10/87→05/90	Centre Rod	RV-DL-8177		Push Rod
	10/87→05/90	Suspension Strut Repair Kit		DF-RK-8671	
	10/87→05/90	Tie Rod End	CV-ES-0912		
	10/87→05/90	Tie Rod End	CV-ES-0914		for Steering Rod
	10/87→05/90	Tie Rod End	CV-ES-14162		for Steering Rod
	10/87→05/90	Tie Rod End	CV-ES-14163		for Steering Rod
	10/87→05/90	Tie Rod End	RV-ES-12445		
10/87→05/90	Tie Rod End	RV-ES-12446			
R 365.17/T	10/87→05/90	Ball Head, gearshift linkage	CV-ES-2121		
	10/87→05/90	Centre Rod	RV-DL-0074		Push Rod
	10/87→05/90	Centre Rod	RV-DL-2181		Coupling Rod
	10/87→05/90	Centre Rod	RV-DL-8177		Push Rod
	10/87→05/90	Suspension Strut Repair Kit		DF-RK-8671	
	10/87→05/90	Tie Rod End	CV-ES-0912		
	10/87→05/90	Tie Rod End	CV-ES-0914		for Steering Rod
	10/87→05/90	Tie Rod End	CV-ES-14162		for Steering Rod
	10/87→05/90	Tie Rod End	CV-ES-14163		for Steering Rod
	10/87→05/90	Tie Rod End	RV-ES-12445		
10/87→05/90	Tie Rod End	RV-ES-12446			
R 365.19	10/87→05/90	Ball Head, gearshift linkage	CV-ES-2121		
	10/87→05/90	Centre Rod	RV-DL-0074		Push Rod
	10/87→05/90	Centre Rod	RV-DL-2181		Coupling Rod
	10/87→05/90	Centre Rod	RV-DL-8177		Push Rod
	10/87→05/90	Suspension Strut Repair Kit		DF-RK-8671	
	10/87→05/90	Tie Rod End	CV-ES-0912		
	10/87→05/90	Tie Rod End	CV-ES-0914		for Steering Rod
	10/87→05/90	Tie Rod End	CV-ES-14162		for Steering Rod
	10/87→05/90	Tie Rod End	CV-ES-14163		for Steering Rod
	10/87→05/90	Tie Rod End	RV-ES-12445		
10/87→05/90	Tie Rod End	RV-ES-12446			

CV-ES-0912

Length: 125
Cone Ø: d1 Ø 30 / d2 Ø 27
Thread: M38 x 1,5 LHT
3401206, 5001832579



RV-DL-0074

Length: 1012
Ø: 52
Cone Ø: d1 Ø 30 / d2 Ø 27
5010130453



CV-ES-0914

Length: 125
Cone Ø: d1 Ø 30 / d2 Ø 27
Thread: M38 x 1,5 RHT
3401207, 5001832580



RV-DL-2181

Length: 1650
Ø: 40
Cone Ø: d1 Ø 30 / d2 Ø 27
5010145581, 5010308215



CV-ES-2121

Length: 85
Cone Ø: d1 Ø 12 / d2 Ø 10,8
Thread: M14 x 1,5 RHT
23162046, 5000516214, 5010144543,
5010245591



RV-DL-8177

Length: 1012
Ø: 52
Cone Ø: d1 Ø 30 / d2 Ø 27
5010130451, 7485114925



CV-ES-14162

Length: 125
Cone Ø: d1 Ø 30 / d2 Ø 27
Thread: M30 x 1,5 LHT
3401170, 5000288361, 5001832581,
5001858759, 5001858774



RV-ES-12445

Length: 170
Cone Ø: d1 Ø 30 / d2 Ø 27
5000288363



CV-ES-14163

Length: 125
Cone Ø: d1 Ø 30 / d2 Ø 27
Thread: M30 x 1,5 RHT
0003406169, 0003406236, 0003406251,
0003406254, 0003406260, 0003406261,
5000288360, 5000590236, 5000804824,
5001858773, 7420937674, 7701011412



RV-ES-12446

Length: 170
Cone Ø: d1 Ø 30 / d2 Ø 27
5000288362



DF-RK-8671

Ø: 80
Hole Distance: 145
Thick/Height: 30
5001014345



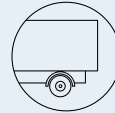

R ...

R 365.19/T	10/87→05/90	Ball Head, gearshift linkage	CV-ES-2121			
	10/87→05/90	Centre Rod	RV-DL-0074		Push Rod	
	10/87→05/90	Centre Rod	RV-DL-2181		Coupling Rod	
	10/87→05/90	Centre Rod	RV-DL-8177		Push Rod	
	10/87→05/90	Suspension Strut Repair Kit		DF-RK-8671		
	10/87→05/90	Tie Rod End	CV-ES-0912			
	10/87→05/90	Tie Rod End	CV-ES-0914		for Steering Rod	
	10/87→05/90	Tie Rod End	CV-ES-14162		for Steering Rod	
	10/87→05/90	Tie Rod End	CV-ES-14163		for Steering Rod	
	10/87→05/90	Tie Rod End	RV-ES-12445			
	10/87→05/90	Tie Rod End	RV-ES-12446			
	R 365.24	10/87→05/90	Ball Head, gearshift linkage	CV-ES-2121		
		10/87→05/90	Centre Rod	RV-DL-0074		Push Rod
10/87→05/90		Centre Rod	RV-DL-2181		Coupling Rod	
10/87→05/90		Centre Rod	RV-DL-8177		Push Rod	
10/87→05/90		Suspension Strut Repair Kit		DF-RK-8671		
10/87→05/90		Tie Rod End	CV-ES-0912			
10/87→05/90		Tie Rod End	CV-ES-0914		for Steering Rod	
10/87→05/90		Tie Rod End	CV-ES-14162		for Steering Rod	
10/87→05/90		Tie Rod End	CV-ES-14163		for Steering Rod	
10/87→05/90		Tie Rod End	RV-ES-12445			
10/87→05/90		Tie Rod End	RV-ES-12446			
R 370.16		10/83→07/85	Ball Head, gearshift linkage	CV-ES-2121		
		10/83→07/85	Centre Rod	RV-DL-0074		Push Rod
	10/83→07/85	Centre Rod	RV-DL-2181		Coupling Rod	
	10/83→07/85	Centre Rod	RV-DL-8177		Push Rod	
	10/83→07/85	Suspension Strut Repair Kit		DF-RK-8671		
	10/83→07/85	Tie Rod End	CV-ES-0912			
	10/83→07/85	Tie Rod End	CV-ES-0914		for Steering Rod	
	10/83→07/85	Tie Rod End	CV-ES-14162		for Steering Rod	
	10/83→07/85	Tie Rod End	CV-ES-14163		for Steering Rod	
	10/83→07/85	Tie Rod End	RV-ES-12445			
	10/83→07/85	Tie Rod End	RV-ES-12446			
	R 370.16/T	10/83→07/85	Ball Head, gearshift linkage	CV-ES-2121		
		10/83→07/85	Centre Rod	RV-DL-0074		Push Rod
10/83→07/85		Centre Rod	RV-DL-2181		Coupling Rod	
10/83→07/85		Centre Rod	RV-DL-8177		Push Rod	
10/83→07/85		Suspension Strut Repair Kit		DF-RK-8671		
10/83→07/85		Tie Rod End	CV-ES-0912			
10/83→07/85		Tie Rod End	CV-ES-0914		for Steering Rod	
10/83→07/85		Tie Rod End	CV-ES-14162		for Steering Rod	
10/83→07/85		Tie Rod End	CV-ES-14163		for Steering Rod	
10/83→07/85		Tie Rod End	RV-ES-12445			
10/83→07/85		Tie Rod End	RV-ES-12446			
R 370.19/T		10/83→07/85	Tie Rod End	CV-ES-14163		for Steering Rod
R 370.22/T		10/83→07/85	Ball Head, gearshift linkage	CV-ES-2121		
	10/83→07/85	Centre Rod	RV-DL-0074		Push Rod	
	10/83→07/85	Centre Rod	RV-DL-2181		Coupling Rod	
	10/83→07/85	Centre Rod	RV-DL-8177		Push Rod	
	10/83→07/85	Suspension Strut Repair Kit		DF-RK-8671		
	10/83→07/85	Tie Rod End	CV-ES-0912			
	10/83→07/85	Tie Rod End	CV-ES-0914		for Steering Rod	
	10/83→07/85	Tie Rod End	CV-ES-14162		for Steering Rod	
	10/83→07/85	Tie Rod End	CV-ES-14163		for Steering Rod	
	10/83→07/85	Tie Rod End	RV-ES-12445			
	10/83→07/85	Tie Rod End	RV-ES-12446			
	R 370.26/T	10/83→07/85	Tie Rod End	CV-ES-14163		for Steering Rod
	R 380.17	01/90→05/91	Ball Head, gearshift linkage	CV-ES-2121		
01/90→05/91		Centre Rod	RV-DL-0074		Push Rod	
01/90→05/91		Centre Rod	RV-DL-2181		Coupling Rod	
01/90→05/91		Centre Rod	RV-DL-8177		Push Rod	
01/90→05/91		Suspension Strut Repair Kit		DF-RK-8671		
01/90→05/91		Tie Rod End	CV-ES-0912			

CV-ES-0912

Length: 125
Cone Ø: d1 Ø 30 / d2 Ø 27
Thread: M38 x 1,5 LHT
3401206, 5001832579



RV-DL-0074

Length: 1012
Ø: 52
Cone Ø: d1 Ø 30 / d2 Ø 27
5010130453



CV-ES-0914

Length: 125
Cone Ø: d1 Ø 30 / d2 Ø 27
Thread: M38 x 1,5 RHT
3401207, 5001832580



RV-DL-2181

Length: 1650
Ø: 40
Cone Ø: d1 Ø 30 / d2 Ø 27
5010145581, 5010308215



CV-ES-2121

Length: 85
Cone Ø: d1 Ø 12 / d2 Ø 10,8
Thread: M14 x 1,5 RHT
23162046, 5000516214, 5010144543,
5010245591



RV-DL-8177

Length: 1012
Ø: 52
Cone Ø: d1 Ø 30 / d2 Ø 27
5010130451, 7485114925



CV-ES-14162

Length: 125
Cone Ø: d1 Ø 30 / d2 Ø 27
Thread: M30 x 1,5 LHT
3401170, 5000288361, 5001832581,
5001858759, 5001858774



RV-ES-12445

Length: 170
Cone Ø: d1 Ø 30 / d2 Ø 27
5000288363



CV-ES-14163

Length: 125
Cone Ø: d1 Ø 30 / d2 Ø 27
Thread: M30 x 1,5 RHT
0003406169, 0003406236, 0003406251,
0003406254, 0003406260, 0003406261,
5000288360, 5000590236, 5000804824,
5001858773, 7420937674, 7701011412



RV-ES-12446

Length: 170
Cone Ø: d1 Ø 30 / d2 Ø 27
5000288362



DF-RK-8671

Ø: 80
Hole Distance: 145
Thick/Height: 30
5001014345





R ...

R 380.17 ...	01/90→05/91	Tie Rod End	CV-ES-0914		for Steering Rod
	01/90→05/91	Tie Rod End	CV-ES-14162		for Steering Rod
	01/90→05/91	Tie Rod End	CV-ES-14163		for Steering Rod
	01/90→05/91	Tie Rod End	RV-ES-12445		
	01/90→05/91	Tie Rod End	RV-ES-12446		
R 380.18	01/90→05/91	Ball Head, gearshift linkage	CV-ES-2121		
	01/90→05/91	Centre Rod	RV-DL-0074		Push Rod
	01/90→05/91	Centre Rod	RV-DL-2181		Coupling Rod
	01/90→05/91	Centre Rod	RV-DL-8177		Push Rod
	01/90→05/91	Suspension Strut Repair Kit		DF-RK-8671	
	01/90→05/91	Tie Rod End	CV-ES-0912		
	01/90→05/91	Tie Rod End	CV-ES-0914		for Steering Rod
	01/90→05/91	Tie Rod End	CV-ES-14162		for Steering Rod
	01/90→05/91	Tie Rod End	CV-ES-14163		for Steering Rod
	01/90→05/91	Tie Rod End	RV-ES-12445		
	01/90→05/91	Tie Rod End	RV-ES-12446		
	R 380.18/T	01/90→05/91	Ball Head, gearshift linkage	CV-ES-2121	
01/90→05/91		Centre Rod	RV-DL-0074		Push Rod
01/90→05/91		Centre Rod	RV-DL-2181		Coupling Rod
01/90→05/91		Centre Rod	RV-DL-8177		Push Rod
01/90→05/91		Suspension Strut Repair Kit		DF-RK-8671	
01/90→05/91		Tie Rod End	CV-ES-0912		
01/90→05/91		Tie Rod End	CV-ES-0914		for Steering Rod
01/90→05/91		Tie Rod End	CV-ES-14162		for Steering Rod
01/90→05/91		Tie Rod End	CV-ES-14163		for Steering Rod
01/90→05/91		Tie Rod End	RV-ES-12445		
01/90→05/91		Tie Rod End	RV-ES-12446		
R 380.19		01/90→05/91	Ball Head, gearshift linkage	CV-ES-2121	
	01/90→05/91	Centre Rod	RV-DL-0074		Push Rod
	01/90→05/91	Centre Rod	RV-DL-2181		Coupling Rod
	01/90→05/91	Centre Rod	RV-DL-8177		Push Rod
	01/90→05/91	Suspension Strut Repair Kit		DF-RK-8671	
	01/90→05/91	Tie Rod End	CV-ES-0912		
	01/90→05/91	Tie Rod End	CV-ES-0914		for Steering Rod
	01/90→05/91	Tie Rod End	CV-ES-14162		for Steering Rod
	01/90→05/91	Tie Rod End	CV-ES-14163		for Steering Rod
	01/90→05/91	Tie Rod End	RV-ES-12445		
	01/90→05/91	Tie Rod End	RV-ES-12446		
	R 380.19/T	01/90→05/91	Ball Head, gearshift linkage	CV-ES-2121	
01/90→05/91		Centre Rod	RV-DL-0074		Push Rod
01/90→05/91		Centre Rod	RV-DL-2181		Coupling Rod
01/90→05/91		Centre Rod	RV-DL-8177		Push Rod
01/90→05/91		Suspension Strut Repair Kit		DF-RK-8671	
01/90→05/91		Tie Rod End	CV-ES-0912		
01/90→05/91		Tie Rod End	CV-ES-0914		for Steering Rod
01/90→05/91		Tie Rod End	CV-ES-14162		for Steering Rod
01/90→05/91		Tie Rod End	CV-ES-14163		for Steering Rod
01/90→05/91		Tie Rod End	RV-ES-12445		
01/90→05/91		Tie Rod End	RV-ES-12446		
R 380.19/TB		01/90→05/91	Ball Head, gearshift linkage	CV-ES-2121	
	01/90→05/91	Centre Rod	RV-DL-0074		Push Rod
	01/90→05/91	Centre Rod	RV-DL-2181		Coupling Rod
	01/90→05/91	Centre Rod	RV-DL-8177		Push Rod
	01/90→05/91	Suspension Strut Repair Kit		DF-RK-8671	
	01/90→05/91	Tie Rod End	CV-ES-0912		
	01/90→05/91	Tie Rod End	CV-ES-0914		for Steering Rod
	01/90→05/91	Tie Rod End	CV-ES-14162		for Steering Rod
	01/90→05/91	Tie Rod End	CV-ES-14163		for Steering Rod
	01/90→05/91	Tie Rod End	RV-ES-12445		
01/90→05/91	Tie Rod End	RV-ES-12446			

CV-ES-0912

Length: 125
Cone Ø: d1 Ø 30 / d2 Ø 27
Thread: M38 x 1,5 LHT
3401206, 5001832579



RV-DL-0074

Length: 1012
Ø: 52
Cone Ø: d1 Ø 30 / d2 Ø 27
5010130453



CV-ES-0914

Length: 125
Cone Ø: d1 Ø 30 / d2 Ø 27
Thread: M38 x 1,5 RHT
3401207, 5001832580



RV-DL-2181

Length: 1650
Ø: 40
Cone Ø: d1 Ø 30 / d2 Ø 27
5010145581, 5010308215



CV-ES-2121

Length: 85
Cone Ø: d1 Ø 12 / d2 Ø 10,8
Thread: M14 x 1,5 RHT
23162046, 5000516214, 5010144543,
5010245591



RV-DL-8177

Length: 1012
Ø: 52
Cone Ø: d1 Ø 30 / d2 Ø 27
5010130451, 7485114925



CV-ES-14162

Length: 125
Cone Ø: d1 Ø 30 / d2 Ø 27
Thread: M30 x 1,5 LHT
3401170, 5000288361, 5001832581,
5001858759, 5001858774



RV-ES-12445

Length: 170
Cone Ø: d1 Ø 30 / d2 Ø 27
5000288363



CV-ES-14163

Length: 125
Cone Ø: d1 Ø 30 / d2 Ø 27
Thread: M30 x 1,5 RHT
0003406169, 0003406236, 0003406251,
0003406254, 0003406260, 0003406261,
5000288360, 5000590236, 5000804824,
5001858773, 7420937674, 7701011412



RV-ES-12446

Length: 170
Cone Ø: d1 Ø 30 / d2 Ø 27
5000288362



DF-RK-8671

Ø: 80
Hole Distance: 145
Thick/Height: 30
5001014345





R ...

R 380.22/T	01/90→05/91	Ball Head, gearshift linkage	CV-ES-2121		
	01/90→05/91	Centre Rod	RV-DL-0074	Push Rod	
	01/90→05/91	Centre Rod	RV-DL-2181	Coupling Rod	
	01/90→05/91	Centre Rod	RV-DL-8177	Push Rod	
	01/90→05/91	Suspension Strut Repair Kit		DF-RK-8671	
	01/90→05/91	Tie Rod End	CV-ES-0912		
	01/90→05/91	Tie Rod End	CV-ES-0914	for Steering Rod	
	01/90→05/91	Tie Rod End	CV-ES-14162	for Steering Rod	
	01/90→05/91	Tie Rod End	CV-ES-14163	for Steering Rod	
	01/90→05/91	Tie Rod End	RV-ES-12445		
	01/90→05/91	Tie Rod End	RV-ES-12446		
	R 380.24	01/90→05/91	Ball Head, gearshift linkage	CV-ES-2121	
		01/90→05/91	Centre Rod	RV-DL-0074	Push Rod
01/90→05/91		Centre Rod	RV-DL-2181	Coupling Rod	
01/90→05/91		Centre Rod	RV-DL-8177	Push Rod	
01/90→05/91		Suspension Strut Repair Kit		DF-RK-8671	
01/90→05/91		Tie Rod End	CV-ES-0912		
01/90→05/91		Tie Rod End	CV-ES-0914	for Steering Rod	
01/90→05/91		Tie Rod End	CV-ES-14162	for Steering Rod	
01/90→05/91		Tie Rod End	CV-ES-14163	for Steering Rod	
01/90→05/91		Tie Rod End	RV-ES-12445		
01/90→05/91		Tie Rod End	RV-ES-12446		
R 380.25		01/90→05/91	Ball Head, gearshift linkage	CV-ES-2121	
		01/90→05/91	Centre Rod	RV-DL-0074	Push Rod
	01/90→05/91	Centre Rod	RV-DL-2181	Coupling Rod	
	01/90→05/91	Centre Rod	RV-DL-8177	Push Rod	
	01/90→05/91	Suspension Strut Repair Kit		DF-RK-8671	
	01/90→05/91	Tie Rod End	CV-ES-0912		
	01/90→05/91	Tie Rod End	CV-ES-0914	for Steering Rod	
	01/90→05/91	Tie Rod End	CV-ES-14162	for Steering Rod	
	01/90→05/91	Tie Rod End	CV-ES-14163	for Steering Rod	
	01/90→05/91	Tie Rod End	RV-ES-12445		
	01/90→05/91	Tie Rod End	RV-ES-12446		
	R 380.25/T	01/90→05/91	Ball Head, gearshift linkage	CV-ES-2121	
		01/90→05/91	Centre Rod	RV-DL-0074	Push Rod
01/90→05/91		Centre Rod	RV-DL-2181	Coupling Rod	
01/90→05/91		Centre Rod	RV-DL-8177	Push Rod	
01/90→05/91		Suspension Strut Repair Kit		DF-RK-8671	
01/90→05/91		Tie Rod End	CV-ES-0912		
01/90→05/91		Tie Rod End	CV-ES-0914	for Steering Rod	
01/90→05/91		Tie Rod End	CV-ES-14162	for Steering Rod	
01/90→05/91		Tie Rod End	CV-ES-14163	for Steering Rod	
01/90→05/91		Tie Rod End	RV-ES-12445		
01/90→05/91		Tie Rod End	RV-ES-12446		
R 380.26		01/90→05/91	Ball Head, gearshift linkage	CV-ES-2121	
		01/90→05/91	Centre Rod	RV-DL-0074	Push Rod
	01/90→05/91	Centre Rod	RV-DL-2181	Coupling Rod	
	01/90→05/91	Centre Rod	RV-DL-8177	Push Rod	
	01/90→05/91	Suspension Strut Repair Kit		DF-RK-8671	
	01/90→05/91	Tie Rod End	CV-ES-0912		
	01/90→05/91	Tie Rod End	CV-ES-0914	for Steering Rod	
	01/90→05/91	Tie Rod End	CV-ES-14162	for Steering Rod	
	01/90→05/91	Tie Rod End	CV-ES-14163	for Steering Rod	
	01/90→05/91	Tie Rod End	RV-ES-12445		
	01/90→05/91	Tie Rod End	RV-ES-12446		
	R 380.26/T	01/90→05/91	Ball Head, gearshift linkage	CV-ES-2121	
		01/90→05/91	Centre Rod	RV-DL-0074	Push Rod
01/90→05/91		Centre Rod	RV-DL-2181	Coupling Rod	
01/90→05/91		Centre Rod	RV-DL-8177	Push Rod	
01/90→05/91		Suspension Strut Repair Kit		DF-RK-8671	
01/90→05/91		Tie Rod End	CV-ES-0912		
01/90→05/91		Tie Rod End	CV-ES-0914	for Steering Rod	

CV-ES-0912

Length: 125
Cone Ø: d1 Ø 30 / d2 Ø 27
Thread: M38 x 1,5 LHT
3401206, 5001832579



RV-DL-0074

Length: 1012
Ø: 52
Cone Ø: d1 Ø 30 / d2 Ø 27
5010130453



CV-ES-0914

Length: 125
Cone Ø: d1 Ø 30 / d2 Ø 27
Thread: M38 x 1,5 RHT
3401207, 5001832580



RV-DL-2181

Length: 1650
Ø: 40
Cone Ø: d1 Ø 30 / d2 Ø 27
5010145581, 5010308215



CV-ES-2121

Length: 85
Cone Ø: d1 Ø 12 / d2 Ø 10,8
Thread: M14 x 1,5 RHT
23162046, 5000516214, 5010144543,
5010245591



RV-DL-8177

Length: 1012
Ø: 52
Cone Ø: d1 Ø 30 / d2 Ø 27
5010130451, 7485114925



CV-ES-14162

Length: 125
Cone Ø: d1 Ø 30 / d2 Ø 27
Thread: M30 x 1,5 LHT
3401170, 5000288361, 5001832581,
5001858759, 5001858774



RV-ES-12445

Length: 170
Cone Ø: d1 Ø 30 / d2 Ø 27
5000288363



CV-ES-14163

Length: 125
Cone Ø: d1 Ø 30 / d2 Ø 27
Thread: M30 x 1,5 RHT
0003406169, 0003406236, 0003406251,
0003406254, 0003406260, 0003406261,
5000288360, 5000590236, 5000804824,
5001858773, 7420937674, 7701011412



RV-ES-12446

Length: 170
Cone Ø: d1 Ø 30 / d2 Ø 27
5000288362



DF-RK-8671

Ø: 80
Hole Distance: 145
Thick/Height: 30
5001014345





R ...

R 380.26/T ...	01/90→05/91	Tie Rod End	CV-ES-14163		for Steering Rod
	01/90→05/91	Tie Rod End	RV-ES-12445		
	01/90→05/91	Tie Rod End	RV-ES-12446		
R 390.16	07/85→03/89	Ball Head, gearshift linkage	CV-ES-2121		
	07/85→03/89	Centre Rod	RV-DL-0074		Push Rod
	07/85→03/89	Centre Rod	RV-DL-2181		Coupling Rod
	07/85→03/89	Centre Rod	RV-DL-8177		Push Rod
	07/85→03/89	Stabiliser Link	RV-DL-10249		Pressure Rod
	07/85→03/89	Suspension Strut Repair Kit		DF-RK-8671	
	07/85→03/89	Tie Rod End	CV-ES-0912		
	07/85→03/89	Tie Rod End	CV-ES-0914		for Steering Rod
	07/85→03/89	Tie Rod End	CV-ES-14162		for Steering Rod
	07/85→03/89	Tie Rod End	CV-ES-14163		for Steering Rod
	07/85→03/89	Tie Rod End	RV-ES-12445		
	07/85→03/89	Tie Rod End	RV-ES-12446		
R 390.16/T	07/85→03/89	Ball Head, gearshift linkage	CV-ES-2121		
	07/85→03/89	Centre Rod	RV-DL-0074		Push Rod
	07/85→03/89	Centre Rod	RV-DL-2181		Coupling Rod
	07/85→03/89	Centre Rod	RV-DL-8177		Push Rod
	07/85→03/89	Stabiliser Link	RV-DL-10249		Pressure Rod
	07/85→03/89	Suspension Strut Repair Kit		DF-RK-8671	
	07/85→03/89	Tie Rod End	CV-ES-0912		
	07/85→03/89	Tie Rod End	CV-ES-0914		for Steering Rod
	07/85→03/89	Tie Rod End	CV-ES-14162		for Steering Rod
	07/85→03/89	Tie Rod End	CV-ES-14163		for Steering Rod
	07/85→03/89	Tie Rod End	RV-ES-12445		
	07/85→03/89	Tie Rod End	RV-ES-12446		
R 390.17	07/85→03/89	Ball Head, gearshift linkage	CV-ES-2121		
	07/85→03/89	Centre Rod	RV-DL-0074		Push Rod
	07/85→03/89	Centre Rod	RV-DL-2181		Coupling Rod
	07/85→03/89	Centre Rod	RV-DL-8177		Push Rod
	07/85→03/89	Stabiliser Link	RV-DL-10249		Pressure Rod
	07/85→03/89	Suspension Strut Repair Kit		DF-RK-8671	
	07/85→03/89	Tie Rod End	CV-ES-0912		
	07/85→03/89	Tie Rod End	CV-ES-0914		for Steering Rod
	07/85→03/89	Tie Rod End	CV-ES-14162		for Steering Rod
	07/85→03/89	Tie Rod End	CV-ES-14163		for Steering Rod
	07/85→03/89	Tie Rod End	RV-ES-12445		
	07/85→03/89	Tie Rod End	RV-ES-12446		
R 390.17/T	07/85→03/89	Ball Head, gearshift linkage	CV-ES-2121		
	07/85→03/89	Centre Rod	RV-DL-0074		Push Rod
	07/85→03/89	Centre Rod	RV-DL-2181		Coupling Rod
	07/85→03/89	Centre Rod	RV-DL-8177		Push Rod
	07/85→03/89	Stabiliser Link	RV-DL-10249		Pressure Rod
	07/85→03/89	Suspension Strut Repair Kit		DF-RK-8671	
	07/85→03/89	Tie Rod End	CV-ES-0912		
	07/85→03/89	Tie Rod End	CV-ES-0914		for Steering Rod
	07/85→03/89	Tie Rod End	CV-ES-14162		for Steering Rod
	07/85→03/89	Tie Rod End	CV-ES-14163		for Steering Rod
	07/85→03/89	Tie Rod End	RV-ES-12445		
	07/85→03/89	Tie Rod End	RV-ES-12446		
R 390.19/T	07/85→03/89	Tie Rod End	CV-ES-14163		for Steering Rod
R 390.22/T	07/85→03/89	Ball Head, gearshift linkage	CV-ES-2121		
	07/85→03/89	Centre Rod	RV-DL-0074		Push Rod
	07/85→03/89	Centre Rod	RV-DL-2181		Coupling Rod
	07/85→03/89	Centre Rod	RV-DL-8177		Push Rod
	07/85→03/89	Stabiliser Link	RV-DL-10249		Pressure Rod
	07/85→03/89	Suspension Strut Repair Kit		DF-RK-8671	
	07/85→03/89	Tie Rod End	CV-ES-0912		
	07/85→03/89	Tie Rod End	CV-ES-0914		for Steering Rod
	07/85→03/89	Tie Rod End	CV-ES-14162		for Steering Rod
	07/85→03/89	Tie Rod End	CV-ES-14163		for Steering Rod
	07/85→03/89	Tie Rod End	RV-ES-12445		
	07/85→03/89	Tie Rod End	RV-ES-12446		

CV-ES-0912

Length: 125
Cone Ø: d1 Ø 30 / d2 Ø 27
Thread: M38 x 1,5 LHT
3401206, 5001832579



RV-DL-0074

Length: 1012
Ø: 52
Cone Ø: d1 Ø 30 / d2 Ø 27
5010130453



CV-ES-0914

Length: 125
Cone Ø: d1 Ø 30 / d2 Ø 27
Thread: M38 x 1,5 RHT
3401207, 5001832580



RV-DL-2181

Length: 1650
Ø: 40
Cone Ø: d1 Ø 30 / d2 Ø 27
5010145581, 5010308215



CV-ES-2121

Length: 85
Cone Ø: d1 Ø 12 / d2 Ø 10,8
Thread: M14 x 1,5 RHT
23162046, 5000516214, 5010144543,
5010245591



RV-DL-8177

Length: 1012
Ø: 52
Cone Ø: d1 Ø 30 / d2 Ø 27
5010130451, 7485114925



CV-ES-14162

Length: 125
Cone Ø: d1 Ø 30 / d2 Ø 27
Thread: M30 x 1,5 LHT
3401170, 5000288361, 5001832581,
5001858759, 5001858774



RV-DL-10249

Length: 440
Ø: 36
Cone Ø: d1 Ø 26 / d2 Ø 23,5
0000758006, 5000874575, 5010065789



CV-ES-14163

Length: 125
Cone Ø: d1 Ø 30 / d2 Ø 27
Thread: M30 x 1,5 RHT
0003406169, 0003406236, 0003406251,
0003406254, 0003406260, 0003406261,
5000288360, 5000590236, 5000804824,
5001858773, 7420937674, 7701011412



RV-ES-12445

Length: 170
Cone Ø: d1 Ø 30 / d2 Ø 27
5000288363



RV-ES-12446

Length: 170
Cone Ø: d1 Ø 30 / d2 Ø 27
5000288362



DF-RK-8671

Ø: 80
Hole Distance: 145
Thick/Height: 30
5001014345



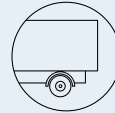

R ...

R 390.24	07/85→03/89	Ball Head, gearshift linkage	CV-ES-2121			
	07/85→03/89	Centre Rod	RV-DL-0074		Push Rod	
	07/85→03/89	Centre Rod	RV-DL-2181		Coupling Rod	
	07/85→03/89	Centre Rod	RV-DL-8177		Push Rod	
	07/85→03/89	Stabiliser Link	RV-DL-10249		Pressure Rod	
	07/85→03/89	Suspension Strut Repair Kit		DF-RK-8671		
	07/85→03/89	Tie Rod End	CV-ES-0912			
	07/85→03/89	Tie Rod End	CV-ES-0914		for Steering Rod	
	07/85→03/89	Tie Rod End	CV-ES-14162		for Steering Rod	
	07/85→03/89	Tie Rod End	CV-ES-14163		for Steering Rod	
	07/85→03/89	Tie Rod End	RV-ES-12445			
	07/85→03/89	Tie Rod End	RV-ES-12446			
	R 390.24/T	07/85→03/89	Ball Head, gearshift linkage	CV-ES-2121		
07/85→03/89		Centre Rod	RV-DL-0074		Push Rod	
07/85→03/89		Centre Rod	RV-DL-2181		Coupling Rod	
07/85→03/89		Centre Rod	RV-DL-8177		Push Rod	
07/85→03/89		Stabiliser Link	RV-DL-10249		Pressure Rod	
07/85→03/89		Suspension Strut Repair Kit		DF-RK-8671		
07/85→03/89		Tie Rod End	CV-ES-0912			
07/85→03/89		Tie Rod End	CV-ES-0914		for Steering Rod	
07/85→03/89		Tie Rod End	CV-ES-14162		for Steering Rod	
07/85→03/89		Tie Rod End	CV-ES-14163		for Steering Rod	
07/85→03/89		Tie Rod End	RV-ES-12445			
07/85→03/89		Tie Rod End	RV-ES-12446			
R 420.17		10/88→10/91	Ball Head, gearshift linkage	CV-ES-2121		
	10/88→10/91	Centre Rod	RV-DL-0074		Push Rod	
	10/88→10/91	Centre Rod	RV-DL-2181		Coupling Rod	
	10/88→10/91	Centre Rod	RV-DL-8177		Push Rod	
	10/88→10/91	Suspension Strut Repair Kit		DF-RK-8671		
	10/88→10/91	Tie Rod End	CV-ES-0912			
	10/88→10/91	Tie Rod End	CV-ES-0914		for Steering Rod	
	10/88→10/91	Tie Rod End	CV-ES-14162		for Steering Rod	
	10/88→10/91	Tie Rod End	CV-ES-14163		for Steering Rod	
	10/88→10/91	Tie Rod End	RV-ES-12445			
	10/88→10/91	Tie Rod End	RV-ES-12446			
	R 420.17/T	10/88→10/91	Ball Head, gearshift linkage	CV-ES-2121		
		10/88→10/91	Centre Rod	RV-DL-0074		Push Rod
10/88→10/91		Centre Rod	RV-DL-2181		Coupling Rod	
10/88→10/91		Centre Rod	RV-DL-8177		Push Rod	
10/88→10/91		Suspension Strut Repair Kit		DF-RK-8671		
10/88→10/91		Tie Rod End	CV-ES-0912			
10/88→10/91		Tie Rod End	CV-ES-0914		for Steering Rod	
10/88→10/91		Tie Rod End	CV-ES-14162		for Steering Rod	
10/88→10/91		Tie Rod End	CV-ES-14163		for Steering Rod	
10/88→10/91		Tie Rod End	RV-ES-12445			
10/88→10/91		Tie Rod End	RV-ES-12446			
R 420.19		10/88→10/91	Ball Head, gearshift linkage	CV-ES-2121		
		10/88→10/91	Centre Rod	RV-DL-0074		Push Rod
	10/88→10/91	Centre Rod	RV-DL-2181		Coupling Rod	
	10/88→10/91	Centre Rod	RV-DL-8177		Push Rod	
	10/88→10/91	Suspension Strut Repair Kit		DF-RK-8671		
	10/88→10/91	Tie Rod End	CV-ES-0912			
	10/88→10/91	Tie Rod End	CV-ES-0914		for Steering Rod	
	10/88→10/91	Tie Rod End	CV-ES-14162		for Steering Rod	
	10/88→10/91	Tie Rod End	CV-ES-14163		for Steering Rod	
	10/88→10/91	Tie Rod End	RV-ES-12445			
	10/88→10/91	Tie Rod End	RV-ES-12446			
	R 420.19/T	10/88→10/91	Ball Head, gearshift linkage	CV-ES-2121		
		10/88→10/91	Centre Rod	RV-DL-0074		Push Rod
10/88→10/91		Centre Rod	RV-DL-2181		Coupling Rod	
10/88→10/91		Centre Rod	RV-DL-8177		Push Rod	
10/88→10/91		Suspension Strut Repair Kit		DF-RK-8671		
10/88→10/91		Tie Rod End	CV-ES-0912			
10/88→10/91		Tie Rod End	CV-ES-0914		for Steering Rod	

CV-ES-0912

Length: 125
Cone Ø: d1 Ø 30 / d2 Ø 27
Thread: M38 x 1,5 LHT
3401206, 5001832579



RV-DL-0074

Length: 1012
Ø: 52
Cone Ø: d1 Ø 30 / d2 Ø 27
5010130453



CV-ES-0914

Length: 125
Cone Ø: d1 Ø 30 / d2 Ø 27
Thread: M38 x 1,5 RHT
3401207, 5001832580



RV-DL-2181

Length: 1650
Ø: 40
Cone Ø: d1 Ø 30 / d2 Ø 27
5010145581, 5010308215



CV-ES-2121

Length: 85
Cone Ø: d1 Ø 12 / d2 Ø 10,8
Thread: M14 x 1,5 RHT
23162046, 5000516214, 5010144543,
5010245591



RV-DL-8177

Length: 1012
Ø: 52
Cone Ø: d1 Ø 30 / d2 Ø 27
5010130451, 7485114925



CV-ES-14162

Length: 125
Cone Ø: d1 Ø 30 / d2 Ø 27
Thread: M30 x 1,5 LHT
3401170, 5000288361, 5001832581,
5001858759, 5001858774



RV-DL-10249

Length: 440
Ø: 36
Cone Ø: d1 Ø 26 / d2 Ø 23,5
0000758006, 5000874575, 5010065789



CV-ES-14163

Length: 125
Cone Ø: d1 Ø 30 / d2 Ø 27
Thread: M30 x 1,5 RHT
0003406169, 0003406236, 0003406251,
0003406254, 0003406260, 0003406261,
5000288360, 5000590236, 5000804824,
5001858773, 7420937674, 7701011412



RV-ES-12445

Length: 170
Cone Ø: d1 Ø 30 / d2 Ø 27
5000288363



RV-ES-12446

Length: 170
Cone Ø: d1 Ø 30 / d2 Ø 27
5000288362



DF-RK-8671

Ø: 80
Hole Distance: 145
Thick/Height: 30
5001014345





R ...

R 420.19/T ...	10/88→10/91	Tie Rod End	CV-ES-0914		for Steering Rod	
	10/88→10/91	Tie Rod End	CV-ES-14162		for Steering Rod	
	10/88→10/91	Tie Rod End	CV-ES-14163		for Steering Rod	
	10/88→10/91	Tie Rod End	RV-ES-12445			
	10/88→10/91	Tie Rod End	RV-ES-12446			
R 420.24	10/88→10/91	Ball Head, gearshift linkage	CV-ES-2121			
	10/88→10/91	Centre Rod	RV-DL-0074		Push Rod	
	10/88→10/91	Centre Rod	RV-DL-2181		Coupling Rod	
	10/88→10/91	Centre Rod	RV-DL-8177		Push Rod	
	10/88→10/91	Suspension Strut Repair Kit		DF-RK-8671		
	10/88→10/91	Tie Rod End	CV-ES-0912			
	10/88→10/91	Tie Rod End	CV-ES-0914		for Steering Rod	
	10/88→10/91	Tie Rod End	CV-ES-14162		for Steering Rod	
	10/88→10/91	Tie Rod End	CV-ES-14163		for Steering Rod	
	10/88→10/91	Tie Rod End	RV-ES-12445			
	10/88→10/91	Tie Rod End	RV-ES-12446			
	R 420.24/T	10/88→10/91	Ball Head, gearshift linkage	CV-ES-2121		
		10/88→10/91	Centre Rod	RV-DL-0074		Push Rod
10/88→10/91		Centre Rod	RV-DL-2181		Coupling Rod	
10/88→10/91		Centre Rod	RV-DL-8177		Push Rod	
10/88→10/91		Suspension Strut Repair Kit		DF-RK-8671		
10/88→10/91		Tie Rod End	CV-ES-0912			
10/88→10/91		Tie Rod End	CV-ES-0914		for Steering Rod	
10/88→10/91		Tie Rod End	CV-ES-14162		for Steering Rod	
10/88→10/91		Tie Rod End	CV-ES-14163		for Steering Rod	
10/88→10/91		Tie Rod End	RV-ES-12445			
10/88→10/91		Tie Rod End	RV-ES-12446			
R 420.35/T		10/88→10/91	Ball Head, gearshift linkage	CV-ES-2121		
		10/88→10/91	Centre Rod	RV-DL-0074		Push Rod
	10/88→10/91	Centre Rod	RV-DL-2181		Coupling Rod	
	10/88→10/91	Centre Rod	RV-DL-8177		Push Rod	
	10/88→10/91	Suspension Strut Repair Kit		DF-RK-8671		
	10/88→10/91	Tie Rod End	CV-ES-0912			
	10/88→10/91	Tie Rod End	CV-ES-0914		for Steering Rod	
	10/88→10/91	Tie Rod End	CV-ES-14162		for Steering Rod	
	10/88→10/91	Tie Rod End	CV-ES-14163		for Steering Rod	
	10/88→10/91	Tie Rod End	RV-ES-12445			
	10/88→10/91	Tie Rod End	RV-ES-12446			

TBH

TBH 280	01/77→06/80	Tie Rod End	RV-ES-12446		
---------	-------------	-------------	--------------------	--	--

SCANIA

2 - series

112 H/280	01/81→12/86	Centre Rod	SC-DL-2151		Push Rod
	01/81→12/86	Centre Rod	SC-DL-2904		Push Rod
	01/81→12/86	Centre Rod	SC-DL-2965		Push Rod
	01/81→12/86	Suspension Strut Repair Kit		CV-RK-5311	
	01/81→12/86	Tie Rod End	CV-ES-14162		for Steering Rod
	01/81→12/86	Tie Rod End	CV-ES-14163		for Steering Rod
112 H/305	01/81→08/91	Centre Rod	SC-DL-2151		Push Rod
	01/81→08/91	Centre Rod	SC-DL-2904		Push Rod
	01/81→08/91	Centre Rod	SC-DL-2965		Push Rod
	01/81→08/91	Suspension Strut Repair Kit		CV-RK-5311	
	01/81→08/91	Tie Rod End	CV-ES-14162		for Steering Rod
	01/81→08/91	Tie Rod End	CV-ES-14163		for Steering Rod
112 M/305	01/81→12/86	Centre Rod	SC-DL-2151		Push Rod
	01/81→12/86	Centre Rod	SC-DL-2904		Push Rod
	01/81→12/86	Centre Rod	SC-DL-2965		Push Rod
	01/81→12/86	Suspension Strut Repair Kit		CV-RK-5311	
	01/81→12/86	Tie Rod End	CV-ES-14162		for Steering Rod
	01/81→12/86	Tie Rod End	CV-ES-14163		for Steering Rod

CV-ES-0912

Length: 125
Cone Ø: d1 Ø 30 / d2 Ø 27
Thread: M38 x 1,5 LHT
3401206, 5001832579



DF-RK-8671

Ø: 80
Hole Distance: 145
Thick/Height: 30
5001014345



SC-DL-2151

Length: 912
Ø: 50
Cone Ø: d1 Ø 30 / d2 Ø 27
370875, 1369919



CV-ES-0914

Length: 125
Cone Ø: d1 Ø 30 / d2 Ø 27
Thread: M38 x 1,5 RHT
3401207, 5001832580



RV-DL-0074

Length: 1012
Ø: 52
Cone Ø: d1 Ø 30 / d2 Ø 27
5010130453



SC-DL-2904

Length: 940
Ø: 46
Cone Ø: d1 Ø 30 / d2 Ø 27
0278665, 278665



CV-ES-2121

Length: 85
Cone Ø: d1 Ø 12 / d2 Ø 10,8
Thread: M14 x 1,5 RHT
23162046, 5000516214, 5010144543,
5010245591



RV-DL-2181

Length: 1650
Ø: 40
Cone Ø: d1 Ø 30 / d2 Ø 27
5010145581, 5010308215



SC-DL-2965

Length: 950
Ø: 46
Cone Ø: d1 Ø 30 / d2 Ø 27
0278663, 0352635



CV-ES-14162

Length: 125
Cone Ø: d1 Ø 30 / d2 Ø 27
Thread: M30 x 1,5 LHT
283783, 395009, 1358792, 1738380, 1
914 426, 2051165, 3401170, 5000288361,
5001832581, 5001858759, 5001858774



RV-DL-8177

Length: 1012
Ø: 52
Cone Ø: d1 Ø 30 / d2 Ø 27
5010130451, 7485114925



CV-ES-14163

Length: 125
Cone Ø: d1 Ø 30 / d2 Ø 27
Thread: M30 x 1,5 RHT
283784, 395010, 1358793, 1488890,
1738381, 1767328, 1914427, 2051166,
0003406169, 0003406236, 0003406251,
0003406254, 0003406260, 0003406261,
5000288360, 5000590236, 5000804824,
5001858773, 7420937674, 7701011412



RV-ES-12445

Length: 170
Cone Ø: d1 Ø 30 / d2 Ø 27
5000288363



RV-ES-12446

Length: 170
Cone Ø: d1 Ø 30 / d2 Ø 27
5000288362



CV-RK-5311

0638862, 638862, 0639287, 639287,
1104335, 1953248, 81432206006,
81432206107





2 - series ...

82 H/210	01/81→12/86	Centre Rod	SC-DL-2151		Push Rod
	01/81→12/86	Centre Rod	SC-DL-2904		Push Rod
	01/81→12/86	Centre Rod	SC-DL-2965		Push Rod
	01/81→12/86	Suspension Strut Repair Kit		CV-RK-5311	
	01/81→12/86	Tie Rod End	CV-ES-14162		for Steering Rod
	01/81→12/86	Tie Rod End	CV-ES-14163		for Steering Rod
82 M/190	10/82→03/88	Centre Rod	SC-DL-2151		Push Rod
	10/82→03/88	Centre Rod	SC-DL-2904		Push Rod
	10/82→03/88	Centre Rod	SC-DL-2965		Push Rod
	10/82→03/88	Suspension Strut Repair Kit		CV-RK-5311	
	10/82→03/88	Tie Rod End	CV-ES-14162		for Steering Rod
	10/82→03/88	Tie Rod End	CV-ES-14163		for Steering Rod
82 M/210	01/81→12/86	Centre Rod	SC-DL-2151		Push Rod
	01/81→12/86	Centre Rod	SC-DL-2904		Push Rod
	01/81→12/86	Centre Rod	SC-DL-2965		Push Rod
	01/81→12/86	Suspension Strut Repair Kit		CV-RK-5311	
	01/81→12/86	Tie Rod End	CV-ES-14162		for Steering Rod
	01/81→12/86	Tie Rod End	CV-ES-14163		for Steering Rod
92 H/245	01/85→12/88	Centre Rod	SC-DL-2151		Push Rod
	01/85→12/88	Centre Rod	SC-DL-2904		Push Rod
	01/85→12/88	Centre Rod	SC-DL-2965		Push Rod
	01/85→12/88	Suspension Strut Repair Kit		CV-RK-5311	
	01/85→12/88	Tie Rod End	CV-ES-14162		for Steering Rod
	01/85→12/88	Tie Rod End	CV-ES-14163		for Steering Rod
92 H/275	01/85→12/88	Centre Rod	SC-DL-2151		Push Rod
	01/85→12/88	Centre Rod	SC-DL-2904		Push Rod
	01/85→12/88	Centre Rod	SC-DL-2965		Push Rod
	01/85→12/88	Suspension Strut Repair Kit		CV-RK-5311	
	01/85→12/88	Tie Rod End	CV-ES-14162		for Steering Rod
	01/85→12/88	Tie Rod End	CV-ES-14163		for Steering Rod
92 M/245	01/85→12/88	Centre Rod	SC-DL-2151		Push Rod
	01/85→12/88	Centre Rod	SC-DL-2904		Push Rod
	01/85→12/88	Centre Rod	SC-DL-2965		Push Rod
	01/85→12/88	Suspension Strut Repair Kit		CV-RK-5311	
	01/85→12/88	Tie Rod End	CV-ES-14162		for Steering Rod
	01/85→12/88	Tie Rod End	CV-ES-14163		for Steering Rod
92 M/275	01/85→12/88	Centre Rod	SC-DL-2151		Push Rod
	01/85→12/88	Centre Rod	SC-DL-2904		Push Rod
	01/85→12/88	Centre Rod	SC-DL-2965		Push Rod
	01/85→12/88	Suspension Strut Repair Kit		CV-RK-5311	
	01/85→12/88	Tie Rod End	CV-ES-14162		for Steering Rod
	01/85→12/88	Tie Rod End	CV-ES-14163		for Steering Rod

3 - series

113 E/320	11/91→12/96	Ball Head, gearshift linkage	CV-ES-2119		
	11/91→12/96	Ball Head, gearshift linkage	CV-ES-2182		
	11/91→12/96	Centre Rod	SC-DL-0305		Push Rod
	11/91→12/96	Centre Rod	SC-DL-2151		Push Rod
	11/91→12/96	Centre Rod	SC-DL-2904		Push Rod
	11/91→12/96	Centre Rod	SC-DL-2965		Push Rod
	11/91→12/96	Centre Rod	SC-DL-2968		Push Rod
	11/91→12/96	Centre Rod	SC-DL-8127		Suspension Rod
	11/91→12/96	Centre Rod	SC-DL-9440		Push Rod
	11/91→12/96	Suspension Strut Repair Kit		CV-RK-5311	
	11/91→12/96	Tie Rod End	CV-ES-14162		for Steering Rod
	11/91→12/96	Tie Rod End	CV-ES-14163		for Steering Rod
	113 E/360	01/90→12/96	Ball Head, gearshift linkage	CV-ES-2119	
01/90→12/96		Ball Head, gearshift linkage	CV-ES-2182		
01/90→12/96		Centre Rod	SC-DL-0305		Push Rod
01/90→12/96		Centre Rod	SC-DL-2151		Push Rod
01/90→12/96		Centre Rod	SC-DL-2904		Push Rod
01/90→12/96		Centre Rod	SC-DL-2965		Push Rod
01/90→12/96		Centre Rod	SC-DL-2968		Push Rod
01/90→12/96		Centre Rod	SC-DL-2968		Push Rod

CV-ES-2119

Length: 55
Cone Ø: d1 Ø 10 / d2 Ø 10
Thread: M12 x 1,75 LHT
305319, 371451



SC-DL-2151

Length: 912
Ø: 50
Cone Ø: d1 Ø 30 / d2 Ø 27
370875, 1369919



CV-ES-2182

Length: 55
Cone Ø: d1 Ø 10 / d2 Ø 10
Thread: M12 x 1,75 RHT
305320, 371452



SC-DL-2904

Length: 940
Ø: 46
Cone Ø: d1 Ø 30 / d2 Ø 27
0278665, 278665



CV-ES-14162

Length: 125
Cone Ø: d1 Ø 30 / d2 Ø 27
Thread: M30 x 1,5 LHT
283783, 395009, 1358792, 1738380, 1 914
426, 2051165



SC-DL-2965

Length: 950
Ø: 46
Cone Ø: d1 Ø 30 / d2 Ø 27
0278663, 0352635



CV-ES-14163

Length: 125
Cone Ø: d1 Ø 30 / d2 Ø 27
Thread: M30 x 1,5 RHT
283784, 395010, 1358793, 1488890,
1738381, 1767328, 1914427, 2051166



SC-DL-2968

Length: 855
Ø: 42
Cone Ø: d1 Ø 30 / d2 Ø 27
390784



CV-RK-5311

0638862, 638862, 0639287, 639287,
1104335, 1953248, 81432206006,
81432206107



SC-DL-8127

Length: 792
Ø: 52
Cone Ø: d1 Ø 30 / d2 Ø 27
1305012, 1316872, 1324483



SC-DL-0305

Length: 920
Ø: 50
Cone Ø: d1 Ø 30 / d2 Ø 27
1304571

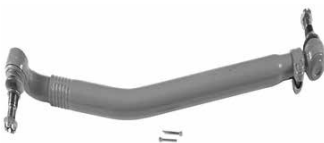

SC-DL-9440

Length: 1590
Ø: 40
Cone Ø: d1 Ø 30 / d2 Ø 27
1308643



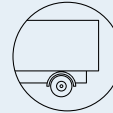
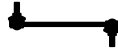

3 - series ...

113 E/360 ...	01/90→12/96	Centre Rod	SC-DL-8127		Suspension Rod
	01/90→12/96	Centre Rod	SC-DL-9440		Push Rod
	01/90→12/96	Suspension Strut Repair Kit		CV-RK-5311	
	01/90→12/96	Tie Rod End	CV-ES-14162		for Steering Rod
	01/90→12/96	Tie Rod End	CV-ES-14163		for Steering Rod
113 E/380	01/91→12/96	Ball Head, gearshift linkage	CV-ES-2119		
	01/91→12/96	Ball Head, gearshift linkage	CV-ES-2182		
	01/91→12/96	Centre Rod	SC-DL-0305		Push Rod
	01/91→12/96	Centre Rod	SC-DL-2151		Push Rod
	01/91→12/96	Centre Rod	SC-DL-2904		Push Rod
	01/91→12/96	Centre Rod	SC-DL-2965		Push Rod
	01/91→12/96	Centre Rod	SC-DL-2968		Push Rod
	01/91→12/96	Centre Rod	SC-DL-8127		Suspension Rod
	01/91→12/96	Centre Rod	SC-DL-9440		Push Rod
	01/91→12/96	Suspension Strut Repair Kit		CV-RK-5311	
	01/91→12/96	Tie Rod End	CV-ES-14162		for Steering Rod
	01/91→12/96	Tie Rod End	CV-ES-14163		for Steering Rod
	113 H/310	05/88→12/91	Ball Head, gearshift linkage	CV-ES-2119	
05/88→12/91		Ball Head, gearshift linkage	CV-ES-2182		
05/88→12/91		Centre Rod	SC-DL-0305		Push Rod
05/88→12/91		Centre Rod	SC-DL-2151		Push Rod
05/88→12/91		Centre Rod	SC-DL-2904		Push Rod
05/88→12/91		Centre Rod	SC-DL-2965		Push Rod
05/88→12/91		Centre Rod	SC-DL-2968		Push Rod
05/88→12/91		Suspension Strut Repair Kit		CV-RK-5311	
05/88→12/91		Tie Rod End	CV-ES-14162		for Steering Rod
05/88→12/91		Tie Rod End	CV-ES-14163		for Steering Rod
113 H/320	05/88→12/96	Ball Head, gearshift linkage	CV-ES-2119		
	05/88→12/96	Ball Head, gearshift linkage	CV-ES-2182		
	05/88→12/96	Centre Rod	SC-DL-0305		Push Rod
	05/88→12/96	Centre Rod	SC-DL-2151		Push Rod
	05/88→12/96	Centre Rod	SC-DL-2904		Push Rod
	05/88→12/96	Centre Rod	SC-DL-2965		Push Rod
	05/88→12/96	Centre Rod	SC-DL-2968		Push Rod
	05/88→12/96	Centre Rod	SC-DL-8127		Suspension Rod
	05/88→12/96	Suspension Strut Repair Kit		CV-RK-5311	
	05/88→12/96	Tie Rod End	CV-ES-14162		for Steering Rod
	05/88→12/96	Tie Rod End	CV-ES-14163		for Steering Rod
	01/90→12/96	Centre Rod	SC-DL-9440		Push Rod
	113 H/360	05/88→12/96	Ball Head, gearshift linkage	CV-ES-2119	
05/88→12/96		Ball Head, gearshift linkage	CV-ES-2182		
05/88→12/96		Centre Rod	SC-DL-0305		Push Rod
05/88→12/96		Centre Rod	SC-DL-2151		Push Rod
05/88→12/96		Centre Rod	SC-DL-2904		Push Rod
05/88→12/96		Centre Rod	SC-DL-2965		Push Rod
05/88→12/96		Centre Rod	SC-DL-2968		Push Rod
05/88→12/96		Centre Rod	SC-DL-8127		Suspension Rod
05/88→12/96		Suspension Strut Repair Kit		CV-RK-5311	
05/88→12/96		Suspension Strut Repair Kit	DF-RK-9341		
05/88→12/96		Tie Rod End	CV-ES-14162		for Steering Rod
05/88→12/96		Tie Rod End	CV-ES-14163		for Steering Rod
01/90→12/96		Centre Rod	SC-DL-9440		Push Rod
113 H/380	01/91→12/96	Ball Head, gearshift linkage	CV-ES-2119		
	01/91→12/96	Ball Head, gearshift linkage	CV-ES-2182		
	01/91→12/96	Centre Rod	SC-DL-0305		Push Rod
	01/91→12/96	Centre Rod	SC-DL-2151		Push Rod
	01/91→12/96	Centre Rod	SC-DL-2904		Push Rod
	01/91→12/96	Centre Rod	SC-DL-2965		Push Rod
	01/91→12/96	Centre Rod	SC-DL-2968		Push Rod
	01/91→12/96	Centre Rod	SC-DL-8127		Suspension Rod
	01/91→12/96	Centre Rod	SC-DL-9440		Push Rod
	01/91→12/96	Suspension Strut Repair Kit		CV-RK-5311	
	01/91→12/96	Suspension Strut Repair Kit	DF-RK-9341		

CV-ES-2119

Length: 55
Cone Ø: d1 Ø 10 / d2 Ø 10
Thread: M12 x 1,75 LHT
305319, 371451



CV-ES-2182

Length: 55
Cone Ø: d1 Ø 10 / d2 Ø 10
Thread: M12 x 1,75 RHT
305320, 371452



CV-ES-14162

Length: 125
Cone Ø: d1 Ø 30 / d2 Ø 27
Thread: M30 x 1,5 LHT
283783, 395009, 1358792, 1738380, 1 914
426, 2051165



CV-ES-14163

Length: 125
Cone Ø: d1 Ø 30 / d2 Ø 27
Thread: M30 x 1,5 RHT
283784, 395010, 1358793, 1488890,
1738381, 1767328, 1914427, 2051166



CV-RK-5311

0638862, 638862, 639287, 0639287,
1104335, 1953248, 81432206006,
81432206107



DF-RK-9341

Ø: 67
550807, 5508072



SC-DL-0305

Length: 920
Ø: 50
Cone Ø: d1 Ø 30 / d2 Ø 27
1304571

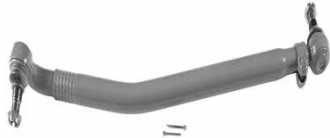

SC-DL-2151

Length: 912
Ø: 50
Cone Ø: d1 Ø 30 / d2 Ø 27
370875, 1369919



SC-DL-2904

Length: 940
Ø: 46
Cone Ø: d1 Ø 30 / d2 Ø 27
278665, 0278665



SC-DL-2965

Length: 950
Ø: 46
Cone Ø: d1 Ø 30 / d2 Ø 27
0278663, 0352635



SC-DL-2968

Length: 855
Ø: 42
Cone Ø: d1 Ø 30 / d2 Ø 27
390784



SC-DL-8127

Length: 792
Ø: 52
Cone Ø: d1 Ø 30 / d2 Ø 27
1305012, 1316872, 1324483



SC-DL-9440

Length: 1590
Ø: 40
Cone Ø: d1 Ø 30 / d2 Ø 27
1308643





3 - series ...

113 H/380 ...	01/91→12/96	Tie Rod End	CV-ES-14162		for Steering Rod
	01/91→12/96	Tie Rod End	CV-ES-14163		for Steering Rod
113 M/320	05/88→12/96	Ball Head, gearshift linkage	CV-ES-2119		
	05/88→12/96	Ball Head, gearshift linkage	CV-ES-2182		
	05/88→12/96	Centre Rod	SC-DL-0305		Push Rod
	05/88→12/96	Centre Rod	SC-DL-2151		Push Rod
	05/88→12/96	Centre Rod	SC-DL-2904		Push Rod
	05/88→12/96	Centre Rod	SC-DL-2965		Push Rod
	05/88→12/96	Centre Rod	SC-DL-2968		Push Rod
	05/88→12/96	Centre Rod	SC-DL-8127		Suspension Rod
	05/88→12/96	Suspension Strut Repair Kit		CV-RK-5311	
	05/88→12/96	Suspension Strut Repair Kit	DF-RK-9341		
	05/88→12/96	Tie Rod End	CV-ES-14162		for Steering Rod
	05/88→12/96	Tie Rod End	CV-ES-14163		for Steering Rod
	01/90→12/96	Centre Rod	SC-DL-9440		Push Rod
113 M/360	05/88→12/96	Ball Head, gearshift linkage	CV-ES-2119		
	05/88→12/96	Ball Head, gearshift linkage	CV-ES-2182		
	05/88→12/96	Centre Rod	SC-DL-0305		Push Rod
	05/88→12/96	Centre Rod	SC-DL-2151		Push Rod
	05/88→12/96	Centre Rod	SC-DL-2904		Push Rod
	05/88→12/96	Centre Rod	SC-DL-2965		Push Rod
	05/88→12/96	Centre Rod	SC-DL-2968		Push Rod
	05/88→12/96	Centre Rod	SC-DL-8127		Suspension Rod
	05/88→12/96	Suspension Strut Repair Kit		CV-RK-5311	
	05/88→12/96	Suspension Strut Repair Kit	DF-RK-9341		
	05/88→12/96	Tie Rod End	CV-ES-14162		for Steering Rod
	05/88→12/96	Tie Rod End	CV-ES-14163		for Steering Rod
	01/90→12/96	Centre Rod	SC-DL-9440		Push Rod
113 M/380	01/91→12/96	Ball Head, gearshift linkage	CV-ES-2119		
	01/91→12/96	Ball Head, gearshift linkage	CV-ES-2182		
	01/91→12/96	Centre Rod	SC-DL-0305		Push Rod
	01/91→12/96	Centre Rod	SC-DL-2151		Push Rod
	01/91→12/96	Centre Rod	SC-DL-2904		Push Rod
	01/91→12/96	Centre Rod	SC-DL-2965		Push Rod
	01/91→12/96	Centre Rod	SC-DL-2968		Push Rod
	01/91→12/96	Centre Rod	SC-DL-8127		Suspension Rod
	01/91→12/96	Suspension Strut Repair Kit		CV-RK-5311	
	01/91→12/96	Suspension Strut Repair Kit	DF-RK-9341		
	01/91→12/96	Tie Rod End	CV-ES-14162		for Steering Rod
	01/91→12/96	Tie Rod End	CV-ES-14163		for Steering Rod
	01/91→12/96	Tie Rod End	CV-ES-14163		for Steering Rod
113 M/400	01/92→12/96	Ball Head, gearshift linkage	CV-ES-2119		
	01/92→12/96	Ball Head, gearshift linkage	CV-ES-2182		
	01/92→12/96	Centre Rod	SC-DL-0305		Push Rod
	01/92→12/96	Centre Rod	SC-DL-2151		Push Rod
	01/92→12/96	Centre Rod	SC-DL-2904		Push Rod
	01/92→12/96	Centre Rod	SC-DL-2965		Push Rod
	01/92→12/96	Centre Rod	SC-DL-2968		Push Rod
	01/92→12/96	Suspension Strut Repair Kit		CV-RK-5311	
	01/92→12/96	Suspension Strut Repair Kit	DF-RK-9341		
	01/92→12/96	Tie Rod End	CV-ES-14162		for Steering Rod
	01/92→12/96	Tie Rod End	CV-ES-14163		for Steering Rod
	01/92→12/96	Tie Rod End	CV-ES-14163		for Steering Rod
	143 E/420	01/91→12/96	Ball Head, gearshift linkage	CV-ES-2119	
01/91→12/96		Ball Head, gearshift linkage	CV-ES-2182		
01/91→12/96		Centre Rod	SC-DL-0305		Push Rod
01/91→12/96		Centre Rod	SC-DL-2151		Push Rod
01/91→12/96		Centre Rod	SC-DL-2904		Push Rod
01/91→12/96		Centre Rod	SC-DL-2965		Push Rod
01/91→12/96		Centre Rod	SC-DL-2968		Push Rod
01/91→12/96		Centre Rod	SC-DL-9440		Push Rod
01/91→12/96		Suspension Strut Repair Kit		CV-RK-5311	
01/91→12/96		Tie Rod End	CV-ES-14162		for Steering Rod
01/91→12/96		Tie Rod End	CV-ES-14163		for Steering Rod
01/91→12/96		Tie Rod End	CV-ES-14163		for Steering Rod

CV-ES-2119

Length: 55
Cone Ø: d1 Ø 10 / d2 Ø 10
Thread: M12 x 1,75 LHT
305319, 371451



SC-DL-2151

Length: 912
Ø: 50
Cone Ø: d1 Ø 30 / d2 Ø 27
370875, 1369919



CV-ES-2182

Length: 55
Cone Ø: d1 Ø 10 / d2 Ø 10
Thread: M12 x 1,75 RHT
305320, 371452



SC-DL-2904

Length: 940
Ø: 46
Cone Ø: d1 Ø 30 / d2 Ø 27
0278665, 278665



CV-ES-14162

Length: 125
Cone Ø: d1 Ø 30 / d2 Ø 27
Thread: M30 x 1,5 LHT
283783, 395009, 1358792, 1738380, 1 914
426, 2051165



SC-DL-2965

Length: 950
Ø: 46
Cone Ø: d1 Ø 30 / d2 Ø 27
0278663, 0352635



CV-ES-14163

Length: 125
Cone Ø: d1 Ø 30 / d2 Ø 27
Thread: M30 x 1,5 RHT
283784, 395010, 1358793, 1488890,
1738381, 1767328, 1914427, 2051166



SC-DL-2968

Length: 855
Ø: 42
Cone Ø: d1 Ø 30 / d2 Ø 27
390784



CV-RK-5311

0638862, 638862, 0639287, 639287,
1104335, 1953248, 81432206006,
81432206107



SC-DL-8127

Length: 792
Ø: 52
Cone Ø: d1 Ø 30 / d2 Ø 27
1305012, 1316872, 1324483



DF-RK-9341

Ø: 67
550807, 5508072



SC-DL-9440

Length: 1590
Ø: 40
Cone Ø: d1 Ø 30 / d2 Ø 27
1308643



SC-DL-0305

Length: 920
Ø: 50
Cone Ø: d1 Ø 30 / d2 Ø 27
1304571

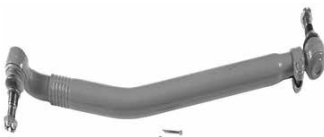



3 - series ...

143 E/450	01/88→12/96	Ball Head, gearshift linkage	CV-ES-2119		
	01/88→12/96	Ball Head, gearshift linkage	CV-ES-2182		
	01/88→12/96	Centre Rod	SC-DL-0305		Push Rod
	01/88→12/96	Centre Rod	SC-DL-2151		Push Rod
	01/88→12/96	Centre Rod	SC-DL-2904		Push Rod
	01/88→12/96	Centre Rod	SC-DL-2965		Push Rod
	01/88→12/96	Centre Rod	SC-DL-2968		Push Rod
	01/88→12/96	Centre Rod	SC-DL-9440		Push Rod
	01/88→12/96	Suspension Strut Repair Kit		CV-RK-5311	
	01/88→12/96	Tie Rod End	CV-ES-14162		for Steering Rod
	01/88→12/96	Tie Rod End	CV-ES-14163		for Steering Rod
143 E/500	01/91→12/96	Ball Head, gearshift linkage	CV-ES-2119		
	01/91→12/96	Ball Head, gearshift linkage	CV-ES-2182		
	01/91→12/96	Centre Rod	SC-DL-0305		Push Rod
	01/91→12/96	Centre Rod	SC-DL-2151		Push Rod
	01/91→12/96	Centre Rod	SC-DL-2904		Push Rod
	01/91→12/96	Centre Rod	SC-DL-2965		Push Rod
	01/91→12/96	Centre Rod	SC-DL-2968		Push Rod
	01/91→12/96	Centre Rod	SC-DL-9440		Push Rod
	01/91→12/96	Suspension Strut Repair Kit		CV-RK-5311	
	01/91→12/96	Tie Rod End	CV-ES-14162		for Steering Rod
	01/91→12/96	Tie Rod End	CV-ES-14163		for Steering Rod
143 H/400	01/88→12/96	Ball Head, gearshift linkage	CV-ES-2119		
	01/88→12/96	Ball Head, gearshift linkage	CV-ES-2182		
	01/88→12/96	Centre Rod	SC-DL-0305		Push Rod
	01/88→12/96	Centre Rod	SC-DL-2151		Push Rod
	01/88→12/96	Centre Rod	SC-DL-2904		Push Rod
	01/88→12/96	Centre Rod	SC-DL-2965		Push Rod
	01/88→12/96	Centre Rod	SC-DL-2968		Push Rod
	01/88→12/96	Suspension Strut Repair Kit		CV-RK-5311	
	01/88→12/96	Tie Rod End	CV-ES-14162		for Steering Rod
	01/88→12/96	Tie Rod End	CV-ES-14163		for Steering Rod
	143 H/420	01/91→12/96	Ball Head, gearshift linkage	CV-ES-2119	
01/91→12/96		Ball Head, gearshift linkage	CV-ES-2182		
01/91→12/96		Centre Rod	SC-DL-0305		Push Rod
01/91→12/96		Centre Rod	SC-DL-2151		Push Rod
01/91→12/96		Centre Rod	SC-DL-2904		Push Rod
01/91→12/96		Centre Rod	SC-DL-2965		Push Rod
01/91→12/96		Centre Rod	SC-DL-2968		Push Rod
01/91→12/96		Suspension Strut Repair Kit		CV-RK-5311	
01/91→12/96		Suspension Strut Repair Kit	DF-RK-9341		
01/91→12/96		Tie Rod End	CV-ES-14162		for Steering Rod
01/91→12/96		Tie Rod End	CV-ES-14163		for Steering Rod
143 H/450	01/88→12/96	Ball Head, gearshift linkage	CV-ES-2119		
	01/88→12/96	Ball Head, gearshift linkage	CV-ES-2182		
	01/88→12/96	Centre Rod	SC-DL-0305		Push Rod
	01/88→12/96	Centre Rod	SC-DL-2151		Push Rod
	01/88→12/96	Centre Rod	SC-DL-2904		Push Rod
	01/88→12/96	Centre Rod	SC-DL-2965		Push Rod
	01/88→12/96	Centre Rod	SC-DL-2968		Push Rod
	01/88→12/96	Suspension Strut Repair Kit		CV-RK-5311	
	01/88→12/96	Suspension Strut Repair Kit	DF-RK-9341		
	01/88→12/96	Tie Rod End	CV-ES-14162		for Steering Rod
	01/88→12/96	Tie Rod End	CV-ES-14163		for Steering Rod
143 H/470	01/88→12/96	Ball Head, gearshift linkage	CV-ES-2119		
	01/88→12/96	Ball Head, gearshift linkage	CV-ES-2182		
	01/88→12/96	Centre Rod	SC-DL-0305		Push Rod
	01/88→12/96	Centre Rod	SC-DL-2151		Push Rod
	01/88→12/96	Centre Rod	SC-DL-2904		Push Rod
	01/88→12/96	Centre Rod	SC-DL-2965		Push Rod
	01/88→12/96	Centre Rod	SC-DL-2968		Push Rod
	01/88→12/96	Suspension Strut Repair Kit		CV-RK-5311	
	01/88→12/96	Suspension Strut Repair Kit	DF-RK-9341		

CV-ES-2119

Length: 55
Cone Ø: d1 Ø 10 / d2 Ø 10
Thread: M12 x 1,75 LHT
305319, 371451



SC-DL-2151

Length: 912
Ø: 50
Cone Ø: d1 Ø 30 / d2 Ø 27
370875, 1369919



CV-ES-2182

Length: 55
Cone Ø: d1 Ø 10 / d2 Ø 10
Thread: M12 x 1,75 RHT
305320, 371452



SC-DL-2904

Length: 940
Ø: 46
Cone Ø: d1 Ø 30 / d2 Ø 27
0278665, 278665



CV-ES-14162

Length: 125
Cone Ø: d1 Ø 30 / d2 Ø 27
Thread: M30 x 1,5 LHT
283783, 395009, 1358792, 1738380, 1 914
426, 2051165



SC-DL-2965

Length: 950
Ø: 46
Cone Ø: d1 Ø 30 / d2 Ø 27
0278663, 0352635



CV-ES-14163

Length: 125
Cone Ø: d1 Ø 30 / d2 Ø 27
Thread: M30 x 1,5 RHT
283784, 395010, 1358793, 1488890,
1738381, 1767328, 1914427, 2051166



SC-DL-2968

Length: 855
Ø: 42
Cone Ø: d1 Ø 30 / d2 Ø 27
390784



CV-RK-5311

0638862, 638862, 0639287, 639287,
1104335, 1953248, 81432206006,
81432206107



SC-DL-9440

Length: 1590
Ø: 40
Cone Ø: d1 Ø 30 / d2 Ø 27
1308643



DF-RK-9341

Ø: 67
550807, 5508072



SC-DL-0305

Length: 920
Ø: 50
Cone Ø: d1 Ø 30 / d2 Ø 27
1304571





3 - series ...

143 H/470 ...	01/88→12/96	Tie Rod End	CV-ES-14162		for Steering Rod	
	01/88→12/96	Tie Rod End	CV-ES-14163		for Steering Rod	
143 H/500	01/91→12/96	Ball Head, gearshift linkage	CV-ES-2119			
	01/91→12/96	Ball Head, gearshift linkage	CV-ES-2182			
	01/91→12/96	Centre Rod	SC-DL-0305		Push Rod	
	01/91→12/96	Centre Rod	SC-DL-2151		Push Rod	
	01/91→12/96	Centre Rod	SC-DL-2904		Push Rod	
	01/91→12/96	Centre Rod	SC-DL-2965		Push Rod	
	01/91→12/96	Centre Rod	SC-DL-2968		Push Rod	
	01/91→12/96	Suspension Strut Repair Kit		CV-RK-5311		
	01/91→12/96	Tie Rod End	CV-ES-14162		for Steering Rod	
	01/91→12/96	Tie Rod End	CV-ES-14163		for Steering Rod	
143 M/420	01/91→12/96	Ball Head, gearshift linkage	CV-ES-2119			
	01/91→12/96	Ball Head, gearshift linkage	CV-ES-2182			
	01/91→12/96	Centre Rod	SC-DL-0305		Push Rod	
	01/91→12/96	Centre Rod	SC-DL-2151		Push Rod	
	01/91→12/96	Centre Rod	SC-DL-2904		Push Rod	
	01/91→12/96	Centre Rod	SC-DL-2965		Push Rod	
	01/91→12/96	Centre Rod	SC-DL-2968		Push Rod	
	01/91→12/96	Centre Rod	SC-DL-8127		Suspension Rod	
	01/91→12/96	Suspension Strut Repair Kit		CV-RK-5311		
	01/91→12/96	Suspension Strut Repair Kit	DF-RK-9341			
	01/91→12/96	Tie Rod End	CV-ES-14162		for Steering Rod	
	01/91→12/96	Tie Rod End	CV-ES-14163		for Steering Rod	
	143 M/450	05/88→12/96	Ball Head, gearshift linkage	CV-ES-2119		
05/88→12/96		Ball Head, gearshift linkage	CV-ES-2182			
05/88→12/96		Centre Rod	SC-DL-0305		Push Rod	
05/88→12/96		Centre Rod	SC-DL-2151		Push Rod	
05/88→12/96		Centre Rod	SC-DL-2904		Push Rod	
05/88→12/96		Centre Rod	SC-DL-2965		Push Rod	
05/88→12/96		Centre Rod	SC-DL-2968		Push Rod	
05/88→12/96		Centre Rod	SC-DL-8127		Suspension Rod	
05/88→12/96		Suspension Strut Repair Kit		CV-RK-5311		
05/88→12/96		Tie Rod End	CV-ES-14162		for Steering Rod	
05/88→12/96		Tie Rod End	CV-ES-14163		for Steering Rod	
143 M/470		01/88→12/96	Ball Head, gearshift linkage	CV-ES-2119		
		01/88→12/96	Ball Head, gearshift linkage	CV-ES-2182		
	01/88→12/96	Centre Rod	SC-DL-0305		Push Rod	
	01/88→12/96	Centre Rod	SC-DL-2151		Push Rod	
	01/88→12/96	Centre Rod	SC-DL-2904		Push Rod	
	01/88→12/96	Centre Rod	SC-DL-2965		Push Rod	
	01/88→12/96	Centre Rod	SC-DL-2968		Push Rod	
	01/88→12/96	Suspension Strut Repair Kit		CV-RK-5311		
	01/88→12/96	Suspension Strut Repair Kit	DF-RK-9341			
	01/88→12/96	Tie Rod End	CV-ES-14162		for Steering Rod	
	01/88→12/96	Tie Rod End	CV-ES-14163		for Steering Rod	
	143 M/500	01/91→12/96	Ball Head, gearshift linkage	CV-ES-2119		
		01/91→12/96	Ball Head, gearshift linkage	CV-ES-2182		
01/91→12/96		Centre Rod	SC-DL-0305		Push Rod	
01/91→12/96		Centre Rod	SC-DL-2151		Push Rod	
01/91→12/96		Centre Rod	SC-DL-2904		Push Rod	
01/91→12/96		Centre Rod	SC-DL-2965		Push Rod	
01/91→12/96		Centre Rod	SC-DL-2968		Push Rod	
01/91→12/96		Centre Rod	SC-DL-8127		Suspension Rod	
01/91→12/96		Suspension Strut Repair Kit		CV-RK-5311		
01/91→12/96		Suspension Strut Repair Kit	DF-RK-9341			
01/91→12/96		Tie Rod End	CV-ES-14162		for Steering Rod	
01/91→12/96		Tie Rod End	CV-ES-14163		for Steering Rod	
93 H/220		12/91→12/96	Ball Head, gearshift linkage	CV-ES-2119		
	12/91→12/96	Ball Head, gearshift linkage	CV-ES-2182			
	12/91→12/96	Centre Rod	SC-DL-0305		Push Rod	
	12/91→12/96	Centre Rod	SC-DL-2151		Push Rod	
	12/91→12/96	Centre Rod	SC-DL-2904		Push Rod	

CV-ES-2119

Length: 55
Cone Ø: d1 Ø 10 / d2 Ø 10
Thread: M12 x 1,75 LHT
305319, 371451



SC-DL-2151

Length: 912
Ø: 50
Cone Ø: d1 Ø 30 / d2 Ø 27
370875, 1369919



CV-ES-2182

Length: 55
Cone Ø: d1 Ø 10 / d2 Ø 10
Thread: M12 x 1,75 RHT
305320, 371452



SC-DL-2904

Length: 940
Ø: 46
Cone Ø: d1 Ø 30 / d2 Ø 27
0278665, 278665



CV-ES-14162

Length: 125
Cone Ø: d1 Ø 30 / d2 Ø 27
Thread: M30 x 1,5 LHT
283783, 395009, 1358792, 1738380, 1 914
426, 2051165



SC-DL-2965

Length: 950
Ø: 46
Cone Ø: d1 Ø 30 / d2 Ø 27
0278663, 0352635



CV-ES-14163

Length: 125
Cone Ø: d1 Ø 30 / d2 Ø 27
Thread: M30 x 1,5 RHT
283784, 395010, 1358793, 1488890,
1738381, 1767328, 1914427, 2051166



SC-DL-2968

Length: 855
Ø: 42
Cone Ø: d1 Ø 30 / d2 Ø 27
390784



CV-RK-5311

0638862, 638862, 0639287, 639287,
1104335, 1953248, 81432206006,
81432206107



SC-DL-8127

Length: 792
Ø: 52
Cone Ø: d1 Ø 30 / d2 Ø 27
1305012, 1316872, 1324483



DF-RK-9341

Ø: 67
550807, 5508072



SC-DL-0305

Length: 920
Ø: 50
Cone Ø: d1 Ø 30 / d2 Ø 27
1304571



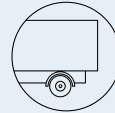
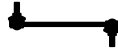

3 - series ...

93 H/220 ...	12/91→12/96	Centre Rod	SC-DL-2965		Push Rod
	12/91→12/96	Centre Rod	SC-DL-2968		Push Rod
	12/91→12/96	Centre Rod	SC-DL-8127		Suspension Rod
	12/91→12/96	Suspension Strut Repair Kit		CV-RK-5311	
	12/91→12/96	Suspension Strut Repair Kit	DF-RK-9341		
	12/91→12/96	Tie Rod End	CV-ES-14162		for Steering Rod
	12/91→12/96	Tie Rod End	CV-ES-14163		for Steering Rod
	12/91→12/96	Tie Rod End	CV-ES-14163		for Steering Rod
93 H/250	03/88→12/96	Centre Rod	SC-DL-8127		Suspension Rod
	03/88→12/96	Suspension Strut Repair Kit		CV-RK-5311	
	01/89→12/96	Ball Head, gearshift linkage	CV-ES-2119		
	01/89→12/96	Ball Head, gearshift linkage	CV-ES-2182		
	01/89→12/96	Centre Rod	SC-DL-0305		Push Rod
	01/89→12/96	Centre Rod	SC-DL-2151		Push Rod
	01/89→12/96	Centre Rod	SC-DL-2904		Push Rod
	01/89→12/96	Centre Rod	SC-DL-2965		Push Rod
	01/89→12/96	Centre Rod	SC-DL-2968		Push Rod
	01/89→12/96	Tie Rod End	CV-ES-14162		for Steering Rod
	01/89→12/96	Tie Rod End	CV-ES-14163		for Steering Rod
	01/89→12/96	Tie Rod End	CV-ES-14163		for Steering Rod
	01/89→12/96	Tie Rod End	CV-ES-14163		for Steering Rod
	01/89→12/96	Tie Rod End	CV-ES-14163		for Steering Rod
93 H/280	12/91→12/96	Ball Head, gearshift linkage	CV-ES-2119		
	12/91→12/96	Ball Head, gearshift linkage	CV-ES-2182		
	12/91→12/96	Centre Rod	SC-DL-0305		Push Rod
	12/91→12/96	Centre Rod	SC-DL-2151		Push Rod
	12/91→12/96	Centre Rod	SC-DL-2904		Push Rod
	12/91→12/96	Centre Rod	SC-DL-2965		Push Rod
	12/91→12/96	Centre Rod	SC-DL-2968		Push Rod
	12/91→12/96	Centre Rod	SC-DL-8127		Suspension Rod
	12/91→12/96	Suspension Strut Repair Kit		CV-RK-5311	
	12/91→12/96	Suspension Strut Repair Kit	DF-RK-9341		
	12/91→12/96	Tie Rod End	CV-ES-14162		for Steering Rod
	12/91→12/96	Tie Rod End	CV-ES-14163		for Steering Rod
	12/91→12/96	Tie Rod End	CV-ES-14163		for Steering Rod
	12/91→12/96	Tie Rod End	CV-ES-14163		for Steering Rod
93 M/210	03/88→12/91	Ball Head, gearshift linkage	CV-ES-2119		
	03/88→12/91	Ball Head, gearshift linkage	CV-ES-2182		
	03/88→12/91	Centre Rod	SC-DL-0305		Push Rod
	03/88→12/91	Centre Rod	SC-DL-2151		Push Rod
	03/88→12/91	Centre Rod	SC-DL-2904		Push Rod
	03/88→12/91	Centre Rod	SC-DL-2965		Push Rod
	03/88→12/91	Centre Rod	SC-DL-2968		Push Rod
	03/88→12/91	Centre Rod	SC-DL-8127		Suspension Rod
	03/88→12/91	Suspension Strut Repair Kit		CV-RK-5311	
	03/88→12/91	Suspension Strut Repair Kit	DF-RK-9341		
	03/88→12/91	Tie Rod End	CV-ES-14162		for Steering Rod
	03/88→12/91	Tie Rod End	CV-ES-14163		for Steering Rod
	03/88→12/91	Tie Rod End	CV-ES-14163		for Steering Rod
	03/88→12/91	Tie Rod End	CV-ES-14163		for Steering Rod
93 M/220	12/91→12/96	Ball Head, gearshift linkage	CV-ES-2119		
	12/91→12/96	Ball Head, gearshift linkage	CV-ES-2182		
	12/91→12/96	Centre Rod	SC-DL-0305		Push Rod
	12/91→12/96	Centre Rod	SC-DL-2151		Push Rod
	12/91→12/96	Centre Rod	SC-DL-2904		Push Rod
	12/91→12/96	Centre Rod	SC-DL-2965		Push Rod
	12/91→12/96	Centre Rod	SC-DL-2968		Push Rod
	12/91→12/96	Centre Rod	SC-DL-8127		Suspension Rod
	12/91→12/96	Suspension Strut Repair Kit		CV-RK-5311	
	12/91→12/96	Tie Rod End	CV-ES-14162		for Steering Rod
	12/91→12/96	Tie Rod End	CV-ES-14163		for Steering Rod
	12/91→12/96	Tie Rod End	CV-ES-14163		for Steering Rod
	12/91→12/96	Tie Rod End	CV-ES-14163		for Steering Rod
	12/91→12/96	Tie Rod End	CV-ES-14163		for Steering Rod
93 M/230	03/88→12/91	Ball Head, gearshift linkage	CV-ES-2119		
	03/88→12/91	Ball Head, gearshift linkage	CV-ES-2182		
	03/88→12/91	Centre Rod	SC-DL-0305		Push Rod
	03/88→12/91	Centre Rod	SC-DL-2151		Push Rod
	03/88→12/91	Centre Rod	SC-DL-2904		Push Rod
	03/88→12/91	Centre Rod	SC-DL-2965		Push Rod
	03/88→12/91	Centre Rod	SC-DL-2968		Push Rod
	03/88→12/91	Centre Rod	SC-DL-8127		Suspension Rod
	03/88→12/91	Suspension Strut Repair Kit		CV-RK-5311	
	03/88→12/91	Suspension Strut Repair Kit	DF-RK-9341		
	03/88→12/91	Suspension Strut Repair Kit	DF-RK-9341		
	03/88→12/91	Suspension Strut Repair Kit	DF-RK-9341		
	03/88→12/91	Suspension Strut Repair Kit	DF-RK-9341		
	03/88→12/91	Suspension Strut Repair Kit	DF-RK-9341		

CV-ES-2119

Length: 55
Cone Ø: d1 Ø 10 / d2 Ø 10
Thread: M12 x 1,75 LHT
305319, 371451



SC-DL-2151

Length: 912
Ø: 50
Cone Ø: d1 Ø 30 / d2 Ø 27
370875, 1369919



CV-ES-2182

Length: 55
Cone Ø: d1 Ø 10 / d2 Ø 10
Thread: M12 x 1,75 RHT
305320, 371452



SC-DL-2904

Length: 940
Ø: 46
Cone Ø: d1 Ø 30 / d2 Ø 27
0278665, 278665



CV-ES-14162

Length: 125
Cone Ø: d1 Ø 30 / d2 Ø 27
Thread: M30 x 1,5 LHT
283783, 395009, 1358792, 1738380, 1 914
426, 2051165



SC-DL-2965

Length: 950
Ø: 46
Cone Ø: d1 Ø 30 / d2 Ø 27
0278663, 0352635



CV-ES-14163

Length: 125
Cone Ø: d1 Ø 30 / d2 Ø 27
Thread: M30 x 1,5 RHT
283784, 395010, 1358793, 1488890,
1738381, 1767328, 1914427, 2051166



SC-DL-2968

Length: 855
Ø: 42
Cone Ø: d1 Ø 30 / d2 Ø 27
390784



CV-RK-5311

0638862, 638862, 0639287, 639287,
1104335, 1953248, 81432206006,
81432206107



SC-DL-8127

Length: 792
Ø: 52
Cone Ø: d1 Ø 30 / d2 Ø 27
1305012, 1316872, 1324483



DF-RK-9341

Ø: 67
550807, 5508072



SC-DL-0305

Length: 920
Ø: 50
Cone Ø: d1 Ø 30 / d2 Ø 27
1304571



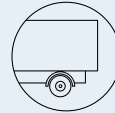

3 - series ...

93 M/230 ...	03/88→12/91	Tie Rod End	CV-ES-14162		for Steering Rod	
	03/88→12/91	Tie Rod End	CV-ES-14163		for Steering Rod	
93 M/250	03/88→12/96	Ball Head, gearshift linkage	CV-ES-2119			
	03/88→12/96	Ball Head, gearshift linkage	CV-ES-2182			
	03/88→12/96	Centre Rod	SC-DL-0305		Push Rod	
	03/88→12/96	Centre Rod	SC-DL-2151		Push Rod	
	03/88→12/96	Centre Rod	SC-DL-2904		Push Rod	
	03/88→12/96	Centre Rod	SC-DL-2965		Push Rod	
	03/88→12/96	Centre Rod	SC-DL-2968		Push Rod	
	03/88→12/96	Centre Rod	SC-DL-8127		Suspension Rod	
	03/88→12/96	Suspension Strut Repair Kit		CV-RK-5311		
	03/88→12/96	Tie Rod End	CV-ES-14162		for Steering Rod	
93 M/280	03/88→12/96	Tie Rod End	CV-ES-14163		for Steering Rod	
	03/88→12/96	Ball Head, gearshift linkage	CV-ES-2119			
T 113 E/320	03/88→12/96	Ball Head, gearshift linkage	CV-ES-2182			
	03/88→12/96	Centre Rod	SC-DL-0305		Push Rod	
	03/88→12/96	Centre Rod	SC-DL-2151		Push Rod	
	03/88→12/96	Centre Rod	SC-DL-2904		Push Rod	
	03/88→12/96	Centre Rod	SC-DL-2965		Push Rod	
	03/88→12/96	Centre Rod	SC-DL-2968		Push Rod	
	03/88→12/96	Centre Rod	SC-DL-8127		Suspension Rod	
	03/88→12/96	Suspension Strut Repair Kit		CV-RK-5311		
	03/88→12/96	Suspension Strut Repair Kit	DF-RK-9341			
	03/88→12/96	Tie Rod End	CV-ES-14162		for Steering Rod	
	03/88→12/96	Tie Rod End	CV-ES-14163		for Steering Rod	
	T 113 E/360	01/90→12/96	Ball Head, gearshift linkage	CV-ES-2119		
		01/90→12/96	Ball Head, gearshift linkage	CV-ES-2182		
		01/90→12/96	Centre Rod	SC-DL-0305		Push Rod
01/90→12/96		Centre Rod	SC-DL-2151		Push Rod	
01/90→12/96		Centre Rod	SC-DL-2904		Push Rod	
01/90→12/96		Centre Rod	SC-DL-2965		Push Rod	
01/90→12/96		Centre Rod	SC-DL-2968		Push Rod	
01/90→12/96		Suspension Strut Repair Kit		CV-RK-5311		
01/90→12/96		Tie Rod	SC-DL-8137			
01/90→12/96		Tie Rod End	CV-ES-14162		for Steering Rod	
T 113 H/320	01/90→12/96	Tie Rod End	CV-ES-14163		for Steering Rod	
	01/90→12/96	Ball Head, gearshift linkage	CV-ES-2119			
	01/90→12/96	Ball Head, gearshift linkage	CV-ES-2182			
	01/90→12/96	Centre Rod	SC-DL-0305		Push Rod	
	01/90→12/96	Centre Rod	SC-DL-2151		Push Rod	
	01/90→12/96	Centre Rod	SC-DL-2904		Push Rod	
	01/90→12/96	Centre Rod	SC-DL-2965		Push Rod	
	01/90→12/96	Centre Rod	SC-DL-2968		Push Rod	
	01/90→12/96	Suspension Strut Repair Kit		CV-RK-5311		
	01/90→12/96	Tie Rod	SC-DL-8137			
T 113 H/360	01/90→12/96	Tie Rod End	CV-ES-14162		for Steering Rod	
	01/90→12/96	Tie Rod End	CV-ES-14163		for Steering Rod	
	01/90→12/96	Ball Head, gearshift linkage	CV-ES-2119			
	01/90→12/96	Ball Head, gearshift linkage	CV-ES-2182			
	01/90→12/96	Centre Rod	SC-DL-0305		Push Rod	
	01/90→12/96	Centre Rod	SC-DL-2151		Push Rod	
	01/90→12/96	Centre Rod	SC-DL-2904		Push Rod	
	01/90→12/96	Centre Rod	SC-DL-2965		Push Rod	
	01/90→12/96	Centre Rod	SC-DL-2968		Push Rod	

CV-ES-2119

Length: 55
Cone Ø: d1 Ø 10 / d2 Ø 10
Thread: M12 x 1,75 LHT
305319, 371451



SC-DL-2151

Length: 912
Ø: 50
Cone Ø: d1 Ø 30 / d2 Ø 27
370875, 1369919



CV-ES-2182

Length: 55
Cone Ø: d1 Ø 10 / d2 Ø 10
Thread: M12 x 1,75 RHT
305320, 371452



SC-DL-2904

Length: 940
Ø: 46
Cone Ø: d1 Ø 30 / d2 Ø 27
278665, 0278665



CV-ES-14162

Length: 125
Cone Ø: d1 Ø 30 / d2 Ø 27
Thread: M30 x 1,5 LHT
283783, 395009, 1358792, 1738380, 1 914 426, 2051165



SC-DL-2965

Length: 950
Ø: 46
Cone Ø: d1 Ø 30 / d2 Ø 27
0278663, 0352635



CV-ES-14163

Length: 125
Cone Ø: d1 Ø 30 / d2 Ø 27
Thread: M30 x 1,5 RHT
283784, 395010, 1358793, 1488890, 1738381, 1767328, 1914427, 2051166



SC-DL-2968

Length: 855
Ø: 42
Cone Ø: d1 Ø 30 / d2 Ø 27
390784



CV-RK-5311

0638862, 638862, 0639287, 639287, 1104335, 1953248, 81432206006, 81432206107



SC-DL-8127

Length: 792
Ø: 52
Cone Ø: d1 Ø 30 / d2 Ø 27
1305012, 1316872, 1324483



DF-RK-9341

Ø: 67
550807, 5508072



SC-DL-8137

Length: 1736 Ø: 40
Cone Ø: d1 Ø 30 / d2 Ø 27
301639, 311847, 395350, 1358675, 1378435, 1397866, 1734020, 2028998, 12202900A



SC-DL-0305

Length: 920
Ø: 50
Cone Ø: d1 Ø 30 / d2 Ø 27
1304571



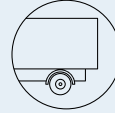

3 - series ...

T 113 H/360 ...	01/90→12/96	Centre Rod	SC-DL-2965		Push Rod	
	01/90→12/96	Centre Rod	SC-DL-2968		Push Rod	
	01/90→12/96	Suspension Strut Repair Kit		CV-RK-5311		
	01/90→12/96	Tie Rod	SC-DL-8137			
	01/90→12/96	Tie Rod End	CV-ES-14162		for Steering Rod	
	01/90→12/96	Tie Rod End	CV-ES-14163		for Steering Rod	
T 143 E/420	01/91→12/96	Ball Head, gearshift linkage	CV-ES-2119			
	01/91→12/96	Ball Head, gearshift linkage	CV-ES-2182			
	01/91→12/96	Centre Rod	SC-DL-0305		Push Rod	
	01/91→12/96	Centre Rod	SC-DL-2151		Push Rod	
	01/91→12/96	Centre Rod	SC-DL-2904		Push Rod	
	01/91→12/96	Centre Rod	SC-DL-2965		Push Rod	
	01/91→12/96	Centre Rod	SC-DL-2968		Push Rod	
	01/91→12/96	Suspension Strut Repair Kit		CV-RK-5311		
	01/91→12/96	Tie Rod	SC-DL-8137			
	01/91→12/96	Tie Rod End	CV-ES-14162		for Steering Rod	
	01/91→12/96	Tie Rod End	CV-ES-14163		for Steering Rod	
	T 143 E/450	01/88→12/96	Ball Head, gearshift linkage	CV-ES-2119		
		01/88→12/96	Ball Head, gearshift linkage	CV-ES-2182		
		01/88→12/96	Centre Rod	SC-DL-0305		Push Rod
01/88→12/96		Centre Rod	SC-DL-2151		Push Rod	
01/88→12/96		Centre Rod	SC-DL-2904		Push Rod	
01/88→12/96		Centre Rod	SC-DL-2965		Push Rod	
01/88→12/96		Centre Rod	SC-DL-2968		Push Rod	
01/88→12/96		Suspension Strut Repair Kit		CV-RK-5311		
01/88→12/96		Tie Rod	SC-DL-8137			
01/88→12/96		Tie Rod End	CV-ES-14162		for Steering Rod	
01/88→12/96		Tie Rod End	CV-ES-14163		for Steering Rod	
T 143 E/500		01/91→12/96	Ball Head, gearshift linkage	CV-ES-2119		
		01/91→12/96	Ball Head, gearshift linkage	CV-ES-2182		
		01/91→12/96	Centre Rod	SC-DL-0305		Push Rod
	01/91→12/96	Centre Rod	SC-DL-2151		Push Rod	
	01/91→12/96	Centre Rod	SC-DL-2904		Push Rod	
	01/91→12/96	Centre Rod	SC-DL-2965		Push Rod	
	01/91→12/96	Centre Rod	SC-DL-2968		Push Rod	
	01/91→12/96	Suspension Strut Repair Kit		CV-RK-5311		
	01/91→12/96	Tie Rod	SC-DL-8137			
	01/91→12/96	Tie Rod End	CV-ES-14162		for Steering Rod	
	01/91→12/96	Tie Rod End	CV-ES-14163		for Steering Rod	
	T 143 H/420	01/91→12/96	Ball Head, gearshift linkage	CV-ES-2119		
		01/91→12/96	Ball Head, gearshift linkage	CV-ES-2182		
		01/91→12/96	Centre Rod	SC-DL-0305		Push Rod
01/91→12/96		Centre Rod	SC-DL-2151		Push Rod	
01/91→12/96		Centre Rod	SC-DL-2904		Push Rod	
01/91→12/96		Centre Rod	SC-DL-2965		Push Rod	
01/91→12/96		Centre Rod	SC-DL-2968		Push Rod	
01/91→12/96		Suspension Strut Repair Kit		CV-RK-5311		
01/91→12/96		Tie Rod	SC-DL-8137			
01/91→12/96		Tie Rod End	CV-ES-14162		for Steering Rod	
01/91→12/96		Tie Rod End	CV-ES-14163		for Steering Rod	
T 143 H/450		01/90→12/96	Ball Head, gearshift linkage	CV-ES-2119		
		01/90→12/96	Ball Head, gearshift linkage	CV-ES-2182		
		01/90→12/96	Centre Rod	SC-DL-0305		Push Rod
	01/90→12/96	Centre Rod	SC-DL-2151		Push Rod	
	01/90→12/96	Centre Rod	SC-DL-2904		Push Rod	
	01/90→12/96	Centre Rod	SC-DL-2965		Push Rod	
	01/90→12/96	Centre Rod	SC-DL-2968		Push Rod	
	01/90→12/96	Suspension Strut Repair Kit		CV-RK-5311		
	01/90→12/96	Tie Rod	SC-DL-8137			
	01/90→12/96	Tie Rod End	CV-ES-14162		for Steering Rod	
	01/90→12/96	Tie Rod End	CV-ES-14163		for Steering Rod	

CV-ES-2119

Length: 55
Cone Ø: d1 Ø 10 / d2 Ø 10
Thread: M12 x 1,75 LHT
305319, 371451



SC-DL-2151

Length: 912
Ø: 50
Cone Ø: d1 Ø 30 / d2 Ø 27
370875, 1369919



CV-ES-2182

Length: 55
Cone Ø: d1 Ø 10 / d2 Ø 10
Thread: M12 x 1,75 RHT
305320, 371452



SC-DL-2904

Length: 940
Ø: 46
Cone Ø: d1 Ø 30 / d2 Ø 27
278665, 0278665



CV-ES-14162

Length: 125
Cone Ø: d1 Ø 30 / d2 Ø 27
Thread: M30 x 1,5 LHT
283783, 395009, 1358792, 1738380, 1 914 426, 2051165



SC-DL-2965

Length: 950
Ø: 46
Cone Ø: d1 Ø 30 / d2 Ø 27
0278663, 0352635



CV-ES-14163

Length: 125
Cone Ø: d1 Ø 30 / d2 Ø 27
Thread: M30 x 1,5 RHT
283784, 395010, 1358793, 1488890, 1738381, 1767328, 1914427, 2051166



SC-DL-2968

Length: 855
Ø: 42
Cone Ø: d1 Ø 30 / d2 Ø 27
390784



CV-RK-5311

638862, 0638862, 639287, 0639287, 1104335, 1953248, 81432206006, 81432206107



SC-DL-8137

Length: 1736 Ø: 40
Cone Ø: d1 Ø 30 / d2 Ø 27
301639, 311847, 395350, 1358675, 1378435, 1397866, 1734020, 2028998, 12202900A



SC-DL-0305

Length: 920
Ø: 50
Cone Ø: d1 Ø 30 / d2 Ø 27
1304571



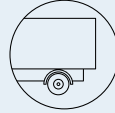

3 - series ...

T 143 H/500	01/91→12/96	Ball Head, gearshift linkage	CV-ES-2119		
	01/91→12/96	Ball Head, gearshift linkage	CV-ES-2182		
	01/91→12/96	Centre Rod	SC-DL-0305		Push Rod
	01/91→12/96	Centre Rod	SC-DL-2151		Push Rod
	01/91→12/96	Centre Rod	SC-DL-2904		Push Rod
	01/91→12/96	Centre Rod	SC-DL-2965		Push Rod
	01/91→12/96	Centre Rod	SC-DL-2968		Push Rod
	01/91→12/96	Suspension Strut Repair Kit		CV-RK-5311	
	01/91→12/96	Tie Rod	SC-DL-8137		
	01/91→12/96	Tie Rod End	CV-ES-14162		for Steering Rod
	01/91→12/96	Tie Rod End	CV-ES-14163		for Steering Rod
T 93 H/250	01/90→12/96	Ball Head, gearshift linkage	CV-ES-2119		
	01/90→12/96	Ball Head, gearshift linkage	CV-ES-2182		
	01/90→12/96	Centre Rod	SC-DL-0305		Push Rod
	01/90→12/96	Centre Rod	SC-DL-2151		Push Rod
	01/90→12/96	Centre Rod	SC-DL-2904		Push Rod
	01/90→12/96	Centre Rod	SC-DL-2965		Push Rod
	01/90→12/96	Centre Rod	SC-DL-2968		Push Rod
	01/90→12/96	Suspension Strut Repair Kit		CV-RK-5311	
	01/90→12/96	Tie Rod	SC-DL-8137		
	01/90→12/96	Tie Rod End	CV-ES-14162		for Steering Rod
	01/90→12/96	Tie Rod End	CV-ES-14163		for Steering Rod
T 93 H/280	12/91→12/96	Ball Head, gearshift linkage	CV-ES-2119		
	12/91→12/96	Ball Head, gearshift linkage	CV-ES-2182		
	12/91→12/96	Centre Rod	SC-DL-0305		Push Rod
	12/91→12/96	Centre Rod	SC-DL-2151		Push Rod
	12/91→12/96	Centre Rod	SC-DL-2904		Push Rod
	12/91→12/96	Centre Rod	SC-DL-2965		Push Rod
	12/91→12/96	Centre Rod	SC-DL-2968		Push Rod
	12/91→12/96	Suspension Strut Repair Kit		CV-RK-5311	
	12/91→12/96	Tie Rod	SC-DL-8137		
	12/91→12/96	Tie Rod End	CV-ES-14162		for Steering Rod
	12/91→12/96	Tie Rod End	CV-ES-14163		for Steering Rod

3 - series bus

K 113	11/90→	Tie Rod End	CV-ES-14162		for Steering Rod
	11/90→	Tie Rod End	CV-ES-14163		for Steering Rod
K 113 CLB	07/90→12/97	Tie Rod End	CV-ES-14162		for Steering Rod
	07/90→12/97	Tie Rod End	CV-ES-14163		for Steering Rod

4 - series

114 C/330	05/96→	Centre Rod	SC-DL-5229		Push Rod
	05/96→	Centre Rod	SC-DL-5354		Push Rod
	05/96→	Tie Rod	SC-DL-7264		
	05/96→	Tie Rod	SC-DL-8137		
	05/96→	Track Control Arm		SC-DL-8179	Trailing Arm, Leaf Spring Axle, * 1247519 SSS **; 4406944 SNL *; * 9039630 SAN **; 3507980 SLA *→
	05/96→	Track Control Arm		SC-DL-8400	Trailing Arm
	05/96→	Track Control Arm		SC-DL-8511	Trailing Arm, Leaf Spring Axle, * 1280185 SSS **; 4471603 SNL *; * 9069960 SAN **; 3533627 SLA *→
	05/96→	Track Control Arm		SC-DL-8547	Trailing Arm, Leaf Spring Axle, * 1280185 SSS **; 4471603 SNL *; * 9069959 SAN **; 3533626 SLA *→
	05/96→	Track Control Arm		SC-DL-9466	Trailing Arm, Leaf Spring Axle
	05/96→	Track Control Arm		SC-DL-9467	Trailing Arm, Leaf Spring Axle, →* 1247518 SSS **; 4406943 SNL *; * 9039629 SAN **; 3507979 SLA *
	05/96→	Track Control Arm		SC-DL-9467	Trailing Arm, Leaf Spring Axle, → * 1280184 SSS **; 4471602 SNL *; * 9069959 SAN **; 3533626 SLA *

CV-ES-2119

Length: 55
Cone Ø: d1 Ø 10 / d2 Ø 10
Thread: M12 x 1,75 LHT
305319, 371451



CV-ES-2182

Length: 55
Cone Ø: d1 Ø 10 / d2 Ø 10
Thread: M12 x 1,75 RHT
305320, 371452



CV-ES-14162

Length: 125
Cone Ø: d1 Ø 30 / d2 Ø 27
Thread: M30 x 1,5 LHT
283783, 395009, 1358792, 1738380, 1 914 426, 2051165



CV-ES-14163

Length: 125
Cone Ø: d1 Ø 30 / d2 Ø 27
Thread: M30 x 1,5 RHT
283784, 395010, 1358793, 1488890, 1738381, 1767328, 1914427, 2051166



CV-RK-5311

0638862, 638862, 0639287, 639287, 1104335, 1953248, 81432206006, 81432206107



SC-DL-0305

Length: 920
Ø: 50
Cone Ø: d1 Ø 30 / d2 Ø 27
1304571

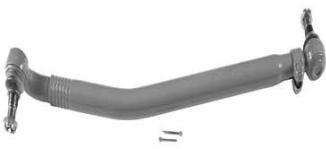

SC-DL-2151

Length: 912
Ø: 50
Cone Ø: d1 Ø 30 / d2 Ø 27
370875, 1369919



SC-DL-2904

Length: 940
Ø: 46
Cone Ø: d1 Ø 30 / d2 Ø 27
0278665, 278665



SC-DL-2965

Length: 950
Ø: 46
Cone Ø: d1 Ø 30 / d2 Ø 27
0278663, 0352635



SC-DL-2968

Length: 855
Ø: 42
Cone Ø: d1 Ø 30 / d2 Ø 27
390784



SC-DL-5229

Length: 1053 Ø: 50
Cone Ø: d1 Ø 30 / d2 Ø 27
1356055, 1379071, 1384025, 1768898, 1847311, 1912757, 12201600A



SC-DL-5354

Length: 1060 Ø: 52
Cone Ø: d1 Ø 30 / d2 Ø 27
1384027, 1769597, 1847312, 1912758, 12200800A



SC-DL-7264

Length: 1743 Ø: 62
Cone Ø: d1 Ø 30 / d2 Ø 27
1361413, 1395614, 1734019, 1897333, 2040254, 2146105



SC-DL-8137

Length: 1736 Ø: 40
Cone Ø: d1 Ø 30 / d2 Ø 27
301639, 311847, 395350, 1358675, 1378435, 1397866, 1734020, 2028998, 12202900A



SC-DL-8179

Length: 568 Ø: 46
Hole Distance: 115 / 115
1399180, 1428347



SC-DL-8179

Length: 568 Ø: 46
Hole Distance: 115 / 115
1399180, 1428347



SC-DL-8511

Length: 616,5 Ø: 50
Hole Distance: 115 / 115
1485760, 1499478, 1722750



SC-DL-8547

Length: 568 Ø: 50
Hole Distance: 115 / 115
1499474, 1722746, 1906940



SC-DL-9466

Length: 568 Ø: 19
1486756



SC-DL-9467

Length: 568,5 Ø: 50
Hole Distance: 115 / 115
1500572





4 - series ...

114 C/330 ...	05/96 →	Track Control Arm	SC-DL-8179	SC-DL-8179	Trailing Arm, Leaf Spring Axle, → * 1280184 SSS *; * 4471602 SNL *; * 9069959 SAN *; * 3533626 SLA *
	05/96 →	Track Control Arm	SC-DL-8509	SC-DL-8509	Trailing Arm, Leaf Spring Axle, * 1280185 SSS *; * 4471603 SNL *; * 9069960 SAN *; * 3533627 SLA * →
	05/96 →	Track Control Arm	SC-DL-8531	SC-DL-8531	Trailing Arm, Leaf Spring Axle, * 1280185 SSS *; * 4471603 SNL *; * 9069960 SAN *; * 3533956 SLA * →
	05/96 →	Track Control Arm	SC-DL-10302	SC-DL-10302	Trailing Arm, Air Suspension Axle
114 C/340	05/96 →	Centre Rod	SC-DL-2161		Coupling Rod
	05/96 →	Centre Rod	SC-DL-5229		Push Rod
	05/96 →	Centre Rod	SC-DL-5354		Push Rod
	05/96 →	Centre Rod	SC-DL-8154		Push Rod
	05/96 →	Centre Rod	SC-DL-8169		Push Rod
	05/96 →	Centre Rod	SC-DL-8182		Push Rod
	05/96 →	Centre Rod	SC-DL-8399		Push Rod
	05/96 →	Centre Rod	SC-DL-12341		Push Rod
	05/96 →	Centre Rod	SC-DL-12342		for Steering Rod
	05/96 →	Centre Rod	SC-DL-12343		for Steering Rod
	05/96 →	Suspension Arm Repair Kit		MN-RK-7280	for Drag Link; for Semi-Trailing Arm; for Wishbone (CV)
	05/96 →	Suspension Arm Repair Kit		SC-RK-12366	for Control Arm
	05/96 →	Suspension Arm Repair Kit	MN-RK-7280	MN-RK-7280	for Drag Link; for Semi-Trailing Arm; for Wishbone (CV)
	05/96 →	Suspension Strut Repair Kit		MN-RK-8501	
	05/96 →	Suspension Strut Repair Kit	MN-RK-12436	MN-RK-12436	
	05/96 →	Tie Rod		SC-DL-7264	Steering Axle
	05/96 →	Tie Rod		SC-DL-8137	Steering Axle
	05/96 →	Tie Rod	SC-DL-7264		
	05/96 →	Tie Rod	SC-DL-7264		1st FA; 2nd FA
	05/96 →	Tie Rod	SC-DL-8137		
	05/96 →	Tie Rod	SC-DL-8137		1st FA; 2nd FA
	05/96 →	Tie Rod End		MN-ES-8490	for vehicles with Hinged Trailing Axle
	05/96 →	Tie Rod End	CV-ES-14162		for Steering Rod
	05/96 →	Tie Rod End	CV-ES-14163		for Steering Rod
	05/96 →	Tie Rod End	SC-ES-5764		
	05/96 →	Tie Rod End	SC-ES-7279		for Steering Rod
	05/96 →	Tie Rod End	SC-ES-8517		for Push Rod
	05/96 →	Track Control Arm		SC-DL-8179	Trailing Arm, 1st RA; 2nd RA, Parabolic Leaf Spring, →1280184/4471602
	05/96 →	Track Control Arm		SC-DL-8179	Trailing Arm, 1st RA; 2nd RA, Parabolic Leaf Spring, →9069959/3533626
	05/96 →	Track Control Arm		SC-DL-8179	Trailing Arm, Leaf Spring Axle
	05/96 →	Track Control Arm		SC-DL-8400	Trailing Arm
	05/96 →	Track Control Arm		SC-DL-8511	Trailing Arm, Leaf Spring Axle
	05/96 →	Track Control Arm		SC-DL-8547	Trailing Arm, Leaf Spring Axle
	05/96 →	Track Control Arm		SC-DL-8623	Trailing Arm, 1st Drive Axle, for Leaf-Spring Suspension vehicles, →1280184/4471602
	05/96 →	Track Control Arm		SC-DL-8623	Trailing Arm, 1st Drive Axle, for Leaf-Spring Suspension vehicles, →9069959/3533626
	05/96 →	Track Control Arm		SC-DL-9462	Trailing Arm, 2nd Drive Axle, for Leaf-Spring Suspension vehicles, < 1280184/4471602 →
05/96 →	Track Control Arm		SC-DL-9462	Trailing Arm, 2nd Drive Axle, for Leaf-Spring Suspension vehicles, →1280184/4471602	
05/96 →	Track Control Arm		SC-DL-9462	Trailing Arm, 2nd Drive Axle, for Leaf-Spring Suspension vehicles, →1280185/4471603 >	
05/96 →	Track Control Arm		SC-DL-9462	Trailing Arm, 2nd Drive Axle, for Leaf-Spring Suspension vehicles, →9069959/3533626	
05/96 →	Track Control Arm		SC-DL-9462	Trailing Arm, 2nd Drive Axle, for Leaf-Spring Suspension vehicles, 1280185/4471603 →	
05/96 →	Track Control Arm		SC-DL-9462	Trailing Arm, 2nd Drive Axle, for Leaf-Spring Suspension vehicles, 9069960/3533627 →	

CV-ES-14162

Length: 125
Cone Ø: d1 Ø 30 / d2 Ø 27
Thread: M30 x 1,5 LHT
283783, 395009, 1358792, 1738380, 1 914 426, 2051165



CV-ES-14163

Length: 125
Cone Ø: d1 Ø 30 / d2 Ø 27
Thread: M30 x 1,5 RHT
283784, 395010, 1358793, 1488890, 1738381, 1767328, 1914427, 2051166



MN-ES-8490

Length: 90
Cone Ø: d1 Ø 30 / d2 Ø 27
Thread: M26 x 1,5 RHT
1394444, 0014606948, 14606948



MN-RK-7280

Ø: 75 Hole Distance: 115
Thick/Height: 24
550806, 0550806, 639370, 0639370, 689748, 1104334



MN-RK-8501

Ø: 75 Hole Distance: 115
Thick/Height: 24
1515981



MN-RK-12436

Ø: 75 Hole Distance: 115
Thick/Height: 24
550799, 1517403, 1783020



SC-DL-2161

Length: 1740 Ø: 50
Cone Ø: d1 Ø 30 / d2 Ø 27
1369411, 1385251, 1409918, 1501030, 1723865, 1723895, 1737683, 1897335, 2113903, 2125090, 2161883



SC-DL-5229

Length: 1053 Ø: 50
Cone Ø: d1 Ø 30 / d2 Ø 27
1356055, 1379071, 1384025, 1768898, 1847311, 1912757, 12201600A



SC-DL-5354

Length: 1060 Ø: 52
Cone Ø: d1 Ø 30 / d2 Ø 27
1384027, 1769597, 1847312, 1912758, 12200800A



SC-DL-7264

Length: 1743 Ø: 62
Cone Ø: d1 Ø 30 / d2 Ø 27
1361413, 1395614, 1734019, 1897333, 2040254, 2146105



SC-DL-8137

Length: 1736 Ø: 40
Cone Ø: d1 Ø 30 / d2 Ø 27
301639, 311847, 395350, 1358675, 1378435, 1397866, 1734020, 2028998, 12202900A



SC-DL-8154

Length: 495 Ø: 40
Cone Ø: d1 Ø 30 / d2 Ø 27
1343266, 1759690



SC-DL-8169

Length: 1920 Ø: 62
Cone Ø: d1 Ø 30 / d2 Ø 27
1343264, 1732635, 2007278



SC-DL-8179

Length: 568 Ø: 46
Hole Distance: 115 / 115
1399180, 1428347



SC-DL-8182

1343262, 1869413



SC-DL-8399

Length: 433 Ø: 40
Cone Ø: d1 Ø 30 / d2 Ø 26
1394884, 1938387



SC-DL-8179

Length: 568 Ø: 46
Hole Distance: 115 / 115
1399180, 1428347



SC-DL-8509

Length: 568,5 Ø: 46
Hole Distance: 115 / 115
1485758, 1486757



SC-DL-8511

Length: 616,5 Ø: 50
Hole Distance: 115 / 115
1485760, 1499478, 1722750



SC-DL-8531

Length: 522 Ø: 46
Hole Distance: 115 / 115
1486758



SC-DL-8547

Length: 568 Ø: 50
Hole Distance: 115 / 115
1499474, 1722746, 1906940



SC-DL-8623

Length: 592 Ø: 50
Hole Distance: 115 / 115
1388436, 1499476, 1722748, 1906942



SC-DL-9462

Length: 568,5 Ø: 50
Hole Distance: 115 / 115
1499475, 1500573, 1722747, 1906941



SC-DL-10302

Length: 752 Ø: 48
Hole Distance: 115 / 115
1101843, 1379423, 1393298, 1431470, 1942075



SC-DL-12341

Length: 1776 Ø: 62
Cone Ø: d1 Ø 30 / d2 Ø 27
1386620



SC-DL-12342

Length: 601 Ø: 42
Cone Ø: d1 Ø 26 / d2 Ø 23,5
1343262, 1869413



SC-DL-12343

Length: 1062 Ø: 52
Cone Ø: d1 Ø 30 / d2 Ø 27
1348269, 2007275



SC-ES-5764

Length: 95
Cone Ø: d1 Ø 30 / d2 Ø 27
Thread: M26 x 1,5 RHT
325614, 1375228, 4604948



SC-ES-7279

Length: 150
Cone Ø: d1 Ø 30 / d2 Ø 27
Thread: M30 x 1,5 RHT
1357674, 1603883, 1738379



SC-ES-8517

Length: 140
Cone Ø: d1 Ø 30 / d2 Ø 27
Thread: M30 x 1,5 RHT
1358793, 1435746, 1488890, 1534756, 1914427, 2051166



SC-RK-12366

Ø: 75 Hole Distance: 115 / 115
Thick/Height: 24
1 722 753, 2 096 392



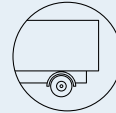

4 - series ...

114 C/340 ...	05/96→	Track Control Arm		SC-DL-9466	Trailing Arm, Leaf Spring Axle	
	05/96→	Track Control Arm		SC-DL-9467	Trailing Arm, Leaf Spring Axle, →* 1247518 SSS *;* 4406943 SNL *; * 9039629 SAN *;* 3507979 SLA *	
	05/96→	Track Control Arm		SC-DL-9467	Trailing Arm, Leaf Spring Axle, → * 1280184 SSS *;* 4471602 SNL *; * 9069959 SAN *;* 3533626 SLA *	
	05/96→	Track Control Arm		SC-TC-12451	Control Arm	
	05/96→	Track Control Arm		SC-TC-12452	Control Arm	
	05/96→	Track Control Arm		SC-TC-12472	Control Arm	
	05/96→	Track Control Arm	SC-DL-8179	SC-DL-8179	Trailing Arm, Leaf Spring Axle, → * 1280184 SSS *;* 4471602 SNL *; * 9069959 SAN *;* 3533626 SLA *	
	05/96→	Track Control Arm	SC-DL-8509	SC-DL-8509	Trailing Arm, Leaf Spring Axle	
	05/96→	Track Control Arm	SC-DL-8531	SC-DL-8531	Trailing Arm, Leaf Spring Axle	
	05/96→	Track Control Arm	SC-DL-10302	SC-DL-10302	Trailing Arm, 1st FA;Air Suspension Axle	
	05/96→	Track Control Arm	SC-DL-10302	SC-DL-10302	Trailing Arm, Air Suspension Axle	
	03/98→	Suspension Strut Repair Kit		CV-RK-5311		
	114 C/380	03/98→	Centre Rod	SC-DL-2161		Coupling Rod
		03/98→	Centre Rod	SC-DL-5229		Push Rod
03/98→		Centre Rod	SC-DL-5354		Push Rod	
03/98→		Centre Rod	SC-DL-8154		Push Rod	
03/98→		Centre Rod	SC-DL-8169		Push Rod	
03/98→		Centre Rod	SC-DL-8182		Push Rod	
03/98→		Centre Rod	SC-DL-8399		Push Rod	
03/98→		Centre Rod	SC-DL-12341		Push Rod	
03/98→		Centre Rod	SC-DL-12342		for Steering Rod	
03/98→		Centre Rod	SC-DL-12343		for Steering Rod	
03/98→		Suspension Arm Repair Kit		MN-RK-7280	for Drag Link;for Semi-Trailing Arm; for Wishbone (CV)	
03/98→		Suspension Arm Repair Kit		SC-RK-12366	for Control Arm	
03/98→		Suspension Arm Repair Kit	MN-RK-7280	MN-RK-7280	for Drag Link;for Semi-Trailing Arm; for Wishbone (CV)	
03/98→		Suspension Strut Repair Kit		CV-RK-5311		
03/98→		Suspension Strut Repair Kit		MN-RK-8501		
03/98→		Suspension Strut Repair Kit	MN-RK-12436	MN-RK-12436		
03/98→		Tie Rod		SC-DL-7264	Steering Axle	
03/98→		Tie Rod		SC-DL-8137	Steering Axle	
03/98→		Tie Rod	SC-DL-7264			
03/98→		Tie Rod	SC-DL-7264		1st FA;2nd FA	
03/98→		Tie Rod	SC-DL-8137			
03/98→		Tie Rod	SC-DL-8137		1st FA;2nd FA	
03/98→		Tie Rod End		MN-ES-8490	for vehicles with Hinged Trailing Axle	
03/98→		Tie Rod End	CV-ES-14162		for Steering Rod	
03/98→		Tie Rod End	CV-ES-14163		for Steering Rod	
03/98→		Tie Rod End	SC-ES-5764			
03/98→		Tie Rod End	SC-ES-7279		for Steering Rod	
03/98→		Track Control Arm		SC-DL-8179	Trailing Arm, Leaf Spring Axle	
03/98→		Track Control Arm		SC-DL-8400	Trailing Arm	
03/98→		Track Control Arm		SC-DL-8511	Trailing Arm, Leaf Spring Axle	
03/98→		Track Control Arm		SC-DL-8547	Trailing Arm, Leaf Spring Axle	
03/98→		Track Control Arm		SC-DL-8623	Trailing Arm, 1st Drive Axle, for Leaf-Spring Suspension vehicles, →1280184/4471602	
03/98→		Track Control Arm		SC-DL-8623	Trailing Arm, 1st Drive Axle, for Leaf-Spring Suspension vehicles, →9069959/3533626	
03/98→		Track Control Arm		SC-DL-9462	Trailing Arm, 2nd Drive Axle, for Leaf-Spring Suspension vehicles, →1280184/4471602	
03/98→	Track Control Arm		SC-DL-9462	Trailing Arm, 2nd Drive Axle, for Leaf-Spring Suspension vehicles, →1280185/4471603_>		
03/98→	Track Control Arm		SC-DL-9462	Trailing Arm, 2nd Drive Axle, for Leaf-Spring Suspension vehicles, →9069959/3533626		
03/98→	Track Control Arm		SC-DL-9462	Trailing Arm, 2nd Drive Axle, for Leaf-Spring Suspension vehicles, 9069960/3533627→		

CV-ES-14162

Length: 125
Cone Ø: d1 Ø 30 / d2 Ø 27
Thread: M30 x 1,5 LHT
283783, 395009, 1358792, 1738380, 1 914 426, 2051165



CV-ES-14163

Length: 125
Cone Ø: d1 Ø 30 / d2 Ø 27
Thread: M30 x 1,5 RHT
283784, 395010, 1358793, 1488890, 1738381, 1767328, 1914427, 2051166



CV-RK-5311

0638862, 638862, 0639287, 639287, 1104335, 1953248, 81432206006, 81432206107



MN-ES-8490

Length: 90
Cone Ø: d1 Ø 30 / d2 Ø 27
Thread: M26 x 1,5 RHT
1394444, 0014606948, 14606948



MN-RK-7280

Ø: 75 **Hole Distance:** 115
Thick/Height: 24
550806, 0550806, 0639370, 639370, 689748, 1104334



MN-RK-8501

Ø: 75 **Hole Distance:** 115
Thick/Height: 24
1515981



MN-RK-12436

Ø: 75 **Hole Distance:** 115
Thick/Height: 24
550799, 1517403, 1783020



SC-DL-2161

Length: 1740 **Ø:** 50
Cone Ø: d1 Ø 30 / d2 Ø 27
1369411, 1385251, 1409918, 1501030, 1723865, 1723895, 1737683, 1897335, 2113903, 2125090, 2161883



SC-DL-5229

Length: 1053 **Ø:** 50
Cone Ø: d1 Ø 30 / d2 Ø 27
1356055, 1379071, 1384025, 1768898, 1847311, 1912757, 12201600A



SC-DL-5354

Length: 1060 **Ø:** 52
Cone Ø: d1 Ø 30 / d2 Ø 27
1384027, 1769597, 1847312, 1912758, 12200800A



SC-DL-7264

Length: 1743 **Ø:** 62
Cone Ø: d1 Ø 30 / d2 Ø 27
1361413, 1395614, 1734019, 1897333, 2040254, 2146105



SC-DL-8137

Length: 1736 **Ø:** 40
Cone Ø: d1 Ø 30 / d2 Ø 27
301639, 311847, 395350, 1358675, 1378435, 1397866, 1734020, 2028998, 12202900A



SC-DL-8154

Length: 495 **Ø:** 40
Cone Ø: d1 Ø 30 / d2 Ø 27
1343266, 1759690



SC-DL-8169

Length: 1920 **Ø:** 62
Cone Ø: d1 Ø 30 / d2 Ø 27
1343264, 1732635, 2007278



SC-DL-8179

Length: 568 **Ø:** 46
Hole Distance: 115 / 115
1399180, 1428347



SC-DL-8182

1343262, 1869413



SC-DL-8399

Length: 433 **Ø:** 40
Cone Ø: d1 Ø 30 / d2 Ø 26
1394884, 1938387



SC-DL-8179

Length: 568 **Ø:** 46
Hole Distance: 115 / 115
1399180, 1428347



SC-DL-8509

Length: 568,5 **Ø:** 46
Hole Distance: 115 / 115
1485758, 1486757



SC-DL-8511

Length: 616,5 **Ø:** 50
Hole Distance: 115 / 115
1485760, 1499478, 1722750



SC-DL-8531

Length: 522 **Ø:** 46
Hole Distance: 115 / 115
1486758



SC-DL-8547

Length: 568 **Ø:** 50
Hole Distance: 115 / 115
1499474, 1722746, 1906940



SC-DL-8623

Length: 592 **Ø:** 50
Hole Distance: 115 / 115
1388436, 1499476, 1722748, 1906942



SC-DL-9462

Length: 568,5 **Ø:** 50
Hole Distance: 115 / 115
1499475, 1500573, 1722747, 1906941



SC-DL-9466

Length: 568 **Ø:** 19
1486756



SC-DL-9467

Length: 568,5 **Ø:** 50
Hole Distance: 115 / 115
1500572



SC-DL-10302

Length: 752 **Ø:** 48
Hole Distance: 115 / 115
1101843, 1379423, 1393298, 1431470, 1942075



SC-DL-12341

Length: 1776 **Ø:** 62
Cone Ø: d1 Ø 30 / d2 Ø 27
1386620



SC-DL-12342

Length: 601 **Ø:** 42
Cone Ø: d1 Ø 26 / d2 Ø 23,5
1343262, 1869413



SC-DL-12343

Length: 1062 **Ø:** 52
Cone Ø: d1 Ø 30 / d2 Ø 27
1348269, 2007275



SC-ES-5764

Length: 95
Cone Ø: d1 Ø 30 / d2 Ø 27
Thread: M26 x 1,5 RHT
325614, 1375228, 4604948



SC-ES-7279

Length: 150
Cone Ø: d1 Ø 30 / d2 Ø 27
Thread: M30 x 1,5 RHT
1357674, 1603883, 1738379



SC-RK-12366

Ø: 75 **Hole Distance:** 115 / 115
Thick/Height: 24
1 722 753, 2 096 392



SC-TC-12451

Length: 552 **Ø:** 46
Hole Distance: 115 / 115
1494296



SC-TC-12452

Length: 580,5 **Ø:** 46
Hole Distance: 115 / 115
1485759



SC-TC-12472

Length: 580 **Ø:** 46
Hole Distance: 115 / 115
1399182



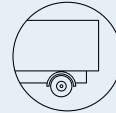

4 - series ...

114 C/380 ...	03/98 →	Track Control Arm		SC-DL-9466	Trailing Arm, Leaf Spring Axle	
	03/98 →	Track Control Arm		SC-DL-9467	Trailing Arm, Leaf Spring Axle, → * 1247518 SSS *; * 4406943 SNL *; * 9039629 SAN *; * 3507979 SLA *	
	03/98 →	Track Control Arm		SC-DL-9467	Trailing Arm, Leaf Spring Axle, → * 1280184 SSS *; * 4471602 SNL *; * 9069959 SAN *; * 3533626 SLA *	
	03/98 →	Track Control Arm		SC-TC-12451	Trailing Arm, 1st Drive Axle, for Leaf-Spring Suspension vehicles	
	03/98 →	Track Control Arm		SC-TC-12452	Trailing Arm, 1st RA; 2nd RA, for Leaf-Spring Suspension vehicles	
	03/98 →	Track Control Arm	SC-DL-8179	SC-DL-8179	Trailing Arm, Leaf Spring Axle, → * 1280184 SSS *; * 4471602 SNL *; * 9069959 SAN *; * 3533626 SLA *	
	03/98 →	Track Control Arm	SC-DL-8509	SC-DL-8509	Trailing Arm, Leaf Spring Axle	
	03/98 →	Track Control Arm	SC-DL-8531	SC-DL-8531	Trailing Arm, Leaf Spring Axle	
	03/98 →	Track Control Arm	SC-DL-10302	SC-DL-10302	Trailing Arm, 1st FA; Air Suspension Axle	
	03/98 →	Track Control Arm	SC-DL-10302	SC-DL-10302	Trailing Arm, Air Suspension Axle	
	114 G/340	05/96 →	Centre Rod	SC-DL-2161		Coupling Rod
		05/96 →	Centre Rod	SC-DL-5229		Push Rod
		05/96 →	Centre Rod	SC-DL-5354		Push Rod
05/96 →		Centre Rod	SC-DL-8154		Push Rod	
05/96 →		Centre Rod	SC-DL-8169		Push Rod	
05/96 →		Centre Rod	SC-DL-8182		Push Rod	
05/96 →		Centre Rod	SC-DL-8399		Push Rod	
05/96 →		Centre Rod	SC-DL-8399		Push Rod, for vehicles with Hinged Leading Axle	
05/96 →		Centre Rod	SC-DL-8553	SC-DL-8553	Push Rod, for vehicles with Hinged Leading Axle	
05/96 →		Centre Rod	SC-DL-10225		for Steering Rod	
05/96 →		Centre Rod	SC-DL-10225		Push Rod	
05/96 →		Centre Rod	SC-DL-12341		Push Rod	
05/96 →		Centre Rod	SC-DL-12342		for Steering Rod	
05/96 →		Centre Rod	SC-DL-12413		for Steering Rod	
05/96 →		Centre Rod	SC-DL-12449		Push Rod	
05/96 →		Suspension Arm Repair Kit		MN-RK-7280	for Drag Link; for Semi-Trailing Arm; for Wishbone (CV)	
05/96 →		Suspension Arm Repair Kit		SC-RK-12366	for Control Arm	
05/96 →		Suspension Arm Repair Kit	MN-RK-7280	MN-RK-7280	for Drag Link; for Semi-Trailing Arm; for Wishbone (CV)	
05/96 →		Suspension Strut Repair Kit		CV-RK-5311		
05/96 →		Suspension Strut Repair Kit		DF-RK-9341		
05/96 →		Suspension Strut Repair Kit		MN-RK-8501		
05/96 →		Suspension Strut Repair Kit	MN-RK-12436	MN-RK-12436		
05/96 →		Tie Rod		SC-DL-7264	Steering Axle	
05/96 →		Tie Rod		SC-DL-8137	Steering Axle	
05/96 →		Tie Rod	SC-DL-7264			
05/96 →		Tie Rod	SC-DL-7264		1st FA; 2nd FA	
05/96 →		Tie Rod	SC-DL-8137			
05/96 →		Tie Rod	SC-DL-8137		1st FA; 2nd FA	
05/96 →		Tie Rod End		MN-ES-8490	for vehicles with Hinged Trailing Axle	
05/96 →		Tie Rod End	CV-ES-14162		for Steering Rod	
05/96 →		Tie Rod End	CV-ES-14162	CV-ES-14162	for Steering Rod	
05/96 →		Tie Rod End	CV-ES-14163		for Steering Rod	
05/96 →		Tie Rod End	IV-ES-12272		for Steering Rod	
05/96 →		Tie Rod End	MN-ES-8490	MN-ES-8490	for vehicles with Hinged Trailing Axle	
05/96 →		Tie Rod End	SC-ES-5764			
05/96 →		Tie Rod End	SC-ES-7279		for Steering Rod	
05/96 →	Tie Rod End	SC-ES-7279	SC-ES-7279	for Steering Rod		
05/96 →	Track Control Arm		SC-DL-8179	Trailing Arm, Leaf Spring Axle		
05/96 →	Track Control Arm		SC-DL-8400	Trailing Arm		
05/96 →	Track Control Arm		SC-DL-8511	Trailing Arm, Leaf Spring Axle		
05/96 →	Track Control Arm		SC-DL-8547	Trailing Arm, Leaf Spring Axle		
05/96 →	Track Control Arm		SC-DL-8623	Trailing Arm, 1st Drive Axle, for Leaf-Spring Suspension vehicles, → 1280184/4471602		

CV-ES-14162

Length: 125
Cone Ø: d1 Ø 30 / d2 Ø 27
Thread: M30 x 1,5 LHT
283783, 395009, 1358792, 1738380, 1 914 426, 2051165



CV-ES-14163

Length: 125
Cone Ø: d1 Ø 30 / d2 Ø 27
Thread: M30 x 1,5 RHT
283784, 395010, 1358793, 1488890, 1738381, 1767328, 1914427, 2051166



CV-RK-5311

638862, 0638862, 0639287, 639287, 1104335, 1953248, 81432206006, 81432206107



DF-RK-9341

Ø: 67
550807, 5508072



IV-ES-12272

Length: 75
Cone Ø: d1 Ø 30 / d2 Ø 27
Thread: M26 x 1,5 RHT
1394443



MN-ES-8490

Length: 90
Cone Ø: d1 Ø 30 / d2 Ø 27
Thread: M26 x 1,5 RHT
1394444, 14606948, 0014606948



MN-RK-7280

Ø: 75 Hole Distance: 115
Thick/Height: 24
550806, 0550806, 0639370, 639370, 689748, 1104334



MN-RK-8501

Ø: 75 Hole Distance: 115
Thick/Height: 24
1515981



MN-RK-12436

Ø: 75 Hole Distance: 115
Thick/Height: 24
550799, 1517403, 1783020



SC-DL-2161

Length: 1740 Ø: 50
Cone Ø: d1 Ø 30 / d2 Ø 27
1369411, 1385251, 1409918, 1501030, 1723865, 1723895, 1737683, 1897335, 2113903, 2125090, 2161883



SC-DL-5229

Length: 1053 Ø: 50
Cone Ø: d1 Ø 30 / d2 Ø 27
1356055, 1379071, 1384025, 1768898, 1847311, 1912757, 12201600A



SC-DL-5354

Length: 1060 Ø: 52
Cone Ø: d1 Ø 30 / d2 Ø 27
1384027, 1769597, 1847312, 1912758, 12200800A



SC-DL-7264

Length: 1743 Ø: 62
Cone Ø: d1 Ø 30 / d2 Ø 27
1361413, 1395614, 1734019, 1897333, 2040254, 2146105



SC-DL-8137

Length: 1736 Ø: 40
Cone Ø: d1 Ø 30 / d2 Ø 27
301639, 311847, 395350, 1358675, 1378435, 1397866, 1734020, 2028998, 12202900A



SC-DL-8154

Length: 495 Ø: 40
Cone Ø: d1 Ø 30 / d2 Ø 27
1343266, 1759690



SC-DL-8169

Length: 1920 Ø: 62
Cone Ø: d1 Ø 30 / d2 Ø 27
1343264, 1732635, 2007278



SC-DL-8179

Length: 568 Ø: 46
Hole Distance: 115 / 115
1399180, 1428347



SC-DL-8182

Length: 568,5 Ø: 62
Cone Ø: d1 Ø 30 / d2 Ø 27
1386618, 1788522



SC-DL-8399

Length: 433 Ø: 40
Cone Ø: d1 Ø 30 / d2 Ø 26
1394884, 1938387



SC-DL-8179

Length: 568 Ø: 46
Hole Distance: 115 / 115
1399180, 1428347



SC-DL-8509

Length: 568,5 Ø: 46
Hole Distance: 115 / 115
1485758, 1486757



SC-DL-8511

Length: 616,5 Ø: 50
Hole Distance: 115 / 115
1485760, 1499478, 1722750



SC-DL-8531

Length: 522 Ø: 46
Hole Distance: 115 / 115
1486758



SC-DL-8547

Length: 568 Ø: 50
Hole Distance: 115 / 115
1499474, 1722746, 1906940



SC-DL-8553

Length: 435 Ø: 38
Cone Ø: d1 Ø 30 / d2 Ø 27
1343283, 1759691



SC-DL-8623

Length: 592 Ø: 50
Hole Distance: 115 / 115
1388436, 1499476, 1722748, 1906942



SC-DL-9466

Length: 568 Ø: 19
1486756



SC-DL-9467

Length: 568,5 Ø: 50
Hole Distance: 115 / 115
1500572



SC-DL-10225

Length: 2179 Ø: 62
Cone Ø: d1 Ø 30 / d2 Ø 27
1386618, 1788522



SC-DL-10302

Length: 752 Ø: 48
Hole Distance: 115 / 115
1101843, 1379423, 1393298, 1431470, 1942075



SC-DL-12341

Length: 1776 Ø: 62
Cone Ø: d1 Ø 30 / d2 Ø 27
1386620



SC-DL-12342

Length: 601 Ø: 42
Cone Ø: d1 Ø 26 / d2 Ø 23,5
1343262, 1869413



SC-DL-12413

Length: 1950 Ø: 62
Cone Ø: d1 Ø 30 / d2 Ø 27
1393383, 1788520



SC-DL-12449

Length: 1206 Ø: 38
Cone Ø: d1 Ø 30 / d2 Ø 27
1385763, 1765375



SC-ES-5764

Length: 95
Cone Ø: d1 Ø 30 / d2 Ø 27
Thread: M26 x 1,5 RHT
325614, 1375228, 4604948



SC-ES-7279

Length: 150
Cone Ø: d1 Ø 30 / d2 Ø 27
Thread: M30 x 1,5 RHT
1357674, 1603883, 1738379



SC-RK-12366

Ø: 75 Hole Distance: 115 / 115
Thick/Height: 24
1 722 753, 2 096 392



SC-TC-12451

Length: 552 Ø: 46
Hole Distance: 115 / 115
1494296



SC-TC-12452

Length: 580,5 Ø: 46
Hole Distance: 115 / 115
1485759



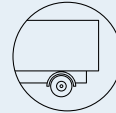
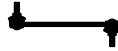

4 - series ...

114 G/340 ...	05/96 →	Track Control Arm		SC-DL-8623	Trailing Arm, 1st Drive Axle, for Leaf-Spring Suspension vehicles, →9069959/3533626	
	05/96 →	Track Control Arm		SC-DL-9462	Trailing Arm, 2nd Drive Axle, for Leaf-Spring Suspension vehicles, →1280184/4471602	
	05/96 →	Track Control Arm		SC-DL-9462	Trailing Arm, 2nd Drive Axle, for Leaf-Spring Suspension vehicles, →1280185/4471603_>	
	05/96 →	Track Control Arm		SC-DL-9462	Trailing Arm, 2nd Drive Axle, for Leaf-Spring Suspension vehicles, →9069959/3533626	
	05/96 →	Track Control Arm		SC-DL-9462	Trailing Arm, 2nd Drive Axle, for Leaf-Spring Suspension vehicles, 9069960/3533627→	
	05/96 →	Track Control Arm		SC-DL-9466	Trailing Arm, Leaf Spring Axle	
	05/96 →	Track Control Arm		SC-DL-9467	Trailing Arm, Leaf Spring Axle, →* 1247518 SSS **; 4406943 SNL *; * 9039629 SAN **; 3507979 SLA *	
	05/96 →	Track Control Arm		SC-DL-9467	Trailing Arm, Leaf Spring Axle, →* 1280184 SSS **; 4471602 SNL *; * 9069959 SAN **; 3533626 SLA *	
	05/96 →	Track Control Arm		SC-TC-12451	Control Arm	
	05/96 →	Track Control Arm		SC-TC-12452	Trailing Arm, 1st RA;2nd RA, for Leaf-Spring Suspension vehicles	
	05/96 →	Track Control Arm		SC-TC-12472	Control Arm	
	05/96 →	Track Control Arm	SC-DL-8179	SC-DL-8179	Trailing Arm, Leaf Spring Axle, →* 1280184 SSS **; 4471602 SNL *; * 9069959 SAN **; 3533626 SLA *	
	05/96 →	Track Control Arm	SC-DL-8509	SC-DL-8509	Trailing Arm, Leaf Spring Axle	
	05/96 →	Track Control Arm	SC-DL-8531	SC-DL-8531	Trailing Arm, Leaf Spring Axle	
	05/96 →	Track Control Arm	SC-DL-10302	SC-DL-10302	Trailing Arm, 1st FA;Air Suspension Axle	
	05/96 →	Track Control Arm	SC-DL-10302	SC-DL-10302	Trailing Arm, Air Suspension Axle	
	05/96 →	Track Control Arm	SC-TC-12361		Control Arm, 1st Front Axle, for Pneumatic Suspension vehicles	
	114 G/380	03/98 →	Centre Rod	SC-DL-2161		Coupling Rod
		03/98 →	Centre Rod	SC-DL-5229		Push Rod
		03/98 →	Centre Rod	SC-DL-5354		Push Rod
03/98 →		Centre Rod	SC-DL-8154		Push Rod	
03/98 →		Centre Rod	SC-DL-8169		Push Rod	
03/98 →		Centre Rod	SC-DL-8182		Push Rod	
03/98 →		Centre Rod	SC-DL-8399		Push Rod	
03/98 →		Centre Rod	SC-DL-8399		Push Rod, for vehicles with Hinged Leading Axle	
03/98 →		Centre Rod	SC-DL-8553	SC-DL-8553	Push Rod, for vehicles with Hinged Leading Axle	
03/98 →		Centre Rod	SC-DL-10225		for Steering Rod	
03/98 →		Centre Rod	SC-DL-10225		Push Rod	
03/98 →		Centre Rod	SC-DL-12341		Push Rod	
03/98 →		Centre Rod	SC-DL-12342		for Steering Rod	
03/98 →		Centre Rod	SC-DL-12413		for Steering Rod	
03/98 →		Centre Rod	SC-DL-12449		Push Rod	
03/98 →		Suspension Arm Repair Kit		MN-RK-7280	for Drag Link;for Semi-Trailing Arm; for Wishbone (CV)	
03/98 →		Suspension Arm Repair Kit		SC-RK-12366	for Control Arm	
03/98 →		Suspension Arm Repair Kit	MN-RK-7280	MN-RK-7280	for Drag Link;for Semi-Trailing Arm; for Wishbone (CV)	
03/98 →		Suspension Strut Repair Kit		CV-RK-5311		
03/98 →		Suspension Strut Repair Kit		DF-RK-9341		
03/98 →		Suspension Strut Repair Kit		MN-RK-8501		
03/98 →		Suspension Strut Repair Kit	MN-RK-12436	MN-RK-12436		
03/98 →		Tie Rod		SC-DL-7264	Steering Axle	
03/98 →		Tie Rod		SC-DL-8137	Steering Axle	
03/98 →		Tie Rod	SC-DL-7264			
03/98 →		Tie Rod	SC-DL-7264		1st FA;2nd FA	
03/98 →		Tie Rod	SC-DL-8137			
03/98 →		Tie Rod	SC-DL-8137		1st FA;2nd FA	
03/98 →		Tie Rod End		MN-ES-8490	for vehicles with Hinged Trailing Axle	
03/98 →		Tie Rod End	CV-ES-14162		for Steering Rod	
03/98 →	Tie Rod End	CV-ES-14162	CV-ES-14162	for Steering Rod		

CV-ES-14162

Length: 125
Cone Ø: d1 Ø 30 / d2 Ø 27
Thread: M30 x 1,5 LHT
283783, 395009, 1358792, 1738380, 1 914 426, 2051165



CV-RK-5311

0638862, 638862, 0639287, 639287, 1104335, 1953248, 81432206006, 81432206107



DF-RK-9341

Ø: 67
550807, 5508072



MN-ES-8490

Length: 90
Cone Ø: d1 Ø 30 / d2 Ø 27
Thread: M26 x 1,5 RHT
1394444, 0014606948, 14606948



MN-RK-7280

Ø: 75 Hole Distance: 115
Thick/Height: 24
0550806, 550806, 0639370, 639370, 689748, 1104334



MN-RK-8501

Ø: 75 Hole Distance: 115
Thick/Height: 24
1515981



MN-RK-12436

Ø: 75 Hole Distance: 115
Thick/Height: 24
550799, 1517403, 1783020



SC-DL-2161

Length: 1740 Ø: 50
Cone Ø: d1 Ø 30 / d2 Ø 27
1369411, 1385251, 1409918, 1501030, 1723865, 1723895, 1737683, 1897335, 2113903, 2125090, 2161883



SC-DL-5229

Length: 1053 Ø: 50
Cone Ø: d1 Ø 30 / d2 Ø 27
1356055, 1379071, 1384025, 1768898, 1847311, 1912757, 12201600A



SC-DL-5354

Length: 1060 Ø: 52
Cone Ø: d1 Ø 30 / d2 Ø 27
1384027, 1769597, 1847312, 1912758, 12200800A



SC-DL-7264

Length: 1743 Ø: 62
Cone Ø: d1 Ø 30 / d2 Ø 27
1361413, 1395614, 1734019, 1897333, 2040254, 2146105



SC-DL-8137

Length: 1736 Ø: 40
Cone Ø: d1 Ø 30 / d2 Ø 27
301639, 311847, 395350, 1358675, 1378435, 1397866, 1734020, 2028998, 12202900A



SC-DL-8154

Length: 495 Ø: 40
Cone Ø: d1 Ø 30 / d2 Ø 27
1343266, 1759690



SC-DL-8169

Length: 1920 Ø: 62
Cone Ø: d1 Ø 30 / d2 Ø 27
1343264, 1732635, 2007278



SC-DL-8179

Length: 568 Ø: 46
Hole Distance: 115 / 115
1399180, 1428347



SC-DL-8182

1343262, 1869413



SC-DL-8399

Length: 433 Ø: 40
Cone Ø: d1 Ø 30 / d2 Ø 26
1394884, 1938387



SC-DL-8509

Length: 568,5 Ø: 46
Hole Distance: 115 / 115
1485758, 1486757



SC-DL-8531

Length: 522 Ø: 46
Hole Distance: 115 / 115
1486758



SC-DL-8553

Length: 435 Ø: 38
Cone Ø: d1 Ø 30 / d2 Ø 27
1343283, 1759691



SC-DL-8623

Length: 592 Ø: 50
Hole Distance: 115 / 115
1388436, 1499476, 1722748, 1906942



SC-DL-9462

Length: 568,5 Ø: 50
Hole Distance: 115 / 115
1499475, 1500573, 1722747, 1906941



SC-DL-9466

Length: 568 Ø: 19
1486756



SC-DL-9467

Length: 568,5 Ø: 50
Hole Distance: 115 / 115
1500572



SC-DL-10225

Length: 2179 Ø: 62
Cone Ø: d1 Ø 30 / d2 Ø 27
1386618, 1788522



SC-DL-10302

Length: 752 Ø: 48
Hole Distance: 115 / 115
1101843, 1379423, 1393298, 1431470, 1942075



SC-DL-12341

Length: 1776 Ø: 62
Cone Ø: d1 Ø 30 / d2 Ø 27
1386620



SC-DL-12342

Length: 601 Ø: 42
Cone Ø: d1 Ø 26 / d2 Ø 23,5
1343262, 1869413



SC-DL-12413

Length: 1950 Ø: 62
Cone Ø: d1 Ø 30 / d2 Ø 27
1393383, 1788520



SC-DL-12449

Length: 1206 Ø: 38
Cone Ø: d1 Ø 30 / d2 Ø 27
1385763, 1765375



SC-RK-12366

Ø: 75 Hole Distance: 115 / 115
Thick/Height: 24
1 722 753, 2 096 392



SC-TC-12361

Length: 705 Ø: 42
Cone Ø: d1 Ø 38
Hole Distance: 115
1353445, 1464611, 1942147



SC-TC-12451

Length: 552 Ø: 46
Hole Distance: 115 / 115
1494296



SC-TC-12452

Length: 580,5 Ø: 46
Hole Distance: 115 / 115
1485759



SC-TC-12472

Length: 580 Ø: 46
Hole Distance: 115 / 115
1399182



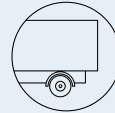

4 - series ...

114 G/380 ...	03/98 →	Tie Rod End	CV-ES-14163		for Steering Rod	
	03/98 →	Tie Rod End	IV-ES-12272		for Steering Rod	
	03/98 →	Tie Rod End	MN-ES-8490	MN-ES-8490	for vehicles with Hinged Trailing Axle	
	03/98 →	Tie Rod End	SC-ES-5764			
	03/98 →	Tie Rod End	SC-ES-7279		for Steering Rod	
	03/98 →	Tie Rod End	SC-ES-7279	SC-ES-7279	for Steering Rod	
	03/98 →	Track Control Arm		SC-DL-8179	Trailing Arm, Leaf Spring Axle	
	03/98 →	Track Control Arm		SC-DL-8400	Trailing Arm	
	03/98 →	Track Control Arm		SC-DL-8511	Trailing Arm, Leaf Spring Axle	
	03/98 →	Track Control Arm		SC-DL-8547	Trailing Arm, Leaf Spring Axle	
	03/98 →	Track Control Arm		SC-DL-8623	Trailing Arm, 1st Drive Axle, for Leaf-Spring Suspension vehicles, →1280184/4471602	
	03/98 →	Track Control Arm		SC-DL-8623	Trailing Arm, 1st Drive Axle, for Leaf-Spring Suspension vehicles, →9069959/3533626	
	03/98 →	Track Control Arm		SC-DL-9462	Trailing Arm, 2nd Drive Axle, for Leaf-Spring Suspension vehicles, →1280184/4471602	
	03/98 →	Track Control Arm		SC-DL-9462	Trailing Arm, 2nd Drive Axle, for Leaf-Spring Suspension vehicles, →1280185/4471603_>	
	03/98 →	Track Control Arm		SC-DL-9462	Trailing Arm, 2nd Drive Axle, for Leaf-Spring Suspension vehicles, →9069959/3533626	
	03/98 →	Track Control Arm		SC-DL-9462	Trailing Arm, 2nd Drive Axle, for Leaf-Spring Suspension vehicles, 9069960/3533627 →	
	03/98 →	Track Control Arm		SC-DL-9466	Trailing Arm, Leaf Spring Axle	
	03/98 →	Track Control Arm		SC-DL-9467	Trailing Arm, Leaf Spring Axle, →* 1247518 SSS *; * 4406943 SNL *; * 9039629 SAN *; * 3507979 SLA *	
	03/98 →	Track Control Arm		SC-DL-9467	Trailing Arm, Leaf Spring Axle, →* 1280184 SSS *; * 4471602 SNL *; * 9069959 SAN *; * 3533626 SLA *	
	03/98 →	Track Control Arm		SC-TC-12451	Trailing Arm, 1st Drive Axle, for Leaf-Spring Suspension vehicles	
	03/98 →	Track Control Arm		SC-TC-12452	Trailing Arm, 1st RA; 2nd RA, for Leaf-Spring Suspension vehicles	
	03/98 →	Track Control Arm	SC-DL-8179	SC-DL-8179	Trailing Arm, Leaf Spring Axle, →* 1280184 SSS *; * 4471602 SNL *; * 9069959 SAN *; * 3533626 SLA *	
	03/98 →	Track Control Arm	SC-DL-8509	SC-DL-8509	Trailing Arm, Leaf Spring Axle	
	03/98 →	Track Control Arm	SC-DL-8531	SC-DL-8531	Trailing Arm, Leaf Spring Axle	
	03/98 →	Track Control Arm	SC-DL-10302	SC-DL-10302	Trailing Arm, 1st FA; Air Suspension Axle	
	03/98 →	Track Control Arm	SC-DL-10302	SC-DL-10302	Trailing Arm, Air Suspension Axle	
	03/98 →	Track Control Arm	SC-TC-12361		Control Arm, 1st Front Axle, for Pneumatic Suspension vehicles	
	114 L/340	05/96 →	Centre Rod	SC-DL-2161		Coupling Rod
		05/96 →	Centre Rod	SC-DL-5229		Push Rod
		05/96 →	Centre Rod	SC-DL-5354		Push Rod
05/96 →		Centre Rod	SC-DL-8182		Push Rod	
05/96 →		Centre Rod	SC-DL-8399		Push Rod, for vehicles with Hinged Leading Axle	
05/96 →		Centre Rod	SC-DL-8553	SC-DL-8553	Push Rod, for vehicles with Hinged Leading Axle	
05/96 →		Centre Rod	SC-DL-10225		for Steering Rod	
05/96 →		Centre Rod	SC-DL-10225		Push Rod	
05/96 →		Centre Rod	SC-DL-12342		for Steering Rod	
05/96 →		Centre Rod	SC-DL-12449		Push Rod	
05/96 →		Suspension Arm Repair Kit		SC-RK-12366	for Control Arm	
05/96 →		Suspension Arm Repair Kit	MN-RK-7280	MN-RK-7280	for Drag Link; for Semi-Trailing Arm; for Wishbone (CV)	
05/96 →		Suspension Strut Repair Kit		CV-RK-5311		
05/96 →		Suspension Strut Repair Kit		DF-RK-9341		
05/96 →		Suspension Strut Repair Kit		MN-RK-8501		
05/96 →		Suspension Strut Repair Kit	MN-RK-12436	MN-RK-12436		
05/96 →		Tie Rod		SC-DL-7264	Steering Axle	
05/96 →		Tie Rod		SC-DL-8137	Steering Axle	
05/96 →	Tie Rod	SC-DL-7264				
05/96 →	Tie Rod	SC-DL-8137				

CV-ES-14163

Length: 125
Cone Ø: d1 Ø 30 / d2 Ø 27
Thread: M30 x 1,5 RHT
283784, 395010, 1358793, 1488890,
1738381, 1767328, 1914427, 2051166



CV-RK-5311

0638862, 638862, 0639287, 639287,
1104335, 1953248, 81432206006,
81432206107



DF-RK-9341

Ø: 67
550807, 5508072



IV-ES-12272

Length: 75
Cone Ø: d1 Ø 30 / d2 Ø 27
Thread: M26 x 1,5 RHT
1394443



MN-ES-8490

Length: 90
Cone Ø: d1 Ø 30 / d2 Ø 27
Thread: M26 x 1,5 RHT
1394444, 0014606948, 14606948



MN-RK-7280

Ø: 75 Hole Distance: 115
Thick/Height: 24
0550806, 550806, 0639370, 639370,
689748, 1104334



MN-RK-8501

Ø: 75 Hole Distance: 115
Thick/Height: 24
1515981



MN-RK-12436

Ø: 75 Hole Distance: 115
Thick/Height: 24
550799, 1517403, 1783020



SC-DL-2161

Length: 1740 Ø: 50
Cone Ø: d1 Ø 30 / d2 Ø 27
1369411, 1385251, 1409918, 1501030,
1723865, 1723895, 1737683, 1897335,
2113903, 2125090, 2161883



SC-DL-5229

Length: 1053 Ø: 50
Cone Ø: d1 Ø 30 / d2 Ø 27
1356055, 1379071, 1384025, 1768898,
1847311, 1912757, 12201600A



SC-DL-5354

Length: 1060 Ø: 52
Cone Ø: d1 Ø 30 / d2 Ø 27
1384027, 1769597, 1847312, 1912758,
12200800A



SC-DL-7264

Length: 1743 Ø: 62
Cone Ø: d1 Ø 30 / d2 Ø 27
1361413, 1395614, 1734019, 1897333,
2040254, 2146105



SC-DL-8137

Length: 1736 Ø: 40
Cone Ø: d1 Ø 30 / d2 Ø 27
301639, 311847, 395350, 1358675,
1378435, 1397866, 1734020, 2028998,
12202900A



SC-DL-8179

Length: 568 Ø: 46
Hole Distance: 115 / 115
1399180, 1428347



SC-DL-8182

1343262, 1869413



SC-DL-8399

Length: 433 Ø: 40
Cone Ø: d1 Ø 30 / d2 Ø 26
1394884, 1938387



SC-DL-8179

Length: 568 Ø: 46
Hole Distance: 115 / 115
1399180, 1428347



SC-DL-8509

Length: 568,5 Ø: 46
Hole Distance: 115 / 115
1485758, 1486757



SC-DL-8511

Length: 616,5 Ø: 50
Hole Distance: 115 / 115
1485760, 1499478, 1722750



SC-DL-8531

Length: 522 Ø: 46
Hole Distance: 115 / 115
1486758



SC-DL-8547

Length: 568 Ø: 50
Hole Distance: 115 / 115
1499474, 1722746, 1906940



SC-DL-8553

Length: 435 Ø: 38
Cone Ø: d1 Ø 30 / d2 Ø 27
1343283, 1759691



SC-DL-8623

Length: 592 Ø: 50
Hole Distance: 115 / 115
1388436, 1499476, 1722748, 1906942



SC-DL-9462

Length: 568,5 Ø: 50
Hole Distance: 115 / 115
1499475, 1500573, 1722747, 1906941



SC-DL-9466

Length: 568 Ø: 19
1486756



SC-DL-9467

Length: 568,5 Ø: 50
Hole Distance: 115 / 115
1500572



SC-DL-10225

Length: 2179 Ø: 62
Cone Ø: d1 Ø 30 / d2 Ø 27
1386618, 1788522



SC-DL-10302

Length: 752 Ø: 48
Hole Distance: 115 / 115
1101843, 1379423, 1393298, 1431470,
1942075



SC-DL-12342

Length: 601 Ø: 42
Cone Ø: d1 Ø 26 / d2 Ø 23,5
1343262, 1869413



SC-DL-12449

Length: 1206 Ø: 38
Cone Ø: d1 Ø 30 / d2 Ø 27
1385763, 1765375



SC-ES-5764

Length: 95
Cone Ø: d1 Ø 30 / d2 Ø 27
Thread: M26 x 1,5 RHT
325614, 1375228, 4604948



SC-ES-7279

Length: 150
Cone Ø: d1 Ø 30 / d2 Ø 27
Thread: M30 x 1,5 RHT
1357674, 1603883, 1738379



SC-RK-12366

Ø: 75 Hole Distance: 115 / 115
Thick/Height: 24
1 722 753, 2 096 392



SC-TC-12361

Length: 705 Ø: 42
Cone Ø: d1 Ø 38
Hole Distance: 115
1353445, 1464611, 1942147



SC-TC-12451

Length: 552 Ø: 46
Hole Distance: 115 / 115
1494296



SC-TC-12452

Length: 580,5 Ø: 46
Hole Distance: 115 / 115
1485759



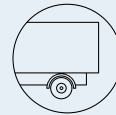

4 - series ...

114 L/340 ...	05/96→	Tie Rod End		MN-ES-8490	for vehicles with Hinged Trailing Axle
	05/96→	Tie Rod End	CV-ES-14162		for Steering Rod
	05/96→	Tie Rod End	CV-ES-14162	CV-ES-14162	for Steering Rod
	05/96→	Tie Rod End	CV-ES-14163		for Steering Rod
	05/96→	Tie Rod End	SC-ES-7279		for Steering Rod
	05/96→	Tie Rod End	SC-ES-7279	SC-ES-7279	for Steering Rod
	05/96→	Track Control Arm		SC-DL-8179	Trailing Arm, Leaf Spring Axle
	05/96→	Track Control Arm		SC-DL-8400	Trailing Arm
	05/96→	Track Control Arm		SC-DL-8511	Trailing Arm, Leaf Spring Axle
	05/96→	Track Control Arm		SC-DL-8547	Trailing Arm, Leaf Spring Axle
	05/96→	Track Control Arm		SC-DL-9466	Trailing Arm, Leaf Spring Axle
	05/96→	Track Control Arm		SC-DL-9467	Trailing Arm, Leaf Spring Axle, →* 1247518 SSS *;* 4406943 SNL *; * 9039629 SAN *;* 3507979 SLA *
	05/96→	Track Control Arm		SC-DL-9467	Trailing Arm, Leaf Spring Axle, → * 1280184 SSS *;* 4471602 SNL *; * 9069959 SAN *;* 3533626 SLA *
	05/96→	Track Control Arm	SC-DL-8179	SC-DL-8179	Trailing Arm, Leaf Spring Axle, → * 1280184 SSS *;* 4471602 SNL *; * 9069959 SAN *;* 3533626 SLA *
	05/96→	Track Control Arm	SC-DL-8509	SC-DL-8509	Trailing Arm, Leaf Spring Axle
	05/96→	Track Control Arm	SC-DL-8531	SC-DL-8531	Trailing Arm, Leaf Spring Axle
	05/96→	Track Control Arm	SC-DL-10302	SC-DL-10302	Trailing Arm, Air Suspension Axle
	03/98→	Tie Rod End	IV-ES-12272		for Steering Rod
	03/98→	Track Control Arm		SC-DL-8623	Trailing Arm, 1st Drive Axle, for Leaf-Spring Suspension vehicles, →1280184/4471602
	03/98→	Track Control Arm		SC-DL-8623	Trailing Arm, 1st Drive Axle, for Leaf-Spring Suspension vehicles, →9069959/3533626
	03/98→	Track Control Arm		SC-DL-9462	Trailing Arm, 2nd Drive Axle, for Leaf-Spring Suspension vehicles, →1280184/4471602
	03/98→	Track Control Arm		SC-DL-9462	Trailing Arm, 2nd Drive Axle, for Leaf-Spring Suspension vehicles, →1280185/4471603 →
	03/98→	Track Control Arm		SC-DL-9462	Trailing Arm, 2nd Drive Axle, for Leaf-Spring Suspension vehicles, →9069959/3533626
	03/98→	Track Control Arm		SC-DL-9462	Trailing Arm, 2nd Drive Axle, for Leaf-Spring Suspension vehicles, 9069960/3533627 →
	03/98→	Track Control Arm		SC-TC-12451	Trailing Arm, 1st Drive Axle, for Leaf-Spring Suspension vehicles
	03/98→	Track Control Arm		SC-TC-12452	Trailing Arm, 1st RA;2nd RA, for Leaf-Spring Suspension vehicles
	03/98→	Track Control Arm	SC-TC-12361		Control Arm, 1st Front Axle, for Pneumatic Suspension vehicles
114 L/380	03/98→	Centre Rod	SC-DL-2161		Coupling Rod
	03/98→	Centre Rod	SC-DL-5229		Push Rod
	03/98→	Centre Rod	SC-DL-5354		Push Rod
	03/98→	Centre Rod	SC-DL-8182		Push Rod
	03/98→	Centre Rod	SC-DL-8399		Push Rod, for vehicles with Hinged Leading Axle
	03/98→	Centre Rod	SC-DL-8553	SC-DL-8553	Push Rod, for vehicles with Hinged Leading Axle
	03/98→	Centre Rod	SC-DL-10225		for Steering Rod
	03/98→	Centre Rod	SC-DL-10225		Push Rod
	03/98→	Centre Rod	SC-DL-12342		for Steering Rod
	03/98→	Centre Rod	SC-DL-12449		Push Rod
	03/98→	Suspension Arm Repair Kit		SC-RK-12366	for Control Arm
	03/98→	Suspension Arm Repair Kit	MN-RK-7280	MN-RK-7280	for Drag Link;for Semi-Trailing Arm; for Wishbone (CV)
	03/98→	Suspension Strut Repair Kit		CV-RK-5311	
	03/98→	Suspension Strut Repair Kit		DF-RK-9341	
	03/98→	Suspension Strut Repair Kit		MN-RK-8501	
	03/98→	Suspension Strut Repair Kit	MN-RK-12436	MN-RK-12436	
	03/98→	Tie Rod		SC-DL-7264	Steering Axle
	03/98→	Tie Rod		SC-DL-8137	Steering Axle
	03/98→	Tie Rod	SC-DL-7264		
	03/98→	Tie Rod	SC-DL-8137		

CV-ES-14162

Length: 125
Cone Ø: d1 Ø 30 / d2 Ø 27
Thread: M30 x 1,5 LHT
283784, 395009, 1358792, 1738380, 1 914 426, 2051165



CV-ES-14163

Length: 125
Cone Ø: d1 Ø 30 / d2 Ø 27
Thread: M30 x 1,5 RHT
283784, 395010, 1358793, 1488890, 1738381, 1767328, 1914427, 2051166



CV-RK-5311

0638862, 638862, 0639287, 639287, 1104335, 1953248, 81432206006, 81432206107



DF-RK-9341

Ø: 67
550807, 5508072



IV-ES-12272

Length: 75
Cone Ø: d1 Ø 30 / d2 Ø 27
Thread: M26 x 1,5 RHT
1394443



MN-ES-8490

Length: 90
Cone Ø: d1 Ø 30 / d2 Ø 27
Thread: M26 x 1,5 RHT
1394444, 0014606948, 14606948



MN-RK-7280

Ø: 75 Hole Distance: 115
Thick/Height: 24
0550806, 550806, 0639370, 639370, 689748, 1104334



MN-RK-8501

Ø: 75 Hole Distance: 115
Thick/Height: 24
1515981



MN-RK-12436

Ø: 75 Hole Distance: 115
Thick/Height: 24
550799, 1517403, 1783020



SC-DL-2161

Length: 1740 Ø: 50
Cone Ø: d1 Ø 30 / d2 Ø 27
1369411, 1385251, 1409918, 1501030, 1723865, 1723895, 1737683, 1897335, 2113903, 2125090, 2161883



SC-DL-5229

Length: 1053 Ø: 50
Cone Ø: d1 Ø 30 / d2 Ø 27
1356055, 1379071, 1384025, 1768898, 1847311, 1912757, 12201600A



SC-DL-5354

Length: 1060 Ø: 52
Cone Ø: d1 Ø 30 / d2 Ø 27
1384027, 1769597, 1847312, 1912758, 12200800A



SC-DL-7264

Length: 1743 Ø: 62
Cone Ø: d1 Ø 30 / d2 Ø 27
1361413, 1395614, 1734019, 1897333, 2040254, 2146105



SC-DL-8137

Length: 1736 Ø: 40
Cone Ø: d1 Ø 30 / d2 Ø 27
301639, 311847, 395350, 1358675, 1378435, 1397866, 1734020, 2028998, 12202900A



SC-DL-8179

Length: 568 Ø: 46
Hole Distance: 115 / 115
1399180, 1428347



SC-DL-8182

1343262, 1869413



SC-DL-8399

Length: 433 Ø: 40
Cone Ø: d1 Ø 30 / d2 Ø 26
1394884, 1938387



SC-DL-8179

Length: 568 Ø: 46
Hole Distance: 115 / 115
1399180, 1428347



SC-DL-8509

Length: 568,5 Ø: 46
Hole Distance: 115 / 115
1485758, 1486757



SC-DL-8511

Length: 616,5 Ø: 50
Hole Distance: 115 / 115
1485760, 1499478, 1722750



SC-DL-8531

Length: 522 Ø: 46
Hole Distance: 115 / 115
1486758



SC-DL-8547

Length: 568 Ø: 50
Hole Distance: 115 / 115
1499474, 1722746, 1906940



SC-DL-8553

Length: 435 Ø: 38
Cone Ø: d1 Ø 30 / d2 Ø 27
1343283, 1759691



SC-DL-8623

Length: 592 Ø: 50
Hole Distance: 115 / 115
1388436, 1499476, 1722748, 1906942



SC-DL-9462

Length: 568,5 Ø: 50
Hole Distance: 115 / 115
1499475, 1500573, 1722747, 1906941



SC-DL-9466

Length: 568 Ø: 19
1486756



SC-DL-9467

Length: 568,5 Ø: 50
Hole Distance: 115 / 115
1500572



SC-DL-10225

Length: 2179 Ø: 62
Cone Ø: d1 Ø 30 / d2 Ø 27
1386618, 1788522



SC-DL-10302

Length: 752 Ø: 48
Hole Distance: 115 / 115
1101843, 1379423, 1393298, 1431470, 1942075



SC-DL-12342

Length: 601 Ø: 42
Cone Ø: d1 Ø 26 / d2 Ø 23,5
1343262, 1869413



SC-DL-12449

Length: 1206 Ø: 38
Cone Ø: d1 Ø 30 / d2 Ø 27
1385763, 1765375



SC-ES-7279

Length: 150
Cone Ø: d1 Ø 30 / d2 Ø 27
Thread: M30 x 1,5 RHT
1357674, 1603883, 1738379



SC-RK-12366

Ø: 75 Hole Distance: 115 / 115
Thick/Height: 24
1 722 753, 2 096 392



SC-TC-12361

Length: 705 Ø: 42
Cone Ø: d1 Ø 38
Hole Distance: 115
1353445, 1464611, 1942147



SC-TC-12451

Length: 552 Ø: 46
Hole Distance: 115 / 115
1494296



SC-TC-12452

Length: 580,5 Ø: 46
Hole Distance: 115 / 115
1485759





4 - series ...

114 L/380 ...	03/98 →	Tie Rod End		MN-ES-8490	for vehicles with Hinged Trailing Axle	
	03/98 →	Tie Rod End	CV-ES-14162		for Steering Rod	
	03/98 →	Tie Rod End	CV-ES-14162	CV-ES-14162	for Steering Rod	
	03/98 →	Tie Rod End	CV-ES-14163		for Steering Rod	
	03/98 →	Tie Rod End	IV-ES-12272		for Steering Rod	
	03/98 →	Tie Rod End	SC-ES-7279		for Steering Rod	
	03/98 →	Tie Rod End	SC-ES-7279	SC-ES-7279	for Steering Rod	
	03/98 →	Track Control Arm		SC-DL-8179	Trailing Arm, Leaf Spring Axle	
	03/98 →	Track Control Arm		SC-DL-8400	Trailing Arm	
	03/98 →	Track Control Arm		SC-DL-8511	Trailing Arm, Leaf Spring Axle	
	03/98 →	Track Control Arm		SC-DL-8547	Trailing Arm, Leaf Spring Axle	
	03/98 →	Track Control Arm		SC-DL-8623	Trailing Arm, 1st Drive Axle, for Leaf-Spring Suspension vehicles, →1280184/4471602	
	03/98 →	Track Control Arm		SC-DL-8623	Trailing Arm, 1st Drive Axle, for Leaf-Spring Suspension vehicles, →9069959/3533626	
	03/98 →	Track Control Arm		SC-DL-9462	Trailing Arm, 2nd Drive Axle, for Leaf-Spring Suspension vehicles, →1280184/4471602	
	03/98 →	Track Control Arm		SC-DL-9462	Trailing Arm, 2nd Drive Axle, for Leaf-Spring Suspension vehicles, →1280185/4471603 >	
	03/98 →	Track Control Arm		SC-DL-9462	Trailing Arm, 2nd Drive Axle, for Leaf-Spring Suspension vehicles, →9069959/3533626	
	03/98 →	Track Control Arm		SC-DL-9462	Trailing Arm, 2nd Drive Axle, for Leaf-Spring Suspension vehicles, 9069960/3533627 →	
	03/98 →	Track Control Arm		SC-DL-9466	Trailing Arm, Leaf Spring Axle	
	03/98 →	Track Control Arm		SC-DL-9467	Trailing Arm, Leaf Spring Axle, →* 1247518 SSS *;* 4406943 SNL *;* 9039629 SAN *;* 3507979 SLA *	
	03/98 →	Track Control Arm		SC-DL-9467	Trailing Arm, Leaf Spring Axle, →* 1280184 SSS *;* 4471602 SNL *;* 9069959 SAN *;* 3533626 SLA *	
	03/98 →	Track Control Arm		SC-TC-12451	Trailing Arm, 1st Drive Axle, for Leaf-Spring Suspension vehicles	
	03/98 →	Track Control Arm		SC-TC-12452	Trailing Arm, 1st RA;2nd RA, for Leaf-Spring Suspension vehicles	
	03/98 →	Track Control Arm	SC-DL-8179	SC-DL-8179	Trailing Arm, Leaf Spring Axle, →* 1280184 SSS *;* 4471602 SNL *;* 9069959 SAN *;* 3533626 SLA *	
	03/98 →	Track Control Arm	SC-DL-8509	SC-DL-8509	Trailing Arm, Leaf Spring Axle	
	03/98 →	Track Control Arm	SC-DL-8531	SC-DL-8531	Trailing Arm, Leaf Spring Axle	
	03/98 →	Track Control Arm	SC-DL-10302	SC-DL-10302	Trailing Arm, Air Suspension Axle	
	03/98 →	Track Control Arm	SC-TC-12361		Control Arm, 1st Front Axle, for Pneumatic Suspension vehicles	
	124 /G420	05/96 →	Centre Rod	SC-DL-5229		Push Rod
		05/96 →	Centre Rod	SC-DL-5354		Push Rod
		05/96 →	Centre Rod	SC-DL-12342		for Steering Rod
05/96 →		Suspension Arm Repair Kit		SC-RK-12366	for Control Arm	
05/96 →		Tie Rod	SC-DL-7264			
05/96 →		Tie Rod	SC-DL-8137			
05/96 →		Tie Rod End	CV-ES-14162		for Steering Rod	
05/96 →		Tie Rod End	CV-ES-14163		for Steering Rod	
05/96 →		Tie Rod End	SC-ES-7279		for Steering Rod	
05/96 →		Track Control Arm	SC-DL-10302	SC-DL-10302	Trailing Arm, Air Suspension Axle	
124 C/360		05/96 →	Centre Rod	SC-DL-5229		Push Rod
		05/96 →	Centre Rod	SC-DL-5354		Push Rod
	05/96 →	Centre Rod	SC-DL-8154		Push Rod	
	05/96 →	Centre Rod	SC-DL-8169		Push Rod	
	05/96 →	Centre Rod	SC-DL-8182		Push Rod	
	05/96 →	Centre Rod	SC-DL-8399		Push Rod	
	05/96 →	Centre Rod	SC-DL-12341		Push Rod	
	05/96 →	Centre Rod	SC-DL-12342		for Steering Rod	
	05/96 →	Centre Rod	SC-DL-12343		for Steering Rod	
	05/96 →	Suspension Arm Repair Kit		SC-RK-12366	for Control Arm	

CV-ES-14162

Length: 125
Cone Ø: d1 Ø 30 / d2 Ø 27
Thread: M30 x 1,5 LHT
283783, 395009, 1358792, 1738380, 1 914 426, 2051165



CV-ES-14163

Length: 125
Cone Ø: d1 Ø 30 / d2 Ø 27
Thread: M30 x 1,5 RHT
283784, 395010, 1358793, 1488890, 1738381, 1767328, 1914427, 2051166



IV-ES-12272

Length: 75
Cone Ø: d1 Ø 30 / d2 Ø 27
Thread: M26 x 1,5 RHT
1394443



MN-ES-8490

Length: 90
Cone Ø: d1 Ø 30 / d2 Ø 27
Thread: M26 x 1,5 RHT
1394444, 14606948, 0014606948



SC-DL-5229

Length: 1053 Ø: 50
Cone Ø: d1 Ø 30 / d2 Ø 27
1356055, 1379071, 1384025, 1768898, 1847311, 1912757, 12201600A



SC-DL-5354

Length: 1060 Ø: 52
Cone Ø: d1 Ø 30 / d2 Ø 27
1384027, 1769597, 1847312, 1912758, 12200800A



SC-DL-7264

Length: 1743 Ø: 62
Cone Ø: d1 Ø 30 / d2 Ø 27
1361413, 1395614, 1734019, 1897333, 2040254, 2146105



SC-DL-8137

Length: 1736 Ø: 40
Cone Ø: d1 Ø 30 / d2 Ø 27
301639, 311847, 395350, 1358675, 1378435, 1397866, 1734020, 2028998, 12202900A



SC-DL-8154

Length: 495 Ø: 40
Cone Ø: d1 Ø 30 / d2 Ø 27
1343266, 1759690



SC-DL-8169

Length: 1920 Ø: 62
Cone Ø: d1 Ø 30 / d2 Ø 27
1343264, 1732635, 2007278



SC-DL-8179

Length: 568 Ø: 46
Hole Distance: 115 / 115
1399180, 1428347



SC-DL-8182

Length: 568 Ø: 46
Hole Distance: 115 / 115
1343262, 1869413



SC-DL-8399

Length: 433 Ø: 40
Cone Ø: d1 Ø 30 / d2 Ø 26
1394884, 1938387



SC-DL-8179

Length: 568 Ø: 46
Hole Distance: 115 / 115
1399180, 1428347



SC-DL-8509

Length: 568,5 Ø: 46
Hole Distance: 115 / 115
1485758, 1486757



SC-DL-8511

Length: 616,5 Ø: 50
Hole Distance: 115 / 115
1485760, 1499478, 1722750



SC-DL-8531

Length: 522 Ø: 46
Hole Distance: 115 / 115
1486758



SC-DL-8547

Length: 568 Ø: 50
Hole Distance: 115 / 115
1499474, 1722746, 1906940



SC-DL-8623

Length: 592 Ø: 50
Hole Distance: 115 / 115
1388436, 1499476, 1722748, 1906942



SC-DL-9462

Length: 568,5 Ø: 50
Hole Distance: 115 / 115
1499475, 1500573, 1722747, 1906941



SC-DL-9466

Length: 568 Ø: 19
1486756



SC-DL-9467

Length: 568,5 Ø: 50
Hole Distance: 115 / 115
1500572



SC-DL-10302

Length: 752 Ø: 48
Hole Distance: 115 / 115
1101843, 1379423, 1393298, 1431470, 1942075



SC-DL-12341

Length: 1776 Ø: 62
Cone Ø: d1 Ø 30 / d2 Ø 27
1386620



SC-DL-12342

Length: 601 Ø: 42
Cone Ø: d1 Ø 26 / d2 Ø 23,5
1343262, 1869413



SC-DL-12343

Length: 1062 Ø: 52
Cone Ø: d1 Ø 30 / d2 Ø 27
1348269, 2007275



SC-ES-7279

Length: 150
Cone Ø: d1 Ø 30 / d2 Ø 27
Thread: M30 x 1,5 RHT
1357674, 1603883, 1738379



SC-RK-12366

Ø: 75 Hole Distance: 115 / 115
Thick/Height: 24
1 722 753, 2 096 392



SC-TC-12361

Length: 705 Ø: 42
Cone Ø: d1 Ø 38
Hole Distance: 115
1353445, 1464611, 1942147



SC-TC-12451

Length: 552 Ø: 46
Hole Distance: 115 / 115
1494296



SC-TC-12452

Length: 580,5 Ø: 46
Hole Distance: 115 / 115
1485759





4 - series ...

124 C/360 ...	05/96 →	Suspension Arm Repair Kit	MN-RK-7280	MN-RK-7280	for Drag Link;for Semi-Trailing Arm; for Wishbone (CV)
	05/96 →	Suspension Strut Repair Kit		MN-RK-8501	
	05/96 →	Tie Rod	SC-DL-7264		
	05/96 →	Tie Rod	SC-DL-7264		1st FA;2nd FA
	05/96 →	Tie Rod	SC-DL-8137		
	05/96 →	Tie Rod	SC-DL-8137		1st FA;2nd FA
	05/96 →	Tie Rod End	CV-ES-14162		for Steering Rod
	05/96 →	Tie Rod End	CV-ES-14163		for Steering Rod
	05/96 →	Tie Rod End	SC-ES-5764		
	05/96 →	Tie Rod End	SC-ES-7279		for Steering Rod
	05/96 →	Track Control Arm		SC-DL-8179	Trailing Arm, Leaf Spring Axle
	05/96 →	Track Control Arm		SC-DL-8400	Trailing Arm
	05/96 →	Track Control Arm		SC-DL-8511	Trailing Arm, Leaf Spring Axle
	05/96 →	Track Control Arm		SC-DL-8547	Trailing Arm, Leaf Spring Axle
	05/96 →	Track Control Arm		SC-DL-9462	Trailing Arm, Leaf Spring Axle
	05/96 →	Track Control Arm		SC-DL-9466	Trailing Arm, Leaf Spring Axle
	05/96 →	Track Control Arm		SC-DL-9467	Trailing Arm, Leaf Spring Axle, →* 1247518 SSS *;* 4406943 SNL *; * 9039629 SAN *;* 3507979 SLA *
	05/96 →	Track Control Arm		SC-DL-9467	Trailing Arm, Leaf Spring Axle, → * 1280184 SSS *;* 4471602 SNL *; * 9069959 SAN *;* 3533626 SLA *
	05/96 →	Track Control Arm		SC-TC-12451	Control Arm
	05/96 →	Track Control Arm		SC-TC-12452	Control Arm
	05/96 →	Track Control Arm		SC-TC-12472	Control Arm
	05/96 →	Track Control Arm	SC-DL-8179	SC-DL-8179	Trailing Arm, Leaf Spring Axle, → * 1280184 SSS *;* 4471602 SNL *; * 9069959 SAN *;* 3533626 SLA *
	05/96 →	Track Control Arm	SC-DL-8509	SC-DL-8509	Trailing Arm, Leaf Spring Axle
	05/96 →	Track Control Arm	SC-DL-8531	SC-DL-8531	Trailing Arm, Leaf Spring Axle
	05/96 →	Track Control Arm	SC-DL-8623	SC-DL-8623	Trailing Arm, Leaf Spring Axle
	05/96 →	Track Control Arm	SC-DL-10302	SC-DL-10302	Trailing Arm, 1st FA;Air Suspension Axle
	05/96 →	Track Control Arm	SC-DL-10302	SC-DL-10302	Trailing Arm, Air Suspension Axle
	09/96 →	Centre Rod	SC-DL-2161		Coupling Rod
	09/96 →	Suspension Arm Repair Kit		MN-RK-7280	for Drag Link;for Semi-Trailing Arm; for Wishbone (CV)
	09/96 →	Suspension Strut Repair Kit		CV-RK-5311	
	09/96 →	Suspension Strut Repair Kit	MN-RK-12436	MN-RK-12436	
	09/96 →	Tie Rod		SC-DL-7264	Steering Axle
	09/96 →	Tie Rod		SC-DL-8137	Steering Axle
09/96 →	Tie Rod End		MN-ES-8490	for vehicles with Hinged Trailing Axle	
124 C/400	09/96 →	Centre Rod	SC-DL-2161		Coupling Rod
	09/96 →	Centre Rod	SC-DL-5229		Push Rod
	09/96 →	Centre Rod	SC-DL-5354		Push Rod
	09/96 →	Centre Rod	SC-DL-12343		for Steering Rod
	09/96 →	Suspension Arm Repair Kit		MN-RK-7280	for Drag Link;for Semi-Trailing Arm; for Wishbone (CV)
	09/96 →	Suspension Arm Repair Kit		SC-RK-12366	for Control Arm
	09/96 →	Suspension Strut Repair Kit		CV-RK-5311	
	09/96 →	Suspension Strut Repair Kit		MN-RK-8501	
	09/96 →	Suspension Strut Repair Kit	MN-RK-12436	MN-RK-12436	
	09/96 →	Tie Rod		SC-DL-7264	Steering Axle
	09/96 →	Tie Rod		SC-DL-8137	Steering Axle
	09/96 →	Tie Rod	SC-DL-7264		
	09/96 →	Tie Rod	SC-DL-8137		
	09/96 →	Tie Rod End		MN-ES-8490	for vehicles with Hinged Trailing Axle
	09/96 →	Tie Rod End	CV-ES-14162		for Steering Rod
	09/96 →	Tie Rod End	CV-ES-14163		for Steering Rod
	09/96 →	Tie Rod End	SC-ES-7279		for Steering Rod
	09/96 →	Track Control Arm		SC-DL-8179	Trailing Arm, Leaf Spring Axle
	09/96 →	Track Control Arm		SC-DL-8400	Trailing Arm
	09/96 →	Track Control Arm		SC-DL-8511	Trailing Arm, Leaf Spring Axle

CV-ES-14162

Length: 125
Cone Ø: d1 Ø 30 / d2 Ø 27
Thread: M30 x 1,5 LHT
283784, 395009, 1358792, 1738380, 1 914 426, 2051165



CV-ES-14163

Length: 125
Cone Ø: d1 Ø 30 / d2 Ø 27
Thread: M30 x 1,5 RHT
283784, 395010, 1358793, 1488890, 1738381, 1767328, 1914427, 2051166



CV-RK-5311

0638862, 638862, 0639287, 639287, 1104335, 1953248, 81432206006, 81432206107



MN-ES-8490

Length: 90
Cone Ø: d1 Ø 30 / d2 Ø 27
Thread: M26 x 1,5 RHT
1394444, 0014606948, 14606948



MN-RK-7280

Ø: 75 Hole Distance: 115
Thick/Height: 24
550806, 0550806, 0639370, 639370, 689748, 1104334



MN-RK-8501

Ø: 75 Hole Distance: 115
Thick/Height: 24
1515981



MN-RK-12436

Ø: 75 Hole Distance: 115
Thick/Height: 24
550799, 1517403, 1783020



SC-DL-2161

Length: 1740 Ø: 50
Cone Ø: d1 Ø 30 / d2 Ø 27
1369411, 1385251, 1409918, 1501030, 1723865, 1723895, 1737683, 1897335, 2113903, 2125090, 2161883



SC-DL-5229

Length: 1053 Ø: 50
Cone Ø: d1 Ø 30 / d2 Ø 27
1356055, 1379071, 1384025, 1768898, 1847311, 1912757, 12201600A



SC-DL-5354

Length: 1060 Ø: 52
Cone Ø: d1 Ø 30 / d2 Ø 27
1384027, 1769597, 1847312, 1912758, 12200800A



SC-DL-7264

Length: 1743 Ø: 62
Cone Ø: d1 Ø 30 / d2 Ø 27
1361413, 1395614, 1734019, 1897333, 2040254, 2146105



SC-DL-8137

Length: 1736 Ø: 40
Cone Ø: d1 Ø 30 / d2 Ø 27
301639, 311847, 395350, 1358675, 1378435, 1397866, 1734020, 2028998, 12202900A



SC-DL-8179

Length: 568 Ø: 46
Hole Distance: 115 / 115
1399180, 1428347



SC-DL-8179

Length: 568 Ø: 46
Hole Distance: 115 / 115
1399180, 1428347



SC-DL-8509

Length: 568,5 Ø: 46
Hole Distance: 115 / 115
1485758, 1486757



SC-DL-8511

Length: 616,5 Ø: 50
Hole Distance: 115 / 115
1485760, 1499478, 1722750



SC-DL-8531

Length: 522 Ø: 46
Hole Distance: 115 / 115
1486758



SC-DL-8547

Length: 568 Ø: 50
Hole Distance: 115 / 115
1499474, 1722746, 1906940



SC-DL-8623

Length: 592 Ø: 50
Hole Distance: 115 / 115
1388436, 1499476, 1722748, 1906942



SC-DL-9462

Length: 568,5 Ø: 50
Hole Distance: 115 / 115
1499475, 1500573, 1722747, 1906941



SC-DL-9466

Length: 568 Ø: 19
1486756



SC-DL-9467

Length: 568,5 Ø: 50
Hole Distance: 115 / 115
1500572



SC-DL-10302

Length: 752 Ø: 48
Hole Distance: 115 / 115
1101843, 1379423, 1393298, 1431470, 1942075



SC-DL-12343

Length: 1062 Ø: 52
Cone Ø: d1 Ø 30 / d2 Ø 27
1348269, 2007275



SC-ES-5764

Length: 95
Cone Ø: d1 Ø 30 / d2 Ø 27
Thread: M26 x 1,5 RHT
325614, 1375228, 4604948



SC-ES-7279

Length: 150
Cone Ø: d1 Ø 30 / d2 Ø 27
Thread: M30 x 1,5 RHT
1357674, 1603883, 1738379



SC-RK-12366

Ø: 75 Hole Distance: 115 / 115
Thick/Height: 24
1 722 753, 2 096 392



SC-TC-12451

Length: 552 Ø: 46
Hole Distance: 115 / 115
1494296



SC-TC-12452

Length: 580,5 Ø: 46
Hole Distance: 115 / 115
1485759



SC-TC-12472

Length: 580 Ø: 46
Hole Distance: 115 / 115
1399182





4 - series ...

124 C/400 ...	09/96 →	Track Control Arm		SC-DL-8547	Trailing Arm, Leaf Spring Axle
	09/96 →	Track Control Arm		SC-DL-9462	Trailing Arm, Leaf Spring Axle
	09/96 →	Track Control Arm		SC-DL-9466	Trailing Arm, Leaf Spring Axle
	09/96 →	Track Control Arm		SC-DL-9467	Trailing Arm, Leaf Spring Axle, →* 1247518 SSS **; 4406943 SNL *; * 9039629 SAN **; 3507979 SLA *
	09/96 →	Track Control Arm		SC-DL-9467	Trailing Arm, Leaf Spring Axle, → * 1280184 SSS **; 4471602 SNL *; * 9069959 SAN **; 3533626 SLA *
	09/96 →	Track Control Arm		SC-TC-12451	Control Arm
	09/96 →	Track Control Arm		SC-TC-12452	Control Arm
	09/96 →	Track Control Arm		SC-TC-12472	Control Arm
	09/96 →	Track Control Arm	SC-DL-8179	SC-DL-8179	Trailing Arm, Leaf Spring Axle, → * 1280184 SSS **; 4471602 SNL *; * 9069959 SAN **; 3533626 SLA *
	09/96 →	Track Control Arm	SC-DL-8509	SC-DL-8509	Trailing Arm, Leaf Spring Axle
	09/96 →	Track Control Arm	SC-DL-8531	SC-DL-8531	Trailing Arm, Leaf Spring Axle
	09/96 →	Track Control Arm	SC-DL-8623	SC-DL-8623	Trailing Arm, Leaf Spring Axle
	09/96 →	Track Control Arm	SC-DL-10302	SC-DL-10302	Trailing Arm, Air Suspension Axle
	124 C/420	05/96 →	Centre Rod	SC-DL-5229	
05/96 →		Centre Rod	SC-DL-5354		Push Rod
05/96 →		Centre Rod	SC-DL-8154		Push Rod
05/96 →		Centre Rod	SC-DL-8169		Push Rod
05/96 →		Centre Rod	SC-DL-8182		Push Rod
05/96 →		Centre Rod	SC-DL-8399		Push Rod
05/96 →		Centre Rod	SC-DL-12341		Push Rod
05/96 →		Centre Rod	SC-DL-12342		for Steering Rod
05/96 →		Centre Rod	SC-DL-12343		for Steering Rod
05/96 →		Suspension Arm Repair Kit		SC-RK-12366	for Control Arm
05/96 →		Suspension Arm Repair Kit	MN-RK-7280	MN-RK-7280	for Drag Link;for Semi-Trailing Arm; for Wishbone (CV)
05/96 →		Suspension Strut Repair Kit		MN-RK-8501	
05/96 →		Tie Rod	SC-DL-7264		
05/96 →		Tie Rod	SC-DL-7264		1st FA;2nd FA
05/96 →		Tie Rod	SC-DL-8137		
05/96 →		Tie Rod	SC-DL-8137		1st FA;2nd FA
05/96 →		Tie Rod End	CV-ES-14162		for Steering Rod
05/96 →		Tie Rod End	CV-ES-14163		for Steering Rod
05/96 →		Tie Rod End	SC-ES-5764		
05/96 →		Tie Rod End	SC-ES-7279		for Steering Rod
05/96 →		Track Control Arm		SC-DL-8179	Trailing Arm, Leaf Spring Axle
05/96 →		Track Control Arm		SC-DL-8400	Trailing Arm
05/96 →		Track Control Arm		SC-DL-8511	Trailing Arm, Leaf Spring Axle
05/96 →		Track Control Arm		SC-DL-8547	Trailing Arm, Leaf Spring Axle
05/96 →		Track Control Arm		SC-DL-9462	Trailing Arm, Leaf Spring Axle
05/96 →		Track Control Arm		SC-DL-9466	Trailing Arm, Leaf Spring Axle
05/96 →		Track Control Arm		SC-DL-9467	Trailing Arm, Leaf Spring Axle, →* 1247518 SSS **; 4406943 SNL *; * 9039629 SAN **; 3507979 SLA *
05/96 →		Track Control Arm		SC-DL-9467	Trailing Arm, Leaf Spring Axle, → * 1280184 SSS **; 4471602 SNL *; * 9069959 SAN **; 3533626 SLA *
05/96 →		Track Control Arm		SC-TC-12451	Control Arm
05/96 →		Track Control Arm		SC-TC-12452	Control Arm
05/96 →		Track Control Arm		SC-TC-12472	Control Arm
05/96 →		Track Control Arm	SC-DL-8179	SC-DL-8179	Trailing Arm, Leaf Spring Axle, → * 1280184 SSS **; 4471602 SNL *; * 9069959 SAN **; 3533626 SLA *
05/96 →		Track Control Arm	SC-DL-8509	SC-DL-8509	Trailing Arm, Leaf Spring Axle
05/96 →		Track Control Arm	SC-DL-8531	SC-DL-8531	Trailing Arm, Leaf Spring Axle
05/96 →		Track Control Arm	SC-DL-8623	SC-DL-8623	Trailing Arm, Leaf Spring Axle
05/96 →		Track Control Arm	SC-DL-10302	SC-DL-10302	Trailing Arm, 1st FA;Air Suspension Axle
05/96 →		Track Control Arm	SC-DL-10302	SC-DL-10302	Trailing Arm, Air Suspension Axle

CV-ES-14162

Length: 125
Cone Ø: d1 Ø 30 / d2 Ø 27
Thread: M30 x 1,5 LHT
283783, 395009, 1358792, 1738380, 1 914 426, 2051165



CV-ES-14163

Length: 125
Cone Ø: d1 Ø 30 / d2 Ø 27
Thread: M30 x 1,5 RHT
283784, 395010, 1358793, 1488890, 1738381, 1767328, 1914427, 2051166



MN-RK-7280

Ø: 75 Hole Distance: 115
Thick/Height: 24
550806, 0550806, 0639370, 639370, 689748, 1104334



MN-RK-8501

Ø: 75 Hole Distance: 115
Thick/Height: 24
1515981



SC-DL-5229

Length: 1053 Ø: 50
Cone Ø: d1 Ø 30 / d2 Ø 27
1356055, 1379071, 1384025, 1768898, 1847311, 1912757, 12201600A



SC-DL-5354

Length: 1060 Ø: 52
Cone Ø: d1 Ø 30 / d2 Ø 27
1384027, 1769597, 1847312, 1912758, 12200800A



SC-DL-7264

Length: 1743 Ø: 62
Cone Ø: d1 Ø 30 / d2 Ø 27
1361413, 1395614, 1734019, 1897333, 2040254, 2146105



SC-DL-8137

Length: 1736 Ø: 40
Cone Ø: d1 Ø 30 / d2 Ø 27
301639, 311847, 395350, 1358675, 1378435, 1397866, 1734020, 2028998, 12202900A



SC-DL-8154

Length: 495 Ø: 40
Cone Ø: d1 Ø 30 / d2 Ø 27
1343264, 1759690



SC-DL-8169

Length: 1920 Ø: 62
Cone Ø: d1 Ø 30 / d2 Ø 27
1343264, 1732635, 2007278



SC-DL-8179

Length: 568 Ø: 46
Hole Distance: 115 / 115
1399180, 1428347



SC-DL-8182

1343262, 1869413



SC-DL-8399

Length: 433 Ø: 40
Cone Ø: d1 Ø 30 / d2 Ø 26
1394884, 1938387



SC-DL-8179

Length: 568 Ø: 46
Hole Distance: 115 / 115
1399180, 1428347



SC-DL-8509

Length: 568,5 Ø: 46
Hole Distance: 115 / 115
1485758, 1486757



SC-DL-8511

Length: 616,5 Ø: 50
Hole Distance: 115 / 115
1485760, 1499478, 1722750



SC-DL-8531

Length: 522 Ø: 46
Hole Distance: 115 / 115
1486758



SC-DL-8547

Length: 568 Ø: 50
Hole Distance: 115 / 115
1499474, 1722746, 1906940



SC-DL-8623

Length: 592 Ø: 50
Hole Distance: 115 / 115
1388436, 1499476, 1722748, 1906942



SC-DL-9462

Length: 568,5 Ø: 50
Hole Distance: 115 / 115
1499475, 1500573, 1722747, 1906941



SC-DL-9466

Length: 568 Ø: 19
1486756



SC-DL-9467

Length: 568,5 Ø: 50
Hole Distance: 115 / 115
1500572



SC-DL-10302

Length: 752 Ø: 48
Hole Distance: 115 / 115
1101843, 1379423, 1393298, 1431470, 1942075



SC-DL-12341

Length: 1776 Ø: 62
Cone Ø: d1 Ø 30 / d2 Ø 27
1386620



SC-DL-12342

Length: 601 Ø: 42
Cone Ø: d1 Ø 26 / d2 Ø 23,5
1343262, 1869413



SC-DL-12343

Length: 1062 Ø: 52
Cone Ø: d1 Ø 30 / d2 Ø 27
1348269, 2007275



SC-ES-5764

Length: 95
Cone Ø: d1 Ø 30 / d2 Ø 27
Thread: M26 x 1,5 RHT
325614, 1375228, 4604948



SC-ES-7279

Length: 150
Cone Ø: d1 Ø 30 / d2 Ø 27
Thread: M30 x 1,5 RHT
1357674, 1603883, 1738379



SC-RK-12366

Ø: 75 Hole Distance: 115 / 115
Thick/Height: 24
1 722 753, 2 096 392



SC-TC-12451

Length: 552 Ø: 46
Hole Distance: 115 / 115
1494296



SC-TC-12452

Length: 580,5 Ø: 46
Hole Distance: 115 / 115
1485759



SC-TC-12472

Length: 580 Ø: 46
Hole Distance: 115 / 115
1399182



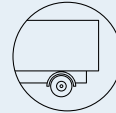

4 - series ...

124 C/470	01/00→	Centre Rod	SC-DL-5229		Push Rod
	01/00→	Centre Rod	SC-DL-5354		Push Rod
	01/00→	Centre Rod	SC-DL-8154		Push Rod
	01/00→	Centre Rod	SC-DL-8169		Push Rod
	01/00→	Centre Rod	SC-DL-8182		Push Rod
	01/00→	Centre Rod	SC-DL-8399		Push Rod
	01/00→	Centre Rod	SC-DL-12341		Push Rod
	01/00→	Centre Rod	SC-DL-12342		for Steering Rod
	01/00→	Suspension Arm Repair Kit		SC-RK-12366	for Control Arm
	01/00→	Suspension Arm Repair Kit	MN-RK-7280	MN-RK-7280	for Drag Link;for Semi-Trailing Arm; for Wishbone (CV)
	01/00→	Suspension Strut Repair Kit		MN-RK-8501	
	01/00→	Tie Rod	SC-DL-7264		
	01/00→	Tie Rod	SC-DL-7264		1st FA;2nd FA
	01/00→	Tie Rod	SC-DL-8137		
	01/00→	Tie Rod	SC-DL-8137		1st FA;2nd FA
	01/00→	Tie Rod End	CV-ES-14162		for Steering Rod
	01/00→	Tie Rod End	CV-ES-14163		for Steering Rod
	01/00→	Tie Rod End	SC-ES-5764		
	01/00→	Tie Rod End	SC-ES-7279		for Steering Rod
	01/00→	Track Control Arm		SC-DL-8179	Trailing Arm, Leaf Spring Axle
	01/00→	Track Control Arm		SC-DL-8400	Trailing Arm
	01/00→	Track Control Arm		SC-DL-8511	Trailing Arm, Leaf Spring Axle
	01/00→	Track Control Arm		SC-DL-8547	Trailing Arm, Leaf Spring Axle
	01/00→	Track Control Arm		SC-DL-9462	Trailing Arm, Leaf Spring Axle
	01/00→	Track Control Arm		SC-DL-9466	Trailing Arm, Leaf Spring Axle
	01/00→	Track Control Arm		SC-DL-9467	Trailing Arm, Leaf Spring Axle, →* 1247518 SSS *;* 4406943 SNL *; * 9039629 SAN *;* 3507979 SLA *
	01/00→	Track Control Arm		SC-DL-9467	Trailing Arm, Leaf Spring Axle, → * 1280184 SSS *;* 4471602 SNL *; * 9069959 SAN *;* 3533626 SLA *
	01/00→	Track Control Arm		SC-TC-12451	Control Arm
	01/00→	Track Control Arm		SC-TC-12452	Control Arm
	01/00→	Track Control Arm		SC-TC-12472	Control Arm
	01/00→	Track Control Arm	SC-DL-8179	SC-DL-8179	Trailing Arm, Leaf Spring Axle, → * 1280184 SSS *;* 4471602 SNL *; * 9069959 SAN *;* 3533626 SLA *
	01/00→	Track Control Arm	SC-DL-8509	SC-DL-8509	Trailing Arm, Leaf Spring Axle
	01/00→	Track Control Arm	SC-DL-8531	SC-DL-8531	Trailing Arm, Leaf Spring Axle
	01/00→	Track Control Arm	SC-DL-8623	SC-DL-8623	Trailing Arm, Leaf Spring Axle
	01/00→	Track Control Arm	SC-DL-10302	SC-DL-10302	Trailing Arm, 1st FA;Air Suspension Axle
	01/00→	Track Control Arm	SC-DL-10302	SC-DL-10302	Trailing Arm, Air Suspension Axle
124 G/360	05/96→	Centre Rod	SC-DL-2161		Coupling Rod
	05/96→	Centre Rod	SC-DL-5229		Push Rod
	05/96→	Centre Rod	SC-DL-5354		Push Rod
	05/96→	Centre Rod	SC-DL-8154		Push Rod
	05/96→	Centre Rod	SC-DL-8182		Push Rod
	05/96→	Centre Rod	SC-DL-8399		Push Rod
	05/96→	Centre Rod	SC-DL-8399		Push Rod, for vehicles with Hinged Leading Axle
	05/96→	Centre Rod	SC-DL-8553	SC-DL-8553	Push Rod, for vehicles with Hinged Leading Axle
	05/96→	Centre Rod	SC-DL-10225		for Steering Rod
	05/96→	Centre Rod	SC-DL-10225		Push Rod
	05/96→	Centre Rod	SC-DL-12342		for Steering Rod
	05/96→	Centre Rod	SC-DL-12343		for Steering Rod
	05/96→	Centre Rod	SC-DL-12413		for Steering Rod
	05/96→	Centre Rod	SC-DL-12449		Push Rod
	05/96→	Suspension Arm Repair Kit		MN-RK-7280	for Drag Link;for Semi-Trailing Arm; for Wishbone (CV)
	05/96→	Suspension Arm Repair Kit		SC-RK-12366	for Control Arm
	05/96→	Suspension Strut Repair Kit		CV-RK-5311	
	05/96→	Suspension Strut Repair Kit		MN-RK-8501	
05/96→	Suspension Strut Repair Kit	MN-RK-12436	MN-RK-12436		

CV-ES-14162

Length: 125
Cone Ø: d1 Ø 30 / d2 Ø 27
Thread: M30 x 1,5 LHT
283783, 395009, 1358792, 1738380, 1 914 426, 2051165



CV-ES-14163

Length: 125
Cone Ø: d1 Ø 30 / d2 Ø 27
Thread: M30 x 1,5 RHT
283784, 395010, 1358793, 1488890, 1738381, 1767328, 1914427, 2051166



CV-RK-5311

0638862, 638862, 0639287, 639287, 1104335, 1953248, 81432206006, 81432206107



MN-RK-7280

Ø: 75 Hole Distance: 115
Thick/Height: 24
0550806, 550806, 0639370, 639370, 689748, 1104334



MN-RK-8501

Ø: 75 Hole Distance: 115
Thick/Height: 24
1515981



MN-RK-12436

Ø: 75 Hole Distance: 115
Thick/Height: 24
550799, 1517403, 1783020



SC-DL-2161

Length: 1740 Ø: 50
Cone Ø: d1 Ø 30 / d2 Ø 27
1369411, 1385251, 1409918, 1501030, 1723865, 1723895, 1737683, 1897335, 2113903, 2125090, 2161883



SC-DL-5229

Length: 1053 Ø: 50
Cone Ø: d1 Ø 30 / d2 Ø 27
1356055, 1379071, 1384025, 1768898, 1847311, 1912757, 12201600A



SC-DL-5354

Length: 1060 Ø: 52
Cone Ø: d1 Ø 30 / d2 Ø 27
1384027, 1769597, 1847312, 1912758, 12200800A



SC-DL-7264

Length: 1743 Ø: 62
Cone Ø: d1 Ø 30 / d2 Ø 27
1361413, 1395614, 1734019, 1897333, 2040254, 2146105



SC-DL-8137

Length: 1736 Ø: 40
Cone Ø: d1 Ø 30 / d2 Ø 27
301639, 311847, 395350, 1358675, 1378435, 1397866, 1734020, 2028998, 12202900A



SC-DL-8154

Length: 495 Ø: 40
Cone Ø: d1 Ø 30 / d2 Ø 27
1343266, 1759690



SC-DL-8169

Length: 1920 Ø: 62
Cone Ø: d1 Ø 30 / d2 Ø 27
1343264, 1732635, 2007278



SC-DL-8179

Length: 568 Ø: 46
Hole Distance: 115 / 115
1399180, 1428347



SC-DL-8182

1343262, 1869413



SC-DL-8399

Length: 433 Ø: 40
Cone Ø: d1 Ø 30 / d2 Ø 26
1394884, 1938387



SC-DL-8179

Length: 568 Ø: 46
Hole Distance: 115 / 115
1399180, 1428347



SC-DL-8509

Length: 568,5 Ø: 46
Hole Distance: 115 / 115
1485758, 1486757



SC-DL-8511

Length: 616,5 Ø: 50
Hole Distance: 115 / 115
1485760, 1499478, 1722750



SC-DL-8531

Length: 522 Ø: 46
Hole Distance: 115 / 115
1486758



SC-DL-8547

Length: 568 Ø: 50
Hole Distance: 115 / 115
1499474, 1722746, 1906940



SC-DL-8553

Length: 435 Ø: 38
Cone Ø: d1 Ø 30 / d2 Ø 27
1343283, 1759691



SC-DL-8623

Length: 592 Ø: 50
Hole Distance: 115 / 115
1388436, 1499476, 1722748, 1906942



SC-DL-9462

Length: 568,5 Ø: 50
Hole Distance: 115 / 115
1499475, 1500573, 1722747, 1906941



SC-DL-9466

Length: 568 Ø: 19
1486756



SC-DL-9467

Length: 568,5 Ø: 50
Hole Distance: 115 / 115
1500572



SC-DL-10225

Length: 2179 Ø: 62
Cone Ø: d1 Ø 30 / d2 Ø 27
1386618, 1788522



SC-DL-10302

Length: 752 Ø: 48
Hole Distance: 115 / 115
1101843, 1379423, 1393298, 1431470, 1942075



SC-DL-12341

Length: 1776 Ø: 62
Cone Ø: d1 Ø 30 / d2 Ø 27
1386620



SC-DL-12342

Length: 601 Ø: 42
Cone Ø: d1 Ø 26 / d2 Ø 23,5
1343262, 1869413



SC-DL-12343

Length: 1062 Ø: 52
Cone Ø: d1 Ø 30 / d2 Ø 27
1348269, 2007275



SC-DL-12413

Length: 1950 Ø: 62
Cone Ø: d1 Ø 30 / d2 Ø 27
1393383, 1788520



SC-DL-12449

Length: 1206 Ø: 38
Cone Ø: d1 Ø 30 / d2 Ø 27
1385763, 1765375



SC-ES-5764

Length: 95
Cone Ø: d1 Ø 30 / d2 Ø 27
Thread: M26 x 1,5 RHT
325614, 1375228, 4604948



SC-ES-7279

Length: 150
Cone Ø: d1 Ø 30 / d2 Ø 27
Thread: M30 x 1,5 RHT
1357674, 1603883, 1738379



SC-RK-12366

Ø: 75 Hole Distance: 115 / 115
Thick/Height: 24
1 722 753, 2 096 392



SC-TC-12451

Length: 552 Ø: 46
Hole Distance: 115 / 115
1494296



SC-TC-12452

Length: 580,5 Ø: 46
Hole Distance: 115 / 115
1485759



SC-TC-12472

Length: 580 Ø: 46
Hole Distance: 115 / 115
1399182



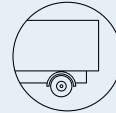

4 - series ...

124 G/360 ...	05/96 →	Tie Rod		SC-DL-7264	Steering Axle
	05/96 →	Tie Rod		SC-DL-8137	Steering Axle
	05/96 →	Tie Rod	SC-DL-7264		
	05/96 →	Tie Rod	SC-DL-7264		1st FA;2nd FA
	05/96 →	Tie Rod	SC-DL-8137		
	05/96 →	Tie Rod	SC-DL-8137		1st FA;2nd FA
	05/96 →	Tie Rod End		MN-ES-8490	for vehicles with Hinged Trailing Axle
	05/96 →	Tie Rod End	CV-ES-14162		for Steering Rod
	05/96 →	Tie Rod End	CV-ES-14162	CV-ES-14162	for Steering Rod
	05/96 →	Tie Rod End	CV-ES-14163		for Steering Rod
	05/96 →	Tie Rod End	IV-ES-12272		for Steering Rod
	05/96 →	Tie Rod End	MN-ES-8490	MN-ES-8490	for vehicles with Hinged Trailing Axle
	05/96 →	Tie Rod End	SC-ES-5764		
	05/96 →	Tie Rod End	SC-ES-7279		for Steering Rod
	05/96 →	Track Control Arm		SC-DL-8179	Trailing Arm, Leaf Spring Axle
	05/96 →	Track Control Arm		SC-DL-8400	Trailing Arm
	05/96 →	Track Control Arm		SC-DL-8511	Trailing Arm, Leaf Spring Axle
	05/96 →	Track Control Arm		SC-DL-8547	Trailing Arm, Leaf Spring Axle
	05/96 →	Track Control Arm		SC-DL-9462	Trailing Arm, Leaf Spring Axle
	05/96 →	Track Control Arm		SC-DL-9466	Trailing Arm, Leaf Spring Axle
	05/96 →	Track Control Arm		SC-DL-9467	Trailing Arm, Leaf Spring Axle, →* 1247518 SSS *;* 4406943 SNL *; * 9039629 SAN *;* 3507979 SLA *
	05/96 →	Track Control Arm		SC-DL-9467	Trailing Arm, Leaf Spring Axle, → * 1280184 SSS *;* 4471602 SNL *; * 9069959 SAN *;* 3533626 SLA *
	05/96 →	Track Control Arm		SC-TC-12451	Control Arm
	05/96 →	Track Control Arm		SC-TC-12452	Control Arm
	05/96 →	Track Control Arm		SC-TC-12472	Control Arm
	05/96 →	Track Control Arm	SC-DL-8179	SC-DL-8179	Trailing Arm, Leaf Spring Axle, → * 1280184 SSS *;* 4471602 SNL *; * 9069959 SAN *;* 3533626 SLA *
	05/96 →	Track Control Arm	SC-DL-8509	SC-DL-8509	Trailing Arm, Leaf Spring Axle
	05/96 →	Track Control Arm	SC-DL-8531	SC-DL-8531	Trailing Arm, Leaf Spring Axle
	05/96 →	Track Control Arm	SC-DL-8623	SC-DL-8623	Trailing Arm, Leaf Spring Axle
	05/96 →	Track Control Arm	SC-DL-10302	SC-DL-10302	Trailing Arm, 1st FA;Air Suspension Axle
	05/96 →	Track Control Arm	SC-DL-10302	SC-DL-10302	Trailing Arm, Air Suspension Axle
	05/96 →	Track Control Arm	SC-TC-12361		Control Arm, 1st Front Axle, for Pneumatic Suspension vehicles
	124 G/400	05/96 →	Centre Rod	SC-DL-2161	
05/96 →		Centre Rod	SC-DL-5229		Push Rod
05/96 →		Centre Rod	SC-DL-5354		Push Rod
05/96 →		Centre Rod	SC-DL-8154		Push Rod
05/96 →		Centre Rod	SC-DL-8182		Push Rod
05/96 →		Centre Rod	SC-DL-8399		Push Rod
05/96 →		Centre Rod	SC-DL-8399		Push Rod, for vehicles with Hinged Leading Axle
05/96 →		Centre Rod	SC-DL-8553	SC-DL-8553	Push Rod, for vehicles with Hinged Leading Axle
05/96 →		Centre Rod	SC-DL-10225		for Steering Rod
05/96 →		Centre Rod	SC-DL-10225		Push Rod
05/96 →		Centre Rod	SC-DL-12342		for Steering Rod
05/96 →		Centre Rod	SC-DL-12343		for Steering Rod
05/96 →		Centre Rod	SC-DL-12413		for Steering Rod
05/96 →		Centre Rod	SC-DL-12449		Push Rod
05/96 →		Suspension Arm Repair Kit		MN-RK-7280	for Drag Link;for Semi-Trailing Arm; for Wishbone (CV)
05/96 →		Suspension Arm Repair Kit		SC-RK-12366	for Control Arm
05/96 →		Suspension Strut Repair Kit		CV-RK-5311	
05/96 →		Suspension Strut Repair Kit		MN-RK-8501	
05/96 →		Suspension Strut Repair Kit	MN-RK-12436	MN-RK-12436	
05/96 →		Tie Rod		SC-DL-7264	Steering Axle
05/96 →		Tie Rod		SC-DL-8137	Steering Axle
05/96 →	Tie Rod	SC-DL-7264			
05/96 →	Tie Rod	SC-DL-7264		1st FA;2nd FA	

CV-ES-14162

Length: 125
Cone Ø: d1 Ø 30 / d2 Ø 27
Thread: M30 x 1,5 LHT
283783, 395009, 1358792, 1738380, 1 914 426, 2051165



CV-ES-14163

Length: 125
Cone Ø: d1 Ø 30 / d2 Ø 27
Thread: M30 x 1,5 RHT
283784, 395010, 1358793, 1488890, 1738381, 1767328, 1914427, 2051166



CV-RK-5311

0638862, 638862, 0639287, 639287, 1104335, 1953248, 81432206006, 81432206107



IV-ES-12272

Length: 75
Cone Ø: d1 Ø 30 / d2 Ø 27
Thread: M26 x 1,5 RHT
1394443



MN-ES-8490

Length: 90
Cone Ø: d1 Ø 30 / d2 Ø 27
Thread: M26 x 1,5 RHT
1394444, 0014606948, 14606948



MN-RK-7280

Ø: 75 Hole Distance: 115
Thick/Height: 24
550806, 0550806, 0639370, 639370, 689748, 1104334



MN-RK-8501

Ø: 75 Hole Distance: 115
Thick/Height: 24
1515981



MN-RK-12436

Ø: 75 Hole Distance: 115
Thick/Height: 24
550799, 1517403, 1783020



SC-DL-2161

Length: 1740 Ø: 50
Cone Ø: d1 Ø 30 / d2 Ø 27
1369411, 1385251, 1409918, 1501030, 1723865, 1723895, 1737683, 1897335, 2113903, 2125090, 2161883



SC-DL-5229

Length: 1053 Ø: 50
Cone Ø: d1 Ø 30 / d2 Ø 27
1356055, 1379071, 1384025, 1768898, 1847311, 1912757, 12201600A



SC-DL-5354

Length: 1060 Ø: 52
Cone Ø: d1 Ø 30 / d2 Ø 27
1384027, 1769597, 1847312, 1912758, 12200800A



SC-DL-7264

Length: 1743 Ø: 62
Cone Ø: d1 Ø 30 / d2 Ø 27
1361413, 1395614, 1734019, 1897333, 2040254, 2146105



SC-DL-8137

Length: 1736 Ø: 40
Cone Ø: d1 Ø 30 / d2 Ø 27
301639, 311847, 395350, 1358675, 1378435, 1397866, 1734020, 2028998, 12202900A



SC-DL-8154

Length: 495 Ø: 40
Cone Ø: d1 Ø 30 / d2 Ø 27
1343266, 1759690



SC-DL-8179

Length: 568 Ø: 46
Hole Distance: 115 / 115
1399180, 1428347



SC-DL-8182

1343262, 1869413



SC-DL-8399

Length: 433 Ø: 40
Cone Ø: d1 Ø 30 / d2 Ø 26
1394884, 1938387



SC-DL-8179

Length: 568 Ø: 46
Hole Distance: 115 / 115
1399180, 1428347



SC-DL-8509

Length: 568,5 Ø: 46
Hole Distance: 115 / 115
1485758, 1486757



SC-DL-8511

Length: 616,5 Ø: 50
Hole Distance: 115 / 115
1485760, 1499478, 1722750



SC-DL-8531

Length: 522 Ø: 46
Hole Distance: 115 / 115
1486758



SC-DL-8547

Length: 568 Ø: 50
Hole Distance: 115 / 115
1499474, 1722746, 1906940



SC-DL-8553

Length: 435 Ø: 38
Cone Ø: d1 Ø 30 / d2 Ø 27
1343283, 1759691



SC-DL-8623

Length: 592 Ø: 50
Hole Distance: 115 / 115
1388436, 1499476, 1722748, 1906942



SC-DL-9462

Length: 568,5 Ø: 50
Hole Distance: 115 / 115
1499475, 1500573, 1722747, 1906941



SC-DL-9466

Length: 568 Ø: 19
1486756



SC-DL-9467

Length: 568,5 Ø: 50
Hole Distance: 115 / 115
1500572



SC-DL-10225

Length: 2179 Ø: 62
Cone Ø: d1 Ø 30 / d2 Ø 27
1386618, 1788522



SC-DL-10302

Length: 752 Ø: 48
Hole Distance: 115 / 115
1101843, 1379423, 1393298, 1431470, 1942075



SC-DL-12342

Length: 601 Ø: 42
Cone Ø: d1 Ø 26 / d2 Ø 23,5
1343262, 1869413



SC-DL-12343

Length: 1062 Ø: 52
Cone Ø: d1 Ø 30 / d2 Ø 27
1348269, 2007275



SC-DL-12413

Length: 1950 Ø: 62
Cone Ø: d1 Ø 30 / d2 Ø 27
1393383, 1788520



SC-DL-12449

Length: 1206 Ø: 38
Cone Ø: d1 Ø 30 / d2 Ø 27
1385763, 1765375



SC-ES-5764

Length: 95
Cone Ø: d1 Ø 30 / d2 Ø 27
Thread: M26 x 1,5 RHT
325614, 1375228, 4604948



SC-ES-7279

Length: 150
Cone Ø: d1 Ø 30 / d2 Ø 27
Thread: M30 x 1,5 RHT
1357674, 1603883, 1738379



SC-RK-12366

Ø: 75 Hole Distance: 115 / 115
Thick/Height: 24
1 722 753, 2 096 392



SC-TC-12361

Length: 705 Ø: 42
Cone Ø: d1 Ø 38
Hole Distance: 115
1353445, 1464611, 1942147



SC-TC-12451

Length: 552 Ø: 46
Hole Distance: 115 / 115
1494296



SC-TC-12452

Length: 580,5 Ø: 46
Hole Distance: 115 / 115
1485759



SC-TC-12472

Length: 580 Ø: 46
Hole Distance: 115 / 115
1399182





4 - series ...

124 G/400 ...	05/96 →	Tie Rod	SC-DL-8137			
	05/96 →	Tie Rod	SC-DL-8137		1st FA;2nd FA	
	05/96 →	Tie Rod End		MN-ES-8490	for vehicles with Hinged Trailing Axle	
	05/96 →	Tie Rod End	CV-ES-14162		for Steering Rod	
	05/96 →	Tie Rod End	CV-ES-14162	CV-ES-14162	for Steering Rod	
	05/96 →	Tie Rod End	CV-ES-14163		for Steering Rod	
	05/96 →	Tie Rod End	IV-ES-12272		for Steering Rod	
	05/96 →	Tie Rod End	MN-ES-8490	MN-ES-8490	for vehicles with Hinged Trailing Axle	
	05/96 →	Tie Rod End	SC-ES-5764			
	05/96 →	Tie Rod End	SC-ES-7279		for Steering Rod	
	05/96 →	Track Control Arm		SC-DL-8179	Trailing Arm, Leaf Spring Axle	
	05/96 →	Track Control Arm		SC-DL-8179	Trailing Arm, Leaf Spring Axle, → * 1280184 SSS *; * 4471602 SNL *; * 9069959 SAN *; * 3533626 SLA *	
	05/96 →	Track Control Arm		SC-DL-8400	Trailing Arm	
	05/96 →	Track Control Arm		SC-DL-8511	Trailing Arm, Leaf Spring Axle	
	05/96 →	Track Control Arm		SC-DL-8547	Trailing Arm, Leaf Spring Axle	
	05/96 →	Track Control Arm		SC-DL-9462	Trailing Arm, Leaf Spring Axle	
	05/96 →	Track Control Arm		SC-DL-9466	Trailing Arm, Leaf Spring Axle	
	05/96 →	Track Control Arm		SC-DL-9467	Trailing Arm, Leaf Spring Axle, → * 1247518 SSS *; * 4406943 SNL *; * 9039629 SAN *; * 3507979 SLA *	
	05/96 →	Track Control Arm		SC-DL-9467	Trailing Arm, Leaf Spring Axle, → * 1280184 SSS *; * 4471602 SNL *; * 9069959 SAN *; * 3533626 SLA *	
	05/96 →	Track Control Arm		SC-TC-12451	Control Arm	
	05/96 →	Track Control Arm		SC-TC-12452	Control Arm	
	05/96 →	Track Control Arm		SC-TC-12472	Control Arm	
	05/96 →	Track Control Arm	SC-DL-8179	SC-DL-8179	Trailing Arm, Leaf Spring Axle, → * 1280184 SSS *; * 4471602 SNL *; * 9069959 SAN *; * 3533626 SLA *	
	05/96 →	Track Control Arm	SC-DL-8509	SC-DL-8509	Trailing Arm, Leaf Spring Axle	
	05/96 →	Track Control Arm	SC-DL-8531	SC-DL-8531	Trailing Arm, Leaf Spring Axle	
	05/96 →	Track Control Arm	SC-DL-8623	SC-DL-8623	Trailing Arm, Leaf Spring Axle	
	05/96 →	Track Control Arm	SC-DL-10302	SC-DL-10302	Trailing Arm, 1st FA; Air Suspension Axle	
	05/96 →	Track Control Arm	SC-DL-10302	SC-DL-10302	Trailing Arm, Air Suspension Axle	
	05/96 →	Track Control Arm	SC-TC-12361		Control Arm, 1st Front Axle, for Pneumatic Suspension vehicles	
	124 G/420	05/96 →	Centre Rod	SC-DL-5229		Push Rod
		05/96 →	Centre Rod	SC-DL-5354		Push Rod
		05/96 →	Centre Rod	SC-DL-8154		Push Rod
		05/96 →	Centre Rod	SC-DL-8169		Push Rod
05/96 →		Centre Rod	SC-DL-8182		Push Rod	
05/96 →		Centre Rod	SC-DL-8399		Push Rod	
05/96 →		Centre Rod	SC-DL-12341		Push Rod	
05/96 →		Centre Rod	SC-DL-12342		for Steering Rod	
05/96 →		Centre Rod	SC-DL-12413		for Steering Rod	
05/96 →		Suspension Arm Repair Kit		SC-RK-12366	for Control Arm	
05/96 →		Suspension Arm Repair Kit	MN-RK-7280	MN-RK-7280	for Drag Link; for Semi-Trailing Arm; for Wishbone (CV)	
05/96 →		Suspension Strut Repair Kit		DF-RK-9341		
05/96 →		Suspension Strut Repair Kit		MN-RK-8501		
05/96 →		Tie Rod		SC-DL-7264	Steering Axle	
05/96 →		Tie Rod		SC-DL-8137	Steering Axle	
05/96 →		Tie Rod	SC-DL-7264			
05/96 →		Tie Rod	SC-DL-7264		1st FA;2nd FA	
05/96 →		Tie Rod	SC-DL-8137			
05/96 →		Tie Rod	SC-DL-8137		1st FA;2nd FA	
05/96 →		Tie Rod End		MN-ES-8490	for vehicles with Hinged Trailing Axle	
05/96 →		Tie Rod End	CV-ES-14162		for Steering Rod	
05/96 →		Tie Rod End	CV-ES-14162	CV-ES-14162	for Steering Rod	
05/96 →		Tie Rod End	CV-ES-14163		for Steering Rod	
05/96 →		Tie Rod End	IV-ES-12272		for Steering Rod	

CV-ES-14162

Length: 125
Cone Ø: d1 Ø 30 / d2 Ø 27
Thread: M30 x 1,5 LHT
283783, 395009, 1358792, 1738380, 1 914 426, 2051165



CV-ES-14163

Length: 125
Cone Ø: d1 Ø 30 / d2 Ø 27
Thread: M30 x 1,5 RHT
283784, 395010, 1358793, 1488890, 1738381, 1767328, 1914427, 2051166



DF-RK-9341

Ø: 67
550807, 5508072



IV-ES-12272

Length: 75
Cone Ø: d1 Ø 30 / d2 Ø 27
Thread: M26 x 1,5 RHT
1394443



MN-ES-8490

Length: 90
Cone Ø: d1 Ø 30 / d2 Ø 27
Thread: M26 x 1,5 RHT
1394444, 0014606948, 14606948



MN-RK-7280

Ø: 75 Hole Distance: 115
Thick/Height: 24
0550806, 550806, 0639370, 639370, 689748, 1104334



MN-RK-8501

Ø: 75 Hole Distance: 115
Thick/Height: 24
1515981



SC-DL-5229

Length: 1053 Ø: 50
Cone Ø: d1 Ø 30 / d2 Ø 27
1356055, 1379071, 1384025, 1768898, 1847311, 1912757, 12201600A



SC-DL-5354

Length: 1060 Ø: 52
Cone Ø: d1 Ø 30 / d2 Ø 27
1384027, 1769597, 1847312, 1912758, 12200800A



SC-DL-7264

Length: 1743 Ø: 62
Cone Ø: d1 Ø 30 / d2 Ø 27
1361413, 1395614, 1734019, 1897333, 2040254, 2146105



SC-DL-8137

Length: 1736 Ø: 40
Cone Ø: d1 Ø 30 / d2 Ø 27
301639, 311847, 395350, 1358675, 1378435, 1397866, 1734020, 2028998, 12202900A



SC-DL-8154

Length: 495 Ø: 40
Cone Ø: d1 Ø 30 / d2 Ø 27
1343266, 1759690



SC-DL-8169

Length: 1920 Ø: 62
Cone Ø: d1 Ø 30 / d2 Ø 27
1343264, 1732635, 2007278



SC-DL-8179

Length: 568 Ø: 46
Hole Distance: 115 / 115
1399180, 1428347



SC-DL-8182

1343262, 1869413



SC-DL-8399

Length: 433 Ø: 40
Cone Ø: d1 Ø 30 / d2 Ø 26
1394884, 1938387



SC-DL-8179

Length: 568 Ø: 46
Hole Distance: 115 / 115
1399180, 1428347



SC-DL-8509

Length: 568,5 Ø: 46
Hole Distance: 115 / 115
1485758, 1486757



SC-DL-8511

Length: 616,5 Ø: 50
Hole Distance: 115 / 115
1485760, 1499478, 1722750



SC-DL-8531

Length: 522 Ø: 46
Hole Distance: 115 / 115
1486758



SC-DL-8547

Length: 568 Ø: 50
Hole Distance: 115 / 115
1499474, 1722746, 1906940



SC-DL-8623

Length: 592 Ø: 50
Hole Distance: 115 / 115
1388436, 1499476, 1722748, 1906942



SC-DL-9462

Length: 568,5 Ø: 50
Hole Distance: 115 / 115
1499475, 1500573, 1722747, 1906941



SC-DL-9466

Length: 568 Ø: 19
1486756



SC-DL-9467

Length: 568,5 Ø: 50
Hole Distance: 115 / 115
1500572



SC-DL-10302

Length: 752 Ø: 48
Hole Distance: 115 / 115
1101843, 1379423, 1393298, 1431470, 1942075



SC-DL-12341

Length: 1776 Ø: 62
Cone Ø: d1 Ø 30 / d2 Ø 27
1386620



SC-DL-12342

Length: 601 Ø: 42
Cone Ø: d1 Ø 26 / d2 Ø 23,5
1343262, 1869413



SC-DL-12413

Length: 1950 Ø: 62
Cone Ø: d1 Ø 30 / d2 Ø 27
1393383, 1788520



SC-ES-5764

Length: 95
Cone Ø: d1 Ø 30 / d2 Ø 27
Thread: M26 x 1,5 RHT
325614, 1375228, 4604948



SC-ES-7279

Length: 150
Cone Ø: d1 Ø 30 / d2 Ø 27
Thread: M30 x 1,5 RHT
1357674, 1603883, 1738379



SC-RK-12366

Ø: 75 Hole Distance: 115 / 115
Thick/Height: 24
1 722 753, 2 096 392



SC-TC-12361

Length: 705 Ø: 42
Cone Ø: d1 Ø 38
Hole Distance: 115
1353445, 1464611, 1942147



SC-TC-12451

Length: 552 Ø: 46
Hole Distance: 115 / 115
1494296



SC-TC-12452

Length: 580,5 Ø: 46
Hole Distance: 115 / 115
1485759



SC-TC-12472

Length: 580 Ø: 46
Hole Distance: 115 / 115
1399182





4 - series ...

124 G/420 ...	05/96→	Tie Rod End	MN-ES-8490	MN-ES-8490	for vehicles with Hinged Trailing Axle
	05/96→	Tie Rod End	SC-ES-5764		
	05/96→	Tie Rod End	SC-ES-7279		for Steering Rod
	05/96→	Tie Rod End	SC-ES-7279	SC-ES-7279	for Steering Rod
	05/96→	Track Control Arm		SC-DL-8179	Trailing Arm, Leaf Spring Axle
	05/96→	Track Control Arm		SC-DL-8179	Trailing Arm, Leaf Spring Axle, → * 1280184 SSS *; * 4471602 SNL *; * 9069959 SAN *; * 3533626 SLA *
	05/96→	Track Control Arm		SC-DL-8400	Trailing Arm
	05/96→	Track Control Arm		SC-DL-8511	Trailing Arm, Leaf Spring Axle
	05/96→	Track Control Arm		SC-DL-8547	Trailing Arm, Leaf Spring Axle
	05/96→	Track Control Arm		SC-DL-9462	Trailing Arm, Leaf Spring Axle
	05/96→	Track Control Arm		SC-DL-9466	Trailing Arm, Leaf Spring Axle
	05/96→	Track Control Arm		SC-DL-9467	Trailing Arm, Leaf Spring Axle, →* 1247518 SSS *; * 4406943 SNL *; * 9039629 SAN *; * 3507979 SLA *
	05/96→	Track Control Arm		SC-DL-9467	Trailing Arm, Leaf Spring Axle, → * 1280184 SSS *; * 4471602 SNL *; * 9069959 SAN *; * 3533626 SLA *
	05/96→	Track Control Arm		SC-TC-12451	Control Arm
	05/96→	Track Control Arm		SC-TC-12452	Control Arm
	05/96→	Track Control Arm		SC-TC-12472	Control Arm
	05/96→	Track Control Arm	SC-DL-8509	SC-DL-8509	Trailing Arm, Leaf Spring Axle
	05/96→	Track Control Arm	SC-DL-8531	SC-DL-8531	Trailing Arm, Leaf Spring Axle
	05/96→	Track Control Arm	SC-DL-8623	SC-DL-8623	Trailing Arm, Leaf Spring Axle
	05/96→	Track Control Arm	SC-DL-10302	SC-DL-10302	Trailing Arm, 1st FA; Air Suspension Axle
05/96→	Track Control Arm	SC-DL-10302	SC-DL-10302	Trailing Arm, Air Suspension Axle	
05/96→	Track Control Arm	SC-TC-12361		Control Arm, 1st Front Axle, for Pneumatic Suspension vehicles	
124 G/470	01/00→	Centre Rod	SC-DL-5229		Push Rod
	01/00→	Centre Rod	SC-DL-5354		Push Rod
	01/00→	Centre Rod	SC-DL-8154		Push Rod
	01/00→	Centre Rod	SC-DL-8169		Push Rod
	01/00→	Centre Rod	SC-DL-8182		Push Rod
	01/00→	Centre Rod	SC-DL-8399		Push Rod
	01/00→	Centre Rod	SC-DL-12341		Push Rod
	01/00→	Centre Rod	SC-DL-12342		for Steering Rod
	01/00→	Suspension Arm Repair Kit		SC-RK-12366	for Control Arm
	01/00→	Suspension Arm Repair Kit	MN-RK-7280	MN-RK-7280	for Drag Link; for Semi-Trailing Arm; for Wishbone (CV)
	01/00→	Suspension Strut Repair Kit		DF-RK-9341	
	01/00→	Suspension Strut Repair Kit		MN-RK-8501	
	01/00→	Tie Rod	SC-DL-7264		
	01/00→	Tie Rod	SC-DL-7264		1st FA; 2nd FA
	01/00→	Tie Rod	SC-DL-8137		
	01/00→	Tie Rod	SC-DL-8137		1st FA; 2nd FA
	01/00→	Tie Rod End	CV-ES-14162	CV-ES-14162	for Steering Rod
	01/00→	Tie Rod End	CV-ES-14163		for Steering Rod
	01/00→	Tie Rod End	SC-ES-5764		
	01/00→	Tie Rod End	SC-ES-7279	SC-ES-7279	for Steering Rod
	01/00→	Track Control Arm		SC-DL-8179	Trailing Arm, Leaf Spring Axle
	01/00→	Track Control Arm		SC-DL-8179	Trailing Arm, Leaf Spring Axle, → * 1280184 SSS *; * 4471602 SNL *; * 9069959 SAN *; * 3533626 SLA *
	01/00→	Track Control Arm		SC-DL-8400	Trailing Arm
	01/00→	Track Control Arm		SC-DL-8511	Trailing Arm, Leaf Spring Axle
	01/00→	Track Control Arm		SC-DL-8547	Trailing Arm, Leaf Spring Axle
	01/00→	Track Control Arm		SC-DL-9462	Trailing Arm, Leaf Spring Axle
	01/00→	Track Control Arm		SC-DL-9466	Trailing Arm, Leaf Spring Axle
	01/00→	Track Control Arm		SC-DL-9467	Trailing Arm, Leaf Spring Axle, →* 1247518 SSS *; * 4406943 SNL *; * 9039629 SAN *; * 3507979 SLA *

CV-ES-14162

Length: 125
Cone Ø: d1 Ø 30 / d2 Ø 27
Thread: M30 x 1,5 LHT
283783, 395009, 1358792, 1738380, 1 914 426, 2051165



CV-ES-14163

Length: 125
Cone Ø: d1 Ø 30 / d2 Ø 27
Thread: M30 x 1,5 RHT
283784, 395010, 1358793, 1488890, 1738381, 1767328, 1914427, 2051166



DF-RK-9341

Ø: 67
550807, 5508072



MN-ES-8490

Length: 90
Cone Ø: d1 Ø 30 / d2 Ø 27
Thread: M26 x 1,5 RHT
1394444, 0014606948, 14606948



MN-RK-7280

Ø: 75 Hole Distance: 115
Thick/Height: 24
0550806, 550806, 0639370, 639370, 689748, 1104334



MN-RK-8501

Ø: 75 Hole Distance: 115
Thick/Height: 24
1515981



SC-DL-5229

Length: 1053 Ø: 50
Cone Ø: d1 Ø 30 / d2 Ø 27
1356055, 1379071, 1384025, 1768898, 1847311, 1912757, 12201600A



SC-DL-5354

Length: 1060 Ø: 52
Cone Ø: d1 Ø 30 / d2 Ø 27
1384027, 1769597, 1847312, 1912758, 12200800A



SC-DL-7264

Length: 1743 Ø: 62
Cone Ø: d1 Ø 30 / d2 Ø 27
1361413, 1395614, 1734019, 1897333, 2040254, 2146105



SC-DL-8137

Length: 1736 Ø: 40
Cone Ø: d1 Ø 30 / d2 Ø 27
301639, 311847, 395350, 1358675, 1378435, 1397866, 1734020, 2028998, 12202900A



SC-DL-8154

Length: 495 Ø: 40
Cone Ø: d1 Ø 30 / d2 Ø 27
1343266, 1759690



SC-DL-8169

Length: 1920 Ø: 62
Cone Ø: d1 Ø 30 / d2 Ø 27
1343264, 1732635, 2007278



SC-DL-8179

Length: 568 Ø: 46
Hole Distance: 115 / 115
1399180, 1428347



SC-DL-8182

1343262, 1869413



SC-DL-8399

Length: 433 Ø: 40
Cone Ø: d1 Ø 30 / d2 Ø 26
1394884, 1938387



SC-DL-8179

Length: 568 Ø: 46
Hole Distance: 115 / 115
1399180, 1428347



SC-DL-8509

Length: 568,5 Ø: 46
Hole Distance: 115 / 115
1485758, 1486757



SC-DL-8511

Length: 616,5 Ø: 50
Hole Distance: 115 / 115
1485760, 1499478, 1722750



SC-DL-8531

Length: 522 Ø: 46
Hole Distance: 115 / 115
1486758



SC-DL-8547

Length: 568 Ø: 50
Hole Distance: 115 / 115
1499474, 1722746, 1906940



SC-DL-8623

Length: 592 Ø: 50
Hole Distance: 115 / 115
1388436, 1499476, 1722748, 1906942



SC-DL-9462

Length: 568,5 Ø: 50
Hole Distance: 115 / 115
1499475, 1500573, 1722747, 1906941



SC-DL-9466

Length: 568 Ø: 19
1486756



SC-DL-9467

Length: 568,5 Ø: 50
Hole Distance: 115 / 115
1500572



SC-DL-10302

Length: 752 Ø: 48
Hole Distance: 115 / 115
1101843, 1379423, 1393298, 1431470, 1942075



SC-DL-12341

Length: 1776 Ø: 62
Cone Ø: d1 Ø 30 / d2 Ø 27
1386620



SC-DL-12342

Length: 601 Ø: 42
Cone Ø: d1 Ø 26 / d2 Ø 23,5
1343262, 1869413



SC-ES-5764

Length: 95
Cone Ø: d1 Ø 30 / d2 Ø 27
Thread: M26 x 1,5 RHT
325614, 1375228, 4604948



SC-ES-7279

Length: 150
Cone Ø: d1 Ø 30 / d2 Ø 27
Thread: M30 x 1,5 RHT
1357674, 1603883, 1738379



SC-RK-12366

Ø: 75 Hole Distance: 115 / 115
Thick/Height: 24
1 722 753, 2 096 392



SC-TC-12361

Length: 705 Ø: 42
Cone Ø: d1 Ø 38
Hole Distance: 115
1353445, 1464611, 1942147



SC-TC-12451

Length: 552 Ø: 46
Hole Distance: 115 / 115
1494296



SC-TC-12452

Length: 580,5 Ø: 46
Hole Distance: 115 / 115
1485759



SC-TC-12472

Length: 580 Ø: 46
Hole Distance: 115 / 115
1399182



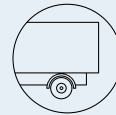

4 - series ...

124 G/470 ...	01/00 →	Track Control Arm		SC-DL-9467	Trailing Arm, Leaf Spring Axle, → * 1280184 SSS *; * 4471602 SNL *; * 9069959 SAN *; * 3533626 SLA *
	01/00 →	Track Control Arm		SC-TC-12451	Control Arm
	01/00 →	Track Control Arm		SC-TC-12452	Control Arm
	01/00 →	Track Control Arm		SC-TC-12472	Control Arm
	01/00 →	Track Control Arm	SC-DL-8509	SC-DL-8509	Trailing Arm, Leaf Spring Axle
	01/00 →	Track Control Arm	SC-DL-8531	SC-DL-8531	Trailing Arm, Leaf Spring Axle
	01/00 →	Track Control Arm	SC-DL-8623	SC-DL-8623	Trailing Arm, Leaf Spring Axle
	01/00 →	Track Control Arm	SC-DL-10302	SC-DL-10302	Trailing Arm, 1st FA; Air Suspension Axle
	01/00 →	Track Control Arm	SC-DL-10302	SC-DL-10302	Trailing Arm, Air Suspension Axle
01/00 →	Track Control Arm	SC-TC-12361		Control Arm, 1st Front Axle, for Pneumatic Suspension vehicles	
124 L/360	09/96 →	Centre Rod	SC-DL-2161		Coupling Rod
	09/96 →	Centre Rod	SC-DL-5229		Push Rod
	09/96 →	Centre Rod	SC-DL-5354		Push Rod
	09/96 →	Centre Rod	SC-DL-8182		Push Rod
	09/96 →	Centre Rod	SC-DL-8399		Push Rod, for vehicles with Hinged Leading Axle
	09/96 →	Centre Rod	SC-DL-8553	SC-DL-8553	Push Rod, for vehicles with Hinged Leading Axle
	09/96 →	Centre Rod	SC-DL-10225		for Steering Rod
	09/96 →	Centre Rod	SC-DL-10225		Push Rod
	09/96 →	Centre Rod	SC-DL-12342		for Steering Rod
	09/96 →	Centre Rod	SC-DL-12343		for Steering Rod
	09/96 →	Centre Rod	SC-DL-12449		Push Rod
	09/96 →	Suspension Arm Repair Kit		MN-RK-7280	for Drag Link; for Semi-Trailing Arm; for Wishbone (CV)
	09/96 →	Suspension Arm Repair Kit		SC-RK-12366	for Control Arm
	09/96 →	Suspension Strut Repair Kit		CV-RK-5311	
	09/96 →	Suspension Strut Repair Kit		MN-RK-8501	
	09/96 →	Suspension Strut Repair Kit	MN-RK-12436	MN-RK-12436	
	09/96 →	Tie Rod		SC-DL-7264	Steering Axle
	09/96 →	Tie Rod		SC-DL-8137	Steering Axle
	09/96 →	Tie Rod	SC-DL-7264		
	09/96 →	Tie Rod	SC-DL-8137		
	09/96 →	Tie Rod End		MN-ES-8490	for vehicles with Hinged Trailing Axle
	09/96 →	Tie Rod End	CV-ES-14162		for Steering Rod
	09/96 →	Tie Rod End	CV-ES-14163		for Steering Rod
	09/96 →	Tie Rod End	IV-ES-12272		for Steering Rod
	09/96 →	Tie Rod End	SC-ES-7279		for Steering Rod
	09/96 →	Track Control Arm		SC-DL-8179	Trailing Arm, Leaf Spring Axle
	09/96 →	Track Control Arm		SC-DL-8179	Trailing Arm, Leaf Spring Axle, → * 1280184 SSS *; * 4471602 SNL *; * 9069959 SAN *; * 3533626 SLA *
	09/96 →	Track Control Arm		SC-DL-8400	Trailing Arm
	09/96 →	Track Control Arm		SC-DL-8511	Trailing Arm, Leaf Spring Axle
	09/96 →	Track Control Arm		SC-DL-8547	Trailing Arm, Leaf Spring Axle
	09/96 →	Track Control Arm		SC-DL-9462	Trailing Arm, Leaf Spring Axle
	09/96 →	Track Control Arm		SC-DL-9466	Trailing Arm, Leaf Spring Axle
	09/96 →	Track Control Arm		SC-DL-9467	Trailing Arm, Leaf Spring Axle, → * 1247518 SSS *; * 4406943 SNL *; * 9039629 SAN *; * 3507979 SLA *
	09/96 →	Track Control Arm		SC-DL-9467	Trailing Arm, Leaf Spring Axle, → * 1280184 SSS *; * 4471602 SNL *; * 9069959 SAN *; * 3533626 SLA *
	09/96 →	Track Control Arm		SC-TC-12451	Control Arm
	09/96 →	Track Control Arm		SC-TC-12452	Control Arm
	09/96 →	Track Control Arm		SC-TC-12472	Control Arm
	09/96 →	Track Control Arm	SC-DL-8509	SC-DL-8509	Trailing Arm, Leaf Spring Axle
	09/96 →	Track Control Arm	SC-DL-8531	SC-DL-8531	Trailing Arm, Leaf Spring Axle
	09/96 →	Track Control Arm	SC-DL-8623	SC-DL-8623	Trailing Arm, Leaf Spring Axle
	09/96 →	Track Control Arm	SC-DL-10302	SC-DL-10302	Trailing Arm, Air Suspension Axle
	09/96 →	Track Control Arm	SC-TC-12361		Control Arm, 1st Front Axle, for Pneumatic Suspension vehicles

CV-ES-14162

Length: 125
Cone Ø: d1 Ø 30 / d2 Ø 27
Thread: M30 x 1,5 LHT
283784, 395009, 1358792, 1738380, 1 914 426, 2051165



CV-ES-14163

Length: 125
Cone Ø: d1 Ø 30 / d2 Ø 27
Thread: M30 x 1,5 RHT
283784, 395010, 1358793, 1488890, 1738381, 1767328, 1914427, 2051166



CV-RK-5311

638862, 0638862, 639287, 0639287, 1104335, 1953248, 81432206006, 81432206107



IV-ES-12272

Length: 75
Cone Ø: d1 Ø 30 / d2 Ø 27
Thread: M26 x 1,5 RHT
1394443



MN-ES-8490

Length: 90
Cone Ø: d1 Ø 30 / d2 Ø 27
Thread: M26 x 1,5 RHT
1394444, 0014606948, 14606948



MN-RK-7280

Ø: 75 Hole Distance: 115
Thick/Height: 24
0550806, 550806, 639370, 0639370, 689748, 1104334



MN-RK-8501

Ø: 75 Hole Distance: 115
Thick/Height: 24
1515981



MN-RK-12436

Ø: 75 Hole Distance: 115
Thick/Height: 24
550799, 1517403, 1783020



SC-DL-2161

Length: 1740 Ø: 50
Cone Ø: d1 Ø 30 / d2 Ø 27
1369411, 1385251, 1409918, 1501030, 1723865, 1723895, 1737683, 1897335, 2113903, 2125090, 2161883



SC-DL-5229

Length: 1053 Ø: 50
Cone Ø: d1 Ø 30 / d2 Ø 27
1356055, 1379071, 1384025, 1768898, 1847311, 1912757, 12201600A



SC-DL-5354

Length: 1060 Ø: 52
Cone Ø: d1 Ø 30 / d2 Ø 27
1384027, 1769597, 1847312, 1912758, 12200800A



SC-DL-7264

Length: 1743 Ø: 62
Cone Ø: d1 Ø 30 / d2 Ø 27
1361413, 1395614, 1734019, 1897333, 2040254, 2146105



SC-DL-8137

Length: 1736 Ø: 40
Cone Ø: d1 Ø 30 / d2 Ø 27
301639, 311847, 395350, 1358675, 1378435, 1397866, 1734020, 2028998, 12202900A



SC-DL-8179

Length: 568 Ø: 46
Hole Distance: 115 / 115
1399180, 1428347



SC-DL-8182

1343262, 1869413



SC-DL-8399

Length: 433 Ø: 40
Cone Ø: d1 Ø 30 / d2 Ø 26
1394884, 1938387



SC-DL-8179

Length: 568 Ø: 46
Hole Distance: 115 / 115
1399180, 1428347



SC-DL-8509

Length: 568,5 Ø: 46
Hole Distance: 115 / 115
1485758, 1486757



SC-DL-8511

Length: 616,5 Ø: 50
Hole Distance: 115 / 115
1485760, 1499478, 1722750



SC-DL-8531

Length: 522 Ø: 46
Hole Distance: 115 / 115
1486758



SC-DL-8547

Length: 568 Ø: 50
Hole Distance: 115 / 115
1499474, 1722746, 1906940



SC-DL-8553

Length: 435 Ø: 38
Cone Ø: d1 Ø 30 / d2 Ø 27
1343283, 1759691



SC-DL-8623

Length: 592 Ø: 50
Hole Distance: 115 / 115
1388436, 1499476, 1722748, 1906942



SC-DL-9462

Length: 568,5 Ø: 50
Hole Distance: 115 / 115
1499475, 1500573, 1722747, 1906941



SC-DL-9466

Length: 568 Ø: 19
1486756



SC-DL-9467

Length: 568,5 Ø: 50
Hole Distance: 115 / 115
1500572



SC-DL-10225

Length: 2179 Ø: 62
Cone Ø: d1 Ø 30 / d2 Ø 27
1386618, 1788522



SC-DL-10302

Length: 752 Ø: 48
Hole Distance: 115 / 115
1101843, 1379423, 1393298, 1431470, 1942075



SC-DL-12342

Length: 601 Ø: 42
Cone Ø: d1 Ø 26 / d2 Ø 23,5
1343262, 1869413



SC-DL-12343

Length: 1062 Ø: 52
Cone Ø: d1 Ø 30 / d2 Ø 27
1348269, 2007275



SC-DL-12449

Length: 1206 Ø: 38
Cone Ø: d1 Ø 30 / d2 Ø 27
1385763, 1765375



SC-ES-7279

Length: 150
Cone Ø: d1 Ø 30 / d2 Ø 27
Thread: M30 x 1,5 RHT
1357674, 1603883, 1738379



SC-RK-12366

Ø: 75 Hole Distance: 115 / 115
Thick/Height: 24
1 722 753, 2 096 392



SC-TC-12361

Length: 705 Ø: 42
Cone Ø: d1 Ø 38
Hole Distance: 115
1353445, 1464611, 1942147



SC-TC-12451

Length: 552 Ø: 46
Hole Distance: 115 / 115
1494296



SC-TC-12452

Length: 580,5 Ø: 46
Hole Distance: 115 / 115
1485759



SC-TC-12472

Length: 580 Ø: 46
Hole Distance: 115 / 115
1399182





4 - series ...

124 L/400	09/96 →	Centre Rod	SC-DL-2161		Coupling Rod
	09/96 →	Centre Rod	SC-DL-5229		Push Rod
	09/96 →	Centre Rod	SC-DL-5354		Push Rod
	09/96 →	Centre Rod	SC-DL-8182		Push Rod
	09/96 →	Centre Rod	SC-DL-8399		Push Rod, for vehicles with Hinged Leading Axle
	09/96 →	Centre Rod	SC-DL-8553	SC-DL-8553	Push Rod, for vehicles with Hinged Leading Axle
	09/96 →	Centre Rod	SC-DL-10225		for Steering Rod
	09/96 →	Centre Rod	SC-DL-10225		Push Rod
	09/96 →	Centre Rod	SC-DL-12342		for Steering Rod
	09/96 →	Centre Rod	SC-DL-12343		for Steering Rod
	09/96 →	Centre Rod	SC-DL-12449		Push Rod
	09/96 →	Suspension Arm Repair Kit		MN-RK-7280	for Drag Link;for Semi-Trailing Arm; for Wishbone (CV)
	09/96 →	Suspension Arm Repair Kit		SC-RK-12366	for Control Arm
	09/96 →	Suspension Strut Repair Kit		CV-RK-5311	
	09/96 →	Suspension Strut Repair Kit		MN-RK-8501	
	09/96 →	Suspension Strut Repair Kit	MN-RK-12436	MN-RK-12436	
	09/96 →	Tie Rod		SC-DL-7264	Steering Axle
	09/96 →	Tie Rod		SC-DL-8137	Steering Axle
	09/96 →	Tie Rod	SC-DL-7264		
	09/96 →	Tie Rod	SC-DL-8137		
	09/96 →	Tie Rod End		MN-ES-8490	for vehicles with Hinged Trailing Axle
	09/96 →	Tie Rod End	CV-ES-14162		for Steering Rod
	09/96 →	Tie Rod End	CV-ES-14163		for Steering Rod
	09/96 →	Tie Rod End	IV-ES-12272		for Steering Rod
	09/96 →	Tie Rod End	SC-ES-7279		for Steering Rod
	09/96 →	Track Control Arm		SC-DL-8179	Trailing Arm, Leaf Spring Axle
	09/96 →	Track Control Arm		SC-DL-8179	Trailing Arm, Leaf Spring Axle, → * 1280184 SSS **; 4471602 SNL *; * 9069959 SAN **; 3533626 SLA *
	09/96 →	Track Control Arm		SC-DL-8400	Trailing Arm
	09/96 →	Track Control Arm		SC-DL-8511	Trailing Arm, Leaf Spring Axle
	09/96 →	Track Control Arm		SC-DL-8547	Trailing Arm, Leaf Spring Axle
	09/96 →	Track Control Arm		SC-DL-9462	Trailing Arm, Leaf Spring Axle
	09/96 →	Track Control Arm		SC-DL-9466	Trailing Arm, Leaf Spring Axle
	09/96 →	Track Control Arm		SC-DL-9467	Trailing Arm, Leaf Spring Axle, →* 1247518 SSS **; 4406943 SNL *; * 9039629 SAN **; 3507979 SLA *
	09/96 →	Track Control Arm		SC-DL-9467	Trailing Arm, Leaf Spring Axle, → * 1280184 SSS **; 4471602 SNL *; * 9069959 SAN **; 3533626 SLA *
09/96 →	Track Control Arm		SC-TC-12451	Control Arm	
09/96 →	Track Control Arm		SC-TC-12452	Control Arm	
09/96 →	Track Control Arm		SC-TC-12472	Control Arm	
09/96 →	Track Control Arm	SC-DL-8509	SC-DL-8509	Trailing Arm, Leaf Spring Axle	
09/96 →	Track Control Arm	SC-DL-8531	SC-DL-8531	Trailing Arm, Leaf Spring Axle	
09/96 →	Track Control Arm	SC-DL-8623	SC-DL-8623	Trailing Arm, Leaf Spring Axle	
09/96 →	Track Control Arm	SC-DL-10302	SC-DL-10302	Trailing Arm, Air Suspension Axle	
09/96 →	Track Control Arm	SC-TC-12361		Control Arm, 1st Front Axle, for Pneumatic Suspension vehicles	
124 L/420	05/96 →	Centre Rod	SC-DL-5229		Push Rod
	05/96 →	Centre Rod	SC-DL-5354		Push Rod
	05/96 →	Centre Rod	SC-DL-8182		Push Rod
	05/96 →	Centre Rod	SC-DL-8399		Push Rod, for vehicles with Hinged Leading Axle
	05/96 →	Centre Rod	SC-DL-8553	SC-DL-8553	Push Rod, for vehicles with Hinged Leading Axle
	05/96 →	Centre Rod	SC-DL-10225		for Steering Rod
	05/96 →	Centre Rod	SC-DL-10225		Push Rod
	05/96 →	Centre Rod	SC-DL-12342		for Steering Rod
	05/96 →	Centre Rod	SC-DL-12343		for Steering Rod
	05/96 →	Centre Rod	SC-DL-12449		Push Rod
	05/96 →	Suspension Arm Repair Kit		SC-RK-12366	for Control Arm
	05/96 →	Suspension Arm Repair Kit	MN-RK-7280	MN-RK-7280	for Drag Link;for Semi-Trailing Arm; for Wishbone (CV)

CV-ES-14162

Length: 125
Cone Ø: d1 Ø 30 / d2 Ø 27
Thread: M30 x 1,5 LHT
283783, 395009, 1358792, 1738380, 1 914 426, 2051165



CV-ES-14163

Length: 125
Cone Ø: d1 Ø 30 / d2 Ø 27
Thread: M30 x 1,5 RHT
283784, 395010, 1358793, 1488890, 1738381, 1767328, 1914427, 2051166



CV-RK-5311

0638862, 638862, 639287, 0639287, 1104335, 1953248, 81432206006, 81432206107



IV-ES-12272

Length: 75
Cone Ø: d1 Ø 30 / d2 Ø 27
Thread: M26 x 1,5 RHT
1394443



MN-ES-8490

Length: 90
Cone Ø: d1 Ø 30 / d2 Ø 27
Thread: M26 x 1,5 RHT
1394444, 0014606948, 14606948



MN-RK-7280

Ø: 75 Hole Distance: 115
Thick/Height: 24
0550806, 550806, 639370, 0639370, 689748, 1104334



MN-RK-8501

Ø: 75 Hole Distance: 115
Thick/Height: 24
1515981



MN-RK-12436

Ø: 75 Hole Distance: 115
Thick/Height: 24
550799, 1517403, 1783020



SC-DL-2161

Length: 1740 Ø: 50
Cone Ø: d1 Ø 30 / d2 Ø 27
1369411, 1385251, 1409918, 1501030, 1723865, 1723895, 1737683, 1897335, 2113903, 2125090, 2161883



SC-DL-5229

Length: 1053 Ø: 50
Cone Ø: d1 Ø 30 / d2 Ø 27
1356055, 1379071, 1384025, 1768898, 1847311, 1912757, 12201600A



SC-DL-5354

Length: 1060 Ø: 52
Cone Ø: d1 Ø 30 / d2 Ø 27
1384027, 1769597, 1847312, 1912758, 12200800A



SC-DL-7264

Length: 1743 Ø: 62
Cone Ø: d1 Ø 30 / d2 Ø 27
1361413, 1395614, 1734019, 1897333, 2040254, 2146105



SC-DL-8137

Length: 1736 Ø: 40
Cone Ø: d1 Ø 30 / d2 Ø 27
301639, 311847, 395350, 1358675, 1378435, 1397866, 1734020, 2028998, 12202900A



SC-DL-8179

Length: 568 Ø: 46
Hole Distance: 115 / 115
1399180, 1428347



SC-DL-8182

1343262, 1869413



SC-DL-8399

Length: 433 Ø: 40
Cone Ø: d1 Ø 30 / d2 Ø 26
1394884, 1938387



SC-DL-8179

Length: 568 Ø: 46
Hole Distance: 115 / 115
1399180, 1428347



SC-DL-8509

Length: 568,5 Ø: 46
Hole Distance: 115 / 115
1485758, 1486757



SC-DL-8511

Length: 616,5 Ø: 50
Hole Distance: 115 / 115
1485760, 1499478, 1722750



SC-DL-8531

Length: 522 Ø: 46
Hole Distance: 115 / 115
1486758



SC-DL-8547

Length: 568 Ø: 50
Hole Distance: 115 / 115
1499474, 1722746, 1906940



SC-DL-8553

Length: 435 Ø: 38
Cone Ø: d1 Ø 30 / d2 Ø 27
1343283, 1759691



SC-DL-8623

Length: 592 Ø: 50
Hole Distance: 115 / 115
1388436, 1499476, 1722748, 1906942



SC-DL-9462

Length: 568,5 Ø: 50
Hole Distance: 115 / 115
1499475, 1500573, 1722747, 1906941



SC-DL-9466

Length: 568 Ø: 19
1486756



SC-DL-9467

Length: 568,5 Ø: 50
Hole Distance: 115 / 115
1500572



SC-DL-10225

Length: 2179 Ø: 62
Cone Ø: d1 Ø 30 / d2 Ø 27
1386618, 1788522



SC-DL-10302

Length: 752 Ø: 48
Hole Distance: 115 / 115
1101843, 1379423, 1393298, 1431470, 1942075



SC-DL-12342

Length: 601 Ø: 42
Cone Ø: d1 Ø 26 / d2 Ø 23,5
1343262, 1869413



SC-DL-12343

Length: 1062 Ø: 52
Cone Ø: d1 Ø 30 / d2 Ø 27
1348269, 2007275



SC-DL-12449

Length: 1206 Ø: 38
Cone Ø: d1 Ø 30 / d2 Ø 27
1385763, 1765375



SC-ES-7279

Length: 150
Cone Ø: d1 Ø 30 / d2 Ø 27
Thread: M30 x 1,5 RHT
1357674, 1603883, 1738379



SC-RK-12366

Ø: 75 Hole Distance: 115 / 115
Thick/Height: 24
1 722 753, 2 096 392



SC-TC-12361

Length: 705 Ø: 42
Cone Ø: d1 Ø 38
Hole Distance: 115
1353445, 1464611, 1942147



SC-TC-12451

Length: 552 Ø: 46
Hole Distance: 115 / 115
1494296



SC-TC-12452

Length: 580,5 Ø: 46
Hole Distance: 115 / 115
1485759



SC-TC-12472

Length: 580 Ø: 46
Hole Distance: 115 / 115
1399182





4 - series ...

124 L/420 ...	05/96→	Suspension Strut Repair Kit		DF-RK-9341	
	05/96→	Tie Rod		SC-DL-7264	Steering Axle
	05/96→	Tie Rod		SC-DL-8137	Steering Axle
	05/96→	Tie Rod	SC-DL-7264		
	05/96→	Tie Rod	SC-DL-8137		
	05/96→	Tie Rod End		MN-ES-8490	for vehicles with Hinged Trailing Axle
	05/96→	Tie Rod End	CV-ES-14162		for Steering Rod
	05/96→	Tie Rod End	CV-ES-14162	CV-ES-14162	for Steering Rod
	05/96→	Tie Rod End	CV-ES-14163		for Steering Rod
	05/96→	Tie Rod End	SC-ES-7279		for Steering Rod
	05/96→	Track Control Arm		SC-TC-12451	Control Arm
	05/96→	Track Control Arm		SC-TC-12452	Control Arm
	05/96→	Track Control Arm		SC-TC-12472	Control Arm
	05/96→	Track Control Arm	SC-DL-10302	SC-DL-10302	Trailing Arm, Air Suspension Axle
	05/96→	Track Control Arm	SC-TC-12361		Control Arm, 1st Front Axle, for Pneumatic Suspension vehicles
	09/97→	Centre Rod	SC-DL-2161		Coupling Rod
	09/97→	Suspension Arm Repair Kit		MN-RK-7280	for Drag Link;for Semi-Trailing Arm; for Wishbone (CV)
	09/97→	Suspension Strut Repair Kit		CV-RK-5311	
	09/97→	Suspension Strut Repair Kit		MN-RK-8501	
	09/97→	Suspension Strut Repair Kit	MN-RK-12436	MN-RK-12436	
	09/97→	Tie Rod End	IV-ES-12272		for Steering Rod
	09/97→	Track Control Arm		SC-DL-8179	Trailing Arm, Leaf Spring Axle
	09/97→	Track Control Arm		SC-DL-8179	Trailing Arm, Leaf Spring Axle, → * 1280184 SSS *; * 4471602 SNL *; * 9069959 SAN *; * 3533626 SLA *
	09/97→	Track Control Arm		SC-DL-8400	Trailing Arm
	09/97→	Track Control Arm		SC-DL-8511	Trailing Arm, Leaf Spring Axle
	09/97→	Track Control Arm		SC-DL-8547	Trailing Arm, Leaf Spring Axle
	09/97→	Track Control Arm		SC-DL-9462	Trailing Arm, Leaf Spring Axle
	09/97→	Track Control Arm		SC-DL-9466	Trailing Arm, Leaf Spring Axle
	09/97→	Track Control Arm		SC-DL-9467	Trailing Arm, Leaf Spring Axle, →* 1247518 SSS *; * 4406943 SNL *; * 9039629 SAN *; * 3507979 SLA *
	09/97→	Track Control Arm		SC-DL-9467	Trailing Arm, Leaf Spring Axle, → * 1280184 SSS *; * 4471602 SNL *; * 9069959 SAN *; * 3533626 SLA *
	09/97→	Track Control Arm	SC-DL-8509	SC-DL-8509	Trailing Arm, Leaf Spring Axle
	09/97→	Track Control Arm	SC-DL-8531	SC-DL-8531	Trailing Arm, Leaf Spring Axle
	09/97→	Track Control Arm	SC-DL-8623	SC-DL-8623	Trailing Arm, Leaf Spring Axle
	124 L/440	01/01→	Centre Rod	SC-DL-2161	
01/01→		Centre Rod	SC-DL-5229		Push Rod
01/01→		Centre Rod	SC-DL-5354		Push Rod
01/01→		Centre Rod	SC-DL-8182		Push Rod
01/01→		Centre Rod	SC-DL-8399		Push Rod, for vehicles with Hinged Leading Axle
01/01→		Centre Rod	SC-DL-8553	SC-DL-8553	Push Rod, for vehicles with Hinged Leading Axle
01/01→		Centre Rod	SC-DL-10225		for Steering Rod
01/01→		Centre Rod	SC-DL-10225		Push Rod
01/01→		Centre Rod	SC-DL-12342		for Steering Rod
01/01→		Centre Rod	SC-DL-12343		for Steering Rod
01/01→		Centre Rod	SC-DL-12449		Push Rod
01/01→		Suspension Arm Repair Kit		SC-RK-12366	for Control Arm
01/01→		Suspension Strut Repair Kit		CV-RK-5311	
01/01→		Suspension Strut Repair Kit		MN-RK-8501	
01/01→		Suspension Strut Repair Kit	MN-RK-12436	MN-RK-12436	
01/01→		Tie Rod		SC-DL-7264	Steering Axle
01/01→		Tie Rod		SC-DL-8137	Steering Axle
01/01→		Tie Rod	SC-DL-7264		
01/01→		Tie Rod	SC-DL-8137		
01/01→		Tie Rod End		MN-ES-8490	for vehicles with Hinged Trailing Axle
01/01→		Tie Rod End	CV-ES-14162		for Steering Rod
01/01→		Tie Rod End	CV-ES-14163		for Steering Rod

CV-ES-14162

Length: 125
Cone Ø: d1 Ø 30 / d2 Ø 27
Thread: M30 x 1,5 LHT
283783, 395009, 1358792, 1738380, 1 914 426, 2051165



CV-ES-14163

Length: 125
Cone Ø: d1 Ø 30 / d2 Ø 27
Thread: M30 x 1,5 RHT
283784, 395010, 1358793, 1488890, 1738381, 1767328, 1914427, 2051166



CV-RK-5311

0638862, 638862, 0639287, 639287, 1104335, 1953248, 81432206006, 81432206107



DF-RK-9341

Ø: 67
550807, 5508072



IV-ES-12272

Length: 75
Cone Ø: d1 Ø 30 / d2 Ø 27
Thread: M26 x 1,5 RHT
1394443



MN-ES-8490

Length: 90
Cone Ø: d1 Ø 30 / d2 Ø 27
Thread: M26 x 1,5 RHT
1394444, 0014606948, 14606948



MN-RK-7280

Ø: 75 Hole Distance: 115
Thick/Height: 24
0550806, 550806, 0639370, 639370, 689748, 1104334



MN-RK-8501

Ø: 75 Hole Distance: 115
Thick/Height: 24
1515981



MN-RK-12436

Ø: 75 Hole Distance: 115
Thick/Height: 24
550799, 1517403, 1783020



SC-DL-2161

Length: 1740 Ø: 50
Cone Ø: d1 Ø 30 / d2 Ø 27
1369411, 1385251, 1409918, 1501030, 1723865, 1723895, 1737683, 1897335, 2113903, 2125090, 2161883



SC-DL-5229

Length: 1053 Ø: 50
Cone Ø: d1 Ø 30 / d2 Ø 27
1356055, 1379071, 1384025, 1768898, 1847311, 1912757, 12201600A



SC-DL-5354

Length: 1060 Ø: 52
Cone Ø: d1 Ø 30 / d2 Ø 27
1384027, 1769597, 1847312, 1912758, 12200800A



SC-DL-7264

Length: 1743 Ø: 62
Cone Ø: d1 Ø 30 / d2 Ø 27
1361413, 1395614, 1734019, 1897333, 2040254, 2146105



SC-DL-8137

Length: 1736 Ø: 40
Cone Ø: d1 Ø 30 / d2 Ø 27
301639, 311847, 395350, 1358675, 1378435, 1397866, 1734020, 2028998, 12202900A



SC-DL-8179

Length: 568 Ø: 46
Hole Distance: 115 / 115
1399180, 1428347



SC-DL-8182

1343262, 1869413



SC-DL-8399

Length: 433 Ø: 40
Cone Ø: d1 Ø 30 / d2 Ø 26
1394884, 1938387



SC-DL-8179

Length: 568 Ø: 46
Hole Distance: 115 / 115
1399180, 1428347



SC-DL-8509

Length: 568,5 Ø: 46
Hole Distance: 115 / 115
1485758, 1486757



SC-DL-8511

Length: 616,5 Ø: 50
Hole Distance: 115 / 115
1485760, 1499478, 1722750



SC-DL-8531

Length: 522 Ø: 46
Hole Distance: 115 / 115
1486758



SC-DL-8547

Length: 568 Ø: 50
Hole Distance: 115 / 115
1499474, 1722746, 1906940



SC-DL-8553

Length: 435 Ø: 38
Cone Ø: d1 Ø 30 / d2 Ø 27
1343283, 1759691



SC-DL-8623

Length: 592 Ø: 50
Hole Distance: 115 / 115
1388436, 1499476, 1722748, 1906942



SC-DL-9462

Length: 568,5 Ø: 50
Hole Distance: 115 / 115
1499475, 1500573, 1722747, 1906941



SC-DL-9466

Length: 568 Ø: 19
1486756



SC-DL-9467

Length: 568,5 Ø: 50
Hole Distance: 115 / 115
1500572



SC-DL-10225

Length: 2179 Ø: 62
Cone Ø: d1 Ø 30 / d2 Ø 27
1386618, 1788522



SC-DL-10302

Length: 752 Ø: 48
Hole Distance: 115 / 115
1101843, 1379423, 1393298, 1431470, 1942075



SC-DL-12342

Length: 601 Ø: 42
Cone Ø: d1 Ø 26 / d2 Ø 23,5
1343262, 1869413



SC-DL-12343

Length: 1062 Ø: 52
Cone Ø: d1 Ø 30 / d2 Ø 27
1348269, 2007275



SC-DL-12449

Length: 1206 Ø: 38
Cone Ø: d1 Ø 30 / d2 Ø 27
1385763, 1765375



SC-ES-7279

Length: 150
Cone Ø: d1 Ø 30 / d2 Ø 27
Thread: M30 x 1,5 RHT
1357674, 1603883, 1738379



SC-RK-12366

Ø: 75 Hole Distance: 115 / 115
Thick/Height: 24
1 722 753, 2 096 392



SC-TC-12361

Length: 705 Ø: 42
Cone Ø: d1 Ø 38
Hole Distance: 115
1353445, 1464611, 1942147



SC-TC-12451

Length: 552 Ø: 46
Hole Distance: 115 / 115
1494296



SC-TC-12452

Length: 580,5 Ø: 46
Hole Distance: 115 / 115
1485759



SC-TC-12472

Length: 580 Ø: 46
Hole Distance: 115 / 115
1399182





4 - series ...

124 L/440 ...	01/01→	Tie Rod End	IV-ES-12272		for Steering Rod	
	01/01→	Tie Rod End	SC-ES-7279		for Steering Rod	
	01/01→	Track Control Arm	SC-DL-10302	SC-DL-10302	Trailing Arm, Air Suspension Axle	
	01/01→	Track Control Arm	SC-TC-12361		Control Arm, 1st Front Axle, for Pneumatic Suspension vehicles	
124 L/470	01/00→	Centre Rod	SC-DL-5229		Push Rod	
	01/00→	Centre Rod	SC-DL-5354		Push Rod	
	01/00→	Centre Rod	SC-DL-8182		Push Rod	
	01/00→	Centre Rod	SC-DL-8399		Push Rod, for vehicles with Hinged Leading Axle	
	01/00→	Centre Rod	SC-DL-8553	SC-DL-8553	Push Rod, for vehicles with Hinged Leading Axle	
	01/00→	Centre Rod	SC-DL-10225		for Steering Rod	
	01/00→	Centre Rod	SC-DL-10225		Push Rod	
	01/00→	Centre Rod	SC-DL-12342		for Steering Rod	
	01/00→	Centre Rod	SC-DL-12343		for Steering Rod	
	01/00→	Centre Rod	SC-DL-12449		Push Rod	
	01/00→	Suspension Arm Repair Kit		SC-RK-12366	for Control Arm	
	01/00→	Suspension Arm Repair Kit	MN-RK-7280	MN-RK-7280	for Drag Link;for Semi-Trailing Arm; for Wishbone (CV)	
	01/00→	Suspension Strut Repair Kit		DF-RK-9341		
	01/00→	Tie Rod		SC-DL-7264	Steering Axle	
	01/00→	Tie Rod		SC-DL-8137	Steering Axle	
	01/00→	Tie Rod	SC-DL-7264			
	01/00→	Tie Rod	SC-DL-8137			
	01/00→	Tie Rod End	CV-ES-14162		for Steering Rod	
	01/00→	Tie Rod End	CV-ES-14162	CV-ES-14162	for Steering Rod	
	01/00→	Tie Rod End	CV-ES-14163		for Steering Rod	
	01/00→	Track Control Arm	SC-DL-10302	SC-DL-10302	Trailing Arm, Air Suspension Axle	
	01/01→	Centre Rod	SC-DL-2161		Coupling Rod	
	01/01→	Suspension Arm Repair Kit		MN-RK-7280	for Drag Link;for Semi-Trailing Arm; for Wishbone (CV)	
	01/01→	Suspension Strut Repair Kit		CV-RK-5311		
	01/01→	Suspension Strut Repair Kit		MN-RK-8501		
	01/01→	Suspension Strut Repair Kit	MN-RK-12436	MN-RK-12436		
	01/01→	Tie Rod End		MN-ES-8490	for vehicles with Hinged Trailing Axle	
	01/01→	Tie Rod End	IV-ES-12272		for Steering Rod	
	01/01→	Tie Rod End	SC-ES-7279		for Steering Rod	
	01/01→	Track Control Arm	SC-TC-12361		Control Arm, 1st Front Axle, for Pneumatic Suspension vehicles	
	144 C/460	09/96→	Centre Rod	SC-DL-2161		Coupling Rod
		09/96→	Centre Rod	SC-DL-5229		Push Rod
		09/96→	Centre Rod	SC-DL-5354		Push Rod
09/96→		Centre Rod	SC-DL-12343		for Steering Rod	
09/96→		Suspension Arm Repair Kit		SC-RK-12366	for Control Arm	
09/96→		Suspension Strut Repair Kit		CV-RK-5311		
09/96→		Suspension Strut Repair Kit		MN-RK-8501		
09/96→		Suspension Strut Repair Kit	MN-RK-12436	MN-RK-12436		
09/96→		Tie Rod		SC-DL-7264	Steering Axle	
09/96→		Tie Rod		SC-DL-8137	Steering Axle	
09/96→		Tie Rod	SC-DL-7264			
09/96→		Tie Rod	SC-DL-8137			
09/96→		Tie Rod End		MN-ES-8490	for vehicles with Hinged Trailing Axle	
09/96→		Tie Rod End	CV-ES-14162		for Steering Rod	
09/96→		Tie Rod End	CV-ES-14163		for Steering Rod	
09/96→		Tie Rod End	SC-ES-7279		for Steering Rod	
09/96→		Track Control Arm		SC-DL-8179	Trailing Arm, Leaf Spring Axle	
09/96→		Track Control Arm		SC-DL-8179	Trailing Arm, Leaf Spring Axle, → * 1280184 SSS **; 4471602 SNL *; * 9069959 SAN **; 3533626 SLA *	
09/96→		Track Control Arm		SC-DL-8400	Trailing Arm	
09/96→		Track Control Arm		SC-DL-8511	Trailing Arm, Leaf Spring Axle	
09/96→		Track Control Arm		SC-DL-8547	Trailing Arm, Leaf Spring Axle	
09/96→		Track Control Arm		SC-DL-8623	Trailing Arm, 1st Drive Axle, for Leaf-Spring Suspension vehicles, →1280184/4471602	

CV-ES-14162

Length: 125
Cone Ø: d1 Ø 30 / d2 Ø 27
Thread: M30 x 1,5 LHT
283783, 395009, 1358792, 1738380, 1 914 426, 2051165



CV-ES-14163

Length: 125
Cone Ø: d1 Ø 30 / d2 Ø 27
Thread: M30 x 1,5 RHT
283784, 395010, 1358793, 1488890, 1738381, 1767328, 1914427, 2051166



CV-RK-5311

0638862, 638862, 0639287, 639287, 1104335, 1953248, 81432206006, 81432206107



DF-RK-9341

Ø: 67
550807, 5508072



IV-ES-12272

Length: 75
Cone Ø: d1 Ø 30 / d2 Ø 27
Thread: M26 x 1,5 RHT
1394443



MN-ES-8490

Length: 90
Cone Ø: d1 Ø 30 / d2 Ø 27
Thread: M26 x 1,5 RHT
1394444, 0014606948, 14606948



MN-RK-7280

Ø: 75 Hole Distance: 115
Thick/Height: 24
0550806, 550806, 0639370, 639370, 689748, 1104334



MN-RK-8501

Ø: 75 Hole Distance: 115
Thick/Height: 24
1515981



MN-RK-12436

Ø: 75 Hole Distance: 115
Thick/Height: 24
550799, 1517403, 1783020



SC-DL-2161

Length: 1740 Ø: 50
Cone Ø: d1 Ø 30 / d2 Ø 27
1369411, 1385251, 1409918, 1501030, 1723865, 1723895, 1737683, 1897335, 2113903, 2125090, 2161883



SC-DL-5229

Length: 1053 Ø: 50
Cone Ø: d1 Ø 30 / d2 Ø 27
1356055, 1379071, 1384025, 1768898, 1847311, 1912757, 12201600A



SC-DL-5354

Length: 1060 Ø: 52
Cone Ø: d1 Ø 30 / d2 Ø 27
1384027, 1769597, 1847312, 1912758, 12200800A



SC-DL-7264

Length: 1743 Ø: 62
Cone Ø: d1 Ø 30 / d2 Ø 27
1361413, 1395614, 1734019, 1897333, 2040254, 2146105



SC-DL-8137

Length: 1736 Ø: 40
Cone Ø: d1 Ø 30 / d2 Ø 27
301639, 311847, 395350, 1358675, 1378435, 1397866, 1734020, 2028998, 12202900A



SC-DL-8179

Length: 568 Ø: 46
Hole Distance: 115 / 115
1399180, 1428347



SC-DL-8182

1343262, 1869413



SC-DL-8399

Length: 433 Ø: 40
Cone Ø: d1 Ø 30 / d2 Ø 26
1394884, 1938387



SC-DL-8179

Length: 568 Ø: 46
Hole Distance: 115 / 115
1399180, 1428347



SC-DL-8511

Length: 616,5 Ø: 50
Hole Distance: 115 / 115
1485760, 1499478, 1722750



SC-DL-8547

Length: 568 Ø: 50
Hole Distance: 115 / 115
1499474, 1722746, 1906940



SC-DL-8553

Length: 435 Ø: 38
Cone Ø: d1 Ø 30 / d2 Ø 27
1343283, 1759691



SC-DL-8623

Length: 592 Ø: 50
Hole Distance: 115 / 115
1388436, 1499476, 1722748, 1906942



SC-DL-10225

Length: 2179 Ø: 62
Cone Ø: d1 Ø 30 / d2 Ø 27
1386618, 1788522



SC-DL-10302

Length: 752 Ø: 48
Hole Distance: 115 / 115
1101843, 1379423, 1393298, 1431470, 1942075



SC-DL-12342

Length: 601 Ø: 42
Cone Ø: d1 Ø 26 / d2 Ø 23,5
1343262, 1869413



SC-DL-12343

Length: 1062 Ø: 52
Cone Ø: d1 Ø 30 / d2 Ø 27
1348269, 2007275



SC-DL-12449

Length: 1206 Ø: 38
Cone Ø: d1 Ø 30 / d2 Ø 27
1385763, 1765375



SC-ES-7279

Length: 150
Cone Ø: d1 Ø 30 / d2 Ø 27
Thread: M30 x 1,5 RHT
1357674, 1603883, 1738379



SC-RK-12366

Ø: 75 Hole Distance: 115 / 115
Thick/Height: 24
1 722 753, 2 096 392



SC-TC-12361

Length: 705 Ø: 42
Cone Ø: d1 Ø 38
Hole Distance: 115
1353445, 1464611, 1942147





4 - series ...

144 C/460 ...	09/96 →	Track Control Arm		SC-DL-8623	Trailing Arm, 1st Drive Axle, for Leaf-Spring Suspension vehicles, →9069959/3533626
	09/96 →	Track Control Arm		SC-DL-9462	Trailing Arm, 2nd Drive Axle, for Leaf-Spring Suspension vehicles, →1280184/4471602
	09/96 →	Track Control Arm		SC-DL-9462	Trailing Arm, 2nd Drive Axle, for Leaf-Spring Suspension vehicles, →1280185/4471603_>
	09/96 →	Track Control Arm		SC-DL-9462	Trailing Arm, 2nd Drive Axle, for Leaf-Spring Suspension vehicles, →9069959/3533626
	09/96 →	Track Control Arm		SC-DL-9462	Trailing Arm, 2nd Drive Axle, for Leaf-Spring Suspension vehicles, 9069960/3533627 →
	09/96 →	Track Control Arm		SC-DL-9466	Trailing Arm, Leaf Spring Axle
	09/96 →	Track Control Arm		SC-DL-9467	Trailing Arm, Leaf Spring Axle, →* 1247518 SSS **; 4406943 SNL *; * 9039629 SAN **; 3507979 SLA *
	09/96 →	Track Control Arm		SC-DL-9467	Trailing Arm, Leaf Spring Axle, →* 1280184 SSS **; 4471602 SNL *; * 9069959 SAN **; 3533626 SLA *
	09/96 →	Track Control Arm		SC-TC-12451	Trailing Arm, 1st Drive Axle, for Leaf-Spring Suspension vehicles
	09/96 →	Track Control Arm		SC-TC-12452	Trailing Arm, 1st RA;2nd RA, for Leaf-Spring Suspension vehicles
	09/96 →	Track Control Arm	SC-DL-8509	SC-DL-8509	Trailing Arm, Leaf Spring Axle
	09/96 →	Track Control Arm	SC-DL-8531	SC-DL-8531	Trailing Arm, Leaf Spring Axle
	09/96 →	Track Control Arm	SC-DL-10302	SC-DL-10302	Trailing Arm, Air Suspension Axle
144 C/530	09/96 →	Centre Rod	SC-DL-2161		Coupling Rod
	09/96 →	Centre Rod	SC-DL-5229		Push Rod
	09/96 →	Centre Rod	SC-DL-5354		Push Rod
	09/96 →	Centre Rod	SC-DL-12343		for Steering Rod
	09/96 →	Suspension Arm Repair Kit		SC-RK-12366	for Control Arm
	09/96 →	Suspension Strut Repair Kit		CV-RK-5311	
	09/96 →	Suspension Strut Repair Kit		MN-RK-8501	
	09/96 →	Suspension Strut Repair Kit	MN-RK-12436	MN-RK-12436	
	09/96 →	Tie Rod		SC-DL-7264	Steering Axle
	09/96 →	Tie Rod		SC-DL-8137	Steering Axle
	09/96 →	Tie Rod	SC-DL-7264		
	09/96 →	Tie Rod	SC-DL-8137		
	09/96 →	Tie Rod End		MN-ES-8490	for vehicles with Hinged Trailing Axle
	09/96 →	Tie Rod End	CV-ES-14162		for Steering Rod
	09/96 →	Tie Rod End	CV-ES-14163		for Steering Rod
	09/96 →	Tie Rod End	SC-ES-7279		for Steering Rod
	09/96 →	Track Control Arm		SC-DL-8179	Trailing Arm, Leaf Spring Axle
	09/96 →	Track Control Arm		SC-DL-8179	Trailing Arm, Leaf Spring Axle, →* 1280184 SSS **; 4471602 SNL *; * 9069959 SAN **; 3533626 SLA *
	09/96 →	Track Control Arm		SC-DL-8400	Trailing Arm
	09/96 →	Track Control Arm		SC-DL-8511	Trailing Arm, Leaf Spring Axle
	09/96 →	Track Control Arm		SC-DL-8547	Trailing Arm, Leaf Spring Axle
	09/96 →	Track Control Arm		SC-DL-8623	Trailing Arm, 1st Drive Axle, for Leaf-Spring Suspension vehicles, →1280184/4471602
	09/96 →	Track Control Arm		SC-DL-8623	Trailing Arm, 1st Drive Axle, for Leaf-Spring Suspension vehicles, →9069959/3533626
	09/96 →	Track Control Arm		SC-DL-9462	Trailing Arm, 2nd Drive Axle, for Leaf-Spring Suspension vehicles, →1280184/4471602
	09/96 →	Track Control Arm		SC-DL-9462	Trailing Arm, 2nd Drive Axle, for Leaf-Spring Suspension vehicles, →1280185/4471603_>
	09/96 →	Track Control Arm		SC-DL-9462	Trailing Arm, 2nd Drive Axle, for Leaf-Spring Suspension vehicles, →9069959/3533626
	09/96 →	Track Control Arm		SC-DL-9462	Trailing Arm, 2nd Drive Axle, for Leaf-Spring Suspension vehicles, 9069960/3533627 →
	09/96 →	Track Control Arm		SC-DL-9466	Trailing Arm, Leaf Spring Axle
	09/96 →	Track Control Arm		SC-DL-9467	Trailing Arm, Leaf Spring Axle, →* 1247518 SSS **; 4406943 SNL *; * 9039629 SAN **; 3507979 SLA *

CV-ES-14162

Length: 125
Cone Ø: d1 Ø 30 / d2 Ø 27
Thread: M30 x 1,5 LHT
283783, 395009, 1358792, 1738380, 1 914 426, 2051165



CV-ES-14163

Length: 125
Cone Ø: d1 Ø 30 / d2 Ø 27
Thread: M30 x 1,5 RHT
283784, 395010, 1358793, 1488890, 1738381, 1767328, 1914427, 2051166



CV-RK-5311

0638862, 638862, 0639287, 639287, 1104335, 1953248, 81432206006, 81432206107



MN-ES-8490

Length: 90
Cone Ø: d1 Ø 30 / d2 Ø 27
Thread: M26 x 1,5 RHT
1394444, 0014606948, 14606948



MN-RK-8501

Ø: 75 Hole Distance: 115
Thick/Height: 24
1515981



MN-RK-12436

Ø: 75 Hole Distance: 115
Thick/Height: 24
550799, 1517403, 1783020



SC-DL-2161

Length: 1740 Ø: 50
Cone Ø: d1 Ø 30 / d2 Ø 27
1369411, 1385251, 1409918, 1501030, 1723865, 1723895, 1737683, 1897335, 2113903, 2125090, 2161883



SC-DL-5229

Length: 1053 Ø: 50
Cone Ø: d1 Ø 30 / d2 Ø 27
1356055, 1379071, 1384025, 1768898, 1847311, 1912757, 12201600A



SC-DL-5354

Length: 1060 Ø: 52
Cone Ø: d1 Ø 30 / d2 Ø 27
1384027, 1769597, 1847312, 1912758, 12200800A



SC-DL-7264

Length: 1743 Ø: 62
Cone Ø: d1 Ø 30 / d2 Ø 27
1361413, 1395614, 1734019, 1897333, 2040254, 2146105



SC-DL-8137

Length: 1736 Ø: 40
Cone Ø: d1 Ø 30 / d2 Ø 27
301639, 311847, 395350, 1358675, 1378435, 1397866, 1734020, 2028998, 12202900A



SC-DL-8179

Length: 568 Ø: 46
Hole Distance: 115 / 115
1399180, 1428347



SC-DL-8179

Length: 568 Ø: 46
Hole Distance: 115 / 115
1399180, 1428347



SC-DL-8509

Length: 568,5 Ø: 46
Hole Distance: 115 / 115
1485758, 1486757



SC-DL-8511

Length: 616,5 Ø: 50
Hole Distance: 115 / 115
1485760, 1499478, 1722750



SC-DL-8531

Length: 522 Ø: 46
Hole Distance: 115 / 115
1486758



SC-DL-8547

Length: 568 Ø: 50
Hole Distance: 115 / 115
1499474, 1722746, 1906940



SC-DL-8623

Length: 592 Ø: 50
Hole Distance: 115 / 115
1388436, 1499476, 1722748, 1906942



SC-DL-9462

Length: 568,5 Ø: 50
Hole Distance: 115 / 115
1499475, 1500573, 1722747, 1906941



SC-DL-9466

Length: 568 Ø: 19
1486756



SC-DL-9467

Length: 568,5 Ø: 50
Hole Distance: 115 / 115
1500572



SC-DL-10302

Length: 752 Ø: 48
Hole Distance: 115 / 115
1101843, 1379423, 1393298, 1431470, 1942075



SC-DL-12343

Length: 1062 Ø: 52
Cone Ø: d1 Ø 30 / d2 Ø 27
1348269, 2007275



SC-ES-7279

Length: 150
Cone Ø: d1 Ø 30 / d2 Ø 27
Thread: M30 x 1,5 RHT
1357674, 1603883, 1738379



SC-RK-12366

Ø: 75 Hole Distance: 115 / 115
Thick/Height: 24
1 722 753, 2 096 392



SC-TC-12451

Length: 552 Ø: 46
Hole Distance: 115 / 115
1494296



SC-TC-12452

Length: 580,5 Ø: 46
Hole Distance: 115 / 115
1485759



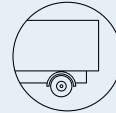

4 - series ...

144 C/530 ...	09/96 →	Track Control Arm		SC-DL-9467	Trailing Arm, Leaf Spring Axle, → * 1280184 SSS *; * 4471602 SNL *; * 9069959 SAN *; * 3533626 SLA *
	09/96 →	Track Control Arm		SC-TC-12451	Trailing Arm, 1st Drive Axle, for Leaf-Spring Suspension vehicles
	09/96 →	Track Control Arm		SC-TC-12452	Trailing Arm, 1st RA; 2nd RA, for Leaf-Spring Suspension vehicles
	09/96 →	Track Control Arm	SC-DL-8509	SC-DL-8509	Trailing Arm, Leaf Spring Axle
	09/96 →	Track Control Arm	SC-DL-8531	SC-DL-8531	Trailing Arm, Leaf Spring Axle
	09/96 →	Track Control Arm	SC-DL-10302	SC-DL-10302	Trailing Arm, Air Suspension Axle
144 G/460	04/96 →	Centre Rod	SC-DL-2161		Coupling Rod
	04/96 →	Centre Rod	SC-DL-5229		Push Rod
	04/96 →	Centre Rod	SC-DL-5354		Push Rod
	04/96 →	Centre Rod	SC-DL-8154		Push Rod
	04/96 →	Centre Rod	SC-DL-8182		Push Rod
	04/96 →	Centre Rod	SC-DL-8399		Push Rod
	04/96 →	Centre Rod	SC-DL-8553	SC-DL-8553	Push Rod, for vehicles with Hinged Leading Axle
	04/96 →	Centre Rod	SC-DL-12342		for Steering Rod
	04/96 →	Centre Rod	SC-DL-12343		for Steering Rod
	04/96 →	Centre Rod	SC-DL-12449		Push Rod
	04/96 →	Suspension Arm Repair Kit		MN-RK-7280	for Drag Link; for Semi-Trailing Arm; for Wishbone (CV)
	04/96 →	Suspension Arm Repair Kit		SC-RK-12366	for Control Arm
	04/96 →	Suspension Strut Repair Kit		CV-RK-5311	
	04/96 →	Suspension Strut Repair Kit		MN-RK-8501	
	04/96 →	Suspension Strut Repair Kit	MN-RK-12436	MN-RK-12436	
	04/96 →	Tie Rod		SC-DL-7264	Steering Axle
	04/96 →	Tie Rod		SC-DL-8137	Steering Axle
	04/96 →	Tie Rod	SC-DL-7264		
	04/96 →	Tie Rod	SC-DL-7264		1st FA; 2nd FA
	04/96 →	Tie Rod	SC-DL-8137		
	04/96 →	Tie Rod	SC-DL-8137		1st FA; 2nd FA
	04/96 →	Tie Rod End		MN-ES-8490	for vehicles with Hinged Trailing Axle
	04/96 →	Tie Rod End	CV-ES-14162		for Steering Rod
	04/96 →	Tie Rod End	CV-ES-14162	CV-ES-14162	for Steering Rod
	04/96 →	Tie Rod End	CV-ES-14163		for Steering Rod
	04/96 →	Tie Rod End	IV-ES-12272		for Steering Rod
	04/96 →	Tie Rod End	MN-ES-8490	MN-ES-8490	for vehicles with Hinged Trailing Axle
	04/96 →	Tie Rod End	SC-ES-7279		for Steering Rod
	04/96 →	Track Control Arm		SC-DL-8179	Trailing Arm, Leaf Spring Axle
	04/96 →	Track Control Arm		SC-DL-8179	Trailing Arm, Leaf Spring Axle, → * 1280184 SSS *; * 4471602 SNL *; * 9069959 SAN *; * 3533626 SLA *
	04/96 →	Track Control Arm		SC-DL-8400	Trailing Arm
	04/96 →	Track Control Arm		SC-DL-8511	Trailing Arm, Leaf Spring Axle
	04/96 →	Track Control Arm		SC-DL-8547	Trailing Arm, Leaf Spring Axle
	04/96 →	Track Control Arm		SC-DL-8623	Trailing Arm, 1st Drive Axle, for Leaf-Spring Suspension vehicles, →1280184/4471602
	04/96 →	Track Control Arm		SC-DL-8623	Trailing Arm, 1st Drive Axle, for Leaf-Spring Suspension vehicles, →9069959/3533626
	04/96 →	Track Control Arm		SC-DL-9462	Trailing Arm, 2nd Drive Axle, for Leaf-Spring Suspension vehicles, →1280184/4471602
04/96 →	Track Control Arm		SC-DL-9462	Trailing Arm, 2nd Drive Axle, for Leaf-Spring Suspension vehicles, →1280185/4471603 >	
04/96 →	Track Control Arm		SC-DL-9462	Trailing Arm, 2nd Drive Axle, for Leaf-Spring Suspension vehicles, →9069959/3533626	
04/96 →	Track Control Arm		SC-DL-9462	Trailing Arm, 2nd Drive Axle, for Leaf-Spring Suspension vehicles, 9069960/3533627 →	
04/96 →	Track Control Arm		SC-DL-9466	Trailing Arm, Leaf Spring Axle	
04/96 →	Track Control Arm		SC-DL-9467	Trailing Arm, Leaf Spring Axle, →* 1247518 SSS *; * 4406943 SNL *; * 9039629 SAN *; * 3507979 SLA *	

CV-ES-14162

Length: 125
Cone Ø: d1 Ø 30 / d2 Ø 27
Thread: M30 x 1,5 LHT
283783, 395009, 1358792, 1738380, 1 914 426, 2051165



CV-ES-14163

Length: 125
Cone Ø: d1 Ø 30 / d2 Ø 27
Thread: M30 x 1,5 RHT
283784, 395010, 1358793, 1488890, 1738381, 1767328, 1914427, 2051166



CV-RK-5311

638862, 0638862, 0639287, 639287, 1104335, 1953248, 81432206006, 81432206107



IV-ES-12272

Length: 75
Cone Ø: d1 Ø 30 / d2 Ø 27
Thread: M26 x 1,5 RHT
1394443



MN-ES-8490

Length: 90
Cone Ø: d1 Ø 30 / d2 Ø 27
Thread: M26 x 1,5 RHT
1394444, 0014606948, 14606948



MN-RK-7280

Ø: 75 Hole Distance: 115
Thick/Height: 24
0550806, 550806, 0639370, 639370, 689748, 1104334



MN-RK-8501

Ø: 75 Hole Distance: 115
Thick/Height: 24
1515981



MN-RK-12436

Ø: 75 Hole Distance: 115
Thick/Height: 24
550799, 1517403, 1783020



SC-DL-2161

Length: 1740 Ø: 50
Cone Ø: d1 Ø 30 / d2 Ø 27
1369411, 1385251, 1409918, 1501030, 1723865, 1723895, 1737683, 1897335, 2113903, 2125090, 2161883



SC-DL-5229

Length: 1053 Ø: 50
Cone Ø: d1 Ø 30 / d2 Ø 27
1356055, 1379071, 1384025, 1768898, 1847311, 1912757, 12201600A



SC-DL-5354

Length: 1060 Ø: 52
Cone Ø: d1 Ø 30 / d2 Ø 27
1384027, 1769597, 1847312, 1912758, 12200800A



SC-DL-7264

Length: 1743 Ø: 62
Cone Ø: d1 Ø 30 / d2 Ø 27
1361413, 1395614, 1734019, 1897333, 2040254, 2146105



SC-DL-8137

Length: 1736 Ø: 40
Cone Ø: d1 Ø 30 / d2 Ø 27
301639, 311847, 395350, 1358675, 1378435, 1397866, 1734020, 2028998, 12202900A



SC-DL-8154

Length: 495 Ø: 40
Cone Ø: d1 Ø 30 / d2 Ø 27
1343266, 1759690



SC-DL-8179

Length: 568 Ø: 46
Hole Distance: 115 / 115
1399180, 1428347



SC-DL-8182

1343262, 1869413



SC-DL-8399

Length: 433 Ø: 40
Cone Ø: d1 Ø 30 / d2 Ø 26
1394884, 1938387



SC-DL-8179

Length: 568 Ø: 46
Hole Distance: 115 / 115
1399180, 1428347



SC-DL-8509

Length: 568,5 Ø: 46
Hole Distance: 115 / 115
1485758, 1486757



SC-DL-8511

Length: 616,5 Ø: 50
Hole Distance: 115 / 115
1485760, 1499478, 1722750



SC-DL-8531

Length: 522 Ø: 46
Hole Distance: 115 / 115
1486758



SC-DL-8547

Length: 568 Ø: 50
Hole Distance: 115 / 115
1499474, 1722746, 1906940



SC-DL-8553

Length: 435 Ø: 38
Cone Ø: d1 Ø 30 / d2 Ø 27
1343283, 1759691



SC-DL-8623

Length: 592 Ø: 50
Hole Distance: 115 / 115
1388436, 1499476, 1722748, 1906942



SC-DL-9462

Length: 568,5 Ø: 50
Hole Distance: 115 / 115
1499475, 1500573, 1722747, 1906941



SC-DL-9466

Length: 568 Ø: 19
1486756



SC-DL-9467

Length: 568,5 Ø: 50
Hole Distance: 115 / 115
1500572



SC-DL-10302

Length: 752 Ø: 48
Hole Distance: 115 / 115
1101843, 1379423, 1393298, 1431470, 1942075



SC-DL-12342

Length: 601 Ø: 42
Cone Ø: d1 Ø 26 / d2 Ø 23,5
1343262, 1869413



SC-DL-12343

Length: 1062 Ø: 52
Cone Ø: d1 Ø 30 / d2 Ø 27
1348269, 2007275



SC-DL-12449

Length: 1206 Ø: 38
Cone Ø: d1 Ø 30 / d2 Ø 27
1385763, 1765375



SC-ES-7279

Length: 150
Cone Ø: d1 Ø 30 / d2 Ø 27
Thread: M30 x 1,5 RHT
1357674, 1603883, 1738379



SC-RK-12366

Ø: 75 Hole Distance: 115 / 115
Thick/Height: 24
1 722 753, 2 096 392



SC-TC-12451

Length: 552 Ø: 46
Hole Distance: 115 / 115
1494296



SC-TC-12452

Length: 580,5 Ø: 46
Hole Distance: 115 / 115
1485759





4 - series ...

144 G/460 ...	04/96 →	Track Control Arm		SC-DL-9467	Trailing Arm, Leaf Spring Axle, → * 1280184 SSS *; * 4471602 SNL *; * 9069959 SAN *; * 3533626 SLA *
	04/96 →	Track Control Arm		SC-TC-12451	Trailing Arm, 1st Drive Axle, for Leaf-Spring Suspension vehicles
	04/96 →	Track Control Arm		SC-TC-12452	Trailing Arm, 1st RA;2nd RA, for Leaf-Spring Suspension vehicles
	04/96 →	Track Control Arm	SC-DL-8179	SC-DL-8179	Trailing Arm, Leaf Spring Axle, → * 1280184 SSS *; * 4471602 SNL *; * 9069959 SAN *; * 3533626 SLA *
	04/96 →	Track Control Arm	SC-DL-8509	SC-DL-8509	Trailing Arm, Leaf Spring Axle
	04/96 →	Track Control Arm	SC-DL-8531	SC-DL-8531	Trailing Arm, Leaf Spring Axle
	04/96 →	Track Control Arm	SC-DL-10302	SC-DL-10302	Trailing Arm, 1st FA;Air Suspension Axle
	04/96 →	Track Control Arm	SC-DL-10302	SC-DL-10302	Trailing Arm, Air Suspension Axle
	04/96 →	Track Control Arm	SC-TC-12361		Control Arm, 1st Front Axle, for Pneumatic Suspension vehicles
	144 G/530	04/96 →	Centre Rod	SC-DL-2161	
04/96 →		Centre Rod	SC-DL-5229		Push Rod
04/96 →		Centre Rod	SC-DL-5354		Push Rod
04/96 →		Centre Rod	SC-DL-8154		Push Rod
04/96 →		Centre Rod	SC-DL-8182		Push Rod
04/96 →		Centre Rod	SC-DL-8399		Push Rod
04/96 →		Centre Rod	SC-DL-8553	SC-DL-8553	Push Rod, for vehicles with Hinged Leading Axle
04/96 →		Centre Rod	SC-DL-12342		for Steering Rod
04/96 →		Centre Rod	SC-DL-12343		for Steering Rod
04/96 →		Centre Rod	SC-DL-12449		Push Rod
04/96 →		Suspension Arm Repair Kit		MN-RK-7280	for Drag Link;for Semi-Trailing Arm; for Wishbone (CV)
04/96 →		Suspension Arm Repair Kit		SC-RK-12366	for Control Arm
04/96 →		Suspension Strut Repair Kit		CV-RK-5311	
04/96 →		Suspension Strut Repair Kit		MN-RK-8501	
04/96 →		Suspension Strut Repair Kit	MN-RK-12436	MN-RK-12436	
04/96 →		Tie Rod		SC-DL-7264	Steering Axle
04/96 →		Tie Rod		SC-DL-8137	Steering Axle
04/96 →		Tie Rod	SC-DL-7264		
04/96 →		Tie Rod	SC-DL-7264		1st FA;2nd FA
04/96 →		Tie Rod	SC-DL-8137		
04/96 →		Tie Rod	SC-DL-8137		1st FA;2nd FA
04/96 →		Tie Rod End		MN-ES-8490	for vehicles with Hinged Trailing Axle
04/96 →		Tie Rod End	CV-ES-14162		for Steering Rod
04/96 →		Tie Rod End	CV-ES-14162	CV-ES-14162	for Steering Rod
04/96 →		Tie Rod End	CV-ES-14163		for Steering Rod
04/96 →		Tie Rod End	IV-ES-12272		for Steering Rod
04/96 →		Tie Rod End	MN-ES-8490	MN-ES-8490	for vehicles with Hinged Trailing Axle
04/96 →		Tie Rod End	SC-ES-7279		for Steering Rod
04/96 →		Track Control Arm		SC-DL-8179	Trailing Arm, Leaf Spring Axle
04/96 →		Track Control Arm		SC-DL-8179	Trailing Arm, Leaf Spring Axle, → * 1280184 SSS *; * 4471602 SNL *; * 9069959 SAN *; * 3533626 SLA *
04/96 →		Track Control Arm		SC-DL-8400	Trailing Arm
04/96 →		Track Control Arm		SC-DL-8511	Trailing Arm, Leaf Spring Axle
04/96 →		Track Control Arm		SC-DL-8547	Trailing Arm, Leaf Spring Axle
04/96 →		Track Control Arm		SC-DL-8623	Trailing Arm, 1st Drive Axle, for Leaf-Spring Suspension vehicles, →1280184/4471602
04/96 →		Track Control Arm		SC-DL-8623	Trailing Arm, 1st Drive Axle, for Leaf-Spring Suspension vehicles, →9069959/3533626
04/96 →		Track Control Arm		SC-DL-9462	Trailing Arm, 2nd Drive Axle, for Leaf-Spring Suspension vehicles, →1280184/4471602
04/96 →		Track Control Arm		SC-DL-9462	Trailing Arm, 2nd Drive Axle, for Leaf-Spring Suspension vehicles, →1280185/4471603 >
04/96 →		Track Control Arm		SC-DL-9462	Trailing Arm, 2nd Drive Axle, for Leaf-Spring Suspension vehicles, →9069959/3533626

CV-ES-14162

Length: 125
Cone Ø: d1 Ø 30 / d2 Ø 27
Thread: M30 x 1,5 LHT
283784, 395009, 1358792, 1738380, 1 914 426, 2051165



CV-ES-14163

Length: 125
Cone Ø: d1 Ø 30 / d2 Ø 27
Thread: M30 x 1,5 RHT
283784, 395010, 1358793, 1488890, 1738381, 1767328, 1914427, 2051166



CV-RK-5311

0638862, 638862, 0639287, 639287, 1104335, 1953248, 81432206006, 81432206107



IV-ES-12272

Length: 75
Cone Ø: d1 Ø 30 / d2 Ø 27
Thread: M26 x 1,5 RHT
1394443



MN-ES-8490

Length: 90
Cone Ø: d1 Ø 30 / d2 Ø 27
Thread: M26 x 1,5 RHT
1394444, 0014606948, 14606948



MN-RK-7280

Ø: 75 Hole Distance: 115
Thick/Height: 24
0550806, 550806, 0639370, 639370, 689748, 1104334



MN-RK-8501

Ø: 75 Hole Distance: 115
Thick/Height: 24
1515981



MN-RK-12436

Ø: 75 Hole Distance: 115
Thick/Height: 24
550799, 1517403, 1783020



SC-DL-2161

Length: 1740 Ø: 50
Cone Ø: d1 Ø 30 / d2 Ø 27
1369411, 1385251, 1409918, 1501030, 1723865, 1723895, 1737683, 1897335, 2113903, 2125090, 2161883



SC-DL-5229

Length: 1053 Ø: 50
Cone Ø: d1 Ø 30 / d2 Ø 27
1356055, 1379071, 1384025, 1768898, 1847311, 1912757, 12201600A



SC-DL-5354

Length: 1060 Ø: 52
Cone Ø: d1 Ø 30 / d2 Ø 27
1384027, 1769597, 1847312, 1912758, 12200800A



SC-DL-7264

Length: 1743 Ø: 62
Cone Ø: d1 Ø 30 / d2 Ø 27
1361413, 1395614, 1734019, 1897333, 2040254, 2146105



SC-DL-8137

Length: 1736 Ø: 40
Cone Ø: d1 Ø 30 / d2 Ø 27
301639, 311847, 395350, 1358675, 1378435, 1397866, 1734020, 2028998, 12202900A



SC-DL-8154

Length: 495 Ø: 40
Cone Ø: d1 Ø 30 / d2 Ø 27
1343266, 1759690



SC-DL-8179

Length: 568 Ø: 46
Hole Distance: 115 / 115
1399180, 1428347



SC-DL-8182

Length: 568 Ø: 46
Hole Distance: 115 / 115
1343262, 1869413



SC-DL-8399

Length: 433 Ø: 40
Cone Ø: d1 Ø 30 / d2 Ø 26
1394884, 1938387



SC-DL-8179

Length: 568 Ø: 46
Hole Distance: 115 / 115
1399180, 1428347



SC-DL-8509

Length: 568,5 Ø: 46
Hole Distance: 115 / 115
1485758, 1486757



SC-DL-8511

Length: 616,5 Ø: 50
Hole Distance: 115 / 115
1485760, 1499478, 1722750



SC-DL-8531

Length: 522 Ø: 46
Hole Distance: 115 / 115
1486758



SC-DL-8547

Length: 568 Ø: 50
Hole Distance: 115 / 115
1499474, 1722746, 1906940



SC-DL-8553

Length: 435 Ø: 38
Cone Ø: d1 Ø 30 / d2 Ø 27
1343283, 1759691



SC-DL-8623

Length: 592 Ø: 50
Hole Distance: 115 / 115
1388436, 1499476, 1722748, 1906942



SC-DL-9462

Length: 568,5 Ø: 50
Hole Distance: 115 / 115
1499475, 1500573, 1722747, 1906941



SC-DL-9467

Length: 568,5 Ø: 50
Hole Distance: 115 / 115
1500572



SC-DL-10302

Length: 752 Ø: 48
Hole Distance: 115 / 115
1101843, 1379423, 1393298, 1431470, 1942075



SC-DL-12342

Length: 601 Ø: 42
Cone Ø: d1 Ø 26 / d2 Ø 23,5
1343262, 1869413



SC-DL-12343

Length: 1062 Ø: 52
Cone Ø: d1 Ø 30 / d2 Ø 27
1348269, 2007275



SC-DL-12449

Length: 1206 Ø: 38
Cone Ø: d1 Ø 30 / d2 Ø 27
1385763, 1765375



SC-ES-7279

Length: 150
Cone Ø: d1 Ø 30 / d2 Ø 27
Thread: M30 x 1,5 RHT
1357674, 1603883, 1738379



SC-RK-12366

Ø: 75 Hole Distance: 115 / 115
Thick/Height: 24
1 722 753, 2 096 392



SC-TC-12361

Length: 705 Ø: 42
Cone Ø: d1 Ø 38
Hole Distance: 115
1353445, 1464611, 1942147



SC-TC-12451

Length: 552 Ø: 46
Hole Distance: 115 / 115
1494296



SC-TC-12452

Length: 580,5 Ø: 46
Hole Distance: 115 / 115
1485759





4 - series ...

144 G/530 ...	04/96 →	Track Control Arm		SC-DL-9462	Trailing Arm, 2nd Drive Axle, for Leaf-Spring Suspension vehicles, 9069960/3533627 →
	04/96 →	Track Control Arm		SC-DL-9466	Trailing Arm, Leaf Spring Axle
	04/96 →	Track Control Arm		SC-DL-9467	Trailing Arm, Leaf Spring Axle, →* 1247518 SSS *; * 4406943 SNL *; * 9039629 SAN *; * 3507979 SLA *
	04/96 →	Track Control Arm		SC-DL-9467	Trailing Arm, Leaf Spring Axle, → * 1280184 SSS *; * 4471602 SNL *; * 9069959 SAN *; * 3533626 SLA *
	04/96 →	Track Control Arm		SC-TC-12451	Trailing Arm, 1st Drive Axle, for Leaf-Spring Suspension vehicles
	04/96 →	Track Control Arm		SC-TC-12452	Trailing Arm, 1st RA; 2nd RA, for Leaf-Spring Suspension vehicles
	04/96 →	Track Control Arm	SC-DL-8179	SC-DL-8179	Trailing Arm, Leaf Spring Axle, → * 1280184 SSS *; * 4471602 SNL *; * 9069959 SAN *; * 3533626 SLA *
	04/96 →	Track Control Arm	SC-DL-8509	SC-DL-8509	Trailing Arm, Leaf Spring Axle
	04/96 →	Track Control Arm	SC-DL-8531	SC-DL-8531	Trailing Arm, Leaf Spring Axle
	04/96 →	Track Control Arm	SC-DL-10302	SC-DL-10302	Trailing Arm, 1st FA; Air Suspension Axle
	04/96 →	Track Control Arm	SC-DL-10302	SC-DL-10302	Trailing Arm, Air Suspension Axle
	04/96 →	Track Control Arm	SC-TC-12361		Control Arm, 1st Front Axle, for Pneumatic Suspension vehicles
	144 L/460	11/95 →	Centre Rod	SC-DL-2161	
11/95 →		Centre Rod	SC-DL-5229		Push Rod
11/95 →		Centre Rod	SC-DL-5354		Push Rod
11/95 →		Centre Rod	SC-DL-8182		Push Rod
11/95 →		Centre Rod	SC-DL-8399		Push Rod, for vehicles with Hinged Leading Axle
11/95 →		Centre Rod	SC-DL-8553	SC-DL-8553	Push Rod, for vehicles with Hinged Leading Axle
11/95 →		Centre Rod	SC-DL-12342		for Steering Rod
11/95 →		Centre Rod	SC-DL-12343		for Steering Rod
11/95 →		Centre Rod	SC-DL-12449		Push Rod
11/95 →		Suspension Arm Repair Kit		MN-RK-7280	for Drag Link; for Semi-Trailing Arm; for Wishbone (CV)
11/95 →		Suspension Arm Repair Kit		SC-RK-12366	for Control Arm
11/95 →		Suspension Arm Repair Kit	MN-RK-7280	MN-RK-7280	for Drag Link; for Semi-Trailing Arm; for Wishbone (CV)
11/95 →		Suspension Strut Repair Kit		CV-RK-5311	
11/95 →		Suspension Strut Repair Kit		DF-RK-9341	
11/95 →		Suspension Strut Repair Kit		MN-RK-8501	
11/95 →		Suspension Strut Repair Kit	MN-RK-12436	MN-RK-12436	
11/95 →		Tie Rod		SC-DL-7264	Steering Axle
11/95 →		Tie Rod		SC-DL-8137	Steering Axle
11/95 →		Tie Rod	SC-DL-7264		
11/95 →		Tie Rod	SC-DL-8137		
11/95 →		Tie Rod End		MN-ES-8490	for vehicles with Hinged Trailing Axle
11/95 →		Tie Rod End	CV-ES-14162		for Steering Rod
11/95 →		Tie Rod End	CV-ES-14163		for Steering Rod
11/95 →		Tie Rod End	IV-ES-12272		for Steering Rod
11/95 →		Tie Rod End	SC-ES-7279		for Steering Rod
11/95 →		Tie Rod End	SC-ES-7279	SC-ES-7279	for Steering Rod
11/95 →		Track Control Arm		SC-DL-8179	Trailing Arm, Leaf Spring Axle
11/95 →		Track Control Arm		SC-DL-8400	Trailing Arm
11/95 →		Track Control Arm		SC-DL-8511	Trailing Arm, Leaf Spring Axle
11/95 →		Track Control Arm		SC-DL-8547	Trailing Arm, Leaf Spring Axle
11/95 →		Track Control Arm		SC-DL-8623	Trailing Arm, 1st Drive Axle, for Leaf-Spring Suspension vehicles, →1280184/4471602
11/95 →		Track Control Arm		SC-DL-8623	Trailing Arm, 1st Drive Axle, for Leaf-Spring Suspension vehicles, →9069959/3533626
11/95 →		Track Control Arm		SC-DL-9462	Trailing Arm, 2nd Drive Axle, for Leaf-Spring Suspension vehicles, →1280184/4471602
11/95 →		Track Control Arm		SC-DL-9462	Trailing Arm, 2nd Drive Axle, for Leaf-Spring Suspension vehicles, →1280185/4471603_>

CV-ES-14162

Length: 125
Cone Ø: d1 Ø 30 / d2 Ø 27
Thread: M30 x 1,5 LHT
283783, 395009, 1358792, 1738380, 1 914 426, 2051165



CV-ES-14163

Length: 125
Cone Ø: d1 Ø 30 / d2 Ø 27
Thread: M30 x 1,5 RHT
283784, 395010, 1358793, 1488890, 1738381, 1767328, 1914427, 2051166



CV-RK-5311

0638862, 638862, 0639287, 639287, 1104335, 1953248, 81432206006, 81432206107



DF-RK-9341

Ø: 67
550807, 5508072



IV-ES-12272

Length: 75
Cone Ø: d1 Ø 30 / d2 Ø 27
Thread: M26 x 1,5 RHT
1394443



MN-ES-8490

Length: 90
Cone Ø: d1 Ø 30 / d2 Ø 27
Thread: M26 x 1,5 RHT
1394444, 0014606948, 14606948



MN-RK-7280

Ø: 75 Hole Distance: 115
Thick/Height: 24
0550806, 550806, 0639370, 639370, 689748, 1104334



MN-RK-8501

Ø: 75 Hole Distance: 115
Thick/Height: 24
1515981



MN-RK-12436

Ø: 75 Hole Distance: 115
Thick/Height: 24
550799, 1517403, 1783020



SC-DL-2161

Length: 1740 Ø: 50
Cone Ø: d1 Ø 30 / d2 Ø 27
1369411, 1385251, 1409918, 1501030, 1723865, 1723895, 1737683, 1897335, 2113903, 2125090, 2161883



SC-DL-5229

Length: 1053 Ø: 50
Cone Ø: d1 Ø 30 / d2 Ø 27
1356055, 1379071, 1384025, 1768898, 1847311, 1912757, 12201600A



SC-DL-5354

Length: 1060 Ø: 52
Cone Ø: d1 Ø 30 / d2 Ø 27
1384027, 1769597, 1847312, 1912758, 12200800A



SC-DL-7264

Length: 1743 Ø: 62
Cone Ø: d1 Ø 30 / d2 Ø 27
1361413, 1395614, 1734019, 1897333, 2040254, 2146105



SC-DL-8137

Length: 1736 Ø: 40
Cone Ø: d1 Ø 30 / d2 Ø 27
301639, 311847, 395350, 1358675, 1378435, 1397866, 1734020, 2028998, 12202900A



SC-DL-8179

Length: 568 Ø: 46
Hole Distance: 115 / 115
1399180, 1428347



SC-DL-8182

1343262, 1869413



SC-DL-8399

Length: 433 Ø: 40
Cone Ø: d1 Ø 30 / d2 Ø 26
1394884, 1938387



SC-DL-8179

Length: 568 Ø: 46
Hole Distance: 115 / 115
1399180, 1428347



SC-DL-8509

Length: 568,5 Ø: 46
Hole Distance: 115 / 115
1485758, 1486757



SC-DL-8511

Length: 616,5 Ø: 50
Hole Distance: 115 / 115
1485760, 1499478, 1722750



SC-DL-8531

Length: 522 Ø: 46
Hole Distance: 115 / 115
1486758



SC-DL-8547

Length: 568 Ø: 50
Hole Distance: 115 / 115
1499474, 1722746, 1906940



SC-DL-8553

Length: 435 Ø: 38
Cone Ø: d1 Ø 30 / d2 Ø 27
1343283, 1759691



SC-DL-8623

Length: 592 Ø: 50
Hole Distance: 115 / 115
1388436, 1499476, 1722748, 1906942



SC-DL-9462

Length: 568,5 Ø: 50
Hole Distance: 115 / 115
1499475, 1500573, 1722747, 1906941



SC-DL-9466

Length: 568 Ø: 19
1486756



SC-DL-9467

Length: 568,5 Ø: 50
Hole Distance: 115 / 115
1500572



SC-DL-10302

Length: 752 Ø: 48
Hole Distance: 115 / 115
1101843, 1379423, 1393298, 1431470, 1942075



SC-DL-12342

Length: 601 Ø: 42
Cone Ø: d1 Ø 26 / d2 Ø 23,5
1343262, 1869413



SC-DL-12343

Length: 1062 Ø: 52
Cone Ø: d1 Ø 30 / d2 Ø 27
1348269, 2007275



SC-DL-12449

Length: 1206 Ø: 38
Cone Ø: d1 Ø 30 / d2 Ø 27
1385763, 1765375



SC-ES-7279

Length: 150
Cone Ø: d1 Ø 30 / d2 Ø 27
Thread: M30 x 1,5 RHT
1357674, 1603883, 1738379



SC-RK-12366

Ø: 75 Hole Distance: 115 / 115
Thick/Height: 24
1 722 753, 2 096 392



SC-TC-12361

Length: 705 Ø: 42
Cone Ø: d1 Ø 38
Hole Distance: 115
1353445, 1464611, 1942147



SC-TC-12451

Length: 552 Ø: 46
Hole Distance: 115 / 115
1494296



SC-TC-12452

Length: 580,5 Ø: 46
Hole Distance: 115 / 115
1485759





4 - series ...

144 L/460 ...	11/95→	Track Control Arm		SC-DL-9462	Trailing Arm, 2nd Drive Axle, for Leaf-Spring Suspension vehicles, →9069959/3533626
	11/95→	Track Control Arm		SC-DL-9462	Trailing Arm, 2nd Drive Axle, for Leaf-Spring Suspension vehicles, 9069960/3533627→
	11/95→	Track Control Arm		SC-DL-9466	Trailing Arm, Leaf Spring Axle
	11/95→	Track Control Arm		SC-DL-9467	Trailing Arm, Leaf Spring Axle, →* 1247518 SSS ** 4406943 SNL *; * 9039629 SAN *; * 3507979 SLA *
	11/95→	Track Control Arm		SC-DL-9467	Trailing Arm, Leaf Spring Axle, → * 1280184 SSS **; * 4471602 SNL *; * 9069959 SAN **; * 3533626 SLA *
	11/95→	Track Control Arm		SC-TC-12451	Trailing Arm, 1st Drive Axle, for Leaf-Spring Suspension vehicles
	11/95→	Track Control Arm		SC-TC-12452	Trailing Arm, 1st RA;2nd RA, for Leaf-Spring Suspension vehicles
	11/95→	Track Control Arm	SC-DL-8179	SC-DL-8179	Trailing Arm, Leaf Spring Axle, → * 1280184 SSS **; * 4471602 SNL *; * 9069959 SAN **; * 3533626 SLA *
	11/95→	Track Control Arm	SC-DL-8509	SC-DL-8509	Trailing Arm, Leaf Spring Axle
	11/95→	Track Control Arm	SC-DL-8531	SC-DL-8531	Trailing Arm, Leaf Spring Axle
	11/95→	Track Control Arm	SC-DL-10302	SC-DL-10302	Trailing Arm, Air Suspension Axle
	11/95→	Track Control Arm	SC-TC-12361		Control Arm, 1st Front Axle, for Pneumatic Suspension vehicles
	144 L/530	11/95→	Centre Rod	SC-DL-2161	
11/95→		Centre Rod	SC-DL-5229		Push Rod
11/95→		Centre Rod	SC-DL-5354		Push Rod
11/95→		Centre Rod	SC-DL-8182		Push Rod
11/95→		Centre Rod	SC-DL-8399		Push Rod, for vehicles with Hinged Leading Axle
11/95→		Centre Rod	SC-DL-8553	SC-DL-8553	Push Rod, for vehicles with Hinged Leading Axle
11/95→		Centre Rod	SC-DL-12342		for Steering Rod
11/95→		Centre Rod	SC-DL-12343		for Steering Rod
11/95→		Centre Rod	SC-DL-12449		Push Rod
11/95→		Suspension Arm Repair Kit		MN-RK-7280	for Drag Link;for Semi-Trailing Arm; for Wishbone (CV)
11/95→		Suspension Arm Repair Kit		SC-RK-12366	for Control Arm
11/95→		Suspension Strut Repair Kit		CV-RK-5311	
11/95→		Suspension Strut Repair Kit		MN-RK-8501	
11/95→		Suspension Strut Repair Kit	MN-RK-12436	MN-RK-12436	
11/95→		Tie Rod		SC-DL-7264	Steering Axle
11/95→		Tie Rod		SC-DL-8137	Steering Axle
11/95→		Tie Rod	SC-DL-7264		
11/95→		Tie Rod	SC-DL-8137		
11/95→		Tie Rod End		MN-ES-8490	for vehicles with Hinged Trailing Axle
11/95→		Tie Rod End	CV-ES-14162		for Steering Rod
11/95→		Tie Rod End	CV-ES-14163		for Steering Rod
11/95→		Tie Rod End	IV-ES-12272		for Steering Rod
11/95→		Tie Rod End	SC-ES-7279		for Steering Rod
11/95→		Tie Rod End	SC-ES-7279	SC-ES-7279	for Steering Rod
11/95→		Track Control Arm		SC-DL-8179	Trailing Arm, Leaf Spring Axle
11/95→		Track Control Arm		SC-DL-8400	Trailing Arm
11/95→		Track Control Arm		SC-DL-8511	Trailing Arm, Leaf Spring Axle
11/95→		Track Control Arm		SC-DL-8547	Trailing Arm, Leaf Spring Axle
11/95→		Track Control Arm		SC-DL-8623	Trailing Arm, 1st Drive Axle, for Leaf-Spring Suspension vehicles, →1280184/4471602
11/95→		Track Control Arm		SC-DL-8623	Trailing Arm, 1st Drive Axle, for Leaf-Spring Suspension vehicles, →9069959/3533626
11/95→		Track Control Arm		SC-DL-9462	Trailing Arm, 2nd Drive Axle, for Leaf-Spring Suspension vehicles, →1280184/4471602
11/95→		Track Control Arm		SC-DL-9462	Trailing Arm, 2nd Drive Axle, for Leaf-Spring Suspension vehicles, →1280185/4471603 >
11/95→		Track Control Arm		SC-DL-9462	Trailing Arm, 2nd Drive Axle, for Leaf-Spring Suspension vehicles, →9069959/3533626

CV-ES-14162

Length: 125
Cone Ø: d1 Ø 30 / d2 Ø 27
Thread: M30 x 1,5 LHT
283783, 395009, 1358792, 1738380, 1 914 426, 2051165



CV-ES-14163

Length: 125
Cone Ø: d1 Ø 30 / d2 Ø 27
Thread: M30 x 1,5 RHT
283784, 395010, 1358793, 1488890, 1738381, 1767328, 1914427, 2051166



CV-RK-5311

638862, 0638862, 0639287, 639287, 1104335, 1953248, 81432206006, 81432206107



IV-ES-12272

Length: 75
Cone Ø: d1 Ø 30 / d2 Ø 27
Thread: M26 x 1,5 RHT
1394443



MN-ES-8490

Length: 90
Cone Ø: d1 Ø 30 / d2 Ø 27
Thread: M26 x 1,5 RHT
1394444, 0014606948, 14606948



MN-RK-7280

Ø: 75 Hole Distance: 115
Thick/Height: 24
550806, 0550806, 639370, 0639370, 689748, 1104334



MN-RK-8501

Ø: 75 Hole Distance: 115
Thick/Height: 24
1515981



MN-RK-12436

Ø: 75 Hole Distance: 115
Thick/Height: 24
550799, 1517403, 1783020



SC-DL-2161

Length: 1740 Ø: 50
Cone Ø: d1 Ø 30 / d2 Ø 27
1369411, 1385251, 1409918, 1501030, 1723865, 1723895, 1737683, 1897335, 2113903, 2125090, 2161883



SC-DL-5229

Length: 1053 Ø: 50
Cone Ø: d1 Ø 30 / d2 Ø 27
1356055, 1379071, 1384025, 1768898, 1847311, 1912757, 12201600A



SC-DL-5354

Length: 1060 Ø: 52
Cone Ø: d1 Ø 30 / d2 Ø 27
1384027, 1769597, 1847312, 1912758, 12200800A



SC-DL-7264

Length: 1743 Ø: 62
Cone Ø: d1 Ø 30 / d2 Ø 27
1361413, 1395614, 1734019, 1897333, 2040254, 2146105



SC-DL-8137

Length: 1736 Ø: 40
Cone Ø: d1 Ø 30 / d2 Ø 27
301639, 311847, 395350, 1358675, 1378435, 1397866, 1734020, 2028998, 12202900A



SC-DL-8179

Length: 568 Ø: 46
Hole Distance: 115 / 115
1399180, 1428347



SC-DL-8182

1343262, 1869413



SC-DL-8399

Length: 433 Ø: 40
Cone Ø: d1 Ø 30 / d2 Ø 26
1394884, 1938387



SC-DL-8179

Length: 568 Ø: 46
Hole Distance: 115 / 115
1399180, 1428347



SC-DL-8509

Length: 568,5 Ø: 46
Hole Distance: 115 / 115
1485758, 1486757



SC-DL-8511

Length: 616,5 Ø: 50
Hole Distance: 115 / 115
1485760, 1499478, 1722750



SC-DL-8531

Length: 522 Ø: 46
Hole Distance: 115 / 115
1486758



SC-DL-8547

Length: 568 Ø: 50
Hole Distance: 115 / 115
1499474, 1722746, 1906940



SC-DL-8553

Length: 435 Ø: 38
Cone Ø: d1 Ø 30 / d2 Ø 27
1343283, 1759691



SC-DL-8623

Length: 592 Ø: 50
Hole Distance: 115 / 115
1388436, 1499476, 1722748, 1906942



SC-DL-9462

Length: 568,5 Ø: 50
Hole Distance: 115 / 115
1499475, 1500573, 1722747, 1906941



SC-DL-9466

Length: 568 Ø: 19
1486756



SC-DL-9467

Length: 568,5 Ø: 50
Hole Distance: 115 / 115
1500572



SC-DL-10302

Length: 752 Ø: 48
Hole Distance: 115 / 115
1101843, 1379423, 1393298, 1431470, 1942075



SC-DL-12342

Length: 601 Ø: 42
Cone Ø: d1 Ø 26 / d2 Ø 23,5
1343262, 1869413



SC-DL-12343

Length: 1062 Ø: 52
Cone Ø: d1 Ø 30 / d2 Ø 27
1348269, 2007275



SC-DL-12449

Length: 1206 Ø: 38
Cone Ø: d1 Ø 30 / d2 Ø 27
1385763, 1765375



SC-ES-7279

Length: 150
Cone Ø: d1 Ø 30 / d2 Ø 27
Thread: M30 x 1,5 RHT
1357674, 1603883, 1738379



SC-RK-12366

Ø: 75 Hole Distance: 115 / 115
Thick/Height: 24
1 722 753, 2 096 392



SC-TC-12361

Length: 705 Ø: 42
Cone Ø: d1 Ø 38
Hole Distance: 115
1353445, 1464611, 1942147



SC-TC-12451

Length: 552 Ø: 46
Hole Distance: 115 / 115
1494296



SC-TC-12452

Length: 580,5 Ø: 46
Hole Distance: 115 / 115
1485759



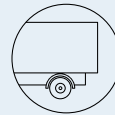

4 - series ...

144 L/530 ...	11/95→	Track Control Arm		SC-DL-9462	Trailing Arm, 2nd Drive Axle, for Leaf-Spring Suspension vehicles, 9069960/3533627→	
	11/95→	Track Control Arm		SC-DL-9466	Trailing Arm, Leaf Spring Axle	
	11/95→	Track Control Arm		SC-DL-9467	Trailing Arm, Leaf Spring Axle, →* 1247518 SSS *;* 4406943 SNL *; * 9039629 SAN *;* 3507979 SLA *	
	11/95→	Track Control Arm		SC-DL-9467	Trailing Arm, Leaf Spring Axle, → * 1280184 SSS *;* 4471602 SNL *; * 9069959 SAN *;* 3533626 SLA *	
	11/95→	Track Control Arm		SC-TC-12451	Trailing Arm, 1st Drive Axle, for Leaf-Spring Suspension vehicles	
	11/95→	Track Control Arm		SC-TC-12452	Trailing Arm, 1st RA;2nd RA, for Leaf-Spring Suspension vehicles	
	11/95→	Track Control Arm	SC-DL-8179	SC-DL-8179	Trailing Arm, Leaf Spring Axle, → * 1280184 SSS *;* 4471602 SNL *; * 9069959 SAN *;* 3533626 SLA *	
	11/95→	Track Control Arm	SC-DL-8509	SC-DL-8509	Trailing Arm, Leaf Spring Axle	
	11/95→	Track Control Arm	SC-DL-8531	SC-DL-8531	Trailing Arm, Leaf Spring Axle	
	11/95→	Track Control Arm	SC-DL-10302	SC-DL-10302	Trailing Arm, Air Suspension Axle	
	11/95→	Track Control Arm	SC-TC-12361		Control Arm, 1st Front Axle, for Pneumatic Suspension vehicles	
	164 C/480	05/00→	Centre Rod	SC-DL-2161		Coupling Rod
		05/00→	Centre Rod	SC-DL-5229		Push Rod
05/00→		Centre Rod	SC-DL-5354		Push Rod	
05/00→		Centre Rod	SC-DL-12343		for Steering Rod	
05/00→		Suspension Arm Repair Kit		SC-RK-12366	for Control Arm	
05/00→		Suspension Strut Repair Kit		CV-RK-5311		
05/00→		Suspension Strut Repair Kit		MN-RK-8501		
05/00→		Suspension Strut Repair Kit	MN-RK-12436	MN-RK-12436		
05/00→		Tie Rod		SC-DL-7264	Steering Axle	
05/00→		Tie Rod		SC-DL-8137	Steering Axle	
05/00→		Tie Rod	SC-DL-7264			
05/00→		Tie Rod	SC-DL-8137			
05/00→		Tie Rod End		MN-ES-8490	for vehicles with Hinged Trailing Axle	
05/00→		Tie Rod End	CV-ES-14162		for Steering Rod	
05/00→		Tie Rod End	CV-ES-14163		for Steering Rod	
05/00→		Tie Rod End	SC-ES-7279		for Steering Rod	
05/00→		Track Control Arm		SC-DL-8179	Trailing Arm, Leaf Spring Axle	
05/00→		Track Control Arm		SC-DL-8400	Trailing Arm	
05/00→		Track Control Arm		SC-DL-8511	Trailing Arm, Leaf Spring Axle	
05/00→		Track Control Arm		SC-DL-8547	Trailing Arm, Leaf Spring Axle	
05/00→		Track Control Arm		SC-DL-8623	Trailing Arm, 1st Drive Axle, for Leaf-Spring Suspension vehicles, →1280184/4471602	
05/00→		Track Control Arm		SC-DL-8623	Trailing Arm, 1st Drive Axle, for Leaf-Spring Suspension vehicles, →9069959/3533626	
05/00→		Track Control Arm		SC-DL-9462	Trailing Arm, 2nd Drive Axle, for Leaf-Spring Suspension vehicles, →1280184/4471602	
05/00→		Track Control Arm		SC-DL-9462	Trailing Arm, 2nd Drive Axle, for Leaf-Spring Suspension vehicles, →1280185/4471603 >	
05/00→		Track Control Arm		SC-DL-9462	Trailing Arm, 2nd Drive Axle, for Leaf-Spring Suspension vehicles, →9069959/3533626	
05/00→		Track Control Arm		SC-DL-9462	Trailing Arm, 2nd Drive Axle, for Leaf-Spring Suspension vehicles, 9069960/3533627→	
05/00→		Track Control Arm		SC-DL-9466	Trailing Arm, Leaf Spring Axle	
05/00→		Track Control Arm		SC-DL-9467	Trailing Arm, Leaf Spring Axle, →* 1247518 SSS *;* 4406943 SNL *; * 9039629 SAN *;* 3507979 SLA *	
05/00→		Track Control Arm		SC-DL-9467	Trailing Arm, Leaf Spring Axle, → * 1280184 SSS *;* 4471602 SNL *; * 9069959 SAN *;* 3533626 SLA *	
05/00→		Track Control Arm		SC-TC-12451	Trailing Arm, 1st Drive Axle, for Leaf-Spring Suspension vehicles	

CV-ES-14162

Length: 125
Cone Ø: d1 Ø 30 / d2 Ø 27
Thread: M30 x 1,5 LHT
283784, 395009, 1358792, 1738380, 1 914 426, 2051165



CV-ES-14163

Length: 125
Cone Ø: d1 Ø 30 / d2 Ø 27
Thread: M30 x 1,5 RHT
283784, 395010, 1358793, 1488890, 1738381, 1767328, 1914427, 2051166



CV-RK-5311

0638862, 638862, 0639287, 639287, 1104335, 1953248, 81432206006, 81432206107



MN-ES-8490

Length: 90
Cone Ø: d1 Ø 30 / d2 Ø 27
Thread: M26 x 1,5 RHT
1394444, 14606948, 0014606948



MN-RK-8501

Ø: 75 Hole Distance: 115
Thick/Height: 24
1515981



MN-RK-12436

Ø: 75 Hole Distance: 115
Thick/Height: 24
550799, 1517403, 1783020



SC-DL-2161

Length: 1740 Ø: 50
Cone Ø: d1 Ø 30 / d2 Ø 27
1369411, 1385251, 1409918, 1501030, 1723865, 1723895, 1737683, 1897335, 2113903, 2125090, 2161883



SC-DL-5229

Length: 1053 Ø: 50
Cone Ø: d1 Ø 30 / d2 Ø 27
1356055, 1379071, 1384025, 1768898, 1847311, 1912757, 12201600A



SC-DL-5354

Length: 1060 Ø: 52
Cone Ø: d1 Ø 30 / d2 Ø 27
1384027, 1769597, 1847312, 1912758, 12200800A



SC-DL-7264

Length: 1743 Ø: 62
Cone Ø: d1 Ø 30 / d2 Ø 27
1361413, 1395614, 1734019, 1897333, 2040254, 2146105



SC-DL-8137

Length: 1736 Ø: 40
Cone Ø: d1 Ø 30 / d2 Ø 27
301639, 311847, 395350, 1358675, 1378435, 1397866, 1734020, 2028998, 12202900A



SC-DL-8179

Length: 568 Ø: 46
Hole Distance: 115 / 115
1399180, 1428347



SC-DL-8179

Length: 568 Ø: 46
Hole Distance: 115 / 115
1399180, 1428347



SC-DL-8509

Length: 568,5 Ø: 46
Hole Distance: 115 / 115
1485758, 1486757



SC-DL-8511

Length: 616,5 Ø: 50
Hole Distance: 115 / 115
1485760, 1499478, 1722750



SC-DL-8531

Length: 522 Ø: 46
Hole Distance: 115 / 115
1486758



SC-DL-8547

Length: 568 Ø: 50
Hole Distance: 115 / 115
1499474, 1722746, 1906940



SC-DL-8623

Length: 592 Ø: 50
Hole Distance: 115 / 115
1388436, 1499476, 1722748, 1906942



SC-DL-9462

Length: 568,5 Ø: 50
Hole Distance: 115 / 115
1499475, 1500573, 1722747, 1906941



SC-DL-9466

Length: 568 Ø: 19
1486756



SC-DL-9467

Length: 568,5 Ø: 50
Hole Distance: 115 / 115
1500572



SC-DL-10302

Length: 752 Ø: 48
Hole Distance: 115 / 115
1101843, 1379423, 1393298, 1431470, 1942075



SC-DL-12343

Length: 1062 Ø: 52
Cone Ø: d1 Ø 30 / d2 Ø 27
1348269, 2007275



SC-ES-7279

Length: 150
Cone Ø: d1 Ø 30 / d2 Ø 27
Thread: M30 x 1,5 RHT
1357674, 1603883, 1738379



SC-RK-12366

Ø: 75 Hole Distance: 115 / 115
Thick/Height: 24
1 722 753, 2 096 392



SC-TC-12361

Length: 705 Ø: 42
Cone Ø: d1 Ø 38
Hole Distance: 115
1353445, 1464611, 1942147



SC-TC-12451

Length: 552 Ø: 46
Hole Distance: 115 / 115
1494296



SC-TC-12452

Length: 580,5 Ø: 46
Hole Distance: 115 / 115
1485759



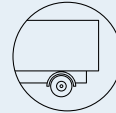
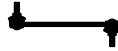

4 - series ...

164 C/480 ...	05/00→	Track Control Arm		SC-TC-12452	Trailing Arm, 1st RA;2nd RA, for Leaf-Spring Suspension vehicles
	05/00→	Track Control Arm	SC-DL-8179	SC-DL-8179	Trailing Arm, Leaf Spring Axle, → * 1280184 SSS **; 4471602 SNL *; * 9069959 SAN **; 3533626 SLA *
	05/00→	Track Control Arm	SC-DL-8509	SC-DL-8509	Trailing Arm, Leaf Spring Axle
	05/00→	Track Control Arm	SC-DL-8531	SC-DL-8531	Trailing Arm, Leaf Spring Axle
	05/00→	Track Control Arm	SC-DL-10302	SC-DL-10302	Trailing Arm, Air Suspension Axle
164 C/580	05/00→	Centre Rod	SC-DL-2161		Coupling Rod
	05/00→	Centre Rod	SC-DL-5229		Push Rod
	05/00→	Centre Rod	SC-DL-5354		Push Rod
	05/00→	Centre Rod	SC-DL-12343		for Steering Rod
	05/00→	Suspension Arm Repair Kit		SC-RK-12366	for Control Arm
	05/00→	Suspension Strut Repair Kit		CV-RK-5311	
	05/00→	Suspension Strut Repair Kit		MN-RK-8501	
	05/00→	Suspension Strut Repair Kit	MN-RK-12436	MN-RK-12436	
	05/00→	Tie Rod	SC-DL-7264		
	05/00→	Tie Rod	SC-DL-8137		
	05/00→	Tie Rod End	CV-ES-14162		for Steering Rod
	05/00→	Tie Rod End	CV-ES-14163		for Steering Rod
	05/00→	Tie Rod End	SC-ES-7279		for Steering Rod
	05/00→	Track Control Arm		SC-DL-8179	Trailing Arm, Leaf Spring Axle
	05/00→	Track Control Arm		SC-DL-8400	Trailing Arm
	05/00→	Track Control Arm		SC-DL-8511	Trailing Arm, Leaf Spring Axle
	05/00→	Track Control Arm		SC-DL-8547	Trailing Arm, Leaf Spring Axle
	05/00→	Track Control Arm		SC-DL-8623	Trailing Arm, 1st Drive Axle, for Leaf-Spring Suspension vehicles, →1280184/4471602
	05/00→	Track Control Arm		SC-DL-8623	Trailing Arm, 1st Drive Axle, for Leaf-Spring Suspension vehicles, →9069959/3533626
	05/00→	Track Control Arm		SC-DL-9462	Trailing Arm, 2nd Drive Axle, for Leaf-Spring Suspension vehicles, →1280184/4471602
	05/00→	Track Control Arm		SC-DL-9462	Trailing Arm, 2nd Drive Axle, for Leaf-Spring Suspension vehicles, →1280185/4471603_>
	05/00→	Track Control Arm		SC-DL-9462	Trailing Arm, 2nd Drive Axle, for Leaf-Spring Suspension vehicles, →9069959/3533626
	05/00→	Track Control Arm		SC-DL-9462	Trailing Arm, 2nd Drive Axle, for Leaf-Spring Suspension vehicles, 9069960/3533627→
	05/00→	Track Control Arm		SC-DL-9466	Trailing Arm, Leaf Spring Axle
	05/00→	Track Control Arm		SC-DL-9467	Trailing Arm, Leaf Spring Axle, →* 1247518 SSS **; 4406943 SNL *; * 9039629 SAN **; 3507979 SLA *
	05/00→	Track Control Arm		SC-DL-9467	Trailing Arm, Leaf Spring Axle, → * 1280184 SSS **; 4471602 SNL *; * 9069959 SAN **; 3533626 SLA *
	05/00→	Track Control Arm		SC-TC-12451	Trailing Arm, 1st Drive Axle, for Leaf-Spring Suspension vehicles
	05/00→	Track Control Arm		SC-TC-12452	Trailing Arm, 1st RA;2nd RA, for Leaf-Spring Suspension vehicles
	05/00→	Track Control Arm	SC-DL-8179	SC-DL-8179	Trailing Arm, Leaf Spring Axle, → * 1280184 SSS **; 4471602 SNL *; * 9069959 SAN **; 3533626 SLA *
	05/00→	Track Control Arm	SC-DL-8509	SC-DL-8509	Trailing Arm, Leaf Spring Axle
	05/00→	Track Control Arm	SC-DL-8531	SC-DL-8531	Trailing Arm, Leaf Spring Axle
	05/00→	Track Control Arm	SC-DL-10302	SC-DL-10302	Trailing Arm, Air Suspension Axle
	164 G/480	01/00→	Centre Rod	SC-DL-5229	
01/00→		Centre Rod	SC-DL-5354		Push Rod
01/00→		Suspension Arm Repair Kit		SC-RK-12366	for Control Arm
01/00→		Suspension Arm Repair Kit	MN-RK-7280	MN-RK-7280	for Drag Link;for Semi-Trailing Arm; for Wishbone (CV)
01/00→		Suspension Strut Repair Kit		DF-RK-9341	
01/00→		Suspension Strut Repair Kit		MN-RK-8501	
01/00→		Tie Rod	SC-DL-7264		
01/00→	Tie Rod	SC-DL-8137			

CV-ES-14162

Length: 125
Cone Ø: d1 Ø 30 / d2 Ø 27
Thread: M30 x 1,5 LHT
283783, 395009, 1358792, 1738380, 1 914 426, 2051165



CV-ES-14163

Length: 125
Cone Ø: d1 Ø 30 / d2 Ø 27
Thread: M30 x 1,5 RHT
283784, 395010, 1358793, 1488890, 1738381, 1767328, 1914427, 2051166



CV-RK-5311

0638862, 638862, 0639287, 639287, 1104335, 1953248, 81432206006, 81432206107



DF-RK-9341

Ø: 67
550807, 5508072



MN-RK-7280

Ø: 75 Hole Distance: 115
Thick/Height: 24
0550806, 550806, 0639370, 639370, 689748, 1104334



MN-RK-8501

Ø: 75 Hole Distance: 115
Thick/Height: 24
1515981



MN-RK-12436

Ø: 75 Hole Distance: 115
Thick/Height: 24
550799, 1517403, 1783020



SC-DL-2161

Length: 1740 Ø: 50
Cone Ø: d1 Ø 30 / d2 Ø 27
1369411, 1385251, 1409918, 1501030, 1723865, 1723895, 1737683, 1897335, 2113903, 2125090, 2161883



SC-DL-5229

Length: 1053 Ø: 50
Cone Ø: d1 Ø 30 / d2 Ø 27
1356055, 1379071, 1384025, 1768898, 1847311, 1912757, 12201600A



SC-DL-5354

Length: 1060 Ø: 52
Cone Ø: d1 Ø 30 / d2 Ø 27
1384027, 1769597, 1847312, 1912758, 12200800A



SC-DL-7264

Length: 1743 Ø: 62
Cone Ø: d1 Ø 30 / d2 Ø 27
1361413, 1395614, 1734019, 1897333, 2040254, 2146105



SC-DL-8137

Length: 1736 Ø: 40
Cone Ø: d1 Ø 30 / d2 Ø 27
301639, 311847, 395350, 1358675, 1378435, 1397866, 1734020, 2028998, 12202900A



SC-DL-8179

Length: 568 Ø: 46
Hole Distance: 115 / 115
1399180, 1428347



SC-DL-8179

Length: 568 Ø: 46
Hole Distance: 115 / 115
1399180, 1428347



SC-DL-8509

Length: 568,5 Ø: 46
Hole Distance: 115 / 115
1485758, 1486757



SC-DL-8511

Length: 616,5 Ø: 50
Hole Distance: 115 / 115
1485760, 1499478, 1722750



SC-DL-8531

Length: 522 Ø: 46
Hole Distance: 115 / 115
1486758



SC-DL-8547

Length: 568 Ø: 50
Hole Distance: 115 / 115
1499474, 1722746, 1906940



SC-DL-8623

Length: 592 Ø: 50
Hole Distance: 115 / 115
1388436, 1499476, 1722748, 1906942



SC-DL-9462

Length: 568,5 Ø: 50
Hole Distance: 115 / 115
1499475, 1500573, 1722747, 1906941



SC-DL-9466

Length: 568 Ø: 19
1486756



SC-DL-9467

Length: 568,5 Ø: 50
Hole Distance: 115 / 115
1500572



SC-DL-10302

Length: 752 Ø: 48
Hole Distance: 115 / 115
1101843, 1379423, 1393298, 1431470, 1942075



SC-DL-12343

Length: 1062 Ø: 52
Cone Ø: d1 Ø 30 / d2 Ø 27
1348269, 2007275



SC-ES-7279

Length: 150
Cone Ø: d1 Ø 30 / d2 Ø 27
Thread: M30 x 1,5 RHT
1357674, 1603883, 1738379



SC-RK-12366

Ø: 75 Hole Distance: 115 / 115
Thick/Height: 24
1 722 753, 2 096 392



SC-TC-12451

Length: 552 Ø: 46
Hole Distance: 115 / 115
1494296



SC-TC-12452

Length: 580,5 Ø: 46
Hole Distance: 115 / 115
1485759





4 - series ...

164 G/480 ...	01/00→	Tie Rod End	CV-ES-14162		for Steering Rod	
	01/00→	Tie Rod End	CV-ES-14163		for Steering Rod	
	01/00→	Tie Rod End	SC-ES-7279		for Steering Rod	
	01/00→	Track Control Arm		SC-DL-8179	Trailing Arm, Leaf Spring Axle	
	01/00→	Track Control Arm		SC-DL-8400	Trailing Arm	
	01/00→	Track Control Arm		SC-DL-8511	Trailing Arm, Leaf Spring Axle	
	01/00→	Track Control Arm		SC-DL-8547	Trailing Arm, Leaf Spring Axle	
	01/00→	Track Control Arm		SC-DL-8623	Trailing Arm, 1st Drive Axle, for Leaf-Spring Suspension vehicles, →1280184/4471602	
	01/00→	Track Control Arm		SC-DL-8623	Trailing Arm, 1st Drive Axle, for Leaf-Spring Suspension vehicles, →9069959/3533626	
	01/00→	Track Control Arm		SC-DL-9462	Trailing Arm, 2nd Drive Axle, for Leaf-Spring Suspension vehicles, →1280184/4471602	
	01/00→	Track Control Arm		SC-DL-9462	Trailing Arm, 2nd Drive Axle, for Leaf-Spring Suspension vehicles, →1280185/4471603_>	
	01/00→	Track Control Arm		SC-DL-9462	Trailing Arm, 2nd Drive Axle, for Leaf-Spring Suspension vehicles, →9069959/3533626	
	01/00→	Track Control Arm		SC-DL-9462	Trailing Arm, 2nd Drive Axle, for Leaf-Spring Suspension vehicles, 9069960/3533627→	
	01/00→	Track Control Arm		SC-DL-9466	Trailing Arm, Leaf Spring Axle	
	01/00→	Track Control Arm		SC-DL-9467	Trailing Arm, Leaf Spring Axle, →* 1247518 SSS *; * 4406943 SNL *; * 9039629 SAN *; * 3507979 SLA *	
	01/00→	Track Control Arm		SC-DL-9467	Trailing Arm, Leaf Spring Axle, →* 1280184 SSS *; * 4471602 SNL *; * 9069959 SAN *; * 3533626 SLA *	
	01/00→	Track Control Arm		SC-TC-12451	Trailing Arm, 1st Drive Axle, for Leaf-Spring Suspension vehicles	
	01/00→	Track Control Arm		SC-TC-12452	Trailing Arm, 1st RA;2nd RA, for Leaf-Spring Suspension vehicles	
	01/00→	Track Control Arm	SC-DL-8179	SC-DL-8179	Trailing Arm, Leaf Spring Axle, →* 1280184 SSS *; * 4471602 SNL *; * 9069959 SAN *; * 3533626 SLA *	
	01/00→	Track Control Arm	SC-DL-8509	SC-DL-8509	Trailing Arm, Leaf Spring Axle	
	01/00→	Track Control Arm	SC-DL-8531	SC-DL-8531	Trailing Arm, Leaf Spring Axle	
	01/00→	Track Control Arm	SC-DL-10302	SC-DL-10302	Trailing Arm, Air Suspension Axle	
	01/00→	Track Control Arm	SC-TC-12361		Control Arm, 1st Front Axle, for Pneumatic Suspension vehicles	
	05/00→	Centre Rod	SC-DL-2161		Coupling Rod	
	05/00→	Suspension Strut Repair Kit		CV-RK-5311		
	164 G/580	01/00→	Centre Rod	SC-DL-5229		Push Rod
		01/00→	Centre Rod	SC-DL-5354		Push Rod
		01/00→	Suspension Arm Repair Kit		SC-RK-12366	for Control Arm
		01/00→	Suspension Arm Repair Kit	MN-RK-7280	MN-RK-7280	for Drag Link;for Semi-Trailing Arm; for Wishbone (CV)
		01/00→	Suspension Strut Repair Kit		DF-RK-9341	
01/00→		Suspension Strut Repair Kit		MN-RK-8501		
01/00→		Tie Rod	SC-DL-7264			
01/00→		Tie Rod	SC-DL-8137			
01/00→		Tie Rod End	CV-ES-14162		for Steering Rod	
01/00→		Tie Rod End	CV-ES-14163		for Steering Rod	
01/00→		Tie Rod End	SC-ES-7279		for Steering Rod	
01/00→		Tie Rod End	SC-ES-8517		for Push Rod	
01/00→		Track Control Arm		SC-DL-8179	Trailing Arm, Leaf Spring Axle	
01/00→		Track Control Arm		SC-DL-8400	Trailing Arm	
01/00→		Track Control Arm		SC-DL-8511	Trailing Arm, Leaf Spring Axle	
01/00→		Track Control Arm		SC-DL-8547	Trailing Arm, Leaf Spring Axle	
01/00→		Track Control Arm		SC-DL-8623	Trailing Arm, 1st Drive Axle, for Leaf-Spring Suspension vehicles, →1280184/4471602	
01/00→		Track Control Arm		SC-DL-8623	Trailing Arm, 1st Drive Axle, for Leaf-Spring Suspension vehicles, →9069959/3533626	
01/00→		Track Control Arm		SC-DL-9462	Trailing Arm, 2nd Drive Axle, for Leaf-Spring Suspension vehicles, →1280184/4471602	

CV-ES-14162

Length: 125
Cone Ø: d1 Ø 30 / d2 Ø 27
Thread: M30 x 1,5 LHT
283783, 395009, 1358792, 1738380, 1 914 426, 2051165



CV-ES-14163

Length: 125
Cone Ø: d1 Ø 30 / d2 Ø 27
Thread: M30 x 1,5 RHT
283784, 395010, 1358793, 1488890, 1738381, 1767328, 1914427, 2051166



CV-RK-5311

0638862, 638862, 0639287, 639287, 1104335, 1953248, 81432206006, 81432206107



DF-RK-9341

Ø: 67
550807, 5508072



MN-RK-7280

Ø: 75 Hole Distance: 115
Thick/Height: 24
0550806, 550806, 0639370, 639370, 689748, 1104334



MN-RK-8501

Ø: 75 Hole Distance: 115
Thick/Height: 24
1515981



SC-DL-2161

Length: 1740 Ø: 50
Cone Ø: d1 Ø 30 / d2 Ø 27
1369411, 1385251, 1409918, 1501030, 1723865, 1723895, 1737683, 1897335, 2113903, 2125090, 2161883



SC-DL-5229

Length: 1053 Ø: 50
Cone Ø: d1 Ø 30 / d2 Ø 27
1356055, 1379071, 1384025, 1768898, 1847311, 1912757, 12201600A



SC-DL-5354

Length: 1060 Ø: 52
Cone Ø: d1 Ø 30 / d2 Ø 27
1384027, 1769597, 1847312, 1912758, 12200800A



SC-DL-7264

Length: 1743 Ø: 62
Cone Ø: d1 Ø 30 / d2 Ø 27
1361413, 1395614, 1734019, 1897333, 2040254, 2146105



SC-DL-8137

Length: 1736 Ø: 40
Cone Ø: d1 Ø 30 / d2 Ø 27
301639, 311847, 395350, 1358675, 1378435, 1397866, 1734020, 2028998, 12202900A



SC-DL-8179

Length: 568 Ø: 46
Hole Distance: 115 / 115
1399180, 1428347



SC-DL-8179

Length: 568 Ø: 46
Hole Distance: 115 / 115
1399180, 1428347



SC-DL-8509

Length: 568,5 Ø: 46
Hole Distance: 115 / 115
1485758, 1486757



SC-DL-8511

Length: 616,5 Ø: 50
Hole Distance: 115 / 115
1485760, 1499478, 1722750



SC-DL-8531

Length: 522 Ø: 46
Hole Distance: 115 / 115
1486758



SC-DL-8547

Length: 568 Ø: 50
Hole Distance: 115 / 115
1499474, 1722746, 1906940



SC-DL-8623

Length: 592 Ø: 50
Hole Distance: 115 / 115
1388436, 1499476, 1722748, 1906942



SC-DL-9462

Length: 568,5 Ø: 50
Hole Distance: 115 / 115
1499475, 1500573, 1722747, 1906941



SC-DL-9466

Length: 568 Ø: 19
1486756



SC-DL-9467

Length: 568,5 Ø: 50
Hole Distance: 115 / 115
1500572



SC-DL-10302

Length: 752 Ø: 48
Hole Distance: 115 / 115
1101843, 1379423, 1393298, 1431470, 1942075



SC-ES-7279

Length: 150
Cone Ø: d1 Ø 30 / d2 Ø 27
Thread: M30 x 1,5 RHT
1357674, 1603883, 1738379



SC-ES-8517

Length: 140
Cone Ø: d1 Ø 30 / d2 Ø 27
Thread: M30 x 1,5 RHT
1358793, 1435746, 1488890, 1534756, 1914427, 2051166



SC-RK-12366

Ø: 75 Hole Distance: 115 / 115
Thick/Height: 24
1 722 753, 2 096 392



SC-TC-12361

Length: 705 Ø: 42
Cone Ø: d1 Ø 38
Hole Distance: 115
1353445, 1464611, 1942147



SC-TC-12451

Length: 552 Ø: 46
Hole Distance: 115 / 115
1494296



SC-TC-12452

Length: 580,5 Ø: 46
Hole Distance: 115 / 115
1485759



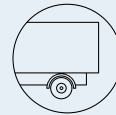

4 - series ...

164 G/580 ...	01/00→	Track Control Arm		SC-DL-9462	Trailing Arm, 2nd Drive Axle, for Leaf-Spring Suspension vehicles, →1280185/4471603 >
	01/00→	Track Control Arm		SC-DL-9462	Trailing Arm, 2nd Drive Axle, for Leaf-Spring Suspension vehicles, →9069959/3533626
	01/00→	Track Control Arm		SC-DL-9462	Trailing Arm, 2nd Drive Axle, for Leaf-Spring Suspension vehicles, 9069960/3533627→
	01/00→	Track Control Arm		SC-DL-9466	Trailing Arm, Leaf Spring Axle
	01/00→	Track Control Arm		SC-DL-9467	Trailing Arm, Leaf Spring Axle, →* 1247518 SSS *;* 4406943 SNL *; * 9039629 SAN *;* 3507979 SLA *
	01/00→	Track Control Arm		SC-DL-9467	Trailing Arm, Leaf Spring Axle, →* 1280184 SSS *;* 4471602 SNL *; * 9069959 SAN *;* 3533626 SLA *
	01/00→	Track Control Arm		SC-TC-12451	Trailing Arm, 1st Drive Axle, for Leaf-Spring Suspension vehicles
	01/00→	Track Control Arm		SC-TC-12452	Trailing Arm, 1st RA;2nd RA, for Leaf-Spring Suspension vehicles
	01/00→	Track Control Arm	SC-DL-8179	SC-DL-8179	Trailing Arm, Leaf Spring Axle, →* 1280184 SSS *;* 4471602 SNL *; * 9069959 SAN *;* 3533626 SLA *
	01/00→	Track Control Arm	SC-DL-8509	SC-DL-8509	Trailing Arm, Leaf Spring Axle
	01/00→	Track Control Arm	SC-DL-8531	SC-DL-8531	Trailing Arm, Leaf Spring Axle
	01/00→	Track Control Arm	SC-DL-10302	SC-DL-10302	Trailing Arm, Air Suspension Axle
	01/00→	Track Control Arm	SC-TC-12361		Control Arm, 1st Front Axle, for Pneumatic Suspension vehicles
	05/00→	Centre Rod	SC-DL-2161		Coupling Rod
	164 L/480	05/00→	Suspension Strut Repair Kit		CV-RK-5311
05/00→		Suspension Strut Repair Kit	MN-RK-12436	MN-RK-12436	
01/00→		Centre Rod	SC-DL-5229		Push Rod
01/00→		Centre Rod	SC-DL-5354		Push Rod
01/00→		Centre Rod	SC-DL-8182		Push Rod
01/00→		Centre Rod	SC-DL-8399		Push Rod, for vehicles with Hinged Leading Axle
01/00→		Centre Rod	SC-DL-8553	SC-DL-8553	Push Rod, for vehicles with Hinged Leading Axle
01/00→		Centre Rod	SC-DL-12342		for Steering Rod
01/00→		Centre Rod	SC-DL-12449		Push Rod
01/00→		Suspension Arm Repair Kit		SC-RK-12366	for Control Arm
01/00→		Suspension Arm Repair Kit	MN-RK-7280	MN-RK-7280	for Drag Link;for Semi-Trailing Arm; for Wishbone (CV)
01/00→		Suspension Strut Repair Kit		DF-RK-9341	
01/00→		Tie Rod		SC-DL-7264	Steering Axle
01/00→		Tie Rod		SC-DL-8137	Steering Axle
01/00→		Tie Rod	SC-DL-7264		
01/00→		Tie Rod	SC-DL-8137		
01/00→		Tie Rod End	CV-ES-14162		for Steering Rod
01/00→		Tie Rod End	CV-ES-14162	CV-ES-14162	for Steering Rod
01/00→		Tie Rod End	CV-ES-14163		for Steering Rod
01/00→		Tie Rod End	SC-ES-7279		for Steering Rod
01/00→		Tie Rod End	SC-ES-7279	SC-ES-7279	for Steering Rod
01/00→		Track Control Arm	SC-DL-10302	SC-DL-10302	Trailing Arm, Air Suspension Axle
05/00→		Centre Rod	SC-DL-2161		Coupling Rod
05/00→		Suspension Strut Repair Kit		CV-RK-5311	
05/00→		Suspension Strut Repair Kit		MN-RK-8501	
05/00→		Suspension Strut Repair Kit	MN-RK-12436	MN-RK-12436	
05/00→		Tie Rod End		MN-ES-8490	for vehicles with Hinged Trailing Axle
05/00→		Tie Rod End	IV-ES-12272		for Steering Rod
05/00→	Track Control Arm		SC-DL-8179	Trailing Arm, Leaf Spring Axle	
05/00→	Track Control Arm		SC-DL-8400	Trailing Arm	
05/00→	Track Control Arm		SC-DL-8511	Trailing Arm, Leaf Spring Axle	
05/00→	Track Control Arm		SC-DL-8547	Trailing Arm, Leaf Spring Axle	
05/00→	Track Control Arm		SC-DL-8623	Trailing Arm, 1st Drive Axle, for Leaf-Spring Suspension vehicles, →1280184/4471602	
05/00→	Track Control Arm		SC-DL-8623	Trailing Arm, 1st Drive Axle, for Leaf-Spring Suspension vehicles, →9069959/3533626	

CV-ES-14162

Length: 125
Cone Ø: d1 Ø 30 / d2 Ø 27
Thread: M30 x 1,5 LHT
283783, 395009, 1358792, 1738380, 1 914 426, 2051165



CV-ES-14163

Length: 125
Cone Ø: d1 Ø 30 / d2 Ø 27
Thread: M30 x 1,5 RHT
283784, 395010, 1358793, 1488890, 1738381, 1767328, 1914427, 2051166



CV-RK-5311

0638862, 638862, 0639287, 639287, 1104335, 1953248, 81432206006, 81432206107



DF-RK-9341

Ø: 67
550807, 5508072



IV-ES-12272

Length: 75
Cone Ø: d1 Ø 30 / d2 Ø 27
Thread: M26 x 1,5 RHT
1394443



MN-ES-8490

Length: 90
Cone Ø: d1 Ø 30 / d2 Ø 27
Thread: M26 x 1,5 RHT
1394444, 0014606948, 14606948



MN-RK-7280

Ø: 75 Hole Distance: 115
Thick/Height: 24
0550806, 550806, 0639370, 639370, 689748, 1104334



MN-RK-8501

Ø: 75 Hole Distance: 115
Thick/Height: 24
1515981



MN-RK-12436

Ø: 75 Hole Distance: 115
Thick/Height: 24
550799, 1517403, 1783020



SC-DL-2161

Length: 1740 Ø: 50
Cone Ø: d1 Ø 30 / d2 Ø 27
1369411, 1385251, 1409918, 1501030, 1723865, 1723895, 1737683, 1897335, 2113903, 2125090, 2161883



SC-DL-5229

Length: 1053 Ø: 50
Cone Ø: d1 Ø 30 / d2 Ø 27
1356055, 1379071, 1384025, 1768898, 1847311, 1912757, 12201600A



SC-DL-5354

Length: 1060 Ø: 52
Cone Ø: d1 Ø 30 / d2 Ø 27
1384027, 1769597, 1847312, 1912758, 12200800A



SC-DL-7264

Length: 1743 Ø: 62
Cone Ø: d1 Ø 30 / d2 Ø 27
1361413, 1395614, 1734019, 1897333, 2040254, 2146105



SC-DL-8137

Length: 1736 Ø: 40
Cone Ø: d1 Ø 30 / d2 Ø 27
301639, 311847, 395350, 1358675, 1378435, 1397866, 1734020, 2028998, 12202900A



SC-DL-8179

Length: 568 Ø: 46
Hole Distance: 115 / 115
1399180, 1428347



SC-DL-8182

1343262, 1869413



SC-DL-8399

Length: 433 Ø: 40
Cone Ø: d1 Ø 30 / d2 Ø 26
1394884, 1938387



SC-DL-8179

Length: 568 Ø: 46
Hole Distance: 115 / 115
1399180, 1428347



SC-DL-8509

Length: 568,5 Ø: 46
Hole Distance: 115 / 115
1485758, 1486757



SC-DL-8511

Length: 616,5 Ø: 50
Hole Distance: 115 / 115
1485760, 1499478, 1722750



SC-DL-8531

Length: 522 Ø: 46
Hole Distance: 115 / 115
1486758



SC-DL-8547

Length: 568 Ø: 50
Hole Distance: 115 / 115
1499474, 1722746, 1906940



SC-DL-8553

Length: 435 Ø: 38
Cone Ø: d1 Ø 30 / d2 Ø 27
1343283, 1759691



SC-DL-8623

Length: 592 Ø: 50
Hole Distance: 115 / 115
1388436, 1499476, 1722748, 1906942



SC-DL-9462

Length: 568,5 Ø: 50
Hole Distance: 115 / 115
1499475, 1500573, 1722747, 1906941



SC-DL-9466

Length: 568 Ø: 19
1486756



SC-DL-9467

Length: 568,5 Ø: 50
Hole Distance: 115 / 115
1500572



SC-DL-10302

Length: 752 Ø: 48
Hole Distance: 115 / 115
1101843, 1379423, 1393298, 1431470, 1942075



SC-DL-12342

Length: 601 Ø: 42
Cone Ø: d1 Ø 26 / d2 Ø 23,5
1343262, 1869413



SC-DL-12449

Length: 1206 Ø: 38
Cone Ø: d1 Ø 30 / d2 Ø 27
1385763, 1765375



SC-ES-7279

Length: 150
Cone Ø: d1 Ø 30 / d2 Ø 27
Thread: M30 x 1,5 RHT
1357674, 1603883, 1738379



SC-RK-12366

Ø: 75 Hole Distance: 115 / 115
Thick/Height: 24
1 722 753, 2 096 392



SC-TC-12361

Length: 705 Ø: 42
Cone Ø: d1 Ø 38
Hole Distance: 115
1353445, 1464611, 1942147



SC-TC-12451

Length: 552 Ø: 46
Hole Distance: 115 / 115
1494296



SC-TC-12452

Length: 580,5 Ø: 46
Hole Distance: 115 / 115
1485759





4 - series ...

164 L/480 ...	05/00→	Track Control Arm		SC-DL-9462	Trailing Arm, 2nd Drive Axle, for Leaf-Spring Suspension vehicles, →1280184/4471602
	05/00→	Track Control Arm		SC-DL-9462	Trailing Arm, 2nd Drive Axle, for Leaf-Spring Suspension vehicles, →1280185/4471603_>
	05/00→	Track Control Arm		SC-DL-9462	Trailing Arm, 2nd Drive Axle, for Leaf-Spring Suspension vehicles, →9069959/3533626
	05/00→	Track Control Arm		SC-DL-9462	Trailing Arm, 2nd Drive Axle, for Leaf-Spring Suspension vehicles, 9069960/3533627→
	05/00→	Track Control Arm		SC-DL-9466	Trailing Arm, Leaf Spring Axle
	05/00→	Track Control Arm		SC-DL-9467	Trailing Arm, Leaf Spring Axle, →* 1247518 SSS *;* 4406943 SNL *;* 9039629 SAN *;* 3507979 SLA *
	05/00→	Track Control Arm		SC-DL-9467	Trailing Arm, Leaf Spring Axle, →* 1280184 SSS *;* 4471602 SNL *;* 9069959 SAN *;* 3533626 SLA *
	05/00→	Track Control Arm		SC-TC-12451	Trailing Arm, 1st Drive Axle, for Leaf-Spring Suspension vehicles
	05/00→	Track Control Arm		SC-TC-12452	Trailing Arm, 1st RA;2nd RA, for Leaf-Spring Suspension vehicles
	05/00→	Track Control Arm	SC-DL-8179	SC-DL-8179	Trailing Arm, Leaf Spring Axle, →* 1280184 SSS *;* 4471602 SNL *;* 9069959 SAN *;* 3533626 SLA *
	05/00→	Track Control Arm	SC-DL-8509	SC-DL-8509	Trailing Arm, Leaf Spring Axle
	05/00→	Track Control Arm	SC-DL-8531	SC-DL-8531	Trailing Arm, Leaf Spring Axle
	05/00→	Track Control Arm	SC-TC-12361		Control Arm, 1st Front Axle, for Pneumatic Suspension vehicles
164 L/580	01/00→	Centre Rod	SC-DL-5229		Push Rod
	01/00→	Centre Rod	SC-DL-5354		Push Rod
	01/00→	Centre Rod	SC-DL-8182		Push Rod
	01/00→	Centre Rod	SC-DL-8399		Push Rod, for vehicles with Hinged Leading Axle
	01/00→	Centre Rod	SC-DL-8553	SC-DL-8553	Push Rod, for vehicles with Hinged Leading Axle
	01/00→	Centre Rod	SC-DL-12342		for Steering Rod
	01/00→	Centre Rod	SC-DL-12449		Push Rod
	01/00→	Suspension Arm Repair Kit		SC-RK-12366	for Control Arm
	01/00→	Suspension Arm Repair Kit	MN-RK-7280	MN-RK-7280	for Drag Link;for Semi-Trailing Arm; for Wishbone (CV)
	01/00→	Suspension Strut Repair Kit		DF-RK-9341	
	01/00→	Tie Rod		SC-DL-7264	Steering Axle
	01/00→	Tie Rod		SC-DL-8137	Steering Axle
	01/00→	Tie Rod	SC-DL-7264		
	01/00→	Tie Rod	SC-DL-8137		
	01/00→	Tie Rod End	CV-ES-14162		for Steering Rod
	01/00→	Tie Rod End	CV-ES-14162	CV-ES-14162	for Steering Rod
	01/00→	Tie Rod End	CV-ES-14163		for Steering Rod
	01/00→	Tie Rod End	SC-ES-7279		for Steering Rod
	01/00→	Tie Rod End	SC-ES-7279	SC-ES-7279	for Steering Rod
	01/00→	Track Control Arm	SC-DL-10302	SC-DL-10302	Trailing Arm, Air Suspension Axle
	05/00→	Centre Rod	SC-DL-2161		Coupling Rod
	05/00→	Suspension Strut Repair Kit		CV-RK-5311	
	05/00→	Suspension Strut Repair Kit		MN-RK-8501	
	05/00→	Suspension Strut Repair Kit	MN-RK-12436	MN-RK-12436	
	05/00→	Tie Rod End		MN-ES-8490	for vehicles with Hinged Trailing Axle
	05/00→	Tie Rod End	IV-ES-12272		for Steering Rod
	05/00→	Track Control Arm		SC-DL-8179	Trailing Arm, Leaf Spring Axle
	05/00→	Track Control Arm		SC-DL-8400	Trailing Arm
	05/00→	Track Control Arm		SC-DL-8511	Trailing Arm, Leaf Spring Axle
	05/00→	Track Control Arm		SC-DL-8547	Trailing Arm, Leaf Spring Axle
05/00→	Track Control Arm		SC-DL-8623	Trailing Arm, 1st Drive Axle, for Leaf-Spring Suspension vehicles, →1280184/4471602	
05/00→	Track Control Arm		SC-DL-8623	Trailing Arm, 1st Drive Axle, for Leaf-Spring Suspension vehicles, →9069959/3533626	
05/00→	Track Control Arm		SC-DL-9462	Trailing Arm, 2nd Drive Axle, for Leaf-Spring Suspension vehicles, →1280184/4471602	

CV-ES-14162

Length: 125
Cone Ø: d1 Ø 30 / d2 Ø 27
Thread: M30 x 1,5 LHT
283783, 395009, 1358792, 1738380, 1 914 426, 2051165

**CV-ES-14163**

Length: 125
Cone Ø: d1 Ø 30 / d2 Ø 27
Thread: M30 x 1,5 RHT
283784, 395010, 1358793, 1488890, 1738381, 1767328, 1914427, 2051166

**CV-RK-5311**

0638862, 638862, 0639287, 639287, 1104335, 1953248, 81432206006, 81432206107

**DF-RK-9341**

Ø: 67
550807, 5508072

**IV-ES-12272**

Length: 75
Cone Ø: d1 Ø 30 / d2 Ø 27
Thread: M26 x 1,5 RHT
1394443

**MN-ES-8490**

Length: 90
Cone Ø: d1 Ø 30 / d2 Ø 27
Thread: M26 x 1,5 RHT
1394444, 0014606948, 14606948

**MN-RK-7280**

Ø: 75 Hole Distance: 115
Thick/Height: 24
0550806, 550806, 639370, 0639370, 689748, 1104334

**MN-RK-8501**

Ø: 75 Hole Distance: 115
Thick/Height: 24
1515981

**MN-RK-12436**

Ø: 75 Hole Distance: 115
Thick/Height: 24
550799, 1517403, 1783020

**SC-DL-2161**

Length: 1740 Ø: 50
Cone Ø: d1 Ø 30 / d2 Ø 27
1369411, 1385251, 1409918, 1501030, 1723865, 1723895, 1737683, 1897335, 2113903, 2125090, 2161883

**SC-DL-5229**

Length: 1053 Ø: 50
Cone Ø: d1 Ø 30 / d2 Ø 27
1356055, 1379071, 1384025, 1768898, 1847311, 1912757, 12201600A

**SC-DL-5354**

Length: 1060 Ø: 52
Cone Ø: d1 Ø 30 / d2 Ø 27
1384027, 1769597, 1847312, 1912758, 12200800A

**SC-DL-7264**

Length: 1743 Ø: 62
Cone Ø: d1 Ø 30 / d2 Ø 27
1361413, 1395614, 1734019, 1897333, 2040254, 2146105

**SC-DL-8137**

Length: 1736 Ø: 40
Cone Ø: d1 Ø 30 / d2 Ø 27
301639, 311847, 395350, 1358675, 1378435, 1397866, 1734020, 2028998, 12202900A

**SC-DL-8179**

Length: 568 Ø: 46
Hole Distance: 115 / 115
1399180, 1428347

**SC-DL-8182**

1343262, 1869413

**SC-DL-8399**

Length: 433 Ø: 40
Cone Ø: d1 Ø 30 / d2 Ø 26
1394884, 1938387

**SC-DL-8179**

Length: 568 Ø: 46
Hole Distance: 115 / 115
1399180, 1428347

**SC-DL-8509**

Length: 568,5 Ø: 46
Hole Distance: 115 / 115
1485758, 1486757

**SC-DL-8511**

Length: 616,5 Ø: 50
Hole Distance: 115 / 115
1485760, 1499478, 1722750

**SC-DL-8531**

Length: 522 Ø: 46
Hole Distance: 115 / 115
1486758

**SC-DL-8547**

Length: 568 Ø: 50
Hole Distance: 115 / 115
1499474, 1722746, 1906940

**SC-DL-8553**

Length: 435 Ø: 38
Cone Ø: d1 Ø 30 / d2 Ø 27
1343283, 1759691

**SC-DL-8623**

Length: 592 Ø: 50
Hole Distance: 115 / 115
1388436, 1499476, 1722748, 1906942

**SC-DL-9462**

Length: 568,5 Ø: 50
Hole Distance: 115 / 115
1499475, 1500573, 1722747, 1906941

**SC-DL-9466**

Length: 568 Ø: 19
1486756

**SC-DL-9467**

Length: 568,5 Ø: 50
Hole Distance: 115 / 115
1500572

**SC-DL-10302**

Length: 752 Ø: 48
Hole Distance: 115 / 115
1101843, 1379423, 1393298, 1431470, 1942075

**SC-DL-12342**

Length: 601 Ø: 42
Cone Ø: d1 Ø 26 / d2 Ø 23,5
1343262, 1869413

**SC-DL-12449**

Length: 1206 Ø: 38
Cone Ø: d1 Ø 30 / d2 Ø 27
1385763, 1765375

**SC-ES-7279**

Length: 150
Cone Ø: d1 Ø 30 / d2 Ø 27
Thread: M30 x 1,5 RHT
1357674, 1603883, 1738379

**SC-RK-12366**

Ø: 75 Hole Distance: 115 / 115
Thick/Height: 24
1 722 753, 2 096 392

**SC-TC-12361**

Length: 705 Ø: 42
Cone Ø: d1 Ø 38
Hole Distance: 115
1353445, 1464611, 1942147

**SC-TC-12451**

Length: 552 Ø: 46
Hole Distance: 115 / 115
1494296

**SC-TC-12452**

Length: 580,5 Ø: 46
Hole Distance: 115 / 115
1485759



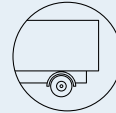

4 - series ...

164 L/580 ...	05/00→	Track Control Arm		SC-DL-9462	Trailing Arm, 2nd Drive Axle, for Leaf-Spring Suspension vehicles, →1280185/4471603 >
	05/00→	Track Control Arm		SC-DL-9462	Trailing Arm, 2nd Drive Axle, for Leaf-Spring Suspension vehicles, →9069959/3533626
	05/00→	Track Control Arm		SC-DL-9462	Trailing Arm, 2nd Drive Axle, for Leaf-Spring Suspension vehicles, 9069960/3533627 →
	05/00→	Track Control Arm		SC-DL-9466	Trailing Arm, Leaf Spring Axle
	05/00→	Track Control Arm		SC-DL-9467	Trailing Arm, Leaf Spring Axle, →* 1247518 SSS *; * 4406943 SNL *; * 9039629 SAN *; * 3507979 SLA *
	05/00→	Track Control Arm		SC-DL-9467	Trailing Arm, Leaf Spring Axle, →* 1280184 SSS *; * 4471602 SNL *; * 9069959 SAN *; * 3533626 SLA *
	05/00→	Track Control Arm		SC-TC-12451	Trailing Arm, 1st Drive Axle, for Leaf-Spring Suspension vehicles
	05/00→	Track Control Arm		SC-TC-12452	Trailing Arm, 1st RA;2nd RA, for Leaf-Spring Suspension vehicles
	05/00→	Track Control Arm	SC-DL-8179	SC-DL-8179	Trailing Arm, Leaf Spring Axle, →* 1280184 SSS *; * 4471602 SNL *; * 9069959 SAN *; * 3533626 SLA *
	05/00→	Track Control Arm	SC-DL-8509	SC-DL-8509	Trailing Arm, Leaf Spring Axle
	05/00→	Track Control Arm	SC-DL-8531	SC-DL-8531	Trailing Arm, Leaf Spring Axle
05/00→	Track Control Arm	SC-TC-12361		Control Arm, 1st Front Axle, for Pneumatic Suspension vehicles	
94 /G260	08/96→	Centre Rod	SC-DL-5229		Push Rod
	08/96→	Centre Rod	SC-DL-5354		Push Rod
	08/96→	Centre Rod	SC-DL-12343		for Steering Rod
	08/96→	Suspension Arm Repair Kit		SC-RK-12366	for Control Arm
	08/96→	Suspension Arm Repair Kit	MN-RK-7280	MN-RK-7280	for Drag Link;for Semi-Trailing Arm; for Wishbone (CV)
	08/96→	Suspension Strut Repair Kit		DF-RK-9341	
	08/96→	Tie Rod		SC-DL-7264	Steering Axle
	08/96→	Tie Rod		SC-DL-8137	Steering Axle
	08/96→	Tie Rod	SC-DL-7264		
	08/96→	Tie Rod	SC-DL-8137		
	08/96→	Tie Rod End		MN-ES-8490	for vehicles with Hinged Trailing Axle
	08/96→	Tie Rod End	CV-ES-14162	CV-ES-14162	for Steering Rod
	08/96→	Tie Rod End	CV-ES-14163		for Steering Rod
	08/96→	Tie Rod End	SC-ES-7279	SC-ES-7279	for Steering Rod
	08/96→	Track Control Arm	SC-DL-10302	SC-DL-10302	Trailing Arm, Air Suspension Axle
94 C/260	12/96→	Centre Rod	SC-DL-2161		Coupling Rod
	12/96→	Centre Rod	SC-DL-5229		Push Rod
	12/96→	Centre Rod	SC-DL-5354		Push Rod
	12/96→	Centre Rod	SC-DL-12343		for Steering Rod
	12/96→	Suspension Arm Repair Kit		MN-RK-7280	for Drag Link;for Semi-Trailing Arm; for Wishbone (CV)
	12/96→	Suspension Arm Repair Kit		SC-RK-12366	for Control Arm
	12/96→	Suspension Strut Repair Kit		CV-RK-5311	
	12/96→	Suspension Strut Repair Kit		MN-RK-8501	
	12/96→	Suspension Strut Repair Kit	MN-RK-12436	MN-RK-12436	
	12/96→	Tie Rod		SC-DL-7264	Steering Axle
	12/96→	Tie Rod		SC-DL-8137	Steering Axle
	12/96→	Tie Rod	SC-DL-7264		
	12/96→	Tie Rod	SC-DL-8137		
	12/96→	Tie Rod End		MN-ES-8490	for vehicles with Hinged Trailing Axle
	12/96→	Tie Rod End	CV-ES-14162		for Steering Rod
	12/96→	Tie Rod End	CV-ES-14163		for Steering Rod
	12/96→	Tie Rod End	SC-ES-7279		for Steering Rod
	12/96→	Track Control Arm		SC-DL-8179	Trailing Arm, Leaf Spring Axle
	12/96→	Track Control Arm		SC-DL-8400	Trailing Arm
	12/96→	Track Control Arm		SC-DL-8511	Trailing Arm, Leaf Spring Axle
12/96→	Track Control Arm		SC-DL-8547	Trailing Arm, Leaf Spring Axle	

CV-ES-14162

Length: 125
Cone Ø: d1 Ø 30 / d2 Ø 27
Thread: M30 x 1,5 LHT
283784, 395009, 1358792, 1738380, 1 914 426, 2051165



CV-ES-14163

Length: 125
Cone Ø: d1 Ø 30 / d2 Ø 27
Thread: M30 x 1,5 RHT
283784, 395010, 1358793, 1488890, 1738381, 1767328, 1914427, 2051166



CV-RK-5311

0638862, 638862, 0639287, 639287, 1104335, 1953248, 81432206006, 81432206107



DF-RK-9341

Ø: 67
550807, 5508072



MN-ES-8490

Length: 90
Cone Ø: d1 Ø 30 / d2 Ø 27
Thread: M26 x 1,5 RHT
1394444, 0014606948, 14606948



MN-RK-7280

Ø: 75 Hole Distance: 115
Thick/Height: 24
0550806, 550806, 0639370, 639370, 689748, 1104334



MN-RK-8501

Ø: 75 Hole Distance: 115
Thick/Height: 24
1515981



MN-RK-12436

Ø: 75 Hole Distance: 115
Thick/Height: 24
550799, 1517403, 1783020



SC-DL-2161

Length: 1740 Ø: 50
Cone Ø: d1 Ø 30 / d2 Ø 27
1369411, 1385251, 1409918, 1501030, 1723865, 1723895, 1737683, 1897335, 2113903, 2125090, 2161883



SC-DL-5229

Length: 1053 Ø: 50
Cone Ø: d1 Ø 30 / d2 Ø 27
1356055, 1379071, 1384025, 1768898, 1847311, 1912757, 12201600A



SC-DL-5354

Length: 1060 Ø: 52
Cone Ø: d1 Ø 30 / d2 Ø 27
1384027, 1769597, 1847312, 1912758, 12200800A



SC-DL-7264

Length: 1743 Ø: 62
Cone Ø: d1 Ø 30 / d2 Ø 27
1361413, 1395614, 1734019, 1897333, 2040254, 2146105



SC-DL-8137

Length: 1736 Ø: 40
Cone Ø: d1 Ø 30 / d2 Ø 27
301639, 311847, 395350, 1358675, 1378435, 1397866, 1734020, 2028998, 12202900A



SC-DL-8179

Length: 568 Ø: 46
Hole Distance: 115 / 115
1399180, 1428347



SC-DL-8179

Length: 568 Ø: 46
Hole Distance: 115 / 115
1399180, 1428347



SC-DL-8509

Length: 568,5 Ø: 46
Hole Distance: 115 / 115
1485758, 1486757



SC-DL-8511

Length: 616,5 Ø: 50
Hole Distance: 115 / 115
1485760, 1499478, 1722750



SC-DL-8531

Length: 522 Ø: 46
Hole Distance: 115 / 115
1486758



SC-DL-8547

Length: 568 Ø: 50
Hole Distance: 115 / 115
1499474, 1722746, 1906940



SC-DL-9462

Length: 568,5 Ø: 50
Hole Distance: 115 / 115
1499475, 1500573, 1722747, 1906941



SC-DL-9466

Length: 568 Ø: 19
1486756



SC-DL-9467

Length: 568,5 Ø: 50
Hole Distance: 115 / 115
1500572



SC-DL-10302

Length: 752 Ø: 48
Hole Distance: 115 / 115
1101843, 1379423, 1393298, 1431470, 1942075



SC-DL-12343

Length: 1062 Ø: 52
Cone Ø: d1 Ø 30 / d2 Ø 27
1348269, 2007275



SC-ES-7279

Length: 150
Cone Ø: d1 Ø 30 / d2 Ø 27
Thread: M30 x 1,5 RHT
1357674, 1603883, 1738379



SC-RK-12366

Ø: 75 Hole Distance: 115 / 115
Thick/Height: 24
1 722 753, 2 096 392



SC-TC-12361

Length: 705 Ø: 42
Cone Ø: d1 Ø 38
Hole Distance: 115
1353445, 1464611, 1942147



SC-TC-12451

Length: 552 Ø: 46
Hole Distance: 115 / 115
1494296



SC-TC-12452

Length: 580,5 Ø: 46
Hole Distance: 115 / 115
1485759



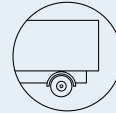

4 - series ...

94 C/260 ...	12/96 →	Track Control Arm		SC-DL-8623	Trailing Arm, 1st Drive Axle, for Leaf-Spring Suspension vehicles, →1280184/4471602
	12/96 →	Track Control Arm		SC-DL-8623	Trailing Arm, 1st Drive Axle, for Leaf-Spring Suspension vehicles, →9069959/3533626
	12/96 →	Track Control Arm		SC-DL-9462	Trailing Arm, 2nd Drive Axle, for Leaf-Spring Suspension vehicles, →1280184/4471602
	12/96 →	Track Control Arm		SC-DL-9462	Trailing Arm, 2nd Drive Axle, for Leaf-Spring Suspension vehicles, →1280185/4471603_>
	12/96 →	Track Control Arm		SC-DL-9462	Trailing Arm, 2nd Drive Axle, for Leaf-Spring Suspension vehicles, →9069959/3533626
	12/96 →	Track Control Arm		SC-DL-9462	Trailing Arm, 2nd Drive Axle, for Leaf-Spring Suspension vehicles, 9069960/3533627 →
	12/96 →	Track Control Arm		SC-DL-9466	Trailing Arm, Leaf Spring Axle
	12/96 →	Track Control Arm		SC-DL-9467	Trailing Arm, Leaf Spring Axle, →* 1247518 SSS *,* 4406943 SNL *,* 9039629 SAN *,* 3507979 SLA *
	12/96 →	Track Control Arm		SC-DL-9467	Trailing Arm, Leaf Spring Axle, →* 1280184 SSS *,* 4471602 SNL *,* 9069959 SAN *,* 3533626 SLA *
	12/96 →	Track Control Arm		SC-TC-12451	Trailing Arm, 1st Drive Axle, for Leaf-Spring Suspension vehicles
	12/96 →	Track Control Arm		SC-TC-12452	Trailing Arm, 1st RA;2nd RA, for Leaf-Spring Suspension vehicles
	12/96 →	Track Control Arm	SC-DL-8179	SC-DL-8179	Trailing Arm, Leaf Spring Axle, →* 1280184 SSS *,* 4471602 SNL *,* 9069959 SAN *,* 3533626 SLA *
	12/96 →	Track Control Arm	SC-DL-8509	SC-DL-8509	Trailing Arm, Leaf Spring Axle
	12/96 →	Track Control Arm	SC-DL-8531	SC-DL-8531	Trailing Arm, Leaf Spring Axle
	12/96 →	Track Control Arm	SC-DL-10302	SC-DL-10302	Trailing Arm, Air Suspension Axle
	94 C/300	12/96 →	Track Control Arm	SC-TC-12361	
08/96 →		Centre Rod	SC-DL-5229		Push Rod
08/96 →		Centre Rod	SC-DL-5354		Push Rod
08/96 →		Tie Rod	SC-DL-7264		
08/96 →		Tie Rod	SC-DL-8137		
08/96 →		Track Control Arm		SC-DL-8179	Trailing Arm, Leaf Spring Axle
08/96 →		Track Control Arm		SC-DL-8400	Trailing Arm
08/96 →		Track Control Arm		SC-DL-8511	Trailing Arm, Leaf Spring Axle
08/96 →		Track Control Arm		SC-DL-8547	Trailing Arm, Leaf Spring Axle
08/96 →		Track Control Arm		SC-DL-9466	Trailing Arm, Leaf Spring Axle
08/96 →		Track Control Arm		SC-DL-9467	Trailing Arm, Leaf Spring Axle, →* 1247518 SSS *,* 4406943 SNL *,* 9039629 SAN *,* 3507979 SLA *
08/96 →		Track Control Arm		SC-DL-9467	Trailing Arm, Leaf Spring Axle, →* 1280184 SSS *,* 4471602 SNL *,* 9069959 SAN *,* 3533626 SLA *
08/96 →		Track Control Arm	SC-DL-8179	SC-DL-8179	Trailing Arm, Leaf Spring Axle, →* 1280184 SSS *,* 4471602 SNL *,* 9069959 SAN *,* 3533626 SLA *
08/96 →		Track Control Arm	SC-DL-8509	SC-DL-8509	Trailing Arm, Leaf Spring Axle
08/96 →		Track Control Arm	SC-DL-8531	SC-DL-8531	Trailing Arm, Leaf Spring Axle
08/96 →		Track Control Arm	SC-DL-10302	SC-DL-10302	Trailing Arm, Air Suspension Axle
94 C/310	08/96 →	Centre Rod	SC-DL-2161		Coupling Rod
	08/96 →	Centre Rod	SC-DL-5229		Push Rod
	08/96 →	Centre Rod	SC-DL-5354		Push Rod
	08/96 →	Centre Rod	SC-DL-12343		for Steering Rod
	08/96 →	Suspension Arm Repair Kit		MN-RK-7280	for Drag Link;for Semi-Trailing Arm; for Wishbone (CV)
	08/96 →	Suspension Arm Repair Kit		SC-RK-12366	for Control Arm
	08/96 →	Suspension Strut Repair Kit		CV-RK-5311	
	08/96 →	Suspension Strut Repair Kit		MN-RK-8501	
	08/96 →	Suspension Strut Repair Kit	MN-RK-12436	MN-RK-12436	
	08/96 →	Tie Rod		SC-DL-7264	Steering Axle
08/96 →	Tie Rod		SC-DL-8137	Steering Axle	

CV-RK-5311

0638862, 638862, 0639287, 639287,
1104335, 1953248, 81432206006,
81432206107



MN-RK-7280

Ø: 75 Hole Distance: 115
Thick/Height: 24

0550806, 550806, 0639370, 639370,
689748, 1104334



MN-RK-8501

Ø: 75 Hole Distance: 115
Thick/Height: 24

1515981



MN-RK-12436

Ø: 75 Hole Distance: 115
Thick/Height: 24

550799, 1517403, 1783020



SC-DL-2161

Length: 1740 Ø: 50
Cone Ø: d1 Ø 30 / d2 Ø 27

1369411, 1385251, 1409918, 1501030,
1723865, 1723895, 1737683, 1897335,
2113903, 2125090, 2161883



SC-DL-5229

Length: 1053 Ø: 50
Cone Ø: d1 Ø 30 / d2 Ø 27

1356055, 1379071, 1384025, 1768898,
1847311, 1912757, 12201600A



SC-DL-5354

Length: 1060 Ø: 52
Cone Ø: d1 Ø 30 / d2 Ø 27

1384027, 1769597, 1847312, 1912758,
12200800A



SC-DL-7264

Length: 1743 Ø: 62
Cone Ø: d1 Ø 30 / d2 Ø 27

1361413, 1395614, 1734019, 1897333,
2040254, 2146105



SC-DL-8137

Length: 1736 Ø: 40
Cone Ø: d1 Ø 30 / d2 Ø 27

301639, 311847, 395350, 1358675,
1378435, 1397866, 1734020, 2028998,
12202900A



SC-DL-8179

Length: 568 Ø: 46
Hole Distance: 115 / 115

1399180, 1428347



SC-DL-8179

Length: 568 Ø: 46
Hole Distance: 115 / 115

1399180, 1428347



SC-DL-8509

Length: 568,5 Ø: 46
Hole Distance: 115 / 115

1485758, 1486757



SC-DL-8511

Length: 616,5 Ø: 50
Hole Distance: 115 / 115

1485760, 1499478, 1722750



SC-DL-8531

Length: 522 Ø: 46
Hole Distance: 115 / 115

1486758



SC-DL-8547

Length: 568 Ø: 50
Hole Distance: 115 / 115

1499474, 1722746, 1906940



SC-DL-8623

Length: 592 Ø: 50
Hole Distance: 115 / 115

1388436, 1499476, 1722748, 1906942



SC-DL-9462

Length: 568,5 Ø: 50
Hole Distance: 115 / 115

1499475, 1500573, 1722747, 1906941



SC-DL-9466

Length: 568 Ø: 19

1486756



SC-DL-9467

Length: 568,5 Ø: 50
Hole Distance: 115 / 115

1500572



SC-DL-10302

Length: 752 Ø: 48
Hole Distance: 115 / 115

1101843, 1379423, 1393298, 1431470,
1942075



SC-DL-12343

Length: 1062 Ø: 52
Cone Ø: d1 Ø 30 / d2 Ø 27

1348269, 2007275



SC-RK-12366

Ø: 75 Hole Distance: 115 / 115
Thick/Height: 24

1 722 753, 2 096 392



SC-TC-12361

Length: 705 Ø: 42
Cone Ø: d1 Ø 38

Hole Distance: 115
1353445, 1464611, 1942147



SC-TC-12451

Length: 552 Ø: 46
Hole Distance: 115 / 115

1494296



SC-TC-12452

Length: 580,5 Ø: 46
Hole Distance: 115 / 115

1485759





4 - series ...

94 C/310 ...	08/96 →	Tie Rod	SC-DL-7264			
	08/96 →	Tie Rod	SC-DL-8137			
	08/96 →	Tie Rod End		MN-ES-8490	for vehicles with Hinged Trailing Axle	
	08/96 →	Tie Rod End	CV-ES-14162		for Steering Rod	
	08/96 →	Tie Rod End	CV-ES-14163		for Steering Rod	
	08/96 →	Tie Rod End	SC-ES-7279		for Steering Rod	
	08/96 →	Track Control Arm		SC-DL-8179	Trailing Arm, Leaf Spring Axle	
	08/96 →	Track Control Arm		SC-DL-8400	Trailing Arm	
	08/96 →	Track Control Arm		SC-DL-8511	Trailing Arm, Leaf Spring Axle	
	08/96 →	Track Control Arm		SC-DL-8547	Trailing Arm, Leaf Spring Axle	
	08/96 →	Track Control Arm		SC-DL-8623	Trailing Arm, 1st Drive Axle, for Leaf-Spring Suspension vehicles, →1280184/4471602	
	08/96 →	Track Control Arm		SC-DL-8623	Trailing Arm, 1st Drive Axle, for Leaf-Spring Suspension vehicles, →9069959/3533626	
	08/96 →	Track Control Arm		SC-DL-9462	Trailing Arm, 2nd Drive Axle, for Leaf-Spring Suspension vehicles, →1280184/4471602	
	08/96 →	Track Control Arm		SC-DL-9462	Trailing Arm, 2nd Drive Axle, for Leaf-Spring Suspension vehicles, →1280185/4471603_>	
	08/96 →	Track Control Arm		SC-DL-9462	Trailing Arm, 2nd Drive Axle, for Leaf-Spring Suspension vehicles, →9069959/3533626	
	08/96 →	Track Control Arm		SC-DL-9462	Trailing Arm, 2nd Drive Axle, for Leaf-Spring Suspension vehicles, 9069960/3533627 →	
	08/96 →	Track Control Arm		SC-DL-9466	Trailing Arm, Leaf Spring Axle	
	08/96 →	Track Control Arm		SC-DL-9467	Trailing Arm, Leaf Spring Axle, →* 1247518 SSS *,* 4406943 SNL *, * 9039629 SAN *,* 3507979 SLA *	
	08/96 →	Track Control Arm		SC-DL-9467	Trailing Arm, Leaf Spring Axle, →* 1280184 SSS *,* 4471602 SNL *, * 9069959 SAN *,* 3533626 SLA *	
	08/96 →	Track Control Arm		SC-TC-12451	Trailing Arm, 1st Drive Axle, for Leaf-Spring Suspension vehicles	
	08/96 →	Track Control Arm		SC-TC-12452	Trailing Arm, 1st RA;2nd RA, for Leaf-Spring Suspension vehicles	
	08/96 →	Track Control Arm	SC-DL-8179	SC-DL-8179	Trailing Arm, Leaf Spring Axle, →* 1280184 SSS *,* 4471602 SNL *, * 9069959 SAN *,* 3533626 SLA *	
	08/96 →	Track Control Arm	SC-DL-8509	SC-DL-8509	Trailing Arm, Leaf Spring Axle	
	08/96 →	Track Control Arm	SC-DL-8531	SC-DL-8531	Trailing Arm, Leaf Spring Axle	
	08/96 →	Track Control Arm	SC-DL-10302	SC-DL-10302	Trailing Arm, Air Suspension Axle	
	94 D/220	08/96 →	Centre Rod	SC-DL-2161		Coupling Rod
		08/96 →	Centre Rod	SC-DL-5229		Push Rod
08/96 →		Centre Rod	SC-DL-5354		Push Rod	
08/96 →		Centre Rod	SC-DL-8182		Push Rod	
08/96 →		Centre Rod	SC-DL-8399		Push Rod, for vehicles with Hinged Leading Axle	
08/96 →		Centre Rod	SC-DL-8553	SC-DL-8553	Push Rod, for vehicles with Hinged Leading Axle	
08/96 →		Centre Rod	SC-DL-10225		for Steering Rod	
08/96 →		Centre Rod	SC-DL-10225		Push Rod	
08/96 →		Centre Rod	SC-DL-12342		for Steering Rod	
08/96 →		Centre Rod	SC-DL-12343		for Steering Rod	
08/96 →		Centre Rod	SC-DL-12449		Push Rod	
08/96 →		Suspension Arm Repair Kit		MN-RK-7280	for Drag Link;for Semi-Trailing Arm; for Wishbone (CV)	
08/96 →		Suspension Arm Repair Kit		SC-RK-12366	for Control Arm	
08/96 →		Suspension Arm Repair Kit	MN-RK-7280	MN-RK-7280	for Drag Link;for Semi-Trailing Arm; for Wishbone (CV)	
08/96 →		Suspension Strut Repair Kit		CV-RK-5311		
08/96 →		Suspension Strut Repair Kit		DF-RK-9341		
08/96 →		Suspension Strut Repair Kit		MN-RK-8501		
08/96 →		Suspension Strut Repair Kit	MN-RK-12436	MN-RK-12436		
08/96 →		Tie Rod		SC-DL-7264	Steering Axle	
08/96 →		Tie Rod		SC-DL-8137	Steering Axle	
08/96 →	Tie Rod	SC-DL-7264				
08/96 →	Tie Rod	SC-DL-8137				

CV-ES-14162

Length: 125
Cone Ø: d1 Ø 30 / d2 Ø 27
Thread: M30 x 1,5 LHT
283784, 395009, 1358792, 1738380, 1 914 426, 2051165



CV-ES-14163

Length: 125
Cone Ø: d1 Ø 30 / d2 Ø 27
Thread: M30 x 1,5 RHT
283784, 395010, 1358793, 1488890, 1738381, 1767328, 1914427, 2051166



CV-RK-5311

0638862, 638862, 0639287, 639287, 1104335, 1953248, 81432206006, 81432206107



DF-RK-9341

Ø: 67
550807, 5508072



MN-ES-8490

Length: 90
Cone Ø: d1 Ø 30 / d2 Ø 27
Thread: M26 x 1,5 RHT
1394444, 0014606948, 14606948



MN-RK-7280

Ø: 75 Hole Distance: 115
Thick/Height: 24
0550806, 550806, 639370, 0639370, 689748, 1104334



MN-RK-8501

Ø: 75 Hole Distance: 115
Thick/Height: 24
1515981



MN-RK-12436

Ø: 75 Hole Distance: 115
Thick/Height: 24
550799, 1517403, 1783020



SC-DL-2161

Length: 1740 Ø: 50
Cone Ø: d1 Ø 30 / d2 Ø 27
1369411, 1385251, 1409918, 1501030, 1723865, 1723895, 1737683, 1897335, 2113903, 2125090, 2161883



SC-DL-5229

Length: 1053 Ø: 50
Cone Ø: d1 Ø 30 / d2 Ø 27
1356055, 1379071, 1384025, 1768898, 1847311, 1912757, 12201600A



SC-DL-5354

Length: 1060 Ø: 52
Cone Ø: d1 Ø 30 / d2 Ø 27
1384027, 1769597, 1847312, 1912758, 12200800A



SC-DL-7264

Length: 1743 Ø: 62
Cone Ø: d1 Ø 30 / d2 Ø 27
1361413, 1395614, 1734019, 1897333, 2040254, 2146105



SC-DL-8137

Length: 1736 Ø: 40
Cone Ø: d1 Ø 30 / d2 Ø 27
301639, 311847, 395350, 1358675, 1378435, 1397866, 1734020, 2028998, 12202900A



SC-DL-8179

Length: 568 Ø: 46
Hole Distance: 115 / 115
1399180, 1428347



SC-DL-8182

1343262, 1869413



SC-DL-8399

Length: 433 Ø: 40
Cone Ø: d1 Ø 30 / d2 Ø 26
1394884, 1938387



SC-DL-8179

Length: 568 Ø: 46
Hole Distance: 115 / 115
1399180, 1428347



SC-DL-8509

Length: 568,5 Ø: 46
Hole Distance: 115 / 115
1485758, 1486757



SC-DL-8511

Length: 616,5 Ø: 50
Hole Distance: 115 / 115
1485760, 1499478, 1722750



SC-DL-8531

Length: 522 Ø: 46
Hole Distance: 115 / 115
1486758



SC-DL-8547

Length: 568 Ø: 50
Hole Distance: 115 / 115
1499474, 1722746, 1906940



SC-DL-8553

Length: 435 Ø: 38
Cone Ø: d1 Ø 30 / d2 Ø 27
1343283, 1759691



SC-DL-8623

Length: 592 Ø: 50
Hole Distance: 115 / 115
1388436, 1499476, 1722748, 1906942



SC-DL-9462

Length: 568,5 Ø: 50
Hole Distance: 115 / 115
1499475, 1500573, 1722747, 1906941



SC-DL-9466

Length: 568 Ø: 19
1486756



SC-DL-9467

Length: 568,5 Ø: 50
Hole Distance: 115 / 115
1500572



SC-DL-10225

Length: 2179 Ø: 62
Cone Ø: d1 Ø 30 / d2 Ø 27
1386618, 1788522



SC-DL-10302

Length: 752 Ø: 48
Hole Distance: 115 / 115
1101843, 1379423, 1393298, 1431470, 1942075



SC-DL-12342

Length: 601 Ø: 42
Cone Ø: d1 Ø 26 / d2 Ø 23,5
1343262, 1869413



SC-DL-12343

Length: 1062 Ø: 52
Cone Ø: d1 Ø 30 / d2 Ø 27
1348269, 2007275



SC-DL-12449

Length: 1206 Ø: 38
Cone Ø: d1 Ø 30 / d2 Ø 27
1385763, 1765375



SC-ES-7279

Length: 150
Cone Ø: d1 Ø 30 / d2 Ø 27
Thread: M30 x 1,5 RHT
1357674, 1603883, 1738379



SC-RK-12366

Ø: 75 Hole Distance: 115 / 115
Thick/Height: 24
1 722 753, 2 096 392



SC-TC-12451

Length: 552 Ø: 46
Hole Distance: 115 / 115
1494296



SC-TC-12452

Length: 580,5 Ø: 46
Hole Distance: 115 / 115
1485759





4 - series ...

94 D/220 ...	08/96 →	Tie Rod End		MN-ES-8490	for vehicles with Hinged Trailing Axle	
	08/96 →	Tie Rod End	CV-ES-14162		for Steering Rod	
	08/96 →	Tie Rod End	CV-ES-14162	CV-ES-14162	for Steering Rod	
	08/96 →	Tie Rod End	CV-ES-14163		for Steering Rod	
	08/96 →	Tie Rod End	IV-ES-12272		for Steering Rod	
	08/96 →	Tie Rod End	SC-ES-7279		for Steering Rod	
	08/96 →	Tie Rod End	SC-ES-7279	SC-ES-7279	for Steering Rod	
	08/96 →	Track Control Arm	SC-DL-10302	SC-DL-10302	Trailing Arm, Air Suspension Axle	
	08/96 →	Track Control Arm	SC-TC-12361		Control Arm, 1st Front Axle, for Pneumatic Suspension vehicles	
94 D/230	04/99 →	Centre Rod	SC-DL-5229		Push Rod	
	04/99 →	Centre Rod	SC-DL-5354		Push Rod	
	04/99 →	Centre Rod	SC-DL-10225		for Steering Rod	
	04/99 →	Centre Rod	SC-DL-12342		for Steering Rod	
	04/99 →	Centre Rod	SC-DL-12343		for Steering Rod	
	04/99 →	Suspension Arm Repair Kit		SC-RK-12366	for Control Arm	
	04/99 →	Suspension Arm Repair Kit	MN-RK-7280	MN-RK-7280	for Drag Link;for Semi-Trailing Arm; for Wishbone (CV)	
	04/99 →	Suspension Strut Repair Kit		DF-RK-9341		
	04/99 →	Tie Rod	SC-DL-7264			
	04/99 →	Tie Rod	SC-DL-8137			
	04/99 →	Tie Rod End	CV-ES-14162		for Steering Rod	
	04/99 →	Tie Rod End	CV-ES-14163		for Steering Rod	
	04/99 →	Track Control Arm	SC-DL-10302	SC-DL-10302	Trailing Arm, Air Suspension Axle	
	08/99 →	Centre Rod	SC-DL-2161		Coupling Rod	
	08/99 →	Centre Rod	SC-DL-8182		Push Rod	
	08/99 →	Centre Rod	SC-DL-8399		Push Rod, for vehicles with Hinged Leading Axle	
	08/99 →	Centre Rod	SC-DL-8553	SC-DL-8553	Push Rod, for vehicles with Hinged Leading Axle	
	08/99 →	Centre Rod	SC-DL-10225		Push Rod	
	08/99 →	Centre Rod	SC-DL-12449		Push Rod	
	08/99 →	Suspension Arm Repair Kit		MN-RK-7280	for Drag Link;for Semi-Trailing Arm; for Wishbone (CV)	
	08/99 →	Suspension Strut Repair Kit		CV-RK-5311		
	08/99 →	Suspension Strut Repair Kit		MN-RK-8501		
	08/99 →	Suspension Strut Repair Kit	MN-RK-12436	MN-RK-12436		
	08/99 →	Tie Rod		SC-DL-7264	Steering Axle	
	08/99 →	Tie Rod		SC-DL-8137	Steering Axle	
	08/99 →	Tie Rod End		MN-ES-8490	for vehicles with Hinged Trailing Axle	
	08/99 →	Tie Rod End	IV-ES-12272		for Steering Rod	
	08/99 →	Tie Rod End	SC-ES-7279		for Steering Rod	
	08/99 →	Tie Rod End	SC-ES-7279	SC-ES-7279	for Steering Rod	
	08/99 →	Track Control Arm	SC-TC-12361		Control Arm, 1st Front Axle, for Pneumatic Suspension vehicles	
	94 D/260	08/96 →	Centre Rod	SC-DL-2161		Coupling Rod
		08/96 →	Centre Rod	SC-DL-5229		Push Rod
08/96 →		Centre Rod	SC-DL-5354		Push Rod	
08/96 →		Centre Rod	SC-DL-8182		Push Rod	
08/96 →		Centre Rod	SC-DL-8399		Push Rod, for vehicles with Hinged Leading Axle	
08/96 →		Centre Rod	SC-DL-8553	SC-DL-8553	Push Rod, for vehicles with Hinged Leading Axle	
08/96 →		Centre Rod	SC-DL-10225		for Steering Rod	
08/96 →		Centre Rod	SC-DL-10225		Push Rod	
08/96 →		Centre Rod	SC-DL-12342		for Steering Rod	
08/96 →		Centre Rod	SC-DL-12343		for Steering Rod	
08/96 →		Centre Rod	SC-DL-12449		Push Rod	
08/96 →		Suspension Arm Repair Kit		MN-RK-7280	for Drag Link;for Semi-Trailing Arm; for Wishbone (CV)	
08/96 →		Suspension Arm Repair Kit		SC-RK-12366	for Control Arm	
08/96 →		Suspension Arm Repair Kit	MN-RK-7280	MN-RK-7280	for Drag Link;for Semi-Trailing Arm; for Wishbone (CV)	
08/96 →		Suspension Strut Repair Kit		CV-RK-5311		
08/96 →		Suspension Strut Repair Kit		DF-RK-9341		
08/96 →		Suspension Strut Repair Kit		MN-RK-8501		
08/96 →		Suspension Strut Repair Kit	MN-RK-12436	MN-RK-12436		

CV-ES-14162

Length: 125
Cone Ø: d1 Ø 30 / d2 Ø 27
Thread: M30 x 1,5 LHT
283783, 395009, 1358792, 1738380, 1 914 426, 2051165



CV-ES-14163

Length: 125
Cone Ø: d1 Ø 30 / d2 Ø 27
Thread: M30 x 1,5 RHT
283784, 395010, 1358793, 1488890, 1738381, 1767328, 1914427, 2051166



CV-RK-5311

0638862, 638862, 0639287, 639287, 1104335, 1953248, 81432206006, 81432206107



DF-RK-9341

Ø: 67
550807, 5508072



IV-ES-12272

Length: 75
Cone Ø: d1 Ø 30 / d2 Ø 27
Thread: M26 x 1,5 RHT
1394443



MN-ES-8490

Length: 90
Cone Ø: d1 Ø 30 / d2 Ø 27
Thread: M26 x 1,5 RHT
1394444, 14606948, 0014606948



MN-RK-7280

Ø: 75 Hole Distance: 115
Thick/Height: 24
0550806, 550806, 0639370, 639370, 689748, 1104334



MN-RK-8501

Ø: 75 Hole Distance: 115
Thick/Height: 24
1515981



MN-RK-12436

Ø: 75 Hole Distance: 115
Thick/Height: 24
550799, 1517403, 1783020



SC-DL-2161

Length: 1740 Ø: 50
Cone Ø: d1 Ø 30 / d2 Ø 27
1369411, 1385251, 1409918, 1501030, 1723865, 1723895, 1737683, 1897335, 2113903, 2125090, 2161883



SC-DL-5229

Length: 1053 Ø: 50
Cone Ø: d1 Ø 30 / d2 Ø 27
1356055, 1379071, 1384025, 1768898, 1847311, 1912757, 12201600A



SC-DL-5354

Length: 1060 Ø: 52
Cone Ø: d1 Ø 30 / d2 Ø 27
1384027, 1769597, 1847312, 1912758, 12200800A



SC-DL-7264

Length: 1743 Ø: 62
Cone Ø: d1 Ø 30 / d2 Ø 27
1361413, 1395614, 1734019, 1897333, 2040254, 2146105



SC-DL-8137

Length: 1736 Ø: 40
Cone Ø: d1 Ø 30 / d2 Ø 27
301639, 311847, 395350, 1358675, 1378435, 1397866, 1734020, 2028998, 12202900A



SC-DL-8182

1343262, 1869413



SC-DL-8399

Length: 433 Ø: 40
Cone Ø: d1 Ø 30 / d2 Ø 26
1394884, 1938387



SC-DL-8553

Length: 435 Ø: 38
Cone Ø: d1 Ø 30 / d2 Ø 27
1343283, 1759691



SC-DL-10225

Length: 2179 Ø: 62
Cone Ø: d1 Ø 30 / d2 Ø 27
1386618, 1788522



SC-DL-10302

Length: 752 Ø: 48
Hole Distance: 115 / 115
1101843, 1379423, 1393298, 1431470, 1942075



SC-DL-12342

Length: 601 Ø: 42
Cone Ø: d1 Ø 26 / d2 Ø 23,5
1343262, 1869413



SC-DL-12343

Length: 1062 Ø: 52
Cone Ø: d1 Ø 30 / d2 Ø 27
1348269, 2007275



SC-DL-12449

Length: 1206 Ø: 38
Cone Ø: d1 Ø 30 / d2 Ø 27
1385763, 1765375



SC-ES-7279

Length: 150
Cone Ø: d1 Ø 30 / d2 Ø 27
Thread: M30 x 1,5 RHT
1357674, 1603883, 1738379



SC-RK-12366

Ø: 75 Hole Distance: 115 / 115
Thick/Height: 24
1 722 753, 2 096 392



SC-TC-12361

Length: 705 Ø: 42
Cone Ø: d1 Ø 38
Hole Distance: 115
1353445, 1464611, 1942147





4 - series ...

94 D/260 ...	08/96 →	Tie Rod		SC-DL-7264	Steering Axle
	08/96 →	Tie Rod		SC-DL-8137	Steering Axle
	08/96 →	Tie Rod	SC-DL-7264		
	08/96 →	Tie Rod	SC-DL-8137		
	08/96 →	Tie Rod End		MN-ES-8490	for vehicles with Hinged Trailing Axle
	08/96 →	Tie Rod End	CV-ES-14162		for Steering Rod
	08/96 →	Tie Rod End	CV-ES-14162	CV-ES-14162	for Steering Rod
	08/96 →	Tie Rod End	CV-ES-14163		for Steering Rod
	08/96 →	Tie Rod End	IV-ES-12272		for Steering Rod
	08/96 →	Tie Rod End	SC-ES-7279		for Steering Rod
	08/96 →	Tie Rod End	SC-ES-7279	SC-ES-7279	for Steering Rod
	08/96 →	Track Control Arm	SC-DL-10302	SC-DL-10302	Trailing Arm, Air Suspension Axle
	08/96 →	Track Control Arm	SC-TC-12361		Control Arm, 1st Front Axle, for Pneumatic Suspension vehicles
94 D/270	08/96 →	Centre Rod	SC-DL-5229		Push Rod
	08/96 →	Centre Rod	SC-DL-5354		Push Rod
	08/96 →	Tie Rod	SC-DL-7264		
	08/96 →	Tie Rod	SC-DL-8137		
	08/96 →	Track Control Arm	SC-DL-10302	SC-DL-10302	Trailing Arm, Air Suspension Axle
94 D/300	08/96 →	Centre Rod	SC-DL-5229		Push Rod
	08/96 →	Centre Rod	SC-DL-5354		Push Rod
	08/96 →	Centre Rod	SC-DL-12342		for Steering Rod
	08/96 →	Suspension Arm Repair Kit		SC-RK-12366	for Control Arm
	08/96 →	Suspension Arm Repair Kit	MN-RK-7280	MN-RK-7280	for Drag Link;for Semi-Trailing Arm; for Wishbone (CV)
	08/96 →	Suspension Strut Repair Kit		DF-RK-9341	
	08/96 →	Suspension Strut Repair Kit		MN-RK-8501	
	08/96 →	Suspension Strut Repair Kit	MN-RK-12436	MN-RK-12436	
	08/96 →	Tie Rod		SC-DL-7264	Steering Axle
	08/96 →	Tie Rod		SC-DL-8137	Steering Axle
	08/96 →	Tie Rod	SC-DL-7264		
	08/96 →	Tie Rod	SC-DL-8137		
	08/96 →	Tie Rod End		MN-ES-8490	for vehicles with Hinged Trailing Axle
	08/96 →	Tie Rod End	CV-ES-14162		for Steering Rod
	08/96 →	Tie Rod End	CV-ES-14162	CV-ES-14162	for Steering Rod
	08/96 →	Tie Rod End	CV-ES-14163		for Steering Rod
	08/96 →	Tie Rod End	IV-ES-12272		for Steering Rod
	08/96 →	Tie Rod End	SC-ES-7279		for Steering Rod
	08/96 →	Tie Rod End	SC-ES-7279	SC-ES-7279	for Steering Rod
	08/96 →	Track Control Arm	SC-DL-10302	SC-DL-10302	Trailing Arm, Air Suspension Axle
08/96 →	Track Control Arm	SC-TC-12361		Control Arm, 1st Front Axle, for Pneumatic Suspension vehicles	
94 D/310	08/96 →	Centre Rod	SC-DL-5229		Push Rod
	08/96 →	Centre Rod	SC-DL-5354		Push Rod
	08/96 →	Centre Rod	SC-DL-10225		for Steering Rod
	08/96 →	Centre Rod	SC-DL-12342		for Steering Rod
	08/96 →	Centre Rod	SC-DL-12343		for Steering Rod
	08/96 →	Suspension Arm Repair Kit		SC-RK-12366	for Control Arm
	08/96 →	Suspension Arm Repair Kit	MN-RK-7280	MN-RK-7280	for Drag Link;for Semi-Trailing Arm; for Wishbone (CV)
	08/96 →	Suspension Strut Repair Kit		DF-RK-9341	
	08/96 →	Tie Rod		SC-DL-7264	Steering Axle
	08/96 →	Tie Rod		SC-DL-8137	Steering Axle
	08/96 →	Tie Rod	SC-DL-7264		
	08/96 →	Tie Rod	SC-DL-8137		
	08/96 →	Tie Rod End		MN-ES-8490	for vehicles with Hinged Trailing Axle
	08/96 →	Tie Rod End	CV-ES-14162		for Steering Rod
	08/96 →	Tie Rod End	CV-ES-14162	CV-ES-14162	for Steering Rod
	08/96 →	Tie Rod End	CV-ES-14163		for Steering Rod
	08/96 →	Tie Rod End	SC-ES-7279		for Steering Rod
	08/96 →	Track Control Arm	SC-DL-10302	SC-DL-10302	Trailing Arm, Air Suspension Axle
	12/96 →	Centre Rod	SC-DL-2161		Coupling Rod

CV-ES-14162

Length: 125
Cone Ø: d1 Ø 30 / d2 Ø 27
Thread: M30 x 1,5 LHT
283783, 395009, 1358792, 1738380, 1 914 426, 2051165



CV-ES-14163

Length: 125
Cone Ø: d1 Ø 30 / d2 Ø 27
Thread: M30 x 1,5 RHT
283784, 395010, 1358793, 1488890, 1738381, 1767328, 1914427, 2051166



DF-RK-9341

Ø: 67
550807, 5508072



IV-ES-12272

Length: 75
Cone Ø: d1 Ø 30 / d2 Ø 27
Thread: M26 x 1,5 RHT
1394443



MN-ES-8490

Length: 90
Cone Ø: d1 Ø 30 / d2 Ø 27
Thread: M26 x 1,5 RHT
1394444, 14606948, 0014606948



MN-RK-7280

Ø: 75 Hole Distance: 115
Thick/Height: 24
0550806, 550806, 0639370, 639370, 689748, 1104334



MN-RK-8501

Ø: 75 Hole Distance: 115
Thick/Height: 24
1515981



MN-RK-12436

Ø: 75 Hole Distance: 115
Thick/Height: 24
550799, 1517403, 1783020



SC-DL-2161

Length: 1740 Ø: 50
Cone Ø: d1 Ø 30 / d2 Ø 27
1369411, 1385251, 1409918, 1501030, 1723865, 1723895, 1737683, 1897335, 2113903, 2125090, 2161883



SC-DL-5229

Length: 1053 Ø: 50
Cone Ø: d1 Ø 30 / d2 Ø 27
1356055, 1379071, 1384025, 1768898, 1847311, 1912757, 12201600A



SC-DL-5354

Length: 1060 Ø: 52
Cone Ø: d1 Ø 30 / d2 Ø 27
1384027, 1769597, 1847312, 1912758, 12200800A



SC-DL-7264

Length: 1743 Ø: 62
Cone Ø: d1 Ø 30 / d2 Ø 27
1361413, 1395614, 1734019, 1897333, 2040254, 2146105



SC-DL-8137

Length: 1736 Ø: 40
Cone Ø: d1 Ø 30 / d2 Ø 27
301639, 311847, 395350, 1358675, 1378435, 1397866, 1734020, 2028998, 12202900A



SC-DL-10225

Length: 2179 Ø: 62
Cone Ø: d1 Ø 30 / d2 Ø 27
1386618, 1788522



SC-DL-10302

Length: 752 Ø: 48
Hole Distance: 115 / 115
1101843, 1379423, 1393298, 1431470, 1942075



SC-DL-12342

Length: 601 Ø: 42
Cone Ø: d1 Ø 26 / d2 Ø 23,5
1343262, 1869413



SC-DL-12343

Length: 1062 Ø: 52
Cone Ø: d1 Ø 30 / d2 Ø 27
1348269, 2007275



SC-ES-7279

Length: 150
Cone Ø: d1 Ø 30 / d2 Ø 27
Thread: M30 x 1,5 RHT
1357674, 1603883, 1738379



SC-RK-12366

Ø: 75 Hole Distance: 115 / 115
Thick/Height: 24
1 722 753, 2 096 392



SC-TC-12361

Length: 705 Ø: 42
Cone Ø: d1 Ø 38
Hole Distance: 115
1353445, 1464611, 1942147



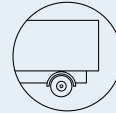

4 - series ...

94 D/310 ...	12/96 →	Suspension Arm Repair Kit		MN-RK-7280	for Drag Link;for Semi-Trailing Arm; for Wishbone (CV)	
	12/96 →	Suspension Strut Repair Kit		CV-RK-5311		
	12/96 →	Suspension Strut Repair Kit		MN-RK-8501		
	12/96 →	Suspension Strut Repair Kit	MN-RK-12436	MN-RK-12436		
	12/96 →	Track Control Arm	SC-TC-12361		Control Arm, 1st Front Axle, for Pneumatic Suspension vehicles	
	01/98 →	Centre Rod	SC-DL-8182		Push Rod	
	01/98 →	Centre Rod	SC-DL-8399		Push Rod, for vehicles with Hinged Leading Axle	
	01/98 →	Centre Rod	SC-DL-8553	SC-DL-8553	Push Rod, for vehicles with Hinged Leading Axle	
	01/98 →	Centre Rod	SC-DL-10225		Push Rod	
	01/98 →	Centre Rod	SC-DL-12449		Push Rod	
	01/98 →	Tie Rod End	IV-ES-12272		for Steering Rod	
	01/98 →	Tie Rod End	SC-ES-7279	SC-ES-7279	for Steering Rod	
	94 G/220	08/96 →	Centre Rod	SC-DL-2161		Coupling Rod
		08/96 →	Centre Rod	SC-DL-5229		Push Rod
		08/96 →	Centre Rod	SC-DL-5354		Push Rod
08/96 →		Centre Rod	SC-DL-10225		for Steering Rod	
08/96 →		Centre Rod	SC-DL-12342		for Steering Rod	
08/96 →		Suspension Arm Repair Kit		MN-RK-7280	for Drag Link;for Semi-Trailing Arm; for Wishbone (CV)	
08/96 →		Suspension Arm Repair Kit		SC-RK-12366	for Control Arm	
08/96 →		Suspension Strut Repair Kit		CV-RK-5311		
08/96 →		Suspension Strut Repair Kit		MN-RK-8501		
08/96 →		Suspension Strut Repair Kit	MN-RK-12436	MN-RK-12436		
08/96 →		Tie Rod	SC-DL-7264			
08/96 →		Tie Rod	SC-DL-8137			
08/96 →		Tie Rod End	CV-ES-14162		for Steering Rod	
08/96 →		Tie Rod End	CV-ES-14163		for Steering Rod	
08/96 →		Tie Rod End	SC-ES-7279		for Steering Rod	
08/96 →		Track Control Arm	SC-DL-10302	SC-DL-10302	Trailing Arm, Air Suspension Axle	
08/96 →		Track Control Arm	SC-TC-12361		Control Arm, 1st Front Axle, for Pneumatic Suspension vehicles	
01/98 →		Centre Rod	SC-DL-8182		Push Rod	
01/98 →		Centre Rod	SC-DL-8399		Push Rod, for vehicles with Hinged Leading Axle	
01/98 →		Centre Rod	SC-DL-8553	SC-DL-8553	Push Rod, for vehicles with Hinged Leading Axle	
01/98 →		Centre Rod	SC-DL-10225		Push Rod	
01/98 →		Centre Rod	SC-DL-12449		Push Rod	
01/98 →		Tie Rod		SC-DL-7264	Steering Axle	
01/98 →		Tie Rod		SC-DL-8137	Steering Axle	
01/98 →		Tie Rod End		MN-ES-8490	for vehicles with Hinged Trailing Axle	
01/98 →		Tie Rod End	IV-ES-12272		for Steering Rod	
01/98 →		Tie Rod End	SC-ES-7279	SC-ES-7279	for Steering Rod	
94 G/260		08/96 →	Centre Rod	SC-DL-2161		Coupling Rod
		08/96 →	Centre Rod	SC-DL-5229		Push Rod
		08/96 →	Centre Rod	SC-DL-5354		Push Rod
		08/96 →	Centre Rod	SC-DL-10225		for Steering Rod
		08/96 →	Centre Rod	SC-DL-12342		for Steering Rod
		08/96 →	Centre Rod	SC-DL-12343		for Steering Rod
	08/96 →	Suspension Arm Repair Kit		MN-RK-7280	for Drag Link;for Semi-Trailing Arm; for Wishbone (CV)	
	08/96 →	Suspension Arm Repair Kit		SC-RK-12366	for Control Arm	
	08/96 →	Suspension Arm Repair Kit	MN-RK-7280	MN-RK-7280	for Drag Link;for Semi-Trailing Arm; for Wishbone (CV)	
	08/96 →	Suspension Strut Repair Kit		CV-RK-5311		
	08/96 →	Suspension Strut Repair Kit		DF-RK-9341		
	08/96 →	Suspension Strut Repair Kit		MN-RK-8501		
	08/96 →	Suspension Strut Repair Kit	MN-RK-12436	MN-RK-12436		
	08/96 →	Tie Rod	SC-DL-7264			
	08/96 →	Tie Rod	SC-DL-8137			
	08/96 →	Tie Rod End	CV-ES-14162		for Steering Rod	
	08/96 →	Tie Rod End	CV-ES-14163		for Steering Rod	
	08/96 →	Tie Rod End	SC-ES-7279		for Steering Rod	

CV-ES-14162

Length: 125
Cone Ø: d1 Ø 30 / d2 Ø 27
Thread: M30 x 1,5 LHT
283783, 395009, 1358792, 1738380, 1 914 426, 2051165



CV-ES-14163

Length: 125
Cone Ø: d1 Ø 30 / d2 Ø 27
Thread: M30 x 1,5 RHT
283784, 395010, 1358793, 1488890, 1738381, 1767328, 1914427, 2051166



CV-RK-5311

638862, 0638862, 0639287, 639287, 1104335, 1953248, 81432206006, 81432206107



DF-RK-9341

Ø: 67
550807, 5508072



IV-ES-12272

Length: 75
Cone Ø: d1 Ø 30 / d2 Ø 27
Thread: M26 x 1,5 RHT
1394443



MN-ES-8490

Length: 90
Cone Ø: d1 Ø 30 / d2 Ø 27
Thread: M26 x 1,5 RHT
1394444, 0014606948, 14606948



MN-RK-7280

Ø: 75 Hole Distance: 115
Thick/Height: 24
0550806, 550806, 0639370, 639370, 689748, 1104334



MN-RK-8501

Ø: 75 Hole Distance: 115
Thick/Height: 24
1515981



MN-RK-12436

Ø: 75 Hole Distance: 115
Thick/Height: 24
550799, 1517403, 1783020



SC-DL-2161

Length: 1740 Ø: 50
Cone Ø: d1 Ø 30 / d2 Ø 27
1369411, 1385251, 1409918, 1501030, 1723865, 1723895, 1737683, 1897335, 2113903, 2125090, 2161883



SC-DL-5229

Length: 1053 Ø: 50
Cone Ø: d1 Ø 30 / d2 Ø 27
1356055, 1379071, 1384025, 1768898, 1847311, 1912757, 12201600A



SC-DL-5354

Length: 1060 Ø: 52
Cone Ø: d1 Ø 30 / d2 Ø 27
1384027, 1769597, 1847312, 1912758, 12200800A



SC-DL-7264

Length: 1743 Ø: 62
Cone Ø: d1 Ø 30 / d2 Ø 27
1361413, 1395614, 1734019, 1897333, 2040254, 2146105



SC-DL-8137

Length: 1736 Ø: 40
Cone Ø: d1 Ø 30 / d2 Ø 27
301639, 311847, 395350, 1358675, 1378435, 1397866, 1734020, 2028998, 12202900A



SC-DL-8182

1343262, 1869413



SC-DL-8399

Length: 433 Ø: 40
Cone Ø: d1 Ø 30 / d2 Ø 26
1394884, 1938387



SC-DL-8553

Length: 435 Ø: 38
Cone Ø: d1 Ø 30 / d2 Ø 27
1343283, 1759691



SC-DL-10225

Length: 2179 Ø: 62
Cone Ø: d1 Ø 30 / d2 Ø 27
1386618, 1788522



SC-DL-10302

Length: 752 Ø: 48
Hole Distance: 115 / 115
1101843, 1379423, 1393298, 1431470, 1942075



SC-DL-12342

Length: 601 Ø: 42
Cone Ø: d1 Ø 26 / d2 Ø 23,5
1343262, 1869413



SC-DL-12343

Length: 1062 Ø: 52
Cone Ø: d1 Ø 30 / d2 Ø 27
1348269, 2007275



SC-DL-12449

Length: 1206 Ø: 38
Cone Ø: d1 Ø 30 / d2 Ø 27
1385763, 1765375



SC-ES-7279

Length: 150
Cone Ø: d1 Ø 30 / d2 Ø 27
Thread: M30 x 1,5 RHT
1357674, 1603883, 1738379



SC-RK-12366

Ø: 75 Hole Distance: 115 / 115
Thick/Height: 24
1 722 753, 2 096 392



SC-TC-12361

Length: 705 Ø: 42
Cone Ø: d1 Ø 30
Hole Distance: 115
1353445, 1464611, 1942147





4 - series ...

94 G/260 ...	08/96→	Track Control Arm	SC-DL-10302	SC-DL-10302	Trailing Arm, Air Suspension Axle	
	08/96→	Track Control Arm	SC-TC-12361		Control Arm, 1st Front Axle, for Pneumatic Suspension vehicles	
	01/98→	Centre Rod	SC-DL-8182		Push Rod	
	01/98→	Centre Rod	SC-DL-8399		Push Rod, for vehicles with Hinged Leading Axle	
	01/98→	Centre Rod	SC-DL-8553	SC-DL-8553	Push Rod, for vehicles with Hinged Leading Axle	
	01/98→	Centre Rod	SC-DL-10225		Push Rod	
	01/98→	Centre Rod	SC-DL-12449		Push Rod	
	01/98→	Tie Rod		SC-DL-7264	Steering Axle	
	01/98→	Tie Rod		SC-DL-8137	Steering Axle	
	01/98→	Tie Rod End		MN-ES-8490	for vehicles with Hinged Trailing Axle	
	01/98→	Tie Rod End	IV-ES-12272		for Steering Rod	
	01/98→	Tie Rod End	SC-ES-7279	SC-ES-7279	for Steering Rod	
	94 G/310	08/96→	Centre Rod	SC-DL-2161		Coupling Rod
		08/96→	Centre Rod	SC-DL-5229		Push Rod
08/96→		Centre Rod	SC-DL-5354		Push Rod	
08/96→		Centre Rod	SC-DL-8182		Push Rod	
08/96→		Centre Rod	SC-DL-8399		Push Rod, for vehicles with Hinged Leading Axle	
08/96→		Centre Rod	SC-DL-8553	SC-DL-8553	Push Rod, for vehicles with Hinged Leading Axle	
08/96→		Centre Rod	SC-DL-10225		for Steering Rod	
08/96→		Centre Rod	SC-DL-10225		Push Rod	
08/96→		Centre Rod	SC-DL-12342		for Steering Rod	
08/96→		Centre Rod	SC-DL-12343		for Steering Rod	
08/96→		Centre Rod	SC-DL-12449		Push Rod	
08/96→		Suspension Arm Repair Kit		MN-RK-7280	for Drag Link;for Semi-Trailing Arm; for Wishbone (CV)	
08/96→		Suspension Arm Repair Kit		SC-RK-12366	for Control Arm	
08/96→		Suspension Arm Repair Kit	MN-RK-7280	MN-RK-7280	for Drag Link;for Semi-Trailing Arm; for Wishbone (CV)	
08/96→		Suspension Strut Repair Kit		CV-RK-5311		
08/96→		Suspension Strut Repair Kit		DF-RK-9341		
08/96→		Suspension Strut Repair Kit		MN-RK-8501		
08/96→		Suspension Strut Repair Kit	MN-RK-12436	MN-RK-12436		
08/96→		Tie Rod		SC-DL-7264	Steering Axle	
08/96→		Tie Rod		SC-DL-8137	Steering Axle	
08/96→		Tie Rod	SC-DL-7264			
08/96→		Tie Rod	SC-DL-8137			
08/96→		Tie Rod End		MN-ES-8490	for vehicles with Hinged Trailing Axle	
08/96→		Tie Rod End	CV-ES-14162		for Steering Rod	
08/96→		Tie Rod End	CV-ES-14162	CV-ES-14162	for Steering Rod	
08/96→		Tie Rod End	CV-ES-14163		for Steering Rod	
08/96→		Tie Rod End	IV-ES-12272		for Steering Rod	
08/96→		Tie Rod End	SC-ES-7279		for Steering Rod	
08/96→		Tie Rod End	SC-ES-7279	SC-ES-7279	for Steering Rod	
08/96→		Track Control Arm		SC-DL-8179	Trailing Arm, Leaf Spring Axle	
08/96→		Track Control Arm		SC-DL-8400	Trailing Arm	
08/96→		Track Control Arm		SC-DL-8511	Trailing Arm, Leaf Spring Axle	
08/96→		Track Control Arm		SC-DL-8547	Trailing Arm, Leaf Spring Axle	
08/96→		Track Control Arm		SC-DL-8623	Trailing Arm, 1st Drive Axle, for Leaf-Spring Suspension vehicles, →1280184/4471602	
08/96→		Track Control Arm		SC-DL-8623	Trailing Arm, 1st Drive Axle, for Leaf-Spring Suspension vehicles, →9069959/3533626	
08/96→		Track Control Arm		SC-DL-9462	Trailing Arm, 2nd Drive Axle, for Leaf-Spring Suspension vehicles, →1280184/4471602	
08/96→		Track Control Arm		SC-DL-9462	Trailing Arm, 2nd Drive Axle, for Leaf-Spring Suspension vehicles, →1280185/4471603_>	
08/96→		Track Control Arm		SC-DL-9462	Trailing Arm, 2nd Drive Axle, for Leaf-Spring Suspension vehicles, →9069959/3533626	
08/96→		Track Control Arm		SC-DL-9462	Trailing Arm, 2nd Drive Axle, for Leaf-Spring Suspension vehicles, 9069960/3533627→	
08/96→		Track Control Arm		SC-DL-9466	Trailing Arm, Leaf Spring Axle	

CV-ES-14162

Length: 125
Cone Ø: d1 Ø 30 / d2 Ø 27
Thread: M30 x 1,5 LHT
283784, 395009, 1358792, 1738380, 1 914 426, 2051165



CV-ES-14163

Length: 125
Cone Ø: d1 Ø 30 / d2 Ø 27
Thread: M30 x 1,5 RHT
283784, 395010, 1358793, 1488890, 1738381, 1767328, 1914427, 2051166



CV-RK-5311

0638862, 638862, 639287, 0639287, 1104335, 1953248, 81432206006, 81432206107



DF-RK-9341

Ø: 67
550807, 5508072



IV-ES-12272

Length: 75
Cone Ø: d1 Ø 30 / d2 Ø 27
Thread: M26 x 1,5 RHT
1394443



MN-ES-8490

Length: 90
Cone Ø: d1 Ø 30 / d2 Ø 27
Thread: M26 x 1,5 RHT
1394444, 0014606948, 14606948



MN-RK-7280

Ø: 75 Hole Distance: 115
Thick/Height: 24
550806, 0550806, 639370, 0639370, 689748, 1104334



MN-RK-8501

Ø: 75 Hole Distance: 115
Thick/Height: 24
1515981



MN-RK-12436

Ø: 75 Hole Distance: 115
Thick/Height: 24
550799, 1517403, 1783020



SC-DL-2161

Length: 1740 Ø: 50
Cone Ø: d1 Ø 30 / d2 Ø 27
1369411, 1385251, 1409918, 1501030, 1723865, 1723895, 1737683, 1897335, 2113903, 2125090, 2161883



SC-DL-5229

Length: 1053 Ø: 50
Cone Ø: d1 Ø 30 / d2 Ø 27
1356055, 1379071, 1384025, 1768898, 1847311, 1912757, 12201600A



SC-DL-5354

Length: 1060 Ø: 52
Cone Ø: d1 Ø 30 / d2 Ø 27
1384027, 1769597, 1847312, 1912758, 12200800A



SC-DL-7264

Length: 1743 Ø: 62
Cone Ø: d1 Ø 30 / d2 Ø 27
1361413, 1395614, 1734019, 1897333, 2040254, 2146105



SC-DL-8137

Length: 1736 Ø: 40
Cone Ø: d1 Ø 30 / d2 Ø 27
301639, 311847, 395350, 1358675, 1378435, 1397866, 1734020, 2028998, 12202900A



SC-DL-8179

Length: 568 Ø: 46
Hole Distance: 115 / 115
1399180, 1428347



SC-DL-8182

1343262, 1869413



SC-DL-8399

Length: 433 Ø: 40
Cone Ø: d1 Ø 30 / d2 Ø 26
1394884, 1938387



SC-DL-8179

Length: 568 Ø: 46
Hole Distance: 115 / 115
1399180, 1428347



SC-DL-8511

Length: 616,5 Ø: 50
Hole Distance: 115 / 115
1485760, 1499478, 1722750



SC-DL-8547

Length: 568 Ø: 50
Hole Distance: 115 / 115
1499474, 1722746, 1906940



SC-DL-8553

Length: 435 Ø: 38
Cone Ø: d1 Ø 30 / d2 Ø 27
1343283, 1759691



SC-DL-8623

Length: 592 Ø: 50
Hole Distance: 115 / 115
1388436, 1499476, 1722748, 1906942



SC-DL-9462

Length: 568,5 Ø: 50
Hole Distance: 115 / 115
1499475, 1500573, 1722747, 1906941



SC-DL-9466

Length: 568 Ø: 19
1486756



SC-DL-10225

Length: 2179 Ø: 62
Cone Ø: d1 Ø 30 / d2 Ø 27
1386618, 1788522



SC-DL-10302

Length: 752 Ø: 48
Hole Distance: 115 / 115
1101843, 1379423, 1393298, 1431470, 1942075



SC-DL-12342

Length: 601 Ø: 42
Cone Ø: d1 Ø 26 / d2 Ø 23,5
1343262, 1869413



SC-DL-12343

Length: 1062 Ø: 52
Cone Ø: d1 Ø 30 / d2 Ø 27
1348269, 2007275



SC-DL-12449

Length: 1206 Ø: 38
Cone Ø: d1 Ø 30 / d2 Ø 27
1385763, 1765375



SC-ES-7279

Length: 150
Cone Ø: d1 Ø 30 / d2 Ø 27
Thread: M30 x 1,5 RHT
1357674, 1603883, 1738379



SC-RK-12366

Ø: 75 Hole Distance: 115 / 115
Thick/Height: 24
1 722 753, 2 096 392



SC-TC-12361

Length: 705 Ø: 42
Cone Ø: d1 Ø 38
Hole Distance: 115
1353445, 1464611, 1942147



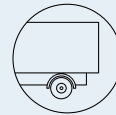

4 - series ...

94 G/310 ...	08/96 →	Track Control Arm		SC-DL-9467	Trailing Arm, Leaf Spring Axle, →* 1247518 SSS *;* 4406943 SNL *; * 9039629 SAN *;* 3507979 SLA *
	08/96 →	Track Control Arm		SC-DL-9467	Trailing Arm, Leaf Spring Axle, → * 1280184 SSS *;* 4471602 SNL *; * 9069959 SAN *;* 3533626 SLA *
	08/96 →	Track Control Arm		SC-TC-12451	Trailing Arm, 1st Drive Axle, for Leaf-Spring Suspension vehicles
	08/96 →	Track Control Arm		SC-TC-12452	Trailing Arm, 1st RA;2nd RA, for Leaf-Spring Suspension vehicles
	08/96 →	Track Control Arm	SC-DL-8179	SC-DL-8179	Trailing Arm, Leaf Spring Axle, → * 1280184 SSS *;* 4471602 SNL *; * 9069959 SAN *;* 3533626 SLA *
	08/96 →	Track Control Arm	SC-DL-8509	SC-DL-8509	Trailing Arm, Leaf Spring Axle
	08/96 →	Track Control Arm	SC-DL-8531	SC-DL-8531	Trailing Arm, Leaf Spring Axle
	08/96 →	Track Control Arm	SC-DL-10302	SC-DL-10302	Trailing Arm, Air Suspension Axle
	08/96 →	Track Control Arm	SC-TC-12361		Control Arm, 1st Front Axle, for Pneumatic Suspension vehicles
	94 L/310	08/96 →	Centre Rod	SC-DL-2161	
08/96 →		Centre Rod	SC-DL-5229		Push Rod
08/96 →		Centre Rod	SC-DL-5354		Push Rod
08/96 →		Centre Rod	SC-DL-8182		Push Rod
08/96 →		Centre Rod	SC-DL-8399		Push Rod, for vehicles with Hinged Leading Axle
08/96 →		Centre Rod	SC-DL-8553	SC-DL-8553	Push Rod, for vehicles with Hinged Leading Axle
08/96 →		Centre Rod	SC-DL-10225		for Steering Rod
08/96 →		Centre Rod	SC-DL-10225		Push Rod
08/96 →		Centre Rod	SC-DL-12342		for Steering Rod
08/96 →		Centre Rod	SC-DL-12449		Push Rod
08/96 →		Suspension Arm Repair Kit		SC-RK-12366	for Control Arm
08/96 →		Suspension Arm Repair Kit	MN-RK-7280	MN-RK-7280	for Drag Link;for Semi-Trailing Arm; for Wishbone (CV)
08/96 →		Suspension Strut Repair Kit		CV-RK-5311	
08/96 →		Suspension Strut Repair Kit		DF-RK-9341	
08/96 →		Suspension Strut Repair Kit		MN-RK-8501	
08/96 →		Suspension Strut Repair Kit	MN-RK-12436	MN-RK-12436	
08/96 →		Tie Rod		SC-DL-7264	Steering Axle
08/96 →		Tie Rod		SC-DL-8137	Steering Axle
08/96 →		Tie Rod	SC-DL-7264		
08/96 →		Tie Rod	SC-DL-8137		
08/96 →		Tie Rod End		MN-ES-8490	for vehicles with Hinged Trailing Axle
08/96 →		Tie Rod End	CV-ES-14162		for Steering Rod
08/96 →		Tie Rod End	CV-ES-14162	CV-ES-14162	for Steering Rod
08/96 →		Tie Rod End	CV-ES-14163		for Steering Rod
08/96 →		Tie Rod End	IV-ES-12272		for Steering Rod
08/96 →		Tie Rod End	SC-ES-7279		for Steering Rod
08/96 →		Tie Rod End	SC-ES-7279	SC-ES-7279	for Steering Rod
08/96 →		Track Control Arm		SC-DL-8179	Trailing Arm, Leaf Spring Axle
08/96 →		Track Control Arm		SC-DL-8400	Trailing Arm
08/96 →		Track Control Arm		SC-DL-8511	Trailing Arm, Leaf Spring Axle
08/96 →		Track Control Arm		SC-DL-8547	Trailing Arm, Leaf Spring Axle
08/96 →		Track Control Arm		SC-DL-8623	Trailing Arm, 1st Drive Axle, for Leaf-Spring Suspension vehicles, →1280184/4471602
08/96 →		Track Control Arm		SC-DL-8623	Trailing Arm, 1st Drive Axle, for Leaf-Spring Suspension vehicles, →9069959/3533626
08/96 →	Track Control Arm		SC-DL-9462	Trailing Arm, 2nd Drive Axle, for Leaf-Spring Suspension vehicles, →1280184/4471602	
08/96 →	Track Control Arm		SC-DL-9462	Trailing Arm, 2nd Drive Axle, for Leaf-Spring Suspension vehicles, →1280185/4471603_>	
08/96 →	Track Control Arm		SC-DL-9462	Trailing Arm, 2nd Drive Axle, for Leaf-Spring Suspension vehicles, →9069959/3533626	
08/96 →	Track Control Arm		SC-DL-9462	Trailing Arm, 2nd Drive Axle, for Leaf-Spring Suspension vehicles, 9069960/3533627→	
08/96 →	Track Control Arm		SC-DL-9466	Trailing Arm, Leaf Spring Axle	

CV-ES-14162

Length: 125
Cone Ø: d1 Ø 30 / d2 Ø 27
Thread: M30 x 1,5 LHT
283783, 395009, 1358792, 1738380, 1 914 426, 2051165



CV-ES-14163

Length: 125
Cone Ø: d1 Ø 30 / d2 Ø 27
Thread: M30 x 1,5 RHT
283784, 395010, 1358793, 1488890, 1738381, 1767328, 1914427, 2051166



CV-RK-5311

0638862, 638862, 0639287, 639287, 1104335, 1953248, 81432206006, 81432206107



DF-RK-9341

Ø: 67
550807, 5508072



IV-ES-12272

Length: 75
Cone Ø: d1 Ø 30 / d2 Ø 27
Thread: M26 x 1,5 RHT
1394443



MN-ES-8490

Length: 90
Cone Ø: d1 Ø 30 / d2 Ø 27
Thread: M26 x 1,5 RHT
1394444, 14606948, 0014606948



MN-RK-7280

Ø: 75 Hole Distance: 115
Thick/Height: 24
0550806, 550806, 0639370, 639370, 689748, 1104334



MN-RK-8501

Ø: 75 Hole Distance: 115
Thick/Height: 24
1515981



MN-RK-12436

Ø: 75 Hole Distance: 115
Thick/Height: 24
550799, 1517403, 1783020



SC-DL-2161

Length: 1740 Ø: 50
Cone Ø: d1 Ø 30 / d2 Ø 27
1369411, 1385251, 1409918, 1501030, 1723865, 1723895, 1737683, 1897335, 2113903, 2125090, 2161883



SC-DL-5229

Length: 1053 Ø: 50
Cone Ø: d1 Ø 30 / d2 Ø 27
1356055, 1379071, 1384025, 1768898, 1847311, 1912757, 12201600A



SC-DL-5354

Length: 1060 Ø: 52
Cone Ø: d1 Ø 30 / d2 Ø 27
1384027, 1769597, 1847312, 1912758, 12200800A



SC-DL-7264

Length: 1743 Ø: 62
Cone Ø: d1 Ø 30 / d2 Ø 27
1361413, 1395614, 1734019, 1897333, 2040254, 2146105



SC-DL-8137

Length: 1736 Ø: 40
Cone Ø: d1 Ø 30 / d2 Ø 27
301639, 311847, 395350, 1358675, 1378435, 1397866, 1734020, 2028998, 12202900A



SC-DL-8179

Length: 568 Ø: 46
Hole Distance: 115 / 115
1399180, 1428347



SC-DL-8182

1343262, 1869413



SC-DL-8399

Length: 433 Ø: 40
Cone Ø: d1 Ø 30 / d2 Ø 26
1394884, 1938387



SC-DL-8179

Length: 568 Ø: 46
Hole Distance: 115 / 115
1399180, 1428347



SC-DL-8509

Length: 568,5 Ø: 46
Hole Distance: 115 / 115
1485758, 1486757



SC-DL-8511

Length: 616,5 Ø: 50
Hole Distance: 115 / 115
1485760, 1499478, 1722750



SC-DL-8531

Length: 522 Ø: 46
Hole Distance: 115 / 115
1486758



SC-DL-8547

Length: 568 Ø: 50
Hole Distance: 115 / 115
1499474, 1722746, 1906940



SC-DL-8553

Length: 435 Ø: 38
Cone Ø: d1 Ø 30 / d2 Ø 27
1343283, 1759691



SC-DL-8623

Length: 592 Ø: 50
Hole Distance: 115 / 115
1388436, 1499476, 1722748, 1906942



SC-DL-9462

Length: 568,5 Ø: 50
Hole Distance: 115 / 115
1499475, 1500573, 1722747, 1906941



SC-DL-9466

Length: 568 Ø: 19
1486756



SC-DL-9467

Length: 568,5 Ø: 50
Hole Distance: 115 / 115
1500572



SC-DL-10225

Length: 2179 Ø: 62
Cone Ø: d1 Ø 30 / d2 Ø 27
1386618, 1788522



SC-DL-10302

Length: 752 Ø: 48
Hole Distance: 115 / 115
1101843, 1379423, 1393298, 1431470, 1942075



SC-DL-12342

Length: 601 Ø: 42
Cone Ø: d1 Ø 26 / d2 Ø 23,5
1343262, 1869413



SC-DL-12449

Length: 1206 Ø: 38
Cone Ø: d1 Ø 30 / d2 Ø 27
1385763, 1765375



SC-ES-7279

Length: 150
Cone Ø: d1 Ø 30 / d2 Ø 27
Thread: M30 x 1,5 RHT
1357674, 1603883, 1738379



SC-RK-12366

Ø: 75 Hole Distance: 115 / 115
Thick/Height: 24
1 722 753, 2 096 392



SC-TC-12361

Length: 705 Ø: 42
Cone Ø: d1 Ø 38
Hole Distance: 115
1353445, 1464611, 1942147



SC-TC-12451

Length: 552 Ø: 46
Hole Distance: 115 / 115
1494296



SC-TC-12452

Length: 580,5 Ø: 46
Hole Distance: 115 / 115
1485759



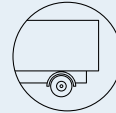

4 - series ...

94 L/310 ...	08/96→	Track Control Arm		SC-DL-9467	Trailing Arm, Leaf Spring Axle, →* 1247518 SSS *,* 4406943 SNL *, * 9039629 SAN *,* 3507979 SLA *
	08/96→	Track Control Arm		SC-DL-9467	Trailing Arm, Leaf Spring Axle, → * 1280184 SSS *,* 4471602 SNL *, * 9069959 SAN *,* 3533626 SLA *
	08/96→	Track Control Arm		SC-TC-12451	Trailing Arm, 1st Drive Axle, for Leaf-Spring Suspension vehicles
	08/96→	Track Control Arm		SC-TC-12452	Trailing Arm, 1st RA;2nd RA, for Leaf-Spring Suspension vehicles
	08/96→	Track Control Arm	SC-DL-8179	SC-DL-8179	Trailing Arm, Leaf Spring Axle, → * 1280184 SSS *,* 4471602 SNL *, * 9069959 SAN *,* 3533626 SLA *
	08/96→	Track Control Arm	SC-DL-8509	SC-DL-8509	Trailing Arm, Leaf Spring Axle
	08/96→	Track Control Arm	SC-DL-8531	SC-DL-8531	Trailing Arm, Leaf Spring Axle
	08/96→	Track Control Arm	SC-DL-10302	SC-DL-10302	Trailing Arm, Air Suspension Axle
	08/96→	Track Control Arm	SC-TC-12361		Control Arm, 1st Front Axle, for Pneumatic Suspension vehicles
	T 114 C/340	05/96→	Centre Rod	SC-DL-5229	
05/96→		Centre Rod	SC-DL-5354		Push Rod
05/96→		Centre Rod	SC-DL-12343		for Steering Rod
05/96→		Suspension Arm Repair Kit		SC-RK-12366	for Control Arm
05/96→		Suspension Arm Repair Kit	MN-RK-7280	MN-RK-7280	for Drag Link;for Semi-Trailing Arm; for Wishbone (CV)
05/96→		Suspension Strut Repair Kit		MN-RK-8501	
05/96→		Tie Rod	SC-DL-7264		
05/96→		Tie Rod	SC-DL-8137		
05/96→		Tie Rod End	CV-ES-14162		for Steering Rod
05/96→		Tie Rod End	CV-ES-14163		for Steering Rod
05/96→		Tie Rod End	SC-ES-7279		for Steering Rod
05/96→		Track Control Arm		SC-DL-8179	Trailing Arm, 1st RA;2nd RA, Parabolic Leaf Spring, →1280184/4471602
05/96→		Track Control Arm		SC-DL-8179	Trailing Arm, 1st RA;2nd RA, Parabolic Leaf Spring, →9069959/3533626
05/96→		Track Control Arm		SC-DL-8179	Trailing Arm, Leaf Spring Axle
05/96→		Track Control Arm		SC-DL-8400	Trailing Arm
05/96→		Track Control Arm		SC-DL-8511	Trailing Arm, Leaf Spring Axle
05/96→		Track Control Arm		SC-DL-8547	Trailing Arm, Leaf Spring Axle
05/96→		Track Control Arm		SC-DL-8623	Trailing Arm, 1st Drive Axle, for Leaf-Spring Suspension vehicles, →1280184/4471602
05/96→		Track Control Arm		SC-DL-8623	Trailing Arm, 1st Drive Axle, for Leaf-Spring Suspension vehicles, →9069959/3533626
05/96→		Track Control Arm		SC-DL-9462	Trailing Arm, 2nd Drive Axle, for Leaf-Spring Suspension vehicles, →1280184/4471602
05/96→		Track Control Arm		SC-DL-9462	Trailing Arm, 2nd Drive Axle, for Leaf-Spring Suspension vehicles, →1280185/4471603_>
05/96→		Track Control Arm		SC-DL-9462	Trailing Arm, 2nd Drive Axle, for Leaf-Spring Suspension vehicles, →9069959/3533626
05/96→		Track Control Arm		SC-DL-9462	Trailing Arm, 2nd Drive Axle, for Leaf-Spring Suspension vehicles, 9069960/3533627→
05/96→		Track Control Arm		SC-DL-9466	Trailing Arm, Leaf Spring Axle
05/96→		Track Control Arm		SC-DL-9467	Trailing Arm, Leaf Spring Axle, →* 1247518 SSS *,* 4406943 SNL *, * 9039629 SAN *,* 3507979 SLA *
05/96→		Track Control Arm		SC-DL-9467	Trailing Arm, Leaf Spring Axle, → * 1280184 SSS *,* 4471602 SNL *, * 9069959 SAN *,* 3533626 SLA *
05/96→		Track Control Arm	SC-DL-8179	SC-DL-8179	Trailing Arm, Leaf Spring Axle, → * 1280184 SSS *,* 4471602 SNL *, * 9069959 SAN *,* 3533626 SLA *
05/96→		Track Control Arm	SC-DL-8509	SC-DL-8509	Trailing Arm, Leaf Spring Axle
05/96→		Track Control Arm	SC-DL-8531	SC-DL-8531	Trailing Arm, Leaf Spring Axle
05/96→		Track Control Arm	SC-DL-10302	SC-DL-10302	Trailing Arm, Air Suspension Axle

CV-ES-14162

Length: 125
Cone Ø: d1 Ø 30 / d2 Ø 27
Thread: M30 x 1,5 LHT
283783, 395009, 1358792, 1738380, 1 914 426, 2051165



CV-ES-14163

Length: 125
Cone Ø: d1 Ø 30 / d2 Ø 27
Thread: M30 x 1,5 RHT
283784, 395010, 1358793, 1488890, 1738381, 1767328, 1914427, 2051166



MN-RK-7280

Ø: 75 Hole Distance: 115
Thick/Height: 24
0550806, 550806, 639370, 0639370, 689748, 1104334



MN-RK-8501

Ø: 75 Hole Distance: 115
Thick/Height: 24
1515981



SC-DL-5229

Length: 1053 Ø: 50
Cone Ø: d1 Ø 30 / d2 Ø 27
1356055, 1379071, 1384025, 1768898, 1847311, 1912757, 12201600A



SC-DL-5354

Length: 1060 Ø: 52
Cone Ø: d1 Ø 30 / d2 Ø 27
1384027, 1769597, 1847312, 1912758, 12200800A



SC-DL-7264

Length: 1743 Ø: 62
Cone Ø: d1 Ø 30 / d2 Ø 27
1361413, 1395614, 1734019, 1897333, 2040254, 2146105



SC-DL-8137

Length: 1736 Ø: 40
Cone Ø: d1 Ø 30 / d2 Ø 27
301639, 311847, 395350, 1358675, 1378435, 1397866, 1734020, 2028998, 12202900A



SC-DL-8179

Length: 568 Ø: 46
Hole Distance: 115 / 115
1399180, 1428347



SC-DL-8179

Length: 568 Ø: 46
Hole Distance: 115 / 115
1399180, 1428347



SC-DL-8509

Length: 568,5 Ø: 46
Hole Distance: 115 / 115
1485758, 1486757



SC-DL-8511

Length: 616,5 Ø: 50
Hole Distance: 115 / 115
1485760, 1499478, 1722750



SC-DL-8531

Length: 522 Ø: 46
Hole Distance: 115 / 115
1486758



SC-DL-8547

Length: 568 Ø: 50
Hole Distance: 115 / 115
1499474, 1722746, 1906940



SC-DL-8623

Length: 592 Ø: 50
Hole Distance: 115 / 115
1388436, 1499476, 1722748, 1906942



SC-DL-9462

Length: 568,5 Ø: 50
Hole Distance: 115 / 115
1499475, 1500573, 1722747, 1906941



SC-DL-9466

Length: 568 Ø: 19
1486756



SC-DL-9467

Length: 568,5 Ø: 50
Hole Distance: 115 / 115
1500572



SC-DL-10302

Length: 752 Ø: 48
Hole Distance: 115 / 115
1101843, 1379423, 1393298, 1431470, 1942075



SC-DL-12343

Length: 1062 Ø: 52
Cone Ø: d1 Ø 30 / d2 Ø 27
1348269, 2007275



SC-ES-7279

Length: 150
Cone Ø: d1 Ø 30 / d2 Ø 27
Thread: M30 x 1,5 RHT
1357674, 1603883, 1738379



SC-RK-12366

Ø: 75 Hole Distance: 115 / 115
Thick/Height: 24
1 722 753, 2 096 392



SC-TC-12361

Length: 705 Ø: 42
Cone Ø: d1 Ø 38
Hole Distance: 115
1353445, 1464611, 1942147



SC-TC-12451

Length: 552 Ø: 46
Hole Distance: 115 / 115
1494296



SC-TC-12452

Length: 580,5 Ø: 46
Hole Distance: 115 / 115
1485759



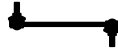

4 - series ...

T 114 C/340 ...	03/98 →	Centre Rod	SC-DL-2161		Coupling Rod	
	03/98 →	Suspension Arm Repair Kit		MN-RK-7280	for Drag Link;for Semi-Trailing Arm; for Wishbone (CV)	
	03/98 →	Suspension Strut Repair Kit		CV-RK-5311		
T 114 C/380	03/98 →	Centre Rod	SC-DL-2161		Coupling Rod	
	03/98 →	Centre Rod	SC-DL-5229		Push Rod	
	03/98 →	Centre Rod	SC-DL-5354		Push Rod	
	03/98 →	Centre Rod	SC-DL-12343		for Steering Rod	
	03/98 →	Suspension Arm Repair Kit		SC-RK-12366	for Control Arm	
	03/98 →	Suspension Strut Repair Kit		CV-RK-5311		
	03/98 →	Tie Rod	SC-DL-7264			
	03/98 →	Tie Rod	SC-DL-8137			
	03/98 →	Tie Rod End	CV-ES-14162		for Steering Rod	
	03/98 →	Tie Rod End	CV-ES-14163		for Steering Rod	
	03/98 →	Tie Rod End	SC-ES-7279		for Steering Rod	
	03/98 →	Track Control Arm		SC-DL-8179	Trailing Arm, Leaf Spring Axle	
	03/98 →	Track Control Arm		SC-DL-8400	Trailing Arm	
	03/98 →	Track Control Arm		SC-DL-8511	Trailing Arm, Leaf Spring Axle	
	03/98 →	Track Control Arm		SC-DL-8547	Trailing Arm, Leaf Spring Axle	
	03/98 →	Track Control Arm		SC-DL-8623	Trailing Arm, 1st Drive Axle, for Leaf-Spring Suspension vehicles, →1280184/4471602	
	03/98 →	Track Control Arm		SC-DL-8623	Trailing Arm, 1st Drive Axle, for Leaf-Spring Suspension vehicles, →9069959/3533626	
	03/98 →	Track Control Arm		SC-DL-9462	Trailing Arm, 2nd Drive Axle, for Leaf-Spring Suspension vehicles, →1280184/4471602	
	03/98 →	Track Control Arm		SC-DL-9462	Trailing Arm, 2nd Drive Axle, for Leaf-Spring Suspension vehicles, →1280185/4471603_>	
	03/98 →	Track Control Arm		SC-DL-9462	Trailing Arm, 2nd Drive Axle, for Leaf-Spring Suspension vehicles, →9069959/3533626	
	03/98 →	Track Control Arm		SC-DL-9462	Trailing Arm, 2nd Drive Axle, for Leaf-Spring Suspension vehicles, 9069960/3533627→	
	03/98 →	Track Control Arm		SC-DL-9466	Trailing Arm, Leaf Spring Axle	
	03/98 →	Track Control Arm		SC-DL-9467	Trailing Arm, Leaf Spring Axle, →* 1247518 SSS *;* 4406943 SNL *; * 9039629 SAN *;* 3507979 SLA *	
	03/98 →	Track Control Arm		SC-DL-9467	Trailing Arm, Leaf Spring Axle, → * 1280184 SSS *;* 4471602 SNL *; * 9069959 SAN *;* 3533626 SLA *	
	03/98 →	Track Control Arm		SC-TC-12451	Trailing Arm, 1st Drive Axle, for Leaf-Spring Suspension vehicles	
	03/98 →	Track Control Arm		SC-TC-12452	Trailing Arm, 1st RA;2nd RA, for Leaf-Spring Suspension vehicles	
	03/98 →	Track Control Arm	SC-DL-8179	SC-DL-8179	Trailing Arm, Leaf Spring Axle, → * 1280184 SSS *;* 4471602 SNL *; * 9069959 SAN *;* 3533626 SLA *	
	03/98 →	Track Control Arm	SC-DL-8509	SC-DL-8509	Trailing Arm, Leaf Spring Axle	
	03/98 →	Track Control Arm	SC-DL-8531	SC-DL-8531	Trailing Arm, Leaf Spring Axle	
	03/98 →	Track Control Arm	SC-DL-10302	SC-DL-10302	Trailing Arm, Air Suspension Axle	
	T 114 G/340	05/96 →	Centre Rod	SC-DL-2161		Coupling Rod
		05/96 →	Centre Rod	SC-DL-5229		Push Rod
05/96 →		Centre Rod	SC-DL-5354		Push Rod	
05/96 →		Centre Rod	SC-DL-12343		for Steering Rod	
05/96 →		Suspension Arm Repair Kit		SC-RK-12366	for Control Arm	
05/96 →		Suspension Strut Repair Kit		CV-RK-5311		
05/96 →		Tie Rod	SC-DL-7264			
05/96 →		Tie Rod	SC-DL-8137			
05/96 →		Tie Rod End	CV-ES-14162		for Steering Rod	
05/96 →		Tie Rod End	CV-ES-14163		for Steering Rod	
05/96 →		Tie Rod End	SC-ES-7279		for Steering Rod	
05/96 →		Track Control Arm		SC-DL-8179	Trailing Arm, Leaf Spring Axle	
05/96 →		Track Control Arm		SC-DL-8400	Trailing Arm	
05/96 →		Track Control Arm		SC-DL-8511	Trailing Arm, Leaf Spring Axle	
05/96 →		Track Control Arm		SC-DL-8547	Trailing Arm, Leaf Spring Axle	

CV-ES-14162

Length: 125
Cone Ø: d1 Ø 30 / d2 Ø 27
Thread: M30 x 1,5 LHT
283783, 395009, 1358792, 1738380, 1 914 426, 2051165



CV-ES-14163

Length: 125
Cone Ø: d1 Ø 30 / d2 Ø 27
Thread: M30 x 1,5 RHT
283784, 395010, 1358793, 1488890, 1738381, 1767328, 1914427, 2051166



CV-RK-5311

638862, 0638862, 0639287, 639287, 1104335, 1953248, 81432206006, 81432206107



MN-RK-7280

Ø: 75 Hole Distance: 115
Thick/Height: 24
0550806, 550806, 0639370, 639370, 689748, 1104334



SC-DL-2161

Length: 1740 Ø: 50
Cone Ø: d1 Ø 30 / d2 Ø 27
1369411, 1385251, 1409918, 1501030, 1723865, 1723895, 1737683, 1897335, 2113903, 2125090, 2161883



SC-DL-5229

Length: 1053 Ø: 50
Cone Ø: d1 Ø 30 / d2 Ø 27
1356055, 1379071, 1384025, 1768898, 1847311, 1912757, 12201600A



SC-DL-5354

Length: 1060 Ø: 52
Cone Ø: d1 Ø 30 / d2 Ø 27
1384027, 1769597, 1847312, 1912758, 12200800A



SC-DL-7264

Length: 1743 Ø: 62
Cone Ø: d1 Ø 30 / d2 Ø 27
1361413, 1395614, 1734019, 1897333, 2040254, 2146105



SC-DL-8137

Length: 1736 Ø: 40
Cone Ø: d1 Ø 30 / d2 Ø 27
301639, 311847, 395350, 1358675, 1378435, 1397866, 1734020, 2028998, 12202900A



SC-DL-8179

Length: 568 Ø: 46
Hole Distance: 115 / 115
1399180, 1428347



SC-DL-8179

Length: 568 Ø: 46
Hole Distance: 115 / 115
1399180, 1428347



SC-DL-8509

Length: 568,5 Ø: 46
Hole Distance: 115 / 115
1485758, 1486757



SC-DL-8511

Length: 616,5 Ø: 50
Hole Distance: 115 / 115
1485760, 1499478, 1722750



SC-DL-8531

Length: 522 Ø: 46
Hole Distance: 115 / 115
1486758



SC-DL-8547

Length: 568 Ø: 50
Hole Distance: 115 / 115
1499474, 1722746, 1906940



SC-DL-8623

Length: 592 Ø: 50
Hole Distance: 115 / 115
1388436, 1499476, 1722748, 1906942



SC-DL-9462

Length: 568,5 Ø: 50
Hole Distance: 115 / 115
1499475, 1500573, 1722747, 1906941



SC-DL-9466

Length: 568 Ø: 19
1486756



SC-DL-9467

Length: 568,5 Ø: 50
Hole Distance: 115 / 115
1500572



SC-DL-10302

Length: 752 Ø: 48
Hole Distance: 115 / 115
1101843, 1379423, 1393298, 1431470, 1942075



SC-DL-12343

Length: 1062 Ø: 52
Cone Ø: d1 Ø 30 / d2 Ø 27
1348269, 2007275



SC-ES-7279

Length: 150
Cone Ø: d1 Ø 30 / d2 Ø 27
Thread: M30 x 1,5 RHT
1357674, 1603883, 1738379



SC-RK-12366

Ø: 75 Hole Distance: 115 / 115
Thick/Height: 24
1 722 753, 2 096 392



SC-TC-12451

Length: 552 Ø: 46
Hole Distance: 115 / 115
1494296



SC-TC-12452

Length: 580,5 Ø: 46
Hole Distance: 115 / 115
1485759



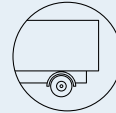

4 - series ...

T 114 G/340 ...	05/96→	Track Control Arm		SC-DL-9466	Trailing Arm, Leaf Spring Axle
	05/96→	Track Control Arm		SC-DL-9467	Trailing Arm, Leaf Spring Axle, →* 1247518 SSS *;* 4406943 SNL *; * 9039629 SAN *;* 3507979 SLA *
	05/96→	Track Control Arm		SC-DL-9467	Trailing Arm, Leaf Spring Axle, → * 1280184 SSS *;* 4471602 SNL *; * 9069959 SAN *;* 3533626 SLA *
	05/96→	Track Control Arm	SC-DL-8179	SC-DL-8179	Trailing Arm, Leaf Spring Axle, → * 1280184 SSS *;* 4471602 SNL *; * 9069959 SAN *;* 3533626 SLA *
	05/96→	Track Control Arm	SC-DL-8509	SC-DL-8509	Trailing Arm, Leaf Spring Axle
	05/96→	Track Control Arm	SC-DL-8531	SC-DL-8531	Trailing Arm, Leaf Spring Axle
	05/96→	Track Control Arm	SC-DL-10302	SC-DL-10302	Trailing Arm, Air Suspension Axle
	03/98→	Suspension Arm Repair Kit	MN-RK-7280	MN-RK-7280	for Drag Link;for Semi-Trailing Arm; for Wishbone (CV)
	03/98→	Suspension Strut Repair Kit		DF-RK-9341	
	03/98→	Track Control Arm		SC-DL-8623	Trailing Arm, 1st Drive Axle, for Leaf-Spring Suspension vehicles, →1280184/4471602
	03/98→	Track Control Arm		SC-DL-8623	Trailing Arm, 1st Drive Axle, for Leaf-Spring Suspension vehicles, →9069959/3533626
	03/98→	Track Control Arm		SC-DL-9462	Trailing Arm, 2nd Drive Axle, for Leaf-Spring Suspension vehicles, →1280184/4471602
	03/98→	Track Control Arm		SC-DL-9462	Trailing Arm, 2nd Drive Axle, for Leaf-Spring Suspension vehicles, →1280185/4471603_>
	03/98→	Track Control Arm		SC-DL-9462	Trailing Arm, 2nd Drive Axle, for Leaf-Spring Suspension vehicles, →9069959/3533626
	03/98→	Track Control Arm		SC-DL-9462	Trailing Arm, 2nd Drive Axle, for Leaf-Spring Suspension vehicles, 9069960/3533627→
	03/98→	Track Control Arm		SC-TC-12452	Trailing Arm, 1st RA;2nd RA, for Leaf-Spring Suspension vehicles
T 114 G/380	03/98→	Centre Rod	SC-DL-2161		Coupling Rod
	03/98→	Centre Rod	SC-DL-5229		Push Rod
	03/98→	Centre Rod	SC-DL-5354		Push Rod
	03/98→	Centre Rod	SC-DL-12343		for Steering Rod
	03/98→	Suspension Arm Repair Kit		SC-RK-12366	for Control Arm
	03/98→	Suspension Arm Repair Kit	MN-RK-7280	MN-RK-7280	for Drag Link;for Semi-Trailing Arm; for Wishbone (CV)
	03/98→	Suspension Strut Repair Kit		CV-RK-5311	
	03/98→	Suspension Strut Repair Kit		DF-RK-9341	
	03/98→	Tie Rod	SC-DL-7264		
	03/98→	Tie Rod	SC-DL-8137		
	03/98→	Tie Rod End	CV-ES-14162		for Steering Rod
	03/98→	Tie Rod End	CV-ES-14163		for Steering Rod
	03/98→	Tie Rod End	SC-ES-7279		for Steering Rod
	03/98→	Track Control Arm		SC-DL-8179	Trailing Arm, Leaf Spring Axle
	03/98→	Track Control Arm		SC-DL-8400	Trailing Arm
	03/98→	Track Control Arm		SC-DL-8511	Trailing Arm, Leaf Spring Axle
	03/98→	Track Control Arm		SC-DL-8547	Trailing Arm, Leaf Spring Axle
	03/98→	Track Control Arm		SC-DL-8623	Trailing Arm, 1st Drive Axle, for Leaf-Spring Suspension vehicles, →1280184/4471602
	03/98→	Track Control Arm		SC-DL-8623	Trailing Arm, 1st Drive Axle, for Leaf-Spring Suspension vehicles, →9069959/3533626
	03/98→	Track Control Arm		SC-DL-9462	Trailing Arm, 2nd Drive Axle, for Leaf-Spring Suspension vehicles, →1280184/4471602
	03/98→	Track Control Arm		SC-DL-9462	Trailing Arm, 2nd Drive Axle, for Leaf-Spring Suspension vehicles, →1280185/4471603_>
	03/98→	Track Control Arm		SC-DL-9462	Trailing Arm, 2nd Drive Axle, for Leaf-Spring Suspension vehicles, →9069959/3533626
	03/98→	Track Control Arm		SC-DL-9462	Trailing Arm, 2nd Drive Axle, for Leaf-Spring Suspension vehicles, 9069960/3533627→
	03/98→	Track Control Arm		SC-DL-9466	Trailing Arm, Leaf Spring Axle

CV-ES-14162

Length: 125
Cone Ø: d1 Ø 30 / d2 Ø 27
Thread: M30 x 1,5 LHT
283784, 395009, 1358792, 1738380, 1 914 426, 2051165



CV-ES-14163

Length: 125
Cone Ø: d1 Ø 30 / d2 Ø 27
Thread: M30 x 1,5 RHT
283784, 395010, 1358793, 1488890, 1738381, 1767328, 1914427, 2051166



CV-RK-5311

638862, 0638862, 639287, 0639287, 1104335, 1953248, 81432206006, 81432206107



DF-RK-9341

Ø: 67
550807, 5508072



MN-RK-7280

Ø: 75 Hole Distance: 115
Thick/Height: 24
0550806, 550806, 0639370, 639370, 689748, 1104334



SC-DL-2161

Length: 1740 Ø: 50
Cone Ø: d1 Ø 30 / d2 Ø 27
1369411, 1385251, 1409918, 1501030, 1723865, 1723895, 1737683, 1897335, 2113903, 2125090, 2161883



SC-DL-5229

Length: 1053 Ø: 50
Cone Ø: d1 Ø 30 / d2 Ø 27
1356055, 1379071, 1384025, 1768898, 1847311, 1912757, 12201600A



SC-DL-5354

Length: 1060 Ø: 52
Cone Ø: d1 Ø 30 / d2 Ø 27
1384027, 1769597, 1847312, 1912758, 12200800A



SC-DL-7264

Length: 1743 Ø: 62
Cone Ø: d1 Ø 30 / d2 Ø 27
1361413, 1395614, 1734019, 1897333, 2040254, 2146105



SC-DL-8137

Length: 1736 Ø: 40
Cone Ø: d1 Ø 30 / d2 Ø 27
301639, 311847, 395350, 1358675, 1378435, 1397866, 1734020, 2028998, 12202900A



SC-DL-8179

Length: 568 Ø: 46
Hole Distance: 115 / 115
1399180, 1428347



SC-DL-8179

Length: 568 Ø: 46
Hole Distance: 115 / 115
1399180, 1428347



SC-DL-8509

Length: 568,5 Ø: 46
Hole Distance: 115 / 115
1485758, 1486757



SC-DL-8511

Length: 616,5 Ø: 50
Hole Distance: 115 / 115
1485760, 1499478, 1722750



SC-DL-8531

Length: 522 Ø: 46
Hole Distance: 115 / 115
1486758



SC-DL-8547

Length: 568 Ø: 50
Hole Distance: 115 / 115
1499474, 1722746, 1906940



SC-DL-8623

Length: 592 Ø: 50
Hole Distance: 115 / 115
1388436, 1499476, 1722748, 1906942



SC-DL-9462

Length: 568,5 Ø: 50
Hole Distance: 115 / 115
1499475, 1500573, 1722747, 1906941



SC-DL-9466

Length: 568 Ø: 19
1486756



SC-DL-9467

Length: 568,5 Ø: 50
Hole Distance: 115 / 115
1500572



SC-DL-10302

Length: 752 Ø: 48
Hole Distance: 115 / 115
1101843, 1379423, 1393298, 1431470, 1942075



SC-DL-12343

Length: 1062 Ø: 52
Cone Ø: d1 Ø 30 / d2 Ø 27
1348269, 2007275



SC-ES-7279

Length: 150
Cone Ø: d1 Ø 30 / d2 Ø 27
Thread: M30 x 1,5 RHT
1357674, 1603883, 1738379



SC-RK-12366

Ø: 75 Hole Distance: 115 / 115
Thick/Height: 24
1 722 753, 2 096 392



SC-TC-12452

Length: 580,5 Ø: 46
Hole Distance: 115 / 115
1485759



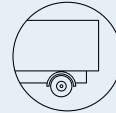

4 - series ...

T 114 G/380 ...	03/98 →	Track Control Arm		SC-DL-9467	Trailing Arm, Leaf Spring Axle, →* 1247518 SSS **; 4406943 SNL *; * 9039629 SAN **; 3507979 SLA *
	03/98 →	Track Control Arm		SC-DL-9467	Trailing Arm, Leaf Spring Axle, → * 1280184 SSS **; 4471602 SNL *; * 9069959 SAN **; 3533626 SLA *
	03/98 →	Track Control Arm		SC-TC-12451	Trailing Arm, 1st Drive Axle, for Leaf-Spring Suspension vehicles
	03/98 →	Track Control Arm		SC-TC-12452	Trailing Arm, 1st RA; 2nd RA, for Leaf-Spring Suspension vehicles
	03/98 →	Track Control Arm	SC-DL-8179	SC-DL-8179	Trailing Arm, Leaf Spring Axle, → * 1280184 SSS **; 4471602 SNL *; * 9069959 SAN **; 3533626 SLA *
	03/98 →	Track Control Arm	SC-DL-8509	SC-DL-8509	Trailing Arm, Leaf Spring Axle
	03/98 →	Track Control Arm	SC-DL-8531	SC-DL-8531	Trailing Arm, Leaf Spring Axle
	03/98 →	Track Control Arm	SC-DL-10302	SC-DL-10302	Trailing Arm, Air Suspension Axle
	T 114 L/340	05/96 →	Centre Rod	SC-DL-2161	
05/96 →		Centre Rod	SC-DL-5229		Push Rod
05/96 →		Centre Rod	SC-DL-5354		Push Rod
05/96 →		Suspension Arm Repair Kit		SC-RK-12366	for Control Arm
05/96 →		Suspension Arm Repair Kit	MN-RK-7280	MN-RK-7280	for Drag Link; for Semi-Trailing Arm; for Wishbone (CV)
05/96 →		Suspension Strut Repair Kit		CV-RK-5311	
05/96 →		Suspension Strut Repair Kit		DF-RK-9341	
05/96 →		Tie Rod	SC-DL-7264		
05/96 →		Tie Rod	SC-DL-8137		
05/96 →		Tie Rod End	CV-ES-14162		for Steering Rod
05/96 →		Tie Rod End	CV-ES-14163		for Steering Rod
05/96 →		Tie Rod End	SC-ES-7279		for Steering Rod
05/96 →		Track Control Arm	SC-DL-10302	SC-DL-10302	Trailing Arm, Air Suspension Axle
T 114 L/380	03/98 →	Centre Rod	SC-DL-2161		Coupling Rod
	03/98 →	Centre Rod	SC-DL-5229		Push Rod
	03/98 →	Centre Rod	SC-DL-5354		Push Rod
	03/98 →	Suspension Arm Repair Kit		SC-RK-12366	for Control Arm
	03/98 →	Suspension Arm Repair Kit	MN-RK-7280	MN-RK-7280	for Drag Link; for Semi-Trailing Arm; for Wishbone (CV)
	03/98 →	Suspension Strut Repair Kit		CV-RK-5311	
	03/98 →	Suspension Strut Repair Kit		DF-RK-9341	
	03/98 →	Tie Rod	SC-DL-7264		
	03/98 →	Tie Rod	SC-DL-8137		
	03/98 →	Tie Rod End	CV-ES-14162		for Steering Rod
	03/98 →	Tie Rod End	CV-ES-14163		for Steering Rod
	03/98 →	Tie Rod End	SC-ES-7279		for Steering Rod
	03/98 →	Track Control Arm		SC-DL-8179	Trailing Arm, Leaf Spring Axle
	03/98 →	Track Control Arm		SC-DL-8400	Trailing Arm
	03/98 →	Track Control Arm		SC-DL-8511	Trailing Arm, Leaf Spring Axle
	03/98 →	Track Control Arm		SC-DL-8547	Trailing Arm, Leaf Spring Axle
	03/98 →	Track Control Arm		SC-DL-8623	Trailing Arm, 1st Drive Axle, for Leaf-Spring Suspension vehicles, →1280184/4471602
	03/98 →	Track Control Arm		SC-DL-8623	Trailing Arm, 1st Drive Axle, for Leaf-Spring Suspension vehicles, →9069959/3533626
	03/98 →	Track Control Arm		SC-DL-9462	Trailing Arm, 2nd Drive Axle, for Leaf-Spring Suspension vehicles, →1280184/4471602
	03/98 →	Track Control Arm		SC-DL-9462	Trailing Arm, 2nd Drive Axle, for Leaf-Spring Suspension vehicles, →1280185/4471603 >
	03/98 →	Track Control Arm		SC-DL-9462	Trailing Arm, 2nd Drive Axle, for Leaf-Spring Suspension vehicles, →9069959/3533626
	03/98 →	Track Control Arm		SC-DL-9462	Trailing Arm, 2nd Drive Axle, for Leaf-Spring Suspension vehicles, 9069960/3533626 →
	03/98 →	Track Control Arm		SC-DL-9466	Trailing Arm, Leaf Spring Axle
	03/98 →	Track Control Arm		SC-DL-9467	Trailing Arm, Leaf Spring Axle, →* 1247518 SSS **; 4406943 SNL *; * 9039629 SAN **; 3507979 SLA *

CV-ES-14162

Length: 125
Cone Ø: d1 Ø 30 / d2 Ø 27
Thread: M30 x 1,5 LHT
283783, 395009, 1358792, 1738380, 1 914 426, 2051165



CV-ES-14163

Length: 125
Cone Ø: d1 Ø 30 / d2 Ø 27
Thread: M30 x 1,5 RHT
283784, 395010, 1358793, 1488890, 1738381, 1767328, 1914427, 2051166



CV-RK-5311

0638862, 638862, 0639287, 639287, 1104335, 1953248, 81432206006, 81432206107



DF-RK-9341

Ø: 67
550807, 5508072



MN-RK-7280

Ø: 75 Hole Distance: 115
Thick/Height: 24
0550806, 550806, 0639370, 639370, 689748, 1104334



SC-DL-2161

Length: 1740 Ø: 50
Cone Ø: d1 Ø 30 / d2 Ø 27
1369411, 1385251, 1409918, 1501030, 1723865, 1723895, 1737683, 1897335, 2113903, 2125090, 2161883



SC-DL-5229

Length: 1053 Ø: 50
Cone Ø: d1 Ø 30 / d2 Ø 27
1356055, 1379071, 1384025, 1768898, 1847311, 1912757, 12201600A



SC-DL-5354

Length: 1060 Ø: 52
Cone Ø: d1 Ø 30 / d2 Ø 27
1384027, 1769597, 1847312, 1912758, 12200800A



SC-DL-7264

Length: 1743 Ø: 62
Cone Ø: d1 Ø 30 / d2 Ø 27
1361413, 1395614, 1734019, 1897333, 2040254, 2146105



SC-DL-8137

Length: 1736 Ø: 40
Cone Ø: d1 Ø 30 / d2 Ø 27
301639, 311847, 395350, 1358675, 1378435, 1397866, 1734020, 2028998, 12202900A



SC-DL-8179

Length: 568 Ø: 46
Hole Distance: 115 / 115
1399180, 1428347



SC-DL-8179

Length: 568 Ø: 46
Hole Distance: 115 / 115
1399180, 1428347



SC-DL-8509

Length: 568,5 Ø: 46
Hole Distance: 115 / 115
1485758, 1486757



SC-DL-8511

Length: 616,5 Ø: 50
Hole Distance: 115 / 115
1485760, 1499478, 1722750



SC-DL-8531

Length: 522 Ø: 46
Hole Distance: 115 / 115
1486758



SC-DL-8547

Length: 568 Ø: 50
Hole Distance: 115 / 115
1499474, 1722746, 1906940



SC-DL-8623

Length: 592 Ø: 50
Hole Distance: 115 / 115
1388436, 1499476, 1722748, 1906942



SC-DL-9462

Length: 568,5 Ø: 50
Hole Distance: 115 / 115
1499475, 1500573, 1722747, 1906941



SC-DL-9466

Length: 568 Ø: 19
1486756



SC-DL-9467

Length: 568,5 Ø: 50
Hole Distance: 115 / 115
1500572



SC-DL-10302

Length: 752 Ø: 48
Hole Distance: 115 / 115
1101843, 1379423, 1393298, 1431470, 1942075



SC-ES-7279

Length: 150
Cone Ø: d1 Ø 30 / d2 Ø 27
Thread: M30 x 1,5 RHT
1357674, 1603883, 1738379



SC-RK-12366

Ø: 75 Hole Distance: 115 / 115
Thick/Height: 24
1 722 753, 2 096 392



SC-TC-12451

Length: 552 Ø: 46
Hole Distance: 115 / 115
1494296



SC-TC-12452

Length: 580,5 Ø: 46
Hole Distance: 115 / 115
1485759



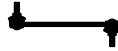

4 - series ...

T 114 L/380 ...	03/98 →	Track Control Arm		SC-DL-9467	Trailing Arm, Leaf Spring Axle, → * 1280184 SSS *; * 4471602 SNL *; * 9069959 SAN *; * 3533626 SLA *
	03/98 →	Track Control Arm		SC-TC-12451	Trailing Arm, 1st Drive Axle, for Leaf-Spring Suspension vehicles
	03/98 →	Track Control Arm		SC-TC-12452	Trailing Arm, 1st RA; 2nd RA, for Leaf-Spring Suspension vehicles
	03/98 →	Track Control Arm	SC-DL-8179	SC-DL-8179	Trailing Arm, Leaf Spring Axle, → * 1280184 SSS *; * 4471602 SNL *; * 9069959 SAN *; * 3533626 SLA *
	03/98 →	Track Control Arm	SC-DL-8509	SC-DL-8509	Trailing Arm, Leaf Spring Axle
	03/98 →	Track Control Arm	SC-DL-8531	SC-DL-8531	Trailing Arm, Leaf Spring Axle
	03/98 →	Track Control Arm	SC-DL-10302	SC-DL-10302	Trailing Arm, Air Suspension Axle
T 124 C/360	09/95 →	Centre Rod	SC-DL-2161		Coupling Rod
	09/95 →	Centre Rod	SC-DL-5229		Push Rod
	09/95 →	Centre Rod	SC-DL-5354		Push Rod
	09/95 →	Centre Rod	SC-DL-12343		for Steering Rod
	09/95 →	Suspension Arm Repair Kit		SC-RK-12366	for Control Arm
	09/95 →	Suspension Strut Repair Kit		CV-RK-5311	
	09/95 →	Tie Rod	SC-DL-7264		
	09/95 →	Tie Rod	SC-DL-8137		
	09/95 →	Tie Rod End	CV-ES-14162		for Steering Rod
	09/95 →	Tie Rod End	CV-ES-14163		for Steering Rod
	09/95 →	Track Control Arm		SC-DL-8179	Trailing Arm, Leaf Spring Axle
	09/95 →	Track Control Arm		SC-DL-8400	Trailing Arm
	09/95 →	Track Control Arm		SC-DL-8511	Trailing Arm, Leaf Spring Axle
	09/95 →	Track Control Arm		SC-DL-8547	Trailing Arm, Leaf Spring Axle
	09/95 →	Track Control Arm		SC-DL-9462	Trailing Arm, Leaf Spring Axle
	09/95 →	Track Control Arm		SC-DL-9466	Trailing Arm, Leaf Spring Axle
	09/95 →	Track Control Arm		SC-DL-9467	Trailing Arm, Leaf Spring Axle, → * 1247518 SSS *; * 4406943 SNL *; * 9039629 SAN *; * 3507979 SLA *
	09/95 →	Track Control Arm		SC-DL-9467	Trailing Arm, Leaf Spring Axle, → * 1280184 SSS *; * 4471602 SNL *; * 9069959 SAN *; * 3533626 SLA *
	09/95 →	Track Control Arm		SC-TC-12451	Control Arm
	09/95 →	Track Control Arm		SC-TC-12452	Control Arm
	09/95 →	Track Control Arm		SC-TC-12472	Control Arm
	09/95 →	Track Control Arm	SC-DL-8179	SC-DL-8179	Trailing Arm, Leaf Spring Axle, → * 1280184 SSS *; * 4471602 SNL *; * 9069959 SAN *; * 3533626 SLA *
	09/95 →	Track Control Arm	SC-DL-8509	SC-DL-8509	Trailing Arm, Leaf Spring Axle
09/95 →	Track Control Arm	SC-DL-8531	SC-DL-8531	Trailing Arm, Leaf Spring Axle	
09/95 →	Track Control Arm	SC-DL-8623	SC-DL-8623	Trailing Arm, Leaf Spring Axle	
09/95 →	Track Control Arm	SC-DL-10302	SC-DL-10302	Trailing Arm, Air Suspension Axle	
T 124 C/400	05/96 →	Centre Rod	SC-DL-2161		Coupling Rod
	05/96 →	Centre Rod	SC-DL-5229		Push Rod
	05/96 →	Centre Rod	SC-DL-5354		Push Rod
	05/96 →	Centre Rod	SC-DL-12343		for Steering Rod
	05/96 →	Suspension Arm Repair Kit		SC-RK-12366	for Control Arm
	05/96 →	Suspension Strut Repair Kit		CV-RK-5311	
	05/96 →	Tie Rod	SC-DL-7264		
	05/96 →	Tie Rod	SC-DL-8137		
	05/96 →	Tie Rod End	CV-ES-14162		for Steering Rod
	05/96 →	Tie Rod End	CV-ES-14163		for Steering Rod
	05/96 →	Track Control Arm		SC-DL-8179	Trailing Arm, Leaf Spring Axle
	05/96 →	Track Control Arm		SC-DL-8400	Trailing Arm
	05/96 →	Track Control Arm		SC-DL-8511	Trailing Arm, Leaf Spring Axle
	05/96 →	Track Control Arm		SC-DL-8547	Trailing Arm, Leaf Spring Axle
	05/96 →	Track Control Arm		SC-DL-9462	Trailing Arm, Leaf Spring Axle
	05/96 →	Track Control Arm		SC-DL-9466	Trailing Arm, Leaf Spring Axle

CV-ES-14162

Length: 125
Cone Ø: d1 Ø 30 / d2 Ø 27
Thread: M30 x 1,5 LHT
283783, 395009, 1358792, 1738380, 1 914 426, 2051165



CV-ES-14163

Length: 125
Cone Ø: d1 Ø 30 / d2 Ø 27
Thread: M30 x 1,5 RHT
283784, 395010, 1358793, 1488890, 1738381, 1767328, 1914427, 2051166



CV-RK-5311

0638862, 638862, 0639287, 639287, 1104335, 1953248, 81432206006, 81432206107



SC-DL-2161

Length: 1740 Ø: 50
Cone Ø: d1 Ø 30 / d2 Ø 27
1369411, 1385251, 1409918, 1501030, 1723865, 1723895, 1737683, 1897335, 2113903, 2125090, 2161883



SC-DL-5229

Length: 1053 Ø: 50
Cone Ø: d1 Ø 30 / d2 Ø 27
1356055, 1379071, 1384025, 1768898, 1847311, 1912757, 12201600A



SC-DL-5354

Length: 1060 Ø: 52
Cone Ø: d1 Ø 30 / d2 Ø 27
1384027, 1769597, 1847312, 1912758, 12200800A



SC-DL-7264

Length: 1743 Ø: 62
Cone Ø: d1 Ø 30 / d2 Ø 27
1361413, 1395614, 1734019, 1897333, 2040254, 2146105



SC-DL-8137

Length: 1736 Ø: 40
Cone Ø: d1 Ø 30 / d2 Ø 27
301639, 311847, 395350, 1358675, 1378435, 1397866, 1734020, 2028998, 12202900A



SC-DL-8179

Length: 568 Ø: 46
Hole Distance: 115 / 115
1399180, 1428347



SC-DL-8179

Length: 568 Ø: 46
Hole Distance: 115 / 115
1399180, 1428347



SC-DL-8509

Length: 568,5 Ø: 46
Hole Distance: 115 / 115
1485758, 1486757



SC-DL-8511

Length: 616,5 Ø: 50
Hole Distance: 115 / 115
1485760, 1499478, 1722750



SC-DL-8531

Length: 522 Ø: 46
Hole Distance: 115 / 115
1486758



SC-DL-8547

Length: 568 Ø: 50
Hole Distance: 115 / 115
1499474, 1722746, 1906940



SC-DL-8623

Length: 592 Ø: 50
Hole Distance: 115 / 115
1388436, 1499476, 1722748, 1906942



SC-DL-9462

Length: 568,5 Ø: 50
Hole Distance: 115 / 115
1499475, 1500573, 1722747, 1906941



SC-DL-9466

Length: 568 Ø: 19
1486756



SC-DL-9467

Length: 568,5 Ø: 50
Hole Distance: 115 / 115
1500572



SC-DL-10302

Length: 752 Ø: 48
Hole Distance: 115 / 115
1101843, 1379423, 1393298, 1431470, 1942075



SC-DL-12343

Length: 1062 Ø: 52
Cone Ø: d1 Ø 30 / d2 Ø 27
1348269, 2007275



SC-RK-12366

Ø: 75 Hole Distance: 115 / 115
Thick/Height: 24
1 722 753, 2 096 392



SC-TC-12451

Length: 552 Ø: 46
Hole Distance: 115 / 115
1494296



SC-TC-12452

Length: 580,5 Ø: 46
Hole Distance: 115 / 115
1485759



SC-TC-12472

Length: 580 Ø: 46
Hole Distance: 115 / 115
1399182





4 - series ...

T 124 C/400 ...	05/96→	Track Control Arm		SC-DL-9467	Trailing Arm, Leaf Spring Axle, →* 1247518 SSS *;* 4406943 SNL *; * 9039629 SAN *;* 3507979 SLA *
	05/96→	Track Control Arm		SC-DL-9467	Trailing Arm, Leaf Spring Axle, → * 1280184 SSS *;* 4471602 SNL *; * 9069959 SAN *;* 3533626 SLA *
	05/96→	Track Control Arm		SC-TC-12451	Control Arm
	05/96→	Track Control Arm		SC-TC-12452	Control Arm
	05/96→	Track Control Arm		SC-TC-12472	Control Arm
	05/96→	Track Control Arm	SC-DL-8179	SC-DL-8179	Trailing Arm, Leaf Spring Axle, → * 1280184 SSS *;* 4471602 SNL *; * 9069959 SAN *;* 3533626 SLA *
	05/96→	Track Control Arm	SC-DL-8509	SC-DL-8509	Trailing Arm, Leaf Spring Axle
	05/96→	Track Control Arm	SC-DL-8531	SC-DL-8531	Trailing Arm, Leaf Spring Axle
	05/96→	Track Control Arm	SC-DL-8623	SC-DL-8623	Trailing Arm, Leaf Spring Axle
	05/96→	Track Control Arm	SC-DL-10302	SC-DL-10302	Trailing Arm, Air Suspension Axle
T 124 C/420	05/96→	Centre Rod	SC-DL-2161		Coupling Rod
	05/96→	Centre Rod	SC-DL-5229		Push Rod
	05/96→	Centre Rod	SC-DL-5354		Push Rod
	05/96→	Centre Rod	SC-DL-12343		for Steering Rod
	05/96→	Suspension Arm Repair Kit		SC-RK-12366	for Control Arm
	05/96→	Suspension Strut Repair Kit		CV-RK-5311	
	05/96→	Tie Rod	SC-DL-7264		
	05/96→	Tie Rod	SC-DL-8137		
	05/96→	Tie Rod End	CV-ES-14162		for Steering Rod
	05/96→	Tie Rod End	CV-ES-14163		for Steering Rod
	05/96→	Tie Rod End	SC-ES-7279		for Steering Rod
	05/96→	Track Control Arm		SC-DL-8179	Trailing Arm, Leaf Spring Axle
	05/96→	Track Control Arm		SC-DL-8400	Trailing Arm
	05/96→	Track Control Arm		SC-DL-8511	Trailing Arm, Leaf Spring Axle
	05/96→	Track Control Arm		SC-DL-8547	Trailing Arm, Leaf Spring Axle
	05/96→	Track Control Arm		SC-DL-9462	Trailing Arm, Leaf Spring Axle
	05/96→	Track Control Arm		SC-DL-9466	Trailing Arm, Leaf Spring Axle
	05/96→	Track Control Arm		SC-DL-9467	Trailing Arm, Leaf Spring Axle, →* 1247518 SSS *;* 4406943 SNL *; * 9039629 SAN *;* 3507979 SLA *
	05/96→	Track Control Arm		SC-DL-9467	Trailing Arm, Leaf Spring Axle, → * 1280184 SSS *;* 4471602 SNL *; * 9069959 SAN *;* 3533626 SLA *
	05/96→	Track Control Arm		SC-TC-12451	Control Arm
	05/96→	Track Control Arm		SC-TC-12452	Control Arm
	05/96→	Track Control Arm		SC-TC-12472	Control Arm
	05/96→	Track Control Arm	SC-DL-8179	SC-DL-8179	Trailing Arm, Leaf Spring Axle, → * 1280184 SSS *;* 4471602 SNL *; * 9069959 SAN *;* 3533626 SLA *
	05/96→	Track Control Arm	SC-DL-8509	SC-DL-8509	Trailing Arm, Leaf Spring Axle
	05/96→	Track Control Arm	SC-DL-8531	SC-DL-8531	Trailing Arm, Leaf Spring Axle
05/96→	Track Control Arm	SC-DL-8623	SC-DL-8623	Trailing Arm, Leaf Spring Axle	
05/96→	Track Control Arm	SC-DL-10302	SC-DL-10302	Trailing Arm, Air Suspension Axle	
T 124 G/360	03/97→	Centre Rod	SC-DL-2161		Coupling Rod
	03/97→	Centre Rod	SC-DL-5229		Push Rod
	03/97→	Centre Rod	SC-DL-5354		Push Rod
	03/97→	Centre Rod	SC-DL-12343		for Steering Rod
	03/97→	Suspension Arm Repair Kit		SC-RK-12366	for Control Arm
	03/97→	Suspension Arm Repair Kit	MN-RK-7280	MN-RK-7280	for Drag Link;for Semi-Trailing Arm; for Wishbone (CV)
	03/97→	Suspension Strut Repair Kit		CV-RK-5311	
	03/97→	Suspension Strut Repair Kit		DF-RK-9341	
	03/97→	Tie Rod	SC-DL-7264		
	03/97→	Tie Rod	SC-DL-8137		
	03/97→	Tie Rod End	CV-ES-14162		for Steering Rod
	03/97→	Tie Rod End	CV-ES-14163		for Steering Rod
	03/97→	Tie Rod End	SC-ES-7279		for Steering Rod

CV-ES-14162

Length: 125
Cone Ø: d1 Ø 30 / d2 Ø 27
Thread: M30 x 1,5 LHT
283783, 395009, 1358792, 1738380, 1 914 426, 2051165



CV-ES-14163

Length: 125
Cone Ø: d1 Ø 30 / d2 Ø 27
Thread: M30 x 1,5 RHT
283784, 395010, 1358793, 1488890, 1738381, 1767328, 1914427, 2051166



CV-RK-5311

0638862, 638862, 0639287, 639287, 1104335, 1953248, 81432206006, 81432206107



DF-RK-9341

Ø: 67
550807, 5508072



MN-RK-7280

Ø: 75 Hole Distance: 115
Thick/Height: 24
0550806, 550806, 0639370, 639370, 689748, 1104334



SC-DL-2161

Length: 1740 Ø: 50
Cone Ø: d1 Ø 30 / d2 Ø 27
1369411, 1385251, 1409918, 1501030, 1723865, 1723895, 1737683, 1897335, 2113903, 2125090, 2161883



SC-DL-5229

Length: 1053 Ø: 50
Cone Ø: d1 Ø 30 / d2 Ø 27
1356055, 1379071, 1384025, 1768898, 1847311, 1912757, 12201600A



SC-DL-5354

Length: 1060 Ø: 52
Cone Ø: d1 Ø 30 / d2 Ø 27
1384027, 1769597, 1847312, 1912758, 12200800A



SC-DL-7264

Length: 1743 Ø: 62
Cone Ø: d1 Ø 30 / d2 Ø 27
1361413, 1395614, 1734019, 1897333, 2040254, 2146105



SC-DL-8137

Length: 1736 Ø: 40
Cone Ø: d1 Ø 30 / d2 Ø 27
301639, 311847, 395350, 1358675, 1378435, 1397866, 1734020, 2028998, 12202900A



SC-DL-8179

Length: 568 Ø: 46
Hole Distance: 115 / 115
1399180, 1428347



SC-DL-8179

Length: 568 Ø: 46
Hole Distance: 115 / 115
1399180, 1428347



SC-DL-8509

Length: 568,5 Ø: 46
Hole Distance: 115 / 115
1485758, 1486757



SC-DL-8511

Length: 616,5 Ø: 50
Hole Distance: 115 / 115
1485760, 1499478, 1722750



SC-DL-8531

Length: 522 Ø: 46
Hole Distance: 115 / 115
1486758



SC-DL-8547

Length: 568 Ø: 50
Hole Distance: 115 / 115
1499474, 1722746, 1906940



SC-DL-8623

Length: 592 Ø: 50
Hole Distance: 115 / 115
1388436, 1499476, 1722748, 1906942



SC-DL-9462

Length: 568,5 Ø: 50
Hole Distance: 115 / 115
1499475, 1500573, 1722747, 1906941



SC-DL-9466

Length: 568 Ø: 19
1486756



SC-DL-9467

Length: 568,5 Ø: 50
Hole Distance: 115 / 115
1500572



SC-DL-10302

Length: 752 Ø: 48
Hole Distance: 115 / 115
1101843, 1379423, 1393298, 1431470, 1942075



SC-DL-12343

Length: 1062 Ø: 52
Cone Ø: d1 Ø 30 / d2 Ø 27
1348269, 2007275



SC-ES-7279

Length: 150
Cone Ø: d1 Ø 30 / d2 Ø 27
Thread: M30 x 1,5 RHT
1357674, 1603883, 1738379



SC-RK-12366

Ø: 75 Hole Distance: 115 / 115
Thick/Height: 24
1 722 753, 2 096 392



SC-TC-12451

Length: 552 Ø: 46
Hole Distance: 115 / 115
1494296



SC-TC-12452

Length: 580,5 Ø: 46
Hole Distance: 115 / 115
1485759



SC-TC-12472

Length: 580 Ø: 46
Hole Distance: 115 / 115
1399182





4 - series ...

T 124 G/360 ...	03/97→	Track Control Arm		SC-DL-8179	Trailing Arm, Leaf Spring Axle
	03/97→	Track Control Arm		SC-DL-8400	Trailing Arm
	03/97→	Track Control Arm		SC-DL-8511	Trailing Arm, Leaf Spring Axle
	03/97→	Track Control Arm		SC-DL-8547	Trailing Arm, Leaf Spring Axle
	03/97→	Track Control Arm		SC-DL-9462	Trailing Arm, Leaf Spring Axle
	03/97→	Track Control Arm		SC-DL-9466	Trailing Arm, Leaf Spring Axle
	03/97→	Track Control Arm		SC-DL-9467	Trailing Arm, Leaf Spring Axle, →* 1247518 SSS *;* 4406943 SNL *; * 9039629 SAN *;* 3507979 SLA *
	03/97→	Track Control Arm		SC-DL-9467	Trailing Arm, Leaf Spring Axle, → * 1280184 SSS *;* 4471602 SNL *; * 9069959 SAN *;* 3533626 SLA *
	03/97→	Track Control Arm		SC-TC-12451	Control Arm
	03/97→	Track Control Arm		SC-TC-12452	Control Arm
	03/97→	Track Control Arm		SC-TC-12472	Control Arm
	03/97→	Track Control Arm	SC-DL-8179	SC-DL-8179	Trailing Arm, Leaf Spring Axle, → * 1280184 SSS *;* 4471602 SNL *; * 9069959 SAN *;* 3533626 SLA *
	03/97→	Track Control Arm	SC-DL-8509	SC-DL-8509	Trailing Arm, Leaf Spring Axle
	03/97→	Track Control Arm	SC-DL-8531	SC-DL-8531	Trailing Arm, Leaf Spring Axle
	03/97→	Track Control Arm	SC-DL-8623	SC-DL-8623	Trailing Arm, Leaf Spring Axle
	03/97→	Track Control Arm	SC-DL-10302	SC-DL-10302	Trailing Arm, Air Suspension Axle
	03/97→	Track Control Arm	SC-TC-12361		Control Arm, 1st Front Axle, for Pneumatic Suspension vehicles
T 124 G/400	03/97→	Centre Rod	SC-DL-2161		Coupling Rod
	03/97→	Centre Rod	SC-DL-5229		Push Rod
	03/97→	Centre Rod	SC-DL-5354		Push Rod
	03/97→	Centre Rod	SC-DL-12343		for Steering Rod
	03/97→	Suspension Arm Repair Kit		SC-RK-12366	for Control Arm
	03/97→	Suspension Arm Repair Kit	MN-RK-7280	MN-RK-7280	for Drag Link;for Semi-Trailing Arm; for Wishbone (CV)
	03/97→	Suspension Strut Repair Kit		CV-RK-5311	
	03/97→	Suspension Strut Repair Kit		DF-RK-9341	
	03/97→	Tie Rod	SC-DL-7264		
	03/97→	Tie Rod	SC-DL-8137		
	03/97→	Tie Rod End	CV-ES-14162		for Steering Rod
	03/97→	Tie Rod End	CV-ES-14163		for Steering Rod
	03/97→	Track Control Arm		SC-DL-8179	Trailing Arm, Leaf Spring Axle
	03/97→	Track Control Arm		SC-DL-8400	Trailing Arm
	03/97→	Track Control Arm		SC-DL-8511	Trailing Arm, Leaf Spring Axle
	03/97→	Track Control Arm		SC-DL-8547	Trailing Arm, Leaf Spring Axle
	03/97→	Track Control Arm		SC-DL-9462	Trailing Arm, Leaf Spring Axle
	03/97→	Track Control Arm		SC-DL-9466	Trailing Arm, Leaf Spring Axle
	03/97→	Track Control Arm		SC-DL-9467	Trailing Arm, Leaf Spring Axle, →* 1247518 SSS *;* 4406943 SNL *; * 9039629 SAN *;* 3507979 SLA *
	03/97→	Track Control Arm		SC-DL-9467	Trailing Arm, Leaf Spring Axle, → * 1280184 SSS *;* 4471602 SNL *; * 9069959 SAN *;* 3533626 SLA *
	03/97→	Track Control Arm		SC-TC-12451	Control Arm
	03/97→	Track Control Arm		SC-TC-12452	Control Arm
	03/97→	Track Control Arm		SC-TC-12472	Control Arm
	03/97→	Track Control Arm	SC-DL-8179	SC-DL-8179	Trailing Arm, Leaf Spring Axle, → * 1280184 SSS *;* 4471602 SNL *; * 9069959 SAN *;* 3533626 SLA *
	03/97→	Track Control Arm	SC-DL-8509	SC-DL-8509	Trailing Arm, Leaf Spring Axle
	03/97→	Track Control Arm	SC-DL-8531	SC-DL-8531	Trailing Arm, Leaf Spring Axle
	03/97→	Track Control Arm	SC-DL-8623	SC-DL-8623	Trailing Arm, Leaf Spring Axle
03/97→	Track Control Arm	SC-DL-10302	SC-DL-10302	Trailing Arm, Air Suspension Axle	
T 124 G/420	05/96→	Centre Rod	SC-DL-2161		Coupling Rod
	05/96→	Centre Rod	SC-DL-5229		Push Rod
	05/96→	Centre Rod	SC-DL-5354		Push Rod
	05/96→	Centre Rod	SC-DL-12343		for Steering Rod

CV-ES-14162

Length: 125
Cone Ø: d1 Ø 30 / d2 Ø 27
Thread: M30 x 1,5 LHT
283784, 395009, 1358792, 1738380, 1 914 426, 2051165



CV-ES-14163

Length: 125
Cone Ø: d1 Ø 30 / d2 Ø 27
Thread: M30 x 1,5 RHT
283784, 395010, 1358793, 1488890, 1738381, 1767328, 1914427, 2051166



CV-RK-5311

0638862, 638862, 0639287, 639287, 1104335, 1953248, 81432206006, 81432206107



DF-RK-9341

Ø: 67
550807, 5508072



MN-RK-7280

Ø: 75 Hole Distance: 115
Thick/Height: 24
0550806, 550806, 0639370, 639370, 689748, 1104334



SC-DL-2161

Length: 1740 Ø: 50
Cone Ø: d1 Ø 30 / d2 Ø 27
1369411, 1385251, 1409918, 1501030, 1723865, 1723895, 1737683, 1897335, 2113903, 2125090, 2161883



SC-DL-5229

Length: 1053 Ø: 50
Cone Ø: d1 Ø 30 / d2 Ø 27
1356055, 1379071, 1384025, 1768898, 1847311, 1912757, 12201600A



SC-DL-5354

Length: 1060 Ø: 52
Cone Ø: d1 Ø 30 / d2 Ø 27
1384027, 1769597, 1847312, 1912758, 12200800A



SC-DL-7264

Length: 1743 Ø: 62
Cone Ø: d1 Ø 30 / d2 Ø 27
1361413, 1395614, 1734019, 1897333, 2040254, 2146105



SC-DL-8137

Length: 1736 Ø: 40
Cone Ø: d1 Ø 30 / d2 Ø 27
301639, 311847, 395350, 1358675, 1378435, 1397866, 1734020, 2028998, 12202900A



SC-DL-8179

Length: 568 Ø: 46
Hole Distance: 115 / 115
1399180, 1428347



SC-DL-8179

Length: 568 Ø: 46
Hole Distance: 115 / 115
1399180, 1428347



SC-DL-8509

Length: 568,5 Ø: 46
Hole Distance: 115 / 115
1485758, 1486757



SC-DL-8511

Length: 616,5 Ø: 50
Hole Distance: 115 / 115
1485760, 1499478, 1722750



SC-DL-8531

Length: 522 Ø: 46
Hole Distance: 115 / 115
1486758



SC-DL-8547

Length: 568 Ø: 50
Hole Distance: 115 / 115
1499474, 1722746, 1906940



SC-DL-8623

Length: 592 Ø: 50
Hole Distance: 115 / 115
1388436, 1499476, 1722748, 1906942



SC-DL-9462

Length: 568,5 Ø: 50
Hole Distance: 115 / 115
1499475, 1500573, 1722747, 1906941



SC-DL-9466

Length: 568 Ø: 19
1486756



SC-DL-9467

Length: 568,5 Ø: 50
Hole Distance: 115 / 115
1500572



SC-DL-10302

Length: 752 Ø: 48
Hole Distance: 115 / 115
1101843, 1379423, 1393298, 1431470, 1942075



SC-DL-12343

Length: 1062 Ø: 52
Cone Ø: d1 Ø 30 / d2 Ø 27
1348269, 2007275



SC-RK-12366

Ø: 75 Hole Distance: 115 / 115
Thick/Height: 24
1 722 753, 2 096 392



SC-TC-12361

Length: 705 Ø: 42
Cone Ø: d1 Ø 38
Hole Distance: 115
1353445, 1464611, 1942147



SC-TC-12451

Length: 552 Ø: 46
Hole Distance: 115 / 115
1494296



SC-TC-12452

Length: 580,5 Ø: 46
Hole Distance: 115 / 115
1485759



SC-TC-12472

Length: 580 Ø: 46
Hole Distance: 115 / 115
1399182



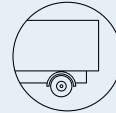

4 - series ...

T 124 G/420 ...	05/96→	Suspension Arm Repair Kit		SC-RK-12366	for Control Arm	
	05/96→	Suspension Arm Repair Kit	MN-RK-7280	MN-RK-7280	for Drag Link;for Semi-Trailing Arm; for Wishbone (CV)	
	05/96→	Suspension Strut Repair Kit		CV-RK-5311		
	05/96→	Suspension Strut Repair Kit		DF-RK-9341		
	05/96→	Tie Rod	SC-DL-7264			
	05/96→	Tie Rod	SC-DL-8137			
	05/96→	Tie Rod End	CV-ES-14162		for Steering Rod	
	05/96→	Tie Rod End	CV-ES-14163		for Steering Rod	
	05/96→	Tie Rod End	SC-ES-7279		for Steering Rod	
	05/96→	Track Control Arm		SC-DL-8179	Trailing Arm, Leaf Spring Axle	
	05/96→	Track Control Arm		SC-DL-8400	Trailing Arm	
	05/96→	Track Control Arm		SC-DL-8511	Trailing Arm, Leaf Spring Axle	
	05/96→	Track Control Arm		SC-DL-8547	Trailing Arm, Leaf Spring Axle	
	05/96→	Track Control Arm		SC-DL-9462	Trailing Arm, Leaf Spring Axle	
	05/96→	Track Control Arm		SC-DL-9466	Trailing Arm, Leaf Spring Axle	
	05/96→	Track Control Arm		SC-DL-9467	Trailing Arm, Leaf Spring Axle, →* 1247518 SSS *,* 4406943 SNL *; * 9039629 SAN *,* 3507979 SLA *	
	05/96→	Track Control Arm		SC-DL-9467	Trailing Arm, Leaf Spring Axle, → * 1280184 SSS *,* 4471602 SNL *; * 9069959 SAN *,* 3533626 SLA *	
	05/96→	Track Control Arm		SC-TC-12451	Control Arm	
	05/96→	Track Control Arm		SC-TC-12452	Control Arm	
	05/96→	Track Control Arm		SC-TC-12472	Control Arm	
	05/96→	Track Control Arm	SC-DL-8179	SC-DL-8179	Trailing Arm, Leaf Spring Axle, → * 1280184 SSS *,* 4471602 SNL *; * 9069959 SAN *,* 3533626 SLA *	
	05/96→	Track Control Arm	SC-DL-8509	SC-DL-8509	Trailing Arm, Leaf Spring Axle	
	05/96→	Track Control Arm	SC-DL-8531	SC-DL-8531	Trailing Arm, Leaf Spring Axle	
	05/96→	Track Control Arm	SC-DL-8623	SC-DL-8623	Trailing Arm, Leaf Spring Axle	
	05/96→	Track Control Arm	SC-DL-10302	SC-DL-10302	Trailing Arm, Air Suspension Axle	
	05/96→	Track Control Arm	SC-TC-12361		Control Arm, 1st Front Axle, for Pneumatic Suspension vehicles	
	T 124 L/360	05/95→12/16	Tie Rod End	SC-ES-7279		for Steering Rod
		05/95→	Centre Rod	SC-DL-2161		Coupling Rod
		05/95→	Centre Rod	SC-DL-5229		Push Rod
		05/95→	Centre Rod	SC-DL-5354		Push Rod
05/95→		Suspension Arm Repair Kit		SC-RK-12366	for Control Arm	
05/95→		Suspension Strut Repair Kit		CV-RK-5311		
05/95→		Tie Rod	SC-DL-7264			
05/95→		Tie Rod	SC-DL-8137			
05/95→		Tie Rod End	CV-ES-14162		for Steering Rod	
05/95→		Tie Rod End	CV-ES-14163		for Steering Rod	
05/95→		Track Control Arm		SC-TC-12451	Control Arm	
05/95→		Track Control Arm		SC-TC-12452	Control Arm	
05/95→		Track Control Arm		SC-TC-12472	Control Arm	
05/95→		Track Control Arm	SC-DL-10302	SC-DL-10302	Trailing Arm, Air Suspension Axle	
09/95→		Track Control Arm		SC-DL-8179	Trailing Arm, Leaf Spring Axle	
09/95→		Track Control Arm		SC-DL-8400	Trailing Arm	
09/95→		Track Control Arm		SC-DL-8511	Trailing Arm, Leaf Spring Axle	
09/95→		Track Control Arm		SC-DL-8547	Trailing Arm, Leaf Spring Axle	
09/95→		Track Control Arm		SC-DL-9462	Trailing Arm, Leaf Spring Axle	
09/95→		Track Control Arm		SC-DL-9466	Trailing Arm, Leaf Spring Axle	
09/95→		Track Control Arm		SC-DL-9467	Trailing Arm, Leaf Spring Axle, →* 1247518 SSS *,* 4406943 SNL *; * 9039629 SAN *,* 3507979 SLA *	
09/95→		Track Control Arm		SC-DL-9467	Trailing Arm, Leaf Spring Axle, → * 1280184 SSS *,* 4471602 SNL *; * 9069959 SAN *,* 3533626 SLA *	
09/95→		Track Control Arm	SC-DL-8179	SC-DL-8179	Trailing Arm, Leaf Spring Axle, → * 1280184 SSS *,* 4471602 SNL *; * 9069959 SAN *,* 3533626 SLA *	

CV-ES-14162

Length: 125
Cone Ø: d1 Ø 30 / d2 Ø 27
Thread: M30 x 1,5 LHT
283784, 395009, 1358792, 1738380, 1 914 426, 2051165



CV-ES-14163

Length: 125
Cone Ø: d1 Ø 30 / d2 Ø 27
Thread: M30 x 1,5 RHT
283784, 395010, 1358793, 1488890, 1738381, 1767328, 1914427, 2051166



CV-RK-5311

0638862, 638862, 0639287, 639287, 1104335, 1953248, 81432206006, 81432206107



DF-RK-9341

Ø: 67
550807, 5508072



MN-RK-7280

Ø: 75 Hole Distance: 115
Thick/Height: 24
0550806, 550806, 0639370, 639370, 689748, 1104334



SC-DL-2161

Length: 1740 Ø: 50
Cone Ø: d1 Ø 30 / d2 Ø 27
1369411, 1385251, 1409918, 1501030, 1723865, 1723895, 1737683, 1897335, 2113903, 2125090, 2161883



SC-DL-5229

Length: 1053 Ø: 50
Cone Ø: d1 Ø 30 / d2 Ø 27
1356055, 1379071, 1384025, 1768898, 1847311, 1912757, 12201600A



SC-DL-5354

Length: 1060 Ø: 52
Cone Ø: d1 Ø 30 / d2 Ø 27
1384027, 1769597, 1847312, 1912758, 12200800A



SC-DL-7264

Length: 1743 Ø: 62
Cone Ø: d1 Ø 30 / d2 Ø 27
1361413, 1395614, 1734019, 1897333, 2040254, 2146105



SC-DL-8137

Length: 1736 Ø: 40
Cone Ø: d1 Ø 30 / d2 Ø 27
301639, 311847, 395350, 1358675, 1378435, 1397866, 1734020, 2028998, 12202900A



SC-DL-8179

Length: 568 Ø: 46
Hole Distance: 115 / 115
1399180, 1428347



SC-DL-8179

Length: 568 Ø: 46
Hole Distance: 115 / 115
1399180, 1428347



SC-DL-8509

Length: 568,5 Ø: 46
Hole Distance: 115 / 115
1485758, 1486757



SC-DL-8511

Length: 616,5 Ø: 50
Hole Distance: 115 / 115
1485760, 1499478, 1722750



SC-DL-8531

Length: 522 Ø: 46
Hole Distance: 115 / 115
1486758



SC-DL-8547

Length: 568 Ø: 50
Hole Distance: 115 / 115
1499474, 1722746, 1906940



SC-DL-8623

Length: 592 Ø: 50
Hole Distance: 115 / 115
1388436, 1499476, 1722748, 1906942



SC-DL-9462

Length: 568,5 Ø: 50
Hole Distance: 115 / 115
1499475, 1500573, 1722747, 1906941



SC-DL-9466

Length: 568 Ø: 19
1486756



SC-DL-9467

Length: 568,5 Ø: 50
Hole Distance: 115 / 115
1500572



SC-DL-10302

Length: 752 Ø: 48
Hole Distance: 115 / 115
1101843, 1379423, 1393298, 1431470, 1942075



SC-ES-7279

Length: 150
Cone Ø: d1 Ø 30 / d2 Ø 27
Thread: M30 x 1,5 RHT
1357674, 1603883, 1738379



SC-RK-12366

Ø: 75 Hole Distance: 115 / 115
Thick/Height: 24
1 722 753, 2 096 392



SC-TC-12361

Length: 705 Ø: 42
Cone Ø: d1 Ø 38
Hole Distance: 115
1353445, 1464611, 1942147



SC-TC-12451

Length: 552 Ø: 46
Hole Distance: 115 / 115
1494296



SC-TC-12452

Length: 580,5 Ø: 46
Hole Distance: 115 / 115
1485759



SC-TC-12472

Length: 580 Ø: 46
Hole Distance: 115 / 115
1399182





4 - series ...

T 124 L/360 ...	09/95 →	Track Control Arm	SC-DL-8509	SC-DL-8509	Trailing Arm, Leaf Spring Axle	
	09/95 →	Track Control Arm	SC-DL-8531	SC-DL-8531	Trailing Arm, Leaf Spring Axle	
	09/95 →	Track Control Arm	SC-DL-8623	SC-DL-8623	Trailing Arm, Leaf Spring Axle	
	02/97 →	Suspension Arm Repair Kit	MN-RK-7280	MN-RK-7280	for Drag Link;for Semi-Trailing Arm; for Wishbone (CV)	
	02/97 →	Suspension Strut Repair Kit		DF-RK-9341		
T 124 L/400	05/96 →	Centre Rod	SC-DL-2161		Coupling Rod	
	05/96 →	Centre Rod	SC-DL-5229		Push Rod	
	05/96 →	Centre Rod	SC-DL-5354		Push Rod	
	05/96 →	Suspension Arm Repair Kit		SC-RK-12366	for Control Arm	
	05/96 →	Suspension Strut Repair Kit		CV-RK-5311		
	05/96 →	Tie Rod	SC-DL-7264			
	05/96 →	Tie Rod	SC-DL-8137			
	05/96 →	Tie Rod End	CV-ES-14162		for Steering Rod	
	05/96 →	Tie Rod End	CV-ES-14163		for Steering Rod	
	05/96 →	Tie Rod End	SC-ES-7279		for Steering Rod	
	05/96 →	Track Control Arm		SC-DL-8179	Trailing Arm, Leaf Spring Axle	
	05/96 →	Track Control Arm		SC-DL-8400	Trailing Arm	
	05/96 →	Track Control Arm		SC-DL-8511	Trailing Arm, Leaf Spring Axle	
	05/96 →	Track Control Arm		SC-DL-8547	Trailing Arm, Leaf Spring Axle	
	05/96 →	Track Control Arm		SC-DL-9462	Trailing Arm, Leaf Spring Axle	
	05/96 →	Track Control Arm		SC-DL-9466	Trailing Arm, Leaf Spring Axle	
	05/96 →	Track Control Arm		SC-DL-9467	Trailing Arm, Leaf Spring Axle, →* 1247518 SSS ** 4406943 SNL *; * 9039629 SAN **; * 3507979 SLA *	
	05/96 →	Track Control Arm		SC-DL-9467	Trailing Arm, Leaf Spring Axle, → * 1280184 SSS **; * 4471602 SNL *; * 9069959 SAN **; * 3533626 SLA *	
	05/96 →	Track Control Arm		SC-TC-12451	Control Arm	
	05/96 →	Track Control Arm		SC-TC-12452	Control Arm	
	05/96 →	Track Control Arm		SC-TC-12472	Control Arm	
	05/96 →	Track Control Arm	SC-DL-8179	SC-DL-8179	Trailing Arm, Leaf Spring Axle, → * 1280184 SSS **; * 4471602 SNL *; * 9069959 SAN **; * 3533626 SLA *	
	05/96 →	Track Control Arm	SC-DL-8509	SC-DL-8509	Trailing Arm, Leaf Spring Axle	
	05/96 →	Track Control Arm	SC-DL-8531	SC-DL-8531	Trailing Arm, Leaf Spring Axle	
	05/96 →	Track Control Arm	SC-DL-8623	SC-DL-8623	Trailing Arm, Leaf Spring Axle	
	05/96 →	Track Control Arm	SC-DL-10302	SC-DL-10302	Trailing Arm, Air Suspension Axle	
	02/97 →	Suspension Arm Repair Kit	MN-RK-7280	MN-RK-7280	for Drag Link;for Semi-Trailing Arm; for Wishbone (CV)	
	02/97 →	Suspension Strut Repair Kit		DF-RK-9341		
	T 124 L/420	05/96 →	Centre Rod	SC-DL-2161		Coupling Rod
		05/96 →	Centre Rod	SC-DL-5229		Push Rod
		05/96 →	Centre Rod	SC-DL-5354		Push Rod
		05/96 →	Suspension Arm Repair Kit		SC-RK-12366	for Control Arm
05/96 →		Suspension Arm Repair Kit	MN-RK-7280	MN-RK-7280	for Drag Link;for Semi-Trailing Arm; for Wishbone (CV)	
05/96 →		Suspension Strut Repair Kit		CV-RK-5311		
05/96 →		Suspension Strut Repair Kit		DF-RK-9341		
05/96 →		Tie Rod	SC-DL-7264			
05/96 →		Tie Rod	SC-DL-8137			
05/96 →		Tie Rod End	CV-ES-14162		for Steering Rod	
05/96 →		Tie Rod End	CV-ES-14163		for Steering Rod	
05/96 →		Track Control Arm		SC-TC-12451	Control Arm	
05/96 →		Track Control Arm		SC-TC-12452	Control Arm	
05/96 →		Track Control Arm		SC-TC-12472	Control Arm	
05/96 →		Track Control Arm	SC-DL-10302	SC-DL-10302	Trailing Arm, Air Suspension Axle	
09/97 →		Track Control Arm		SC-DL-8179	Trailing Arm, Leaf Spring Axle	
09/97 →		Track Control Arm		SC-DL-8400	Trailing Arm	
09/97 →		Track Control Arm		SC-DL-8511	Trailing Arm, Leaf Spring Axle	
09/97 →		Track Control Arm		SC-DL-8547	Trailing Arm, Leaf Spring Axle	
09/97 →		Track Control Arm		SC-DL-9462	Trailing Arm, Leaf Spring Axle	
09/97 →		Track Control Arm		SC-DL-9466	Trailing Arm, Leaf Spring Axle	

CV-ES-14162

Length: 125
Cone Ø: d1 Ø 30 / d2 Ø 27
Thread: M30 x 1,5 LHT
283784, 395009, 1358792, 1738380, 1 914 426, 2051165



CV-ES-14163

Length: 125
Cone Ø: d1 Ø 30 / d2 Ø 27
Thread: M30 x 1,5 RHT
283784, 395010, 1358793, 1488890, 1738381, 1767328, 1914427, 2051166



CV-RK-5311

0638862, 638862, 0639287, 639287, 1104335, 1953248, 81432206006, 81432206107



DF-RK-9341

Ø: 67
550807, 5508072



MN-RK-7280

Ø: 75 Hole Distance: 115
Thick/Height: 24
0550806, 550806, 0639370, 639370, 689748, 1104334



SC-DL-2161

Length: 1740 Ø: 50
Cone Ø: d1 Ø 30 / d2 Ø 27
1369411, 1385251, 1409918, 1501030, 1723865, 1723895, 1737683, 1897335, 2113903, 2125090, 2161883



SC-DL-5229

Length: 1053 Ø: 50
Cone Ø: d1 Ø 30 / d2 Ø 27
1356055, 1379071, 1384025, 1768898, 1847311, 1912757, 12201600A



SC-DL-5354

Length: 1060 Ø: 52
Cone Ø: d1 Ø 30 / d2 Ø 27
1384027, 1769597, 1847312, 1912758, 12200800A



SC-DL-7264

Length: 1743 Ø: 62
Cone Ø: d1 Ø 30 / d2 Ø 27
1361413, 1395614, 1734019, 1897333, 2040254, 2146105



SC-DL-8137

Length: 1736 Ø: 40
Cone Ø: d1 Ø 30 / d2 Ø 27
301639, 311847, 395350, 1358675, 1378435, 1397866, 1734020, 2028998, 12202900A



SC-DL-8179

Length: 568 Ø: 46
Hole Distance: 115 / 115
1399180, 1428347



SC-DL-8179

Length: 568 Ø: 46
Hole Distance: 115 / 115
1399180, 1428347



SC-DL-8509

Length: 568,5 Ø: 46
Hole Distance: 115 / 115
1485758, 1486757



SC-DL-8511

Length: 616,5 Ø: 50
Hole Distance: 115 / 115
1485760, 1499478, 1722750



SC-DL-8531

Length: 522 Ø: 46
Hole Distance: 115 / 115
1486758



SC-DL-8547

Length: 568 Ø: 50
Hole Distance: 115 / 115
1499474, 1722746, 1906940



SC-DL-8623

Length: 592 Ø: 50
Hole Distance: 115 / 115
1388436, 1499476, 1722748, 1906942



SC-DL-9462

Length: 568,5 Ø: 50
Hole Distance: 115 / 115
1499475, 1500573, 1722747, 1906941



SC-DL-9466

Length: 568 Ø: 19
1486756



SC-DL-9467

Length: 568,5 Ø: 50
Hole Distance: 115 / 115
1500572



SC-DL-10302

Length: 752 Ø: 48
Hole Distance: 115 / 115
1101843, 1379423, 1393298, 1431470, 1942075



SC-ES-7279

Length: 150
Cone Ø: d1 Ø 30 / d2 Ø 27
Thread: M30 x 1,5 RHT
1357674, 1603883, 1738379



SC-RK-12366

Ø: 75 Hole Distance: 115 / 115
Thick/Height: 24
1 722 753, 2 096 392



SC-TC-12451

Length: 552 Ø: 46
Hole Distance: 115 / 115
1494296



SC-TC-12452

Length: 580,5 Ø: 46
Hole Distance: 115 / 115
1485759



SC-TC-12472

Length: 580 Ø: 46
Hole Distance: 115 / 115
1399182





4 - series ...

T 124 L/420 ...	09/97→	Track Control Arm		SC-DL-9467	Trailing Arm, Leaf Spring Axle, →* 1247518 SSS *;* 4406943 SNL *;* 9039629 SAN *;* 3507979 SLA *
	09/97→	Track Control Arm		SC-DL-9467	Trailing Arm, Leaf Spring Axle, → * 1280184 SSS *;* 4471602 SNL *;* 9069959 SAN *;* 3533626 SLA *
	09/97→	Track Control Arm	SC-DL-8179	SC-DL-8179	Trailing Arm, Leaf Spring Axle, → * 1280184 SSS *;* 4471602 SNL *;* 9069959 SAN *;* 3533626 SLA *
	09/97→	Track Control Arm	SC-DL-8509	SC-DL-8509	Trailing Arm, Leaf Spring Axle
	09/97→	Track Control Arm	SC-DL-8531	SC-DL-8531	Trailing Arm, Leaf Spring Axle
	09/97→	Track Control Arm	SC-DL-8623	SC-DL-8623	Trailing Arm, Leaf Spring Axle
T 124 L/470	01/00→	Centre Rod	SC-DL-5229		Push Rod
	01/00→	Centre Rod	SC-DL-5354		Push Rod
	01/00→	Centre Rod	SC-DL-12343		for Steering Rod
	01/00→	Suspension Arm Repair Kit		SC-RK-12366	for Control Arm
	01/00→	Suspension Arm Repair Kit	MN-RK-7280	MN-RK-7280	for Drag Link;for Semi-Trailing Arm; for Wishbone (CV)
	01/00→	Suspension Strut Repair Kit		DF-RK-9341	
	01/00→	Tie Rod	SC-DL-7264		
	01/00→	Tie Rod	SC-DL-8137		
	01/00→	Tie Rod End	CV-ES-14162		for Steering Rod
	01/00→	Tie Rod End	CV-ES-14163		for Steering Rod
	01/00→	Track Control Arm	SC-DL-10302	SC-DL-10302	Trailing Arm, Air Suspension Axle
	01/01→	Centre Rod	SC-DL-2161		Coupling Rod
	01/01→	Suspension Arm Repair Kit		MN-RK-7280	for Drag Link;for Semi-Trailing Arm; for Wishbone (CV)
	T 144 C/460	09/95→	Centre Rod	SC-DL-2161	
09/95→		Centre Rod	SC-DL-5229		Push Rod
09/95→		Centre Rod	SC-DL-5354		Push Rod
09/95→		Suspension Arm Repair Kit		SC-RK-12366	for Control Arm
09/95→		Suspension Strut Repair Kit		CV-RK-5311	
09/95→		Tie Rod	SC-DL-7264		
09/95→		Tie Rod	SC-DL-8137		
09/95→		Tie Rod End	CV-ES-14162		for Steering Rod
09/95→		Tie Rod End	CV-ES-14163		for Steering Rod
09/95→		Tie Rod End	SC-ES-7279		for Steering Rod
09/95→		Track Control Arm		SC-DL-8179	Trailing Arm, Leaf Spring Axle
09/95→		Track Control Arm		SC-DL-8400	Trailing Arm
09/95→		Track Control Arm		SC-DL-8511	Trailing Arm, Leaf Spring Axle
09/95→		Track Control Arm		SC-DL-8547	Trailing Arm, Leaf Spring Axle
09/95→		Track Control Arm		SC-DL-8623	Trailing Arm, 1st Drive Axle, for Leaf-Spring Suspension vehicles, →1280184/4471602
09/95→		Track Control Arm		SC-DL-8623	Trailing Arm, 1st Drive Axle, for Leaf-Spring Suspension vehicles, →9069959/3533626
09/95→		Track Control Arm		SC-DL-9462	Trailing Arm, 2nd Drive Axle, for Leaf-Spring Suspension vehicles, →1280184/4471602
09/95→		Track Control Arm		SC-DL-9462	Trailing Arm, 2nd Drive Axle, for Leaf-Spring Suspension vehicles, →1280185/4471603
09/95→		Track Control Arm		SC-DL-9462	Trailing Arm, 2nd Drive Axle, for Leaf-Spring Suspension vehicles, →9069959/3533626
09/95→		Track Control Arm		SC-DL-9462	Trailing Arm, 2nd Drive Axle, for Leaf-Spring Suspension vehicles, 9069960/3533627→
09/95→		Track Control Arm		SC-DL-9466	Trailing Arm, Leaf Spring Axle
09/95→		Track Control Arm		SC-DL-9467	Trailing Arm, Leaf Spring Axle, →* 1247518 SSS *;* 4406943 SNL *;* 9039629 SAN *;* 3507979 SLA *
09/95→		Track Control Arm		SC-DL-9467	Trailing Arm, Leaf Spring Axle, → * 1280184 SSS *;* 4471602 SNL *;* 9069959 SAN *;* 3533626 SLA *
09/95→		Track Control Arm		SC-TC-12451	Trailing Arm, 1st Drive Axle, for Leaf-Spring Suspension vehicles

CV-ES-14162

Length: 125
Cone Ø: d1 Ø 30 / d2 Ø 27
Thread: M30 x 1,5 LHT
283784, 395009, 1358792, 1738380, 1 914 426, 2051165



CV-ES-14163

Length: 125
Cone Ø: d1 Ø 30 / d2 Ø 27
Thread: M30 x 1,5 RHT
283784, 395010, 1358793, 1488890, 1738381, 1767328, 1914427, 2051166



CV-RK-5311

0638862, 638862, 0639287, 639287, 1104335, 1953248, 81432206006, 81432206107



DF-RK-9341

Ø: 67
550807, 5508072



MN-RK-7280

Ø: 75 Hole Distance: 115
Thick/Height: 24
0550806, 550806, 0639370, 639370, 689748, 1104334



SC-DL-2161

Length: 1740 Ø: 50
Cone Ø: d1 Ø 30 / d2 Ø 27
1369411, 1385251, 1409918, 1501030, 1723865, 1723895, 1737683, 1897335, 2113903, 2125090, 2161883



SC-DL-5229

Length: 1053 Ø: 50
Cone Ø: d1 Ø 30 / d2 Ø 27
1356055, 1379071, 1384025, 1768898, 1847311, 1912757, 12201600A



SC-DL-5354

Length: 1060 Ø: 52
Cone Ø: d1 Ø 30 / d2 Ø 27
1384027, 1769597, 1847312, 1912758, 12200800A



SC-DL-7264

Length: 1743 Ø: 62
Cone Ø: d1 Ø 30 / d2 Ø 27
1361413, 1395614, 1734019, 1897333, 2040254, 2146105



SC-DL-8137

Length: 1736 Ø: 40
Cone Ø: d1 Ø 30 / d2 Ø 27
301639, 311847, 395350, 1358675, 1378435, 1397866, 1734020, 2028998, 12202900A



SC-DL-8179

Length: 568 Ø: 46
Hole Distance: 115 / 115
1399180, 1428347



SC-DL-8179

Length: 568 Ø: 46
Hole Distance: 115 / 115
1399180, 1428347



SC-DL-8509

Length: 568,5 Ø: 46
Hole Distance: 115 / 115
1485758, 1486757



SC-DL-8511

Length: 616,5 Ø: 50
Hole Distance: 115 / 115
1485760, 1499478, 1722750



SC-DL-8531

Length: 522 Ø: 46
Hole Distance: 115 / 115
1486758



SC-DL-8547

Length: 568 Ø: 50
Hole Distance: 115 / 115
1499474, 1722746, 1906940



SC-DL-8623

Length: 592 Ø: 50
Hole Distance: 115 / 115
1388436, 1499476, 1722748, 1906942



SC-DL-9462

Length: 568,5 Ø: 50
Hole Distance: 115 / 115
1499475, 1500573, 1722747, 1906941



SC-DL-9466

Length: 568 Ø: 19
1486756



SC-DL-9467

Length: 568,5 Ø: 50
Hole Distance: 115 / 115
1500572



SC-DL-10302

Length: 752 Ø: 48
Hole Distance: 115 / 115
1101843, 1379423, 1393298, 1431470, 1942075



SC-DL-12343

Length: 1062 Ø: 52
Cone Ø: d1 Ø 30 / d2 Ø 27
1348269, 2007275



SC-ES-7279

Length: 150
Cone Ø: d1 Ø 30 / d2 Ø 27
Thread: M30 x 1,5 RHT
1357674, 1603883, 1738379



SC-RK-12366

Ø: 75 Hole Distance: 115 / 115
Thick/Height: 24
1 722 753, 2 096 392



SC-TC-12451

Length: 552 Ø: 46
Hole Distance: 115 / 115
1494296



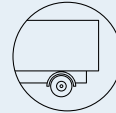

4 - series ...

T 144 C/460 ...	09/95→	Track Control Arm		SC-TC-12452	Trailing Arm, 1st RA;2nd RA, for Leaf-Spring Suspension vehicles
	09/95→	Track Control Arm	SC-DL-8179	SC-DL-8179	Trailing Arm, Leaf Spring Axle, → * 1280184 SSS *; * 4471602 SNL *; * 9069959 SAN *; * 3533626 SLA *
	09/95→	Track Control Arm	SC-DL-8509	SC-DL-8509	Trailing Arm, Leaf Spring Axle
	09/95→	Track Control Arm	SC-DL-8531	SC-DL-8531	Trailing Arm, Leaf Spring Axle
	09/95→	Track Control Arm	SC-DL-10302	SC-DL-10302	Trailing Arm, Air Suspension Axle
T 144 C/530	09/95→	Centre Rod	SC-DL-2161		Coupling Rod
	09/95→	Centre Rod	SC-DL-5229		Push Rod
	09/95→	Centre Rod	SC-DL-5354		Push Rod
	09/95→	Suspension Arm Repair Kit		SC-RK-12366	for Control Arm
	09/95→	Suspension Strut Repair Kit		CV-RK-5311	
	09/95→	Tie Rod	SC-DL-7264		
	09/95→	Tie Rod	SC-DL-8137		
	09/95→	Tie Rod End	CV-ES-14162		for Steering Rod
	09/95→	Tie Rod End	CV-ES-14163		for Steering Rod
	09/95→	Tie Rod End	SC-ES-7279		for Steering Rod
	09/95→	Track Control Arm		SC-DL-8179	Trailing Arm, Leaf Spring Axle
	09/95→	Track Control Arm		SC-DL-8400	Trailing Arm
	09/95→	Track Control Arm		SC-DL-8511	Trailing Arm, Leaf Spring Axle
	09/95→	Track Control Arm		SC-DL-8547	Trailing Arm, Leaf Spring Axle
	09/95→	Track Control Arm		SC-DL-8623	Trailing Arm, 1st Drive Axle, for Leaf-Spring Suspension vehicles, →1280184/4471602
	09/95→	Track Control Arm		SC-DL-8623	Trailing Arm, 1st Drive Axle, for Leaf-Spring Suspension vehicles, →9069959/3533626
	09/95→	Track Control Arm		SC-DL-9462	Trailing Arm, 2nd Drive Axle, for Leaf-Spring Suspension vehicles, →1280184/4471602
	09/95→	Track Control Arm		SC-DL-9462	Trailing Arm, 2nd Drive Axle, for Leaf-Spring Suspension vehicles, →1280185/4471603_>
	09/95→	Track Control Arm		SC-DL-9462	Trailing Arm, 2nd Drive Axle, for Leaf-Spring Suspension vehicles, →9069959/3533626
	09/95→	Track Control Arm		SC-DL-9462	Trailing Arm, 2nd Drive Axle, for Leaf-Spring Suspension vehicles, 9069960/3533627 →
	09/95→	Track Control Arm		SC-DL-9466	Trailing Arm, Leaf Spring Axle
	09/95→	Track Control Arm		SC-DL-9467	Trailing Arm, Leaf Spring Axle, →* 1247518 SSS *; * 4406943 SNL *; * 9039629 SAN *; * 3507979 SLA *
	09/95→	Track Control Arm		SC-DL-9467	Trailing Arm, Leaf Spring Axle, → * 1280184 SSS *; * 4471602 SNL *; * 9069959 SAN *; * 3533626 SLA *
	09/95→	Track Control Arm		SC-TC-12451	Trailing Arm, 1st Drive Axle, for Leaf-Spring Suspension vehicles
	09/95→	Track Control Arm		SC-TC-12452	Trailing Arm, 1st RA;2nd RA, for Leaf-Spring Suspension vehicles
	09/95→	Track Control Arm	SC-DL-8179	SC-DL-8179	Trailing Arm, Leaf Spring Axle, → * 1280184 SSS *; * 4471602 SNL *; * 9069959 SAN *; * 3533626 SLA *
	09/95→	Track Control Arm	SC-DL-8509	SC-DL-8509	Trailing Arm, Leaf Spring Axle
09/95→	Track Control Arm	SC-DL-8531	SC-DL-8531	Trailing Arm, Leaf Spring Axle	
09/95→	Track Control Arm	SC-DL-10302	SC-DL-10302	Trailing Arm, Air Suspension Axle	
T 144 G/460	03/97→	Centre Rod	SC-DL-2161		Coupling Rod
	03/97→	Centre Rod	SC-DL-5229		Push Rod
	03/97→	Centre Rod	SC-DL-5354		Push Rod
	03/97→	Suspension Arm Repair Kit		SC-RK-12366	for Control Arm
	03/97→	Suspension Arm Repair Kit	MN-RK-7280	MN-RK-7280	for Drag Link;for Semi-Trailing Arm; for Wishbone (CV)
	03/97→	Suspension Strut Repair Kit		CV-RK-5311	
	03/97→	Suspension Strut Repair Kit		DF-RK-9341	
	03/97→	Tie Rod	SC-DL-7264		
	03/97→	Tie Rod	SC-DL-8137		
	03/97→	Tie Rod End	CV-ES-14162		for Steering Rod
	03/97→	Tie Rod End	CV-ES-14163		for Steering Rod

CV-ES-14162

Length: 125
Cone Ø: d1 Ø 30 / d2 Ø 27
Thread: M30 x 1,5 LHT
283784, 395009, 1358792, 1738380, 1 914 426, 2051165



CV-ES-14163

Length: 125
Cone Ø: d1 Ø 30 / d2 Ø 27
Thread: M30 x 1,5 RHT
283784, 395010, 1358793, 1488890, 1738381, 1767328, 1914427, 2051166



CV-RK-5311

0638862, 638862, 0639287, 639287, 1104335, 1953248, 81432206006, 81432206107



DF-RK-9341

Ø: 67
550807, 5508072



MN-RK-7280

Ø: 75 Hole Distance: 115
Thick/Height: 24
550806, 0550806, 0639370, 639370, 689748, 1104334



SC-DL-2161

Length: 1740 Ø: 50
Cone Ø: d1 Ø 30 / d2 Ø 27
1369411, 1385251, 1409918, 1501030, 1723865, 1723895, 1737683, 1897335, 2113903, 2125090, 2161883



SC-DL-5229

Length: 1053 Ø: 50
Cone Ø: d1 Ø 30 / d2 Ø 27
1356055, 1379071, 1384025, 1768898, 1847311, 1912757, 12201600A



SC-DL-5354

Length: 1060 Ø: 52
Cone Ø: d1 Ø 30 / d2 Ø 27
1384027, 1769597, 1847312, 1912758, 12200800A



SC-DL-7264

Length: 1743 Ø: 62
Cone Ø: d1 Ø 30 / d2 Ø 27
1361413, 1395614, 1734019, 1897333, 2040254, 2146105



SC-DL-8137

Length: 1736 Ø: 40
Cone Ø: d1 Ø 30 / d2 Ø 27
301639, 311847, 395350, 1358675, 1378435, 1397866, 1734020, 2028998, 12202900A



SC-DL-8179

Length: 568 Ø: 46
Hole Distance: 115 / 115
1399180, 1428347



SC-DL-8179

Length: 568 Ø: 46
Hole Distance: 115 / 115
1399180, 1428347



SC-DL-8509

Length: 568,5 Ø: 46
Hole Distance: 115 / 115
1485758, 1486757



SC-DL-8511

Length: 616,5 Ø: 50
Hole Distance: 115 / 115
1485760, 1499478, 1722750



SC-DL-8531

Length: 522 Ø: 46
Hole Distance: 115 / 115
1486758



SC-DL-8547

Length: 568 Ø: 50
Hole Distance: 115 / 115
1499474, 1722746, 1906940



SC-DL-8623

Length: 592 Ø: 50
Hole Distance: 115 / 115
1388436, 1499476, 1722748, 1906942



SC-DL-9462

Length: 568,5 Ø: 50
Hole Distance: 115 / 115
1499475, 1500573, 1722747, 1906941



SC-DL-9466

Length: 568 Ø: 19
1486756



SC-DL-9467

Length: 568,5 Ø: 50
Hole Distance: 115 / 115
1500572



SC-DL-10302

Length: 752 Ø: 48
Hole Distance: 115 / 115
1101843, 1379423, 1393298, 1431470, 1942075



SC-ES-7279

Length: 150
Cone Ø: d1 Ø 30 / d2 Ø 27
Thread: M30 x 1,5 RHT
1357674, 1603883, 1738379



SC-RK-12366

Ø: 75 Hole Distance: 115 / 115
Thick/Height: 24
1 722 753, 2 096 392



SC-TC-12451

Length: 552 Ø: 46
Hole Distance: 115 / 115
1494296



SC-TC-12452

Length: 580,5 Ø: 46
Hole Distance: 115 / 115
1485759





4 - series ...

T 144 G/460 ...	03/97→	Track Control Arm		SC-DL-8179	Trailing Arm, Leaf Spring Axle
	03/97→	Track Control Arm		SC-DL-8400	Trailing Arm
	03/97→	Track Control Arm		SC-DL-8511	Trailing Arm, Leaf Spring Axle
	03/97→	Track Control Arm		SC-DL-8547	Trailing Arm, Leaf Spring Axle
	03/97→	Track Control Arm		SC-DL-8623	Trailing Arm, 1st Drive Axle, for Leaf-Spring Suspension vehicles, →1280184/4471602
	03/97→	Track Control Arm		SC-DL-8623	Trailing Arm, 1st Drive Axle, for Leaf-Spring Suspension vehicles, →9069959/3533626
	03/97→	Track Control Arm		SC-DL-9462	Trailing Arm, 2nd Drive Axle, for Leaf-Spring Suspension vehicles, →1280184/4471602
	03/97→	Track Control Arm		SC-DL-9462	Trailing Arm, 2nd Drive Axle, for Leaf-Spring Suspension vehicles, →1280185/4471603_>
	03/97→	Track Control Arm		SC-DL-9462	Trailing Arm, 2nd Drive Axle, for Leaf-Spring Suspension vehicles, →9069959/3533626
	03/97→	Track Control Arm		SC-DL-9462	Trailing Arm, 2nd Drive Axle, for Leaf-Spring Suspension vehicles, 9069960/3533627→
	03/97→	Track Control Arm		SC-DL-9466	Trailing Arm, Leaf Spring Axle
	03/97→	Track Control Arm		SC-DL-9467	Trailing Arm, Leaf Spring Axle, →* 1247518 SSS **; 4406943 SNL *; * 9039629 SAN **; 3507979 SLA *
	03/97→	Track Control Arm		SC-DL-9467	Trailing Arm, Leaf Spring Axle, →* 1280184 SSS **; 4471602 SNL *; * 9069959 SAN **; 3533626 SLA *
	03/97→	Track Control Arm		SC-TC-12451	Trailing Arm, 1st Drive Axle, for Leaf-Spring Suspension vehicles
	03/97→	Track Control Arm		SC-TC-12452	Trailing Arm, 1st RA;2nd RA, for Leaf-Spring Suspension vehicles
	03/97→	Track Control Arm	SC-DL-8179	SC-DL-8179	Trailing Arm, Leaf Spring Axle, →* 1280184 SSS **; 4471602 SNL *; * 9069959 SAN **; 3533626 SLA *
	03/97→	Track Control Arm	SC-DL-8509	SC-DL-8509	Trailing Arm, Leaf Spring Axle
	03/97→	Track Control Arm	SC-DL-8531	SC-DL-8531	Trailing Arm, Leaf Spring Axle
	03/97→	Track Control Arm	SC-DL-10302	SC-DL-10302	Trailing Arm, Air Suspension Axle
	T 144 G/530	03/97→	Centre Rod	SC-DL-2161	
03/97→		Centre Rod	SC-DL-5229		Push Rod
03/97→		Centre Rod	SC-DL-5354		Push Rod
03/97→		Suspension Arm Repair Kit		SC-RK-12366	for Control Arm
03/97→		Suspension Arm Repair Kit	MN-RK-7280	MN-RK-7280	for Drag Link;for Semi-Trailing Arm; for Wishbone (CV)
03/97→		Suspension Strut Repair Kit		CV-RK-5311	
03/97→		Suspension Strut Repair Kit		DF-RK-9341	
03/97→		Tie Rod	SC-DL-7264		
03/97→		Tie Rod	SC-DL-8137		
03/97→		Tie Rod End	CV-ES-14162		for Steering Rod
03/97→		Tie Rod End	CV-ES-14163		for Steering Rod
03/97→		Track Control Arm		SC-DL-8179	Trailing Arm, Leaf Spring Axle
03/97→		Track Control Arm		SC-DL-8400	Trailing Arm
03/97→		Track Control Arm		SC-DL-8511	Trailing Arm, Leaf Spring Axle
03/97→		Track Control Arm		SC-DL-8547	Trailing Arm, Leaf Spring Axle
03/97→		Track Control Arm		SC-DL-8623	Trailing Arm, 1st Drive Axle, for Leaf-Spring Suspension vehicles, →1280184/4471602
03/97→		Track Control Arm		SC-DL-8623	Trailing Arm, 1st Drive Axle, for Leaf-Spring Suspension vehicles, →9069959/3533626
03/97→		Track Control Arm		SC-DL-9462	Trailing Arm, 2nd Drive Axle, for Leaf-Spring Suspension vehicles, →1280184/4471602
03/97→		Track Control Arm		SC-DL-9462	Trailing Arm, 2nd Drive Axle, for Leaf-Spring Suspension vehicles, →1280185/4471603_>
03/97→		Track Control Arm		SC-DL-9462	Trailing Arm, 2nd Drive Axle, for Leaf-Spring Suspension vehicles, →9069959/3533626
03/97→		Track Control Arm		SC-DL-9462	Trailing Arm, 2nd Drive Axle, for Leaf-Spring Suspension vehicles, 9069960/3533627→
03/97→		Track Control Arm		SC-DL-9466	Trailing Arm, Leaf Spring Axle

CV-ES-14162

Length: 125
Cone Ø: d1 Ø 30 / d2 Ø 27
Thread: M30 x 1,5 LHT
283784, 395009, 1358792, 1738380, 1 914 426, 2051165



CV-ES-14163

Length: 125
Cone Ø: d1 Ø 30 / d2 Ø 27
Thread: M30 x 1,5 RHT
283784, 395010, 1358793, 1488890, 1738381, 1767328, 1914427, 2051166



CV-RK-5311

0638862, 638862, 0639287, 639287, 1104335, 1953248, 81432206006, 81432206107



DF-RK-9341

Ø: 67
550807, 5508072



MN-RK-7280

Ø: 75 Hole Distance: 115
Thick/Height: 24
550806, 0550806, 639370, 0639370, 689748, 1104334



SC-DL-2161

Length: 1740 Ø: 50
Cone Ø: d1 Ø 30 / d2 Ø 27
1369411, 1385251, 1409918, 1501030, 1723865, 1723895, 1737683, 1897335, 2113903, 2125090, 2161883



SC-DL-5229

Length: 1053 Ø: 50
Cone Ø: d1 Ø 30 / d2 Ø 27
1356055, 1379071, 1384025, 1768898, 1847311, 1912757, 12201600A



SC-DL-5354

Length: 1060 Ø: 52
Cone Ø: d1 Ø 30 / d2 Ø 27
1384027, 1769597, 1847312, 1912758, 12200800A



SC-DL-7264

Length: 1743 Ø: 62
Cone Ø: d1 Ø 30 / d2 Ø 27
1361413, 1395614, 1734019, 1897333, 2040254, 2146105



SC-DL-8137

Length: 1736 Ø: 40
Cone Ø: d1 Ø 30 / d2 Ø 27
301639, 311847, 395350, 1358675, 1378435, 1397866, 1734020, 2028998, 12202900A



SC-DL-8179

Length: 568 Ø: 46
Hole Distance: 115 / 115
1399180, 1428347



SC-DL-8179

Length: 568 Ø: 46
Hole Distance: 115 / 115
1399180, 1428347



SC-DL-8509

Length: 568,5 Ø: 46
Hole Distance: 115 / 115
1485758, 1486757



SC-DL-8511

Length: 616,5 Ø: 50
Hole Distance: 115 / 115
1485760, 1499478, 1722750



SC-DL-8531

Length: 522 Ø: 46
Hole Distance: 115 / 115
1486758



SC-DL-8547

Length: 568 Ø: 50
Hole Distance: 115 / 115
1499474, 1722746, 1906940



SC-DL-8623

Length: 592 Ø: 50
Hole Distance: 115 / 115
1388436, 1499476, 1722748, 1906942



SC-DL-9462

Length: 568,5 Ø: 50
Hole Distance: 115 / 115
1499475, 1500573, 1722747, 1906941



SC-DL-9466

Length: 568 Ø: 19
1486756



SC-DL-9467

Length: 568,5 Ø: 50
Hole Distance: 115 / 115
1500572



SC-DL-10302

Length: 752 Ø: 48
Hole Distance: 115 / 115
1101843, 1379423, 1393298, 1431470, 1942075



SC-RK-12366

Ø: 75 Hole Distance: 115 / 115
Thick/Height: 24
1 722 753, 2 096 392



SC-TC-12451

Length: 552 Ø: 46
Hole Distance: 115 / 115
1494296



SC-TC-12452

Length: 580,5 Ø: 46
Hole Distance: 115 / 115
1485759



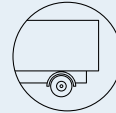

4 - series ...

T 144 G/530 ...	03/97→	Track Control Arm		SC-DL-9467	Trailing Arm, Leaf Spring Axle, →* 1247518 SSS *;* 4406943 SNL *; * 9039629 SAN *;* 3507979 SLA *
	03/97→	Track Control Arm		SC-DL-9467	Trailing Arm, Leaf Spring Axle, → * 1280184 SSS *;* 4471602 SNL *; * 9069959 SAN *;* 3533626 SLA *
	03/97→	Track Control Arm		SC-TC-12451	Trailing Arm, 1st Drive Axle, for Leaf-Spring Suspension vehicles
	03/97→	Track Control Arm		SC-TC-12452	Trailing Arm, 1st RA;2nd RA, for Leaf-Spring Suspension vehicles
	03/97→	Track Control Arm	SC-DL-8179	SC-DL-8179	Trailing Arm, Leaf Spring Axle, → * 1280184 SSS *;* 4471602 SNL *; * 9069959 SAN *;* 3533626 SLA *
	03/97→	Track Control Arm	SC-DL-8509	SC-DL-8509	Trailing Arm, Leaf Spring Axle
	03/97→	Track Control Arm	SC-DL-8531	SC-DL-8531	Trailing Arm, Leaf Spring Axle
T 144 L/460	03/97→	Track Control Arm	SC-DL-10302	SC-DL-10302	Trailing Arm, Air Suspension Axle
	09/95→	Centre Rod	SC-DL-2161		Coupling Rod
	09/95→	Centre Rod	SC-DL-5229		Push Rod
	09/95→	Centre Rod	SC-DL-5354		Push Rod
	09/95→	Suspension Arm Repair Kit		SC-RK-12366	for Control Arm
	09/95→	Suspension Strut Repair Kit		CV-RK-5311	
	09/95→	Tie Rod	SC-DL-7264		
	09/95→	Tie Rod	SC-DL-8137		
	09/95→	Tie Rod End	CV-ES-14162		for Steering Rod
	09/95→	Tie Rod End	CV-ES-14163		for Steering Rod
	09/95→	Tie Rod End	SC-ES-7279		for Steering Rod
	09/95→	Track Control Arm		SC-DL-8179	Trailing Arm, Leaf Spring Axle
	09/95→	Track Control Arm		SC-DL-8400	Trailing Arm
	09/95→	Track Control Arm		SC-DL-8511	Trailing Arm, Leaf Spring Axle
	09/95→	Track Control Arm		SC-DL-8547	Trailing Arm, Leaf Spring Axle
	09/95→	Track Control Arm		SC-DL-8623	Trailing Arm, 1st Drive Axle, for Leaf-Spring Suspension vehicles, →1280184/4471602
	09/95→	Track Control Arm		SC-DL-8623	Trailing Arm, 1st Drive Axle, for Leaf-Spring Suspension vehicles, →9069959/3533626
	09/95→	Track Control Arm		SC-DL-9462	Trailing Arm, 2nd Drive Axle, for Leaf-Spring Suspension vehicles, →1280184/4471602
	09/95→	Track Control Arm		SC-DL-9462	Trailing Arm, 2nd Drive Axle, for Leaf-Spring Suspension vehicles, →1280185/4471603
	09/95→	Track Control Arm		SC-DL-9462	Trailing Arm, 2nd Drive Axle, for Leaf-Spring Suspension vehicles, →9069959/3533626
	09/95→	Track Control Arm		SC-DL-9462	Trailing Arm, 2nd Drive Axle, for Leaf-Spring Suspension vehicles, 9069960/3533627→
	09/95→	Track Control Arm		SC-DL-9466	Trailing Arm, Leaf Spring Axle
	09/95→	Track Control Arm		SC-DL-9467	Trailing Arm, Leaf Spring Axle, →* 1247518 SSS *;* 4406943 SNL *; * 9039629 SAN *;* 3507979 SLA *
	09/95→	Track Control Arm		SC-DL-9467	Trailing Arm, Leaf Spring Axle, → * 1280184 SSS *;* 4471602 SNL *; * 9069959 SAN *;* 3533626 SLA *
	09/95→	Track Control Arm		SC-TC-12451	Trailing Arm, 1st Drive Axle, for Leaf-Spring Suspension vehicles
	09/95→	Track Control Arm		SC-TC-12452	Trailing Arm, 1st RA;2nd RA, for Leaf-Spring Suspension vehicles
	09/95→	Track Control Arm	SC-DL-8179	SC-DL-8179	Trailing Arm, Leaf Spring Axle, → * 1280184 SSS *;* 4471602 SNL *; * 9069959 SAN *;* 3533626 SLA *
	09/95→	Track Control Arm	SC-DL-8509	SC-DL-8509	Trailing Arm, Leaf Spring Axle
	09/95→	Track Control Arm	SC-DL-8531	SC-DL-8531	Trailing Arm, Leaf Spring Axle
	09/95→	Track Control Arm	SC-DL-10302	SC-DL-10302	Trailing Arm, Air Suspension Axle
03/97→	Suspension Arm Repair Kit	MN-RK-7280	MN-RK-7280	for Drag Link;for Semi-Trailing Arm; for Wishbone (CV)	
03/97→	Suspension Strut Repair Kit		DF-RK-9341		

CV-ES-14162

Length: 125
Cone Ø: d1 Ø 30 / d2 Ø 27
Thread: M30 x 1,5 LHT
283783, 395009, 1358792, 1738380, 1 914 426, 2051165



CV-ES-14163

Length: 125
Cone Ø: d1 Ø 30 / d2 Ø 27
Thread: M30 x 1,5 RHT
283784, 395010, 1358793, 1488890, 1738381, 1767328, 1914427, 2051166



CV-RK-5311

0638862, 638862, 0639287, 639287, 1104335, 1953248, 81432206006, 81432206107



DF-RK-9341

Ø: 67
550807, 5508072



MN-RK-7280

Ø: 75 Hole Distance: 115
Thick/Height: 24
0550806, 550806, 0639370, 639370, 689748, 1104334



SC-DL-2161

Length: 1740 Ø: 50
Cone Ø: d1 Ø 30 / d2 Ø 27
1369411, 1385251, 1409918, 1501030, 1723865, 1723895, 1737683, 1897335, 2113903, 2125090, 2161883



SC-DL-5229

Length: 1053 Ø: 50
Cone Ø: d1 Ø 30 / d2 Ø 27
1356055, 1379071, 1384025, 1768898, 1847311, 1912757, 12201600A



SC-DL-5354

Length: 1060 Ø: 52
Cone Ø: d1 Ø 30 / d2 Ø 27
1384027, 1769597, 1847312, 1912758, 12200800A



SC-DL-7264

Length: 1743 Ø: 62
Cone Ø: d1 Ø 30 / d2 Ø 27
1361413, 1395614, 1734019, 1897333, 2040254, 2146105



SC-DL-8137

Length: 1736 Ø: 40
Cone Ø: d1 Ø 30 / d2 Ø 27
301639, 311847, 395350, 1358675, 1378435, 1397866, 1734020, 2028998, 12202900A



SC-DL-8179

Length: 568 Ø: 46
Hole Distance: 115 / 115
1399180, 1428347



SC-DL-8179

Length: 568 Ø: 46
Hole Distance: 115 / 115
1399180, 1428347



SC-DL-8509

Length: 568,5 Ø: 46
Hole Distance: 115 / 115
1485758, 1486757



SC-DL-8511

Length: 616,5 Ø: 50
Hole Distance: 115 / 115
1485760, 1499478, 1722750



SC-DL-8531

Length: 522 Ø: 46
Hole Distance: 115 / 115
1486758



SC-DL-8547

Length: 568 Ø: 50
Hole Distance: 115 / 115
1499474, 1722746, 1906940



SC-DL-8623

Length: 592 Ø: 50
Hole Distance: 115 / 115
1388436, 1499476, 1722748, 1906942



SC-DL-9462

Length: 568,5 Ø: 50
Hole Distance: 115 / 115
1499475, 1500573, 1722747, 1906941



SC-DL-9466

Length: 568 Ø: 19
1486756



SC-DL-9467

Length: 568,5 Ø: 50
Hole Distance: 115 / 115
1500572



SC-DL-10302

Length: 752 Ø: 48
Hole Distance: 115 / 115
1101843, 1379423, 1393298, 1431470, 1942075



SC-ES-7279

Length: 150
Cone Ø: d1 Ø 30 / d2 Ø 27
Thread: M30 x 1,5 RHT
1357674, 1603883, 1738379



SC-RK-12366

Ø: 75 Hole Distance: 115 / 115
Thick/Height: 24
1 722 753, 2 096 392



SC-TC-12451

Length: 552 Ø: 46
Hole Distance: 115 / 115
1494296



SC-TC-12452

Length: 580,5 Ø: 46
Hole Distance: 115 / 115
1485759





4 - series ...

T 144 L/530	09/95→	Centre Rod	SC-DL-2161		Coupling Rod	
	09/95→	Centre Rod	SC-DL-5229		Push Rod	
	09/95→	Centre Rod	SC-DL-5354		Push Rod	
	09/95→	Suspension Arm Repair Kit		SC-RK-12366	for Control Arm	
	09/95→	Suspension Strut Repair Kit		CV-RK-5311		
	09/95→	Tie Rod	SC-DL-7264			
	09/95→	Tie Rod	SC-DL-8137			
	09/95→	Tie Rod End	CV-ES-14162		for Steering Rod	
	09/95→	Tie Rod End	CV-ES-14163		for Steering Rod	
	09/95→	Tie Rod End	SC-ES-7279		for Steering Rod	
	09/95→	Track Control Arm		SC-DL-8179	Trailing Arm, Leaf Spring Axle	
	09/95→	Track Control Arm		SC-DL-8400	Trailing Arm	
	09/95→	Track Control Arm		SC-DL-8511	Trailing Arm, Leaf Spring Axle	
	09/95→	Track Control Arm		SC-DL-8547	Trailing Arm, Leaf Spring Axle	
	09/95→	Track Control Arm		SC-DL-8623	Trailing Arm, 1st Drive Axle, for Leaf-Spring Suspension vehicles, →1280184/4471602	
	09/95→	Track Control Arm		SC-DL-8623	Trailing Arm, 1st Drive Axle, for Leaf-Spring Suspension vehicles, →9069959/3533626	
	09/95→	Track Control Arm		SC-DL-9462	Trailing Arm, 2nd Drive Axle, for Leaf-Spring Suspension vehicles, →1280184/4471602	
	09/95→	Track Control Arm		SC-DL-9462	Trailing Arm, 2nd Drive Axle, for Leaf-Spring Suspension vehicles, →1280185/4471603_>	
	09/95→	Track Control Arm		SC-DL-9462	Trailing Arm, 2nd Drive Axle, for Leaf-Spring Suspension vehicles, →9069959/3533626	
	09/95→	Track Control Arm		SC-DL-9462	Trailing Arm, 2nd Drive Axle, for Leaf-Spring Suspension vehicles, 9069960/3533627→	
	09/95→	Track Control Arm		SC-DL-9466	Trailing Arm, Leaf Spring Axle	
	09/95→	Track Control Arm		SC-DL-9467	Trailing Arm, Leaf Spring Axle, →* 1247518 SSS *,* 4406943 SNL *, * 9039629 SAN *,* 3507979 SLA *	
	09/95→	Track Control Arm		SC-DL-9467	Trailing Arm, Leaf Spring Axle, →* 1280184 SSS *,* 4471602 SNL *, * 9069959 SAN *,* 3533626 SLA *	
	09/95→	Track Control Arm		SC-TC-12451	Trailing Arm, 1st Drive Axle, for Leaf-Spring Suspension vehicles	
	09/95→	Track Control Arm		SC-TC-12452	Trailing Arm, 1st RA;2nd RA, for Leaf-Spring Suspension vehicles	
	09/95→	Track Control Arm	SC-DL-8179	SC-DL-8179	Trailing Arm, Leaf Spring Axle, →* 1280184 SSS *,* 4471602 SNL *, * 9069959 SAN *,* 3533626 SLA *	
	09/95→	Track Control Arm	SC-DL-8509	SC-DL-8509	Trailing Arm, Leaf Spring Axle	
	09/95→	Track Control Arm	SC-DL-8531	SC-DL-8531	Trailing Arm, Leaf Spring Axle	
	09/95→	Track Control Arm	SC-DL-10302	SC-DL-10302	Trailing Arm, Air Suspension Axle	
	03/97→	Suspension Arm Repair Kit	MN-RK-7280	MN-RK-7280	for Drag Link;for Semi-Trailing Arm; for Wishbone (CV)	
	03/97→	Suspension Strut Repair Kit		DF-RK-9341		
	T 94 C/260	12/96→	Centre Rod	SC-DL-2161		Coupling Rod
		12/96→	Centre Rod	SC-DL-5229		Push Rod
12/96→		Centre Rod	SC-DL-5354		Push Rod	
12/96→		Centre Rod	SC-DL-12343		for Steering Rod	
12/96→		Suspension Arm Repair Kit		SC-RK-12366	for Control Arm	
12/96→		Suspension Arm Repair Kit	MN-RK-7280	MN-RK-7280	for Drag Link;for Semi-Trailing Arm; for Wishbone (CV)	
12/96→		Suspension Strut Repair Kit		CV-RK-5311		
12/96→		Suspension Strut Repair Kit		DF-RK-9341		
12/96→		Tie Rod	SC-DL-7264			
12/96→		Tie Rod	SC-DL-8137			
12/96→		Tie Rod End	CV-ES-14162		for Steering Rod	
12/96→		Tie Rod End	CV-ES-14163		for Steering Rod	
12/96→		Tie Rod End	SC-ES-7279		for Steering Rod	
12/96→		Track Control Arm		SC-DL-8179	Trailing Arm, Leaf Spring Axle	
12/96→		Track Control Arm		SC-DL-8400	Trailing Arm	
12/96→		Track Control Arm		SC-DL-8511	Trailing Arm, Leaf Spring Axle	

CV-ES-14162

Length: 125
Cone Ø: d1 Ø 30 / d2 Ø 27
Thread: M30 x 1,5 LHT
283784, 395009, 1358792, 1738380, 1 914 426, 2051165



CV-ES-14163

Length: 125
Cone Ø: d1 Ø 30 / d2 Ø 27
Thread: M30 x 1,5 RHT
283784, 395010, 1358793, 1488890, 1738381, 1767328, 1914427, 2051166



CV-RK-5311

0638862, 638862, 0639287, 639287, 1104335, 1953248, 81432206006, 81432206107



DF-RK-9341

Ø: 67
550807, 5508072



MN-RK-7280

Ø: 75 Hole Distance: 115
Thick/Height: 24
0550806, 550806, 0639370, 639370, 689748, 1104334



SC-DL-2161

Length: 1740 Ø: 50
Cone Ø: d1 Ø 30 / d2 Ø 27
1369411, 1385251, 1409918, 1501030, 1723865, 1723895, 1737683, 1897335, 2113903, 2125090, 2161883



SC-DL-5229

Length: 1053 Ø: 50
Cone Ø: d1 Ø 30 / d2 Ø 27
1356055, 1379071, 1384025, 1768898, 1847311, 1912757, 12201600A



SC-DL-5354

Length: 1060 Ø: 52
Cone Ø: d1 Ø 30 / d2 Ø 27
1384027, 1769597, 1847312, 1912758, 12200800A



SC-DL-7264

Length: 1743 Ø: 62
Cone Ø: d1 Ø 30 / d2 Ø 27
1361413, 1395614, 1734019, 1897333, 2040254, 2146105



SC-DL-8137

Length: 1736 Ø: 40
Cone Ø: d1 Ø 30 / d2 Ø 27
301639, 311847, 395350, 1358675, 1378435, 1397866, 1734020, 2028998, 12202900A



SC-DL-8179

Length: 568 Ø: 46
Hole Distance: 115 / 115
1399180, 1428347



SC-DL-8179

Length: 568 Ø: 46
Hole Distance: 115 / 115
1399180, 1428347



SC-DL-8509

Length: 568,5 Ø: 46
Hole Distance: 115 / 115
1485758, 1486757



SC-DL-8511

Length: 616,5 Ø: 50
Hole Distance: 115 / 115
1485760, 1499478, 1722750



SC-DL-8531

Length: 522 Ø: 46
Hole Distance: 115 / 115
1486758



SC-DL-8547

Length: 568 Ø: 50
Hole Distance: 115 / 115
1499474, 1722746, 1906940



SC-DL-8623

Length: 592 Ø: 50
Hole Distance: 115 / 115
1388436, 1499476, 1722748, 1906942



SC-DL-9462

Length: 568,5 Ø: 50
Hole Distance: 115 / 115
1499475, 1500573, 1722747, 1906941



SC-DL-9466

Length: 568 Ø: 19
1486756



SC-DL-9467

Length: 568,5 Ø: 50
Hole Distance: 115 / 115
1500572



SC-DL-10302

Length: 752 Ø: 48
Hole Distance: 115 / 115
1101843, 1379423, 1393298, 1431470, 1942075



SC-DL-12343

Length: 1062 Ø: 52
Cone Ø: d1 Ø 30 / d2 Ø 27
1348269, 2007275



SC-ES-7279

Length: 150
Cone Ø: d1 Ø 30 / d2 Ø 27
Thread: M30 x 1,5 RHT
1357674, 1603883, 1738379



SC-RK-12366

Ø: 75 Hole Distance: 115 / 115
Thick/Height: 24
1 722 753, 2 096 392



SC-TC-12451

Length: 552 Ø: 46
Hole Distance: 115 / 115
1494296



SC-TC-12452

Length: 580,5 Ø: 46
Hole Distance: 115 / 115
1485759





4 - series ...

T 94 C/260 ...

12/96→	Track Control Arm			SC-DL-8547	Trailing Arm, Leaf Spring Axle
12/96→	Track Control Arm			SC-DL-8623	Trailing Arm, 1st Drive Axle, for Leaf-Spring Suspension vehicles, →1280184/4471602
12/96→	Track Control Arm			SC-DL-8623	Trailing Arm, 1st Drive Axle, for Leaf-Spring Suspension vehicles, →9069959/3533626
12/96→	Track Control Arm			SC-DL-9462	Trailing Arm, 2nd Drive Axle, for Leaf-Spring Suspension vehicles, →1280184/4471602
12/96→	Track Control Arm			SC-DL-9462	Trailing Arm, 2nd Drive Axle, for Leaf-Spring Suspension vehicles, →1280185/4471603_>
12/96→	Track Control Arm			SC-DL-9462	Trailing Arm, 2nd Drive Axle, for Leaf-Spring Suspension vehicles, →9069959/3533626
12/96→	Track Control Arm			SC-DL-9462	Trailing Arm, 2nd Drive Axle, for Leaf-Spring Suspension vehicles, 9069960/3533627→
12/96→	Track Control Arm			SC-DL-9466	Trailing Arm, Leaf Spring Axle
12/96→	Track Control Arm			SC-DL-9467	Trailing Arm, Leaf Spring Axle, →* 1247518 SSS *;* 4406943 SNL *; * 9039629 SAN *;* 3507979 SLA *
12/96→	Track Control Arm			SC-DL-9467	Trailing Arm, Leaf Spring Axle, →* 1280184 SSS *;* 4471602 SNL *; * 9069959 SAN *;* 3533626 SLA *
12/96→	Track Control Arm			SC-TC-12451	Trailing Arm, 1st Drive Axle, for Leaf-Spring Suspension vehicles
12/96→	Track Control Arm			SC-TC-12452	Trailing Arm, 1st RA;2nd RA, for Leaf-Spring Suspension vehicles
12/96→	Track Control Arm	SC-DL-8179	SC-DL-8179		Trailing Arm, Leaf Spring Axle, →* 1280184 SSS *;* 4471602 SNL *; * 9069959 SAN *;* 3533626 SLA *
12/96→	Track Control Arm	SC-DL-8509	SC-DL-8509		Trailing Arm, Leaf Spring Axle
12/96→	Track Control Arm	SC-DL-8531	SC-DL-8531		Trailing Arm, Leaf Spring Axle
12/96→	Track Control Arm	SC-DL-10302	SC-DL-10302		Trailing Arm, Air Suspension Axle

T 94 C/310

09/96→	Centre Rod	SC-DL-2161			Coupling Rod
09/96→	Centre Rod	SC-DL-5229			Push Rod
09/96→	Centre Rod	SC-DL-5354			Push Rod
09/96→	Centre Rod	SC-DL-12343			for Steering Rod
09/96→	Suspension Arm Repair Kit			SC-RK-12366	for Control Arm
09/96→	Suspension Strut Repair Kit			CV-RK-5311	
09/96→	Tie Rod	SC-DL-7264			
09/96→	Tie Rod	SC-DL-8137			
09/96→	Tie Rod End	CV-ES-14162			for Steering Rod
09/96→	Tie Rod End	CV-ES-14163			for Steering Rod
09/96→	Tie Rod End	SC-ES-7279			for Steering Rod
09/96→	Track Control Arm			SC-DL-8179	Trailing Arm, Leaf Spring Axle
09/96→	Track Control Arm			SC-DL-8400	Trailing Arm
09/96→	Track Control Arm			SC-DL-8511	Trailing Arm, Leaf Spring Axle
09/96→	Track Control Arm			SC-DL-8547	Trailing Arm, Leaf Spring Axle
09/96→	Track Control Arm			SC-DL-8623	Trailing Arm, 1st Drive Axle, for Leaf-Spring Suspension vehicles, →1280184/4471602
09/96→	Track Control Arm			SC-DL-8623	Trailing Arm, 1st Drive Axle, for Leaf-Spring Suspension vehicles, →9069959/3533626
09/96→	Track Control Arm			SC-DL-9462	Trailing Arm, 2nd Drive Axle, for Leaf-Spring Suspension vehicles, →1280184/4471602
09/96→	Track Control Arm			SC-DL-9462	Trailing Arm, 2nd Drive Axle, for Leaf-Spring Suspension vehicles, →1280185/4471603_>
09/96→	Track Control Arm			SC-DL-9462	Trailing Arm, 2nd Drive Axle, for Leaf-Spring Suspension vehicles, →9069959/3533626
09/96→	Track Control Arm			SC-DL-9462	Trailing Arm, 2nd Drive Axle, for Leaf-Spring Suspension vehicles, 9069960/3533627→
09/96→	Track Control Arm			SC-DL-9466	Trailing Arm, Leaf Spring Axle
09/96→	Track Control Arm			SC-DL-9467	Trailing Arm, Leaf Spring Axle, →* 1247518 SSS *;* 4406943 SNL *; * 9039629 SAN *;* 3507979 SLA *

CV-ES-14162

Length: 125
Cone Ø: d1 Ø 30 / d2 Ø 27
Thread: M30 x 1,5 LHT
283783, 395009, 1358792, 1738380, 1 914 426, 2051165



CV-ES-14163

Length: 125
Cone Ø: d1 Ø 30 / d2 Ø 27
Thread: M30 x 1,5 RHT
283784, 395010, 1358793, 1488890, 1738381, 1767328, 1914427, 2051166



CV-RK-5311

0638862, 638862, 0639287, 639287, 1104335, 1953248, 81432206006, 81432206107



SC-DL-2161

Length: 1740 Ø: 50
Cone Ø: d1 Ø 30 / d2 Ø 27
1369411, 1385251, 1409918, 1501030, 1723865, 1723895, 1737683, 1897335, 2113903, 2125090, 2161883



SC-DL-5229

Length: 1053 Ø: 50
Cone Ø: d1 Ø 30 / d2 Ø 27
1356055, 1379071, 1384025, 1768898, 1847311, 1912757, 12201600A



SC-DL-5354

Length: 1060 Ø: 52
Cone Ø: d1 Ø 30 / d2 Ø 27
1384027, 1769597, 1847312, 1912758, 12200800A



SC-DL-7264

Length: 1743 Ø: 62
Cone Ø: d1 Ø 30 / d2 Ø 27
1361413, 1395614, 1734019, 1897333, 2040254, 2146105



SC-DL-8137

Length: 1736 Ø: 40
Cone Ø: d1 Ø 30 / d2 Ø 27
301639, 311847, 395350, 1358675, 1378435, 1397866, 1734020, 2028998, 12202900A



SC-DL-8179

Length: 568 Ø: 46
Hole Distance: 115 / 115
1399180, 1428347



SC-DL-8179

Length: 568 Ø: 46
Hole Distance: 115 / 115
1399180, 1428347



SC-DL-8509

Length: 568,5 Ø: 46
Hole Distance: 115 / 115
1485758, 1486757



SC-DL-8511

Length: 616,5 Ø: 50
Hole Distance: 115 / 115
1485760, 1499478, 1722750



SC-DL-8531

Length: 522 Ø: 46
Hole Distance: 115 / 115
1486758



SC-DL-8547

Length: 568 Ø: 50
Hole Distance: 115 / 115
1499474, 1722746, 1906940



SC-DL-8623

Length: 592 Ø: 50
Hole Distance: 115 / 115
1388436, 1499476, 1722748, 1906942



SC-DL-9462

Length: 568,5 Ø: 50
Hole Distance: 115 / 115
1499475, 1500573, 1722747, 1906941



SC-DL-9466

Length: 568 Ø: 19
1486756



SC-DL-9467

Length: 568,5 Ø: 50
Hole Distance: 115 / 115
1500572



SC-DL-10302

Length: 752 Ø: 48
Hole Distance: 115 / 115
1101843, 1379423, 1393298, 1431470, 1942075



SC-DL-12343

Length: 1062 Ø: 52
Cone Ø: d1 Ø 30 / d2 Ø 27
1348269, 2007275



SC-ES-7279

Length: 150
Cone Ø: d1 Ø 30 / d2 Ø 27
Thread: M30 x 1,5 RHT
1357674, 1603883, 1738379



SC-RK-12366

Ø: 75 Hole Distance: 115 / 115
Thick/Height: 24
1 722 753, 2 096 392



SC-TC-12451

Length: 552 Ø: 46
Hole Distance: 115 / 115
1494296



SC-TC-12452

Length: 580,5 Ø: 46
Hole Distance: 115 / 115
1485759



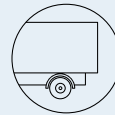

4 - series ...

T 94 C/310 ...	09/96 →	Track Control Arm		SC-DL-9467	Trailing Arm, Leaf Spring Axle, → * 1280184 SSS *; * 4471602 SNL *; * 9069959 SAN *; * 3533626 SLA *
	09/96 →	Track Control Arm		SC-TC-12451	Trailing Arm, 1st Drive Axle, for Leaf-Spring Suspension vehicles
	09/96 →	Track Control Arm		SC-TC-12452	Trailing Arm, 1st RA; 2nd RA, for Leaf-Spring Suspension vehicles
	09/96 →	Track Control Arm	SC-DL-8179	SC-DL-8179	Trailing Arm, Leaf Spring Axle, → * 1280184 SSS *; * 4471602 SNL *; * 9069959 SAN *; * 3533626 SLA *
	09/96 →	Track Control Arm	SC-DL-8509	SC-DL-8509	Trailing Arm, Leaf Spring Axle
	09/96 →	Track Control Arm	SC-DL-8531	SC-DL-8531	Trailing Arm, Leaf Spring Axle
	09/96 →	Track Control Arm	SC-DL-10302	SC-DL-10302	Trailing Arm, Air Suspension Axle
T 94 G/220	08/96 →	Centre Rod	SC-DL-2161		Coupling Rod
	08/96 →	Centre Rod	SC-DL-5229		Push Rod
	08/96 →	Centre Rod	SC-DL-5354		Push Rod
	08/96 →	Suspension Arm Repair Kit		SC-RK-12366	for Control Arm
	08/96 →	Suspension Arm Repair Kit	MN-RK-7280	MN-RK-7280	for Drag Link; for Semi-Trailing Arm; for Wishbone (CV)
	08/96 →	Suspension Strut Repair Kit		CV-RK-5311	
	08/96 →	Suspension Strut Repair Kit		DF-RK-9341	
	08/96 →	Tie Rod	SC-DL-7264		
	08/96 →	Tie Rod	SC-DL-8137		
	08/96 →	Tie Rod End	CV-ES-14162		for Steering Rod
	08/96 →	Tie Rod End	CV-ES-14163		for Steering Rod
	08/96 →	Tie Rod End	SC-ES-7279		for Steering Rod
	08/96 →	Track Control Arm	SC-DL-10302	SC-DL-10302	Trailing Arm, Air Suspension Axle
	08/96 →	Track Control Arm	SC-TC-12361		Control Arm, 1st Front Axle, for Pneumatic Suspension vehicles
T 94 G/230	04/99 →	Centre Rod	SC-DL-2161		Coupling Rod
	04/99 →	Centre Rod	SC-DL-5229		Push Rod
	04/99 →	Centre Rod	SC-DL-5354		Push Rod
	04/99 →	Suspension Arm Repair Kit		SC-RK-12366	for Control Arm
	04/99 →	Suspension Arm Repair Kit	MN-RK-7280	MN-RK-7280	for Drag Link; for Semi-Trailing Arm; for Wishbone (CV)
	04/99 →	Suspension Strut Repair Kit		CV-RK-5311	
	04/99 →	Suspension Strut Repair Kit		DF-RK-9341	
	04/99 →	Tie Rod	SC-DL-7264		
	04/99 →	Tie Rod	SC-DL-8137		
	04/99 →	Tie Rod End	CV-ES-14162		for Steering Rod
	04/99 →	Tie Rod End	CV-ES-14163		for Steering Rod
	04/99 →	Tie Rod End	SC-ES-7279		for Steering Rod
	04/99 →	Track Control Arm	SC-DL-10302	SC-DL-10302	Trailing Arm, Air Suspension Axle
	04/99 →	Track Control Arm	SC-TC-12361		Control Arm, 1st Front Axle, for Pneumatic Suspension vehicles
T 94 G/260	12/96 →	Centre Rod	SC-DL-2161		Coupling Rod
	12/96 →	Centre Rod	SC-DL-5229		Push Rod
	12/96 →	Centre Rod	SC-DL-5354		Push Rod
	12/96 →	Suspension Arm Repair Kit		SC-RK-12366	for Control Arm
	12/96 →	Suspension Arm Repair Kit	MN-RK-7280	MN-RK-7280	for Drag Link; for Semi-Trailing Arm; for Wishbone (CV)
	12/96 →	Suspension Strut Repair Kit		CV-RK-5311	
	12/96 →	Suspension Strut Repair Kit		DF-RK-9341	
	12/96 →	Tie Rod	SC-DL-7264		
	12/96 →	Tie Rod	SC-DL-8137		
	12/96 →	Tie Rod End	CV-ES-14162		for Steering Rod
	12/96 →	Tie Rod End	CV-ES-14163		for Steering Rod
	12/96 →	Tie Rod End	SC-ES-7279		for Steering Rod
	12/96 →	Track Control Arm		SC-DL-8179	Trailing Arm, Leaf Spring Axle
	12/96 →	Track Control Arm		SC-DL-8400	Trailing Arm
12/96 →	Track Control Arm		SC-DL-8511	Trailing Arm, Leaf Spring Axle	
12/96 →	Track Control Arm		SC-DL-8547	Trailing Arm, Leaf Spring Axle	

CV-ES-14162

Length: 125
Cone Ø: d1 Ø 30 / d2 Ø 27
Thread: M30 x 1,5 LHT
283784, 395009, 1358792, 1738380, 1 914 426, 2051165



CV-ES-14163

Length: 125
Cone Ø: d1 Ø 30 / d2 Ø 27
Thread: M30 x 1,5 RHT
283784, 395010, 1358793, 1488890, 1738381, 1767328, 1914427, 2051166



CV-RK-5311

0638862, 638862, 0639287, 639287, 1104335, 1953248, 81432206006, 81432206107



DF-RK-9341

Ø: 67
550807, 5508072



MN-RK-7280

Ø: 75 Hole Distance: 115
Thick/Height: 24
0550806, 550806, 0639370, 639370, 689748, 1104334



SC-DL-2161

Length: 1740 Ø: 50
Cone Ø: d1 Ø 30 / d2 Ø 27
1369411, 1385251, 1409918, 1501030, 1723865, 1723895, 1737683, 1897335, 2113903, 2125090, 2161883



SC-DL-5229

Length: 1053 Ø: 50
Cone Ø: d1 Ø 30 / d2 Ø 27
1356055, 1379071, 1384025, 1768898, 1847311, 1912757, 12201600A



SC-DL-5354

Length: 1060 Ø: 52
Cone Ø: d1 Ø 30 / d2 Ø 27
1384027, 1769597, 1847312, 1912758, 12200800A



SC-DL-7264

Length: 1743 Ø: 62
Cone Ø: d1 Ø 30 / d2 Ø 27
1361413, 1395614, 1734019, 1897333, 2040254, 2146105



SC-DL-8137

Length: 1736 Ø: 40
Cone Ø: d1 Ø 30 / d2 Ø 27
301639, 311847, 395350, 1358675, 1378435, 1397866, 1734020, 2028998, 12202900A



SC-DL-8179

Length: 568 Ø: 46
Hole Distance: 115 / 115
1399180, 1428347



SC-DL-8179

Length: 568 Ø: 46
Hole Distance: 115 / 115
1399180, 1428347



SC-DL-8509

Length: 568,5 Ø: 46
Hole Distance: 115 / 115
1485758, 1486757



SC-DL-8511

Length: 616,5 Ø: 50
Hole Distance: 115 / 115
1485760, 1499478, 1722750



SC-DL-8531

Length: 522 Ø: 46
Hole Distance: 115 / 115
1486758



SC-DL-8547

Length: 568 Ø: 50
Hole Distance: 115 / 115
1499474, 1722746, 1906940



SC-DL-9467

Length: 568,5 Ø: 50
Hole Distance: 115 / 115
1500572



SC-DL-10302

Length: 752 Ø: 48
Hole Distance: 115 / 115
1101843, 1379423, 1393298, 1431470, 1942075



SC-ES-7279

Length: 150
Cone Ø: d1 Ø 30 / d2 Ø 27
Thread: M30 x 1,5 RHT
1357674, 1603883, 1738379



SC-RK-12366

Ø: 75 Hole Distance: 115 / 115
Thick/Height: 24
1 722 753, 2 096 392



SC-TC-12361

Length: 705 Ø: 42
Cone Ø: d1 Ø 38
Hole Distance: 115
1353445, 1464611, 1942147



SC-TC-12451

Length: 552 Ø: 46
Hole Distance: 115 / 115
1494296



SC-TC-12452

Length: 580,5 Ø: 46
Hole Distance: 115 / 115
1485759





4 - series ...

T 94 G/260 ...	12/96 →	Track Control Arm		SC-DL-8623	Trailing Arm, 1st Drive Axle, for Leaf-Spring Suspension vehicles, →1280184/4471602
	12/96 →	Track Control Arm		SC-DL-8623	Trailing Arm, 1st Drive Axle, for Leaf-Spring Suspension vehicles, →9069959/3533626
	12/96 →	Track Control Arm		SC-DL-9462	Trailing Arm, 2nd Drive Axle, for Leaf-Spring Suspension vehicles, <_1280184/4471602 →
	12/96 →	Track Control Arm		SC-DL-9462	Trailing Arm, 2nd Drive Axle, for Leaf-Spring Suspension vehicles, →9069959/3533626
	12/96 →	Track Control Arm		SC-DL-9462	Trailing Arm, 2nd Drive Axle, for Leaf-Spring Suspension vehicles, 1280185/4471603 →
	12/96 →	Track Control Arm		SC-DL-9462	Trailing Arm, 2nd Drive Axle, for Leaf-Spring Suspension vehicles, 9069960/3533627 →
	12/96 →	Track Control Arm		SC-DL-9466	Trailing Arm, Leaf Spring Axle
	12/96 →	Track Control Arm		SC-DL-9467	Trailing Arm, Leaf Spring Axle, * 1247518 SSS *; * 4406943 SNL *; * 9039629 SAN *; * 3507979 SLA * →
	12/96 →	Track Control Arm		SC-DL-9467	Trailing Arm, Leaf Spring Axle, * 1280184 SSS *; * 4471602 SNL *; * 9069959 SAN *; * 3533626 SLA * →
	12/96 →	Track Control Arm		SC-TC-12451	Trailing Arm, 1st Drive Axle, for Leaf-Spring Suspension vehicles
	12/96 →	Track Control Arm		SC-TC-12452	Trailing Arm, 1st RA; 2nd RA, for Leaf-Spring Suspension vehicles
	12/96 →	Track Control Arm	SC-DL-8179	SC-DL-8179	Trailing Arm, Leaf Spring Axle, * 1280184 SSS *; * 4471602 SNL *; * 9069959 SAN *; * 3533626 SLA * →
	12/96 →	Track Control Arm	SC-DL-8509	SC-DL-8509	Trailing Arm, Leaf Spring Axle
	12/96 →	Track Control Arm	SC-DL-8531	SC-DL-8531	Trailing Arm, Leaf Spring Axle
12/96 →	Track Control Arm	SC-DL-10302	SC-DL-10302	Trailing Arm, Air Suspension Axle	
T 94 G/310	09/96 →	Centre Rod	SC-DL-2161		Coupling Rod
	09/96 →	Centre Rod	SC-DL-5229		Push Rod
	09/96 →	Centre Rod	SC-DL-5354		Push Rod
	09/96 →	Suspension Arm Repair Kit		SC-RK-12366	for Control Arm
	09/96 →	Suspension Arm Repair Kit	MN-RK-7280	MN-RK-7280	for Drag Link; for Semi-Trailing Arm; for Wishbone (CV)
	09/96 →	Suspension Strut Repair Kit		CV-RK-5311	
	09/96 →	Suspension Strut Repair Kit		DF-RK-9341	
	09/96 →	Tie Rod	SC-DL-7264		
	09/96 →	Tie Rod	SC-DL-8137		
	09/96 →	Tie Rod End	CV-ES-14162		for Steering Rod
	09/96 →	Tie Rod End	CV-ES-14163		for Steering Rod
	09/96 →	Tie Rod End	SC-ES-7279		for Steering Rod
	09/96 →	Track Control Arm		SC-DL-8179	Trailing Arm, Leaf Spring Axle, * 1247519 SSS *; * 4406944 SNL *; * 9039630 SAN *; * 3507980 SLA * →
	09/96 →	Track Control Arm		SC-DL-8400	Trailing Arm
	09/96 →	Track Control Arm		SC-DL-8511	Trailing Arm, Leaf Spring Axle, * 1280185 SSS *; * 4471603 SNL *; * 9069960 SAN *; * 3533627 SLA * →
	09/96 →	Track Control Arm		SC-DL-8547	Trailing Arm, Leaf Spring Axle, * 1280185 SSS *; * 4471603 SNL *; * 9069959 SAN *; * 3533626 SLA * →
	09/96 →	Track Control Arm		SC-DL-8623	Trailing Arm, 1st Drive Axle, for Leaf-Spring Suspension vehicles, →1280184/4471602
	09/96 →	Track Control Arm		SC-DL-8623	Trailing Arm, 1st Drive Axle, for Leaf-Spring Suspension vehicles, →9069959/3533626
	09/96 →	Track Control Arm		SC-DL-9462	Trailing Arm, 2nd Drive Axle, for Leaf-Spring Suspension vehicles, →1280184/4471602
	09/96 →	Track Control Arm		SC-DL-9462	Trailing Arm, 2nd Drive Axle, for Leaf-Spring Suspension vehicles, →9069959/3533626
09/96 →	Track Control Arm		SC-DL-9462	Trailing Arm, 2nd Drive Axle, for Leaf-Spring Suspension vehicles, 1280185/4471603 →	

CV-ES-14162

Length: 125
Cone Ø: d1 Ø 30 / d2 Ø 27
Thread: M30 x 1,5 LHT
283784, 395009, 1358792, 1738380, 1 914 426, 2051165



CV-ES-14163

Length: 125
Cone Ø: d1 Ø 30 / d2 Ø 27
Thread: M30 x 1,5 RHT
283784, 395010, 1358793, 1488890, 1738381, 1767328, 1914427, 2051166



CV-RK-5311

0638862, 638862, 639287, 0639287, 1104335, 1953248, 81432206006, 81432206107



DF-RK-9341

Ø: 67
550807, 5508072



MN-RK-7280

Ø: 75 Hole Distance: 115
Thick/Height: 24
0550806, 550806, 0639370, 639370, 689748, 1104334



SC-DL-2161

Length: 1740 Ø: 50
Cone Ø: d1 Ø 30 / d2 Ø 27
1369411, 1385251, 1409918, 1501030, 1723865, 1723895, 1737683, 1897335, 2113903, 2125090, 2161883



SC-DL-5229

Length: 1053 Ø: 50
Cone Ø: d1 Ø 30 / d2 Ø 27
1356055, 1379071, 1384025, 1768898, 1847311, 1912757, 12201600A



SC-DL-5354

Length: 1060 Ø: 52
Cone Ø: d1 Ø 30 / d2 Ø 27
1384027, 1769597, 1847312, 1912758, 12200800A



SC-DL-7264

Length: 1743 Ø: 62
Cone Ø: d1 Ø 30 / d2 Ø 27
1361413, 1395614, 1734019, 1897333, 2040254, 2146105



SC-DL-8137

Length: 1736 Ø: 40
Cone Ø: d1 Ø 30 / d2 Ø 27
301639, 311847, 395350, 1358675, 1378435, 1397866, 1734020, 2028998, 12202900A



SC-DL-8179

Length: 568 Ø: 46
Hole Distance: 115 / 115
1399180, 1428347



SC-DL-8179

Length: 568 Ø: 46
Hole Distance: 115 / 115
1399180, 1428347



SC-DL-8509

Length: 568,5 Ø: 46
Hole Distance: 115 / 115
1485758, 1486757



SC-DL-8511

Length: 616,5 Ø: 50
Hole Distance: 115 / 115
1485760, 1499478, 1722750



SC-DL-8531

Length: 522 Ø: 46
Hole Distance: 115 / 115
1486758



SC-DL-8547

Length: 568 Ø: 50
Hole Distance: 115 / 115
1499474, 1722746, 1906940



SC-DL-8623

Length: 592 Ø: 50
Hole Distance: 115 / 115
1388436, 1499476, 1722748, 1906942



SC-DL-9462

Length: 568,5 Ø: 50
Hole Distance: 115 / 115
1499475, 1500573, 1722747, 1906941



SC-DL-9466

Length: 568 Ø: 19
1486756



SC-DL-9467

Length: 568,5 Ø: 50
Hole Distance: 115 / 115
1500572



SC-DL-10302

Length: 752 Ø: 48
Hole Distance: 115 / 115
1101843, 1379423, 1393298, 1431470, 1942075



SC-ES-7279

Length: 150
Cone Ø: d1 Ø 30 / d2 Ø 27
Thread: M30 x 1,5 RHT
1357674, 1603883, 1738379



SC-RK-12366

Ø: 75 Hole Distance: 115 / 115
Thick/Height: 24
1 722 753, 2 096 392



SC-TC-12451

Length: 552 Ø: 46
Hole Distance: 115 / 115
1494296



SC-TC-12452

Length: 580,5 Ø: 46
Hole Distance: 115 / 115
1485759





4 - series ...

T 94 G/310 ...	09/96 →	Track Control Arm		SC-DL-9462	Trailing Arm, 2nd Drive Axle, for Leaf-Spring Suspension vehicles, 9069960/3533627 →
	09/96 →	Track Control Arm		SC-DL-9466	Trailing Arm, Leaf Spring Axle
	09/96 →	Track Control Arm		SC-DL-9467	Trailing Arm, Leaf Spring Axle, → * 1247518 SSS *, * 4406943 SNL *, * 9039629 SAN *, * 3507979 SLA *
	09/96 →	Track Control Arm		SC-DL-9467	Trailing Arm, Leaf Spring Axle, → * 1280184 SSS *, * 4471602 SNL *, * 9069959 SAN *, * 3533626 SLA *
	09/96 →	Track Control Arm		SC-TC-12451	Trailing Arm, 1st Drive Axle, for Leaf-Spring Suspension vehicles
	09/96 →	Track Control Arm		SC-TC-12452	Trailing Arm, 1st RA; 2nd RA, for Leaf-Spring Suspension vehicles
	09/96 →	Track Control Arm	SC-DL-8179	SC-DL-8179	Trailing Arm, Leaf Spring Axle, → * 1280184 SSS *, * 4471602 SNL *, * 9069959 SAN *, * 3533626 SLA *
	09/96 →	Track Control Arm	SC-DL-8509	SC-DL-8509	Trailing Arm, Leaf Spring Axle, * 1280185 SSS *, * 4471603 SNL *, * 9069960 SAN *, * 3533627 SLA * →
	09/96 →	Track Control Arm	SC-DL-8531	SC-DL-8531	Trailing Arm, Leaf Spring Axle, * 1280185 SSS *, * 4471603 SNL *, * 9069960 SAN *, * 3533956 SLA * →
	09/96 →	Track Control Arm	SC-DL-10302	SC-DL-10302	Trailing Arm, Air Suspension Axle
	09/96 →	Track Control Arm	SC-TC-12361		Control Arm, 1st Front Axle, for Pneumatic Suspension vehicles
T 94 L/310	09/96 →	Centre Rod	SC-DL-2161		Coupling Rod
	09/96 →	Centre Rod	SC-DL-5229		Push Rod
	09/96 →	Centre Rod	SC-DL-5354		Push Rod
	09/96 →	Suspension Arm Repair Kit		SC-RK-12366	for Control Arm
	09/96 →	Suspension Arm Repair Kit	MN-RK-7280	MN-RK-7280	for Drag Link; for Semi-Trailing Arm; for Wishbone (CV)
	09/96 →	Suspension Strut Repair Kit		CV-RK-5311	
	09/96 →	Suspension Strut Repair Kit		DF-RK-9341	
	09/96 →	Tie Rod	SC-DL-7264		
	09/96 →	Tie Rod	SC-DL-8137		
	09/96 →	Tie Rod End	CV-ES-14162		for Steering Rod
	09/96 →	Tie Rod End	CV-ES-14163		for Steering Rod
	09/96 →	Tie Rod End	SC-ES-7279		for Steering Rod
	09/96 →	Track Control Arm	SC-DL-10302	SC-DL-10302	Trailing Arm, Air Suspension Axle

IRIZAR PB

12.35		Centre Rod	SC-DL-8711		Push Rod
		Centre Rod	SC-DL-9449		Push Rod
		Stabiliser Link		SC-DL-7273	Coupling Rod
		Stabiliser Link		SC-DL-9461	Coupling Rod
		Stabiliser Link	SC-DL-10254		Coupling Rod
		Stabiliser Link	SC-DL-10255		Coupling Rod
		Suspension Arm Repair Kit	DB-RK-8366	DB-RK-8366	for Control Arm; for Drag Link
		Tie Rod	SC-DL-9458		
		Tie Rod	SC-DL-10226		
		Tie Rod	SC-DL-10273		
		Tie Rod End	MN-ES-8490		
		Track Control Arm		SC-DL-9459	Trailing Arm
		Track Control Arm		SC-DL-9460	Trailing Arm
	12.37		Centre Rod	SC-DL-8711	
		Centre Rod	SC-DL-9447		Push Rod
		Centre Rod	SC-DL-9449		Push Rod
		Stabiliser Link		SC-DL-7273	Coupling Rod
		Stabiliser Link		SC-DL-9461	Coupling Rod
		Stabiliser Link	SC-DL-10253		Coupling Rod
		Stabiliser Link	SC-DL-10254		Coupling Rod
		Stabiliser Link	SC-DL-10255		Coupling Rod
		Suspension Arm Repair Kit	DB-RK-8366	DB-RK-8366	for Control Arm; for Drag Link

CV-ES-14162

Length: 125
 Cone Ø: d1 Ø 30 / d2 Ø 27
 Thread: M30 x 1,5 LHT
 283784, 395009, 1358792, 1738380, 1 914
 426, 2051165

**CV-ES-14163**

Length: 125
 Cone Ø: d1 Ø 30 / d2 Ø 27
 Thread: M30 x 1,5 RHT
 283784, 395010, 1358793, 1488890,
 1738381, 1767328, 1914427, 2051166

**CV-RK-5311**

0638862, 638862, 0639287, 639287,
 1104335, 1953248, 81432206006,
 81432206107

**DB-RK-8366**

Ø: 85 Hole Distance: 130
 Thick/Height: 30
 1435944

**DF-RK-9341**

Ø: 67
 550807, 5508072

**MN-ES-8490**

Length: 90
 Cone Ø: d1 Ø 30 / d2 Ø 27
 Thread: M26 x 1,5 RHT
 1394444, 0014606948, 14606948

**MN-RK-7280**

Ø: 75 Hole Distance: 115
 Thick/Height: 24
 0550806, 550806, 0639370, 639370,
 689748, 1104334

**SC-DL-2161**

Length: 1740 Ø: 50
 Cone Ø: d1 Ø 30 / d2 Ø 27
 1369411, 1385251, 1409918, 1501030,
 1723865, 1723895, 1737683, 1897335,
 2113903, 2125090, 2161883

**SC-DL-5229**

Length: 1053 Ø: 50
 Cone Ø: d1 Ø 30 / d2 Ø 27
 1356055, 1379071, 1384025, 1768898,
 1847311, 1912757, 12201600A

**SC-DL-5354**

Length: 1060 Ø: 52
 Cone Ø: d1 Ø 30 / d2 Ø 27
 1384027, 1769597, 1847312, 1912758,
 12200800A

**SC-DL-7264**

Length: 1743 Ø: 62
 Cone Ø: d1 Ø 30 / d2 Ø 27
 1361413, 1395614, 1734019, 1897333,
 2040254, 2146105

**SC-DL-7273**

Length: 284 Ø: 36
 Cone Ø: d1 Ø 26 / d2 Ø 23,5
 483527, 1455327, 1789082

**SC-DL-8137**

Length: 1736 Ø: 40
 Cone Ø: d1 Ø 30 / d2 Ø 27
 301639, 311847, 395350, 1358675,
 1378435, 1397866, 1734020, 2028998,
 12202900A

**SC-DL-8179**

Length: 568 Ø: 46
 Hole Distance: 115 / 115
 1399180, 1428347

**SC-DL-8509**

Length: 568,5 Ø: 46
 Hole Distance: 115 / 115
 1485758, 1486757

**SC-DL-8531**

Length: 522 Ø: 46
 Hole Distance: 115 / 115
 1486758

**SC-DL-8711**

Length: 882 Ø: 48
 Cone Ø: d1 Ø 30 / d2 Ø 27
 1450364, 1755502, 1895860

**SC-DL-9447**

Length: 870 Ø: 48
 Cone Ø: d1 Ø 30 / d2 Ø 27
 0475463, 475463, 1897673

**SC-DL-9449**

Length: 882 Ø: 48
 Cone Ø: d1 Ø 30 / d2 Ø 27
 1432723, 1755500, 1895859

**SC-DL-9458**

Length: 635 Ø: 48
 Cone Ø: d1 Ø 30 / d2 Ø 27
 0475460, 1433532, 1755506, 1895862

**SC-DL-9459**

Length: 670 Ø: 48
 Hole Distance: 130 / 130
 0481959, 1431475

**SC-DL-9460**

Length: 650 Ø: 48
 Hole Distance: 130 / 130
 465816, 466801, 489987

**SC-DL-9461**

Length: 293 Ø: 36
 Hole Distance: 90
 488738

**SC-DL-9462**

Length: 568,5 Ø: 50
 Hole Distance: 115 / 115
 1499475, 1500573, 1722747, 1906941

**SC-DL-9466**

Length: 568 Ø: 19
 1486756

**SC-DL-9467**

Length: 568,5 Ø: 50
 Hole Distance: 115 / 115
 1500572

**SC-DL-10226**

Length: 538 Ø: 52
 Cone Ø: d1 Ø 30 / d2 Ø 27
 486760, 488834, 1755507, 2755601

**SC-DL-10253**

Length: 145 Ø: 30
 Cone Ø: d1 Ø 26 / d2 Ø 23,5
 488739

**SC-DL-10254**

Length: 150 Ø: 30
 Cone Ø: d1 Ø 26 / d2 Ø 23,5
 1506924

**SC-DL-10255**

Length: 150 Ø: 30
 Cone Ø: d1 Ø 26 / d2 Ø 23,5
 1506925

**SC-DL-10273**

Length: 635 Ø: 48
 Cone Ø: d1 Ø 30 / d2 Ø 27
 1433533, 1755504, 1895861

**SC-DL-10302**

Length: 752 Ø: 48
 Hole Distance: 115 / 115
 1101843, 1379423, 1393298, 1431470,
 1942075

**SC-ES-7279**

Length: 150
 Cone Ø: d1 Ø 30 / d2 Ø 27
 Thread: M30 x 1,5 RHT
 1357674, 1603883, 1738379

**SC-RK-12366**

Ø: 75 Hole Distance: 115 / 115
 Thick/Height: 24
 1 722 753, 2 096 392

**SC-TC-12361**

Length: 705 Ø: 42
 Cone Ø: d1 Ø 38
 Hole Distance: 115
 1353445, 1464611, 1942147

**SC-TC-12451**

Length: 552 Ø: 46
 Hole Distance: 115 / 115
 1494296

**SC-TC-12452**

Length: 580,5 Ø: 46
 Hole Distance: 115 / 115
 1485759



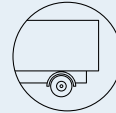

IRIZAR PB ...

12.37 ...	Tie Rod	SC-DL-7264		
	Tie Rod	SC-DL-8137		
	Tie Rod	SC-DL-9458		
	Tie Rod	SC-DL-10226		
	Tie Rod	SC-DL-10273		
	Tie Rod End		MN-ES-8490	
	Track Control Arm		SC-DL-9459	Trailing Arm
	Track Control Arm		SC-DL-10304	Trailing Arm
	Track Control Arm	SC-DL-8713	SC-DL-8713	Trailing Arm
	Track Control Arm	SC-DL-9446	SC-DL-9446	Trailing Arm
12.92, 13.87, 15.37	Centre Rod	SC-DL-8711		Push Rod
	Centre Rod	SC-DL-9447		Push Rod
	Centre Rod	SC-DL-9449		Push Rod
	Stabiliser Link		SC-DL-7273	Coupling Rod
	Stabiliser Link		SC-DL-9461	Coupling Rod
	Stabiliser Link	SC-DL-10253		Coupling Rod
	Stabiliser Link	SC-DL-10254		Coupling Rod
	Stabiliser Link	SC-DL-10255		Coupling Rod
	Suspension Arm Repair Kit	DB-RK-8366	DB-RK-8366	for Control Arm;for Drag Link
	Tie Rod	SC-DL-7264		
	Tie Rod	SC-DL-8137		
	Tie Rod	SC-DL-9458		
	Tie Rod	SC-DL-10226		
	Tie Rod	SC-DL-10273		
	Tie Rod End		MN-ES-8490	
	Track Control Arm		SC-DL-9459	Trailing Arm
	Track Control Arm		SC-DL-9460	Trailing Arm
	Track Control Arm		SC-DL-10304	Trailing Arm
	Track Control Arm	SC-DL-8713	SC-DL-8713	Trailing Arm
	Track Control Arm	SC-DL-9446	SC-DL-9446	Trailing Arm

K - series

K 230 C	01/09→	Tie Rod End	SC-ES-7279		for Steering Rod
K 270 C Ethanol	01/06→	Tie Rod End	SC-ES-7279	SC-ES-7279	for Steering Rod
K 270 Ethanol	01/06→	Tie Rod End	SC-ES-7279		for Steering Rod
	01/06→	Tie Rod End	SC-ES-7279	SC-ES-7279	for Steering Rod
K 280 C	01/09→	Tie Rod End	SC-ES-7279		for Steering Rod
K 310 IB	01/06→	Tie Rod End	SC-ES-7279		for Steering Rod
K 310 IB, K 310 UB	01/06→	Tie Rod End	SC-ES-7279	SC-ES-7279	for Steering Rod
K 320 C	01/11→	Tie Rod End	SC-ES-7279		for Steering Rod
K 400 IB	01/06→	Tie Rod End	SC-ES-7279	SC-ES-7279	for Steering Rod
K 440 IB	01/06→	Tie Rod End	SC-ES-7279		for Steering Rod

P,G,R,T - series

G 230	09/07→	Centre Rod	SC-DL-5229		Push Rod
	09/07→	Centre Rod	SC-DL-5354	SC-DL-5354	Push Rod, for vehicles with Hinged Trailing Axle
	09/07→	Centre Rod	SC-DL-8182		Push Rod
	09/07→	Centre Rod	SC-DL-8399		Push Rod, for vehicles with Hinged Leading Axle, for vehicles with Part-Pneumatic Suspension
	09/07→	Centre Rod	SC-DL-8553	SC-DL-8553	Push Rod, for vehicles with Hinged Leading Axle
	09/07→	Centre Rod	SC-DL-12342		for Steering Rod
	09/07→	Centre Rod	SC-DL-12449		Push Rod
	09/07→	Suspension Arm Repair Kit		SC-RK-12366	for Control Arm
	09/07→	Suspension Strut Repair Kit		DF-RK-9341	
	09/07→	Tie Rod		SC-DL-7264	Tag Axle;for vehicles with Hinged Trailing Axle
	09/07→	Tie Rod		SC-DL-8137	Tag Axle;for vehicles with Hinged Trailing Axle
	09/07→	Tie Rod	SC-DL-7264		
	09/07→	Tie Rod	SC-DL-8137		Leaf Spring Axle
	09/07→	Tie Rod	SC-DL-9457		Leaf Spring Axle
	09/07→	Tie Rod End		MN-ES-8490	Tag Axle;for vehicles with Hinged Trailing Axle
	09/07→	Tie Rod End	CV-ES-14162	CV-ES-14162	for Steering Rod
	09/07→	Tie Rod End	CV-ES-14163		for Steering Rod
	09/07→	Tie Rod End	IV-ES-12272		for Steering Rod
	09/07→	Tie Rod End	MN-ES-8490	MN-ES-8490	for vehicles with Hinged Trailing Axle

CV-ES-14162

Length: 125
Cone Ø: d1 Ø 30 / d2 Ø 27
Thread: M30 x 1,5 LHT
283784, 395009, 1358792, 1738380, 1 914 426, 2051165



CV-ES-14163

Length: 125
Cone Ø: d1 Ø 30 / d2 Ø 27
Thread: M30 x 1,5 RHT
283784, 395010, 1358793, 1488890, 1738381, 1767328, 1914427, 2051166



DB-RK-8366

Ø: 85 Hole Distance: 130
Thick/Height: 30
1435944



DF-RK-9341

Ø: 67
550807, 5508072



IV-ES-12272

Length: 75
Cone Ø: d1 Ø 30 / d2 Ø 27
Thread: M26 x 1,5 RHT
1394443



MN-ES-8490

Length: 90
Cone Ø: d1 Ø 30 / d2 Ø 27
Thread: M26 x 1,5 RHT
1394444, 0014606948, 14606948



SC-DL-5229

Length: 1053 Ø: 50
Cone Ø: d1 Ø 30 / d2 Ø 27
1356055, 1379071, 1384025, 1768898, 1847311, 1912757, 12201600A



SC-DL-5354

Length: 1060 Ø: 52
Cone Ø: d1 Ø 30 / d2 Ø 27
1384027, 1769597, 1847312, 1912758, 12200800A



SC-DL-7264

Length: 1743 Ø: 62
Cone Ø: d1 Ø 30 / d2 Ø 27
1361413, 1395614, 1734019, 1897333, 2040254, 2146105



SC-DL-7273

Length: 284 Ø: 36
Cone Ø: d1 Ø 26 / d2 Ø 23,5
483527, 1455327, 1789082



SC-DL-8137

Length: 1736 Ø: 40
Cone Ø: d1 Ø 30 / d2 Ø 27
301639, 311847, 395350, 1358675, 1378435, 1397866, 1734020, 2028998, 12202900A



SC-DL-8182

1343262, 1869413



SC-DL-8399

Length: 433 Ø: 40
Cone Ø: d1 Ø 30 / d2 Ø 26
1394884, 1938387



SC-DL-8553

Length: 435 Ø: 38
Cone Ø: d1 Ø 30 / d2 Ø 27
1343283, 1759691



SC-DL-8711

Length: 882 Ø: 48
Cone Ø: d1 Ø 30 / d2 Ø 27
1450364, 1755502, 1895860



SC-DL-8713

Length: 637 Ø: 48
Hole Distance: 115 / 115
477890, 1431472, 1770732



SC-DL-9446

Length: 532 Ø: 46
Hole Distance: 115 / 115
0477889, 1431471



SC-DL-9447

Length: 870 Ø: 48
Cone Ø: d1 Ø 30 / d2 Ø 27
0475463, 475463, 1897673



SC-DL-9449

Length: 882 Ø: 48
Cone Ø: d1 Ø 30 / d2 Ø 27
1432723, 1755500, 1895859



SC-DL-9457

Length: 1743 Ø: 52
Cone Ø: d1 Ø 30 / d2 Ø 27
1527989, 1723896, 1737684, 1897336



SC-DL-9458

Length: 635 Ø: 48
Cone Ø: d1 Ø 30 / d2 Ø 27
0475460, 1433532, 1755506, 1895862



SC-DL-9459

Length: 670 Ø: 48
Hole Distance: 130 / 130
0481959, 1431475



SC-DL-9460

Length: 650 Ø: 48
Hole Distance: 130 / 130
465816, 466801, 489987



SC-DL-9461

Length: 293 Ø: 36
Hole Distance: 90
488738



SC-DL-10226

Length: 538 Ø: 52
Cone Ø: d1 Ø 30 / d2 Ø 27
486760, 488834, 1755507, 2755601



SC-DL-10253

Length: 145 Ø: 30
Cone Ø: d1 Ø 26 / d2 Ø 23,5
488739



SC-DL-10254

Length: 150 Ø: 30
Cone Ø: d1 Ø 26 / d2 Ø 23,5
1506924



SC-DL-10255

Length: 150 Ø: 30
Cone Ø: d1 Ø 26 / d2 Ø 23,5
1506925



SC-DL-10273

Length: 635 Ø: 48
Cone Ø: d1 Ø 30 / d2 Ø 27
1433533, 1755504, 1895861



SC-DL-10304

Length: 640 Ø: 48
Hole Distance: 130 / 130
1431710



SC-DL-12342

Length: 601 Ø: 42
Cone Ø: d1 Ø 26 / d2 Ø 23,5
1343262, 1869413



SC-DL-12449

Length: 1206 Ø: 38
Cone Ø: d1 Ø 30 / d2 Ø 27
135763, 1765375



SC-ES-7279

Length: 150
Cone Ø: d1 Ø 30 / d2 Ø 27
Thread: M30 x 1,5 RHT
1357674, 1603883, 1738379



SC-RK-12366

Ø: 75 Hole Distance: 115 / 115
Thick/Height: 24
1 722 753, 2 096 392



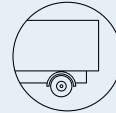

P,G,R,T - series ...

G 230 ...	09/07→	Tie Rod End	SC-ES-8517		for Push Rod
	09/07→	Tie Rod End	SC-ES-8535		for Guide Rod
	09/07→	Track Control Arm	SC-DL-10302	SC-DL-10302	Trailing Arm, Air Suspension Axle
	09/07→	Track Control Arm	SC-TC-12361		Control Arm, 1st Front Axle, for Pneumatic Suspension vehicles
G 230, P 230	08/06→	Centre Rod	SC-DL-5229		Push Rod
	08/06→	Centre Rod	SC-DL-5354		Push Rod
	08/06→	Centre Rod	SC-DL-10225		for Steering Rod
	08/06→	Centre Rod	SC-DL-12342		for Steering Rod
	08/06→	Centre Rod	SC-DL-12343		for Steering Rod
	08/06→	Suspension Arm Repair Kit		SC-RK-12366	for Control Arm
	08/06→	Suspension Arm Repair Kit	SC-RK-12346	SC-RK-12346	for Control Arm
	08/06→	Suspension Strut Repair Kit		MN-RK-8501	
	08/06→	Suspension Strut Repair Kit		MN-RK-12436	
	08/06→	Suspension Strut Repair Kit	DF-RK-9341		
	08/06→	Tie Rod	SC-DL-7264		
	08/06→	Tie Rod	SC-DL-8137		Leaf Spring Axle
	08/06→	Tie Rod	SC-DL-9457		Leaf Spring Axle
	08/06→	Tie Rod End	CV-ES-14162		for Steering Rod
	08/06→	Tie Rod End	CV-ES-14163		for Steering Rod
	08/06→	Tie Rod End	SC-ES-8535		for Guide Rod
	08/06→	Track Control Arm		SC-TC-12452	Control Arm
	08/06→	Track Control Arm		SC-VB-12418	Control Arm
	08/06→	Track Control Arm	SC-DL-10302	SC-DL-10302	Trailing Arm, Air Suspension Axle
	08/06→	Track Control Arm	SC-TC-12361		Control Arm, 1st Front Axle, for Pneumatic Suspension vehicles
	09/07→	Centre Rod	SC-DL-5354	SC-DL-5354	Push Rod, for vehicles with Hinged Trailing Axle
	09/07→	Centre Rod	SC-DL-8182		Push Rod
	09/07→	Centre Rod	SC-DL-8399		Push Rod, for vehicles with Hinged Leading Axle, for vehicles with Part-Pneumatic Suspension
	09/07→	Centre Rod	SC-DL-10225		Push Rod, for vehicles with Hinged Leading Axle
	09/07→	Centre Rod	SC-DL-12449		Push Rod
	09/07→	Tie Rod		SC-DL-7264	Leading Axle;for vehicles with Hinged Leading Axle
	09/07→	Tie Rod		SC-DL-7264	Leading Axle;for vehicles with Hinged Leading Axle;Air Suspension Axle
	09/07→	Tie Rod		SC-DL-7264	Tag Axle;for vehicles with Hinged Trailing Axle
	09/07→	Tie Rod		SC-DL-8137	Leading Axle;for vehicles with Hinged Leading Axle
	09/07→	Tie Rod		SC-DL-8137	Tag Axle;for vehicles with Hinged Trailing Axle
	09/07→	Tie Rod End		MN-ES-8490	Tag Axle;for vehicles with Hinged Trailing Axle
	09/07→	Tie Rod End	CV-ES-14162	CV-ES-14162	for Steering Rod
	09/07→	Tie Rod End	IV-ES-12272		for Steering Rod
	09/07→	Tie Rod End	MN-ES-8490	MN-ES-8490	for vehicles with Hinged Trailing Axle
	09/07→	Tie Rod End	SC-ES-8517		for Push Rod
	09/07→	Track Control Arm		SC-DL-8511	Trailing Arm, Leaf Spring Axle
	09/07→	Track Control Arm		SC-DL-8511	Trailing Arm, Leaf Spring Axle, →* 3512097 *
	09/07→	Track Control Arm		SC-DL-8547	Trailing Arm, Leaf Spring Axle
	09/07→	Track Control Arm		SC-DL-9462	Trailing Arm, Leaf Spring Axle, →* 2006231 SSS *; * 5117423 SNL *; * 9097199 SAN *; * 3564002 SLA *
	09/07→	Track Control Arm		SC-DL-9466	Trailing Arm, Leaf Spring Axle
	09/07→	Track Control Arm		SC-TC-12451	Trailing Arm, 1st Drive Axle, for Leaf-Spring Suspension vehicles
	09/07→	Track Control Arm		SC-TC-12451	Trailing Arm, 1st Drive Axle, for Leaf-Spring Suspension vehicles, 1280185/4471603→
	09/07→	Track Control Arm		SC-TC-12451	Trailing Arm, 1st Drive Axle, for Leaf-Spring Suspension vehicles, 9069961/3536016→
	09/07→	Track Control Arm		SC-TC-12472	Trailing Arm, 2nd Drive Axle, for Leaf-Spring Suspension vehicles, →1280184/4471602
	09/07→	Track Control Arm		SC-TC-12472	Trailing Arm, 2nd Drive Axle, for Leaf-Spring Suspension vehicles, →9069960/3536015
	09/07→	Track Control Arm	SC-DL-8179	SC-DL-8179	Trailing Arm, Leaf Spring Axle

CV-ES-14162

Length: 125
Cone Ø: d1 Ø 30 / d2 Ø 27
Thread: M30 x 1,5 LHT
283783, 395009, 1358792, 1738380, 1 914 426, 2051165



CV-ES-14163

Length: 125
Cone Ø: d1 Ø 30 / d2 Ø 27
Thread: M30 x 1,5 RHT
283784, 395010, 1358793, 1488890, 1738381, 1767328, 1914427, 2051166



DF-RK-9341

Ø: 67
550807, 5508072



IV-ES-12272

Length: 75
Cone Ø: d1 Ø 30 / d2 Ø 27
Thread: M26 x 1,5 RHT
1394443



MN-ES-8490

Length: 90
Cone Ø: d1 Ø 30 / d2 Ø 27
Thread: M26 x 1,5 RHT
1394444, 0014606948, 14606948



MN-RK-8501

Ø: 75 Hole Distance: 115
Thick/Height: 24
1515981



MN-RK-12436

Ø: 75 Hole Distance: 115
Thick/Height: 24
550799, 1517403, 1783020



SC-DL-5229

Length: 1053 Ø: 50
Cone Ø: d1 Ø 30 / d2 Ø 27
1356055, 1379071, 1384025, 1768898, 1847311, 1912757, 12201600A



SC-DL-5354

Length: 1060 Ø: 52
Cone Ø: d1 Ø 30 / d2 Ø 27
1384027, 1769597, 1847312, 1912758, 12200800A



SC-DL-7264

Length: 1743 Ø: 62
Cone Ø: d1 Ø 30 / d2 Ø 27
1361413, 1395614, 1734019, 1897333, 2040254, 2146105



SC-DL-8137

Length: 1736 Ø: 40
Cone Ø: d1 Ø 30 / d2 Ø 27
301639, 311847, 395350, 1358675, 1378435, 1397866, 1734020, 2028998, 12202900A



SC-DL-8179

Length: 568 Ø: 46
Hole Distance: 115 / 115
1399180, 1428347



SC-DL-8182

1343262, 1869413



SC-DL-8399

Length: 433 Ø: 40
Cone Ø: d1 Ø 30 / d2 Ø 26
1394884, 1938387



SC-DL-8511

Length: 616,5 Ø: 50
Hole Distance: 115 / 115
1485760, 1499478, 1722750



SC-DL-8547

Length: 568 Ø: 50
Hole Distance: 115 / 115
1499474, 1722746, 1906940



SC-DL-9457

Length: 1743 Ø: 52
Cone Ø: d1 Ø 30 / d2 Ø 27
1527989, 1723896, 1737684, 1897336



SC-DL-9462

Length: 568,5 Ø: 50
Hole Distance: 115 / 115
1499475, 1500573, 1722747, 1906941



SC-DL-9466

Length: 568 Ø: 19
1486756



SC-DL-10225

Length: 2179 Ø: 62
Cone Ø: d1 Ø 30 / d2 Ø 27
1386618, 1788522



SC-DL-10302

Length: 752 Ø: 48
Hole Distance: 115 / 115
1101843, 1379423, 1393298, 1431470, 1942075



SC-DL-12342

Length: 601 Ø: 42
Cone Ø: d1 Ø 26 / d2 Ø 23,5
1343262, 1869413



SC-DL-12343

Length: 1062 Ø: 52
Cone Ø: d1 Ø 30 / d2 Ø 27
1348269, 2007275



SC-DL-12449

Length: 1206 Ø: 38
Cone Ø: d1 Ø 30 / d2 Ø 27
1385763, 1765375



SC-ES-8517

Length: 140
Cone Ø: d1 Ø 30 / d2 Ø 27
Thread: M30 x 1,5 RHT
1358793, 1435746, 1488890, 1534756, 1914427, 2051166



SC-ES-8535

Length: 145
Cone Ø: d1 Ø 30 / d2 Ø 27
Thread: M30 x 1,5 RHT
1723897, 2051041



SC-RK-12346

Ø: 67 Hole Distance: 115
Thick/Height: 24
550800



SC-RK-12366

Ø: 75 Hole Distance: 115 / 115
Thick/Height: 24
1 722 753, 2 096 392



SC-TC-12361

Length: 705 Ø: 42
Cone Ø: d1 Ø 38
Hole Distance: 115
1353445, 1464611, 1942147



SC-TC-12451

Length: 552 Ø: 46
Hole Distance: 115 / 115
1494296



SC-TC-12452

Length: 580,5 Ø: 46
Hole Distance: 115 / 115
1485759



SC-TC-12472

Length: 580 Ø: 46
Hole Distance: 115 / 115
1399182



SC-VB-12418

Length: 613,2
Ø: 46
Hole Ø 25 / 19 / 19
Hole Distance: 152 / 115 / 115
1440028, 1722582



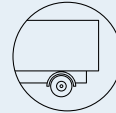

P,G,R,T - series ...

G 230, P 230 ...	09/07→	Track Control Arm	SC-DL-8509	SC-DL-8509	Trailing Arm	
	09/07→	Track Control Arm	SC-DL-8509	SC-DL-8509	Trailing Arm, Leaf Spring Axle	
	09/07→	Track Control Arm	SC-DL-8531	SC-DL-8531	Trailing Arm, Leaf Spring Axle	
	09/07→	Track Control Arm	SC-DL-8623	SC-DL-8623	Trailing Arm, Leaf Spring Axle, →* 2006231 SSS ** 5117423 SNL *; * 9097199 SAN ** 3564002 SLA *	
G 270, P 270	04/04→	Centre Rod	SC-DL-5229		Push Rod	
	04/04→	Centre Rod	SC-DL-5354	SC-DL-5354	Push Rod, for vehicles with Hinged Trailing Axle	
	04/04→	Centre Rod	SC-DL-8182		Push Rod	
	04/04→	Centre Rod	SC-DL-8399		Push Rod, for vehicles with Hinged Leading Axle, for vehicles with Part-Pneumatic Suspension	
	04/04→	Centre Rod	SC-DL-8553	SC-DL-8553	Push Rod, for vehicles with Hinged Leading Axle	
	04/04→	Centre Rod	SC-DL-12342		for Steering Rod	
	04/04→	Centre Rod	SC-DL-12343		for Steering Rod	
	04/04→	Centre Rod	SC-DL-12449		Push Rod	
	04/04→	Suspension Arm Repair Kit		SC-RK-12366	for Control Arm	
	04/04→	Suspension Arm Repair Kit	SC-RK-12346	SC-RK-12346	for Control Arm	
	04/04→	Suspension Strut Repair Kit		MN-RK-8501		
	04/04→	Suspension Strut Repair Kit		MN-RK-12436		
	04/04→	Suspension Strut Repair Kit	DF-RK-9341			
	04/04→	Tie Rod		SC-DL-7264	Tag Axle;for vehicles with Hinged Trailing Axle	
	04/04→	Tie Rod		SC-DL-8137	Tag Axle;for vehicles with Hinged Trailing Axle	
	04/04→	Tie Rod	SC-DL-7264			
	04/04→	Tie Rod	SC-DL-8137		Leaf Spring Axle	
	04/04→	Tie Rod	SC-DL-9457		Leaf Spring Axle	
	04/04→	Tie Rod End		MN-ES-8490	Tag Axle;for vehicles with Hinged Trailing Axle	
	04/04→	Tie Rod End	CV-ES-14162	CV-ES-14162	for Steering Rod	
	04/04→	Tie Rod End	CV-ES-14163		for Steering Rod	
	04/04→	Tie Rod End	IV-ES-12272		for Steering Rod	
	04/04→	Tie Rod End	MN-ES-8490	MN-ES-8490	for vehicles with Hinged Trailing Axle	
	04/04→	Tie Rod End	SC-ES-8517		for Push Rod	
	04/04→	Tie Rod End	SC-ES-8535		for Guide Rod	
	04/04→	Track Control Arm		SC-VB-12418	Control Arm	
	04/04→	Track Control Arm	SC-DL-10302	SC-DL-10302	Trailing Arm, Air Suspension Axle	
	04/04→	Track Control Arm	SC-TC-12361		Control Arm, 1st Front Axle, for Pneumatic Suspension vehicles	
	G 270, P 270, R 270	09/04→	Centre Rod	SC-DL-5229		Push Rod
		09/04→	Centre Rod	SC-DL-5354		Push Rod
		09/04→	Centre Rod	SC-DL-12342		for Steering Rod
		09/04→	Centre Rod	SC-DL-12343		for Steering Rod
09/04→		Suspension Arm Repair Kit		SC-RK-12366	for Control Arm	
09/04→		Suspension Arm Repair Kit	SC-RK-12346	SC-RK-12346	for Control Arm	
09/04→		Suspension Strut Repair Kit		MN-RK-8501		
09/04→		Suspension Strut Repair Kit		MN-RK-12436		
09/04→		Suspension Strut Repair Kit	DF-RK-9341			
09/04→		Tie Rod	SC-DL-7264			
09/04→		Tie Rod	SC-DL-8137		Leaf Spring Axle	
09/04→		Tie Rod	SC-DL-9457		Leaf Spring Axle	
09/04→		Tie Rod End	CV-ES-14162		for Steering Rod	
09/04→		Tie Rod End	CV-ES-14163		for Steering Rod	
09/04→		Tie Rod End	SC-ES-8535		for Guide Rod	
09/04→		Track Control Arm		SC-VB-12418	Control Arm	
09/04→		Track Control Arm	SC-DL-10302	SC-DL-10302	Trailing Arm, Air Suspension Axle	
09/04→		Track Control Arm	SC-TC-12361		Control Arm, 1st Front Axle, for Pneumatic Suspension vehicles	
G 310, P 310		09/04→	Centre Rod	SC-DL-5229		Push Rod
		09/04→	Centre Rod	SC-DL-5354		Push Rod
	09/04→	Centre Rod	SC-DL-5354	SC-DL-5354	Push Rod, for vehicles with Hinged Trailing Axle	
	09/04→	Centre Rod	SC-DL-8182		Push Rod	
	09/04→	Centre Rod	SC-DL-8399		Push Rod, for vehicles with Hinged Leading Axle, for vehicles with Part-Pneumatic Suspension	
	09/04→	Centre Rod	SC-DL-8553	SC-DL-8553	Push Rod, for vehicles with Hinged Leading Axle	
09/04→	Centre Rod	SC-DL-12342		for Steering Rod		

CV-ES-14162

Length: 125
Cone Ø: d1 Ø 30 / d2 Ø 27
Thread: M30 x 1,5 LHT
283783, 395009, 1358792, 1738380, 1 914 426, 2051165



CV-ES-14163

Length: 125
Cone Ø: d1 Ø 30 / d2 Ø 27
Thread: M30 x 1,5 RHT
283784, 395010, 1358793, 1488890, 1738381, 1767328, 1914427, 2051166



DF-RK-9341

Ø: 67
550807, 5508072



IV-ES-12272

Length: 75
Cone Ø: d1 Ø 30 / d2 Ø 27
Thread: M26 x 1,5 RHT
1394443



MN-ES-8490

Length: 90
Cone Ø: d1 Ø 30 / d2 Ø 27
Thread: M26 x 1,5 RHT
1394444, 0014606948, 14606948



MN-RK-8501

Ø: 75 Hole Distance: 115
Thick/Height: 24
1515981



MN-RK-12436

Ø: 75 Hole Distance: 115
Thick/Height: 24
550799, 1517403, 1783020



SC-DL-5229

Length: 1053 Ø: 50
Cone Ø: d1 Ø 30 / d2 Ø 27
1356055, 1379071, 1384025, 1768898, 1847311, 1912757, 12201600A



SC-DL-5354

Length: 1060 Ø: 52
Cone Ø: d1 Ø 30 / d2 Ø 27
1384027, 1769597, 1847312, 1912758, 12200800A



SC-DL-7264

Length: 1743 Ø: 62
Cone Ø: d1 Ø 30 / d2 Ø 27
1361413, 1395614, 1734019, 1897333, 2040254, 2146105



SC-DL-8137

Length: 1736 Ø: 40
Cone Ø: d1 Ø 30 / d2 Ø 27
301639, 311847, 395350, 1358675, 1378435, 1397866, 1734020, 2028998, 12202900A



SC-DL-8182

1343262, 1869413



SC-DL-8399

Length: 433 Ø: 40
Cone Ø: d1 Ø 30 / d2 Ø 26
1394884, 1938387



SC-DL-8509

Length: 568,5 Ø: 46
Hole Distance: 115 / 115
1485758, 1486757



SC-DL-8531

Length: 522 Ø: 46
Hole Distance: 115 / 115
1486758



SC-DL-8553

Length: 435 Ø: 38
Cone Ø: d1 Ø 30 / d2 Ø 27
1343283, 1759691



SC-DL-8623

Length: 592 Ø: 50
Hole Distance: 115 / 115
1388436, 1499476, 1722748, 1906942



SC-DL-9457

Length: 1743 Ø: 52
Cone Ø: d1 Ø 30 / d2 Ø 27
1527989, 1723896, 1737684, 1897336



SC-DL-10302

Length: 752 Ø: 48
Hole Distance: 115 / 115
1101843, 1379423, 1393298, 1431470, 1942075



SC-DL-12342

Length: 601 Ø: 42
Cone Ø: d1 Ø 26 / d2 Ø 23,5
1343262, 1869413



SC-DL-12343

Length: 1062 Ø: 52
Cone Ø: d1 Ø 30 / d2 Ø 27
1348269, 2007275



SC-DL-12449

Length: 1206 Ø: 38
Cone Ø: d1 Ø 30 / d2 Ø 27
1385763, 1765375



SC-ES-8517

Length: 140
Cone Ø: d1 Ø 30 / d2 Ø 27
Thread: M30 x 1,5 RHT
1358793, 1435746, 1488890, 1534756, 1914427, 2051166



SC-ES-8535

Length: 145
Cone Ø: d1 Ø 30 / d2 Ø 27
Thread: M30 x 1,5 RHT
1723897, 2051041



SC-RK-12346

Ø: 67 Hole Distance: 115
Thick/Height: 24
550800



SC-RK-12366

Ø: 75 Hole Distance: 115 / 115
Thick/Height: 24
1 722 753, 2 096 392



SC-TC-12361

Length: 705 Ø: 42
Cone Ø: d1 Ø 38
Hole Distance: 115
1353445, 1464611, 1942147



SC-VB-12418

Length: 613,2
Ø: 46
Hole Ø 25 / 19 / 19
Hole Distance: 152 / 115 / 115
1440028, 1722582





P,G,R,T - series ...

G 310, P 310 ...

09/04 →	Centre Rod	SC-DL-12343		for Steering Rod
09/04 →	Centre Rod	SC-DL-12449		Push Rod
09/04 →	Suspension Arm Repair Kit		SC-RK-12366	for Control Arm
09/04 →	Suspension Arm Repair Kit	SC-RK-12346	SC-RK-12346	for Control Arm
09/04 →	Suspension Strut Repair Kit		MN-RK-8501	
09/04 →	Suspension Strut Repair Kit		MN-RK-12436	
09/04 →	Suspension Strut Repair Kit	DF-RK-9341		
09/04 →	Tie Rod		SC-DL-7264	Tag Axle;for vehicles with Hinged Trailing Axle
09/04 →	Tie Rod		SC-DL-8137	Tag Axle;for vehicles with Hinged Trailing Axle
09/04 →	Tie Rod	SC-DL-7264		
09/04 →	Tie Rod	SC-DL-8137		Leaf Spring Axle
09/04 →	Tie Rod	SC-DL-9457		Leaf Spring Axle
09/04 →	Tie Rod End		MN-ES-8490	Tag Axle;for vehicles with Hinged Trailing Axle
09/04 →	Tie Rod End	CV-ES-14162		for Steering Rod
09/04 →	Tie Rod End	CV-ES-14162	CV-ES-14162	for Steering Rod
09/04 →	Tie Rod End	CV-ES-14163		for Steering Rod
09/04 →	Tie Rod End	IV-ES-12272		for Steering Rod
09/04 →	Tie Rod End	MN-ES-8490	MN-ES-8490	for vehicles with Hinged Trailing Axle
09/04 →	Tie Rod End	SC-ES-8517		for Push Rod
09/04 →	Tie Rod End	SC-ES-8535		for Guide Rod
09/04 →	Track Control Arm		SC-VB-12418	Control Arm
09/04 →	Track Control Arm	SC-DL-10302	SC-DL-10302	Trailing Arm, Air Suspension Axle
09/04 →	Track Control Arm	SC-TC-12361		Control Arm, 1st Front Axle, for Pneumatic Suspension vehicles
07/09 →	Track Control Arm	SC-DL-10302	SC-DL-10302	Trailing Arm, 1st Front Axle, for Pneumatic Suspension vehicles
01/12 →	Centre Rod	SC-DL-10225		for Steering Rod
01/12 →	Centre Rod	SC-DL-12341		Push Rod

G 340, P 340

04/04 →	Centre Rod	SC-DL-5229		Push Rod
04/04 →	Centre Rod	SC-DL-5354		Push Rod
04/04 →	Centre Rod	SC-DL-8154		Push Rod
04/04 →	Centre Rod	SC-DL-8169		Push Rod
04/04 →	Centre Rod	SC-DL-8182		Push Rod
04/04 →	Centre Rod	SC-DL-8399		Push Rod, Leaf Spring Axle
04/04 →	Centre Rod	SC-DL-12341		Push Rod
04/04 →	Centre Rod	SC-DL-12342		for Steering Rod
04/04 →	Centre Rod	SC-DL-12343		for Steering Rod
04/04 →	Suspension Arm Repair Kit		SC-RK-12366	for Control Arm
04/04 →	Suspension Arm Repair Kit	SC-RK-12346	SC-RK-12346	for Control Arm
04/04 →	Suspension Strut Repair Kit		MN-RK-8501	
04/04 →	Suspension Strut Repair Kit		MN-RK-12436	
04/04 →	Suspension Strut Repair Kit	DF-RK-9341		
04/04 →	Tie Rod	SC-DL-7264		1st FA;2nd FA
04/04 →	Tie Rod	SC-DL-8137		Leaf Spring Axle
04/04 →	Tie Rod	SC-DL-8137		Leaf Spring Axle;1st FA;2nd FA
04/04 →	Tie Rod	SC-DL-9457		1st FA;2nd FA;Leaf Spring Axle
04/04 →	Tie Rod	SC-DL-9457		Leaf Spring Axle
04/04 →	Tie Rod End	CV-ES-14162		for Steering Rod
04/04 →	Tie Rod End	CV-ES-14162	CV-ES-14162	for Steering Rod
04/04 →	Tie Rod End	CV-ES-14163		for Steering Rod
04/04 →	Tie Rod End	SC-ES-5764		
04/04 →	Tie Rod End	SC-ES-8517		for Push Rod
04/04 →	Tie Rod End	SC-ES-8535		for Guide Rod
04/04 →	Track Control Arm		SC-DL-8511	Trailing Arm, Leaf Spring Axle
04/04 →	Track Control Arm		SC-DL-8511	Trailing Arm, Leaf Spring Axle, →* 3512097 *
04/04 →	Track Control Arm		SC-DL-8547	Trailing Arm, Leaf Spring Axle
04/04 →	Track Control Arm		SC-DL-9462	Trailing Arm, Leaf Spring Axle, →* 2006231 SSS *; * 5117423 SNL *; * 9097199 SAN *; * 3564002 SLA *
04/04 →	Track Control Arm		SC-DL-9466	Trailing Arm, Leaf Spring Axle
04/04 →	Track Control Arm		SC-TC-12451	Trailing Arm, 1st Drive Axle, for Leaf-Spring Suspension vehicles

CV-ES-14162

Length: 125
Cone Ø: d1 Ø 30 / d2 Ø 27
Thread: M30 x 1,5 LHT
283784, 395009, 1358792, 1738380, 1 914 426, 2051165



CV-ES-14163

Length: 125
Cone Ø: d1 Ø 30 / d2 Ø 27
Thread: M30 x 1,5 RHT
283784, 395010, 1358793, 1488890, 1738381, 1767328, 1914427, 2051166



DF-RK-9341

Ø: 67
550807, 5508072



IV-ES-12272

Length: 75
Cone Ø: d1 Ø 30 / d2 Ø 27
Thread: M26 x 1,5 RHT
1394443



MN-ES-8490

Length: 90
Cone Ø: d1 Ø 30 / d2 Ø 27
Thread: M26 x 1,5 RHT
1394444, 0014606948, 14606948



MN-RK-8501

Ø: 75 Hole Distance: 115
Thick/Height: 24
1515981



MN-RK-12436

Ø: 75 Hole Distance: 115
Thick/Height: 24
550799, 1517403, 1783020



SC-DL-5229

Length: 1053 Ø: 50
Cone Ø: d1 Ø 30 / d2 Ø 27
1356055, 1379071, 1384025, 1768898, 1847311, 1912757, 12201600A



SC-DL-5354

Length: 1060 Ø: 52
Cone Ø: d1 Ø 30 / d2 Ø 27
1384027, 1769597, 1847312, 1912758, 12200800A



SC-DL-7264

Length: 1743 Ø: 62
Cone Ø: d1 Ø 30 / d2 Ø 27
1361413, 1395614, 1734019, 1897333, 2040254, 2146105



SC-DL-8137

Length: 1736 Ø: 40
Cone Ø: d1 Ø 30 / d2 Ø 27
301639, 311847, 395350, 1358675, 1378435, 1397866, 1734020, 2028998, 12202900A



SC-DL-8154

Length: 495 Ø: 40
Cone Ø: d1 Ø 30 / d2 Ø 27
1343266, 1759690



SC-DL-8169

Length: 1920 Ø: 62
Cone Ø: d1 Ø 30 / d2 Ø 27
1343264, 1732635, 2007278



SC-DL-8182

1343262, 1869413



SC-DL-8399

Length: 433 Ø: 40
Cone Ø: d1 Ø 30 / d2 Ø 26
1394884, 1938387



SC-DL-8511

Length: 616,5 Ø: 50
Hole Distance: 115 / 115
1485760, 1499478, 1722750



SC-DL-8547

Length: 568 Ø: 50
Hole Distance: 115 / 115
1499474, 1722746, 1906940



SC-DL-9457

Length: 1743 Ø: 52
Cone Ø: d1 Ø 30 / d2 Ø 27
1527989, 1723896, 1737684, 1897336



SC-DL-9462

Length: 568,5 Ø: 50
Hole Distance: 115 / 115
1499475, 1500573, 1722747, 1906941



SC-DL-9466

Length: 568 Ø: 19
1486756



SC-DL-10225

Length: 2179 Ø: 62
Cone Ø: d1 Ø 30 / d2 Ø 27
1386618, 1788522



SC-DL-10302

Length: 752 Ø: 48
Hole Distance: 115 / 115
1101843, 1379423, 1393298, 1431470, 1942075



SC-DL-12341

Length: 1776 Ø: 62
Cone Ø: d1 Ø 30 / d2 Ø 27
1386620



SC-DL-12342

Length: 601 Ø: 42
Cone Ø: d1 Ø 26 / d2 Ø 23,5
1343262, 1869413



SC-DL-12343

Length: 1062 Ø: 52
Cone Ø: d1 Ø 30 / d2 Ø 27
1348269, 2007275



SC-DL-12449

Length: 1206 Ø: 38
Cone Ø: d1 Ø 30 / d2 Ø 27
1385763, 1765375



SC-ES-5764

Length: 95
Cone Ø: d1 Ø 30 / d2 Ø 27
Thread: M26 x 1,5 RHT
325614, 1375228, 4604948



SC-ES-8517

Length: 140
Cone Ø: d1 Ø 30 / d2 Ø 27
Thread: M30 x 1,5 RHT
1358793, 1435746, 1488890, 1534756, 1914427, 2051166



SC-ES-8535

Length: 145
Cone Ø: d1 Ø 30 / d2 Ø 27
Thread: M30 x 1,5 RHT
1723897, 2051041



SC-RK-12346

Ø: 67 Hole Distance: 115
Thick/Height: 24
550800



SC-RK-12366

Ø: 75 Hole Distance: 115 / 115
Thick/Height: 24
1 722 753, 2 096 392



SC-TC-12361

Length: 705 Ø: 42
Cone Ø: d1 Ø 38
Hole Distance: 115
1353445, 1464611, 1942147



SC-TC-12451

Length: 552 Ø: 46
Hole Distance: 115 / 115
1494296



SC-VB-12418

Length: 613,2
Ø: 46
Hole Ø 25 / 19 / 19
Hole Distance: 152 / 115 / 115
1440028, 1722582



SCANIA

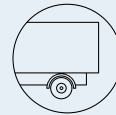

P,G,R,T - series ...

G 340, P 340 ...	04/04 →	Track Control Arm		SC-TC-12451	Trailing Arm, 1st Drive Axle, for Leaf-Spring Suspension vehicles, 1280185/4471603 →
	04/04 →	Track Control Arm		SC-TC-12451	Trailing Arm, 1st Drive Axle, for Leaf-Spring Suspension vehicles, 9069961/3536016 →
	04/04 →	Track Control Arm		SC-TC-12452	Control Arm
	04/04 →	Track Control Arm		SC-TC-12472	Trailing Arm, 2nd Drive Axle, for Leaf-Spring Suspension vehicles, →1280184/4471602
	04/04 →	Track Control Arm		SC-TC-12472	Trailing Arm, 2nd Drive Axle, for Leaf-Spring Suspension vehicles, →9069960/3536015
	04/04 →	Track Control Arm		SC-VB-12418	Control Arm
	04/04 →	Track Control Arm	SC-DL-8179	SC-DL-8179	Trailing Arm, Leaf Spring Axle
	04/04 →	Track Control Arm	SC-DL-8509	SC-DL-8509	Trailing Arm
	04/04 →	Track Control Arm	SC-DL-8509	SC-DL-8509	Trailing Arm, Leaf Spring Axle
	04/04 →	Track Control Arm	SC-DL-8531	SC-DL-8531	Trailing Arm, Leaf Spring Axle
	04/04 →	Track Control Arm	SC-DL-8623	SC-DL-8623	Trailing Arm, Leaf Spring Axle, →* 2006231 SSS *; * 5117423 SNL *; * 9097199 SAN *; * 3564002 SLA *
	04/04 →	Track Control Arm	SC-DL-10302	SC-DL-10302	Trailing Arm, Air Suspension Axle
	04/04 →	Track Control Arm	SC-DL-10302	SC-DL-10302	Trailing Arm, Air Suspension Axle; 1st FA
	04/04 →	Track Control Arm	SC-TC-12361		Control Arm, 1st & 2nd Front Axle, for Pneumatic Suspension vehicles
	08/04 →	Track Control Arm	SC-TC-12361		Control Arm, 1st Front Axle, for Pneumatic Suspension vehicles
G 340, P 340, R 340	04/04 →	Centre Rod	SC-DL-5229		Push Rod
	04/04 →	Centre Rod	SC-DL-5354		Push Rod
	04/04 →	Centre Rod	SC-DL-8154		Push Rod
	04/04 →	Centre Rod	SC-DL-8169		Push Rod
	04/04 →	Centre Rod	SC-DL-8182		Push Rod
	04/04 →	Centre Rod	SC-DL-8399		Push Rod, Leaf Spring Axle
	04/04 →	Centre Rod	SC-DL-10225		for Steering Rod
	04/04 →	Centre Rod	SC-DL-12341		Push Rod
	04/04 →	Centre Rod	SC-DL-12342		for Steering Rod
	04/04 →	Centre Rod	SC-DL-12343		for Steering Rod
	04/04 →	Centre Rod	SC-DL-12413		for Steering Rod
	04/04 →	Suspension Arm Repair Kit		SC-RK-12366	for Control Arm
	04/04 →	Suspension Arm Repair Kit	SC-RK-12346	SC-RK-12346	for Control Arm
	04/04 →	Suspension Strut Repair Kit		MN-RK-8501	
	04/04 →	Suspension Strut Repair Kit		MN-RK-12436	
	04/04 →	Suspension Strut Repair Kit	DF-RK-9341		
	04/04 →	Tie Rod	SC-DL-7264		
	04/04 →	Tie Rod	SC-DL-7264		1st FA; 2nd FA
	04/04 →	Tie Rod	SC-DL-8137		Leaf Spring Axle
	04/04 →	Tie Rod	SC-DL-8137		Leaf Spring Axle; 1st FA; 2nd FA
	04/04 →	Tie Rod	SC-DL-9457		1st FA; 2nd FA; Leaf Spring Axle
	04/04 →	Tie Rod	SC-DL-9457		Leaf Spring Axle
	04/04 →	Tie Rod End	CV-ES-14162		for Steering Rod
	04/04 →	Tie Rod End	CV-ES-14163		for Steering Rod
	04/04 →	Tie Rod End	SC-ES-5764		
	04/04 →	Tie Rod End	SC-ES-8517		for Push Rod
	04/04 →	Tie Rod End	SC-ES-8535		for Guide Rod
	04/04 →	Track Control Arm		SC-DL-8511	Trailing Arm, Leaf Spring Axle
	04/04 →	Track Control Arm		SC-DL-8511	Trailing Arm, Leaf Spring Axle, →* 3512097 *
	04/04 →	Track Control Arm		SC-DL-8547	Trailing Arm, Leaf Spring Axle
	04/04 →	Track Control Arm		SC-DL-9462	Trailing Arm, Leaf Spring Axle, →* 2006231 SSS *; * 5117423 SNL *; * 9097199 SAN *; * 3564002 SLA *
	04/04 →	Track Control Arm		SC-DL-9466	Trailing Arm, Leaf Spring Axle
	04/04 →	Track Control Arm		SC-TC-12451	Trailing Arm, 1st Drive Axle, for Leaf-Spring Suspension vehicles
04/04 →	Track Control Arm		SC-TC-12451	Trailing Arm, 1st Drive Axle, for Leaf-Spring Suspension vehicles, 1280185/4471603 →	
04/04 →	Track Control Arm		SC-TC-12451	Trailing Arm, 1st Drive Axle, for Leaf-Spring Suspension vehicles, 9069961/3536016 →	

CV-ES-14162

Length: 125
Cone Ø: d1 Ø 30 / d2 Ø 27
Thread: M30 x 1,5 LHT
283783, 395009, 1358792, 1738380, 1 914 426, 2051165



CV-ES-14163

Length: 125
Cone Ø: d1 Ø 30 / d2 Ø 27
Thread: M30 x 1,5 RHT
283784, 395010, 1358793, 1488890, 1738381, 1767328, 1914427, 2051166



DF-RK-9341

Ø: 67
550807, 5508072



MN-RK-8501

Ø: 75 Hole Distance: 115
Thick/Height: 24
1515981



MN-RK-12436

Ø: 75 Hole Distance: 115
Thick/Height: 24
550799, 1517403, 1783020



SC-DL-5229

Length: 1053 Ø: 50
Cone Ø: d1 Ø 30 / d2 Ø 27
1356055, 1379071, 1384025, 1768898, 1847311, 1912757, 12201600A



SC-DL-5354

Length: 1060 Ø: 52
Cone Ø: d1 Ø 30 / d2 Ø 27
1384027, 1769597, 1847312, 1912758, 12200800A



SC-DL-7264

Length: 1743 Ø: 62
Cone Ø: d1 Ø 30 / d2 Ø 27
1361413, 1395614, 1734019, 1897333, 2040254, 2146105



SC-DL-8137

Length: 1736 Ø: 40
Cone Ø: d1 Ø 30 / d2 Ø 27
301639, 311847, 395350, 1358675, 1378435, 1397866, 1734020, 2028998, 12202900A



SC-DL-8154

Length: 495 Ø: 40
Cone Ø: d1 Ø 30 / d2 Ø 27
1343266, 1759690



SC-DL-8169

Length: 1920 Ø: 62
Cone Ø: d1 Ø 30 / d2 Ø 27
1343264, 1732635, 2007278



SC-DL-8179

Length: 568 Ø: 46
Hole Distance: 115 / 115
1399180, 1428347



SC-DL-8182

1343262, 1869413



SC-DL-8399

Length: 433 Ø: 40
Cone Ø: d1 Ø 30 / d2 Ø 26
1394884, 1938387



SC-DL-8509

Length: 568,5 Ø: 46
Hole Distance: 115 / 115
1485758, 1486757



SC-DL-8511

Length: 616,5 Ø: 50
Hole Distance: 115 / 115
1485760, 1499478, 1722750



SC-DL-8531

Length: 522 Ø: 46
Hole Distance: 115 / 115
1486758



SC-DL-8547

Length: 568 Ø: 50
Hole Distance: 115 / 115
1499474, 1722746, 1906940



SC-DL-8623

Length: 592 Ø: 50
Hole Distance: 115 / 115
1388436, 1499476, 1722748, 1906942



SC-DL-9457

Length: 1743 Ø: 52
Cone Ø: d1 Ø 30 / d2 Ø 27
1527989, 1723896, 1737684, 1897336



SC-DL-9462

Length: 568,5 Ø: 50
Hole Distance: 115 / 115
1499475, 1500573, 1722747, 1906941



SC-DL-9466

Length: 568 Ø: 19
1486756



SC-DL-10225

Length: 2179 Ø: 62
Cone Ø: d1 Ø 30 / d2 Ø 27
1386618, 1788522



SC-DL-10302

Length: 752 Ø: 48
Hole Distance: 115 / 115
1101843, 1379423, 1393298, 1431470, 1942075



SC-DL-12341

Length: 1776 Ø: 62
Cone Ø: d1 Ø 30 / d2 Ø 27
1386620



SC-DL-12342

Length: 601 Ø: 42
Cone Ø: d1 Ø 26 / d2 Ø 23,5
1343262, 1869413



SC-DL-12343

Length: 1062 Ø: 52
Cone Ø: d1 Ø 30 / d2 Ø 27
1348269, 2007275



SC-DL-12413

Length: 1950 Ø: 62
Cone Ø: d1 Ø 30 / d2 Ø 27
1393383, 1788520



SC-ES-5764

Length: 95
Cone Ø: d1 Ø 30 / d2 Ø 27
Thread: M26 x 1,5 RHT
325614, 1375228, 4604948



SC-ES-8517

Length: 140
Cone Ø: d1 Ø 30 / d2 Ø 27
Thread: M30 x 1,5 RHT
1358793, 1435746, 1488890, 1534756, 1914427, 2051166



SC-ES-8535

Length: 145
Cone Ø: d1 Ø 30 / d2 Ø 27
Thread: M30 x 1,5 RHT
1723897, 2051041



SC-RK-12346

Ø: 67 Hole Distance: 115
Thick/Height: 24
550800



SC-RK-12366

Ø: 75 Hole Distance: 115 / 115
Thick/Height: 24
1 722 753, 2 096 392



SC-TC-12361

Length: 705 Ø: 42
Cone Ø: d1 Ø 38
Hole Distance: 115
1353445, 1464611, 1942147



SC-TC-12451

Length: 552 Ø: 46
Hole Distance: 115 / 115
1494296



SC-TC-12452

Length: 580,5 Ø: 46
Hole Distance: 115 / 115
1485759



SC-TC-12472

Length: 580 Ø: 46
Hole Distance: 115 / 115
1399182



SC-VB-12418

Length: 613,2 Ø: 46
Hole Ø 25 / 19 / 19
Hole Distance: 152 / 115 / 115
1440028, 1722582





P,G,R,T - series ...

G 340, P 340, R 340 ...	04/04 →	Track Control Arm		SC-TC-12452	Control Arm
	04/04 →	Track Control Arm		SC-TC-12472	Trailing Arm, 2nd Drive Axle, for Leaf-Spring Suspension vehicles, →1280184/4471602
	04/04 →	Track Control Arm		SC-TC-12472	Trailing Arm, 2nd Drive Axle, for Leaf-Spring Suspension vehicles, →9069960/3536015
	04/04 →	Track Control Arm		SC-VB-12418	Control Arm
	04/04 →	Track Control Arm	SC-DL-8179	SC-DL-8179	Trailing Arm, Leaf Spring Axle
	04/04 →	Track Control Arm	SC-DL-8509	SC-DL-8509	Trailing Arm
	04/04 →	Track Control Arm	SC-DL-8509	SC-DL-8509	Trailing Arm, Leaf Spring Axle
	04/04 →	Track Control Arm	SC-DL-8531	SC-DL-8531	Trailing Arm, Leaf Spring Axle
	04/04 →	Track Control Arm	SC-DL-8623	SC-DL-8623	Trailing Arm, Leaf Spring Axle, →* 2006231 SSS *;* 5117423 SNL *; * 9097199 SAN *;* 3564002 SLA *
	04/04 →	Track Control Arm	SC-DL-10302	SC-DL-10302	Trailing Arm, Air Suspension Axle
	04/04 →	Track Control Arm	SC-DL-10302	SC-DL-10302	Trailing Arm, Air Suspension Axle;1st FA
	04/04 →	Track Control Arm	SC-TC-12361		Control Arm, 1st Front Axle, for Pneumatic Suspension vehicles
	G 340, R 340	08/06 →	Centre Rod	SC-DL-5229	
08/06 →		Centre Rod	SC-DL-5354		Push Rod
08/06 →		Centre Rod	SC-DL-12343		for Steering Rod
08/06 →		Suspension Arm Repair Kit		SC-RK-12366	for Control Arm
08/06 →		Suspension Strut Repair Kit		DF-RK-9341	
08/06 →		Tie Rod	SC-DL-7264		
08/06 →		Tie Rod	SC-DL-8137		Leaf Spring Axle
08/06 →		Tie Rod	SC-DL-9457		Leaf Spring Axle
08/06 →		Tie Rod End	CV-ES-14162		for Steering Rod
08/06 →		Tie Rod End	CV-ES-14163		for Steering Rod
08/06 →		Tie Rod End	SC-ES-8535		for Guide Rod
08/06 →		Track Control Arm		SC-VB-12418	Control Arm
08/06 →		Track Control Arm	SC-DL-10302	SC-DL-10302	Trailing Arm, Air Suspension Axle
08/06 →	Track Control Arm	SC-TC-12361		Control Arm, 1st Front Axle, for Pneumatic Suspension vehicles	
G 360, P 360	04/10 →	Centre Rod	SC-DL-10225		for Steering Rod
	04/10 →	Centre Rod	SC-DL-12341		Push Rod
	04/10 →	Centre Rod	SC-DL-12342		for Steering Rod
	04/10 →	Centre Rod	SC-DL-12343		for Steering Rod
	04/10 →	Centre Rod	SC-DL-12413		for Steering Rod
	04/10 →	Suspension Arm Repair Kit		SC-RK-12366	for Control Arm
	04/10 →	Suspension Arm Repair Kit	SC-RK-12346	SC-RK-12346	for Control Arm
	04/10 →	Tie Rod End	CV-ES-14162		for Steering Rod
	04/10 →	Tie Rod End	CV-ES-14163		for Steering Rod
	04/10 →	Tie Rod End	SC-ES-8535		for Guide Rod
	04/10 →	Track Control Arm		SC-TC-12452	Control Arm
	04/10 →	Track Control Arm		SC-VB-12418	Control Arm
	04/10 →	Track Control Arm	SC-DL-10302	SC-DL-10302	Trailing Arm, 1st Front Axle, for Pneumatic Suspension vehicles
04/10 →	Track Control Arm	SC-TC-12361		Control Arm, 1st Front Axle, for Pneumatic Suspension vehicles	
G 360, P 360, R 360	04/10 →	Centre Rod	SC-DL-5229		Push Rod
	04/10 →	Centre Rod	SC-DL-5354		Push Rod
	04/10 →	Centre Rod	SC-DL-12342		for Steering Rod
	04/10 →	Centre Rod	SC-DL-12343		for Steering Rod
	04/10 →	Centre Rod	SC-DL-12413		for Steering Rod
	04/10 →	Suspension Arm Repair Kit		SC-RK-12366	for Control Arm
	04/10 →	Suspension Arm Repair Kit	SC-RK-12346	SC-RK-12346	for Control Arm
	04/10 →	Suspension Strut Repair Kit		MN-RK-8501	
	04/10 →	Suspension Strut Repair Kit		MN-RK-12436	
	04/10 →	Suspension Strut Repair Kit	DF-RK-9341		
	04/10 →	Tie Rod	SC-DL-7264		
	04/10 →	Tie Rod	SC-DL-8137		Leaf Spring Axle
	04/10 →	Tie Rod	SC-DL-9457		Leaf Spring Axle
04/10 →	Tie Rod End	CV-ES-14162		for Steering Rod	
04/10 →	Tie Rod End	CV-ES-14163		for Steering Rod	

CV-ES-14162

Length: 125
Cone Ø: d1 Ø 30 / d2 Ø 27
Thread: M30 x 1,5 LHT
283784, 395009, 1358792, 1738380, 1 914 426, 2051165



CV-ES-14163

Length: 125
Cone Ø: d1 Ø 30 / d2 Ø 27
Thread: M30 x 1,5 RHT
283784, 395010, 1358793, 1488890, 1738381, 1767328, 1914427, 2051166



DF-RK-9341

Ø: 67
550807, 5508072



MN-RK-8501

Ø: 75 Hole Distance: 115
Thick/Height: 24
1515981



MN-RK-12436

Ø: 75 Hole Distance: 115
Thick/Height: 24
550799, 1517403, 1783020



SC-DL-5229

Length: 1053 Ø: 50
Cone Ø: d1 Ø 30 / d2 Ø 27
1356055, 1379071, 1384025, 1768898, 1847311, 1912757, 12201600A



SC-DL-5354

Length: 1060 Ø: 52
Cone Ø: d1 Ø 30 / d2 Ø 27
1384027, 1769597, 1847312, 1912758, 12200800A



SC-DL-7264

Length: 1743 Ø: 62
Cone Ø: d1 Ø 30 / d2 Ø 27
1361413, 1395614, 1734019, 1897333, 2040254, 2146105



SC-DL-8137

Length: 1736 Ø: 40
Cone Ø: d1 Ø 30 / d2 Ø 27
301639, 311847, 395350, 1358675, 1378435, 1397866, 1734020, 2028998, 12202900A



SC-DL-8179

Length: 568 Ø: 46
Hole Distance: 115 / 115
1399180, 1428347



SC-DL-8509

Length: 568,5 Ø: 46
Hole Distance: 115 / 115
1485758, 1486757



SC-DL-8531

Length: 522 Ø: 46
Hole Distance: 115 / 115
1486758



SC-DL-8623

Length: 592 Ø: 50
Hole Distance: 115 / 115
1388436, 1499476, 1722748, 1906942



SC-DL-9457

Length: 1743 Ø: 52
Cone Ø: d1 Ø 30 / d2 Ø 27
1527989, 1723896, 1737684, 1897336



SC-DL-10225

Length: 2179 Ø: 62
Cone Ø: d1 Ø 30 / d2 Ø 27
1386618, 1788522



SC-DL-10302

Length: 752 Ø: 48
Hole Distance: 115 / 115
1101843, 1379423, 1393298, 1431470, 1942075



SC-DL-12341

Length: 1776 Ø: 62
Cone Ø: d1 Ø 30 / d2 Ø 27
1386620



SC-DL-12342

Length: 601 Ø: 42
Cone Ø: d1 Ø 26 / d2 Ø 23,5
1343262, 1869413



SC-DL-12343

Length: 1062 Ø: 52
Cone Ø: d1 Ø 30 / d2 Ø 27
1348269, 2007275



SC-DL-12413

Length: 1950 Ø: 62
Cone Ø: d1 Ø 30 / d2 Ø 27
1393383, 1788520



SC-ES-8535

Length: 145
Cone Ø: d1 Ø 30 / d2 Ø 27
Thread: M30 x 1,5 RHT
1723897, 2051041



SC-RK-12346

Ø: 67 Hole Distance: 115
Thick/Height: 24
550800



SC-RK-12366

Ø: 75 Hole Distance: 115 / 115
Thick/Height: 24
1 722 753, 2 096 392



SC-TC-12361

Length: 705 Ø: 42
Cone Ø: d1 Ø 38
Hole Distance: 115
1353445, 1464611, 1942147



SC-TC-12452

Length: 580,5 Ø: 46
Hole Distance: 115 / 115
1485759



SC-TC-12472

Length: 580 Ø: 46
Hole Distance: 115 / 115
1399182



SC-VB-12418

Length: 613,2
Ø: 46
Hole Ø 25 / 19 / 19
Hole Distance: 152 / 115 / 115
1440028, 1722582





P,G,R,T - series ...

G 360, P 360, R 360 ...	04/10→	Tie Rod End	SC-ES-8535		for Guide Rod	
	04/10→	Track Control Arm		SC-TC-12452	Control Arm	
	04/10→	Track Control Arm		SC-VB-12418	Control Arm	
	04/10→	Track Control Arm	SC-DL-10302	SC-DL-10302	Trailing Arm, Air Suspension Axle	
	04/10→	Track Control Arm	SC-TC-12361		Control Arm, 1st Front Axle, for Pneumatic Suspension vehicles	
G 380, P 380	04/04→	Centre Rod	SC-DL-5229		Push Rod	
	04/04→	Centre Rod	SC-DL-5354		Push Rod	
	04/04→	Centre Rod	SC-DL-10225		for Steering Rod	
	04/04→	Centre Rod	SC-DL-12341		Push Rod	
	04/04→	Centre Rod	SC-DL-12342		for Steering Rod	
	04/04→	Centre Rod	SC-DL-12343		for Steering Rod	
	04/04→	Centre Rod	SC-DL-12413		for Steering Rod	
	04/04→	Suspension Arm Repair Kit		SC-RK-12366	for Control Arm	
	04/04→	Suspension Arm Repair Kit	SC-RK-12346	SC-RK-12346	for Control Arm	
	04/04→	Suspension Strut Repair Kit		MN-RK-8501		
	04/04→	Suspension Strut Repair Kit		MN-RK-12436		
	04/04→	Suspension Strut Repair Kit	DF-RK-9341			
	04/04→	Tie Rod	SC-DL-7264			
	04/04→	Tie Rod	SC-DL-8137		Leaf Spring Axle	
	04/04→	Tie Rod	SC-DL-9457		Leaf Spring Axle	
	04/04→	Tie Rod End	CV-ES-14162		for Steering Rod	
	04/04→	Tie Rod End	CV-ES-14163		for Steering Rod	
	04/04→	Tie Rod End	SC-ES-8535		for Guide Rod	
	04/04→	Track Control Arm		SC-DL-8511	Trailing Arm, Leaf Spring Axle	
	04/04→	Track Control Arm		SC-DL-8511	Trailing Arm, Leaf Spring Axle, →* 3512097 *	
	04/04→	Track Control Arm		SC-DL-8547	Trailing Arm, Leaf Spring Axle	
	04/04→	Track Control Arm		SC-DL-9462	Trailing Arm, Leaf Spring Axle, →* 2006231 SSS *; * 5117423 SNL *; * 9097199 SAN **; 3564002 SLA *	
	04/04→	Track Control Arm		SC-DL-9466	Trailing Arm, Leaf Spring Axle	
	04/04→	Track Control Arm		SC-TC-12451	Trailing Arm, 1st Drive Axle, for Leaf-Spring Suspension vehicles	
	04/04→	Track Control Arm		SC-TC-12451	Trailing Arm, 1st Drive Axle, for Leaf-Spring Suspension vehicles, 1280185/4471603→	
	04/04→	Track Control Arm		SC-TC-12451	Trailing Arm, 1st Drive Axle, for Leaf-Spring Suspension vehicles, 9069961/3536016→	
	04/04→	Track Control Arm		SC-TC-12452	Control Arm	
	04/04→	Track Control Arm		SC-TC-12472	Trailing Arm, 2nd Drive Axle, for Leaf-Spring Suspension vehicles, →1280184/4471602	
	04/04→	Track Control Arm		SC-TC-12472	Trailing Arm, 2nd Drive Axle, for Leaf-Spring Suspension vehicles, →9069960/3536015	
	04/04→	Track Control Arm		SC-VB-12418	Control Arm	
	04/04→	Track Control Arm	SC-DL-8179	SC-DL-8179	Trailing Arm, Leaf Spring Axle	
	04/04→	Track Control Arm	SC-DL-8509	SC-DL-8509	Trailing Arm	
	04/04→	Track Control Arm	SC-DL-8509	SC-DL-8509	Trailing Arm, Leaf Spring Axle	
	04/04→	Track Control Arm	SC-DL-8531	SC-DL-8531	Trailing Arm, Leaf Spring Axle	
	04/04→	Track Control Arm	SC-DL-8623	SC-DL-8623	Trailing Arm, Leaf Spring Axle, →* 2006231 SSS *; * 5117423 SNL *; * 9097199 SAN **; 3564002 SLA *	
	04/04→	Track Control Arm	SC-DL-10302	SC-DL-10302	Trailing Arm, Air Suspension Axle	
	04/04→	Track Control Arm	SC-TC-12361		Control Arm, 1st Front Axle, for Pneumatic Suspension vehicles	
	G 380, P 380, R 380	04/04→	Centre Rod	SC-DL-5229		Push Rod
		04/04→	Centre Rod	SC-DL-5354		Push Rod
		04/04→	Centre Rod	SC-DL-8154		Push Rod
04/04→		Centre Rod	SC-DL-8169		Push Rod	
04/04→		Centre Rod	SC-DL-8182		Push Rod	
04/04→		Centre Rod	SC-DL-8399		Push Rod, Leaf Spring Axle	
04/04→		Centre Rod	SC-DL-10225		for Steering Rod	
04/04→		Centre Rod	SC-DL-12341		Push Rod	
04/04→		Centre Rod	SC-DL-12342		for Steering Rod	
04/04→		Centre Rod	SC-DL-12343		for Steering Rod	

CV-ES-14162

Length: 125
Cone Ø: d1 Ø 30 / d2 Ø 27
Thread: M30 x 1,5 LHT
283783, 395009, 1358792, 1738380, 1 914 426, 2051165



CV-ES-14163

Length: 125
Cone Ø: d1 Ø 30 / d2 Ø 27
Thread: M30 x 1,5 RHT
283784, 395010, 1358793, 1488890, 1738381, 1767328, 1914427, 2051166



DF-RK-9341

Ø: 67
550807, 5508072



MN-RK-8501

Ø: 75 Hole Distance: 115
Thick/Height: 24
1515981



MN-RK-12436

Ø: 75 Hole Distance: 115
Thick/Height: 24
550799, 1517403, 1783020



SC-DL-5229

Length: 1053 Ø: 50
Cone Ø: d1 Ø 30 / d2 Ø 27
1356055, 1379071, 1384025, 1768898, 1847311, 1912757, 12201600A



SC-DL-5354

Length: 1060 Ø: 52
Cone Ø: d1 Ø 30 / d2 Ø 27
1384027, 1769597, 1847312, 1912758, 12200800A



SC-DL-7264

Length: 1743 Ø: 62
Cone Ø: d1 Ø 30 / d2 Ø 27
1361413, 1395614, 1734019, 1897333, 2040254, 2146105



SC-DL-8137

Length: 1736 Ø: 40
Cone Ø: d1 Ø 30 / d2 Ø 27
301639, 311847, 395350, 1358675, 1378435, 1397866, 1734020, 2028998, 12202900A



SC-DL-8154

Length: 495 Ø: 40
Cone Ø: d1 Ø 30 / d2 Ø 27
1343266, 1759690



SC-DL-8169

Length: 1920 Ø: 62
Cone Ø: d1 Ø 30 / d2 Ø 27
1343264, 1732635, 2007278



SC-DL-8179

Length: 568 Ø: 46
Hole Distance: 115 / 115
1399180, 1428347



SC-DL-8182

Length: 568 Ø: 46
Hole Distance: 115 / 115
1343262, 1869413



SC-DL-8399

Length: 433 Ø: 40
Cone Ø: d1 Ø 30 / d2 Ø 26
1394884, 1938387



SC-DL-8509

Length: 568,5 Ø: 46
Hole Distance: 115 / 115
1485758, 1486757



SC-DL-8511

Length: 616,5 Ø: 50
Hole Distance: 115 / 115
1485760, 1499478, 1722750



SC-DL-8531

Length: 522 Ø: 46
Hole Distance: 115 / 115
1486758



SC-DL-8547

Length: 568 Ø: 50
Hole Distance: 115 / 115
1499474, 1722746, 1906940



SC-DL-8623

Length: 592 Ø: 50
Hole Distance: 115 / 115
1388436, 1499476, 1722748, 1906942



SC-DL-9457

Length: 1743 Ø: 52
Cone Ø: d1 Ø 30 / d2 Ø 27
1527989, 1723896, 1737684, 1897336



SC-DL-9462

Length: 568,5 Ø: 50
Hole Distance: 115 / 115
1499475, 1500573, 1722747, 1906941



SC-DL-9466

Length: 568 Ø: 19
1486756



SC-DL-10225

Length: 2179 Ø: 62
Cone Ø: d1 Ø 30 / d2 Ø 27
1386618, 1788522



SC-DL-10302

Length: 752 Ø: 48
Hole Distance: 115 / 115
1101843, 1379423, 1393298, 1431470, 1942075



SC-DL-12341

Length: 1776 Ø: 62
Cone Ø: d1 Ø 30 / d2 Ø 27
1386620



SC-DL-12342

Length: 601 Ø: 42
Cone Ø: d1 Ø 26 / d2 Ø 23,5
1343262, 1869413



SC-DL-12343

Length: 1062 Ø: 52
Cone Ø: d1 Ø 30 / d2 Ø 27
1348269, 2007275



SC-DL-12413

Length: 1950 Ø: 62
Cone Ø: d1 Ø 30 / d2 Ø 27
1393383, 1788520



SC-ES-8535

Length: 145
Cone Ø: d1 Ø 30 / d2 Ø 27
Thread: M30 x 1,5 RHT
1723897, 2051041



SC-RK-12346

Ø: 67 Hole Distance: 115
Thick/Height: 24
550800



SC-RK-12366

Ø: 75 Hole Distance: 115 / 115
Thick/Height: 24
1 722 753, 2 096 392



SC-TC-12361

Length: 705 Ø: 42
Cone Ø: d1 Ø 38
Hole Distance: 115
1353445, 1464611, 1942147



SC-TC-12451

Length: 552 Ø: 46
Hole Distance: 115 / 115
1494296



SC-TC-12452

Length: 580,5 Ø: 46
Hole Distance: 115 / 115
1485759



SC-TC-12472

Length: 580 Ø: 46
Hole Distance: 115 / 115
1399182



SC-VB-12418

Length: 613,2
Ø: 46
Hole Ø 25 / 19 / 19
Hole Distance: 152 / 115 / 115
1440028, 1722582





P,G,R,T - series ...

G 380, P 380, R 380 ...

04/04 →	Centre Rod	SC-DL-12413		for Steering Rod
04/04 →	Suspension Arm Repair Kit		SC-RK-12366	for Control Arm
04/04 →	Suspension Arm Repair Kit	SC-RK-12346	SC-RK-12346	for Control Arm
04/04 →	Suspension Strut Repair Kit		MN-RK-8501	
04/04 →	Suspension Strut Repair Kit		MN-RK-12436	
04/04 →	Suspension Strut Repair Kit	DF-RK-9341		
04/04 →	Tie Rod	SC-DL-7264		
04/04 →	Tie Rod	SC-DL-7264		1st FA;2nd FA
04/04 →	Tie Rod	SC-DL-8137		Leaf Spring Axle
04/04 →	Tie Rod	SC-DL-8137		Leaf Spring Axle;1st FA;2nd FA
04/04 →	Tie Rod	SC-DL-9457		1st FA;2nd FA;Leaf Spring Axle
04/04 →	Tie Rod	SC-DL-9457		Leaf Spring Axle
04/04 →	Tie Rod End	CV-ES-14162		for Steering Rod
04/04 →	Tie Rod End	CV-ES-14163		for Steering Rod
04/04 →	Tie Rod End	SC-ES-5764		
04/04 →	Tie Rod End	SC-ES-8517		for Push Rod
04/04 →	Tie Rod End	SC-ES-8535		for Guide Rod
04/04 →	Track Control Arm		SC-DL-8511	Trailing Arm, Leaf Spring Axle
04/04 →	Track Control Arm		SC-DL-8511	Trailing Arm, Leaf Spring Axle, →* 3512097 *
04/04 →	Track Control Arm		SC-DL-8547	Trailing Arm, Leaf Spring Axle
04/04 →	Track Control Arm		SC-DL-9462	Trailing Arm, Leaf Spring Axle, →* 2006231 SSS *;* 5117423 SNL *; * 9097199 SAN *;* 3564002 SLA *
04/04 →	Track Control Arm		SC-DL-9466	Trailing Arm, Leaf Spring Axle
04/04 →	Track Control Arm		SC-TC-12451	Trailing Arm, 1st Drive Axle, for Leaf-Spring Suspension vehicles
04/04 →	Track Control Arm		SC-TC-12451	Trailing Arm, 1st Drive Axle, for Leaf-Spring Suspension vehicles, 1280185/4471603 →
04/04 →	Track Control Arm		SC-TC-12451	Trailing Arm, 1st Drive Axle, for Leaf-Spring Suspension vehicles, 9069961/3536016 →
04/04 →	Track Control Arm		SC-TC-12452	Control Arm
04/04 →	Track Control Arm		SC-TC-12472	Trailing Arm, 2nd Drive Axle, for Leaf-Spring Suspension vehicles, →1280184/4471602
04/04 →	Track Control Arm		SC-TC-12472	Trailing Arm, 2nd Drive Axle, for Leaf-Spring Suspension vehicles, →9069960/3536015
04/04 →	Track Control Arm		SC-VB-12418	Control Arm
04/04 →	Track Control Arm	SC-DL-8179	SC-DL-8179	Trailing Arm, Leaf Spring Axle
04/04 →	Track Control Arm	SC-DL-8509	SC-DL-8509	Trailing Arm
04/04 →	Track Control Arm	SC-DL-8509	SC-DL-8509	Trailing Arm, Leaf Spring Axle
04/04 →	Track Control Arm	SC-DL-8531	SC-DL-8531	Trailing Arm, Leaf Spring Axle
04/04 →	Track Control Arm	SC-DL-8623	SC-DL-8623	Trailing Arm, Leaf Spring Axle, →* 2006231 SSS *;* 5117423 SNL *; * 9097199 SAN *;* 3564002 SLA *
04/04 →	Track Control Arm	SC-DL-10302	SC-DL-10302	Trailing Arm, Air Suspension Axle
04/04 →	Track Control Arm	SC-DL-10302	SC-DL-10302	Trailing Arm, Air Suspension Axle;1st FA
04/04 →	Track Control Arm	SC-TC-12361		Control Arm, 1st Front Axle, for Pneumatic Suspension vehicles
09/05 →	Tie Rod End	CV-ES-14162	CV-ES-14162	for Steering Rod
09/05 →	Tie Rod End	IV-ES-12272		for Steering Rod
09/05 →	Track Control Arm	SC-TC-12361		Control Arm, 1st & 2nd Front Axle, for Pneumatic Suspension vehicles

G 400, P 400, R 400

03/08 →	Centre Rod	SC-DL-5229		Push Rod
03/08 →	Centre Rod	SC-DL-5354		Push Rod
03/08 →	Centre Rod	SC-DL-12341		Push Rod
03/08 →	Centre Rod	SC-DL-12342		for Steering Rod
03/08 →	Centre Rod	SC-DL-12343		for Steering Rod
03/08 →	Suspension Arm Repair Kit		SC-RK-12366	for Control Arm
03/08 →	Suspension Arm Repair Kit	SC-RK-12346	SC-RK-12346	for Control Arm
03/08 →	Suspension Strut Repair Kit		MN-RK-8501	
03/08 →	Suspension Strut Repair Kit		MN-RK-12436	
03/08 →	Suspension Strut Repair Kit	DF-RK-9341		
03/08 →	Tie Rod	SC-DL-7264		
03/08 →	Tie Rod	SC-DL-8137		Leaf Spring Axle

CV-ES-14162

Length: 125
Cone Ø: d1 Ø 30 / d2 Ø 27
Thread: M30 x 1,5 LHT
283783, 395009, 1358792, 1738380, 1 914 426, 2051165



CV-ES-14163

Length: 125
Cone Ø: d1 Ø 30 / d2 Ø 27
Thread: M30 x 1,5 RHT
283784, 395010, 1358793, 1488890, 1738381, 1767328, 1914427, 2051166



DF-RK-9341

Ø: 67
550807, 5508072



IV-ES-12272

Length: 75
Cone Ø: d1 Ø 30 / d2 Ø 27
Thread: M26 x 1,5 RHT
1394443



MN-RK-8501

Ø: 75 Hole Distance: 115
Thick/Height: 24
1515981



MN-RK-12436

Ø: 75 Hole Distance: 115
Thick/Height: 24
550799, 1517403, 1783020



SC-DL-5229

Length: 1053 Ø: 50
Cone Ø: d1 Ø 30 / d2 Ø 27
1356055, 1379071, 1384025, 1768898, 1847311, 1912757, 12201600A



SC-DL-5354

Length: 1060 Ø: 52
Cone Ø: d1 Ø 30 / d2 Ø 27
1384027, 1769597, 1847312, 1912758, 12200800A



SC-DL-7264

Length: 1743 Ø: 62
Cone Ø: d1 Ø 30 / d2 Ø 27
1361413, 1395614, 1734019, 1897333, 2040254, 2146105



SC-DL-8137

Length: 1736 Ø: 40
Cone Ø: d1 Ø 30 / d2 Ø 27
301639, 311847, 395350, 1358675, 1378435, 1397866, 1734020, 2028998, 12202900A



SC-DL-8179

Length: 568 Ø: 46
Hole Distance: 115 / 115
1399180, 1428347



SC-DL-8509

Length: 568,5 Ø: 46
Hole Distance: 115 / 115
1485758, 1486757



SC-DL-8511

Length: 616,5 Ø: 50
Hole Distance: 115 / 115
1485760, 1499478, 1722750



SC-DL-8531

Length: 522 Ø: 46
Hole Distance: 115 / 115
1486758



SC-DL-8547

Length: 568 Ø: 50
Hole Distance: 115 / 115
1499474, 1722746, 1906940



SC-DL-8623

Length: 592 Ø: 50
Hole Distance: 115 / 115
1388436, 1499476, 1722748, 1906942



SC-DL-9457

Length: 1743 Ø: 52
Cone Ø: d1 Ø 30 / d2 Ø 27
1527989, 1723896, 1737684, 1897336



SC-DL-9462

Length: 568,5 Ø: 50
Hole Distance: 115 / 115
1499475, 1500573, 1722747, 1906941



SC-DL-9466

Length: 568 Ø: 19
1486756



SC-DL-10302

Length: 752 Ø: 48
Hole Distance: 115 / 115
1101843, 1379423, 1393298, 1431470, 1942075



SC-DL-12341

Length: 1776 Ø: 62
Cone Ø: d1 Ø 30 / d2 Ø 27
1386620



SC-DL-12342

Length: 601 Ø: 42
Cone Ø: d1 Ø 26 / d2 Ø 23,5
1343262, 1869413



SC-DL-12343

Length: 1062 Ø: 52
Cone Ø: d1 Ø 30 / d2 Ø 27
1348269, 2007275



SC-DL-12413

Length: 1950 Ø: 62
Cone Ø: d1 Ø 30 / d2 Ø 27
1393383, 1788520



SC-ES-5764

Length: 95
Cone Ø: d1 Ø 30 / d2 Ø 27
Thread: M26 x 1,5 RHT
325614, 1375228, 4604948



SC-ES-8517

Length: 140
Cone Ø: d1 Ø 30 / d2 Ø 27
Thread: M30 x 1,5 RHT
1358793, 1435746, 1488890, 1534756, 1914427, 2051166



SC-ES-8535

Length: 145
Cone Ø: d1 Ø 30 / d2 Ø 27
Thread: M30 x 1,5 RHT
1723897, 2051041



SC-RK-12346

Ø: 67 Hole Distance: 115
Thick/Height: 24
550800



SC-RK-12366

Ø: 75 Hole Distance: 115 / 115
Thick/Height: 24
1 722 753, 2 096 392



SC-TC-12361

Length: 705 Ø: 42
Cone Ø: d1 Ø 38
Hole Distance: 115
1353445, 1464611, 1942147



SC-TC-12451

Length: 552 Ø: 46
Hole Distance: 115 / 115
1494296



SC-TC-12452

Length: 580,5 Ø: 46
Hole Distance: 115 / 115
1485759



SC-TC-12472

Length: 580 Ø: 46
Hole Distance: 115 / 115
1399182



SC-VB-12418

Length: 613,2
Ø: 46
Hole Ø 25 / 19 / 19
Hole Distance: 152 / 115 / 115
1440028, 1722582



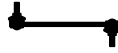

P,G,R,T - series ...

G 400, P 400, R 400 ...

03/08→	Tie Rod	SC-DL-9457		Leaf Spring Axle
03/08→	Tie Rod End	CV-ES-14162		for Steering Rod
03/08→	Tie Rod End	CV-ES-14163		for Steering Rod
03/08→	Tie Rod End	SC-ES-8535		for Guide Rod
03/08→	Track Control Arm		SC-TC-12452	Control Arm
03/08→	Track Control Arm		SC-VB-12418	Control Arm
03/08→	Track Control Arm	SC-DL-10302	SC-DL-10302	Trailing Arm, Air Suspension Axle
03/08→	Track Control Arm	SC-TC-12361		Control Arm, 1st Front Axle, for Pneumatic Suspension vehicles
07/09→	Centre Rod	SC-DL-8154		Push Rod
07/09→	Centre Rod	SC-DL-8169		Push Rod
07/09→	Centre Rod	SC-DL-8182		Push Rod
07/09→	Centre Rod	SC-DL-8399		Push Rod, Leaf Spring Axle
07/09→	Tie Rod	SC-DL-7264		1st FA;2nd FA
07/09→	Tie Rod	SC-DL-8137		Leaf Spring Axle;1st FA;2nd FA
07/09→	Tie Rod	SC-DL-9457		1st FA;2nd FA;Leaf Spring Axle
07/09→	Tie Rod End	SC-ES-5764		
07/09→	Tie Rod End	SC-ES-8517		for Push Rod
07/09→	Track Control Arm		SC-DL-8511	Trailing Arm, Leaf Spring Axle
07/09→	Track Control Arm		SC-DL-8511	Trailing Arm, Leaf Spring Axle, →* 3512097 *
07/09→	Track Control Arm		SC-DL-8547	Trailing Arm, Leaf Spring Axle
07/09→	Track Control Arm		SC-DL-9462	Trailing Arm, Leaf Spring Axle, →* 2006231 SSS *; * 5117423 SNL *; * 9097199 SAN **; 3564002 SLA *
07/09→	Track Control Arm		SC-DL-9466	Trailing Arm, Leaf Spring Axle
07/09→	Track Control Arm		SC-TC-12451	Trailing Arm, 1st Drive Axle, for Leaf-Spring Suspension vehicles
07/09→	Track Control Arm		SC-TC-12451	Trailing Arm, 1st Drive Axle, for Leaf-Spring Suspension vehicles, 1280185/4471603→
07/09→	Track Control Arm		SC-TC-12451	Trailing Arm, 1st Drive Axle, for Leaf-Spring Suspension vehicles, 9069961/3536016→
07/09→	Track Control Arm		SC-TC-12472	Trailing Arm, 2nd Drive Axle, for Leaf-Spring Suspension vehicles, →1280184/4471602
07/09→	Track Control Arm		SC-TC-12472	Trailing Arm, 2nd Drive Axle, for Leaf-Spring Suspension vehicles, →9069960/3536015
07/09→	Track Control Arm	SC-DL-8179	SC-DL-8179	Trailing Arm, Leaf Spring Axle
07/09→	Track Control Arm	SC-DL-8509	SC-DL-8509	Trailing Arm
07/09→	Track Control Arm	SC-DL-8509	SC-DL-8509	Trailing Arm, Leaf Spring Axle
07/09→	Track Control Arm	SC-DL-8531	SC-DL-8531	Trailing Arm, Leaf Spring Axle
07/09→	Track Control Arm	SC-DL-8623	SC-DL-8623	Trailing Arm, Leaf Spring Axle, →* 2006231 SSS *; * 5117423 SNL *; * 9097199 SAN **; 3564002 SLA *
07/09→	Track Control Arm	SC-DL-10302	SC-DL-10302	Trailing Arm, Air Suspension Axle;1st FA
04/10→	Centre Rod	SC-DL-5354	SC-DL-5354	Push Rod, for vehicles with Hinged Trailing Axle
04/10→	Centre Rod	SC-DL-8399		Push Rod, for vehicles with Hinged Leading Axle, for vehicles with Part-Pneumatic Suspension
04/10→	Centre Rod	SC-DL-8553	SC-DL-8553	Push Rod, for vehicles with Hinged Leading Axle
04/10→	Centre Rod	SC-DL-12449		Push Rod
04/10→	Tie Rod		SC-DL-7264	Leading Axle;for vehicles with Hinged Leading Axle
04/10→	Tie Rod		SC-DL-7264	Leading Axle;for vehicles with Hinged Leading Axle;Air Suspension Axle
04/10→	Tie Rod		SC-DL-7264	Tag Axle;for vehicles with Hinged Trailing Axle
04/10→	Tie Rod		SC-DL-8137	Leading Axle;for vehicles with Hinged Leading Axle
04/10→	Tie Rod		SC-DL-8137	Tag Axle;for vehicles with Hinged Trailing Axle
04/10→	Tie Rod End		MN-ES-8490	Tag Axle;for vehicles with Hinged Trailing Axle
04/10→	Tie Rod End	CV-ES-14162	CV-ES-14162	for Steering Rod
04/10→	Tie Rod End	IV-ES-12272		for Steering Rod
04/10→	Tie Rod End	MN-ES-8490	MN-ES-8490	for vehicles with Hinged Trailing Axle

CV-ES-14162

Length: 125
Cone Ø: d1 Ø 30 / d2 Ø 27
Thread: M30 x 1,5 LHT
283783, 395009, 1358792, 1738380, 1 914 426, 2051165



CV-ES-14163

Length: 125
Cone Ø: d1 Ø 30 / d2 Ø 27
Thread: M30 x 1,5 RHT
283784, 395010, 1358793, 1488890, 1738381, 1767328, 1914427, 2051166



IV-ES-12272

Length: 75
Cone Ø: d1 Ø 30 / d2 Ø 27
Thread: M26 x 1,5 RHT
1394443



MN-ES-8490

Length: 90
Cone Ø: d1 Ø 30 / d2 Ø 27
Thread: M26 x 1,5 RHT
1394444, 0014606948, 14606948



SC-DL-5354

Length: 1060 Ø: 52
Cone Ø: d1 Ø 30 / d2 Ø 27
1384027, 1769597, 1847312, 1912758, 12200800A



SC-DL-7264

Length: 1743 Ø: 62
Cone Ø: d1 Ø 30 / d2 Ø 27
1361413, 1395614, 1734019, 1897333, 2040254, 2146105



SC-DL-8137

Length: 1736 Ø: 40
Cone Ø: d1 Ø 30 / d2 Ø 27
301639, 311847, 395350, 1358675, 1378435, 1397866, 1734020, 2028998, 12202900A



SC-DL-8154

Length: 495 Ø: 40
Cone Ø: d1 Ø 30 / d2 Ø 27
1343266, 1759690



SC-DL-8169

Length: 1920 Ø: 62
Cone Ø: d1 Ø 30 / d2 Ø 27
1343264, 1732635, 2007278



SC-DL-8179

Length: 568 Ø: 46
Hole Distance: 115 / 115
1399180, 1428347



SC-DL-8182

1343262, 1869413



SC-DL-8399

Length: 433 Ø: 40
Cone Ø: d1 Ø 30 / d2 Ø 26
1394884, 1938387



SC-DL-8509

Length: 568,5 Ø: 46
Hole Distance: 115 / 115
1485758, 1486757



SC-DL-8511

Length: 616,5 Ø: 50
Hole Distance: 115 / 115
1485760, 1499478, 1722750



SC-DL-8531

Length: 522 Ø: 46
Hole Distance: 115 / 115
1486758



SC-DL-8547

Length: 568 Ø: 50
Hole Distance: 115 / 115
1499474, 1722746, 1906940



SC-DL-8553

Length: 435 Ø: 38
Cone Ø: d1 Ø 30 / d2 Ø 27
1343283, 1759691



SC-DL-8623

Length: 592 Ø: 50
Hole Distance: 115 / 115
1388436, 1499476, 1722748, 1906942



SC-DL-9457

Length: 1743 Ø: 52
Cone Ø: d1 Ø 30 / d2 Ø 27
1527989, 1723896, 1737684, 1897336



SC-DL-9462

Length: 568,5 Ø: 50
Hole Distance: 115 / 115
1499475, 1500573, 1722747, 1906941



SC-DL-9466

Length: 568 Ø: 19
1486756



SC-DL-10302

Length: 752 Ø: 48
Hole Distance: 115 / 115
1101843, 1379423, 1393298, 1431470, 1942075



SC-DL-12449

Length: 1206 Ø: 38
Cone Ø: d1 Ø 30 / d2 Ø 27
1385763, 1765375



SC-ES-5764

Length: 95
Cone Ø: d1 Ø 30 / d2 Ø 27
Thread: M26 x 1,5 RHT
325614, 1375228, 4604948



SC-ES-8517

Length: 140
Cone Ø: d1 Ø 30 / d2 Ø 27
Thread: M30 x 1,5 RHT
1358793, 1435746, 1488890, 1534756, 1914427, 2051166



SC-ES-8535

Length: 145
Cone Ø: d1 Ø 30 / d2 Ø 27
Thread: M30 x 1,5 RHT
1723897, 2051041



SC-TC-12361

Length: 705 Ø: 42
Cone Ø: d1 Ø 38
Hole Distance: 115
1353445, 1464611, 1942147



SC-TC-12451

Length: 552 Ø: 46
Hole Distance: 115 / 115
1494296



SC-TC-12452

Length: 580,5 Ø: 46
Hole Distance: 115 / 115
1485759



SC-TC-12472

Length: 580 Ø: 46
Hole Distance: 115 / 115
1399182



SC-VB-12418

Length: 613,2
Ø: 46
Hole Ø 25 / 19 / 19
Hole Distance: 152 / 115 / 115
1440028, 1722582





P,G,R,T - series ...

G 400, R 400

03/08→	Centre Rod	SC-DL-5229		Push Rod
03/08→	Centre Rod	SC-DL-5354		Push Rod
03/08→	Centre Rod	SC-DL-12342		for Steering Rod
03/08→	Centre Rod	SC-DL-12343		for Steering Rod
03/08→	Suspension Arm Repair Kit		SC-RK-12366	for Control Arm
03/08→	Suspension Strut Repair Kit		DF-RK-9341	
03/08→	Tie Rod	SC-DL-7264		
03/08→	Tie Rod	SC-DL-8137		Leaf Spring Axle
03/08→	Tie Rod	SC-DL-9457		Leaf Spring Axle
03/08→	Tie Rod End	CV-ES-14162		for Steering Rod
03/08→	Tie Rod End	CV-ES-14163		for Steering Rod
03/08→	Tie Rod End	SC-ES-8535		for Guide Rod
03/08→	Track Control Arm		SC-VB-12418	Control Arm
03/08→	Track Control Arm	SC-DL-10302	SC-DL-10302	Trailing Arm, Air Suspension Axle
03/08→	Track Control Arm	SC-TC-12361		Control Arm, 1st Front Axle, for Pneumatic Suspension vehicles
03/09→	Track Control Arm		SC-TC-12452	Control Arm
01/10→	Centre Rod	SC-DL-12449		Push Rod
01/10→	Suspension Arm Repair Kit	MN-RK-7280	MN-RK-7280	for Drag Link;for Semi-Trailing Arm; for Wishbone (CV)
01/10→	Suspension Strut Repair Kit		MN-RK-8501	
01/10→	Tie Rod End	CV-ES-14162	CV-ES-14162	for Steering Rod
01/10→	Tie Rod End	SC-ES-8517		for Push Rod
01/10→	Track Control Arm		SC-DL-8179	Trailing Arm, 1st & 2nd Drive Axle, for Leaf-Spring Suspension vehicles
01/10→	Track Control Arm		SC-DL-8179	Trailing Arm, 1st & 2nd Drive Axle, for Leaf-Spring Suspension vehicles, Ch.3512097→
01/10→	Track Control Arm		SC-DL-8179	Trailing Arm, 1st Drive Axle, for Leaf-Spring Suspension vehicles, →1280184/4471602
01/10→	Track Control Arm		SC-DL-8179	Trailing Arm, 1st Drive Axle, for Leaf-Spring Suspension vehicles, →9069960/3536015
01/10→	Track Control Arm		SC-DL-8509	Trailing Arm, 1st & 2nd Drive Axle, for Leaf-Spring Suspension vehicles
01/10→	Track Control Arm		SC-DL-8511	Trailing Arm, 1st & 2nd Drive Axle, for Leaf-Spring Suspension vehicles
01/10→	Track Control Arm		SC-DL-8531	Trailing Arm, 1st & 2nd Drive Axle, for Leaf-Spring Suspension vehicles
01/10→	Track Control Arm		SC-DL-8547	Trailing Arm, 1st & 2nd Drive Axle, for Leaf-Spring Suspension vehicles
01/10→	Track Control Arm		SC-DL-8623	Trailing Arm, 1st Drive Axle, for Leaf-Spring Suspension vehicles, →2006231/5117423
01/10→	Track Control Arm		SC-DL-8623	Trailing Arm, 1st Drive Axle, for Leaf-Spring Suspension vehicles, →9097199/3564002
01/10→	Track Control Arm		SC-DL-9462	Trailing Arm, 2nd Drive Axle, for Leaf-Spring Suspension vehicles, →2006231/5117423
01/10→	Track Control Arm		SC-DL-9462	Trailing Arm, 2nd Drive Axle, for Leaf-Spring Suspension vehicles, →9097199/3564002
01/10→	Track Control Arm		SC-DL-9466	Trailing Arm, 1st & 2nd Drive Axle, for Leaf-Spring Suspension vehicles
01/10→	Track Control Arm		SC-TC-12451	Trailing Arm, 1st Drive Axle, for Leaf-Spring Suspension vehicles
01/10→	Track Control Arm		SC-TC-12451	Trailing Arm, 1st Drive Axle, for Leaf-Spring Suspension vehicles, 1280185/4471603→
01/10→	Track Control Arm		SC-TC-12451	Trailing Arm, 1st Drive Axle, for Leaf-Spring Suspension vehicles, 9069961/3536016→
01/10→	Track Control Arm		SC-TC-12472	Trailing Arm, 2nd Drive Axle, for Leaf-Spring Suspension vehicles, →1280184/4471602
01/10→	Track Control Arm		SC-TC-12472	Trailing Arm, 2nd Drive Axle, for Leaf-Spring Suspension vehicles, →9069960/3536015
01/10→	Track Control Arm	SC-DL-10302	SC-DL-10302	Trailing Arm, 1st Front Axle, for Pneumatic Suspension vehicles

CV-ES-14162

Length: 125
Cone Ø: d1 Ø 30 / d2 Ø 27
Thread: M30 x 1,5 LHT
283783, 395009, 1358792, 1738380, 1 914 426, 2051165



CV-ES-14163

Length: 125
Cone Ø: d1 Ø 30 / d2 Ø 27
Thread: M30 x 1,5 RHT
283784, 395010, 1358793, 1488890, 1738381, 1767328, 1914427, 2051166



DF-RK-9341

Ø: 67
550807, 5508072



MN-RK-7280

Ø: 75 Hole Distance: 115
Thick/Height: 24
0550806, 550806, 0639370, 639370, 689748, 1104334



MN-RK-8501

Ø: 75 Hole Distance: 115
Thick/Height: 24
1515981



SC-DL-5229

Length: 1053 Ø: 50
Cone Ø: d1 Ø 30 / d2 Ø 27
1356055, 1379071, 1384025, 1768898, 1847311, 1912757, 12201600A



SC-DL-5354

Length: 1060 Ø: 52
Cone Ø: d1 Ø 30 / d2 Ø 27
1384027, 1769597, 1847312, 1912758, 12200800A



SC-DL-7264

Length: 1743 Ø: 62
Cone Ø: d1 Ø 30 / d2 Ø 27
1361413, 1395614, 1734019, 1897333, 2040254, 2146105



SC-DL-8137

Length: 1736 Ø: 40
Cone Ø: d1 Ø 30 / d2 Ø 27
301639, 311847, 395350, 1358675, 1378435, 1397866, 1734020, 2028998, 12202900A



SC-DL-8179

Length: 568 Ø: 46
Hole Distance: 115 / 115
1399180, 1428347



SC-DL-8509

Length: 568,5 Ø: 46
Hole Distance: 115 / 115
1485758, 1486757



SC-DL-8511

Length: 616,5 Ø: 50
Hole Distance: 115 / 115
1485760, 1499478, 1722750



SC-DL-8531

Length: 522 Ø: 46
Hole Distance: 115 / 115
1486758



SC-DL-8547

Length: 568 Ø: 50
Hole Distance: 115 / 115
1499474, 1722746, 1906940



SC-DL-8623

Length: 592 Ø: 50
Hole Distance: 115 / 115
1388436, 1499476, 1722748, 1906942



SC-DL-9457

Length: 1743 Ø: 52
Cone Ø: d1 Ø 30 / d2 Ø 27
1527989, 1723896, 1737684, 1897336



SC-DL-9462

Length: 568,5 Ø: 50
Hole Distance: 115 / 115
1499475, 1500573, 1722747, 1906941



SC-DL-9466

Length: 568 Ø: 19
1486756



SC-DL-10302

Length: 752 Ø: 48
Hole Distance: 115 / 115
1101843, 1379423, 1393298, 1431470, 1942075



SC-DL-12342

Length: 601 Ø: 42
Cone Ø: d1 Ø 26 / d2 Ø 23,5
1343262, 1869413



SC-DL-12343

Length: 1062 Ø: 52
Cone Ø: d1 Ø 30 / d2 Ø 27
1348269, 2007275



SC-DL-12449

Length: 1206 Ø: 38
Cone Ø: d1 Ø 30 / d2 Ø 27
1385763, 1765375



SC-ES-8517

Length: 140
Cone Ø: d1 Ø 30 / d2 Ø 27
Thread: M30 x 1,5 RHT
1358793, 1435746, 1488890, 1534756, 1914427, 2051166



SC-ES-8535

Length: 145
Cone Ø: d1 Ø 30 / d2 Ø 27
Thread: M30 x 1,5 RHT
1723897, 2051041



SC-RK-12366

Ø: 75 Hole Distance: 115 / 115
Thick/Height: 24
1 722 753, 2 096 392



SC-TC-12361

Length: 705 Ø: 42
Cone Ø: d1 Ø 38
Hole Distance: 115
1353445, 1464611, 1942147



SC-TC-12451

Length: 552 Ø: 46
Hole Distance: 115 / 115
1494296



SC-TC-12452

Length: 580,5 Ø: 46
Hole Distance: 115 / 115
1485759



SC-TC-12472

Length: 580 Ø: 46
Hole Distance: 115 / 115
1399182



SC-VB-12418

Length: 613,2
Ø: 46
Hole Ø 25 / 19 / 19
Hole Distance: 152 / 115 / 115
1440028, 1722582



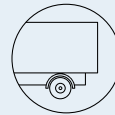

P,G,R,T - series ...

G 410, P 410	09/13→	Centre Rod	SC-DL-12342		for Steering Rod	
	09/13→	Centre Rod	SC-DL-12343		for Steering Rod	
	09/13→	Centre Rod	SC-DL-12413		for Steering Rod	
	09/13→	Suspension Arm Repair Kit		SC-RK-12366	for Control Arm	
	09/13→	Suspension Arm Repair Kit	SC-RK-12346	SC-RK-12346	for Control Arm	
	09/13→	Tie Rod End	CV-ES-14163		for Steering Rod	
	09/13→	Track Control Arm		SC-VB-12418	Control Arm	
G 410, P 410, R 410	09/13→	Centre Rod	SC-DL-12342		for Steering Rod	
	09/13→	Centre Rod	SC-DL-12343		for Steering Rod	
	09/13→	Centre Rod	SC-DL-12449		Push Rod	
	09/13→	Suspension Arm Repair Kit		SC-RK-12366	for Control Arm	
	09/13→	Suspension Arm Repair Kit	SC-RK-12346	SC-RK-12346	for Control Arm	
	09/13→	Tie Rod End	CV-ES-14163		for Steering Rod	
	09/13→	Track Control Arm		SC-VB-12418	Control Arm	
G 410, R 410	09/13→	Centre Rod	SC-DL-12342		for Steering Rod	
	09/13→	Centre Rod	SC-DL-12449		Push Rod	
	09/13→	Suspension Arm Repair Kit		SC-RK-12366	for Control Arm	
	09/13→	Track Control Arm		SC-TC-12452	Control Arm	
G 420	03/04→	Centre Rod	SC-DL-5229		Push Rod	
	03/04→	Centre Rod	SC-DL-5354		Push Rod	
	03/04→	Centre Rod	SC-DL-12343		for Steering Rod	
	03/04→	Suspension Arm Repair Kit		SC-RK-12366	for Control Arm	
	03/04→	Suspension Arm Repair Kit	MN-RK-7280	MN-RK-7280	for Drag Link;for Semi-Trailing Arm; for Wishbone (CV)	
	03/04→	Suspension Strut Repair Kit		DF-RK-9341		
	03/04→	Suspension Strut Repair Kit		MN-RK-8501		
	03/04→	Tie Rod	SC-DL-8137		Leaf Spring Axle	
	03/04→	Tie Rod	SC-DL-9457		Leaf Spring Axle	
	03/04→	Tie Rod End	CV-ES-14162		for Steering Rod	
	03/04→	Tie Rod End	CV-ES-14163		for Steering Rod	
	03/04→	Tie Rod End	SC-ES-8535		for Guide Rod	
	03/04→	Track Control Arm		SC-DL-8511	Trailing Arm, Leaf Spring Axle	
	03/04→	Track Control Arm		SC-DL-8511	Trailing Arm, Leaf Spring Axle, →* 3512097 *	
	03/04→	Track Control Arm		SC-DL-8547	Trailing Arm, Leaf Spring Axle	
	03/04→	Track Control Arm		SC-DL-9462	Trailing Arm, Leaf Spring Axle, →* 2006231 SSS *;* 5117423 SNL *; * 9097199 SAN *;* 3564002 SLA *	
	03/04→	Track Control Arm		SC-DL-9466	Trailing Arm, Leaf Spring Axle	
	03/04→	Track Control Arm		SC-TC-12451	Trailing Arm, 1st Drive Axle, for Leaf-Spring Suspension vehicles	
	03/04→	Track Control Arm		SC-TC-12451	Trailing Arm, 1st Drive Axle, for Leaf-Spring Suspension vehicles, 1280185/4471603→	
	03/04→	Track Control Arm		SC-TC-12451	Trailing Arm, 1st Drive Axle, for Leaf-Spring Suspension vehicles, 9069961/3536016→	
	03/04→	Track Control Arm		SC-TC-12452	Control Arm	
	03/04→	Track Control Arm		SC-TC-12472	Trailing Arm, 2nd Drive Axle, for Leaf-Spring Suspension vehicles, →1280184/4471602	
	03/04→	Track Control Arm		SC-TC-12472	Trailing Arm, 2nd Drive Axle, for Leaf-Spring Suspension vehicles, →9069960/3536015	
	03/04→	Track Control Arm	SC-DL-8179	SC-DL-8179	Trailing Arm, Leaf Spring Axle	
	03/04→	Track Control Arm	SC-DL-8509	SC-DL-8509	Trailing Arm	
	03/04→	Track Control Arm	SC-DL-8509	SC-DL-8509	Trailing Arm, Leaf Spring Axle	
	03/04→	Track Control Arm	SC-DL-8531	SC-DL-8531	Trailing Arm, Leaf Spring Axle	
	03/04→	Track Control Arm	SC-DL-8623	SC-DL-8623	Trailing Arm, Leaf Spring Axle, →* 2006231 SSS *;* 5117423 SNL *; * 9097199 SAN *;* 3564002 SLA *	
	03/04→	Track Control Arm	SC-DL-10302	SC-DL-10302	Trailing Arm, Air Suspension Axle	
	G 420, P 420, R 420	03/04→	Centre Rod	SC-DL-5229		Push Rod
		03/04→	Centre Rod	SC-DL-5354		Push Rod
		03/04→	Centre Rod	SC-DL-10225		for Steering Rod
03/04→		Centre Rod	SC-DL-12341		Push Rod	
03/04→		Centre Rod	SC-DL-12342		for Steering Rod	
03/04→		Centre Rod	SC-DL-12343		for Steering Rod	

CV-ES-14162

Length: 125
Cone Ø: d1 Ø 30 / d2 Ø 27
Thread: M30 x 1,5 LHT
283783, 395009, 1358792, 1738380, 1 914 426, 2051165



CV-ES-14163

Length: 125
Cone Ø: d1 Ø 30 / d2 Ø 27
Thread: M30 x 1,5 RHT
283784, 395010, 1358793, 1488890, 1738381, 1767328, 1914427, 2051166



DF-RK-9341

Ø: 67
550807, 5508072



MN-RK-7280

Ø: 75 Hole Distance: 115
Thick/Height: 24
0550806, 550806, 0639370, 639370, 689748, 1104334



MN-RK-8501

Ø: 75 Hole Distance: 115
Thick/Height: 24
1515981



SC-DL-5229

Length: 1053 Ø: 50
Cone Ø: d1 Ø 30 / d2 Ø 27
1356055, 1379071, 1384025, 1768898, 1847311, 1912757, 12201600A



SC-DL-5354

Length: 1060 Ø: 52
Cone Ø: d1 Ø 30 / d2 Ø 27
1384027, 1769597, 1847312, 1912758, 12200800A



SC-DL-8137

Length: 1736 Ø: 40
Cone Ø: d1 Ø 30 / d2 Ø 27
301639, 311847, 395350, 1358675, 1378435, 1397866, 1734020, 2028998, 12202900A



SC-DL-8179

Length: 568 Ø: 46
Hole Distance: 115 / 115
1399180, 1428347



SC-DL-8509

Length: 568,5 Ø: 46
Hole Distance: 115 / 115
1485758, 1486757



SC-DL-8511

Length: 616,5 Ø: 50
Hole Distance: 115 / 115
1485760, 1499478, 1722750



SC-DL-8531

Length: 522 Ø: 46
Hole Distance: 115 / 115
1486758



SC-DL-8547

Length: 568 Ø: 50
Hole Distance: 115 / 115
1499474, 1722746, 1906940



SC-DL-8623

Length: 592 Ø: 50
Hole Distance: 115 / 115
1388436, 1499476, 1722748, 1906942



SC-DL-9457

Length: 1743 Ø: 52
Cone Ø: d1 Ø 30 / d2 Ø 27
1527989, 1723896, 1737684, 1897336



SC-DL-9462

Length: 568,5 Ø: 50
Hole Distance: 115 / 115
1499475, 1500573, 1722747, 1906941



SC-DL-9466

Length: 568 Ø: 19
1486756



SC-DL-10225

Length: 2179 Ø: 62
Cone Ø: d1 Ø 30 / d2 Ø 27
1386618, 1788522



SC-DL-10302

Length: 752 Ø: 48
Hole Distance: 115 / 115
1101843, 1379423, 1393298, 1431470, 1942075



SC-DL-12341

Length: 1776 Ø: 62
Cone Ø: d1 Ø 30 / d2 Ø 27
1386620



SC-DL-12342

Length: 601 Ø: 42
Cone Ø: d1 Ø 26 / d2 Ø 23,5
1343262, 1869413



SC-DL-12343

Length: 1062 Ø: 52
Cone Ø: d1 Ø 30 / d2 Ø 27
1348269, 2007275



SC-DL-12413

Length: 1950 Ø: 62
Cone Ø: d1 Ø 30 / d2 Ø 27
1393383, 1788520



SC-DL-12449

Length: 1206 Ø: 38
Cone Ø: d1 Ø 30 / d2 Ø 27
1385763, 1765375



SC-ES-8535

Length: 145
Cone Ø: d1 Ø 30 / d2 Ø 27
Thread: M30 x 1,5 RHT
1723897, 2051041



SC-RK-12346

Ø: 67 Hole Distance: 115
Thick/Height: 24
550800



SC-RK-12366

Ø: 75 Hole Distance: 115 / 115
Thick/Height: 24
1 722 753, 2 096 392



SC-TC-12451

Length: 552 Ø: 46
Hole Distance: 115 / 115
1494296



SC-TC-12452

Length: 580,5 Ø: 46
Hole Distance: 115 / 115
1485759



SC-TC-12472

Length: 580 Ø: 46
Hole Distance: 115 / 115
1399182



SC-VB-12418

Length: 613,2
Ø: 46
Hole Ø 25 / 19 / 19
Hole Distance: 152 / 115 / 115
1440028, 1722582



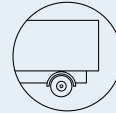

P,G,R,T - series ...

G 420, P 420, R 420 ...	03/04 →	Suspension Arm Repair Kit		SC-RK-12366	for Control Arm
	03/04 →	Suspension Arm Repair Kit	SC-RK-12346	SC-RK-12346	for Control Arm
	03/04 →	Suspension Strut Repair Kit		CV-RK-5311	
	03/04 →	Suspension Strut Repair Kit		MN-RK-8501	
	03/04 →	Suspension Strut Repair Kit		MN-RK-12436	
	03/04 →	Suspension Strut Repair Kit	DF-RK-9341		
	03/04 →	Tie Rod	SC-DL-7264		
	03/04 →	Tie Rod	SC-DL-8137		Leaf Spring Axle
	03/04 →	Tie Rod	SC-DL-9457		Leaf Spring Axle
	03/04 →	Tie Rod End	CV-ES-14162		for Steering Rod
	03/04 →	Tie Rod End	CV-ES-14163		for Steering Rod
	03/04 →	Tie Rod End	SC-ES-8535		for Guide Rod
	03/04 →	Track Control Arm		SC-TC-12452	Control Arm
	03/04 →	Track Control Arm		SC-VB-12418	Control Arm
	03/04 →	Track Control Arm	SC-DL-10302	SC-DL-10302	Trailing Arm, Air Suspension Axle
	03/04 →	Track Control Arm	SC-TC-12361		Control Arm, 1st Front Axle, for Pneumatic Suspension vehicles
	09/05 →	Centre Rod	SC-DL-8154		Push Rod
	09/05 →	Centre Rod	SC-DL-8169		Push Rod
	09/05 →	Centre Rod	SC-DL-8182		Push Rod
	09/05 →	Centre Rod	SC-DL-8399		Push Rod, Leaf Spring Axle
	09/05 →	Tie Rod	SC-DL-7264		1st FA;2nd FA
	09/05 →	Tie Rod	SC-DL-8137		Leaf Spring Axle;1st FA;2nd FA
	09/05 →	Tie Rod	SC-DL-9457		1st FA;2nd FA;Leaf Spring Axle
	09/05 →	Tie Rod End	IV-ES-12272		for Steering Rod
	09/05 →	Tie Rod End	SC-ES-5764		
	09/05 →	Tie Rod End	SC-ES-8517		for Push Rod
	09/05 →	Track Control Arm		SC-DL-8511	Trailing Arm, Leaf Spring Axle
	09/05 →	Track Control Arm		SC-DL-8511	Trailing Arm, Leaf Spring Axle, →* 3512097 *
	09/05 →	Track Control Arm		SC-DL-8547	Trailing Arm, Leaf Spring Axle
	09/05 →	Track Control Arm		SC-DL-9462	Trailing Arm, Leaf Spring Axle, →* 2006231 SSS *; * 5117423 SNL *; * 9097199 SAN *; * 3564002 SLA *
	09/05 →	Track Control Arm		SC-DL-9466	Trailing Arm, Leaf Spring Axle
	09/05 →	Track Control Arm		SC-TC-12451	Trailing Arm, 1st Drive Axle, for Leaf-Spring Suspension vehicles
	09/05 →	Track Control Arm		SC-TC-12451	Trailing Arm, 1st Drive Axle, for Leaf-Spring Suspension vehicles, 1280185/4471603 →
09/05 →	Track Control Arm		SC-TC-12451	Trailing Arm, 1st Drive Axle, for Leaf-Spring Suspension vehicles, 9069961/3536016 →	
09/05 →	Track Control Arm		SC-TC-12472	Trailing Arm, 2nd Drive Axle, for Leaf-Spring Suspension vehicles, →1280184/4471602	
09/05 →	Track Control Arm		SC-TC-12472	Trailing Arm, 2nd Drive Axle, for Leaf-Spring Suspension vehicles, →9069960/3536015	
09/05 →	Track Control Arm	SC-DL-8179	SC-DL-8179	Trailing Arm, Leaf Spring Axle	
09/05 →	Track Control Arm	SC-DL-8509	SC-DL-8509	Trailing Arm	
09/05 →	Track Control Arm	SC-DL-8509	SC-DL-8509	Trailing Arm, Leaf Spring Axle	
09/05 →	Track Control Arm	SC-DL-8531	SC-DL-8531	Trailing Arm, Leaf Spring Axle	
09/05 →	Track Control Arm	SC-DL-8623	SC-DL-8623	Trailing Arm, Leaf Spring Axle, →* 2006231 SSS *; * 5117423 SNL *; * 9097199 SAN *; * 3564002 SLA *	
09/05 →	Track Control Arm	SC-DL-10302	SC-DL-10302	Trailing Arm, Air Suspension Axle;1st FA	
G 420, R 420	01/08 →	Centre Rod	SC-DL-5229		Push Rod
	01/08 →	Centre Rod	SC-DL-5354		Push Rod
	01/08 →	Centre Rod	SC-DL-5354	SC-DL-5354	Push Rod, for vehicles with Hinged Trailing Axle
	01/08 →	Centre Rod	SC-DL-8182		Push Rod
	01/08 →	Centre Rod	SC-DL-8399		Push Rod, for vehicles with Hinged Leading Axle, for vehicles with Part-Pneumatic Suspension
	01/08 →	Centre Rod	SC-DL-8553	SC-DL-8553	Push Rod, for vehicles with Hinged Leading Axle
	01/08 →	Centre Rod	SC-DL-12342		for Steering Rod
	01/08 →	Centre Rod	SC-DL-12343		for Steering Rod
	01/08 →	Centre Rod	SC-DL-12449		Push Rod
01/08 →	Suspension Arm Repair Kit		SC-RK-12366	for Control Arm	

CV-ES-14162

Length: 125
Cone Ø: d1 Ø 30 / d2 Ø 27
Thread: M30 x 1,5 LHT
283783, 395009, 1358792, 1738380, 1 914
426, 2051165



CV-ES-14163

Length: 125
Cone Ø: d1 Ø 30 / d2 Ø 27
Thread: M30 x 1,5 RHT
283784, 395010, 1358793, 1488890,
1738381, 1767328, 1914427, 2051166



CV-RK-5311

0638862, 638862, 0639287, 639287,
1104335, 1953248, 81432206006,
81432206107



DF-RK-9341

Ø: 67
550807, 5508072



IV-ES-12272

Length: 75
Cone Ø: d1 Ø 30 / d2 Ø 27
Thread: M26 x 1,5 RHT
1394443



MN-RK-8501

Ø: 75 Hole Distance: 115
Thick/Height: 24
1515981



MN-RK-12436

Ø: 75 Hole Distance: 115
Thick/Height: 24
550799, 1517403, 1783020



SC-DL-5229

Length: 1053 Ø: 50
Cone Ø: d1 Ø 30 / d2 Ø 27
1356055, 1379071, 1384025, 1768898,
1847311, 1912757, 12201600A



SC-DL-5354

Length: 1060 Ø: 52
Cone Ø: d1 Ø 30 / d2 Ø 27
1384027, 1769597, 1847312, 1912758,
12200800A



SC-DL-7264

Length: 1743 Ø: 62
Cone Ø: d1 Ø 30 / d2 Ø 27
1361413, 1395614, 1734019, 1897333,
2040254, 2146105



SC-DL-8137

Length: 1736 Ø: 40
Cone Ø: d1 Ø 30 / d2 Ø 27
301639, 311847, 395350, 1358675,
1378435, 1397866, 1734020, 2028998,
12202900A



SC-DL-8154

Length: 495 Ø: 40
Cone Ø: d1 Ø 30 / d2 Ø 27
1343266, 1759690



SC-DL-8169

Length: 1920 Ø: 62
Cone Ø: d1 Ø 30 / d2 Ø 27
1343264, 1732635, 2007278



SC-DL-8179

Length: 568 Ø: 46
Hole Distance: 115 / 115
1399180, 1428347



SC-DL-8182

Length: 752 Ø: 48
Hole Distance: 115 / 115
1101843, 1379423, 1393298, 1431470,
1942075



SC-DL-8399

Length: 433 Ø: 40
Cone Ø: d1 Ø 30 / d2 Ø 26
1394884, 1938387



SC-DL-8509

Length: 568,5 Ø: 46
Hole Distance: 115 / 115
1485758, 1486757



SC-DL-8511

Length: 616,5 Ø: 50
Hole Distance: 115 / 115
1485760, 1499478, 1722750



SC-DL-8531

Length: 522 Ø: 46
Hole Distance: 115 / 115
1486758



SC-DL-8547

Length: 568 Ø: 50
Hole Distance: 115 / 115
1499474, 1722746, 1906940



SC-DL-8553

Length: 435 Ø: 38
Cone Ø: d1 Ø 30 / d2 Ø 27
1343283, 1759691



SC-DL-8623

Length: 592 Ø: 50
Hole Distance: 115 / 115
1388436, 1499476, 1722748, 1906942



SC-DL-9457

Length: 1743 Ø: 52
Cone Ø: d1 Ø 30 / d2 Ø 27
1527989, 1723896, 1737684, 1897336



SC-DL-9462

Length: 568,5 Ø: 50
Hole Distance: 115 / 115
1499475, 1500573, 1722747, 1906941



SC-DL-9466

Length: 568 Ø: 19
1486756



SC-DL-10302

Length: 752 Ø: 48
Hole Distance: 115 / 115
1101843, 1379423, 1393298, 1431470,
1942075



SC-DL-12342

Length: 601 Ø: 42
Cone Ø: d1 Ø 26 / d2 Ø 23,5
1343262, 1869413



SC-DL-12343

Length: 1062 Ø: 52
Cone Ø: d1 Ø 30 / d2 Ø 27
1348269, 2007275



SC-DL-12449

Length: 1206 Ø: 38
Cone Ø: d1 Ø 30 / d2 Ø 27
1385763, 1765375



SC-ES-5764

Length: 95
Cone Ø: d1 Ø 30 / d2 Ø 27
Thread: M26 x 1,5 RHT
325614, 1375228, 4604948



SC-ES-8517

Length: 140
Cone Ø: d1 Ø 30 / d2 Ø 27
Thread: M30 x 1,5 RHT
1358793, 1435746, 1488890, 1534756,
1914427, 2051166



SC-ES-8535

Length: 145
Cone Ø: d1 Ø 30 / d2 Ø 27
Thread: M30 x 1,5 RHT
1723897, 2051041



SC-RK-12346

Ø: 67 Hole Distance: 115
Thick/Height: 24
550800



SC-RK-12366

Ø: 75 Hole Distance: 115 / 115
Thick/Height: 24
1 722 753, 2 096 392



SC-TC-12361

Length: 705 Ø: 42
Cone Ø: d1 Ø 38
Hole Distance: 115
1353445, 1464611, 1942147



SC-TC-12451

Length: 552 Ø: 46
Hole Distance: 115 / 115
1494296



SC-TC-12452

Length: 580,5 Ø: 46
Hole Distance: 115 / 115
1485759



SC-TC-12472

Length: 580 Ø: 46
Hole Distance: 115 / 115
1399182



SC-VB-12418

Length: 613,2 Ø: 46
Hole Ø 25 / 19 / 19
Hole Distance: 152 / 115 / 115
1440028, 1722582





P,G,R,T - series ...

G 420, R 420 ...	01/08→	Suspension Arm Repair Kit	SC-RK-12346	SC-RK-12346	for Control Arm
	01/08→	Suspension Strut Repair Kit		MN-RK-8501	
	01/08→	Suspension Strut Repair Kit		MN-RK-12436	
	01/08→	Suspension Strut Repair Kit	DF-RK-9341		
	01/08→	Tie Rod		SC-DL-7264	Tag Axle;for vehicles with Hinged Trailing Axle
	01/08→	Tie Rod		SC-DL-8137	Tag Axle;for vehicles with Hinged Trailing Axle
	01/08→	Tie Rod	SC-DL-7264		
	01/08→	Tie Rod	SC-DL-7264		1st FA
	01/08→	Tie Rod	SC-DL-8137		Leaf Spring Axle
	01/08→	Tie Rod	SC-DL-8137		Leaf Spring Axle;1st FA
	01/08→	Tie Rod	SC-DL-9457		1st FA;Leaf Spring Axle
	01/08→	Tie Rod	SC-DL-9457		Leaf Spring Axle
	01/08→	Tie Rod End		MN-ES-8490	Tag Axle;for vehicles with Hinged Trailing Axle
	01/08→	Tie Rod End	CV-ES-14162		for Steering Rod
	01/08→	Tie Rod End	CV-ES-14162	CV-ES-14162	for Steering Rod
	01/08→	Tie Rod End	CV-ES-14163		for Steering Rod
	01/08→	Tie Rod End	IV-ES-12272		for Steering Rod
	01/08→	Tie Rod End	MN-ES-8490	MN-ES-8490	for vehicles with Hinged Trailing Axle
	01/08→	Tie Rod End	SC-ES-8517		for Push Rod
	01/08→	Tie Rod End	SC-ES-8535		for Guide Rod
	01/08→	Track Control Arm		SC-DL-8511	Trailing Arm, Leaf Spring Axle
	01/08→	Track Control Arm		SC-DL-8511	Trailing Arm, Leaf Spring Axle, →* 3512097 *
	01/08→	Track Control Arm		SC-DL-8547	Trailing Arm, Leaf Spring Axle
	01/08→	Track Control Arm		SC-DL-9462	Trailing Arm, Leaf Spring Axle, →* 2006231 SSS *; * 5117423 SNL *; * 9097199 SAN *; * 3564002 SLA *
	01/08→	Track Control Arm		SC-DL-9466	Trailing Arm, Leaf Spring Axle
	01/08→	Track Control Arm		SC-TC-12451	Trailing Arm, 1st Drive Axle, for Leaf-Spring Suspension vehicles
	01/08→	Track Control Arm		SC-TC-12451	Trailing Arm, 1st Drive Axle, for Leaf-Spring Suspension vehicles, 1280185/4471603→
	01/08→	Track Control Arm		SC-TC-12451	Trailing Arm, 1st Drive Axle, for Leaf-Spring Suspension vehicles, 9069961/3536016→
	01/08→	Track Control Arm		SC-TC-12452	Control Arm
	01/08→	Track Control Arm		SC-TC-12472	Trailing Arm, 2nd Drive Axle, for Leaf-Spring Suspension vehicles, →1280184/4471602
	01/08→	Track Control Arm		SC-TC-12472	Trailing Arm, 2nd Drive Axle, for Leaf-Spring Suspension vehicles, →9069960/3536015
	01/08→	Track Control Arm		SC-VB-12418	Control Arm
	01/08→	Track Control Arm	SC-DL-8179	SC-DL-8179	Trailing Arm, Leaf Spring Axle
01/08→	Track Control Arm	SC-DL-8509	SC-DL-8509	Trailing Arm	
01/08→	Track Control Arm	SC-DL-8509	SC-DL-8509	Trailing Arm, Leaf Spring Axle	
01/08→	Track Control Arm	SC-DL-8531	SC-DL-8531	Trailing Arm, Leaf Spring Axle	
01/08→	Track Control Arm	SC-DL-8623	SC-DL-8623	Trailing Arm, Leaf Spring Axle, →* 2006231 SSS *; * 5117423 SNL *; * 9097199 SAN *; * 3564002 SLA *	
01/08→	Track Control Arm	SC-DL-10302	SC-DL-10302	Trailing Arm, Air Suspension Axle	
01/08→	Track Control Arm	SC-DL-10302	SC-DL-10302	Trailing Arm, Air Suspension Axle;1st FA	
01/08→	Track Control Arm	SC-TC-12361		Control Arm, 1st Front Axle, for Pneumatic Suspension vehicles	
G 440, R 440	01/07→	Centre Rod	SC-DL-12341		Push Rod
	01/07→	Suspension Arm Repair Kit		SC-RK-12366	for Control Arm
	01/07→	Suspension Strut Repair Kit		DF-RK-9341	
	01/07→	Tie Rod End	CV-ES-14162		for Steering Rod
	01/07→	Tie Rod End	CV-ES-14163		for Steering Rod
	01/07→	Tie Rod End	SC-ES-8535		for Guide Rod
	01/07→	Track Control Arm		SC-VB-12418	Wishbone (CV), 1st Drive Axle, for Pneumatic Suspension vehicles
01/07→	Track Control Arm	SC-DL-10302	SC-DL-10302	Trailing Arm, 1st Front Axle, for Pneumatic Suspension vehicles	
01/07→	Track Control Arm	SC-TC-12361		Control Arm, 1st Front Axle, for Pneumatic Suspension vehicles	

CV-ES-14162

Length: 125
Cone Ø: d1 Ø 30 / d2 Ø 27
Thread: M30 x 1,5 LHT
283783, 395009, 1358792, 1738380, 1 914 426, 2051165



CV-ES-14163

Length: 125
Cone Ø: d1 Ø 30 / d2 Ø 27
Thread: M30 x 1,5 RHT
283784, 395010, 1358793, 1488890, 1738381, 1767328, 1914427, 2051166



DF-RK-9341

Ø: 67
550807, 5508072



IV-ES-12272

Length: 75
Cone Ø: d1 Ø 30 / d2 Ø 27
Thread: M26 x 1,5 RHT
1394443



MN-ES-8490

Length: 90
Cone Ø: d1 Ø 30 / d2 Ø 27
Thread: M26 x 1,5 RHT
1394444, 0014606948, 14606948



MN-RK-8501

Ø: 75 Hole Distance: 115
Thick/Height: 24
1515981



MN-RK-12436

Ø: 75 Hole Distance: 115
Thick/Height: 24
550799, 1517403, 1783020



SC-DL-7264

Length: 1743 Ø: 62
Cone Ø: d1 Ø 30 / d2 Ø 27
1361413, 1395614, 1734019, 1897333, 2040254, 2146105



SC-DL-8137

Length: 1736 Ø: 40
Cone Ø: d1 Ø 30 / d2 Ø 27
301639, 311847, 395350, 1358675, 1378435, 1397866, 1734020, 2028998, 12202900A



SC-DL-8179

Length: 568 Ø: 46
Hole Distance: 115 / 115
1399180, 1428347



SC-DL-8509

Length: 568,5 Ø: 46
Hole Distance: 115 / 115
1485758, 1486757



SC-DL-8511

Length: 616,5 Ø: 50
Hole Distance: 115 / 115
1485760, 1499478, 1722750



SC-DL-8531

Length: 522 Ø: 46
Hole Distance: 115 / 115
1486758



SC-DL-8547

Length: 568 Ø: 50
Hole Distance: 115 / 115
1499474, 1722746, 1906940



SC-DL-8623

Length: 592 Ø: 50
Hole Distance: 115 / 115
1388436, 1499476, 1722748, 1906942



SC-DL-9457

Length: 1743 Ø: 52
Cone Ø: d1 Ø 30 / d2 Ø 27
1527989, 1723896, 1737684, 1897336



SC-DL-9462

Length: 568,5 Ø: 50
Hole Distance: 115 / 115
1499475, 1500573, 1722747, 1906941



SC-DL-9466

Length: 568 Ø: 19
1486756



SC-DL-10302

Length: 752 Ø: 48
Hole Distance: 115 / 115
1101843, 1379423, 1393298, 1431470, 1942075



SC-DL-12341

Length: 1776 Ø: 62
Cone Ø: d1 Ø 30 / d2 Ø 27
1386620



SC-ES-8517

Length: 140
Cone Ø: d1 Ø 30 / d2 Ø 27
Thread: M30 x 1,5 RHT
1358793, 1435746, 1488890, 1534756, 1914427, 2051166



SC-ES-8535

Length: 145
Cone Ø: d1 Ø 30 / d2 Ø 27
Thread: M30 x 1,5 RHT
1723897, 2051041



SC-RK-12346

Ø: 67 Hole Distance: 115
Thick/Height: 24
550800



SC-RK-12366

Ø: 75 Hole Distance: 115 / 115
Thick/Height: 24
1 722 753, 2 096 392



SC-TC-12361

Length: 705 Ø: 42
Cone Ø: d1 Ø 38
Hole Distance: 115
1353445, 1464611, 1942147



SC-TC-12451

Length: 552 Ø: 46
Hole Distance: 115 / 115
1494296



SC-TC-12452

Length: 580,5 Ø: 46
Hole Distance: 115 / 115
1485759



SC-TC-12472

Length: 580 Ø: 46
Hole Distance: 115 / 115
1399182



SC-VB-12418

Length: 613,2
Ø: 46
Hole Ø 25 / 19 / 19
Hole Distance: 152 / 115 / 115
1440028, 1722582





P,G,R,T - series ...

G 440, R 440 ...

01/08→	Suspension Arm Repair Kit	MN-RK-7280	MN-RK-7280	for Drag Link;for Semi-Trailing Arm; for Wishbone (CV)
01/08→	Suspension Strut Repair Kit		MN-RK-8501	
01/08→	Track Control Arm		SC-DL-8509	Trailing Arm, 1st & 2nd Drive Axle, for Leaf-Spring Suspension vehicles
01/08→	Track Control Arm		SC-DL-8509	Trailing Arm, 1st Drive Axle, for Leaf-Spring Suspension vehicles
01/08→	Track Control Arm		SC-DL-8509	Trailing Arm, 1st Drive Axle, for Leaf-Spring Suspension vehicles, 1280185/4471603→
01/08→	Track Control Arm		SC-DL-8511	Trailing Arm, 1st & 2nd Drive Axle, for Leaf-Spring Suspension vehicles
01/08→	Track Control Arm		SC-DL-8531	Trailing Arm, 1st & 2nd Drive Axle, for Leaf-Spring Suspension vehicles
01/08→	Track Control Arm		SC-DL-8547	Trailing Arm, for Leaf-Spring Suspension vehicles
01/08→	Track Control Arm		SC-DL-9462	Trailing Arm, for Leaf-Spring Suspension vehicles
01/08→	Track Control Arm		SC-DL-9466	Trailing Arm
01/08→	Track Control Arm		SC-TC-12451	Trailing Arm, 1st Drive Axle, for Leaf-Spring Suspension vehicles
01/08→	Track Control Arm		SC-TC-12451	Trailing Arm, 1st Drive Axle, for Leaf-Spring Suspension vehicles, 1280185/4471603→
01/08→	Track Control Arm		SC-TC-12451	Trailing Arm, 1st Drive Axle, for Leaf-Spring Suspension vehicles, 9069961/3536016→
01/08→	Track Control Arm		SC-TC-12452	Trailing Arm, 2nd Drive Axle, for Leaf-Spring Suspension vehicles, 1280185/4471603→
01/08→	Track Control Arm		SC-TC-12452	Trailing Arm, 2nd Drive Axle, for Leaf-Spring Suspension vehicles, 9069961/3536016→
01/08→	Track Control Arm		SC-TC-12472	Control Arm
01/08→	Track Control Arm	SC-DL-8179	SC-DL-8179	Trailing Arm, for Leaf-Spring Suspension vehicles
01/08→	Track Control Arm	SC-DL-8623	SC-DL-8623	Trailing Arm, for Leaf-Spring Suspension vehicles
03/08→	Centre Rod	SC-DL-5229		Push Rod
03/08→	Centre Rod	SC-DL-5354		Push Rod
03/08→	Centre Rod	SC-DL-12342		for Steering Rod
03/08→	Centre Rod	SC-DL-12343		for Steering Rod
03/08→	Suspension Arm Repair Kit	SC-RK-12346	SC-RK-12346	for Control Arm
03/08→	Tie Rod	SC-DL-7264		
03/08→	Tie Rod	SC-DL-8137		Leaf Spring Axle
03/08→	Tie Rod	SC-DL-9457		Leaf Spring Axle
03/08→	Track Control Arm		SC-TC-12452	Control Arm
03/08→	Track Control Arm		SC-VB-12418	Control Arm
03/08→	Track Control Arm	SC-DL-10302	SC-DL-10302	Trailing Arm, Air Suspension Axle
07/09→	Tie Rod End	SC-ES-8517		for Push Rod
07/09→	Track Control Arm		SC-DL-8179	Trailing Arm, 1st & 2nd Drive Axle, for Leaf-Spring Suspension vehicles
07/09→	Track Control Arm		SC-DL-8179	Trailing Arm, 1st & 2nd Drive Axle, for Leaf-Spring Suspension vehicles, Ch.3512097→
07/09→	Track Control Arm		SC-DL-8179	Trailing Arm, 1st Drive Axle, for Leaf-Spring Suspension vehicles, →1280184/4471602
07/09→	Track Control Arm		SC-DL-8179	Trailing Arm, 1st Drive Axle, for Leaf-Spring Suspension vehicles, →9069960/3536015
07/09→	Track Control Arm		SC-DL-8547	Trailing Arm, 1st & 2nd Drive Axle, for Leaf-Spring Suspension vehicles
07/09→	Track Control Arm		SC-DL-8623	Trailing Arm, 1st Drive Axle, for Leaf-Spring Suspension vehicles, →2006231/5117423
07/09→	Track Control Arm		SC-DL-8623	Trailing Arm, 1st Drive Axle, for Leaf-Spring Suspension vehicles, →9097199/3564002
07/09→	Track Control Arm		SC-DL-9462	Trailing Arm, 2nd Drive Axle, for Leaf-Spring Suspension vehicles, →2006231/5117423
07/09→	Track Control Arm		SC-DL-9462	Trailing Arm, 2nd Drive Axle, for Leaf-Spring Suspension vehicles, →9097199/3564002
07/09→	Track Control Arm		SC-DL-9466	Trailing Arm, 1st & 2nd Drive Axle, for Leaf-Spring Suspension vehicles

MN-RK-7280

Ø: 75 Hole Distance: 115
Thick/Height: 24
0550806, 550806, 0639370, 639370,
689748, 1104334



MN-RK-8501

Ø: 75 Hole Distance: 115
Thick/Height: 24
1515981



SC-DL-5229

Length: 1053 Ø: 50
Cone Ø: d1 Ø 30 / d2 Ø 27
1356055, 1379071, 1384025, 1768898,
1847311, 1912757, 12201600A



SC-DL-5354

Length: 1060 Ø: 52
Cone Ø: d1 Ø 30 / d2 Ø 27
1384027, 1769597, 1847312, 1912758,
12200800A



SC-DL-7264

Length: 1743 Ø: 62
Cone Ø: d1 Ø 30 / d2 Ø 27
1361413, 1395614, 1734019, 1897333,
2040254, 2146105



SC-DL-8137

Length: 1736 Ø: 40
Cone Ø: d1 Ø 30 / d2 Ø 27
301639, 311847, 395350, 1358675,
1378435, 1397866, 1734020, 2028998,
12202900A



SC-DL-8179

Length: 568 Ø: 46
Hole Distance: 115 / 115
1399180, 1428347



SC-DL-8509

Length: 568,5 Ø: 46
Hole Distance: 115 / 115
1485758, 1486757



SC-DL-8511

Length: 616,5 Ø: 50
Hole Distance: 115 / 115
1485760, 1499478, 1722750



SC-DL-8531

Length: 522 Ø: 46
Hole Distance: 115 / 115
1486758



SC-DL-8547

Length: 568 Ø: 50
Hole Distance: 115 / 115
1499474, 1722746, 1906940



SC-DL-8623

Length: 592 Ø: 50
Hole Distance: 115 / 115
1388436, 1499476, 1722748, 1906942



SC-DL-9457

Length: 1743 Ø: 52
Cone Ø: d1 Ø 30 / d2 Ø 27
1527989, 1723896, 1737684, 1897336



SC-DL-9462

Length: 568,5 Ø: 50
Hole Distance: 115 / 115
1499475, 1500573, 1722747, 1906941



SC-DL-9466

Length: 568 Ø: 19
1486756



SC-DL-10302

Length: 752 Ø: 48
Hole Distance: 115 / 115
1101843, 1379423, 1393298, 1431470,
1942075



SC-DL-12342

Length: 601 Ø: 42
Cone Ø: d1 Ø 26 / d2 Ø 23,5
1343262, 1869413



SC-DL-12343

Length: 1062 Ø: 52
Cone Ø: d1 Ø 30 / d2 Ø 27
1348269, 2007275



SC-ES-8517

Length: 140
Cone Ø: d1 Ø 30 / d2 Ø 27
Thread: M30 x 1,5 RHT
1358793, 1435746, 1488890, 1534756,
1914427, 2051166



SC-RK-12346

Ø: 67 Hole Distance: 115
Thick/Height: 24
550800



SC-TC-12451

Length: 552 Ø: 46
Hole Distance: 115 / 115
1494296



SC-TC-12452

Length: 580,5 Ø: 46
Hole Distance: 115 / 115
1485759



SC-TC-12472

Length: 580 Ø: 46
Hole Distance: 115 / 115
1399182



SC-VB-12418

Length: 613,2
Ø: 46
Hole Ø 25 / 19 / 19
Hole Distance: 152 / 115 / 115
1440028, 1722582





P,G,R,T - series ...

G 440, R 440 ...	07/09→	Track Control Arm		SC-TC-12472	Trailing Arm, 2nd Drive Axle, for Leaf-Spring Suspension vehicles, →1280184/4471602
	07/09→	Track Control Arm		SC-TC-12472	Trailing Arm, 2nd Drive Axle, for Leaf-Spring Suspension vehicles, →9069960/3536015
	01/10→	Centre Rod	SC-DL-5354	SC-DL-5354	Push Rod, for vehicles with Hinged Trailing Axle
	01/10→	Centre Rod	SC-DL-8182		Push Rod
	01/10→	Centre Rod	SC-DL-8399		Push Rod, for vehicles with Hinged Leading Axle, for vehicles with Part-Pneumatic Suspension
	01/10→	Centre Rod	SC-DL-8553	SC-DL-8553	Push Rod, for vehicles with Hinged Leading Axle
	01/10→	Centre Rod	SC-DL-12449		Push Rod
	01/10→	Tie Rod		SC-DL-7264	Leading Axle;for vehicles with Hinged Leading Axle
	01/10→	Tie Rod		SC-DL-7264	Leading Axle;for vehicles with Hinged Leading Axle;Air Suspension Axle
	01/10→	Tie Rod		SC-DL-7264	Tag Axle;for vehicles with Hinged Trailing Axle
	01/10→	Tie Rod		SC-DL-8137	Leading Axle;for vehicles with Hinged Leading Axle
	01/10→	Tie Rod End		MN-ES-8490	Tag Axle;for vehicles with Hinged Trailing Axle
	01/10→	Tie Rod End	CV-ES-14162	CV-ES-14162	for Steering Rod
	01/10→	Tie Rod End	IV-ES-12272		for Steering Rod
	G 450, P 450, R 450	01/10→	Tie Rod End	MN-ES-8490	MN-ES-8490
09/13→		Centre Rod	SC-DL-12342		for Steering Rod
09/13→		Centre Rod	SC-DL-12343		for Steering Rod
09/13→		Centre Rod	SC-DL-12449		Push Rod
09/13→		Suspension Arm Repair Kit		SC-RK-12366	for Control Arm
09/13→		Suspension Arm Repair Kit	SC-RK-12346	SC-RK-12346	for Control Arm
G 450, R 450	09/13→	Tie Rod End	CV-ES-14163		for Steering Rod
	09/13→	Track Control Arm		SC-VB-12418	Control Arm
	01/12→	Centre Rod	SC-DL-12342		for Steering Rod
	01/12→	Suspension Arm Repair Kit		SC-RK-12366	for Control Arm
G 470, P 470, R 470	01/12→	Track Control Arm		SC-TC-12452	Control Arm
	09/13→	Centre Rod	SC-DL-12449		Push Rod
	09/05→	Centre Rod	SC-DL-5229		Push Rod
	09/05→	Centre Rod	SC-DL-5354		Push Rod
	09/05→	Centre Rod	SC-DL-12342		for Steering Rod
	09/05→	Centre Rod	SC-DL-12343		for Steering Rod
	09/05→	Suspension Arm Repair Kit		SC-RK-12366	for Control Arm
	09/05→	Suspension Arm Repair Kit	SC-RK-12346	SC-RK-12346	for Control Arm
	09/05→	Tie Rod	SC-DL-8137		Leaf Spring Axle
	09/05→	Tie Rod	SC-DL-9457		Leaf Spring Axle
	09/05→	Tie Rod End	CV-ES-14162		for Steering Rod
	09/05→	Tie Rod End	CV-ES-14163		for Steering Rod
	09/05→	Tie Rod End	SC-ES-8535		for Guide Rod
	09/05→	Track Control Arm		SC-DL-8511	Trailing Arm, Leaf Spring Axle
	09/05→	Track Control Arm		SC-DL-8511	Trailing Arm, Leaf Spring Axle, →* 3512097 *
	09/05→	Track Control Arm		SC-DL-8547	Trailing Arm, Leaf Spring Axle
	09/05→	Track Control Arm		SC-DL-9462	Trailing Arm, Leaf Spring Axle, →* 2006231 SSS ** 5117423 SNL *; * 9097199 SAN *; * 3564002 SLA *
	09/05→	Track Control Arm		SC-DL-9466	Trailing Arm, Leaf Spring Axle
	09/05→	Track Control Arm		SC-TC-12451	Trailing Arm, 1st Drive Axle, for Leaf-Spring Suspension vehicles
	09/05→	Track Control Arm		SC-TC-12451	Trailing Arm, 1st Drive Axle, for Leaf-Spring Suspension vehicles, 1280185/4471603→
	09/05→	Track Control Arm		SC-TC-12451	Trailing Arm, 1st Drive Axle, for Leaf-Spring Suspension vehicles, 9069961/3536016→
	09/05→	Track Control Arm		SC-TC-12452	Control Arm
	09/05→	Track Control Arm		SC-TC-12472	Trailing Arm, 2nd Drive Axle, for Leaf-Spring Suspension vehicles, →1280184/4471602
	09/05→	Track Control Arm		SC-TC-12472	Trailing Arm, 2nd Drive Axle, for Leaf-Spring Suspension vehicles, →9069960/3536015
	09/05→	Track Control Arm		SC-VB-12418	Control Arm
	09/05→	Track Control Arm	SC-DL-8179	SC-DL-8179	Trailing Arm, Leaf Spring Axle

CV-ES-14162

Length: 125
Cone Ø: d1 Ø 30 / d2 Ø 27
Thread: M30 x 1,5 LHT
283783, 395009, 1358792, 1738380, 1 914 426, 2051165



CV-ES-14163

Length: 125
Cone Ø: d1 Ø 30 / d2 Ø 27
Thread: M30 x 1,5 RHT
283784, 395010, 1358793, 1488890, 1738381, 1767328, 1914427, 2051166



IV-ES-12272

Length: 75
Cone Ø: d1 Ø 30 / d2 Ø 27
Thread: M26 x 1,5 RHT
1394443



MN-ES-8490

Length: 90
Cone Ø: d1 Ø 30 / d2 Ø 27
Thread: M26 x 1,5 RHT
1394444, 0014606948, 14606948



SC-DL-5229

Length: 1053 Ø: 50
Cone Ø: d1 Ø 30 / d2 Ø 27
1356055, 1379071, 1384025, 1768898, 1847311, 1912757, 12201600A



SC-DL-5354

Length: 1060 Ø: 52
Cone Ø: d1 Ø 30 / d2 Ø 27
1384027, 1769597, 1847312, 1912758, 12200800A



SC-DL-7264

Length: 1743 Ø: 62
Cone Ø: d1 Ø 30 / d2 Ø 27
1361413, 1395614, 1734019, 1897333, 2040254, 2146105



SC-DL-8137

Length: 1736 Ø: 40
Cone Ø: d1 Ø 30 / d2 Ø 27
301639, 311847, 395350, 1358675, 1378435, 1397866, 1734020, 2028998, 12202900A



SC-DL-8179

Length: 568 Ø: 46
Hole Distance: 115 / 115
1399180, 1428347



SC-DL-8182

1343262, 1869413



SC-DL-8399

Length: 433 Ø: 40
Cone Ø: d1 Ø 30 / d2 Ø 26
1394884, 1938387



SC-DL-8511

Length: 616,5 Ø: 50
Hole Distance: 115 / 115
1485760, 1499478, 1722750



SC-DL-8547

Length: 568 Ø: 50
Hole Distance: 115 / 115
1499474, 1722746, 1906940



SC-DL-8553

Length: 435 Ø: 38
Cone Ø: d1 Ø 30 / d2 Ø 27
1343283, 1759691



SC-DL-9457

Length: 1743 Ø: 52
Cone Ø: d1 Ø 30 / d2 Ø 27
1527989, 1723896, 1737684, 1897336



SC-DL-9462

Length: 568,5 Ø: 50
Hole Distance: 115 / 115
1499475, 1500573, 1722747, 1906941



SC-DL-9466

Length: 568 Ø: 19
1486756



SC-DL-12342

Length: 601 Ø: 42
Cone Ø: d1 Ø 26 / d2 Ø 23,5
1343262, 1869413



SC-DL-12343

Length: 1062 Ø: 52
Cone Ø: d1 Ø 30 / d2 Ø 27
1348269, 2007275



SC-DL-12449

Length: 1206 Ø: 38
Cone Ø: d1 Ø 30 / d2 Ø 27
1385763, 1765375



SC-ES-8535

Length: 145
Cone Ø: d1 Ø 30 / d2 Ø 27
Thread: M30 x 1,5 RHT
1723897, 2051041



SC-RK-12346

Ø: 67 Hole Distance: 115
Thick/Height: 24
550800



SC-RK-12366

Ø: 75 Hole Distance: 115 / 115
Thick/Height: 24
1 722 753, 2 096 392



SC-TC-12451

Length: 552 Ø: 46
Hole Distance: 115 / 115
1494296



SC-TC-12452

Length: 580,5 Ø: 46
Hole Distance: 115 / 115
1485759



SC-TC-12472

Length: 580 Ø: 46
Hole Distance: 115 / 115
1399182



SC-VB-12418

Length: 613,2
Ø: 46
Hole Ø 25 / 19 / 19
Hole Distance: 152 / 115 / 115
1440028, 1722582





P,G,R,T - series ...

G 470, P 470, R 470 ...	09/05→	Track Control Arm	SC-DL-8509	SC-DL-8509	Trailing Arm
	09/05→	Track Control Arm	SC-DL-8509	SC-DL-8509	Trailing Arm, Leaf Spring Axle
	09/05→	Track Control Arm	SC-DL-8531	SC-DL-8531	Trailing Arm, Leaf Spring Axle
	09/05→	Track Control Arm	SC-DL-8623	SC-DL-8623	Trailing Arm, Leaf Spring Axle, →* 2006231 SSS *; * 5117423 SNL *; * 9097199 SAN *; * 3564002 SLA *
	09/05→	Track Control Arm	SC-DL-10302	SC-DL-10302	Trailing Arm, Air Suspension Axle
	09/05→	Track Control Arm	SC-TC-12361		Control Arm, 1st Front Axle, for Pneumatic Suspension vehicles
G 470, R 470	03/04→	Centre Rod	SC-DL-5229		Push Rod
	03/04→	Centre Rod	SC-DL-5354		Push Rod
	03/04→	Centre Rod	SC-DL-12342		for Steering Rod
	03/04→	Centre Rod	SC-DL-12343		for Steering Rod
	03/04→	Suspension Arm Repair Kit		SC-RK-12366	for Control Arm
	03/04→	Suspension Strut Repair Kit		DF-RK-9341	
	03/04→	Tie Rod	SC-DL-7264		
	03/04→	Tie Rod	SC-DL-8137		Leaf Spring Axle
	03/04→	Tie Rod	SC-DL-9457		Leaf Spring Axle
	03/04→	Tie Rod End	CV-ES-14162		for Steering Rod
	03/04→	Tie Rod End	CV-ES-14163		for Steering Rod
	03/04→	Tie Rod End	SC-ES-8535		for Guide Rod
	03/04→	Track Control Arm		SC-VB-12418	Control Arm
	03/04→	Track Control Arm	SC-DL-10302	SC-DL-10302	Trailing Arm, Air Suspension Axle
	03/04→	Track Control Arm	SC-TC-12361		Control Arm, 1st Front Axle, for Pneumatic Suspension vehicles
G 480, R 480	04/04→	Centre Rod	SC-DL-5229		Push Rod
	04/04→	Centre Rod	SC-DL-5354		Push Rod
	04/04→	Centre Rod	SC-DL-8154		Push Rod
	04/04→	Centre Rod	SC-DL-8169		Push Rod
	04/04→	Centre Rod	SC-DL-8182		Push Rod
	04/04→	Centre Rod	SC-DL-8399		Push Rod, Leaf Spring Axle
	04/04→	Centre Rod	SC-DL-10225		for Steering Rod
	04/04→	Centre Rod	SC-DL-12341		Push Rod
	04/04→	Centre Rod	SC-DL-12342		for Steering Rod
	04/04→	Centre Rod	SC-DL-12343		for Steering Rod
	04/04→	Suspension Arm Repair Kit		SC-RK-12366	for Control Arm
	04/04→	Suspension Arm Repair Kit	MN-RK-7280	MN-RK-7280	for Drag Link; for Semi-Trailing Arm; for Wishbone (CV)
	04/04→	Suspension Strut Repair Kit		MN-RK-8501	
	04/04→	Tie Rod	SC-DL-7264		1st FA; 2nd FA
	04/04→	Tie Rod	SC-DL-8137		Leaf Spring Axle; 1st FA; 2nd FA
	04/04→	Tie Rod	SC-DL-9457		1st FA; 2nd FA; Leaf Spring Axle
	04/04→	Tie Rod End	CV-ES-14162		for Steering Rod
	04/04→	Tie Rod End	CV-ES-14163		for Steering Rod
	04/04→	Tie Rod End	SC-ES-5764		
	04/04→	Tie Rod End	SC-ES-8517		for Push Rod
	04/04→	Tie Rod End	SC-ES-8535		for Guide Rod
	04/04→	Track Control Arm		SC-DL-8179	Trailing Arm, 1st & 2nd Drive Axle, for Leaf-Spring Suspension vehicles
	04/04→	Track Control Arm		SC-DL-8179	Trailing Arm, 1st & 2nd Drive Axle, for Leaf-Spring Suspension vehicles, Ch.3512097→
	04/04→	Track Control Arm		SC-DL-8179	Trailing Arm, 1st Drive Axle, for Leaf-Spring Suspension vehicles, →1280184/4471602
	04/04→	Track Control Arm		SC-DL-8179	Trailing Arm, 1st Drive Axle, for Leaf-Spring Suspension vehicles, →9069960/3536015
	04/04→	Track Control Arm		SC-DL-8509	Trailing Arm, 1st & 2nd Drive Axle, for Leaf-Spring Suspension vehicles
	04/04→	Track Control Arm		SC-DL-8511	Trailing Arm, 1st & 2nd Drive Axle, for Leaf-Spring Suspension vehicles
04/04→	Track Control Arm		SC-DL-8511	Trailing Arm, Leaf Spring Axle	
04/04→	Track Control Arm		SC-DL-8511	Trailing Arm, Leaf Spring Axle, →* 3512097 *	

CV-ES-14162

Length: 125
Cone Ø: d1 Ø 30 / d2 Ø 27
Thread: M30 x 1,5 LHT
283783, 395009, 1358792, 1738380, 1 914 426, 2051165



CV-ES-14163

Length: 125
Cone Ø: d1 Ø 30 / d2 Ø 27
Thread: M30 x 1,5 RHT
283784, 395010, 1358793, 1488890, 1738381, 1767328, 1914427, 2051166



DF-RK-9341

Ø: 67
550807, 5508072



MN-RK-7280

Ø: 75 Hole Distance: 115
Thick/Height: 24
0550806, 550806, 0639370, 639370, 689748, 1104334



MN-RK-8501

Ø: 75 Hole Distance: 115
Thick/Height: 24
1515981



SC-DL-5229

Length: 1053 Ø: 50
Cone Ø: d1 Ø 30 / d2 Ø 27
1356055, 1379071, 1384025, 1768898, 1847311, 1912757, 12201600A



SC-DL-5354

Length: 1060 Ø: 52
Cone Ø: d1 Ø 30 / d2 Ø 27
1384027, 1769597, 1847312, 1912758, 12200800A



SC-DL-7264

Length: 1743 Ø: 62
Cone Ø: d1 Ø 30 / d2 Ø 27
1361413, 1395614, 1734019, 1897333, 2040254, 2146105



SC-DL-8137

Length: 1736 Ø: 40
Cone Ø: d1 Ø 30 / d2 Ø 27
301639, 311847, 395350, 1358675, 1378435, 1397866, 1734020, 2028998, 12202900A



SC-DL-8154

Length: 495 Ø: 40
Cone Ø: d1 Ø 30 / d2 Ø 27
1343266, 1759690



SC-DL-8169

Length: 1920 Ø: 62
Cone Ø: d1 Ø 30 / d2 Ø 27
1343264, 1732635, 2007278



SC-DL-8179

Length: 568 Ø: 46
Hole Distance: 115 / 115
1399180, 1428347



SC-DL-8182

1343262, 1869413



SC-DL-8399

Length: 433 Ø: 40
Cone Ø: d1 Ø 30 / d2 Ø 26
1394884, 1938387



SC-DL-8509

Length: 568,5 Ø: 46
Hole Distance: 115 / 115
1485758, 1486757



SC-DL-8511

Length: 616,5 Ø: 50
Hole Distance: 115 / 115
1485760, 1499478, 1722750



SC-DL-8531

Length: 522 Ø: 46
Hole Distance: 115 / 115
1486758



SC-DL-8623

Length: 592 Ø: 50
Hole Distance: 115 / 115
1388436, 1499476, 1722748, 1906942



SC-DL-9457

Length: 1743 Ø: 52
Cone Ø: d1 Ø 30 / d2 Ø 27
1527989, 1723896, 1737684, 1897336



SC-DL-10225

Length: 2179 Ø: 62
Cone Ø: d1 Ø 30 / d2 Ø 27
1386618, 1788522



SC-DL-10302

Length: 752 Ø: 48
Hole Distance: 115 / 115
1101843, 1379423, 1393298, 1431470, 1942075



SC-DL-12341

Length: 1776 Ø: 62
Cone Ø: d1 Ø 30 / d2 Ø 27
1386620



SC-DL-12342

Length: 601 Ø: 42
Cone Ø: d1 Ø 26 / d2 Ø 23,5
1343262, 1869413



SC-DL-12343

Length: 1062 Ø: 52
Cone Ø: d1 Ø 30 / d2 Ø 27
1348269, 2007275



SC-ES-5764

Length: 95
Cone Ø: d1 Ø 30 / d2 Ø 27
Thread: M26 x 1,5 RHT
325614, 1375228, 4604948



SC-ES-8517

Length: 140
Cone Ø: d1 Ø 30 / d2 Ø 27
Thread: M30 x 1,5 RHT
1358793, 1435746, 1488890, 1534756, 1914427, 2051166



SC-ES-8535

Length: 145
Cone Ø: d1 Ø 30 / d2 Ø 27
Thread: M30 x 1,5 RHT
1723897, 2051041



SC-RK-12366

Ø: 75 Hole Distance: 115 / 115
Thick/Height: 24
1 722 753, 2 096 392



SC-TC-12361

Length: 705 Ø: 42
Cone Ø: d1 Ø 38
Hole Distance: 115
1353445, 1464611, 1942147



SC-VB-12418

Length: 613,2
Ø: 46
Hole Ø 25 / 19 / 19
Hole Distance: 152 / 115 / 115
1440028, 1722582





P,G,R,T - series ...

G 480, R 480 ...

04/04 →	Track Control Arm		SC-DL-8531	Trailing Arm, 1st & 2nd Drive Axle, for Leaf-Spring Suspension vehicles
04/04 →	Track Control Arm		SC-DL-8547	Trailing Arm, 1st & 2nd Drive Axle, for Leaf-Spring Suspension vehicles
04/04 →	Track Control Arm		SC-DL-8547	Trailing Arm, Leaf Spring Axle
04/04 →	Track Control Arm		SC-DL-8623	Trailing Arm, 1st Drive Axle, for Leaf-Spring Suspension vehicles, →2006231/5117423
04/04 →	Track Control Arm		SC-DL-8623	Trailing Arm, 1st Drive Axle, for Leaf-Spring Suspension vehicles, →9097199/3564002
04/04 →	Track Control Arm		SC-DL-9462	Trailing Arm, 2nd Drive Axle, for Leaf-Spring Suspension vehicles, →2006231/5117423
04/04 →	Track Control Arm		SC-DL-9462	Trailing Arm, 2nd Drive Axle, for Leaf-Spring Suspension vehicles, →9097199/3564002
04/04 →	Track Control Arm		SC-DL-9462	Trailing Arm, Leaf Spring Axle, →* 2006231 SSS *; * 5117423 SNL *; * 9097199 SAN *; * 3564002 SLA *
04/04 →	Track Control Arm		SC-DL-9466	Trailing Arm, 1st & 2nd Drive Axle, for Leaf-Spring Suspension vehicles
04/04 →	Track Control Arm		SC-DL-9466	Trailing Arm, Leaf Spring Axle
04/04 →	Track Control Arm		SC-TC-12451	Trailing Arm, 1st Drive Axle, for Leaf-Spring Suspension vehicles
04/04 →	Track Control Arm		SC-TC-12451	Trailing Arm, 1st Drive Axle, for Leaf-Spring Suspension vehicles, 1280185/4471603 →
04/04 →	Track Control Arm		SC-TC-12451	Trailing Arm, 1st Drive Axle, for Leaf-Spring Suspension vehicles, 9069961/3536016 →
04/04 →	Track Control Arm		SC-TC-12452	Control Arm
04/04 →	Track Control Arm		SC-TC-12472	Trailing Arm, 2nd Drive Axle, for Leaf-Spring Suspension vehicles, →1280184/4471602
04/04 →	Track Control Arm		SC-TC-12472	Trailing Arm, 2nd Drive Axle, for Leaf-Spring Suspension vehicles, →9069960/3536015
04/04 →	Track Control Arm		SC-VB-12418	Control Arm
04/04 →	Track Control Arm	SC-DL-8179	SC-DL-8179	Trailing Arm, Leaf Spring Axle
04/04 →	Track Control Arm	SC-DL-8509	SC-DL-8509	Trailing Arm
04/04 →	Track Control Arm	SC-DL-8509	SC-DL-8509	Trailing Arm, Leaf Spring Axle
04/04 →	Track Control Arm	SC-DL-8531	SC-DL-8531	Trailing Arm, Leaf Spring Axle
04/04 →	Track Control Arm	SC-DL-8623	SC-DL-8623	Trailing Arm, Leaf Spring Axle, →* 2006231 SSS *; * 5117423 SNL *; * 9097199 SAN *; * 3564002 SLA *
04/04 →	Track Control Arm	SC-DL-10302	SC-DL-10302	Trailing Arm, Air Suspension Axle; 1st FA
07/04 →	Suspension Strut Repair Kit		DF-RK-9341	
07/04 →	Track Control Arm	SC-DL-10302	SC-DL-10302	Trailing Arm, 1st Front Axle, for Pneumatic Suspension vehicles
07/04 →	Track Control Arm	SC-TC-12361		Control Arm, 1st Front Axle, for Pneumatic Suspension vehicles
08/06 →	Centre Rod	SC-DL-5354	SC-DL-5354	Push Rod, for vehicles with Hinged Trailing Axle
08/06 →	Centre Rod	SC-DL-8399		Push Rod, for vehicles with Hinged Leading Axle, for vehicles with Part-Pneumatic Suspension
08/06 →	Centre Rod	SC-DL-8553	SC-DL-8553	Push Rod, for vehicles with Hinged Leading Axle
08/06 →	Centre Rod	SC-DL-10225		Push Rod, for vehicles with Hinged Leading Axle
08/06 →	Centre Rod	SC-DL-12449		Push Rod
08/06 →	Tie Rod		SC-DL-7264	Leading Axle; for vehicles with Hinged Leading Axle
08/06 →	Tie Rod		SC-DL-7264	Leading Axle; for vehicles with Hinged Leading Axle; Air Suspension Axle
08/06 →	Tie Rod		SC-DL-8137	Leading Axle; for vehicles with Hinged Leading Axle
08/06 →	Tie Rod	SC-DL-7264		
08/06 →	Tie Rod	SC-DL-8137		Leaf Spring Axle
08/06 →	Tie Rod	SC-DL-9457		Leaf Spring Axle
08/06 →	Tie Rod End	CV-ES-14162	CV-ES-14162	for Steering Rod
08/06 →	Track Control Arm	SC-DL-10302	SC-DL-10302	Trailing Arm, Air Suspension Axle
01/08 →	Tie Rod		SC-DL-7264	Tag Axle; for vehicles with Hinged Trailing Axle
01/08 →	Tie Rod		SC-DL-8137	Tag Axle; for vehicles with Hinged Trailing Axle

CV-ES-14162

Length: 125
Cone Ø: d1 Ø 30 / d2 Ø 27
Thread: M30 x 1,5 LHT
283783, 395009, 1358792, 1738380, 1 914
426, 2051165



DF-RK-9341

Ø: 67
550807, 5508072



SC-DL-5354

Length: 1060 Ø: 52
Cone Ø: d1 Ø 30 / d2 Ø 27
1384027, 1769597, 1847312, 1912758,
12200800A



SC-DL-7264

Length: 1743 Ø: 62
Cone Ø: d1 Ø 30 / d2 Ø 27
1361413, 1395614, 1734019, 1897333,
2040254, 2146105



SC-DL-8137

Length: 1736 Ø: 40
Cone Ø: d1 Ø 30 / d2 Ø 27
301639, 311847, 395350, 1358675,
1378435, 1397866, 1734020, 2028998,
12202900A



SC-DL-8179

Length: 568 Ø: 46
Hole Distance: 115 / 115
1399180, 1428347



SC-DL-8399

Length: 433 Ø: 40
Cone Ø: d1 Ø 30 / d2 Ø 26
1394884, 1938387



SC-DL-8509

Length: 568,5 Ø: 46
Hole Distance: 115 / 115
1485758, 1486757



SC-DL-8531

Length: 522 Ø: 46
Hole Distance: 115 / 115
1486758



SC-DL-8547

Length: 568 Ø: 50
Hole Distance: 115 / 115
1499474, 1722746, 1906940



SC-DL-8553

Length: 435 Ø: 38
Cone Ø: d1 Ø 30 / d2 Ø 27
1343283, 1759691



SC-DL-8623

Length: 592 Ø: 50
Hole Distance: 115 / 115
1388436, 1499476, 1722748, 1906942



SC-DL-9457

Length: 1743 Ø: 52
Cone Ø: d1 Ø 30 / d2 Ø 27
1527989, 1723896, 1737684, 1897336



SC-DL-9462

Length: 568,5 Ø: 50
Hole Distance: 115 / 115
1499475, 1500573, 1722747, 1906941



SC-DL-9466

Length: 568 Ø: 19
1486756



SC-DL-10225

Length: 2179 Ø: 62
Cone Ø: d1 Ø 30 / d2 Ø 27
1386618, 1788522



SC-DL-10302

Length: 752 Ø: 48
Hole Distance: 115 / 115
1101843, 1379423, 1393298, 1431470,
1942075



SC-DL-12449

Length: 1206 Ø: 38
Cone Ø: d1 Ø 30 / d2 Ø 27
1385763, 1765375



SC-TC-12361

Length: 705 Ø: 42
Cone Ø: d1 Ø 38
Hole Distance: 115
1353445, 1464611, 1942147



SC-TC-12451

Length: 552 Ø: 46
Hole Distance: 115 / 115
1494296



SC-TC-12452

Length: 580,5 Ø: 46
Hole Distance: 115 / 115
1485759



SC-TC-12472

Length: 580 Ø: 46
Hole Distance: 115 / 115
1399182



SC-VB-12418

Length: 613,2
Ø: 46
Hole Ø 25 / 19 / 19
Hole Distance: 152 / 115 / 115
1440028, 1722582



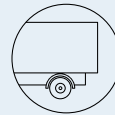

P,G,R,T - series ...

G 480, R 480 ...	01/08→	Tie Rod	SC-DL-7264		1st FA
	01/08→	Tie Rod	SC-DL-8137		Leaf Spring Axle;1st FA
	01/08→	Tie Rod	SC-DL-9457		1st FA;Leaf Spring Axle
	01/08→	Tie Rod End		MN-ES-8490	Tag Axle;for vehicles with Hinged Trailing Axle
	01/08→	Tie Rod End	IV-ES-12272		for Steering Rod
	01/08→	Tie Rod End	MN-ES-8490	MN-ES-8490	for vehicles with Hinged Trailing Axle
G 480, R 480, P 480	04/10→	Centre Rod	SC-DL-5229		Push Rod
	04/10→	Centre Rod	SC-DL-5354		Push Rod
	04/10→	Centre Rod	SC-DL-12343		for Steering Rod
	04/10→	Suspension Arm Repair Kit		SC-RK-12366	for Control Arm
	04/10→	Suspension Strut Repair Kit		DF-RK-9341	
	04/10→	Tie Rod	SC-DL-7264		
	04/10→	Tie Rod	SC-DL-8137		Leaf Spring Axle
	04/10→	Tie Rod	SC-DL-9457		Leaf Spring Axle
	04/10→	Tie Rod End	CV-ES-14162		for Steering Rod
	04/10→	Tie Rod End	CV-ES-14163		for Steering Rod
	04/10→	Tie Rod End	SC-ES-8535		for Guide Rod
	04/10→	Track Control Arm		SC-VB-12418	Control Arm
	04/10→	Track Control Arm	SC-DL-10302	SC-DL-10302	Trailing Arm, Air Suspension Axle
	G 490, R 490	09/13→	Centre Rod	SC-DL-12342	
09/13→		Centre Rod	SC-DL-12449		Push Rod
09/13→		Suspension Arm Repair Kit		SC-RK-12366	for Control Arm
09/13→		Track Control Arm		SC-TC-12452	Control Arm
09/13→		Track Control Arm		SC-VB-12418	Control Arm
P 230	04/04→	Centre Rod	SC-DL-5229		Push Rod
	04/04→	Centre Rod	SC-DL-5354		Push Rod
	04/04→	Centre Rod	SC-DL-12342		for Steering Rod
	04/04→	Centre Rod	SC-DL-12343		for Steering Rod
	04/04→	Suspension Arm Repair Kit		SC-RK-12366	for Control Arm
	04/04→	Suspension Strut Repair Kit		MN-RK-8501	
	04/04→	Suspension Strut Repair Kit		MN-RK-12436	
	04/04→	Suspension Strut Repair Kit	DF-RK-9341		
	04/04→	Tie Rod	SC-DL-7264		
	04/04→	Tie Rod	SC-DL-8137		Leaf Spring Axle
	04/04→	Tie Rod	SC-DL-9457		Leaf Spring Axle
	04/04→	Tie Rod End	CV-ES-14162		for Steering Rod
	04/04→	Tie Rod End	CV-ES-14163		for Steering Rod
	04/04→	Tie Rod End	SC-ES-8535		for Guide Rod
	04/04→	Track Control Arm		SC-TC-12452	Control Arm
	04/04→	Track Control Arm		SC-VB-12418	Control Arm
	04/04→	Track Control Arm	SC-DL-10302	SC-DL-10302	Trailing Arm, Air Suspension Axle
	09/04→	Suspension Arm Repair Kit	SC-RK-12346	SC-RK-12346	for Control Arm
	04/06→	Centre Rod	SC-DL-5354	SC-DL-5354	Push Rod, for vehicles with Hinged Trailing Axle
	04/06→	Centre Rod	SC-DL-8182		Push Rod
	04/06→	Centre Rod	SC-DL-8399		Push Rod, for vehicles with Hinged Leading Axle, for vehicles with Part-Pneumatic Suspension
	04/06→	Centre Rod	SC-DL-8553	SC-DL-8553	Push Rod, for vehicles with Hinged Leading Axle
	04/06→	Centre Rod	SC-DL-12449		Push Rod
	04/06→	Tie Rod		SC-DL-7264	Tag Axle;for vehicles with Hinged Trailing Axle
	04/06→	Tie Rod		SC-DL-8137	Tag Axle;for vehicles with Hinged Trailing Axle
	04/06→	Tie Rod End		MN-ES-8490	Tag Axle;for vehicles with Hinged Trailing Axle
	04/06→	Tie Rod End	CV-ES-14162	CV-ES-14162	for Steering Rod
	04/06→	Tie Rod End	IV-ES-12272		for Steering Rod
	04/06→	Tie Rod End	MN-ES-8490	MN-ES-8490	for vehicles with Hinged Trailing Axle
	04/06→	Tie Rod End	SC-ES-8517		for Push Rod
	04/06→	Track Control Arm	SC-TC-12361		Control Arm, 1st Front Axle, for Pneumatic Suspension vehicles
	09/07→	Track Control Arm		SC-DL-8511	Trailing Arm, Leaf Spring Axle
	09/07→	Track Control Arm		SC-DL-8511	Trailing Arm, Leaf Spring Axle, →* 3512097 *
09/07→	Track Control Arm		SC-DL-8547	Trailing Arm, Leaf Spring Axle	
09/07→	Track Control Arm		SC-DL-9462	Trailing Arm, Leaf Spring Axle, →* 2006231 SSS *;* 5117423 SNL *; * 9097199 SAN *;* 3564002 SLA *	

CV-ES-14162

Length: 125
Cone Ø: d1 Ø 30 / d2 Ø 27
Thread: M30 x 1,5 LHT
283783, 395009, 1358792, 1738380, 1 914 426, 2051165



CV-ES-14163

Length: 125
Cone Ø: d1 Ø 30 / d2 Ø 27
Thread: M30 x 1,5 RHT
283784, 395010, 1358793, 1488890, 1738381, 1767328, 1914427, 2051166



DF-RK-9341

Ø: 67
550807, 5508072



IV-ES-12272

Length: 75
Cone Ø: d1 Ø 30 / d2 Ø 27
Thread: M26 x 1,5 RHT
1394443



MN-ES-8490

Length: 90
Cone Ø: d1 Ø 30 / d2 Ø 27
Thread: M26 x 1,5 RHT
1394444, 0014606948, 14606948



MN-RK-8501

Ø: 75 Hole Distance: 115
Thick/Height: 24
1515981



MN-RK-12436

Ø: 75 Hole Distance: 115
Thick/Height: 24
550799, 1517403, 1783020



SC-DL-5229

Length: 1053 Ø: 50
Cone Ø: d1 Ø 30 / d2 Ø 27
1356055, 1379071, 1384025, 1768898, 1847311, 1912757, 12201600A



SC-DL-5354

Length: 1060 Ø: 52
Cone Ø: d1 Ø 30 / d2 Ø 27
1384027, 1769597, 1847312, 1912758, 12200800A



SC-DL-7264

Length: 1743 Ø: 62
Cone Ø: d1 Ø 30 / d2 Ø 27
1361413, 1395614, 1734019, 1897333, 2040254, 2146105



SC-DL-8137

Length: 1736 Ø: 40
Cone Ø: d1 Ø 30 / d2 Ø 27
301639, 311847, 395350, 1358675, 1378435, 1397866, 1734020, 2028998, 12202900A



SC-DL-8182

1343262, 1869413



SC-DL-8399

Length: 433 Ø: 40
Cone Ø: d1 Ø 30 / d2 Ø 26
1394884, 1938387



SC-DL-8511

Length: 616,5 Ø: 50
Hole Distance: 115 / 115
1485760, 1499478, 1722750



SC-DL-8547

Length: 568 Ø: 50
Hole Distance: 115 / 115
1499474, 1722746, 1906940



SC-DL-8553

Length: 435 Ø: 38
Cone Ø: d1 Ø 30 / d2 Ø 27
1343283, 1759691



SC-DL-9457

Length: 1743 Ø: 52
Cone Ø: d1 Ø 30 / d2 Ø 27
1527989, 1723896, 1737684, 1897336



SC-DL-9462

Length: 568,5 Ø: 50
Hole Distance: 115 / 115
1499475, 1500573, 1722747, 1906941



SC-DL-10302

Length: 752 Ø: 48
Hole Distance: 115 / 115
1101843, 1379423, 1393298, 1431470, 1942075



SC-DL-12342

Length: 601 Ø: 42
Cone Ø: d1 Ø 26 / d2 Ø 23,5
1343262, 1869413



SC-DL-12343

Length: 1062 Ø: 52
Cone Ø: d1 Ø 30 / d2 Ø 27
1348269, 2007275



SC-DL-12449

Length: 1206 Ø: 38
Cone Ø: d1 Ø 30 / d2 Ø 27
1385763, 1765375



SC-ES-8517

Length: 140
Cone Ø: d1 Ø 30 / d2 Ø 27
Thread: M30 x 1,5 RHT
1358793, 1435746, 1488890, 1534756, 1914427, 2051166



SC-ES-8535

Length: 145
Cone Ø: d1 Ø 30 / d2 Ø 27
Thread: M30 x 1,5 RHT
1723897, 2051041



SC-RK-12346

Ø: 67 Hole Distance: 115
Thick/Height: 24
550800



SC-RK-12366

Ø: 75 Hole Distance: 115 / 115
Thick/Height: 24
1 722 753, 2 096 392



SC-TC-12361

Length: 705 Ø: 42
Cone Ø: d1 Ø 38
Hole Distance: 115
1353445, 1464611, 1942147



SC-TC-12452

Length: 580,5 Ø: 46
Hole Distance: 115 / 115
1485759



SC-VB-12418

Length: 613,2
Ø: 46
Hole Ø 25 / 19 / 19
Hole Distance: 152 / 115 / 115
1440028, 1722582



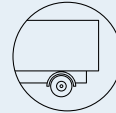

P,G,R,T - series ...

P 230 ...	09/07→	Track Control Arm		SC-DL-9466	Trailing Arm, Leaf Spring Axle
	09/07→	Track Control Arm		SC-TC-12451	Trailing Arm, 1st Drive Axle, for Leaf-Spring Suspension vehicles
	09/07→	Track Control Arm		SC-TC-12451	Trailing Arm, 1st Drive Axle, for Leaf-Spring Suspension vehicles, 1280185/4471603→
	09/07→	Track Control Arm		SC-TC-12451	Trailing Arm, 1st Drive Axle, for Leaf-Spring Suspension vehicles, 9069961/3536016→
	09/07→	Track Control Arm		SC-TC-12472	Trailing Arm, 2nd Drive Axle, for Leaf-Spring Suspension vehicles, →1280184/4471602
	09/07→	Track Control Arm		SC-TC-12472	Trailing Arm, 2nd Drive Axle, for Leaf-Spring Suspension vehicles, →9069960/3536015
	09/07→	Track Control Arm	SC-DL-8179	SC-DL-8179	Trailing Arm, Leaf Spring Axle
	09/07→	Track Control Arm	SC-DL-8509	SC-DL-8509	Trailing Arm
	09/07→	Track Control Arm	SC-DL-8509	SC-DL-8509	Trailing Arm, Leaf Spring Axle
	09/07→	Track Control Arm	SC-DL-8531	SC-DL-8531	Trailing Arm, Leaf Spring Axle
	09/07→	Track Control Arm	SC-DL-8623	SC-DL-8623	Trailing Arm, Leaf Spring Axle, →* 2006231 SSS *;* 5117423 SNL *; * 9097199 SAN **; 3564002 SLA *
	09/07→	Track Control Arm	SC-DL-10302	SC-DL-10302	Trailing Arm, 1st Front Axle, for Pneumatic Suspension vehicles
	P 230, R 230	09/04→	Centre Rod	SC-DL-5229	
09/04→		Centre Rod	SC-DL-5354		Push Rod
09/04→		Centre Rod	SC-DL-10225		for Steering Rod
09/04→		Centre Rod	SC-DL-12342		for Steering Rod
09/04→		Centre Rod	SC-DL-12343		for Steering Rod
09/04→		Suspension Arm Repair Kit		SC-RK-12366	for Control Arm
09/04→		Suspension Arm Repair Kit	SC-RK-12346	SC-RK-12346	for Control Arm
09/04→		Suspension Strut Repair Kit		CV-RK-5311	
09/04→		Suspension Strut Repair Kit		MN-RK-8501	
09/04→		Suspension Strut Repair Kit		MN-RK-12436	
09/04→		Suspension Strut Repair Kit	DF-RK-9341		
09/04→		Tie Rod	SC-DL-7264		
09/04→		Tie Rod	SC-DL-8137		Leaf Spring Axle
09/04→		Tie Rod	SC-DL-9457		Leaf Spring Axle
09/04→		Tie Rod End	CV-ES-14162		for Steering Rod
09/04→		Tie Rod End	CV-ES-14163		for Steering Rod
09/04→		Tie Rod End	SC-ES-8535		for Guide Rod
09/04→		Track Control Arm		SC-VB-12418	Control Arm
09/04→		Track Control Arm	SC-DL-10302	SC-DL-10302	Trailing Arm, Air Suspension Axle
09/04→		Track Control Arm	SC-TC-12361		Control Arm, 1st Front Axle, for Pneumatic Suspension vehicles
09/05→		Centre Rod	SC-DL-5354	SC-DL-5354	Push Rod, for vehicles with Hinged Trailing Axle
09/05→		Centre Rod	SC-DL-8182		Push Rod
09/05→		Centre Rod	SC-DL-8399		Push Rod, for vehicles with Hinged Leading Axle, for vehicles with Part-Pneumatic Suspension
09/05→		Centre Rod	SC-DL-8553	SC-DL-8553	Push Rod, for vehicles with Hinged Leading Axle
09/05→		Centre Rod	SC-DL-10225		Push Rod, for vehicles with Hinged Leading Axle
09/05→		Centre Rod	SC-DL-12449		Push Rod
09/05→		Tie Rod		SC-DL-7264	Leading Axle;for vehicles with Hinged Leading Axle
09/05→		Tie Rod		SC-DL-7264	Leading Axle;for vehicles with Hinged Leading Axle;Air Suspension Axle
09/05→		Tie Rod		SC-DL-7264	Tag Axle;for vehicles with Hinged Trailing Axle
09/05→		Tie Rod		SC-DL-8137	Leading Axle;for vehicles with Hinged Leading Axle
09/05→		Tie Rod		SC-DL-8137	Tag Axle;for vehicles with Hinged Trailing Axle
09/05→		Tie Rod End		MN-ES-8490	Tag Axle;for vehicles with Hinged Trailing Axle
09/05→		Tie Rod End	CV-ES-14162	CV-ES-14162	for Steering Rod
09/05→	Tie Rod End	IV-ES-12272		for Steering Rod	
09/05→	Tie Rod End	MN-ES-8490	MN-ES-8490	for vehicles with Hinged Trailing Axle	
09/05→	Tie Rod End	SC-ES-8517		for Push Rod	

CV-ES-14162

Length: 125
Cone Ø: d1 Ø 30 / d2 Ø 27
Thread: M30 x 1,5 LHT
283783, 395009, 1358792, 1738380, 1 914 426, 2051165



CV-ES-14163

Length: 125
Cone Ø: d1 Ø 30 / d2 Ø 27
Thread: M30 x 1,5 RHT
283784, 395010, 1358793, 1488890, 1738381, 1767328, 1914427, 2051166



CV-RK-5311

0638862, 638862, 0639287, 639287, 1104335, 1953248, 81432206006, 81432206107



DF-RK-9341

Ø: 67
550807, 5508072



IV-ES-12272

Length: 75
Cone Ø: d1 Ø 30 / d2 Ø 27
Thread: M26 x 1,5 RHT
1394443



MN-ES-8490

Length: 90
Cone Ø: d1 Ø 30 / d2 Ø 27
Thread: M26 x 1,5 RHT
1394444, 0014606948, 14606948



MN-RK-8501

Ø: 75 Hole Distance: 115
Thick/Height: 24
1515981



MN-RK-12436

Ø: 75 Hole Distance: 115
Thick/Height: 24
550799, 1517403, 1783020



SC-DL-5229

Length: 1053 Ø: 50
Cone Ø: d1 Ø 30 / d2 Ø 27
1356055, 1379071, 1384025, 1768898, 1847311, 1912757, 12201600A



SC-DL-5354

Length: 1060 Ø: 52
Cone Ø: d1 Ø 30 / d2 Ø 27
1384027, 1769597, 1847312, 1912758, 12200800A



SC-DL-7264

Length: 1743 Ø: 62
Cone Ø: d1 Ø 30 / d2 Ø 27
1361413, 1395614, 1734019, 1897333, 2040254, 2146105



SC-DL-8137

Length: 1736 Ø: 40
Cone Ø: d1 Ø 30 / d2 Ø 27
301639, 311847, 395350, 1358675, 1378435, 1397866, 1734020, 2028998, 12202900A



SC-DL-8179

Length: 568 Ø: 46
Hole Distance: 115 / 115
1399180, 1428347



SC-DL-8182

1343262, 1869413



SC-DL-8399

Length: 433 Ø: 40
Cone Ø: d1 Ø 30 / d2 Ø 26
1394884, 1938387



SC-DL-8509

Length: 568,5 Ø: 46
Hole Distance: 115 / 115
1485758, 1486757



SC-DL-8531

Length: 522 Ø: 46
Hole Distance: 115 / 115
1486758



SC-DL-8553

Length: 435 Ø: 38
Cone Ø: d1 Ø 30 / d2 Ø 27
1343283, 1759691



SC-DL-8623

Length: 592 Ø: 50
Hole Distance: 115 / 115
1388436, 1499476, 1722748, 1906942



SC-DL-9457

Length: 1743 Ø: 52
Cone Ø: d1 Ø 30 / d2 Ø 27
1527989, 1723896, 1737684, 1897336



SC-DL-9466

Length: 568 Ø: 19
1486756



SC-DL-10225

Length: 2179 Ø: 62
Cone Ø: d1 Ø 30 / d2 Ø 27
1386618, 1788522



SC-DL-10302

Length: 752 Ø: 48
Hole Distance: 115 / 115
1101843, 1379423, 1393298, 1431470, 1942075



SC-DL-12342

Length: 601 Ø: 42
Cone Ø: d1 Ø 26 / d2 Ø 23,5
1343262, 1869413



SC-DL-12343

Length: 1062 Ø: 52
Cone Ø: d1 Ø 30 / d2 Ø 27
1348269, 2007275



SC-DL-12449

Length: 1206 Ø: 38
Cone Ø: d1 Ø 30 / d2 Ø 27
1385763, 1765375



SC-ES-8517

Length: 140
Cone Ø: d1 Ø 30 / d2 Ø 27
Thread: M30 x 1,5 RHT
1358793, 1435746, 1488890, 1534756, 1914427, 2051166



SC-ES-8535

Length: 145
Cone Ø: d1 Ø 30 / d2 Ø 27
Thread: M30 x 1,5 RHT
1723897, 2051041



SC-RK-12346

Ø: 67 Hole Distance: 115
Thick/Height: 24
550800



SC-RK-12366

Ø: 75 Hole Distance: 115 / 115
Thick/Height: 24
1 722 753, 2 096 392



SC-TC-12361

Length: 705 Ø: 42
Cone Ø: d1 Ø 38
Hole Distance: 115
1353445, 1464611, 1942147



SC-TC-12451

Length: 552 Ø: 46
Hole Distance: 115 / 115
1494296



SC-TC-12472

Length: 580 Ø: 46
Hole Distance: 115 / 115
1399182



SC-VB-12418

Length: 613,2
Ø: 46
Hole Ø 25 / 19 / 19
Hole Distance: 152 / 115 / 115
1440028, 1722582



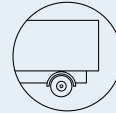

P,G,R,T - series ...

P 250	01/10→	Centre Rod	SC-DL-10225		for Steering Rod
	01/10→	Centre Rod	SC-DL-12342		for Steering Rod
	01/10→	Centre Rod	SC-DL-12343		for Steering Rod
	01/10→	Suspension Arm Repair Kit		SC-RK-12366	for Control Arm
	01/10→	Suspension Arm Repair Kit	SC-RK-12346	SC-RK-12346	for Control Arm
	01/10→	Tie Rod End	CV-ES-14163		for Steering Rod
	01/10→	Track Control Arm		SC-TC-12452	Control Arm
	01/10→	Track Control Arm		SC-VB-12418	Control Arm
	01/12→	Centre Rod	SC-DL-12449		Push Rod
	P 260	04/04→	Centre Rod	SC-DL-5229	
04/04→		Centre Rod	SC-DL-5354		Push Rod
04/04→		Centre Rod	SC-DL-12342		for Steering Rod
04/04→		Centre Rod	SC-DL-12343		for Steering Rod
04/04→		Suspension Arm Repair Kit	SC-RK-12346	SC-RK-12346	for Control Arm
04/04→		Suspension Strut Repair Kit		MN-RK-8501	
04/04→		Suspension Strut Repair Kit		MN-RK-12436	
04/04→		Suspension Strut Repair Kit	DF-RK-9341		
04/04→		Tie Rod	SC-DL-7264		
04/04→		Tie Rod	SC-DL-8137		Leaf Spring Axle
04/04→		Tie Rod	SC-DL-9457		Leaf Spring Axle
04/04→		Tie Rod End	CV-ES-14163		for Steering Rod
04/04→		Track Control Arm		SC-VB-12418	Control Arm
04/04→		Track Control Arm	SC-DL-10302	SC-DL-10302	Trailing Arm, Air Suspension Axle
P 270	04/04→	Centre Rod	SC-DL-5229		Push Rod
	04/04→	Centre Rod	SC-DL-5354		Push Rod
	04/04→	Centre Rod	SC-DL-5354	SC-DL-5354	Push Rod, for vehicles with Hinged Trailing Axle
	04/04→	Centre Rod	SC-DL-8154		Push Rod
	04/04→	Centre Rod	SC-DL-8169		Push Rod
	04/04→	Centre Rod	SC-DL-8182		Push Rod
	04/04→	Centre Rod	SC-DL-8399		Push Rod, for vehicles with Hinged Leading Axle, for vehicles with Part-Pneumatic Suspension
	04/04→	Centre Rod	SC-DL-8399		Push Rod, Leaf Spring Axle
	04/04→	Centre Rod	SC-DL-8553	SC-DL-8553	Push Rod, for vehicles with Hinged Leading Axle
	04/04→	Centre Rod	SC-DL-10225		for Steering Rod
	04/04→	Centre Rod	SC-DL-12341		Push Rod
	04/04→	Centre Rod	SC-DL-12342		for Steering Rod
	04/04→	Centre Rod	SC-DL-12343		for Steering Rod
	04/04→	Centre Rod	SC-DL-12449		Push Rod
	04/04→	Suspension Arm Repair Kit		SC-RK-12366	for Control Arm
	04/04→	Suspension Arm Repair Kit	SC-RK-12346	SC-RK-12346	for Control Arm
	04/04→	Suspension Strut Repair Kit		MN-RK-8501	
	04/04→	Suspension Strut Repair Kit		MN-RK-12436	
	04/04→	Suspension Strut Repair Kit	DF-RK-9341		
	04/04→	Tie Rod		SC-DL-7264	Tag Axle;for vehicles with Hinged Trailing Axle
	04/04→	Tie Rod		SC-DL-8137	Tag Axle;for vehicles with Hinged Trailing Axle
	04/04→	Tie Rod	SC-DL-7264		
	04/04→	Tie Rod	SC-DL-7264		1st FA;2nd FA
	04/04→	Tie Rod	SC-DL-8137		Leaf Spring Axle
	04/04→	Tie Rod	SC-DL-8137		Leaf Spring Axle;1st FA;2nd FA
	04/04→	Tie Rod	SC-DL-9457		1st FA;2nd FA;Leaf Spring Axle
	04/04→	Tie Rod	SC-DL-9457		Leaf Spring Axle
	04/04→	Tie Rod End		MN-ES-8490	Tag Axle;for vehicles with Hinged Trailing Axle
	04/04→	Tie Rod End	CV-ES-14162		for Steering Rod
	04/04→	Tie Rod End	CV-ES-14162	CV-ES-14162	for Steering Rod
	04/04→	Tie Rod End	CV-ES-14163		for Steering Rod
	04/04→	Tie Rod End	IV-ES-12272		for Steering Rod
	04/04→	Tie Rod End	MN-ES-8490	MN-ES-8490	for vehicles with Hinged Trailing Axle
	04/04→	Tie Rod End	SC-ES-5764		
	04/04→	Tie Rod End	SC-ES-8517		for Push Rod
	04/04→	Tie Rod End	SC-ES-8535		for Guide Rod
	04/04→	Track Control Arm		SC-DL-8511	Trailing Arm, Leaf Spring Axle
	04/04→	Track Control Arm		SC-DL-8511	Trailing Arm, Leaf Spring Axle, →* 3512097 *
	04/04→	Track Control Arm		SC-DL-8547	Trailing Arm, Leaf Spring Axle

CV-ES-14162

Length: 125
 Cone Ø: d1 Ø 30 / d2 Ø 27
 Thread: M30 x 1,5 LHT
 283783, 395009, 1358792, 1738380, 1 914 426, 2051165

**CV-ES-14163**

Length: 125
 Cone Ø: d1 Ø 30 / d2 Ø 27
 Thread: M30 x 1,5 RHT
 283784, 395010, 1358793, 1488890, 1738381, 1767328, 1914427, 2051166

**DF-RK-9341**

Ø: 67
 550807, 5508072

**IV-ES-12272**

Length: 75
 Cone Ø: d1 Ø 30 / d2 Ø 27
 Thread: M26 x 1,5 RHT
 1394443

**MN-ES-8490**

Length: 90
 Cone Ø: d1 Ø 30 / d2 Ø 27
 Thread: M26 x 1,5 RHT
 1394444, 0014606948, 14606948

**MN-RK-8501**

Ø: 75 Hole Distance: 115
 Thick/Height: 24
 1515981

**MN-RK-12436**

Ø: 75 Hole Distance: 115
 Thick/Height: 24
 550799, 1517403, 1783020

**SC-DL-5229**

Length: 1053 Ø: 50
 Cone Ø: d1 Ø 30 / d2 Ø 27
 1356055, 1379071, 1384025, 1768898, 1847311, 1912757, 12201600A

**SC-DL-5354**

Length: 1060 Ø: 52
 Cone Ø: d1 Ø 30 / d2 Ø 27
 1384027, 1769597, 1847312, 1912758, 12200800A

**SC-DL-7264**

Length: 1743 Ø: 62
 Cone Ø: d1 Ø 30 / d2 Ø 27
 1361413, 1395614, 1734019, 1897333, 2040254, 2146105

**SC-DL-8137**

Length: 1736 Ø: 40
 Cone Ø: d1 Ø 30 / d2 Ø 27
 301639, 311847, 395350, 1358675, 1378435, 1397866, 1734020, 2028998, 12202900A

**SC-DL-8154**

Length: 495 Ø: 40
 Cone Ø: d1 Ø 30 / d2 Ø 27
 1343266, 1759690

**SC-DL-8169**

Length: 1920 Ø: 62
 Cone Ø: d1 Ø 30 / d2 Ø 27
 1343264, 1732635, 2007278

**SC-DL-8182**

1343262, 1869413

**SC-DL-8399**

Length: 433 Ø: 40
 Cone Ø: d1 Ø 30 / d2 Ø 26
 1394884, 1938387

**SC-DL-8511**

Length: 616,5 Ø: 50
 Hole Distance: 115 / 115
 1485760, 1499478, 1722750

**SC-DL-8547**

Length: 568 Ø: 50
 Hole Distance: 115 / 115
 1499474, 1722746, 1906940

**SC-DL-8553**

Length: 435 Ø: 38
 Cone Ø: d1 Ø 30 / d2 Ø 27
 1343283, 1759691

**SC-DL-9457**

Length: 1743 Ø: 52
 Cone Ø: d1 Ø 30 / d2 Ø 27
 1527989, 1723896, 1737684, 1897336

**SC-DL-10225**

Length: 2179 Ø: 62
 Cone Ø: d1 Ø 30 / d2 Ø 27
 1386618, 1788522

**SC-DL-10302**

Length: 752 Ø: 48
 Hole Distance: 115 / 115
 1101843, 1379423, 1393298, 1431470, 1942075

**SC-DL-12341**

Length: 1776 Ø: 62
 Cone Ø: d1 Ø 30 / d2 Ø 27
 1386620

**SC-DL-12342**

Length: 601 Ø: 42
 Cone Ø: d1 Ø 26 / d2 Ø 23,5
 1343262, 1869413

**SC-DL-12343**

Length: 1062 Ø: 52
 Cone Ø: d1 Ø 30 / d2 Ø 27
 1348269, 2007275

**SC-DL-12449**

Length: 1206 Ø: 38
 Cone Ø: d1 Ø 30 / d2 Ø 27
 1385763, 1765375

**SC-ES-5764**

Length: 95
 Cone Ø: d1 Ø 30 / d2 Ø 27
 Thread: M26 x 1,5 RHT
 325614, 1375228, 4604948

**SC-ES-8517**

Length: 140
 Cone Ø: d1 Ø 30 / d2 Ø 27
 Thread: M30 x 1,5 RHT
 1358793, 1435746, 1488890, 1534756, 1914427, 2051166

**SC-ES-8535**

Length: 145
 Cone Ø: d1 Ø 30 / d2 Ø 27
 Thread: M30 x 1,5 RHT
 1723897, 2051041

**SC-RK-12346**

Ø: 67 Hole Distance: 115
 Thick/Height: 24
 550800

**SC-RK-12366**

Ø: 75 Hole Distance: 115 / 115
 Thick/Height: 24
 1 722 753, 2 096 392

**SC-TC-12452**

Length: 580,5 Ø: 46
 Hole Distance: 115 / 115
 1485759

**SC-VB-12418**

Length: 613,2
 Ø: 46
 Hole Ø 25 / 19 / 19
 Hole Distance: 152 / 115 / 115
 1440028, 1722582





P,G,R,T - series ...

P 270 ...

04/04 →	Track Control Arm		SC-DL-9462	Trailing Arm, Leaf Spring Axle, →* 2006231 SSS *;* 5117423 SNL *; * 9097199 SAN *;* 3564002 SLA *
04/04 →	Track Control Arm		SC-DL-9466	Trailing Arm, Leaf Spring Axle
04/04 →	Track Control Arm		SC-TC-12451	Trailing Arm, 1st Drive Axle, for Leaf-Spring Suspension vehicles
04/04 →	Track Control Arm		SC-TC-12451	Trailing Arm, 1st Drive Axle, for Leaf-Spring Suspension vehicles, 1280185/4471603→
04/04 →	Track Control Arm		SC-TC-12451	Trailing Arm, 1st Drive Axle, for Leaf-Spring Suspension vehicles, 9069961/3536016→
04/04 →	Track Control Arm		SC-TC-12452	Control Arm
04/04 →	Track Control Arm		SC-TC-12472	Trailing Arm, 2nd Drive Axle, for Leaf-Spring Suspension vehicles, →1280184/4471602
04/04 →	Track Control Arm		SC-TC-12472	Trailing Arm, 2nd Drive Axle, for Leaf-Spring Suspension vehicles, →9069960/3536015
04/04 →	Track Control Arm		SC-VB-12418	Control Arm
04/04 →	Track Control Arm	SC-DL-8179	SC-DL-8179	Trailing Arm, Leaf Spring Axle
04/04 →	Track Control Arm	SC-DL-8509	SC-DL-8509	Trailing Arm
04/04 →	Track Control Arm	SC-DL-8509	SC-DL-8509	Trailing Arm, Leaf Spring Axle
04/04 →	Track Control Arm	SC-DL-8531	SC-DL-8531	Trailing Arm, Leaf Spring Axle
04/04 →	Track Control Arm	SC-DL-8623	SC-DL-8623	Trailing Arm, Leaf Spring Axle, →* 2006231 SSS *;* 5117423 SNL *; * 9097199 SAN *;* 3564002 SLA *
04/04 →	Track Control Arm	SC-DL-10302	SC-DL-10302	Trailing Arm, Air Suspension Axle
04/04 →	Track Control Arm	SC-DL-10302	SC-DL-10302	Trailing Arm, Air Suspension Axle;1st FA
04/04 →	Track Control Arm	SC-TC-12361		Control Arm, 1st & 2nd Front Axle, for Pneumatic Suspension vehicles
04/04 →	Track Control Arm	SC-TC-12361		Control Arm, 1st Front Axle, for Pneumatic Suspension vehicles
09/04 →	Suspension Strut Repair Kit		CV-RK-5311	
04/06 →	Centre Rod	SC-DL-10225		Push Rod, for vehicles with Hinged Leading Axle
04/06 →	Tie Rod		SC-DL-7264	Leading Axle;for vehicles with Hinged Leading Axle
04/06 →	Tie Rod		SC-DL-7264	Leading Axle;for vehicles with Hinged Leading Axle;Air Suspension Axle
04/06 →	Tie Rod		SC-DL-8137	Leading Axle;for vehicles with Hinged Leading Axle
01/12 →	Suspension Arm Repair Kit	MN-RK-7280	MN-RK-7280	for Drag Link;for Semi-Trailing Arm; for Wishbone (CV)
01/12 →	Track Control Arm		SC-DL-8509	Trailing Arm, 1st & 2nd Drive Axle, for Leaf-Spring Suspension vehicles
01/12 →	Track Control Arm		SC-DL-8509	Trailing Arm, 1st Drive Axle, for Leaf-Spring Suspension vehicles
01/12 →	Track Control Arm		SC-DL-8509	Trailing Arm, 1st Drive Axle, for Leaf-Spring Suspension vehicles, 1280185/4471603→
01/12 →	Track Control Arm		SC-DL-8511	Trailing Arm, 1st & 2nd Drive Axle, for Leaf-Spring Suspension vehicles
01/12 →	Track Control Arm		SC-DL-8531	Trailing Arm, 1st & 2nd Drive Axle, for Leaf-Spring Suspension vehicles
01/12 →	Track Control Arm		SC-DL-8547	Trailing Arm, for Leaf-Spring Suspension vehicles
01/12 →	Track Control Arm		SC-DL-9462	Trailing Arm, for Leaf-Spring Suspension vehicles
01/12 →	Track Control Arm		SC-DL-9466	Trailing Arm
01/12 →	Track Control Arm		SC-TC-12452	Trailing Arm, 2nd Drive Axle, for Leaf-Spring Suspension vehicles, 1280185/4471603→
01/12 →	Track Control Arm		SC-TC-12452	Trailing Arm, 2nd Drive Axle, for Leaf-Spring Suspension vehicles, 9069961/3536016→
01/12 →	Track Control Arm		SC-TC-12472	Control Arm
01/12 →	Track Control Arm	SC-DL-8179	SC-DL-8179	Trailing Arm, for Leaf-Spring Suspension vehicles
01/12 →	Track Control Arm	SC-DL-8623	SC-DL-8623	Trailing Arm, for Leaf-Spring Suspension vehicles
01/12 →	Track Control Arm	SC-DL-10302	SC-DL-10302	Trailing Arm, 1st Front Axle, for Pneumatic Suspension vehicles

CV-RK-5311

0638862, 638862, 0639287, 639287,
1104335, 1953248, 81432206006,
81432206107



MN-RK-7280

Ø: 75 Hole Distance: 115
Thick/Height: 24
550806, 0550806, 639370, 0639370,
689748, 1104334



SC-DL-7264

Length: 1743 Ø: 62
Cone Ø: d1 Ø 30 / d2 Ø 27
1361413, 1395614, 1734019, 1897333,
2040254, 2146105



SC-DL-8137

Length: 1736 Ø: 40
Cone Ø: d1 Ø 30 / d2 Ø 27
301639, 311847, 395350, 1358675,
1378435, 1397866, 1734020, 2028998,
12202900A



SC-DL-8179

Length: 568 Ø: 46
Hole Distance: 115 / 115
1399180, 1428347



SC-DL-8509

Length: 568,5 Ø: 46
Hole Distance: 115 / 115
1485758, 1486757



SC-DL-8511

Length: 616,5 Ø: 50
Hole Distance: 115 / 115
1485760, 1499478, 1722750



SC-DL-8531

Length: 522 Ø: 46
Hole Distance: 115 / 115
1486758



SC-DL-8547

Length: 568 Ø: 50
Hole Distance: 115 / 115
1499474, 1722746, 1906940



SC-DL-8623

Length: 592 Ø: 50
Hole Distance: 115 / 115
1388436, 1499476, 1722748, 1906942



SC-DL-9462

Length: 568,5 Ø: 50
Hole Distance: 115 / 115
1499475, 1500573, 1722747, 1906941



SC-DL-9466

Length: 568 Ø: 19
1486756



SC-DL-10225

Length: 2179 Ø: 62
Cone Ø: d1 Ø 30 / d2 Ø 27
1386618, 1788522



SC-DL-10302

Length: 752 Ø: 48
Hole Distance: 115 / 115
1101843, 1379423, 1393298, 1431470,
1942075



SC-TC-12361

Length: 705 Ø: 42
Cone Ø: d1 Ø 38
Hole Distance: 115
1353445, 1464611, 1942147



SC-TC-12451

Length: 552 Ø: 46
Hole Distance: 115 / 115
1494296



SC-TC-12452

Length: 580,5 Ø: 46
Hole Distance: 115 / 115
1485759



SC-TC-12472

Length: 580 Ø: 46
Hole Distance: 115 / 115
1399182



SC-VB-12418

Length: 613,2
Ø: 46
Hole Ø 25 / 19 / 19
Hole Distance: 152 / 115 / 115
1440028, 1722582





P,G,R,T - series ...

P 270, R 270

04/04 →	Centre Rod	SC-DL-5229		Push Rod
04/04 →	Centre Rod	SC-DL-5354		Push Rod
04/04 →	Centre Rod	SC-DL-5354	SC-DL-5354	Push Rod, for vehicles with Hinged Trailing Axle
04/04 →	Centre Rod	SC-DL-8182		Push Rod
04/04 →	Centre Rod	SC-DL-8399		Push Rod, for vehicles with Hinged Leading Axle, for vehicles with Part-Pneumatic Suspension
04/04 →	Centre Rod	SC-DL-8553	SC-DL-8553	Push Rod, for vehicles with Hinged Leading Axle
04/04 →	Centre Rod	SC-DL-10225		for Steering Rod
04/04 →	Centre Rod	SC-DL-10225		Push Rod, for vehicles with Hinged Leading Axle
04/04 →	Centre Rod	SC-DL-12342		for Steering Rod
04/04 →	Centre Rod	SC-DL-12343		for Steering Rod
04/04 →	Centre Rod	SC-DL-12449		Push Rod
04/04 →	Suspension Arm Repair Kit		SC-RK-12366	for Control Arm
04/04 →	Suspension Arm Repair Kit	SC-RK-12346	SC-RK-12346	for Control Arm
04/04 →	Suspension Strut Repair Kit		MN-RK-8501	
04/04 →	Suspension Strut Repair Kit		MN-RK-12436	
04/04 →	Suspension Strut Repair Kit	DF-RK-9341		
04/04 →	Tie Rod		SC-DL-7264	Leading Axle;for vehicles with Hinged Leading Axle
04/04 →	Tie Rod		SC-DL-7264	Leading Axle;for vehicles with Hinged Leading Axle;Air Suspension Axle
04/04 →	Tie Rod		SC-DL-7264	Tag Axle;for vehicles with Hinged Trailing Axle
04/04 →	Tie Rod		SC-DL-8137	Leading Axle;for vehicles with Hinged Leading Axle
04/04 →	Tie Rod		SC-DL-8137	Tag Axle;for vehicles with Hinged Trailing Axle
04/04 →	Tie Rod	SC-DL-7264		
04/04 →	Tie Rod	SC-DL-8137		Leaf Spring Axle
04/04 →	Tie Rod	SC-DL-9457		Leaf Spring Axle
04/04 →	Tie Rod End		MN-ES-8490	Tag Axle;for vehicles with Hinged Trailing Axle
04/04 →	Tie Rod End	CV-ES-14162		for Steering Rod
04/04 →	Tie Rod End	CV-ES-14162	CV-ES-14162	for Steering Rod
04/04 →	Tie Rod End	CV-ES-14163		for Steering Rod
04/04 →	Tie Rod End	IV-ES-12272		for Steering Rod
04/04 →	Tie Rod End	MN-ES-8490	MN-ES-8490	for vehicles with Hinged Trailing Axle
04/04 →	Tie Rod End	SC-ES-8517		for Push Rod
04/04 →	Tie Rod End	SC-ES-8535		for Guide Rod
04/04 →	Track Control Arm		SC-VB-12418	Control Arm
04/04 →	Track Control Arm	SC-DL-10302	SC-DL-10302	Trailing Arm, Air Suspension Axle
04/04 →	Track Control Arm	SC-TC-12361		Control Arm, 1st Front Axle, for Pneumatic Suspension vehicles

P 280

04/04 →	Centre Rod	SC-DL-5229		Push Rod
04/04 →	Centre Rod	SC-DL-5354		Push Rod
04/04 →	Centre Rod	SC-DL-12342		for Steering Rod
04/04 →	Centre Rod	SC-DL-12343		for Steering Rod
04/04 →	Suspension Arm Repair Kit		SC-RK-12366	for Control Arm
04/04 →	Suspension Arm Repair Kit	SC-RK-12346	SC-RK-12346	for Control Arm
04/04 →	Suspension Strut Repair Kit		MN-RK-8501	
04/04 →	Suspension Strut Repair Kit		MN-RK-12436	
04/04 →	Suspension Strut Repair Kit	DF-RK-9341		
04/04 →	Tie Rod	SC-DL-7264		
04/04 →	Tie Rod	SC-DL-8137		Leaf Spring Axle
04/04 →	Tie Rod	SC-DL-9457		Leaf Spring Axle
04/04 →	Tie Rod End	CV-ES-14162		for Steering Rod
04/04 →	Tie Rod End	CV-ES-14163		for Steering Rod
04/04 →	Tie Rod End	SC-ES-8535		for Guide Rod
04/04 →	Track Control Arm		SC-TC-12452	Control Arm
04/04 →	Track Control Arm		SC-VB-12418	Control Arm
04/04 →	Track Control Arm	SC-DL-10302	SC-DL-10302	Trailing Arm, Air Suspension Axle
04/04 →	Track Control Arm	SC-TC-12361		Control Arm, 1st Front Axle, for Pneumatic Suspension vehicles
07/09 →	Centre Rod	SC-DL-12449		Push Rod
07/09 →	Tie Rod End	CV-ES-14162	CV-ES-14162	for Steering Rod
07/09 →	Tie Rod End	SC-ES-8517		for Push Rod

CV-ES-14162

Length: 125
Cone Ø: d1 Ø 30 / d2 Ø 27
Thread: M30 x 1,5 LHT
283783, 395009, 1358792, 1738380, 1 914 426, 2051165



CV-ES-14163

Length: 125
Cone Ø: d1 Ø 30 / d2 Ø 27
Thread: M30 x 1,5 RHT
283784, 395010, 1358793, 1488890, 1738381, 1767328, 1914427, 2051166



DF-RK-9341

Ø: 67
550807, 5508072



IV-ES-12272

Length: 75
Cone Ø: d1 Ø 30 / d2 Ø 27
Thread: M26 x 1,5 RHT
1394443



MN-ES-8490

Length: 90
Cone Ø: d1 Ø 30 / d2 Ø 27
Thread: M26 x 1,5 RHT
1394444, 0014606948, 14606948



MN-RK-8501

Ø: 75 Hole Distance: 115
Thick/Height: 24
1515981



MN-RK-12436

Ø: 75 Hole Distance: 115
Thick/Height: 24
550799, 1517403, 1783020



SC-DL-5229

Length: 1053 Ø: 50
Cone Ø: d1 Ø 30 / d2 Ø 27
1356055, 1379071, 1384025, 1768898, 1847311, 1912757, 12201600A



SC-DL-5354

Length: 1060 Ø: 52
Cone Ø: d1 Ø 30 / d2 Ø 27
1384027, 1769597, 1847312, 1912758, 12200800A



SC-DL-7264

Length: 1743 Ø: 62
Cone Ø: d1 Ø 30 / d2 Ø 27
1361413, 1395614, 1734019, 1897333, 2040254, 2146105



SC-DL-8137

Length: 1736 Ø: 40
Cone Ø: d1 Ø 30 / d2 Ø 27
301639, 311847, 395350, 1358675, 1378435, 1397866, 1734020, 2028998, 12202900A



SC-DL-8182

1343262, 1869413



SC-DL-8399

Length: 433 Ø: 40
Cone Ø: d1 Ø 30 / d2 Ø 26
1394884, 1938387



SC-DL-8553

Length: 435 Ø: 38
Cone Ø: d1 Ø 30 / d2 Ø 27
1343283, 1759691



SC-DL-9457

Length: 1743 Ø: 52
Cone Ø: d1 Ø 30 / d2 Ø 27
1527989, 1723896, 1737684, 1897336



SC-DL-10225

Length: 2179 Ø: 62
Cone Ø: d1 Ø 30 / d2 Ø 27
1386618, 1788522



SC-DL-10302

Length: 752 Ø: 48
Hole Distance: 115 / 115
1101843, 1379423, 1393298, 1431470, 1942075



SC-DL-12342

Length: 601 Ø: 42
Cone Ø: d1 Ø 26 / d2 Ø 23,5
1343262, 1869413



SC-DL-12343

Length: 1062 Ø: 52
Cone Ø: d1 Ø 30 / d2 Ø 27
1348269, 2007275



SC-DL-12449

Length: 1206 Ø: 38
Cone Ø: d1 Ø 30 / d2 Ø 27
1385763, 1765375



SC-ES-8517

Length: 140
Cone Ø: d1 Ø 30 / d2 Ø 27
Thread: M30 x 1,5 RHT
1358793, 1435746, 1488890, 1534756, 1914427, 2051166



SC-ES-8535

Length: 145
Cone Ø: d1 Ø 30 / d2 Ø 27
Thread: M30 x 1,5 RHT
1723897, 2051041



SC-RK-12346

Ø: 67 Hole Distance: 115
Thick/Height: 24
550800



SC-RK-12366

Ø: 75 Hole Distance: 115 / 115
Thick/Height: 24
1 722 753, 2 096 392



SC-TC-12361

Length: 705 Ø: 42
Cone Ø: d1 Ø 38
Hole Distance: 115
1353445, 1464611, 1942147



SC-TC-12452

Length: 580,5 Ø: 46
Hole Distance: 115 / 115
1485759



SC-VB-12418

Length: 613,2
Ø: 46
Hole Ø 25 / 19 / 19
Hole Distance: 152 / 115 / 115
1440028, 1722582





P,G,R,T - series ...

P 280 ...	07/09 →	Track Control Arm		SC-DL-8179	Trailing Arm, 1st & 2nd Drive Axle, for Leaf-Spring Suspension vehicles
	07/09 →	Track Control Arm		SC-DL-8179	Trailing Arm, 1st & 2nd Drive Axle, for Leaf-Spring Suspension vehicles, Ch.3512097 →
	07/09 →	Track Control Arm		SC-DL-8179	Trailing Arm, 1st Drive Axle, for Leaf-Spring Suspension vehicles, →1280184/4471602
	07/09 →	Track Control Arm		SC-DL-8179	Trailing Arm, 1st Drive Axle, for Leaf-Spring Suspension vehicles, →9069960/3536015
	07/09 →	Track Control Arm		SC-DL-8509	Trailing Arm, 1st & 2nd Drive Axle, for Leaf-Spring Suspension vehicles
	07/09 →	Track Control Arm		SC-DL-8511	Trailing Arm, 1st & 2nd Drive Axle, for Leaf-Spring Suspension vehicles
	07/09 →	Track Control Arm		SC-DL-8531	Trailing Arm, 1st & 2nd Drive Axle, for Leaf-Spring Suspension vehicles
	07/09 →	Track Control Arm		SC-DL-8547	Trailing Arm, 1st & 2nd Drive Axle, for Leaf-Spring Suspension vehicles
	07/09 →	Track Control Arm		SC-DL-8623	Trailing Arm, 1st Drive Axle, for Leaf-Spring Suspension vehicles, →2006231/5117423
	07/09 →	Track Control Arm		SC-DL-8623	Trailing Arm, 1st Drive Axle, for Leaf-Spring Suspension vehicles, →9097199/3564002
	07/09 →	Track Control Arm		SC-DL-9462	Trailing Arm, 2nd Drive Axle, for Leaf-Spring Suspension vehicles, →2006231/5117423
	07/09 →	Track Control Arm		SC-DL-9462	Trailing Arm, 2nd Drive Axle, for Leaf-Spring Suspension vehicles, →9097199/3564002
	07/09 →	Track Control Arm		SC-DL-9466	Trailing Arm, 1st & 2nd Drive Axle, for Leaf-Spring Suspension vehicles
	07/09 →	Track Control Arm		SC-TC-12451	Trailing Arm, 1st Drive Axle, for Leaf-Spring Suspension vehicles
	07/09 →	Track Control Arm		SC-TC-12451	Trailing Arm, 1st Drive Axle, for Leaf-Spring Suspension vehicles, 1280185/4471603 →
	07/09 →	Track Control Arm		SC-TC-12451	Trailing Arm, 1st Drive Axle, for Leaf-Spring Suspension vehicles, 9069961/3536016 →
	07/09 →	Track Control Arm		SC-TC-12472	Trailing Arm, 2nd Drive Axle, for Leaf-Spring Suspension vehicles, →1280184/4471602
07/09 →	Track Control Arm		SC-TC-12472	Trailing Arm, 2nd Drive Axle, for Leaf-Spring Suspension vehicles, →9069960/3536015	
07/09 →	Track Control Arm	SC-DL-10302	SC-DL-10302	Trailing Arm, 1st Front Axle, for Pneumatic Suspension vehicles	
P 300	04/04 →	Centre Rod	SC-DL-5229		Push Rod
	04/04 →	Centre Rod	SC-DL-5354		Push Rod
	04/04 →	Centre Rod	SC-DL-12342		for Steering Rod
	04/04 →	Centre Rod	SC-DL-12343		for Steering Rod
	04/04 →	Suspension Arm Repair Kit	SC-RK-12346	SC-RK-12346	for Control Arm
	04/04 →	Suspension Strut Repair Kit		MN-RK-8501	
	04/04 →	Suspension Strut Repair Kit		MN-RK-12436	
	04/04 →	Suspension Strut Repair Kit	DF-RK-9341		
	04/04 →	Tie Rod	SC-DL-7264		
	04/04 →	Tie Rod	SC-DL-8137		Leaf Spring Axle
	04/04 →	Tie Rod	SC-DL-9457		Leaf Spring Axle
	04/04 →	Tie Rod End	CV-ES-14163		for Steering Rod
	04/04 →	Track Control Arm		SC-VB-12418	Control Arm
	04/04 →	Track Control Arm	SC-DL-10302	SC-DL-10302	Trailing Arm, Air Suspension Axle
P 310	01/03 →	Centre Rod	SC-DL-10225		for Steering Rod
	01/03 →	Centre Rod	SC-DL-12341		Push Rod
	01/03 →	Centre Rod	SC-DL-12449		Push Rod
	01/03 →	Suspension Arm Repair Kit		SC-RK-12366	for Control Arm
	01/03 →	Suspension Arm Repair Kit	MN-RK-7280	MN-RK-7280	for Drag Link; for Semi-Trailing Arm; for Wishbone (CV)
	01/03 →	Suspension Strut Repair Kit		DF-RK-9341	
	01/03 →	Suspension Strut Repair Kit		MN-RK-8501	
	01/03 →	Tie Rod End	CV-ES-14162		for Steering Rod
01/03 →	Tie Rod End	CV-ES-14162	CV-ES-14162	for Steering Rod	

CV-ES-14162

Length: 125
Cone Ø: d1 Ø 30 / d2 Ø 27
Thread: M30 x 1,5 LHT
283784, 395009, 1358792, 1738380, 1 914 426, 2051165



CV-ES-14163

Length: 125
Cone Ø: d1 Ø 30 / d2 Ø 27
Thread: M30 x 1,5 RHT
283784, 395010, 1358793, 1488890, 1738381, 1767328, 1914427, 2051166



DF-RK-9341

Ø: 67
550807, 5508072



MN-RK-7280

Ø: 75 Hole Distance: 115
Thick/Height: 24
0550806, 550806, 0639370, 639370, 689748, 1104334



MN-RK-8501

Ø: 75 Hole Distance: 115
Thick/Height: 24
1515981



MN-RK-12436

Ø: 75 Hole Distance: 115
Thick/Height: 24
550799, 1517403, 1783020



SC-DL-5229

Length: 1053 Ø: 50
Cone Ø: d1 Ø 30 / d2 Ø 27
1356055, 1379071, 1384025, 1768898, 1847311, 1912757, 12201600A



SC-DL-5354

Length: 1060 Ø: 52
Cone Ø: d1 Ø 30 / d2 Ø 27
1384027, 1769597, 1847312, 1912758, 12200800A



SC-DL-7264

Length: 1743 Ø: 62
Cone Ø: d1 Ø 30 / d2 Ø 27
1361413, 1395614, 1734019, 1897333, 2040254, 2146105



SC-DL-8137

Length: 1736 Ø: 40
Cone Ø: d1 Ø 30 / d2 Ø 27
301639, 311847, 395350, 1358675, 1378435, 1397866, 1734020, 2028998, 12202900A



SC-DL-8179

Length: 568 Ø: 46
Hole Distance: 115 / 115
1399180, 1428347



SC-DL-8509

Length: 568,5 Ø: 46
Hole Distance: 115 / 115
1485758, 1486757



SC-DL-8511

Length: 616,5 Ø: 50
Hole Distance: 115 / 115
1485760, 1499478, 1722750



SC-DL-8531

Length: 522 Ø: 46
Hole Distance: 115 / 115
1486758



SC-DL-8547

Length: 568 Ø: 50
Hole Distance: 115 / 115
1499474, 1722746, 1906940



SC-DL-8623

Length: 592 Ø: 50
Hole Distance: 115 / 115
1388436, 1499476, 1722748, 1906942



SC-DL-9457

Length: 1743 Ø: 52
Cone Ø: d1 Ø 30 / d2 Ø 27
1527989, 1723896, 1737684, 1897336



SC-DL-9462

Length: 568,5 Ø: 50
Hole Distance: 115 / 115
1499475, 1500573, 1722747, 1906941



SC-DL-9466

Length: 568 Ø: 19
1486756



SC-DL-10225

Length: 2179 Ø: 62
Cone Ø: d1 Ø 30 / d2 Ø 27
1386618, 1788522



SC-DL-10302

Length: 752 Ø: 48
Hole Distance: 115 / 115
1101843, 1379423, 1393298, 1431470, 1942075



SC-DL-12341

Length: 1776 Ø: 62
Cone Ø: d1 Ø 30 / d2 Ø 27
1386620



SC-DL-12342

Length: 601 Ø: 42
Cone Ø: d1 Ø 26 / d2 Ø 23,5
1343262, 1869413



SC-DL-12343

Length: 1062 Ø: 52
Cone Ø: d1 Ø 30 / d2 Ø 27
1348269, 2007275



SC-DL-12449

Length: 1206 Ø: 38
Cone Ø: d1 Ø 30 / d2 Ø 27
1385763, 1765375



SC-RK-12346

Ø: 67 Hole Distance: 115
Thick/Height: 24
550800



SC-RK-12366

Ø: 75 Hole Distance: 115 / 115
Thick/Height: 24
1 722 753, 2 096 392



SC-TC-12451

Length: 552 Ø: 46
Hole Distance: 115 / 115
1494296



SC-TC-12472

Length: 580 Ø: 46
Hole Distance: 115 / 115
1399182



SC-VB-12418

Length: 613,2
Ø: 46
Hole Ø 25 / 19 / 19
Hole Distance: 152 / 115 / 115
1440028, 1722582





P,G,R,T - series ...

P 310 ...	01/03→	Tie Rod End	CV-ES-14163		for Steering Rod
	01/03→	Tie Rod End	SC-ES-8517		for Push Rod
	01/03→	Tie Rod End	SC-ES-8535		for Guide Rod
	01/03→	Track Control Arm		SC-DL-8509	Trailing Arm, 1st & 2nd Drive Axle, for Leaf-Spring Suspension vehicles
	01/03→	Track Control Arm		SC-DL-8509	Trailing Arm, 1st Drive Axle, for Leaf-Spring Suspension vehicles
	01/03→	Track Control Arm		SC-DL-8509	Trailing Arm, 1st Drive Axle, for Leaf-Spring Suspension vehicles, 1280185/4471603→
	01/03→	Track Control Arm		SC-DL-8511	Trailing Arm, 1st & 2nd Drive Axle, for Leaf-Spring Suspension vehicles
	01/03→	Track Control Arm		SC-DL-8531	Trailing Arm, 1st & 2nd Drive Axle, for Leaf-Spring Suspension vehicles
	01/03→	Track Control Arm		SC-DL-8547	Trailing Arm, for Leaf-Spring Suspension vehicles
	01/03→	Track Control Arm		SC-DL-9462	Trailing Arm, for Leaf-Spring Suspension vehicles
	01/03→	Track Control Arm		SC-DL-9466	Trailing Arm
	01/03→	Track Control Arm		SC-TC-12451	Trailing Arm, 1st Drive Axle, for Leaf-Spring Suspension vehicles
	01/03→	Track Control Arm		SC-TC-12451	Trailing Arm, 1st Drive Axle, for Leaf-Spring Suspension vehicles, 1280185/4471603→
	01/03→	Track Control Arm		SC-TC-12451	Trailing Arm, 1st Drive Axle, for Leaf-Spring Suspension vehicles, 9069961/3536016→
	01/03→	Track Control Arm		SC-TC-12452	Trailing Arm, 2nd Drive Axle, for Leaf-Spring Suspension vehicles, 1280185/4471603→
	01/03→	Track Control Arm		SC-TC-12452	Trailing Arm, 2nd Drive Axle, for Leaf-Spring Suspension vehicles, 9069961/3536016→
	01/03→	Track Control Arm		SC-TC-12472	Control Arm
	01/03→	Track Control Arm	SC-DL-8179	SC-DL-8179	Trailing Arm, for Leaf-Spring Suspension vehicles
	01/03→	Track Control Arm	SC-DL-8623	SC-DL-8623	Trailing Arm, for Leaf-Spring Suspension vehicles
	01/03→	Track Control Arm	SC-DL-10302	SC-DL-10302	Trailing Arm, 1st Front Axle, for Pneumatic Suspension vehicles
	01/03→	Track Control Arm	SC-TC-12361		Control Arm, 1st & 2nd Front Axle, for Pneumatic Suspension vehicles
	01/03→	Track Control Arm	SC-TC-12361		Control Arm, 1st Front Axle, for Pneumatic Suspension vehicles
	04/04→	Centre Rod	SC-DL-5229		Push Rod
	04/04→	Centre Rod	SC-DL-5354		Push Rod
	04/04→	Centre Rod	SC-DL-8154		Push Rod
	04/04→	Centre Rod	SC-DL-8169		Push Rod
	04/04→	Centre Rod	SC-DL-8182		Push Rod
	04/04→	Centre Rod	SC-DL-8399		Push Rod, Leaf Spring Axle
	04/04→	Centre Rod	SC-DL-12342		for Steering Rod
	04/04→	Centre Rod	SC-DL-12343		for Steering Rod
	04/04→	Suspension Arm Repair Kit	SC-RK-12346	SC-RK-12346	for Control Arm
	04/04→	Suspension Strut Repair Kit		MN-RK-12436	
	04/04→	Tie Rod	SC-DL-7264		1st FA;2nd FA
	04/04→	Tie Rod	SC-DL-8137		Leaf Spring Axle
	04/04→	Tie Rod	SC-DL-8137		Leaf Spring Axle;1st FA;2nd FA
	04/04→	Tie Rod	SC-DL-9457		1st FA;2nd FA;Leaf Spring Axle
	04/04→	Tie Rod	SC-DL-9457		Leaf Spring Axle
	04/04→	Tie Rod End	SC-ES-5764		
	04/04→	Track Control Arm		SC-DL-8511	Trailing Arm, Leaf Spring Axle
	04/04→	Track Control Arm		SC-DL-8511	Trailing Arm, Leaf Spring Axle, →* 3512097 *
	04/04→	Track Control Arm		SC-DL-8547	Trailing Arm, Leaf Spring Axle
	04/04→	Track Control Arm		SC-DL-9462	Trailing Arm, Leaf Spring Axle, →* 2006231 SSS *; * 5117423 SNL *; * 9097199 SAN *; * 3564002 SLA *
	04/04→	Track Control Arm		SC-DL-9466	Trailing Arm, Leaf Spring Axle
	04/04→	Track Control Arm		SC-TC-12452	Control Arm
	04/04→	Track Control Arm		SC-TC-12472	Trailing Arm, 2nd Drive Axle, for Leaf-Spring Suspension vehicles, →1280184/4471602
	04/04→	Track Control Arm		SC-TC-12472	Trailing Arm, 2nd Drive Axle, for Leaf-Spring Suspension vehicles, →9069960/3536015

CV-ES-14163

Length: 125
Cone Ø: d1 Ø 30 / d2 Ø 27
Thread: M30 x 1,5 RHT
283784, 395010, 1358793, 1488890,
1738381, 1767328, 1914427, 2051166



MN-RK-12436

Ø: 75 Hole Distance: 115
Thick/Height: 24
550799, 1517403, 1783020



SC-DL-5229

Length: 1053 Ø: 50
Cone Ø: d1 Ø 30 / d2 Ø 27
1356055, 1379071, 1384025, 1768898,
1847311, 1912757, 12201600A



SC-DL-5354

Length: 1060 Ø: 52
Cone Ø: d1 Ø 30 / d2 Ø 27
1384027, 1769597, 1847312, 1912758,
12200800A



SC-DL-7264

Length: 1743 Ø: 62
Cone Ø: d1 Ø 30 / d2 Ø 27
1361413, 1395614, 1734019, 1897333,
2040254, 2146105



SC-DL-8137

Length: 1736 Ø: 40
Cone Ø: d1 Ø 30 / d2 Ø 27
301639, 311847, 395350, 1358675,
1378435, 1397866, 1734020, 2028998,
12202900A



SC-DL-8154

Length: 495 Ø: 40
Cone Ø: d1 Ø 30 / d2 Ø 27
1343266, 1759690



SC-DL-8169

Length: 1920 Ø: 62
Cone Ø: d1 Ø 30 / d2 Ø 27
1343264, 1732635, 2007278



SC-DL-8179

Length: 568 Ø: 46
Hole Distance: 115 / 115
1399180, 1428347



SC-DL-8182

1343262, 1869413



SC-DL-8399

Length: 433 Ø: 40
Cone Ø: d1 Ø 30 / d2 Ø 26
1394884, 1938387



SC-DL-8509

Length: 568,5 Ø: 46
Hole Distance: 115 / 115
1485758, 1486757



SC-DL-8511

Length: 616,5 Ø: 50
Hole Distance: 115 / 115
1485760, 1499478, 1722750



SC-DL-8531

Length: 522 Ø: 46
Hole Distance: 115 / 115
1486758



SC-DL-8547

Length: 568 Ø: 50
Hole Distance: 115 / 115
1499474, 1722746, 1906940



SC-DL-8623

Length: 592 Ø: 50
Hole Distance: 115 / 115
1388436, 1499476, 1722748, 1906942



SC-DL-9457

Length: 1743 Ø: 52
Cone Ø: d1 Ø 30 / d2 Ø 27
1527989, 1723896, 1737684, 1897336



SC-DL-9462

Length: 568,5 Ø: 50
Hole Distance: 115 / 115
1499475, 1500573, 1722747, 1906941



SC-DL-9466

Length: 568 Ø: 19
1486756



SC-DL-10302

Length: 752 Ø: 48
Hole Distance: 115 / 115
1101843, 1379423, 1393298, 1431470,
1942075



SC-DL-12342

Length: 601 Ø: 42
Cone Ø: d1 Ø 26 / d2 Ø 23,5
1343262, 1869413



SC-DL-12343

Length: 1062 Ø: 52
Cone Ø: d1 Ø 30 / d2 Ø 27
1348269, 2007275



SC-ES-5764

Length: 95
Cone Ø: d1 Ø 30 / d2 Ø 27
Thread: M26 x 1,5 RHT
325614, 1375228, 4604948



SC-ES-8517

Length: 140
Cone Ø: d1 Ø 30 / d2 Ø 27
Thread: M30 x 1,5 RHT
1358793, 1435746, 1488890, 1534756,
1914427, 2051166



SC-ES-8535

Length: 145
Cone Ø: d1 Ø 30 / d2 Ø 27
Thread: M30 x 1,5 RHT
1723897, 2051041



SC-RK-12346

Ø: 67 Hole Distance: 115
Thick/Height: 24
550800



SC-TC-12361

Length: 705 Ø: 42
Cone Ø: d1 Ø 38
Hole Distance: 115
1353445, 1464611, 1942147



SC-TC-12451

Length: 552 Ø: 46
Hole Distance: 115 / 115
1494296



SC-TC-12452

Length: 580,5 Ø: 46
Hole Distance: 115 / 115
1485759



SC-TC-12472

Length: 580 Ø: 46
Hole Distance: 115 / 115
1399182



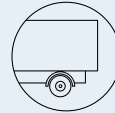

P,G,R,T - series ...

P 310 ...	04/04 →	Track Control Arm		SC-VB-12418	Control Arm	
	04/04 →	Track Control Arm	SC-DL-8179	SC-DL-8179	Trailing Arm, Leaf Spring Axle	
	04/04 →	Track Control Arm	SC-DL-8509	SC-DL-8509	Trailing Arm	
	04/04 →	Track Control Arm	SC-DL-8509	SC-DL-8509	Trailing Arm, Leaf Spring Axle	
	04/04 →	Track Control Arm	SC-DL-8531	SC-DL-8531	Trailing Arm, Leaf Spring Axle	
	04/04 →	Track Control Arm	SC-DL-8623	SC-DL-8623	Trailing Arm, Leaf Spring Axle, →* 2006231 SSS ** 5117423 SNL *; * 9097199 SAN *; * 3564002 SLA *	
	04/04 →	Track Control Arm	SC-DL-10302	SC-DL-10302	Trailing Arm, Air Suspension Axle	
	04/04 →	Track Control Arm	SC-DL-10302	SC-DL-10302	Trailing Arm, Air Suspension Axle; 1st FA	
	09/04 →	Centre Rod	SC-DL-5354	SC-DL-5354	Push Rod, for vehicles with Hinged Trailing Axle	
	09/04 →	Centre Rod	SC-DL-8399		Push Rod, for vehicles with Hinged Leading Axle, for vehicles with Part-Pneumatic Suspension	
	09/04 →	Centre Rod	SC-DL-8553	SC-DL-8553	Push Rod, for vehicles with Hinged Leading Axle	
	09/04 →	Tie Rod		SC-DL-7264	Tag Axle; for vehicles with Hinged Trailing Axle	
	09/04 →	Tie Rod		SC-DL-8137	Tag Axle; for vehicles with Hinged Trailing Axle	
	09/04 →	Tie Rod	SC-DL-7264			
	09/04 →	Tie Rod End		MN-ES-8490	Tag Axle; for vehicles with Hinged Trailing Axle	
	09/04 →	Tie Rod End	IV-ES-12272		for Steering Rod	
	09/04 →	Tie Rod End	MN-ES-8490	MN-ES-8490	for vehicles with Hinged Trailing Axle	
	04/06 →	Centre Rod	SC-DL-10225		Push Rod, for vehicles with Hinged Leading Axle	
	04/06 →	Tie Rod		SC-DL-7264	Leading Axle; for vehicles with Hinged Leading Axle	
	04/06 →	Tie Rod		SC-DL-7264	Leading Axle; for vehicles with Hinged Leading Axle; Air Suspension Axle	
	04/06 →	Tie Rod		SC-DL-8137	Leading Axle; for vehicles with Hinged Leading Axle	
	P 310, R 310	04/04 →	Centre Rod	SC-DL-5229		Push Rod
		04/04 →	Centre Rod	SC-DL-5354		Push Rod
		04/04 →	Centre Rod	SC-DL-5354	SC-DL-5354	Push Rod, for vehicles with Hinged Trailing Axle
		04/04 →	Centre Rod	SC-DL-8182		Push Rod
04/04 →		Centre Rod	SC-DL-8399		Push Rod, for vehicles with Hinged Leading Axle, for vehicles with Part-Pneumatic Suspension	
04/04 →		Centre Rod	SC-DL-8553	SC-DL-8553	Push Rod, for vehicles with Hinged Leading Axle	
04/04 →		Centre Rod	SC-DL-10225		for Steering Rod	
04/04 →		Centre Rod	SC-DL-10225		Push Rod, for vehicles with Hinged Leading Axle	
04/04 →		Centre Rod	SC-DL-12342		for Steering Rod	
04/04 →		Centre Rod	SC-DL-12343		for Steering Rod	
04/04 →		Centre Rod	SC-DL-12449		Push Rod	
04/04 →		Suspension Arm Repair Kit		SC-RK-12366	for Control Arm	
04/04 →		Suspension Arm Repair Kit	SC-RK-12346	SC-RK-12346	for Control Arm	
04/04 →		Suspension Strut Repair Kit		MN-RK-8501		
04/04 →		Suspension Strut Repair Kit		MN-RK-12436		
04/04 →		Suspension Strut Repair Kit	DF-RK-9341			
04/04 →		Tie Rod		SC-DL-7264	Leading Axle; for vehicles with Hinged Leading Axle	
04/04 →		Tie Rod		SC-DL-7264	Leading Axle; for vehicles with Hinged Leading Axle; Air Suspension Axle	
04/04 →		Tie Rod		SC-DL-7264	Tag Axle; for vehicles with Hinged Trailing Axle	
04/04 →		Tie Rod		SC-DL-8137	Leading Axle; for vehicles with Hinged Leading Axle	
04/04 →		Tie Rod		SC-DL-8137	Tag Axle; for vehicles with Hinged Trailing Axle	
04/04 →		Tie Rod	SC-DL-7264			
04/04 →		Tie Rod	SC-DL-8137		Leaf Spring Axle	
04/04 →		Tie Rod	SC-DL-9457		Leaf Spring Axle	
04/04 →		Tie Rod End		MN-ES-8490	Tag Axle; for vehicles with Hinged Trailing Axle	
04/04 →		Tie Rod End	CV-ES-14162		for Steering Rod	
04/04 →		Tie Rod End	CV-ES-14162	CV-ES-14162	for Steering Rod	
04/04 →		Tie Rod End	CV-ES-14163		for Steering Rod	
04/04 →		Tie Rod End	IV-ES-12272		for Steering Rod	
04/04 →		Tie Rod End	MN-ES-8490	MN-ES-8490	for vehicles with Hinged Trailing Axle	
04/04 →		Tie Rod End	SC-ES-8517		for Push Rod	
04/04 →		Tie Rod End	SC-ES-8535		for Guide Rod	

CV-ES-14162

Length: 125
Cone Ø: d1 Ø 30 / d2 Ø 27
Thread: M30 x 1,5 LHT
283783, 395009, 1358792, 1738380, 1 914 426, 2051165



CV-ES-14163

Length: 125
Cone Ø: d1 Ø 30 / d2 Ø 27
Thread: M30 x 1,5 RHT
283784, 395010, 1358793, 1488890, 1738381, 1767328, 1914427, 2051166



DF-RK-9341

Ø: 67
550807, 5508072



IV-ES-12272

Length: 75
Cone Ø: d1 Ø 30 / d2 Ø 27
Thread: M26 x 1,5 RHT
1394443



MN-ES-8490

Length: 90
Cone Ø: d1 Ø 30 / d2 Ø 27
Thread: M26 x 1,5 RHT
1394444, 0014606948, 14606948



MN-RK-8501

Ø: 75 Hole Distance: 115
Thick/Height: 24
1515981



MN-RK-12436

Ø: 75 Hole Distance: 115
Thick/Height: 24
550799, 1517403, 1783020



SC-DL-5229

Length: 1053 Ø: 50
Cone Ø: d1 Ø 30 / d2 Ø 27
1356055, 1379071, 1384025, 1768898, 1847311, 1912757, 12201600A



SC-DL-5354

Length: 1060 Ø: 52
Cone Ø: d1 Ø 30 / d2 Ø 27
1384027, 1769597, 1847312, 1912758, 12200800A



SC-DL-7264

Length: 1743 Ø: 62
Cone Ø: d1 Ø 30 / d2 Ø 27
1361413, 1395614, 1734019, 1897333, 2040254, 2146105



SC-DL-8137

Length: 1736 Ø: 40
Cone Ø: d1 Ø 30 / d2 Ø 27
301639, 311847, 395350, 1358675, 1378435, 1397866, 1734020, 2028998, 12202900A



SC-DL-8179

Length: 568 Ø: 46
Hole Distance: 115 / 115
1399180, 1428347



SC-DL-8182

1343262, 1869413



SC-DL-8399

Length: 433 Ø: 40
Cone Ø: d1 Ø 30 / d2 Ø 26
1394884, 1938387



SC-DL-8509

Length: 568,5 Ø: 46
Hole Distance: 115 / 115
1485758, 1486757



SC-DL-8531

Length: 522 Ø: 46
Hole Distance: 115 / 115
1486758



SC-DL-8553

Length: 435 Ø: 38
Cone Ø: d1 Ø 30 / d2 Ø 27
1343283, 1759691



SC-DL-8623

Length: 592 Ø: 50
Hole Distance: 115 / 115
1388436, 1499476, 1722748, 1906942



SC-DL-9457

Length: 1743 Ø: 52
Cone Ø: d1 Ø 30 / d2 Ø 27
1527989, 1723896, 1737684, 1897336



SC-DL-10225

Length: 2179 Ø: 62
Cone Ø: d1 Ø 30 / d2 Ø 27
1386618, 1788522



SC-DL-10302

Length: 752 Ø: 48
Hole Distance: 115 / 115
1101843, 1379423, 1393298, 1431470, 1942075



SC-DL-12342

Length: 601 Ø: 42
Cone Ø: d1 Ø 26 / d2 Ø 23,5
1343262, 1869413



SC-DL-12343

Length: 1062 Ø: 52
Cone Ø: d1 Ø 30 / d2 Ø 27
1348269, 2007275



SC-DL-12449

Length: 1206 Ø: 38
Cone Ø: d1 Ø 30 / d2 Ø 27
1385763, 1765375



SC-ES-8517

Length: 140
Cone Ø: d1 Ø 30 / d2 Ø 27
Thread: M30 x 1,5 RHT
1358793, 1435746, 1488890, 1534756, 1914427, 2051166



SC-ES-8535

Length: 145
Cone Ø: d1 Ø 30 / d2 Ø 27
Thread: M30 x 1,5 RHT
1723897, 2051041



SC-RK-12346

Ø: 67 Hole Distance: 115
Thick/Height: 24
550800



SC-RK-12366

Ø: 75 Hole Distance: 115 / 115
Thick/Height: 24
1 722 753, 2 096 392



SC-VB-12418

Length: 613,2
Ø: 46
Hole Ø 25 / 19 / 19
Hole Distance: 152 / 115 / 115
1440028, 1722582





P,G,R,T - series ...

P 310, R 310 ...	04/04 →	Track Control Arm		SC-VB-12418	Control Arm
	04/04 →	Track Control Arm	SC-DL-10302	SC-DL-10302	Trailing Arm, Air Suspension Axle
	04/04 →	Track Control Arm	SC-TC-12361		Control Arm, 1st Front Axle, for Pneumatic Suspension vehicles
	09/04 →	Suspension Strut Repair Kit		CV-RK-5311	
P 320	07/09 →	Centre Rod	SC-DL-12342		for Steering Rod
	07/09 →	Centre Rod	SC-DL-12343		for Steering Rod
	07/09 →	Centre Rod	SC-DL-12449		Push Rod
	07/09 →	Suspension Arm Repair Kit		SC-RK-12366	for Control Arm
	07/09 →	Suspension Arm Repair Kit	SC-RK-12346	SC-RK-12346	for Control Arm
	07/09 →	Tie Rod End	CV-ES-14162		for Steering Rod
	07/09 →	Tie Rod End	CV-ES-14162	CV-ES-14162	for Steering Rod
	07/09 →	Tie Rod End	CV-ES-14163		for Steering Rod
	07/09 →	Tie Rod End	SC-ES-8517		for Push Rod
	07/09 →	Tie Rod End	SC-ES-8535		for Guide Rod
	07/09 →	Track Control Arm		SC-DL-8179	Trailing Arm, 1st & 2nd Drive Axle, for Leaf-Spring Suspension vehicles
	07/09 →	Track Control Arm		SC-DL-8179	Trailing Arm, 1st & 2nd Drive Axle, for Leaf-Spring Suspension vehicles, Ch.3512097 →
	07/09 →	Track Control Arm		SC-DL-8179	Trailing Arm, 1st Drive Axle, for Leaf-Spring Suspension vehicles, →1280184/4471602
	07/09 →	Track Control Arm		SC-DL-8179	Trailing Arm, 1st Drive Axle, for Leaf-Spring Suspension vehicles, →9069960/3536015
	07/09 →	Track Control Arm		SC-DL-8509	Trailing Arm, 1st & 2nd Drive Axle, for Leaf-Spring Suspension vehicles
	07/09 →	Track Control Arm		SC-DL-8511	Trailing Arm, 1st & 2nd Drive Axle, for Leaf-Spring Suspension vehicles
	07/09 →	Track Control Arm		SC-DL-8531	Trailing Arm, 1st & 2nd Drive Axle, for Leaf-Spring Suspension vehicles
	07/09 →	Track Control Arm		SC-DL-8547	Trailing Arm, 1st & 2nd Drive Axle, for Leaf-Spring Suspension vehicles
	07/09 →	Track Control Arm		SC-DL-8623	Trailing Arm, 1st Drive Axle, for Leaf-Spring Suspension vehicles, →2006231/5117423
	07/09 →	Track Control Arm		SC-DL-8623	Trailing Arm, 1st Drive Axle, for Leaf-Spring Suspension vehicles, →9097199/3564002
	07/09 →	Track Control Arm		SC-DL-9462	Trailing Arm, 2nd Drive Axle, for Leaf-Spring Suspension vehicles, →2006231/5117423
	07/09 →	Track Control Arm		SC-DL-9462	Trailing Arm, 2nd Drive Axle, for Leaf-Spring Suspension vehicles, →9097199/3564002
	07/09 →	Track Control Arm		SC-DL-9466	Trailing Arm, 1st & 2nd Drive Axle, for Leaf-Spring Suspension vehicles
	07/09 →	Track Control Arm		SC-TC-12451	Trailing Arm, 1st Drive Axle, for Leaf-Spring Suspension vehicles
	07/09 →	Track Control Arm		SC-TC-12451	Trailing Arm, 1st Drive Axle, for Leaf-Spring Suspension vehicles, 1280185/4471603 →
	07/09 →	Track Control Arm		SC-TC-12451	Trailing Arm, 1st Drive Axle, for Leaf-Spring Suspension vehicles, 9069961/3536016 →
	07/09 →	Track Control Arm		SC-TC-12452	Control Arm
	07/09 →	Track Control Arm		SC-TC-12472	Trailing Arm, 2nd Drive Axle, for Leaf-Spring Suspension vehicles, →1280184/4471602
	07/09 →	Track Control Arm		SC-TC-12472	Trailing Arm, 2nd Drive Axle, for Leaf-Spring Suspension vehicles, →9069960/3536015
	07/09 →	Track Control Arm		SC-VB-12418	Control Arm
	07/09 →	Track Control Arm	SC-DL-10302	SC-DL-10302	Trailing Arm, 1st Front Axle, for Pneumatic Suspension vehicles
	08/12 →	Track Control Arm	SC-TC-12361		Control Arm, 1st Front Axle, for Pneumatic Suspension vehicles
	P 340	04/04 →	Centre Rod	SC-DL-5229	
04/04 →		Centre Rod	SC-DL-5354		Push Rod
04/04 →		Centre Rod	SC-DL-5354	SC-DL-5354	Push Rod, for vehicles with Hinged Trailing Axle
04/04 →		Centre Rod	SC-DL-8154		Push Rod
04/04 →		Centre Rod	SC-DL-8169		Push Rod

CV-ES-14162

Length: 125
Cone Ø: d1 Ø 30 / d2 Ø 27
Thread: M30 x 1,5 LHT
283784, 395009, 1358792, 1738380, 1 914 426, 2051165



CV-ES-14163

Length: 125
Cone Ø: d1 Ø 30 / d2 Ø 27
Thread: M30 x 1,5 RHT
283784, 395010, 1358793, 1488890, 1738381, 1767328, 1914427, 2051166



CV-RK-5311

638862, 0638862, 0639287, 639287, 1104335, 1953248, 81432206006, 81432206107



SC-DL-5229

Length: 1053 Ø: 50
Cone Ø: d1 Ø 30 / d2 Ø 27
1356055, 1379071, 1384025, 1768898, 1847311, 1912757, 12201600A



SC-DL-5354

Length: 1060 Ø: 52
Cone Ø: d1 Ø 30 / d2 Ø 27
1384027, 1769597, 1847312, 1912758, 12200800A



SC-DL-8154

Length: 495 Ø: 40
Cone Ø: d1 Ø 30 / d2 Ø 27
1343266, 1759690



SC-DL-8169

Length: 1920 Ø: 62
Cone Ø: d1 Ø 30 / d2 Ø 27
1343264, 1732635, 2007278



SC-DL-8179

Length: 568 Ø: 46
Hole Distance: 115 / 115
1399180, 1428347



SC-DL-8509

Length: 568,5 Ø: 46
Hole Distance: 115 / 115
1485758, 1486757



SC-DL-8511

Length: 616,5 Ø: 50
Hole Distance: 115 / 115
1485760, 1499478, 1722750



SC-DL-8531

Length: 522 Ø: 46
Hole Distance: 115 / 115
1486758



SC-DL-8547

Length: 568 Ø: 50
Hole Distance: 115 / 115
1499474, 1722746, 1906940



SC-DL-8623

Length: 592 Ø: 50
Hole Distance: 115 / 115
1388436, 1499476, 1722748, 1906942



SC-DL-9462

Length: 568,5 Ø: 50
Hole Distance: 115 / 115
1499475, 1500573, 1722747, 1906941



SC-DL-9466

Length: 568 Ø: 19
1486756



SC-DL-10302

Length: 752 Ø: 48
Hole Distance: 115 / 115
1101843, 1379423, 1393298, 1431470, 1942075



SC-DL-12342

Length: 601 Ø: 42
Cone Ø: d1 Ø 26 / d2 Ø 23,5
1343262, 1869413



SC-DL-12343

Length: 1062 Ø: 52
Cone Ø: d1 Ø 30 / d2 Ø 27
1348269, 2007275



SC-DL-12449

Length: 1206 Ø: 38
Cone Ø: d1 Ø 30 / d2 Ø 27
1385763, 1765375



SC-ES-8517

Length: 140
Cone Ø: d1 Ø 30 / d2 Ø 27
Thread: M30 x 1,5 RHT
1358793, 1435746, 1488890, 1534756, 1914427, 2051166



SC-ES-8535

Length: 145
Cone Ø: d1 Ø 30 / d2 Ø 27
Thread: M30 x 1,5 RHT
1723897, 2051041



SC-RK-12346

Ø: 67 Hole Distance: 115
Thick/Height: 24
550800



SC-RK-12366

Ø: 75 Hole Distance: 115 / 115
Thick/Height: 24
1 722 753, 2 096 392



SC-TC-12361

Length: 705 Ø: 42
Cone Ø: d1 Ø 38
Hole Distance: 115
1353445, 1464611, 1942147



SC-TC-12451

Length: 552 Ø: 46
Hole Distance: 115 / 115
1494296



SC-TC-12452

Length: 580,5 Ø: 46
Hole Distance: 115 / 115
1485759



SC-TC-12472

Length: 580 Ø: 46
Hole Distance: 115 / 115
1399182



SC-VB-12418

Length: 613,2
Ø: 46
Hole Ø 25 / 19 / 19
Hole Distance: 152 / 115 / 115
1440028, 1722582



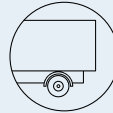

P,G,R,T - series ...

P 340 ...

04/04 →	Centre Rod	SC-DL-8182		Push Rod
04/04 →	Centre Rod	SC-DL-8399		Push Rod, for vehicles with Hinged Leading Axle, for vehicles with Part-Pneumatic Suspension
04/04 →	Centre Rod	SC-DL-8399		Push Rod, for vehicles with Part-Pneumatic Suspension
04/04 →	Centre Rod	SC-DL-8399		Push Rod, Leaf Spring Axle
04/04 →	Centre Rod	SC-DL-8553	SC-DL-8553	Push Rod, for vehicles with Hinged Leading Axle
04/04 →	Centre Rod	SC-DL-10225		for Steering Rod
04/04 →	Centre Rod	SC-DL-10225		Push Rod, for vehicles with Hinged Leading Axle
04/04 →	Centre Rod	SC-DL-12341		Push Rod
04/04 →	Centre Rod	SC-DL-12342		for Steering Rod
04/04 →	Centre Rod	SC-DL-12343		for Steering Rod
04/04 →	Centre Rod	SC-DL-12413		for Steering Rod
04/04 →	Centre Rod	SC-DL-12449		Push Rod
04/04 →	Suspension Arm Repair Kit		SC-RK-12366	for Control Arm
04/04 →	Suspension Arm Repair Kit	SC-RK-12346	SC-RK-12346	for Control Arm
04/04 →	Suspension Strut Repair Kit		MN-RK-8501	
04/04 →	Suspension Strut Repair Kit		MN-RK-12436	
04/04 →	Suspension Strut Repair Kit	DF-RK-9341		
04/04 →	Tie Rod		SC-DL-7264	Tag Axle;for vehicles with Hinged Trailing Axle
04/04 →	Tie Rod		SC-DL-8137	Tag Axle;for vehicles with Hinged Trailing Axle
04/04 →	Tie Rod	SC-DL-7264		
04/04 →	Tie Rod	SC-DL-7264		1st FA;2nd FA
04/04 →	Tie Rod	SC-DL-7264		Drive Axle;Air Suspension Axle
04/04 →	Tie Rod	SC-DL-8137		Leaf Spring Axle
04/04 →	Tie Rod	SC-DL-8137		Leaf Spring Axle;1st FA;2nd FA
04/04 →	Tie Rod	SC-DL-9457		1st FA;2nd FA;Leaf Spring Axle
04/04 →	Tie Rod	SC-DL-9457		Leaf Spring Axle
04/04 →	Tie Rod End		MN-ES-8490	Tag Axle;for vehicles with Hinged Trailing Axle
04/04 →	Tie Rod End	CV-ES-14162		for Steering Rod
04/04 →	Tie Rod End	CV-ES-14162	CV-ES-14162	for Steering Rod
04/04 →	Tie Rod End	CV-ES-14163		for Steering Rod
04/04 →	Tie Rod End	IV-ES-12272		for Steering Rod
04/04 →	Tie Rod End	MN-ES-8490	MN-ES-8490	for vehicles with Hinged Trailing Axle
04/04 →	Tie Rod End	SC-ES-5764		
04/04 →	Tie Rod End	SC-ES-8517		for Push Rod
04/04 →	Tie Rod End	SC-ES-8535		for Guide Rod
04/04 →	Track Control Arm		SC-DL-8179	Trailing Arm, 1st & 2nd Drive Axle, for Leaf-Spring Suspension vehicles
04/04 →	Track Control Arm		SC-DL-8179	Trailing Arm, 1st & 2nd Drive Axle, for Leaf-Spring Suspension vehicles, Ch.3512097 →
04/04 →	Track Control Arm		SC-DL-8179	Trailing Arm, 1st Drive Axle, for Leaf-Spring Suspension vehicles, →1280184/4471602
04/04 →	Track Control Arm		SC-DL-8179	Trailing Arm, 1st Drive Axle, for Leaf-Spring Suspension vehicles, →9069960/3536015
04/04 →	Track Control Arm		SC-DL-8511	Trailing Arm, Leaf Spring Axle
04/04 →	Track Control Arm		SC-DL-8511	Trailing Arm, Leaf Spring Axle, →* 3512097 *
04/04 →	Track Control Arm		SC-DL-8547	Trailing Arm, Leaf Spring Axle
04/04 →	Track Control Arm		SC-DL-9462	Trailing Arm, Leaf Spring Axle, →* 2006231 SSS *; * 5117423 SNL *; * 9097199 SAN *; * 3564002 SLA *
04/04 →	Track Control Arm		SC-DL-9466	Trailing Arm, Leaf Spring Axle
04/04 →	Track Control Arm		SC-TC-12451	Trailing Arm, 1st Drive Axle, for Leaf-Spring Suspension vehicles
04/04 →	Track Control Arm		SC-TC-12451	Trailing Arm, 1st Drive Axle, for Leaf-Spring Suspension vehicles, 1280185/4471603 →
04/04 →	Track Control Arm		SC-TC-12451	Trailing Arm, 1st Drive Axle, for Leaf-Spring Suspension vehicles, 9069961/3536016 →
04/04 →	Track Control Arm		SC-TC-12452	Control Arm
04/04 →	Track Control Arm		SC-TC-12472	Trailing Arm, 2nd Drive Axle, for Leaf-Spring Suspension vehicles, →1280184/4471602

CV-ES-14162

Length: 125
Cone Ø: d1 Ø 30 / d2 Ø 27
Thread: M30 x 1,5 LHT
283783, 395009, 1358792, 1738380, 1 914 426, 2051165



CV-ES-14163

Length: 125
Cone Ø: d1 Ø 30 / d2 Ø 27
Thread: M30 x 1,5 RHT
283784, 395010, 1358793, 1488890, 1738381, 1767328, 1914427, 2051166



DF-RK-9341

Ø: 67
550807, 5508072



IV-ES-12272

Length: 75
Cone Ø: d1 Ø 30 / d2 Ø 27
Thread: M26 x 1,5 RHT
1394443



MN-ES-8490

Length: 90
Cone Ø: d1 Ø 30 / d2 Ø 27
Thread: M26 x 1,5 RHT
1394444, 14606948, 0014606948



MN-RK-8501

Ø: 75 Hole Distance: 115
Thick/Height: 24
1515981



MN-RK-12436

Ø: 75 Hole Distance: 115
Thick/Height: 24
550799, 1517403, 1783020



SC-DL-7264

Length: 1743 Ø: 62
Cone Ø: d1 Ø 30 / d2 Ø 27
1361413, 1395614, 1734019, 1897333, 2040254, 2146105



SC-DL-8137

Length: 1736 Ø: 40
Cone Ø: d1 Ø 30 / d2 Ø 27
301639, 311847, 395350, 1358675, 1378435, 1397866, 1734020, 2028998, 12202900A



SC-DL-8179

Length: 568 Ø: 46
Hole Distance: 115 / 115
1399180, 1428347



SC-DL-8182

1343262, 1869413



SC-DL-8399

Length: 433 Ø: 40
Cone Ø: d1 Ø 30 / d2 Ø 26
1394884, 1938387



SC-DL-8511

Length: 616,5 Ø: 50
Hole Distance: 115 / 115
1485760, 1499478, 1722750



SC-DL-8547

Length: 568 Ø: 50
Hole Distance: 115 / 115
1499474, 1722746, 1906940



SC-DL-8553

Length: 435 Ø: 38
Cone Ø: d1 Ø 30 / d2 Ø 27
1343283, 1759691



SC-DL-9457

Length: 1743 Ø: 52
Cone Ø: d1 Ø 30 / d2 Ø 27
1527989, 1723896, 1737684, 1897336



SC-DL-9462

Length: 568,5 Ø: 50
Hole Distance: 115 / 115
1499475, 1500573, 1722747, 1906941



SC-DL-9466

Length: 568 Ø: 19
1486756



SC-DL-10225

Length: 2179 Ø: 62
Cone Ø: d1 Ø 30 / d2 Ø 27
1386618, 1788522



SC-DL-12341

Length: 1776 Ø: 62
Cone Ø: d1 Ø 30 / d2 Ø 27
1386620



SC-DL-12342

Length: 601 Ø: 42
Cone Ø: d1 Ø 26 / d2 Ø 23,5
1343262, 1869413



SC-DL-12343

Length: 1062 Ø: 52
Cone Ø: d1 Ø 30 / d2 Ø 27
1348269, 2007275



SC-DL-12413

Length: 1950 Ø: 62
Cone Ø: d1 Ø 30 / d2 Ø 27
1393383, 1788520



SC-DL-12449

Length: 1206 Ø: 38
Cone Ø: d1 Ø 30 / d2 Ø 27
1385763, 1765375



SC-ES-5764

Length: 95
Cone Ø: d1 Ø 30 / d2 Ø 27
Thread: M26 x 1,5 RHT
325614, 1375228, 4604948



SC-ES-8517

Length: 140
Cone Ø: d1 Ø 30 / d2 Ø 27
Thread: M30 x 1,5 RHT
1358793, 1435746, 1488890, 1534756, 1914427, 2051166



SC-ES-8535

Length: 145
Cone Ø: d1 Ø 30 / d2 Ø 27
Thread: M30 x 1,5 RHT
1723897, 2051041



SC-RK-12346

Ø: 67 Hole Distance: 115
Thick/Height: 24
550800



SC-RK-12366

Ø: 75 Hole Distance: 115 / 115
Thick/Height: 24
1 722 753, 2 096 392



SC-TC-12451

Length: 552 Ø: 46
Hole Distance: 115 / 115
1494296



SC-TC-12452

Length: 580,5 Ø: 46
Hole Distance: 115 / 115
1485759



SC-TC-12472

Length: 580 Ø: 46
Hole Distance: 115 / 115
1399182





P,G,R,T - series ...

P 340 ...	04/04 →	Track Control Arm		SC-TC-12472	Trailing Arm, 2nd Drive Axle, for Leaf-Spring Suspension vehicles, →9069960/3536015
	04/04 →	Track Control Arm		SC-VB-12418	Control Arm
	04/04 →	Track Control Arm	SC-DL-8179	SC-DL-8179	Trailing Arm, Leaf Spring Axle
	04/04 →	Track Control Arm	SC-DL-8509	SC-DL-8509	Trailing Arm
	04/04 →	Track Control Arm	SC-DL-8509	SC-DL-8509	Trailing Arm, Leaf Spring Axle
	04/04 →	Track Control Arm	SC-DL-8531	SC-DL-8531	Trailing Arm, Leaf Spring Axle
	04/04 →	Track Control Arm	SC-DL-8623	SC-DL-8623	Trailing Arm, Leaf Spring Axle, →* 2006231 SSS *;* 5117423 SNL *; * 9097199 SAN *;* 3564002 SLA *
	04/04 →	Track Control Arm	SC-DL-10302	SC-DL-10302	Trailing Arm, Air Suspension Axle
	04/04 →	Track Control Arm	SC-DL-10302	SC-DL-10302	Trailing Arm, Air Suspension Axle;1st FA
	04/04 →	Track Control Arm	SC-TC-12361		Control Arm, 1st Front Axle, for Pneumatic Suspension vehicles
	09/04 →	Suspension Strut Repair Kit		CV-RK-5311	
	10/06 →	Centre Rod	SC-DL-8154	SC-DL-8154	Push Rod, for vehicles with Hinged Trailing Axle
	10/06 →	Track Control Arm	SC-TC-12361		Control Arm, 1st & 2nd Front Axle, for Pneumatic Suspension vehicles
	01/08 →	Track Control Arm		SC-VB-12418	Wishbone (CV), 1st Drive Axle, for Pneumatic Suspension vehicles
P 340, R 340	04/04 →	Centre Rod	SC-DL-5229		Push Rod
	04/04 →	Centre Rod	SC-DL-5354		Push Rod
	04/04 →	Centre Rod	SC-DL-8154		Push Rod
	04/04 →	Centre Rod	SC-DL-8154	SC-DL-8154	Push Rod, for vehicles with Hinged Trailing Axle
	04/04 →	Centre Rod	SC-DL-8169		Push Rod
	04/04 →	Centre Rod	SC-DL-8182		Push Rod
	04/04 →	Centre Rod	SC-DL-8399		Push Rod, for vehicles with Part-Pneumatic Suspension
	04/04 →	Centre Rod	SC-DL-8399		Push Rod, Leaf Spring Axle
	04/04 →	Centre Rod	SC-DL-10225		for Steering Rod
	04/04 →	Centre Rod	SC-DL-12341		Push Rod
	04/04 →	Centre Rod	SC-DL-12342		for Steering Rod
	04/04 →	Centre Rod	SC-DL-12343		for Steering Rod
	04/04 →	Centre Rod	SC-DL-12413		for Steering Rod
	04/04 →	Suspension Arm Repair Kit		SC-RK-12366	for Control Arm
	04/04 →	Suspension Arm Repair Kit	SC-RK-12346	SC-RK-12346	for Control Arm
	04/04 →	Suspension Strut Repair Kit		MN-RK-8501	
	04/04 →	Suspension Strut Repair Kit		MN-RK-12436	
	04/04 →	Suspension Strut Repair Kit	DF-RK-9341		
	04/04 →	Tie Rod		SC-DL-7264	Tag Axle;for vehicles with Hinged Trailing Axle
	04/04 →	Tie Rod		SC-DL-8137	Leading Axle;for vehicles with Hinged Leading Axle
	04/04 →	Tie Rod		SC-DL-8137	Tag Axle;for vehicles with Hinged Trailing Axle
	04/04 →	Tie Rod	SC-DL-7264		
	04/04 →	Tie Rod	SC-DL-7264		1st FA
	04/04 →	Tie Rod	SC-DL-7264		1st FA;2nd FA
	04/04 →	Tie Rod	SC-DL-8137		Leaf Spring Axle
	04/04 →	Tie Rod	SC-DL-8137		Leaf Spring Axle;1st FA
	04/04 →	Tie Rod	SC-DL-8137		Leaf Spring Axle;1st FA;2nd FA
	04/04 →	Tie Rod	SC-DL-9457		1st FA;2nd FA;Leaf Spring Axle
	04/04 →	Tie Rod	SC-DL-9457		1st FA;Leaf Spring Axle
	04/04 →	Tie Rod	SC-DL-9457		Leaf Spring Axle
	04/04 →	Tie Rod End		MN-ES-8490	Tag Axle;for vehicles with Hinged Trailing Axle
	04/04 →	Tie Rod End	CV-ES-14162		for Steering Rod
	04/04 →	Tie Rod End	CV-ES-14162	CV-ES-14162	for Steering Rod
	04/04 →	Tie Rod End	CV-ES-14163		for Steering Rod
	04/04 →	Tie Rod End	IV-ES-12272		for Steering Rod
	04/04 →	Tie Rod End	MN-ES-8490	MN-ES-8490	for vehicles with Hinged Trailing Axle
	04/04 →	Tie Rod End	SC-ES-5764		
	04/04 →	Tie Rod End	SC-ES-8517		for Push Rod
	04/04 →	Tie Rod End	SC-ES-8535		for Guide Rod
	04/04 →	Track Control Arm		SC-DL-8511	Trailing Arm, Leaf Spring Axle
04/04 →	Track Control Arm		SC-DL-8511	Trailing Arm, Leaf Spring Axle, →* 3512097 *	

CV-ES-14162

Length: 125
Cone Ø: d1 Ø 30 / d2 Ø 27
Thread: M30 x 1,5 LHT
283783, 395009, 1358792, 1738380, 1 914 426, 2051165



CV-ES-14163

Length: 125
Cone Ø: d1 Ø 30 / d2 Ø 27
Thread: M30 x 1,5 RHT
283784, 395010, 1358793, 1488890, 1738381, 1767328, 1914427, 2051166



CV-RK-5311

638862, 0638862, 0639287, 639287, 1104335, 1953248, 81432206006, 81432206107



DF-RK-9341

Ø: 67
550807, 5508072



IV-ES-12272

Length: 75
Cone Ø: d1 Ø 30 / d2 Ø 27
Thread: M26 x 1,5 RHT
1394443



MN-ES-8490

Length: 90
Cone Ø: d1 Ø 30 / d2 Ø 27
Thread: M26 x 1,5 RHT
1394444, 0014606948, 14606948



MN-RK-8501

Ø: 75 Hole Distance: 115
Thick/Height: 24
1515981



MN-RK-12436

Ø: 75 Hole Distance: 115
Thick/Height: 24
550799, 1517403, 1783020



SC-DL-5229

Length: 1053 Ø: 50
Cone Ø: d1 Ø 30 / d2 Ø 27
1356055, 1379071, 1384025, 1768898, 1847311, 1912757, 12201600A



SC-DL-5354

Length: 1060 Ø: 52
Cone Ø: d1 Ø 30 / d2 Ø 27
1384027, 1769597, 1847312, 1912758, 12200800A



SC-DL-7264

Length: 1743 Ø: 62
Cone Ø: d1 Ø 30 / d2 Ø 27
1361413, 1395614, 1734019, 1897333, 2040254, 2146105



SC-DL-8137

Length: 1736 Ø: 40
Cone Ø: d1 Ø 30 / d2 Ø 27
301639, 311847, 395350, 1358675, 1378435, 1397866, 1734020, 2028998, 12202900A



SC-DL-8154

Length: 495 Ø: 40
Cone Ø: d1 Ø 30 / d2 Ø 27
1343266, 1759690



SC-DL-8169

Length: 1920 Ø: 62
Cone Ø: d1 Ø 30 / d2 Ø 27
1343264, 1732635, 2007278



SC-DL-8179

Length: 568 Ø: 46
Hole Distance: 115 / 115
1399180, 1428347



SC-DL-8182

1343262, 1869413



SC-DL-8399

Length: 433 Ø: 40
Cone Ø: d1 Ø 30 / d2 Ø 26
1394884, 1938387



SC-DL-8509

Length: 568,5 Ø: 46
Hole Distance: 115 / 115
1485758, 1486757



SC-DL-8511

Length: 616,5 Ø: 50
Hole Distance: 115 / 115
1485760, 1499478, 1722750



SC-DL-8531

Length: 522 Ø: 46
Hole Distance: 115 / 115
1486758



SC-DL-8623

Length: 592 Ø: 50
Hole Distance: 115 / 115
1388436, 1499476, 1722748, 1906942



SC-DL-9457

Length: 1743 Ø: 52
Cone Ø: d1 Ø 30 / d2 Ø 27
1527989, 1723896, 1737684, 1897336



SC-DL-10225

Length: 2179 Ø: 62
Cone Ø: d1 Ø 30 / d2 Ø 27
1386618, 1788522



SC-DL-10302

Length: 752 Ø: 48
Hole Distance: 115 / 115
1101843, 1379423, 1393298, 1431470, 1942075



SC-DL-12341

Length: 1776 Ø: 62
Cone Ø: d1 Ø 30 / d2 Ø 27
1386620



SC-DL-12342

Length: 601 Ø: 42
Cone Ø: d1 Ø 26 / d2 Ø 23,5
1343262, 1869413



SC-DL-12343

Length: 1062 Ø: 52
Cone Ø: d1 Ø 30 / d2 Ø 27
1348269, 2007275



SC-DL-12413

Length: 1950 Ø: 62
Cone Ø: d1 Ø 30 / d2 Ø 27
1393383, 1788520



SC-ES-5764

Length: 95
Cone Ø: d1 Ø 30 / d2 Ø 27
Thread: M26 x 1,5 RHT
325614, 1375228, 4604948



SC-ES-8517

Length: 140
Cone Ø: d1 Ø 30 / d2 Ø 27
Thread: M30 x 1,5 RHT
1358793, 1435746, 1488890, 1534756, 1914427, 2051166



SC-ES-8535

Length: 145
Cone Ø: d1 Ø 30 / d2 Ø 27
Thread: M30 x 1,5 RHT
1723897, 2051041



SC-RK-12346

Ø: 67 Hole Distance: 115
Thick/Height: 24
550800



SC-RK-12366

Ø: 75 Hole Distance: 115 / 115
Thick/Height: 24
1 722 753, 2 096 392



SC-TC-12361

Length: 705 Ø: 42
Cone Ø: d1 Ø 38
Hole Distance: 115
1353445, 1464611, 1942147



SC-TC-12472

Length: 580 Ø: 46
Hole Distance: 115 / 115
1399182



SC-VB-12418

Length: 613,2 Ø: 46
Hole Ø 25 / 19 / 19
Hole Distance: 152 / 115 / 115
1440028, 1722582





P,G,R,T - series ...

P 340, R 340 ...	04/04→	Track Control Arm		SC-DL-8547	Trailing Arm, Leaf Spring Axle	
	04/04→	Track Control Arm		SC-DL-9462	Trailing Arm, Leaf Spring Axle, →* 2006231 SSS *;* 5117423 SNL *; * 9097199 SAN *;* 3564002 SLA *	
	04/04→	Track Control Arm		SC-DL-9466	Trailing Arm, Leaf Spring Axle	
	04/04→	Track Control Arm		SC-TC-12451	Trailing Arm, 1st Drive Axle, for Leaf-Spring Suspension vehicles	
	04/04→	Track Control Arm		SC-TC-12451	Trailing Arm, 1st Drive Axle, for Leaf-Spring Suspension vehicles, 1280185/4471603→	
	04/04→	Track Control Arm		SC-TC-12451	Trailing Arm, 1st Drive Axle, for Leaf-Spring Suspension vehicles, 9069961/3536016→	
	04/04→	Track Control Arm		SC-TC-12452	Control Arm	
	04/04→	Track Control Arm		SC-TC-12472	Trailing Arm, 2nd Drive Axle, for Leaf-Spring Suspension vehicles, →1280184/4471602	
	04/04→	Track Control Arm		SC-TC-12472	Trailing Arm, 2nd Drive Axle, for Leaf-Spring Suspension vehicles, →9069960/3536015	
	04/04→	Track Control Arm		SC-VB-12418	Control Arm	
	04/04→	Track Control Arm	SC-DL-8179	SC-DL-8179	Trailing Arm, Leaf Spring Axle	
	04/04→	Track Control Arm	SC-DL-8509	SC-DL-8509	Trailing Arm	
	04/04→	Track Control Arm	SC-DL-8509	SC-DL-8509	Trailing Arm, Leaf Spring Axle	
	04/04→	Track Control Arm	SC-DL-8531	SC-DL-8531	Trailing Arm, Leaf Spring Axle	
	04/04→	Track Control Arm	SC-DL-8623	SC-DL-8623	Trailing Arm, Leaf Spring Axle, →* 2006231 SSS *;* 5117423 SNL *; * 9097199 SAN *;* 3564002 SLA *	
	04/04→	Track Control Arm	SC-DL-10302	SC-DL-10302	Trailing Arm, Air Suspension Axle	
	04/04→	Track Control Arm	SC-DL-10302	SC-DL-10302	Trailing Arm, Air Suspension Axle;1st FA	
	04/04→	Track Control Arm	SC-TC-12361		Control Arm, 1st & 2nd Front Axle, for Pneumatic Suspension vehicles	
	04/04→	Track Control Arm	SC-TC-12361		Control Arm, 1st Front Axle, for Pneumatic Suspension vehicles	
	09/04→	Centre Rod	SC-DL-5354	SC-DL-5354	Push Rod, for vehicles with Hinged Trailing Axle	
	09/04→	Centre Rod	SC-DL-8399		Push Rod, for vehicles with Hinged Leading Axle, for vehicles with Part-Pneumatic Suspension	
	09/04→	Centre Rod	SC-DL-8553	SC-DL-8553	Push Rod, for vehicles with Hinged Leading Axle	
	09/04→	Centre Rod	SC-DL-10225		Push Rod, for vehicles with Hinged Leading Axle	
	09/04→	Centre Rod	SC-DL-12449		Push Rod	
	09/04→	Tie Rod		SC-DL-7264	Leading Axle;for vehicles with Hinged Leading Axle	
	09/04→	Tie Rod		SC-DL-7264	Leading Axle;for vehicles with Hinged Leading Axle;Air Suspension Axle	
	P 360	10/07→	Centre Rod	SC-DL-5229		Push Rod
		10/07→	Centre Rod	SC-DL-5354		Push Rod
		10/07→	Centre Rod	SC-DL-10225		for Steering Rod
		10/07→	Centre Rod	SC-DL-12341		Push Rod
10/07→		Centre Rod	SC-DL-12342		for Steering Rod	
10/07→		Centre Rod	SC-DL-12343		for Steering Rod	
10/07→		Centre Rod	SC-DL-12413		for Steering Rod	
10/07→		Suspension Arm Repair Kit		SC-RK-12366	for Control Arm	
10/07→		Suspension Arm Repair Kit	SC-RK-12346	SC-RK-12346	for Control Arm	
10/07→		Suspension Strut Repair Kit		MN-RK-8501		
10/07→		Suspension Strut Repair Kit		MN-RK-12436		
10/07→		Suspension Strut Repair Kit	DF-RK-9341			
10/07→		Tie Rod	SC-DL-8137		Leaf Spring Axle	
10/07→		Tie Rod	SC-DL-9457		Leaf Spring Axle	
10/07→		Tie Rod End	CV-ES-14162		for Steering Rod	
10/07→		Tie Rod End	CV-ES-14163		for Steering Rod	
10/07→		Tie Rod End	SC-ES-8535		for Guide Rod	
10/07→		Track Control Arm		SC-DL-8511	Trailing Arm, Leaf Spring Axle	
10/07→		Track Control Arm		SC-DL-8511	Trailing Arm, Leaf Spring Axle, →* 3512097 *	
10/07→		Track Control Arm		SC-DL-8547	Trailing Arm, Leaf Spring Axle	
10/07→	Track Control Arm		SC-DL-9462	Trailing Arm, Leaf Spring Axle, →* 2006231 SSS *;* 5117423 SNL *; * 9097199 SAN *;* 3564002 SLA *		

CV-ES-14162

Length: 125
Cone Ø: d1 Ø 30 / d2 Ø 27
Thread: M30 x 1,5 LHT
283783, 395009, 1358792, 1738380, 1 914 426, 2051165



CV-ES-14163

Length: 125
Cone Ø: d1 Ø 30 / d2 Ø 27
Thread: M30 x 1,5 RHT
283784, 395010, 1358793, 1488890, 1738381, 1767328, 1914427, 2051166



DF-RK-9341

Ø: 67
550807, 5508072



MN-RK-8501

Ø: 75 Hole Distance: 115
Thick/Height: 24
1515981



MN-RK-12436

Ø: 75 Hole Distance: 115
Thick/Height: 24
550799, 1517403, 1783020



SC-DL-5229

Length: 1053 Ø: 50
Cone Ø: d1 Ø 30 / d2 Ø 27
1356055, 1379071, 1384025, 1768898, 1847311, 1912757, 12201600A



SC-DL-5354

Length: 1060 Ø: 52
Cone Ø: d1 Ø 30 / d2 Ø 27
1384027, 1769597, 1847312, 1912758, 12200800A



SC-DL-7264

Length: 1743 Ø: 62
Cone Ø: d1 Ø 30 / d2 Ø 27
1361413, 1395614, 1734019, 1897333, 2040254, 2146105



SC-DL-8137

Length: 1736 Ø: 40
Cone Ø: d1 Ø 30 / d2 Ø 27
301639, 311847, 395350, 1358675, 1378435, 1397866, 1734020, 2028998, 12202900A



SC-DL-8179

Length: 568 Ø: 46
Hole Distance: 115 / 115
1399180, 1428347



SC-DL-8399

Length: 433 Ø: 40
Cone Ø: d1 Ø 30 / d2 Ø 26
1394884, 1938387



SC-DL-8509

Length: 568,5 Ø: 46
Hole Distance: 115 / 115
1485758, 1486757



SC-DL-8511

Length: 616,5 Ø: 50
Hole Distance: 115 / 115
1485760, 1499478, 1722750



SC-DL-8531

Length: 522 Ø: 46
Hole Distance: 115 / 115
1486758



SC-DL-8547

Length: 568 Ø: 50
Hole Distance: 115 / 115
1499474, 1722746, 1906940



SC-DL-8553

Length: 435 Ø: 38
Cone Ø: d1 Ø 30 / d2 Ø 27
1343283, 1759691



SC-DL-8623

Length: 592 Ø: 50
Hole Distance: 115 / 115
1388436, 1499476, 1722748, 1906942



SC-DL-9457

Length: 1743 Ø: 52
Cone Ø: d1 Ø 30 / d2 Ø 27
1527989, 1723896, 1737684, 1897336



SC-DL-9462

Length: 568,5 Ø: 50
Hole Distance: 115 / 115
1499475, 1500573, 1722747, 1906941



SC-DL-9466

Length: 568 Ø: 19
1486756



SC-DL-10225

Length: 2179 Ø: 62
Cone Ø: d1 Ø 30 / d2 Ø 27
1386618, 1788522



SC-DL-10302

Length: 752 Ø: 48
Hole Distance: 115 / 115
1101843, 1379423, 1393298, 1431470, 1942075



SC-DL-12341

Length: 1776 Ø: 62
Cone Ø: d1 Ø 30 / d2 Ø 27
1386620



SC-DL-12342

Length: 601 Ø: 42
Cone Ø: d1 Ø 26 / d2 Ø 23,5
1343262, 1869413



SC-DL-12343

Length: 1062 Ø: 52
Cone Ø: d1 Ø 30 / d2 Ø 27
1348269, 2007275



SC-DL-12413

Length: 1950 Ø: 62
Cone Ø: d1 Ø 30 / d2 Ø 27
1393383, 1788520



SC-DL-12449

Length: 1206 Ø: 38
Cone Ø: d1 Ø 30 / d2 Ø 27
1385763, 1765375



SC-ES-8535

Length: 145
Cone Ø: d1 Ø 30 / d2 Ø 27
Thread: M30 x 1,5 RHT
1723897, 2051041



SC-RK-12346

Ø: 67 Hole Distance: 115
Thick/Height: 24
550800



SC-RK-12366

Ø: 75 Hole Distance: 115 / 115
Thick/Height: 24
1 722 753, 2 096 392



SC-TC-12361

Length: 705 Ø: 42
Cone Ø: d1 Ø 38
Hole Distance: 115
1353445, 1464611, 1942147



SC-TC-12451

Length: 552 Ø: 46
Hole Distance: 115 / 115
1494296



SC-TC-12452

Length: 580,5 Ø: 46
Hole Distance: 115 / 115
1485759



SC-TC-12472

Length: 580 Ø: 46
Hole Distance: 115 / 115
1399182



SC-VB-12418

Length: 613,2
Ø: 46
Hole Ø 25 / 19 / 19
Hole Distance: 152 / 115 / 115
1440028, 1722582



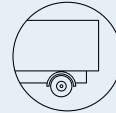
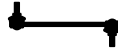

P,G,R,T - series ...

P 360 ...	10/07→	Track Control Arm		SC-DL-9466	Trailing Arm, Leaf Spring Axle
	10/07→	Track Control Arm		SC-TC-12451	Trailing Arm, 1st Drive Axle, for Leaf-Spring Suspension vehicles
	10/07→	Track Control Arm		SC-TC-12451	Trailing Arm, 1st Drive Axle, for Leaf-Spring Suspension vehicles, 1280185/4471603→
	10/07→	Track Control Arm		SC-TC-12451	Trailing Arm, 1st Drive Axle, for Leaf-Spring Suspension vehicles, 9069961/3536016→
	10/07→	Track Control Arm		SC-TC-12452	Control Arm
	10/07→	Track Control Arm		SC-TC-12472	Trailing Arm, 2nd Drive Axle, for Leaf-Spring Suspension vehicles, →1280184/4471602
	10/07→	Track Control Arm		SC-TC-12472	Trailing Arm, 2nd Drive Axle, for Leaf-Spring Suspension vehicles, →9069960/3536015
	10/07→	Track Control Arm		SC-VB-12418	Control Arm
	10/07→	Track Control Arm	SC-DL-8179	SC-DL-8179	Trailing Arm, Leaf Spring Axle
	10/07→	Track Control Arm	SC-DL-8509	SC-DL-8509	Trailing Arm
	10/07→	Track Control Arm	SC-DL-8509	SC-DL-8509	Trailing Arm, Leaf Spring Axle
	10/07→	Track Control Arm	SC-DL-8531	SC-DL-8531	Trailing Arm, Leaf Spring Axle
	10/07→	Track Control Arm	SC-DL-8623	SC-DL-8623	Trailing Arm, Leaf Spring Axle, →* 2006231 SSS *;* 5117423 SNL *; * 9097199 SAN *;* 3564002 SLA *
	10/07→	Track Control Arm	SC-DL-10302	SC-DL-10302	Trailing Arm, Air Suspension Axle
	10/07→	Track Control Arm	SC-TC-12361		Control Arm, 1st Front Axle, for Pneumatic Suspension vehicles
	07/09→	Centre Rod	SC-DL-8154		Push Rod
	07/09→	Centre Rod	SC-DL-8169		Push Rod
	07/09→	Centre Rod	SC-DL-8182		Push Rod
	07/09→	Centre Rod	SC-DL-8399		Push Rod, Leaf Spring Axle
	07/09→	Tie Rod	SC-DL-7264		1st FA;2nd FA
	07/09→	Tie Rod	SC-DL-8137		Leaf Spring Axle;1st FA;2nd FA
	07/09→	Tie Rod	SC-DL-9457		1st FA;2nd FA;Leaf Spring Axle
	07/09→	Tie Rod End	CV-ES-14162	CV-ES-14162	for Steering Rod
	07/09→	Tie Rod End	SC-ES-5764		
	07/09→	Tie Rod End	SC-ES-8517		for Push Rod
	07/09→	Track Control Arm		SC-DL-8179	Trailing Arm, 1st & 2nd Drive Axle, for Leaf-Spring Suspension vehicles
	07/09→	Track Control Arm		SC-DL-8179	Trailing Arm, 1st & 2nd Drive Axle, for Leaf-Spring Suspension vehicles, Ch.3512097→
	07/09→	Track Control Arm		SC-DL-8179	Trailing Arm, 1st Drive Axle, for Leaf-Spring Suspension vehicles, →1280184/4471602
	07/09→	Track Control Arm		SC-DL-8179	Trailing Arm, 1st Drive Axle, for Leaf-Spring Suspension vehicles, →9069960/3536015
	07/09→	Track Control Arm		SC-DL-8509	Trailing Arm, 1st & 2nd Drive Axle, for Leaf-Spring Suspension vehicles
	07/09→	Track Control Arm		SC-DL-8511	Trailing Arm, 1st & 2nd Drive Axle, for Leaf-Spring Suspension vehicles
	07/09→	Track Control Arm		SC-DL-8531	Trailing Arm, 1st & 2nd Drive Axle, for Leaf-Spring Suspension vehicles
	07/09→	Track Control Arm		SC-DL-8547	Trailing Arm, 1st & 2nd Drive Axle, for Leaf-Spring Suspension vehicles
	07/09→	Track Control Arm		SC-DL-8623	Trailing Arm, 1st Drive Axle, for Leaf-Spring Suspension vehicles, →2006231/5117423
	07/09→	Track Control Arm		SC-DL-8623	Trailing Arm, 1st Drive Axle, for Leaf-Spring Suspension vehicles, →9097199/3564002
	07/09→	Track Control Arm		SC-DL-9462	Trailing Arm, 2nd Drive Axle, for Leaf-Spring Suspension vehicles, →2006231/5117423
	07/09→	Track Control Arm		SC-DL-9462	Trailing Arm, 2nd Drive Axle, for Leaf-Spring Suspension vehicles, →9097199/3564002
	07/09→	Track Control Arm		SC-DL-9466	Trailing Arm, 1st & 2nd Drive Axle, for Leaf-Spring Suspension vehicles
	07/09→	Track Control Arm	SC-DL-10302	SC-DL-10302	Trailing Arm, 1st Front Axle, for Pneumatic Suspension vehicles
	07/09→	Track Control Arm	SC-DL-10302	SC-DL-10302	Trailing Arm, Air Suspension Axle;1st FA

CV-ES-14162

Length: 125
Cone Ø: d1 Ø 30 / d2 Ø 27
Thread: M30 x 1,5 LHT
283783, 395009, 1358792, 1738380, 1 914 426, 2051165



SC-DL-7264

Length: 1743 Ø: 62
Cone Ø: d1 Ø 30 / d2 Ø 27
1361413, 1395614, 1734019, 1897333, 2040254, 2146105



SC-DL-8137

Length: 1736 Ø: 40
Cone Ø: d1 Ø 30 / d2 Ø 27
301639, 311847, 395350, 1358675, 1378435, 1397866, 1734020, 2028998, 12202900A



SC-DL-8154

Length: 495 Ø: 40
Cone Ø: d1 Ø 30 / d2 Ø 27
1343266, 1759690



SC-DL-8169

Length: 1920 Ø: 62
Cone Ø: d1 Ø 30 / d2 Ø 27
1343264, 1732635, 2007278



SC-DL-8179

Length: 568 Ø: 46
Hole Distance: 115 / 115
1399180, 1428347



SC-DL-8182

1343262, 1869413



SC-DL-8399

Length: 433 Ø: 40
Cone Ø: d1 Ø 30 / d2 Ø 26
1394884, 1938387



SC-DL-8509

Length: 568,5 Ø: 46
Hole Distance: 115 / 115
1485758, 1486757



SC-DL-8511

Length: 616,5 Ø: 50
Hole Distance: 115 / 115
1485760, 1499478, 1722750



SC-DL-8531

Length: 522 Ø: 46
Hole Distance: 115 / 115
1486758



SC-DL-8547

Length: 568 Ø: 50
Hole Distance: 115 / 115
1499474, 1722746, 1906940



SC-DL-8623

Length: 592 Ø: 50
Hole Distance: 115 / 115
1388436, 1499476, 1722748, 1906942



SC-DL-9457

Length: 1743 Ø: 52
Cone Ø: d1 Ø 30 / d2 Ø 27
1527989, 1723896, 1737684, 1897336



SC-DL-9462

Length: 568,5 Ø: 50
Hole Distance: 115 / 115
1499475, 1500573, 1722747, 1906941



SC-DL-9466

Length: 568 Ø: 19
1486756



SC-DL-10302

Length: 752 Ø: 48
Hole Distance: 115 / 115
1101843, 1379423, 1393298, 1431470, 1942075



SC-ES-5764

Length: 95
Cone Ø: d1 Ø 30 / d2 Ø 27
Thread: M26 x 1,5 RHT
325614, 1375228, 4604948



SC-ES-8517

Length: 140
Cone Ø: d1 Ø 30 / d2 Ø 27
Thread: M30 x 1,5 RHT
1358793, 1435746, 1488890, 1534756, 1914427, 2051166



SC-TC-12361

Length: 705 Ø: 42
Cone Ø: d1 Ø 38
Hole Distance: 115
1353445, 1464611, 1942147



SC-TC-12451

Length: 552 Ø: 46
Hole Distance: 115 / 115
1494296



SC-TC-12452

Length: 580,5 Ø: 46
Hole Distance: 115 / 115
1485759



SC-TC-12472

Length: 580 Ø: 46
Hole Distance: 115 / 115
1399182



SC-VB-12418

Length: 613,2
Ø: 46
Hole Ø 25 / 19 / 19
Hole Distance: 152 / 115 / 115
1440028, 1722582



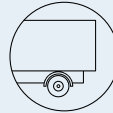

P,G,R,T - series ...

P 360 ...	07/09 →	Track Control Arm	SC-TC-12361		Control Arm, 1st & 2nd Front Axle, for Pneumatic Suspension vehicles
	09/09 →	Centre Rod	SC-DL-5354	SC-DL-5354	Push Rod, for vehicles with Hinged Trailing Axle
	09/09 →	Centre Rod	SC-DL-8399		Push Rod, for vehicles with Hinged Leading Axle, for vehicles with Part-Pneumatic Suspension
	09/09 →	Centre Rod	SC-DL-8553	SC-DL-8553	Push Rod, for vehicles with Hinged Leading Axle
	09/09 →	Centre Rod	SC-DL-10225		Push Rod, for vehicles with Hinged Leading Axle
	09/09 →	Centre Rod	SC-DL-12449		Push Rod
	09/09 →	Tie Rod		SC-DL-7264	Leading Axle;for vehicles with Hinged Leading Axle
	09/09 →	Tie Rod		SC-DL-7264	Leading Axle;for vehicles with Hinged Leading Axle;Air Suspension Axle
	09/09 →	Tie Rod		SC-DL-8137	Leading Axle;for vehicles with Hinged Leading Axle
	09/09 →	Tie Rod	SC-DL-7264		
P 360, R 360	04/10 →	Centre Rod	SC-DL-5229		Push Rod
	04/10 →	Centre Rod	SC-DL-5354		Push Rod
	04/10 →	Centre Rod	SC-DL-5354	SC-DL-5354	Push Rod, for vehicles with Hinged Trailing Axle
	04/10 →	Centre Rod	SC-DL-8154	SC-DL-8154	Push Rod, for vehicles with Hinged Trailing Axle
	04/10 →	Centre Rod	SC-DL-8182		Push Rod
	04/10 →	Centre Rod	SC-DL-8399		Push Rod, for vehicles with Hinged Leading Axle, for vehicles with Part-Pneumatic Suspension
	04/10 →	Centre Rod	SC-DL-8399		Push Rod, for vehicles with Part-Pneumatic Suspension
	04/10 →	Centre Rod	SC-DL-8553	SC-DL-8553	Push Rod, for vehicles with Hinged Leading Axle
	04/10 →	Centre Rod	SC-DL-12342		for Steering Rod
	04/10 →	Centre Rod	SC-DL-12343		for Steering Rod
	04/10 →	Centre Rod	SC-DL-12413		for Steering Rod
	04/10 →	Centre Rod	SC-DL-12449		Push Rod
	04/10 →	Suspension Arm Repair Kit		SC-RK-12366	for Control Arm
	04/10 →	Suspension Arm Repair Kit	SC-RK-12346	SC-RK-12346	for Control Arm
	04/10 →	Suspension Strut Repair Kit		MN-RK-8501	
	04/10 →	Suspension Strut Repair Kit		MN-RK-12436	
	04/10 →	Suspension Strut Repair Kit	DF-RK-9341		
	04/10 →	Tie Rod		SC-DL-7264	Leading Axle;for vehicles with Hinged Leading Axle
	04/10 →	Tie Rod		SC-DL-7264	Leading Axle;for vehicles with Hinged Leading Axle;Air Suspension Axle
	04/10 →	Tie Rod		SC-DL-7264	Tag Axle;for vehicles with Hinged Trailing Axle
	04/10 →	Tie Rod		SC-DL-8137	Leading Axle;for vehicles with Hinged Leading Axle
	04/10 →	Tie Rod		SC-DL-8137	Tag Axle;for vehicles with Hinged Trailing Axle
	04/10 →	Tie Rod	SC-DL-7264		
	04/10 →	Tie Rod	SC-DL-7264		1st FA
	04/10 →	Tie Rod	SC-DL-7264		1st FA;2nd FA
	04/10 →	Tie Rod	SC-DL-8137		Leaf Spring Axle
	04/10 →	Tie Rod	SC-DL-8137		Leaf Spring Axle;1st FA
	04/10 →	Tie Rod	SC-DL-8137		Leaf Spring Axle;1st FA;2nd FA
	04/10 →	Tie Rod	SC-DL-9457		1st FA;2nd FA;Leaf Spring Axle
	04/10 →	Tie Rod	SC-DL-9457		1st FA;Leaf Spring Axle
	04/10 →	Tie Rod	SC-DL-9457		Leaf Spring Axle
	04/10 →	Tie Rod End		MN-ES-8490	Tag Axle;for vehicles with Hinged Trailing Axle
	04/10 →	Tie Rod End	CV-ES-14162		for Steering Rod
	04/10 →	Tie Rod End	CV-ES-14162	CV-ES-14162	for Steering Rod
	04/10 →	Tie Rod End	CV-ES-14163		for Steering Rod
	04/10 →	Tie Rod End	IV-ES-12272		for Steering Rod
	04/10 →	Tie Rod End	MN-ES-8490	MN-ES-8490	for vehicles with Hinged Trailing Axle
	04/10 →	Tie Rod End	SC-ES-8517		for Push Rod
	04/10 →	Tie Rod End	SC-ES-8535		for Guide Rod
	04/10 →	Track Control Arm		SC-DL-8511	Trailing Arm, Leaf Spring Axle
04/10 →	Track Control Arm		SC-DL-8511	Trailing Arm, Leaf Spring Axle, →* 3512097 *	

CV-ES-14162

Length: 125
Cone Ø: d1 Ø 30 / d2 Ø 27
Thread: M30 x 1,5 LHT
283783, 395009, 1358792, 1738380, 1 914 426, 2051165



CV-ES-14163

Length: 125
Cone Ø: d1 Ø 30 / d2 Ø 27
Thread: M30 x 1,5 RHT
283784, 395010, 1358793, 1488890, 1738381, 1767328, 1914427, 2051166



DF-RK-9341

Ø: 67
550807, 5508072



IV-ES-12272

Length: 75
Cone Ø: d1 Ø 30 / d2 Ø 27
Thread: M26 x 1,5 RHT
1394443



MN-ES-8490

Length: 90
Cone Ø: d1 Ø 30 / d2 Ø 27
Thread: M26 x 1,5 RHT
1394444, 0014606948, 14606948



MN-RK-8501

Ø: 75 Hole Distance: 115
Thick/Height: 24
1515981



MN-RK-12436

Ø: 75 Hole Distance: 115
Thick/Height: 24
550799, 1517403, 1783020



SC-DL-5229

Length: 1053 Ø: 50
Cone Ø: d1 Ø 30 / d2 Ø 27
1356055, 1379071, 1384025, 1768898, 1847311, 1912757, 12201600A



SC-DL-5354

Length: 1060 Ø: 52
Cone Ø: d1 Ø 30 / d2 Ø 27
1384027, 1769597, 1847312, 1912758, 12200800A



SC-DL-7264

Length: 1743 Ø: 62
Cone Ø: d1 Ø 30 / d2 Ø 27
1361413, 1395614, 1734019, 1897333, 2040254, 2146105



SC-DL-8137

Length: 1736 Ø: 40
Cone Ø: d1 Ø 30 / d2 Ø 27
301639, 311847, 395350, 1358675, 1378435, 1397866, 1734020, 2028998, 12202900A



SC-DL-8154

Length: 495 Ø: 40
Cone Ø: d1 Ø 30 / d2 Ø 27
1343266, 1759690



SC-DL-8182

1343262, 1869413



SC-DL-8399

Length: 433 Ø: 40
Cone Ø: d1 Ø 30 / d2 Ø 26
1394884, 1938387



SC-DL-8511

Length: 616,5 Ø: 50
Hole Distance: 115 / 115
1485760, 1499478, 1722750



SC-DL-8553

Length: 435 Ø: 38
Cone Ø: d1 Ø 30 / d2 Ø 27
1343283, 1759691



SC-DL-9457

Length: 1743 Ø: 52
Cone Ø: d1 Ø 30 / d2 Ø 27
1527989, 1723896, 1737684, 1897336



SC-DL-10225

Length: 2179 Ø: 62
Cone Ø: d1 Ø 30 / d2 Ø 27
1386618, 1788522



SC-DL-12342

Length: 601 Ø: 42
Cone Ø: d1 Ø 26 / d2 Ø 23,5
1343262, 1869413



SC-DL-12343

Length: 1062 Ø: 52
Cone Ø: d1 Ø 30 / d2 Ø 27
1348269, 2007275



SC-DL-12413

Length: 1950 Ø: 62
Cone Ø: d1 Ø 30 / d2 Ø 27
1393383, 1788520



SC-DL-12449

Length: 1206 Ø: 38
Cone Ø: d1 Ø 30 / d2 Ø 27
1385763, 1765375



SC-ES-8517

Length: 140
Cone Ø: d1 Ø 30 / d2 Ø 27
Thread: M30 x 1,5 RHT
1358793, 1435746, 1488890, 1534756, 1914427, 2051166



SC-ES-8535

Length: 145
Cone Ø: d1 Ø 30 / d2 Ø 27
Thread: M30 x 1,5 RHT
1723897, 2051041



SC-RK-12346

Ø: 67 Hole Distance: 115
Thick/Height: 24
550800



SC-RK-12366

Ø: 75 Hole Distance: 115 / 115
Thick/Height: 24
1 722 753, 2 096 392



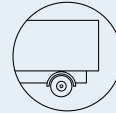

P,G,R,T - series ...

P 360, R 360 ...	04/10→	Track Control Arm		SC-DL-8547	Trailing Arm, Leaf Spring Axle
	04/10→	Track Control Arm		SC-DL-9462	Trailing Arm, Leaf Spring Axle, →* 2006231 SSS *;* 5117423 SNL *; * 9097199 SAN *;* 3564002 SLA *
	04/10→	Track Control Arm		SC-DL-9466	Trailing Arm, Leaf Spring Axle
	04/10→	Track Control Arm		SC-TC-12451	Trailing Arm, 1st Drive Axle, for Leaf-Spring Suspension vehicles
	04/10→	Track Control Arm		SC-TC-12451	Trailing Arm, 1st Drive Axle, for Leaf-Spring Suspension vehicles, 1280185/4471603→
	04/10→	Track Control Arm		SC-TC-12451	Trailing Arm, 1st Drive Axle, for Leaf-Spring Suspension vehicles, 9069961/3536016→
	04/10→	Track Control Arm		SC-TC-12452	Control Arm
	04/10→	Track Control Arm		SC-TC-12472	Trailing Arm, 2nd Drive Axle, for Leaf-Spring Suspension vehicles, →1280184/4471602
	04/10→	Track Control Arm		SC-TC-12472	Trailing Arm, 2nd Drive Axle, for Leaf-Spring Suspension vehicles, →9069960/3536015
	04/10→	Track Control Arm		SC-VB-12418	Control Arm
	04/10→	Track Control Arm	SC-DL-8179	SC-DL-8179	Trailing Arm, Leaf Spring Axle
	04/10→	Track Control Arm	SC-DL-8509	SC-DL-8509	Trailing Arm
	04/10→	Track Control Arm	SC-DL-8509	SC-DL-8509	Trailing Arm, Leaf Spring Axle
	04/10→	Track Control Arm	SC-DL-8531	SC-DL-8531	Trailing Arm, Leaf Spring Axle
	04/10→	Track Control Arm	SC-DL-8623	SC-DL-8623	Trailing Arm, Leaf Spring Axle, →* 2006231 SSS *;* 5117423 SNL *; * 9097199 SAN *;* 3564002 SLA *
	04/10→	Track Control Arm	SC-DL-10302	SC-DL-10302	Trailing Arm, Air Suspension Axle
	04/10→	Track Control Arm	SC-DL-10302	SC-DL-10302	Trailing Arm, Air Suspension Axle;1st FA
	04/10→	Track Control Arm	SC-TC-12361		Control Arm, 1st & 2nd Front Axle, for Pneumatic Suspension vehicles
	04/10→	Track Control Arm	SC-TC-12361		Control Arm, 1st Front Axle, for Pneumatic Suspension vehicles
	P 370	09/13→	Centre Rod	SC-DL-12342	
09/13→		Centre Rod	SC-DL-12343		for Steering Rod
09/13→		Centre Rod	SC-DL-12449		Push Rod
09/13→		Suspension Arm Repair Kit		SC-RK-12366	for Control Arm
09/13→		Suspension Arm Repair Kit	SC-RK-12346	SC-RK-12346	for Control Arm
09/13→		Tie Rod End	CV-ES-14163		for Steering Rod
09/13→		Track Control Arm		SC-VB-12418	Control Arm
P 380	04/04→	Centre Rod	SC-DL-5229		Push Rod
	04/04→	Centre Rod	SC-DL-5354		Push Rod
	04/04→	Centre Rod	SC-DL-5354	SC-DL-5354	Push Rod, for vehicles with Hinged Trailing Axle
	04/04→	Centre Rod	SC-DL-8154		Push Rod
	04/04→	Centre Rod	SC-DL-8169		Push Rod
	04/04→	Centre Rod	SC-DL-8182		Push Rod
	04/04→	Centre Rod	SC-DL-8399		Push Rod, for vehicles with Hinged Leading Axle, for vehicles with Part-Pneumatic Suspension
	04/04→	Centre Rod	SC-DL-8399		Push Rod, for vehicles with Part-Pneumatic Suspension
	04/04→	Centre Rod	SC-DL-8399		Push Rod, Leaf Spring Axle
	04/04→	Centre Rod	SC-DL-8553	SC-DL-8553	Push Rod, for vehicles with Hinged Leading Axle
	04/04→	Centre Rod	SC-DL-10225		for Steering Rod
	04/04→	Centre Rod	SC-DL-10225		Push Rod, for vehicles with Hinged Leading Axle
	04/04→	Centre Rod	SC-DL-12341		Push Rod
	04/04→	Centre Rod	SC-DL-12342		for Steering Rod
	04/04→	Centre Rod	SC-DL-12343		for Steering Rod
	04/04→	Centre Rod	SC-DL-12413		for Steering Rod
	04/04→	Centre Rod	SC-DL-12449		Push Rod
	04/04→	Suspension Arm Repair Kit		SC-RK-12366	for Control Arm
	04/04→	Suspension Arm Repair Kit	SC-RK-12346	SC-RK-12346	for Control Arm
	04/04→	Suspension Strut Repair Kit		MN-RK-8501	
	04/04→	Suspension Strut Repair Kit		MN-RK-12436	
	04/04→	Suspension Strut Repair Kit	DF-RK-9341		
	04/04→	Tie Rod		SC-DL-7264	Tag Axle;for vehicles with Hinged Trailing Axle
	04/04→	Tie Rod		SC-DL-8137	Tag Axle;for vehicles with Hinged Trailing Axle

CV-ES-14163

Length: 125
Cone Ø: d1 Ø 30 / d2 Ø 27
Thread: M30 x 1,5 RHT
283784, 395010, 1358793, 1488890,
1738381, 1767328, 1914427, 2051166



DF-RK-9341

Ø: 67
550807, 5508072



MN-RK-8501

Ø: 75 Hole Distance: 115
Thick/Height: 24
1515981



MN-RK-12436

Ø: 75 Hole Distance: 115
Thick/Height: 24
550799, 1517403, 1783020



SC-DL-5229

Length: 1053 Ø: 50
Cone Ø: d1 Ø 30 / d2 Ø 27
1356055, 1379071, 1384025, 1768898,
1847311, 1912757, 12201600A



SC-DL-5354

Length: 1060 Ø: 52
Cone Ø: d1 Ø 30 / d2 Ø 27
1384027, 1769597, 1847312, 1912758,
12200800A



SC-DL-7264

Length: 1743 Ø: 62
Cone Ø: d1 Ø 30 / d2 Ø 27
1361413, 1395614, 1734019, 1897333,
2040254, 2146105



SC-DL-8137

Length: 1736 Ø: 40
Cone Ø: d1 Ø 30 / d2 Ø 27
301639, 311847, 395350, 1358675,
1378435, 1397866, 1734020, 2028998,
12202900A



SC-DL-8154

Length: 495 Ø: 40
Cone Ø: d1 Ø 30 / d2 Ø 27
1343266, 1759690



SC-DL-8169

Length: 1920 Ø: 62
Cone Ø: d1 Ø 30 / d2 Ø 27
1343264, 1732635, 2007278



SC-DL-8179

Length: 568 Ø: 46
Hole Distance: 115 / 115
1399180, 1428347



SC-DL-8182

1343262, 1869413



SC-DL-8399

Length: 433 Ø: 40
Cone Ø: d1 Ø 30 / d2 Ø 26
1394884, 1938387



SC-DL-8509

Length: 568,5 Ø: 46
Hole Distance: 115 / 115
1485758, 1486757



SC-DL-8531

Length: 522 Ø: 46
Hole Distance: 115 / 115
1486758



SC-DL-8547

Length: 568 Ø: 50
Hole Distance: 115 / 115
1499474, 1722746, 1906940



SC-DL-8553

Length: 435 Ø: 38
Cone Ø: d1 Ø 30 / d2 Ø 27
1343283, 1759691



SC-DL-8623

Length: 592 Ø: 50
Hole Distance: 115 / 115
1388436, 1499476, 1722748, 1906942



SC-DL-9462

Length: 568,5 Ø: 50
Hole Distance: 115 / 115
1499475, 1500573, 1722747, 1906941



SC-DL-9466

Length: 568 Ø: 19
1486756



SC-DL-10225

Length: 2179 Ø: 62
Cone Ø: d1 Ø 30 / d2 Ø 27
1386618, 1788522



SC-DL-10302

Length: 752 Ø: 48
Hole Distance: 115 / 115
1101843, 1379423, 1393298, 1431470,
1942075



SC-DL-12341

Length: 1776 Ø: 62
Cone Ø: d1 Ø 30 / d2 Ø 27
1386620



SC-DL-12342

Length: 601 Ø: 42
Cone Ø: d1 Ø 26 / d2 Ø 23,5
1343262, 1869413



SC-DL-12343

Length: 1062 Ø: 52
Cone Ø: d1 Ø 30 / d2 Ø 27
1348269, 2007275



SC-DL-12413

Length: 1950 Ø: 62
Cone Ø: d1 Ø 30 / d2 Ø 27
1393383, 1788520



SC-DL-12449

Length: 1206 Ø: 38
Cone Ø: d1 Ø 30 / d2 Ø 27
1385763, 1765375



SC-RK-12346

Ø: 67 Hole Distance: 115
Thick/Height: 24
550800



SC-RK-12366

Ø: 75 Hole Distance: 115 / 115
Thick/Height: 24
1 722 753, 2 096 392



SC-TC-12361

Length: 705 Ø: 42
Cone Ø: d1 Ø 38
Hole Distance: 115
1353445, 1464611, 1942147



SC-TC-12451

Length: 552 Ø: 46
Hole Distance: 115 / 115
1494296



SC-TC-12452

Length: 580,5 Ø: 46
Hole Distance: 115 / 115
1485759



SC-TC-12472

Length: 580 Ø: 46
Hole Distance: 115 / 115
1399182



SC-VB-12418

Length: 613,2
Ø: 46
Hole Ø 25 / 19 / 19
Hole Distance: 152 / 115 / 115
1440028, 1722582





P,G,R,T - series ...

P 380 ...

04/04 →	Tie Rod	SC-DL-7264		
04/04 →	Tie Rod	SC-DL-7264		1st FA;2nd FA
04/04 →	Tie Rod	SC-DL-7264		Drive Axle;Air Suspension Axle
04/04 →	Tie Rod	SC-DL-8137		Leaf Spring Axle
04/04 →	Tie Rod	SC-DL-8137		Leaf Spring Axle;1st FA;2nd FA
04/04 →	Tie Rod	SC-DL-9457		1st FA;2nd FA;Leaf Spring Axle
04/04 →	Tie Rod	SC-DL-9457		Leaf Spring Axle
04/04 →	Tie Rod End		MN-ES-8490	Tag Axle;for vehicles with Hinged Trailing Axle
04/04 →	Tie Rod End	CV-ES-14162		for Steering Rod
04/04 →	Tie Rod End	CV-ES-14162	CV-ES-14162	for Steering Rod
04/04 →	Tie Rod End	CV-ES-14163		for Steering Rod
04/04 →	Tie Rod End	IV-ES-12272		for Steering Rod
04/04 →	Tie Rod End	MN-ES-8490	MN-ES-8490	for vehicles with Hinged Trailing Axle
04/04 →	Tie Rod End	SC-ES-5764		
04/04 →	Tie Rod End	SC-ES-8517		for Push Rod
04/04 →	Tie Rod End	SC-ES-8535		for Guide Rod
04/04 →	Track Control Arm		SC-DL-8179	Trailing Arm, 1st & 2nd Drive Axle, for Leaf-Spring Suspension vehicles
04/04 →	Track Control Arm		SC-DL-8179	Trailing Arm, 1st & 2nd Drive Axle, for Leaf-Spring Suspension vehicles, Ch.3512097 →
04/04 →	Track Control Arm		SC-DL-8179	Trailing Arm, 1st Drive Axle, for Leaf-Spring Suspension vehicles, →1280184/4471602
04/04 →	Track Control Arm		SC-DL-8179	Trailing Arm, 1st Drive Axle, for Leaf-Spring Suspension vehicles, →9069960/3536015
04/04 →	Track Control Arm		SC-DL-8509	Trailing Arm, 1st & 2nd Drive Axle, for Leaf-Spring Suspension vehicles
04/04 →	Track Control Arm		SC-DL-8511	Trailing Arm, 1st & 2nd Drive Axle, for Leaf-Spring Suspension vehicles
04/04 →	Track Control Arm		SC-DL-8511	Trailing Arm, Leaf Spring Axle
04/04 →	Track Control Arm		SC-DL-8511	Trailing Arm, Leaf Spring Axle, →* 2006231 SSS *;* 5117423 SNL *; * 9097199 SAN *;* 3564002 SLA *
04/04 →	Track Control Arm		SC-DL-8511	Trailing Arm, Leaf Spring Axle, →* 3512097 *
04/04 →	Track Control Arm		SC-DL-8531	Trailing Arm, 1st & 2nd Drive Axle, for Leaf-Spring Suspension vehicles
04/04 →	Track Control Arm		SC-DL-8547	Trailing Arm, 1st & 2nd Drive Axle, for Leaf-Spring Suspension vehicles
04/04 →	Track Control Arm		SC-DL-8547	Trailing Arm, Leaf Spring Axle
04/04 →	Track Control Arm		SC-DL-8547	Trailing Arm, Leaf Spring Axle, →* 2006231 SSS *;* 5117423 SNL *; * 9097199 SAN *;* 3564002 SLA *
04/04 →	Track Control Arm		SC-DL-8623	Trailing Arm, 1st Drive Axle, for Leaf-Spring Suspension vehicles, →2006231/5117423
04/04 →	Track Control Arm		SC-DL-8623	Trailing Arm, 1st Drive Axle, for Leaf-Spring Suspension vehicles, →9097199/3564002
04/04 →	Track Control Arm		SC-DL-8623	Trailing Arm, Leaf Spring Axle, * 2006232 SSS *;* 5117424 SNL *; * 9097200 SAN *;* 3564003 SLA * →
04/04 →	Track Control Arm		SC-DL-9462	Trailing Arm, 2nd Drive Axle, for Leaf-Spring Suspension vehicles, →2006231/5117423
04/04 →	Track Control Arm		SC-DL-9462	Trailing Arm, 2nd Drive Axle, for Leaf-Spring Suspension vehicles, →9097199/3564002
04/04 →	Track Control Arm		SC-DL-9462	Trailing Arm, Leaf Spring Axle, * 2006232 SSS *;* 5117424 SNL *; * 9097200 SAN *;* 3564003 SLA * →
04/04 →	Track Control Arm		SC-DL-9462	Trailing Arm, Leaf Spring Axle, →* 2006231 SSS *;* 5117423 SNL *; * 9097199 SAN *;* 3564002 SLA *
04/04 →	Track Control Arm		SC-DL-9466	Trailing Arm, 1st & 2nd Drive Axle, for Leaf-Spring Suspension vehicles
04/04 →	Track Control Arm		SC-DL-9466	Trailing Arm, Leaf Spring Axle

CV-ES-14162

Length: 125
Cone Ø: d1 Ø 30 / d2 Ø 27
Thread: M30 x 1,5 LHT
283783, 395009, 1358792, 1738380, 1 914 426, 2051165



CV-ES-14163

Length: 125
Cone Ø: d1 Ø 30 / d2 Ø 27
Thread: M30 x 1,5 RHT
283784, 395010, 1358793, 1488890, 1738381, 1767328, 1914427, 2051166



IV-ES-12272

Length: 75
Cone Ø: d1 Ø 30 / d2 Ø 27
Thread: M26 x 1,5 RHT
1394443



MN-ES-8490

Length: 90
Cone Ø: d1 Ø 30 / d2 Ø 27
Thread: M26 x 1,5 RHT
1394444, 0014606948, 14606948



SC-DL-7264

Length: 1743 Ø: 62
Cone Ø: d1 Ø 30 / d2 Ø 27
1361413, 1395614, 1734019, 1897333, 2040254, 2146105



SC-DL-8137

Length: 1736 Ø: 40
Cone Ø: d1 Ø 30 / d2 Ø 27
301639, 311847, 395350, 1358675, 1378435, 1397866, 1734020, 2028998, 12202900A



SC-DL-8179

Length: 568 Ø: 46
Hole Distance: 115 / 115
1399180, 1428347



SC-DL-8509

Length: 568,5 Ø: 46
Hole Distance: 115 / 115
1485758, 1486757



SC-DL-8511

Length: 616,5 Ø: 50
Hole Distance: 115 / 115
1485760, 1499478, 1722750



SC-DL-8531

Length: 522 Ø: 46
Hole Distance: 115 / 115
1486758



SC-DL-8547

Length: 568 Ø: 50
Hole Distance: 115 / 115
1499474, 1722746, 1906940



SC-DL-8623

Length: 592 Ø: 50
Hole Distance: 115 / 115
1388436, 1499476, 1722748, 1906942



SC-DL-9457

Length: 1743 Ø: 52
Cone Ø: d1 Ø 30 / d2 Ø 27
1527989, 1723896, 1737684, 1897336



SC-DL-9462

Length: 568,5 Ø: 50
Hole Distance: 115 / 115
1499475, 1500573, 1722747, 1906941



SC-DL-9466

Length: 568 Ø: 19
1486756



SC-ES-5764

Length: 95
Cone Ø: d1 Ø 30 / d2 Ø 27
Thread: M26 x 1,5 RHT
325614, 1375228, 4604948



SC-ES-8517

Length: 140
Cone Ø: d1 Ø 30 / d2 Ø 27
Thread: M30 x 1,5 RHT
1358793, 1435746, 1488890, 1534756, 1914427, 2051166



SC-ES-8535

Length: 145
Cone Ø: d1 Ø 30 / d2 Ø 27
Thread: M30 x 1,5 RHT
1723897, 2051041



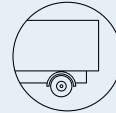

P,G,R,T - series ...

P 380 ...	04/04 →	Track Control Arm		SC-TC-12451	Trailing Arm, 1st Drive Axle, for Leaf-Spring Suspension vehicles	
	04/04 →	Track Control Arm		SC-TC-12451	Trailing Arm, 1st Drive Axle, for Leaf-Spring Suspension vehicles, 1280185/4471603 →	
	04/04 →	Track Control Arm		SC-TC-12451	Trailing Arm, 1st Drive Axle, for Leaf-Spring Suspension vehicles, 9069961/3536016 →	
	04/04 →	Track Control Arm		SC-TC-12452	Control Arm	
	04/04 →	Track Control Arm		SC-TC-12472	Trailing Arm, 2nd Drive Axle, for Leaf-Spring Suspension vehicles, →1280184/4471602	
	04/04 →	Track Control Arm		SC-TC-12472	Trailing Arm, 2nd Drive Axle, for Leaf-Spring Suspension vehicles, →9069960/3536015	
	04/04 →	Track Control Arm		SC-VB-12418	Control Arm	
	04/04 →	Track Control Arm	SC-DL-8179	SC-DL-8179	Trailing Arm, Leaf Spring Axle	
	04/04 →	Track Control Arm	SC-DL-8509	SC-DL-8509	Trailing Arm	
	04/04 →	Track Control Arm	SC-DL-8509	SC-DL-8509	Trailing Arm, Leaf Spring Axle	
	04/04 →	Track Control Arm	SC-DL-8531	SC-DL-8531	Trailing Arm, Leaf Spring Axle	
	04/04 →	Track Control Arm	SC-DL-8623	SC-DL-8623	Trailing Arm, Leaf Spring Axle, →* 2006231 SSS *; * 5117423 SNL *; * 9097199 SAN *; * 3564002 SLA *	
	04/04 →	Track Control Arm	SC-DL-10302	SC-DL-10302	Trailing Arm, 1st Front Axle, for Pneumatic Suspension vehicles	
	04/04 →	Track Control Arm	SC-DL-10302	SC-DL-10302	Trailing Arm, Air Suspension Axle	
	04/04 →	Track Control Arm	SC-DL-10302	SC-DL-10302	Trailing Arm, Air Suspension Axle; 1st FA	
	04/04 →	Track Control Arm	SC-TC-12361		Control Arm, 1st Front Axle, for Pneumatic Suspension vehicles	
	09/04 →	Suspension Strut Repair Kit		CV-RK-5311		
	P 380, R 380	10/06 →	Centre Rod	SC-DL-8154	SC-DL-8154	Push Rod, for vehicles with Hinged Trailing Axle
		04/04 →	Centre Rod	SC-DL-5229		Push Rod
		04/04 →	Centre Rod	SC-DL-5354		Push Rod
04/04 →		Centre Rod	SC-DL-5354	SC-DL-5354	Push Rod, for vehicles with Hinged Trailing Axle	
04/04 →		Centre Rod	SC-DL-8154		Push Rod	
04/04 →		Centre Rod	SC-DL-8154	SC-DL-8154	Push Rod, for vehicles with Hinged Trailing Axle	
04/04 →		Centre Rod	SC-DL-8169		Push Rod	
04/04 →		Centre Rod	SC-DL-8182		Push Rod	
04/04 →		Centre Rod	SC-DL-8399		Push Rod, for vehicles with Hinged Leading Axle, for vehicles with Part-Pneumatic Suspension	
04/04 →		Centre Rod	SC-DL-8399		Push Rod, for vehicles with Part-Pneumatic Suspension	
04/04 →		Centre Rod	SC-DL-8399		Push Rod, Leaf Spring Axle	
04/04 →		Centre Rod	SC-DL-8553	SC-DL-8553	Push Rod, for vehicles with Hinged Leading Axle	
04/04 →		Centre Rod	SC-DL-10225		for Steering Rod	
04/04 →		Centre Rod	SC-DL-10225		Push Rod, for vehicles with Hinged Leading Axle	
04/04 →		Centre Rod	SC-DL-12341		Push Rod	
04/04 →		Centre Rod	SC-DL-12342		for Steering Rod	
04/04 →		Centre Rod	SC-DL-12343		for Steering Rod	
04/04 →		Centre Rod	SC-DL-12413		for Steering Rod	
04/04 →		Centre Rod	SC-DL-12449		Push Rod	
04/04 →		Suspension Arm Repair Kit		SC-RK-12366	for Control Arm	
04/04 →		Suspension Arm Repair Kit	SC-RK-12346	SC-RK-12346	for Control Arm	
04/04 →		Suspension Strut Repair Kit		MN-RK-8501		
04/04 →		Suspension Strut Repair Kit		MN-RK-12436		
04/04 →		Suspension Strut Repair Kit	DF-RK-9341			
04/04 →		Tie Rod		SC-DL-7264	Leading Axle; for vehicles with Hinged Leading Axle	
04/04 →		Tie Rod		SC-DL-7264	Leading Axle; for vehicles with Hinged Leading Axle; Air Suspension Axle	
04/04 →		Tie Rod		SC-DL-7264	Tag Axle; for vehicles with Hinged Trailing Axle	
04/04 →		Tie Rod		SC-DL-8137	Leading Axle; for vehicles with Hinged Leading Axle	
04/04 →		Tie Rod		SC-DL-8137	Tag Axle; for vehicles with Hinged Trailing Axle	
04/04 →		Tie Rod	SC-DL-7264			
04/04 →	Tie Rod	SC-DL-7264		1st FA		
04/04 →	Tie Rod	SC-DL-7264		1st FA; 2nd FA		

CV-RK-5311

0638862, 638862, 0639287, 639287,
1104335, 1953248, 81432206006,
81432206107



DF-RK-9341

Ø: 67
550807, 5508072



MN-RK-8501

Ø: 75 Hole Distance: 115
Thick/Height: 24
1515981



MN-RK-12436

Ø: 75 Hole Distance: 115
Thick/Height: 24
550799, 1517403, 1783020



SC-DL-5229

Length: 1053 Ø: 50
Cone Ø: d1 Ø 30 / d2 Ø 27
1356055, 1379071, 1384025, 1768898,
1847311, 1912757, 12201600A



SC-DL-5354

Length: 1060 Ø: 52
Cone Ø: d1 Ø 30 / d2 Ø 27
1384027, 1769597, 1847312, 1912758,
12200800A



SC-DL-7264

Length: 1743 Ø: 62
Cone Ø: d1 Ø 30 / d2 Ø 27
1361413, 1395614, 1734019, 1897333,
2040254, 2146105



SC-DL-8137

Length: 1736 Ø: 40
Cone Ø: d1 Ø 30 / d2 Ø 27
301639, 311847, 395350, 1358675,
1378435, 1397866, 1734020, 2028998,
12202900A



SC-DL-8154

Length: 495 Ø: 40
Cone Ø: d1 Ø 30 / d2 Ø 27
1343266, 1759690



SC-DL-8169

Length: 1920 Ø: 62
Cone Ø: d1 Ø 30 / d2 Ø 27
1343264, 1732635, 2007278



SC-DL-8179

Length: 568 Ø: 46
Hole Distance: 115 / 115
1399180, 1428347



SC-DL-8182

1343262, 1869413



SC-DL-8399

Length: 433 Ø: 40
Cone Ø: d1 Ø 30 / d2 Ø 26
1394884, 1938387



SC-DL-8509

Length: 568,5 Ø: 46
Hole Distance: 115 / 115
1485758, 1486757



SC-DL-8531

Length: 522 Ø: 46
Hole Distance: 115 / 115
1486758



SC-DL-8553

Length: 435 Ø: 38
Cone Ø: d1 Ø 30 / d2 Ø 27
1343283, 1759691



SC-DL-8623

Length: 592 Ø: 50
Hole Distance: 115 / 115
1388436, 1499476, 1722748, 1906942



SC-DL-10225

Length: 2179 Ø: 62
Cone Ø: d1 Ø 30 / d2 Ø 27
1386618, 1788522



SC-DL-10302

Length: 752 Ø: 48
Hole Distance: 115 / 115
1101843, 1379423, 1393298, 1431470,
1942075



SC-DL-12341

Length: 1776 Ø: 62
Cone Ø: d1 Ø 30 / d2 Ø 27
1386620



SC-DL-12342

Length: 601 Ø: 42
Cone Ø: d1 Ø 26 / d2 Ø 23,5
1343262, 1869413



SC-DL-12343

Length: 1062 Ø: 52
Cone Ø: d1 Ø 30 / d2 Ø 27
1348269, 2007275



SC-DL-12413

Length: 1950 Ø: 62
Cone Ø: d1 Ø 30 / d2 Ø 27
1393383, 1788520



SC-DL-12449

Length: 1206 Ø: 38
Cone Ø: d1 Ø 30 / d2 Ø 27
1385763, 1765375



SC-RK-12346

Ø: 67 Hole Distance: 115
Thick/Height: 24
550800



SC-RK-12366

Ø: 75 Hole Distance: 115 / 115
Thick/Height: 24
1 722 753, 2 096 392



SC-TC-12361

Length: 705 Ø: 42
Cone Ø: d1 Ø 38
Hole Distance: 115
1353445, 1464611, 1942147



SC-TC-12451

Length: 552 Ø: 46
Hole Distance: 115 / 115
1494296



SC-TC-12452

Length: 580,5 Ø: 46
Hole Distance: 115 / 115
1485759



SC-TC-12472

Length: 580 Ø: 46
Hole Distance: 115 / 115
1399182



SC-VB-12418

Length: 613,2
Ø: 46
Hole Ø 25 / 19 / 19
Hole Distance: 152 / 115 / 115
1440028, 1722582





P,G,R,T - series ...

P 380, R 380 ...

04/04 →	Tie Rod	SC-DL-8137		Leaf Spring Axle
04/04 →	Tie Rod	SC-DL-8137		Leaf Spring Axle;1st FA
04/04 →	Tie Rod	SC-DL-8137		Leaf Spring Axle;1st FA;2nd FA
04/04 →	Tie Rod	SC-DL-9457		1st FA;2nd FA;Leaf Spring Axle
04/04 →	Tie Rod	SC-DL-9457		1st FA;Leaf Spring Axle
04/04 →	Tie Rod	SC-DL-9457		Leaf Spring Axle
04/04 →	Tie Rod End		MN-ES-8490	Tag Axle;for vehicles with Hinged Trailing Axle
04/04 →	Tie Rod End	CV-ES-14162		for Steering Rod
04/04 →	Tie Rod End	CV-ES-14162	CV-ES-14162	for Steering Rod
04/04 →	Tie Rod End	CV-ES-14163		for Steering Rod
04/04 →	Tie Rod End	IV-ES-12272		for Steering Rod
04/04 →	Tie Rod End	MN-ES-8490	MN-ES-8490	for vehicles with Hinged Trailing Axle
04/04 →	Tie Rod End	SC-ES-5764		
04/04 →	Tie Rod End	SC-ES-8517		for Push Rod
04/04 →	Tie Rod End	SC-ES-8535		for Guide Rod
04/04 →	Track Control Arm		SC-DL-8511	Trailing Arm, Leaf Spring Axle
04/04 →	Track Control Arm		SC-DL-8511	Trailing Arm, Leaf Spring Axle, →* 3512097 *
04/04 →	Track Control Arm		SC-DL-8547	Trailing Arm, Leaf Spring Axle
04/04 →	Track Control Arm		SC-DL-9462	Trailing Arm, Leaf Spring Axle, →* 2006231 SSS *;* 5117423 SNL *; * 9097199 SAN *;* 3564002 SLA *
04/04 →	Track Control Arm		SC-DL-9466	Trailing Arm, Leaf Spring Axle
04/04 →	Track Control Arm		SC-TC-12451	Trailing Arm, 1st Drive Axle, for Leaf-Spring Suspension vehicles
04/04 →	Track Control Arm		SC-TC-12451	Trailing Arm, 1st Drive Axle, for Leaf-Spring Suspension vehicles, 1280185/4471603→
04/04 →	Track Control Arm		SC-TC-12451	Trailing Arm, 1st Drive Axle, for Leaf-Spring Suspension vehicles, 9069961/3536016→
04/04 →	Track Control Arm		SC-TC-12452	Control Arm
04/04 →	Track Control Arm		SC-TC-12472	Trailing Arm, 2nd Drive Axle, for Leaf-Spring Suspension vehicles, →1280184/4471602
04/04 →	Track Control Arm		SC-TC-12472	Trailing Arm, 2nd Drive Axle, for Leaf-Spring Suspension vehicles, →9069960/3536015
04/04 →	Track Control Arm		SC-VB-12418	Control Arm
04/04 →	Track Control Arm	SC-DL-8179	SC-DL-8179	Trailing Arm, Leaf Spring Axle
04/04 →	Track Control Arm	SC-DL-8509	SC-DL-8509	Trailing Arm
04/04 →	Track Control Arm	SC-DL-8509	SC-DL-8509	Trailing Arm, Leaf Spring Axle
04/04 →	Track Control Arm	SC-DL-8531	SC-DL-8531	Trailing Arm, Leaf Spring Axle
04/04 →	Track Control Arm	SC-DL-8623	SC-DL-8623	Trailing Arm, Leaf Spring Axle, →* 2006231 SSS *;* 5117423 SNL *; * 9097199 SAN *;* 3564002 SLA *
04/04 →	Track Control Arm	SC-DL-10302	SC-DL-10302	Trailing Arm, Air Suspension Axle
04/04 →	Track Control Arm	SC-DL-10302	SC-DL-10302	Trailing Arm, Air Suspension Axle;1st FA
04/04 →	Track Control Arm	SC-TC-12361		Control Arm, 1st & 2nd Front Axle, for Pneumatic Suspension vehicles
04/04 →	Track Control Arm	SC-TC-12361		Control Arm, 1st Front Axle, for Pneumatic Suspension vehicles
09/05 →	Tie Rod	SC-DL-7264		Drive Axle;Air Suspension Axle
09/05 →	Track Control Arm		SC-DL-8511	Trailing Arm, Leaf Spring Axle, →* 2006231 SSS *;* 5117423 SNL *; * 9097199 SAN *;* 3564002 SLA *
09/05 →	Track Control Arm		SC-DL-8547	Trailing Arm, Leaf Spring Axle, →* 2006231 SSS *;* 5117423 SNL *; * 9097199 SAN *;* 3564002 SLA *
09/05 →	Track Control Arm		SC-DL-8623	Trailing Arm, Leaf Spring Axle, * 2006232 SSS *;* 5117424 SNL *; * 9097200 SAN *;* 3564003 SLA *→
09/05 →	Track Control Arm		SC-DL-9462	Trailing Arm, Leaf Spring Axle, * 2006232 SSS *;* 5117424 SNL *; * 9097200 SAN *;* 3564003 SLA *→

CV-ES-14162

Length: 125
Cone Ø: d1 Ø 30 / d2 Ø 27
Thread: M30 x 1,5 LHT
283783, 395009, 1358792, 1738380, 1 914 426, 2051165



CV-ES-14163

Length: 125
Cone Ø: d1 Ø 30 / d2 Ø 27
Thread: M30 x 1,5 RHT
283784, 395010, 1358793, 1488890, 1738381, 1767328, 1914427, 2051166



IV-ES-12272

Length: 75
Cone Ø: d1 Ø 30 / d2 Ø 27
Thread: M26 x 1,5 RHT
1394443



MN-ES-8490

Length: 90
Cone Ø: d1 Ø 30 / d2 Ø 27
Thread: M26 x 1,5 RHT
1394444, 0014606948, 14606948



SC-DL-7264

Length: 1743 Ø: 62
Cone Ø: d1 Ø 30 / d2 Ø 27
1361413, 1395614, 1734019, 1897333, 2040254, 2146105



SC-DL-8137

Length: 1736 Ø: 40
Cone Ø: d1 Ø 30 / d2 Ø 27
301639, 311847, 395350, 1358675, 1378435, 1397866, 1734020, 2028998, 12202900A



SC-DL-8179

Length: 568 Ø: 46
Hole Distance: 115 / 115
1399180, 1428347



SC-DL-8509

Length: 568,5 Ø: 46
Hole Distance: 115 / 115
1485758, 1486757



SC-DL-8511

Length: 616,5 Ø: 50
Hole Distance: 115 / 115
1485760, 1499478, 1722750



SC-DL-8531

Length: 522 Ø: 46
Hole Distance: 115 / 115
1486758



SC-DL-8547

Length: 568 Ø: 50
Hole Distance: 115 / 115
1499474, 1722746, 1906940



SC-DL-8623

Length: 592 Ø: 50
Hole Distance: 115 / 115
1388436, 1499476, 1722748, 1906942



SC-DL-9457

Length: 1743 Ø: 52
Cone Ø: d1 Ø 30 / d2 Ø 27
1527989, 1723896, 1737684, 1897336



SC-DL-9462

Length: 568,5 Ø: 50
Hole Distance: 115 / 115
1499475, 1500573, 1722747, 1906941



SC-DL-9466

Length: 568 Ø: 19
1486756



SC-DL-10302

Length: 752 Ø: 48
Hole Distance: 115 / 115
1101843, 1379423, 1393298, 1431470, 1942075



SC-ES-5764

Length: 95
Cone Ø: d1 Ø 30 / d2 Ø 27
Thread: M26 x 1,5 RHT
325614, 1375228, 4604948



SC-ES-8517

Length: 140
Cone Ø: d1 Ø 30 / d2 Ø 27
Thread: M30 x 1,5 RHT
1358793, 1435746, 1488890, 1534756, 1914427, 2051166



SC-ES-8535

Length: 145
Cone Ø: d1 Ø 30 / d2 Ø 27
Thread: M30 x 1,5 RHT
1723897, 2051041



SC-TC-12361

Length: 705 Ø: 42
Cone Ø: d1 Ø 38
Hole Distance: 115
1353445, 1464611, 1942147



SC-TC-12451

Length: 552 Ø: 46
Hole Distance: 115 / 115
1494296



SC-TC-12452

Length: 580,5 Ø: 46
Hole Distance: 115 / 115
1485759



SC-TC-12472

Length: 580 Ø: 46
Hole Distance: 115 / 115
1399182



SC-VB-12418

Length: 613,2
Ø: 46
Hole Ø 25 / 19 / 19
Hole Distance: 152 / 115 / 115
1440028, 1722582



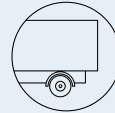

P,G,R,T - series ...

P 400	07/09→	Centre Rod	SC-DL-10225		for Steering Rod
	07/09→	Centre Rod	SC-DL-12342		for Steering Rod
	07/09→	Centre Rod	SC-DL-12343		for Steering Rod
	07/09→	Centre Rod	SC-DL-12413		for Steering Rod
	07/09→	Suspension Arm Repair Kit		SC-RK-12366	for Control Arm
	07/09→	Suspension Arm Repair Kit	SC-RK-12346	SC-RK-12346	for Control Arm
	07/09→	Tie Rod End	CV-ES-14162	CV-ES-14162	for Steering Rod
	07/09→	Tie Rod End	CV-ES-14163		for Steering Rod
	07/09→	Tie Rod End	SC-ES-8517		for Push Rod
	07/09→	Tie Rod End	SC-ES-8535		for Guide Rod
	07/09→	Track Control Arm		SC-TC-12452	Control Arm
	07/09→	Track Control Arm		SC-VB-12418	Control Arm
	07/09→	Track Control Arm	SC-DL-10302	SC-DL-10302	Trailing Arm, 1st Front Axle, for Pneumatic Suspension vehicles
	07/09→	Track Control Arm	SC-TC-12361		Control Arm, 1st & 2nd Front Axle, for Pneumatic Suspension vehicles
	04/10→	Centre Rod	SC-DL-5229		Push Rod
	04/10→	Centre Rod	SC-DL-5354		Push Rod
	04/10→	Centre Rod	SC-DL-8154		Push Rod
	04/10→	Centre Rod	SC-DL-8169		Push Rod
	04/10→	Centre Rod	SC-DL-8182		Push Rod
	04/10→	Centre Rod	SC-DL-8399		Push Rod, for vehicles with Part-Pneumatic Suspension
	04/10→	Centre Rod	SC-DL-8553	SC-DL-8553	Push Rod, for vehicles with Hinged Leading Axle
	04/10→	Centre Rod	SC-DL-10225		Push Rod, for vehicles with Hinged Leading Axle
	04/10→	Centre Rod	SC-DL-12449		Push Rod
	04/10→	Suspension Strut Repair Kit		MN-RK-8501	
	04/10→	Suspension Strut Repair Kit		MN-RK-12436	
	04/10→	Suspension Strut Repair Kit	DF-RK-9341		
	04/10→	Tie Rod	SC-DL-7264		1st FA;2nd FA
	04/10→	Tie Rod	SC-DL-8137		Leaf Spring Axle
	04/10→	Tie Rod	SC-DL-8137		Leaf Spring Axle;1st FA;2nd FA
	04/10→	Tie Rod	SC-DL-9457		1st FA;2nd FA;Leaf Spring Axle
	04/10→	Tie Rod	SC-DL-9457		Leaf Spring Axle
	04/10→	Tie Rod End	CV-ES-14162		for Steering Rod
	04/10→	Tie Rod End	SC-ES-5764		
04/10→	Track Control Arm		SC-DL-8511	Trailing Arm, Leaf Spring Axle	
04/10→	Track Control Arm		SC-DL-8511	Trailing Arm, Leaf Spring Axle, →* 3512097 *	
04/10→	Track Control Arm		SC-DL-8547	Trailing Arm, Leaf Spring Axle	
04/10→	Track Control Arm		SC-DL-9462	Trailing Arm, Leaf Spring Axle, →* 2006231 SSS *; * 5117423 SNL *; * 9097199 SAN *; * 3564002 SLA *	
04/10→	Track Control Arm		SC-DL-9466	Trailing Arm, Leaf Spring Axle	
04/10→	Track Control Arm	SC-DL-8179	SC-DL-8179	Trailing Arm, Leaf Spring Axle	
04/10→	Track Control Arm	SC-DL-8509	SC-DL-8509	Trailing Arm	
04/10→	Track Control Arm	SC-DL-8509	SC-DL-8509	Trailing Arm, Leaf Spring Axle	
04/10→	Track Control Arm	SC-DL-8531	SC-DL-8531	Trailing Arm, Leaf Spring Axle	
04/10→	Track Control Arm	SC-DL-8623	SC-DL-8623	Trailing Arm, Leaf Spring Axle, →* 2006231 SSS *; * 5117423 SNL *; * 9097199 SAN *; * 3564002 SLA *	
04/10→	Track Control Arm	SC-DL-10302	SC-DL-10302	Trailing Arm, Air Suspension Axle	
04/10→	Track Control Arm	SC-DL-10302	SC-DL-10302	Trailing Arm, Air Suspension Axle;1st FA	
04/10→	Track Control Arm	SC-TC-12361		Control Arm, 1st Front Axle, for Pneumatic Suspension vehicles	
P 400, R 400	04/10→	Centre Rod	SC-DL-5229		Push Rod
	04/10→	Centre Rod	SC-DL-5354		Push Rod
	04/10→	Centre Rod	SC-DL-8154	SC-DL-8154	Push Rod, for vehicles with Hinged Trailing Axle
	04/10→	Centre Rod	SC-DL-8182		Push Rod
	04/10→	Centre Rod	SC-DL-8399		Push Rod, for vehicles with Part-Pneumatic Suspension
	04/10→	Centre Rod	SC-DL-12342		for Steering Rod
	04/10→	Centre Rod	SC-DL-12343		for Steering Rod
04/10→	Centre Rod	SC-DL-12413		for Steering Rod	

CV-ES-14162

Length: 125
Cone Ø: d1 Ø 30 / d2 Ø 27
Thread: M30 x 1,5 LHT
283783, 395009, 1358792, 1738380, 1 914 426, 2051165



CV-ES-14163

Length: 125
Cone Ø: d1 Ø 30 / d2 Ø 27
Thread: M30 x 1,5 RHT
283784, 395010, 1358793, 1488890, 1738381, 1767328, 1914427, 2051166



DF-RK-9341

Ø: 67
550807, 5508072



MN-RK-8501

Ø: 75 Hole Distance: 115
Thick/Height: 24
1515981



MN-RK-12436

Ø: 75 Hole Distance: 115
Thick/Height: 24
550799, 1517403, 1783020



SC-DL-5229

Length: 1053 Ø: 50
Cone Ø: d1 Ø 30 / d2 Ø 27
1356055, 1379071, 1384025, 1768898, 1847311, 1912757, 12201600A



SC-DL-5354

Length: 1060 Ø: 52
Cone Ø: d1 Ø 30 / d2 Ø 27
1384027, 1769597, 1847312, 1912758, 12200800A



SC-DL-7264

Length: 1743 Ø: 62
Cone Ø: d1 Ø 30 / d2 Ø 27
1361413, 1395614, 1734019, 1897333, 2040254, 2146105



SC-DL-8137

Length: 1736 Ø: 40
Cone Ø: d1 Ø 30 / d2 Ø 27
301639, 311847, 395350, 1358675, 1378435, 1397866, 1734020, 2028998, 12202900A



SC-DL-8154

Length: 495 Ø: 40
Cone Ø: d1 Ø 30 / d2 Ø 27
1343266, 1759690



SC-DL-8169

Length: 1920 Ø: 62
Cone Ø: d1 Ø 30 / d2 Ø 27
1343264, 1732635, 2007278



SC-DL-8179

Length: 568 Ø: 46
Hole Distance: 115 / 115
1399180, 1428347



SC-DL-8182

1343262, 1869413



SC-DL-8399

Length: 433 Ø: 40
Cone Ø: d1 Ø 30 / d2 Ø 26
1394884, 1938387



SC-DL-8509

Length: 568,5 Ø: 46
Hole Distance: 115 / 115
1485758, 1486757



SC-DL-8511

Length: 616,5 Ø: 50
Hole Distance: 115 / 115
1485760, 1499478, 1722750



SC-DL-8531

Length: 522 Ø: 46
Hole Distance: 115 / 115
1486758



SC-DL-8547

Length: 568 Ø: 50
Hole Distance: 115 / 115
1499474, 1722746, 1906940



SC-DL-8553

Length: 435 Ø: 38
Cone Ø: d1 Ø 30 / d2 Ø 27
1343283, 1759691



SC-DL-8623

Length: 592 Ø: 50
Hole Distance: 115 / 115
1388436, 1499476, 1722748, 1906942



SC-DL-9457

Length: 1743 Ø: 52
Cone Ø: d1 Ø 30 / d2 Ø 27
1527989, 1723896, 1737684, 1897336



SC-DL-9462

Length: 568,5 Ø: 50
Hole Distance: 115 / 115
1499475, 1500573, 1722747, 1906941



SC-DL-9466

Length: 568 Ø: 19
1486756



SC-DL-10225

Length: 2179 Ø: 62
Cone Ø: d1 Ø 30 / d2 Ø 27
1386618, 1788522



SC-DL-10302

Length: 752 Ø: 48
Hole Distance: 115 / 115
1101843, 1379423, 1393298, 1431470, 1942075



SC-DL-12342

Length: 601 Ø: 42
Cone Ø: d1 Ø 26 / d2 Ø 23,5
1343262, 1869413



SC-DL-12343

Length: 1062 Ø: 52
Cone Ø: d1 Ø 30 / d2 Ø 27
1348269, 2007275



SC-DL-12413

Length: 1950 Ø: 62
Cone Ø: d1 Ø 30 / d2 Ø 27
1393383, 1788520



SC-DL-12449

Length: 1206 Ø: 38
Cone Ø: d1 Ø 30 / d2 Ø 27
1385763, 1765375



SC-ES-5764

Length: 95
Cone Ø: d1 Ø 30 / d2 Ø 27
Thread: M26 x 1,5 RHT
325614, 1375228, 4604948



SC-ES-8517

Length: 140
Cone Ø: d1 Ø 30 / d2 Ø 27
Thread: M30 x 1,5 RHT
1358793, 1435746, 1488890, 1534756, 1914427, 2051166



SC-ES-8535

Length: 145
Cone Ø: d1 Ø 30 / d2 Ø 27
Thread: M30 x 1,5 RHT
1723897, 2051041



SC-RK-12346

Ø: 67 Hole Distance: 115
Thick/Height: 24
550800



SC-RK-12366

Ø: 75 Hole Distance: 115 / 115
Thick/Height: 24
1 722 753, 2 096 392



SC-TC-12361

Length: 705 Ø: 42
Cone Ø: d1 Ø 38
Hole Distance: 115
1353445, 1464611, 1942147



SC-TC-12452

Length: 580,5 Ø: 46
Hole Distance: 115 / 115
1485759



SC-VB-12418

Length: 613,2 Ø: 46
Hole Ø 25 / 19 / 19
Hole Distance: 152 / 115 / 115
1440028, 1722582



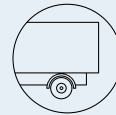

P,G,R,T - series ...

P 400, R 400 ...

04/10→	Suspension Arm Repair Kit		SC-RK-12366	for Control Arm
04/10→	Suspension Arm Repair Kit	SC-RK-12346	SC-RK-12346	for Control Arm
04/10→	Suspension Strut Repair Kit		MN-RK-8501	
04/10→	Suspension Strut Repair Kit		MN-RK-12436	
04/10→	Suspension Strut Repair Kit	DF-RK-9341		
04/10→	Tie Rod		SC-DL-7264	Tag Axle;for vehicles with Hinged Trailing Axle
04/10→	Tie Rod		SC-DL-8137	Tag Axle;for vehicles with Hinged Trailing Axle
04/10→	Tie Rod	SC-DL-7264		1st FA
04/10→	Tie Rod	SC-DL-7264		1st FA;2nd FA
04/10→	Tie Rod	SC-DL-8137		Leaf Spring Axle
04/10→	Tie Rod	SC-DL-8137		Leaf Spring Axle;1st FA
04/10→	Tie Rod	SC-DL-8137		Leaf Spring Axle;1st FA;2nd FA
04/10→	Tie Rod	SC-DL-9457		1st FA;2nd FA;Leaf Spring Axle
04/10→	Tie Rod	SC-DL-9457		1st FA;Leaf Spring Axle
04/10→	Tie Rod	SC-DL-9457		Leaf Spring Axle
04/10→	Tie Rod End		MN-ES-8490	Tag Axle;for vehicles with Hinged Trailing Axle
04/10→	Tie Rod End	CV-ES-14162		for Steering Rod
04/10→	Tie Rod End	CV-ES-14162	CV-ES-14162	for Steering Rod
04/10→	Tie Rod End	CV-ES-14163		for Steering Rod
04/10→	Tie Rod End	IV-ES-12272		for Steering Rod
04/10→	Tie Rod End	MN-ES-8490	MN-ES-8490	for vehicles with Hinged Trailing Axle
04/10→	Tie Rod End	SC-ES-8517		for Push Rod
04/10→	Tie Rod End	SC-ES-8535		for Guide Rod
04/10→	Track Control Arm		SC-DL-8511	Trailing Arm, Leaf Spring Axle
04/10→	Track Control Arm		SC-DL-8511	Trailing Arm, Leaf Spring Axle, →* 3512097 *
04/10→	Track Control Arm		SC-DL-8547	Trailing Arm, Leaf Spring Axle
04/10→	Track Control Arm		SC-DL-9462	Trailing Arm, Leaf Spring Axle, →* 2006231 SSS *;* 5117423 SNL *; * 9097199 SAN *;* 3564002 SLA *
04/10→	Track Control Arm		SC-DL-9466	Trailing Arm, Leaf Spring Axle
04/10→	Track Control Arm		SC-TC-12451	Trailing Arm, 1st Drive Axle, for Leaf-Spring Suspension vehicles
04/10→	Track Control Arm		SC-TC-12451	Trailing Arm, 1st Drive Axle, for Leaf-Spring Suspension vehicles, 1280185/4471603→
04/10→	Track Control Arm		SC-TC-12451	Trailing Arm, 1st Drive Axle, for Leaf-Spring Suspension vehicles, 9069961/3536016→
04/10→	Track Control Arm		SC-TC-12452	Control Arm
04/10→	Track Control Arm		SC-TC-12472	Trailing Arm, 2nd Drive Axle, for Leaf-Spring Suspension vehicles, →1280184/4471602
04/10→	Track Control Arm		SC-TC-12472	Trailing Arm, 2nd Drive Axle, for Leaf-Spring Suspension vehicles, →9069960/3536015
04/10→	Track Control Arm		SC-VB-12418	Control Arm
04/10→	Track Control Arm	SC-DL-8179	SC-DL-8179	Trailing Arm, Leaf Spring Axle
04/10→	Track Control Arm	SC-DL-8509	SC-DL-8509	Trailing Arm
04/10→	Track Control Arm	SC-DL-8509	SC-DL-8509	Trailing Arm, Leaf Spring Axle
04/10→	Track Control Arm	SC-DL-8531	SC-DL-8531	Trailing Arm, Leaf Spring Axle
04/10→	Track Control Arm	SC-DL-8623	SC-DL-8623	Trailing Arm, Leaf Spring Axle, →* 2006231 SSS *;* 5117423 SNL *; * 9097199 SAN *;* 3564002 SLA *
04/10→	Track Control Arm	SC-DL-10302	SC-DL-10302	Trailing Arm, Air Suspension Axle
04/10→	Track Control Arm	SC-DL-10302	SC-DL-10302	Trailing Arm, Air Suspension Axle;1st FA
04/10→	Track Control Arm	SC-TC-12361		Control Arm, 1st & 2nd Front Axle, for Pneumatic Suspension vehicles
04/10→	Track Control Arm	SC-TC-12361		Control Arm, 1st Front Axle, for Pneumatic Suspension vehicles
P 410	09/13→	Centre Rod	SC-DL-12342	for Steering Rod
	09/13→	Centre Rod	SC-DL-12343	for Steering Rod
	09/13→	Centre Rod	SC-DL-12413	for Steering Rod
	09/13→	Suspension Arm Repair Kit		SC-RK-12366 for Control Arm
	09/13→	Suspension Arm Repair Kit	SC-RK-12346	SC-RK-12346 for Control Arm
	09/13→	Tie Rod End	CV-ES-14163	for Steering Rod
	09/13→	Track Control Arm		SC-VB-12418 Control Arm

CV-ES-14162

Length: 125
Cone Ø: d1 Ø 30 / d2 Ø 27
Thread: M30 x 1,5 LHT
283783, 395009, 1358792, 1738380, 1 914 426, 2051165



CV-ES-14163

Length: 125
Cone Ø: d1 Ø 30 / d2 Ø 27
Thread: M30 x 1,5 RHT
283784, 395010, 1358793, 1488890, 1738381, 1767328, 1914427, 2051166



DF-RK-9341

Ø: 67
550807, 5508072



IV-ES-12272

Length: 75
Cone Ø: d1 Ø 30 / d2 Ø 27
Thread: M26 x 1,5 RHT
1394443



MN-ES-8490

Length: 90
Cone Ø: d1 Ø 30 / d2 Ø 27
Thread: M26 x 1,5 RHT
1394444, 14606948, 0014606948



MN-RK-8501

Ø: 75 Hole Distance: 115
Thick/Height: 24
1515981



MN-RK-12436

Ø: 75 Hole Distance: 115
Thick/Height: 24
550799, 1517403, 1783020



SC-DL-7264

Length: 1743 Ø: 62
Cone Ø: d1 Ø 30 / d2 Ø 27
1361413, 1395614, 1734019, 1897333, 2040254, 2146105



SC-DL-8137

Length: 1736 Ø: 40
Cone Ø: d1 Ø 30 / d2 Ø 27
301639, 311847, 395350, 1358675, 1378435, 1397866, 1734020, 2028998, 12202900A



SC-DL-8179

Length: 568 Ø: 46
Hole Distance: 115 / 115
1399180, 1428347



SC-DL-8509

Length: 568,5 Ø: 46
Hole Distance: 115 / 115
1485758, 1486757



SC-DL-8511

Length: 616,5 Ø: 50
Hole Distance: 115 / 115
1485760, 1499478, 1722750



SC-DL-8531

Length: 522 Ø: 46
Hole Distance: 115 / 115
1486758



SC-DL-8547

Length: 568 Ø: 50
Hole Distance: 115 / 115
1499474, 1722746, 1906940



SC-DL-8623

Length: 592 Ø: 50
Hole Distance: 115 / 115
1388436, 1499476, 1722748, 1906942



SC-DL-9457

Length: 1743 Ø: 52
Cone Ø: d1 Ø 30 / d2 Ø 27
1527989, 1723896, 1737684, 1897336



SC-DL-9462

Length: 568,5 Ø: 50
Hole Distance: 115 / 115
1499475, 1500573, 1722747, 1906941



SC-DL-9466

Length: 568 Ø: 19
1486756



SC-DL-10302

Length: 752 Ø: 48
Hole Distance: 115 / 115
1101843, 1379423, 1393298, 1431470, 1942075



SC-DL-12342

Length: 601 Ø: 42
Cone Ø: d1 Ø 26 / d2 Ø 23,5
1343262, 1869413



SC-DL-12343

Length: 1062 Ø: 52
Cone Ø: d1 Ø 30 / d2 Ø 27
1348269, 2007275



SC-DL-12413

Length: 1950 Ø: 62
Cone Ø: d1 Ø 30 / d2 Ø 27
1393383, 1788520



SC-ES-8517

Length: 140
Cone Ø: d1 Ø 30 / d2 Ø 27
Thread: M30 x 1,5 RHT
1358793, 1435746, 1488890, 1534756, 1914427, 2051166



SC-ES-8535

Length: 145
Cone Ø: d1 Ø 30 / d2 Ø 27
Thread: M30 x 1,5 RHT
1723897, 2051041



SC-RK-12346

Ø: 67 Hole Distance: 115
Thick/Height: 24
550800



SC-RK-12366

Ø: 75 Hole Distance: 115 / 115
Thick/Height: 24
1 722 753, 2 096 392



SC-TC-12361

Length: 705 Ø: 42
Cone Ø: d1 Ø 38
Hole Distance: 115
1353445, 1464611, 1942147



SC-TC-12451

Length: 552 Ø: 46
Hole Distance: 115 / 115
1494296



SC-TC-12452

Length: 580,5 Ø: 46
Hole Distance: 115 / 115
1485759



SC-TC-12472

Length: 580 Ø: 46
Hole Distance: 115 / 115
1399182



SC-VB-12418

Length: 613,2
Ø: 46
Hole Ø 25 / 19 / 19
Hole Distance: 152 / 115 / 115
1440028, 1722582



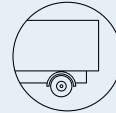
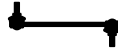

P,G,R,T - series ...

P 420, G 420	01/08→	Centre Rod	SC-DL-2161		Coupling Rod
	01/08→	Centre Rod	SC-DL-12343		for Steering Rod
	01/08→	Suspension Arm Repair Kit		SC-RK-12366	for Control Arm
	01/08→	Suspension Arm Repair Kit	MN-RK-7280	MN-RK-7280	for Drag Link;for Semi-Trailing Arm; for Wishbone (CV)
	01/08→	Suspension Strut Repair Kit		MN-RK-8501	
	01/08→	Tie Rod End	CV-ES-14162		for Steering Rod
	01/08→	Tie Rod End	CV-ES-14163		for Steering Rod
	01/08→	Tie Rod End	SC-ES-7279		for Steering Rod
	01/08→	Tie Rod End	SC-ES-8517		for Push Rod
	01/08→	Tie Rod End	SC-ES-8535		for Guide Rod
	01/08→	Track Control Arm		SC-DL-8509	Trailing Arm, 1st & 2nd Drive Axle, for Leaf-Spring Suspension vehicles
	01/08→	Track Control Arm		SC-DL-8509	Trailing Arm, 1st Drive Axle, for Leaf-Spring Suspension vehicles
	01/08→	Track Control Arm		SC-DL-8509	Trailing Arm, 1st Drive Axle, for Leaf-Spring Suspension vehicles, 1280185/4471603→
	01/08→	Track Control Arm		SC-DL-8511	Trailing Arm, 1st & 2nd Drive Axle, for Leaf-Spring Suspension vehicles
	01/08→	Track Control Arm		SC-DL-8531	Trailing Arm, 1st & 2nd Drive Axle, for Leaf-Spring Suspension vehicles
	01/08→	Track Control Arm		SC-DL-8547	Trailing Arm, for Leaf-Spring Suspension vehicles
	01/08→	Track Control Arm		SC-DL-9462	Trailing Arm, for Leaf-Spring Suspension vehicles
	01/08→	Track Control Arm		SC-DL-9466	Trailing Arm
	01/08→	Track Control Arm		SC-TC-12451	Trailing Arm, 1st Drive Axle, for Leaf-Spring Suspension vehicles
	01/08→	Track Control Arm		SC-TC-12451	Trailing Arm, 1st Drive Axle, for Leaf-Spring Suspension vehicles, 1280185/4471603→
	01/08→	Track Control Arm		SC-TC-12451	Trailing Arm, 1st Drive Axle, for Leaf-Spring Suspension vehicles, 9069961/3536016→
	01/08→	Track Control Arm		SC-TC-12452	Trailing Arm, 2nd Drive Axle, for Leaf-Spring Suspension vehicles, 1280185/4471603→
	01/08→	Track Control Arm		SC-TC-12452	Trailing Arm, 2nd Drive Axle, for Leaf-Spring Suspension vehicles, 9069961/3536016→
	01/08→	Track Control Arm		SC-TC-12472	Control Arm
	01/08→	Track Control Arm	SC-DL-8179	SC-DL-8179	Trailing Arm, for Leaf-Spring Suspension vehicles
	01/08→	Track Control Arm	SC-DL-8623	SC-DL-8623	Trailing Arm, for Leaf-Spring Suspension vehicles
	P 420, R 420	03/04→	Centre Rod	SC-DL-5229	
03/04→		Centre Rod	SC-DL-5354		Push Rod
03/04→		Centre Rod	SC-DL-5354	SC-DL-5354	Push Rod, for vehicles with Hinged Trailing Axle
03/04→		Centre Rod	SC-DL-8182		Push Rod
03/04→		Centre Rod	SC-DL-8399		Push Rod, for vehicles with Hinged Leading Axle, for vehicles with Part-Pneumatic Suspension
03/04→		Centre Rod	SC-DL-8553	SC-DL-8553	Push Rod, for vehicles with Hinged Leading Axle
03/04→		Centre Rod	SC-DL-10225		for Steering Rod
03/04→		Centre Rod	SC-DL-10225		Push Rod, for vehicles with Hinged Leading Axle
03/04→		Centre Rod	SC-DL-12342		for Steering Rod
03/04→		Centre Rod	SC-DL-12343		for Steering Rod
03/04→		Centre Rod	SC-DL-12449		Push Rod
03/04→		Suspension Arm Repair Kit		SC-RK-12366	for Control Arm
03/04→		Suspension Arm Repair Kit	SC-RK-12346	SC-RK-12346	for Control Arm
03/04→		Suspension Strut Repair Kit		MN-RK-8501	
03/04→		Suspension Strut Repair Kit		MN-RK-12436	
03/04→		Suspension Strut Repair Kit	DF-RK-9341		
03/04→		Tie Rod		SC-DL-7264	Leading Axle;for vehicles with Hinged Leading Axle
03/04→		Tie Rod		SC-DL-7264	Leading Axle;for vehicles with Hinged Leading Axle;Air Suspension Axle
03/04→		Tie Rod		SC-DL-8137	Tag Axle;for vehicles with Hinged Trailing Axle
03/04→		Tie Rod	SC-DL-7264		
03/04→		Tie Rod	SC-DL-8137		Leaf Spring Axle
03/04→		Tie Rod	SC-DL-9457		Leaf Spring Axle
03/04→		Tie Rod End	CV-ES-14162		for Steering Rod

CV-ES-14162

Length: 125
Cone Ø: d1 Ø 30 / d2 Ø 27
Thread: M30 x 1,5 LHT
283783, 395009, 1358792, 1738380, 1 914 426, 2051165



CV-ES-14163

Length: 125
Cone Ø: d1 Ø 30 / d2 Ø 27
Thread: M30 x 1,5 RHT
283784, 395010, 1358793, 1488890, 1738381, 1767328, 1914427, 2051166



DF-RK-9341

Ø: 67
550807, 5508072



MN-RK-7280

Ø: 75 Hole Distance: 115
Thick/Height: 24
0550806, 550806, 0639370, 639370, 689748, 1104334



MN-RK-8501

Ø: 75 Hole Distance: 115
Thick/Height: 24
1515981



MN-RK-12436

Ø: 75 Hole Distance: 115
Thick/Height: 24
550799, 1517403, 1783020



SC-DL-2161

Length: 1740 Ø: 50
Cone Ø: d1 Ø 30 / d2 Ø 27
1369411, 1385251, 1409918, 1501030, 1723865, 1723895, 1737683, 1897335, 2113903, 2125090, 2161883



SC-DL-5229

Length: 1053 Ø: 50
Cone Ø: d1 Ø 30 / d2 Ø 27
1356055, 1379071, 1384025, 1768898, 1847311, 1912757, 12201600A



SC-DL-5354

Length: 1060 Ø: 52
Cone Ø: d1 Ø 30 / d2 Ø 27
1384027, 1769597, 1847312, 1912758, 12200800A



SC-DL-7264

Length: 1743 Ø: 62
Cone Ø: d1 Ø 30 / d2 Ø 27
1361413, 1395614, 1734019, 1897333, 2040254, 2146105



SC-DL-8137

Length: 1736 Ø: 40
Cone Ø: d1 Ø 30 / d2 Ø 27
301639, 311847, 395350, 1358675, 1378435, 1397866, 1734020, 2028998, 12202900A



SC-DL-8179

Length: 568 Ø: 46
Hole Distance: 115 / 115
1399180, 1428347



SC-DL-8182

1343262, 1869413



SC-DL-8399

Length: 433 Ø: 40
Cone Ø: d1 Ø 30 / d2 Ø 26
1394884, 1938387



SC-DL-8509

Length: 568,5 Ø: 46
Hole Distance: 115 / 115
1485758, 1486757



SC-DL-8511

Length: 616,5 Ø: 50
Hole Distance: 115 / 115
1485760, 1499478, 1722750



SC-DL-8531

Length: 522 Ø: 46
Hole Distance: 115 / 115
1486758



SC-DL-8547

Length: 568 Ø: 50
Hole Distance: 115 / 115
1499474, 1722746, 1906940



SC-DL-8553

Length: 435 Ø: 38
Cone Ø: d1 Ø 30 / d2 Ø 27
1343283, 1759691



SC-DL-8623

Length: 592 Ø: 50
Hole Distance: 115 / 115
1388436, 1499476, 1722748, 1906942



SC-DL-9457

Length: 1743 Ø: 52
Cone Ø: d1 Ø 30 / d2 Ø 27
1527989, 1723896, 1737684, 1897336



SC-DL-9462

Length: 568,5 Ø: 50
Hole Distance: 115 / 115
1499475, 1500573, 1722747, 1906941



SC-DL-9466

Length: 568 Ø: 19
1486756



SC-DL-10225

Length: 2179 Ø: 62
Cone Ø: d1 Ø 30 / d2 Ø 27
1386618, 1788522



SC-DL-12342

Length: 601 Ø: 42
Cone Ø: d1 Ø 26 / d2 Ø 23,5
1343262, 1869413



SC-DL-12343

Length: 1062 Ø: 52
Cone Ø: d1 Ø 30 / d2 Ø 27
1348269, 2007275



SC-DL-12449

Length: 1206 Ø: 38
Cone Ø: d1 Ø 30 / d2 Ø 27
1385763, 1765375



SC-ES-7279

Length: 150
Cone Ø: d1 Ø 30 / d2 Ø 27
Thread: M30 x 1,5 RHT
1357674, 1603883, 1738379



SC-ES-8517

Length: 140
Cone Ø: d1 Ø 30 / d2 Ø 27
Thread: M30 x 1,5 RHT
1358793, 1435746, 1488890, 1534756, 1914427, 2051166



SC-ES-8535

Length: 145
Cone Ø: d1 Ø 30 / d2 Ø 27
Thread: M30 x 1,5 RHT
1723897, 2051041



SC-RK-12346

Ø: 67 Hole Distance: 115
Thick/Height: 24
550800



SC-RK-12366

Ø: 75 Hole Distance: 115 / 115
Thick/Height: 24
1 722 753, 2 096 392



SC-TC-12451

Length: 552 Ø: 46
Hole Distance: 115 / 115
1494296



SC-TC-12452

Length: 580,5 Ø: 46
Hole Distance: 115 / 115
1485759



SC-TC-12472

Length: 580 Ø: 46
Hole Distance: 115 / 115
1399182





P,G,R,T - series ...

P 420, R 420 ...	03/04→	Tie Rod End	CV-ES-14162	CV-ES-14162	for Steering Rod
	03/04→	Tie Rod End	CV-ES-14163		for Steering Rod
	03/04→	Tie Rod End	SC-ES-8517		for Push Rod
	03/04→	Tie Rod End	SC-ES-8535		for Guide Rod
	03/04→	Track Control Arm		SC-DL-8511	Trailing Arm, Leaf Spring Axle
	03/04→	Track Control Arm		SC-DL-8511	Trailing Arm, Leaf Spring Axle, →* 3512097 *
	03/04→	Track Control Arm		SC-DL-8547	Trailing Arm, Leaf Spring Axle
	03/04→	Track Control Arm		SC-DL-9462	Trailing Arm, Leaf Spring Axle, →* 2006231 SSS *; * 5117423 SNL *; * 9097199 SAN *; * 3564002 SLA *
	03/04→	Track Control Arm		SC-DL-9466	Trailing Arm, Leaf Spring Axle
	03/04→	Track Control Arm		SC-TC-12451	Trailing Arm, 1st Drive Axle, for Leaf-Spring Suspension vehicles
	03/04→	Track Control Arm		SC-TC-12451	Trailing Arm, 1st Drive Axle, for Leaf-Spring Suspension vehicles, 1280185/4471603→
	03/04→	Track Control Arm		SC-TC-12451	Trailing Arm, 1st Drive Axle, for Leaf-Spring Suspension vehicles, 9069961/3536016→
	03/04→	Track Control Arm		SC-TC-12452	Control Arm
	03/04→	Track Control Arm		SC-TC-12472	Trailing Arm, 2nd Drive Axle, for Leaf-Spring Suspension vehicles, →1280184/4471602
	03/04→	Track Control Arm		SC-TC-12472	Trailing Arm, 2nd Drive Axle, for Leaf-Spring Suspension vehicles, →9069960/3536015
	03/04→	Track Control Arm		SC-VB-12418	Control Arm
	03/04→	Track Control Arm	SC-DL-8179	SC-DL-8179	Trailing Arm, Leaf Spring Axle
	03/04→	Track Control Arm	SC-DL-8509	SC-DL-8509	Trailing Arm
	03/04→	Track Control Arm	SC-DL-8509	SC-DL-8509	Trailing Arm, Leaf Spring Axle
	03/04→	Track Control Arm	SC-DL-8531	SC-DL-8531	Trailing Arm, Leaf Spring Axle
	03/04→	Track Control Arm	SC-DL-8623	SC-DL-8623	Trailing Arm, Leaf Spring Axle, →* 2006231 SSS *; * 5117423 SNL *; * 9097199 SAN *; * 3564002 SLA *
	03/04→	Track Control Arm	SC-DL-10302	SC-DL-10302	Trailing Arm, Air Suspension Axle
	03/04→	Track Control Arm	SC-TC-12361		Control Arm, 1st Front Axle, for Pneumatic Suspension vehicles
	09/05→	Tie Rod		SC-DL-7264	Tag Axle;for vehicles with Hinged Trailing Axle
	09/05→	Tie Rod		SC-DL-8137	Leading Axle;for vehicles with Hinged Leading Axle
	09/05→	Tie Rod End		MN-ES-8490	Tag Axle;for vehicles with Hinged Trailing Axle
	09/05→	Tie Rod End	IV-ES-12272		for Steering Rod
09/05→	Tie Rod End	MN-ES-8490	MN-ES-8490	for vehicles with Hinged Trailing Axle	
P 440, R 440	04/10→	Centre Rod	SC-DL-5229		Push Rod
	04/10→	Centre Rod	SC-DL-5354		Push Rod
	04/10→	Centre Rod	SC-DL-12342		for Steering Rod
	04/10→	Centre Rod	SC-DL-12343		for Steering Rod
	04/10→	Suspension Arm Repair Kit		SC-RK-12366	for Control Arm
	04/10→	Suspension Arm Repair Kit	SC-RK-12346	SC-RK-12346	for Control Arm
	04/10→	Suspension Strut Repair Kit		MN-RK-8501	
	04/10→	Suspension Strut Repair Kit		MN-RK-12436	
	04/10→	Suspension Strut Repair Kit	DF-RK-9341		
	04/10→	Tie Rod		SC-DL-7264	Tag Axle;for vehicles with Hinged Trailing Axle
	04/10→	Tie Rod		SC-DL-8137	Tag Axle;for vehicles with Hinged Trailing Axle
	04/10→	Tie Rod	SC-DL-7264		1st FA
	04/10→	Tie Rod	SC-DL-8137		Leaf Spring Axle;1st FA
	04/10→	Tie Rod	SC-DL-9457		1st FA;Leaf Spring Axle
	04/10→	Tie Rod End		MN-ES-8490	Tag Axle;for vehicles with Hinged Trailing Axle
	04/10→	Tie Rod End	CV-ES-14162	CV-ES-14162	for Steering Rod
	04/10→	Tie Rod End	CV-ES-14163		for Steering Rod
	04/10→	Tie Rod End	IV-ES-12272		for Steering Rod
	04/10→	Tie Rod End	SC-ES-8517		for Push Rod
	04/10→	Tie Rod End	SC-ES-8535		for Guide Rod
	04/10→	Track Control Arm		SC-DL-8511	Trailing Arm, Leaf Spring Axle
	04/10→	Track Control Arm		SC-DL-8511	Trailing Arm, Leaf Spring Axle, →* 3512097 *
	04/10→	Track Control Arm		SC-DL-8547	Trailing Arm, Leaf Spring Axle

CV-ES-14162

Length: 125
Cone Ø: d1 Ø 30 / d2 Ø 27
Thread: M30 x 1,5 LHT
283783, 395009, 1358792, 1738380, 1 914 426, 2051165



CV-ES-14163

Length: 125
Cone Ø: d1 Ø 30 / d2 Ø 27
Thread: M30 x 1,5 RHT
283784, 395010, 1358793, 1488890, 1738381, 1767328, 1914427, 2051166



DF-RK-9341

Ø: 67
550807, 5508072



IV-ES-12272

Length: 75
Cone Ø: d1 Ø 30 / d2 Ø 27
Thread: M26 x 1,5 RHT
1394443



MN-ES-8490

Length: 90
Cone Ø: d1 Ø 30 / d2 Ø 27
Thread: M26 x 1,5 RHT
1394444, 0014606948, 14606948



MN-RK-8501

Ø: 75 Hole Distance: 115
Thick/Height: 24
1515981



MN-RK-12436

Ø: 75 Hole Distance: 115
Thick/Height: 24
550799, 1517403, 1783020



SC-DL-5229

Length: 1053 Ø: 50
Cone Ø: d1 Ø 30 / d2 Ø 27
1356055, 1379071, 1384025, 1768898, 1847311, 1912757, 12201600A



SC-DL-5354

Length: 1060 Ø: 52
Cone Ø: d1 Ø 30 / d2 Ø 27
1384027, 1769597, 1847312, 1912758, 12200800A



SC-DL-7264

Length: 1743 Ø: 62
Cone Ø: d1 Ø 30 / d2 Ø 27
1361413, 1395614, 1734019, 1897333, 2040254, 2146105



SC-DL-8137

Length: 1736 Ø: 40
Cone Ø: d1 Ø 30 / d2 Ø 27
301639, 311847, 395350, 1358675, 1378435, 1397866, 1734020, 2028998, 12202900A



SC-DL-8179

Length: 568 Ø: 46
Hole Distance: 115 / 115
1399180, 1428347



SC-DL-8509

Length: 568,5 Ø: 46
Hole Distance: 115 / 115
1485758, 1486757



SC-DL-8511

Length: 616,5 Ø: 50
Hole Distance: 115 / 115
1485760, 1499478, 1722750



SC-DL-8531

Length: 522 Ø: 46
Hole Distance: 115 / 115
1486758



SC-DL-8547

Length: 568 Ø: 50
Hole Distance: 115 / 115
1499474, 1722746, 1906940



SC-DL-8623

Length: 592 Ø: 50
Hole Distance: 115 / 115
1388436, 1499476, 1722748, 1906942



SC-DL-9457

Length: 1743 Ø: 52
Cone Ø: d1 Ø 30 / d2 Ø 27
1527989, 1723896, 1737684, 1897336



SC-DL-9462

Length: 568,5 Ø: 50
Hole Distance: 115 / 115
1499475, 1500573, 1722747, 1906941



SC-DL-9466

Length: 568 Ø: 19
1486756



SC-DL-10302

Length: 752 Ø: 48
Hole Distance: 115 / 115
1101843, 1379423, 1393298, 1431470, 1942075



SC-DL-12342

Length: 601 Ø: 42
Cone Ø: d1 Ø 26 / d2 Ø 23,5
1343262, 1869413



SC-DL-12343

Length: 1062 Ø: 52
Cone Ø: d1 Ø 30 / d2 Ø 27
1348269, 2007275



SC-ES-8517

Length: 140
Cone Ø: d1 Ø 30 / d2 Ø 27
Thread: M30 x 1,5 RHT
1358793, 1435746, 1488890, 1534756, 1914427, 2051166



SC-ES-8535

Length: 145
Cone Ø: d1 Ø 30 / d2 Ø 27
Thread: M30 x 1,5 RHT
1723897, 2051041



SC-RK-12346

Ø: 67 Hole Distance: 115
Thick/Height: 24
550800



SC-RK-12366

Ø: 75 Hole Distance: 115 / 115
Thick/Height: 24
1 722 753, 2 096 392



SC-TC-12361

Length: 705 Ø: 42
Cone Ø: d1 Ø 38
Hole Distance: 115
1353445, 1464611, 1942147



SC-TC-12451

Length: 552 Ø: 46
Hole Distance: 115 / 115
1494296



SC-TC-12452

Length: 580,5 Ø: 46
Hole Distance: 115 / 115
1485759



SC-TC-12472

Length: 580 Ø: 46
Hole Distance: 115 / 115
1399182



SC-VB-12418

Length: 613,2
Ø: 46
Hole Ø 25 / 19 / 19
Hole Distance: 152 / 115 / 115
1440028, 1722582



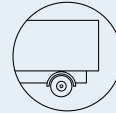
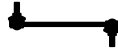

P,G,R,T - series ...

P 440, R 440 ...	04/10→	Track Control Arm		SC-DL-9462	Trailing Arm, Leaf Spring Axle, →* 2006231 SSS *;* 5117423 SNL *; * 9097199 SAN *;* 3564002 SLA *	
	04/10→	Track Control Arm		SC-DL-9466	Trailing Arm, Leaf Spring Axle	
	04/10→	Track Control Arm		SC-TC-12451	Trailing Arm, 1st Drive Axle, for Leaf-Spring Suspension vehicles	
	04/10→	Track Control Arm		SC-TC-12451	Trailing Arm, 1st Drive Axle, for Leaf-Spring Suspension vehicles, 1280185/4471603→	
	04/10→	Track Control Arm		SC-TC-12451	Trailing Arm, 1st Drive Axle, for Leaf-Spring Suspension vehicles, 9069961/3536016→	
	04/10→	Track Control Arm		SC-TC-12452	Control Arm	
	04/10→	Track Control Arm		SC-TC-12472	Trailing Arm, 2nd Drive Axle, for Leaf-Spring Suspension vehicles, →1280184/4471602	
	04/10→	Track Control Arm		SC-TC-12472	Trailing Arm, 2nd Drive Axle, for Leaf-Spring Suspension vehicles, →9069960/3536015	
	04/10→	Track Control Arm		SC-VB-12418	Control Arm	
	04/10→	Track Control Arm	SC-DL-8179	SC-DL-8179	Trailing Arm, Leaf Spring Axle	
	04/10→	Track Control Arm	SC-DL-8509	SC-DL-8509	Trailing Arm	
	04/10→	Track Control Arm	SC-DL-8509	SC-DL-8509	Trailing Arm, Leaf Spring Axle	
	04/10→	Track Control Arm	SC-DL-8531	SC-DL-8531	Trailing Arm, Leaf Spring Axle	
	04/10→	Track Control Arm	SC-DL-8623	SC-DL-8623	Trailing Arm, Leaf Spring Axle, →* 2006231 SSS *;* 5117423 SNL *; * 9097199 SAN *;* 3564002 SLA *	
	04/10→	Track Control Arm	SC-DL-10302	SC-DL-10302	Trailing Arm, Air Suspension Axle;1st FA	
	04/10→	Track Control Arm	SC-TC-12361		Control Arm, 1st & 2nd Front Axle, for Pneumatic Suspension vehicles	
	P 450	09/13→	Centre Rod	SC-DL-12342		for Steering Rod
09/13→		Centre Rod	SC-DL-12343		for Steering Rod	
09/13→		Centre Rod	SC-DL-12413		for Steering Rod	
09/13→		Suspension Arm Repair Kit		SC-RK-12366	for Control Arm	
09/13→		Suspension Arm Repair Kit	SC-RK-12346	SC-RK-12346	for Control Arm	
09/13→		Tie Rod End	CV-ES-14163		for Steering Rod	
09/13→		Track Control Arm		SC-VB-12418	Control Arm	
P 470, R 470	03/04→	Centre Rod	SC-DL-5229		Push Rod	
	03/04→	Centre Rod	SC-DL-5354		Push Rod	
	03/04→	Centre Rod	SC-DL-12342		for Steering Rod	
	03/04→	Centre Rod	SC-DL-12343		for Steering Rod	
	03/04→	Suspension Arm Repair Kit		SC-RK-12366	for Control Arm	
	03/04→	Suspension Arm Repair Kit	SC-RK-12346	SC-RK-12346	for Control Arm	
	03/04→	Suspension Strut Repair Kit		CV-RK-5311		
	03/04→	Suspension Strut Repair Kit		MN-RK-8501		
	03/04→	Suspension Strut Repair Kit		MN-RK-12436		
	03/04→	Suspension Strut Repair Kit	DF-RK-9341			
	03/04→	Tie Rod	SC-DL-7264			
	03/04→	Tie Rod	SC-DL-8137		Leaf Spring Axle	
	03/04→	Tie Rod	SC-DL-9457		Leaf Spring Axle	
	03/04→	Tie Rod End	CV-ES-14162		for Steering Rod	
	03/04→	Tie Rod End	CV-ES-14163		for Steering Rod	
	03/04→	Tie Rod End	SC-ES-8535		for Guide Rod	
	03/04→	Track Control Arm		SC-VB-12418	Control Arm	
	03/04→	Track Control Arm	SC-DL-10302	SC-DL-10302	Trailing Arm, Air Suspension Axle	
	03/04→	Track Control Arm	SC-TC-12361		Control Arm, 1st Front Axle, for Pneumatic Suspension vehicles	
	P 480, R 480	04/04→	Centre Rod	SC-DL-5229		Push Rod
		04/04→	Centre Rod	SC-DL-5354		Push Rod
		04/04→	Centre Rod	SC-DL-5354	SC-DL-5354	Push Rod, for vehicles with Hinged Trailing Axle
		04/04→	Centre Rod	SC-DL-8182		Push Rod
04/04→		Centre Rod	SC-DL-8399		Push Rod, for vehicles with Hinged Leading Axle, for vehicles with Part-Pneumatic Suspension	
04/04→		Centre Rod	SC-DL-8553	SC-DL-8553	Push Rod, for vehicles with Hinged Leading Axle	
04/04→		Centre Rod	SC-DL-10225		for Steering Rod	
04/04→		Centre Rod	SC-DL-10225		Push Rod, for vehicles with Hinged Leading Axle for Steering Rod	
04/04→	Centre Rod	SC-DL-12342		for Steering Rod		

CV-ES-14162

Length: 125
Cone Ø: d1 Ø 30 / d2 Ø 27
Thread: M30 x 1,5 LHT
283783, 395009, 1358792, 1738380, 1 914 426, 2051165



CV-ES-14163

Length: 125
Cone Ø: d1 Ø 30 / d2 Ø 27
Thread: M30 x 1,5 RHT
283784, 395010, 1358793, 1488890, 1738381, 1767328, 1914427, 2051166



CV-RK-5311

638862, 0638862, 0639287, 639287, 1104335, 1953248, 81432206006, 81432206107



DF-RK-9341

Ø: 67
550807, 5508072



MN-RK-8501

Ø: 75 Hole Distance: 115
Thick/Height: 24
1515981



MN-RK-12436

Ø: 75 Hole Distance: 115
Thick/Height: 24
550799, 1517403, 1783020



SC-DL-5229

Length: 1053 Ø: 50
Cone Ø: d1 Ø 30 / d2 Ø 27
1356055, 1379071, 1384025, 1768898, 1847311, 1912757, 12201600A



SC-DL-5354

Length: 1060 Ø: 52
Cone Ø: d1 Ø 30 / d2 Ø 27
1384027, 1769597, 1847312, 1912758, 12200800A



SC-DL-7264

Length: 1743 Ø: 62
Cone Ø: d1 Ø 30 / d2 Ø 27
1361413, 1395614, 1734019, 1897333, 2040254, 2146105



SC-DL-8137

Length: 1736 Ø: 40
Cone Ø: d1 Ø 30 / d2 Ø 27
301639, 311847, 395350, 1358675, 1378435, 1397866, 1734020, 2028998, 12202900A



SC-DL-8179

Length: 568 Ø: 46
Hole Distance: 115 / 115
1399180, 1428347



SC-DL-8182

1343262, 1869413



SC-DL-8399

Length: 433 Ø: 40
Cone Ø: d1 Ø 30 / d2 Ø 26
1394884, 1938387



SC-DL-8509

Length: 568,5 Ø: 46
Hole Distance: 115 / 115
1485758, 1486757



SC-DL-8531

Length: 522 Ø: 46
Hole Distance: 115 / 115
1486758



SC-DL-8553

Length: 435 Ø: 38
Cone Ø: d1 Ø 30 / d2 Ø 27
1343283, 1759691



SC-DL-8623

Length: 592 Ø: 50
Hole Distance: 115 / 115
1388436, 1499476, 1722748, 1906942



SC-DL-9457

Length: 1743 Ø: 52
Cone Ø: d1 Ø 30 / d2 Ø 27
1527989, 1723896, 1737684, 1897336



SC-DL-9462

Length: 568,5 Ø: 50
Hole Distance: 115 / 115
1499475, 1500573, 1722747, 1906941



SC-DL-9466

Length: 568 Ø: 19
1486756



SC-DL-10225

Length: 2179 Ø: 62
Cone Ø: d1 Ø 30 / d2 Ø 27
1386618, 1788522



SC-DL-10302

Length: 752 Ø: 48
Hole Distance: 115 / 115
1101843, 1379423, 1393298, 1431470, 1942075



SC-DL-12342

Length: 601 Ø: 42
Cone Ø: d1 Ø 26 / d2 Ø 23,5
1343262, 1869413



SC-DL-12343

Length: 1062 Ø: 52
Cone Ø: d1 Ø 30 / d2 Ø 27
1348269, 2007275



SC-DL-12413

Length: 1950 Ø: 62
Cone Ø: d1 Ø 30 / d2 Ø 27
1393383, 1788520



SC-ES-8535

Length: 145
Cone Ø: d1 Ø 30 / d2 Ø 27
Thread: M30 x 1,5 RHT
1723897, 2051041



SC-RK-12346

Ø: 67 Hole Distance: 115
Thick/Height: 24
550800



SC-RK-12366

Ø: 75 Hole Distance: 115 / 115
Thick/Height: 24
1 722 753, 2 096 392



SC-TC-12361

Length: 705 Ø: 42
Cone Ø: d1 Ø 38
Hole Distance: 115
1353445, 1464611, 1942147



SC-TC-12451

Length: 552 Ø: 46
Hole Distance: 115 / 115
1494296



SC-TC-12452

Length: 580,5 Ø: 46
Hole Distance: 115 / 115
1485759



SC-TC-12472

Length: 580 Ø: 46
Hole Distance: 115 / 115
1399182



SC-VB-12418

Length: 613,2
Ø: 46
Hole Ø 25 / 19 / 19
Hole Distance: 152 / 115 / 115
1440028, 1722582



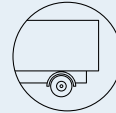

P,G,R,T - series ...

P 480, R 480 ...

04/04 →	Centre Rod	SC-DL-12343		for Steering Rod
04/04 →	Centre Rod	SC-DL-12449		Push Rod
04/04 →	Suspension Arm Repair Kit		SC-RK-12366	for Control Arm
04/04 →	Suspension Arm Repair Kit	SC-RK-12346	SC-RK-12346	for Control Arm
04/04 →	Suspension Strut Repair Kit		MN-RK-8501	
04/04 →	Suspension Strut Repair Kit		MN-RK-12436	
04/04 →	Suspension Strut Repair Kit	DF-RK-9341		
04/04 →	Tie Rod		SC-DL-7264	Leading Axle;for vehicles with Hinged Leading Axle
04/04 →	Tie Rod		SC-DL-7264	Leading Axle;for vehicles with Hinged Leading Axle;Air Suspension Axle
04/04 →	Tie Rod		SC-DL-8137	Leading Axle;for vehicles with Hinged Leading Axle
04/04 →	Tie Rod	SC-DL-7264		
04/04 →	Tie Rod	SC-DL-8137		Leaf Spring Axle
04/04 →	Tie Rod	SC-DL-9457		Leaf Spring Axle
04/04 →	Tie Rod End	CV-ES-14162		for Steering Rod
04/04 →	Tie Rod End	CV-ES-14162	CV-ES-14162	for Steering Rod
04/04 →	Tie Rod End	CV-ES-14163		for Steering Rod
04/04 →	Tie Rod End	SC-ES-8517		for Push Rod
04/04 →	Tie Rod End	SC-ES-8535		for Guide Rod
04/04 →	Track Control Arm		SC-TC-12452	Control Arm
04/04 →	Track Control Arm		SC-VB-12418	Control Arm
04/04 →	Track Control Arm	SC-DL-10302	SC-DL-10302	Trailing Arm, Air Suspension Axle
04/04 →	Track Control Arm	SC-TC-12361		Control Arm, 1st Front Axle, for Pneumatic Suspension vehicles
04/10 →	Tie Rod		SC-DL-7264	Tag Axle;for vehicles with Hinged Trailing Axle
04/10 →	Tie Rod		SC-DL-8137	Tag Axle;for vehicles with Hinged Trailing Axle
04/10 →	Tie Rod	SC-DL-7264		1st FA
04/10 →	Tie Rod	SC-DL-8137		Leaf Spring Axle;1st FA
04/10 →	Tie Rod	SC-DL-9457		1st FA;Leaf Spring Axle
04/10 →	Tie Rod End		MN-ES-8490	Tag Axle;for vehicles with Hinged Trailing Axle
04/10 →	Tie Rod End	IV-ES-12272		for Steering Rod
04/10 →	Track Control Arm		SC-DL-8179	Trailing Arm, 1st & 2nd Drive Axle, for Leaf-Spring Suspension vehicles
04/10 →	Track Control Arm		SC-DL-8179	Trailing Arm, 1st & 2nd Drive Axle, for Leaf-Spring Suspension vehicles, Ch.3512097 →
04/10 →	Track Control Arm		SC-DL-8179	Trailing Arm, 1st Drive Axle, for Leaf-Spring Suspension vehicles, →1280184/4471602
04/10 →	Track Control Arm		SC-DL-8179	Trailing Arm, 1st Drive Axle, for Leaf-Spring Suspension vehicles, →9069960/3536015
04/10 →	Track Control Arm		SC-DL-8509	Trailing Arm, 1st & 2nd Drive Axle, for Leaf-Spring Suspension vehicles
04/10 →	Track Control Arm		SC-DL-8511	Trailing Arm, 1st & 2nd Drive Axle, for Leaf-Spring Suspension vehicles
04/10 →	Track Control Arm		SC-DL-8511	Trailing Arm, Leaf Spring Axle
04/10 →	Track Control Arm		SC-DL-8511	Trailing Arm, Leaf Spring Axle, →* 3512097 *
04/10 →	Track Control Arm		SC-DL-8531	Trailing Arm, 1st & 2nd Drive Axle, for Leaf-Spring Suspension vehicles
04/10 →	Track Control Arm		SC-DL-8547	Trailing Arm, 1st & 2nd Drive Axle, for Leaf-Spring Suspension vehicles
04/10 →	Track Control Arm		SC-DL-8547	Trailing Arm, Leaf Spring Axle
04/10 →	Track Control Arm		SC-DL-8623	Trailing Arm, 1st Drive Axle, for Leaf-Spring Suspension vehicles, →2006231/5117423
04/10 →	Track Control Arm		SC-DL-8623	Trailing Arm, 1st Drive Axle, for Leaf-Spring Suspension vehicles, →9097199/3564002
04/10 →	Track Control Arm		SC-DL-9462	Trailing Arm, 2nd Drive Axle, for Leaf-Spring Suspension vehicles, →2006231/5117423
04/10 →	Track Control Arm		SC-DL-9462	Trailing Arm, 2nd Drive Axle, for Leaf-Spring Suspension vehicles, →9097199/3564002

CV-ES-14162

Length: 125
Cone Ø: d1 Ø 30 / d2 Ø 27
Thread: M30 x 1,5 LHT
283783, 395009, 1358792, 1738380, 1 914 426, 2051165



CV-ES-14163

Length: 125
Cone Ø: d1 Ø 30 / d2 Ø 27
Thread: M30 x 1,5 RHT
283784, 395010, 1358793, 1488890, 1738381, 1767328, 1914427, 2051166



DF-RK-9341

Ø: 67
550807, 5508072



IV-ES-12272

Length: 75
Cone Ø: d1 Ø 30 / d2 Ø 27
Thread: M26 x 1,5 RHT
1394443



MN-ES-8490

Length: 90
Cone Ø: d1 Ø 30 / d2 Ø 27
Thread: M26 x 1,5 RHT
1394444, 14606948, 0014606948



MN-RK-8501

Ø: 75 Hole Distance: 115
Thick/Height: 24
1515981



MN-RK-12436

Ø: 75 Hole Distance: 115
Thick/Height: 24
550799, 1517403, 1783020



SC-DL-7264

Length: 1743 Ø: 62
Cone Ø: d1 Ø 30 / d2 Ø 27
1361413, 1395614, 1734019, 1897333, 2040254, 2146105



SC-DL-8137

Length: 1736 Ø: 40
Cone Ø: d1 Ø 30 / d2 Ø 27
301639, 311847, 395350, 1358675, 1378435, 1397866, 1734020, 2028998, 12202900A



SC-DL-8179

Length: 568 Ø: 46
Hole Distance: 115 / 115
1399180, 1428347



SC-DL-8509

Length: 568,5 Ø: 46
Hole Distance: 115 / 115
1485758, 1486757



SC-DL-8511

Length: 616,5 Ø: 50
Hole Distance: 115 / 115
1485760, 1499478, 1722750



SC-DL-8531

Length: 522 Ø: 46
Hole Distance: 115 / 115
1486758



SC-DL-8547

Length: 568 Ø: 50
Hole Distance: 115 / 115
1499474, 1722746, 1906940



SC-DL-8623

Length: 592 Ø: 50
Hole Distance: 115 / 115
1388436, 1499476, 1722748, 1906942



SC-DL-9457

Length: 1743 Ø: 52
Cone Ø: d1 Ø 30 / d2 Ø 27
1527989, 1723896, 1737684, 1897336



SC-DL-9462

Length: 568,5 Ø: 50
Hole Distance: 115 / 115
1499475, 1500573, 1722747, 1906941



SC-DL-10302

Length: 752 Ø: 48
Hole Distance: 115 / 115
1101843, 1379423, 1393298, 1431470, 1942075



SC-DL-12343

Length: 1062 Ø: 52
Cone Ø: d1 Ø 30 / d2 Ø 27
1348269, 2007275



SC-DL-12449

Length: 1206 Ø: 38
Cone Ø: d1 Ø 30 / d2 Ø 27
1385763, 1765375



SC-ES-8517

Length: 140
Cone Ø: d1 Ø 30 / d2 Ø 27
Thread: M30 x 1,5 RHT
1358793, 1435746, 1488890, 1534756, 1914427, 2051166



SC-ES-8535

Length: 145
Cone Ø: d1 Ø 30 / d2 Ø 27
Thread: M30 x 1,5 RHT
1723897, 2051041



SC-RK-12346

Ø: 67 Hole Distance: 115
Thick/Height: 24
550800



SC-RK-12366

Ø: 75 Hole Distance: 115 / 115
Thick/Height: 24
1 722 753, 2 096 392



SC-TC-12361

Length: 705 Ø: 42
Cone Ø: d1 Ø 38
Hole Distance: 115
1353445, 1464611, 1942147



SC-TC-12452

Length: 580,5 Ø: 46
Hole Distance: 115 / 115
1485759



SC-VB-12418

Length: 613,2
Ø: 46
Hole Ø 25 / 19 / 19
Hole Distance: 152 / 115 / 115
1440028, 1722582



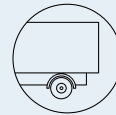

P,G,R,T - series ...

P 480, R 480 ...	04/10→	Track Control Arm		SC-DL-9462	Trailing Arm, Leaf Spring Axle, →* 2006231 SSS *;* 5117423 SNL *; * 9097199 SAN *;* 3564002 SLA *	
	04/10→	Track Control Arm		SC-DL-9466	Trailing Arm, 1st & 2nd Drive Axle, for Leaf-Spring Suspension vehicles	
	04/10→	Track Control Arm		SC-DL-9466	Trailing Arm, Leaf Spring Axle	
	04/10→	Track Control Arm		SC-TC-12451	Trailing Arm, 1st Drive Axle, for Leaf-Spring Suspension vehicles	
	04/10→	Track Control Arm		SC-TC-12451	Trailing Arm, 1st Drive Axle, for Leaf-Spring Suspension vehicles, 1280185/4471603→	
	04/10→	Track Control Arm		SC-TC-12451	Trailing Arm, 1st Drive Axle, for Leaf-Spring Suspension vehicles, 9069961/3536016→	
	04/10→	Track Control Arm		SC-TC-12472	Trailing Arm, 2nd Drive Axle, for Leaf-Spring Suspension vehicles, →1280184/4471602	
	04/10→	Track Control Arm		SC-TC-12472	Trailing Arm, 2nd Drive Axle, for Leaf-Spring Suspension vehicles, →9069960/3536015	
	04/10→	Track Control Arm	SC-DL-8179	SC-DL-8179	Trailing Arm, Leaf Spring Axle	
	04/10→	Track Control Arm	SC-DL-8509	SC-DL-8509	Trailing Arm	
	04/10→	Track Control Arm	SC-DL-8509	SC-DL-8509	Trailing Arm, Leaf Spring Axle	
	04/10→	Track Control Arm	SC-DL-8531	SC-DL-8531	Trailing Arm, Leaf Spring Axle	
	04/10→	Track Control Arm	SC-DL-8623	SC-DL-8623	Trailing Arm, Leaf Spring Axle, →* 2006231 SSS *;* 5117423 SNL *; * 9097199 SAN *;* 3564002 SLA *	
	04/10→	Track Control Arm	SC-DL-10302	SC-DL-10302	Trailing Arm, 1st Front Axle, for Pneumatic Suspension vehicles	
	04/10→	Track Control Arm	SC-DL-10302	SC-DL-10302	Trailing Arm, Air Suspension Axle;1st FA	
	04/10→	Track Control Arm	SC-TC-12361		Control Arm, 1st & 2nd Front Axle, for Pneumatic Suspension vehicles	
	P 500, R 500	03/04→	Centre Rod	SC-DL-5229		Push Rod
		03/04→	Centre Rod	SC-DL-5354	SC-DL-5354	Push Rod, for vehicles with Hinged Trailing Axle
03/04→		Centre Rod	SC-DL-8182		Push Rod	
03/04→		Centre Rod	SC-DL-8399		Push Rod, for vehicles with Hinged Leading Axle, for vehicles with Part-Pneumatic Suspension	
03/04→		Centre Rod	SC-DL-8553	SC-DL-8553	Push Rod, for vehicles with Hinged Leading Axle	
03/04→		Centre Rod	SC-DL-10225		Push Rod, for vehicles with Hinged Leading Axle	
03/04→		Centre Rod	SC-DL-12342		for Steering Rod	
03/04→		Centre Rod	SC-DL-12343		for Steering Rod	
03/04→		Centre Rod	SC-DL-12449		Push Rod	
03/04→		Suspension Arm Repair Kit		SC-RK-12366	for Control Arm	
03/04→		Suspension Arm Repair Kit	SC-RK-12346	SC-RK-12346	for Control Arm	
03/04→		Suspension Strut Repair Kit		MN-RK-8501		
03/04→		Suspension Strut Repair Kit		MN-RK-12436		
03/04→		Suspension Strut Repair Kit	DF-RK-9341			
03/04→		Tie Rod		SC-DL-7264	Leading Axle;for vehicles with Hinged Leading Axle	
03/04→		Tie Rod		SC-DL-7264	Leading Axle;for vehicles with Hinged Leading Axle;Air Suspension Axle	
03/04→		Tie Rod		SC-DL-7264	Tag Axle;for vehicles with Hinged Trailing Axle	
03/04→		Tie Rod		SC-DL-8137	Leading Axle;for vehicles with Hinged Leading Axle	
03/04→		Tie Rod		SC-DL-8137	Tag Axle;for vehicles with Hinged Trailing Axle	
03/04→		Tie Rod	SC-DL-7264			
03/04→		Tie Rod	SC-DL-8137		Leaf Spring Axle	
03/04→		Tie Rod	SC-DL-9457		Leaf Spring Axle	
03/04→		Tie Rod End		MN-ES-8490	Tag Axle;for vehicles with Hinged Trailing Axle	
03/04→		Tie Rod End	CV-ES-14162	CV-ES-14162	for Steering Rod	
03/04→		Tie Rod End	CV-ES-14163		for Steering Rod	
03/04→		Tie Rod End	MN-ES-8490	MN-ES-8490	for vehicles with Hinged Trailing Axle	
03/04→		Tie Rod End	SC-ES-8517		for Push Rod	
03/04→		Tie Rod End	SC-ES-8535		for Guide Rod	
03/04→		Track Control Arm		SC-VB-12418	Control Arm	
03/04→		Track Control Arm	SC-DL-10302	SC-DL-10302	Trailing Arm, Air Suspension Axle	
04/04→		Centre Rod	SC-DL-5354		Push Rod	

CV-ES-14162

Length: 125
Cone Ø: d1 Ø 30 / d2 Ø 27
Thread: M30 x 1,5 LHT
283783, 395009, 1358792, 1738380, 1 914 426, 2051165



CV-ES-14163

Length: 125
Cone Ø: d1 Ø 30 / d2 Ø 27
Thread: M30 x 1,5 RHT
283784, 395010, 1358793, 1488890, 1738381, 1767328, 1914427, 2051166



DF-RK-9341

Ø: 67
550807, 5508072



MN-ES-8490

Length: 90
Cone Ø: d1 Ø 30 / d2 Ø 27
Thread: M26 x 1,5 RHT
1394444, 0014606948, 14606948



MN-RK-8501

Ø: 75 Hole Distance: 115
Thick/Height: 24
1515981



MN-RK-12436

Ø: 75 Hole Distance: 115
Thick/Height: 24
550799, 1517403, 17383020



SC-DL-5229

Length: 1053 Ø: 50
Cone Ø: d1 Ø 30 / d2 Ø 27
1356055, 1379071, 1384025, 1768898, 1847311, 1912757, 12201600A



SC-DL-5354

Length: 1060 Ø: 52
Cone Ø: d1 Ø 30 / d2 Ø 27
1384027, 1769597, 1847312, 1912758, 12200800A



SC-DL-7264

Length: 1743 Ø: 62
Cone Ø: d1 Ø 30 / d2 Ø 27
1361413, 1395614, 1734019, 1897333, 2040254, 2146105



SC-DL-8137

Length: 1736 Ø: 40
Cone Ø: d1 Ø 30 / d2 Ø 27
301639, 311847, 395350, 1358675, 1378435, 1397866, 1734020, 2028998, 12202900A



SC-DL-8179

Length: 568 Ø: 46
Hole Distance: 115 / 115
1399180, 1428347



SC-DL-8182

1343262, 1869413



SC-DL-8399

Length: 433 Ø: 40
Cone Ø: d1 Ø 30 / d2 Ø 26
1394884, 1938387



SC-DL-8509

Length: 568,5 Ø: 46
Hole Distance: 115 / 115
1485758, 1486757



SC-DL-8531

Length: 522 Ø: 46
Hole Distance: 115 / 115
1486758



SC-DL-8553

Length: 435 Ø: 38
Cone Ø: d1 Ø 30 / d2 Ø 27
1343283, 1759691



SC-DL-8623

Length: 592 Ø: 50
Hole Distance: 115 / 115
1388436, 1499476, 1722748, 1906942



SC-DL-9457

Length: 1743 Ø: 52
Cone Ø: d1 Ø 30 / d2 Ø 27
1527989, 1723896, 1737684, 1897336



SC-DL-9462

Length: 568,5 Ø: 50
Hole Distance: 115 / 115
1499475, 1500573, 1722747, 1906941



SC-DL-9466

Length: 568 Ø: 19
1486756



SC-DL-10225

Length: 2179 Ø: 62
Cone Ø: d1 Ø 30 / d2 Ø 27
1386618, 1788522



SC-DL-10302

Length: 752 Ø: 48
Hole Distance: 115 / 115
1101843, 1379423, 1393298, 1431470, 1942075



SC-DL-12342

Length: 601 Ø: 42
Cone Ø: d1 Ø 26 / d2 Ø 23,5
1343262, 1869413



SC-DL-12343

Length: 1062 Ø: 52
Cone Ø: d1 Ø 30 / d2 Ø 27
1348269, 2007275



SC-DL-12449

Length: 1206 Ø: 38
Cone Ø: d1 Ø 30 / d2 Ø 27
1385763, 1765375



SC-ES-8517

Length: 140
Cone Ø: d1 Ø 30 / d2 Ø 27
Thread: M30 x 1,5 RHT
1358793, 1435746, 1488890, 1534756, 1914427, 2051166



SC-ES-8535

Length: 145
Cone Ø: d1 Ø 30 / d2 Ø 27
Thread: M30 x 1,5 RHT
1723897, 2051041



SC-RK-12346

Ø: 67 Hole Distance: 115
Thick/Height: 24
550800



SC-RK-12366

Ø: 75 Hole Distance: 115 / 115
Thick/Height: 24
1 722 753, 2 096 392



SC-TC-12361

Length: 705 Ø: 42
Cone Ø: d1 Ø 38
Hole Distance: 115
1353445, 1464611, 1942147



SC-TC-12451

Length: 552 Ø: 46
Hole Distance: 115 / 115
1494296



SC-TC-12472

Length: 580 Ø: 46
Hole Distance: 115 / 115
1399182



SC-VB-12418

Length: 613,2
Ø: 46
Hole Ø 25 / 19 / 19
Hole Distance: 152 / 115 / 115
1440028, 1722582



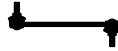

P,G,R,T - series ...

P 500, R 500 ...	04/04 →	Centre Rod	SC-DL-10225		for Steering Rod	
	04/04 →	Tie Rod End	CV-ES-14162		for Steering Rod	
	04/04 →	Track Control Arm	SC-TC-12361		Control Arm, 1st Front Axle, for Pneumatic Suspension vehicles	
	07/09 →	Track Control Arm		SC-DL-8179	Trailing Arm, 1st & 2nd Drive Axle, for Leaf-Spring Suspension vehicles	
	07/09 →	Track Control Arm		SC-DL-8179	Trailing Arm, 1st & 2nd Drive Axle, for Leaf-Spring Suspension vehicles, Ch.3512097 →	
	07/09 →	Track Control Arm		SC-DL-8179	Trailing Arm, 1st Drive Axle, for Leaf-Spring Suspension vehicles, →1280184/4471602	
	07/09 →	Track Control Arm		SC-DL-8179	Trailing Arm, 1st Drive Axle, for Leaf-Spring Suspension vehicles, →9069960/3536015	
	07/09 →	Track Control Arm		SC-DL-8509	Trailing Arm, 1st & 2nd Drive Axle, for Leaf-Spring Suspension vehicles	
	07/09 →	Track Control Arm		SC-DL-8511	Trailing Arm, 1st & 2nd Drive Axle, for Leaf-Spring Suspension vehicles	
	07/09 →	Track Control Arm		SC-DL-8531	Trailing Arm, 1st & 2nd Drive Axle, for Leaf-Spring Suspension vehicles	
	07/09 →	Track Control Arm		SC-DL-8547	Trailing Arm, 1st & 2nd Drive Axle, for Leaf-Spring Suspension vehicles	
	07/09 →	Track Control Arm		SC-DL-8623	Trailing Arm, 1st Drive Axle, for Leaf-Spring Suspension vehicles, →2006231/5117423	
	07/09 →	Track Control Arm		SC-DL-8623	Trailing Arm, 1st Drive Axle, for Leaf-Spring Suspension vehicles, →9097199/3564002	
	07/09 →	Track Control Arm		SC-DL-9462	Trailing Arm, 2nd Drive Axle, for Leaf-Spring Suspension vehicles, →2006231/5117423	
	07/09 →	Track Control Arm		SC-DL-9462	Trailing Arm, 2nd Drive Axle, for Leaf-Spring Suspension vehicles, →9097199/3564002	
	07/09 →	Track Control Arm		SC-DL-9466	Trailing Arm, 1st & 2nd Drive Axle, for Leaf-Spring Suspension vehicles	
	07/09 →	Track Control Arm		SC-TC-12451	Trailing Arm, 1st Drive Axle, for Leaf-Spring Suspension vehicles	
	07/09 →	Track Control Arm		SC-TC-12451	Trailing Arm, 1st Drive Axle, for Leaf-Spring Suspension vehicles, 1280185/4471603 →	
	07/09 →	Track Control Arm		SC-TC-12451	Trailing Arm, 1st Drive Axle, for Leaf-Spring Suspension vehicles, 9069961/3536016 →	
	07/09 →	Track Control Arm		SC-TC-12452	Trailing Arm, 2nd Drive Axle, for Leaf-Spring Suspension vehicles, 1280185/4471603 →	
	07/09 →	Track Control Arm		SC-TC-12452	Trailing Arm, 2nd Drive Axle, for Leaf-Spring Suspension vehicles, 9069961/3536016 →	
	07/09 →	Track Control Arm		SC-TC-12472	Trailing Arm, 2nd Drive Axle, for Leaf-Spring Suspension vehicles, →1280184/4471602	
	07/09 →	Track Control Arm		SC-TC-12472	Trailing Arm, 2nd Drive Axle, for Leaf-Spring Suspension vehicles, →9069960/3536015	
	07/09 →	Track Control Arm	SC-DL-10302	SC-DL-10302	Trailing Arm, 1st Front Axle, for Pneumatic Suspension vehicles	
	07/09 →	Track Control Arm	SC-TC-12361		Control Arm, 1st & 2nd Front Axle, for Pneumatic Suspension vehicles	
	P 560, R 560	04/04 →	Centre Rod	SC-DL-5229		Push Rod
		04/04 →	Centre Rod	SC-DL-5354	SC-DL-5354	Push Rod, for vehicles with Hinged Trailing Axle
04/04 →		Centre Rod	SC-DL-8182		Push Rod	
04/04 →		Centre Rod	SC-DL-8399		Push Rod, for vehicles with Hinged Leading Axle, for vehicles with Part-Pneumatic Suspension	
04/04 →		Centre Rod	SC-DL-8553	SC-DL-8553	Push Rod, for vehicles with Hinged Leading Axle	
04/04 →		Centre Rod	SC-DL-10225		Push Rod, for vehicles with Hinged Leading Axle	
04/04 →		Centre Rod	SC-DL-12342		for Steering Rod	
04/04 →		Centre Rod	SC-DL-12343		for Steering Rod	
04/04 →		Centre Rod	SC-DL-12449		Push Rod	
04/04 →		Suspension Arm Repair Kit		SC-RK-12366	for Control Arm	
04/04 →		Suspension Arm Repair Kit	SC-RK-12346	SC-RK-12346	for Control Arm	
04/04 →		Suspension Strut Repair Kit		MN-RK-8501		
04/04 →		Suspension Strut Repair Kit		MN-RK-12436		

CV-ES-14162

Length: 125
Cone Ø: d1 Ø 30 / d2 Ø 27
Thread: M30 x 1,5 LHT
283783, 395009, 1358792, 1738380, 1 914 426, 2051165



MN-RK-8501

Ø: 75 Hole Distance: 115
Thick/Height: 24
1515981



MN-RK-12436

Ø: 75 Hole Distance: 115
Thick/Height: 24
550799, 1517403, 1783020



SC-DL-5229

Length: 1053 Ø: 50
Cone Ø: d1 Ø 30 / d2 Ø 27
1356055, 1379071, 1384025, 1768898,
1847311, 1912757, 12201600A



SC-DL-5354

Length: 1060 Ø: 52
Cone Ø: d1 Ø 30 / d2 Ø 27
1384027, 1769597, 1847312, 1912758,
12200800A



SC-DL-8179

Length: 568 Ø: 46
Hole Distance: 115 / 115
1399180, 1428347



SC-DL-8182

1343262, 1869413



SC-DL-8399

Length: 433 Ø: 40
Cone Ø: d1 Ø 30 / d2 Ø 26
1394884, 1938387



SC-DL-8509

Length: 568,5 Ø: 46
Hole Distance: 115 / 115
1485758, 1486757



SC-DL-8511

Length: 616,5 Ø: 50
Hole Distance: 115 / 115
1485760, 1499478, 1722750



SC-DL-8531

Length: 522 Ø: 46
Hole Distance: 115 / 115
1486758



SC-DL-8547

Length: 568 Ø: 50
Hole Distance: 115 / 115
1499474, 1722746, 1906940



SC-DL-8553

Length: 435 Ø: 38
Cone Ø: d1 Ø 30 / d2 Ø 27
1343283, 1759691



SC-DL-8623

Length: 592 Ø: 50
Hole Distance: 115 / 115
1388436, 1499476, 1722748, 1906942



SC-DL-9462

Length: 568,5 Ø: 50
Hole Distance: 115 / 115
1499475, 1500573, 1722747, 1906941



SC-DL-9466

Length: 568 Ø: 19
1486756



SC-DL-10225

Length: 2179 Ø: 62
Cone Ø: d1 Ø 30 / d2 Ø 27
1386618, 1788522



SC-DL-10302

Length: 752 Ø: 48
Hole Distance: 115 / 115
1101843, 1379423, 1393298, 1431470,
1942075



SC-DL-12342

Length: 601 Ø: 42
Cone Ø: d1 Ø 26 / d2 Ø 23,5
1343262, 1869413



SC-DL-12343

Length: 1062 Ø: 52
Cone Ø: d1 Ø 30 / d2 Ø 27
1348269, 2007275



SC-DL-12449

Length: 1206 Ø: 38
Cone Ø: d1 Ø 30 / d2 Ø 27
1385763, 1765375



SC-RK-12346

Ø: 67 Hole Distance: 115
Thick/Height: 24
550800



SC-RK-12366

Ø: 75 Hole Distance: 115 / 115
Thick/Height: 24
1 722 753, 2 096 392



SC-TC-12361

Length: 705 Ø: 42
Cone Ø: d1 Ø 38
Hole Distance: 115
1353445, 1464611, 1942147



SC-TC-12451

Length: 552 Ø: 46
Hole Distance: 115 / 115
1494296



SC-TC-12452

Length: 580,5 Ø: 46
Hole Distance: 115 / 115
1485759



SC-TC-12472

Length: 580 Ø: 46
Hole Distance: 115 / 115
1399182



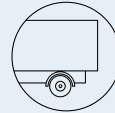

P,G,R,T - series ...

P 560, R 560 ...

04/04 →	Suspension Strut Repair Kit	DF-RK-9341		
04/04 →	Tie Rod		SC-DL-7264	Leading Axle;for vehicles with Hinged Leading Axle
04/04 →	Tie Rod		SC-DL-7264	Leading Axle;for vehicles with Hinged Leading Axle;Air Suspension Axle
04/04 →	Tie Rod		SC-DL-8137	Leading Axle;for vehicles with Hinged Leading Axle
04/04 →	Tie Rod	SC-DL-7264		
04/04 →	Tie Rod	SC-DL-8137		Leaf Spring Axle
04/04 →	Tie Rod	SC-DL-9457		Leaf Spring Axle
04/04 →	Tie Rod End	CV-ES-14162	CV-ES-14162	for Steering Rod
04/04 →	Tie Rod End	CV-ES-14163		for Steering Rod
04/04 →	Tie Rod End	SC-ES-8517		for Push Rod
04/04 →	Tie Rod End	SC-ES-8535		for Guide Rod
04/04 →	Track Control Arm		SC-VB-12418	Control Arm
04/04 →	Track Control Arm	SC-DL-10302	SC-DL-10302	Trailing Arm, Air Suspension Axle
04/04 →	Track Control Arm	SC-TC-12361		Control Arm, 1st Front Axle, for Pneumatic Suspension vehicles
11/06 →	Centre Rod	SC-DL-5354		Push Rod
11/06 →	Centre Rod	SC-DL-10225		for Steering Rod
11/06 →	Tie Rod End	CV-ES-14162		for Steering Rod

P 580, R 580

04/04 →	Centre Rod	SC-DL-5229		Push Rod
04/04 →	Centre Rod	SC-DL-5354		Push Rod
04/04 →	Centre Rod	SC-DL-12342		for Steering Rod
04/04 →	Centre Rod	SC-DL-12343		for Steering Rod
04/04 →	Suspension Arm Repair Kit		SC-RK-12366	for Control Arm
04/04 →	Suspension Arm Repair Kit	SC-RK-12346	SC-RK-12346	for Control Arm
04/04 →	Suspension Strut Repair Kit		MN-RK-8501	
04/04 →	Suspension Strut Repair Kit		MN-RK-12436	
04/04 →	Suspension Strut Repair Kit	DF-RK-9341		
04/04 →	Tie Rod	SC-DL-7264		
04/04 →	Tie Rod	SC-DL-8137		Leaf Spring Axle
04/04 →	Tie Rod	SC-DL-9457		Leaf Spring Axle
04/04 →	Tie Rod End	CV-ES-14162		for Steering Rod
04/04 →	Tie Rod End	CV-ES-14163		for Steering Rod
04/04 →	Tie Rod End	SC-ES-8535		for Guide Rod
04/04 →	Track Control Arm		SC-VB-12418	Control Arm
04/04 →	Track Control Arm	SC-DL-10302	SC-DL-10302	Trailing Arm, Air Suspension Axle

P 620, R 620

08/06 →	Centre Rod	SC-DL-5229		Push Rod
08/06 →	Centre Rod	SC-DL-5354	SC-DL-5354	Push Rod, for vehicles with Hinged Trailing Axle
08/06 →	Centre Rod	SC-DL-8182		Push Rod
08/06 →	Centre Rod	SC-DL-8399		Push Rod, for vehicles with Hinged Leading Axle, for vehicles with Part-Pneumatic Suspension
08/06 →	Centre Rod	SC-DL-8553	SC-DL-8553	Push Rod, for vehicles with Hinged Leading Axle
08/06 →	Centre Rod	SC-DL-10225		Push Rod, for vehicles with Hinged Leading Axle
08/06 →	Centre Rod	SC-DL-12342		for Steering Rod
08/06 →	Centre Rod	SC-DL-12343		for Steering Rod
08/06 →	Centre Rod	SC-DL-12449		Push Rod
08/06 →	Suspension Arm Repair Kit		SC-RK-12366	for Control Arm
08/06 →	Suspension Arm Repair Kit	SC-RK-12346	SC-RK-12346	for Control Arm
08/06 →	Suspension Strut Repair Kit		MN-RK-8501	
08/06 →	Suspension Strut Repair Kit		MN-RK-12436	
08/06 →	Suspension Strut Repair Kit	DF-RK-9341		
08/06 →	Tie Rod		SC-DL-7264	Leading Axle;for vehicles with Hinged Leading Axle
08/06 →	Tie Rod		SC-DL-7264	Leading Axle;for vehicles with Hinged Leading Axle;Air Suspension Axle
08/06 →	Tie Rod		SC-DL-8137	Leading Axle;for vehicles with Hinged Leading Axle
08/06 →	Tie Rod	SC-DL-7264		
08/06 →	Tie Rod	SC-DL-8137		Leaf Spring Axle
08/06 →	Tie Rod	SC-DL-9457		Leaf Spring Axle
08/06 →	Tie Rod End	CV-ES-14162	CV-ES-14162	for Steering Rod

CV-ES-14162

Length: 125
Cone Ø: d1 Ø 30 / d2 Ø 27
Thread: M30 x 1,5 LHT
283783, 395009, 1358792, 1738380, 1 914 426, 2051165



CV-ES-14163

Length: 125
Cone Ø: d1 Ø 30 / d2 Ø 27
Thread: M30 x 1,5 RHT
283784, 395010, 1358793, 1488890, 1738381, 1767328, 1914427, 2051166



DF-RK-9341

Ø: 67
550807, 5508072



MN-RK-8501

Ø: 75 Hole Distance: 115
Thick/Height: 24
1515981



MN-RK-12436

Ø: 75 Hole Distance: 115
Thick/Height: 24
550799, 1517403, 1783020



SC-DL-5229

Length: 1053 Ø: 50
Cone Ø: d1 Ø 30 / d2 Ø 27
1356055, 1379071, 1384025, 1768898, 1847311, 1912757, 12201600A



SC-DL-5354

Length: 1060 Ø: 52
Cone Ø: d1 Ø 30 / d2 Ø 27
1384027, 1769597, 1847312, 1912758, 12200800A



SC-DL-7264

Length: 1743 Ø: 62
Cone Ø: d1 Ø 30 / d2 Ø 27
1361413, 1395614, 1734019, 1897333, 2040254, 2146105



SC-DL-8137

Length: 1736 Ø: 40
Cone Ø: d1 Ø 30 / d2 Ø 27
301639, 311847, 395350, 1358675, 1378435, 1397866, 1734020, 2028998, 12202900A



SC-DL-8182

1343262, 1869413



SC-DL-8399

Length: 433 Ø: 40
Cone Ø: d1 Ø 30 / d2 Ø 26
1394884, 1938387



SC-DL-8553

Length: 435 Ø: 38
Cone Ø: d1 Ø 30 / d2 Ø 27
1343283, 1759691



SC-DL-9457

Length: 1743 Ø: 52
Cone Ø: d1 Ø 30 / d2 Ø 27
1527989, 1723896, 1737684, 1897336



SC-DL-10225

Length: 2179 Ø: 62
Cone Ø: d1 Ø 30 / d2 Ø 27
1386618, 1788522



SC-DL-10302

Length: 752 Ø: 48
Hole Distance: 115 / 115
1101843, 1379423, 1393298, 1431470, 1942075



SC-DL-12342

Length: 601 Ø: 42
Cone Ø: d1 Ø 26 / d2 Ø 23,5
1343262, 1869413



SC-DL-12343

Length: 1062 Ø: 52
Cone Ø: d1 Ø 30 / d2 Ø 27
1348269, 2007275



SC-DL-12449

Length: 1206 Ø: 38
Cone Ø: d1 Ø 30 / d2 Ø 27
1385763, 1765375



SC-ES-8517

Length: 140
Cone Ø: d1 Ø 30 / d2 Ø 27
Thread: M30 x 1,5 RHT
1358793, 1435746, 1488890, 1534756, 1914427, 2051166



SC-ES-8535

Length: 145
Cone Ø: d1 Ø 30 / d2 Ø 27
Thread: M30 x 1,5 RHT
1723897, 2051041



SC-RK-12346

Ø: 67 Hole Distance: 115
Thick/Height: 24
550800



SC-RK-12366

Ø: 75 Hole Distance: 115 / 115
Thick/Height: 24
1 722 753, 2 096 392



SC-TC-12361

Length: 705 Ø: 42
Cone Ø: d1 Ø 38
Hole Distance: 115
1353445, 1464611, 1942147



SC-VB-12418

Length: 613,2
Ø: 46
Hole Ø 25 / 19 / 19
Hole Distance: 152 / 115 / 115
1440028, 1722582



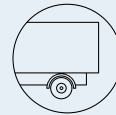

P,G,R,T - series ...

P 620, R 620 ...	08/06→	Tie Rod End	CV-ES-14163		for Steering Rod	
	08/06→	Tie Rod End	SC-ES-8517		for Push Rod	
	08/06→	Tie Rod End	SC-ES-8535		for Guide Rod	
	08/06→	Track Control Arm		SC-VB-12418	Control Arm	
	08/06→	Track Control Arm	SC-DL-10302	SC-DL-10302	Trailing Arm, Air Suspension Axle	
	11/06→	Centre Rod	SC-DL-5354		Push Rod	
	11/06→	Centre Rod	SC-DL-10225		for Steering Rod	
	11/06→	Tie Rod End	CV-ES-14162		for Steering Rod	
	R 340	03/04→	Centre Rod	SC-DL-5229		Push Rod
		03/04→	Centre Rod	SC-DL-5354		Push Rod
		03/04→	Centre Rod	SC-DL-10225		for Steering Rod
03/04→		Centre Rod	SC-DL-12342		for Steering Rod	
03/04→		Centre Rod	SC-DL-12343		for Steering Rod	
03/04→		Suspension Arm Repair Kit		CV-RK-8118	for Drag Link	
03/04→		Suspension Arm Repair Kit		SC-RK-12366	for Control Arm	
03/04→		Suspension Strut Repair Kit		CV-RK-5311		
03/04→		Tie Rod	SC-DL-7264			
03/04→		Tie Rod	SC-DL-8137		Leaf Spring Axle	
03/04→		Tie Rod	SC-DL-9457		Leaf Spring Axle	
03/04→		Tie Rod End	CV-ES-14162		for Steering Rod	
03/04→		Tie Rod End	CV-ES-14163		for Steering Rod	
03/04→		Tie Rod End	SC-ES-8535		for Guide Rod	
03/04→		Track Control Arm		SC-VB-12418	Control Arm	
03/04→		Track Control Arm	SC-DL-10302	SC-DL-10302	Trailing Arm, Air Suspension Axle	
03/04→		Track Control Arm	SC-TC-12361		Control Arm, 1st Front Axle, for Pneumatic Suspension vehicles	
08/06→		Centre Rod	SC-DL-5354	SC-DL-5354	Push Rod, for vehicles with Hinged Trailing Axle	
08/06→		Centre Rod	SC-DL-8182		Push Rod	
08/06→		Centre Rod	SC-DL-8399		Push Rod, for vehicles with Hinged Leading Axle, for vehicles with Part-Pneumatic Suspension	
08/06→		Centre Rod	SC-DL-8553	SC-DL-8553	Push Rod, for vehicles with Hinged Leading Axle	
08/06→		Centre Rod	SC-DL-10225		Push Rod, for vehicles with Hinged Leading Axle	
08/06→		Centre Rod	SC-DL-12449		Push Rod	
08/06→		Suspension Strut Repair Kit		DF-RK-9341		
08/06→		Tie Rod		SC-DL-7264	Leading Axle;for vehicles with Hinged Leading Axle	
08/06→		Tie Rod		SC-DL-7264	Leading Axle;for vehicles with Hinged Leading Axle;Air Suspension Axle	
08/06→		Tie Rod		SC-DL-8137	Leading Axle;for vehicles with Hinged Leading Axle	
08/06→		Tie Rod End	CV-ES-14162	CV-ES-14162	for Steering Rod	
08/06→		Tie Rod End	SC-ES-8517		for Push Rod	
R 360		04/10→	Centre Rod	SC-DL-5229		Push Rod
		04/10→	Centre Rod	SC-DL-5354	SC-DL-5354	Push Rod, for vehicles with Hinged Trailing Axle
		04/10→	Centre Rod	SC-DL-8182		Push Rod
		04/10→	Centre Rod	SC-DL-8399		Push Rod, for vehicles with Hinged Leading Axle, for vehicles with Part-Pneumatic Suspension
		04/10→	Centre Rod	SC-DL-8553	SC-DL-8553	Push Rod, for vehicles with Hinged Leading Axle
	04/10→	Centre Rod	SC-DL-12342		for Steering Rod	
	04/10→	Centre Rod	SC-DL-12343		for Steering Rod	
	04/10→	Centre Rod	SC-DL-12449		Push Rod	
	04/10→	Suspension Arm Repair Kit		SC-RK-12366	for Control Arm	
	04/10→	Suspension Arm Repair Kit	SC-RK-12346	SC-RK-12346	for Control Arm	
	04/10→	Suspension Strut Repair Kit		MN-RK-8501		
	04/10→	Suspension Strut Repair Kit		MN-RK-12436		
	04/10→	Suspension Strut Repair Kit	DF-RK-9341			
	04/10→	Tie Rod		SC-DL-7264	Leading Axle;for vehicles with Hinged Leading Axle	
	04/10→	Tie Rod		SC-DL-7264	Leading Axle;for vehicles with Hinged Leading Axle;Air Suspension Axle	
	04/10→	Tie Rod		SC-DL-8137	Leading Axle;for vehicles with Hinged Leading Axle	
	04/10→	Tie Rod		SC-DL-8137	Tag Axle;for vehicles with Hinged Trailing Axle	

CV-ES-14162

Length: 125
Cone Ø: d1 Ø 30 / d2 Ø 27
Thread: M30 x 1,5 LHT
283784, 395009, 1358792, 1738380, 1 914 426, 2051165



CV-ES-14163

Length: 125
Cone Ø: d1 Ø 30 / d2 Ø 27
Thread: M30 x 1,5 RHT
283784, 395010, 1358793, 1488890, 1738381, 1767328, 1914427, 2051166



CV-RK-5311

0638862, 638862, 0639287, 639287, 1104335, 1953248, 81432206006, 81432206107



CV-RK-8118

Ø: 85
Hole Distance: 130
Thick/Height: 30
638862, 639287, 1104335, 1953248



DF-RK-9341

Ø: 67
550807, 5508072



MN-RK-8501

Ø: 75 Hole Distance: 115
Thick/Height: 24
1515981



MN-RK-12436

Ø: 75 Hole Distance: 115
Thick/Height: 24
550799, 1517403, 1783020



SC-DL-5229

Length: 1053 Ø: 50
Cone Ø: d1 Ø 30 / d2 Ø 27
1356055, 1379071, 1384025, 1768898, 1847311, 1912757, 12201600A



SC-DL-5354

Length: 1060 Ø: 52
Cone Ø: d1 Ø 30 / d2 Ø 27
1384027, 1769597, 1847312, 1912758, 12200800A



SC-DL-7264

Length: 1743 Ø: 62
Cone Ø: d1 Ø 30 / d2 Ø 27
1361413, 1395614, 1734019, 1897333, 2040254, 2146105



SC-DL-8137

Length: 1736 Ø: 40
Cone Ø: d1 Ø 30 / d2 Ø 27
301639, 311847, 395350, 1358675, 1378435, 1397866, 1734020, 2028998, 12202900A



SC-DL-8182

1343262, 1869413



SC-DL-8399

Length: 433 Ø: 40
Cone Ø: d1 Ø 30 / d2 Ø 26
1394884, 1938387



SC-DL-8553

Length: 435 Ø: 38
Cone Ø: d1 Ø 30 / d2 Ø 27
1343283, 1759691



SC-DL-9457

Length: 1743 Ø: 52
Cone Ø: d1 Ø 30 / d2 Ø 27
1527989, 1723896, 1737684, 1897336



SC-DL-10225

Length: 2179 Ø: 62
Cone Ø: d1 Ø 30 / d2 Ø 27
1386618, 1788522



SC-DL-10302

Length: 752 Ø: 48
Hole Distance: 115 / 115
1101843, 1379423, 1393298, 1431470, 1942075



SC-DL-12342

Length: 601 Ø: 42
Cone Ø: d1 Ø 26 / d2 Ø 23,5
1343262, 1869413



SC-DL-12343

Length: 1062 Ø: 52
Cone Ø: d1 Ø 30 / d2 Ø 27
1348269, 2007275



SC-DL-12449

Length: 1206 Ø: 38
Cone Ø: d1 Ø 30 / d2 Ø 27
1385763, 1765375



SC-ES-8517

Length: 140
Cone Ø: d1 Ø 30 / d2 Ø 27
Thread: M30 x 1,5 RHT
1358793, 1435746, 1488890, 1534756, 1914427, 2051166



SC-ES-8535

Length: 145
Cone Ø: d1 Ø 30 / d2 Ø 27
Thread: M30 x 1,5 RHT
1723897, 2051041



SC-RK-12346

Ø: 67 Hole Distance: 115
Thick/Height: 24
550800



SC-RK-12366

Ø: 75 Hole Distance: 115 / 115
Thick/Height: 24
1 722 753, 2 096 392



SC-TC-12361

Length: 705 Ø: 42
Cone Ø: d1 Ø 38
Hole Distance: 115
1353445, 1464611, 1942147



SC-VB-12418

Length: 613,2
Ø: 46
Hole Ø 25 / 19 / 19
Hole Distance: 152 / 115 / 115
1440028, 1722582



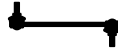

P,G,R,T - series ...

R 360 ...	04/10→	Tie Rod	SC-DL-7264		
	04/10→	Tie Rod	SC-DL-8137		Leaf Spring Axle
	04/10→	Tie Rod	SC-DL-9457		Leaf Spring Axle
	04/10→	Tie Rod End	CV-ES-14162	CV-ES-14162	for Steering Rod
	04/10→	Tie Rod End	CV-ES-14163		for Steering Rod
	04/10→	Tie Rod End	SC-ES-8517		for Push Rod
	04/10→	Tie Rod End	SC-ES-8535		for Guide Rod
	04/10→	Track Control Arm		SC-VB-12418	Control Arm
	04/10→	Track Control Arm	SC-DL-10302	SC-DL-10302	Trailing Arm, Air Suspension Axle
	04/10→	Track Control Arm	SC-TC-12361		Control Arm, 1st Front Axle, for Pneumatic Suspension vehicles
R 380	03/04→	Centre Rod	SC-DL-5229		Push Rod
	03/04→	Centre Rod	SC-DL-5354		Push Rod
	03/04→	Centre Rod	SC-DL-12343		for Steering Rod
	03/04→	Suspension Arm Repair Kit		SC-RK-12366	for Control Arm
	03/04→	Suspension Strut Repair Kit		CV-RK-5311	
	03/04→	Suspension Strut Repair Kit		DF-RK-9341	
	03/04→	Tie Rod	SC-DL-7264		
	03/04→	Tie Rod	SC-DL-8137		Leaf Spring Axle
	03/04→	Tie Rod	SC-DL-9457		Leaf Spring Axle
	03/04→	Tie Rod End	CV-ES-14162		for Steering Rod
	03/04→	Tie Rod End	CV-ES-14163		for Steering Rod
	03/04→	Tie Rod End	SC-ES-8535		for Guide Rod
	03/04→	Track Control Arm		SC-TC-12452	Control Arm
	03/04→	Track Control Arm		SC-VB-12418	Control Arm
	03/04→	Track Control Arm	SC-DL-10302	SC-DL-10302	Trailing Arm, Air Suspension Axle
	03/04→	Track Control Arm	SC-TC-12361		Control Arm, 1st Front Axle, for Pneumatic Suspension vehicles
	04/04→	Suspension Arm Repair Kit	MN-RK-7280	MN-RK-7280	for Drag Link;for Semi-Trailing Arm; for Wishbone (CV)
	04/04→	Suspension Strut Repair Kit		MN-RK-8501	
	04/04→	Track Control Arm		SC-DL-8511	Trailing Arm, Leaf Spring Axle
	04/04→	Track Control Arm		SC-DL-8511	Trailing Arm, Leaf Spring Axle, →* 3512097 *
	04/04→	Track Control Arm		SC-DL-8547	Trailing Arm, Leaf Spring Axle
	04/04→	Track Control Arm		SC-DL-9462	Trailing Arm, Leaf Spring Axle, →* 2006231 SSS ** 5117423 SNL *; * 9097199 SAN *; * 3564002 SLA *
	04/04→	Track Control Arm		SC-DL-9466	Trailing Arm, Leaf Spring Axle
	04/04→	Track Control Arm		SC-TC-12451	Trailing Arm, 1st Drive Axle, for Leaf-Spring Suspension vehicles
	04/04→	Track Control Arm		SC-TC-12451	Trailing Arm, 1st Drive Axle, for Leaf-Spring Suspension vehicles, 1280185/4471603→
	04/04→	Track Control Arm		SC-TC-12451	Trailing Arm, 1st Drive Axle, for Leaf-Spring Suspension vehicles, 9069961/3536016→
	04/04→	Track Control Arm		SC-TC-12472	Trailing Arm, 2nd Drive Axle, for Leaf-Spring Suspension vehicles, →1280184/4471602
	04/04→	Track Control Arm		SC-TC-12472	Trailing Arm, 2nd Drive Axle, for Leaf-Spring Suspension vehicles, →9069960/3536015
	04/04→	Track Control Arm	SC-DL-8179	SC-DL-8179	Trailing Arm, Leaf Spring Axle
	04/04→	Track Control Arm	SC-DL-8509	SC-DL-8509	Trailing Arm
	04/04→	Track Control Arm	SC-DL-8509	SC-DL-8509	Trailing Arm, Leaf Spring Axle
	04/04→	Track Control Arm	SC-DL-8531	SC-DL-8531	Trailing Arm, Leaf Spring Axle
	04/04→	Track Control Arm	SC-DL-8623	SC-DL-8623	Trailing Arm, Leaf Spring Axle, →* 2006231 SSS ** 5117423 SNL *; * 9097199 SAN *; * 3564002 SLA *
R 400	04/10→	Centre Rod	SC-DL-5229		Push Rod
	04/10→	Centre Rod	SC-DL-5354	SC-DL-5354	Push Rod, for vehicles with Hinged Trailing Axle
	04/10→	Centre Rod	SC-DL-8182		Push Rod
	04/10→	Centre Rod	SC-DL-8399		Push Rod, for vehicles with Hinged Leading Axle, for vehicles with Part-Pneumatic Suspension
	04/10→	Centre Rod	SC-DL-8553	SC-DL-8553	Push Rod, for vehicles with Hinged Leading Axle
	04/10→	Centre Rod	SC-DL-12342		for Steering Rod
	04/10→	Centre Rod	SC-DL-12343		for Steering Rod

CV-ES-14162

Length: 125
Cone Ø: d1 Ø 30 / d2 Ø 27
Thread: M30 x 1,5 LHT
283783, 395009, 1358792, 1738380, 1 914 426, 2051165



CV-ES-14163

Length: 125
Cone Ø: d1 Ø 30 / d2 Ø 27
Thread: M30 x 1,5 RHT
283784, 395010, 1358793, 1488890, 1738381, 1767328, 1914427, 2051166



CV-RK-5311

0638862, 638862, 0639287, 639287, 1104335, 1953248, 81432206006, 81432206107



DF-RK-9341

Ø: 67
550807, 5508072



MN-RK-7280

Ø: 75 Hole Distance: 115
Thick/Height: 24
0550806, 550806, 0639370, 639370, 689748, 1104334



MN-RK-8501

Ø: 75 Hole Distance: 115
Thick/Height: 24
1515981



SC-DL-5229

Length: 1053 Ø: 50
Cone Ø: d1 Ø 30 / d2 Ø 27
1356055, 1379071, 1384025, 1768898, 1847311, 1912757, 12201600A



SC-DL-5354

Length: 1060 Ø: 52
Cone Ø: d1 Ø 30 / d2 Ø 27
1384027, 1769597, 1847312, 1912758, 12200800A



SC-DL-7264

Length: 1743 Ø: 62
Cone Ø: d1 Ø 30 / d2 Ø 27
1361413, 1395614, 1734019, 1897333, 2040254, 2146105



SC-DL-8137

Length: 1736 Ø: 40
Cone Ø: d1 Ø 30 / d2 Ø 27
301639, 311847, 395350, 1358675, 1378435, 1397866, 1734020, 2028998, 12202900A



SC-DL-8179

Length: 568 Ø: 46
Hole Distance: 115 / 115
1399180, 1428347



SC-DL-8182

1343262, 1869413



SC-DL-8399

Length: 433 Ø: 40
Cone Ø: d1 Ø 30 / d2 Ø 26
1394884, 1938387



SC-DL-8509

Length: 568,5 Ø: 46
Hole Distance: 115 / 115
1485758, 1486757



SC-DL-8511

Length: 616,5 Ø: 50
Hole Distance: 115 / 115
1485760, 1499478, 1722750



SC-DL-8531

Length: 522 Ø: 46
Hole Distance: 115 / 115
1486758



SC-DL-8547

Length: 568 Ø: 50
Hole Distance: 115 / 115
1499474, 1722746, 1906940



SC-DL-8553

Length: 435 Ø: 38
Cone Ø: d1 Ø 30 / d2 Ø 27
1343283, 1759691



SC-DL-8623

Length: 592 Ø: 50
Hole Distance: 115 / 115
1388436, 1499476, 1722748, 1906942



SC-DL-9457

Length: 1743 Ø: 52
Cone Ø: d1 Ø 30 / d2 Ø 27
1527989, 1723896, 1737684, 1897336



SC-DL-9462

Length: 568,5 Ø: 50
Hole Distance: 115 / 115
1499475, 1500573, 1722747, 1906941



SC-DL-9466

Length: 568 Ø: 19
1486756



SC-DL-10302

Length: 752 Ø: 48
Hole Distance: 115 / 115
1101843, 1379423, 1393298, 1431470, 1942075



SC-DL-12342

Length: 601 Ø: 42
Cone Ø: d1 Ø 26 / d2 Ø 23,5
1343262, 1869413



SC-DL-12343

Length: 1062 Ø: 52
Cone Ø: d1 Ø 30 / d2 Ø 27
1348269, 2007275



SC-ES-8517

Length: 140
Cone Ø: d1 Ø 30 / d2 Ø 27
Thread: M30 x 1,5 RHT
1358793, 1435746, 1488890, 1534756, 1914427, 2051166



SC-ES-8535

Length: 145
Cone Ø: d1 Ø 30 / d2 Ø 27
Thread: M30 x 1,5 RHT
1723897, 2051041



SC-RK-12366

Ø: 75 Hole Distance: 115 / 115
Thick/Height: 24
1 722 753, 2 096 392



SC-TC-12361

Length: 705 Ø: 42
Cone Ø: d1 Ø 38
Hole Distance: 115
1353445, 1464611, 1942147



SC-TC-12451

Length: 552 Ø: 46
Hole Distance: 115 / 115
1494296



SC-TC-12452

Length: 580,5 Ø: 46
Hole Distance: 115 / 115
1485759



SC-TC-12472

Length: 580 Ø: 46
Hole Distance: 115 / 115
1399182



SC-VB-12418

Length: 613,2
Ø: 46
Hole Ø 25 / 19 / 19
Hole Distance: 152 / 115 / 115
1440028, 1722582





P,G,R,T - series ...

R 400 ...	04/10→	Centre Rod	SC-DL-12449		Push Rod
	04/10→	Suspension Arm Repair Kit		SC-RK-12366	for Control Arm
	04/10→	Suspension Strut Repair Kit		DF-RK-9341	
	04/10→	Tie Rod		SC-DL-7264	Leading Axle;for vehicles with Hinged Leading Axle
	04/10→	Tie Rod		SC-DL-7264	Leading Axle;for vehicles with Hinged Leading Axle;Air Suspension Axle
	04/10→	Tie Rod		SC-DL-8137	Leading Axle;for vehicles with Hinged Leading Axle
	04/10→	Tie Rod		SC-DL-8137	Tag Axle;for vehicles with Hinged Trailing Axle
	04/10→	Tie Rod	SC-DL-7264		
	04/10→	Tie Rod	SC-DL-8137		Leaf Spring Axle
	04/10→	Tie Rod	SC-DL-9457		Leaf Spring Axle
	04/10→	Tie Rod End	CV-ES-14162	CV-ES-14162	for Steering Rod
	04/10→	Tie Rod End	CV-ES-14163		for Steering Rod
	04/10→	Tie Rod End	SC-ES-8517		for Push Rod
	04/10→	Tie Rod End	SC-ES-8535		for Guide Rod
	04/10→	Track Control Arm		SC-VB-12418	Control Arm
	04/10→	Track Control Arm	SC-DL-10302	SC-DL-10302	Trailing Arm, Air Suspension Axle
	04/10→	Track Control Arm	SC-TC-12361		Control Arm, 1st Front Axle, for Pneumatic Suspension vehicles
	R 420	03/04→	Centre Rod	SC-DL-5229	
03/04→		Centre Rod	SC-DL-5354		Push Rod
03/04→		Centre Rod	SC-DL-5354	SC-DL-5354	Push Rod, for vehicles with Hinged Trailing Axle
03/04→		Centre Rod	SC-DL-8154		Push Rod
03/04→		Centre Rod	SC-DL-8169		Push Rod
03/04→		Centre Rod	SC-DL-8182		Push Rod
03/04→		Centre Rod	SC-DL-8399		Push Rod, for vehicles with Hinged Leading Axle, for vehicles with Part-Pneumatic Suspension
03/04→		Centre Rod	SC-DL-8399		Push Rod, Leaf Spring Axle
03/04→		Centre Rod	SC-DL-8553	SC-DL-8553	Push Rod, for vehicles with Hinged Leading Axle
03/04→		Centre Rod	SC-DL-12341		Push Rod
03/04→		Centre Rod	SC-DL-12342		for Steering Rod
03/04→		Centre Rod	SC-DL-12343		for Steering Rod
03/04→		Centre Rod	SC-DL-12449		Push Rod
03/04→		Suspension Arm Repair Kit		SC-RK-12366	for Control Arm
03/04→		Suspension Arm Repair Kit	MN-RK-7280	MN-RK-7280	for Drag Link;for Semi-Trailing Arm; for Wishbone (CV)
03/04→		Suspension Strut Repair Kit		DF-RK-9341	
03/04→		Suspension Strut Repair Kit		MN-RK-8501	
03/04→		Tie Rod		SC-DL-7264	Tag Axle;for vehicles with Hinged Trailing Axle
03/04→		Tie Rod		SC-DL-8137	Tag Axle;for vehicles with Hinged Trailing Axle
03/04→		Tie Rod	SC-DL-7264		
03/04→		Tie Rod	SC-DL-7264		1st FA;2nd FA
03/04→		Tie Rod	SC-DL-8137		Leaf Spring Axle
03/04→		Tie Rod	SC-DL-8137		Leaf Spring Axle;1st FA;2nd FA
03/04→		Tie Rod	SC-DL-9457		1st FA;2nd FA;Leaf Spring Axle
03/04→		Tie Rod	SC-DL-9457		Leaf Spring Axle
03/04→		Tie Rod End		MN-ES-8490	Tag Axle;for vehicles with Hinged Trailing Axle
03/04→		Tie Rod End	CV-ES-14162		for Steering Rod
03/04→		Tie Rod End	CV-ES-14162	CV-ES-14162	for Steering Rod
03/04→		Tie Rod End	CV-ES-14163		for Steering Rod
03/04→		Tie Rod End	MN-ES-8490	MN-ES-8490	for vehicles with Hinged Trailing Axle
03/04→		Tie Rod End	SC-ES-5764		
03/04→		Tie Rod End	SC-ES-8517		for Push Rod
03/04→		Tie Rod End	SC-ES-8535		for Guide Rod
03/04→		Track Control Arm		SC-DL-8511	Trailing Arm, Leaf Spring Axle
03/04→		Track Control Arm		SC-DL-8511	Trailing Arm, Leaf Spring Axle, →* 3512097 *
03/04→		Track Control Arm		SC-DL-8547	Trailing Arm, Leaf Spring Axle
03/04→		Track Control Arm		SC-DL-9462	Trailing Arm, Leaf Spring Axle, →* 2006231 SSS *; * 5117423 SNL *; * 9097199 SAN *; * 3564002 SLA *
03/04→		Track Control Arm		SC-DL-9466	Trailing Arm, Leaf Spring Axle

CV-ES-14162

Length: 125
Cone Ø: d1 Ø 30 / d2 Ø 27
Thread: M30 x 1,5 LHT
283783, 395009, 1358792, 1738380, 1 914 426, 2051165



CV-ES-14163

Length: 125
Cone Ø: d1 Ø 30 / d2 Ø 27
Thread: M30 x 1,5 RHT
283784, 395010, 1358793, 1488890, 1738381, 1767328, 1914427, 2051166



DF-RK-9341

Ø: 67
550807, 5508072



MN-ES-8490

Length: 90
Cone Ø: d1 Ø 30 / d2 Ø 27
Thread: M26 x 1,5 RHT
1394444, 0014606948, 14606948



MN-RK-7280

Ø: 75 Hole Distance: 115
Thick/Height: 24
0550806, 550806, 0639370, 639370, 689748, 1104334



MN-RK-8501

Ø: 75 Hole Distance: 115
Thick/Height: 24
1515981



SC-DL-5229

Length: 1053 Ø: 50
Cone Ø: d1 Ø 30 / d2 Ø 27
1356055, 1379071, 1384025, 1768898, 1847311, 1912757, 12201600A



SC-DL-5354

Length: 1060 Ø: 52
Cone Ø: d1 Ø 30 / d2 Ø 27
1384027, 1769597, 1847312, 1912758, 12200800A



SC-DL-7264

Length: 1743 Ø: 62
Cone Ø: d1 Ø 30 / d2 Ø 27
1361413, 1395614, 1734019, 1897333, 2040254, 2146105



SC-DL-8137

Length: 1736 Ø: 40
Cone Ø: d1 Ø 30 / d2 Ø 27
301639, 311847, 395350, 1358675, 1378435, 1397866, 1734020, 2028998, 12202900A



SC-DL-8154

Length: 495 Ø: 40
Cone Ø: d1 Ø 30 / d2 Ø 27
1343266, 1759690



SC-DL-8169

Length: 1920 Ø: 62
Cone Ø: d1 Ø 30 / d2 Ø 27
1343264, 1732635, 2007278



SC-DL-8182

1343262, 1869413



SC-DL-8399

Length: 433 Ø: 40
Cone Ø: d1 Ø 30 / d2 Ø 26
1394884, 1938387



SC-DL-8511

Length: 616,5 Ø: 50
Hole Distance: 115 / 115
1485760, 1499478, 1722750



SC-DL-8547

Length: 568 Ø: 50
Hole Distance: 115 / 115
1499474, 1722746, 1906940



SC-DL-8553

Length: 435 Ø: 38
Cone Ø: d1 Ø 30 / d2 Ø 27
1343283, 1759691



SC-DL-9457

Length: 1743 Ø: 52
Cone Ø: d1 Ø 30 / d2 Ø 27
1527989, 1723896, 1737684, 1897336



SC-DL-9462

Length: 568,5 Ø: 50
Hole Distance: 115 / 115
1499475, 1500573, 1722747, 1906941



SC-DL-9466

Length: 568 Ø: 19
1486756



SC-DL-10302

Length: 752 Ø: 48
Hole Distance: 115 / 115
1101843, 1379423, 1393298, 1431470, 1942075



SC-DL-12341

Length: 1776 Ø: 62
Cone Ø: d1 Ø 30 / d2 Ø 27
1386620



SC-DL-12342

Length: 601 Ø: 42
Cone Ø: d1 Ø 26 / d2 Ø 23,5
1343262, 1869413



SC-DL-12343

Length: 1062 Ø: 52
Cone Ø: d1 Ø 30 / d2 Ø 27
1348269, 2007275



SC-DL-12449

Length: 1206 Ø: 38
Cone Ø: d1 Ø 30 / d2 Ø 27
1385763, 1765375



SC-ES-5764

Length: 95
Cone Ø: d1 Ø 30 / d2 Ø 27
Thread: M26 x 1,5 RHT
325614, 1375228, 4604948



SC-ES-8517

Length: 140
Cone Ø: d1 Ø 30 / d2 Ø 27
Thread: M30 x 1,5 RHT
1358793, 1435746, 1488890, 1534756, 1914427, 2051166



SC-ES-8535

Length: 145
Cone Ø: d1 Ø 30 / d2 Ø 27
Thread: M30 x 1,5 RHT
1723897, 2051041



SC-RK-12366

Ø: 75 Hole Distance: 115 / 115
Thick/Height: 24
1 722 753, 2 096 392



SC-TC-12361

Length: 705 Ø: 42
Cone Ø: d1 Ø 38
Hole Distance: 115
1353445, 1464611, 1942147



SC-VB-12418

Length: 613,2
Ø: 46
Hole Ø 25 / 19 / 19
Hole Distance: 152 / 115 / 115
1440028, 1722582





P,G,R,T - series ...

R 420 ...	03/04 →	Track Control Arm		SC-TC-12451	Trailing Arm, 1st Drive Axle, for Leaf-Spring Suspension vehicles
	03/04 →	Track Control Arm		SC-TC-12451	Trailing Arm, 1st Drive Axle, for Leaf-Spring Suspension vehicles, 1280185/4471603 →
	03/04 →	Track Control Arm		SC-TC-12451	Trailing Arm, 1st Drive Axle, for Leaf-Spring Suspension vehicles, 9069961/3536016 →
	03/04 →	Track Control Arm		SC-TC-12452	Control Arm
	03/04 →	Track Control Arm		SC-TC-12472	Trailing Arm, 2nd Drive Axle, for Leaf-Spring Suspension vehicles, →1280184/4471602
	03/04 →	Track Control Arm		SC-TC-12472	Trailing Arm, 2nd Drive Axle, for Leaf-Spring Suspension vehicles, →9069960/3536015
	03/04 →	Track Control Arm	SC-DL-8179	SC-DL-8179	Trailing Arm, Leaf Spring Axle
	03/04 →	Track Control Arm	SC-DL-8509	SC-DL-8509	Trailing Arm
	03/04 →	Track Control Arm	SC-DL-8509	SC-DL-8509	Trailing Arm, Leaf Spring Axle
	03/04 →	Track Control Arm	SC-DL-8531	SC-DL-8531	Trailing Arm, Leaf Spring Axle
	03/04 →	Track Control Arm	SC-DL-8623	SC-DL-8623	Trailing Arm, Leaf Spring Axle, →* 2006231 SSS *;* 5117423 SNL *; * 9097199 SAN **; 3564002 SLA *
	03/04 →	Track Control Arm	SC-DL-10302	SC-DL-10302	Trailing Arm, Air Suspension Axle
	03/04 →	Track Control Arm	SC-DL-10302	SC-DL-10302	Trailing Arm, Air Suspension Axle;1st FA
	03/04 →	Track Control Arm	SC-TC-12361		Control Arm, 1st & 2nd Front Axle, for Pneumatic Suspension vehicles
	R 440	04/10 →	Centre Rod	SC-DL-5229	
04/10 →		Centre Rod	SC-DL-5354		Push Rod
04/10 →		Centre Rod	SC-DL-5354	SC-DL-5354	Push Rod, for vehicles with Hinged Trailing Axle
04/10 →		Centre Rod	SC-DL-8154	SC-DL-8154	Push Rod, for vehicles with Hinged Trailing Axle
04/10 →		Centre Rod	SC-DL-8182		Push Rod
04/10 →		Centre Rod	SC-DL-8399		Push Rod, for vehicles with Hinged Leading Axle, for vehicles with Part-Pneumatic Suspension
04/10 →		Centre Rod	SC-DL-8399		Push Rod, for vehicles with Part-Pneumatic Suspension
04/10 →		Centre Rod	SC-DL-8553	SC-DL-8553	Push Rod, for vehicles with Hinged Leading Axle
04/10 →		Centre Rod	SC-DL-12342		for Steering Rod
04/10 →		Centre Rod	SC-DL-12343		for Steering Rod
04/10 →		Centre Rod	SC-DL-12413		for Steering Rod
04/10 →		Centre Rod	SC-DL-12449		Push Rod
04/10 →		Suspension Arm Repair Kit		SC-RK-12366	for Control Arm
04/10 →		Suspension Strut Repair Kit		DF-RK-9341	
04/10 →		Tie Rod		SC-DL-7264	Leading Axle;for vehicles with Hinged Leading Axle
04/10 →		Tie Rod		SC-DL-7264	Leading Axle;for vehicles with Hinged Leading Axle;Air Suspension Axle
04/10 →		Tie Rod		SC-DL-7264	Tag Axle;for vehicles with Hinged Trailing Axle
04/10 →		Tie Rod		SC-DL-8137	Leading Axle;for vehicles with Hinged Leading Axle
04/10 →		Tie Rod		SC-DL-8137	Tag Axle;for vehicles with Hinged Trailing Axle
04/10 →		Tie Rod	SC-DL-7264		
04/10 →		Tie Rod	SC-DL-7264		1st FA;2nd FA
04/10 →		Tie Rod	SC-DL-8137		Leaf Spring Axle
04/10 →		Tie Rod	SC-DL-8137		Leaf Spring Axle;1st FA;2nd FA
04/10 →		Tie Rod	SC-DL-9457		1st FA;2nd FA;Leaf Spring Axle
04/10 →		Tie Rod	SC-DL-9457		Leaf Spring Axle
04/10 →		Tie Rod End		MN-ES-8490	Tag Axle;for vehicles with Hinged Trailing Axle
04/10 →		Tie Rod End	CV-ES-14162		for Steering Rod
04/10 →		Tie Rod End	CV-ES-14162	CV-ES-14162	for Steering Rod
04/10 →		Tie Rod End	CV-ES-14163		for Steering Rod
04/10 →		Tie Rod End	IV-ES-12272		for Steering Rod
04/10 →		Tie Rod End	MN-ES-8490	MN-ES-8490	for vehicles with Hinged Trailing Axle
04/10 →		Tie Rod End	SC-ES-8517		for Push Rod
04/10 →		Tie Rod End	SC-ES-8535		for Guide Rod
04/10 →		Track Control Arm		SC-VB-12418	Control Arm
04/10 →		Track Control Arm	SC-DL-10302	SC-DL-10302	Trailing Arm, Air Suspension Axle

CV-ES-14162

Length: 125
Cone Ø: d1 Ø 30 / d2 Ø 27
Thread: M30 x 1,5 LHT
283783, 395009, 1358792, 1738380, 1 914 426, 2051165



CV-ES-14163

Length: 125
Cone Ø: d1 Ø 30 / d2 Ø 27
Thread: M30 x 1,5 RHT
283784, 395010, 1358793, 1488890, 1738381, 1767328, 1914427, 2051166



DF-RK-9341

Ø: 67
550807, 5508072



IV-ES-12272

Length: 75
Cone Ø: d1 Ø 30 / d2 Ø 27
Thread: M26 x 1,5 RHT
1394443



MN-ES-8490

Length: 90
Cone Ø: d1 Ø 30 / d2 Ø 27
Thread: M26 x 1,5 RHT
1394444, 0014606948, 14606948



SC-DL-5229

Length: 1053 Ø: 50
Cone Ø: d1 Ø 30 / d2 Ø 27
1356055, 1379071, 1384025, 1768898, 1847311, 1912757, 12201600A



SC-DL-5354

Length: 1060 Ø: 52
Cone Ø: d1 Ø 30 / d2 Ø 27
1384027, 1769597, 1847312, 1912758, 12200800A



SC-DL-7264

Length: 1743 Ø: 62
Cone Ø: d1 Ø 30 / d2 Ø 27
1361413, 1395614, 1734019, 1897333, 2040254, 2146105



SC-DL-8137

Length: 1736 Ø: 40
Cone Ø: d1 Ø 30 / d2 Ø 27
301639, 311847, 395350, 1358675, 1378435, 1397866, 1734020, 2028998, 12202900A



SC-DL-8154

Length: 495 Ø: 40
Cone Ø: d1 Ø 30 / d2 Ø 27
1343266, 1759690



SC-DL-8179

Length: 568 Ø: 46
Hole Distance: 115 / 115
1399180, 1428347



SC-DL-8182

1343262, 1869413



SC-DL-8399

Length: 433 Ø: 40
Cone Ø: d1 Ø 30 / d2 Ø 26
1394884, 1938387



SC-DL-8509

Length: 568,5 Ø: 46
Hole Distance: 115 / 115
1485758, 1486757



SC-DL-8531

Length: 522 Ø: 46
Hole Distance: 115 / 115
1486758



SC-DL-8553

Length: 435 Ø: 38
Cone Ø: d1 Ø 30 / d2 Ø 27
1343283, 1759691



SC-DL-8623

Length: 592 Ø: 50
Hole Distance: 115 / 115
1388436, 1499476, 1722748, 1906942



SC-DL-9457

Length: 1743 Ø: 52
Cone Ø: d1 Ø 30 / d2 Ø 27
1527989, 1723896, 1737684, 1897336



SC-DL-10302

Length: 752 Ø: 48
Hole Distance: 115 / 115
1101843, 1379423, 1393298, 1431470, 1942075



SC-DL-12342

Length: 601 Ø: 42
Cone Ø: d1 Ø 26 / d2 Ø 23,5
1343262, 1869413



SC-DL-12343

Length: 1062 Ø: 52
Cone Ø: d1 Ø 30 / d2 Ø 27
1348269, 2007275



SC-DL-12413

Length: 1950 Ø: 62
Cone Ø: d1 Ø 30 / d2 Ø 27
1393383, 1788520



SC-DL-12449

Length: 1206 Ø: 38
Cone Ø: d1 Ø 30 / d2 Ø 27
1385763, 1765375



SC-ES-8517

Length: 140
Cone Ø: d1 Ø 30 / d2 Ø 27
Thread: M30 x 1,5 RHT
1358793, 1435746, 1488890, 1534756, 1914427, 2051166



SC-ES-8535

Length: 145
Cone Ø: d1 Ø 30 / d2 Ø 27
Thread: M30 x 1,5 RHT
1723897, 2051041



SC-RK-12366

Ø: 75 Hole Distance: 115 / 115
Thick/Height: 24
1 722 753, 2 096 392



SC-TC-12361

Length: 705 Ø: 42
Cone Ø: d1 Ø 38
Hole Distance: 115
1353445, 1464611, 1942147



SC-TC-12451

Length: 552 Ø: 46
Hole Distance: 115 / 115
1494296



SC-TC-12452

Length: 580,5 Ø: 46
Hole Distance: 115 / 115
1485759



SC-TC-12472

Length: 580 Ø: 46
Hole Distance: 115 / 115
1399182



SC-VB-12418

Length: 613,2
Ø: 46
Hole Ø 25 / 19 / 19
Hole Distance: 152 / 115 / 115
1440028, 1722582





P,G,R,T - series ...

R 440 ...	04/10 →	Track Control Arm	SC-TC-12361		Control Arm, 1st & 2nd Front Axle, for Pneumatic Suspension vehicles
	04/10 →	Track Control Arm	SC-TC-12361		Control Arm, 1st Front Axle, for Pneumatic Suspension vehicles
R 450	09/13 →	Suspension Arm Repair Kit		SC-RK-12366	for Control Arm
R 470	03/04 →	Centre Rod	SC-DL-5229		Push Rod
	03/04 →	Centre Rod	SC-DL-5354		Push Rod
	03/04 →	Centre Rod	SC-DL-5354	SC-DL-5354	Push Rod, for vehicles with Hinged Trailing Axle
	03/04 →	Centre Rod	SC-DL-8182		Push Rod
	03/04 →	Centre Rod	SC-DL-8399		Push Rod, for vehicles with Hinged Leading Axle, for vehicles with Part-Pneumatic Suspension
	03/04 →	Centre Rod	SC-DL-8553	SC-DL-8553	Push Rod, for vehicles with Hinged Leading Axle
	03/04 →	Centre Rod	SC-DL-10225		for Steering Rod
	03/04 →	Centre Rod	SC-DL-10225		Push Rod, for vehicles with Hinged Leading Axle
	03/04 →	Centre Rod	SC-DL-12342		for Steering Rod
	03/04 →	Centre Rod	SC-DL-12343		for Steering Rod
	03/04 →	Centre Rod	SC-DL-12449		Push Rod
	03/04 →	Suspension Arm Repair Kit		SC-RK-12366	for Control Arm
	03/04 →	Suspension Strut Repair Kit		DF-RK-9341	
	03/04 →	Tie Rod		SC-DL-7264	Leading Axle;for vehicles with Hinged Leading Axle
	03/04 →	Tie Rod		SC-DL-7264	Leading Axle;for vehicles with Hinged Leading Axle;Air Suspension Axle
	03/04 →	Tie Rod		SC-DL-7264	Tag Axle;for vehicles with Hinged Trailing Axle
	03/04 →	Tie Rod		SC-DL-8137	Leading Axle;for vehicles with Hinged Leading Axle
	03/04 →	Tie Rod		SC-DL-8137	Tag Axle;for vehicles with Hinged Trailing Axle
	03/04 →	Tie Rod	SC-DL-7264		
	03/04 →	Tie Rod	SC-DL-8137		Leaf Spring Axle
	03/04 →	Tie Rod	SC-DL-9457		Leaf Spring Axle
	03/04 →	Tie Rod End		MN-ES-8490	Tag Axle;for vehicles with Hinged Trailing Axle
	03/04 →	Tie Rod End	CV-ES-14162		for Steering Rod
	03/04 →	Tie Rod End	CV-ES-14162	CV-ES-14162	for Steering Rod
	03/04 →	Tie Rod End	CV-ES-14163		for Steering Rod
	03/04 →	Tie Rod End	IV-ES-12272		for Steering Rod
	03/04 →	Tie Rod End	MN-ES-8490	MN-ES-8490	for vehicles with Hinged Trailing Axle
	03/04 →	Tie Rod End	SC-ES-8517		for Push Rod
	03/04 →	Tie Rod End	SC-ES-8535		for Guide Rod
	03/04 →	Track Control Arm		SC-VB-12418	Control Arm
	03/04 →	Track Control Arm	SC-DL-10302	SC-DL-10302	Trailing Arm, Air Suspension Axle
	03/04 →	Track Control Arm	SC-TC-12361		Control Arm, 1st Front Axle, for Pneumatic Suspension vehicles
	R 480	04/04 →	Centre Rod	SC-DL-5229	
04/04 →		Centre Rod	SC-DL-5354		Push Rod
04/04 →		Centre Rod	SC-DL-5354	SC-DL-5354	Push Rod, for vehicles with Hinged Trailing Axle
04/04 →		Centre Rod	SC-DL-8182		Push Rod
04/04 →		Centre Rod	SC-DL-8399		Push Rod, for vehicles with Hinged Leading Axle, for vehicles with Part-Pneumatic Suspension
04/04 →		Centre Rod	SC-DL-8553	SC-DL-8553	Push Rod, for vehicles with Hinged Leading Axle
04/04 →		Centre Rod	SC-DL-10225		for Steering Rod
04/04 →		Centre Rod	SC-DL-10225		Push Rod, for vehicles with Hinged Leading Axle
04/04 →		Centre Rod	SC-DL-12342		for Steering Rod
04/04 →		Centre Rod	SC-DL-12343		for Steering Rod
04/04 →		Centre Rod	SC-DL-12413		for Steering Rod
04/04 →		Centre Rod	SC-DL-12449		Push Rod
04/04 →		Suspension Arm Repair Kit		SC-RK-12366	for Control Arm
04/04 →		Suspension Strut Repair Kit		DF-RK-9341	
04/04 →		Tie Rod		SC-DL-7264	Leading Axle;for vehicles with Hinged Leading Axle
04/04 →		Tie Rod		SC-DL-7264	Leading Axle;for vehicles with Hinged Leading Axle;Air Suspension Axle
04/04 →		Tie Rod		SC-DL-7264	Tag Axle;for vehicles with Hinged Trailing Axle

CV-ES-14162

Length: 125
Cone Ø: d1 Ø 30 / d2 Ø 27
Thread: M30 x 1,5 LHT
283783, 395009, 1358792, 1738380, 1 914 426, 2051165



CV-ES-14163

Length: 125
Cone Ø: d1 Ø 30 / d2 Ø 27
Thread: M30 x 1,5 RHT
283784, 395010, 1358793, 1488890, 1738381, 1767328, 1914427, 2051166



DF-RK-9341

Ø: 67
550807, 5508072



IV-ES-12272

Length: 75
Cone Ø: d1 Ø 30 / d2 Ø 27
Thread: M26 x 1,5 RHT
1394443



MN-ES-8490

Length: 90
Cone Ø: d1 Ø 30 / d2 Ø 27
Thread: M26 x 1,5 RHT
1394444, 0014606948, 14606948



SC-DL-5229

Length: 1053 Ø: 50
Cone Ø: d1 Ø 30 / d2 Ø 27
1356055, 1379071, 1384025, 1768898, 1847311, 1912757, 12201600A



SC-DL-5354

Length: 1060 Ø: 52
Cone Ø: d1 Ø 30 / d2 Ø 27
1384027, 1769597, 1847312, 1912758, 12200800A



SC-DL-7264

Length: 1743 Ø: 62
Cone Ø: d1 Ø 30 / d2 Ø 27
1361413, 1395614, 1734019, 1897333, 2040254, 2146105



SC-DL-8137

Length: 1736 Ø: 40
Cone Ø: d1 Ø 30 / d2 Ø 27
301639, 311847, 395350, 1358675, 1378435, 1397866, 1734020, 2028998, 12202900A



SC-DL-8182

1343262, 1869413



SC-DL-8399

Length: 433 Ø: 40
Cone Ø: d1 Ø 30 / d2 Ø 26
1394884, 1938387



SC-DL-8553

Length: 435 Ø: 38
Cone Ø: d1 Ø 30 / d2 Ø 27
1343283, 1759691



SC-DL-9457

Length: 1743 Ø: 52
Cone Ø: d1 Ø 30 / d2 Ø 27
1527989, 1723896, 1737684, 1897336



SC-DL-10225

Length: 2179 Ø: 62
Cone Ø: d1 Ø 30 / d2 Ø 27
1386618, 1788522



SC-DL-10302

Length: 752 Ø: 48
Hole Distance: 115 / 115
1101843, 1379423, 1393298, 1431470, 1942075



SC-DL-12342

Length: 601 Ø: 42
Cone Ø: d1 Ø 26 / d2 Ø 23,5
1343262, 1869413



SC-DL-12343

Length: 1062 Ø: 52
Cone Ø: d1 Ø 30 / d2 Ø 27
1348269, 2007275



SC-DL-12413

Length: 1950 Ø: 62
Cone Ø: d1 Ø 30 / d2 Ø 27
1393383, 1788520



SC-DL-12449

Length: 1206 Ø: 38
Cone Ø: d1 Ø 30 / d2 Ø 27
1385763, 1765375



SC-ES-8517

Length: 140
Cone Ø: d1 Ø 30 / d2 Ø 27
Thread: M30 x 1,5 RHT
1358793, 1435746, 1488890, 1534756, 1914427, 2051166



SC-ES-8535

Length: 145
Cone Ø: d1 Ø 30 / d2 Ø 27
Thread: M30 x 1,5 RHT
1723897, 2051041



SC-RK-12366

Ø: 75 Hole Distance: 115 / 115
Thick/Height: 24
1 722 753, 2 096 392



SC-TC-12361

Length: 705 Ø: 42
Cone Ø: d1 Ø 38
Hole Distance: 115
1353445, 1464611, 1942147



SC-VB-12418

Length: 613,2 Ø: 46
Hole Ø 25 / 19 / 19
Hole Distance: 152 / 115 / 115
1440028, 1722582



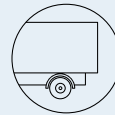

P,G,R,T - series ...

R 480 ...	04/04 →	Tie Rod		SC-DL-8137	Leading Axle;for vehicles with Hinged Leading Axle
	04/04 →	Tie Rod		SC-DL-8137	Tag Axle;for vehicles with Hinged Trailing Axle
	04/04 →	Tie Rod	SC-DL-7264		
	04/04 →	Tie Rod	SC-DL-8137		Leaf Spring Axle
	04/04 →	Tie Rod	SC-DL-9457		Leaf Spring Axle
	04/04 →	Tie Rod End		MN-ES-8490	Tag Axle;for vehicles with Hinged Trailing Axle
	04/04 →	Tie Rod End	CV-ES-14162		for Steering Rod
	04/04 →	Tie Rod End	CV-ES-14162	CV-ES-14162	for Steering Rod
	04/04 →	Tie Rod End	CV-ES-14163		for Steering Rod
	04/04 →	Tie Rod End	IV-ES-12272		for Steering Rod
	04/04 →	Tie Rod End	MN-ES-8490	MN-ES-8490	for vehicles with Hinged Trailing Axle
	04/04 →	Tie Rod End	SC-ES-8517		for Push Rod
	04/04 →	Tie Rod End	SC-ES-8535		for Guide Rod
	04/04 →	Track Control Arm		SC-TC-12452	Control Arm
	04/04 →	Track Control Arm		SC-VB-12418	Control Arm
	04/04 →	Track Control Arm	SC-DL-10302	SC-DL-10302	Trailing Arm, Air Suspension Axle
	04/04 →	Track Control Arm	SC-TC-12361		Control Arm, 1st Front Axle, for Pneumatic Suspension vehicles
	07/04 →	Suspension Arm Repair Kit	MN-RK-7280	MN-RK-7280	for Drag Link;for Semi-Trailing Arm; for Wishbone (CV)
	07/04 →	Suspension Strut Repair Kit		MN-RK-8501	
	07/04 →	Track Control Arm		SC-DL-8179	Trailing Arm, 1st & 2nd Drive Axle, for Leaf-Spring Suspension vehicles
	07/04 →	Track Control Arm		SC-DL-8179	Trailing Arm, 1st & 2nd Drive Axle, for Leaf-Spring Suspension vehicles, Ch.3512097 →
	07/04 →	Track Control Arm		SC-DL-8179	Trailing Arm, 1st Drive Axle, for Leaf-Spring Suspension vehicles, →1280184/4471602
	07/04 →	Track Control Arm		SC-DL-8179	Trailing Arm, 1st Drive Axle, for Leaf-Spring Suspension vehicles, →9069960/3536015
	07/04 →	Track Control Arm		SC-DL-8509	Trailing Arm, 1st & 2nd Drive Axle, for Leaf-Spring Suspension vehicles
	07/04 →	Track Control Arm		SC-DL-8511	Trailing Arm, 1st & 2nd Drive Axle, for Leaf-Spring Suspension vehicles
	07/04 →	Track Control Arm		SC-DL-8531	Trailing Arm, 1st & 2nd Drive Axle, for Leaf-Spring Suspension vehicles
	07/04 →	Track Control Arm		SC-DL-8547	Trailing Arm, 1st & 2nd Drive Axle, for Leaf-Spring Suspension vehicles
	07/04 →	Track Control Arm		SC-DL-8623	Trailing Arm, 1st Drive Axle, for Leaf-Spring Suspension vehicles, →2006231/5117423
	07/04 →	Track Control Arm		SC-DL-8623	Trailing Arm, 1st Drive Axle, for Leaf-Spring Suspension vehicles, →9097199/3564002
	07/04 →	Track Control Arm		SC-DL-9462	Trailing Arm, 2nd Drive Axle, for Leaf-Spring Suspension vehicles, →2006231/5117423
	07/04 →	Track Control Arm		SC-DL-9462	Trailing Arm, 2nd Drive Axle, for Leaf-Spring Suspension vehicles, →9097199/3564002
	07/04 →	Track Control Arm		SC-DL-9466	Trailing Arm, 1st & 2nd Drive Axle, for Leaf-Spring Suspension vehicles
	07/04 →	Track Control Arm		SC-TC-12451	Trailing Arm, 1st Drive Axle, for Leaf-Spring Suspension vehicles
	07/04 →	Track Control Arm		SC-TC-12451	Trailing Arm, 1st Drive Axle, for Leaf-Spring Suspension vehicles, 1280185/4471603 →
	07/04 →	Track Control Arm		SC-TC-12451	Trailing Arm, 1st Drive Axle, for Leaf-Spring Suspension vehicles, 9069961/3536016 →
	07/04 →	Track Control Arm		SC-TC-12472	Trailing Arm, 2nd Drive Axle, for Leaf-Spring Suspension vehicles, →1280184/4471602
	07/04 →	Track Control Arm		SC-TC-12472	Trailing Arm, 2nd Drive Axle, for Leaf-Spring Suspension vehicles, →9069960/3536015
	07/04 →	Track Control Arm	SC-DL-10302	SC-DL-10302	Trailing Arm, 1st Front Axle, for Pneumatic Suspension vehicles
	04/10 →	Centre Rod	SC-DL-8154	SC-DL-8154	Push Rod, for vehicles with Hinged Trailing Axle

CV-ES-14162

Length: 125
Cone Ø: d1 Ø 30 / d2 Ø 27
Thread: M30 x 1,5 LHT
283783, 395009, 1358792, 1738380, 1 914 426, 2051165



CV-ES-14163

Length: 125
Cone Ø: d1 Ø 30 / d2 Ø 27
Thread: M30 x 1,5 RHT
283784, 395010, 1358793, 1488890, 1738381, 1767328, 1914427, 2051166



IV-ES-12272

Length: 75
Cone Ø: d1 Ø 30 / d2 Ø 27
Thread: M26 x 1,5 RHT
1394443



MN-ES-8490

Length: 90
Cone Ø: d1 Ø 30 / d2 Ø 27
Thread: M26 x 1,5 RHT
1394444, 0014606948, 14606948



MN-RK-7280

Ø: 75 Hole Distance: 115
Thick/Height: 24
0550806, 550806, 639370, 0639370, 689748, 1104334



MN-RK-8501

Ø: 75 Hole Distance: 115
Thick/Height: 24
1515981



SC-DL-7264

Length: 1743 Ø: 62
Cone Ø: d1 Ø 30 / d2 Ø 27
1361413, 1395614, 1734019, 1897333, 2040254, 2146105



SC-DL-8137

Length: 1736 Ø: 40
Cone Ø: d1 Ø 30 / d2 Ø 27
301639, 311847, 395350, 1358675, 1378435, 1397866, 1734020, 2028998, 12202900A



SC-DL-8154

Length: 495 Ø: 40
Cone Ø: d1 Ø 30 / d2 Ø 27
1343266, 1759690



SC-DL-8179

Length: 568 Ø: 46
Hole Distance: 115 / 115
1399180, 1428347



SC-DL-8509

Length: 568,5 Ø: 46
Hole Distance: 115 / 115
1485758, 1486757



SC-DL-8511

Length: 616,5 Ø: 50
Hole Distance: 115 / 115
1485760, 1499478, 1722750



SC-DL-8531

Length: 522 Ø: 46
Hole Distance: 115 / 115
1486758



SC-DL-8547

Length: 568 Ø: 50
Hole Distance: 115 / 115
1499474, 1722746, 1906940



SC-DL-8623

Length: 592 Ø: 50
Hole Distance: 115 / 115
1388436, 1499476, 1722748, 1906942



SC-DL-9457

Length: 1743 Ø: 52
Cone Ø: d1 Ø 30 / d2 Ø 27
1527989, 1723896, 1737684, 1897336



SC-DL-9462

Length: 568,5 Ø: 50
Hole Distance: 115 / 115
1499475, 1500573, 1722747, 1906941



SC-DL-9466

Length: 568 Ø: 19
1486756



SC-DL-10302

Length: 752 Ø: 48
Hole Distance: 115 / 115
1101843, 1379423, 1393298, 1431470, 1942075



SC-ES-8517

Length: 140
Cone Ø: d1 Ø 30 / d2 Ø 27
Thread: M30 x 1,5 RHT
1358793, 1435746, 1488890, 1534756, 1914427, 2051166



SC-ES-8535

Length: 145
Cone Ø: d1 Ø 30 / d2 Ø 27
Thread: M30 x 1,5 RHT
1723897, 2051041



SC-TC-12361

Length: 705 Ø: 42
Cone Ø: d1 Ø 38
Hole Distance: 115
1353445, 1464611, 1942147



SC-TC-12451

Length: 552 Ø: 46
Hole Distance: 115 / 115
1494296



SC-TC-12452

Length: 580,5 Ø: 46
Hole Distance: 115 / 115
1485759



SC-TC-12472

Length: 580 Ø: 46
Hole Distance: 115 / 115
1399182



SC-VB-12418

Length: 613,2
Ø: 46
Hole Ø 25 / 19 / 19
Hole Distance: 152 / 115 / 115
1440028, 1722582





P,G,R,T - series ...

R 480 ...	04/10→	Centre Rod	SC-DL-8399		Push Rod, for vehicles with Part-Pneumatic Suspension
	04/10→	Tie Rod	SC-DL-7264		1st FA;2nd FA
	04/10→	Tie Rod	SC-DL-8137		Leaf Spring Axle;1st FA;2nd FA
	04/10→	Tie Rod	SC-DL-9457		1st FA;2nd FA;Leaf Spring Axle
	04/10→	Track Control Arm	SC-TC-12361		Control Arm, 1st & 2nd Front Axle, for Pneumatic Suspension vehicles
R 500	03/04→	Centre Rod	SC-DL-5229		Push Rod
	03/04→	Centre Rod	SC-DL-5354		Push Rod
	03/04→	Centre Rod	SC-DL-10225		for Steering Rod
	03/04→	Centre Rod	SC-DL-12342		for Steering Rod
	03/04→	Centre Rod	SC-DL-12343		for Steering Rod
	03/04→	Suspension Arm Repair Kit		CV-RK-8118	for Drag Link
	03/04→	Suspension Arm Repair Kit		SC-RK-12366	for Control Arm
	03/04→	Suspension Arm Repair Kit	SC-RK-12346	SC-RK-12346	for Control Arm
	03/04→	Suspension Strut Repair Kit		CV-RK-5311	
	03/04→	Tie Rod	SC-DL-7264		
	03/04→	Tie Rod	SC-DL-8137		Leaf Spring Axle
	03/04→	Tie Rod	SC-DL-9457		Leaf Spring Axle
	03/04→	Tie Rod End	CV-ES-14162		for Steering Rod
	03/04→	Tie Rod End	CV-ES-14163		for Steering Rod
	03/04→	Tie Rod End	SC-ES-8535		for Guide Rod
	03/04→	Track Control Arm		SC-DL-8511	Trailing Arm, Leaf Spring Axle
	03/04→	Track Control Arm		SC-DL-8511	Trailing Arm, Leaf Spring Axle, →* 3512097 *
	03/04→	Track Control Arm		SC-DL-8547	Trailing Arm, Leaf Spring Axle
	03/04→	Track Control Arm		SC-DL-9462	Trailing Arm, Leaf Spring Axle, →* 2006231 SSS **; 5117423 SNL *; * 9097199 SAN **; 3564002 SLA *
	03/04→	Track Control Arm		SC-DL-9466	Trailing Arm, Leaf Spring Axle
	03/04→	Track Control Arm		SC-TC-12451	Trailing Arm, 1st Drive Axle, for Leaf-Spring Suspension vehicles
	03/04→	Track Control Arm		SC-TC-12451	Trailing Arm, 1st Drive Axle, for Leaf-Spring Suspension vehicles, 1280185/4471603→
	03/04→	Track Control Arm		SC-TC-12451	Trailing Arm, 1st Drive Axle, for Leaf-Spring Suspension vehicles, 9069961/3536016→
	03/04→	Track Control Arm		SC-TC-12452	Control Arm
	03/04→	Track Control Arm		SC-TC-12472	Trailing Arm, 2nd Drive Axle, for Leaf-Spring Suspension vehicles, →1280184/4471602
	03/04→	Track Control Arm		SC-TC-12472	Trailing Arm, 2nd Drive Axle, for Leaf-Spring Suspension vehicles, →9069960/3536015
	03/04→	Track Control Arm		SC-VB-12418	Control Arm
	03/04→	Track Control Arm	SC-DL-8179	SC-DL-8179	Trailing Arm, Leaf Spring Axle
	03/04→	Track Control Arm	SC-DL-8509	SC-DL-8509	Trailing Arm
	03/04→	Track Control Arm	SC-DL-8509	SC-DL-8509	Trailing Arm, Leaf Spring Axle
	03/04→	Track Control Arm	SC-DL-8531	SC-DL-8531	Trailing Arm, Leaf Spring Axle
	03/04→	Track Control Arm	SC-DL-8623	SC-DL-8623	Trailing Arm, Leaf Spring Axle, →* 2006231 SSS **; 5117423 SNL *; * 9097199 SAN **; 3564002 SLA *
	03/04→	Track Control Arm	SC-DL-10302	SC-DL-10302	Trailing Arm, 1st Front Axle, for Pneumatic Suspension vehicles
	03/04→	Track Control Arm	SC-DL-10302	SC-DL-10302	Trailing Arm, Air Suspension Axle
	03/04→	Track Control Arm	SC-TC-12361		Control Arm, 1st Front Axle, for Pneumatic Suspension vehicles
	04/04→	Centre Rod	SC-DL-5354	SC-DL-5354	Push Rod, for vehicles with Hinged Trailing Axle
	04/04→	Centre Rod	SC-DL-8182		Push Rod
	04/04→	Centre Rod	SC-DL-8399		Push Rod, for vehicles with Hinged Leading Axle, for vehicles with Part-Pneumatic Suspension
	04/04→	Centre Rod	SC-DL-8553	SC-DL-8553	Push Rod, for vehicles with Hinged Leading Axle
	04/04→	Centre Rod	SC-DL-10225		Push Rod, for vehicles with Hinged Leading Axle
04/04→	Centre Rod	SC-DL-12449		Push Rod	
04/04→	Tie Rod		SC-DL-7264	Leading Axle;for vehicles with Hinged Leading Axle	

CV-ES-14162

Length: 125
Cone Ø: d1 Ø 30 / d2 Ø 27
Thread: M30 x 1,5 LHT
283783, 395009, 1358792, 1738380, 1 914 426, 2051165



CV-ES-14163

Length: 125
Cone Ø: d1 Ø 30 / d2 Ø 27
Thread: M30 x 1,5 RHT
283784, 395010, 1358793, 1488890, 1738381, 1767328, 1914427, 2051166



CV-RK-5311

638862, 0638862, 639287, 0639287, 1104335, 1953248, 81432206006, 81432206107



CV-RK-8118

Ø: 85
Hole Distance: 130
Thick/Height: 30
638862, 639287, 1104335, 1953248



SC-DL-5229

Length: 1053 Ø: 50
Cone Ø: d1 Ø 30 / d2 Ø 27
1356055, 1379071, 1384025, 1766898, 1847311, 1912757, 12201600A



SC-DL-5354

Length: 1060 Ø: 52
Cone Ø: d1 Ø 30 / d2 Ø 27
1384027, 1769597, 1847312, 1912758, 12200800A



SC-DL-7264

Length: 1743 Ø: 62
Cone Ø: d1 Ø 30 / d2 Ø 27
1361413, 1395614, 1734019, 1897333, 2040254, 2146105



SC-DL-8137

Length: 1736 Ø: 40
Cone Ø: d1 Ø 30 / d2 Ø 27
301639, 311847, 395350, 1358675, 1378435, 1397866, 1734020, 2028998, 12202900A



SC-DL-8179

Length: 568 Ø: 46
Hole Distance: 115 / 115
1399180, 1428347



SC-DL-8182

1343262, 1869413



SC-DL-8399

Length: 433 Ø: 40
Cone Ø: d1 Ø 30 / d2 Ø 26
1394884, 1938387



SC-DL-8509

Length: 568,5 Ø: 46
Hole Distance: 115 / 115
1485758, 1486757



SC-DL-8511

Length: 616,5 Ø: 50
Hole Distance: 115 / 115
1485760, 1499478, 1722750



SC-DL-8531

Length: 522 Ø: 46
Hole Distance: 115 / 115
1486758



SC-DL-8547

Length: 568 Ø: 50
Hole Distance: 115 / 115
1499474, 1722746, 1906940



SC-DL-8553

Length: 435 Ø: 38
Cone Ø: d1 Ø 30 / d2 Ø 27
1343283, 1759691



SC-DL-8623

Length: 592 Ø: 50
Hole Distance: 115 / 115
1388436, 1499476, 1722748, 1906942



SC-DL-9457

Length: 1743 Ø: 52
Cone Ø: d1 Ø 30 / d2 Ø 27
1527989, 1723896, 1737684, 1897336



SC-DL-9462

Length: 568,5 Ø: 50
Hole Distance: 115 / 115
1499475, 1500573, 1722747, 1906941



SC-DL-9466

Length: 568 Ø: 19
1486756



SC-DL-10225

Length: 2179 Ø: 62
Cone Ø: d1 Ø 30 / d2 Ø 27
1386618, 1788522



SC-DL-10302

Length: 752 Ø: 48
Hole Distance: 115 / 115
1101843, 1379423, 1393298, 1431470, 1942075



SC-DL-12342

Length: 601 Ø: 42
Cone Ø: d1 Ø 26 / d2 Ø 23,5
1343262, 1869413



SC-DL-12343

Length: 1062 Ø: 52
Cone Ø: d1 Ø 30 / d2 Ø 27
1348269, 2007275



SC-DL-12449

Length: 1206 Ø: 38
Cone Ø: d1 Ø 30 / d2 Ø 27
1385763, 1765375



SC-ES-8535

Length: 145
Cone Ø: d1 Ø 30 / d2 Ø 27
Thread: M30 x 1,5 RHT
1723897, 2051041



SC-RK-12346

Ø: 67 Hole Distance: 115
Thick/Height: 24
550800



SC-RK-12366

Ø: 75 Hole Distance: 115 / 115
Thick/Height: 24
1 722 753, 2 096 392



SC-TC-12361

Length: 705 Ø: 42
Cone Ø: d1 Ø 38
Hole Distance: 115
1353445, 1464611, 1942147



SC-TC-12451

Length: 552 Ø: 46
Hole Distance: 115 / 115
1494296



SC-TC-12452

Length: 580,5 Ø: 46
Hole Distance: 115 / 115
1485759



SC-TC-12472

Length: 580 Ø: 46
Hole Distance: 115 / 115
1399182



SC-VB-12418

Length: 613,2
Ø: 46
Hole Ø 25 / 19 / 19
Hole Distance: 152 / 115 / 115
1440028, 1722582





P,G,R,T - series ...

R 500 ...	04/04 →	Tie Rod		SC-DL-7264	Leading Axle;for vehicles with Hinged Leading Axle;Air Suspension Axle
	04/04 →	Tie Rod		SC-DL-8137	Leading Axle;for vehicles with Hinged Leading Axle
	04/04 →	Tie Rod End	CV-ES-14162	CV-ES-14162	for Steering Rod
	04/04 →	Tie Rod End	IV-ES-12272		for Steering Rod
	04/04 →	Tie Rod End	SC-ES-8517		for Push Rod
	01/08 →	Suspension Arm Repair Kit	MN-RK-7280	MN-RK-7280	for Drag Link;for Semi-Trailing Arm; for Wishbone (CV)
	01/08 →	Suspension Strut Repair Kit		MN-RK-8501	
	01/08 →	Track Control Arm		SC-DL-8509	Trailing Arm, 1st & 2nd Drive Axle, for Leaf-Spring Suspension vehicles
	01/08 →	Track Control Arm		SC-DL-8509	Trailing Arm, 1st Drive Axle, for Leaf-Spring Suspension vehicles
	01/08 →	Track Control Arm		SC-DL-8509	Trailing Arm, 1st Drive Axle, for Leaf-Spring Suspension vehicles, 1280185/4471603 →
	01/08 →	Track Control Arm		SC-DL-8511	Trailing Arm, 1st & 2nd Drive Axle, for Leaf-Spring Suspension vehicles
	01/08 →	Track Control Arm		SC-DL-8531	Trailing Arm, 1st & 2nd Drive Axle, for Leaf-Spring Suspension vehicles
	01/08 →	Track Control Arm		SC-DL-8547	Trailing Arm, for Leaf-Spring Suspension vehicles
	01/08 →	Track Control Arm		SC-DL-9462	Trailing Arm, for Leaf-Spring Suspension vehicles
	01/08 →	Track Control Arm		SC-DL-9466	Trailing Arm
	01/08 →	Track Control Arm		SC-TC-12452	Trailing Arm, 2nd Drive Axle, for Leaf-Spring Suspension vehicles, 1280185/4471603 →
	01/08 →	Track Control Arm		SC-TC-12452	Trailing Arm, 2nd Drive Axle, for Leaf-Spring Suspension vehicles, 9069961/3536016 →
	01/08 →	Track Control Arm		SC-TC-12472	Control Arm
	01/08 →	Track Control Arm	SC-DL-8179	SC-DL-8179	Trailing Arm, for Leaf-Spring Suspension vehicles
	01/08 →	Track Control Arm	SC-DL-8623	SC-DL-8623	Trailing Arm, for Leaf-Spring Suspension vehicles
R 520	07/13 →	Centre Rod	SC-DL-12449		Push Rod
	07/13 →	Suspension Arm Repair Kit		SC-RK-12366	for Control Arm
R 560	03/04 →	Centre Rod	SC-DL-5229		Push Rod
	03/04 →	Centre Rod	SC-DL-5354		Push Rod
	03/04 →	Centre Rod	SC-DL-12342		for Steering Rod
	03/04 →	Centre Rod	SC-DL-12343		for Steering Rod
	03/04 →	Suspension Arm Repair Kit		SC-RK-12366	for Control Arm
	03/04 →	Suspension Arm Repair Kit	SC-RK-12346	SC-RK-12346	for Control Arm
	03/04 →	Tie Rod	SC-DL-7264		
	03/04 →	Tie Rod	SC-DL-8137		Leaf Spring Axle
	03/04 →	Tie Rod	SC-DL-9457		Leaf Spring Axle
	03/04 →	Tie Rod End	CV-ES-14162		for Steering Rod
	03/04 →	Tie Rod End	CV-ES-14163		for Steering Rod
	03/04 →	Tie Rod End	SC-ES-8535		for Guide Rod
	03/04 →	Track Control Arm		SC-DL-8511	Trailing Arm, Leaf Spring Axle
	03/04 →	Track Control Arm		SC-DL-8511	Trailing Arm, Leaf Spring Axle, →* 3512097 *
	03/04 →	Track Control Arm		SC-DL-8547	Trailing Arm, Leaf Spring Axle
	03/04 →	Track Control Arm		SC-DL-9462	Trailing Arm, Leaf Spring Axle, →* 2006231 SSS *; * 5117423 SNL *; * 9097199 SAN *; * 3564002 SLA *
	03/04 →	Track Control Arm		SC-DL-9466	Trailing Arm, Leaf Spring Axle
	03/04 →	Track Control Arm		SC-TC-12451	Trailing Arm, 1st Drive Axle, for Leaf-Spring Suspension vehicles
	03/04 →	Track Control Arm		SC-TC-12451	Trailing Arm, 1st Drive Axle, for Leaf-Spring Suspension vehicles, 1280185/4471603 →
	03/04 →	Track Control Arm		SC-TC-12451	Trailing Arm, 1st Drive Axle, for Leaf-Spring Suspension vehicles, 9069961/3536016 →
	03/04 →	Track Control Arm		SC-TC-12452	Control Arm
	03/04 →	Track Control Arm		SC-TC-12472	Trailing Arm, 2nd Drive Axle, for Leaf-Spring Suspension vehicles, →1280184/4471602
	03/04 →	Track Control Arm		SC-TC-12472	Trailing Arm, 2nd Drive Axle, for Leaf-Spring Suspension vehicles, →9069960/3536015
	03/04 →	Track Control Arm		SC-VB-12418	Control Arm

CV-ES-14162

Length: 125
Cone Ø: d1 Ø 30 / d2 Ø 27
Thread: M30 x 1,5 LHT
283783, 395009, 1358792, 1738380, 1 914 426, 2051165



CV-ES-14163

Length: 125
Cone Ø: d1 Ø 30 / d2 Ø 27
Thread: M30 x 1,5 RHT
283784, 395010, 1358793, 1488890, 1738381, 1767328, 1914427, 2051166



IV-ES-12272

Length: 75
Cone Ø: d1 Ø 30 / d2 Ø 27
Thread: M26 x 1,5 RHT
1394443



MN-RK-7280

Ø: 75 Hole Distance: 115
Thick/Height: 24
0550806, 550806, 0639370, 639370, 689748, 1104334



MN-RK-8501

Ø: 75 Hole Distance: 115
Thick/Height: 24
1515981



SC-DL-5229

Length: 1053 Ø: 50
Cone Ø: d1 Ø 30 / d2 Ø 27
1356055, 1379071, 1384025, 1768898, 1847311, 1912757, 12201600A



SC-DL-5354

Length: 1060 Ø: 52
Cone Ø: d1 Ø 30 / d2 Ø 27
1384027, 1769597, 1847312, 1912758, 12200800A



SC-DL-7264

Length: 1743 Ø: 62
Cone Ø: d1 Ø 30 / d2 Ø 27
1361413, 1395614, 1734019, 1897333, 2040254, 2146105



SC-DL-8137

Length: 1736 Ø: 40
Cone Ø: d1 Ø 30 / d2 Ø 27
301639, 311847, 395350, 1358675, 1378435, 1397866, 1734020, 2028998, 12202900A



SC-DL-8179

Length: 568 Ø: 46
Hole Distance: 115 / 115
1399180, 1428347



SC-DL-8509

Length: 568,5 Ø: 46
Hole Distance: 115 / 115
1485758, 1486757



SC-DL-8511

Length: 616,5 Ø: 50
Hole Distance: 115 / 115
1485760, 1499478, 1722750



SC-DL-8531

Length: 522 Ø: 46
Hole Distance: 115 / 115
1486758



SC-DL-8547

Length: 568 Ø: 50
Hole Distance: 115 / 115
1499474, 1722746, 1906940



SC-DL-8623

Length: 592 Ø: 50
Hole Distance: 115 / 115
1388436, 1499476, 1722748, 1906942



SC-DL-9457

Length: 1743 Ø: 52
Cone Ø: d1 Ø 30 / d2 Ø 27
1527989, 1723896, 1737684, 1897336



SC-DL-9462

Length: 568,5 Ø: 50
Hole Distance: 115 / 115
1499475, 1500573, 1722747, 1906941



SC-DL-9466

Length: 568 Ø: 19
1486756



SC-DL-12342

Length: 601 Ø: 42
Cone Ø: d1 Ø 26 / d2 Ø 23,5
1343262, 1869413



SC-DL-12343

Length: 1062 Ø: 52
Cone Ø: d1 Ø 30 / d2 Ø 27
1348269, 2007275



SC-DL-12449

Length: 1206 Ø: 38
Cone Ø: d1 Ø 30 / d2 Ø 27
1385763, 1765375



SC-ES-8517

Length: 140
Cone Ø: d1 Ø 30 / d2 Ø 27
Thread: M30 x 1,5 RHT
1358793, 1435746, 1488890, 1534756, 1914427, 2051166



SC-ES-8535

Length: 145
Cone Ø: d1 Ø 30 / d2 Ø 27
Thread: M30 x 1,5 RHT
1723897, 2051041



SC-RK-12346

Ø: 67 Hole Distance: 115
Thick/Height: 24
550800



SC-RK-12366

Ø: 75 Hole Distance: 115 / 115
Thick/Height: 24
1 722 753, 2 096 392



SC-TC-12451

Length: 552 Ø: 46
Hole Distance: 115 / 115
1494296



SC-TC-12452

Length: 580,5 Ø: 46
Hole Distance: 115 / 115
1485759



SC-TC-12472

Length: 580 Ø: 46
Hole Distance: 115 / 115
1399182



SC-VB-12418

Length: 613,2
Ø: 46
Hole Ø 25 / 19 / 19
Hole Distance: 152 / 115 / 115
1440028, 1722582



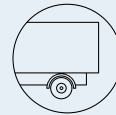

P,G,R,T - series ...

R 560 ...	03/04 →	Track Control Arm	SC-DL-8179	SC-DL-8179	Trailing Arm, Leaf Spring Axle	
	03/04 →	Track Control Arm	SC-DL-8509	SC-DL-8509	Trailing Arm	
	03/04 →	Track Control Arm	SC-DL-8509	SC-DL-8509	Trailing Arm, Leaf Spring Axle	
	03/04 →	Track Control Arm	SC-DL-8531	SC-DL-8531	Trailing Arm, Leaf Spring Axle	
	03/04 →	Track Control Arm	SC-DL-8623	SC-DL-8623	Trailing Arm, Leaf Spring Axle, →* 2006231 SSS *,* 5117423 SNL *, * 9097199 SAN *,* 3564002 SLA *	
	03/04 →	Track Control Arm	SC-DL-10302	SC-DL-10302	Trailing Arm, Air Suspension Axle	
	03/04 →	Track Control Arm	SC-TC-12361		Control Arm, 1st Front Axle, for Pneumatic Suspension vehicles	
	04/04 →	Track Control Arm		SC-DL-8179	Trailing Arm, 1st & 2nd Drive Axle, for Leaf-Spring Suspension vehicles	
	04/04 →	Track Control Arm		SC-DL-8179	Trailing Arm, 1st & 2nd Drive Axle, for Leaf-Spring Suspension vehicles, Ch.3512097 →	
	04/04 →	Track Control Arm		SC-DL-8179	Trailing Arm, 1st Drive Axle, for Leaf-Spring Suspension vehicles, →1280184/4471602	
	04/04 →	Track Control Arm		SC-DL-8179	Trailing Arm, 1st Drive Axle, for Leaf-Spring Suspension vehicles, →9069960/3536015	
	09/04 →	Centre Rod	SC-DL-2161		Coupling Rod	
	09/04 →	Centre Rod	SC-DL-8182		Push Rod	
	09/04 →	Centre Rod	SC-DL-8553		Push Rod, for vehicles with Hinged Leading Axle	
	09/04 →	Centre Rod	SC-DL-12449		Push Rod	
	09/04 →	Suspension Strut Repair Kit		DF-RK-9341		
	09/04 →	Tie Rod End	CV-ES-14162	CV-ES-14162	for Steering Rod	
	09/04 →	Tie Rod End	SC-ES-8517		for Push Rod	
	09/04 →	Track Control Arm	SC-DL-10302	SC-DL-10302	Trailing Arm, 1st Front Axle, for Pneumatic Suspension vehicles	
	09/06 →	Track Control Arm		SC-DL-8509	Trailing Arm, 1st & 2nd Drive Axle, for Leaf-Spring Suspension vehicles	
	09/06 →	Track Control Arm		SC-DL-8511	Trailing Arm, 1st & 2nd Drive Axle, for Leaf-Spring Suspension vehicles	
	09/06 →	Track Control Arm		SC-DL-8531	Trailing Arm, 1st & 2nd Drive Axle, for Leaf-Spring Suspension vehicles	
	09/06 →	Track Control Arm		SC-DL-8547	Trailing Arm, 1st & 2nd Drive Axle, for Leaf-Spring Suspension vehicles	
	09/06 →	Track Control Arm		SC-DL-8623	Trailing Arm, 1st Drive Axle, for Leaf-Spring Suspension vehicles, →2006231/5117423	
	09/06 →	Track Control Arm		SC-DL-8623	Trailing Arm, 1st Drive Axle, for Leaf-Spring Suspension vehicles, →9097199/3564002	
	09/06 →	Track Control Arm		SC-DL-9462	Trailing Arm, 2nd Drive Axle, for Leaf-Spring Suspension vehicles, →2006231/5117423	
	09/06 →	Track Control Arm		SC-DL-9462	Trailing Arm, 2nd Drive Axle, for Leaf-Spring Suspension vehicles, →9097199/3564002	
	09/06 →	Track Control Arm		SC-DL-9466	Trailing Arm, 1st & 2nd Drive Axle, for Leaf-Spring Suspension vehicles	
	R 560, P 560	07/09 →	Centre Rod	SC-DL-12342		for Steering Rod
		07/09 →	Centre Rod	SC-DL-12343		for Steering Rod
07/09 →		Suspension Arm Repair Kit		SC-RK-12366	for Control Arm	
07/09 →		Suspension Arm Repair Kit	SC-RK-12346	SC-RK-12346	for Control Arm	
07/09 →		Tie Rod End	CV-ES-14162		for Steering Rod	
07/09 →		Tie Rod End	CV-ES-14162	CV-ES-14162	for Steering Rod	
07/09 →		Tie Rod End	CV-ES-14163		for Steering Rod	
07/09 →		Tie Rod End	SC-ES-8517		for Push Rod	
07/09 →		Tie Rod End	SC-ES-8535		for Guide Rod	
07/09 →		Track Control Arm		SC-DL-8179	Trailing Arm, 1st & 2nd Drive Axle, for Leaf-Spring Suspension vehicles	
07/09 →		Track Control Arm		SC-DL-8179	Trailing Arm, 1st & 2nd Drive Axle, for Leaf-Spring Suspension vehicles, Ch.3512097 →	
07/09 →		Track Control Arm		SC-DL-8179	Trailing Arm, 1st Drive Axle, for Leaf-Spring Suspension vehicles, →1280184/4471602	

CV-ES-14162

Length: 125
Cone Ø: d1 Ø 30 / d2 Ø 27
Thread: M30 x 1,5 LHT
283783, 395009, 1358792, 1738380, 1 914 426, 2051165



CV-ES-14163

Length: 125
Cone Ø: d1 Ø 30 / d2 Ø 27
Thread: M30 x 1,5 RHT
283784, 395010, 1358793, 1488890, 1738381, 1767328, 1914427, 2051166



DF-RK-9341

Ø: 67
550807, 5508072



SC-DL-2161

Length: 1740 Ø: 50
Cone Ø: d1 Ø 30 / d2 Ø 27
1369411, 1385251, 1409918, 1501030, 1723865, 1723895, 1737683, 1897335, 2113903, 2125090, 2161883



SC-DL-8179

Length: 568 Ø: 46
Hole Distance: 115 / 115
1399180, 1428347



SC-DL-8182

1343262, 1869413



SC-DL-8509

Length: 568,5 Ø: 46
Hole Distance: 115 / 115
1485758, 1486757



SC-DL-8511

Length: 616,5 Ø: 50
Hole Distance: 115 / 115
1485760, 1499478, 1722750



SC-DL-8531

Length: 522 Ø: 46
Hole Distance: 115 / 115
1486758



SC-DL-8547

Length: 568 Ø: 50
Hole Distance: 115 / 115
1499474, 1722746, 1906940



SC-DL-8553

Length: 435 Ø: 38
Cone Ø: d1 Ø 30 / d2 Ø 27
1343283, 1759691



SC-DL-8623

Length: 592 Ø: 50
Hole Distance: 115 / 115
1388436, 1499476, 1722748, 1906942



SC-DL-9462

Length: 568,5 Ø: 50
Hole Distance: 115 / 115
1499475, 1500573, 1722747, 1906941



SC-DL-9466

Length: 568 Ø: 19
1486756



SC-DL-10302

Length: 752 Ø: 48
Hole Distance: 115 / 115
1101843, 1379423, 1393298, 1431470, 1942075



SC-DL-12342

Length: 601 Ø: 42
Cone Ø: d1 Ø 26 / d2 Ø 23,5
1343262, 1869413



SC-DL-12343

Length: 1062 Ø: 52
Cone Ø: d1 Ø 30 / d2 Ø 27
1348269, 2007275



SC-DL-12449

Length: 1206 Ø: 38
Cone Ø: d1 Ø 30 / d2 Ø 27
1385763, 1765375



SC-ES-8517

Length: 140
Cone Ø: d1 Ø 30 / d2 Ø 27
Thread: M30 x 1,5 RHT
1358793, 1435746, 1488890, 1534756, 1914427, 2051166



SC-ES-8535

Length: 145
Cone Ø: d1 Ø 30 / d2 Ø 27
Thread: M30 x 1,5 RHT
1723897, 2051041



SC-RK-12346

Ø: 67 Hole Distance: 115
Thick/Height: 24
550800



SC-RK-12366

Ø: 75 Hole Distance: 115 / 115
Thick/Height: 24
1 722 753, 2 096 392



SC-TC-12361

Length: 705 Ø: 42
Cone Ø: d1 Ø 38
Hole Distance: 115
1353445, 1464611, 1942147



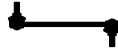

P,G,R,T - series ...

R 560, P 560 ...	07/09 →	Track Control Arm		SC-DL-8179	Trailing Arm, 1st Drive Axle, for Leaf-Spring Suspension vehicles, →9069960/3536015
	07/09 →	Track Control Arm		SC-DL-8509	Trailing Arm, 1st & 2nd Drive Axle, for Leaf-Spring Suspension vehicles
	07/09 →	Track Control Arm		SC-DL-8511	Trailing Arm, 1st & 2nd Drive Axle, for Leaf-Spring Suspension vehicles
	07/09 →	Track Control Arm		SC-DL-8531	Trailing Arm, 1st & 2nd Drive Axle, for Leaf-Spring Suspension vehicles
	07/09 →	Track Control Arm		SC-DL-8547	Trailing Arm, 1st & 2nd Drive Axle, for Leaf-Spring Suspension vehicles
	07/09 →	Track Control Arm		SC-DL-8623	Trailing Arm, 1st Drive Axle, for Leaf-Spring Suspension vehicles, →2006231/5117423
	07/09 →	Track Control Arm		SC-DL-8623	Trailing Arm, 1st Drive Axle, for Leaf-Spring Suspension vehicles, →9097199/3564002
	07/09 →	Track Control Arm		SC-DL-9462	Trailing Arm, 2nd Drive Axle, for Leaf-Spring Suspension vehicles, →2006231/5117423
	07/09 →	Track Control Arm		SC-DL-9462	Trailing Arm, 2nd Drive Axle, for Leaf-Spring Suspension vehicles, →9097199/3564002
	07/09 →	Track Control Arm		SC-DL-9466	Trailing Arm, 1st & 2nd Drive Axle, for Leaf-Spring Suspension vehicles
	07/09 →	Track Control Arm		SC-TC-12451	Trailing Arm, 1st Drive Axle, for Leaf-Spring Suspension vehicles
	07/09 →	Track Control Arm		SC-TC-12451	Trailing Arm, 1st Drive Axle, for Leaf-Spring Suspension vehicles, 1280185/4471603 →
	07/09 →	Track Control Arm		SC-TC-12451	Trailing Arm, 1st Drive Axle, for Leaf-Spring Suspension vehicles, 9069961/3536016 →
	07/09 →	Track Control Arm		SC-TC-12452	Trailing Arm, 2nd Drive Axle, for Leaf-Spring Suspension vehicles, 1280185/4471603 →
	07/09 →	Track Control Arm		SC-TC-12452	Trailing Arm, 2nd Drive Axle, for Leaf-Spring Suspension vehicles, 9069961/3536016 →
	07/09 →	Track Control Arm		SC-TC-12472	Trailing Arm, 2nd Drive Axle, for Leaf-Spring Suspension vehicles, →1280184/4471602
	07/09 →	Track Control Arm		SC-TC-12472	Trailing Arm, 2nd Drive Axle, for Leaf-Spring Suspension vehicles, →9069960/3536015
	07/09 →	Track Control Arm		SC-VB-12418	Control Arm
	07/09 →	Track Control Arm	SC-DL-10302	SC-DL-10302	Trailing Arm, 1st Front Axle, for Pneumatic Suspension vehicles
	07/09 →	Track Control Arm	SC-TC-12361		Control Arm, 1st & 2nd Front Axle, for Pneumatic Suspension vehicles
R 580	03/04 →	Centre Rod	SC-DL-5229		Push Rod
	03/04 →	Centre Rod	SC-DL-5354		Push Rod
	03/04 →	Centre Rod	SC-DL-10225		for Steering Rod
	03/04 →	Centre Rod	SC-DL-12342		for Steering Rod
	03/04 →	Centre Rod	SC-DL-12343		for Steering Rod
	03/04 →	Suspension Arm Repair Kit		SC-RK-12366	for Control Arm
	03/04 →	Suspension Arm Repair Kit	MN-RK-7280	MN-RK-7280	for Drag Link;for Semi-Trailing Arm; for Wishbone (CV)
	03/04 →	Suspension Strut Repair Kit		CV-RK-5311	
	03/04 →	Suspension Strut Repair Kit		DF-RK-9341	
	03/04 →	Suspension Strut Repair Kit		MN-RK-8501	
	03/04 →	Tie Rod	SC-DL-7264		
	03/04 →	Tie Rod	SC-DL-8137		Leaf Spring Axle
	03/04 →	Tie Rod	SC-DL-9457		Leaf Spring Axle
	03/04 →	Tie Rod End	CV-ES-14162		for Steering Rod
	03/04 →	Tie Rod End	CV-ES-14163		for Steering Rod
	03/04 →	Tie Rod End	SC-ES-8535		for Guide Rod
	03/04 →	Track Control Arm		SC-DL-8511	Trailing Arm, Leaf Spring Axle
	03/04 →	Track Control Arm		SC-DL-8511	Trailing Arm, Leaf Spring Axle, →* 3512097 *
	03/04 →	Track Control Arm		SC-DL-8547	Trailing Arm, Leaf Spring Axle
	03/04 →	Track Control Arm		SC-DL-9462	Trailing Arm, Leaf Spring Axle, →* 2006231 SSS *; * 5117423 SNL *; * 9097199 SAN *; * 3564002 SLA *
	03/04 →	Track Control Arm		SC-DL-9466	Trailing Arm, Leaf Spring Axle

CV-ES-14162

Length: 125
Cone Ø: d1 Ø 30 / d2 Ø 27
Thread: M30 x 1,5 LHT
283784, 395009, 1358792, 1738380, 1 914 426, 2051165



CV-ES-14163

Length: 125
Cone Ø: d1 Ø 30 / d2 Ø 27
Thread: M30 x 1,5 RHT
283784, 395010, 1358793, 1488890, 1738381, 1767328, 1914427, 2051166



CV-RK-5311

0638862, 638862, 0639287, 639287, 1104335, 1953248, 81432206006, 81432206107



DF-RK-9341

Ø: 67
550807, 5508072



MN-RK-7280

Ø: 75 Hole Distance: 115
Thick/Height: 24
0550806, 550806, 0639370, 639370, 689748, 1104334



MN-RK-8501

Ø: 75 Hole Distance: 115
Thick/Height: 24
1515981



SC-DL-5229

Length: 1053 Ø: 50
Cone Ø: d1 Ø 30 / d2 Ø 27
1356055, 1379071, 1384025, 1768898, 1847311, 1912757, 12201600A



SC-DL-5354

Length: 1060 Ø: 52
Cone Ø: d1 Ø 30 / d2 Ø 27
1384027, 1769597, 1847312, 1912758, 12200800A



SC-DL-7264

Length: 1743 Ø: 62
Cone Ø: d1 Ø 30 / d2 Ø 27
1361413, 1395614, 1734019, 1897333, 2040254, 2146105



SC-DL-8137

Length: 1736 Ø: 40
Cone Ø: d1 Ø 30 / d2 Ø 27
301639, 311847, 395350, 1358675, 1378435, 1397866, 1734020, 2028998, 12202900A



SC-DL-8179

Length: 568 Ø: 46
Hole Distance: 115 / 115
1399180, 1428347



SC-DL-8509

Length: 568,5 Ø: 46
Hole Distance: 115 / 115
1485758, 1486757



SC-DL-8511

Length: 616,5 Ø: 50
Hole Distance: 115 / 115
1485760, 1499478, 1722750



SC-DL-8531

Length: 522 Ø: 46
Hole Distance: 115 / 115
1486758



SC-DL-8547

Length: 568 Ø: 50
Hole Distance: 115 / 115
1499474, 1722746, 1906940



SC-DL-8623

Length: 592 Ø: 50
Hole Distance: 115 / 115
1388436, 1499476, 1722748, 1906942



SC-DL-9457

Length: 1743 Ø: 52
Cone Ø: d1 Ø 30 / d2 Ø 27
1527989, 1723896, 1737684, 1897336



SC-DL-9462

Length: 568,5 Ø: 50
Hole Distance: 115 / 115
1499475, 1500573, 1722747, 1906941



SC-DL-9466

Length: 568 Ø: 19
1486756



SC-DL-10225

Length: 2179 Ø: 62
Cone Ø: d1 Ø 30 / d2 Ø 27
1386618, 1788522



SC-DL-10302

Length: 752 Ø: 48
Hole Distance: 115 / 115
1101843, 1379423, 1393298, 1431470, 1942075



SC-DL-12342

Length: 601 Ø: 42
Cone Ø: d1 Ø 26 / d2 Ø 23,5
1343262, 1869413



SC-DL-12343

Length: 1062 Ø: 52
Cone Ø: d1 Ø 30 / d2 Ø 27
1348269, 2007275



SC-ES-8535

Length: 145
Cone Ø: d1 Ø 30 / d2 Ø 27
Thread: M30 x 1,5 RHT
1723897, 2051041



SC-RK-12366

Ø: 75 Hole Distance: 115 / 115
Thick/Height: 24
1 722 753, 2 096 392



SC-TC-12361

Length: 705 Ø: 42
Cone Ø: d1 Ø 38
Hole Distance: 115
1353445, 1464611, 1942147



SC-TC-12451

Length: 552 Ø: 46
Hole Distance: 115 / 115
1494296



SC-TC-12452

Length: 580,5 Ø: 46
Hole Distance: 115 / 115
1485759



SC-TC-12472

Length: 580 Ø: 46
Hole Distance: 115 / 115
1399182



SC-VB-12418

Length: 613,2
Ø: 46
Hole Ø 25 / 19 / 19
Hole Distance: 152 / 115 / 115
1440028, 1722582



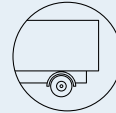

P,G,R,T - series ...

R 580 ...	03/04 →	Track Control Arm		SC-TC-12451	Trailing Arm, 1st Drive Axle, for Leaf-Spring Suspension vehicles	
	03/04 →	Track Control Arm		SC-TC-12451	Trailing Arm, 1st Drive Axle, for Leaf-Spring Suspension vehicles, 1280185/4471603 →	
	03/04 →	Track Control Arm		SC-TC-12451	Trailing Arm, 1st Drive Axle, for Leaf-Spring Suspension vehicles, 9069961/3536016 →	
	03/04 →	Track Control Arm		SC-TC-12452	Control Arm	
	03/04 →	Track Control Arm		SC-TC-12472	Trailing Arm, 2nd Drive Axle, for Leaf-Spring Suspension vehicles, →1280184/4471602	
	03/04 →	Track Control Arm		SC-TC-12472	Trailing Arm, 2nd Drive Axle, for Leaf-Spring Suspension vehicles, →9069960/3536015	
	03/04 →	Track Control Arm		SC-VB-12418	Control Arm	
	03/04 →	Track Control Arm	SC-DL-8179	SC-DL-8179	Trailing Arm, Leaf Spring Axle	
	03/04 →	Track Control Arm	SC-DL-8509	SC-DL-8509	Trailing Arm	
	03/04 →	Track Control Arm	SC-DL-8509	SC-DL-8509	Trailing Arm, Leaf Spring Axle	
	03/04 →	Track Control Arm	SC-DL-8531	SC-DL-8531	Trailing Arm, Leaf Spring Axle	
	03/04 →	Track Control Arm	SC-DL-8623	SC-DL-8623	Trailing Arm, Leaf Spring Axle, →* 2006231 SSS *; * 5117423 SNL *; * 9097199 SAN *; * 3564002 SLA *	
	03/04 →	Track Control Arm	SC-DL-10302	SC-DL-10302	Trailing Arm, Air Suspension Axle	
	03/04 →	Track Control Arm	SC-TC-12361		Control Arm, 1st Front Axle, for Pneumatic Suspension vehicles	
	04/04 →	Centre Rod	SC-DL-5354	SC-DL-5354	Push Rod, for vehicles with Hinged Trailing Axle	
	04/04 →	Centre Rod	SC-DL-8182		Push Rod	
	04/04 →	Centre Rod	SC-DL-8399		Push Rod, for vehicles with Hinged Leading Axle, for vehicles with Part-Pneumatic Suspension	
	04/04 →	Centre Rod	SC-DL-8553	SC-DL-8553	Push Rod, for vehicles with Hinged Leading Axle	
	04/04 →	Centre Rod	SC-DL-10225		Push Rod, for vehicles with Hinged Leading Axle	
	04/04 →	Centre Rod	SC-DL-12449		Push Rod	
	04/04 →	Tie Rod		SC-DL-7264	Leading Axle;for vehicles with Hinged Leading Axle	
	04/04 →	Tie Rod		SC-DL-7264	Leading Axle;for vehicles with Hinged Leading Axle;Air Suspension Axle	
	04/04 →	Tie Rod		SC-DL-8137	Leading Axle;for vehicles with Hinged Leading Axle	
	04/04 →	Tie Rod End	CV-ES-14162	CV-ES-14162	for Steering Rod	
	04/04 →	Tie Rod End	SC-ES-8517		for Push Rod	
	R 580, P 580	07/09 →	Centre Rod	SC-DL-12342		for Steering Rod
		07/09 →	Centre Rod	SC-DL-12343		for Steering Rod
		07/09 →	Suspension Arm Repair Kit		SC-RK-12366	for Control Arm
		07/09 →	Suspension Arm Repair Kit	SC-RK-12346	SC-RK-12346	for Control Arm
		07/09 →	Tie Rod End	CV-ES-14162		for Steering Rod
07/09 →		Tie Rod End	CV-ES-14163		for Steering Rod	
07/09 →		Tie Rod End	SC-ES-8517		for Push Rod	
07/09 →		Tie Rod End	SC-ES-8535		for Guide Rod	
07/09 →		Track Control Arm		SC-DL-8179	Trailing Arm, 1st & 2nd Drive Axle, for Leaf-Spring Suspension vehicles	
07/09 →		Track Control Arm		SC-DL-8179	Trailing Arm, 1st & 2nd Drive Axle, for Leaf-Spring Suspension vehicles, Ch.3512097 →	
07/09 →		Track Control Arm		SC-DL-8179	Trailing Arm, 1st Drive Axle, for Leaf-Spring Suspension vehicles, →1280184/4471602	
07/09 →		Track Control Arm		SC-DL-8179	Trailing Arm, 1st Drive Axle, for Leaf-Spring Suspension vehicles, →9069960/3536015	
07/09 →		Track Control Arm		SC-DL-8509	Trailing Arm, 1st & 2nd Drive Axle, for Leaf-Spring Suspension vehicles	
07/09 →		Track Control Arm		SC-DL-8511	Trailing Arm, 1st & 2nd Drive Axle, for Leaf-Spring Suspension vehicles	
07/09 →		Track Control Arm		SC-DL-8531	Trailing Arm, 1st & 2nd Drive Axle, for Leaf-Spring Suspension vehicles	
07/09 →	Track Control Arm		SC-DL-8547	Trailing Arm, 1st & 2nd Drive Axle, for Leaf-Spring Suspension vehicles		

CV-ES-14162

Length: 125
Cone Ø: d1 Ø 30 / d2 Ø 27
Thread: M30 x 1,5 LHT
283783, 395009, 1358792, 1738380, 1 914 426, 2051165



CV-ES-14163

Length: 125
Cone Ø: d1 Ø 30 / d2 Ø 27
Thread: M30 x 1,5 RHT
283784, 395010, 1358793, 1488890, 1738381, 1767328, 1914427, 2051166



SC-DL-5354

Length: 1060 Ø: 52
Cone Ø: d1 Ø 30 / d2 Ø 27
1384027, 1769597, 1847312, 1912758, 12200800A



SC-DL-7264

Length: 1743 Ø: 62
Cone Ø: d1 Ø 30 / d2 Ø 27
1361413, 1395614, 1734019, 1897333, 2040254, 2146105



SC-DL-8137

Length: 1736 Ø: 40
Cone Ø: d1 Ø 30 / d2 Ø 27
301639, 311847, 395350, 1358675, 1378435, 1397866, 1734020, 2028998, 12202900A



SC-DL-8179

Length: 568 Ø: 46
Hole Distance: 115 / 115
1399180, 1428347



SC-DL-8182

1343262, 1869413



SC-DL-8399

Length: 433 Ø: 40
Cone Ø: d1 Ø 30 / d2 Ø 26
1394884, 1938387



SC-DL-8509

Length: 568,5 Ø: 46
Hole Distance: 115 / 115
1485758, 1486757



SC-DL-8511

Length: 616,5 Ø: 50
Hole Distance: 115 / 115
1485760, 1499478, 1722750



SC-DL-8531

Length: 522 Ø: 46
Hole Distance: 115 / 115
1486758



SC-DL-8547

Length: 568 Ø: 50
Hole Distance: 115 / 115
1499474, 1722746, 1906940



SC-DL-8553

Length: 435 Ø: 38
Cone Ø: d1 Ø 30 / d2 Ø 27
1343283, 1759691



SC-DL-8623

Length: 592 Ø: 50
Hole Distance: 115 / 115
1388436, 1499476, 1722748, 1906942



SC-DL-10225

Length: 2179 Ø: 62
Cone Ø: d1 Ø 30 / d2 Ø 27
1386618, 1788522



SC-DL-10302

Length: 752 Ø: 48
Hole Distance: 115 / 115
1101843, 1379423, 1393298, 1431470, 1942075



SC-DL-12342

Length: 601 Ø: 42
Cone Ø: d1 Ø 26 / d2 Ø 23,5
1343262, 1869413



SC-DL-12343

Length: 1062 Ø: 52
Cone Ø: d1 Ø 30 / d2 Ø 27
1348269, 2007275



SC-DL-12449

Length: 1206 Ø: 38
Cone Ø: d1 Ø 30 / d2 Ø 27
1385763, 1765375



SC-ES-8517

Length: 140
Cone Ø: d1 Ø 30 / d2 Ø 27
Thread: M30 x 1,5 RHT
1358793, 1435746, 1488890, 1534756, 1914427, 2051166



SC-ES-8535

Length: 145
Cone Ø: d1 Ø 30 / d2 Ø 27
Thread: M30 x 1,5 RHT
1723897, 2051041



SC-RK-12346

Ø: 67 Hole Distance: 115
Thick/Height: 24
550800



SC-RK-12366

Ø: 75 Hole Distance: 115 / 115
Thick/Height: 24
1 722 753, 2 096 392



SC-TC-12361

Length: 705 Ø: 42
Cone Ø: d1 Ø 38
Hole Distance: 115
1353445, 1464611, 1942147



SC-TC-12451

Length: 552 Ø: 46
Hole Distance: 115 / 115
1494296



SC-TC-12452

Length: 580,5 Ø: 46
Hole Distance: 115 / 115
1485759



SC-TC-12472

Length: 580 Ø: 46
Hole Distance: 115 / 115
1399182



SC-VB-12418

Length: 613,2
Ø: 46
Hole Ø 25 / 19 / 19
Hole Distance: 152 / 115 / 115
1440028, 1722582





P,G,R,T - series ...

R 580, P 580 ...	07/09 →	Track Control Arm		SC-DL-8623	Trailing Arm, 1st Drive Axle, for Leaf-Spring Suspension vehicles, →2006231/5117423
	07/09 →	Track Control Arm		SC-DL-8623	Trailing Arm, 1st Drive Axle, for Leaf-Spring Suspension vehicles, →9097199/3564002
	07/09 →	Track Control Arm		SC-DL-9462	Trailing Arm, 2nd Drive Axle, for Leaf-Spring Suspension vehicles, →2006231/5117423
	07/09 →	Track Control Arm		SC-DL-9462	Trailing Arm, 2nd Drive Axle, for Leaf-Spring Suspension vehicles, →9097199/3564002
	07/09 →	Track Control Arm		SC-DL-9466	Trailing Arm, 1st & 2nd Drive Axle, for Leaf-Spring Suspension vehicles
	07/09 →	Track Control Arm		SC-TC-12451	Trailing Arm, 1st Drive Axle, for Leaf-Spring Suspension vehicles
	07/09 →	Track Control Arm		SC-TC-12451	Trailing Arm, 1st Drive Axle, for Leaf-Spring Suspension vehicles, 1280185/4471603 →
	07/09 →	Track Control Arm		SC-TC-12451	Trailing Arm, 1st Drive Axle, for Leaf-Spring Suspension vehicles, 9069961/3536016 →
	07/09 →	Track Control Arm		SC-TC-12452	Trailing Arm, 2nd Drive Axle, for Leaf-Spring Suspension vehicles, 1280185/4471603 →
	07/09 →	Track Control Arm		SC-TC-12452	Trailing Arm, 2nd Drive Axle, for Leaf-Spring Suspension vehicles, 9069961/3536016 →
	07/09 →	Track Control Arm		SC-TC-12472	Trailing Arm, 2nd Drive Axle, for Leaf-Spring Suspension vehicles, →1280184/4471602
	07/09 →	Track Control Arm		SC-TC-12472	Trailing Arm, 2nd Drive Axle, for Leaf-Spring Suspension vehicles, →9069960/3536015
	07/09 →	Track Control Arm		SC-VB-12418	Control Arm
R 620	03/04 →	Centre Rod	SC-DL-5229		Push Rod
	03/04 →	Centre Rod	SC-DL-5354		Push Rod
	03/04 →	Centre Rod	SC-DL-8154		Push Rod
	03/04 →	Centre Rod	SC-DL-8169		Push Rod
	03/04 →	Centre Rod	SC-DL-8182		Push Rod
	03/04 →	Centre Rod	SC-DL-8399		Push Rod, Leaf Spring Axle
	03/04 →	Centre Rod	SC-DL-10225		for Steering Rod
	03/04 →	Centre Rod	SC-DL-12341		Push Rod
	03/04 →	Centre Rod	SC-DL-12342		for Steering Rod
	03/04 →	Centre Rod	SC-DL-12343		for Steering Rod
	03/04 →	Suspension Arm Repair Kit		SC-RK-12366	for Control Arm
	03/04 →	Suspension Arm Repair Kit	SC-RK-12346	SC-RK-12346	for Control Arm
	03/04 →	Tie Rod	SC-DL-7264		
	03/04 →	Tie Rod	SC-DL-7264		1st FA;2nd FA
	03/04 →	Tie Rod	SC-DL-8137		Leaf Spring Axle
	03/04 →	Tie Rod	SC-DL-8137		Leaf Spring Axle;1st FA;2nd FA
	03/04 →	Tie Rod	SC-DL-9457		1st FA;2nd FA;Leaf Spring Axle
	03/04 →	Tie Rod	SC-DL-9457		Leaf Spring Axle
	03/04 →	Tie Rod End	CV-ES-14162		for Steering Rod
	03/04 →	Tie Rod End	CV-ES-14162	CV-ES-14162	for Steering Rod
	03/04 →	Tie Rod End	CV-ES-14163		for Steering Rod
	03/04 →	Tie Rod End	SC-ES-5764		
	03/04 →	Tie Rod End	SC-ES-8517		for Push Rod
	03/04 →	Tie Rod End	SC-ES-8535		for Guide Rod
	03/04 →	Track Control Arm		SC-DL-8511	Trailing Arm, Leaf Spring Axle
	03/04 →	Track Control Arm		SC-DL-8511	Trailing Arm, Leaf Spring Axle, →* 3512097 *
	03/04 →	Track Control Arm		SC-DL-8547	Trailing Arm, Leaf Spring Axle
	03/04 →	Track Control Arm		SC-DL-9462	Trailing Arm, Leaf Spring Axle, →* 2006231 SSS *; * 5117423 SNL *; * 9097199 SAN *; * 3564002 SLA *
	03/04 →	Track Control Arm		SC-DL-9466	Trailing Arm, Leaf Spring Axle
	03/04 →	Track Control Arm		SC-TC-12451	Trailing Arm, 1st Drive Axle, for Leaf-Spring Suspension vehicles
	03/04 →	Track Control Arm		SC-TC-12451	Trailing Arm, 1st Drive Axle, for Leaf-Spring Suspension vehicles, 1280185/4471603 →
	03/04 →	Track Control Arm		SC-TC-12451	Trailing Arm, 1st Drive Axle, for Leaf-Spring Suspension vehicles, 9069961/3536016 →
	03/04 →	Track Control Arm		SC-TC-12452	Control Arm

CV-ES-14162

Length: 125
Cone Ø: d1 Ø 30 / d2 Ø 27
Thread: M30 x 1,5 LHT
283783, 395009, 1358792, 1738380, 1 914 426, 2051165



CV-ES-14163

Length: 125
Cone Ø: d1 Ø 30 / d2 Ø 27
Thread: M30 x 1,5 RHT
283784, 395010, 1358793, 1488890, 1738381, 1767328, 1914427, 2051166



SC-DL-5229

Length: 1053 Ø: 50
Cone Ø: d1 Ø 30 / d2 Ø 27
1356055, 1379071, 1384025, 1768898, 1847311, 1912757, 12201600A



SC-DL-5354

Length: 1060 Ø: 52
Cone Ø: d1 Ø 30 / d2 Ø 27
1384027, 1769597, 1847312, 1912758, 12200800A



SC-DL-7264

Length: 1743 Ø: 62
Cone Ø: d1 Ø 30 / d2 Ø 27
1361413, 1395614, 1734019, 1897333, 2040254, 2146105



SC-DL-8137

Length: 1736 Ø: 40
Cone Ø: d1 Ø 30 / d2 Ø 27
301639, 311847, 395350, 1358675, 1378435, 1397866, 1734020, 2028998, 12202900A



SC-DL-8154

Length: 495 Ø: 40
Cone Ø: d1 Ø 30 / d2 Ø 27
1343266, 1759690



SC-DL-8169

Length: 1920 Ø: 62
Cone Ø: d1 Ø 30 / d2 Ø 27
1343264, 1732635, 2007278



SC-DL-8182

1343262, 1869413



SC-DL-8399

Length: 433 Ø: 40
Cone Ø: d1 Ø 30 / d2 Ø 26
1394884, 1938387



SC-DL-8511

Length: 616,5 Ø: 50
Hole Distance: 115 / 115
1485760, 1499478, 1722750



SC-DL-8547

Length: 568 Ø: 50
Hole Distance: 115 / 115
1499474, 1722746, 1906940



SC-DL-8623

Length: 592 Ø: 50
Hole Distance: 115 / 115
1388436, 1499476, 1722748, 1906942



SC-DL-9457

Length: 1743 Ø: 52
Cone Ø: d1 Ø 30 / d2 Ø 27
1527989, 1723896, 1737684, 1897336



SC-DL-9462

Length: 568,5 Ø: 50
Hole Distance: 115 / 115
1499475, 1500573, 1722747, 1906941



SC-DL-9466

Length: 568 Ø: 19
1486756



SC-DL-10225

Length: 2179 Ø: 62
Cone Ø: d1 Ø 30 / d2 Ø 27
1386618, 1788522



SC-DL-12341

Length: 1776 Ø: 62
Cone Ø: d1 Ø 30 / d2 Ø 27
1386620



SC-DL-12342

Length: 601 Ø: 42
Cone Ø: d1 Ø 26 / d2 Ø 23,5
1343262, 1869413



SC-DL-12343

Length: 1062 Ø: 52
Cone Ø: d1 Ø 30 / d2 Ø 27
1348269, 2007275



SC-ES-5764

Length: 95
Cone Ø: d1 Ø 30 / d2 Ø 27
Thread: M26 x 1,5 RHT
325614, 1375228, 4604948



SC-ES-8517

Length: 140
Cone Ø: d1 Ø 30 / d2 Ø 27
Thread: M30 x 1,5 RHT
1358793, 1435746, 1488890, 1534756, 1914427, 2051166



SC-ES-8535

Length: 145
Cone Ø: d1 Ø 30 / d2 Ø 27
Thread: M30 x 1,5 RHT
1723897, 2051041



SC-RK-12346

Ø: 67 Hole Distance: 115
Thick/Height: 24
550800



SC-RK-12366

Ø: 75 Hole Distance: 115 / 115
Thick/Height: 24
1 722 753, 2 096 392



SC-TC-12451

Length: 552 Ø: 46
Hole Distance: 115 / 115
1494296



SC-TC-12452

Length: 580,5 Ø: 46
Hole Distance: 115 / 115
1485759



SC-TC-12472

Length: 580 Ø: 46
Hole Distance: 115 / 115
1399182



SC-VB-12418

Length: 613,2
Ø: 46
Hole Ø 25 / 19 / 19
Hole Distance: 152 / 115 / 115
1440028, 1722582



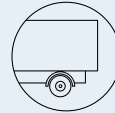

P,G,R,T - series ...

R 620 ...	03/04 →	Track Control Arm		SC-TC-12472	Trailing Arm, 2nd Drive Axle, for Leaf-Spring Suspension vehicles, →1280184/4471602
	03/04 →	Track Control Arm		SC-TC-12472	Trailing Arm, 2nd Drive Axle, for Leaf-Spring Suspension vehicles, →9069960/3536015
	03/04 →	Track Control Arm		SC-VB-12418	Control Arm
	03/04 →	Track Control Arm	SC-DL-8179	SC-DL-8179	Trailing Arm, Leaf Spring Axle
	03/04 →	Track Control Arm	SC-DL-8509	SC-DL-8509	Trailing Arm
	03/04 →	Track Control Arm	SC-DL-8509	SC-DL-8509	Trailing Arm, Leaf Spring Axle
	03/04 →	Track Control Arm	SC-DL-8531	SC-DL-8531	Trailing Arm, Leaf Spring Axle
	03/04 →	Track Control Arm	SC-DL-8623	SC-DL-8623	Trailing Arm, Leaf Spring Axle, →* 2006231 SSS *;* 5117423 SNL *; * 9097199 SAN *;* 3564002 SLA *
	03/04 →	Track Control Arm	SC-DL-10302	SC-DL-10302	Trailing Arm, Air Suspension Axle
	03/04 →	Track Control Arm	SC-DL-10302	SC-DL-10302	Trailing Arm, Air Suspension Axle;1st FA
	03/04 →	Track Control Arm	SC-TC-12361		Control Arm, 1st & 2nd Front Axle, for Pneumatic Suspension vehicles
	03/04 →	Track Control Arm	SC-TC-12361		Control Arm, 1st Front Axle, for Pneumatic Suspension vehicles
	10/04 →	Track Control Arm		SC-DL-8179	Trailing Arm, 1st & 2nd Drive Axle, for Leaf-Spring Suspension vehicles
	10/04 →	Track Control Arm		SC-DL-8179	Trailing Arm, 1st & 2nd Drive Axle, for Leaf-Spring Suspension vehicles, Ch.3512097→
	10/04 →	Track Control Arm		SC-DL-8179	Trailing Arm, 1st Drive Axle, for Leaf-Spring Suspension vehicles, →1280184/4471602
	10/04 →	Track Control Arm		SC-DL-8179	Trailing Arm, 1st Drive Axle, for Leaf-Spring Suspension vehicles, →9069960/3536015
	10/04 →	Track Control Arm		SC-DL-8509	Trailing Arm, 1st & 2nd Drive Axle, for Leaf-Spring Suspension vehicles
	10/04 →	Track Control Arm		SC-DL-8511	Trailing Arm, 1st & 2nd Drive Axle, for Leaf-Spring Suspension vehicles
	10/04 →	Track Control Arm		SC-DL-8531	Trailing Arm, 1st & 2nd Drive Axle, for Leaf-Spring Suspension vehicles
	10/04 →	Track Control Arm		SC-DL-8547	Trailing Arm, 1st & 2nd Drive Axle, for Leaf-Spring Suspension vehicles
	10/04 →	Track Control Arm		SC-DL-8623	Trailing Arm, 1st Drive Axle, for Leaf-Spring Suspension vehicles, →2006231/5117423
	10/04 →	Track Control Arm		SC-DL-8623	Trailing Arm, 1st Drive Axle, for Leaf-Spring Suspension vehicles, →9097199/3564002
	10/04 →	Track Control Arm		SC-DL-9462	Trailing Arm, 2nd Drive Axle, for Leaf-Spring Suspension vehicles, →2006231/5117423
	10/04 →	Track Control Arm		SC-DL-9462	Trailing Arm, 2nd Drive Axle, for Leaf-Spring Suspension vehicles, →9097199/3564002
	10/04 →	Track Control Arm		SC-DL-9466	Trailing Arm, 1st & 2nd Drive Axle, for Leaf-Spring Suspension vehicles
	10/04 →	Track Control Arm	SC-DL-10302	SC-DL-10302	Trailing Arm, 1st Front Axle, for Pneumatic Suspension vehicles
	09/05 →	Centre Rod	SC-DL-5354	SC-DL-5354	Push Rod, for vehicles with Hinged Trailing Axle
	09/05 →	Centre Rod	SC-DL-8399		Push Rod, for vehicles with Hinged Leading Axle, for vehicles with Part-Pneumatic Suspension
	09/05 →	Centre Rod	SC-DL-10225		Push Rod, for vehicles with Hinged Leading Axle
	09/05 →	Centre Rod	SC-DL-12449		Push Rod
	09/05 →	Tie Rod		SC-DL-7264	Leading Axle;for vehicles with Hinged Leading Axle
	09/05 →	Tie Rod		SC-DL-7264	Leading Axle;for vehicles with Hinged Leading Axle;Air Suspension Axle
	09/05 →	Tie Rod		SC-DL-7264	Tag Axle;for vehicles with Hinged Trailing Axle
	09/05 →	Tie Rod		SC-DL-8137	Leading Axle;for vehicles with Hinged Leading Axle
	09/05 →	Tie Rod		SC-DL-8137	Tag Axle;for vehicles with Hinged Trailing Axle
	09/05 →	Tie Rod End		MN-ES-8490	Tag Axle;for vehicles with Hinged Trailing Axle
	09/05 →	Tie Rod End	IV-ES-12272		for Steering Rod
	09/05 →	Tie Rod End	MN-ES-8490	MN-ES-8490	for vehicles with Hinged Trailing Axle

IV-ES-12272

Length: 75
Cone Ø: d1 Ø 30 / d2 Ø 27
Thread: M26 x 1,5 RHT
1394443



MN-ES-8490

Length: 90
Cone Ø: d1 Ø 30 / d2 Ø 27
Thread: M26 x 1,5 RHT
1394444, 0014606948, 14606948



SC-DL-5354

Length: 1060 Ø: 52
Cone Ø: d1 Ø 30 / d2 Ø 27
1384027, 1769597, 1847312, 1912758,
12200800A



SC-DL-7264

Length: 1743 Ø: 62
Cone Ø: d1 Ø 30 / d2 Ø 27
1361413, 1395614, 1734019, 1897333,
2040254, 2146105



SC-DL-8137

Length: 1736 Ø: 40
Cone Ø: d1 Ø 30 / d2 Ø 27
301639, 311847, 395350, 1358675,
1378435, 1397866, 1734020, 2028998,
12202900A



SC-DL-8179

Length: 568 Ø: 46
Hole Distance: 115 / 115
1399180, 1428347



SC-DL-8399

Length: 433 Ø: 40
Cone Ø: d1 Ø 30 / d2 Ø 26
1394884, 1938387



SC-DL-8509

Length: 568,5 Ø: 46
Hole Distance: 115 / 115
1485758, 1486757



SC-DL-8511

Length: 616,5 Ø: 50
Hole Distance: 115 / 115
1485760, 1499478, 1722750



SC-DL-8531

Length: 522 Ø: 46
Hole Distance: 115 / 115
1486758



SC-DL-8547

Length: 568 Ø: 50
Hole Distance: 115 / 115
1499474, 1722746, 1906940



SC-DL-8623

Length: 592 Ø: 50
Hole Distance: 115 / 115
1388436, 1499476, 1722748, 1906942



SC-DL-9462

Length: 568,5 Ø: 50
Hole Distance: 115 / 115
1499475, 1500573, 1722747, 1906941



SC-DL-9466

Length: 568 Ø: 19
1486756



SC-DL-10225

Length: 2179 Ø: 62
Cone Ø: d1 Ø 30 / d2 Ø 27
1386618, 1788522



SC-DL-10302

Length: 752 Ø: 48
Hole Distance: 115 / 115
1101843, 1379423, 1393298, 1431470,
1942075



SC-DL-12449

Length: 1206 Ø: 38
Cone Ø: d1 Ø 30 / d2 Ø 27
1385763, 1765375



SC-TC-12361

Length: 705 Ø: 42
Cone Ø: d1 Ø 38
Hole Distance: 115
1353445, 1464611, 1942147



SC-TC-12472

Length: 580 Ø: 46
Hole Distance: 115 / 115
1399182



SC-VB-12418

Length: 613,2
Ø: 46
Hole Ø 25 / 19 / 19
Hole Distance: 152 / 115 / 115
1440028, 1722582



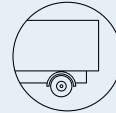

P,G,R,T - series ...

R 620 ...	11/06→	Suspension Arm Repair Kit	MN-RK-7280	MN-RK-7280	for Drag Link;for Semi-Trailing Arm; for Wishbone (CV)	
	11/06→	Suspension Strut Repair Kit		DF-RK-9341		
	11/06→	Suspension Strut Repair Kit		MN-RK-8501		
	11/06→	Track Control Arm		SC-DL-8509	Trailing Arm, 1st Drive Axle, for Leaf-Spring Suspension vehicles	
	11/06→	Track Control Arm		SC-DL-8509	Trailing Arm, 1st Drive Axle, for Leaf-Spring Suspension vehicles, 1280185/4471603→	
	11/06→	Track Control Arm		SC-DL-8547	Trailing Arm, for Leaf-Spring Suspension vehicles	
	11/06→	Track Control Arm		SC-DL-9462	Trailing Arm, for Leaf-Spring Suspension vehicles	
	11/06→	Track Control Arm		SC-DL-9466	Trailing Arm	
	11/06→	Track Control Arm		SC-TC-12452	Trailing Arm, 2nd Drive Axle, for Leaf-Spring Suspension vehicles, 1280185/4471603→	
	11/06→	Track Control Arm		SC-TC-12452	Trailing Arm, 2nd Drive Axle, for Leaf-Spring Suspension vehicles, 9069961/3536016→	
	11/06→	Track Control Arm		SC-TC-12472	Control Arm	
	11/06→	Track Control Arm	SC-DL-8179	SC-DL-8179	Trailing Arm, for Leaf-Spring Suspension vehicles	
	11/06→	Track Control Arm	SC-DL-8623	SC-DL-8623	Trailing Arm, for Leaf-Spring Suspension vehicles	
	R 730	04/10→	Centre Rod	SC-DL-2161		Coupling Rod
		04/10→	Centre Rod	SC-DL-5229		Push Rod
04/10→		Centre Rod	SC-DL-5354		Push Rod	
04/10→		Centre Rod	SC-DL-8154		Push Rod	
04/10→		Centre Rod	SC-DL-8182		Push Rod	
04/10→		Centre Rod	SC-DL-12342		for Steering Rod	
04/10→		Centre Rod	SC-DL-12343		for Steering Rod	
04/10→		Suspension Arm Repair Kit		SC-RK-12366	for Control Arm	
04/10→		Suspension Arm Repair Kit	MN-RK-7280	MN-RK-7280	for Drag Link;for Semi-Trailing Arm; for Wishbone (CV)	
04/10→		Suspension Strut Repair Kit		DF-RK-9341		
04/10→		Suspension Strut Repair Kit		MN-RK-8501		
04/10→		Tie Rod	SC-DL-7264			
04/10→		Tie Rod	SC-DL-8137		Leaf Spring Axle	
04/10→		Tie Rod	SC-DL-9457		Leaf Spring Axle	
04/10→		Tie Rod End	CV-ES-14162		for Steering Rod	
04/10→		Tie Rod End	CV-ES-14162	CV-ES-14162	for Steering Rod	
04/10→		Tie Rod End	CV-ES-14163		for Steering Rod	
04/10→		Tie Rod End	SC-ES-8517		for Push Rod	
04/10→		Tie Rod End	SC-ES-8535		for Guide Rod	
04/10→		Track Control Arm		SC-DL-8179	Trailing Arm, 1st & 2nd Drive Axle, for Leaf-Spring Suspension vehicles	
04/10→		Track Control Arm		SC-DL-8179	Trailing Arm, 1st & 2nd Drive Axle, for Leaf-Spring Suspension vehicles, Ch.3512097→	
04/10→		Track Control Arm		SC-DL-8179	Trailing Arm, 1st Drive Axle, for Leaf-Spring Suspension vehicles, →1280184/4471602	
04/10→		Track Control Arm		SC-DL-8179	Trailing Arm, 1st Drive Axle, for Leaf-Spring Suspension vehicles, →9069960/3536015	
04/10→		Track Control Arm		SC-DL-8509	Trailing Arm, 1st & 2nd Drive Axle, for Leaf-Spring Suspension vehicles	
04/10→		Track Control Arm		SC-DL-8509	Trailing Arm, 1st Drive Axle, for Leaf-Spring Suspension vehicles	
04/10→		Track Control Arm		SC-DL-8509	Trailing Arm, 1st Drive Axle, for Leaf-Spring Suspension vehicles, 1280185/4471603→	
04/10→		Track Control Arm		SC-DL-8511	Trailing Arm, 1st & 2nd Drive Axle, for Leaf-Spring Suspension vehicles	
04/10→		Track Control Arm		SC-DL-8511	Trailing Arm, Leaf Spring Axle	
04/10→		Track Control Arm		SC-DL-8511	Trailing Arm, Leaf Spring Axle, →* 3512097 *	
04/10→		Track Control Arm		SC-DL-8531	Trailing Arm, 1st & 2nd Drive Axle, for Leaf-Spring Suspension vehicles	
04/10→		Track Control Arm		SC-DL-8547	Trailing Arm, 1st & 2nd Drive Axle, for Leaf-Spring Suspension vehicles	
04/10→		Track Control Arm		SC-DL-8547	Trailing Arm, for Leaf-Spring Suspension vehicles	
04/10→		Track Control Arm		SC-DL-8547	Trailing Arm, Leaf Spring Axle	

CV-ES-14162

Length: 125
Cone Ø: d1 Ø 30 / d2 Ø 27
Thread: M30 x 1,5 LHT
283783, 395009, 1358792, 1738380, 1 914 426, 2051165



CV-ES-14163

Length: 125
Cone Ø: d1 Ø 30 / d2 Ø 27
Thread: M30 x 1,5 RHT
283784, 395010, 1358793, 1488890, 1738381, 1767328, 1914427, 2051166



DF-RK-9341

Ø: 67
550807, 5508072



MN-RK-7280

Ø: 75 Hole Distance: 115
Thick/Height: 24
0550806, 550806, 0639370, 639370, 689748, 1104334



MN-RK-8501

Ø: 75 Hole Distance: 115
Thick/Height: 24
1515981



SC-DL-2161

Length: 1740 Ø: 50
Cone Ø: d1 Ø 30 / d2 Ø 27
1369411, 1385251, 1409918, 1501030, 1723865, 1723895, 1737683, 1897335, 2113903, 2125090, 2161883



SC-DL-5229

Length: 1053 Ø: 50
Cone Ø: d1 Ø 30 / d2 Ø 27
1356055, 1379071, 1384025, 1768898, 1847311, 1912757, 12201600A



SC-DL-5354

Length: 1060 Ø: 52
Cone Ø: d1 Ø 30 / d2 Ø 27
1384027, 1769597, 1847312, 1912758, 12200800A



SC-DL-7264

Length: 1743 Ø: 62
Cone Ø: d1 Ø 30 / d2 Ø 27
1361413, 1395614, 1734019, 1897333, 2040254, 2146105



SC-DL-8137

Length: 1736 Ø: 40
Cone Ø: d1 Ø 30 / d2 Ø 27
301639, 311847, 395350, 1358675, 1378435, 1397866, 1734020, 2028998, 12202900A



SC-DL-8154

Length: 495 Ø: 40
Cone Ø: d1 Ø 30 / d2 Ø 27
1343266, 1759690



SC-DL-8179

Length: 568 Ø: 46
Hole Distance: 115 / 115
1399180, 1428347



SC-DL-8182

1343262, 1869413



SC-DL-8509

Length: 568,5 Ø: 46
Hole Distance: 115 / 115
1485758, 1486757



SC-DL-8511

Length: 616,5 Ø: 50
Hole Distance: 115 / 115
1485760, 1499478, 1722750



SC-DL-8531

Length: 522 Ø: 46
Hole Distance: 115 / 115
1486758



SC-DL-8547

Length: 568 Ø: 50
Hole Distance: 115 / 115
1499474, 1722746, 1906940



SC-DL-8623

Length: 592 Ø: 50
Hole Distance: 115 / 115
1388436, 1499476, 1722748, 1906942



SC-DL-9457

Length: 1743 Ø: 52
Cone Ø: d1 Ø 30 / d2 Ø 27
1527989, 1723896, 1737684, 1897336



SC-DL-9462

Length: 568,5 Ø: 50
Hole Distance: 115 / 115
1499475, 1500573, 1722747, 1906941



SC-DL-9466

Length: 568 Ø: 19
1486756



SC-DL-12342

Length: 601 Ø: 42
Cone Ø: d1 Ø 26 / d2 Ø 23,5
1343262, 1869413



SC-DL-12343

Length: 1062 Ø: 52
Cone Ø: d1 Ø 30 / d2 Ø 27
1348269, 2007275



SC-ES-8517

Length: 140
Cone Ø: d1 Ø 30 / d2 Ø 27
Thread: M30 x 1,5 RHT
1358793, 1435746, 1488890, 1534756, 1914427, 2051166



SC-ES-8535

Length: 145
Cone Ø: d1 Ø 30 / d2 Ø 27
Thread: M30 x 1,5 RHT
1723897, 2051041



SC-RK-12366

Ø: 75 Hole Distance: 115 / 115
Thick/Height: 24
1 722 753, 2 096 392



SC-TC-12452

Length: 580,5 Ø: 46
Hole Distance: 115 / 115
1485759



SC-TC-12472

Length: 580 Ø: 46
Hole Distance: 115 / 115
1399182





P,G,R,T - series ...

R 730 ...	04/10→	Track Control Arm		SC-DL-8623	Trailing Arm, 1st Drive Axle, for Leaf-Spring Suspension vehicles, →2006231/5117423	
	04/10→	Track Control Arm		SC-DL-8623	Trailing Arm, 1st Drive Axle, for Leaf-Spring Suspension vehicles, →9097199/3564002	
	04/10→	Track Control Arm		SC-DL-9462	Trailing Arm, 2nd Drive Axle, for Leaf-Spring Suspension vehicles, →2006231/5117423	
	04/10→	Track Control Arm		SC-DL-9462	Trailing Arm, 2nd Drive Axle, for Leaf-Spring Suspension vehicles, →9097199/3564002	
	04/10→	Track Control Arm		SC-DL-9462	Trailing Arm, for Leaf-Spring Suspension vehicles	
	04/10→	Track Control Arm		SC-DL-9462	Trailing Arm, Leaf Spring Axle, →* 2006231 SSS *,* 5117423 SNL *, * 9097199 SAN *,* 3564002 SLA *	
	04/10→	Track Control Arm		SC-DL-9466	Trailing Arm	
	04/10→	Track Control Arm		SC-DL-9466	Trailing Arm, 1st & 2nd Drive Axle, for Leaf-Spring Suspension vehicles	
	04/10→	Track Control Arm		SC-DL-9466	Trailing Arm, Leaf Spring Axle	
	04/10→	Track Control Arm		SC-TC-12451	Trailing Arm, 1st Drive Axle, for Leaf-Spring Suspension vehicles	
	04/10→	Track Control Arm		SC-TC-12451	Trailing Arm, 1st Drive Axle, for Leaf-Spring Suspension vehicles, 1280185/4471603→	
	04/10→	Track Control Arm		SC-TC-12451	Trailing Arm, 1st Drive Axle, for Leaf-Spring Suspension vehicles, 9069961/3536016→	
	04/10→	Track Control Arm		SC-TC-12452	Control Arm	
	04/10→	Track Control Arm		SC-TC-12452	Trailing Arm, 2nd Drive Axle, for Leaf-Spring Suspension vehicles, 1280185/4471603→	
	04/10→	Track Control Arm		SC-TC-12452	Trailing Arm, 2nd Drive Axle, for Leaf-Spring Suspension vehicles, 9069961/3536016→	
	04/10→	Track Control Arm		SC-TC-12472	Control Arm	
	04/10→	Track Control Arm		SC-TC-12472	Trailing Arm, 2nd Drive Axle, for Leaf-Spring Suspension vehicles, →1280184/4471602	
	04/10→	Track Control Arm		SC-TC-12472	Trailing Arm, 2nd Drive Axle, for Leaf-Spring Suspension vehicles, →9069960/3536015	
	04/10→	Track Control Arm		SC-VB-12418	Control Arm	
	04/10→	Track Control Arm	SC-DL-8179	SC-DL-8179	Trailing Arm, for Leaf-Spring Suspension vehicles	
	04/10→	Track Control Arm	SC-DL-8179	SC-DL-8179	Trailing Arm, Leaf Spring Axle	
	04/10→	Track Control Arm	SC-DL-8509	SC-DL-8509	Trailing Arm	
	04/10→	Track Control Arm	SC-DL-8509	SC-DL-8509	Trailing Arm, Leaf Spring Axle	
	04/10→	Track Control Arm	SC-DL-8531	SC-DL-8531	Trailing Arm, Leaf Spring Axle	
	04/10→	Track Control Arm	SC-DL-8623	SC-DL-8623	Trailing Arm, for Leaf-Spring Suspension vehicles	
	04/10→	Track Control Arm	SC-DL-8623	SC-DL-8623	Trailing Arm, Leaf Spring Axle, →* 2006231 SSS *,* 5117423 SNL *, * 9097199 SAN *,* 3564002 SLA *	
	04/10→	Track Control Arm	SC-DL-10302	SC-DL-10302	Trailing Arm, 1st Front Axle, for Pneumatic Suspension vehicles	
	04/10→	Track Control Arm	SC-DL-10302	SC-DL-10302	Trailing Arm, Air Suspension Axle	
	04/10→	Track Control Arm	SC-TC-12361		Control Arm, 1st Front Axle, for Pneumatic Suspension vehicles	
	10/10→	Centre Rod	SC-DL-8553		Push Rod, for vehicles with Hinged Leading Axle	
	10/10→	Centre Rod	SC-DL-12449		Push Rod	
	T 470	09/04→10/05	Centre Rod	SC-DL-5229		Push Rod
		09/04→10/05	Centre Rod	SC-DL-5354		Push Rod
09/04→10/05		Suspension Arm Repair Kit		SC-RK-12366	for Control Arm	
09/04→10/05		Suspension Strut Repair Kit		DF-RK-9341		
09/04→10/05		Tie Rod	SC-DL-7264			
09/04→10/05		Tie Rod	SC-DL-8137		Leaf Spring Axle	
09/04→10/05		Tie Rod	SC-DL-9457		Leaf Spring Axle	
09/04→10/05		Tie Rod End	CV-ES-14162		for Steering Rod	
09/04→10/05		Tie Rod End	CV-ES-14163		for Steering Rod	
09/04→10/05		Tie Rod End	SC-ES-8535		for Guide Rod	
09/04→10/05		Track Control Arm	SC-DL-10302	SC-DL-10302	Trailing Arm, Air Suspension Axle	
09/04→10/05		Track Control Arm	SC-TC-12361		Control Arm, 1st Front Axle, for Pneumatic Suspension vehicles	

CV-ES-14162

Length: 125
Cone Ø: d1 Ø 30 / d2 Ø 27
Thread: M30 x 1,5 LHT
283783, 395009, 1358792, 1738380, 1 914 426, 2051165



CV-ES-14163

Length: 125
Cone Ø: d1 Ø 30 / d2 Ø 27
Thread: M30 x 1,5 RHT
283784, 395010, 1358793, 1488890, 1738381, 1767328, 1914427, 2051166



DF-RK-9341

Ø: 67
550807, 5508072



SC-DL-5229

Length: 1053 Ø: 50
Cone Ø: d1 Ø 30 / d2 Ø 27
1356055, 1379071, 1384025, 1768898, 1847311, 1912757, 12201600A



SC-DL-5354

Length: 1060 Ø: 52
Cone Ø: d1 Ø 30 / d2 Ø 27
1384027, 1769597, 1847312, 1912758, 12200800A



SC-DL-7264

Length: 1743 Ø: 62
Cone Ø: d1 Ø 30 / d2 Ø 27
1361413, 1395614, 1734019, 1897333, 2040254, 2146105



SC-DL-8137

Length: 1736 Ø: 40
Cone Ø: d1 Ø 30 / d2 Ø 27
301639, 311847, 395350, 1358675, 1378435, 1397866, 1734020, 2028998, 12202900A



SC-DL-8179

Length: 568 Ø: 46
Hole Distance: 115 / 115
1399180, 1428347



SC-DL-8509

Length: 568,5 Ø: 46
Hole Distance: 115 / 115
1485758, 1486757



SC-DL-8531

Length: 522 Ø: 46
Hole Distance: 115 / 115
1486758



SC-DL-8553

Length: 435 Ø: 38
Cone Ø: d1 Ø 30 / d2 Ø 27
1343283, 1759691



SC-DL-8623

Length: 592 Ø: 50
Hole Distance: 115 / 115
1388436, 1499476, 1722748, 1906942



SC-DL-9457

Length: 1743 Ø: 52
Cone Ø: d1 Ø 30 / d2 Ø 27
1527989, 1723896, 1737684, 1897336



SC-DL-9462

Length: 568,5 Ø: 50
Hole Distance: 115 / 115
1499475, 1500573, 1722747, 1906941



SC-DL-9466

Length: 568 Ø: 19
1486756



SC-DL-10302

Length: 752 Ø: 48
Hole Distance: 115 / 115
1101843, 1379423, 1393298, 1431470, 1942075



SC-DL-12449

Length: 1206 Ø: 38
Cone Ø: d1 Ø 30 / d2 Ø 27
1385763, 1765375



SC-ES-8535

Length: 145
Cone Ø: d1 Ø 30 / d2 Ø 27
Thread: M30 x 1,5 RHT
1723897, 2051041



SC-RK-12366

Ø: 75 Hole Distance: 115 / 115
Thick/Height: 24
1 722 753, 2 096 392



SC-TC-12361

Length: 705 Ø: 42
Cone Ø: d1 Ø 38
Hole Distance: 115
1353445, 1464611, 1942147



SC-TC-12451

Length: 552 Ø: 46
Hole Distance: 115 / 115
1494296



SC-TC-12452

Length: 580,5 Ø: 46
Hole Distance: 115 / 115
1485759



SC-TC-12472

Length: 580 Ø: 46
Hole Distance: 115 / 115
1399182



SC-VB-12418

Length: 613,2
Ø: 46
Hole Ø 25 / 19 / 19
Hole Distance: 152 / 115 / 115
1440028, 1722582



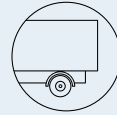

Series 200

S 215 HD	01/77→	Tie Rod	CV-DL-9119	
----------	--------	---------	------------	--

Series 300

S313UL, S315H, S315UL, S315NF	09/91→02/02	Stabiliser Link	DB-DL-12363	Coupling Rod
	09/91→02/02	Tie Rod	CV-DL-9103	
	09/91→02/02	Track Control Arm		DB-DL-7788 Trailing Arm
	09/91→02/02	Track Control Arm		DB-DL-8393 for Steering Rod, Trailing Arm

Series 400

ComfortClass S 415 GT	10/03→	Stabiliser Link		DB-DL-12364	Coupling Rod
	10/03→	Stabiliser Link	DB-DL-12363		Coupling Rod
	10/03→	Tie Rod End	CV-ES-0543		for Push Rod
	10/03→	Tie Rod End	CV-ES-0888		for Push Rod
	10/03→	Tie Rod End	DB-ES-0822		
	10/03→	Tie Rod End	KB-ES-0536		
	10/03→	Track Control Arm		DB-TC-12376	Control Arm
ComfortClass S 415 GT, GT-HD	10/03→	Stabiliser Link		DB-DL-12364	Coupling Rod
	10/03→	Stabiliser Link	DB-DL-12363		Coupling Rod
	10/03→	Tie Rod End	CV-ES-0543		for Push Rod
	10/03→	Tie Rod End	CV-ES-0888		for Push Rod
	10/03→	Tie Rod End	DB-ES-0822		
	10/03→	Tie Rod End	KB-ES-0536		
	10/03→	Track Control Arm		DB-TC-12376	Control Arm
ComfortClass S 415 GT, S 416 GT	10/03→	Stabiliser Link		DB-DL-12364	Coupling Rod
	10/03→	Stabiliser Link	DB-DL-12363		Coupling Rod
	10/03→	Tie Rod End	CV-ES-0543		for Push Rod
	10/03→	Tie Rod End	CV-ES-0888		for Push Rod
	10/03→	Tie Rod End	DB-ES-0822		
	10/03→	Tie Rod End	KB-ES-0536		
	10/03→	Track Control Arm		DB-TC-12376	Control Arm
ComfortClass S 415 GT-HD	10/03→	Stabiliser Link		DB-DL-12364	Coupling Rod
	10/03→	Stabiliser Link	DB-DL-12363		Coupling Rod
	10/03→	Track Control Arm		DB-TC-12376	Control Arm
	10/03→	Track Control Arm		DB-DL-12364	Coupling Rod
ComfortClass S 415 GT-HD, S 416 GT-HD	10/03→	Stabiliser Link		DB-DL-12364	Coupling Rod
	10/03→	Stabiliser Link	DB-DL-12363		Coupling Rod
	10/03→	Track Control Arm		DB-TC-12376	Control Arm
ComfortClass S 416 GT	10/03→	Stabiliser Link		DB-DL-12364	Coupling Rod
	10/03→	Stabiliser Link	DB-DL-12363		Coupling Rod
	10/03→	Track Control Arm		DB-TC-12376	Control Arm
	10/03→	Track Control Arm		DB-DL-12364	Coupling Rod
ComfortClass S 416 GT-HD	10/03→	Stabiliser Link		DB-DL-12364	Coupling Rod
	10/03→	Stabiliser Link	DB-DL-12363		Coupling Rod
	10/03→	Tie Rod End		MN-ES-8490	
	10/03→	Track Control Arm		DB-DL-7788	Trailing Arm
	10/03→	Track Control Arm		DB-DL-8393	for Steering Rod, Trailing Arm
	10/03→	Track Control Arm		DB-TC-12376	Control Arm
	10/03→	Track Control Arm		DB-DL-12364	Coupling Rod
ComfortClass S 416 GT-HD, ComfortClass S 417 GT-HD	10/03→	Stabiliser Link		DB-DL-12364	Coupling Rod
	10/03→	Stabiliser Link	DB-DL-12363		Coupling Rod
	10/03→	Tie Rod End		MN-ES-8490	for vehicles with Hinged Trailing Axle
	10/03→	Tie Rod End	CV-ES-0543		for Push Rod
	10/03→	Tie Rod End	CV-ES-0888		for Push Rod
	10/03→	Tie Rod End	DB-ES-0822		
	10/03→	Tie Rod End	KB-ES-0536		
	10/03→	Track Control Arm		DB-DL-7788	Trailing Arm, Tag Axle
	10/03→	Track Control Arm		DB-DL-8393	for Steering Rod, Trailing Arm
	10/03→	Track Control Arm		DB-TC-12376	Control Arm
	10/03→	Track Control Arm		DB-DL-12364	Coupling Rod
ComfortClass S 417 GT-HD	10/03→	Stabiliser Link		DB-DL-12364	Coupling Rod
	10/03→	Stabiliser Link	DB-DL-12363		Coupling Rod
	10/03→	Tie Rod End		MN-ES-8490	
	10/03→	Track Control Arm		DB-DL-7788	Trailing Arm
	10/03→	Track Control Arm		DB-DL-8393	for Steering Rod, Trailing Arm
	10/03→	Track Control Arm		DB-TC-12376	Control Arm

CV-DL-9103



KB-ES-0536



CV-DL-9119



MN-ES-8490



CV-ES-0543



CV-ES-0888



DB-DL-7788



DB-DL-8393



DB-DL-12363



DB-DL-12364



DB-ES-0822



DB-TC-12376



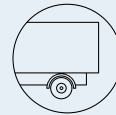

Series 400 ...

ComfortClass S 419 GT-HD	10/03→	Stabiliser Link		DB-DL-12364	Coupling Rod
	10/03→	Stabiliser Link	DB-DL-12363		Coupling Rod
	10/03→	Tie Rod End		MN-ES-8490	
	10/03→	Track Control Arm		DB-DL-7788	Trailing Arm
	10/03→	Track Control Arm		DB-TC-12376	Control Arm
MultiClass S 412 UL	01/05→	Stabiliser Link		DB-DL-12364	Coupling Rod
	01/05→	Stabiliser Link	DB-DL-12363		Coupling Rod
	01/05→	Track Control Arm		DB-TC-12376	Control Arm
MultiClass S 415 H	01/05→	Stabiliser Link		DB-DL-12364	Coupling Rod
	01/05→	Stabiliser Link	DB-DL-12363		Coupling Rod
	01/05→	Track Control Arm		DB-TC-12376	Control Arm
MultiClass S 415 NF	01/05→	Centre Rod	DB-DL-9251		Push Rod
	01/05→	Stabiliser Link		DB-DL-7262	Coupling Rod
	01/05→	Stabiliser Link		DB-DL-7263	Coupling Rod
	01/05→	Stabiliser Link	DB-DL-12363		Coupling Rod
	01/05→	Tie Rod	CV-DL-9082		
	01/05→	Tie Rod	DB-DL-9249		
	01/05→	Track Control Arm		DB-DL-7788	Trailing Arm
	01/05→	Track Control Arm		DB-DL-8393	for Steering Rod, Trailing Arm
MultiClass S 415 UL	01/05→	Stabiliser Link		DB-DL-12364	Coupling Rod
	01/05→	Stabiliser Link	DB-DL-12363		Coupling Rod
	01/05→	Track Control Arm		DB-TC-12376	Control Arm
MultiClass S 415 UL, MultiClass S 415 UL business	01/05→	Stabiliser Link		DB-DL-12364	Coupling Rod
	01/05→	Stabiliser Link	DB-DL-12363		Coupling Rod
	01/05→	Track Control Arm		DB-TC-12376	Control Arm
MultiClass S 416 H	01/05→	Stabiliser Link		DB-DL-12364	Coupling Rod
	01/05→	Stabiliser Link	DB-DL-12363		Coupling Rod
	01/05→	Track Control Arm		DB-TC-12376	Control Arm
MultiClass S 416 NF	01/05→	Centre Rod	DB-DL-9251		Push Rod
	01/05→	Stabiliser Link		DB-DL-7262	Coupling Rod
	01/05→	Stabiliser Link		DB-DL-7263	Coupling Rod
	01/05→	Stabiliser Link	DB-DL-12363		Coupling Rod
	01/05→	Tie Rod	CV-DL-9082		
	01/05→	Tie Rod	DB-DL-9249		
	01/05→	Track Control Arm		DB-DL-7788	Trailing Arm
	01/05→	Track Control Arm		DB-DL-8393	for Steering Rod, Trailing Arm
MultiClass S 416 UL	01/05→	Stabiliser Link		DB-DL-12364	Coupling Rod
	01/05→	Stabiliser Link	DB-DL-12363		Coupling Rod
	01/05→	Track Control Arm		DB-TC-12376	Control Arm
MultiClass S 417 UL	01/05→	Stabiliser Link		DB-DL-12364	Coupling Rod
	01/05→	Stabiliser Link	DB-DL-12363		Coupling Rod
	01/05→	Tie Rod End		MN-ES-8490	
	01/05→	Track Control Arm		DB-DL-7788	Trailing Arm
	01/05→	Track Control Arm		DB-DL-8393	for Steering Rod, Trailing Arm
	01/05→	Track Control Arm		DB-TC-12376	Control Arm
MultiClass S 419 UL	01/05→	Stabiliser Link		DB-DL-12364	Coupling Rod
	01/05→	Stabiliser Link	DB-DL-12363		Coupling Rod
	01/05→	Tie Rod End		MN-ES-8490	
	01/05→	Track Control Arm		DB-DL-7788	Trailing Arm
	01/05→	Track Control Arm		DB-DL-8393	for Steering Rod, Trailing Arm
	01/05→	Track Control Arm		DB-TC-12376	Control Arm
TopClass S 411 HD	10/01→	Stabiliser Link		DB-DL-12364	Coupling Rod
	10/01→	Stabiliser Link	DB-DL-12363		Coupling Rod
	10/01→	Tie Rod End	CV-ES-0543		for Push Rod
	10/01→	Tie Rod End	CV-ES-0888		for Push Rod
	10/01→	Tie Rod End	DB-ES-0822		
	10/01→	Tie Rod End	KB-ES-0536		
TopClass S 415 HD	10/01→	Track Control Arm		DB-TC-12376	Control Arm
	10/01→	Stabiliser Link		DB-DL-12364	Coupling Rod
	10/01→	Stabiliser Link	DB-DL-12363		Coupling Rod
	10/01→	Tie Rod End	CV-ES-0543		for Push Rod
	10/01→	Tie Rod End	CV-ES-0888		for Push Rod
	10/01→	Tie Rod End	DB-ES-0822		

CV-DL-9082



DB-DL-12364



CV-ES-0543



DB-ES-0822



CV-ES-0888



DB-TC-12376



DB-DL-7262



KB-ES-0536



DB-DL-7263



MN-ES-8490



DB-DL-7788



DB-DL-8393



DB-DL-9249



DB-DL-9251



DB-DL-12363



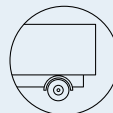

SETRA ...

Series 400 ...

TopClass S 415 HD ...	10/01→	Tie Rod End	KB-ES-0536		
	10/01→	Track Control Arm		DB-TC-12376	Control Arm
TopClass S 415 HDH	10/01→	Stabiliser Link		DB-DL-12364	Coupling Rod
	10/01→	Stabiliser Link	DB-DL-12363		Coupling Rod
	10/01→	Tie Rod End		MN-ES-8490	
	10/01→	Tie Rod End		MN-ES-8490	for vehicles with Hinged Trailing Axle
	10/01→	Tie Rod End	CV-ES-0543		for Push Rod
	10/01→	Tie Rod End	CV-ES-0888		for Push Rod
	10/01→	Tie Rod End	DB-ES-0822		
	10/01→	Tie Rod End	KB-ES-0536		
	10/01→	Track Control Arm		DB-DL-7788	Trailing Arm
	10/01→	Track Control Arm		DB-DL-7788	Trailing Arm, Tag Axle
	10/01→	Track Control Arm		DB-DL-8393	for Steering Rod, Trailing Arm
	10/01→	Track Control Arm		DB-TC-12376	Control Arm
	TopClass S 416 HDH	10/01→	Stabiliser Link		DB-DL-12364
10/01→		Stabiliser Link	DB-DL-12363		Coupling Rod
10/01→		Track Control Arm		DB-TC-12376	Control Arm
01/03→		Tie Rod End		MN-ES-8490	
01/03→		Track Control Arm		DB-DL-7788	Trailing Arm
TopClass S 416 HDH, TopClass S 417 HDH	01/03→	Track Control Arm		DB-DL-8393	for Steering Rod, Trailing Arm
	10/02→	Stabiliser Link		DB-DL-12364	Coupling Rod
	10/02→	Stabiliser Link	DB-DL-12363		Coupling Rod
	10/02→	Tie Rod End		MN-ES-8490	for vehicles with Hinged Trailing Axle
	10/02→	Tie Rod End	CV-ES-0543		for Push Rod
	10/02→	Tie Rod End	CV-ES-0888		for Push Rod
	10/02→	Tie Rod End	DB-ES-0822		
	10/02→	Tie Rod End	KB-ES-0536		
	10/02→	Track Control Arm		DB-DL-7788	Trailing Arm, Tag Axle
	10/02→	Track Control Arm		DB-DL-8393	for Steering Rod, Trailing Arm
TopClass S 417 HDH	10/02→	Track Control Arm		DB-TC-12376	Control Arm
	10/02→	Stabiliser Link		DB-DL-12364	Coupling Rod
	10/02→	Stabiliser Link	DB-DL-12363		Coupling Rod
	10/02→	Track Control Arm		DB-TC-12376	Control Arm
TopClass S 431 DT	10/02→	Stabiliser Link		DB-DL-12364	Coupling Rod
	10/02→	Tie Rod	CV-DL-9103		
	10/02→	Tie Rod End		MN-ES-8490	
	10/02→	Tie Rod End		MN-ES-8490	for vehicles with Hinged Trailing Axle
	10/02→	Tie Rod End	CV-ES-0543		for Push Rod
	10/02→	Tie Rod End	CV-ES-0888		for Push Rod
	10/02→	Tie Rod End	DB-ES-0822		
	10/02→	Tie Rod End	KB-ES-0536		
	10/02→	Track Control Arm		DB-DL-7788	Trailing Arm
	10/02→	Track Control Arm		DB-DL-7788	Trailing Arm, Tag Axle
10/02→	Track Control Arm		DB-DL-8393	for Steering Rod, Trailing Arm	

VOLVO

8700

8700	01/99→	Centre Rod	VL-DL-9489		Push Rod
	01/99→	Stabiliser Link		VL-DL-8518	Coupling Rod, Control Arm
	01/99→	Stabiliser Link	VL-DL-8595	VL-DL-8595	Coupling Rod
	01/99→	Stabiliser Link	VL-DL-10257		Coupling Rod
	01/99→	Tie Rod	VL-DL-12414		
	01/99→	Track Control Arm		VL-DL-8180	Trailing Arm
	01/99→	Track Control Arm		VL-DL-8189	Trailing Arm

B 7

B 7	01/98→	Suspension Strut Repair Kit		MN-RK-12436	
-----	--------	-----------------------------	--	--------------------	--

B 9

B 9	09/05→	Tie Rod	VL-DL-12414		
-----	--------	---------	--------------------	--	--

CV-DL-9103



MN-ES-8490



CV-ES-0543



MN-RK-12436

Ø: 75 Hole Distance: 115
Thick/Height: 24
3093462, 85104224



CV-ES-0888



VL-DL-8180

Length: 625 Ø: 17
20374444, 20410530, 20509018, 20517494,
70371270



DB-DL-7788



VL-DL-8189

Length: 666 Ø: 48
Hole Distance: 125
1082104, 1605035



DB-DL-8393

Length: 576 Ø: 48
Hole Distance: 130 / 130
6283330905, 6283331705, 6443500306



VL-DL-8518

Length: 350 Ø: 36
Cone Ø: d1 Ø 28,9 / d2 Ø 24,7
20443063, 20443067, 20994420



DB-DL-12363



VL-DL-8595

Length: 150 Ø: 26
Cone Ø: d1 Ø 28,6 / d2 Ø 23,9
9521922, 70376892



DB-DL-12364



VL-DL-9489

Length: 1243 Ø: 42
Cone Ø: d1 Ø 28,6 / d2 Ø 23,9
20739082, 70311664



DB-ES-0822



VL-DL-10257

Length: 160
Ø: 26
Cone Ø: d1 Ø 30 / d2 Ø 27
24425411



DB-TC-12376



VL-DL-12414

Length: 1728
Ø: 48
Cone Ø: d1 Ø 28,6 / d2 Ø 23,9
Thread: M30 x 1,5 RHT
21426652



KB-ES-0536



**B 10**

B10M		Centre Rod	VL-DL-8405		Push Rod* 46168 *→
		Centre Rod	VL-DL-8405		Push Rod* 60354 *→
		Stabiliser Mounting		VL-SB-10392	
		Tie Rod End	VL-ES-7286		
		Track Control Arm		VL-DL-9485	Trailing Arm
		Track Control Arm		VL-DL-9485	Trailing Arm, Drive Axle
		Track Control Arm		VL-DL-9485	Trailing Arm, Tag Axle
		Track Control Arm		VL-DL-9485	Trailing Arm, Trailing Axle
		Track Control Arm		VL-VB-9503	Wishbone (CV), Drive Axle
		Track Control Arm		VL-VB-9503	Wishbone (CV), Tag Axle
		Track Control Arm		VL-VB-9503	Wishbone (CV), Trailing Axle
		Track Control Arm	VL-DL-9485	VL-DL-9485	Trailing Arm, Air Suspension Axle
		Track Control Arm	VL-VB-9503		Wishbone (CV)

B 12

B 12	01/92→	Centre Rod	VL-DL-4895		Push Rod
	01/92→	Centre Rod	VL-DL-4912		Push Rod
	01/92→	Centre Rod	VL-DL-8405		Push Rod
	01/92→	Centre Rod	VL-DL-9489		Push Rod, Rigid Axle
	01/92→	Control Arm-/Trailing Arm Bush		VL-RK-5357	
	01/92→	Stabiliser Link		VL-DL-8595	Coupling Rod, Drive Axle, * 100 *→* 11535 *
	01/92→	Stabiliser Link		VL-DL-8595	Coupling Rod, Drive Axle, * 100 *→* 13674 *
	01/92→	Stabiliser Link	VL-DL-12415		Suspension Rod
	01/92→	Stabiliser Link	VL-DL-12416		Suspension Rod
	01/92→	Stabiliser Mounting		VL-SB-5276	
	01/92→	Stabiliser Mounting		VL-SB-5345	
	01/92→	Stabiliser Mounting		VL-SB-10392	
	01/92→	Suspension Strut Repair Kit		DF-RK-8637	
	01/92→	Tie Bar Bush	VL-SB-9501	VL-SB-9501	
	01/92→	Tie Rod End	RV-ES-12442		
	01/92→	Tie Rod End	VL-ES-7266		
	01/92→	Track Control Arm	VL-DL-9485	VL-DL-9485	Trailing Arm, Air Suspension Axle
	01/92→	Track Control Arm	VL-VB-9503		Wishbone (CV)
	02/06→	Centre Rod	VL-DL-9489		Push Rod
	02/06→	Stabiliser Link		VL-DL-8595	Coupling Rod
	02/06→	Suspension Arm Repair Kit	VL-RK-10383	VL-RK-10383	for Wishbone (CV);for Drag Link;for Control Arm
	02/06→	Tie Rod	VL-DL-8404		
	02/06→	Tie Rod	VL-DL-8597		
	02/06→	Tie Rod	VL-DL-10230		
	02/06→	Tie Rod	VL-DL-10259		
	02/06→	Track Control Arm	VL-DL-9485	VL-DL-9485	Trailing Arm
	02/06→	Track Control Arm	VL-VB-10430		Wishbone (CV)

F 6

F 609	03/75→02/80	Tie Rod End	CV-ES-12461		for Steering Rod
	03/75→02/80	Tie Rod End	CV-ES-12462		for Steering Rod
	03/75→02/80	Tie Rod End	VL-ES-7266		
F 610	02/80→10/86	Tie Rod End	CV-ES-12461		for Steering Rod
	02/80→10/86	Tie Rod End	CV-ES-12462		for Steering Rod
	02/80→10/86	Tie Rod End	VL-ES-7266		
F 611	09/75→02/86	Tie Rod End	CV-ES-12461		for Steering Rod
	09/75→02/86	Tie Rod End	CV-ES-12462		for Steering Rod
	09/75→02/86	Tie Rod End	VL-ES-7266		
F 612	04/83→02/86	Tie Rod End	CV-ES-12461		for Steering Rod
	04/83→02/86	Tie Rod End	CV-ES-12462		for Steering Rod
F 613,F 614	09/75→02/86	Tie Rod End	CV-ES-12461		for Steering Rod
	09/75→02/86	Tie Rod End	CV-ES-12462		for Steering Rod
	09/75→02/86	Tie Rod End	VL-ES-7266		
F 616	02/81→02/86	Tie Rod End	VL-ES-7266		

CV-ES-12461

Length: 120
Cone Ø: d1 Ø 26 / d2 Ø 23,5
Thread: M30 x 1,5 LHT
1517647, 3096212



CV-ES-12462

Length: 120
Cone Ø: d1 Ø 26 / d2 Ø 23,5
Thread: M30 x 1,5 RHT
1517577, 1695690, 1697297, 15175771



DF-RK-8637

Ø: 72
3093469



RV-ES-12442

Length: 88
Cone Ø: d1 Ø 28,6
Thread: M26 x 1,5 RHT
3987648



VL-DL-4895

Length: 1026 Ø: 60
Cone Ø: d1 Ø 28,6 / d2 Ø 23,9
9519279, 20490120, 20745924, 21308024



VL-DL-4912

Length: 763 Ø: 38
Cone Ø: d1 Ø 28,6 / d2 Ø 23,9
3112122, 9959153, 14203000A, 20497800



VL-DL-8404

Length: 300 Ø: 36
Cone Ø: d1 Ø 28,6 / d2 Ø 23,9
3112050, 9959151, 14205100A, 20497798, 85114240



VL-DL-8405

Length: 1030 Ø: 62
Cone Ø: d1 Ø 28,6 / d2 Ø 23,9
9519278, 20490123, 20745923, 21308022



VL-DL-8595

Length: 150 Ø: 26
Cone Ø: d1 Ø 28,6 / d2 Ø 23,9
9521922, 70376892



VL-DL-8597

Length: 743
Ø: 40
Cone Ø: d1 Ø 28,6 / d2 Ø 23,9
3112273, 9959152, 20497799



VL-DL-9485

Length: 666 Ø: 48
Hole Distance: 125 / 125
1589817



VL-DL-9489

Length: 1243 Ø: 42
Cone Ø: d1 Ø 28,6 / d2 Ø 23,9
20739082, 70311664



VL-DL-10230

Length: 770 Ø: 38
Cone Ø: d1 Ø 28,6 / d2 Ø 23,9
9522701



VL-DL-10259

Length: 150 Ø: 26
Cone Ø: d1 Ø 31,7 / d2 Ø 27,3
9959503



VL-DL-12415

Length: 367 Ø: 36
Cone Ø: d1 Ø 28,6 / d2 Ø 23,9
9523163, 70314305, 70397006



VL-DL-12416

Length: 367 Ø: 36
Cone Ø: d1 Ø 28,6 / d2 Ø 23,9
9959462, 70314307, 70397005



VL-ES-7266

Length: 125
Cone Ø: d1 Ø 31,5 / d2 Ø 27,5
Thread: M30 x 1,5 RHT
0356310, 1507826, 1695585, 1695776, 1698557, 6882111, 6882111(BRAZIL), 6889480, 6889482, 14200800A, 85114146



VL-ES-7286

Length: 87
Cone Ø: d1 Ø 16 / d2 Ø 14,4
Thread: M28 x 1,5 RHT
382745, 1527234, 1668638



VL-RK-5357

Ø: 138
Hole Ø 14 / 16 / 14
Hole Distance: 21
Thick/Height: 96 / 96
1075255, 1591689, 3173759, 14301900A, 20554908



VL-RK-10383

Ø: 75
Hole Distance: 130
Thick/Height: 24
3093467, 9523029, 20426061, 20740700, 20753761



VL-SB-5276

Length: 55 Ø: 74
Thick/Height: 96 / 96
1605047



VL-SB-5345

Ø: 57,5
Thick/Height: 64
1134955, 1190030, 14301500A



VL-SB-9501

Ø: 91 Thick/Height: 85 / 85
1135080



VL-SB-10392

Ø: 90 Thick/Height: 95 / 95
3028448, 9516523, 9959304



VL-VB-9503

Length: 773 Ø: 88
Hole Distance: 125 / 125
1194631



VL-VB-10430

Length: 760 Ø: 48
Hole Distance: 130 / 130
3193895, 24426048, 70376894



**F 7**

F 7	08/78→12/85	Centre Rod	VL-DL-5301		Coupling Rod
	08/78→12/85	Tie Rod End	VL-ES-5287		for Guide Rod
	08/78→12/85	Tie Rod End	VL-ES-5288		for Guide Rod
	08/78→12/85	Tie Rod End	VL-ES-5347		for Steering Rod
	08/78→12/85	Tie Rod End	VL-ES-5348		for Steering Rod
	08/78→12/85	Tie Rod End	VL-ES-7266		
	08/78→12/85	Tie Rod End	VL-ES-7286		

F 10

F 10/260	02/82→06/85	Centre Rod	VL-DL-5301		Coupling Rod
	02/82→06/85	Centre Rod	VL-DL-5318		Push Rod
	02/82→06/85	Centre Rod	VL-DL-5319		Push Rod
	02/82→06/85	Centre Rod	VL-DL-5540		Push Rod
	02/82→06/85	Centre Rod	VL-DL-8401		Push Rod, 1st FA;Air Suspension Axle
	02/82→06/85	Control Arm-/Trailing Arm Bush		VL-RK-5357	
	02/82→06/85	Stabiliser Mounting	VL-SB-5345	VL-SB-5345	
	02/82→06/85	Suspension Arm Repair Kit	VL-RK-5323	VL-RK-5323	for Drag Link, Air Suspension Axle, * 314 000 *→
	02/82→06/85	Tie Bar Bush		VL-SB-9501	
	02/82→06/85	Tie Rod End	VL-ES-5287		for Guide Rod
	02/82→06/85	Tie Rod End	VL-ES-5288		for Guide Rod
	02/82→06/85	Tie Rod End	VL-ES-5347		for Steering Rod
	02/82→06/85	Tie Rod End	VL-ES-5348		for Steering Rod
	02/82→06/85	Tie Rod End	VL-ES-7266		
	02/82→06/85	Tie Rod End	VL-ES-7286		
	02/82→06/85	Track Control Arm		VL-DL-8189	Trailing Arm
	02/82→06/85	Track Control Arm		VL-DL-8189	Trailing Arm, Drive Axle;Air Suspension Axle
	02/82→06/85	Track Control Arm		VL-DL-8545	Trailing Arm, 1st RA;2nd RA
	02/82→06/85	Track Control Arm		VL-DL-9485	Trailing Arm
	02/82→06/85	Track Control Arm		VL-VB-8527	Wishbone (CV)
	02/82→06/85	Track Control Arm		VL-VB-8527	Wishbone (CV)→* 31429 *
	02/82→06/85	Track Control Arm		VL-VB-8539	Wishbone (CV)
	02/82→06/85	Track Control Arm		VL-VB-8539	Wishbone (CV)* 31430 *→
	02/82→06/85	Track Control Arm		VL-VB-8546	Wishbone (CV)
	02/82→06/85	Track Control Arm		VL-VB-12359	Control Arm
	02/82→06/85	Track Control Arm	VL-DL-9485	VL-DL-9485	Trailing Arm, Air Suspension Axle
	01/84→06/85	Track Control Arm		VL-DL-8619	Trailing Arm
F 10/280	08/77→02/82	Centre Rod	VL-DL-5301		Coupling Rod
	08/77→02/82	Centre Rod	VL-DL-5318		Push Rod
	08/77→02/82	Centre Rod	VL-DL-5319		Push Rod
	08/77→02/82	Centre Rod	VL-DL-5540		Push Rod
	08/77→02/82	Centre Rod	VL-DL-8401		Push Rod, 1st FA;Air Suspension Axle
	08/77→02/82	Control Arm-/Trailing Arm Bush		VL-RK-5357	
	08/77→02/82	Suspension Arm Repair Kit	VL-RK-5323	VL-RK-5323	for Drag Link, Air Suspension Axle, * 314 000 *→
	08/77→02/82	Tie Bar Bush		VL-SB-9501	
	08/77→02/82	Tie Rod End	VL-ES-5287		for Guide Rod
	08/77→02/82	Tie Rod End	VL-ES-5288		for Guide Rod
	08/77→02/82	Tie Rod End	VL-ES-5347		for Steering Rod
	08/77→02/82	Tie Rod End	VL-ES-5348		for Steering Rod
	08/77→02/82	Tie Rod End	VL-ES-7266		
	08/77→02/82	Tie Rod End	VL-ES-7286		
	08/77→02/82	Track Control Arm		VL-DL-8189	Trailing Arm
	08/77→02/82	Track Control Arm		VL-DL-9485	Trailing Arm
	08/77→02/82	Track Control Arm		VL-VB-12359	Control Arm
08/77→02/82	Track Control Arm	VL-DL-9485	VL-DL-9485	Trailing Arm, Air Suspension Axle	
F 10/300	10/83→12/86	Centre Rod	VL-DL-8128		Push Rod
	10/83→12/86	Track Control Arm		VL-DL-8189	Trailing Arm
	10/83→12/87	Centre Rod	VL-DL-5301		Coupling Rod
	10/83→12/87	Centre Rod	VL-DL-5318		Push Rod
	10/83→12/87	Centre Rod	VL-DL-5319		Push Rod
	10/83→12/87	Centre Rod	VL-DL-5540		Push Rod
	10/83→12/87	Centre Rod	VL-DL-8401		Push Rod, 1st FA;Air Suspension Axle

VL-DL-5301

Length: 1592 Ø: 42
 Cone Ø: d1 Ø 28,6 / d2 Ø 23,9
 1606274, 1626494

**VL-DL-5318**

Length: 860 Ø: 42
 Cone Ø: d1 Ø 31,5 / d2 Ø 27,5
 1576092, 1606283

**VL-DL-5319**

Length: 865 Ø: 40
 Cone Ø: d1 Ø 31,5 / d2 Ø 27,5
 1576093, 1606284

**VL-DL-5540**

Length: 845 Ø: 42
 Cone Ø: d1 Ø 31,5 / d2 Ø 27,5
 1610338, 1626751

**VL-DL-8128**

Length: 845 Ø: 42
 Cone Ø: d1 Ø 31,5 / d2 Ø 27,5
 1083744

**VL-DL-8189**

Length: 666 Ø: 48
 Hole Distance: 125
 1082104, 1605035

**VL-DL-8401**

Length: 880 Ø: 42
 Cone Ø: d1 Ø 31,5 / d2 Ø 27,5
 1613562, 1626749, 14203500A

**VL-DL-8545**

Length: 660 Ø: 48
 Hole Distance: 130 / 130
 1581527, 1607079, 3944818, 3944819,
 3944820, 8154017, 8154018, 8158206,
 8158207

**VL-DL-8619**

Length: 621 Ø: 48
 Hole Distance: 100 / 100
 1608151, 1621419

**VL-DL-9485**

Length: 666 Ø: 48
 Hole Distance: 125 / 125
 1589817

**VL-ES-5287**

Length: 167
 Cone Ø: d1 Ø 28,6 / d2 Ø 23,9
 Thread: M52 x 1,5 RHT
 1696901, 1699401

**VL-ES-5288**

Length: 167
 Cone Ø: d1 Ø 28,6 / d2 Ø 23,9
 Thread: M52 x 1,5 LHT
 1696900, 1699400

**VL-ES-5347**

Length: 125
 Cone Ø: d1 Ø 28,6 / d2 Ø 23,9
 Thread: M30 x 1,5 LHT
 1507822, 1698847, 3092471

**VL-ES-5348**

Length: 125
 Cone Ø: d1 Ø 28,6 / d2 Ø 23,9
 Thread: M30 x 1,5 RHT
 1507823, 1698846, 3092472

**VL-ES-7266**

Length: 125
 Cone Ø: d1 Ø 31,5 / d2 Ø 27,5
 Thread: M30 x 1,5 RHT
 0356310, 1507826, 1695585, 1695776,
 1698557, 6882111, 6882111(BRAZIL),
 6889480, 6889482, 14200800A, 85114146

**VL-ES-7286**

Length: 87
 Cone Ø: d1 Ø 16 / d2 Ø 14,4
 Thread: M28 x 1,5 RHT
 382745, 1527234, 1668638

**VL-RK-5323**

Ø: 91 Hole Distance: 125
 Thick/Height: 20
 1598588, 14302100A

**VL-RK-5357**

Ø: 138
 Hole Ø 14 / 16 / 14
 Hole Distance: 21
 Thick/Height: 96 / 96
 1075255, 1591689, 3173759, 14301900A,
 20554908

**VL-SB-5345**

Ø: 57,5
 Thick/Height: 64
 1134955, 1190030, 14301500A

**VL-SB-9501**

Ø: 91 Thick/Height: 85 / 85
 1135080

**VL-VB-8527**

Length: 635 Ø: 58
 Hole Distance: 152 / 152
 1080690, 1509222, 1576952, 1606200,
 6886777

**VL-VB-8539**

Length: 641 Ø: 48
 Hole Distance: 152 / 152
 1606552

**VL-VB-8546**

Length: 644 Ø: 46
 Hole Distance: 115 / 115
 1590068

**VL-VB-12359**

Length: 687,5 Ø: 58
 Hole Distance: 125 / 125
 Thick/Height: 30
 1605244, 1628483, 3173294, 8156994,
 20556586





F 10 ...

F 10/300 ...	10/83→12/87	Control Arm-/Trailing Arm Bush		VL-RK-5357	
	10/83→12/87	Suspension Arm Repair Kit	VL-RK-5323	VL-RK-5323	for Drag Link, Air Suspension Axle, * 314 000 *→
	10/83→12/87	Tie Bar Bush		VL-SB-9501	
	10/83→12/87	Tie Rod End	VL-ES-5287		for Guide Rod
	10/83→12/87	Tie Rod End	VL-ES-5288		for Guide Rod
	10/83→12/87	Tie Rod End	VL-ES-5347		for Steering Rod
	10/83→12/87	Tie Rod End	VL-ES-5348		for Steering Rod
	10/83→12/87	Tie Rod End	VL-ES-7266		
	10/83→12/87	Tie Rod End	VL-ES-7286		
	10/83→12/87	Track Control Arm		VL-VB-12359	Control Arm
	10/83→12/87	Track Control Arm	VL-DL-9485	VL-DL-9485	Trailing Arm, Air Suspension Axle
	01/84→12/87	Track Control Arm		VL-DL-8189	Trailing Arm, Drive Axle;Air Suspension Axle
	01/84→12/87	Track Control Arm		VL-DL-9485	Trailing Arm
	01/87→12/87	Centre Rod	VL-DL-8128		Push Rod* 458606 **; 347136 *; * A220311 **; B100000 *→* 494865 *; * 384836 **; A224523 **; B114725 *
01/87→12/87	Track Control Arm		VL-DL-8189	Trailing Arm, Air Suspension Axle	
F 10/320	10/87→12/94	Centre Rod	VL-DL-5301		Coupling Rod
	10/87→12/94	Centre Rod	VL-DL-5318		Push Rod
	10/87→12/94	Centre Rod	VL-DL-5319		Push Rod
	10/87→12/94	Centre Rod	VL-DL-5540		Push Rod
	10/87→12/94	Centre Rod	VL-DL-8128		Push Rod* 458606 **; 347136 *; * A220311 **; B100000 *→* 494865 *; * 384836 **; A224523 **; B114725 *
	10/87→12/94	Centre Rod	VL-DL-8401		Push Rod, 1st FA;Air Suspension Axle
	10/87→12/94	Control Arm-/Trailing Arm Bush		VL-RK-5357	
	10/87→12/94	Suspension Arm Repair Kit	VL-RK-5323	VL-RK-5323	for Drag Link, Air Suspension Axle, * 314 000 *→
	10/87→12/94	Tie Bar Bush		VL-SB-9501	
	10/87→12/94	Tie Rod End	VL-ES-5287		for Guide Rod
	10/87→12/94	Tie Rod End	VL-ES-5288		for Guide Rod
	10/87→12/94	Tie Rod End	VL-ES-5347		for Steering Rod
	10/87→12/94	Tie Rod End	VL-ES-5348		for Steering Rod
	10/87→12/94	Tie Rod End	VL-ES-7266		
	10/87→12/94	Tie Rod End	VL-ES-7286		
	10/87→12/94	Track Control Arm		VL-DL-8189	Trailing Arm, Air Suspension Axle
	10/87→12/94	Track Control Arm		VL-DL-8189	Trailing Arm, Drive Axle;Air Suspension Axle
	10/87→12/94	Track Control Arm		VL-DL-9485	Trailing Arm
	10/87→12/94	Track Control Arm		VL-VB-12359	Control Arm
	10/87→12/94	Track Control Arm	VL-DL-9485	VL-DL-9485	Trailing Arm, Air Suspension Axle
	12/90→12/94	Track Control Arm		VL-DL-8189	Trailing Arm
	12/90→12/94	Track Control Arm		VL-DL-8545	Trailing Arm, 1st RA;2nd RA
	12/90→12/94	Track Control Arm		VL-DL-8619	Trailing Arm
	12/90→12/94	Track Control Arm		VL-VB-8527	Wishbone (CV)
	12/90→12/94	Track Control Arm		VL-VB-8539	Wishbone (CV)
	12/90→12/94	Track Control Arm		VL-VB-8539	Wishbone (CV)* 31430 *→
	12/90→12/94	Track Control Arm		VL-VB-8546	Wishbone (CV)

F 12

F 12/320	01/87→12/87	Centre Rod	VL-DL-5301		Coupling Rod
	01/87→12/87	Centre Rod	VL-DL-5318		Push Rod
	01/87→12/87	Centre Rod	VL-DL-5319		Push Rod
	01/87→12/87	Centre Rod	VL-DL-5540		Push Rod
	01/87→12/87	Centre Rod	VL-DL-8128		Push Rod* 458606 **; 347136 *; * A220311 **; B100000 *→* 494865 *; * 384836 **; A224523 **; B114725 *
	01/87→12/87	Centre Rod	VL-DL-8401		Push Rod, 1st FA;Air Suspension Axle
	01/87→12/87	Control Arm-/Trailing Arm Bush		VL-RK-5357	
	01/87→12/87	Stabiliser Mounting	VL-SB-5345	VL-SB-5345	
	01/87→12/87	Suspension Arm Repair Kit	VL-RK-5323	VL-RK-5323	for Drag Link, Air Suspension Axle, * 314 000 *→
	01/87→12/87	Tie Bar Bush		VL-SB-9501	

VL-DL-5301

Length: 1592 Ø: 42
 Cone Ø: d1 Ø 28,6 / d2 Ø 23,9
 1606274, 1626494

**VL-DL-5318**

Length: 860 Ø: 42
 Cone Ø: d1 Ø 31,5 / d2 Ø 27,5
 1576092, 1606283

**VL-DL-5319**

Length: 865 Ø: 40
 Cone Ø: d1 Ø 31,5 / d2 Ø 27,5
 1576093, 1606284

**VL-DL-5540**

Length: 845 Ø: 42
 Cone Ø: d1 Ø 31,5 / d2 Ø 27,5
 1610338, 1626751

**VL-DL-8128**

Length: 845 Ø: 42
 Cone Ø: d1 Ø 31,5 / d2 Ø 27,5
 1083744

**VL-DL-8189**

Length: 666 Ø: 48
 Hole Distance: 125
 1082104, 1605035

**VL-DL-8401**

Length: 880 Ø: 42
 Cone Ø: d1 Ø 31,5 / d2 Ø 27,5
 1613562, 1626749, 14203500A

**VL-DL-8545**

Length: 660 Ø: 48
 Hole Distance: 130 / 130
 1581527, 1607079, 3944818, 3944819,
 3944820, 8154017, 8154018, 8158206,
 8158207

**VL-DL-8619**

Length: 621 Ø: 48
 Hole Distance: 100 / 100
 1608151, 1621419

**VL-DL-9485**

Length: 666 Ø: 48
 Hole Distance: 125 / 125
 1589817

**VL-ES-5287**

Length: 167
 Cone Ø: d1 Ø 28,6 / d2 Ø 23,9
 Thread: M52 x 1,5 RHT
 1696901, 1699401

**VL-ES-5288**

Length: 167
 Cone Ø: d1 Ø 28,6 / d2 Ø 23,9
 Thread: M52 x 1,5 LHT
 1696900, 1699400

**VL-ES-5347**

Length: 125
 Cone Ø: d1 Ø 28,6 / d2 Ø 23,9
 Thread: M30 x 1,5 LHT
 1507822, 1698847, 3092471

**VL-ES-5348**

Length: 125
 Cone Ø: d1 Ø 28,6 / d2 Ø 23,9
 Thread: M30 x 1,5 RHT
 1507823, 1698846, 3092472

**VL-ES-7266**

Length: 125
 Cone Ø: d1 Ø 31,5 / d2 Ø 27,5
 Thread: M30 x 1,5 RHT
 0356310, 1507826, 1695585, 1695776,
 1698557, 6882111, 6882111(BRAZIL),
 6889480, 6889482, 14200800A, 85114146

**VL-ES-7286**

Length: 87
 Cone Ø: d1 Ø 16 / d2 Ø 14,4
 Thread: M28 x 1,5 RHT
 382745, 1527234, 1668638

**VL-RK-5323**

Ø: 91 Hole Distance: 125
 Thick/Height: 20
 1598588, 14302100A

**VL-RK-5357**

Ø: 138
 Hole Ø 14 / 16 / 14
 Hole Distance: 21
 Thick/Height: 96 / 96
 1075255, 1591689, 3173759, 14301900A,
 20554908

**VL-SB-5345**

Ø: 57,5
 Thick/Height: 64
 1134955, 1190030, 14301500A

**VL-SB-9501**

Ø: 91 Thick/Height: 85 / 85
 1135080

**VL-VB-8527**

Length: 635
 Ø: 58
 Hole Distance: 152 / 152
 1080690, 1509222, 1576952, 1606200,
 6886777

**VL-VB-8539**

Length: 641
 Ø: 48
 Hole Distance: 152 / 152
 1606552

**VL-VB-8546**

Length: 644
 Ø: 46
 Hole Distance: 115 / 115
 1590068

**VL-VB-12359**

Length: 687,5
 Ø: 58
 Hole Distance: 125 / 125
 Thick/Height: 30
 1605244, 1628483, 3173294, 8156994,
 20556586





F 12 ...

F 12/320 ...	01/87→12/87	Tie Rod	VL-DL-7789		Air Suspension Axle	
	01/87→12/87	Tie Rod End	VL-ES-5347		for Steering Rod	
	01/87→12/87	Tie Rod End	VL-ES-5348		for Steering Rod	
	01/87→12/87	Tie Rod End	VL-ES-7266			
	01/87→12/87	Tie Rod End	VL-ES-7286			
	01/87→12/87	Track Control Arm		VL-DL-8189	Trailing Arm	
	01/87→12/87	Track Control Arm		VL-DL-8189	Trailing Arm, Air Suspension Axle	
	01/87→12/87	Track Control Arm		VL-DL-8189	Trailing Arm, Drive Axle; Air Suspension Axle	
	01/87→12/87	Track Control Arm		VL-DL-8545	Trailing Arm, 1st RA; 2nd RA, * A234808 *→	
	01/87→12/87	Track Control Arm		VL-DL-8619	Trailing Arm	
	01/87→12/87	Track Control Arm		VL-DL-9485	Trailing Arm	
	01/87→12/87	Track Control Arm		VL-VB-8527	Wishbone (CV)	
	01/87→12/87	Track Control Arm		VL-VB-8527	Wishbone (CV)→* 43812 *	
	01/87→12/87	Track Control Arm		VL-VB-8539	Wishbone (CV)	
	01/87→12/87	Track Control Arm		VL-VB-8539	Wishbone (CV)* 43813 *→	
	01/87→12/87	Track Control Arm		VL-VB-8546	Wishbone (CV)	
	01/87→12/87	Track Control Arm		VL-VB-12359	Control Arm	
	01/87→12/87	Track Control Arm	VL-DL-9485	VL-DL-9485	Trailing Arm, Air Suspension Axle	
	F 12/320, F 12/330	08/77→12/86	Centre Rod	VL-DL-5301		Coupling Rod
		08/77→12/86	Centre Rod	VL-DL-5318		Push Rod
08/77→12/86		Centre Rod	VL-DL-5319		Push Rod	
08/77→12/86		Centre Rod	VL-DL-5540		Push Rod	
08/77→12/86		Centre Rod	VL-DL-8401		Push Rod, 1st FA; Air Suspension Axle	
08/77→12/86		Control Arm-/Trailing Arm Bush		VL-RK-5357		
08/77→12/86		Stabiliser Mounting	VL-SB-5345	VL-SB-5345		
08/77→12/86		Suspension Arm Repair Kit	VL-RK-5323	VL-RK-5323	for Drag Link, Air Suspension Axle, * 314 000 *→	
08/77→12/86		Tie Bar Bush		VL-SB-9501		
08/77→12/86		Tie Rod	VL-DL-7789		Air Suspension Axle	
08/77→12/86		Tie Rod End	VL-ES-5347		for Steering Rod	
08/77→12/86		Tie Rod End	VL-ES-5348		for Steering Rod	
08/77→12/86		Tie Rod End	VL-ES-7266			
08/77→12/86		Tie Rod End	VL-ES-7286			
08/77→12/86		Track Control Arm		VL-DL-8189	Trailing Arm	
08/77→12/86		Track Control Arm		VL-DL-8545	Trailing Arm, 1st RA; 2nd RA, * A234808 *→	
08/77→12/86		Track Control Arm		VL-DL-9485	Trailing Arm	
08/77→12/86		Track Control Arm		VL-VB-8527	Wishbone (CV)	
08/77→12/86		Track Control Arm		VL-VB-8527	Wishbone (CV)→* 43812 *	
08/77→12/86		Track Control Arm		VL-VB-8539	Wishbone (CV)	
08/77→12/86	Track Control Arm		VL-VB-8539	Wishbone (CV)* 43813 *→		
08/77→12/86	Track Control Arm		VL-VB-8546	Wishbone (CV)		
08/77→12/86	Track Control Arm		VL-VB-12359	Control Arm		
08/77→12/86	Track Control Arm	VL-DL-9485	VL-DL-9485	Trailing Arm, Air Suspension Axle		
F 12/360	01/88→12/94	Centre Rod	VL-DL-5301		Coupling Rod	
	01/88→12/94	Centre Rod	VL-DL-5318		Push Rod	
	01/88→12/94	Centre Rod	VL-DL-5319		Push Rod	
	01/88→12/94	Centre Rod	VL-DL-5540		Push Rod	
	01/88→12/94	Centre Rod	VL-DL-8128		Push Rod* 458606 *; * 347136 *; * A220311 *; * B100000 *→* 494865 *; * 384836 *; * A224523 *; * B114725 *	
	01/88→12/94	Centre Rod	VL-DL-8401		Push Rod, 1st FA; Air Suspension Axle	
	01/88→12/94	Control Arm-/Trailing Arm Bush		VL-RK-5357		
	01/88→12/94	Stabiliser Mounting	VL-SB-5345	VL-SB-5345		
	01/88→12/94	Suspension Arm Repair Kit	VL-RK-5323	VL-RK-5323	for Drag Link, Air Suspension Axle, * 314 000 *→	
	01/88→12/94	Tie Bar Bush		VL-SB-9501		
	01/88→12/94	Tie Rod	VL-DL-7789		Air Suspension Axle	
	01/88→12/94	Tie Rod End	VL-ES-5347		for Steering Rod	
	01/88→12/94	Tie Rod End	VL-ES-5348		for Steering Rod	
	01/88→12/94	Tie Rod End	VL-ES-7266			
	01/88→12/94	Tie Rod End	VL-ES-7286			
	01/88→12/94	Track Control Arm		VL-DL-8189	Trailing Arm	
	01/88→12/94	Track Control Arm		VL-DL-8189	Trailing Arm, Air Suspension Axle	

VL-DL-5301

Length: 1592 Ø: 42
 Cone Ø: d1 Ø 28,6 / d2 Ø 23,9
 1606274, 1626494

**VL-DL-5318**

Length: 860 Ø: 42
 Cone Ø: d1 Ø 31,5 / d2 Ø 27,5
 1576092, 1606283

**VL-DL-5319**

Length: 865 Ø: 40
 Cone Ø: d1 Ø 31,5 / d2 Ø 27,5
 1576093, 1606284

**VL-DL-5540**

Length: 845 Ø: 42
 Cone Ø: d1 Ø 31,5 / d2 Ø 27,5
 1610338, 1626751

**VL-DL-7789**

Length: 1640 Ø: 58
 Cone Ø: d1 Ø 28,6 / d2 Ø 23,9
 1612254, 3985570, 4510697, 20393097,
 21260286

**VL-DL-8128**

Length: 845 Ø: 42
 Cone Ø: d1 Ø 31,5 / d2 Ø 27,5
 1083744

**VL-DL-8189**

Length: 666 Ø: 48
 Hole Distance: 125
 1082104, 1605035

**VL-DL-8401**

Length: 880 Ø: 42
 Cone Ø: d1 Ø 31,5 / d2 Ø 27,5
 1613562, 1626749, 14203500A

**VL-DL-8545**

Length: 660 Ø: 48
 Hole Distance: 130 / 130
 1581527, 1607079, 3944818, 3944819,
 3944820, 8154017, 8154018, 8158206,
 8158207

**VL-DL-8619**

Length: 621 Ø: 48
 Hole Distance: 100 / 100
 1608151, 1621419

**VL-DL-9485**

Length: 666 Ø: 48
 Hole Distance: 125 / 125
 1589817

**VL-ES-5347**

Length: 125
 Cone Ø: d1 Ø 28,6 / d2 Ø 23,9
 Thread: M30 x 1,5 LHT
 1507822, 1698847, 3092471

**VL-ES-5348**

Length: 125
 Cone Ø: d1 Ø 28,6 / d2 Ø 23,9
 Thread: M30 x 1,5 RHT
 1507823, 1698846, 3092472

**VL-ES-7266**

Length: 125
 Cone Ø: d1 Ø 31,5 / d2 Ø 27,5
 Thread: M30 x 1,5 RHT
 0356310, 1507826, 1695585, 1695776,
 1698557, 6882111, 6882111(BRAZIL),
 6889480, 6889482, 14200800A, 85114146

**VL-ES-7286**

Length: 87
 Cone Ø: d1 Ø 16 / d2 Ø 14,4
 Thread: M28 x 1,5 RHT
 382745, 1527234, 1668638

**VL-RK-5323**

Ø: 91 Hole Distance: 125
 Thick/Height: 20
 1598588, 14302100A

**VL-RK-5357**

Ø: 138
 Hole Ø 14 / 16 / 14
 Hole Distance: 21
 Thick/Height: 96 / 96
 1075255, 1591689, 3173759, 14301900A,
 20554908

**VL-SB-5345**

Ø: 57,5
 Thick/Height: 64
 1134955, 1190030, 14301500A

**VL-SB-9501**

Ø: 91 Thick/Height: 85 / 85
 1135080

**VL-VB-8527**

Length: 635
 Ø: 58
 Hole Distance: 152 / 152
 1080690, 1509222, 1576952, 1606200,
 6886777

**VL-VB-8539**

Length: 641
 Ø: 48
 Hole Distance: 152 / 152
 1606552

**VL-VB-8546**

Length: 644
 Ø: 46
 Hole Distance: 115 / 115
 1590068

**VL-VB-12359**

Length: 687,5
 Ø: 58
 Hole Distance: 125 / 125
 Thick/Height: 30
 1605244, 1628483, 3173294, 8156994,
 20556586





F 12 ...

F 12/360 ...	01/88→12/94	Track Control Arm		VL-DL-8189	Trailing Arm, Drive Axle;Air Suspension Axle
	01/88→12/94	Track Control Arm		VL-DL-8545	Trailing Arm, 1st RA;2nd RA, * A234808 *→
	01/88→12/94	Track Control Arm		VL-DL-8619	Trailing Arm
	01/88→12/94	Track Control Arm		VL-DL-9485	Trailing Arm
	01/88→12/94	Track Control Arm		VL-VB-8527	Wishbone (CV)
	01/88→12/94	Track Control Arm		VL-VB-8539	Wishbone (CV)
	01/88→12/94	Track Control Arm		VL-VB-8539	Wishbone (CV)* 43813 *→
	01/88→12/94	Track Control Arm		VL-VB-8546	Wishbone (CV)
	01/88→12/94	Track Control Arm		VL-VB-12359	Control Arm
	01/88→12/94	Track Control Arm	VL-DL-9485	VL-DL-9485	Trailing Arm, Air Suspension Axle
F 12/370	08/77→12/86	Centre Rod	VL-DL-8128		Push Rod
	08/77→12/87	Centre Rod	VL-DL-5301		Coupling Rod
	08/77→12/87	Centre Rod	VL-DL-5318		Push Rod
	08/77→12/87	Centre Rod	VL-DL-5319		Push Rod
	08/77→12/87	Centre Rod	VL-DL-5540		Push Rod
	08/77→12/87	Centre Rod	VL-DL-8401		Push Rod, 1st FA;Air Suspension Axle
	08/77→12/87	Control Arm-/Trailing Arm Bush		VL-RK-5357	
	08/77→12/87	Stabiliser Mounting	VL-SB-5345	VL-SB-5345	
	08/77→12/87	Suspension Arm Repair Kit	VL-RK-5323	VL-RK-5323	for Drag Link, Air Suspension Axle, * 314 000 *→
	08/77→12/87	Tie Bar Bush		VL-SB-9501	
	08/77→12/87	Tie Rod	VL-DL-7789		Air Suspension Axle
	08/77→12/87	Tie Rod End	VL-ES-5347		for Steering Rod
	08/77→12/87	Tie Rod End	VL-ES-5348		for Steering Rod
	08/77→12/87	Tie Rod End	VL-ES-7266		
	08/77→12/87	Tie Rod End	VL-ES-7286		
	08/77→12/87	Track Control Arm		VL-DL-8189	Trailing Arm
	08/77→12/87	Track Control Arm		VL-DL-8189	Trailing Arm, Air Suspension Axle
	08/77→12/87	Track Control Arm		VL-DL-8545	Trailing Arm, 1st RA;2nd RA, * A234808 *→
	08/77→12/87	Track Control Arm		VL-DL-9485	Trailing Arm
	08/77→12/87	Track Control Arm		VL-VB-8527	Wishbone (CV)
	08/77→12/87	Track Control Arm		VL-VB-8527	Wishbone (CV)→* 43812 *
	08/77→12/87	Track Control Arm		VL-VB-8539	Wishbone (CV)
	08/77→12/87	Track Control Arm		VL-VB-8539	Wishbone (CV)* 43813 *→
	08/77→12/87	Track Control Arm		VL-VB-8546	Wishbone (CV)
	08/77→12/87	Track Control Arm		VL-VB-12359	Control Arm
	08/77→12/87	Track Control Arm	VL-DL-9485	VL-DL-9485	Trailing Arm, Air Suspension Axle
	01/87→12/87	Centre Rod	VL-DL-8128		Push Rod* 458606 *; 347136 *; * A220311 *; B100000 *→* 494865 *; * 384836 *; A224523 *; B114725 *
	01/87→12/87	Track Control Arm		VL-DL-8189	Trailing Arm, Drive Axle;Air Suspension Axle
	01/87→12/87	Track Control Arm		VL-DL-8619	Trailing Arm
	F 12/400	01/88→12/90	Track Control Arm		VL-DL-8545
01/88→12/90		Track Control Arm		VL-DL-8619	Trailing Arm
01/88→12/90		Track Control Arm		VL-VB-8539	Wishbone (CV)
01/88→12/90		Track Control Arm		VL-VB-8539	Wishbone (CV)* 43813 *→
01/88→12/90		Track Control Arm		VL-VB-8546	Wishbone (CV)
01/88→12/94		Centre Rod	VL-DL-5301		Coupling Rod
01/88→12/94		Centre Rod	VL-DL-5318		Push Rod
01/88→12/94		Centre Rod	VL-DL-5319		Push Rod
01/88→12/94		Centre Rod	VL-DL-5540		Push Rod
01/88→12/94		Centre Rod	VL-DL-8128		Push Rod* 458606 *; 347136 *; * A220311 *; B100000 *→* 494865 *; * 384836 *; A224523 *; B114725 *
01/88→12/94		Centre Rod	VL-DL-8401		Push Rod, 1st FA;Air Suspension Axle
01/88→12/94		Stabiliser Mounting	VL-SB-5345	VL-SB-5345	
01/88→12/94		Suspension Arm Repair Kit		DF-RK-8994	for Wishbone (CV)
01/88→12/94		Suspension Arm Repair Kit		IV-RK-8998	for Wishbone (CV)
01/88→12/94		Suspension Arm Repair Kit		MN-RK-8678	for Wishbone (CV)
01/88→12/94		Suspension Arm Repair Kit		MN-RK-9383	for Control Arm
01/88→12/94		Suspension Arm Repair Kit		SC-RK-8575	for Wishbone (CV)
01/88→12/94		Suspension Arm Repair Kit		VL-RK-9499	for Wishbone (CV)

DF-RK-8994

Ø: 75 Hole Distance: 130
Thick/Height: 24
274070

**IV-RK-8998**

Ø: 85 Hole Distance: 130
Thick/Height: 30
273373, 274019, 4941233, 6889509

**MN-RK-8678**

Length: 100
Ø: 90
276191

**MN-RK-9383**

Ø: 67
Hole Distance: 100
Thick/Height: 24
275988

**SC-RK-8575**

Ø: 95 Hole Distance: 152
Thick/Height: 35
274056

**VL-DL-5301**

Length: 1592 Ø: 42
Cone Ø: d1 Ø 28,6 / d2 Ø 23,9
1606274, 1626494

**VL-DL-5318**

Length: 860 Ø: 42
Cone Ø: d1 Ø 31,5 / d2 Ø 27,5
1576092, 1606283

**VL-DL-5319**

Length: 865 Ø: 40
Cone Ø: d1 Ø 31,5 / d2 Ø 27,5
1576093, 1606284

**VL-DL-5540**

Length: 845 Ø: 42
Cone Ø: d1 Ø 31,5 / d2 Ø 27,5
1610338, 1626751

**VL-DL-7789**

Length: 1640 Ø: 58
Cone Ø: d1 Ø 28,6 / d2 Ø 23,9
1612254, 3985570, 4510697, 20393097,
21260286

**VL-DL-8128**

Length: 845 Ø: 42
Cone Ø: d1 Ø 31,5 / d2 Ø 27,5
1083744

**VL-DL-8189**

Length: 666 Ø: 48
Hole Distance: 125
1082104, 1605035

**VL-DL-8401**

Length: 880 Ø: 42
Cone Ø: d1 Ø 31,5 / d2 Ø 27,5
1613562, 1626749, 14203500A

**VL-DL-8545**

Length: 660 Ø: 48
Hole Distance: 130 / 130
1581527, 1607079, 3944818, 3944819,
3944820, 8154017, 8154018, 8158206,
8158207

**VL-DL-8619**

Length: 621 Ø: 48
Hole Distance: 100 / 100
1608151, 1621419

**VL-DL-9485**

Length: 666 Ø: 48
Hole Distance: 125 / 125
1589817

**VL-ES-5347**

Length: 125
Cone Ø: d1 Ø 28,6 / d2 Ø 23,9
Thread: M30 x 1,5 LHT
1507822, 1698847, 3092471

**VL-ES-5348**

Length: 125
Cone Ø: d1 Ø 28,6 / d2 Ø 23,9
Thread: M30 x 1,5 RHT
1507823, 1698846, 3092472

**VL-ES-7266**

Length: 125
Cone Ø: d1 Ø 31,5 / d2 Ø 27,5
Thread: M30 x 1,5 RHT
0356310, 1507826, 1695585, 1695776,
1698557, 6882111, 6882111(BRAZIL),
6889480, 6889482, 14200800A, 85114146

**VL-ES-7286**

Length: 87
Cone Ø: d1 Ø 16 / d2 Ø 14,4
Thread: M28 x 1,5 RHT
382745, 1527234, 1668638

**VL-RK-5323**

Ø: 91 Hole Distance: 125
Thick/Height: 20
1598588, 14302100A

**VL-RK-5357**

Ø: 138
Hole Ø 14 / 16 / 14
Hole Distance: 21
Thick/Height: 96 / 96
1075255, 1591689, 3173759, 14301900A,
20554908

**VL-RK-9499**

Ø: 72
274069

**VL-SB-5345**

Ø: 57,5
Thick/Height: 64
1134955, 1190030, 14301500A

**VL-SB-9501**

Ø: 91 Thick/Height: 85 / 85
1135080

**VL-VB-8527**

Length: 635
Ø: 58
Hole Distance: 152 / 152
1080690, 1509222, 1576952, 1606200,
6886777

**VL-VB-8539**

Length: 641
Ø: 48
Hole Distance: 152 / 152
1606552

**VL-VB-8546**

Length: 644
Ø: 46
Hole Distance: 115 / 115
1590068

**VL-VB-12359**

Length: 687,5
Ø: 58
Hole Distance: 125 / 125
Thick/Height: 30
1605244, 1628483, 3173294, 8156994,
20556586





F 12 ...

F 12/400 ...	01/88→12/94	Suspension Arm Repair Kit	VL-RK-5323	VL-RK-5323	for Drag Link, Air Suspension Axle, * 314 000 *→
	01/88→12/94	Suspension Strut Repair Kit		MN-RK-8537	
	01/88→12/94	Tie Bar Bush		VL-SB-9501	
	01/88→12/94	Tie Rod	VL-DL-7789		Air Suspension Axle
	01/88→12/94	Tie Rod End	VL-ES-5347		for Steering Rod
	01/88→12/94	Tie Rod End	VL-ES-5348		for Steering Rod
	01/88→12/94	Tie Rod End	VL-ES-7266		
	01/88→12/94	Tie Rod End	VL-ES-7286		
	01/88→12/94	Track Control Arm		VL-DL-8189	Trailing Arm, Air Suspension Axle
	01/88→12/94	Track Control Arm		VL-DL-8189	Trailing Arm, Drive Axle;Air Suspension Axle
	01/88→12/94	Track Control Arm		VL-DL-8545	Trailing Arm
	01/88→12/94	Track Control Arm		VL-DL-9485	Trailing Arm
	01/88→12/94	Track Control Arm		VL-VB-8527	Wishbone (CV)
	01/88→12/94	Track Control Arm		VL-VB-12359	Control Arm
	F 12/400,F 12/410	01/88→12/94	Track Control Arm	VL-DL-9485	VL-DL-9485
01/88→12/94		Centre Rod	VL-DL-5301		Coupling Rod
01/88→12/94		Centre Rod	VL-DL-5318		Push Rod
01/88→12/94		Centre Rod	VL-DL-5319		Push Rod
01/88→12/94		Centre Rod	VL-DL-5540		Push Rod
01/88→12/94		Centre Rod	VL-DL-8128		Push Rod* 458606 *; 347136 *; * A220311 *; B100000 *→* 494865 *; * 384836 *; A224523 *; B114725 *
01/88→12/94		Centre Rod	VL-DL-8401		Push Rod, 1st FA;Air Suspension Axle
01/88→12/94		Control Arm-/Trailing Arm Bush		VL-RK-5357	
01/88→12/94		Stabiliser Mounting	VL-SB-5345	VL-SB-5345	
01/88→12/94		Suspension Arm Repair Kit	VL-RK-5323	VL-RK-5323	for Drag Link, Air Suspension Axle, * 314 000 *→
01/88→12/94		Tie Bar Bush		VL-SB-9501	
01/88→12/94		Tie Rod	VL-DL-7789		Air Suspension Axle
01/88→12/94		Tie Rod End	VL-ES-5347		for Steering Rod
01/88→12/94		Tie Rod End	VL-ES-5348		for Steering Rod
01/88→12/94		Tie Rod End	VL-ES-7266		
01/88→12/94		Tie Rod End	VL-ES-7286		
01/88→12/94		Track Control Arm		VL-DL-8189	Trailing Arm, Drive Axle;Air Suspension Axle
01/88→12/94		Track Control Arm		VL-DL-9485	Trailing Arm
01/88→12/94		Track Control Arm		VL-VB-12359	Control Arm
01/88→12/94		Track Control Arm	VL-DL-9485	VL-DL-9485	Trailing Arm, Air Suspension Axle
12/90→12/94		Track Control Arm		VL-DL-8189	Trailing Arm
12/90→12/94		Track Control Arm		VL-DL-8189	Trailing Arm, Air Suspension Axle
12/90→12/94		Track Control Arm		VL-DL-8545	Trailing Arm, 1st RA;2nd RA, * A234808 *→
12/90→12/94		Track Control Arm		VL-DL-8619	Trailing Arm
12/90→12/94		Track Control Arm		VL-VB-8527	Wishbone (CV)
12/90→12/94		Track Control Arm		VL-VB-8539	Wishbone (CV)
12/90→12/94		Track Control Arm		VL-VB-8539	Wishbone (CV)* 43813 *→
12/90→12/94		Track Control Arm		VL-VB-8546	Wishbone (CV)

F 16

F 16/470	01/88→12/89	Centre Rod	VL-DL-5319		Push Rod
	01/88→12/89	Centre Rod	VL-DL-5540		Push Rod
	01/88→12/89	Centre Rod	VL-DL-8128		Push Rod
	01/88→12/89	Centre Rod	VL-DL-8401		Push Rod, 1st FA;Air Suspension Axle
	01/88→12/89	Control Arm-/Trailing Arm Bush		VL-RK-5357	
	01/88→12/89	Stabiliser Mounting	VL-SB-5345	VL-SB-5345	
	01/88→12/89	Suspension Arm Repair Kit	VL-RK-5323	VL-RK-5323	for Drag Link, Air Suspension Axle
	01/88→12/89	Tie Bar Bush		VL-SB-9501	
	01/88→12/89	Tie Rod	VL-DL-7789		Air Suspension Axle
	01/88→12/89	Tie Rod End	SC-ES-5764		
	01/88→12/89	Tie Rod End	VL-ES-7266		
	01/88→12/89	Tie Rod End	VL-ES-7286		
	01/88→12/89	Track Control Arm		VL-DL-8189	Trailing Arm
	01/88→12/89	Track Control Arm		VL-DL-8189	Trailing Arm, Air Suspension Axle
	01/88→12/89	Track Control Arm		VL-DL-8189	Trailing Arm, Drive Axle;Air Suspension Axle

MN-RK-8537

Ø: 95 Hole Distance: 152
Thick/Height: 24
274056, 276192, 696321, 81432706099



SC-ES-5764

Length: 95
Cone Ø: d1 Ø 30 / d2 Ø 27
Thread: M26 x 1,5 RHT
1606980



VL-DL-5301

Length: 1592 Ø: 42
Cone Ø: d1 Ø 28,6 / d2 Ø 23,9
1606274, 1626494



VL-DL-5318

Length: 860 Ø: 42
Cone Ø: d1 Ø 31,5 / d2 Ø 27,5
1576092, 1606283



VL-DL-5319

Length: 865 Ø: 40
Cone Ø: d1 Ø 31,5 / d2 Ø 27,5
1576093, 1606284



VL-DL-5540

Length: 845 Ø: 42
Cone Ø: d1 Ø 31,5 / d2 Ø 27,5
1610338, 1626751



VL-DL-7789

Length: 1640 Ø: 58
Cone Ø: d1 Ø 28,6 / d2 Ø 23,9
1612254, 3985570, 4510697, 20393097,
21260286



VL-DL-8128

Length: 845 Ø: 42
Cone Ø: d1 Ø 31,5 / d2 Ø 27,5
1083744



VL-DL-8189

Length: 666 Ø: 48
Hole Distance: 125
1082104, 1605035



VL-DL-8401

Length: 880 Ø: 42
Cone Ø: d1 Ø 31,5 / d2 Ø 27,5
1613562, 1626749, 14203500A



VL-DL-8545

Length: 660 Ø: 48
Hole Distance: 130 / 130
1581527, 1607079, 3944818, 3944819,
3944820, 8154017, 8154018, 8158206,
8158207



VL-DL-8619

Length: 621 Ø: 48
Hole Distance: 100 / 100
1608151, 1621419



VL-DL-9485

Length: 666 Ø: 48
Hole Distance: 125 / 125
1589817



VL-ES-5347

Length: 125
Cone Ø: d1 Ø 28,6 / d2 Ø 23,9
Thread: M30 x 1,5 LHT
1507822, 1698847, 3092471



VL-ES-5348

Length: 125
Cone Ø: d1 Ø 28,6 / d2 Ø 23,9
Thread: M30 x 1,5 RHT
1507823, 1698846, 3092472



VL-ES-7266

Length: 125
Cone Ø: d1 Ø 31,5 / d2 Ø 27,5
Thread: M30 x 1,5 RHT
0356310, 1507826, 1695585, 1695776,
1698557, 6882111, 6882111(BRAZIL),
6889480, 6889482, 14200800A, 85114146



VL-ES-7286

Length: 87
Cone Ø: d1 Ø 16 / d2 Ø 14,4
Thread: M28 x 1,5 RHT
382745, 1527234, 1668638



VL-RK-5323

Ø: 91 Hole Distance: 125
Thick/Height: 20
1598588, 14302100A



VL-RK-5357

Ø: 138
Hole Ø 14 / 16 / 14
Hole Distance: 21
Thick/Height: 96 / 96
1075255, 1591689, 3173759, 14301900A,
20554908



VL-SB-5345

Ø: 57,5
Thick/Height: 64
1134955, 1190030, 14301500A



VL-SB-9501

Ø: 91 Thick/Height: 85 / 85
1135080



VL-VB-8527

Length: 635
Ø: 58
Hole Distance: 152 / 152
1080690, 1509222, 1576952, 1606200,
6886777



VL-VB-8539

Length: 641
Ø: 48
Hole Distance: 152 / 152
1606552



VL-VB-8546

Length: 644
Ø: 46
Hole Distance: 115 / 115
1590068



VL-VB-12359

Length: 687,5
Ø: 58
Hole Distance: 125 / 125
Thick/Height: 30
1605244, 1628483, 3173294, 8156994,
20556586



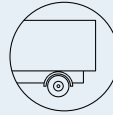
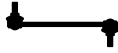

F 16 ...

F 16/470 ...	01/88→12/89	Track Control Arm		VL-DL-8545	Trailing Arm, 1st RA;2nd RA, * A234808 *→
	01/88→12/89	Track Control Arm		VL-DL-8619	Trailing Arm
	01/88→12/89	Track Control Arm		VL-DL-9485	Trailing Arm
	01/88→12/89	Track Control Arm		VL-VB-8527	Wishbone (CV)
	01/88→12/89	Track Control Arm		VL-VB-8539	Wishbone (CV)
	01/88→12/89	Track Control Arm		VL-VB-8546	Wishbone (CV), Air Suspension Axle
F 16/485	01/90→12/92	Centre Rod	VL-DL-5319		Push Rod
	01/90→12/92	Centre Rod	VL-DL-5540		Push Rod
	01/90→12/92	Centre Rod	VL-DL-8128		Push Rod
	01/90→12/92	Centre Rod	VL-DL-8401		Push Rod, 1st FA;Air Suspension Axle
	01/90→12/92	Control Arm-/Trailing Arm Bush		VL-RK-5357	
	01/90→12/92	Stabiliser Mounting	VL-SB-5345	VL-SB-5345	
	01/90→12/92	Suspension Arm Repair Kit	VL-RK-5323	VL-RK-5323	for Drag Link, Air Suspension Axle
	01/90→12/92	Tie Bar Bush		VL-SB-9501	
	01/90→12/92	Tie Rod	VL-DL-7789		Air Suspension Axle
	01/90→12/92	Tie Rod End	SC-ES-5764		
	01/90→12/92	Tie Rod End	VL-ES-7266		
	01/90→12/92	Tie Rod End	VL-ES-7286		
	01/90→12/92	Track Control Arm		VL-DL-8189	Trailing Arm
	01/90→12/92	Track Control Arm		VL-DL-8189	Trailing Arm, Air Suspension Axle
	01/90→12/92	Track Control Arm		VL-DL-8189	Trailing Arm, Drive Axle;Air Suspension Axle
	01/90→12/92	Track Control Arm		VL-DL-8545	Trailing Arm, 1st RA;2nd RA, * A234808 *→
	01/90→12/92	Track Control Arm		VL-DL-8619	Trailing Arm
	01/90→12/92	Track Control Arm		VL-DL-9485	Trailing Arm
	01/90→12/92	Track Control Arm		VL-VB-8527	Wishbone (CV)
	01/90→12/92	Track Control Arm		VL-VB-8539	Wishbone (CV)
01/90→12/92	Track Control Arm		VL-VB-8546	Wishbone (CV), Air Suspension Axle	
F 16/500	01/92→12/94	Centre Rod	VL-DL-5319		Push Rod
	01/92→12/94	Centre Rod	VL-DL-5540		Push Rod
	01/92→12/94	Centre Rod	VL-DL-8128		Push Rod
	01/92→12/94	Centre Rod	VL-DL-8401		Push Rod, 1st FA;Air Suspension Axle
	01/92→12/94	Control Arm-/Trailing Arm Bush		VL-RK-5357	
	01/92→12/94	Stabiliser Mounting	VL-SB-5345	VL-SB-5345	
	01/92→12/94	Suspension Arm Repair Kit	VL-RK-5323	VL-RK-5323	for Drag Link, Air Suspension Axle
	01/92→12/94	Tie Bar Bush		VL-SB-9501	
	01/92→12/94	Tie Rod	VL-DL-7789		Air Suspension Axle
	01/92→12/94	Tie Rod End	SC-ES-5764		
	01/92→12/94	Tie Rod End	VL-ES-7266		
	01/92→12/94	Tie Rod End	VL-ES-7286		
	01/92→12/94	Track Control Arm		VL-DL-8189	Trailing Arm
	01/92→12/94	Track Control Arm		VL-DL-8189	Trailing Arm, Air Suspension Axle
	01/92→12/94	Track Control Arm		VL-DL-8189	Trailing Arm, Drive Axle;Air Suspension Axle
	01/92→12/94	Track Control Arm		VL-DL-8545	Trailing Arm, 1st RA;2nd RA, * A234808 *→
	01/92→12/94	Track Control Arm		VL-DL-8619	Trailing Arm
	01/92→12/94	Track Control Arm		VL-DL-9485	Trailing Arm
	01/92→12/94	Track Control Arm		VL-VB-8527	Wishbone (CV)
	01/92→12/94	Track Control Arm		VL-VB-8539	Wishbone (CV)
01/92→12/94	Track Control Arm		VL-VB-8546	Wishbone (CV), Air Suspension Axle	

F 80

F 88/260	08/65→06/77	Tie Rod End	VL-ES-5287		for Guide Rod
	08/65→06/77	Tie Rod End	VL-ES-5288		for Guide Rod
	08/65→06/77	Tie Rod End	VL-ES-5347		for Steering Rod
	08/65→06/77	Tie Rod End	VL-ES-5348		for Steering Rod
F 89/330	10/70→06/77	Tie Rod End	VL-ES-5287		for Guide Rod
	10/70→06/77	Tie Rod End	VL-ES-5288		for Guide Rod
	10/70→06/77	Tie Rod End	VL-ES-5347		for Steering Rod
	10/70→06/77	Tie Rod End	VL-ES-5348		for Steering Rod

SC-ES-5764

Length: 95
Cone Ø: d1 Ø 30 / d2 Ø 27
Thread: M26 x 1,5 RHT
1606980



VL-DL-9485

Length: 666 Ø: 48
Hole Distance: 125 / 125
1589817



VL-RK-5323

Ø: 91 Hole Distance: 125
Thick/Height: 20
1598588, 14302100A



VL-DL-5319

Length: 865 Ø: 40
Cone Ø: d1 Ø 31,5 / d2 Ø 27,5
1576093, 1606284



VL-ES-5287

Length: 167
Cone Ø: d1 Ø 28,6 / d2 Ø 23,9
Thread: M52 x 1,5 RHT
1696901, 1699401



VL-RK-5357

Ø: 138
Hole Ø 14 / 16 / 14
Hole Distance: 21
Thick/Height: 96 / 96
1075255, 1591689, 3173759, 14301900A,
20554908



VL-DL-5540

Length: 845 Ø: 42
Cone Ø: d1 Ø 31,5 / d2 Ø 27,5
1610338, 1626751



VL-ES-5288

Length: 167
Cone Ø: d1 Ø 28,6 / d2 Ø 23,9
Thread: M52 x 1,5 LHT
1696900, 1699400



VL-SB-5345

Ø: 57,5
Thick/Height: 64
1134955, 1190030, 14301500A



VL-DL-7789

Length: 1640 Ø: 58
Cone Ø: d1 Ø 28,6 / d2 Ø 23,9
1612254, 3985570, 4510697, 20393097,
21260286



VL-ES-5347

Length: 125
Cone Ø: d1 Ø 28,6 / d2 Ø 23,9
Thread: M30 x 1,5 LHT
1507822, 1698847, 3092471



VL-SB-9501

Ø: 91 Thick/Height: 85 / 85
1135080



VL-DL-8128

Length: 845 Ø: 42
Cone Ø: d1 Ø 31,5 / d2 Ø 27,5
1083744



VL-VB-8527

Length: 635
Ø: 58
Hole Distance: 152 / 152
1080690, 1509222, 1576952, 1606200,
6886777



VL-DL-8189

Length: 666 Ø: 48
Hole Distance: 125
1082104, 1605035



VL-ES-5348

Length: 125
Cone Ø: d1 Ø 28,6 / d2 Ø 23,9
Thread: M30 x 1,5 RHT
1507823, 1698846, 3092472



VL-VB-8539

Length: 641
Ø: 48
Hole Distance: 152 / 152
1606552



VL-DL-8401

Length: 880 Ø: 42
Cone Ø: d1 Ø 31,5 / d2 Ø 27,5
1613562, 1626749, 14203500A



VL-ES-7266

Length: 125
Cone Ø: d1 Ø 31,5 / d2 Ø 27,5
Thread: M30 x 1,5 RHT
0356310, 1507826, 1695585, 1695776,
1698557, 6882111, 6882111(BRAZIL),
6889480, 6889482, 14200800A, 85114146



VL-VB-8546

Length: 644
Ø: 46
Hole Distance: 115 / 115
1590068



VL-DL-8619

Length: 621 Ø: 48
Hole Distance: 100 / 100
1608151, 1621419



VL-ES-7286

Length: 87
Cone Ø: d1 Ø 16 / d2 Ø 14,4
Thread: M28 x 1,5 RHT
382745, 1527234, 1668638





FE

FE 240-18	05/06→	Suspension Strut Repair Kit		MN-RK-8501	
	05/06→	Tie Rod End	CV-ES-14163		for Steering Rod
	05/06→	Track Control Arm		RV-VB-8191	Wishbone (CV)
FE 240-22	05/06→	Suspension Strut Repair Kit		MN-RK-8501	
	05/06→	Tie Rod End	CV-ES-14163		for Steering Rod
	05/06→	Track Control Arm		RV-VB-8191	Wishbone (CV)
FE 240-26	05/06→	Suspension Strut Repair Kit		MN-RK-8501	
	05/06→	Tie Rod End	CV-ES-14163		for Steering Rod
	05/06→	Track Control Arm		RV-VB-8191	Wishbone (CV)
	05/06→	Track Control Arm		RV-VB-8191	Wishbone (CV), 1st RA;2nd RA;Leaf Spring Axle
FE 260-18	05/06→	Suspension Strut Repair Kit		MN-RK-8501	
	05/06→	Tie Rod End	CV-ES-14163		for Steering Rod
	05/06→	Track Control Arm		RV-VB-8191	Wishbone (CV)
FE 260-26	05/06→	Suspension Strut Repair Kit		MN-RK-8501	
	05/06→	Tie Rod End	CV-ES-14163		for Steering Rod
	05/06→	Track Control Arm		RV-VB-8191	Wishbone (CV)
FE 280-18	05/06→	Suspension Strut Repair Kit		MN-RK-8501	
	05/06→	Tie Rod End	CV-ES-14163		for Steering Rod
	05/06→	Track Control Arm		RV-VB-8191	Wishbone (CV)
FE 280-22	05/06→	Suspension Strut Repair Kit		MN-RK-8501	
	05/06→	Tie Rod End	CV-ES-14163		for Steering Rod
	05/06→	Track Control Arm		RV-VB-8191	Wishbone (CV)
FE 280-26	05/06→	Suspension Strut Repair Kit		MN-RK-8501	
	05/06→	Tie Rod End	CV-ES-14163		for Steering Rod
	05/06→	Track Control Arm		RV-VB-8191	Wishbone (CV)
	05/06→	Track Control Arm		RV-VB-8191	Wishbone (CV), 1st RA;2nd RA;Leaf Spring Axle
FE 300-18	05/06→	Suspension Strut Repair Kit		MN-RK-8501	
	05/06→	Tie Rod End	CV-ES-14163		for Steering Rod
	05/06→	Track Control Arm		RV-VB-8191	Wishbone (CV)
FE 300-26	05/06→	Suspension Strut Repair Kit		MN-RK-8501	
	05/06→	Tie Rod End	CV-ES-14163		for Steering Rod
	05/06→	Track Control Arm		RV-VB-8191	Wishbone (CV)
FE 320-18	05/06→	Suspension Strut Repair Kit		MN-RK-8501	
	05/06→	Tie Rod End	CV-ES-14163		for Steering Rod
	05/06→	Track Control Arm		RV-VB-8191	Wishbone (CV)
FE 320-22	05/06→	Suspension Strut Repair Kit		MN-RK-8501	
	05/06→	Tie Rod End	CV-ES-14163		for Steering Rod
	05/06→	Track Control Arm		RV-VB-8191	Wishbone (CV)
FE 320-26	05/06→	Suspension Strut Repair Kit		MN-RK-8501	
	05/06→	Tie Rod End	CV-ES-14163		for Steering Rod
	05/06→	Track Control Arm		RV-VB-8191	Wishbone (CV)
	05/06→	Track Control Arm		RV-VB-8191	Wishbone (CV), 1st RA;2nd RA;Leaf Spring Axle
FE 340-18	05/06→	Suspension Strut Repair Kit		MN-RK-8501	
	05/06→	Tie Rod End	CV-ES-14163		for Steering Rod
	05/06→	Track Control Arm		RV-VB-8191	Wishbone (CV)
FE 340-26	05/06→	Suspension Strut Repair Kit		MN-RK-8501	
	05/06→	Tie Rod End	CV-ES-14163		for Steering Rod
	05/06→	Track Control Arm		RV-VB-8191	Wishbone (CV)

FH

400	09/05→	Centre Rod	VL-DL-8407		Push Rod, Leaf Spring Axle
	09/05→	Centre Rod	VL-DL-8566		Push Rod
	09/05→	Centre Rod	VL-DL-8707		Push Rod, Air Suspension Axle
	09/05→	Centre Rod	VL-DL-10228		Push Rod, 1st FA;2nd FA
	09/05→	Centre Rod	VL-DL-12367		for Steering Rod
	09/05→	Centre Rod	VL-DL-12454		for Steering Rod
	09/05→	Centre Rod	VL-DL-12483		Push Rod
	09/05→	Centre Rod	VL-DL-12484		Push Rod
	09/05→	Stabiliser Link		VL-DL-9472	Coupling Rod
	09/05→	Stabiliser Link	VL-DL-10258		Coupling Rod, for Leaf-Spring Suspension vehicles
	09/05→	Stabiliser Link	VL-DL-12356		Coupling Rod
	09/05→	Suspension Arm Repair Kit		VL-RK-9497	for Drag Link

CV-ES-14163

Length: 125
Cone Ø: d1 Ø 30 / d2 Ø 27
Thread: M30 x 1,5 RHT
20742127, 20745043, 20821160, 20862494



MN-RK-8501

Ø: 75 Hole Distance: 115
Thick/Height: 24
20547286



RV-VB-8191

Length: 662,4 Ø: 48
Hole Distance: 115 / 115
20367004, 20507262, 20741695, 20741703,
22318833



VL-DL-8407

Length: 870 Ø: 52
Cone Ø: d1 Ø 28,6 / d2 Ø 23,9
3986452, 20375555, 20393186, 21106930



VL-DL-8566

Length: 863 Ø: 52
Cone Ø: d1 Ø 28,6 / d2 Ø 23,9
20375556, 20393187, 21106952, 21406952



VL-DL-8707

Length: 885 Ø: 50
Cone Ø: d1 Ø 28,6 / d2 Ø 23,9
20390745, 21106936



VL-DL-9472

Length: 435 Ø: 36
Cone Ø: d1 Ø 32,2 / d2 Ø 28
20443061, 20443065, 20994418



VL-DL-10228

Length: 2139 Ø: 62
Cone Ø: d1 Ø 28,6 / d2 Ø 23,9
20453063



VL-DL-10258

Length: 325 Ø: 30
Cone Ø: d1 Ø 22 / d2 Ø 20
1629668, 3986433, 20477805



VL-DL-12356

Length: 275 Ø: 30
Cone Ø: d1 Ø 22
3987423, 20477803



VL-DL-12367

Length: 2139 Ø: 62
Cone Ø: d1 Ø 28,6 / d2 Ø 23,9
Thread: M52 x 1,5 RHT
20453064, 20584291



VL-DL-12454

Length: 2339 Ø: 62
Cone Ø: d1 Ø 28,6 / d2 Ø 23,9
20581632



VL-DL-12483

Length: 485 Ø: 48
Cone Ø: d1 Ø 28,6 / d2 Ø 23,9
20383081, 21260283, 22159761,
81467106355



VL-DL-12484

Length: 1025 Ø: 48
Cone Ø: d1 Ø 28,6 / d2 Ø 23,9
2038308, 21252481



VL-RK-9497

Ø: 95 Hole Distance: 130
Thick/Height: 35
273612, 20702095





FH ...

400 ...	09/05→	Suspension Arm Repair Kit		VL-RK-9497	for Drag Link, Leaf Spring Axle	
	09/05→	Suspension Strut Repair Kit		MN-RK-8501		
	09/05→	Suspension Strut Repair Kit	VL-RK-8533			
	09/05→	Tie Rod	VL-DL-8305		Leaf Spring Axle	
	09/05→	Tie Rod	VL-DL-9492			
	09/05→	Tie Rod	VL-DL-12358			
	09/05→	Tie Rod End	VL-ES-8411			
	09/05→	Tie Rod End	VL-ES-8414		for Guide Rod	
	09/05→	Tie Rod End	VL-ES-10360		for Steering Rod	
	09/05→	Track Control Arm		RV-DL-10299	Trailing Arm, 1st & 2nd Drive Axle, for Leaf-Spring Suspension vehicles	
	09/05→	Track Control Arm		RV-DL-10299	Trailing Arm, 1st RA;2nd RA; Leaf Spring Axle;Unit	
	09/05→	Track Control Arm		RV-TC-12339	Suspension Rod, Trailing Arm	
	09/05→	Track Control Arm		RV-TC-12340	Trailing Arm	
	09/05→	Track Control Arm		RV-VB-8191	Wishbone (CV)	
	09/05→	Track Control Arm		RV-VB-8191	Wishbone (CV), 1st RA;2nd RA;Leaf Spring Axle	
	09/05→	Track Control Arm		RV-VB-8191	Wishbone (CV), Air Suspension Axle	
	09/05→	Track Control Arm		VL-DL-8180	Trailing Arm	
	09/05→	Track Control Arm		VL-DL-8554	Trailing Arm, 1st RA;2nd RA;Leaf Spring Axle	
	09/05→	Track Control Arm		VL-VB-7787	Wishbone (CV)	
	09/05→	Track Control Arm		VL-VB-7787	Wishbone (CV), 1st RA;2nd RA;Unit; Leaf Spring Axle	
	09/05→	Track Control Arm		VL-VB-12460	Wishbone (CV)	
	09/05→	Track Control Arm		VL-VB-12460	Wishbone (CV), 1st & 2nd Drive Axle, for Pneumatic Suspension vehicles	
	09/05→	Track Control Arm		VL-VB-12460	Wishbone (CV), 1st Drive Axle, for Pneumatic Suspension vehicles	
	09/05→	Track Control Arm		VL-VB-12460	Wishbone (CV), Leading Axle Steered, for Pneumatic Suspension vehicles	
	09/05→	Track Control Arm		VL-VB-12460	Wishbone (CV), Leading Axle Steered/not Steered, for Pneumatic Suspension vehicles	
	09/05→	Track Control Arm		VL-VB-12460	Wishbone (CV), Trailing Axle Steered, for Pneumatic Suspension vehicles	
	09/05→	Track Control Arm		VL-VB-12460	Wishbone (CV), Trailing Axle Steered/not Steered, for Pneumatic Suspension vehicles	
	09/05→	Track Control Arm	VL-DL-10309	VL-DL-10309	Trailing Arm, 1st Front Axle, for Pneumatic Suspension vehicles	
	09/05→	Track Control Arm	VL-DL-10309	VL-DL-10309	Trailing Arm, Air Suspension Axle	
	420	01/09→	Centre Rod	VL-DL-8566		Push Rod
		01/09→	Centre Rod	VL-DL-10228		Push Rod, 1st FA;2nd FA
		01/09→	Centre Rod	VL-DL-12367		for Steering Rod
		01/09→	Centre Rod	VL-DL-12454		for Steering Rod
01/09→		Centre Rod	VL-DL-12483		Push Rod	
01/09→		Centre Rod	VL-DL-12484		Push Rod	
01/09→		Stabiliser Link		VL-DL-9472	Coupling Rod	
01/09→		Stabiliser Link	VL-DL-10258		Coupling Rod, for Leaf-Spring Suspension vehicles	
01/09→		Stabiliser Link	VL-DL-12356		Coupling Rod	
01/09→		Suspension Arm Repair Kit		VL-RK-9497	for Drag Link	
01/09→		Suspension Arm Repair Kit		VL-RK-9497	for Drag Link, Leaf Spring Axle	
01/09→		Suspension Strut Repair Kit		MN-RK-8501		
01/09→		Suspension Strut Repair Kit	VL-RK-8533			
01/09→		Tie Rod	VL-DL-9492			
01/09→		Tie Rod	VL-DL-12358			
01/09→		Tie Rod End	VL-ES-8411			
01/09→		Tie Rod End	VL-ES-8414		for Guide Rod	
01/09→		Tie Rod End	VL-ES-10360		for Steering Rod	
01/09→		Track Control Arm		RV-DL-10299	Trailing Arm, 1st RA;2nd RA; Leaf Spring Axle;Unit	
01/09→		Track Control Arm		RV-TC-12339	Suspension Rod, Trailing Arm	
01/09→		Track Control Arm		RV-TC-12340	Trailing Arm	
01/09→		Track Control Arm		RV-VB-8191	Wishbone (CV)	

MN-RK-8501

Ø: 75 Hole Distance: 115
 Thick/Height: 24
 20547286

**RV-DL-10299**

Length: 510 Ø: 21
 20522934, 21051052, 7420864583,
 7421051052

**RV-TC-12339**

Length: 515
 Hole Distance: 13 / 130
 20532931, 21051046

**RV-TC-12340**

Length: 510
 Hole Distance: 115 / 115
 20443044

**RV-VB-8191**

Length: 662,4 Ø: 48
 Hole Distance: 115 / 115
 20367004, 20507262, 20741695, 20741703,
 22318833

**VL-DL-8180**

Length: 625 Ø: 17
 20374444, 20410530, 20509018, 20517494,
 70371270

**VL-DL-8305**

Length: 1634 Ø: 50
 Cone Ø: d1 Ø 28,6 / d2 Ø 23,9
 3198276, 21260274

**VL-DL-8554**

Length: 570 Ø: 48
 Hole Distance: 130 / 130
 1626957, 1626958, 14320200A

**VL-DL-8566**

Length: 863 Ø: 52
 Cone Ø: d1 Ø 28,6 / d2 Ø 23,9
 20375556, 20393187, 21106952, 21406952

**VL-DL-9472**

Length: 435 Ø: 36
 Cone Ø: d1 Ø 32,2 / d2 Ø 28
 20443061, 20443065, 20994418

**VL-DL-9492**

Length: 1660 Ø: 62
 Cone Ø: d1 Ø 32 / d2 Ø 27
 20587731, 21106938

**VL-DL-10228**

Length: 2139 Ø: 62
 Cone Ø: d1 Ø 28,6 / d2 Ø 23,9
 20453063

**VL-DL-10258**

Length: 325 Ø: 30
 Cone Ø: d1 Ø 22 / d2 Ø 20
 1629668, 3986433, 20477805

**VL-DL-10309**

Length: 799 Ø: 48
 Hole Distance: 115 / 115
 20410053, 21106157

**VL-DL-12356**

Length: 275 Ø: 30
 Cone Ø: d1 Ø 22
 3987423, 20477803

**VL-DL-12358**

Length: 1669 Ø: 42
 Cone Ø: d1 Ø 32 / d2 Ø 27
 Thread: M32 x 1,5 RHT / M32 x 1,5 LHT
 20581086, 7420581086

**VL-DL-12367**

Length: 2139 Ø: 62
 Cone Ø: d1 Ø 28,6 / d2 Ø 23,9
 Thread: M52 x 1,5 RHT
 20453064, 20584291

**VL-DL-12454**

Length: 2339 Ø: 62
 Cone Ø: d1 Ø 28,6 / d2 Ø 23,9
 20581632

**VL-DL-12483**

Length: 485 Ø: 48
 Cone Ø: d1 Ø 28,6 / d2 Ø 23,9
 20383081, 21260283, 22159761,
 81467106355

**VL-DL-12484**

Length: 1025 Ø: 48
 Cone Ø: d1 Ø 28,6 / d2 Ø 23,9
 2038308, 21252481

**VL-ES-8411**

Length: 140
 Cone Ø: d1 Ø 28,6 / d2 Ø 23,9
 Thread: M30 x 1,5 RHT
 3093647, 3097999, 21263821

**VL-ES-8414**

Length: 136
 Cone Ø: d1 Ø 32 / d2 Ø 27
 Thread: M30 x 1,5 LHT
 20710008

**VL-ES-10360**

Length: 136
 Cone Ø: d1 Ø 32 / d2 Ø 27
 Thread: M30 x 1,5 RHT
 20581089

**VL-RK-8533**

Ø: 85 Hole Distance: 130
 Thick/Height: 30
 3093630, 3093631, 20840815, 21295230,
 7420840815

**VL-RK-9497**

Ø: 95 Hole Distance: 130
 Thick/Height: 35
 273612, 20702095

**VL-VB-7787**

Length: 671 Ø: 58
 Hole Distance: 130 / 130
 143167, 1076639, 1626896, 1629734,
 20392649, 20829503, 21295227, 21474441,
 22318834, 7421295227

**VL-VB-12460**

Length: 662 Ø: 50
 Hole Distance: 115 / 115
 2223852, 20589061





FH ...

420 ...	01/09→	Track Control Arm		VL-DL-8180	Trailing Arm
	01/09→	Track Control Arm		VL-VB-7787	Wishbone (CV)
	01/09→	Track Control Arm		VL-VB-12460	Wishbone (CV)
	01/09→	Track Control Arm		VL-VB-12460	Wishbone (CV), 1st & 2nd Drive Axle, for Pneumatic Suspension vehicles
	01/09→	Track Control Arm		VL-VB-12460	Wishbone (CV), 1st Drive Axle, for Pneumatic Suspension vehicles
	01/09→	Track Control Arm		VL-VB-12460	Wishbone (CV), Leading Axle Steered, for Pneumatic Suspension vehicles
	01/09→	Track Control Arm		VL-VB-12460	Wishbone (CV), Leading Axle Steered/not Steered, for Pneumatic Suspension vehicles
	01/09→	Track Control Arm		VL-VB-12460	Wishbone (CV), Trailing Axle Steered, for Pneumatic Suspension vehicles
	01/09→	Track Control Arm		VL-VB-12460	Wishbone (CV), Trailing Axle Steered/not Steered, for Pneumatic Suspension vehicles
	01/09→	Track Control Arm	VL-DL-10309	VL-DL-10309	Trailing Arm, 1st Front Axle, for Pneumatic Suspension vehicles
440	09/05→	Centre Rod	VL-DL-8407		Push Rod, Leaf Spring Axle
	09/05→	Centre Rod	VL-DL-8566		Push Rod
	09/05→	Centre Rod	VL-DL-8707		Push Rod, Air Suspension Axle
	09/05→	Centre Rod	VL-DL-10228		Push Rod, 1st FA;2nd FA
	09/05→	Centre Rod	VL-DL-12367		for Steering Rod
	09/05→	Centre Rod	VL-DL-12454		for Steering Rod
	09/05→	Centre Rod	VL-DL-12483		Push Rod
	09/05→	Centre Rod	VL-DL-12484		Push Rod
	09/05→	Stabiliser Link		VL-DL-9472	Coupling Rod
	09/05→	Stabiliser Link	VL-DL-10258		Coupling Rod, for Leaf-Spring Suspension vehicles
	09/05→	Stabiliser Link	VL-DL-12356		Coupling Rod
	09/05→	Suspension Arm Repair Kit		VL-RK-9497	for Drag Link
	09/05→	Suspension Arm Repair Kit		VL-RK-9497	for Drag Link, Leaf Spring Axle
	09/05→	Suspension Strut Repair Kit		MN-RK-8501	
	09/05→	Suspension Strut Repair Kit	VL-RK-8533		
	09/05→	Tie Rod	VL-DL-8305		Leaf Spring Axle
	09/05→	Tie Rod	VL-DL-9492		
	09/05→	Tie Rod	VL-DL-12358		
	09/05→	Tie Rod End	VL-ES-8411		
	09/05→	Tie Rod End	VL-ES-8414		for Guide Rod
	09/05→	Tie Rod End	VL-ES-10360		for Steering Rod
	09/05→	Track Control Arm		RV-DL-10299	Trailing Arm, 1st & 2nd Drive Axle, for Leaf-Spring Suspension vehicles
	09/05→	Track Control Arm		RV-DL-10299	Trailing Arm, 1st RA;2nd RA; Leaf Spring Axle;Unit
	09/05→	Track Control Arm		RV-TC-12339	Suspension Rod, Trailing Arm
	09/05→	Track Control Arm		RV-TC-12340	Trailing Arm
	09/05→	Track Control Arm		RV-VB-8191	Wishbone (CV)
	09/05→	Track Control Arm		RV-VB-8191	Wishbone (CV), 1st RA;2nd RA;Leaf Spring Axle
	09/05→	Track Control Arm		RV-VB-8191	Wishbone (CV), Air Suspension Axle
	09/05→	Track Control Arm		VL-DL-8180	Trailing Arm
	09/05→	Track Control Arm		VL-DL-8554	Trailing Arm, 1st RA;2nd RA;Leaf Spring Axle
	09/05→	Track Control Arm		VL-VB-7787	Wishbone (CV)
	09/05→	Track Control Arm		VL-VB-7787	Wishbone (CV), 1st RA;2nd RA;Unit; Leaf Spring Axle
	09/05→	Track Control Arm		VL-VB-12460	Wishbone (CV)
09/05→	Track Control Arm		VL-VB-12460	Wishbone (CV), 1st & 2nd Drive Axle, for Pneumatic Suspension vehicles	
09/05→	Track Control Arm		VL-VB-12460	Wishbone (CV), 1st Drive Axle, for Pneumatic Suspension vehicles	
09/05→	Track Control Arm		VL-VB-12460	Wishbone (CV), Leading Axle Steered, for Pneumatic Suspension vehicles	
09/05→	Track Control Arm		VL-VB-12460	Wishbone (CV), Leading Axle Steered/not Steered, for Pneumatic Suspension vehicles	

MN-RK-8501

Ø: 75 Hole Distance: 115
Thick/Height: 24
20547286

**RV-DL-10299**

Length: 510 Ø: 21
20522934, 21051052, 7420864583,
7421051052

**RV-TC-12339**

Length: 515
Hole Distance: 13 / 130
20532931, 21051046

**RV-TC-12340**

Length: 510
Hole Distance: 115 / 115
20443044

**RV-VB-8191**

Length: 662,4 Ø: 48
Hole Distance: 115 / 115
20367004, 20507262, 20741695, 20741703,
22318833

**VL-DL-8180**

Length: 625 Ø: 17
20374444, 20410530, 20509018, 20517494,
70371270

**VL-DL-8305**

Length: 1634 Ø: 50
Cone Ø: d1 Ø 28,6 / d2 Ø 23,9
3198276, 21260274

**VL-DL-8407**

Length: 870 Ø: 52
Cone Ø: d1 Ø 28,6 / d2 Ø 23,9
3986452, 20375555, 20393186, 21106930

**VL-DL-8554**

Length: 570 Ø: 48
Hole Distance: 130 / 130
1626957, 1626958, 14320200A

**VL-DL-8566**

Length: 863 Ø: 52
Cone Ø: d1 Ø 28,6 / d2 Ø 23,9
20375556, 20393187, 21106952, 21406952

**VL-DL-8707**

Length: 885 Ø: 50
Cone Ø: d1 Ø 28,6 / d2 Ø 23,9
20390745, 21106936

**VL-DL-9472**

Length: 435 Ø: 36
Cone Ø: d1 Ø 32,2 / d2 Ø 28
20443061, 20443065, 20994418

**VL-DL-9492**

Length: 1660 Ø: 62
Cone Ø: d1 Ø 32 / d2 Ø 27
20587731, 21106938

**VL-DL-10228**

Length: 2139 Ø: 62
Cone Ø: d1 Ø 28,6 / d2 Ø 23,9
20453063

**VL-DL-10258**

Length: 325 Ø: 30
Cone Ø: d1 Ø 22 / d2 Ø 20
1629668, 3986433, 20477805

**VL-DL-10309**

Length: 799 Ø: 48
Hole Distance: 115 / 115
20410053, 21106157

**VL-DL-12356**

Length: 275 Ø: 30
Cone Ø: d1 Ø 22
3987423, 20477803

**VL-DL-12358**

Length: 1669 Ø: 42
Cone Ø: d1 Ø 32 / d2 Ø 27
Thread: M32 x 1,5 RHT / M32 x 1,5 LHT
20581086, 7420581086

**VL-DL-12367**

Length: 2139 Ø: 62
Cone Ø: d1 Ø 28,6 / d2 Ø 23,9
Thread: M52 x 1,5 RHT
20453064, 20584291

**VL-DL-12454**

Length: 2339 Ø: 62
Cone Ø: d1 Ø 28,6 / d2 Ø 23,9
20581632

**VL-DL-12483**

Length: 485 Ø: 48
Cone Ø: d1 Ø 28,6 / d2 Ø 23,9
20383081, 21260283, 22159761,
81467106355

**VL-DL-12484**

Length: 1025 Ø: 48
Cone Ø: d1 Ø 28,6 / d2 Ø 23,9
2038308, 21252481

**VL-ES-8411**

Length: 140
Cone Ø: d1 Ø 28,6 / d2 Ø 23,9
Thread: M30 x 1,5 RHT
3093647, 3097999, 21263821

**VL-ES-8414**

Length: 136
Cone Ø: d1 Ø 32 / d2 Ø 27
Thread: M30 x 1,5 LHT
20710008

**VL-ES-10360**

Length: 136
Cone Ø: d1 Ø 32 / d2 Ø 27
Thread: M30 x 1,5 RHT
20581089

**VL-RK-8533**

Ø: 85 Hole Distance: 130
Thick/Height: 30
3093630, 3093631, 20840815, 21295230,
7420840815

**VL-RK-9497**

Ø: 95 Hole Distance: 130
Thick/Height: 35
273612, 20702095

**VL-VB-7787**

Length: 671 Ø: 58
Hole Distance: 130 / 130
143167, 1076639, 1626896, 1629734,
20392649, 20829503, 21295227, 21474441,
22318834, 7421295227

**VL-VB-12460**

Length: 662 Ø: 50
Hole Distance: 115 / 115
2223852, 20589061





FH ...

440 ...	09/05 →	Track Control Arm		VL-VB-12460	Wishbone (CV), Trailing Axle Steered, for Pneumatic Suspension vehicles
	09/05 →	Track Control Arm		VL-VB-12460	Wishbone (CV), Trailing Axle Steered/not Steered, for Pneumatic Suspension vehicles
	09/05 →	Track Control Arm	VL-DL-10309	VL-DL-10309	Trailing Arm, 1st Front Axle, for Pneumatic Suspension vehicles
	09/05 →	Track Control Arm	VL-DL-10309	VL-DL-10309	Trailing Arm, Air Suspension Axle
460	01/09 →	Centre Rod	VL-DL-8566		Push Rod
	01/09 →	Centre Rod	VL-DL-10228		Push Rod, 1st FA;2nd FA
	01/09 →	Centre Rod	VL-DL-12367		for Steering Rod
	01/09 →	Centre Rod	VL-DL-12454		for Steering Rod
	01/09 →	Centre Rod	VL-DL-12483		Push Rod
	01/09 →	Centre Rod	VL-DL-12484		Push Rod
	01/09 →	Stabiliser Link		VL-DL-9472	Coupling Rod
	01/09 →	Stabiliser Link	VL-DL-10258		Coupling Rod, for Leaf-Spring Suspension vehicles
	01/09 →	Stabiliser Link	VL-DL-12356		Coupling Rod
	01/09 →	Suspension Arm Repair Kit		VL-RK-9497	for Drag Link
	01/09 →	Suspension Arm Repair Kit		VL-RK-9497	for Drag Link, Leaf Spring Axle
	01/09 →	Suspension Strut Repair Kit		MN-RK-8501	
	01/09 →	Suspension Strut Repair Kit	VL-RK-8533		
	01/09 →	Tie Rod	VL-DL-9492		
	01/09 →	Tie Rod	VL-DL-12358		
	01/09 →	Tie Rod End	VL-ES-8411		
	01/09 →	Tie Rod End	VL-ES-8414		for Guide Rod
	01/09 →	Tie Rod End	VL-ES-10360		for Steering Rod
	01/09 →	Track Control Arm		RV-DL-10299	Trailing Arm, 1st RA;2nd RA; Leaf Spring Axle;Unit
	01/09 →	Track Control Arm		RV-TC-12339	Suspension Rod, Trailing Arm
	01/09 →	Track Control Arm		RV-TC-12340	Trailing Arm
	01/09 →	Track Control Arm		RV-VB-8191	Wishbone (CV)
	01/09 →	Track Control Arm		VL-DL-8180	Trailing Arm
	01/09 →	Track Control Arm		VL-VB-7787	Wishbone (CV)
	01/09 →	Track Control Arm		VL-VB-12460	Wishbone (CV)
	01/09 →	Track Control Arm		VL-VB-12460	Wishbone (CV), 1st & 2nd Drive Axle, for Pneumatic Suspension vehicles
	01/09 →	Track Control Arm		VL-VB-12460	Wishbone (CV), 1st Drive Axle, for Pneumatic Suspension vehicles
	01/09 →	Track Control Arm		VL-VB-12460	Wishbone (CV), Leading Axle Steered, for Pneumatic Suspension vehicles
	01/09 →	Track Control Arm		VL-VB-12460	Wishbone (CV), Leading Axle Steered/not Steered, for Pneumatic Suspension vehicles
	01/09 →	Track Control Arm		VL-VB-12460	Wishbone (CV), Trailing Axle Steered, for Pneumatic Suspension vehicles
	01/09 →	Track Control Arm		VL-VB-12460	Wishbone (CV), Trailing Axle Steered/not Steered, for Pneumatic Suspension vehicles
	01/09 →	Track Control Arm	VL-DL-10309	VL-DL-10309	Trailing Arm, 1st Front Axle, for Pneumatic Suspension vehicles
480	09/05 →	Centre Rod	VL-DL-8407		Push Rod, Leaf Spring Axle
	09/05 →	Centre Rod	VL-DL-8566		Push Rod
	09/05 →	Centre Rod	VL-DL-8707		Push Rod, Air Suspension Axle
	09/05 →	Centre Rod	VL-DL-10228		Push Rod, 1st FA;2nd FA
	09/05 →	Centre Rod	VL-DL-12367		for Steering Rod
	09/05 →	Centre Rod	VL-DL-12454		for Steering Rod
	09/05 →	Centre Rod	VL-DL-12483		Push Rod
	09/05 →	Centre Rod	VL-DL-12484		Push Rod
	09/05 →	Stabiliser Link		VL-DL-9472	Coupling Rod
	09/05 →	Stabiliser Link	VL-DL-10258		Coupling Rod, for Leaf-Spring Suspension vehicles
	09/05 →	Stabiliser Link	VL-DL-12356		Coupling Rod
	09/05 →	Suspension Arm Repair Kit		VL-RK-9497	for Drag Link
09/05 →	Suspension Arm Repair Kit		VL-RK-9497	for Drag Link, Leaf Spring Axle	
09/05 →	Suspension Strut Repair Kit		MN-RK-8501		

MN-RK-8501

Ø: 75 Hole Distance: 115
Thick/Height: 24
20547286

**RV-DL-10299**

Length: 510 Ø: 21
20522934, 21051052, 7420864583,
7421051052

**RV-TC-12339**

Length: 515
Hole Distance: 13 / 130
20532931, 21051046

**RV-TC-12340**

Length: 510
Hole Distance: 115 / 115
20443044

**RV-VB-8191**

Length: 662,4 Ø: 48
Hole Distance: 115 / 115
20367004, 20507262, 20741695, 20741703,
22318833

**VL-DL-8180**

Length: 625 Ø: 17
20374444, 20410530, 20509018, 20517494,
70371270

**VL-DL-8407**

Length: 870 Ø: 52
Cone Ø: d1 Ø 28,6 / d2 Ø 23,9
3986452, 20375555, 20393186, 21106930

**VL-DL-8566**

Length: 863 Ø: 52
Cone Ø: d1 Ø 28,6 / d2 Ø 23,9
20375556, 20393187, 21106952, 21406952

**VL-DL-8707**

Length: 885 Ø: 50
Cone Ø: d1 Ø 28,6 / d2 Ø 23,9
20390745, 21106936

**VL-DL-9472**

Length: 435 Ø: 36
Cone Ø: d1 Ø 32,2 / d2 Ø 28
20443061, 20443065, 20994418

**VL-DL-9492**

Length: 1660 Ø: 62
Cone Ø: d1 Ø 32 / d2 Ø 27
20587731, 21106938

**VL-DL-10228**

Length: 2139 Ø: 62
Cone Ø: d1 Ø 28,6 / d2 Ø 23,9
20453063

**VL-DL-10258**

Length: 325 Ø: 30
Cone Ø: d1 Ø 22 / d2 Ø 20
1629668, 3986433, 20477805

**VL-DL-10309**

Length: 799 Ø: 48
Hole Distance: 115 / 115
20410053, 21106157

**VL-DL-12356**

Length: 275 Ø: 30
Cone Ø: d1 Ø 22
3987423, 20477803

**VL-DL-12358**

Length: 1669 Ø: 42
Cone Ø: d1 Ø 32 / d2 Ø 27
Thread: M32 x 1,5 RHT / M32 x 1,5 LHT
20581086, 7420581086

**VL-DL-12367**

Length: 2139 Ø: 62
Cone Ø: d1 Ø 28,6 / d2 Ø 23,9
Thread: M52 x 1,5 RHT
20453064, 20584291

**VL-DL-12454**

Length: 2339 Ø: 62
Cone Ø: d1 Ø 28,6 / d2 Ø 23,9
20581632

**VL-DL-12483**

Length: 485 Ø: 48
Cone Ø: d1 Ø 28,6 / d2 Ø 23,9
20383081, 21260283, 22159761,
81467106355

**VL-DL-12484**

Length: 1025 Ø: 48
Cone Ø: d1 Ø 28,6 / d2 Ø 23,9
2038308, 21252481

**VL-ES-8411**

Length: 140
Cone Ø: d1 Ø 28,6 / d2 Ø 23,9
Thread: M30 x 1,5 RHT
3093647, 3097999, 21263821

**VL-ES-8414**

Length: 136
Cone Ø: d1 Ø 32 / d2 Ø 27
Thread: M30 x 1,5 LHT
20710008

**VL-ES-10360**

Length: 136
Cone Ø: d1 Ø 32 / d2 Ø 27
Thread: M30 x 1,5 RHT
20581089

**VL-RK-8533**

Ø: 85 Hole Distance: 130
Thick/Height: 30
3093630, 3093631, 20840815, 21295230,
7420840815

**VL-RK-9497**

Ø: 95 Hole Distance: 130
Thick/Height: 35
273612, 20702095

**VL-VB-7787**

Length: 671
Ø: 58
Hole Distance: 130 / 130
143167, 1076639, 1626896, 1629734,
20392649, 20829503, 21295227, 21474441,
22318834, 7421295227

**VL-VB-12460**

Length: 662
Ø: 50
Hole Distance: 115 / 115
2223852, 20589061





FH ...

480 ...	09/05→	Suspension Strut Repair Kit	VL-RK-8533			
	09/05→	Tie Rod	VL-DL-8305		Leaf Spring Axle	
	09/05→	Tie Rod	VL-DL-9492			
	09/05→	Tie Rod	VL-DL-12355			
	09/05→	Tie Rod	VL-DL-12358			
	09/05→	Tie Rod End	VL-ES-8411			
	09/05→	Tie Rod End	VL-ES-8414		for Guide Rod	
	09/05→	Tie Rod End	VL-ES-10360		for Steering Rod	
	09/05→	Track Control Arm		RV-DL-10299	Trailing Arm, 1st & 2nd Drive Axle, for Leaf-Spring Suspension vehicles	
	09/05→	Track Control Arm		RV-DL-10299	Trailing Arm, 1st RA;2nd RA; Leaf Spring Axle;Unit	
	09/05→	Track Control Arm		RV-TC-12339	Suspension Rod, Trailing Arm	
	09/05→	Track Control Arm		RV-TC-12340	Trailing Arm	
	09/05→	Track Control Arm		RV-VB-8191	Wishbone (CV)	
	09/05→	Track Control Arm		RV-VB-8191	Wishbone (CV), 1st RA;2nd RA;Leaf Spring Axle	
	09/05→	Track Control Arm		RV-VB-8191	Wishbone (CV), Air Suspension Axle	
	09/05→	Track Control Arm		VL-DL-8180	Trailing Arm	
	09/05→	Track Control Arm		VL-DL-8554	Trailing Arm, 1st RA;2nd RA;Leaf Spring Axle	
	09/05→	Track Control Arm		VL-VB-7787	Wishbone (CV)	
	09/05→	Track Control Arm		VL-VB-7787	Wishbone (CV), 1st RA;2nd RA;Unit; Leaf Spring Axle	
	09/05→	Track Control Arm		VL-VB-12460	Wishbone (CV)	
	09/05→	Track Control Arm		VL-VB-12460	Wishbone (CV), 1st & 2nd Drive Axle, for Pneumatic Suspension vehicles	
	09/05→	Track Control Arm		VL-VB-12460	Wishbone (CV), 1st Drive Axle, for Pneumatic Suspension vehicles	
	09/05→	Track Control Arm		VL-VB-12460	Wishbone (CV), Leading Axle Steered, for Pneumatic Suspension vehicles	
	09/05→	Track Control Arm		VL-VB-12460	Wishbone (CV), Leading Axle Steered/not Steered, for Pneumatic Suspension vehicles	
	09/05→	Track Control Arm		VL-VB-12460	Wishbone (CV), Trailing Axle Steered, for Pneumatic Suspension vehicles	
	09/05→	Track Control Arm		VL-VB-12460	Wishbone (CV), Trailing Axle Steered/not Steered, for Pneumatic Suspension vehicles	
	09/05→	Track Control Arm	VL-DL-10309	VL-DL-10309	Trailing Arm, 1st Front Axle, for Pneumatic Suspension vehicles	
	09/05→	Track Control Arm	VL-DL-10309	VL-DL-10309	Trailing Arm, Air Suspension Axle	
	500	09/05→	Centre Rod	VL-DL-8566		Push Rod
		09/05→	Centre Rod	VL-DL-12367		for Steering Rod
		09/05→	Centre Rod	VL-DL-12454		for Steering Rod
		09/05→	Stabiliser Link		VL-DL-9472	Coupling Rod
		09/05→	Stabiliser Link	VL-DL-10258		Coupling Rod, for Leaf-Spring Suspension vehicles
09/05→		Stabiliser Link	VL-DL-12356		Coupling Rod	
09/05→		Suspension Arm Repair Kit		VL-RK-9497	for Drag Link	
09/05→		Suspension Strut Repair Kit		MN-RK-8501		
09/05→		Suspension Strut Repair Kit	VL-RK-8533			
09/05→		Tie Rod	VL-DL-9492			
09/05→		Tie Rod	VL-DL-12358			
09/05→		Tie Rod End	VL-ES-8411			
09/05→		Tie Rod End	VL-ES-8414		for Guide Rod	
09/05→		Tie Rod End	VL-ES-10360		for Steering Rod	
09/05→		Track Control Arm		RV-TC-12339	Suspension Rod, Trailing Arm	
09/05→		Track Control Arm		RV-TC-12340	Trailing Arm	
09/05→		Track Control Arm		RV-VB-8191	Wishbone (CV)	
09/05→		Track Control Arm		VL-DL-8180	Trailing Arm	
09/05→		Track Control Arm		VL-VB-7787	Wishbone (CV)	
09/05→		Track Control Arm		VL-VB-12460	Wishbone (CV), 1st Drive Axle, for Pneumatic Suspension vehicles	
09/05→		Track Control Arm	VL-DL-10309	VL-DL-10309	Trailing Arm, 1st Front Axle, for Pneumatic Suspension vehicles	
09/07→		Centre Rod	VL-DL-10228		Push Rod, 1st FA;2nd FA	

MN-RK-8501

Ø: 75 Hole Distance: 115
 Thick/Height: 24
 20547286

**RV-DL-10299**

Length: 510 Ø: 21
 20522934, 21051052, 7420864583,
 7421051052

**RV-TC-12339**

Length: 515
 Hole Distance: 13 / 130
 20532931, 21051046

**RV-TC-12340**

Length: 510
 Hole Distance: 115 / 115
 20443044

**RV-VB-8191**

Length: 662,4 Ø: 48
 Hole Distance: 115 / 115
 20367004, 20507262, 20741695, 20741703,
 22318833

**VL-DL-8180**

Length: 625 Ø: 17
 20374444, 20410530, 20509018, 20517494,
 70371270

**VL-DL-8305**

Length: 1634 Ø: 50
 Cone Ø: d1 Ø 28,6 / d2 Ø 23,9
 3198276, 21260274

**VL-DL-8554**

Length: 570 Ø: 48
 Hole Distance: 130 / 130
 1626957, 1626958, 14320200A

**VL-DL-8566**

Length: 863 Ø: 52
 Cone Ø: d1 Ø 28,6 / d2 Ø 23,9
 20375556, 20393187, 21106952, 21406952

**VL-DL-9472**

Length: 435 Ø: 36
 Cone Ø: d1 Ø 32,2 / d2 Ø 28
 20443061, 20443065, 20994418

**VL-DL-9492**

Length: 1660 Ø: 62
 Cone Ø: d1 Ø 32 / d2 Ø 27
 20587731, 21106938

**VL-DL-10228**

Length: 2139 Ø: 62
 Cone Ø: d1 Ø 28,6 / d2 Ø 23,9
 20453063

**VL-DL-10258**

Length: 325 Ø: 30
 Cone Ø: d1 Ø 22 / d2 Ø 20
 1629668, 3986433, 20477805

**VL-DL-10309**

Length: 799 Ø: 48
 Hole Distance: 115 / 115
 20410053, 21106157

**VL-DL-12355**

Length: 368 Ø: 38
 Cone Ø: d1 Ø 28,6 / d2 Ø 23,9
 1628207

**VL-DL-12356**

Length: 275 Ø: 30
 Cone Ø: d1 Ø 22
 3987423, 20477803

**VL-DL-12358**

Length: 1669 Ø: 42
 Cone Ø: d1 Ø 32 / d2 Ø 27
 Thread: M32 x 1,5 RHT / M32 x 1,5 LHT
 20581086, 7420581086

**VL-DL-12367**

Length: 2139 Ø: 62
 Cone Ø: d1 Ø 28,6 / d2 Ø 23,9
 Thread: M52 x 1,5 RHT
 20453064, 20584291

**VL-DL-12454**

Length: 2339 Ø: 62
 Cone Ø: d1 Ø 28,6 / d2 Ø 23,9
 20581632

**VL-ES-8411**

Length: 140
 Cone Ø: d1 Ø 28,6 / d2 Ø 23,9
 Thread: M30 x 1,5 RHT
 3093647, 3097999, 21263821

**VL-ES-8414**

Length: 136
 Cone Ø: d1 Ø 32 / d2 Ø 27
 Thread: M30 x 1,5 LHT
 20710008

**VL-ES-10360**

Length: 136
 Cone Ø: d1 Ø 32 / d2 Ø 27
 Thread: M30 x 1,5 RHT
 20581089

**VL-RK-8533**

Ø: 85 Hole Distance: 130
 Thick/Height: 30
 3093630, 3093631, 20840815, 21295230,
 7420840815

**VL-RK-9497**

Ø: 95 Hole Distance: 130
 Thick/Height: 35
 273612, 20702095

**VL-VB-7787**

Length: 671 Ø: 58
 Hole Distance: 130 / 130
 143167, 1076639, 1626896, 1629734,
 20392649, 20829503, 21295227, 21474441,
 22318834, 7421295227

**VL-VB-12460**

Length: 662 Ø: 50
 Hole Distance: 115 / 115
 2223852, 20589061





FH ...

500 ...	09/07→	Suspension Arm Repair Kit		VL-RK-9497	for Drag Link, Leaf Spring Axle	
	09/07→	Tie Rod	VL-DL-12355			
	09/07→	Track Control Arm		VL-DL-8180	Trailing Arm, 1st Drive Axle, for Pneumatic Suspension vehicles	
	09/07→	Track Control Arm		VL-VB-12460	Wishbone (CV), Leading Axle Steered, for Pneumatic Suspension vehicles	
	09/07→	Track Control Arm		VL-VB-12460	Wishbone (CV), Leading Axle Steered/not Steered, for Pneumatic Suspension vehicles	
	09/07→	Track Control Arm		VL-VB-12460	Wishbone (CV), Trailing Axle Steered, for Pneumatic Suspension vehicles	
	09/07→	Track Control Arm		VL-VB-12460	Wishbone (CV), Trailing Axle Steered/not Steered, for Pneumatic Suspension vehicles	
	01/09→	Centre Rod	VL-DL-12483		Push Rod	
	01/09→	Centre Rod	VL-DL-12484		Push Rod	
	01/09→	Track Control Arm		RV-DL-10299	Trailing Arm, 1st RA;2nd RA; Leaf Spring Axle;Unit	
	01/09→	Track Control Arm		VL-VB-12460	Wishbone (CV)	
	01/09→	Track Control Arm		VL-VB-12460	Wishbone (CV), 1st & 2nd Drive Axle, for Pneumatic Suspension vehicles	
	520	09/05→	Centre Rod	VL-DL-8407		Push Rod, Leaf Spring Axle
		09/05→	Centre Rod	VL-DL-8566		Push Rod
09/05→		Centre Rod	VL-DL-8707		Push Rod, Air Suspension Axle	
09/05→		Centre Rod	VL-DL-10228		Push Rod, 1st FA;2nd FA	
09/05→		Centre Rod	VL-DL-12367		for Steering Rod	
09/05→		Centre Rod	VL-DL-12454		for Steering Rod	
09/05→		Centre Rod	VL-DL-12483		Push Rod	
09/05→		Centre Rod	VL-DL-12484		Push Rod	
09/05→		Stabiliser Link		VL-DL-9472	Coupling Rod	
09/05→		Stabiliser Link	VL-DL-10258		Coupling Rod, for Leaf-Spring Suspension vehicles	
09/05→		Stabiliser Link	VL-DL-12356		Coupling Rod	
09/05→		Suspension Arm Repair Kit		VL-RK-9497	for Drag Link	
09/05→		Suspension Arm Repair Kit		VL-RK-9497	for Drag Link, Leaf Spring Axle	
09/05→		Suspension Strut Repair Kit		MN-RK-8501		
09/05→		Suspension Strut Repair Kit	VL-RK-8533			
09/05→		Tie Rod	VL-DL-8305		Leaf Spring Axle	
09/05→		Tie Rod	VL-DL-9492			
09/05→		Tie Rod	VL-DL-12355			
09/05→		Tie Rod	VL-DL-12358			
09/05→		Tie Rod End	VL-ES-8411			
09/05→		Tie Rod End	VL-ES-8414		for Guide Rod	
09/05→		Tie Rod End	VL-ES-10360		for Steering Rod	
09/05→		Track Control Arm		RV-DL-10299	Trailing Arm, 1st & 2nd Drive Axle, for Leaf-Spring Suspension vehicles	
09/05→		Track Control Arm		RV-DL-10299	Trailing Arm, 1st RA;2nd RA; Leaf Spring Axle;Unit	
09/05→		Track Control Arm		RV-TC-12339	Suspension Rod, Trailing Arm	
09/05→		Track Control Arm		RV-TC-12340	Trailing Arm	
09/05→		Track Control Arm		RV-VB-8191	Wishbone (CV)	
09/05→		Track Control Arm		RV-VB-8191	Wishbone (CV), 1st RA;2nd RA;Leaf Spring Axle	
09/05→		Track Control Arm		RV-VB-8191	Wishbone (CV), Air Suspension Axle	
09/05→		Track Control Arm		VL-DL-8180	Trailing Arm	
09/05→		Track Control Arm		VL-DL-8554	Trailing Arm, 1st RA;2nd RA;Leaf Spring Axle	
09/05→		Track Control Arm		VL-VB-7787	Wishbone (CV)	
09/05→		Track Control Arm		VL-VB-7787	Wishbone (CV), 1st RA;2nd RA;Unit; Leaf Spring Axle	
09/05→		Track Control Arm		VL-VB-12460	Wishbone (CV)	
09/05→		Track Control Arm		VL-VB-12460	Wishbone (CV), 1st & 2nd Drive Axle, for Pneumatic Suspension vehicles	
09/05→		Track Control Arm		VL-VB-12460	Wishbone (CV), 1st Drive Axle, for Pneumatic Suspension vehicles	
09/05→	Track Control Arm		VL-VB-12460	Wishbone (CV), Leading Axle Steered, for Pneumatic Suspension vehicles		

MN-RK-8501

Ø: 75 Hole Distance: 115
 Thick/Height: 24
 20547286

**RV-DL-10299**

Length: 510 Ø: 21
 20522934, 21051052, 7420864583,
 7421051052

**RV-TC-12339**

Length: 515
 Hole Distance: 13 / 130
 20532931, 21051046

**RV-TC-12340**

Length: 510
 Hole Distance: 115 / 115
 20443044

**RV-VB-8191**

Length: 662,4 Ø: 48
 Hole Distance: 115 / 115
 20367004, 20507262, 20741695, 20741703,
 22318833

**VL-DL-8180**

Length: 625 Ø: 17
 20374444, 20410530, 20509018, 20517494,
 70371270

**VL-DL-8305**

Length: 1634 Ø: 50
 Cone Ø: d1 Ø 28,6 / d2 Ø 23,9
 3198276, 21260274

**VL-DL-8407**

Length: 870 Ø: 52
 Cone Ø: d1 Ø 28,6 / d2 Ø 23,9
 3986452, 20375555, 20393186, 21106930

**VL-DL-8554**

Length: 570 Ø: 48
 Hole Distance: 130 / 130
 1626957, 1626958, 14320200A

**VL-DL-8566**

Length: 863 Ø: 52
 Cone Ø: d1 Ø 28,6 / d2 Ø 23,9
 20375556, 20393187, 21106952, 21406952

**VL-DL-8707**

Length: 885 Ø: 50
 Cone Ø: d1 Ø 28,6 / d2 Ø 23,9
 20390745, 21106936

**VL-DL-9472**

Length: 435 Ø: 36
 Cone Ø: d1 Ø 32,2 / d2 Ø 28
 20443061, 20443065, 20994418

**VL-DL-9492**

Length: 1660 Ø: 62
 Cone Ø: d1 Ø 32 / d2 Ø 27
 20587731, 21106938

**VL-DL-10228**

Length: 2139 Ø: 62
 Cone Ø: d1 Ø 28,6 / d2 Ø 23,9
 20453063

**VL-DL-10258**

Length: 325 Ø: 30
 Cone Ø: d1 Ø 22 / d2 Ø 20
 1629668, 3986433, 20477805

**VL-DL-12355**

Length: 368 Ø: 38
 Cone Ø: d1 Ø 28,6 / d2 Ø 23,9
 1628207

**VL-DL-12356**

Length: 275 Ø: 30
 Cone Ø: d1 Ø 22
 3987423, 20477803

**VL-DL-12358**

Length: 1669 Ø: 42
 Cone Ø: d1 Ø 32 / d2 Ø 27
 Thread: M32 x 1,5 RHT / M32 x 1,5 LHT
 20581086, 7420581086

**VL-DL-12367**

Length: 2139 Ø: 62
 Cone Ø: d1 Ø 28,6 / d2 Ø 23,9
 Thread: M52 x 1,5 RHT
 20453064, 20584291

**VL-DL-12454**

Length: 2339 Ø: 62
 Cone Ø: d1 Ø 28,6 / d2 Ø 23,9
 20581632

**VL-DL-12483**

Length: 485 Ø: 48
 Cone Ø: d1 Ø 28,6 / d2 Ø 23,9
 20383081, 21260283, 22159761,
 81467106355

**VL-DL-12484**

Length: 1025 Ø: 48
 Cone Ø: d1 Ø 28,6 / d2 Ø 23,9
 2038308, 21252481

**VL-ES-8411**

Length: 140
 Cone Ø: d1 Ø 28,6 / d2 Ø 23,9
 Thread: M30 x 1,5 RHT
 3093647, 3097999, 21263821

**VL-ES-8414**

Length: 136
 Cone Ø: d1 Ø 32 / d2 Ø 27
 Thread: M30 x 1,5 LHT
 20710008

**VL-ES-10360**

Length: 136
 Cone Ø: d1 Ø 32 / d2 Ø 27
 Thread: M30 x 1,5 RHT
 20581089

**VL-RK-8533**

Ø: 85 Hole Distance: 130
 Thick/Height: 30
 3093630, 3093631, 20840815, 21295230,
 7420840815

**VL-RK-9497**

Ø: 95 Hole Distance: 130
 Thick/Height: 35
 273612, 20702095

**VL-VB-7787**

Length: 671 Ø: 58
 Hole Distance: 130 / 130
 143167, 1076639, 1626896, 1629734,
 20392649, 20829503, 21295227, 21474441,
 22318834, 7421295227

**VL-VB-12460**

Length: 662 Ø: 50
 Hole Distance: 115 / 115
 2223852, 20589061





FH ...

520 ...	09/05→	Track Control Arm		VL-VB-12460	Wishbone (CV), Leading Axle Steered/not Steered, for Pneumatic Suspension vehicles
	09/05→	Track Control Arm		VL-VB-12460	Wishbone (CV), Trailing Axle Steered, for Pneumatic Suspension vehicles
	09/05→	Track Control Arm		VL-VB-12460	Wishbone (CV), Trailing Axle Steered/not Steered, for Pneumatic Suspension vehicles
	09/05→	Track Control Arm	VL-DL-10309	VL-DL-10309	Trailing Arm, 1st Front Axle, for Pneumatic Suspension vehicles
	09/05→	Track Control Arm	VL-DL-10309	VL-DL-10309	Trailing Arm, Air Suspension Axle
540	01/09→	Centre Rod	VL-DL-8566		Push Rod
	01/09→	Centre Rod	VL-DL-10228		Push Rod, 1st FA;2nd FA
	01/09→	Centre Rod	VL-DL-12367		for Steering Rod
	01/09→	Centre Rod	VL-DL-12454		for Steering Rod
	01/09→	Centre Rod	VL-DL-12483		Push Rod
	01/09→	Centre Rod	VL-DL-12484		Push Rod
	01/09→	Stabiliser Link		VL-DL-9472	Coupling Rod
	01/09→	Stabiliser Link	VL-DL-10258		Coupling Rod, for Leaf-Spring Suspension vehicles
	01/09→	Stabiliser Link	VL-DL-12356		Coupling Rod
	01/09→	Suspension Arm Repair Kit		VL-RK-9497	for Drag Link
	01/09→	Suspension Arm Repair Kit		VL-RK-9497	for Drag Link, Leaf Spring Axle
	01/09→	Suspension Strut Repair Kit		MN-RK-8501	
	01/09→	Suspension Strut Repair Kit	VL-RK-8533		
	01/09→	Tie Rod	VL-DL-9492		
	01/09→	Tie Rod	VL-DL-12355		
	01/09→	Tie Rod	VL-DL-12358		
	01/09→	Tie Rod End	VL-ES-8411		
	01/09→	Tie Rod End	VL-ES-8414		for Guide Rod
	01/09→	Tie Rod End	VL-ES-10360		for Steering Rod
	01/09→	Track Control Arm		RV-DL-10299	Trailing Arm, 1st RA;2nd RA; Leaf Spring Axle;Unit
	01/09→	Track Control Arm		RV-TC-12339	Suspension Rod, Trailing Arm
	01/09→	Track Control Arm		RV-TC-12340	Trailing Arm
	01/09→	Track Control Arm		RV-VB-8191	Wishbone (CV)
	01/09→	Track Control Arm		VL-DL-8180	Trailing Arm
	01/09→	Track Control Arm		VL-VB-7787	Wishbone (CV)
	01/09→	Track Control Arm		VL-VB-12460	Wishbone (CV)
	01/09→	Track Control Arm		VL-VB-12460	Wishbone (CV), 1st & 2nd Drive Axle, for Pneumatic Suspension vehicles
	01/09→	Track Control Arm		VL-VB-12460	Wishbone (CV), 1st Drive Axle, for Pneumatic Suspension vehicles
	01/09→	Track Control Arm		VL-VB-12460	Wishbone (CV), Leading Axle Steered, for Pneumatic Suspension vehicles
	01/09→	Track Control Arm		VL-VB-12460	Wishbone (CV), Leading Axle Steered/not Steered, for Pneumatic Suspension vehicles
	01/09→	Track Control Arm		VL-VB-12460	Wishbone (CV), Trailing Axle Steered, for Pneumatic Suspension vehicles
	01/09→	Track Control Arm		VL-VB-12460	Wishbone (CV), Trailing Axle Steered/not Steered, for Pneumatic Suspension vehicles
	01/09→	Track Control Arm	VL-DL-10309	VL-DL-10309	Trailing Arm, 1st Front Axle, for Pneumatic Suspension vehicles

FH 12

FH 12/340	08/93→	Centre Rod	RV-DL-12320		for Steering Rod
	08/93→	Centre Rod	VL-DL-0911		Push Rod136426→
	08/93→	Centre Rod	VL-DL-2139		Push Rod, for Pneumatic Suspension vehicles
	08/93→	Centre Rod	VL-DL-5372		Push Rod
	08/93→	Centre Rod	VL-DL-8178		Push Rod
	08/93→	Centre Rod	VL-DL-8187		Push Rod
	08/93→	Centre Rod	VL-DL-8403		Push Rod
	08/93→	Centre Rod	VL-DL-8403		Push Rod, 1st FA;Air Suspension Axle, * B109622 *→* A230971 *; * B125525 *
	08/93→	Centre Rod	VL-DL-8406		Push Rod, Air Suspension Axle

MN-RK-8501

Ø: 75 Hole Distance: 115
Thick/Height: 24
20547286

**RV-DL-10299**

Length: 510 Ø: 21
20522934, 21051052, 7420864583,
7421051052

**RV-DL-12320**

Length: 881 Ø: 50
Cone Ø: d1 Ø 28,6 / d2 Ø 23,9
20390746, 21106968

**RV-TC-12339**

Length: 515
Hole Distance: 13 / 130
20532931, 21051046

**RV-TC-12340**

Length: 510
Hole Distance: 115 / 115
20443044

**RV-VB-8191**

Length: 662,4 Ø: 48
Hole Distance: 115 / 115
20367004, 20507262, 20741695, 20741703,
22318833

**VL-DL-0911**

Length: 880
Ø: 52
Cone Ø: d1 Ø 28,6 / d2 Ø 23,9
1075663, 3988704, 20393069

**VL-DL-2139**

Length: 880
Ø: 52
Cone Ø: d1 Ø 28,6 / d2 Ø 23,9
1075153, 3988695, 20393061

**VL-DL-5372**

Length: 875
Ø: 50
Cone Ø: d1 Ø 28,6 / d2 Ø 23,9
1628635, 3988708, 3988710, 14203800A,
20393079

**VL-DL-8178**

Length: 572 Ø: 38
Cone Ø: d1 Ø 28,6 / d2 Ø 23,9
1088985, 20393083

**VL-DL-8180**

Length: 625 Ø: 17
20374444, 20410530, 20509018, 20517494,
70371270

**VL-DL-8187**

Length: 2140 Ø: 52
Cone Ø: d1 Ø 28,6 / d2 Ø 23,9
3199225, 20393093, 20442115, 20513953,
24425662

**VL-DL-8403**

Length: 880 Ø: 52
Cone Ø: d1 Ø 28,6 / d2 Ø 23,9
1628636, 14204300A, 85114200

**VL-DL-8406**

Length: 888 Ø: 52
Cone Ø: d1 Ø 28,6 / d2 Ø 23,9
8190146, 20393071

**VL-DL-8566**

Length: 863 Ø: 52
Cone Ø: d1 Ø 28,6 / d2 Ø 23,9
20375556, 20393187, 21106952, 21406952

**VL-DL-9472**

Length: 435 Ø: 36
Cone Ø: d1 Ø 32,2 / d2 Ø 28
20443061, 20443065, 20994418

**VL-DL-9492**

Length: 1660 Ø: 62
Cone Ø: d1 Ø 32 / d2 Ø 27
20587731, 21106938

**VL-DL-10228**

Length: 2139 Ø: 62
Cone Ø: d1 Ø 28,6 / d2 Ø 23,9
20453063

**VL-DL-10258**

Length: 325 Ø: 30
Cone Ø: d1 Ø 22 / d2 Ø 20
1629668, 3986433, 20477805

**VL-DL-10309**

Length: 799 Ø: 48
Hole Distance: 115 / 115
20410053, 21106157

**VL-DL-12355**

Length: 368 Ø: 38
Cone Ø: d1 Ø 28,6 / d2 Ø 23,9
1628207

**VL-DL-12356**

Length: 275 Ø: 30
Cone Ø: d1 Ø 22
3987423, 20477803

**VL-DL-12358**

Length: 1669 Ø: 42
Cone Ø: d1 Ø 32 / d2 Ø 27
Thread: M32 x 1,5 RHT / M32 x 1,5 LHT
20581086, 7420581086

**VL-DL-12367**

Length: 2139 Ø: 62
Cone Ø: d1 Ø 28,6 / d2 Ø 23,9
Thread: M52 x 1,5 RHT
20453064, 20584291

**VL-DL-12454**

Length: 2339 Ø: 62
Cone Ø: d1 Ø 28,6 / d2 Ø 23,9
20581632

**VL-DL-12483**

Length: 485 Ø: 48
Cone Ø: d1 Ø 28,6 / d2 Ø 23,9
20383081, 21260283, 22159761,
81467106355

**VL-DL-12484**

Length: 1025 Ø: 48
Cone Ø: d1 Ø 28,6 / d2 Ø 23,9
2038308, 21252481

**VL-ES-8411**

Length: 140
Cone Ø: d1 Ø 28,6 / d2 Ø 23,9
Thread: M30 x 1,5 RHT
3093647, 3097999, 21263821

**VL-ES-8414**

Length: 136
Cone Ø: d1 Ø 32 / d2 Ø 27
Thread: M30 x 1,5 LHT
20710008

**VL-ES-10360**

Length: 136
Cone Ø: d1 Ø 32 / d2 Ø 27
Thread: M30 x 1,5 RHT
20581089

**VL-RK-8533**

Ø: 85 Hole Distance: 130
Thick/Height: 30
3093630, 3093631, 20840815, 21295230,
7420840815

**VL-RK-9497**

Ø: 95 Hole Distance: 130
Thick/Height: 35
273612, 20702095

**VL-VB-7787**

Length: 671
Ø: 58
Hole Distance: 130 / 130
143167, 1076639, 1626896, 1629734,
20392649, 20829503, 21295227, 21474441,
22318834, 7421295227

**VL-VB-12460**

Length: 662
Ø: 50
Hole Distance: 115 / 115
2223852, 20589061



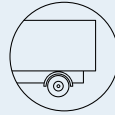
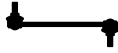

FH 12 ...

FH 12/340 ...

08/93→	Centre Rod	VL-DL-8407		Push Rod, Leaf Spring Axle
08/93→	Centre Rod	VL-DL-8566		Push Rod
08/93→	Centre Rod	VL-DL-8566		Push Rod, Leaf Spring Axle
08/93→	Centre Rod	VL-DL-8594		Push Rod
08/93→	Centre Rod	VL-DL-8594		Push Rod, 1st FA;Leaf Spring Axle, * B109622 *; * D100000 * → * A238753 *; * B136425 *; * D100639 *
08/93→	Centre Rod	VL-DL-8681		Push Rod, 1st FA;Air Suspension Axle
08/93→	Centre Rod	VL-DL-8681		Push Rod, 1st FA;Leaf Spring Axle
08/93→	Centre Rod	VL-DL-8707		Push Rod
08/93→	Centre Rod	VL-DL-8707		Push Rod, Air Suspension Axle
08/93→	Centre Rod	VL-DL-9488		Push Rod
08/93→	Centre Rod	VL-DL-9954		Push Rod → 136425
08/93→	Centre Rod	VL-DL-10228		Push Rod, 1st FA;2nd FA
08/93→	Centre Rod	VL-DL-12367		for Steering Rod
08/93→	Centre Rod	VL-DL-12454		for Steering Rod
08/93→	Centre Rod	VL-DL-12455		for Steering Rod
08/93→	Centre Rod	VL-DL-12483		Push Rod
08/93→	Centre Rod	VL-DL-12484		Push Rod
08/93→	Stabiliser Link		VL-DL-8412	Coupling Rod, Control Arm
08/93→	Stabiliser Link		VL-DL-8518	Coupling Rod, Control Arm
08/93→	Stabiliser Link		VL-DL-8543	Coupling Rod, Control Arm
08/93→	Stabiliser Link		VL-DL-9472	Coupling Rod
08/93→	Stabiliser Link		VL-DL-9491	Coupling Rod, Control Arm
08/93→	Stabiliser Link	VL-DL-8157		Coupling Rod, for Leaf-Spring Suspension vehicles
08/93→	Stabiliser Link	VL-DL-8157		Coupling Rod, for Pneumatic Suspension vehicles
08/93→	Stabiliser Link	VL-DL-8536		Coupling Rod, Air Suspension Axle
08/93→	Stabiliser Link	VL-DL-10258		Coupling Rod, for Leaf-Spring Suspension vehicles
08/93→	Stabiliser Link	VL-DL-12356		Coupling Rod
08/93→	Stabiliser Mounting	VL-SB-10394	VL-SB-10394	
08/93→	Stabiliser Mounting	VL-SB-10397		
08/93→	Stabiliser Mounting	VL-SB-10398		
08/93→	Suspension Arm Repair Kit		CV-RK-5322	for Wishbone (CV)
08/93→	Suspension Arm Repair Kit		IV-RK-8998	for Wishbone (CV)
08/93→	Suspension Arm Repair Kit		VL-RK-9497	for Drag Link
08/93→	Suspension Arm Repair Kit		VL-RK-9497	for Drag Link, Leaf Spring Axle
08/93→	Suspension Arm Repair Kit	VL-RK-5323	VL-RK-5323	for Drag Link
08/93→	Suspension Strut Repair Kit	MN-RK-12436	MN-RK-12436	
08/93→	Tie Bar Bush		VL-RK-8656	
08/93→	Tie Bar Bush		VL-SB-9501	
08/93→	Tie Rod	RV-DL-12447		
08/93→	Tie Rod	VL-DL-7789		
08/93→	Tie Rod	VL-DL-8163		
08/93→	Tie Rod	VL-DL-8305		1st FA;2nd FA;Leaf Spring Axle
08/93→	Tie Rod	VL-DL-8305		Leaf Spring Axle
08/93→	Tie Rod	VL-DL-9492		Air Suspension Axle
08/93→	Tie Rod	VL-DL-9493		Air Suspension Axle
08/93→	Tie Rod	VL-DL-12355		
08/93→	Tie Rod	VL-DL-12358		
08/93→	Tie Rod	VV-DL-0287		
08/93→	Tie Rod End		RV-ES-9432	Leading Axle
08/93→	Tie Rod End		RV-ES-9432	Tag Axle
08/93→	Tie Rod End		VL-ES-10361	Tag Axle
08/93→	Tie Rod End	MN-ES-10333		for Steering Rod
08/93→	Tie Rod End	RV-ES-12442		
08/93→	Tie Rod End	VL-ES-8411		
08/93→	Tie Rod End	VL-ES-8568		
08/93→	Tie Rod End	VL-ES-10361		
08/93→	Track Control Arm		RV-TC-12339	Suspension Rod, Trailing Arm
08/93→	Track Control Arm		RV-TC-12340	Trailing Arm

CV-RK-5322

Ø: 72 Thick/Height: 50
271188, 3091598

**IV-RK-8998**

Ø: 85 Hole Distance: 130
Thick/Height: 30
273373, 274019, 4941233,
6889509

**MN-ES-10333**

Length: 90
Cone Ø: d1 Ø 38 / d2 Ø 34,35
Thread: M36 x 1,5 RHT
1271126, 3090291, 3099128,
42538048, 81953016268,
82953016018, 82953016019

**MN-RK-12436**

Ø: 75 Hole Distance: 115
Thick/Height: 24
3093462, 85104224

**RV-DL-12447**

Length: 1818 Ø: 52
Cone Ø: d1 Ø 28,6 / d2 Ø 23,9
20399543, 21299034, 85115631

**RV-ES-9432**

Length: 120
Cone Ø: d1 Ø 28 / d2 Ø 23,9
Thread: M26 x 1,5 RHT
3193731

**RV-ES-12442**

Length: 88
Cone Ø: d1 Ø 28,6
Thread: M26 x 1,5 RHT
3987648

**RV-TC-12339**

Length: 515
Hole Distance: 13 / 130
20532931, 21051046

**RV-TC-12340**

Length: 510
Hole Distance: 115 / 115
20443044

**VL-DL-7789**

Length: 1640 Ø: 58
Cone Ø: d1 Ø 28,6 / d2 Ø 23,9
1612254, 3985570, 4510697,
20393097, 21260286

**VL-DL-8157**

Length: 325 Ø: 30
Cone Ø: d1 Ø 22 / d2 Ø 20
1629668, 3986433, 14316200A,
20477805

**VL-DL-8163**

Length: 1640 Ø: 42
Cone Ø: d1 Ø 28,6 / d2 Ø 23,9
1628637, 3962343, 3986450,
3988711

**VL-DL-8305**

Length: 1634 Ø: 50
Cone Ø: d1 Ø 28,6 / d2 Ø 23,9
3198276, 21260274

**VL-DL-8407**

Length: 870 Ø: 52
Cone Ø: d1 Ø 28,6 / d2 Ø 23,9
3986452, 20375555, 20393186,
21106930

**VL-DL-8412**

Length: 435 Ø: 36
Cone Ø: d1 Ø 28,6 / d2 Ø 25,5
3173613, 3987354

**VL-DL-8518**

Length: 350 Ø: 36
Cone Ø: d1 Ø 28,9 / d2 Ø 24,7
20443063, 20443067, 20994420

**VL-DL-8536**

Length: 340 Ø: 30
Cone Ø: d1 Ø 22 / d2 Ø 19,9
3944046, 20477807

**VL-DL-8543**

Length: 380 Ø: 36
Cone Ø: d1 Ø 28,6 / d2 Ø 24,7
20443062, 20443066, 20994419

**VL-DL-8566**

Length: 863 Ø: 52
Cone Ø: d1 Ø 28,6 / d2 Ø 23,9
20375556, 20393187, 21106952,
21406952

**VL-DL-8594**

Length: 865 Ø: 52
Cone Ø: d1 Ø 28,6 / d2 Ø 23,9
1075006, 1691660, 85114190

**VL-DL-8681**

Length: 888 Ø: 52
Cone Ø: d1 Ø 28,6 / d2 Ø 23,9
8190147, 20393073

**VL-DL-8707**

Length: 885 Ø: 50
Cone Ø: d1 Ø 28,6 / d2 Ø 23,9
20390745, 21106936

**VL-DL-9472**

Length: 435 Ø: 36
Cone Ø: d1 Ø 32,2 / d2 Ø 28
20443061, 20443065, 20994418

**VL-DL-9488**

Length: 563 Ø: 48
Cone Ø: d1 Ø 28,6 / d2 Ø 23,9
20374831, 21252480

**VL-DL-9491**

Length: 380 Ø: 36
Cone Ø: d1 Ø 28,6 / d2 Ø 25,5
3173914, 3987355

**VL-DL-9492**

Length: 1660 Ø: 62
Cone Ø: d1 Ø 32 / d2 Ø 27
20587731, 21106938

**VL-DL-9493**

Length: 1660 Ø: 62
Cone Ø: d1 Ø 28,6 / d2 Ø 23,9
3198234, 21260275

**VL-DL-9954**

Length: 870 Ø: 50
Cone Ø: d1 Ø 28,6 / d2 Ø 23,9
1075005

**VL-DL-10228**

Length: 2139 Ø: 62
Cone Ø: d1 Ø 28,6 / d2 Ø 23,9
20453063

**VL-DL-10258**

Length: 325 Ø: 30
Cone Ø: d1 Ø 22 / d2 Ø 20
1629668, 3986433, 20477805

**VL-DL-12355**

Length: 368 Ø: 38
Cone Ø: d1 Ø 28,6 / d2 Ø 23,9
1628207

**VL-DL-12356**

Length: 275 Ø: 30
Cone Ø: d1 Ø 22
3987423, 20477803

**VL-DL-12358**

Length: 1669 Ø: 42
Cone Ø: d1 Ø 32 / d2 Ø 27
Thread: M32 x 1,5 RHT / M32 x 1,5 LHT
20581086, 7420581086

**VL-DL-12367**

Length: 2139 Ø: 62
Cone Ø: d1 Ø 28,6 / d2 Ø 23,9
Thread: M52 x 1,5 RHT
20453064, 20584291

**VL-DL-12454**

Length: 2339 Ø: 62
Cone Ø: d1 Ø 28,6 / d2 Ø 23,9
20581632

**VL-DL-12455**

Length: 2141 Ø: 52
Cone Ø: d1 Ø 28,6 / d2 Ø 23,9
1088987

**VL-DL-12483**

Length: 485 Ø: 48
Cone Ø: d1 Ø 28,6 / d2 Ø 23,9
20383081, 21260283, 22159761,
81467106355

**VL-DL-12484**

Length: 1025 Ø: 48
Cone Ø: d1 Ø 28,6 / d2 Ø 23,9
2038308, 21252481

**VL-ES-8411**

Length: 140
Cone Ø: d1 Ø 28,6 / d2 Ø 23,9
Thread: M30 x 1,5 RHT
3093647, 3097999, 21263821

**VL-ES-8568**

Length: 100
Cone Ø: d1 Ø 38 / d2 Ø 34,3
Thread: M26 x 1,5 RHT
8151876

**VL-ES-10361**

Length: 88
Cone Ø: d1 Ø 28,6 / d2 Ø 24
Thread: M26 x 1,5 RHT
20374698

**VL-RK-5323**

Ø: 91 Hole Distance: 125
Thick/Height: 20
1598588, 14302100A

**VL-RK-8656**

Ø: 91 Hole Distance: 145
Thick/Height: 26
1628107

**VL-RK-9497**

Ø: 95 Hole Distance: 130
Thick/Height: 35
273612, 20702095

**VL-SB-9501**

Ø: 91 Thick/Height: 85 / 85
1135080

**VL-SB-10394**

Ø: 90 Thick/Height: 95 / 95
9519245

**VL-SB-10397**

Thick/Height: 89 / 89
1075179

**VL-SB-10398**

Thick/Height: 87,5 / 87,5
1075180

**VV-DL-0287**

Length: 860 Ø: 52
Cone Ø: d1 Ø 28,6 / d2 Ø 23,9
1075664, 3988701



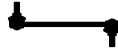

FH 12 ...

FH 12/340 ...	08/93→	Track Control Arm		RV-VB-8191	Wishbone (CV)	
	08/93→	Track Control Arm		RV-VB-8191	Wishbone (CV), 1st RA;2nd RA;Leaf Spring Axle	
	08/93→	Track Control Arm		RV-VB-8191	Wishbone (CV), Air Suspension Axle	
	08/93→	Track Control Arm		VL-DL-8180	Trailing Arm	
	08/93→	Track Control Arm		VL-DL-8189	Trailing Arm	
	08/93→	Track Control Arm		VL-DL-8554	Trailing Arm, 1st RA;2nd RA;Leaf Spring Axle	
	08/93→	Track Control Arm		VL-DL-9485	Trailing Arm	
	08/93→	Track Control Arm		VL-VB-7787	Wishbone (CV)	
	08/93→	Track Control Arm		VL-VB-7787	Wishbone (CV), 1st RA;2nd RA; Leaf Spring Axle;Unit	
	08/93→	Track Control Arm		VL-VB-8525	Wishbone (CV)	
	08/93→	Track Control Arm		VL-VB-8525	Wishbone (CV), Tag Axle;Air Suspension Axle	
	08/93→	Track Control Arm		VL-VB-8541	Wishbone (CV), Air Suspension Axle	
	08/93→	Track Control Arm		VL-VB-8541	Wishbone (CV), Drive Axle;Air Suspension Axle	
	08/93→	Track Control Arm		VL-VB-8541	Wishbone (CV), Tag Axle;Air Suspension Axle	
	08/93→	Track Control Arm		VL-VB-12460	Wishbone (CV)	
	08/93→	Track Control Arm	VL-DL-8554	VL-DL-8554	Trailing Arm	
	08/93→	Track Control Arm	VL-DL-10309	VL-DL-10309	Trailing Arm, Air Suspension Axle	
	FH 12/380	08/93→	Centre Rod	RV-DL-12320		for Steering Rod
		08/93→	Centre Rod	VL-DL-0911		Push Rod136426→
		08/93→	Centre Rod	VL-DL-2139		Push Rod, for Pneumatic Suspension vehicles
08/93→		Centre Rod	VL-DL-5372		Push Rod	
08/93→		Centre Rod	VL-DL-8178		Push Rod	
08/93→		Centre Rod	VL-DL-8187		Push Rod	
08/93→		Centre Rod	VL-DL-8403		Push Rod	
08/93→		Centre Rod	VL-DL-8403		Push Rod, 1st FA;Air Suspension Axle, * B109622 *→* A230971 *;* B125525 *	
08/93→		Centre Rod	VL-DL-8406		Push Rod, Air Suspension Axle	
08/93→		Centre Rod	VL-DL-8407		Push Rod, Leaf Spring Axle	
08/93→		Centre Rod	VL-DL-8566		Push Rod	
08/93→		Centre Rod	VL-DL-8566		Push Rod, Leaf Spring Axle	
08/93→		Centre Rod	VL-DL-8594		Push Rod	
08/93→		Centre Rod	VL-DL-8594		Push Rod, 1st FA;Leaf Spring Axle, * B109622 *;* D100000 *→* A238753 *; * B136425 *;* D100639 *	
08/93→		Centre Rod	VL-DL-8681		Push Rod, 1st FA;Air Suspension Axle	
08/93→		Centre Rod	VL-DL-8681		Push Rod, 1st FA;Leaf Spring Axle	
08/93→		Centre Rod	VL-DL-8707		Push Rod	
08/93→		Centre Rod	VL-DL-8707		Push Rod, Air Suspension Axle	
08/93→		Centre Rod	VL-DL-9488		Push Rod	
08/93→		Centre Rod	VL-DL-9954		Push Rod→136425	
08/93→		Centre Rod	VL-DL-10228		Push Rod, 1st FA;2nd FA	
08/93→		Centre Rod	VL-DL-12367		for Steering Rod	
08/93→		Centre Rod	VL-DL-12454		for Steering Rod	
08/93→		Centre Rod	VL-DL-12455		for Steering Rod	
08/93→		Centre Rod	VL-DL-12483		Push Rod	
08/93→		Centre Rod	VL-DL-12484		Push Rod	
08/93→		Stabiliser Link		VL-DL-8412	Coupling Rod, Control Arm	
08/93→		Stabiliser Link		VL-DL-8518	Coupling Rod, Control Arm	
08/93→		Stabiliser Link		VL-DL-8543	Coupling Rod, Control Arm	
08/93→		Stabiliser Link		VL-DL-9472	Coupling Rod	
08/93→		Stabiliser Link		VL-DL-9491	Coupling Rod, Control Arm	
08/93→		Stabiliser Link	VL-DL-8157		Coupling Rod, for Leaf-Spring Suspension vehicles	
08/93→		Stabiliser Link	VL-DL-8157		Coupling Rod, for Pneumatic Suspension vehicles	
08/93→		Stabiliser Link	VL-DL-8536		Coupling Rod, Air Suspension Axle	
08/93→		Stabiliser Link	VL-DL-10258		Coupling Rod, for Leaf-Spring Suspension vehicles	
08/93→		Stabiliser Link	VL-DL-12356		Coupling Rod	
08/93→		Stabiliser Mounting	VL-SB-10394	VL-SB-10394		
08/93→		Stabiliser Mounting	VL-SB-10397			
08/93→		Stabiliser Mounting	VL-SB-10398			

RV-DL-12320

Length: 881 Ø: 50
 Cone Ø: d1 Ø 28,6 / d2 Ø 23,9
 20390746, 21106968

**RV-VB-8191**

Length: 662,4 Ø: 48
 Hole Distance: 115 / 115
 20367004, 20507262, 20741695, 20741703,
 22318833

**VL-DL-0911**

Length: 880 Ø: 52
 Cone Ø: d1 Ø 28,6 / d2 Ø 23,9
 1075663, 3988704, 20393069

**VL-DL-2139**

Length: 880 Ø: 52
 Cone Ø: d1 Ø 28,6 / d2 Ø 23,9
 1075153, 3988695, 20393061

**VL-DL-5372**

Length: 875 Ø: 50
 Cone Ø: d1 Ø 28,6 / d2 Ø 23,9
 1628635, 3988708, 3988710, 14203800A,
 20393079

**VL-DL-8157**

Length: 325 Ø: 30
 Cone Ø: d1 Ø 22 / d2 Ø 20
 1629668, 3986433, 14316200A, 20477805

**VL-DL-8178**

Length: 572 Ø: 38
 Cone Ø: d1 Ø 28,6 / d2 Ø 23,9
 1088985, 20393083

**VL-DL-8180**

Length: 625 Ø: 17
 20374444, 20410530, 20509018, 20517494,
 70371270

**VL-DL-8187**

Length: 2140 Ø: 52
 Cone Ø: d1 Ø 28,6 / d2 Ø 23,9
 3199225, 20393093, 20442115, 20513953,
 24425662

**VL-DL-8189**

Length: 666 Ø: 48
 Hole Distance: 125
 1082104, 1605035

**VL-DL-8403**

Length: 880 Ø: 52
 Cone Ø: d1 Ø 28,6 / d2 Ø 23,9
 1628636, 14204300A, 85114200

**VL-DL-8406**

Length: 888 Ø: 52
 Cone Ø: d1 Ø 28,6 / d2 Ø 23,9
 8190146, 20393071

**VL-DL-8407**

Length: 870 Ø: 52
 Cone Ø: d1 Ø 28,6 / d2 Ø 23,9
 3986452, 20375555, 20393186, 21106930

**VL-DL-8412**

Length: 435 Ø: 36
 Cone Ø: d1 Ø 28,6 / d2 Ø 25,5
 3173613, 3987354

**VL-DL-8518**

Length: 350 Ø: 36
 Cone Ø: d1 Ø 28,9 / d2 Ø 24,7
 20443063, 20443067, 20994420

**VL-DL-8536**

Length: 340 Ø: 30
 Cone Ø: d1 Ø 22 / d2 Ø 19,9
 3944046, 20477807

**VL-DL-8543**

Length: 380 Ø: 36
 Cone Ø: d1 Ø 28,6 / d2 Ø 24,7
 20443062, 20443066, 20994419

**VL-DL-8554**

Length: 570 Ø: 48
 Hole Distance: 130 / 130
 1626957, 1626958, 14320200A

**VL-DL-8566**

Length: 863 Ø: 52
 Cone Ø: d1 Ø 28,6 / d2 Ø 23,9
 20375556, 20393187, 21106952, 21406952

**VL-DL-8594**

Length: 865 Ø: 52
 Cone Ø: d1 Ø 28,6 / d2 Ø 23,9
 1075006, 1691660, 85114190

**VL-DL-8681**

Length: 888 Ø: 52
 Cone Ø: d1 Ø 28,6 / d2 Ø 23,9
 8190147, 20393073

**VL-DL-8707**

Length: 885 Ø: 50
 Cone Ø: d1 Ø 28,6 / d2 Ø 23,9
 20390745, 21106936

**VL-DL-9472**

Length: 435 Ø: 36
 Cone Ø: d1 Ø 32,2 / d2 Ø 28
 20443061, 20443065, 20994418

**VL-DL-9485**

Length: 666 Ø: 48
 Hole Distance: 125 / 125
 1589817

**VL-DL-9488**

Length: 563 Ø: 48
 Cone Ø: d1 Ø 28,6 / d2 Ø 23,9
 20374831, 21252480

**VL-DL-9491**

Length: 380 Ø: 36
 Cone Ø: d1 Ø 28,6 / d2 Ø 25,5
 3173914, 3987355

**VL-DL-9954**

Length: 870 Ø: 50
 Cone Ø: d1 Ø 28,6 / d2 Ø 23,9
 1075005

**VL-DL-10228**

Length: 2139 Ø: 62
 Cone Ø: d1 Ø 28,6 / d2 Ø 23,9
 20453063

**VL-DL-10258**

Length: 325 Ø: 30
 Cone Ø: d1 Ø 22 / d2 Ø 20
 1629668, 3986433, 20477805

**VL-DL-10309**

Length: 799 Ø: 48
 Hole Distance: 115 / 115
 20410053, 21106157

**VL-DL-12356**

Length: 275 Ø: 30
 Cone Ø: d1 Ø 22
 3987423, 20477803

**VL-DL-12367**

Length: 2139 Ø: 62
 Cone Ø: d1 Ø 28,6 / d2 Ø 23,9
 Thread: M52 x 1,5 RHT
 20453064, 20584291

**VL-DL-12454**

Length: 2339 Ø: 62
 Cone Ø: d1 Ø 28,6 / d2 Ø 23,9
 20581632

**VL-DL-12455**

Length: 2141 Ø: 52
 Cone Ø: d1 Ø 28,6 / d2 Ø 23,9
 1088987

**VL-DL-12483**

Length: 485 Ø: 48
 Cone Ø: d1 Ø 28,6 / d2 Ø 23,9
 20383081, 21260283, 22159761,
 81467106355

**VL-DL-12484**

Length: 1025 Ø: 48
 Cone Ø: d1 Ø 28,6 / d2 Ø 23,9
 2038308, 21252481

**VL-SB-10394**

Ø: 90 Thick/Height: 95 / 95
 9519245

**VL-SB-10397**

Thick/Height: 89 / 89
 1075179

**VL-SB-10398**

Thick/Height: 87,5 / 87,5
 1075180

**VL-VB-7787**

Length: 671 Ø: 58
 Hole Distance: 130 / 130
 143167, 1076639, 1626896, 1629734,
 20392649, 20829503, 21295227, 21474441,
 22318834, 7421295227

**VL-VB-8525**

Length: 677,3 Ø: 48
 Hole Distance: 145 / 145
 3173291, 20556490

**VL-VB-8541**

Length: 677,3 Ø: 48
 Hole Distance: 145 / 145
 3173292, 20556491

**VL-VB-12460**

Length: 662 Ø: 50
 Hole Distance: 115 / 115
 2223852, 20589061





FH 12 ...

FH 12/380 ...	08/93→	Suspension Arm Repair Kit		CV-RK-5322	for Wishbone (CV)
	08/93→	Suspension Arm Repair Kit		IV-RK-8998	for Wishbone (CV)
	08/93→	Suspension Arm Repair Kit		VL-RK-9497	for Drag Link
	08/93→	Suspension Arm Repair Kit		VL-RK-9497	for Drag Link, Leaf Spring Axle
	08/93→	Suspension Arm Repair Kit	VL-RK-5323	VL-RK-5323	for Drag Link
	08/93→	Suspension Strut Repair Kit		MN-RK-8501	
	08/93→	Suspension Strut Repair Kit	MN-RK-12436	MN-RK-12436	
	08/93→	Tie Bar Bush		VL-RK-8656	
	08/93→	Tie Bar Bush		VL-SB-9501	
	08/93→	Tie Rod	RV-DL-12447		
	08/93→	Tie Rod	VL-DL-7789		
	08/93→	Tie Rod	VL-DL-8163		
	08/93→	Tie Rod	VL-DL-8305		Leaf Spring Axle
	08/93→	Tie Rod	VL-DL-9492		Air Suspension Axle
	08/93→	Tie Rod	VL-DL-9493		Air Suspension Axle
	08/93→	Tie Rod	VL-DL-12355		
	08/93→	Tie Rod	VL-DL-12358		
	08/93→	Tie Rod	VV-DL-0287		
	08/93→	Tie Rod End		RV-ES-9432	Leading Axle
	08/93→	Tie Rod End		RV-ES-9432	Tag Axle
	08/93→	Tie Rod End		VL-ES-10361	Tag Axle
	08/93→	Tie Rod End	MN-ES-10333		for Steering Rod
	08/93→	Tie Rod End	RV-ES-12442		
	08/93→	Tie Rod End	VL-ES-8411		
	08/93→	Tie Rod End	VL-ES-8568		
	08/93→	Tie Rod End	VL-ES-10361		
	08/93→	Track Control Arm		RV-TC-12339	Suspension Rod, Trailing Arm
	08/93→	Track Control Arm		RV-TC-12340	Trailing Arm
	08/93→	Track Control Arm		RV-VB-8191	Wishbone (CV)
	08/93→	Track Control Arm		RV-VB-8191	Wishbone (CV), 1st RA;2nd RA;Leaf Spring Axle
	08/93→	Track Control Arm		RV-VB-8191	Wishbone (CV), Air Suspension Axle
	08/93→	Track Control Arm		VL-DL-8180	Trailing Arm
	08/93→	Track Control Arm		VL-DL-8189	Trailing Arm
	08/93→	Track Control Arm		VL-DL-8554	Trailing Arm, 1st RA;2nd RA;Leaf Spring Axle
	08/93→	Track Control Arm		VL-DL-9485	Trailing Arm
	08/93→	Track Control Arm		VL-VB-7787	Wishbone (CV)
	08/93→	Track Control Arm		VL-VB-7787	Wishbone (CV), 1st RA;2nd RA; Leaf Spring Axle;Unit
	08/93→	Track Control Arm		VL-VB-8525	Wishbone (CV)
	08/93→	Track Control Arm		VL-VB-8525	Wishbone (CV), Tag Axle;Air Suspension Axle
	08/93→	Track Control Arm		VL-VB-8541	Wishbone (CV), Air Suspension Axle
	08/93→	Track Control Arm		VL-VB-8541	Wishbone (CV), Drive Axle;Air Suspension Axle
	08/93→	Track Control Arm		VL-VB-8541	Wishbone (CV), Tag Axle;Air Suspension Axle
	08/93→	Track Control Arm		VL-VB-12460	Wishbone (CV)
	08/93→	Track Control Arm	VL-DL-8554	VL-DL-8554	Trailing Arm
	08/93→	Track Control Arm	VL-DL-10309	VL-DL-10309	Trailing Arm, Air Suspension Axle
FH 12/420	08/93→	Bush, parabolic spring		VL-SB-5356	
	08/93→	Centre Rod	RV-DL-12320		for Steering Rod
	08/93→	Centre Rod	VL-DL-0911		Push Rod136426→
	08/93→	Centre Rod	VL-DL-2139		Push Rod, for Pneumatic Suspension vehicles
	08/93→	Centre Rod	VL-DL-5372		Push Rod
	08/93→	Centre Rod	VL-DL-8178		Push Rod
	08/93→	Centre Rod	VL-DL-8187		Push Rod
	08/93→	Centre Rod	VL-DL-8403		Push Rod
	08/93→	Centre Rod	VL-DL-8403		Push Rod, 1st FA;Air Suspension Axle, * B109622 *→* A230971 *;* B125525 *
	08/93→	Centre Rod	VL-DL-8406		Push Rod, Air Suspension Axle
	08/93→	Centre Rod	VL-DL-8407		Push Rod, Leaf Spring Axle
	08/93→	Centre Rod	VL-DL-8566		Push Rod
	08/93→	Centre Rod	VL-DL-8566		Push Rod, Leaf Spring Axle
	08/93→	Centre Rod	VL-DL-8594		Push Rod

CV-RK-5322
Ø: 72 Thick/Height: 50
271188, 3091598



IV-RK-8998
Ø: 85 Hole Distance: 130
Thick/Height: 30
273373, 274019, 4941233,
6889509



MN-ES-10333
Length: 90
Cone Ø: d1 Ø 38 / d2 Ø 34,35
Thread: M36 x 1,5 RHT
1271126, 3090291, 3099128,
42538048, 81953016268,
82953016018, 82953016019



MN-RK-8501
Ø: 75 Hole Distance: 115
Thick/Height: 24
20547286



MN-RK-12436
Ø: 75 Hole Distance: 115
Thick/Height: 24
3093462, 85104224



RV-DL-12320
Length: 881 Ø: 50
Cone Ø: d1 Ø 28,6 / d2 Ø 23,9
20390746, 21106968



RV-DL-12447
Length: 1818 Ø: 52
Cone Ø: d1 Ø 28,6 / d2 Ø 23,9
20399543, 21299034, 85115631



RV-ES-9432
Length: 120
Cone Ø: d1 Ø 28 / d2 Ø 23,9
Thread: M26 x 1,5 RHT
3193731



RV-ES-12442
Length: 88
Cone Ø: d1 Ø 28,6
Thread: M26 x 1,5 RHT
3987648



RV-TC-12339
Length: 515
Hole Distance: 13 / 130
20532931, 21051046



RV-TC-12340
Length: 510
Hole Distance: 115 / 115
20443044



RV-VB-8191
Length: 662,4 Ø: 48
Hole Distance: 115 / 115
20367004, 20507262, 20741695,
20741703, 22318833



VL-DL-0911
Length: 880 Ø: 52
Cone Ø: d1 Ø 28,6 / d2 Ø 23,9
1075663, 3988704, 20393069



VL-DL-2139
Length: 880 Ø: 52
Cone Ø: d1 Ø 28,6 / d2 Ø 23,9
1075153, 3988695, 20393061



VL-DL-5372
Length: 875 Ø: 50
Cone Ø: d1 Ø 28,6 / d2 Ø 23,9
1628635, 3988708, 3988710,
14203800A, 20393079



VL-DL-7789
Length: 1640 Ø: 58
Cone Ø: d1 Ø 28,6 / d2 Ø 23,9
1612254, 3988570, 4510697,
20393097, 21260286



VL-DL-8163
Length: 1640 Ø: 42
Cone Ø: d1 Ø 28,6 / d2 Ø 23,9
1628637, 3962343, 3986450,
3988711



VL-DL-8178
Length: 572 Ø: 38
Cone Ø: d1 Ø 28,6 / d2 Ø 23,9
1088985, 20393083



VL-DL-8180
Length: 625 Ø: 17
20374444, 20410530, 20509018,
20517494, 70371270



VL-DL-8187
Length: 2140 Ø: 52
Cone Ø: d1 Ø 28,6 / d2 Ø 23,9
3199225, 20393093, 20442115,
20513953, 24425662



VL-DL-8189
Length: 666 Ø: 48
Hole Distance: 125
1082104, 1605035



VL-DL-8305
Length: 1634 Ø: 50
Cone Ø: d1 Ø 28,6 / d2 Ø 23,9
3198276, 21260274



VL-DL-8403
Length: 880 Ø: 52
Cone Ø: d1 Ø 28,6 / d2 Ø 23,9
1628636, 14204300A, 85114200



VL-DL-8406
Length: 888 Ø: 52
Cone Ø: d1 Ø 28,6 / d2 Ø 23,9
8190146, 20393071



VL-DL-8407
Length: 870 Ø: 52
Cone Ø: d1 Ø 28,6 / d2 Ø 23,9
3986452, 20375555, 20393186,
21106930



VL-DL-8554
Length: 570 Ø: 48
Hole Distance: 130 / 130
1626957, 1626958, 14320200A



VL-DL-8566
Length: 863 Ø: 52
Cone Ø: d1 Ø 28,6 / d2 Ø 23,9
20375556, 20393187, 21106952,
21406952



VL-DL-8594
Length: 865 Ø: 52
Cone Ø: d1 Ø 28,6 / d2 Ø 23,9
1075006, 1691660, 85114190



VL-DL-9485
Length: 666 Ø: 48
Hole Distance: 125 / 125
1589817



VL-DL-9492
Length: 1660 Ø: 62
Cone Ø: d1 Ø 32 / d2 Ø 27
20587731, 21106938



VL-DL-9493
Length: 1660 Ø: 62
Cone Ø: d1 Ø 28,6 / d2 Ø 23,9
3198234, 21260275



VL-DL-10309
Length: 799 Ø: 48
Hole Distance: 115 / 115
20410053, 21106157



VL-DL-12355
Length: 368 Ø: 38
Cone Ø: d1 Ø 28,6 / d2 Ø 23,9
1628207



VL-DL-12358
Length: 1669 Ø: 42
Cone Ø: d1 Ø 32 / d2 Ø 27
Thread: M32 x 1,5 RHT / M32 x 1,5 LHT
20581086, 7420581086



VL-ES-8411
Length: 140
Cone Ø: d1 Ø 28,6 / d2 Ø 23,9
Thread: M30 x 1,5 RHT
3093647, 3097999, 21263821



VL-ES-8568
Length: 100
Cone Ø: d1 Ø 38 / d2 Ø 34,3
Thread: M26 x 1,5 RHT
8151876



VL-ES-10361
Length: 88
Cone Ø: d1 Ø 28,6 / d2 Ø 24
Thread: M26 x 1,5 RHT
20374698



VL-RK-5323
Ø: 91 Hole Distance: 125
Thick/Height: 20
1598588, 14302100A



VL-RK-8656
Ø: 91 Hole Distance: 145
Thick/Height: 26
1628107



VL-RK-9497
Ø: 95 Hole Distance:
130
Thick/Height: 35
273612, 20702095



VL-SB-5356
Thick/Height: 150
1629553, 14403900A, 20390836



VL-SB-9501
Ø: 91 Thick/Height:
85 / 85
1135080



VL-VB-7787
Length: 671 Ø: 58
Hole Distance: 130 / 130
143167, 1076639, 1626896,
1629734, 20392649, 20829503,
21295227, 21474441, 22318834,
7421295227



VL-VB-8525
Length: 677,3 Ø: 48
Hole Distance: 145 / 145
3173291, 20556490



VL-VB-8541
Length: 677,3 Ø: 48
Hole Distance: 145 / 145
3173292, 20556491



VL-VB-12460
Length: 662 Ø: 50
Hole Distance: 115 / 115
2223852, 20589061



VV-DL-0287
Length: 860 Ø: 52
Cone Ø: d1 Ø 28,6 / d2 Ø 23,9
1075664, 3988701





FH 12 ...

FH 12/420 ...

08/93 →	Centre Rod	VL-DL-8594		Push Rod, 1st FA; Leaf Spring Axle, * B109622 *; * D100000 * → * A238753 *; * B136425 *; * D100639 *
08/93 →	Centre Rod	VL-DL-8681		Push Rod, 1st FA; Air Suspension Axle
08/93 →	Centre Rod	VL-DL-8681		Push Rod, 1st FA; Leaf Spring Axle
08/93 →	Centre Rod	VL-DL-8707		Push Rod
08/93 →	Centre Rod	VL-DL-8707		Push Rod, Air Suspension Axle
08/93 →	Centre Rod	VL-DL-9488		Push Rod
08/93 →	Centre Rod	VL-DL-9954		Push Rod → 136425
08/93 →	Centre Rod	VL-DL-10228		Push Rod, 1st FA; 2nd FA
08/93 →	Centre Rod	VL-DL-12367		for Steering Rod
08/93 →	Centre Rod	VL-DL-12454		for Steering Rod
08/93 →	Centre Rod	VL-DL-12455		for Steering Rod
08/93 →	Centre Rod	VL-DL-12483		Push Rod
08/93 →	Centre Rod	VL-DL-12484		Push Rod
08/93 →	Stabiliser Link		VL-DL-8412	Coupling Rod, Control Arm
08/93 →	Stabiliser Link		VL-DL-8518	Coupling Rod, Control Arm
08/93 →	Stabiliser Link		VL-DL-8543	Coupling Rod, Control Arm
08/93 →	Stabiliser Link		VL-DL-9472	Coupling Rod
08/93 →	Stabiliser Link		VL-DL-9491	Coupling Rod, Control Arm
08/93 →	Stabiliser Link	VL-DL-8157		Coupling Rod, for Leaf-Spring Suspension vehicles
08/93 →	Stabiliser Link	VL-DL-8157		Coupling Rod, for Pneumatic Suspension vehicles
08/93 →	Stabiliser Link	VL-DL-8536		Coupling Rod, Air Suspension Axle
08/93 →	Stabiliser Link	VL-DL-10258		Coupling Rod, for Leaf-Spring Suspension vehicles
08/93 →	Stabiliser Link	VL-DL-12356		Coupling Rod
08/93 →	Stabiliser Mounting	VL-SB-10397		
08/93 →	Stabiliser Mounting	VL-SB-10398		
08/93 →	Suspension Arm Repair Kit		CV-RK-5322	for Wishbone (CV)
08/93 →	Suspension Arm Repair Kit		IV-RK-8998	for Wishbone (CV)
08/93 →	Suspension Arm Repair Kit		MN-RK-9383	for Control Arm
08/93 →	Suspension Arm Repair Kit		VL-RK-9497	for Drag Link
08/93 →	Suspension Arm Repair Kit		VL-RK-9497	for Drag Link, Leaf Spring Axle
08/93 →	Suspension Strut Repair Kit		MN-RK-8501	
08/93 →	Suspension Strut Repair Kit	MN-RK-12436	MN-RK-12436	
08/93 →	Suspension Strut Repair Kit	VL-RK-8533		
08/93 →	Tie Bar Bush		VL-SB-9501	
08/93 →	Tie Rod	RV-DL-12447		
08/93 →	Tie Rod	VL-DL-7789		
08/93 →	Tie Rod	VL-DL-8163		
08/93 →	Tie Rod	VL-DL-8305		Leaf Spring Axle
08/93 →	Tie Rod	VL-DL-9492		Air Suspension Axle
08/93 →	Tie Rod	VL-DL-9493		Air Suspension Axle
08/93 →	Tie Rod	VL-DL-12355		
08/93 →	Tie Rod	VL-DL-12358		
08/93 →	Tie Rod	VV-DL-0287		
08/93 →	Tie Rod End		RV-ES-9432	Leading Axle
08/93 →	Tie Rod End		RV-ES-9432	Tag Axle
08/93 →	Tie Rod End		VL-ES-10361	Tag Axle
08/93 →	Tie Rod End	MN-ES-10333		for Steering Rod
08/93 →	Tie Rod End	RV-ES-12442		
08/93 →	Tie Rod End	VL-ES-8411		
08/93 →	Tie Rod End	VL-ES-8568		
08/93 →	Tie Rod End	VL-ES-10361		
08/93 →	Track Control Arm		RV-TC-12339	Suspension Rod, Trailing Arm
08/93 →	Track Control Arm		RV-TC-12340	Trailing Arm
08/93 →	Track Control Arm		RV-VB-8191	Wishbone (CV)
08/93 →	Track Control Arm		RV-VB-8191	Wishbone (CV), 1st RA; 2nd RA; Leaf Spring Axle
08/93 →	Track Control Arm		RV-VB-8191	Wishbone (CV), Air Suspension Axle
08/93 →	Track Control Arm		VL-DL-8180	Trailing Arm
08/93 →	Track Control Arm		VL-DL-8554	Trailing Arm, 1st RA; 2nd RA; Leaf Spring Axle

CV-RK-5322

Ø: 72 Thick/Height: 50
271188, 3091598

**IV-RK-8998**

Ø: 85 Hole Distance: 130
Thick/Height: 30
273373, 274019, 4941233,
6889509

**MN-ES-10333**

Length: 90
Cone Ø: d1 Ø 38 / d2 Ø 34,35
Thread: M36 x 1,5 RHT
1271126, 3090291, 3099128,
42538048, 81953016268,
82953016018, 82953016019

**MN-RK-8501**

Ø: 75 Hole Distance: 115
Thick/Height: 24
20547286

**MN-RK-9383**

Ø: 67 Hole Distance: 100
Thick/Height: 24
275988

**MN-RK-12436**

Ø: 75 Hole Distance: 115
Thick/Height: 24
3093462, 85104224

**RV-DL-12447**

Length: 1818 Ø: 52
Cone Ø: d1 Ø 28,6 / d2 Ø 23,9
20399543, 21299034, 85115631

**RV-ES-9432**

Length: 120
Cone Ø: d1 Ø 28 / d2 Ø 23,9
Thread: M26 x 1,5 RHT
3193731

**RV-ES-12442**

Length: 88
Cone Ø: d1 Ø 28,6
Thread: M26 x 1,5 RHT
3987648

**RV-TC-12339**

Length: 515
Hole Distance: 13 / 130
20532931, 21051046

**RV-TC-12340**

Length: 510
Hole Distance: 115 / 115
20443044

**RV-VB-8191**

Length: 662,4 Ø: 48
Hole Distance: 115 / 115
20367004, 20507262, 20741695,
20741703, 22318833

**VL-DL-7789**

Length: 1640 Ø: 58
Cone Ø: d1 Ø 28,6 / d2 Ø 23,9
1612254, 3985570, 4510697,
20393097, 21260286

**VL-DL-8157**

Length: 325 Ø: 30
Cone Ø: d1 Ø 22 / d2 Ø 20
1629668, 3986433, 14316200A,
20477805

**VL-DL-8163**

Length: 1640 Ø: 42
Cone Ø: d1 Ø 28,6 / d2 Ø 23,9
1628637, 3962343, 3986450,
3988711

**VL-DL-8180**

Length: 625 Ø: 17
20374444, 20410530, 20509018,
20517494, 70371270

**VL-DL-8305**

Length: 1634 Ø: 50
Cone Ø: d1 Ø 28,6 / d2 Ø 23,9
3198276, 21260274

**VL-DL-8412**

Length: 435 Ø: 36
Cone Ø: d1 Ø 28,6 / d2 Ø 25,5
3173613, 3987354

**VL-DL-8518**

Length: 350 Ø: 36
Cone Ø: d1 Ø 28,9 / d2 Ø 24,7
20443063, 20443067, 20994420

**VL-DL-8536**

Length: 340 Ø: 30
Cone Ø: d1 Ø 22 / d2 Ø 19,9
3944046, 20477807

**VL-DL-8543**

Length: 380 Ø: 36
Cone Ø: d1 Ø 28,6 / d2 Ø 24,7
20443062, 20443066, 20994419

**VL-DL-8554**

Length: 570 Ø: 48
Hole Distance: 130 / 130
1626957, 1626958, 14320200A

**VL-DL-8594**

Length: 865 Ø: 52
Cone Ø: d1 Ø 28,6 / d2 Ø 23,9
1075006, 1691660, 85114190

**VL-DL-8681**

Length: 888 Ø: 52
Cone Ø: d1 Ø 28,6 / d2 Ø 23,9
8190147, 20393073

**VL-DL-8707**

Length: 885 Ø: 50
Cone Ø: d1 Ø 28,6 / d2 Ø 23,9
20390745, 21106936

**VL-DL-9472**

Length: 435 Ø: 36
Cone Ø: d1 Ø 32,2 / d2 Ø 28
20443061, 20443065, 20994418

**VL-DL-9488**

Length: 563 Ø: 48
Cone Ø: d1 Ø 28,6 / d2 Ø 23,9
20374831, 21252480

**VL-DL-9491**

Length: 380 Ø: 36
Cone Ø: d1 Ø 28,6 / d2 Ø 25,5
3173914, 3987355

**VL-DL-9492**

Length: 1660 Ø: 62
Cone Ø: d1 Ø 32 / d2 Ø 27
20587731, 21106938

**VL-DL-9493**

Length: 1660 Ø: 62
Cone Ø: d1 Ø 28,6 / d2 Ø 23,9
3198234, 21260275

**VL-DL-9954**

Length: 870 Ø: 50
Cone Ø: d1 Ø 28,6 / d2 Ø 23,9
1075005

**VL-DL-10228**

Length: 2139 Ø: 62
Cone Ø: d1 Ø 28,6 / d2 Ø 23,9
20453063

**VL-DL-10258**

Length: 325 Ø: 30
Cone Ø: d1 Ø 22 / d2 Ø 20
1629668, 3986433, 20477805

**VL-DL-12355**

Length: 368 Ø: 38
Cone Ø: d1 Ø 28,6 / d2 Ø 23,9
1628207

**VL-DL-12356**

Length: 275 Ø: 30
Cone Ø: d1 Ø 22
3987423, 20477803

**VL-DL-12358**

Length: 1669 Ø: 42
Cone Ø: d1 Ø 32 / d2 Ø 27
Thread: M32 x 1,5 RHT / M32
x 1,5 LHT
20581086, 7420581086

**VL-DL-12367**

Length: 2139 Ø: 62
Cone Ø: d1 Ø 28,6 / d2 Ø 23,9
Thread: M52 x 1,5 RHT
20453064, 20584291

**VL-DL-12454**

Length: 2339 Ø: 62
Cone Ø: d1 Ø 28,6 / d2 Ø 23,9
20581632

**VL-DL-12455**

Length: 2141 Ø: 52
Cone Ø: d1 Ø 28,6 / d2 Ø 23,9
1088987

**VL-DL-12483**

Length: 485 Ø: 48
Cone Ø: d1 Ø 28,6 / d2 Ø 23,9
20383081, 21260283, 22159761,
81467106355

**VL-DL-12484**

Length: 1025 Ø: 48
Cone Ø: d1 Ø 28,6 / d2 Ø 23,9
2038308, 21252481

**VL-ES-8411**

Length: 140
Cone Ø: d1 Ø 28,6 / d2 Ø 23,9
Thread: M30 x 1,5 RHT
3093647, 3097999, 21263821

**VL-ES-8568**

Length: 100
Cone Ø: d1 Ø 38 / d2 Ø 34,3
Thread: M26 x 1,5 RHT
8151876

**VL-ES-10361**

Length: 88
Cone Ø: d1 Ø 28,6 / d2 Ø 24
Thread: M26 x 1,5 RHT
20374698

**VL-RK-8533**

Ø: 85 Hole Distance: 130
Thick/Height: 30
3093630, 3093631, 20840815,
21295230, 7420840815

**VL-RK-9497**

Ø: 95 Hole Distance: 130
Thick/Height: 35
273612, 20702095

**VL-SB-9501**

Ø: 91 Thick/Height: 85 / 85
1135080

**VL-SB-10397**

Thick/Height: 89 / 89
1075179

**VL-SB-10398**

Thick/Height: 87,5 / 87,5
1075180

**VV-DL-0287**

Length: 860 Ø: 52
Cone Ø: d1 Ø 28,6 / d2 Ø 23,9
1075664, 3988701





FH 12 ...

FH 12/420 ...	08/93→	Track Control Arm		VL-DL-9485	Trailing Arm
	08/93→	Track Control Arm		VL-VB-7787	Wishbone (CV)
	08/93→	Track Control Arm		VL-VB-7787	Wishbone (CV), 1st RA;2nd RA; Leaf Spring Axle;Unit
	08/93→	Track Control Arm		VL-VB-8525	Wishbone (CV)
	08/93→	Track Control Arm		VL-VB-8525	Wishbone (CV), Tag Axle;Air Suspension Axle
	08/93→	Track Control Arm		VL-VB-8541	Wishbone (CV), Air Suspension Axle
	08/93→	Track Control Arm		VL-VB-8541	Wishbone (CV), Drive Axle;Air Suspension Axle
	08/93→	Track Control Arm		VL-VB-8541	Wishbone (CV), Tag Axle;Air Suspension Axle
	08/93→	Track Control Arm		VL-VB-8576	Wishbone (CV), Drive Axle;Leading Axle; Air Suspension Axle
	08/93→	Track Control Arm		VL-VB-12460	Wishbone (CV)
08/93→	Track Control Arm	VL-DL-8554	VL-DL-8554	Trailing Arm	
08/93→	Track Control Arm	VL-DL-10309	VL-DL-10309	Trailing Arm, Air Suspension Axle	
FH 12/460	08/98→	Bush, parabolic spring		VL-SB-5356	
	08/98→	Centre Rod	RV-DL-12320		for Steering Rod
	08/98→	Centre Rod	VL-DL-0911		Push Rod136426→
	08/98→	Centre Rod	VL-DL-2139		Push Rod, for Pneumatic Suspension vehicles
	08/98→	Centre Rod	VL-DL-8178		Push Rod
	08/98→	Centre Rod	VL-DL-8187		Push Rod
	08/98→	Centre Rod	VL-DL-8403		Push Rod
	08/98→	Centre Rod	VL-DL-8403		Push Rod, 1st FA;Air Suspension Axle, * B109622 *→* A230971 *; * B125525 *
	08/98→	Centre Rod	VL-DL-8406		Push Rod, Air Suspension Axle
	08/98→	Centre Rod	VL-DL-8407		Push Rod, Leaf Spring Axle
	08/98→	Centre Rod	VL-DL-8566		Push Rod
	08/98→	Centre Rod	VL-DL-8594		Push Rod
	08/98→	Centre Rod	VL-DL-8594		Push Rod, 1st FA;Leaf Spring Axle, * B109622 *; * D100000 *→* A238753 *; * B136425 *; * D100639 *
	08/98→	Centre Rod	VL-DL-8681		Push Rod, 1st FA;Air Suspension Axle
	08/98→	Centre Rod	VL-DL-8681		Push Rod, 1st FA;Leaf Spring Axle
	08/98→	Centre Rod	VL-DL-8707		Push Rod
	08/98→	Centre Rod	VL-DL-8707		Push Rod, Air Suspension Axle
	08/98→	Centre Rod	VL-DL-9488		Push Rod
	08/98→	Centre Rod	VL-DL-9954		Push Rod→136425
	08/98→	Centre Rod	VL-DL-10228		Push Rod, 1st FA;2nd FA
	08/98→	Centre Rod	VL-DL-12367		for Steering Rod
	08/98→	Centre Rod	VL-DL-12454		for Steering Rod
	08/98→	Centre Rod	VL-DL-12455		for Steering Rod
	08/98→	Centre Rod	VL-DL-12483		Push Rod
	08/98→	Centre Rod	VL-DL-12484		Push Rod
	08/98→	Stabiliser Link		VL-DL-8412	Coupling Rod, Control Arm
	08/98→	Stabiliser Link		VL-DL-8518	Coupling Rod, Control Arm
	08/98→	Stabiliser Link		VL-DL-8543	Coupling Rod, Control Arm
	08/98→	Stabiliser Link		VL-DL-9472	Coupling Rod
	08/98→	Stabiliser Link		VL-DL-9491	Coupling Rod, Control Arm
	08/98→	Stabiliser Link	VL-DL-8157		Coupling Rod, for Leaf-Spring Suspension vehicles
	08/98→	Stabiliser Link	VL-DL-8157		Coupling Rod, for Pneumatic Suspension vehicles
	08/98→	Stabiliser Link	VL-DL-8536		Coupling Rod, Air Suspension Axle
	08/98→	Stabiliser Link	VL-DL-10258		Coupling Rod, for Leaf-Spring Suspension vehicles
	08/98→	Stabiliser Link	VL-DL-12356		Coupling Rod
	08/98→	Stabiliser Mounting	VL-SB-10397		
	08/98→	Stabiliser Mounting	VL-SB-10398		
	08/98→	Suspension Arm Repair Kit		CV-RK-5322	for Wishbone (CV)
	08/98→	Suspension Arm Repair Kit		IV-RK-8998	for Wishbone (CV)
	08/98→	Suspension Arm Repair Kit		MN-RK-9383	for Control Arm
08/98→	Suspension Arm Repair Kit		VL-RK-9497	for Drag Link	
08/98→	Suspension Arm Repair Kit		VL-RK-9497	for Drag Link, Leaf Spring Axle	
08/98→	Suspension Strut Repair Kit		MN-RK-8501		

CV-RK-5322

Ø: 72 Thick/Height: 50
271188, 3091598

**IV-RK-8998**

Ø: 85 Hole Distance: 130
Thick/Height: 30
273373, 274019, 4941233,
6889509

**MN-RK-8501**

Ø: 75 Hole Distance: 115
Thick/Height: 24
20547286

**MN-RK-9383**

Ø: 67 Hole Distance: 100
Thick/Height: 24
275988

**RV-DL-12320**

Length: 881 Ø: 50
Cone Ø: d1 Ø 28,6 / d2 Ø 23,9
20390746, 21106968

**VL-DL-0911**

Length: 880 Ø: 52
Cone Ø: d1 Ø 28,6 / d2 Ø 23,9
1075663, 3988704, 20393069

**VL-DL-2139**

Length: 880 Ø: 52
Cone Ø: d1 Ø 28,6 / d2 Ø 23,9
1075153, 3988695, 20393061

**VL-DL-8157**

Length: 325 Ø: 30
Cone Ø: d1 Ø 22 / d2 Ø 20
1629668, 3986433, 14316200A,
20477805

**VL-DL-8178**

Length: 572 Ø: 38
Cone Ø: d1 Ø 28,6 / d2 Ø 23,9
1088985, 20393083

**VL-DL-8187**

Length: 2140 Ø: 52
Cone Ø: d1 Ø 28,6 / d2 Ø 23,9
3199225, 20393093, 20442115,
20513953, 24425662

**VL-DL-8403**

Length: 880 Ø: 52
Cone Ø: d1 Ø 28,6 / d2 Ø 23,9
1628636, 14204300A, 85114200

**VL-DL-8406**

Length: 888 Ø: 52
Cone Ø: d1 Ø 28,6 / d2 Ø 23,9
8190146, 20393071

**VL-DL-8407**

Length: 870 Ø: 52
Cone Ø: d1 Ø 28,6 / d2 Ø 23,9
3986452, 20375555, 20393186,
21106930

**VL-DL-8412**

Length: 435 Ø: 36
Cone Ø: d1 Ø 28,6 / d2 Ø 25,5
3173613, 3987354

**VL-DL-8518**

Length: 350 Ø: 36
Cone Ø: d1 Ø 28,9 / d2 Ø 24,7
20443063, 20443067, 20994420

**VL-DL-8536**

Length: 340 Ø: 30
Cone Ø: d1 Ø 22 / d2 Ø 19,9
3944046, 20477807

**VL-DL-8543**

Length: 380 Ø: 36
Cone Ø: d1 Ø 28,6 / d2 Ø 24,7
20443062, 20443066, 20994419

**VL-DL-8554**

Length: 570 Ø: 48
Hole Distance: 130 / 130
1626957, 1626958, 14320200A

**VL-DL-8566**

Length: 863 Ø: 52
Cone Ø: d1 Ø 28,6 / d2 Ø 23,9
20375556, 20393187, 21106952,
21406952

**VL-DL-8594**

Length: 865 Ø: 52
Cone Ø: d1 Ø 28,6 / d2 Ø 23,9
1075006, 1691660, 85114190

**VL-DL-8681**

Length: 888 Ø: 52
Cone Ø: d1 Ø 28,6 / d2 Ø 23,9
8190147, 20393073

**VL-DL-8707**

Length: 885 Ø: 50
Cone Ø: d1 Ø 28,6 / d2 Ø 23,9
20390745, 21106936

**VL-DL-9472**

Length: 435 Ø: 36
Cone Ø: d1 Ø 32,2 / d2 Ø 28
20443061, 20443065, 20994418

**VL-DL-9485**

Length: 666 Ø: 48
Hole Distance: 125 / 125
1589817

**VL-DL-9488**

Length: 563 Ø: 48
Cone Ø: d1 Ø 28,6 / d2 Ø 23,9
20374831, 21252480

**VL-DL-9491**

Length: 380 Ø: 36
Cone Ø: d1 Ø 28,6 / d2 Ø 25,5
3173914, 3987355

**VL-DL-9954**

Length: 870 Ø: 50
Cone Ø: d1 Ø 28,6 / d2 Ø 23,9
1075005

**VL-DL-10228**

Length: 2139 Ø: 62
Cone Ø: d1 Ø 28,6 / d2 Ø 23,9
20453063

**VL-DL-10258**

Length: 325 Ø: 30
Cone Ø: d1 Ø 22 / d2 Ø 20
1629668, 3986433, 20477805

**VL-DL-10309**

Length: 799 Ø: 48
Hole Distance: 115 / 115
20410053, 21106157

**VL-DL-12356**

Length: 275 Ø: 30
Cone Ø: d1 Ø 22
3987423, 20477803

**VL-DL-12367**

Length: 2139 Ø: 62
Cone Ø: d1 Ø 28,6 / d2 Ø 23,9
Thread: M52 x 1,5 RHT
20453064, 20584291

**VL-DL-12454**

Length: 2339 Ø: 62
Cone Ø: d1 Ø 28,6 / d2 Ø 23,9
20581632

**VL-DL-12455**

Length: 2141 Ø: 52
Cone Ø: d1 Ø 28,6 / d2 Ø 23,9
1088987

**VL-DL-12483**

Length: 485 Ø: 48
Cone Ø: d1 Ø 28,6 / d2 Ø 23,9
20383081, 21260283, 22159761,
81467106355

**VL-DL-12484**

Length: 1025 Ø: 48
Cone Ø: d1 Ø 28,6 / d2 Ø 23,9
2038308, 21252481

**VL-RK-9497**

Ø: 95 Hole Distance: 130
Thick/Height: 35
273612, 20702095

**VL-SB-5356**

Thick/Height: 150
1629553, 14403900A, 20390836

**VL-SB-10397**

Thick/Height: 89 / 89
1075179

**VL-SB-10398**

Thick/Height: 87,5 / 87,5
1075180

**VL-VB-7787**

Length: 671 Ø: 58
Hole Distance: 130 / 130
143167, 1076639, 1626896,
1629734, 20392649, 20829503,
21295227, 21474441, 22318834,
7421295227

**VL-VB-8525**

Length: 677,3 Ø: 48
Hole Distance: 145 / 145
3173291, 20556490

**VL-VB-8541**

Length: 677,3 Ø: 48
Hole Distance: 145 / 145
3173292, 20556491

**VL-VB-8576**

Length: 660,3 Ø: 48
Hole Distance: 145 / 145
3173293, 20556492

**VL-VB-12460**

Length: 662 Ø: 50
Hole Distance: 115 / 115
2223852, 20589061





FH 12 ...

FH 12/460 ...	08/98→	Suspension Strut Repair Kit	MN-RK-12436	MN-RK-12436	
	08/98→	Suspension Strut Repair Kit	VL-RK-8533		
	08/98→	Tie Bar Bush		VL-SB-9501	
	08/98→	Tie Rod	RV-DL-12447		
	08/98→	Tie Rod	VL-DL-7789		
	08/98→	Tie Rod	VL-DL-8163		
	08/98→	Tie Rod	VL-DL-8305		Leaf Spring Axle
	08/98→	Tie Rod	VL-DL-9492		Air Suspension Axle
	08/98→	Tie Rod	VL-DL-9493		Air Suspension Axle
	08/98→	Tie Rod	VL-DL-12355		
	08/98→	Tie Rod	VL-DL-12358		
	08/98→	Tie Rod	VV-DL-0287		
	08/98→	Tie Rod End		RV-ES-9432	Leading Axle
	08/98→	Tie Rod End		RV-ES-9432	Tag Axle
	08/98→	Tie Rod End		VL-ES-10361	Tag Axle
	08/98→	Tie Rod End	MN-ES-10333		for Steering Rod
	08/98→	Tie Rod End	RV-ES-12442		
	08/98→	Tie Rod End	VL-ES-8411		
	08/98→	Tie Rod End	VL-ES-8568		
	08/98→	Tie Rod End	VL-ES-10361		
	08/98→	Track Control Arm		RV-TC-12339	Suspension Rod, Trailing Arm
	08/98→	Track Control Arm		RV-TC-12340	Trailing Arm
	08/98→	Track Control Arm		RV-VB-8191	Wishbone (CV)
	08/98→	Track Control Arm		RV-VB-8191	Wishbone (CV), 1st RA;2nd RA;Leaf Spring Axle
	08/98→	Track Control Arm		RV-VB-8191	Wishbone (CV), Air Suspension Axle
	08/98→	Track Control Arm		VL-DL-8180	Trailing Arm
	08/98→	Track Control Arm		VL-DL-8554	Trailing Arm, 1st RA;2nd RA;Leaf Spring Axle
	08/98→	Track Control Arm		VL-DL-9485	Trailing Arm
	08/98→	Track Control Arm		VL-VB-7787	Wishbone (CV)
	08/98→	Track Control Arm		VL-VB-7787	Wishbone (CV), 1st RA;2nd RA; Leaf Spring Axle;Unit
	08/98→	Track Control Arm		VL-VB-7787	Wishbone (CV), 1st RA;2nd RA;Unit; Leaf Spring Axle
	08/98→	Track Control Arm		VL-VB-8525	Wishbone (CV)
	08/98→	Track Control Arm		VL-VB-8525	Wishbone (CV), Tag Axle;Air Suspension Axle
08/98→	Track Control Arm		VL-VB-8541	Wishbone (CV), Drive Axle;Air Suspension Axle	
08/98→	Track Control Arm		VL-VB-8541	Wishbone (CV), Tag Axle;Air Suspension Axle	
08/98→	Track Control Arm		VL-VB-12460	Wishbone (CV)	
08/98→	Track Control Arm	VL-DL-10309	VL-DL-10309	Trailing Arm, Air Suspension Axle	
FH 12/500	09/01→	Centre Rod	RV-DL-12320		for Steering Rod
	09/01→	Centre Rod	VL-DL-0911		Push Rod136426→
	09/01→	Centre Rod	VL-DL-2139		Push Rod, for Pneumatic Suspension vehicles
	09/01→	Centre Rod	VL-DL-8178		Push Rod
	09/01→	Centre Rod	VL-DL-8403		Push Rod, 1st FA;Air Suspension Axle, * B109622 *→* A230971 *;* B125525 *
	09/01→	Centre Rod	VL-DL-8406		Push Rod, Air Suspension Axle
	09/01→	Centre Rod	VL-DL-8407		Push Rod, Leaf Spring Axle
	09/01→	Centre Rod	VL-DL-8566		Push Rod
	09/01→	Centre Rod	VL-DL-8594		Push Rod, 1st FA;Leaf Spring Axle, * B109622 *;* D100000 *→* A238753 *; * B136425 *;* D100639 *
	09/01→	Centre Rod	VL-DL-8681		Push Rod, 1st FA;Air Suspension Axle
	09/01→	Centre Rod	VL-DL-8707		Push Rod, Air Suspension Axle
	09/01→	Centre Rod	VL-DL-9954		Push Rod→136425
	09/01→	Centre Rod	VL-DL-12483		Push Rod
	09/01→	Centre Rod	VL-DL-12484		Push Rod
	09/01→	Stabiliser Link		VL-DL-8412	Coupling Rod, Control Arm
	09/01→	Stabiliser Link		VL-DL-8518	Coupling Rod, Control Arm
	09/01→	Stabiliser Link		VL-DL-8543	Coupling Rod, Control Arm
	09/01→	Stabiliser Link		VL-DL-9472	Coupling Rod
09/01→	Stabiliser Link		VL-DL-9491	Coupling Rod, Control Arm	
09/01→	Stabiliser Link	VL-DL-8157		Coupling Rod, for Leaf-Spring Suspension vehicles	

MN-ES-10333

Length: 90
Cone Ø: d1 Ø 38 / d2 Ø 34,35
Thread: M36 x 1,5 RHT
1271126, 3090291, 3099128,
42538048, 81953016268,
82953016018, 82953016019



MN-RK-12436

Ø: 75 Hole Distance: 115
Thick/Height: 24
3093462, 85104224



RV-DL-12320

Length: 881 Ø: 50
Cone Ø: d1 Ø 28,6 / d2 Ø 23,9
20390746, 21106968



RV-DL-12447

Length: 1818 Ø: 52
Cone Ø: d1 Ø 28,6 / d2 Ø 23,9
20399543, 21299034, 85115631



RV-ES-9432

Length: 120
Cone Ø: d1 Ø 28 / d2 Ø 23,9
Thread: M26 x 1,5 RHT
3193731



RV-ES-12442

Length: 88
Cone Ø: d1 Ø 28,6
Thread: M26 x 1,5 RHT
3987648



RV-TC-12339

Length: 515
Hole Distance: 13 / 130
20532931, 21051046



RV-TC-12340

Length: 510
Hole Distance: 115 / 115
20443044



RV-VB-8191

Length: 662,4 Ø: 48
Hole Distance: 115 / 115
20367004, 20507262, 20741695,
20741703, 22318833



VL-DL-0911

Length: 880 Ø: 52
Cone Ø: d1 Ø 28,6 / d2 Ø 23,9
1075663, 3988704, 20393069



VL-DL-2139

Length: 880 Ø: 52
Cone Ø: d1 Ø 28,6 / d2 Ø 23,9
1075153, 3988695, 20393061



VL-DL-7789

Length: 1640 Ø: 58
Cone Ø: d1 Ø 28,6 / d2 Ø 23,9
1612254, 3985570, 4510697,
20393097, 21260286



VL-DL-8157

Length: 325 Ø: 30
Cone Ø: d1 Ø 22 / d2 Ø 20
1629668, 3986433, 14316200A,
20477805



VL-DL-8163

Length: 1640 Ø: 42
Cone Ø: d1 Ø 28,6 / d2 Ø 23,9
1628637, 3962343, 3986450,
3988711



VL-DL-8178

Length: 572 Ø: 38
Cone Ø: d1 Ø 28,6 / d2 Ø 23,9
1088985, 20393083



VL-DL-8180

Length: 625 Ø: 17
20374444, 20410530, 20509018,
20517494, 70371270



VL-DL-8305

Length: 1634 Ø: 50
Cone Ø: d1 Ø 28,6 / d2 Ø 23,9
3198276, 21260274



VL-DL-8403

Length: 880 Ø: 52
Cone Ø: d1 Ø 28,6 / d2 Ø 23,9
1628636, 14204300A, 85114200



VL-DL-8406

Length: 888 Ø: 52
Cone Ø: d1 Ø 28,6 / d2 Ø 23,9
8190146, 20393071



VL-DL-8407

Length: 870 Ø: 52
Cone Ø: d1 Ø 28,6 / d2 Ø 23,9
3986452, 20375555, 20393186,
21106930



VL-DL-8412

Length: 435 Ø: 36
Cone Ø: d1 Ø 28,6 / d2 Ø 25,5
3173613, 3987354



VL-DL-8518

Length: 350 Ø: 36
Cone Ø: d1 Ø 28,9 / d2 Ø 24,7
20443063, 20443067, 20994420



VL-DL-8543

Length: 380 Ø: 36
Cone Ø: d1 Ø 28,6 / d2 Ø 24,7
20443062, 20443066, 20994419



VL-DL-8554

Length: 570 Ø: 48
Hole Distance: 130 / 130
1626957, 1626958, 14320200A



VL-DL-8566

Length: 863 Ø: 52
Cone Ø: d1 Ø 28,6 / d2 Ø 23,9
20375556, 20393187, 21106952,
21406952



VL-DL-8594

Length: 865 Ø: 52
Cone Ø: d1 Ø 28,6 / d2 Ø 23,9
1075006, 1691660, 85114190



VL-DL-8681

Length: 888 Ø: 52
Cone Ø: d1 Ø 28,6 / d2 Ø 23,9
8190147, 20393073



VL-DL-8707

Length: 885 Ø: 50
Cone Ø: d1 Ø 28,6 / d2 Ø 23,9
20390745, 21106936



VL-DL-9472

Length: 435 Ø: 36
Cone Ø: d1 Ø 32,2 / d2 Ø 28
20443061, 20443065, 20994418



VL-DL-9485

Length: 666 Ø: 48
Hole Distance: 125 / 125
1589817



VL-DL-9491

Length: 380 Ø: 36
Cone Ø: d1 Ø 28,6 / d2 Ø 25,5
3173914, 3987355

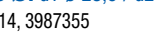

VL-DL-9492

Length: 1660 Ø: 62
Cone Ø: d1 Ø 32 / d2 Ø 27
20587731, 21106938



VL-DL-9493

Length: 1660 Ø: 62
Cone Ø: d1 Ø 28,6 / d2 Ø 23,9
3198234, 21260275



VL-DL-9954

Length: 870 Ø: 50
Cone Ø: d1 Ø 28,6 / d2 Ø 23,9
1075005



VL-DL-10309

Length: 799 Ø: 48
Hole Distance: 115 / 115
20410053, 21106157



VL-DL-12355

Length: 368 Ø: 38
Cone Ø: d1 Ø 28,6 / d2 Ø 23,9
1628207



VL-DL-12358

Length: 1669 Ø: 42
Cone Ø: d1 Ø 32 / d2 Ø 27
Thread: M32 x 1,5 RHT / M32 x 1,5 LHT
20581086, 7420581086



VL-DL-12483

Length: 485 Ø: 48
Cone Ø: d1 Ø 28,6 / d2 Ø 23,9
20383081, 21260283, 22159761,
81467106355



VL-DL-12484

Length: 1025 Ø: 48
Cone Ø: d1 Ø 28,6 / d2 Ø 23,9
2038308, 21252481



VL-ES-8411

Length: 140
Cone Ø: d1 Ø 28,6 / d2 Ø 23,9
Thread: M30 x 1,5 RHT
3093647, 3097999, 21263821



VL-ES-8568

Length: 100
Cone Ø: d1 Ø 38 / d2 Ø 34,3
Thread: M26 x 1,5 RHT
8151876

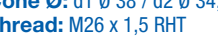

VL-ES-10361

Length: 88
Cone Ø: d1 Ø 28,6 / d2 Ø 24
Thread: M26 x 1,5 RHT
20374698



VL-RK-8533

Ø: 85 Hole Distance: 130
Thick/Height: 30
3093630, 3093631, 20840815,
21295230, 7420840815



VL-SB-9501

Ø: 91 Thick/Height: 85 / 85
1135080



VL-VB-7787

Length: 671 Ø: 58
Hole Distance: 130 / 130
143167, 1076639, 1626896,
1629734, 20392649, 20829503,
21295227, 21474441, 22318834,
7421295227



VL-VB-8525

Length: 677,3 Ø: 48
Hole Distance: 145 / 145
3173291, 20556490



VL-VB-8541

Length: 677,3 Ø: 48
Hole Distance: 145 / 145
3173292, 20556491



VL-VB-12460

Length: 662 Ø: 50
Hole Distance: 115 / 115
2223852, 20589061



VV-DL-0287

Length: 860 Ø: 52
Cone Ø: d1 Ø 28,6 / d2 Ø 23,9
1075664, 3988701





FH 12 ...

FH 12/500 ...	09/01→	Stabiliser Link	VL-DL-8157		Coupling Rod, for Pneumatic Suspension vehicles
	09/01→	Stabiliser Link	VL-DL-8536		Coupling Rod, Air Suspension Axle
	09/01→	Stabiliser Link	VL-DL-10258		Coupling Rod, for Leaf-Spring Suspension vehicles
	09/01→	Stabiliser Link	VL-DL-12356		Coupling Rod
	09/01→	Stabiliser Mounting	VL-SB-10394	VL-SB-10394	
	09/01→	Stabiliser Mounting	VL-SB-10397		
	09/01→	Stabiliser Mounting	VL-SB-10398		
	09/01→	Suspension Arm Repair Kit		IV-RK-8998	for Wishbone (CV)
	09/01→	Suspension Arm Repair Kit		VL-RK-9497	for Drag Link
	09/01→	Suspension Arm Repair Kit	VL-RK-5323	VL-RK-5323	for Drag Link
	09/01→	Suspension Strut Repair Kit		MN-RK-8501	
	09/01→	Suspension Strut Repair Kit	MN-RK-12436	MN-RK-12436	
	09/01→	Tie Bar Bush		VL-RK-8656	
	09/01→	Tie Bar Bush		VL-SB-9501	
	09/01→	Tie Rod	RV-DL-12447		
	09/01→	Tie Rod	VL-DL-7789		
	09/01→	Tie Rod	VL-DL-8163		
	09/01→	Tie Rod	VL-DL-8305		Leaf Spring Axle
	09/01→	Tie Rod	VL-DL-9492		Air Suspension Axle
	09/01→	Tie Rod	VL-DL-9493		Air Suspension Axle
	09/01→	Tie Rod	VL-DL-12358		
	09/01→	Tie Rod End	RV-ES-12442		
	09/01→	Tie Rod End	VL-ES-8411		
	09/01→	Tie Rod End	VL-ES-8568		
	09/01→	Track Control Arm		RV-TC-12339	Suspension Rod, Trailing Arm
	09/01→	Track Control Arm		RV-VB-8191	Wishbone (CV), Air Suspension Axle
	09/01→	Track Control Arm		VL-DL-8180	Trailing Arm
	09/01→	Track Control Arm		VL-DL-8189	Trailing Arm
	09/01→	Track Control Arm		VL-VB-7787	Wishbone (CV)
	09/01→	Track Control Arm		VL-VB-8525	Wishbone (CV)
	09/01→	Track Control Arm		VL-VB-12460	Wishbone (CV)

FH 16

FH 16/470	08/93→12/99	Bush, parabolic spring		VL-SB-5356	
	08/93→12/99	Centre Rod	RV-DL-12320		for Steering Rod
	08/93→12/99	Centre Rod	VL-DL-0911		Push Rod136426→
	08/93→12/99	Centre Rod	VL-DL-2139		Push Rod, for Pneumatic Suspension vehicles
	08/93→12/99	Centre Rod	VL-DL-8178		Push Rod
	08/93→12/99	Centre Rod	VL-DL-8403		Push Rod, 1st FA;Air Suspension Axle, * B109715 *→* A230971 *; * B125525 *
	08/93→12/99	Centre Rod	VL-DL-8406		Push Rod, Air Suspension Axle
	08/93→12/99	Centre Rod	VL-DL-8407		Push Rod, Leaf Spring Axle
	08/93→12/99	Centre Rod	VL-DL-8566		Push Rod
	08/93→12/99	Centre Rod	VL-DL-8594		Push Rod, 1st FA;Leaf Spring Axle, * B109715 *; * D110000 *→* A238753 *; * B136425 *; * D110125 *
	08/93→12/99	Centre Rod	VL-DL-8681		Push Rod, 1st FA;Air Suspension Axle
	08/93→12/99	Centre Rod	VL-DL-8707		Push Rod, Air Suspension Axle
	08/93→12/99	Centre Rod	VL-DL-9954		Push Rod→136425
	08/93→12/99	Stabiliser Link		VL-DL-8518	Coupling Rod, Control Arm
	08/93→12/99	Stabiliser Link		VL-DL-8543	Coupling Rod, Control Arm
	08/93→12/99	Stabiliser Link		VL-DL-9472	Coupling Rod
	08/93→12/99	Stabiliser Link	VL-DL-8157		Coupling Rod, for Leaf-Spring Suspension vehicles
	08/93→12/99	Stabiliser Link	VL-DL-8157		Coupling Rod, for Pneumatic Suspension vehicles
	08/93→12/99	Stabiliser Link	VL-DL-8536		Coupling Rod, Air Suspension Axle
	08/93→12/99	Stabiliser Link	VL-DL-10258		Coupling Rod, for Leaf-Spring Suspension vehicles
	08/93→12/99	Stabiliser Link	VL-DL-12356		Coupling Rod
	08/93→12/99	Stabiliser Mounting	VL-SB-10397		

IV-RK-8998

Ø: 85 Hole Distance: 130
Thick/Height: 30
273373, 274019, 4941233,
6889509



MN-RK-8501

Ø: 75 Hole Distance: 115
Thick/Height: 24
20547286



MN-RK-12436

Ø: 75 Hole Distance: 115
Thick/Height: 24
3093462, 85104224



RV-DL-12320

Length: 881 Ø: 50
Cone Ø: d1 Ø 28,6 / d2 Ø 23,9
20390746, 21106968



RV-DL-12447

Length: 1818 Ø: 52
Cone Ø: d1 Ø 28,6 / d2 Ø 23,9
20399543, 21299034, 85115631



RV-ES-12442

Length: 88
Cone Ø: d1 Ø 28,6
Thread: M26 x 1,5 RHT
3987648



RV-TC-12339

Length: 515
Hole Distance: 13 / 130
20532931, 21051046



RV-VB-8191

Length: 662,4 Ø: 48
Hole Distance: 115 / 115
20367004, 20507262, 20741695,
20741703, 22318833



VL-DL-0911

Length: 880 Ø: 52
Cone Ø: d1 Ø 28,6 / d2 Ø 23,9
1075663, 3988704, 20393069



VL-DL-2139

Length: 880 Ø: 52
Cone Ø: d1 Ø 28,6 / d2 Ø 23,9
1075153, 3988695, 20393061



VL-DL-7789

Length: 1640 Ø: 58
Cone Ø: d1 Ø 28,6 / d2 Ø 23,9
1612254, 3985570, 4510697,
20393097, 21260286



VL-DL-8157

Length: 325 Ø: 30
Cone Ø: d1 Ø 22 / d2 Ø 20
1629668, 3986433, 14316200A,
20477805



VL-DL-8163

Length: 1640 Ø: 42
Cone Ø: d1 Ø 28,6 / d2 Ø 23,9
1628637, 3962343, 3986450,
3988711



VL-DL-8178

Length: 572 Ø: 38
Cone Ø: d1 Ø 28,6 / d2 Ø 23,9
1088985, 20393083



VL-DL-8180

Length: 625 Ø: 17
20374444, 20410530, 20509018,
20517494, 70371270



VL-DL-8189

Length: 666 Ø: 48
Hole Distance: 125
1082104, 1605035



VL-DL-8305

Length: 1634 Ø: 50
Cone Ø: d1 Ø 28,6 / d2 Ø 23,9
3198276, 21260274



VL-DL-8403

Length: 880 Ø: 52
Cone Ø: d1 Ø 28,6 / d2 Ø 23,9
1628636, 14204300A, 85114200



VL-DL-8406

Length: 888 Ø: 52
Cone Ø: d1 Ø 28,6 / d2 Ø 23,9
8190146, 20393071



VL-DL-8407

Length: 870 Ø: 52
Cone Ø: d1 Ø 28,6 / d2 Ø 23,9
3986452, 20375555, 20393186,
21106930



VL-DL-8518

Length: 350 Ø: 36
Cone Ø: d1 Ø 28,9 / d2 Ø 24,7
20443063, 20443067, 20994420



VL-DL-8536

Length: 340 Ø: 30
Cone Ø: d1 Ø 22 / d2 Ø 19,9
3944046, 20477807



VL-DL-8543

Length: 380 Ø: 36
Cone Ø: d1 Ø 28,6 / d2 Ø 24,7
20443062, 20443066, 20994419



VL-DL-8566

Length: 863 Ø: 52
Cone Ø: d1 Ø 28,6 / d2 Ø 23,9
20375556, 20393187, 21106952,
21406952



VL-DL-8594

Length: 865 Ø: 52
Cone Ø: d1 Ø 28,6 / d2 Ø 23,9
1075006, 1691660, 85114190



VL-DL-8681

Length: 888 Ø: 52
Cone Ø: d1 Ø 28,6 / d2 Ø 23,9
8190147, 20393073



VL-DL-8707

Length: 885 Ø: 50
Cone Ø: d1 Ø 28,6 / d2 Ø 23,9
20390745, 21106936



VL-DL-9472

Length: 435 Ø: 36
Cone Ø: d1 Ø 32,2 / d2 Ø 28
20443061, 20443065, 20994418



VL-DL-9492

Length: 1660 Ø: 62
Cone Ø: d1 Ø 32 / d2 Ø 27
20587731, 21106938



VL-DL-9493

Length: 1660 Ø: 62
Cone Ø: d1 Ø 28,6 / d2 Ø 23,9
3198234, 21260275



VL-DL-9954

Length: 870 Ø: 50
Cone Ø: d1 Ø 28,6 / d2 Ø 23,9
1075005

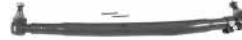

VL-DL-10258

Length: 325 Ø: 30
Cone Ø: d1 Ø 22 / d2 Ø 20
1629668, 3986433, 20477805



VL-DL-12356

Length: 275 Ø: 30
Cone Ø: d1 Ø 22
3987423, 20477803



VL-DL-12358

Length: 1669 Ø: 42
Cone Ø: d1 Ø 32 / d2 Ø 27
Thread: M32 x 1,5 RHT / M32 x 1,5 LHT
20581086, 7420581086



VL-ES-8411

Length: 140
Cone Ø: d1 Ø 28,6 / d2 Ø 23,9
Thread: M30 x 1,5 RHT
3093647, 3097999, 21263821



VL-ES-8568

Length: 100
Cone Ø: d1 Ø 38 / d2 Ø 34,3
Thread: M26 x 1,5 RHT
8151876



VL-RK-5323

Ø: 91 Hole Distance: 125
Thick/Height: 20
1598588, 14302100A



VL-RK-8656

Ø: 91 Hole Distance: 145
Thick/Height: 26
1628107



VL-RK-9497

Ø: 95 Hole Distance: 130
Thick/Height: 35
273612, 20702095



VL-SB-5356

Thick/Height: 150
1629553, 14403900A, 20390836



VL-SB-9501

Ø: 91 Thick/Height: 85 / 85
1135080



VL-SB-1039A

Ø: 90 Thick/Height: 95 / 95
9519245



VL-SB-10397

Thick/Height: 89 / 89
1075179



VL-SB-10398

Thick/Height: 87,5 / 87,5
1075180



VL-VB-7787

Length: 671 Ø: 58
Hole Distance: 130 / 130
143167, 1076639, 1626896,
1629734, 20392649, 20829503,
21295227, 21474441, 22318834,
7421295227



VL-VB-8525

Length: 677,3 Ø: 48
Hole Distance: 145 / 145
3173291, 20556490



VL-VB-12460

Length: 662 Ø: 50
Hole Distance: 115 / 115
2223852, 20589061





FH 16 ...

FH 16/470 ...	08/93→12/99	Stabiliser Mounting	VL-SB-10398		
	08/93→12/99	Suspension Arm Repair Kit		CV-RK-5322	for Wishbone (CV)
	08/93→12/99	Suspension Arm Repair Kit		IV-RK-8998	for Wishbone (CV)
	08/93→12/99	Suspension Arm Repair Kit		MN-RK-7280	for Drag Link
	08/93→12/99	Suspension Arm Repair Kit		MN-RK-9383	for Control Arm
	08/93→12/99	Suspension Arm Repair Kit		VL-RK-9497	for Drag Link
	08/93→12/99	Suspension Arm Repair Kit		VL-RK-9497	for Drag Link, Leaf Spring Axle
	08/93→12/99	Suspension Strut Repair Kit		MN-RK-8501	
	08/93→12/99	Suspension Strut Repair Kit	MN-RK-12436	MN-RK-12436	
	08/93→12/99	Suspension Strut Repair Kit	VL-RK-8533		
	08/93→12/99	Tie Bar Bush		VL-SB-9501	
	08/93→12/99	Tie Rod	RV-DL-12447		
	08/93→12/99	Tie Rod	VL-DL-7789		
	08/93→12/99	Tie Rod	VL-DL-8163		
	08/93→12/99	Tie Rod	VL-DL-8305		Leaf Spring Axle
	08/93→12/99	Tie Rod	VL-DL-9492		Air Suspension Axle
	08/93→12/99	Tie Rod	VL-DL-9493		Air Suspension Axle
	08/93→12/99	Tie Rod	VL-DL-12358		
	08/93→12/99	Tie Rod	VV-DL-0287		
	08/93→12/99	Tie Rod End		RV-ES-9432	Leading Axle
	08/93→12/99	Tie Rod End		VL-ES-10361	Tag Axle
	08/93→12/99	Tie Rod End	RV-ES-12442		
	08/93→12/99	Tie Rod End	VL-ES-8411		
	08/93→12/99	Tie Rod End	VL-ES-8568		
	08/93→12/99	Track Control Arm		RV-TC-12339	Suspension Rod, Trailing Arm
	08/93→12/99	Track Control Arm		RV-TC-12340	Trailing Arm
	08/93→12/99	Track Control Arm		RV-VB-8191	Wishbone (CV)
	08/93→12/99	Track Control Arm		RV-VB-8191	Wishbone (CV), 1st RA;2nd RA;Leaf Spring Axle
	08/93→12/99	Track Control Arm		RV-VB-8191	Wishbone (CV), Air Suspension Axle
	08/93→12/99	Track Control Arm		VL-DL-8180	Trailing Arm
	08/93→12/99	Track Control Arm		VL-DL-8554	Trailing Arm, 1st RA;2nd RA;Leaf Spring Axle
	08/93→12/99	Track Control Arm		VL-DL-9485	Trailing Arm
	08/93→12/99	Track Control Arm		VL-VB-5369	Wishbone (CV)
	08/93→12/99	Track Control Arm		VL-VB-7787	Wishbone (CV)
	08/93→12/99	Track Control Arm		VL-VB-7787	Wishbone (CV), 1st RA;2nd RA;Unit; Leaf Spring Axle
	08/93→12/99	Track Control Arm		VL-VB-8525	Wishbone (CV)
	08/93→12/99	Track Control Arm		VL-VB-8525	Wishbone (CV), Tag Axle;Air Suspension Axle
	08/93→12/99	Track Control Arm		VL-VB-8541	Wishbone (CV), Air Suspension Axle
	08/93→12/99	Track Control Arm		VL-VB-8541	Wishbone (CV), Drive Axle;Air Suspension Axle
	08/93→12/99	Track Control Arm		VL-VB-8541	Wishbone (CV), Tag Axle;Air Suspension Axle
	08/93→12/99	Track Control Arm		VL-VB-12460	Wishbone (CV)
	08/93→12/99	Track Control Arm	VL-DL-10309	VL-DL-10309	Trailing Arm, Air Suspension Axle
FH 16/520	08/93→12/02	Suspension Arm Repair Kit		VL-RK-9497	for Drag Link, Leaf Spring Axle
	08/93→12/02	Suspension Arm Repair Kit	CV-RK-5322		for Wishbone (CV)
	08/93→12/02	Track Control Arm		RV-VB-8191	Wishbone (CV), 1st RA;2nd RA;Leaf Spring Axle
	08/93→12/02	Track Control Arm		RV-VB-8191	Wishbone (CV), Air Suspension Axle
	08/93→12/02	Track Control Arm		VL-DL-8554	Trailing Arm, 1st RA;2nd RA;Leaf Spring Axle
	08/93→12/02	Track Control Arm		VL-VB-7787	Wishbone (CV), 1st RA;2nd RA;Unit; Leaf Spring Axle
	08/93→12/02	Track Control Arm		VL-VB-8525	Wishbone (CV)
	08/93→12/02	Track Control Arm		VL-VB-8541	Wishbone (CV), Air Suspension Axle
	08/93→	Centre Rod	RV-DL-12320		for Steering Rod
	08/93→	Centre Rod	VL-DL-0911		Push Rod136426→
	08/93→	Centre Rod	VL-DL-2139		Push Rod, for Pneumatic Suspension vehicles
	08/93→	Centre Rod	VL-DL-8178		Push Rod
	08/93→	Centre Rod	VL-DL-8403		Push Rod, 1st FA;Air Suspension Axle, * B109715 *→* A230971 *;* B125525 *
	08/93→	Centre Rod	VL-DL-8406		Push Rod, Air Suspension Axle
	08/93→	Centre Rod	VL-DL-8407		Push Rod, Leaf Spring Axle
	08/93→	Centre Rod	VL-DL-8566		Push Rod

CV-RK-5322

Ø: 72 Thick/Height: 50
271188, 3091598



IV-RK-8998

Ø: 85 Hole Distance: 130
Thick/Height: 30
273373, 274019, 4941233,
6889509



MN-RK-7280

Ø: 75 Hole Distance: 115
Thick/Height: 24
271187, 689748



MN-RK-8501

Ø: 75 Hole Distance: 115
Thick/Height: 24
20547286



MN-RK-9383

Ø: 67 Hole Distance: 100
Thick/Height: 24
275988



MN-RK-12436

Ø: 75 Hole Distance: 115
Thick/Height: 24
3093462, 85104224



RV-DL-12320

Length: 881 Ø: 50
Cone Ø: d1 Ø 28,6 / d2 Ø 23,9
20390746, 21106968



RV-DL-12447

Length: 1818 Ø: 52
Cone Ø: d1 Ø 28,6 / d2 Ø 23,9
20399543, 21299034, 85115631



RV-ES-9432

Length: 120
Cone Ø: d1 Ø 28 / d2 Ø 23,9
Thread: M26 x 1,5 RHT
3193731



RV-ES-12442

Length: 88
Cone Ø: d1 Ø 28,6
Thread: M26 x 1,5 RHT
3987648



RV-TC-12339

Length: 515
Hole Distance: 13 / 130
20532931, 21051046



RV-TC-12340

Length: 510
Hole Distance: 115 / 115
20443044



RV-VB-8191

Length: 662,4 Ø: 48
Hole Distance: 115 / 115
20367004, 20507262, 20741695,
20741703, 22318833



VL-DL-0911

Length: 880 Ø: 52
Cone Ø: d1 Ø 28,6 / d2 Ø 23,9
1075663, 3988704, 20393069



VL-DL-2139

Length: 880 Ø: 52
Cone Ø: d1 Ø 28,6 / d2 Ø 23,9
1075153, 3988695, 20393061



VL-DL-7789

Length: 1640 Ø: 58
Cone Ø: d1 Ø 28,6 / d2 Ø 23,9
1612254, 3985570, 4510697,
20393097, 21260286



VL-DL-8163

Length: 1640 Ø: 42
Cone Ø: d1 Ø 28,6 / d2 Ø 23,9
1628637, 3962343, 3986450,
3988711



VL-DL-8178

Length: 572 Ø: 38
Cone Ø: d1 Ø 28,6 / d2 Ø 23,9
1088985, 20393083



VL-DL-8180

Length: 625 Ø: 17
20374444, 20410530, 20509018,
20517494, 70371270



VL-DL-8305

Length: 1634 Ø: 50
Cone Ø: d1 Ø 28,6 / d2 Ø 23,9
3198276, 21260274



VL-DL-8403

Length: 880 Ø: 52
Cone Ø: d1 Ø 28,6 / d2 Ø 23,9
1628636, 14204300A, 85114200



VL-DL-8406

Length: 888 Ø: 52
Cone Ø: d1 Ø 28,6 / d2 Ø 23,9
8190146, 20393071



VL-DL-8407

Length: 870 Ø: 52
Cone Ø: d1 Ø 28,6 / d2 Ø 23,9
3986452, 20375555, 20393186,
21106930



VL-DL-8554

Length: 570 Ø: 48
Hole Distance: 130 / 130
1626957, 1626958, 14320200A



VL-DL-8566

Length: 863 Ø: 52
Cone Ø: d1 Ø 28,6 / d2 Ø 23,9
20375556, 20393187, 21106952,
21406952



VL-DL-9485

Length: 666 Ø: 48
Hole Distance: 125 / 125
1589817



VL-DL-9492

Length: 1660 Ø: 62
Cone Ø: d1 Ø 32 / d2 Ø 27
20587731, 21106938



VL-DL-9493

Length: 1660 Ø: 62
Cone Ø: d1 Ø 28,6 / d2 Ø 23,9
3198234, 21260275



VL-DL-10309

Length: 799 Ø: 48
Hole Distance: 115 / 115
20410053, 21106157



VL-DL-12358

Length: 1669 Ø: 42
Cone Ø: d1 Ø 32 / d2 Ø 27
Thread: M32 x 1,5 RHT / M32 x 1,5 LHT
20581086, 7420581086



VL-ES-8411

Length: 140
Cone Ø: d1 Ø 28,6 / d2 Ø 23,9
Thread: M30 x 1,5 RHT
3093647, 3097999, 21263821



VL-ES-8568

Length: 100
Cone Ø: d1 Ø 38 / d2 Ø 34,3
Thread: M26 x 1,5 RHT
8151876



VL-ES-10361

Length: 88
Cone Ø: d1 Ø 28,6 / d2 Ø 24
Thread: M26 x 1,5 RHT
20374698



VL-RK-8533

Ø: 85 Hole Distance: 130
Thick/Height: 30
3093630, 3093631, 20840815,
21295230, 7420840815



VL-RK-9497

Ø: 95 Hole Distance: 130
Thick/Height: 35
273612, 20702095



VL-SB-9501

Ø: 91 Thick/Height: 85 / 85
1135080



VL-SB-10398

Thick/Height: 87,5 / 87,5
1075180



VL-VB-5369

Length: 677 Ø: 48
Hole Distance: 115 / 115
3172829, 8073569, 14319600A



VL-VB-7787

Length: 671 Ø: 58
Hole Distance: 130 / 130
143167, 1076639, 1626896,
1629734, 20392649, 20829503,
21295227, 21474441, 22318834,
7421295227



VL-VB-8525

Length: 677,3 Ø: 48
Hole Distance: 145 / 145
3173291, 20556490



VL-VB-8541

Length: 677,3 Ø: 48
Hole Distance: 145 / 145
3173292, 20556491



VL-VB-12460

Length: 662 Ø: 50
Hole Distance: 115 / 115
2223852, 20589061



VV-DL-0287

Length: 860 Ø: 52
Cone Ø: d1 Ø 28,6 / d2 Ø 23,9
1075664, 3988701





FH 16 ...

FH 16/520 ...	08/93 →	Centre Rod	VL-DL-8594		Push Rod, 1st FA; Leaf Spring Axle, * B109715 *; * D110000 * → * A238753 *; * B136425 *; * D110125 *
	08/93 →	Centre Rod	VL-DL-8681		Push Rod, 1st FA; Air Suspension Axle
	08/93 →	Centre Rod	VL-DL-8707		Push Rod, Air Suspension Axle
	08/93 →	Centre Rod	VL-DL-9954		Push Rod → 136425
	08/93 →	Centre Rod	VL-DL-12483		Push Rod
	08/93 →	Centre Rod	VL-DL-12484		Push Rod
	08/93 →	Stabiliser Link		VL-DL-8518	Coupling Rod, Control Arm
	08/93 →	Stabiliser Link		VL-DL-8543	Coupling Rod, Control Arm
	08/93 →	Stabiliser Link		VL-DL-9472	Coupling Rod
	08/93 →	Stabiliser Link	VL-DL-8157		Coupling Rod, for Leaf-Spring Suspension vehicles
	08/93 →	Stabiliser Link	VL-DL-8157		Coupling Rod, for Pneumatic Suspension vehicles
	08/93 →	Stabiliser Link	VL-DL-8536		Coupling Rod, Air Suspension Axle
	08/93 →	Stabiliser Link	VL-DL-10258		Coupling Rod, for Leaf-Spring Suspension vehicles
	08/93 →	Stabiliser Link	VL-DL-12356		Coupling Rod
	08/93 →	Stabiliser Mounting	VL-SB-10394	VL-SB-10394	
	08/93 →	Stabiliser Mounting	VL-SB-10397		
	08/93 →	Stabiliser Mounting	VL-SB-10398		
	08/93 →	Suspension Arm Repair Kit		IV-RK-8998	for Wishbone (CV)
	08/93 →	Suspension Arm Repair Kit		VL-RK-9497	for Drag Link
	08/93 →	Suspension Arm Repair Kit	VL-RK-5323	VL-RK-5323	for Drag Link
	08/93 →	Suspension Strut Repair Kit		MN-RK-8501	
	08/93 →	Suspension Strut Repair Kit	MN-RK-12436	MN-RK-12436	
	08/93 →	Tie Bar Bush		VL-RK-8656	
	08/93 →	Tie Bar Bush		VL-SB-9501	
	08/93 →	Tie Rod	RV-DL-12447		
	08/93 →	Tie Rod	VL-DL-7789		
	08/93 →	Tie Rod	VL-DL-8163		
	08/93 →	Tie Rod	VL-DL-8305		Leaf Spring Axle
	08/93 →	Tie Rod	VL-DL-9492		Air Suspension Axle
	08/93 →	Tie Rod	VL-DL-9493		Air Suspension Axle
	08/93 →	Tie Rod	VL-DL-12358		
	08/93 →	Tie Rod	VV-DL-0287		
	08/93 →	Tie Rod End		RV-ES-9432	Leading Axle
	08/93 →	Tie Rod End		RV-ES-9432	Tag Axle
	08/93 →	Tie Rod End		VL-ES-10361	Tag Axle
	08/93 →	Tie Rod End	RV-ES-12442		
	08/93 →	Tie Rod End	VL-ES-8411		
	08/93 →	Tie Rod End	VL-ES-8568		
	08/93 →	Track Control Arm		RV-TC-12339	Suspension Rod, Trailing Arm
	08/93 →	Track Control Arm		RV-TC-12340	Trailing Arm
	08/93 →	Track Control Arm		RV-VB-8191	Wishbone (CV)
	08/93 →	Track Control Arm		VL-DL-8180	Trailing Arm
	08/93 →	Track Control Arm		VL-DL-8189	Trailing Arm
	08/93 →	Track Control Arm		VL-DL-9485	Trailing Arm
	08/93 →	Track Control Arm		VL-VB-7787	Wishbone (CV)
	08/93 →	Track Control Arm		VL-VB-8525	Wishbone (CV), Tag Axle; Air Suspension Axle
	08/93 →	Track Control Arm		VL-VB-8541	Wishbone (CV), Drive Axle; Air Suspension Axle
	08/93 →	Track Control Arm		VL-VB-8541	Wishbone (CV), Tag Axle; Air Suspension Axle
	08/93 →	Track Control Arm		VL-VB-12460	Wishbone (CV)
	08/93 →	Track Control Arm	VL-DL-10309	VL-DL-10309	Trailing Arm, Air Suspension Axle
	01/95 →	Track Control Arm		VL-VB-8576	Wishbone (CV), Drive Axle; Leading Axle; Air Suspension Axle
FH 16/540	01/09 →	Centre Rod	VL-DL-8178		Push Rod
	01/09 →	Centre Rod	VL-DL-8406		Push Rod
	01/09 →	Centre Rod	VL-DL-8407		Push Rod
	01/09 →	Centre Rod	VL-DL-8566		Push Rod
	01/09 →	Centre Rod	VL-DL-12367		for Steering Rod
	01/09 →	Centre Rod	VL-DL-12454		for Steering Rod

IV-RK-8998

Ø: 85 Hole Distance: 130
Thick/Height: 30

273373, 274019, 4941233,
6889509



MN-RK-8501

Ø: 75 Hole Distance: 115
Thick/Height: 24

20547286



MN-RK-12436

Ø: 75 Hole Distance: 115
Thick/Height: 24

3093462, 85104224



RV-DL-12447

Length: 1818 Ø: 52
Cone Ø: d1 Ø 28,6 / d2 Ø 23,9

20399543, 21299034, 85115631



RV-ES-9432

Length: 120
Cone Ø: d1 Ø 28 / d2 Ø 23,9

Thread: M26 x 1,5 RHT

3193731



RV-ES-12442

Length: 88
Cone Ø: d1 Ø 28,6

Thread: M26 x 1,5 RHT

3987648



RV-TC-12339

Length: 515
Hole Distance: 13 / 130

20532931, 21051046



RV-TC-12340

Length: 510
Hole Distance: 115 / 115

20443044



RV-VB-8191

Length: 662,4 Ø: 48
Hole Distance: 115 / 115

20367004, 20507262, 20741695,
20741703, 22318833



VL-DL-7789

Length: 1640 Ø: 58
Cone Ø: d1 Ø 28,6 / d2 Ø 23,9

1612254, 3985570, 4510697,
20393097, 21260286



VL-DL-8157

Length: 325 Ø: 30
Cone Ø: d1 Ø 22 / d2 Ø 20

1629668, 3986433, 14316200A,
20477805



VL-DL-8163

Length: 1640 Ø: 42
Cone Ø: d1 Ø 28,6 / d2 Ø 23,9

1628637, 3962343, 3986450,
3988711



VL-DL-8178

Length: 572 Ø: 38
Cone Ø: d1 Ø 28,6 / d2 Ø 23,9

1088985, 20393083



VL-DL-8180

Length: 625 Ø: 17
20374444, 20410530, 20509018,
20517494, 70371270

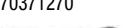

VL-DL-8189

Length: 666 Ø: 48
Hole Distance: 125

1082104, 1605035



VL-DL-8305

Length: 1634 Ø: 50
Cone Ø: d1 Ø 28,6 / d2 Ø 23,9

3198276, 21260274



VL-DL-8406

Length: 888 Ø: 52
Cone Ø: d1 Ø 28,6 / d2 Ø 23,9

8190146, 20393071



VL-DL-8407

Length: 870 Ø: 52
Cone Ø: d1 Ø 28,6 / d2 Ø 23,9

3986452, 20375555, 20393186,
21106930



VL-DL-8518

Length: 350 Ø: 36
Cone Ø: d1 Ø 28,9 / d2 Ø 24,7

20443063, 20443067, 20994420



VL-DL-8536

Length: 340 Ø: 30
Cone Ø: d1 Ø 22 / d2 Ø 19,9

3944046, 20477807



VL-DL-8543

Length: 380 Ø: 36
Cone Ø: d1 Ø 28,6 / d2 Ø 24,7

20443062, 20443066, 20994419



VL-DL-8566

Length: 863 Ø: 52
Cone Ø: d1 Ø 28,6 / d2 Ø 23,9

20375556, 20393187, 21106952,
21406952



VL-DL-8594

Length: 865 Ø: 52
Cone Ø: d1 Ø 28,6 / d2 Ø 23,9

1075006, 1691660, 85114190



VL-DL-8681

Length: 888 Ø: 52
Cone Ø: d1 Ø 28,6 / d2 Ø 23,9

8190147, 20393073



VL-DL-8707

Length: 885 Ø: 50
Cone Ø: d1 Ø 28,6 / d2 Ø 23,9

20390745, 21106936



VL-DL-9472

Length: 435 Ø: 36
Cone Ø: d1 Ø 32,2 / d2 Ø 28

20443061, 20443065, 20994418



VL-DL-9485

Length: 666 Ø: 48
Hole Distance: 125 / 125

1589817



VL-DL-9492

Length: 1660 Ø: 62
Cone Ø: d1 Ø 32 / d2 Ø 27

20587731, 21106938



VL-DL-9493

Length: 1660 Ø: 62
Cone Ø: d1 Ø 28,6 / d2 Ø 23,9

3198234, 21260275



VL-DL-9954

Length: 870 Ø: 50
Cone Ø: d1 Ø 28,6 / d2 Ø 23,9

1075005



VL-DL-10258

Length: 325 Ø: 30
Cone Ø: d1 Ø 22 / d2 Ø 20

1629668, 3986433, 20477805



VL-DL-10309

Length: 799 Ø: 48
Hole Distance: 115 / 115

20410053, 21106157



VL-DL-12356

Length: 275 Ø: 30
Cone Ø: d1 Ø 22

3987423, 20477803



VL-DL-12358

Length: 1669 Ø: 42
Cone Ø: d1 Ø 32 / d2 Ø 27

Thread: M32 x 1,5 RHT / M32 x 1,5 LHT
20581086, 7420581086



VL-DL-12367

Length: 2139 Ø: 62
Cone Ø: d1 Ø 28,6 / d2 Ø 23,9

Thread: M52 x 1,5 RHT

20453064, 20584291



VL-DL-12454

Length: 2339 Ø: 62
Cone Ø: d1 Ø 28,6 / d2 Ø 23,9

20581632



VL-DL-12483

Length: 485 Ø: 48
Cone Ø: d1 Ø 28,6 / d2 Ø 23,9

20383081, 21260283, 22159761,
81467106355



VL-DL-12484

Length: 1025 Ø: 48
Cone Ø: d1 Ø 28,6 / d2 Ø 23,9

2038308, 21252481



VL-ES-8411

Length: 140
Cone Ø: d1 Ø 28,6 / d2 Ø 23,9

Thread: M30 x 1,5 RHT

3093647, 3097999, 21263821



VL-ES-8568

Length: 100
Cone Ø: d1 Ø 38 / d2 Ø 34,3

Thread: M26 x 1,5 RHT

8151876



VL-ES-10361

Length: 88
Cone Ø: d1 Ø 28,6 / d2 Ø 24

Thread: M26 x 1,5 RHT

20374698



VL-RK-5323

Ø: 91 Hole Distance: 125
Thick/Height: 20

1598588, 14302100A



VL-RK-8656

Ø: 91 Hole Distance: 145
Thick/Height: 26

1628107



VL-RK-9497

Ø: 95 Hole Distance: 130
Thick/Height: 35

273612, 20702095



VL-SB-9501

Ø: 91 Thick/Height: 85 / 85
1135080



VL-SB-10394

Ø: 90 Thick/Height: 95 / 95
9519245



VL-SB-10397

Thick/Height: 89 / 89
1075179



VL-SB-10398

Thick/Height: 87,5 / 87,5
1075180



VL-VB-7787

Length: 671 Ø: 58
Hole Distance: 130 / 130

143167, 1076639, 1626896,
1629734, 20392649, 20829503,
21295227, 21474441, 22318834,
7421295227



VL-VB-8525

Length: 677,3 Ø: 48
Hole Distance: 145 / 145

3173291, 20556490



VL-VB-8541

Length: 677,3 Ø: 48
Hole Distance: 145 / 145

3173292, 20556491



VL-VB-8576

Length: 660,3 Ø: 48
Hole Distance: 145 / 145

3173293, 20556492



VL-VB-12460

Length: 662 Ø: 50
Hole Distance: 115 / 115

2223852, 20589061



VV-DL-0287

Length: 860 Ø: 52
Cone Ø: d1 Ø 28,6 / d2 Ø 23,9

1075664, 3988701





FH 16 ...

FH 16/540 ...

01/09→	Centre Rod	VL-DL-12483		Push Rod
01/09→	Centre Rod	VL-DL-12484		Push Rod
01/09→	Stabiliser Link		VL-DL-9472	Coupling Rod
01/09→	Stabiliser Link	VL-DL-8157		Coupling Rod, for Leaf-Spring Suspension vehicles
01/09→	Stabiliser Link	VL-DL-8157		Coupling Rod, for Pneumatic Suspension vehicles
01/09→	Stabiliser Link	VL-DL-10258		Coupling Rod, for Leaf-Spring Suspension vehicles
01/09→	Stabiliser Link	VL-DL-12356		Coupling Rod
01/09→	Suspension Arm Repair Kit		VL-RK-9497	for Drag Link
01/09→	Suspension Arm Repair Kit		VL-RK-9497	for Drag Link, Leaf Spring Axle
01/09→	Suspension Strut Repair Kit		MN-RK-8501	
01/09→	Suspension Strut Repair Kit	MN-RK-12436	MN-RK-12436	
01/09→	Tie Bar Bush		VL-SB-9501	
01/09→	Tie Rod	VL-DL-12355		
01/09→	Tie Rod	VL-DL-12358		
01/09→	Tie Rod End	VL-ES-8411		
01/09→	Tie Rod End	VL-ES-8414		for Guide Rod
01/09→	Tie Rod End	VL-ES-10360		for Steering Rod
01/09→	Track Control Arm		RV-DL-10299	Trailing Arm, 1st & 2nd Drive Axle, for Leaf-Spring Suspension vehicles
01/09→	Track Control Arm		RV-TC-12339	Suspension Rod, Trailing Arm
01/09→	Track Control Arm		RV-TC-12340	Trailing Arm, 1st & 2nd Drive Axle, for Leaf-Spring Suspension vehicles
01/09→	Track Control Arm		RV-TC-12340	Trailing Arm, 1st Drive Axle, for Leaf-Spring Suspension vehicles
01/09→	Track Control Arm		RV-TC-12340	Trailing Arm, Trailing Axle not Steered, for Leaf-Spring Suspension vehicles
01/09→	Track Control Arm		RV-TC-12340	Trailing Arm, Trailing Axle Steered, for Leaf-Spring Suspension vehicles
01/09→	Track Control Arm		RV-VB-8191	Wishbone (CV)
01/09→	Track Control Arm		RV-VB-8191	Wishbone (CV), 1st Drive Axle, for Leaf-Spring Suspension vehicles
01/09→	Track Control Arm		RV-VB-8191	Wishbone (CV), 1st Drive Axle, for Pneumatic Suspension vehicles
01/09→	Track Control Arm		RV-VB-8191	Wishbone (CV), Leading Axle not Steered, for Pneumatic Suspension vehicles
01/09→	Track Control Arm		RV-VB-8191	Wishbone (CV), Trailing Axle not Steered, for Pneumatic Suspension vehicles
01/09→	Track Control Arm		RV-VB-8191	Wishbone (CV), Trailing Axle Steered, for Leaf-Spring Suspension vehicles
01/09→	Track Control Arm		VL-DL-8180	Trailing Arm
01/09→	Track Control Arm		VL-DL-8180	Trailing Arm, 1st & 2nd Drive Axle, for Pneumatic Suspension vehicles
01/09→	Track Control Arm		VL-DL-8180	Trailing Arm, 1st Drive Axle, for Pneumatic Suspension vehicles
01/09→	Track Control Arm		VL-DL-8180	Trailing Arm, Leading Axle Steered/not Steered, for Pneumatic Suspension vehicles
01/09→	Track Control Arm		VL-DL-8180	Trailing Arm, Trailing Axle Steered/not Steered, for Pneumatic Suspension vehicles
01/09→	Track Control Arm		VL-VB-7787	Wishbone (CV)
01/09→	Track Control Arm		VL-VB-8525	Wishbone (CV)
01/09→	Track Control Arm		VL-VB-12460	Wishbone (CV)
01/09→	Track Control Arm		VL-VB-12460	Wishbone (CV), 1st & 2nd Drive Axle, for Pneumatic Suspension vehicles
01/09→	Track Control Arm		VL-VB-12460	Wishbone (CV), 1st Drive Axle, for Pneumatic Suspension vehicles
01/09→	Track Control Arm		VL-VB-12460	Wishbone (CV), Leading Axle Steered, for Pneumatic Suspension vehicles
01/09→	Track Control Arm		VL-VB-12460	Wishbone (CV), Leading Axle Steered/not Steered, for Pneumatic Suspension vehicles

MN-RK-8501

Ø: 75 Hole Distance: 115
Thick/Height: 24
20547286

**MN-RK-12436**

Ø: 75 Hole Distance: 115
Thick/Height: 24
3093462, 85104224

**RV-DL-10299**

Length: 510 Ø: 21
20522934, 21051052, 7420864583,
7421051052

**RV-TC-12339**

Length: 515
Hole Distance: 13 / 130
20532931, 21051046

**RV-TC-12340**

Length: 510
Hole Distance: 115 / 115
20443044

**RV-VB-8191**

Length: 662,4 Ø: 48
Hole Distance: 115 / 115
20367004, 20507262, 20741695, 20741703,
22318833

**VL-DL-8157**

Length: 325 Ø: 30
Cone Ø: d1 Ø 22 / d2 Ø 20
1629668, 3986433, 14316200A, 20477805

**VL-DL-8180**

Length: 625 Ø: 17
20374444, 20410530, 20509018, 20517494,
70371270

**VL-DL-9472**

Length: 435 Ø: 36
Cone Ø: d1 Ø 32,2 / d2 Ø 28
20443061, 20443065, 20994418

**VL-DL-10258**

Length: 325 Ø: 30
Cone Ø: d1 Ø 22 / d2 Ø 20
1629668, 3986433, 20477805

**VL-DL-12355**

Length: 368 Ø: 38
Cone Ø: d1 Ø 28,6 / d2 Ø 23,9
1628207

**VL-DL-12356**

Length: 275 Ø: 30
Cone Ø: d1 Ø 22
3987423, 20477803

**VL-DL-12358**

Length: 1669 Ø: 42
Cone Ø: d1 Ø 32 / d2 Ø 27
Thread: M32 x 1,5 RHT / M32 x 1,5 LHT
20581086, 7420581086

**VL-DL-12483**

Length: 485 Ø: 48
Cone Ø: d1 Ø 28,6 / d2 Ø 23,9
20383081, 21260283, 22159761,
81467106355

**VL-DL-12484**

Length: 1025 Ø: 48
Cone Ø: d1 Ø 28,6 / d2 Ø 23,9
2038308, 21252481

**VL-ES-8411**

Length: 140
Cone Ø: d1 Ø 28,6 / d2 Ø 23,9
Thread: M30 x 1,5 RHT
3093647, 3097999, 21263821

**VL-ES-8414**

Length: 136
Cone Ø: d1 Ø 32 / d2 Ø 27
Thread: M30 x 1,5 LHT
20710008

**VL-ES-10360**

Length: 136
Cone Ø: d1 Ø 32 / d2 Ø 27
Thread: M30 x 1,5 RHT
20581089

**VL-RK-9497**

Ø: 95 Hole Distance: 130
Thick/Height: 35
273612, 20702095

**VL-SB-9501**

Ø: 91 Thick/Height: 85 / 85
1135080

**VL-VB-7787**

Length: 671 Ø: 58
Hole Distance: 130 / 130
143167, 1076639, 1626896, 1629734,
20392649, 20829503, 21295227, 21474441,
22318834, 7421295227

**VL-VB-8525**

Length: 677,3 Ø: 48
Hole Distance: 145 / 145
3173291, 20556490

**VL-VB-12460**

Length: 662 Ø: 50
Hole Distance: 115 / 115
2223852, 20589061





FH 16 ...

FH 16/540 ...	01/09 →	Track Control Arm		VL-VB-12460	Wishbone (CV), Trailing Axle Steered, for Pneumatic Suspension vehicles	
	01/09 →	Track Control Arm		VL-VB-12460	Wishbone (CV), Trailing Axle Steered/not Steered, for Pneumatic Suspension vehicles	
	01/09 →	Track Control Arm	VL-DL-10309	VL-DL-10309	Trailing Arm, 1st Front Axle, for Pneumatic Suspension vehicles	
FH 16/540, FH 16/550	01/03 →	Centre Rod	RV-DL-12320		for Steering Rod	
	01/03 →	Centre Rod	VL-DL-0911		Push Rod136426 →	
	01/03 →	Centre Rod	VL-DL-2139		Push Rod, for Pneumatic Suspension vehicles	
	01/03 →	Centre Rod	VL-DL-5372		Push Rod	
	01/03 →	Centre Rod	VL-DL-8178		Push Rod	
	01/03 →	Centre Rod	VL-DL-8403		Push Rod	
	01/03 →	Centre Rod	VL-DL-8403		Push Rod, 1st FA; Air Suspension Axle, * B109715 * → * A230971 *; * B125525 *	
	01/03 →	Centre Rod	VL-DL-8406		Push Rod	
	01/03 →	Centre Rod	VL-DL-8406		Push Rod, Air Suspension Axle	
	01/03 →	Centre Rod	VL-DL-8407		Push Rod	
	01/03 →	Centre Rod	VL-DL-8407		Push Rod, Leaf Spring Axle	
	01/03 →	Centre Rod	VL-DL-8566		Push Rod	
	01/03 →	Centre Rod	VL-DL-8566		Push Rod, Leaf Spring Axle	
	01/03 →	Centre Rod	VL-DL-8594		Push Rod	
	01/03 →	Centre Rod	VL-DL-8594		Push Rod, 1st FA; Leaf Spring Axle, * B109715 *; * D110000 * → * A238753 *; * B136425 *; * D110125 *	
	01/03 →	Centre Rod	VL-DL-8681		Push Rod, 1st FA; Air Suspension Axle	
	01/03 →	Centre Rod	VL-DL-8707		Push Rod, Air Suspension Axle	
	01/03 →	Centre Rod	VL-DL-9488		Push Rod	
	01/03 →	Centre Rod	VL-DL-9954		Push Rod → 136425	
	01/03 →	Centre Rod	VL-DL-10228		Push Rod, 1st FA; 2nd FA	
	01/03 →	Centre Rod	VL-DL-12454		for Steering Rod	
	01/03 →	Centre Rod	VL-DL-12455		for Steering Rod	
	01/03 →	Centre Rod	VL-DL-12483		Push Rod	
	01/03 →	Centre Rod	VL-DL-12484		Push Rod	
	01/03 →	Stabiliser Link			VL-DL-8518	Coupling Rod, Control Arm
	01/03 →	Stabiliser Link			VL-DL-8543	Coupling Rod, Control Arm
	01/03 →	Stabiliser Link			VL-DL-9472	Coupling Rod
	01/03 →	Stabiliser Link	VL-DL-8157			Coupling Rod, for Leaf-Spring Suspension vehicles
	01/03 →	Stabiliser Link	VL-DL-8157			Coupling Rod, for Pneumatic Suspension vehicles
	01/03 →	Stabiliser Link	VL-DL-8536			Coupling Rod, Air Suspension Axle
	01/03 →	Stabiliser Link	VL-DL-10258			Coupling Rod, for Leaf-Spring Suspension vehicles
	01/03 →	Stabiliser Link	VL-DL-12356			Coupling Rod
	01/03 →	Stabiliser Mounting	VL-SB-10397			
	01/03 →	Stabiliser Mounting	VL-SB-10398			
	01/03 →	Suspension Arm Repair Kit			IV-RK-8998	for Wishbone (CV)
	01/03 →	Suspension Arm Repair Kit			VL-RK-9497	for Drag Link
	01/03 →	Suspension Arm Repair Kit			VL-RK-9497	for Drag Link, Leaf Spring Axle
	01/03 →	Suspension Arm Repair Kit	CV-RK-5322			for Wishbone (CV)
	01/03 →	Suspension Strut Repair Kit	MN-RK-12436		MN-RK-12436	
	01/03 →	Tie Bar Bush			VL-SB-9501	
	01/03 →	Tie Rod	RV-DL-12447			
01/03 →	Tie Rod	VL-DL-7789				
01/03 →	Tie Rod	VL-DL-8163				
01/03 →	Tie Rod	VL-DL-8163			1st FA	
01/03 →	Tie Rod	VL-DL-8163			2nd FA	
01/03 →	Tie Rod	VL-DL-8305			Leaf Spring Axle	
01/03 →	Tie Rod	VL-DL-9492			Air Suspension Axle	
01/03 →	Tie Rod	VL-DL-9493			Air Suspension Axle	
01/03 →	Tie Rod	VL-DL-12358				
01/03 →	Tie Rod End			RV-ES-9432	Leading Axle	
01/03 →	Tie Rod End			RV-ES-9432	Tag Axle	

CV-RK-5322

Ø: 72 Thick/Height: 50
271188, 3091598



IV-RK-8998

Ø: 85 Hole Distance: 130
Thick/Height: 30
273373, 274019, 4941233, 6889509



MN-RK-12436

Ø: 75 Hole Distance: 115
Thick/Height: 24
3093462, 85104224



RV-DL-12320

Length: 881 Ø: 50
Cone Ø: d1 Ø 28,6 / d2 Ø 23,9
20390746, 21106968



RV-DL-12447

Length: 1818 Ø: 52
Cone Ø: d1 Ø 28,6 / d2 Ø 23,9
20399543, 21299034, 85115631



RV-ES-9432

Length: 120
Cone Ø: d1 Ø 28 / d2 Ø 23,9
Thread: M26 x 1,5 RHT
3193731



VL-DL-0911

Length: 880 Ø: 52
Cone Ø: d1 Ø 28,6 / d2 Ø 23,9
1075663, 3988704, 20393069



VL-DL-2139

Length: 880 Ø: 52
Cone Ø: d1 Ø 28,6 / d2 Ø 23,9
1075153, 3988695, 20393061



VL-DL-5372

Length: 875 Ø: 50
Cone Ø: d1 Ø 28,6 / d2 Ø 23,9
1628635, 3988708, 3988710, 14203800A,
20393079



VL-DL-7789

Length: 1640 Ø: 58
Cone Ø: d1 Ø 28,6 / d2 Ø 23,9
1612254, 3985570, 4510697, 20393097,
21260286



VL-DL-8157

Length: 325 Ø: 30
Cone Ø: d1 Ø 22 / d2 Ø 20
1629668, 3986433, 14316200A, 20477805



VL-DL-8163

Length: 1640 Ø: 42
Cone Ø: d1 Ø 28,6 / d2 Ø 23,9
1628637, 3962343, 3986450, 3988711



VL-DL-8178

Length: 572 Ø: 38
Cone Ø: d1 Ø 28,6 / d2 Ø 23,9
1088985, 20393083



VL-DL-8305

Length: 1634 Ø: 50
Cone Ø: d1 Ø 28,6 / d2 Ø 23,9
3198276, 21260274



VL-DL-8403

Length: 880 Ø: 52
Cone Ø: d1 Ø 28,6 / d2 Ø 23,9
1628636, 14204300A, 85114200



VL-DL-8406

Length: 888 Ø: 52
Cone Ø: d1 Ø 28,6 / d2 Ø 23,9
8190146, 20393071



VL-DL-8407

Length: 870 Ø: 52
Cone Ø: d1 Ø 28,6 / d2 Ø 23,9
3986452, 20375555, 20393186, 21106930



VL-DL-8518

Length: 350 Ø: 36
Cone Ø: d1 Ø 28,9 / d2 Ø 24,7
20443063, 20443067, 20994420



VL-DL-8536

Length: 340 Ø: 30
Cone Ø: d1 Ø 22 / d2 Ø 19,9
3944046, 20477807



VL-DL-8543

Length: 380 Ø: 36
Cone Ø: d1 Ø 28,6 / d2 Ø 24,7
20443062, 20443066, 20994419



VL-DL-8566

Length: 863 Ø: 52
Cone Ø: d1 Ø 28,6 / d2 Ø 23,9
20375556, 20393187, 21106952, 21406952



VL-DL-8594

Length: 865 Ø: 52
Cone Ø: d1 Ø 28,6 / d2 Ø 23,9
1075006, 1691660, 85114190



VL-DL-8681

Length: 888 Ø: 52
Cone Ø: d1 Ø 28,6 / d2 Ø 23,9
8190147, 20393073



VL-DL-8707

Length: 885 Ø: 50
Cone Ø: d1 Ø 28,6 / d2 Ø 23,9
20390745, 21106936



VL-DL-9472

Length: 435 Ø: 36
Cone Ø: d1 Ø 32,2 / d2 Ø 28
20443061, 20443065, 20994418



VL-DL-9488

Length: 563 Ø: 48
Cone Ø: d1 Ø 28,6 / d2 Ø 23,9
20374831, 21252480



VL-DL-9492

Length: 1660 Ø: 62
Cone Ø: d1 Ø 32 / d2 Ø 27
20587731, 21106938



VL-DL-9493

Length: 1660 Ø: 62
Cone Ø: d1 Ø 28,6 / d2 Ø 23,9
3198234, 21260275



VL-DL-9954

Length: 870 Ø: 50
Cone Ø: d1 Ø 28,6 / d2 Ø 23,9
1075005



VL-DL-10228

Length: 2139 Ø: 62
Cone Ø: d1 Ø 28,6 / d2 Ø 23,9
20453063



VL-DL-10258

Length: 325 Ø: 30
Cone Ø: d1 Ø 22 / d2 Ø 20
1629668, 3986433, 20477805



VL-DL-10309

Length: 799 Ø: 48
Hole Distance: 115 / 115
20410053, 21106157



VL-DL-12356

Length: 275 Ø: 30
Cone Ø: d1 Ø 22
3987423, 20477803



VL-DL-12358

Length: 1669 Ø: 42
Cone Ø: d1 Ø 32 / d2 Ø 27
Thread: M32 x 1,5 RHT / M32 x 1,5 LHT
20581086, 7420581086



VL-DL-12454

Length: 2339 Ø: 62
Cone Ø: d1 Ø 28,6 / d2 Ø 23,9
20581632



VL-DL-12455

Length: 2141 Ø: 52
Cone Ø: d1 Ø 28,6 / d2 Ø 23,9
1088987



VL-DL-12483

Length: 485 Ø: 48
Cone Ø: d1 Ø 28,6 / d2 Ø 23,9
20383081, 21260283, 22159761,
81467106355



VL-DL-12484

Length: 1025 Ø: 48
Cone Ø: d1 Ø 28,6 / d2 Ø 23,9
2038308, 21252481



VL-RK-9497

Ø: 95 Hole Distance: 130
Thick/Height: 35
273612, 20702095



VL-SB-9501

Ø: 91 Thick/Height: 85 / 85
1135080



VL-SB-10397

Thick/Height: 89 / 89
1075179



VL-SB-10398

Thick/Height: 87,5 / 87,5
1075180



VL-VB-12460

Length: 662 Ø: 50
Hole Distance: 115 / 115
2223852, 20589061





FH 16 ...

FH 16/540, FH 16/550 ...

01/03→	Tie Rod End		VL-ES-10361	Tag Axle
01/03→	Tie Rod End	MN-ES-10333		for Steering Rod
01/03→	Tie Rod End	RV-ES-12442		
01/03→	Tie Rod End	VL-ES-8411		
01/03→	Tie Rod End	VL-ES-8414		for Guide Rod
01/03→	Tie Rod End	VL-ES-8568		
01/03→	Tie Rod End	VL-ES-10360		for Steering Rod
01/03→	Tie Rod End	VL-ES-10361		
01/03→	Track Control Arm		RV-DL-10299	Trailing Arm, 1st & 2nd Drive Axle, for Leaf-Spring Suspension vehicles
01/03→	Track Control Arm		RV-TC-12339	Suspension Rod, Trailing Arm
01/03→	Track Control Arm		RV-TC-12340	Trailing Arm, 1st & 2nd Drive Axle, for Leaf-Spring Suspension vehicles
01/03→	Track Control Arm		RV-TC-12340	Trailing Arm, 1st Drive Axle, for Leaf-Spring Suspension vehicles
01/03→	Track Control Arm		RV-TC-12340	Trailing Arm, Trailing Axle not Steered, for Leaf-Spring Suspension vehicles
01/03→	Track Control Arm		RV-TC-12340	Trailing Arm, Trailing Axle Steered/ not Steered, for Leaf-Spring Suspension vehicles
01/03→	Track Control Arm		RV-VB-8191	Wishbone (CV)
01/03→	Track Control Arm		RV-VB-8191	Wishbone (CV), 1st RA;2nd RA;Leaf Spring Axle
01/03→	Track Control Arm		RV-VB-8191	Wishbone (CV), Air Suspension Axle
01/03→	Track Control Arm		VL-DL-8180	Trailing Arm
01/03→	Track Control Arm		VL-DL-8180	Trailing Arm, 1st & 2nd Drive Axle, for Pneumatic Suspension vehicles
01/03→	Track Control Arm		VL-DL-8180	Trailing Arm, 1st Drive Axle, for Pneumatic Suspension vehicles
01/03→	Track Control Arm		VL-DL-8180	Trailing Arm, Leading Axle Steered/not Steered, for Pneumatic Suspension vehicles
01/03→	Track Control Arm		VL-DL-8180	Trailing Arm, Trailing Axle Steered/not Steered, for Pneumatic Suspension vehicles
01/03→	Track Control Arm		VL-DL-8554	Trailing Arm, 1st RA;2nd RA;Leaf Spring Axle
01/03→	Track Control Arm		VL-DL-9485	Trailing Arm
01/03→	Track Control Arm		VL-VB-7787	Wishbone (CV)
01/03→	Track Control Arm		VL-VB-7787	Wishbone (CV), 1st RA;2nd RA;Unit; Leaf Spring Axle
01/03→	Track Control Arm		VL-VB-8525	Wishbone (CV)
01/03→	Track Control Arm		VL-VB-8525	Wishbone (CV), Tag Axle;Air Suspension Axle
01/03→	Track Control Arm		VL-VB-8541	Wishbone (CV), Drive Axle;Air Suspension Axle
01/03→	Track Control Arm		VL-VB-8541	Wishbone (CV), Tag Axle;Air Suspension Axle
01/03→	Track Control Arm		VL-VB-12460	Wishbone (CV)
01/03→	Track Control Arm		VL-VB-12460	Wishbone (CV), 1st & 2nd Drive Axle, for Pneumatic Suspension vehicles
01/03→	Track Control Arm		VL-VB-12460	Wishbone (CV), 1st Drive Axle, for Pneumatic Suspension vehicles
01/03→	Track Control Arm		VL-VB-12460	Wishbone (CV), Leading Axle not Steered, for Pneumatic Suspension vehicles
01/03→	Track Control Arm		VL-VB-12460	Wishbone (CV), Leading Axle Steered, for Pneumatic Suspension vehicles
01/03→	Track Control Arm		VL-VB-12460	Wishbone (CV), Leading Axle Steered/not Steered, for Pneumatic Suspension vehicles
01/03→	Track Control Arm		VL-VB-12460	Wishbone (CV), Trailing Axle not Steered, for Pneumatic Suspension vehicles
01/03→	Track Control Arm		VL-VB-12460	Wishbone (CV), Trailing Axle Steered, for Pneumatic Suspension vehicles
01/03→	Track Control Arm		VL-VB-12460	Wishbone (CV), Trailing Axle Steered/not Steered, for Pneumatic Suspension vehicles
01/03→	Track Control Arm	VL-DL-10309	VL-DL-10309	Trailing Arm, 1st Front Axle, for Pneumatic Suspension vehicles
01/03→	Track Control Arm	VL-DL-10309	VL-DL-10309	Trailing Arm, Air Suspension Axle
08/07→	Suspension Strut Repair Kit		MN-RK-8501	

MN-ES-10333

Length: 90
Cone Ø: d1 Ø 38 / d2 Ø 34,35
Thread: M36 x 1,5 RHT
1271126, 3090291, 3099128, 42538048,
81953016268, 82953016018, 82953016019



MN-RK-8501

Ø: 75 Hole Distance: 115
Thick/Height: 24
20547286



RV-DL-10299

Length: 510 Ø: 21
20522934, 21051052, 7420864583,
7421051052



RV-ES-12442

Length: 88
Cone Ø: d1 Ø 28,6
Thread: M26 x 1,5 RHT
3987648



RV-TC-12339

Length: 515
Hole Distance: 13 / 130
20532931, 21051046



RV-TC-12340

Length: 510
Hole Distance: 115 / 115
20443044



RV-VB-8191

Length: 662,4 Ø: 48
Hole Distance: 115 / 115
20367004, 20507262, 20741695, 20741703,
22318833



VL-DL-8180

Length: 625 Ø: 17
20374444, 20410530, 20509018, 20517494,
70371270



VL-DL-8554

Length: 570 Ø: 48
Hole Distance: 130 / 130
1626957, 1626958, 14320200A



VL-DL-9485

Length: 666 Ø: 48
Hole Distance: 125 / 125
1589817



VL-DL-10309

Length: 799 Ø: 48
Hole Distance: 115 / 115
20410053, 21106157



VL-ES-8411

Length: 140
Cone Ø: d1 Ø 28,6 / d2 Ø 23,9
Thread: M30 x 1,5 RHT
3093647, 3097999, 21263821



VL-ES-8414

Length: 136
Cone Ø: d1 Ø 32 / d2 Ø 27
Thread: M30 x 1,5 LHT
20710008



VL-ES-8568

Length: 100
Cone Ø: d1 Ø 38 / d2 Ø 34,3
Thread: M26 x 1,5 RHT
8151876



VL-ES-10360

Length: 136
Cone Ø: d1 Ø 32 / d2 Ø 27
Thread: M30 x 1,5 RHT
20581089



VL-ES-10361

Length: 88
Cone Ø: d1 Ø 28,6 / d2 Ø 24
Thread: M26 x 1,5 RHT
20374698



VL-VB-7787

Length: 671
Ø: 58
Hole Distance: 130 / 130
143167, 1076639, 1626896, 1629734,
20392649, 20829503, 21295227, 21474441,
22318834, 7421295227



VL-VB-8525

Length: 677,3 Ø: 48
Hole Distance: 145 / 145
3173291, 20556490



VL-VB-8541

Length: 677,3
Ø: 48
Hole Distance: 145 / 145
3173292, 20556491



VL-VB-12460

Length: 662
Ø: 50
Hole Distance: 115 / 115
2223852, 20589061





FH 16 ...

FH 16/550	01/03→	Centre Rod	VL-DL-12367		for Steering Rod
	01/03→	Centre Rod	VL-DL-12454		for Steering Rod
	01/03→	Stabiliser Link		VL-DL-8518	Coupling Rod, Control Arm
	01/03→	Stabiliser Link		VL-DL-8543	Coupling Rod, Control Arm
	01/03→	Suspension Strut Repair Kit		MN-RK-8501	
	01/03→	Tie Rod	RV-DL-12447		
	01/03→	Tie Rod End	RV-ES-12442		
	01/03→	Tie Rod End	VL-ES-8411		
	01/03→	Tie Rod End	VL-ES-8414		for Guide Rod
	01/03→	Tie Rod End	VL-ES-10360		for Steering Rod
	01/03→	Track Control Arm		RV-DL-10299	Trailing Arm, 1st & 2nd Drive Axle, for Leaf-Spring Suspension vehicles
	01/03→	Track Control Arm		RV-TC-12339	Suspension Rod, Trailing Arm
	01/03→	Track Control Arm		RV-TC-12340	Trailing Arm
	01/03→	Track Control Arm		RV-VB-8191	Wishbone (CV)
	01/03→	Track Control Arm		VL-DL-8180	Trailing Arm, 1st & 2nd Drive Axle, for Pneumatic Suspension vehicles
	01/03→	Track Control Arm		VL-VB-7787	Wishbone (CV), 1st & 2nd Drive Axle
	01/03→	Track Control Arm		VL-VB-12460	Wishbone (CV), 1st & 2nd Drive Axle, for Pneumatic Suspension vehicles
	01/03→	Track Control Arm		VL-VB-12460	Wishbone (CV), Trailing Axle Steered, for Pneumatic Suspension vehicles
	01/03→	Track Control Arm	VL-DL-10309	VL-DL-10309	Trailing Arm, 1st Front Axle, for Pneumatic Suspension vehicles
	05/05→	Centre Rod	VL-DL-12483		Push Rod
	05/05→	Centre Rod	VL-DL-12484		Push Rod
	05/05→	Track Control Arm		VL-VB-12460	Wishbone (CV)
	09/05→	Centre Rod	VL-DL-8566		Push Rod
	09/05→	Stabiliser Link		VL-DL-9472	Coupling Rod
	09/05→	Stabiliser Link	VL-DL-10258		Coupling Rod, for Leaf-Spring Suspension vehicles
	09/05→	Stabiliser Link	VL-DL-12356		Coupling Rod
	09/05→	Suspension Arm Repair Kit		VL-RK-9497	for Drag Link, Leaf Spring Axle
	09/05→	Suspension Strut Repair Kit	VL-RK-8533		
	09/05→	Tie Rod	VL-DL-9492		
	09/05→	Tie Rod	VL-DL-12358		
	09/05→	Track Control Arm		VL-DL-8180	Trailing Arm
	09/05→	Track Control Arm		VL-VB-7787	Wishbone (CV)
	FH 16/580	09/06→	Centre Rod	VL-DL-8178	
09/06→		Centre Rod	VL-DL-8403		Push Rod
09/06→		Centre Rod	VL-DL-8406		Push Rod
09/06→		Centre Rod	VL-DL-8407		Push Rod
09/06→		Centre Rod	VL-DL-8566		Push Rod
09/06→		Centre Rod	VL-DL-8594		Suspension Rod
09/06→		Centre Rod	VL-DL-12483		Push Rod
09/06→		Centre Rod	VL-DL-12484		Push Rod
09/06→		Stabiliser Link		VL-DL-9472	Coupling Rod
09/06→		Stabiliser Link	VL-DL-8157		Coupling Rod, for Leaf-Spring Suspension vehicles
09/06→		Stabiliser Link	VL-DL-8157		Coupling Rod, for Pneumatic Suspension vehicles
09/06→		Stabiliser Link	VL-DL-10258		Coupling Rod, for Leaf-Spring Suspension vehicles
09/06→		Stabiliser Link	VL-DL-12356		Coupling Rod
09/06→		Stabiliser Mounting	VL-SB-10394	VL-SB-10394	
09/06→		Stabiliser Mounting	VL-SB-10397		
09/06→		Stabiliser Mounting	VL-SB-10398		
09/06→		Suspension Arm Repair Kit		CV-RK-5322	for Wishbone (CV)
09/06→		Suspension Arm Repair Kit		MN-RK-7280	for Drag Link
09/06→		Suspension Arm Repair Kit		MN-RK-9383	for Control Arm
09/06→		Suspension Arm Repair Kit		VL-RK-9497	for Drag Link
09/06→		Suspension Arm Repair Kit		VL-RK-9497	for Drag Link, Leaf Spring Axle
09/06→	Suspension Arm Repair Kit	VL-RK-5323	VL-RK-5323	for Drag Link	

CV-RK-5322

Ø: 72 Thick/Height: 50
271188, 3091598



MN-RK-7280

Ø: 75 Hole Distance: 115
Thick/Height: 24
271187, 689748



MN-RK-8501

Ø: 75 Hole Distance: 115
Thick/Height: 24
20547286



MN-RK-9383

Ø: 67 Hole Distance: 100
Thick/Height: 24
275988



RV-DL-10299

Length: 510 Ø: 21
20522934, 21051052, 7420864583,
7421051052



RV-DL-12447

Length: 1818 Ø: 52
Cone Ø: d1 Ø 28,6 / d2 Ø 23,9
20399543, 21299034, 85115631



RV-ES-12442

Length: 88
Cone Ø: d1 Ø 28,6
Thread: M26 x 1,5 RHT
3987648



RV-TC-12339

Length: 515
Hole Distance: 13 / 130
20532931, 21051046



RV-TC-12340

Length: 510
Hole Distance: 115 / 115
20443044



RV-VB-8191

Length: 662,4 Ø: 48
Hole Distance: 115 / 115
20367004, 20507262, 20741695, 20741703,
22318833



VL-DL-8157

Length: 325 Ø: 30
Cone Ø: d1 Ø 22 / d2 Ø 20
1629668, 3986433, 14316200A, 20477805



VL-DL-8178

Length: 572 Ø: 38
Cone Ø: d1 Ø 28,6 / d2 Ø 23,9
1088985, 20393083



VL-DL-8180

Length: 625 Ø: 17
20374444, 20410530, 20509018, 20517494,
70371270



VL-DL-8403

Length: 880 Ø: 52
Cone Ø: d1 Ø 28,6 / d2 Ø 23,9
1628636, 14204300A, 85114200



VL-DL-8406

Length: 888 Ø: 52
Cone Ø: d1 Ø 28,6 / d2 Ø 23,9
8190146, 20393071



VL-DL-8407

Length: 870 Ø: 52
Cone Ø: d1 Ø 28,6 / d2 Ø 23,9
3986452, 20375555, 20393186, 21106930



VL-DL-8518

Length: 350 Ø: 36
Cone Ø: d1 Ø 28,9 / d2 Ø 24,7
20443063, 20443067, 20994420



VL-DL-8543

Length: 380 Ø: 36
Cone Ø: d1 Ø 28,6 / d2 Ø 24,7
20443062, 20443066, 20994419



VL-DL-8566

Length: 863 Ø: 52
Cone Ø: d1 Ø 28,6 / d2 Ø 23,9
20375556, 20393187, 21106952, 21406952



VL-DL-8594

Length: 865 Ø: 52
Cone Ø: d1 Ø 28,6 / d2 Ø 23,9
1075006, 1691660, 85114190



VL-DL-9472

Length: 435 Ø: 36
Cone Ø: d1 Ø 32,2 / d2 Ø 28
20443061, 20443065, 20994418



VL-DL-9492

Length: 1660 Ø: 62
Cone Ø: d1 Ø 32 / d2 Ø 27
20587731, 21106938



VL-DL-10258

Length: 325 Ø: 30
Cone Ø: d1 Ø 22 / d2 Ø 20
1629668, 3986433, 20477805



VL-DL-10309

Length: 799 Ø: 48
Hole Distance: 115 / 115
20410053, 21106157



VL-DL-12356

Length: 275 Ø: 30
Cone Ø: d1 Ø 22
3987423, 20477803



VL-DL-12358

Length: 1669 Ø: 42
Cone Ø: d1 Ø 32 / d2 Ø 27
Thread: M32 x 1,5 RHT / M32 x 1,5 LHT
20581086, 7420581086



VL-DL-12367

Length: 2139 Ø: 62
Cone Ø: d1 Ø 28,6 / d2 Ø 23,9
Thread: M52 x 1,5 RHT
20453064, 20584291



VL-DL-12454

Length: 2339 Ø: 62
Cone Ø: d1 Ø 28,6 / d2 Ø 23,9
20581632



VL-DL-12483

Length: 485 Ø: 48
Cone Ø: d1 Ø 28,6 / d2 Ø 23,9
20383081, 21260283, 22159761,
81467106355



VL-DL-12484

Length: 1025 Ø: 48
Cone Ø: d1 Ø 28,6 / d2 Ø 23,9
2038308, 21252481



VL-ES-8411

Length: 140
Cone Ø: d1 Ø 28,6 / d2 Ø 23,9
Thread: M30 x 1,5 RHT
3093647, 3097999, 21263821



VL-ES-8414

Length: 136
Cone Ø: d1 Ø 32 / d2 Ø 27
Thread: M30 x 1,5 LHT
20710008



VL-ES-10360

Length: 136
Cone Ø: d1 Ø 32 / d2 Ø 27
Thread: M30 x 1,5 RHT
20581089



VL-RK-5323

Ø: 91 Hole Distance: 125
Thick/Height: 20
1598588, 14302100A



VL-RK-8533

Ø: 85 Hole Distance: 130
Thick/Height: 30
3093630, 3093631, 20840815, 21295230,
7420840815



VL-RK-9497

Ø: 95 Hole Distance: 130
Thick/Height: 35
273612, 20702095



VL-SB-10394

Ø: 90 Thick/Height: 95 / 95
9519245



VL-SB-10397

Thick/Height: 89 / 89
1075179



VL-SB-10398

Thick/Height: 87,5 / 87,5
1075180



VL-VB-7787

Length: 671 Ø: 58
Hole Distance: 130 / 130
143167, 1076639, 1626896, 1629734,
20392649, 20829503, 21295227, 21474441,
22318834, 7421295227



VL-VB-12460

Length: 662 Ø: 50
Hole Distance: 115 / 115
2223852, 20589061





FH 16 ...

FH 16/580 ...

09/06→	Suspension Strut Repair Kit		MN-RK-8501	
09/06→	Suspension Strut Repair Kit	MN-RK-12436	MN-RK-12436	
09/06→	Tie Bar Bush		VL-RK-8656	
09/06→	Tie Bar Bush		VL-SB-9501	
09/06→	Tie Rod	VL-DL-12358		
09/06→	Tie Rod End	VL-ES-8411		
09/06→	Tie Rod End	VL-ES-8414		for Guide Rod
09/06→	Tie Rod End	VL-ES-10360		for Steering Rod
09/06→	Track Control Arm		RV-DL-10299	Trailing Arm, 1st & 2nd Drive Axle, for Leaf-Spring Suspension vehicles
09/06→	Track Control Arm		RV-TC-12339	Suspension Rod, Trailing Arm
09/06→	Track Control Arm		RV-TC-12340	Trailing Arm, 1st & 2nd Drive Axle, for Leaf-Spring Suspension vehicles
09/06→	Track Control Arm		RV-TC-12340	Trailing Arm, 1st Drive Axle, for Leaf-Spring Suspension vehicles
09/06→	Track Control Arm		RV-TC-12340	Trailing Arm, Trailing Axle not Steered, for Leaf-Spring Suspension vehicles
09/06→	Track Control Arm		RV-VB-8191	Wishbone (CV)
09/06→	Track Control Arm		RV-VB-8191	Wishbone (CV), 1st Drive Axle, for Leaf-Spring Suspension vehicles
09/06→	Track Control Arm		RV-VB-8191	Wishbone (CV), 1st Drive Axle, for Pneumatic Suspension vehicles
09/06→	Track Control Arm		RV-VB-8191	Wishbone (CV), Leading Axle not Steered, for Pneumatic Suspension vehicles
09/06→	Track Control Arm		RV-VB-8191	Wishbone (CV), Trailing Axle not Steered, for Leaf-Spring Suspension vehicles
09/06→	Track Control Arm		RV-VB-8191	Wishbone (CV), Trailing Axle not Steered, for Pneumatic Suspension vehicles
09/06→	Track Control Arm		VL-DL-8180	Trailing Arm
09/06→	Track Control Arm		VL-DL-8180	Trailing Arm, 1st & 2nd Drive Axle, for Pneumatic Suspension vehicles
09/06→	Track Control Arm		VL-DL-8180	Trailing Arm, 1st Drive Axle, for Pneumatic Suspension vehicles
09/06→	Track Control Arm		VL-DL-8180	Trailing Arm, Leading Axle Steered/not Steered, for Pneumatic Suspension vehicles
09/06→	Track Control Arm		VL-DL-8180	Trailing Arm, Trailing Axle Steered/not Steered, for Pneumatic Suspension vehicles
09/06→	Track Control Arm		VL-DL-8189	Trailing Arm
09/06→	Track Control Arm		VL-VB-5369	Wishbone (CV)
09/06→	Track Control Arm		VL-VB-7787	Wishbone (CV)
09/06→	Track Control Arm		VL-VB-8525	Wishbone (CV)
09/06→	Track Control Arm		VL-VB-12460	Wishbone (CV)
09/06→	Track Control Arm		VL-VB-12460	Wishbone (CV), 1st & 2nd Drive Axle, for Pneumatic Suspension vehicles
09/06→	Track Control Arm		VL-VB-12460	Wishbone (CV), 1st Drive Axle, for Pneumatic Suspension vehicles
09/06→	Track Control Arm		VL-VB-12460	Wishbone (CV), Leading Axle Steered/not Steered, for Pneumatic Suspension vehicles
09/06→	Track Control Arm		VL-VB-12460	Wishbone (CV), Trailing Axle Steered, for Pneumatic Suspension vehicles
09/06→	Track Control Arm		VL-VB-12460	Wishbone (CV), Trailing Axle Steered/not Steered, for Pneumatic Suspension vehicles
09/06→	Track Control Arm	VL-DL-10309	VL-DL-10309	Trailing Arm, 1st Front Axle, for Pneumatic Suspension vehicles
01/09→	Tie Rod	VL-DL-12355		
01/09→	Track Control Arm		RV-TC-12340	Trailing Arm, Trailing Axle Steered, for Leaf-Spring Suspension vehicles
01/09→	Track Control Arm		RV-VB-8191	Wishbone (CV), Trailing Axle Steered, for Leaf-Spring Suspension vehicles
01/09→	Track Control Arm		VL-VB-12460	Wishbone (CV), Leading Axle Steered, for Pneumatic Suspension vehicles

MN-RK-8501

Ø: 75 Hole Distance: 115
 Thick/Height: 24
 20547286

**MN-RK-12436**

Ø: 75 Hole Distance: 115
 Thick/Height: 14
 3093462, 85104224

**RV-DL-10299**

Length: 510 Ø: 21
 20522934, 21051052, 7420864583,
 7421051052

**RV-TC-12339**

Length: 515
 Hole Distance: 13 / 130
 20532931, 21051046

**RV-TC-12340**

Length: 510
 Hole Distance: 115 / 115
 20443044

**RV-VB-8191**

Length: 662,4 Ø: 48
 Hole Distance: 115 / 115
 20367004, 20507262, 20741695, 20741703,
 22318833

**VL-DL-8180**

Length: 625 Ø: 17
 20374444, 20410530, 20509018, 20517494,
 70371270

**VL-DL-8189**

Length: 666 Ø: 48
 Hole Distance: 125
 1082104, 1605035

**VL-DL-10309**

Length: 799 Ø: 48
 Hole Distance: 115 / 115
 20410053, 21106157

**VL-DL-12355**

Length: 368 Ø: 38
 Cone Ø: d1 Ø 28,6 / d2 Ø 23,9
 1628207

**VL-DL-12358**

Length: 1669 Ø: 42
 Cone Ø: d1 Ø 32 / d2 Ø 27
 Thread: M32 x 1,5 RHT / M32 x 1,5 LHT
 20581086, 7420581086

**VL-ES-8411**

Length: 140
 Cone Ø: d1 Ø 28,6 / d2 Ø 23,9
 Thread: M30 x 1,5 RHT
 3093647, 3097999, 21263821

**VL-ES-8414**

Length: 136
 Cone Ø: d1 Ø 32 / d2 Ø 27
 Thread: M30 x 1,5 LHT
 20710008

**VL-ES-10360**

Length: 136
 Cone Ø: d1 Ø 32 / d2 Ø 27
 Thread: M30 x 1,5 RHT
 20581089

**VL-RK-8656**

Ø: 91 Hole Distance: 145
 Thick/Height: 26
 1628107

**VL-SB-9501**

Ø: 91 Thick/Height: 85 / 85
 1135080

**VL-VB-5369**

Length: 677
 Ø: 48
 Hole Distance: 115 / 115
 3172829, 8073569, 14319600A

**VL-VB-7787**

Length: 671
 Ø: 58
 Hole Distance: 130 / 130
 143167, 1076639, 1626896, 1629734,
 20392649, 20829503, 21295227, 21474441,
 22318834, 7421295227

**VL-VB-8525**

Length: 677,3 Ø: 48
 Hole Distance: 145 / 145
 3173291, 20556490

**VL-VB-12460**

Length: 662
 Ø: 50
 Hole Distance: 115 / 115
 2223852, 20589061



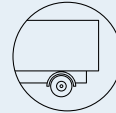

FH 16 ...

FH 16/600

09/06→	Centre Rod	VL-DL-8178		Push Rod
09/06→	Centre Rod	VL-DL-8406		Push Rod
09/06→	Centre Rod	VL-DL-8407		Push Rod
09/06→	Centre Rod	VL-DL-8566		Push Rod
09/06→	Stabiliser Link		VL-DL-9472	Coupling Rod
09/06→	Stabiliser Link	VL-DL-8157		Coupling Rod, for Leaf-Spring Suspension vehicles
09/06→	Stabiliser Link	VL-DL-8157		Coupling Rod, for Pneumatic Suspension vehicles
09/06→	Stabiliser Link	VL-DL-10258		Coupling Rod, for Leaf-Spring Suspension vehicles
09/06→	Stabiliser Link	VL-DL-12356		Coupling Rod
09/06→	Suspension Arm Repair Kit		VL-RK-9497	for Drag Link
09/06→	Suspension Strut Repair Kit		MN-RK-8501	
09/06→	Suspension Strut Repair Kit	MN-RK-12436	MN-RK-12436	
09/06→	Tie Bar Bush		VL-SB-9501	
09/06→	Tie Rod	VL-DL-12358		
09/06→	Tie Rod End	VL-ES-8411		
09/06→	Tie Rod End	VL-ES-8414		for Guide Rod
09/06→	Tie Rod End	VL-ES-10360		for Steering Rod
09/06→	Track Control Arm		RV-TC-12339	Suspension Rod, Trailing Arm
09/06→	Track Control Arm		RV-VB-8191	Wishbone (CV)
09/06→	Track Control Arm		VL-DL-8180	Trailing Arm
09/06→	Track Control Arm		VL-VB-7787	Wishbone (CV)
09/06→	Track Control Arm		VL-VB-8525	Wishbone (CV)
09/06→	Track Control Arm		VL-VB-12460	Wishbone (CV), 1st Drive Axle, for Pneumatic Suspension vehicles
09/06→	Track Control Arm	VL-DL-10309	VL-DL-10309	Trailing Arm, 1st Front Axle, for Pneumatic Suspension vehicles
01/09→	Centre Rod	DF-DL-5226		Push Rod
01/09→	Centre Rod	DF-DL-8196		Push Rod
01/09→	Centre Rod	VL-DL-12483		Push Rod
01/09→	Centre Rod	VL-DL-12484		Push Rod
01/09→	Stabiliser Mounting	DF-SB-5253	DF-SB-5253	
01/09→	Suspension Arm Repair Kit		DF-RK-9336	
01/09→	Suspension Arm Repair Kit		IV-RK-8998	for Wishbone (CV)
01/09→	Suspension Arm Repair Kit		SC-RK-8575	for Wishbone (CV)
01/09→	Suspension Arm Repair Kit		VL-RK-9497	for Drag Link, Leaf Spring Axle
01/09→	Suspension Strut Repair Kit		DF-RK-8637	
01/09→	Suspension Strut Repair Kit		MN-RK-8537	
01/09→	Suspension Strut Repair Kit	VL-RK-8533		
01/09→	Tie Rod	DF-DL-7780		
01/09→	Tie Rod	VL-DL-12355		
01/09→	Track Control Arm		DF-DL-8158	Trailing Arm
01/09→	Track Control Arm		DF-VB-8561	Wishbone (CV)
01/09→	Track Control Arm		RV-DL-10299	Trailing Arm, 1st & 2nd Drive Axle, for Leaf-Spring Suspension vehicles
01/09→	Track Control Arm		RV-TC-12340	Trailing Arm, 1st & 2nd Drive Axle, for Leaf-Spring Suspension vehicles
01/09→	Track Control Arm		RV-TC-12340	Trailing Arm, 1st Drive Axle, for Leaf-Spring Suspension vehicles
01/09→	Track Control Arm		RV-TC-12340	Trailing Arm, Trailing Axle not Steered, for Leaf-Spring Suspension vehicles
01/09→	Track Control Arm		RV-TC-12340	Trailing Arm, Trailing Axle Steered, for Leaf-Spring Suspension vehicles
01/09→	Track Control Arm		RV-VB-8191	Wishbone (CV), 1st Drive Axle, for Leaf-Spring Suspension vehicles
01/09→	Track Control Arm		RV-VB-8191	Wishbone (CV), 1st Drive Axle, for Pneumatic Suspension vehicles
01/09→	Track Control Arm		RV-VB-8191	Wishbone (CV), Leading Axle not Steered, for Pneumatic Suspension vehicles
01/09→	Track Control Arm		RV-VB-8191	Wishbone (CV), Trailing Axle not Steered, for Leaf-Spring Suspension vehicles

DF-DL-5226**DF-DL-7780****DF-DL-8158****DF-DL-8196****DF-RK-8637**

Ø: 72
3093469

**DF-RK-9336****DF-SB-5253****DF-VB-8561****IV-RK-8998**

Ø: 85 Hole Distance: 130
Thick/Height: 30
273373, 274019, 4941233, 6889509

**MN-RK-8501**

Ø: 75 Hole Distance: 115
Thick/Height: 24
20547286

**MN-RK-8537**

Ø: 95 Hole Distance: 152
Thick/Height: 24
274056, 276192, 696321, 81432706099

**MN-RK-12436**

Ø: 75 Hole Distance: 115
Thick/Height: 24
3093462, 85104224

**RV-DL-10299**

Length: 510 Ø: 21
20522934, 21051052, 7420864583,
7421051052

**RV-TC-12339**

Length: 515
Hole Distance: 13 / 130
20532931, 21051046

**RV-TC-12340**

Length: 510
Hole Distance: 115 / 115
20443044

**RV-VB-8191**

Length: 662,4 Ø: 48
Hole Distance: 115 / 115
20367004, 20507262, 20741695, 20741703,
22318833

**SC-RK-8575**

Ø: 95 Hole Distance: 152
Thick/Height: 35
274056

**VL-DL-8157**

Length: 325 Ø: 30
Cone Ø: d1 Ø 22 / d2 Ø 20
1629668, 3986433, 14316200A, 20477805

**VL-DL-8178**

Length: 572 Ø: 38
Cone Ø: d1 Ø 28,6 / d2 Ø 23,9
1088985, 20393083

**VL-DL-8180**

Length: 625 Ø: 17
20374444, 20410530, 20509018, 20517494,
70371270

**VL-DL-8406**

Length: 888 Ø: 52
Cone Ø: d1 Ø 28,6 / d2 Ø 23,9
8190146, 20393071

**VL-DL-8407**

Length: 870 Ø: 52
Cone Ø: d1 Ø 28,6 / d2 Ø 23,9
3986452, 20375555, 20393186, 21106930

**VL-DL-8566**

Length: 863 Ø: 52
Cone Ø: d1 Ø 28,6 / d2 Ø 23,9
20375556, 20393187, 21106952, 21406952

**VL-DL-9472**

Length: 435 Ø: 36
Cone Ø: d1 Ø 32,2 / d2 Ø 28
20443061, 20443065, 20994418

**VL-DL-10258**

Length: 325 Ø: 30
Cone Ø: d1 Ø 22 / d2 Ø 20
1629668, 3986433, 20477805

**VL-DL-10309**

Length: 799 Ø: 48
Hole Distance: 115 / 115
20410053, 21106157

**VL-DL-12355**

Length: 368 Ø: 38
Cone Ø: d1 Ø 28,6 / d2 Ø 23,9
1628207

**VL-DL-12356**

Length: 275 Ø: 30
Cone Ø: d1 Ø 22
3987423, 20477803

**VL-DL-12358**

Length: 1669 Ø: 42
Cone Ø: d1 Ø 32 / d2 Ø 27
Thread: M32 x 1,5 RHT / M32 x 1,5 LHT
20581086, 7420581086

**VL-DL-12483**

Length: 485 Ø: 48
Cone Ø: d1 Ø 28,6 / d2 Ø 23,9
20383081, 21260283, 22159761,
81467106355

**VL-DL-12484**

Length: 1025 Ø: 48
Cone Ø: d1 Ø 28,6 / d2 Ø 23,9
2038308, 21252481

**VL-ES-8411**

Length: 140
Cone Ø: d1 Ø 28,6 / d2 Ø 23,9
Thread: M30 x 1,5 RHT
3093647, 3097999, 21263821

**VL-ES-8414**

Length: 136
Cone Ø: d1 Ø 32 / d2 Ø 27
Thread: M30 x 1,5 LHT
20710008

**VL-ES-10360**

Length: 136
Cone Ø: d1 Ø 32 / d2 Ø 27
Thread: M30 x 1,5 RHT
20581089

**VL-RK-8533**

Ø: 85 Hole Distance: 130
Thick/Height: 30
3093630, 3093631, 20840815, 21295230,
7420840815

**VL-RK-9497**

Ø: 95 Hole Distance: 130
Thick/Height: 35
273612, 20702095

**VL-SB-9501**

Ø: 91 Thick/Height: 85 / 85
1135080

**VL-VB-7787**

Length: 671 Ø: 58
Hole Distance: 130 / 130
143167, 1076639, 1626896, 1629734,
20392649, 20829503, 21295227, 21474441,
22318834, 7421295227

**VL-VB-8525**

Length: 677,3 Ø: 48
Hole Distance: 145 / 145
3173291, 20556490

**VL-VB-12460**

Length: 662 Ø: 50
Hole Distance: 115 / 115
2223852, 20589061





FH 16 ...

FH 16/600 ...	01/09 →	Track Control Arm		RV-VB-8191	Wishbone (CV), Trailing Axle not Steered, for Pneumatic Suspension vehicles
	01/09 →	Track Control Arm		RV-VB-8191	Wishbone (CV), Trailing Axle Steered, for Leaf-Spring Suspension vehicles
	01/09 →	Track Control Arm		VL-DL-8180	Trailing Arm, 1st & 2nd Drive Axle, for Pneumatic Suspension vehicles
	01/09 →	Track Control Arm		VL-VB-12460	Wishbone (CV)
	01/09 →	Track Control Arm		VL-VB-12460	Wishbone (CV), 1st & 2nd Drive Axle, for Pneumatic Suspension vehicles
	01/09 →	Track Control Arm		VL-VB-12460	Wishbone (CV), Leading Axle Steered, for Pneumatic Suspension vehicles
	01/09 →	Track Control Arm		VL-VB-12460	Wishbone (CV), Trailing Axle Steered, for Pneumatic Suspension vehicles
FH 16/610	01/03 →	Centre Rod	RV-DL-12320		for Steering Rod
	01/03 →	Centre Rod	VL-DL-0911		Push Rod 136426 →
	01/03 →	Centre Rod	VL-DL-2139		Push Rod, for Pneumatic Suspension vehicles
	01/03 →	Centre Rod	VL-DL-5372		Push Rod
	01/03 →	Centre Rod	VL-DL-8178		Push Rod
	01/03 →	Centre Rod	VL-DL-8403		Push Rod
	01/03 →	Centre Rod	VL-DL-8403		Push Rod, 1st FA; Air Suspension Axle, * B109715 * → * A230971 *; * B125525 *
	01/03 →	Centre Rod	VL-DL-8406		Push Rod
	01/03 →	Centre Rod	VL-DL-8406		Push Rod, Air Suspension Axle
	01/03 →	Centre Rod	VL-DL-8407		Push Rod
	01/03 →	Centre Rod	VL-DL-8407		Push Rod, Leaf Spring Axle
	01/03 →	Centre Rod	VL-DL-8566		Push Rod
	01/03 →	Centre Rod	VL-DL-8566		Push Rod, Leaf Spring Axle
	01/03 →	Centre Rod	VL-DL-8594		Push Rod
	01/03 →	Centre Rod	VL-DL-8594		Push Rod, 1st FA; Leaf Spring Axle, * B109715 *; * D110000 * → * A238753 *; * B136425 *; * D110125 *
	01/03 →	Centre Rod	VL-DL-8681		Push Rod, 1st FA; Air Suspension Axle
	01/03 →	Centre Rod	VL-DL-8707		Push Rod, Air Suspension Axle
	01/03 →	Centre Rod	VL-DL-9488		Push Rod
	01/03 →	Centre Rod	VL-DL-9954		Push Rod → 136425
	01/03 →	Centre Rod	VL-DL-10228		Push Rod, 1st FA; 2nd FA
	01/03 →	Centre Rod	VL-DL-12367		for Steering Rod
	01/03 →	Centre Rod	VL-DL-12454		for Steering Rod
	01/03 →	Centre Rod	VL-DL-12455		for Steering Rod
	01/03 →	Stabiliser Link		VL-DL-8518	Coupling Rod, Control Arm
	01/03 →	Stabiliser Link		VL-DL-8543	Coupling Rod, Control Arm
	01/03 →	Stabiliser Link		VL-DL-9472	Coupling Rod
	01/03 →	Stabiliser Link	VL-DL-8157		Coupling Rod, for Leaf-Spring Suspension vehicles
	01/03 →	Stabiliser Link	VL-DL-8157		Coupling Rod, for Pneumatic Suspension vehicles
	01/03 →	Stabiliser Link	VL-DL-8536		Coupling Rod, Air Suspension Axle
	01/03 →	Stabiliser Link	VL-DL-10258		Coupling Rod, for Leaf-Spring Suspension vehicles
	01/03 →	Stabiliser Link	VL-DL-12356		Coupling Rod
	01/03 →	Stabiliser Mounting	VL-SB-10397		
	01/03 →	Stabiliser Mounting	VL-SB-10398		
	01/03 →	Suspension Arm Repair Kit		IV-RK-8998	for Wishbone (CV)
	01/03 →	Suspension Arm Repair Kit		VL-RK-9497	for Drag Link
	01/03 →	Suspension Arm Repair Kit		VL-RK-9497	for Drag Link, Leaf Spring Axle
	01/03 →	Suspension Arm Repair Kit	CV-RK-5322		for Wishbone (CV)
	01/03 →	Suspension Strut Repair Kit	MN-RK-12436	MN-RK-12436	
	01/03 →	Tie Bar Bush		VL-SB-9501	
	01/03 →	Tie Rod	RV-DL-12447		
	01/03 →	Tie Rod	VL-DL-7789		
	01/03 →	Tie Rod	VL-DL-8163		
	01/03 →	Tie Rod	VL-DL-8163		1st FA
	01/03 →	Tie Rod	VL-DL-8163		2nd FA

CV-RK-5322

Ø: 72 Thick/Height: 50
271188, 3091598

**IV-RK-8998**

Ø: 85 Hole Distance: 130
Thick/Height: 30
273373, 274019, 4941233, 6889509

**MN-RK-12436**

Ø: 75 Hole Distance: 115
Thick/Height: 24
3093462, 85104224

**RV-DL-12320**

Length: 881 Ø: 50
Cone Ø: d1 Ø 28,6 / d2 Ø 23,9
20390746, 21106968

**RV-DL-12447**

Length: 1818 Ø: 52
Cone Ø: d1 Ø 28,6 / d2 Ø 23,9
20399543, 21299034, 85115631

**RV-VB-8191**

Length: 662,4 Ø: 48
Hole Distance: 115 / 115
20367004, 20507262, 20741695, 20741703,
22318833

**VL-DL-0911**

Length: 880 Ø: 52
Cone Ø: d1 Ø 28,6 / d2 Ø 23,9
1075663, 3988704, 20393069

**VL-DL-2139**

Length: 880 Ø: 52
Cone Ø: d1 Ø 28,6 / d2 Ø 23,9
1075153, 3988695, 20393061

**VL-DL-5372**

Length: 875 Ø: 50
Cone Ø: d1 Ø 28,6 / d2 Ø 23,9
1628635, 3988708, 3988710, 14203800A,
20393079

**VL-DL-7789**

Length: 1640 Ø: 58
Cone Ø: d1 Ø 28,6 / d2 Ø 23,9
1612254, 3985570, 4510697, 20393097,
21260286

**VL-DL-8157**

Length: 325 Ø: 30
Cone Ø: d1 Ø 22 / d2 Ø 20
1629668, 3986433, 14316200A, 20477805

**VL-DL-8163**

Length: 1640 Ø: 42
Cone Ø: d1 Ø 28,6 / d2 Ø 23,9
1628637, 3962343, 3986450, 3988711

**VL-DL-8178**

Length: 572 Ø: 38
Cone Ø: d1 Ø 28,6 / d2 Ø 23,9
1088985, 20393083

**VL-DL-8180**

Length: 625 Ø: 17
20374444, 20410530, 20509018, 20517494,
70371270

**VL-DL-8403**

Length: 880 Ø: 52
Cone Ø: d1 Ø 28,6 / d2 Ø 23,9
1628636, 14204300A, 85114200

**VL-DL-8406**

Length: 888 Ø: 52
Cone Ø: d1 Ø 28,6 / d2 Ø 23,9
8190146, 20393071

**VL-DL-8407**

Length: 870 Ø: 52
Cone Ø: d1 Ø 28,6 / d2 Ø 23,9
3986452, 20375555, 20393186, 21106930

**VL-DL-8518**

Length: 350 Ø: 36
Cone Ø: d1 Ø 28,9 / d2 Ø 24,7
20443063, 20443067, 20994420

**VL-DL-8536**

Length: 340 Ø: 30
Cone Ø: d1 Ø 22 / d2 Ø 19,9
3944046, 20477807

**VL-DL-8543**

Length: 380 Ø: 36
Cone Ø: d1 Ø 28,6 / d2 Ø 24,7
20443062, 20443066, 20994419

**VL-DL-8566**

Length: 863 Ø: 52
Cone Ø: d1 Ø 28,6 / d2 Ø 23,9
20375556, 20393187, 21106952, 21406952

**VL-DL-8594**

Length: 865 Ø: 52
Cone Ø: d1 Ø 28,6 / d2 Ø 23,9
1075006, 1691660, 85114190

**VL-DL-8681**

Length: 888 Ø: 52
Cone Ø: d1 Ø 28,6 / d2 Ø 23,9
8190147, 20393073

**VL-DL-8707**

Length: 885 Ø: 50
Cone Ø: d1 Ø 28,6 / d2 Ø 23,9
20390745, 21106936

**VL-DL-9472**

Length: 435 Ø: 36
Cone Ø: d1 Ø 32,2 / d2 Ø 28
20443061, 20443065, 20994418

**VL-DL-9488**

Length: 563 Ø: 48
Cone Ø: d1 Ø 28,6 / d2 Ø 23,9
20374831, 21252480

**VL-DL-9954**

Length: 870 Ø: 50
Cone Ø: d1 Ø 28,6 / d2 Ø 23,9
1075005

**VL-DL-10228**

Length: 2139 Ø: 62
Cone Ø: d1 Ø 28,6 / d2 Ø 23,9
20453063

**VL-DL-10258**

Length: 325 Ø: 30
Cone Ø: d1 Ø 22 / d2 Ø 20
1629668, 3986433, 20477805

**VL-DL-12356**

Length: 275 Ø: 30
Cone Ø: d1 Ø 22
3987423, 20477803

**VL-DL-12367**

Length: 2139 Ø: 62
Cone Ø: d1 Ø 28,6 / d2 Ø 23,9
Thread: M52 x 1,5 RHT
20453064, 20584291

**VL-DL-12454**

Length: 2339 Ø: 62
Cone Ø: d1 Ø 28,6 / d2 Ø 23,9
20581632

**VL-DL-12455**

Length: 2141 Ø: 52
Cone Ø: d1 Ø 28,6 / d2 Ø 23,9
1088987

**VL-RK-9497**

Ø: 95 Hole Distance: 130
Thick/Height: 35
273612, 20702095

**VL-SB-9501**

Ø: 91 Thick/Height: 85 / 85
1135080

**VL-SB-10397**

Thick/Height: 89 / 89
1075179

**VL-SB-10398**

Thick/Height: 87,5 / 87,5
1075180

**VL-VB-12460**

Length: 662 Ø: 50
Hole Distance: 115 / 115
2223852, 20589061





FH 16 ...

FH 16/610 ...

01/03→	Tie Rod	VL-DL-8305		Leaf Spring Axle
01/03→	Tie Rod	VL-DL-9492		Air Suspension Axle
01/03→	Tie Rod	VL-DL-9493		Air Suspension Axle
01/03→	Tie Rod	VL-DL-12355		
01/03→	Tie Rod	VL-DL-12358		
01/03→	Tie Rod End		RV-ES-9432	Tag Axle
01/03→	Tie Rod End		VL-ES-10361	Tag Axle
01/03→	Tie Rod End	MN-ES-10333		for Steering Rod
01/03→	Tie Rod End	RV-ES-12442		
01/03→	Tie Rod End	VL-ES-8411		
01/03→	Tie Rod End	VL-ES-8414		for Guide Rod
01/03→	Tie Rod End	VL-ES-8568		
01/03→	Tie Rod End	VL-ES-10360		for Steering Rod
01/03→	Tie Rod End	VL-ES-10361		
01/03→	Track Control Arm		RV-DL-10299	Trailing Arm, 1st & 2nd Drive Axle, for Leaf-Spring Suspension vehicles
01/03→	Track Control Arm		RV-TC-12339	Suspension Rod, Trailing Arm
01/03→	Track Control Arm		RV-TC-12340	Trailing Arm, 1st & 2nd Drive Axle, for Leaf-Spring Suspension vehicles
01/03→	Track Control Arm		RV-TC-12340	Trailing Arm, 1st Drive Axle, for Leaf-Spring Suspension vehicles
01/03→	Track Control Arm		RV-TC-12340	Trailing Arm, Trailing Axle not Steered, for Leaf-Spring Suspension vehicles
01/03→	Track Control Arm		RV-TC-12340	Trailing Arm, Trailing Axle Steered, for Leaf-Spring Suspension vehicles
01/03→	Track Control Arm		RV-VB-8191	Wishbone (CV)
01/03→	Track Control Arm		RV-VB-8191	Wishbone (CV), 1st RA;2nd RA;Leaf Spring Axle
01/03→	Track Control Arm		RV-VB-8191	Wishbone (CV), Air Suspension Axle
01/03→	Track Control Arm		VL-DL-8180	Trailing Arm
01/03→	Track Control Arm		VL-DL-8180	Trailing Arm, 1st & 2nd Drive Axle, for Pneumatic Suspension vehicles
01/03→	Track Control Arm		VL-DL-8180	Trailing Arm, 1st Drive Axle, for Pneumatic Suspension vehicles
01/03→	Track Control Arm		VL-DL-8180	Trailing Arm, Leading Axle Steered/not Steered, for Pneumatic Suspension vehicles
01/03→	Track Control Arm		VL-DL-8180	Trailing Arm, Trailing Axle Steered/not Steered, for Pneumatic Suspension vehicles
01/03→	Track Control Arm		VL-DL-8554	Trailing Arm, 1st RA;2nd RA;Leaf Spring Axle
01/03→	Track Control Arm		VL-DL-9485	Trailing Arm
01/03→	Track Control Arm		VL-VB-7787	Wishbone (CV)
01/03→	Track Control Arm		VL-VB-7787	Wishbone (CV), 1st RA;2nd RA;Unit; Leaf Spring Axle
01/03→	Track Control Arm		VL-VB-8525	Wishbone (CV)
01/03→	Track Control Arm		VL-VB-8525	Wishbone (CV), Tag Axle
01/03→	Track Control Arm		VL-VB-12460	Wishbone (CV)
01/03→	Track Control Arm		VL-VB-12460	Wishbone (CV), 1st & 2nd Drive Axle, for Pneumatic Suspension vehicles
01/03→	Track Control Arm		VL-VB-12460	Wishbone (CV), 1st Drive Axle, for Pneumatic Suspension vehicles
01/03→	Track Control Arm		VL-VB-12460	Wishbone (CV), Leading Axle Steered, for Pneumatic Suspension vehicles
01/03→	Track Control Arm		VL-VB-12460	Wishbone (CV), Leading Axle Steered/not Steered, for Pneumatic Suspension vehicles
01/03→	Track Control Arm		VL-VB-12460	Wishbone (CV), Trailing Axle Steered, for Pneumatic Suspension vehicles
01/03→	Track Control Arm		VL-VB-12460	Wishbone (CV), Trailing Axle Steered/not Steered, for Pneumatic Suspension vehicles
01/03→	Track Control Arm	VL-DL-10309	VL-DL-10309	Trailing Arm, 1st Front Axle, for Pneumatic Suspension vehicles
01/03→	Track Control Arm	VL-DL-10309	VL-DL-10309	Trailing Arm, Air Suspension Axle
09/05→	Suspension Strut Repair Kit		MN-RK-8501	
09/05→	Suspension Strut Repair Kit	VL-RK-8533		
09/05→	Tie Rod	VL-DL-9492		

MN-ES-10333

Length: 90
Cone Ø: d1 Ø 38 / d2 Ø 34,35
Thread: M36 x 1,5 RHT
1271126, 3090291, 3099128, 42538048,
81953016268, 82953016018, 82953016019



MN-RK-8501

Ø: 75 Hole Distance: 115
Thick/Height: 24
20547286



RV-DL-10299

Length: 510 Ø: 21
20522934, 21051052, 7420864583,
7421051052



RV-ES-9432

Length: 120
Cone Ø: d1 Ø 28 / d2 Ø 23,9
Thread: M26 x 1,5 RHT
3193731



RV-ES-12442

Length: 88
Cone Ø: d1 Ø 28,6
Thread: M26 x 1,5 RHT
3987648



RV-TC-12339

Length: 515
Hole Distance: 13 / 130
20532931, 21051046



RV-TC-12340

Length: 510
Hole Distance: 115 / 115
20443044



RV-VB-8191

Length: 662,4 Ø: 48
Hole Distance: 115 / 115
20367004, 20507262, 20741695, 20741703,
22318833



VL-DL-8180

Length: 625 Ø: 17
20374444, 20410530, 20509018, 20517494,
70371270



VL-DL-8305

Length: 1634 Ø: 50
Cone Ø: d1 Ø 28,6 / d2 Ø 23,9
3198276, 21260274



VL-DL-8554

Length: 570 Ø: 48
Hole Distance: 130 / 130
1626957, 1626958, 14320200A



VL-DL-9485

Length: 666 Ø: 48
Hole Distance: 125 / 125
1589817



VL-DL-9492

Length: 1660 Ø: 62
Cone Ø: d1 Ø 32 / d2 Ø 27
20587731, 21106938



VL-DL-9493

Length: 1660 Ø: 62
Cone Ø: d1 Ø 28,6 / d2 Ø 23,9
3198234, 21260275



VL-DL-10309

Length: 799 Ø: 48
Hole Distance: 115 / 115
20410053, 21106157



VL-DL-12355

Length: 368 Ø: 38
Cone Ø: d1 Ø 28,6 / d2 Ø 23,9
1628207



VL-DL-12358

Length: 1669 Ø: 42
Cone Ø: d1 Ø 32 / d2 Ø 27
Thread: M32 x 1,5 RHT / M32 x 1,5 LHT
20581086, 7420581086



VL-ES-8411

Length: 140
Cone Ø: d1 Ø 28,6 / d2 Ø 23,9
Thread: M30 x 1,5 RHT
3093647, 3097999, 21263821



VL-ES-8414

Length: 136
Cone Ø: d1 Ø 32 / d2 Ø 27
Thread: M30 x 1,5 LHT
20710008



VL-ES-8568

Length: 100
Cone Ø: d1 Ø 38 / d2 Ø 34,3
Thread: M26 x 1,5 RHT
8151876



VL-ES-10360

Length: 136
Cone Ø: d1 Ø 32 / d2 Ø 27
Thread: M30 x 1,5 RHT
20581089



VL-ES-10361

Length: 88
Cone Ø: d1 Ø 28,6 / d2 Ø 24
Thread: M26 x 1,5 RHT
20374698



VL-RK-8533

Ø: 85 Hole Distance: 130
Thick/Height: 30
3093630, 3093631, 20840815, 21295230,
7420840815



VL-VB-7787

Length: 671
Ø: 58
Hole Distance: 130 / 130
143167, 1076639, 1626896, 1629734,
20392649, 20829503, 21295227, 21474441,
22318834, 7421295227



VL-VB-8525

Length: 677,3 Ø: 48
Hole Distance: 145 / 145
3173291, 20556490



VL-VB-12460

Length: 662 Ø: 50
Hole Distance: 115 / 115
2223852, 20589061





FH 16 ...

FH 16/610 ...	09/05→	Track Control Arm		RV-TC-12340	Trailing Arm
	08/07→	Centre Rod	DF-DL-5226		Push Rod
	08/07→	Centre Rod	DF-DL-8196		Push Rod
	08/07→	Stabiliser Mounting	DF-SB-5253	DF-SB-5253	
	08/07→	Suspension Arm Repair Kit		DF-RK-9336	
	08/07→	Suspension Arm Repair Kit		SC-RK-8575	for Wishbone (CV)
	08/07→	Suspension Strut Repair Kit		DF-RK-8637	
	08/07→	Suspension Strut Repair Kit		MN-RK-8537	
	08/07→	Tie Rod	DF-DL-7780		
	08/07→	Track Control Arm		DF-DL-8158	Trailing Arm
	08/07→	Track Control Arm		DF-VB-8561	Wishbone (CV)
FH 16/660	09/06→	Centre Rod	VL-DL-8178		Push Rod
	09/06→	Centre Rod	VL-DL-8403		Push Rod
	09/06→	Centre Rod	VL-DL-8406		Push Rod
	09/06→	Centre Rod	VL-DL-8407		Push Rod
	09/06→	Centre Rod	VL-DL-8566		Push Rod
	09/06→	Centre Rod	VL-DL-8594		Suspension Rod
	09/06→	Centre Rod	VL-DL-12483		Push Rod
	09/06→	Centre Rod	VL-DL-12484		Push Rod
	09/06→	Stabiliser Link	VL-DL-8157		Coupling Rod, for Leaf-Spring Suspension vehicles
	09/06→	Stabiliser Link	VL-DL-8157		Coupling Rod, for Pneumatic Suspension vehicles
	09/06→	Stabiliser Link	VL-DL-10258		Coupling Rod, for Leaf-Spring Suspension vehicles
	09/06→	Stabiliser Link	VL-DL-12356		Coupling Rod
	09/06→	Stabiliser Mounting	VL-SB-10394	VL-SB-10394	
	09/06→	Stabiliser Mounting	VL-SB-10397		
	09/06→	Stabiliser Mounting	VL-SB-10398		
	09/06→	Suspension Arm Repair Kit		CV-RK-5322	for Wishbone (CV)
	09/06→	Suspension Arm Repair Kit		MN-RK-7280	for Drag Link
	09/06→	Suspension Arm Repair Kit		MN-RK-9383	for Control Arm
	09/06→	Suspension Arm Repair Kit		VL-RK-9497	for Drag Link
	09/06→	Suspension Arm Repair Kit		VL-RK-9497	for Drag Link, Leaf Spring Axle
	09/06→	Suspension Arm Repair Kit	VL-RK-5323	VL-RK-5323	for Drag Link
	09/06→	Suspension Strut Repair Kit		MN-RK-8501	
	09/06→	Suspension Strut Repair Kit	MN-RK-12436	MN-RK-12436	
	09/06→	Tie Bar Bush		VL-RK-8656	
	09/06→	Tie Bar Bush		VL-SB-9501	
	09/06→	Tie Rod	VL-DL-12355		
	09/06→	Tie Rod	VL-DL-12358		
	09/06→	Tie Rod End	VL-ES-8411		
	09/06→	Tie Rod End	VL-ES-8414		for Guide Rod
	09/06→	Tie Rod End	VL-ES-10360		for Steering Rod
	09/06→	Track Control Arm		RV-DL-10299	Trailing Arm, 1st & 2nd Drive Axle, for Leaf-Spring Suspension vehicles
	09/06→	Track Control Arm		RV-TC-12339	Suspension Rod, Trailing Arm
	09/06→	Track Control Arm		RV-TC-12340	Trailing Arm, 1st & 2nd Drive Axle, for Leaf-Spring Suspension vehicles
	09/06→	Track Control Arm		RV-TC-12340	Trailing Arm, 1st Drive Axle, for Leaf-Spring Suspension vehicles
	09/06→	Track Control Arm		RV-TC-12340	Trailing Arm, Trailing Axle not Steered, for Leaf-Spring Suspension vehicles
	09/06→	Track Control Arm		RV-TC-12340	Trailing Arm, Trailing Axle Steered, for Leaf-Spring Suspension vehicles
	09/06→	Track Control Arm		RV-VB-8191	Wishbone (CV)
	09/06→	Track Control Arm		RV-VB-8191	Wishbone (CV), 1st Drive Axle, for Leaf-Spring Suspension vehicles
	09/06→	Track Control Arm		RV-VB-8191	Wishbone (CV), 1st Drive Axle, for Pneumatic Suspension vehicles
	09/06→	Track Control Arm		RV-VB-8191	Wishbone (CV), Leading Axle not Steered, for Pneumatic Suspension vehicles

CV-RK-5322

Ø: 72 Thick/Height: 50
271188, 3091598

**DF-DL-5226****DF-DL-7780****DF-DL-8158****DF-DL-8196****DF-RK-8637**

Ø: 72
3093469

**DF-RK-9336****DF-SB-5253****DF-VB-8561****MN-RK-7280**

Ø: 75 Hole Distance: 115
Thick/Height: 24
271187, 689748

**MN-RK-8501**

Ø: 75 Hole Distance: 115
Thick/Height: 24
20547286

**MN-RK-8537**

Ø: 95 Hole Distance: 152
Thick/Height: 24
274056, 276192, 696321, 81432706099

**MN-RK-9383**

Ø: 67 Hole Distance: 100
Thick/Height: 24
275988

**MN-RK-12436**

Ø: 75 Hole Distance: 115
Thick/Height: 24
3093462, 85104224

**RV-DL-10299**

Length: 510 Ø: 21
20522934, 21051052, 7420864583,
7421051052

**RV-TC-12339**

Length: 515
Hole Distance: 13 / 130
20532931, 21051046

**RV-TC-12340**

Length: 510
Hole Distance: 115 / 115
20443044

**RV-VB-8191**

Length: 662,4 Ø: 48
Hole Distance: 115 / 115
20367004, 20507262, 20741695, 20741703,
22318833

**SC-RK-8575**

Ø: 95 Hole Distance: 152
Thick/Height: 35
274056

**VL-DL-8157**

Length: 325 Ø: 30
Cone Ø: d1 Ø 22 / d2 Ø 20
1629668, 3986433, 14316200A, 20477805

**VL-DL-8178**

Length: 572 Ø: 38
Cone Ø: d1 Ø 28,6 / d2 Ø 23,9
1088985, 20393083

**VL-DL-8403**

Length: 880 Ø: 52
Cone Ø: d1 Ø 28,6 / d2 Ø 23,9
1628636, 14204300A, 85114200

**VL-DL-8406**

Length: 888 Ø: 52
Cone Ø: d1 Ø 28,6 / d2 Ø 23,9
8190146, 20393071

**VL-DL-8407**

Length: 870 Ø: 52
Cone Ø: d1 Ø 28,6 / d2 Ø 23,9
3986452, 20375555, 20393186, 21106930

**VL-DL-8566**

Length: 863 Ø: 52
Cone Ø: d1 Ø 28,6 / d2 Ø 23,9
20375556, 20393187, 21106952, 21406952

**VL-DL-8594**

Length: 865 Ø: 52
Cone Ø: d1 Ø 28,6 / d2 Ø 23,9
1075006, 1691660, 85114190

**VL-DL-10258**

Length: 325 Ø: 30
Cone Ø: d1 Ø 22 / d2 Ø 20
1629668, 3986433, 20477805

**VL-DL-12355**

Length: 368 Ø: 38
Cone Ø: d1 Ø 28,6 / d2 Ø 23,9
1628207

**VL-DL-12356**

Length: 275 Ø: 30
Cone Ø: d1 Ø 22
3987423, 20477803

**VL-DL-12358**

Length: 1669 Ø: 42
Cone Ø: d1 Ø 32 / d2 Ø 27
Thread: M32 x 1,5 RHT / M32 x 1,5 LHT
20581086, 7420581086

**VL-DL-12483**

Length: 485 Ø: 48
Cone Ø: d1 Ø 28,6 / d2 Ø 23,9
20383081, 21260283, 22159761,
81467106355

**VL-DL-12484**

Length: 1025 Ø: 48
Cone Ø: d1 Ø 28,6 / d2 Ø 23,9
2038308, 21252481

**VL-ES-8411**

Length: 140
Cone Ø: d1 Ø 28,6 / d2 Ø 23,9
Thread: M30 x 1,5 RHT
3093647, 3097999, 21263821

**VL-ES-8414**

Length: 136
Cone Ø: d1 Ø 32 / d2 Ø 27
Thread: M30 x 1,5 LHT
20710008

**VL-ES-10360**

Length: 136
Cone Ø: d1 Ø 32 / d2 Ø 27
Thread: M30 x 1,5 RHT
20581089

**VL-RK-5323**

Ø: 91 Hole Distance: 125
Thick/Height: 20
1598588, 14302100A

**VL-RK-8656**

Ø: 91 Hole Distance: 145
Thick/Height: 26
1628107

**VL-RK-9497**

Ø: 95 Hole Distance: 130
Thick/Height: 35
273612, 20702095

**VL-SB-9501**

Ø: 91 Thick/Height: 85 / 85
1135080

**VL-SB-10394**

Ø: 90 Thick/Height: 95 / 95
9519245

**VL-SB-10397**

Thick/Height: 89 / 89
1075179

**VL-SB-10398**

Thick/Height: 87,5 / 87,5
1075180





FH 16 ...

FH 16/660 ...	09/06→	Track Control Arm		RV-VB-8191	Wishbone (CV), Trailing Axle not Steered, for Leaf-Spring Suspension vehicles
	09/06→	Track Control Arm		RV-VB-8191	Wishbone (CV), Trailing Axle not Steered, for Pneumatic Suspension vehicles
	09/06→	Track Control Arm		RV-VB-8191	Wishbone (CV), Trailing Axle Steered, for Leaf-Spring Suspension vehicles
	09/06→	Track Control Arm		VL-DL-8180	Trailing Arm
	09/06→	Track Control Arm		VL-DL-8180	Trailing Arm, 1st & 2nd Drive Axle, for Pneumatic Suspension vehicles
	09/06→	Track Control Arm		VL-DL-8180	Trailing Arm, 1st Drive Axle, for Pneumatic Suspension vehicles
	09/06→	Track Control Arm		VL-DL-8180	Trailing Arm, Leading Axle Steered/not Steered, for Pneumatic Suspension vehicles
	09/06→	Track Control Arm		VL-DL-8180	Trailing Arm, Trailing Axle Steered/not Steered, for Pneumatic Suspension vehicles
	09/06→	Track Control Arm		VL-DL-8189	Trailing Arm
	09/06→	Track Control Arm		VL-VB-5369	Wishbone (CV)
	09/06→	Track Control Arm		VL-VB-7787	Wishbone (CV)
	09/06→	Track Control Arm		VL-VB-8525	Wishbone (CV)
	09/06→	Track Control Arm		VL-VB-12460	Wishbone (CV)
	09/06→	Track Control Arm		VL-VB-12460	Wishbone (CV), 1st & 2nd Drive Axle, for Pneumatic Suspension vehicles
	09/06→	Track Control Arm		VL-VB-12460	Wishbone (CV), 1st Drive Axle, for Pneumatic Suspension vehicles
	09/06→	Track Control Arm		VL-VB-12460	Wishbone (CV), Leading Axle Steered, for Pneumatic Suspension vehicles
	09/06→	Track Control Arm		VL-VB-12460	Wishbone (CV), Leading Axle Steered/not Steered, for Pneumatic Suspension vehicles
	09/06→	Track Control Arm		VL-VB-12460	Wishbone (CV), Trailing Axle Steered, for Pneumatic Suspension vehicles
	09/06→	Track Control Arm		VL-VB-12460	Wishbone (CV), Trailing Axle Steered/not Steered, for Pneumatic Suspension vehicles
	09/06→	Track Control Arm	VL-DL-10309	VL-DL-10309	Trailing Arm, 1st Front Axle, for Pneumatic Suspension vehicles
FH 16/700	01/09→	Centre Rod	DF-DL-5226		Push Rod
	01/09→	Centre Rod	DF-DL-8196		Push Rod
	01/09→	Centre Rod	VL-DL-8178		Push Rod
	01/09→	Centre Rod	VL-DL-8406		Push Rod
	01/09→	Centre Rod	VL-DL-8407		Push Rod
	01/09→	Centre Rod	VL-DL-8566		Push Rod
	01/09→	Stabiliser Link	VL-DL-8157		Coupling Rod, for Leaf-Spring Suspension vehicles
	01/09→	Stabiliser Link	VL-DL-8157		Coupling Rod, for Pneumatic Suspension vehicles
	01/09→	Stabiliser Link	VL-DL-10258		Coupling Rod, for Leaf-Spring Suspension vehicles
	01/09→	Stabiliser Link	VL-DL-12356		Coupling Rod
	01/09→	Stabiliser Mounting	DF-SB-5253	DF-SB-5253	
	01/09→	Suspension Arm Repair Kit		DF-RK-9336	
	01/09→	Suspension Arm Repair Kit		IV-RK-8998	for Wishbone (CV)
	01/09→	Suspension Arm Repair Kit		SC-RK-8575	for Wishbone (CV)
	01/09→	Suspension Arm Repair Kit		VL-RK-9497	for Drag Link
	01/09→	Suspension Arm Repair Kit		VL-RK-9497	for Drag Link, Leaf Spring Axle
	01/09→	Suspension Strut Repair Kit		DF-RK-8637	
	01/09→	Suspension Strut Repair Kit		MN-RK-8501	
	01/09→	Suspension Strut Repair Kit		MN-RK-8537	
	01/09→	Suspension Strut Repair Kit	MN-RK-12436	MN-RK-12436	
	01/09→	Tie Bar Bush		VL-SB-9501	
	01/09→	Tie Rod	DF-DL-7780		
	01/09→	Tie Rod	VL-DL-12355		
	01/09→	Tie Rod	VL-DL-12358		
01/09→	Tie Rod End		VL-ES-8411		
01/09→	Tie Rod End	CV-ES-12461		for Steering Rod	

CV-ES-12461

Length: 120
 Cone Ø: d1 Ø 26 / d2 Ø 23,5
 Thread: M30 x 1,5 LHT
 1517647, 3096212

**DF-DL-5226****DF-DL-7780****DF-DL-8196****DF-RK-8637**

Ø: 72
 3093469

**DF-RK-9336****DF-SB-5253****IV-RK-8998**

Ø: 85 Hole Distance: 130
 Thick/Height: 30
 273373, 274019, 4941233, 6889509

**MN-RK-8501**

Ø: 75 Hole Distance: 115
 Thick/Height: 24
 20547286

**MN-RK-8537**

Ø: 95 Hole Distance: 152
 Thick/Height: 24
 274056, 276192, 696321, 81432706099

**MN-RK-12436**

Ø: 75 Hole Distance: 115
 Thick/Height: 24
 3093462, 85104224

**RV-VB-8191**

Length: 662,4 Ø: 48
 Hole Distance: 115 / 115
 20367004, 20507262, 20741695, 20741703,
 22318833

**SC-RK-8575**

Ø: 95 Hole Distance: 152
 Thick/Height: 35
 274056

**VL-DL-8157**

Length: 325 Ø: 30
 Cone Ø: d1 Ø 22 / d2 Ø 20
 1629668, 3986433, 14316200A, 20477805

**VL-DL-8178**

Length: 572 Ø: 38
 Cone Ø: d1 Ø 28,6 / d2 Ø 23,9
 1088985, 20393083

**VL-DL-8180**

Length: 625 Ø: 17
 20374444, 20410530, 20509018, 20517494,
 70371270

**VL-DL-8189**

Length: 666 Ø: 48
 Hole Distance: 125
 1082104, 1605035

**VL-DL-8406**

Length: 888 Ø: 52
 Cone Ø: d1 Ø 28,6 / d2 Ø 23,9
 8190146, 20393071

**VL-DL-8407**

Length: 870 Ø: 52
 Cone Ø: d1 Ø 28,6 / d2 Ø 23,9
 3986452, 20375555, 20393186, 21106930

**VL-DL-8566**

Length: 863 Ø: 52
 Cone Ø: d1 Ø 28,6 / d2 Ø 23,9
 20375556, 20393187, 21106952, 21406952

**VL-DL-10258**

Length: 325 Ø: 30
 Cone Ø: d1 Ø 22 / d2 Ø 20
 1629668, 3986433, 20477805

**VL-DL-10309**

Length: 799 Ø: 48
 Hole Distance: 115 / 115
 20410053, 21106157

**VL-DL-12355**

Length: 368 Ø: 38
 Cone Ø: d1 Ø 28,6 / d2 Ø 23,9
 1628207

**VL-DL-12356**

Length: 275 Ø: 30
 Cone Ø: d1 Ø 22
 3987423, 20477803

**VL-DL-12358**

Length: 1669 Ø: 42
 Cone Ø: d1 Ø 32 / d2 Ø 27
 Thread: M32 x 1,5 RHT / M32 x 1,5 LHT
 20581086, 7420581086

**VL-ES-8411**

Length: 140
 Cone Ø: d1 Ø 28,6 / d2 Ø 23,9
 Thread: M30 x 1,5 RHT
 3093647, 3097999, 21263821

**VL-RK-9497**

Ø: 95 Hole Distance: 130
 Thick/Height: 35
 273612, 20702095

**VL-SB-9501**

Ø: 91 Thick/Height: 85 / 85
 1135080

**VL-VB-5369**

Length: 677 Ø: 48
 Hole Distance: 115 / 115
 3172829, 8073569, 14319600A

**VL-VB-7787**

Length: 671 Ø: 58
 Hole Distance: 130 / 130
 143167, 1076639, 1626896, 1629734,
 20392649, 20829503, 21295227, 21474441,
 22318834, 7421295227

**VL-VB-8525**

Length: 677,3 Ø: 48
 Hole Distance: 145 / 145
 3173291, 20556490

**VL-VB-12460**

Length: 662 Ø: 50
 Hole Distance: 115 / 115
 2223852, 20589061



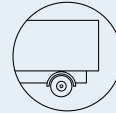

FH 16 ...

FH 16/700 ...	01/09→	Tie Rod End	CV-ES-12462		for Steering Rod
	01/09→	Tie Rod End	CV-ES-14163		for Steering Rod
	01/09→	Tie Rod End	VL-ES-8414		for Guide Rod
	01/09→	Tie Rod End	VL-ES-10360		for Steering Rod
	01/09→	Track Control Arm		DF-DL-8158	Trailing Arm
	01/09→	Track Control Arm		DF-VB-8561	Wishbone (CV)
	01/09→	Track Control Arm		RV-DL-10299	Trailing Arm, 1st & 2nd Drive Axle, for Leaf-Spring Suspension vehicles
	01/09→	Track Control Arm		RV-TC-12339	Suspension Rod, Trailing Arm
	01/09→	Track Control Arm		RV-TC-12340	Trailing Arm, 1st & 2nd Drive Axle, for Leaf-Spring Suspension vehicles
	01/09→	Track Control Arm		RV-TC-12340	Trailing Arm, 1st Drive Axle, for Leaf-Spring Suspension vehicles
	01/09→	Track Control Arm		RV-TC-12340	Trailing Arm, Trailing Axle not Steered, for Leaf-Spring Suspension vehicles
	01/09→	Track Control Arm		RV-TC-12340	Trailing Arm, Trailing Axle Steered, for Leaf-Spring Suspension vehicles
	01/09→	Track Control Arm		RV-VB-8191	Wishbone (CV)
	01/09→	Track Control Arm		RV-VB-8191	Wishbone (CV), 1st & 2nd Drive Axle, for Leaf-Spring Suspension vehicles
	01/09→	Track Control Arm		RV-VB-8191	Wishbone (CV), 1st Drive Axle, for Leaf-Spring Suspension vehicles
	01/09→	Track Control Arm		RV-VB-8191	Wishbone (CV), 1st Drive Axle, for Pneumatic Suspension vehicles
	01/09→	Track Control Arm		RV-VB-8191	Wishbone (CV), Leading Axle not Steered, for Pneumatic Suspension vehicles
	01/09→	Track Control Arm		RV-VB-8191	Wishbone (CV), Trailing Axle not Steered, for Leaf-Spring Suspension vehicles
	01/09→	Track Control Arm		RV-VB-8191	Wishbone (CV), Trailing Axle not Steered, for Pneumatic Suspension vehicles
	01/09→	Track Control Arm		RV-VB-8191	Wishbone (CV), Trailing Axle Steered, for Leaf-Spring Suspension vehicles
	01/09→	Track Control Arm		VL-DL-8180	Trailing Arm
	01/09→	Track Control Arm		VL-DL-8180	Trailing Arm, 1st & 2nd Drive Axle, for Pneumatic Suspension vehicles
	01/09→	Track Control Arm		VL-VB-7787	Wishbone (CV)
	01/09→	Track Control Arm		VL-VB-7787	Wishbone (CV), 1st & 2nd Drive Axle, for Leaf-Spring Suspension vehicles
	01/09→	Track Control Arm		VL-VB-8525	Wishbone (CV)
	01/09→	Track Control Arm		VL-VB-12460	Wishbone (CV)
	01/09→	Track Control Arm		VL-VB-12460	Wishbone (CV), 1st & 2nd Drive Axle, for Pneumatic Suspension vehicles
	01/09→	Track Control Arm		VL-VB-12460	Wishbone (CV), 1st Drive Axle, for Pneumatic Suspension vehicles
	01/09→	Track Control Arm		VL-VB-12460	Wishbone (CV), Leading Axle Steered, for Pneumatic Suspension vehicles
	01/09→	Track Control Arm		VL-VB-12460	Wishbone (CV), Trailing Axle Steered, for Pneumatic Suspension vehicles
	01/09→	Track Control Arm	VL-DL-10309	VL-DL-10309	Trailing Arm, 1st Front Axle, for Pneumatic Suspension vehicles

FH 16 II

FH 16/540, FH 16/550	05/12→	Centre Rod	VL-DL-12484		Push Rod
	05/12→	Track Control Arm		RV-TC-12339	Suspension Rod, Trailing Arm
	05/12→	Track Control Arm		VL-VB-12460	Wishbone (CV)
FH 16/600	05/12→	Centre Rod	VL-DL-12484		Push Rod
	05/12→	Track Control Arm		RV-TC-12339	Suspension Rod, Trailing Arm
	05/12→	Track Control Arm		VL-VB-12460	Wishbone (CV)
FH 16/650	03/14→	Centre Rod	VL-DL-12484		Push Rod
	03/14→	Track Control Arm		VL-VB-12460	Wishbone (CV)
FH 16/700	05/12→	Centre Rod	VL-DL-12484		Push Rod
	05/12→	Track Control Arm		RV-TC-12339	Suspension Rod, Trailing Arm
	05/12→	Track Control Arm		VL-VB-12460	Wishbone (CV)

CV-ES-12462

Length: 120
Cone Ø: d1 Ø 26 / d2 Ø 23,5
Thread: M30 x 1,5 RHT
1517577, 1695690, 1697297, 15175771



CV-ES-14163

Length: 125
Cone Ø: d1 Ø 30 / d2 Ø 27
Thread: M30 x 1,5 RHT
20742127, 20745043, 20821160, 20862494



DF-DL-8158



DF-VB-8561



RV-DL-10299

Length: 510 Ø: 21
20522934, 21051052, 7420864583,
7421051052



RV-TC-12339

Length: 515
Hole Distance: 13 / 130
20532931, 21051046



RV-TC-12340

Length: 510
Hole Distance: 115 / 115
20443044



RV-VB-8191

Length: 662,4 Ø: 48
Hole Distance: 115 / 115
20367004, 20507262, 20741695, 20741703,
22318833



VL-DL-8180

Length: 625 Ø: 17
20374444, 20410530, 20509018, 20517494,
70371270



VL-DL-10309

Length: 799 Ø: 48
Hole Distance: 115 / 115
20410053, 21106157



VL-DL-12484

Length: 1025 Ø: 48
Cone Ø: d1 Ø 28,6 / d2 Ø 23,9
2038308, 21252481



VL-ES-8414

Length: 136
Cone Ø: d1 Ø 32 / d2 Ø 27
Thread: M30 x 1,5 LHT
20710008



VL-ES-10360

Length: 136
Cone Ø: d1 Ø 32 / d2 Ø 27
Thread: M30 x 1,5 RHT
20581089



VL-VB-7787

Length: 671 Ø: 58
Hole Distance: 130 / 130
143167, 1076639, 1626896, 1629734,
20392649, 20829503, 21295227, 21474441,
22318834, 7421295227



VL-VB-8525

Length: 677,3 Ø: 48
Hole Distance: 145 / 145
3173291, 20556490



VL-VB-12460

Length: 662 Ø: 50
Hole Distance: 115 / 115
2223852, 20589061



**FH 16 II ...**

FH 16/750	05/12→	Centre Rod	VL-DL-12484	Push Rod
	05/12→	Track Control Arm		RV-TC-12339 Suspension Rod, Trailing Arm
	05/12→	Track Control Arm		VL-VB-12460 Wishbone (CV)

FH II

420	01/12→	Centre Rod	VL-DL-12484	Push Rod
	01/12→	Track Control Arm		RV-TC-12339 Suspension Rod, Trailing Arm
	01/12→	Track Control Arm		VL-VB-12460 Wishbone (CV)
460	01/12→	Centre Rod	VL-DL-12484	Push Rod
	01/12→	Track Control Arm		RV-TC-12339 Suspension Rod, Trailing Arm
	01/12→	Track Control Arm		VL-VB-12460 Wishbone (CV)
500	01/12→	Centre Rod	VL-DL-12484	Push Rod
	01/12→	Track Control Arm		RV-TC-12339 Suspension Rod, Trailing Arm
	01/12→	Track Control Arm		VL-VB-12460 Wishbone (CV)
540	01/12→	Centre Rod	VL-DL-12484	Push Rod
	01/12→	Track Control Arm		RV-TC-12339 Suspension Rod, Trailing Arm
	01/12→	Track Control Arm		VL-VB-12460 Wishbone (CV)

FL

FL 180-10	03/00→	Centre Rod	RV-DL-12448	for Steering Rod
	03/00→	Centre Rod	VL-DL-5218	Push Rod
	03/00→	Tie Rod	RV-DL-12465	
	03/00→	Tie Rod End	CV-ES-14163	for Steering Rod
FL 180-11	03/00→	Centre Rod	RV-DL-12448	for Steering Rod
	03/00→	Centre Rod	VL-DL-5218	Push Rod
	03/00→	Tie Rod	RV-DL-12465	
	03/00→	Tie Rod End	CV-ES-14163	for Steering Rod
FL 180-12	03/00→	Centre Rod	RV-DL-12448	for Steering Rod
	03/00→	Centre Rod	VL-DL-5218	Push Rod
	03/00→	Tie Rod	RV-DL-12465	
	03/00→	Tie Rod End	CV-ES-14163	for Steering Rod
FL 180-13	03/00→	Centre Rod	RV-DL-12448	for Steering Rod
	03/00→	Centre Rod	RV-DL-12480	Push Rod
	03/00→	Tie Rod	RV-DL-12465	
	03/00→	Tie Rod End	CV-ES-14163	for Steering Rod
FL 180-14	03/00→	Centre Rod	RV-DL-8190	Push Rod
	03/00→	Centre Rod	RV-DL-12448	for Steering Rod
	03/00→	Centre Rod	RV-DL-12480	Push Rod
	03/00→	Tie Rod	RV-DL-12465	
FL 180-15	03/00→	Tie Rod End	CV-ES-14163	for Steering Rod
	03/00→	Centre Rod	RV-DL-8190	Push Rod
	03/00→	Centre Rod	RV-DL-12448	for Steering Rod
	03/00→	Centre Rod	RV-DL-12480	Push Rod
FL 180-16	03/00→	Tie Rod	RV-DL-12465	
	03/00→	Tie Rod End	CV-ES-14163	for Steering Rod
	03/00→	Centre Rod	RV-DL-8190	Push Rod
	03/00→	Centre Rod	RV-DL-12448	for Steering Rod
FL 180-17	03/00→	Centre Rod	RV-DL-12480	Push Rod
	03/00→	Centre Rod	RV-DL-12448	for Steering Rod
	03/00→	Tie Rod	RV-DL-12465	
	03/00→	Tie Rod End	CV-ES-14163	for Steering Rod
FL 180-18	03/00→	Tie Rod End	CV-ES-14163	for Steering Rod
	03/00→	Centre Rod	RV-DL-12448	for Steering Rod
	03/00→	Tie Rod	RV-DL-12465	
	03/00→	Tie Rod End	CV-ES-14163	for Steering Rod
FL 180-7,5	03/00→	Centre Rod	RV-DL-12448	for Steering Rod
	03/00→	Tie Rod	RV-DL-12465	
	03/00→	Tie Rod End	CV-ES-14163	for Steering Rod
	03/00→	Centre Rod	RV-DL-12448	for Steering Rod
FL 180-8	03/00→	Centre Rod	RV-DL-12448	for Steering Rod
	03/00→	Centre Rod	VL-DL-5218	Push Rod
	03/00→	Tie Rod	RV-DL-12465	
	03/00→	Tie Rod End	CV-ES-14163	for Steering Rod

CV-ES-14163

Length: 125
Cone Ø: d1 Ø 30 / d2 Ø 27
Thread: M30 x 1,5 RHT
20742127, 20745043, 20821160, 20862494



VL-DL-5218

Length: 980 Ø: 30
Cone Ø: d1 Ø 22 / d2 Ø 20
3124480, 6777855, 20400909



RV-DL-8190

Length: 946 Ø: 42
Cone Ø: d1 Ø 26 / d2 Ø 23,5
20709844



VL-DL-12484

Length: 1025 Ø: 48
Cone Ø: d1 Ø 28,6 / d2 Ø 23,9
2038308, 21252481



RV-DL-12448

Length: 900 Ø: 50
Cone Ø: d1 Ø 30 / d2 Ø 27
20818854



VL-VB-12460

Length: 662 Ø: 50
Hole Distance: 115 / 115
2223852, 20589061



RV-DL-12465

Length: 1580 Ø: 40
Cone Ø: d1 Ø 30 / d2 Ø 27
Thread: M30 x 1,5 LHT / M30 x 1,5 RHT
20582399, 22482972



RV-DL-12480

Length: 922 Ø: 42
Cone Ø: d1 Ø 26 / d2 Ø 23,5
20 818 840



RV-TC-12339

Length: 515
Hole Distance: 13 / 130
20532931, 21051046



CV-ES-14163

Length: 125

Cone Ø: d1 Ø 30 / d2 Ø 27

Thread: M30 x 1,5 RHT

20742127, 20745043, 20821160, 20862494



RV-DL-8190

Length: 946 Ø: 42

Cone Ø: d1 Ø 26 / d2 Ø 23,5

20709844



RV-DL-12448

Length: 900 Ø: 50

Cone Ø: d1 Ø 30 / d2 Ø 27

20818854



RV-DL-12465

Length: 1580 Ø: 40

Cone Ø: d1 Ø 30 / d2 Ø 27

Thread: M30 x 1,5 LHT / M30 x 1,5 RHT

20582399, 22482972



RV-DL-12480

Length: 922 Ø: 42

Cone Ø: d1 Ø 26 / d2 Ø 23,5

20 818 840



VL-DL-5218

Length: 980 Ø: 30

Cone Ø: d1 Ø 22 / d2 Ø 20

3124480, 6777855, 20400909





FL ...

FL 250-12	03/00→	Centre Rod	RV-DL-12448	for Steering Rod
	03/00→	Centre Rod	RV-DL-12480	Push Rod
	03/00→	Centre Rod	VL-DL-5218	Push Rod
	03/00→	Tie Rod	RV-DL-12465	
	03/00→	Tie Rod End	CV-ES-14163	for Steering Rod
FL 250-13	03/00→	Centre Rod	RV-DL-12448	for Steering Rod
	03/00→	Centre Rod	RV-DL-12480	Push Rod
	03/00→	Tie Rod	RV-DL-12465	
	03/00→	Tie Rod End	CV-ES-14163	for Steering Rod
FL 250-14	03/00→	Centre Rod	RV-DL-8190	Push Rod
	03/00→	Centre Rod	RV-DL-12448	for Steering Rod
	03/00→	Centre Rod	RV-DL-12480	Push Rod
	03/00→	Tie Rod	RV-DL-12465	
	03/00→	Tie Rod End	CV-ES-14163	for Steering Rod
FL 250-15	03/00→	Centre Rod	RV-DL-8190	Push Rod
	03/00→	Centre Rod	RV-DL-12448	for Steering Rod
	03/00→	Centre Rod	RV-DL-12480	Push Rod
	03/00→	Tie Rod	RV-DL-12465	
	03/00→	Tie Rod End	CV-ES-14163	for Steering Rod
FL 250-16	03/00→	Centre Rod	RV-DL-8190	Push Rod
	03/00→	Centre Rod	RV-DL-12448	for Steering Rod
	03/00→	Centre Rod	RV-DL-12480	Push Rod
	03/00→	Tie Rod	RV-DL-12465	
	03/00→	Tie Rod End	CV-ES-14163	for Steering Rod
FL 250-17	03/00→	Centre Rod	RV-DL-12448	for Steering Rod
	03/00→	Tie Rod	RV-DL-12465	
	03/00→	Tie Rod End	CV-ES-14163	for Steering Rod
FL 250-18	03/00→	Centre Rod	RV-DL-12448	for Steering Rod
	03/00→	Tie Rod	RV-DL-12465	
	03/00→	Tie Rod End	CV-ES-14163	for Steering Rod
FL 250-7,5	03/00→	Centre Rod	RV-DL-12448	for Steering Rod
	03/00→	Tie Rod	RV-DL-12465	
	03/00→	Tie Rod End	CV-ES-14163	for Steering Rod
FL 250-8	03/00→	Centre Rod	RV-DL-12448	for Steering Rod
	03/00→	Centre Rod	VL-DL-5218	Push Rod
	03/00→	Tie Rod	RV-DL-12465	
	03/00→	Tie Rod End	CV-ES-14163	for Steering Rod
FL 250-9	03/00→	Centre Rod	RV-DL-12448	for Steering Rod
	03/00→	Centre Rod	VL-DL-5218	Push Rod
	03/00→	Tie Rod	RV-DL-12465	
	03/00→	Tie Rod End	CV-ES-14163	for Steering Rod

FL 4

FL 408	02/86→10/89	Ball Head, gearshift linkage	CV-ES-2121	
	02/86→10/89	Centre Rod	VL-DL-0911	Push Rod
	02/86→10/89	Centre Rod	VL-DL-2139	Push Rod

FL 6

FL 608	10/85→01/96	Centre Rod	VL-DL-5218	Push Rod	
	10/85→01/96	Tie Rod	VL-DL-8729		
	10/85→12/99	Ball Head, gearshift linkage	CV-ES-2120		
	10/85→12/99	Centre Rod	VL-DL-8155	Push Rod	
	10/85→12/99	Centre Rod	VL-DL-8706	Push Rod	
	10/85→12/99	Centre Rod	VL-DL-12456	for Steering Rod	
	10/85→12/99	Stabiliser Link		VL-DL-8518	Coupling Rod, Control Arm
	10/85→12/99	Stabiliser Link		VL-DL-8543	Coupling Rod, Control Arm
	10/85→12/99	Stabiliser Mounting	VL-SB-10392		Air Suspension Axle
	10/85→12/99	Suspension Arm Repair Kit		MN-RK-8723	for Control Arm
	10/85→12/99	Suspension Arm Repair Kit	VL-RK-5323		for Drag Link
	10/85→12/99	Suspension Strut Repair Kit		MN-RK-12436	
	10/85→12/99	Tie Bar Bush	VL-SB-9501		
	10/85→12/99	Tie Rod	DB-DL-8174		Guide Rod
	10/85→12/99	Tie Rod	VL-DL-8141		
10/85→12/99	Tie Rod End	CV-ES-12461		for Steering Rod	

CV-ES-2120

Length: 115
 Cone Ø: d1 Ø 12,4 / d2 Ø 10,8
 Thread: M14 x 1,5 RHT
 3124625

**CV-ES-2121**

Length: 85
 Cone Ø: d1 Ø 12 / d2 Ø 10,8
 Thread: M14 x 1,5 RHT
 1527453, 1672152, 6027074, 6853913

**CV-ES-12461**

Length: 120
 Cone Ø: d1 Ø 26 / d2 Ø 23,5
 Thread: M30 x 1,5 LHT
 1517647, 3096212

**CV-ES-14163**

Length: 125
 Cone Ø: d1 Ø 30 / d2 Ø 27
 Thread: M30 x 1,5 RHT
 20742127, 20745043, 20821160, 20862494

**DB-DL-8174**

Length: 1605 Ø: 40
 Cone Ø: d1 Ø 30 / d2 Ø 27
 3099230, 20830369

**MN-RK-8723**

Length: 100 Ø: 46
 Hole Distance: 60
 3090015

**MN-RK-12436**

Ø: 75 Hole Distance: 115
 Thick/Height: 24
 3093462, 85104224

**RV-DL-8190**

Length: 946 Ø: 42
 Cone Ø: d1 Ø 26 / d2 Ø 23,5
 20709844

**RV-DL-12448**

Length: 900 Ø: 50
 Cone Ø: d1 Ø 30 / d2 Ø 27
 20818854

**RV-DL-12465**

Length: 1580 Ø: 40
 Cone Ø: d1 Ø 30 / d2 Ø 27
 Thread: M30 x 1,5 LHT / M30 x 1,5 RHT
 20582399, 22482972

**RV-DL-12480**

Length: 922 Ø: 42
 Cone Ø: d1 Ø 26 / d2 Ø 23,5
 20 818 840

**VL-DL-0911**

Length: 880 Ø: 52
 Cone Ø: d1 Ø 28,6 / d2 Ø 23,9
 1075663, 3988704, 20393069

**VL-DL-2139**

Length: 880 Ø: 52
 Cone Ø: d1 Ø 28,6 / d2 Ø 23,9
 1075153, 3988695, 20393061

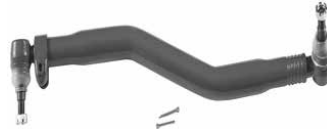
**VL-DL-5218**

Length: 980 Ø: 30
 Cone Ø: d1 Ø 22 / d2 Ø 20
 3124480, 6777855, 20400909

**VL-DL-8141**

Length: 1582 Ø: 38
 Cone Ø: d1 Ø 26 / d2 Ø 23,5
 6771112

**VL-DL-8155**

Length: 821 Ø: 42
 Cone Ø: d1 Ø 26 / d2 Ø 23,5
 1071169, 20400939

**VL-DL-8518**

Length: 350 Ø: 36
 Cone Ø: d1 Ø 28,9 / d2 Ø 24,7
 20443063, 20443067, 20994420

**VL-DL-8543**

Length: 380 Ø: 36
 Cone Ø: d1 Ø 28,6 / d2 Ø 24,7
 20443062, 20443066, 20994419

**VL-DL-8706**

Length: 890 Ø: 50
 Cone Ø: d1 Ø 26 / d2 Ø 23,5
 20376808, 85115621

**VL-DL-8729**

Length: 1556 Ø: 32
 Cone Ø: d1 Ø 22 / d2 Ø 20
 6771120

**VL-DL-12456**

Length: 871 Ø: 52
 Cone Ø: d1 Ø 26 / d2 Ø 23,5
 3950703, 20900943

**VL-RK-5323**

Ø: 91 Hole Distance: 125
 Thick/Height: 20
 1598588, 14302100A

**VL-SB-9501**

Ø: 91 Thick/Height: 85 / 95
 1135080

**VL-SB-10392**

Ø: 90 Thick/Height: 95 / 95
 3028448, 9516523, 9959304





FL 6 ...

FL 608 ...	10/85→12/99	Tie Rod End	VL-ES-8411			
	10/85→12/99	Tie Rod End	VL-ES-8615		for Steering Rod	
	10/85→12/99	Track Control Arm		RV-VB-8191	Wishbone (CV)	
	10/85→12/99	Track Control Arm		VL-VB-7787	Wishbone (CV)	
	01/93→12/99	Track Control Arm		VL-DL-9479	Trailing Arm, for Pneumatic Suspension vehicles	
	01/93→12/99	Track Control Arm		VL-DL-10310	Trailing Arm, for Pneumatic Suspension vehicles	
	01/96→12/99	Tie Rod	VL-DL-8729			1st FA, * 166080 *→
FL 610	09/85→11/94	Ball Head, gearshift linkage	CV-ES-2120			
	09/85→11/94	Centre Rod	VL-DL-5218		Push Rod	
	09/85→11/94	Centre Rod	VL-DL-8706		Push Rod	
	09/85→11/94	Centre Rod	VL-DL-12456		for Steering Rod	
	09/85→11/94	Stabiliser Mounting	VL-SB-10392		Air Suspension Axle	
	09/85→11/94	Suspension Arm Repair Kit		MN-RK-8723	for Control Arm	
	09/85→11/94	Tie Bar Bush	VL-SB-9501			
	09/85→11/94	Tie Rod	VL-DL-8141			
	09/85→11/94	Tie Rod	VL-DL-8729			
	09/85→11/94	Tie Rod End	CV-ES-12461		for Steering Rod	
	09/85→11/94	Tie Rod End	VL-ES-8615		for Steering Rod	
	09/85→11/94	Track Control Arm		RV-VB-8191	Wishbone (CV)	
	09/85→11/94	Track Control Arm		VL-DL-9479	Trailing Arm, for Pneumatic Suspension vehicles	
	09/85→11/94	Track Control Arm		VL-DL-10310	Trailing Arm, for Pneumatic Suspension vehicles	
	FL 611	09/85→11/94	Centre Rod	VL-DL-8706		Push Rod
		09/85→01/96	Centre Rod	VL-DL-5218		Push Rod
		09/85→01/96	Tie Rod	VL-DL-8729		
09/85→03/00		Ball Head, gearshift linkage	CV-ES-2120			
09/85→03/00		Centre Rod	VL-DL-8155		Push Rod	
09/85→03/00		Centre Rod	VL-DL-12456		for Steering Rod	
09/85→03/00		Stabiliser Link		VL-DL-8518	Coupling Rod, Control Arm	
09/85→03/00		Stabiliser Link		VL-DL-8543	Coupling Rod, Control Arm	
09/85→03/00		Stabiliser Mounting	VL-SB-10392		Air Suspension Axle	
09/85→03/00		Suspension Arm Repair Kit		MN-RK-8723	for Control Arm	
09/85→03/00		Suspension Arm Repair Kit	VL-RK-5323	VL-RK-5323	for Drag Link	
09/85→03/00		Suspension Strut Repair Kit		MN-RK-12436		
09/85→03/00		Tie Bar Bush	VL-SB-9501			
09/85→03/00		Tie Rod	DB-DL-8174		Guide Rod	
09/85→03/00		Tie Rod	VL-DL-8141			
09/85→03/00		Tie Rod End	CV-ES-12461		for Steering Rod	
09/85→03/00		Tie Rod End	VL-ES-8411			
09/85→03/00		Tie Rod End	VL-ES-8615		for Steering Rod	
09/85→03/00		Track Control Arm		RV-VB-8191	Wishbone (CV)	
09/85→03/00		Track Control Arm		VL-DL-9479	Trailing Arm, for Pneumatic Suspension vehicles	
09/85→03/00		Track Control Arm		VL-DL-10310	Trailing Arm, for Pneumatic Suspension vehicles	
09/85→03/00		Track Control Arm		VL-VB-7787	Wishbone (CV)	
01/96→03/00		Tie Rod	VL-DL-8729			1st FA, * 166080 *→
FL 612		09/85→01/96	Centre Rod	VL-DL-5218		Push Rod
		09/85→12/99	Ball Head, gearshift linkage	CV-ES-2120		
		09/85→12/99	Centre Rod	VL-DL-5411		Push Rod
		09/85→12/99	Centre Rod	VL-DL-8155		Push Rod
		09/85→12/99	Centre Rod	VL-DL-8706		Push Rod
	09/85→12/99	Stabiliser Link		VL-DL-8518	Coupling Rod, Control Arm	
	09/85→12/99	Stabiliser Link		VL-DL-8543	Coupling Rod, Control Arm	
	09/85→12/99	Stabiliser Mounting	VL-SB-10392		Air Suspension Axle	
	09/85→12/99	Suspension Arm Repair Kit		MN-RK-8723	for Control Arm	
	09/85→12/99	Suspension Arm Repair Kit	VL-RK-5323	VL-RK-5323	for Drag Link	
	09/85→12/99	Suspension Arm Repair Kit	VL-RK-5323	VL-RK-5323	for Drag Link, Air Suspension Axle	
	09/85→12/99	Suspension Strut Repair Kit		MN-RK-12436		
	09/85→12/99	Tie Bar Bush	VL-SB-9501	VL-SB-9501		
	09/85→12/99	Tie Rod	DB-DL-8174		Guide Rod	
	09/85→12/99	Tie Rod	VL-DL-8141			
	09/85→12/99	Tie Rod	VL-DL-8729			
	09/85→12/99	Tie Rod End	CV-ES-12461		for Steering Rod	
	09/85→12/99	Tie Rod End	VL-ES-8411			
	09/85→12/99	Tie Rod End	VL-ES-8615		for Steering Rod	

CV-ES-2120

Length: 115
 Cone Ø: d1 Ø 12,4 / d2 Ø 10,8
 Thread: M14 x 1,5 RHT
 3124625

**CV-ES-12461**

Length: 120
 Cone Ø: d1 Ø 26 / d2 Ø 23,5
 Thread: M30 x 1,5 LHT
 1517647, 3096212

**DB-DL-8174**

Length: 1605 Ø: 40
 Cone Ø: d1 Ø 30 / d2 Ø 27
 3099230, 20830369

**MN-RK-8723**

Length: 100 Ø: 46
 Hole Distance: 60
 3090015

**MN-RK-12436**

Ø: 75 Hole Distance: 115
 Thick/Height: 24
 3093462, 85104224

**RV-VB-8191**

Length: 662,4 Ø: 48
 Hole Distance: 115 / 115
 20367004, 20507262, 20741695, 20741703,
 22318833

**VL-DL-5218**

Length: 980 Ø: 30
 Cone Ø: d1 Ø 22 / d2 Ø 20
 3124480, 6777855, 20400909

**VL-DL-5411**

Length: 870 Ø: 42
 Cone Ø: d1 Ø 26 / d2 Ø 23,5
 6790572, 14204000A, 20400941, 67905729

**VL-DL-8141**

Length: 1582 Ø: 38
 Cone Ø: d1 Ø 26 / d2 Ø 23,5
 6771112

**VL-DL-8155**

Length: 821 Ø: 42
 Cone Ø: d1 Ø 26 / d2 Ø 23,5
 1071169, 20400939

**VL-DL-8518**

Length: 350 Ø: 36
 Cone Ø: d1 Ø 28,9 / d2 Ø 24,7
 20443063, 20443067, 20994420

**VL-DL-8543**

Length: 380 Ø: 36
 Cone Ø: d1 Ø 28,6 / d2 Ø 24,7
 20443062, 20443066, 20994419

**VL-DL-8706**

Length: 890 Ø: 50
 Cone Ø: d1 Ø 26 / d2 Ø 23,5
 20376808, 85115621

**VL-DL-8729**

Length: 1556 Ø: 32
 Cone Ø: d1 Ø 22 / d2 Ø 20
 6771120

**VL-DL-9479**

Length: 510 Ø: 36
 6777705

**VL-DL-10310**

Length: 570 Ø: 36
 1071674

**VL-DL-12456**

Length: 871 Ø: 52
 Cone Ø: d1 Ø 26 / d2 Ø 23,5
 3950703, 20900943

**VL-ES-8411**

Length: 140
 Cone Ø: d1 Ø 28,6 / d2 Ø 23,9
 Thread: M30 x 1,5 RHT
 3093647, 3097999, 21263821

**VL-ES-8615**

Length: 125
 Cone Ø: d1 Ø 30 / d2 Ø 26,5
 Thread: M30 x 1,5 RHT
 1697246, 1698047, 3098332

**VL-RK-5323**

Ø: 91 Hole Distance: 125
 Thick/Height: 20
 1598588, 14302100A

**VL-SB-9501**

Ø: 91 Thick/Height: 85 / 85
 1135080

**VL-SB-10392**

Ø: 90 Thick/Height: 95 / 95
 3028448, 9516523, 9959304

**VL-VB-7787**

Length: 671
 Ø: 58
 Hole Distance: 130 / 130
 143167, 1076639, 1626896, 1629734,
 20392649, 20829503, 21295227, 21474441,
 22318834, 7421295227





FL 6 ...

FL 612 ...	09/85→12/99	Track Control Arm		RV-VB-8191	Wishbone (CV)
	09/85→12/99	Track Control Arm		VL-DL-9479	Trailing Arm, for Pneumatic Suspension vehicles
	09/85→12/99	Track Control Arm		VL-DL-10310	Trailing Arm, for Pneumatic Suspension vehicles
	09/85→12/99	Track Control Arm		VL-VB-7787	Wishbone (CV)
	01/96→12/99	Tie Rod	VL-DL-8729		1st FA, * 166080 *→
FL 614	09/85→03/00	Ball Head, gearshift linkage	CV-ES-2120		
	09/85→03/00	Centre Rod	VL-DL-5411		Push Rod
	09/85→03/00	Centre Rod	VL-DL-8155		Push Rod
	09/85→03/00	Centre Rod	VL-DL-8706		Push Rod
	09/85→03/00	Stabiliser Link		VL-DL-8518	Coupling Rod, Control Arm
	09/85→03/00	Stabiliser Link		VL-DL-8543	Coupling Rod, Control Arm
	09/85→03/00	Stabiliser Mounting	VL-SB-10392		Air Suspension Axle
	09/85→03/00	Suspension Arm Repair Kit		MN-RK-8723	for Control Arm
	09/85→03/00	Suspension Arm Repair Kit	VL-RK-5323	VL-RK-5323	for Drag Link
	09/85→03/00	Suspension Arm Repair Kit	VL-RK-5323	VL-RK-5323	for Drag Link, Air Suspension Axle
	09/85→03/00	Suspension Strut Repair Kit		MN-RK-12436	
	09/85→03/00	Tie Bar Bush	VL-SB-9501	VL-SB-9501	
	09/85→03/00	Tie Rod	DB-DL-8174		Guide Rod
	09/85→03/00	Tie Rod	VL-DL-8141		
	09/85→03/00	Tie Rod End	CV-ES-12461		for Steering Rod
	09/85→03/00	Tie Rod End	VL-ES-8411		
	09/85→03/00	Tie Rod End	VL-ES-8615		for Steering Rod
	09/85→03/00	Track Control Arm		RV-VB-8191	Wishbone (CV)
	09/85→03/00	Track Control Arm		VL-VB-7787	Wishbone (CV)
	FL 615	11/91→03/00	Ball Head, gearshift linkage	CV-ES-2120	
11/91→03/00		Centre Rod	VL-DL-8119		Push Rod, Air Suspension Axle; 1st FA, * B154268 *→
11/91→03/00		Centre Rod	VL-DL-8119		Push Rod→* B154267 *
11/91→03/00		Centre Rod	VL-DL-8155		Push Rod
11/91→03/00		Centre Rod	VL-DL-8706		Push Rod
11/91→03/00		Centre Rod	VL-DL-12456		for Steering Rod
11/91→03/00		Stabiliser Link		VL-DL-8518	Coupling Rod, Control Arm
11/91→03/00		Stabiliser Link		VL-DL-8543	Coupling Rod, Control Arm
11/91→03/00		Stabiliser Mounting	VL-SB-10392		Air Suspension Axle
11/91→03/00		Suspension Arm Repair Kit		MN-RK-8723	for Control Arm
11/91→03/00		Suspension Strut Repair Kit		MN-RK-12436	
11/91→03/00		Tie Bar Bush	VL-SB-9501	VL-SB-9501	
11/91→03/00		Tie Rod	DB-DL-8174		Guide Rod
11/91→03/00		Tie Rod	VL-DL-8141		
11/91→03/00		Tie Rod End	CV-ES-12461		for Steering Rod
11/91→03/00		Tie Rod End	VL-ES-8411		
11/91→03/00		Tie Rod End	VL-ES-8615		for Steering Rod
11/91→03/00		Track Control Arm		RV-VB-8191	Wishbone (CV)
11/91→03/00		Track Control Arm		VL-VB-7787	Wishbone (CV)
FL 618		11/91→03/00	Ball Head, gearshift linkage	CV-ES-2120	
	11/91→03/00	Centre Rod	VL-DL-5358		Push Rod, Leaf Spring Axle
	11/91→03/00	Centre Rod	VL-DL-8151		Push Rod, Leaf Spring Axle
	11/91→03/00	Centre Rod	VL-DL-8706		Push Rod
	11/91→03/00	Centre Rod	VL-DL-12456		for Steering Rod
	11/91→03/00	Stabiliser Link		VL-DL-8518	Coupling Rod, Control Arm
	11/91→03/00	Stabiliser Link		VL-DL-8543	Coupling Rod, Control Arm, Air Suspension Axle, * B308067 *→
	11/91→03/00	Stabiliser Link		VL-DL-9491	Coupling Rod, Control Arm, Air Suspension Axle, →* B308066 *
	11/91→03/00	Stabiliser Mounting	VL-SB-10392		Air Suspension Axle
	11/91→03/00	Suspension Arm Repair Kit		MN-RK-8723	for Control Arm
	11/91→03/00	Suspension Arm Repair Kit	VL-RK-5323	VL-RK-5323	for Drag Link, Air Suspension Axle
	11/91→03/00	Suspension Strut Repair Kit		MN-RK-12436	
	11/91→03/00	Tie Bar Bush		VL-SB-9501	
	11/91→03/00	Tie Rod	DB-DL-8174		Guide Rod
	11/91→03/00	Tie Rod	VL-DL-7789		Air Suspension Axle
	11/91→03/00	Tie Rod End	CV-ES-12461		for Steering Rod
	11/91→03/00	Tie Rod End	VL-ES-7286		→* 199612 *

CV-ES-2120

Length: 115
 Cone Ø: d1 Ø 12,4 / d2 Ø 10,8
 Thread: M14 x 1,5 RHT
 3124625

**CV-ES-12461**

Length: 120
 Cone Ø: d1 Ø 26 / d2 Ø 23,5
 Thread: M30 x 1,5 LHT
 1517647, 3096212

**DB-DL-8174**

Length: 1605 Ø: 40
 Cone Ø: d1 Ø 30 / d2 Ø 27
 3099230, 20830369

**MN-RK-8723**

Length: 100 Ø: 46
 Hole Distance: 60
 3090015

**MN-RK-12436**

Ø: 75 Hole Distance: 115
 Thick/Height: 24
 3093462, 85104224

**RV-VB-8191**

Length: 662,4 Ø: 48
 Hole Distance: 115 / 115
 20367004, 20507262, 20741695, 20741703,
 22318833

**VL-DL-5358**

Length: 893 Ø: 40
 Cone Ø: d1 Ø 30 / d2 Ø 26,5
 6799190, 14204400A

**VL-DL-5411**

Length: 870 Ø: 42
 Cone Ø: d1 Ø 26 / d2 Ø 23,5
 6790572, 14204000A, 20400941, 67905729

**VL-DL-7789**

Length: 1640 Ø: 58
 Cone Ø: d1 Ø 28,6 / d2 Ø 23,9
 1612254, 3985570, 4510697, 20393097,
 21260286

**VL-DL-8119**

Length: 870 Ø: 52
 Cone Ø: d1 Ø 26 / d2 Ø 23,5
 1071344, 3127737, 14204100A, 20400944

**VL-DL-8141**

Length: 1582 Ø: 38
 Cone Ø: d1 Ø 26 / d2 Ø 23,5
 6771112

**VL-DL-8151**

Length: 893 Ø: 40
 Cone Ø: d1 Ø 30 / d2 Ø 26,5
 6799189

**VL-DL-8155**

Length: 821 Ø: 42
 Cone Ø: d1 Ø 26 / d2 Ø 23,5
 1071169, 20400939

**VL-DL-8518**

Length: 350 Ø: 36
 Cone Ø: d1 Ø 28,9 / d2 Ø 24,7
 20443063, 20443067, 20994420

**VL-DL-8543**

Length: 380 Ø: 36
 Cone Ø: d1 Ø 28,6 / d2 Ø 24,7
 20443062, 20443066, 20994419

**VL-DL-8706**

Length: 890 Ø: 50
 Cone Ø: d1 Ø 26 / d2 Ø 23,5
 20376808, 85115621

**VL-DL-8729**

Length: 1556 Ø: 32
 Cone Ø: d1 Ø 22 / d2 Ø 20
 6771120

**VL-DL-9479**

Length: 510 Ø: 36
 6777705

**VL-DL-9491**

Length: 380 Ø: 36
 Cone Ø: d1 Ø 28,6 / d2 Ø 25,5
 3173914, 3987355

**VL-DL-10310**

Length: 570 Ø: 36
 1071674

**VL-DL-12456**

Length: 871 Ø: 52
 Cone Ø: d1 Ø 26 / d2 Ø 23,5
 3950703, 20900943

**VL-ES-7286**

Length: 87
 Cone Ø: d1 Ø 16 / d2 Ø 14,4
 Thread: M28 x 1,5 RHT
 382745, 1527234, 1668638

**VL-ES-8411**

Length: 140
 Cone Ø: d1 Ø 28,6 / d2 Ø 23,9
 Thread: M30 x 1,5 RHT
 3093647, 3097999, 21263821

**VL-ES-8615**

Length: 125
 Cone Ø: d1 Ø 30 / d2 Ø 26,5
 Thread: M30 x 1,5 RHT
 1697246, 1698047, 3098332

**VL-RK-5323**

Ø: 91 Hole Distance: 125
 Thick/Height: 20
 1598588, 14302100A

**VL-SB-9501**

Ø: 91 Thick/Height: 85 / 85
 1135080

**VL-SB-10392**

Ø: 90 Thick/Height: 95 / 95
 3028448, 9516523, 9959304

**VL-VB-7787**

Length: 671 Ø: 58
 Hole Distance: 130 / 130
 143167, 1076639, 1626896, 1629734,
 20392649, 20829503, 21295227, 21474441,
 22318834, 7421295227





FL 6 ...

FL 618 ...	11/91→03/00	Tie Rod End	VL-ES-8411		
	11/91→03/00	Tie Rod End	VL-ES-8615		for Steering Rod
	11/91→03/00	Track Control Arm		RV-VB-8191	Wishbone (CV), Drive Axle; Air Suspension Axle
	11/91→03/00	Track Control Arm		VL-VB-7787	Wishbone (CV)
	11/91→03/00	Track Control Arm		VL-VB-8195	Wishbone (CV), Air Suspension Axle
	01/96→03/00	Centre Rod	VL-DL-8155		Push Rod
FL 619	09/85→11/94	Ball Head, gearshift linkage	CV-ES-2120		
	09/85→11/94	Centre Rod	VL-DL-5358		Push Rod, Leaf Spring Axle
	09/85→11/94	Centre Rod	VL-DL-8151		Push Rod, Leaf Spring Axle
	09/85→11/94	Centre Rod	VL-DL-8706		Push Rod
	09/85→11/94	Stabiliser Link		VL-DL-8543	Coupling Rod, Control Arm, Air Suspension Axle, * B308067 * →
	09/85→11/94	Stabiliser Link		VL-DL-9491	Coupling Rod, Control Arm, Air Suspension Axle, →* B308066 *
	09/85→11/94	Stabiliser Mounting	VL-SB-10392		Air Suspension Axle
	09/85→11/94	Suspension Arm Repair Kit		MN-RK-8723	for Control Arm
	09/85→11/94	Tie Bar Bush		VL-SB-9501	
	09/85→11/94	Tie Rod	VL-DL-7789		Air Suspension Axle
	09/85→11/94	Tie Rod End	CV-ES-12461		for Steering Rod
	09/85→11/94	Tie Rod End	VL-ES-7286		→* 199612 *
	09/85→11/94	Tie Rod End	VL-ES-8615		for Steering Rod
	09/85→11/94	Track Control Arm		RV-VB-8191	Wishbone (CV), Drive Axle; Air Suspension Axle
	09/85→11/94	Track Control Arm		VL-VB-8195	Wishbone (CV), Air Suspension Axle

FL 7

FL 7/230	09/85→09/98	Centre Rod	VL-DL-5301		Coupling Rod
	09/85→09/98	Control Arm-/Trailing Arm Bush		VL-RK-5357	
	09/85→09/98	Stabiliser Mounting	VL-SB-5345	VL-SB-5345	
	09/85→09/98	Suspension Arm Repair Kit		CV-RK-5322	for Wishbone (CV)
	09/85→09/98	Suspension Arm Repair Kit	VL-RK-5323	VL-RK-5323	for Drag Link, Air Suspension Axle
	09/85→09/98	Suspension Arm Repair Kit	VL-RK-5323	VL-RK-5323	for Drag Link, Air Suspension Axle, →* 306 619 *
	09/85→09/98	Tie Bar Bush		VL-SB-9501	
	09/85→09/98	Tie Rod	VL-DL-7789		Air Suspension Axle
	09/85→09/98	Tie Rod End	VL-ES-5287		for Guide Rod
	09/85→09/98	Tie Rod End	VL-ES-5288		for Guide Rod
	09/85→09/98	Tie Rod End	VL-ES-5347		for Steering Rod
	09/85→09/98	Tie Rod End	VL-ES-5348		for Steering Rod
	09/85→09/98	Tie Rod End	VL-ES-7266		
	09/85→09/98	Tie Rod End	VL-ES-7286		
	09/85→09/98	Track Control Arm		VL-DL-8189	Trailing Arm
	09/85→09/98	Track Control Arm		VL-DL-8189	Trailing Arm, Air Suspension Axle
	09/85→09/98	Track Control Arm		VL-DL-8189	Trailing Arm, Drive Axle; Air Suspension Axle
	09/85→09/98	Track Control Arm		VL-DL-9485	Trailing Arm
	09/85→09/98	Track Control Arm		VL-VB-8527	Wishbone (CV)
	09/85→09/98	Track Control Arm		VL-VB-8546	Wishbone (CV)
	09/85→09/98	Track Control Arm		VL-VB-12359	Control Arm
FL 7/260	11/91→09/98	Centre Rod	VL-DL-5301		Coupling Rod
	11/91→09/98	Control Arm-/Trailing Arm Bush		VL-RK-5357	
	11/91→09/98	Stabiliser Mounting	VL-SB-5345	VL-SB-5345	
	11/91→09/98	Suspension Arm Repair Kit		CV-RK-5322	for Wishbone (CV)
	11/91→09/98	Suspension Arm Repair Kit	VL-RK-5323	VL-RK-5323	for Drag Link, Air Suspension Axle
	11/91→09/98	Suspension Arm Repair Kit	VL-RK-5323	VL-RK-5323	for Drag Link, Air Suspension Axle, →* 306 619 *
	11/91→09/98	Tie Bar Bush		VL-SB-9501	
	11/91→09/98	Tie Rod	VL-DL-7789		Air Suspension Axle
	11/91→09/98	Tie Rod End	VL-ES-5287		for Guide Rod
	11/91→09/98	Tie Rod End	VL-ES-5288		for Guide Rod
	11/91→09/98	Tie Rod End	VL-ES-5347		for Steering Rod
	11/91→09/98	Tie Rod End	VL-ES-5348		for Steering Rod
	11/91→09/98	Tie Rod End	VL-ES-7266		
	11/91→09/98	Tie Rod End	VL-ES-7286		
	11/91→09/98	Track Control Arm		VL-DL-8189	Trailing Arm

CV-ES-2120

Length: 115
Cone Ø: d1 Ø 12,4 / d2 Ø 10,8
Thread: M14 x 1,5 RHT
3124625



CV-ES-12461

Length: 120
Cone Ø: d1 Ø 26 / d2 Ø 23,5
Thread: M30 x 1,5 LHT
1517647, 3096212



CV-RK-5322

Ø: 72 Thick/Height: 50
271188, 3091598



MN-RK-8723

Length: 100 Ø: 46
Hole Distance: 60
3090015



RV-VB-8191

Length: 662,4 Ø: 48
Hole Distance: 115 / 115
20367004, 20507262, 20741695, 20741703,
22318833



VL-DL-5301

Length: 1592 Ø: 42
Cone Ø: d1 Ø 28,6 / d2 Ø 23,9
1606274, 1626494



VL-DL-5358

Length: 893 Ø: 40
Cone Ø: d1 Ø 30 / d2 Ø 26,5
6799190, 14204400A



VL-DL-7789

Length: 1640 Ø: 58
Cone Ø: d1 Ø 28,6 / d2 Ø 23,9
1612254, 3985570, 4510697, 20393097,
21260286



VL-DL-8151

Length: 893 Ø: 40
Cone Ø: d1 Ø 30 / d2 Ø 26,5
6799189



VL-DL-8155

Length: 821 Ø: 42
Cone Ø: d1 Ø 26 / d2 Ø 23,5
1071169, 20400939



VL-DL-8189

Length: 666 Ø: 48
Hole Distance: 125
1082104, 1605035



VL-DL-8543

Length: 380 Ø: 36
Cone Ø: d1 Ø 28,6 / d2 Ø 24,7
20443062, 20443066, 20994419



VL-DL-8706

Length: 890 Ø: 50
Cone Ø: d1 Ø 26 / d2 Ø 23,5
20376808, 85115621



VL-DL-9485

Length: 666 Ø: 48
Hole Distance: 125 / 125
1589817



VL-DL-9491

Length: 380 Ø: 36
Cone Ø: d1 Ø 28,6 / d2 Ø 25,5
3173914, 3987355



VL-ES-5287

Length: 167
Cone Ø: d1 Ø 28,6 / d2 Ø 23,9
Thread: M52 x 1,5 RHT
1696901, 1699401



VL-ES-5288

Length: 167
Cone Ø: d1 Ø 28,6 / d2 Ø 23,9
Thread: M52 x 1,5 LHT
1696900, 1699400



VL-ES-5347

Length: 125
Cone Ø: d1 Ø 28,6 / d2 Ø 23,9
Thread: M30 x 1,5 LHT
1507822, 1698847, 3092471



VL-ES-5348

Length: 125
Cone Ø: d1 Ø 28,6 / d2 Ø 23,9
Thread: M30 x 1,5 RHT
1507823, 1698846, 3092472



VL-ES-7266

Length: 125
Cone Ø: d1 Ø 31,5 / d2 Ø 27,5
Thread: M30 x 1,5 RHT
0356310, 1507826, 1695585, 1695776,
1698557, 6882111, 6882111(BRAZIL),
6889480, 6889482, 14200800A, 85114146



VL-ES-7286

Length: 87
Cone Ø: d1 Ø 16 / d2 Ø 14,4
Thread: M28 x 1,5 RHT
382745, 1527234, 1668638



VL-ES-8411

Length: 140
Cone Ø: d1 Ø 28,6 / d2 Ø 23,9
Thread: M30 x 1,5 RHT
3093647, 3097999, 21263821



VL-ES-8615

Length: 125
Cone Ø: d1 Ø 30 / d2 Ø 26,5
Thread: M30 x 1,5 RHT
1697246, 1698047, 3098332



VL-RK-5323

Ø: 91 Hole Distance: 125
Thick/Height: 20
1598588, 14302100A



VL-RK-5357

Ø: 138
Hole Ø 14 / 16 / 14
Hole Distance: 21
Thick/Height: 96 / 96
1075255, 1591689, 3173759, 14301900A,
20554908



VL-SB-5345

Ø: 57,5 Thick/Height: 64
1134955, 1190030, 14301500A



VL-SB-9501

Ø: 91 Thick/Height: 85 / 85
1135080



VL-SB-10392

Ø: 90 Thick/Height: 95 / 95
3028448, 9516523, 9959304



VL-VB-7787

Length: 671 Ø: 58
Hole Distance: 130 / 130
143167, 1076639, 1626896, 1629734,
20392649, 20829503, 21295227, 21474441,
22318834, 7421295227



VL-VB-8195

Length: 649 Ø: 48
Hole Distance: 115 / 115
1094466, 20374689, 20382314, 20502944



VL-VB-8527

Length: 635 Ø: 58
Hole Distance: 152 / 152
1080690, 1509222, 1576952, 1606200,
6886777



VL-VB-8546

Length: 644 Ø: 46
Hole Distance: 115 / 115
1590068



VL-VB-12359

Length: 687,5 Ø: 58
Hole Distance: 125 / 125
Thick/Height: 30
1605244, 1628483, 3173294, 8156994,
20556586





FL 7 ...

FL 7/260 ...	11/91→09/98	Track Control Arm		VL-DL-8189	Trailing Arm, Air Suspension Axle
	11/91→09/98	Track Control Arm		VL-DL-8189	Trailing Arm, Drive Axle;Air Suspension Axle
	11/91→09/98	Track Control Arm		VL-DL-9485	Trailing Arm
	11/91→09/98	Track Control Arm		VL-VB-8527	Wishbone (CV)
	11/91→09/98	Track Control Arm		VL-VB-8546	Wishbone (CV)
	11/91→09/98	Track Control Arm		VL-VB-12359	Control Arm
FL 7/290	10/93→09/98	Centre Rod	VL-DL-5301		Coupling Rod
	10/93→09/98	Control Arm-/Trailing Arm Bush		VL-RK-5357	
	10/93→09/98	Stabiliser Mounting	VL-SB-5345	VL-SB-5345	
	10/93→09/98	Suspension Arm Repair Kit		CV-RK-5313	for Wishbone (CV)
	10/93→09/98	Suspension Arm Repair Kit		CV-RK-5322	for Wishbone (CV)
	10/93→09/98	Suspension Arm Repair Kit		DF-RK-8994	for Wishbone (CV)
	10/93→09/98	Suspension Arm Repair Kit		IV-RK-8998	for Wishbone (CV)
	10/93→09/98	Suspension Arm Repair Kit		MN-RK-7287	for Wishbone (CV)
	10/93→09/98	Suspension Arm Repair Kit		MN-RK-8678	for Wishbone (CV)
	10/93→09/98	Suspension Arm Repair Kit		VL-RK-9499	for Wishbone (CV)
	10/93→09/98	Suspension Arm Repair Kit	VL-RK-5323	VL-RK-5323	for Drag Link, Air Suspension Axle
	10/93→09/98	Suspension Arm Repair Kit	VL-RK-5323	VL-RK-5323	for Drag Link, Air Suspension Axle, →* 306 619 *
	10/93→09/98	Tie Bar Bush		VL-SB-9501	
	10/93→09/98	Tie Rod	VL-DL-7789		Air Suspension Axle
	10/93→09/98	Tie Rod End	VL-ES-5287		for Guide Rod
	10/93→09/98	Tie Rod End	VL-ES-5288		for Guide Rod
	10/93→09/98	Tie Rod End	VL-ES-5347		for Steering Rod
	10/93→09/98	Tie Rod End	VL-ES-5348		for Steering Rod
	10/93→09/98	Tie Rod End	VL-ES-7266		
	10/93→09/98	Tie Rod End	VL-ES-7286		
	10/93→09/98	Track Control Arm		VL-DL-8189	Trailing Arm
	10/93→09/98	Track Control Arm		VL-DL-8189	Trailing Arm, Air Suspension Axle
	10/93→09/98	Track Control Arm		VL-DL-8189	Trailing Arm, Drive Axle;Air Suspension Axle
	10/93→09/98	Track Control Arm		VL-DL-8545	Trailing Arm, 1st RA;2nd RA
	10/93→09/98	Track Control Arm		VL-DL-8619	Trailing Arm
	10/93→09/98	Track Control Arm		VL-DL-9485	Trailing Arm
	10/93→09/98	Track Control Arm		VL-VB-8527	Wishbone (CV)
	10/93→09/98	Track Control Arm		VL-VB-8539	Wishbone (CV)
	10/93→09/98	Track Control Arm		VL-VB-8546	Wishbone (CV)
	10/93→09/98	Track Control Arm		VL-VB-12359	Control Arm

FL 10

FL 10/280	09/85→12/90	Centre Rod	VL-DL-5301		Coupling Rod
	09/85→12/90	Control Arm-/Trailing Arm Bush		VL-RK-5357	
	09/85→12/90	Control Arm-/Trailing Arm Bush	VL-RK-5357	VL-RK-5357	
	09/85→12/90	Stabiliser Mounting	VL-SB-5345	VL-SB-5345	
	09/85→12/90	Suspension Arm Repair Kit		CV-RK-5322	for Wishbone (CV)
	09/85→12/90	Suspension Arm Repair Kit	VL-RK-5323	VL-RK-5323	for Drag Link, Air Suspension Axle
	09/85→12/90	Suspension Arm Repair Kit	VL-RK-5323	VL-RK-5323	for Drag Link, Air Suspension Axle, →* 306 671 *
	09/85→12/90	Tie Bar Bush		VL-SB-9501	
	09/85→12/90	Tie Rod	VL-DL-7789		Air Suspension Axle
	09/85→12/90	Tie Rod End	VL-ES-5287		for Guide Rod
	09/85→12/90	Tie Rod End	VL-ES-5288		for Guide Rod
	09/85→12/90	Tie Rod End	VL-ES-5347		for Steering Rod
	09/85→12/90	Tie Rod End	VL-ES-5348		for Steering Rod
	09/85→12/90	Tie Rod End	VL-ES-7265		
	09/85→12/90	Tie Rod End	VL-ES-7266		
	09/85→12/90	Tie Rod End	VL-ES-7286		
	09/85→12/90	Track Control Arm		VL-DL-8189	Trailing Arm, Air Suspension Axle
	09/85→12/90	Track Control Arm		VL-DL-8189	Trailing Arm, Drive Axle;Air Suspension Axle
	09/85→12/90	Track Control Arm		VL-DL-9485	Trailing Arm
	09/85→12/90	Track Control Arm		VL-VB-12359	Control Arm

CV-RK-5313

Ø: 90
273706, 6889512



CV-RK-5322

Ø: 72 Thick/Height: 50
271188, 3091598



DF-RK-8994

Ø: 75 Hole Distance: 130
Thick/Height: 24
274070



IV-RK-8998

Ø: 85 Hole Distance: 130
Thick/Height: 30
273373, 274019, 4941233, 6889509



MN-RK-7287

Ø: 90 Hole Distance: 152
Thick/Height: 35
273375



MN-RK-8678

Length: 100 Ø: 90
276191



VL-DL-5301

Length: 1592 Ø: 42
Cone Ø: d1 Ø 28,6 / d2 Ø 23,9
1606274, 1626494



VL-DL-7789

Length: 1640 Ø: 58
Cone Ø: d1 Ø 28,6 / d2 Ø 23,9
1612254, 3985570, 4510697, 20393097,
21260286



VL-DL-8189

Length: 666 Ø: 48
Hole Distance: 125
1082104, 1605035



VL-DL-8545

Length: 660 Ø: 48
Hole Distance: 130 / 130
1581527, 1607079, 3944818, 3944819,
3944820, 8154017, 8154018, 8158206,
8158207



VL-DL-8619

Length: 621 Ø: 48
Hole Distance: 100 / 100
1608151, 1621419



VL-DL-9485

Length: 666 Ø: 48
Hole Distance: 125 / 125
1589817



VL-ES-5287

Length: 167
Cone Ø: d1 Ø 28,6 / d2 Ø 23,9
Thread: M52 x 1,5 RHT
1696901, 1699401



VL-ES-5288

Length: 167
Cone Ø: d1 Ø 28,6 / d2 Ø 23,9
Thread: M52 x 1,5 LHT
1696900, 1699400



VL-ES-5347

Length: 125
Cone Ø: d1 Ø 28,6 / d2 Ø 23,9
Thread: M30 x 1,5 LHT
1507822, 1698847, 3092471



VL-ES-5348

Length: 125
Cone Ø: d1 Ø 28,6 / d2 Ø 23,9
Thread: M30 x 1,5 RHT
1507823, 1698846, 3092472



VL-ES-7265

Length: 125
Cone Ø: d1 Ø 31,5 / d2 Ø 27,5
Thread: M30 x 1,5 LHT
1131744, 1313744, 1698558, 1698840,
2072161F, 3092795, 6869744, 6882112,
6889481, 85114147



VL-ES-7266

Length: 125
Cone Ø: d1 Ø 31,5 / d2 Ø 27,5
Thread: M30 x 1,5 RHT
0356310, 1507826, 1695585, 1695776,
1698557, 6882111, 6882111(BRAZIL),
6889480, 6889482, 14200800A, 85114146



VL-ES-7286

Length: 87
Cone Ø: d1 Ø 16 / d2 Ø 14,4
Thread: M28 x 1,5 RHT
382745, 1527234, 1668638



VL-RK-5323

Ø: 91 Hole Distance: 125
Thick/Height: 20
1598588, 14302100A



VL-RK-5357

Ø: 138
Hole Ø 14 / 16 / 14
Hole Distance: 21
Thick/Height: 96 / 96
1075255, 1591689, 3173759, 14301900A,
20554908



VL-RK-9499

Ø: 72
274069



VL-SB-5345

Ø: 57,5
Thick/Height: 64
1134955, 1190030, 14301500A



VL-SB-9501

Ø: 91 Thick/Height: 85 / 85
1135080



VL-VB-8527

Length: 635 Ø: 58
Hole Distance: 152 / 152
1080690, 1509222, 1576952, 1606200,
6886777



VL-VB-8539

Length: 641 Ø: 48
Hole Distance: 152 / 152
1606552



VL-VB-8546

Length: 644 Ø: 46
Hole Distance: 115 / 115
1590068



VL-VB-12359

Length: 687,5 Ø: 58
Hole Distance: 125 / 125
Thick/Height: 30
1605244, 1628483, 3173294, 8156994,
20556586





FL 10 ...

FL 10/320	12/95→09/98	Centre Rod	VL-DL-5301		Coupling Rod
	12/95→09/98	Centre Rod	VL-DL-8679		Push Rod
	12/95→09/98	Control Arm-/Trailing Arm Bush		VL-RK-5357	
	12/95→09/98	Stabiliser Mounting	VL-SB-5345	VL-SB-5345	
	12/95→09/98	Suspension Arm Repair Kit		CV-RK-5313	for Wishbone (CV)
	12/95→09/98	Suspension Arm Repair Kit		CV-RK-5322	for Wishbone (CV)
	12/95→09/98	Suspension Arm Repair Kit		DF-RK-8994	for Wishbone (CV)
	12/95→09/98	Suspension Arm Repair Kit		IV-RK-8998	for Wishbone (CV)
	12/95→09/98	Suspension Arm Repair Kit		MN-RK-7287	for Wishbone (CV)
	12/95→09/98	Suspension Arm Repair Kit		MN-RK-8678	for Wishbone (CV)
	12/95→09/98	Suspension Arm Repair Kit		SC-RK-8575	for Wishbone (CV)
	12/95→09/98	Suspension Arm Repair Kit		VL-RK-9499	for Wishbone (CV)
	12/95→09/98	Suspension Arm Repair Kit	VL-RK-5323	VL-RK-5323	for Drag Link, Air Suspension Axle
	12/95→09/98	Suspension Arm Repair Kit	VL-RK-5323	VL-RK-5323	for Drag Link, Air Suspension Axle, →* 306 671 *
	12/95→09/98	Tie Bar Bush		VL-SB-9501	
	12/95→09/98	Tie Rod	VL-DL-7789		Air Suspension Axle
	12/95→09/98	Tie Rod End	MN-ES-10333		for Steering Rod
	12/95→09/98	Tie Rod End	SC-ES-5764		
	12/95→09/98	Tie Rod End	VL-ES-5287		for Guide Rod
	12/95→09/98	Tie Rod End	VL-ES-5288		for Guide Rod
	12/95→09/98	Tie Rod End	VL-ES-5347		for Steering Rod
	12/95→09/98	Tie Rod End	VL-ES-5348		for Steering Rod
	12/95→09/98	Tie Rod End	VL-ES-7265		
	12/95→09/98	Tie Rod End	VL-ES-7266		
	12/95→09/98	Tie Rod End	VL-ES-7286		
	12/95→09/98	Tie Rod End	VL-ES-8568		
	12/95→09/98	Track Control Arm		VL-DL-8189	Trailing Arm
	12/95→09/98	Track Control Arm		VL-DL-8189	Trailing Arm, Air Suspension Axle
	12/95→09/98	Track Control Arm		VL-DL-8189	Trailing Arm, Drive Axle; Air Suspension Axle
	12/95→09/98	Track Control Arm		VL-DL-8545	Trailing Arm, 1st RA; 2nd RA
	12/95→09/98	Track Control Arm		VL-DL-8619	Trailing Arm
	12/95→09/98	Track Control Arm		VL-DL-9485	Trailing Arm
	12/95→09/98	Track Control Arm		VL-VB-8527	Wishbone (CV)
12/95→09/98	Track Control Arm		VL-VB-8539	Wishbone (CV)	
12/95→09/98	Track Control Arm		VL-VB-8546	Wishbone (CV)	
12/95→09/98	Track Control Arm		VL-VB-8546	Wishbone (CV), Air Suspension Axle	
12/95→09/98	Track Control Arm		VL-VB-12359	Control Arm	
FL 10/360	12/95→09/98	Bush, parabolic spring		VL-SB-5356	
	12/95→09/98	Centre Rod	VL-DL-5301		Coupling Rod
	12/95→09/98	Centre Rod	VL-DL-8679		Push Rod
	12/95→09/98	Stabiliser Mounting	VL-SB-5345	VL-SB-5345	
	12/95→09/98	Suspension Arm Repair Kit		CV-RK-5313	for Wishbone (CV)
	12/95→09/98	Suspension Arm Repair Kit		CV-RK-5322	for Wishbone (CV)
	12/95→09/98	Suspension Arm Repair Kit		DF-RK-8994	for Wishbone (CV)
	12/95→09/98	Suspension Arm Repair Kit		IV-RK-8998	for Wishbone (CV)
	12/95→09/98	Suspension Arm Repair Kit		MN-RK-7287	for Wishbone (CV)
	12/95→09/98	Suspension Arm Repair Kit		MN-RK-8678	for Wishbone (CV)
	12/95→09/98	Suspension Arm Repair Kit		MN-RK-9383	for Control Arm
	12/95→09/98	Suspension Arm Repair Kit		SC-RK-8575	for Wishbone (CV)
	12/95→09/98	Suspension Arm Repair Kit		VL-RK-9499	for Wishbone (CV)
	12/95→09/98	Suspension Arm Repair Kit	VL-RK-5323	VL-RK-5323	for Drag Link, Air Suspension Axle
	12/95→09/98	Suspension Arm Repair Kit	VL-RK-5323	VL-RK-5323	for Drag Link, Air Suspension Axle, →* 306 671 *
	12/95→09/98	Suspension Strut Repair Kit		MN-RK-8537	
	12/95→09/98	Tie Bar Bush		VL-SB-9501	
	12/95→09/98	Tie Rod	VL-DL-7789		Air Suspension Axle
	12/95→09/98	Tie Rod End	MN-ES-10333		for Steering Rod
	12/95→09/98	Tie Rod End	SC-ES-5764		
	12/95→09/98	Tie Rod End	VL-ES-5287		for Guide Rod
	12/95→09/98	Tie Rod End	VL-ES-5288		for Guide Rod
	12/95→09/98	Tie Rod End	VL-ES-5347		for Steering Rod
	12/95→09/98	Tie Rod End	VL-ES-5348		for Steering Rod

CV-RK-5313

Ø: 90
273706, 6889512

**CV-RK-5322**

Ø: 72 Thick/Height: 50
271188, 3091598

**DF-RK-8994**

Ø: 75 Hole Distance: 130
Thick/Height: 24
274070

**IV-RK-8998**

Ø: 85 Hole Distance: 130
Thick/Height: 30
273373, 274019, 4941233, 6889509

**MN-ES-10333**

Length: 90
Cone Ø: d1 Ø 38 / d2 Ø 34,35
Thread: M36 x 1,5 RHT
1271126, 3090291, 3099128, 42538048,
81953016268, 82953016018, 82953016019

**MN-RK-7287**

Ø: 90 Hole Distance: 152
Thick/Height: 35
273375

**MN-RK-8537**

Ø: 95 Hole Distance: 152
Thick/Height: 24
274056, 276192, 696321, 81432706099

**MN-RK-8678**

Length: 100 Ø: 90
276191

**MN-RK-9383**

Ø: 67 Hole Distance: 100
Thick/Height: 24
275988

**SC-ES-5764**

Length: 95
Cone Ø: d1 Ø 30 / d2 Ø 27
Thread: M26 x 1,5 RHT
1606980

**SC-RK-8575**

Ø: 95 Hole Distance: 152
Thick/Height: 35
274056

**VL-DL-5301**

Length: 1592 Ø: 42
Cone Ø: d1 Ø 28,6 / d2 Ø 23,9
1606274, 1626494

**VL-DL-7789**

Length: 1640 Ø: 58
Cone Ø: d1 Ø 28,6 / d2 Ø 23,9
1612254, 3985570, 4510697, 20393097,
21260286

**VL-DL-8189**

Length: 666 Ø: 48
Hole Distance: 125
1082104, 1605035

**VL-DL-8545**

Length: 660 Ø: 48
Hole Distance: 130 / 130
1581527, 1607079, 3944818, 3944819,
3944820, 8154017, 8154018, 8158206,
8158207

**VL-DL-8619**

Length: 621 Ø: 48
Hole Distance: 100 / 100
1608151, 1621419

**VL-DL-8679**

Length: 1779 Ø: 60
Cone Ø: d1 Ø 31,5 / d2 Ø 27,5
1626671

**VL-DL-9485**

Length: 666 Ø: 48
Hole Distance: 125 / 125
1589817

**VL-ES-5287**

Length: 167
Cone Ø: d1 Ø 28,6 / d2 Ø 23,9
Thread: M52 x 1,5 RHT
1696901, 1699401

**VL-ES-5288**

Length: 167
Cone Ø: d1 Ø 28,6 / d2 Ø 23,9
Thread: M52 x 1,5 LHT
1696900, 1699400

**VL-ES-5347**

Length: 125
Cone Ø: d1 Ø 28,6 / d2 Ø 23,9
Thread: M30 x 1,5 LHT
1507822, 1698847, 3092471

**VL-ES-5348**

Length: 125
Cone Ø: d1 Ø 28,6 / d2 Ø 23,9
Thread: M30 x 1,5 RHT
1507823, 1698846, 3092472

**VL-ES-7265**

Length: 125
Cone Ø: d1 Ø 31,5 / d2 Ø 27,5
Thread: M30 x 1,5 LHT
1131744, 1313744, 1698558, 1698840,
2072161F, 3092795, 6869744, 6882112,
6889481, 85114147

**VL-ES-7266**

Length: 125
Cone Ø: d1 Ø 31,5 / d2 Ø 27,5
Thread: M30 x 1,5 RHT
0356310, 1507826, 1695585, 1695776,
1698557, 6882111, 6882111(BRAZIL),
6889480, 6889482, 14200800A, 85114146

**VL-ES-7286**

Length: 87
Cone Ø: d1 Ø 16 / d2 Ø 14,4
Thread: M28 x 1,5 RHT
382745, 1527234, 1668638

**VL-ES-8568**

Length: 100
Cone Ø: d1 Ø 38 / d2 Ø 34,3
Thread: M26 x 1,5 RHT
8151876

**VL-RK-5323**

Ø: 91 Hole Distance: 125
Thick/Height: 20
1598588, 14302100A

**VL-RK-5357**

Ø: 138
Hole Ø 14 / 16 / 14
Hole Distance: 21
Thick/Height: 96 / 96
1075255, 1591689, 3173759, 14301900A,
20554908

**VL-RK-9499**

Ø: 72
274069

**VL-SB-5345**

Ø: 57,5 Thick/Height: 64
1134955, 1190030, 14301500A

**VL-SB-5356**

Thick/Height: 150
1629553, 14403900A, 20390836

**VL-SB-9501**

Ø: 91 Thick/Height: 85 / 85
1135080

**VL-VB-8527**

Length: 635 Ø: 58
Hole Distance: 152 / 152
1080690, 1509222, 1576952, 1606200,
6886777

**VL-VB-8539**

Length: 641 Ø: 48
Hole Distance: 152 / 152
1606552

**VL-VB-8546**

Length: 644 Ø: 46
Hole Distance: 115 / 115
1590068

**VL-VB-12359**

Length: 687,5 Ø: 58
Hole Distance: 125 / 125
Thick/Height: 30
1605244, 1628483, 3173294, 8156994,
20556586





FL 10 ...

FL 10/360 ...	12/95→09/98	Tie Rod End	VL-ES-7265			
	12/95→09/98	Tie Rod End	VL-ES-7266			
	12/95→09/98	Tie Rod End	VL-ES-7286			
	12/95→09/98	Tie Rod End	VL-ES-8568			
	12/95→09/98	Track Control Arm		VL-DL-8189	Trailing Arm, Air Suspension Axle	
	12/95→09/98	Track Control Arm		VL-DL-8189	Trailing Arm, Drive Axle; Air Suspension Axle	
	12/95→09/98	Track Control Arm		VL-DL-8545	Trailing Arm	
	12/95→09/98	Track Control Arm		VL-DL-8545	Trailing Arm, 1st RA; 2nd RA	
	12/95→09/98	Track Control Arm		VL-DL-8619	Trailing Arm	
	12/95→09/98	Track Control Arm		VL-DL-9485	Trailing Arm	
	12/95→09/98	Track Control Arm		VL-VB-8527	Wishbone (CV)	
	12/95→09/98	Track Control Arm		VL-VB-8539	Wishbone (CV)	
	12/95→09/98	Track Control Arm		VL-VB-8546	Wishbone (CV)	
	12/95→09/98	Track Control Arm		VL-VB-8546	Wishbone (CV), Air Suspension Axle	
	12/95→09/98	Track Control Arm		VL-VB-12359	Control Arm	
FL 10H/320	12/95→09/98	Centre Rod	VL-DL-5301		Coupling Rod	
	12/95→09/98	Stabiliser Mounting	VL-SB-5345	VL-SB-5345		
	12/95→09/98	Suspension Arm Repair Kit		CV-RK-5313	for Wishbone (CV)	
	12/95→09/98	Suspension Arm Repair Kit		CV-RK-5322	for Wishbone (CV)	
	12/95→09/98	Suspension Arm Repair Kit		DF-RK-8994	for Wishbone (CV)	
	12/95→09/98	Suspension Arm Repair Kit		IV-RK-8998	for Wishbone (CV)	
	12/95→09/98	Suspension Arm Repair Kit		MN-RK-7287	for Wishbone (CV)	
	12/95→09/98	Suspension Arm Repair Kit		MN-RK-8678	for Wishbone (CV)	
	12/95→09/98	Suspension Arm Repair Kit		SC-RK-8575	for Wishbone (CV)	
	12/95→09/98	Suspension Arm Repair Kit		VL-RK-9499	for Wishbone (CV)	
	12/95→09/98	Suspension Arm Repair Kit	VL-RK-5323	VL-RK-5323	for Drag Link, Air Suspension Axle	
	12/95→09/98	Suspension Arm Repair Kit	VL-RK-5323	VL-RK-5323	for Drag Link, Air Suspension Axle, →* 306 671 *	
	12/95→09/98	Tie Bar Bush		VL-SB-9501		
	12/95→09/98	Tie Rod	VL-DL-7789		Air Suspension Axle	
	12/95→09/98	Tie Rod End	MN-ES-10333		for Steering Rod	
	12/95→09/98	Tie Rod End	SC-ES-5764			
	12/95→09/98	Tie Rod End	VL-ES-5287		for Guide Rod	
	12/95→09/98	Tie Rod End	VL-ES-5288		for Guide Rod	
	12/95→09/98	Tie Rod End	VL-ES-5347		for Steering Rod	
	12/95→09/98	Tie Rod End	VL-ES-5348		for Steering Rod	
	12/95→09/98	Tie Rod End	VL-ES-7265			
	12/95→09/98	Tie Rod End	VL-ES-7266			
	12/95→09/98	Tie Rod End	VL-ES-7286			
	12/95→09/98	Tie Rod End	VL-ES-8568			
	12/95→09/98	Track Control Arm		VL-DL-8545	Trailing Arm, 1st RA; 2nd RA	
	12/95→09/98	Track Control Arm		VL-DL-8619	Trailing Arm	
	12/95→09/98	Track Control Arm		VL-VB-8527	Wishbone (CV)	
	12/95→09/98	Track Control Arm		VL-VB-8539	Wishbone (CV)	
	12/95→09/98	Track Control Arm		VL-VB-8539	Wishbone (CV)* 905007 *→	
	12/95→09/98	Track Control Arm		VL-VB-8546	Wishbone (CV)	
	12/95→09/98	Track Control Arm		VL-VB-8546	Wishbone (CV), Air Suspension Axle	
	12/95→09/98	Track Control Arm		VL-VB-8584	Wishbone (CV)→* 905005 *	
	12/95→09/98	Track Control Arm		VL-VB-12359	Control Arm	
	FL 10H/360	12/95→09/98	Centre Rod	VL-DL-5301		Coupling Rod
		12/95→09/98	Stabiliser Mounting	VL-SB-5345	VL-SB-5345	
		12/95→09/98	Suspension Arm Repair Kit		CV-RK-5313	for Wishbone (CV)
		12/95→09/98	Suspension Arm Repair Kit		CV-RK-5322	for Wishbone (CV)
		12/95→09/98	Suspension Arm Repair Kit		DF-RK-8994	for Wishbone (CV)
		12/95→09/98	Suspension Arm Repair Kit		IV-RK-8998	for Wishbone (CV)
		12/95→09/98	Suspension Arm Repair Kit		MN-RK-7287	for Wishbone (CV)
		12/95→09/98	Suspension Arm Repair Kit		MN-RK-8678	for Wishbone (CV)
		12/95→09/98	Suspension Arm Repair Kit		SC-RK-8575	for Wishbone (CV)
		12/95→09/98	Suspension Arm Repair Kit		VL-RK-9499	for Wishbone (CV)
		12/95→09/98	Suspension Arm Repair Kit	VL-RK-5323	VL-RK-5323	for Drag Link, Air Suspension Axle
		12/95→09/98	Suspension Arm Repair Kit	VL-RK-5323	VL-RK-5323	for Drag Link, Air Suspension Axle, →* 306 671 *
12/95→09/98		Tie Bar Bush		VL-SB-9501		

CV-RK-5313

Ø: 90
273706, 6889512

**CV-RK-5322**

Ø: 72 Thick/Height: 50
271188, 3091598

**DF-RK-8994**

Ø: 75 Hole Distance: 130
Thick/Height: 24
274070

**IV-RK-8998**

Ø: 85 Hole Distance: 130
Thick/Height: 30
273373, 274019, 4941233, 6889509

**MN-ES-10333**

Length: 90
Cone Ø: d1 Ø 38 / d2 Ø 34,35
Thread: M36 x 1,5 RHT
1271126, 3090291, 3099128, 42538048,
81953016268, 82953016018, 82953016019

**MN-RK-7287**

Ø: 90 Hole Distance: 152
Thick/Height: 35
273375

**MN-RK-8678**

Length: 100 Ø: 90
276191

**SC-ES-5764**

Length: 95
Cone Ø: d1 Ø 30 / d2 Ø 27
Thread: M26 x 1,5 RHT
1606980

**SC-RK-8575**

Ø: 95 Hole Distance: 152
Thick/Height: 35
274056

**VL-DL-5301**

Length: 1592 Ø: 42
Cone Ø: d1 Ø 28,6 / d2 Ø 23,9
1606274, 1626494

**VL-DL-7789**

Length: 1640 Ø: 58
Cone Ø: d1 Ø 28,6 / d2 Ø 23,9
1612254, 3985570, 4510697, 20393097,
21260286

**VL-DL-8189**

Length: 666 Ø: 48
Hole Distance: 125
1082104, 1605035

**VL-DL-8545**

Length: 660 Ø: 48
Hole Distance: 130 / 130
1581527, 1607079, 3944818, 3944819,
3944820, 8154017, 8154018, 8158206,
8158207

**VL-DL-8619**

Length: 621 Ø: 48
Hole Distance: 100 / 100
1608151, 1621419

**VL-DL-9485**

Length: 666 Ø: 48
Hole Distance: 125 / 125
1589817

**VL-ES-5287**

Length: 167
Cone Ø: d1 Ø 28,6 / d2 Ø 23,9
Thread: M52 x 1,5 RHT
1696901, 1699401

**VL-ES-5288**

Length: 167
Cone Ø: d1 Ø 28,6 / d2 Ø 23,9
Thread: M52 x 1,5 RHT
1696900, 1699400

**VL-ES-5347**

Length: 125
Cone Ø: d1 Ø 28,6 / d2 Ø 23,9
Thread: M30 x 1,5 LHT
1507822, 1698847, 3092471

**VL-ES-5348**

Length: 125
Cone Ø: d1 Ø 28,6 / d2 Ø 23,9
Thread: M30 x 1,5 RHT
1507823, 1698846, 3092472

**VL-ES-7265**

Length: 125
Cone Ø: d1 Ø 31,5 / d2 Ø 27,5
Thread: M30 x 1,5 LHT
1131744, 1313744, 1698558, 1698840,
2072161F, 3092795, 6869744, 6882112,
6889481, 85114147

**VL-ES-7266**

Length: 125
Cone Ø: d1 Ø 31,5 / d2 Ø 27,5
Thread: M30 x 1,5 RHT
0356310, 1507826, 1695585, 1695776,
1698557, 6882111, 6882111(BRAZIL),
6889480, 6889482, 14200800A, 85114146

**VL-ES-7286**

Length: 87
Cone Ø: d1 Ø 16 / d2 Ø 14,4
Thread: M28 x 1,5 RHT
382745, 1527234, 1668638

**VL-ES-8568**

Length: 100
Cone Ø: d1 Ø 38 / d2 Ø 34,3
Thread: M26 x 1,5 RHT
8151876

**VL-RK-5323**

Ø: 91 Hole Distance: 125
Thick/Height: 20
1598588, 14302100A

**VL-RK-9499**

Ø: 72
274069

**VL-SB-5345**

Ø: 57,5
Thick/Height: 64
1134955, 1190030, 14301500A

**VL-SB-9501**

Ø: 91 Thick/Height: 85 / 85
1135080

**VL-VB-8527**

Length: 635 Ø: 58
Hole Distance: 152 / 152
1080690, 1509222, 1576952, 1606200,
6886777

**VL-VB-8539**

Length: 641 Ø: 48
Hole Distance: 152 / 152
1606552

**VL-VB-8546**

Length: 644 Ø: 46
Hole Distance: 115 / 115
1590068

**VL-VB-8584**

Length: 700 Ø: 58
Hole Distance: 152 / 152
1576953

**VL-VB-12359**

Length: 687,5 Ø: 58
Hole Distance: 125 / 125
Thick/Height: 30
1605244, 1628483, 3173294, 8156994,
20556586





FL 10 ...

FL 10H/360 ...	12/95→09/98	Tie Rod	VL-DL-7789		Air Suspension Axle
	12/95→09/98	Tie Rod End	MN-ES-10333		for Steering Rod
	12/95→09/98	Tie Rod End	SC-ES-5764		
	12/95→09/98	Tie Rod End	VL-ES-5287		for Guide Rod
	12/95→09/98	Tie Rod End	VL-ES-5288		for Guide Rod
	12/95→09/98	Tie Rod End	VL-ES-5347		for Steering Rod
	12/95→09/98	Tie Rod End	VL-ES-5348		for Steering Rod
	12/95→09/98	Tie Rod End	VL-ES-7265		
	12/95→09/98	Tie Rod End	VL-ES-7266		
	12/95→09/98	Tie Rod End	VL-ES-7286		
	12/95→09/98	Tie Rod End	VL-ES-8568		
	12/95→09/98	Track Control Arm		VL-DL-8545	Trailing Arm, 1st RA;2nd RA
	12/95→09/98	Track Control Arm		VL-DL-8619	Trailing Arm
	12/95→09/98	Track Control Arm		VL-VB-8527	Wishbone (CV)
	12/95→09/98	Track Control Arm		VL-VB-8539	Wishbone (CV)
	12/95→09/98	Track Control Arm		VL-VB-8539	Wishbone (CV)* 905007 *→
	12/95→09/98	Track Control Arm		VL-VB-8546	Wishbone (CV)
	12/95→09/98	Track Control Arm		VL-VB-8546	Wishbone (CV), Air Suspension Axle
	12/95→09/98	Track Control Arm		VL-VB-8584	Wishbone (CV)→* 905005 *
	12/95→09/98	Track Control Arm		VL-VB-12359	Control Arm

FL 12

FL 12/380	09/95→09/98	Bush, parabolic spring		VL-SB-5356		
	09/95→09/98	Centre Rod	VL-DL-5301		Coupling Rod	
	09/95→09/98	Centre Rod	VL-DL-8679		Suspension Rod	
	09/95→09/98	Control Arm-/Trailing Arm Bush		VL-RK-5357		
	09/95→09/98	Stabiliser Mounting	VL-SB-5345	VL-SB-5345		
	09/95→09/98	Suspension Arm Repair Kit		CV-RK-5313	for Wishbone (CV)	
	09/95→09/98	Suspension Arm Repair Kit		CV-RK-5322	for Wishbone (CV)	
	09/95→09/98	Suspension Arm Repair Kit		DF-RK-8994	for Wishbone (CV)	
	09/95→09/98	Suspension Arm Repair Kit		IV-RK-8998	for Wishbone (CV)	
	09/95→09/98	Suspension Arm Repair Kit		MN-RK-7280	for Drag Link	
	09/95→09/98	Suspension Arm Repair Kit		MN-RK-7287	for Wishbone (CV)	
	09/95→09/98	Suspension Arm Repair Kit		MN-RK-8678	for Wishbone (CV)	
	09/95→09/98	Suspension Arm Repair Kit		SC-RK-8575	for Wishbone (CV)	
	09/95→09/98	Suspension Arm Repair Kit		VL-RK-9499	for Wishbone (CV)	
	09/95→09/98	Suspension Strut Repair Kit		MN-RK-8537		
	09/95→09/98	Tie Bar Bush		VL-SB-9501		
	09/95→09/98	Tie Rod	VL-DL-7789		Air Suspension Axle	
	09/95→09/98	Tie Rod End	VL-ES-5347		for Steering Rod	
	09/95→09/98	Tie Rod End	VL-ES-5348		for Steering Rod	
	09/95→09/98	Tie Rod End	VL-ES-7265			
	09/95→09/98	Tie Rod End	VL-ES-7266			
	09/95→09/98	Tie Rod End	VL-ES-7286			
	09/95→09/98	Tie Rod End	VL-ES-8568			
	09/95→09/98	Track Control Arm		VL-DL-8189	Trailing Arm, Air Suspension Axle	
	09/95→09/98	Track Control Arm		VL-DL-8189	Trailing Arm, Drive Axle;Air Suspension Axle	
	09/95→09/98	Track Control Arm		VL-DL-8545	Trailing Arm	
	09/95→09/98	Track Control Arm		VL-DL-8545	Trailing Arm, 1st RA;2nd RA	
	09/95→09/98	Track Control Arm		VL-DL-8619	Trailing Arm	
	09/95→09/98	Track Control Arm		VL-DL-9485	Trailing Arm	
	09/95→09/98	Track Control Arm		VL-VB-5369	Wishbone (CV)	
	09/95→09/98	Track Control Arm		VL-VB-5369	Wishbone (CV), 1st RA;Air Suspension Axle	
	09/95→09/98	Track Control Arm		VL-VB-8527	Wishbone (CV)	
	09/95→09/98	Track Control Arm		VL-VB-8539	Wishbone (CV)	
	09/95→09/98	Track Control Arm		VL-VB-8546	Wishbone (CV)	
	09/95→09/98	Track Control Arm		VL-VB-12359	Control Arm	
	FL 12/420	09/95→09/98	Centre Rod	VL-DL-5301		Coupling Rod
		09/95→09/98	Centre Rod	VL-DL-8679		Suspension Rod
		09/95→09/98	Control Arm-/Trailing Arm Bush		VL-RK-5357	
		09/95→09/98	Stabiliser Mounting	VL-SB-5345	VL-SB-5345	
		09/95→09/98	Suspension Arm Repair Kit		CV-RK-5313	for Wishbone (CV)
		09/95→09/98	Suspension Arm Repair Kit		CV-RK-5322	for Wishbone (CV)

CV-RK-5313

Ø: 90
273706, 6889512



CV-RK-5322

Ø: 72 Thick/Height: 50
271188, 3091598



DF-RK-8994

Ø: 75 Hole Distance: 130
Thick/Height: 24
274070



IV-RK-8998

Ø: 85 Hole Distance: 130
Thick/Height: 30
273373, 274019, 4941233, 6889509



MN-ES-10333

Length: 90
Cone Ø: d1 Ø 38 / d2 Ø 34,35
Thread: M36 x 1,5 RHT
1271126, 3090291, 3099128, 42538048,
81953016268, 82953016018, 82953016019



MN-RK-7280

Ø: 75 Hole Distance: 115
Thick/Height: 24
271187, 689748



MN-RK-7287

Ø: 90 Hole Distance: 152
Thick/Height: 35
273375



MN-RK-8537

Ø: 95 Hole Distance: 152
Thick/Height: 24
274056, 276192, 696321, 81432706099



MN-RK-8678

Length: 100 Ø: 90
276191



SC-ES-5764

Length: 95
Cone Ø: d1 Ø 30 / d2 Ø 27
Thread: M26 x 1,5 RHT
1606980



SC-RK-8575

Ø: 95 Hole Distance: 152
Thick/Height: 35
274056



VL-DL-5301

Length: 1592 Ø: 42
Cone Ø: d1 Ø 28,6 / d2 Ø 23,9
1606274, 1626494



VL-DL-7789

Length: 1640 Ø: 58
Cone Ø: d1 Ø 28,6 / d2 Ø 23,9
1612254, 3985570, 4510697, 20393097,
21260286



VL-DL-8189

Length: 666 Ø: 48
Hole Distance: 125
1082104, 1605035



VL-DL-8545

Length: 660 Ø: 48
Hole Distance: 130 / 130
1581527, 1607079, 3944818, 3944819,
3944820, 8154017, 8154018, 8158206,
8158207



VL-DL-8619

Length: 621 Ø: 48
Hole Distance: 100 / 100
1608151, 1621419



VL-DL-8679

Length: 1779 Ø: 60
Cone Ø: d1 Ø 31,5 / d2 Ø 27,5
1626671



VL-DL-9485

Length: 666 Ø: 48
Hole Distance: 125 / 125
1589817



VL-ES-5287

Length: 167
Cone Ø: d1 Ø 28,6 / d2 Ø 23,9
Thread: M52 x 1,5 RHT
1696901, 1699401



VL-ES-5288

Length: 167
Cone Ø: d1 Ø 28,6 / d2 Ø 23,9
Thread: M52 x 1,5 LHT
1696900, 1699400



VL-ES-5347

Length: 125
Cone Ø: d1 Ø 28,6 / d2 Ø 23,9
Thread: M30 x 1,5 LHT
1507822, 1698847, 3092471



VL-ES-5348

Length: 125
Cone Ø: d1 Ø 28,6 / d2 Ø 23,9
Thread: M30 x 1,5 RHT
1507823, 1698846, 3092472



VL-ES-7265

Length: 125
Cone Ø: d1 Ø 31,5 / d2 Ø 27,5
Thread: M30 x 1,5 LHT
1131744, 1313744, 1698558, 1698840,
2072161F, 3092795, 6869744, 6882112,
6889481, 85114147



VL-ES-7266

Length: 125
Cone Ø: d1 Ø 31,5 / d2 Ø 27,5
Thread: M30 x 1,5 RHT
0356310, 1507826, 1695585, 1695776,
1698557, 6882111, 6882111(BRAZIL),
6889480, 6889482, 14200800A, 85114146



VL-ES-7286

Length: 87
Cone Ø: d1 Ø 16 / d2 Ø 14,4
Thread: M28 x 1,5 RHT
382745, 1527234, 1668638



VL-ES-8568

Length: 100
Cone Ø: d1 Ø 38 / d2 Ø 34,3
Thread: M26 x 1,5 RHT
8151876



VL-RK-5357

Ø: 138
Hole Ø 14 / 16 / 14
Hole Distance: 21
Thick/Height: 96 / 96
1075255, 1591689, 3173759, 14301900A,
20554908



VL-RK-9499

Ø: 72
274069



VL-SB-5345

Ø: 57,5 Thick/Height: 64
1134955, 1190030, 14301500A



VL-SB-5356

Thick/Height: 150
1629553, 14403900A, 20390836



VL-SB-9501

Ø: 91 Thick/Height: 85 / 85
1135080



VL-VB-5369

Length: 677 Ø: 48
Hole Distance: 115 / 115
3172829, 8073569, 14319600A



VL-VB-8527

Length: 635 Ø: 58
Hole Distance: 152 / 152
1080690, 1509222, 1576952, 1606200,
6886777



VL-VB-8539

Length: 641 Ø: 48
Hole Distance: 152 / 152
1606552



VL-VB-8546

Length: 644 Ø: 46
Hole Distance: 115 / 115
1590068



VL-VB-8584

Length: 700 Ø: 58
Hole Distance: 152 / 152
1576953



VL-VB-12359

Length: 687,5 Ø: 58
Hole Distance: 125 / 125
Thick/Height: 30
1605244, 1628483, 3173294, 8156994,
20556586





FL 12 ...

FL 12/420 ...	09/95→09/98	Suspension Arm Repair Kit		DF-RK-8994	for Wishbone (CV)
	09/95→09/98	Suspension Arm Repair Kit		IV-RK-8998	for Wishbone (CV)
	09/95→09/98	Suspension Arm Repair Kit		MN-RK-7287	for Wishbone (CV)
	09/95→09/98	Suspension Arm Repair Kit		MN-RK-8678	for Wishbone (CV)
	09/95→09/98	Suspension Arm Repair Kit		SC-RK-8575	for Wishbone (CV)
	09/95→09/98	Suspension Arm Repair Kit		VL-RK-9499	for Wishbone (CV)
	09/95→09/98	Suspension Strut Repair Kit		MN-RK-8537	
	09/95→09/98	Tie Bar Bush		VL-SB-9501	
	09/95→09/98	Tie Rod	VL-DL-7789		Air Suspension Axle
	09/95→09/98	Tie Rod End	VL-ES-5347		for Steering Rod
	09/95→09/98	Tie Rod End	VL-ES-5348		for Steering Rod
	09/95→09/98	Tie Rod End	VL-ES-7265		
	09/95→09/98	Tie Rod End	VL-ES-7266		
	09/95→09/98	Tie Rod End	VL-ES-7286		
	09/95→09/98	Tie Rod End	VL-ES-8568		
	09/95→09/98	Track Control Arm		VL-DL-8189	Trailing Arm, Air Suspension Axle
	09/95→09/98	Track Control Arm		VL-DL-8189	Trailing Arm, Drive Axle;Air Suspension Axle
	09/95→09/98	Track Control Arm		VL-DL-8545	Trailing Arm, 1st RA;2nd RA
	09/95→09/98	Track Control Arm		VL-DL-8619	Trailing Arm
	09/95→09/98	Track Control Arm		VL-DL-9485	Trailing Arm
	09/95→09/98	Track Control Arm		VL-VB-5369	Wishbone (CV), 1st RA;Air Suspension Axle
	09/95→09/98	Track Control Arm		VL-VB-8527	Wishbone (CV)
	09/95→09/98	Track Control Arm		VL-VB-8539	Wishbone (CV)
	09/95→09/98	Track Control Arm		VL-VB-8546	Wishbone (CV)
09/95→09/98	Track Control Arm		VL-VB-12359	Control Arm	
FL 12H/380	09/95→09/98	Centre Rod	VL-DL-5301		Coupling Rod
	09/95→09/98	Centre Rod	VL-DL-8679		Push Rod
	09/95→09/98	Centre Rod	VL-DL-8679		Suspension Rod
	09/95→09/98	Stabiliser Mounting	VL-SB-5345	VL-SB-5345	
	09/95→09/98	Suspension Arm Repair Kit		CV-RK-5313	for Wishbone (CV)
	09/95→09/98	Suspension Arm Repair Kit		CV-RK-5322	for Wishbone (CV)
	09/95→09/98	Suspension Arm Repair Kit		DF-RK-8994	for Wishbone (CV)
	09/95→09/98	Suspension Arm Repair Kit		IV-RK-8998	for Wishbone (CV)
	09/95→09/98	Suspension Arm Repair Kit		MN-RK-7287	for Wishbone (CV)
	09/95→09/98	Suspension Arm Repair Kit		MN-RK-8678	for Wishbone (CV)
	09/95→09/98	Suspension Arm Repair Kit		SC-RK-8575	for Wishbone (CV)
	09/95→09/98	Suspension Arm Repair Kit		VL-RK-9499	for Wishbone (CV)
	09/95→09/98	Suspension Strut Repair Kit		MN-RK-8537	
	09/95→09/98	Tie Bar Bush		VL-SB-9501	
	09/95→09/98	Tie Rod End	MN-ES-10333		for Steering Rod
	09/95→09/98	Tie Rod End	VL-ES-5347		for Steering Rod
	09/95→09/98	Tie Rod End	VL-ES-5348		for Steering Rod
	09/95→09/98	Tie Rod End	VL-ES-7265		
	09/95→09/98	Tie Rod End	VL-ES-7266		
	09/95→09/98	Tie Rod End	VL-ES-7286		
	09/95→09/98	Tie Rod End	VL-ES-8568		
	09/95→09/98	Track Control Arm		VL-DL-8545	Trailing Arm, 1st RA;2nd RA
	09/95→09/98	Track Control Arm		VL-DL-8619	Trailing Arm
	09/95→09/98	Track Control Arm		VL-VB-5369	Wishbone (CV), 1st RA;Air Suspension Axle
	09/95→09/98	Track Control Arm		VL-VB-8195	Wishbone (CV), 2nd RA;Air Suspension Axle
	09/95→09/98	Track Control Arm		VL-VB-8527	Wishbone (CV)
	09/95→09/98	Track Control Arm		VL-VB-8539	Wishbone (CV)
	09/95→09/98	Track Control Arm		VL-VB-8539	Wishbone (CV)* 905007 *→
	09/95→09/98	Track Control Arm		VL-VB-8546	Wishbone (CV)
	09/95→09/98	Track Control Arm		VL-VB-8584	Wishbone (CV)→* 905005 *
	09/95→09/98	Track Control Arm		VL-VB-12359	Control Arm
	FL 12H/420	09/95→09/98	Centre Rod	VL-DL-5301	
09/95→09/98		Centre Rod	VL-DL-8679		Push Rod
09/95→09/98		Centre Rod	VL-DL-8679		Suspension Rod
09/95→09/98		Stabiliser Mounting	VL-SB-5345	VL-SB-5345	
09/95→09/98		Suspension Arm Repair Kit		CV-RK-5313	for Wishbone (CV)
09/95→09/98		Suspension Arm Repair Kit		CV-RK-5322	for Wishbone (CV)
09/95→09/98	Suspension Arm Repair Kit		DF-RK-8994	for Wishbone (CV)	

CV-RK-5313

Ø: 90
273706, 6889512

**CV-RK-5322**

Ø: 72 Thick/Height: 50
271188, 3091598

**DF-RK-8994**

Ø: 75 Hole Distance: 130
Thick/Height: 24
274070

**IV-RK-8998**

Ø: 85 Hole Distance: 130
Thick/Height: 30
273373, 274019, 4941233, 6889509

**MN-ES-10333**

Length: 90
Cone Ø: d1 Ø 38 / d2 Ø 34,35
Thread: M36 x 1,5 RHT
1271126, 3090291, 3099128, 42538048,
81953016268, 82953016018, 82953016019

**MN-RK-7287**

Ø: 90 Hole Distance: 152
Thick/Height: 35
273375

**MN-RK-8537**

Ø: 95 Hole Distance: 152
Thick/Height: 24
274056, 276192, 696321, 81432706099

**MN-RK-8678**

Length: 100
Ø: 90
276191

**SC-RK-8575**

Ø: 95 Hole Distance: 152
Thick/Height: 35
274056

**VL-DL-5301**

Length: 1592 Ø: 42
Cone Ø: d1 Ø 28,6 / d2 Ø 23,9
1606274, 1626494

**VL-DL-7789**

Length: 1640 Ø: 58
Cone Ø: d1 Ø 28,6 / d2 Ø 23,9
1612254, 3985570, 4510697, 20393097,
21260286

**VL-DL-8189**

Length: 666 Ø: 48
Hole Distance: 125
1082104, 1605035

**VL-DL-8545**

Length: 660 Ø: 48
Hole Distance: 130 / 130
1581527, 1607079, 3944818, 3944819,
3944820, 8154017, 8154018, 8158206,
8158207

**VL-DL-8619**

Length: 621 Ø: 48
Hole Distance: 100 / 100
1608151, 1621419

**VL-DL-8679**

Length: 1779 Ø: 60
Cone Ø: d1 Ø 31,5 / d2 Ø 27,5
1626671

**VL-DL-9485**

Length: 666 Ø: 48
Hole Distance: 125 / 125
1589817

**VL-ES-5347**

Length: 125
Cone Ø: d1 Ø 28,6 / d2 Ø 23,9
Thread: M30 x 1,5 LHT
1507822, 1698847, 3092471

**VL-ES-5348**

Length: 125
Cone Ø: d1 Ø 28,6 / d2 Ø 23,9
Thread: M30 x 1,5 RHT
1507823, 1698846, 3092472

**VL-ES-7265**

Length: 125
Cone Ø: d1 Ø 31,5 / d2 Ø 27,5
Thread: M30 x 1,5 LHT
1131744, 1313744, 1698558, 1698840,
2072161F, 3092795, 6869744, 6882112,
6889481, 85114147

**VL-ES-7266**

Length: 125
Cone Ø: d1 Ø 31,5 / d2 Ø 27,5
Thread: M30 x 1,5 RHT
0356310, 1507826, 1695585, 1695776,
1698557, 6882111, 6882111(BRAZIL),
6889480, 6889482, 14200800A, 85114146

**VL-ES-7286**

Length: 87
Cone Ø: d1 Ø 16 / d2 Ø 14,4
Thread: M28 x 1,5 RHT
382745, 1527234, 1668638

**VL-ES-8568**

Length: 100
Cone Ø: d1 Ø 38 / d2 Ø 34,3
Thread: M26 x 1,5 RHT
8151876

**VL-RK-9499**

Ø: 72
274069

**VL-SB-5345**

Ø: 57,5 Thick/Height: 64
1134955, 1190030, 14301500A

**VL-SB-9501**

Ø: 91 Thick/Height: 85 / 85
1135080

**VL-VB-5369**

Length: 677 Ø: 48
Hole Distance: 115 / 115
3172829, 8073569, 14319600A

**VL-VB-8195**

Length: 649 Ø: 48
Hole Distance: 115 / 115
1094466, 20374689, 20382314, 20502944

**VL-VB-8527**

Length: 635 Ø: 58
Hole Distance: 152 / 152
1080690, 1509222, 1576952, 1606200,
6886777

**VL-VB-8539**

Length: 641 Ø: 48
Hole Distance: 152 / 152
1606552

**VL-VB-8546**

Length: 644 Ø: 46
Hole Distance: 115 / 115
1590068

**VL-VB-8584**

Length: 700 Ø: 58
Hole Distance: 152 / 152
1576953

**VL-VB-12359**

Length: 687,5 Ø: 58
Hole Distance: 125 / 125
Thick/Height: 30
1605244, 1628483, 3173294, 8156994,
20556586



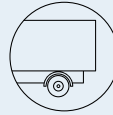
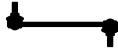

FL 12 ...

FL 12H/420 ...	09/95→09/98	Suspension Arm Repair Kit		IV-RK-8998	for Wishbone (CV)
	09/95→09/98	Suspension Arm Repair Kit		MN-RK-7287	for Wishbone (CV)
	09/95→09/98	Suspension Arm Repair Kit		MN-RK-8678	for Wishbone (CV)
	09/95→09/98	Suspension Arm Repair Kit		SC-RK-8575	for Wishbone (CV)
	09/95→09/98	Suspension Arm Repair Kit		VL-RK-9499	for Wishbone (CV)
	09/95→09/98	Suspension Strut Repair Kit		MN-RK-8537	
	09/95→09/98	Tie Bar Bush		VL-SB-9501	
	09/95→09/98	Tie Rod End	MN-ES-10333		for Steering Rod
	09/95→09/98	Tie Rod End	VL-ES-5347		for Steering Rod
	09/95→09/98	Tie Rod End	VL-ES-5348		for Steering Rod
	09/95→09/98	Tie Rod End	VL-ES-7265		
	09/95→09/98	Tie Rod End	VL-ES-7266		
	09/95→09/98	Tie Rod End	VL-ES-7286		
	09/95→09/98	Tie Rod End	VL-ES-8568		
	09/95→09/98	Track Control Arm		VL-DL-8545	Trailing Arm, 1st RA;2nd RA
	09/95→09/98	Track Control Arm		VL-DL-8619	Trailing Arm
	09/95→09/98	Track Control Arm		VL-VB-5369	Wishbone (CV), 1st RA;Air Suspension Axle
	09/95→09/98	Track Control Arm		VL-VB-8195	Wishbone (CV), 2nd RA;Air Suspension Axle
	09/95→09/98	Track Control Arm		VL-VB-8527	Wishbone (CV)
	09/95→09/98	Track Control Arm		VL-VB-8539	Wishbone (CV)
	09/95→09/98	Track Control Arm		VL-VB-8539	Wishbone (CV)* 905007 *→
	09/95→09/98	Track Control Arm		VL-VB-8546	Wishbone (CV)
	09/95→09/98	Track Control Arm		VL-VB-8584	Wishbone (CV)→* 905005 *
	09/95→09/98	Track Control Arm		VL-VB-12359	Control Arm

FLC

FLC 140	09/96→09/00	Tie Rod	VL-DL-8729		
	09/96→09/00	Track Control Arm		VL-DL-9479	Trailing Arm, 1st RA;2nd RA; Air Suspension Axle

FL II

FL 240-12	05/06→	Centre Rod	RV-DL-12480		Push Rod
	05/06→	Tie Rod End	CV-ES-14163		for Steering Rod
FL 240-14	06/09→	Centre Rod	RV-DL-8190		Push Rod
	06/09→	Centre Rod	RV-DL-12480		Push Rod
	06/09→	Tie Rod End	CV-ES-14163		for Steering Rod
FL 240-15	05/06→	Centre Rod	RV-DL-8190		Push Rod
	05/06→	Centre Rod	RV-DL-12480		Push Rod
	05/06→	Tie Rod End	CV-ES-14163		for Steering Rod
FL 240-16	05/06→	Centre Rod	RV-DL-8190		Push Rod
	05/06→	Centre Rod	RV-DL-12480		Push Rod
	05/06→	Tie Rod End	CV-ES-14163		for Steering Rod
FL 240-18	05/06→	Tie Rod End	CV-ES-14163		for Steering Rod
FL 260-12	06/09→	Centre Rod	RV-DL-12480		Push Rod
	06/09→	Tie Rod End	CV-ES-14163		for Steering Rod
FL 260-14	06/09→	Centre Rod	RV-DL-8190		Push Rod
	06/09→	Centre Rod	RV-DL-12480		Push Rod
	06/09→	Tie Rod End	CV-ES-14163		for Steering Rod
FL 260-15	06/09→	Centre Rod	RV-DL-8190		Push Rod
	06/09→	Centre Rod	RV-DL-12480		Push Rod
	06/09→	Tie Rod End	CV-ES-14163		for Steering Rod
FL 260-16	06/09→	Centre Rod	RV-DL-8190		Push Rod
	06/09→	Centre Rod	RV-DL-12480		Push Rod
	06/09→	Tie Rod End	CV-ES-14163		for Steering Rod
FL 260-18	06/09→	Tie Rod End	CV-ES-14163		for Steering Rod
FL 280-12	05/06→	Centre Rod	RV-DL-12480		Push Rod
	05/06→	Tie Rod End	CV-ES-14163		for Steering Rod
FL 280-14	06/09→	Centre Rod	RV-DL-8190		Push Rod
	06/09→	Centre Rod	RV-DL-12480		Push Rod
	06/09→	Tie Rod End	CV-ES-14163		for Steering Rod
FL 280-15	05/06→	Centre Rod	RV-DL-8190		Push Rod
	05/06→	Centre Rod	RV-DL-12480		Push Rod
	05/06→	Tie Rod End	CV-ES-14163		for Steering Rod

CV-ES-14163

Length: 125
Cone Ø: d1 Ø 30 / d2 Ø 27
Thread: M30 x 1,5 RHT
20742127, 20745043, 20821160, 20862494



IV-RK-8998

Ø: 85 Hole Distance: 130
Thick/Height: 30
273373, 274019, 4941233, 6889509



MN-ES-10333

Length: 90
Cone Ø: d1 Ø 38 / d2 Ø 34,35
Thread: M36 x 1,5 RHT
1271126, 3090291, 3099128, 42538048,
81953016268, 82953016018, 82953016019



MN-RK-7287

Ø: 90
Hole Distance: 152
Thick/Height: 35
273375



MN-RK-8537

Ø: 95 Hole Distance: 152
Thick/Height: 24
274056, 276192, 696321, 81432706099



MN-RK-8678

Length: 100
Ø: 90
276191



RV-DL-8190

Length: 946 Ø: 42
Cone Ø: d1 Ø 26 / d2 Ø 23,5
20709844



RV-DL-12480

Length: 922 Ø: 42
Cone Ø: d1 Ø 26 / d2 Ø 23,5
20 818 840



SC-RK-8575

Ø: 95 Hole Distance: 152
Thick/Height: 35
274056



VL-DL-8545

Length: 660 Ø: 48
Hole Distance: 130 / 130
1581527, 1607079, 3944818, 3944819,
3944820, 8154017, 8154018, 8158206,
8158207



VL-DL-8619

Length: 621 Ø: 48
Hole Distance: 100 / 100
1608151, 1621419



VL-DL-8729

Length: 1556 Ø: 32
Cone Ø: d1 Ø 22 / d2 Ø 20
6771120



VL-DL-9479

Length: 510 Ø: 36
6777705



VL-ES-5347

Length: 125
Cone Ø: d1 Ø 28,6 / d2 Ø 23,9
Thread: M30 x 1,5 LHT
1507822, 1698847, 3092471



VL-ES-5348

Length: 125
Cone Ø: d1 Ø 28,6 / d2 Ø 23,9
Thread: M30 x 1,5 RHT
1507823, 1698846, 3092472



VL-ES-7265

Length: 125
Cone Ø: d1 Ø 31,5 / d2 Ø 27,5
Thread: M30 x 1,5 LHT
1131744, 1313744, 1698558, 1698840,
2072161F, 3092795, 6869744, 6882112,
6889481, 85114147



VL-ES-7266

Length: 125
Cone Ø: d1 Ø 31,5 / d2 Ø 27,5
Thread: M30 x 1,5 RHT
0356310, 1507826, 1695585, 1695776,
1698557, 6882111, 6882111(BRAZIL),
6889480, 6889482, 14200800A, 85114146



VL-ES-7286

Length: 87
Cone Ø: d1 Ø 16 / d2 Ø 14,4
Thread: M28 x 1,5 RHT
382745, 1527234, 1668638



VL-ES-8568

Length: 100
Cone Ø: d1 Ø 38 / d2 Ø 34,3
Thread: M26 x 1,5 RHT
8151876



VL-RK-9499

Ø: 72
274069



VL-SB-9501

Ø: 91 Thick/Height: 85 / 85
1135080



VL-VB-5369

Length: 677 Ø: 48
Hole Distance: 115 / 115
3172829, 8073569, 14319600A



VL-VB-8195

Length: 649 Ø: 48
Hole Distance: 115 / 115
1094466, 20374689, 20382314, 20502944



VL-VB-8527

Length: 635 Ø: 58
Hole Distance: 152 / 152
1080690, 1509222, 1576952, 1606200,
686777



VL-VB-8539

Length: 641 Ø: 48
Hole Distance: 152 / 152
1606552



VL-VB-8546

Length: 644 Ø: 48
Hole Distance: 115 / 115
1590068



VL-VB-8584

Length: 700 Ø: 58
Hole Distance: 152 / 152
1576953



VL-VB-12359

Length: 687,5 Ø: 58
Hole Distance: 125 / 125
Thick/Height: 30
1605244, 1628483, 3173294, 8156994,
20556586



**FL II ...**

FL 280-16	05/06→	Centre Rod	RV-DL-8190	Push Rod
	05/06→	Centre Rod	RV-DL-12480	Push Rod
	05/06→	Tie Rod End	CV-ES-14163	for Steering Rod
FL 280-18	05/06→	Tie Rod End	CV-ES-14163	for Steering Rod
FL 290-12	06/09→	Centre Rod	RV-DL-12480	Push Rod
	06/09→	Tie Rod End	CV-ES-14163	for Steering Rod
FL 290-14	06/09→	Centre Rod	RV-DL-8190	Push Rod
	06/09→	Centre Rod	RV-DL-12480	Push Rod
	06/09→	Tie Rod End	CV-ES-14163	for Steering Rod
FL 290-16	06/09→	Centre Rod	RV-DL-8190	Push Rod
	06/09→	Centre Rod	RV-DL-12480	Push Rod
	06/09→	Tie Rod End	CV-ES-14163	for Steering Rod
FL 290-18	06/09→	Tie Rod End	CV-ES-14163	for Steering Rod

FL III

FL 210-12	05/13→	Centre Rod	RV-DL-12448	for Steering Rod
	05/13→	Centre Rod	RV-DL-12480	Push Rod
	05/13→	Tie Rod	RV-DL-12465	
FL 240-12	05/13→	Centre Rod	RV-DL-12448	for Steering Rod
	05/13→	Centre Rod	RV-DL-12480	Push Rod
	05/13→	Tie Rod	RV-DL-12465	
FL 240-14	05/13→	Centre Rod	RV-DL-12448	for Steering Rod
	05/13→	Centre Rod	RV-DL-12480	Push Rod
	05/13→	Tie Rod	RV-DL-12465	
FL 240-15	05/13→	Centre Rod	RV-DL-12448	for Steering Rod
	05/13→	Centre Rod	RV-DL-12480	Push Rod
	05/13→	Tie Rod	RV-DL-12465	
FL 240-16	05/13→	Centre Rod	RV-DL-12448	for Steering Rod
	05/13→	Centre Rod	RV-DL-12480	Push Rod
	05/13→	Tie Rod	RV-DL-12465	
FL 240-18	05/13→	Centre Rod	RV-DL-12448	for Steering Rod
	05/13→	Centre Rod	RV-DL-12480	Push Rod
	05/13→	Tie Rod	RV-DL-12465	
FL 250-12	05/13→	Centre Rod	RV-DL-12448	for Steering Rod
	05/13→	Centre Rod	RV-DL-12480	Push Rod
	05/13→	Tie Rod	RV-DL-12465	
FL 250-14	05/13→	Centre Rod	RV-DL-12448	for Steering Rod
	05/13→	Centre Rod	RV-DL-12480	Push Rod
	05/13→	Tie Rod	RV-DL-12465	
FL 250-16	05/13→	Centre Rod	RV-DL-12448	for Steering Rod
	05/13→	Centre Rod	RV-DL-12480	Push Rod
	05/13→	Tie Rod	RV-DL-12465	
FL 260-12	05/13→	Centre Rod	RV-DL-12448	for Steering Rod
	05/13→	Centre Rod	RV-DL-12480	Push Rod
	05/13→	Tie Rod	RV-DL-12465	
FL 260-14	05/13→	Centre Rod	RV-DL-12448	for Steering Rod
	05/13→	Centre Rod	RV-DL-12480	Push Rod
	05/13→	Tie Rod	RV-DL-12465	
FL 260-15	05/13→	Centre Rod	RV-DL-12448	for Steering Rod
	05/13→	Centre Rod	RV-DL-12480	Push Rod
	05/13→	Tie Rod	RV-DL-12465	
FL 260-16	05/13→	Centre Rod	RV-DL-12448	for Steering Rod
	05/13→	Centre Rod	RV-DL-12480	Push Rod
	05/13→	Tie Rod	RV-DL-12465	
FL 260-18	05/13→	Centre Rod	RV-DL-12448	for Steering Rod
	05/13→	Centre Rod	RV-DL-12480	Push Rod
	05/13→	Tie Rod	RV-DL-12465	
FL 280-12	05/13→	Centre Rod	RV-DL-12448	for Steering Rod
	05/13→	Centre Rod	RV-DL-12480	Push Rod
	05/13→	Tie Rod	RV-DL-12465	
FL 280-14	05/13→	Centre Rod	RV-DL-12448	for Steering Rod
	05/13→	Centre Rod	RV-DL-12480	Push Rod
	05/13→	Tie Rod	RV-DL-12465	

CV-ES-14163

Length: 125

Cone Ø: d1 Ø 30 / d2 Ø 27

Thread: M30 x 1,5 RHT

20742127, 20745043, 20821160, 20862494



RV-DL-8190

Length: 946 Ø: 42

Cone Ø: d1 Ø 26 / d2 Ø 23,5

20709844



RV-DL-12448

Length: 900 Ø: 50

Cone Ø: d1 Ø 30 / d2 Ø 27

20818854



RV-DL-12465

Length: 1580 Ø: 40

Cone Ø: d1 Ø 30 / d2 Ø 27

Thread: M30 x 1,5 LHT / M30 x 1,5 RHT

20582399, 22482972



RV-DL-12480

Length: 922 Ø: 42

Cone Ø: d1 Ø 26 / d2 Ø 23,5

20 818 840



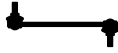

FL III ...

FL 280-16	05/13→	Centre Rod	RV-DL-12448	for Steering Rod
	05/13→	Centre Rod	RV-DL-12480	Push Rod
	05/13→	Tie Rod	RV-DL-12465	
FL 280-18	05/13→	Centre Rod	RV-DL-12448	for Steering Rod
	05/13→	Centre Rod	RV-DL-12480	Push Rod
	05/13→	Tie Rod	RV-DL-12465	
FL 290-12	05/13→	Centre Rod	RV-DL-12448	for Steering Rod
	05/13→	Centre Rod	RV-DL-12480	Push Rod
	05/13→	Tie Rod	RV-DL-12465	
FL 290-14	05/13→	Centre Rod	RV-DL-12448	for Steering Rod
	05/13→	Centre Rod	RV-DL-12480	Push Rod
	05/13→	Tie Rod	RV-DL-12465	
FL 290-16	05/13→	Centre Rod	RV-DL-12448	for Steering Rod
	05/13→	Centre Rod	RV-DL-12480	Push Rod
	05/13→	Tie Rod	RV-DL-12465	
FL 290-18	05/13→	Centre Rod	RV-DL-12448	for Steering Rod
	05/13→	Centre Rod	RV-DL-12480	Push Rod
	05/13→	Tie Rod	RV-DL-12465	

FM

FM 300	09/05→	Centre Rod	RV-DL-12320	for Steering Rod	
	09/05→	Centre Rod	VL-DL-8194	Push Rod	
	09/05→	Centre Rod	VL-DL-8407	Push Rod, Leaf Spring Axle	
	09/05→	Centre Rod	VL-DL-8566	Push Rod	
	09/05→	Centre Rod	VL-DL-8707	Push Rod, Air Suspension Axle	
	09/05→	Centre Rod	VL-DL-10228	Push Rod, 1st FA;2nd FA	
	09/05→	Centre Rod	VL-DL-12367	for Steering Rod	
	09/05→	Centre Rod	VL-DL-12454	for Steering Rod	
	09/05→	Centre Rod	VL-DL-12483	Push Rod	
	09/05→	Centre Rod	VL-DL-12484	Push Rod	
	09/05→	Stabiliser Link		VL-DL-9472	Coupling Rod
	09/05→	Stabiliser Link	VL-DL-12356		Coupling Rod
	09/05→	Suspension Arm Repair Kit		VL-RK-9497	for Drag Link
	09/05→	Suspension Arm Repair Kit		VL-RK-9497	for Drag Link, Leaf Spring Axle
	09/05→	Suspension Strut Repair Kit		MN-RK-8501	
	09/05→	Suspension Strut Repair Kit	VL-RK-8533		
	09/05→	Tie Rod	VL-DL-8305		Leaf Spring Axle
	09/05→	Tie Rod	VL-DL-9492		
	09/05→	Tie Rod	VL-DL-12355		
	09/05→	Tie Rod	VL-DL-12358		
	09/05→	Tie Rod End	VL-ES-5347		for Steering Rod
	09/05→	Tie Rod End	VL-ES-5348		for Steering Rod
	09/05→	Tie Rod End	VL-ES-8411		
	09/05→	Tie Rod End	VL-ES-8414		for Guide Rod
	09/05→	Tie Rod End	VL-ES-10360		for Steering Rod
	09/05→	Track Control Arm		RV-DL-10299	Trailing Arm, 1st & 2nd Drive Axle, for Leaf-Spring Suspension vehicles
	09/05→	Track Control Arm		RV-DL-10299	Trailing Arm, 1st RA;2nd RA; Leaf Spring Axle;Unit
	09/05→	Track Control Arm		RV-TC-12339	Suspension Rod, Trailing Arm
	09/05→	Track Control Arm		RV-TC-12340	Trailing Arm
	09/05→	Track Control Arm		RV-VB-8191	Wishbone (CV)
	09/05→	Track Control Arm		RV-VB-8191	Wishbone (CV), Air Suspension Axle
	09/05→	Track Control Arm		VL-DL-8180	Trailing Arm
	09/05→	Track Control Arm		VL-DL-8180	Trailing Arm, 1st Drive Axle, for Pneumatic Suspension vehicles
09/05→	Track Control Arm		VL-VB-7787	Wishbone (CV)	
09/05→	Track Control Arm		VL-VB-12460	Wishbone (CV)	
09/05→	Track Control Arm		VL-VB-12460	Wishbone (CV), 1st & 2nd Drive Axle, for Leaf-Spring Suspension vehicles	
09/05→	Track Control Arm		VL-VB-12460	Wishbone (CV), 1st & 2nd Drive Axle, for Pneumatic Suspension vehicles	

MN-RK-8501

Ø: 75 Hole Distance: 115
 Thick/Height: 24
 20547286

**RV-DL-10299**

Length: 510 Ø: 21
 20522934, 21051052, 7420864583,
 7421051052

**RV-DL-12320**

Length: 881 Ø: 50
 Cone Ø: d1 Ø 28,6 / d2 Ø 23,9
 20390746, 21106968

**RV-DL-12448**

Length: 900 Ø: 50
 Cone Ø: d1 Ø 30 / d2 Ø 27
 20818854

**RV-DL-12465**

Length: 1580 Ø: 40
 Cone Ø: d1 Ø 30 / d2 Ø 27
 Thread: M30 x 1,5 LHT / M30 x 1,5 RHT
 20582399, 22482972

**RV-DL-12480**

Length: 922 Ø: 42
 Cone Ø: d1 Ø 26 / d2 Ø 23,5
 20 818 840

**RV-TC-12339**

Length: 515
 Hole Distance: 13 / 130
 20532931, 21051046

**RV-TC-12340**

Length: 510
 Hole Distance: 115 / 115
 20443044

**RV-VB-8191**

Length: 662,4 Ø: 48
 Hole Distance: 115 / 115
 20367004, 20507262, 20741695, 20741703,
 22318833

**VL-DL-8180**

Length: 625 Ø: 17
 20374444, 20410530, 20509018, 20517494,
 70371270

**VL-DL-8194**

Length: 824 Ø: 50
 Cone Ø: d1 Ø 28,6 / d2 Ø 23,9
 20375787, 21106933

**VL-DL-8305**

Length: 1634 Ø: 50
 Cone Ø: d1 Ø 28,6 / d2 Ø 23,9
 3198276, 21260274

**VL-DL-8407**

Length: 870 Ø: 52
 Cone Ø: d1 Ø 28,6 / d2 Ø 23,9
 3986452, 20375555, 20393186, 21106930

**VL-DL-8566**

Length: 863 Ø: 52
 Cone Ø: d1 Ø 28,6 / d2 Ø 23,9
 20375556, 20393187, 21106952, 21406952

**VL-DL-8707**

Length: 885 Ø: 50
 Cone Ø: d1 Ø 28,6 / d2 Ø 23,9
 20390745, 21106936

**VL-DL-9472**

Length: 435 Ø: 36
 Cone Ø: d1 Ø 32,2 / d2 Ø 28
 20443061, 20443065, 20994418

**VL-DL-9492**

Length: 1660 Ø: 62
 Cone Ø: d1 Ø 32 / d2 Ø 27
 20587731, 21106938

**VL-DL-10228**

Length: 2139 Ø: 62
 Cone Ø: d1 Ø 28,6 / d2 Ø 23,9
 20453063

**VL-DL-12355**

Length: 368 Ø: 38
 Cone Ø: d1 Ø 28,6 / d2 Ø 23,9
 1628207

**VL-DL-12356**

Length: 275 Ø: 30
 Cone Ø: d1 Ø 22
 3987423, 20477803

**VL-DL-12358**

Length: 1669 Ø: 42
 Cone Ø: d1 Ø 32 / d2 Ø 27
 Thread: M32 x 1,5 RHT / M32 x 1,5 LHT
 20581086, 7420581086

**VL-DL-12367**

Length: 2139 Ø: 62
 Cone Ø: d1 Ø 28,6 / d2 Ø 23,9
 Thread: M52 x 1,5 RHT
 20453064, 20584291

**VL-DL-12454**

Length: 2339 Ø: 62
 Cone Ø: d1 Ø 28,6 / d2 Ø 23,9
 20581632

**VL-DL-12483**

Length: 485 Ø: 48
 Cone Ø: d1 Ø 28,6 / d2 Ø 23,9
 20383081, 21260283, 22159761,
 81467106355

**VL-DL-12484**

Length: 1025 Ø: 48
 Cone Ø: d1 Ø 28,6 / d2 Ø 23,9
 2038308, 21252481

**VL-ES-5347**

Length: 125
 Cone Ø: d1 Ø 28,6 / d2 Ø 23,9
 Thread: M30 x 1,5 LHT
 1507822, 1698847, 3092471

**VL-ES-5348**

Length: 125
 Cone Ø: d1 Ø 28,6 / d2 Ø 23,9
 Thread: M30 x 1,5 RHT
 1507823, 1698846, 3092472

**VL-ES-8411**

Length: 140
 Cone Ø: d1 Ø 28,6 / d2 Ø 23,9
 Thread: M30 x 1,5 RHT
 3093647, 3097999, 21263821

**VL-ES-8414**

Length: 136
 Cone Ø: d1 Ø 32 / d2 Ø 27
 Thread: M30 x 1,5 LHT
 20710008

**VL-ES-10360**

Length: 136
 Cone Ø: d1 Ø 32 / d2 Ø 27
 Thread: M30 x 1,5 RHT
 20581089

**VL-RK-8533**

Ø: 85 Hole Distance: 130
 Thick/Height: 30
 3093630, 3093631, 20840815, 21295230,
 7420840815

**VL-RK-9497**

Ø: 95 Hole Distance: 130
 Thick/Height: 35
 273612, 20702095

**VL-VB-7787**

Length: 671
 Ø: 58
 Hole Distance: 130 / 130
 143167, 1076639, 1626896, 1629734,
 20392649, 20829503, 21295227, 21474441,
 22318834, 7421295227

**VL-VB-12460**

Length: 662
 Ø: 50
 Hole Distance: 115 / 115
 2223852, 20589061





FM ...

FM 300 ...	09/05 →	Track Control Arm		VL-VB-12460	Wishbone (CV), 1st Drive Axle, for Pneumatic Suspension vehicles
	09/05 →	Track Control Arm		VL-VB-12460	Wishbone (CV), Trailing Axle not Steered, for Pneumatic Suspension vehicles
	09/05 →	Track Control Arm		VL-VB-12460	Wishbone (CV), Trailing Axle Steered, for Pneumatic Suspension vehicles
	09/05 →	Track Control Arm		VL-VB-12460	Wishbone (CV), Trailing Axle Steered/not Steered, for Pneumatic Suspension vehicles
	09/05 →	Track Control Arm	VL-DL-10309	VL-DL-10309	Trailing Arm, Air Suspension Axle
FM 330	09/05 →	Centre Rod	VL-DL-8194		Push Rod
	09/05 →	Centre Rod	VL-DL-8566		Push Rod
	09/05 →	Centre Rod	VL-DL-10228		Push Rod, 1st FA;2nd FA
	09/05 →	Centre Rod	VL-DL-12367		for Steering Rod
	09/05 →	Centre Rod	VL-DL-12454		for Steering Rod
	09/05 →	Centre Rod	VL-DL-12483		Push Rod
	09/05 →	Centre Rod	VL-DL-12484		Push Rod
	09/05 →	Stabiliser Link		VL-DL-9472	Coupling Rod
	09/05 →	Stabiliser Link	VL-DL-12356		Coupling Rod
	09/05 →	Suspension Arm Repair Kit		VL-RK-9497	for Drag Link
	09/05 →	Suspension Arm Repair Kit		VL-RK-9497	for Drag Link, Leaf Spring Axle
	09/05 →	Suspension Strut Repair Kit		MN-RK-8501	
	09/05 →	Suspension Strut Repair Kit	VL-RK-8533		
	09/05 →	Tie Rod	VL-DL-12355		
	09/05 →	Tie Rod	VL-DL-12358		
	09/05 →	Tie Rod End	VL-ES-5347		for Steering Rod
	09/05 →	Tie Rod End	VL-ES-5348		for Steering Rod
	09/05 →	Tie Rod End	VL-ES-8411		
	09/05 →	Tie Rod End	VL-ES-8414		for Guide Rod
	09/05 →	Tie Rod End	VL-ES-10360		for Steering Rod
	09/05 →	Track Control Arm		RV-DL-10299	Trailing Arm, 1st RA;2nd RA; Leaf Spring Axle;Unit
	09/05 →	Track Control Arm		RV-TC-12339	Suspension Rod, Trailing Arm
	09/05 →	Track Control Arm		RV-TC-12340	Trailing Arm
	09/05 →	Track Control Arm		RV-VB-8191	Wishbone (CV)
	09/05 →	Track Control Arm		VL-DL-8180	Trailing Arm
	09/05 →	Track Control Arm		VL-VB-7787	Wishbone (CV)
	09/05 →	Track Control Arm		VL-VB-12460	Wishbone (CV)
	09/05 →	Track Control Arm		VL-VB-12460	Wishbone (CV), 1st & 2nd Drive Axle, for Leaf-Spring Suspension vehicles
	09/05 →	Track Control Arm		VL-VB-12460	Wishbone (CV), 1st & 2nd Drive Axle, for Pneumatic Suspension vehicles
	09/05 →	Track Control Arm		VL-VB-12460	Wishbone (CV), 1st Drive Axle, for Pneumatic Suspension vehicles
	09/05 →	Track Control Arm		VL-VB-12460	Wishbone (CV), Trailing Axle not Steered, for Pneumatic Suspension vehicles
	09/05 →	Track Control Arm		VL-VB-12460	Wishbone (CV), Trailing Axle Steered, for Pneumatic Suspension vehicles
	09/05 →	Track Control Arm		VL-VB-12460	Wishbone (CV), Trailing Axle Steered/not Steered, for Pneumatic Suspension vehicles
FM 340	09/05 →	Centre Rod	RV-DL-12320		for Steering Rod
	09/05 →	Centre Rod	VL-DL-8194		Push Rod
	09/05 →	Centre Rod	VL-DL-8407		Push Rod, Leaf Spring Axle
	09/05 →	Centre Rod	VL-DL-8566		Push Rod
	09/05 →	Centre Rod	VL-DL-8707		Push Rod, Air Suspension Axle
	09/05 →	Centre Rod	VL-DL-10228		Push Rod, 1st FA;2nd FA
	09/05 →	Centre Rod	VL-DL-12367		for Steering Rod
	09/05 →	Centre Rod	VL-DL-12454		for Steering Rod
	09/05 →	Centre Rod	VL-DL-12483		Push Rod
	09/05 →	Centre Rod	VL-DL-12484		Push Rod
	09/05 →	Stabiliser Link		VL-DL-9472	Coupling Rod
	09/05 →	Stabiliser Link	VL-DL-12356		Coupling Rod
	09/05 →	Suspension Arm Repair Kit		VL-RK-9497	for Drag Link
	09/05 →	Suspension Arm Repair Kit		VL-RK-9497	for Drag Link, Leaf Spring Axle

MN-RK-8501

Ø: 75 Hole Distance: 115
 Thick/Height: 24
 20547286

**RV-DL-10299**

Length: 510 Ø: 21
 20522934, 21051052, 7420864583,
 7421051052

**RV-DL-12320**

Length: 881 Ø: 50
 Cone Ø: d1 Ø 28,6 / d2 Ø 23,9
 20390746, 21106968

**RV-TC-12339**

Length: 515
 Hole Distance: 13 / 130
 20532931, 21051046

**RV-TC-12340**

Length: 510
 Hole Distance: 115 / 115
 20443044

**RV-VB-8191**

Length: 662,4 Ø: 48
 Hole Distance: 115 / 115
 20367004, 20507262, 20741695, 20741703,
 22318833

**VL-DL-8180**

Length: 625 Ø: 17
 20374444, 20410530, 20509018, 20517494,
 70371270

**VL-DL-8194**

Length: 824 Ø: 50
 Cone Ø: d1 Ø 28,6 / d2 Ø 23,9
 20375787, 21106933

**VL-DL-8407**

Length: 870 Ø: 52
 Cone Ø: d1 Ø 28,6 / d2 Ø 23,9
 3986452, 20375555, 20393186, 21106930

**VL-DL-8566**

Length: 863 Ø: 52
 Cone Ø: d1 Ø 28,6 / d2 Ø 23,9
 20375556, 20393187, 21106952, 21406952

**VL-DL-8707**

Length: 885 Ø: 50
 Cone Ø: d1 Ø 28,6 / d2 Ø 23,9
 20390745, 21106936

**VL-DL-9472**

Length: 435 Ø: 36
 Cone Ø: d1 Ø 32,2 / d2 Ø 28
 20443061, 20443065, 20994418

**VL-DL-10228**

Length: 2139 Ø: 62
 Cone Ø: d1 Ø 28,6 / d2 Ø 23,9
 20453063

**VL-DL-10309**

Length: 799 Ø: 48
 Hole Distance: 115 / 115
 20410053, 21106157

**VL-DL-12355**

Length: 368 Ø: 38
 Cone Ø: d1 Ø 28,6 / d2 Ø 23,9
 1628207

**VL-DL-12356**

Length: 275 Ø: 30
 Cone Ø: d1 Ø 22
 3987423, 20477803

**VL-DL-12358**

Length: 1669 Ø: 42
 Cone Ø: d1 Ø 32 / d2 Ø 27
 Thread: M32 x 1,5 RHT / M32 x 1,5 LHT
 20581086, 7420581086

**VL-DL-12367**

Length: 2139 Ø: 62
 Cone Ø: d1 Ø 28,6 / d2 Ø 23,9
 Thread: M52 x 1,5 RHT
 20453064, 20584291

**VL-DL-12454**

Length: 2339 Ø: 62
 Cone Ø: d1 Ø 28,6 / d2 Ø 23,9
 20581632

**VL-DL-12483**

Length: 485 Ø: 48
 Cone Ø: d1 Ø 28,6 / d2 Ø 23,9
 20383081, 21260283, 22159761,
 81467106355

**VL-DL-12484**

Length: 1025 Ø: 48
 Cone Ø: d1 Ø 28,6 / d2 Ø 23,9
 2038308, 21252481

**VL-ES-5347**

Length: 125
 Cone Ø: d1 Ø 28,6 / d2 Ø 23,9
 Thread: M30 x 1,5 LHT
 1507822, 1698847, 3092471

**VL-ES-5348**

Length: 125
 Cone Ø: d1 Ø 28,6 / d2 Ø 23,9
 Thread: M30 x 1,5 RHT
 1507823, 1698846, 3092472

**VL-ES-8411**

Length: 140
 Cone Ø: d1 Ø 28,6 / d2 Ø 23,9
 Thread: M30 x 1,5 RHT
 3093647, 3097999, 21263821

**VL-ES-8414**

Length: 136
 Cone Ø: d1 Ø 32 / d2 Ø 27
 Thread: M30 x 1,5 LHT
 20710008

**VL-ES-10360**

Length: 136
 Cone Ø: d1 Ø 32 / d2 Ø 27
 Thread: M30 x 1,5 RHT
 20581089

**VL-RK-8533**

Ø: 85 Hole Distance: 130
 Thick/Height: 30
 3093630, 3093631, 20840815, 21295230,
 7420840815

**VL-RK-9497**

Ø: 95 Hole Distance: 130
 Thick/Height: 35
 273612, 20702095

**VL-VB-7787**

Length: 671 Ø: 58
 Hole Distance: 130 / 130
 143167, 1076639, 1626896, 1629734,
 20392649, 20829503, 21295227, 21474441,
 22318834, 7421295227

**VL-VB-12460**

Length: 662 Ø: 50
 Hole Distance: 115 / 115
 2223852, 20589061





FM ...

FM 340 ...	09/05→	Suspension Strut Repair Kit		MN-RK-8501	
	09/05→	Suspension Strut Repair Kit	VL-RK-8533		
	09/05→	Tie Rod	VL-DL-8305		Leaf Spring Axle
	09/05→	Tie Rod	VL-DL-9492		
	09/05→	Tie Rod	VL-DL-12355		
	09/05→	Tie Rod	VL-DL-12358		
	09/05→	Tie Rod End	VL-ES-5347		for Steering Rod
	09/05→	Tie Rod End	VL-ES-5348		for Steering Rod
	09/05→	Tie Rod End	VL-ES-8411		
	09/05→	Tie Rod End	VL-ES-8414		for Guide Rod
	09/05→	Tie Rod End	VL-ES-10360		for Steering Rod
	09/05→	Track Control Arm		RV-DL-10299	Trailing Arm, 1st & 2nd Drive Axle, for Leaf-Spring Suspension vehicles
	09/05→	Track Control Arm		RV-DL-10299	Trailing Arm, 1st RA;2nd RA; Leaf Spring Axle;Unit
	09/05→	Track Control Arm		RV-TC-12339	Suspension Rod, Trailing Arm
	09/05→	Track Control Arm		RV-TC-12340	Trailing Arm
	09/05→	Track Control Arm		RV-VB-8191	Wishbone (CV)
	09/05→	Track Control Arm		RV-VB-8191	Wishbone (CV), Air Suspension Axle
	09/05→	Track Control Arm		VL-DL-8180	Trailing Arm
	09/05→	Track Control Arm		VL-VB-7787	Wishbone (CV)
	09/05→	Track Control Arm		VL-VB-12460	Wishbone (CV)
	09/05→	Track Control Arm		VL-VB-12460	Wishbone (CV), 1st & 2nd Drive Axle, for Leaf-Spring Suspension vehicles
	09/05→	Track Control Arm		VL-VB-12460	Wishbone (CV), 1st & 2nd Drive Axle, for Pneumatic Suspension vehicles
	09/05→	Track Control Arm		VL-VB-12460	Wishbone (CV), 1st Drive Axle, for Pneumatic Suspension vehicles
	09/05→	Track Control Arm		VL-VB-12460	Wishbone (CV), Trailing Axle not Steered, for Pneumatic Suspension vehicles
	09/05→	Track Control Arm		VL-VB-12460	Wishbone (CV), Trailing Axle Steered, for Pneumatic Suspension vehicles
	09/05→	Track Control Arm		VL-VB-12460	Wishbone (CV), Trailing Axle Steered/not Steered, for Pneumatic Suspension vehicles
	09/05→	Track Control Arm	VL-DL-10309	VL-DL-10309	Trailing Arm, Air Suspension Axle
FM 360	09/05→	Centre Rod	VL-DL-8194		Push Rod
	09/05→	Centre Rod	VL-DL-8566		Push Rod
	09/05→	Centre Rod	VL-DL-10228		Push Rod, 1st FA;2nd FA
	09/05→	Centre Rod	VL-DL-12367		for Steering Rod
	09/05→	Centre Rod	VL-DL-12454		for Steering Rod
	09/05→	Centre Rod	VL-DL-12483		Push Rod
	09/05→	Centre Rod	VL-DL-12484		Push Rod
	09/05→	Stabiliser Link		VL-DL-9472	Coupling Rod
	09/05→	Stabiliser Link	VL-DL-12356		Coupling Rod
	09/05→	Suspension Arm Repair Kit		VL-RK-9497	for Drag Link
	09/05→	Suspension Arm Repair Kit		VL-RK-9497	for Drag Link, Leaf Spring Axle
	09/05→	Suspension Strut Repair Kit		MN-RK-8501	
	09/05→	Suspension Strut Repair Kit	VL-RK-8533		
	09/05→	Tie Rod	VL-DL-12358		
	09/05→	Tie Rod End	VL-ES-5347		for Steering Rod
	09/05→	Tie Rod End	VL-ES-5348		for Steering Rod
	09/05→	Tie Rod End	VL-ES-8411		
	09/05→	Tie Rod End	VL-ES-8414		for Guide Rod
	09/05→	Tie Rod End	VL-ES-10360		for Steering Rod
	09/05→	Track Control Arm		RV-DL-10299	Trailing Arm, 1st & 2nd Drive Axle, for Leaf-Spring Suspension vehicles
	09/05→	Track Control Arm		RV-DL-10299	Trailing Arm, 1st RA;2nd RA; Leaf Spring Axle;Unit
	09/05→	Track Control Arm		RV-TC-12339	Suspension Rod, Trailing Arm
	09/05→	Track Control Arm		RV-TC-12340	Trailing Arm
	09/05→	Track Control Arm		RV-VB-8191	Wishbone (CV)
	09/05→	Track Control Arm		VL-DL-8180	Trailing Arm
	09/05→	Track Control Arm		VL-VB-7787	Wishbone (CV)

MN-RK-8501

Ø: 75 Hole Distance: 115
Thick/Height: 24
20547286



RV-DL-10299

Length: 510 Ø: 21
20522934, 21051052, 7420864583,
7421051052



RV-TC-12339

Length: 515
Hole Distance: 13 / 130
20532931, 21051046



RV-TC-12340

Length: 510
Hole Distance: 115 / 115
20443044



RV-VB-8191

Length: 662,4 Ø: 48
Hole Distance: 115 / 115
20367004, 20507262, 20741695, 20741703,
22318833



VL-DL-8180

Length: 625 Ø: 17
20374444, 20410530, 20509018, 20517494,
70371270



VL-DL-8194

Length: 824 Ø: 50
Cone Ø: d1 Ø 28,6 / d2 Ø 23,9
20375787, 21106933



VL-DL-8305

Length: 1634 Ø: 50
Cone Ø: d1 Ø 28,6 / d2 Ø 23,9
3198276, 21260274



VL-DL-8566

Length: 863 Ø: 52
Cone Ø: d1 Ø 28,6 / d2 Ø 23,9
20375556, 20393187, 21106952, 21406952



VL-DL-9472

Length: 435 Ø: 36
Cone Ø: d1 Ø 32,2 / d2 Ø 28
20443061, 20443065, 20994418



VL-DL-9492

Length: 1660 Ø: 62
Cone Ø: d1 Ø 32 / d2 Ø 27
20587731, 21106938



VL-DL-10228

Length: 2139 Ø: 62
Cone Ø: d1 Ø 28,6 / d2 Ø 23,9
20453063



VL-DL-10309

Length: 799 Ø: 48
Hole Distance: 115 / 115
20410053, 21106157



VL-DL-12355

Length: 368 Ø: 38
Cone Ø: d1 Ø 28,6 / d2 Ø 23,9
1628207



VL-DL-12356

Length: 275 Ø: 30
Cone Ø: d1 Ø 22
3987423, 20477803



VL-DL-12358

Length: 1669 Ø: 42
Cone Ø: d1 Ø 32 / d2 Ø 27
Thread: M32 x 1,5 RHT / M32 x 1,5 LHT
20581086, 7420581086



VL-DL-12367

Length: 2139 Ø: 62
Cone Ø: d1 Ø 28,6 / d2 Ø 23,9
Thread: M52 x 1,5 RHT
20453064, 20584291



VL-DL-12454

Length: 2339 Ø: 62
Cone Ø: d1 Ø 28,6 / d2 Ø 23,9
20581632



VL-DL-12483

Length: 485 Ø: 48
Cone Ø: d1 Ø 28,6 / d2 Ø 23,9
20383081, 21260283, 22159761,
81467106355



VL-DL-12484

Length: 1025 Ø: 48
Cone Ø: d1 Ø 28,6 / d2 Ø 23,9
2038308, 21252481



VL-ES-5347

Length: 125
Cone Ø: d1 Ø 28,6 / d2 Ø 23,9
Thread: M30 x 1,5 LHT
1507822, 1698847, 3092471



VL-ES-5348

Length: 125
Cone Ø: d1 Ø 28,6 / d2 Ø 23,9
Thread: M30 x 1,5 RHT
1507823, 1698846, 3092472



VL-ES-8411

Length: 140
Cone Ø: d1 Ø 28,6 / d2 Ø 23,9
Thread: M30 x 1,5 RHT
3093647, 3097999, 21263821



VL-ES-8414

Length: 136
Cone Ø: d1 Ø 32 / d2 Ø 27
Thread: M30 x 1,5 LHT
20710008



VL-ES-10360

Length: 136
Cone Ø: d1 Ø 32 / d2 Ø 27
Thread: M30 x 1,5 RHT
20581089



VL-RK-8533

Ø: 85 Hole Distance: 130
Thick/Height: 30
3093630, 3093631, 20840815, 21295230,
7420840815



VL-RK-9497

Ø: 95 Hole Distance: 130
Thick/Height: 35
273612, 20702095



VL-VB-7787

Length: 671 Ø: 58
Hole Distance: 130 / 130
143167, 1076639, 1626896, 1629734,
20392649, 20829503, 21295227, 21474441,
22318834, 7421295227



VL-VB-12460

Length: 662 Ø: 50
Hole Distance: 115 / 115
2223852, 20589061





FM ...

FM 360 ...	09/05→	Track Control Arm		VL-VB-12460	Wishbone (CV)
	09/05→	Track Control Arm		VL-VB-12460	Wishbone (CV), 1st & 2nd Drive Axle, for Leaf-Spring Suspension vehicles
	09/05→	Track Control Arm		VL-VB-12460	Wishbone (CV), 1st & 2nd Drive Axle, for Pneumatic Suspension vehicles
	09/05→	Track Control Arm		VL-VB-12460	Wishbone (CV), 1st Drive Axle, for Pneumatic Suspension vehicles
	09/05→	Track Control Arm		VL-VB-12460	Wishbone (CV), Trailing Axle not Steered, for Pneumatic Suspension vehicles
	09/05→	Track Control Arm		VL-VB-12460	Wishbone (CV), Trailing Axle Steered, for Pneumatic Suspension vehicles
	09/05→	Track Control Arm		VL-VB-12460	Wishbone (CV), Trailing Axle Steered/not Steered, for Pneumatic Suspension vehicles
	09/05→	Track Control Arm	VL-DL-10309	VL-DL-10309	Trailing Arm, 1st Front Axle, for Pneumatic Suspension vehicles
FM 370	09/05→	Centre Rod	VL-DL-8194		Push Rod
	09/05→	Centre Rod	VL-DL-8566		Push Rod
	09/05→	Centre Rod	VL-DL-10228		Push Rod, 1st FA;2nd FA
	09/05→	Centre Rod	VL-DL-12367		for Steering Rod
	09/05→	Centre Rod	VL-DL-12454		for Steering Rod
	09/05→	Stabiliser Link		VL-DL-9472	Coupling Rod
	09/05→	Stabiliser Link	VL-DL-12356		Coupling Rod
	09/05→	Suspension Arm Repair Kit		VL-RK-9497	for Drag Link
	09/05→	Suspension Arm Repair Kit		VL-RK-9497	for Drag Link, Leaf Spring Axle
	09/05→	Suspension Strut Repair Kit		MN-RK-8501	
	09/05→	Suspension Strut Repair Kit	VL-RK-8533		
	09/05→	Tie Rod	VL-DL-12355		
	09/05→	Tie Rod	VL-DL-12358		
	09/05→	Tie Rod End	VL-ES-5347		for Steering Rod
	09/05→	Tie Rod End	VL-ES-5348		for Steering Rod
	09/05→	Tie Rod End	VL-ES-8411		
	09/05→	Tie Rod End	VL-ES-8414		for Guide Rod
	09/05→	Tie Rod End	VL-ES-10360		for Steering Rod
	09/05→	Track Control Arm		RV-DL-10299	Trailing Arm, 1st RA;2nd RA; Leaf Spring Axle;Unit
	09/05→	Track Control Arm		RV-TC-12339	Suspension Rod, Trailing Arm
	09/05→	Track Control Arm		RV-TC-12340	Trailing Arm
	09/05→	Track Control Arm		RV-VB-8191	Wishbone (CV)
	09/05→	Track Control Arm		VL-DL-8180	Trailing Arm
	09/05→	Track Control Arm		VL-VB-7787	Wishbone (CV)
	09/05→	Track Control Arm		VL-VB-12460	Wishbone (CV)
	09/05→	Track Control Arm		VL-VB-12460	Wishbone (CV), 1st & 2nd Drive Axle, for Leaf-Spring Suspension vehicles
	09/05→	Track Control Arm		VL-VB-12460	Wishbone (CV), 1st & 2nd Drive Axle, for Pneumatic Suspension vehicles
	09/05→	Track Control Arm		VL-VB-12460	Wishbone (CV), 1st Drive Axle, for Pneumatic Suspension vehicles
	09/05→	Track Control Arm		VL-VB-12460	Wishbone (CV), Trailing Axle not Steered, for Pneumatic Suspension vehicles
	09/05→	Track Control Arm		VL-VB-12460	Wishbone (CV), Trailing Axle Steered, for Pneumatic Suspension vehicles
09/05→	Track Control Arm		VL-VB-12460	Wishbone (CV), Trailing Axle Steered/not Steered, for Pneumatic Suspension vehicles	
FM 380	09/05→	Centre Rod	RV-DL-12320		for Steering Rod
	09/05→	Centre Rod	VL-DL-8194		Push Rod
	09/05→	Centre Rod	VL-DL-8407		Push Rod, Leaf Spring Axle
	09/05→	Centre Rod	VL-DL-8566		Push Rod
	09/05→	Centre Rod	VL-DL-8707		Push Rod, Air Suspension Axle
	09/05→	Centre Rod	VL-DL-10228		Push Rod, 1st FA;2nd FA
	09/05→	Centre Rod	VL-DL-12367		for Steering Rod
	09/05→	Centre Rod	VL-DL-12454		for Steering Rod
	09/05→	Centre Rod	VL-DL-12483		Push Rod
	09/05→	Centre Rod	VL-DL-12484		Push Rod

MN-RK-8501

Ø: 75 Hole Distance: 115
 Thick/Height: 24
 20547286

**RV-DL-10299**

Length: 510 Ø: 21
 20522934, 21051052, 7420864583,
 7421051052

**RV-DL-12320**

Length: 881 Ø: 50
 Cone Ø: d1 Ø 28,6 / d2 Ø 23,9
 20390746, 21106968

**RV-TC-12339**

Length: 515
 Hole Distance: 13 / 130
 20532931, 21051046

**RV-TC-12340**

Length: 510
 Hole Distance: 115 / 115
 20443044

**RV-VB-8191**

Length: 662,4 Ø: 48
 Hole Distance: 115 / 115
 20367004, 20507262, 20741695, 20741703,
 22318833

**VL-DL-8180**

Length: 625 Ø: 17
 20374444, 20410530, 20509018, 20517494,
 70371270

**VL-DL-8194**

Length: 824 Ø: 50
 Cone Ø: d1 Ø 28,6 / d2 Ø 23,9
 20375787, 21106933

**VL-DL-8407**

Length: 870 Ø: 52
 Cone Ø: d1 Ø 28,6 / d2 Ø 23,9
 3986452, 20375555, 20393186, 21106930

**VL-DL-8566**

Length: 863 Ø: 52
 Cone Ø: d1 Ø 28,6 / d2 Ø 23,9
 20375556, 20393187, 21106952, 21406952

**VL-DL-8707**

Length: 885 Ø: 50
 Cone Ø: d1 Ø 28,6 / d2 Ø 23,9
 20390745, 21106936

**VL-DL-9472**

Length: 435 Ø: 36
 Cone Ø: d1 Ø 32,2 / d2 Ø 28
 20443061, 20443065, 20994418

**VL-DL-10228**

Length: 2139 Ø: 62
 Cone Ø: d1 Ø 28,6 / d2 Ø 23,9
 20453063

**VL-DL-10309**

Length: 799 Ø: 48
 Hole Distance: 115 / 115
 20410053, 21106157

**VL-DL-12355**

Length: 368 Ø: 38
 Cone Ø: d1 Ø 28,6 / d2 Ø 23,9
 1628207

**VL-DL-12356**

Length: 275 Ø: 30
 Cone Ø: d1 Ø 22
 3987423, 20477803

**VL-DL-12358**

Length: 1669 Ø: 42
 Cone Ø: d1 Ø 32 / d2 Ø 27
 Thread: M32 x 1,5 RHT / M32 x 1,5 LHT
 20581086, 7420581086

**VL-DL-12367**

Length: 2139 Ø: 62
 Cone Ø: d1 Ø 28,6 / d2 Ø 23,9
 Thread: M52 x 1,5 RHT
 20453064, 20584291

**VL-DL-12454**

Length: 2339 Ø: 62
 Cone Ø: d1 Ø 28,6 / d2 Ø 23,9
 20581632

**VL-DL-12483**

Length: 485 Ø: 48
 Cone Ø: d1 Ø 28,6 / d2 Ø 23,9
 20383081, 21260283, 22159761,
 81467106355

**VL-DL-12484**

Length: 1025 Ø: 48
 Cone Ø: d1 Ø 28,6 / d2 Ø 23,9
 2038308, 21252481

**VL-ES-5347**

Length: 125
 Cone Ø: d1 Ø 28,6 / d2 Ø 23,9
 Thread: M30 x 1,5 LHT
 1507822, 1698847, 3092471

**VL-ES-5348**

Length: 125
 Cone Ø: d1 Ø 28,6 / d2 Ø 23,9
 Thread: M30 x 1,5 RHT
 1507823, 1698846, 3092472

**VL-ES-8411**

Length: 140
 Cone Ø: d1 Ø 28,6 / d2 Ø 23,9
 Thread: M30 x 1,5 RHT
 3093647, 3097999, 21263821

**VL-ES-8414**

Length: 136
 Cone Ø: d1 Ø 32 / d2 Ø 27
 Thread: M30 x 1,5 LHT
 20710008

**VL-ES-10360**

Length: 136
 Cone Ø: d1 Ø 32 / d2 Ø 27
 Thread: M30 x 1,5 RHT
 20581089

**VL-RK-8533**

Ø: 85 Hole Distance: 130
 Thick/Height: 30
 3093630, 3093631, 20840815, 21295230,
 7420840815

**VL-RK-9497**

Ø: 95 Hole Distance: 130
 Thick/Height: 35
 273612, 20702095

**VL-VB-7787**

Length: 671 Ø: 58
 Hole Distance: 130 / 130
 143167, 1076639, 1626896, 1629734,
 20392649, 20829503, 21295227, 21474441,
 22318834, 7421295227

**VL-VB-12460**

Length: 662 Ø: 50
 Hole Distance: 115 / 115
 2223852, 20589061





FM ...

FM 380 ...

09/05→	Stabiliser Link		VL-DL-9472	Coupling Rod
09/05→	Stabiliser Link	VL-DL-12356		Coupling Rod
09/05→	Suspension Arm Repair Kit		VL-RK-9497	for Drag Link
09/05→	Suspension Arm Repair Kit		VL-RK-9497	for Drag Link, Leaf Spring Axle
09/05→	Suspension Strut Repair Kit		MN-RK-8501	
09/05→	Suspension Strut Repair Kit	VL-RK-8533		
09/05→	Tie Rod	VL-DL-8305		Leaf Spring Axle
09/05→	Tie Rod	VL-DL-9492		
09/05→	Tie Rod	VL-DL-12355		
09/05→	Tie Rod	VL-DL-12358		
09/05→	Tie Rod End	VL-ES-5347		for Steering Rod
09/05→	Tie Rod End	VL-ES-5348		for Steering Rod
09/05→	Tie Rod End	VL-ES-8411		
09/05→	Tie Rod End	VL-ES-8414		for Guide Rod
09/05→	Tie Rod End	VL-ES-10360		for Steering Rod
09/05→	Track Control Arm		RV-DL-10299	Trailing Arm, 1st & 2nd Drive Axle, for Leaf-Spring Suspension vehicles
09/05→	Track Control Arm		RV-DL-10299	Trailing Arm, 1st RA;2nd RA; Leaf Spring Axle;Unit
09/05→	Track Control Arm		RV-TC-12339	Suspension Rod, Trailing Arm
09/05→	Track Control Arm		RV-TC-12340	Trailing Arm
09/05→	Track Control Arm		RV-VB-8191	Wishbone (CV)
09/05→	Track Control Arm		RV-VB-8191	Wishbone (CV), Air Suspension Axle
09/05→	Track Control Arm		VL-DL-8180	Trailing Arm
09/05→	Track Control Arm		VL-VB-7787	Wishbone (CV)
09/05→	Track Control Arm		VL-VB-12460	Wishbone (CV)
09/05→	Track Control Arm		VL-VB-12460	Wishbone (CV), 1st & 2nd Drive Axle, for Leaf-Spring Suspension vehicles
09/05→	Track Control Arm		VL-VB-12460	Wishbone (CV), 1st & 2nd Drive Axle, for Pneumatic Suspension vehicles
09/05→	Track Control Arm		VL-VB-12460	Wishbone (CV), 1st Drive Axle, for Pneumatic Suspension vehicles
09/05→	Track Control Arm		VL-VB-12460	Wishbone (CV), Trailing Axle not Steered, for Pneumatic Suspension vehicles
09/05→	Track Control Arm		VL-VB-12460	Wishbone (CV), Trailing Axle Steered, for Pneumatic Suspension vehicles
09/05→	Track Control Arm		VL-VB-12460	Wishbone (CV), Trailing Axle Steered/not Steered, for Pneumatic Suspension vehicles
09/05→	Track Control Arm	VL-DL-10309	VL-DL-10309	Trailing Arm, 1st Front Axle, for Pneumatic Suspension vehicles
09/05→	Track Control Arm	VL-DL-10309	VL-DL-10309	Trailing Arm, Air Suspension Axle
04/12→	Track Control Arm		RV-VB-8191	Wishbone (CV), 1st Drive Axle, for Pneumatic Suspension vehicles
04/12→	Track Control Arm		RV-VB-8191	Wishbone (CV), Trailing Axle not Steered, for Pneumatic Suspension vehicles
04/12→	Track Control Arm		RV-VB-8191	Wishbone (CV), Trailing Axle Steered, for Pneumatic Suspension vehicles
04/12→	Track Control Arm		VL-DL-8180	Trailing Arm, 1st Drive Axle, for Pneumatic Suspension vehicles
04/12→	Track Control Arm		VL-DL-8180	Trailing Arm, Trailing Axle not Steered, for Pneumatic Suspension vehicles
04/12→	Track Control Arm		VL-DL-8180	Trailing Arm, Trailing Axle Steered, for Pneumatic Suspension vehicles
FM 390	06/08→	Centre Rod	VL-DL-12483	Push Rod
	06/08→	Centre Rod	VL-DL-12484	Push Rod
	06/08→	Stabiliser Link		VL-DL-9472 Coupling Rod
	06/08→	Stabiliser Link	VL-DL-12356	Coupling Rod
	06/08→	Suspension Strut Repair Kit		MN-RK-8501
	06/08→	Tie Rod	VL-DL-12358	
	06/08→	Tie Rod End		VL-ES-8411
	06/08→	Tie Rod End	VL-ES-5347	for Steering Rod
	06/08→	Tie Rod End	VL-ES-5348	for Steering Rod
	06/08→	Tie Rod End	VL-ES-8414	for Guide Rod

MN-RK-8501

Ø: 75 Hole Distance: 115
Thick/Height: 24
20547286

**RV-DL-10299**

Length: 510 Ø: 21
20522934, 21051052, 7420864583,
7421051052

**RV-TC-12339**

Length: 515
Hole Distance: 13 / 130
20532931, 21051046

**RV-TC-12340**

Length: 510
Hole Distance: 115 / 115
20443044

**RV-VB-8191**

Length: 662,4 Ø: 48
Hole Distance: 115 / 115
20367004, 20507262, 20741695, 20741703,
22318833

**VL-DL-8180**

Length: 625 Ø: 17
20374444, 20410530, 20509018, 20517494,
70371270

**VL-DL-8305**

Length: 1634 Ø: 50
Cone Ø: d1 Ø 28,6 / d2 Ø 23,9
3198276, 21260274

**VL-DL-9472**

Length: 435 Ø: 36
Cone Ø: d1 Ø 32,2 / d2 Ø 28
20443061, 20443065, 20994418

**VL-DL-9492**

Length: 1660 Ø: 62
Cone Ø: d1 Ø 32 / d2 Ø 27
20587731, 21106938

**VL-DL-10309**

Length: 799 Ø: 48
Hole Distance: 115 / 115
20410053, 21106157

**VL-DL-12355**

Length: 368 Ø: 38
Cone Ø: d1 Ø 28,6 / d2 Ø 23,9
1628207

**VL-DL-12356**

Length: 275 Ø: 30
Cone Ø: d1 Ø 22
3987423, 20477803

**VL-DL-12358**

Length: 1669 Ø: 42
Cone Ø: d1 Ø 32 / d2 Ø 27
Thread: M32 x 1,5 RHT / M32 x 1,5 LHT
20581086, 7420581086

**VL-DL-12483**

Length: 485 Ø: 48
Cone Ø: d1 Ø 28,6 / d2 Ø 23,9
20383081, 21260283, 22159761,
81467106355

**VL-DL-12484**

Length: 1025 Ø: 48
Cone Ø: d1 Ø 28,6 / d2 Ø 23,9
2038308, 21252481

**VL-ES-5347**

Length: 125
Cone Ø: d1 Ø 28,6 / d2 Ø 23,9
Thread: M30 x 1,5 LHT
1507822, 1698847, 3092471

**VL-ES-5348**

Length: 125
Cone Ø: d1 Ø 28,6 / d2 Ø 23,9
Thread: M30 x 1,5 RHT
1507823, 1698846, 3092472

**VL-ES-8411**

Length: 140
Cone Ø: d1 Ø 28,6 / d2 Ø 23,9
Thread: M30 x 1,5 RHT
3093647, 3097999, 21263821

**VL-ES-8414**

Length: 136
Cone Ø: d1 Ø 32 / d2 Ø 27
Thread: M30 x 1,5 LHT
20710008

**VL-ES-10360**

Length: 136
Cone Ø: d1 Ø 32 / d2 Ø 27
Thread: M30 x 1,5 RHT
20581089

**VL-RK-8533**

Ø: 85 Hole Distance: 130
Thick/Height: 30
3093630, 3093631, 20840815, 21295230,
7420840815

**VL-RK-9497**

Ø: 95 Hole Distance: 130
Thick/Height: 35
273612, 20702095

**VL-VB-7787**

Length: 671 Ø: 58
Hole Distance: 130 / 130
143167, 1076639, 1626896, 1629734,
20392649, 20829503, 21295227, 21474441,
22318834, 7421295227

**VL-VB-12460**

Length: 662 Ø: 50
Hole Distance: 115 / 115
2223852, 20589061





FM ...

FM 390 ...	06/08 →	Tie Rod End	VL-ES-10360		for Steering Rod
	06/08 →	Track Control Arm		RV-DL-10299	Trailing Arm, 1st & 2nd Drive Axle, for Leaf-Spring Suspension vehicles
	06/08 →	Track Control Arm		RV-TC-12339	Suspension Rod, Trailing Arm, 1st & 2nd Drive Axle, for Leaf-Spring Suspension vehicles
	06/08 →	Track Control Arm		RV-TC-12340	Trailing Arm
	06/08 →	Track Control Arm		RV-VB-8191	Wishbone (CV), 1st & 2nd Drive Axle, for Pneumatic Suspension vehicles
	06/08 →	Track Control Arm		RV-VB-8191	Wishbone (CV), 1st Drive Axle, for Pneumatic Suspension vehicles
	06/08 →	Track Control Arm		RV-VB-8191	Wishbone (CV), Trailing Axle not Steered, for Pneumatic Suspension vehicles
	06/08 →	Track Control Arm		VL-DL-8180	Trailing Arm
	06/08 →	Track Control Arm		VL-VB-7787	Wishbone (CV), 1st & 2nd Drive Axle, for Leaf-Spring Suspension vehicles
	06/08 →	Track Control Arm		VL-VB-12460	Wishbone (CV)
FM 400	09/05 →	Centre Rod	RV-DL-12320		for Steering Rod
	09/05 →	Centre Rod	VL-DL-8194		Push Rod
	09/05 →	Centre Rod	VL-DL-8407		Push Rod, Leaf Spring Axle
	09/05 →	Centre Rod	VL-DL-8566		Push Rod
	09/05 →	Centre Rod	VL-DL-8707		Push Rod, Air Suspension Axle
	09/05 →	Centre Rod	VL-DL-10228		Push Rod, 1st FA;2nd FA
	09/05 →	Centre Rod	VL-DL-12367		for Steering Rod
	09/05 →	Centre Rod	VL-DL-12454		for Steering Rod
	09/05 →	Centre Rod	VL-DL-12483		Push Rod
	09/05 →	Centre Rod	VL-DL-12484		Push Rod
	09/05 →	Stabiliser Link		VL-DL-9472	Coupling Rod
	09/05 →	Stabiliser Link	VL-DL-12356		Coupling Rod
	09/05 →	Suspension Arm Repair Kit		VL-RK-9497	for Drag Link
	09/05 →	Suspension Arm Repair Kit		VL-RK-9497	for Drag Link, Leaf Spring Axle
	09/05 →	Suspension Strut Repair Kit		MN-RK-8501	
	09/05 →	Suspension Strut Repair Kit		MN-RK-12436	
	09/05 →	Suspension Strut Repair Kit	VL-RK-8533		
	09/05 →	Tie Rod	VL-DL-8305		Leaf Spring Axle
	09/05 →	Tie Rod	VL-DL-9492		
	09/05 →	Tie Rod	VL-DL-12358		
	09/05 →	Tie Rod End	VL-ES-5347		for Steering Rod
	09/05 →	Tie Rod End	VL-ES-5348		for Steering Rod
	09/05 →	Tie Rod End	VL-ES-8411		
	09/05 →	Tie Rod End	VL-ES-8414		for Guide Rod
	09/05 →	Tie Rod End	VL-ES-10360		for Steering Rod
	09/05 →	Track Control Arm		RV-DL-10299	Trailing Arm, 1st & 2nd Drive Axle, for Leaf-Spring Suspension vehicles
	09/05 →	Track Control Arm		RV-DL-10299	Trailing Arm, 1st RA;2nd RA; Leaf Spring Axle;Unit
	09/05 →	Track Control Arm		RV-TC-12339	Suspension Rod, Trailing Arm
	09/05 →	Track Control Arm		RV-TC-12340	Trailing Arm
	09/05 →	Track Control Arm		RV-VB-8191	Wishbone (CV)
	09/05 →	Track Control Arm		RV-VB-8191	Wishbone (CV), Air Suspension Axle
	09/05 →	Track Control Arm		VL-DL-8180	Trailing Arm
	09/05 →	Track Control Arm		VL-VB-7787	Wishbone (CV)
	09/05 →	Track Control Arm		VL-VB-12460	Wishbone (CV)
	09/05 →	Track Control Arm		VL-VB-12460	Wishbone (CV), 1st & 2nd Drive Axle, for Leaf-Spring Suspension vehicles
	09/05 →	Track Control Arm		VL-VB-12460	Wishbone (CV), 1st & 2nd Drive Axle, for Pneumatic Suspension vehicles
09/05 →	Track Control Arm		VL-VB-12460	Wishbone (CV), 1st Drive Axle, for Pneumatic Suspension vehicles	
09/05 →	Track Control Arm		VL-VB-12460	Wishbone (CV), Trailing Axle not Steered, for Pneumatic Suspension vehicles	
09/05 →	Track Control Arm		VL-VB-12460	Wishbone (CV), Trailing Axle Steered, for Pneumatic Suspension vehicles	

MN-RK-8501

Ø: 75 Hole Distance: 115
Thick/Height: 24
20547286

**MN-RK-12436**

Ø: 75 Hole Distance: 115
Thick/Height: 24
3093462, 85104224

**RV-DL-10299**

Length: 510 Ø: 21
20522934, 21051052, 7420864583,
7421051052

**RV-DL-12320**

Length: 881 Ø: 50
Cone Ø: d1 Ø 28,6 / d2 Ø 23,9
20390746, 21106968

**RV-TC-12339**

Length: 515
Hole Distance: 13 / 130
20532931, 21051046

**RV-TC-12340**

Length: 510
Hole Distance: 115 / 115
20443044

**RV-VB-8191**

Length: 662,4 Ø: 48
Hole Distance: 115 / 115
20367004, 20507262, 20741695, 20741703,
22318833

**VL-DL-8180**

Length: 625 Ø: 17
20374444, 20410530, 20509018, 20517494,
70371270

**VL-DL-8194**

Length: 824 Ø: 50
Cone Ø: d1 Ø 28,6 / d2 Ø 23,9
20375787, 21106933

**VL-DL-8305**

Length: 1634 Ø: 50
Cone Ø: d1 Ø 28,6 / d2 Ø 23,9
3198276, 21260274

**VL-DL-8407**

Length: 870 Ø: 52
Cone Ø: d1 Ø 28,6 / d2 Ø 23,9
3986452, 20375555, 20393186, 21106930

**VL-DL-8566**

Length: 863 Ø: 52
Cone Ø: d1 Ø 28,6 / d2 Ø 23,9
20375556, 20393187, 21106952, 21406952

**VL-DL-8707**

Length: 885 Ø: 50
Cone Ø: d1 Ø 28,6 / d2 Ø 23,9
20390745, 21106936

**VL-DL-9472**

Length: 435 Ø: 36
Cone Ø: d1 Ø 32,2 / d2 Ø 28
20443061, 20443065, 20994418

**VL-DL-9492**

Length: 1660 Ø: 62
Cone Ø: d1 Ø 32 / d2 Ø 27
20587731, 21106938

**VL-DL-10228**

Length: 2139 Ø: 62
Cone Ø: d1 Ø 28,6 / d2 Ø 23,9
20453063

**VL-DL-12356**

Length: 275 Ø: 30
Cone Ø: d1 Ø 22
3987423, 20477803

**VL-DL-12358**

Length: 1669 Ø: 42
Cone Ø: d1 Ø 32 / d2 Ø 27
Thread: M32 x 1,5 RHT / M32 x 1,5 LHT
20581086, 7420581086

**VL-DL-12367**

Length: 2139 Ø: 62
Cone Ø: d1 Ø 28,6 / d2 Ø 23,9
Thread: M52 x 1,5 RHT
20453064, 20584291

**VL-DL-12454**

Length: 2339 Ø: 62
Cone Ø: d1 Ø 28,6 / d2 Ø 23,9
20581632

**VL-DL-12483**

Length: 485 Ø: 48
Cone Ø: d1 Ø 28,6 / d2 Ø 23,9
20383081, 21260283, 22159761,
81467106355

**VL-DL-12484**

Length: 1025 Ø: 48
Cone Ø: d1 Ø 28,6 / d2 Ø 23,9
2038308, 21252481

**VL-ES-5347**

Length: 125
Cone Ø: d1 Ø 28,6 / d2 Ø 23,9
Thread: M30 x 1,5 LHT
1507822, 1698847, 3092471

**VL-ES-5348**

Length: 125
Cone Ø: d1 Ø 28,6 / d2 Ø 23,9
Thread: M30 x 1,5 RHT
1507823, 1698846, 3092472

**VL-ES-8411**

Length: 140
Cone Ø: d1 Ø 28,6 / d2 Ø 23,9
Thread: M30 x 1,5 RHT
3093647, 3097999, 21263821

**VL-ES-8414**

Length: 136
Cone Ø: d1 Ø 32 / d2 Ø 27
Thread: M30 x 1,5 LHT
20710008

**VL-ES-10360**

Length: 136
Cone Ø: d1 Ø 32 / d2 Ø 27
Thread: M30 x 1,5 RHT
20581089

**VL-RK-8533**

Ø: 85 Hole Distance: 130
Thick/Height: 30
3093630, 3093631, 20840815, 21295230,
7420840815

**VL-RK-9497**

Ø: 95 Hole Distance: 130
Thick/Height: 35
273612, 20702095

**VL-VB-7787**

Length: 671 Ø: 58
Hole Distance: 130 / 130
143167, 1076639, 1626896, 1629734,
20392649, 20829503, 21295227, 21474441,
22318834, 7421295227

**VL-VB-12460**

Length: 662 Ø: 50
Hole Distance: 115 / 115
2223852, 20589061





FM ...

FM 400 ...	09/05 →	Track Control Arm		VL-VB-12460	Wishbone (CV), Trailing Axle Steered/not Steered, for Pneumatic Suspension vehicles	
	09/05 →	Track Control Arm	VL-DL-10309	VL-DL-10309	Trailing Arm, 1st Front Axle, for Pneumatic Suspension vehicles	
	09/05 →	Track Control Arm	VL-DL-10309	VL-DL-10309	Trailing Arm, Air Suspension Axle	
FM 410	09/05 →	Centre Rod	VL-DL-8194		Push Rod	
	09/05 →	Centre Rod	VL-DL-8566		Push Rod	
	09/05 →	Centre Rod	VL-DL-10228		Push Rod, 1st FA;2nd FA	
	09/05 →	Centre Rod	VL-DL-12367		for Steering Rod	
	09/05 →	Centre Rod	VL-DL-12454		for Steering Rod	
	09/05 →	Stabiliser Link		VL-DL-9472	Coupling Rod	
	09/05 →	Stabiliser Link	VL-DL-12356		Coupling Rod	
	09/05 →	Suspension Arm Repair Kit		VL-RK-9497	for Drag Link	
	09/05 →	Suspension Arm Repair Kit		VL-RK-9497	for Drag Link, Leaf Spring Axle	
	09/05 →	Suspension Strut Repair Kit		MN-RK-8501		
	09/05 →	Suspension Strut Repair Kit	VL-RK-8533			
	09/05 →	Tie Rod	VL-DL-12355			
	09/05 →	Tie Rod	VL-DL-12358			
	09/05 →	Tie Rod End	VL-ES-5347		for Steering Rod	
	09/05 →	Tie Rod End	VL-ES-5348		for Steering Rod	
	09/05 →	Tie Rod End	VL-ES-8411			
	09/05 →	Tie Rod End	VL-ES-8414		for Guide Rod	
	09/05 →	Tie Rod End	VL-ES-10360		for Steering Rod	
	09/05 →	Track Control Arm		RV-DL-10299	Trailing Arm, 1st RA;2nd RA; Leaf Spring Axle;Unit	
	09/05 →	Track Control Arm		RV-TC-12339	Suspension Rod, Trailing Arm	
	09/05 →	Track Control Arm		RV-TC-12340	Trailing Arm	
	09/05 →	Track Control Arm		RV-VB-8191	Wishbone (CV)	
	09/05 →	Track Control Arm		VL-DL-8180	Trailing Arm	
	09/05 →	Track Control Arm		VL-VB-7787	Wishbone (CV)	
	09/05 →	Track Control Arm		VL-VB-12460	Wishbone (CV)	
	09/05 →	Track Control Arm		VL-VB-12460	Wishbone (CV), 1st & 2nd Drive Axle, for Leaf-Spring Suspension vehicles	
	09/05 →	Track Control Arm		VL-VB-12460	Wishbone (CV), 1st & 2nd Drive Axle, for Pneumatic Suspension vehicles	
	09/05 →	Track Control Arm		VL-VB-12460	Wishbone (CV), 1st Drive Axle, for Pneumatic Suspension vehicles	
	09/05 →	Track Control Arm		VL-VB-12460	Wishbone (CV), Trailing Axle not Steered, for Pneumatic Suspension vehicles	
	09/05 →	Track Control Arm		VL-VB-12460	Wishbone (CV), Trailing Axle Steered, for Pneumatic Suspension vehicles	
	09/05 →	Track Control Arm		VL-VB-12460	Wishbone (CV), Trailing Axle Steered/not Steered, for Pneumatic Suspension vehicles	
	FM 420	09/05 →	Centre Rod	VL-DL-8194		Push Rod
		09/05 →	Centre Rod	VL-DL-8566		Push Rod
09/05 →		Centre Rod	VL-DL-10228		Push Rod, 1st FA;2nd FA	
09/05 →		Centre Rod	VL-DL-12367		for Steering Rod	
09/05 →		Centre Rod	VL-DL-12454		for Steering Rod	
09/05 →		Centre Rod	VL-DL-12483		Push Rod	
09/05 →		Centre Rod	VL-DL-12484		Push Rod	
09/05 →		Stabiliser Link		VL-DL-9472	Coupling Rod	
09/05 →		Stabiliser Link	VL-DL-12356		Coupling Rod	
09/05 →		Suspension Arm Repair Kit		VL-RK-9497	for Drag Link	
09/05 →		Suspension Arm Repair Kit		VL-RK-9497	for Drag Link, Leaf Spring Axle	
09/05 →		Suspension Strut Repair Kit		MN-RK-8501		
09/05 →		Suspension Strut Repair Kit	VL-RK-8533			
09/05 →		Tie Rod	VL-DL-12358			
09/05 →		Tie Rod End	VL-ES-5347		for Steering Rod	
09/05 →		Tie Rod End	VL-ES-5348		for Steering Rod	
09/05 →		Tie Rod End	VL-ES-8411			
09/05 →		Tie Rod End	VL-ES-8414		for Guide Rod	
09/05 →		Tie Rod End	VL-ES-10360		for Steering Rod	

MN-RK-8501

Ø: 75 Hole Distance: 115
Thick/Height: 24
20547286

**RV-DL-10299**

Length: 510 Ø: 21
20522934, 21051052, 7420864583,
7421051052

**RV-TC-12339**

Length: 515
Hole Distance: 13 / 130
20532931, 21051046

**RV-TC-12340**

Length: 510
Hole Distance: 115 / 115
20443044

**RV-VB-8191**

Length: 662,4 Ø: 48
Hole Distance: 115 / 115
20367004, 20507262, 20741695, 20741703,
22318833

**VL-DL-8180**

Length: 625 Ø: 17
20374444, 20410530, 20509018, 20517494,
70371270

**VL-DL-8194**

Length: 824 Ø: 50
Cone Ø: d1 Ø 28,6 / d2 Ø 23,9
20375787, 21106933

**VL-DL-8566**

Length: 863 Ø: 52
Cone Ø: d1 Ø 28,6 / d2 Ø 23,9
20375556, 20393187, 21106952, 21406952

**VL-DL-9472**

Length: 435 Ø: 36
Cone Ø: d1 Ø 32,2 / d2 Ø 28
20443061, 20443065, 20994418

**VL-DL-10228**

Length: 2139 Ø: 62
Cone Ø: d1 Ø 28,6 / d2 Ø 23,9
20453063

**VL-DL-10309**

Length: 799 Ø: 48
Hole Distance: 115 / 115
20410053, 21106157

**VL-DL-12355**

Length: 368 Ø: 38
Cone Ø: d1 Ø 28,6 / d2 Ø 23,9
1628207

**VL-DL-12356**

Length: 275 Ø: 30
Cone Ø: d1 Ø 22
3987423, 20477803

**VL-DL-12358**

Length: 1669 Ø: 42
Cone Ø: d1 Ø 32 / d2 Ø 27
Thread: M32 x 1,5 RHT / M32 x 1,5 LHT
20581086, 7420581086

**VL-DL-12367**

Length: 2139 Ø: 62
Cone Ø: d1 Ø 28,6 / d2 Ø 23,9
Thread: M52 x 1,5 RHT
20453064, 20584291

**VL-DL-12454**

Length: 2339 Ø: 62
Cone Ø: d1 Ø 28,6 / d2 Ø 23,9
20581632

**VL-DL-12483**

Length: 485 Ø: 48
Cone Ø: d1 Ø 28,6 / d2 Ø 23,9
20383081, 21260283, 22159761,
81467106355

**VL-DL-12484**

Length: 1025 Ø: 48
Cone Ø: d1 Ø 28,6 / d2 Ø 23,9
2038308, 21252481

**VL-ES-5347**

Length: 125
Cone Ø: d1 Ø 28,6 / d2 Ø 23,9
Thread: M30 x 1,5 LHT
1507822, 1698847, 3092471

**VL-ES-5348**

Length: 125
Cone Ø: d1 Ø 28,6 / d2 Ø 23,9
Thread: M30 x 1,5 RHT
1507823, 1698846, 3092472

**VL-ES-8411**

Length: 140
Cone Ø: d1 Ø 28,6 / d2 Ø 23,9
Thread: M30 x 1,5 RHT
3093647, 3097999, 21263821

**VL-ES-8414**

Length: 136
Cone Ø: d1 Ø 32 / d2 Ø 27
Thread: M30 x 1,5 LHT
20710008

**VL-ES-10360**

Length: 136
Cone Ø: d1 Ø 32 / d2 Ø 27
Thread: M30 x 1,5 RHT
20581089

**VL-RK-8533**

Ø: 85 Hole Distance: 130
Thick/Height: 30
3093630, 3093631, 20840815, 21295230,
7420840815

**VL-RK-9497**

Ø: 95 Hole Distance: 130
Thick/Height: 35
273612, 20702095

**VL-VB-7787**

Length: 671 Ø: 58
Hole Distance: 130 / 130
143167, 1076639, 1626896, 1629734,
20392649, 20829503, 21295227, 21474441,
22318834, 7421295227

**VL-VB-12460**

Length: 662 Ø: 50
Hole Distance: 115 / 115
2223852, 20589061





FM ...

FM 420 ...	09/05→	Track Control Arm		RV-DL-10299	Trailing Arm, 1st & 2nd Drive Axle, for Leaf-Spring Suspension vehicles
	09/05→	Track Control Arm		RV-DL-10299	Trailing Arm, 1st RA;2nd RA; Leaf Spring Axle;Unit
	09/05→	Track Control Arm		RV-TC-12339	Suspension Rod, Trailing Arm
	09/05→	Track Control Arm		RV-TC-12340	Trailing Arm
	09/05→	Track Control Arm		RV-VB-8191	Wishbone (CV)
	09/05→	Track Control Arm		VL-DL-8180	Trailing Arm
	09/05→	Track Control Arm		VL-VB-7787	Wishbone (CV)
	09/05→	Track Control Arm		VL-VB-12460	Wishbone (CV)
	09/05→	Track Control Arm		VL-VB-12460	Wishbone (CV), 1st & 2nd Drive Axle, for Leaf-Spring Suspension vehicles
	09/05→	Track Control Arm		VL-VB-12460	Wishbone (CV), 1st & 2nd Drive Axle, for Pneumatic Suspension vehicles
	09/05→	Track Control Arm		VL-VB-12460	Wishbone (CV), 1st Drive Axle, for Pneumatic Suspension vehicles
	09/05→	Track Control Arm		VL-VB-12460	Wishbone (CV), Trailing Axle not Steered, for Pneumatic Suspension vehicles
	09/05→	Track Control Arm		VL-VB-12460	Wishbone (CV), Trailing Axle Steered, for Pneumatic Suspension vehicles
	09/05→	Track Control Arm		VL-VB-12460	Wishbone (CV), Trailing Axle Steered/not Steered, for Pneumatic Suspension vehicles
	09/05→	Track Control Arm	VL-DL-10309	VL-DL-10309	Trailing Arm, 1st Front Axle, for Pneumatic Suspension vehicles
	04/12→	Track Control Arm		RV-VB-8191	Wishbone (CV), 1st Drive Axle, for Pneumatic Suspension vehicles
	04/12→	Track Control Arm		RV-VB-8191	Wishbone (CV), Trailing Axle not Steered, for Pneumatic Suspension vehicles
	04/12→	Track Control Arm		RV-VB-8191	Wishbone (CV), Trailing Axle Steered, for Pneumatic Suspension vehicles
	04/12→	Track Control Arm		VL-DL-8180	Trailing Arm, 1st Drive Axle, for Pneumatic Suspension vehicles
	04/12→	Track Control Arm		VL-DL-8180	Trailing Arm, Trailing Axle not Steered, for Pneumatic Suspension vehicles
	04/12→	Track Control Arm		VL-DL-8180	Trailing Arm, Trailing Axle Steered, for Pneumatic Suspension vehicles
FM 440	09/05→	Centre Rod	RV-DL-12320		for Steering Rod
	09/05→	Centre Rod	VL-DL-8194		Push Rod
	09/05→	Centre Rod	VL-DL-8407		Push Rod, Leaf Spring Axle
	09/05→	Centre Rod	VL-DL-8566		Push Rod
	09/05→	Centre Rod	VL-DL-8707		Push Rod, Air Suspension Axle
	09/05→	Centre Rod	VL-DL-10228		Push Rod, 1st FA;2nd FA
	09/05→	Centre Rod	VL-DL-12367		for Steering Rod
	09/05→	Centre Rod	VL-DL-12454		for Steering Rod
	09/05→	Centre Rod	VL-DL-12483		Push Rod
	09/05→	Centre Rod	VL-DL-12484		Push Rod
	09/05→	Stabiliser Link		VL-DL-9472	Coupling Rod
	09/05→	Stabiliser Link	VL-DL-12356		Coupling Rod
	09/05→	Suspension Arm Repair Kit		VL-RK-9497	for Drag Link
	09/05→	Suspension Arm Repair Kit		VL-RK-9497	for Drag Link, Leaf Spring Axle
	09/05→	Suspension Strut Repair Kit		MN-RK-8501	
	09/05→	Suspension Strut Repair Kit	VL-RK-8533		
	09/05→	Tie Rod	VL-DL-8305		Leaf Spring Axle
	09/05→	Tie Rod	VL-DL-9492		
	09/05→	Tie Rod	VL-DL-12358		
	09/05→	Tie Rod End	VL-ES-5347		for Steering Rod
	09/05→	Tie Rod End	VL-ES-5348		for Steering Rod
	09/05→	Tie Rod End	VL-ES-8411		
	09/05→	Tie Rod End	VL-ES-8414		for Guide Rod
	09/05→	Tie Rod End	VL-ES-10360		for Steering Rod
	09/05→	Track Control Arm		RV-DL-10299	Trailing Arm, 1st & 2nd Drive Axle, for Leaf-Spring Suspension vehicles

MN-RK-8501

Ø: 75 Hole Distance: 115
Thick/Height: 24
20547286

**RV-DL-10299**

Length: 510 Ø: 21
20522934, 21051052, 7420864583,
7421051052

**RV-DL-12320**

Length: 881 Ø: 50
Cone Ø: d1 Ø 28,6 / d2 Ø 23,9
20390746, 21106968

**RV-TC-12339**

Length: 515
Hole Distance: 13 / 130
20532931, 21051046

**RV-TC-12340**

Length: 510
Hole Distance: 115 / 115
20443044

**RV-VB-8191**

Length: 662,4 Ø: 48
Hole Distance: 115 / 115
20367004, 20507262, 20741695, 20741703,
22318833

**VL-DL-8180**

Length: 625 Ø: 17
20374444, 20410530, 20509018, 20517494,
70371270

**VL-DL-8194**

Length: 824 Ø: 50
Cone Ø: d1 Ø 28,6 / d2 Ø 23,9
20375787, 21106933

**VL-DL-8305**

Length: 1634 Ø: 50
Cone Ø: d1 Ø 28,6 / d2 Ø 23,9
3198276, 21260274

**VL-DL-8407**

Length: 870 Ø: 52
Cone Ø: d1 Ø 28,6 / d2 Ø 23,9
3986452, 20375555, 20393186, 21106930

**VL-DL-8566**

Length: 863 Ø: 52
Cone Ø: d1 Ø 28,6 / d2 Ø 23,9
20375556, 20393187, 21106952, 21406952

**VL-DL-8707**

Length: 885 Ø: 50
Cone Ø: d1 Ø 28,6 / d2 Ø 23,9
20390745, 21106936

**VL-DL-9472**

Length: 435 Ø: 36
Cone Ø: d1 Ø 32,2 / d2 Ø 28
20443061, 20443065, 20994418

**VL-DL-9492**

Length: 1660 Ø: 62
Cone Ø: d1 Ø 32 / d2 Ø 27
20587731, 21106938

**VL-DL-10228**

Length: 2139 Ø: 62
Cone Ø: d1 Ø 28,6 / d2 Ø 23,9
20453063

**VL-DL-10309**

Length: 799 Ø: 48
Hole Distance: 115 / 115
20410053, 21106157

**VL-DL-12356**

Length: 275 Ø: 30
Cone Ø: d1 Ø 22
3987423, 20477803

**VL-DL-12358**

Length: 1669 Ø: 42
Cone Ø: d1 Ø 32 / d2 Ø 27
Thread: M32 x 1,5 RHT / M32 x 1,5 LHT
20581086, 7420581086

**VL-DL-12367**

Length: 2139 Ø: 62
Cone Ø: d1 Ø 28,6 / d2 Ø 23,9
Thread: M52 x 1,5 RHT
20453064, 20584291

**VL-DL-12454**

Length: 2339 Ø: 62
Cone Ø: d1 Ø 28,6 / d2 Ø 23,9
20581632

**VL-DL-12483**

Length: 485 Ø: 48
Cone Ø: d1 Ø 28,6 / d2 Ø 23,9
20383081, 21260283, 22159761,
81467106355

**VL-DL-12484**

Length: 1025 Ø: 68
Cone Ø: d1 Ø 28,6 / d2 Ø 23,9
2038308, 21252481

**VL-ES-5347**

Length: 125
Cone Ø: d1 Ø 28,6 / d2 Ø 23,9
Thread: M30 x 1,5 LHT
1507822, 1698847, 3092471

**VL-ES-5348**

Length: 125
Cone Ø: d1 Ø 28,6 / d2 Ø 23,9
Thread: M30 x 1,5 RHT
1507823, 1698846, 3092472

**VL-ES-8411**

Length: 140
Cone Ø: d1 Ø 28,6 / d2 Ø 23,9
Thread: M30 x 1,5 RHT
3093647, 3097999, 21263821

**VL-ES-8414**

Length: 136
Cone Ø: d1 Ø 32 / d2 Ø 27
Thread: M30 x 1,5 LHT
20710008

**VL-ES-10360**

Length: 136
Cone Ø: d1 Ø 32 / d2 Ø 27
Thread: M30 x 1,5 RHT
20581089

**VL-RK-8533**

Ø: 85 Hole Distance: 130
Thick/Height: 30
3093630, 3093631, 20840815, 21295230,
7420840815

**VL-RK-9497**

Ø: 95 Hole Distance: 130
Thick/Height: 35
273612, 20702095

**VL-VB-7787**

Length: 671
Ø: 58
Hole Distance: 130 / 130
143167, 1076639, 1626896, 1629734,
20392649, 20829503, 21295227, 21474441,
22318834, 7421295227

**VL-VB-12460**

Length: 662
Ø: 50
Hole Distance: 115 / 115
2223852, 20589061





FM ...

FM 440 ...	09/05 →	Track Control Arm		RV-DL-10299	Trailing Arm, 1st RA;2nd RA; Leaf Spring Axle;Unit	
	09/05 →	Track Control Arm		RV-TC-12339	Suspension Rod, Trailing Arm	
	09/05 →	Track Control Arm		RV-TC-12340	Trailing Arm	
	09/05 →	Track Control Arm		RV-VB-8191	Wishbone (CV)	
	09/05 →	Track Control Arm		RV-VB-8191	Wishbone (CV), Air Suspension Axle	
	09/05 →	Track Control Arm		VL-DL-8180	Trailing Arm	
	09/05 →	Track Control Arm		VL-VB-7787	Wishbone (CV)	
	09/05 →	Track Control Arm		VL-VB-12460	Wishbone (CV)	
	09/05 →	Track Control Arm		VL-VB-12460	Wishbone (CV), 1st & 2nd Drive Axle, for Leaf-Spring Suspension vehicles	
	09/05 →	Track Control Arm		VL-VB-12460	Wishbone (CV), 1st & 2nd Drive Axle, for Pneumatic Suspension vehicles	
	09/05 →	Track Control Arm		VL-VB-12460	Wishbone (CV), 1st Drive Axle, for Pneumatic Suspension vehicles	
	09/05 →	Track Control Arm		VL-VB-12460	Wishbone (CV), Trailing Axle not Steered, for Pneumatic Suspension vehicles	
	09/05 →	Track Control Arm		VL-VB-12460	Wishbone (CV), Trailing Axle Steered, for Pneumatic Suspension vehicles	
	09/05 →	Track Control Arm		VL-VB-12460	Wishbone (CV), Trailing Axle Steered/not Steered, for Pneumatic Suspension vehicles	
	09/05 →	Track Control Arm	VL-DL-10309	VL-DL-10309	Trailing Arm, 1st Front Axle, for Pneumatic Suspension vehicles	
	09/05 →	Track Control Arm	VL-DL-10309	VL-DL-10309	Trailing Arm, Air Suspension Axle	
	FM 450	09/05 →	Centre Rod	VL-DL-8194		Push Rod
		09/05 →	Centre Rod	VL-DL-8566		Push Rod
		09/05 →	Centre Rod	VL-DL-10228		Push Rod, 1st FA;2nd FA
		09/05 →	Centre Rod	VL-DL-12367		for Steering Rod
09/05 →		Centre Rod	VL-DL-12454		for Steering Rod	
09/05 →		Centre Rod	VL-DL-12483		Push Rod	
09/05 →		Centre Rod	VL-DL-12484		Push Rod	
09/05 →		Stabiliser Link		VL-DL-9472	Coupling Rod	
09/05 →		Stabiliser Link	VL-DL-12356		Coupling Rod	
09/05 →		Suspension Arm Repair Kit		VL-RK-9497	for Drag Link	
09/05 →		Suspension Arm Repair Kit		VL-RK-9497	for Drag Link, Leaf Spring Axle	
09/05 →		Suspension Strut Repair Kit		MN-RK-8501		
09/05 →		Suspension Strut Repair Kit	VL-RK-8533			
09/05 →		Tie Rod	VL-DL-12355			
09/05 →		Tie Rod	VL-DL-12358			
09/05 →		Tie Rod End	VL-ES-5347		for Steering Rod	
09/05 →		Tie Rod End	VL-ES-5348		for Steering Rod	
09/05 →		Tie Rod End	VL-ES-8411			
09/05 →		Tie Rod End	VL-ES-8414		for Guide Rod	
09/05 →		Tie Rod End	VL-ES-10360		for Steering Rod	
09/05 →		Track Control Arm		RV-DL-10299	Trailing Arm, 1st RA;2nd RA; Leaf Spring Axle;Unit	
09/05 →		Track Control Arm		RV-TC-12339	Suspension Rod, Trailing Arm	
09/05 →		Track Control Arm		RV-TC-12340	Trailing Arm	
09/05 →		Track Control Arm		RV-VB-8191	Wishbone (CV)	
09/05 →		Track Control Arm		VL-DL-8180	Trailing Arm	
09/05 →		Track Control Arm		VL-VB-7787	Wishbone (CV)	
09/05 →		Track Control Arm		VL-VB-12460	Wishbone (CV)	
09/05 →		Track Control Arm		VL-VB-12460	Wishbone (CV), 1st & 2nd Drive Axle, for Leaf-Spring Suspension vehicles	
09/05 →		Track Control Arm		VL-VB-12460	Wishbone (CV), 1st & 2nd Drive Axle, for Pneumatic Suspension vehicles	
09/05 →		Track Control Arm		VL-VB-12460	Wishbone (CV), 1st Drive Axle, for Pneumatic Suspension vehicles	
09/05 →		Track Control Arm		VL-VB-12460	Wishbone (CV), Trailing Axle not Steered, for Pneumatic Suspension vehicles	
09/05 →		Track Control Arm		VL-VB-12460	Wishbone (CV), Trailing Axle Steered, for Pneumatic Suspension vehicles	
09/05 →	Track Control Arm		VL-VB-12460	Wishbone (CV), Trailing Axle Steered/not Steered, for Pneumatic Suspension vehicles		

MN-RK-8501

Ø: 75 Hole Distance: 115
 Thick/Height: 24
 20547286

**RV-DL-10299**

Length: 510 Ø: 21
 20522934, 21051052, 7420864583,
 7421051052

**RV-TC-12339**

Length: 515
 Hole Distance: 13 / 130
 20532931, 21051046

**RV-TC-12340**

Length: 510
 Hole Distance: 115 / 115
 20443044

**RV-VB-8191**

Length: 662,4 Ø: 48
 Hole Distance: 115 / 115
 20367004, 20507262, 20741695, 20741703,
 22318833

**VL-DL-8180**

Length: 625 Ø: 17
 20374444, 20410530, 20509018, 20517494,
 70371270

**VL-DL-8194**

Length: 824 Ø: 50
 Cone Ø: d1 Ø 28,6 / d2 Ø 23,9
 20375787, 21106933

**VL-DL-8566**

Length: 863 Ø: 52
 Cone Ø: d1 Ø 28,6 / d2 Ø 23,9
 20375556, 20393187, 21106952, 21406952

**VL-DL-9472**

Length: 435 Ø: 36
 Cone Ø: d1 Ø 32,2 / d2 Ø 28
 20443061, 20443065, 20994418

**VL-DL-10228**

Length: 2139 Ø: 62
 Cone Ø: d1 Ø 28,6 / d2 Ø 23,9
 20453063

**VL-DL-10309**

Length: 799 Ø: 48
 Hole Distance: 115 / 115
 20410053, 21106157

**VL-DL-12355**

Length: 368 Ø: 38
 Cone Ø: d1 Ø 28,6 / d2 Ø 23,9
 1628207

**VL-DL-12356**

Length: 275 Ø: 30
 Cone Ø: d1 Ø 22
 3987423, 20477803

**VL-DL-12358**

Length: 1669 Ø: 42
 Cone Ø: d1 Ø 32 / d2 Ø 27
 Thread: M32 x 1,5 RHT / M32 x 1,5 LHT
 20581086, 7420581086

**VL-DL-12367**

Length: 2139 Ø: 62
 Cone Ø: d1 Ø 28,6 / d2 Ø 23,9
 Thread: M52 x 1,5 RHT
 20453064, 20584291

**VL-DL-12454**

Length: 2339 Ø: 62
 Cone Ø: d1 Ø 28,6 / d2 Ø 23,9
 20581632

**VL-DL-12483**

Length: 485 Ø: 48
 Cone Ø: d1 Ø 28,6 / d2 Ø 23,9
 20383081, 21260283, 22159761,
 81467106355

**VL-DL-12484**

Length: 1025 Ø: 48
 Cone Ø: d1 Ø 28,6 / d2 Ø 23,9
 2038308, 21252481

**VL-ES-5347**

Length: 125
 Cone Ø: d1 Ø 28,6 / d2 Ø 23,9
 Thread: M30 x 1,5 LHT
 1507822, 1698847, 3092471

**VL-ES-5348**

Length: 125
 Cone Ø: d1 Ø 28,6 / d2 Ø 23,9
 Thread: M30 x 1,5 RHT
 1507823, 1698846, 3092472

**VL-ES-8411**

Length: 140
 Cone Ø: d1 Ø 28,6 / d2 Ø 23,9
 Thread: M30 x 1,5 RHT
 3093647, 3097999, 21263821

**VL-ES-8414**

Length: 136
 Cone Ø: d1 Ø 32 / d2 Ø 27
 Thread: M30 x 1,5 LHT
 20710008

**VL-ES-10360**

Length: 136
 Cone Ø: d1 Ø 32 / d2 Ø 27
 Thread: M30 x 1,5 RHT
 20581089

**VL-RK-8533**

Ø: 85 Hole Distance: 130
 Thick/Height: 30
 3093630, 3093631, 20840815, 21295230,
 7420840815

**VL-RK-9497**

Ø: 95 Hole Distance: 130
 Thick/Height: 35
 273612, 20702095

**VL-VB-7787**

Length: 671 Ø: 58
 Hole Distance: 130 / 130
 143167, 1076639, 1626896, 1629734,
 20392649, 20829503, 21295227, 21474441,
 22318834, 7421295227

**VL-VB-12460**

Length: 662 Ø: 50
 Hole Distance: 115 / 115
 2223852, 20589061





FM ...

FM 460	09/05→	Centre Rod	VL-DL-8194		Push Rod
	09/05→	Centre Rod	VL-DL-8566		Push Rod
	09/05→	Centre Rod	VL-DL-10228		Push Rod, 1st FA;2nd FA
	09/05→	Centre Rod	VL-DL-12367		for Steering Rod
	09/05→	Centre Rod	VL-DL-12454		for Steering Rod
	09/05→	Centre Rod	VL-DL-12483		Push Rod
	09/05→	Centre Rod	VL-DL-12484		Push Rod
	09/05→	Stabiliser Link		VL-DL-9472	Coupling Rod
	09/05→	Stabiliser Link	VL-DL-12356		Coupling Rod
	09/05→	Suspension Arm Repair Kit		VL-RK-9497	for Drag Link
	09/05→	Suspension Arm Repair Kit		VL-RK-9497	for Drag Link, Leaf Spring Axle
	09/05→	Suspension Strut Repair Kit		MN-RK-8501	
	09/05→	Suspension Strut Repair Kit	VL-RK-8533		
	09/05→	Tie Rod	VL-DL-12358		
	09/05→	Tie Rod End	VL-ES-5347		for Steering Rod
	09/05→	Tie Rod End	VL-ES-5348		for Steering Rod
	09/05→	Tie Rod End	VL-ES-8411		
	09/05→	Tie Rod End	VL-ES-8414		for Guide Rod
	09/05→	Tie Rod End	VL-ES-10360		for Steering Rod
	09/05→	Track Control Arm		RV-DL-10299	Trailing Arm, 1st & 2nd Drive Axle, for Leaf-Spring Suspension vehicles
	09/05→	Track Control Arm		RV-DL-10299	Trailing Arm, 1st RA;2nd RA; Leaf Spring Axle;Unit
	09/05→	Track Control Arm		RV-TC-12339	Suspension Rod, Trailing Arm
	09/05→	Track Control Arm		RV-TC-12340	Trailing Arm
	09/05→	Track Control Arm		RV-VB-8191	Wishbone (CV)
	09/05→	Track Control Arm		VL-DL-8180	Trailing Arm
	09/05→	Track Control Arm		VL-VB-7787	Wishbone (CV)
	09/05→	Track Control Arm		VL-VB-12460	Wishbone (CV)
	09/05→	Track Control Arm		VL-VB-12460	Wishbone (CV), 1st & 2nd Drive Axle, for Leaf-Spring Suspension vehicles
	09/05→	Track Control Arm		VL-VB-12460	Wishbone (CV), 1st & 2nd Drive Axle, for Pneumatic Suspension vehicles
	09/05→	Track Control Arm		VL-VB-12460	Wishbone (CV), 1st Drive Axle, for Pneumatic Suspension vehicles
	09/05→	Track Control Arm		VL-VB-12460	Wishbone (CV), Trailing Axle not Steered, for Pneumatic Suspension vehicles
	09/05→	Track Control Arm		VL-VB-12460	Wishbone (CV), Trailing Axle Steered, for Pneumatic Suspension vehicles
	09/05→	Track Control Arm		VL-VB-12460	Wishbone (CV), Trailing Axle Steered/not Steered, for Pneumatic Suspension vehicles
	09/05→	Track Control Arm	VL-DL-10309	VL-DL-10309	Trailing Arm, 1st Front Axle, for Pneumatic Suspension vehicles
	04/12→	Track Control Arm		RV-VB-8191	Wishbone (CV), 1st Drive Axle, for Pneumatic Suspension vehicles
	04/12→	Track Control Arm		RV-VB-8191	Wishbone (CV), Trailing Axle not Steered, for Pneumatic Suspension vehicles
	04/12→	Track Control Arm		RV-VB-8191	Wishbone (CV), Trailing Axle Steered, for Pneumatic Suspension vehicles
	04/12→	Track Control Arm		VL-DL-8180	Trailing Arm, 1st Drive Axle, for Pneumatic Suspension vehicles
	04/12→	Track Control Arm		VL-DL-8180	Trailing Arm, Trailing Axle not Steered, for Pneumatic Suspension vehicles
	04/12→	Track Control Arm		VL-DL-8180	Trailing Arm, Trailing Axle Steered, for Pneumatic Suspension vehicles
FM 480	09/05→	Centre Rod	RV-DL-12320		for Steering Rod
	09/05→	Centre Rod	VL-DL-8194		Push Rod
	09/05→	Centre Rod	VL-DL-8407		Push Rod, Leaf Spring Axle
	09/05→	Centre Rod	VL-DL-8566		Push Rod
	09/05→	Centre Rod	VL-DL-8707		Push Rod, Air Suspension Axle
	09/05→	Centre Rod	VL-DL-10228		Push Rod, 1st FA;2nd FA
	09/05→	Centre Rod	VL-DL-12367		for Steering Rod
	09/05→	Centre Rod	VL-DL-12454		for Steering Rod

MN-RK-8501

Ø: 75 Hole Distance: 115
Thick/Height: 24
20547286

**RV-DL-10299**

Length: 510 Ø: 21
20522934, 21051052, 7420864583,
7421051052

**RV-DL-12320**

Length: 881 Ø: 50
Cone Ø: d1 Ø 28,6 / d2 Ø 23,9
20390746, 21106968

**RV-TC-12339**

Length: 515
Hole Distance: 13 / 130
20532931, 21051046

**RV-TC-12340**

Length: 510
Hole Distance: 115 / 115
20443044

**RV-VB-8191**

Length: 662,4 Ø: 48
Hole Distance: 115 / 115
20367004, 20507262, 20741695, 20741703,
22318833

**VL-DL-8180**

Length: 625 Ø: 17
20374444, 20410530, 20509018, 20517494,
70371270

**VL-DL-8194**

Length: 824 Ø: 50
Cone Ø: d1 Ø 28,6 / d2 Ø 23,9
20375787, 21106933

**VL-DL-8407**

Length: 870 Ø: 52
Cone Ø: d1 Ø 28,6 / d2 Ø 23,9
3986452, 20375555, 20393186, 21106930

**VL-DL-8566**

Length: 863 Ø: 52
Cone Ø: d1 Ø 28,6 / d2 Ø 23,9
20375556, 20393187, 21106952, 21406952

**VL-DL-8707**

Length: 885 Ø: 50
Cone Ø: d1 Ø 28,6 / d2 Ø 23,9
20390745, 21106936

**VL-DL-9472**

Length: 435 Ø: 36
Cone Ø: d1 Ø 32,2 / d2 Ø 28
20443061, 20443065, 20994418

**VL-DL-10228**

Length: 2139 Ø: 62
Cone Ø: d1 Ø 28,6 / d2 Ø 23,9
20453063

**VL-DL-10309**

Length: 799 Ø: 48
Hole Distance: 115 / 115
20410053, 21106157

**VL-DL-12356**

Length: 275 Ø: 30
Cone Ø: d1 Ø 22
3987423, 20477803

**VL-DL-12358**

Length: 1669 Ø: 42
Cone Ø: d1 Ø 32 / d2 Ø 27
Thread: M32 x 1,5 RHT / M32 x 1,5 LHT
20581086, 7420581086

**VL-DL-12367**

Length: 2139 Ø: 62
Cone Ø: d1 Ø 28,6 / d2 Ø 23,9
Thread: M52 x 1,5 RHT
20453064, 20584291

**VL-DL-12454**

Length: 2339 Ø: 62
Cone Ø: d1 Ø 28,6 / d2 Ø 23,9
20581632

**VL-DL-12483**

Length: 485 Ø: 48
Cone Ø: d1 Ø 28,6 / d2 Ø 23,9
20383081, 21260283, 22159761,
81467106355

**VL-DL-12484**

Length: 1025 Ø: 48
Cone Ø: d1 Ø 28,6 / d2 Ø 23,9
2038308, 21252481

**VL-ES-5347**

Length: 125
Cone Ø: d1 Ø 28,6 / d2 Ø 23,9
Thread: M30 x 1,5 LHT
1507822, 1698847, 3092471

**VL-ES-5348**

Length: 125
Cone Ø: d1 Ø 28,6 / d2 Ø 23,9
Thread: M30 x 1,5 RHT
1507823, 1698846, 3092472

**VL-ES-8411**

Length: 140
Cone Ø: d1 Ø 28,6 / d2 Ø 23,9
Thread: M30 x 1,5 RHT
3093647, 3097999, 21263821

**VL-ES-8414**

Length: 136
Cone Ø: d1 Ø 32 / d2 Ø 27
Thread: M30 x 1,5 LHT
20710008

**VL-ES-10360**

Length: 136
Cone Ø: d1 Ø 32 / d2 Ø 27
Thread: M30 x 1,5 RHT
20581089

**VL-RK-8533**

Ø: 85 Hole Distance: 130
Thick/Height: 30
3093630, 3093631, 20840815, 21295230,
7420840815

**VL-RK-9497**

Ø: 95 Hole Distance: 130
Thick/Height: 35
273612, 20702095

**VL-VB-7787**

Length: 671 Ø: 58
Hole Distance: 130 / 130
143167, 1076639, 1626896, 1629734,
20392649, 20829503, 21295227, 21474441,
22318834, 7421295227

**VL-VB-12460**

Length: 662 Ø: 50
Hole Distance: 115 / 115
2223852, 20589061





FM ...

FM 480 ...	09/05→	Centre Rod	VL-DL-12483		Push Rod
	09/05→	Centre Rod	VL-DL-12484		Push Rod
	09/05→	Stabiliser Link		VL-DL-9472	Coupling Rod
	09/05→	Stabiliser Link	VL-DL-12356		Coupling Rod
	09/05→	Suspension Arm Repair Kit		VL-RK-9497	for Drag Link
	09/05→	Suspension Arm Repair Kit		VL-RK-9497	for Drag Link, Leaf Spring Axle
	09/05→	Suspension Strut Repair Kit		MN-RK-8501	
	09/05→	Suspension Strut Repair Kit	VL-RK-8533		
	09/05→	Tie Rod	VL-DL-8305		Leaf Spring Axle
	09/05→	Tie Rod	VL-DL-9492		
	09/05→	Tie Rod	VL-DL-12358		
	09/05→	Tie Rod End	VL-ES-5347		for Steering Rod
	09/05→	Tie Rod End	VL-ES-5348		for Steering Rod
	09/05→	Tie Rod End	VL-ES-8411		
	09/05→	Tie Rod End	VL-ES-8414		for Guide Rod
	09/05→	Tie Rod End	VL-ES-10360		for Steering Rod
	09/05→	Track Control Arm		RV-DL-10299	Trailing Arm, 1st & 2nd Drive Axle, for Leaf-Spring Suspension vehicles
	09/05→	Track Control Arm		RV-DL-10299	Trailing Arm, 1st RA;2nd RA; Leaf Spring Axle;Unit
	09/05→	Track Control Arm		RV-TC-12339	Suspension Rod, Trailing Arm
	09/05→	Track Control Arm		RV-TC-12340	Trailing Arm
	09/05→	Track Control Arm		RV-VB-8191	Wishbone (CV)
	09/05→	Track Control Arm		RV-VB-8191	Wishbone (CV), Air Suspension Axle
	09/05→	Track Control Arm		VL-DL-8180	Trailing Arm
	09/05→	Track Control Arm		VL-VB-7787	Wishbone (CV)
	09/05→	Track Control Arm		VL-VB-12460	Wishbone (CV)
	09/05→	Track Control Arm		VL-VB-12460	Wishbone (CV), 1st & 2nd Drive Axle, for Leaf-Spring Suspension vehicles
	09/05→	Track Control Arm		VL-VB-12460	Wishbone (CV), 1st & 2nd Drive Axle, for Pneumatic Suspension vehicles
	09/05→	Track Control Arm		VL-VB-12460	Wishbone (CV), 1st Drive Axle, for Pneumatic Suspension vehicles
	09/05→	Track Control Arm		VL-VB-12460	Wishbone (CV), Trailing Axle not Steered, for Pneumatic Suspension vehicles
	09/05→	Track Control Arm		VL-VB-12460	Wishbone (CV), Trailing Axle Steered, for Pneumatic Suspension vehicles
	09/05→	Track Control Arm		VL-VB-12460	Wishbone (CV), Trailing Axle Steered/not Steered, for Pneumatic Suspension vehicles
	09/05→	Track Control Arm	VL-DL-10309	VL-DL-10309	Trailing Arm, 1st Front Axle, for Pneumatic Suspension vehicles
	09/05→	Track Control Arm	VL-DL-10309	VL-DL-10309	Trailing Arm, Air Suspension Axle
FM 500	09/05→	Centre Rod	VL-DL-8194		Push Rod
	09/05→	Centre Rod	VL-DL-8566		Push Rod
	09/05→	Centre Rod	VL-DL-10228		Push Rod, 1st FA;2nd FA
	09/05→	Centre Rod	VL-DL-12367		for Steering Rod
	09/05→	Centre Rod	VL-DL-12454		for Steering Rod
	09/05→	Centre Rod	VL-DL-12483		Push Rod
	09/05→	Centre Rod	VL-DL-12484		Push Rod
	09/05→	Stabiliser Link		VL-DL-9472	Coupling Rod
	09/05→	Stabiliser Link	VL-DL-12356		Coupling Rod
	09/05→	Suspension Arm Repair Kit		VL-RK-9497	for Drag Link
	09/05→	Suspension Arm Repair Kit		VL-RK-9497	for Drag Link, Leaf Spring Axle
	09/05→	Suspension Strut Repair Kit		MN-RK-8501	
	09/05→	Suspension Strut Repair Kit	VL-RK-8533		
	09/05→	Tie Rod	VL-DL-12358		
	09/05→	Tie Rod End	VL-ES-5347		for Steering Rod
	09/05→	Tie Rod End	VL-ES-5348		for Steering Rod
	09/05→	Tie Rod End	VL-ES-8411		
	09/05→	Tie Rod End	VL-ES-8414		for Guide Rod
	09/05→	Tie Rod End	VL-ES-10360		for Steering Rod
	09/05→	Track Control Arm		RV-DL-10299	Trailing Arm, 1st & 2nd Drive Axle, for Leaf-Spring Suspension vehicles

MN-RK-8501

Ø: 75 Hole Distance: 115
Thick/Height: 24
20547286

**RV-DL-10299**

Length: 510 Ø: 21
20522934, 21051052, 7420864583,
7421051052

**RV-TC-12339**

Length: 515
Hole Distance: 13 / 130
20532931, 21051046

**RV-TC-12340**

Length: 510
Hole Distance: 115 / 115
20443044

**RV-VB-8191**

Length: 662,4 Ø: 48
Hole Distance: 115 / 115
20367004, 20507262, 20741695, 20741703,
22318833

**VL-DL-8180**

Length: 625 Ø: 17
20374444, 20410530, 20509018, 20517494,
70371270

**VL-DL-8194**

Length: 824 Ø: 50
Cone Ø: d1 Ø 28,6 / d2 Ø 23,9
20375787, 21106933

**VL-DL-8305**

Length: 1634 Ø: 50
Cone Ø: d1 Ø 28,6 / d2 Ø 23,9
3198276, 21260274

**VL-DL-8566**

Length: 863 Ø: 52
Cone Ø: d1 Ø 28,6 / d2 Ø 23,9
20375556, 20393187, 21106952, 21406952

**VL-DL-9472**

Length: 435 Ø: 36
Cone Ø: d1 Ø 32,2 / d2 Ø 28
20443061, 20443065, 20994418

**VL-DL-9492**

Length: 1660 Ø: 62
Cone Ø: d1 Ø 32 / d2 Ø 27
20587731, 21106938

**VL-DL-10228**

Length: 2139 Ø: 62
Cone Ø: d1 Ø 28,6 / d2 Ø 23,9
20453063

**VL-DL-10309**

Length: 799 Ø: 48
Hole Distance: 115 / 115
20410053, 21106157

**VL-DL-12356**

Length: 275 Ø: 30
Cone Ø: d1 Ø 22
3987423, 20477803

**VL-DL-12358**

Length: 1669 Ø: 42
Cone Ø: d1 Ø 32 / d2 Ø 27
Thread: M32 x 1,5 RHT / M32 x 1,5 LHT
20581086, 7420581086

**VL-DL-12367**

Length: 2139 Ø: 62
Cone Ø: d1 Ø 28,6 / d2 Ø 23,9
Thread: M52 x 1,5 RHT
20453064, 20584291

**VL-DL-12454**

Length: 2339 Ø: 62
Cone Ø: d1 Ø 28,6 / d2 Ø 23,9
20581632

**VL-DL-12483**

Length: 485 Ø: 48
Cone Ø: d1 Ø 28,6 / d2 Ø 23,9
20383081, 21260283, 22159761,
81467106355

**VL-DL-12484**

Length: 1025 Ø: 48
Cone Ø: d1 Ø 28,6 / d2 Ø 23,9
2038308, 21252481

**VL-ES-5347**

Length: 125
Cone Ø: d1 Ø 28,6 / d2 Ø 23,9
Thread: M30 x 1,5 LHT
1507822, 1698847, 3092471

**VL-ES-5348**

Length: 125
Cone Ø: d1 Ø 28,6 / d2 Ø 23,9
Thread: M30 x 1,5 RHT
1507823, 1698846, 3092472

**VL-ES-8411**

Length: 140
Cone Ø: d1 Ø 28,6 / d2 Ø 23,9
Thread: M30 x 1,5 RHT
3093647, 3097999, 21263821

**VL-ES-8414**

Length: 136
Cone Ø: d1 Ø 32 / d2 Ø 27
Thread: M30 x 1,5 LHT
20710008

**VL-ES-10360**

Length: 136
Cone Ø: d1 Ø 32 / d2 Ø 27
Thread: M30 x 1,5 RHT
20581089

**VL-RK-8533**

Ø: 85 Hole Distance: 130
Thick/Height: 30
3093630, 3093631, 20840815, 21295230,
7420840815

**VL-RK-9497**

Ø: 95 Hole Distance: 130
Thick/Height: 35
273612, 20702095

**VL-VB-7787**

Length: 671 Ø: 58
Hole Distance: 130 / 130
143167, 1076639, 1626896, 1629734,
20392649, 20829503, 21295227, 21474441,
22318834, 7421295227

**VL-VB-12460**

Length: 662 Ø: 50
Hole Distance: 115 / 115
2223852, 20589061





FM ...

FM 500 ...	09/05→	Track Control Arm		RV-DL-10299	Trailing Arm, 1st RA;2nd RA; Leaf Spring Axle;Unit
	09/05→	Track Control Arm		RV-TC-12339	Suspension Rod, Trailing Arm
	09/05→	Track Control Arm		RV-TC-12340	Trailing Arm
	09/05→	Track Control Arm		RV-VB-8191	Wishbone (CV)
	09/05→	Track Control Arm		VL-DL-8180	Trailing Arm
	09/05→	Track Control Arm		VL-VB-7787	Wishbone (CV)
	09/05→	Track Control Arm		VL-VB-12460	Wishbone (CV)
	09/05→	Track Control Arm		VL-VB-12460	Wishbone (CV), 1st & 2nd Drive Axle, for Leaf-Spring Suspension vehicles
	09/05→	Track Control Arm		VL-VB-12460	Wishbone (CV), 1st & 2nd Drive Axle, for Pneumatic Suspension vehicles
	09/05→	Track Control Arm		VL-VB-12460	Wishbone (CV), 1st Drive Axle, for Pneumatic Suspension vehicles
	09/05→	Track Control Arm		VL-VB-12460	Wishbone (CV), Trailing Axle not Steered, for Pneumatic Suspension vehicles
	09/05→	Track Control Arm		VL-VB-12460	Wishbone (CV), Trailing Axle Steered, for Pneumatic Suspension vehicles
	09/05→	Track Control Arm		VL-VB-12460	Wishbone (CV), Trailing Axle Steered/not Steered, for Pneumatic Suspension vehicles
	09/05→	Track Control Arm	VL-DL-10309	VL-DL-10309	Trailing Arm, 1st Front Axle, for Pneumatic Suspension vehicles
	04/12→	Track Control Arm		RV-VB-8191	Wishbone (CV), 1st Drive Axle, for Pneumatic Suspension vehicles
	04/12→	Track Control Arm		RV-VB-8191	Wishbone (CV), Trailing Axle not Steered, for Pneumatic Suspension vehicles
	04/12→	Track Control Arm		RV-VB-8191	Wishbone (CV), Trailing Axle Steered, for Pneumatic Suspension vehicles
	04/12→	Track Control Arm		VL-DL-8180	Trailing Arm, 1st Drive Axle, for Pneumatic Suspension vehicles
	04/12→	Track Control Arm		VL-DL-8180	Trailing Arm, Trailing Axle not Steered, for Pneumatic Suspension vehicles
	04/12→	Track Control Arm		VL-DL-8180	Trailing Arm, Trailing Axle Steered, for Pneumatic Suspension vehicles

FM 7

FM 7/250	08/98→12/01	Centre Rod		RV-DL-12320	for Steering Rod
	08/98→12/01	Centre Rod		VL-DL-8178	Push Rod
	08/98→12/01	Centre Rod		VL-DL-8406	Push Rod, Air Suspension Axle
	08/98→12/01	Centre Rod		VL-DL-8407	Push Rod, Leaf Spring Axle
	08/98→12/01	Centre Rod		VL-DL-8566	Push Rod
	08/98→12/01	Centre Rod		VL-DL-8681	Push Rod, 1st FA;Air Suspension Axle
	08/98→12/01	Centre Rod		VL-DL-8707	Push Rod, Air Suspension Axle
	08/98→12/01	Stabiliser Link		VL-DL-8412	Coupling Rod, Control Arm
	08/98→12/01	Stabiliser Link		VL-DL-9491	Coupling Rod, Control Arm
	08/98→12/01	Stabiliser Link	VL-DL-8157		Coupling Rod, for Leaf-Spring Suspension vehicles
	08/98→12/01	Stabiliser Link	VL-DL-8536		Coupling Rod, Air Suspension Axle
	08/98→12/01	Stabiliser Mounting	VL-SB-10394	VL-SB-10394	
	08/98→12/01	Suspension Arm Repair Kit		IV-RK-8998	for Wishbone (CV)
	08/98→12/01	Suspension Arm Repair Kit	CV-RK-5322		for Wishbone (CV)
	08/98→12/01	Suspension Arm Repair Kit	VL-RK-5323	VL-RK-5323	for Drag Link
	08/98→12/01	Suspension Strut Repair Kit	MN-RK-12436		
	08/98→12/01	Tie Bar Bush		VL-RK-8656	
	08/98→12/01	Tie Bar Bush		VL-SB-9501	
	08/98→12/01	Tie Rod		VL-DL-8163	Leading Axle;for vehicles with Hinged Leading Axle
	08/98→12/01	Tie Rod	VL-DL-7789		
	08/98→12/01	Tie Rod End		VL-ES-10361	Tag Axle
	08/98→12/01	Tie Rod End	CV-ES-12462		for Steering Rod
	08/98→12/01	Tie Rod End	RV-ES-12442		
	08/98→12/01	Tie Rod End	VL-ES-5287		for Guide Rod
	08/98→12/01	Tie Rod End	VL-ES-5288		for Guide Rod

CV-ES-12462

Length: 120
Cone Ø: d1 Ø 26 / d2 Ø 23,5
Thread: M30 x 1,5 RHT
1517577, 1695690, 1697297, 15175771



CV-RK-5322

Ø: 72
Thick/Height: 50
271188, 3091598



IV-RK-8998

Ø: 85 Hole Distance: 130
Thick/Height: 30
273373, 274019, 4941233, 6889509



MN-RK-12436

Ø: 75 Hole Distance: 115
Thick/Height: 24
3093462, 85104224



RV-DL-10299

Length: 510 Ø: 21
20522934, 21051052, 7420864583,
7421051052



RV-DL-12320

Length: 881 Ø: 50
Cone Ø: d1 Ø 28,6 / d2 Ø 23,9
20390746, 21106968



RV-ES-12442

Length: 88
Cone Ø: d1 Ø 28,6
Thread: M26 x 1,5 RHT
3987648



RV-TC-12339

Length: 515
Hole Distance: 13 / 130
20532931, 21051046



RV-TC-12340

Length: 510
Hole Distance: 115 / 115
20443044



RV-VB-8191

Length: 662,4 Ø: 48
Hole Distance: 115 / 115
20367004, 20507262, 20741695, 20741703,
22318833



VL-DL-7789

Length: 1640 Ø: 58
Cone Ø: d1 Ø 28,6 / d2 Ø 23,9
1612254, 3985570, 4510697, 20393097,
21260286



VL-DL-8157

Length: 325 Ø: 30
Cone Ø: d1 Ø 22 / d2 Ø 20
1629668, 3986433, 14316200A, 20477805



VL-DL-8163

Length: 1640 Ø: 42
Cone Ø: d1 Ø 28,6 / d2 Ø 23,9
1628637, 3962343, 3986450, 3988711



VL-DL-8178

Length: 572 Ø: 38
Cone Ø: d1 Ø 28,6 / d2 Ø 23,9
1088985, 20393083



VL-DL-8180

Length: 625 Ø: 17
20374444, 20410530, 20509018, 20517494,
70371270



VL-DL-8406

Length: 888 Ø: 52
Cone Ø: d1 Ø 28,6 / d2 Ø 23,9
8190146, 20393071



VL-DL-8407

Length: 870 Ø: 52
Cone Ø: d1 Ø 28,6 / d2 Ø 23,9
3986452, 20375555, 20393186, 21106930



VL-DL-8412

Length: 435 Ø: 36
Cone Ø: d1 Ø 28,6 / d2 Ø 25,5
3173613, 3987354



VL-DL-8536

Length: 340 Ø: 30
Cone Ø: d1 Ø 22 / d2 Ø 19,9
3944046, 20477807



VL-DL-8566

Length: 863 Ø: 52
Cone Ø: d1 Ø 28,6 / d2 Ø 23,9
20375556, 20393187, 21106952, 21406952



VL-DL-8681

Length: 888 Ø: 52
Cone Ø: d1 Ø 28,6 / d2 Ø 23,9
8190147, 20393073



VL-DL-8707

Length: 885 Ø: 50
Cone Ø: d1 Ø 28,6 / d2 Ø 23,9
20390745, 21106936



VL-DL-9491

Length: 380 Ø: 36
Cone Ø: d1 Ø 28,6 / d2 Ø 25,5
3173914, 3987355



VL-DL-10309

Length: 799 Ø: 48
Hole Distance: 115 / 115
20410053, 21106157



VL-ES-5287

Length: 167
Cone Ø: d1 Ø 28,6 / d2 Ø 23,9
Thread: M52 x 1,5 RHT
1696901, 1699401



VL-ES-5288

Length: 167
Cone Ø: d1 Ø 28,6 / d2 Ø 23,9
Thread: M52 x 1,5 LHT
1696900, 1699400



VL-ES-10361

Length: 88
Cone Ø: d1 Ø 28,6 / d2 Ø 24
Thread: M26 x 1,5 RHT
20374698



VL-RK-5323

Ø: 91 Hole Distance: 125
Thick/Height: 20
1598588, 14302100A



VL-RK-8656

Ø: 91 Hole Distance: 145
Thick/Height: 26
1628107



VL-SB-9501

Ø: 91 Thick/Height: 85 / 85
1135080



VL-SB-10394

Ø: 90 Thick/Height: 95 / 95
9519245



VL-VB-7787

Length: 671 Ø: 58
Hole Distance: 130 / 130
143167, 1076639, 1626896, 1629734,
20392649, 20829503, 21295227, 21474441,
22318834, 7421295227



VL-VB-12460

Length: 662 Ø: 50
Hole Distance: 115 / 115
2223852, 20589061





FM 7 ...

FM 7/250 ...	08/98→12/01	Tie Rod End	VL-ES-5347		for Steering Rod	
	08/98→12/01	Tie Rod End	VL-ES-5348		for Steering Rod	
	08/98→12/01	Tie Rod End	VL-ES-7265	VL-ES-7265		
	08/98→12/01	Tie Rod End	VL-ES-7266	VL-ES-7266		
	08/98→12/01	Tie Rod End	VL-ES-8411			
	08/98→12/01	Track Control Arm		RV-VB-8191	Wishbone (CV)	
	08/98→12/01	Track Control Arm		RV-VB-8191	Wishbone (CV), Air Suspension Axle	
	08/98→12/01	Track Control Arm		VL-DL-8189	Trailing Arm	
	08/98→12/01	Track Control Arm		VL-DL-8189	Trailing Arm, Drive Axle;for vehicles with Rigid Leading Axle	
	08/98→12/01	Track Control Arm		VL-DL-8189	Trailing Arm, Drive Axle;for vehicles with Rigid Trailing Axle	
	08/98→12/01	Track Control Arm		VL-DL-8554	Trailing Arm, 1st RA;2nd RA;Leaf Spring Axle	
	08/98→12/01	Track Control Arm		VL-DL-8619	Trailing Arm, 1st & 2nd Drive Axle, for Leaf-Spring Suspension vehicles	
	08/98→12/01	Track Control Arm		VL-DL-9485	Trailing Arm	
	08/98→12/01	Track Control Arm		VL-DL-9485	Trailing Arm, Tag Axle;for vehicles with Rigid Trailing Axle	
	08/98→12/01	Track Control Arm		VL-VB-5369	Wishbone (CV), 1st RA;2nd RA;Leaf Spring Axle	
	08/98→12/01	Track Control Arm		VL-VB-5369	Wishbone (CV), 1st RA;Air Suspension Axle	
	08/98→12/01	Track Control Arm		VL-VB-7787	Wishbone (CV)	
	08/98→12/01	Track Control Arm		VL-VB-7787	Wishbone (CV), 1st RA;2nd RA;Unit; Leaf Spring Axle	
	08/98→12/01	Track Control Arm		VL-VB-8195	Wishbone (CV), 1st Drive Axle, for Pneumatic Suspension vehicles, →Ch.1202645/A527108	
	08/98→12/01	Track Control Arm		VL-VB-8195	Wishbone (CV), 1st Drive Axle, for Pneumatic Suspension vehicles, →Ch.B281986	
	08/98→12/01	Track Control Arm		VL-VB-8195	Wishbone (CV), 2nd RA;Air Suspension Axle	
	08/98→12/01	Track Control Arm		VL-VB-8525	Wishbone (CV)	
	08/98→12/01	Track Control Arm		VL-VB-8525	Wishbone (CV), Air Suspension Axle	
	08/98→12/01	Track Control Arm		VL-VB-8525	Wishbone (CV), Tag Axle;Air Suspension Axle	
	08/98→12/01	Track Control Arm		VL-VB-8541	Wishbone (CV), Drive Axle;Air Suspension Axle	
	08/98→12/01	Track Control Arm		VL-VB-8541	Wishbone (CV), Tag Axle;Air Suspension Axle	
	08/98→12/01	Track Control Arm		VL-VB-8576	Wishbone (CV), Drive Axle;Leading Axle; Air Suspension Axle	
	08/98→12/01	Track Control Arm	VL-DL-10309	VL-DL-10309	Trailing Arm, 1st Front Axle, for Pneumatic Suspension vehicles, Ch.A519971/B270523→	
	FM 7/290	08/98→12/01	Bush, parabolic spring		VL-SB-5356	
		08/98→12/01	Centre Rod	RV-DL-12320		for Steering Rod
08/98→12/01		Centre Rod	VL-DL-8178		Push Rod	
08/98→12/01		Centre Rod	VL-DL-8406		Push Rod, Air Suspension Axle	
08/98→12/01		Centre Rod	VL-DL-8407		Push Rod, Leaf Spring Axle	
08/98→12/01		Centre Rod	VL-DL-8566		Push Rod, Leaf Spring Axle	
08/98→12/01		Centre Rod	VL-DL-8681		Push Rod, 1st FA;Air Suspension Axle	
08/98→12/01		Centre Rod	VL-DL-8707		Push Rod, Air Suspension Axle	
08/98→12/01		Stabiliser Link		VL-DL-8412	Coupling Rod, Control Arm	
08/98→12/01		Stabiliser Link		VL-DL-9491	Coupling Rod, Control Arm	
08/98→12/01		Stabiliser Link	VL-DL-8157		Coupling Rod, for Leaf-Spring Suspension vehicles	
08/98→12/01		Stabiliser Link	VL-DL-8536		Coupling Rod, Air Suspension Axle	
08/98→12/01		Suspension Arm Repair Kit		CV-RK-5322	for Wishbone (CV)	
08/98→12/01		Suspension Arm Repair Kit		IV-RK-8998	for Wishbone (CV)	
08/98→12/01		Suspension Arm Repair Kit		MN-RK-7280	for Drag Link	
08/98→12/01		Suspension Strut Repair Kit	MN-RK-12436			
08/98→12/01		Suspension Strut Repair Kit	VL-RK-8533			
08/98→12/01		Tie Bar Bush		VL-RK-8656		
08/98→12/01		Tie Bar Bush		VL-SB-9501		
08/98→12/01		Tie Rod		VL-DL-8163	Leading Axle;for vehicles with Hinged Leading Axle	
08/98→12/01		Tie Rod	VL-DL-7789			
08/98→12/01		Tie Rod End		VL-ES-10361	Tag Axle	

CV-RK-5322

Ø: 72 Thick/Height: 50
271188, 3091598



IV-RK-8998

Ø: 85 Hole Distance: 130
Thick/Height: 30
273373, 274019, 4941233, 6889509



MN-RK-7280

Ø: 75 Hole Distance: 115
Thick/Height: 24
271187, 689748



MN-RK-12436

Ø: 75 Hole Distance: 115
Thick/Height: 24
3093462, 85104224



RV-DL-12320

Length: 881 Ø: 50
Cone Ø: d1 Ø 28,6 / d2 Ø 23,9
20390746, 21106968



RV-VB-8191

Length: 662,4 Ø: 48
Hole Distance: 115 / 115
20367004, 20507262, 20741695, 20741703,
22318833



VL-DL-7789

Length: 1640 Ø: 58
Cone Ø: d1 Ø 28,6 / d2 Ø 23,9
1612254, 3985570, 4510697, 20393097,
21260286



VL-DL-8157

Length: 325 Ø: 30
Cone Ø: d1 Ø 22 / d2 Ø 20
1629668, 3986433, 14316200A, 20477805



VL-DL-8163

Length: 1640 Ø: 42
Cone Ø: d1 Ø 28,6 / d2 Ø 23,9
1628637, 3962343, 3986450, 3988711



VL-DL-8178

Length: 572 Ø: 38
Cone Ø: d1 Ø 28,6 / d2 Ø 23,9
1088985, 20393083



VL-DL-8189

Length: 666 Ø: 48
Hole Distance: 125
1082104, 1605035



VL-DL-8406

Length: 888 Ø: 52
Cone Ø: d1 Ø 28,6 / d2 Ø 23,9
8190146, 20393071



VL-DL-8407

Length: 870 Ø: 52
Cone Ø: d1 Ø 28,6 / d2 Ø 23,9
3986452, 20375555, 20393186, 21106930



VL-DL-8412

Length: 435 Ø: 36
Cone Ø: d1 Ø 28,6 / d2 Ø 25,5
3173613, 3987354



VL-DL-8536

Length: 340 Ø: 30
Cone Ø: d1 Ø 22 / d2 Ø 19,9
3944046, 20477807



VL-DL-8554

Length: 570 Ø: 48
Hole Distance: 130 / 130
1626957, 1626958, 14320200A



VL-DL-8566

Length: 863 Ø: 52
Cone Ø: d1 Ø 28,6 / d2 Ø 23,9
20375556, 20393187, 21106952, 21406952



VL-DL-8619

Length: 621 Ø: 48
Hole Distance: 100 / 100
1608151, 1621419



VL-DL-8681

Length: 888 Ø: 52
Cone Ø: d1 Ø 28,6 / d2 Ø 23,9
8190147, 20393073



VL-DL-8707

Length: 885 Ø: 50
Cone Ø: d1 Ø 28,6 / d2 Ø 23,9
20390745, 21106936



VL-DL-9485

Length: 666 Ø: 48
Hole Distance: 125 / 125
1589817



VL-DL-9491

Length: 380 Ø: 36
Cone Ø: d1 Ø 28,6 / d2 Ø 25,5
3173914, 3987355



VL-DL-10309

Length: 799 Ø: 48
Hole Distance: 115 / 115
20410053, 21106157



VL-ES-5347

Length: 125
Cone Ø: d1 Ø 28,6 / d2 Ø 23,9
Thread: M30 x 1,5 LHT
1507822, 1698847, 3092471



VL-ES-5348

Length: 125
Cone Ø: d1 Ø 28,6 / d2 Ø 23,9
Thread: M30 x 1,5 RHT
1507823, 1698846, 3092472



VL-ES-7265

Length: 125
Cone Ø: d1 Ø 31,5 / d2 Ø 27,5
Thread: M30 x 1,5 LHT
1131744, 1313744, 1698558, 1698840,
2072161F, 3092795, 6869744, 6882112,
6889481, 85114147



VL-ES-7266

Length: 125
Cone Ø: d1 Ø 31,5 / d2 Ø 27,5
Thread: M30 x 1,5 RHT
0356310, 1507826, 1695585, 1695776,
1698557, 6882111, 6882111(BRAZIL),
6889480, 6889482, 14200800A, 85114146



VL-ES-8411

Length: 140
Cone Ø: d1 Ø 28,6 / d2 Ø 23,9
Thread: M30 x 1,5 RHT
3093647, 3097999, 21263821



VL-ES-10361

Length: 88
Cone Ø: d1 Ø 28,6 / d2 Ø 24
Thread: M26 x 1,5 RHT
20374698



VL-RK-8533

Ø: 85 Hole Distance: 130
Thick/Height: 30
3093630, 3093631, 20840815, 21295230,
7420840815



VL-RK-8656

Ø: 91 Hole Distance: 145
Thick/Height: 26
1628107



VL-SB-5356

Thick/Height: 150
1629553, 14403900A, 20390836



VL-SB-9501

Ø: 91 Thick/Height: 85 / 85
1135080



VL-VB-5369

Length: 677 Ø: 48
Hole Distance: 115 / 115
3172829, 8073569, 14319600A



VL-VB-7787

Length: 671 Ø: 58
Hole Distance: 130 / 130
143167, 1076639, 1626896, 1629734,
20392649, 20829503, 21295227, 21474441,
22318834, 7421295227



VL-VB-8195

Length: 649 Ø: 48
Hole Distance: 115 / 115
1094466, 20374689, 20382314, 20502944



VL-VB-8525

Length: 677,3 Ø: 48
Hole Distance: 145 / 145
3173291, 20556490



VL-VB-8541

Length: 677,3 Ø: 48
Hole Distance: 145 / 145
3173292, 20556491



VL-VB-8576

Length: 660,3 Ø: 48
Hole Distance: 145 / 145
3173293, 20556492



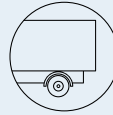

FM 7 ...

FM 7/290 ...	08/98→12/01	Tie Rod End	CV-ES-12462		for Steering Rod
	08/98→12/01	Tie Rod End	RV-ES-12442		
	08/98→12/01	Tie Rod End	VL-ES-5287		for Guide Rod
	08/98→12/01	Tie Rod End	VL-ES-5288		for Guide Rod
	08/98→12/01	Tie Rod End	VL-ES-5347		for Steering Rod
	08/98→12/01	Tie Rod End	VL-ES-5348		for Steering Rod
	08/98→12/01	Tie Rod End	VL-ES-7265	VL-ES-7265	
	08/98→12/01	Tie Rod End	VL-ES-7266	VL-ES-7266	
	08/98→12/01	Tie Rod End	VL-ES-8411		
	08/98→12/01	Track Control Arm		RV-VB-8191	Wishbone (CV)
	08/98→12/01	Track Control Arm		RV-VB-8191	Wishbone (CV), Air Suspension Axle
	08/98→12/01	Track Control Arm		VL-DL-8189	Trailing Arm, 1st Drive Axle, for Pneumatic Suspension vehicles
	08/98→12/01	Track Control Arm		VL-DL-8189	Trailing Arm, Drive Axle;for vehicles with Rigid Leading Axle
	08/98→12/01	Track Control Arm		VL-DL-8189	Trailing Arm, Drive Axle;for vehicles with Rigid Trailing Axle
	08/98→12/01	Track Control Arm		VL-DL-8554	Trailing Arm, 1st RA;2nd RA;Leaf Spring Axle
	08/98→12/01	Track Control Arm		VL-DL-8619	Trailing Arm, 1st & 2nd Drive Axle, for Leaf-Spring Suspension vehicles
	08/98→12/01	Track Control Arm		VL-DL-9485	Trailing Arm
	08/98→12/01	Track Control Arm		VL-DL-9485	Trailing Arm, Tag Axle;for vehicles with Rigid Trailing Axle
	08/98→12/01	Track Control Arm		VL-VB-5369	Wishbone (CV)
	08/98→12/01	Track Control Arm		VL-VB-5369	Wishbone (CV), 1st RA;2nd RA;Leaf Spring Axle
	08/98→12/01	Track Control Arm		VL-VB-5369	Wishbone (CV), 1st RA;Air Suspension Axle
	08/98→12/01	Track Control Arm		VL-VB-7787	Wishbone (CV)
	08/98→12/01	Track Control Arm		VL-VB-7787	Wishbone (CV), 1st RA;2nd RA;Unit; Leaf Spring Axle
	08/98→12/01	Track Control Arm		VL-VB-8195	Wishbone (CV), 1st Drive Axle, for Pneumatic Suspension vehicles, →Ch.1202645/A527108
	08/98→12/01	Track Control Arm		VL-VB-8195	Wishbone (CV), 1st Drive Axle, for Pneumatic Suspension vehicles, →Ch.B281986
	08/98→12/01	Track Control Arm		VL-VB-8195	Wishbone (CV), 2nd RA;Air Suspension Axle
	08/98→12/01	Track Control Arm		VL-VB-8525	Wishbone (CV)
	08/98→12/01	Track Control Arm		VL-VB-8525	Wishbone (CV), Air Suspension Axle
	08/98→12/01	Track Control Arm		VL-VB-8525	Wishbone (CV), Tag Axle;Air Suspension Axle
	08/98→12/01	Track Control Arm		VL-VB-8541	Wishbone (CV), Drive Axle;Air Suspension Axle
	08/98→12/01	Track Control Arm		VL-VB-8541	Wishbone (CV), Tag Axle;Air Suspension Axle
	08/98→12/01	Track Control Arm		VL-VB-8576	Wishbone (CV), Drive Axle;Leading Axle; Air Suspension Axle
	08/98→12/01	Track Control Arm	VL-DL-10309	VL-DL-10309	Trailing Arm, 1st Front Axle, for Pneumatic Suspension vehicles, Ch.A519971/B270523→

FM 9

FM 9/260	12/01→09/05	Centre Rod	RV-DL-12320		for Steering Rod
	12/01→09/05	Centre Rod	VL-DL-8407		Push Rod, Leaf Spring Axle
	12/01→09/05	Centre Rod	VL-DL-8566		Push Rod
	12/01→09/05	Centre Rod	VL-DL-8707		Push Rod, Air Suspension Axle
	12/01→09/05	Centre Rod	VL-DL-12483		Push Rod
	12/01→09/05	Centre Rod	VL-DL-12484		Push Rod
	12/01→09/05	Stabiliser Link		VL-DL-8518	Coupling Rod, Control Arm
	12/01→09/05	Stabiliser Link		VL-DL-8543	Coupling Rod, Control Arm
	12/01→09/05	Stabiliser Link		VL-DL-9472	Coupling Rod
	12/01→09/05	Stabiliser Link	VL-DL-8157		Coupling Rod, for Leaf-Spring Suspension vehicles
	12/01→09/05	Stabiliser Link	VL-DL-8157		Coupling Rod, for Pneumatic Suspension vehicles
	12/01→09/05	Stabiliser Link	VL-DL-8536		Coupling Rod, Air Suspension Axle
	12/01→09/05	Stabiliser Link	VL-DL-10258		Coupling Rod, for Leaf-Spring Suspension vehicles

CV-ES-12462

Length: 120
 Cone Ø: d1 Ø 26 / d2 Ø 23,5
 Thread: M30 x 1,5 RHT
 1517577, 1695690, 1697297, 15175771

**RV-DL-12320**

Length: 881 Ø: 50
 Cone Ø: d1 Ø 28,6 / d2 Ø 23,9
 20390746, 21106968

**RV-ES-12442**

Length: 88
 Cone Ø: d1 Ø 28,6
 Thread: M26 x 1,5 RHT
 3987648

**RV-VB-8191**

Length: 662,4 Ø: 48
 Hole Distance: 115 / 115
 20367004, 20507262, 20741695, 20741703,
 22318833

**VL-DL-8157**

Length: 325 Ø: 30
 Cone Ø: d1 Ø 22 / d2 Ø 20
 1629668, 3986433, 14316200A, 20477805

**VL-DL-8189**

Length: 666 Ø: 48
 Hole Distance: 125
 1082104, 1605035

**VL-DL-8407**

Length: 870 Ø: 52
 Cone Ø: d1 Ø 28,6 / d2 Ø 23,9
 3986452, 20375555, 20393186, 21106930

**VL-DL-8518**

Length: 350 Ø: 36
 Cone Ø: d1 Ø 28,9 / d2 Ø 24,7
 20443063, 20443067, 20994420

**VL-DL-8536**

Length: 340 Ø: 30
 Cone Ø: d1 Ø 22 / d2 Ø 19,9
 3944046, 20477807

**VL-DL-8543**

Length: 380 Ø: 36
 Cone Ø: d1 Ø 28,6 / d2 Ø 24,7
 20443062, 20443066, 20994419

**VL-DL-8554**

Length: 570 Ø: 48
 Hole Distance: 130 / 130
 1626957, 1626958, 14320200A

**VL-DL-8566**

Length: 863 Ø: 52
 Cone Ø: d1 Ø 28,6 / d2 Ø 23,9
 20375556, 20393187, 21106952, 21406952

**VL-DL-8619**

Length: 621 Ø: 48
 Hole Distance: 100 / 100
 1608151, 1621419

**VL-DL-8707**

Length: 885 Ø: 50
 Cone Ø: d1 Ø 28,6 / d2 Ø 23,9
 20390745, 21106936

**VL-DL-9472**

Length: 435 Ø: 36
 Cone Ø: d1 Ø 32,2 / d2 Ø 28
 20443061, 20443065, 20994418

**VL-DL-9485**

Length: 666 Ø: 48
 Hole Distance: 125 / 125
 1589817

**VL-DL-10258**

Length: 325 Ø: 30
 Cone Ø: d1 Ø 22 / d2 Ø 20
 1629668, 3986433, 20477805

**VL-DL-10309**

Length: 799 Ø: 48
 Hole Distance: 115 / 115
 20410053, 21106157

**VL-DL-12483**

Length: 485 Ø: 48
 Cone Ø: d1 Ø 28,6 / d2 Ø 23,9
 20383081, 21260283, 22159761,
 81467106355

**VL-DL-12484**

Length: 1025 Ø: 48
 Cone Ø: d1 Ø 28,6 / d2 Ø 23,9
 2038308, 21252481

**VL-ES-5287**

Length: 167
 Cone Ø: d1 Ø 28,6 / d2 Ø 23,9
 Thread: M52 x 1,5 RHT
 1696901, 1699401

**VL-ES-5288**

Length: 167
 Cone Ø: d1 Ø 28,6 / d2 Ø 23,9
 Thread: M52 x 1,5 LHT
 1696900, 1699400

**VL-ES-5347**

Length: 125
 Cone Ø: d1 Ø 28,6 / d2 Ø 23,9
 Thread: M30 x 1,5 LHT
 1507822, 1698847, 3092471

**VL-ES-5348**

Length: 125
 Cone Ø: d1 Ø 28,6 / d2 Ø 23,9
 Thread: M30 x 1,5 RHT
 1507823, 1698846, 3092472

**VL-ES-7265**

Length: 125
 Cone Ø: d1 Ø 31,5 / d2 Ø 27,5
 Thread: M30 x 1,5 LHT
 1131744, 1313744, 1698558, 1698840,
 2072161F, 3092795, 6869744, 6882112,
 6889481, 85114147

**VL-ES-7266**

Length: 125
 Cone Ø: d1 Ø 31,5 / d2 Ø 27,5
 Thread: M30 x 1,5 RHT
 0356310, 1507826, 1695585, 1695776,
 1698557, 6882111, 6882111(BRAZIL),
 6889480, 6889482, 14200800A, 85114146

**VL-ES-8411**

Length: 140
 Cone Ø: d1 Ø 28,6 / d2 Ø 23,9
 Thread: M30 x 1,5 RHT
 3093647, 3097999, 21263821

**VL-VB-5369**

Length: 677 Ø: 48
 Hole Distance: 115 / 115
 3172829, 8073569, 14319600A

**VL-VB-7787**

Length: 671 Ø: 58
 Hole Distance: 130 / 130
 143167, 1076639, 1626896, 1629734,
 20392649, 20829503, 21295227, 21474441,
 22318834, 7421295227

**VL-VB-8195**

Length: 649 Ø: 48
 Hole Distance: 115 / 115
 1094466, 20374689, 20382314, 20502944

**VL-VB-8525**

Length: 677,3 Ø: 48
 Hole Distance: 145 / 145
 3173291, 20556490

**VL-VB-8541**

Length: 677,3 Ø: 48
 Hole Distance: 145 / 145
 3173292, 20556491

**VL-VB-8576**

Ø: 48 Hole Distance: 145 / 145
 3173293, 20556492





FM 9 ...

FM 9/260 ...	12/01→09/05	Stabiliser Link	VL-DL-12356		Coupling Rod	
	12/01→09/05	Suspension Arm Repair Kit		VL-RK-9497	for Drag Link	
	12/01→09/05	Suspension Strut Repair Kit		MN-RK-12436		
	12/01→09/05	Tie Rod	RV-DL-12447			
	12/01→09/05	Tie Rod	VL-DL-7789			
	12/01→09/05	Tie Rod	VL-DL-8163			
	12/01→09/05	Tie Rod	VL-DL-8305		Leaf Spring Axle	
	12/01→09/05	Tie Rod	VL-DL-8322		Leaf Spring Axle	
	12/01→09/05	Tie Rod	VL-DL-9492		Air Suspension Axle	
	12/01→09/05	Tie Rod	VL-DL-9493		Air Suspension Axle	
	12/01→09/05	Tie Rod	VL-DL-12355			
	12/01→09/05	Tie Rod	VL-DL-12358			
	12/01→09/05	Tie Rod End		RV-ES-9432	Leading Axle	
	12/01→09/05	Tie Rod End		RV-ES-9432	Tag Axle	
	12/01→09/05	Tie Rod End	RV-ES-12442			
	12/01→09/05	Tie Rod End	VL-ES-5347		for Steering Rod	
	12/01→09/05	Tie Rod End	VL-ES-5348		for Steering Rod	
	12/01→09/05	Tie Rod End	VL-ES-8411			
	12/01→09/05	Track Control Arm		RV-VB-8191	Wishbone (CV), 1st Drive Axle, for Pneumatic Suspension vehicles	
	12/01→09/05	Track Control Arm		RV-VB-8191	Wishbone (CV), Air Suspension Axle	
	12/01→09/05	Track Control Arm		RV-VB-8191	Wishbone (CV), Leading Axle Steered/not Steered, for Pneumatic Suspension vehicles	
	12/01→09/05	Track Control Arm		RV-VB-8191	Wishbone (CV), Trailing Axle Steered/not Steered, for Pneumatic Suspension vehicles	
	12/01→09/05	Track Control Arm		VL-DL-8180	Trailing Arm	
	12/01→09/05	Track Control Arm		VL-VB-7787	Wishbone (CV)	
	12/01→09/05	Track Control Arm		VL-VB-12460	Wishbone (CV)	
	12/01→09/05	Track Control Arm		VL-VB-12460	Wishbone (CV), 1st Drive Axle, for Pneumatic Suspension vehicles	
	12/01→09/05	Track Control Arm	VL-DL-10309	VL-DL-10309	Trailing Arm, Air Suspension Axle	
	FM 9/300	12/01→09/05	Centre Rod	RV-DL-12320		for Steering Rod
		12/01→09/05	Centre Rod	VL-DL-8566		Push Rod
		12/01→09/05	Centre Rod	VL-DL-8707		Push Rod, Air Suspension Axle
		12/01→09/05	Centre Rod	VL-DL-12483		Push Rod
		12/01→09/05	Centre Rod	VL-DL-12484		Push Rod
		12/01→09/05	Stabiliser Link		VL-DL-8518	Coupling Rod, Control Arm
12/01→09/05		Stabiliser Link		VL-DL-8543	Coupling Rod, Control Arm	
12/01→09/05		Stabiliser Link		VL-DL-9472	Coupling Rod	
12/01→09/05		Stabiliser Link	VL-DL-8157		Coupling Rod, for Leaf-Spring Suspension vehicles	
12/01→09/05		Stabiliser Link	VL-DL-8157		Coupling Rod, for Pneumatic Suspension vehicles	
12/01→09/05		Stabiliser Link	VL-DL-8536		Coupling Rod, Air Suspension Axle	
12/01→09/05		Stabiliser Link	VL-DL-10258		Coupling Rod, for Leaf-Spring Suspension vehicles	
12/01→09/05		Stabiliser Link	VL-DL-12356		Coupling Rod	
12/01→09/05		Suspension Arm Repair Kit		VL-RK-9497	for Drag Link	
12/01→09/05		Suspension Arm Repair Kit		VL-RK-9497	for Drag Link, Leaf Spring Axle	
12/01→09/05		Suspension Strut Repair Kit		MN-RK-12436		
12/01→09/05		Tie Rod	RV-DL-12447			
12/01→09/05		Tie Rod	VL-DL-8163			
12/01→09/05		Tie Rod	VL-DL-8305		Leaf Spring Axle	
12/01→09/05		Tie Rod	VL-DL-8322		Leaf Spring Axle	
12/01→09/05		Tie Rod	VL-DL-9492		Air Suspension Axle	
12/01→09/05		Tie Rod	VL-DL-9493		Air Suspension Axle	
12/01→09/05		Tie Rod	VL-DL-12355			
12/01→09/05		Tie Rod	VL-DL-12358			
12/01→09/05		Tie Rod End		RV-ES-9432	Leading Axle	
12/01→09/05		Tie Rod End		RV-ES-9432	Tag Axle	
12/01→09/05		Tie Rod End	RV-ES-12442			
12/01→09/05		Tie Rod End	VL-ES-5347		for Steering Rod	
12/01→09/05		Tie Rod End	VL-ES-5348		for Steering Rod	

MN-RK-12436

Ø: 75 Hole Distance: 115
 Thick/Height: 24
 3093462, 85104224

**RV-DL-12320**

Length: 881 Ø: 50
 Cone Ø: d1 Ø 28,6 / d2 Ø 23,9
 20390746, 21106968

**RV-DL-12447**

Length: 1818 Ø: 52
 Cone Ø: d1 Ø 28,6 / d2 Ø 23,9
 20399543, 21299034, 85115631

**RV-ES-9432**

Length: 120
 Cone Ø: d1 Ø 28 / d2 Ø 23,9
 Thread: M26 x 1,5 RHT
 3193731

**RV-ES-12442**

Length: 88
 Cone Ø: d1 Ø 28,6
 Thread: M26 x 1,5 RHT
 3987648

**RV-VB-8191**

Length: 662,4 Ø: 48
 Hole Distance: 115 / 115
 20367004, 20507262, 20741695, 20741703,
 22318833

**VL-DL-7789**

Length: 1640 Ø: 58
 Cone Ø: d1 Ø 28,6 / d2 Ø 23,9
 1612254, 3985570, 4510697, 20393097,
 21260286

**VL-DL-8157**

Length: 325 Ø: 30
 Cone Ø: d1 Ø 22 / d2 Ø 20
 1629668, 3986433, 14316200A, 20477805

**VL-DL-8163**

Length: 1640 Ø: 42
 Cone Ø: d1 Ø 28,6 / d2 Ø 23,9
 1628637, 3962343, 3986450, 3988711

**VL-DL-8180**

Length: 625 Ø: 17
 20374444, 20410530, 20509018, 20517494,
 70371270

**VL-DL-8305**

Length: 1634 Ø: 50
 Cone Ø: d1 Ø 28,6 / d2 Ø 23,9
 3198276, 21260274

**VL-DL-8322**

Length: 1645 Ø: 50
 Cone Ø: d1 Ø 28,6 / d2 Ø 23,9
 20392778, 21260296

**VL-DL-8518**

Length: 350 Ø: 36
 Cone Ø: d1 Ø 28,9 / d2 Ø 24,7
 20443063, 20443067, 20994420

**VL-DL-8536**

Length: 340 Ø: 30
 Cone Ø: d1 Ø 22 / d2 Ø 19,9
 3944046, 20477807

**VL-DL-8543**

Length: 380 Ø: 36
 Cone Ø: d1 Ø 28,6 / d2 Ø 24,7
 20443062, 20443066, 20994419

**VL-DL-8566**

Length: 863 Ø: 52
 Cone Ø: d1 Ø 28,6 / d2 Ø 23,9
 20375556, 20393187, 21106952, 21406952

**VL-DL-8707**

Length: 885 Ø: 50
 Cone Ø: d1 Ø 28,6 / d2 Ø 23,9
 20390745, 21106936

**VL-DL-9472**

Length: 435 Ø: 36
 Cone Ø: d1 Ø 32,2 / d2 Ø 28
 20443061, 20443065, 20994418

**VL-DL-9492**

Length: 1660 Ø: 62
 Cone Ø: d1 Ø 32 / d2 Ø 27
 20587731, 21106938

**VL-DL-9493**

Length: 1660 Ø: 62
 Cone Ø: d1 Ø 28,6 / d2 Ø 23,9
 3198234, 21260275

**VL-DL-10258**

Length: 325 Ø: 30
 Cone Ø: d1 Ø 22 / d2 Ø 20
 1629668, 3986433, 20477805

**VL-DL-10309**

Length: 799 Ø: 48
 Hole Distance: 115 / 115
 20410053, 21106157

**VL-DL-12355**

Length: 368 Ø: 38
 Cone Ø: d1 Ø 28,6 / d2 Ø 23,9
 1628207

**VL-DL-12356**

Length: 275 Ø: 30
 Cone Ø: d1 Ø 22
 3987423, 20477803

**VL-DL-12358**

Length: 1669 Ø: 42
 Cone Ø: d1 Ø 32 / d2 Ø 27
 Thread: M32 x 1,5 RHT / M32 x 1,5 LHT
 20581086, 7420581086

**VL-DL-12483**

Length: 485 Ø: 48
 Cone Ø: d1 Ø 28,6 / d2 Ø 23,9
 20383081, 21260283, 22159761,
 81467106355

**VL-DL-12484**

Length: 1025 Ø: 48
 Cone Ø: d1 Ø 28,6 / d2 Ø 23,9
 2038308, 21252481

**VL-ES-5347**

Length: 125
 Cone Ø: d1 Ø 28,6 / d2 Ø 23,9
 Thread: M30 x 1,5 LHT
 1507822, 1698847, 3092471

**VL-ES-5348**

Length: 125
 Cone Ø: d1 Ø 28,6 / d2 Ø 23,9
 Thread: M30 x 1,5 RHT
 1507823, 1698846, 3092472

**VL-ES-8411**

Length: 140
 Cone Ø: d1 Ø 28,6 / d2 Ø 23,9
 Thread: M30 x 1,5 RHT
 3093647, 3097999, 21263821

**VL-RK-9497**

Ø: 95 Hole Distance: 130
 Thick/Height: 35
 273612, 20702095

**VL-VB-7787**

Length: 671 Ø: 58
 Hole Distance: 130 / 130
 143167, 1076639, 1626896, 1629734,
 20392649, 20829503, 21295227, 21474441,
 22318834, 7421295227

**VL-VB-12460**

Length: 662 Ø: 50
 Hole Distance: 115 / 115
 2223852, 20589061



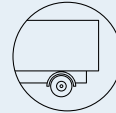

FM 9 ...

FM 9/300 ...	12/01→09/05	Tie Rod End	VL-ES-8411			
	12/01→09/05	Track Control Arm		RV-DL-10299	Trailing Arm, 1st RA;2nd RA; Leaf Spring Axle;Unit	
	12/01→09/05	Track Control Arm		RV-TC-12339	Suspension Rod, Trailing Arm	
	12/01→09/05	Track Control Arm		RV-TC-12340	Trailing Arm, 1st & 2nd Drive Axle, for Leaf-Spring Suspension vehicles, Ch.A557646/B330019→	
	12/01→09/05	Track Control Arm		RV-VB-8191	Wishbone (CV), 1st Drive Axle, for Pneumatic Suspension vehicles	
	12/01→09/05	Track Control Arm		RV-VB-8191	Wishbone (CV), Air Suspension Axle	
	12/01→09/05	Track Control Arm		RV-VB-8191	Wishbone (CV), Leading Axle Steered/not Steered, for Pneumatic Suspension vehicles	
	12/01→09/05	Track Control Arm		RV-VB-8191	Wishbone (CV), Trailing Axle Steered/not Steered, for Leaf-Spring Suspension vehicles, Ch.A557646/B330019→	
	12/01→09/05	Track Control Arm		RV-VB-8191	Wishbone (CV), Trailing Axle Steered/not Steered, for Pneumatic Suspension vehicles	
	12/01→09/05	Track Control Arm		VL-DL-8180	Trailing Arm	
	12/01→09/05	Track Control Arm		VL-DL-8554	Trailing Arm, 1st RA;2nd RA;Leaf Spring Axle	
	12/01→09/05	Track Control Arm		VL-DL-8619	Trailing Arm, 1st & 2nd Drive Axle, for Leaf-Spring Suspension vehicles, →Ch.A557645/B330018	
	12/01→09/05	Track Control Arm		VL-VB-5369	Wishbone (CV), 1st & 2nd Drive Axle, for Leaf-Spring Suspension vehicles, →Ch.A557645/B330018	
	12/01→09/05	Track Control Arm		VL-VB-7787	Wishbone (CV)	
	12/01→09/05	Track Control Arm		VL-VB-7787	Wishbone (CV), 1st RA;2nd RA;Unit; Leaf Spring Axle	
	12/01→09/05	Track Control Arm		VL-VB-12460	Wishbone (CV)	
	12/01→09/05	Track Control Arm		VL-VB-12460	Wishbone (CV), 1st Drive Axle, for Pneumatic Suspension vehicles	
	12/01→09/05	Track Control Arm	VL-DL-10309	VL-DL-10309	Trailing Arm, 1st Front Axle, for Pneumatic Suspension vehicles	
	12/01→09/05	Track Control Arm	VL-DL-10309	VL-DL-10309	Trailing Arm, Air Suspension Axle	
	FM 9/340	12/01→09/05	Centre Rod	RV-DL-12320		for Steering Rod
		12/01→09/05	Centre Rod	VL-DL-8566		Push Rod
		12/01→09/05	Centre Rod	VL-DL-8707		Push Rod, Air Suspension Axle
		12/01→09/05	Centre Rod	VL-DL-12483		Push Rod
12/01→09/05		Centre Rod	VL-DL-12484		Push Rod	
12/01→09/05		Stabiliser Link		VL-DL-8518	Coupling Rod, Control Arm	
12/01→09/05		Stabiliser Link		VL-DL-8543	Coupling Rod, Control Arm	
12/01→09/05		Stabiliser Link		VL-DL-9472	Coupling Rod	
12/01→09/05		Stabiliser Link	VL-DL-8157		Coupling Rod, for Leaf-Spring Suspension vehicles	
12/01→09/05		Stabiliser Link	VL-DL-8157		Coupling Rod, for Pneumatic Suspension vehicles	
12/01→09/05		Stabiliser Link	VL-DL-8536		Coupling Rod, Air Suspension Axle	
12/01→09/05		Stabiliser Link	VL-DL-10258		Coupling Rod, for Leaf-Spring Suspension vehicles	
12/01→09/05		Stabiliser Link	VL-DL-12356		Coupling Rod	
12/01→09/05		Suspension Arm Repair Kit		VL-RK-9497	for Drag Link	
12/01→09/05		Suspension Arm Repair Kit		VL-RK-9497	for Drag Link, Leaf Spring Axle	
12/01→09/05		Suspension Strut Repair Kit		MN-RK-12436		
12/01→09/05		Tie Rod	RV-DL-12447			
12/01→09/05		Tie Rod	VL-DL-8163			
12/01→09/05		Tie Rod	VL-DL-8305		Leaf Spring Axle	
12/01→09/05		Tie Rod	VL-DL-8322		Leaf Spring Axle	
12/01→09/05		Tie Rod	VL-DL-9492		Air Suspension Axle	
12/01→09/05		Tie Rod	VL-DL-9493		Air Suspension Axle	
12/01→09/05		Tie Rod	VL-DL-12355			
12/01→09/05		Tie Rod	VL-DL-12358			
12/01→09/05		Tie Rod End		RV-ES-9432	Leading Axle	
12/01→09/05		Tie Rod End		RV-ES-9432	Tag Axle	

MN-RK-12436

Ø: 75 Hole Distance: 115
Thick/Height: 24
3093462, 85104224

**RV-DL-10299**

Length: 510 Ø: 21
20522934, 21051052, 7420864583,
7421051052

**RV-DL-12320**

Length: 881 Ø: 50
Cone Ø: d1 Ø 28,6 / d2 Ø 23,9
20390746, 21106968

**RV-DL-12447**

Length: 1818 Ø: 52
Cone Ø: d1 Ø 28,6 / d2 Ø 23,9
20399543, 21299034, 85115631

**RV-ES-9432**

Length: 120
Cone Ø: d1 Ø 28 / d2 Ø 23,9
Thread: M26 x 1,5 RHT
3193731

**RV-TC-12339**

Length: 515
Hole Distance: 13 / 130
20532931, 21051046

**RV-TC-12340**

Length: 510
Hole Distance: 115 / 115
20443044

**RV-VB-8191**

Length: 662,4 Ø: 48
Hole Distance: 115 / 115
20367004, 20507262, 20741695, 20741703,
22318833

**VL-DL-8157**

Length: 325 Ø: 30
Cone Ø: d1 Ø 22 / d2 Ø 20
1629668, 3986433, 14316200A, 20477805

**VL-DL-8163**

Length: 1640 Ø: 42
Cone Ø: d1 Ø 28,6 / d2 Ø 23,9
1628637, 3962343, 3986450, 3988711

**VL-DL-8180**

Length: 625 Ø: 17
20374444, 20410530, 20509018, 20517494,
70371270

**VL-DL-8305**

Length: 1634 Ø: 50
Cone Ø: d1 Ø 28,6 / d2 Ø 23,9
3198276, 21260274

**VL-DL-8322**

Length: 1645 Ø: 50
Cone Ø: d1 Ø 28,6 / d2 Ø 23,9
20392778, 21260296

**VL-DL-8518**

Length: 350 Ø: 36
Cone Ø: d1 Ø 28,9 / d2 Ø 24,7
20443063, 20443067, 20994420

**VL-DL-8536**

Length: 340 Ø: 30
Cone Ø: d1 Ø 22 / d2 Ø 19,9
3944046, 20477807

**VL-DL-8543**

Length: 380 Ø: 36
Cone Ø: d1 Ø 28,6 / d2 Ø 24,7
20443062, 20443066, 20994419

**VL-DL-8554**

Length: 570 Ø: 48
Hole Distance: 130 / 130
1626957, 1626958, 14320200A

**VL-DL-8566**

Length: 863 Ø: 52
Cone Ø: d1 Ø 28,6 / d2 Ø 23,9
20375556, 20393187, 21106952, 21406952

**VL-DL-8619**

Length: 621 Ø: 48
Hole Distance: 100 / 100
1608151, 1621419

**VL-DL-8707**

Length: 885 Ø: 50
Cone Ø: d1 Ø 28,6 / d2 Ø 23,9
20390745, 21106936

**VL-DL-9472**

Length: 435 Ø: 36
Cone Ø: d1 Ø 32,2 / d2 Ø 28
20443061, 20443065, 20994418

**VL-DL-9492**

Length: 1660 Ø: 62
Cone Ø: d1 Ø 32 / d2 Ø 27
20587731, 21106938

**VL-DL-9493**

Length: 1660 Ø: 62
Cone Ø: d1 Ø 28,6 / d2 Ø 23,9
3198234, 21260275

**VL-DL-10258**

Length: 325 Ø: 30
Cone Ø: d1 Ø 22 / d2 Ø 20
1629668, 3986433, 20477805

**VL-DL-10309**

Length: 799 Ø: 48
Hole Distance: 115 / 115
20410053, 21106157

**VL-DL-12355**

Length: 368 Ø: 38
Cone Ø: d1 Ø 28,6 / d2 Ø 23,9
1628207

**VL-DL-12356**

Length: 275 Ø: 30
Cone Ø: d1 Ø 22
3987423, 20477803

**VL-DL-12358**

Length: 1669 Ø: 42
Cone Ø: d1 Ø 32 / d2 Ø 27
Thread: M32 x 1,5 RHT / M32 x 1,5 LHT
20581086, 7420581086

**VL-DL-12483**

Length: 485 Ø: 48
Cone Ø: d1 Ø 28,6 / d2 Ø 23,9
20383081, 21260283, 22159761,
81467106355

**VL-DL-12484**

Length: 1025 Ø: 48
Cone Ø: d1 Ø 28,6 / d2 Ø 23,9
2038308, 21252481

**VL-ES-8411**

Length: 140
Cone Ø: d1 Ø 28,6 / d2 Ø 23,9
Thread: M30 x 1,5 RHT
3093647, 3097999, 21263821

**VL-RK-9497**

Ø: 95 Hole Distance: 130
Thick/Height: 35
273612, 20702095

**VL-VB-5369**

Length: 677
Ø: 48
Hole Distance: 115 / 115
3172829, 8073569, 14319600A

**VL-VB-7787**

Length: 671
Ø: 58
Hole Distance: 130 / 130
143167, 1076639, 1626896, 1629734,
20392649, 20829503, 21295227, 21474441,
22318834, 7421295227

**VL-VB-12460**

Length: 662
Ø: 50
Hole Distance: 115 / 115
2223852, 20589061





FM 9 ...

FM 9/340 ...	12/01→09/05	Tie Rod End	RV-ES-12442			
	12/01→09/05	Tie Rod End	VL-ES-5347		for Steering Rod	
	12/01→09/05	Tie Rod End	VL-ES-5348		for Steering Rod	
	12/01→09/05	Tie Rod End	VL-ES-8411			
	12/01→09/05	Track Control Arm		RV-DL-10299	Trailing Arm, 1st & 2nd Drive Axle, for Leaf-Spring Suspension vehicles	
	12/01→09/05	Track Control Arm		RV-DL-10299	Trailing Arm, 1st RA;2nd RA; Leaf Spring Axle;Unit	
	12/01→09/05	Track Control Arm		RV-TC-12339	Suspension Rod, Trailing Arm	
	12/01→09/05	Track Control Arm		RV-TC-12340	Trailing Arm, 1st & 2nd Drive Axle, for Leaf-Spring Suspension vehicles, Ch.A557646/B330019→	
	12/01→09/05	Track Control Arm		RV-VB-8191	Wishbone (CV), 1st Drive Axle, for Pneumatic Suspension vehicles	
	12/01→09/05	Track Control Arm		RV-VB-8191	Wishbone (CV), Air Suspension Axle	
	12/01→09/05	Track Control Arm		RV-VB-8191	Wishbone (CV), Leading Axle Steered/not Steered, for Pneumatic Suspension vehicles	
	12/01→09/05	Track Control Arm		RV-VB-8191	Wishbone (CV), Trailing Axle Steered/not Steered, for Leaf-Spring Suspension vehicles, Ch.A557646/B330019→	
	12/01→09/05	Track Control Arm		RV-VB-8191	Wishbone (CV), Trailing Axle Steered/not Steered, for Pneumatic Suspension vehicles	
	12/01→09/05	Track Control Arm		VL-DL-8180	Trailing Arm	
	12/01→09/05	Track Control Arm		VL-DL-8554	Trailing Arm, 1st RA;2nd RA;Leaf Spring Axle	
	12/01→09/05	Track Control Arm		VL-DL-8619	Trailing Arm, 1st & 2nd Drive Axle, for Leaf-Spring Suspension vehicles, →Ch.A557645/B330018	
	12/01→09/05	Track Control Arm		VL-VB-5369	Wishbone (CV), 1st & 2nd Drive Axle, for Leaf-Spring Suspension vehicles, →Ch.A557645/B330018	
	12/01→09/05	Track Control Arm		VL-VB-7787	Wishbone (CV)	
	12/01→09/05	Track Control Arm		VL-VB-7787	Wishbone (CV), 1st RA;2nd RA;Unit; Leaf Spring Axle	
	12/01→09/05	Track Control Arm		VL-VB-12460	Wishbone (CV)	
	12/01→09/05	Track Control Arm		VL-VB-12460	Wishbone (CV), 1st Drive Axle, for Pneumatic Suspension vehicles	
	12/01→09/05	Track Control Arm	VL-DL-10309	VL-DL-10309	Trailing Arm, 1st Front Axle, for Pneumatic Suspension vehicles	
	12/01→09/05	Track Control Arm	VL-DL-10309	VL-DL-10309	Trailing Arm, Air Suspension Axle	
	FM 9/380	12/01→09/05	Centre Rod	RV-DL-12320		for Steering Rod
		12/01→09/05	Centre Rod	VL-DL-8566		Push Rod
12/01→09/05		Centre Rod	VL-DL-8707		Push Rod, Air Suspension Axle	
12/01→09/05		Centre Rod	VL-DL-12483		Push Rod	
12/01→09/05		Centre Rod	VL-DL-12484		Push Rod	
12/01→09/05		Stabiliser Link		VL-DL-8518	Coupling Rod, Control Arm	
12/01→09/05		Stabiliser Link		VL-DL-8543	Coupling Rod, Control Arm	
12/01→09/05		Stabiliser Link		VL-DL-9472	Coupling Rod	
12/01→09/05		Stabiliser Link	VL-DL-8157		Coupling Rod, for Leaf-Spring Suspension vehicles	
12/01→09/05		Stabiliser Link	VL-DL-8157		Coupling Rod, for Pneumatic Suspension vehicles	
12/01→09/05		Stabiliser Link	VL-DL-8536		Coupling Rod, Air Suspension Axle	
12/01→09/05		Stabiliser Link	VL-DL-10258		Coupling Rod, for Leaf-Spring Suspension vehicles	
12/01→09/05		Stabiliser Link	VL-DL-12356		Coupling Rod	
12/01→09/05		Suspension Arm Repair Kit		VL-RK-9497	for Drag Link	
12/01→09/05		Suspension Strut Repair Kit		MN-RK-12436		
12/01→09/05		Tie Rod	RV-DL-12447			
12/01→09/05		Tie Rod	VL-DL-8163			
12/01→09/05	Tie Rod	VL-DL-8305		Leaf Spring Axle		
12/01→09/05	Tie Rod	VL-DL-8322		Leaf Spring Axle		
12/01→09/05	Tie Rod	VL-DL-9492		Air Suspension Axle		
12/01→09/05	Tie Rod	VL-DL-9493		Air Suspension Axle		

MN-RK-12436

Ø: 75 Hole Distance: 115
 Thick/Height: 24
 3093462, 85104224

**RV-DL-10299**

Length: 510 Ø: 21
 20522934, 21051052, 7420864583,
 7421051052

**RV-DL-12320**

Length: 881 Ø: 50
 Cone Ø: d1 Ø 28,6 / d2 Ø 23,9
 20390746, 21106968

**RV-DL-12447**

Length: 1818 Ø: 52
 Cone Ø: d1 Ø 28,6 / d2 Ø 23,9
 20399543, 21299034, 85115631

**RV-ES-12442**

Length: 88
 Cone Ø: d1 Ø 28,6
 Thread: M26 x 1,5 RHT
 3987648

**RV-TC-12339**

Length: 515
 Hole Distance: 13 / 130
 20532931, 21051046

**RV-TC-12340**

Length: 510
 Hole Distance: 115 / 115
 20443044

**RV-VB-8191**

Length: 662,4 Ø: 48
 Hole Distance: 115 / 115
 20367004, 20507262, 20741695, 20741703,
 22318833

**VL-DL-8157**

Length: 325 Ø: 30
 Cone Ø: d1 Ø 22 / d2 Ø 20
 1629668, 3986433, 14316200A, 20477805

**VL-DL-8163**

Length: 1640 Ø: 42
 Cone Ø: d1 Ø 28,6 / d2 Ø 23,9
 1628637, 3962343, 3986450, 3988711

**VL-DL-8180**

Length: 625 Ø: 17
 20374444, 20410530, 20509018, 20517494,
 70371270

**VL-DL-8305**

Length: 1634 Ø: 50
 Cone Ø: d1 Ø 28,6 / d2 Ø 23,9
 3198276, 21260274

**VL-DL-8322**

Length: 1645 Ø: 50
 Cone Ø: d1 Ø 28,6 / d2 Ø 23,9
 20392778, 21260296

**VL-DL-8518**

Length: 350 Ø: 36
 Cone Ø: d1 Ø 28,9 / d2 Ø 24,7
 20443063, 20443067, 20994420

**VL-DL-8536**

Length: 340 Ø: 30
 Cone Ø: d1 Ø 22 / d2 Ø 19,9
 3944046, 20477807

**VL-DL-8543**

Length: 380 Ø: 36
 Cone Ø: d1 Ø 28,6 / d2 Ø 24,7
 20443062, 20443066, 20994419

**VL-DL-8554**

Length: 570 Ø: 48
 Hole Distance: 130 / 130
 1626957, 1626958, 14320200A

**VL-DL-8566**

Length: 863 Ø: 52
 Cone Ø: d1 Ø 28,6 / d2 Ø 23,9
 20375556, 20393187, 21106952, 21406952

**VL-DL-8619**

Length: 621 Ø: 48
 Hole Distance: 100 / 100
 1608151, 1621419

**VL-DL-8707**

Length: 885 Ø: 50
 Cone Ø: d1 Ø 28,6 / d2 Ø 23,9
 20390745, 21106936

**VL-DL-9472**

Length: 435 Ø: 36
 Cone Ø: d1 Ø 32,2 / d2 Ø 28
 20443061, 20443065, 20994418

**VL-DL-9492**

Length: 1660 Ø: 62
 Cone Ø: d1 Ø 32 / d2 Ø 27
 20587731, 21106938

**VL-DL-9493**

Length: 1660 Ø: 62
 Cone Ø: d1 Ø 28,6 / d2 Ø 23,9
 3198234, 21260275

**VL-DL-10258**

Length: 325 Ø: 30
 Cone Ø: d1 Ø 22 / d2 Ø 20
 1629668, 3986433, 20477805

**VL-DL-10309**

Length: 799 Ø: 48
 Hole Distance: 115 / 115
 20410053, 21106157

**VL-DL-12356**

Length: 275 Ø: 30
 Cone Ø: d1 Ø 22
 3987423, 20477803

**VL-DL-12483**

Length: 485 Ø: 48
 Cone Ø: d1 Ø 28,6 / d2 Ø 23,9
 20383081, 21260283, 22159761,
 81467106355

**VL-DL-12484**

Length: 1025 Ø: 48
 Cone Ø: d1 Ø 28,6 / d2 Ø 23,9
 2038308, 21252481

**VL-ES-5347**

Length: 125
 Cone Ø: d1 Ø 28,6 / d2 Ø 23,9
 Thread: M30 x 1,5 LHT
 1507822, 1698847, 3092471

**VL-ES-5348**

Length: 125
 Cone Ø: d1 Ø 28,6 / d2 Ø 23,9
 Thread: M30 x 1,5 RHT
 1507823, 1698846, 3092472

**VL-ES-8411**

Length: 140
 Cone Ø: d1 Ø 28,6 / d2 Ø 23,9
 Thread: M30 x 1,5 RHT
 3093647, 3097999, 21263821

**VL-RK-9497**

Ø: 95 Hole Distance: 130
 Thick/Height: 35
 273612, 20702095

**VL-VB-5369**

Length: 677 Ø: 48
 Hole Distance: 115 / 115
 3172829, 8073569, 14319600A

**VL-VB-7787**

Length: 671 Ø: 58
 Hole Distance: 130 / 130
 143167, 1076639, 1626896, 1629734,
 20392649, 20829503, 21295227, 21474441,
 22318834, 7421295227

**VL-VB-12460**

Length: 662 Ø: 50
 Hole Distance: 115 / 115
 2223852, 20589061





FM 9 ...

FM 9/380 ...	12/01→09/05	Tie Rod	VL-DL-12355		
	12/01→09/05	Tie Rod	VL-DL-12358		
	12/01→09/05	Tie Rod End		RV-ES-9432	Leading Axle
	12/01→09/05	Tie Rod End		RV-ES-9432	Tag Axle
	12/01→09/05	Tie Rod End	RV-ES-12442		
	12/01→09/05	Tie Rod End	VL-ES-5347		for Steering Rod
	12/01→09/05	Tie Rod End	VL-ES-5348		for Steering Rod
	12/01→09/05	Tie Rod End	VL-ES-8411		
	12/01→09/05	Track Control Arm		RV-VB-8191	Wishbone (CV), 1st Drive Axle, for Pneumatic Suspension vehicles
	12/01→09/05	Track Control Arm		RV-VB-8191	Wishbone (CV), Air Suspension Axle
	12/01→09/05	Track Control Arm		RV-VB-8191	Wishbone (CV), Leading Axle Steered/not Steered, for Pneumatic Suspension vehicles
	12/01→09/05	Track Control Arm		RV-VB-8191	Wishbone (CV), Trailing Axle Steered/not Steered, for Pneumatic Suspension vehicles
	12/01→09/05	Track Control Arm		VL-DL-8180	Trailing Arm
	12/01→09/05	Track Control Arm		VL-VB-7787	Wishbone (CV)
	12/01→09/05	Track Control Arm		VL-VB-12460	Wishbone (CV)
	12/01→09/05	Track Control Arm		VL-VB-12460	Wishbone (CV), 1st Drive Axle, for Pneumatic Suspension vehicles
	12/01→09/05	Track Control Arm	VL-DL-10309	VL-DL-10309	Trailing Arm, 1st Front Axle, for Pneumatic Suspension vehicles
	12/01→09/05	Track Control Arm	VL-DL-10309	VL-DL-10309	Trailing Arm, Air Suspension Axle

FM 10

FM 10/320	04/99→12/01	Centre Rod	RV-DL-12320		for Steering Rod
	04/99→12/01	Centre Rod	VL-DL-8178		Push Rod
	04/99→12/01	Centre Rod	VL-DL-8406		Push Rod, Air Suspension Axle
	04/99→12/01	Centre Rod	VL-DL-8407		Push Rod, Leaf Spring Axle
	04/99→12/01	Centre Rod	VL-DL-8566		Push Rod, Leaf Spring Axle
	04/99→12/01	Centre Rod	VL-DL-8681		Push Rod, 1st FA; Air Suspension Axle
	04/99→12/01	Centre Rod	VL-DL-8707		Push Rod, Air Suspension Axle
	04/99→12/01	Stabiliser Link	VL-DL-8157		Coupling Rod, for Leaf-Spring Suspension vehicles
	04/99→12/01	Stabiliser Link	VL-DL-8536		Coupling Rod, Air Suspension Axle
	04/99→12/01	Stabiliser Mounting	VL-SB-10394	VL-SB-10394	
	04/99→12/01	Stabiliser Mounting	VL-SB-10397		
	04/99→12/01	Stabiliser Mounting	VL-SB-10398		
	04/99→12/01	Suspension Arm Repair Kit		IV-RK-8998	for Wishbone (CV)
	04/99→12/01	Suspension Arm Repair Kit	VL-RK-5323	VL-RK-5323	for Drag Link
	04/99→12/01	Suspension Strut Repair Kit	MN-RK-12436		
	04/99→12/01	Tie Bar Bush		VL-SB-9501	
	04/99→12/01	Tie Rod	VL-DL-7789		
	04/99→12/01	Tie Rod End		VL-ES-10361	Tag Axle
	04/99→12/01	Tie Rod End	VL-ES-5287		for Guide Rod
	04/99→12/01	Tie Rod End	VL-ES-5288		for Guide Rod
	04/99→12/01	Tie Rod End	VL-ES-5347		for Steering Rod
	04/99→12/01	Tie Rod End	VL-ES-5348		for Steering Rod
	04/99→12/01	Tie Rod End	VL-ES-7265		
	04/99→12/01	Tie Rod End	VL-ES-7266		
	04/99→12/01	Tie Rod End	VL-ES-8411		
	04/99→12/01	Tie Rod End	VL-ES-8568		
	04/99→12/01	Track Control Arm		RV-VB-8191	Wishbone (CV)
	04/99→12/01	Track Control Arm		RV-VB-8191	Wishbone (CV), Drive Axle; Air Suspension Axle, * 1202645 ** A527108 ** B281986 *→
	04/99→12/01	Track Control Arm		VL-DL-8180	Trailing Arm, 1st Drive Axle, for Pneumatic Suspension vehicles
	04/99→12/01	Track Control Arm		VL-DL-8189	Trailing Arm
	04/99→12/01	Track Control Arm		VL-DL-8189	Trailing Arm, Drive Axle
	04/99→12/01	Track Control Arm		VL-DL-8189	Trailing Arm, Drive Axle; for vehicles with Hinged Trailing Axle; for vehicles with Rigid Trailing Axle
	04/99→12/01	Track Control Arm		VL-DL-9485	Trailing Arm, Tag Axle

IV-RK-8998

Ø: 85 Hole Distance: 130
Thick/Height: 30
273373, 274019, 4941233, 6889509



MN-RK-12436

Ø: 75 Hole Distance: 115
Thick/Height: 24
3093462, 85104224



RV-DL-12320

Length: 881 Ø: 50
Cone Ø: d1 Ø 28,6 / d2 Ø 23,9
20390746, 21106968



RV-ES-9432

Length: 120
Cone Ø: d1 Ø 28 / d2 Ø 23,9
Thread: M26 x 1,5 RHT
3193731



RV-ES-12442

Length: 88
Cone Ø: d1 Ø 28,6
Thread: M26 x 1,5 RHT
3987648



RV-VB-8191

Length: 662,4 Ø: 48
Hole Distance: 115 / 115
20367004, 20507262, 20741695, 20741703,
22318833



VL-DL-7789

Length: 1640 Ø: 58
Cone Ø: d1 Ø 28,6 / d2 Ø 23,9
1612254, 3985570, 4510697, 20393097,
21260286



VL-DL-8157

Length: 325 Ø: 30
Cone Ø: d1 Ø 22 / d2 Ø 20
1629668, 3986433, 14316200A, 20477805



VL-DL-8178

Length: 572 Ø: 38
Cone Ø: d1 Ø 28,6 / d2 Ø 23,9
1088985, 20393083



VL-DL-8180

Length: 625 Ø: 17
20374444, 20410530, 20509018, 20517494,
70371270



VL-DL-8189

Length: 666 Ø: 48
Hole Distance: 125
1082104, 1605035



VL-DL-8406

Length: 888 Ø: 52
Cone Ø: d1 Ø 28,6 / d2 Ø 23,9
8190146, 20393071



VL-DL-8407

Length: 870 Ø: 52
Cone Ø: d1 Ø 28,6 / d2 Ø 23,9
3986452, 20375555, 20393186, 21106930



VL-DL-8536

Length: 340 Ø: 30
Cone Ø: d1 Ø 22 / d2 Ø 19,9
3944046, 20477807



VL-DL-8566

Length: 863 Ø: 52
Cone Ø: d1 Ø 28,6 / d2 Ø 23,9
20375556, 20393187, 21106952, 21406952



VL-DL-8681

Length: 888 Ø: 52
Cone Ø: d1 Ø 28,6 / d2 Ø 23,9
8190147, 20393073



VL-DL-8707

Length: 885 Ø: 50
Cone Ø: d1 Ø 28,6 / d2 Ø 23,9
20390745, 21106936



VL-DL-9485

Length: 666 Ø: 48
Hole Distance: 125 / 125
1589817



VL-DL-10309

Length: 799 Ø: 48
Hole Distance: 115 / 115
20410053, 21106157



VL-DL-12355

Length: 368 Ø: 38
Cone Ø: d1 Ø 28,6 / d2 Ø 23,9
1628207



VL-DL-12358

Length: 1669 Ø: 42
Cone Ø: d1 Ø 32 / d2 Ø 27
Thread: M32 x 1,5 RHT / M32 x 1,5 LHT
20581086, 7420581086



VL-ES-5287

Length: 167
Cone Ø: d1 Ø 28,6 / d2 Ø 23,9
Thread: M52 x 1,5 RHT
1696901, 1699401



VL-ES-5288

Length: 167
Cone Ø: d1 Ø 28,6 / d2 Ø 23,9
Thread: M52 x 1,5 LHT
1696900, 1699400



VL-ES-5347

Length: 125
Cone Ø: d1 Ø 28,6 / d2 Ø 23,9
Thread: M30 x 1,5 LHT
1507822, 1698847, 3092471



VL-ES-5348

Length: 125
Cone Ø: d1 Ø 28,6 / d2 Ø 23,9
Thread: M30 x 1,5 RHT
1507823, 1698846, 3092472



VL-ES-7265

Length: 125
Cone Ø: d1 Ø 31,5 / d2 Ø 27,5
Thread: M30 x 1,5 LHT
1131744, 1313744, 1698558, 1698840,
2072161F, 3092795, 6869744, 6882112,
6889481, 85114147



VL-ES-7266

Length: 125
Cone Ø: d1 Ø 31,5 / d2 Ø 27,5
Thread: M30 x 1,5 RHT
0356310, 1507826, 1695585, 1695776,
1698557, 6882111, 6882111(BRAZIL),
6889480, 6889482, 14200800A, 85114146



VL-ES-8411

Length: 140
Cone Ø: d1 Ø 28,6 / d2 Ø 23,9
Thread: M30 x 1,5 RHT
3093647, 3097999, 21263821



VL-ES-8568

Length: 100
Cone Ø: d1 Ø 38 / d2 Ø 34,3
Thread: M26 x 1,5 RHT
8151876



VL-ES-10361

Length: 88
Cone Ø: d1 Ø 28,6 / d2 Ø 24
Thread: M26 x 1,5 RHT
20374698



VL-RK-5323

Ø: 91 Hole Distance: 125
Thick/Height: 20
1598588, 14302100A



VL-SB-9501

Ø: 91 Thick/Height: 85 / 85
1135080



VL-SB-10394

Ø: 90 Thick/Height: 95 / 95
9519245



VL-SB-10397

Thick/Height: 89 / 89
1075179



VL-SB-10398

Thick/Height: 87,5 / 87,5
1075180



VL-VB-7787

Length: 671 Ø: 58
Hole Distance: 130 / 130
143167, 1076639, 1626896, 1629734,
20392649, 20829503, 21295227, 21474441,
22318834, 7421295227



VL-VB-12460

Length: 662 Ø: 50
Hole Distance: 115 / 115
2223852, 20589061





FM 10 ...

FM 10/320 ...	04/99→12/01	Track Control Arm		VL-DL-9485	Trailing Arm, Tag Axle;for vehicles with Rigid Trailing Axle;not for Lift Axle	
	04/99→12/01	Track Control Arm		VL-VB-7787	Wishbone (CV)	
	04/99→12/01	Track Control Arm		VL-VB-8195	Wishbone (CV), Drive Axle;Air Suspension Axle, →*1202645*;A527108*;B281986*	
	04/99→12/01	Track Control Arm		VL-VB-8525	Wishbone (CV), Air Suspension Axle	
	04/99→12/01	Track Control Arm		VL-VB-8525	Wishbone (CV), Tag Axle;Air Suspension Axle	
	04/99→12/01	Track Control Arm		VL-VB-8541	Wishbone (CV), Drive Axle;Air Suspension Axle	
	04/99→12/01	Track Control Arm		VL-VB-8541	Wishbone (CV), Drive Axle;Leaf Spring Axle	
	04/99→12/01	Track Control Arm		VL-VB-8541	Wishbone (CV), Tag Axle;Air Suspension Axle	
	04/99→12/01	Track Control Arm		VL-VB-8576	Wishbone (CV), Drive Axle;Leading Axle; Air Suspension Axle	
04/99→12/01	Track Control Arm	VL-DL-10309	VL-DL-10309	Trailing Arm, 1st Front Axle, for Pneumatic Suspension vehicles, Ch.A519971/B270523→		
FM 10/360	04/99→12/01	Centre Rod	RV-DL-12320		for Steering Rod	
	04/99→12/01	Centre Rod	VL-DL-8178		Push Rod	
	04/99→12/01	Centre Rod	VL-DL-8406		Push Rod, Air Suspension Axle	
	04/99→12/01	Centre Rod	VL-DL-8407		Push Rod, Leaf Spring Axle	
	04/99→12/01	Centre Rod	VL-DL-8566		Push Rod, Leaf Spring Axle	
	04/99→12/01	Centre Rod	VL-DL-8681		Push Rod, 1st FA;Air Suspension Axle	
	04/99→12/01	Centre Rod	VL-DL-8707		Push Rod, Air Suspension Axle	
	04/99→12/01	Stabiliser Link	VL-DL-8157		Coupling Rod, for Leaf-Spring Suspension vehicles	
	04/99→12/01	Stabiliser Link	VL-DL-8536		Coupling Rod, Air Suspension Axle	
	04/99→12/01	Stabiliser Mounting	VL-SB-10394	VL-SB-10394		
	04/99→12/01	Stabiliser Mounting	VL-SB-10397			
	04/99→12/01	Stabiliser Mounting	VL-SB-10398			
	04/99→12/01	Suspension Arm Repair Kit		IV-RK-8998		for Wishbone (CV)
	04/99→12/01	Suspension Arm Repair Kit	VL-RK-5323	VL-RK-5323		for Drag Link
	04/99→12/01	Suspension Strut Repair Kit	MN-RK-12436			
	04/99→12/01	Tie Bar Bush		VL-SB-9501		
	04/99→12/01	Tie Rod	VL-DL-7789			
	04/99→12/01	Tie Rod End		VL-ES-10361		Tag Axle
	04/99→12/01	Tie Rod End	VL-ES-5287			for Guide Rod
	04/99→12/01	Tie Rod End	VL-ES-5288			for Guide Rod
	04/99→12/01	Tie Rod End	VL-ES-5347			for Steering Rod
	04/99→12/01	Tie Rod End	VL-ES-5348			for Steering Rod
	04/99→12/01	Tie Rod End	VL-ES-7265			
	04/99→12/01	Tie Rod End	VL-ES-7266			
	04/99→12/01	Tie Rod End	VL-ES-8411			
	04/99→12/01	Tie Rod End	VL-ES-8568			
	04/99→12/01	Track Control Arm		RV-VB-8191		Wishbone (CV)
	04/99→12/01	Track Control Arm		RV-VB-8191		Wishbone (CV), Drive Axle;Air Suspension Axle, * 1202645 *,* A527108 *,* B281986 *→
	04/99→12/01	Track Control Arm		VL-DL-8180		Trailing Arm, 1st Drive Axle, for Pneumatic Suspension vehicles
	04/99→12/01	Track Control Arm		VL-DL-8189		Trailing Arm
	04/99→12/01	Track Control Arm		VL-DL-8189		Trailing Arm, Drive Axle
	04/99→12/01	Track Control Arm		VL-DL-8189		Trailing Arm, Drive Axle; for vehicles with Hinged Trailing Axle; for vehicles with Rigid Trailing Axle
	04/99→12/01	Track Control Arm		VL-DL-9485		Trailing Arm, Tag Axle
	04/99→12/01	Track Control Arm		VL-DL-9485		Trailing Arm, Tag Axle;for vehicles with Rigid Trailing Axle;not for Lift Axle
	04/99→12/01	Track Control Arm		VL-VB-7787		Wishbone (CV)
	04/99→12/01	Track Control Arm		VL-VB-8195		Wishbone (CV), Drive Axle;Air Suspension Axle, →*1202645*;A527108*;B281986*
04/99→12/01	Track Control Arm		VL-VB-8525		Wishbone (CV), Air Suspension Axle	
04/99→12/01	Track Control Arm		VL-VB-8525		Wishbone (CV), Tag Axle;Air Suspension Axle	
04/99→12/01	Track Control Arm		VL-VB-8541		Wishbone (CV), Drive Axle;Air Suspension Axle	
04/99→12/01	Track Control Arm		VL-VB-8541		Wishbone (CV), Drive Axle;Leaf Spring Axle	
04/99→12/01	Track Control Arm		VL-VB-8541		Wishbone (CV), Tag Axle;Air Suspension Axle	

IV-RK-8998

Ø: 85 Hole Distance: 130
 Thick/Height: 30
 273373, 274019, 4941233, 6889509

**MN-RK-12436**

Ø: 75 Hole Distance: 115
 Thick/Height: 24
 3093462, 85104224

**RV-DL-12320**

Length: 881 Ø: 50
 Cone Ø: d1 Ø 28,6 / d2 Ø 23,9
 20390746, 21106968

**RV-VB-8191**

Length: 662,4 Ø: 48
 Hole Distance: 115 / 115
 20367004, 20507262, 20741695, 20741703,
 22318833

**VL-DL-7789**

Length: 1640 Ø: 58
 Cone Ø: d1 Ø 28,6 / d2 Ø 23,9
 1612254, 3985570, 4510697, 20393097,
 21260286

**VL-DL-8157**

Length: 325 Ø: 30
 Cone Ø: d1 Ø 22 / d2 Ø 20
 1629668, 3986433, 14316200A, 20477805

**VL-DL-8178**

Length: 572 Ø: 38
 Cone Ø: d1 Ø 28,6 / d2 Ø 23,9
 1088985, 20393083

**VL-DL-8180**

Length: 625 Ø: 17
 20374444, 20410530, 20509018, 20517494,
 70371270

**VL-DL-8189**

Length: 666 Ø: 48
 Hole Distance: 125
 1082104, 1605035

**VL-DL-8406**

Length: 888 Ø: 52
 Cone Ø: d1 Ø 28,6 / d2 Ø 23,9
 8190146, 20393071

**VL-DL-8407**

Length: 870 Ø: 52
 Cone Ø: d1 Ø 28,6 / d2 Ø 23,9
 3986452, 20375555, 20393186, 21106930

**VL-DL-8536**

Length: 340 Ø: 30
 Cone Ø: d1 Ø 22 / d2 Ø 19,9
 3944046, 20477807

**VL-DL-8566**

Length: 863 Ø: 52
 Cone Ø: d1 Ø 28,6 / d2 Ø 23,9
 20375556, 20393187, 21106952, 21406952

**VL-DL-8681**

Length: 888 Ø: 52
 Cone Ø: d1 Ø 28,6 / d2 Ø 23,9
 8190147, 20393073

**VL-DL-8707**

Length: 885 Ø: 50
 Cone Ø: d1 Ø 28,6 / d2 Ø 23,9
 20390745, 21106936

**VL-DL-9485**

Length: 666 Ø: 48
 Hole Distance: 125 / 125
 1589817

**VL-DL-10309**

Length: 799 Ø: 48
 Hole Distance: 115 / 115
 20410053, 21106157

**VL-ES-5287**

Length: 167
 Cone Ø: d1 Ø 28,6 / d2 Ø 23,9
 Thread: M52 x 1,5 RHT
 1696901, 1699401

**VL-ES-5288**

Length: 167
 Cone Ø: d1 Ø 28,6 / d2 Ø 23,9
 Thread: M52 x 1,5 RHT
 1696900, 1699400

**VL-ES-5347**

Length: 125
 Cone Ø: d1 Ø 28,6 / d2 Ø 23,9
 Thread: M30 x 1,5 LHT
 1507822, 1698847, 3092471

**VL-ES-5348**

Length: 125
 Cone Ø: d1 Ø 28,6 / d2 Ø 23,9
 Thread: M30 x 1,5 RHT
 1507823, 1698846, 3092472

**VL-ES-7265**

Length: 125
 Cone Ø: d1 Ø 31,5 / d2 Ø 27,5
 Thread: M30 x 1,5 LHT
 1131744, 1313744, 1698558, 1698840,
 2072161F, 3092795, 6869744, 6882112,
 6889481, 85114147

**VL-ES-7266**

Length: 125
 Cone Ø: d1 Ø 31,5 / d2 Ø 27,5
 Thread: M30 x 1,5 RHT
 0356310, 1507826, 1695585, 1695776,
 1698557, 6882111, 6882111(BRAZIL),
 6889480, 6889482, 14200800A, 85114146

**VL-ES-8411**

Length: 140
 Cone Ø: d1 Ø 28,6 / d2 Ø 23,9
 Thread: M30 x 1,5 RHT
 3093647, 3097999, 21263821

**VL-ES-8568**

Length: 100
 Cone Ø: d1 Ø 38 / d2 Ø 34,3
 Thread: M26 x 1,5 RHT
 8151876

**VL-ES-10361**

Length: 88
 Cone Ø: d1 Ø 28,6 / d2 Ø 24
 Thread: M26 x 1,5 RHT
 20374698

**VL-RK-5323**

Ø: 91 Hole Distance: 125
 Thick/Height: 20
 1598588, 14302100A

**VL-SB-9501**

Ø: 91 Thick/Height: 85 / 85
 1135080

**VL-SB-10394**

Ø: 90 Thick/Height: 95 / 95
 9519245

**VL-SB-10397**

Thick/Height: 89 / 89
 1075179

**VL-SB-10398**

Thick/Height: 87,5 / 87,5
 1075180

**VL-VB-7787**

Length: 671 Ø: 58
 Hole Distance: 130 / 130
 143167, 1076639, 1626896, 1629734,
 20392649, 20829503, 21295227, 21474441,
 22318834, 742129527

**VL-VB-8195**

Length: 649 Ø: 48
 Hole Distance: 115 / 115
 1094466, 20374689, 20382314, 20502944

**VL-VB-8525**

Length: 677,3 Ø: 48
 Hole Distance: 145 / 145
 3173291, 20556490

**VL-VB-8541**

Length: 677,3 Ø: 48
 Hole Distance: 145 / 145
 3173292, 20556491

**VL-VB-8576**

Length: 660,3 Ø: 48
 Hole Distance: 145 / 145
 3173293, 20556492





FM 10 ...

FM 10/360 ...	04/99 → 12/01	Track Control Arm		VL-VB-8576	Wishbone (CV), Drive Axle; Leading Axle; Air Suspension Axle
	04/99 → 12/01	Track Control Arm	VL-DL-10309	VL-DL-10309	Trailing Arm, 1st Front Axle, for Pneumatic Suspension vehicles, Ch.A519971/B270523 →

FM 12

FM 12/340	08/98 → 09/05	Bush, parabolic spring		VL-SB-5356	
	08/98 → 09/05	Centre Rod	RV-DL-12320		for Steering Rod
	08/98 → 09/05	Centre Rod	VL-DL-0911		Push Rod
	08/98 → 09/05	Centre Rod	VL-DL-2139		Push Rod
	08/98 → 09/05	Centre Rod	VL-DL-8178		Push Rod
	08/98 → 09/05	Centre Rod	VL-DL-8187		Push Rod
	08/98 → 09/05	Centre Rod	VL-DL-8406		Push Rod
	08/98 → 09/05	Centre Rod	VL-DL-8406		Push Rod, Air Suspension Axle
	08/98 → 09/05	Centre Rod	VL-DL-8407		Push Rod
	08/98 → 09/05	Centre Rod	VL-DL-8407		Push Rod, Leaf Spring Axle
	08/98 → 09/05	Centre Rod	VL-DL-8566		Push Rod
	08/98 → 09/05	Centre Rod	VL-DL-8566		Push Rod, Leaf Spring Axle
	08/98 → 09/05	Centre Rod	VL-DL-8681		Push Rod, 1st FA; Air Suspension Axle
	08/98 → 09/05	Centre Rod	VL-DL-8707		Push Rod
	08/98 → 09/05	Centre Rod	VL-DL-8707		Push Rod, Air Suspension Axle
	08/98 → 09/05	Centre Rod	VL-DL-9488		Push Rod
	08/98 → 09/05	Centre Rod	VL-DL-10228		Push Rod, 1st FA; 2nd FA
	08/98 → 09/05	Centre Rod	VL-DL-12367		for Steering Rod
	08/98 → 09/05	Centre Rod	VL-DL-12454		for Steering Rod
	08/98 → 09/05	Centre Rod	VL-DL-12483		Push Rod
	08/98 → 09/05	Centre Rod	VL-DL-12484		Push Rod
	08/98 → 09/05	Stabiliser Link		VL-DL-8412	Coupling Rod, Control Arm
	08/98 → 09/05	Stabiliser Link		VL-DL-8518	Coupling Rod, Control Arm
	08/98 → 09/05	Stabiliser Link		VL-DL-8543	Coupling Rod, Control Arm
	08/98 → 09/05	Stabiliser Link		VL-DL-9472	Coupling Rod
	08/98 → 09/05	Stabiliser Link		VL-DL-9491	Coupling Rod, Control Arm
	08/98 → 09/05	Stabiliser Link	VL-DL-8157		Coupling Rod, for Leaf-Spring Suspension vehicles
	08/98 → 09/05	Stabiliser Link	VL-DL-8157		Coupling Rod, for Pneumatic Suspension vehicles
	08/98 → 09/05	Stabiliser Link	VL-DL-8536		Coupling Rod, Air Suspension Axle
	08/98 → 09/05	Stabiliser Link	VL-DL-10258		Coupling Rod, for Leaf-Spring Suspension vehicles
	08/98 → 09/05	Stabiliser Link	VL-DL-12356		Coupling Rod
	08/98 → 09/05	Stabiliser Mounting	VL-SB-10397		
	08/98 → 09/05	Stabiliser Mounting	VL-SB-10398		
	08/98 → 09/05	Suspension Arm Repair Kit		CV-RK-5322	for Wishbone (CV)
	08/98 → 09/05	Suspension Arm Repair Kit		IV-RK-8998	for Wishbone (CV)
	08/98 → 09/05	Suspension Arm Repair Kit		MN-RK-7280	for Drag Link
	08/98 → 09/05	Suspension Arm Repair Kit		MN-RK-9383	for Control Arm
	08/98 → 09/05	Suspension Arm Repair Kit		VL-RK-9497	for Drag Link
	08/98 → 09/05	Suspension Arm Repair Kit		VL-RK-9497	for Drag Link, Leaf Spring Axle
	08/98 → 09/05	Suspension Strut Repair Kit		MN-RK-8501	
	08/98 → 09/05	Suspension Strut Repair Kit	MN-RK-12436	MN-RK-12436	
	08/98 → 09/05	Suspension Strut Repair Kit	VL-RK-8533		
	08/98 → 09/05	Tie Bar Bush		VL-SB-9501	
	08/98 → 09/05	Tie Rod		VL-DL-8163	Leading Axle; for vehicles with Hinged Leading Axle
	08/98 → 09/05	Tie Rod	RV-DL-12447		
	08/98 → 09/05	Tie Rod	VL-DL-7789		
	08/98 → 09/05	Tie Rod	VL-DL-8163		
	08/98 → 09/05	Tie Rod	VL-DL-8305		Leaf Spring Axle
	08/98 → 09/05	Tie Rod	VL-DL-9492		Air Suspension Axle
	08/98 → 09/05	Tie Rod	VL-DL-9493		Air Suspension Axle
	08/98 → 09/05	Tie Rod	VL-DL-12355		
	08/98 → 09/05	Tie Rod	VL-DL-12358		

CV-RK-5322

Ø: 72 Thick/Height: 50
271188, 3091598

**IV-RK-8998**

Ø: 85 Hole Distance: 130
Thick/Height: 30
273373, 274019, 4941233,
6889509

**MN-RK-7280**

Ø: 75 Hole Distance: 115
Thick/Height: 24
271187, 689748

**MN-RK-8501**

Ø: 75 Hole Distance: 115
Thick/Height: 24
20547286

**MN-RK-9383**

Ø: 67 Hole Distance: 100
Thick/Height: 24
275988

**MN-RK-12436**

Ø: 75 Hole Distance: 115
Thick/Height: 24
3093462, 85104224

**RV-DL-12320**

Length: 881 Ø: 50
Cone Ø: d1 Ø 28,6 / d2 Ø 23,9
20390746, 21106968

**RV-DL-12447**

Length: 1818 Ø: 52
Cone Ø: d1 Ø 28,6 / d2 Ø 23,9
20399543, 21299034, 85115631

**VL-DL-0911**

Length: 880 Ø: 52
Cone Ø: d1 Ø 28,6 / d2 Ø 23,9
1075663, 3988704, 20393069

**VL-DL-2139**

Length: 880 Ø: 52
Cone Ø: d1 Ø 28,6 / d2 Ø 23,9
1075153, 3988695, 20393061

**VL-DL-7789**

Length: 1640 Ø: 58
Cone Ø: d1 Ø 28,6 / d2 Ø 23,9
1612254, 3985570, 4510697,
20393097, 21260286

**VL-DL-8157**

Length: 325 Ø: 30
Cone Ø: d1 Ø 22 / d2 Ø 20
1629668, 3986433, 14316200A,
20477805

**VL-DL-8163**

Length: 1640 Ø: 42
Cone Ø: d1 Ø 28,6 / d2 Ø 23,9
1628637, 3962343, 3986450,
3988711

**VL-DL-8178**

Length: 572 Ø: 38
Cone Ø: d1 Ø 28,6 / d2 Ø 23,9
1088985, 20393083

**VL-DL-8187**

Length: 2140 Ø: 52
Cone Ø: d1 Ø 28,6 / d2 Ø 23,9
3199225, 20393093, 20442115,
20513953, 24425662

**VL-DL-8305**

Length: 1634 Ø: 50
Cone Ø: d1 Ø 28,6 / d2 Ø 23,9
3198276, 21260274

**VL-DL-8406**

Length: 888 Ø: 52
Cone Ø: d1 Ø 28,6 / d2 Ø 23,9
8190146, 20393071

**VL-DL-8407**

Length: 870 Ø: 52
Cone Ø: d1 Ø 28,6 / d2 Ø 23,9
3986452, 20375555, 20393186,
21106930

**VL-DL-8412**

Length: 435 Ø: 36
Cone Ø: d1 Ø 28,6 / d2 Ø 25,5
3173613, 3987354

**VL-DL-8518**

Length: 350 Ø: 36
Cone Ø: d1 Ø 28,9 / d2 Ø 24,7
20443063, 20443067, 20994420

**VL-DL-8536**

Length: 340 Ø: 30
Cone Ø: d1 Ø 22 / d2 Ø 19,9
3944046, 20477807

**VL-DL-8543**

Length: 380 Ø: 36
Cone Ø: d1 Ø 28,6 / d2 Ø 24,7
20443062, 20443066, 20994419

**VL-DL-8566**

Length: 863 Ø: 52
Cone Ø: d1 Ø 28,6 / d2 Ø 23,9
20375556, 20393187, 21106952,
21406952

**VL-DL-8681**

Length: 888 Ø: 52
Cone Ø: d1 Ø 28,6 / d2 Ø 23,9
8190147, 20393073

**VL-DL-8707**

Length: 885 Ø: 50
Cone Ø: d1 Ø 28,6 / d2 Ø 23,9
20390745, 21106936

**VL-DL-9472**

Length: 435 Ø: 36
Cone Ø: d1 Ø 32,2 / d2 Ø 28
20443061, 20443065, 20994418

**VL-DL-9488**

Length: 563 Ø: 48
Cone Ø: d1 Ø 28,6 / d2 Ø 23,9
20374831, 21252480

**VL-DL-9491**

Length: 380 Ø: 36
Cone Ø: d1 Ø 28,6 / d2 Ø 25,5
3173914, 3987355

**VL-DL-9492**

Length: 1660 Ø: 62
Cone Ø: d1 Ø 32 / d2 Ø 27
20587731, 21106938

**VL-DL-9493**

Length: 1660 Ø: 62
Cone Ø: d1 Ø 28,6 / d2 Ø 23,9
3198234, 21260275

**VL-DL-10228**

Length: 2139 Ø: 62
Cone Ø: d1 Ø 28,6 / d2 Ø 23,9
20453063

**VL-DL-10258**

Length: 325 Ø: 30
Cone Ø: d1 Ø 22 / d2 Ø 20
1629668, 3986433, 20477805

**VL-DL-10309**

Length: 799 Ø: 48
Hole Distance: 115 / 115
20410053, 21106157

**VL-DL-12355**

Length: 368 Ø: 38
Cone Ø: d1 Ø 28,6 / d2 Ø 23,9
1628207

**VL-DL-12356**

Length: 275 Ø: 30
Cone Ø: d1 Ø 22
3987423, 20477803

**VL-DL-12358**

Length: 1669 Ø: 42
Cone Ø: d1 Ø 32 / d2 Ø 27
Thread: M32 x 1,5 RHT / M32
x 1,5 LHT
20581086, 7420581086

**VL-DL-12367**

Length: 2139 Ø: 62
Cone Ø: d1 Ø 28,6 / d2 Ø 23,9
Thread: M52 x 1,5 RHT
20453064, 20584291

**VL-DL-12454**

Length: 2339 Ø: 62
Cone Ø: d1 Ø 28,6 / d2 Ø 23,9
20581632

**VL-DL-12483**

Length: 485 Ø: 48
Cone Ø: d1 Ø 28,6 / d2 Ø 23,9
20383081, 21260283, 22159761,
81467106355

**VL-DL-12484**

Length: 1025 Ø: 48
Cone Ø: d1 Ø 28,6 / d2 Ø 23,9
2038308, 21252481

**VL-RK-8533**

Ø: 85 Hole Distance: 130
Thick/Height: 30
3093630, 3093631, 20840815,
21295230, 7420840815

**VL-RK-9497**

Ø: 95 Hole Distance: 130
Thick/Height: 35
273612, 20702095

**VL-SB-5356**

Thick/Height: 150
1629553, 14403900A, 20390836

**VL-SB-9501**

Ø: 91 Thick/Height: 85 / 85
1135080

**VL-SB-10397**

Thick/Height: 89 / 89
1075179

**VL-SB-10398**

Thick/Height: 87,5 / 87,5
1075180

**VL-VB-8576**

Length: 660,3 Ø: 48
Hole Distance: 145 / 145
3173293, 20556492



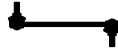

FM 12 ...

FM 12/340 ...

08/98→09/05	Tie Rod End		RV-ES-9432	Leading Axle
08/98→09/05	Tie Rod End		RV-ES-9432	Tag Axle
08/98→09/05	Tie Rod End		VL-ES-10361	Tag Axle
08/98→09/05	Tie Rod End	RV-ES-12442		
08/98→09/05	Tie Rod End	VL-ES-5287		for Guide Rod
08/98→09/05	Tie Rod End	VL-ES-5288		for Guide Rod
08/98→09/05	Tie Rod End	VL-ES-5347		for Steering Rod
08/98→09/05	Tie Rod End	VL-ES-5347	VL-ES-5347	for Steering Rod
08/98→09/05	Tie Rod End	VL-ES-5348		for Steering Rod
08/98→09/05	Tie Rod End	VL-ES-5348	VL-ES-5348	for Steering Rod
08/98→09/05	Tie Rod End	VL-ES-7265	VL-ES-7265	
08/98→09/05	Tie Rod End	VL-ES-7266	VL-ES-7266	
08/98→09/05	Tie Rod End	VL-ES-8411	VL-ES-8411	* 2828332 *→* 2831818 *
08/98→09/05	Tie Rod End	VL-ES-8411	VL-ES-8411	* 6800000 *→* 6831387 *
08/98→09/05	Tie Rod End	VL-ES-8411	VL-ES-8411	* 9825999 *→* 9826006 *
08/98→09/05	Tie Rod End	VL-ES-8411	VL-ES-8411	* A287349 *→* A299999 *
08/98→09/05	Tie Rod End	VL-ES-8411	VL-ES-8411	* A500000 *→* A544695 *
08/98→09/05	Tie Rod End	VL-ES-8411	VL-ES-8411	* B229721 *→* B311773 *
08/98→09/05	Tie Rod End	VL-ES-8411	VL-ES-8411	* C760568 *→* C763461 *
08/98→09/05	Tie Rod End	VL-ES-8411	VL-ES-8411	* D120771 *→* D123487 *
08/98→09/05	Tie Rod End	VL-ES-8411	VL-ES-8411	* S827721 *→* S832416 *
08/98→09/05	Tie Rod End	VL-ES-8411	VL-ES-8411	→* 1200634 *
08/98→09/05	Tie Rod End	VL-ES-8414		for Guide Rod
08/98→09/05	Tie Rod End	VL-ES-8568		
08/98→09/05	Tie Rod End	VL-ES-10360		for Steering Rod
08/98→09/05	Tie Rod End	VL-ES-10361		
08/98→09/05	Track Control Arm		RV-DL-10299	Trailing Arm, 1st & 2nd Drive Axle, for Leaf-Spring Suspension vehicles
08/98→09/05	Track Control Arm		RV-TC-12339	Suspension Rod, Trailing Arm
08/98→09/05	Track Control Arm		RV-TC-12340	Trailing Arm
08/98→09/05	Track Control Arm		RV-VB-8191	Wishbone (CV)
08/98→09/05	Track Control Arm		RV-VB-8191	Wishbone (CV), 1st RA;2nd RA;Leaf Spring Axle
08/98→09/05	Track Control Arm		RV-VB-8191	Wishbone (CV), Air Suspension Axle, * 1202645 **; A527108 **; B281986 *→
08/98→09/05	Track Control Arm		RV-VB-8191	Wishbone (CV), Air Suspension Axle, →* A833235 **; B321098 *
08/98→09/05	Track Control Arm		VL-DL-8180	Trailing Arm
08/98→09/05	Track Control Arm		VL-DL-8189	Trailing Arm, 1st Drive Axle
08/98→09/05	Track Control Arm		VL-DL-8189	Trailing Arm, 1st Drive Axle, for Pneumatic Suspension vehicles
08/98→09/05	Track Control Arm		VL-DL-8189	Trailing Arm, Drive Axle
08/98→09/05	Track Control Arm		VL-DL-8189	Trailing Arm, Drive Axle; for vehicles with Rigid Trailing Axle; for vehicles with Hinged Trailing Axle
08/98→09/05	Track Control Arm		VL-DL-8554	Trailing Arm, 1st RA;2nd RA;Leaf Spring Axle
08/98→09/05	Track Control Arm		VL-DL-8619	Trailing Arm, 1st & 2nd Drive Axle, for Leaf-Spring Suspension vehicles
08/98→09/05	Track Control Arm		VL-DL-9485	Trailing Arm, Tag Axle;for vehicles with Rigid Trailing Axle
08/98→09/05	Track Control Arm		VL-DL-9485	Trailing Arm, Trailing Axle Steered/not Steered, for Pneumatic Suspension vehicles
08/98→09/05	Track Control Arm		VL-VB-5369	Wishbone (CV)
08/98→09/05	Track Control Arm		VL-VB-5369	Wishbone (CV), 1st RA;2nd RA;Leaf Spring Axle
08/98→09/05	Track Control Arm		VL-VB-5369	Wishbone (CV), 1st RA;2nd RA;Leaf Spring Axle, →* A557645 **; B330018 *
08/98→09/05	Track Control Arm		VL-VB-5369	Wishbone (CV), 1st RA;Air Suspension Axle
08/98→09/05	Track Control Arm		VL-VB-7787	Wishbone (CV)
08/98→09/05	Track Control Arm		VL-VB-7787	Wishbone (CV), 1st RA;2nd RA;Unit; Leaf Spring Axle
08/98→09/05	Track Control Arm		VL-VB-8195	Wishbone (CV), 2nd RA;Air Suspension Axle
08/98→09/05	Track Control Arm		VL-VB-8195	Wishbone (CV), Air Suspension Axle, →* A527108 **; B281986 *
08/98→09/05	Track Control Arm		VL-VB-8525	Wishbone (CV), Drive Axle;Air Suspension Axle

RV-DL-10299

Length: 510 Ø: 21
 20522934, 21051052, 7420864583,
 7421051052

**RV-ES-9432**

Length: 120
 Cone Ø: d1 Ø 28 / d2 Ø 23,9
 Thread: M26 x 1,5 RHT
 3193731

**RV-ES-12442**

Length: 88
 Cone Ø: d1 Ø 28,6
 Thread: M26 x 1,5 RHT
 3987648

**RV-TC-12339**

Length: 515
 Hole Distance: 13 / 130
 20532931, 21051046

**RV-TC-12340**

Length: 510
 Hole Distance: 115 / 115
 20443044

**RV-VB-8191**

Length: 662,4 Ø: 48
 Hole Distance: 115 / 115
 20367004, 20507262, 20741695, 20741703,
 22318833

**VL-DL-8180**

Length: 625 Ø: 17
 20374444, 20410530, 20509018, 20517494,
 70371270

**VL-DL-8189**

Length: 666 Ø: 48
 Hole Distance: 125
 1082104, 1605035

**VL-DL-8554**

Length: 570 Ø: 48
 Hole Distance: 130 / 130
 1626957, 1626958, 14320200A

**VL-DL-8619**

Length: 621 Ø: 48
 Hole Distance: 100 / 100
 1608151, 1621419

**VL-DL-9485**

Length: 666 Ø: 48
 Hole Distance: 125 / 125
 1589817

**VL-ES-5287**

Length: 167
 Cone Ø: d1 Ø 28,6 / d2 Ø 23,9
 Thread: M52 x 1,5 RHT
 1696901, 1699401

**VL-ES-5288**

Length: 167
 Cone Ø: d1 Ø 28,6 / d2 Ø 23,9
 Thread: M52 x 1,5 LHT
 1696900, 1699400

**VL-ES-5347**

Length: 125
 Cone Ø: d1 Ø 28,6 / d2 Ø 23,9
 Thread: M30 x 1,5 LHT
 1507822, 1698847, 3092471

**VL-ES-5348**

Length: 125
 Cone Ø: d1 Ø 28,6 / d2 Ø 23,9
 Thread: M30 x 1,5 RHT
 1507823, 1698846, 3092472

**VL-ES-7265**

Length: 125
 Cone Ø: d1 Ø 31,5 / d2 Ø 27,5
 Thread: M30 x 1,5 LHT
 1131744, 1313744, 1698558, 1698840,
 2072161F, 3092795, 6869744, 6882112,
 6889481, 85114147

**VL-ES-7266**

Length: 125
 Cone Ø: d1 Ø 31,5 / d2 Ø 27,5
 Thread: M30 x 1,5 RHT
 0356310, 1507826, 1695585, 1695776,
 1698557, 6882111, 6882111(BRAZIL),
 6889480, 6889482, 14200800A, 85114146

**VL-ES-8411**

Length: 140
 Cone Ø: d1 Ø 28,6 / d2 Ø 23,9
 Thread: M30 x 1,5 RHT
 3093647, 3097999, 21263821

**VL-ES-8414**

Length: 136
 Cone Ø: d1 Ø 32 / d2 Ø 27
 Thread: M30 x 1,5 LHT
 20710008

**VL-ES-8568**

Length: 100
 Cone Ø: d1 Ø 38 / d2 Ø 34,3
 Thread: M26 x 1,5 RHT
 8151876

**VL-ES-10360**

Length: 136
 Cone Ø: d1 Ø 32 / d2 Ø 27
 Thread: M30 x 1,5 RHT
 20581089

**VL-ES-10361**

Length: 88
 Cone Ø: d1 Ø 28,6 / d2 Ø 24
 Thread: M26 x 1,5 RHT
 20374698

**VL-VB-5369**

Length: 677
 Ø: 48
 Hole Distance: 115 / 115
 3172829, 8073569, 14319600A

**VL-VB-7787**

Length: 671
 Ø: 58
 Hole Distance: 130 / 130
 143167, 1076639, 1626896, 1629734,
 20392649, 20829503, 21295227, 21474441,
 22318834, 7421295227

**VL-VB-8195**

Length: 649
 Ø: 48
 Hole Distance: 115 / 115
 1094466, 20374689, 20382314, 20502944

**VL-VB-8525**

Length: 677,3 Ø: 48
 Hole Distance: 145 / 145
 3173291, 20556490



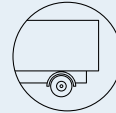

FM 12 ...

FM 12/340 ...	08/98→09/05	Track Control Arm		VL-VB-8525	Wishbone (CV), Tag Axle
	08/98→09/05	Track Control Arm		VL-VB-8525	Wishbone (CV), Tag Axle;Air Suspension Axle
	08/98→09/05	Track Control Arm		VL-VB-8525	Wishbone (CV), Trailing Axle Steered/not Steered, for Pneumatic Suspension vehicles
	08/98→09/05	Track Control Arm		VL-VB-8541	Wishbone (CV), 1st Drive Axle, for Leaf-Spring/Pneumatic Suspension vehicles
	08/98→09/05	Track Control Arm		VL-VB-8541	Wishbone (CV), Drive Axle
	08/98→09/05	Track Control Arm		VL-VB-8541	Wishbone (CV), Tag Axle;Air Suspension Axle
	08/98→09/05	Track Control Arm		VL-VB-8541	Wishbone (CV), Trailing Axle Steered/not Steered, For Leaf-Spring/Pneumatic Suspension vehicles
	08/98→09/05	Track Control Arm		VL-VB-8576	Wishbone (CV), 1st Drive Axle, for Pneumatic Suspension vehicles
	08/98→09/05	Track Control Arm		VL-VB-8576	Wishbone (CV), Drive Axle;Leading Axle; Air Suspension Axle
	08/98→09/05	Track Control Arm		VL-VB-8576	Wishbone (CV), Trailing Axle Steered/not Steered, for Pneumatic Suspension vehicles
	08/98→09/05	Track Control Arm		VL-VB-12460	Wishbone (CV)
	08/98→09/05	Track Control Arm		VL-VB-12460	Wishbone (CV), 1st & 2nd Drive Axle, for Pneumatic Suspension vehicles
	08/98→09/05	Track Control Arm		VL-VB-12460	Wishbone (CV), 1st Drive Axle, for Pneumatic Suspension vehicles
	08/98→09/05	Track Control Arm		VL-VB-12460	Wishbone (CV), Trailing Axle Steered/not Steered, for Pneumatic Suspension vehicles
	FM 12/380	08/98→09/05	Track Control Arm	VL-DL-8554	VL-DL-8554
08/98→09/05		Track Control Arm	VL-DL-10309	VL-DL-10309	Trailing Arm, 1st Front Axle, for Pneumatic Suspension vehicles, Ch.A519971/B270523→
08/98→09/05		Track Control Arm	VL-DL-10309	VL-DL-10309	Trailing Arm, Air Suspension Axle
08/98→09/05		Bush, parabolic spring		VL-SB-5356	
08/98→09/05		Centre Rod	RV-DL-12320		for Steering Rod
08/98→09/05		Centre Rod	VL-DL-0911		Push Rod
08/98→09/05		Centre Rod	VL-DL-2139		Push Rod
08/98→09/05		Centre Rod	VL-DL-8178		Push Rod
08/98→09/05		Centre Rod	VL-DL-8187		Push Rod
08/98→09/05		Centre Rod	VL-DL-8406		Push Rod
08/98→09/05		Centre Rod	VL-DL-8406		Push Rod, Air Suspension Axle
08/98→09/05		Centre Rod	VL-DL-8407		Push Rod
08/98→09/05		Centre Rod	VL-DL-8407		Push Rod, Leaf Spring Axle
08/98→09/05		Centre Rod	VL-DL-8566		Push Rod
08/98→09/05		Centre Rod	VL-DL-8566		Push Rod, Leaf Spring Axle
08/98→09/05		Centre Rod	VL-DL-8681		Push Rod, 1st FA;Air Suspension Axle
08/98→09/05		Centre Rod	VL-DL-8707		Push Rod
08/98→09/05		Centre Rod	VL-DL-8707		Push Rod, Air Suspension Axle
08/98→09/05		Centre Rod	VL-DL-9488		Push Rod
08/98→09/05		Centre Rod	VL-DL-10228		Push Rod, 1st FA;2nd FA
08/98→09/05	Centre Rod	VL-DL-12367		for Steering Rod	
08/98→09/05	Centre Rod	VL-DL-12454		for Steering Rod	
08/98→09/05	Centre Rod	VL-DL-12483		Push Rod	
08/98→09/05	Centre Rod	VL-DL-12484		Push Rod	
08/98→09/05	Stabiliser Link		VL-DL-8412	Coupling Rod, Control Arm	
08/98→09/05	Stabiliser Link		VL-DL-8518	Coupling Rod, Control Arm	
08/98→09/05	Stabiliser Link		VL-DL-8543	Coupling Rod, Control Arm	
08/98→09/05	Stabiliser Link		VL-DL-9472	Coupling Rod	
08/98→09/05	Stabiliser Link		VL-DL-9491	Coupling Rod, Control Arm	
08/98→09/05	Stabiliser Link	VL-DL-8157		Coupling Rod, for Leaf-Spring Suspension vehicles	
08/98→09/05	Stabiliser Link	VL-DL-8157		Coupling Rod, for Pneumatic Suspension vehicles	
08/98→09/05	Stabiliser Link	VL-DL-8536		Coupling Rod, Air Suspension Axle	
08/98→09/05	Stabiliser Link	VL-DL-10258		Coupling Rod, for Leaf-Spring Suspension vehicles	
08/98→09/05	Stabiliser Link	VL-DL-12356		Coupling Rod	

RV-DL-12320

Length: 881 Ø: 50
 Cone Ø: d1 Ø 28,6 / d2 Ø 23,9
 20390746, 21106968

**VL-DL-0911**

Length: 880 Ø: 52
 Cone Ø: d1 Ø 28,6 / d2 Ø 23,9
 1075663, 3988704, 20393069

**VL-DL-2139**

Length: 880 Ø: 52
 Cone Ø: d1 Ø 28,6 / d2 Ø 23,9
 1075153, 3988695, 20393061

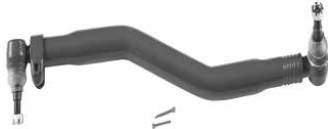
**VL-DL-8157**

Length: 325 Ø: 30
 Cone Ø: d1 Ø 22 / d2 Ø 20
 1629668, 3986433, 14316200A, 20477805

**VL-DL-8178**

Length: 572 Ø: 38
 Cone Ø: d1 Ø 28,6 / d2 Ø 23,9
 1088985, 20393083

**VL-DL-8187**

Length: 2140 Ø: 52
 Cone Ø: d1 Ø 28,6 / d2 Ø 23,9
 3199225, 20393093, 20442115, 20513953,
 24425662

**VL-DL-8406**

Length: 888 Ø: 52
 Cone Ø: d1 Ø 28,6 / d2 Ø 23,9
 8190146, 20393071

**VL-DL-8407**

Length: 870 Ø: 52
 Cone Ø: d1 Ø 28,6 / d2 Ø 23,9
 3986452, 20375555, 20393186, 21106930

**VL-DL-8412**

Length: 435 Ø: 36
 Cone Ø: d1 Ø 28,6 / d2 Ø 25,5
 3173613, 3987354

**VL-DL-8518**

Length: 350 Ø: 36
 Cone Ø: d1 Ø 28,9 / d2 Ø 24,7
 20443063, 20443067, 20994420

**VL-DL-8536**

Length: 340 Ø: 30
 Cone Ø: d1 Ø 22 / d2 Ø 19,9
 3944046, 20477807

**VL-DL-8543**

Length: 380 Ø: 36
 Cone Ø: d1 Ø 28,6 / d2 Ø 24,7
 20443062, 20443066, 20994419

**VL-DL-8554**

Length: 570 Ø: 48
 Hole Distance: 130 / 130
 1626957, 1626958, 14320200A

**VL-DL-8566**

Length: 863 Ø: 52
 Cone Ø: d1 Ø 28,6 / d2 Ø 23,9
 20375556, 20393187, 21106952, 21406952

**VL-DL-8681**

Length: 888 Ø: 52
 Cone Ø: d1 Ø 28,6 / d2 Ø 23,9
 8190147, 20393073

**VL-DL-8707**

Length: 885 Ø: 50
 Cone Ø: d1 Ø 28,6 / d2 Ø 23,9
 20390745, 21106936

**VL-DL-9472**

Length: 435 Ø: 36
 Cone Ø: d1 Ø 32,2 / d2 Ø 28
 20443061, 20443065, 20994418

**VL-DL-9488**

Length: 563 Ø: 48
 Cone Ø: d1 Ø 28,6 / d2 Ø 23,9
 20374831, 21252480

**VL-DL-9491**

Length: 380 Ø: 36
 Cone Ø: d1 Ø 28,6 / d2 Ø 25,5
 3173914, 3987355

**VL-DL-10228**

Length: 2139 Ø: 62
 Cone Ø: d1 Ø 28,6 / d2 Ø 23,9
 20453063

**VL-DL-10258**

Length: 325 Ø: 30
 Cone Ø: d1 Ø 22 / d2 Ø 20
 1629668, 3986433, 20477805

**VL-DL-10309**

Length: 799 Ø: 48
 Hole Distance: 115 / 115
 20410053, 21106157

**VL-DL-12356**

Length: 275 Ø: 30
 Cone Ø: d1 Ø 22
 3987423, 20477803

**VL-DL-12367**

Length: 2139 Ø: 62
 Cone Ø: d1 Ø 28,6 / d2 Ø 23,9
 Thread: M52 x 1,5 RHT
 20453064, 20584291

**VL-DL-12454**

Length: 2339 Ø: 62
 Cone Ø: d1 Ø 28,6 / d2 Ø 23,9
 20581632

**VL-DL-12483**

Length: 485 Ø: 48
 Cone Ø: d1 Ø 28,6 / d2 Ø 23,9
 20383081, 21260283, 22159761,
 81467106355

**VL-DL-12484**

Length: 1025 Ø: 48
 Cone Ø: d1 Ø 28,6 / d2 Ø 23,9
 2038308, 21252481

**VL-SB-5356**

Thick/Height: 150
 1629553, 14403900A, 20390836

**VL-VB-8525**

Length: 677,3 Ø: 48
 Hole Distance: 145 / 145
 3173291, 20556490

**VL-VB-8541**

Length: 677,3
 Ø: 48
 Hole Distance: 145 / 145
 3173292, 20556491

**VL-VB-8576**

Length: 660,3
 Ø: 48
 Hole Distance: 145 / 145
 3173293, 20556492

**VL-VB-12460**

Length: 662
 Ø: 50
 Hole Distance: 115 / 115
 2223852, 20589061





FM 12 ...

FM 12/380 ...

08/98→09/05	Stabiliser Mounting	VL-SB-10397		
08/98→09/05	Stabiliser Mounting	VL-SB-10398		
08/98→09/05	Suspension Arm Repair Kit		CV-RK-5322	for Wishbone (CV)
08/98→09/05	Suspension Arm Repair Kit		IV-RK-8998	for Wishbone (CV)
08/98→09/05	Suspension Arm Repair Kit		MN-RK-7280	for Drag Link
08/98→09/05	Suspension Arm Repair Kit		MN-RK-9383	for Control Arm
08/98→09/05	Suspension Arm Repair Kit		VL-RK-9497	for Drag Link
08/98→09/05	Suspension Arm Repair Kit		VL-RK-9497	for Drag Link, Leaf Spring Axle
08/98→09/05	Suspension Strut Repair Kit		MN-RK-8501	
08/98→09/05	Suspension Strut Repair Kit	MN-RK-12436	MN-RK-12436	
08/98→09/05	Suspension Strut Repair Kit	VL-RK-8533		
08/98→09/05	Tie Bar Bush		VL-SB-9501	
08/98→09/05	Tie Rod		VL-DL-8163	Leading Axle;for vehicles with Hinged Leading Axle
08/98→09/05	Tie Rod	RV-DL-12447		
08/98→09/05	Tie Rod	VL-DL-7789		
08/98→09/05	Tie Rod	VL-DL-8163		
08/98→09/05	Tie Rod	VL-DL-8305		Leaf Spring Axle
08/98→09/05	Tie Rod	VL-DL-9492		Air Suspension Axle
08/98→09/05	Tie Rod	VL-DL-9493		Air Suspension Axle
08/98→09/05	Tie Rod	VL-DL-12355		
08/98→09/05	Tie Rod	VL-DL-12358		
08/98→09/05	Tie Rod End		RV-ES-9432	Leading Axle
08/98→09/05	Tie Rod End		RV-ES-9432	Tag Axle
08/98→09/05	Tie Rod End		VL-ES-10361	Tag Axle
08/98→09/05	Tie Rod End	RV-ES-12442		
08/98→09/05	Tie Rod End	VL-ES-5287		for Guide Rod
08/98→09/05	Tie Rod End	VL-ES-5288		for Guide Rod
08/98→09/05	Tie Rod End	VL-ES-5347		for Steering Rod
08/98→09/05	Tie Rod End	VL-ES-5347	VL-ES-5347	for Steering Rod
08/98→09/05	Tie Rod End	VL-ES-5348		for Steering Rod
08/98→09/05	Tie Rod End	VL-ES-5348	VL-ES-5348	for Steering Rod
08/98→09/05	Tie Rod End	VL-ES-7265	VL-ES-7265	
08/98→09/05	Tie Rod End	VL-ES-7266	VL-ES-7266	
08/98→09/05	Tie Rod End	VL-ES-8411	VL-ES-8411	* 2828332 *→* 2831818 *
08/98→09/05	Tie Rod End	VL-ES-8411	VL-ES-8411	* 6800000 *→* 6831387 *
08/98→09/05	Tie Rod End	VL-ES-8411	VL-ES-8411	* 9825999 *→* 9826006 *
08/98→09/05	Tie Rod End	VL-ES-8411	VL-ES-8411	* A287349 *→* A299999 *
08/98→09/05	Tie Rod End	VL-ES-8411	VL-ES-8411	* A500000 *→* A544695 *
08/98→09/05	Tie Rod End	VL-ES-8411	VL-ES-8411	* B229721 *→* B311773 *
08/98→09/05	Tie Rod End	VL-ES-8411	VL-ES-8411	* C760568 *→* C763461 *
08/98→09/05	Tie Rod End	VL-ES-8411	VL-ES-8411	* D120771 *→* D123487 *
08/98→09/05	Tie Rod End	VL-ES-8411	VL-ES-8411	* S827721 *→* S832416 *
08/98→09/05	Tie Rod End	VL-ES-8411	VL-ES-8411	→* 1200634 *
08/98→09/05	Tie Rod End	VL-ES-8414		for Guide Rod
08/98→09/05	Tie Rod End	VL-ES-8568		
08/98→09/05	Tie Rod End	VL-ES-10360		for Steering Rod
08/98→09/05	Tie Rod End	VL-ES-10361		
08/98→09/05	Track Control Arm		RV-DL-10299	Trailing Arm, 1st & 2nd Drive Axle, for Leaf-Spring Suspension vehicles
08/98→09/05	Track Control Arm		RV-TC-12339	Suspension Rod, Trailing Arm
08/98→09/05	Track Control Arm		RV-TC-12340	Trailing Arm
08/98→09/05	Track Control Arm		RV-VB-8191	Wishbone (CV)
08/98→09/05	Track Control Arm		RV-VB-8191	Wishbone (CV), 1st RA;2nd RA;Leaf Spring Axle
08/98→09/05	Track Control Arm		RV-VB-8191	Wishbone (CV), Air Suspension Axle, * 1202645 *,* A527108 *,* B281986 *→
08/98→09/05	Track Control Arm		RV-VB-8191	Wishbone (CV), Air Suspension Axle, →* A833235 *,* B321098 *
08/98→09/05	Track Control Arm		VL-DL-8180	Trailing Arm
08/98→09/05	Track Control Arm		VL-DL-8189	Trailing Arm, 1st Drive Axle
08/98→09/05	Track Control Arm		VL-DL-8189	Trailing Arm, 1st Drive Axle, for Pneumatic Suspension vehicles
08/98→09/05	Track Control Arm		VL-DL-8189	Trailing Arm, Drive Axle

CV-RK-5322

Ø: 72 Thick/Height: 50
271188, 3091598

**IV-RK-8998**

Ø: 85 Hole Distance: 130
Thick/Height: 30
273373, 274019, 4941233, 6889509

**MN-RK-7280**

Ø: 75 Hole Distance: 115
Thick/Height: 24
271187, 689748

**MN-RK-8501**

Ø: 75 Hole Distance: 115
Thick/Height: 24
20547286

**MN-RK-9383**

Ø: 67 Hole Distance: 100
Thick/Height: 24
275988

**MN-RK-12436**

Ø: 75 Hole Distance: 115
Thick/Height: 24
3093462, 85104224

**RV-DL-10299**

Length: 510 Ø: 21
20522934, 21051052, 7420864583,
7421051052

**RV-DL-12447**

Length: 1818 Ø: 52
Cone Ø: d1 Ø 28,6 / d2 Ø 23,9
20399543, 21299034, 85115631

**RV-ES-9432**

Length: 120
Cone Ø: d1 Ø 28 / d2 Ø 23,9
Thread: M26 x 1,5 RHT
3193731

**RV-ES-12442**

Length: 88
Cone Ø: d1 Ø 28,6
Thread: M26 x 1,5 RHT
3987648

**RV-TC-12339**

Length: 515
Hole Distance: 13 / 130
20532931, 21051046

**RV-TC-12340**

Length: 510
Hole Distance: 115 / 115
20443044

**RV-VB-8191**

Length: 662,4 Ø: 48
Hole Distance: 115 / 115
20367004, 20507262, 20741695, 20741703,
22318833

**VL-DL-7789**

Length: 1640 Ø: 58
Cone Ø: d1 Ø 28,6 / d2 Ø 23,9
1612254, 3985570, 4510697, 20393097,
21260286

**VL-DL-8163**

Length: 1640 Ø: 42
Cone Ø: d1 Ø 28,6 / d2 Ø 23,9
1628637, 3962343, 3986450, 3988711

**VL-DL-8180**

Length: 625 Ø: 17
20374444, 20410530, 20509018, 20517494,
70371270

**VL-DL-8189**

Length: 666 Ø: 48
Hole Distance: 125
1082104, 1605035

**VL-DL-8305**

Length: 1634 Ø: 50
Cone Ø: d1 Ø 28,6 / d2 Ø 23,9
3198276, 21260274

**VL-DL-9492**

Length: 1660 Ø: 62
Cone Ø: d1 Ø 32 / d2 Ø 27
20587731, 21106938

**VL-DL-9493**

Length: 1660 Ø: 62
Cone Ø: d1 Ø 28,6 / d2 Ø 23,9
3198234, 21260275

**VL-DL-12355**

Length: 368 Ø: 38
Cone Ø: d1 Ø 28,6 / d2 Ø 23,9
1628207

**VL-DL-12358**

Length: 1669 Ø: 42
Cone Ø: d1 Ø 32 / d2 Ø 27
Thread: M32 x 1,5 RHT / M32 x 1,5 LHT
20581086, 7420581086

**VL-ES-5287**

Length: 167
Cone Ø: d1 Ø 28,6 / d2 Ø 23,9
Thread: M52 x 1,5 RHT
1696901, 1699401

**VL-ES-5288**

Length: 167
Cone Ø: d1 Ø 28,6 / d2 Ø 23,9
Thread: M52 x 1,5 LHT
1696900, 1699400

**VL-ES-5347**

Length: 125
Cone Ø: d1 Ø 28,6 / d2 Ø 23,9
Thread: M30 x 1,5 LHT
1507822, 1698847, 3092471

**VL-ES-5348**

Length: 125
Cone Ø: d1 Ø 28,6 / d2 Ø 23,9
Thread: M30 x 1,5 RHT
1507823, 1698846, 3092472

**VL-ES-7265**

Length: 125
Cone Ø: d1 Ø 31,5 / d2 Ø 27,5
Thread: M30 x 1,5 LHT
1131744, 1313744, 1698558, 1698840,
2072161F, 3092795, 6869744, 6882112,
6889481, 85114147

**VL-ES-7266**

Length: 125
Cone Ø: d1 Ø 31,5 / d2 Ø 27,5
Thread: M30 x 1,5 RHT
0356310, 1507826, 1695585, 1695776,
1698557, 6882111, 6882111(BRAZIL),
6889480, 6889482, 14200800A, 85114146

**VL-ES-8411**

Length: 140
Cone Ø: d1 Ø 28,6 / d2 Ø 23,9
Thread: M30 x 1,5 RHT
3093647, 3097999, 21263821

**VL-ES-8414**

Length: 136
Cone Ø: d1 Ø 32 / d2 Ø 27
Thread: M30 x 1,5 LHT
20710008

**VL-ES-8568**

Length: 100
Cone Ø: d1 Ø 38 / d2 Ø 34,3
Thread: M26 x 1,5 RHT
8151876

**VL-ES-10360**

Length: 136
Cone Ø: d1 Ø 32 / d2 Ø 27
Thread: M30 x 1,5 RHT
20581089

**VL-ES-10361**

Length: 88
Cone Ø: d1 Ø 28,6 / d2 Ø 24
Thread: M26 x 1,5 RHT
20374698

**VL-RK-8533**

Ø: 85 Hole Distance: 130
Thick/Height: 30
3093630, 3093631, 20840815, 21295230,
7420840815

**VL-RK-9497**

Ø: 95 Hole Distance: 130
Thick/Height: 35
273612, 20702095

**VL-SB-9501**

Ø: 91 Thick/Height: 85 / 85
1135080

**VL-SB-10397**

Thick/Height: 89 / 89
1075179

**VL-SB-10398**

Thick/Height: 87,5 / 87,5
1075180





FM 12 ...

FM 12/380 ...	08/98→09/05	Track Control Arm		VL-DL-8189	Trailing Arm, Drive Axle; for vehicles with Rigid Trailing Axle; for vehicles with Hinged Trailing Axle
	08/98→09/05	Track Control Arm		VL-DL-8554	Trailing Arm, 1st RA;2nd RA;Leaf Spring Axle
	08/98→09/05	Track Control Arm		VL-DL-8619	Trailing Arm, 1st & 2nd Drive Axle, for Leaf-Spring Suspension vehicles
	08/98→09/05	Track Control Arm		VL-DL-9485	Trailing Arm, Tag Axle;for vehicles with Rigid Trailing Axle
	08/98→09/05	Track Control Arm		VL-DL-9485	Trailing Arm, Trailing Axle Steered/not Steered, for Pneumatic Suspension vehicles
	08/98→09/05	Track Control Arm		VL-VB-5369	Wishbone (CV)
	08/98→09/05	Track Control Arm		VL-VB-5369	Wishbone (CV), 1st RA;2nd RA;Leaf Spring Axle
	08/98→09/05	Track Control Arm		VL-VB-5369	Wishbone (CV), 1st RA;2nd RA;Leaf Spring Axle, →* A557645 *,* B330018 *
	08/98→09/05	Track Control Arm		VL-VB-5369	Wishbone (CV), 1st RA;Air Suspension Axle
	08/98→09/05	Track Control Arm		VL-VB-7787	Wishbone (CV)
	08/98→09/05	Track Control Arm		VL-VB-7787	Wishbone (CV), 1st RA;2nd RA;Unit; Leaf Spring Axle
	08/98→09/05	Track Control Arm		VL-VB-8195	Wishbone (CV), 2nd RA;Air Suspension Axle
	08/98→09/05	Track Control Arm		VL-VB-8195	Wishbone (CV), Air Suspension Axle, →* A527108 *,* B281986 *
	08/98→09/05	Track Control Arm		VL-VB-8525	Wishbone (CV), Drive Axle;Air Suspension Axle
	08/98→09/05	Track Control Arm		VL-VB-8525	Wishbone (CV), Tag Axle;Air Suspension Axle
	08/98→09/05	Track Control Arm		VL-VB-8525	Wishbone (CV), Trailing Axle Steered/not Steered, for Pneumatic Suspension vehicles
	08/98→09/05	Track Control Arm		VL-VB-8541	Wishbone (CV), 1st Drive Axle, for Leaf-Spring/Pneumatic Suspension vehicles
	08/98→09/05	Track Control Arm		VL-VB-8541	Wishbone (CV), Drive Axle
	08/98→09/05	Track Control Arm		VL-VB-8541	Wishbone (CV), Tag Axle;Air Suspension Axle
	08/98→09/05	Track Control Arm		VL-VB-8541	Wishbone (CV), Trailing Axle Steered/not Steered, For Leaf-Spring/Pneumatic Suspension vehicles
	08/98→09/05	Track Control Arm		VL-VB-8576	Wishbone (CV), 1st Drive Axle, for Pneumatic Suspension vehicles
	08/98→09/05	Track Control Arm		VL-VB-8576	Wishbone (CV), Drive Axle;Leading Axle; Air Suspension Axle
	08/98→09/05	Track Control Arm		VL-VB-8576	Wishbone (CV), Trailing Axle Steered/not Steered, for Pneumatic Suspension vehicles
	08/98→09/05	Track Control Arm		VL-VB-12460	Wishbone (CV)
	08/98→09/05	Track Control Arm		VL-VB-12460	Wishbone (CV), 1st & 2nd Drive Axle, for Pneumatic Suspension vehicles
	08/98→09/05	Track Control Arm		VL-VB-12460	Wishbone (CV), 1st Drive Axle, for Pneumatic Suspension vehicles
	08/98→09/05	Track Control Arm		VL-VB-12460	Wishbone (CV), Trailing Axle Steered/not Steered, for Pneumatic Suspension vehicles
	08/98→09/05	Track Control Arm	VL-DL-8554	VL-DL-8554	Trailing Arm
	08/98→09/05	Track Control Arm	VL-DL-10309	VL-DL-10309	Trailing Arm, 1st Front Axle, for Pneumatic Suspension vehicles, Ch.A519971/B270523→
	08/98→09/05	Track Control Arm	VL-DL-10309	VL-DL-10309	Trailing Arm, Air Suspension Axle
FM 12/420	08/98→09/05	Bush, parabolic spring		VL-SB-5356	
	08/98→09/05	Centre Rod	RV-DL-12320		for Steering Rod
	08/98→09/05	Centre Rod	VL-DL-0911		Push Rod
	08/98→09/05	Centre Rod	VL-DL-2139		Push Rod
	08/98→09/05	Centre Rod	VL-DL-8178		Push Rod
	08/98→09/05	Centre Rod	VL-DL-8187		Push Rod
	08/98→09/05	Centre Rod	VL-DL-8406		Push Rod
	08/98→09/05	Centre Rod	VL-DL-8406		Push Rod, Air Suspension Axle
	08/98→09/05	Centre Rod	VL-DL-8407		Push Rod
	08/98→09/05	Centre Rod	VL-DL-8407		Push Rod, Leaf Spring Axle
	08/98→09/05	Centre Rod	VL-DL-8566		Push Rod, Leaf Spring Axle
	08/98→09/05	Centre Rod	VL-DL-8681		Push Rod, 1st FA;Air Suspension Axle
	08/98→09/05	Centre Rod	VL-DL-8707		Push Rod

RV-DL-12320

Length: 881 Ø: 50
 Cone Ø: d1 Ø 28,6 / d2 Ø 23,9
 20390746, 21106968

**VL-DL-0911**

Length: 880 Ø: 52
 Cone Ø: d1 Ø 28,6 / d2 Ø 23,9
 1075663, 3988704, 20393069

**VL-DL-2139**

Length: 880 Ø: 52
 Cone Ø: d1 Ø 28,6 / d2 Ø 23,9
 1075153, 3988695, 20393061

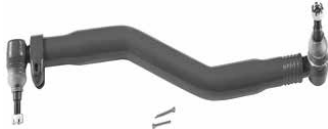
**VL-DL-8178**

Length: 572 Ø: 38
 Cone Ø: d1 Ø 28,6 / d2 Ø 23,9
 1088985, 20393083

**VL-DL-8187**

Length: 2140 Ø: 52
 Cone Ø: d1 Ø 28,6 / d2 Ø 23,9
 3199225, 20393093, 20442115, 20513953,
 24425662

**VL-DL-8189**

Length: 666 Ø: 48
 Hole Distance: 125
 1082104, 1605035

**VL-DL-8406**

Length: 888 Ø: 52
 Cone Ø: d1 Ø 28,6 / d2 Ø 23,9
 8190146, 20393071

**VL-DL-8407**

Length: 870 Ø: 52
 Cone Ø: d1 Ø 28,6 / d2 Ø 23,9
 3986452, 20375555, 20393186, 21106930

**VL-DL-8554**

Length: 570 Ø: 48
 Hole Distance: 130 / 130
 1626957, 1626958, 14320200A

**VL-DL-8566**

Length: 863 Ø: 52
 Cone Ø: d1 Ø 28,6 / d2 Ø 23,9
 20375556, 20393187, 21106952, 21406952

**VL-DL-8619**

Length: 621 Ø: 48
 Hole Distance: 100 / 100
 1608151, 1621419

**VL-DL-8681**

Length: 888 Ø: 52
 Cone Ø: d1 Ø 28,6 / d2 Ø 23,9
 8190147, 20393073

**VL-DL-8707**

Length: 885 Ø: 50
 Cone Ø: d1 Ø 28,6 / d2 Ø 23,9
 20390745, 21106936

**VL-DL-9485**

Length: 666 Ø: 48
 Hole Distance: 125 / 125
 1589817

**VL-DL-10309**

Length: 799 Ø: 48
 Hole Distance: 115 / 115
 20410053, 21106157

**VL-SB-5356**

Thick/Height: 150
 1629553, 14403900A, 20390836

**VL-VB-5369**

Length: 677
 Ø: 48
 Hole Distance: 115 / 115
 3172829, 8073569, 14319600A

**VL-VB-7787**

Length: 671
 Ø: 58
 Hole Distance: 130 / 130
 143167, 1076639, 1626896, 1629734,
 20392649, 20829503, 21295227, 21474441,
 22318834, 7421295227

**VL-VB-8195**

Length: 649
 Ø: 48
 Hole Distance: 115 / 115
 1094466, 20374689, 20382314, 20502944

**VL-VB-8525**

Length: 677,3 Ø: 48
 Hole Distance: 145 / 145
 3173291, 20556490

**VL-VB-8541**

Length: 677,3
 Ø: 48
 Hole Distance: 145 / 145
 3173292, 20556491

**VL-VB-8576**

Length: 660,3
 Ø: 48
 Hole Distance: 145 / 145
 3173293, 20556492

**VL-VB-12460**

Length: 662
 Ø: 50
 Hole Distance: 115 / 115
 2223852, 20589061





FM 12 ...

FM 12/420 ...

08/98→09/05	Centre Rod	VL-DL-8707		Push Rod, Air Suspension Axle
08/98→09/05	Centre Rod	VL-DL-9488		Push Rod
08/98→09/05	Centre Rod	VL-DL-10228		Push Rod, 1st FA;2nd FA
08/98→09/05	Centre Rod	VL-DL-12367		for Steering Rod
08/98→09/05	Centre Rod	VL-DL-12454		for Steering Rod
08/98→09/05	Centre Rod	VL-DL-12483		Push Rod
08/98→09/05	Centre Rod	VL-DL-12484		Push Rod
08/98→09/05	Stabiliser Link		VL-DL-8412	Coupling Rod, Control Arm
08/98→09/05	Stabiliser Link		VL-DL-8518	Coupling Rod, Control Arm
08/98→09/05	Stabiliser Link		VL-DL-8543	Coupling Rod, Control Arm
08/98→09/05	Stabiliser Link		VL-DL-9472	Coupling Rod
08/98→09/05	Stabiliser Link		VL-DL-9491	Coupling Rod, Control Arm
08/98→09/05	Stabiliser Link	VL-DL-8157		Coupling Rod, for Leaf-Spring Suspension vehicles
08/98→09/05	Stabiliser Link	VL-DL-8157		Coupling Rod, for Pneumatic Suspension vehicles
08/98→09/05	Stabiliser Link	VL-DL-8536		Coupling Rod, Air Suspension Axle
08/98→09/05	Stabiliser Link	VL-DL-10258		Coupling Rod, for Leaf-Spring Suspension vehicles
08/98→09/05	Stabiliser Link	VL-DL-12356		Coupling Rod
08/98→09/05	Stabiliser Mounting	VL-SB-10397		
08/98→09/05	Stabiliser Mounting	VL-SB-10398		
08/98→09/05	Suspension Arm Repair Kit		CV-RK-5322	for Wishbone (CV)
08/98→09/05	Suspension Arm Repair Kit		IV-RK-8998	for Wishbone (CV)
08/98→09/05	Suspension Arm Repair Kit		MN-RK-9383	for Control Arm
08/98→09/05	Suspension Arm Repair Kit		VL-RK-9497	for Drag Link
08/98→09/05	Suspension Arm Repair Kit		VL-RK-9497	for Drag Link, Leaf Spring Axle
08/98→09/05	Suspension Strut Repair Kit		MN-RK-8501	
08/98→09/05	Suspension Strut Repair Kit	MN-RK-12436	MN-RK-12436	
08/98→09/05	Suspension Strut Repair Kit	VL-RK-8533		
08/98→09/05	Tie Bar Bush		VL-SB-9501	
08/98→09/05	Tie Rod		VL-DL-8163	Leading Axle;for vehicles with Hinged Leading Axle
08/98→09/05	Tie Rod	RV-DL-12447		
08/98→09/05	Tie Rod	VL-DL-7789		
08/98→09/05	Tie Rod	VL-DL-8163		
08/98→09/05	Tie Rod	VL-DL-8305		Leaf Spring Axle
08/98→09/05	Tie Rod	VL-DL-9492		Air Suspension Axle
08/98→09/05	Tie Rod	VL-DL-9493		Air Suspension Axle
08/98→09/05	Tie Rod	VL-DL-12355		
08/98→09/05	Tie Rod	VL-DL-12358		
08/98→09/05	Tie Rod End		RV-ES-9432	Leading Axle
08/98→09/05	Tie Rod End		RV-ES-9432	Tag Axle
08/98→09/05	Tie Rod End		VL-ES-10361	Tag Axle
08/98→09/05	Tie Rod End	RV-ES-12442		
08/98→09/05	Tie Rod End	VL-ES-5287		for Guide Rod
08/98→09/05	Tie Rod End	VL-ES-5288		for Guide Rod
08/98→09/05	Tie Rod End	VL-ES-5347		for Steering Rod
08/98→09/05	Tie Rod End	VL-ES-5347	VL-ES-5347	for Steering Rod
08/98→09/05	Tie Rod End	VL-ES-5348		for Steering Rod
08/98→09/05	Tie Rod End	VL-ES-5348	VL-ES-5348	for Steering Rod
08/98→09/05	Tie Rod End	VL-ES-7265	VL-ES-7265	
08/98→09/05	Tie Rod End	VL-ES-7266	VL-ES-7266	
08/98→09/05	Tie Rod End	VL-ES-8411	VL-ES-8411	* 2828332 *→* 2831818 *
08/98→09/05	Tie Rod End	VL-ES-8411	VL-ES-8411	* 6800000 *→* 6831387 *
08/98→09/05	Tie Rod End	VL-ES-8411	VL-ES-8411	* 9825999 *→* 9826006 *
08/98→09/05	Tie Rod End	VL-ES-8411	VL-ES-8411	* A287349 *→* A299999 *
08/98→09/05	Tie Rod End	VL-ES-8411	VL-ES-8411	* A500000 *→* A544695 *
08/98→09/05	Tie Rod End	VL-ES-8411	VL-ES-8411	* B229721 *→* B311773 *
08/98→09/05	Tie Rod End	VL-ES-8411	VL-ES-8411	* C760568 *→* C763461 *
08/98→09/05	Tie Rod End	VL-ES-8411	VL-ES-8411	* D120771 *→* D123487 *
08/98→09/05	Tie Rod End	VL-ES-8411	VL-ES-8411	* S827721 *→* S832416 *
08/98→09/05	Tie Rod End	VL-ES-8411	VL-ES-8411	→* 1200634 *

CV-RK-5322

Ø: 72 Thick/Height: 50
271188, 3091598



IV-RK-8998

Ø: 85 Hole Distance: 130
Thick/Height: 30
273373, 274019, 4941233,
6889509



MN-RK-8501

Ø: 75 Hole Distance: 115
Thick/Height: 24
20547286



MN-RK-9383

Ø: 67 Hole Distance: 100
Thick/Height: 24
275988



MN-RK-12436

Ø: 75 Hole Distance: 115
Thick/Height: 24
3093462, 85104224



RV-DL-12447

Length: 1818 Ø: 52
Cone Ø: d1 Ø 28,6 / d2 Ø 23,9
20399543, 21299034, 85115631



RV-ES-9432

Length: 120
Cone Ø: d1 Ø 28 / d2 Ø 23,9
Thread: M26 x 1,5 RHT
3193731



RV-ES-12442

Length: 88
Cone Ø: d1 Ø 28,6
Thread: M26 x 1,5 RHT
3987648



VL-DL-7789

Length: 1640 Ø: 58
Cone Ø: d1 Ø 28,6 / d2 Ø 23,9
1612254, 3985570, 4510697,
20393097, 21260286



VL-DL-8157

Length: 325 Ø: 30
Cone Ø: d1 Ø 22 / d2 Ø 20
1629668, 3986433, 14316200A,
20477805



VL-DL-8163

Length: 1640 Ø: 42
Cone Ø: d1 Ø 28,6 / d2 Ø 23,9
1628637, 3962343, 3986450,
3988711



VL-DL-8305

Length: 1634 Ø: 50
Cone Ø: d1 Ø 28,6 / d2 Ø 23,9
3198276, 21260274



VL-DL-8412

Length: 435 Ø: 36
Cone Ø: d1 Ø 28,6 / d2 Ø 25,5
3173613, 3987354



VL-DL-8518

Length: 350 Ø: 36
Cone Ø: d1 Ø 28,9 / d2 Ø 24,7
20443063, 20443067, 20994420



VL-DL-8536

Length: 340 Ø: 30
Cone Ø: d1 Ø 22 / d2 Ø 19,9
3944046, 20477807



VL-DL-8543

Length: 380 Ø: 36
Cone Ø: d1 Ø 28,6 / d2 Ø 24,7
20443062, 20443066, 20994419



VL-DL-8707

Length: 885 Ø: 50
Cone Ø: d1 Ø 28,6 / d2 Ø 23,9
20390745, 21106936



VL-DL-9472

Length: 435 Ø: 36
Cone Ø: d1 Ø 32,2 / d2 Ø 28
20443061, 20443065, 20994418



VL-DL-9488

Length: 563 Ø: 48
Cone Ø: d1 Ø 28,6 / d2 Ø 23,9
20374831, 21252480



VL-DL-9491

Length: 380 Ø: 36
Cone Ø: d1 Ø 28,6 / d2 Ø 25,5
3173914, 3987355



VL-DL-9492

Length: 1660 Ø: 62
Cone Ø: d1 Ø 32 / d2 Ø 27
20587731, 21106938



VL-DL-9493

Length: 1660 Ø: 62
Cone Ø: d1 Ø 28,6 / d2 Ø 23,9
3198234, 21260275



VL-DL-10228

Length: 2139 Ø: 62
Cone Ø: d1 Ø 28,6 / d2 Ø 23,9
20453063



VL-DL-10258

Length: 325 Ø: 30
Cone Ø: d1 Ø 22 / d2 Ø 20
1629668, 3986433, 20477805



VL-DL-12355

Length: 368 Ø: 38
Cone Ø: d1 Ø 28,6 / d2 Ø 23,9
1628207



VL-DL-12356

Length: 275 Ø: 30
Cone Ø: d1 Ø 22
3987423, 20477803



VL-DL-12358

Length: 1669 Ø: 42
Cone Ø: d1 Ø 32 / d2 Ø 27
Thread: M32 x 1,5 RHT / M32
x 1,5 LHT
20581086, 7420581086



VL-DL-12367

Length: 2139 Ø: 62
Cone Ø: d1 Ø 28,6 / d2 Ø 23,9
Thread: M52 x 1,5 RHT
20453064, 20584291



VL-DL-12454

Length: 2339 Ø: 62
Cone Ø: d1 Ø 28,6 / d2 Ø 23,9
20581632



VL-DL-12483

Length: 485 Ø: 48
Cone Ø: d1 Ø 28,6 / d2 Ø 23,9
20383081, 21260283, 22159761,
81467106355



VL-DL-12484

Length: 1025 Ø: 48
Cone Ø: d1 Ø 28,6 / d2 Ø 23,9
2038308, 21252481



VL-ES-5287

Length: 167
Cone Ø: d1 Ø 28,6 / d2 Ø 23,9
Thread: M52 x 1,5 RHT
1696901, 1699401



VL-ES-5288

Length: 167
Cone Ø: d1 Ø 28,6 / d2 Ø 23,9
Thread: M52 x 1,5 LHT
1696900, 1699400



VL-ES-5347

Length: 125
Cone Ø: d1 Ø 28,6 / d2 Ø 23,9
Thread: M30 x 1,5 LHT
1507822, 1698847, 3092471



VL-ES-5348

Length: 125
Cone Ø: d1 Ø 28,6 / d2 Ø 23,9
Thread: M30 x 1,5 RHT
1507823, 1698846, 3092472



VL-ES-7265

Length: 125
Cone Ø: d1 Ø 31,5 / d2 Ø 27,5
Thread: M30 x 1,5 LHT
1131744, 1313744, 1698558,
1698840, 2072161F, 3092795,
6869744, 6882112, 6889481,
85114147



VL-ES-7266

Length: 125
Cone Ø: d1 Ø 31,5 / d2 Ø 27,5
Thread: M30 x 1,5 RHT
0356310, 1507826, 1695585,
1695776, 1698557, 6882111,
6882111(BRAZIL), 6889480,
6889482, 14200800A, 85114146



VL-ES-8411

Length: 140
Cone Ø: d1 Ø 28,6 / d2 Ø 23,9
Thread: M30 x 1,5 RHT
3093647, 3097999, 21263821



VL-ES-10361

Length: 88
Cone Ø: d1 Ø 28,6 / d2 Ø 24
Thread: M26 x 1,5 RHT
20374698



VL-RK-8533

Ø: 85 Hole Distance: 130
Thick/Height: 30
3093630, 3093631, 20840815,
21295230, 7420840815



VL-RK-9497

Ø: 95 Hole Distance: 130
Thick/Height: 35
273612, 20702095



VL-SB-9501

Ø: 91 Thick/Height: 85 / 85
1135080



VL-SB-10397

Thick/Height: 89 / 89
1075179



VL-SB-10398

Thick/Height: 87,5 / 87,5
1075180





FM 12 ...

FM 12/420 ...

08/98→09/05	Tie Rod End	VL-ES-8414		for Guide Rod
08/98→09/05	Tie Rod End	VL-ES-8568		
08/98→09/05	Tie Rod End	VL-ES-10360		for Steering Rod
08/98→09/05	Tie Rod End	VL-ES-10361		
08/98→09/05	Track Control Arm		RV-DL-10299	Trailing Arm, 1st & 2nd Drive Axle, for Leaf-Spring Suspension vehicles
08/98→09/05	Track Control Arm		RV-TC-12339	Suspension Rod, Trailing Arm
08/98→09/05	Track Control Arm		RV-TC-12340	Trailing Arm
08/98→09/05	Track Control Arm		RV-VB-8191	Wishbone (CV)
08/98→09/05	Track Control Arm		RV-VB-8191	Wishbone (CV), 1st RA;2nd RA;Leaf Spring Axle
08/98→09/05	Track Control Arm		RV-VB-8191	Wishbone (CV), Air Suspension Axle, * 1202645 *,* A527108 *,* B281986 *→
08/98→09/05	Track Control Arm		RV-VB-8191	Wishbone (CV), Air Suspension Axle, →* A833235 *,* B321098 *
08/98→09/05	Track Control Arm		VL-DL-8180	Trailing Arm
08/98→09/05	Track Control Arm		VL-DL-8189	Trailing Arm, 1st Drive Axle
08/98→09/05	Track Control Arm		VL-DL-8189	Trailing Arm, 1st Drive Axle, for Pneumatic Suspension vehicles
08/98→09/05	Track Control Arm		VL-DL-8189	Trailing Arm, Drive Axle
08/98→09/05	Track Control Arm		VL-DL-8189	Trailing Arm, Drive Axle; for vehicles with Rigid Trailing Axle; for vehicles with Hinged Trailing Axle
08/98→09/05	Track Control Arm		VL-DL-8554	Trailing Arm, 1st RA;2nd RA;Leaf Spring Axle
08/98→09/05	Track Control Arm		VL-DL-8619	Trailing Arm, 1st & 2nd Drive Axle, for Leaf-Spring Suspension vehicles
08/98→09/05	Track Control Arm		VL-DL-9485	Trailing Arm, Tag Axle;for vehicles with Rigid Trailing Axle
08/98→09/05	Track Control Arm		VL-DL-9485	Trailing Arm, Trailing Axle Steered/not Steered, for Pneumatic Suspension vehicles
08/98→09/05	Track Control Arm		VL-VB-5369	Wishbone (CV), 1st RA;2nd RA;Leaf Spring Axle
08/98→09/05	Track Control Arm		VL-VB-5369	Wishbone (CV), 1st RA;2nd RA;Leaf Spring Axle, →* A557645 *,* B330018 *
08/98→09/05	Track Control Arm		VL-VB-5369	Wishbone (CV), 1st RA;Air Suspension Axle
08/98→09/05	Track Control Arm		VL-VB-7787	Wishbone (CV)
08/98→09/05	Track Control Arm		VL-VB-7787	Wishbone (CV), 1st RA;2nd RA;Unit; Leaf Spring Axle
08/98→09/05	Track Control Arm		VL-VB-8195	Wishbone (CV), 2nd RA;Air Suspension Axle
08/98→09/05	Track Control Arm		VL-VB-8195	Wishbone (CV), Air Suspension Axle, →* A527108 *,* B281986 *
08/98→09/05	Track Control Arm		VL-VB-8525	Wishbone (CV), Drive Axle;Air Suspension Axle
08/98→09/05	Track Control Arm		VL-VB-8525	Wishbone (CV), Tag Axle;Air Suspension Axle
08/98→09/05	Track Control Arm		VL-VB-8525	Wishbone (CV), Trailing Axle Steered/not Steered, for Pneumatic Suspension vehicles
08/98→09/05	Track Control Arm		VL-VB-8541	Wishbone (CV), 1st Drive Axle, for Leaf-Spring/Pneumatic Suspension vehicles
08/98→09/05	Track Control Arm		VL-VB-8541	Wishbone (CV), Drive Axle
08/98→09/05	Track Control Arm		VL-VB-8541	Wishbone (CV), Tag Axle;Air Suspension Axle
08/98→09/05	Track Control Arm		VL-VB-8541	Wishbone (CV), Trailing Axle Steered/not Steered, For Leaf-Spring/Pneumatic Suspension vehicles
08/98→09/05	Track Control Arm		VL-VB-8576	Wishbone (CV), 1st Drive Axle, for Pneumatic Suspension vehicles
08/98→09/05	Track Control Arm		VL-VB-8576	Wishbone (CV), Drive Axle;Leading Axle; Air Suspension Axle
08/98→09/05	Track Control Arm		VL-VB-8576	Wishbone (CV), Trailing Axle Steered/not Steered, for Pneumatic Suspension vehicles
08/98→09/05	Track Control Arm		VL-VB-12460	Wishbone (CV)
08/98→09/05	Track Control Arm		VL-VB-12460	Wishbone (CV), 1st & 2nd Drive Axle, for Pneumatic Suspension vehicles
08/98→09/05	Track Control Arm		VL-VB-12460	Wishbone (CV), 1st Drive Axle, for Pneumatic Suspension vehicles
08/98→09/05	Track Control Arm		VL-VB-12460	Wishbone (CV), Trailing Axle Steered/not Steered, for Pneumatic Suspension vehicles

RV-DL-10299

Length: 510 Ø: 21
 20522934, 21051052, 7420864583,
 7421051052

**RV-TC-12339**

Length: 515
 Hole Distance: 13 / 130
 20532931, 21051046

**RV-TC-12340**

Length: 510
 Hole Distance: 115 / 115
 20443044

**RV-VB-8191**

Length: 662,4 Ø: 48
 Hole Distance: 115 / 115
 20367004, 20507262, 20741695, 20741703,
 22318833

**VL-DL-8180**

Length: 625 Ø: 17
 20374444, 20410530, 20509018, 20517494,
 70371270

**VL-DL-8189**

Length: 666 Ø: 48
 Hole Distance: 125
 1082104, 1605035

**VL-DL-8554**

Length: 570 Ø: 48
 Hole Distance: 130 / 130
 1626957, 1626958, 14320200A

**VL-DL-8619**

Length: 621 Ø: 48
 Hole Distance: 100 / 100
 1608151, 1621419

**VL-DL-9485**

Length: 666 Ø: 48
 Hole Distance: 125 / 125
 1589817

**VL-ES-8414**

Length: 136
 Cone Ø: d1 Ø 32 / d2 Ø 27
 Thread: M30 x 1,5 LHT
 20710008

**VL-ES-8568**

Length: 100
 Cone Ø: d1 Ø 38 / d2 Ø 34,3
 Thread: M26 x 1,5 RHT
 8151876

**VL-ES-10360**

Length: 136
 Cone Ø: d1 Ø 32 / d2 Ø 27
 Thread: M30 x 1,5 RHT
 20581089

**VL-ES-10361**

Length: 88
 Cone Ø: d1 Ø 28,6 / d2 Ø 24
 Thread: M26 x 1,5 RHT
 20374698

**VL-VB-5369**

Length: 677
 Ø: 48
 Hole Distance: 115 / 115
 3172829, 8073569, 14319600A

**VL-VB-7787**

Length: 671
 Ø: 58
 Hole Distance: 130 / 130
 143167, 1076639, 1626896, 1629734,
 20392649, 20829503, 21295227, 21474441,
 22318834, 7421295227

**VL-VB-8195**

Length: 649
 Ø: 48
 Hole Distance: 115 / 115
 1094466, 20374689, 20382314, 20502944

**VL-VB-8525**

Length: 677,3 Ø: 48
 Hole Distance: 145 / 145
 3173291, 20556490

**VL-VB-8541**

Length: 677,3
 Ø: 48
 Hole Distance: 145 / 145
 3173292, 20556491

**VL-VB-8576**

Length: 660,3
 Ø: 48
 Hole Distance: 145 / 145
 3173293, 20556492

**VL-VB-12460**

Length: 662
 Ø: 50
 Hole Distance: 115 / 115
 2223852, 20589061





FM 12 ...

FM 12/420 ...	08/98→09/05	Track Control Arm	VL-DL-8554	VL-DL-8554	Trailing Arm
	08/98→09/05	Track Control Arm	VL-DL-10309	VL-DL-10309	Trailing Arm, 1st Front Axle, for Pneumatic Suspension vehicles, Ch.A519971/B270523→
	08/98→09/05	Track Control Arm	VL-DL-10309	VL-DL-10309	Trailing Arm, Air Suspension Axle
FM 12/460	08/98→09/05	Centre Rod	RV-DL-12320		for Steering Rod
	08/98→09/05	Centre Rod	VL-DL-8178		Push Rod
	08/98→09/05	Centre Rod	VL-DL-8406		Push Rod
	08/98→09/05	Centre Rod	VL-DL-8407		Push Rod
	08/98→09/05	Centre Rod	VL-DL-8566		Push Rod
	08/98→09/05	Centre Rod	VL-DL-12367		for Steering Rod
	08/98→09/05	Centre Rod	VL-DL-12454		for Steering Rod
	08/98→09/05	Centre Rod	VL-DL-12483		Push Rod
	08/98→09/05	Centre Rod	VL-DL-12484		Push Rod
	08/98→09/05	Stabiliser Link		VL-DL-9472	Coupling Rod
	08/98→09/05	Stabiliser Link	VL-DL-8157		Coupling Rod, for Leaf-Spring Suspension vehicles
	08/98→09/05	Stabiliser Link	VL-DL-8157		Coupling Rod, for Pneumatic Suspension vehicles
	08/98→09/05	Stabiliser Link	VL-DL-10258		Coupling Rod, for Leaf-Spring Suspension vehicles
	08/98→09/05	Stabiliser Link	VL-DL-12356		Coupling Rod
	08/98→09/05	Suspension Arm Repair Kit		VL-RK-9497	for Drag Link
	08/98→09/05	Suspension Strut Repair Kit		MN-RK-8501	
	08/98→09/05	Suspension Strut Repair Kit	MN-RK-12436	MN-RK-12436	
	08/98→09/05	Tie Bar Bush		VL-SB-9501	
	08/98→09/05	Tie Rod	RV-DL-12447		
	08/98→09/05	Tie Rod	VL-DL-12355		
	08/98→09/05	Tie Rod	VL-DL-12358		
	08/98→09/05	Tie Rod End		VL-ES-8411	
	08/98→09/05	Tie Rod End	RV-ES-12442		
	08/98→09/05	Tie Rod End	VL-ES-5287		for Guide Rod
	08/98→09/05	Tie Rod End	VL-ES-5288		for Guide Rod
	08/98→09/05	Tie Rod End	VL-ES-5347		for Steering Rod
	08/98→09/05	Tie Rod End	VL-ES-5348		for Steering Rod
	08/98→09/05	Tie Rod End	VL-ES-8414		for Guide Rod
	08/98→09/05	Tie Rod End	VL-ES-10360		for Steering Rod
	08/98→09/05	Track Control Arm		RV-TC-12340	Trailing Arm
	08/98→09/05	Track Control Arm		RV-VB-8191	Wishbone (CV), 1st Drive Axle, for Pneumatic Suspension vehicles
	08/98→09/05	Track Control Arm		RV-VB-8191	Wishbone (CV), Air Suspension Axle, * 1202645 ** A527108 ** B281986 *→
	08/98→09/05	Track Control Arm		RV-VB-8191	Wishbone (CV), Air Suspension Axle, →* A833235 ** B321098 *
08/98→09/05	Track Control Arm		RV-VB-8191	Wishbone (CV), Trailing Axle Steered/not Steered, for Pneumatic Suspension vehicles	
08/98→09/05	Track Control Arm		VL-DL-8180	Trailing Arm	
08/98→09/05	Track Control Arm		VL-DL-8180	Trailing Arm, 1st Drive Axle, for Pneumatic Suspension vehicles	
08/98→09/05	Track Control Arm		VL-DL-8180	Trailing Arm, Trailing Axle Steered/not Steered, for Pneumatic Suspension vehicles	
08/98→09/05	Track Control Arm		VL-DL-8189	Trailing Arm, 1st Drive Axle	
08/98→09/05	Track Control Arm		VL-DL-8189	Trailing Arm, 1st Drive Axle, for Pneumatic Suspension vehicles	
08/98→09/05	Track Control Arm		VL-DL-9485	Trailing Arm, Trailing Axle Steered/not Steered, for Pneumatic Suspension vehicles	
08/98→09/05	Track Control Arm		VL-VB-7787	Wishbone (CV)	
08/98→09/05	Track Control Arm		VL-VB-8195	Wishbone (CV), Air Suspension Axle, →* A527108 ** B281986 *	
08/98→09/05	Track Control Arm		VL-VB-8525	Wishbone (CV), Drive Axle; Air Suspension Axle	
08/98→09/05	Track Control Arm		VL-VB-8525	Wishbone (CV), Trailing Axle Steered/not Steered, for Pneumatic Suspension vehicles	

MN-RK-8501

Ø: 75 Hole Distance: 115
Thick/Height: 24
20547286

**MN-RK-12436**

Ø: 75 Hole Distance: 115
Thick/Height: 24
3093462, 85104224

**RV-DL-12320**

Length: 881 Ø: 50
Cone Ø: d1 Ø 28,6 / d2 Ø 23,9
20390746, 21106968

**RV-DL-12447**

Length: 1818 Ø: 52
Cone Ø: d1 Ø 28,6 / d2 Ø 23,9
20399543, 21299034, 85115631

**RV-ES-12442**

Length: 88
Cone Ø: d1 Ø 28,6
Thread: M26 x 1,5 RHT
3987648

**RV-TC-12340**

Length: 510
Hole Distance: 115 / 115
20443044

**RV-VB-8191**

Length: 662,4 Ø: 48
Hole Distance: 115 / 115
20367004, 20507262, 20741695, 20741703,
22318833

**VL-DL-8157**

Length: 325 Ø: 30
Cone Ø: d1 Ø 22 / d2 Ø 20
1629668, 3986433, 14316200A, 20477805

**VL-DL-8178**

Length: 572 Ø: 38
Cone Ø: d1 Ø 28,6 / d2 Ø 23,9
1088985, 20393083

**VL-DL-8180**

Length: 625 Ø: 17
20374444, 20410530, 20509018, 20517494,
70371270

**VL-DL-8189**

Length: 666 Ø: 48
Hole Distance: 125
1082104, 1605035

**VL-DL-8406**

Length: 888 Ø: 52
Cone Ø: d1 Ø 28,6 / d2 Ø 23,9
8190146, 20393071

**VL-DL-8407**

Length: 870 Ø: 52
Cone Ø: d1 Ø 28,6 / d2 Ø 23,9
3986452, 20375555, 20393186, 21106930

**VL-DL-8554**

Length: 570 Ø: 48
Hole Distance: 130 / 130
1626957, 1626958, 14320200A

**VL-DL-8566**

Length: 863 Ø: 52
Cone Ø: d1 Ø 28,6 / d2 Ø 23,9
20375556, 20393187, 21106952, 21406952

**VL-DL-9472**

Length: 435 Ø: 36
Cone Ø: d1 Ø 32,2 / d2 Ø 28
20443061, 20443065, 20994418

**VL-DL-9485**

Length: 666 Ø: 48
Hole Distance: 125 / 125
1589817

**VL-DL-10258**

Length: 325 Ø: 30
Cone Ø: d1 Ø 22 / d2 Ø 20
1629668, 3986433, 20477805

**VL-DL-10309**

Length: 799 Ø: 48
Hole Distance: 115 / 115
20410053, 21106157

**VL-DL-12355**

Length: 368 Ø: 38
Cone Ø: d1 Ø 28,6 / d2 Ø 23,9
1628207

**VL-DL-12356**

Length: 275 Ø: 30
Cone Ø: d1 Ø 22
3987423, 20477803

**VL-DL-12358**

Length: 1669 Ø: 42
Cone Ø: d1 Ø 32 / d2 Ø 27
Thread: M32 x 1,5 RHT / M32 x 1,5 LHT
20581086, 7420581086

**VL-DL-12367**

Length: 2139 Ø: 62
Cone Ø: d1 Ø 28,6 / d2 Ø 23,9
Thread: M52 x 1,5 RHT
20453064, 20584291

**VL-DL-12454**

Length: 2339 Ø: 62
Cone Ø: d1 Ø 28,6 / d2 Ø 23,9
20581632

**VL-DL-12483**

Length: 485 Ø: 48
Cone Ø: d1 Ø 28,6 / d2 Ø 23,9
20383081, 21260283, 22159761,
81467106355

**VL-DL-12484**

Length: 1025 Ø: 48
Cone Ø: d1 Ø 28,6 / d2 Ø 23,9
2038308, 21252481

**VL-ES-5287**

Length: 167
Cone Ø: d1 Ø 28,6 / d2 Ø 23,9
Thread: M52 x 1,5 RHT
1696901, 1699401

**VL-ES-5288**

Length: 167
Cone Ø: d1 Ø 28,6 / d2 Ø 23,9
Thread: M52 x 1,5 LHT
1696900, 1699400

**VL-ES-5347**

Length: 125
Cone Ø: d1 Ø 28,6 / d2 Ø 23,9
Thread: M30 x 1,5 LHT
1507822, 1698847, 3092471

**VL-ES-5348**

Length: 125
Cone Ø: d1 Ø 28,6 / d2 Ø 23,9
Thread: M30 x 1,5 RHT
1507823, 1698846, 3092472

**VL-ES-8411**

Length: 140
Cone Ø: d1 Ø 28,6 / d2 Ø 23,9
Thread: M30 x 1,5 RHT
3093647, 3097999, 21263821

**VL-ES-8414**

Length: 136
Cone Ø: d1 Ø 32 / d2 Ø 27
Thread: M30 x 1,5 LHT
20710008

**VL-ES-10360**

Length: 136
Cone Ø: d1 Ø 32 / d2 Ø 27
Thread: M30 x 1,5 RHT
20581089

**VL-RK-9497**

Ø: 95 Hole Distance: 130
Thick/Height: 35
273612, 20702095

**VL-SB-9501**

Ø: 91 Thick/Height: 85 / 85
1135080

**VL-VB-7787**

Length: 671 Ø: 58
Hole Distance: 130 / 130
143167, 1076639, 1626896, 1629734,
20392649, 20829503, 21295227, 21474441,
22318834, 7421295227

**VL-VB-8195**

Length: 649 Ø: 48
Hole Distance: 115 / 115
1094466, 20374689, 20382314, 20502944

**VL-VB-8525**

Length: 677,3 Ø: 48
Hole Distance: 145 / 145
3173291, 20556490





FM 12 ...

FM 12/460 ...	08/98→09/05	Track Control Arm		VL-VB-8541	Wishbone (CV), 1st Drive Axle, for Leaf-Spring/Pneumatic Suspension vehicles
	08/98→09/05	Track Control Arm		VL-VB-8541	Wishbone (CV), Trailing Axle Steered/not Steered, For Leaf-Spring/Pneumatic Suspension vehicles
	08/98→09/05	Track Control Arm		VL-VB-8576	Wishbone (CV), 1st Drive Axle, for Pneumatic Suspension vehicles
	08/98→09/05	Track Control Arm		VL-VB-8576	Wishbone (CV), Trailing Axle Steered/not Steered, for Pneumatic Suspension vehicles
	08/98→09/05	Track Control Arm		VL-VB-12460	Wishbone (CV)
	08/98→09/05	Track Control Arm	VL-DL-10309	VL-DL-10309	Trailing Arm, 1st Front Axle, for Pneumatic Suspension vehicles, Ch.A519971/B270523→
FM 12H/340	08/98→09/05	Centre Rod	VL-DL-8178		Push Rod
	08/98→09/05	Centre Rod	VL-DL-8187		Push Rod
	08/98→09/05	Centre Rod	VL-DL-8406		Push Rod
	08/98→09/05	Centre Rod	VL-DL-8407		Push Rod
	08/98→09/05	Centre Rod	VL-DL-8566		Push Rod, Leaf Spring Axle
	08/98→09/05	Centre Rod	VL-DL-8707		Push Rod
	08/98→09/05	Centre Rod	VL-DL-9488		Push Rod
	08/98→09/05	Centre Rod	VL-DL-10228		Push Rod, 1st FA;2nd FA
	08/98→09/05	Centre Rod	VL-DL-12367		for Steering Rod
	08/98→09/05	Centre Rod	VL-DL-12454		for Steering Rod
	08/98→09/05	Stabiliser Link		VL-DL-8518	Coupling Rod, Control Arm
	08/98→09/05	Stabiliser Link		VL-DL-8543	Coupling Rod, Control Arm
	08/98→09/05	Stabiliser Link	VL-DL-8157		Coupling Rod, for Leaf-Spring Suspension vehicles
	08/98→09/05	Stabiliser Link	VL-DL-8157		Coupling Rod, for Pneumatic Suspension vehicles
	08/98→09/05	Stabiliser Link	VL-DL-8536		Coupling Rod, Air Suspension Axle
	08/98→09/05	Stabiliser Link	VL-DL-10258		Coupling Rod, for Leaf-Spring Suspension vehicles
	08/98→09/05	Stabiliser Mounting	VL-SB-10397		
	08/98→09/05	Stabiliser Mounting	VL-SB-10398		
	08/98→09/05	Suspension Arm Repair Kit		IV-RK-8998	for Wishbone (CV)
	08/98→09/05	Suspension Arm Repair Kit		MN-RK-9383	for Control Arm
	08/98→09/05	Suspension Arm Repair Kit		VL-RK-9497	for Drag Link, Leaf Spring Axle
	08/98→09/05	Suspension Strut Repair Kit		MN-RK-8501	
	08/98→09/05	Suspension Strut Repair Kit	MN-RK-12436	MN-RK-12436	
	08/98→09/05	Tie Bar Bush		VL-SB-9501	
	08/98→09/05	Tie Rod	VL-DL-8305		Leaf Spring Axle
	08/98→09/05	Tie Rod	VL-DL-12358		
	08/98→09/05	Tie Rod End	VL-ES-5347	VL-ES-5347	for Steering Rod
	08/98→09/05	Tie Rod End	VL-ES-5348		for Steering Rod
	08/98→09/05	Tie Rod End	VL-ES-5348	VL-ES-5348	for Steering Rod
	08/98→09/05	Tie Rod End	VL-ES-7265	VL-ES-7265	
	08/98→09/05	Tie Rod End	VL-ES-7266	VL-ES-7266	
	08/98→09/05	Tie Rod End	VL-ES-8411	VL-ES-8411	* 2828332 *→* 2831818 *
	08/98→09/05	Tie Rod End	VL-ES-8411	VL-ES-8411	* 6800000 *→* 6831387 *
	08/98→09/05	Tie Rod End	VL-ES-8411	VL-ES-8411	* 9825999 *→* 9826006 *
	08/98→09/05	Tie Rod End	VL-ES-8411	VL-ES-8411	* A287349 *→* A299999 *
	08/98→09/05	Tie Rod End	VL-ES-8411	VL-ES-8411	* A500000 *→* A544695 *
	08/98→09/05	Tie Rod End	VL-ES-8411	VL-ES-8411	* B229721 *→* B311773 *
	08/98→09/05	Tie Rod End	VL-ES-8411	VL-ES-8411	* C760568 *→* C763461 *
	08/98→09/05	Tie Rod End	VL-ES-8411	VL-ES-8411	* D120771 *→* D123487 *
	08/98→09/05	Tie Rod End	VL-ES-8411	VL-ES-8411	* S827721 *→* S832416 *
	08/98→09/05	Tie Rod End	VL-ES-8411	VL-ES-8411	→* 1200634 *
	08/98→09/05	Tie Rod End	VL-ES-8414		for Guide Rod
	08/98→09/05	Tie Rod End	VL-ES-8568		
	08/98→09/05	Tie Rod End	VL-ES-10360		for Steering Rod
	08/98→09/05	Tie Rod End	VL-ES-10361		
	08/98→09/05	Track Control Arm		RV-DL-10299	Trailing Arm, 1st & 2nd Drive Axle, for Leaf-Spring Suspension vehicles

IV-RK-8998

Ø: 85 Hole Distance: 130
Thick/Height: 30
273373, 274019, 4941233, 6889509

**MN-RK-8501**

Ø: 75 Hole Distance: 115
Thick/Height: 24
20547286

**MN-RK-9383**

Ø: 67 Hole Distance: 100
Thick/Height: 24
275988

**MN-RK-12436**

Ø: 75 Hole Distance: 115
Thick/Height: 24
3093462, 85104224

**RV-DL-10299**

Length: 510 Ø: 21
20522934, 21051052, 7420864583,
7421051052

**VL-DL-8157**

Length: 325 Ø: 30
Cone Ø: d1 Ø 22 / d2 Ø 20
1629668, 3986433, 14316200A, 20477805

**VL-DL-8178**

Length: 572 Ø: 38
Cone Ø: d1 Ø 28,6 / d2 Ø 23,9
1088985, 20393083

**VL-DL-8187**

Length: 2140 Ø: 52
Cone Ø: d1 Ø 28,6 / d2 Ø 23,9
3199225, 20393093, 20442115, 20513953,
24425662

**VL-DL-8305**

Length: 1634 Ø: 50
Cone Ø: d1 Ø 28,6 / d2 Ø 23,9
3198276, 21260274

**VL-DL-8406**

Length: 888 Ø: 52
Cone Ø: d1 Ø 28,6 / d2 Ø 23,9
8190146, 20393071

**VL-DL-8407**

Length: 870 Ø: 52
Cone Ø: d1 Ø 28,6 / d2 Ø 23,9
3986452, 20375555, 20393186, 21106930

**VL-DL-8518**

Length: 350 Ø: 36
Cone Ø: d1 Ø 28,9 / d2 Ø 24,7
20443063, 20443067, 20994420

**VL-DL-8536**

Length: 340 Ø: 30
Cone Ø: d1 Ø 22 / d2 Ø 19,9
3944046, 20477807

**VL-DL-8543**

Length: 380 Ø: 36
Cone Ø: d1 Ø 28,6 / d2 Ø 24,7
20443062, 20443066, 20994419

**VL-DL-8566**

Length: 863 Ø: 52
Cone Ø: d1 Ø 28,6 / d2 Ø 23,9
20375556, 20393187, 21106952, 21406952

**VL-DL-8707**

Length: 885 Ø: 50
Cone Ø: d1 Ø 28,6 / d2 Ø 23,9
20390745, 21106936

**VL-DL-9488**

Length: 563 Ø: 48
Cone Ø: d1 Ø 28,6 / d2 Ø 23,9
20374831, 21252480

**VL-DL-10228**

Length: 2139 Ø: 62
Cone Ø: d1 Ø 28,6 / d2 Ø 23,9
20453063

**VL-DL-10258**

Length: 325 Ø: 30
Cone Ø: d1 Ø 22 / d2 Ø 20
1629668, 3986433, 20477805

**VL-DL-10309**

Length: 799 Ø: 48
Hole Distance: 115 / 115
20410053, 21106157

**VL-DL-12358**

Length: 1669 Ø: 42
Cone Ø: d1 Ø 32 / d2 Ø 27
Thread: M32 x 1,5 RHT / M32 x 1,5 LHT
20581086, 7420581086

**VL-DL-12367**

Length: 2139 Ø: 62
Cone Ø: d1 Ø 28,6 / d2 Ø 23,9
Thread: M52 x 1,5 RHT
20453064, 20584291

**VL-DL-12454**

Length: 2339 Ø: 62
Cone Ø: d1 Ø 28,6 / d2 Ø 23,9
20581632

**VL-ES-5347**

Length: 125
Cone Ø: d1 Ø 28,6 / d2 Ø 23,9
Thread: M30 x 1,5 LHT
1507822, 1698847, 3092471

**VL-ES-5348**

Length: 125
Cone Ø: d1 Ø 28,6 / d2 Ø 23,9
Thread: M30 x 1,5 RHT
1507823, 1698846, 3092472

**VL-ES-7265**

Length: 125
Cone Ø: d1 Ø 31,5 / d2 Ø 27,5
Thread: M30 x 1,5 LHT
1131744, 1313744, 1698558, 1698840,
2072161F, 3092795, 6869744, 6882112,
6889481, 85114147

**VL-ES-7266**

Length: 125
Cone Ø: d1 Ø 31,5 / d2 Ø 27,5
Thread: M30 x 1,5 RHT
0356310, 1507826, 1695585, 1695776,
1698557, 6882111, 6882111(BRAZIL),
6889480, 6889482, 14200800A, 85114146

**VL-ES-8411**

Length: 140
Cone Ø: d1 Ø 28,6 / d2 Ø 23,9
Thread: M30 x 1,5 RHT
3093647, 3097999, 21263821

**VL-ES-8414**

Length: 136
Cone Ø: d1 Ø 32 / d2 Ø 27
Thread: M30 x 1,5 LHT
20710008

**VL-ES-8568**

Length: 100
Cone Ø: d1 Ø 38 / d2 Ø 34,3
Thread: M26 x 1,5 RHT
8151876

**VL-ES-10360**

Length: 136
Cone Ø: d1 Ø 32 / d2 Ø 27
Thread: M30 x 1,5 RHT
20581089

**VL-ES-10361**

Length: 88
Cone Ø: d1 Ø 28,6 / d2 Ø 24
Thread: M26 x 1,5 RHT
20374698

**VL-RK-9497**

Ø: 95 Hole Distance: 130
Thick/Height: 35
273612, 20702095

**VL-SB-9501**

Ø: 91 Thick/Height: 85 / 85
1135080

**VL-SB-10397**

Thick/Height: 89 / 89
1075179

**VL-SB-10398**

Thick/Height: 87,5 / 87,5
1075180

**VL-VB-8541**

Length: 677,3 Ø: 48
Hole Distance: 145 / 145
3173292, 20556491

**VL-VB-8576**

Length: 660,3 Ø: 48
Hole Distance: 145 / 145
3173293, 20556492

**VL-VB-12460**

Length: 662 Ø: 50
Hole Distance: 115 / 115
2223852, 20589061





FM 12 ...

FM 12H/340 ...	08/98→09/05	Track Control Arm		RV-TC-12339	Suspension Rod, Trailing Arm
	08/98→09/05	Track Control Arm		RV-TC-12340	Trailing Arm
	08/98→09/05	Track Control Arm		RV-VB-8191	Wishbone (CV), 1st RA;2nd RA;Leaf Spring Axle
	08/98→09/05	Track Control Arm		VL-DL-8180	Trailing Arm
	08/98→09/05	Track Control Arm		VL-DL-8554	Trailing Arm, 1st RA;2nd RA;Leaf Spring Axle
	08/98→09/05	Track Control Arm		VL-DL-8619	Trailing Arm, 1st & 2nd Drive Axle, for Leaf-Spring Suspension vehicles
	08/98→09/05	Track Control Arm		VL-VB-5369	Wishbone (CV), 1st RA;2nd RA;Leaf Spring Axle
	08/98→09/05	Track Control Arm		VL-VB-5369	Wishbone (CV), 1st RA;2nd RA;Leaf Spring Axle, →* A557645 *,* B330018 *
	08/98→09/05	Track Control Arm		VL-VB-5369	Wishbone (CV), 1st RA;Air Suspension Axle
	08/98→09/05	Track Control Arm		VL-VB-7787	Wishbone (CV), 1st RA;2nd RA;Unit; Leaf Spring Axle
	08/98→09/05	Track Control Arm		VL-VB-8195	Wishbone (CV), 2nd RA;Air Suspension Axle
	08/98→09/05	Track Control Arm		VL-VB-12460	Wishbone (CV)
	08/98→09/05	Track Control Arm	VL-DL-10309	VL-DL-10309	Trailing Arm, 1st Front Axle, for Pneumatic Suspension vehicles, Ch.A519971/B270523→
	FM 12H/380	08/98→09/05	Centre Rod	VL-DL-8178	
08/98→09/05		Centre Rod	VL-DL-8187		Push Rod
08/98→09/05		Centre Rod	VL-DL-8406		Push Rod
08/98→09/05		Centre Rod	VL-DL-8407		Push Rod
08/98→09/05		Centre Rod	VL-DL-8566		Push Rod, Leaf Spring Axle
08/98→09/05		Centre Rod	VL-DL-8707		Push Rod
08/98→09/05		Centre Rod	VL-DL-9488		Push Rod
08/98→09/05		Centre Rod	VL-DL-10228		Push Rod, 1st FA;2nd FA
08/98→09/05		Centre Rod	VL-DL-12367		for Steering Rod
08/98→09/05		Centre Rod	VL-DL-12454		for Steering Rod
08/98→09/05		Stabiliser Link		VL-DL-8518	Coupling Rod, Control Arm
08/98→09/05		Stabiliser Link		VL-DL-8543	Coupling Rod, Control Arm
08/98→09/05		Stabiliser Link	VL-DL-8157		Coupling Rod, for Leaf-Spring Suspension vehicles
08/98→09/05		Stabiliser Link	VL-DL-8157		Coupling Rod, for Pneumatic Suspension vehicles
08/98→09/05		Stabiliser Link	VL-DL-8536		Coupling Rod, Air Suspension Axle
08/98→09/05		Stabiliser Link	VL-DL-10258		Coupling Rod, for Leaf-Spring Suspension vehicles
08/98→09/05		Stabiliser Mounting	VL-SB-10397		
08/98→09/05		Stabiliser Mounting	VL-SB-10398		
08/98→09/05		Suspension Arm Repair Kit		IV-RK-8998	for Wishbone (CV)
08/98→09/05		Suspension Arm Repair Kit		MN-RK-9383	for Control Arm
08/98→09/05		Suspension Arm Repair Kit		VL-RK-9497	for Drag Link, Leaf Spring Axle
08/98→09/05		Suspension Strut Repair Kit		MN-RK-8501	
08/98→09/05		Suspension Strut Repair Kit	MN-RK-12436	MN-RK-12436	
08/98→09/05		Tie Bar Bush		VL-SB-9501	
08/98→09/05		Tie Rod	VL-DL-8305		Leaf Spring Axle
08/98→09/05		Tie Rod	VL-DL-12358		
08/98→09/05		Tie Rod End	VL-ES-5347	VL-ES-5347	for Steering Rod
08/98→09/05		Tie Rod End	VL-ES-5348		for Steering Rod
08/98→09/05		Tie Rod End	VL-ES-5348	VL-ES-5348	for Steering Rod
08/98→09/05		Tie Rod End	VL-ES-7265	VL-ES-7265	
08/98→09/05		Tie Rod End	VL-ES-7266	VL-ES-7266	
08/98→09/05		Tie Rod End	VL-ES-8411	VL-ES-8411	* 2828332 *→* 2831818 *
08/98→09/05		Tie Rod End	VL-ES-8411	VL-ES-8411	* 6800000 *→* 6831387 *
08/98→09/05		Tie Rod End	VL-ES-8411	VL-ES-8411	* 9825999 *→* 9826006 *
08/98→09/05		Tie Rod End	VL-ES-8411	VL-ES-8411	* A287349 *→* A299999 *
08/98→09/05		Tie Rod End	VL-ES-8411	VL-ES-8411	* A500000 *→* A544695 *
08/98→09/05		Tie Rod End	VL-ES-8411	VL-ES-8411	* B229721 *→* B311773 *
08/98→09/05		Tie Rod End	VL-ES-8411	VL-ES-8411	* C760568 *→* C763461 *
08/98→09/05		Tie Rod End	VL-ES-8411	VL-ES-8411	* D120771 *→* D123487 *
08/98→09/05		Tie Rod End	VL-ES-8411	VL-ES-8411	* S827721 *→* S832416 *
08/98→09/05	Tie Rod End	VL-ES-8411	VL-ES-8411	→* 1200634 *	
08/98→09/05	Tie Rod End	VL-ES-8414		for Guide Rod	

IV-RK-8998

Ø: 85 Hole Distance: 130
 Thick/Height: 30
 273373, 274019, 4941233,
 6889509

**MN-RK-8501**

Ø: 75 Hole Distance: 115
 Thick/Height: 24
 20547286

**MN-RK-9383**

Ø: 67 Hole Distance: 100
 Thick/Height: 24
 275988

**MN-RK-12436**

Ø: 75 Hole Distance: 115
 Thick/Height: 24
 3093462, 85104224

**RV-TC-12339**

Length: 515
 Hole Distance: 13 / 130
 20532931, 21051046

**RV-TC-12340**

Length: 510
 Hole Distance: 115 / 115
 20443044

**RV-VB-8191**

Length: 662,4 Ø: 48
 Hole Distance: 115 / 115
 20367004, 20507262, 20741695,
 20741703, 22318833

**VL-DL-8157**

Length: 325 Ø: 30
 Cone Ø: d1 Ø 22 / d2 Ø 20
 1629668, 3986433, 14316200A,
 20477805

**VL-DL-8178**

Length: 572 Ø: 38
 Cone Ø: d1 Ø 28,6 / d2 Ø 23,9
 1088985, 20393083

**VL-DL-8180**

Length: 625 Ø: 17
 20374444, 20410530, 20509018,
 20517494, 70371270

**VL-DL-8187**

Length: 2140 Ø: 52
 Cone Ø: d1 Ø 28,6 / d2 Ø 23,9
 3199225, 20393093, 20442115,
 20513953, 24425662

**VL-DL-8305**

Length: 1634 Ø: 50
 Cone Ø: d1 Ø 28,6 / d2 Ø 23,9
 3198276, 21260274

**VL-DL-8406**

Length: 888 Ø: 52
 Cone Ø: d1 Ø 28,6 / d2 Ø 23,9
 8190146, 20393071

**VL-DL-8407**

Length: 870 Ø: 52
 Cone Ø: d1 Ø 28,6 / d2 Ø 23,9
 3986452, 20375555, 20393186,
 21106930

**VL-DL-8518**

Length: 350 Ø: 36
 Cone Ø: d1 Ø 28,9 / d2 Ø 24,7
 20443063, 20443067, 20994420

**VL-DL-8536**

Length: 340 Ø: 30
 Cone Ø: d1 Ø 22 / d2 Ø 19,9
 3944046, 20477807

**VL-DL-8543**

Length: 380 Ø: 36
 Cone Ø: d1 Ø 28,6 / d2 Ø 24,7
 20443062, 20443066, 20994419

**VL-DL-8554**

Length: 570 Ø: 48
 Hole Distance: 130 / 130
 1626957, 1626958, 14320200A

**VL-DL-8566**

Length: 863 Ø: 52
 Cone Ø: d1 Ø 28,6 / d2 Ø 23,9
 20375556, 20393187, 21106952,
 21406952

**VL-DL-8619**

Length: 621 Ø: 48
 Hole Distance: 100 / 100
 1608151, 1621419

**VL-DL-8707**

Length: 885 Ø: 50
 Cone Ø: d1 Ø 28,6 / d2 Ø 23,9
 20390745, 21106936

**VL-DL-9488**

Length: 563 Ø: 48
 Cone Ø: d1 Ø 28,6 / d2 Ø 23,9
 20374831, 21252480

**VL-DL-10228**

Length: 2139 Ø: 62
 Cone Ø: d1 Ø 28,6 / d2 Ø 23,9
 20453063

**VL-DL-10258**

Length: 325 Ø: 30
 Cone Ø: d1 Ø 22 / d2 Ø 20
 1629668, 3986433, 20477805

**VL-DL-10309**

Length: 799 Ø: 48
 Hole Distance: 115 / 115
 20410053, 21106157

**VL-DL-12358**

Length: 1669 Ø: 42
 Cone Ø: d1 Ø 32 / d2 Ø 27
 Thread: M32 x 1,5 RHT / M32
 x 1,5 LHT
 20581086, 7420581086

**VL-DL-12367**

Length: 2139 Ø: 62
 Cone Ø: d1 Ø 28,6 / d2 Ø 23,9
 Thread: M52 x 1,5 RHT
 20453064, 20584291

**VL-DL-12454**

Length: 2339 Ø: 62
 Cone Ø: d1 Ø 28,6 / d2 Ø 23,9
 20581632

**VL-ES-5347**

Length: 125
 Cone Ø: d1 Ø 28,6 / d2 Ø 23,9
 Thread: M30 x 1,5 LHT
 1507822, 1698847, 3092471

**VL-ES-5348**

Length: 125
 Cone Ø: d1 Ø 28,6 / d2 Ø 23,9
 Thread: M30 x 1,5 RHT
 1507823, 1698846, 3092472

**VL-ES-7265**

Length: 125
 Cone Ø: d1 Ø 31,5 / d2 Ø 27,5
 Thread: M30 x 1,5 LHT
 1131744, 1313744, 1698558,
 1698840, 2072161F, 3092795,
 6869744, 6882112, 6889481,
 85114147

**VL-ES-7266**

Length: 125
 Cone Ø: d1 Ø 31,5 / d2 Ø 27,5
 Thread: M30 x 1,5 RHT
 0356310, 1507826, 1698558,
 1698840, 1698557, 6882111,
 6882111(BRAZIL), 6889480,
 6889482, 14200800A, 85114146

**VL-ES-8411**

Length: 140
 Cone Ø: d1 Ø 28,6 / d2 Ø 23,9
 Thread: M30 x 1,5 RHT
 3093647, 3097999, 21263821

**VL-ES-8414**

Length: 136
 Cone Ø: d1 Ø 32 / d2 Ø 27
 Thread: M30 x 1,5 LHT
 20710008

**VL-RK-9497**

Ø: 95 Hole Distance:
 130
 Thick/Height: 35
 273612, 20702095

**VL-SB-9501**

Ø: 91 Thick/Height:
 85 / 85
 1135080

**VL-SB-10397**

Thick/Height: 89 / 89
 1075179

**VL-SB-10398**

Thick/Height: 87,5 / 87,5
 1075180

**VL-VB-5369**

Length: 677 Ø: 48
 Hole Distance: 115 / 115
 3172829, 8073569, 14319600A

**VL-VB-7787**

Length: 671 Ø: 58
 Hole Distance: 130 / 130
 143167, 1076639, 1626896,
 1629734, 20392649, 20829503,
 21295227, 21474441, 22318834,
 7421295227

**VL-VB-8195**

Length: 649 Ø: 48
 Hole Distance: 115 / 115
 1094466, 20374689, 20382314,
 20502944

**VL-VB-12460**

Length: 662 Ø: 50
 Hole Distance: 115 / 115
 2223852, 20589061





FM 12 ...

FM 12H/380 ...	08/98→09/05	Tie Rod End	VL-ES-8568		
	08/98→09/05	Tie Rod End	VL-ES-10360		for Steering Rod
	08/98→09/05	Tie Rod End	VL-ES-10361		
	08/98→09/05	Track Control Arm		RV-DL-10299	Trailing Arm, 1st & 2nd Drive Axle, for Leaf-Spring Suspension vehicles
	08/98→09/05	Track Control Arm		RV-TC-12339	Suspension Rod, Trailing Arm
	08/98→09/05	Track Control Arm		RV-TC-12340	Trailing Arm
	08/98→09/05	Track Control Arm		RV-VB-8191	Wishbone (CV), 1st RA;2nd RA;Leaf Spring Axle
	08/98→09/05	Track Control Arm		VL-DL-8180	Trailing Arm
	08/98→09/05	Track Control Arm		VL-DL-8554	Trailing Arm, 1st RA;2nd RA;Leaf Spring Axle
	08/98→09/05	Track Control Arm		VL-DL-8619	Trailing Arm, 1st & 2nd Drive Axle, for Leaf-Spring Suspension vehicles
	08/98→09/05	Track Control Arm		VL-VB-5369	Wishbone (CV), 1st RA;2nd RA;Leaf Spring Axle
	08/98→09/05	Track Control Arm		VL-VB-5369	Wishbone (CV), 1st RA;2nd RA;Leaf Spring Axle, →* A557645 *;* B330018 *
	08/98→09/05	Track Control Arm		VL-VB-5369	Wishbone (CV), 1st RA;Air Suspension Axle
	08/98→09/05	Track Control Arm		VL-VB-7787	Wishbone (CV), 1st RA;2nd RA;Unit; Leaf Spring Axle
	08/98→09/05	Track Control Arm		VL-VB-8195	Wishbone (CV), 2nd RA;Air Suspension Axle
08/98→09/05	Track Control Arm		VL-VB-12460	Wishbone (CV)	
08/98→09/05	Track Control Arm	VL-DL-10309	VL-DL-10309	Trailing Arm, 1st Front Axle, for Pneumatic Suspension vehicles, Ch.A519971/B270523→	
FM 12H/420	08/98→09/05	Centre Rod	VL-DL-8178		Push Rod
	08/98→09/05	Centre Rod	VL-DL-8187		Push Rod
	08/98→09/05	Centre Rod	VL-DL-8406		Push Rod
	08/98→09/05	Centre Rod	VL-DL-8407		Push Rod
	08/98→09/05	Centre Rod	VL-DL-8566		Push Rod, Leaf Spring Axle
	08/98→09/05	Centre Rod	VL-DL-8707		Push Rod
	08/98→09/05	Centre Rod	VL-DL-9488		Push Rod
	08/98→09/05	Centre Rod	VL-DL-10228		Push Rod, 1st FA;2nd FA
	08/98→09/05	Centre Rod	VL-DL-12367		for Steering Rod
	08/98→09/05	Centre Rod	VL-DL-12454		for Steering Rod
	08/98→09/05	Stabiliser Link		VL-DL-8518	Coupling Rod, Control Arm
	08/98→09/05	Stabiliser Link		VL-DL-8543	Coupling Rod, Control Arm
	08/98→09/05	Stabiliser Link	VL-DL-8157		Coupling Rod, for Leaf-Spring Suspension vehicles
	08/98→09/05	Stabiliser Link	VL-DL-8157		Coupling Rod, for Pneumatic Suspension vehicles
	08/98→09/05	Stabiliser Link	VL-DL-8536		Coupling Rod, Air Suspension Axle
	08/98→09/05	Stabiliser Link	VL-DL-10258		Coupling Rod, for Leaf-Spring Suspension vehicles
	08/98→09/05	Stabiliser Mounting	VL-SB-10397		
	08/98→09/05	Stabiliser Mounting	VL-SB-10398		
	08/98→09/05	Suspension Arm Repair Kit		IV-RK-8998	for Wishbone (CV)
	08/98→09/05	Suspension Arm Repair Kit		MN-RK-9383	for Control Arm
	08/98→09/05	Suspension Arm Repair Kit		VL-RK-9497	for Drag Link, Leaf Spring Axle
	08/98→09/05	Suspension Strut Repair Kit		MN-RK-8501	
	08/98→09/05	Suspension Strut Repair Kit	MN-RK-12436	MN-RK-12436	
	08/98→09/05	Tie Bar Bush		VL-SB-9501	
	08/98→09/05	Tie Rod	VL-DL-8305		Leaf Spring Axle
	08/98→09/05	Tie Rod	VL-DL-12358		
	08/98→09/05	Tie Rod End	VL-ES-5347	VL-ES-5347	for Steering Rod
	08/98→09/05	Tie Rod End	VL-ES-5348		for Steering Rod
	08/98→09/05	Tie Rod End	VL-ES-5348	VL-ES-5348	for Steering Rod
	08/98→09/05	Tie Rod End	VL-ES-7265	VL-ES-7265	
	08/98→09/05	Tie Rod End	VL-ES-7266	VL-ES-7266	
	08/98→09/05	Tie Rod End	VL-ES-8411	VL-ES-8411	* 2828332 *→* 2831818 *
	08/98→09/05	Tie Rod End	VL-ES-8411	VL-ES-8411	* 6800000 *→* 6831387 *
	08/98→09/05	Tie Rod End	VL-ES-8411	VL-ES-8411	* 9825999 *→* 9826006 *
08/98→09/05	Tie Rod End	VL-ES-8411	VL-ES-8411	* A287349 *→* A299999 *	
08/98→09/05	Tie Rod End	VL-ES-8411	VL-ES-8411	* A500000 *→* A544695 *	
08/98→09/05	Tie Rod End	VL-ES-8411	VL-ES-8411	* B229721 *→* B311773 *	

IV-RK-8998
 Ø: 85 Hole Distance: 130
 Thick/Height: 30
 273373, 274019, 4941233,
 6889509



MN-RK-8501
 Ø: 75 Hole Distance: 115
 Thick/Height: 24
 20547286



MN-RK-9383
 Ø: 67 Hole Distance: 100
 Thick/Height: 24
 275988



MN-RK-12436
 Ø: 75 Hole Distance: 115
 Thick/Height: 24
 3093462, 85104224



RV-DL-10299
 Length: 510 Ø: 21
 20522934, 21051052, 7420864583,
 7421051052



RV-TC-12339
 Length: 515
 Hole Distance: 13 / 130
 20532931, 21051046



RV-TC-12340
 Length: 510
 Hole Distance: 115 / 115
 20443044



RV-VB-8191
 Length: 662,4 Ø: 48
 Hole Distance: 115 / 115
 20367004, 20507262, 20741695,
 20741703, 22318833



VL-DL-8157
 Length: 325 Ø: 30
 Cone Ø: d1 Ø 22 / d2 Ø 20
 1629668, 3986433, 14316200A,
 20477805



VL-DL-8178
 Length: 572 Ø: 38
 Cone Ø: d1 Ø 28,6 / d2 Ø 23,9
 1088985, 20393083



VL-DL-8180
 Length: 625 Ø: 17
 20374444, 20410530, 20509018,
 20517494, 70371270



VL-DL-8187
 Length: 2140 Ø: 52
 Cone Ø: d1 Ø 28,6 / d2 Ø 23,9
 3199225, 20393093, 20442115,
 20513953, 24425662



VL-DL-8305
 Length: 1634 Ø: 50
 Cone Ø: d1 Ø 28,6 / d2 Ø 23,9
 3198276, 21260274



VL-DL-8406
 Length: 888 Ø: 52
 Cone Ø: d1 Ø 28,6 / d2 Ø 23,9
 8190146, 20393071



VL-DL-8407
 Length: 870 Ø: 52
 Cone Ø: d1 Ø 28,6 / d2 Ø 23,9
 3986452, 20375555, 20393186,
 21106930



VL-DL-8518
 Length: 350 Ø: 36
 Cone Ø: d1 Ø 28,9 / d2 Ø 24,7
 20443063, 20443067, 20994420



VL-DL-8536
 Length: 340 Ø: 30
 Cone Ø: d1 Ø 22 / d2 Ø 19,9
 3944046, 20477807



VL-DL-8543
 Length: 380 Ø: 36
 Cone Ø: d1 Ø 28,6 / d2 Ø 24,7
 20443062, 20443066, 20994419



VL-DL-8554
 Length: 570 Ø: 48
 Hole Distance: 130 / 130
 1626957, 1626958, 14320200A



VL-DL-8566
 Length: 863 Ø: 52
 Cone Ø: d1 Ø 28,6 / d2 Ø 23,9
 20375556, 20393187, 21106952,
 21406952



VL-DL-8619
 Length: 621 Ø: 48
 Hole Distance: 100 / 100
 1608151, 1621419



VL-DL-8707
 Length: 885 Ø: 50
 Cone Ø: d1 Ø 28,6 / d2 Ø 23,9
 20390745, 21106936



VL-DL-9488
 Length: 563 Ø: 48
 Cone Ø: d1 Ø 28,6 / d2 Ø 23,9
 20374831, 21252480



VL-DL-10228
 Length: 2139 Ø: 62
 Cone Ø: d1 Ø 28,6 / d2 Ø 23,9
 20453063



VL-DL-10258
 Length: 325 Ø: 30
 Cone Ø: d1 Ø 22 / d2 Ø 20
 1629668, 3986433, 20477805



VL-DL-10309
 Length: 799 Ø: 48
 Hole Distance: 115 / 115
 20410053, 21106157



VL-DL-12358
 Length: 1669 Ø: 42
 Cone Ø: d1 Ø 32 / d2 Ø 27
 Thread: M32 x 1,5 RHT / M32
 x 1,5 LHT
 20581086, 7420581086



VL-DL-12367
 Length: 2139 Ø: 62
 Cone Ø: d1 Ø 28,6 / d2 Ø 23,9
 Thread: M52 x 1,5 RHT
 20453064, 20584291



VL-DL-12454
 Length: 2339 Ø: 62
 Cone Ø: d1 Ø 28,6 / d2 Ø 23,9
 20581632



VL-ES-5347
 Length: 125
 Cone Ø: d1 Ø 28,6 / d2 Ø 23,9
 Thread: M30 x 1,5 LHT
 1507822, 1698847, 3092471



VL-ES-5348
 Length: 125
 Cone Ø: d1 Ø 28,6 / d2 Ø 23,9
 Thread: M30 x 1,5 RHT
 1507823, 1698846, 3092472



VL-ES-7265
 Length: 125
 Cone Ø: d1 Ø 31,5 / d2 Ø 27,5
 Thread: M30 x 1,5 LHT
 1131744, 1313744, 1698558,
 1698840, 2072161F, 3092795,
 6869744, 6882112, 6889481,
 85114147



VL-ES-7266
 Length: 125
 Cone Ø: d1 Ø 31,5 / d2 Ø 27,5
 Thread: M30 x 1,5 RHT
 0356310, 1507826, 1695585,
 1695776, 1698557, 6882111,
 6882111(BRAZIL), 6889480,
 6889482, 14200800A, 85114146



VL-ES-8411
 Length: 140
 Cone Ø: d1 Ø 28,6 / d2 Ø 23,9
 Thread: M30 x 1,5 RHT
 3093647, 3097999, 21263821



VL-ES-8568
 Length: 100
 Cone Ø: d1 Ø 38 / d2 Ø 34,3
 Thread: M26 x 1,5 RHT
 8151876



VL-ES-10360
 Length: 136
 Cone Ø: d1 Ø 32 / d2 Ø 27
 Thread: M30 x 1,5 RHT
 20581089



VL-ES-10361
 Length: 88
 Cone Ø: d1 Ø 28,6 / d2 Ø 24
 Thread: M26 x 1,5 RHT
 20374698



VL-RK-9497
 Ø: 95 Hole Distance:
 130
 Thick/Height: 35
 273612, 20702095



VL-SB-9501
 Ø: 91 Thick/Height:
 85 / 85
 1135080



VL-SB-10397
 Thick/Height: 89 / 89
 1075179



VL-SB-10398
 Thick/Height: 87,5 / 87,5
 1075180



VL-VB-5369
 Length: 677 Ø: 48
 Hole Distance: 115 / 115
 3172829, 8073569, 14319600A



VL-VB-7787
 Length: 671 Ø: 58
 Hole Distance: 130 / 130
 143167, 1076639, 1626896,
 1629734, 20392649, 20829503,
 21295227, 21474441, 22318834,
 7421295227



VL-VB-8195
 Length: 649 Ø: 48
 Hole Distance: 115 / 115
 1094466, 20374689, 20382314,
 20502944



VL-VB-12460
 Length: 662 Ø: 50
 Hole Distance: 115 / 115
 2223852, 20589061



**FM 12 ...**

FM 12H/420 ...	08/98→09/05	Tie Rod End	VL-ES-8411	VL-ES-8411	* C760568 *→* C763461 *
	08/98→09/05	Tie Rod End	VL-ES-8411	VL-ES-8411	* D120771 *→* D123487 *
	08/98→09/05	Tie Rod End	VL-ES-8411	VL-ES-8411	* S827721 *→* S832416 *
	08/98→09/05	Tie Rod End	VL-ES-8411	VL-ES-8411	→* 1200634 *
	08/98→09/05	Tie Rod End	VL-ES-8414		for Guide Rod
	08/98→09/05	Tie Rod End	VL-ES-8568		
	08/98→09/05	Tie Rod End	VL-ES-10360		for Steering Rod
	08/98→09/05	Tie Rod End	VL-ES-10361		
	08/98→09/05	Track Control Arm		RV-DL-10299	Trailing Arm, 1st & 2nd Drive Axle, for Leaf-Spring Suspension vehicles
	08/98→09/05	Track Control Arm		RV-TC-12339	Suspension Rod, Trailing Arm
	08/98→09/05	Track Control Arm		RV-TC-12340	Trailing Arm
	08/98→09/05	Track Control Arm		RV-VB-8191	Wishbone (CV), 1st RA;2nd RA;Leaf Spring Axle
	08/98→09/05	Track Control Arm		VL-DL-8180	Trailing Arm
	08/98→09/05	Track Control Arm		VL-DL-8554	Trailing Arm, 1st RA;2nd RA;Leaf Spring Axle
	08/98→09/05	Track Control Arm		VL-DL-8619	Trailing Arm, 1st & 2nd Drive Axle, for Leaf-Spring Suspension vehicles
	08/98→09/05	Track Control Arm		VL-VB-5369	Wishbone (CV), 1st RA;2nd RA;Leaf Spring Axle
	08/98→09/05	Track Control Arm		VL-VB-5369	Wishbone (CV), 1st RA;2nd RA;Leaf Spring Axle, →* A557645 *,* B330018 *
	08/98→09/05	Track Control Arm		VL-VB-5369	Wishbone (CV), 1st RA;Air Suspension Axle
	08/98→09/05	Track Control Arm		VL-VB-7787	Wishbone (CV), 1st RA;2nd RA;Unit; Leaf Spring Axle
	08/98→09/05	Track Control Arm		VL-VB-8195	Wishbone (CV), 2nd RA;Air Suspension Axle
08/98→09/05	Track Control Arm		VL-VB-12460	Wishbone (CV)	
08/98→09/05	Track Control Arm	VL-DL-10309	VL-DL-10309	Trailing Arm, 1st Front Axle, for Pneumatic Suspension vehicles, Ch.A519971/B270523→	

FMX

330	04/10→	Centre Rod	VL-DL-12484		Push Rod
	04/10→	Track Control Arm		RV-TC-12339	Suspension Rod, Trailing Arm
370	04/10→	Centre Rod	VL-DL-12484		Push Rod
	04/10→	Track Control Arm		RV-TC-12339	Suspension Rod, Trailing Arm
380	04/10→	Centre Rod	VL-DL-12484		Push Rod
	04/10→	Track Control Arm		RV-TC-12339	Suspension Rod, Trailing Arm
410	04/10→	Centre Rod	VL-DL-12484		Push Rod
	04/10→	Track Control Arm		RV-TC-12339	Suspension Rod, Trailing Arm
420	04/10→	Centre Rod	VL-DL-12484		Push Rod
	04/10→	Track Control Arm		RV-TC-12339	Suspension Rod, Trailing Arm
450	04/10→	Centre Rod	VL-DL-12484		Push Rod
	04/10→	Track Control Arm		RV-TC-12339	Suspension Rod, Trailing Arm
460	04/10→	Centre Rod	VL-DL-12484		Push Rod
	04/10→	Track Control Arm		RV-TC-12339	Suspension Rod, Trailing Arm
500	04/10→	Centre Rod	VL-DL-12484		Push Rod
	04/10→	Track Control Arm		RV-TC-12339	Suspension Rod, Trailing Arm
540	04/10→	Centre Rod	VL-DL-12484		Push Rod
	04/10→	Track Control Arm		RV-TC-12339	Suspension Rod, Trailing Arm

FS 7

FS 718/230	09/94→03/96	Tie Rod End	VL-ES-7286		
FS 718/260	09/94→03/96	Tie Rod End	VL-ES-7286		

N 7

N7	01/73→09/80	Tie Rod End	VL-ES-7266		
----	-------------	-------------	------------	--	--

N 10

N 10/270	01/73→12/89	Centre Rod	VL-DL-5456		Push Rod
	01/73→12/89	Tie Rod End	VL-ES-7266		
	01/73→12/89	Track Control Arm		VL-DL-8545	Trailing Arm, 1st RA;2nd RA
	01/73→12/89	Track Control Arm		VL-DL-8619	Trailing Arm
	01/73→12/89	Track Control Arm		VL-VB-8527	Wishbone (CV)
	01/73→12/89	Track Control Arm		VL-VB-8539	Wishbone (CV)
	01/73→12/89	Track Control Arm		VL-VB-8546	Wishbone (CV)
	01/80→12/89	Tie Rod End	VL-ES-7286		* 600803 *→* 621251 *

RV-DL-10299

Length: 510 Ø: 21
 20522934, 21051052, 7420864583,
 7421051052

**RV-TC-12339**

Length: 515
 Hole Distance: 13 / 130
 20532931, 21051046

**RV-TC-12340**

Length: 510
 Hole Distance: 115 / 115
 20443044

**RV-VB-8191**

Length: 662,4 Ø: 48
 Hole Distance: 115 / 115
 20367004, 20507262, 20741695, 20741703,
 22318833

**VL-DL-5456**

Length: 740 Ø: 40
 Cone Ø: d1 Ø 31,5 / d2 Ø 27,5
 1584620, 1588263, 1626493

**VL-DL-8180**

Length: 625 Ø: 17
 20374444, 20410530, 20509018, 20517494,
 70371270

**VL-DL-8545**

Length: 660 Ø: 48
 Hole Distance: 130 / 130
 1581527, 1607079, 3944818, 3944819,
 3944820, 8154017, 8154018, 8158206,
 8158207

**VL-DL-8554**

Length: 570 Ø: 48
 Hole Distance: 130 / 130
 1626957, 1626958, 14320200A

**VL-DL-8619**

Length: 621 Ø: 48
 Hole Distance: 100 / 100
 1608151, 1621419

**VL-DL-10309**

Length: 799 Ø: 48
 Hole Distance: 115 / 115
 20410053, 21106157

**VL-DL-12484**

Length: 1025 Ø: 48
 Cone Ø: d1 Ø 28,6 / d2 Ø 23,9
 2038308, 21252481

**VL-ES-7266**

Length: 125
 Cone Ø: d1 Ø 31,5 / d2 Ø 27,5
 Thread: M30 x 1,5 RHT
 0356310, 1507826, 1695585, 1695776,
 1698557, 6882111, 6882111(BRAZIL),
 6889480, 6889482, 14200800A, 85114146

**VL-ES-7286**

Length: 87
 Cone Ø: d1 Ø 16 / d2 Ø 14,4
 Thread: M28 x 1,5 RHT
 382745, 1527234, 1668638

**VL-ES-8411**

Length: 140
 Cone Ø: d1 Ø 28,6 / d2 Ø 23,9
 Thread: M30 x 1,5 RHT
 3093647, 3097999, 21263821

**VL-ES-8414**

Length: 136
 Cone Ø: d1 Ø 32 / d2 Ø 27
 Thread: M30 x 1,5 LHT
 20710008

**VL-ES-8568**

Length: 100
 Cone Ø: d1 Ø 38 / d2 Ø 34,3
 Thread: M26 x 1,5 RHT
 8151876

**VL-ES-10360**

Length: 136
 Cone Ø: d1 Ø 32 / d2 Ø 27
 Thread: M30 x 1,5 RHT
 20581089

**VL-ES-10361**

Length: 88
 Cone Ø: d1 Ø 28,6 / d2 Ø 24
 Thread: M26 x 1,5 RHT
 20374698

**VL-VB-5369**

Length: 677 Ø: 48
 Hole Distance: 115 / 115
 3172829, 8073569, 14319600A

**VL-VB-7787**

Length: 671 Ø: 58
 Hole Distance: 130 / 130
 143167, 1076639, 1626896, 1629734,
 20392649, 20829503, 21295227, 21474441,
 22318834, 7421295227

**VL-VB-8195**

Length: 649 Ø: 48
 Hole Distance: 115 / 115
 1094466, 20374689, 20382314, 20502944

**VL-VB-8527**

Length: 635 Ø: 58
 Hole Distance: 152 / 152
 1080690, 1509222, 1576952, 1606200,
 6886777

**VL-VB-8539**

Length: 641 Ø: 48
 Hole Distance: 152 / 152
 1606552

**VL-VB-8546**

Length: 644 Ø: 46
 Hole Distance: 115 / 115
 1590068

**VL-VB-12460**

Length: 662 Ø: 50
 Hole Distance: 115 / 115
 2223852, 20589061





N 10 ...

N 10/300	01/73→12/89	Centre Rod	VL-DL-5456		Push Rod
	01/73→12/89	Tie Rod End	VL-ES-7266		
	01/73→12/89	Track Control Arm		VL-DL-8545	Trailing Arm, 1st RA;2nd RA
	01/73→12/89	Track Control Arm		VL-DL-8619	Trailing Arm
	01/73→12/89	Track Control Arm		VL-VB-8527	Wishbone (CV)
	01/73→12/89	Track Control Arm		VL-VB-8539	Wishbone (CV)
	01/73→12/89	Track Control Arm		VL-VB-8546	Wishbone (CV)
	01/80→12/89	Tie Rod End	VL-ES-7286		* 600803 *→* 621251 *

NH 12

NH 12/380	05/99→	Bush, parabolic spring		VL-SB-5356	
	05/99→	Centre Rod	VL-DL-8178		Push Rod
	05/99→	Stabiliser Link	VL-DL-8157		Coupling Rod
	05/99→	Stabiliser Link	VL-DL-10258		Coupling Rod, for Leaf-Spring Suspension vehicles
	05/99→	Stabiliser Mounting	VL-SB-10397		
	05/99→	Stabiliser Mounting	VL-SB-10398		
	05/99→	Suspension Arm Repair Kit		CV-RK-5322	for Wishbone (CV)
	05/99→	Suspension Arm Repair Kit		MN-RK-7280	for Drag Link
	05/99→	Suspension Arm Repair Kit		MN-RK-9383	for Control Arm
	05/99→	Suspension Arm Repair Kit		SC-RK-8575	for Wishbone (CV)
	05/99→	Suspension Arm Repair Kit		VL-RK-9497	for Drag Link
	05/99→	Suspension Arm Repair Kit		VL-RK-9497	for Drag Link, Leaf Spring Axle
	05/99→	Suspension Strut Repair Kit		MN-RK-8537	
	05/99→	Suspension Strut Repair Kit	VL-RK-8533		
	05/99→	Tie Rod	VL-DL-8163		
	05/99→	Track Control Arm		RV-TC-12339	Suspension Rod, Trailing Arm
	05/99→	Track Control Arm		VL-DL-8189	Trailing Arm
	05/99→	Track Control Arm		VL-DL-8554	Trailing Arm, 1st RA;2nd RA;Leaf Spring Axle
	05/99→	Track Control Arm		VL-DL-8619	Trailing Arm
	05/99→	Track Control Arm		VL-VB-5369	Wishbone (CV)
05/99→	Track Control Arm		VL-VB-5369	Wishbone (CV), 1st RA;2nd RA; Air Suspension Axle	
05/99→	Track Control Arm		VL-VB-7787	Wishbone (CV)	
05/99→	Track Control Arm		VL-VB-7787	Wishbone (CV), 1st RA;2nd RA;Unit; Leaf Spring Axle	
05/99→	Track Control Arm		VL-VB-8525	Wishbone (CV)	
05/99→	Track Control Arm		VL-VB-8527	Wishbone (CV)	
NH 12/420	05/99→	Centre Rod	VL-DL-8178		Push Rod
	05/99→	Stabiliser Link	VL-DL-8157		Coupling Rod
	05/99→	Stabiliser Link	VL-DL-10258		Coupling Rod, for Leaf-Spring Suspension vehicles
	05/99→	Stabiliser Mounting	VL-SB-10394	VL-SB-10394	
	05/99→	Stabiliser Mounting	VL-SB-10397		
	05/99→	Stabiliser Mounting	VL-SB-10398		
	05/99→	Suspension Arm Repair Kit		VL-RK-9497	for Drag Link
	05/99→	Suspension Arm Repair Kit	VL-RK-5323	VL-RK-5323	for Drag Link
	05/99→	Tie Bar Bush		VL-SB-9501	
	05/99→	Tie Rod	VL-DL-8163		
	05/99→	Track Control Arm		RV-TC-12339	Suspension Rod, Trailing Arm
	05/99→	Track Control Arm		VL-DL-8189	Trailing Arm
	05/99→	Track Control Arm		VL-VB-7787	Wishbone (CV)
	05/99→	Track Control Arm		VL-VB-8525	Wishbone (CV)

CV-RK-5322

Ø: 72 Thick/Height: 50
271188, 3091598



MN-RK-7280

Ø: 75 Hole Distance: 115
Thick/Height: 24
271187, 689748



MN-RK-8537

Ø: 95 Hole Distance: 152
Thick/Height: 24
274056, 276192, 696321, 81432706099



MN-RK-9383

Ø: 67 Hole Distance: 100
Thick/Height: 24
275988



RV-TC-12339

Length: 515
Hole Distance: 13 / 130
20532931, 21051046



SC-RK-8575

Ø: 95 Hole Distance: 152
Thick/Height: 35
274056



VL-DL-5456

Length: 740 Ø: 40
Cone Ø: d1 Ø 31,5 / d2 Ø 27,5
1584620, 1588263, 1626493



VL-DL-8157

Length: 325 Ø: 30
Cone Ø: d1 Ø 22 / d2 Ø 20
1629668, 3986433, 14316200A, 20477805



VL-DL-8163

Length: 1640 Ø: 42
Cone Ø: d1 Ø 28,6 / d2 Ø 23,9
1628637, 3962343, 3986450, 3988711



VL-DL-8178

Length: 572 Ø: 38
Cone Ø: d1 Ø 28,6 / d2 Ø 23,9
1088985, 20393083



VL-DL-8189

Length: 666 Ø: 48
Hole Distance: 125
1082104, 1605035



VL-DL-8545

Length: 660 Ø: 48
Hole Distance: 130 / 130
1581527, 1607079, 3944818, 3944819,
3944820, 8154017, 8154018, 8158206,
8158207



VL-DL-8554

Length: 570 Ø: 48
Hole Distance: 130 / 130
1626957, 1626958, 14320200A



VL-DL-8619

Length: 621 Ø: 48
Hole Distance: 100 / 100
1608151, 1621419



VL-DL-10258

Length: 325 Ø: 30
Cone Ø: d1 Ø 22 / d2 Ø 20
1629668, 3986433, 20477805



VL-ES-7266

Length: 125
Cone Ø: d1 Ø 31,5 / d2 Ø 27,5
Thread: M30 x 1,5 RHT
0356310, 1507826, 1695585, 1695776,
1698557, 6882111, 6882111(BRAZIL),
6889480, 6889482, 14200800A, 85114146



VL-ES-7286

Length: 87
Cone Ø: d1 Ø 16 / d2 Ø 14,4
Thread: M28 x 1,5 RHT
382745, 1527234, 1668638



VL-RK-5323

Ø: 91 Hole Distance: 125
Thick/Height: 20
1598588, 14302100A



VL-RK-8533

Ø: 85 Hole Distance: 130
Thick/Height: 30
3093630, 3093631, 20840815, 21295230,
7420840815



VL-RK-9497

Ø: 95 Hole Distance: 130
Thick/Height: 35
273612, 20702095



VL-SB-5356

Thick/Height: 150
1629553, 14403900A, 20390836



VL-SB-9501

Ø: 91 Thick/Height: 85 / 85
1135080



VL-SB-10394

Ø: 90 Thick/Height: 95 / 95
9519245



VL-SB-10397

Thick/Height: 89 / 89
1075179



VL-SB-10398

Thick/Height: 87,5 / 87,5
1075180



VL-VB-5369

Length: 677 Ø: 48
Hole Distance: 115 / 115
3172829, 8073569, 14319600A



VL-VB-7787

Length: 671 Ø: 58
Hole Distance: 130 / 130
143167, 1076639, 1626896, 1629734,
20392649, 20829503, 21295227, 21474441,
22318834, 7421295227



VL-VB-8525

Length: 677,3 Ø: 48
Hole Distance: 145 / 145
3173291, 20556490



VL-VB-8527

Length: 635 Ø: 58
Hole Distance: 152 / 152
1080690, 1509222, 1576952, 1606200,
6886777







VL-VB-8539





Length: 641 Ø: 48
Hole Distance: 152 / 152
1606552













VL-VB-8546













MOOG					TAPER	THREAD		HOLE DISTANCE	THICK/ HEIGHT
CV-DL-0546	Centre Rod	990	36	d1 Ø 26 / d2 Ø 23,5					
CV-DL-9082	Tie Rod	768	38	d1 Ø 26 / d2 Ø 23,5	1/10				
CV-DL-9103	Tie Rod	630	40	d1 Ø 30 / d2 Ø 27	1/10				
CV-DL-9119	Tie Rod	380	40	d1 Ø 26 / d2 Ø 23,5	1/10				
CV-ES-0543	Tie Rod End	125		d1 Ø 32 / d2 Ø 29		M30 x 1,5 RHT			
CV-ES-0888	Tie Rod End	125		d1 Ø 32 / d2 Ø 29		M30 x 1,5 LHT			
CV-ES-0912	Tie Rod End	125		d1 Ø 30 / d2 Ø 27		M38 x 1,5 LHT			
CV-ES-0914	Tie Rod End	125		d1 Ø 30 / d2 Ø 27	1/10	M38 x 1,5 RHT			
CV-ES-2119	Ball Head, gearshift linkage	55		d1 Ø 10 / d2 Ø 10		M12 x 1,75 LHT			
CV-ES-2120	Ball Head, gearshift linkage	115		d1 Ø 12,4 / d2 Ø 10,8	1/10	M14 x 1,5 RHT			
CV-ES-2121	Ball Head, gearshift linkage	85		d1 Ø 12 / d2 Ø 10,8		M14 x 1,5 RHT			
CV-ES-2135	Tie Rod End	115		d1 Ø 26 / d2 Ø 23,5		M28 x 1,5 RHT			
CV-ES-2146	Tie Rod End	80		d1 Ø 30 / d2 Ø 27		M26 x 1,5 RHT			
CV-ES-2149	Tie Rod End	160		d1 Ø 30 / d2 Ø 27		M30 x 1,5 RHT			
CV-ES-2182	Ball Head, gearshift linkage	55		d1 Ø 10 / d2 Ø 10		M12 x 1,75 RHT			
CV-ES-2534	Tie Rod End	101		d1 Ø 22 / d2 Ø 20		M28 x 1,5 LHT			
CV-ES-2774	Tie Rod End	95		d1 Ø 20 / d2 Ø 18		M24 x 1,5 RHT			
CV-ES-5336	Tie Rod End	140		d1 Ø 26 / d2 Ø 23,5	1/10	M30 x 1,5 LHT			
CV-ES-12461	Tie Rod End	120		d1 Ø 26 / d2 Ø 23,5	1/10	M30 x 1,5 LHT			
CV-ES-12462	Tie Rod End	120		d1 Ø 26 / d2 Ø 23,5	1/10	M30 x 1,5 RHT			
CV-ES-14162	Tie Rod End	125		d1 Ø 30 / d2 Ø 27	1/10	M30 x 1,5 LHT			
CV-ES-14163	Tie Rod End	125		d1 Ø 30 / d2 Ø 27	1/10	M30 x 1,5 RHT			
CV-RK-1583	Suspension Arm Repair Kit		80					152	24
CV-RK-5311	Suspension Strut Repair Kit								
CV-RK-5313	Suspension Arm Repair Kit		90						
CV-RK-5322	Suspension Arm Repair Kit		72						50
CV-RK-7850	Suspension Strut Repair Kit		85						171
CV-RK-8118	Suspension Arm Repair Kit		85					130	30
CV-TC-12384	Track control arm	585	56					130	
DB-DL-0280	Centre Rod	890							
DB-DL-1179	Centre Rod	533	36	d1 Ø 22 / d2 Ø 19,9					
DB-DL-2144	Centre Rod	872	35	d1 Ø 28,6 / d2 Ø 23,9					
DB-DL-2178	Rod Assembly	1735	52	d1 Ø 32 / d2 Ø 29	1/10	M30 x 1,5 RHT			
DB-DL-3228	Centre Rod	1066	40	d1 Ø 26 / d2 Ø 23,5	1/10				
DB-DL-3405	Track Control Arm	585	56						
DB-DL-3461	Suspension Arm	625	36					90 / 90	
DB-DL-3475	Track Control Arm	565	52					152 / 152	
DB-DL-5207	Centre Rod	875	42	d1 Ø 30 / d2 Ø 27	1/10				
DB-DL-5213	Centre Rod	846	42	d1 Ø 26 / d2 Ø 23,5	1/10				
DB-DL-5215	Centre Rod	780	40	d1 Ø 26 / d2 Ø 23,5	1/10				
DB-DL-5216	Centre Rod	890	42	d1 Ø 26 / d2 Ø 23,5	1/10				
DB-DL-5217	Centre Rod	862	40	d1 Ø 30 / d2 Ø 27	1/10				
DB-DL-5219	Centre Rod	785	40	d1 Ø 26 / d2 Ø 22	1/10				
DB-DL-5220	Track Control Arm	522	52					151	
DB-DL-5224	Track Control Arm	850	60					100 / 100	
DB-DL-5230	Centre Rod	879	42	d1 Ø 30 / d2 Ø 27	1/10				
DB-DL-5231	Centre Rod	840	52	d1 Ø 32 / d2 Ø 29	1/10				
DB-DL-5233	Centre Rod	895	48	d1 Ø 30 / d2 Ø 27	1/10				
DB-DL-5239	Centre Rod	862	42	d1 Ø 30 / d2 Ø 27	1/10				
DB-DL-5241	Centre Rod	875	40	d1 Ø 30 / d2 Ø 27	1/10				
DB-DL-5405	Centre Rod	890	35	d1 Ø 28,6 / d2 Ø 23,9	1/6				
DB-DL-5412	Centre Rod	840	48	d1 Ø 32 / d2 Ø 30	1/10				
DB-DL-6140	Centre Rod	885	40	d1 Ø 30 / d2 Ø 27					
DB-DL-6197	Track Control Arm	579	50					152 / 152	
DB-DL-6198	Track Control Arm	579	58					152 / 152	
DB-DL-6227	Track Control Arm	629	58					152 / 152	
DB-DL-6235	Centre Rod	725	36	d1 Ø 22 / d2 Ø 19,9					
DB-DL-7262	Stabiliser Link	260	36	d1 Ø 26		M20 x 1,5			
DB-DL-7263	Stabiliser Link	260	36	d1 Ø 26		M20 x 1,5			
DB-DL-7270	Centre Rod	875	40	d1 Ø 28,6 / d2 Ø 23,9	1/6				
DB-DL-7275	Stabiliser Link	260	36	d1 Ø 26 / d2 Ø 23,5					
DB-DL-7276	Stabiliser Link	260	36	d1 Ø 26 / d2 Ø 23,5					
DB-DL-7775	Centre Rod	1000	38	d1 Ø 26 / d2 Ø 23,5	1/10				
DB-DL-7788	Track Control Arm	664	48					130 / 130	
DB-DL-7794	Centre Rod	837	40	d1 Ø 26 / d2 Ø 23,5	1/10				
DB-DL-7795	Centre Rod	920	36	d1 Ø 30 / d2 Ø 27	1/10				
DB-DL-7799	Centre Rod	895	50	d1 Ø 30 / d2 Ø 26	1/10				





MOOG					TAPER	THREAD	HOLE 	HOLE DISTANCE	THICK/ HEIGHT
DB-DL-7815	Centre Rod	895	50	d1 Ø 30 / d2 Ø 27	1/10				
DB-DL-7831	Centre Rod	870	42	d1 Ø 30 / d2 Ø 27	1/10				
DB-DL-7832	Centre Rod	783	42	d1 Ø 26 / d2 Ø 23,5	1/10				
DB-DL-7839	Track Control Arm	585	50					152 / 152	
DB-DL-7840	Track Control Arm	595	62					152 / 152	
DB-DL-8121	Centre Rod	895	40	d1 Ø 22 / d2 Ø 19,9	1/10				
DB-DL-8122	Centre Rod	875	42	d1 Ø 30 / d2 Ø 27	1/10				
DB-DL-8131	Centre Rod	1115	52	d1 Ø 32 / d2 Ø 28,8	1/10				
DB-DL-8138	Centre Rod	1130	40	d1 Ø 32 / d2 Ø 28,8	1/10				
DB-DL-8167	Centre Rod	866	38	d1 Ø 30 / d2 Ø 27	1/10				
DB-DL-8168	Centre Rod	904	52	d1 Ø 32 / d2 Ø 29	1/10				
DB-DL-8171	Tie Rod	1687	52	d1 Ø 32 / d2 Ø 29	1/10				
DB-DL-8172	Tie Rod	1700	52	d1 Ø 32 / d2 Ø 29	1/10				
DB-DL-8174	Tie Rod	1605	40	d1 Ø 30 / d2 Ø 27	1/10				
DB-DL-8176	Centre Rod	783	42	d1 Ø 26 / d2 Ø 23,5	1/10				
DB-DL-8184	Centre Rod	1095	42	d1 Ø 32 / d2 Ø 28,8	1/10				
DB-DL-8185	Centre Rod	711	42	d1 Ø 32 / d2 Ø 28,8	1/10				
DB-DL-8188	Centre Rod	895	40	d1 Ø 28,6 / d2 Ø 23,9	1/6				
DB-DL-8307	Centre Rod	885	38	d1 Ø 32 / d2 Ø 30	1/10				
DB-DL-8327	Tie Rod	1745	48	d1 Ø 32 / d2 Ø 29	1/10				
DB-DL-8388	Tie Rod	1735	62	d1 Ø 32 / d2 Ø 28,8	1/10				
DB-DL-8389	Tie Rod	1465	40	d1 Ø 32 / d2 Ø 29	1/10				
DB-DL-8390	Tie Rod	1596	50	d1 Ø 32 / d2 Ø 29	1/10				
DB-DL-8392	Centre Rod	860	40	d1 Ø 28,6 / d2 Ø 23,9	1/6				
DB-DL-8393	Track Control Arm	576	48					130 / 130	
DB-DL-8618	Centre Rod	680	42	d1 Ø 32 / d2 Ø 28,8	1/10				
DB-DL-8620	Centre Rod	884	50	d1 Ø 30 / d2 Ø 27	1/10	M24 x 1,5 / M20 x 1,5			
DB-DL-8622	Centre Rod	1558	52	d1 Ø 30 / d2 Ø 27	1/10				
DB-DL-8632	Tie Rod	1635	60	d1 Ø 30 / d2 Ø 27	1/10				
DB-DL-8639	Centre Rod	888	38	d1 Ø 30 / d2 Ø 27	1/10				
DB-DL-8640	Tie Rod	1615	50	d1 Ø 32 / d2 Ø 29	1/10				
DB-DL-8641	Centre Rod	905	42	d1 Ø 30 / d2 Ø 27	1/10				
DB-DL-8642	Centre Rod	954	42	d1 Ø 30 / d2 Ø 27	1/10				
DB-DL-8644	Centre Rod	894	50	d1 Ø 30 / d2 Ø 27	1/10				
DB-DL-8652	Track Control Arm	713	56					130 / 130	
DB-DL-8672	Centre Rod	860	48	d1 Ø 30 / d2 Ø 27	1/10				
DB-DL-8676	Centre Rod	865	42	d1 Ø 26 / d2 Ø 23,5	1/10				
DB-DL-8702	Centre Rod	958	38	d1 Ø 32 / d2 Ø 30	1/10				
DB-DL-8717	Centre Rod	886	38	d1 Ø 30 / d2 Ø 27	1/10				
DB-DL-8728	Tie Rod	506	30	d1 Ø 30 / d2 Ø 27	1/10				
DB-DL-8731	Centre Rod	846	42	d1 Ø 26 / d2 Ø 23,5	1/10				
DB-DL-8735	Centre Rod	825	42	d1 Ø 30 / d2 Ø 27	1/10	M24 x 1,5			
DB-DL-9143	Tie Rod	1476	40	d1 Ø 18 / d2 Ø 16,2	1/10				
DB-DL-9164	Track Control Arm	500	50					152 / 152	
DB-DL-9187	Centre Rod	846	42	d1 Ø 26 / d2 Ø 23,5	1/10				
DB-DL-9188	Centre Rod	1160	38	d1 Ø 30 / d2 Ø 27	1/10				
DB-DL-9193	Tie Rod	1170	46	d1 Ø 26 / d2 Ø 23,5	1/10				
DB-DL-9194	Centre Rod	882	38	d1 Ø 26 / d2 Ø 23,5	1/10				
DB-DL-9208	Stabiliser Link	260	24	d1 Ø 18 / d2 Ø 16,2		M14 x 1,5			
DB-DL-9211	Tie Rod	697	32	d1 Ø 30 / d2 Ø 27	1/10				
DB-DL-9215	Centre Rod	975	42	d1 Ø 30 / d2 Ø 27	1/10				
DB-DL-9218	Track Control Arm	754	40					100	
DB-DL-9221	Track Control Arm	652	52					152	
DB-DL-9225	Tie Rod	1132	46	d1 Ø 22 / d2 Ø 20	1/10				
DB-DL-9226	Track Control Arm	628	50					152 / 152	
DB-DL-9247	Centre Rod	873	40	d1 Ø 26 / d2 Ø 23,5	1/10				
DB-DL-9249	Tie Rod	566	36	d1 Ø 30 / d2 Ø 27	1/10				
DB-DL-9251	Centre Rod	651	38	d1 Ø 30 / d2 Ø 27	1/10				
DB-DL-9254	Stabiliser Link	1815	58						
DB-DL-9256	Centre Rod	905	48	d1 Ø 32 / d2 Ø 29	1/10				
DB-DL-9257	Track Control Arm	638	50					152 / 152	
DB-DL-9258	Centre Rod	905	42	d1 Ø 28,6 / d2 Ø 23,9	1/6				
DB-DL-9259	Centre Rod	883	38	d1 Ø 32 / d2 Ø 29	1/10				
DB-DL-9261	Tie Rod	1730	62	d1 Ø 26 / d2 Ø 23,5	1/10				
DB-DL-9263	Centre Rod	870	42	d1 Ø 32 / d2 Ø 27	1/10				
DB-DL-9269	Centre Rod	387	36	d1 Ø 32 / d2 Ø 29	1/10				
DB-DL-9271	Stabiliser Link	1815	60						





MOOG						TAPER	THREAD		HOLE DISTANCE	THICK/ HEIGHT
DB-DL-9272	Stabiliser Link	1815	80							
DB-DL-9275	Track Control Arm	659	46						115 / 115	
DB-DL-10140	Centre Rod	865	40	d1 Ø 26 / d2 Ø 23,5	1/10					
DB-DL-10207	Centre Rod	780	40	d1 Ø 26 / d2 Ø 23,5	1/10					
DB-DL-10208	Centre Rod	708	40	d1 Ø 32 / d2 Ø 29	1/10					
DB-DL-10209	Tie Rod	1281	38	d1 Ø 30 / d2 Ø 27	1/10					
DB-DL-10212	Centre Rod	953	42	d1 Ø 32 / d2 Ø 29	1/10					
DB-DL-10213	Centre Rod	860	52	d1 Ø 32 / d2 Ø 29	1/10					
DB-DL-10216	Centre Rod	1190	40	d1 Ø 32 / d2 Ø 29	1/10					
DB-DL-12298	Centre Rod	927	50	d1 Ø 30 / d2 Ø 27	1/10					
DB-DL-12299	Centre Rod	2069	40	d1 Ø 30 / d2 Ø 27	1/10					
DB-DL-12300	Centre Rod	733	36	d1 Ø 32 / d2 Ø 29	1/10					
DB-DL-12301	Centre Rod	716	38	d1 Ø 32 / d2 Ø 29	1/10		M30 x 1,5			
DB-DL-12303	Centre Rod	888	42	d1 Ø 28,6 / d2 Ø 23,9	1/6					
DB-DL-12304	Tie Rod	1560	40	d1 Ø 30 / d2 Ø 27	1/10		M30 x 1,5 LHT / M30 x 1,5 RHT			
DB-DL-12308	Centre Rod	885	42	d1 Ø 30 / d2 Ø 27	1/10					
DB-DL-12309	Centre Rod	685	40	d1 Ø 32 / d2 Ø 28,8	1/10					
DB-DL-12310	Tie Rod	1532	50	d1 Ø 32 / d2 Ø 29	1/10		M27 x 1,5 LHT			
DB-DL-12311	Tie Rod	1565	60	d1 Ø 30 / d2 Ø 27	1/10					
DB-DL-12363	Stabiliser Link	148	31	d1 Ø 30 / d2 Ø 27						
DB-DL-12364	Stabiliser Link	200	32	d1 Ø 30 / d2 Ø 27						
DB-DL-12375	Centre Rod	1708	56	d1 Ø 30 / d2 Ø 27						
DB-DL-12403	Centre Rod	893	42	d1 Ø 32 / d2 Ø 29						
DB-DL-12404	Centre Rod	875	50	d1 Ø 30/26 / d2 Ø 27/23,5	1/10					
DB-DL-12405	Centre Rod	895	50	d1 Ø 30 / d2 Ø 28,6	1/10		M24 x 1,5 / M20 x 1,5			
DB-DL-12437	Centre Rod	875	50	d1 Ø 30 / d2 Ø 27	1/10					
DB-DL-12438	Centre Rod	743	42	d1 Ø 30 / d2 Ø 27	1/10					
DB-DL-12440	Centre Rod	783	42	d1 Ø 26 / d2 Ø 23,5	1/10		M30 x 1,5 RHT			
DB-DL-12466	Centre Rod	905	38	d1 Ø 32 / d2 Ø 29	1/10					
DB-DL-12470	Centre Rod	723	42	d1 Ø 30 / d2 Ø 27	1/10					
DB-DL-12475	Centre Rod	888	50	d1 Ø 30 / d2 Ø 27	1/10					
DB-DS-6088	Track Control Arm	585	50						152 / 152	
DB-ES-0822	Tie Rod End	125		d1 Ø 26 / d2 Ø 23,5			M30 x 1,5 RHT			
DB-ES-0830	Tie Rod End	95		d1 Ø 20 / d2 Ø 18			M24 x 1,5 LHT			
DB-ES-0834	Tie Rod End	101		d1 Ø 22 / d2 Ø 20			M28 x 1,5 RHT			
DB-ES-1084	Tie Rod End	106		d1 Ø 22 / d2 Ø 20			M18 x 1,5 RHT / M24 x 1,5 RHT			
DB-ES-1281	Tie Rod End	115		d1 Ø 22 / d2 Ø 19,9			M30 x 1,5 RHT			
DB-ES-2558	Tie Rod End	150		d1 Ø 26 / d2 Ø 23,5			M35 x 1,5 RHT			
DB-ES-2559	Tie Rod End	150		d1 Ø 26 / d2 Ø 23,5			M35 x 1,5 LHT			
DB-ES-2752	Tie Rod End	160		d1 Ø 18 / d2 Ø 16,2			M24 x 1,5 RHT			
DB-ES-2753	Tie Rod End	160		d1 Ø 18 / d2 Ø 16,2			M24 x 1,5 LHT			
DB-ES-5209	Tie Rod	1670	50	d1 Ø 30 / d2 Ø 27	1/10					
DB-ES-5214	Tie Rod	1640	40	d1 Ø 26 / d2 Ø 23,5	1/10					
DB-ES-5227	Tie Rod	1588	60	d1 Ø 38 / d2 Ø 34,3	1/10					
DB-ES-5234	Tie Rod End	135		d1 Ø 38 / d2 Ø 34,3	1/10		M38 x 1,5 RHT			
DB-ES-7782	Ball Joint	120		d1 Ø 26 / d2 Ø 23,5	1/10		M24 x 1,5 RHT			
DB-ES-7783	Drag Link End	125		d1 Ø 30 / d2 Ø 27	1/10		M24 x 1,5 RHT			
DB-ES-7784	Drag Link End	125		d1 Ø 30 / d2 Ø 27	1/10		M24 x 1,5 LHT			
DB-ES-8164	Tie Rod End	140		d1 Ø 28,6 / d2 Ø 23,9	1/6		M28 x 1,5 RHT			
DB-ES-8323	Tie Rod End	75		d1 Ø 32 / d2 Ø 28,8			M26 x 1,5 RHT			
DB-ES-8387	Ball Head, gearshift linkage	55		d1 Ø 10 / d2 Ø 10			M14 x 1,5 RHT			
DB-ES-8491	Ball Head, gearshift linkage	60		d1 Ø 10 / d2 Ø 10			M12 x 1,75 LHT			
DB-ES-8492	Ball Head, gearshift linkage	60		d1 Ø 10 / d2 Ø 10			M12 x 1,75 RHT			
DB-ES-8498	Bolt, wheel alignment	100					M30 x 1,5 RHT / M38 x 1,5 LHT			
DB-ES-8500	Ball Head, gearshift linkage	55		d1 Ø 12 / d2 Ø 10,8	1/10		M14 x 1,5 RHT			
DB-ES-8510	Ball Head, gearshift linkage	56		d1 Ø 10 / d2 Ø 10			M12 x 1,75 LHT			
DB-ES-8529	Drag Link End	145		d1 Ø 32 / d2 Ø 28,8	1/10		M30 x 1,5 RHT			
DB-ES-8530	Tie Rod End	115		d1 Ø 28,6 / d2 Ø 23,9	1/6		M30 x 1,5 RHT			
DB-ES-8570	Tie Rod End	75		d1 Ø 26 / d2 Ø 23,5			M22 x 1,5 RHT			
DB-ES-8617	Tie Rod End	155		d1 Ø 32 / d2 Ø 28,8			M30 x 1,5 RHT			
DB-RK-5280	Suspension Arm Repair Kit		86							
DB-RK-5281	Suspension Arm Repair Kit		86							
DB-RK-5282	Suspension Arm Repair Kit		59							
DB-RK-5283	Suspension Arm Repair Kit		70							
DB-RK-5284	Suspension Arm Repair Kit		65							
DB-RK-5303	Suspension Arm Repair Kit		37							
DB-RK-5307	Suspension Arm Repair Kit		70							





MOOG					TAPER	THREAD	HOLE 	HOLE DISTANCE	THICK/ HEIGHT
DB-RK-6111	Suspension Arm Repair Kit	193	85					152	24
DB-RK-7267	Suspension Arm Repair Kit		95					152	24
DB-RK-8366	Suspension Arm Repair Kit		85					130	30
DB-RK-8380	Suspension Arm Repair Kit		80						
DB-RK-8391	Suspension Strut Repair Kit		85					152	24
DB-RK-8550	Suspension Arm Repair Kit		75					152	24
DB-RK-8555	Suspension Strut Repair Kit		67					130	24
DB-RK-8564	Suspension Arm Repair Kit		90						
DB-RK-8581	Suspension Strut Repair Kit		85					130	24
DB-RK-8626	Suspension Arm Repair Kit		75					130	24
DB-RK-8635	Suspension Arm Repair Kit		75					130	24
DB-RK-8638	Suspension Arm Repair Kit	100	67					100	20
DB-RK-8674	Suspension Arm Repair Kit		67					115	24
DB-RK-8710	Suspension Strut Repair Kit		85					130	30
DB-RK-8725	Suspension Arm Repair Kit		87						70
DB-RK-9262	Suspension Arm Repair Kit		87					130	30
DB-RK-9291	Suspension Strut Repair Kit		107,5					152	30
DB-RK-9294	Suspension Strut Repair Kit		85					152	24
DB-RK-9296	Stabiliser Mounting		88					130	24
DB-RK-9297	Suspension Arm Repair Kit		90						
DB-RK-9298	Suspension Arm Repair Kit		67					115	24
DB-RK-9300	Suspension Arm Repair Kit		75					130	24
DB-RK-10372	Suspension Arm Repair Kit		56					90	20
DB-RK-10374	Suspension Arm Repair Kit		85					152	24
DB-RK-10375	Suspension Arm Repair Kit		100					152	24
DB-RK-10378	Suspension Arm Repair Kit		86						
DB-RK-12372	Suspension Arm Repair Kit		85					152	24
DB-SB-5250	Stabiliser Mounting		66						56
DB-SB-5257	Stabiliser Mounting		60						60,5
DB-SB-5258	Stabiliser Mounting		70						62
DB-SB-5259	Stabiliser Mounting		44						25
DB-SB-5260	Stabiliser Mounting		70						36,5 / 46
DB-SB-5261	Stabiliser Mounting	85	82						56
DB-SB-5267	Stabiliser Mounting								60
DB-SB-5268	Stabiliser Mounting	55							60
DB-SB-5269	Stabiliser Mounting		58						47
DB-SB-5270	Stabiliser Mounting		54						47
DB-SB-5272	Stabiliser Mounting								57
DB-SB-5274	Stabiliser Mounting		64						60
DB-SB-5275	Stabiliser Mounting								60
DB-SB-5277	Stabiliser Mounting		52						
DB-SB-5279	Stabiliser Mounting		42						55
DB-SB-5312	Tie Bar Bush	100	97						40
DB-SB-9302	Stabiliser Mounting		82						80
DB-SB-10384	Bush, driver cab suspension		73						47
DB-SB-10385	Stabiliser Mounting		30						30
DB-SB-10386	Stabiliser Mounting		38						38
DB-SB-10400	Bush, parabolic spring	230							167,5 / 115
DB-SB-10401	Bush, parabolic spring	232							163,5 / 152,5
DB-SB-10406	Stabiliser Mounting		80						46
DB-SB-10407	Stabiliser Mounting		61						46
DB-SB-10409	Stabiliser Mounting		77						56
DB-SB-10410	Stabiliser Mounting		73					100	24
DB-TC-12376	Track Control Arm	628	46					130 / 130	
DB-TC-12410	Track Control Arm	925	62					100 / 100	
DB-TC-12411	Track Control Arm	655	40					115 / 115	
DB-VB-3700	Track Control Arm	800	48					126 / 126	
DB-VB-3701	Track Control Arm	901	48					126 / 126	
DB-VB-3702	Track Control Arm	507	46					115 / 115	
DB-VB-3707	Track Control Arm	622	46				25 / 25 / 25	152 / 130 / 130	24
DB-VB-7261	Track Control Arm	622	46				25 / 25 / 25	152 / 130 / 130	24
DB-VB-7776	Track Control Arm	622	56					152 / 152	
DB-VB-7790	Track Control Arm	622	46				25 / 23 / 23	152 / 130 / 130	
DB-VB-7798	Track Control Arm	622	48				25 / 23 / 23	152 / 130 / 130	
DB-VB-9307	Track Control Arm	667	60				25 / 23 / 23	152 / 130 / 130	30
DB-VB-9308	Track Control Arm	622	46				25 / 25 / 25	152 / 130 / 130	24
DB-VB-10421	Track Control Arm	623	56					152 / 152	





MOOG					TAPER	THREAD	HOLE 	HOLE DISTANCE	THICK/ HEIGHT
DB-VB-10423	Track Control Arm	761,7	46				25 / 23 / 23	152 / 130 / 130	
DB-VB-10425	Track Control Arm	622	46				25 / 23 / 23	152 / 130 / 130	
DB-VB-10426	Track Control Arm	622	46				25 / 25 / 25	152 / 130 / 130	
DF-DL-2142	Centre Rod	1005	52	d1 Ø 26 / d2 Ø 23,5					
DF-DL-3798	Centre Rod	1015	50	d1 Ø 30 / d2 Ø 27					
DF-DL-5226	Centre Rod	850	52	d1 Ø 26 / d2 Ø 23,5	1/10				
DF-DL-5237	Centre Rod	880	52	d1 Ø 26 / d2 Ø 23,5	1/10				
DF-DL-5355	Centre Rod	995	36	d1 Ø 26 / d2 Ø 23,5	1/10				
DF-DL-5403	Tie Rod	1742	40	d1 Ø 26 / d2 Ø 23,5	1/10				
DF-DL-6052	Centre Rod	926	46	d1 Ø 30 / d2 Ø 27	1/10				
DF-DL-7780	Tie Rod	1690	40	d1 Ø 26 / d2 Ø 23,5	1/10				
DF-DL-7836	Tie Rod	1698	52	d1 Ø 26 / d2 Ø 23,5	1/10				
DF-DL-8158	Track Control Arm	611	48					130 / 130	
DF-DL-8196	Centre Rod	867	50	d1 Ø 30 / d2 Ø 27	1/10				
DF-DL-8359	Centre Rod	1018	30	d1 Ø 26 / d2 Ø 23,5	1/10				
DF-DL-8363	Centre Rod	855	50	d1 Ø 30 / d2 Ø 27	1/10				
DF-DL-8506	Centre Rod	900	38	d1 Ø 22 / d2 Ø 19,9	1/10				
DF-DL-8516	Centre Rod	900	38	d1 Ø 22 / d2 Ø 19,9	1/10				
DF-DL-8551	Centre Rod	910	40	d1 Ø 26 / d2 Ø 23,5	1/10				
DF-DL-8571	Tie Rod	1524	60	d1 Ø 30 / d2 Ø 27	1/10				
DF-DL-8658	Centre Rod	622	42	d1 Ø 26 / d2 Ø 23,5	1/10				
DF-DL-8703	Centre Rod	1977	52	d1 Ø 30 / d2 Ø 27	1/10				
DF-DL-8704	Centre Rod	991	50	d1 Ø 30 / d2 Ø 27	1/10				
DF-DL-8705	Centre Rod	996	38	d1 Ø 30 / d2 Ø 27	1/10				
DF-DL-8718	Tie Rod	1690	40	d1 Ø 30 / d2 Ø 27	1/10				
DF-DL-9312	Centre Rod	820	36	d1 Ø 26 / d2 Ø 23,5	1/10				
DF-DL-9318	Track Control Arm	600	50					130 / 130	
DF-DL-9325	Centre Rod	909	42	d1 Ø 26 / d2 Ø 23,5	1/10				
DF-DL-9331	Track Control Arm	390	50					130 / 152	
DF-DL-10183	Centre Rod	588	36	d1 Ø 26 / d2 Ø 23,5	1/10				
DF-DL-10186	Centre Rod	860	38	d1 Ø 30 / d2 Ø 27	1/10				
DF-DL-10187	Centre Rod	1000	52	d1 Ø 30 / d2 Ø 27	1/10				
DF-DL-10188	Centre Rod	860	36	d1 Ø 30 / d2 Ø 27	1/10				
DF-DL-10192	Centre Rod	590	38	d1 Ø 30 / d2 Ø 27	1/10				
DF-DL-10193	Tie Rod	1646	40	d1 Ø 26 / d2 Ø 23,5	1/10				
DF-DL-12420	Centre Rod	1004	52	d1 Ø 30 / d2 Ø 27	1/10	M24 x 1,5 / M30 x 1,5			
DF-DL-12423	Centre Rod	1955	42	d1 Ø 26 / d2 Ø 23,5	1/10				
DF-DL-12424	Centre Rod	925	46	d1 Ø 30 / d2 Ø 27	1/10				
DF-DL-12425	Centre Rod	865	52	d1 Ø 30 / d2 Ø 27	1/10				
DF-DL-12426	Centre Rod	919	41	d1 Ø 26 / d2 Ø 23,5	1/10				
DF-DL-12427	Stabiliser Link	2028	36	d1 Ø 30 / d2 Ø 27					
DF-ES-3634	Tie Rod End	130		d1 Ø 30 / d2 Ø 27		M46 x 1,5 LHT			
DF-ES-3635	Tie Rod End	130		d1 Ø 30 / d2 Ø 27		M46 x 1,5 RHT			
DF-ES-3804	Tie Rod End	140		d1 Ø 30 / d2 Ø 27		M48 x 1,5 LHT			
DF-ES-3805	Tie Rod End	140		d1 Ø 30 / d2 Ø 27		M48 x 1,5 RHT			
DF-ES-5404	Tie Rod End	115		d1 Ø 26 / d2 Ø 23,5		M28 x 1,5 LHT			
DF-ES-5761	Tie Rod	1512	52	d1 Ø 26 / d2 Ø 23,5	1/10				
DF-ES-7777	Tie Rod End	85		d1 Ø 38 / d2 Ø 34,3		M26 x 1,5 RHT			
DF-ES-8362	Tie Rod End	150		d1 Ø 26 / d2 Ø 23,5		M30 x 1,5 RHT			
DF-ES-8496	Tie Rod End	148		d1 Ø 26 / d2 Ø 23,5	1/10	M28 x 1,5 LHT			
DF-ES-8497	Tie Rod End	148		d1 Ø 26 / d2 Ø 23,5	1/10	M28 x 1,5 RHT			
DF-ES-8508	Tie Rod End	120		d1 Ø 22 / d2 Ø 19,9	1/10	M30 x 1,5 LHT			
DF-ES-8524	Tie Rod End	178		d1 Ø 22 / d2 Ø 20		M30 x 1,5 RHT			
DF-ES-8602	Tie Rod End	95		d1 Ø 30 / d2 Ø 27		M22 x 1,5 RHT			
DF-ES-9332	Tie Rod End	120		d1 Ø 26 / d2 Ø 23,5		M30 x 1,5 LHT			
DF-ES-9334	Tie Rod End	115		d1 Ø 26 / d2 Ø 23,5	1/10	M24 x 1,5 RHT			
DF-ES-9335	Ball Head, gearshift linkage	85		d1 Ø 12 / d2 Ø 10,8	1/10	M14 x 1,5 RHT			
DF-ES-12428	Tie Rod End	120		d1 Ø 30		M24 x 1,5 RHT			
DF-ES-12429	Tie Rod End	90		d1 Ø 26 / d2 Ø 23,5					
DF-RK-8503	Suspension Arm Repair Kit		75					130	24
DF-RK-8633	Suspension Arm Repair Kit		90						
DF-RK-8637	Suspension Strut Repair Kit		72						
DF-RK-8671	Suspension Strut Repair Kit		80					145	30
DF-RK-8685	Suspension Strut Repair Kit		67					130	24
DF-RK-8994	Suspension Arm Repair Kit		75					130	24
DF-RK-9336	Suspension Arm Repair Kit		108						
DF-RK-9341	Suspension Strut Repair Kit		67						









MOOG					TAPER	THREAD	HOLE 	HOLE DISTANCE	THICK/ HEIGHT
DF-SB-5251	Stabiliser Mounting		85						60
DF-SB-5253	Stabiliser Mounting		86						60,5
DF-SB-9342	Stabiliser Mounting		94						80 / 70
DF-SB-10402	Stabiliser Mounting		62						60
DF-TC-12262	Track Control Arm	595	50					130 / 130	
DF-TC-12492	Track Control Arm	600	40					115 / 115	
DF-VB-8561	Track Control Arm	609	48					152 / 152	
DF-VB-9343	Track Control Arm	608,2	48					152 / 152	
IV-DL-0214	Centre Rod	982	48	d1 Ø 30 / d2 Ø 27					
IV-DL-0215	Centre Rod	822	40	d1 Ø 26 / d2 Ø 23,5					
IV-DL-2136	Centre Rod	980	35	d1 Ø 26 / d2 Ø 23,5					
IV-DL-2155	Centre Rod	953	52	d1 Ø 30 / d2 Ø 27					
IV-DL-2156	Centre Rod	900	50	d1 Ø 30 / d2 Ø 27					
IV-DL-3234	Centre Rod	1001	46	d1 Ø 30 / d2 Ø 27	1/10				
IV-DL-5371	Centre Rod	878	36	d1 Ø 30 / d2 Ø 27	1/10				
IV-DL-7785	Tie Rod	1490	38	d1 Ø 26 / d2 Ø 23,5	1/10				
IV-DL-8124	Centre Rod	698	52	d1 Ø 30 / d2 Ø 27	1/10				
IV-DL-8142	Track Control Arm	610	50					152 / 152	
IV-DL-8162	Centre Rod	888	62	d1 Ø 30 / d2 Ø 27	1/10				
IV-DL-8166	Centre Rod	952	52	d1 Ø 30 / d2 Ø 27	1/10				
IV-DL-8183	Tie Rod	1584	42	d1 Ø 26 / d2 Ø 23,5	1/10				
IV-DL-8193	Centre Rod	887	52	d1 Ø 30 / d2 Ø 27	1/10				
IV-DL-8304	Centre Rod	953	52	d1 Ø 30 / d2 Ø 27	1/10				
IV-DL-8367	Tie Rod	1620	48	d1 Ø 30 / d2 Ø 27	1/10				
IV-DL-8542	Stabiliser Link	355	40	d1 Ø 30 / d2 Ø 27					
IV-DL-8562	Centre Rod	979	38		1/10				
IV-DL-8613	Track Control Arm	594	50					130 / 130	
IV-DL-8654	Centre Rod	959	52	d1 Ø 30 / d2 Ø 27	1/10				
IV-DL-8665	Centre Rod	892	42	d1 Ø 30 / d2 Ø 27	1/10				
IV-DL-8689	Centre Rod	874	36	d1 Ø 22 / d2 Ø 20	1/10				
IV-DL-8697	Centre Rod	824	52	d1 Ø 30 / d2 Ø 27	1/10				
IV-DL-9351	Track Control Arm	455	50					130 / 130	
IV-DL-9359	Centre Rod	785	40	d1 Ø 26 / d2 Ø 23,5	1/10				
IV-DL-9360	Tie Rod	1627	52	d1 Ø 30 / d2 Ø 27	1/10				
IV-DL-9361	Tie Rod	1477	48	d1 Ø 30 / d2 Ø 27	1/10				
IV-DL-12264	Centre Rod	966	50	d1 Ø 30 / d2 Ø 27	1/10				
IV-DL-12265	Tie Rod	1577	48	d1 Ø 30 / d2 Ø 27	1/10				
IV-DL-12266	Tie Rod	1315	50	d1 Ø 30 / d2 Ø 27	1/10				
IV-DL-12268	Tie Rod	1640	46	d1 Ø 30 / d2 Ø 27	1/10				
IV-DL-12385	Tie Rod	1385	58	d1 Ø 30 / d2 Ø 27	1/10				
IV-DL-12386	Tie Rod	1485	62	d1 Ø 30 / d2 Ø 27	1/10				
IV-DS-0284	Centre Rod	902	42	d1 Ø 26 / d2 Ø 23,5					
IV-DS-1914	Centre Rod	890	46	d1 Ø 30 / d2 Ø 27					
IV-ES-8365	Tie Rod End	139		d1 Ø 30 / d2 Ø 27	1/10	M30 x 1,5 RHT			
IV-ES-8507	Tie Rod End	80		d1 Ø 30 / d2 Ø 27		M30 x 1,5 RHT			
IV-ES-8515	Tie Rod End	86		d1 Ø 38 / d2 Ø 34,3		M30 x 1,5 RHT			
IV-ES-12272	Tie Rod End	75		d1 Ø 30 / d2 Ø 27		M26 x 1,5 RHT			
IV-ES-12273	Ball Head, gearshift linkage	36				M10 x 1,5 RHT			
IV-ES-12419	Tie Rod End	55		d1 Ø 10 / d2 Ø 10		M10 x 1,5 RHT			
IV-RK-8998	Suspension Arm Repair Kit		85					130	30
IV-TC-12341	Track Control Arm	695	46					130 / 130	
IV-TC-12387	Track Control Arm	582	50					152 / 152	
IV-TC-12388	Track Control Arm	594	46					130 / 130	
IV-TC-12431	Track Control Arm	594	40					130 / 130	
IV-VB-5228	Track Control Arm	665	46					130 / 130	
IV-VB-8146	Track Control Arm	659	46					130 / 130	
IV-VB-10418	Track Control Arm	665	46					130 / 130	
IV-VB-12389	Track Control Arm	665	48					152 / 130 / 130	
IV-VB-12390	Track Control Arm	665	48					152 / 130 / 130	
KB-ES-0536	Tie Rod End	125		d1 Ø 26 / d2 Ø 23,5		M30 x 1,5 LHT			
LF-DL-0288	Centre Rod	860	36	d1 Ø 26 / d2 Ø 23,5					
LF-ES-3809	Tie Rod End	178		d1 Ø 22 / d2 Ø 20		M28 x 1,5 LHT			
LF-ES-3810	Tie Rod End	178		d1 Ø 22 / d2 Ø 20		M28 x 1,5 RHT			
ME-AX-2734	Tie Rod	1236	35	d1 Ø 18 / d2 Ø 16,2					
ME-AX-2735	Tie Rod	300	26	d1 Ø 20 / d2 Ø 18,2					
ME-ES-0643	Tie Rod End	92		d1 Ø 18 / d2 Ø 16,2		M22 x 1,5 RHT / M14 x 1,5			
ME-ES-1760	Tie Rod End	92		d1 Ø 18,2 / d2 Ø 16,2		M18 x 1,5 LHT / M14 x 1,5			





MOOG					TAPER	THREAD	HOLE 	HOLE DISTANCE	THICK/ HEIGHT
MN-DL-0549	Centre Rod	820	32	d1 Ø 20 / d2 Ø 18					
MN-DL-2127	Centre Rod	1670	30	d1 Ø 20 / d2 Ø 18					
MN-DL-2131	Centre Rod	780	35	d1 Ø 22 / d2 Ø 20					
MN-DL-2132	Centre Rod	840	38	d1 Ø 22 / d2 Ø 20					
MN-DL-2133	Centre Rod	829	38	d1 Ø 22 / d2 Ø 20					
MN-DL-2138	Centre Rod	1000	40	d1 Ø 26 / d2 Ø 23,5					
MN-DL-2140	Centre Rod	1650	50	d1 Ø 26 / d2 Ø 23,5					
MN-DL-2141	Centre Rod	1689	50	d1 Ø 26 / d2 Ø 23,5					
MN-DL-2160	Centre Rod	1652	50	d1 Ø 30 / d2 Ø 27					
MN-DL-2162	Centre Rod	755	40	d1 Ø 30 / d2 Ø 27					
MN-DL-2166	Centre Rod	1795	50	d1 Ø 30 / d2 Ø 27					
MN-DL-2172	Centre Rod	1050	42	d1 Ø 30 / d2 Ø 27					
MN-DL-2174	Centre Rod	1588	52	d1 Ø 30 / d2 Ø 27					
MN-DL-2175	Centre Rod	1628	50	d1 Ø 30 / d2 Ø 27					
MN-DL-2176	Centre Rod	1628	48	d1 Ø 30 / d2 Ø 27					
MN-DL-2177	Centre Rod	1664	50	d1 Ø 30 / d2 Ø 27					
MN-DL-2293	Centre Rod	729	40	d1 Ø 30 / d2 Ø 27					
MN-DL-3402	Track Control Arm	590	48					130 / 130	
MN-DL-3588	Centre Rod	1035	48	d1 Ø 30 / d2 Ø 27					
MN-DL-5212	Track Control Arm	577	48					130 / 130	
MN-DL-5225	Track Control Arm	572	48					130 / 130	
MN-DL-5232	Centre Rod	1000	42	d1 Ø 30 / d2 Ø 26	1/10				
MN-DL-7272	Track Control Arm	614	48					130 / 130	
MN-DL-7781	Tie Rod	1630	35	d1 Ø 22 / d2 Ø 20	1/10				
MN-DL-7786	Centre Rod	1245	60	d1 Ø 30	1/10				
MN-DL-7792	Centre Rod	1750	52	d1 Ø 30 / d2 Ø 27	1/10				
MN-DL-7797	Track Control Arm	750	48					130 / 130	
MN-DL-7801	Centre Rod	995	52	d1 Ø 30 / d2 Ø 27	1/10				
MN-DL-7802	Tie Rod	1680	52	d1 Ø 30 / d2 Ø 27	1/10				
MN-DL-7803	Track Control Arm	644	50					130 / 102	
MN-DL-7804	Centre Rod	628	40	d1 Ø 30 / d2 Ø 26	1/10				
MN-DL-7808	Centre Rod	1358	52	d1 Ø 30 / d2 Ø 27	1/10				
MN-DL-7833	Centre Rod	900	40	d1 Ø 26 / d2 Ø 23,5	1/10				
MN-DL-7834	Tie Rod	1588	58	d1 Ø 30 / d2 Ø 27	1/10				
MN-DL-7835	Tie Rod	1455	35	d1 Ø 22 / d2 Ø 20	1/10				
MN-DL-7837	Centre Rod	955	40	d1 Ø 26 / d2 Ø 23,5	1/10				
MN-DL-8197	Centre Rod	1055	42	d1 Ø 30 / d2 Ø 27	1/10				
MN-DL-8370	Tie Rod	501	40	d1 Ø 30 / d2 Ø 27	1/10				
MN-DL-8371	Tie Rod	1625	50	d1 Ø 30 / d2 Ø 27	1/10				
MN-DL-8374	Centre Rod	896	38	d1 Ø 30 / d2 Ø 27	1/10				
MN-DL-8376	Centre Rod	980	42	d1 Ø 30 / d2 Ø 27	1/10				
MN-DL-8377	Centre Rod	795	38	d1 Ø 26 / d2 Ø 23,5	1/10				
MN-DL-8378	Centre Rod	882	38	d1 Ø 30 / d2 Ø 26	1/10				
MN-DL-8486	Tie Rod	1545	38	d1 Ø 26 / d2 Ø 23,5	1/10				
MN-DL-8487	Centre Rod	900	38	d1 Ø 30 / d2 Ø 27	1/10				
MN-DL-8488	Track Control Arm	414	50					130 / 130	
MN-DL-8544	Track Control Arm	596	48					130 / 130	
MN-DL-8560	Centre Rod	970	52	d1 Ø 30 / d2 Ø 27	1/10				
MN-DL-8590	Track Control Arm	596	50					130 / 102	
MN-DL-8599	Centre Rod	1800	62	d1 Ø 30 / d2 Ø 27	1/10				
MN-DL-8609	Track Control Arm	585	58					130 / 130	
MN-DL-8621	Tie Rod	1702	50	d1 Ø 30 / d2 Ø 27	1/10				
MN-DL-8624	Tie Rod	1676	50	d1 Ø 30 / d2 Ø 27	1/10				
MN-DL-8646	Centre Rod	1021	52	d1 Ø 30 / d2 Ø 27	1/10				
MN-DL-8662	Centre Rod	860	38	d1 Ø 26 / d2 Ø 23,5	1/10				
MN-DL-8663	Track Control Arm	947	60					115 / 115	
MN-DL-8686	Centre Rod	1375	40	d1 Ø 30 / d2 Ø 26	1/10				
MN-DL-8709	Track Control Arm	572	52					130 / 130	
MN-DL-8714	Track Control Arm	540	38					100 / 100	
MN-DL-8733	Track Control Arm	530	48					130 / 130	
MN-DL-8734	Tie Rod	413	36	d1 Ø 30 / d2 Ø 27	1/10				
MN-DL-9368	Track Control Arm	330	36					80	
MN-DL-9369	Track Control Arm	330	36					80	
MN-DL-9370	Track Control Arm	596	50					130 / 130	
MN-DL-9379	Centre Rod	820	38	d1 Ø 22 / d2 Ø 20	1/10				
MN-DL-9380	Tie Rod	1632	38	d1 Ø 22 / d2 Ø 20	1/10				
MN-DL-9381	Track Control Arm	840	40						





MOOG					TAPER	THREAD	HOLE 	HOLE DISTANCE	THICK/ HEIGHT
MN-DL-10203	Centre Rod	882	42	d1 Ø 30 / d2 Ø 26	1/10				
MN-DL-10268	Tie Rod	661	38	d1 Ø 30 / d2 Ø 27	1/10				
MN-DL-10269	Tie Rod	429	36	d1 Ø 30 / d2 Ø 27	1/10				
MN-DL-10281	Track Control Arm	633	50					130	
MN-DL-10283	Track Control Arm	622	50					130 / 130	
MN-DL-10284	Track Control Arm	633	50					130	
MN-DL-10286	Track Control Arm	570	48					130 / 130	
MN-DL-10288	Track control arm	585	58						
MN-DL-10314	Centre Rod	1103	50	d1 Ø 30 / d2 Ø 27	1/10				
MN-DL-12278	Centre Rod	770	40	d1 Ø 30 / d2 Ø 27	1/10				
MN-DL-12279	Centre Rod	1010	48	d1 Ø 30 / d2 Ø 27	1/10				
MN-DL-12281	Centre Rod	850	36	d1 Ø 26/23,5 / d2 Ø 22/20	1/10				
MN-DL-12282	Centre Rod	874	36	d1 Ø 26 / d2 Ø 23,5	1/10				
MN-DL-12284	Tie Rod	1530	50	d1 Ø 30 / d2 Ø 27	1/10				
MN-DL-12285	Centre Rod	993	40	d1 Ø 30 / d2 Ø 27	1/10				
MN-DL-12287	Tie Rod	1531	42	d1 Ø 30 / d2 Ø 27	1/10				
MN-DL-12288	Track control arm	585	58					130 / 130	
MN-DL-12289	Centre Rod	1796	62	d1 Ø 30 / d2 Ø 27					
MN-DL-12291	Centre Rod	926	38	d1 Ø 26 / d2 Ø 23,5	1/10				
MN-DL-12293	Tie Rod	1680	42	d1 Ø 30 / d2 Ø 27	1/10				
MN-DL-12365	Tie Rod	1680	50	d1 Ø 26 / d2 Ø 23,5	1/10				
MN-DL-12391	Centre Rod	1050	52	d1 Ø 30 / d2 Ø 27	1/10				
MN-DL-12393	Centre Rod	1796	62	d1 Ø 30 / d2 Ø 27	1/10				
MN-DL-12394	Centre Rod	864	38	d1 Ø 22 / d2 Ø 20	1/10				
MN-DL-12421	Centre Rod	1070	48	d1 Ø 30 / d2 Ø 27	1/10	M30 x 1,5 RHT			
MN-DL-12432	Centre Rod	975	40	d1 Ø 26 / d2 Ø 23,5	1/10				
MN-DL-12433	Centre Rod	1020	42	d1 Ø 30 / d2 Ø 27	1/10				
MN-DL-14107	Centre Rod	960	50	d1 Ø 30 / d2 Ø 27	1/10				
MN-ES-8490	Tie Rod End	90		d1 Ø 30 / d2 Ø 27		M26 x 1,5 RHT			
MN-ES-8611	Tie Rod End	168		d1 Ø 30 / d2 Ø 27		M52 x 1,5 RHT			
MN-ES-10333	Tie Rod End	90		d1 Ø 38 / d2 Ø 34,4	1/10	M36 x 1,5 RHT			
MN-ES-10334	Tie Rod	140		d1 Ø 26 / d2 Ø 23,5	1/10	M30 x 1,5 RHT			
MN-ES-10348	Drag Link End	80		d1 Ø 30 / d2 Ø 27,2	1/10	M22 x 1,5 RHT			
MN-RK-7280	Suspension Arm Repair Kit		75					115	24
MN-RK-7287	Suspension Arm Repair Kit		90					152	35
MN-RK-7291	Suspension Arm Repair Kit		72					130	30
MN-RK-8501	Suspension Strut Repair Kit		75					115	24
MN-RK-8523	Suspension Arm Repair Kit		72						
MN-RK-8537	Suspension Strut Repair Kit		95					152	24
MN-RK-8558	Suspension Strut Repair Kit	100	95						
MN-RK-8678	Suspension Arm Repair Kit	100	90						
MN-RK-8723	Suspension Arm Repair Kit	100	46					60	
MN-RK-8997	Suspension Strut Repair Kit		85					130	30
MN-RK-9383	Suspension Arm Repair Kit		67					100	24
MN-RK-9387	Suspension Arm Repair Kit		90						
MN-RK-9392	Suspension Arm Repair Kit		85						250
MN-RK-12436	Suspension Strut Repair Kit		75					115	24
MN-SB-5242	Stabiliser Mounting		65						62
MN-SB-5243	Stabiliser Mounting	55	78						60
MN-SB-5244	Suspension Arm Repair Kit		65					125	22
MN-SB-5245	Stabiliser Mounting		75					125	22
MN-SB-5246	Mounting, stabilizer coupling rod		45						47
MN-SB-5248	Stabiliser Mounting	55	80						80
MN-SB-5249	Stabiliser Mounting	55	71						80
MN-SB-5252	Stabiliser Mounting		37,5						51
MN-SB-5254	Stabiliser Mounting	100	93						70
MN-SB-5265	Stabiliser Mounting		85						80
MN-SB-5278	Stabiliser Mounting	50	39						50,5
MN-SB-9396	Stabiliser Mounting		67						60
MN-SB-9399	Control Arm-/Trailing Arm Bush		75						83 / 83
MN-SB-10387	Engine Mounting		70						85 / 85
MN-SB-10389	Engine Mounting		70						72 / 72
MN-SB-10390	Engine Mounting		70						85 / 85
MN-TC-12397	Track Control Arm	661	40					130 / 130	
MN-TC-12399	Track Control Arm	694	50					130 / 130	
MN-TC-12400	Track Control Arm	413						80 / 80	35
MN-TC-12471	Track Control Arm	840	50						

MOOG					TAPER	THREAD	HOLE 	HOLE DISTANCE	THICK/ HEIGHT
MN-TC-14112	Track Control Arm	777	60					115 / 115	
MN-VB-5222	Track Control Arm	627	50					152 / 152	
MN-VB-5238	Track Control Arm	627	48					130 / 130	
MN-VB-8514	Track Control Arm	627	48				25 / 25 / 25	152 / 130 / 130	24
MN-VB-8565	Track Control Arm	693	46					115 / 115	
MN-VB-8569	Track Control Arm	627	58					152 / 152	
MN-VB-8669	Track Control Arm	627	48				25 / 25 / 25	152 / 130 / 130	24
MN-VB-9403	Track Control Arm	627	48				25 / 23 / 23	152 / 130 / 130	
MN-VB-9404	Track Control Arm	627	58					130 / 130	
RV-DL-0074	Centre Rod	1012	52	d1 Ø 30 / d2 Ø 27					
RV-DL-0882	Centre Rod	1040	62	d1 Ø 30 / d2 Ø 27					
RV-DL-0883	Centre Rod	847	52	d1 Ø 30 / d2 Ø 27					
RV-DL-0886	Centre Rod	945	52	d1 Ø 30 / d2 Ø 27					
RV-DL-0887	Centre Rod	1720	48	d1 Ø 30 / d2 Ø 27					
RV-DL-0900	Centre Rod	990	52	d1 Ø 30 / d2 Ø 27					
RV-DL-0901	Centre Rod	810	50	d1 Ø 30 / d2 Ø 27					
RV-DL-0902	Centre Rod	720	40	d1 Ø 30 / d2 Ø 27					
RV-DL-0904	Centre Rod	872	40	d1 Ø 26 / d2 Ø 23,5					
RV-DL-0905	Centre Rod	840	52	d1 Ø 30 / d2 Ø 27					
RV-DL-0907	Centre Rod	900	40	d1 Ø 22 / d2 Ø 20					
RV-DL-0908	Centre Rod	845	52	d1 Ø 30 / d2 Ø 27					
RV-DL-0909	Centre Rod	1528	40	d1 Ø 26 / d2 Ø 23,5					
RV-DL-0919	Centre Rod	870	62	d1 Ø 30 / d2 Ø 27					
RV-DL-2181	Centre Rod	1650	40	d1 Ø 30 / d2 Ø 27					
RV-DL-7282	Track Control Arm	690	46					122 / 122	
RV-DL-7539	Centre Rod	1690	48	d1 Ø 30 / d2 Ø 27					
RV-DL-7971	Track Control Arm	575	50					152 / 152	
RV-DL-8126	Track Control Arm	575	50					145 / 145	
RV-DL-8136	Centre Rod	725	42	d1 Ø 30 / d2 Ø 27	1/10				
RV-DL-8156	Centre Rod	934	52	d1 Ø 30 / d2 Ø 27	1/10				
RV-DL-8159	Track Control Arm	574	50					152 / 152	
RV-DL-8160	Centre Rod	877	36	d1 Ø 20 / d2 Ø 18	1/10				
RV-DL-8170	Tie Rod	1404	34	d1 Ø 22 / d2 Ø 20	1/10				
RV-DL-8177	Centre Rod	1012	52	d1 Ø 30 / d2 Ø 27	1/10				
RV-DL-8186	Centre Rod	895	40	d1 Ø 22 / d2 Ø 20	1/10				
RV-DL-8190	Centre Rod	946	42	d1 Ø 26 / d2 Ø 23,5	1/10				
RV-DL-8198	Centre Rod	981	52	d1 Ø 30 / d2 Ø 27	1/10				
RV-DL-8199	Tie Rod	1470	36	d1 Ø 26 / d2 Ø 23,5	1/10				
RV-DL-8299	Centre Rod	827	52	d1 Ø 30 / d2 Ø 27	1/10				
RV-DL-8300	Centre Rod	1125	50	d1 Ø 30 / d2 Ø 27	1/10				
RV-DL-8302	Tie Rod	1570	48	d1 Ø 30 / d2 Ø 27	1/10				
RV-DL-8306	Centre Rod	940	40	d1 Ø 26 / d2 Ø 23,5	1/10				
RV-DL-8308	Centre Rod	883	42	d1 Ø 22 / d2 Ø 20	1/10				
RV-DL-8309	Centre Rod	891	42	d1 Ø 22 / d2 Ø 20	1/10				
RV-DL-8310	Tie Rod	1500	38	d1 Ø 26 / d2 Ø 23,5	1/10				
RV-DL-8312	Tie Rod	1560	52	d1 Ø 30 / d2 Ø 27	1/10				
RV-DL-8313	Tie Rod	1752	48	d1 Ø 30 / d2 Ø 27	1/10				
RV-DL-8314	Tie Rod	1758	52	d1 Ø 30 / d2 Ø 27	1/10				
RV-DL-8316	Centre Rod	735	50	d1 Ø 30 / d2 Ø 27	1/10				
RV-DL-8317	Tie Rod	1415	30	d1 Ø 20 / d2 Ø 18	1/10				
RV-DL-8318	Tie Rod	1720	52	d1 Ø 30 / d2 Ø 27	1/10				
RV-DL-8324	Track Control Arm	575	50					152 / 152	
RV-DL-8415	Centre Rod	825	62	d1 Ø 30 / d2 Ø 27	1/10				
RV-DL-8587	Tie Rod	1675	50		1/10				
RV-DL-8653	Centre Rod	940	42	d1 Ø 26 / d2 Ø 23,5	1/10				
RV-DL-10243	Tie Rod	1726	60	d1 Ø 30 / d2 Ø 27	1/10	M24 x 1,5 RHT			
RV-DL-10244	Centre Rod	700	50	d1 Ø 30 / d2 Ø 27	1/10				
RV-DL-10245	Centre Rod	893	62	d1 Ø 30 / d2 Ø 27	1/10				
RV-DL-10246	Centre Rod	895	40	d1 Ø 26 / d2 Ø 23,5	1/10				
RV-DL-10249	Stabiliser Link	440	36	d1 Ø 26 / d2 Ø 23,5					
RV-DL-10299	Track Control Arm	510	21						
RV-DL-12317	Centre Rod	866	60						
RV-DL-12318	Tie Rod	1650	40	d1 Ø 26 / d2 Ø 23,5	1/10				
RV-DL-12319	Centre Rod	697	50	d1 Ø 30					
RV-DL-12320	Centre Rod	881	50	d1 Ø 28,6 / d2 Ø 23,9	1/6				
RV-DL-12321	Tie Rod	1575	38	d1 Ø 26 / d2 Ø 23,5	1/10				
RV-DL-12322	Centre Rod	922	42	d1 Ø 26 / d2 Ø 23,5	1/10	M30 x 1,5 RHT			

MOOG					TAPER	THREAD	HOLE 	HOLE DISTANCE	THICK/ HEIGHT
RV-DL-12326	Stabiliser Link	280	28	d1 Ø 20					
RV-DL-12327	Stabiliser Link	280	28	d1 Ø 20					
RV-DL-12328	Tie Rod	1608	42	d1 Ø 30					
RV-DL-12329	Tie Rod	1694	42	d1 Ø 30					
RV-DL-12334	Tie Rod	1686	60	d1 Ø 30 / d2 Ø 27	1/10				
RV-DL-12337	Tie Rod	1676	40	d1 Ø 30 / d2 Ø 27	1/10	M30 x 1,5 RHT			
RV-DL-12338	Tie Rod	1719	40	d1 Ø 30 / d2 Ø 27	1/10	M30 x 1,5 RHT			
RV-DL-12381	Tie Rod	776	38	d1 Ø 26 / d2 Ø 23,5	1/10				
RV-DL-12447	Tie Rod	1818	52	d1 Ø 28,6 / d2 Ø 23,9	1/6				
RV-DL-12448	Centre Rod	900	50	d1 Ø 30 / d2 Ø 27	1/10				
RV-DL-12465	Tie Rod	1580	40	d1 Ø 30 / d2 Ø 27	1/10	M30 x 1,5 LHT / M30 x 1,5 RHT			
RV-DL-12467	Tie Rod	1376	52	d1 Ø 30 / d2 Ø 27					
RV-DL-12468	Centre Rod	866	60	d1 Ø 30 / d2 Ø 27	1/10				
RV-DL-12478	Centre Rod	696	52	d1 Ø 30					
RV-DL-12480	Centre Rod	922	42	d1 Ø 26 / d2 Ø 23,5	1/10				
RV-ES-8691	Tie Rod End	106		d1 Ø 20 / d2 Ø 18		M24 x 1,5 LHT			
RV-ES-9432	Tie Rod End	120		d1 Ø 28 / d2 Ø 23,9		M26 x 1,5 RHT			
RV-ES-12331	Tie Rod End	140		d1 Ø 30 / d2 Ø 27		M32 x 1,5 RHT / M24 x 1,5 RHT			
RV-ES-12442	Tie Rod End	88		d1 Ø 28,6		M26 x 1,5 RHT			
RV-ES-12445	Tie Rod End	170		d1 Ø 30 / d2 Ø 27	1/10				
RV-ES-12446	Tie Rod End	170		d1 Ø 30 / d2 Ø 27	1/10				
RV-RK-7849	Suspension Arm Repair Kit		21						
RV-RK-8648	Suspension Strut Repair Kit		85					152	35
RV-TC-12339	Track Control Arm	515	40					13 / 130	
RV-TC-12340	Track Control Arm	510						115 / 115	
RV-VB-8191	Track Control Arm	662,4	48					115 / 115	
SC-DL-0305	Centre Rod	920	50	d1 Ø 30 / d2 Ø 27					
SC-DL-2151	Centre Rod	912	50	d1 Ø 30 / d2 Ø 27					
SC-DL-2161	Centre Rod	1740	50	d1 Ø 30 / d2 Ø 27					
SC-DL-2904	Centre Rod	940	46	d1 Ø 30 / d2 Ø 27					
SC-DL-2965	Centre Rod	950	46	d1 Ø 30 / d2 Ø 27					
SC-DL-2968	Centre Rod	855	42	d1 Ø 30 / d2 Ø 27					
SC-DL-5229	Centre Rod	1053	50	d1 Ø 30 / d2 Ø 27	1/10				
SC-DL-5354	Centre Rod	1060	52	d1 Ø 30 / d2 Ø 27	1/10				
SC-DL-7264	Tie Rod	1743	62	d1 Ø 30 / d2 Ø 27	1/10				
SC-DL-7273	Stabiliser Link	284	36	d1 Ø 26 / d2 Ø 23,5					
SC-DL-8127	Centre Rod	792	52	d1 Ø 30 / d2 Ø 27	1/10				
SC-DL-8137	Tie Rod	1736	40	d1 Ø 30 / d2 Ø 27	1/10				
SC-DL-8154	Centre Rod	495	40	d1 Ø 30 / d2 Ø 27	1/10				
SC-DL-8169	Centre Rod	1920	62	d1 Ø 30 / d2 Ø 27	1/10				
SC-DL-8179	Track Control Arm	568	46					115 / 115	
SC-DL-8182	Centre Rod	603	42		1/10				
SC-DL-8399	Centre Rod	433	40	d1 Ø 30 / d2 Ø 26	1/10				
SC-DL-8400	Track Control Arm	615	50					115 / 115	
SC-DL-8509	Track Control Arm	568,5	46					115 / 115	
SC-DL-8511	Track Control Arm	616,5	50					115 / 115	
SC-DL-8531	Track Control Arm	522	46					115 / 115	
SC-DL-8547	Track Control Arm	568	50					115 / 115	
SC-DL-8553	Centre Rod	435	38	d1 Ø 30 / d2 Ø 27	1/10				
SC-DL-8623	Track Control Arm	592	50					115 / 115	
SC-DL-8711	Centre Rod	882	48	d1 Ø 30 / d2 Ø 27	1/10				
SC-DL-8713	Track Control Arm	637	48					115 / 115	
SC-DL-9440	Centre Rod	1590	40	d1 Ø 30 / d2 Ø 27	1/10				
SC-DL-9446	Track Control Arm	532	46					115 / 115	
SC-DL-9447	Centre Rod	870	48	d1 Ø 30 / d2 Ø 27	1/10				
SC-DL-9449	Centre Rod	882	48	d1 Ø 30 / d2 Ø 27	1/10				
SC-DL-9457	Tie Rod	1743	52	d1 Ø 30 / d2 Ø 27	1/10				
SC-DL-9458	Tie Rod	635	48	d1 Ø 30 / d2 Ø 27	1/10				
SC-DL-9459	Track Control Arm	670	48					130 / 130	
SC-DL-9460	Track Control Arm	650	48					130 / 130	
SC-DL-9461	Stabiliser Link	293	36					90	
SC-DL-9462	Track Control Arm	568,5	50					115 / 115	
SC-DL-9466	Track Control Arm	568	19						
SC-DL-9467	Track Control Arm	568,5	50					115 / 115	
SC-DL-10225	Centre Rod	2179	62	d1 Ø 30 / d2 Ø 27	1/10				
SC-DL-10226	Tie Rod	538	52	d1 Ø 30 / d2 Ø 27	1/10				
SC-DL-10253	Stabiliser Link	145	30	d1 Ø 26 / d2 Ø 23,5					

MOOG									
SC-DL-10254	Stabiliser Link	150	30	d1 Ø 26 / d2 Ø 23,5					
SC-DL-10255	Stabiliser Link	150	30	d1 Ø 26 / d2 Ø 23,5					
SC-DL-10273	Tie Rod	635	48	d1 Ø 30 / d2 Ø 27	1/10				
SC-DL-10302	Track Control Arm	752	48					115 / 115	
SC-DL-10304	Track Control Arm	640	48					130 / 130	
SC-DL-12341	Centre Rod	1776	62	d1 Ø 30 / d2 Ø 27	1/10				
SC-DL-12342	Centre Rod	601	42	d1 Ø 26 / d2 Ø 23,5	1/10				
SC-DL-12343	Centre Rod	1062	52	d1 Ø 30 / d2 Ø 27	1/10				
SC-DL-12413	Centre Rod	1950	62	d1 Ø 30 / d2 Ø 27	1/10				
SC-DL-12449	Centre Rod	1206	38	d1 Ø 30 / d2 Ø 27	1/10				
SC-ES-5764	Tie Rod End	95		d1 Ø 30 / d2 Ø 27		M26 x 1,5 RHT			
SC-ES-7279	Tie Rod End	150		d1 Ø 30 / d2 Ø 27	1/10	M30 x 1,5 RHT			
SC-ES-8517	Tie Rod End	140		d1 Ø 30 / d2 Ø 27	1/10	M30 x 1,5 RHT			
SC-ES-8535	Tie Rod End	145		d1 Ø 30 / d2 Ø 27	1/10	M30 x 1,5 RHT			
SC-RK-8575	Suspension Arm Repair Kit		95					152	35
SC-RK-8688	Suspension Arm Repair Kit	95	95						
SC-RK-12346	Suspension Arm Repair Kit		67					115	24
SC-RK-12366	Suspension Arm Repair Kit		75					115 / 115	24
SC-TC-12361	Track Control Arm	705	42	d1 Ø 38				115	
SC-TC-12451	Track Control Arm	552	46					115 / 115	
SC-TC-12452	Track Control Arm	580,5	46					115 / 115	
SC-TC-12472	Track Control Arm	580	46					115 / 115	
SC-VB-12418	Track Control Arm	613,2	46				25 / 19 / 19	152 / 115 / 115	
VL-DL-0911	Centre Rod	880	52	d1 Ø 28,6 / d2 Ø 23,9					
VL-DL-2139	Centre Rod	880	52	d1 Ø 28,6 / d2 Ø 23,9					
VL-DL-4895	Centre Rod	1026	60	d1 Ø 28,6 / d2 Ø 23,9	1/6				
VL-DL-4912	Centre Rod	763	38	d1 Ø 28,6 / d2 Ø 23,9	1/6				
VL-DL-5218	Centre Rod	980	30	d1 Ø 22 / d2 Ø 20	1/10				
VL-DL-5301	Centre Rod	1592	42	d1 Ø 28,6 / d2 Ø 23,9					
VL-DL-5318	Centre Rod	860	42	d1 Ø 31,5 / d2 Ø 27,5					
VL-DL-5319	Centre Rod	865	40	d1 Ø 31,5 / d2 Ø 27,5					
VL-DL-5358	Centre Rod	893	40	d1 Ø 30 / d2 Ø 26,5	1/8				
VL-DL-5372	Centre Rod	875	50	d1 Ø 28,6 / d2 Ø 23,9	1/6				
VL-DL-5411	Centre Rod	870	42	d1 Ø 26 / d2 Ø 23,5	1/10				
VL-DL-5456	Centre Rod	740	40	d1 Ø 31,5 / d2 Ø 27,5					
VL-DL-5540	Centre Rod	845	42	d1 Ø 31,5 / d2 Ø 27,5					
VL-DL-7789	Tie Rod	1640	58	d1 Ø 28,6 / d2 Ø 23,9	1/6				
VL-DL-8119	Centre Rod	870	52	d1 Ø 26 / d2 Ø 23,5	1/10				
VL-DL-8128	Centre Rod	845	42	d1 Ø 31,5 / d2 Ø 27,5	1/8				
VL-DL-8141	Tie Rod	1582	38	d1 Ø 26 / d2 Ø 23,5	1/10				
VL-DL-8151	Centre Rod	893	40	d1 Ø 30 / d2 Ø 26,5	1/8				
VL-DL-8155	Centre Rod	821	42	d1 Ø 26 / d2 Ø 23,5	1/10				
VL-DL-8157	Stabiliser Link	325	30	d1 Ø 22 / d2 Ø 20					
VL-DL-8163	Tie Rod	1640	42	d1 Ø 28,6 / d2 Ø 23,9	1/6				
VL-DL-8178	Centre Rod	572	38	d1 Ø 28,6 / d2 Ø 23,9	1/6				
VL-DL-8180	Track Control Arm	625	17						
VL-DL-8187	Centre Rod	2140	52	d1 Ø 28,6 / d2 Ø 23,9	1/6				
VL-DL-8189	Track Control Arm	666	48					125	
VL-DL-8194	Centre Rod	824	50	d1 Ø 28,6 / d2 Ø 23,9	1/6				
VL-DL-8305	Tie Rod	1634	50	d1 Ø 28,6 / d2 Ø 23,9	1/6				
VL-DL-8322	Tie Rod	1645	50	d1 Ø 28,6 / d2 Ø 23,9	1/6				
VL-DL-8401	Centre Rod	880	42	d1 Ø 31,5 / d2 Ø 27,5	1/8				
VL-DL-8403	Centre Rod	880	52	d1 Ø 28,6 / d2 Ø 23,9	1/6				
VL-DL-8404	Tie Rod	300	36	d1 Ø 28,6 / d2 Ø 23,9	1/6				
VL-DL-8405	Centre Rod	1030	62	d1 Ø 28,6 / d2 Ø 23,9	1/6				
VL-DL-8406	Centre Rod	888	52	d1 Ø 28,6 / d2 Ø 23,9	1/6				
VL-DL-8407	Centre Rod	870	52	d1 Ø 28,6 / d2 Ø 23,9	1/6				
VL-DL-8412	Stabiliser Link	435	36	d1 Ø 28,6 / d2 Ø 25,5					
VL-DL-8518	Stabiliser Link	350	36	d1 Ø 28,9 / d2 Ø 24,7					
VL-DL-8536	Stabiliser Link	340	30	d1 Ø 22 / d2 Ø 19,9					
VL-DL-8543	Stabiliser Link	380	36	d1 Ø 28,6 / d2 Ø 24,7					
VL-DL-8545	Track Control Arm	660	48					130 / 130	
VL-DL-8554	Track Control Arm	570	48					130 / 130	
VL-DL-8566	Centre Rod	863	52	d1 Ø 28,6 / d2 Ø 23,9	1/6				
VL-DL-8594	Centre Rod	865	52	d1 Ø 28,6 / d2 Ø 23,9	1/6				
VL-DL-8595	Stabiliser Link	150	26	d1 Ø 28,6 / d2 Ø 23,9					
VL-DL-8597	Tie Rod	743	40	d1 Ø 28,6 / d2 Ø 23,9	1/6				

MOOG					TAPER	THREAD		HOLE DISTANCE	THICK/ HEIGHT
VL-DL-8619	Track Control Arm	621	48					100 / 100	
VL-DL-8679	Centre Rod	1779	60	d1 Ø 31,5 / d2 Ø 27,5	1/8				
VL-DL-8681	Centre Rod	888	52	d1 Ø 28,6 / d2 Ø 23,9	1/6				
VL-DL-8706	Centre Rod	890	50	d1 Ø 26 / d2 Ø 23,5	1/10				
VL-DL-8707	Centre Rod	885	50	d1 Ø 28,6 / d2 Ø 23,9	1/6				
VL-DL-8729	Tie Rod	1556	32	d1 Ø 22 / d2 Ø 20	1/10				
VL-DL-9472	Stabiliser Link	435	36	d1 Ø 32,2 / d2 Ø 28					
VL-DL-9479	Track Control Arm	510	36						
VL-DL-9485	Track Control Arm	666	48					125 / 125	
VL-DL-9488	Centre Rod	563	48	d1 Ø 28,6 / d2 Ø 23,9	1/6				
VL-DL-9489	Centre Rod	1243	42	d1 Ø 28,6 / d2 Ø 23,9	1/6				
VL-DL-9491	Stabiliser Link	380	36	d1 Ø 28,6 / d2 Ø 25,5					
VL-DL-9492	Tie Rod	1660	62	d1 Ø 32 / d2 Ø 27	1/6				
VL-DL-9493	Tie Rod	1660	62	d1 Ø 28,6 / d2 Ø 23,9	1/6				
VL-DL-9954	Centre Rod	870	50	d1 Ø 28,6 / d2 Ø 23,9					
VL-DL-10228	Centre Rod	2139	62	d1 Ø 28,6 / d2 Ø 23,9	1/6				
VL-DL-10230	Tie Rod	770	38	d1 Ø 28,6 / d2 Ø 23,9	1/6				
VL-DL-10257	Stabiliser Link	160	26	d1 Ø 30 / d2 Ø 27					
VL-DL-10258	Stabiliser Link	325	30	d1 Ø 22 / d2 Ø 20					
VL-DL-10259	Tie Rod	150	26	d1 Ø 31,7 / d2 Ø 27,3	1/8				
VL-DL-10309	Track Control Arm	799	48					115 / 115	
VL-DL-10310	Track Control Arm	570	36						
VL-DL-12355	Tie Rod	368	38	d1 Ø 28,6 / d2 Ø 23,9	1/6				
VL-DL-12356	Stabiliser Link	275	30	d1 Ø 22					
VL-DL-12358	Tie Rod	1669	42	d1 Ø 32 / d2 Ø 27	1/6	M32 x 1,5 RHT / M32 x 1,5 LHT			
VL-DL-12367	Centre Rod	2139	62	d1 Ø 28,6 / d2 Ø 23,9	1/6	M52 x 1,5 RHT			
VL-DL-12414	Tie Rod	1728	48	d1 Ø 28,6 / d2 Ø 23,9	1/6	M30 x 1,5 RHT			
VL-DL-12415	Stabiliser Link	367	36	d1 Ø 28,6 / d2 Ø 23,9					
VL-DL-12416	Stabiliser Link	367	36	d1 Ø 28,6 / d2 Ø 23,9					
VL-DL-12454	Centre Rod	2339	62	d1 Ø 28,6 / d2 Ø 23,9	1/6				
VL-DL-12455	Centre Rod	2141	52	d1 Ø 28,6 / d2 Ø 23,9	1/6				
VL-DL-12456	Centre Rod	871	52	d1 Ø 26 / d2 Ø 23,5	1/10				
VL-DL-12483	Centre Rod	485	48	d1 Ø 28,6 / d2 Ø 23,9	1/6				
VL-DL-12484	Centre Rod	1025	48	d1 Ø 28,6 / d2 Ø 23,9	1/6				
VL-ES-5287	Tie Rod End	167		d1 Ø 28,6 / d2 Ø 23,9		M52 x 1,5 RHT			
VL-ES-5288	Tie Rod End	167		d1 Ø 28,6 / d2 Ø 23,9		M52 x 1,5 LHT			
VL-ES-5347	Tie Rod End	125		d1 Ø 28,6 / d2 Ø 23,9		M30 x 1,5 LHT			
VL-ES-5348	Tie Rod End	125		d1 Ø 28,6 / d2 Ø 23,9	1/6	M30 x 1,5 RHT			
VL-ES-7265	Tie Rod End	125		d1 Ø 31,5 / d2 Ø 27,5		M30 x 1,5 LHT			
VL-ES-7266	Tie Rod End	125		d1 Ø 31,5 / d2 Ø 27,5		M30 x 1,5 RHT			
VL-ES-7286	Tie Rod End	87		d1 Ø 16 / d2 Ø 14,4		M28 x 1,5 RHT			
VL-ES-8411	Tie Rod End	140		d1 Ø 28,6 / d2 Ø 23,9	1/6	M30 x 1,5 RHT			
VL-ES-8414	Tie Rod End	136		d1 Ø 32 / d2 Ø 27	1/6	M30 x 1,5 LHT			
VL-ES-8568	Tie Rod End	100		d1 Ø 38 / d2 Ø 34,3	1/10	M26 x 1,5 RHT			
VL-ES-8615	Tie Rod End	125		d1 Ø 30 / d2 Ø 26,5		M30 x 1,5 RHT			
VL-ES-10360	Tie Rod End	136		d1 Ø 32 / d2 Ø 27	1/6	M30 x 1,5 RHT			
VL-ES-10361	Tie Rod End	88		d1 Ø 28,6 / d2 Ø 24	1/6	M26 x 1,5 RHT			
VL-RK-5323	Suspension Arm Repair Kit		91					125	20
VL-RK-5357	Control Arm-/Trailing Arm Bush		138				14 / 16 / 14	21	96 / 96
VL-RK-8533	Suspension Strut Repair Kit		85					130	30
VL-RK-8656	Tie Bar Bush		91					145	26
VL-RK-9497	Suspension Arm Repair Kit		95					130	35
VL-RK-9499	Suspension Arm Repair Kit		72						
VL-RK-10383	Suspension Arm Repair Kit		75					130	24
VL-SB-5276	Stabiliser Mounting	55	74						96 / 96
VL-SB-5345	Stabiliser Mounting		57,5						64
VL-SB-5356	Bush, parabolic spring								150
VL-SB-9501	Tie Bar Bush		91						85 / 85
VL-SB-10392	Stabiliser Mounting		90						95 / 95
VL-SB-10394	Stabiliser Mounting		90						95 / 95
VL-SB-10397	Stabiliser Mounting	89							89 / 89
VL-SB-10398	Stabiliser Mounting								87,5 / 87,5
VL-VB-5369	Track Control Arm	677	48					115 / 115	
VL-VB-7787	Track Control Arm	671	58					130 / 130	
VL-VB-8195	Track Control Arm	649	48					115 / 115	
VL-VB-8525	Track Control Arm	677,3	48					145 / 145	
VL-VB-8527	Track Control Arm	635	58					152 / 152	

MOOG					TAPER	THREAD	HOLE 	HOLE DISTANCE	THICK/ HEIGHT
VL-VB-8539	Track Control Arm	641	48					152 / 152	
VL-VB-8541	Track Control Arm	677,3	48					145 / 145	
VL-VB-8546	Track Control Arm	644	46					115 / 115	
VL-VB-8576	Track Control Arm	660,3	48					145 / 145	
VL-VB-8584	Track Control Arm	700	58					152 / 152	
VL-VB-9503	Track Control Arm	773	48					125 / 125	
VL-VB-10430	Track Control Arm	760	48					130 / 130	
VL-VB-12359	Track Control Arm	687,5	58					125 / 125	30
VL-VB-12460	Track Control Arm	662	50					115 / 115	
VV-DL-0287	Tie Rod	860	52			d1 Ø 28,6 / d2 Ø 23,9			

ASTRA	MOOG	...DAF	MOOG	...DAF	MOOG	...DAF	MOOG
101347	DB-ES-5234	0689747	CV-RK-7850	1351734	DF-DL-2142	1617096	DF-VB-8561
113251	DB-ES-5234	0689748	MN-RK-7280	1351737	DF-DL-5355	1618048	CV-ES-14163
		0689749	CV-RK-5311	1351739	DF-DL-12423	1620436	DF-VB-9343
		0689749	CV-RK-8118	1351740	DF-DL-8359	1620438	DF-DL-9318
		0691704	CV-RK-5322	1351741	DF-DL-10183	1620439	DF-TC-12262
		0691709	IV-RK-8998	1351743	DF-DL-9312	1656428	DF-DL-8158
		0694298	CV-ES-12462	1351745	DF-DL-8658	1685552	SC-ES-8517
		0694360	CV-ES-12462	1353391	DF-DL-7780	1689604	CV-ES-2135
		0696320	DF-RK-8633	1353395	DF-DL-10193	1689605	DF-ES-5404
		0696321	SC-RK-8575	1353396	DF-DL-7836	1700000	DF-DL-8718
		0698450	CV-ES-14163	1361155	DF-ES-5761	1700912	DF-DL-8506
		0698609	CV-ES-12462	1361618	DF-ES-7777	1700913	DF-DL-8516
		0754922	DF-DL-7836	1361649	DF-DL-8158	1732887	DF-SB-10402
		080521	DF-VB-8561	1361650	DF-DL-8158	1793875	DF-VB-8561
		094613	DF-DL-12420	1361651	DF-VB-8561	1793876	DF-VB-9343
		10200900A	DF-DL-5226	1361652	DF-VB-9343	1801332	DF-DL-12427
		10201000A	DF-DL-5237	1363858	DF-DL-8363	1817808	DF-VB-8561
		10212000A	DF-DL-7780	1363859	DF-DL-8196	1892492	DF-VB-8561
		10220897	MN-ES-10334	1368270	DF-VB-8561	1902996	DF-ES-8496
		10305800A	DF-SB-5251	1373878	DF-DL-12425	1923962	DF-ES-5404
		10306500A	DF-SB-5253	1376730	DF-RK-8637	1923963	CV-ES-2135
		10309600A	DF-VB-9343	1380417	DF-DL-10188	2068997	DF-ES-7777
		1137230	CV-ES-12462	1385487	DF-DL-10183	278473	MN-DL-7797
		1149907	CV-ES-14163	1385488	DF-DL-8658	3090291	MN-ES-10333
		1152350	CV-ES-14163	1385492	DF-DL-5226	3093714	MN-ES-10334
		1152351	DB-ES-8498	1385493	LF-DL-0288	3099128	MN-ES-10333
		1190653	CV-ES-12461	1385494	DF-DL-9312	311300	CV-ES-12461
		120110404	DF-ES-12429	1385497	DF-DL-5237	362413	DF-DL-12420
		1208073	DF-RK-9341	1385498	DF-DL-5355	36438240	DF-ES-7777
		1228115	CV-ES-14162	1385499	DF-DL-2142	366351	DF-SB-5251
		1229944	CV-ES-12462	1385502	DF-DL-8359	386930	DF-ES-9335
		1243618	DB-RK-9298	1385516	DF-DL-12423	4125657	DF-ES-12429
		1247957	DF-DL-5226	1389190	DF-ES-8362	41270883	DF-SB-9342
		1249088	CV-ES-2119	1390932	DF-VB-8561	42538048	MN-ES-10333
		1249129	CV-ES-2182	1392962	DF-DL-12427	542477	CV-ES-2121
		1252284	DF-RK-8994	1394801	DB-ES-8498	589333	CV-ES-2182
		1257890	CV-ES-14163	1395993	DF-DL-8705	592106	CV-ES-2119
		1257991	LF-DL-0288	1395994	DF-DL-8704	606922	DF-ES-3634
		1261101	DF-DL-9331	1395995	DF-DL-10187	606923	DF-ES-3635
		1270853	DF-DL-7780	1399724	DF-ES-8602	607053	CV-ES-14162
		1270854	DF-DL-5403	1401934	CV-ES-12461	607452	CV-ES-2534
		1271124	MN-RK-7291	1401937	DF-DL-8551	607998	CV-ES-12461
		1271126	MN-ES-10333	1401942	DF-ES-8508	6244600348	DF-ES-7777
		1274741	DF-TC-12492	1405309	DF-DL-6052	658104	MN-DL-7797
		1283211	DF-DL-5237	1405363	DF-DL-9325	661406	DF-TC-12262
		1283212	DF-DL-5226	1405499	DF-DL-12424	661407	DF-TC-12262
		1284860	DF-DL-9318	1405655	DF-DL-8506	67354	DF-RK-8503
		1286343	DF-DL-7836	1406025	DF-DL-8506	689748	MN-RK-7280
		1291060	DF-DL-2142	1406600	DF-DL-8516	690225	CV-ES-14162
		1291233	DF-SB-10402	1407144	DF-DL-8506	691709	IV-RK-8998
		1297572	DF-ES-5761	1407394	CV-ES-12461	69513	CV-ES-12461
		1299555	DF-ES-12429	1407774	DF-DL-12426	696225	CV-ES-14162
		1306332	DF-DL-8359	1426101	DF-DL-12420	696320	DF-RK-8633
		1306333	DF-DL-10183	1440171	DF-DL-10192	696321	MN-RK-8537
		1306336	DF-DL-12423	1445656	DF-RK-9336	8123326	DF-ES-5404
		1310760	CV-ES-5336	1448062	DF-DL-8363	81432706099	MN-RK-8537
		1311048	DF-DL-5355	1448063	DF-DL-8196	8169892	DF-SB-9342
		1315447	CV-ES-12461	1448064	DF-DL-12425	81953016231	DF-ES-7777
		1319838	CV-ES-12461	1451118	DF-DL-10186	81953016236	MN-ES-10334
		1320855	MN-ES-10334	1451119	DF-DL-10192	81953016268	MN-ES-10333
		1321170	DF-DL-9312	1451122	DF-DL-8703	81953016331	MN-ES-10334
		1321936	DF-RK-8685	1451129	DF-DL-10188	82953010009	DF-ES-7777
		1326862	CV-ES-12462	1602820	DF-DL-8363	82953016018	MN-ES-10333
		1326896	CV-ES-12462	1602821	DF-DL-8196	82953016019	MN-ES-10333
		1331925	CV-ES-12462	1603418	CV-ES-5336	94613	DF-DL-12420
		1332123	CV-ES-12461	1603419	DF-ES-9332	ACHB063	CV-ES-12461
		1337644	DF-DL-5403	1603788	DF-ES-12428	ACHB064	CV-ES-12462
		1338714	CV-ES-12461	1603789	CV-ES-14163	ACHF060	CV-ES-14163
		1342026	MN-ES-10334	1603883	SC-ES-7279	ACHF241	CV-ES-12461
		1344684	DF-ES-9334	1604105	DF-ES-12428	ACHF242	CV-ES-12462
		1351205	DF-DL-10193	1604247	DF-ES-8496	ACU9239	LF-ES-3809
		1351714	DF-DL-5237	1604248	DF-ES-8497	ACU9240	LF-ES-3810
		1351715	DF-DL-5226	1605300131	DF-ES-7777	AFRA635	DF-ES-8508
		1351718	LF-DL-0288	1605300141	DF-ES-12429	AFRA888	DF-ES-8524
		1351730	DF-DL-8658	1611088	CV-ES-14162	AMPA345	DF-ES-5404

...DAF **MOOG**

MAK1295 CV-ES-12461
 MAK1296 CV-ES-12462

DENNIS **MOOG**

653770 CV-RK-5311
 653770 CV-RK-8118
 655357 CV-ES-14163
 655551 CV-RK-14162
 657691 DB-RK-9300
 657834 MN-RK-7280

DEUTZ **MOOG**

04311552 CV-ES-14163
 08135492 IV-DL-8697
 08137026 IV-VB-5228
 093163617 DF-RK-8685
 1278679 DF-ES-9335
 2478910 DF-DL-8571
 2968454 CV-RK-5322
 2980884 MN-RK-7291
 3221270R91 CV-ES-14163
 41002118 IV-ES-12419
 41002770 IV-VB-5228
 41005450 IV-DL-8367
 41005451 IV-DL-8367
 41005466 IV-DL-8124
 41005469 IV-DL-8697
 41005475 IV-DL-8166
 41006093 IV-DL-8166
 41009661 IV-DL-8613
 41009665 IV-VB-5228
 41009666 IV-DL-8613
 41011476 IV-DL-8697
 41016960 IV-DL-8697
 41016961 IV-DL-8697
 41016964 IV-DL-8124
 41028269 IV-DL-8193
 41028598 IV-VB-5228
 41028600 IV-VB-5228
 41032608 IV-DL-9361
 41033237 IV-DL-9361
 41033731 IV-DL-9351
 41034479 IV-VB-5228
 41035951 IV-DL-8613
 41036943 IV-DL-8367
 41042050 IV-VB-5228
 41042093 IV-VB-10418
 41203863 IV-ES-12419
 41215165 IV-DL-8654
 41226580 IV-DL-8654
 41272429 IV-DL-8613
 41298449 IV-DL-8193
 42037040 DF-DL-8571
 42037041 DF-DL-8571
 42037386 RV-DL-8170
 42041327 IV-ES-12419
 42079853 IV-ES-12419
 42100262 DF-DL-8571
 42100263 DF-DL-8571
 42105474 DF-ES-7777
 42200700 IV-DL-8689
 42204475 IV-DL-8689
 42211146 IV-DL-8689
 42211148 IV-DL-8689
 42493431 DB-RK-7267
 42530316 IV-ES-8515
 42532294 DF-ES-7777
 42533101 MN-ES-8490
 42535204 IV-RK-8998
 42536819 DB-RK-8366
 42538047 IV-ES-8515
 42538383 DB-ES-8498
 42538384 SC-ES-8517

...DEUTZ **MOOG**

4688942 DF-ES-5404
 4741171 IV-DL-8542
 4793166 IV-DL-3234
 4815933 IV-DL-8562
 4834041 IV-DL-3234
 4854871 IV-DL-8183
 500307556 IV-DL-7785
 500309296 IV-ES-8365
 500311471 IV-DL-8162
 500324282 IV-DL-9359
 500333284 DB-RK-9300
 500340451 IV-VB-10418
 500340769 IV-ES-8365
 500397738 IV-DL-8304
 504049893 IV-DL-8665
 504064007 IV-VB-8146
 8135492 IV-DL-8697
 8137026 IV-VB-5228
 8163773 IV-DL-8367
 8582333 DF-ES-5404
 86012923 RV-DL-8170
 93161958 DF-RK-8637
 93161960 DF-RK-8994
 93162239 DF-RK-8637
 93163617 DF-RK-8685
 93192361 DF-RK-8503
 93192619 DB-RK-7267
 93192809 IV-ES-8507
 93194578 DB-ES-8498
 98402553 IV-DL-7785
 98405832 IV-VB-8146
 98449025 IV-DL-5371
 98469650 IV-DL-5371
 98472446 IV-DL-8613
 98472466 IV-DL-8613
 98472468 IV-VB-8146
 98489741 IV-DL-9360
 98491559 IV-DL-8162
 99447734 DB-ES-8498

ERF **MOOG**

81466106624 MN-DL-12284
 81467116720 MN-DL-12284

EVOBUS **MOOG**

0003200132 DB-DL-12363
 0003200532 DB-DL-12363
 0003200832 DB-DL-12363
 0003201132 DB-DL-12363
 0003201232 DB-DL-12364
 0003300148 CV-ES-12461
 0003380250 DB-ES-8498
 0003387310 CV-ES-14163
 0003500906 DB-RK-8366
 0004602648 DB-ES-0822
 0004605748 CV-ES-0543
 0004605848 CV-ES-0888
 0004606048 CV-ES-0543
 0004606148 CV-ES-0888
 0013200832 DB-DL-12363
 0014606948 MN-ES-8490
 0014607048 IV-ES-12272
 13200832 DB-DL-12363
 14606948 MN-ES-8490
 2684889 DF-ES-9335
 2685289 CV-ES-2121
 3023300035 CV-ES-12461
 3023300235 CV-ES-12461
 3023300335 CV-ES-12461
 3200132 DB-DL-12363
 3200532 DB-DL-12363
 3200832 DB-DL-12363
 3201132 DB-DL-12363

...EVOBUS **MOOG**

3201232 DB-DL-12364
 3380250 DB-ES-8498
 3500906 DB-RK-8366
 4103300303 CV-DL-9103
 4103300503 CV-DL-9103
 6273500006 DB-DL-7788
 6273500106 DB-DL-7788
 6273500206 DB-DL-8393
 6273500306 DB-DL-8393
 6283200089 DB-DL-7276
 6283200289 DB-DL-7275
 6283201089 DB-DL-7276
 6283201189 DB-DL-7275
 6283201489 DB-DL-12364
 6283300403 CV-DL-9082
 6283330005 DB-DL-7788
 6283330205 DB-DL-9275
 6283331005 DB-DL-7788
 6283331805 DB-DL-7788
 6284601905 DB-DL-9251
 6284602005 DB-DL-9249
 6293200189 DB-DL-12364
 6293380010 SC-ES-8517
 6323200232 DB-DL-12364
 6323200332 DB-DL-12363
 6323200532 DB-DL-12364
 6443500306 DB-DL-8393
 6733230385 DB-SB-5268
 6733260681 DB-SB-5269
 6733260781 DB-SB-5270
 6851103000 CV-ES-12462
 6851480000 CV-ES-14163
 6851484000 CV-ES-14163
 6851485000 CV-ES-14162
 6851487000 KB-ES-0536
 6851489000 RV-ES-8691
 6851491000 DB-ES-5234
 6851509000 CV-ES-12462
 6851516000 CV-ES-12461
 6851517000 CV-ES-12462
 6851531000 CV-ES-14163
 6851532000 KB-ES-0536
 8226137000 CV-DL-9119
 8226147000C CV-DL-9119
 8226236058 CV-ES-14162
 8226236059 CV-ES-14163
 8226248000C CV-DL-9103
 8226296069 DF-RK-8994
 8226305000C CV-DL-9119
 8226308000 CV-DL-9103
 8226308000C CV-DL-9103
 8226313000C CV-DL-9119
 8226368000 DB-DL-12363
 8226381000 CV-DL-9103
 8321999319 CV-ES-2121
 90804154117 DB-ES-0822

FAUN **MOOG**

0598660 CV-ES-12462
 7399424 CV-ES-2121
 99708408375 CV-ES-14163

FODEN TRUCKS **MOOG**

Y04505101 CV-ES-14162

FORD **MOOG**

1334525 CV-ES-2121
 2RP711551 CV-ES-2121
 2RR512398A CV-RK-5311
 81DB3289RA MN-ES-10334
 TJG711551 CV-ES-2121

GROVE **MOOG**

02212202 SC-ES-5764
 K2212202 SC-ES-5764

HANOMAG **MOOG**

001106037 CV-ES-12462
 X860534903322 ME-ES-0643
 X8800001106037 CV-ES-12462

ISUZU **MOOG**

1443590110 DB-ES-8498

IVECO **MOOG**

0014606948 MN-ES-8490
 002984511 CV-ES-12461
 004833827 CV-ES-12462
 004833828 CV-ES-12461
 02984511 CV-ES-12461
 042493782 CV-ES-12461
 04688948 CV-ES-0914
 04688949 CV-ES-0912
 04833828 CV-ES-12461
 04854874 IV-DS-0284
 08135492 IV-DL-8697
 08137026 IV-VB-5228
 093163617 DF-RK-8685
 11019869 IV-ES-8507
 12216380 IV-ES-8507
 1271126 MN-ES-10333
 1278679 DF-ES-9335
 14606948 MN-ES-8490
 2041327 IV-ES-12419
 2478910 DF-DL-8571
 2966252 CV-ES-14163
 2966688 CV-ES-12462
 2968454 CV-RK-5322
 2969808 CV-ES-14163
 2980129 CV-ES-12461
 2980323 CV-ES-12462
 2980884 MN-RK-7291
 2984061 CV-ES-14162
 2984511 CV-ES-12461
 3090291 MN-ES-10333
 3096213 CV-ES-12462
 3099128 MN-ES-10333
 3435786 CV-ES-2121
 40081 VL-DL-8322
 41002118 IV-ES-12419
 41002770 IV-VB-5228
 41005309 IV-DL-12265
 41005450 IV-DL-8367
 41005451 IV-DL-8367
 41005460 IV-DL-12265
 41005463 IV-DL-2155
 41005466 IV-DL-8124
 41005469 IV-DL-8697
 41005475 IV-DL-8166
 41006093 IV-DL-8166
 41009661 IV-DL-8613
 41009665 IV-VB-5228
 41009666 IV-DL-8613
 41011008 IV-DL-8142
 41011476 IV-DL-8697
 41016960 IV-DL-8697
 41016961 IV-DL-8697
 41016964 IV-DL-8124
 41028269 IV-DL-8193
 41028598 IV-VB-5228
 41028599 IV-VB-8146
 41028600 IV-VB-5228
 41032608 IV-DL-9361
 41033237 IV-DL-9361
 41033731 IV-DL-9351

...IVECO	MOOG	...IVECO	MOOG	KÄSSBOHRER	MOOG	...LEYLAND-DAF	MOOG
41034479	IV-VB-5228	4833821	CV-ES-12461	0003380250	DB-ES-8498	1137230	CV-ES-12462
41035951	IV-DL-8613	4833827	CV-ES-12462	0003500906	DB-RK-8366	1228115	CV-ES-14162
41036943	IV-DL-8367	4833828	CV-ES-12461	0004602648	DB-ES-0822	1229944	CV-ES-12462
41036944	IV-DL-8367	4833829	CV-ES-14163	0004605748	CV-ES-0543	1257890	CV-ES-14163
41042050	IV-VB-5228	4833830	CV-ES-14162	0004605848	CV-ES-0888	1315447	CV-ES-12461
41042092	IV-VB-8146	4834037	IV-DL-2136	0004606048	CV-ES-0543	1319838	CV-ES-12461
41042093	IV-VB-10418	4834039	IV-DL-8562	0004606148	CV-ES-0888	1326896	CV-ES-12462
41042245	IV-DL-12386	4834041	IV-DL-3234	0013200832	DB-DL-12363	1331925	CV-ES-12462
41042749	IV-DL-12385	4854871	IV-DL-8183	13200832	DB-DL-12363	1338714	CV-ES-12461
41042919	IV-DL-2155	4854874	IV-DS-0284	3380250	DB-ES-8498	1603789	CV-ES-14163
41203863	IV-ES-12419	500307556	IV-DL-7785	3500906	DB-RK-8366	542477	CV-ES-2121
41215165	IV-DL-8654	500309296	IV-ES-8365	4103300303	CV-DL-9103	606922	DF-ES-3634
41218020	IV-TC-12387	500311471	IV-DL-8162	4103300503	CV-DL-9103	606923	DF-ES-3635
41218620	IV-VB-12390	500324282	IV-DL-9359	6273500006	DB-DL-7788	607053	CV-ES-14162
41226580	IV-DL-8654	500333284	DB-RK-9300	6273500106	DB-DL-7788	690225	CV-ES-14162
41272426	IV-TC-12388	500338783	IV-TC-12341	6273500206	DB-DL-8393	696225	CV-ES-14162
41272428	IV-VB-12389	500340451	IV-VB-10418	6273500306	DB-DL-8393	698609	CV-ES-12462
41272429	IV-DL-8613	500340769	IV-ES-8365	6283200089	DB-DL-7276	81953016222	CV-ES-2534
41296162	IV-DL-12266	500397738	IV-DL-8304	6283200289	DB-DL-7275	ACHB064	CV-ES-12462
41298449	IV-DL-8193	5010245365	IV-ES-12273	6283201089	DB-DL-7276	ACHF241	CV-ES-12461
4143415	IV-ES-8515	504049893	IV-DL-8665	6283201189	DB-DL-7275	ACHF242	CV-ES-12462
42001325	IV-DS-1914	504064007	IV-VB-8146	6283201489	DB-DL-12364	ACU9239	LF-ES-3809
42001326	IV-DS-1914	55175540	IV-ES-8507	6283300403	CV-DL-9082	ACU9240	LF-ES-3810
42003432	IV-DL-12268	7138966	CV-ES-14162	6283330005	DB-DL-7788	MAK1295	CV-ES-12461
42037040	DF-DL-8571	7138967	CV-ES-14163	6283330205	DB-DL-9275	MAK1296	CV-ES-12462
42037041	DF-DL-8571	7364001574	IV-ES-8515	6283331005	DB-DL-7788		
42037386	RV-DL-8170	7485114941	RV-DL-8170	6283331805	DB-DL-7788		
42041107	IV-DL-8142	7981909	CV-ES-2121	6284601905	DB-DL-9251		
42079853	IV-ES-12419	7981909	DF-ES-9335	6284602005	DB-DL-9249	500607008	CV-ES-2121
42087841	IV-DL-0214	8122752	CV-ES-14163	6293200189	DB-DL-12364	571866508	CV-ES-14162
42087842	IV-DL-0214	8122754	CV-ES-12462	6293380010	SC-ES-8517	571866608	CV-ES-14163
42100262	DF-DL-8571	8122755	CV-ES-12461	6323200532	DB-DL-12364	725010008	CV-ES-14163
42100263	DF-DL-8571	8131582	IV-DL-2155	6443500306	DB-DL-8393		
42105474	DF-ES-7777	8135492	IV-DL-8697	6733230385	DB-SB-5268		
42200700	IV-DL-8689	8137026	IV-VB-5228	6733260681	DB-SB-5269		
42204475	IV-DL-8689	8137027	IV-TC-12431	6733260781	DB-SB-5270	004833827	CV-ES-12462
42211146	IV-DL-8689	8163773	IV-DL-8367	6851485000	CV-ES-14162	1278679	DF-ES-9335
42211148	IV-DL-8689	8165309	IV-DL-12265	6851487000	KB-ES-0536	2966252	CV-ES-14163
42483386	CV-ES-14163	8190225	CV-ES-14162	6851489000	RV-ES-8691	2966688	CV-ES-12462
42483520	CV-ES-12462	81953016238	IV-ES-8507	6851491000	DB-ES-5234	2969808	CV-ES-14163
42485638	CV-ES-2119	81953016268	MN-ES-10333	6851532000	KB-ES-0536	2980129	CV-ES-12461
42485718	CV-ES-12462	8198187	CV-ES-2182	8226137000	CV-DL-9119	2980323	CV-ES-12462
42487482	DF-ES-9335	8198188	CV-ES-2119	8226147000C	CV-DL-9119	2984061	CV-ES-14162
42488269	CV-ES-14163	82953016018	MN-ES-10333	8226236058	CV-ES-14162	2984511	CV-ES-12461
42489395	CV-ES-14162	82953016019	MN-ES-10333	8226248000C	CV-DL-9103	3096213	CV-ES-12462
42489573	CV-ES-14163	8582332	CV-ES-2135	8226296069	DF-RK-8994	3435786	CV-ES-2121
42489594	CV-ES-14163	8582333	DF-ES-5404	8226305000C	CV-DL-9119	42483386	CV-ES-14163
42491638	CV-ES-14163	86012923	RV-DL-8170	8226308000	CV-DL-9103	42483520	CV-ES-12462
42491957	CV-ES-14162	86027074	CV-ES-2121	8226308000C	CV-DL-9103	42485718	CV-ES-12462
42493431	DB-RK-7267	86027074	DF-ES-9335	8226313000C	CV-DL-9119	42488269	CV-ES-14163
42493781	CV-ES-12462	93161958	DF-RK-8637	8226368000	DB-DL-12363	42489395	CV-ES-14162
42493782	CV-ES-12461	93161960	DF-RK-8994	8226381000	CV-DL-9103	42489573	CV-ES-14163
42530316	IV-ES-8515	93162239	DF-RK-8637	8321999319	CV-ES-2121	42489594	CV-ES-14163
42530929	IV-DL-12386	93163617	DF-RK-8685	90804154117	DB-ES-0822	42491638	CV-ES-14163
42532294	DF-ES-7777	93192361	DF-RK-8503			42491957	CV-ES-14162
42533073	IV-ES-12272	93192619	DB-RK-7267			42493781	CV-ES-12462
42533101	MN-ES-8490	93192809	IV-ES-8507	KRUPP	MOOG	42493782	CV-ES-12461
42533102	CV-ES-2146	93194578	DB-ES-8498	02212202	SC-ES-5764	42537936	CV-ES-14163
42535204	IV-RK-8998	937104	IV-VB-5228	K2212202	SC-ES-5764	4802443	CV-ES-14163
42535446	CV-RK-5311	98402544	IV-DL-0215			4802444	CV-ES-14162
42536819	DB-RK-8366	98402553	IV-DL-7785			4833820	CV-ES-12462
42537936	CV-ES-14163	98405832	IV-VB-8146	LEYLAND-DAF	MOOG	4833821	CV-ES-12461
42538047	IV-ES-8515	98446354	IV-DL-2156	0003309435	CV-ES-2534	4833827	CV-ES-12462
42538048	MN-ES-10333	98449025	IV-DL-5371	0311300	CV-ES-12461	4833828	CV-ES-12461
42538383	DB-ES-8498	98467459	IV-DL-0215	0386930	DF-ES-9335	4833829	CV-ES-14163
42538384	SC-ES-8517	98469650	IV-DL-5371	0586753	CV-ES-12462	4833830	CV-ES-14162
4688941	CV-ES-2135	98472446	IV-DL-8613	0606922	DF-ES-3634	7138966	CV-ES-14162
4688942	DF-ES-5404	98472466	IV-DL-8613	0606923	DF-ES-3635	7138967	CV-ES-14163
4741171	IV-DL-8542	98472468	IV-VB-8146	0607981	CV-ES-14163	7981909	CV-ES-2121
4773359	IV-DL-2136	98473328	IV-DL-12264	0607998	CV-ES-12461	8122752	CV-ES-14163
4793166	IV-DL-3234	98489741	IV-DL-9360	0607999	CV-ES-12462	8122754	CV-ES-12462
4802443	CV-ES-14163	98491559	IV-DL-8162	0694298	CV-ES-12462	8122755	CV-ES-12461
4802444	CV-ES-14162	99447734	DB-ES-8498	0694360	CV-ES-12462	8190225	CV-ES-14162
4815933	IV-DL-8562			0698450	CV-ES-14163	86027074	CV-ES-2121
4833820	CV-ES-12462			100cp1903	CV-ES-2121	98473328	IV-DL-12264

MAN	MOOG	...MAN	MOOG	...MAN	MOOG	...MAN	MOOG
0003500506	CV-RK-5311	7000307001	CV-RK-8118	81432206279	MN-DL-10283	81432706114	MN-VB-5238
0003500506	CV-RK-8118	775201	CV-RK-8118	81432206283	MN-DL-8663	81432706116	MN-VB-5238
0004606748	MN-ES-8611	81.43270.6119	SC-RK-12366	81432206284	MN-DL-8663	81432706116	MN-VB-8669
0014606948	MN-ES-8490	81432206055	CV-RK-5311	81432206291	MN-DL-8709	81432706117	MN-VB-9404
03008500A	CV-ES-2120	81432206055	CV-RK-8118	81432206292	MN-DL-8709	81432706119	MN-RK-8501
03206800A	MN-DL-7837	81432206067	MN-DL-3402	81432206294	MN-DL-9369	81432706121	MN-VB-5238
03206900A	MN-DL-8560	81432206068	MN-DL-3402	81432206304	MN-DL-5225	81432706126	MN-RK-8997
03207100A	MN-DL-5232	81432206070	MN-DL-8609	81432206305	MN-DL-5225	81432706127	DB-RK-8366
03207500A	MN-DL-8197	81432206071	MN-DL-8609	81432206319	MN-TC-12397	81432706135	MN-VB-9403
03208300A	MN-DL-7802	81432206072	MN-DL-8609	81432206325	MN-TC-12397	81432706137	MN-VB-8669
03300300A	MN-DL-7272	81432206073	CV-RK-5311	81432206341	MN-DL-8488	81432706150	MN-VB-8669
03301500A	MN-DL-5225	81432206073	CV-RK-8118	81432206342	MN-DL-8488	81432706151	MN-VB-8669
03304700A	MN-RK-7287	81432206090	MN-DL-3402	81432206358	MN-DL-8733	81432706152	MN-VB-9404
03304800A	CV-RK-5313	81432206091	MN-DL-8609	81432206359	MN-DL-8733	81432706153	MN-VB-9404
03304900A	MN-RK-8523	81432206092	MN-DL-3402	81432206386	MN-DL-10288	81432706160	MN-VB-9403
03305800A	DB-RK-8581	81432206093	MN-DL-8609	81432206386	MN-DL-12288	81432706161	MN-VB-9403
03306600A	MN-RK-8537	81432206096	MN-DL-5212	81432209092	MN-DL-3402	81432709034	MN-VB-5222
03307200A	MN-DL-3402	81432206097	MN-DL-5212	81432209096	MN-DL-5212	81432709053	MN-VB-8565
03307300A	MN-DL-7803	81432206098	MN-DL-5212	81432209129	MN-DL-5212	81432709056	MN-VB-8569
03307400A	MN-DL-8663	81432206099	MN-DL-7797	81432209140	MN-DL-8590	81432709076	MN-VB-5222
03310100A	MN-SB-5248	81432206100	MN-DL-7797	81432209236	MN-DL-5225	81432709078	MN-VB-5222
03310200A	MN-SB-5249	81432206106	MN-TC-14112	81432209267	MN-DL-5225	81432710027	MN-SB-5244
03310300A	MN-SB-5265	81432206108	MN-RK-7291	81432209272	MN-DL-5225	81432710033	MN-SB-9399
03310800A	MN-SB-5242	81432206119	MN-DL-8609	81432306014	MN-DL-5212	81432710046	MN-SB-5245
03311100A	MN-SB-5243	81432206129	MN-DL-5212	81432306015	MN-DL-9370	81432710079	MN-SB-5245
03311900A	MN-SB-5245	81432206132	MN-RK-7291	81432306030	MN-DL-5212	81432710081	MN-SB-5254
03312000A	MN-SB-5244	81432206134	MN-DL-10281	81432306031	MN-DL-9370	81432710082	MN-SB-5244
03312200A	MN-SB-5252	81432206135	MN-DL-10281	81432306049	MN-TC-14112	81432710083	MN-SB-5245
03312700A	MN-SB-5278	81432206136	MN-DL-10281	81432306051	MN-RK-7280	81432796094	MN-VB-8514
0550806	MN-RK-7280	81432206137	MN-DL-10281	81432306060	MN-RK-9392	81437040025	MN-SB-5248
0639370	MN-RK-7280	81432206138	MN-DL-10281	81432306061	DF-RK-8503	81437040029	MN-SB-5249
070400009000	CV-RK-8118	81432206140	MN-DL-8590	81432306068	MN-RK-7280	81437040032	MN-SB-5265
070550504	CV-RK-5311	81432206151	MN-DL-10286	81432309031	MN-DL-9370	81437040057	MN-SB-9396
070550504	CV-RK-8118	81432206161	MN-DL-8733	81432506007	MN-DL-9381	81437040061	MN-SB-5243
10220897	MN-ES-10334	81432206164	MN-TC-12400	81432506009	MN-RK-8723	8143706054	MN-VB-5222
10307400A	MN-RK-7280	81432206165	MN-TC-12400	81432506014	MN-TC-12471	81437220020	MN-SB-5243
10307800A	MN-RK-7291	81432206166	MN-TC-12400	81432706030	MN-VB-5222	81437220021	MN-SB-5242
11013547	CV-RK-5311	81432206174	MN-DL-7803	81432706034	MN-VB-5222	81437220022	MN-SB-5246
11013547	CV-RK-8118	81432206177	MN-DL-9368	81432706040	DB-RK-7267	81437220038	MN-SB-5246
11019869	IV-ES-8507	81432206177	MN-DL-9369	81432706045	DB-RK-7267	81437220039	MN-SB-5242
1104335	CV-RK-5311	81432206183	MN-DL-10286	81432706053	MN-VB-8565	81437220063	MN-SB-5242
1104335	CV-RK-8118	81432206185	MN-DL-7797	81432706054	MN-VB-5222	81466106301	MN-DL-2131
12216380	IV-ES-8507	81432206187	MN-DL-10284	81432706055	MN-VB-5222	81466106305	MN-DL-2131
1271126	MN-ES-10333	81432206189	MN-DL-7272	81432706055	MN-VB-8569	81466106333	MN-DL-3588
14606948	MN-ES-8490	81432206190	MN-DL-8733	81432706056	MN-VB-5222	81466106334	MN-DL-3588
1953248	CV-RK-5311	81432206191	MN-DL-10281	81432706056	MN-VB-8569	81466106348	MN-DL-12278
1953248	CV-RK-8118	81432206196	MN-DL-8544	81432706057	MN-VB-5222	81466106354	MN-DL-3588
21032592	CV-RK-8118	81432206202	MN-RK-9383	81432706064	MN-RK-7280	81466106355	MN-DL-3588
3090291	MN-ES-10333	81432206203	IV-RK-8998	81432706065	MN-RK-8523	81466106360	MN-DL-3588
3093714	MN-ES-10334	81432206204	MN-RK-8558	81432706067	MN-VB-5222	81466106361	MN-DL-3588
3099128	MN-ES-10333	81432206215	MN-TC-12400	81432706067	MN-VB-8569	81466106374	MN-DL-2172
3500506	CV-RK-5311	81432206216	MN-DL-8714	81432706068	MN-VB-5222	81466106375	MN-DL-7786
3500506	CV-RK-8118	81432206221	MN-VB-5238	81432706068	MN-VB-8569	81466106578	MN-DL-2162
3573330205	MN-DL-7797	81432206222	MN-DL-8663	81432706074	MN-VB-5222	81466106579	MN-DL-12284
3574602005	MN-DL-7786	81432206227	MN-TC-12400	81432706075	MN-VB-5222	81466106580	MN-DL-12284
3574602305	MN-DL-7786	81432206228	MN-TC-12400	81432706075	MN-VB-8569	81466106624	MN-DL-12284
36466106012	MN-DL-10314	81432206229	MN-DL-5225	81432706076	MN-VB-5222	81466106654	MN-DL-8686
36466106040	MN-DL-10314	81432206232	MN-DL-8544	81432706077	MN-VB-5222	81466106656	MN-DL-12421
42065912	CV-RK-8118	81432206233	MN-DL-8544	81432706077	MN-VB-8569	81466106659	MN-DL-12421
42488722	CV-RK-5311	81432206236	MN-DL-5225	81432706078	MN-VB-5222	81466106669	MN-DL-12421
42488722	CV-RK-8118	81432206241	VL-RK-9497	81432706079	MN-RK-8537	81466106684	MN-DL-7786
42533102	CV-ES-2146	81432206244	MN-RK-12436	81432706080	MN-RK-8678	81466106692	MN-DL-12432
42538048	MN-ES-10333	81432206247	MN-DL-8488	81432706081	MN-VB-5222	81466106693	MN-DL-12432
5001842823	CV-RK-5311	81432206258	MN-DL-10283	81432706081	MN-VB-8569	81466106695	MN-DL-12432
5001842823	CV-RK-8118	81432206260	MN-DL-8663	81432706082	MN-VB-5222	81466106704	MN-DL-2162
55175540	IV-ES-8507	81432206264	MN-DL-10283	81432706087	MN-VB-8514	81466106705	MN-DL-2162
634303610	CV-RK-5311	81432206265	MN-TC-12399	81432706088	MN-VB-8514	81466106721	MN-DL-3588
634303610	CV-RK-8118	81432206267	MN-DL-5225	81432706094	MN-VB-8514	81466106722	MN-DL-3588
638862	CV-RK-5311	81432206268	MN-DL-8709	81432706095	MN-VB-8514	81466106723	MN-DL-3588
638862	CV-RK-8118	81432206270	MN-DL-5225	81432706096	MN-VB-5238	81466106725	MN-DL-0549
639287	CV-RK-5311	81432206272	MN-DL-5225	81432706097	MN-VB-9403	81466106753	MN-DL-2133
639287	CV-RK-8118	81432206274	MN-DL-8709	81432706099	MN-RK-8537	81466106754	MN-DL-2133
689748	MN-RK-7280	81432206275	MN-DL-10283	81432706105	DB-RK-8581	81466106767	MN-DL-8487
696321	MN-RK-8537	81432206276	MN-DL-10286	81432706110	DB-RK-10375	81466106768	MN-DL-8487
7000307001	CV-RK-5311	81432206278	MN-DL-10283	81432706113	MN-VB-9403	81466106774	MN-DL-8487

...MAN	MOOG	...MAN	MOOG	...MAN	MOOG	...MAN	MOOG
81466106779	MN-DL-2176	81467106081	MN-DL-2293	81467116819	MN-DL-12365	81953016074	CV-ES-12461
81466106780	MN-DL-2176	81467106112	MN-DL-2160	81467116841	MN-DL-7781	81953016087	CV-ES-14162
81466106782	MN-DL-2176	81467106136	MN-DL-8370	81467116855	MN-DL-12287	81953016090	CV-ES-14163
81466106790	MN-DL-7792	81467106137	MN-DL-2293	81467116856	MN-DL-12287	81953016091	CV-ES-14162
81466106791	MN-DL-7792	81467106163	MN-DL-2160	81467116857	MN-DL-12287	81953016095	SC-ES-5764
81466106794	MN-DL-7808	81467106165	MN-DL-2160	81467116858	MN-DL-7802	81953016107	CV-ES-14162
81466106798	MN-DL-2162	81467106172	MN-DL-8370	81467116859	MN-DL-7802	81953016108	CV-ES-14163
81466106799	MN-DL-2162	81467106198	MN-DL-2160	81467116860	MN-DL-7802	81953016112	CV-ES-14163
81466106807	MN-DL-7801	81467106236	MN-DL-12293	81467116861	MN-DL-7802	81953016120	CV-ES-14162
81466106808	MN-DL-7801	81467106238	MN-DL-7835	81467116863	MN-DL-7802	81953016125	CV-ES-14162
81466106809	MN-DL-8560	81467106240	MN-DL-7835	81467116874	MN-DL-10268	81953016126	CV-ES-14163
81466106810	MN-DL-8560	81467106242	MN-DL-7835	81467116875	MN-DL-10268	81953016131	CV-ES-2119
81466106811	MN-DL-8646	81467106268	MN-DL-12293	81467116876	MN-DL-10268	81953016132	CV-RK-5313
81466106812	MN-DL-8646	81467106295	MN-DL-8370	81467116877	MN-DL-8734	81953016133	MN-RK-7287
81466106813	MN-DL-14107	81467106314	MN-DL-8486	81467116878	MN-DL-8734	81953016134	CV-ES-2774
81466106816	MN-DL-12285	81467106315	MN-DL-8486	81467116879	MN-DL-8734	81953016135	DB-ES-0834
81466106823	MN-DL-8560	81467106316	MN-DL-8486	81467116882	MN-DL-7802	81953016139	CV-ES-2534
81466106826	MN-DL-12285	81467106337	MN-DL-8370	81467116883	MN-DL-7802	81953016140	DB-ES-0834
81466106838	MN-DL-8560	81467106345	MN-DL-8370	81467116886	MN-DL-10269	81953016142	CV-ES-2774
81466106839	MN-DL-8560	81467106353	MN-DL-2160	81467116887	MN-DL-12365	81953016143	CV-ES-14163
81466116003	MN-DL-8197	81467106354	MN-DL-2160	81467116893	MN-DL-9380	81953016149	CV-ES-14163
81466116004	MN-DL-8197	81467106356	MN-DL-12293	81467116894	MN-DL-9380	81953016152	CV-ES-14162
81466116005	MN-DL-8197	81467106361	MN-DL-2160	81467116896	MN-DL-9380	81953016154	CV-ES-14163
81466116006	MN-DL-12421	81467106378	MN-DL-2174	81467116897	MN-DL-10269	81953016155	CV-ES-14162
81466116007	MN-DL-12421	81467106395	MN-DL-7781	81467116898	MN-DL-10269	81953016156	CV-ES-14163
81466116014	MN-DL-8487	81467106396	MN-DL-2175	81467116899	MN-DL-10269	81953016157	CV-ES-14162
81466116016	MN-DL-7786	81467106409	MN-DL-7835	81467116920	MN-DL-7802	81953016162	CV-ES-12462
81466116019	MN-DL-2172	81467106410	MN-DL-7835	81467116921	MN-DL-7802	81953016163	CV-ES-12461
81466116044	MN-DL-7808	81467106411	MN-DL-7835	81467116933	MN-DL-12293	81953016168	CV-ES-14162
81466116045	MN-DL-7804	81467106418	MN-DL-2166	81467116934	MN-DL-12293	81953016168	CV-ES-14163
81466116061	MN-DL-8686	81467106421	MN-DL-8370	81467116952	MN-DL-12284	81953016169	CV-ES-2121
81466116085	MN-DL-7808	81467106434	MN-DL-7833	81467116966	MN-DL-12293	81953016169	DF-ES-9335
81466116087	MN-DL-7801	81467106435	MN-DL-7833	81953010013	CV-ES-12461	81953016170	CV-ES-2182
81466116088	MN-DL-7801	81467106436	MN-DL-7837	81953010014	CV-ES-12462	81953016172	CV-ES-2121
81466116096	MN-DL-7801	81467106437	MN-DL-7837	81953010015	CV-ES-14162	81953016172	DF-ES-9335
81466116097	MN-DL-7801	81467106438	MN-DL-2138	81953010016	CV-ES-14163	81953016176	CV-ES-2121
81466116099	MN-DL-7801	81467106439	MN-DL-2138	81953010038	CV-ES-2121	81953016176	DF-ES-9335
81466116104	MN-DL-8560	81467106442	MN-DL-5232	81953010038	DF-ES-9335	81953016178	CV-ES-14163
81466116105	MN-DL-8560	81467106451	MN-DL-8370	81953010040	MN-ES-10348	81953016179	CV-ES-14162
81466116107	MN-DL-8560	81467106455	MN-DL-7837	81953010042	CV-ES-12462	81953016181	CV-ES-14162
81466116132	MN-DL-7801	81467106456	MN-DL-7833	81953010045	CV-ES-2121	81953016184	CV-ES-0914
81466116133	MN-DL-7801	81467106851	MN-DL-7781	81953010064	CV-ES-12462	81953016194	CV-ES-14163
81466116134	MN-DL-8560	81467106852	MN-DL-7781	81953010068	CV-ES-12462	81953016200	CV-ES-2120
81466116135	MN-DL-8560	81467106853	MN-DL-7781	81953010074	CV-ES-12461	81953016202	CV-ES-2120
81466116136	MN-DL-7801	81467106862	MN-DL-2141	81953010075	CV-ES-14163	81953016203	CV-ES-2120
81466116137	MN-DL-8560	81467106865	MN-DL-2127	81953010079	CV-ES-2534	81953016206	CV-ES-14163
81466116138	MN-DL-8646	81467106866	MN-DL-2127	81953010082	CV-ES-12461	81953016219	CV-ES-2146
81466116139	MN-DL-8646	81467106876	MN-DL-8370	81953010083	CV-ES-14162	81953016222	CV-ES-2534
81466116146	MN-DL-14107	81467106902	MN-DL-8624	81953010084	CV-ES-14163	81953016223	CV-ES-14162
81466116147	MN-DL-14107	81467106904	MN-DL-2175	81953010087	CV-ES-14162	81953016224	CV-ES-14163
81466116148	MN-DL-14107	81467106912	MN-DL-2174	81953010088	CV-ES-14163	81953016225	CV-ES-2146
81466116151	MN-DL-12285	81467106933	MN-DL-2140	81953010094	CV-ES-14163	81953016226	CV-ES-2146
81466116154	MN-DL-12393	81467106966	MN-DL-8371	81953010103	CV-ES-14163	81953016227	CV-ES-2120
81466116155	MN-DL-12393	81467106994	MN-DL-2177	81953016016	CV-ES-2121	81953016233	MN-ES-8611
81466116156	MN-DL-12393	81467116356	MN-DL-12293	81953016016	DF-ES-9335	81953016234	CV-ES-14163
81466116161	MN-DL-8599	81467116711	MN-DL-2140	81953016029	CV-ES-14162	81953016235	DF-ES-9335
81466116162	MN-DL-8599	81467116712	MN-DL-2141	81953016030	CV-ES-14162	81953016236	MN-ES-10334
81466116174	MN-DL-12289	81467116714	MN-DL-8371	81953016030	CV-ES-14163	81953016237	CV-ES-14162
81466116175	MN-DL-12289	81467116715	MN-DL-8621	81953016043	CV-ES-14162	81953016238	IV-ES-8507
81466116176	MN-DL-12289	81467116719	MN-DL-7781	81953016043	CV-ES-14163	81953016239	CV-ES-12462
81466116197	MN-DL-7801	81467116720	MN-DL-12284	81953016044	CV-ES-14162	81953016240	CV-ES-12462
81466116198	MN-DL-7801	81467116722	MN-DL-8624	81953016048	CV-ES-14163	81953016242	CV-ES-14163
81466116199	MN-DL-8560	81467116723	MN-DL-12293	81953016049	CV-ES-14163	81953016246	CV-ES-12462
81466116200	MN-DL-8560	81467116725	MN-DL-2160	81953016050	CV-ES-14162	81953016249	DB-ES-0834
81466116201	MN-DL-8646	81467116726	MN-DL-2177	81953016053	CV-ES-14163	81953016250	CV-ES-12462
81466116202	MN-DL-8646	81467116729	MN-DL-7781	81953016054	CV-ES-14162	81953016251	CV-ES-0914
81466116204	MN-DL-14107	81467116730	MN-DL-12284	81953016060	DB-ES-0834	81953016252	CV-ES-14163
81466116205	MN-DL-7801	81467116762	MN-DL-8370	81953016061	CV-ES-14163	81953016254	CV-ES-14162
81466116206	MN-DL-8560	81467116770	MN-DL-10268	81953016063	CV-ES-2119	81953016255	MN-ES-8611
81466116216	MN-DL-3588	81467116771	MN-DL-8734	81953016064	CV-ES-2182	81953016263	CV-ES-2149
81466116217	MN-DL-10314	81467116772	MN-DL-10268	81953016065	CV-ES-12462	81953016266	CV-ES-2121
81466116244	MN-DL-12289	81467116773	MN-DL-7802	81953016067	CV-ES-12462	81953016266	DF-ES-9335
81466116720	MN-DL-12284	81467116794	MN-DL-12293	81953016068	CV-ES-12461	81953016266S1	DF-ES-9335
81467100123	DB-ES-8498	81467116803	MN-DL-9380	81953016071	SC-ES-5764	81953016267	CV-ES-2146
81467106080	MN-DL-8370	81467116818	MN-DL-12365	81953016073	CV-ES-12462	81953016268	MN-ES-10333

...MAN	MOOG	...MAN	MOOG	...MERCEDES-BENZ	MOOG	...MERCEDES-BENZ	MOOG
81953016270	DF-ES-8362	82953010010	IV-ES-12272	0003220323	DB-DL-9254	0003500511	DF-RK-8685
81953016271	SC-ES-8535	82953016012	CV-ES-14163	0003220423	DB-DL-9271	0003500613	DB-RK-6111
81953016272	CV-ES-12462	82953016014	CV-ES-12462	0003220623	DB-DL-9254	0003500805	DB-RK-9297
81953016273	CV-ES-12461	82953016016	MN-ES-8490	0003220723	DB-DL-9271	0003501005	DB-RK-8674
81953016274	CV-ES-14163	82953016018	MN-ES-10333	0003232150	DB-SB-5259	0003501013	CV-RK-7850
81953016275	CV-ES-14162	82953016019	MN-ES-10333	0003235985	DB-SB-10407	0003501305	DB-RK-8635
81953016276	CV-ES-0914	83466106001	MN-DL-10314	0003236285	DB-SB-5279	0003501705	DF-RK-9336
81953016277	MN-ES-8611	83466106501	MN-DL-10314	0003237185	DB-SB-5279	0003501905	SC-RK-8688
81953016278	CV-ES-14163	85.46610.6022	MN-DL-12433	0003237485	DB-SB-5260	0003502005	DB-RK-8555
81953016279	CV-ES-14162	85.46610.6056	MN-DL-12291	0003237585	DB-SB-5260	0003502105	DB-RK-8550
81953016280	IV-ES-12272	85.46610.6122	MN-DL-12433	0003237985	DB-SB-5260	0003502205	DB-RK-8626
81953016281	MN-ES-8490	85.46610.6155	MN-DL-12433	0003238185	DB-SB-10406	0003502405	DB-RK-10375
81953016282	CV-ES-12462	85.46610.6222	MN-DL-12433	0003250596	DB-SB-10401	0003502505	DB-RK-8626
81953016283	CV-ES-12461	85432206002	DB-RK-9300	0003250696	DB-SB-10400	0003502705	DB-RK-8391
81953016284	CV-ES-14163	85461106141	MN-DL-8377	0003250796	DB-SB-10401	0003502805	DB-RK-8581
81953016286	CV-ES-14163	85466106012	MN-DL-8662	0003250896	DB-SB-10400	0003503105	DB-RK-9294
81953016286	SC-ES-8517	85466106018	MN-DL-8376	0003262481	DB-SB-10407	0003503405	DB-RK-8626
81953016288	SC-ES-7279	85466106020	MN-DL-12432	0003262681	DB-SB-5250	0003503505	DB-RK-10375
81953016291	CV-ES-2146	85466106021	MN-DL-2132	0003262981	DB-SB-10407	0003503605	DB-RK-9291
81953016302	CV-ES-2121	85466106032	MN-DL-12282	0003263081	DB-SB-5250	0003503705	DB-RK-8710
81953016302	DF-ES-9335	85466106102	MN-DL-0549	0003263281	DB-SB-5250	0003504405	DB-RK-10374
81953016308	CV-ES-14163	85466106103	MN-DL-12282	0003264481	DB-SB-5261	0003504505	DB-RK-8626
81953016310	CV-ES-14163	85466106104	MN-DL-2133	0003264781	DB-SB-5261	0003504605	DB-RK-8550
81953016312	CV-ES-14163	85466106105	MN-DL-8377	0003265181	DB-SB-10409	0003504705	DB-RK-8555
81953016315	CV-ES-2534	85466106108	MN-DL-8374	0003300035	CV-ES-12461	0003504805	MN-RK-8997
81953016316	DB-ES-0834	85466106112	MN-DL-8662	0003300080	DB-RK-9262	0003504905	DB-RK-10375
81953016319	CV-ES-12462	85466106118	MN-DL-8376	0003300107	MN-RK-9392	000360098524	DB-DL-9218
81953016320	CV-ES-12461	85466106120	MN-DL-12432	0003300135	CV-ES-12462	000390098524	DB-DL-9218
81953016325	SC-ES-8535	85466106121	MN-DL-2132	0003300207	DF-RK-8503	0004600348	CV-ES-14163
81953016328	DB-ES-0834	85466106140	MN-DL-2132	0003300235	DB-ES-0830	0004600705	DB-DL-12308
81953016329	CV-ES-2534	85466106141	MN-DL-8377	0003300248	CV-ES-12462	0004600948	CV-ES-14163
81953016331	MN-ES-10334	85466106142	MN-DL-8662	0003300611	CV-RK-5311	0004601005	DB-DL-8735
81953016337	MN-ES-8490	85466106144	MN-DL-8374	0003300635	CV-ES-2774	0004601105	DB-DL-8735
81953016347	CV-ES-14163	85466106151	MN-DL-12432	0003300707	MN-RK-7280	0004601748	DB-ES-5234
81953016350	CV-ES-14163	85466106152	MN-DL-8376	0003300735	DB-ES-0830	0004602148	ME-ES-0643
81953016351	CV-ES-14162	85466106156	MN-DL-8378	0003300827	DB-ES-7782	0004602648	DB-ES-0822
81953016352	CV-ES-14163	85466106160	MN-DL-12394	0003301335	DB-ES-1084	0004602848	CV-ES-14163
81953016358	DB-ES-0834	85466106162	MN-DL-9379	0003301411	DB-RK-8638	0004602948	CV-ES-14163
81953016360	CV-ES-12462	85466106163	MN-DL-10203	0003301435	DB-ES-0834	0004603548	CV-ES-14162
81953016361	CV-ES-12461	85466106202	MN-DL-12282	0003301535	DB-ES-0834	0004604005	DB-DL-8307
81960200286	MN-SB-5252	85466106205	MN-DL-8377	0003301611	DB-RK-8725	0004604305	DB-DL-8618
81960200340	MN-SB-10389	85466106208	MN-DL-8374	0003302011	DB-RK-9300	0004604405	DB-DL-8131
81960200341	MN-SB-10390	85466106212	MN-DL-8662	0003302511	DB-RK-10372	0004604848	DB-ES-8617
81960200373	MN-SB-10390	85466106218	MN-DL-8376	0003302611	DB-RK-10372	0004604905	DB-DL-10216
81960200384	MN-SB-10387	85466106231	MN-DL-8377	0003302635	DB-ES-2753	0004604948	SC-ES-5764
81960200385	MN-SB-10390	85466106246	MN-DL-12394	0003302735	DB-ES-2752	0004605748	CV-ES-0543
81960200408	MN-SB-10390	88953016014	CV-ES-14163	0003302935	DB-ES-2559	0004605848	CV-ES-0888
81960200418	MN-SB-10390	90804102156	CV-ES-14163	0003303135	DB-ES-1281	0004606005	DB-DL-12309
81962100278	MN-SB-5278	90804102216	CV-ES-12461	0003303235	CV-ES-12462	0004606048	CV-ES-0543
81962100450	MN-SB-5246	90804102218	CV-ES-12462	0003304135	DB-ES-2559	0004606148	CV-ES-0888
81962100469	MN-SB-5246	90804102272	CV-ES-14163	0003305035	ME-ES-0643	0004606305	DB-DL-12309
8226232066	CV-RK-5311	90804102612	CV-ES-12461	0003305248	CV-ES-14163	0004606548	ME-ES-1760
8226232066	CV-RK-8118	90804102696	CV-ES-14163	0003305835	CV-ES-12462	0004606605	DB-DL-8138
82262320660	CV-RK-5311	90804102710	CV-ES-14163	0003306935	DB-ES-2753	0004606848	CV-ES-0543
82262320660	CV-RK-8118	90804102720	CV-ES-12461	0003307035	DB-ES-2752	0004606948	CV-ES-0888
82432206007	MN-DL-8709	90804153107	CV-ES-12461	0003307335	CV-ES-12462	0004607048	CV-ES-0543
82432206008	MN-DL-10288	90804153111	CV-ES-12462	0003307635	DB-ES-1084	0004607105	DB-DL-5230
82432206008	MN-DL-12288	90804153113	CV-ES-12461	0003308135	DB-ES-1281	0004607148	CV-ES-0888
82432209008	MN-DL-10288	93192618	CV-RK-8118	0003308535	CV-ES-2774	0004607205	DB-DL-5230
82432209008	MN-DL-12288	938423	CV-RK-5311	0003308635	DB-ES-0830	0004607248	CV-ES-2774
82466106021	MN-DL-12281	938423	CV-RK-8118	0003309335	DB-ES-0834	0004607348	DB-ES-0830
82466106057	MN-DL-12391	95301.0084	CV-ES-14163	0003309435	CV-ES-2534	0004607748	DB-ES-7783
82466106079	MN-DL-12279	9544171010099	CV-RK-8118	0003309535	DB-ES-0834	0004607848	DB-ES-7784
82466106080	MN-DL-2172	N2953016001	CV-ES-14163	0003309835	DB-ES-1084	0004608348	CV-ES-12462
82466106143	MN-DL-12279			0003330827	DB-ES-7782	0004608505	DB-DL-12299
82466106147	MN-DL-12391			0003383410	CV-ES-12462	0004608948	CV-ES-14163
82466106153	MN-DL-12279			0003384929	DB-ES-2558	0004609048	CV-ES-0888
82466106183	MN-DL-8599	0002685989	DB-ES-8500	0003387310	CV-ES-14163	0004609205	DB-DL-5241
82466106184	MN-DL-12285	0003200011	CV-RK-5311	0003406213	CV-ES-12461	0004609305	DB-DL-5241
82466106185	MN-DL-12285	0003200132	DB-DL-12363	0003500105	DB-RK-8564	0004609405	DB-DL-8168
82466106186	MN-DL-8599	0003200532	DB-DL-12363	0003500105	MN-RK-9387	0004609505	DB-DL-8168
82466106187	MN-DL-8599	0003200832	DB-DL-12363	0003500405	DB-RK-8564	0004609805	DB-DL-5233
82466106189	MN-DL-2172	0003201132	DB-DL-12363	0003500413	DB-RK-7267	0004609905	DB-DL-5233
82466106190	MN-DL-2172	0003201232	DB-DL-12364	0003500506	CV-RK-5311	0004632229	CV-ES-12462
82466106191	MN-DL-7792	0003220223	DB-DL-9272	0003500506	CV-RK-8118	0004632429	DB-ES-8570

MERCEDES-BENZ MOOG



...MERCEDES-BENZ MOOG

0004632529 DB-ES-8570
 0004633129 CV-ES-12462
 0004633229 CV-ES-2774
 0004633429 CV-ES-12462
 0004633529 CV-ES-12462
 0005861035 CV-RK-5313
 0005861035 DB-RK-8380
 0005861135 DB-RK-6111
 0005861235 DB-RK-7267
 0005861433 CV-RK-1583
 0005861833 DB-RK-8564
 0009964845 IV-ES-12272
 0009965145 DB-ES-8510
 0009965645 DB-ES-8510
 0009966645 DB-ES-8492
 0009966745 DB-ES-8491
 0009966845 DB-ES-8387
 0009967045 DB-ES-8387
 001 460 37 48 CV-ES-14162
 0013300035 DB-ES-1084
 0013300135 CV-ES-12462
 0013300235 CV-ES-12462
 0013302635 DB-ES-2558
 0013306635 CV-ES-12461
 0013306735 CV-ES-12462
 0013308835 CV-ES-12461
 0014600248 CV-ES-14163
 0014600305 DB-DL-5412
 0014600405 DB-DL-5412
 0014600448 CV-ES-0543
 0014600505 DB-DL-9263
 0014600548 DB-ES-0888
 0014600605 DB-DL-9263
 0014600648 DB-ES-8617
 0014600705 DB-DL-8639
 0014600805 DB-DL-8639
 0014600848 CV-ES-14163
 0014601105 DB-DL-8185
 0014601148 CV-ES-0543
 0014601248 CV-ES-14163
 0014601305 DB-DL-8184
 0014601348 CV-ES-0888
 0014601405 DB-DL-8184
 0014601505 DB-DL-12300
 0014601548 DB-ES-8323
 0014601648 DB-ES-8323
 0014601748 CV-ES-0543
 0014602048 DB-ES-7784
 0014602148 DB-ES-7783
 0014602248 CV-ES-14163
 0014602448 CV-ES-0543
 0014602505 DB-DL-10213
 0014602548 CV-ES-0888
 0014602705 DB-DL-10213
 0014602905 DB-DL-5231
 0014602948 DB-ES-8529
 0014603005 DB-DL-5231
 0014603448 CV-ES-12462
 0014603848 DB-ES-8530
 0014604048 CV-ES-12461
 0014604148 CV-ES-12462
 0014604205 DB-DL-9256
 0014604248 DB-ES-8164
 0014604348 CV-ES-12461
 0014604448 CV-ES-12462
 0014604848 DB-ES-8530
 0014604905 DB-DL-12403
 0014605048 DB-ES-8164
 0014605105 DB-DL-8641
 0014605148 DB-ES-8530
 0014605305 DB-DL-10208
 0014606348 CV-ES-12462
 0014606705 DB-DL-5230
 0014606905 DB-DL-5241
 0014607005 DB-DL-8639

...MERCEDES-BENZ MOOG

0014607105 DB-DL-8168
 0014607305 DB-DL-12300
 0014607405 DB-DL-12403
 0014607648 CV-ES-0543
 0014607748 CV-ES-14163
 0014607848 CV-ES-14162
 0014607948 CV-ES-0888
 0014608105 DB-DL-8641
 0014608348 DB-ES-12462
 0014608448 CV-ES-12462
 0014608548 DB-ES-8164
 0014608605 DB-DL-8642
 0014608648 DB-ES-8530
 0014608705 DB-DL-8642
 0014609005 DB-DL-8622
 0014609105 DB-DL-8622
 0014609648 CV-ES-0543
 0014609705 DB-DL-8672
 0014609748 CV-ES-12462
 0014609805 DB-DL-8167
 0014609905 DB-DL-8167
 0014609948 DB-ES-8530
 0019963145 DB-ES-8510
 002 460 03 48 CV-ES-14162
 0023301135 CV-ES-12462
 0023301535 CV-ES-14163
 0024600148 DB-DL-5412
 0024600248 DB-DL-5412
 0024600405 CV-ES-0543
 0024600505 DB-DL-9263
 0024600548 DB-DL-9263
 0024600605 DB-ES-8617
 0024600648 DB-ES-8617
 0024601005 DB-DL-8639
 0024601648 DB-DL-8639
 0024601705 CV-ES-14163
 0024602405 DB-DL-8185
 0024602505 CV-ES-0543
 0024603005 CV-ES-14163
 0024603105 DB-DL-8184
 0024604305 CV-ES-0888
 0024604405 DB-DL-8184
 0024604505 DB-DL-12300
 0024604605 DB-ES-8323
 0024604705 DB-ES-8323
 0024604805 CV-ES-0543
 0024604905 DB-ES-7784
 0024605005 DB-ES-7783
 0024605105 CV-ES-14163
 0024605205 CV-ES-0543
 0024605305 DB-DL-10213
 0024605405 CV-ES-0888
 0024606105 DB-DL-10213
 0024606205 DB-DL-5231
 0024606305 DB-ES-8529
 0024606405 DB-DL-5231
 0024607505 CV-ES-12462
 0024607605 DB-ES-8530
 0024608605 CV-ES-12461
 0024608705 CV-ES-12462
 0024608805 DB-DL-9256
 0024608905 DB-ES-8164
 0024609205 CV-ES-12461
 0024609305 CV-ES-12462
 0024609605 DB-ES-8530
 0024609705 DB-DL-12403
 0034601805 DB-ES-8164
 0034601905 DB-DL-8641
 0034602905 DB-ES-8530
 0034603105 DB-DL-10208
 0034603205 CV-ES-12462
 0034603305 DB-DL-5230
 0034604005 DB-DL-5241
 0034604205 DB-DL-8639

...MERCEDES-BENZ MOOG

0034604405 DB-DL-8717
 0034604505 DB-DL-10212
 0034604605 DB-DL-7815
 0034604705 DB-DL-8644
 0034604805 DB-DL-2144
 0034604905 DB-DL-7270
 0034605005 DB-DL-5405
 0034605605 DB-DL-8188
 0034605705 DB-DL-8392
 0034605805 DB-DL-12303
 0034605905 DB-DL-7799
 003501805 DB-RK-12372
 004608348 CV-ES-12462
 01208200A DB-DL-5213
 01208300A DB-DL-7270
 01208500A DB-DL-5231
 01208600A DB-DL-5230
 01212200A DB-DL-5219
 01213600A DB-DL-8185
 01214400A DB-DL-5412
 01214500A DB-DL-5239
 01214700A DB-DL-5217
 01215000A DB-DL-8122
 01215100A DB-DL-5207
 01215200A DB-DL-7831
 01215300A DB-DL-5241
 01215500A DB-DL-8307
 01215600A DB-DL-8121
 01215700A DB-DL-5216
 01215800A DB-DL-7815
 01215900A DB-DL-5405
 01217200A DB-DL-8188
 01217300A DB-DL-5233
 01217600A DB-DL-3228
 01217700A DB-DL-8184
 01218000A DB-ES-5214
 01219700A DB-DL-8172
 01219800A DB-DL-12298
 01219900A DB-DL-12438
 01302100A DB-DL-12298
 01302200A DB-DL-12438
 01303000A DB-DL-2144
 01303500A DB-DL-2144
 01303700A DB-DL-5405
 01303800A DB-DL-5405
 01303900A DB-DL-7270
 01304400A DB-DL-7270
 01304700A DB-DL-8188
 01307400A DB-DL-8188
 01307500A DB-DL-8307
 01311400A DB-DL-8307
 01317200A DB-DL-12466
 01319900A DB-DL-12466
 01320100A DB-DL-8702
 01320400A DB-DL-8702
 01320600A DB-DL-8167
 01320700A DB-DL-8167
 01321500A DB-DL-8717
 01328600A DB-DL-8717
 01328700A DB-DL-9259
 01329400A DB-DL-9259
 01330000A DB-DL-12301
 01331400A DB-DL-12301
 01335200A DB-DL-10212
 01335600A DB-DL-10212
 01336100A DB-DL-8392
 01336800A DB-DL-8392
 01337000A DB-DL-12303
 01337100A DB-DL-12303
 01337800A DB-DL-12299
 03305800A DB-DL-8185
 04688948 DB-DL-8184
 120322305 DB-DL-12300
 14204700A DB-DL-8307
 14600305 DB-DL-8702

...MERCEDES-BENZ MOOG

14600348 CV-ES-14162
 14600405 DB-DL-5412
 14600505 DB-DL-9263
 14600605 DB-DL-9263
 14600648 DB-ES-8617
 14600705 DB-DL-8639
 14600805 DB-DL-8639
 14601105 DB-DL-8185
 14601305 DB-DL-8184
 14601405 DB-DL-8184
 14601448 CV-ES-14162
 14601505 DB-DL-12300
 14601548 DB-ES-8323
 14601648 DB-ES-8323
 14602048 DB-ES-7784
 14602148 DB-ES-7783
 14602348 CV-ES-14162
 1460248 DB-DL-5405
 14602905 DB-DL-5231
 14602948 DB-ES-8529
 14603005 DB-DL-5231
 14603848 DB-ES-8530
 14604205 DB-DL-9256
 14604248 DB-ES-8164
 14604848 DB-ES-8530
 14604905 DB-DL-12403
 14605048 DB-ES-8164
 14605105 DB-DL-8641
 14605148 DB-ES-8530
 14606448 CV-ES-12461
 14606705 DB-DL-5230
 14606905 DB-DL-5241
 14607005 DB-DL-8639
 14607105 DB-DL-8168
 14607305 DB-DL-12300
 14607405 DB-DL-12403
 14607848 CV-ES-14162
 14608105 DB-DL-8641
 14608548 DB-ES-8164
 14608605 DB-DL-8642
 14608648 DB-ES-8530
 14608705 DB-DL-8642
 14609005 DB-DL-8622
 14609705 DB-DL-8672
 14609805 DB-DL-8167
 14609905 DB-DL-8167
 14609948 DB-ES-8530
 19963145 DB-ES-8510
 2205000400 DB-ES-5234
 24600405 DB-DL-8185
 24600505 DB-DL-8184
 24600548 DB-ES-8164
 24600648 DB-ES-8323
 24601005 DB-DL-12299
 24601705 DB-DL-8717
 24602405 DB-DL-12298
 24602505 DB-DL-12438
 24603005 DB-DL-12298
 24604505 DB-DL-5405
 24604605 DB-DL-5405
 24604705 DB-DL-7270
 24604805 DB-DL-7270
 24604905 DB-DL-8188
 24605005 DB-DL-8188
 24605105 DB-DL-8307
 24605205 DB-DL-8307
 24606105 DB-DL-8702
 24606205 DB-DL-8702
 24606405 DB-DL-8167
 24607505 DB-DL-8717
 24607605 DB-DL-8717
 24608605 DB-DL-9259
 24608705 DB-DL-9259
 24609605 DB-DL-8392
 24609705 DB-DL-8392

...MERCEDES-BENZ MOOG

2680181 CV-ES-2121 34604905
 2684889 CV-ES-2121 34605005
 2684889 DF-ES-9335 34605605
 2685289 CV-ES-2121 34605905
 2685989 DB-ES-8500 3463303903
 3013260081 DB-SB-9302 3463304903
 3023300035 CV-ES-12461 3500105
 3023300135 CV-ES-12461 3500405
 3023300235 CV-ES-12461 3500413
 3023300335 CV-ES-12461 3500506
 3093200073 DB-SB-10385 3500506
 3093301203 DB-DL-9143 3500511
 3093301303 DB-DL-9143 3500805
 3093301403 DB-DL-9143 3501005
 3093301603 DB-DL-9143 3501013
 3093301703 DB-DL-9143 3501305
 3093301803 DB-DL-9143 3501705
 3093301903 DB-DL-9143 3501905
 3093302003 DB-DL-9143 3502005
 3093302103 DB-DL-9143 3502105
 3103300435 ME-ES-0643 3502205
 3103301335 ME-ES-0643 3502405
 3143260153 DB-SB-10385 3502505
 3164600605 DB-DL-1179 3502705
 3164600805 DB-DL-1179 3502805
 3173330964 DB-SB-5312 3503105
 3173331164 DB-SB-5312 3503307035
 31733311645 DB-SB-5312 3503307135
 3173500606 DB-DL-3405 3503307335
 3183200073 DB-SB-10386 3503405
 3200011 CV-RK-5311 3503505
 3200132 DB-DL-12363 3503605
 3200532 DB-DL-12363 3503705
 3200832 DB-DL-12363 3504505
 3201132 DB-DL-12363 3504605
 3201232 DB-DL-12364 3504705
 3220223 DB-DL-9272 3504805
 3220323 DB-DL-9254 3504905
 3220423 DB-DL-9271 3563300003
 3220623 DB-DL-9254 3563300103
 3220723 DB-DL-9271 3563301410
 3232150 DB-SB-5259 3563301510
 3236285 DB-SB-5279 3563331304
 3237185 DB-SB-5279 3564630015
 3237485 DB-SB-5260 3573301911
 3237585 DB-SB-5260 3573303311
 3237985 DB-SB-5260 3573303411
 3238185 DB-SB-10406 3573330205
 3250796 DB-SB-10401 3573330405
 3262481 DB-SB-10407 3573500306
 3262681 DB-SB-5250 3574601005
 3263081 DB-SB-5250 3574601105
 3263281 DB-SB-5250 3574601405
 3264481 DB-SB-5261 3574601505
 3264781 DB-SB-5261 3574602005
 3300080 DB-RK-9262 3574602305
 3300107 MN-RK-9392 3574603105
 3300148 CV-ES-12461 3574603205
 3300207 DF-RK-8503 3574603505
 3300707 MN-RK-7280 360098524
 3300827 DB-ES-7782 3603200189
 3301411 DB-RK-8638 3603200789
 3301611 DB-RK-8725 3603201089
 3302011 DB-RK-9300 3643307135
 3305035 ME-ES-0643 3714607148
 3330827 DB-ES-7782 3752600637
 3453307135 CV-ES-12462 3752680189
 3453307235 CV-ES-12461 3753220423
 3453307435 CV-ES-12461 3753300111
 34602905 DB-DL-12299 3753500006
 34603105 DB-DL-8185 3753500105
 34603205 DB-DL-8184 3753500206
 34603305 DB-DL-12300 3754600005
 34604005 DB-DL-8307 3754600305
 34604605 DB-DL-7815 3754600405

...MERCEDES-BENZ MOOG

DB-DL-7270 3754600605
 DB-DL-5405 3754601105
 DB-DL-8188 3754601505
 DB-DL-7799 3754601605
 MN-DL-7834 3813500606
 MN-DL-7834 3823300403
 DB-RK-8564 3834600605
 DB-RK-8564 3834600805
 DB-RK-7267 3834601405
 CV-RK-5311 3834601605
 CV-RK-8118 3834602305
 DF-RK-8685 3834602405
 DB-RK-9297 3834604405
 DB-RK-8674 3834604505
 CV-RK-7850 3853301303
 DB-RK-8635 3853302103
 DF-RK-9336 3853302203
 SC-RK-8688 3853500006
 DB-RK-8555 3854600805
 DB-RK-8550 3854602005
 DB-RK-8626 3854603405
 DB-RK-10375 3873230285
 DB-RK-8626 3874600605
 DB-RK-8391 3874600805
 DB-RK-8581 3874604405
 DB-RK-9294 3874604505
 CV-ES-12462 390098524
 CV-ES-12461 3953201432
 CV-ES-12462 3953201532
 DB-RK-8626 3953500006
 DB-RK-10375 3953500206
 DB-RK-9291 3953500706
 DB-RK-8710 3963230050
 DB-RK-8626 3964603005
 DB-RK-8550 3964604805
 DB-RK-8555 4103500906
 MN-RK-8997 4163300003
 DB-RK-10375 4243300303
 DB-DL-9211 4254600105
 DB-DL-8728 4254600205
 DB-VB-3701 4254600305
 DB-VB-3700 4254600405
 DB-VB-3702 4274600005
 DB-DL-12375 4274600105
 DB-DL-8652 4274600305
 DB-DL-8652 4274600405
 DB-DL-3405 4374600105
 MN-DL-7797 4443330127
 DB-DL-3461 4524600405
 CV-TC-12384 4600648
 CV-DL-0546 4600705
 CV-DL-0546 4601005
 DB-DL-3228 4601105
 DB-DL-3228 4601248
 MN-DL-7786 4601748
 MN-DL-7786 4602148
 DB-DL-9188 4603448
 DB-DL-7795 4603548
 DB-DL-10209 4604005
 DB-DL-9218 4604148
 DB-DL-9208 4604305
 DB-DL-9208 4604405
 DB-DL-9208 4604548
 CV-ES-12462 4604848
 DB-ES-8529 4606005
 DB-DL-5405 4606305
 DB-ES-8492 4606605
 DB-DL-9254 4607105
 DB-DL-9218 4607205
 DB-DL-3475 4607748
 DB-VB-7790 4607848
 DB-DL-3475 4608505
 DB-DL-7815 4608548
 DB-DL-7799 4609205
 DB-DL-5405 4609305

...MERCEDES-BENZ MOOG

3754600605 DB-DL-9258
 3754601105 DB-DL-9258
 3754601505 DB-DL-8184
 3754601605 DB-DL-12300
 3813500606 DB-DL-5220
 3823300403 DB-DL-9261
 3834600605 DB-DL-5216
 3834600805 DB-DL-8121
 3834601405 DB-DL-5216
 3834601605 DB-DL-8121
 3834602305 DB-DL-5216
 3834602405 DB-DL-8121
 3834604405 DB-DL-5216
 3834604505 DB-DL-8121
 3853301303 DB-DL-8632
 3853302103 DB-DL-8632
 3853302203 DB-DL-8632
 3853500006 DB-DL-9164
 3854600805 DB-DL-8676
 3854602005 DB-DL-8676
 3854603405 DB-SB-5258
 3873230285 DB-DL-10140
 3874600605 DB-DL-10140
 3874600805 DB-DL-10140
 3874604405 DB-DL-10140
 3874604505 DB-DL-10140
 390098524 DB-DL-9218
 3953201432 DB-DL-9257
 3953201532 DB-DL-9226
 3953500006 DB-DL-6198
 3953500206 DB-DL-7839
 3953500706 DB-DS-6088
 3963230050 MN-SB-5254
 3964603005 DB-DL-9215
 3964604805 DB-DL-9215
 4103500906 DB-TC-12376
 4163300003 DB-DL-9225
 4243300303 DB-DL-9193
 4254600105 DB-DL-7775
 4254600205 DB-DL-7775
 4254600305 DB-DL-7775
 4254600405 DB-DL-7775
 4274600005 DB-DL-9194
 4274600105 DB-DL-9194
 4274600305 DB-DL-9194
 4274600405 DB-DL-9194
 4374600105 DB-DL-7775
 4443330127 DB-RK-9298
 4524600405 DB-DL-7775
 4600648 CV-ES-14162
 4600705 DB-DL-12308
 4601005 DB-DL-8735
 4601105 DB-DL-8735
 4601248 CV-ES-14162
 4601748 DB-ES-5234
 4602148 ME-ES-0643
 4603448 CV-ES-14162
 4603548 CV-ES-14162
 4604005 DB-DL-8307
 4604148 ME-ES-0643
 4604305 DB-DL-8618
 4604405 DB-DL-8131
 4604548 ME-ES-0643
 4604848 DB-ES-8617
 4606005 DB-DL-12309
 4606305 DB-DL-12309
 4606605 DB-DL-8138
 4607105 DB-DL-5230
 4607205 DB-DL-5230
 4607748 DB-ES-7783
 4607848 DB-ES-7784
 4608505 DB-DL-12299
 4608548 ME-ES-0643
 4609205 DB-DL-5241
 4609305 DB-DL-5241

...MERCEDES-BENZ MOOG

4609505 DB-DL-8168
 4609805 DB-DL-5233
 4609905 DB-DL-5233
 4632429 DB-ES-8570
 4632529 DB-ES-8570
 5001832580 CV-ES-0914
 5001832582 CV-ES-12462
 5861035 DB-RK-8380
 5861235 DB-RK-7267
 5861833 DB-RK-8564
 6133300003 DB-DL-9211
 6133300010 DB-VB-3701
 6133300103 DB-DL-8728
 6133300110 DB-VB-3700
 6133330004 DB-VB-3702
 6133330104 DB-VB-3702
 6134630015 DB-DL-12375
 6174602405 DB-DL-5239
 6174603205 DB-DL-8122
 6174603305 DB-DL-8122
 6174603405 DB-DL-5239
 6174603505 DB-DL-5207
 6174603605 DB-DL-5207
 6203200028 DB-RK-10378
 6203200628 DB-RK-5283
 6203300503 DB-ES-5209
 6203300603 DB-ES-5209
 6203500006 DB-DL-7840
 6203500106 DB-DL-7840
 6203500306 DB-DL-7840
 6204600005 DB-DL-6140
 6204600405 DB-DL-5217
 6204600805 DB-DL-5217
 6204602005 DB-DL-6140
 6204602905 DB-DL-5217
 6204603005 DB-DL-5217
 6213200428 DB-RK-5280
 6244600348 DF-ES-7777
 6253200111 DB-RK-5281
 6253200611 DB-RK-5303
 6253300903 DB-ES-5227
 6253301203 DB-ES-5227
 6253301503 DB-DL-8640
 6253301603 DB-DL-8640
 6253302403 DB-DL-8640
 6253302503 DB-DL-8640
 6253303203 MN-DL-7834
 6254602505 DB-DL-7831
 6254604805 DB-DL-8618
 6254605005 DB-DL-8131
 6273500206 DB-DL-8393
 6273500306 DB-DL-8393
 6283200189 DB-DL-7262
 6283200389 DB-DL-7263
 6283201289 DB-DL-7262
 6283201389 DB-DL-7263
 6283201489 DB-DL-12364
 6283300103 DB-DL-9261
 6283330003 DB-DL-7788
 6283330905 DB-DL-8393
 6283331705 DB-DL-8393
 6293200189 DB-DL-12364
 6293500106 DB-TC-12376
 6293501206 DB-TC-12376
 6293502806 DB-TC-12376
 6313300310 ME-ES-1760
 6313300503 ME-AX-2735
 6313380310 ME-ES-1760
 6314600705 ME-AX-2734
 6323200132 DB-DL-12364
 6323200232 DB-DL-12364
 6323200332 DB-DL-12363
 6323200532 DB-DL-12364
 6323500006 DB-TC-12376
 6443500306 DB-DL-8393

...MERCEDES-BENZ MOOG

A9764600405 DB-DL-12405
 GL11319 DB-RK-8626
 SA50831601 DB-DL-9218

METRO CAB MOOG

X6652675 CV-RK-5322
 X6652678 CV-RK-5322
 X6653769 CV-RK-7850
 X6653770 CV-RK-7850

NEOPLAN MOOG

070550504 CV-RK-5311
 070550504 CV-RK-8118
 082192200 CV-ES-12461
 082192300 CV-ES-12462
 082752400 CV-ES-12461
 11013547 CV-RK-5311
 11013547 CV-RK-8118
 11019659 CV-ES-14163
 11019669 DF-ES-5404
 11019869 IV-ES-8507
 11043547 CV-RK-8118
 120322305 DB-ES-5234
 120325000 CV-ES-14163
 120325101 CV-ES-12462
 120325200 CV-ES-14162
 120326200 RV-ES-8691
 122353201 CV-ES-14162
 122353202 CV-ES-14163
 14013769 CV-ES-14163
 521155208 CV-RK-5311
 521155208 CV-RK-8118
 70550504 CV-RK-8118
 81432206151 MN-DL-10286
 81432206183 MN-DL-10286
 81432206215 MN-TC-12400
 81432206276 MN-DL-10286
 81467116770 MN-DL-10268
 81467116772 MN-DL-10268
 81467116874 MN-DL-10268
 81467116875 MN-DL-10268
 81467116876 MN-DL-10268
 81467116886 MN-DL-10269
 81467116897 MN-DL-10269
 81467116898 MN-DL-10269
 81467116899 MN-DL-10269
 N1011020299 CV-ES-14162
 N1011020300 CV-ES-14163

NISSAN MOOG

79025190 CV-ES-2121

PACCAR MOOG

Y05683608 CV-RK-5311

PEGASO MOOG

193689 CV-ES-2121
 579343 CV-ES-12462

RENAULT TRUCKS MOOG

0000758006 RV-DL-10249
 0003406169 CV-ES-14163
 0003406212 CV-ES-12462
 0003406213 CV-ES-12461
 0003406236 CV-ES-14163
 0003406251 CV-ES-14163
 0003406253 CV-ES-12462
 0003406254 CV-ES-14163
 0003406260 CV-ES-14163

...RENAULT TRUCKS MOOG

0003406261 CV-ES-14163
 0014606948 MN-ES-8490
 0014607248 RV-ES-12331
 014607248 RV-ES-12331
 14606948 MN-ES-8490
 208471191 RV-DL-12468
 21051052 RV-DL-10299
 21560963 RV-DL-12334
 21560965 RV-DL-12338
 21560968 RV-DL-12337
 23162046 CV-ES-2121
 23162046 DF-ES-9335
 25370844 RV-DL-12338
 25370845 RV-DL-12337
 25379258 RV-DL-12319
 25379293 RV-DL-8415
 3401170 CV-ES-14162
 3401206 CV-ES-0912
 3401207 CV-ES-0914
 3406218 CV-ES-12461
 50 01 868 376 RV-DL-12478
 50 10 305 365 RV-DL-12480
 50 10 630 255 RV-DL-12480
 50 10 630 648 RV-DL-12478
 5000242159 CV-ES-12462
 5000242467 CV-ES-12461
 5000242488 CV-ES-12461
 5000288360 CV-ES-14163
 5000288361 RV-ES-8691
 5000288362 CV-ES-14162
 5000288363 CV-ES-14163
 5000295214 CV-ES-14163
 5000295215 CV-RK-5311
 5000295336 CV-RK-8118
 5000333285 CV-RK-8118
 5000350120 MN-DL-10286
 5000446681 MN-DL-10286
 5000516214 MN-TC-12400
 5000516214 MN-DL-10286
 5000541224 MN-DL-10268
 5000588470 MN-DL-10268
 5000590236 MN-DL-10268
 5000613598 MN-DL-10268
 5000613837 MN-DL-10268
 5000725267 MN-DL-10269
 5000786902 MN-DL-10269
 5000787472 MN-DL-10269
 5000790218 MN-DL-10269
 5000804824 CV-ES-14162
 5000805280 CV-ES-14163
 5000806187 CV-ES-2121
 5000812483 CV-ES-2121
 5000814096 CV-ES-2121
 5000814097 CV-ES-2121
 5000814347 CV-ES-2121
 5000820879 CV-ES-12461
 5000823654 CV-ES-12461
 5000869573 RV-DL-7282
 5000874575 RV-DL-10249
 5001014345 DF-RK-8671
 5001014520 MN-RK-8523
 5001830480 DB-ES-8323
 5001831473 CV-ES-12462
 5001832579 CV-ES-0912
 5001832580 CV-ES-0914
 5001832581 CV-ES-14162
 5001834533 CV-ES-12461
 5001842337 CV-ES-12462
 5001845430 CV-ES-12461
 5001849879 CV-ES-14163
 5001849880 CV-ES-14163
 5001850549 CV-ES-14163
 5001850550 CV-ES-12462
 5001850588 CV-ES-14163
 5001852263 CV-ES-14163

...RENAULT TRUCKS MOOG

5001852264 CV-ES-12462
 5001852452 SC-ES-7279
 5001853151 DB-ES-8498
 5001858759 CV-ES-14162
 5001858763 SC-ES-7279
 5001858773 CV-ES-14163
 5001858774 CV-ES-14162
 5001859984 CV-ES-12461
 5001859985 CV-ES-12462
 5001860123 CV-ES-2774
 5001860124 DB-ES-0830
 5001860770 CV-ES-2774
 5001866165 RV-ES-12331
 5001867774 RV-ES-12331
 5001868363 RV-DL-10243
 5001868366 RV-DL-12334
 5001868367 RV-DL-12337
 5001868374 RV-DL-10244
 5001868377 RV-DL-12319
 5001868384 RV-DL-8415
 5001868404 RV-DL-12338
 5001872606 DB-ES-8498
 5010037411 RV-DL-8160
 5010037576 RV-DL-8160
 5010037602 RV-DL-0907
 5010039426 RV-DL-10246
 5010060764 RV-DL-0902
 5010065789 RV-DL-10249
 5010094585 RV-DL-8198
 5010094840 RV-DL-7971
 5010097562 RV-DL-8170
 5010098467 RV-DL-8313
 5010130383 RV-DL-8136
 5010130386 RV-DL-10246
 5010130393 DB-RK-8366
 5010130451 RV-DL-8170
 5010130453 RV-DL-8317
 5010130456 CV-ES-2121
 5010130483 DF-ES-9335
 5010130740 RV-DL-8170
 5010144543 CV-ES-12461
 5010144543 CV-ES-14163
 5010144552 SC-DL-8137
 5010145077 RV-DL-0909
 5010145581 RV-DL-0900
 5010145584 RV-DL-7539
 5010207727 RV-DL-0905
 5010224899 RV-DL-7282
 5010229242 CV-ES-14163
 5010229243 CV-ES-12461
 5010238594 CV-ES-12461
 5010239387 CV-ES-12462
 5010245365 DB-ES-0830
 5010245591 CV-ES-2774
 5010245591 CV-ES-12461
 5010245591 CV-ES-12461
 5010253255 CV-ES-12461
 5010253256 CV-ES-12461
 5010268035 RV-DL-7282
 5010294287 RV-DL-10249
 5010294288 DF-RK-8671
 5010294289 MN-RK-8523
 5010294502 DB-ES-8323
 5010294709 CV-ES-12462
 5010294720 CV-ES-0912
 5010294831 CV-ES-0914
 5010305367 CV-ES-14162
 5010308082 CV-ES-12461
 5010308083 RV-RK-8648
 5010308214 DB-ES-8323
 5010308215 IV-ES-12272
 5010347406 MN-ES-8490
 5010347549 CV-ES-12462
 5010383097 CV-ES-12461
 5010383203 DB-RK-8366
 5010383528 CV-ES-12461

...RENAULT TRUCKS MOOG

5010389262 RV-DL-8159
 5010393015 RV-DL-12381
 5010393047 DB-RK-8366
 5010395796 RV-DL-8310
 5010395797 RV-DL-12321
 5010439021 RV-DL-8314
 5010439022 RV-DL-8318
 5010439023 RV-DL-8312
 5010439078 RV-DL-12467
 5010439631 RV-DL-8313
 5010439984 RV-DL-8199
 5010467915 RV-DL-8324
 5010488052 RV-DL-0886
 5010488053 RV-DL-8156
 5010488084 RV-DL-12448
 5010488096 RV-DL-8300
 5010488146 RV-DL-8653
 5010488165 RV-DL-8308
 5010488166 RV-DL-8306
 5010488167 RV-DL-8190
 5010488639 RV-DL-12448
 5010488759 RV-DL-12448
 5010488836 RV-DL-8316
 5010499243 RV-DL-12322
 5010517082 RV-DL-12322
 5010557243 RV-DL-0902
 5010557341 RV-DL-12448
 5010557423 RV-DL-8309
 5010557523 RV-DL-8316
 5010566049 RV-DL-8310
 5010566050 RV-DL-12321
 5010566051 RV-DL-12465
 5010566062 RV-DL-8312
 5010566063 RV-DL-8314
 5010566064 RV-DL-8318
 5010566157 RV-DL-12318
 5010587004 RV-DL-10243
 5010587034 RV-DL-12334
 5010587038 RV-DL-12334
 5010587049 RV-DL-12338
 5010587050 RV-DL-12337
 5010587052 DF-ES-9335
 5010587052 RV-DL-12338
 5010587053 RV-DL-12337
 5010600822 RV-DL-10243
 5010630637 RV-DL-10244
 5010630638 RV-DL-10244
 5010630649 RV-DL-12319
 5010630650 RV-DL-12319
 5010630822 RV-DL-8415
 5010630823 RV-DL-8415
 7020840815 VL-RK-8533
 7403193731 RV-ES-9432
 7403987648 RV-ES-12442
 7420390836 VL-SB-5356
 7420399543 RV-DL-12447
 7420443044 RV-TC-12340
 7420532931 RV-TC-12339
 7420547286 MN-RK-8501
 7420702095 VL-RK-9497
 7420713858 RV-DL-12329
 7420713860 RV-DL-12328
 7420741703 RV-VB-8191
 7420761145 RV-DL-10245
 7420829503 VL-VB-7787
 7420847190 RV-DL-12468
 7420847206 RV-DL-12317
 7420864583 RV-DL-10299
 7420937674 CV-ES-14163
 7420937674 SC-ES-8517
 7421051046 RV-TC-12339
 7421051052 RV-DL-10299
 7421560825 RV-DL-10244
 7421560838 RV-DL-12319
 7421560882 RV-DL-8415
 7421560945 RV-DL-12468

...RENAULT TRUCKS MOOG

7421560950 RV-DL-12317
 7421560957 RV-DL-10243
 7421560963 RV-DL-12334
 7421560965 RV-DL-12338
 7421560968 RV-DL-12337
 7422163637 RV-DL-12334
 7485104224 MN-RK-12436
 7485114919 RV-DL-8198
 7485114920 RV-DL-10246
 7485114925 RV-DL-8177
 7485114938 RV-DL-8186
 7485114941 RV-DL-8170
 7485134391 RV-ES-12331
 7700658834 RV-ES-8691
 7701011412 CV-ES-14163
 7701016946 CV-ES-12462
 81953020037 RV-RK-7849
 81953020049 RV-RK-7849
 81953020050 RV-RK-7849
 81953020059 RV-RK-7849
 RVVB8191 RV-VB-8191

...SCANIA MOOG

1379423 SC-DL-10302
 1384025 SC-DL-5229
 1384027 SC-DL-5354
 1385251 SC-DL-2161
 1385763 SC-DL-12449
 1386618 SC-DL-10225
 1386620 SC-DL-12341
 1388436 SC-DL-8623
 1393298 SC-DL-10302
 1393383 SC-DL-12413
 1394443 IV-ES-12272
 1394444 MN-ES-8490
 1394884 SC-DL-8399
 1395614 SC-DL-7264
 1397866 SC-DL-8137
 1399019 SC-DL-8400
 1399180 SC-DL-8179
 1399182 SC-TC-12472
 1409918 SC-DL-2161
 1426493 DB-ES-8498
 1428347 SC-ES-8179
 1431470 SC-DL-10302
 1431471 SC-DL-9446
 1431472 SC-DL-8713
 1431475 SC-DL-9459
 1431710 SC-DL-10304
 1432723 SC-DL-9449
 1433532 SC-DL-9458
 1433533 SC-DL-10273
 1435746 SC-ES-8517
 1435944 DB-RK-8366
 1440028 SC-VB-12418
 1450364 MN-RK-7280
 1455327 CV-RK-5311
 14606948 CV-RK-5311
 1464611 MN-RK-7280
 1485758 SC-RK-12366
 1485759 CV-ES-14162
 1485760 SC-DL-10302
 1486756 MN-RK-7280
 1486757 CV-RK-5311
 1486758 CV-RK-8118
 1488890 MN-RK-8537
 1488890 SC-RK-8575
 1494296 SC-DL-5354
 1499474 SC-DL-5229
 1499475 SC-DL-8137
 1499476 SC-DL-8400
 1499478 SC-DL-0305
 1500572 SC-DL-8127
 1500573 SC-DL-9440
 1500576 SC-DL-8127
 1501030 SC-DL-8127
 1506924 CV-ES-12462
 1506925 SC-DL-12342
 1515981 SC-DL-8182
 1517403 SC-DL-8169
 1527989 SC-DL-8154
 1534756 SC-DL-8553
 1603883 SC-DL-12343
 1722582 SC-TC-12361
 1722746 SC-DL-5229
 1722747 SC-ES-7279
 1722748 SC-DL-8137
 1722750 CV-ES-14162
 1723865 CV-ES-14163
 1723895 SC-ES-8517
 1723896 SC-DL-7264
 1723897 DB-ES-8498
 1732635 SC-DL-2161
 1734019 SC-DL-2151
 1734020 SC-ES-5764
 1737683 SC-DL-8137
 1737684 SC-DL-5229
 1738376 DB-ES-8498

...SCANIA MOOG

1738379 SC-ES-7279
 1738380 CV-ES-14162
 1738381 CV-ES-14163
 1755500 SC-DL-9449
 1755502 SC-DL-8711
 1755504 SC-DL-10273
 1755506 SC-DL-9458
 1755507 SC-DL-10226
 1759690 SC-DL-8154
 1759691 SC-DL-8553
 1765375 SC-DL-12449
 1767328 CV-ES-14163
 1768898 SC-DL-5229
 1769597 SC-DL-5354
 1770732 SC-DL-8713
 1783020 MN-RK-12436
 1788520 SC-DL-12413
 1788522 SC-DL-10225
 1789082 SC-DL-7273
 1847311 SC-DL-5229
 1847312 SC-DL-5354
 1869413 SC-DL-12342
 1869413 SC-DL-8182
 1895859 SC-DL-9449
 1895860 SC-DL-8711
 1895861 SC-DL-10273
 1895862 SC-DL-9458
 1897333 SC-DL-7264
 1897335 SC-DL-2161
 1897336 SC-DL-9457
 1897337 DB-ES-8498
 1897673 SC-DL-9447
 1906940 SC-DL-8547
 1906941 SC-DL-9462
 1906942 SC-DL-8623
 1912757 SC-DL-5229
 1912758 SC-DL-5354
 1914427 CV-ES-14163
 1914427 SC-ES-8517
 1938387 SC-DL-8399
 1942075 SC-DL-10302
 1942147 SC-TC-12361
 1953248 CV-RK-5311
 1953248 CV-RK-8118
 2 096 392 SC-RK-12366
 2007275 SC-DL-12343
 2007278 SC-DL-8169
 2028998 SC-DL-8137
 2040254 SC-DL-7264
 2051041 SC-ES-8535
 2051165 CV-ES-14162
 2051166 CV-ES-14163
 2051166 SC-ES-8517
 2113903 SC-DL-2161
 2125090 SC-DL-2161
 2146105 SC-DL-7264
 2161883 SC-DL-2161
 2755601 SC-DL-10226
 278665 SC-DL-2904
 283783 CV-ES-14162
 283784 CV-ES-14163
 301639 SC-DL-8137
 305319 CV-ES-2119
 305320 CV-ES-2182
 311847 SC-DL-8137
 325614 SC-ES-5764
 370875 SC-DL-2151
 371451 CV-ES-2119
 371452 CV-ES-2182
 390784 SC-DL-2968
 395009 CV-ES-14162
 395010 CV-ES-14163
 395350 SC-DL-8137
 4604948 SC-ES-5764
 465816 SC-DL-9460

...SCANIA MOOG

466801 SC-DL-9460
 475463 SC-DL-9447
 477890 SC-DL-8713
 483527 SC-DL-7273
 486760 SC-DL-10226
 488738 SC-DL-9461
 488739 SC-DL-10253
 488834 SC-DL-10226
 489987 SC-DL-9460
 550799 MN-RK-12436
 550800 SC-RK-12346
 550806 MN-RK-7280
 550807 DF-RK-9341
 550808 DF-RK-9341
 550808 DB-RK-9298
 550808 DB-RK-9298
 550812 MN-RK-9383
 638861 CV-RK-7850
 638862 CV-RK-5311
 638862 CV-RK-8118
 639287 CV-RK-5311
 639287 CV-RK-8118
 639319 MN-RK-9383
 639340 SC-RK-8688
 639370 MN-RK-7280
 689748 MN-RK-7280
 696321 MN-RK-8537
 81432206006 CV-RK-5311
 81432206107 CV-RK-5311
 81432706099 MN-RK-8537

SCANIA MOOG

0014606948 MN-ES-8490
 0278663 SC-DL-2965
 0278665 SC-DL-2904
 0352635 SC-DL-2965
 0475460 SC-DL-9458
 0475463 SC-DL-9447
 0477889 SC-DL-9446
 0481959 SC-DL-9459
 0550806 MN-RK-7280
 0638862 CV-RK-5311
 0639287 CV-RK-5311
 0639370 MN-RK-7280
 1 722 753 SC-RK-12366
 1 914 426 CV-ES-14162
 1101843 SC-DL-10302
 1104334 MN-RK-7280
 1104335 CV-RK-5311
 1104335 CV-RK-8118
 1104336 MN-RK-8537
 1104336 SC-RK-8575
 12200800A SC-DL-5354
 12201600A SC-DL-5229
 12202900A SC-DL-8137
 12321000A SC-DL-8400
 1304571 SC-DL-0305
 1305012 SC-DL-8127
 1308643 SC-DL-9440
 1316872 SC-DL-8127
 1324483 SC-DL-8127
 1324857 CV-ES-12462
 1343262 SC-DL-12342
 1343262 SC-DL-8182
 1343264 SC-DL-8169
 1343266 SC-DL-8154
 1343283 SC-DL-8553
 1348269 SC-DL-12343
 1353445 SC-TC-12361
 1356055 SC-DL-5229
 1357674 SC-ES-7279
 1358675 SC-DL-8137
 1358792 CV-ES-14162
 1358793 CV-ES-14163
 1358793 SC-ES-8517
 1361413 SC-DL-7264
 1365406 DB-ES-8498
 1369411 SC-DL-2161
 1369919 SC-DL-2151
 1375228 SC-ES-5764
 1378435 SC-DL-8137
 1379071 SC-DL-5229
 1379192 DB-ES-8498

1431475
 1431710
 1432723
 1433532
 1433533
 1435746
 1435944
 1440028
 1450364
 1455327
 14606948
 1464611
 1485758
 1485759
 1485760
 1486756
 1486757
 1486758
 1488890
 1488890
 1494296
 1499474
 1499475
 1499476
 1499478
 1500572
 1500573
 1500576
 1501030
 1506924
 1506925
 1515981
 1517403
 1527989
 1534756
 1603883
 1722582
 1722746
 1722747
 1722748
 1722750
 1723865
 1723895
 1723896
 1723897
 1732635
 1734019
 1734020
 1737683
 1737684
 1738376

1895860
 1895861
 1895862
 1897333
 1897335
 1897336
 1897337
 1897673
 1906940
 1906941
 1906942
 1912757
 1912758
 1914427
 1914427
 1938387
 1942075
 1942147
 1953248
 1953248
 2 096 392
 2007275
 2007278
 2028998
 2040254
 2051041
 2051165
 2051166
 2051166
 2113903
 2125090
 2146105
 2161883
 2755601
 278665
 283783
 283784
 301639
 305319
 305320
 311847
 325614
 370875
 371451
 371452
 390784
 395009
 395010
 395350
 4604948
 465816

466801
 475463
 477890
 483527
 486760
 488738
 488739
 488834
 489987
 550799
 550800
 550806
 550807
 550808
 550808
 550812
 638861
 638862
 638862
 639287
 639287
 639319
 639340
 639370
 689748
 696321
 81432206006
 81432206107
 81432706099

SETRA MOOG

6283330905 DB-DL-8393
 6283331705 DB-DL-8393
 6443500306 DB-DL-8393

SISU MOOG

1605300183 CV-ES-14163
 1605300184 CV-ES-14163
 1605300331 SC-ES-5764

STEYR MOOG

0004602648 DB-ES-0822
 0004605748 CV-ES-0543
 0004606048 CV-ES-0543
 281953016280 IV-ES-12272
 680430719 CV-ES-12462
 79100430703 CV-ES-12462
 90804154117 DB-ES-0822
 99000430704 CV-ES-12462

TATA (TELCO) MOOG

070400009000 CV-RK-8118

VAN HOOL MOOG

10923548 DB-ES-8498
 634203870 DF-ES-7777
 634301250 CV-ES-14163
 634301260 CV-ES-12462
 634301300 CV-ES-14162
 634301330 CV-ES-12462
 634301331 CV-ES-12462
 634301340 CV-ES-12461
 634303610 CV-RK-5311
 634303610 CV-RK-8118

VOLVO MOOG

0356310 VL-ES-7266
 10220897 MN-ES-10334

...VOLVO	MOOG	...VOLVO	MOOG	...VOLVO	MOOG	...VOLVO	MOOG
1071169	VL-DL-8155	1613562	VL-DL-8401	20443044	RV-TC-12340	21106968	RV-DL-12320
1071344	VL-DL-8119	1621419	VL-DL-8619	20443061	VL-DL-9472	21252480	VL-DL-9488
1071674	VL-DL-10310	1626493	VL-DL-5456	20443062	VL-DL-8543	21252481	VL-DL-12484
1075005	VL-DL-9954	1626494	VL-DL-5301	20443063	VL-DL-8518	21260274	VL-DL-8305
1075006	VL-DL-8594	1626671	VL-DL-8679	20443065	VL-DL-9472	21260275	VL-DL-9493
1075153	VL-DL-2139	1626749	VL-DL-8401	20443066	VL-DL-8543	21260283	VL-DL-12483
1075179	VL-SB-10397	1626751	VL-DL-5540	20443067	VL-DL-8518	21260286	VL-DL-7789
1075180	VL-SB-10398	1626896	VL-VB-7787	20453063	VL-DL-10228	21260296	VL-DL-8322
1075255	VL-RK-5357	1626957	VL-DL-8554	20453064	VL-DL-12367	21263821	VL-ES-8411
1075663	VL-DL-0911	1626958	VL-DL-8554	20477803	VL-DL-12356	21264203	DB-ES-8498
1075664	VV-DL-0287	1628107	VL-RK-8656	20477805	VL-DL-10258	21295227	VL-VB-7787
1076639	VL-VB-7787	1628207	VL-DL-12355	20477805	VL-DL-8157	21295230	VL-RK-8533
1080690	VL-VB-8527	1628483	VL-VB-12359	20477807	VL-DL-8536	21299034	RV-DL-12447
1082104	VL-DL-8189	1628635	VL-DL-5372	20490120	VL-DL-4895	21308022	VL-DL-8405
1083744	VL-DL-8128	1628636	VL-DL-8403	20490123	VL-DL-8405	21308024	VL-DL-4895
1088985	VL-DL-8178	1628637	VL-DL-8163	20497798	VL-DL-8404	21406952	VL-DL-8566
1088987	VL-DL-12455	1629553	VL-SB-5356	20497799	VL-DL-8597	21426652	VL-DL-12414
1094466	VL-VB-8195	1629668	VL-DL-10258	20497800	VL-DL-4912	21474441	VL-VB-7787
1131744	VL-ES-7265	1629668	VL-DL-8157	20502944	VL-VB-8195	21560838	RV-DL-12319
1134955	VL-SB-5345	1629734	VL-VB-7787	20507262	RV-VB-8191	21560945	RV-DL-12468
1135080	VL-SB-9501	1668638	VL-ES-7286	20509018	VL-DL-8180	21646203	DB-ES-8498
1190030	VL-SB-5345	1672152	CV-ES-2121	20513953	VL-DL-8187	22159761	VL-DL-12483
1194631	VL-VB-9503	1691660	VL-DL-8594	20517494	VL-DL-8180	2223852	VL-VB-12460
1271126	MN-ES-10333	1695585	VL-ES-7266	20522934	RV-DL-10299	22318833	RV-VB-8191
1313744	VL-ES-7265	1695690	CV-ES-12462	20532931	RV-TC-12339	22318834	VL-VB-7787
14200800A	VL-ES-7266	1695776	VL-ES-7266	20547286	MN-RK-8501	22482972	RV-DL-12465
14203000A	VL-DL-4912	1696900	VL-ES-5288	20554908	VL-RK-5357	24425411	VL-DL-10257
14203500A	VL-DL-8401	1696901	VL-ES-5287	20556490	VL-VB-8525	24425662	VL-DL-8187
14203800A	VL-DL-5372	1697246	VL-ES-8615	20556491	VL-VB-8541	24426048	VL-VB-10430
14204000A	VL-DL-5411	1697297	CV-ES-12462	20556492	VL-VB-8576	271187	MN-RK-7280
14204100A	VL-DL-8119	1698047	VL-ES-8615	20556586	VL-VB-12359	271188	CV-RK-5322
14204300A	VL-DL-8403	1698557	VL-ES-7266	20581086	VL-DL-12358	273373	IV-RK-8998
14204400A	VL-DL-5358	1698558	VL-ES-7265	20581089	VL-ES-10360	273375	MN-RK-7287
14205100A	VL-DL-8404	1698840	VL-ES-7265	20581632	VL-DL-12454	273612	VL-RK-9497
14301500A	VL-SB-5345	1698846	VL-ES-5348	20582399	RV-DL-12465	273706	CV-RK-5313
14301900A	VL-RK-5357	1698847	VL-ES-5347	20584291	VL-DL-12367	274019	IV-RK-8998
14302100A	VL-RK-5323	1699400	VL-ES-5288	20587731	VL-DL-9492	274056	MN-RK-8537
14316200A	VL-DL-8157	1699401	VL-ES-5287	20589061	VL-VB-12460	274056	SC-RK-8575
143167	VL-VB-7787	20 818 840	RV-DL-12480	20702095	VL-RK-9497	274069	VL-RK-9499
14319600A	VL-VB-5369	20367004	RV-VB-8191	20709844	RV-DL-8190	274070	DF-RK-8994
14320200A	VL-DL-8554	20374444	VL-DL-8180	20710008	VL-ES-8414	275988	MN-RK-9383
14403900A	VL-SB-5356	20374689	VL-VB-8195	20713858	RV-DL-12329	276191	MN-RK-8678
1507822	VL-ES-5347	20374698	VL-ES-10361	20713860	RV-DL-12328	276192	MN-RK-8537
1507823	VL-ES-5348	20374831	VL-DL-9488	2072161F	VL-ES-7265	3028448	VL-SB-10392
1507826	VL-ES-7266	20375555	VL-DL-8407	20727843	RV-DL-8415	3090015	MN-RK-8723
1509222	VL-VB-8527	20375556	VL-DL-8566	20739082	VL-DL-9489	3090291	MN-ES-10333
1517577	CV-ES-12462	20375787	VL-DL-8194	20740700	VL-RK-10383	3091598	CV-RK-5322
15175771	CV-ES-12462	20376808	VL-DL-8706	20741695	RV-VB-8191	3092471	VL-ES-5347
1517647	CV-ES-12461	20382314	VL-VB-8195	20741703	RV-VB-8191	3092472	VL-ES-5348
1527234	VL-ES-7286	2038308	VL-DL-12484	20742127	CV-ES-14163	3092548	DB-ES-8498
1527453	CV-ES-2121	20383081	VL-DL-12483	20745042	CV-ES-14162	3092795	VL-ES-7265
1576092	VL-DL-5318	20390745	VL-DL-8707	20745043	CV-ES-14163	3093462	MN-RK-12436
1576093	VL-DL-5319	20390746	RV-DL-12320	20745923	VL-DL-8405	3093467	VL-RK-10383
1576952	VL-VB-8527	20390836	VL-SB-5356	20745924	VL-DL-4895	3093469	DF-RK-8637
1576953	VL-VB-8584	20392649	VL-VB-7787	20753761	VL-RK-10383	3093630	VL-RK-8533
1581527	VL-DL-8545	20392778	VL-DL-8322	20818854	RV-DL-12448	3093631	RV-DL-12448
1584620	VL-DL-5456	20393061	VL-DL-2139	20821150	CV-ES-14162	3093647	VL-ES-8411
1588263	VL-DL-5456	20393069	VL-DL-0911	20821160	CV-ES-14163	3093714	MN-ES-10334
1589817	VL-DL-9485	20393071	VL-DL-8406	20829503	VL-VB-7787	3096212	CV-ES-12461
1590068	VL-VB-8546	20393073	VL-DL-8681	20830369	DB-DL-8174	3097188	MN-RK-9392
1591689	VL-RK-5357	20393079	VL-DL-5372	20840815	VL-RK-8533	3097999	VL-ES-8411
1598588	VL-RK-5323	20393083	VL-DL-8178	20862494	CV-ES-14163	3098332	VL-ES-8615
1605035	VL-DL-8189	20393093	VL-DL-8187	20900943	VL-DL-12456	3099128	MN-ES-10333
1605047	VL-SB-5276	20393097	VL-DL-7789	20937675	DB-ES-8498	3099230	DB-DL-8174
1605244	VL-VB-12359	20393186	VL-DL-8407	20994418	VL-DL-9472	3112050	VL-DL-8404
1606200	VL-VB-8527	20393187	VL-DL-8566	20994419	VL-DL-8543	3112122	VL-DL-4912
1606274	VL-DL-5301	20399543	RV-DL-12447	20994420	VL-DL-8518	3112273	VL-DL-8597
1606283	VL-DL-5318	20400909	VL-DL-5218	21051046	RV-TC-12339	3124480	VL-DL-5218
1606284	VL-DL-5319	20400939	VL-DL-8155	21051052	RV-DL-10299	3124625	CV-ES-2120
1606552	VL-VB-8539	20400941	VL-DL-5411	21106157	VL-DL-10309	3127737	VL-DL-8119
1606980	SC-ES-5764	20400944	VL-DL-8119	21106930	VL-DL-8407	3133173	MN-RK-8523
1607079	VL-DL-8545	20410053	VL-DL-10309	21106933	VL-DL-8194	3172829	VL-VB-5369
1608151	VL-DL-8619	20410530	VL-DL-8180	21106936	VL-DL-8707	3173291	VL-VB-8525
1610338	VL-DL-5540	20426061	VL-RK-10383	21106938	VL-DL-9492	3173292	VL-VB-8541
1612254	VL-DL-7789	20442115	VL-DL-8187	21106952	VL-DL-8566	3173293	VL-VB-8576

...VOLVO	MOOG	...VOLVO	MOOG
3173294	VL-VB-12359	7421560945	RV-DL-12468
3173613	VL-DL-8412	7485114920	RV-DL-10246
3173759	VL-RK-5357	8073569	VL-VB-5369
3173914	VL-DL-9491	81432706099	MN-RK-8537
3193731	RV-ES-9432	81467106355	VL-DL-12483
3193895	VL-VB-10430	8151876	VL-ES-8568
3198234	VL-DL-9493	8154017	VL-DL-8545
3198276	VL-DL-8305	8154018	VL-DL-8545
3199225	VL-DL-8187	8156994	VL-VB-12359
382745	VL-ES-7286	8158206	VL-DL-8545
3944046	VL-DL-8536	8158207	VL-DL-8545
3944818	VL-DL-8545	8190146	VL-DL-8406
3944819	VL-DL-8545	8190147	VL-DL-8681
3944820	VL-DL-8545	81953016236	MN-ES-10334
3950703	VL-DL-12456	81953016268	MN-ES-10333
3962343	VL-DL-8163	81953016331	MN-ES-10334
3985570	VL-DL-7789	82953016018	MN-ES-10333
3986433	VL-DL-10258	82953016019	MN-ES-10333
3986433	VL-DL-8157	85104224	MN-RK-12436
3986450	VL-DL-8163	85112073	DB-ES-8530
3986452	VL-DL-8407	85114146	VL-ES-7266
3987354	VL-DL-8412	85114147	VL-ES-7265
3987355	VL-DL-9491	85114190	VL-DL-8594
3987423	VL-DL-12356	85114200	VL-DL-8403
3987648	RV-ES-12442	85114240	VL-DL-8404
3988695	VL-DL-2139	85115621	VL-DL-8706
3988701	VV-DL-0287	85115631	RV-DL-12447
3988704	VL-DL-0911	9516523	VL-SB-10392
3988708	VL-DL-5372	9519245	VL-SB-10394
3988710	VL-DL-5372	9519278	VL-DL-8405
3988711	VL-DL-8163	9519279	VL-DL-4895
42538048	MN-ES-10333	9521922	VL-DL-8595
4510697	VL-DL-7789	9522701	VL-DL-10230
4941233	IV-RK-8998	9523029	VL-RK-10383
5001868363	RV-DL-10243	9523163	VL-DL-12415
5010039426	RV-DL-10246	9959151	VL-DL-8404
5010130386	RV-DL-10246	9959152	VL-DL-8597
5010439078	RV-DL-12467	9959153	VL-DL-4912
5010600822	RV-DL-10243	9959304	VL-SB-10392
6027074	CV-ES-2121	9959462	VL-DL-12416
6771112	VL-DL-8141	9959503	VL-DL-10259
6771120	VL-DL-8729		
6777705	VL-DL-9479		
6777855	VL-DL-5218		
6790572	VL-DL-5411	2RP711551	CV-ES-2121
67905729	VL-DL-5411	T16415712B	CV-ES-14163
6799189	VL-DL-8151		
6799190	VL-DL-5358		
6853913	CV-ES-2121		
6853913	DF-ES-9335		
6869744	VL-ES-7265		
6882111	VL-ES-7266		
6882111(BRAZIL)	VL-ES-7266		
6882112	VL-ES-7265		
6886777	VL-VB-8527		
6889480	VL-ES-7266		
6889481	VL-ES-7265		
6889482	VL-ES-7266		
6889509	IV-RK-8998		
6889512	CV-RK-5313		
689748	MN-RK-7280		
696321	MN-RK-8537		
70311664	VL-DL-9489		
70314305	VL-DL-12415		
70314307	VL-DL-12416		
70371270	VL-DL-8180		
70376892	VL-DL-8595		
70376894	VL-VB-10430		
70397005	VL-DL-12416		
70397006	VL-DL-12415		
7420581086	VL-DL-12358		
7420840815	VL-RK-8533		
7420864583	RV-DL-10299		
7421051052	RV-DL-10299		
7421295227	VL-VB-7787		

VW MOOG

2RP711551 CV-ES-2121
T16415712B CV-ES-14163

FEBI BILSTEIN		MOOG	...FEBI BILSTEIN	MOOG	...FEBI BILSTEIN	MOOG	...FEBI BILSTEIN	MOOG
01052	DB-RK-5283	06697	DB-RK-10378	17075	DB-DL-3228	21632	CV-RK-7850	
01064	DB-RK-5280	06724	DB-SB-5258	17258	SC-DL-5229	21712	SC-DL-8127	
01281	MN-SB-10389	06732	DB-RK-5281	17259	VL-DL-0911	21714	SC-DL-2151	
01358	DB-ES-2558	07280	CV-ES-14163	17316	SC-DL-5354	21715	SC-DL-9447	
01359	DB-ES-2559	07380	MN-SB-5249	17365	DF-SB-5251	21727	SC-DL-10225	
01363	DB-DL-9226	07681	MN-SB-5265	17419	DF-DL-2142	21730	SC-DL-8154	
01364	DB-DL-9257	07876	DB-SB-5312	17475	DB-SB-10401	21908	MN-VB-8569	
01436	DB-RK-5282	07975	SC-DL-0305	17484	DB-DL-5405	21990	SC-DL-8179	
01437	DB-SB-5257	08204	ME-ES-0643	17495	DB-SB-10400	22049	VL-DL-8128	
01444	MN-SB-5244	08242	CV-ES-2121	17528	DF-DL-12420	22395	DB-DL-5241	
01445	MN-SB-5245	08244	VL-DL-5540	17573	ME-AX-2735	22610	VL-RK-9499	
01447	MN-VB-5222	08252	SC-DL-2904	17577	ME-AX-2734	22618	VL-DL-8189	
01536	MN-SB-5246	08769	CV-ES-2182	17578	MN-DL-7792	22623	DB-VB-3702	
01737	VL-SB-5276	08770	CV-ES-2119	17757	MN-DL-3402	22624	DB-VB-3701	
01909	VL-ES-5287	08771	DF-ES-9335	17870	MN-RK-8537	22625	DB-VB-3700	
01910	VL-ES-5288	08792	CV-ES-12462	18108	MN-RK-8723	22789	KB-ES-0536	
02090	MN-DL-7833	08958	MN-RK-7287	18205	DF-DL-5237	22837	VL-SB-10394	
02093	VL-RK-5357	08959	CV-RK-5313	18207	DF-DL-7836	23237	DF-DL-5226	
02094	VL-RK-5323	08960	DB-RK-7267	18208	SC-DL-2161	23471	DB-RK-9296	
02175	DF-DL-3798	09159	SC-DL-2968	18330	VL-DL-5319	23497	DB-RK-8626	
02331	CV-ES-2119	09283	DB-DL-5219	18333	VL-DL-8594	23503	DB-RK-10375	
02332	CV-ES-2182	09308	DB-DL-5215	18334	VL-DL-2139	23565	VL-VB-5369	
02404	MN-SB-9399	09444	VL-SB-9501	18335	VL-DL-8403	23593	CV-DL-0546	
02538	DB-SB-5270	09925	SC-DL-8137	18410	VL-DL-5411	23692	MN-DL-7837	
02545	CV-ES-12462	10144	DB-SB-10386	18411	VL-DL-5218	23704	MN-DL-2133	
02546	CV-ES-12461	10547	MN-SB-5252	18412	VV-DL-0287	23705	DF-VB-8561	
02563	DB-SB-5269	10756	VL-DL-9954	18413	VL-DL-8163	23706	DF-VB-9343	
02564	DB-SB-5274	10857	MN-SB-5278	18580	SC-DL-8399	23803	VL-DL-8119	
02654	DB-SB-5274	10936	VL-DL-0911	18581	SC-DL-7264	23821	VL-ES-8615	
02735	DB-DL-9143	11514	VL-DL-8545	18711	RV-DL-8317	23834	DF-RK-8994	
02738	MN-DL-3588	11515	VL-DL-8157	18713	RV-ES-12445	23838	DF-RK-8637	
02744	DB-DL-5216	11516	VL-ES-7286	18714	RV-ES-12446	23840	DF-RK-8685	
02904	DB-RK-8564	11565	VL-SB-5345	18801	DB-DL-5230	23853	IV-VB-5228	
02954	CV-ES-14163	11609	MN-RK-8537	18885	CV-ES-0543	23887	ME-ES-1760	
02963	MN-RK-8678	11609	SC-RK-8575	18938	DB-ES-5227	23890	DB-DL-8388	
03132	DB-ES-1084	11612	MN-RK-7280	18939	DB-ES-5234	23891	DB-DL-8174	
03135	DB-ES-1084	11613	CV-RK-5322	18942	DB-DL-10140	23895	DB-DL-7832	
03372	DF-DL-8704	11648	VL-DL-5301	18943	DB-DL-0280	23900	DB-DL-8121	
03409	VL-DL-5318	11653	VL-DL-5456	18966	DB-DL-8672	23911	DB-ES-2752	
03455	MN-SB-5242	11717	CV-ES-2120	19037	DB-RK-8550	23911	DB-ES-2753	
03497	IV-RK-8998	11873	ME-ES-1760	19038	DB-RK-8638	23912	DB-ES-2752	
03528	VL-SB-5356	11921	VL-SB-10398	19053	MN-SB-10390	23919	VL-DL-8141	
03756	DB-RK-8380	11922	VL-SB-10397	19202	VL-RK-8656	23982	VL-DL-8679	
03855	DB-SB-5312	11932	VL-VB-8527	19216	DB-DL-8327	23985	VL-DL-8407	
03922	DB-DL-1179	12225	DB-SB-5277	19217	DB-DL-8389	23986	VL-DL-8178	
03932	VL-DL-8401	12974	DB-ES-0830	19226	DB-DL-3475	23991	RV-RK-8648	
03939	MN-DL-12284	12975	CV-ES-2774	19229	DB-DL-5224	24003	IV-DL-8183	
03939	MN-DL-2174	14219	DB-ES-2753	19230	DB-DL-9218	24004	IV-DL-7785	
03941	VL-ES-7265	14220	DB-ES-2752	19311	DF-SB-9342	24005	IV-DL-5371	
03956	DF-ES-3805	14484	IV-DL-0214	19313	DF-SB-5253	24006	DB-VB-3707	
04374	MN-DL-2131	14485	IV-DL-0214	19319	MN-SB-9399	24038	DB-ES-5209	
04376	MN-DL-7835	14561	DF-ES-3634	19339	DB-DL-5217	24059	VL-DL-4912	
04377	MN-DL-2160	14562	DF-ES-3635	19860	DB-DL-5231	24061	VL-DL-8729	
04384	CV-ES-12462	14627	IV-DS-0284	19896	MN-DL-0549	24063	VL-DL-8151	
04605	DB-ES-0822	14701	DB-SB-5267	19898	MN-DL-7802	24070	VL-DL-5358	
04765	DB-SB-5259	14705	DB-SB-5272	21035	DB-DL-2144	24085	DB-DL-8618	
05014	DB-SB-5268	14712	DB-SB-5275	21037	CV-ES-0888	24086	DB-DL-5233	
05032	MN-SB-5243	14821	IV-DL-0215	21200	MN-VB-5238	24087	DB-DL-8641	
05033	MN-SB-9396	14995	MN-RK-9383	21208	MN-DL-5225	24088	DB-DL-8642	
05034	MN-SB-5254	15135	IV-DL-2156	21310	MN-DL-7834	24089	DB-DL-8622	
05041	DB-RK-5284	15139	IV-DL-2155	21333	DB-DL-5220	24093	DB-DL-12298	
05205	DB-RK-5303	15140	IV-DS-1914	21334	DB-DL-7840	24105	DB-DL-8640	
05297	CV-RK-8118	15167	DB-SB-5250	21336	DB-DL-3405	24109	DB-ES-5214	
05657	DB-SB-10385	15231	DF-RK-8503	21337	DB-DL-6197	24110	DB-DL-5213	
05782	DF-RK-8671	15242	VL-SB-10392	21339	DB-DL-6198	24112	DB-DL-7831	
06082	SC-DL-2965	15246	CV-ES-2135	21340	DB-DS-6088	24117	DB-DL-5239	
06227	DB-RK-5307	15247	DF-ES-5404	21341	DB-DL-9221	24120	DB-DL-9215	
06239	VL-ES-5347	15615	CV-ES-0912	21344	DB-DL-9164	24133	DB-DL-8676	
06240	VL-ES-5348	15616	CV-ES-0914	21348	MN-DL-7797	24136	DB-DL-2178	
06241	VL-ES-7266	15656	RV-ES-8691	21354	DB-DL-7839	24145	DB-DL-9211	
06341	MN-SB-5248	15754	LF-ES-3809	21542	DB-SB-5261	24149	DB-DL-8728	
06372	DB-DL-5207	15755	LF-ES-3810	21544	DB-SB-5260	24150	DB-DL-12375	
06389	CV-RK-5311	15783	DB-DL-5412	21545	DB-SB-10407	24166	MN-DL-12421	
06413	MN-RK-7291	15934	DB-DL-6235	21547	DB-SB-5279	24167	MN-DL-2293	
06582	DB-DL-6140	15936	DB-ES-1281	21595	CV-ES-2149	24168	MN-DL-5232	

...FEBI BILSTEIN MOOG		...FEBI BILSTEIN MOOG		...FEBI BILSTEIN MOOG		...LEMFÖRDER MOOG	
24170	MN-DL-2172	30188	DB-DL-7275	44251	MN-DL-12285	11610 01	DF-ES-3634
24174	CV-ES-2146	30272	DB-DL-7276	44451	MN-DL-10288	1171301	MN-RK-7291
24175	MN-DL-8370	30273	DB-DL-7275	44451	MN-DL-12288	11714 01	IV-DL-2136
24264	SC-ES-7279	30274	DB-DL-7262	44521	CV-ES-14163	1171501	IV-VB-5228
24561	DB-SB-10410	30275	DB-DL-7263	44702	CV-TC-12384	11716 01	IV-DS-1914
24988	DB-ES-8510	30614	MN-VB-9404	44920	SC-DL-12413	11716 02	IV-DS-1914
24989	DB-ES-8492	30814	DB-SB-10406	45030	MN-DL-7786	11721 01	CV-ES-2135
24990	DB-ES-8491	30904	DB-DL-8122	45364	RV-DL-12326	11721 02	CV-ES-2135
24992	DB-ES-8387	31046	MN-SB-10387	46093	RV-DL-12328	1173101	DF-RK-8503
26021	DB-ES-8164	31311	SC-RK-8688	46094	RV-DL-12329	1173202	IV-DL-8613
26210	CV-ES-12462	31802	MN-RK-12436			1175501	CV-RK-5311
26346	DB-ES-8164	31848	DB-RK-8581			1175501	CV-RK-8118
26448	DF-RK-9336	31863	MN-RK-8558			1175702	MN-DL-5212
26449	DB-RK-10374	31981	MN-DL-2141	11371 01	CV-ES-2121	1176002	MN-VB-5222
26574	DB-DL-7794	31982	MN-DL-7781	11372 01	CV-ES-2119	1176101	MN-SB-5244
26575	DB-DL-8731	32234	DB-ES-8617	11373 01	CV-ES-2182	11766 01	MN-DL-3588
26576	DB-DL-7270	32324	VL-RK-9497	11376 01	CV-ES-2774	11768 01	MN-DL-2160
26578	DB-DL-8176	32336	MN-DL-7801	11376 02	CV-ES-2774	11769 01	MN-DL-2293
26631	DB-RK-12372	32383	RV-VB-8191	11377 01	DB-ES-0830	11770 01	MN-DL-2174
26745	DB-DL-8620	32383	VL-VB-12460	11377 02	DB-ES-0830	1177201	MN-RK-7287
26817	VL-DL-5372	32405	MN-RK-8523	11377 03	DB-ES-0830	1177601	RV-RK-7849
26880	DB-DL-7815	32483	DB-RK-8555	11378 02	DB-ES-0834	1181901	VL-VB-8527
26881	DB-DL-8188	32484	DB-RK-9294	11378 03	DB-ES-0834	1183201	CV-RK-5322
26883	DB-DL-8307	32498	DF-ES-8496	11378 04	DB-ES-0834	1183401	CV-RK-7850
26884	DB-DL-7799	32499	VL-VB-8525	11381 01	DB-ES-1084	11926 01	SC-DL-2151
26953	DB-ES-8530	32503	VL-VB-7787	11381 02	DB-ES-1084	1194001	VL-VB-8546
27009	VL-DL-8412	32536	DF-ES-8497	11381 03	DB-ES-1084	1194301	VL-VB-8539
27127	VL-DL-8412	32794	MN-RK-8501	1138201	DB-RK-8564	1194401	VL-ES-7266
27130	VL-DL-9472	32876	DF-DL-8506	1138201	MN-RK-9387	1194501	VL-ES-7265
27131	VL-DL-8543	32982	DB-DL-12310	1138301	DB-RK-9297	11946 02	VL-ES-5348
27188	RV-DL-8314	32983	DB-DL-8639	11384 02	DB-RK-6111	11947 02	VL-ES-5347
27207	CV-ES-14163	32990	DB-DL-8644	11391	ME-ES-0643	1194901	VL-DL-8119
27209	SC-ES-7279	33155	DB-RK-8725	11391 01	ME-ES-0643	1195201	VL-SB-9501
27241	DB-DL-8392	34084	DF-RK-9341	11394 03	CV-ES-0543	1195401	VL-ES-7286
27251	VL-DL-8518	34103	VL-ES-8411	11394 04	CV-ES-0543	11963 01	VL-DL-5319
27252	VL-DL-9472	34118	VL-DL-8406	1139701	DB-RK-8380	11965 01	VL-DL-5318
27485	RV-DL-10244	34119	VL-DL-8566	11402 01	CV-ES-12462	11967 01	VL-ES-5288
27486	RV-DL-8316	35063	IV-DL-8665	11403 01	CV-ES-12461	11968 01	VL-ES-5287
27488	RV-DL-12480	35079	DF-DL-5403	11404 01	DB-ES-1281	11969 02	VL-DL-5540
27528	DB-SB-10409	35080	MN-VB-8514	11404 02	DB-ES-1281	1197001	VL-RK-5323
27570	VL-RK-8533	35081	MN-DL-2140	11405 01	DB-ES-2752	1214702	VL-DL-5411
27574	DB-RK-8674	35089	DB-RK-8564	11405 02	DB-ES-2752	12280 04	CV-ES-0888
27794	RV-DL-12334	35135	SC-TC-12361	11406 01	DB-ES-2753	12299 01	RV-DL-0900
27795	RV-DL-10243	35151	MN-DL-12421	11406 02	DB-ES-2753	1231403	RV-DL-7971
27846	RV-DL-8156	35166	DF-SB-10402	11408 01	DB-ES-2558	1283501	DB-DL-9143
27954	DB-DL-9254	35172	MN-DL-2132	11408 02	DB-ES-2558	12839 01	ME-ES-1760
28050	VL-RK-8533	35178	IV-DL-8193	11408 03	DB-ES-2558	12845 01	ME-AX-2734
28147	DB-VB-7798	35187	IV-DL-12264	11409 01	DB-ES-2559	1285801	DB-VB-3701
28195	DB-VB-7790	35190	VL-DL-12356	11409 02	DB-ES-2559	1285901	DB-VB-3700
28206	MN-DL-2176	35191	VL-DL-7789	11409 03	DB-ES-2559	1286101	DB-DL-9208
28209	MN-DL-2177	35352	SC-ES-5764	1141301	DB-DL-3405	1286801	DB-DL-9257
28273	DB-DL-8184	35353	MN-DL-0549	11417 01	DB-DL-1179	1288101	DB-DL-5412
28275	DB-DL-8171	35419	RV-TC-12339	11417 02	DB-DL-1179	12898 01	CV-DL-0546
28280	DB-DL-8168	35659	SC-RK-12346	11417 03	DB-DL-1179	1290501	DB-DL-8121
28298	DB-DL-12300	35660	VL-DL-12358	1143002	DB-VB-3702	1292101	DB-DL-8122
28304	DB-RK-8391	35789	MN-DL-12394	1143501	DB-DL-5216	1292301	DB-DL-5217
28330	DF-DL-7780	35907	DB-DL-8393	1143801	DB-DL-10140	1292501	DB-DL-7831
28336	RV-DL-8324	36136	CV-ES-14163	1144001	DB-DL-9226	1293601	DB-DL-5215
28408	IV-DL-8367	36326	IV-ES-12419	1145601	DB-DL-5207	1354201	DB-RK-8674
28410	DB-SB-10384	36451	MN-DL-10314	1145802	DB-DL-8672	1355001	DB-DL-9211
28411	DB-ES-7783	39253	DB-DL-12363	11460 01	DB-DL-6140	1355301	CV-TC-12384
28412	DB-ES-7784	39350	RV-ES-12331	11460 02	DB-DL-6140	1355401	DB-DL-3228
28418	LF-DL-0288	39376	SC-DL-12342	11460 03	DB-DL-6140	1355701	DB-DL-8676
28457	DF-DL-8196	39456	IV-ES-12272	1146401	DB-DL-5220	1356001	DB-DL-9225
28459	IV-DL-8613	39596	RV-DL-12334	1146801	DB-DL-7839	1356301	DB-DL-7775
28519	IV-DL-8142	39614	MN-DL-14107	11469 01	DB-DS-6088	1357101	DB-DL-7840
28530	MN-RK-8997	39778	MN-DL-12432	11469 02	DB-DS-6088	1357301	DB-VB-7776
28676	MN-DL-2127	39923	IV-DL-12268	11470 01	DB-DL-6198	13574 01	DB-DL-6197
28679	MN-DL-8560	40035	DB-DL-12364	11470 02	DB-DL-6198	1359801	DB-RK-10378
28684	SC-DL-8169	40045	SC-DL-12343	11476 01	DB-DL-0280	1360001	DB-RK-5283
28698	DF-DL-8158	43447	SC-VB-12418	1147701	DB-DL-5219	13606	ME-ES-1760
2953	CV-ES-14162	43610	RV-DL-12448	1149203	CV-ES-14162	1408301	DB-SB-5268
29862	DB-RK-8710	43611	VL-DL-12414	1149602	DB-SB-5312	1482201	SC-DL-5229
29863	DB-RK-9291	43683	DB-DL-12440	11505 03	CV-ES-14163	1498202	DB-ES-8570
30187	DB-DL-7276	44219	VL-VB-12359	11605 01	DF-DL-3798	1510501	DB-DL-10213

...LEMFÖRDER	MOOG	...LEMFÖRDER	MOOG	...LEMFÖRDER	MOOG	...LEMFÖRDER	MOOG
15107 01	DF-DL-12420	1990401	DB-DL-5230	2159201	DF-ES-5761	23405 01	MN-DL-2132
17802 01	MN-DL-2131	1992701	MN-ES-10334	2166401	DB-DL-7788	23411 01	MN-DL-12281
1800703	DB-ES-8617	1992801	DB-DL-9256	2166901	DB-DL-9275	2341701	MN-DL-8662
1805401	IV-DL-8124	1992901	DB-DL-8138	21673 01	DB-DL-9187	23418 01	MN-DL-12432
1842701	DB-DL-8728	1994701	DB-ES-5209	2169101	DB-ES-8491	23455 01	MN-DL-12279
1843901	DB-DL-9221	1997701	DF-RK-8685	2169301	DB-ES-8510	23457 01	MN-DL-12278
1844701	DB-DL-7832	1997901	SC-DL-9440	2169601	DB-ES-8492	23465 01	MN-DL-12433
1845001	DF-ES-9335	1998001	VL-DL-8141	2170001	DF-RK-8637	2346601	MN-DL-7792
1846101	DF-ES-7777	1998201	VL-DL-8729	2178401	DF-DL-8658	2346701	MN-DL-8374
1846701	CV-ES-5336	1999101	IV-DL-8142	2180501	DF-DL-7836	2346901	DB-DL-8167
18468 01	RV-DL-0886	19995 01	MN-DL-2175	2180701	DF-DL-5403	2347001	DB-DL-8168
18468 02	RV-DL-0886	2019801	VL-DL-8619	2185201	DF-DL-8571	2347601	DB-DL-8639
1847101	IV-RK-8998	2039501	VL-DL-9479	2194201	MN-SB-5245	2349301	SC-DL-8169
1847201	DF-RK-8994	2039701	DB-DL-8632	2197101	DB-ES-8498	2349501	SC-DL-7264
1847301	MN-RK-8678	2039901	MN-VB-8565	2198601	VL-DL-8155	23500 01	SC-DL-12341
1847501	VL-DL-5218	2041001	MN-DL-8370	2198701	IV-DL-8689	2350201	SC-DL-10225
1849301	CV-DL-9119	2042301	IV-DL-5371	2202402	VL-DL-8405	23504 01	SC-DL-12449
1849501	MN-DL-3402	2043001	DB-ES-5227	2205301	DB-DL-9218	2352301	VL-DL-5372
18499 01	MN-DL-2162	2049501	DB-DL-9215	2208001	RV-DL-8156	2366801	MN-DL-10286
1886301	DB-RK-5280	2050001	DF-DL-9331	22083 01	SC-DL-2161	2376301	DF-ES-8362
18919 01	MN-DL-2138	2051601	CV-RK-5311	2209001	DB-RK-8638	2383601	DF-RK-9336
1895401	MN-SB-5249	20585 02	RV-DL-2181	2209201	DB-DL-5224	2384101	DB-RK-8550
18977 01	IV-DS-0284	20586 01	RV-ES-12446	2223201	IV-DL-8562	2384501	DB-RK-8366
18991 01	RV-DL-0907	20587 01	RV-ES-12445	22296 01	DF-DL-2142	2389901	RV-DL-8170
18991 02	RV-DL-0907	2059301	DF-DL-7780	22296 02	DF-DL-2142	23953 01	DB-DL-12304
1899301	RV-DL-8126	2060501	DF-ES-9334	2231501	VL-DL-8157	2397001	DB-DL-9193
19339 01	IV-DL-0215	2060601	DF-RK-8633	2231601	DF-DL-9318	2397701	DB-ES-5214
1939001	VL-DL-8401	2065701	DB-VB-10421	2231702	DF-DL-8158	2398801	DB-DL-8327
19450 01	DB-DL-12375	2088701	MN-DL-8609	22448 01	VL-DL-2139	2398901	DB-DL-8389
1945301	MN-DL-7835	20889 01	MN-DL-2127	22520 01	IV-TC-12431	2399001	DB-DL-8171
1946501	DB-ES-8387	2089001	VL-DL-8151	2252901	MN-DL-8590	2399101	DB-DL-8172
1950801	SC-DL-8127	2089201	DB-DL-5233	2253101	VL-DL-8554	2399201	DB-DL-8640
19521 01	VL-DL-9954	2089701	MN-RK-9392	22536 01	DF-ES-12429	2399401	DB-DL-8390
1952501	VL-DL-8128	2091301	MN-DL-8686	2253801	RV-ES-8691	23995 01	DB-DL-12310
19526 01	VL-DL-12455	20991 01	MN-DL-2133	2254401	MN-DL-8624	2399601	DB-DL-8174
1953901	VL-DL-8679	20999 01	VL-DL-12456	22547 01	VL-DL-5456	23998 01	DB-DL-12311
1958501	DF-DL-5237	2100902	SC-DL-5354	2260801	RV-DL-8159	2400801	RV-DL-8587
1958701	SC-RK-8575	2101401	MN-DL-7781	2260901	RV-DL-8160	24194	DB-DL-8620
1959601	MN-RK-8723	2104801	MN-DL-9370	2265301	VL-RK-8533	24194 01	DB-DL-8620
1959801	MN-RK-8523	2107501	CV-ES-2146	2270401	MN-DL-8621	24198 01	DB-DL-12475
1959901	MN-VB-8569	2107601	MN-ES-10348	2272101	DB-ES-8500	24201 01	DB-DL-12403
1960001	MN-SB-9399	2116801	DB-VB-3707	2279201	VL-DL-8406	2422301	DB-DL-9194
19606 01	MN-DL-12421	2120401	MN-RK-8537	2279301	VL-DL-8407	2423101	DB-DL-8176
19607 01	MN-DL-0549	2127001	VL-DL-8404	2279401	VL-DL-7789	24232 01	DB-DL-12440
1961001	CV-ES-2120	2127101	VL-DL-4912	2280601	IV-ES-8365	2423701	DB-DL-9247
1961501	DB-ES-5234	2127201	VL-DL-8597	2281401	IV-DL-8162	2423901	DB-DL-5213
19621 01	IV-DL-2155	2128001	IV-DL-3234	2282201	VL-DL-8163	2424001	DB-DL-8731
19623 01	IV-ES-12419	2128501	IV-DL-8367	22916 01	DF-TC-12262	2424101	DB-DL-7794
1963101	IV-DL-8542	2129401	DB-ES-7782	2295001	MN-DL-10281	24243 01	DB-DL-2144
19663 01	VL-DL-0911	2129601	DB-ES-7783	22953 01	MN-TC-14112	24243 02	DB-DL-2144
1966501	VL-SB-5345	2129701	DB-ES-7784	2296201	DB-DL-8652	2424401	DB-DL-7270
1967701	MN-RK-9383	2138501	IV-DL-7785	2297801	DB-DL-3461	2427601	DB-DL-5239
1968601	VL-DL-5358	2140801	MN-DL-5232	2298301	DB-DL-3475	2428701	DB-DL-10207
1968901	VL-DL-8681	21410 01	DB-DL-2178	2302201	SC-DL-9460	24291 01	DB-DL-12308
1969401	DB-DL-8618	2141101	DB-DL-8388	2303401	VL-DL-8545	2429401	DB-DL-10216
1969501	DB-DL-8131	2141201	DB-DL-5241	2304901	IV-VB-8146	2430101	DB-DL-9188
1969801	DB-DL-9263	2143201	DB-RK-8635	2306501	DB-VB-7790	2430201	DB-DL-7795
1969901	DB-DL-5231	2144001	SC-ES-7279	2306902	DB-VB-7261	2430301	DB-DL-8641
1971501	DB-DL-9164	21448 01	SC-DL-12413	2307701	DB-ES-8164	2430401	DB-DL-8642
1975201	RV-DL-7282	2145301	SC-DL-9447	2318401	DB-RK-9298	2430501	DB-DL-8622
1978301	DF-ES-8602	2145501	SC-DL-8553	2319301	MN-DL-9381	2430701	DB-DL-10208
1979101	DF-ES-5226	2145601	SC-DL-8154	2319401	MN-TC-12471	24308 01	DB-DL-12470
1982101	DF-ES-5404	2145801	SC-DL-10302	2321101	DB-RK-9300	24311 01	DB-DL-10209
19828 01	DB-DL-12309	2146101	SC-DL-9446	2321701	DF-RK-9341	2431301	DB-DL-12298
1985801	RV-DL-8136	21463 01	SC-TC-12472	23257 01	IV-DL-12268	24314 01	DB-DL-12438
1986201	SC-ES-5764	2146801	SC-DL-9459	2327001	MN-DL-8371	2431501	MN-DL-7834
1986601	SC-DL-8137	21469	MN-DL-7786	2327501	MN-DL-8486	24316 01	DB-DL-12466
19873 01	VV-DL-0287	2146901	MN-DL-7786	23305 01	MN-DL-2177	2434101	RV-DL-10246
1988001	VL-VB-8584	2153401	DB-DL-12363	23307 01	MN-DL-2140	2435401	RV-DL-8177
19882 02	VL-DL-5301	2154001	CV-DL-9103	23336 01	DF-DL-12423	2438001	MN-DL-8376
1988401	VL-DL-8403	2154201	DF-DL-8359	2333701	DF-DL-5355	2438201	VL-DL-8178
19887 01	VL-ES-8615	2154301	DF-DL-10183	2334001	DF-DL-9312	2438601	RV-DL-10249
1988901	VL-DL-8594	2154801	DB-SB-5258	2337201	IV-DL-8166	2438901	VL-DL-10310
1989301	MN-RK-7280	2155101	SC-RK-8688	2337401	IV-DL-9360	2444501	DB-ES-8529
1989401	VL-RK-9499	2157202	VL-DL-4895	2337701	IV-DL-8697	2472701	MN-DL-7797

...LEMFÖRDER	MOOG	...LEMFÖRDER	MOOG	...LEMFÖRDER	MOOG	...LEMFÖRDER	MOOG
2502701	SC-DL-8179	2681301	VL-VB-8195	2832801	MN-DL-8599	30965 01	DB-TC-12376
25036 01	IV-TC-12341	26823 01	DF-TC-12492	2832901	MN-DL-8709	3096601	VL-DL-9491
2504101	MN-DL-8544	2682601	DF-DL-8704	2833001	MN-DL-8378	3096801	SC-DL-9462
2504301	DF-VB-9343	2682801	DF-DL-10192	28331 01	MN-DL-12285	3096901	SC-DL-8623
25051 01	DB-RK-12372	26830 01	DF-DL-12420	28332 01	DB-DL-8393	30986 01	VL-DL-12415
2507201	SC-RK-8688	2683101	DF-DL-8705	2870501	DB-RK-9291	3110401	DB-DL-9272
2507301	IV-ES-8515	2684101	DF-DL-8196	2870601	DB-RK-8710	31112 02	MN-DL-10314
25074 02	SC-DL-12342	2684201	DF-DL-10188	2876001	MN-RK-8501	3113901	CV-RK-5313
2507402	SC-DL-8182	26845 01	MN-TC-12400	28791 01	RV-DL-12447	3114901	DB-DL-10212
2508901	IV-DL-9351	2689601	DB-SB-9302	2879201	RV-ES-9432	3115001	DB-DL-8717
2509902	MN-DL-7833	2691601	MN-DL-8197	2896902	SC-DL-8531	3118201	VL-DL-8543
2510001	MN-DL-7837	2694201	DB-SB-5267	2932401	DB-VB-3702	3118301	VL-DL-8518
2511601	VL-VB-5369	2694601	DB-SB-5269	2938101	SC-DL-10304	3122201	RV-RK-8648
2513901	SC-DL-8399	2694701	DB-SB-5270	29383 01	SC-TC-12452	3130901	VL-DL-10259
2515401	DB-DL-7799	2695201	DB-SB-5275	2938401	SC-DL-9466	3131001	VL-DL-8322
2515701	DB-RK-8581	2695601	DB-SB-5272	29385 01	SC-TC-12451	31313 01	MN-DL-12394
2515801	DB-RK-8391	2695701	DB-SB-5274	2938601	SC-DL-9467	3136501	VL-VB-10430
2516401	IV-VB-10418	2726001	DB-RK-5281	29387 01	SC-VB-12418	3136601	MN-DL-10283
2516501	IV-ES-8507	2726301	DB-RK-5303	2938801	SC-DL-8711	3161301	SC-ES-8517
2517501	IV-DL-8183	2726501	DB-RK-5307	2939201	SC-DL-10254	3188201	MN-DL-9380
2518901	DB-SB-10401	2726601	DB-RK-5284	2939301	SC-DL-10255	3188301	SC-DL-9457
2520701	MN-DL-8663	2726701	DB-RK-5282	2939401	SC-DL-10253	3188501	VL-DL-10228
2520801	MN-RK-12436	2735001	DB-DL-12364	29395 01	SC-TC-12361	31886 01	VL-DL-12454
2520902	MN-DL-5225	27441 01	DB-DL-12299	29396 01	SC-DL-12343	3188701	DB-VB-7798
2521001	MN-VB-5238	27444 02	RV-DL-0882	29396 02	SC-DL-12343	3189501	MN-DL-9379
2521101	MN-VB-9403	2745202	RV-DL-8198	2943301	RV-DL-8308	31929 01	VL-DL-12414
2524601	DB-SB-10400	2745702	RV-DL-8199	2943401	RV-DL-8309	31930 01	MN-DL-12287
2524901	DB-DL-8184	2747702	RV-DL-8299	2943601	RV-DL-8310	31936 01	MN-DL-10288
2525001	DB-DL-8185	2748102	RV-DL-8300	29437 01	RV-DL-12318	31936 01	MN-DL-12288
2526801	MN-RK-8558	2748802	RV-DL-8302	2944301	RV-DL-8653	3193701	DF-DL-10186
2527101	RV-DL-8186	2754702	VL-ES-8411	29444 01	RV-DL-12322	3195601	VL-DL-9492
2527201	MN-DL-8377	2755802	SC-DL-9458	2945201	RV-DL-8312	3196101	VL-ES-8414
25276 01	MN-DL-12284	2755902	SC-DL-10273	2945301	RV-DL-8313	31965 01	RV-DL-12320
25318 01	IV-DL-12265	2757902	SC-DL-8509	2945401	RV-DL-8314	3201901	MN-DL-10269
2535301	SC-ES-8517	2758002	SC-DL-8511	29455 01	RV-DL-12467	3329101	VL-DL-10309
2536101	DB-DL-8702	2758102	SC-DL-8547	29458 01	RV-DL-12321	3329701	VL-DL-9489
2539401	MN-DL-8487	2758202	SC-DL-8400	2950201	RV-DL-8316	3329801	VL-DL-10257
2539501	MN-DL-7802	2762301	DB-ES-8530	29503 01	RV-DL-12448	3330401	CV-DL-9082
2544101	VL-DL-8187	2762601	VL-DL-8412	2954901	VL-RK-10383	3330501	DB-DL-9249
2544701	DB-DL-8188	2763101	VL-DL-8706	2965201	DB-VB-10423	3330601	DB-DL-9251
2545201	MN-SB-10390	2763201	VL-ES-8568	29799 01	DB-DL-12300	3339701	DB-ES-8323
25499 01	DB-DL-12301	2763301	VL-ES-10361	2981401	VL-DL-10230	3340101	RV-DL-8324
2550001	DB-DL-9259	27634 01	RV-ES-12442	29815 01	VL-DL-12416	3341601	IV-DL-8665
2552901	VL-DL-8189	2764701	VL-DL-8707	2995301	RV-DL-8317	33515 01	MN-TC-12397
2553201	DB-RK-9262	2765601	IV-DL-8304	2995401	RV-DL-8318	33517 01	IV-DL-12264
2553301	DB-RK-8725	2767201	IV-DL-9359	29956 01	RV-DL-12327	33575 01	RV-DL-12334
25552 01	VL-ES-8615	27673 01	MN-DL-12391	29957 01	RV-DL-12326	33576 01	RV-DL-12338
2556301	VL-SB-5356	27676 01	DB-DL-8393	3029001	DF-DL-8363	33577 01	RV-DL-12337
2556501	MN-DL-7803	2767701	RV-DL-8316	3036201	DB-SB-10384	33579 01	RV-DL-12319
2562901	MN-DL-7804	2768301	DB-DL-8392	3041601	MN-VB-9404	3358201	RV-DL-8415
2563001	MN-DL-7808	2770901	MN-VB-8669	30584 01	MN-RK-12436	3358401	RV-DL-10245
2572002	RV-DL-8190	2771701	VL-DL-8536	3058501	MN-DL-8646	33585 01	RV-DL-12468
2572101	DB-DL-5405	2774401	SC-DL-9449	3058601	DB-RK-8555	33639 01	IV-VB-12390
2578001	MN-DL-8733	27754 01	SC-RK-12346	3058701	DB-RK-10374	33709 01	DB-TC-12411
2582101	DB-DL-7815	2776101	VL-VB-9503	3058801	MN-RK-8997	33712 01	DB-TC-12410
2601801	MN-DL-7272	2776201	VL-VB-8576	3058901	DB-RK-8626	3373701	DB-VB-9307
26020 01	DB-DL-12404	2776401	VL-VB-8541	3059001	DB-RK-10375	3373801	DB-VB-9308
26023 01	DB-DL-12437	2776501	VL-VB-8525	3059101	SC-DL-8713	3377101	MN-ES-8490
2602401	DB-DL-8644	2784601	MN-DL-8488	3059201	MN-DL-7801	33910 01	RV-ES-12331
26026 01	DB-DL-12405	2784801	MN-DL-10268	3059301	MN-DL-8560	3398001	DF-DL-8718
2602801	VL-RK-5357	2784901	MN-DL-8734	30595 01	VL-DL-9472	3398201	DF-DL-10187
2603601	DF-DL-8703	2785001	DF-DL-10193	3061101	VL-DL-8595	33983 01	DF-DL-12427
2605301	MN-VB-8514	2785301	SC-ES-8535	3066301	DB-DL-9269	33984 01	DF-TC-12262
2605801	RV-VB-8191	2785901	VL-RK-8656	3066401	DB-DL-8735	3399501	MN-ES-8611
2664801	MN-DL-9368	2787401	VL-DL-8305	3068801	MN-DL-8714	33998 01	MN-DL-2141
2664801	MN-DL-9369	2787701	MN-SB-10387	3073001	DB-DL-7276	3400301	DB-DL-9258
2664901	MN-DL-10284	2787801	MN-SB-5246	3073101	DB-DL-7275	3402501	DF-DL-8551
2665401	IV-DL-8654	2788101	MN-SB-5248	3073201	DB-DL-7262	3402601	DF-DL-6052
2665901	MN-SB-10389	2788201	MN-SB-5265	3073301	DB-DL-7263	3402701	DF-DL-9325
2667901	IV-DL-8193	2789101	IV-DL-8367	3075601	MN-ES-10333	34028 01	DF-DL-12424
2676901	SC-DL-9461	2789201	IV-DL-9361	3076401	DB-DL-9271	34032 01	DF-DL-12426
2677901	VL-DL-8194	2789301	VL-DL-9493	3076501	DB-DL-9254	3403401	DF-DL-8506
2678401	DB-DL-9261	2795301	RV-DL-8306	3090001	DB-RK-7267	3403501	DF-DL-8516
26809 01	RV-DL-12381	2795401	DB-DL-8307	30932 01	DB-DL-6227	34051 01	DF-DL-12425
2681201	VL-DL-9485	2809101	VL-DL-8566	3094801	VL-DL-9488	34310 01	DF-ES-12428

...LEMFÖRDER	MOOG	...TRW	MOOG	...TRW	MOOG	...TRW	MOOG
3436201	DB-VB-10426	JRK0020	DB-RK-8638	JRR6211	IV-TC-12387	JTE3535	DB-ES-8530
3436301	DB-VB-10425	JRK0021	DB-RK-8550	JRR6502	MN-DL-5212	JTE3536	DB-ES-8164
3452701	VL-ES-10360	JRK0024	DB-RK-7267	JRR6503	DB-DL-9226	JTE4001	CV-ES-14163
34528 01	VL-DL-12358	JRK0026	RV-RK-8648	JRR6504	DB-DL-9257	JTE4004	CV-ES-0543
34587 01	MN-TC-12399	JRK0027	DF-RK-8637	JRR6505	DB-DL-5220	JTE4005	CV-ES-0888
34590 01	MN-DL-14107	JRK0028	MN-RK-8723	JRR6506	DB-DL-9164	JTE4006	CV-ES-0914
3459101	MN-DL-10203	JRK0029	CV-RK-7850	JRR6510	RV-DL-7971	JTE4007	CV-ES-0912
34592 01	MN-DL-12393	JRK0030	MN-RK-8523	JRR6511	MN-DL-5225	JTE4010	VL-ES-7266
34595 01	MN-DL-12365	JRK0031	DB-RK-10374	JRR6513	MN-DL-8488	JTE4011	VL-ES-7265
3460401	VL-DL-10258	JRK0032	DB-RK-8626	JRR7001	MN-DL-3402	JTE4016	DF-ES-3634
3460401	VL-DL-8157	JRK0035	VL-RK-9499	JRR7003	DB-DL-6197	JTE4019	DF-ES-3804
3460901	VL-RK-9497	JRK0036	DF-RK-8994	JRR7004	DB-DS-6088	JTE4020	VL-ES-5287
3468001	VL-DL-8180	JRK0042	DF-RK-8685	JRR7005	DB-DL-7839	JTE4021	VL-ES-5288
34696 01	RV-DL-12465	JRK0044	DF-RK-8633	JRR7006	DB-DL-3475	JTE4022	VL-ES-5348
34698 01	VL-DL-12367	JRK0045	DB-RK-8366	JRR7010	RV-DL-8159	JTE4023	VL-ES-5347
3470101	SC-DL-7273	JRK0049	DB-RK-8710	JRR7011	RV-DL-8324	JTE4026	VL-ES-8615
34797 01	VL-DL-12356	JRK0050	DB-RK-9291	JRR7012	MN-DL-8733	JTE4040	CV-ES-14163
3491401	SC-DL-10226	JRK0051	DB-RK-8391	JRR7014	SC-DL-9460	JTE4043	IV-ES-8365
34978 01	SC-RK-12366	JRK0052	SC-RK-8688	JRR7016	DB-DL-7788	JTE4044	SC-ES-7279
3498001	DF-VB-8561	JRK0053	MN-RK-12436	JRR7017	MN-DL-8544	JTE4051	CV-ES-2149
3500901	VL-VB-7787	JRK0054	CV-RK-5311	JRR7018	RV-DL-8126	JTE4055	RV-ES-12446
35270 01	RV-TC-12340	JRK0056	DF-RK-9341	JRR7020	DB-DL-8393	JTE4056	RV-ES-12445
35271 01	RV-TC-12339	JRK0057	DB-RK-8674	JRR7023	DF-DL-8158	JTE4057	CV-ES-14163
3527201	RV-DL-10299	JRK0058	VL-RK-5357	JRR7024	MN-DL-7797	JTE4072	CV-ES-14163
35331 01	DB-DL-12303	JRK0059	DB-RK-9300	JRR7026	MN-DL-10286	JTE4074	CV-ES-0543
35333 01	VL-DL-12355	JRK0060	DB-RK-10375	JRR7027	MN-DL-10283	JTE4075	SC-ES-0888
35507 01	IV-DL-12386	JRK0065	MN-RK-8501	JRR7028	IV-DL-8142	JTE4077	SC-ES-5764
35508 01	IV-DL-12385	JRR0102	DB-DL-9218	JRR7029	MN-DL-7797	JTE4078	CV-ES-14163
35509 01	IV-TC-12387	JRR0105	VL-DL-8554	JRR8001	DB-DL-6198	JTE4080	CV-ES-14162
35511 01	IV-TC-12388	JRR0106	VL-DL-8545	JRR8002	DB-DL-6227	JTE5008	VL-ES-8568
35512 01	IV-VB-12389	JRR0108	MN-DL-5225	JRR8005	MN-DL-8609	JTR0001	DB-DL-6235
35513 01	IV-DL-12266	JRR0111	RV-DL-7282	JRT4166	MN-DL-10268	JTR0008	DB-DL-1179
35588 01	RV-DL-12478	JRR0114	DB-DL-7840	JRT4242	MN-DL-10269	JTR0009	DB-DL-5215
35593 01	RV-DL-12480	JRR0115	MN-DL-7272	JSA5001	DB-ES-8498	JTR0010	DB-DL-5219
35596 01	RV-DL-12329	JRR0117	DB-DL-3405	JTE0101	DB-ES-5234	JTR0012	DB-DL-5216
35598 01	RV-DL-12328	JRR0119	IV-DL-8613	JTE0110	CV-ES-2146	JTR0014	DB-DL-8121
35605 01	RV-DL-12317	JRR0122	MN-DL-8590	JTE0118	MN-ES-10334	JTR0019	DB-DL-10140
35805 01	MN-DL-12282	JRR0123	SC-DL-9446	JTE0120	MN-ES-8611	JTR0021	MN-DL-5232
35806 01	DB-DL-12405	JRR0124	MN-DL-10281	JTE0122	CV-ES-2182	JTR0022	VL-DL-8679
35807 01	MN-DL-12289	JRR0124	MN-DL-10284	JTE0123	CV-ES-2119	JTR0030	DB-DL-7799
35809 01	MN-DL-12293	JRR0128	CV-TC-12384	JTE0124	IV-ES-12419	JTR0031	SC-DL-8399
35811 01	MN-DL-12291	JRR0129	MN-TC-12400	JTE0127	MN-ES-8490	JTR0044	DB-DL-0280
3595601	DB-RK-10375	JRR0131	VL-DL-8189	JTE0128	IV-ES-12272	JTR0045	MN-DL-7786
36148 01	VL-VB-12460	JRR0133	MN-DL-7803	JTE0130	DB-ES-7783	JTR0047	IV-DL-5371
36695 01	VL-DL-9472	JRR0137	DB-DL-9275	JTE0131	DB-ES-7784	JTR0056	VL-DL-4912
36895 01	DB-TC-12376	JRR0138	MN-DL-9368	JTE0132	DF-ES-8362	JTR0057	VL-DL-8597
36896 01	DB-DL-8393	JRR0138	MN-DL-9369	JTE0135	VL-ES-10360	JTR0058	VL-DL-4895
37225 01	RV-DL-12447	JRR0139	DF-DL-9331	JTE0136	VL-ES-8414	JTR0060	DF-DL-5355
37229 01	RV-DL-12334	JRR0141	IV-TC-12431	JTE0137	VL-ES-10361	JTR0062	VL-DL-5372
37230 01	VL-DL-12484	JRR0143	DB-DL-3461	JTE0138	DF-ES-12428	JTR0069	DB-DL-8176
37231 01	VL-DL-12483	JRR0146	SC-DL-10304	JTE0142	RV-ES-12442	JTR0070	DB-DL-7832
37247 01	SC-DL-2161	JRR0147	DB-TC-12376	JTE1037	ME-ES-1760	JTR0071	DB-DL-9256
3827201	MN-ES-8490	JRR0148	DB-DL-7788	JTE2404	DB-ES-2753	JTR0073	RV-DL-12447
38273 01	IV-ES-12272	JRR0149	DF-TC-12262	JTE2701	ME-ES-0643	JTR0076	MN-DL-8374
		JRR0150	SC-DL-8547	JTE2702	CV-ES-2774	JTR0078	MN-DL-8486
		JRR0151	SC-DL-9462	JTE2703	DB-ES-0830	JTR0079	DB-DL-8388
		JRR0152	SC-DL-8623	JTE3004	DB-ES-1084	JTR0080	MN-DL-2162
		JRR0157	MN-TC-12397	JTE3006	DF-ES-8524	JTR0081	MN-DL-2132
JRK0001	CV-RK-1583	JRR0164	DB-TC-12410	JTE3014	DF-ES-8508	JTR0084	DB-DL-9188
JRK0002	MN-RK-7291	JRR0165	SC-DL-8179	JTE3501	CV-ES-12462	JTR0085	DB-DL-8632
JRK0003	MN-RK-7287	JRR0168	MN-DL-9381	JTE3502	CV-ES-12461	JTR0086	VL-DL-8566
JRK0005	CV-RK-5313	JRR0172	RV-TC-12339	JTE3503	DB-ES-1281	JTR0088	DB-DL-7799
JRK0005	MN-RK-8678	JRR0173	SC-DL-9466	JTE3504	DB-ES-2558	JTR0090	VL-DL-7789
JRK0006	DF-RK-9336	JRR0174	DB-TC-12411	JTE3505	DB-ES-2559	JTR0091	MN-DL-2177
JRK0007	DB-RK-6111	JRR0178	DB-DL-9221	JTE3506	CV-ES-2135	JTR0092	DF-DL-7780
JRK0010	DB-RK-8564	JRR0179	DB-DL-8652	JTE3507	DF-ES-5404	JTR0093	DF-DL-5403
JRK0010	MN-RK-9387	JRR0182	RV-TC-12340	JTE3508	CV-ES-2135	JTR0096	DB-DL-9261
JRK0011	DB-RK-8380	JRR0210	CV-RK-5322	JTE3518	DF-ES-8497	JTR0097	DB-DL-8390
JRK0013	CV-RK-5322	JRR0217	MN-TC-12471	JTE3519	DF-ES-8496	JTR0099	MN-DL-7834
JRK0014	MN-RK-7280	JRR5501	DB-DL-5224	JTE3522	DF-ES-5404	JTR0101	DF-DL-7836
JRK0015	DF-RK-8503	JRR5502	SC-TC-12361	JTE3527	CV-ES-12462	JTR0103	DF-DL-5237
JRK0016	CV-RK-5311	JRR5505	MN-DL-8663	JTE3528	CV-ES-12461	JTR0104	DF-DL-2142
JRK0016	CV-RK-8118	JRR5508	IV-DL-9351	JTE3532	SC-ES-8535	JTR0106	DB-DL-8672
JRK0017	IV-RK-8998	JRR6201	MN-TC-14112	JTE3533	CV-ES-12462	JTR0107	SC-DL-2151
JRK0018	SC-RK-8575	JRR6210	MN-DL-8709	JTE3534	CV-ES-12461	JTR0108	VL-DL-5411
JRK0019	MN-RK-9383						

TRW **MOOG**

...TRW	MOOG	...TRW	MOOG	...TRW	MOOG	...TRW	MOOG
JTR0110	IV-DL-8689	JTR3501	DB-DL-2144	JTR4084	RV-DL-0901	JTR4288	DB-DL-8174
JTR0111	MN-DL-2140	JTR3504	DB-DL-5405	JTR4085	RV-DL-0908	JTR4292	MN-DL-8599
JTR0113	MN-DL-7804	JTR3512	DB-ES-5214	JTR4087	RV-DL-7539	JTR4302	MN-DL-12287
JTR0114	CV-DL-9103	JTR3513	CV-DL-0546	JTR4090	RV-DL-0883	JTR4320	SC-DL-12343
JTR0117	DB-DL-7794	JTR3514	DB-DL-3228	JTR4091	RV-DL-0886	JTR4333	SC-DL-8137
JTR0118	DF-DL-8363	JTR3517	MN-DL-2138	JTR4092	RV-DL-8314	JTR4335	SC-DL-5229
JTR0119	DF-DL-8703	JTR3518	MN-DL-7833	JTR4094	RV-DL-8318	JTR4392	MN-DL-12421
JTR0120	DF-DL-8506	JTR3519	VL-DL-0911	JTR4099	RV-DL-8299	JTR4425	MN-DL-12284
JTR0121	DF-DL-10186	JTR3521	VL-DL-8594	JTR4101	RV-DL-8300	JTR4433	MN-DL-12293
JTR0122	DF-DL-10188	JTR3522	LF-DL-0288	JTR4102	RV-DL-0882	JTR4438	MN-DL-10314
JTR0123	DF-DL-8658	JTR3528	VV-DL-0287	JTR4103	IV-DL-8367	JTR4450	MN-DL-12289
JTR0124	DB-DL-7795	JTR3530	DB-DL-9194	JTR4104	IV-DL-8304	JTS0001	IV-DL-8542
JTR0126	DB-DL-10208	JTR3531	DB-DL-7775	JTR4105	IV-DL-8193	JTS0003	VL-DL-9479
JTR0127	DB-DL-12403	JTR3532	DB-DL-7270	JTR4106	SC-DL-8127	JTS0006	VL-DL-8412
JTR0128	DB-DL-12466	JTR3534	IV-DL-0215	JTR4112	SC-DL-5229	JTS0007	SC-DL-7273
JTR0130	VL-DL-8407	JTR3535	IV-DL-0215	JTR4114	MN-DL-8197	JTS0008	DB-DL-12364
JTR0132	DB-DL-8167	JTR3536	MN-DL-12432	JTR4116	SC-DL-7264	JTS0009	DB-DL-7276
JTR0135	SC-DL-8711	JTR3539	IV-DL-8183	JTR4119	MN-DL-2176	JTS0010	DB-DL-7275
JTR0139	DB-DL-9211	JTR3542	RV-DL-8199	JTR4120	IV-DL-2155	JTS0011	DB-DL-7262
JTR0140	DB-ES-5227	JTR3544	DF-DL-5226	JTR4123	SC-DL-2904	JTS0012	DB-DL-7263
JTR0141	DB-DL-8171	JTR3545	RV-DL-10246	JTR4124	IV-DL-9361	JTS0013	VL-DL-9472
JTR0142	DB-DL-8172	JTR3546	SC-DL-12342	JTR4130	SC-DL-8169	JTS0014	SC-DL-10254
JTR0143	DF-ES-5761	JTR3546	SC-DL-8182	JTR4136	SC-DL-12343	JTS0015	DF-DL-12427
JTR0144	MN-DL-8624	JTR3547	IV-DL-7785	JTR4140	IV-DL-12265	JTS0017	DB-DL-12363
JTR0147	DB-DL-8728	JTR3548	IV-DL-2136	JTR4141	SC-DL-2904	JTS0018	VL-DL-8518
JTR0150	DF-DL-8551	JTR3549	IV-DL-8562	JTR4143	RV-DL-8313	JTS0019	VL-DL-10259
JTR0151	DF-DL-6052	JTR3553	VL-DL-2139	JTR4144	SC-DL-2161	JTS0020	VL-DL-8543
JTR0152	DF-DL-9325	JTR3554	DB-DL-5213	JTR4146	VL-DL-5540	JTS0021	DB-DL-9271
JTR0153	DF-DL-12424	JTR3556	MN-DL-2141	JTR4148	VL-DL-5318	JTS0022	DB-DL-9254
JTR0156	DF-DL-12426	JTR3564	VL-DL-8403	JTR4149	VL-DL-8151	JTS2703	RV-DL-12326
JTR0158	DF-DL-8506	JTR3571	DB-DL-9193	JTR4159	DB-DL-5241	JTS2704	RV-DL-12327
JTR0159	DF-DL-8516	JTR3572	IV-DL-9359	JTR4170	IV-DL-8665	JTS3501	DB-DL-7262
JTR0167	DF-DL-12425	JTR3573	MN-DL-7837	JTR4172	DB-DL-8702	JTS3502	DB-DL-7263
JTR0169	SC-DL-9458	JTR3579	MN-DL-12365	JTR4185	VL-DL-5358	JTS3504	DB-DL-7276
JTR0173	DF-DL-10187	JTR3580	VL-DL-8178	JTR4188	DB-DL-8168	JTS4009	SC-DL-7273
JTR0174	DB-DL-9258	JTR3586	VL-DL-8163	JTR4189	DB-DL-8639	JTS4012	SC-DL-7273
JTR0177	RV-DL-8309	JTR3587	MN-DL-8662	JTR4190	DB-DL-8640	JVL0001	IV-VB-5228
JTR0179	RV-DL-8190	JTR3588	MN-DL-8377	JTR4191	MN-DL-7834	JVL0002	DB-VB-3707
JTR0183	VL-DL-9954	JTR3592	DB-DL-7270	JTR4192	MN-DL-7802	JVL0011	VL-VB-5369
JTR0184	SC-DL-9440	JTR3594	DB-DL-2144	JTR4193	SC-DL-8553	JVL0012	DB-VB-7798
JTR0186	RV-DL-8653	JTR3596	DB-DL-8188	JTR4194	VL-DL-5456	JVL0013	DB-VB-3701
JTR0188	RV-DL-10245	JTR3597	DB-DL-8392	JTR4196	DB-DL-12309	JVL0014	DB-VB-3700
JTR0189	RV-DL-12468	JTR3598	DB-DL-12303	JTR4201	DB-DL-8735	JVL0015	MN-VB-8514
JTR0191	RV-DL-12465	JTR3601	RV-DL-8310	JTR4206	MN-DL-8370	JVL0016	DB-VB-7261
JTR0194	VL-DL-8404	JTR3602	RV-DL-12321	JTR4207	MN-DL-12393	JVL0017	DB-VB-7776
JTR0195	VL-DL-12414	JTR4001	DB-DL-2178	JTR4209	MN-DL-8646	JVL0018	DB-VB-7790
JTR0198	RV-DL-12467	JTR4002	DB-DL-5207	JTR4211	MN-DL-12391	JVL0020	VL-VB-8546
JTR0204	DF-DL-10192	JTR4003	DB-DL-5412	JTR4212	MN-DL-8487	JVL0021	VL-VB-7787
JTR0213	MN-DL-2166	JTR4005	DB-DL-8389	JTR4220	MN-DL-12284	JVL0022	RV-VB-8191
JTR0219	VL-DL-12484	JTR4010	DB-ES-5209	JTR4223	IV-DL-12264	JVL0023	MN-VB-5238
JTR0220	VL-DL-12483	JTR4014	MN-DL-7834	JTR4228	MN-DL-7808	JVL0024	MN-VB-8669
JTR0237	VL-DL-12367	JTR4016	DB-DL-5231	JTR4239	IV-DL-3234	JVL0029	MN-VB-9403
JTR0241	RV-DL-12334	JTR4017	DB-DL-5230	JTR4240	IV-DL-8654	JVL0031	VL-VB-8539
JTR0248	DF-DL-12420	JTR4018	DB-DL-5233	JTR4245	MN-DL-8621	JVL0032	DF-VB-8561
JTR0271	DB-DL-12310	JTR4020	DB-DL-5239	JTR4248	MN-DL-2172	JVL0033	VL-VB-8195
JTR0284	DB-DL-12375	JTR4023	DB-DL-5217	JTR4250	MN-DL-8376	JVL0035	DF-VB-9343
JTR2401	DB-DL-9143	JTR4025	DB-DL-8122	JTR4251	CV-DL-9119	JVL0038	MN-VB-9404
JTR2402	ME-AX-2734	JTR4026	DB-DL-6140	JTR4252	MN-DL-8734	JVL0044	VL-VB-8525
JTR2701	ME-AX-2735	JTR4028	MN-DL-7792	JTR4254	SC-DL-8154	JVL0048	DB-VB-9307
JTR2703	MN-DL-2127	JTR4029	MN-DL-2293	JTR4255	DB-DL-12299	JVL0049	DB-VB-9308
JTR2704	MN-DL-0549	JTR4031	MN-DL-2174	JTR4258	DB-DL-8185	JVL0050	VL-VB-8541
JTR2710	RV-DL-8160	JTR4032	MN-DL-12421	JTR4259	DB-DL-8184	JVL0065	IV-VB-10418
JTR3007	MN-DL-7835	JTR4033	MN-DL-3588	JTR4260	DB-DL-12300	JVL0101	DB-VB-3702
JTR3008	MN-DL-2133	JTR4041	DF-DL-3798	JTR4267	DB-DL-8307	JVL0102	VL-VB-8527
JTR3009	MN-DL-2131	JTR4042	SC-DL-5354	JTR4269	DB-DL-8702	JVL0103	MN-VB-8565
JTR3010	MN-DL-7781	JTR4047	IV-DL-0214	JTR4271	DB-DL-8717	JVL0104	IV-VB-8146
JTR3017	RV-DL-0907	JTR4048	IV-DS-1914	JTR4272	DB-DL-10212	JVL8002	MN-VB-8569
JTR3018	RV-DL-8186	JTR4049	RV-DL-0900	JTR4273	DB-DL-7815	JVL8003	MN-VB-5222
JTR3019	RV-DL-8170	JTR4052	MN-DL-2175	JTR4274	DB-DL-8644		
JTR3027	VL-DL-10258	JTR4053	MN-DL-2160	JTR4275	DB-DL-2178		
JTR3027	VL-DL-8157	JTR4066	DF-DL-12420	JTR4276	DB-DL-10209		
JTR3031	MN-DL-12394	JTR4072	RV-DL-0074	JTR4277	DB-DL-8327		
JTR3032	VL-DL-5218	JTR4073	DB-DL-7815	JTR4283	DF-DL-8704		
JTR3033	RV-DL-8308	JTR4074	MN-DL-7801	JTR4284	DF-DL-8196		
JTR3038	MN-DL-9380	JTR4075	MN-DL-8560	JTR4285	DF-DL-8718		

A series of horizontal dotted lines spanning the width of the page, intended for handwritten notes.

Federal-Mogul Global Aftermarket EMEA bvba

Prins Boudewijnlaan 5 • 2550 Kontich • Belgium

Central Distribution Centre

Schoondonkweg 17 • 2830 Willebroek • Belgium

Phone +32 (0) 3450 83 10 • Fax +32 (0) 3450 83 38

Federal-Mogul Italy Srl • Aftermarket Division

Via Enrico Fermi 8 • 37135 Verona • Italy

Phone +39 045 828 13 11 • Fax +39 045 828 14 00

Federal-Mogul Aftermarket GmbH

Albert-Ruprecht-Strasse 2 • 71636 Ludwigsburg • Germany

Phone +49 (0) 7141-64865-8230 • Fax +49 (0) 7141-64865-8390

Federal-Mogul Aftermarket UK Limited

Greyhound Drive • Bradford • BD7 1NQ • U.K.

Phone +44 (0) 800 970 0203 • Fax +44 (0) 1274 848282

Federal-Mogul Aftermarket España S.A.

Calle Alcarria, nº 2 • 28823 Coslada • Madrid • Spain

Phone + 34 91 746 1900 • Fax + 34 91 746 18 90

Federal-Mogul Aftermarket France SAS

60-62, rue Danjou • 92517 Boulogne-Billancourt Cedex • France

Phone +33 (0) 1 46 94 27 00 • Fax +33 (0) 1 46 94 27 01

Service Commande de stock :

Phone +33 (0) 810 000 029 • Fax +32 (0) 34 50 80 26

Service Commande express :

Phone +33 (0) 810 000 029 • Fax +32 (0) 34 50 80 26

Federal-Mogul Motorparts Serbia*

Spanskih Boraca 22 • 11070 Novi Beograd • Serbia

Phone +381 11 31 31 918 • Fax +381 11 31 31 848

Federal-Mogul Aftermarket Southern Africa (PTY) Ltd

33 Western Boulevard • 2092 City West Johannesburg • South Africa

Phone +27 (0) 11 630 3000 • Fax +27 (0) 11 630 3106

Federal Mogul Powertrain Otomotiv A.S. (Aftermarket Division)

Meclis-i Mebusan Cad. No: 53 Dereli İş Merkezi 34427 • Fındıklı / İstanbul • Türkiye

Phone +90 212 292 6313 • Fax +90 212 292 6260

Federal-Mogul VCS OOO

Smolnaya street 24D, 13th floor • 125445 Moscow • Russia

Phone +7 495 221 50 60 • Fax +7 495 221 50 64

Federal-Mogul Aftermarket Egypt Ltd.

3 El Yemen St., Giza • 12311 Egypt • P.O. Box: 391 Dokki • Egypt

Phone +202 333 85 725 • Fax +202 374 84 147

Federal-Mogul Motorparts Sharjah*

Sharjah Airport International Free Zone (Saif-Zone)

Building X3 • Phone 20, 21, 22 • P.O.Box. 120548 • Sharjah • UAE

Phone +971 6 557 8870 • Fax +971 6 557 8941

* Branch office of Federal-Mogul Global Aftermarket EMEA, bvba



BERU® is a registered trademark of BorgWarner.

AN EASY SOURCE TO GET THE MOST OUT OF THE AVAILABLE MOOG TOOLS



QUICK IDENTIFICATION OF MOOG PARTS ON E-CATALOGUE

 www.moogparts.eu

Also available in other languages:



VIDEOS

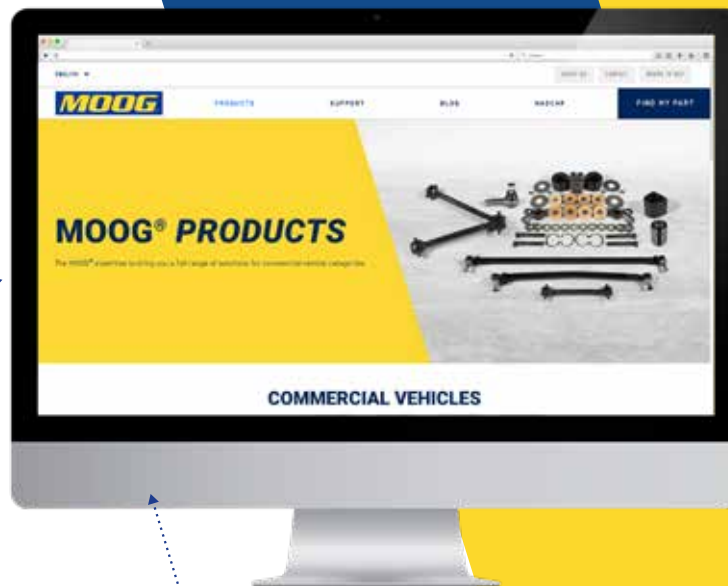

ON-THE-GO

ON-CALL



ONSITE

ONLINE

TRAINING BECOMES EASY WITH VIRTUAL CAMPUS



SUBSCRIBE NOW ON MOOGPARTS.EU AND RECEIVE REGULAR UPDATES!

MOOG E-MAIL ALERTS



ALWAYS UP-TO-DATE ON PRODUCTS AND SERVICES